

Skjutlag

1

Tavla

1

William Öster

Umeå Skf

2009.08.29

Höstträffen 2009

Ramselefors SKF

Provskott

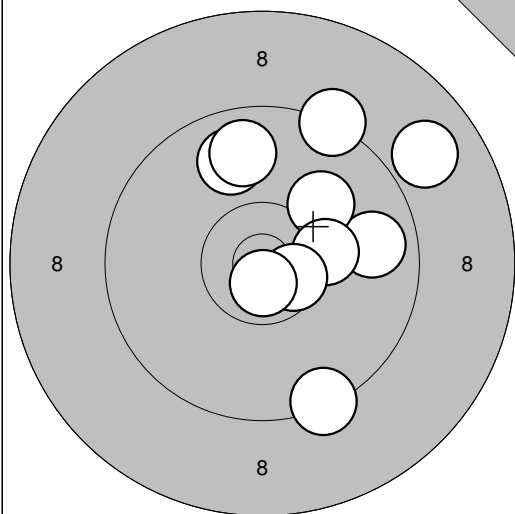

1: 9,8 →
 2: 9,3 ↗
 3: 9,8 ↑
 4: 8,9 ↗
 5: 10,1 ↗
 6: 9,8 ↑
 7: 10,3 →
 8: 10,6* →
 9: 10,7* ↓
 10: 9,4 ↓

Serie 93,0

Totalt 0,0

Provskott

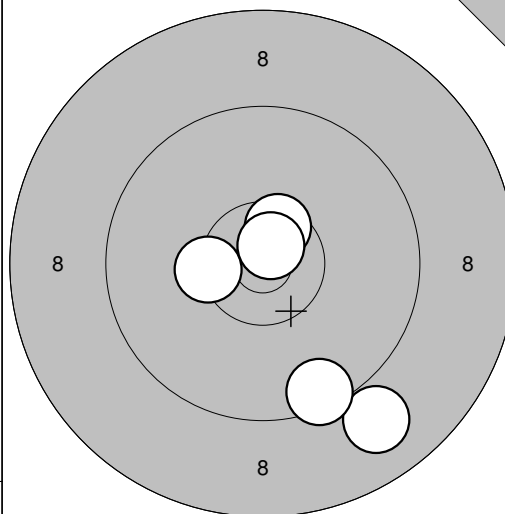

11: 10,5* ↗
 12: 8,9 ↓
 13: 10,4* ←
 14: 10,7* ↗
 15: 9,5 ↓

Serie 47,0

Totalt 0,0

Tävlingsskott

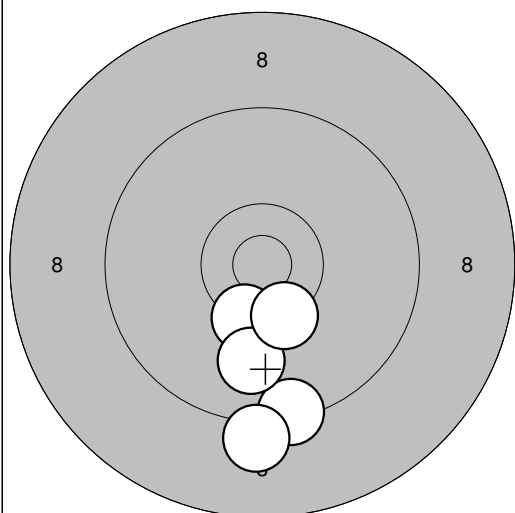

1: 10,4* ↓
 2: 9,4 ↓
 3: 9,9 ↓
 4: 10,4* ↓
 5: 9,1 ↓

Serie 47,0

Totalt 47,0

Tävlingsskott

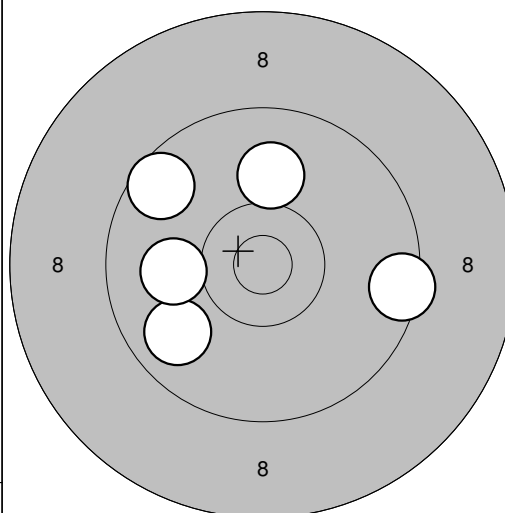

6: 9,5 →
 7: 9,8 ↙
 8: 10,0 ↑
 9: 9,6 ↗
 10: 10,0 ←

Serie 47,0

Totalt 94,0

Tävlingsskott

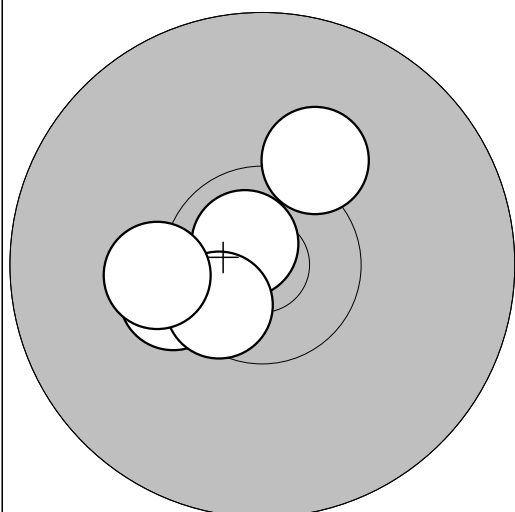

11: 10,2 ↗
 12: 10,8* ↗
 13: 10,3* ←
 14: 10,6* ↙
 15: 10,3 ←

Serie 50,0

Totalt 144,0

Tävlingsskott

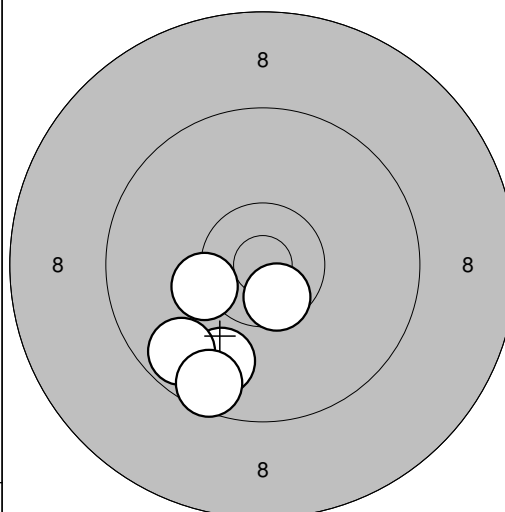

16: 9,9 ↓
 17: 10,3* ←
 18: 9,7 ↙
 19: 9,6 ↓
 20: 10,6* ↓

Serie 47,0

Totalt 191,0

<p>Provskott</p>	<p>Provskott</p>
Serie 93,0	Serie 65,0
Totalt 0,0	Totalt 0,0

<p>Tävlingsskott</p>	<p>Tävlingsskott</p>
Serie 49,0	Serie 50,0
Totalt 49,0	Totalt 99,0

<p>Tävlingsskott</p>	<p>Tävlingsskott</p>
Serie 48,0	Serie 50,0
Totalt 147,0	Totalt 197,0

Umeå Skf

2009.08.29

Höstträffen 2009

Ramselefors SKF

Provskott

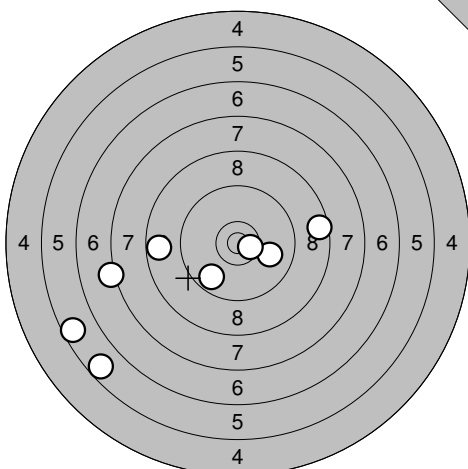

1: 5,6 ↙
 2: 5,7 ↙
 3: 7,2 ←
 4: 10,0 →
 5: 9,7 ↙
 6: 10,6* →
 7: 8,6 →
 8: 8,7 ←

Serie 62,0
 Totalt 0,0

Tävlingsskott

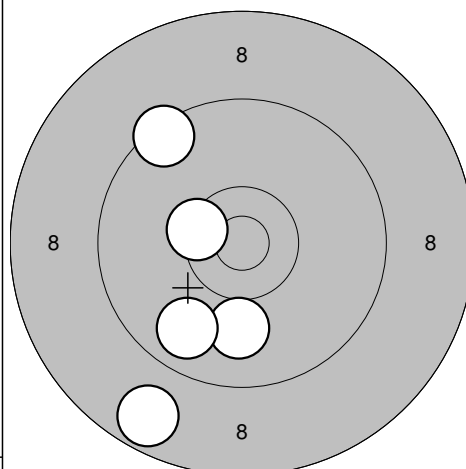

1: 10,0 ↓
 2: 8,7 ↙
 3: 9,8 ↙
 4: 9,4 ↗
 5: 10,4* ←

Serie 46,0
 Totalt 46,0

Tävlingsskott

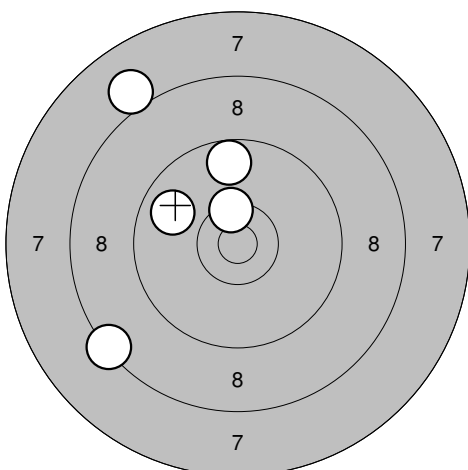

6: 10,4* ↑
 7: 8,4 ↙
 8: 8,0 ↗
 9: 9,8 ↙
 10: 9,7 ↑

Serie 44,0
 Totalt 90,0

Tävlingsskott

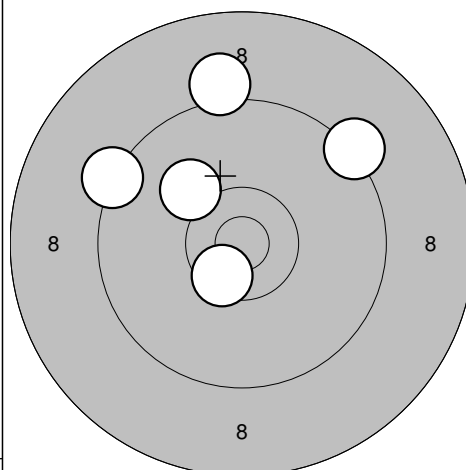

11: 10,1 ↗
 12: 9,3 ↙
 13: 9,1 ↑
 14: 9,3 ↗
 15: 10,5* ↙

Serie 47,0
 Totalt 137,0

Tävlingsskott

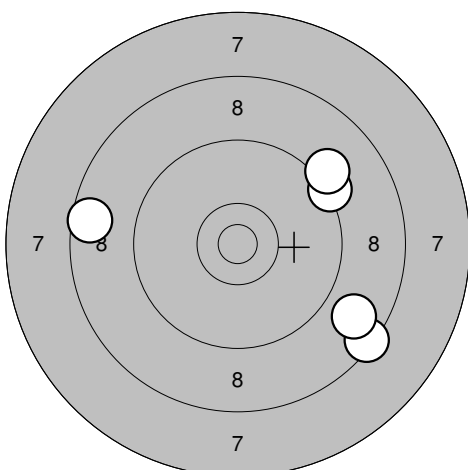

16: 8,6 ←
 17: 8,4 ↙
 18: 8,8 ↙
 19: 9,3 ↗
 20: 9,1 ↗

Serie 42,0
 Totalt 179,0

Umeå Skf

2009.08.29

Höstträffen 2009

Ramselefors SKF

Provskott

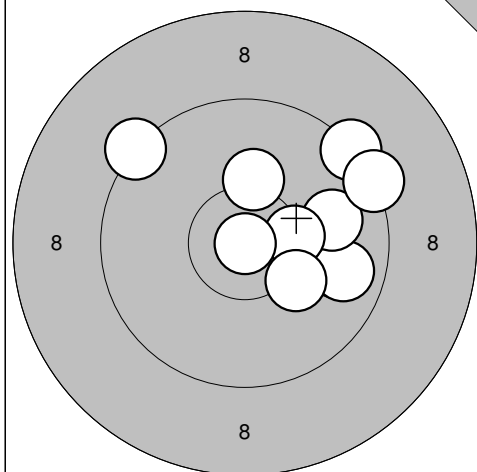

1: 9,9 →
 2: 9,8 →
 3: 9,9 →
 4: 10,2 ↑
 5: 10,4* →
 6: 10,9* ↓
 7: 9,3 ↗
 8: 9,3 →
 9: 10,2 ↓
 10: 9,3 ↖

Serie 94,0

Totalt 0,0

Tävlingsskott

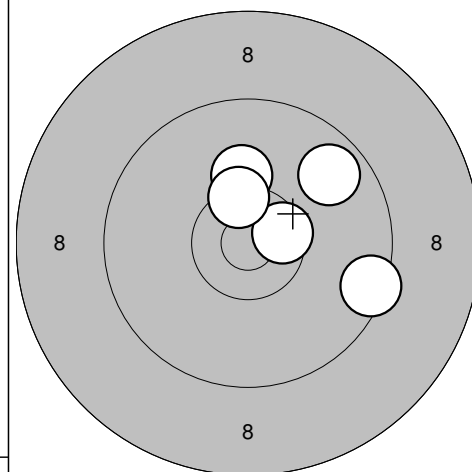

1: 9,7 ↗
 2: 10,5* →
 3: 10,2 ↑
 4: 10,4* ↑
 5: 9,5 →

Serie 48,0

Totalt 48,0

Tävlingsskott

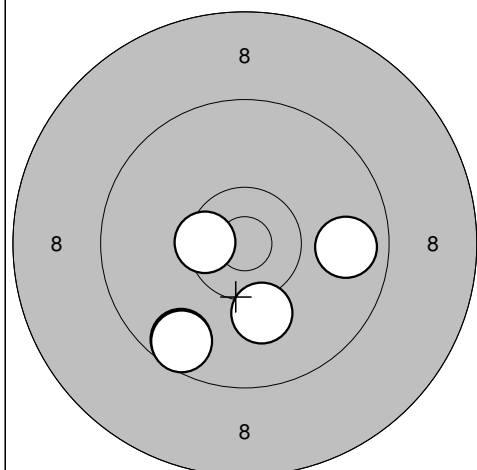

6: 10,1 ↓
 7: 9,8 →
 8: 10,5* ←
 9: 9,6 ↓
 10: 9,6 ↓

Serie 47,0

Totalt 95,0

Tävlingsskott

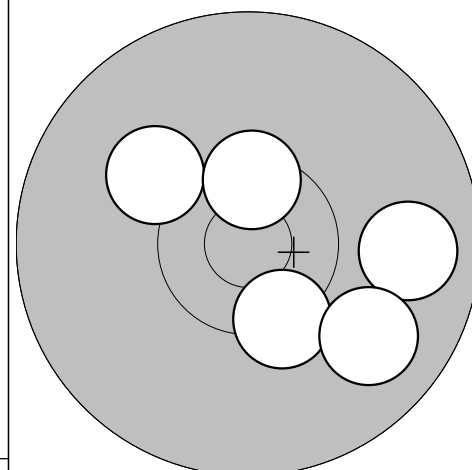

11: 10,1 ↖
 12: 10,4* ↓
 13: 9,8 →
 14: 10,5* ↑
 15: 9,9 ↘

Serie 48,0

Totalt 143,0

Tävlingsskott

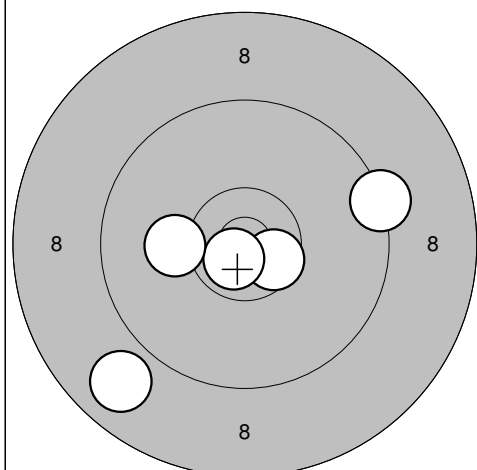

16: 10,6* →
 17: 10,7* ↓
 18: 9,3 →
 19: 10,2 ←
 20: 8,8 ↓

Serie 47,0

Totalt 190,0

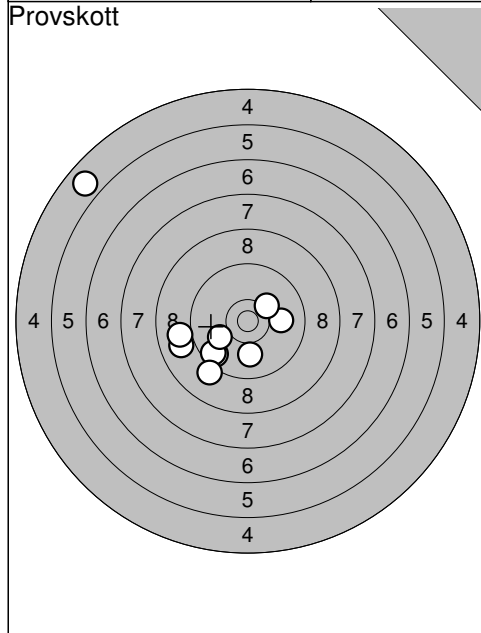

1: 4,9	↖
2: 9,6	↙
3: 8,9	←
4: 9,0	←
5: 9,6	↙
6: 9,1	↙
7: 10,0	←
8: 10,0	↓
9: 10,0	→
10: 10,2	↗
Serie	88,0
Totalt	0,0

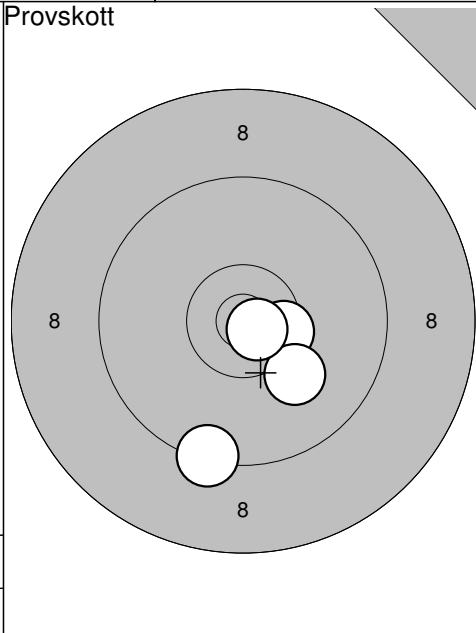

11: 10,5*	→
12: 10,1	↘
13: 10,8*	↘
14: 9,4	↓
Serie	39,0
Totalt	0,0

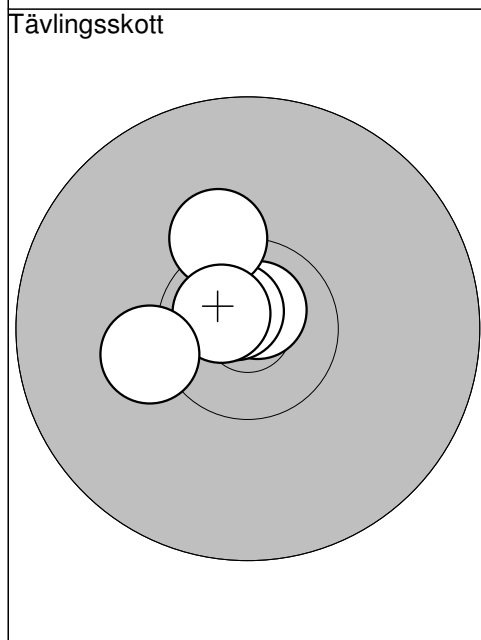

1: 10,8*	↗
2: 10,8*	↗
3: 10,3	↑
4: 10,7*	↖
5: 10,2	←
Serie	50,0
Totalt	50,0

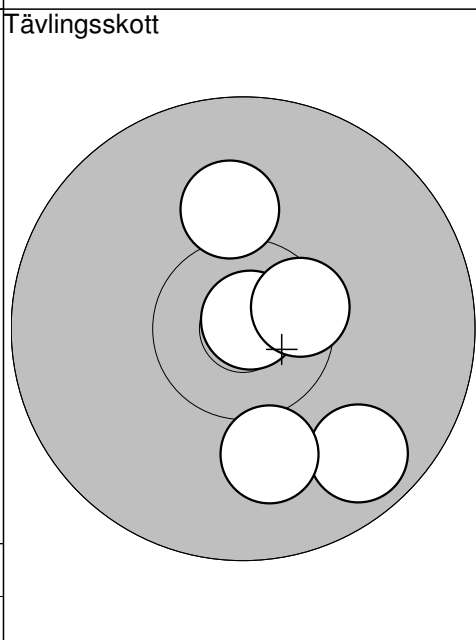

6: 10,1	↑
7: 9,7	↘
8: 10,0	↓
9: 10,9*	↗
10: 10,5*	→
Serie	49,0
Totalt	99,0

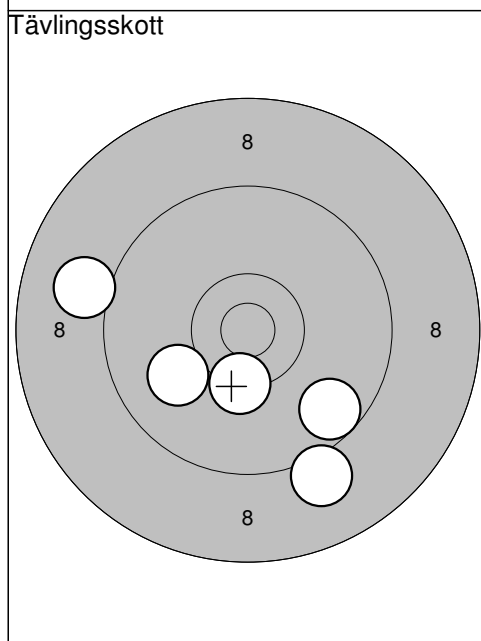

11: 9,6	↘
12: 9,0	←
13: 10,3*	↓
14: 10,0	←
15: 9,1	↘
Serie	47,0
Totalt	146,0

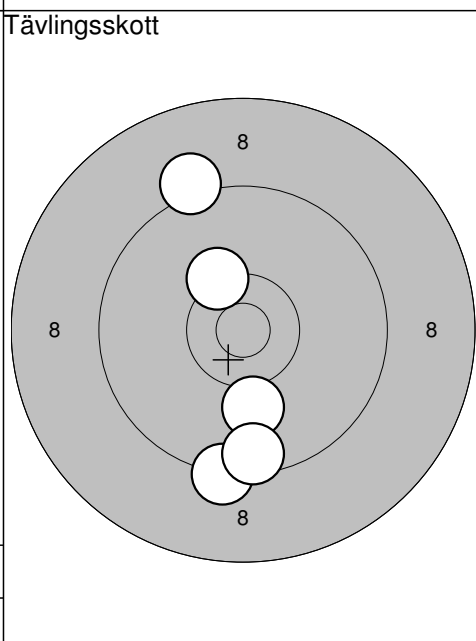

16: 9,3	↓
17: 10,1	↓
18: 9,2	↗
19: 10,3*	↗
20: 9,5	↓
Serie	47,0
Totalt	193,0

Vännäs Skf

2009.08.29

Höstträffen 2009

Ramselefors SKF

Provskott

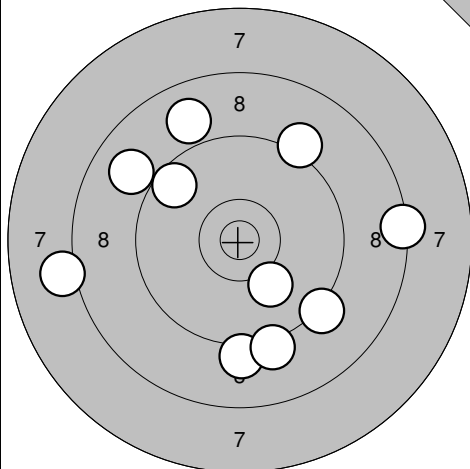

- 1: 8,4 →
- 2: 9,2 ↓
- 3: 8,9 ↗
- 4: 9,2 ↗
- 5: 10,1 ↓
- 6: 8,1 ←
- 7: 8,9 ↗
- 8: 9,6 ↗
- 9: 9,1 ↓
- 10: 9,2 ↓

Serie 87,0
Totalt 0,0

Provskott

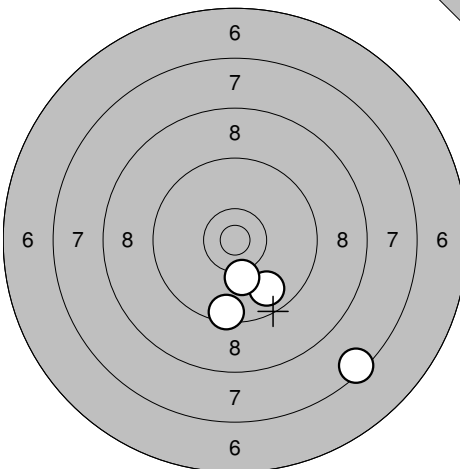

- 11: 9,8 ↓
- 12: 7,5 ↓
- 13: 10,2 ↓
- 14: 9,5 ↓

Serie 35,0
Totalt 0,0

Tävlingsskott

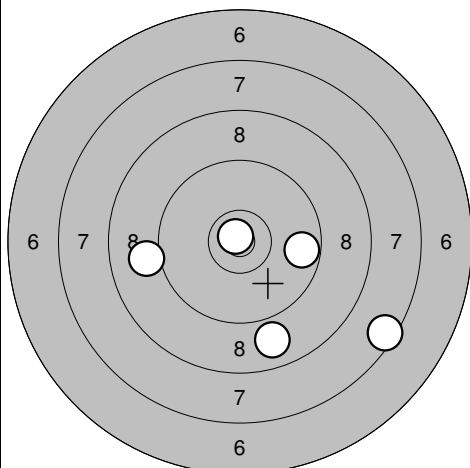

- 1: 10,8* ↗
- 2: 9,1 ←
- 3: 7,5 ↓
- 4: 9,7 →
- 5: 8,9 ↓

Serie 43,0
Totalt 43,0

Tävlingsskott

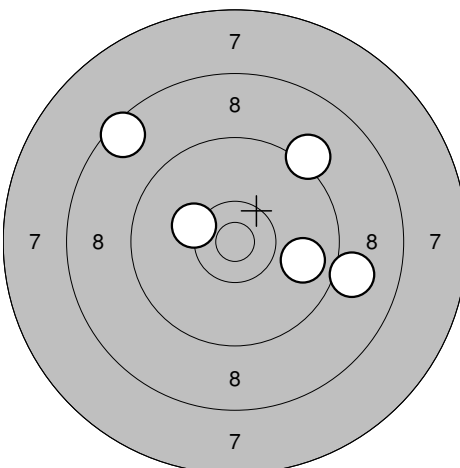

- 6: 9,2 ↗
- 7: 9,0 →
- 8: 10,3 ←
- 9: 9,8 →
- 10: 8,5 ↗

Serie 45,0
Totalt 88,0

Tävlingsskott

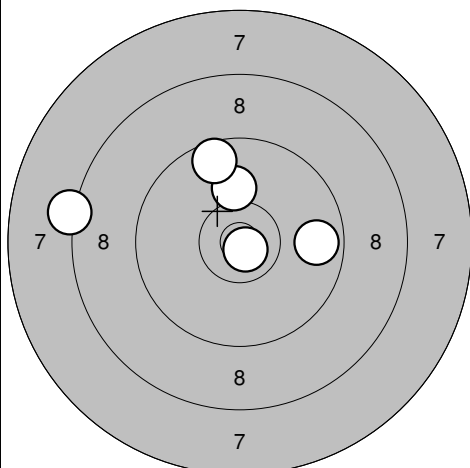

- 11: 10,8* ↓
- 12: 8,2 ←
- 13: 10,1 ↗
- 14: 9,7 →
- 15: 9,6 ↗

Serie 46,0
Totalt 134,0

Tävlingsskott

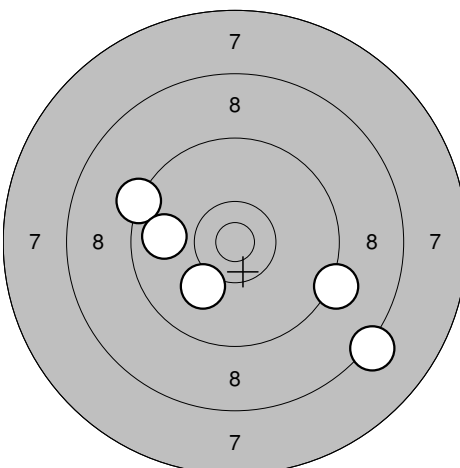

- 16: 8,2 ↓
- 17: 9,2 →
- 18: 9,3 ←
- 19: 10,1 ↓
- 20: 9,8 ←

Serie 45,0
Totalt 179,0

Umeå Skf

2009.08.29

Höstträffen 2009

Ramselefors SKF

Provskott

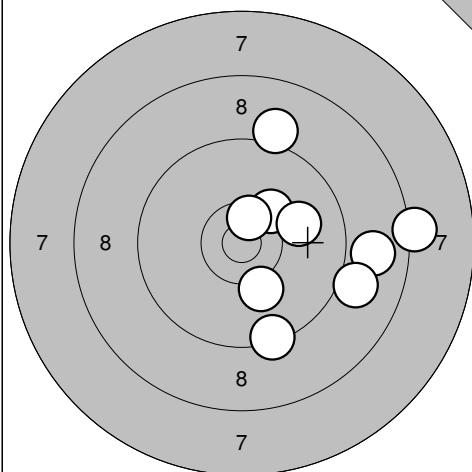

1: 10,3 ↗
 2: 8,9 →
 3: 8,2 →
 4: 9,4 ↓
 5: 9,0 →
 6: 9,1 ↑
 7: 10,0 →
 8: 10,5* ↑
 9: 10,2 ↓

Serie 83,0

Totalt 0,0

Tävlingsskott

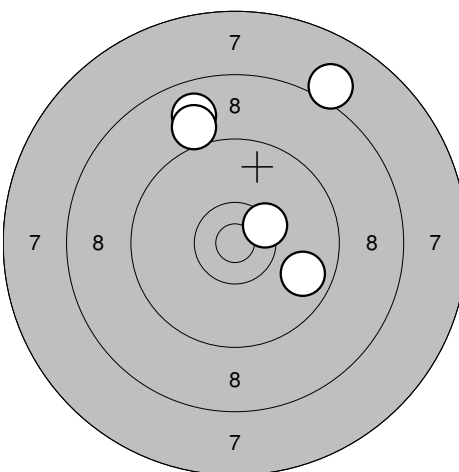

1: 10,4* ↗
 2: 8,9 ↑
 3: 9,0 ↑
 4: 8,1 ↗
 5: 9,8 ↘

Serie 44,0

Totalt 44,0

Tävlingsskott

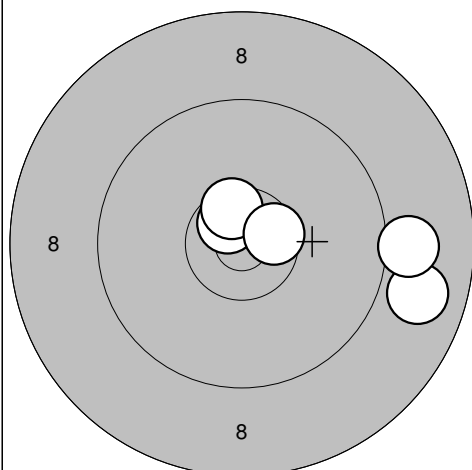

6: 10,7* ↗
 7: 10,5* ↑
 8: 10,6* →
 9: 8,9 →
 10: 9,0 →

Serie 47,0

Totalt 91,0

Tävlingsskott

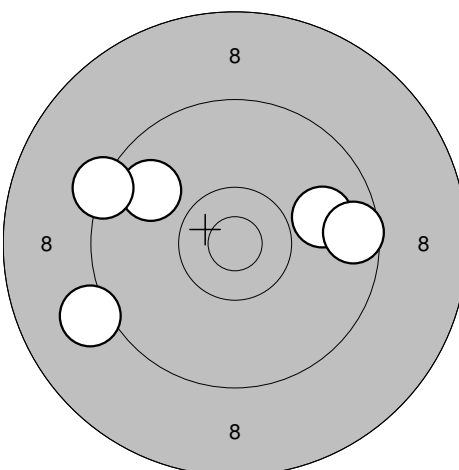

11: 9,8 ↖
 12: 9,9 →
 13: 9,1 ↖
 14: 9,3 ↖
 15: 9,6 →

Serie 45,0

Totalt 136,0

Tävlingsskott

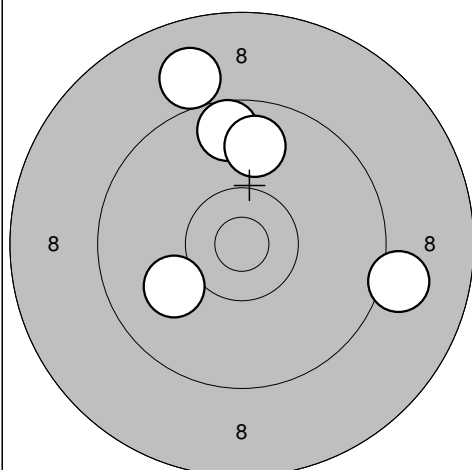

16: 9,6 ↑
 17: 9,0 ↑
 18: 9,8 ↑
 19: 10,0 ↖
 20: 9,1 →

Serie 46,0

Totalt 182,0

Rundviks Skf

2009.08.29

Höstträffen 2009

Ramselefors SKF

Provskott

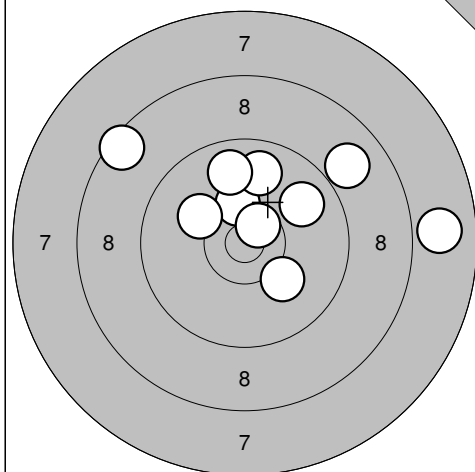

1: 10,3* ↑
 2: 7,9 →
 3: 9,8 ↑
 4: 10,6* ↗
 5: 8,5 ↗
 6: 10,1 ↘
 7: 9,9 ↗
 8: 8,9 ↗
 9: 9,8 ↑
 10: 10,1 ↖

Serie 90,0

Totalt 0,0

Provskott

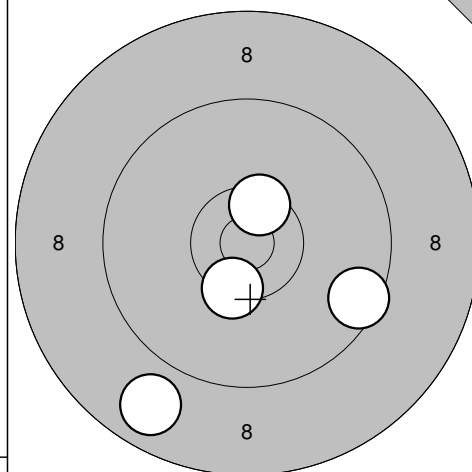

11: 10,5* ↑
 12: 9,5 →
 13: 8,8 ↘
 14: 10,4* ↘

Serie 37,0

Totalt 0,0

Tävlingsskott

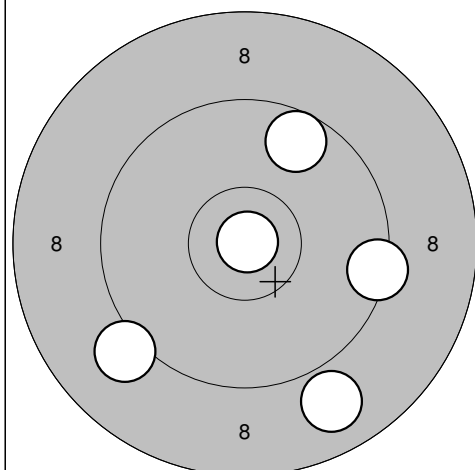

1: 10,9* ↗
 2: 9,4 →
 3: 9,6 ↑
 4: 9,1 ↖
 5: 8,9 ↘

Serie 45,0

Totalt 45,0

Tävlingsskott

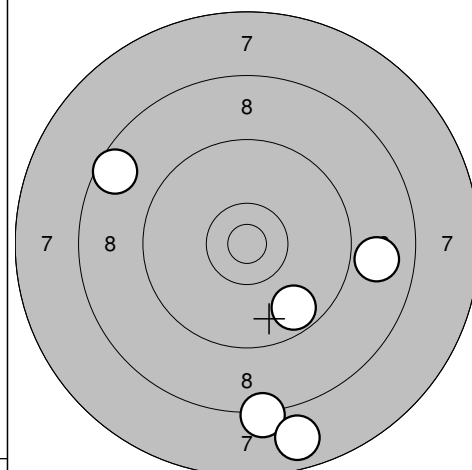

6: 8,3 ↓
 7: 8,9 →
 8: 7,8 ↓
 9: 9,7 ↘
 10: 8,6 ↖

Serie 40,0

Totalt 85,0

Tävlingsskott

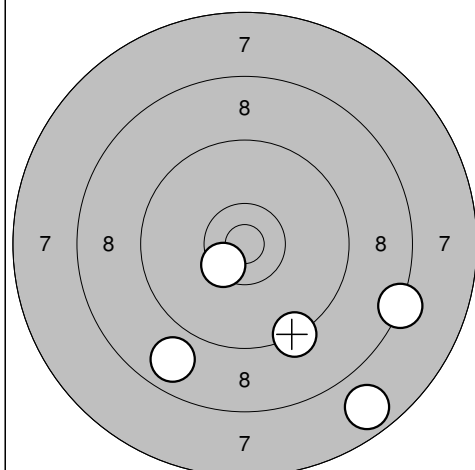

11: 8,8 ↘
 12: 9,3 ↘
 13: 10,5* ↘
 14: 8,3 →
 15: 7,7 ↘

Serie 42,0

Totalt 127,0

Tävlingsskott

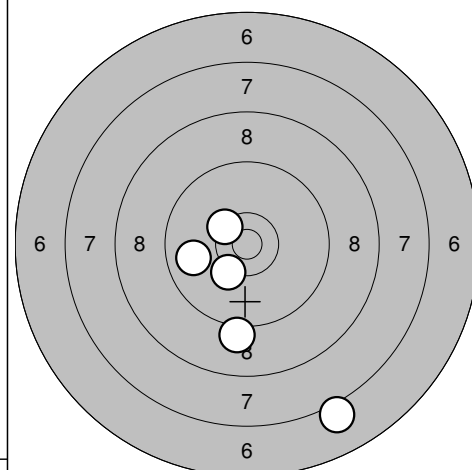

16: 10,4* ↖
 17: 9,9 ↖
 18: 9,1 ↓
 19: 10,3 ↘
 20: 7,1 ↘

Serie 45,0

Totalt 172,0

Ramselefors Skf

2009.08.29

Höstträffen 2009

Ramselefors SKF

Provskott

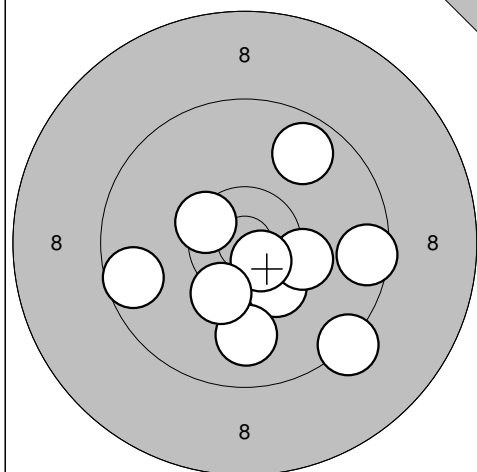

1: 9,7 ↗
 2: 10,3* ↓
 3: 10,3 →
 4: 9,6 ←
 5: 9,5 →
 6: 9,3 ↓
 7: 9,9 ↓
 8: 10,5* ↗
 9: 10,7* ↓
 10: 10,3* ↓

Serie 95,0

Totalt 0,0

Tävlingsskott

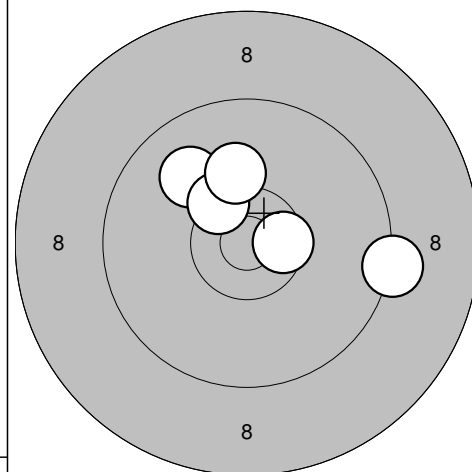

1: 10,5* →
 2: 9,3 →
 3: 10,0 ↗
 4: 10,4* ↗
 5: 10,1 ↑

Serie 49,0

Totalt 49,0

Tävlingsskott

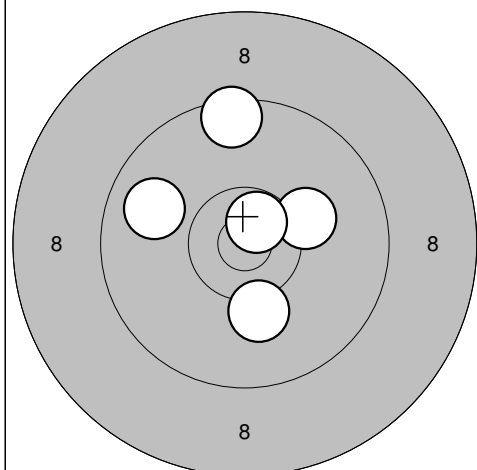

6: 10,2 →
 7: 10,2 ↓
 8: 9,8 ←
 9: 10,7* ↗
 10: 9,5 ↑

Serie 48,0

Totalt 97,0

Tävlingsskott

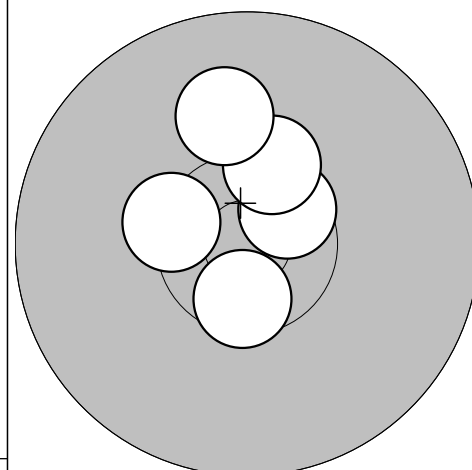

11: 10,6* ↗
 12: 10,6* ↓
 13: 10,4* ←
 14: 10,4* ↑
 15: 10,0 ↑

Serie 50,0

Totalt 147,0

Tävlingsskott

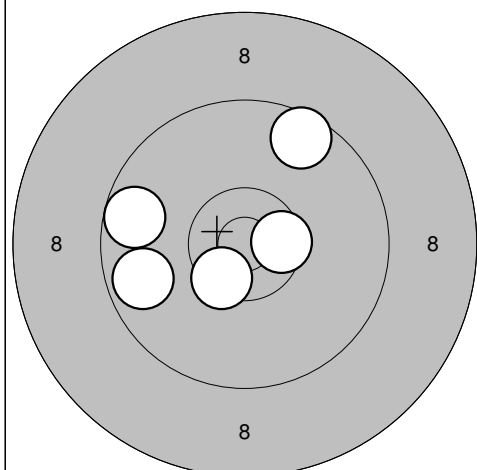

16: 9,7 ←
 17: 9,7 ←
 18: 10,5* →
 19: 10,5* ↓
 20: 9,6 ↗

Serie 47,0

Totalt 194,0

Ramselefors Skf

2009.08.29

Höstträffen 2009

Ramselefors SKF

Provskott

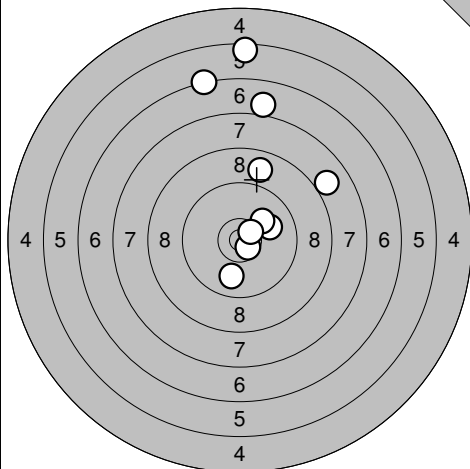

- 1: 5,5 ↑
- 2: 6,3 ↑
- 3: 7,0 ↑
- 4: 8,9 ↑
- 5: 10,0 →
- 6: 10,1 ↗
- 7: 8,0 ↗
- 8: 10,6* ↘
- 9: 9,9 ↓
- 10: 10,6* ↗

Serie 83,0
Totalt 0,0

Provskott

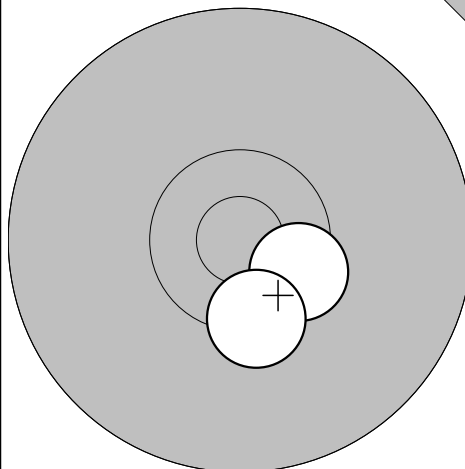

- 11: 10,5* ↘
- 12: 10,4* ↓

Serie 20,0
Totalt 0,0

Tävlingsskott

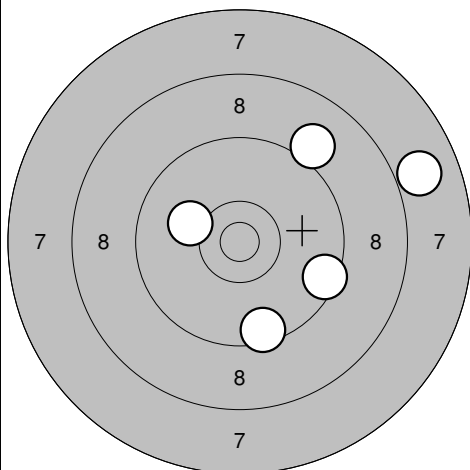

- 1: 9,5 ↘
- 2: 9,5 ↓
- 3: 7,9 →
- 4: 10,1 ←
- 5: 9,1 ↗

Serie 44,0
Totalt 44,0

Tävlingsskott

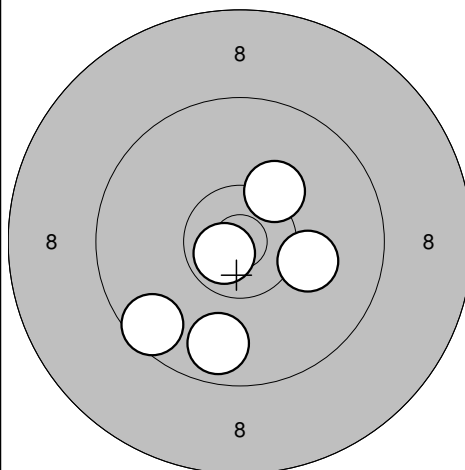

- 6: 10,3 ↗
- 7: 9,6 ↙
- 8: 9,8 ↓
- 9: 10,1 →

Serie 48,0
Totalt 92,0

Tävlingsskott

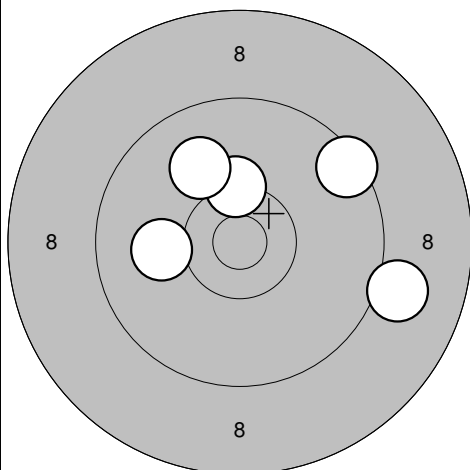

- 11: 10,3* ↑
- 12: 10,0 ↖
- 13: 9,1 →
- 14: 9,5 ↗
- 15: 10,1 ←

Serie 48,0
Totalt 140,0

Tävlingsskott

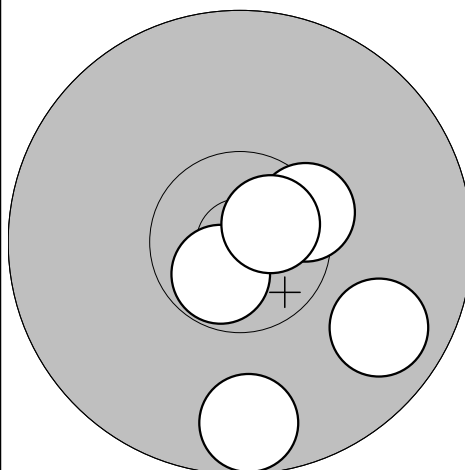

- 16: 9,8 ↘
- 17: 10,7* ↙
- 18: 9,7 ↓
- 19: 10,4* ↗
- 20: 10,7* ↗

Serie 48,0
Totalt 188,0

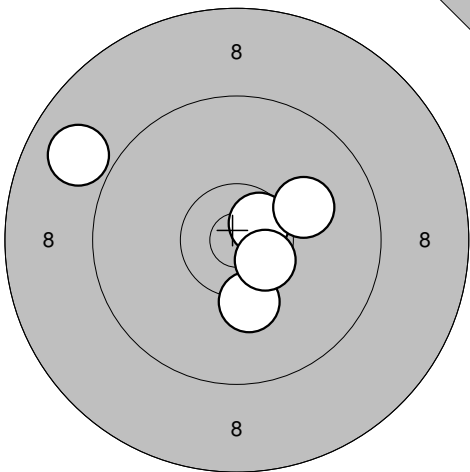
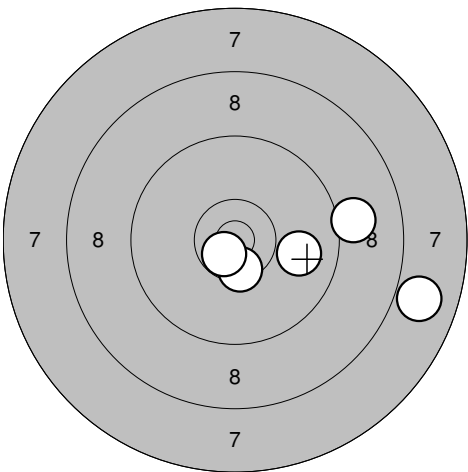
Provskott 	1: 10,6* ↗ 2: 10,2 ↓ 3: 8,9 ↖ 4: 10,1 → 5: 10,5* ↘	Tävlingsskott 	1: 10,5* ↓ 2: 7,9 → 3: 9,9 → 4: 10,7* ↘ 5: 9,1 →
Serie 48,0	Serie 45,0	Serie 45,0	Serie 45,0
Totalt 0,0	Totalt 45,0	Totalt 45,0	Totalt 45,0

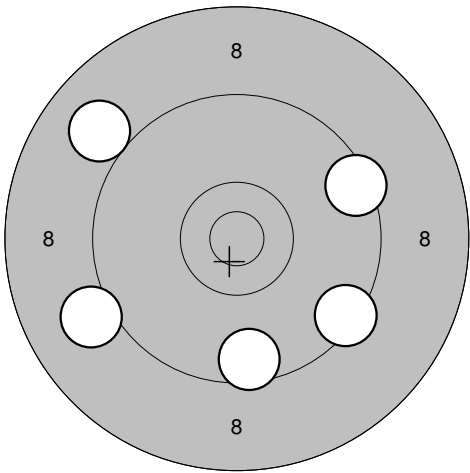
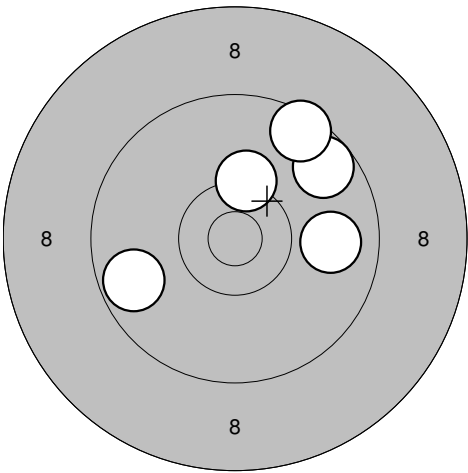
Tävlingsskott 	6: 9,4 ↘ 7: 9,6 ↓ 8: 9,5 → 9: 9,0 ↖ 10: 9,1 ←	Tävlingsskott 	11: 9,7 ↙ 12: 9,7 ↗ 13: 9,5 ↗ 14: 10,3 ↑ 15: 9,9 →
Serie 45,0	Serie 46,0	Serie 46,0	Serie 46,0
Totalt 90,0	Totalt 136,0	Totalt 136,0	Totalt 136,0

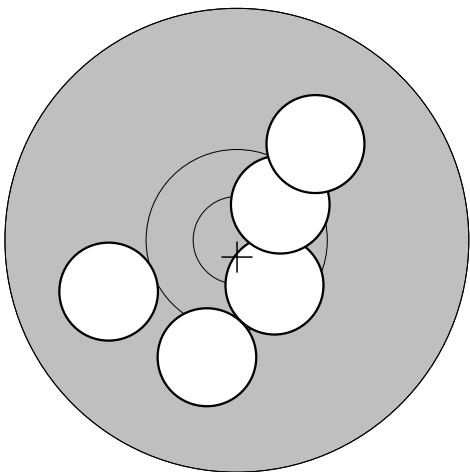
Tävlingsskott 	16: 10,1 ↓ 17: 10,0 ← 18: 10,5* ↘ 19: 10,6* ↗ 20: 10,1 ↗		
Serie 50,0			
Totalt 186,0			

Umeå Skf

2009.08.29

Höstträffen 2009

Ramselefors SKF

Provskott

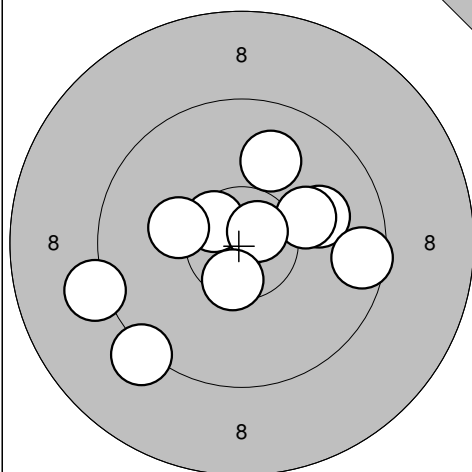

1: 10,0 →
 2: 9,6 →
 3: 10,2 →
 4: 10,0 ↑
 5: 10,6* ↖
 6: 10,2 ←
 7: 9,2 ↙
 8: 10,7* ↗
 9: 10,5* ↓
 10: 9,2 ←

Serie 97,0

Totalt 0,0

Provskott

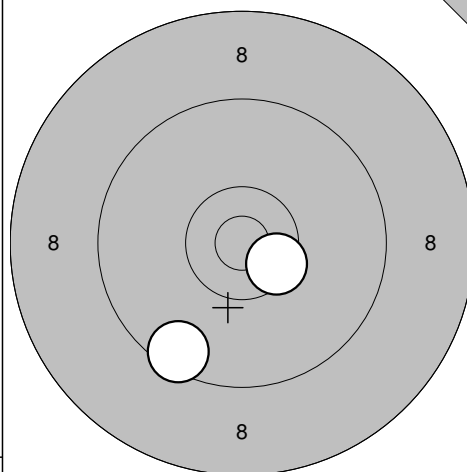

11: 10,5* ↘
 12: 9,5 ↙

Serie 19,0

Totalt 0,0

Tävlingsskott

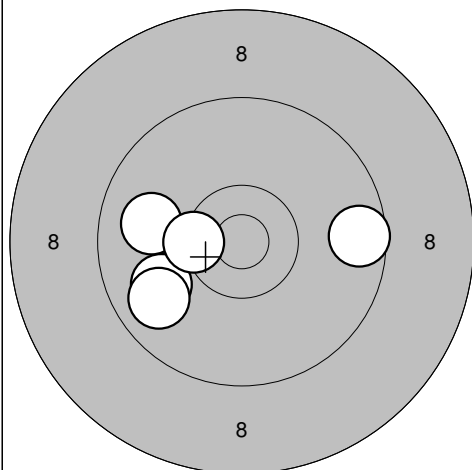

1: 9,9 ←
 2: 9,9 ←
 3: 9,8 ←
 4: 9,6 →
 5: 10,4* ←

Serie 46,0

Totalt 46,0

Tävlingsskott

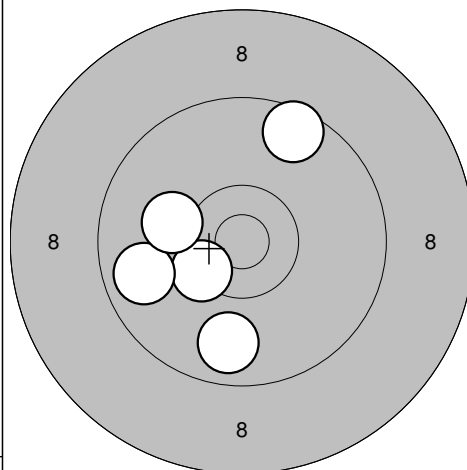

6: 10,4* ↙
 7: 9,6 ↑
 8: 9,8 ←
 9: 10,1 ←
 10: 9,8 ↓

Serie 47,0

Totalt 93,0

Tävlingsskott

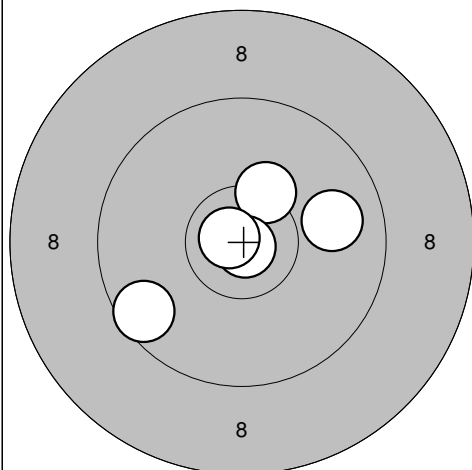

11: 9,9 →
 12: 10,3* ↑
 13: 9,6 ↙
 14: 10,9* ↘
 15: 10,8* ←

Serie 48,0

Totalt 141,0

Tävlingsskott

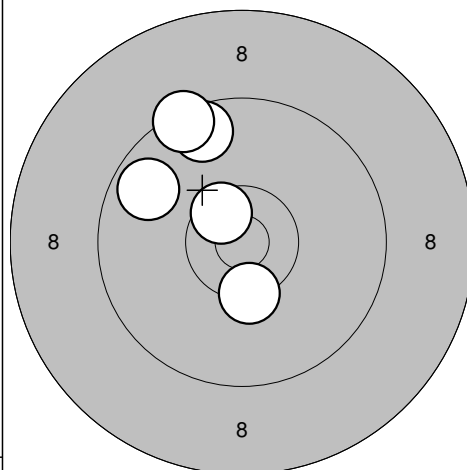

16: 10,4* ↓
 17: 9,7 ↖
 18: 9,6 ↑
 19: 10,5* ↗
 20: 9,4 ↗

Serie 47,0

Totalt 188,0

Umeå Skf

2009.08.29

Höstträffen 2009

Ramselefors SKF

Provskott

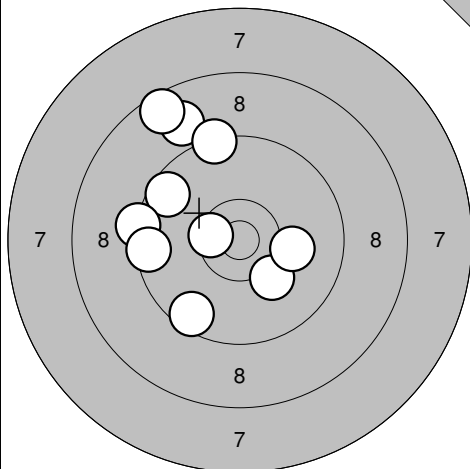

- 1: 8,9 ↗
- 2: 10,2 ↘
- 3: 10,5* ←
- 4: 8,6 ↗
- 5: 10,1 →
- 6: 9,6 ↗
- 7: 9,6 ↘
- 8: 9,4 ↗
- 9: 9,3 ←
- 10: 9,5 ←

Serie 91,0
Totalt 0,0

Provskott

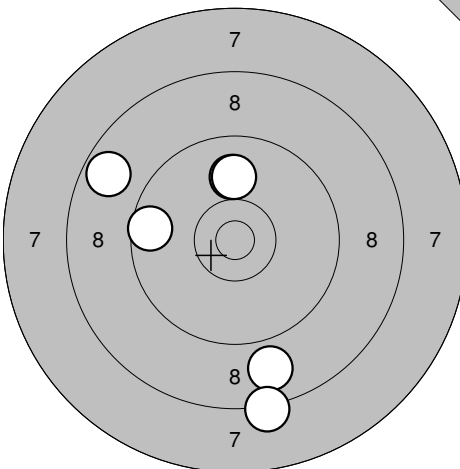

- 11: 9,6 ←
- 12: 10,0 ↑
- 13: 8,9 ↘
- 14: 8,2 ↘
- 15: 8,7 ↖
- 16: 10,0 ↑

Serie 53,0
Totalt 0,0

Tävlingsskott

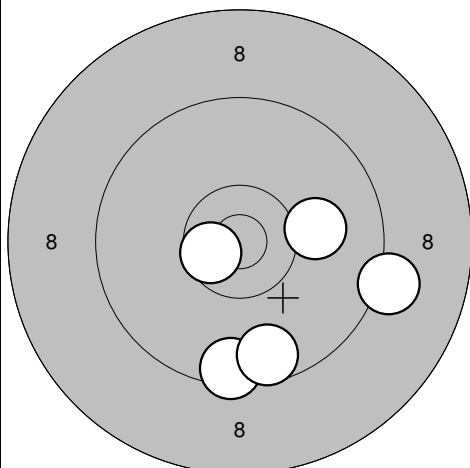

- 1: 10,1 →
- 2: 9,5 ↘
- 3: 9,2 →
- 4: 9,6 ↘
- 5: 10,6* ←

Serie 47,0
Totalt 47,0

Tävlingsskott

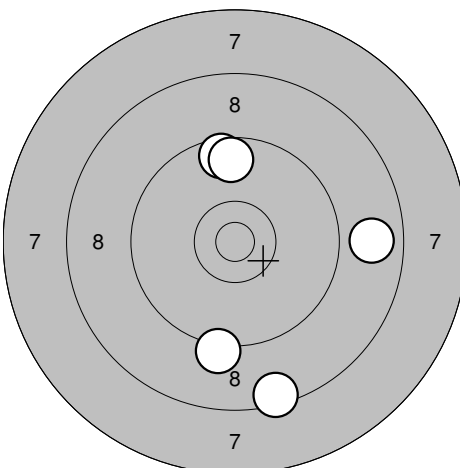

- 6: 9,2 ↘
- 7: 9,6 ↑
- 8: 8,5 ↘
- 9: 9,7 ↑
- 10: 8,8 →

Serie 43,0
Totalt 90,0

Tävlingsskott

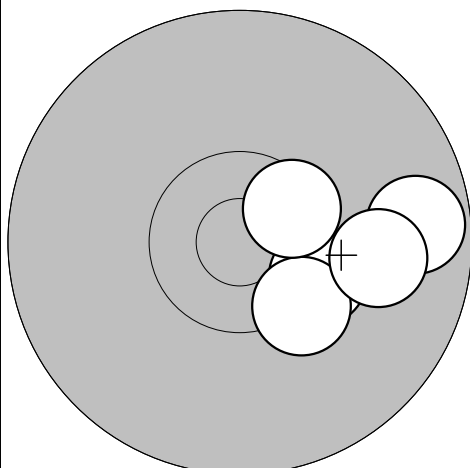

- 11: 10,3* →
- 12: 10,3* ↘
- 13: 9,7 →
- 14: 10,0 →
- 15: 10,5* ↗

Serie 49,0
Totalt 139,0

Tävlingsskott

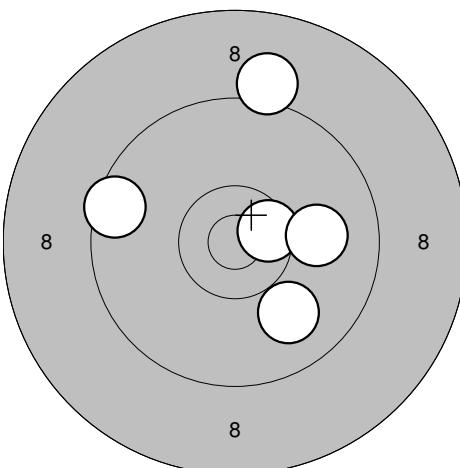

- 16: 10,5* →
- 17: 9,9 ↘
- 18: 9,1 ↑
- 19: 9,5 ←
- 20: 10,0 →

Serie 47,0
Totalt 186,0

Umeå Skf

2009.08.29

Höstträffen 2009

Ramselefors SKF

Provskott

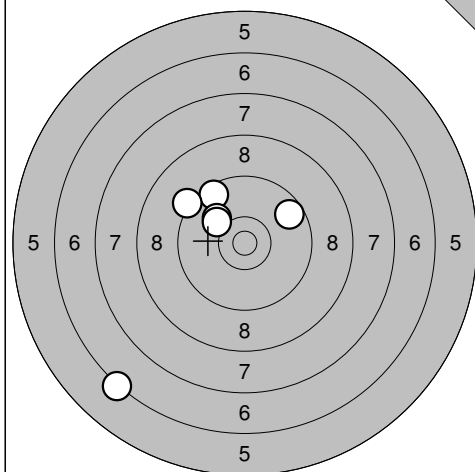

1: 6,3 ↙
 2: 9,6 ↗
 3: 10,0 ↗
 4: 9,3 ↗
 5: 9,7 ↗
 6: 10,1 ↗

Serie 53,0

Totalt 0,0

Tävlingsskott

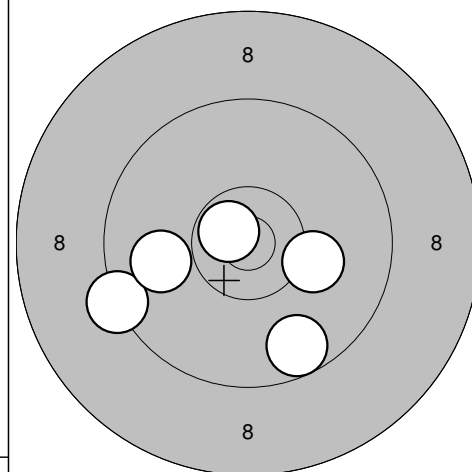

1: 9,7 ↓
 2: 9,3 ←
 3: 10,7* ↖
 4: 9,9 ←
 5: 10,2 →

Serie 47,0

Totalt 47,0

Tävlingsskott

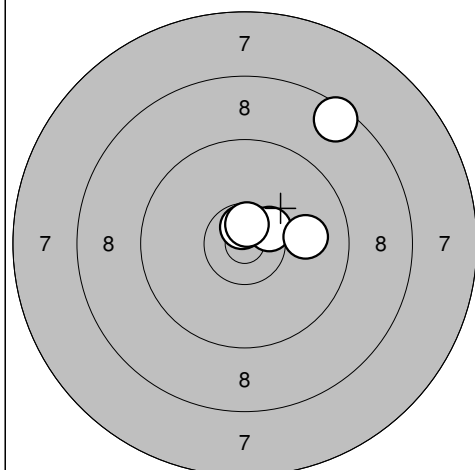

6: 10,5* ↗
 7: 10,7* ↑
 8: 8,5 ↗
 9: 10,7* ↑
 10: 10,0 →

Serie 48,0

Totalt 95,0

Tävlingsskott

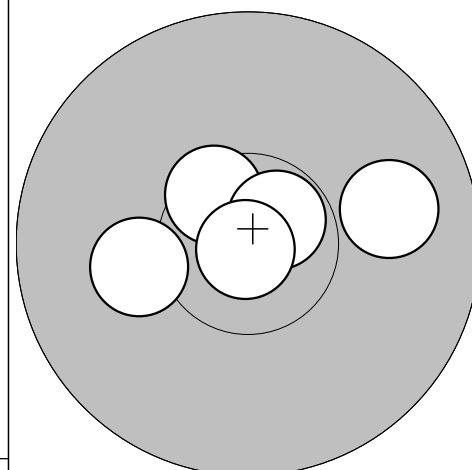

11: 10,2 ←
 12: 10,5* ↖
 13: 10,7* ↗
 14: 10,9* ↓
 15: 9,9 →

Serie 49,0

Totalt 144,0

Tävlingsskott

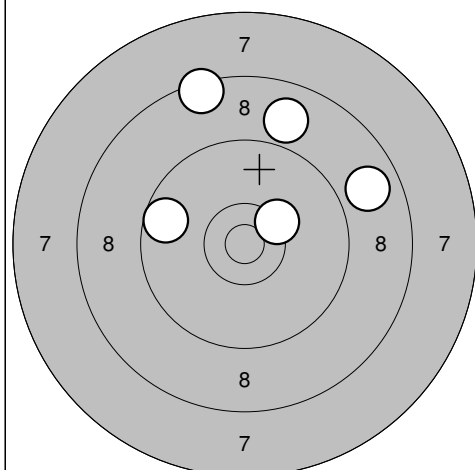

16: 10,3* ↗
 17: 9,7 ←
 18: 8,9 ↑
 19: 8,5 ↑
 20: 8,8 →

Serie 43,0

Totalt 187,0

Umeå Skf

2009.08.29

Höstträffen 2009

Ramselefors SKF

Provskott

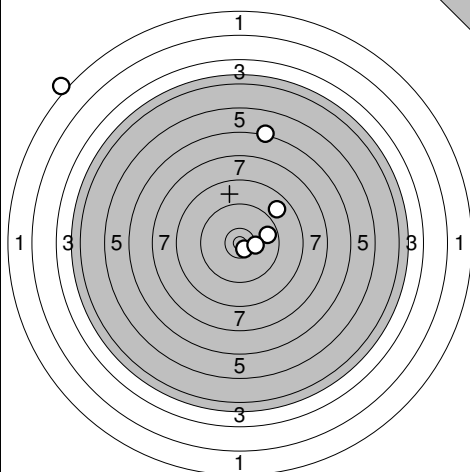

1: 1,1 ↖
 2: 6,3 ↑
 3: 9,7 →
 4: 8,9 ↗
 5: 10,6* ↘
 6: 10,3 →

Serie 44,0

Totalt 0,0

Tävlingsskott

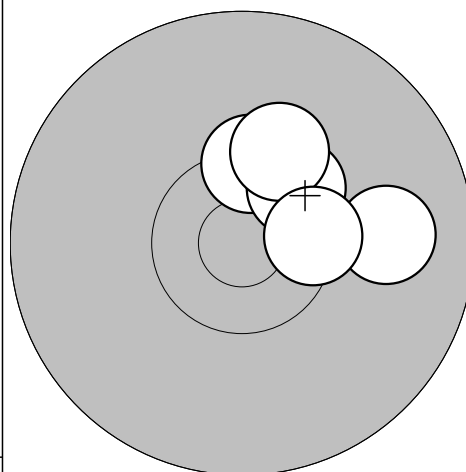

1: 10,4* ↑
 2: 10,4* ↗
 3: 9,9 →
 4: 10,2 ↑
 5: 10,4* →

Serie 49,0

Totalt 49,0

Tävlingsskott

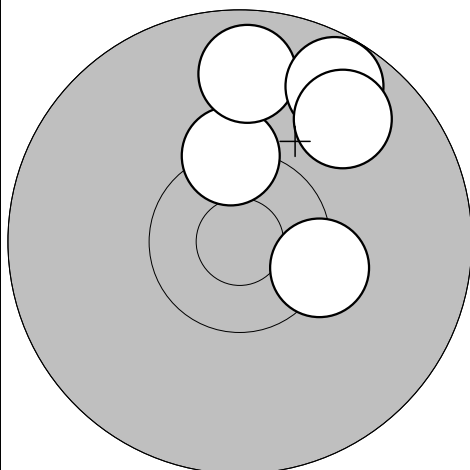

6: 10,3* ↑
 7: 9,8 ↑
 8: 10,4* →
 9: 9,7 ↗
 10: 9,8 ↗

Serie 47,0

Totalt 96,0

Tävlingsskott

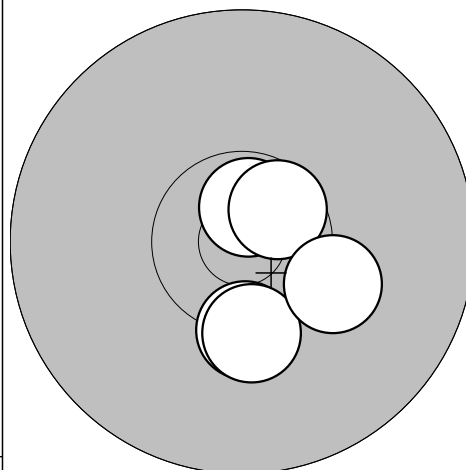

11: 10,7* ↑
 12: 10,3* ↓
 13: 10,6* ↗
 14: 10,3* ↓
 15: 10,2 →

Serie 50,0

Totalt 146,0

Tävlingsskott

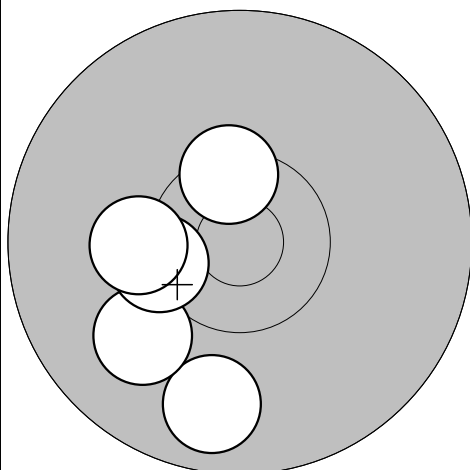

16: 9,8 ↓
 17: 10,0 ↖
 18: 10,4* ←
 19: 10,5* ↑
 20: 10,2 ←

Serie 49,0

Totalt 195,0

Umeå Skf

2009.08.29

Höstträffen 2009

Ramselefors SKF

Provskott

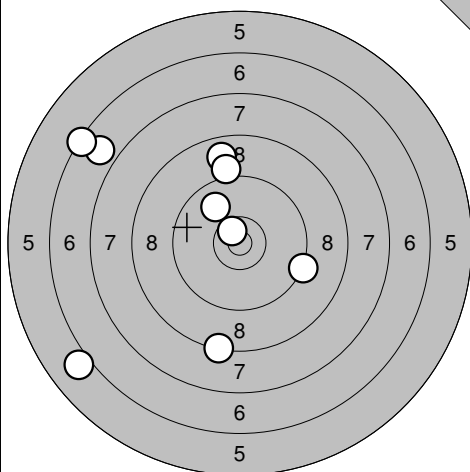

1: 8,3 ↓
 2: 6,0 ↙
 3: 6,9 ↗
 4: 6,4 ↗
 5: 8,8 ↑
 6: 9,1 ↑
 7: 9,9 ↗
 8: 10,6* ↗
 9: 9,3 →

Serie 71,0

Totalt 0,0

Tävlingsskott

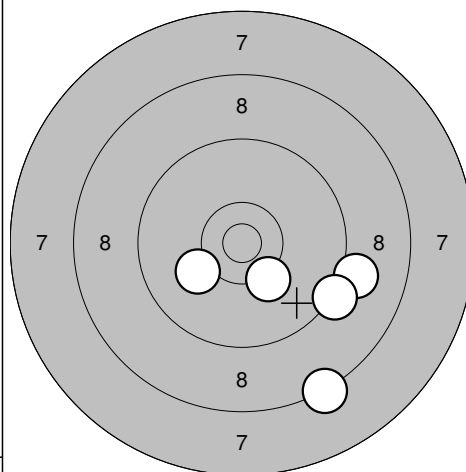

1: 8,3 ↓
 2: 9,1 →
 3: 9,3 ↘
 4: 10,2 ↓
 5: 10,1 ↙

Serie 46,0

Totalt 46,0

Tävlingsskott

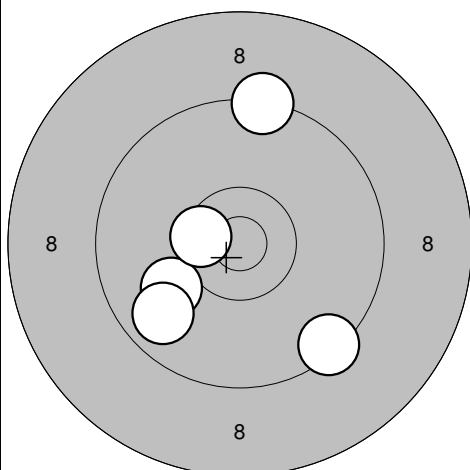

6: 9,4 ↓
 7: 10,0 ↙
 8: 9,3 ↑
 9: 9,8 ↙
 10: 10,5* ←

Serie 47,0

Totalt 93,0

Tävlingsskott

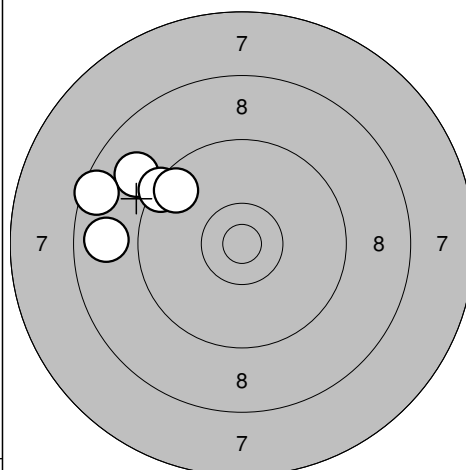

11: 9,0 ↖
 12: 9,4 ↖
 13: 8,5 ↖
 14: 8,8 ←
 15: 9,6 ↗

Serie 43,0

Totalt 136,0

Tävlingsskott

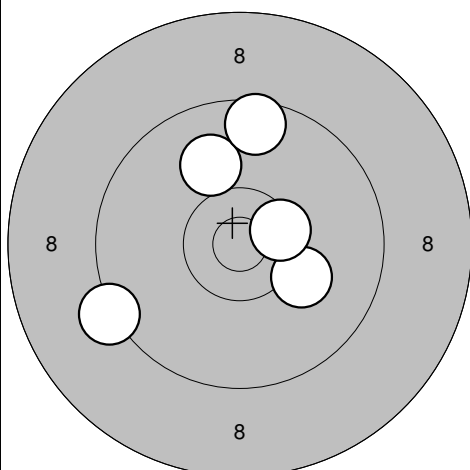

16: 9,3 ↙
 17: 10,0 ↑
 18: 10,2 →
 19: 9,6 ↑
 20: 10,5* →

Serie 48,0

Totalt 184,0

Drängsmarks Skf

2009.08.29

Höstträffen 2009

Ramselefors SKF

Provskott

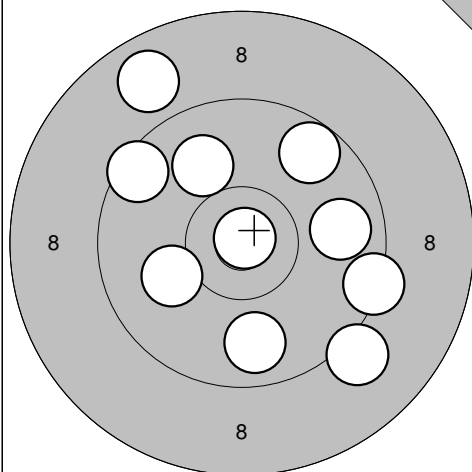

1: 8,8 ↗
 2: 9,7 ↗
 3: 9,1 ↘
 4: 10,9* ↗
 5: 9,4 →
 6: 9,8 →
 7: 9,5 ↗
 8: 10,0 ↗
 9: 10,1 ←
 10: 9,8 ↓

Serie 92,0

Totalt 0,0

Provskott

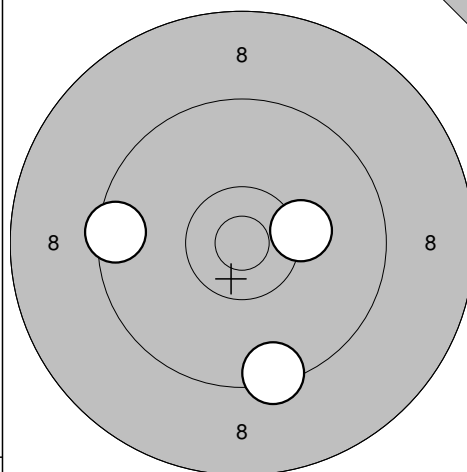

11: 9,4 ↓
 12: 10,3 →
 13: 9,5 ←

Serie 28,0

Totalt 0,0

Tävlingsskott

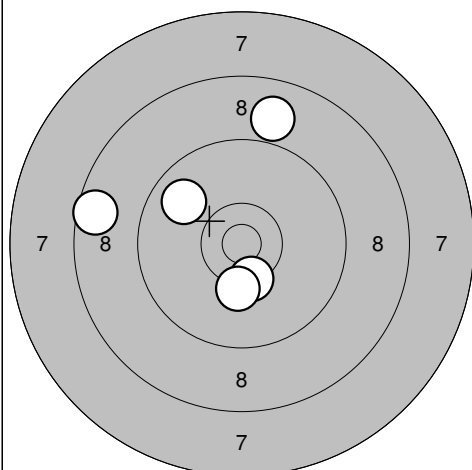

1: 10,4* ↓
 2: 9,8 ↗
 3: 8,6 ←
 4: 10,2 ↓
 5: 8,9 ↑

Serie 45,0

Totalt 45,0

Tävlingsskott

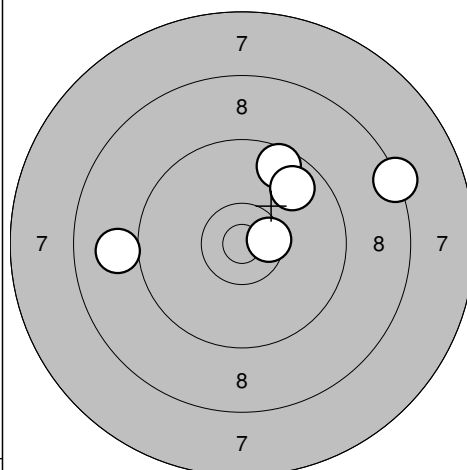

6: 9,6 ↗
 7: 10,5* →
 8: 9,8 ↗
 9: 9,0 ←
 10: 8,3 →

Serie 45,0

Totalt 90,0

Tävlingsskott

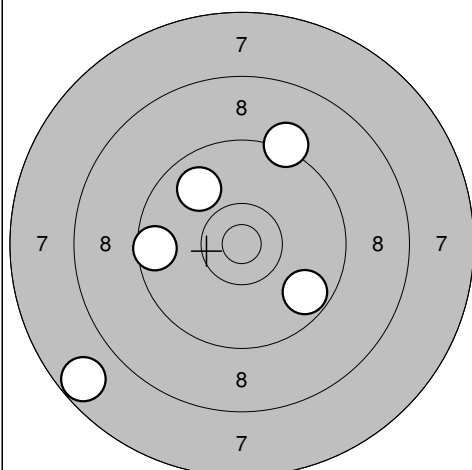

11: 9,2 ↗
 12: 7,7 ↘
 13: 9,6 ←
 14: 9,7 ↘
 15: 9,9 ↗

Serie 43,0

Totalt 133,0

Tävlingsskott

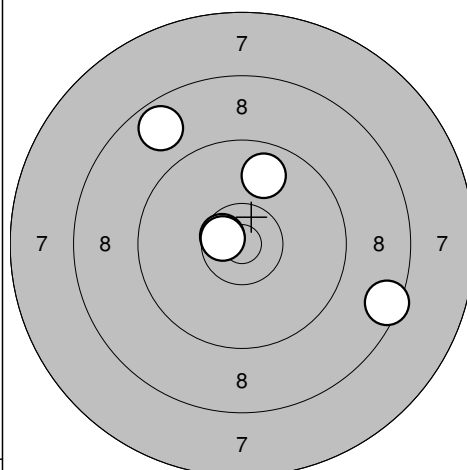

16: 10,6* ←
 17: 10,6* ←
 18: 8,5 →
 19: 8,7 ↗
 20: 9,8 ↗

Serie 45,0

Totalt 178,0

Drängsmarks Skf

2009.08.29

Höstträffen 2009

Ramselefors SKF

Provskott

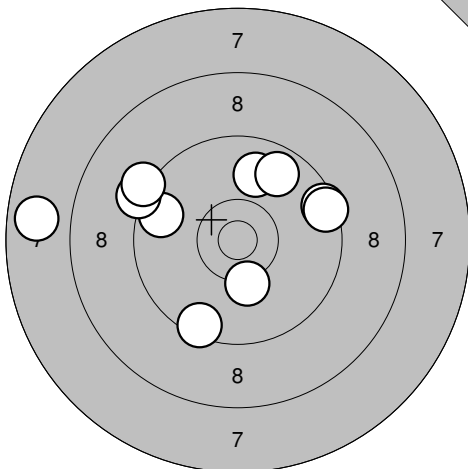

- 1: 9,7 ←
- 2: 9,9 ↑
- 3: 9,5 →
- 4: 7,8 ←
- 5: 9,5 →
- 6: 9,7 ↑
- 7: 10,2 ↓
- 8: 9,3 ↗
- 9: 9,5 ↓
- 10: 9,2 ↖

Serie 89,0
Totalt 0,0

Provskott

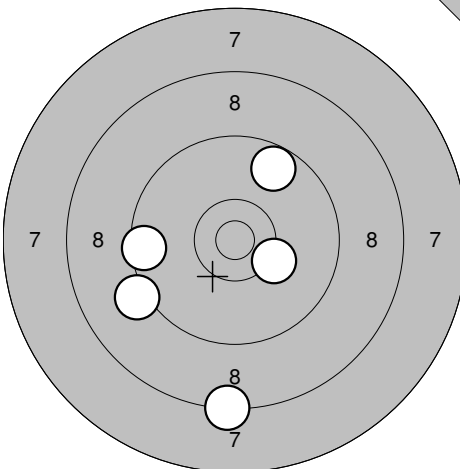

- 11: 9,7 ↗
- 12: 10,2 →
- 13: 8,3 ↓
- 14: 9,5 ←
- 15: 9,2 ↖

Serie 45,0
Totalt 0,0

Tävlingsskott

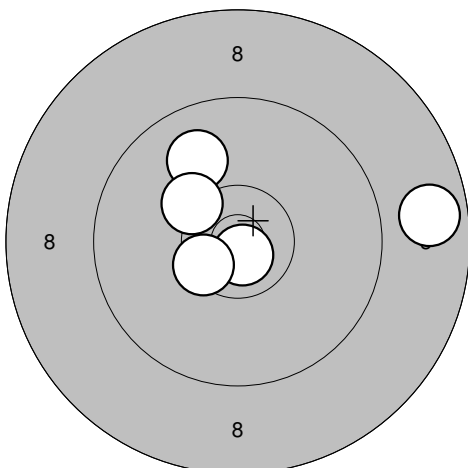

- 1: 8,7 →
- 2: 10,8* ↓
- 3: 10,5* ↖
- 4: 9,9 ↗
- 5: 10,3 ↗

Serie 47,0
Totalt 47,0

Tävlingsskott

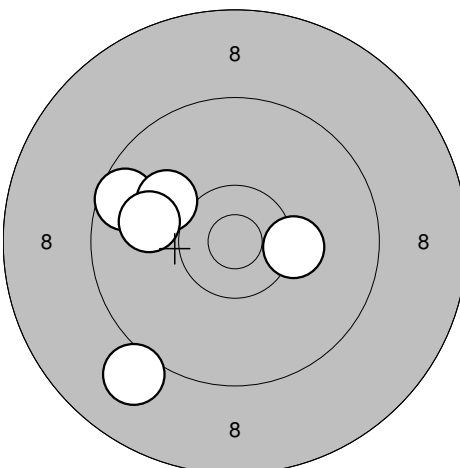

- 6: 9,6 ↖
- 7: 10,1 ↖
- 8: 10,0 ←
- 9: 9,0 ↘
- 10: 10,3 →

Serie 48,0
Totalt 95,0

Tävlingsskott

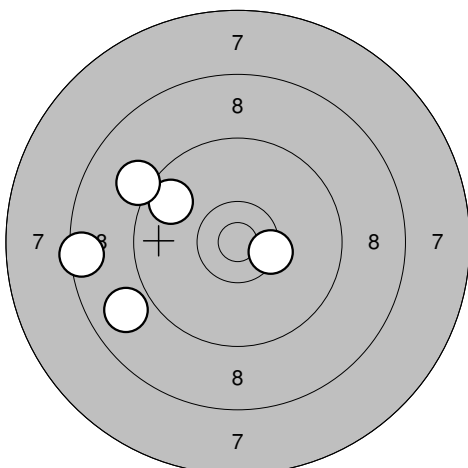

- 11: 8,5 ←
- 12: 10,4* →
- 13: 9,7 ↗
- 14: 8,9 ↖
- 15: 9,1 ↗

Serie 44,0
Totalt 139,0

Tävlingsskott

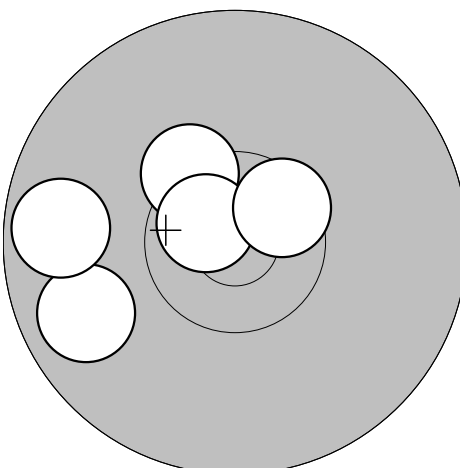

- 16: 9,8 ↖
- 17: 9,7 ←
- 18: 10,4* ↗
- 19: 10,7* ↖
- 20: 10,5* ↗

Serie 48,0
Totalt 187,0

Ramselefors Skf

2009.08.29

Höstträffen 2009

Ramselefors SKF

Provskott

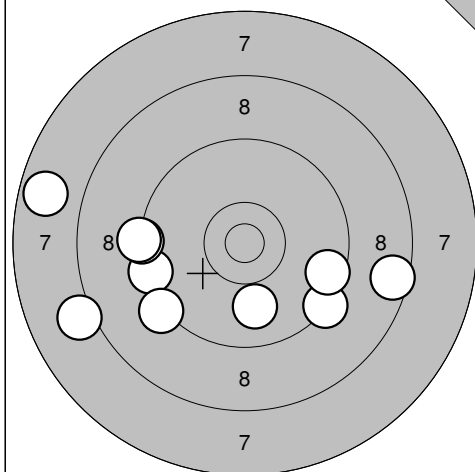

1: 8,1 ←
 2: 8,6 →
 3: 9,3 ↘
 4: 9,6 →
 5: 7,7 ←
 6: 9,4 ←
 7: 9,9 ↓
 8: 9,3 ←
 9: 9,3 ←
 10: 9,3 ↙

Serie 86,0

Totalt 0,0

Provskott

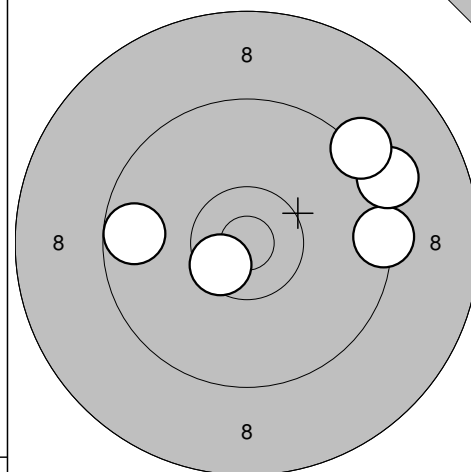

11: 9,4 →
 12: 9,2 ↗
 13: 9,7 ←
 14: 9,3 ↗
 15: 10,6* ↙

Serie 46,0

Totalt 0,0

Tävlingsskott

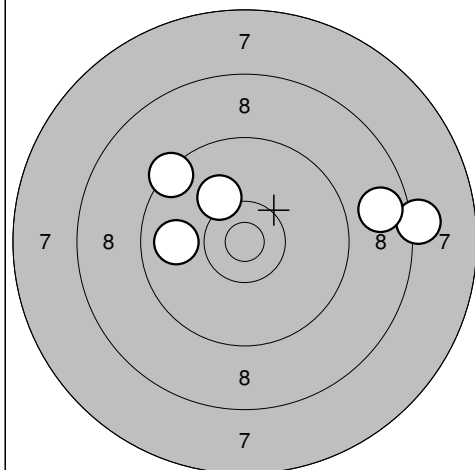

1: 9,9 ←
 2: 8,2 →
 3: 10,2 ↗
 4: 9,4 ↗
 5: 8,7 →

Serie 44,0

Totalt 44,0

Tävlingsskott

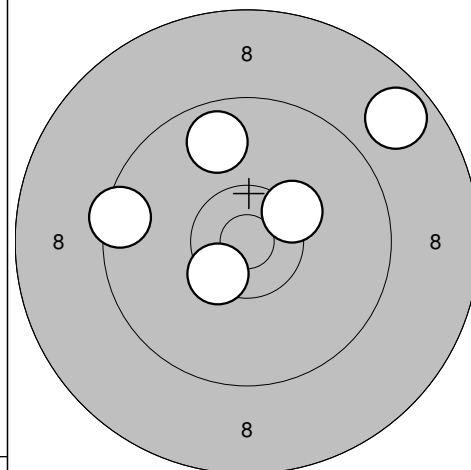

6: 8,7 ↗
 7: 9,5 ←
 8: 9,8 ↑
 9: 10,5* ↙
 10: 10,3* ↗

Serie 46,0

Totalt 90,0

Tävlingsskott

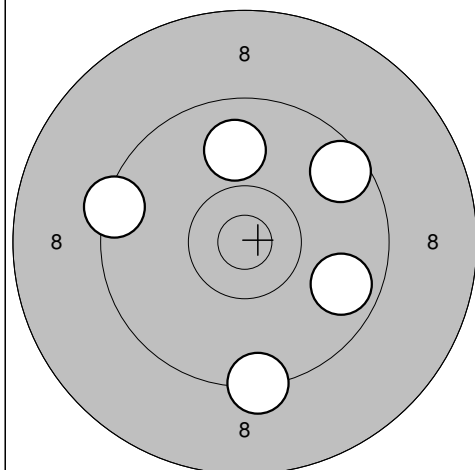

11: 9,4 ←
 12: 9,9 ↑
 13: 9,7 →
 14: 9,6 ↗
 15: 9,3 ↓

Serie 45,0

Totalt 135,0

Tävlingsskott

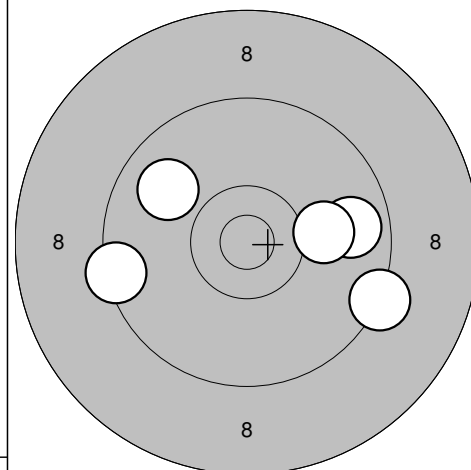

16: 9,3 →
 17: 9,9 ↖
 18: 9,8 →
 19: 9,4 ←
 20: 10,1 →

Serie 46,0

Totalt 181,0

Ramselefors Skf

2009.08.29

Höstträffen 2009

Ramselefors SKF

Provskott

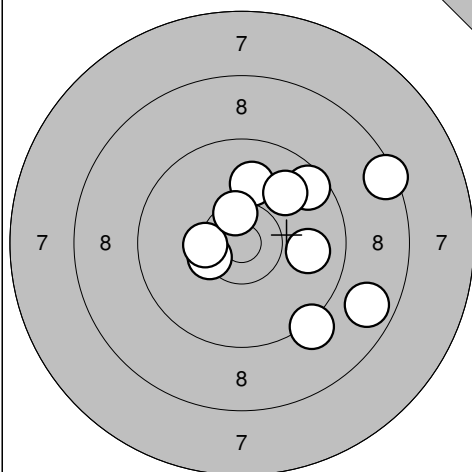

1: 9,2 ↘
 2: 9,6 ↗
 3: 9,9 →
 4: 10,4* ↙
 5: 8,5 ↗
 6: 10,0 ↑
 7: 8,7 →
 8: 10,4* ←
 9: 10,5* ↑
 10: 9,9 ↗

Serie 92,0

Totalt 0,0

Provskott

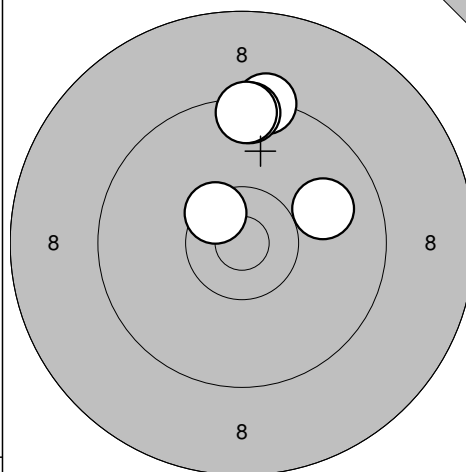

11: 9,9 ↗
 12: 9,3 ↑
 13: 9,5 ↑
 14: 10,5* ↙
 15: 9,5 ↑

Serie 46,0

Totalt 0,0

Tävlingsskott

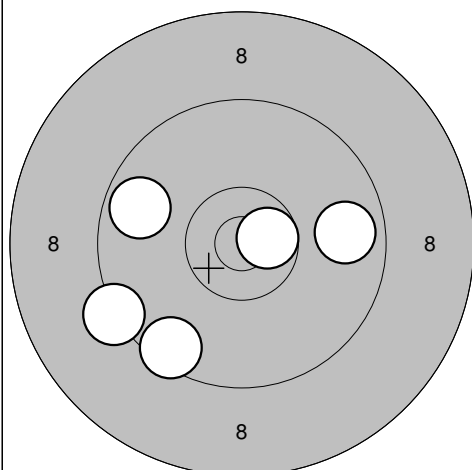

1: 9,5 ↘
 2: 9,8 →
 3: 9,7 ↙
 4: 9,3 ↙
 5: 10,6* →

Serie 46,0

Totalt 46,0

Tävlingsskott

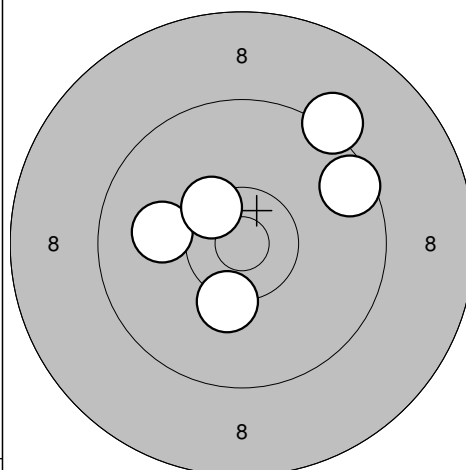

6: 9,6 ↗
 7: 9,2 ↗
 8: 10,3 ↓
 9: 10,0 ←
 10: 10,4* ↙

Serie 48,0

Totalt 94,0

Tävlingsskott

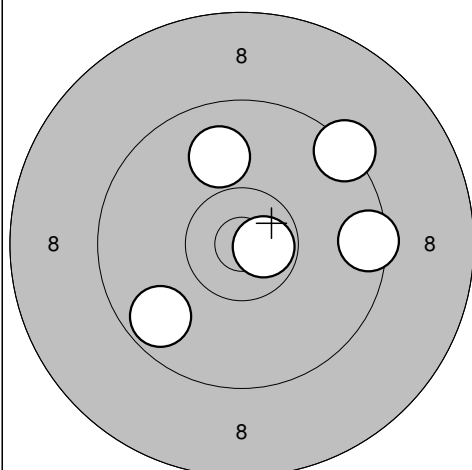

11: 9,9 ↑
 12: 9,7 ↙
 13: 10,7* →
 14: 9,4 ↗
 15: 9,5 →

Serie 46,0

Totalt 140,0

Tävlingsskott

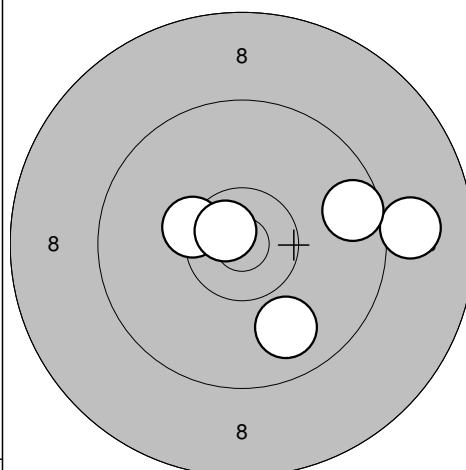

16: 10,4* ↙
 17: 9,0 →
 18: 9,9 ↓
 19: 10,7* ↗
 20: 9,6 →

Serie 47,0

Totalt 187,0

Ramselefors Skf

2009.08.29

Höstträffen 2009

Ramselefors SKF

Provskott

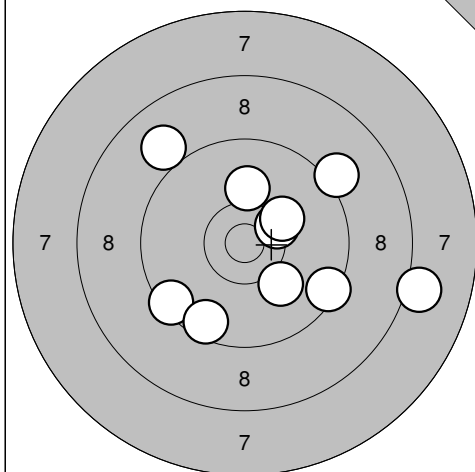

1: 9,0 ↖
 2: 9,1 ↗
 3: 8,1 →
 4: 10,4* ↗
 5: 9,4 →
 6: 10,1 ↓
 7: 10,2 ↗
 8: 10,1 ↑
 9: 9,5 ↙
 10: 9,6 ↓

Serie 93,0

Totalt 0,0

Provskott

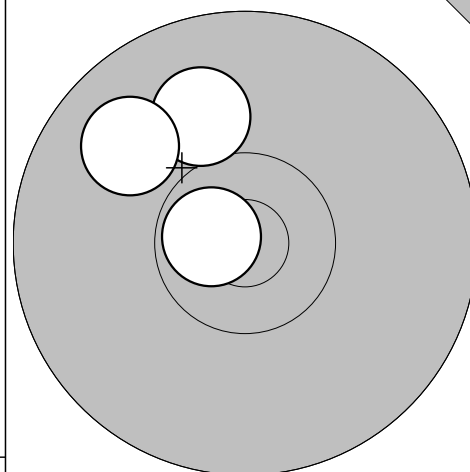

11: 10,0 ↖
 12: 9,9 ↗
 13: 10,7* ←

Serie 29,0

Totalt 0,0

Tävlingsskott

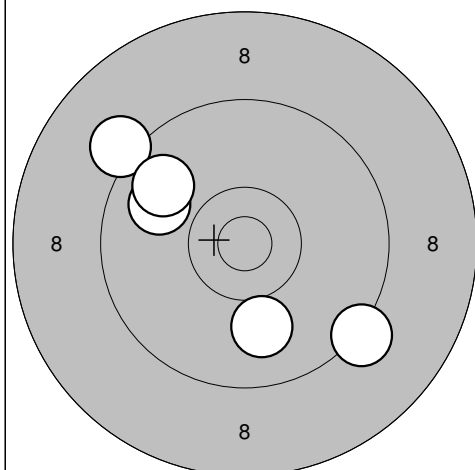

1: 9,2 ↖
 2: 10,0 ↓
 3: 9,9 ↗
 4: 9,8 ↗
 5: 9,3 ↓

Serie 46,0

Totalt 46,0

Tävlingsskott

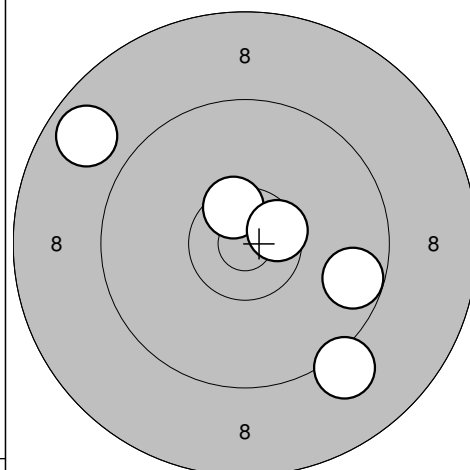

6: 10,5* ↖
 7: 10,6* ↗
 8: 8,8 ↗
 9: 9,1 ↓
 10: 9,7 →

Serie 46,0

Totalt 92,0

Tävlingsskott

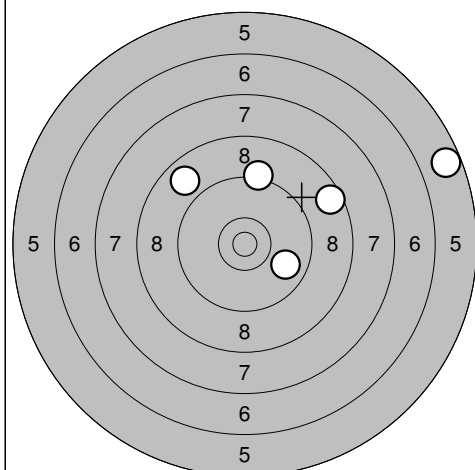

11: 9,8 →
 12: 8,8 ↖
 13: 5,7 →
 14: 9,2 ↑
 15: 8,6 ↗

Serie 39,0

Totalt 131,0

Tävlingsskott

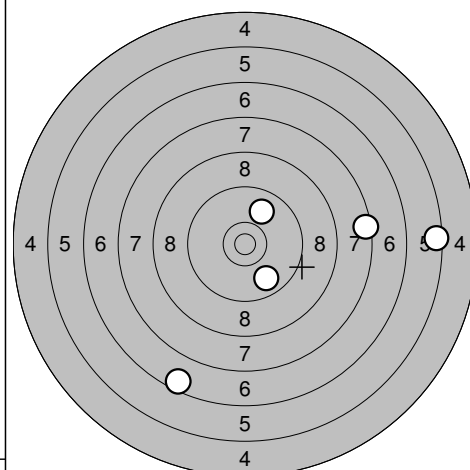

16: 7,5 →
 17: 9,9 ↖
 18: 6,6 ↓
 19: 9,8 ↓
 20: 5,5 →

Serie 36,0

Totalt 167,0

Ramselefors Skf

2009.08.29

Höstträffen 2009

Ramselefors SKF

Provskott

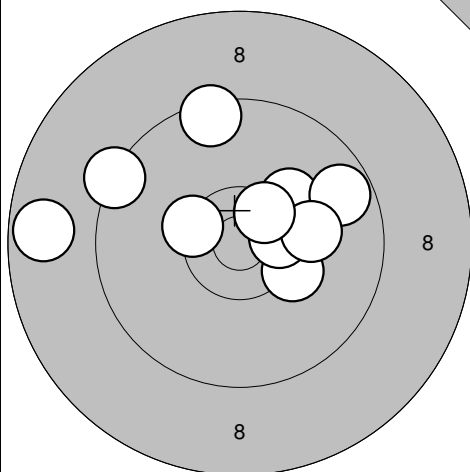

1: 9,5 ↗
 2: 10,2 ↗
 3: 10,3 ↘
 4: 10,5* →
 5: 9,7 ↗
 6: 10,1 →
 7: 10,4* ↖
 8: 9,3 ↖
 9: 8,7 ←
 10: 10,5* ↗

Serie 95,0
 Totalt 0,0

Provskott

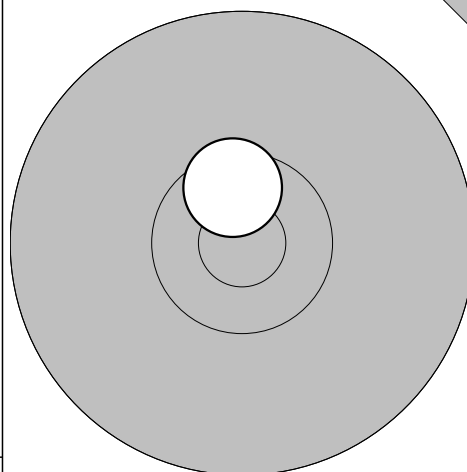

11: 10,6* ↑

Serie 10,0
 Totalt 0,0

Tävlingsskott

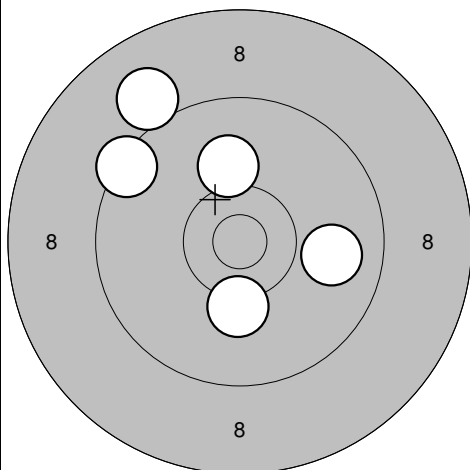

1: 9,9 →
 2: 10,1 ↑
 3: 9,4 ↗
 4: 10,2 ↓
 5: 9,0 ↗

Serie 47,0
 Totalt 47,0

Tävlingsskott

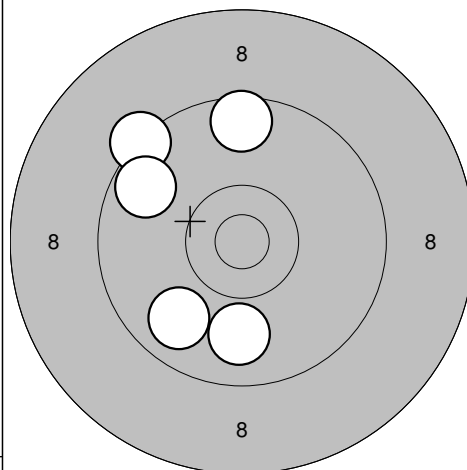

6: 9,9 ↓
 7: 9,6 ↑
 8: 9,3 ↗
 9: 9,8 ↘
 10: 9,7 ↖

Serie 45,0
 Totalt 92,0

Tävlingsskott

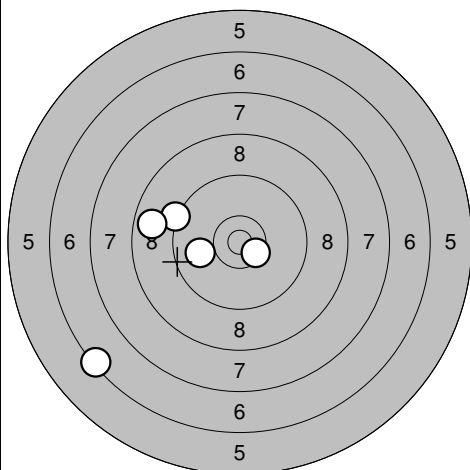

11: 9,3 ↖
 12: 6,4 ↖
 13: 10,0 ←
 14: 10,5* ↘
 15: 8,8 ←

Serie 43,0
 Totalt 135,0

Tävlingsskott

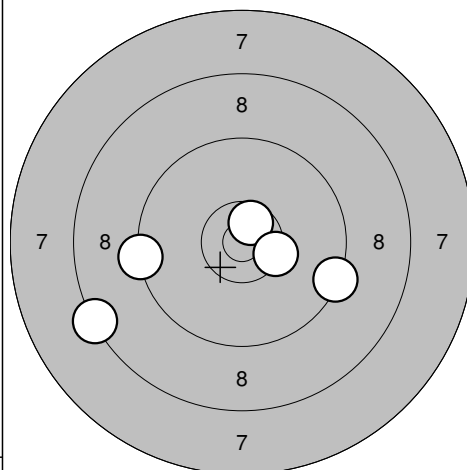

16: 10,6* ↗
 17: 10,4* →
 18: 9,4 →
 19: 8,3 ↖
 20: 9,3 ←

Serie 46,0
 Totalt 181,0

Umeå Skf

2009.08.29

Höstträffen 2009

Ramselefors SKF

Provskott

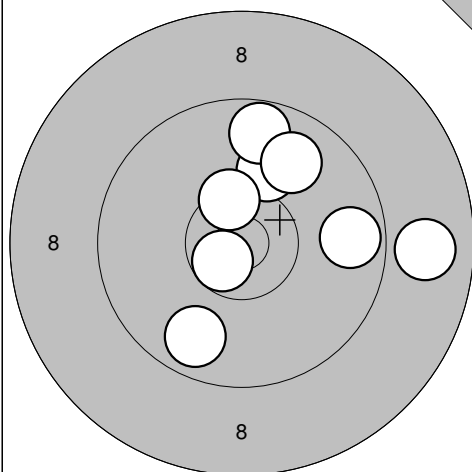

1: 10,1 ↗
 2: 9,7 ↑
 3: 9,7 →
 4: 10,7* ↙
 5: 9,8 ↘
 6: 9,9 ↗
 7: 8,9 →
 8: 10,4* ↑

Serie 74,0
 Totalt 0,0

Tävlingsskott

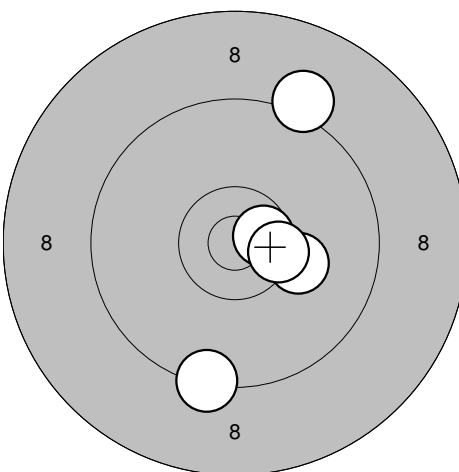

1: 9,3 ↓
 2: 10,2 →
 3: 10,6* →
 4: 10,4* →
 5: 9,2 ↗

Serie 48,0
 Totalt 48,0

Tävlingsskott

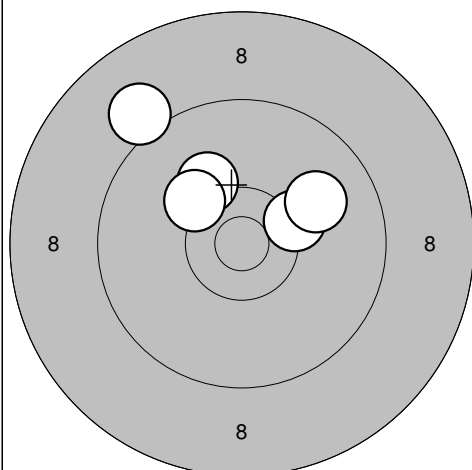

6: 10,2 ↗
 7: 10,2 ↗
 8: 10,3* →
 9: 10,0 ↗
 10: 9,1 ↗

Serie 49,0
 Totalt 97,0

Tävlingsskott

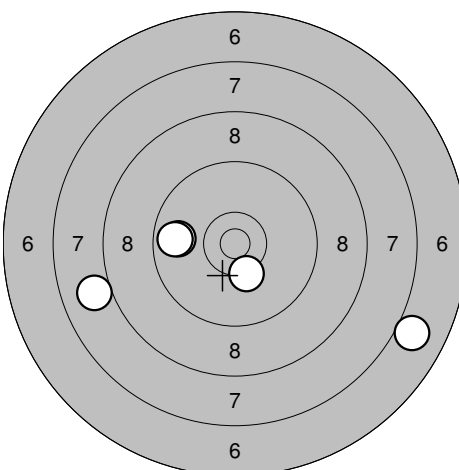

11: 9,8 ←
 12: 9,8 ←
 13: 8,0 ←
 14: 10,3* ↓
 15: 7,0 ↘

Serie 43,0
 Totalt 140,0

Tävlingsskott

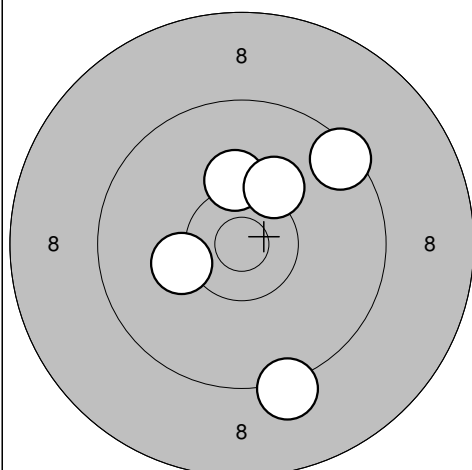

16: 10,2 ↑
 17: 10,2 ↗
 18: 9,2 ↘
 19: 9,5 ↗
 20: 10,2 ←

Serie 48,0
 Totalt 188,0

Skjutlag

Tavla

3

5

Christian Lejon

Umeå Skf

2009.08.29

Höstträffen 2009

Ramselefors SKF

Tävlingskott

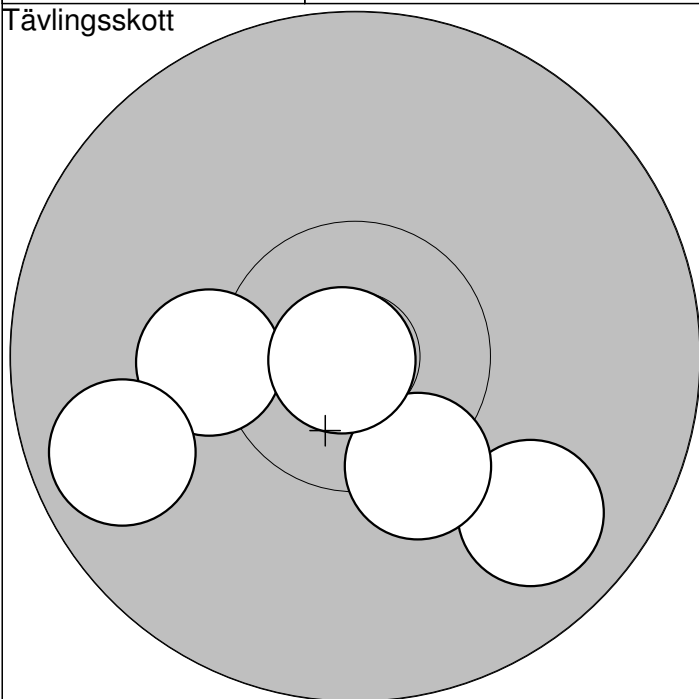

1:10,3 ←
 2: 9,8 ↘
 3: 9,7 ←
 4:10,3* ↘
 5:10,9* ←

Serie 48,0

Totalt 48,0

Tävlingskott

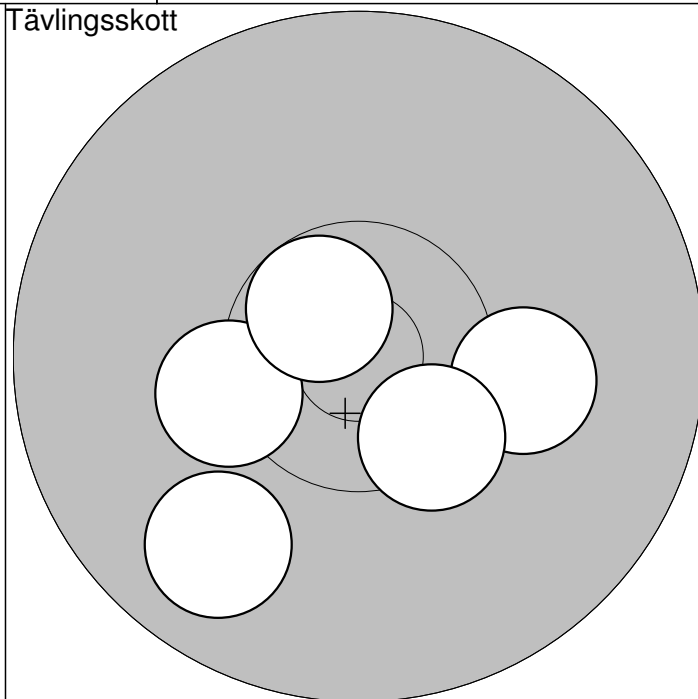

6:10,3* ←
 7:10,7* ↗
 8: 9,8 ↘
 9:10,2 →
 10:10,4* ↘

Serie 49,0

Totalt 97,0

Tävlingskott

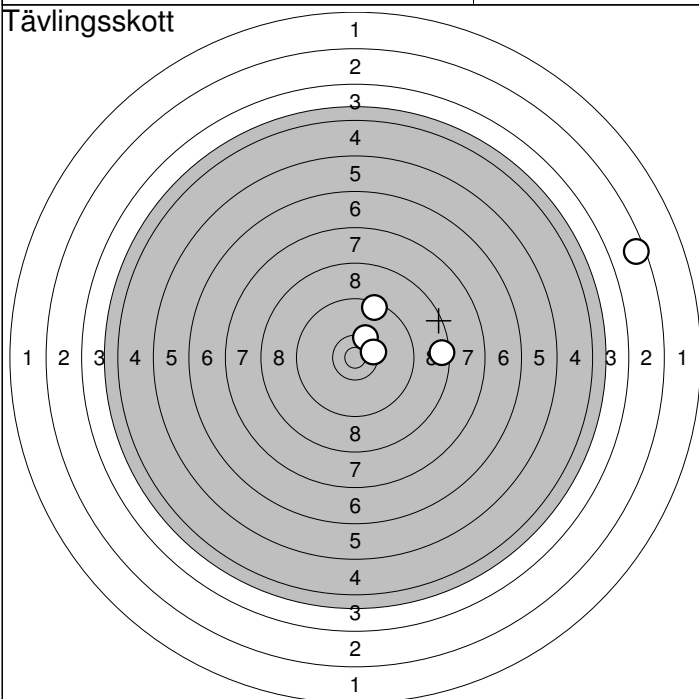

11: 8,5 →
 12: 2,6 →
 13:10,3* ↗
 14: 9,4 ↗
 15:10,4* →

Serie 39,0

Totalt 136,0

Tävlingskott

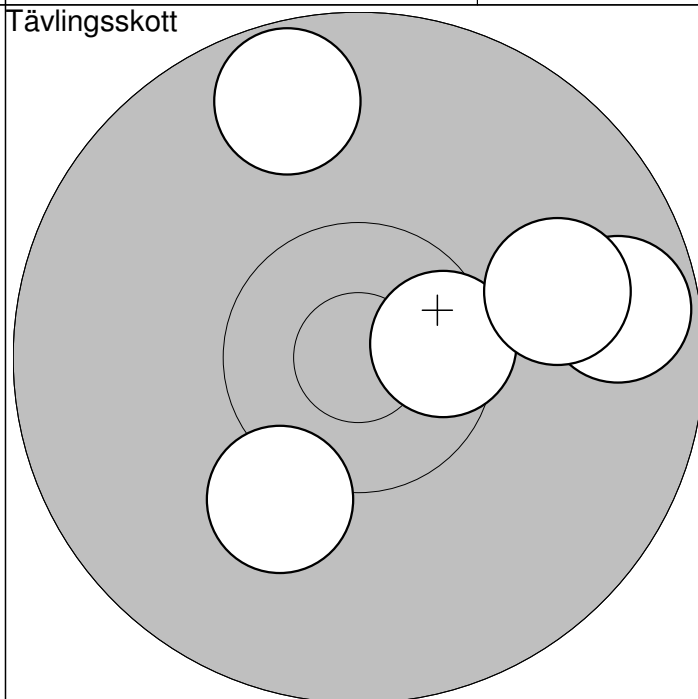

16: 9,7 ↗
 17:10,5* →
 18:10,2 ↘
 19: 9,7 →
 20:10,0 →

Serie 48,0

Totalt 184,0

www.AC-Skytte.com

http://www.megalink.no

MLRemotelISSF 50m Gevär

12:26 - 29.08.2009

Umeå Skf

2009.08.29

Höstträffen 2009

Ramselefors SKF

Provskott

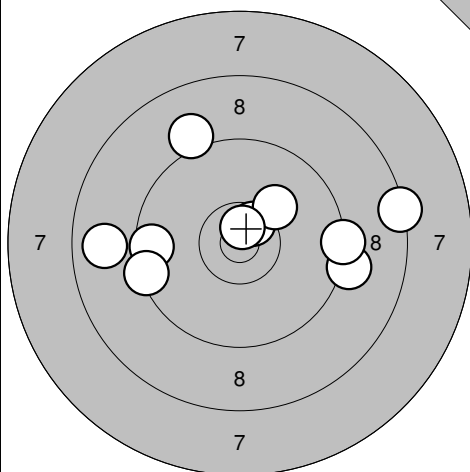

1: 9,2 →
 2: 8,4 →
 3: 9,3 →
 4: 10,6* ↗
 5: 9,1 ↗
 6: 10,2 ↗
 7: 10,7* ↑
 8: 9,6 ←
 9: 9,4 ←
 10: 8,8 ←

Serie 91,0

Totalt 0,0

Provskott

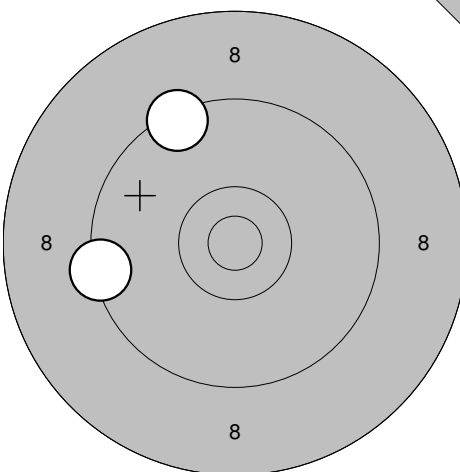

11: 9,4 ←
 12: 9,4 ↗

Serie 18,0

Totalt 0,0

Tävlingsskott

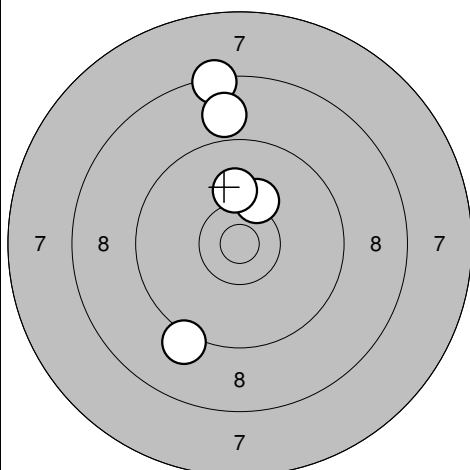

1: 10,2 ↗
 2: 8,4 ↑
 3: 8,9 ↑
 4: 10,1 ↑
 5: 9,2 ↘

Serie 45,0

Totalt 45,0

Tävlingsskott

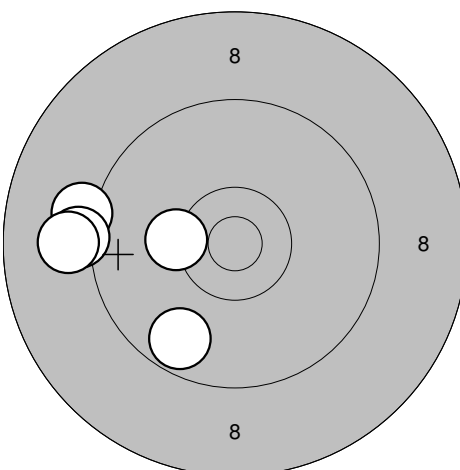

6: 9,7 ↘
 7: 9,2 ←
 8: 9,2 ←
 9: 10,3 ←
 10: 9,1 ←

Serie 46,0

Totalt 91,0

Tävlingsskott

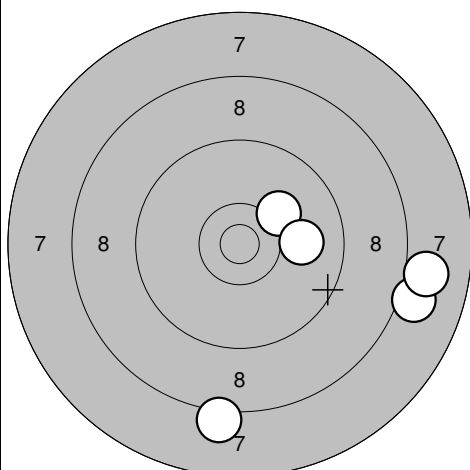

11: 10,2 ↗
 12: 8,2 ↓
 13: 8,1 →
 14: 10,0 →
 15: 8,0 →

Serie 44,0

Totalt 135,0

Tävlingsskott

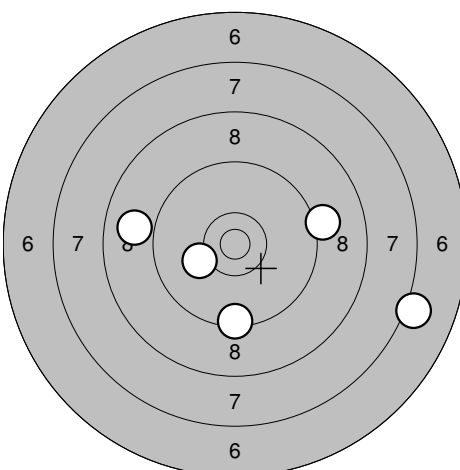

16: 9,1 →
 17: 10,2 ←
 18: 8,9 ←
 19: 9,4 ↓
 20: 7,1 →

Serie 43,0

Totalt 178,0

Drängsmarks Skf

2009.08.29

Höstträffen 2009

Ramselefors SKF

Provskott

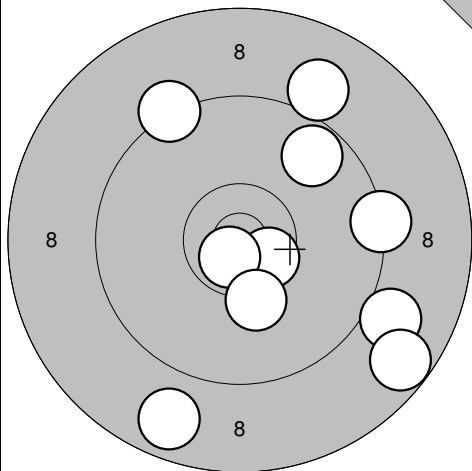

1: 9,3 →
 2: 10,6* ↘
 3: 8,8 ↓
 4: 9,0 →
 5: 8,7 ↘
 6: 9,7 ↗
 7: 10,7* ↓
 8: 10,2 ↓
 9: 9,0 ↗
 10: 9,3 ↗

Serie 91,0

Totalt 0,0

Provskott

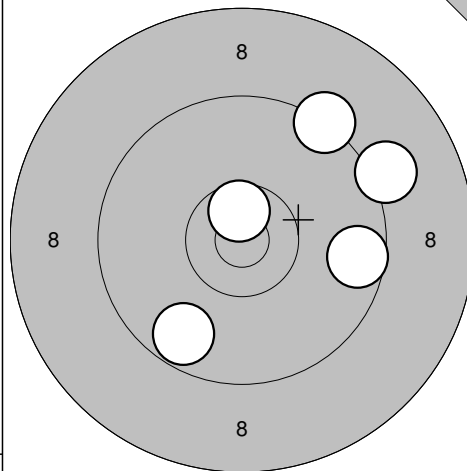

11: 9,1 →
 12: 9,7 ↘
 13: 9,3 ↗
 14: 9,6 →
 15: 10,6* ↑

Serie 46,0

Totalt 0,0

Tävlingsskott

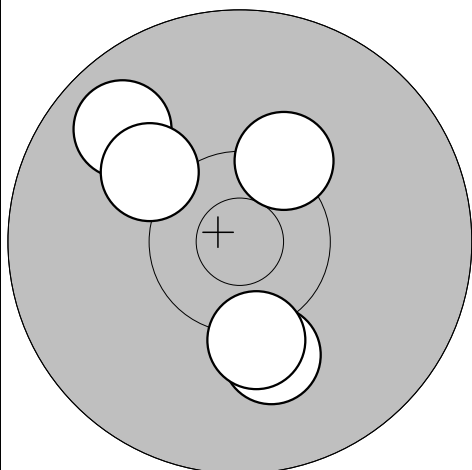

1: 9,8 ↗
 2: 10,1 ↓
 3: 10,2 ↓
 4: 10,1 ↗
 5: 10,3* ↗

Serie 49,0

Totalt 49,0

Tävlingsskott

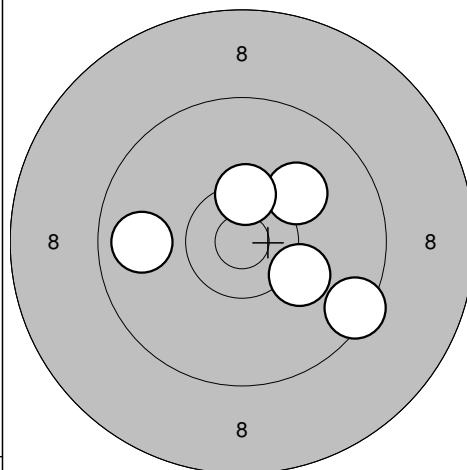

6: 10,1 ↗
 7: 10,2 ↘
 8: 10,4* ↑
 9: 9,8 ←
 10: 9,5 ↘

Serie 48,0

Totalt 97,0

Tävlingsskott

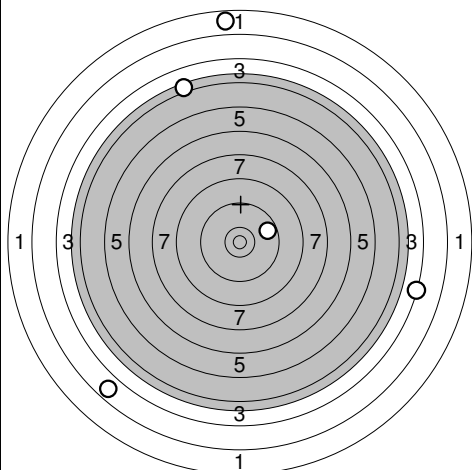

11: 2,8 ↘
 12: 3,3 →
 13: 4,1 ↗
 14: 1,8 ↑
 15: 9,7 →

Serie 19,0

Totalt 116,0

Tävlingsskott

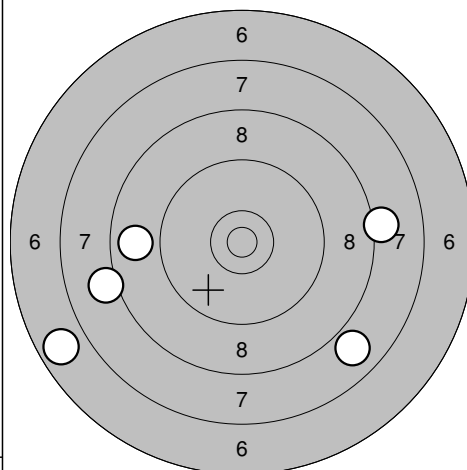

16: 8,1 ←
 17: 7,9 ↘
 18: 8,8 ←
 19: 6,8 ↙
 20: 8,1 →

Serie 37,0

Totalt 153,0

Drängsmarks Skf

2009.08.29

Höstträffen 2009

Ramselefors SKF

Provskott

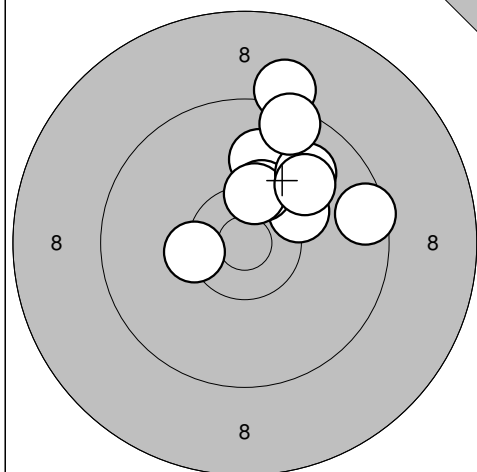

1: 10,0 ↗
 2: 10,4* ←
 3: 10,2 ↗
 4: 10,3* ↑
 5: 10,4* ↑
 6: 9,5 →
 7: 9,9 ↗
 8: 9,1 ↑
 9: 9,5 ↑
 10: 10,0 ↗

Serie 96,0

Totalt 0,0

Tävlingsskott

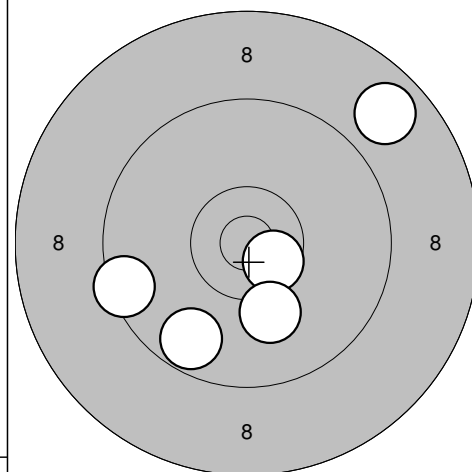

1: 8,8 ↗
 2: 10,6* ↘
 3: 10,1 ↓
 4: 9,5 ←
 5: 9,7 ↘

Serie 46,0

Totalt 46,0

Tävlingsskott

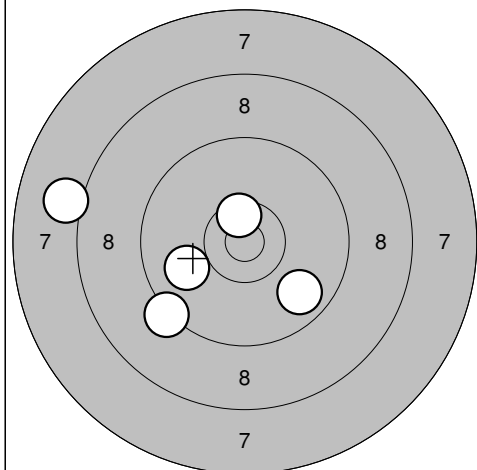

6: 9,8 ↘
 7: 9,3 ↙
 8: 10,5* ↑
 9: 8,1 ←
 10: 10,0 ←

Serie 46,0

Totalt 92,0

Tävlingsskott

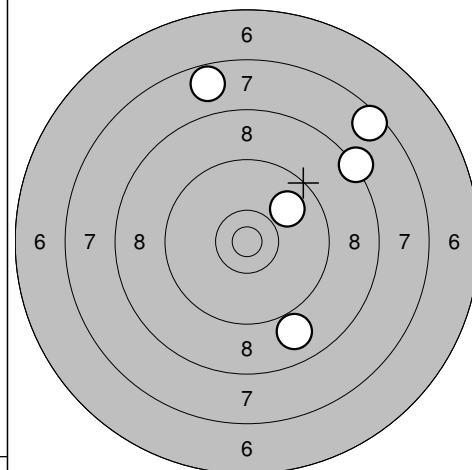

11: 7,5 ↗
 12: 8,3 ↗
 13: 8,9 ↓
 14: 9,9 ↗
 15: 7,7 ↑

Serie 39,0

Totalt 131,0

Tävlingsskott

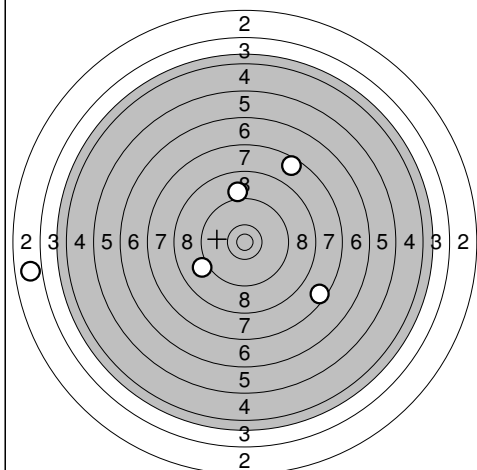

16: 7,5 ↘
 17: 9,1 ←
 18: 7,6 ↗
 19: 9,1 ↑
 20: 2,9 ←

Serie 34,0

Totalt 165,0

Ramselefors Skf

2009.08.29

Höstträffen 2009

Ramselefors SKF

Provskott

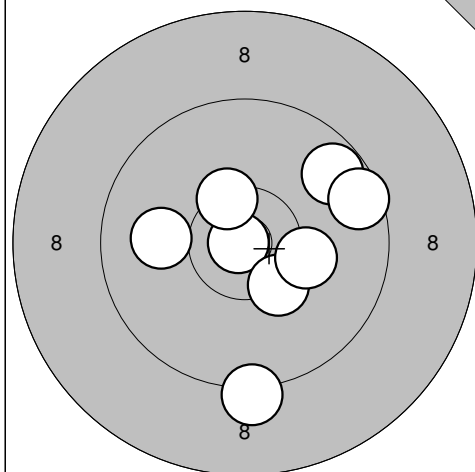

1: 9,7 ↗
 2: 10,9* ←
 3: 9,6 →
 4: 10,3* ↘
 5: 9,2 ↓
 6: 10,2 →
 7: 10,4* ↗
 8: 10,0 ←

Serie 77,0

Totalt 0,0

Tävlingsskott

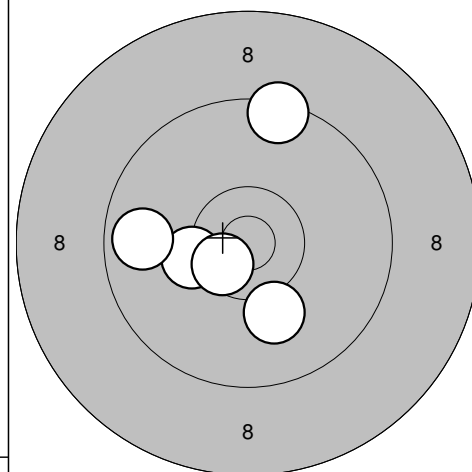

1: 10,3* ←
 2: 9,4 ↑
 3: 10,6* ↘
 4: 10,1 ↓
 5: 9,8 ←

Serie 48,0

Totalt 48,0

Tävlingsskott

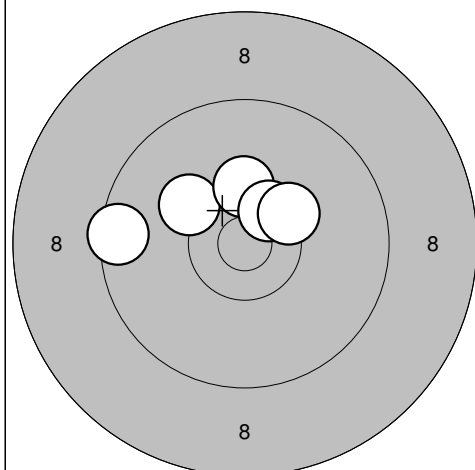

6: 9,5 ←
 7: 10,2 ↖
 8: 10,3* ↑
 9: 10,5* ↗
 10: 10,3* ↗

Serie 49,0

Totalt 97,0

Tävlingsskott

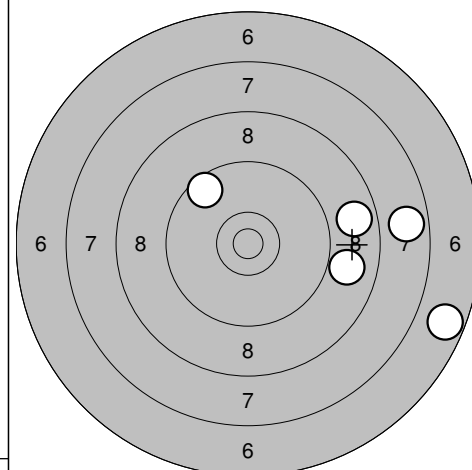

11: 9,6 ↖
 12: 8,8 →
 13: 7,8 →
 14: 8,9 →
 15: 6,7 ↘

Serie 38,0

Totalt 135,0

Tävlingsskott

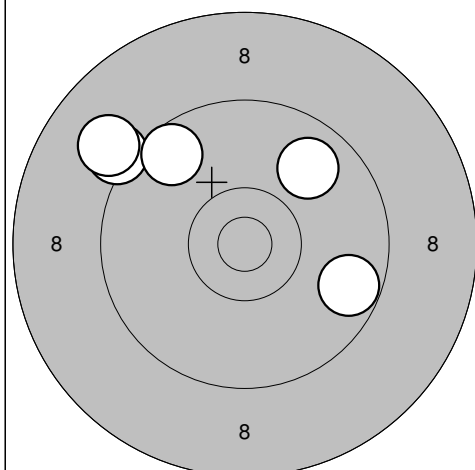

16: 9,8 ↗
 17: 9,2 ↖
 18: 9,6 ↗
 19: 9,7 →
 20: 9,0 ↗

Serie 45,0

Totalt 180,0

Ramselefors Skf

2009.08.29

Höstträffen 2009

Ramselefors SKF

Provskott

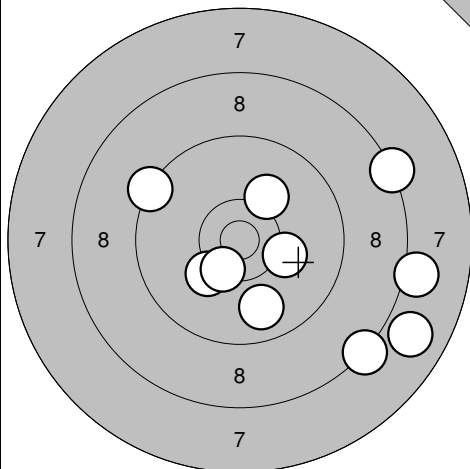

- 1: 8,3 ↘
- 2: 9,3 ↗
- 3: 10,2 →
- 4: 8,3 →
- 5: 9,8 ↘
- 6: 8,1 →
- 7: 7,9 ↘
- 8: 10,2 ↙
- 9: 10,4* ↙
- 10: 10,2 ↗

Serie 89,0
Totalt 0,0

Provskott

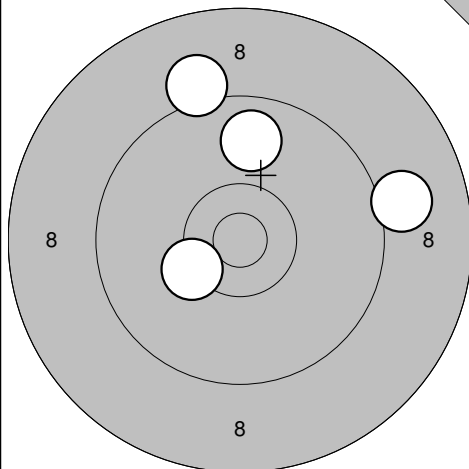

- 11: 9,1 ↗
- 12: 10,3* ↙
- 13: 9,8 ↗
- 14: 9,1 →

Serie 37,0
Totalt 0,0

Tävlingsskott

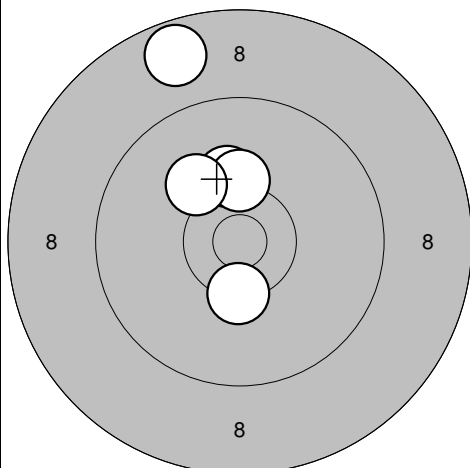

- 1: 10,2 ↗
- 2: 10,3 ↗
- 3: 8,7 ↗
- 4: 10,1 ↗
- 5: 10,4* ↘

Serie 48,0
Totalt 48,0

Tävlingsskott

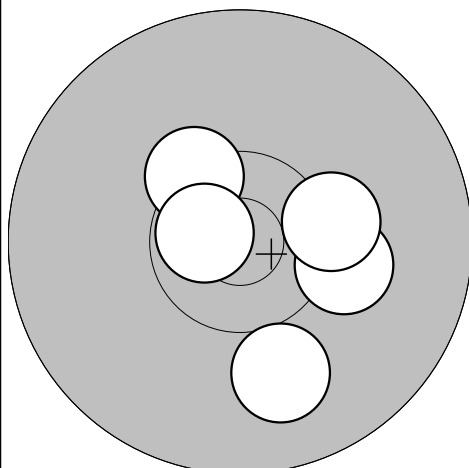

- 6: 10,2 →
- 7: 10,0 ↘
- 8: 10,4* ↗
- 9: 10,3 →
- 10: 10,7* ↙

Serie 50,0
Totalt 98,0

Tävlingsskott

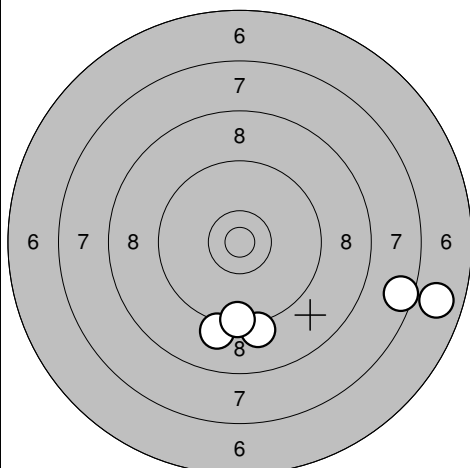

- 11: 9,1 ↘
- 12: 9,2 ↘
- 13: 6,8 →
- 14: 9,4 ↘
- 15: 7,6 →

Serie 40,0
Totalt 138,0

Tävlingsskott

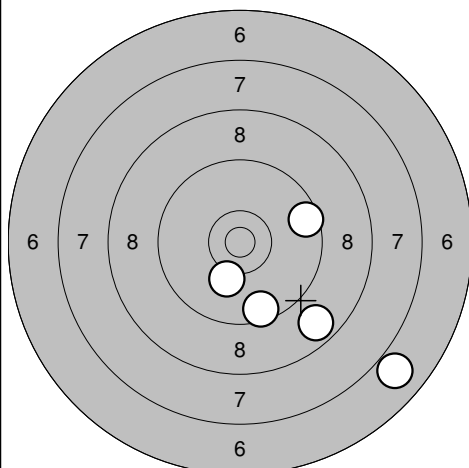

- 16: 6,9 ↘
- 17: 9,5 ↘
- 18: 8,7 ↘
- 19: 10,2 ↘
- 20: 9,5 →

Serie 42,0
Totalt 180,0

Rundviks Skf

2009.08.29

Höstträffen 2009

Ramselefors SKF

Provskott

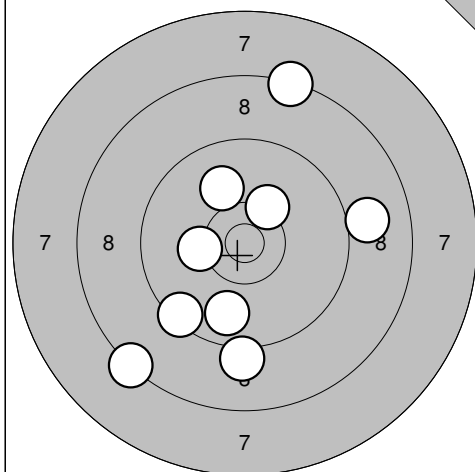

1: 8,3 ↙
 2: 8,3 ↑
 3: 9,1 ↓
 4: 10,3 ↗
 5: 9,0 →
 6: 10,2 ←
 7: 9,4 ↙
 8: 9,8 ↓
 9: 10,0 ↑

Serie 82,0

Totalt 0,0

Tävlingsskott

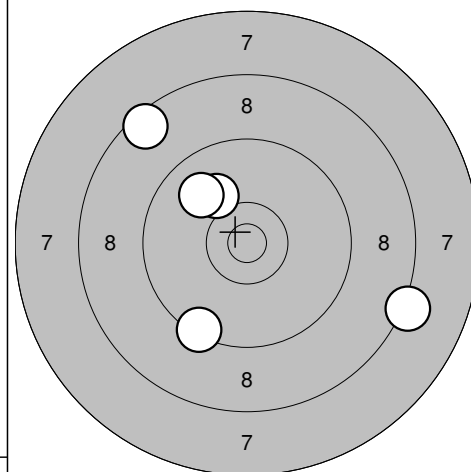

1: 10,1 ↗
 2: 9,4 ↓
 3: 8,2 →
 4: 9,9 ↗
 5: 8,5 ↗

Serie 44,0

Totalt 44,0

Tävlingsskott

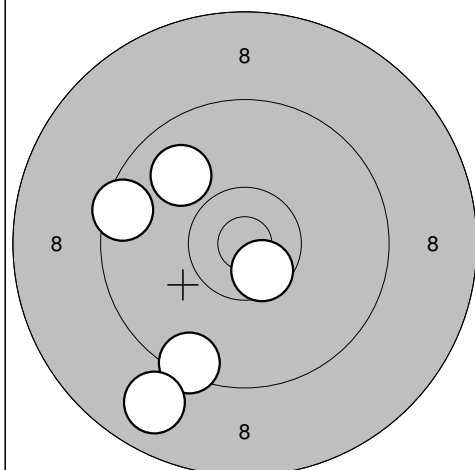

6: 9,4 ↓
 7: 9,5 ←
 8: 8,9 ↓
 9: 9,9 ↗
 10: 10,6* ↓

Serie 45,0

Totalt 89,0

Tävlingsskott

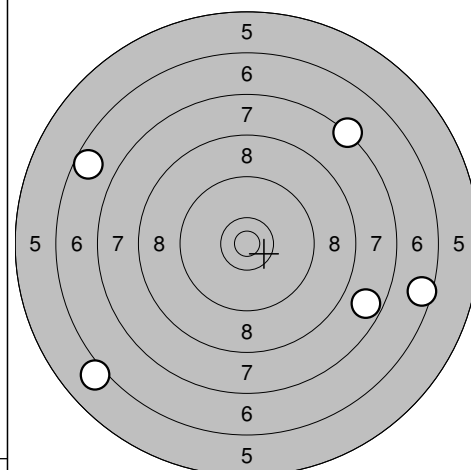

11: 6,5 →
 12: 6,1 ↙
 13: 7,7 →
 14: 7,3 ↗
 15: 6,7 ←

Serie 32,0

Totalt 121,0

Tävlingsskott

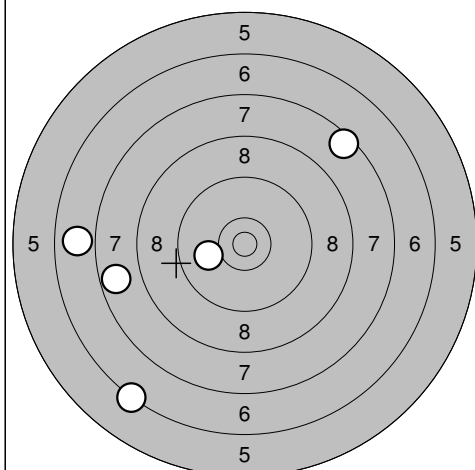

16: 10,0 ←
 17: 6,3 ↓
 18: 6,9 ←
 19: 7,5 ↗
 20: 7,7 ←

Serie 36,0

Totalt 157,0

Ramselefors Skf

2009.08.29

Höstträffen 2009

Ramselefors SKF

Provskott

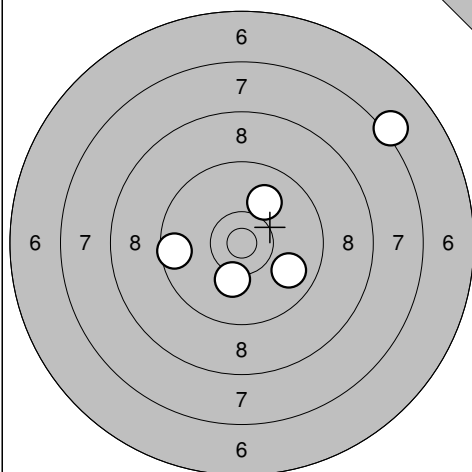

1: 9,6 ←
 2: 7,2 ↗
 3: 10,0 ↗
 4: 9,9 →
 5: 10,2 ↓

Serie 45,0
 Totalt 0,0

Tävlingsskott

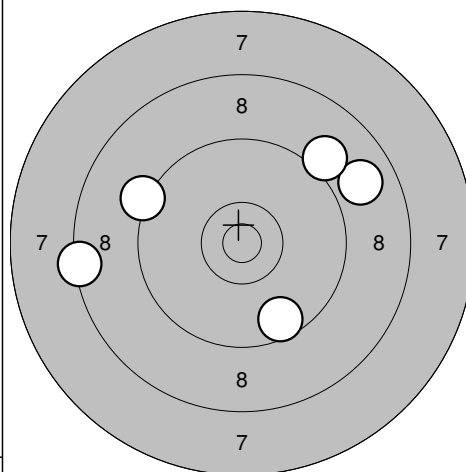

1: 8,9 ↗
 2: 9,6 ↓
 3: 9,1 ↗
 4: 8,4 ←
 5: 9,2 ↖

Serie 43,0
 Totalt 43,0

Tävlingsskott

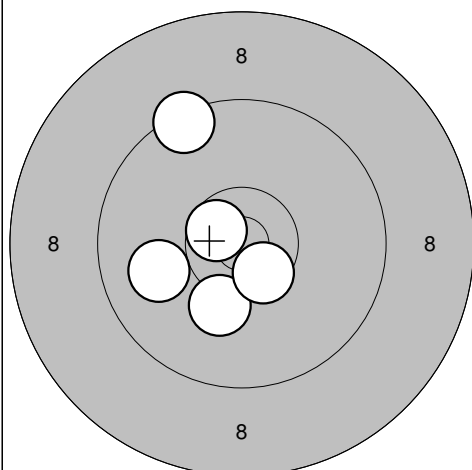

6: 10,0 ←
 7: 10,6* ↖
 8: 10,2 ↓
 9: 9,4 ↗
 10: 10,5* ↓

Serie 49,0
 Totalt 92,0

Tävlingsskott

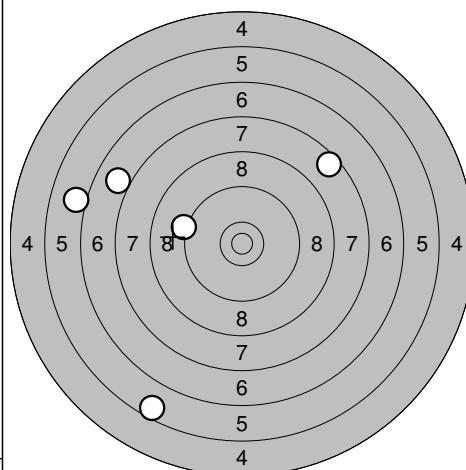

11: 9,2 ↖
 12: 7,6 ↗
 13: 7,0 ↖
 14: 5,6 ↓
 15: 6,1 ↖

Serie 34,0
 Totalt 126,0

Tävlingsskott

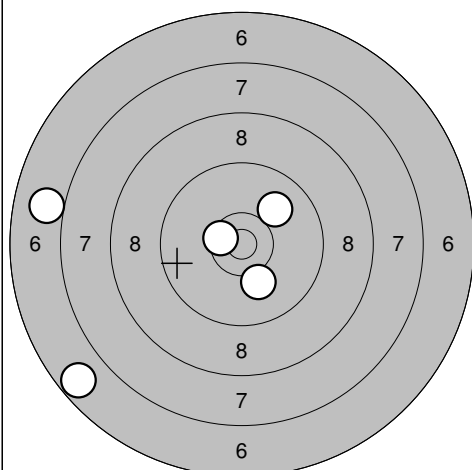

16: 6,7 ↖
 17: 7,0 ←
 18: 10,1 ↓
 19: 10,0 ↗
 20: 10,5* ↖

Serie 43,0
 Totalt 169,0