

| | | | |
|-----------|-----------|-------|------|
| 1: 9,4 ↗ | 6:10,2* ↗ | Serie | 92,0 |
| 2: 9,5 ← | 7: 8,9 ← | | |
| 3:10,0 → | 8: 9,4 ← | Sum | 92,0 |
| 4: 9,4 ← | 9: 9,2 ↑ | | |
| 5:10,2* ← | 10: 9,9 ← | | |

| | | | |
|-----------|------------|-------|-------|
| 1:10,6* ↗ | 6: 9,2 ↗ | Serie | 97,0 |
| 2: 9,7 ↘ | 7:10,4* ↘ | | |
| 3:10,3* ↓ | 8:10,1 ↗ | Sum | 189,0 |
| 4: 9,1 ↘ | 9:10,2* ↑ | | |
| 5:10,3* ↗ | 10:10,7* ← | | |

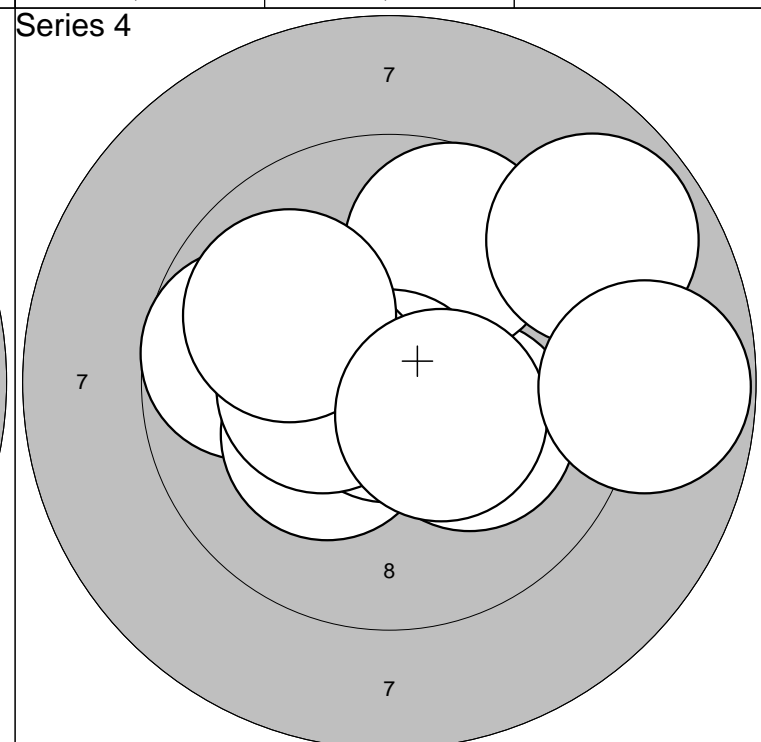
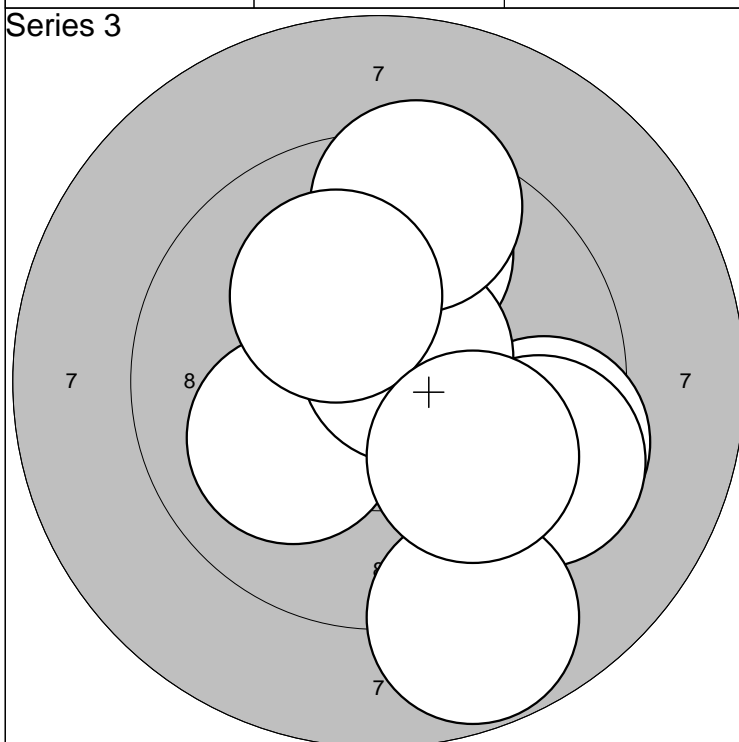

| | | | |
|-----------|-----------|-------|-------|
| 1:10,7* → | 6: 8,8 ↓ | Serie | 93,0 |
| 2:10,1 ↙ | 7:10,7* ↗ | | |
| 3: 9,5 → | 8: 9,4 ↑ | Sum | 282,0 |
| 4: 9,9 ↑ | 9:10,1 ↗ | | |
| 5: 9,4 → | 10: 9,9 ↘ | | |

| | | | |
|-----------|-----------|-------|-------|
| 1: 9,7 ← | 6: 8,9 ↗ | Serie | 93,0 |
| 2:10,2* → | 7:10,4* ← | | |
| 3:10,3* ↙ | 8: 9,9 ↖ | Sum | 375,0 |
| 4: 9,7 ↑ | 9:10,4* ↘ | | |
| 5:10,8* ↓ | 10: 8,8 → | | |

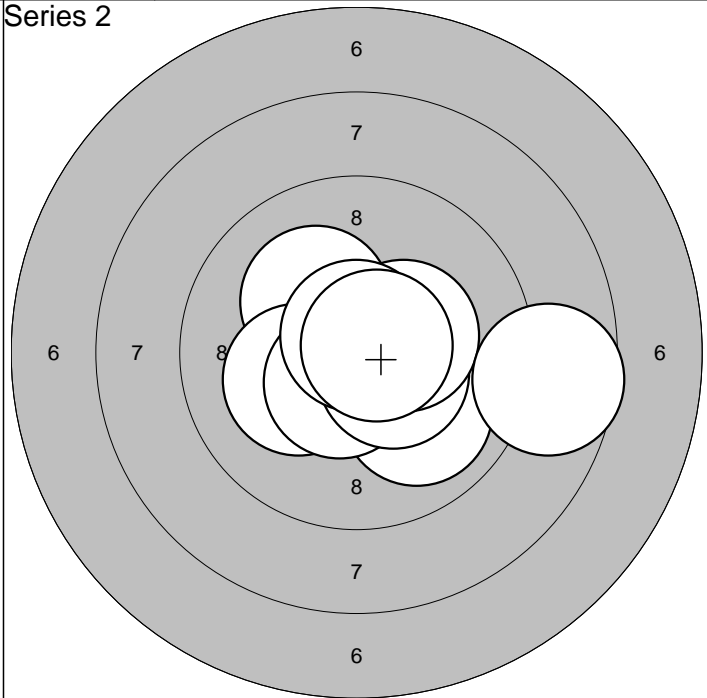
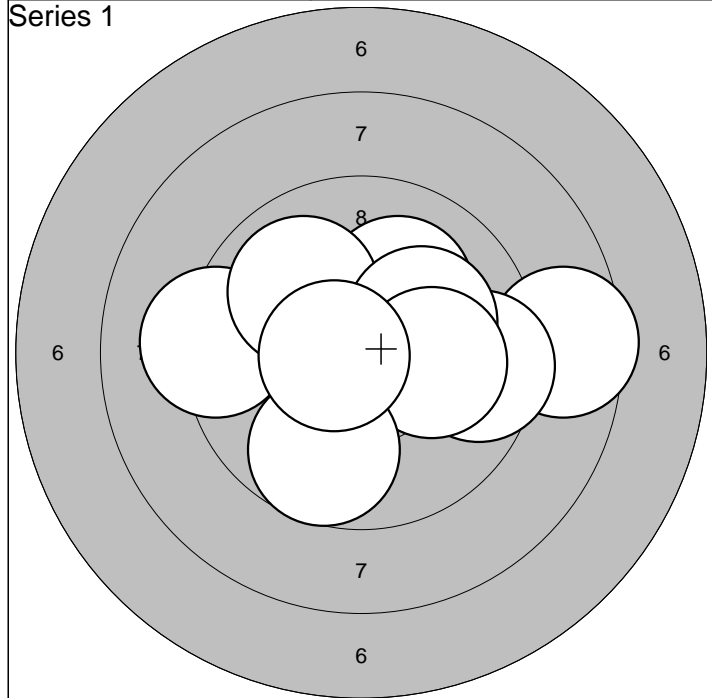

| | | | |
|-----------|------------|-------|------|
| 1:10,1 ↗ | 6:10,0 ↖ | Serie | 95,0 |
| 2: 9,2 ← | 7:10,1 → | | |
| 3: 8,5 → | 8:10,1 → | Sum | 95,0 |
| 4: 9,6 → | 9: 9,7 ↓ | | |
| 5:10,7* ← | 10:10,6* ← | | |

| | | | |
|-----------|------------|-------|-------|
| 1:10,2* ↗ | 6:10,4* ↘ | Serie | 98,0 |
| 2:10,2* ← | 7:10,4* → | | |
| 3:10,9* ↘ | 8: 8,6 → | Sum | 193,0 |
| 4:10,0 ↘ | 9:10,7* ↑ | | |
| 5:10,6* ↘ | 10:10,7* → | | |

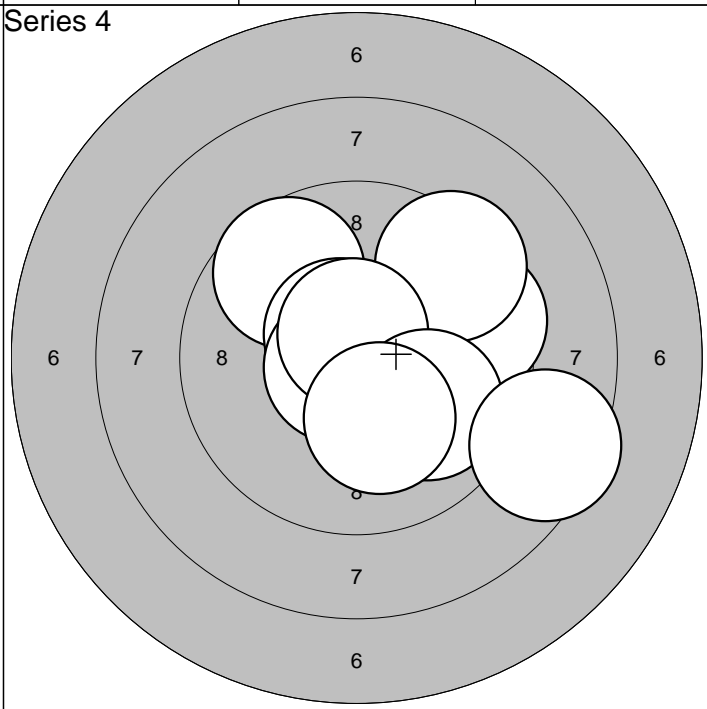
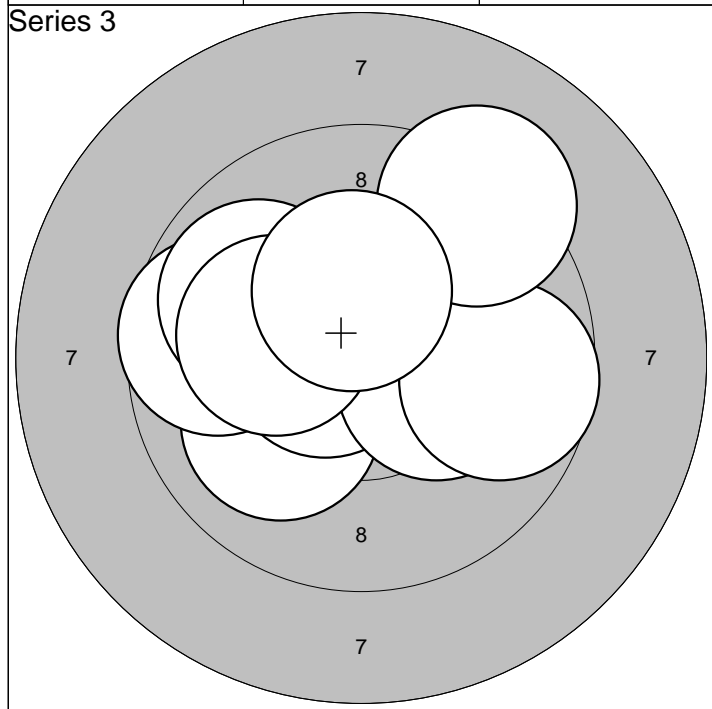

| | | | |
|-----------|------------|-------|-------|
| 1:10,1 ↖ | 6:10,3* → | Serie | 96,0 |
| 2:10,0 ↖ | 7: 9,7 → | | |
| 3: 9,6 ← | 8: 9,2 ↗ | Sum | 289,0 |
| 4: 9,9 ↖ | 9:10,2* ← | | |
| 5:10,6* ← | 10:10,3* ↑ | | |

| | | | |
|-----------|-----------|-------|-------|
| 1:10,8* ↘ | 6:10,7* ↖ | Serie | 94,0 |
| 2: 9,7 ↗ | 7:10,7* ↑ | | |
| 3: 9,5 → | 8: 9,9 ↘ | Sum | 383,0 |
| 4:10,6* ↗ | 9:10,2* ↓ | | |
| 5: 9,4 ↗ | 10: 8,5 ↘ | | |

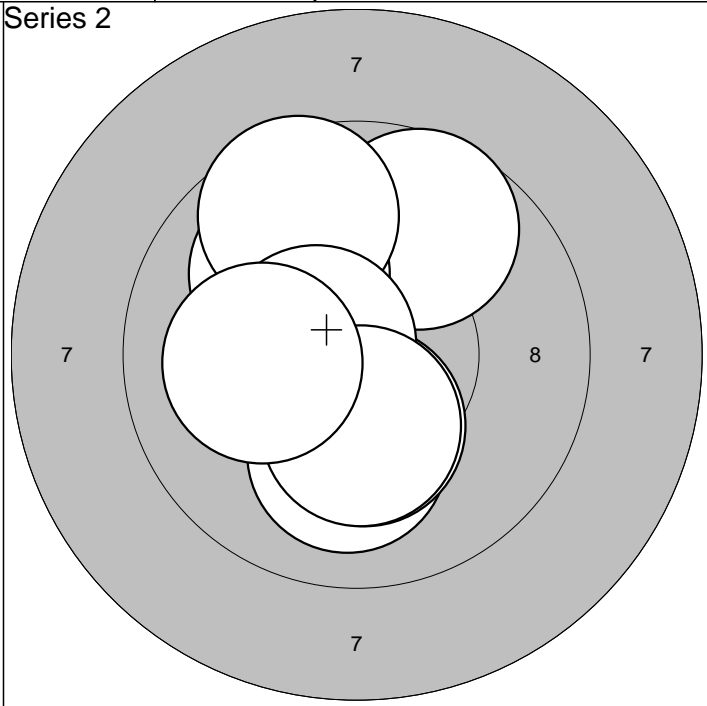
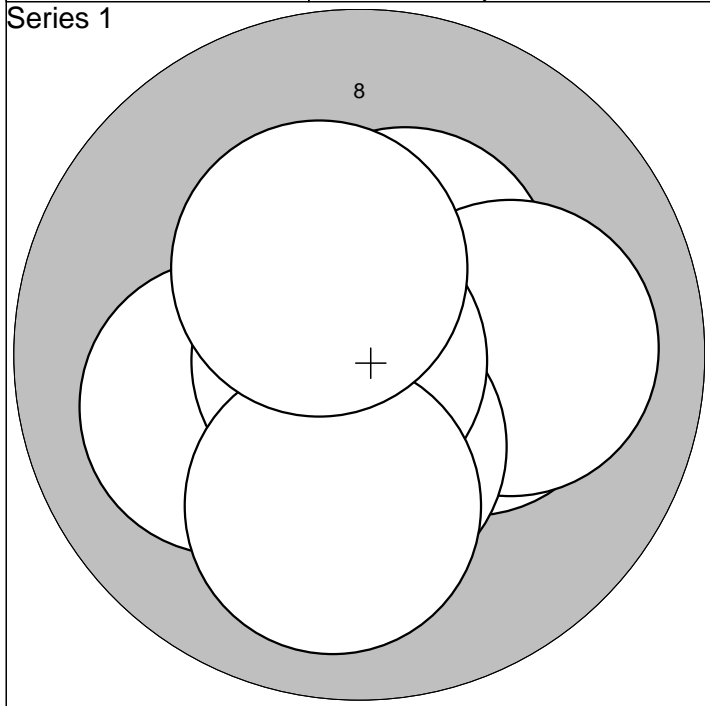

| | | | | | | | |
|-----------|------------|--|--|--|--|-------|-------|
| 1:10,4* ↗ | 6:10,1 ← | | | | | Serie | 100,0 |
| 2:10,3* → | 7:10,4* ↓ | | | | | | |
| 3:10,6* ← | 8:10,8* ← | | | | | | |
| 4:10,4* ↗ | 9:10,0 ↓ | | | | | | |
| 5:10,0 → | 10:10,4* ↗ | | | | | | |
| | | | | | | Sum | 100,0 |

| | | | | | | | |
|-----------|-----------|--|--|--|--|-------|-------|
| 1:10,0 ↗ | 6:10,0 ↗ | | | | | Serie | 98,0 |
| 2:10,0 ↓ | 7: 9,6 ↗ | | | | | | |
| 3:10,3* ↓ | 8:10,6* ← | | | | | | |
| 4:10,2* ↗ | 9:10,3* ↓ | | | | | | |
| 5: 9,7 ↗ | 10:10,1 ← | | | | | | |
| | | | | | | Sum | 198,0 |

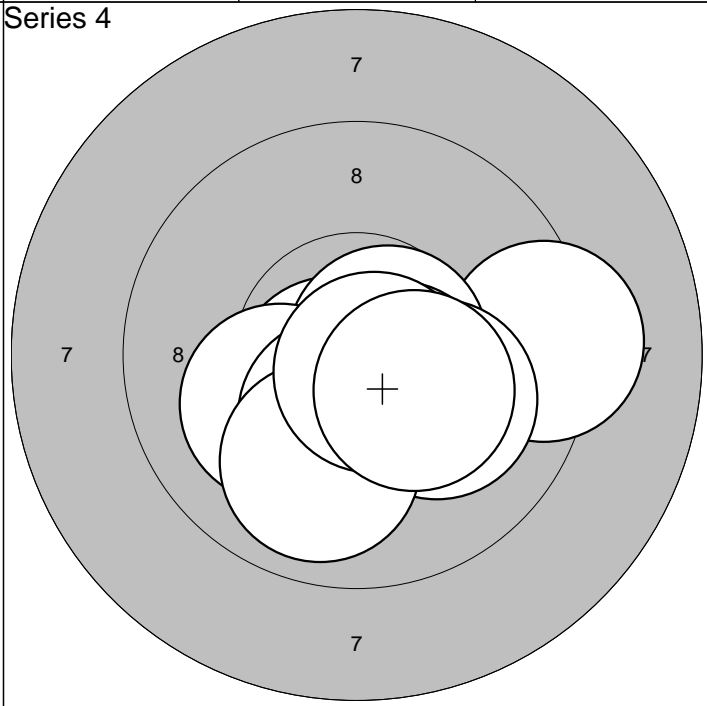
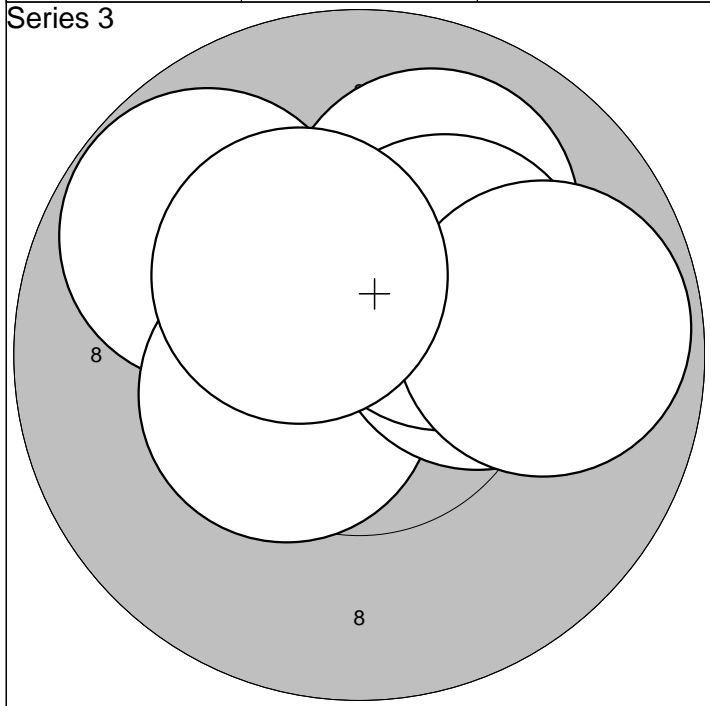

| | | | | | | | |
|-----------|------------|--|--|--|--|-------|-------|
| 1:10,5* ↑ | 6:10,5* ← | | | | | Serie | 98,0 |
| 2:10,4* ↑ | 7:10,2* → | | | | | | |
| 3:10,0 ↗ | 8:10,3* ↗ | | | | | | |
| 4: 9,8 ↗ | 9: 9,8 → | | | | | | |
| 5:10,7* ↗ | 10:10,3* ↗ | | | | | | |
| | | | | | | Sum | 296,0 |

| | | | | | | | |
|-----------|------------|--|--|--|--|-------|-------|
| 1:10,7* ↘ | 6:10,1 ← | | | | | Serie | 98,0 |
| 2: 9,3 → | 7:10,4* ↓ | | | | | | |
| 3:10,7* → | 8: 9,9 ↓ | | | | | | |
| 4:10,5* ↘ | 9:10,7* ↘ | | | | | | |
| 5:10,1 ↘ | 10:10,3* ↘ | | | | | | |
| | | | | | | Sum | 394,0 |

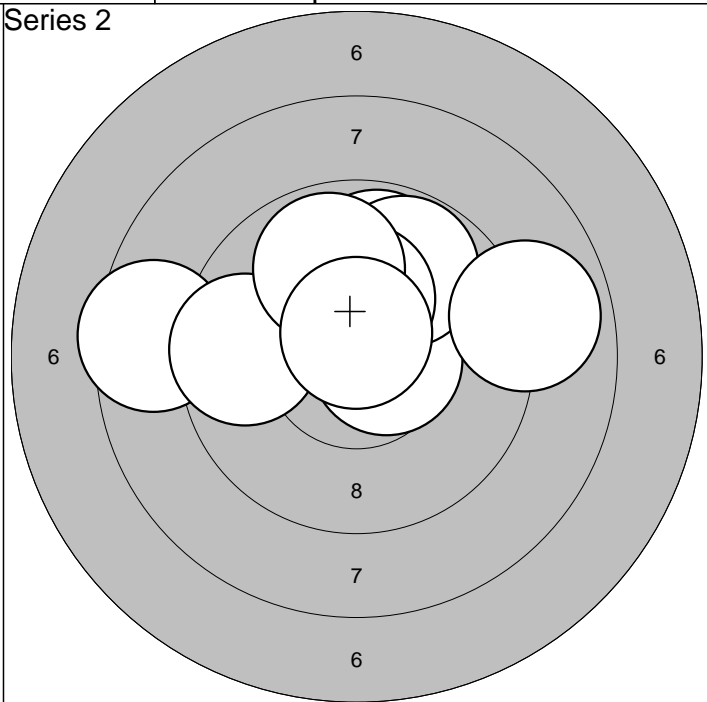
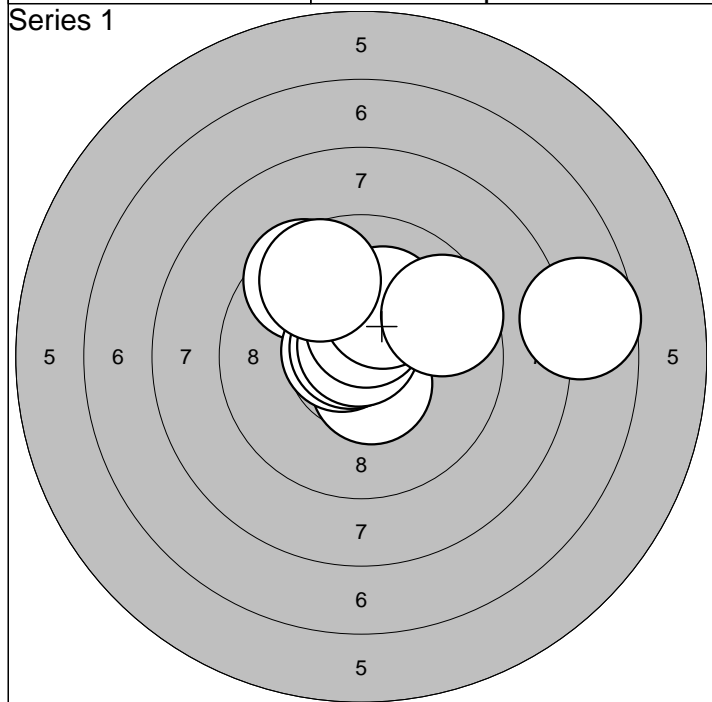

| | | | | | |
|-----------|-----------|-------|------|--|--|
| 1:10,5* ↓ | 6:10,8* ↑ | | | | |
| 2: 9,6 ↗ | 7:10,5* ↑ | | | | |
| 3:10,7* ← | 8:10,2* ↑ | Serie | 94,0 | | |
| 4:10,7* ↗ | 9: 9,7 ↗ | Sum | 94,0 | | |
| 5: 7,7 → | 10: 9,6 ↗ | | | | |

| | | | | | |
|-----------|-----------|-------|-------|--|--|
| 1: 9,8 ↑ | 6:10,3* ↑ | | | | |
| 2:10,3* ↑ | 7: 9,6 ← | | | | |
| 3:10,6* → | 8: 9,9 ↑ | Serie | 92,0 | | |
| 4: 8,5 ← | 9:10,7* ↑ | Sum | 186,0 | | |
| 5: 9,8 ↑ | 10: 8,9 → | | | | |

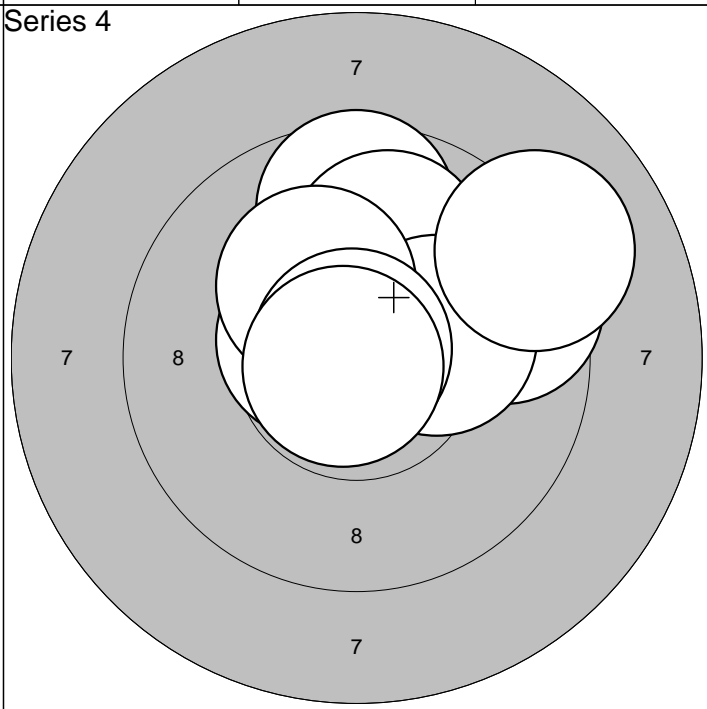
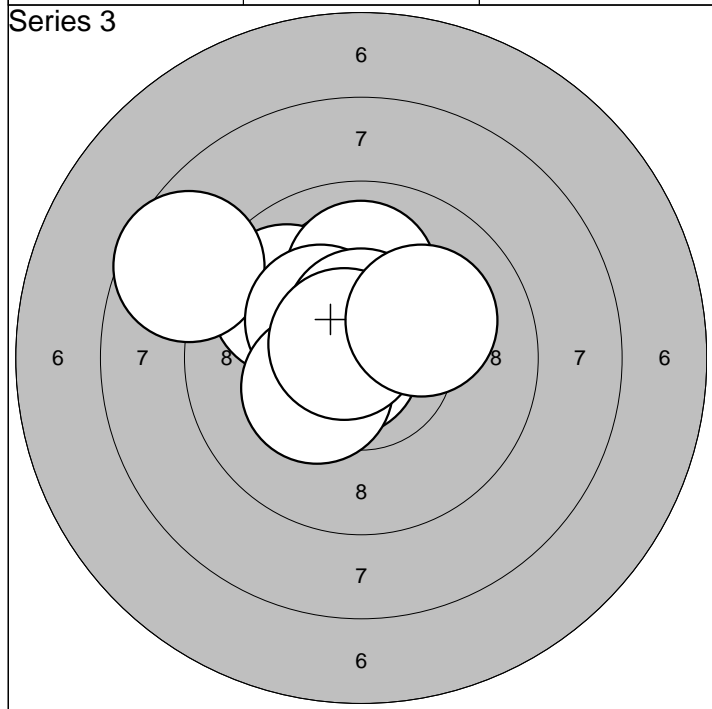

| | | | | | |
|-----------|-----------|-------|-------|--|--|
| 1:10,1 ↑ | 6:10,3* ↖ | | | | |
| 2: 9,8 ↖ | 7:10,3* ↖ | | | | |
| 3: 8,6 ↖ | 8:10,6* ↑ | Serie | 97,0 | | |
| 4:10,7* ← | 9:10,7* ↖ | Sum | 283,0 | | |
| 5:10,0 ↑ | 10:10,1 ↗ | | | | |

| | | | | | |
|-----------|-----------|-------|-------|--|--|
| 1: 9,5 → | 6:10,2* → | | | | |
| 2: 9,6 ↑ | 7:10,2* ↖ | | | | |
| 3:10,6* ↖ | 8:10,9* ↖ | Serie | 97,0 | | |
| 4:10,2* ↑ | 9:10,8* ↖ | Sum | 380,0 | | |
| 5:10,0 ↑ | 10: 9,1 ↗ | | | | |

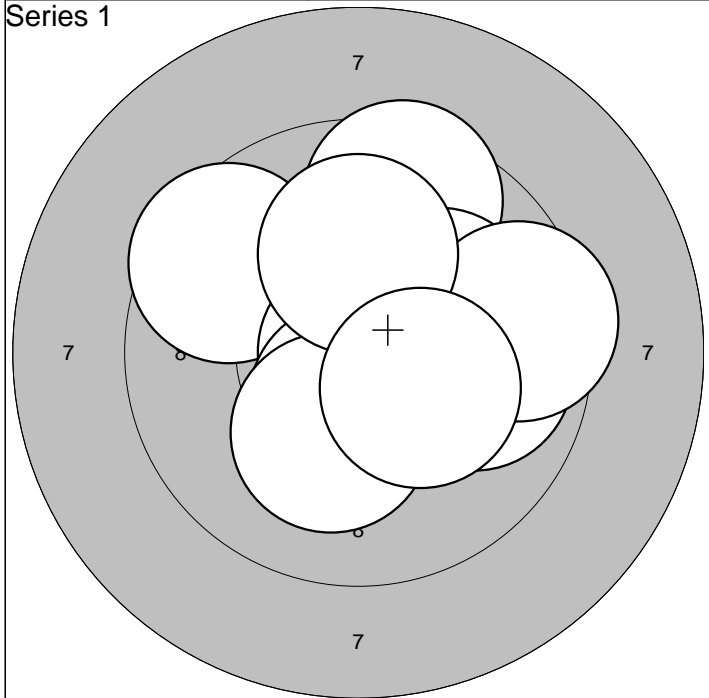

| | | | | | |
|-----------|------------|--|--|-------|------|
| 1: 9,5 ↖ | 6:10,2* ↓ | | | Serie | 96,0 |
| 2: 9,5 ↑ | 7: 9,9 → | | | | |
| 3:10,9* | 8: 9,5 → | | | Sum | 96,0 |
| 4:10,1 ↗ | 9:10,1 ↑ | | | | |
| 5:10,5* ↓ | 10:10,3* ↘ | | | | |

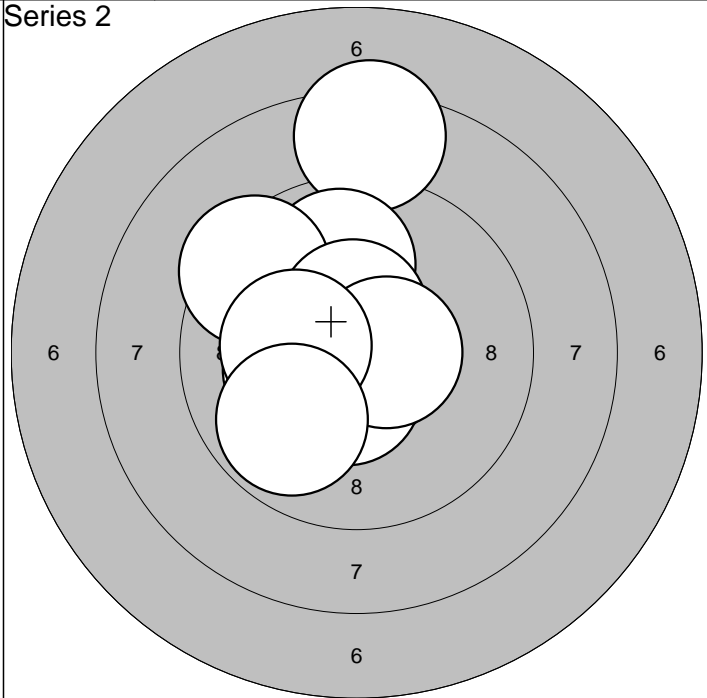

| | | | | | |
|-----------|-----------|--|--|-------|-------|
| 1: 8,4 ↑ | 6:10,5* ↑ | | | Serie | 95,0 |
| 2:10,8* ↗ | 7:10,2* ← | | | | |
| 3:10,5* ↓ | 8:10,6* → | | | Sum | 191,0 |
| 4: 9,9 ↑ | 9:10,2* ← | | | | |
| 5: 9,4 ↖ | 10: 9,9 ↘ | | | | |

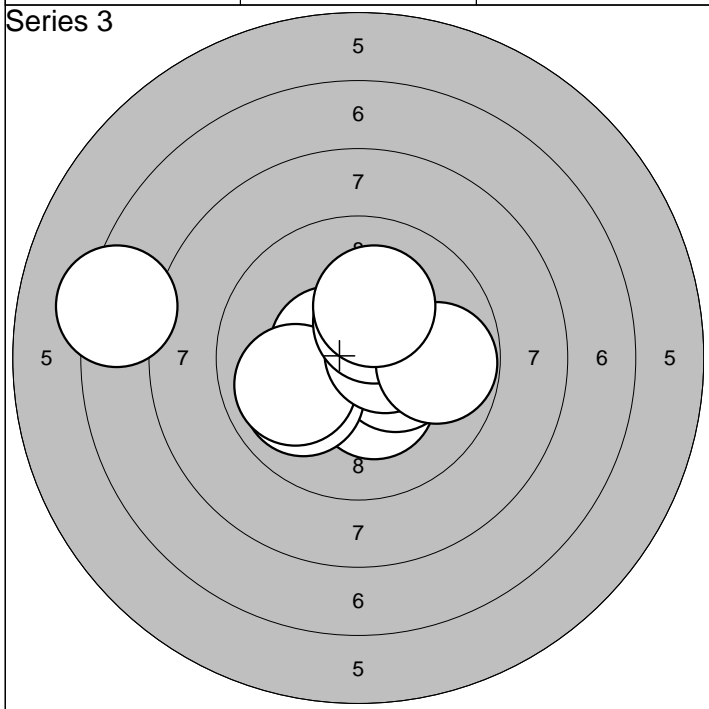

| | | | | | |
|-----------|-----------|--|--|-------|-------|
| 1:10,3* ↓ | 6:10,0 ← | | | Serie | 96,0 |
| 2:10,5* ← | 7:10,5* → | | | | |
| 3: 7,3 ← | 8:10,4* ↑ | | | Sum | 287,0 |
| 4:10,3* → | 9: 9,8 → | | | | |
| 5:10,0 ↖ | 10:10,1 ↑ | | | | |

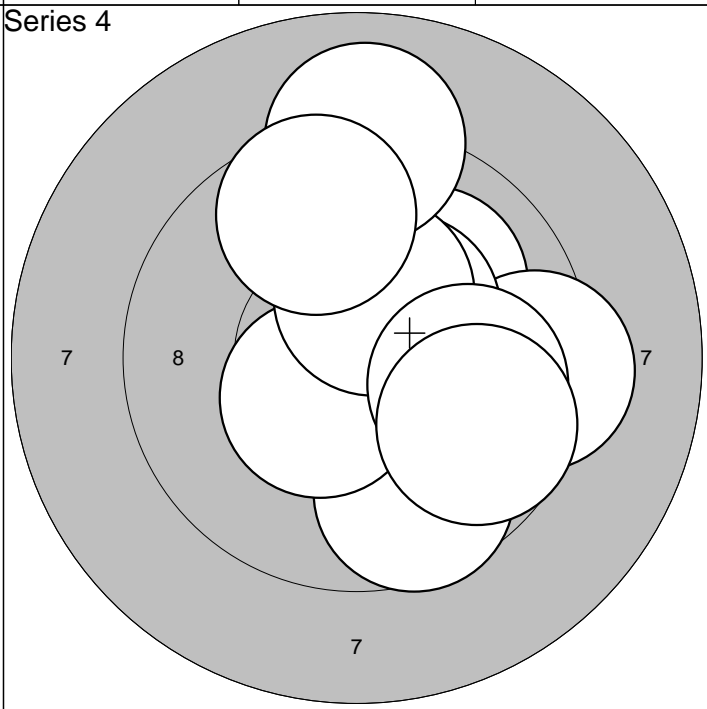

| | | | | | |
|-----------|-----------|--|--|-------|-------|
| 1: 9,6 ↓ | 6:10,4* ↑ | | | Serie | 94,0 |
| 2:10,0 ↗ | 7: 9,9 → | | | | |
| 3: 9,4 → | 8: 9,0 ↑ | | | Sum | 381,0 |
| 4:10,4* ↗ | 9: 9,7 ↘ | | | | |
| 5:10,5* ↘ | 10: 9,6 ↑ | | | | |

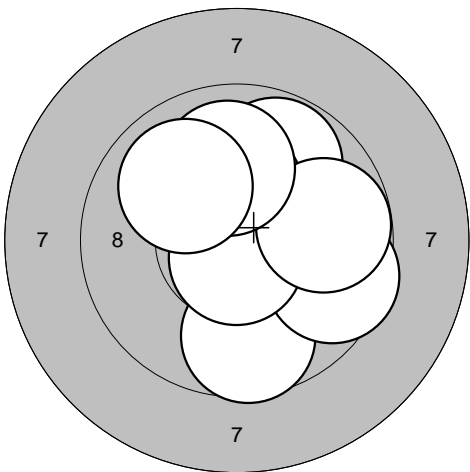
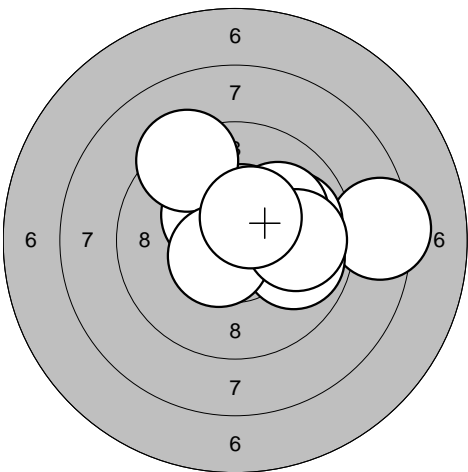
| | | | | | | | | | | | |
|---|--|-------|------|-----|------|---|--|-------|------|-----|-------|
| <p>Series 1</p>  | <p>1: 9,8 ↗ 2: 10,9* ↓ 3: 9,7 ↓ 4: 9,6 → 5: 10,3* ↑ 6: 10,6* ↑ 7: 10,7* ↓ 8: 9,8 → 9: 10,0 ↑ 10: 10,0 ↖</p> <table border="1" style="width:100%; border-collapse: collapse;"> <tr><td style="text-align: right;">Serie</td><td style="text-align: right;">96,0</td></tr> <tr><td style="text-align: right;">Sum</td><td style="text-align: right;">96,0</td></tr> </table> | Serie | 96,0 | Sum | 96,0 | <p>Series 2</p>  | <p>1: 8,4 → 2: 9,9 → 3: 9,9 → 4: 10,5* ↑ 5: 10,4* ↖ 6: 9,3 ↖ 7: 10,1 ↗ 8: 10,5* ↙ 9: 9,9 → 10: 10,5* ↗</p> <table border="1" style="width:100%; border-collapse: collapse;"> <tr><td style="text-align: right;">Serie</td><td style="text-align: right;">94,0</td></tr> <tr><td style="text-align: right;">Sum</td><td style="text-align: right;">190,0</td></tr> </table> | Serie | 94,0 | Sum | 190,0 |
| Serie | 96,0 | | | | | | | | | | |
| Sum | 96,0 | | | | | | | | | | |
| Serie | 94,0 | | | | | | | | | | |
| Sum | 190,0 | | | | | | | | | | |

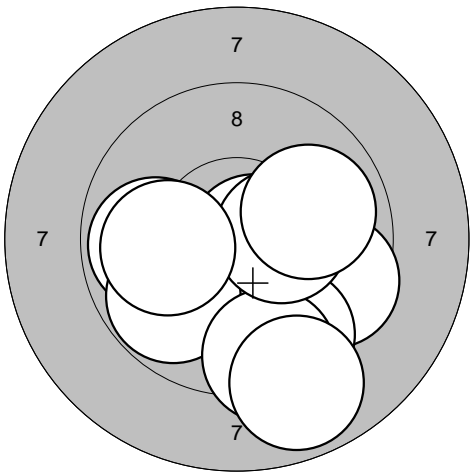
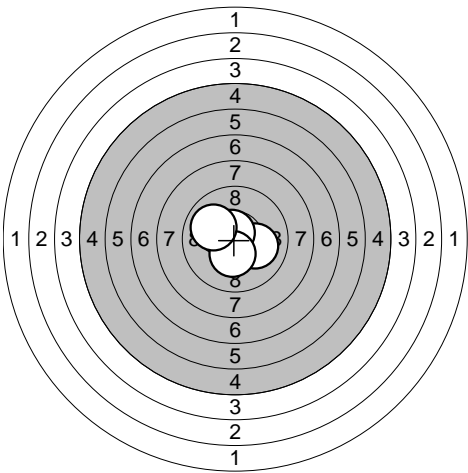
| | | | | | | | | | | | |
|--|--|-------|------|-----|-------|--|---|-------|-------|-----|-------|
| <p>Series 3</p>  | <p>1: 9,9 ← 2: 9,5 → 3: 9,5 ↓ 4: 10,7* → 5: 9,8 ↙ 6: 9,4 ↓ 7: 8,9 ↓ 8: 10,4* → 9: 10,0 ← 10: 9,9 →</p> <table border="1" style="width:100%; border-collapse: collapse;"> <tr><td style="text-align: right;">Serie</td><td style="text-align: right;">92,0</td></tr> <tr><td style="text-align: right;">Sum</td><td style="text-align: right;">282,0</td></tr> </table> | Serie | 92,0 | Sum | 282,0 | <p>Series 4</p>  | <p>1: 10,3* ↖ 2: 10,7* ↓ 3: 10,6* ↙ 4: 10,1 → 5: 10,7* ↖ 6: 10,3* ↓ 7: 10,0 ↖ 8: 10,1 ↙ 9: 10,1 ↙ 10: 10,3 ↙</p> <table border="1" style="width:100%; border-collapse: collapse;"> <tr><td style="text-align: right;">Serie</td><td style="text-align: right;">100,0</td></tr> <tr><td style="text-align: right;">Sum</td><td style="text-align: right;">382,0</td></tr> </table> | Serie | 100,0 | Sum | 382,0 |
| Serie | 92,0 | | | | | | | | | | |
| Sum | 282,0 | | | | | | | | | | |
| Serie | 100,0 | | | | | | | | | | |
| Sum | 382,0 | | | | | | | | | | |

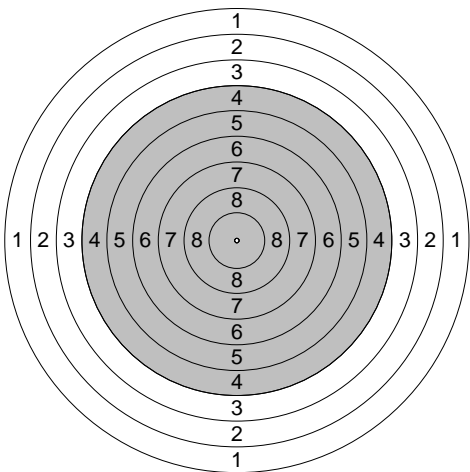
| | | | | | | | |
|---|--|-------|-----|-----|-------|--|--|
| <p>Series 5</p>  | <p>1: 0,0 ↙ 2: 0,0 → 3: 0,0 ↙</p> <table border="1" style="width:100%; border-collapse: collapse;"> <tr><td style="text-align: right;">Serie</td><td style="text-align: right;">0,0</td></tr> <tr><td style="text-align: right;">Sum</td><td style="text-align: right;">382,0</td></tr> </table> | Serie | 0,0 | Sum | 382,0 | | |
| Serie | 0,0 | | | | | | |
| Sum | 382,0 | | | | | | |

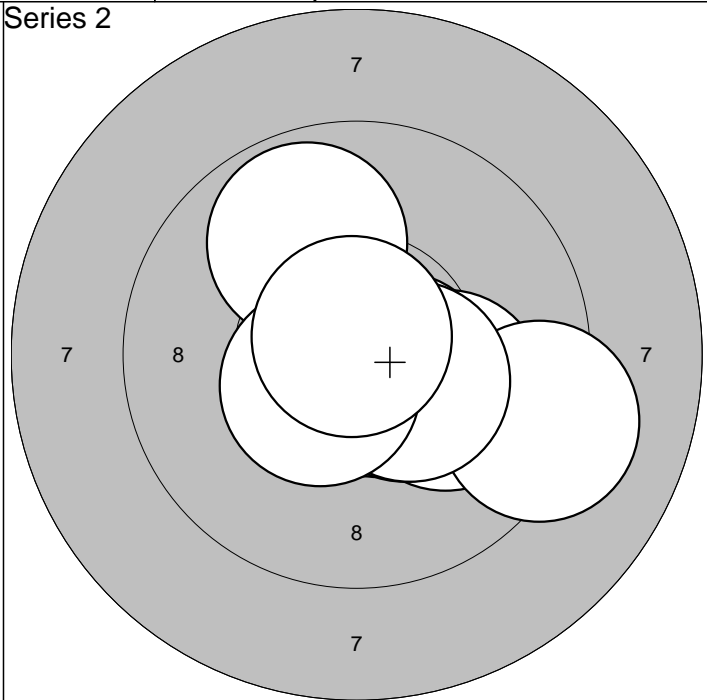
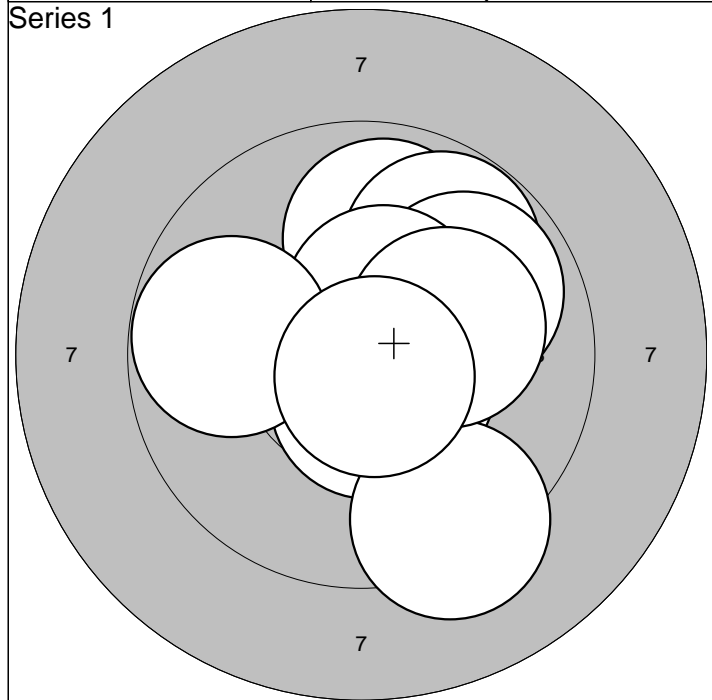

| | | |
|--------------|---------------|---------------|
| 1: 9,9 ↗ | 6:10,5* ↗ | Serie 95,0 |
| 2: 9,8 ↗ | 7: 9,3 ↘ | |
| 3: 9,9 ↗ | 8:10,2* → | Sum 95,0 |
| 4:10,5* ↓ | 9: 9,8 ← | |
| 5:10,6* ↘ | 10:10,7* ↓ | |

| | | |
|--------------|---------------|---------------|
| 1:10,8* ↗ | 6: 9,2 ↘ | Serie 98,0 |
| 2:10,1 ↘ | 7:10,5* ↘ | |
| 3: 9,9 ↗ | 8:10,4* ↘ | Sum 193,0 |
| 4:10,7* ↓ | 9:10,5* ↙ | |
| 5:10,5* ↘ | 10:10,8* ↗ | |

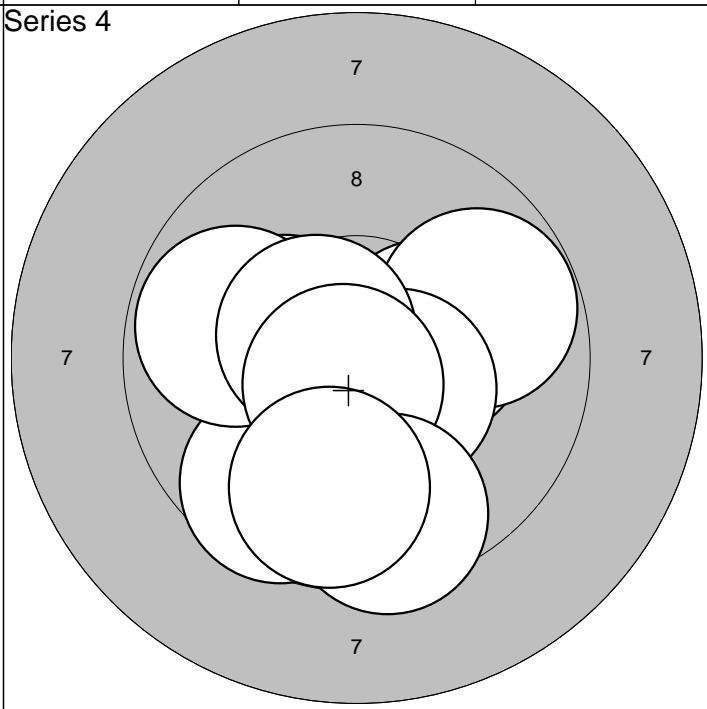
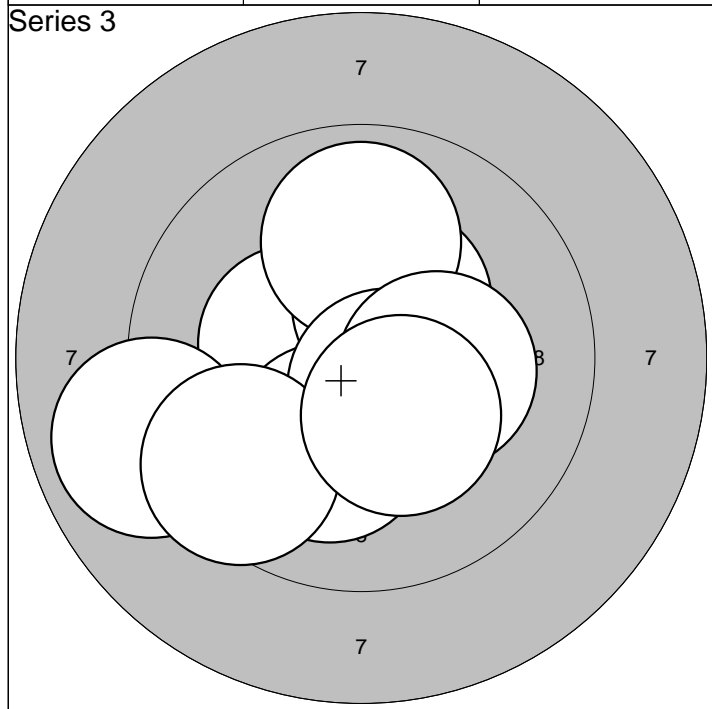

| | | |
|--------------|---------------|---------------|
| 1:10,4* ← | 6: 9,9 ↗ | Serie 97,0 |
| 2:10,4* ↗ | 7:10,6* ↘ | |
| 3:10,4* ↘ | 8:10,3* → | Sum 290,0 |
| 4:10,1 ↓ | 9: 9,5 ↙ | |
| 5: 9,0 ← | 10:10,3* ↓ | |

| | | |
|--------------|--------------|---------------|
| 1:10,3* ← | 6: 9,8 ← | Serie 95,0 |
| 2:10,3* → | 7:10,6* ↙ | |
| 3: 9,8 → | 8:10,7* ↓ | Sum 385,0 |
| 4: 9,6 ↙ | 9: 9,5 ↓ | |
| 5:10,5* ↘ | 10: 9,8 ↓ | |

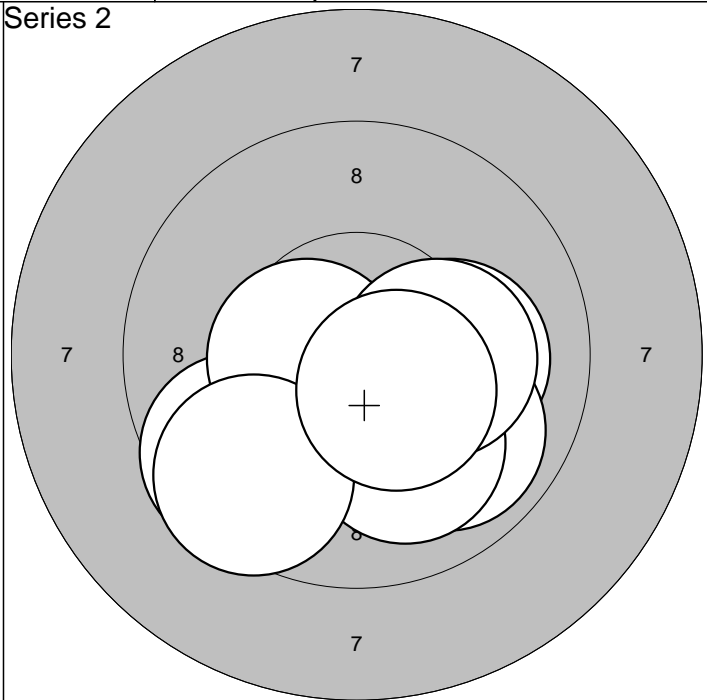
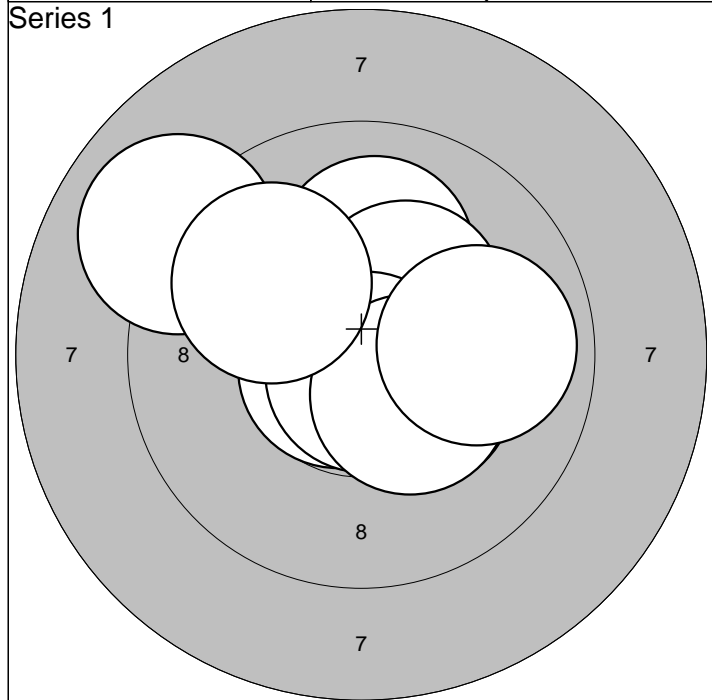

| | | |
|-----------|-----------|------------|
| 1:10,0 ↑ | 6:10,8* ↓ | Serie 97,0 |
| 2:10,7* ↙ | 7:10,4* ↘ | |
| 3:10,7* ↗ | 8: 9,0 ↗ | Sum 97,0 |
| 4:10,4* ↘ | 9: 9,9 → | |
| 5:10,3* ↗ | 10: 9,9 ↖ | |

| | | |
|-----------|------------|------------|
| 1:10,1 → | 6:10,0 ↓ | Serie 97,0 |
| 2:10,7* ↙ | 7:10,5* ← | |
| 3:10,5* ↓ | 8: 9,5 ↙ | Sum 194,0 |
| 4: 9,9 ↘ | 9:10,2* → | |
| 5: 9,6 ↙ | 10:10,5* ↘ | |

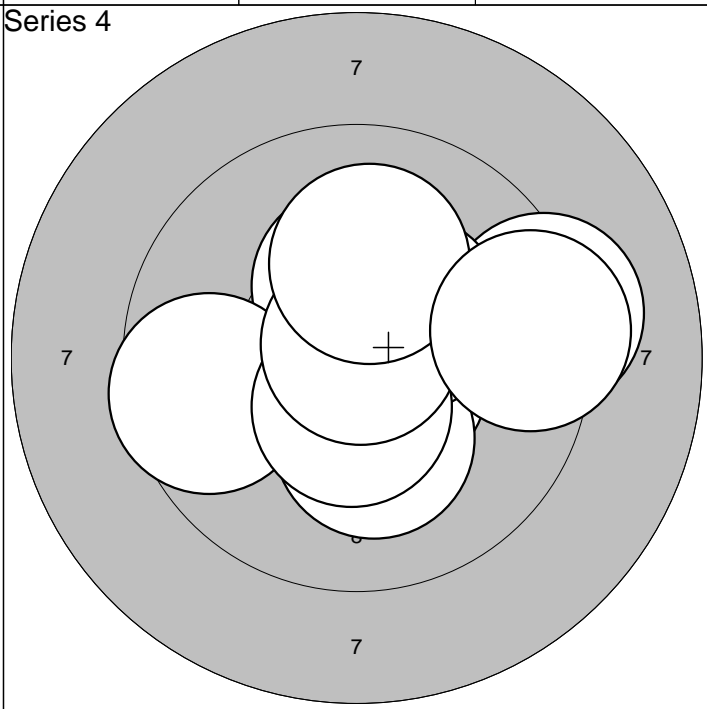
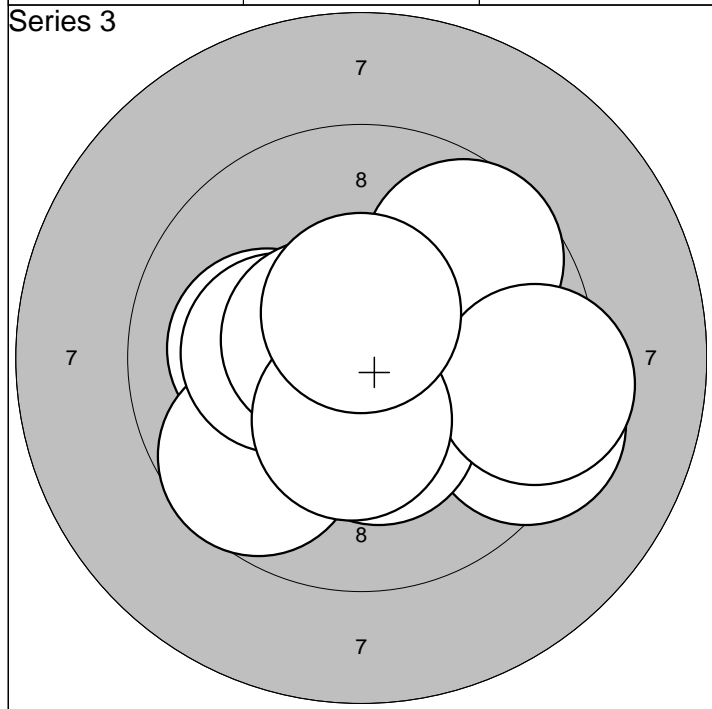

| | | |
|-----------|------------|------------|
| 1:10,1 ← | 6: 9,4 → | Serie 96,0 |
| 2: 9,4 → | 7:10,2* ← | |
| 3: 9,7 ↗ | 8:10,6* ← | Sum 290,0 |
| 4: 9,7 ↙ | 9:10,4* ↓ | |
| 5:10,3* ↓ | 10:10,5* ↑ | |

| | | |
|-----------|-----------|------------|
| 1:10,6* ↘ | 6:10,4* ↗ | Serie 97,0 |
| 2:10,3* ↑ | 7:10,5* ↓ | |
| 3:10,2* ↓ | 8:10,8* ↑ | Sum 387,0 |
| 4: 9,2 → | 9:10,1 ↑ | |
| 5: 9,6 ← | 10: 9,4 → | |

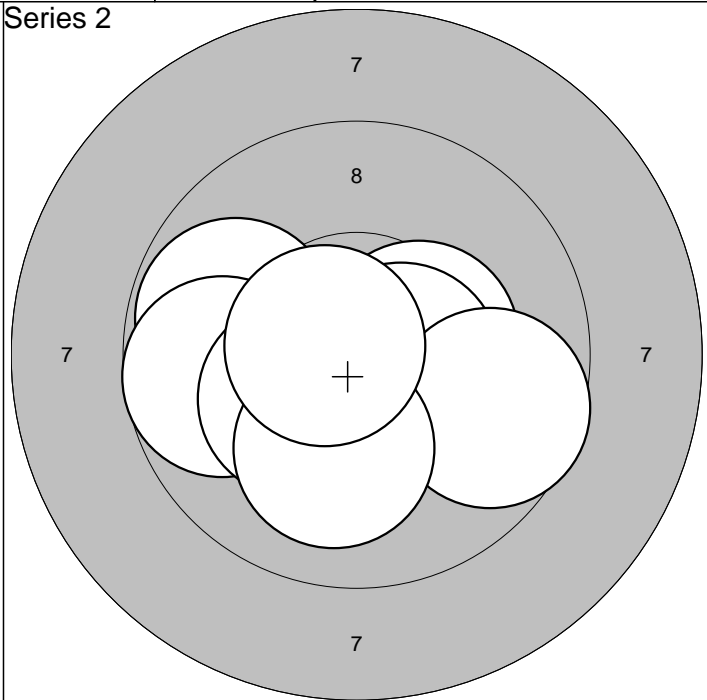
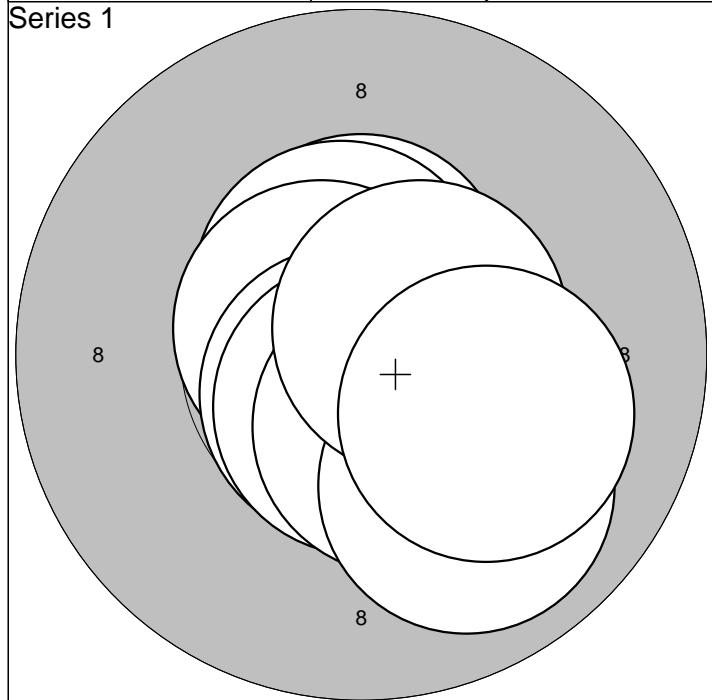

| | | | | | |
|-----------|-----------|-------|------|--|--|
| 1:10,5* ↑ | 6:10,6* ↓ | | | | |
| 2:10,5* ↑ | 7:10,4* ↓ | | | | |
| 3:10,7* ↖ | 8: 9,9 ↓ | Serie | 99,0 | | |
| 4:10,7* ↓ | 9:10,6* → | Sum | 99,0 | | |
| 5:10,4* → | 10:10,1 → | | | | |

| | | | | | |
|-----------|------------|-------|-------|--|--|
| 1:10,5* → | 6:10,4* ↓ | | | | |
| 2: 9,8 ← | 7: 9,7 → | | | | |
| 3:10,4* → | 8:10,3* ↙ | Serie | 97,0 | | |
| 4: 9,7 ← | 9:10,1 ↓ | Sum | 196,0 | | |
| 5:10,5* → | 10:10,7* ← | | | | |

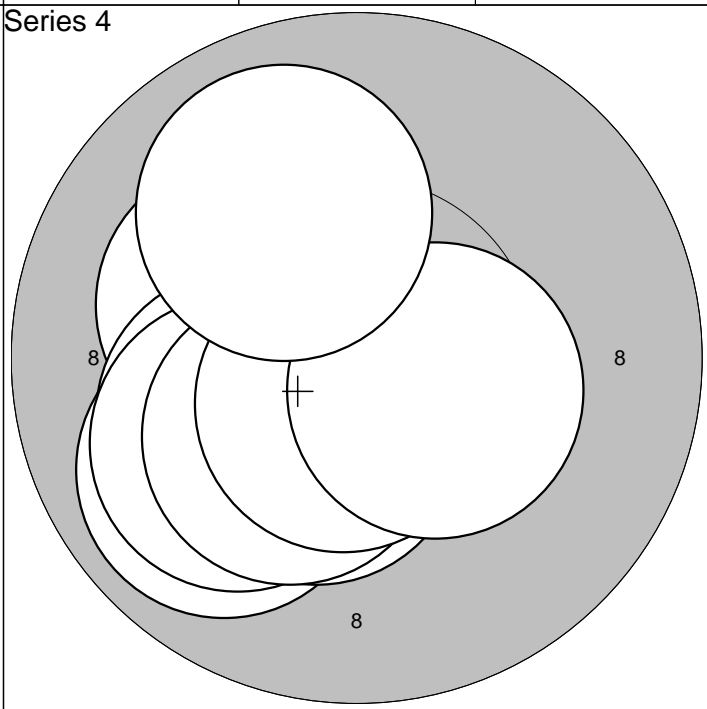
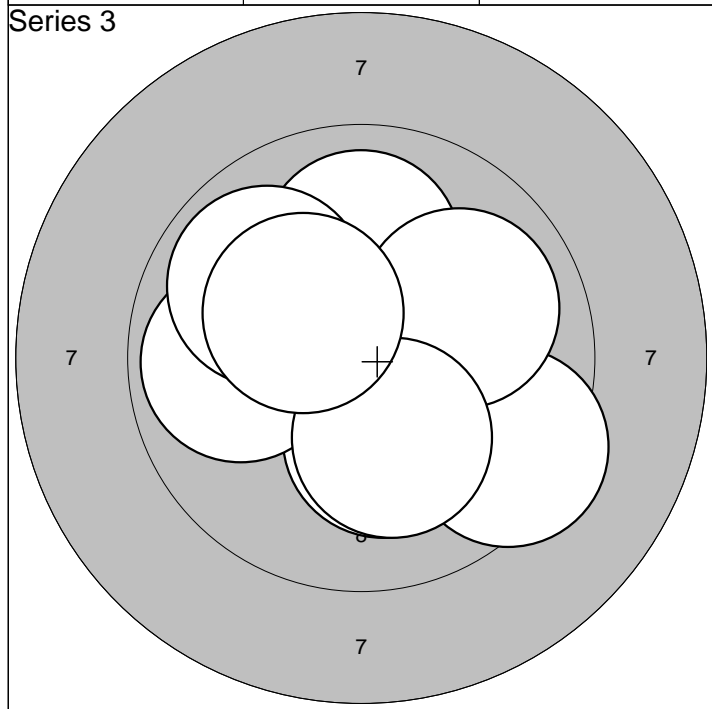

| | | | | | |
|-----------|------------|-------|-------|--|--|
| 1:10,2* → | 6:10,2* ↓ | | | | |
| 2:10,0 ↑ | 7: 9,9 ← | | | | |
| 3:10,3* ↘ | 8:10,2* ↓ | Serie | 96,0 | | |
| 4: 9,4 ↘ | 9: 9,9 ↗ | Sum | 292,0 | | |
| 5: 9,9 → | 10:10,3* ↗ | | | | |

| | | | | | |
|-----------|-----------|-------|-------|--|--|
| 1:10,2* ↖ | 6:10,4* ↓ | | | | |
| 2:10,2* ↙ | 7:10,3* ↙ | | | | |
| 3: 9,9 ↙ | 8:10,7* ↓ | Serie | 99,0 | | |
| 4:10,7* ↓ | 9:10,4* → | Sum | 391,0 | | |
| 5:10,1 ↙ | 10:10,0 ↗ | | | | |

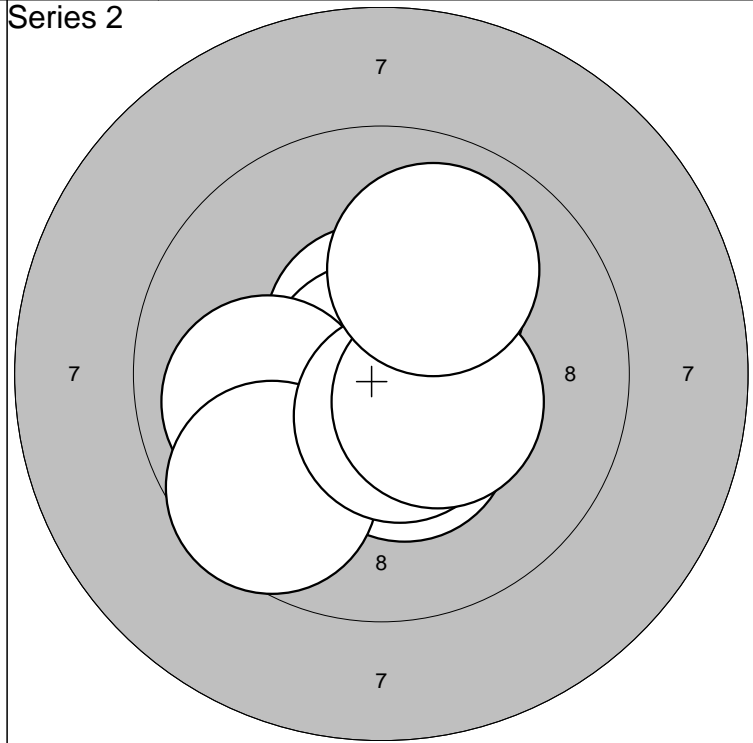
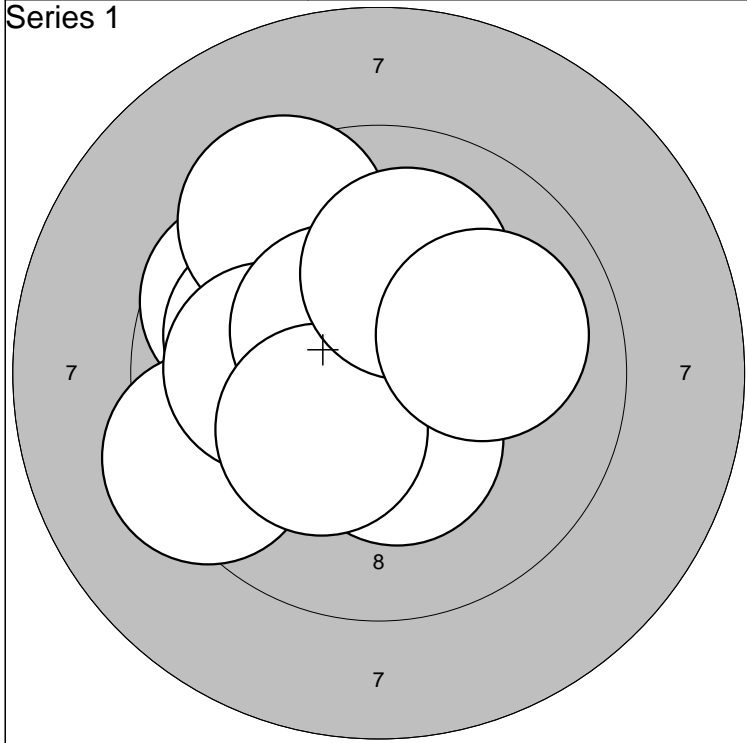

| | | | |
|----------|-----------|-------|------|
| 1: 9,7 ↖ | 6:10,3* ↓ | Serie | 97,0 |
| 2: 9,3 ↙ | 7:10,5* ↗ | | |
| 3:10,0 ↖ | 8:10,3* ↙ | Sum | 97,0 |
| 4: 9,4 ↗ | 9:10,1 ↗ | | |
| 5:10,0 ← | 10:10,0 → | | |

| | | | |
|-----------|-----------|-------|-------|
| 1:10,5* ← | 6:10,0 ← | Serie | 99,0 |
| 2:10,4* ↓ | 7: 9,6 ↙ | | |
| 3:10,3* ↗ | 8:10,6* ↓ | Sum | 196,0 |
| 4:10,6* ↑ | 9:10,4* → | | |
| 5:10,9* ↖ | 10:10,0 ↗ | | |

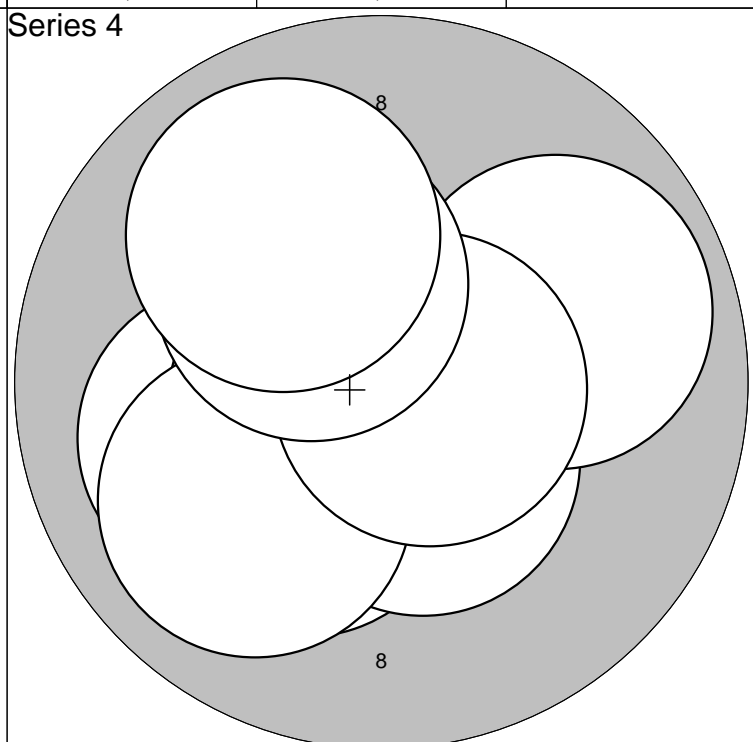
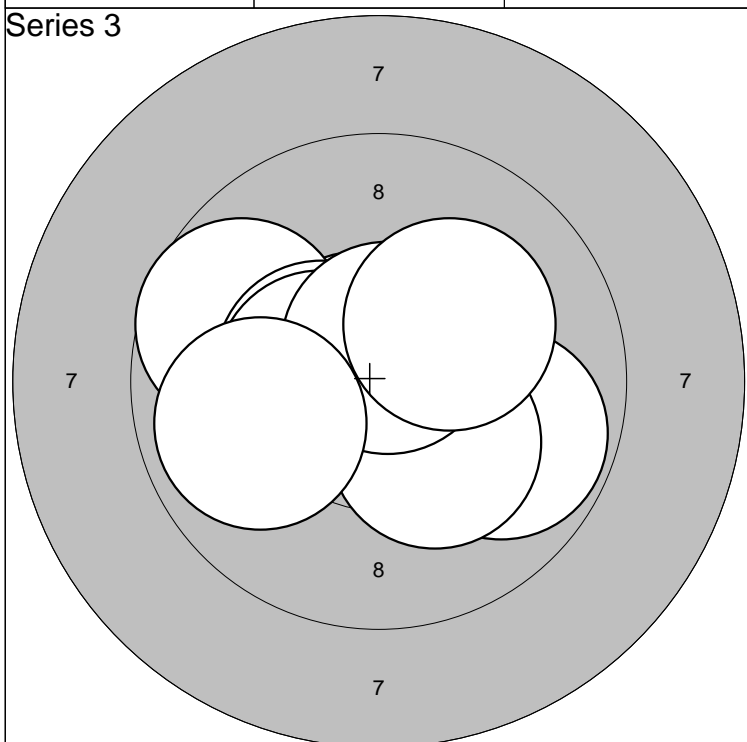

| | | | |
|-----------|------------|-------|-------|
| 1:10,7* → | 6:10,5* ← | Serie | 97,0 |
| 2: 9,8 ↘ | 7:10,2* ↘ | | |
| 3:10,7* ↗ | 8:10,7* ↑ | Sum | 293,0 |
| 4: 9,7 ↖ | 9: 9,9 ← | | |
| 5:10,4* ↙ | 10:10,2* ↗ | | |

| | | | |
|-----------|-----------|-------|-------|
| 1:10,8* ↙ | 6: 9,9 → | Serie | 99,0 |
| 2:10,0 ← | 7:10,0 ↙ | | |
| 3:10,6* ← | 8:10,7* → | Sum | 392,0 |
| 4:10,3* ↙ | 9:10,2* ↗ | | |
| 5:10,5* ↓ | 10:10,0 ↗ | | |

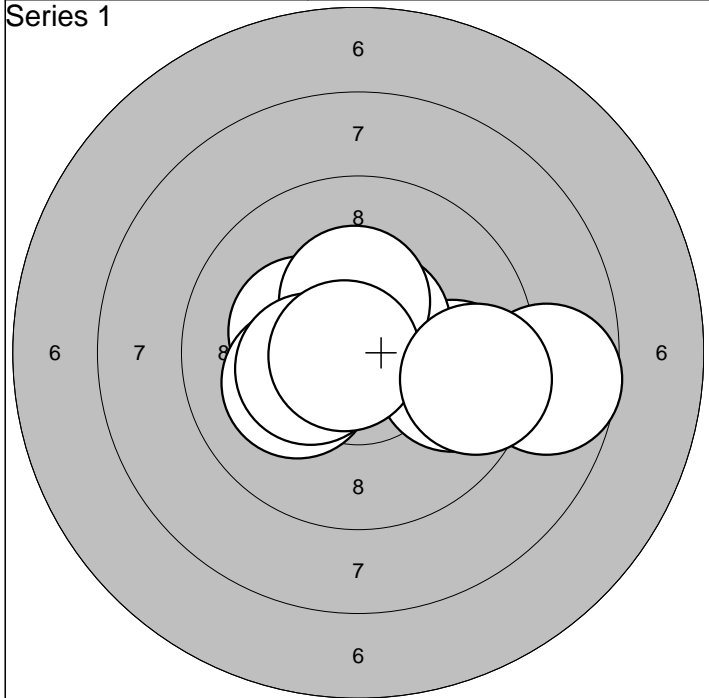

| | | | | |
|-----------|-----------|-----|-------|------|
| 1: 8,7 → | 6:10,2* ← | | Serie | 96,0 |
| 2:10,6* ↑ | 7:10,4* ↑ | | | |
| 3:10,3* ← | 8:10,4* ← | Sum | 96,0 | |
| 4: 9,8 → | 9:10,8* ← | | | |
| 5:10,6* ↗ | 10: 9,5 → | | | |

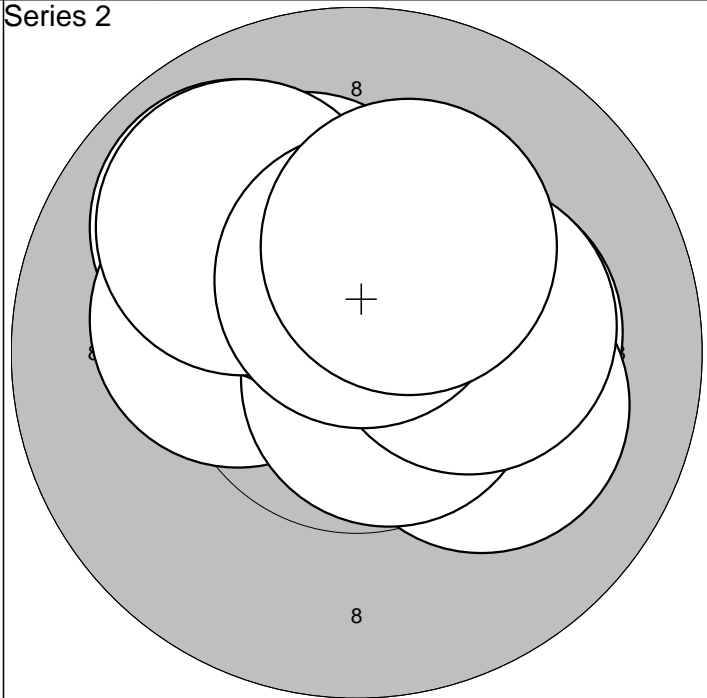

| | | | | |
|-----------|------------|-----|-------|------|
| 1:10,2* → | 6:10,2* ↗ | | Serie | 98,0 |
| 2: 9,9 ↗ | 7:10,3* → | | | |
| 3:10,1 → | 8: 9,9 ↗ | Sum | 194,0 | |
| 4:10,2* ← | 9:10,5* ↑ | | | |
| 5:10,7* ↘ | 10:10,3* ↗ | | | |

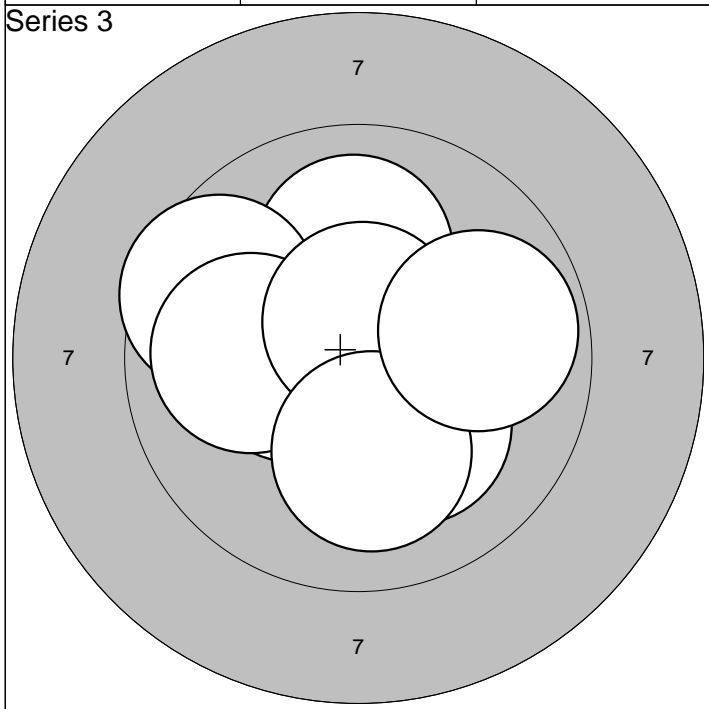

| | | | | |
|-----------|-----------|-----|-------|------|
| 1:10,4* ← | 6: 9,6 ← | | Serie | 98,0 |
| 2:10,6* ↖ | 7:10,0 ← | | | |
| 3:10,0 ↑ | 8:10,6* ↑ | Sum | 292,0 | |
| 4:10,2* ↘ | 9:10,1 ↓ | | | |
| 5:10,6* ← | 10: 9,9 → | | | |

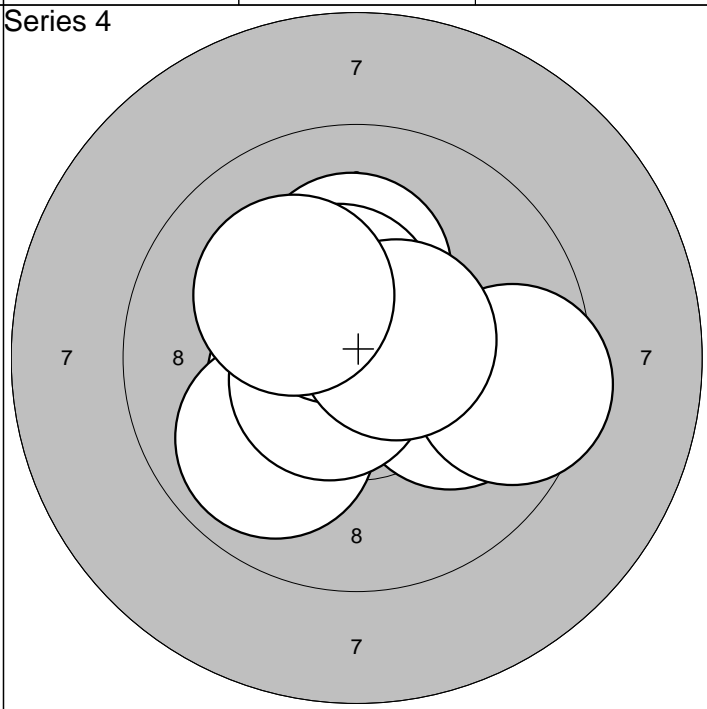

| | | | | |
|-----------|------------|-----|-------|------|
| 1:10,5* ← | 6:10,2* ↑ | | Serie | 98,0 |
| 2: 9,9 ↖ | 7: 9,5 → | | | |
| 3:10,4* ↗ | 8:10,4* ↑ | Sum | 390,0 | |
| 4:10,1 → | 9:10,6* → | | | |
| 5:10,6* ↖ | 10:10,2* ↖ | | | |

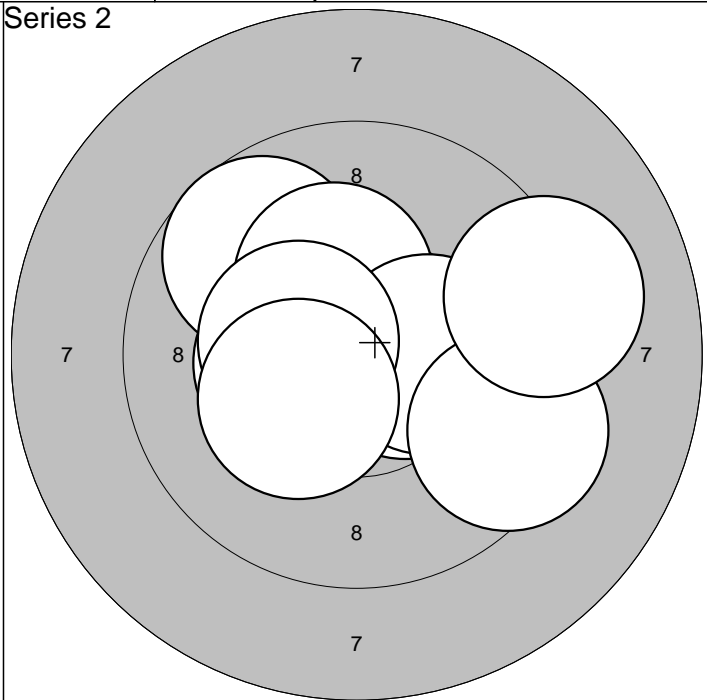
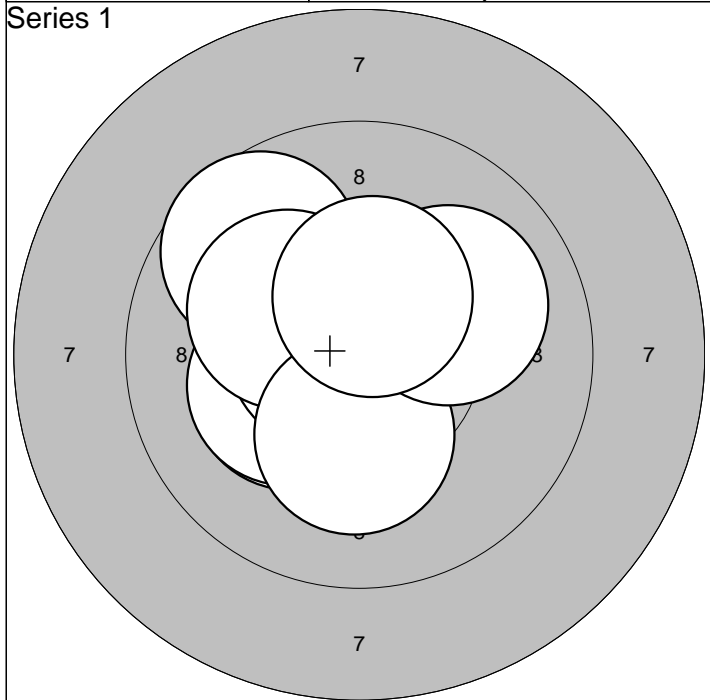

| | | | |
|-----------|------------|-------|------|
| 1:10,3* ↙ | 6:10,7* ← | Serie | 99,0 |
| 2:10,5* ↓ | 7:10,2* ↖ | | |
| 3: 9,7 ↘ | 8:10,2* ↓ | Sum | 99,0 |
| 4:10,5* ← | 9:10,0 ↗ | | |
| 5:10,2* ← | 10:10,4* ↑ | | |

| | | | |
|-----------|------------|-------|-------|
| 1:10,7* ↗ | 6:10,3* → | Serie | 97,0 |
| 2: 9,8 ↖ | 7:10,4* ← | | |
| 3:10,5* → | 8: 9,4 ↘ | Sum | 196,0 |
| 4:10,3* ↑ | 9: 9,2 → | | |
| 5:10,4* ← | 10:10,3* ↙ | | |

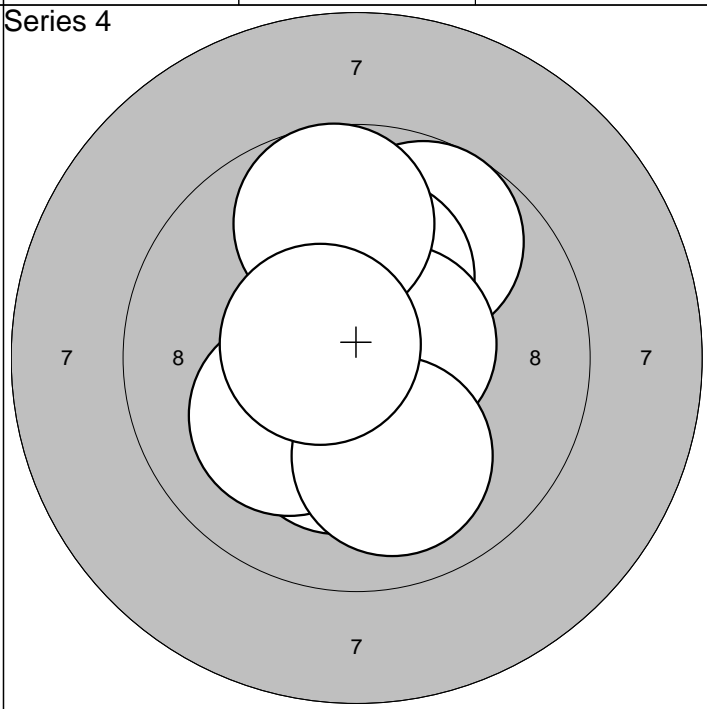
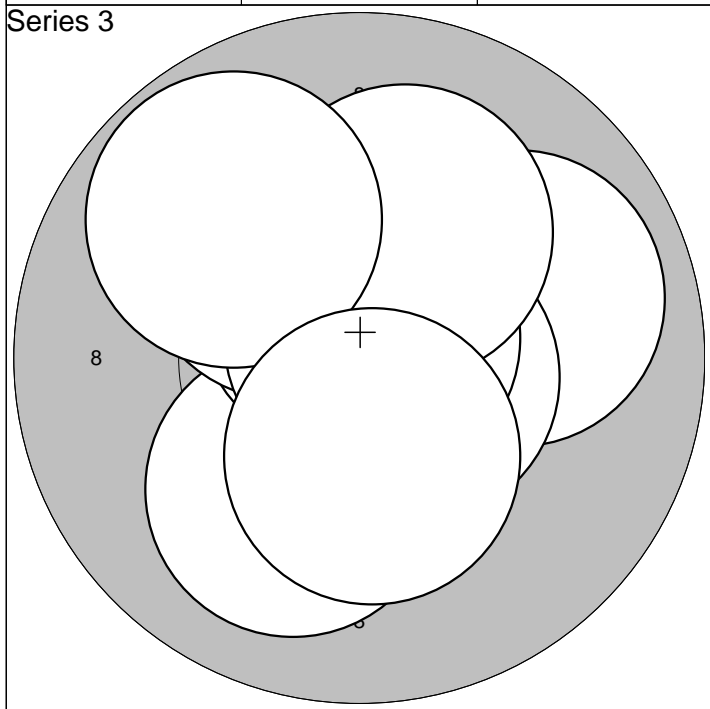

| | | | |
|-----------|------------|-------|-------|
| 1: 9,9 → | 6:10,2* ↖ | Serie | 98,0 |
| 2:10,9* ↗ | 7:10,8* ↗ | | |
| 3:10,0 ↓ | 8:10,1 ↑ | Sum | 294,0 |
| 4:10,6* ↑ | 9: 9,8 ↖ | | |
| 5:10,6* → | 10:10,3* ↓ | | |

| | | | |
|-----------|------------|-------|-------|
| 1: 9,7 ↗ | 6:10,4* ↙ | Serie | 98,0 |
| 2:10,2* ↑ | 7:10,2* ↙ | | |
| 3:10,3* ↓ | 8: 9,7 ↑ | Sum | 392,0 |
| 4:10,2* ↑ | 9:10,0 ↓ | | |
| 5:10,6* → | 10:10,6* ↖ | | |

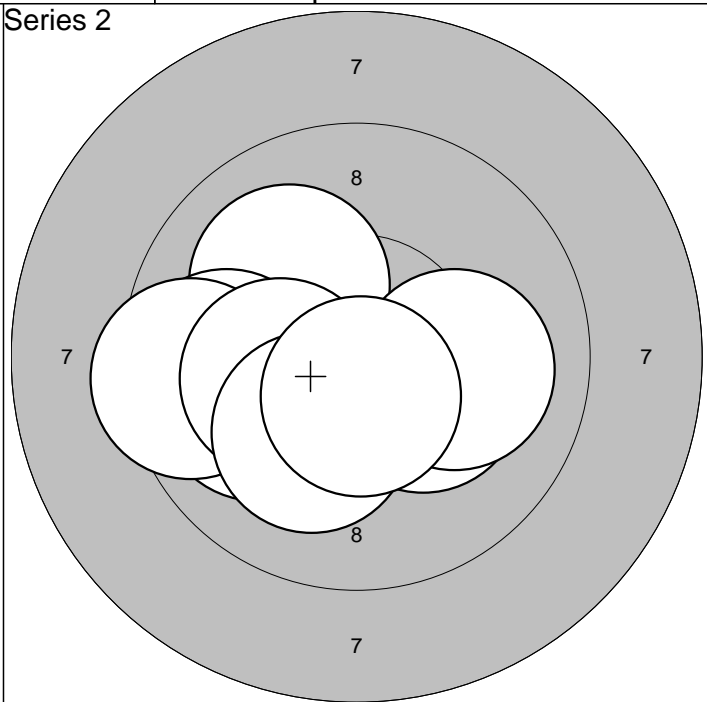
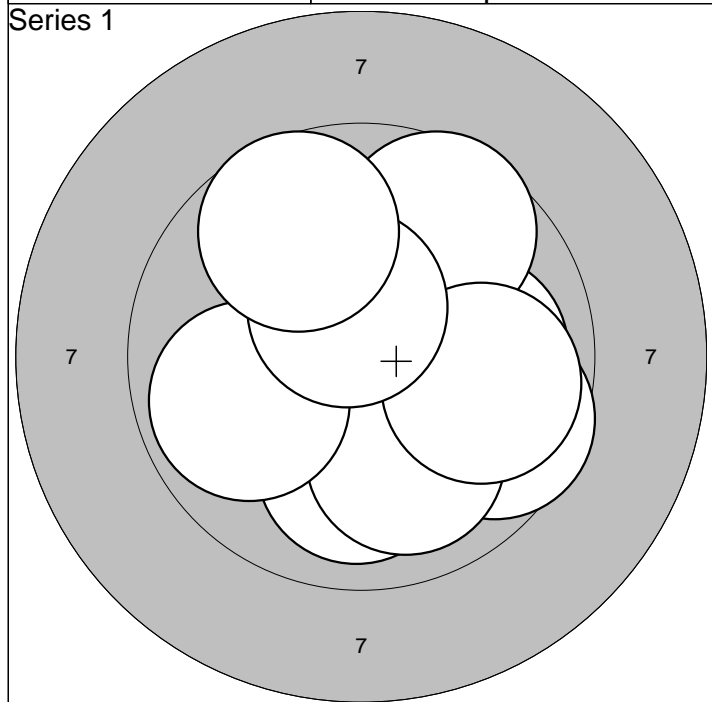

| | | | | | |
|-----------|-----------|-------|------|--|--|
| 1:10,4* → | 6: 9,7 ↗ | | | | |
| 2:10,0 → | 7: 9,8 → | | | | |
| 3: 9,6 ↘ | 8: 9,9 ← | Serie | 95,0 | | |
| 4:10,0 ↓ | 9:10,5* ↗ | Sum | 95,0 | | |
| 5:10,0 ↘ | 10: 9,7 ↗ | | | | |

| | | | | | |
|-----------|------------|-------|-------|--|--|
| 1:10,0 ← | 6: 9,4 ← | | | | |
| 2:10,3* ↘ | 7:10,2* ← | | | | |
| 3:10,5* ← | 8:10,2* ↘ | Serie | 98,0 | | |
| 4:10,1 ↗ | 9:10,1 → | Sum | 193,0 | | |
| 5: 9,8 ← | 10:10,6* ↓ | | | | |

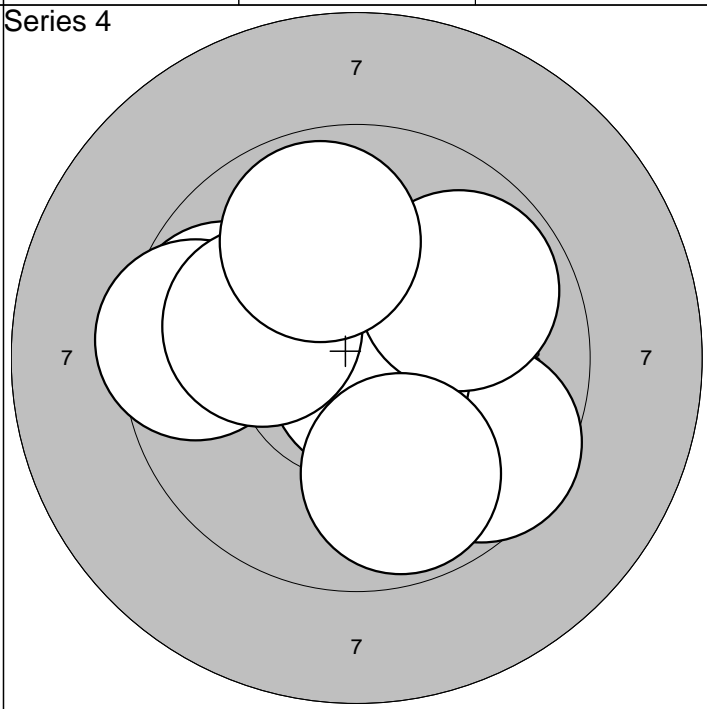
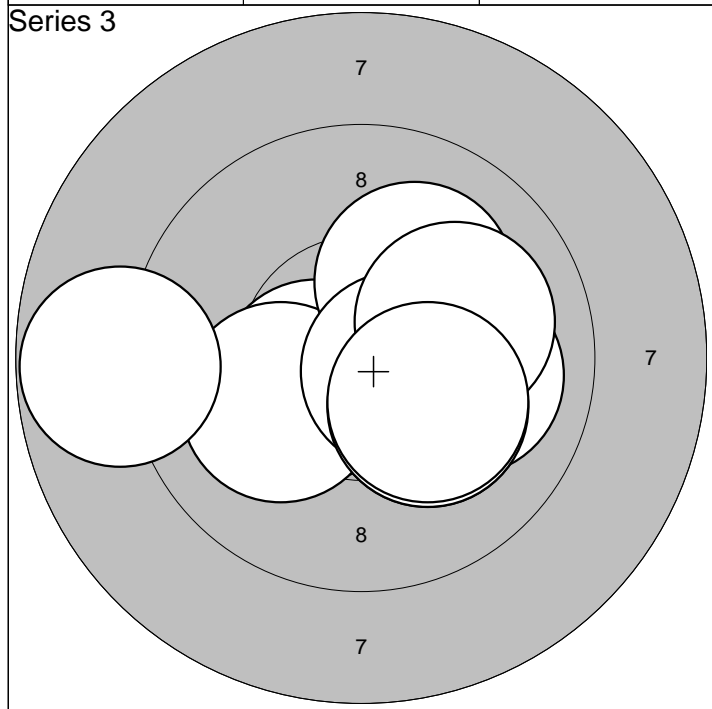

| | | | | | |
|-----------|------------|-------|-------|--|--|
| 1:10,2* ↘ | 6: 8,8 ← | | | | |
| 2:10,5* ← | 7:10,6* → | | | | |
| 3:10,0 → | 8:10,1 → | Serie | 98,0 | | |
| 4:10,1 ← | 9:10,2* ↘ | Sum | 291,0 | | |
| 5:10,1 ↗ | 10:10,2* ↘ | | | | |

| | | | | | |
|-----------|-----------|-------|-------|--|--|
| 1:10,4* ↘ | 6: 9,5 ← | | | | |
| 2: 9,6 ↘ | 7: 9,8 ↗ | | | | |
| 3: 9,7 ← | 8: 9,8 ↓ | Serie | 94,0 | | |
| 4:10,4* ↗ | 9:10,1 ← | Sum | 385,0 | | |
| 5:10,7* ↘ | 10: 9,9 ↗ | | | | |

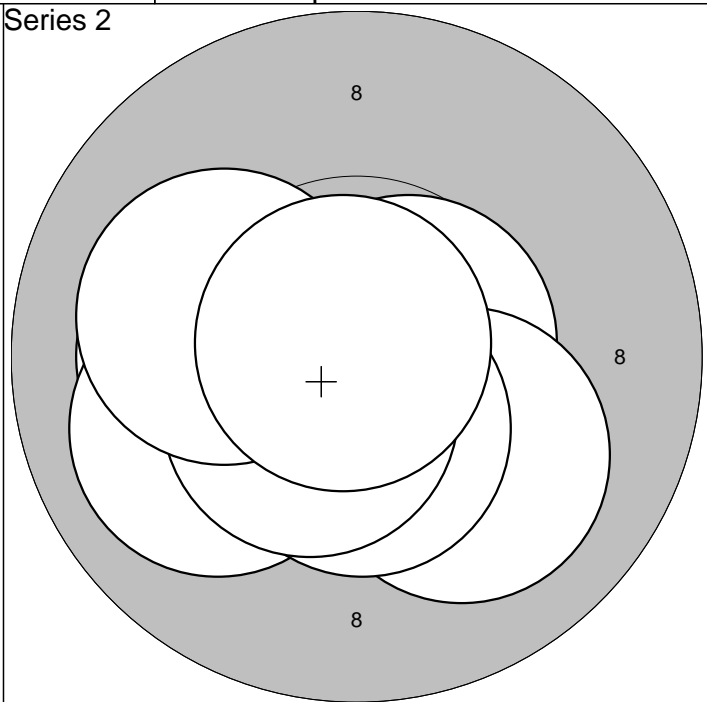
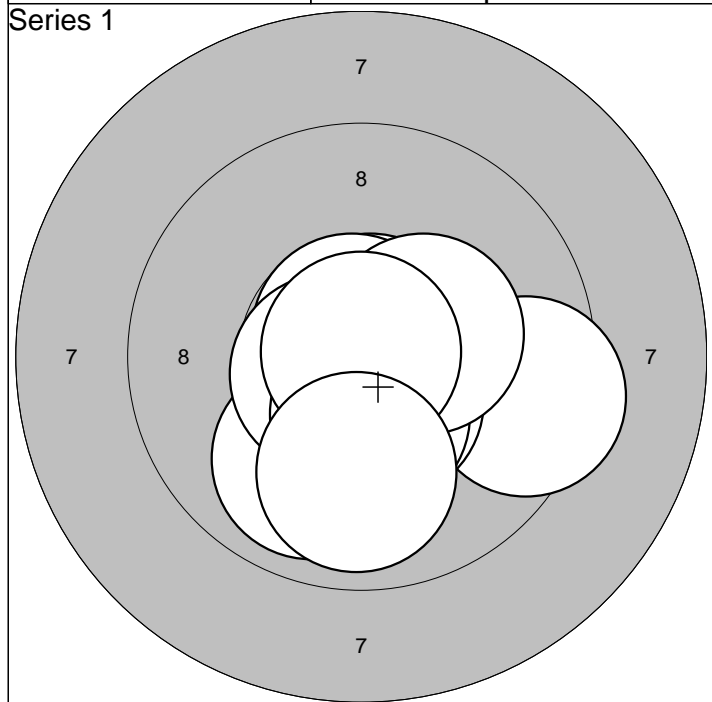

| | | | | | |
|-----------|-----------|--|--|-------|------|
| 1:10,7* ↗ | 6:10,6* ↙ | | | Serie | 97,0 |
| 2: 9,4 → | 7:10,4* ↓ | | | | |
| 3:10,7* ↗ | 8:10,4* → | | | Sum | 97,0 |
| 4:10,5* ↓ | 9:10,9* ↑ | | | | |
| 5: 9,9 ↘ | 10: 9,9 ↓ | | | | |

| | | | | | |
|-----------|------------|--|--|-------|-------|
| 1:10,6* ↙ | 6:10,0 ↙ | | | Serie | 100,0 |
| 2:10,9* ← | 7:10,5* ↓ | | | | |
| 3:10,6* → | 8:10,5* ↘ | | | Sum | 197,0 |
| 4:10,1 ← | 9:10,1 ↙ | | | | |
| 5:10,1 ↘ | 10:10,8* ↗ | | | | |

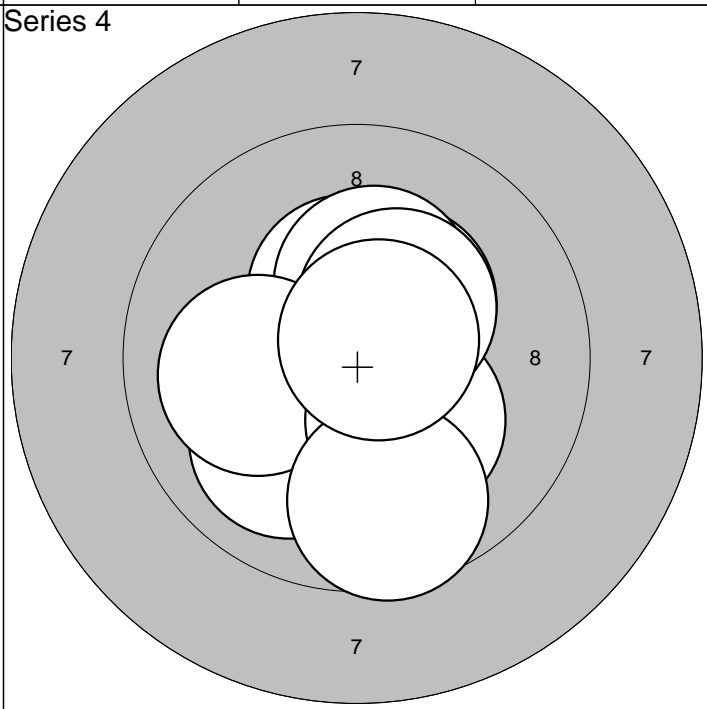
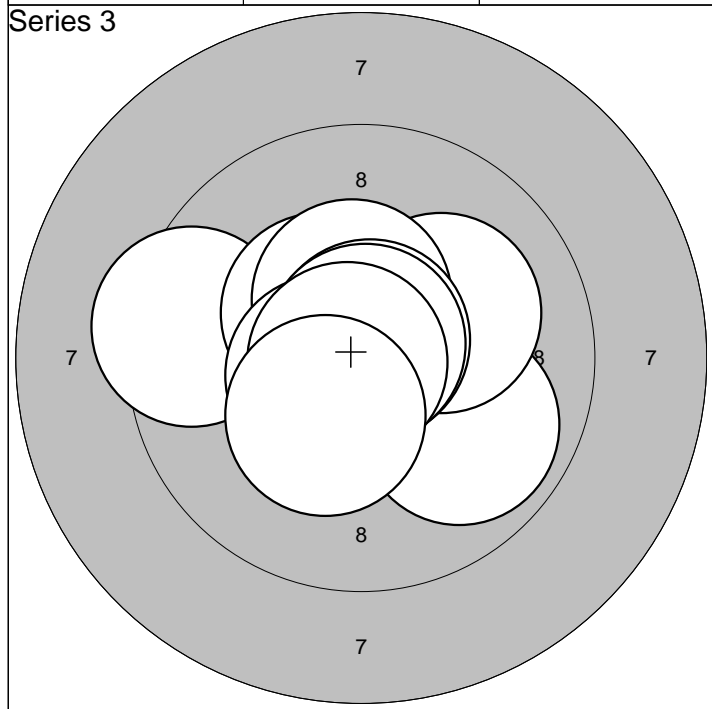

| | | | | | |
|-----------|------------|--|--|-------|-------|
| 1: 9,9 ↘ | 6:10,6* ↙ | | | Serie | 98,0 |
| 2:10,1 → | 7:10,8* ↗ | | | | |
| 3: 9,4 ← | 8:10,8* ↗ | | | Sum | 295,0 |
| 4:10,4* ↗ | 9:10,8* ← | | | | |
| 5:10,4* ↑ | 10:10,4* ↘ | | | | |

| | | | | | |
|-----------|------------|--|--|-------|-------|
| 1:10,4* ↗ | 6:10,1 ← | | | Serie | 99,0 |
| 2:10,5* ↓ | 7:10,2* ↘ | | | | |
| 3:10,3* ↗ | 8: 9,6 ↓ | | | Sum | 394,0 |
| 4:10,3* ↑ | 9:10,4* ↗ | | | | |
| 5:10,0 ↘ | 10:10,7* ↗ | | | | |

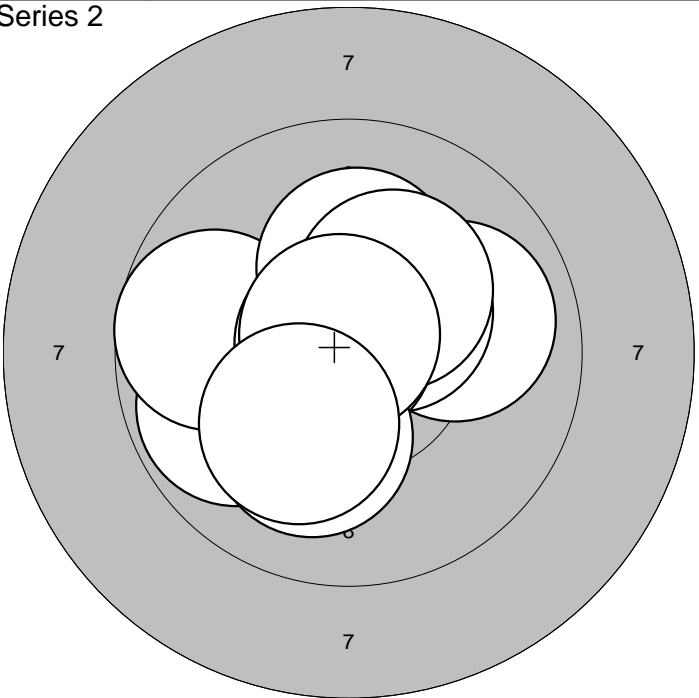
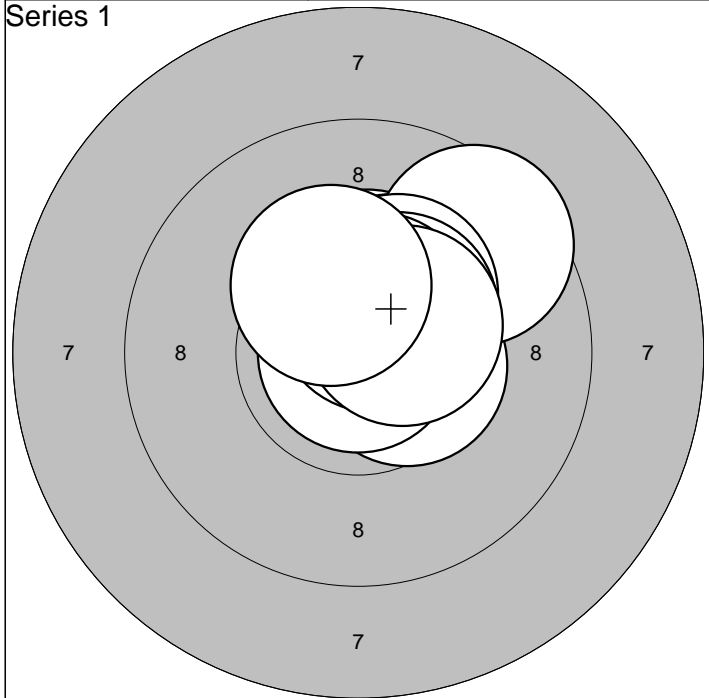

| | | | |
|-----------|------------|-------|------|
| 1:10,5* → | 6:10,3* ↗ | Serie | 99,0 |
| 2:10,9* | 7:10,4* ↗ | | |
| 3:10,4* ↑ | 8:10,6* ↗ | Sum | 99,0 |
| 4:10,3* ↗ | 9:10,5* ↗ | | |
| 5: 9,5 ↗ | 10:10,3* ↗ | | |

| | | | |
|-----------|------------|-------|-------|
| 1:10,0 → | 6:10,8* ↖ | Serie | 98,0 |
| 2: 9,8 ← | 7:10,1 ↓ | | |
| 3: 9,7 ← | 8:10,3* ↗ | Sum | 197,0 |
| 4:10,2* ↑ | 9:10,8* ↖ | | |
| 5:10,4* ↗ | 10:10,2* ↓ | | |

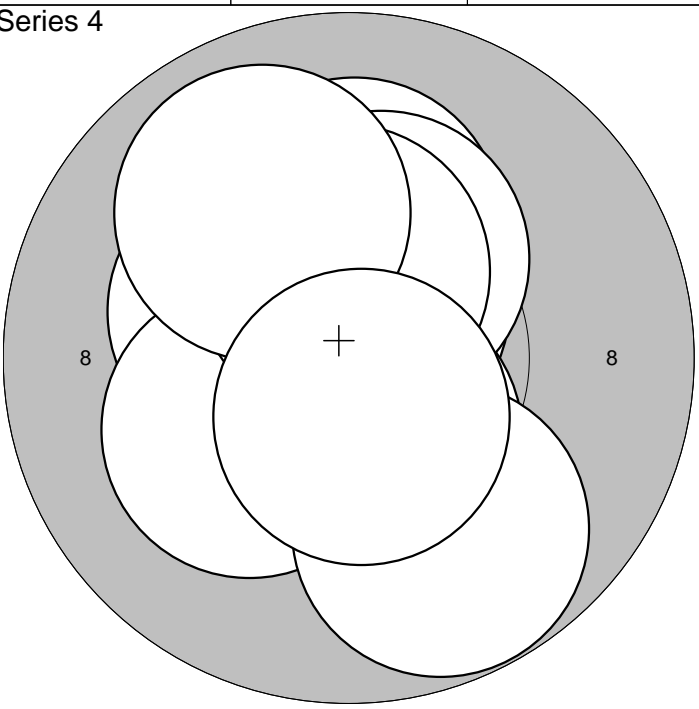
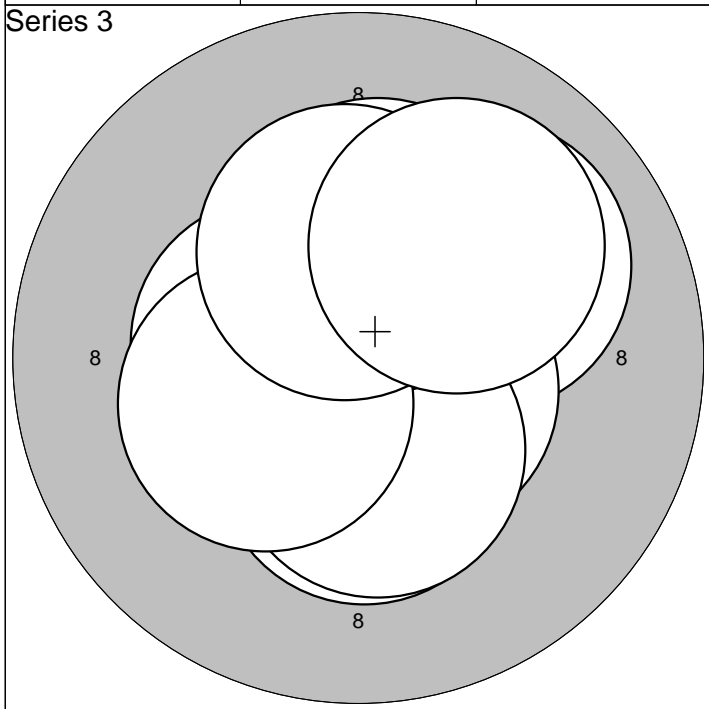

| | | | |
|-----------|-----------|-------|-------|
| 1:10,0 ↗ | 6:10,4* ↓ | Serie | 100,0 |
| 2:10,3* ↑ | 7:10,3* ↑ | | |
| 3:10,6* ↘ | 8:10,3* ← | Sum | 297,0 |
| 4:10,3* ↓ | 9:10,3* ↑ | | |
| 5:10,5* ← | 10:10,0 ↗ | | |

| | | | |
|-----------|------------|-------|-------|
| 1:10,6* ↑ | 6: 9,8 ↓ | Serie | 98,0 |
| 2:10,1 ↑ | 7:10,3* ↑ | | |
| 3:10,4* ↓ | 8:10,4* ↑ | Sum | 395,0 |
| 4:10,3* ↖ | 9: 9,9 ↖ | | |
| 5:10,2* ↖ | 10:10,6* ↓ | | |

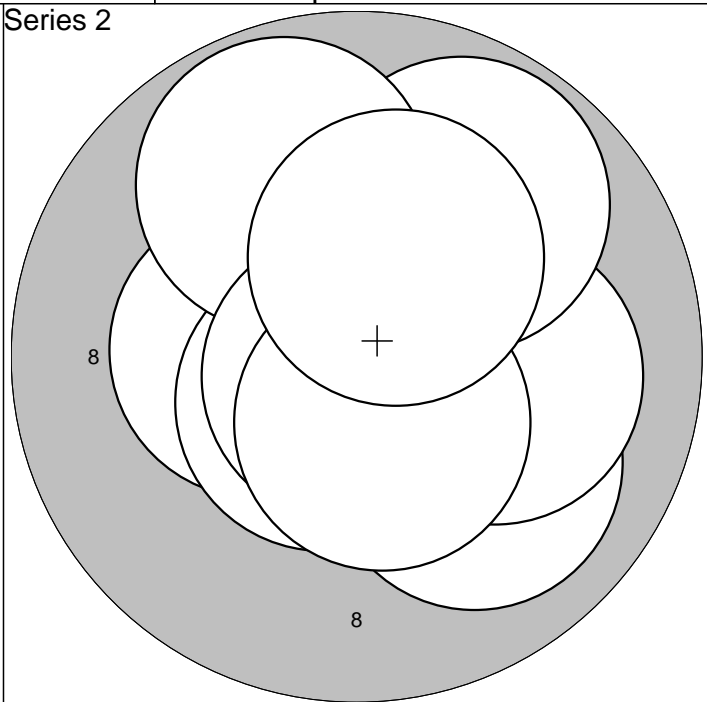
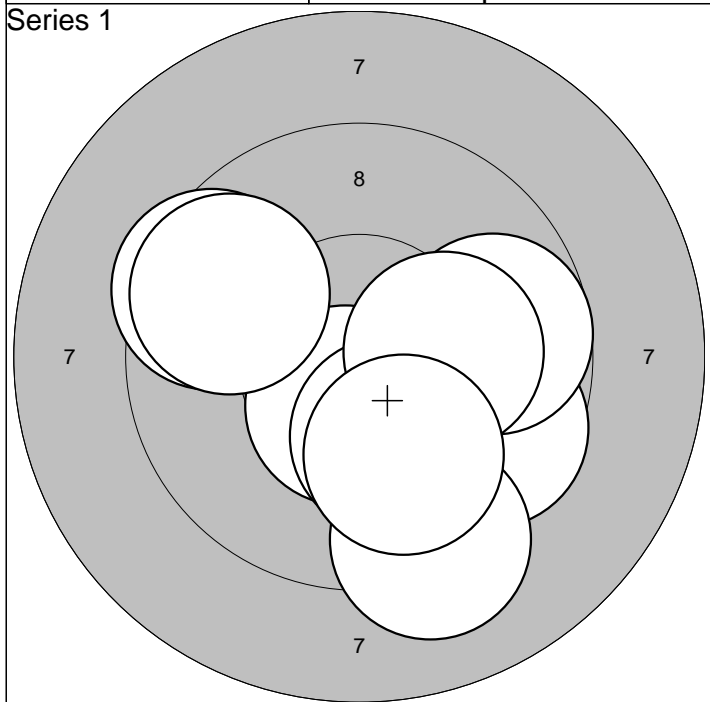

| | | | |
|------------|------------|-------|------|
| 1: 9,5 ↙ | 6: 9,7 → | Serie | 94,0 |
| 2: 9,7 ↘ | 7: 9,7 ↙ | | |
| 3: 10,5* ↘ | 8: 9,2 ↘ | Sum | 94,0 |
| 4: 9,6 ↘ | 9: 10,2* → | | |
| 5: 10,2* ↘ | 10: 10,0 ↘ | | |

| | | | |
|------------|-------------|-------|-------|
| 1: 10,0 ↘ | 6: 9,8 ↗ | Serie | 98,0 |
| 2: 10,9* ↘ | 7: 9,8 ↖ | | |
| 3: 10,1 → | 8: 10,8* ↘ | Sum | 192,0 |
| 4: 10,3* ← | 9: 10,5* ↘ | | |
| 5: 10,6* ↘ | 10: 10,3* ↗ | | |

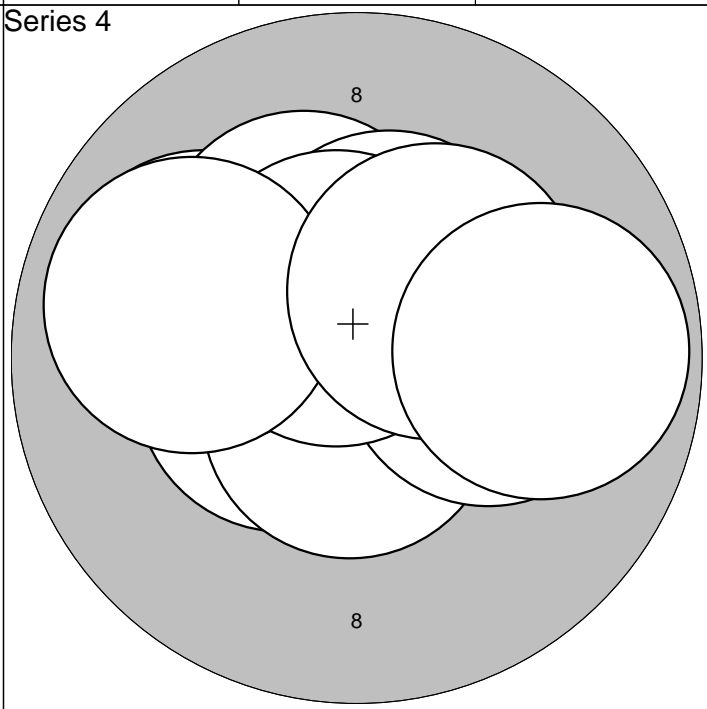
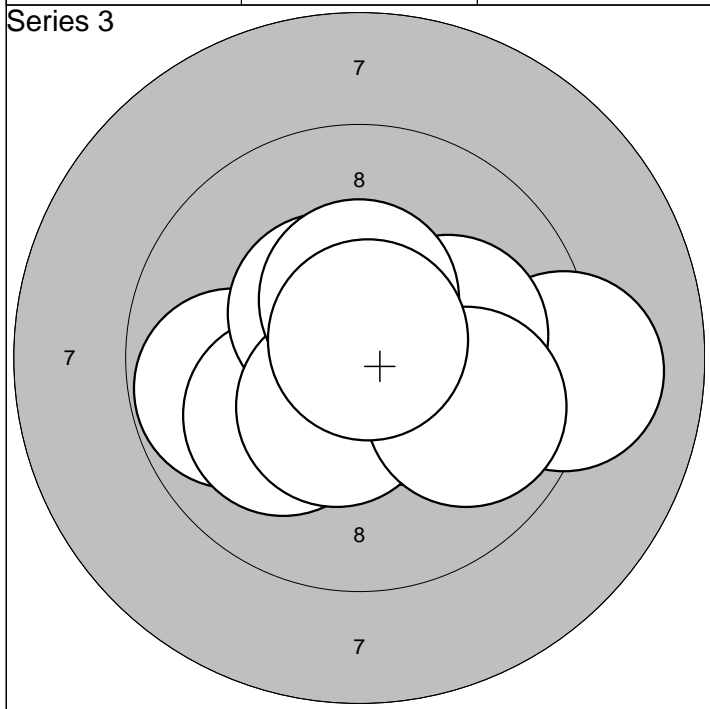

| | | | |
|------------|-------------|-------|-------|
| 1: 9,8 ↙ | 6: 10,4* ↗ | Serie | 97,0 |
| 2: 10,5* ↘ | 7: 10,5* ↘ | | |
| 3: 9,1 → | 8: 10,4* ↗ | Sum | 289,0 |
| 4: 10,1 ↙ | 9: 9,9 ↘ | | |
| 5: 10,1 → | 10: 10,8* ↗ | | |

| | | | |
|------------|------------|-------|-------|
| 1: 10,5* ↙ | 6: 10,2* → | Serie | 98,0 |
| 2: 10,6* ↘ | 7: 10,6* ↖ | | |
| 3: 10,0 ↙ | 8: 9,9 ↙ | Sum | 387,0 |
| 4: 10,3* ↖ | 9: 10,3* ↗ | | |
| 5: 10,4* ↗ | 10: 9,8 → | | |

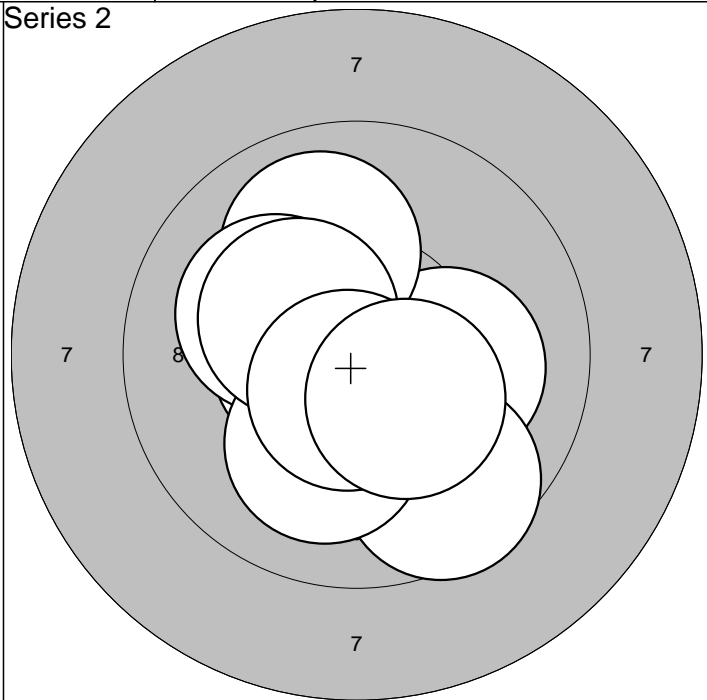
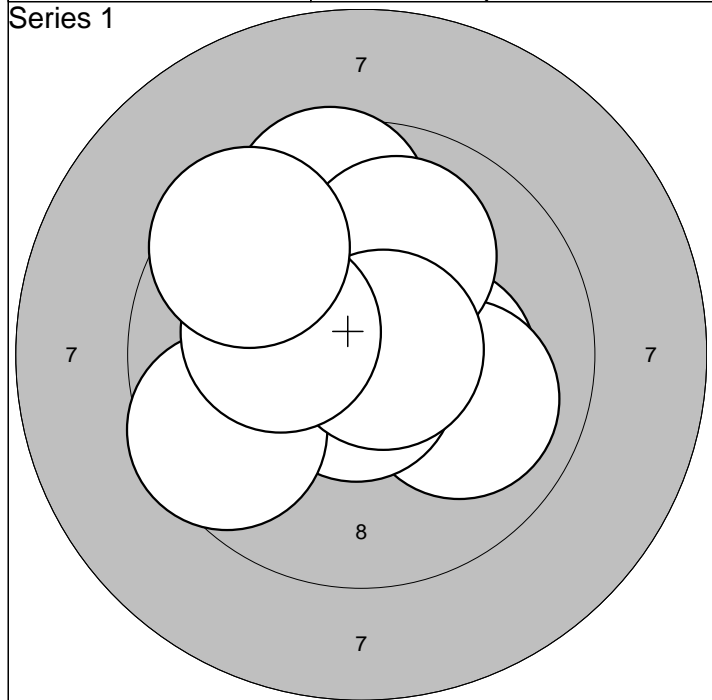

| | | | |
|-----------|-----------|-------|------|
| 1:10,3* → | 6: 9,6 ← | Serie | 97,0 |
| 2: 9,6 ↑ | 7:10,0 ↑ | | |
| 3:10,8* ↗ | 8:10,7* → | Sum | 97,0 |
| 4:10,0 ↘ | 9:10,2* ← | | |
| 5:10,7* ↓ | 10: 9,5 ↗ | | |

| | | | |
|-----------|------------|-------|-------|
| 1:10,6* ← | 6:10,1 ↖ | Serie | 99,0 |
| 2:10,1 → | 7:10,1 ↓ | | |
| 3: 9,6 ↓ | 8:10,3* ↗ | Sum | 196,0 |
| 4:10,7* ← | 9:10,6* ↓ | | |
| 5:10,0 ↑ | 10:10,3* ↘ | | |

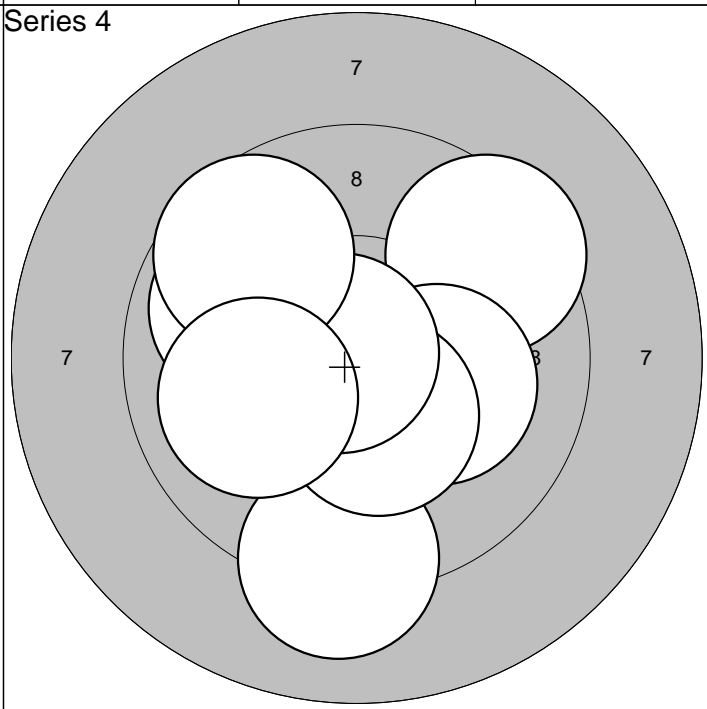
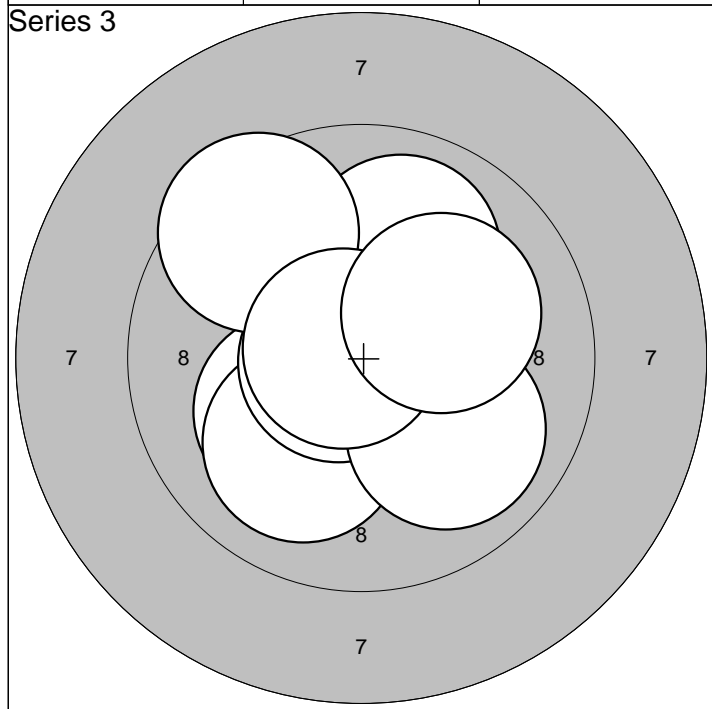

| | | | |
|-----------|-----------|-------|-------|
| 1:10,2* ↖ | 6:10,8* ← | Serie | 99,0 |
| 2:10,5* ↘ | 7: 9,5 ↗ | | |
| 3:10,3* ↘ | 8:10,0 ↓ | Sum | 295,0 |
| 4:10,0 ↘ | 9:10,8* ↖ | | |
| 5:10,0 ↑ | 10:10,1 ↗ | | |

| | | | |
|-----------|-----------|-------|-------|
| 1: 9,9 ↖ | 6:10,2* → | Serie | 96,0 |
| 2:10,5* ← | 7:10,4* ↓ | | |
| 3: 9,1 ↓ | 8:10,8* ← | Sum | 391,0 |
| 4:10,6* ↘ | 9: 9,6 ↗ | | |
| 5: 9,5 ↗ | 10:10,0 ← | | |

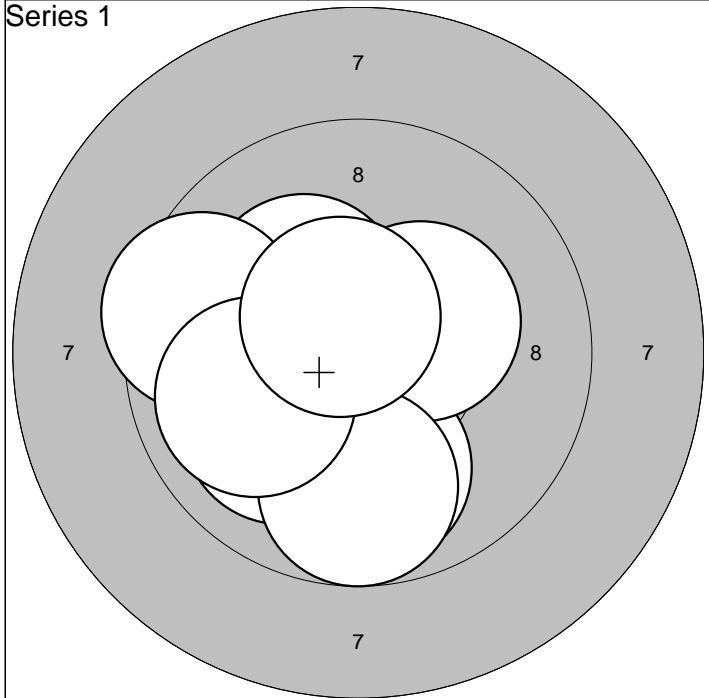

| | | | | | |
|-----------|------------|--|--|-------|------|
| 1:10,0 ↙ | 6: 9,5 ← | | | Serie | 97,0 |
| 2:10,3* ↘ | 7:10,3* → | | | | |
| 3: 9,9 ↓ | 8: 9,8 ↓ | | | Sum | 97,0 |
| 4:10,4* ← | 9:10,0 ← | | | | |
| 5:10,7* ↗ | 10:10,6* ↗ | | | | |

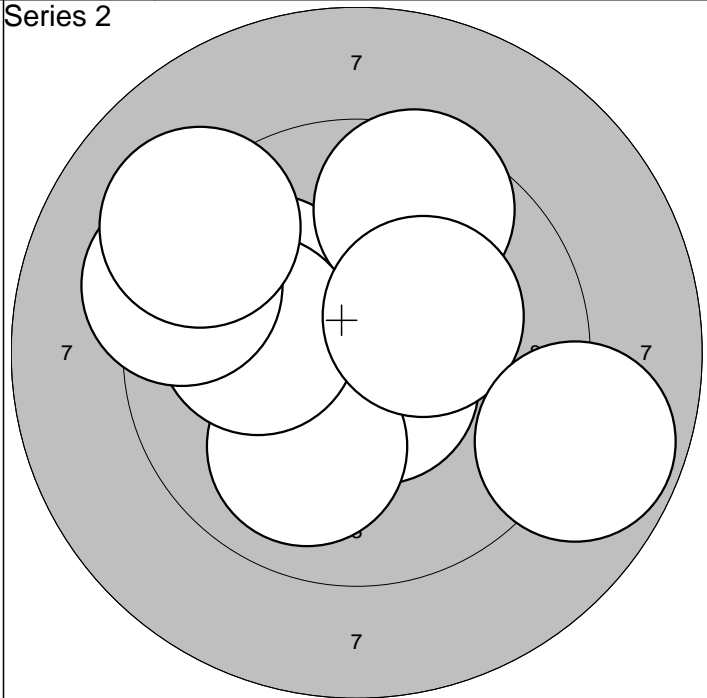

| | | | | | |
|-----------|-----------|--|--|-------|-------|
| 1:10,0 ↗ | 6:10,1 ← | | | Serie | 95,0 |
| 2:10,0 ↖ | 7:10,3* → | | | | |
| 3:10,6* ↘ | 8: 9,3 ← | | | Sum | 192,0 |
| 4:10,0 ↙ | 9: 8,8 → | | | | |
| 5: 9,6 ↗ | 10: 9,2 ↗ | | | | |

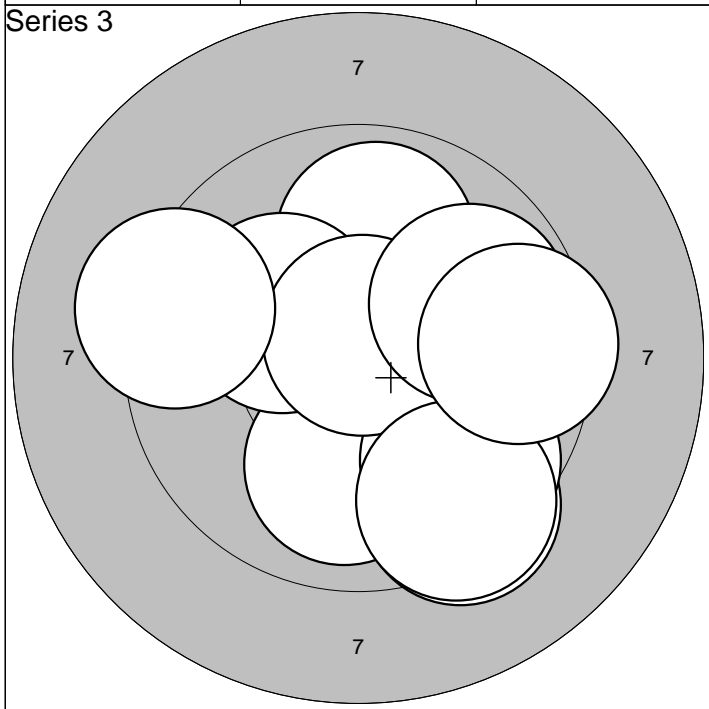

| | | | | | |
|-----------|-----------|--|--|-------|-------|
| 1:10,0 ↓ | 6:10,7* ↑ | | | Serie | 93,0 |
| 2: 9,9 ↑ | 7: 9,2 ← | | | | |
| 3: 9,3 ↘ | 8: 9,8 → | | | Sum | 285,0 |
| 4: 9,6 ↘ | 9: 9,4 ↓ | | | | |
| 5:10,2* ↗ | 10: 9,5 → | | | | |

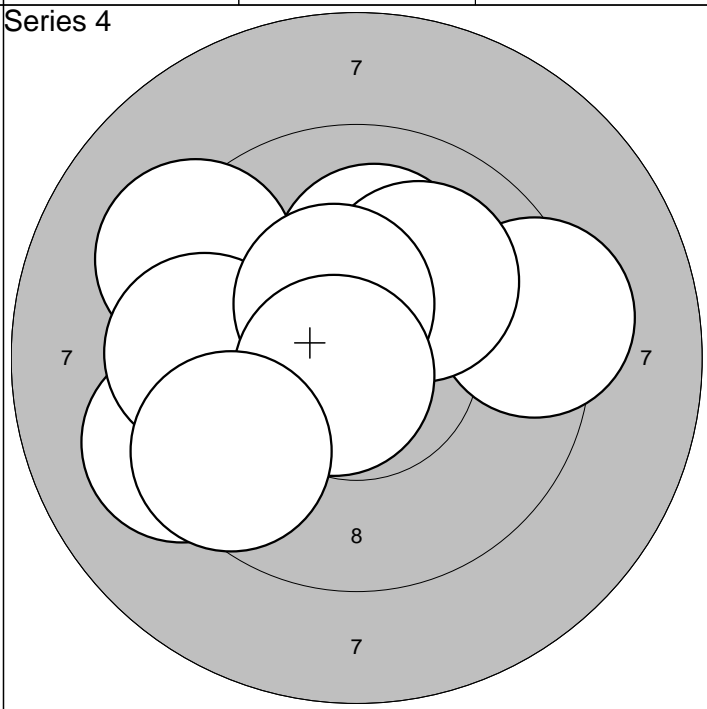

| | | | | | |
|-----------|-----------|--|--|-------|-------|
| 1: 9,3 → | 6: 9,6 ← | | | Serie | 95,0 |
| 2: 9,2 ← | 7:10,1 ↗ | | | | |
| 3:10,3* ← | 8:10,4* ↗ | | | Sum | 380,0 |
| 4:10,1 ↑ | 9:10,7* ↖ | | | | |
| 5: 9,3 ↖ | 10: 9,5 ↖ | | | | |

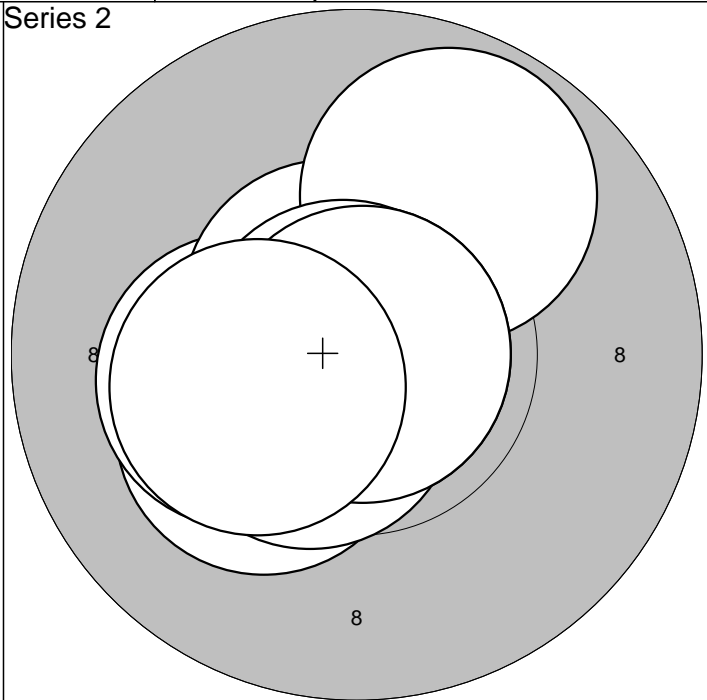
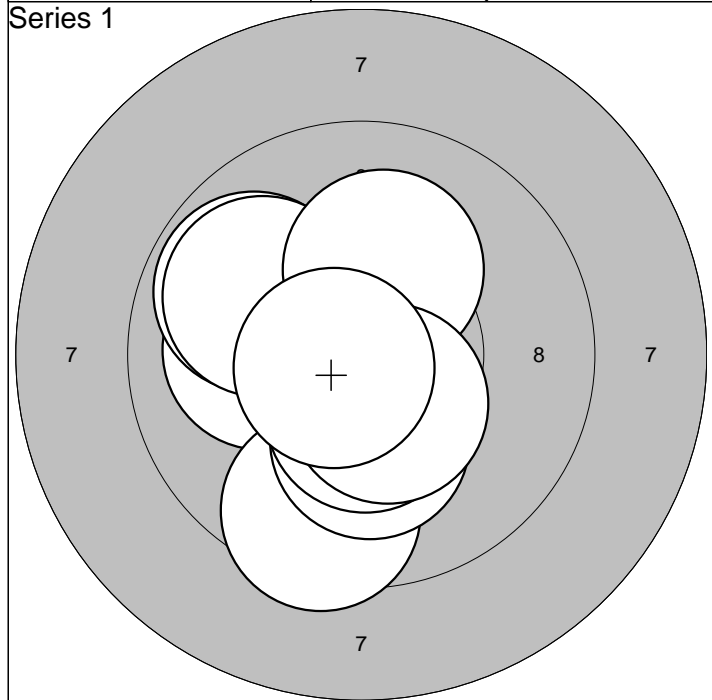

| | | | | | | | |
|---------|---|----------|---|-----|------|-------|------|
| 1:10,4* | ↓ | 6:10,2* | ↑ | | | Serie | 97,0 |
| 2:10,1 | ← | 7:10,2* | ↓ | | | | |
| 3: 9,5 | ↓ | 8:10,4* | ↓ | Sum | 97,0 | | |
| 4: 9,8 | ↖ | 9:10,5* | ↓ | | | | |
| 5: 9,9 | ↖ | 10:10,7* | ↖ | | | | |

| | | | | | | | |
|---------|---|----------|---|-----|-------|-------|------|
| 1:10,2* | ↙ | 6:10,9* | → | | | Serie | 99,0 |
| 2:10,6* | ← | 7:10,8* | ↖ | | | | |
| 3:10,3* | ← | 8:10,6* | ↙ | Sum | 196,0 | | |
| 4:10,6* | ↖ | 9:10,9* | → | | | | |
| 5: 9,8 | ↖ | 10:10,3* | ← | | | | |

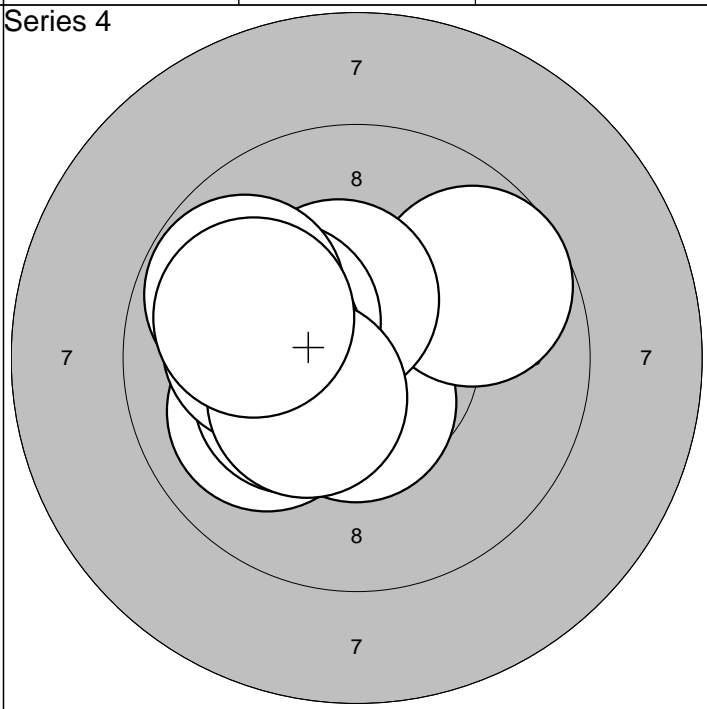
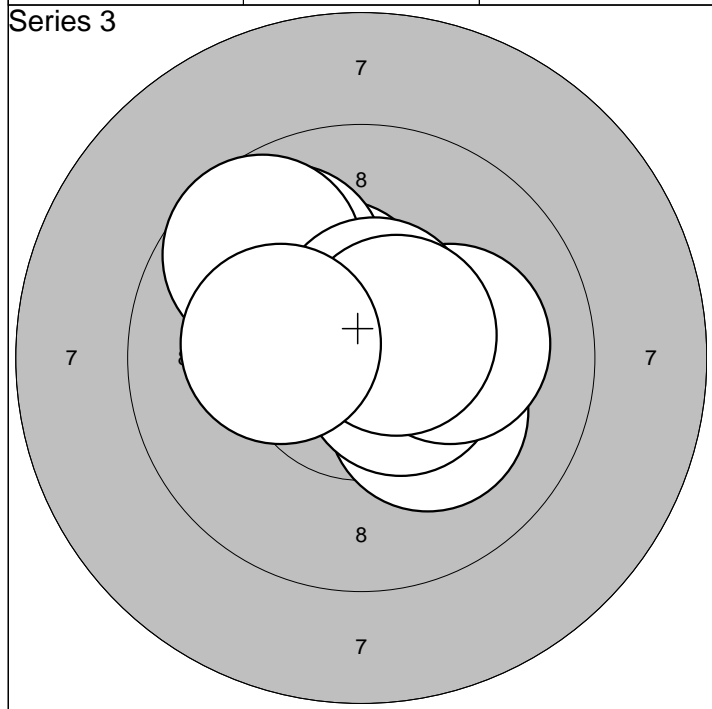

| | | | | | | | |
|---------|---|----------|---|-----|-------|-------|------|
| 1:10,4* | ↖ | 6:10,6* | → | | | Serie | 98,0 |
| 2: 9,9 | ↖ | 7:10,1 | → | | | | |
| 3:10,7* | ↖ | 8:10,6* | ↖ | Sum | 294,0 | | |
| 4:10,2* | ↙ | 9:10,6* | ↗ | | | | |
| 5: 9,7 | ↖ | 10:10,2* | ← | | | | |

| | | | | | | | |
|---------|---|---------|---|-----|-------|-------|------|
| 1:10,5* | ↓ | 6:10,2* | ↖ | | | Serie | 98,0 |
| 2: 9,7 | ↗ | 7:10,1 | ← | | | | |
| 3:10,0 | ↙ | 8: 9,8 | ↖ | Sum | 392,0 | | |
| 4:10,3* | ↙ | 9:10,4* | ↙ | | | | |
| 5:10,4* | ↖ | 10:10,0 | ↖ | | | | |

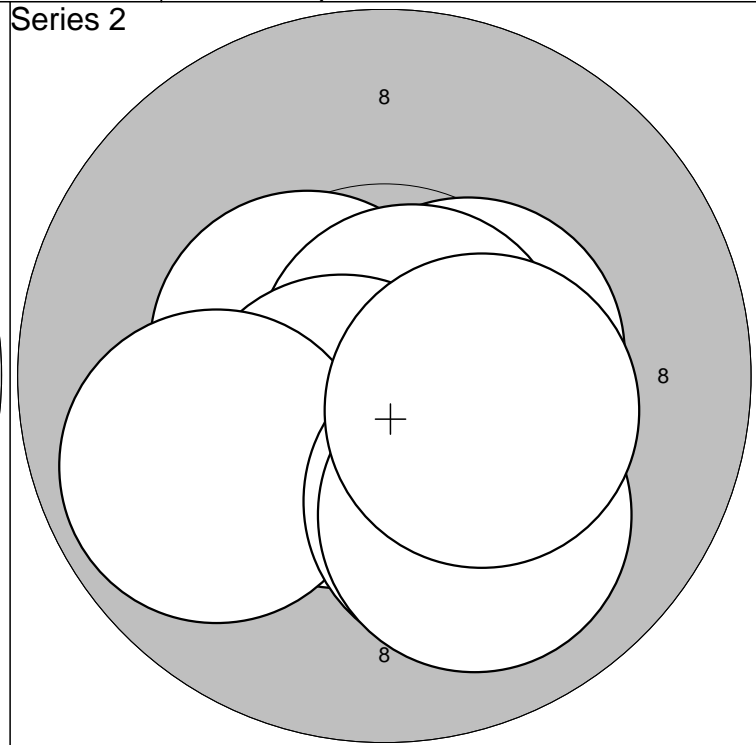

| | | | | | |
|---------|---|----------|---|-------|------|
| 1:10,0 | ← | 6:10,2* | ← | Serie | 99,0 |
| 2:10,5* | → | 7: 9,9 | ← | | |
| 3:10,5* | ↗ | 8:10,5* | ← | Sum | 99,0 |
| 4:10,7* | ↖ | 9:10,5* | → | | |
| 5:10,4* | ↗ | 10:10,4* | ↖ | | |

| | | | | | |
|---------|---|----------|---|-------|-------|
| 1:10,5* | → | 6:10,6* | ↘ | Serie | 99,0 |
| 2:10,7* | ← | 7: 9,9 | ← | | |
| 3:10,7* | ↘ | 8:10,1 | ↘ | Sum | 198,0 |
| 4:10,5* | ↖ | 9:10,0 | ↘ | | |
| 5:10,8* | ↗ | 10:10,4* | → | | |

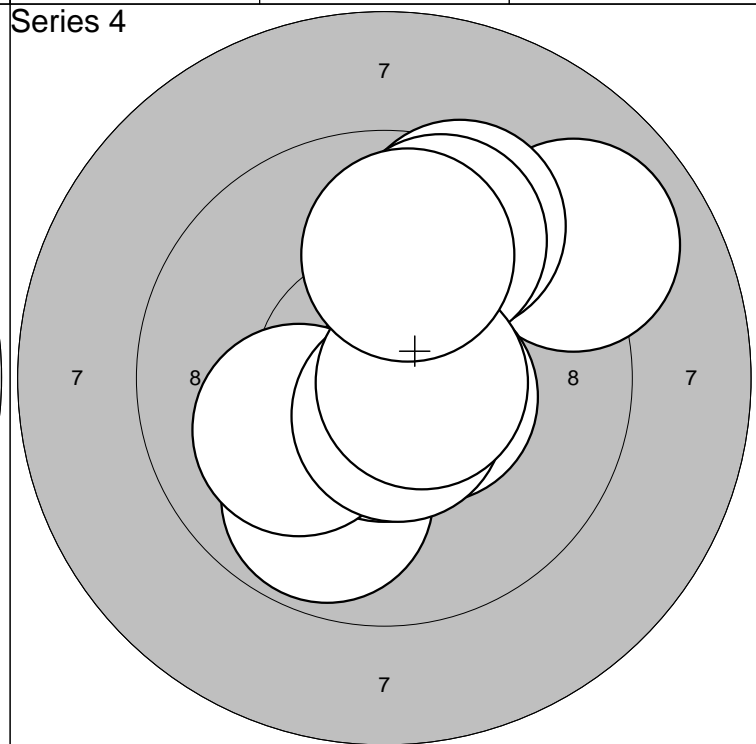
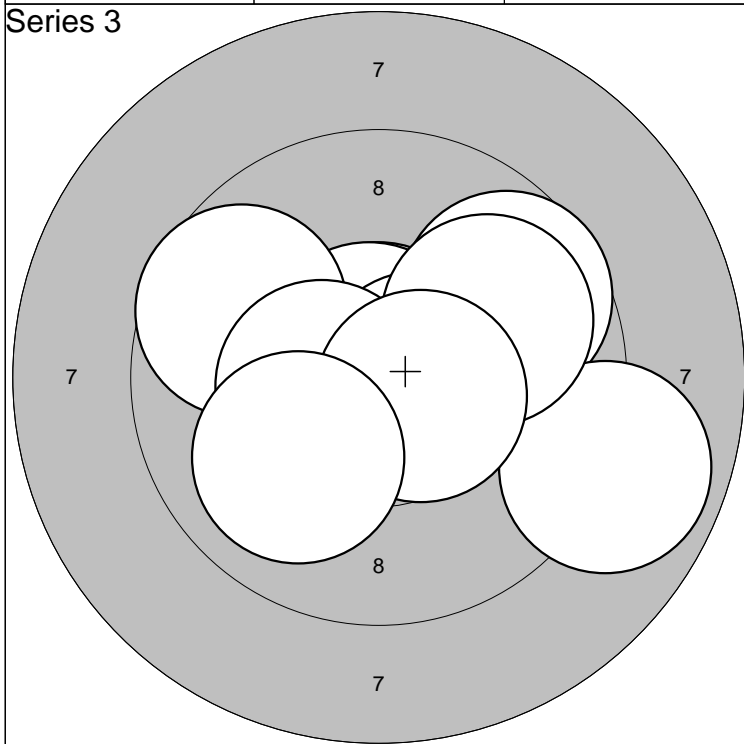

| | | | | | |
|---------|---|---------|---|-------|-------|
| 1: 9,7 | ↗ | 6: 8,9 | → | Serie | 95,0 |
| 2:10,7* | ↑ | 7: 9,9 | ↗ | | |
| 3:10,7* | ↑ | 8:10,5* | ← | Sum | 293,0 |
| 4: 9,7 | ↖ | 9:10,6* | → | | |
| 5:10,6* | → | 10:10,0 | ↘ | | |

| | | | | | |
|---------|---|---------|---|-------|-------|
| 1: 9,0 | ↗ | 6:10,6* | ↘ | Serie | 95,0 |
| 2: 9,8 | ↘ | 7: 9,5 | ↗ | | |
| 3:10,6* | ↘ | 8: 9,7 | ↗ | Sum | 388,0 |
| 4:10,5* | → | 9:10,6* | → | | |
| 5:10,1 | ↖ | 10: 9,9 | ↑ | | |

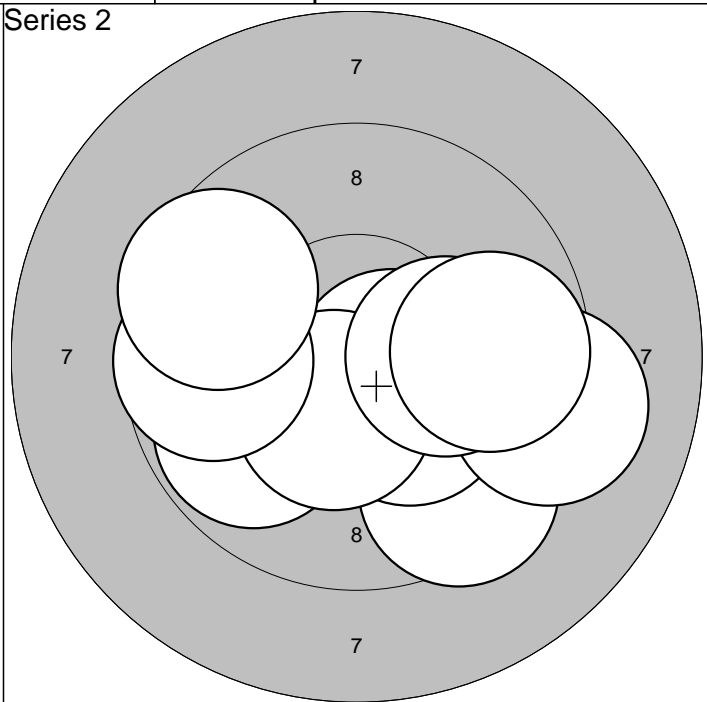
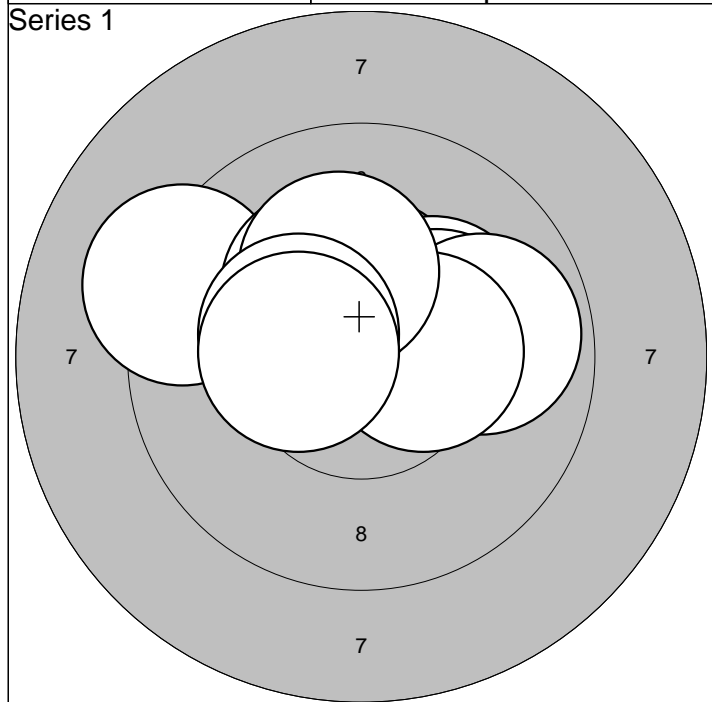

| | | | |
|-----------|------------|-------|------|
| 1: 9,2 ↙ | 6:10,4* → | Serie | 98,0 |
| 2:10,4* ↑ | 7:10,3* ↗ | | |
| 3:10,2* ↘ | 8:10,2* ↑ | Sum | 98,0 |
| 4:10,2* → | 9:10,4* ↙ | | |
| 5: 9,9 → | 10:10,4* ↖ | | |

| | | | |
|-----------|-----------|-------|-------|
| 1:10,6* → | 6: 9,7 ↙ | Serie | 94,0 |
| 2: 9,5 ↘ | 7: 9,6 ↖ | | |
| 3: 9,9 ↙ | 8: 9,2 → | Sum | 192,0 |
| 4:10,3* ↘ | 9:10,2* → | | |
| 5:10,4* ↘ | 10: 9,7 → | | |

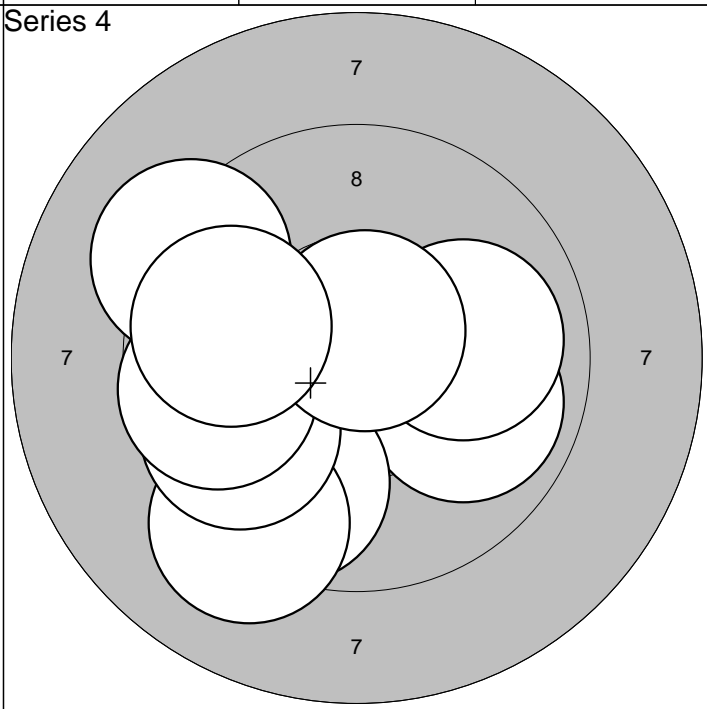
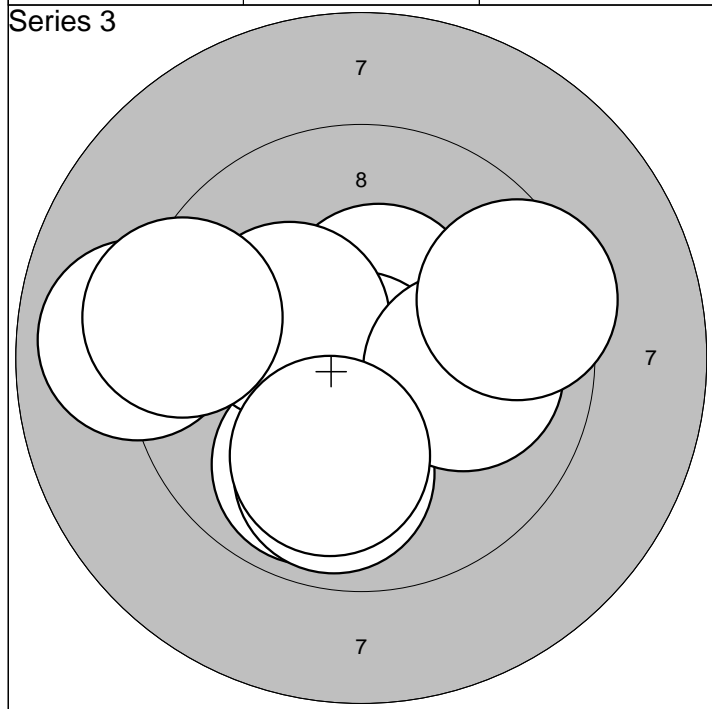

| | | | |
|-----------|-----------|-------|-------|
| 1: 9,9 ↘ | 6:10,0 → | Serie | 94,0 |
| 2: 9,9 ↘ | 7: 8,9 ↖ | | |
| 3:10,5* ↑ | 8:10,0 ↘ | Sum | 286,0 |
| 4:10,8* ↘ | 9: 9,4 → | | |
| 5:10,3* ↖ | 10: 9,3 ↖ | | |

| | | | |
|-----------|-----------|-------|-------|
| 1:10,7* → | 6: 9,7 ↙ | Serie | 93,0 |
| 2: 9,9 → | 7: 9,7 ↖ | | |
| 3: 9,7 ↘ | 8:10,7* ↑ | Sum | 379,0 |
| 4:10,0 → | 9: 9,2 ↖ | | |
| 5: 9,2 ↘ | 10: 9,8 ↖ | | |

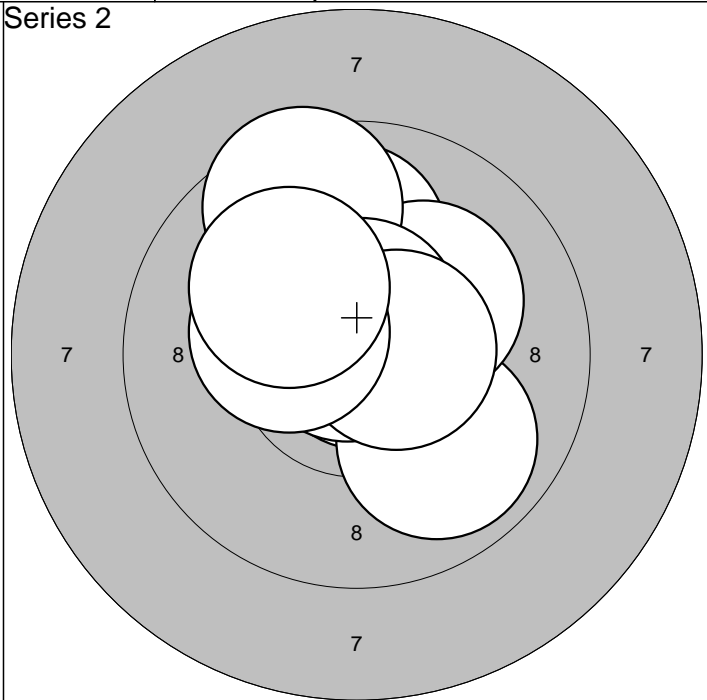
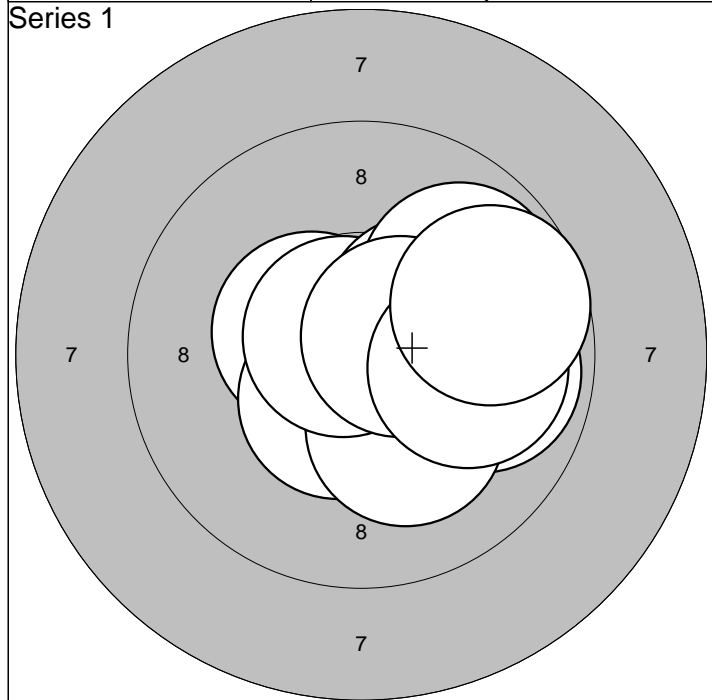

| | | | | | |
|-----------|-----------|--|--|-------|------|
| 1:10,5* ↙ | 6:10,3* ↗ | | | Serie | 97,0 |
| 2:10,5* ↘ | 7: 9,9 ↗ | | | | |
| 3: 9,9 → | 8:10,5* → | | | Sum | 97,0 |
| 4:10,2* ↘ | 9:10,0 → | | | | |
| 5:10,7* ↗ | 10: 9,7 → | | | | |

| | | | | | |
|-----------|-----------|--|--|-------|-------|
| 1:10,9* ↗ | 6: 9,5 ↗ | | | Serie | 97,0 |
| 2: 9,9 ↑ | 7:10,6* ↑ | | | | |
| 3: 9,9 ↘ | 8:10,6* → | | | Sum | 194,0 |
| 4:10,8* ↗ | 9:10,3* ↙ | | | | |
| 5:10,2* ↗ | 10:10,1 ↗ | | | | |

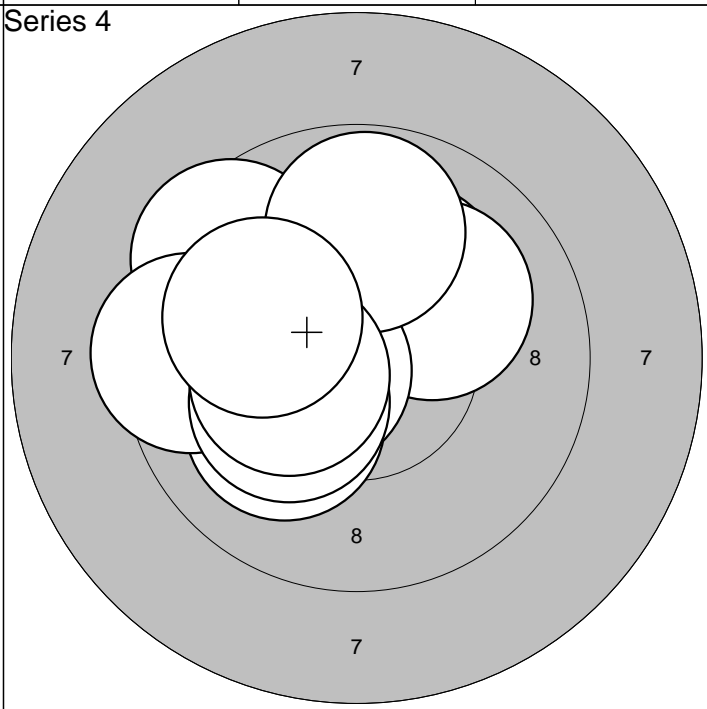
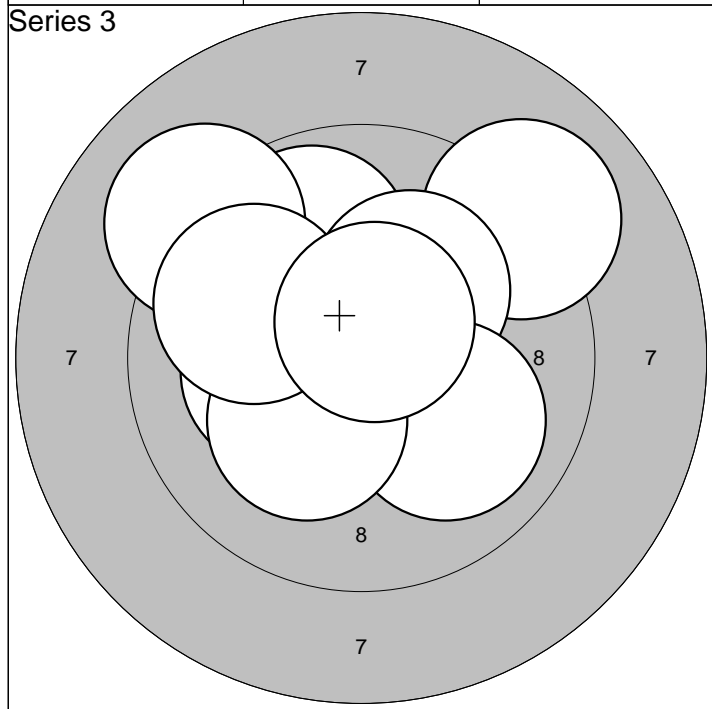

| | | | | | |
|-----------|------------|--|--|-------|-------|
| 1:10,1 ↙ | 6:10,0 ↘ | | | Serie | 96,0 |
| 2: 9,0 ↗ | 7:10,2* ↘ | | | | |
| 3: 9,9 ↗ | 8: 9,1 ↗ | | | Sum | 290,0 |
| 4:10,2* ↗ | 9: 9,9 ↙ | | | | |
| 5:10,2* ← | 10:10,6* ↗ | | | | |

| | | | | | |
|-----------|-----------|--|--|-------|-------|
| 1:10,1 ↗ | 6: 9,5 ← | | | Serie | 97,0 |
| 2: 9,5 ↙ | 7: 9,8 ↑ | | | | |
| 3:10,1 ↘ | 8:10,2* ↙ | | | Sum | 387,0 |
| 4:10,1 ↗ | 9:10,3* ← | | | | |
| 5:10,5* ← | 10:10,1 ↙ | | | | |

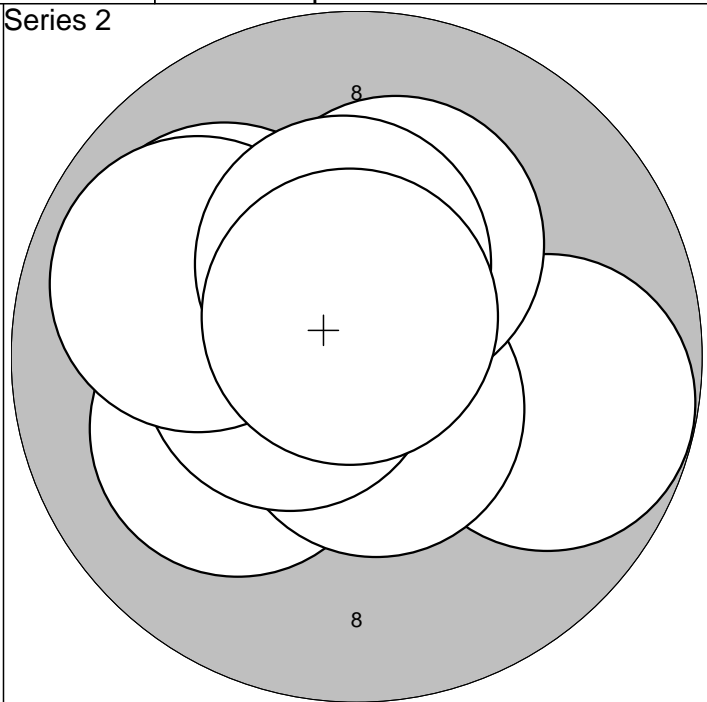
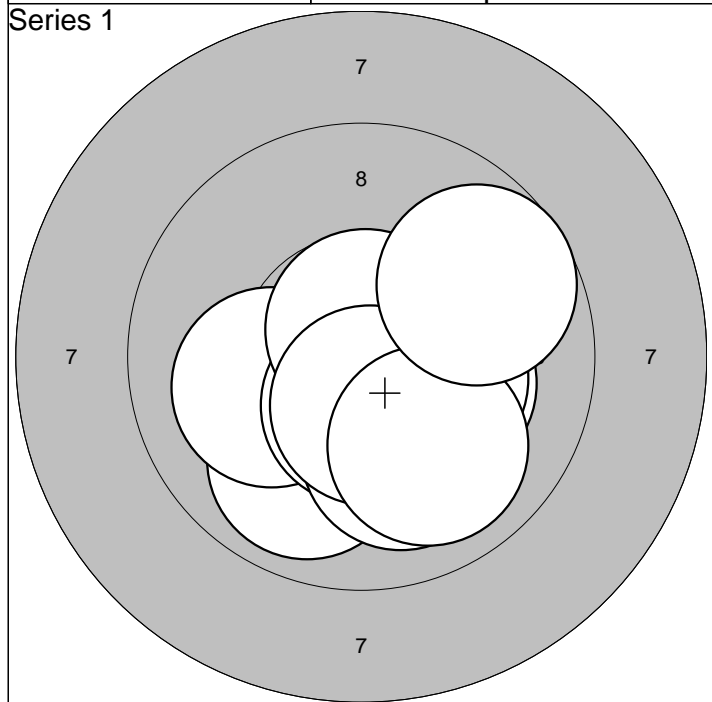

| | | |
|-----------|-----------|------------|
| 1: 9,9 ↓ | 6:10,3* → | Serie 97,0 |
| 2:10,1 ← | 7:10,7* ↑ | |
| 3:10,2* → | 8:10,5* ↓ | Sum 97,0 |
| 4:10,5* ↓ | 9: 9,9 ↓ | |
| 5:10,0 ↓ | 10: 9,7 ↗ | |

| | | |
|-----------|------------|------------|
| 1:10,1 ↙ | 6:10,0 ↖ | Serie 98,0 |
| 2:10,3* ↖ | 7: 9,9 ↖ | |
| 3: 9,8 → | 8:10,2* ↑ | Sum 195,0 |
| 4:10,6* ↓ | 9:10,4* ↑ | |
| 5:10,5* ← | 10:10,7* ↑ | |

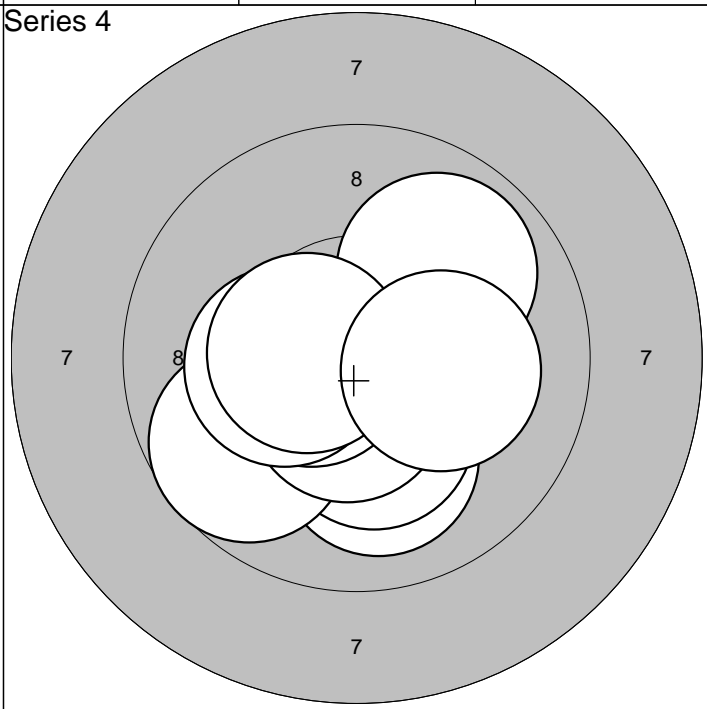
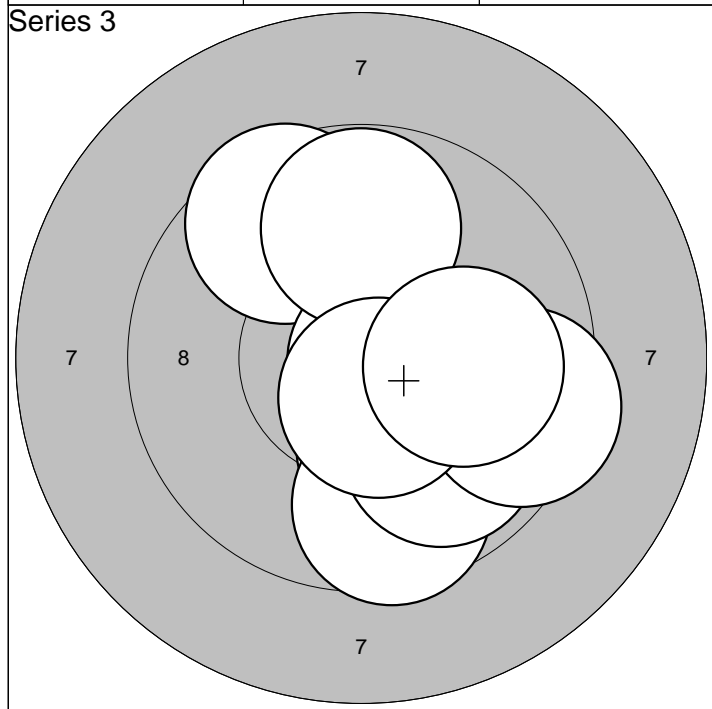

| | | |
|-----------|-----------|------------|
| 1:10,2* ↓ | 6: 9,6 ↓ | Serie 95,0 |
| 2: 9,6 ↗ | 7: 9,9 ↓ | |
| 3:10,7* → | 8: 9,4 → | Sum 290,0 |
| 4: 9,8 ↑ | 9:10,6* ↓ | |
| 5:10,1 ↓ | 10:10,0 → | |

| | | |
|-----------|------------|------------|
| 1:10,6* → | 6:10,6* ↓ | Serie 98,0 |
| 2: 9,9 ↗ | 7:10,5* ← | |
| 3:10,0 ↓ | 8:10,3* ← | Sum 388,0 |
| 4:10,3* ↓ | 9:10,5* ← | |
| 5: 9,7 ↙ | 10:10,2* → | |

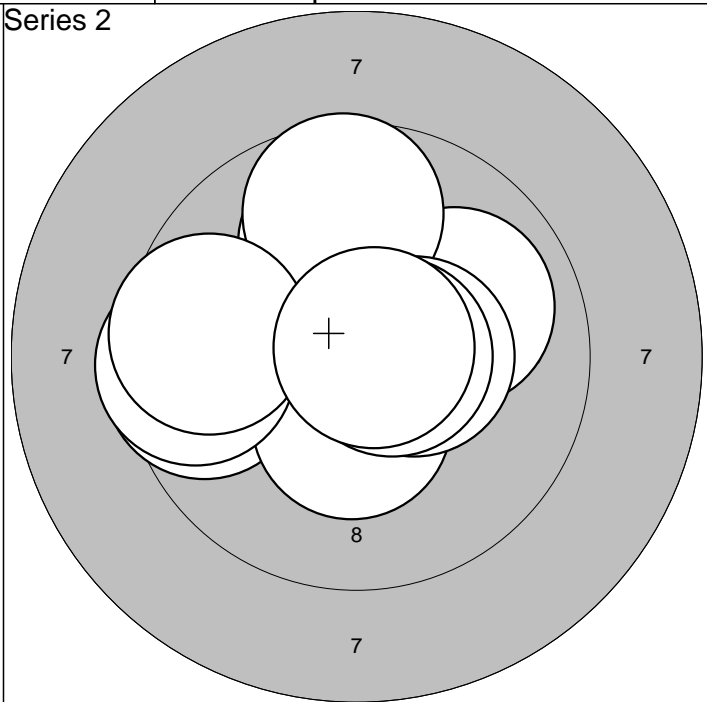
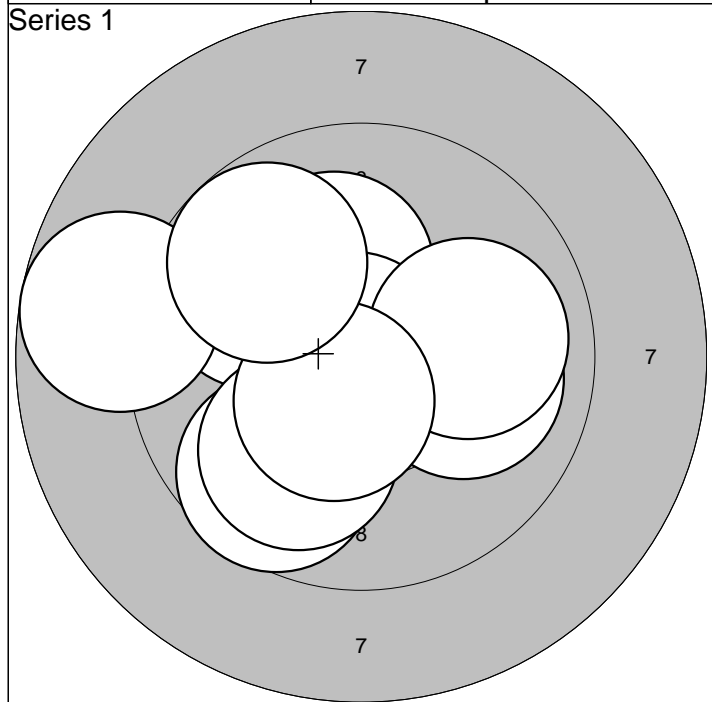

| | | | |
|----------|-----------|-------|------|
| 1:10,1 ↗ | 6:10,8* ↖ | Serie | 94,0 |
| 2:10,0 → | 7: 9,9 ↘ | | |
| 3: 9,7 ↘ | 8:10,0 → | Sum | 94,0 |
| 4: 9,8 ↗ | 9:10,5* ↘ | | |
| 5: 8,8 ← | 10: 9,8 ↗ | | |

| | | | |
|-----------|------------|-------|-------|
| 1: 9,9 ↗ | 6: 9,5 ← | Serie | 95,0 |
| 2: 9,6 ← | 7:10,4* → | | |
| 3:10,0 ↗ | 8:10,6* → | Sum | 189,0 |
| 4:10,4* ↓ | 9: 9,6 ← | | |
| 5: 9,7 ↗ | 10:10,8* ↗ | | |

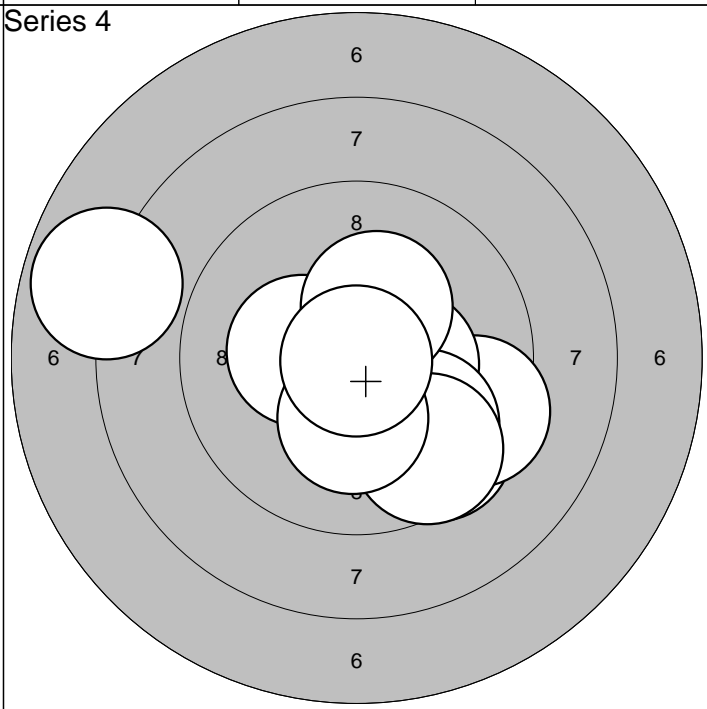
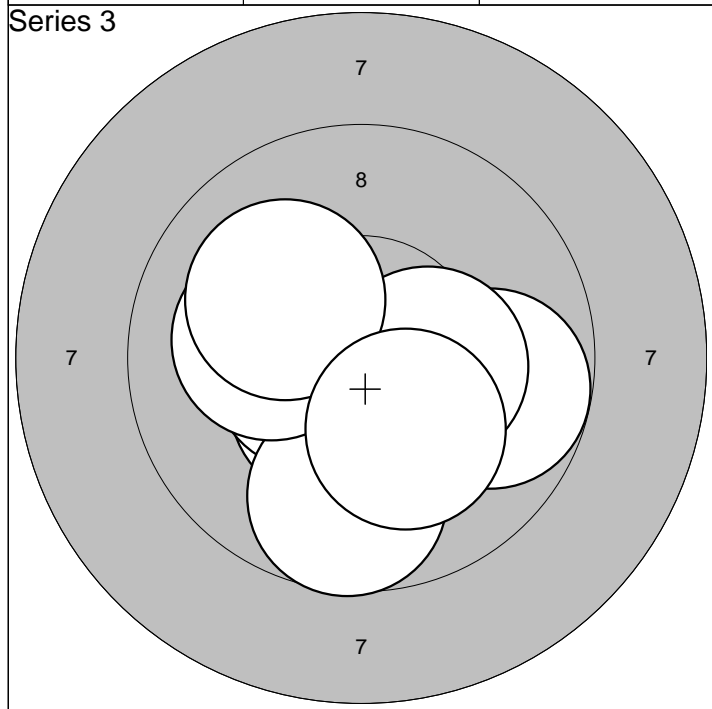

| | | | |
|-----------|------------|-------|-------|
| 1:10,5* ↓ | 6:10,1 ← | Serie | 98,0 |
| 2:10,5* ↘ | 7: 9,8 → | | |
| 3:10,5* ← | 8:10,3* → | Sum | 287,0 |
| 4:10,3* ↘ | 9:10,1 ↗ | | |
| 5: 9,7 ↓ | 10:10,2* ↓ | | |

| | | | |
|-----------|------------|-------|-------|
| 1: 9,5 ↘ | 6: 9,6 ↘ | Serie | 93,0 |
| 2: 9,4 → | 7:10,3* ↗ | | |
| 3:10,4* → | 8: 7,8 ← | Sum | 380,0 |
| 4: 9,8 ↘ | 9:10,2* ↓ | | |
| 5:10,3* ← | 10:10,9* ↓ | | |

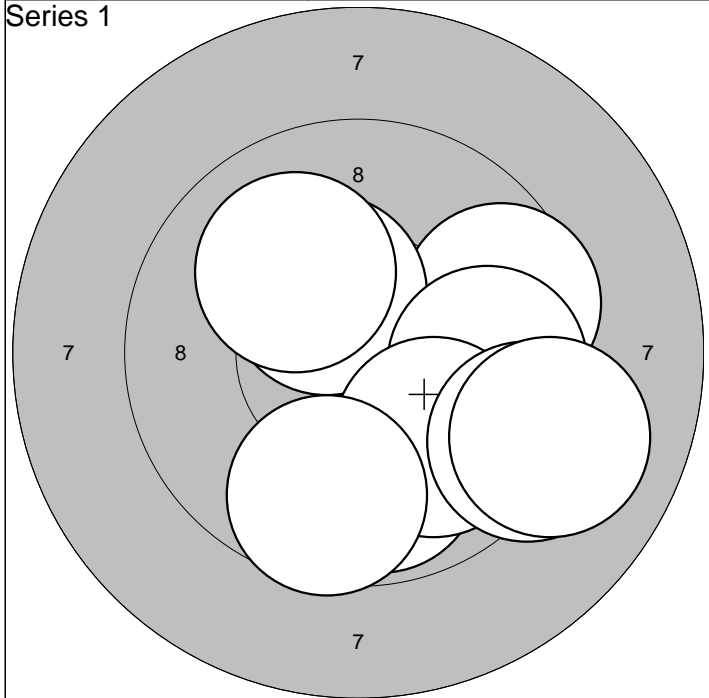

| | | | |
|-----------|-----------|-------|------|
| 1: 9,9 ↓ | 6:10,0 ↗ | Serie | 93,0 |
| 2:10,2* ↓ | 7: 9,9 ↓ | | |
| 3: 9,6 → | 8: 9,2 ↓ | Sum | 93,0 |
| 4:10,3* ↗ | 9: 9,6 ↓ | | |
| 5: 9,8 → | 10: 9,1 ↘ | | |

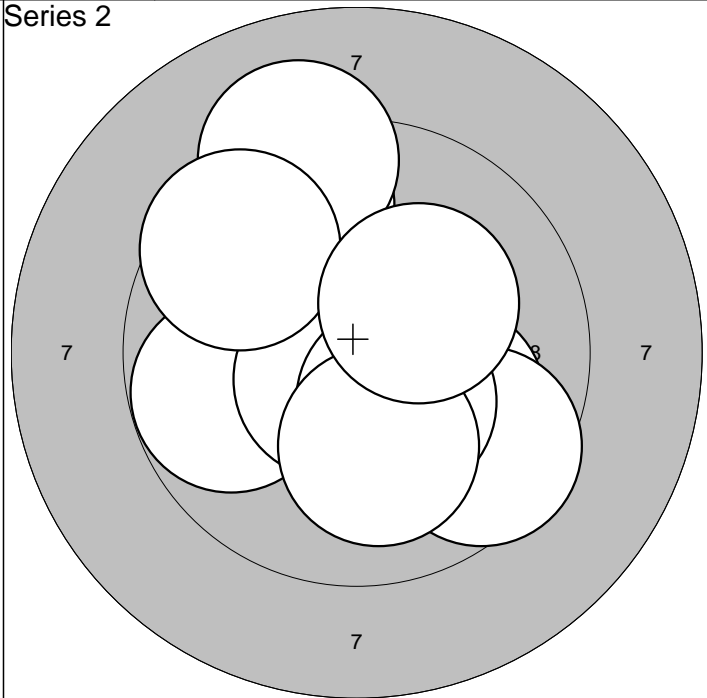

| | | | |
|-----------|------------|-------|-------|
| 1: 9,5 ↗ | 6:10,0 ↘ | Serie | 95,0 |
| 2: 9,2 ↗ | 7: 9,6 ↓ | | |
| 3: 9,8 ← | 8:10,4* ↓ | Sum | 188,0 |
| 4:10,6* ↘ | 9:10,1 ↓ | | |
| 5: 9,6 ↖ | 10:10,2* ↗ | | |

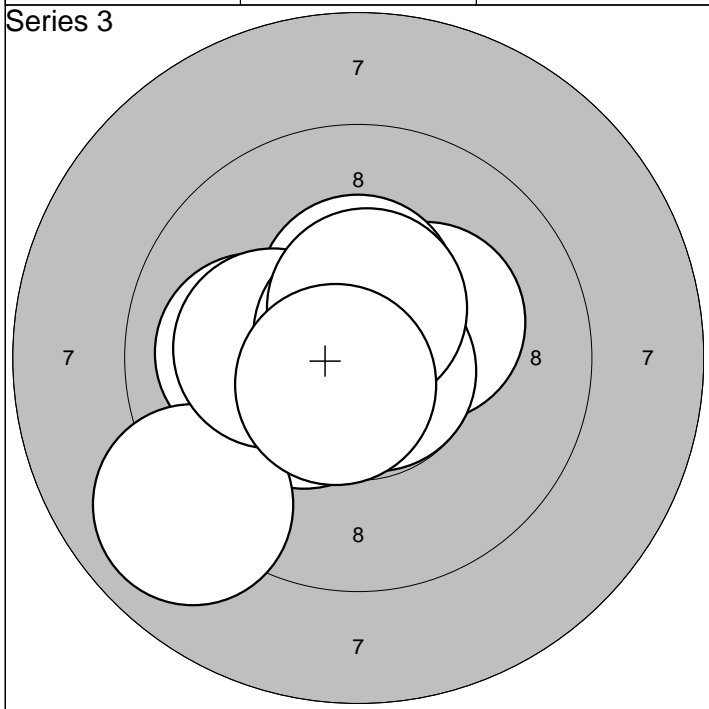

| | | | |
|-----------|------------|-------|-------|
| 1:10,0 ← | 6:10,2* ← | Serie | 99,0 |
| 2:10,3* ↗ | 7:10,8* ↑ | | |
| 3:10,4* ← | 8:10,8* ↘ | Sum | 287,0 |
| 4: 9,0 ← | 9:10,5* ↑ | | |
| 5:10,4* ↑ | 10:10,6* ↘ | | |

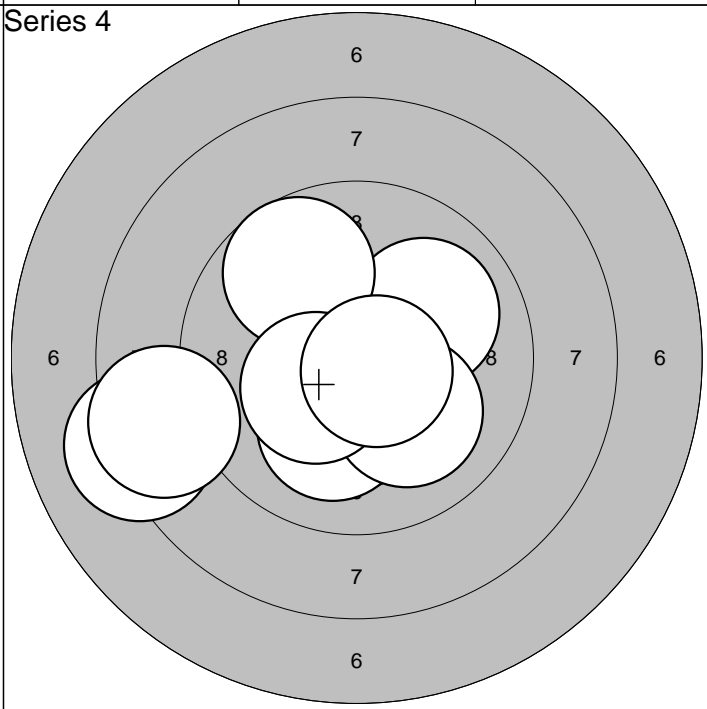

| | | | |
|-----------|-----------|-------|-------|
| 1:10,0 ↗ | 6:10,1 ↓ | Serie | 95,0 |
| 2: 8,2 ← | 7:10,1 ↓ | | |
| 3:10,7* ↘ | 8:10,4* ← | Sum | 382,0 |
| 4: 9,7 ↗ | 9:10,7* ↘ | | |
| 5:10,3* ↓ | 10: 8,6 ← | | |

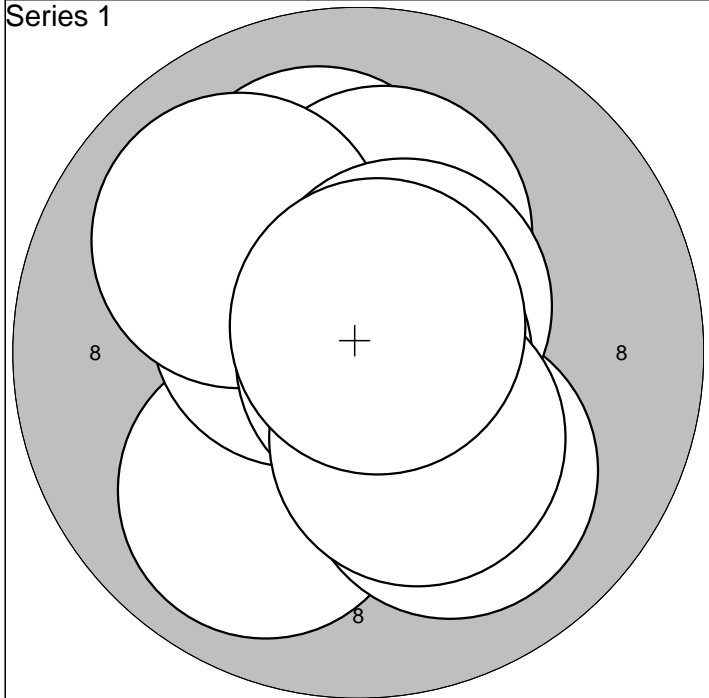

| | | | | | | | |
|---------|---|----------|---|--|--|-------|------|
| 1:10,1 | ↗ | 6: 9,9 | ↖ | | | Serie | 98,0 |
| 2:10,2* | ↗ | 7:10,5* | ↗ | | | | |
| 3: 9,9 | ↘ | 8:10,8* | → | | | | |
| 4:10,0 | ↘ | 9:10,3* | ↘ | | | Sum | 98,0 |
| 5:10,5* | ↖ | 10:10,8* | ↗ | | | | |

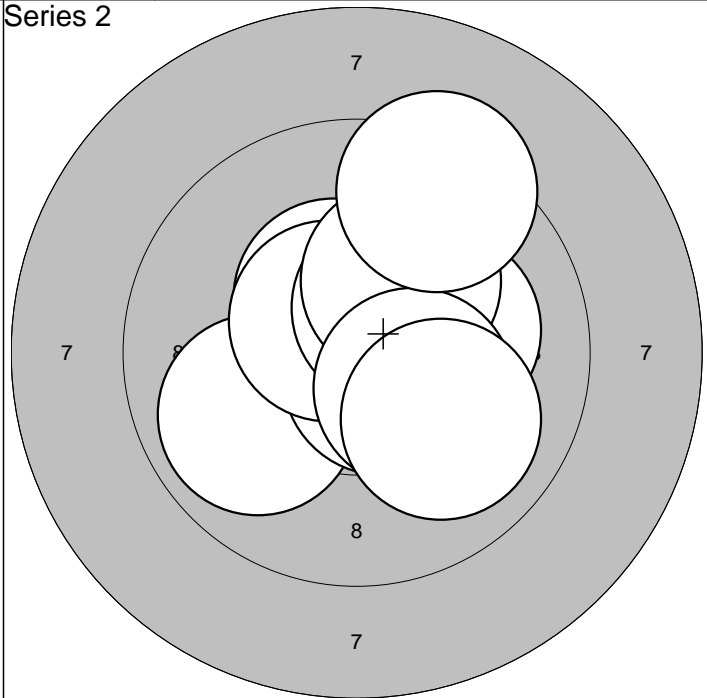

| | | | | | | | |
|---------|---|---------|---|--|--|-------|-------|
| 1:10,4* | ↗ | 6:10,4* | ↗ | | | Serie | 98,0 |
| 2: 9,9 | ↖ | 7:10,2* | ↗ | | | | |
| 3:10,2* | → | 8:10,4* | ↘ | | | | |
| 4:10,6* | ↘ | 9: 9,3 | ↗ | | | Sum | 196,0 |
| 5:10,6* | ↖ | 10:10,0 | ↘ | | | | |

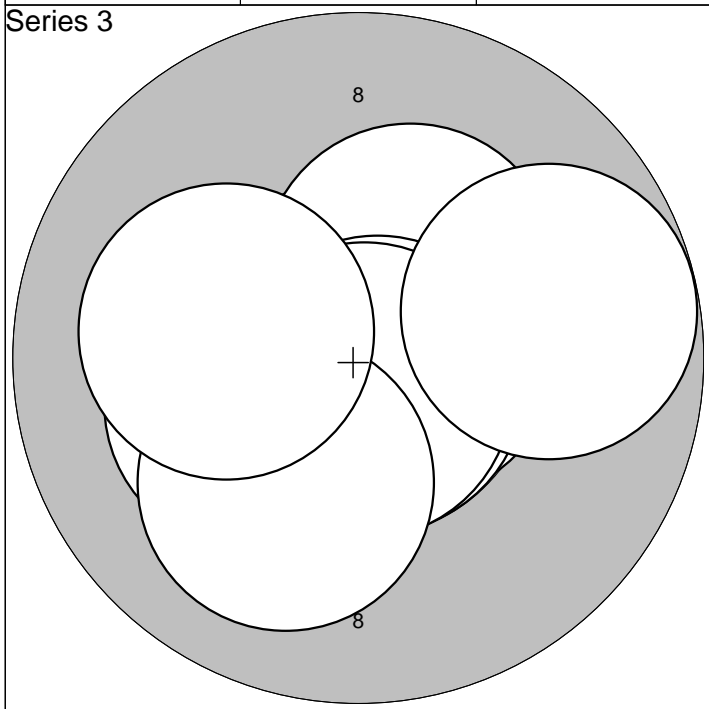

| | | | | | | | |
|---------|---|---------|---|--|--|-------|-------|
| 1:10,6* | → | 6:10,7* | ↘ | | | Serie | 99,0 |
| 2:10,4* | ← | 7:10,8* | ↘ | | | | |
| 3:10,3* | ← | 8:10,1 | ↘ | | | | |
| 4:10,8* | ↗ | 9: 9,8 | → | | | Sum | 295,0 |
| 5:10,3* | ↗ | 10:10,1 | ← | | | | |

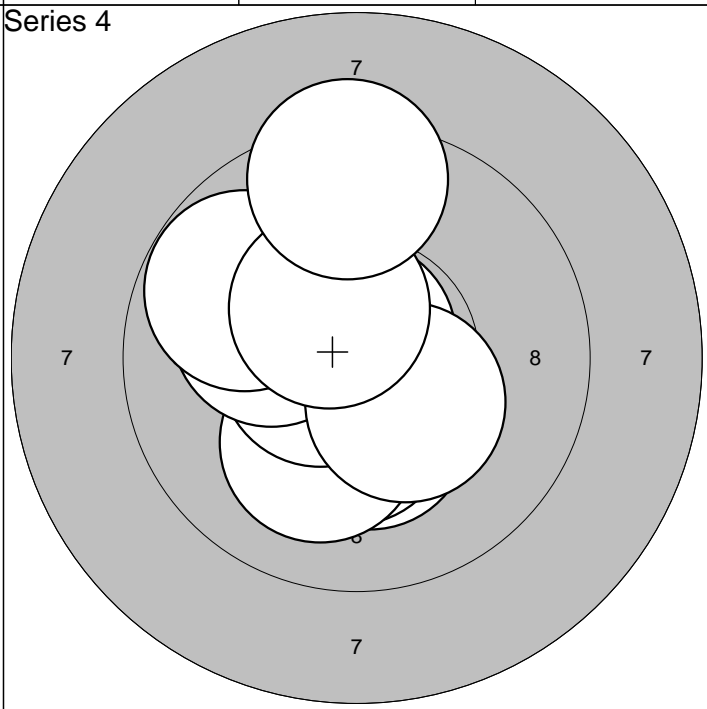

| | | | | | | | |
|---------|---|---------|---|--|--|-------|-------|
| 1:10,8* | ↗ | 6:10,2* | ↖ | | | Serie | 98,0 |
| 2:10,3* | ↘ | 7:10,4* | ↘ | | | | |
| 3:10,4* | ↘ | 8: 9,8 | ↖ | | | | |
| 4:10,1 | ↘ | 9:10,5* | ↗ | | | Sum | 393,0 |
| 5:10,6* | ← | 10: 9,4 | ↗ | | | | |

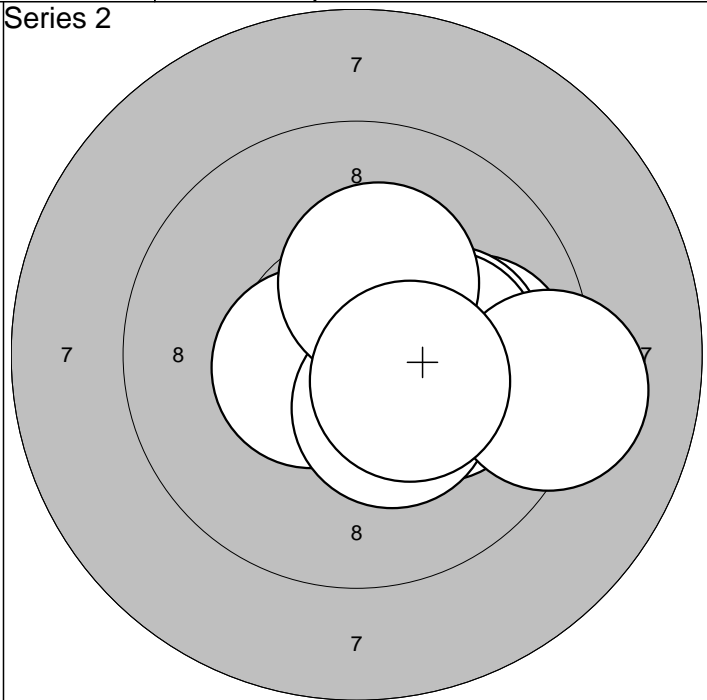
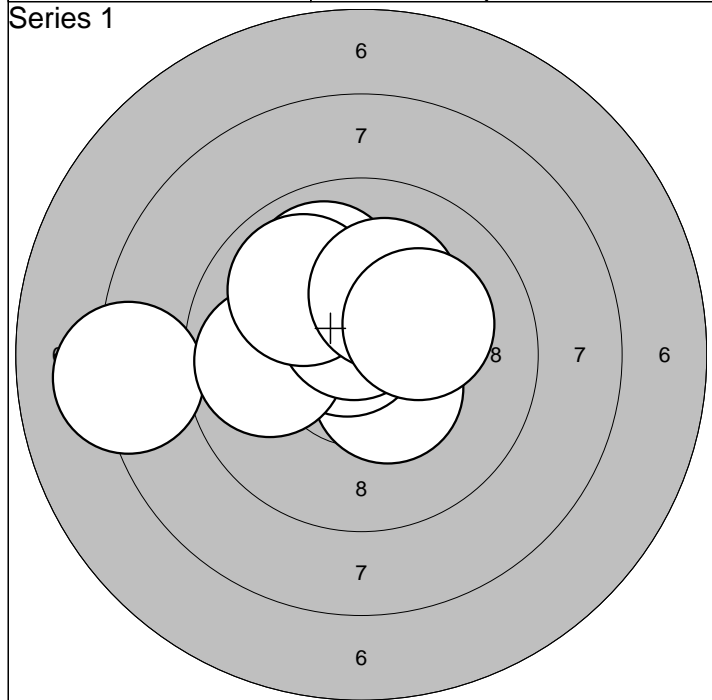

| | | | | | |
|-----------|------------|-----|------|-------|------|
| 1:10,4* ↘ | 6:10,6* ↗ | | | Serie | 96,0 |
| 2:10,3* ↗ | 7: 9,9 ↗ | | | | |
| 3:10,7* ↘ | 8:10,0 ↘ | Sum | 96,0 | | |
| 4: 8,2 ← | 9:10,2* ↗ | | | | |
| 5: 9,9 ← | 10:10,2* ↗ | | | | |

| | | | | | |
|-----------|------------|-----|-------|-------|------|
| 1:10,2* → | 6:10,2* → | | | Serie | 98,0 |
| 2:10,7* → | 7:10,4* ↘ | | | | |
| 3:10,5* ← | 8:10,3* ↗ | Sum | 194,0 | | |
| 4: 9,9 → | 9: 9,2 → | | | | |
| 5:10,1 → | 10:10,4* ↘ | | | | |

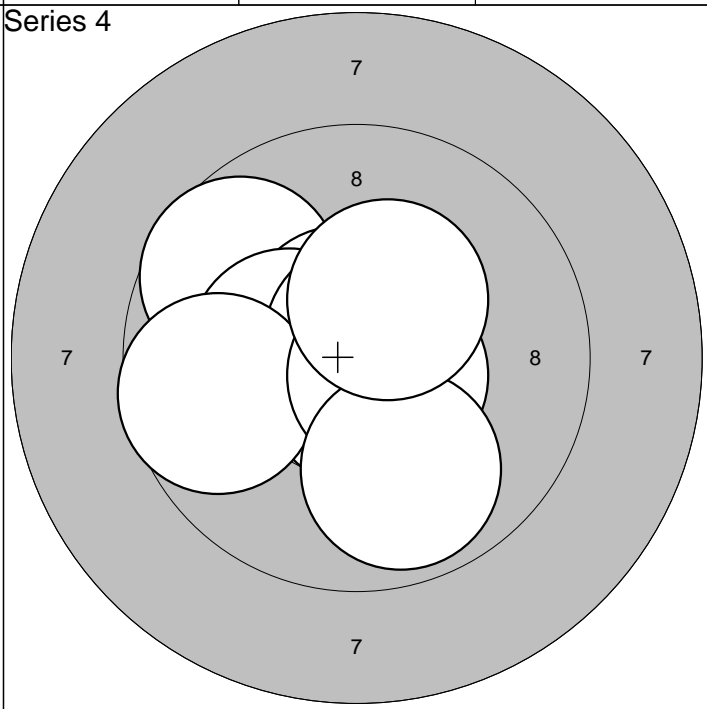
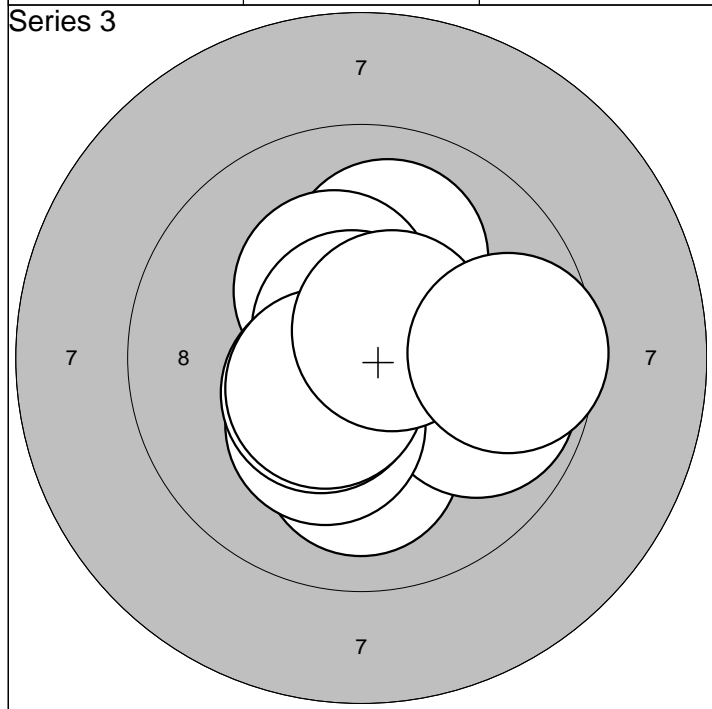

| | | | | | |
|-----------|-----------|-----|-------|-------|------|
| 1:10,1 ↓ | 6:10,3* ↘ | | | Serie | 98,0 |
| 2:10,0 ↗ | 7:10,5* ↘ | | | | |
| 3:10,3* ↗ | 8:10,5* ↘ | Sum | 292,0 | | |
| 4:10,7* ↗ | 9:10,6* ↗ | | | | |
| 5: 9,9 → | 10: 9,6 → | | | | |

| | | | | | |
|-----------|------------|-----|-------|-------|------|
| 1:10,7* ↓ | 6:10,8* ↗ | | | Serie | 97,0 |
| 2:10,8* ↗ | 7: 9,7 ← | | | | |
| 3: 9,7 ↘ | 8:10,6* → | Sum | 389,0 | | |
| 4:10,6* ↗ | 9: 9,9 ↓ | | | | |
| 5:10,3* ← | 10:10,4* ↗ | | | | |

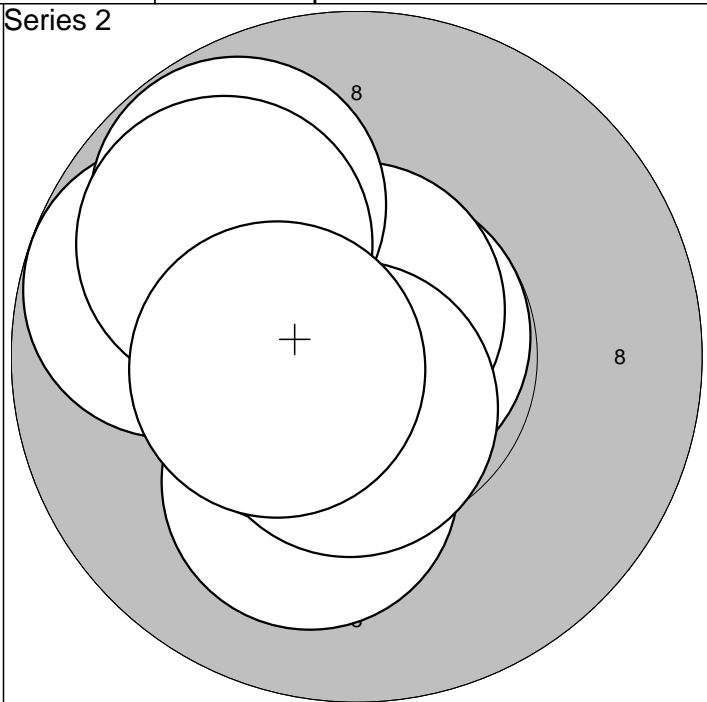
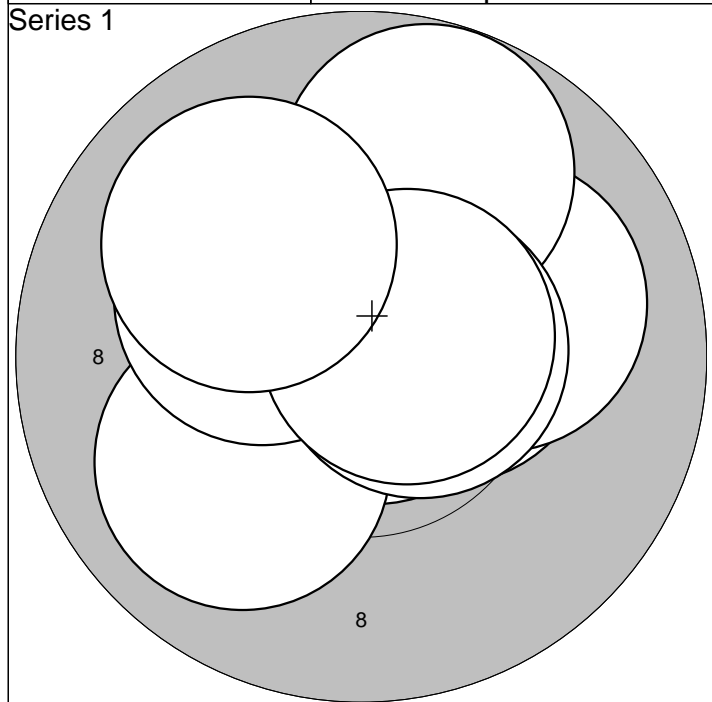

| | | | |
|-----------|-----------|-------|------|
| 1:10,9* → | 6: 9,8 ↑ | Serie | 99,0 |
| 2:10,4* → | 7:10,2* ← | | |
| 3:10,5* ↑ | 8:10,6* → | Sum | 99,0 |
| 4:10,0 → | 9:10,6* → | | |
| 5:10,0 ↙ | 10:10,0 ↖ | | |

| | | | |
|-----------|------------|-------|-------|
| 1:10,1 ↓ | 6:10,7* ↑ | Serie | 97,0 |
| 2:10,8* ← | 7:10,6* ↓ | | |
| 3: 9,7 ← | 8: 9,8 ↖ | Sum | 196,0 |
| 4:10,8* ↗ | 9: 9,9 ↗ | | |
| 5:10,6* ← | 10:10,5* ← | | |

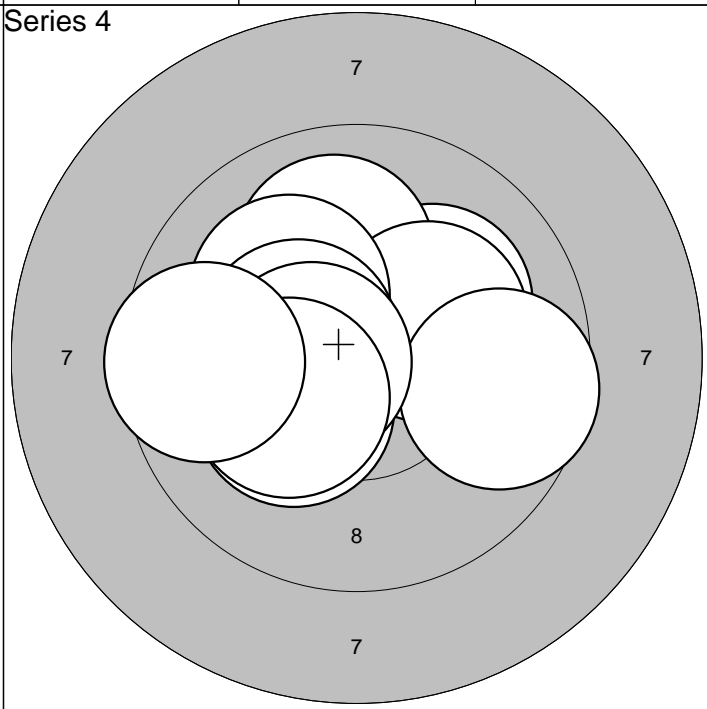
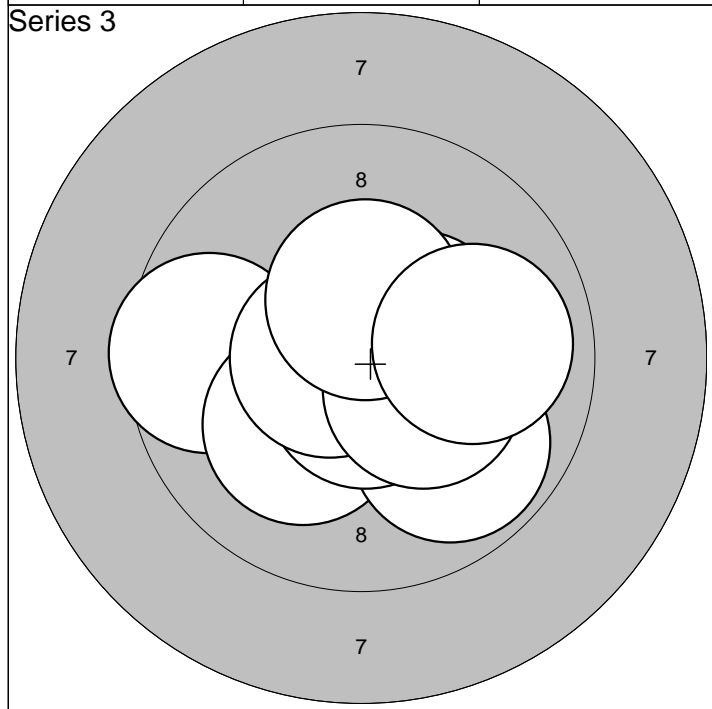

| | | | |
|-----------|-----------|-------|-------|
| 1: 9,6 ← | 6:10,7* ↓ | Serie | 97,0 |
| 2:10,1 ↙ | 7:10,7* ← | | |
| 3: 9,8 ↘ | 8:10,3* → | Sum | 293,0 |
| 4:10,5* ↑ | 9:10,4* ↑ | | |
| 5:10,4* ↗ | 10: 9,9 → | | |

| | | | |
|-----------|-----------|-------|-------|
| 1:10,2* ↙ | 6:10,4* ← | Serie | 98,0 |
| 2:10,1 ↗ | 7: 9,6 → | | |
| 3:10,0 ↑ | 8:10,5* ← | Sum | 391,0 |
| 4:10,3* ↗ | 9:10,3* ← | | |
| 5:10,1 ↖ | 10: 9,6 ← | | |

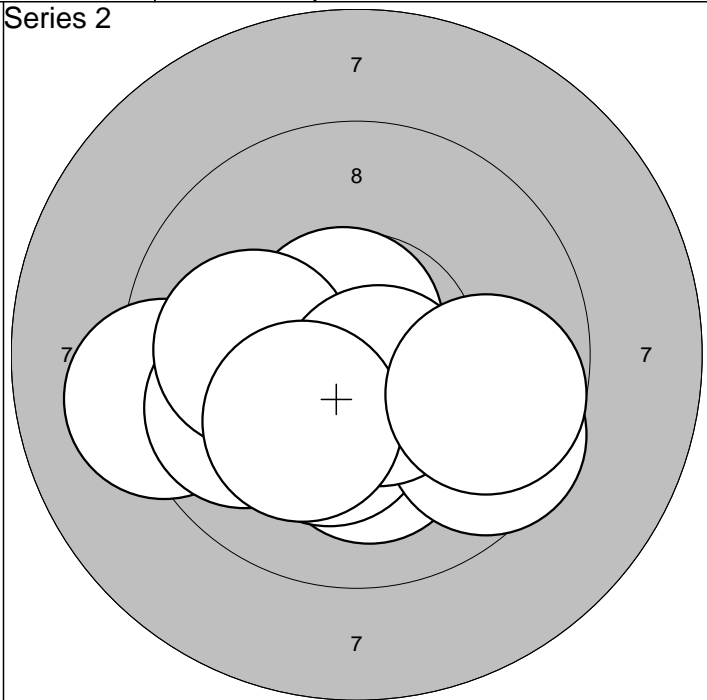
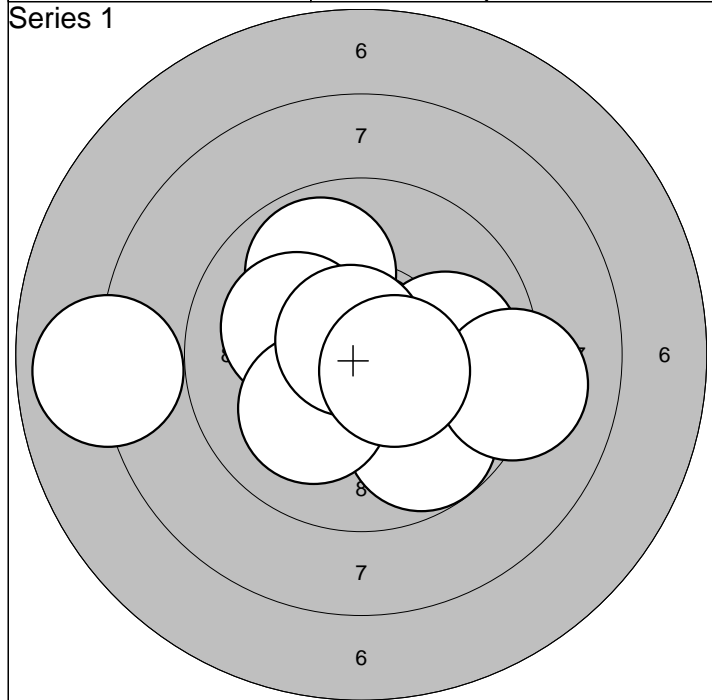

| | | | |
|-----------|------------|-------|------|
| 1: 9,9 ↗ | 6:10,1 ↘ | Serie | 94,0 |
| 2:10,1 ↖ | 7: 9,1 → | | |
| 3:10,9* ↑ | 8:10,7* ↗ | Sum | 94,0 |
| 4:10,0 → | 9: 7,9 ← | | |
| 5: 9,8 ↘ | 10:10,5* ↘ | | |

| | | | |
|-----------|-----------|-------|-------|
| 1: 9,2 ← | 6: 9,6 ↘ | Serie | 96,0 |
| 2:10,2* ↓ | 7:10,0 ← | | |
| 3:10,3* ↓ | 8:10,6* ↓ | Sum | 190,0 |
| 4:10,7* ↗ | 9:10,2* ↘ | | |
| 5: 9,8 ← | 10: 9,8 → | | |

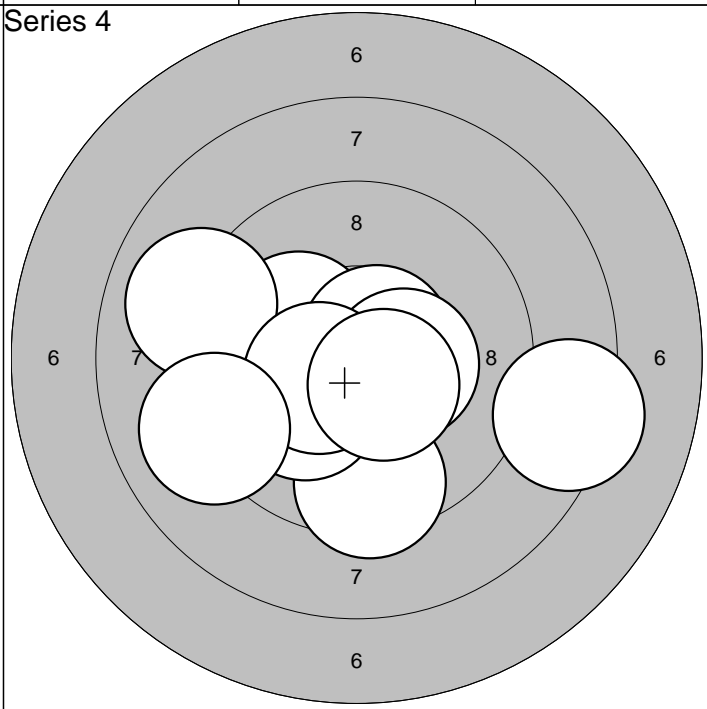
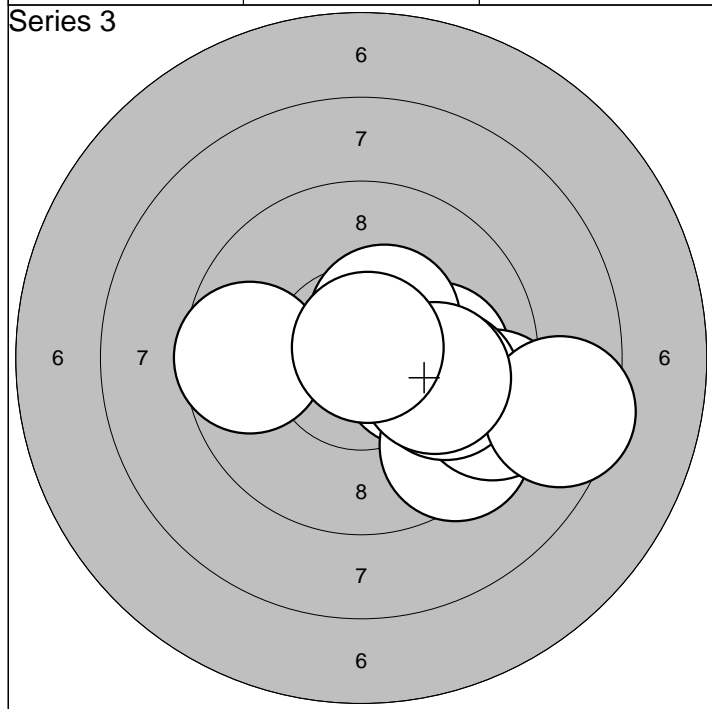

| | | | |
|-----------|------------|-------|-------|
| 1:10,3* → | 6: 9,9 → | Serie | 94,0 |
| 2: 9,4 ↘ | 7:10,4* ↗ | | |
| 3: 9,6 ← | 8: 8,5 → | Sum | 284,0 |
| 4:10,1 → | 9:10,0 → | | |
| 5: 9,3 ↘ | 10:10,8* ↗ | | |

| | | | |
|-----------|-----------|-------|-------|
| 1: 9,5 ↓ | 6:10,1 ↘ | Serie | 95,0 |
| 2:10,2* ↖ | 7:10,4* ↖ | | |
| 3:10,6* ↗ | 8: 9,1 ← | Sum | 379,0 |
| 4:10,4* → | 9:10,5* ↘ | | |
| 5: 9,0 ← | 10: 8,4 → | | |

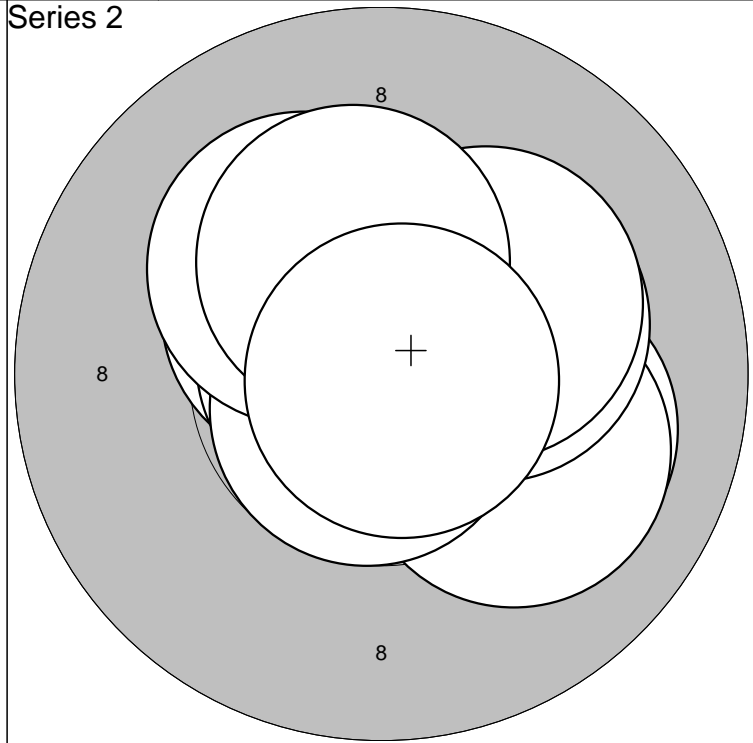

| | | | | | |
|---------|---|----------|---|-------|------|
| 1:10,7* | ↗ | 6: 9,9 | ↘ | Serie | 97,0 |
| 2:10,0 | ← | 7: 9,8 | → | | |
| 3:10,3* | ↙ | 8:10,5* | ↑ | Sum | 97,0 |
| 4:10,4* | → | 9: 9,9 | ← | | |
| 5:10,6* | ↙ | 10:10,4* | ↙ | | |

| | | | | | |
|---------|---|----------|---|-------|-------|
| 1:10,1 | → | 6:10,7* | ↘ | Serie | 100,0 |
| 2:10,4* | ↗ | 7:10,2* | ↗ | | |
| 3:10,1 | ↘ | 8:10,2* | ↗ | Sum | 197,0 |
| 4:10,8* | ← | 9:10,3* | ↑ | | |
| 5:10,3* | → | 10:10,8* | → | | |

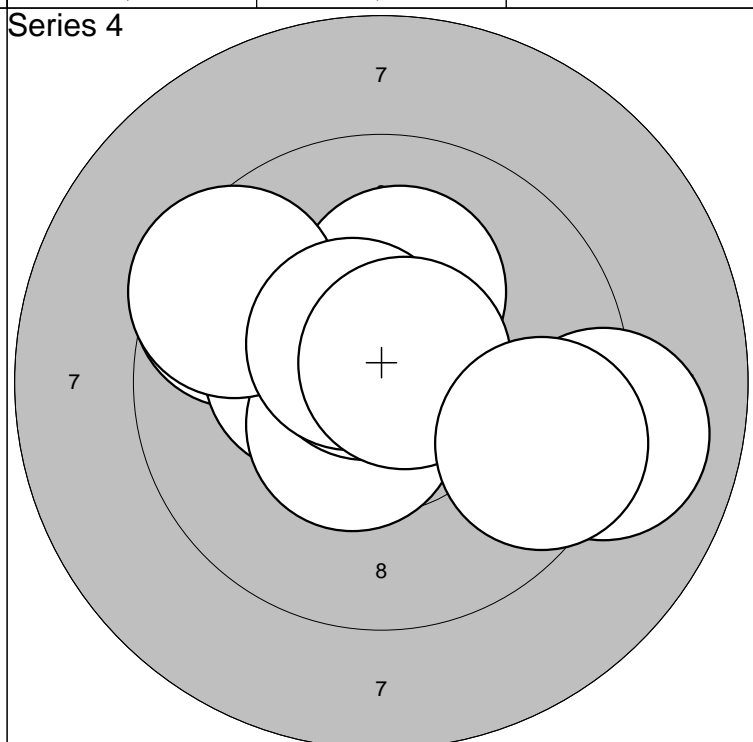
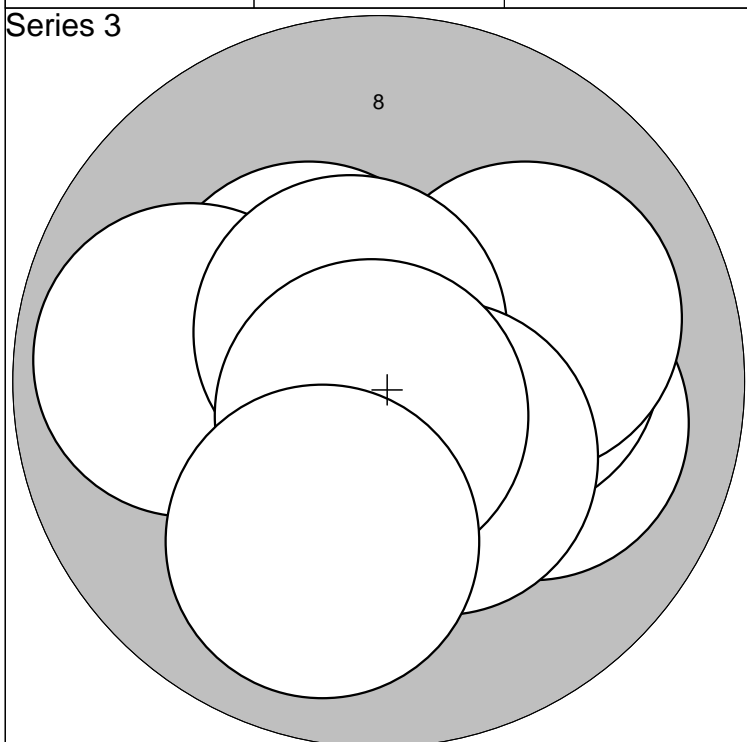

| | | | | | |
|---------|---|---------|---|-------|-------|
| 1:10,7* | ← | 6: 9,9 | ← | Serie | 99,0 |
| 2:10,1 | → | 7:10,6* | ↗ | | |
| 3:10,4* | ↗ | 8:10,4* | ↘ | Sum | 296,0 |
| 4:10,2* | → | 9:10,7* | ↘ | | |
| 5:10,0 | → | 10:10,0 | ↘ | | |

| | | | | | |
|---------|---|---------|---|-------|-------|
| 1: 9,6 | ↖ | 6:10,7* | ↗ | Serie | 96,0 |
| 2:10,3* | ← | 7: 9,5 | ↖ | | |
| 3: 9,0 | → | 8:10,6* | ↗ | Sum | 392,0 |
| 4:10,5* | ↘ | 9:10,7* | ↗ | | |
| 5:10,2* | ↑ | 10: 9,5 | → | | |

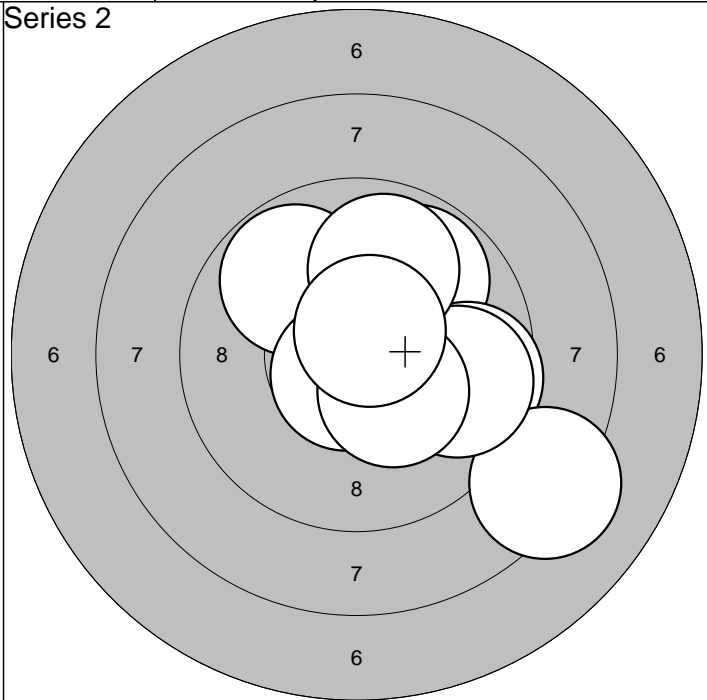
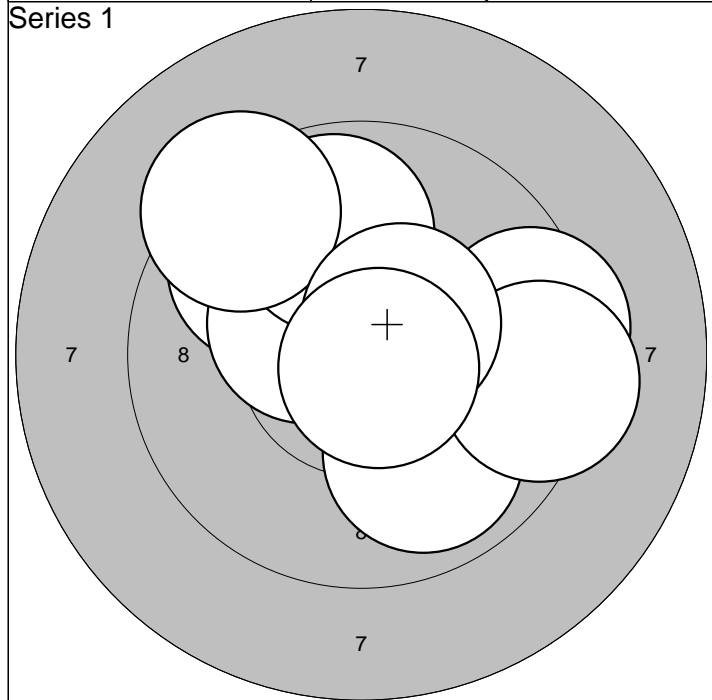

| | | | | |
|-----------|------------|-----|-------|------|
| 1: 9,8 ↗ | 6: 9,3 → | | Serie | 94,0 |
| 2:10,4* ↖ | 7: 9,8 ↑ | | | |
| 3:10,2* → | 8: 9,3 ↗ | Sum | 94,0 | |
| 4: 9,4 → | 9:10,5* ↗ | | | |
| 5: 9,9 ↓ | 10:10,8* ↓ | | | |

| | | | | |
|-----------|------------|-----|-------|------|
| 1: 9,8 ↗ | 6: 9,7 → | | Serie | 93,0 |
| 2: 9,8 ↖ | 7:10,7* ↓ | | | |
| 3: 9,6 → | 8: 9,9 ↑ | Sum | 187,0 | |
| 4:10,7* ↗ | 9:10,3* ↓ | | | |
| 5: 8,2 ↓ | 10:10,6* ↗ | | | |

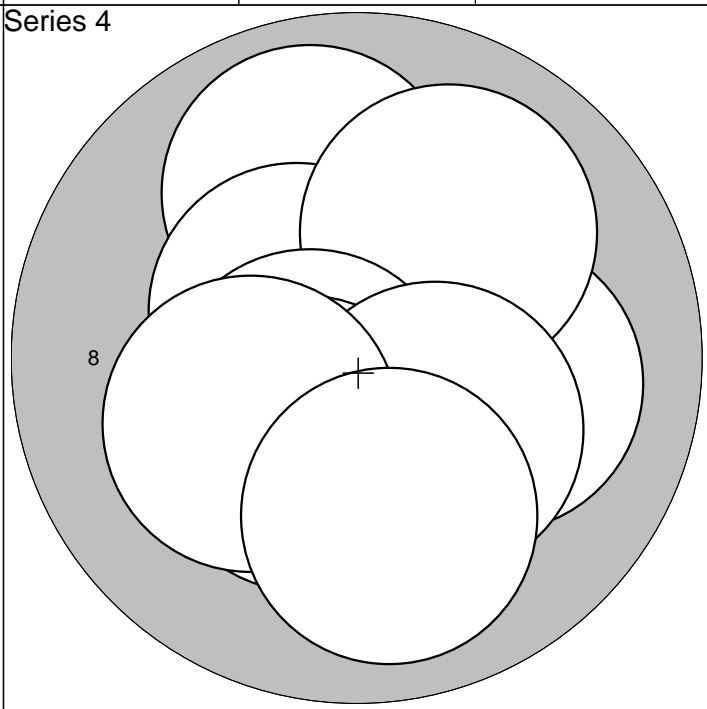
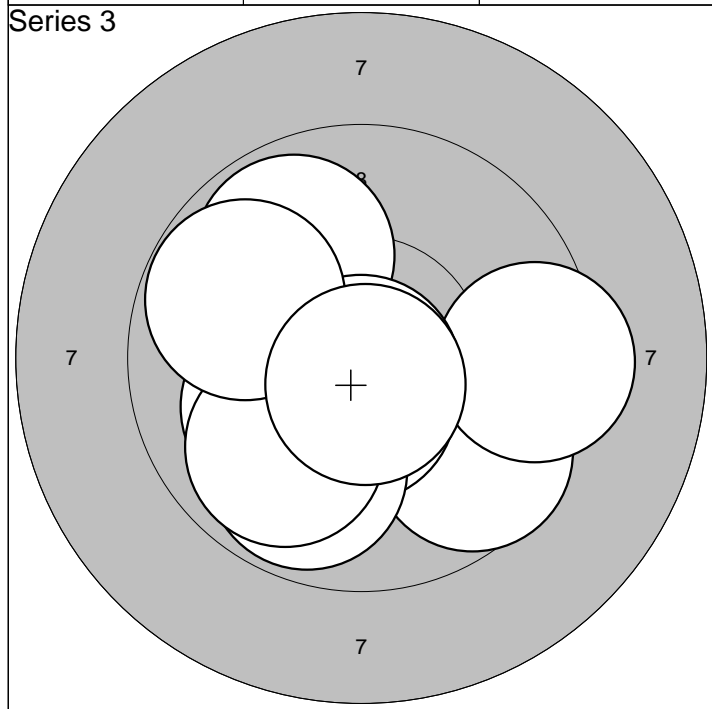

| | | | | |
|-----------|------------|-----|-------|------|
| 1: 9,7 ↓ | 6:10,8* ↓ | | Serie | 94,0 |
| 2:10,6* ↓ | 7:10,1 ↖ | | | |
| 3: 9,9 ↗ | 8: 9,9 ↖ | Sum | 281,0 | |
| 4: 9,8 ↓ | 9: 9,8 ↖ | | | |
| 5: 9,4 → | 10:10,7* ↓ | | | |

| | | | | |
|-----------|-----------|-----|-------|------|
| 1: 9,9 ↗ | 6:10,6* ↖ | | Serie | 99,0 |
| 2:10,7* ↓ | 7:10,3* ↖ | | | |
| 3:10,1 → | 8:10,3* ↓ | Sum | 380,0 | |
| 4:10,5* ↖ | 9:10,2* ↖ | | | |
| 5:10,0 ↗ | 10:10,0 ↓ | | | |

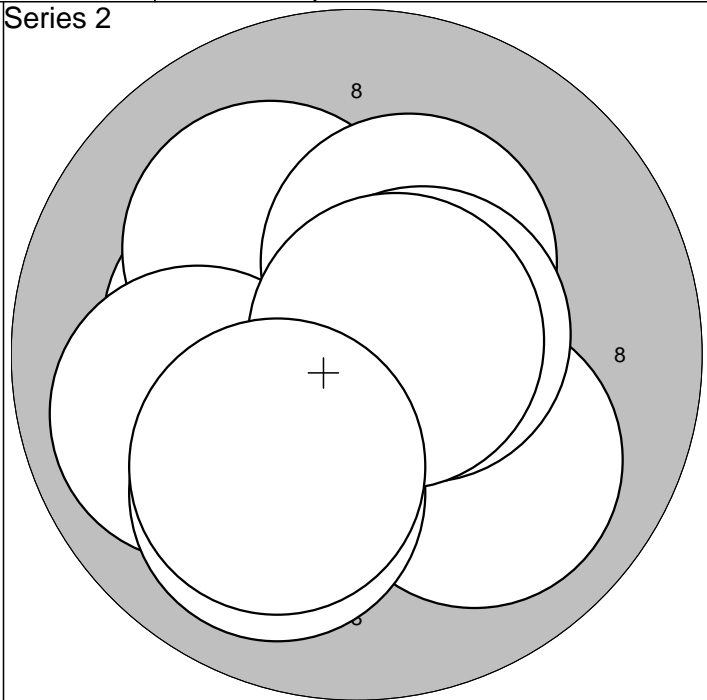
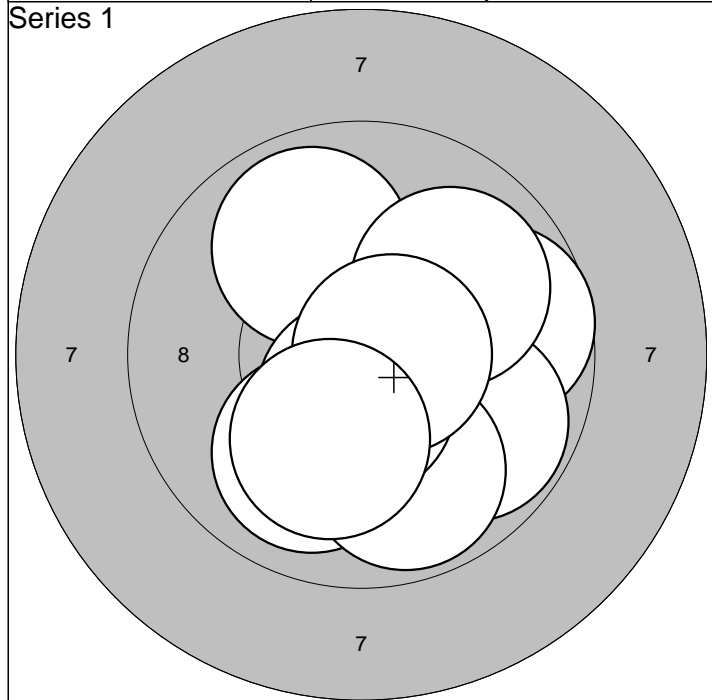

| | | | | | | | |
|-----------|-----------|--|--|--|--|-------|------|
| 1: 9,9 ↗ | 6:10,0 ↓ | | | | | Serie | 96,0 |
| 2:10,4* → | 7: 9,8 ↓ | | | | | Sum | 96,0 |
| 3: 9,7 → | 8:10,5* ↓ | | | | | | |
| 4: 9,8 ↘ | 9:10,7* → | | | | | | |
| 5:10,0 ↗ | 10:10,1 ↓ | | | | | | |

| | | | | | | | |
|-----------|-----------|--|--|--|--|-------|-------|
| 1:10,0 ↘ | 6: 9,9 ← | | | | | Serie | 99,0 |
| 2:10,3* ← | 7:10,6* → | | | | | Sum | 195,0 |
| 3:10,3* ← | 8:10,0 ↓ | | | | | | |
| 4:10,1 ↗ | 9:10,7* → | | | | | | |
| 5:10,3* ↗ | 10:10,1 ↓ | | | | | | |

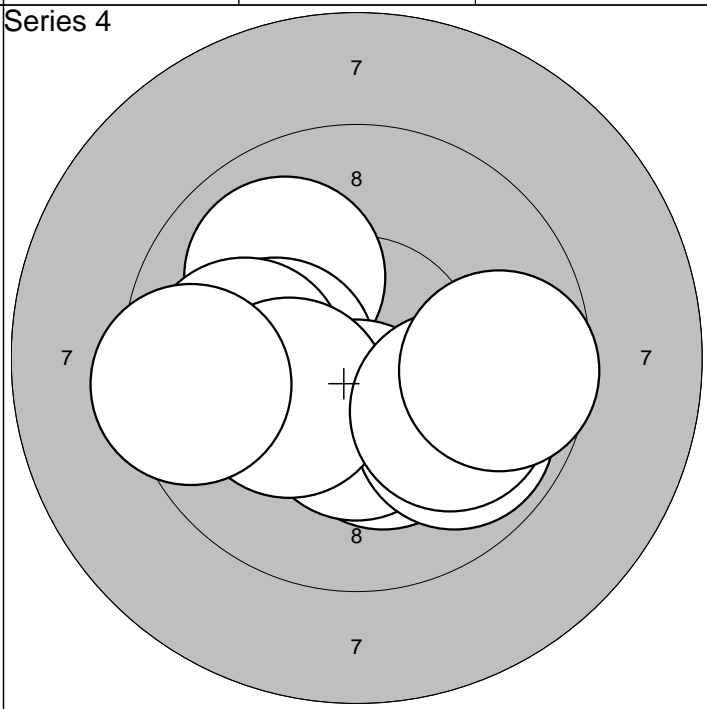
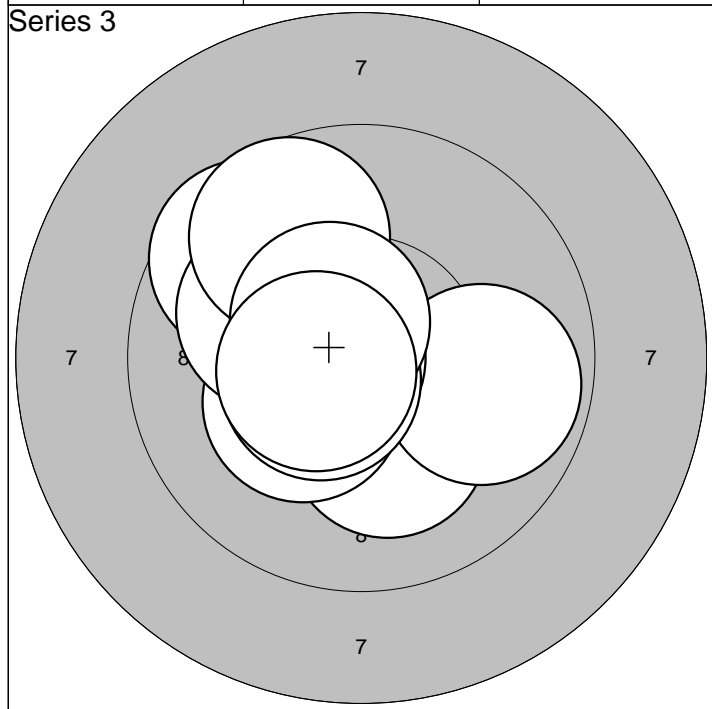

| | | | | | | | |
|-----------|------------|--|--|--|--|-------|-------|
| 1: 9,6 ↗ | 6:10,1 ← | | | | | Serie | 97,0 |
| 2:10,2* ↓ | 7:10,6* ← | | | | | Sum | 292,0 |
| 3: 9,9 → | 8: 9,7 ↗ | | | | | | |
| 4:10,6* ← | 9:10,5* ↗ | | | | | | |
| 5:10,3* ↘ | 10:10,5* ← | | | | | | |

| | | | | | | | |
|-----------|-----------|--|--|--|--|-------|-------|
| 1:10,0 ↗ | 6: 9,8 ↘ | | | | | Serie | 97,0 |
| 2:10,3* ↓ | 7:10,3* ← | | | | | Sum | 389,0 |
| 3:10,2* ← | 8:10,0 → | | | | | | |
| 4:10,0 ← | 9: 9,7 → | | | | | | |
| 5:10,4* ↓ | 10: 9,5 ← | | | | | | |

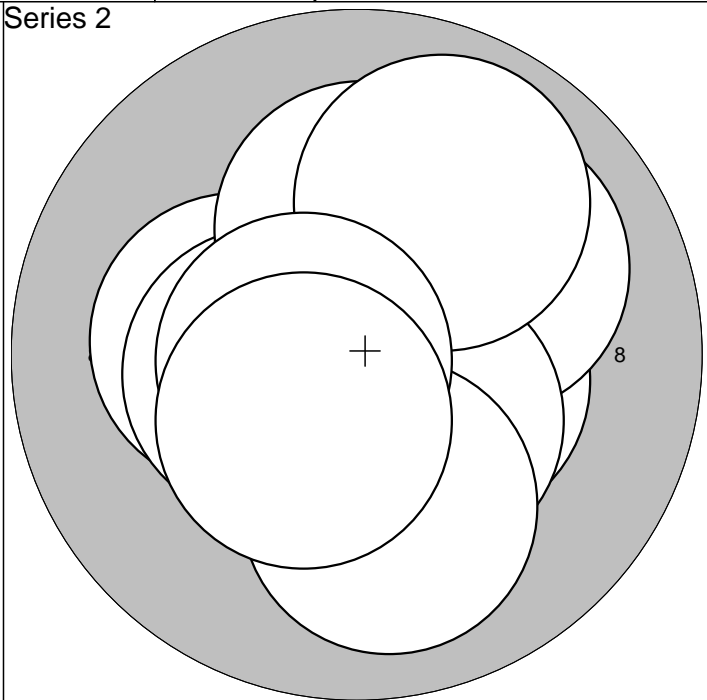
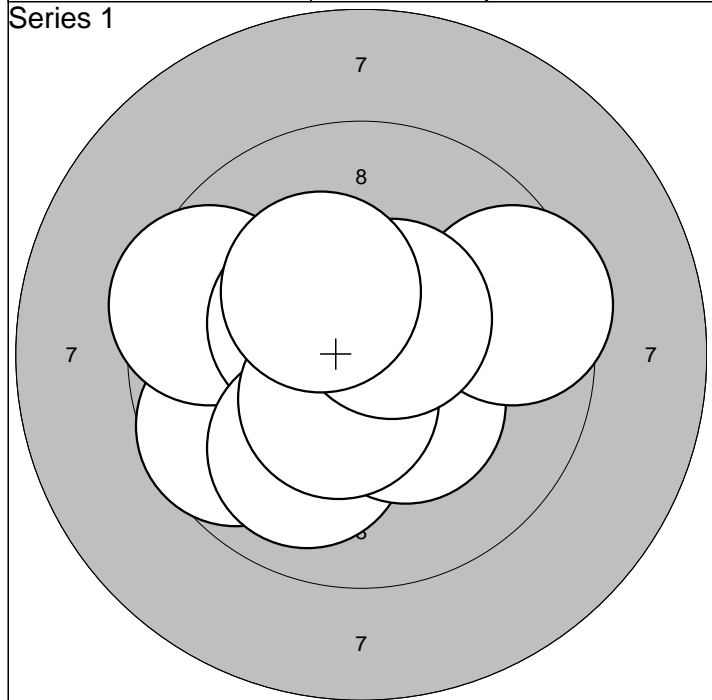

| | | | | | |
|-----------|------------|--|--|-------|------|
| 1: 9,6 ↙ | 6:10,3* ↘ | | | Serie | 97,0 |
| 2:10,4* ↘ | 7: 9,5 → | | | | |
| 3: 9,5 ← | 8:10,5* ↘ | | | Sum | 97,0 |
| 4:10,4* ↘ | 9:10,5* ↗ | | | | |
| 5:10,0 ↘ | 10:10,3* ↗ | | | | |

| | | | | | |
|-----------|------------|--|--|-------|-------|
| 1:10,2* ← | 6:10,4* ↘ | | | Serie | 99,0 |
| 2:10,4* → | 7:10,0 ↘ | | | | |
| 3:10,4* ← | 8: 9,9 ↗ | | | Sum | 196,0 |
| 4:10,2* ↑ | 9:10,6* ← | | | | |
| 5:10,0 ↗ | 10:10,4* ↘ | | | | |

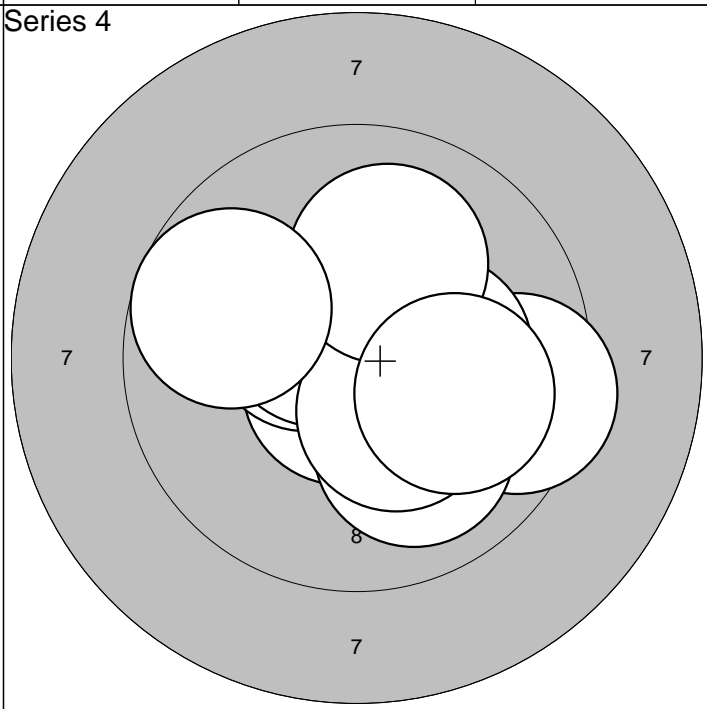
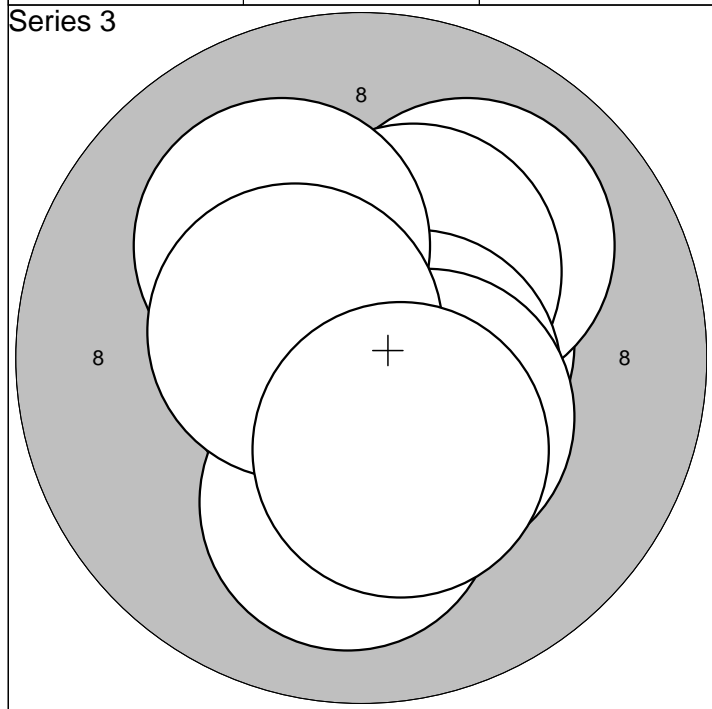

| | | | | | |
|-----------|------------|--|--|-------|-------|
| 1:10,6* → | 6:10,6* → | | | Serie | 100,0 |
| 2:10,5* ↗ | 7:10,1 ↗ | | | | |
| 3:10,0 ↗ | 8:10,4* ↘ | | | Sum | 296,0 |
| 4:10,1 ↘ | 9:10,5* ← | | | | |
| 5:10,3* ↗ | 10:10,3* ↘ | | | | |

| | | | | | |
|-----------|-----------|--|--|-------|-------|
| 1:10,7* ↘ | 6:10,5* ↗ | | | Serie | 98,0 |
| 2: 9,5 → | 7:10,4* ↘ | | | | |
| 3:10,0 ↘ | 8:10,1 ↗ | | | Sum | 394,0 |
| 4:10,3* → | 9: 9,8 ← | | | | |
| 5:10,5* ↗ | 10:10,0 → | | | | |

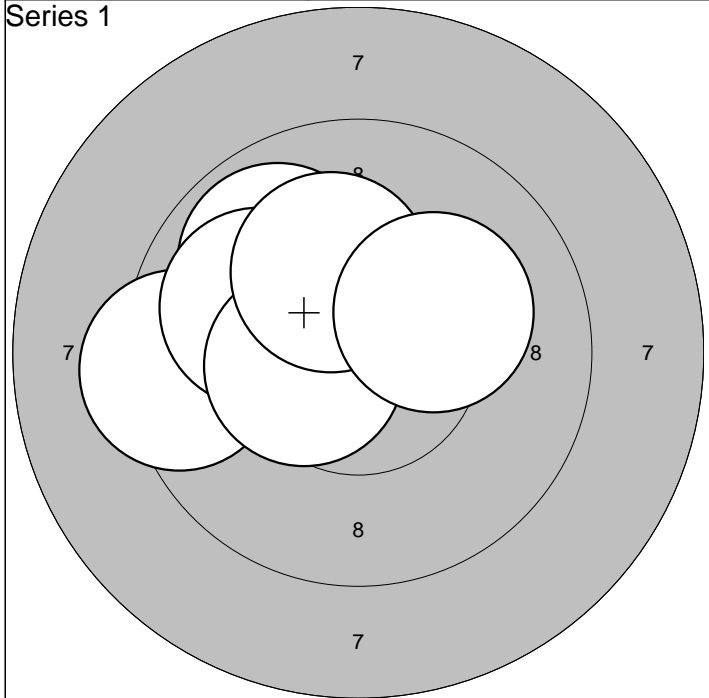

| | | | | |
|------------|-------------|-----|-------|------|
| 1: 9,9 ↖ | 6: 10,0 ↙ | | Serie | 98,0 |
| 2: 10,3* ↖ | 7: 10,5* ↗ | | | |
| 3: 10,3* ↗ | 8: 10,4* ↙ | Sum | 98,0 | |
| 4: 9,4 ↙ | 9: 10,2* ↗ | | | |
| 5: 10,2* ↙ | 10: 10,2* ↗ | | | |

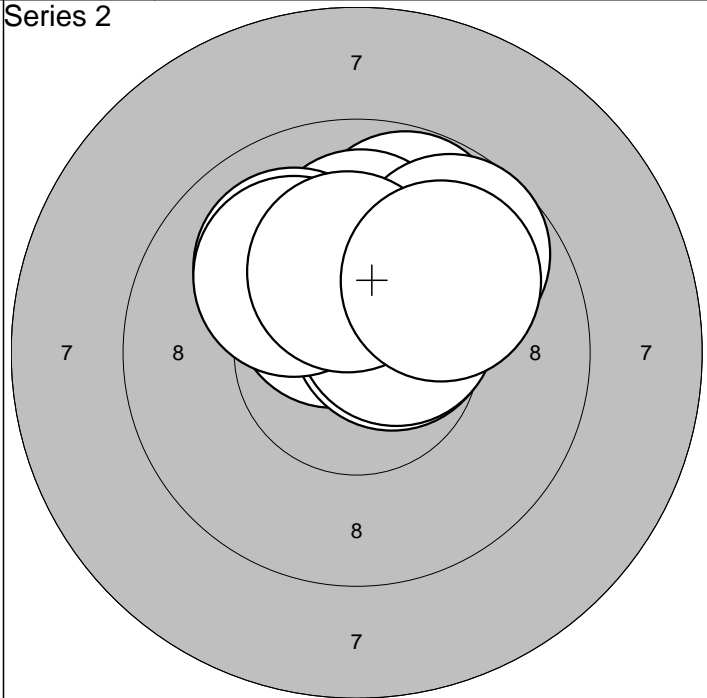

| | | | | |
|------------|------------|-----|-------|------|
| 1: 10,5* ↖ | 6: 9,7 ↗ | | Serie | 98,0 |
| 2: 10,6* ↗ | 7: 10,5* ↗ | | | |
| 3: 9,8 ↗ | 8: 10,1 ↙ | Sum | 196,0 | |
| 4: 10,0 ↗ | 9: 10,2* ↗ | | | |
| 5: 10,0 ↙ | 10: 10,0 ↗ | | | |

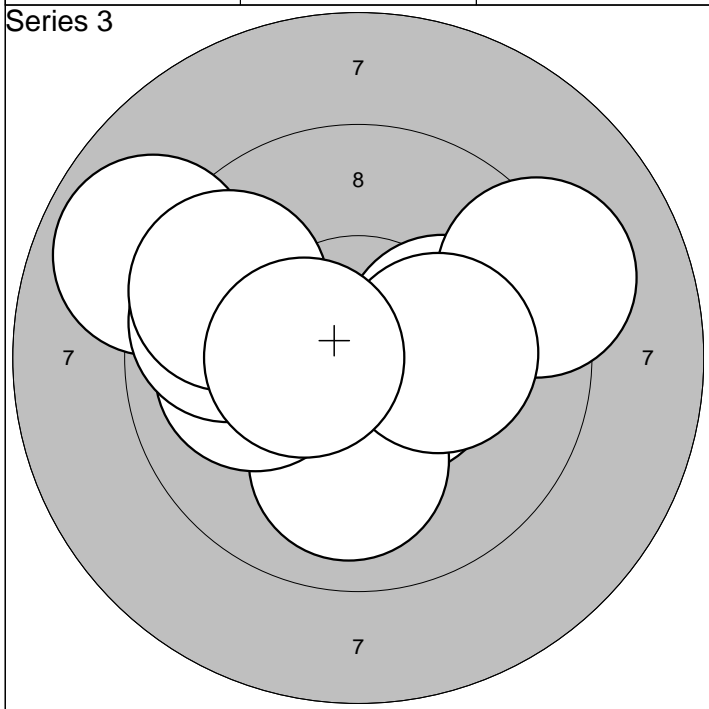

| | | | | |
|------------|-------------|-----|-------|------|
| 1: 10,6* ➤ | 6: 10,0 ↙ | | Serie | 95,0 |
| 2: 10,2* ➤ | 7: 9,8 ↙ | | | |
| 3: 8,9 ↙ | 8: 9,6 ↙ | Sum | 291,0 | |
| 4: 10,0 ↓ | 9: 10,2* ➤ | | | |
| 5: 9,2 ➤ | 10: 10,5* ↙ | | | |

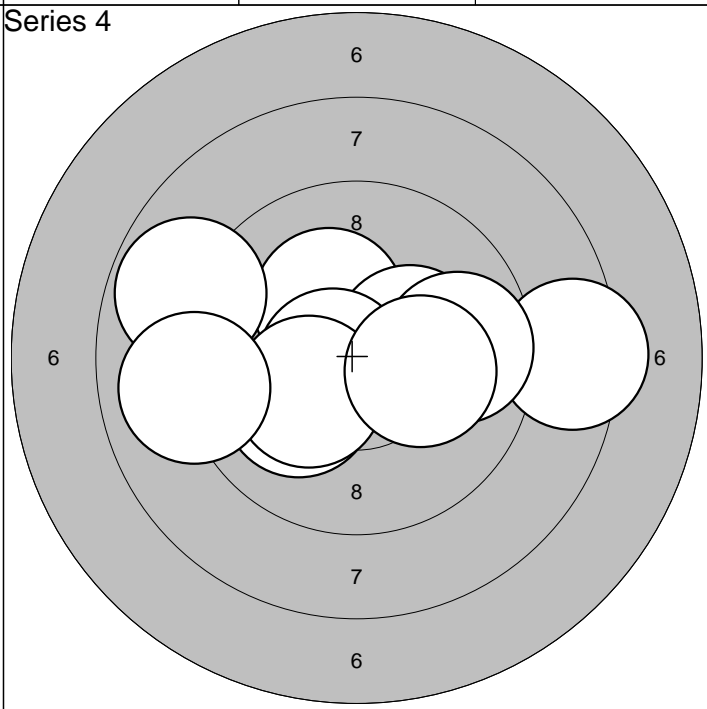

| | | | | |
|------------|-------------|-----|-------|------|
| 1: 10,2* ↖ | 6: 9,8 ➤ | | Serie | 94,0 |
| 2: 8,8 ↙ | 7: 10,7* ↙ | | | |
| 3: 8,4 ➤ | 8: 10,3* ↙ | Sum | 385,0 | |
| 4: 10,1 ↙ | 9: 9,0 ↙ | | | |
| 5: 10,3* ➤ | 10: 10,2* ➤ | | | |

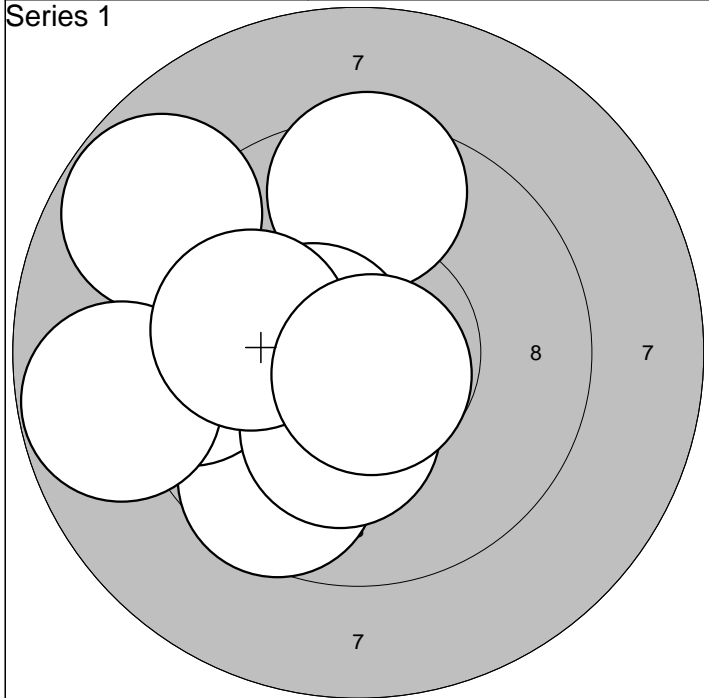

| | | |
|------------|-------------|------------|
| 1: 9,6 ← | 6: 8,8 ↖ | Serie 92,0 |
| 2: 9,5 ↑ | 7: 8,8 ← | |
| 3: 10,6* ← | 8: 10,2* ↓ | Sum 92,0 |
| 4: 9,6 ↘ | 9: 10,0 ← | |
| 5: 9,4 ← | 10: 10,7* ↘ | |

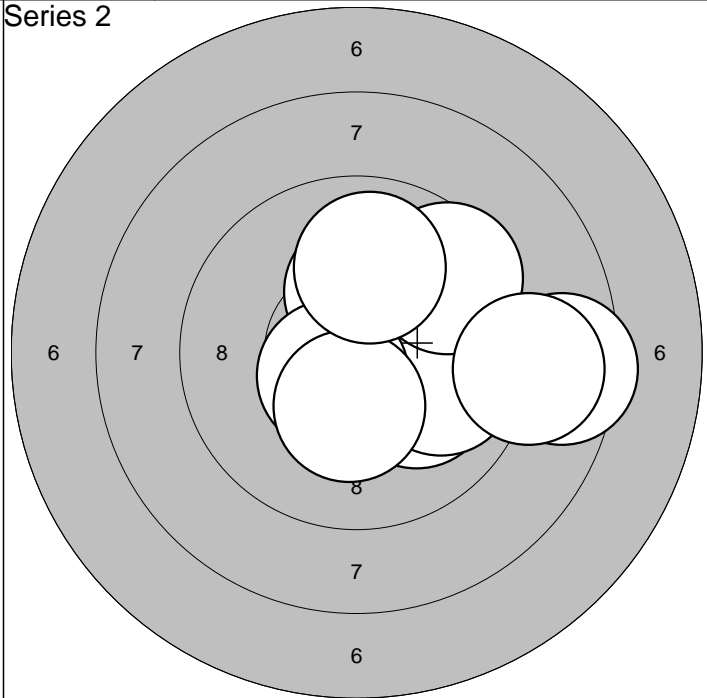

| | | |
|------------|------------|------------|
| 1: 10,2* ↑ | 6: 10,6* ↙ | Serie 93,0 |
| 2: 10,2* ↑ | 7: 8,5 → | |
| 3: 10,1 ↘ | 8: 8,9 → | Sum 185,0 |
| 4: 9,9 → | 9: 10,3* ↓ | |
| 5: 9,6 ↗ | 10: 9,9 ↑ | |

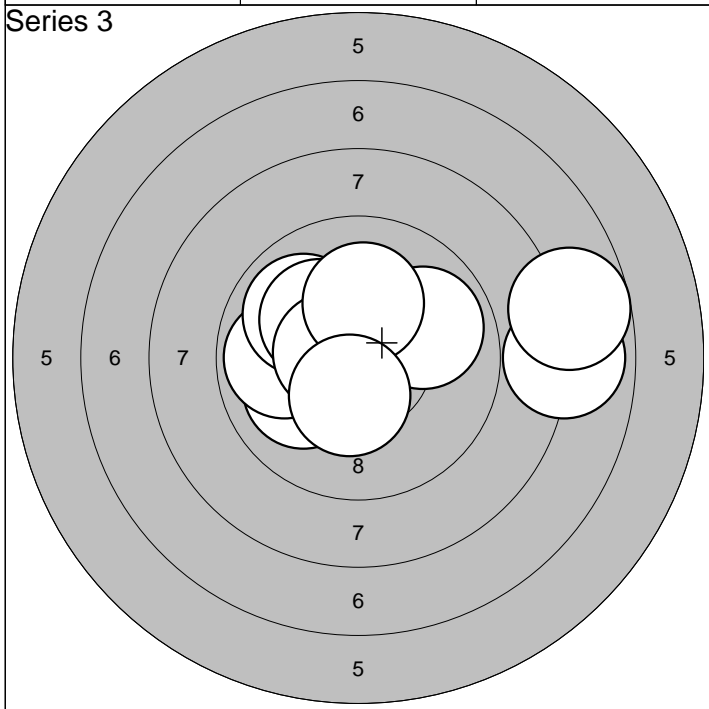

| | | |
|------------|-------------|------------|
| 1: 10,0 ↙ | 6: 7,9 → | Serie 91,0 |
| 2: 9,9 ← | 7: 10,6* ← | |
| 3: 9,9 ↖ | 8: 10,2* ↑ | Sum 276,0 |
| 4: 10,2* ↖ | 9: 7,8 → | |
| 5: 9,9 ↗ | 10: 10,4* ↓ | |

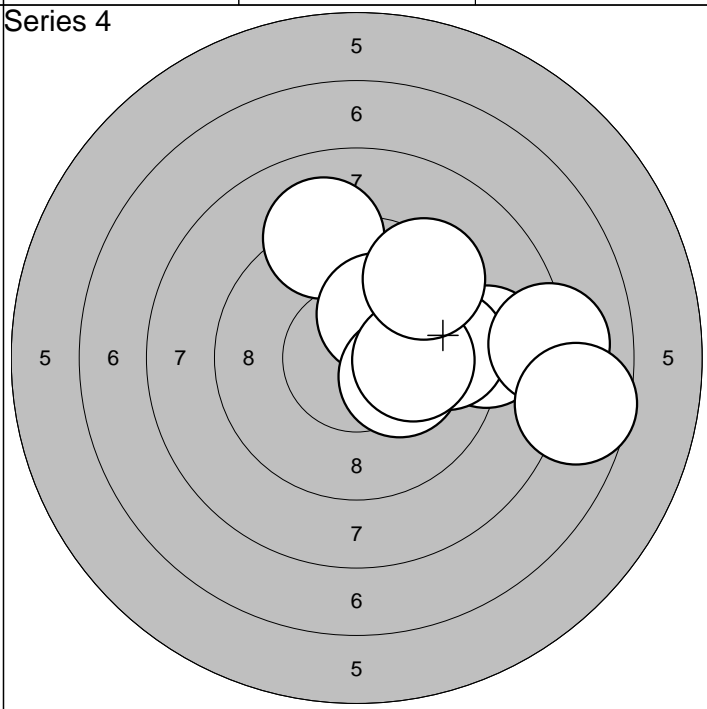

| | | |
|------------|-----------|------------|
| 1: 9,1 ↑ | 6: 9,6 → | Serie 90,0 |
| 2: 9,8 → | 7: 10,1 → | |
| 3: 9,0 → | 8: 8,1 → | Sum 366,0 |
| 4: 10,2* ↑ | 9: 9,4 ↗ | |
| 5: 10,2* ↘ | 10: 7,6 → | |

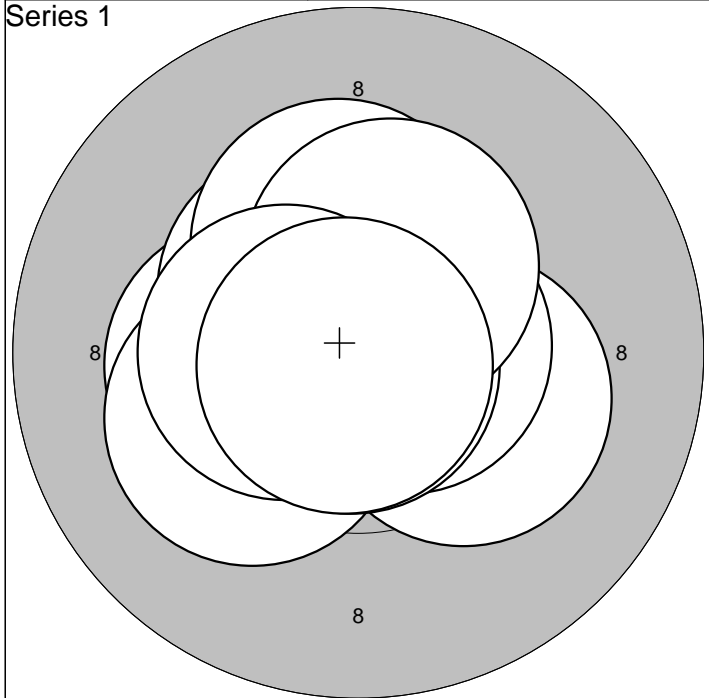

| | | | | | |
|-----------|------------|-----|-------|-------|-------|
| 1:10,3* ← | 6:10,3* ↑ | | | Serie | 100,0 |
| 2:10,2* → | 7:10,9* ↓ | | | | |
| 3:10,7* → | 8:10,4* ↑ | Sum | 100,0 | | |
| 4:10,2* ← | 9:10,5* ← | | | | |
| 5:10,5* ↗ | 10:10,8* ↘ | | | | |

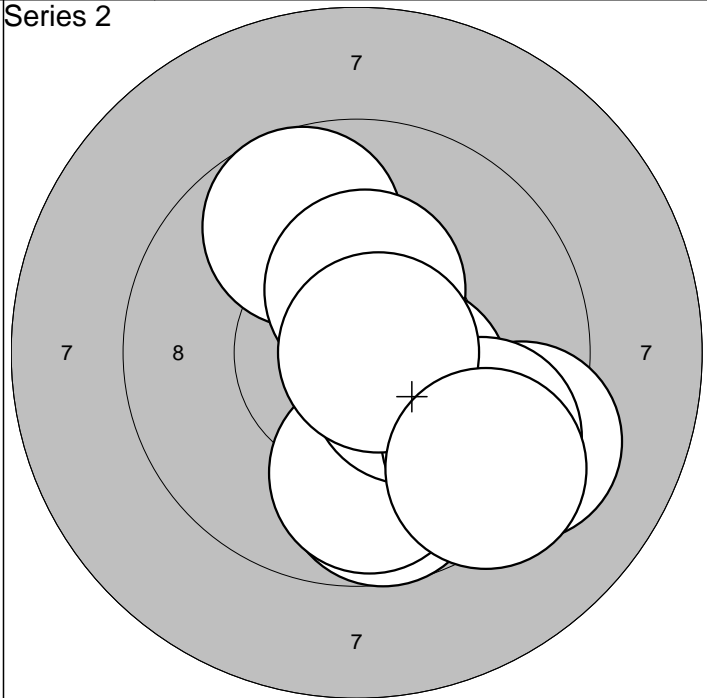

| | | | | | |
|-----------|-----------|-----|-------|-------|------|
| 1: 9,7 ↓ | 6:10,4* ↑ | | | Serie | 94,0 |
| 2: 9,7 ↗ | 7:10,4* → | | | | |
| 3: 9,3 → | 8: 9,6 ↓ | Sum | 194,0 | | |
| 4:10,2* ↓ | 9:10,7* → | | | | |
| 5: 9,9 ↓ | 10: 9,4 ↓ | | | | |

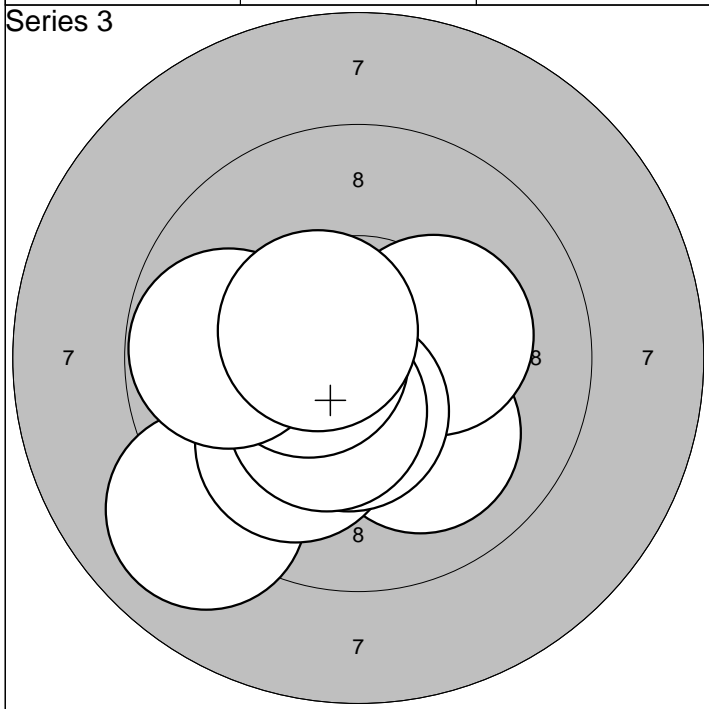

| | | | | | |
|-----------|------------|-----|-------|-------|------|
| 1:10,2* ↓ | 6:10,5* ↓ | | | Serie | 98,0 |
| 2: 9,0 ↙ | 7:10,4* ↓ | | | | |
| 3:10,1 ↓ | 8:10,5* ← | Sum | 292,0 | | |
| 4:10,0 ↙ | 9: 9,8 ← | | | | |
| 5:10,2* → | 10:10,5* ↖ | | | | |

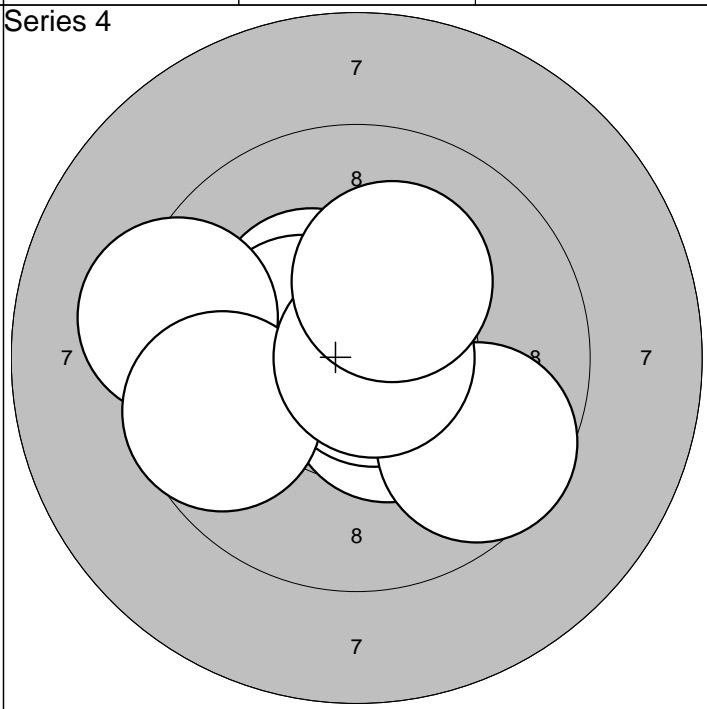

| | | | | | |
|-----------|------------|-----|-------|-------|------|
| 1:10,7* ↖ | 6:10,8* → | | | Serie | 97,0 |
| 2:10,4* ↗ | 7: 9,7 ← | | | | |
| 3:10,5* ↖ | 8: 9,6 ↓ | Sum | 389,0 | | |
| 4: 9,3 ← | 9:10,8* → | | | | |
| 5:10,5* ↓ | 10:10,2* ↗ | | | | |

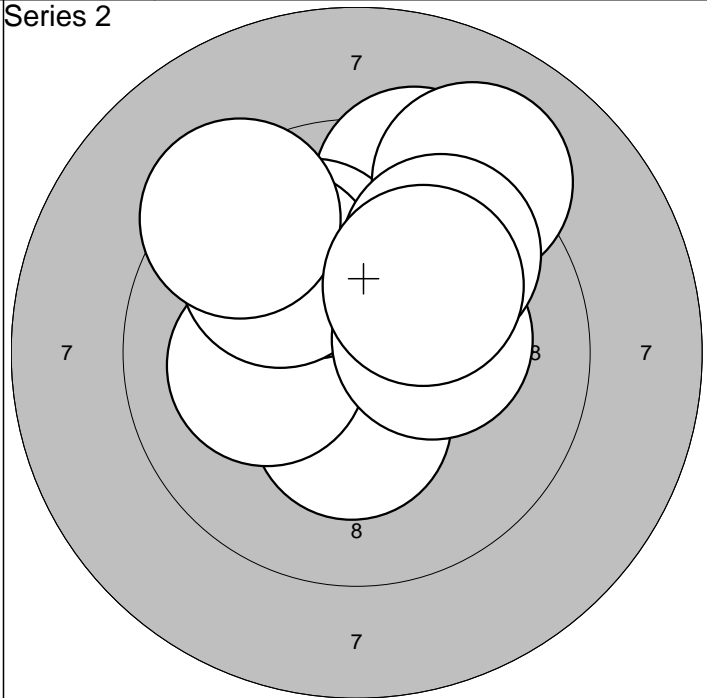
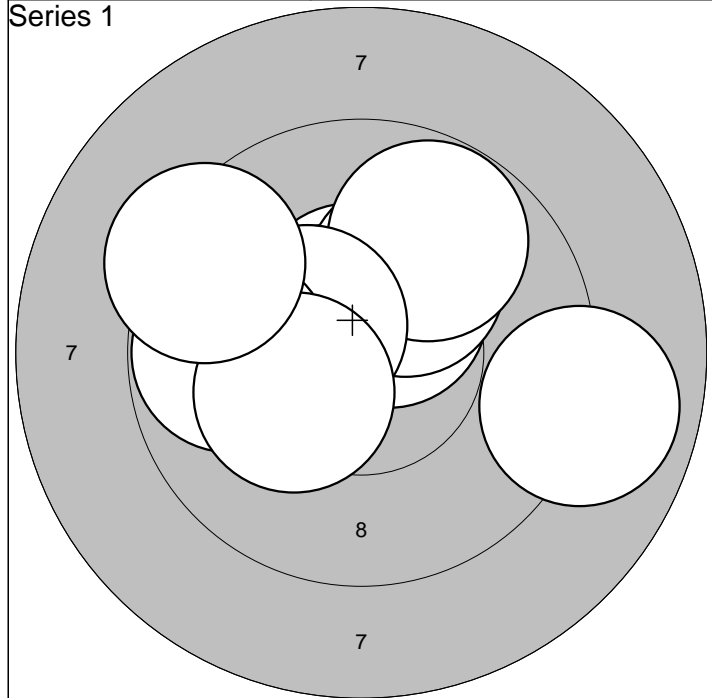

| | | | | | |
|-----------|-----------|-----|------|-------|------|
| 1:10,5* ↑ | 6: 9,8 ↗ | | | Serie | 95,0 |
| 2: 8,9 → | 7:10,4* ↖ | | | | |
| 3:10,5* ↖ | 8: 9,8 ← | Sum | 95,0 | | |
| 4:10,5* ↗ | 9:10,2* ↖ | | | | |
| 5:10,2* ↗ | 10: 9,3 ↖ | | | | |

| | | | | | |
|-----------|-----------|-----|-------|-------|------|
| 1:10,4* ↓ | 6:10,3* → | | | Serie | 95,0 |
| 2:10,1 ← | 7: 9,1 ↗ | | | | |
| 3: 9,4 ↑ | 8: 9,3 ↖ | Sum | 190,0 | | |
| 4:10,0 ↑ | 9: 9,8 ↗ | | | | |
| 5: 9,9 ↖ | 10:10,1 ↗ | | | | |

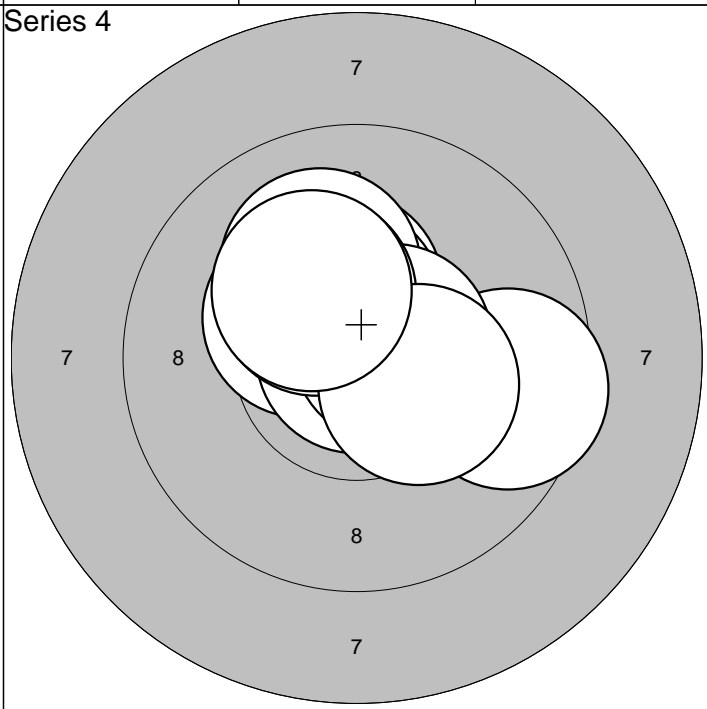
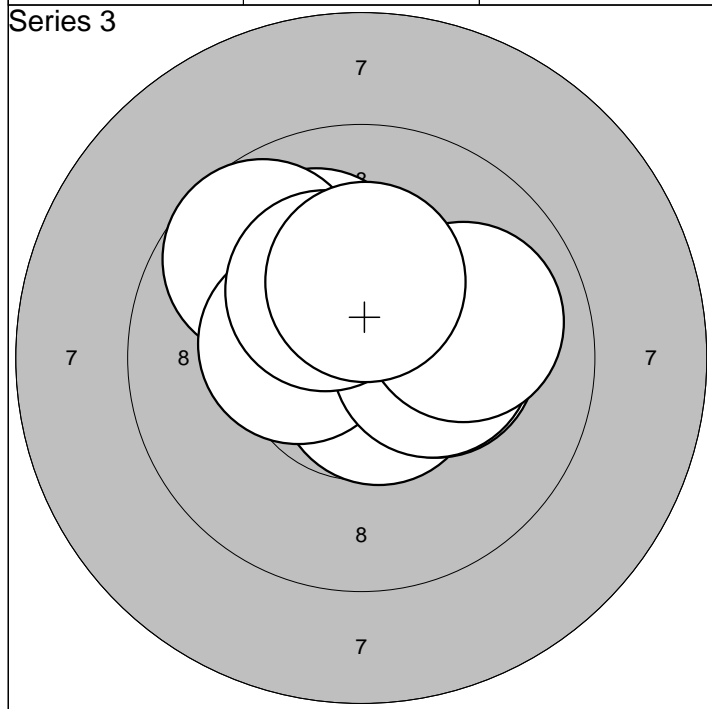

| | | | | | |
|-----------|------------|-----|-------|-------|------|
| 1:10,1 ↗ | 6:10,4* ↖ | | | Serie | 99,0 |
| 2: 9,7 ↗ | 7:10,3* → | | | | |
| 3:10,4* ↑ | 8:10,3* ↗ | Sum | 289,0 | | |
| 4:10,7* ↓ | 9:10,0 → | | | | |
| 5:10,3* → | 10:10,3* ↑ | | | | |

| | | | | | |
|-----------|------------|-----|-------|-------|------|
| 1:10,3* ↖ | 6:10,1 ↑ | | | Serie | 99,0 |
| 2:10,3* ↑ | 7:10,6* → | | | | |
| 3: 9,6 → | 8:10,3* ↗ | Sum | 388,0 | | |
| 4:10,5* ↑ | 9:10,3* → | | | | |
| 5:10,9* ↑ | 10:10,2* ↖ | | | | |

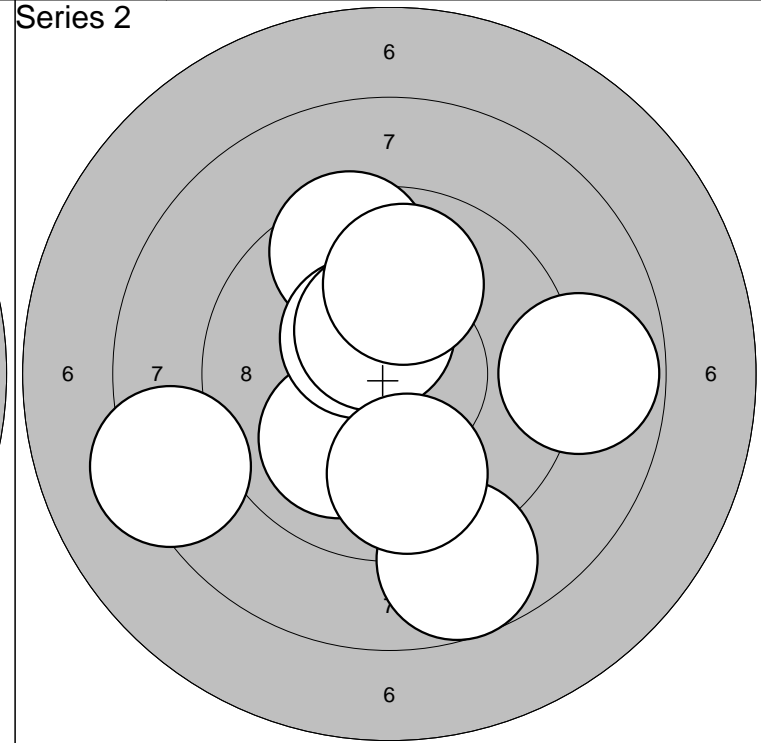
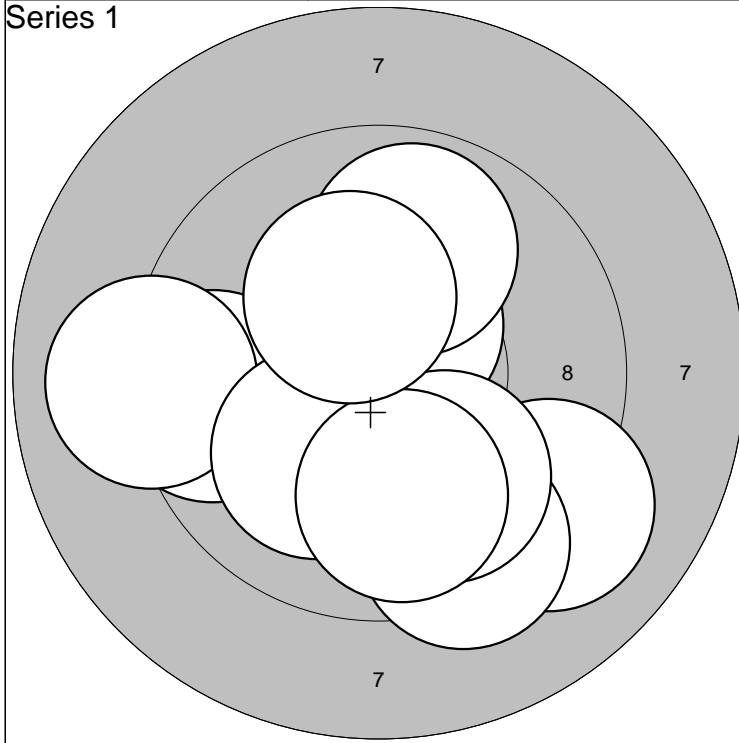

| | | | |
|-----------|------------|-------|------|
| 1: 9,1 ↘ | 6: 9,9 ↘ | Serie | 93,0 |
| 2: 9,5 ← | 7:10,1 ↘ | | |
| 3: 9,4 ↘ | 8: 9,9 ↘ | Sum | 93,0 |
| 4: 9,0 ← | 9: 9,9 ↑ | | |
| 5:10,5* ↑ | 10:10,3* ↑ | | |

| | | | |
|----------|-----------|-------|-------|
| 1:10,1 ↙ | 6:10,5* ↗ | Serie | 92,0 |
| 2:10,0 ↑ | 7:10,5* ↑ | | |
| 3: 9,5 ↑ | 8: 9,8 ↘ | Sum | 185,0 |
| 4: 8,8 ↘ | 9:10,0 ↑ | | |
| 5: 8,8 → | 10: 8,3 ← | | |

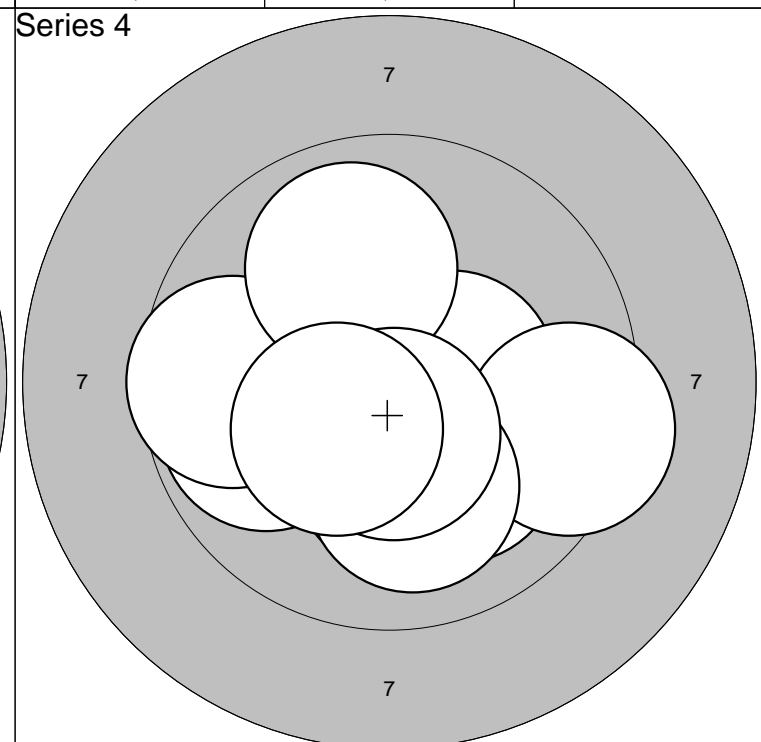
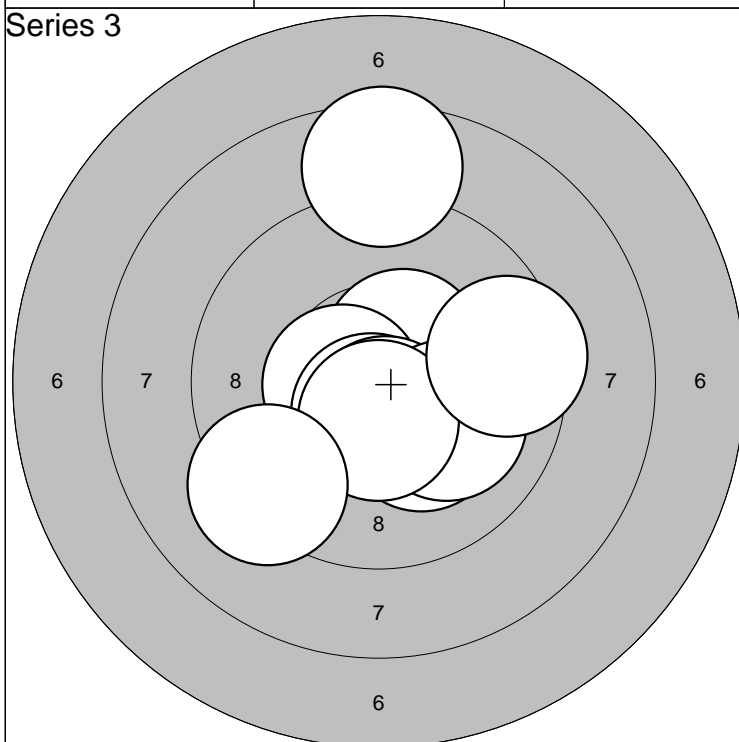

| | | | |
|-----------|-----------|-------|-------|
| 1: 8,6 ↑ | 6:10,5* ↘ | Serie | 96,0 |
| 2:10,5* ↗ | 7:10,1 ↘ | | |
| 3:10,5* ← | 8:10,5* ↘ | Sum | 281,0 |
| 4:10,6* ↘ | 9: 9,3 ↙ | | |
| 5:10,2* ↘ | 10: 9,5 → | | |

| | | | |
|-----------|------------|-------|-------|
| 1: 9,9 ← | 6: 9,9 ↑ | Serie | 96,0 |
| 2:10,1 ↘ | 7: 9,4 → | | |
| 3: 9,6 ← | 8:10,0 ↘ | Sum | 377,0 |
| 4:10,4* → | 9:10,5* ↘ | | |
| 5:10,2* ↘ | 10:10,4* ↙ | | |

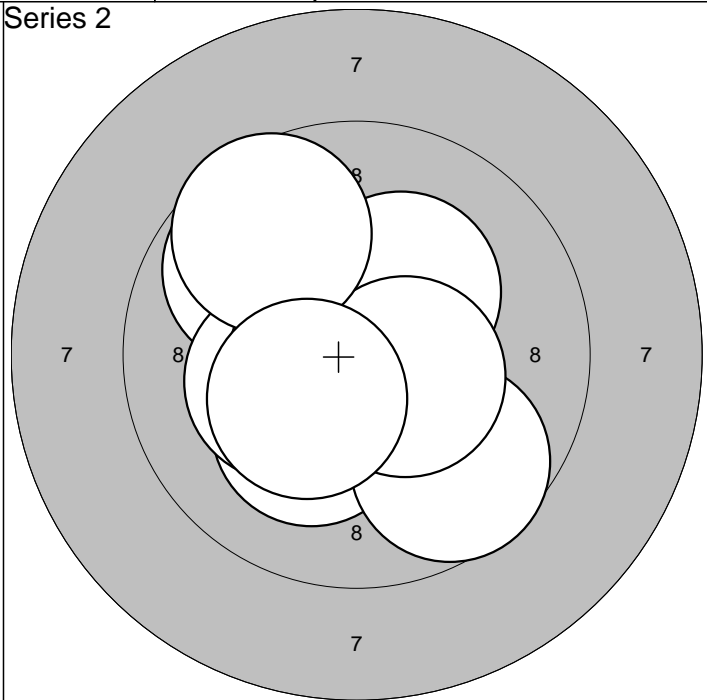
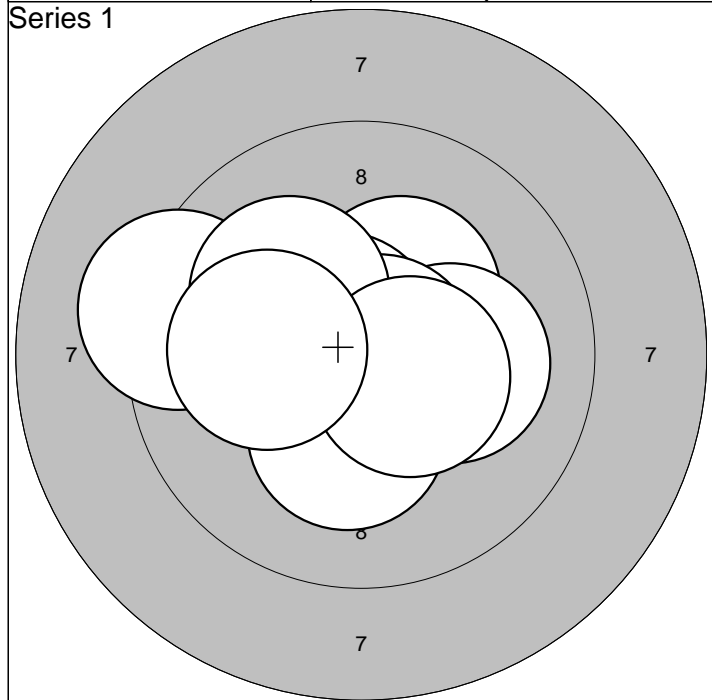

| | | | | | |
|-----------|-----------|--|--|-------|------|
| 1:10,3* ↗ | 6:10,8* → | | | Serie | 99,0 |
| 2: 9,2 ← | 7:10,3* ↓ | | | | |
| 3:10,7* ↗ | 8:10,1 ↗ | | | Sum | 99,0 |
| 4:10,5* ← | 9:10,5* → | | | | |
| 5:10,1 → | 10:10,1 ← | | | | |

| | | | | | |
|-----------|------------|--|--|-------|-------|
| 1:10,2* ↘ | 6: 9,7 ↘ | | | Serie | 97,0 |
| 2: 9,8 ↖ | 7:10,3* ↗ | | | | |
| 3:10,8* ↓ | 8:10,4* → | | | Sum | 196,0 |
| 4:10,3* ← | 9: 9,6 ↗ | | | | |
| 5:10,7* ← | 10:10,3* ↘ | | | | |

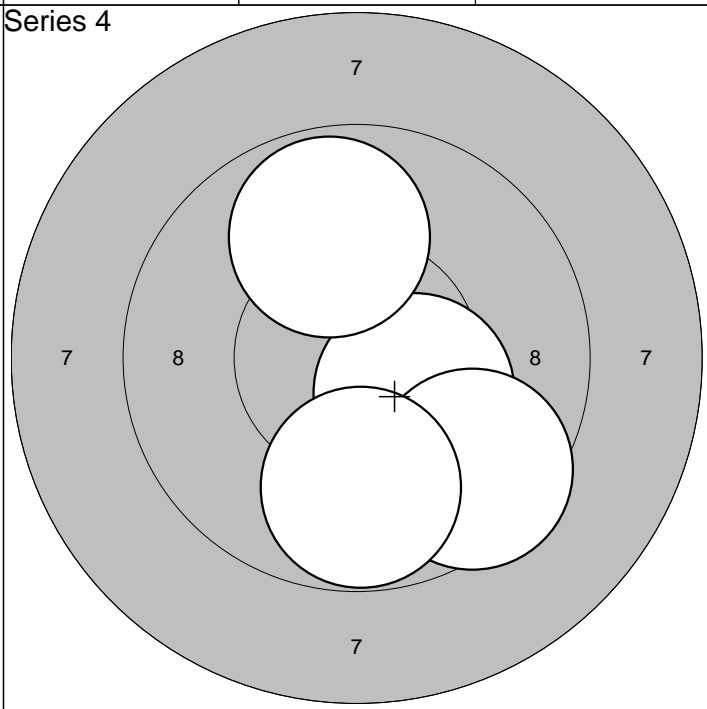
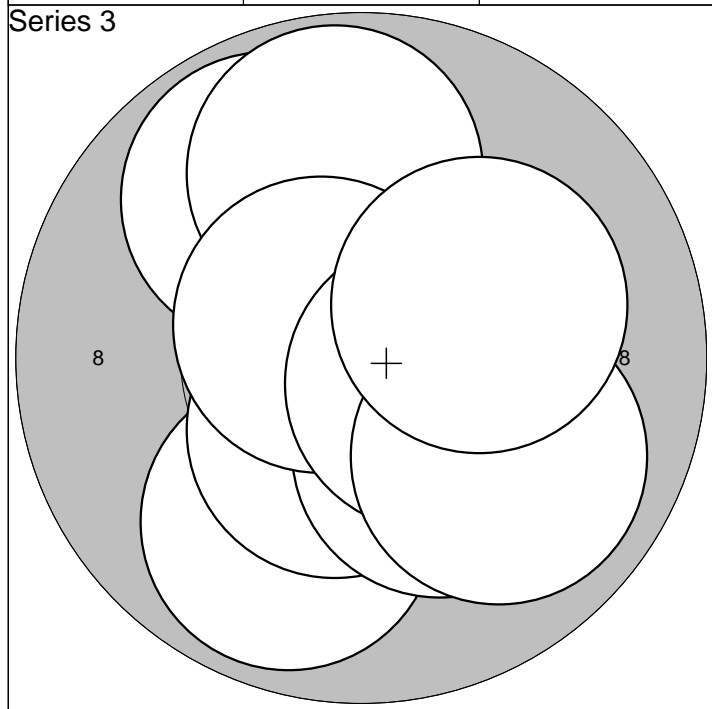

| | | | | | |
|-----------|-----------|--|--|-------|-------|
| 1: 9,8 ↗ | 6:10,2* ↘ | | | Serie | 96,0 |
| 2: 9,8 ↑ | 7:10,6* ↗ | | | | |
| 3: 9,9 ↓ | 8:10,5* → | | | Sum | 292,0 |
| 4:10,3* → | 9: 9,9 ↘ | | | | |
| 5:10,5* ↓ | 10:10,1 → | | | | |

| | | | | |
|-----------|--|--|-------|-------|
| 1:10,4* → | | | Serie | 37,0 |
| 2: 9,5 ↘ | | | | |
| 3: 9,8 ↑ | | | Sum | 329,0 |
| 4: 9,8 ↓ | | | | |

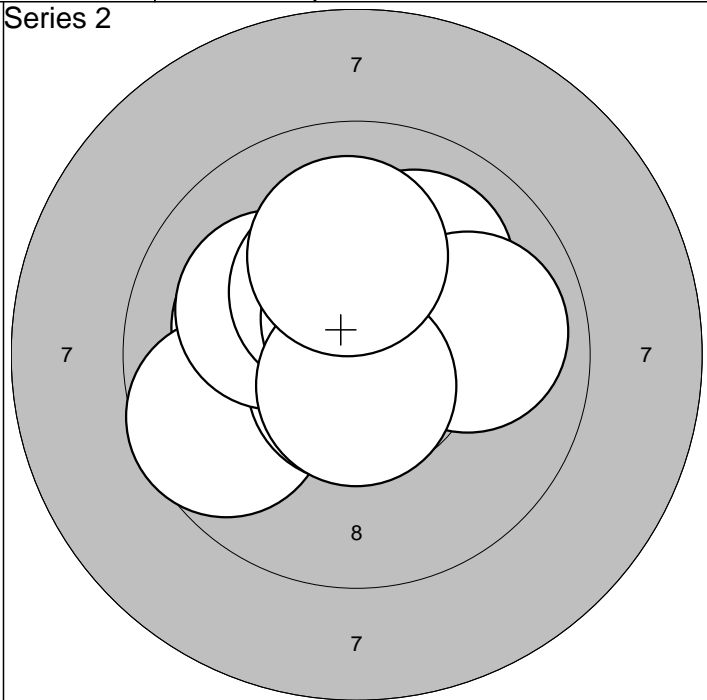
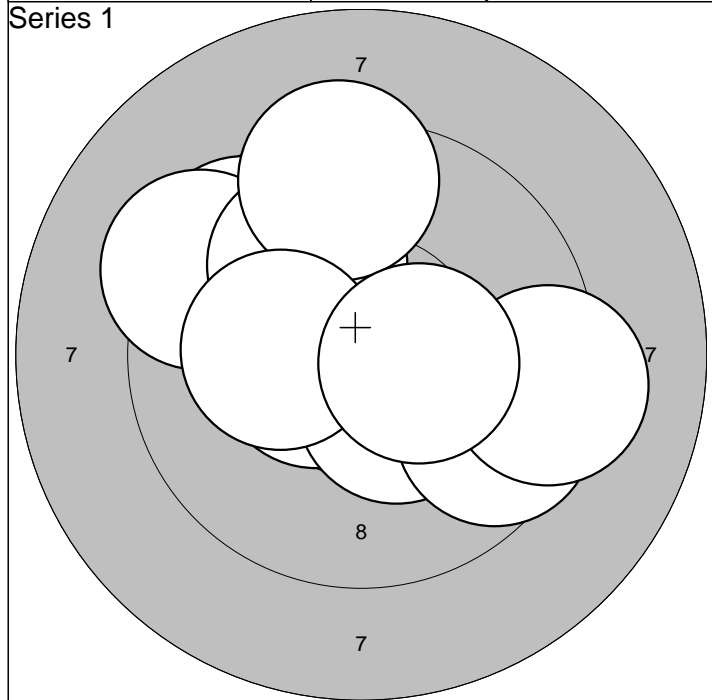

| | | | |
|-----------|------------|-------|------|
| 1: 9,6 ↗ | 6:10,0 ↗ | Serie | 95,0 |
| 2: 9,3 ↗ | 7: 9,2 → | | |
| 3:10,5* ← | 8: 9,4 ↑ | Sum | 95,0 |
| 4:10,4* ↓ | 9:10,2* ← | | |
| 5: 9,6 ↓ | 10:10,4* → | | |

| | | | |
|-----------|-----------|-------|-------|
| 1:10,2* ↖ | 6:10,6* ↑ | Serie | 98,0 |
| 2: 9,7 ↖ | 7:10,0 ↗ | | |
| 3:10,7* ↓ | 8: 9,9 → | Sum | 193,0 |
| 4:10,1 ↖ | 9:10,7* ↓ | | |
| 5:10,3* ↑ | 10:10,1 ↑ | | |

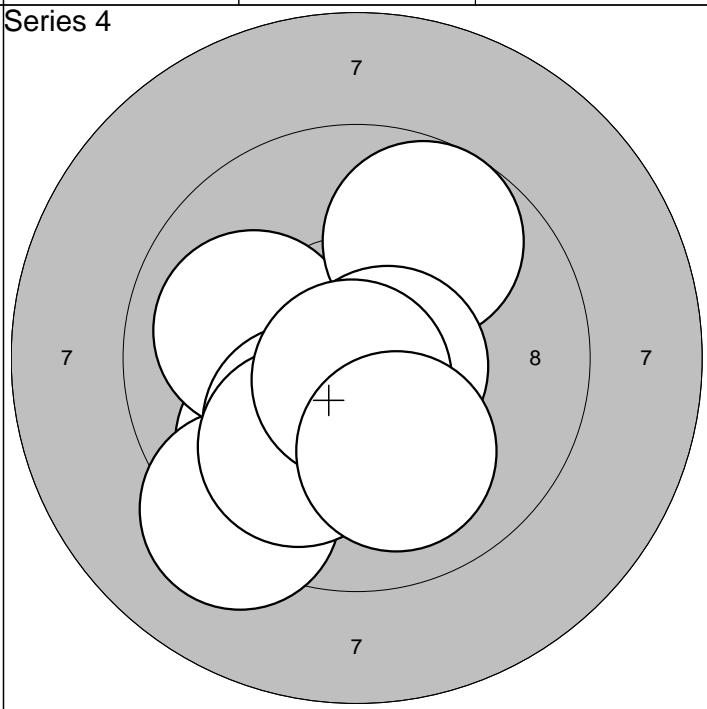
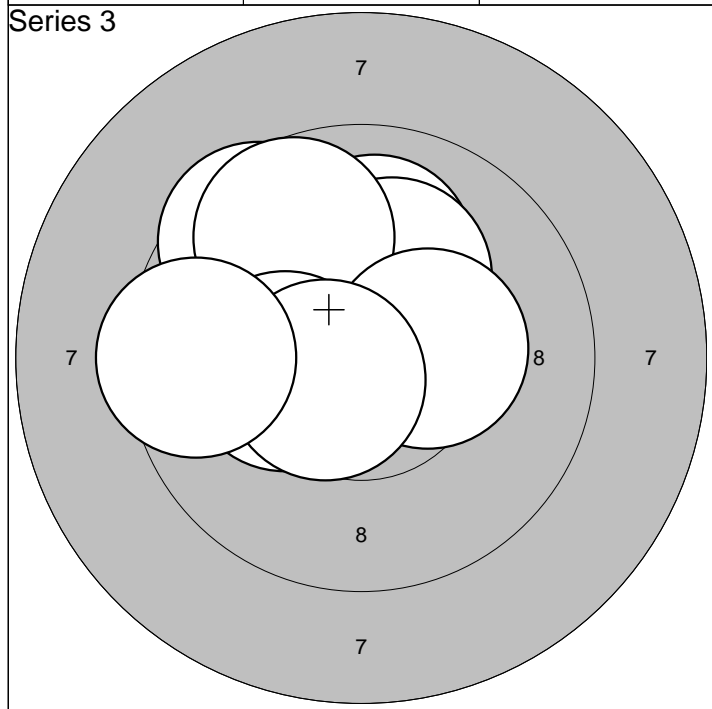

| | | | |
|-----------|-----------|-------|-------|
| 1:10,0 ↑ | 6: 9,7 ↗ | Serie | 97,0 |
| 2:10,3* ↑ | 7:10,4* → | | |
| 3:10,6* ↗ | 8:10,2* ← | Sum | 290,0 |
| 4:10,2* ↑ | 9:10,6* ← | | |
| 5: 9,5 ↖ | 10: 9,5 ← | | |

| | | | |
|-----------|-----------|-------|-------|
| 1:10,5* ↓ | 6:10,2* ↖ | Serie | 97,0 |
| 2: 9,9 ↖ | 7:10,0 ↖ | | |
| 3: 9,3 ↖ | 8:10,6* → | Sum | 387,0 |
| 4:10,0 ← | 9:10,7* ↓ | | |
| 5: 9,8 ↗ | 10:10,0 ↓ | | |

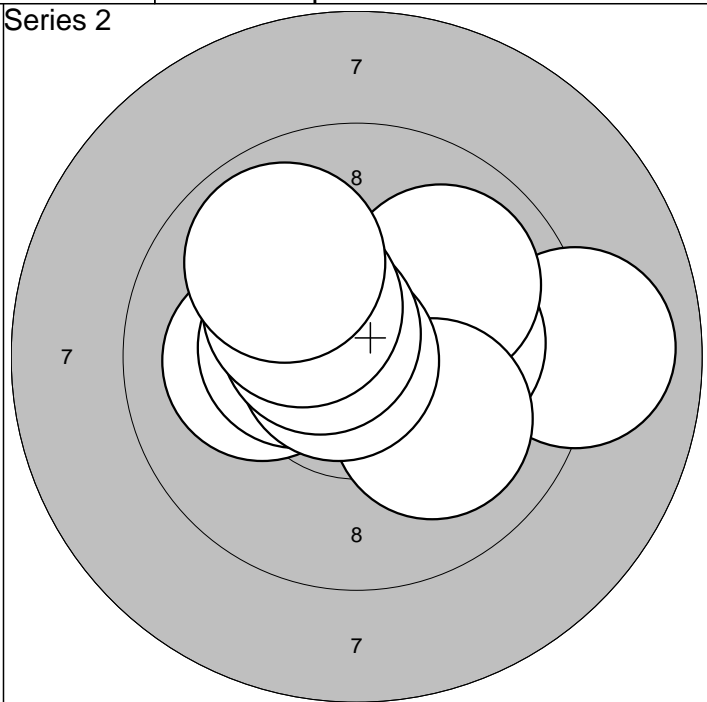
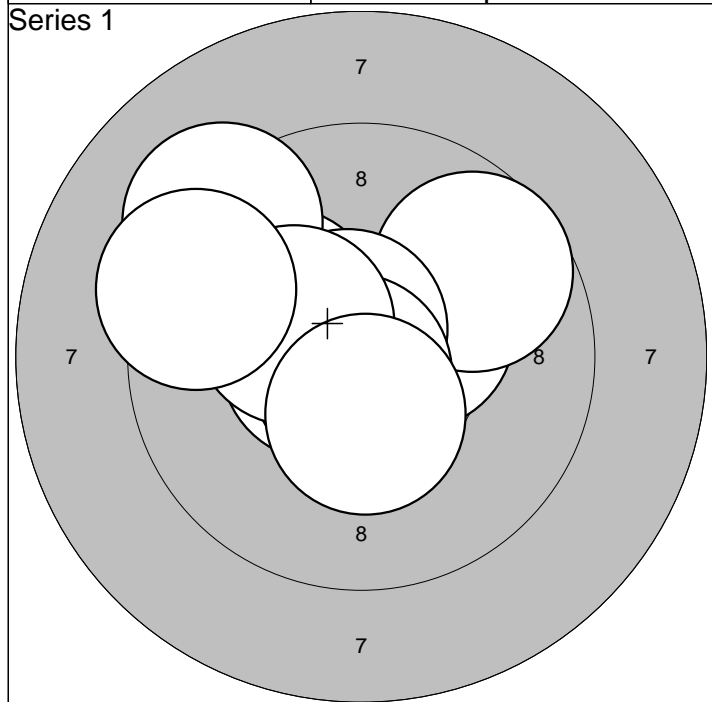

| | | | |
|-----------|------------|-------|------|
| 1:10,4* ↗ | 6: 9,2 ↖ | Serie | 97,0 |
| 2: 9,7 ↗ | 7:10,8* ↓ | | |
| 3:10,1 ↖ | 8:10,3* ↖ | Sum | 97,0 |
| 4:10,7* ↗ | 9: 9,4 ↖ | | |
| 5:10,6* ← | 10:10,4* ↓ | | |

| | | | |
|----------|-----------|-------|-------|
| 1: 9,0 → | 6:10,4* ← | Serie | 97,0 |
| 2:10,1 ← | 7:10,8* ← | | |
| 3:10,1 → | 8:10,6* ↗ | Sum | 194,0 |
| 4: 9,9 ↗ | 9:10,3* ↗ | | |
| 5:10,1 ↓ | 10: 9,9 ↗ | | |

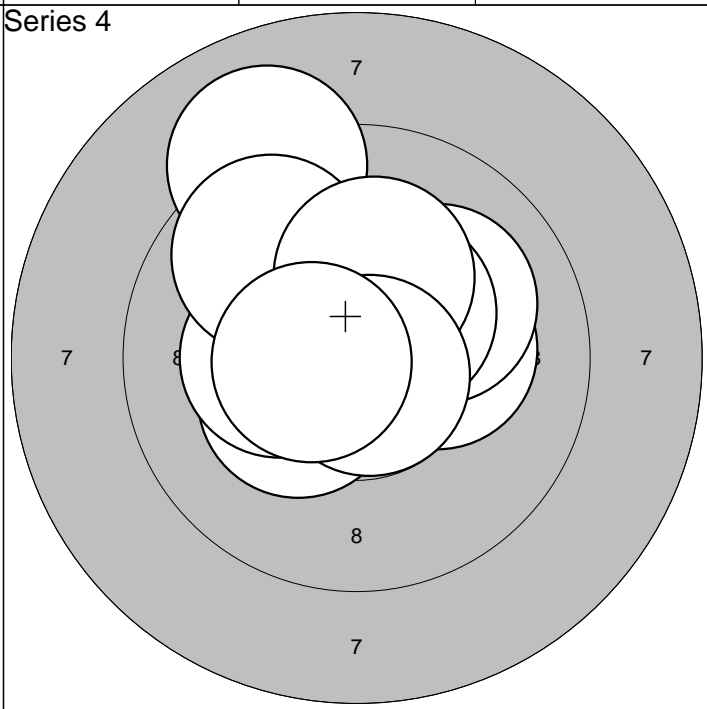
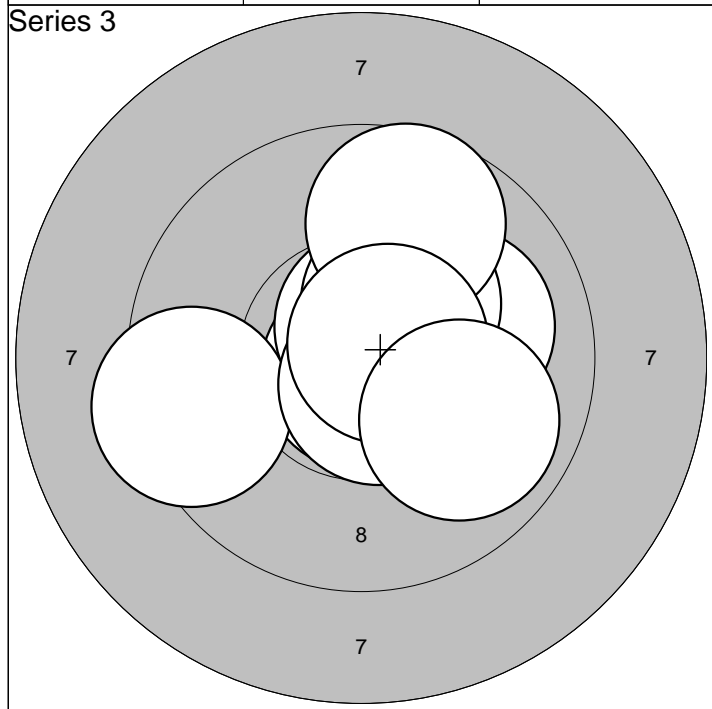

| | | | |
|-----------|-----------|-------|-------|
| 1:10,8* ↓ | 6:10,6* ↘ | Serie | 97,0 |
| 2:10,6* ↗ | 7:10,7* ↓ | | |
| 3:10,0 → | 8: 9,7 ↗ | Sum | 291,0 |
| 4: 9,4 ← | 9:10,7* ↗ | | |
| 5:10,3* ↗ | 10: 9,9 ↘ | | |

| | | | |
|-----------|------------|-------|-------|
| 1:10,2* → | 6:10,3* ← | Serie | 98,0 |
| 2:10,3* ↖ | 7: 9,8 ↗ | | |
| 3: 9,1 ↖ | 8:10,2* ↗ | Sum | 389,0 |
| 4:10,1 ↗ | 9:10,8* ↓ | | |
| 5:10,4* ↗ | 10:10,5* ← | | |

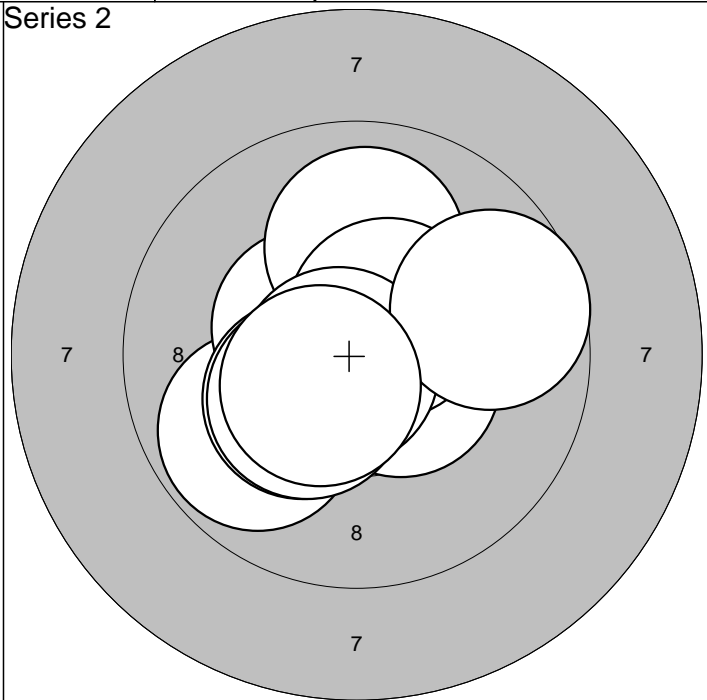
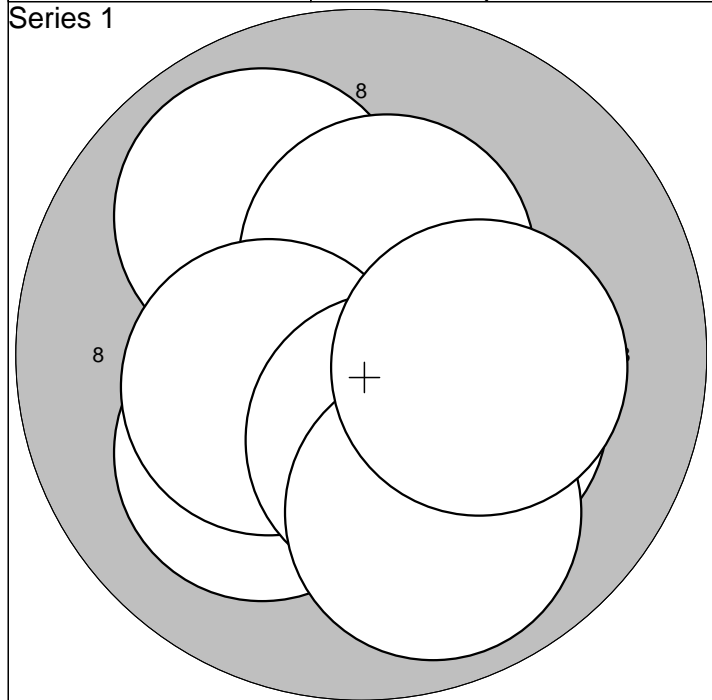

| | | | | | |
|-----------|------------|--|--|-------|------|
| 1: 9,9 ↗ | 6:10,1 ↘ | | | Serie | 98,0 |
| 2:10,5* ↙ | 7:10,3* ← | | | | |
| 3:10,7* ↗ | 8:10,4* ↓ | | | Sum | 98,0 |
| 4:10,4* ↑ | 9: 9,9 ↓ | | | | |
| 5:10,2* ↘ | 10:10,2* → | | | | |

| | | | | | |
|-----------|------------|--|--|-------|-------|
| 1: 9,8 ↙ | 6:10,5* ↗ | | | Serie | 98,0 |
| 2:10,5* ↖ | 7:10,4* ↙ | | | | |
| 3:10,3* ↙ | 8:10,7* ↙ | | | Sum | 196,0 |
| 4:10,5* ➡ | 9: 9,7 ➡ | | | | |
| 5:10,0 ↑ | 10:10,5* ↙ | | | | |

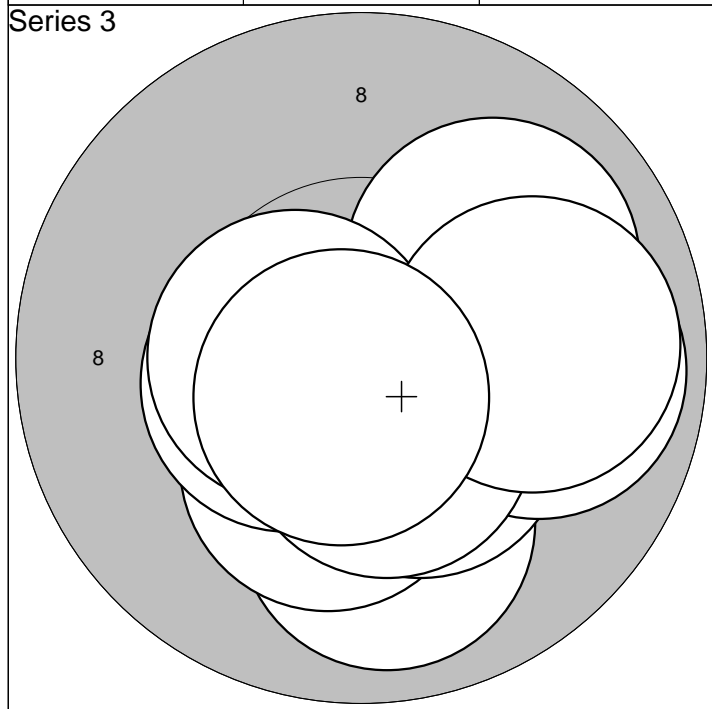

| | | | | | |
|-----------|------------|--|--|-------|-------|
| 1:10,0 ↓ | 6:10,6* ← | | | Serie | 98,0 |
| 2:10,0 ↗ | 7: 9,9 → | | | | |
| 3:10,3* ↓ | 8:10,5* ↓ | | | Sum | 294,0 |
| 4:10,4* ↘ | 9: 9,9 → | | | | |
| 5:10,5* ← | 10:10,7* ↓ | | | | |

| | | | | | |
|-----------|------------|--|--|-------|-------|
| 1:10,0 ← | 6:10,3* ← | | | Serie | 100,0 |
| 2:10,8* ↗ | 7:10,1 ↖ | | | | |
| 3:10,4* ← | 8:10,8* ↓ | | | Sum | 394,0 |
| 4:10,5* ↖ | 9:10,4* ➡ | | | | |
| 5:10,0 ↓ | 10:10,6* ↗ | | | | |

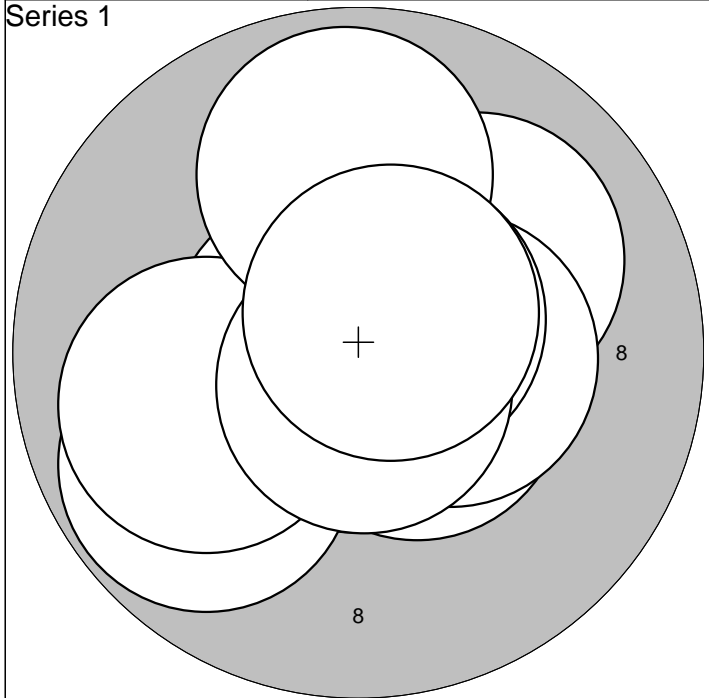

| | | | |
|-----------|------------|-------|------|
| 1:10,7* ↙ | 6:10,4* → | Serie | 98,0 |
| 2: 9,8 ↘ | 7:10,6* ↗ | | |
| 3:10,0 ↙ | 8: 9,9 ↑ | Sum | 98,0 |
| 4:10,5* ↘ | 9:10,7* ↓ | | |
| 5:10,0 ↗ | 10:10,6* ↗ | | |

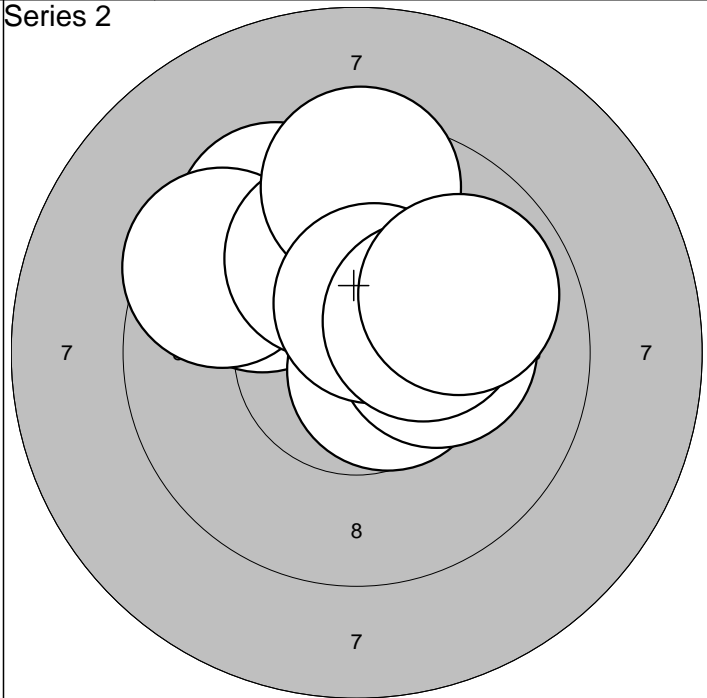

| | | | |
|-----------|-----------|-------|-------|
| 1: 9,8 ↗ | 6:10,2* → | Serie | 95,0 |
| 2: 9,6 ↗ | 7: 9,5 ↑ | | |
| 3: 9,5 ↗ | 8:10,5* ↑ | Sum | 193,0 |
| 4:10,6* ↘ | 9:10,3* → | | |
| 5:10,1 ↑ | 10: 9,9 ↗ | | |

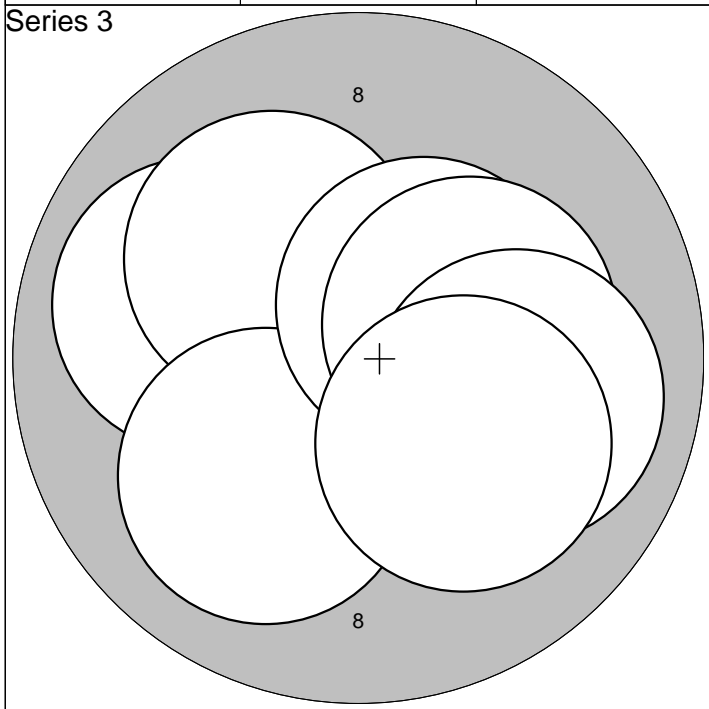

| | | | |
|-----------|-----------|-------|-------|
| 1:10,7* ↙ | 6:10,1 ↘ | Serie | 100,0 |
| 2:10,0 ↙ | 7:10,4* ↗ | | |
| 3:10,5* ↗ | 8:10,3* → | Sum | 293,0 |
| 4:10,2* ↗ | 9:10,0 → | | |
| 5:10,5* → | 10:10,1 ↘ | | |

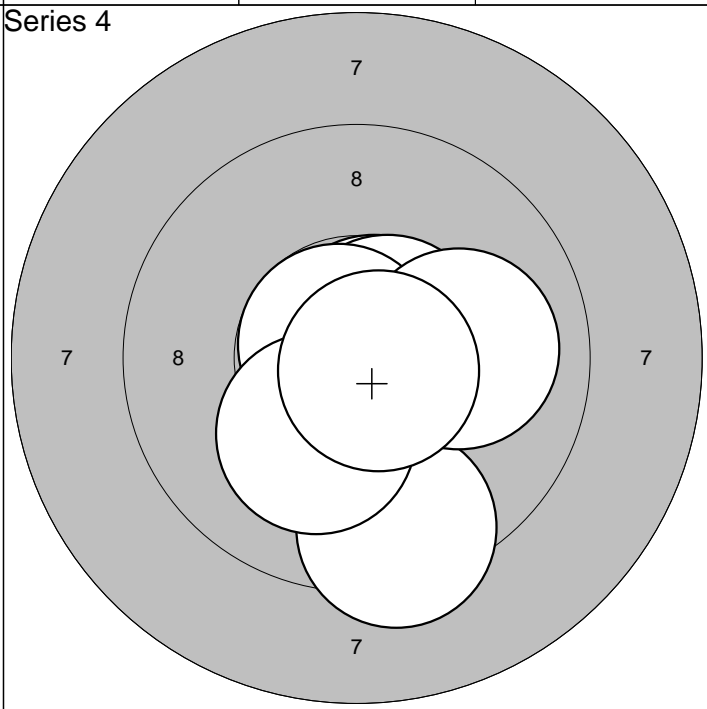

| | | | |
|-----------|------------|-------|-------|
| 1:10,8* ↘ | 6:10,6* ↗ | Serie | 99,0 |
| 2:10,3* ↓ | 7:10,7* ↙ | | |
| 3:10,8* ↑ | 8:10,0 → | Sum | 392,0 |
| 4: 9,4 ↓ | 9:10,2* ↓ | | |
| 5:10,7* ↗ | 10:10,7* ↘ | | |

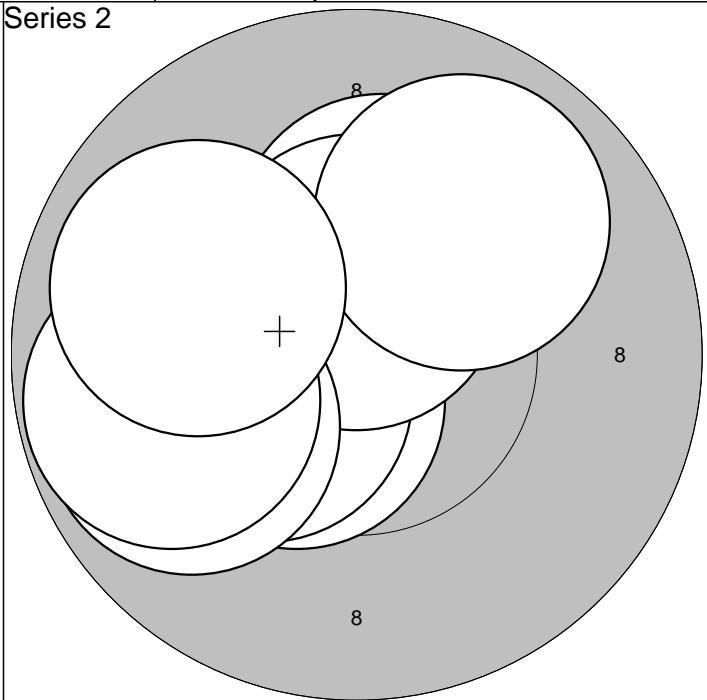
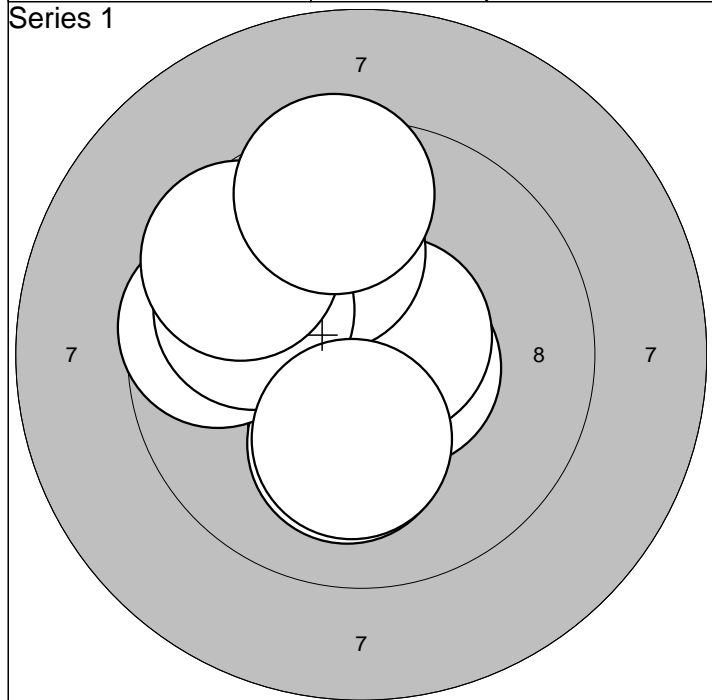

| | | |
|-----------|------------|------------|
| 1:10,6* → | 6:10,0 ↑ | Serie 96,0 |
| 2:10,4* ↓ | 7: 9,9 ← | |
| 3:10,1 ↓ | 8: 9,6 ↗ | Sum 96,0 |
| 4:10,6* ↗ | 9: 9,5 ↑ | |
| 5: 9,6 ← | 10:10,2* ↓ | |

| | | |
|-----------|-----------|------------|
| 1:10,3* ← | 6:10,5* ↑ | Serie 96,0 |
| 2:10,5* ↙ | 7: 9,9 ← | |
| 3:10,2* ↑ | 8: 9,8 ← | Sum 192,0 |
| 4:10,3* ← | 9: 9,9 ↗ | |
| 5:10,1 ← | 10: 9,9 ← | |

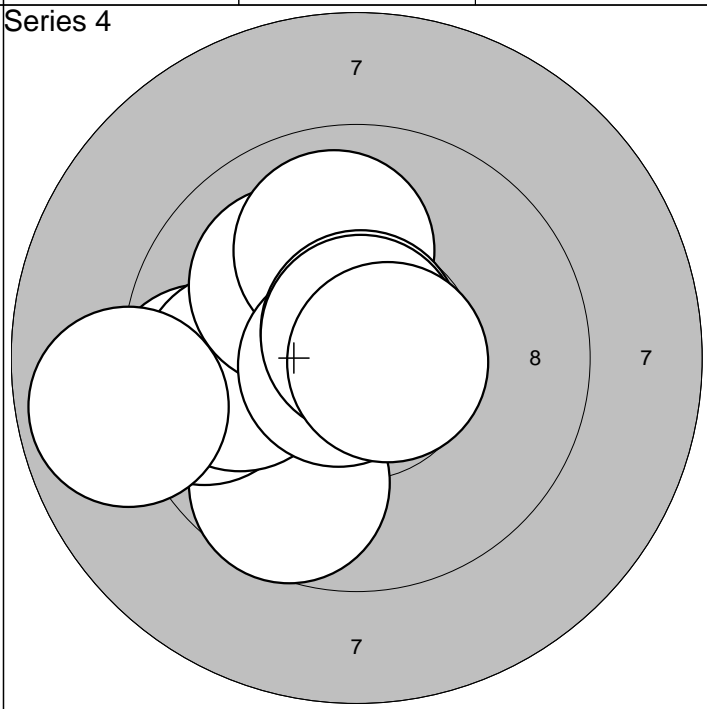
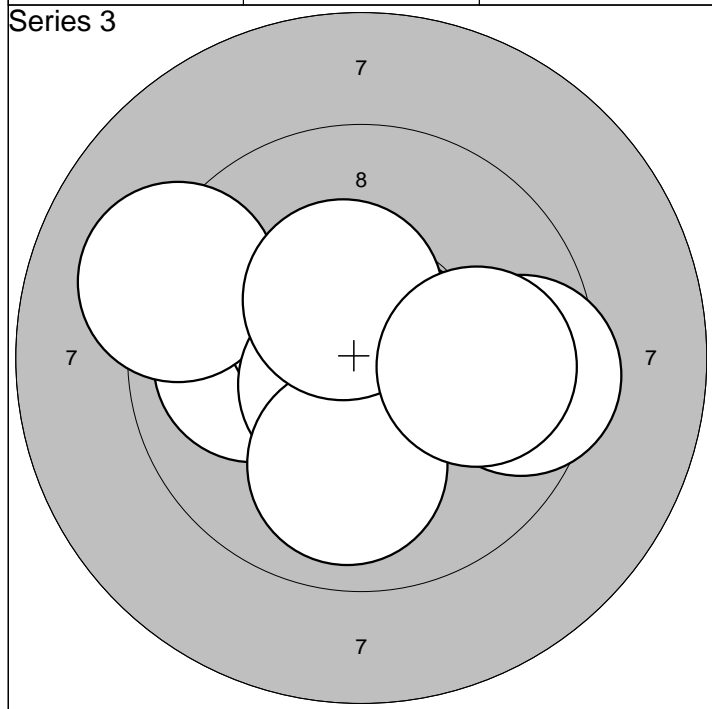

| | | |
|-----------|-----------|------------|
| 1:10,0 ← | 6: 9,2 ← | Serie 97,0 |
| 2:10,8* ↑ | 7:10,6* ↙ | |
| 3:10,5* ↗ | 8:10,0 ↓ | Sum 289,0 |
| 4: 9,5 → | 9:10,4* ↑ | |
| 5:10,7* → | 10: 9,9 → | |

| | | |
|----------|------------|------------|
| 1: 9,7 ↓ | 6:10,8* ← | Serie 95,0 |
| 2: 9,6 ← | 7: 8,9 ← | |
| 3: 9,9 ← | 8:10,7* ↑ | Sum 384,0 |
| 4:10,1 ↗ | 9:10,8* ↑ | |
| 5:10,0 ↑ | 10:10,6* → | |

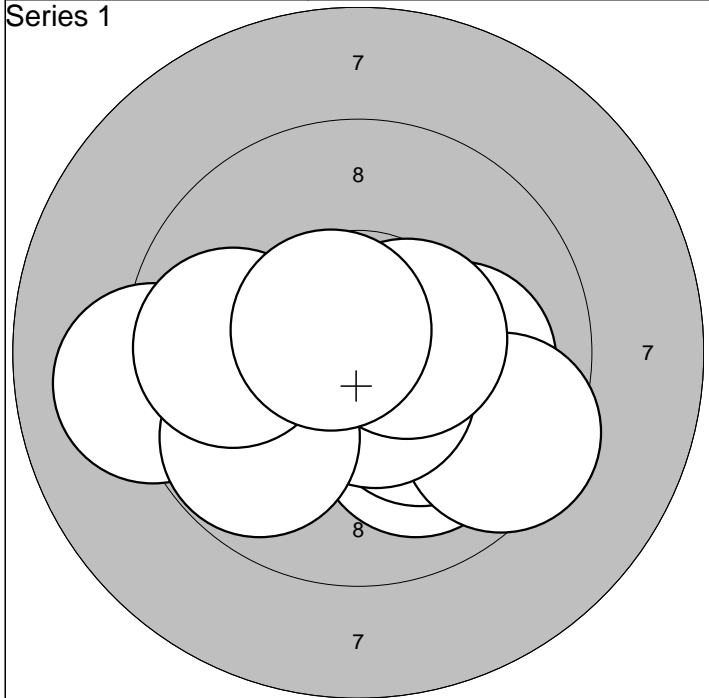

| | | | |
|-----------|------------|-------|------|
| 1:10,0 ↘ | 6:10,6* ↘ | Serie | 96,0 |
| 2:10,1 → | 7:10,5* → | | |
| 3:10,2* ↘ | 8: 9,8 ↘ | Sum | 96,0 |
| 4: 9,5 ↘ | 9: 9,8 ← | | |
| 5: 9,1 ← | 10:10,6* ↗ | | |

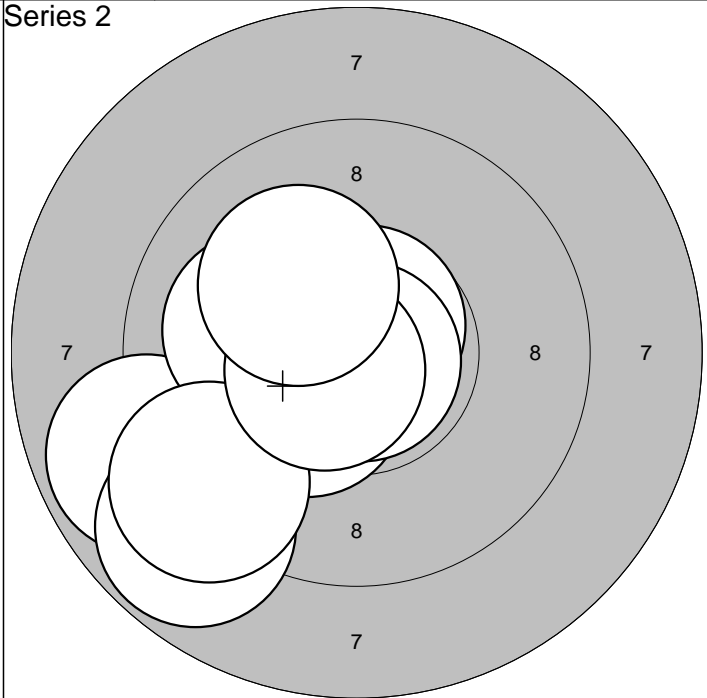

| | | | |
|-----------|------------|-------|-------|
| 1: 8,9 ← | 6:10,7* ↗ | Serie | 95,0 |
| 2:10,7* ↗ | 7: 9,2 ↘ | | |
| 3: 8,8 ↘ | 8:10,9* ↘ | Sum | 191,0 |
| 4:10,4* ↘ | 9:10,6* ← | | |
| 5:10,1 ← | 10:10,2* ↗ | | |

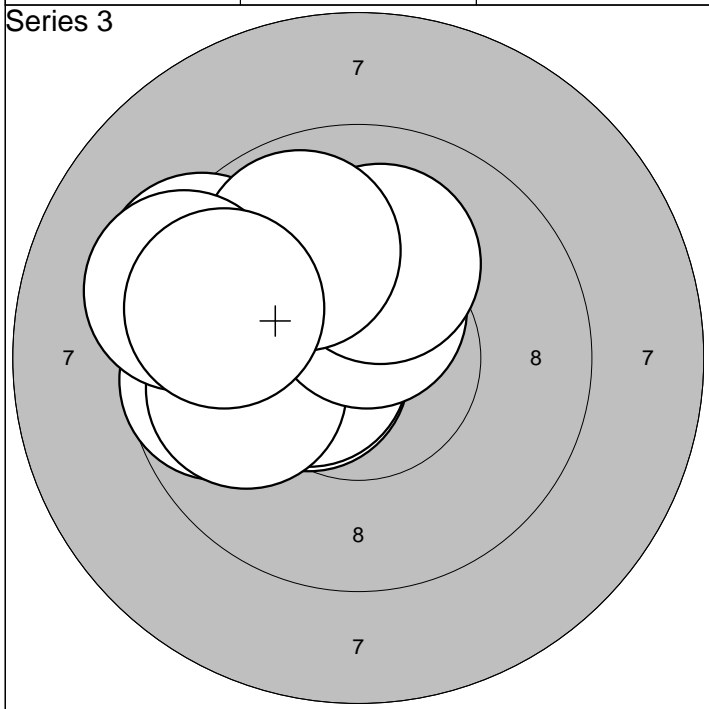

| | | | |
|-----------|-----------|-------|-------|
| 1: 9,7 ← | 6: 9,4 ↘ | Serie | 94,0 |
| 2:10,5* ← | 7:10,1 ↗ | | |
| 3:10,5* ← | 8: 9,9 ↗ | Sum | 285,0 |
| 4: 9,9 ← | 9: 9,3 ↘ | | |
| 5:10,5* ↗ | 10: 9,7 ↘ | | |

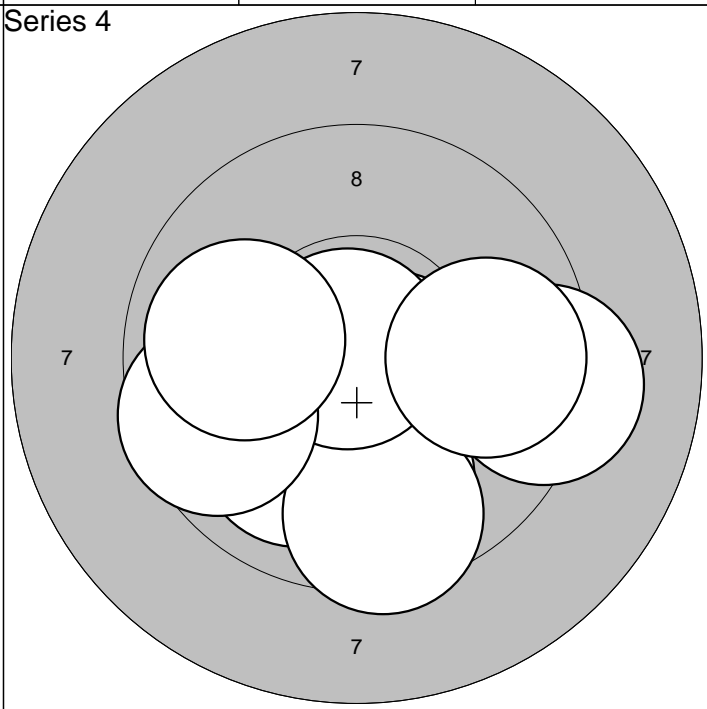

| | | | |
|-----------|-----------|-------|-------|
| 1: 9,9 ↘ | 6:10,8* ↗ | Serie | 94,0 |
| 2:10,6* → | 7: 9,6 ← | | |
| 3:10,0 ↘ | 8: 9,3 → | Sum | 379,0 |
| 4:10,3* ← | 9: 9,8 → | | |
| 5: 9,5 ↘ | 10: 9,9 ← | | |

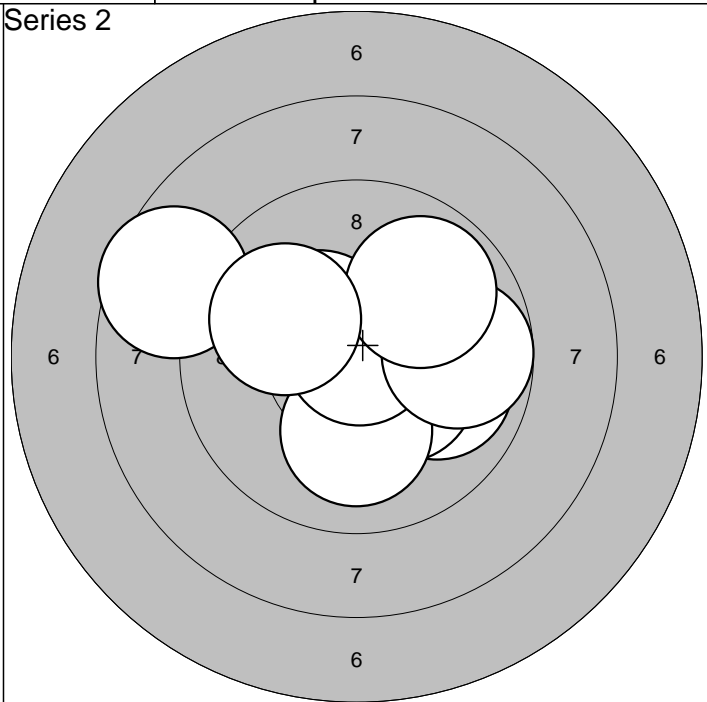
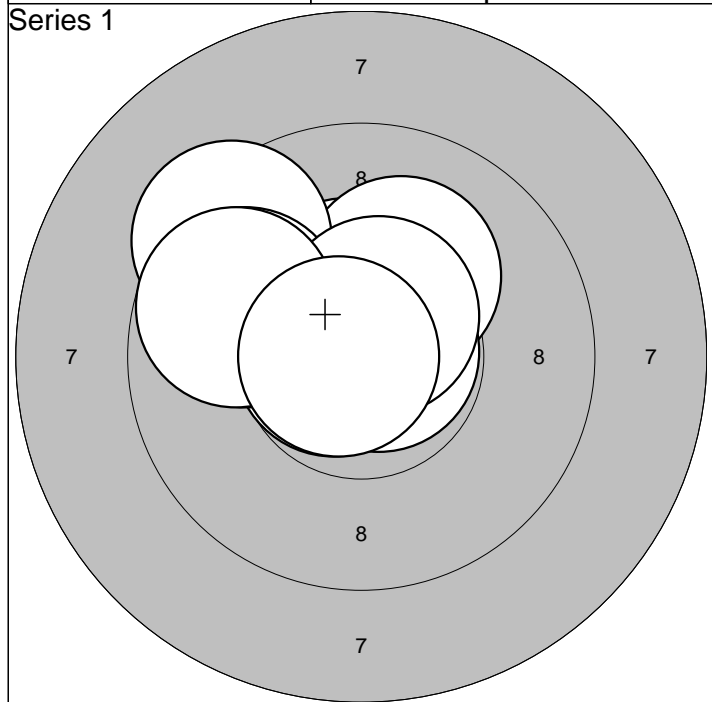

| | | |
|-----------|------------|------------|
| 1:10,7* ↗ | 6: 9,8 ↖ | Serie 97,0 |
| 2:10,7* ← | 7:10,8* → | |
| 3:10,4* ↑ | 8:10,6* ↗ | Sum 97,0 |
| 4:10,1 ↗ | 9: 9,8 ↖ | |
| 5: 9,4 ↖ | 10:10,7* ← | |

| | | |
|-----------|-----------|------------|
| 1:10,1 ↗ | 6:10,1 ↓ | Serie 96,0 |
| 2:10,0 → | 7:10,9* ↗ | |
| 3:10,4* ↖ | 8: 9,7 → | Sum 193,0 |
| 4:10,3* ↘ | 9: 9,9 ↗ | |
| 5: 8,6 ↖ | 10:10,0 ↖ | |

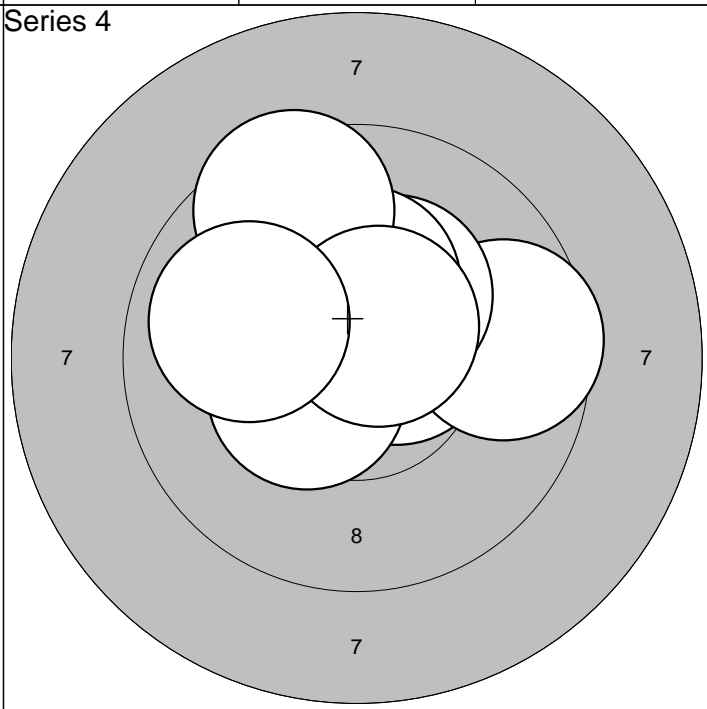
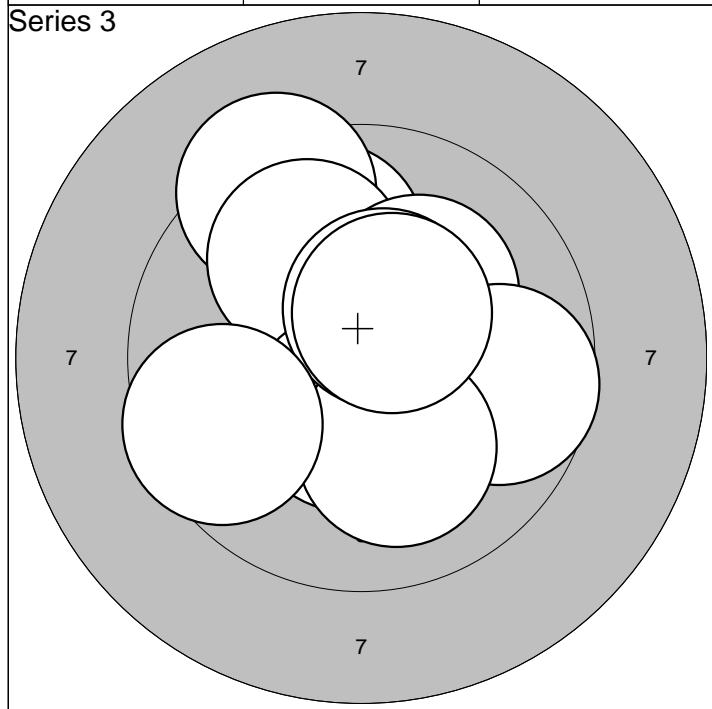

| | | |
|-----------|-----------|------------|
| 1: 9,9 ↑ | 6: 9,7 → | Serie 95,0 |
| 2: 9,3 ↖ | 7:10,1 ↓ | |
| 3: 9,9 ↖ | 8:10,5* ↗ | Sum 288,0 |
| 4:10,2* ↗ | 9:10,5* ↗ | |
| 5:10,5* ↓ | 10: 9,6 ↖ | |

| | | |
|-----------|-----------|------------|
| 1:10,4* ← | 6:10,3* ↑ | Serie 97,0 |
| 2:10,3* ↖ | 7:10,4* ↖ | |
| 3:10,6* → | 8: 9,5 ↗ | Sum 385,0 |
| 4: 9,6 → | 9:10,6* ↗ | |
| 5:10,3* ↗ | 10: 9,9 ↖ | |

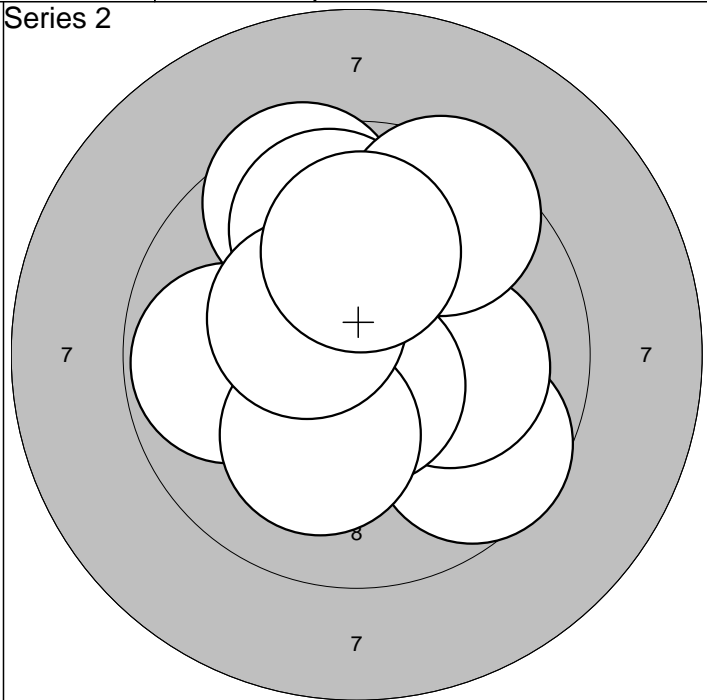
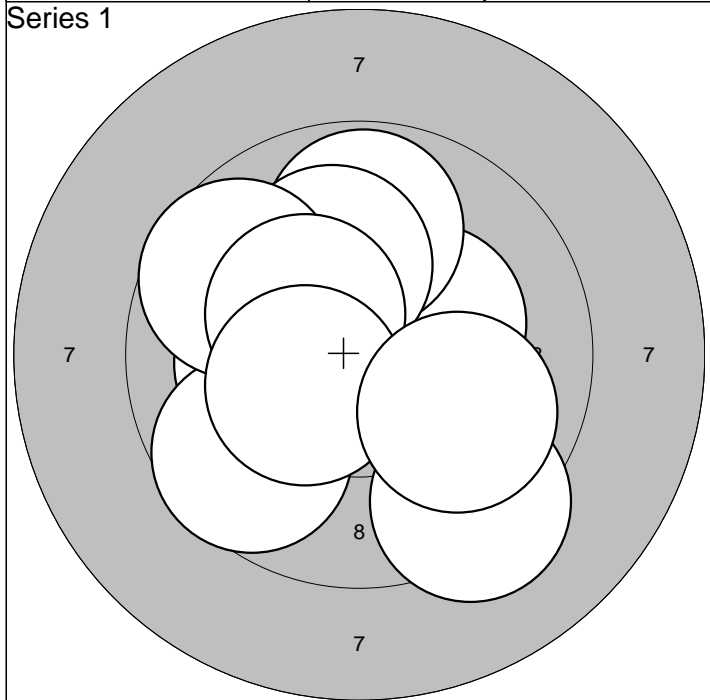

| | | | | |
|-----------|-----------|-----|-------|------|
| 1:10,2* ← | 6: 9,7 ↖ | | Serie | 95,0 |
| 2:10,3* → | 7:10,3* ↗ | | | |
| 3: 9,8 ↑ | 8:10,4* ← | Sum | 95,0 | |
| 4:10,1 ↑ | 9: 9,3 ↓ | | | |
| 5: 9,6 ↙ | 10: 9,9 ↘ | | | |

| | | | | |
|-----------|-----------|-----|-------|------|
| 1: 9,5 ↑ | 6: 9,8 ← | | Serie | 95,0 |
| 2: 9,6 ↘ | 7: 9,5 ↗ | | | |
| 3: 9,8 ↑ | 8:10,2* ↓ | Sum | 190,0 | |
| 4:10,1 → | 9:10,4* ↖ | | | |
| 5:10,7* ↓ | 10:10,0 ↑ | | | |

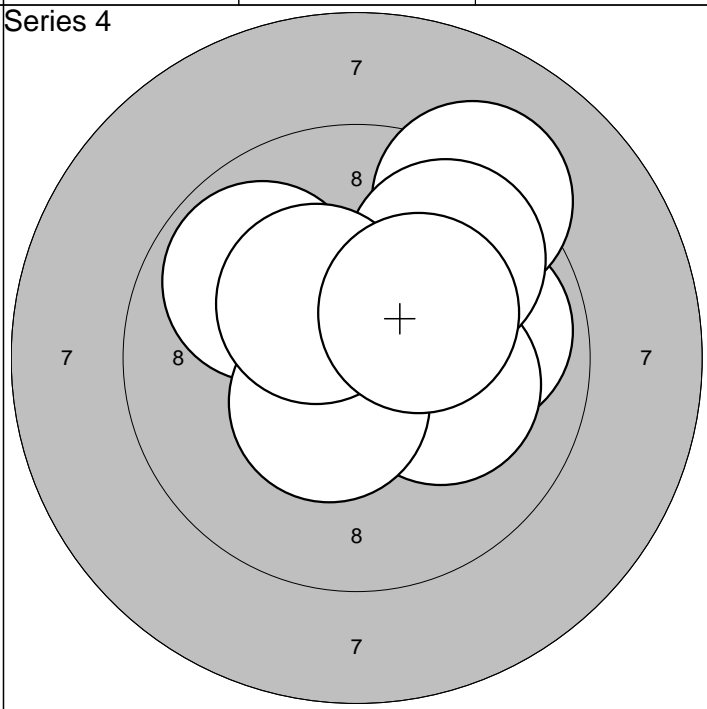
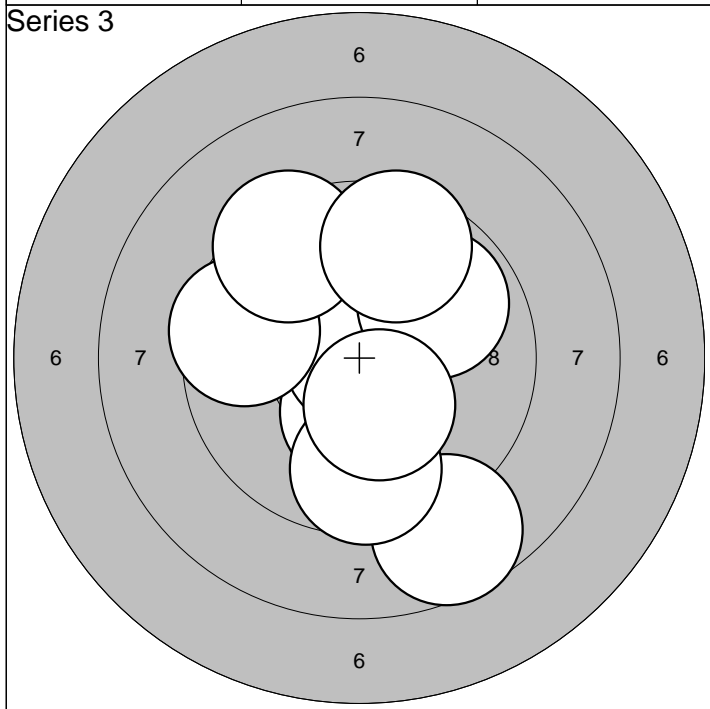

| | | | | |
|-----------|------------|-----|-------|------|
| 1:10,3* ↓ | 6: 9,9 ↗ | | Serie | 92,0 |
| 2: 9,9 ↑ | 7: 9,6 ↑ | | | |
| 3:10,9* ↑ | 8: 8,7 ↓ | Sum | 282,0 | |
| 4: 9,5 ← | 9: 9,6 ↓ | | | |
| 5: 9,4 ↗ | 10:10,4* ↓ | | | |

| | | | | |
|-----------|------------|-----|-------|------|
| 1:10,4* → | 6: 9,9 ↖ | | Serie | 96,0 |
| 2: 9,9 → | 7:10,5* ↓ | | | |
| 3:10,4* → | 8: 9,8 ↗ | Sum | 378,0 | |
| 4:10,2* → | 9:10,4* ↖ | | | |
| 5: 9,2 ↑ | 10:10,3* ↗ | | | |

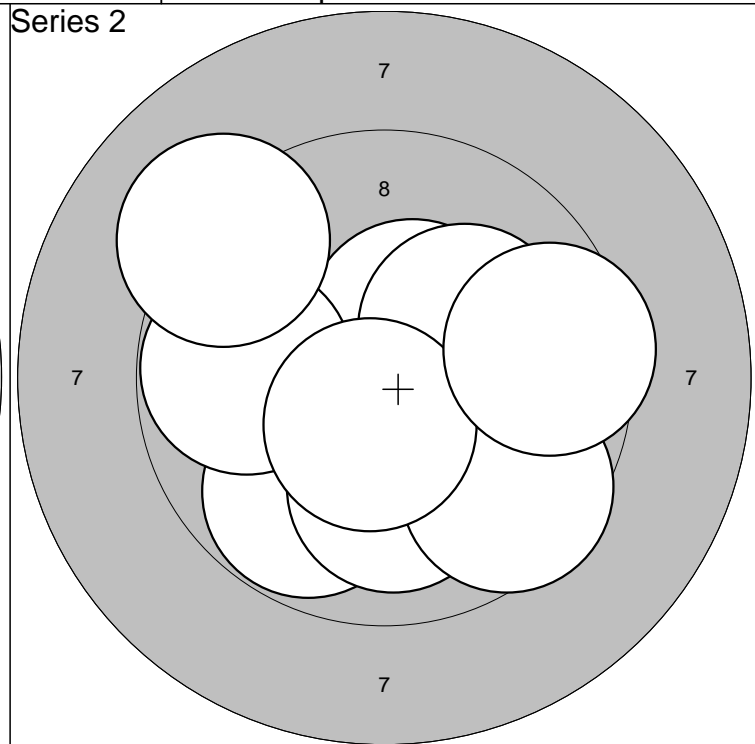
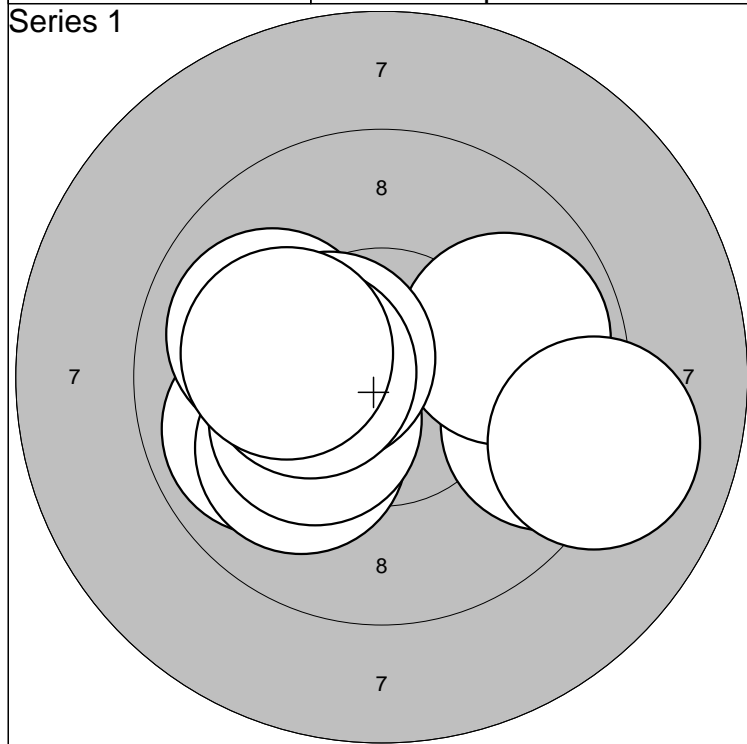

| | | | | | |
|---------|---|---------|---|-------|------|
| 1: 9,5 | → | 6: 9,9 | ← | Serie | 95,0 |
| 2: 9,9 | ← | 7: 9,1 | → | | |
| 3: 9,9 | → | 8:10,5* | ← | Sum | 95,0 |
| 4:10,1 | ↙ | 9:10,3* | ← | | |
| 5:10,3* | ↙ | 10:10,1 | ← | | |

| | | | | | |
|---------|---|---------|---|-------|-------|
| 1:10,5* | ↗ | 6:10,0 | ↓ | Serie | 94,0 |
| 2: 9,8 | ↘ | 7:10,2* | ↗ | | |
| 3: 9,9 | → | 8: 9,6 | ↘ | Sum | 189,0 |
| 4: 9,8 | ← | 9:10,5* | ↓ | | |
| 5: 9,2 | ↖ | 10: 9,5 | → | | |

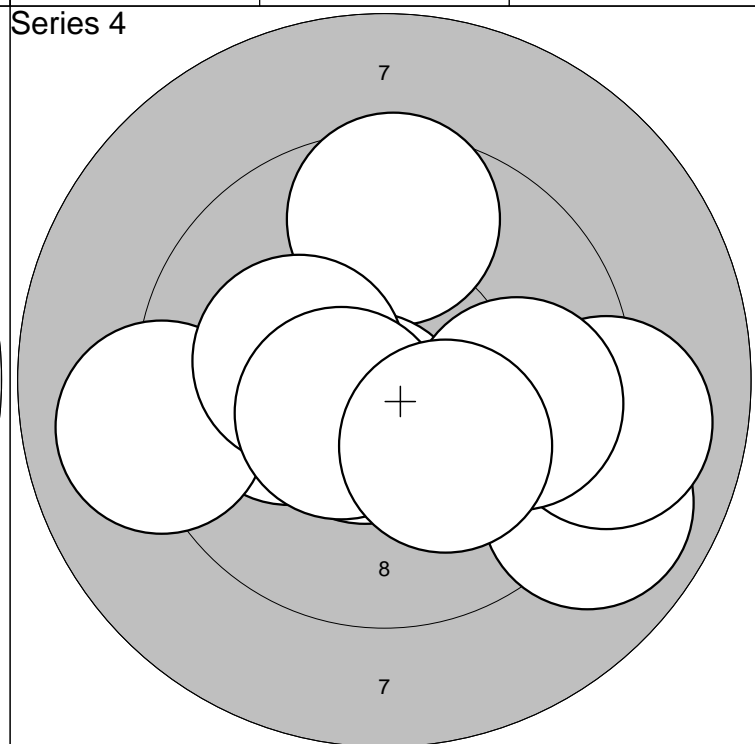
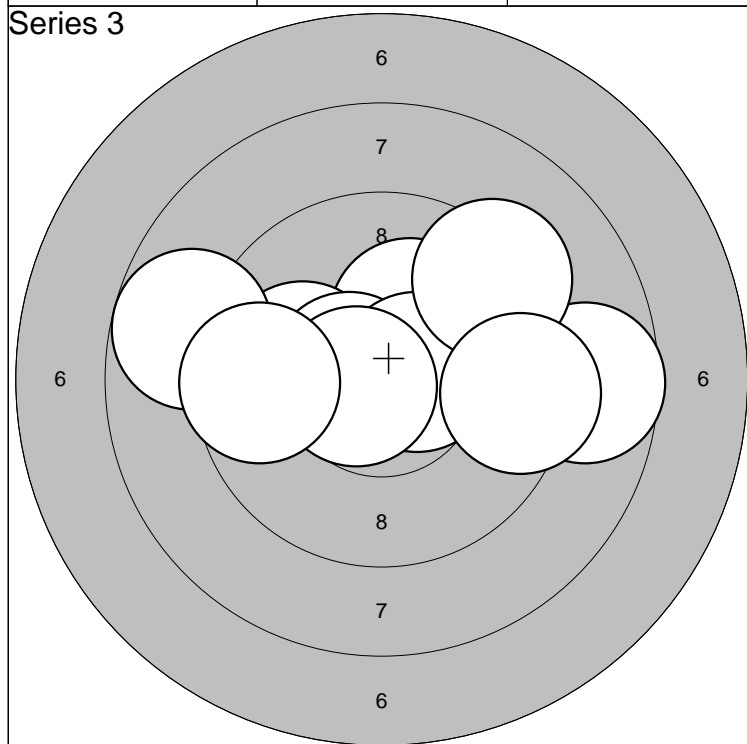

| | | | | | |
|---------|---|---------|---|-------|-------|
| 1:10,2* | ↗ | 6:10,6* | → | Serie | 93,0 |
| 2:10,1 | ← | 7: 9,3 | ↗ | | |
| 3: 8,7 | ← | 8:10,7* | ← | Sum | 282,0 |
| 4:10,6* | ← | 9: 9,4 | → | | |
| 5: 8,7 | → | 10: 9,6 | ← | | |

| | | | | | |
|---------|---|----------|---|-------|-------|
| 1: 9,0 | ↘ | 6:10,2* | ← | Serie | 95,0 |
| 2: 9,6 | ↑ | 7:10,5* | ↙ | | |
| 3:10,6* | ↘ | 8: 9,0 | → | Sum | 377,0 |
| 4:10,1 | ← | 9: 9,8 | → | | |
| 5: 9,0 | ← | 10:10,2* | ↘ | | |

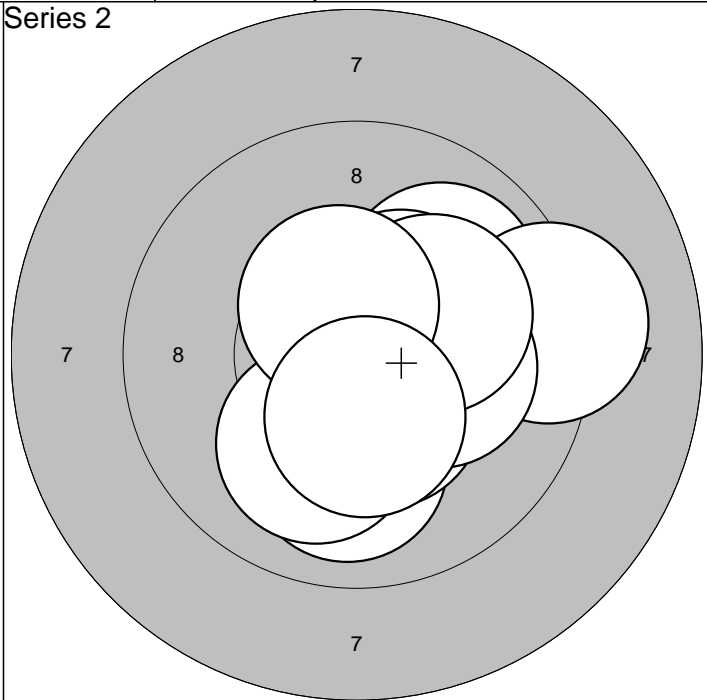
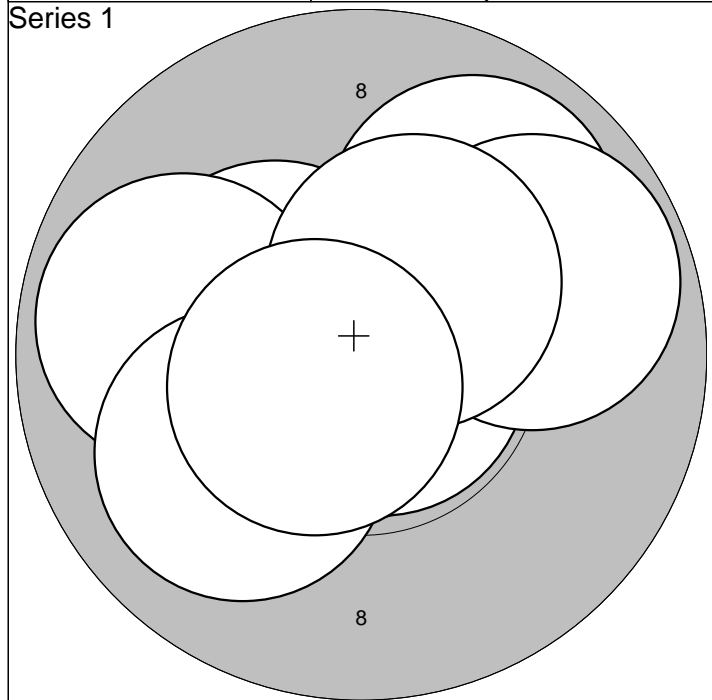

| | | | | | |
|-----------|------------|-------|------|--|--|
| 1:10,9* → | 6: 9,8 ↗ | | | | |
| 2:10,4* ↖ | 7: 9,9 ← | | | | |
| 3: 9,9 ↗ | 8:10,4* ↗ | Serie | 97,0 | | |
| 4:10,8* ↘ | 9:10,0 ↘ | Sum | 97,0 | | |
| 5:10,8* ↘ | 10:10,6* ↙ | | | | |

| | | | | | |
|-----------|------------|-------|-------|--|--|
| 1:10,0 ↗ | 6:10,2* → | | | | |
| 2:10,4* ↗ | 7:10,2* ↗ | | | | |
| 3:10,0 ↓ | 8:10,1 ↓ | Serie | 99,0 | | |
| 4:10,4* ↘ | 9:10,5* ↗ | Sum | 196,0 | | |
| 5: 9,2 → | 10:10,4* ↓ | | | | |

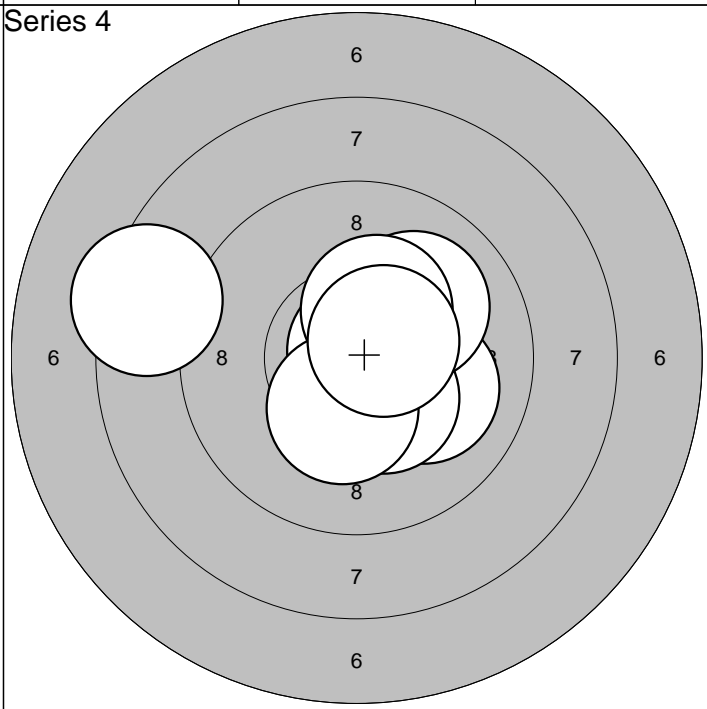
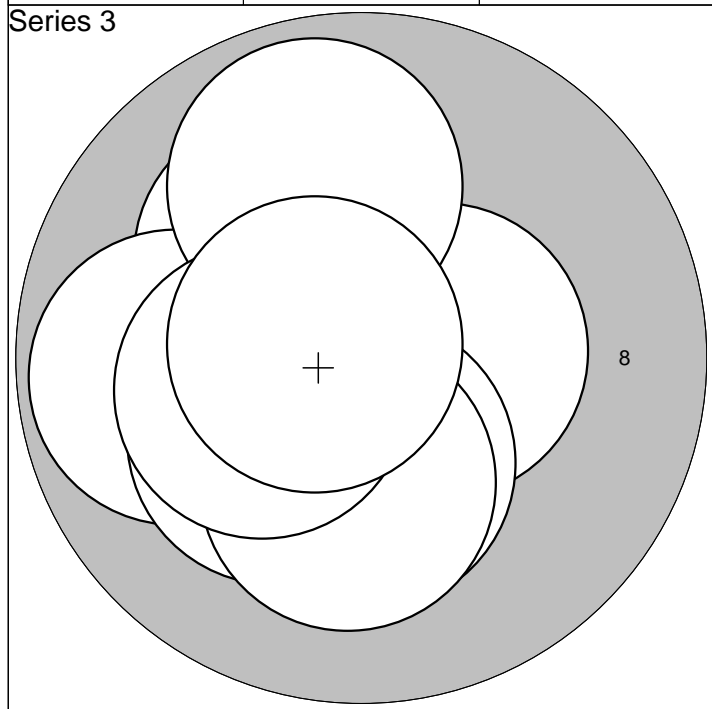

| | | | | | |
|-----------|------------|-------|-------|--|--|
| 1:10,2* ↗ | 6: 9,9 ↗ | | | | |
| 2:10,7* ↘ | 7:10,3* ↓ | | | | |
| 3: 9,8 ← | 8:10,2* ↓ | Serie | 98,0 | | |
| 4:10,5* → | 9:10,3* ← | Sum | 294,0 | | |
| 5:10,2* ↘ | 10:10,7* ← | | | | |

| | | | | | |
|-----------|------------|-------|-------|--|--|
| 1:10,4* → | 6:10,4* ↘ | | | | |
| 2:10,3* → | 7:10,3* ↓ | | | | |
| 3:10,8* ↗ | 8:10,1 ↗ | Serie | 98,0 | | |
| 4: 8,4 ← | 9:10,3* ↗ | Sum | 392,0 | | |
| 5:10,1 → | 10:10,6* ↗ | | | | |

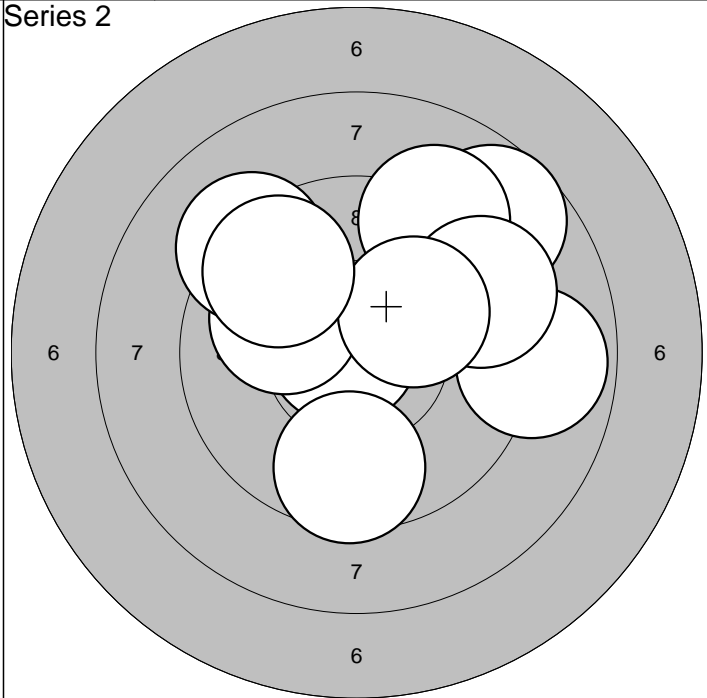
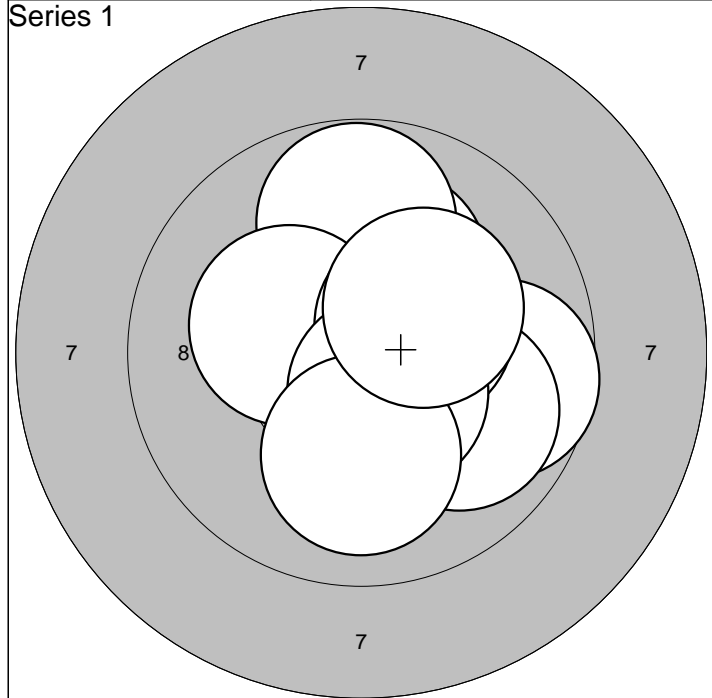

| | | | |
|-----------|------------|-------|------|
| 1:10,2* ↗ | 6: 9,9 ↘ | Serie | 97,0 |
| 2:10,2* ↘ | 7:10,4* ↗ | | |
| 3: 9,8 ↑ | 8:10,5* ↘ | Sum | 97,0 |
| 4:10,3* ↖ | 9:10,0 ↓ | | |
| 5: 9,7 → | 10:10,3* ↗ | | |

| | | | |
|-----------|-----------|-------|-------|
| 1: 8,8 → | 6: 9,3 ↗ | Serie | 91,0 |
| 2: 8,7 ↗ | 7: 9,2 ↖ | | |
| 3:10,8* ← | 8:10,1 ↗ | Sum | 188,0 |
| 4: 9,1 ↗ | 9: 9,6 ↓ | | |
| 5:10,0 ← | 10: 9,6 ↖ | | |

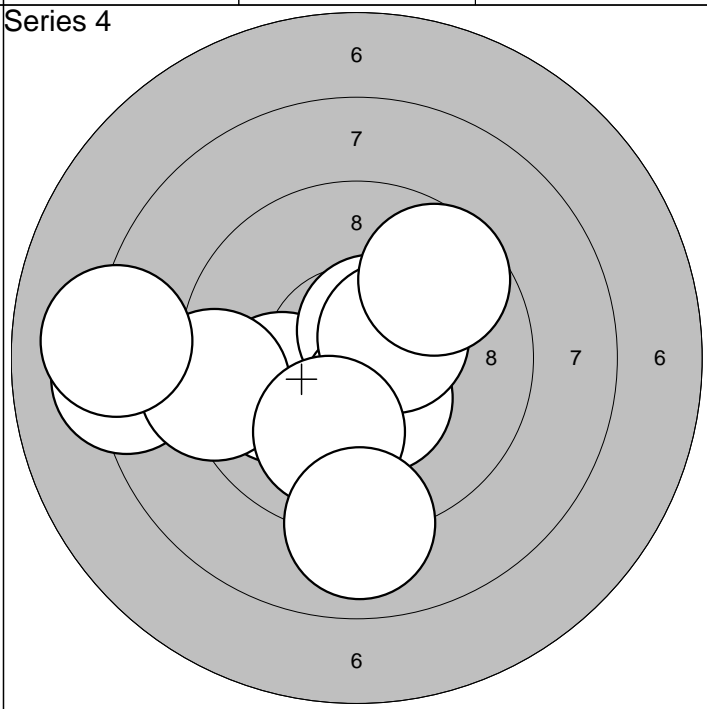
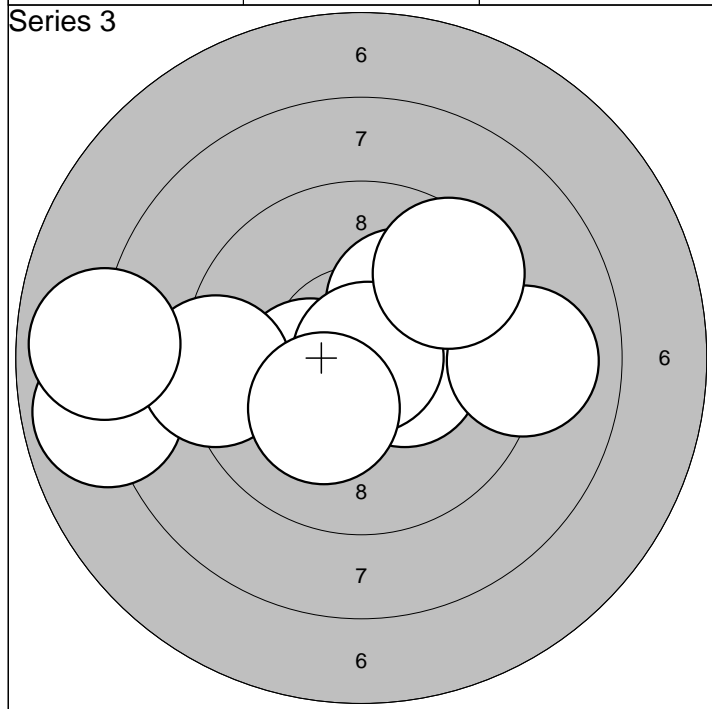

| | | | |
|-----------|-----------|-------|-------|
| 1:10,1 ↗ | 6: 9,2 ← | Serie | 91,0 |
| 2:10,3* ← | 7:10,9* → | | |
| 3: 7,9 ← | 8:10,2* ↘ | Sum | 279,0 |
| 4:10,4* → | 9: 9,5 ↗ | | |
| 5: 9,0 → | 10: 7,9 ← | | |

| | | | |
|-----------|-----------|-------|-------|
| 1:10,0 ← | 6: 8,1 ← | Serie | 93,0 |
| 2: 8,2 ← | 7:10,4* ↗ | | |
| 3:10,6* ↗ | 8: 9,7 ↗ | Sum | 372,0 |
| 4:10,4* ↘ | 9:10,0 ↓ | | |
| 5: 9,2 ← | 10: 9,0 ↓ | | |

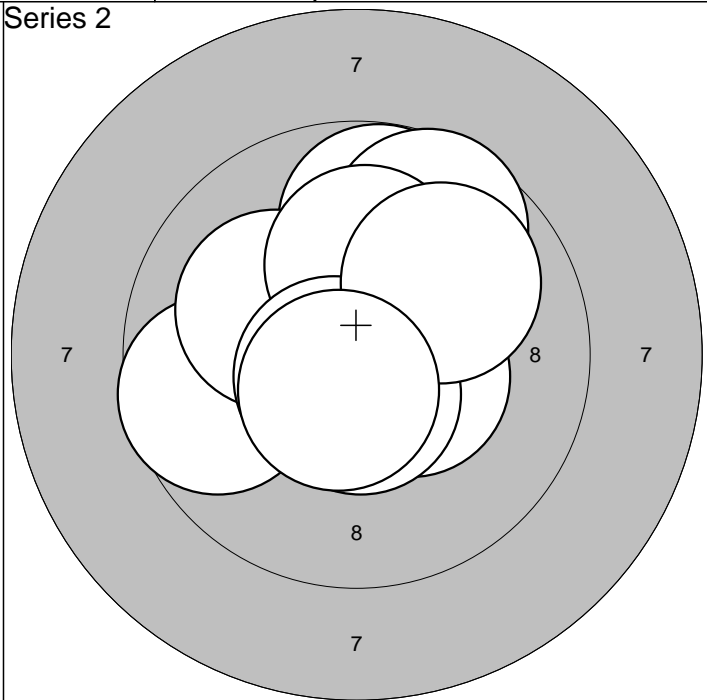
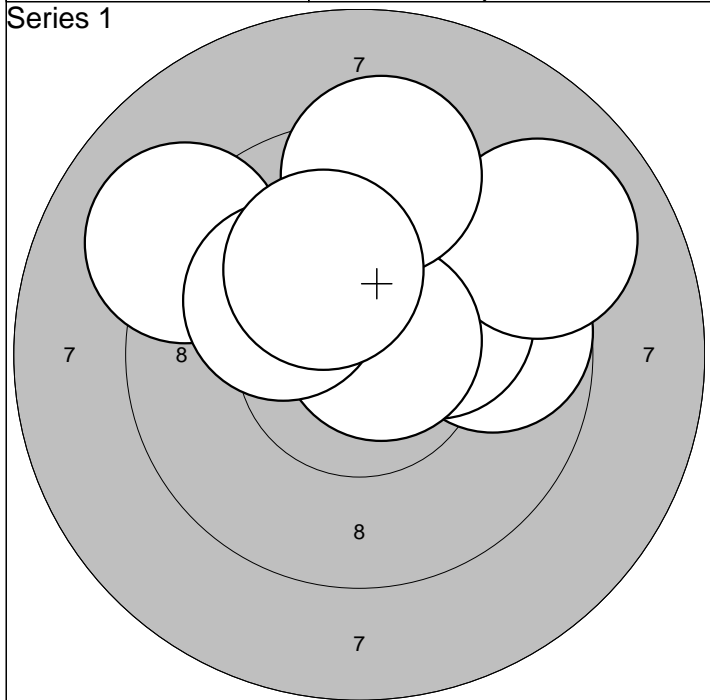

| | | | |
|-----------|-----------|-------|------|
| 1:10,4* ↑ | 6: 9,0 ↗ | Serie | 96,0 |
| 2:10,4* ↗ | 7:10,7* ↗ | | |
| 3: 9,7 → | 8: 9,3 ↑ | Sum | 96,0 |
| 4: 9,1 ↖ | 9:10,1 ↖ | | |
| 5:10,2* ↗ | 10:10,1 ↑ | | |

| | | | |
|-----------|------------|-------|-------|
| 1: 9,8 ↑ | 6:10,6* ↓ | Serie | 97,0 |
| 2: 9,7 ↗ | 7:10,1 ↑ | | |
| 3: 9,7 ← | 8:10,7* ↘ | Sum | 193,0 |
| 4:10,1 ↖ | 9:10,0 ↗ | | |
| 5:10,4* → | 10:10,6* ↓ | | |

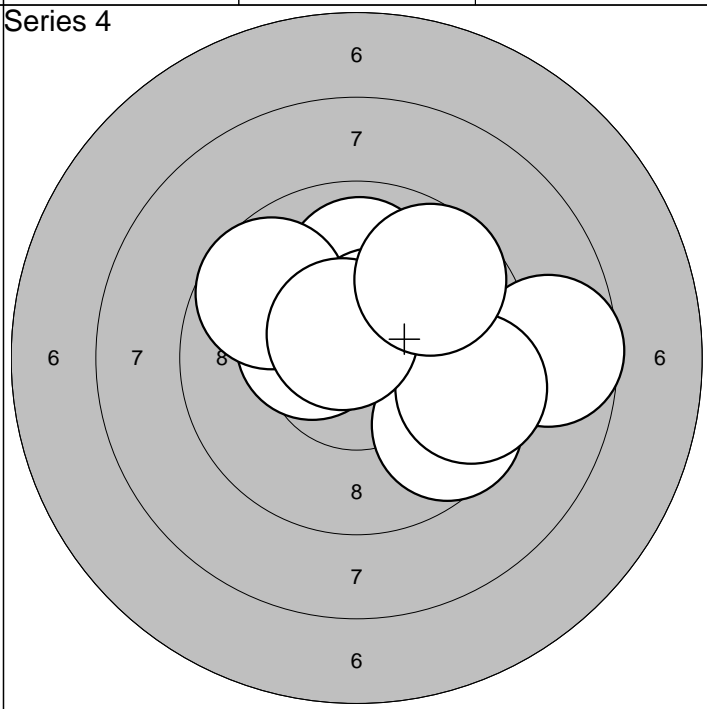
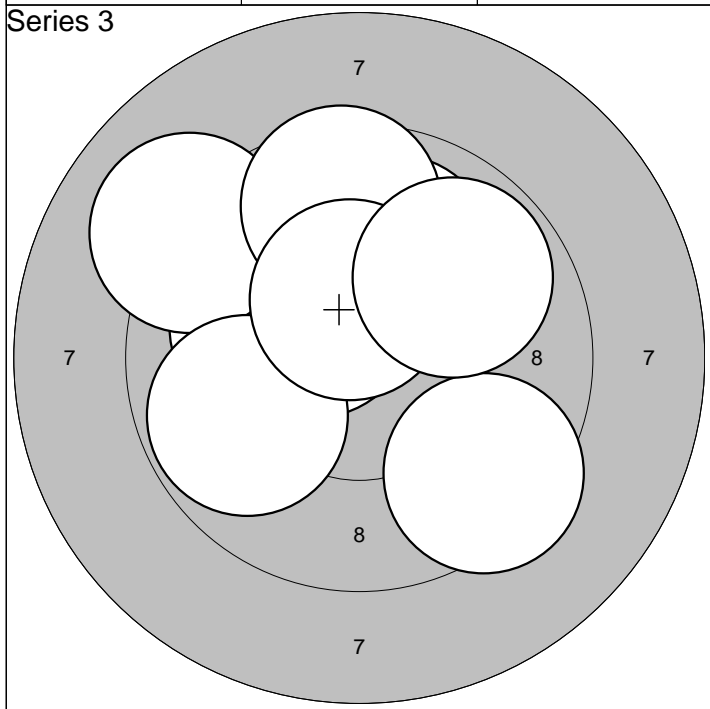

| | | | |
|-----------|-----------|-------|-------|
| 1:10,2* ↑ | 6:10,0 ↑ | Serie | 95,0 |
| 2:10,4* ↗ | 7: 9,8 ↖ | | |
| 3:10,1 ↖ | 8: 9,6 ↑ | Sum | 288,0 |
| 4: 9,1 ↗ | 9:10,4* ↑ | | |
| 5: 9,4 ↘ | 10: 9,8 ↗ | | |

| | | | |
|-----------|-----------|-------|-------|
| 1: 9,9 ↑ | 6:10,5* ↗ | Serie | 92,0 |
| 2: 9,4 → | 7: 9,6 ↘ | | |
| 3:10,4* ↖ | 8: 9,5 → | Sum | 380,0 |
| 4: 8,7 → | 9:10,6* ↖ | | |
| 5: 9,7 ↖ | 10: 9,7 ↗ | | |

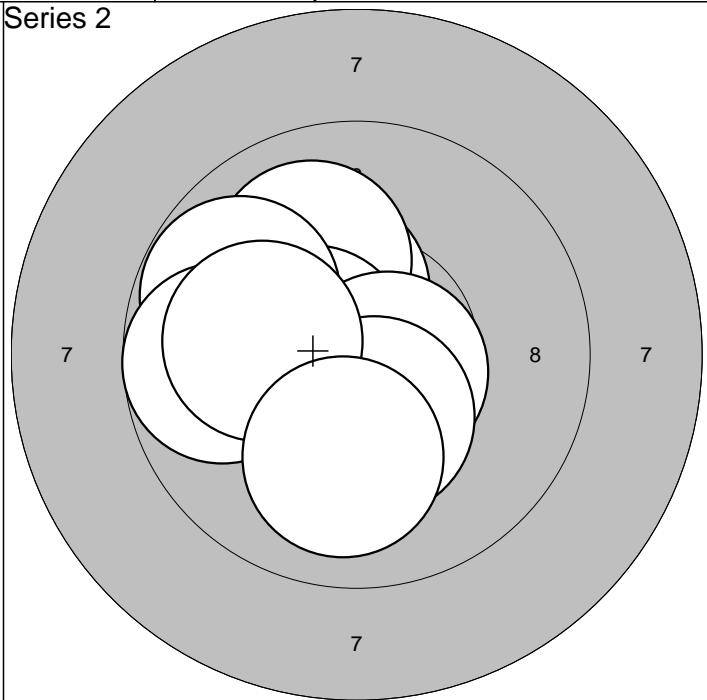
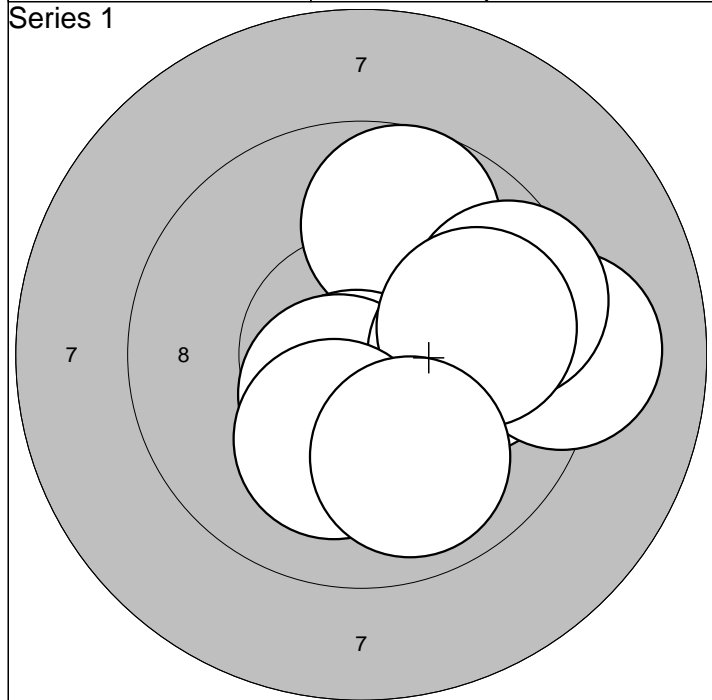

| | | | |
|-----------|-----------|-------|------|
| 1:10,3* → | 6: 9,2 → | Serie | 95,0 |
| 2: 9,7 ↑ | 7: 9,5 → | | |
| 3:10,6* ↓ | 8: 9,9 → | Sum | 95,0 |
| 4:10,5* ↓ | 9:10,1 ↓ | | |
| 5:10,0 → | 10: 9,9 ↓ | | |

| | | | |
|-----------|-----------|-------|-------|
| 1:10,8* ← | 6:10,6* ↘ | Serie | 98,0 |
| 2:10,3* ↑ | 7:10,4* ↓ | | |
| 3:10,0 ↑ | 8: 9,7 ← | Sum | 193,0 |
| 4:10,5* ← | 9:10,1 ← | | |
| 5: 9,8 ↖ | 10:10,0 ↓ | | |

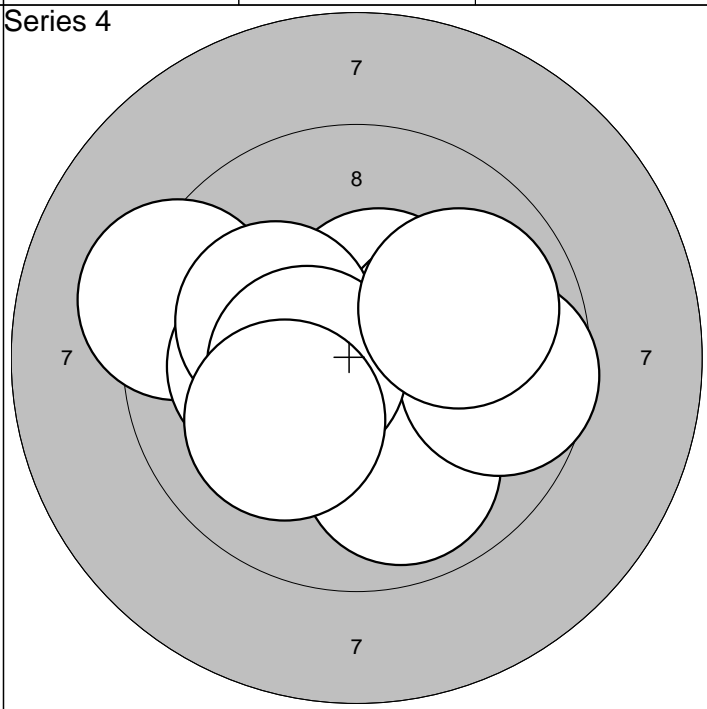
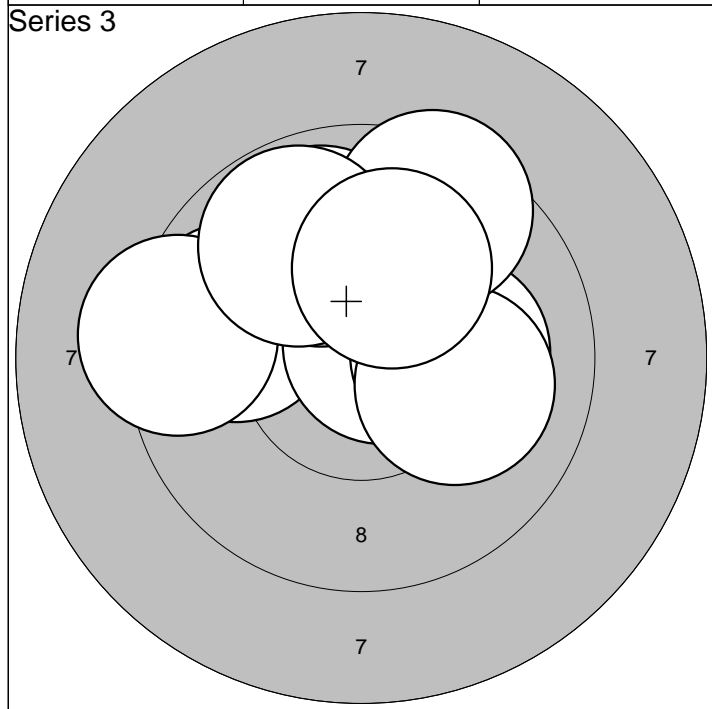

| | | | |
|-----------|-----------|-------|-------|
| 1:10,2* ↖ | 6:10,1 → | Serie | 95,0 |
| 2: 9,8 ← | 7: 9,5 ↑ | | |
| 3:10,7* ↗ | 8: 9,3 ← | Sum | 288,0 |
| 4:10,1 → | 9: 9,8 ↑ | | |
| 5: 9,9 ↑ | 10:10,1 ↑ | | |

| | | | |
|-----------|-----------|-------|-------|
| 1:10,5* ↑ | 6:10,2* ← | Serie | 96,0 |
| 2:10,2* → | 7: 9,7 → | | |
| 3: 9,9 ↓ | 8:10,5* ← | Sum | 384,0 |
| 4: 9,3 ← | 9: 9,9 ↗ | | |
| 5:10,2* ← | 10:10,1 ↙ | | |

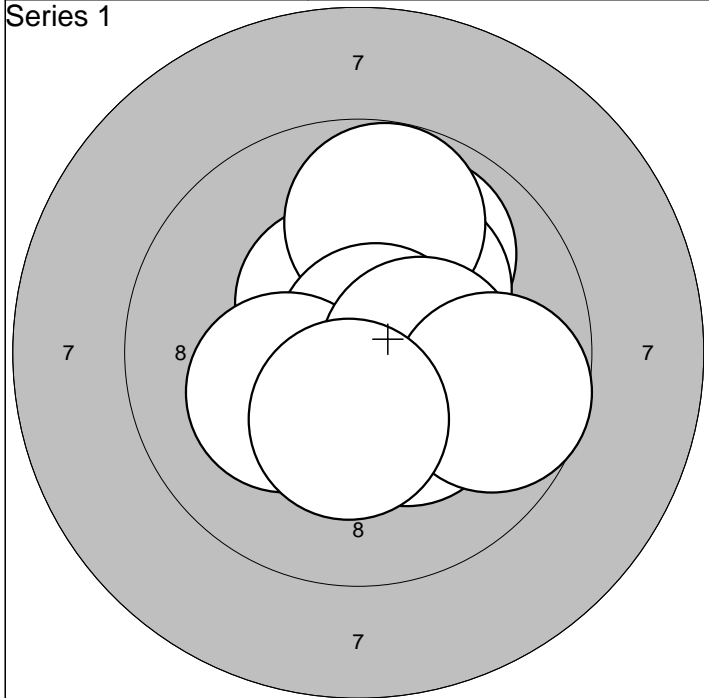

| | | | |
|-----------|------------|-------|------|
| 1:10,5* ↖ | 6:10,8* → | Serie | 97,0 |
| 2: 9,9 ↗ | 7:10,2* ← | | |
| 3:10,2* ↗ | 8:10,4* → | Sum | 97,0 |
| 4: 9,8 ↑ | 9: 9,7 → | | |
| 5:10,3* ↘ | 10:10,3* ↓ | | |

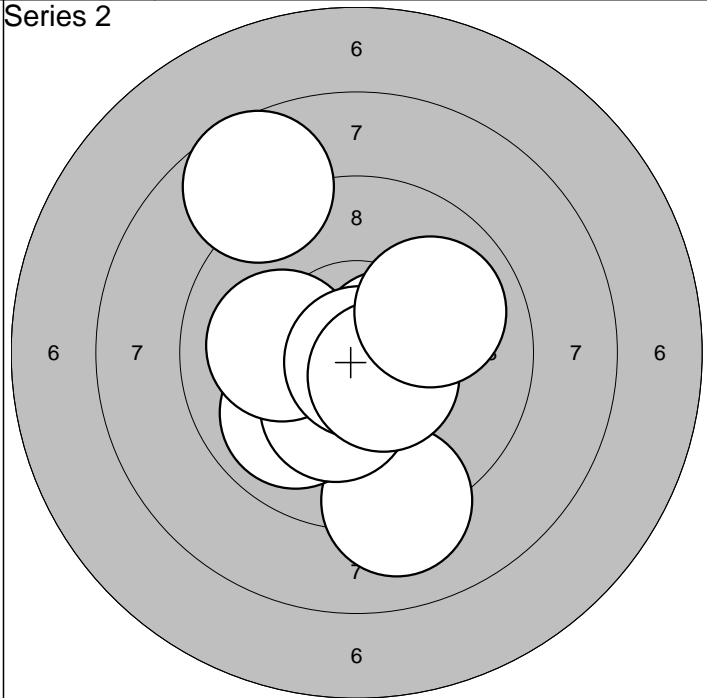

| | | | |
|-----------|-----------|-------|-------|
| 1: 9,1 ↓ | 6:10,3* ↓ | Serie | 96,0 |
| 2: 9,9 ↙ | 7:10,0 ← | | |
| 3:10,6* ↓ | 8:10,8* ↓ | Sum | 193,0 |
| 4:10,5* → | 9:10,5* ↘ | | |
| 5: 8,7 ↖ | 10:10,0 ↗ | | |

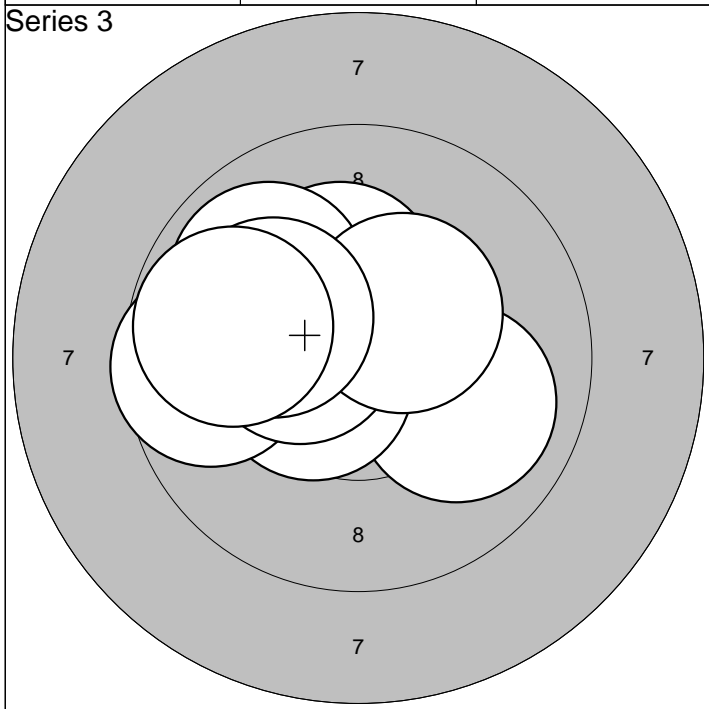

| | | | |
|-----------|-----------|-------|-------|
| 1:10,2* ↑ | 6: 9,6 ← | Serie | 96,0 |
| 2:10,0 ↘ | 7:10,4* ← | | |
| 3:10,5* ↙ | 8:10,4* ↗ | Sum | 289,0 |
| 4: 9,8 ← | 9:10,1 ← | | |
| 5: 9,9 ↖ | 10: 9,8 ← | | |

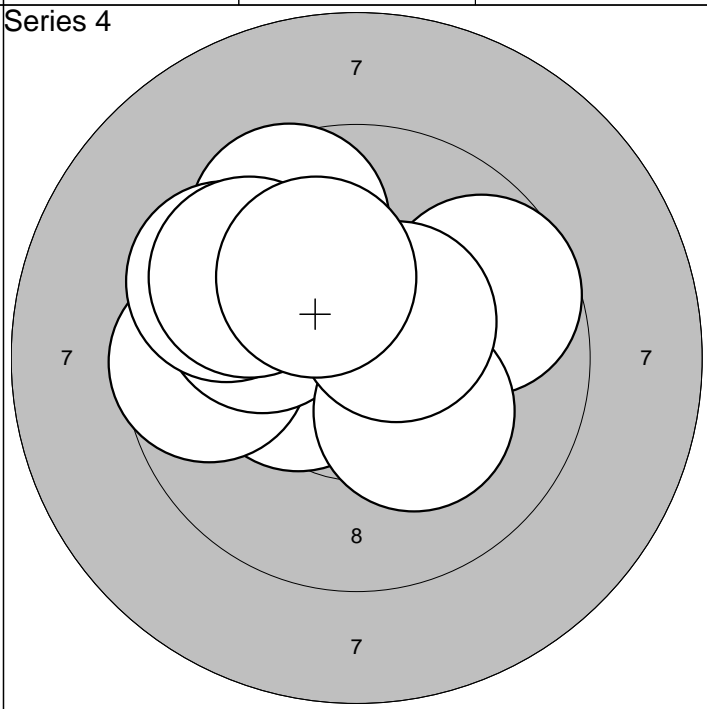

| | | | |
|-----------|------------|-------|-------|
| 1:10,4* ← | 6: 9,6 ↖ | Serie | 95,0 |
| 2: 9,6 ↖ | 7: 9,8 ↖ | | |
| 3: 9,6 ← | 8:10,3* ↘ | Sum | 384,0 |
| 4: 9,7 ↗ | 9:10,5* ↗ | | |
| 5:10,0 ↙ | 10:10,2* ↖ | | |

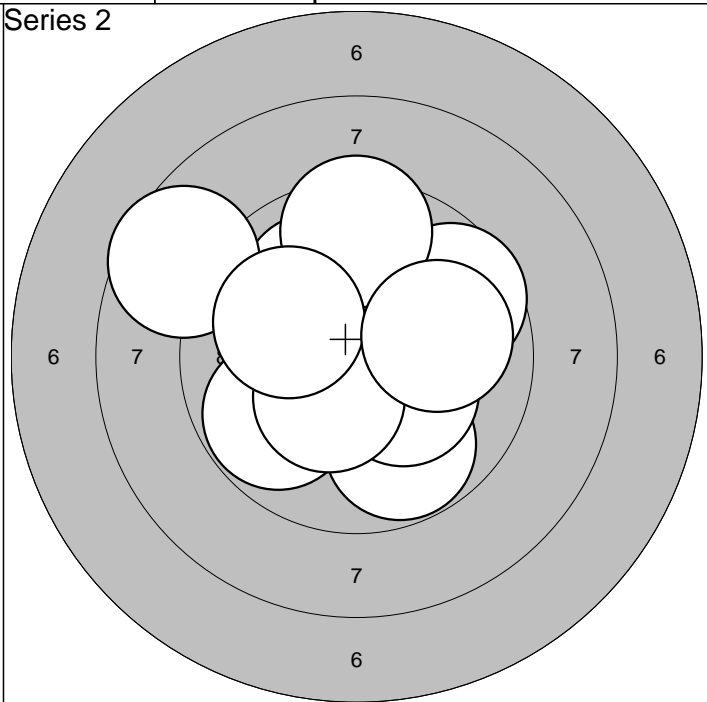
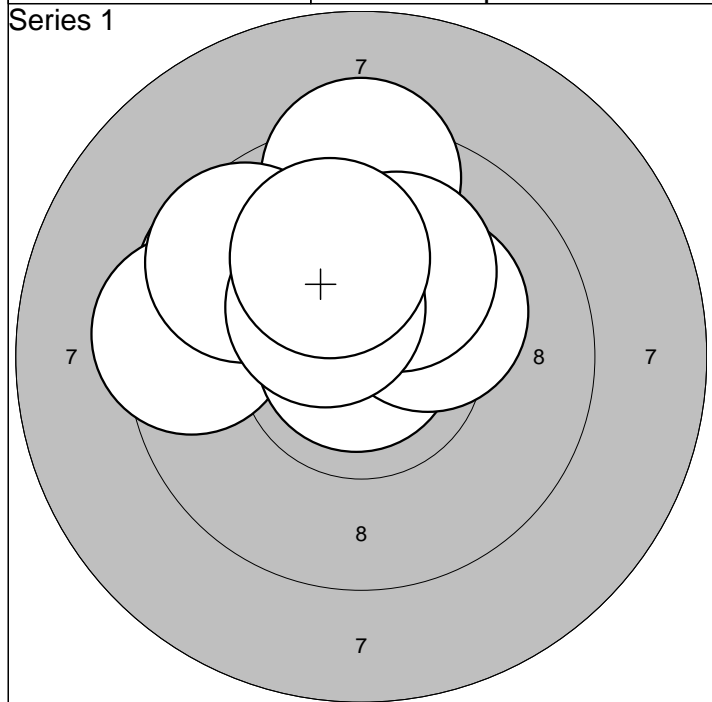

| | | | | | |
|---------|---|---------|---|-------|------|
| 1: 9,4 | ↑ | 6: 9,6 | ↖ | Serie | 96,0 |
| 2: 9,7 | ↖ | 7:10,2* | ↗ | | |
| 3: 9,4 | ← | 8:10,1 | ↗ | | |
| 4:10,2* | ↗ | 9:10,4* | ↗ | | |
| 5:10,9* | ↖ | 10:10,0 | ↑ | | |
| Sum | | | | 96,0 | |

| | | | | | |
|--------|---|---------|---|-------|------|
| 1: 9,6 | ↗ | 6:10,3* | ↘ | Serie | 94,0 |
| 2:10,0 | ↖ | 7: 8,6 | ↖ | | |
| 3: 9,8 | ↙ | 8:10,4* | ↘ | | |
| 4: 9,5 | ↑ | 9:10,1 | ↖ | | |
| 5: 9,8 | ↘ | 10:10,0 | → | | |
| Sum | | | | 190,0 | |

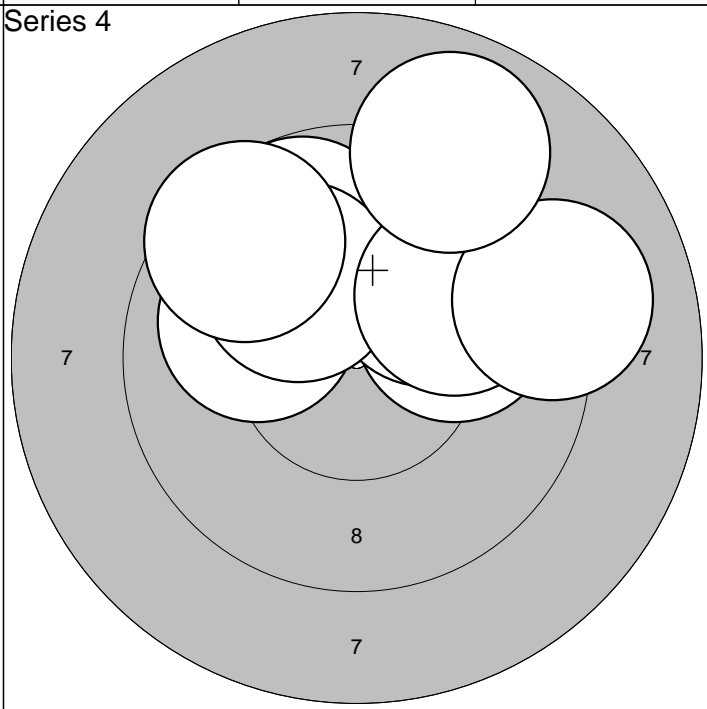
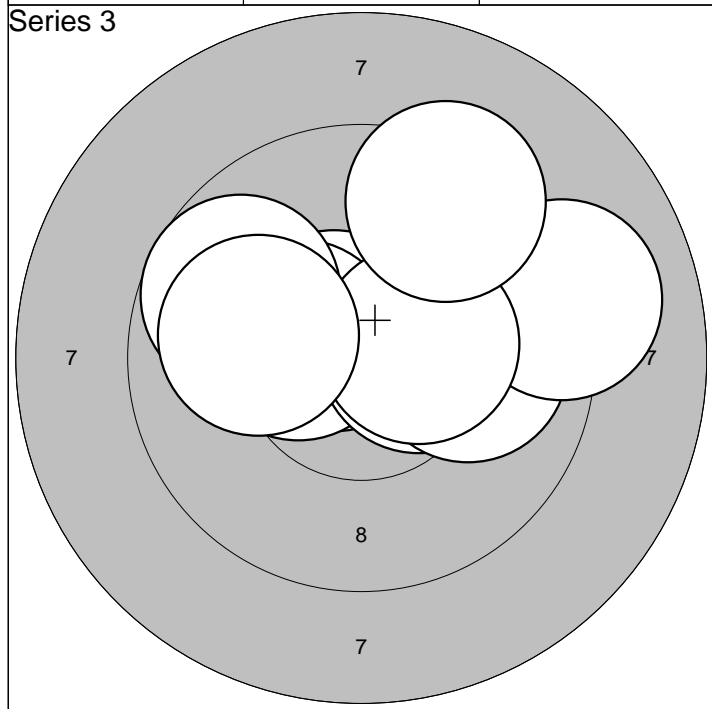

| | | | | | |
|---------|---|---------|---|-------|------|
| 1:10,4* | ↖ | 6:10,0 | → | Serie | 97,0 |
| 2:10,6* | ↖ | 7: 9,1 | → | | |
| 3:10,4* | ↖ | 8:10,4* | → | | |
| 4:10,4* | → | 9:10,0 | ← | | |
| 5: 9,7 | ↖ | 10: 9,4 | ↗ | | |
| Sum | | | | 287,0 | |

| | | | | | |
|--------|---|---------|---|-------|------|
| 1: 9,8 | ↖ | 6:10,1 | ↖ | Serie | 93,0 |
| 2:10,0 | ↗ | 7: 9,9 | ↗ | | |
| 3:10,0 | ↗ | 8: 9,1 | → | | |
| 4:10,0 | ↖ | 9: 8,9 | ↗ | | |
| 5: 9,8 | ↖ | 10: 9,5 | ↖ | | |
| Sum | | | | 380,0 | |

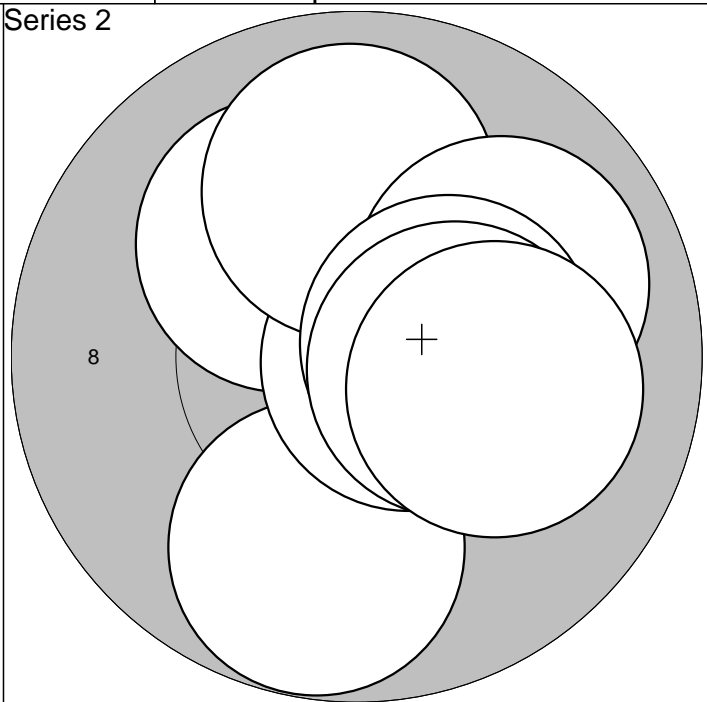
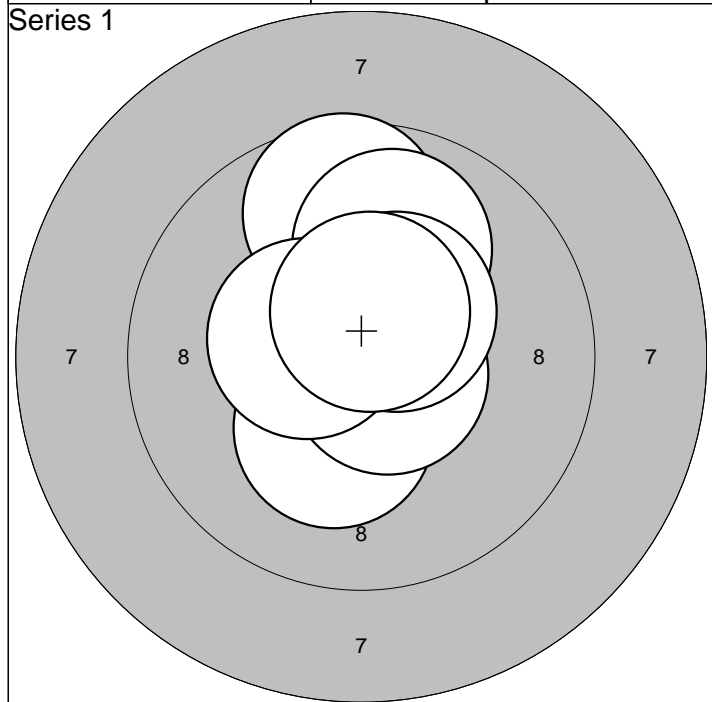

| | | | | |
|-----------|------------|-----|-------|------|
| 1:10,9* ↘ | 6:10,2* ↓ | | Serie | 98,0 |
| 2:10,8* ↘ | 7:10,6* ↘ | | | |
| 3: 9,7 ↑ | 8:10,4* ↗ | Sum | 98,0 | |
| 4:10,8* ↖ | 9:10,4* ↖ | | | |
| 5: 9,9 ↑ | 10:10,5* ↑ | | | |

| | | | | |
|-----------|-----------|-----|-------|------|
| 1:10,1 ↗ | 6:10,0 ↑ | | Serie | 99,0 |
| 2: 9,8 ↓ | 7:10,0 ↗ | | | |
| 3:10,1 ↖ | 8:10,4* → | Sum | 197,0 | |
| 4:10,6* → | 9:10,4* → | | | |
| 5:10,2* → | 10:10,1 → | | | |

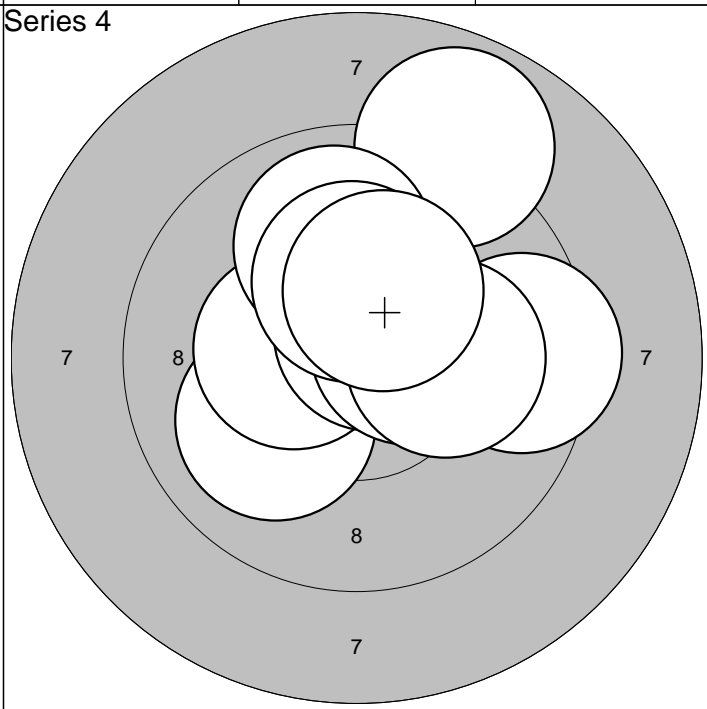
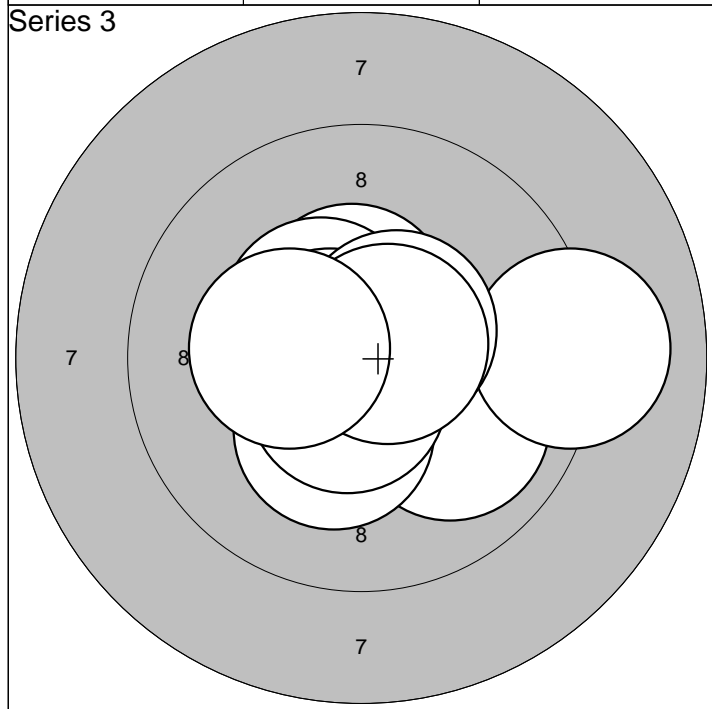

| | | | | |
|-----------|------------|-----|-------|------|
| 1:10,5* ↑ | 6:10,7* ↖ | | Serie | 99,0 |
| 2:10,0 ↘ | 7:10,6* ↗ | | | |
| 3: 9,1 → | 8:10,6* ↓ | Sum | 296,0 | |
| 4:10,4* ↖ | 9:10,7* ↗ | | | |
| 5:10,3* ↓ | 10:10,3* ↖ | | | |

| | | | | |
|-----------|------------|-----|-------|------|
| 1:10,0 ↖ | 6: 9,9 ↑ | | Serie | 96,0 |
| 2:10,4* ↖ | 7:10,4* → | | | |
| 3:10,7* ↗ | 8:10,2* → | Sum | 392,0 | |
| 4: 8,9 ↑ | 9:10,3* ↑ | | | |
| 5: 9,5 → | 10:10,3* ↑ | | | |

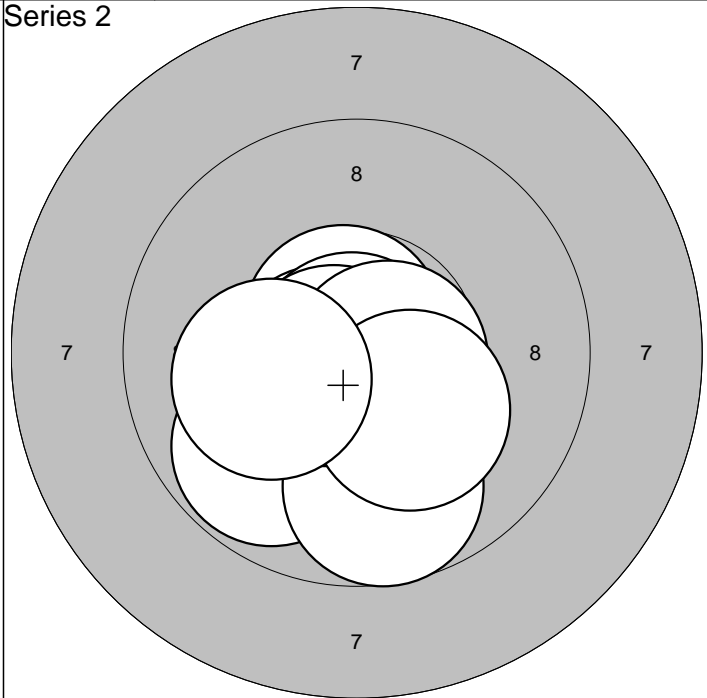
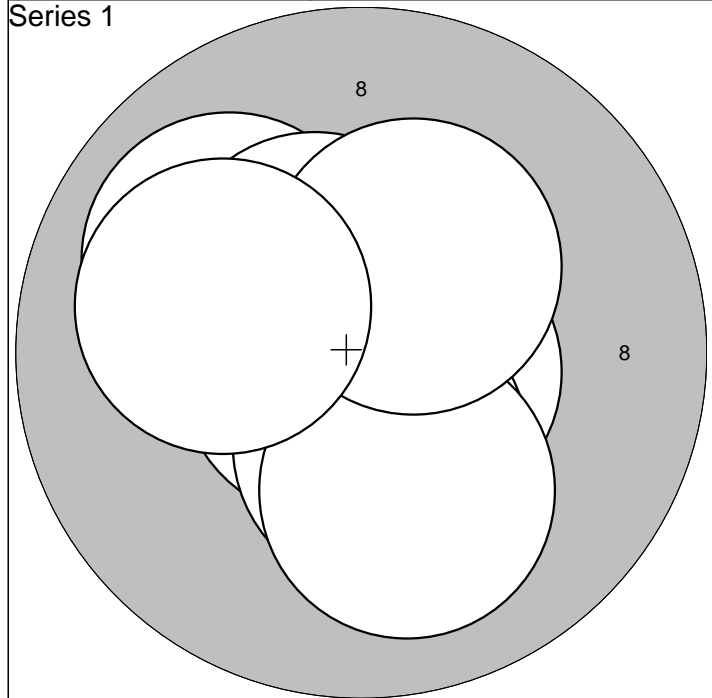

| | | | | |
|-----------|-----------|-----|-------|-------|
| 1:10,7* ↗ | 6:10,7* ↙ | | Serie | 100,0 |
| 2:10,6* → | 7:10,4* ↓ | | | |
| 3:10,0 ↖ | 8:10,1 ↓ | Sum | 100,0 | |
| 4:10,4* ↗ | 9:10,3* ↗ | | | |
| 5:10,8* ↓ | 10:10,1 ← | | | |

| | | | | |
|-----------|------------|-----|-------|------|
| 1:10,7* ↗ | 6:10,9* ← | | Serie | 98,0 |
| 2: 9,8 ↙ | 7:10,7* ↙ | | | |
| 3:10,8* ↙ | 8:10,7* → | Sum | 198,0 | |
| 4: 9,7 ↓ | 9:10,2* ↓ | | | |
| 5:10,7* ↙ | 10:10,2* ← | | | |

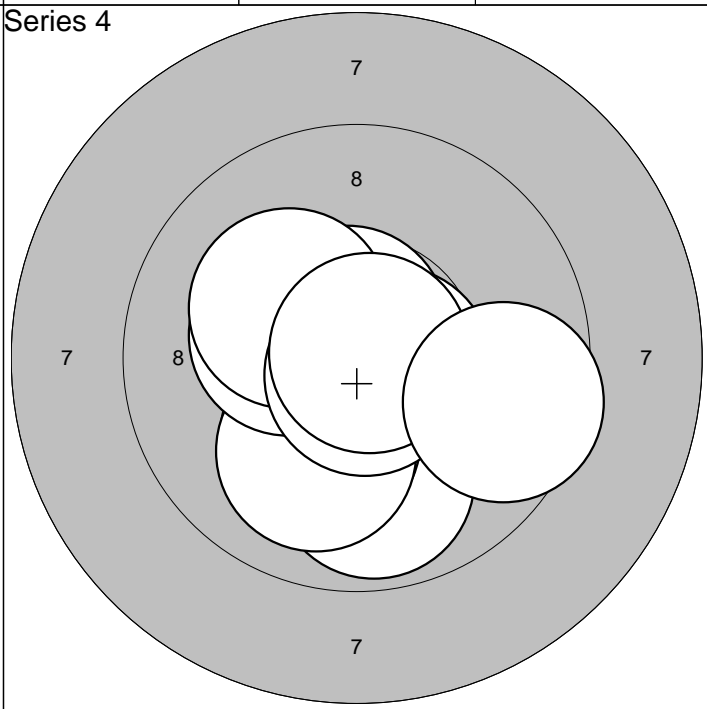

| | | | | |
|-----------|------------|-----|-------|------|
| 1:10,1 ↗ | 6:10,6* ← | | Serie | 99,0 |
| 2:10,7* ↗ | 7:10,5* ← | | | |
| 3:10,1 ↖ | 8: 9,9 ← | Sum | 297,0 | |
| 4:10,1 ↗ | 9:10,2* ↗ | | | |
| 5:10,0 ← | 10:10,5* ← | | | |

| | | | | |
|-----------|-----------|-----|-------|------|
| 1:10,6* → | 6:10,3* ← | | Serie | 98,0 |
| 2: 9,9 ↓ | 7:10,2* ↖ | | | |
| 3:10,1 ↙ | 8:10,8* ↓ | Sum | 395,0 | |
| 4:10,0 ↙ | 9:10,8* → | | | |
| 5:10,7* ↗ | 10: 9,6 → | | | |

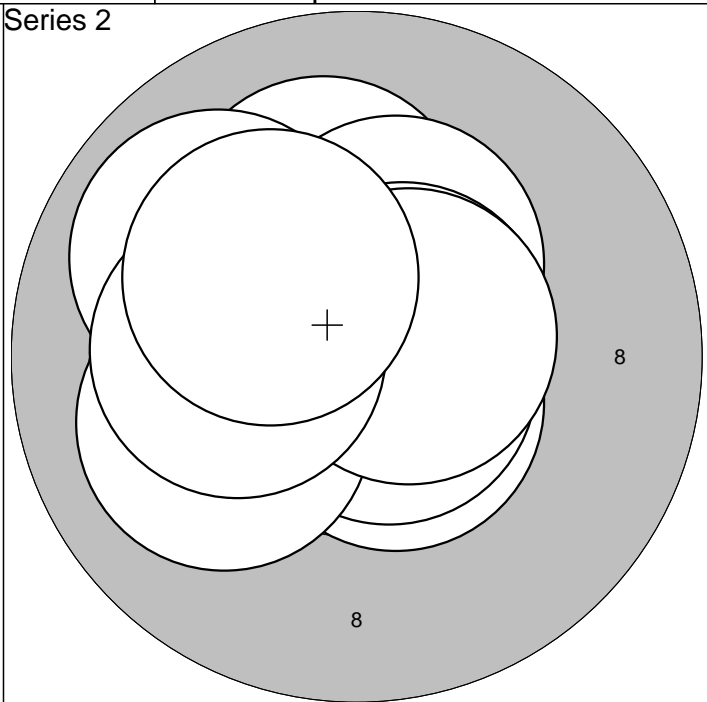
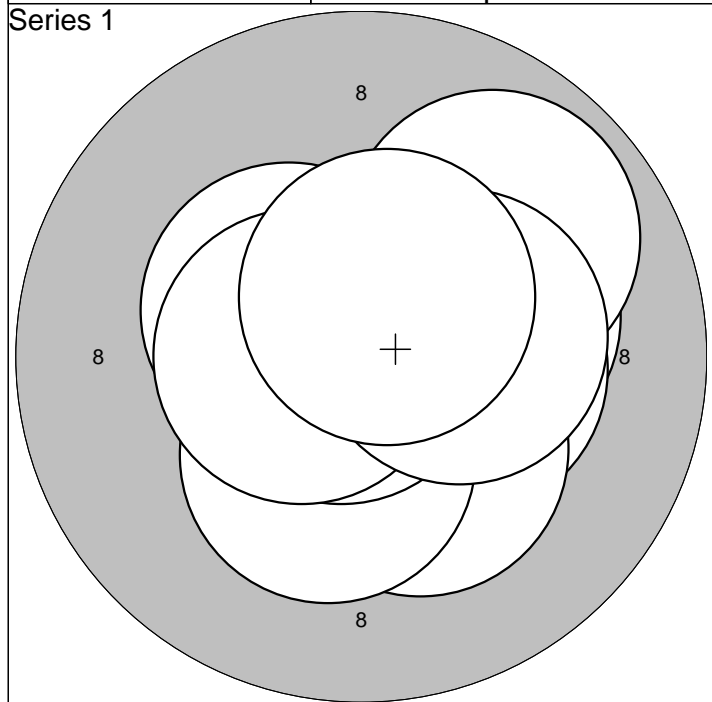

| | | | |
|-----------|------------|-------|------|
| 1:10,4* ↖ | 6:10,3* ↓ | Serie | 99,0 |
| 2:10,2* → | 7:10,8* ← | | |
| 3:10,3* → | 8:10,6* ← | Sum | 99,0 |
| 4: 9,9 ↗ | 9:10,3* → | | |
| 5:10,3* ↓ | 10:10,6* ↗ | | |

| | | | |
|-----------|------------|-------|-------|
| 1:10,1 ↗ | 6:10,6* ↗ | Serie | 99,0 |
| 2:10,6* ↓ | 7:10,6* → | | |
| 3:10,7* ↓ | 8: 9,9 ↖ | Sum | 198,0 |
| 4:10,3* ↗ | 9:10,2* ← | | |
| 5:10,1 ↖ | 10:10,3* ↗ | | |

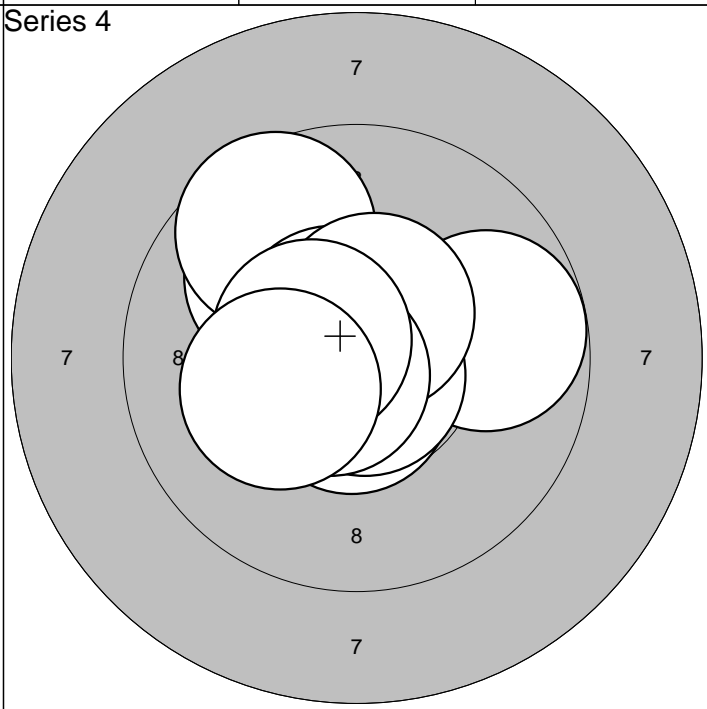
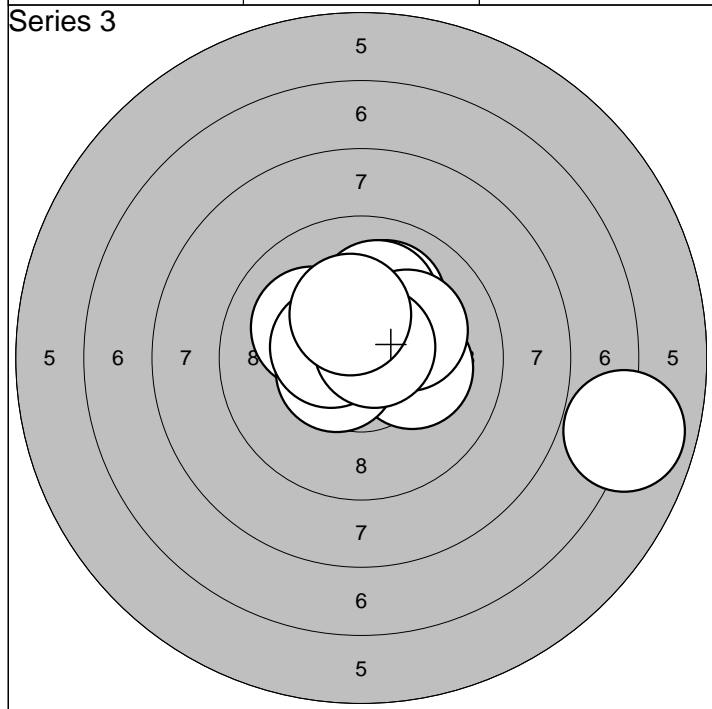

| | | | |
|-----------|------------|-------|-------|
| 1:10,1 ↖ | 6:10,1 ↗ | Serie | 96,0 |
| 2:10,2* → | 7:10,5* ← | | |
| 3:10,0 ↗ | 8:10,2* ↗ | Sum | 294,0 |
| 4:10,5* ← | 9:10,7* ↗ | | |
| 5: 6,9 → | 10:10,3* ↗ | | |

| | | | |
|-----------|------------|-------|-------|
| 1:10,0 ↖ | 6:10,6* ↖ | Serie | 98,0 |
| 2:10,6* ↓ | 7:10,5* ↗ | | |
| 3: 9,8 → | 8:10,7* ↖ | Sum | 392,0 |
| 4:10,8* ↓ | 9:10,5* ← | | |
| 5: 9,6 ↗ | 10:10,2* ↖ | | |

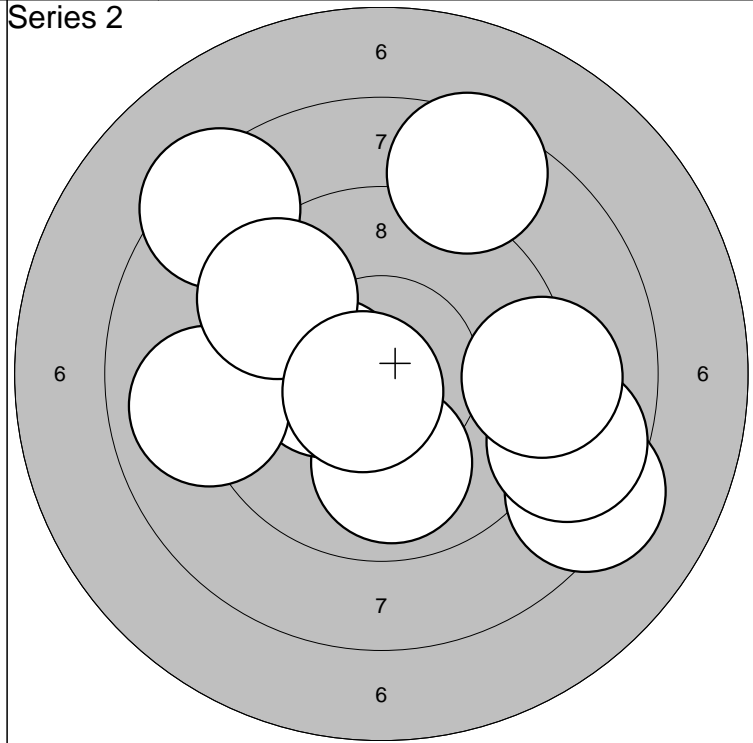

| | | | | | |
|---------|---|---------|---|-------|------|
| 1:10,6* | ↗ | 6:10,1 | ↘ | | |
| 2:10,4* | ↘ | 7: 8,4 | ↓ | Serie | 91,0 |
| 3: 9,6 | ↓ | 8:10,2* | ↑ | | |
| 4: 6,8 | ← | 9: 9,9 | ↓ | Sum | 91,0 |
| 5:10,7* | → | 10: 9,7 | ↑ | | |

| | | | | | |
|---------|---|----------|---|-------|-------|
| 1: 9,9 | ↓ | 6: 8,5 | ↗ | | |
| 2:10,3* | ← | 7: 9,5 | ↖ | Serie | 88,0 |
| 3: 8,3 | ↘ | 8: 8,7 | → | | |
| 4: 9,0 | ← | 9: 9,1 | → | Sum | 179,0 |
| 5: 8,4 | ↗ | 10:10,7* | ↙ | | |

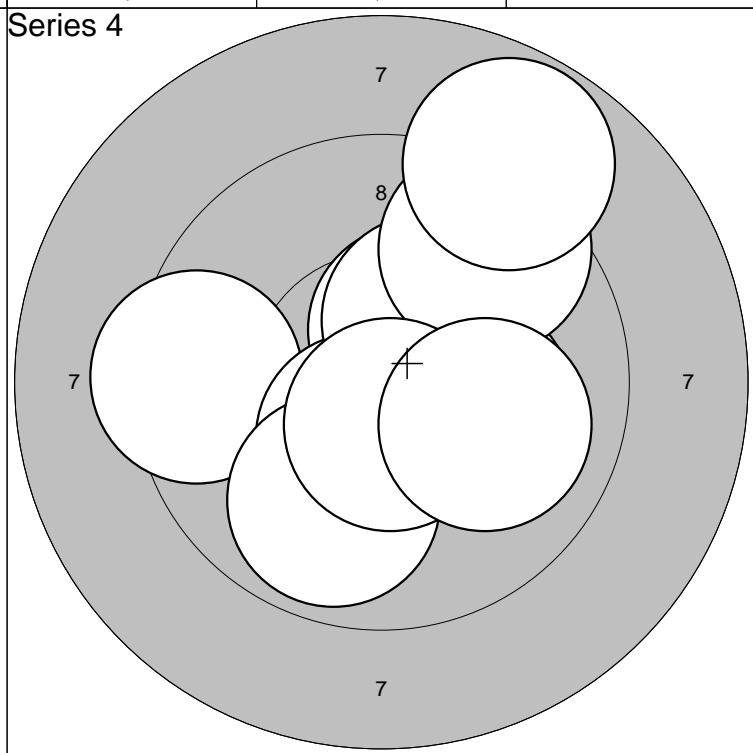
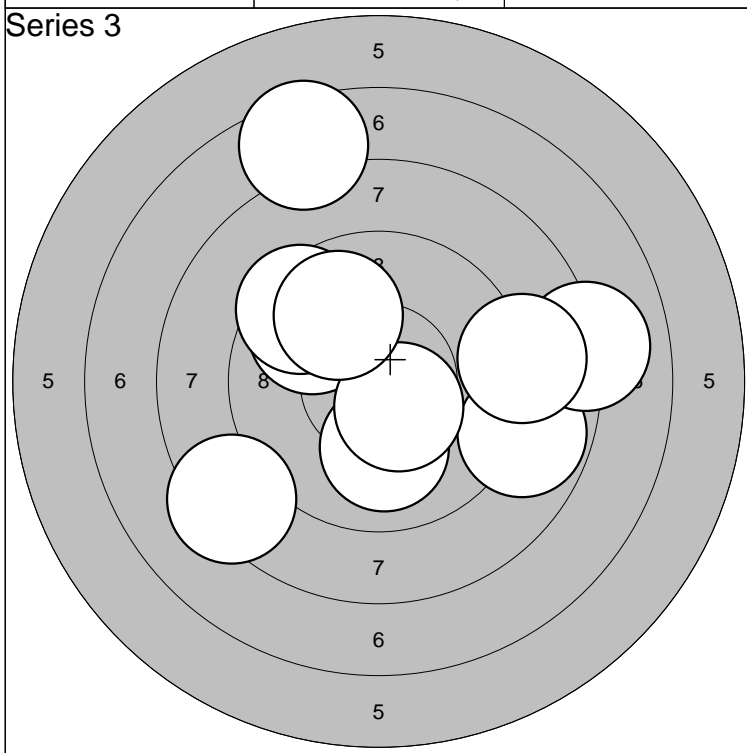

| | | | | | |
|--------|---|---------|---|-------|-------|
| 1: 7,5 | ↑ | 6: 8,3 | ↙ | | |
| 2: 8,8 | ↘ | 7:10,5* | ↓ | Serie | 86,0 |
| 3:10,0 | ↓ | 8: 9,5 | ↗ | | |
| 4: 9,8 | ↗ | 9: 9,9 | ↗ | Sum | 265,0 |
| 5: 8,0 | → | 10: 8,9 | → | | |

| | | | | | |
|---------|---|---------|---|-------|-------|
| 1:10,2* | → | 6:10,3* | ↗ | | |
| 2:10,4* | ↗ | 7: 9,5 | ↗ | Serie | 95,0 |
| 3: 9,4 | ← | 8: 8,8 | ↗ | | |
| 4:10,5* | ↓ | 9:10,6* | ↓ | Sum | 360,0 |
| 5: 9,9 | ↓ | 10:10,0 | ↘ | | |

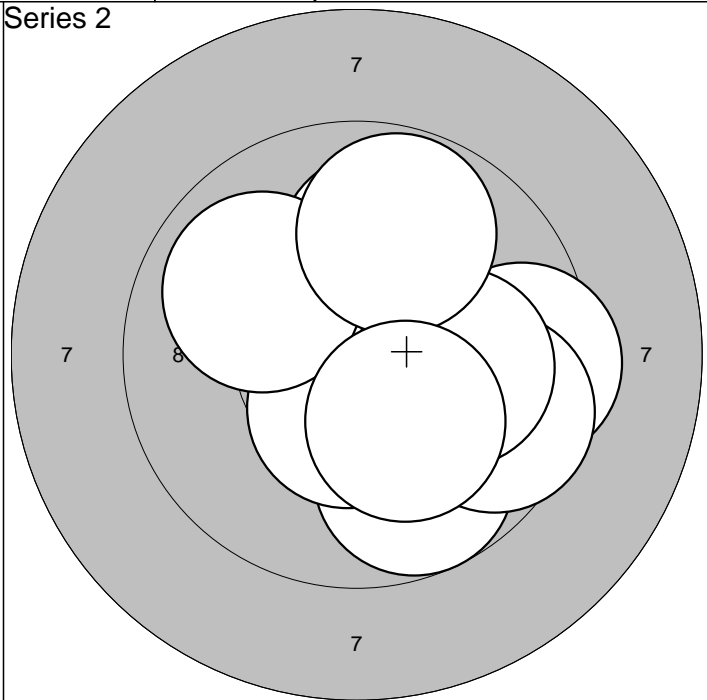
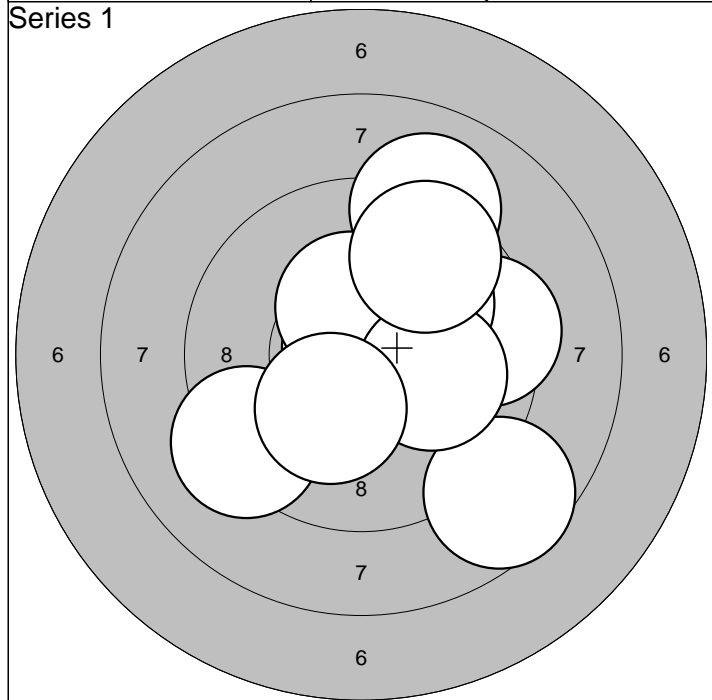

| | | | | |
|-----------|------------|--|-------|------|
| 1: 9,4 → | 6: 9,2 ↙ | | Serie | 94,0 |
| 2:10,9* ↖ | 7: 8,6 ↘ | | | |
| 3:10,0 ↗ | 8:10,1 → | | Sum | 94,0 |
| 4:10,4* ↑ | 9: 9,6 ↗ | | | |
| 5: 9,1 ↗ | 10:10,2* ↘ | | | |

| | | | | |
|-----------|------------|--|-------|-------|
| 1:10,3* ↗ | 6: 9,6 ↘ | | Serie | 95,0 |
| 2: 9,5 → | 7:10,1 → | | | |
| 3: 9,7 ↘ | 8: 9,9 ↖ | | Sum | 189,0 |
| 4:10,5* ↓ | 9: 9,8 ↑ | | | |
| 5:10,0 ↑ | 10:10,2* ↘ | | | |

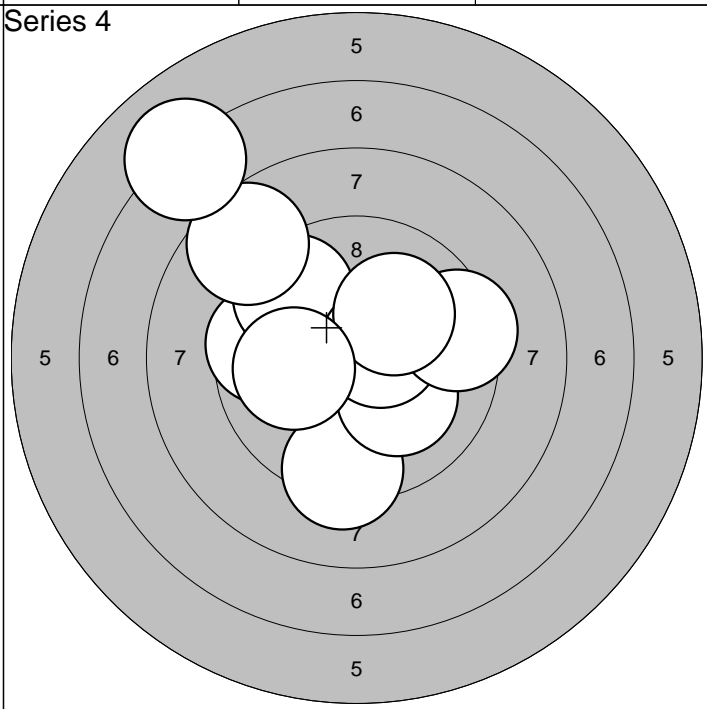
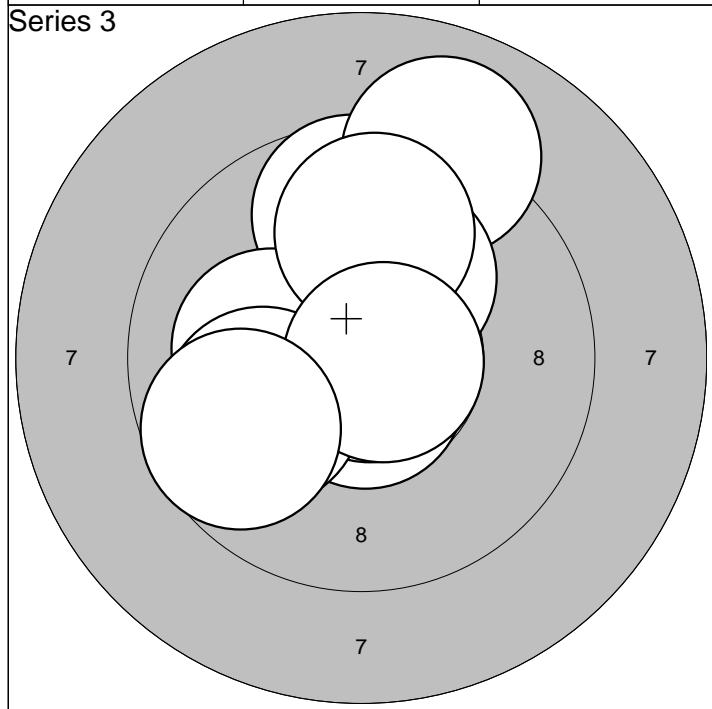

| | | | | |
|-----------|-----------|--|-------|-------|
| 1: 9,7 ↑ | 6:10,2* ← | | Serie | 96,0 |
| 2:10,7* ↓ | 7:10,0 ← | | | |
| 3:10,9* ↘ | 8: 9,8 ↑ | | Sum | 285,0 |
| 4: 9,0 ↗ | 9:10,7* → | | | |
| 5:10,2* ↗ | 10: 9,7 ↙ | | | |

| | | | | |
|----------|-----------|--|-------|-------|
| 1: 9,3 ↓ | 6:10,6* ↗ | | Serie | 91,0 |
| 2:10,1 ↘ | 7: 9,4 → | | | |
| 3: 9,6 ← | 8:10,1 ↗ | | Sum | 376,0 |
| 4: 9,7 ↗ | 9:10,0 ← | | | |
| 5: 8,6 ↗ | 10: 7,1 ↖ | | | |

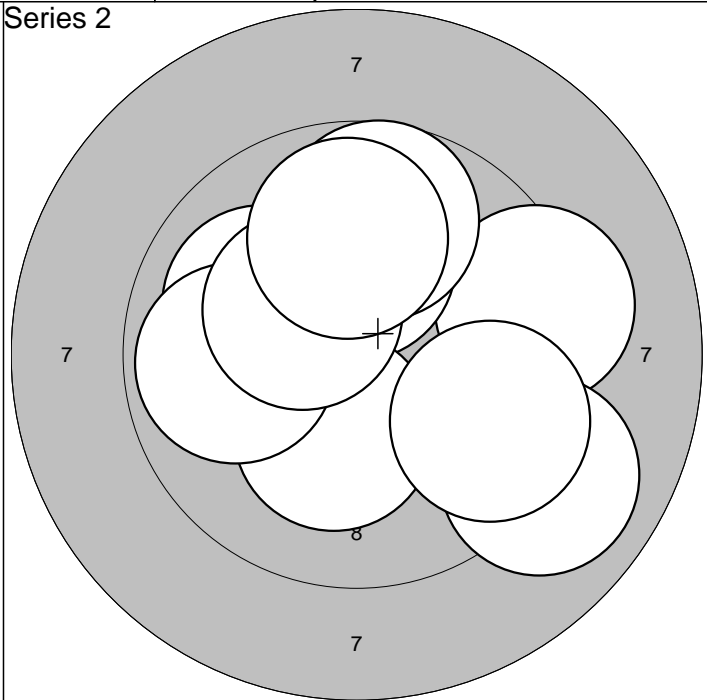
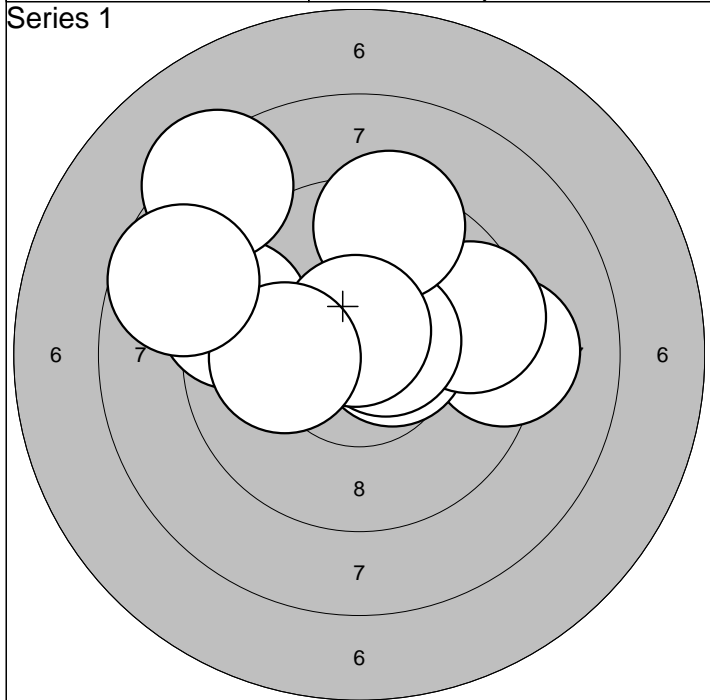

| | | |
|-----------|-----------|------------|
| 1: 9,2 → | 6:10,6* ↗ | Serie 92,0 |
| 2: 9,4 ← | 7: 9,4 ↑ | |
| 3:10,6* → | 8:10,7* ↑ | Sum 92,0 |
| 4: 8,3 ↗ | 9:10,1 ← | |
| 5: 9,6 → | 10: 8,7 ← | |

| | | |
|-----------|-----------|------------|
| 1: 9,3 → | 6: 9,9 ← | Serie 94,0 |
| 2:10,0 ← | 7: 9,0 ↘ | |
| 3:10,1 ↑ | 8:10,3* ↗ | Sum 186,0 |
| 4:10,2* ↓ | 9: 9,6 ↘ | |
| 5: 9,7 ↑ | 10: 9,9 ↑ | |

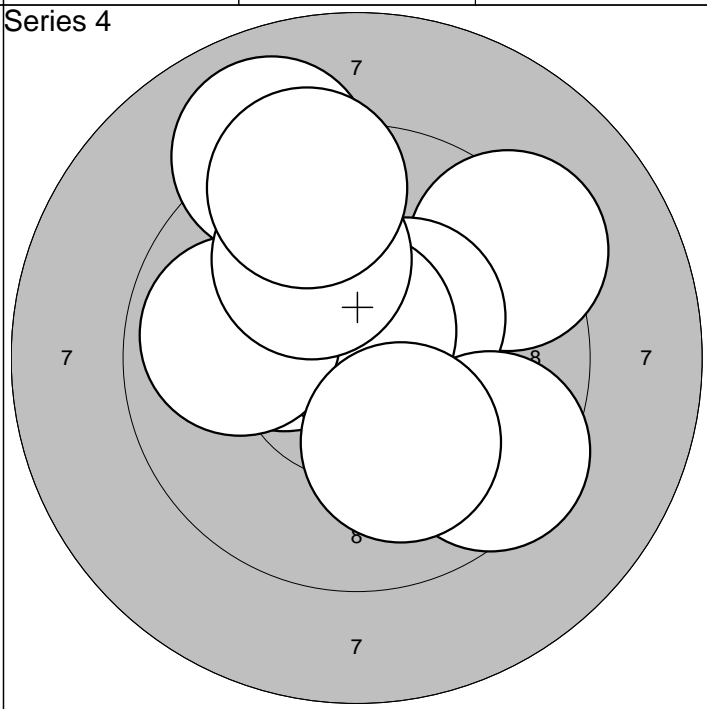
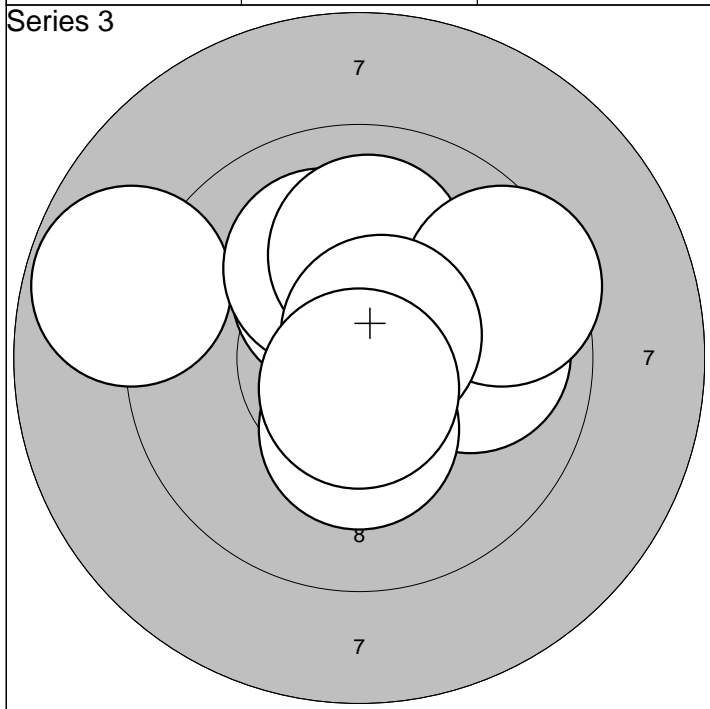

| | | |
|-----------|------------|------------|
| 1:10,3* ↗ | 6:10,3* ↓ | Serie 96,0 |
| 2: 8,8 ← | 7:10,0 ↑ | |
| 3: 9,9 → | 8: 9,5 ↗ | Sum 282,0 |
| 4:10,1 ↗ | 9:10,7* ↗ | |
| 5:10,0 → | 10:10,7* ↓ | |

| | | |
|-----------|-----------|------------|
| 1:10,3* ← | 6: 9,9 ← | Serie 95,0 |
| 2: 9,3 ↗ | 7:10,0 ↑ | |
| 3:10,4* ↗ | 8: 9,5 ↘ | Sum 377,0 |
| 4:10,7* ↑ | 9: 9,4 ↑ | |
| 5: 9,0 ↗ | 10:10,1 ↓ | |

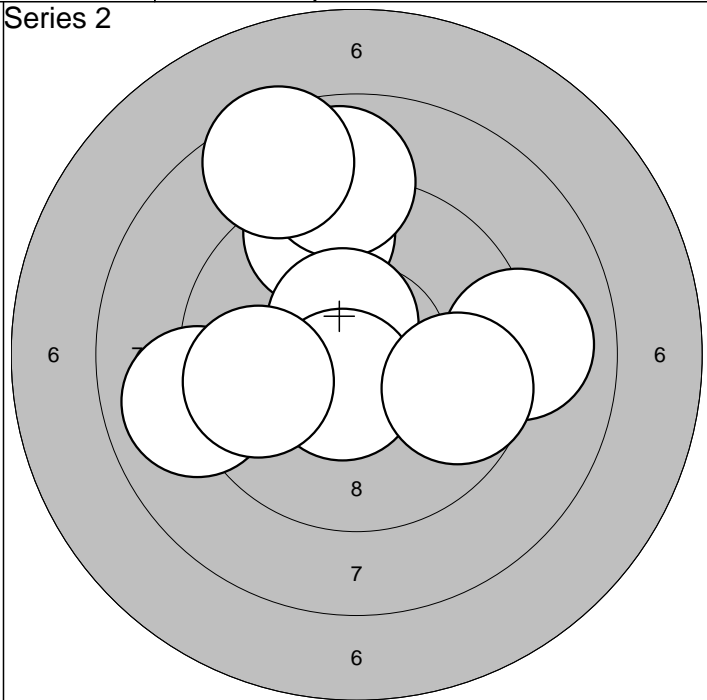
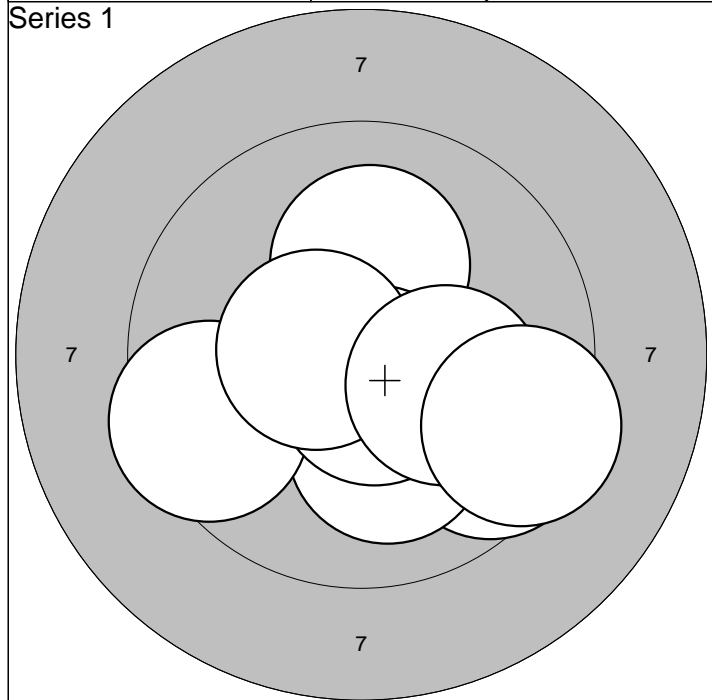

| | | | | | |
|-----------|-----------|-----|------|--|--|
| 1: 9,6 ↘ | 6:10,1 ↑ | | | | |
| 2:10,6* ↑ | 7:10,7* ↓ | | | | |
| 3:10,7* ↓ | 8:10,5* ← | | | | |
| 4:10,1 ↓ | 9:10,1 → | Sum | 97,0 | | |
| 5: 9,5 ← | 10: 9,4 → | | | | |

| | | | | | |
|-----------|-----------|-----|-------|--|--|
| 1: 9,4 ↑ | 6: 8,5 ↑ | | | | |
| 2: 9,0 ← | 7:10,5* ↓ | | | | |
| 3: 8,9 ↑ | 8: 9,7 ← | | | | |
| 4:10,6* ← | 9: 9,0 → | Sum | 188,0 | | |
| 5:10,6* ↑ | 10: 9,7 → | | | | |

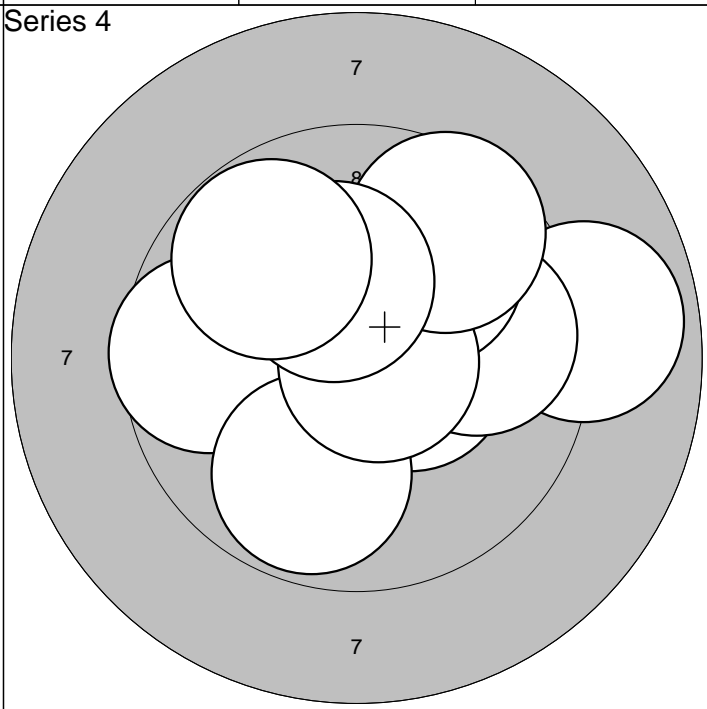
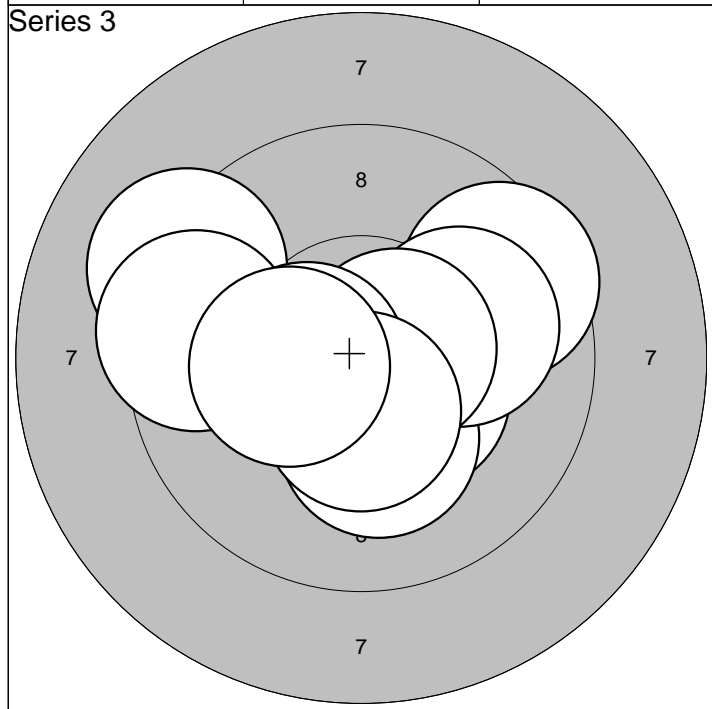

| | | | | | |
|-----------|------------|-----|-------|--|--|
| 1: 9,5 ↗ | 6:10,0 → | | | | |
| 2: 9,2 ← | 7:10,6* → | | | | |
| 3: 9,5 ← | 8:10,5* ← | | | | |
| 4:10,4* ↘ | 9:10,5* ↓ | Sum | 285,0 | | |
| 5:10,2* ↓ | 10:10,3* ← | | | | |

| | | | | | |
|-----------|-----------|-----|-------|--|--|
| 1: 8,9 → | 6: 9,8 ↓ | | | | |
| 2:10,5* → | 7:10,7* → | | | | |
| 3: 9,8 → | 8: 9,6 ↑ | | | | |
| 4:10,0 ↗ | 9:10,2* ↑ | Sum | 378,0 | | |
| 5: 9,6 ← | 10: 9,8 ↖ | | | | |

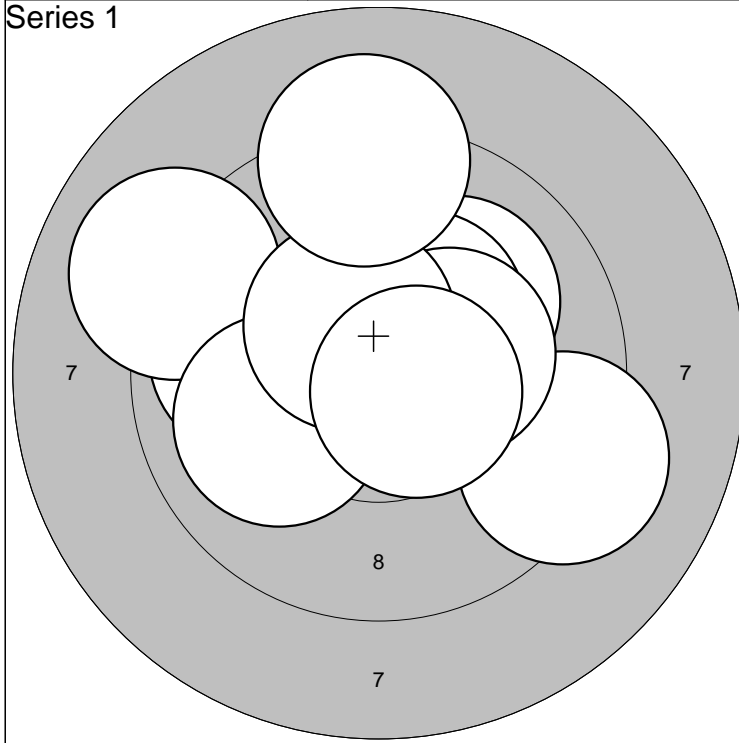

| | | | |
|-----------|-----------|-------|------|
| 1:10,1 ↗ | 6:10,3* → | Serie | 96,0 |
| 2: 9,9 ← | 7:10,0 ← | | |
| 3: 9,0 ↖ | 8:10,5* ↗ | Sum | 96,0 |
| 4: 9,2 ↘ | 9:10,6* ↘ | | |
| 5:10,4* ↗ | 10: 9,2 ↑ | | |

| | | | |
|-----------|-----------|-------|-------|
| 1:10,2* ↓ | 6:10,3* ↑ | Serie | 94,0 |
| 2:10,3* → | 7: 9,7 ↓ | | |
| 3: 9,3 ← | 8: 9,9 ← | Sum | 190,0 |
| 4:10,6* ← | 9: 8,4 ↙ | | |
| 5:10,0 ← | 10: 9,7 ↑ | | |

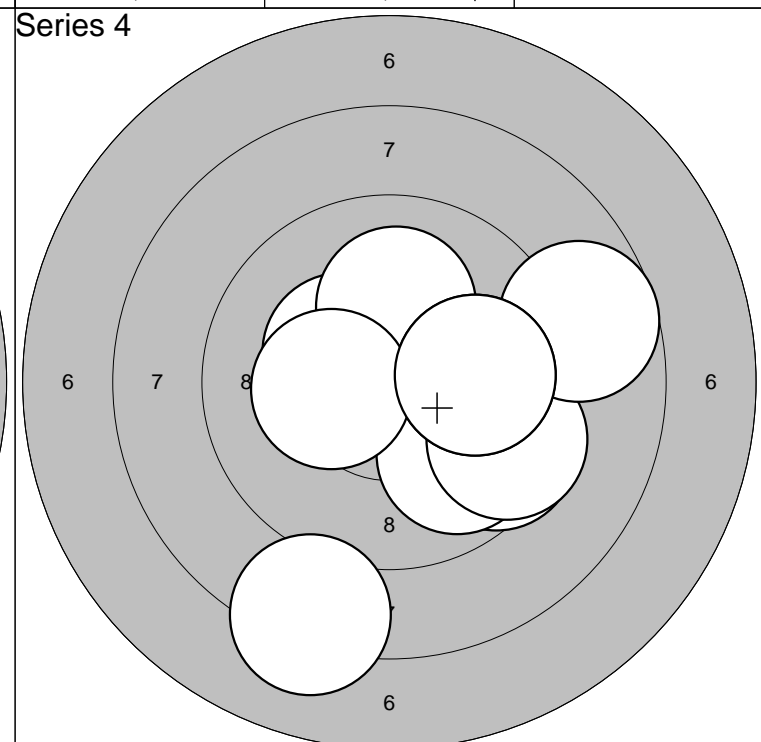
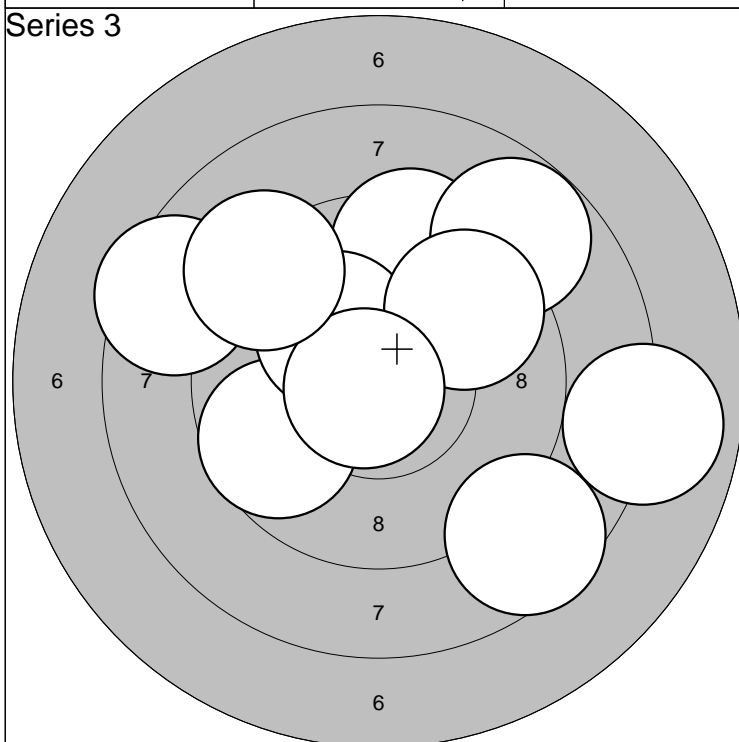

| | | | |
|-----------|-----------|-------|-------|
| 1: 8,5 ↖ | 6: 8,6 ↘ | Serie | 88,0 |
| 2: 9,4 ↑ | 7: 8,0 → | | |
| 3: 8,8 ↗ | 8: 9,7 ↗ | Sum | 278,0 |
| 4: 9,6 ↖ | 9:10,8* ← | | |
| 5:10,2* ↖ | 10: 9,2 ↖ | | |

| | | | |
|-----------|-----------|-------|-------|
| 1: 9,5 ↘ | 6: 8,7 → | Serie | 93,0 |
| 2:10,3* ↖ | 7:10,0 → | | |
| 3: 9,9 ↘ | 8: 8,2 ↓ | Sum | 371,0 |
| 4:10,1 ↑ | 9:10,3* ← | | |
| 5: 9,5 ↘ | 10:10,0 → | | |

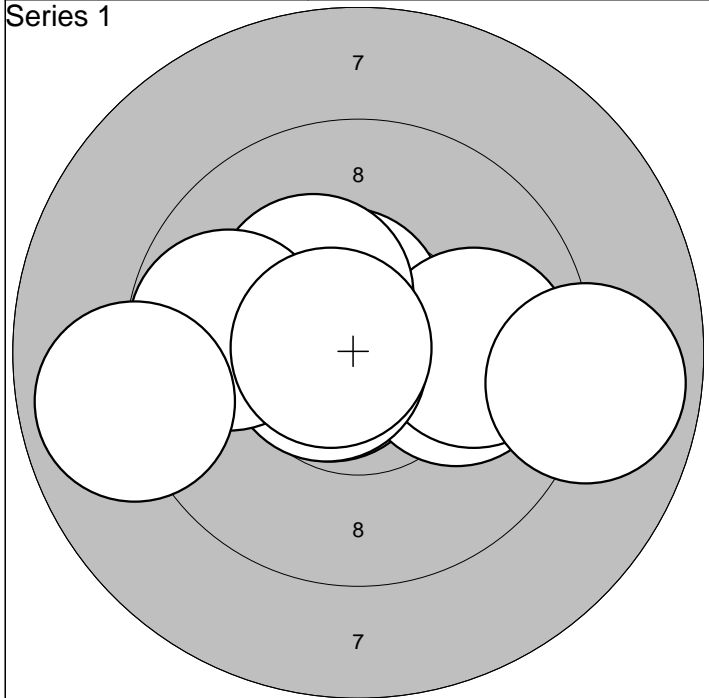

| | | | |
|-----------|-----------|-------|------|
| 1:10,5* ↑ | 6:10,7* ← | Serie | 94,0 |
| 2:10,7* ← | 7: 9,8 ← | | |
| 3:10,1 → | 8:10,7* ← | Sum | 94,0 |
| 4: 9,9 → | 9: 8,9 ← | | |
| 5:10,3* ↗ | 10: 8,9 → | | |

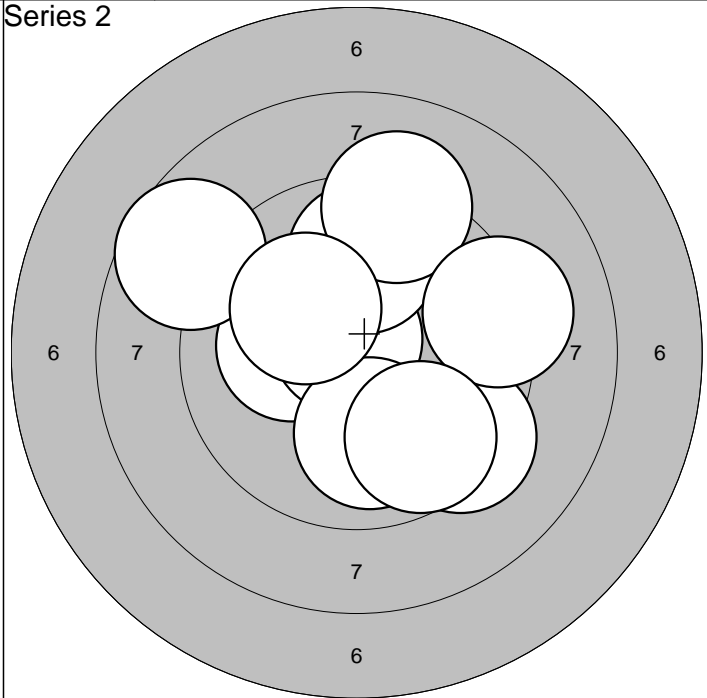

| | | | |
|-----------|-----------|-------|-------|
| 1:10,2* ← | 6: 9,2 ↑ | Serie | 93,0 |
| 2:10,8* ↗ | 7: 8,7 ← | | |
| 3: 9,3 ↘ | 8:10,2* ↗ | Sum | 187,0 |
| 4:10,0 ↓ | 9: 9,2 → | | |
| 5: 9,8 ↑ | 10: 9,7 ↘ | | |

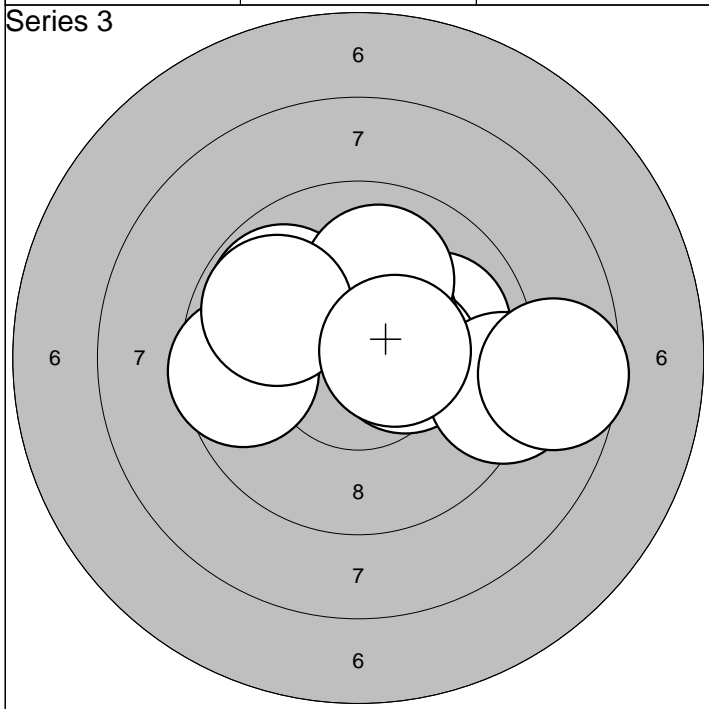

| | | | |
|-----------|------------|-------|-------|
| 1:10,0 → | 6:10,4* ↗ | Serie | 94,0 |
| 2: 9,8 ↖ | 7: 8,6 → | | |
| 3:10,4* → | 8:10,0 ↑ | Sum | 281,0 |
| 4: 9,2 → | 9: 9,8 ← | | |
| 5: 9,6 ← | 10:10,5* → | | |

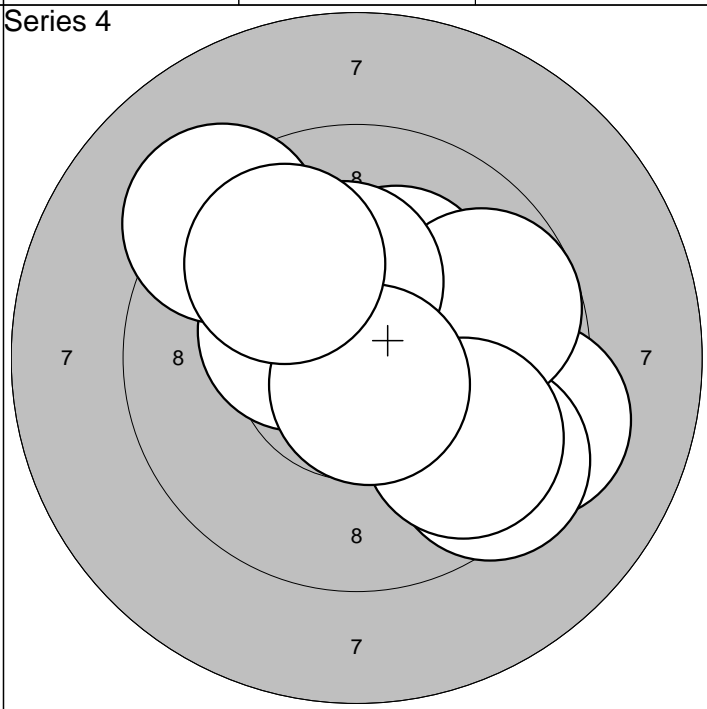

| | | | |
|-----------|-----------|-------|-------|
| 1:10,2* ↗ | 6:10,3* ↑ | Serie | 94,0 |
| 2: 9,3 → | 7: 9,3 ↗ | | |
| 3: 9,4 ↘ | 8: 9,8 ↘ | Sum | 375,0 |
| 4:10,4* ← | 9:10,7* ↘ | | |
| 5: 9,8 → | 10: 9,9 ↗ | | |

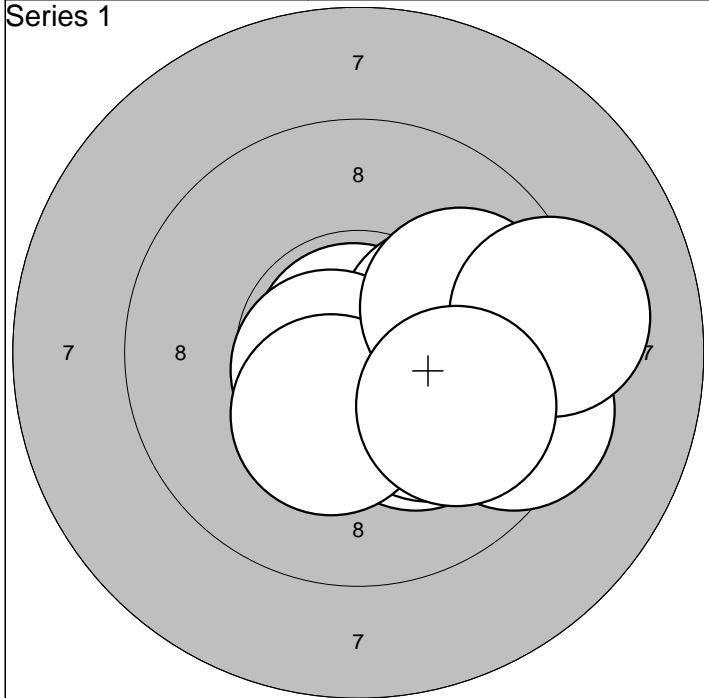

| | | | | |
|-----------|-----------|-----|-------|------|
| 1:10,9* ↗ | 6:10,2* ↘ | | Serie | 97,0 |
| 2:10,2* → | 7:10,3* ↓ | | | |
| 3:10,7* ↙ | 8: 9,9 → | Sum | 97,0 | |
| 4:10,2* ↘ | 9: 9,2 → | | | |
| 5: 9,4 ↘ | 10:10,0 ↘ | | | |

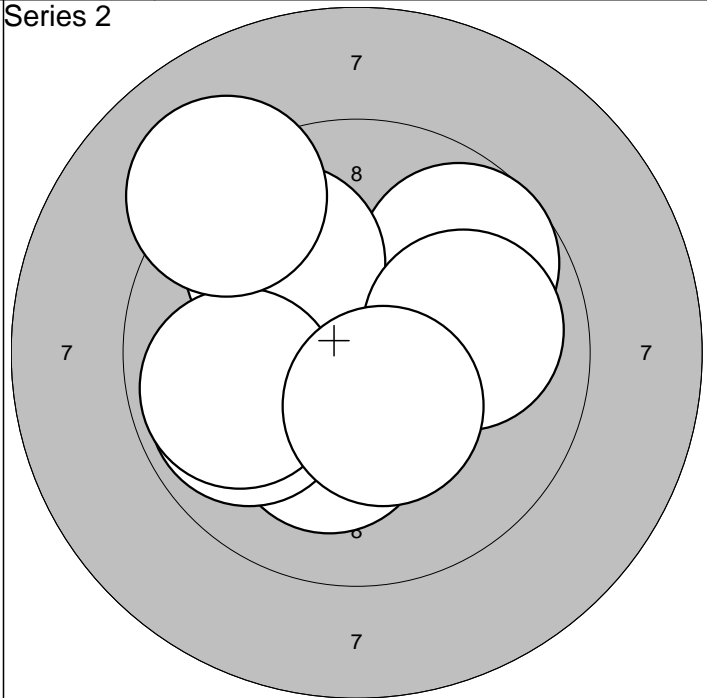

| | | | | |
|-----------|-----------|-----|-------|------|
| 1:10,6* ↙ | 6: 9,9 ↙ | | Serie | 95,0 |
| 2:10,7* ↗ | 7: 9,9 ↙ | | | |
| 3: 9,7 ↗ | 8:10,0 → | Sum | 192,0 | |
| 4: 9,9 ↖ | 9:10,4* ↓ | | | |
| 5:10,2* ↓ | 10: 9,1 ↖ | | | |

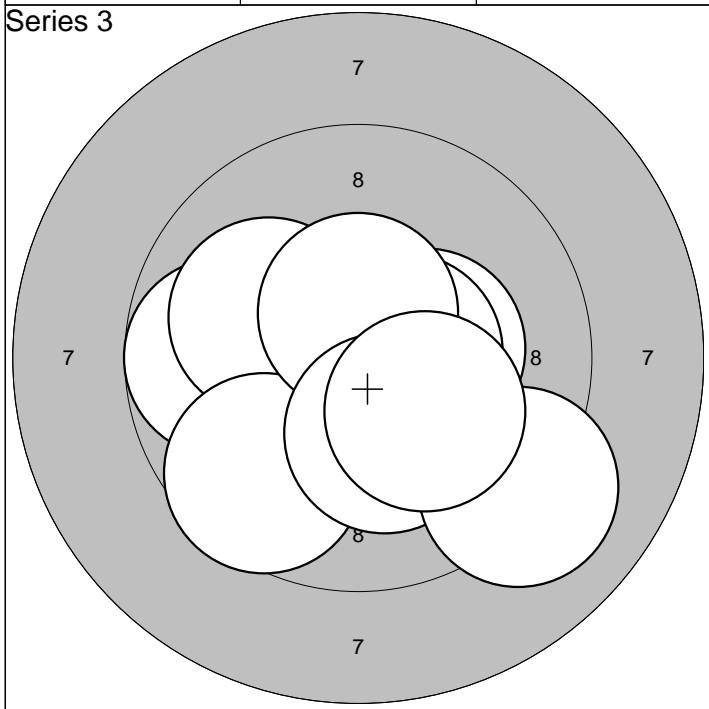

| | | | | |
|-----------|------------|-----|-------|------|
| 1: 9,7 ↙ | 6:10,5* → | | Serie | 97,0 |
| 2:10,4* ↘ | 7:10,6* ↑ | | | |
| 3:10,3* → | 8:10,2* ↓ | Sum | 289,0 | |
| 4:10,1 ↖ | 9: 9,1 ↘ | | | |
| 5: 9,6 ↘ | 10:10,2* ↘ | | | |

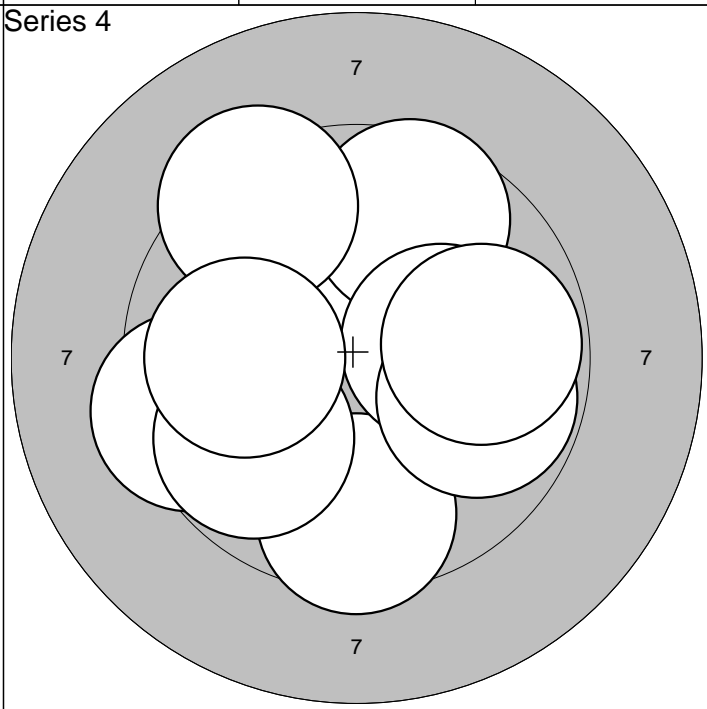

| | | | | |
|-----------|-----------|-----|-------|------|
| 1:10,1 ↗ | 6: 9,3 ↖ | | Serie | 93,0 |
| 2: 9,6 ↓ | 7: 9,8 → | | | |
| 3: 9,4 ↙ | 8: 9,8 → | Sum | 382,0 | |
| 4: 9,6 ↑ | 9: 9,8 ↙ | | | |
| 5:10,2* → | 10:10,0 ↙ | | | |

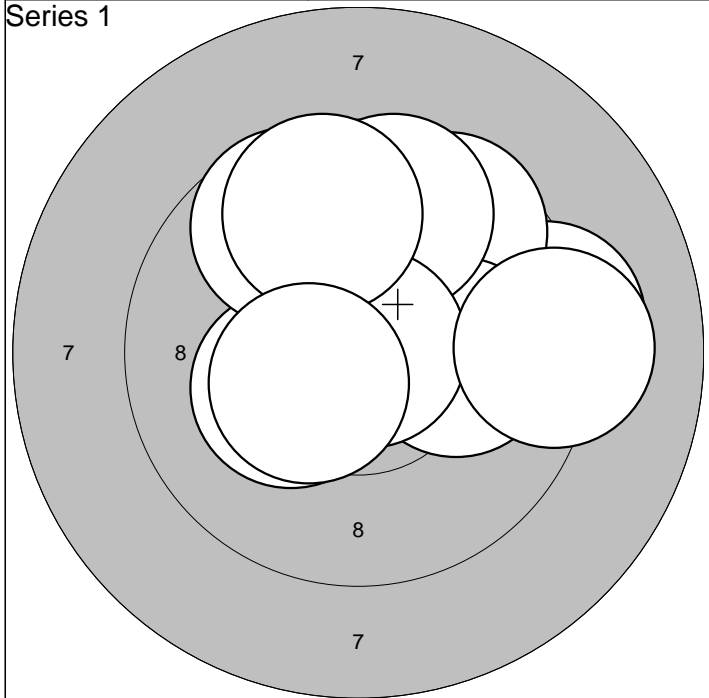

| | | | | | |
|-----------|------------|-------|------|--|--|
| 1: 9,3 → | 6: 9,7 ↖ | | | | |
| 2: 9,6 ↗ | 7:10,9* → | | | | |
| 3:10,1 → | 8: 9,2 → | Serie | 94,0 | | |
| 4:10,3* ← | 9: 9,7 ↑ | Sum | 94,0 | | |
| 5: 9,7 ↑ | 10:10,4* ← | | | | |

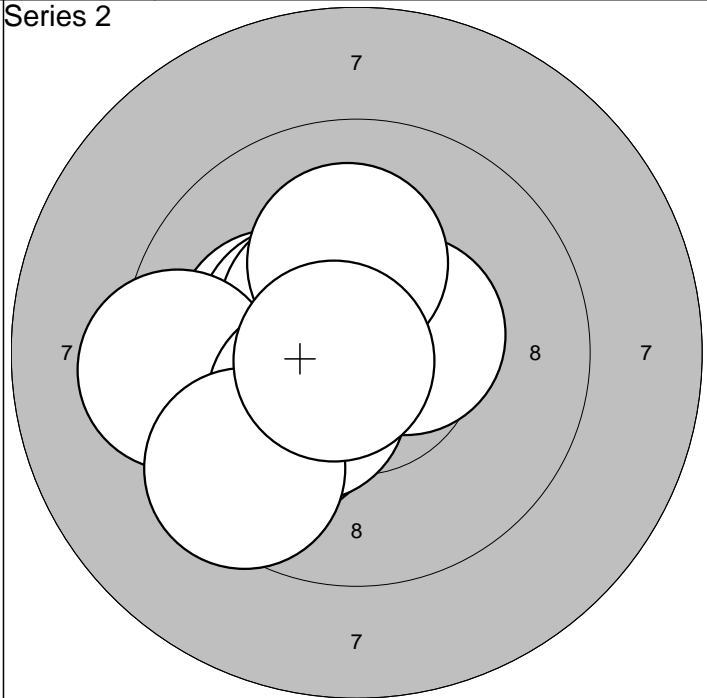

| | | | | | |
|-----------|------------|-------|-------|--|--|
| 1:10,0 ↙ | 6:10,5* → | | | | |
| 2:10,2* ← | 7:10,3* ↙ | | | | |
| 3:10,4* ↖ | 8: 9,5 ↙ | Serie | 98,0 | | |
| 4:10,5* ↗ | 9:10,1 ↑ | Sum | 192,0 | | |
| 5: 9,3 ← | 10:10,7* ← | | | | |

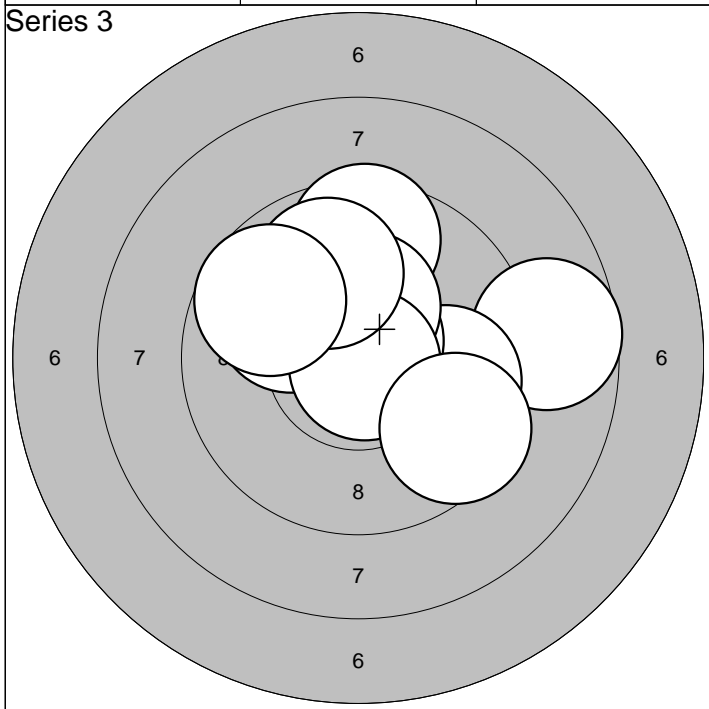

| | | | | | |
|-----------|-----------|-------|-------|--|--|
| 1: 8,7 → | 6:10,4* ↑ | | | | |
| 2:10,0 ↖ | 7:10,8* ↘ | | | | |
| 3: 9,5 ↑ | 8: 9,5 ↘ | Serie | 93,0 | | |
| 4: 9,9 → | 9: 9,9 ↑ | Sum | 285,0 | | |
| 5:10,7* ↗ | 10: 9,7 ↖ | | | | |

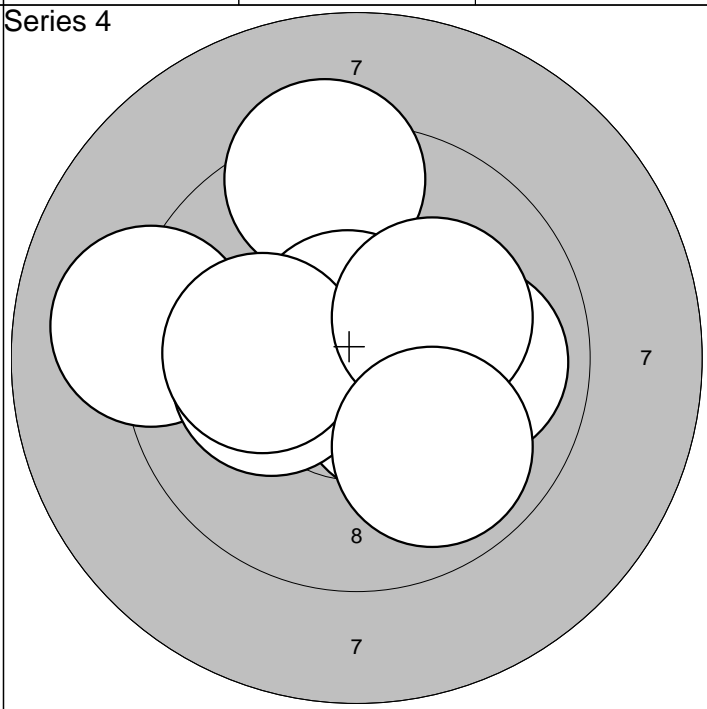

| | | | | | |
|-----------|-----------|-------|-------|--|--|
| 1:10,4* ↘ | 6:10,0 → | | | | |
| 2: 9,3 ↑ | 7:10,2* ← | | | | |
| 3:10,5* → | 8:10,1 ← | Serie | 97,0 | | |
| 4:10,7* ↗ | 9:10,2* → | Sum | 382,0 | | |
| 5: 9,1 ← | 10: 9,9 ↘ | | | | |

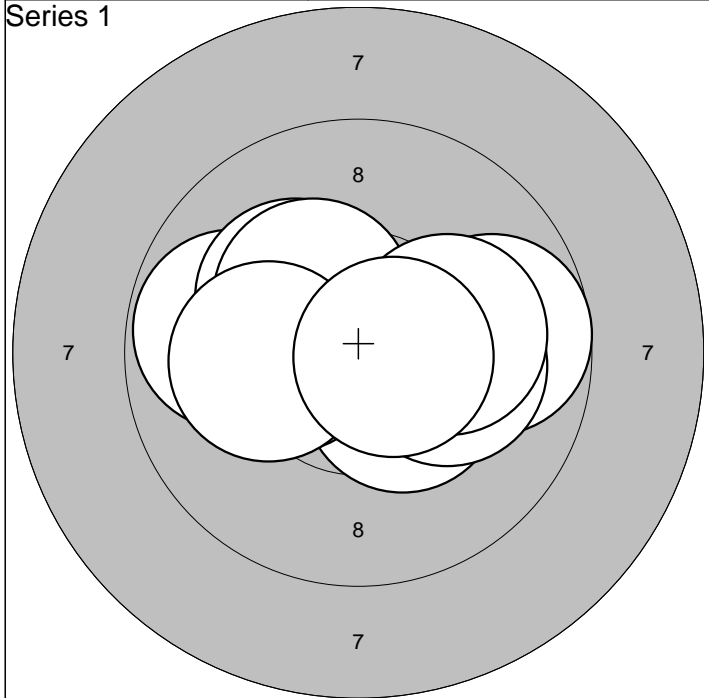

| | | | |
|-----------|------------|-------|------|
| 1:10,4* ↘ | 6:10,3* ← | Serie | 98,0 |
| 2: 9,7 → | 7:10,3* ↗ | | |
| 3:10,1 → | 8:10,1 → | Sum | 98,0 |
| 4: 9,8 ← | 9:10,1 ← | | |
| 5:10,2* ↗ | 10:10,6* → | | |

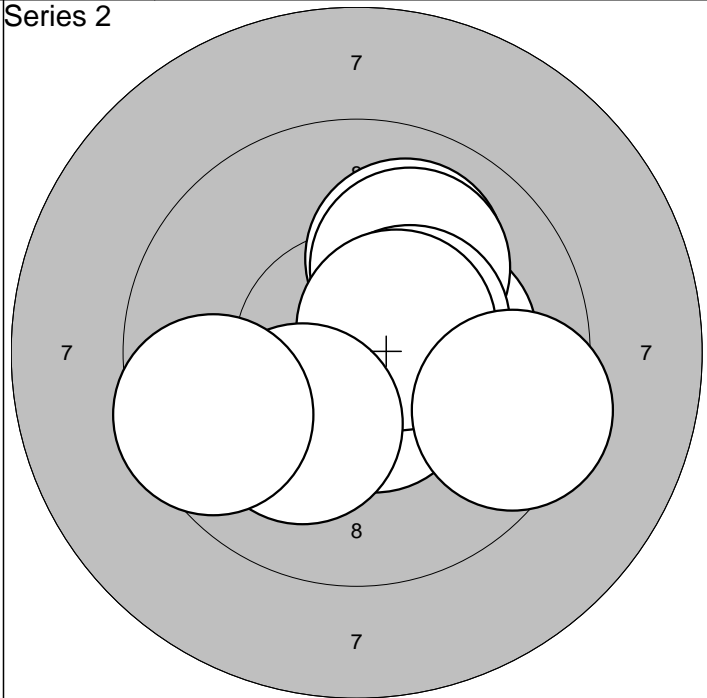

| | | | |
|-----------|-----------|-------|-------|
| 1:10,2* → | 6:10,6* ↓ | Serie | 98,0 |
| 2:10,6* → | 7:10,5* ↗ | | |
| 3:10,0 ↗ | 8:10,1 ↓ | Sum | 196,0 |
| 4:10,0 ↗ | 9: 9,5 → | | |
| 5:10,4* ↗ | 10: 9,6 ← | | |

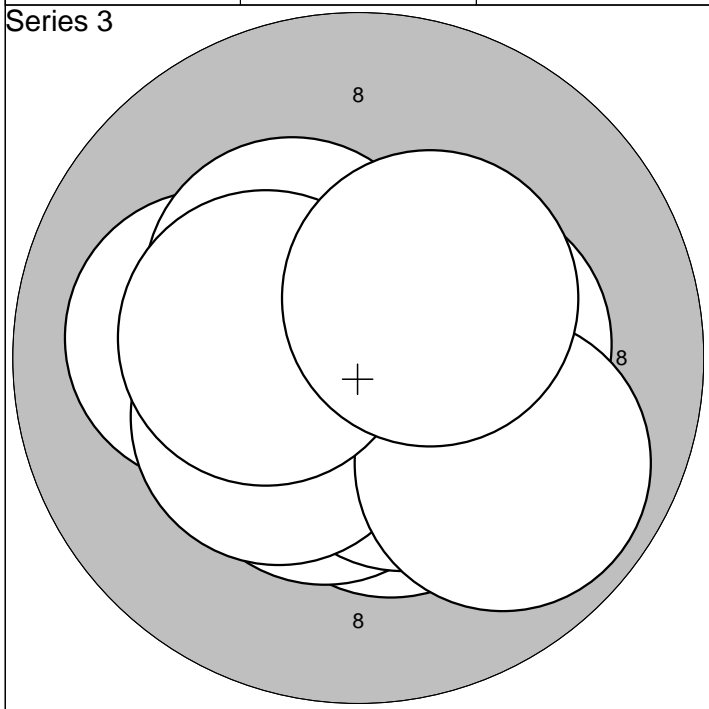

| | | | |
|-----------|------------|-------|-------|
| 1:10,4* ↘ | 6:10,4* ↗ | Serie | 99,0 |
| 2:10,4* ↘ | 7:10,4* ← | | |
| 3:10,1 ← | 8: 9,9 ↘ | Sum | 295,0 |
| 4:10,3* → | 9:10,4* ← | | |
| 5:10,5* ↘ | 10:10,4* ↗ | | |

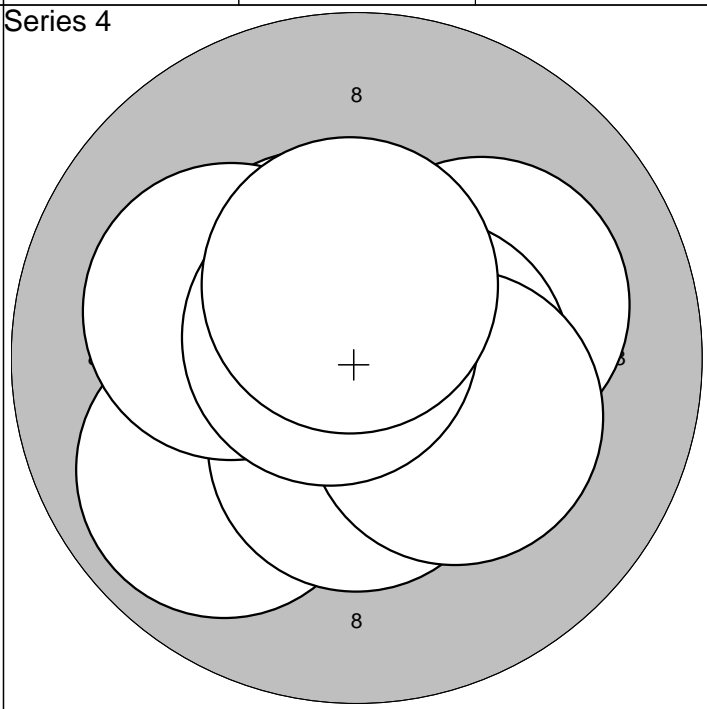

| | | | |
|-----------|------------|-------|-------|
| 1:10,1 → | 6:10,4* ↓ | Serie | 99,0 |
| 2:10,5* ↗ | 7:10,2* ← | | |
| 3:10,5* → | 8:10,3* ↘ | Sum | 394,0 |
| 4:10,6* ↓ | 9:10,8* ↗ | | |
| 5: 9,9 ↘ | 10:10,5* ↗ | | |

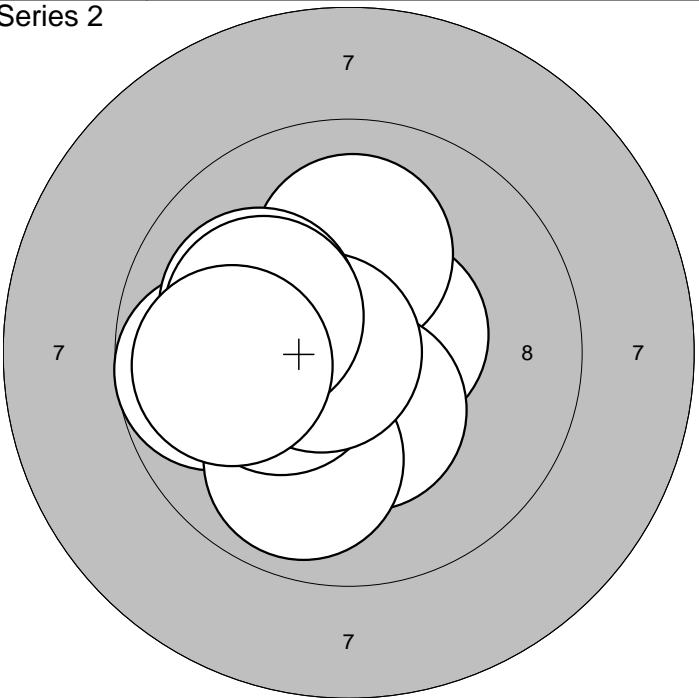
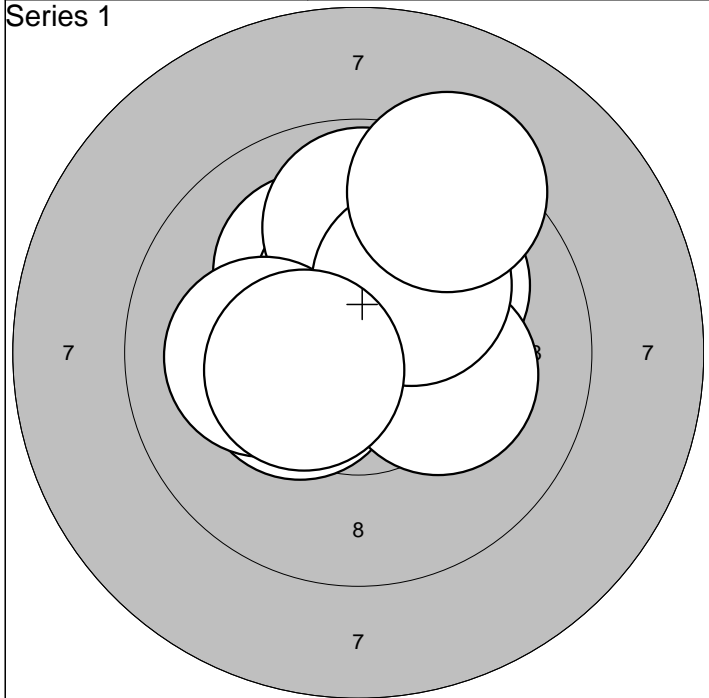

| | | | |
|-----------|------------|-------|------|
| 1:10,1 ↗ | 6: 9,8 ↑ | Serie | 98,0 |
| 2:10,4* ← | 7:10,1 ← | | |
| 3:10,4* ↑ | 8:10,2* ↗ | Sum | 98,0 |
| 4:10,1 ↗ | 9: 9,3 ↗ | | |
| 5:10,2* → | 10:10,4* ← | | |

| | | | |
|-----------|-----------|-------|-------|
| 1:10,6* ↗ | 6:10,3* ← | Serie | 97,0 |
| 2: 9,7 ← | 7:10,7* ← | | |
| 3:10,1 ↑ | 8:10,1 ↗ | Sum | 195,0 |
| 4:10,4* ↓ | 9:10,1 ↗ | | |
| 5: 9,9 ↓ | 10: 9,9 ← | | |

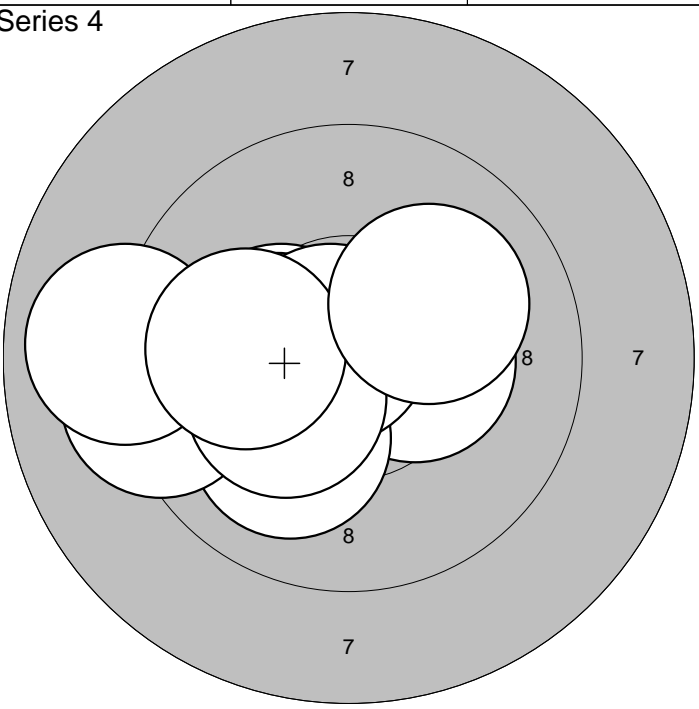
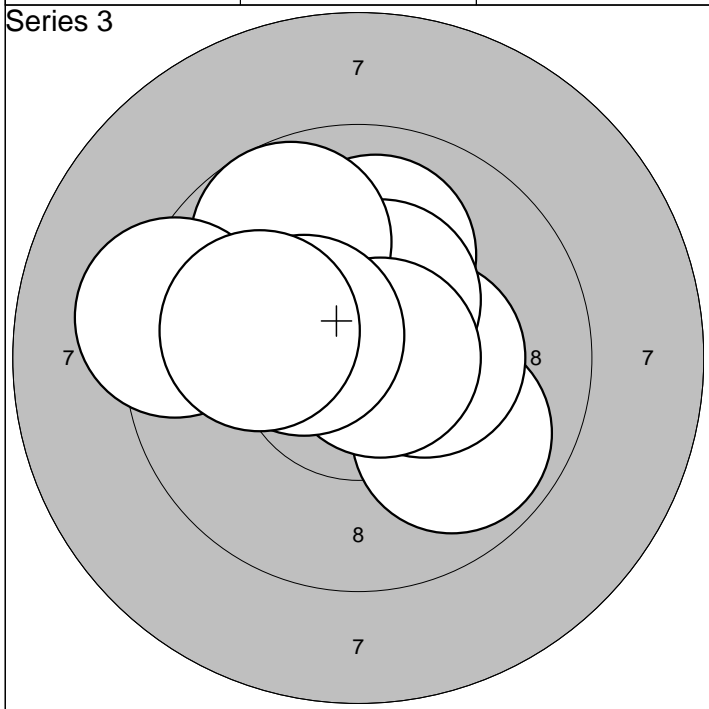

| | | | |
|-----------|-----------|-------|-------|
| 1:10,1 ↗ | 6: 9,8 ↗ | Serie | 97,0 |
| 2: 9,9 ↘ | 7:10,7* → | | |
| 3:10,0 ↑ | 8: 9,3 ← | Sum | 292,0 |
| 4:10,3* → | 9:10,4* ← | | |
| 5:10,4* ↗ | 10:10,0 ← | | |

| | | | |
|-----------|-----------|-------|-------|
| 1:10,4* → | 6: 9,2 ← | Serie | 97,0 |
| 2:10,3* ← | 7:10,3* ← | | |
| 3:10,3* ← | 8: 8,9 ← | Sum | 389,0 |
| 4:10,1 ↘ | 9:10,0 ← | | |
| 5:10,7* ↗ | 10:10,1 ↗ | | |

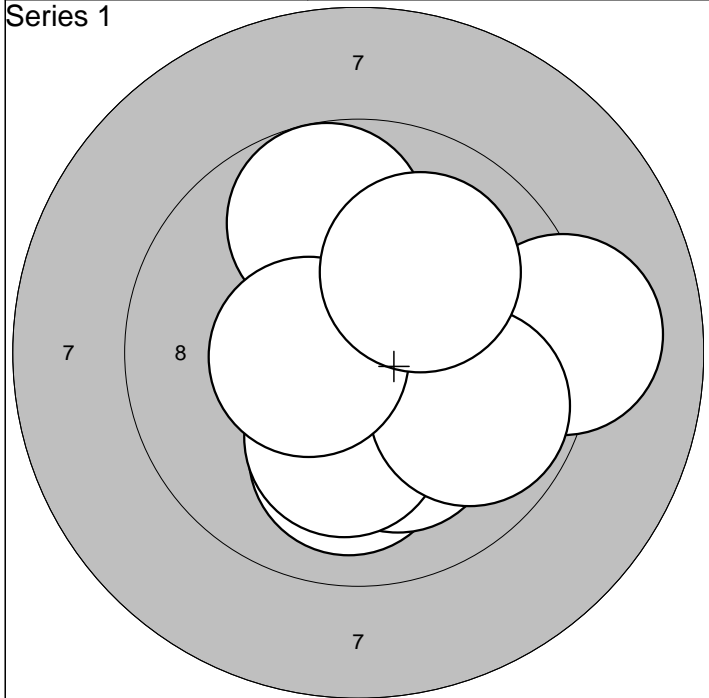

| | | | | | | | |
|---------|---|---------|---|--|--|-------|------|
| 1:10,0 | ↓ | 6: 9,8 | ↑ | | | Serie | 97,0 |
| 2:10,2* | ↘ | 7:10,2* | ↓ | | | | |
| 3:10,7* | ↗ | 8: 9,8 | → | | | | |
| 4:10,1 | ↘ | 9:10,5* | ← | | | Sum | 97,0 |
| 5: 9,1 | → | 10:10,0 | ↗ | | | | |

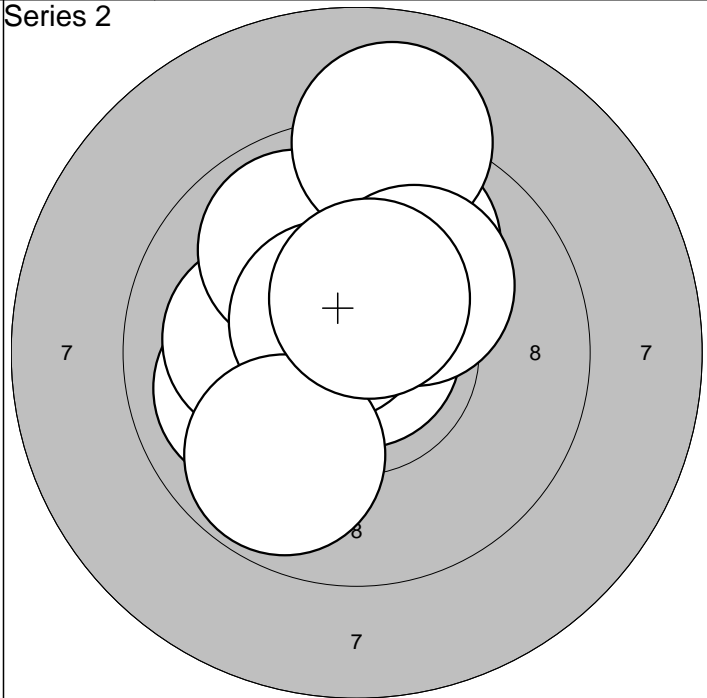

| | | | | | | | |
|---------|---|----------|---|--|--|-------|-------|
| 1:10,0 | ← | 6: 9,0 | ↑ | | | Serie | 96,0 |
| 2: 9,9 | ↑ | 7:10,6* | ↖ | | | | |
| 3:10,9* | ↗ | 8:10,1 | ↗ | | | | |
| 4:10,1 | ← | 9: 9,8 | ↘ | | | Sum | 193,0 |
| 5: 9,9 | ↖ | 10:10,4* | ↑ | | | | |

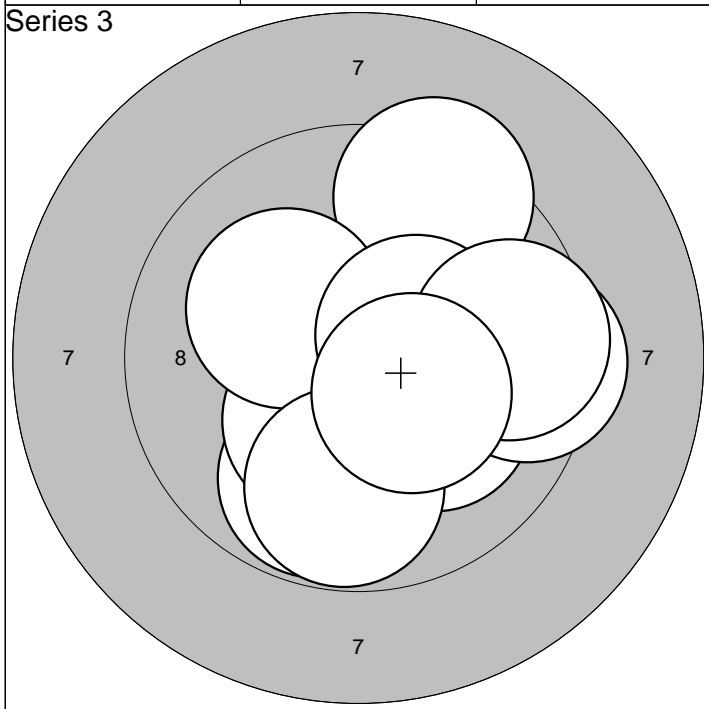

| | | | | | | | |
|---------|---|----------|---|--|--|-------|-------|
| 1: 9,8 | ↓ | 6: 9,4 | → | | | Serie | 95,0 |
| 2:10,3* | ↘ | 7:10,4* | → | | | | |
| 3: 9,3 | ↗ | 8: 9,8 | ↓ | | | | |
| 4:10,2* | ↖ | 9: 9,6 | → | | | Sum | 288,0 |
| 5:10,1 | ↘ | 10:10,4* | ↘ | | | | |

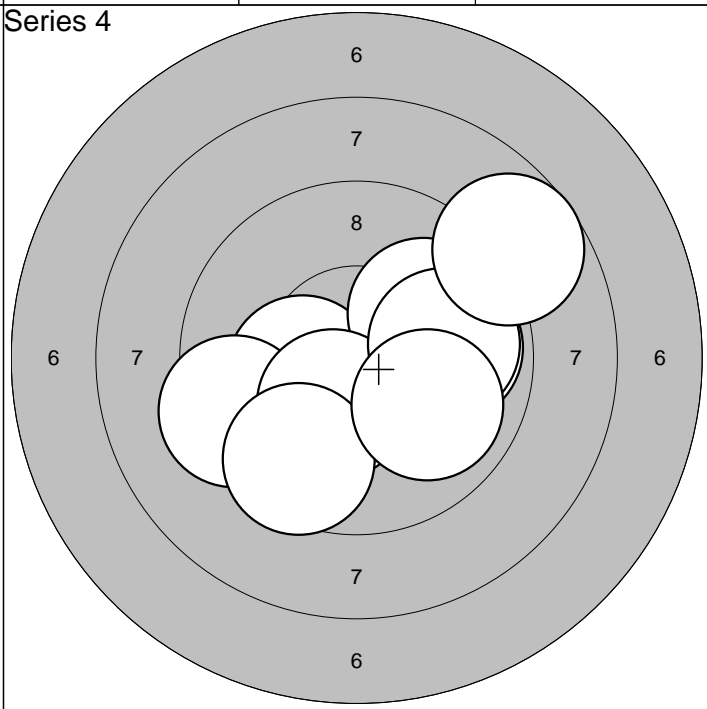

| | | | | | | | |
|---------|---|---------|---|--|--|-------|-------|
| 1: 9,9 | → | 6:10,3* | ↓ | | | Serie | 93,0 |
| 2:10,6* | ↓ | 7: 9,6 | ↓ | | | | |
| 3:10,3* | ← | 8: 9,9 | → | | | | |
| 4: 9,4 | ← | 9: 8,8 | ↗ | | | Sum | 381,0 |
| 5:10,0 | ↗ | 10: 9,9 | ↘ | | | | |

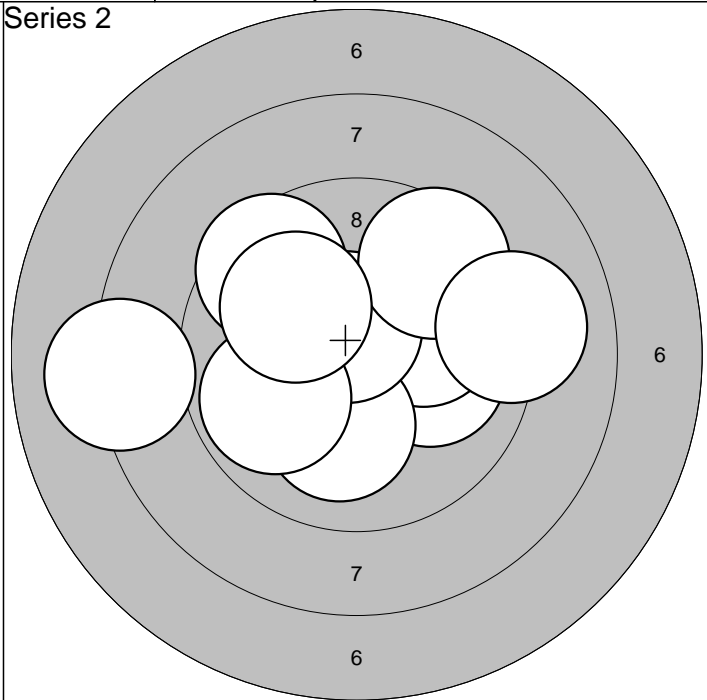
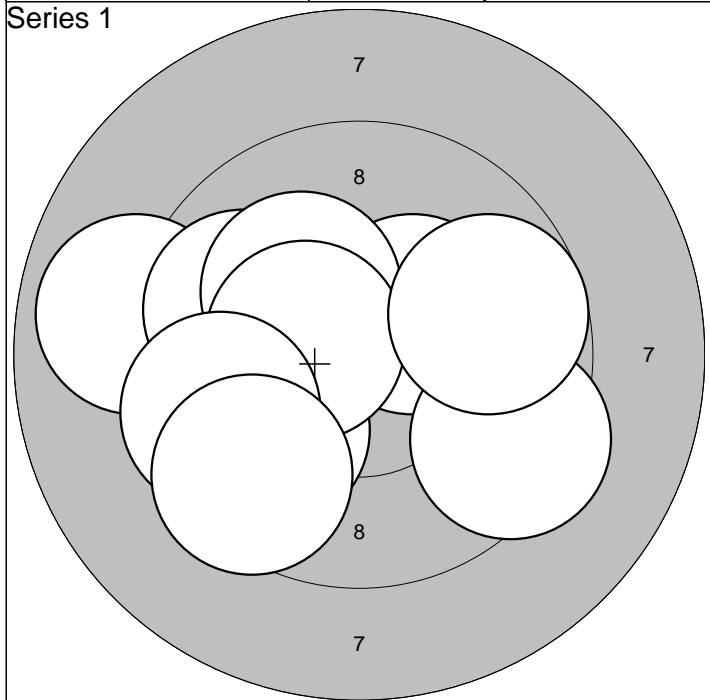

| | | | |
|-----------|-----------|-------|------|
| 1: 8,9 ↙ | 6:10,2* ↖ | Serie | 92,0 |
| 2:10,3* ↗ | 7:10,5* ↖ | | |
| 3: 9,9 ↙ | 8: 9,7 → | Sum | 92,0 |
| 4: 9,4 ↘ | 9: 9,6 ↖ | | |
| 5: 9,8 ↖ | 10: 9,5 ↙ | | |

| | | | |
|----------|-----------|-------|-------|
| 1: 9,5 ↖ | 6:10,6* ↖ | Serie | 94,0 |
| 2:10,1 → | 7: 9,5 ↗ | | |
| 3:10,1 → | 8: 9,1 → | Sum | 186,0 |
| 4: 8,1 ↖ | 9: 9,9 ↖ | | |
| 5:10,1 ↓ | 10:10,0 ↖ | | |

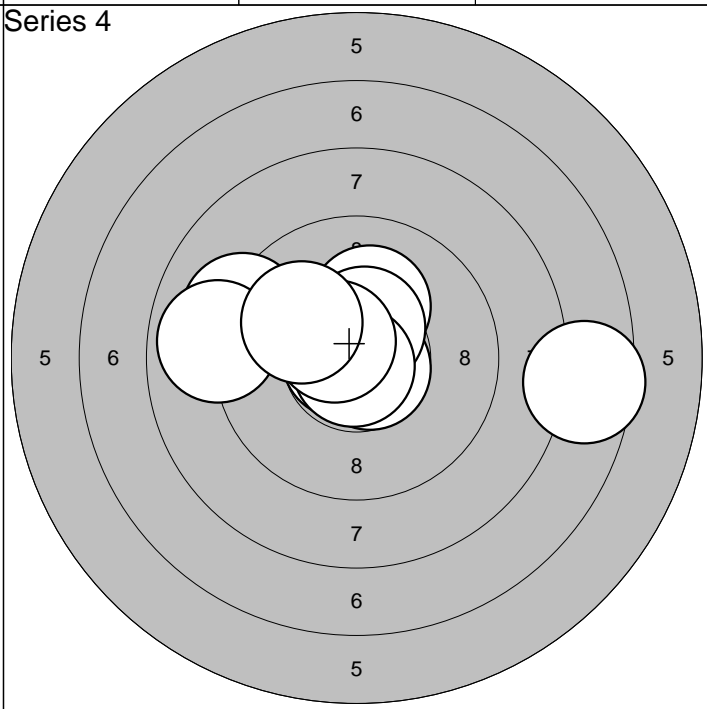
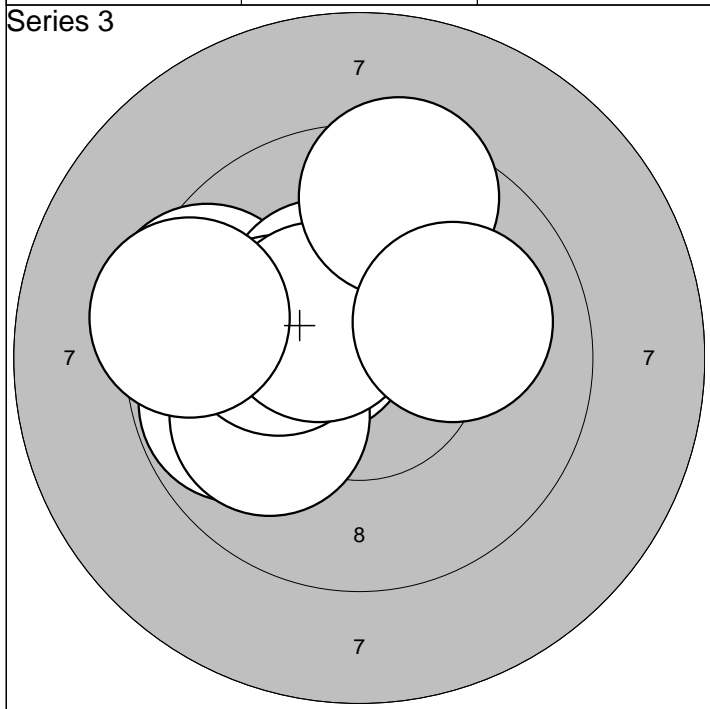

| | | | |
|-----------|-----------|-------|-------|
| 1: 9,8 ↖ | 6:10,2* ↖ | Serie | 96,0 |
| 2: 9,5 ↖ | 7:10,5* ↖ | | |
| 3:10,3* ↗ | 8: 9,4 ↖ | Sum | 282,0 |
| 4:10,5* ↖ | 9: 9,5 ↗ | | |
| 5:10,0 ↖ | 10:10,0 → | | |

| | | | |
|-----------|-----------|-------|-------|
| 1: 9,1 ↖ | 6:10,8* ↖ | Serie | 94,0 |
| 2:10,2* ↗ | 7:10,5* ↗ | | |
| 3:10,7* ↘ | 8:10,8* ↘ | Sum | 376,0 |
| 4: 8,9 ↖ | 9:10,5* ↖ | | |
| 5: 7,6 → | 10:10,0 ↖ | | |

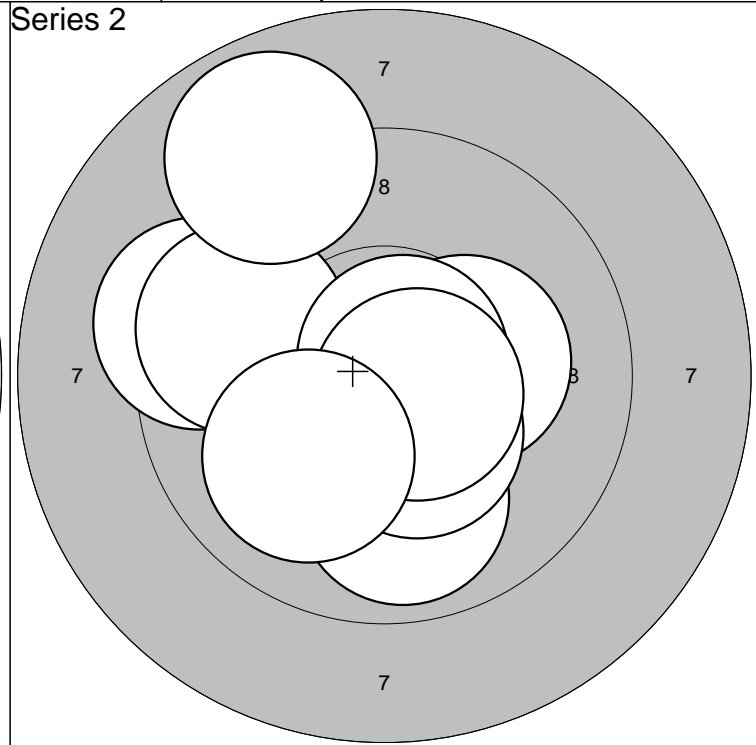
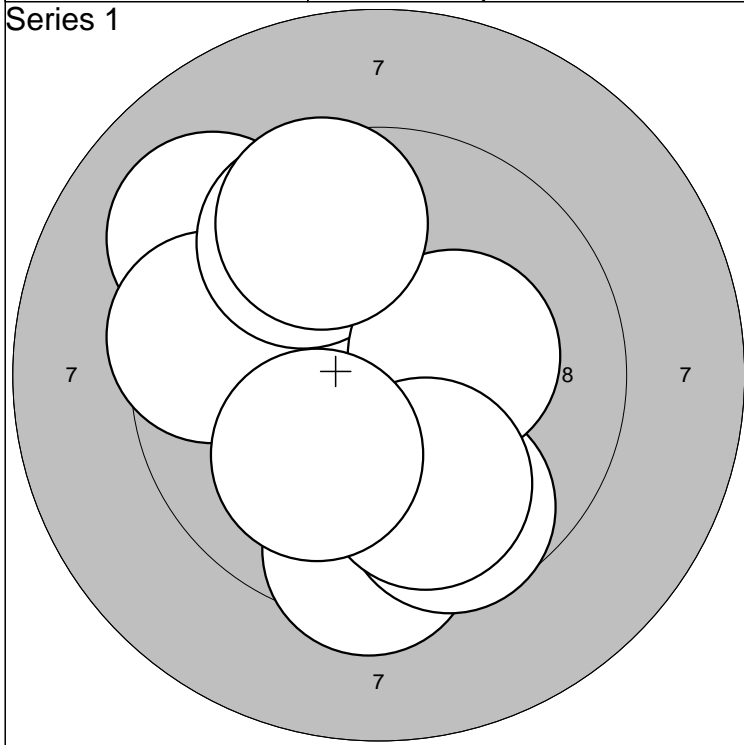

| | | | |
|----------|-----------|-------|------|
| 1:10,0 ↗ | 6: 9,7 ↓ | Serie | 93,0 |
| 2: 9,1 ↗ | 7:10,3* → | | |
| 3: 9,5 ↓ | 8: 9,6 ↗ | Sum | 93,0 |
| 4: 9,5 ← | 9: 9,9 ↓ | | |
| 5: 9,7 ↗ | 10:10,1 ↓ | | |

| | | | |
|-----------|-----------|-------|-------|
| 1: 9,9 ↓ | 6:10,7* ↗ | Serie | 95,0 |
| 2: 9,3 ← | 7:10,4* ↓ | | |
| 3:10,8* ↓ | 8:10,6* ↓ | Sum | 188,0 |
| 4: 9,7 ← | 9: 8,9 ↗ | | |
| 5:10,3* → | 10:10,0 ↓ | | |

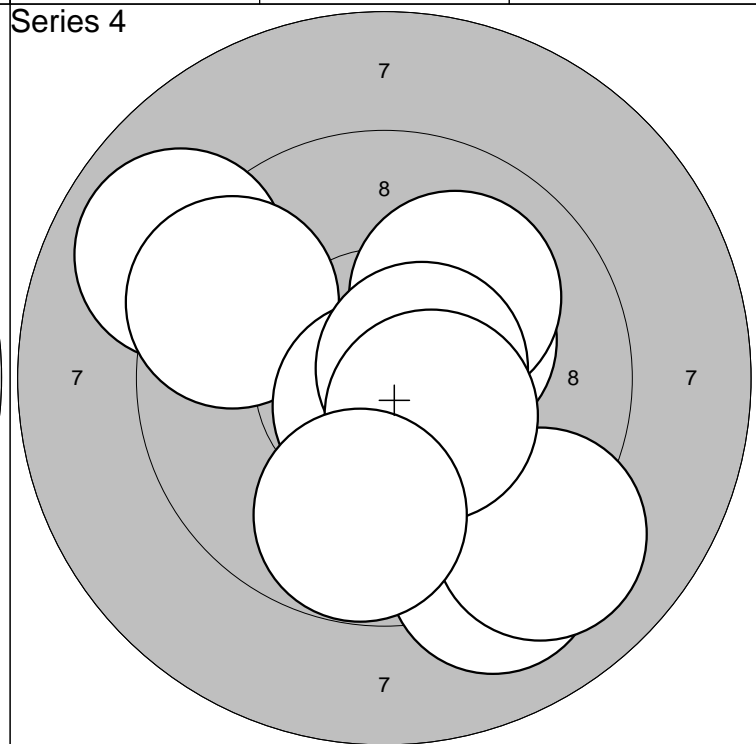
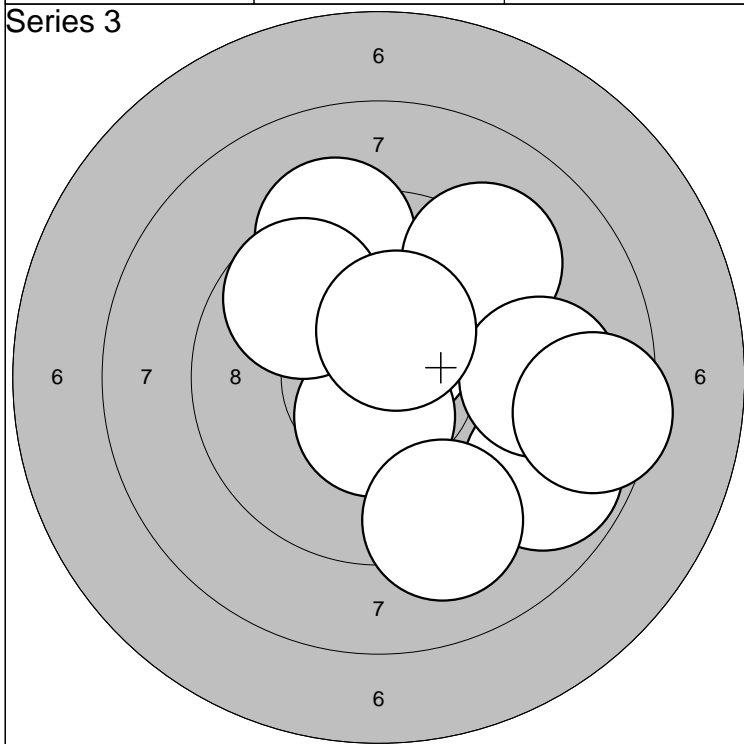

| | | | |
|-----------|------------|-------|-------|
| 1:10,5* ↗ | 6: 9,7 ↗ | Serie | 91,0 |
| 2:10,5* ↓ | 7: 9,1 → | | |
| 3: 8,8 ↘ | 8: 9,2 ↓ | Sum | 279,0 |
| 4: 9,3 ↗ | 9: 8,5 → | | |
| 5: 9,2 ↗ | 10:10,4* ↗ | | |

| | | | |
|-----------|-----------|-------|-------|
| 1: 8,9 ← | 6: 9,1 ↓ | Serie | 94,0 |
| 2: 9,5 ← | 7:10,6* → | | |
| 3:10,3* → | 8: 9,1 ↓ | Sum | 373,0 |
| 4:10,0 ↗ | 9:10,5* ↓ | | |
| 5:10,7* ↓ | 10: 9,8 ↓ | | |

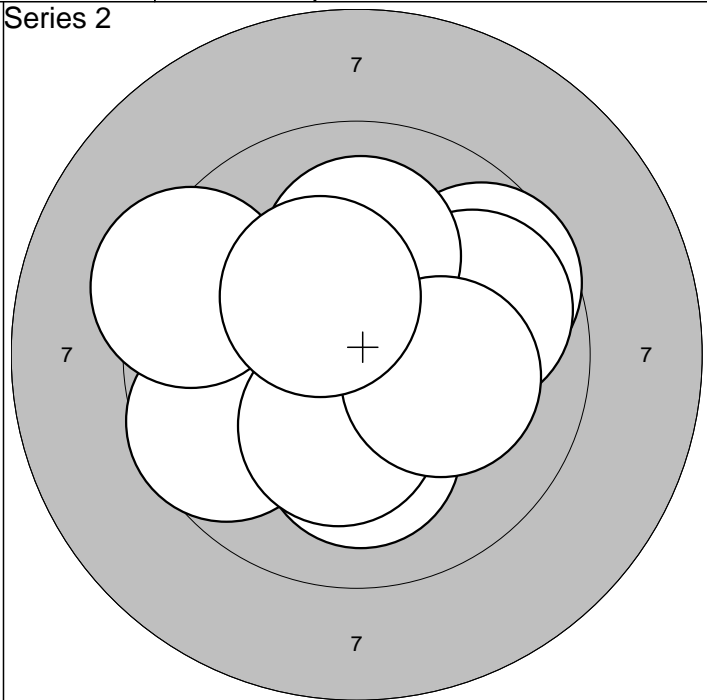
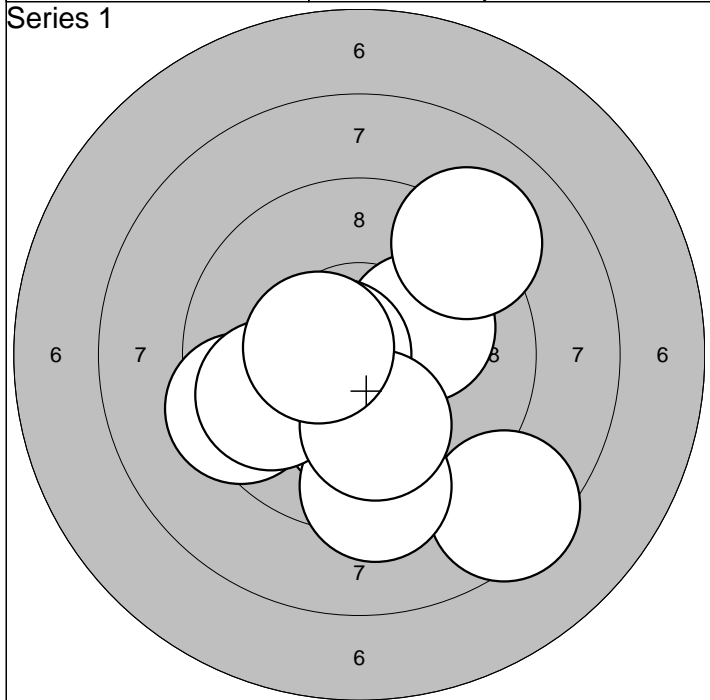

| | | | |
|-----------|------------|-------|------|
| 1:10,2* ↓ | 6: 9,8 ← | Serie | 94,0 |
| 2: 8,5 ↘ | 7:10,7* ← | | |
| 3: 9,4 ← | 8:10,1 ↓ | Sum | 94,0 |
| 4:10,2* → | 9: 9,1 ↗ | | |
| 5: 9,4 ↓ | 10:10,5* ← | | |

| | | | |
|-----------|------------|-------|-------|
| 1: 9,7 ↗ | 6:10,1 ↓ | Serie | 96,0 |
| 2: 9,6 ← | 7:10,3* ↓ | | |
| 3: 9,4 ← | 8:10,1 ↑ | Sum | 190,0 |
| 4:10,2* → | 9:10,2* → | | |
| 5: 9,8 → | 10:10,3* ↖ | | |

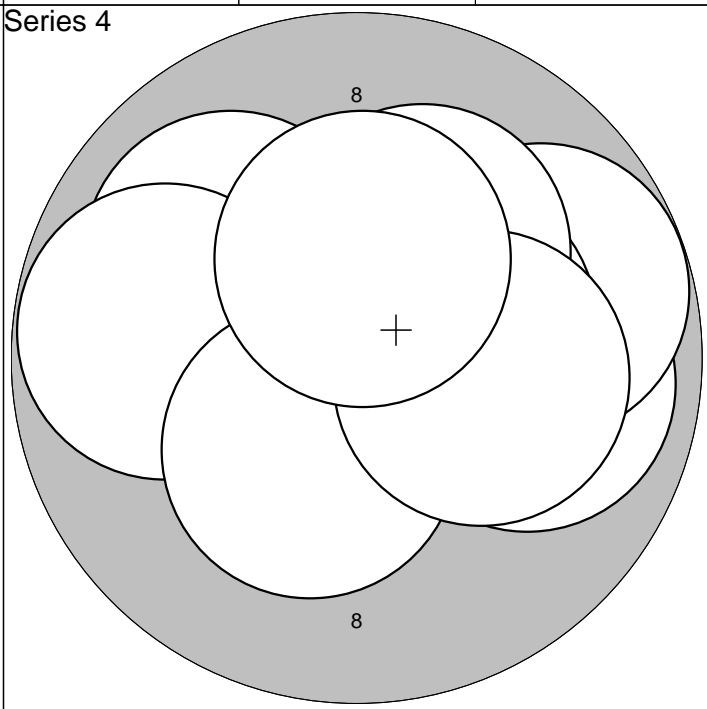
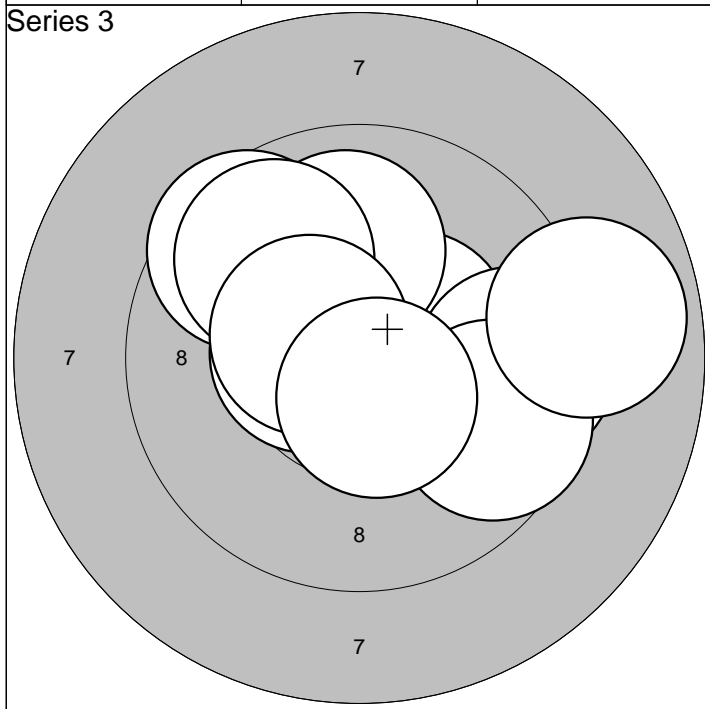

| | | | |
|-----------|------------|-------|-------|
| 1:10,4* → | 6: 9,5 → | Serie | 94,0 |
| 2: 9,6 ↖ | 7:10,4* ← | | |
| 3:10,0 ↑ | 8: 9,6 → | Sum | 284,0 |
| 4:10,5* ← | 9: 8,9 → | | |
| 5: 9,8 ↖ | 10:10,5* ↓ | | |

| | | | |
|-----------|------------|-------|-------|
| 1: 9,9 → | 6:10,0 ↖ | Serie | 97,0 |
| 2: 9,8 → | 7: 9,8 ← | | |
| 3:10,3* → | 8:10,3* ↓ | Sum | 381,0 |
| 4:10,3* → | 9:10,2* → | | |
| 5:10,2* ↗ | 10:10,4* ↑ | | |

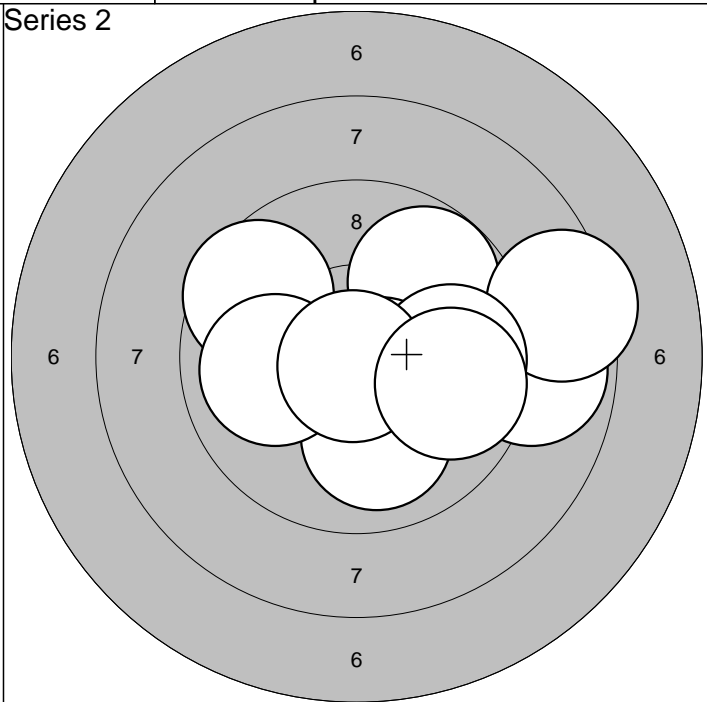
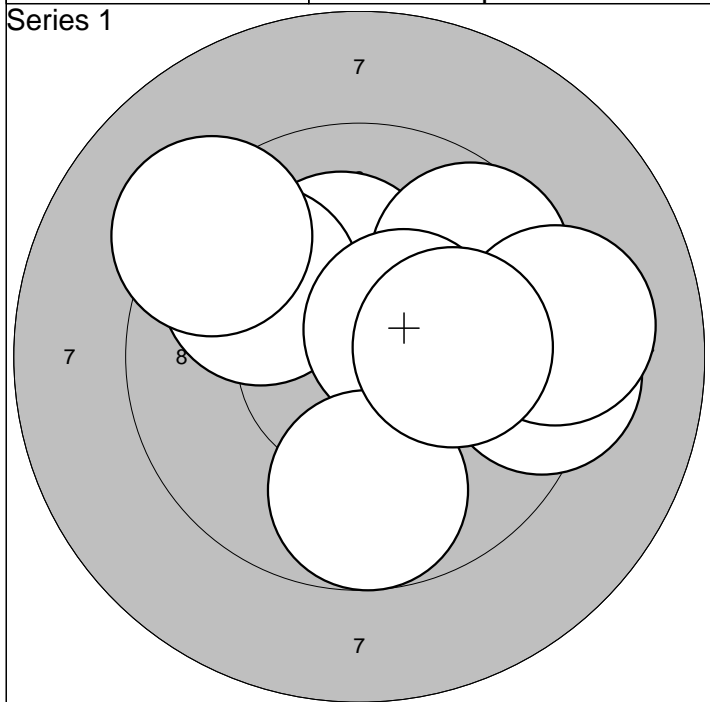

| | | | | | |
|-----------|-----------|-------|------|--|--|
| 1:10,2* ↑ | 6:10,5* ↗ | | | | |
| 2: 9,3 → | 7: 9,7 ↓ | | | | |
| 3:10,3* → | 8: 9,3 ↖ | Serie | 94,0 | | |
| 4: 9,7 ↗ | 9: 9,2 → | Sum | 94,0 | | |
| 5: 9,9 ↖ | 10:10,1 → | | | | |

| | | | | | |
|-----------|-----------|-------|-------|--|--|
| 1: 9,6 ↖ | 6:10,0 ↓ | | | | |
| 2: 8,9 → | 7: 9,8 → | | | | |
| 3: 9,8 ↗ | 8:10,0 ← | Serie | 92,0 | | |
| 4: 8,4 → | 9:10,8* ↓ | Sum | 186,0 | | |
| 5:10,6* ↘ | 10: 9,8 → | | | | |

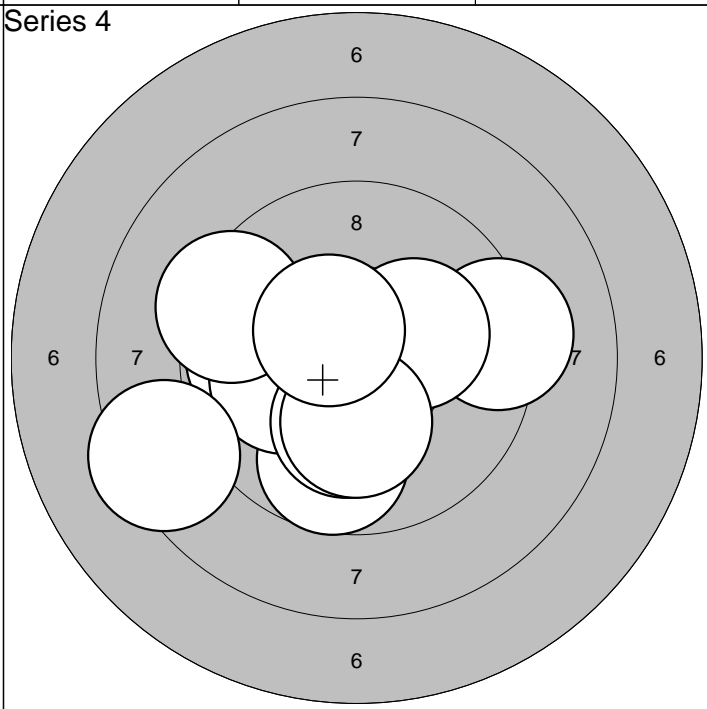
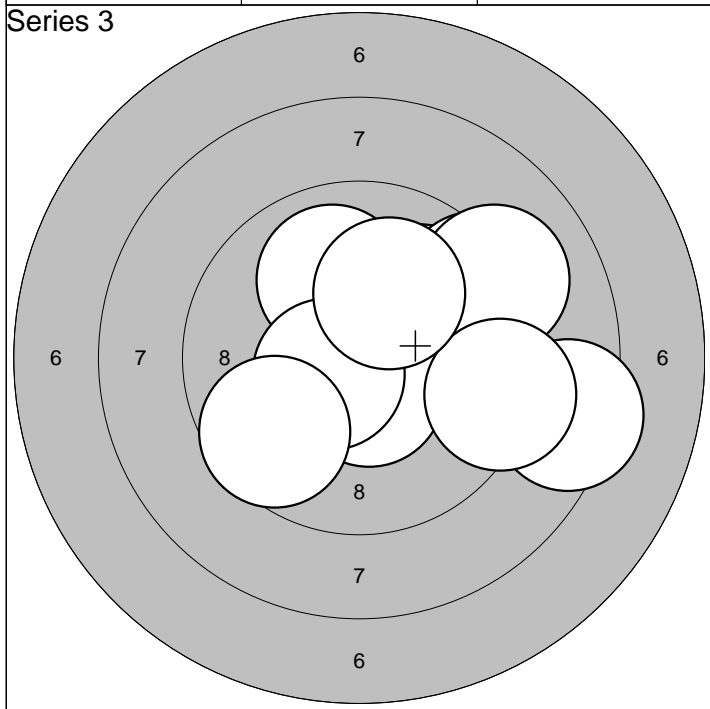

| | | | | | |
|-----------|-----------|-------|-------|--|--|
| 1: 9,9 ↗ | 6: 9,1 ↗ | | | | |
| 2:10,5* ↓ | 7:10,6* ← | | | | |
| 3:10,0 ↑ | 8: 9,2 → | Serie | 93,0 | | |
| 4: 9,3 ↗ | 9: 9,6 ↖ | Sum | 279,0 | | |
| 5: 8,4 → | 10:10,1 ↗ | | | | |

| | | | | | |
|-----------|------------|-------|-------|--|--|
| 1: 9,8 ← | 6:10,2* ↗ | | | | |
| 2: 9,7 ↓ | 7: 9,4 ↖ | | | | |
| 3:10,1 ← | 8: 8,4 ↖ | Serie | 94,0 | | |
| 4:10,2* ↓ | 9:10,2* ↓ | Sum | 373,0 | | |
| 5: 9,3 → | 10:10,5* ↖ | | | | |

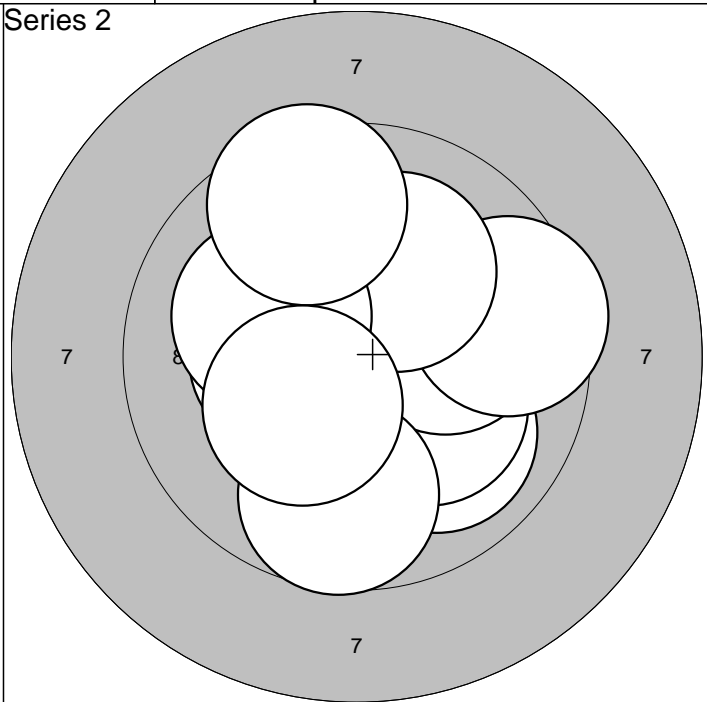
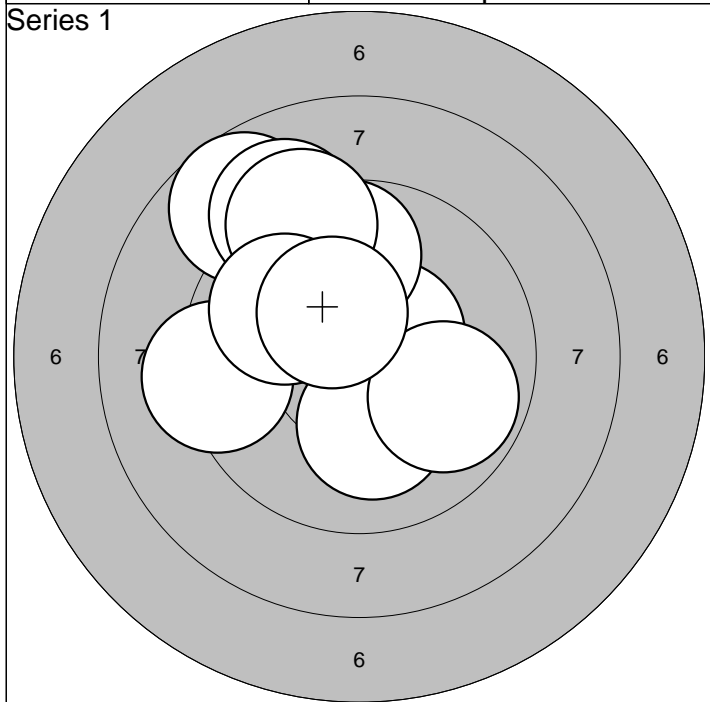

| | | | | |
|-----------|------------|-----|-------|------|
| 1: 8,7 ↗ | 6: 9,3 ↗ | | Serie | 92,0 |
| 2: 9,1 ↗ | 7:10,2* ↓ | | | |
| 3:10,5* ↗ | 8: 9,9 ↗ | Sum | 92,0 | |
| 4: 9,3 ← | 9: 9,8 ↘ | | | |
| 5: 9,7 ↑ | 10:10,3* ↗ | | | |

| | | | | |
|-----------|------------|-----|-------|------|
| 1:10,0 ↘ | 6:10,1 ↗ | | Serie | 97,0 |
| 2:10,2* ↘ | 7:10,1 ← | | | |
| 3:10,1 → | 8: 9,5 ↑ | Sum | 189,0 | |
| 4: 9,5 → | 9: 9,7 ↓ | | | |
| 5:10,4* ← | 10:10,3* ↘ | | | |

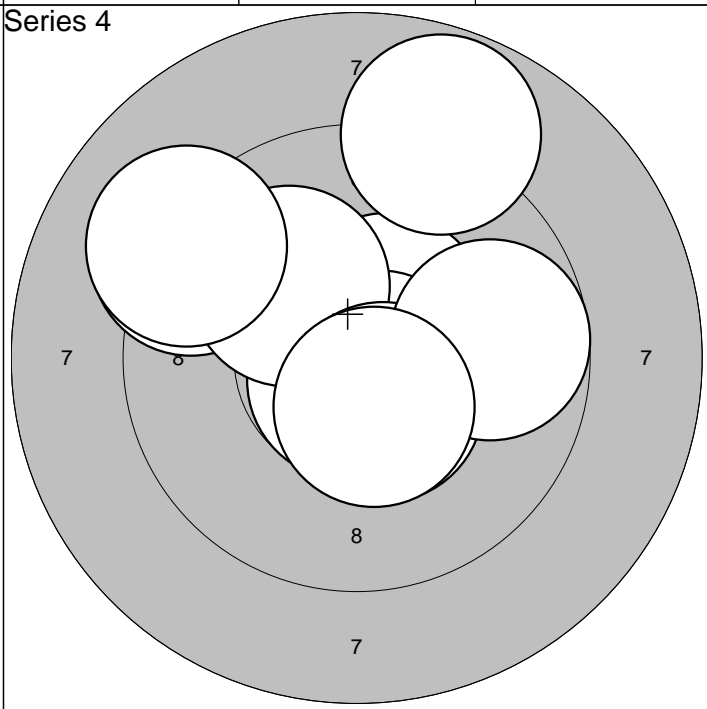
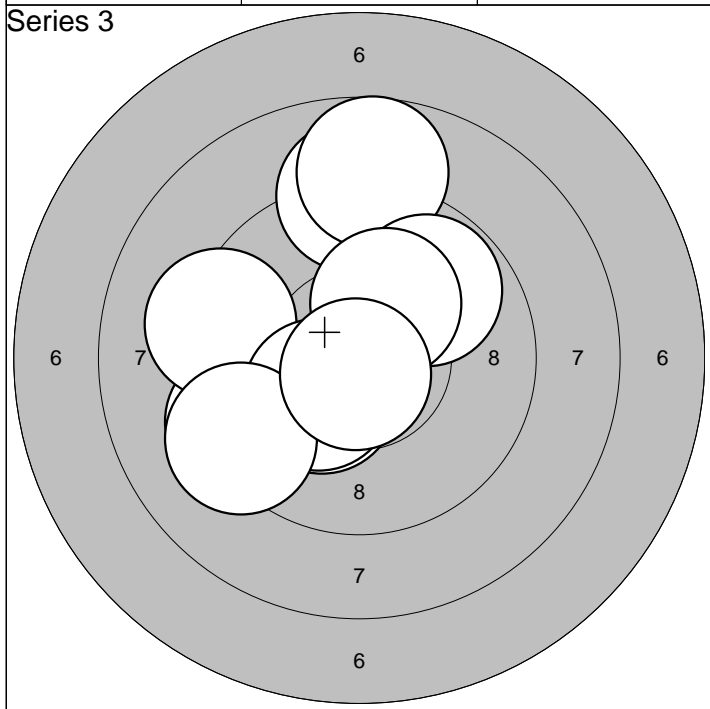

| | | | | |
|-----------|------------|-----|-------|------|
| 1:10,3* ↘ | 6:10,3* ↘ | | Serie | 93,0 |
| 2: 9,4 ← | 7: 9,8 ↗ | | | |
| 3: 9,0 ↑ | 8:10,2* ↗ | Sum | 282,0 | |
| 4: 8,8 ↑ | 9: 9,2 ← | | | |
| 5: 9,3 ← | 10:10,7* ↓ | | | |

| | | | | |
|-----------|------------|-----|-------|------|
| 1:10,7* ↓ | 6:10,1 ↗ | | Serie | 95,0 |
| 2:10,5* ↗ | 7:10,5* ↓ | | | |
| 3: 9,2 ← | 8: 9,8 → | Sum | 377,0 | |
| 4:10,7* ↘ | 9: 9,1 ↗ | | | |
| 5: 8,8 ↑ | 10:10,5* ↓ | | | |

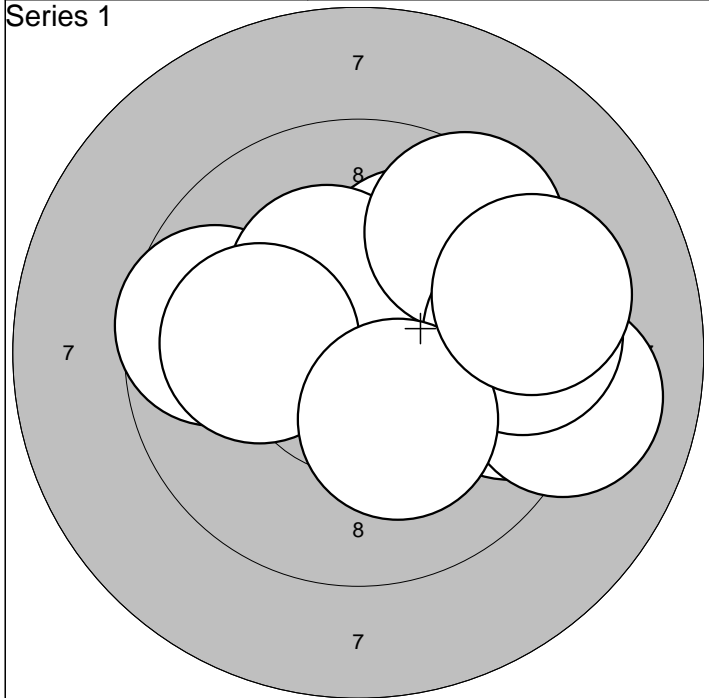

| | | | |
|-----------|-----------|-------|------|
| 1:10,1 ↗ | 6: 9,1 → | Serie | 94,0 |
| 2: 9,6 → | 7: 9,5 ↗ | | |
| 3: 9,6 ← | 8: 9,5 → | Sum | 94,0 |
| 4:10,3* ↗ | 9:10,3* ↘ | | |
| 5:10,1 ← | 10: 9,3 → | | |

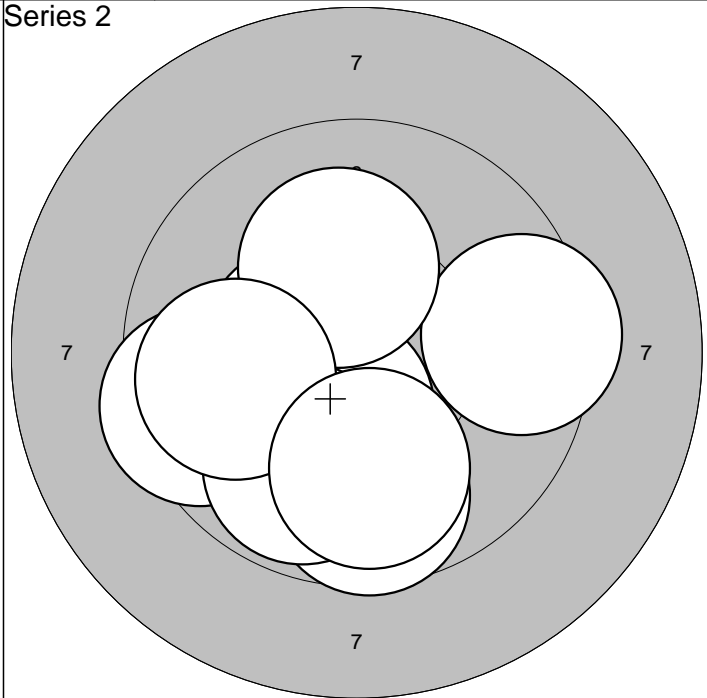

| | | | |
|-----------|-----------|-------|-------|
| 1:10,3* ↘ | 6: 9,5 ← | Serie | 94,0 |
| 2: 9,7 ↘ | 7: 9,8 ↘ | | |
| 3:10,5* ← | 8:10,2* ↗ | Sum | 188,0 |
| 4: 9,5 → | 9: 9,8 ← | | |
| 5:10,4* ↘ | 10: 9,9 ↘ | | |

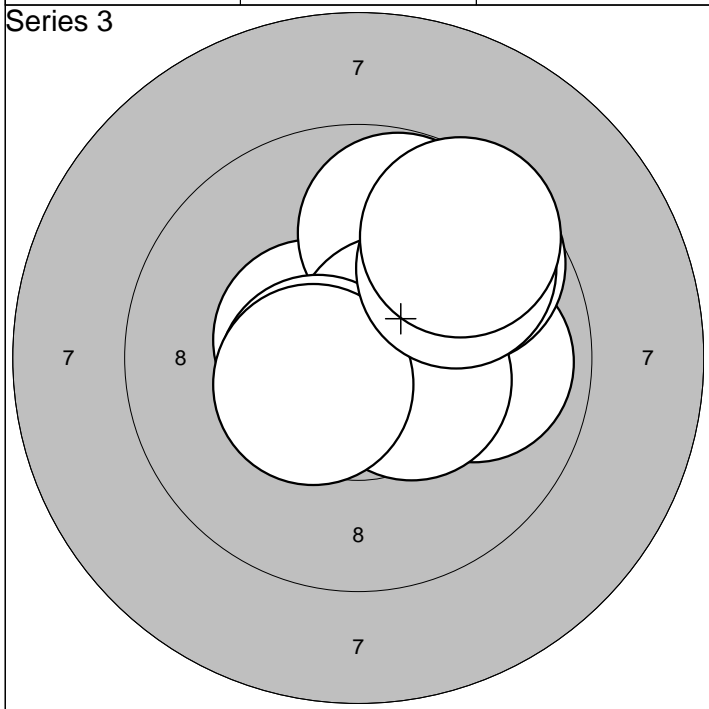

| | | | |
|-----------|-----------|-------|-------|
| 1: 9,9 → | 6:10,5* ← | Serie | 95,0 |
| 2:10,5* ← | 7:10,4* → | | |
| 3: 9,8 ↗ | 8:10,5* ← | Sum | 283,0 |
| 4:10,6* ↗ | 9: 9,8 ↗ | | |
| 5: 9,7 ↗ | 10: 9,5 ↗ | | |

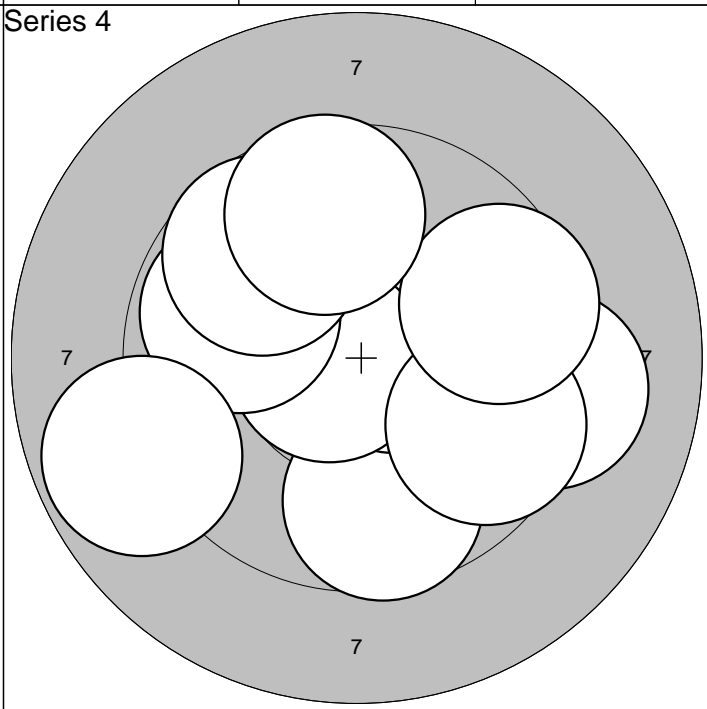

| | | | |
|-----------|-----------|-------|-------|
| 1: 9,6 ↘ | 6: 9,7 ↗ | Serie | 91,0 |
| 2:10,6* → | 7: 9,7 → | | |
| 3:10,7* ← | 8: 8,8 ← | Sum | 374,0 |
| 4: 9,8 ← | 9: 9,6 → | | |
| 5: 9,2 → | 10: 9,7 ↗ | | |

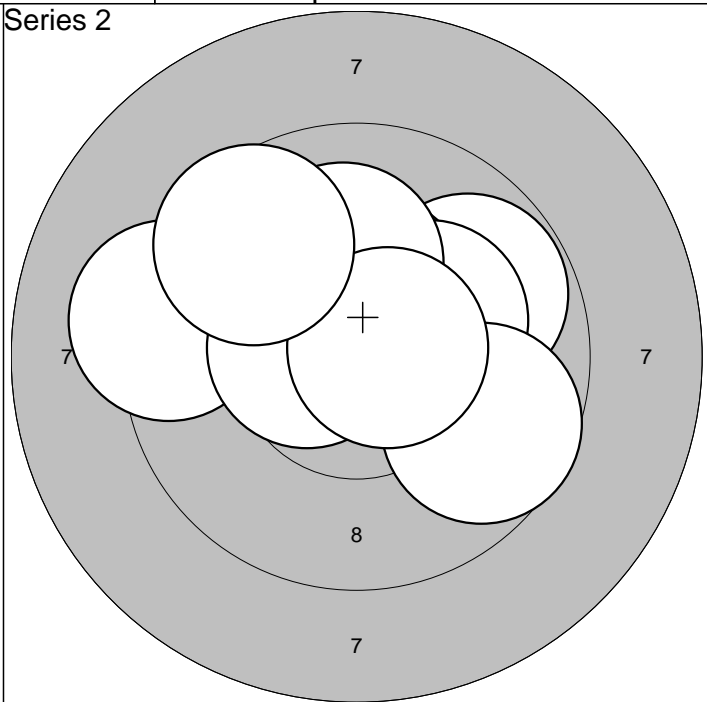
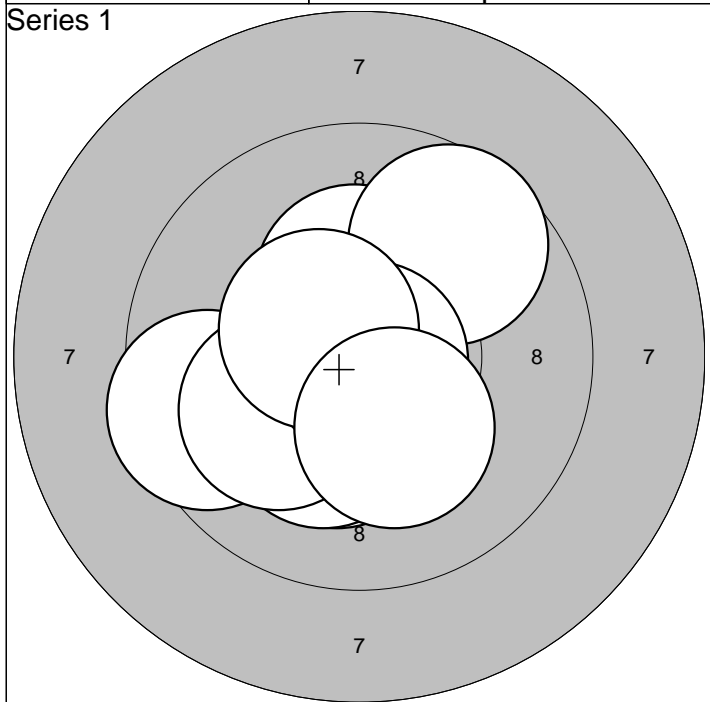

| | | | |
|-----------|------------|-------|------|
| 1:10,8* ↓ | 6:10,3* ↓ | Serie | 98,0 |
| 2: 9,5 ← | 7:10,1 ← | | |
| 3:10,3* ↑ | 8:10,8* → | Sum | 98,0 |
| 4: 9,7 ↗ | 9:10,5* ↖ | | |
| 5:10,3* ↓ | 10:10,2* ↓ | | |

| | | | |
|-----------|-----------|-------|-------|
| 1: 9,3 ← | 6:10,1 ↑ | Serie | 96,0 |
| 2:10,3* ↗ | 7:10,5* ← | | |
| 3: 9,8 ↗ | 8: 9,7 → | Sum | 194,0 |
| 4:10,4* ↑ | 9:10,7* → | | |
| 5:10,2* ↗ | 10: 9,6 ↖ | | |

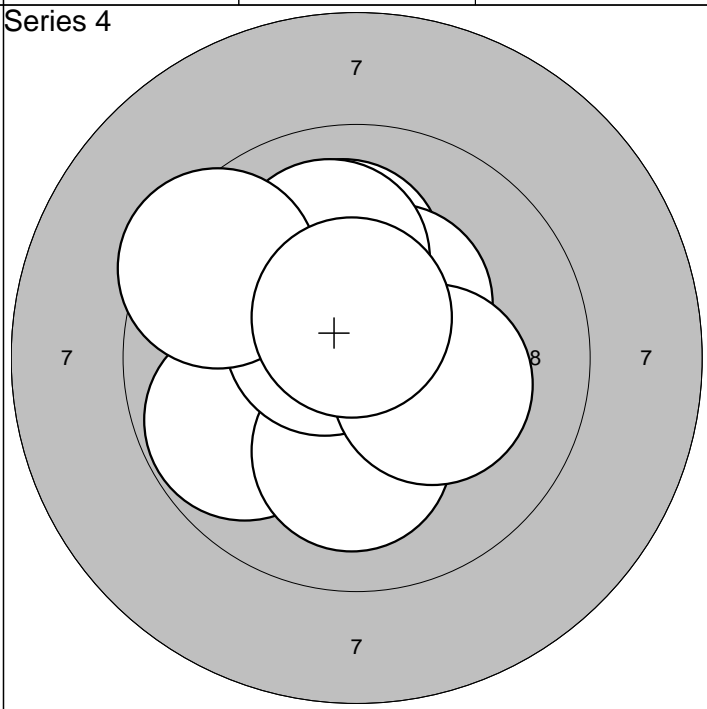
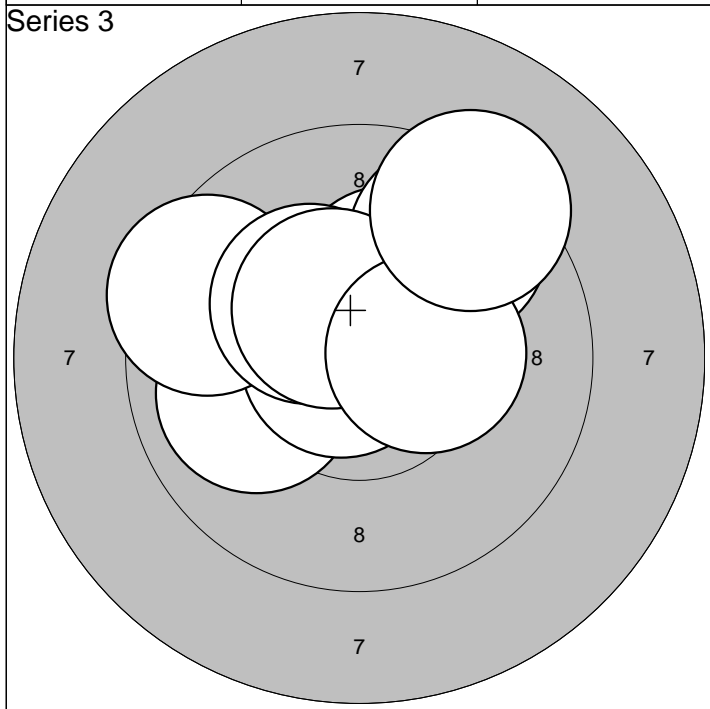

| | | | |
|-----------|-----------|-------|-------|
| 1:10,5* ← | 6: 9,6 ↗ | Serie | 97,0 |
| 2:10,0 ← | 7:10,3* ↖ | | |
| 3:10,8* ← | 8:10,5* ↖ | Sum | 291,0 |
| 4:10,3* ↗ | 9:10,3* → | | |
| 5: 9,5 ← | 10: 9,3 ↗ | | |

| | | | |
|-----------|------------|-------|-------|
| 1:10,6* ↑ | 6:10,0 ↑ | Serie | 98,0 |
| 2: 9,8 ← | 7:10,6* ↖ | | |
| 3:10,1 ↑ | 8: 9,5 ↖ | Sum | 389,0 |
| 4:10,1 ↓ | 9:10,2* → | | |
| 5:10,4* ↗ | 10:10,6* ↑ | | |

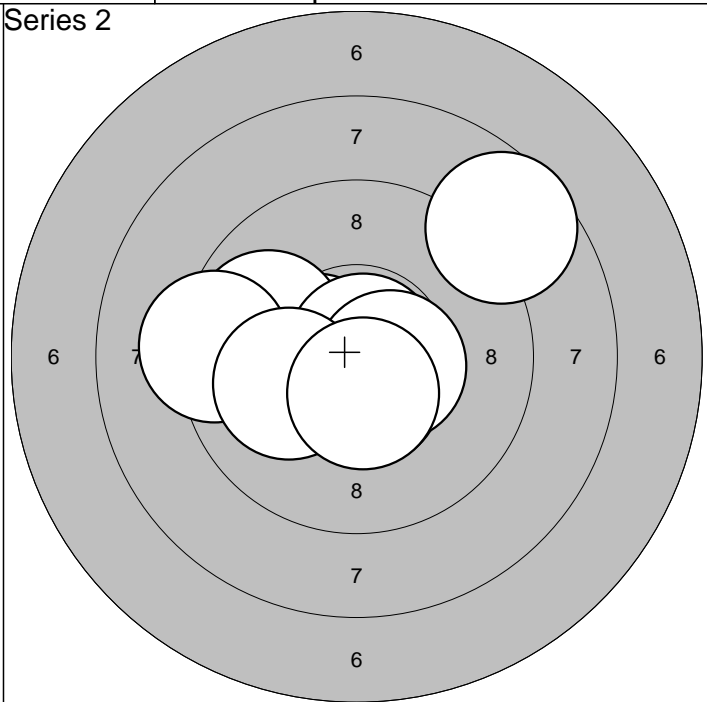
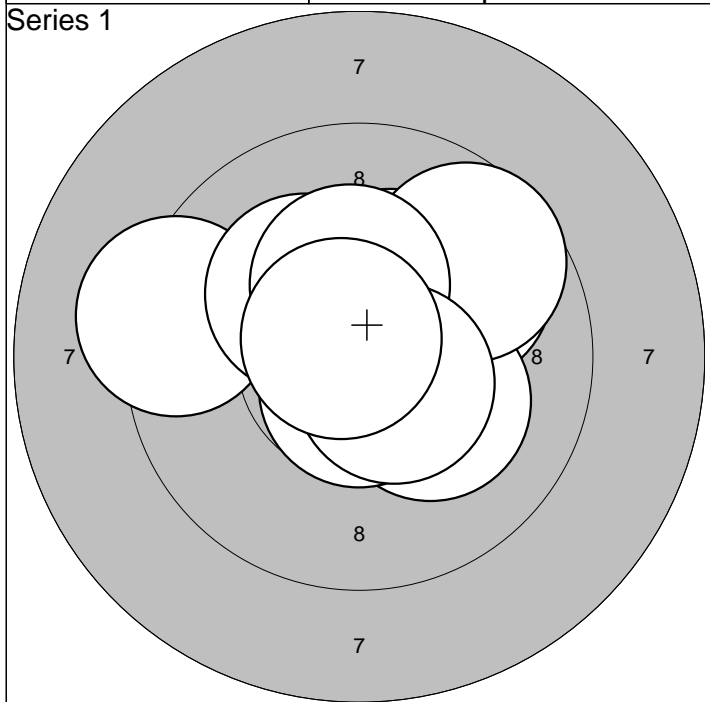

| | | | |
|-----------|------------|-------|------|
| 1:10,3* ↗ | 6:10,2* ↖ | Serie | 97,0 |
| 2: 9,9 ↗ | 7: 9,7 ↗ | | |
| 3: 9,3 ← | 8:10,3* ↑ | Sum | 97,0 |
| 4:10,2* ↘ | 9:10,5* ↘ | | |
| 5:10,7* ↓ | 10:10,7* ↗ | | |

| | | | |
|-----------|------------|-------|-------|
| 1:10,5* ← | 6:10,8* ↗ | Serie | 96,0 |
| 2: 9,9 ← | 7: 9,3 ← | | |
| 3:10,6* ↓ | 8:10,5* → | Sum | 193,0 |
| 4: 8,7 ↗ | 9:10,1 ← | | |
| 5:10,5* ↓ | 10:10,5* ↓ | | |

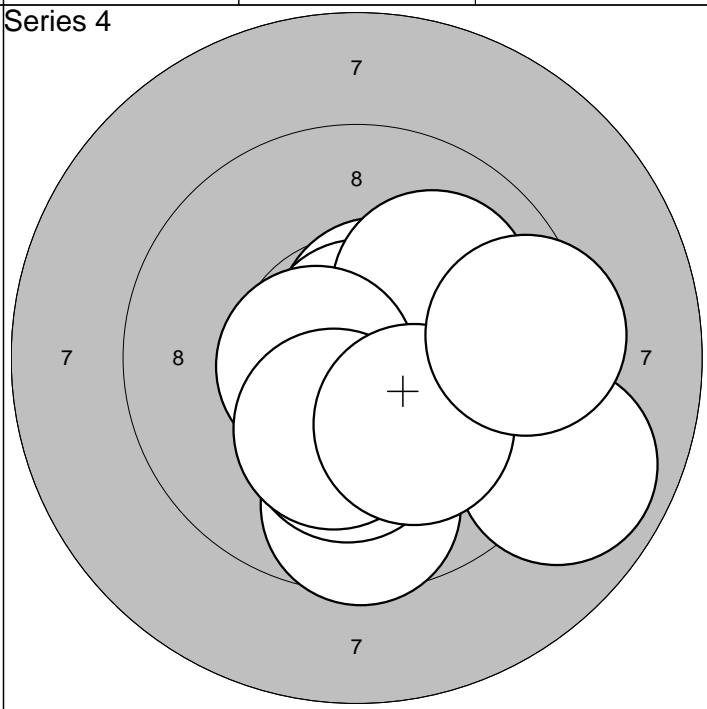
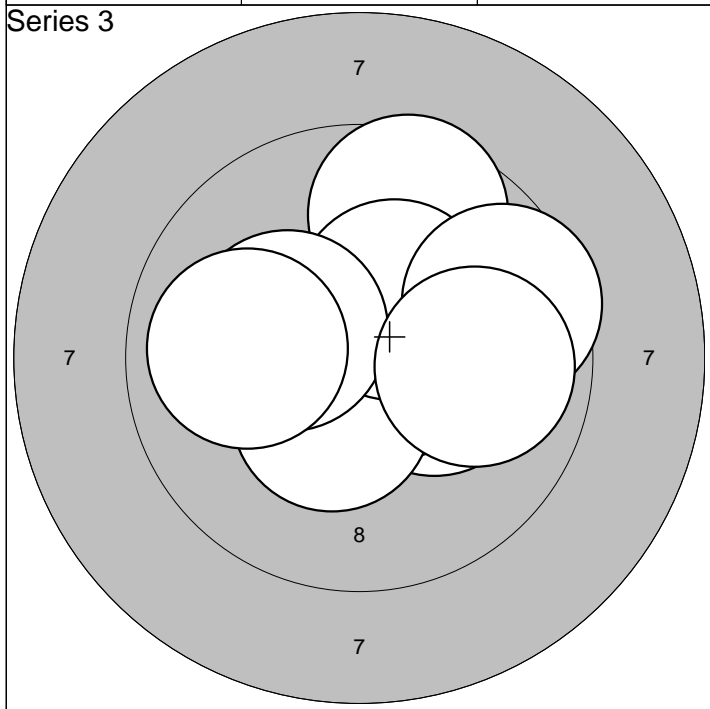

| | | | |
|-----------|-----------|-------|-------|
| 1:10,4* → | 6:10,3* ↗ | Serie | 96,0 |
| 2: 9,6 ↑ | 7: 9,6 ↗ | | |
| 3:10,2* → | 8:10,3* ← | Sum | 289,0 |
| 4:10,6* → | 9: 9,9 ← | | |
| 5:10,4* ↘ | 10: 9,9 → | | |

| | | | |
|-----------|-----------|-------|-------|
| 1: 9,6 ↓ | 6:10,1 ↗ | Serie | 96,0 |
| 2:10,2* ↓ | 7:10,6* ← | | |
| 3:10,5* ↗ | 8:10,3* ↓ | Sum | 385,0 |
| 4: 8,9 ↘ | 9:10,1 ↘ | | |
| 5:10,8* ↑ | 10: 9,4 → | | |

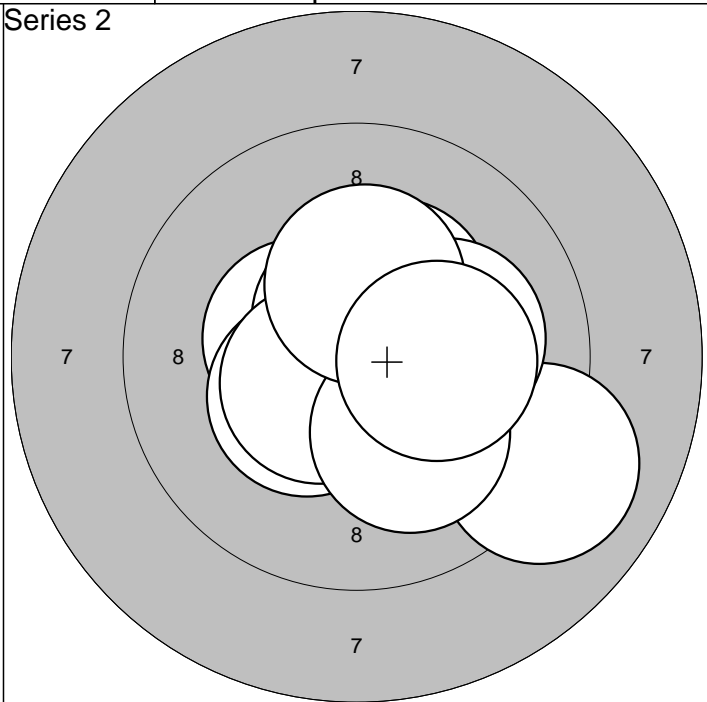
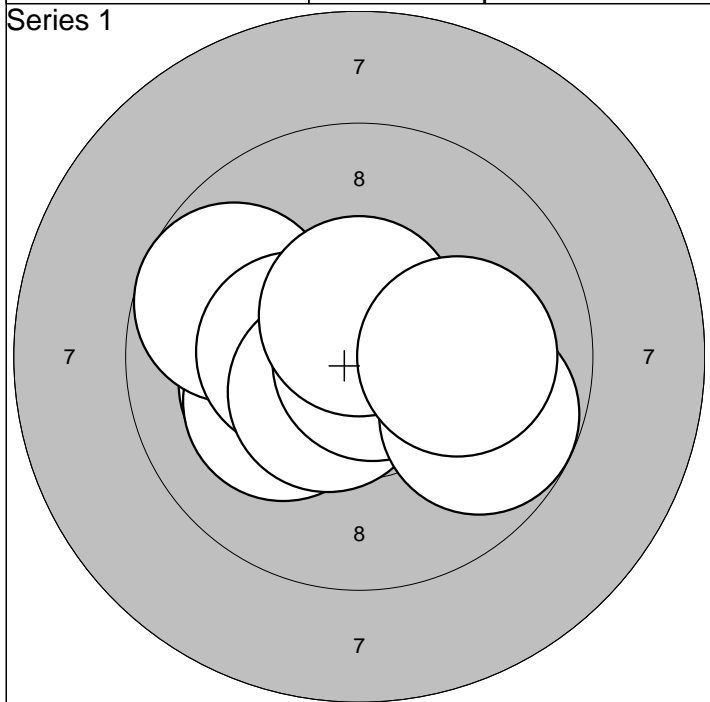

| | | | |
|-----------|-----------|-------|------|
| 1:10,2* ← | 6:10,5* ↙ | Serie | 98,0 |
| 2:10,7* ↘ | 7:10,8* → | | |
| 3:10,2* ← | 8:10,6* ↑ | Sum | 98,0 |
| 4: 9,7 ← | 9: 9,8 → | | |
| 5:10,4* ← | 10:10,1 → | | |

| | | | |
|-----------|------------|-------|-------|
| 1:10,4* ← | 6:10,6* ↑ | Serie | 99,0 |
| 2: 9,0 → | 7:10,5* ↙ | | |
| 3:10,3* ↗ | 8:10,1 ↘ | Sum | 197,0 |
| 4:10,1 → | 9:10,3* ↑ | | |
| 5:10,4* ↙ | 10:10,2* → | | |

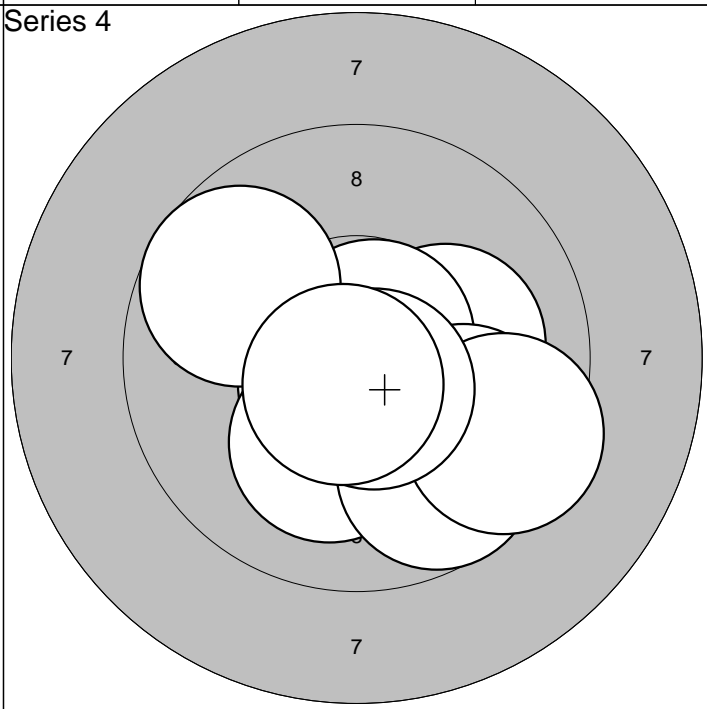
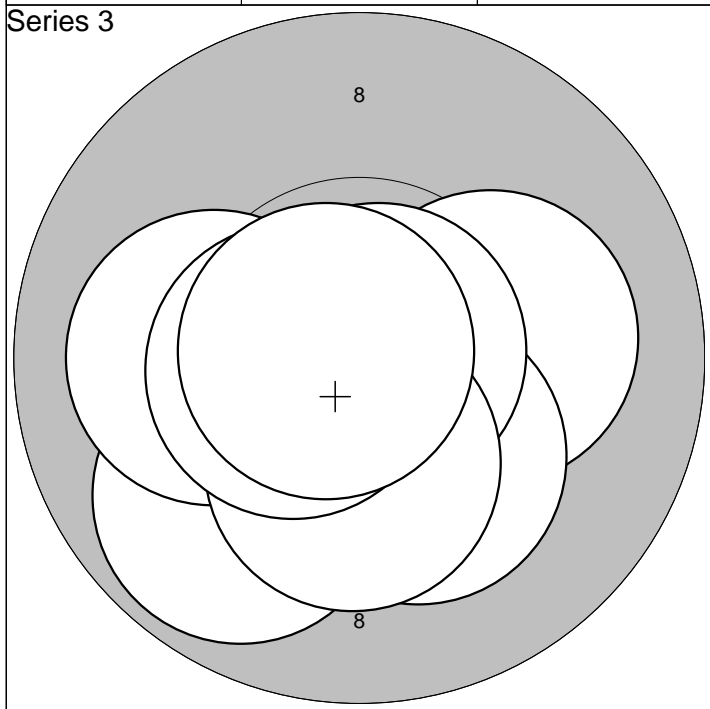

| | | | |
|-----------|------------|-------|-------|
| 1:10,2* ← | 6:10,8* → | Serie | 99,0 |
| 2:10,6* ↘ | 7:10,1 ← | | |
| 3: 9,8 ↘ | 8:10,3* ↓ | Sum | 296,0 |
| 4:10,1 → | 9:10,5* ← | | |
| 5:10,3* ↘ | 10:10,7* ← | | |

| | | | |
|-----------|------------|-------|-------|
| 1:10,1 → | 6:10,2* ↘ | Serie | 96,0 |
| 2:10,7* ↗ | 7: 9,7 ↘ | | |
| 3:10,7* ↘ | 8: 9,5 → | Sum | 392,0 |
| 4: 9,8 ↘ | 9:10,6* ↘ | | |
| 5: 9,7 ↗ | 10:10,7* ↘ | | |

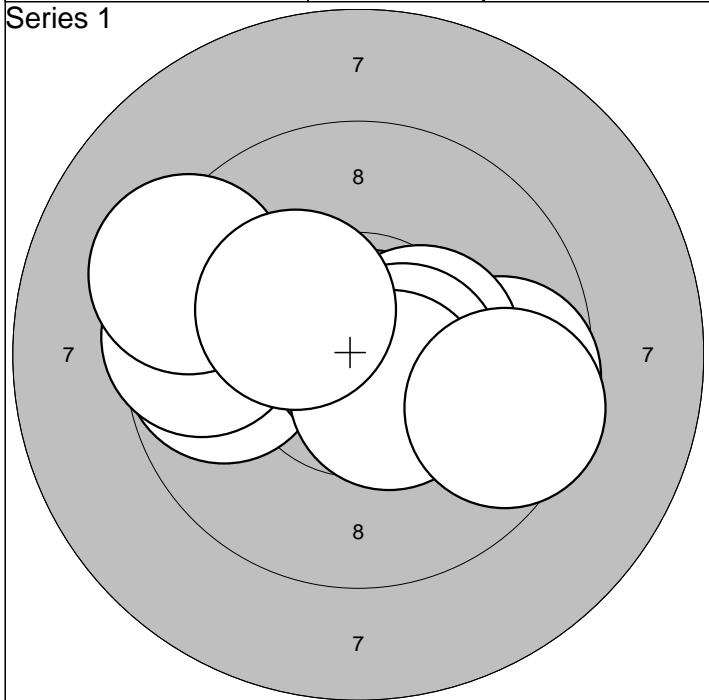

| | | | | | |
|---------|---|---------|---|-------|------|
| 1: 9,7 | ← | 6:10,5* | → | | |
| 2:10,9* | ↗ | 7: 9,3 | ↖ | Serie | 95,0 |
| 3: 9,6 | → | 8:10,5* | ↘ | | |
| 4:10,4* | → | 9:10,3* | ↗ | Sum | 95,0 |
| 5: 9,5 | ← | 10: 9,5 | ↘ | | |

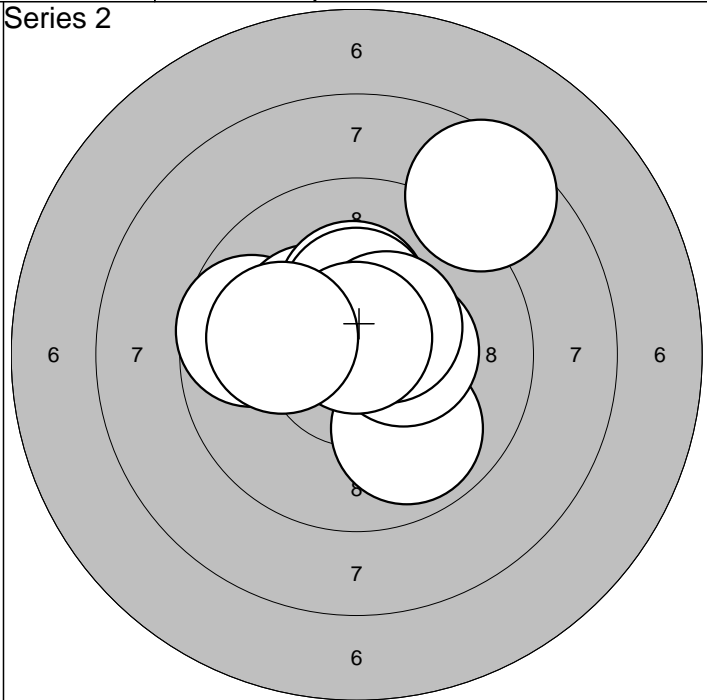

| | | | | | |
|---------|---|---------|---|-------|-------|
| 1: 9,9 | ↘ | 6:10,3* | ↑ | | |
| 2: 9,7 | ← | 7:10,3* | ↑ | Serie | 96,0 |
| 3: 8,6 | ↗ | 8:10,5* | ↗ | | |
| 4:10,4* | → | 9:10,8* | ↑ | Sum | 191,0 |
| 5:10,3* | ↖ | 10:10,0 | ← | | |

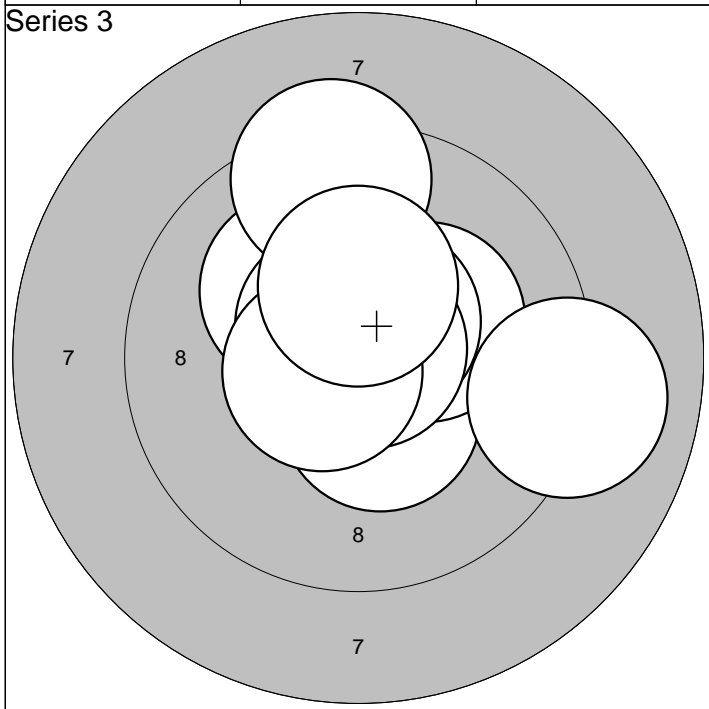

| | | | | | |
|---------|---|----------|---|-------|-------|
| 1:10,4* | ↘ | 6:10,6* | ↗ | | |
| 2:10,3* | ↗ | 7:10,8* | ↗ | Serie | 98,0 |
| 3: 9,0 | → | 8:10,6* | ← | | |
| 4:10,1 | ↗ | 9: 9,3 | ↑ | Sum | 289,0 |
| 5:10,6* | ↗ | 10:10,3* | ↑ | | |

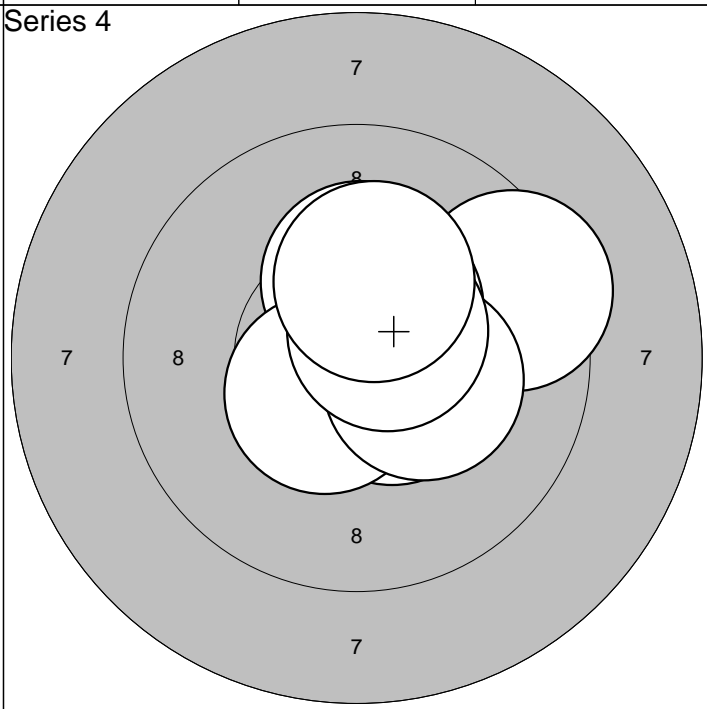

| | | | | | |
|---------|---|----------|---|-------|-------|
| 1:10,7* | ↗ | 6:10,5* | ↗ | | |
| 2:10,4* | ↗ | 7:10,5* | ↘ | Serie | 99,0 |
| 3:10,5* | ↘ | 8:10,3* | → | | |
| 4: 9,4 | ↗ | 9:10,6* | ↗ | Sum | 388,0 |
| 5:10,3* | ↑ | 10:10,3* | ↑ | | |

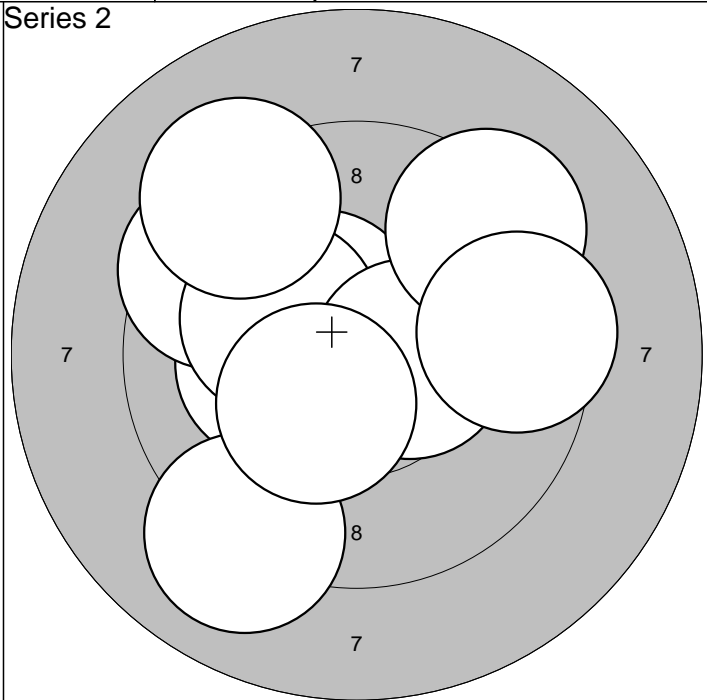
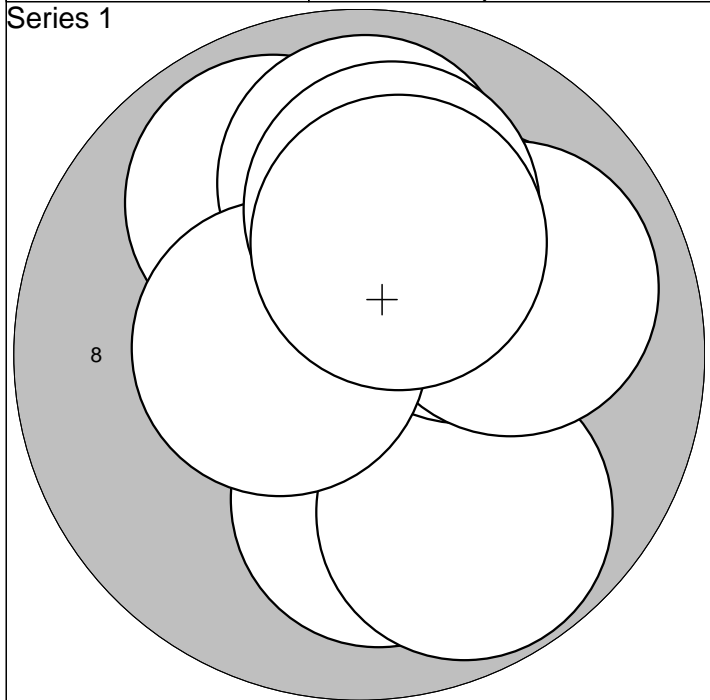

| | | | |
|-----------|------------|-------|------|
| 1:10,1 ↓ | 6:10,0 → | Serie | 97,0 |
| 2: 9,8 ↓ | 7: 9,9 ↑ | | |
| 3:10,2* ↗ | 8:10,5* ← | Sum | 97,0 |
| 4:10,1 ↗ | 9:10,0 ↑ | | |
| 5: 9,9 ↗ | 10:10,2* ↑ | | |

| | | | |
|-----------|-----------|-------|-------|
| 1:10,2* ← | 6:10,5* → | Serie | 95,0 |
| 2: 9,5 ↖ | 7: 9,2 ↖ | | |
| 3: 9,1 ↓ | 8:10,4* ↘ | Sum | 192,0 |
| 4:10,4* ↗ | 9: 9,4 ↗ | | |
| 5:10,2* ↖ | 10: 9,5 → | | |

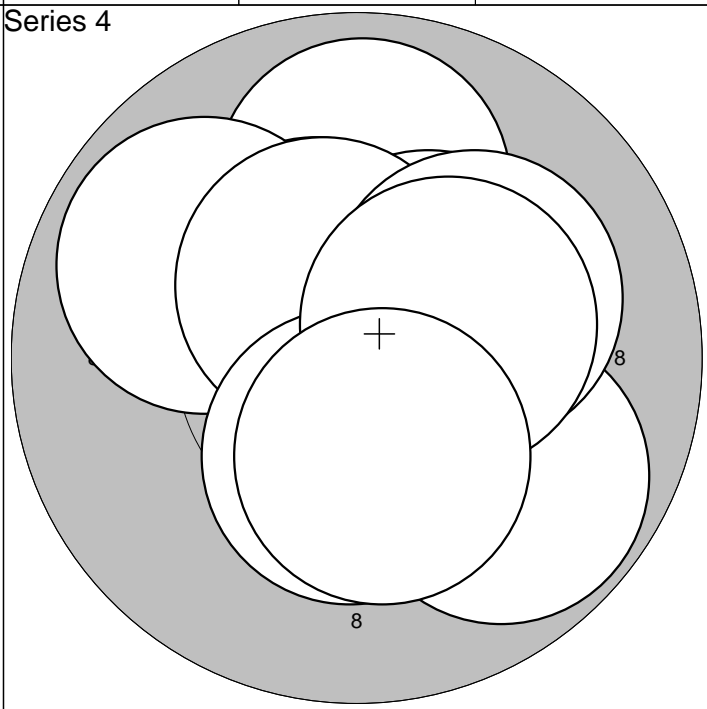
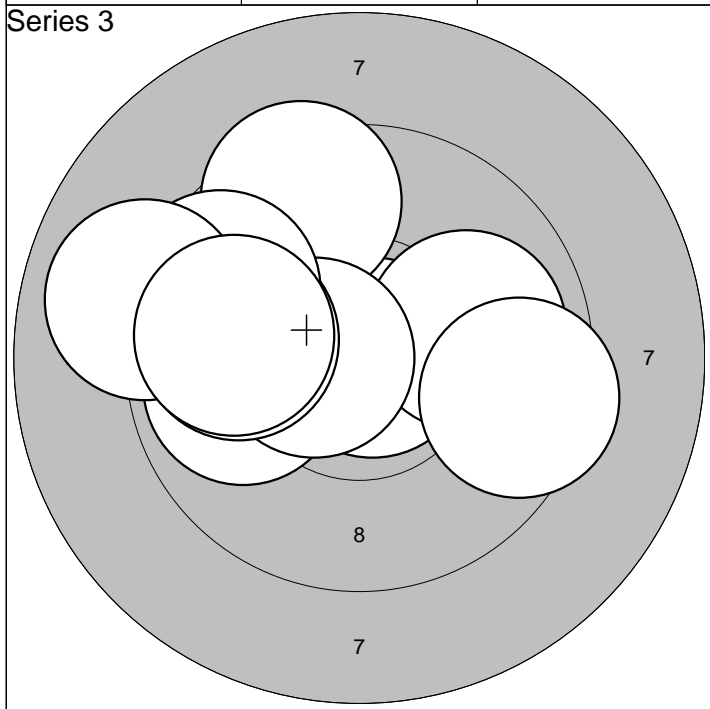

| | | | |
|-----------|-----------|-------|-------|
| 1:10,8* → | 6: 9,9 ← | Serie | 93,0 |
| 2: 9,9 ← | 7: 9,6 ↖ | | |
| 3:10,0 → | 8: 9,5 → | Sum | 285,0 |
| 4: 9,4 ↗ | 9: 9,0 ← | | |
| 5:10,6* ← | 10: 9,8 ← | | |

| | | | |
|-----------|------------|-------|-------|
| 1: 9,9 ↑ | 6:10,5* ↖ | Serie | 97,0 |
| 2:10,5* ↗ | 7:10,1 ↗ | | |
| 3: 9,8 ↘ | 8:10,3* ↓ | Sum | 382,0 |
| 4: 9,9 ↖ | 9:10,4* → | | |
| 5:10,4* ↗ | 10:10,3* ↓ | | |

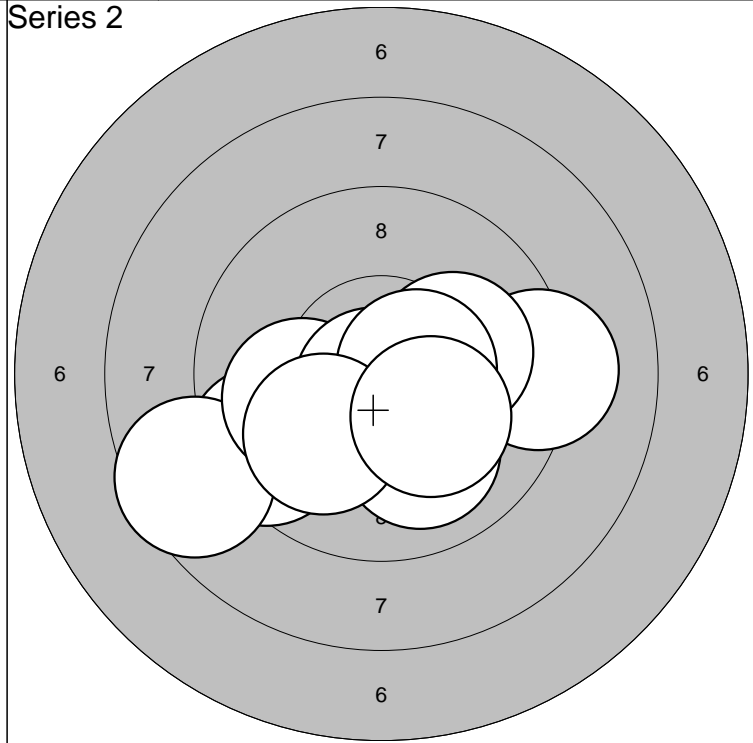
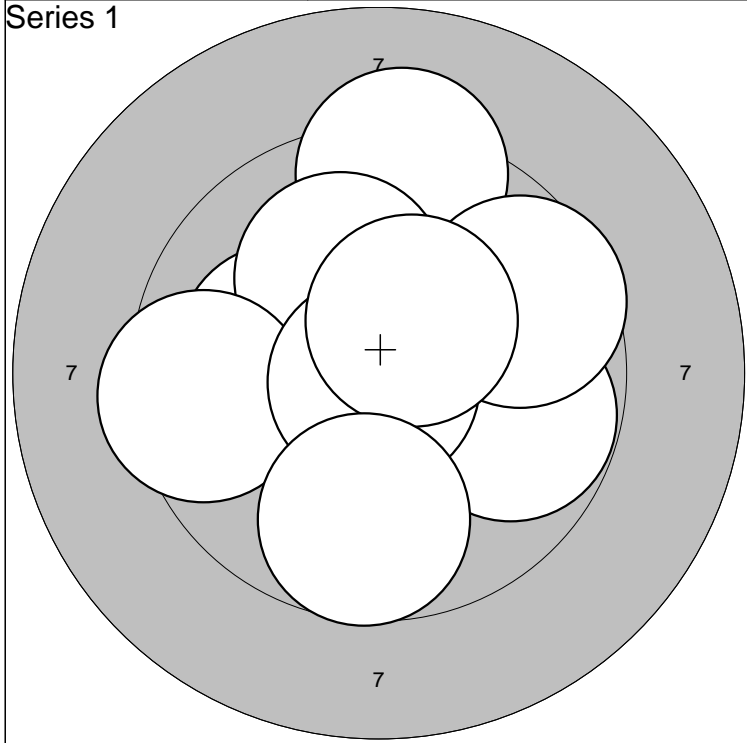

| | | | | | |
|---------|---|---------|---|-------|------|
| 1:10,8* | ↗ | 6: 9,6 | ↘ | Serie | 95,0 |
| 2:10,1 | ↖ | 7: 9,4 | ↙ | | |
| 3: 9,3 | ↑ | 8:10,9* | ↓ | Sum | 95,0 |
| 4:10,1 | ↗ | 9:10,4* | ↖ | | |
| 5: 9,8 | ➔ | 10: 9,7 | ↓ | | |

| | | | | | |
|--------|---|----------|---|-------|-------|
| 1: 9,4 | ↖ | 6:10,0 | ↙ | Serie | 96,0 |
| 2: 9,2 | ➔ | 7:10,8* | ↓ | | |
| 3:10,1 | ➔ | 8:10,5* | ➔ | Sum | 191,0 |
| 4: 8,6 | ↖ | 9:10,0 | ↘ | | |
| 5:10,0 | ↓ | 10:10,2* | ↘ | | |

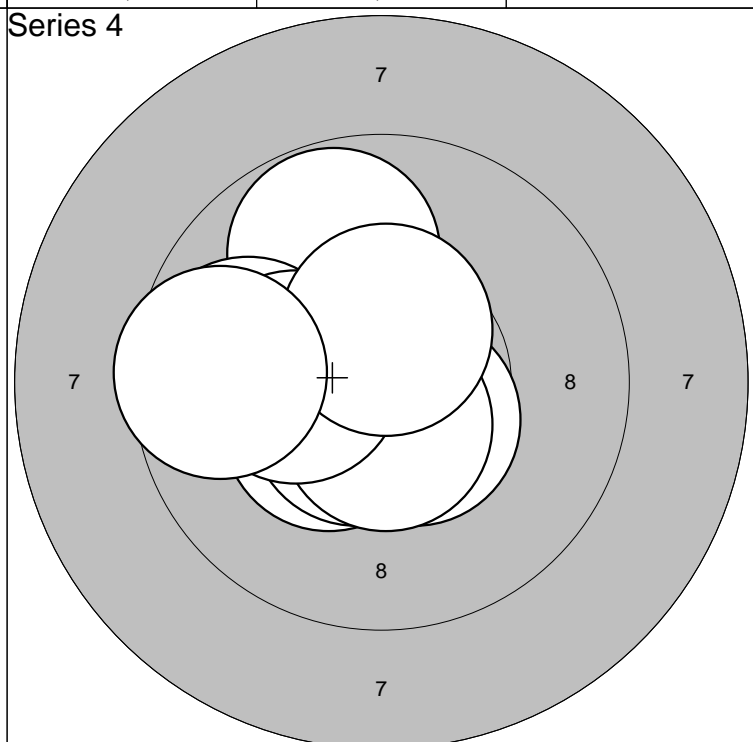
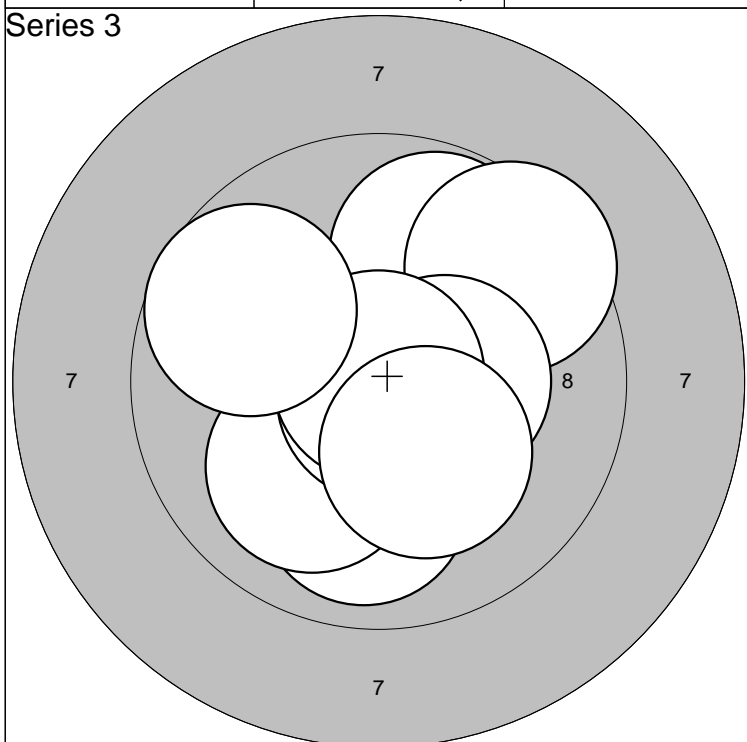

| | | | | | |
|---------|---|----------|---|-------|-------|
| 1: 9,9 | ↓ | 6: 9,5 | ↗ | Serie | 96,0 |
| 2:10,7* | ↑ | 7:10,4* | ➔ | | |
| 3:10,0 | ↘ | 8:10,9* | ↑ | Sum | 287,0 |
| 4:10,8* | ↓ | 9: 9,7 | ↖ | | |
| 5: 9,8 | ↗ | 10:10,2* | ↘ | | |

| | | | | | |
|---------|---|---------|---|-------|-------|
| 1:10,5* | ↘ | 6:10,6* | ↓ | Serie | 97,0 |
| 2:10,4* | ↖ | 7: 9,8 | ↙ | | |
| 3: 9,8 | ↑ | 8:10,2* | ↙ | Sum | 384,0 |
| 4:10,6* | ↙ | 9:10,5* | ↑ | | |
| 5:10,6* | ↘ | 10: 9,6 | ↙ | | |

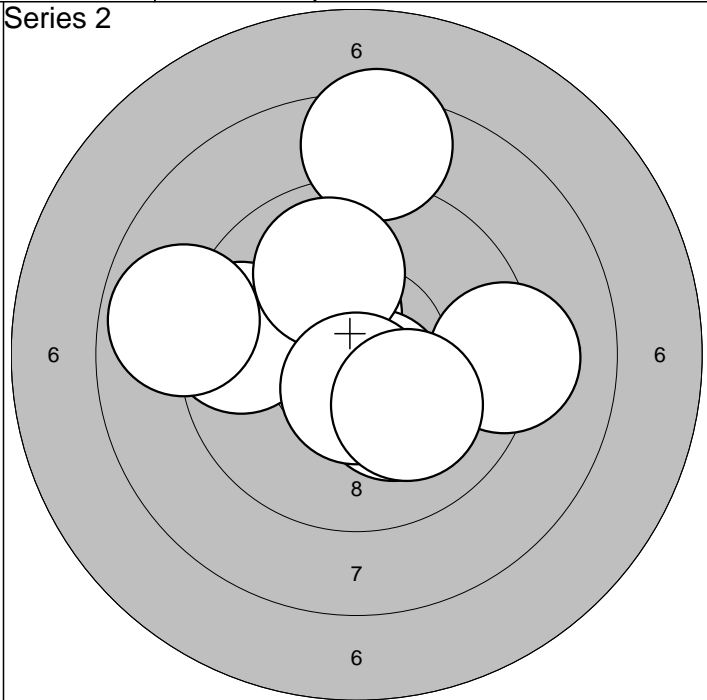
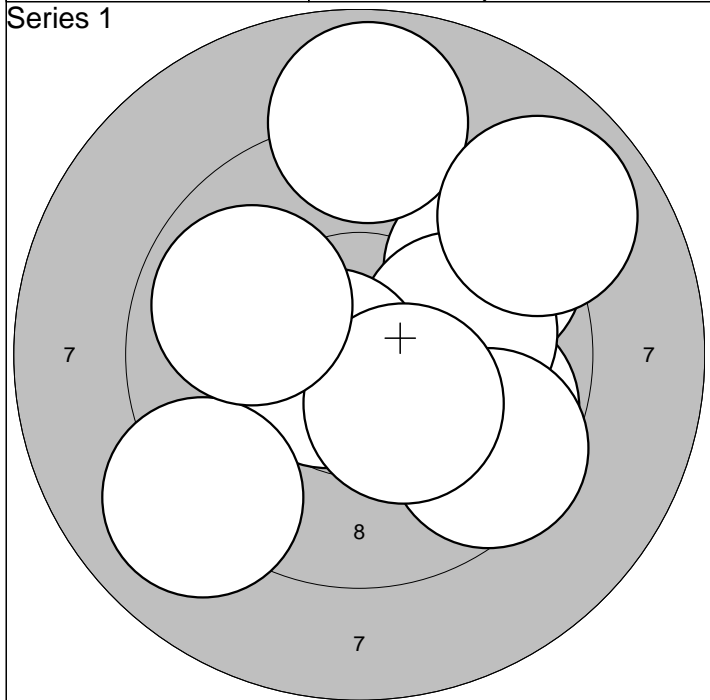

| | | | | | |
|---------|---|---------|---|-------|------|
| 1: 9,8 | ↘ | 6:10,3* | ↘ | Serie | 91,0 |
| 2: 9,6 | ↗ | 7: 8,9 | ↑ | | |
| 3:10,0 | → | 8: 8,9 | ↗ | Sum | 91,0 |
| 4:10,6* | ← | 9: 9,1 | ↙ | | |
| 5: 9,5 | ↘ | 10: 9,9 | ← | | |

| | | | | | |
|---------|---|---------|---|-------|-------|
| 1:10,4* | ↖ | 6: 9,9 | ↗ | Serie | 93,0 |
| 2: 9,2 | → | 7:10,2* | ↘ | | |
| 3: 9,6 | ← | 8:10,6* | ↓ | Sum | 184,0 |
| 4:10,5* | ↘ | 9: 8,9 | ← | | |
| 5: 8,5 | ↑ | 10:10,1 | ↘ | | |

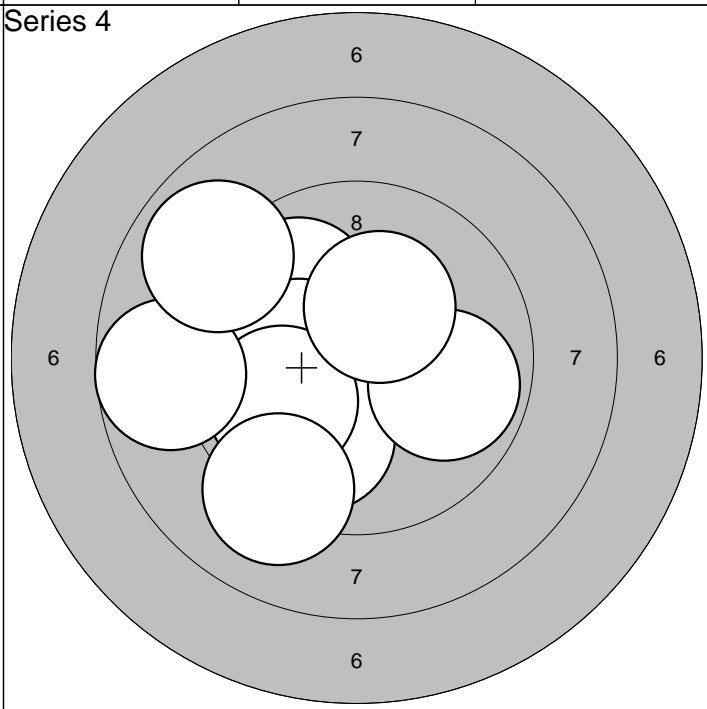
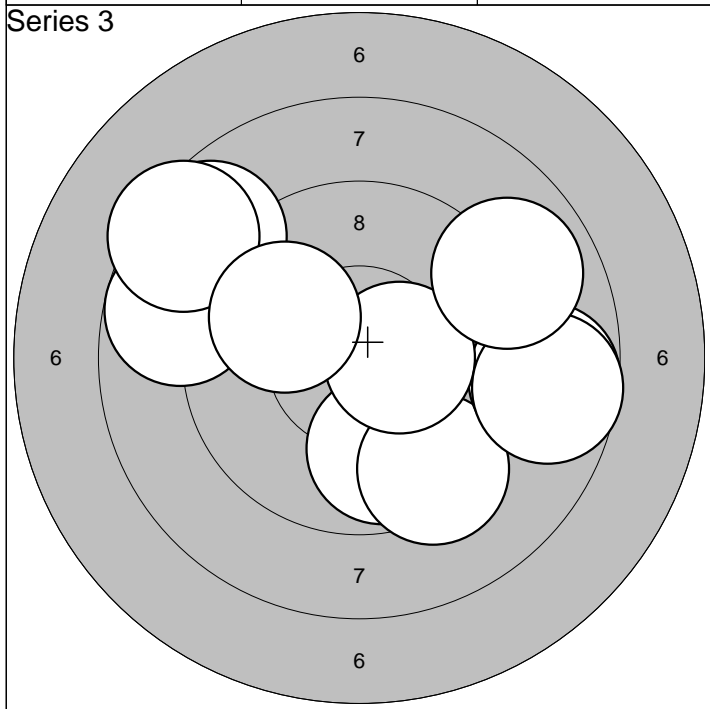

| | | | | | |
|---------|---|---------|---|-------|-------|
| 1: 9,9 | ↓ | 6: 8,8 | ← | Serie | 85,0 |
| 2: 9,4 | ↓ | 7: 8,7 | → | | |
| 3: 8,7 | ↗ | 8: 8,9 | ↗ | Sum | 269,0 |
| 4: 8,8 | → | 9: 8,4 | ↗ | | |
| 5:10,5* | → | 10: 9,9 | ↖ | | |

| | | | | | |
|---------|---|----------|---|-------|-------|
| 1:10,4* | ← | 6: 9,2 | ↓ | Serie | 91,0 |
| 2: 9,9 | ↖ | 7: 9,8 | → | | |
| 3:10,3* | ← | 8: 8,7 | ← | Sum | 360,0 |
| 4: 9,9 | ↓ | 9: 8,9 | ↖ | | |
| 5: 9,9 | ← | 10:10,3* | ↗ | | |

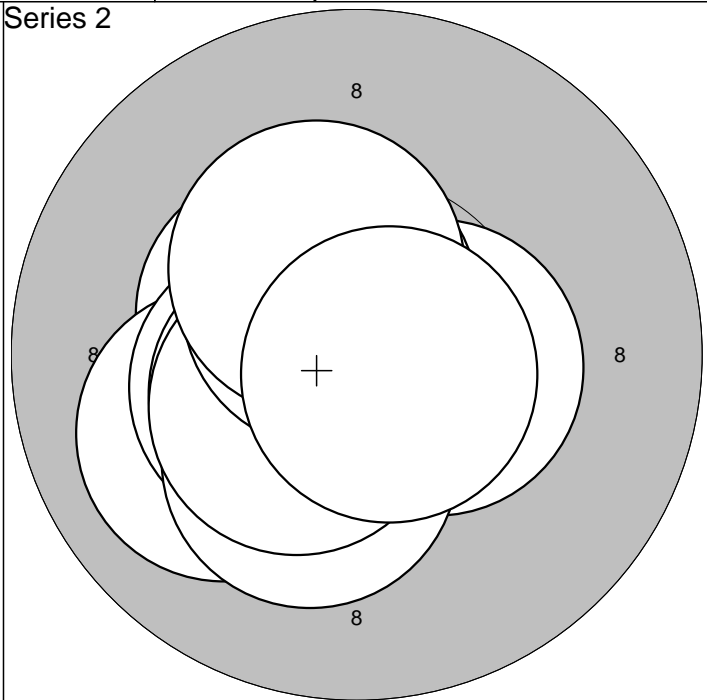
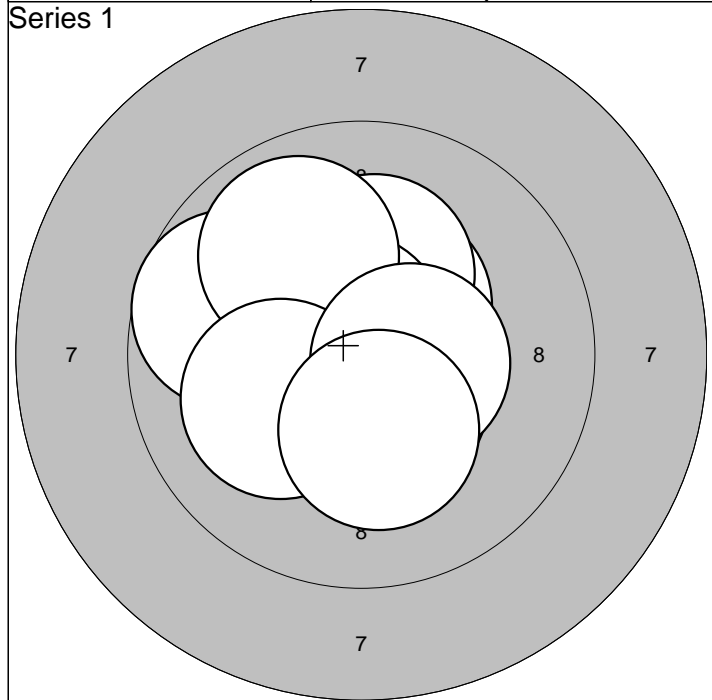

| | | | | | |
|-----------|------------|-------|------|--|--|
| 1:10,4* ↗ | 6:10,5* ↓ | | | | |
| 2:10,2* ↑ | 7: 9,9 ↗ | | | | |
| 3:10,7* ↗ | 8:10,1 ← | Serie | 98,0 | | |
| 4: 9,7 ← | 9:10,5* → | Sum | 98,0 | | |
| 5:10,5* ↙ | 10:10,3* ↓ | | | | |

| | | | | | |
|-----------|------------|-------|-------|--|--|
| 1:10,4* ↖ | 6:10,3* ↓ | | | | |
| 2:10,0 ← | 7:10,5* ↙ | | | | |
| 3:10,5* → | 8:10,6* ↗ | Serie | 100,0 | | |
| 4:10,4* ← | 9:10,4* ↗ | Sum | 198,0 | | |
| 5:10,5* ↙ | 10:10,7* ↘ | | | | |

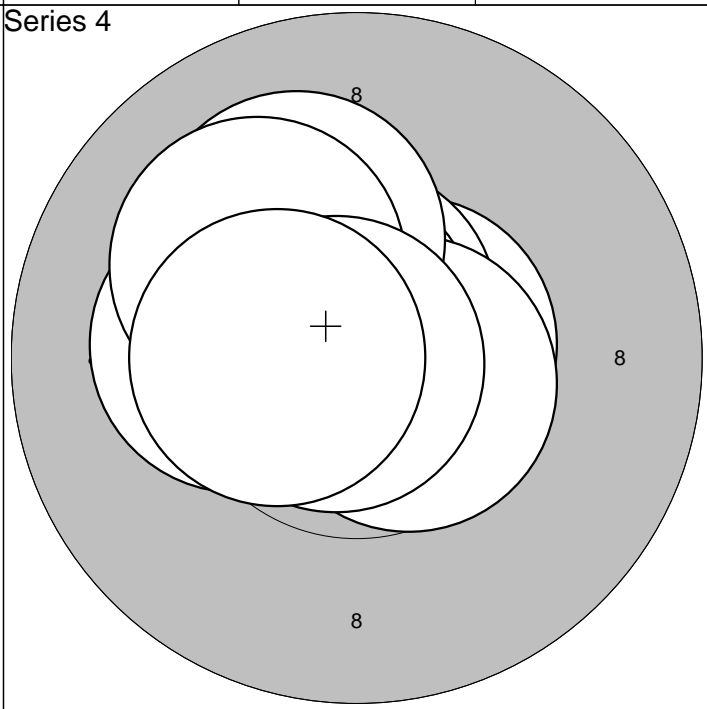
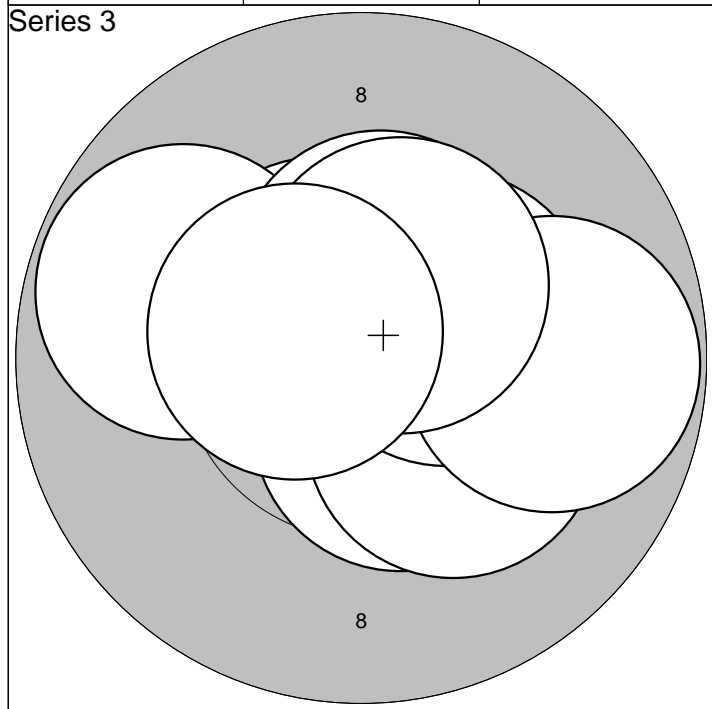

| | | | | | |
|-----------|------------|-------|-------|--|--|
| 1:10,6* ↗ | 6:10,4* → | | | | |
| 2:10,6* ↗ | 7: 9,8 → | | | | |
| 3: 9,8 ← | 8:10,5* ↑ | Serie | 98,0 | | |
| 4:10,5* ↓ | 9:10,4* ↗ | Sum | 296,0 | | |
| 5:10,2* ↘ | 10:10,5* ← | | | | |

| | | | | | |
|-----------|------------|-------|-------|--|--|
| 1:10,6* → | 6:10,6* ↘ | | | | |
| 2:10,7* ↗ | 7:10,1 ↗ | | | | |
| 3:10,7* ↗ | 8:10,1 ↗ | Serie | 100,0 | | |
| 4:10,2* ← | 9:10,8* ← | Sum | 396,0 | | |
| 5:10,7* ↗ | 10:10,5* ← | | | | |

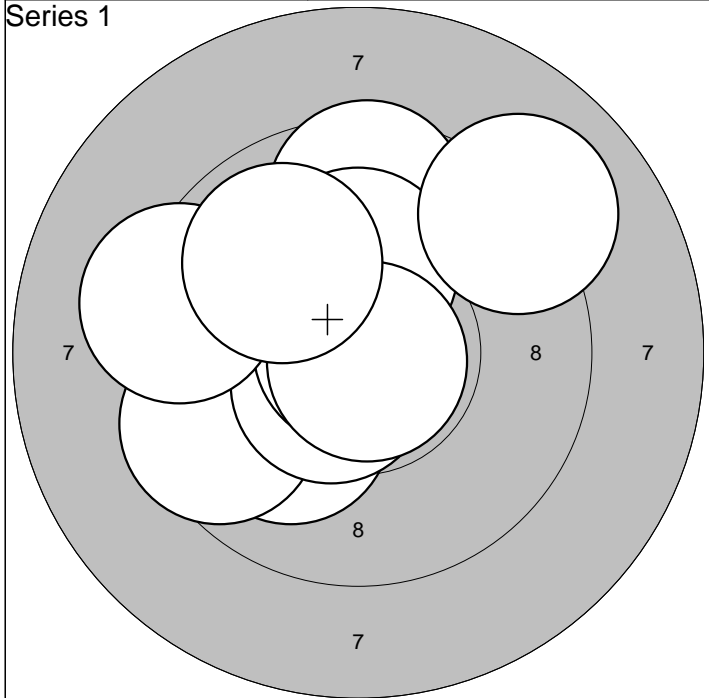

| | | | |
|-----------|-----------|-------|------|
| 1:10,1 ↙ | 6: 9,3 ← | Serie | 95,0 |
| 2: 9,6 ← | 7:10,2* ↑ | | |
| 3: 9,6 ↑ | 8:10,8* ↘ | Sum | 95,0 |
| 4:10,6* ↘ | 9: 9,9 ↗ | | |
| 5:10,9* ↖ | 10: 9,1 ↗ | | |

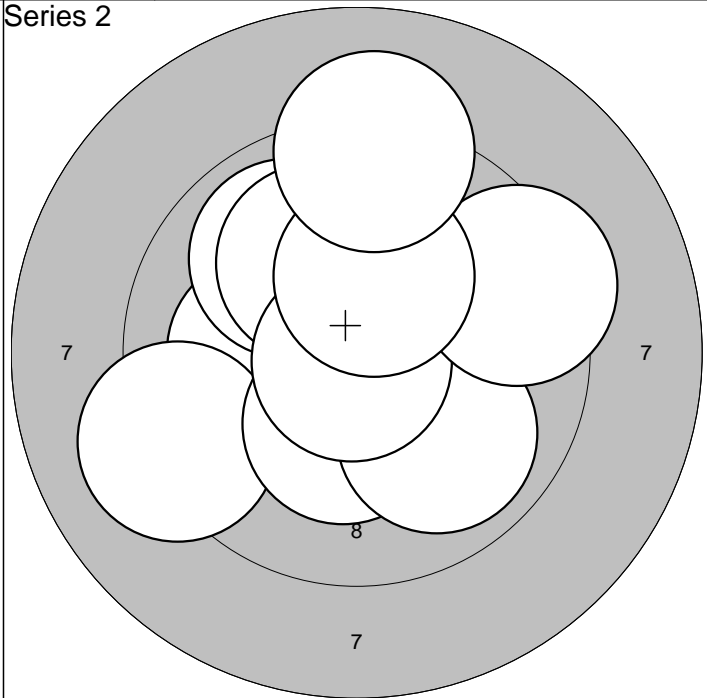

| | | | |
|-----------|-----------|-------|-------|
| 1:10,1 ← | 6: 9,9 ↘ | Serie | 95,0 |
| 2: 9,2 ← | 7:10,9* ↘ | | |
| 3: 9,9 ↗ | 8: 9,4 → | Sum | 190,0 |
| 4:10,1 ↗ | 9:10,3* ↑ | | |
| 5:10,3* ↓ | 10: 9,1 ↑ | | |

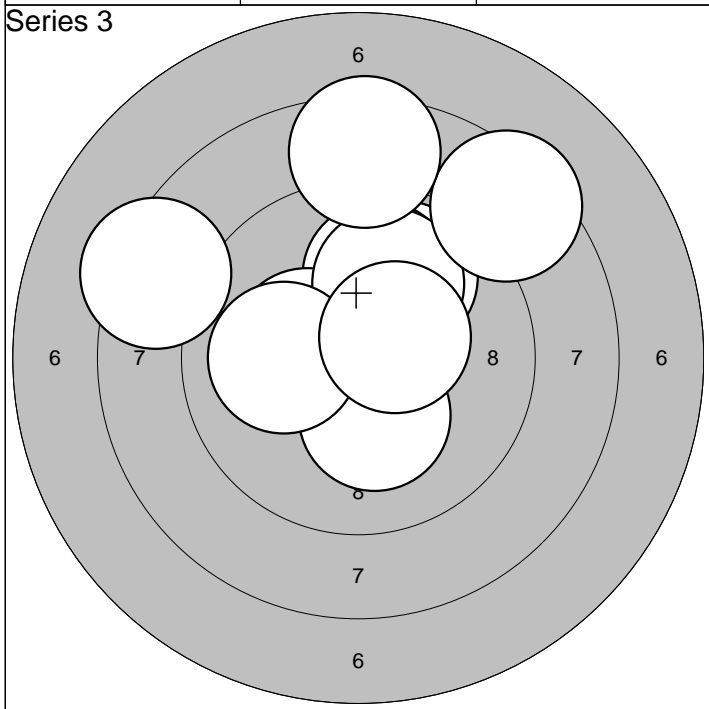

| | | | |
|-----------|------------|-------|-------|
| 1: 9,9 ↗ | 6:10,1 ← | Serie | 92,0 |
| 2: 9,9 ↑ | 7: 8,4 ↗ | | |
| 3:10,3* ← | 8: 8,3 ← | Sum | 282,0 |
| 4:10,0 ↑ | 9: 8,5 ↑ | | |
| 5:10,3* ↓ | 10:10,5* ↗ | | |

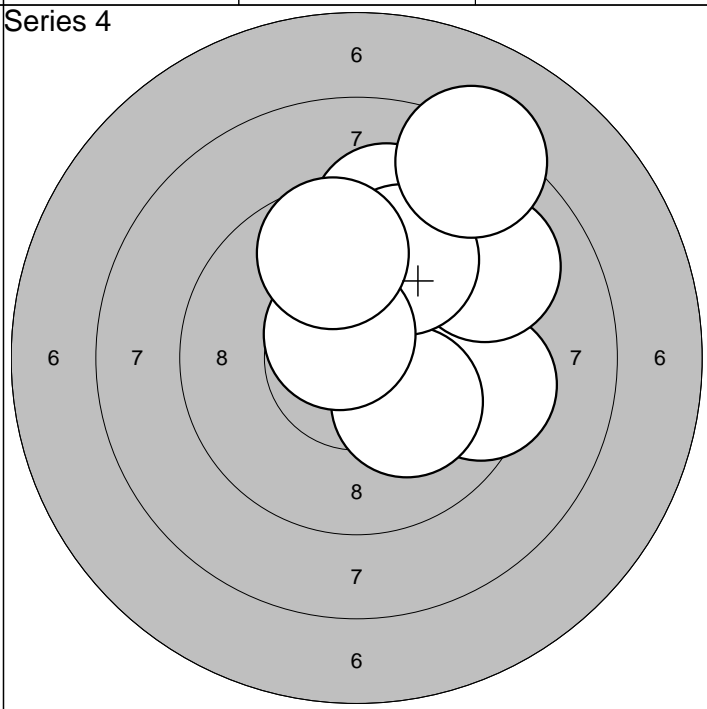

| | | | |
|----------|-----------|-------|-------|
| 1: 9,6 ↑ | 6:10,2* ↘ | Serie | 91,0 |
| 2: 9,2 ↗ | 7: 9,7 ↑ | | |
| 3: 9,4 → | 8:10,6* ↖ | Sum | 373,0 |
| 4: 9,1 ↗ | 9: 9,7 ↑ | | |
| 5: 9,3 ↑ | 10: 8,3 ↑ | | |

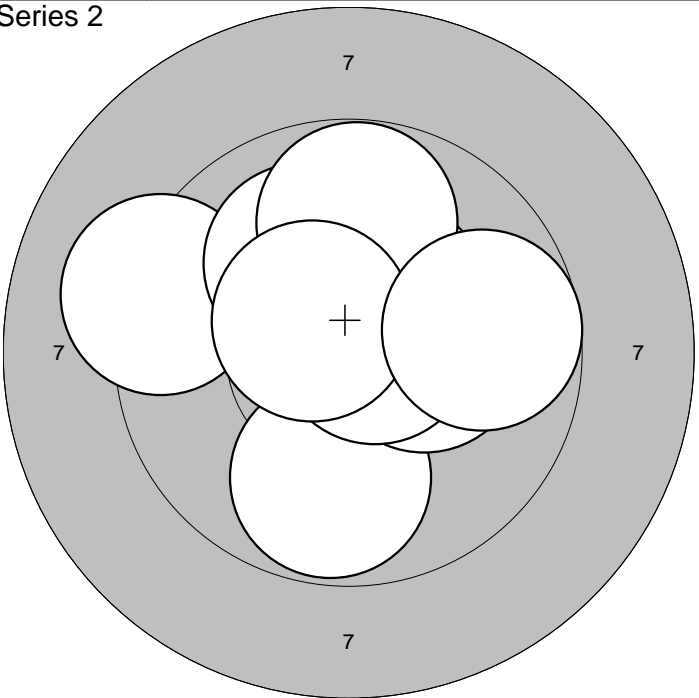
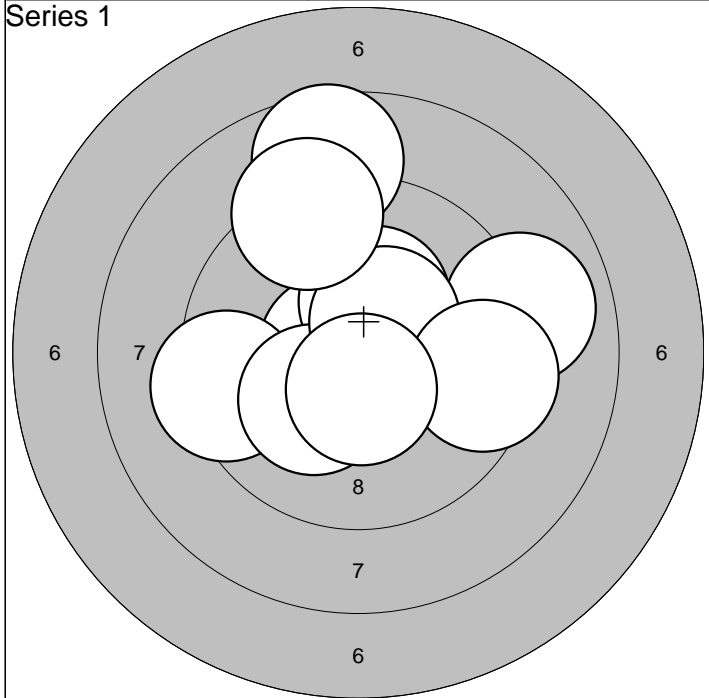

| | | | | | |
|-----------|------------|-----|------|-------|------|
| 1:10,7* ← | 6: 9,0 → | | | Serie | 94,0 |
| 2:10,3* ↑ | 7:10,4* ↗ | | | | |
| 3: 9,3 ← | 8: 9,4 → | Sum | 94,0 | | |
| 4:10,2* ↘ | 9: 9,2 ↑ | | | | |
| 5: 8,6 ↑ | 10:10,5* ↓ | | | | |

| | | | | | |
|-----------|-----------|-----|-------|-------|------|
| 1:10,3* ↖ | 6:10,3* → | | | Serie | 96,0 |
| 2: 9,2 ← | 7:10,7* → | | | | |
| 3: 9,8 ↓ | 8: 9,8 ↑ | Sum | 190,0 | | |
| 4:10,3* ↗ | 9:10,5* ↖ | | | | |
| 5:10,1 ↖ | 10: 9,7 → | | | | |

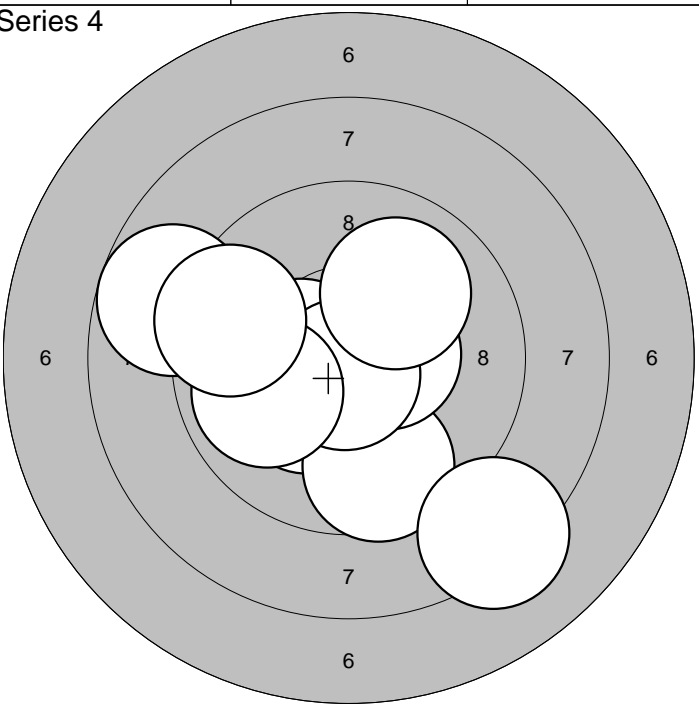
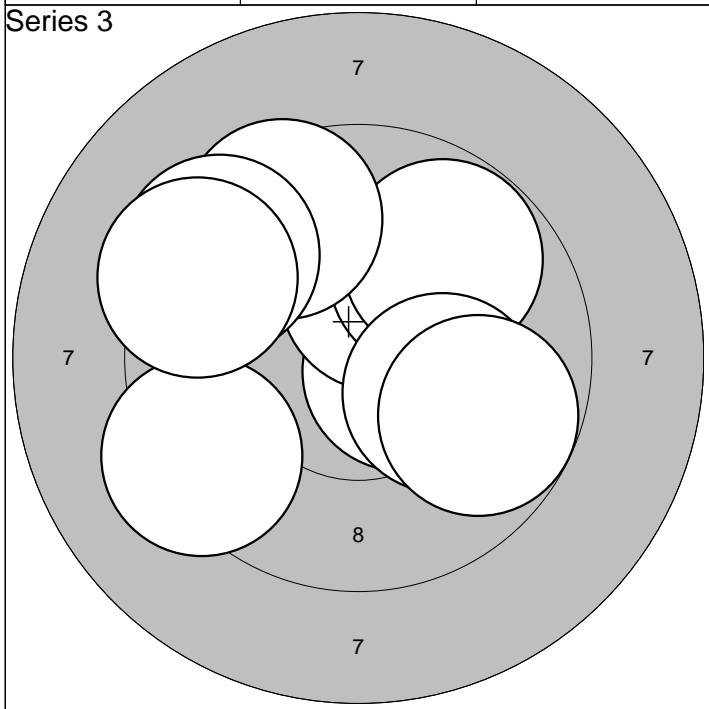

| | | | | | |
|-----------|-----------|-----|-------|-------|------|
| 1:10,5* → | 6:10,1 → | | | Serie | 93,0 |
| 2:10,3* ↑ | 7: 9,5 ↗ | | | | |
| 3: 9,9 ↗ | 8: 9,4 ↖ | Sum | 283,0 | | |
| 4: 9,3 ← | 9: 9,7 → | | | | |
| 5: 9,8 ↗ | 10: 9,4 ↖ | | | | |

| | | | | | |
|-----------|-----------|-----|-------|-------|------|
| 1:10,3* ↘ | 6: 8,2 ↘ | | | Serie | 93,0 |
| 2: 9,6 ↓ | 7:10,7* ↓ | | | | |
| 3:10,5* → | 8: 9,9 ← | Sum | 376,0 | | |
| 4: 8,8 ← | 9:10,0 ↗ | | | | |
| 5:10,4* ← | 10: 9,5 ↖ | | | | |

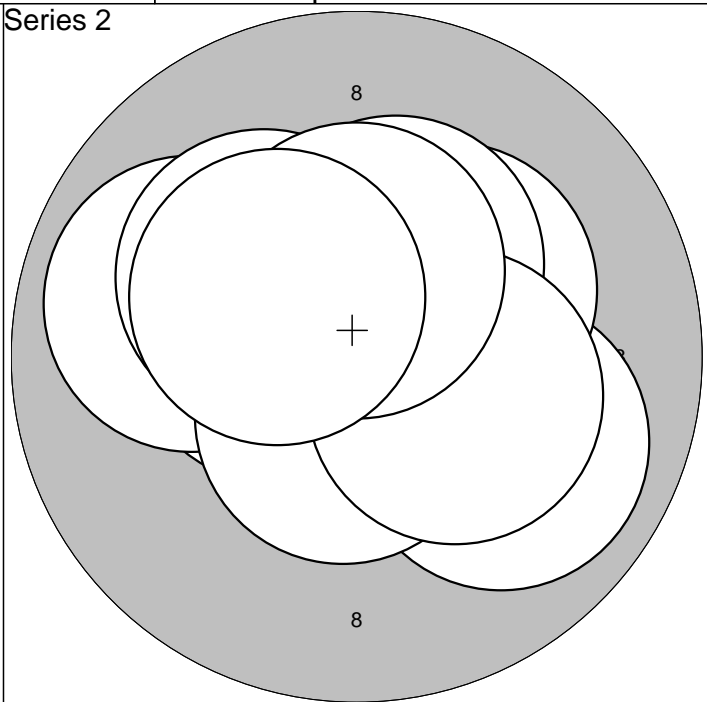
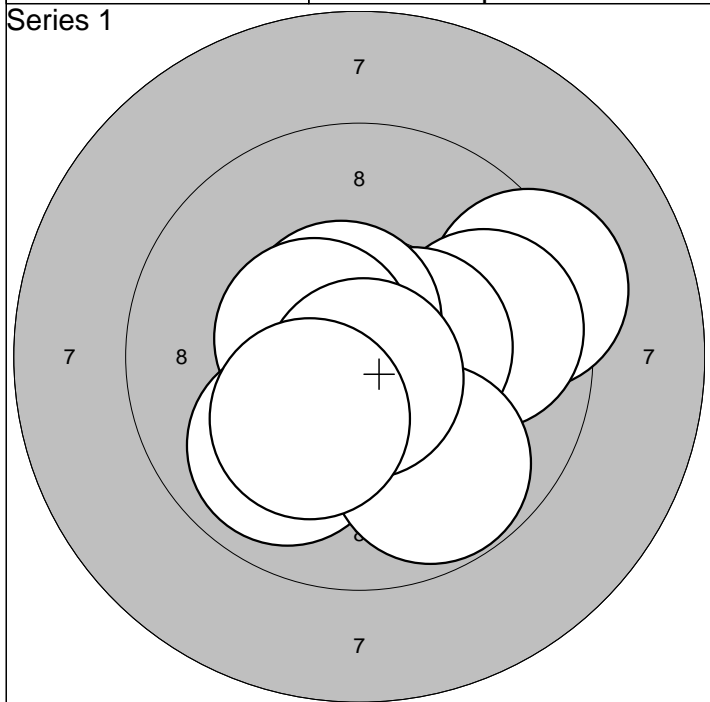

| | | | | | |
|-----------|------------|-------|------|--|--|
| 1: 9,3 → | 6:10,5* ← | | | | |
| 2: 9,8 → | 7: 9,9 ↓ | | | | |
| 3:10,4* → | 8: 9,8 ↓ | Serie | 96,0 | | |
| 4:10,6* ↗ | 9:10,7* ↓ | Sum | 96,0 | | |
| 5:10,4* ↘ | 10:10,2* ↘ | | | | |

| | | | | | |
|-----------|------------|-------|-------|--|--|
| 1:10,4* ← | 6:10,3* ↗ | | | | |
| 2: 9,9 ← | 7:10,4* ↗ | | | | |
| 3:10,2* ↗ | 8:10,3* → | Serie | 98,0 | | |
| 4: 9,9 → | 9:10,4* ↗ | Sum | 194,0 | | |
| 5:10,6* ↓ | 10:10,3* ↖ | | | | |

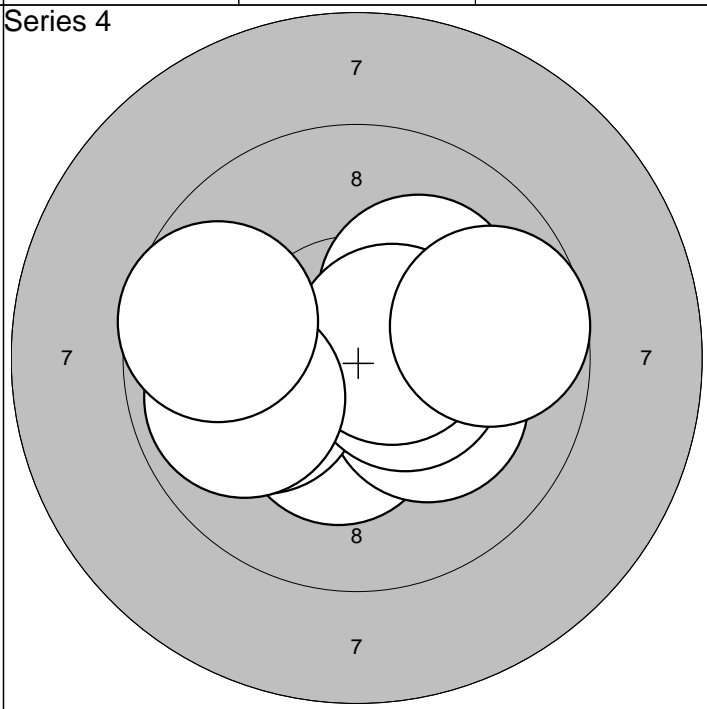
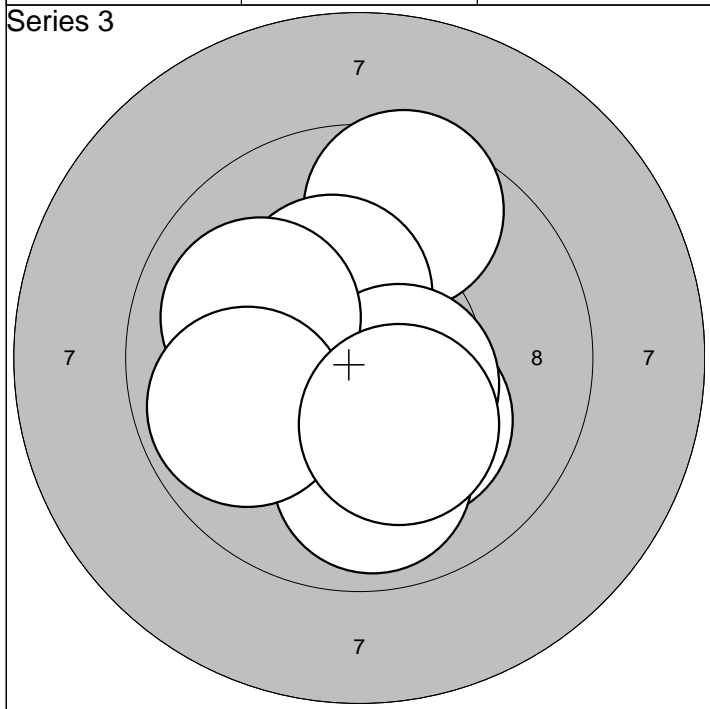

| | | | | | |
|-----------|------------|-------|-------|--|--|
| 1:10,6* ↘ | 6: 9,9 ↓ | | | | |
| 2:10,2* ↘ | 7:10,5* ↘ | | | | |
| 3: 9,6 ↗ | 8:10,0 ← | Serie | 97,0 | | |
| 4:10,5* ↖ | 9: 9,8 ← | Sum | 291,0 | | |
| 5:10,3* ↗ | 10:10,2* ↘ | | | | |

| | | | | | |
|-----------|-----------|-------|-------|--|--|
| 1:10,3* ↓ | 6:10,5* → | | | | |
| 2:10,2* ↗ | 7:10,6* → | | | | |
| 3:10,2* ↘ | 8: 9,7 → | Serie | 97,0 | | |
| 4:10,7* → | 9: 9,9 ← | Sum | 388,0 | | |
| 5:10,0 ← | 10: 9,7 ← | | | | |

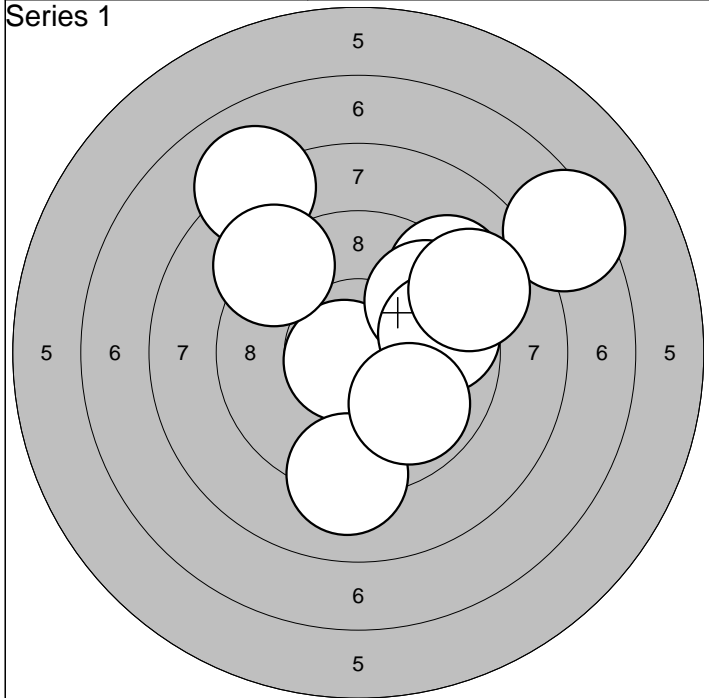

| | | | |
|------------|-----------|-------|------|
| 1: 10,7* ↙ | 6: 9,7 → | Serie | 88,0 |
| 2: 9,2 ↓ | 7: 9,2 ↖ | | |
| 3: 8,1 ↗ | 8: 7,4 → | Sum | 88,0 |
| 4: 9,2 ↗ | 9: 9,1 → | | |
| 5: 9,7 ↗ | 10: 9,9 ↓ | | |

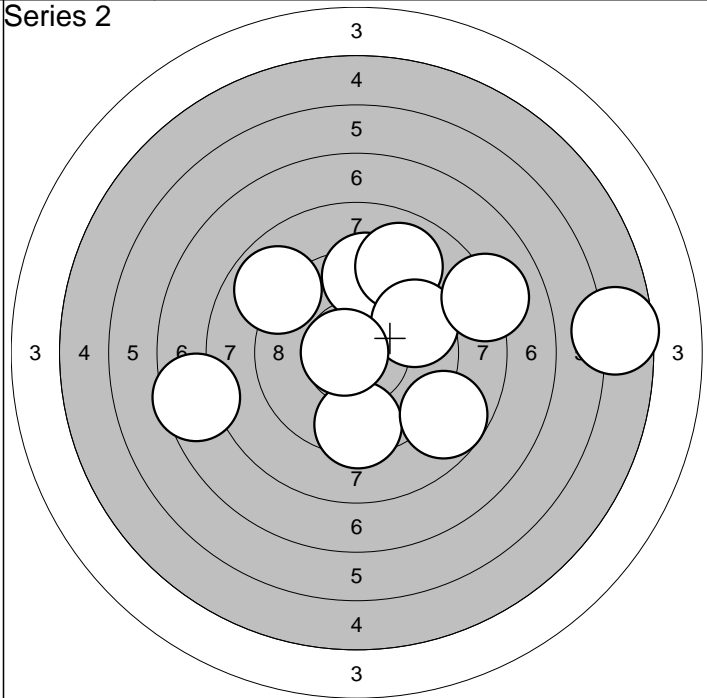

| | | | |
|----------|------------|-------|-------|
| 1: 9,4 ↑ | 6: 8,1 → | Serie | 82,0 |
| 2: 9,5 ↓ | 7: 8,7 ↘ | | |
| 3: 5,6 → | 8: 7,5 ← | Sum | 170,0 |
| 4: 9,0 ↑ | 9: 10,7* ← | | |
| 5: 9,6 → | 10: 8,9 ↖ | | |

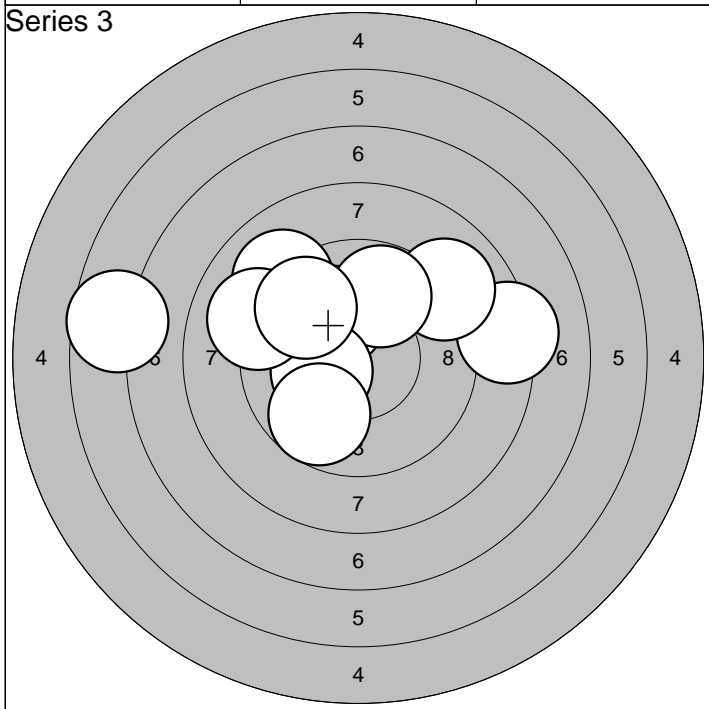

| | | | |
|-----------|------------|-------|-------|
| 1: 8,3 → | 6: 6,7 ← | Serie | 88,0 |
| 2: 9,0 ↗ | 7: 10,3* ← | | |
| 3: 9,0 ↖ | 8: 9,7 ↓ | Sum | 258,0 |
| 4: 10,1 ↖ | 9: 9,0 ← | | |
| 5: 9,8 ↑ | 10: 9,7 ↖ | | |

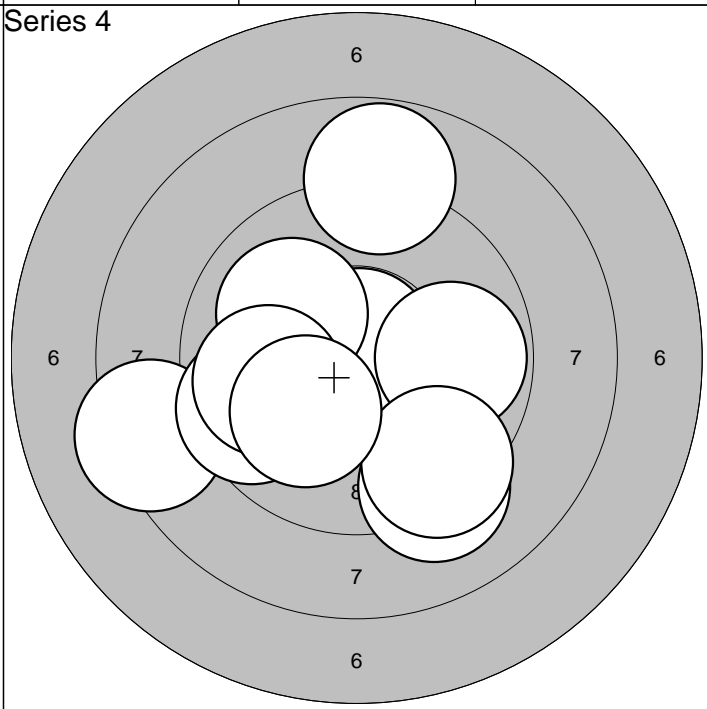

| | | | |
|------------|------------|-------|-------|
| 1: 8,8 ↑ | 6: 9,2 ↓ | Serie | 91,0 |
| 2: 10,8* ↑ | 7: 9,4 ↓ | | |
| 3: 8,4 ← | 8: 10,0 ↖ | Sum | 349,0 |
| 4: 9,6 ← | 9: 9,9 ← | | |
| 5: 9,8 → | 10: 10,1 ↙ | | |

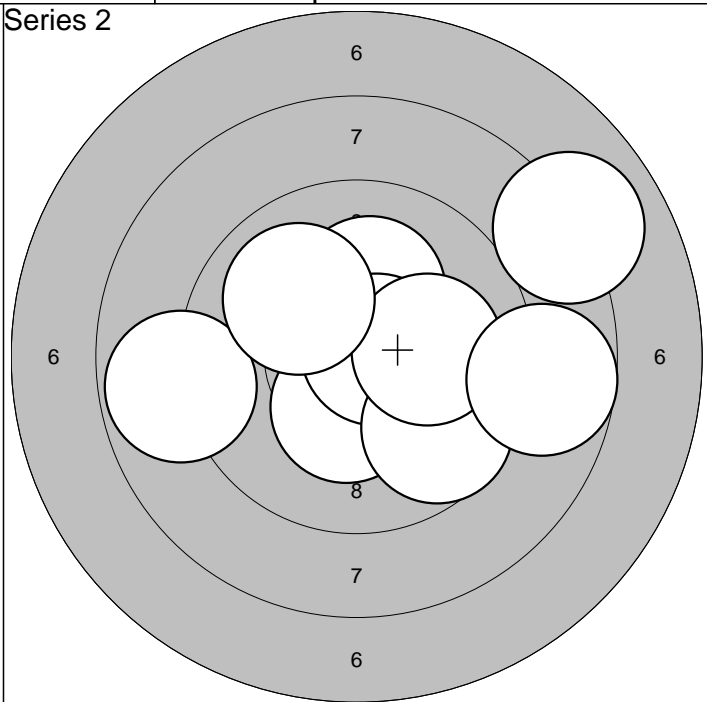
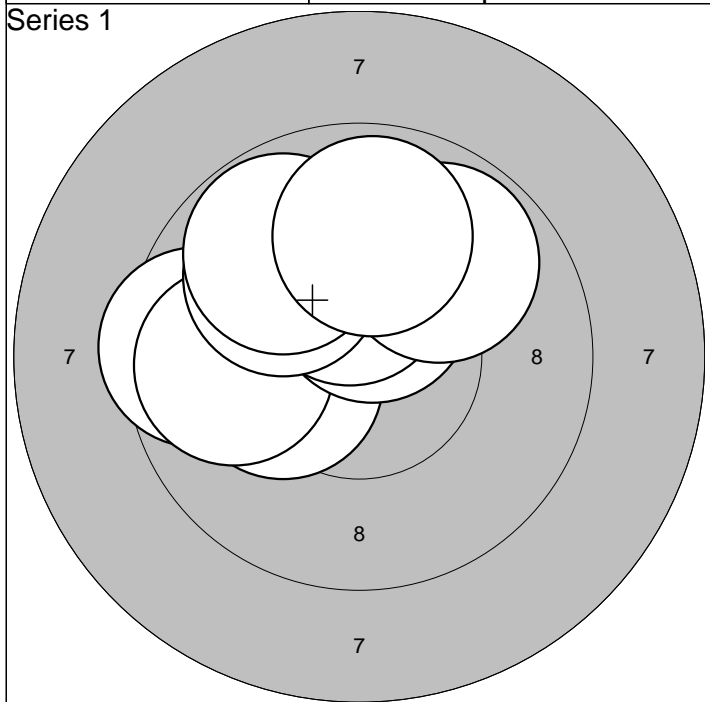

| | | | | | |
|---------|---|---------|---|-------|------|
| 1: 9,5 | ← | 6:10,3* | ↑ | Serie | 95,0 |
| 2:10,1 | ↖ | 7: 9,9 | ↗ | | |
| 3:10,3* | ← | 8:10,0 | ↖ | | |
| 4: 9,8 | ← | 9: 9,8 | ↗ | | |
| 5:10,5* | ↑ | 10: 9,9 | ↑ | | |
| Sum | | | | 95,0 | |

| | | | | | |
|---------|---|---------|---|-------|------|
| 1:10,0 | → | 6:10,7* | → | Serie | 93,0 |
| 2:10,2* | ↑ | 7: 9,7 | ↘ | | |
| 3: 8,9 | ← | 8:10,1 | → | | |
| 4:10,3* | ↓ | 9: 8,7 | → | | |
| 5: 8,0 | ↗ | 10:10,0 | ↖ | | |
| Sum | | | | 188,0 | |

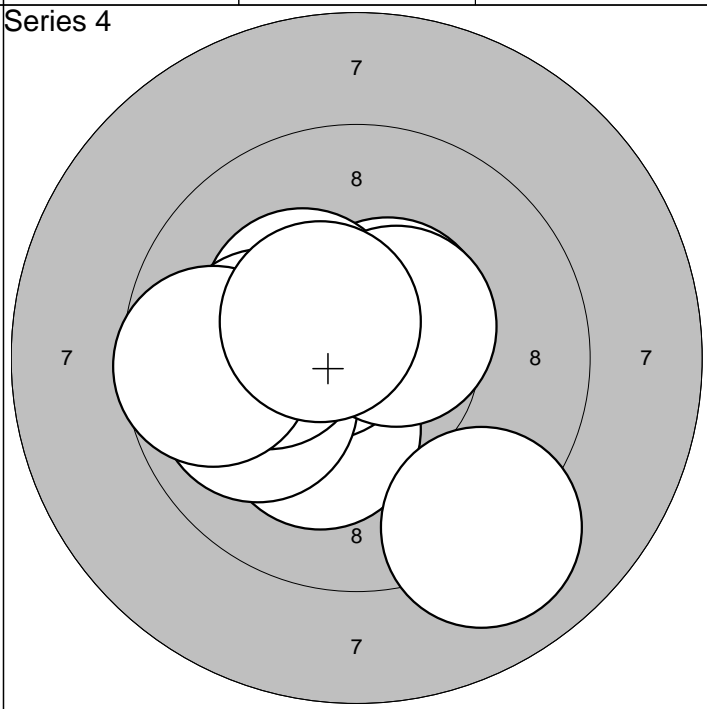
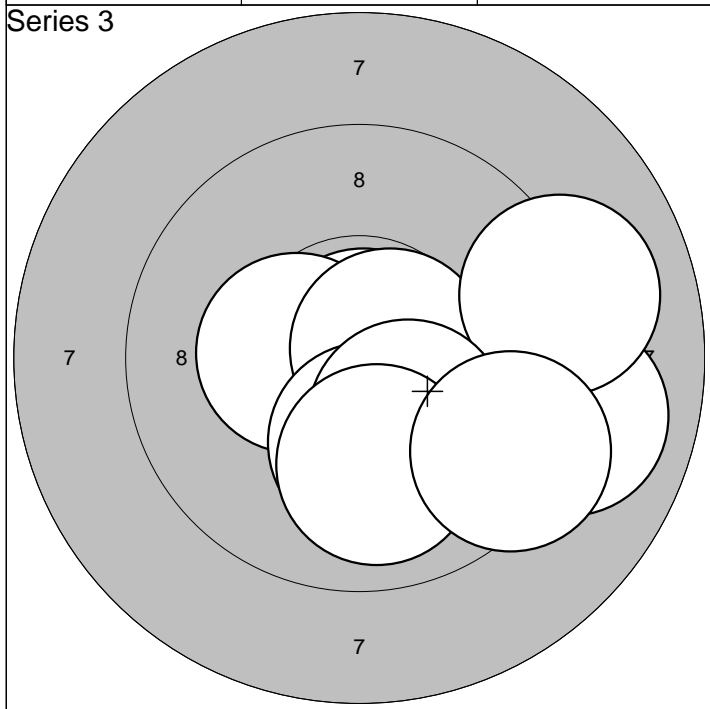

| | | | | | |
|---------|---|---------|---|-------|------|
| 1:10,9* | ↗ | 6:10,2* | ↓ | Serie | 97,0 |
| 2:10,4* | ← | 7: 9,1 | → | | |
| 3: 9,0 | → | 8:10,2* | ↘ | | |
| 4:10,2* | → | 9:10,0 | ↓ | | |
| 5:10,6* | → | 10: 9,4 | ↘ | | |
| Sum | | | | 285,0 | |

| | | | | | |
|---------|---|----------|---|-------|------|
| 1:10,2* | ↘ | 6:10,1 | ← | Serie | 98,0 |
| 2:10,5* | ↗ | 7: 9,7 | ← | | |
| 3:10,6* | ↖ | 8: 9,1 | ↘ | | |
| 4:10,3* | ↖ | 9:10,5* | ↗ | | |
| 5:10,0 | ← | 10:10,5* | ↖ | | |
| Sum | | | | 383,0 | |

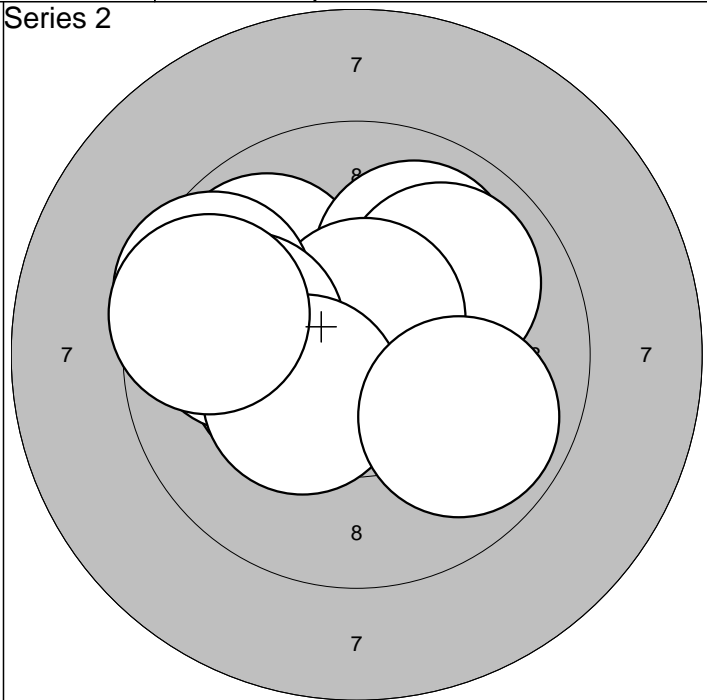
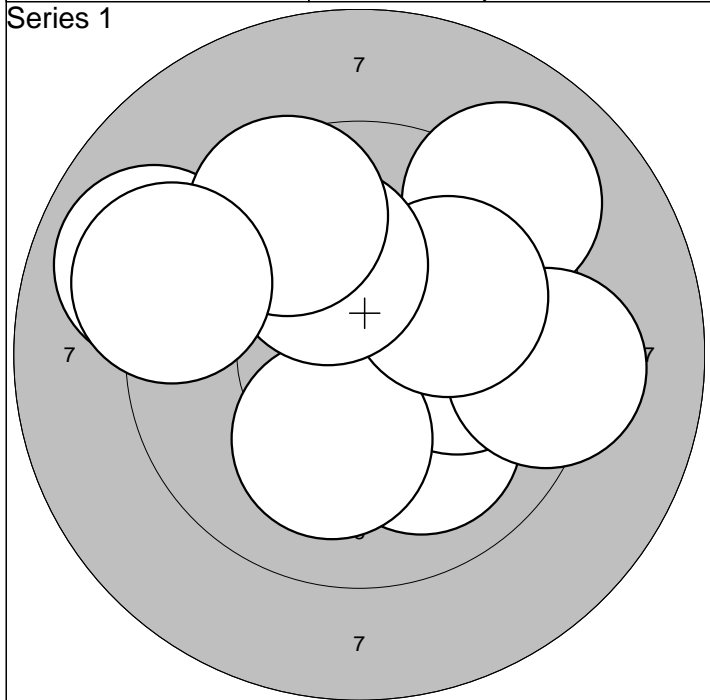

| | | | | |
|----------|-----------|-----|-------|------|
| 1:10,0 ↘ | 6:10,1 ↓ | | Serie | 94,0 |
| 2: 9,1 ↗ | 7:10,0 ↗ | | | |
| 3: 8,9 ↖ | 8:10,1 ↗ | Sum | 94,0 | |
| 4:10,1 → | 9: 9,5 ↗ | | | |
| 5: 9,3 → | 10: 9,2 ↖ | | | |

| | | | | |
|-----------|-----------|-----|-------|------|
| 1: 9,9 ↖ | 6: 9,5 ↖ | | Serie | 95,0 |
| 2:10,0 ↗ | 7: 9,9 ↖ | | | |
| 3:10,0 ↗ | 8:10,4* ↖ | Sum | 189,0 | |
| 4:10,3* ↖ | 9: 9,9 ↘ | | | |
| 5:10,6* ↗ | 10: 9,6 ↖ | | | |

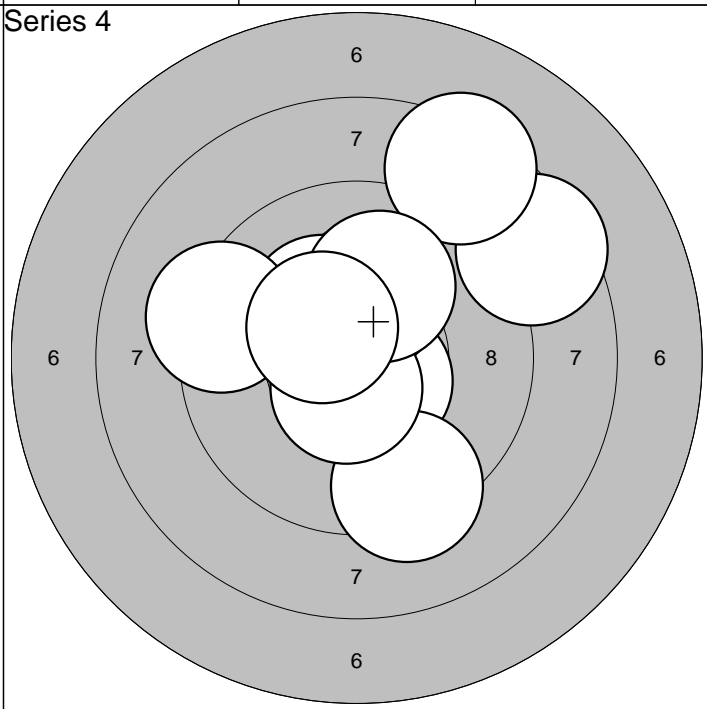
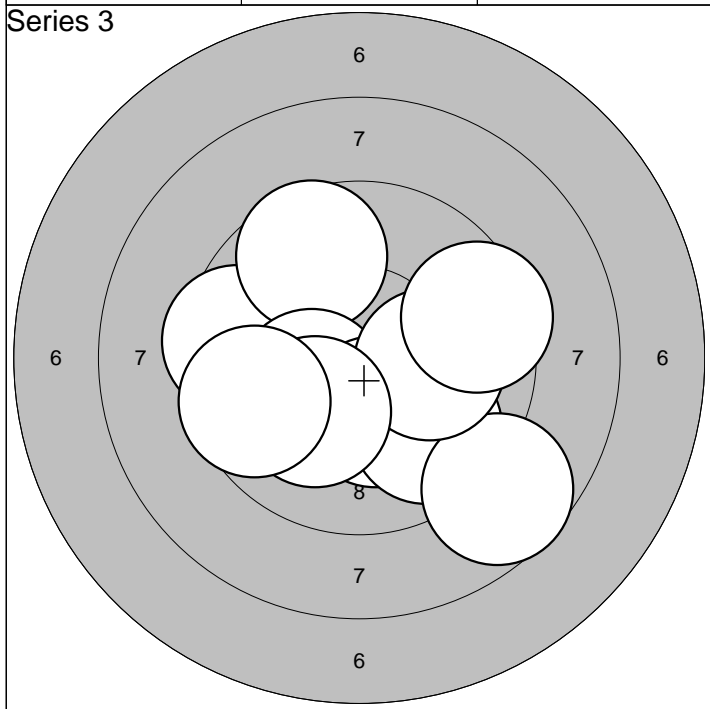

| | | | | |
|-----------|-----------|-----|-------|------|
| 1: 9,5 ↖ | 6: 8,7 ↘ | | Serie | 93,0 |
| 2: 9,6 ↗ | 7:10,1 → | | | |
| 3:10,3* ↖ | 8: 9,5 → | Sum | 282,0 | |
| 4:10,3* ↘ | 9:10,1 ↘ | | | |
| 5: 9,8 ↘ | 10: 9,6 ↖ | | | |

| | | | | |
|-----------|------------|-----|-------|------|
| 1:10,6* ↘ | 6:10,3* ↗ | | Serie | 94,0 |
| 2: 9,3 ↘ | 7: 9,3 ↖ | | | |
| 3: 8,5 ↗ | 8:10,6* ↘ | Sum | 376,0 | |
| 4: 8,4 ↗ | 9:10,1 ↗ | | | |
| 5:10,2* ↗ | 10:10,4* ↖ | | | |

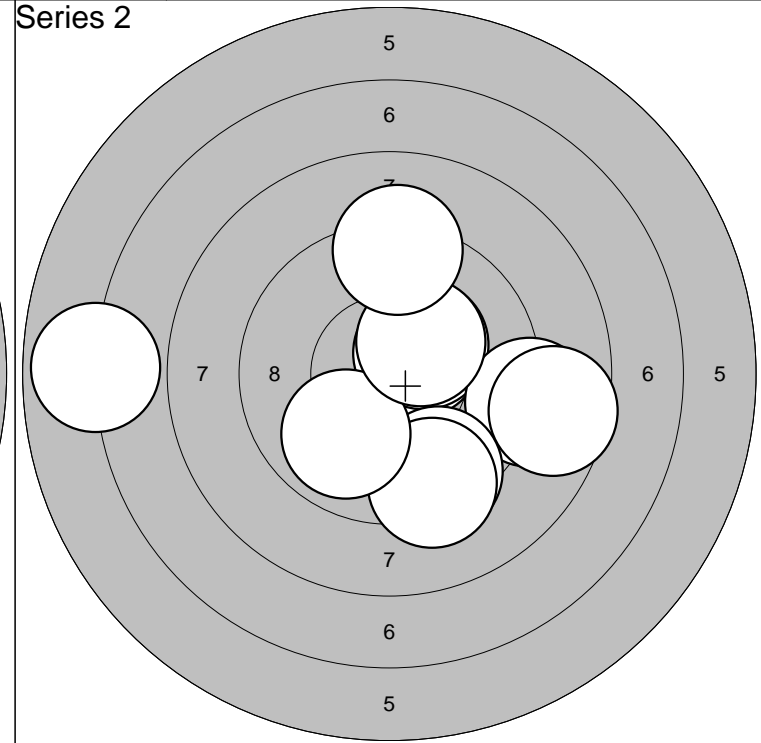
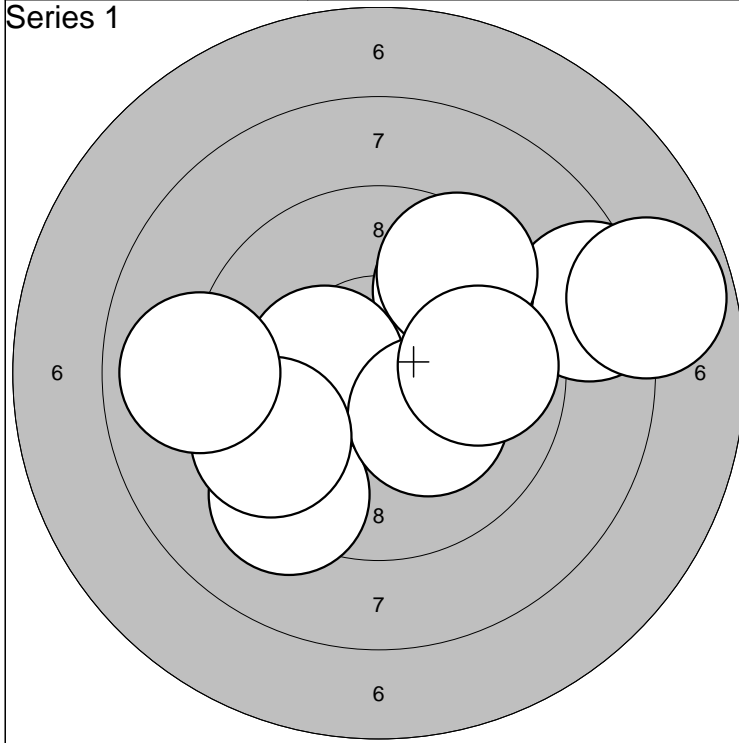

| | | | |
|------------|------------|-------|------|
| 1: 8,5 → | 6: 10,2* ↘ | Serie | 89,0 |
| 2: 9,7 ↗ | 7: 9,6 ↙ | | |
| 3: 9,5 ↗ | 8: 7,8 → | Sum | 89,0 |
| 4: 10,4* ← | 9: 9,0 ← | | |
| 5: 9,3 ↘ | 10: 9,8 → | | |

| | | | |
|------------|------------|-------|-------|
| 1: 10,5* ↗ | 6: 8,6 → | Serie | 88,0 |
| 2: 10,3* ↗ | 7: 9,9 ↘ | | |
| 3: 8,9 → | 8: 6,9 ← | Sum | 177,0 |
| 4: 9,4 ↘ | 9: 10,3* ↗ | | |
| 5: 9,3 ↘ | 10: 9,2 ↑ | | |

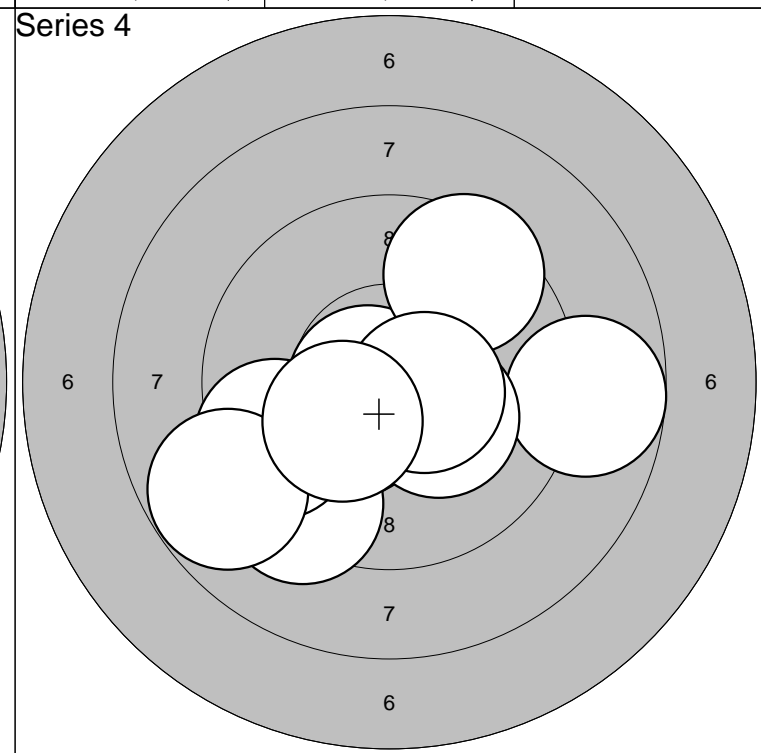
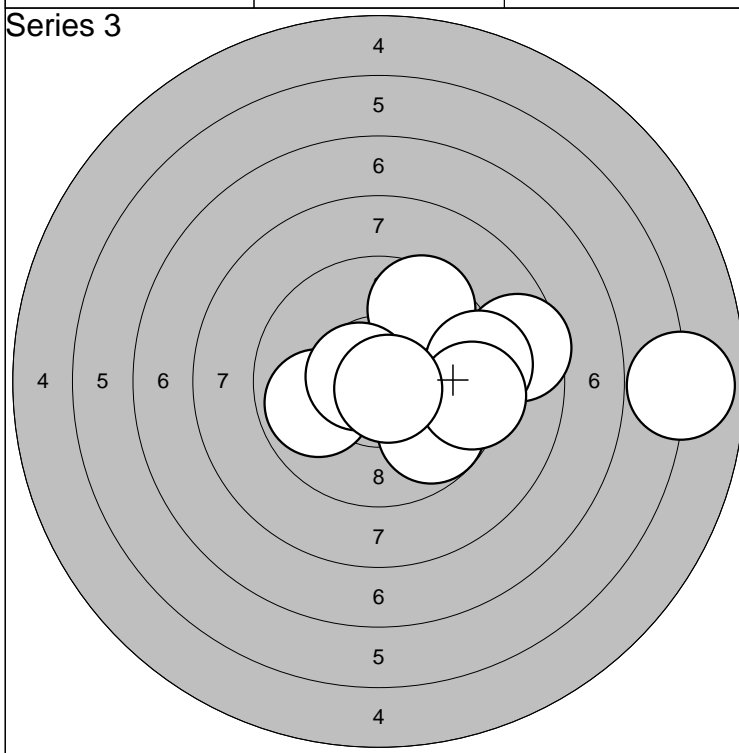

| | | | |
|----------|-------------|-------|-------|
| 1: 8,6 → | 6: 9,8 ↘ | Serie | 87,0 |
| 2: 9,5 ↗ | 7: 9,3 → | | |
| 3: 5,9 → | 8: 9,4 → | Sum | 264,0 |
| 4: 9,6 → | 9: 10,6* ← | | |
| 5: 9,9 ← | 10: 10,7* ↘ | | |

| | | | |
|------------|-------------|-------|-------|
| 1: 10,4* ↙ | 6: 9,5 ← | Serie | 93,0 |
| 2: 10,7* ← | 7: 10,3* ↘ | | |
| 3: 8,8 → | 8: 10,5* → | Sum | 357,0 |
| 4: 9,3 ↘ | 9: 8,8 ← | | |
| 5: 9,5 ↗ | 10: 10,3* ↙ | | |

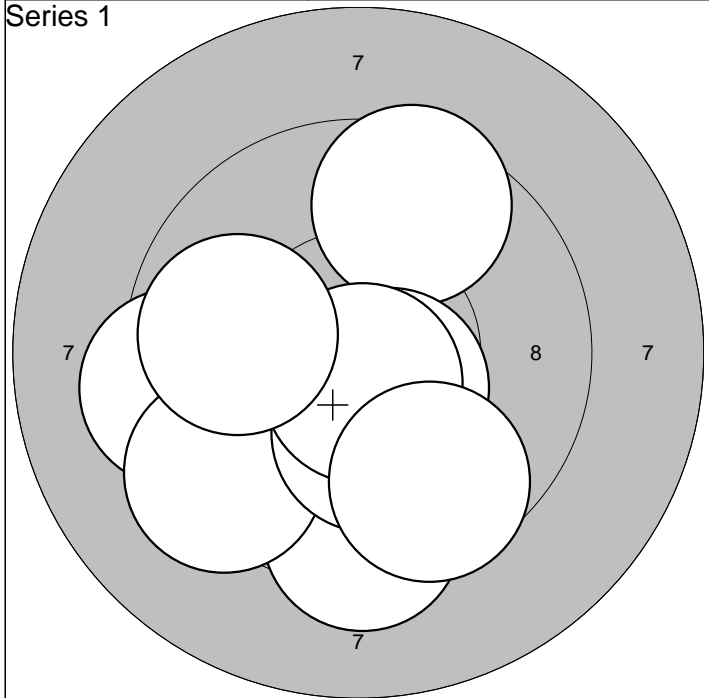

| | | | |
|-----------|-----------|-------|------|
| 1:10,2* ↓ | 6:10,2* ↓ | Serie | 94,0 |
| 2: 9,3 ← | 7:10,5* ↓ | | |
| 3: 9,4 ↓ | 8:10,7* ↓ | Sum | 94,0 |
| 4: 9,3 ↙ | 9: 9,6 ↓ | | |
| 5: 9,5 ↗ | 10: 9,9 ← | | |

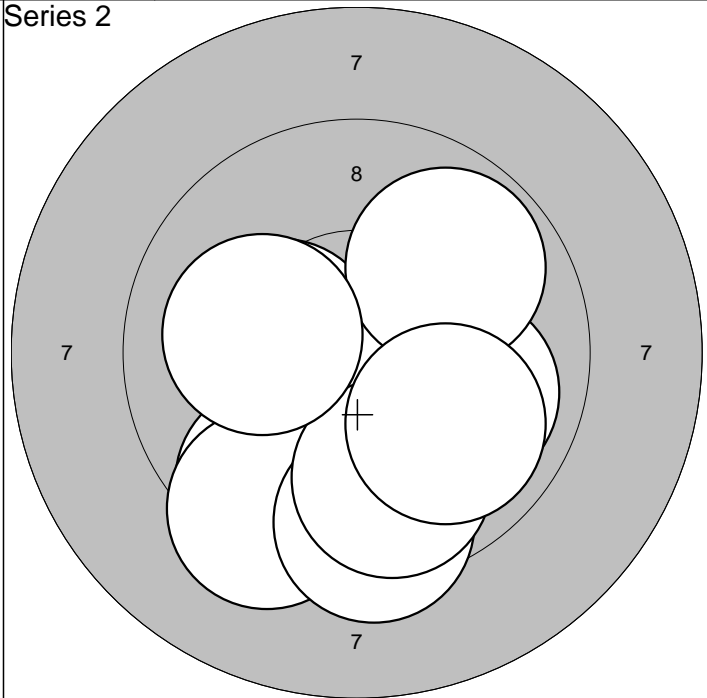

| | | | |
|-----------|-----------|-------|-------|
| 1: 9,6 ↙ | 6: 9,4 ↓ | Serie | 94,0 |
| 2:10,0 → | 7: 9,9 ↗ | | |
| 3:10,2* ← | 8: 9,8 ↓ | Sum | 188,0 |
| 4:10,5* ↓ | 9:10,1 ← | | |
| 5: 9,3 ↓ | 10: 9,9 ↓ | | |

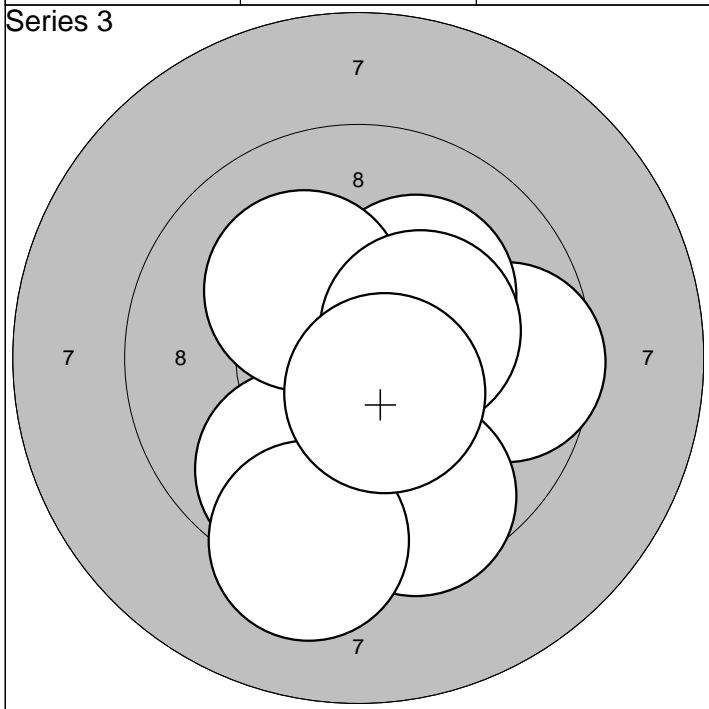

| | | | |
|-----------|------------|-------|-------|
| 1:10,1 ↓ | 6: 9,3 ↓ | Serie | 96,0 |
| 2:10,4* ↓ | 7:10,2* ↗ | | |
| 3: 9,6 → | 8:10,2* ↗ | Sum | 284,0 |
| 4: 9,6 ↓ | 9:10,3* → | | |
| 5: 9,8 ↙ | 10:10,6* ↓ | | |

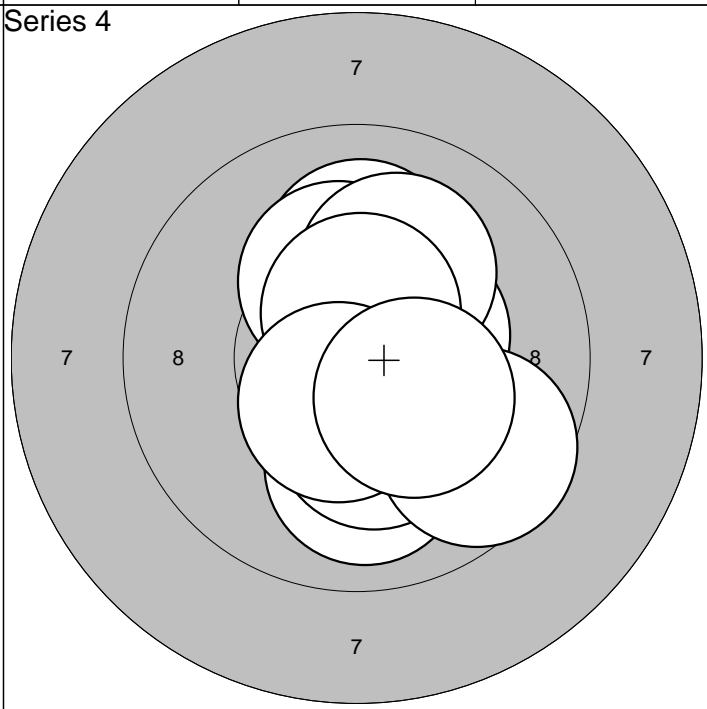

| | | | |
|-----------|------------|-------|-------|
| 1:10,1 ↑ | 6:10,1 ↗ | Serie | 99,0 |
| 2:10,3* ↑ | 7:10,5* ↑ | | |
| 3:10,0 ↓ | 8:10,5* ↓ | Sum | 383,0 |
| 4:10,3* ↓ | 9: 9,6 ↘ | | |
| 5:10,4* → | 10:10,3* ↘ | | |

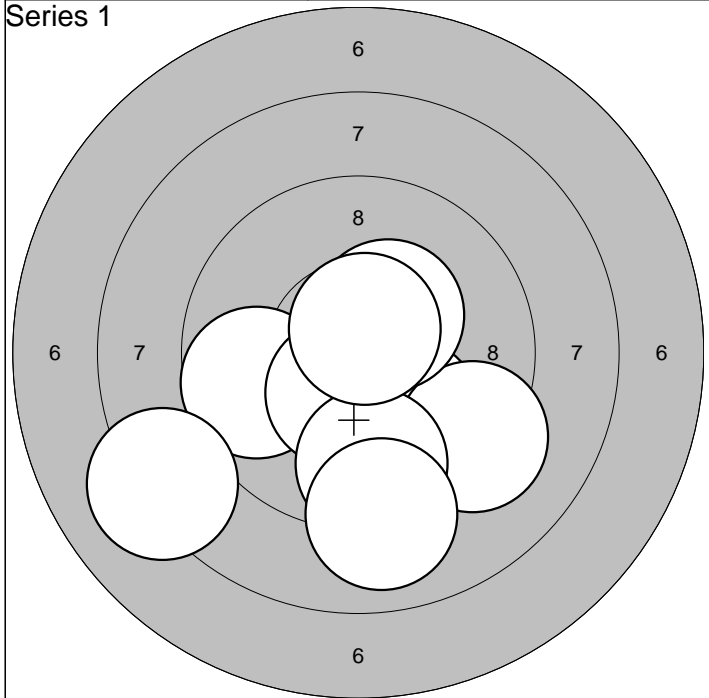

| | | | | |
|------------|-------------|-----|-------|------|
| 1: 9,7 ↙ | 6: 9,3 ↘ | | Serie | 93,0 |
| 2: 10,0 ↘ | 7: 9,6 ↓ | | | |
| 3: 8,2 ↙ | 8: 9,0 ↓ | Sum | 93,0 | |
| 4: 10,4* ↓ | 9: 10,4* ↗ | | | |
| 5: 9,5 ↓ | 10: 10,7* ↑ | | | |

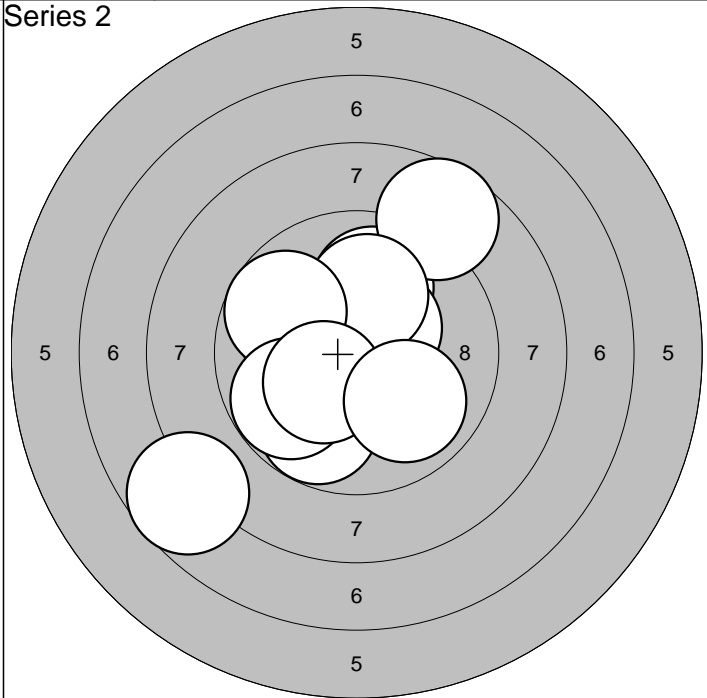

| | | | | |
|------------|------------|-----|-------|------|
| 1: 9,9 ↑ | 6: 9,8 ↓ | | Serie | 90,0 |
| 2: 8,7 ↗ | 7: 9,8 ↙ | | | |
| 3: 10,4* ↗ | 8: 10,3* ↙ | Sum | 183,0 | |
| 4: 10,1 ↑ | 9: 9,9 ↘ | | | |
| 5: 9,8 ↖ | 10: 7,7 ↙ | | | |

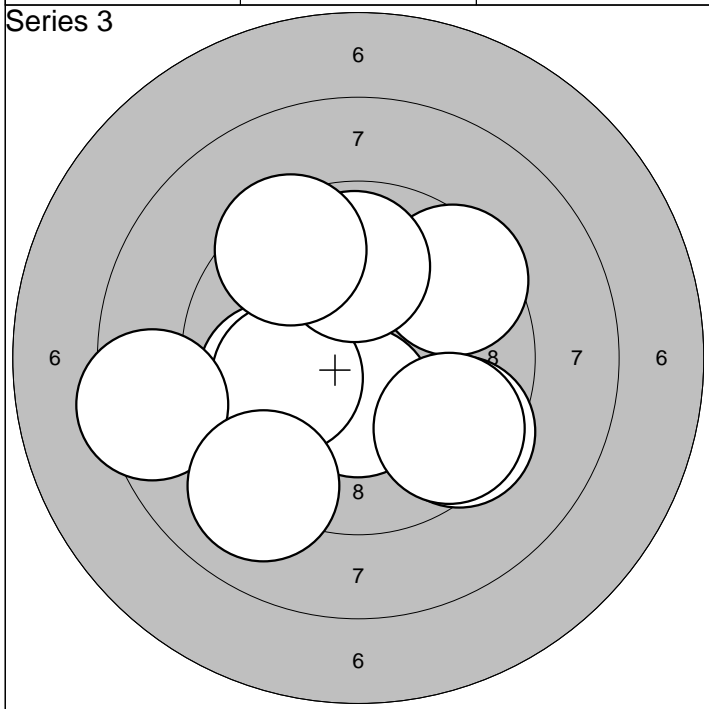

| | | | | |
|------------|-----------|-----|-------|------|
| 1: 10,4* ↓ | 6: 9,9 ↑ | | Serie | 91,0 |
| 2: 9,9 ↖ | 7: 8,4 ↖ | | | |
| 3: 10,1 ↖ | 8: 9,1 ↙ | Sum | 274,0 | |
| 4: 9,5 ↗ | 9: 9,6 ↘ | | | |
| 5: 9,5 ↘ | 10: 9,5 ↗ | | | |

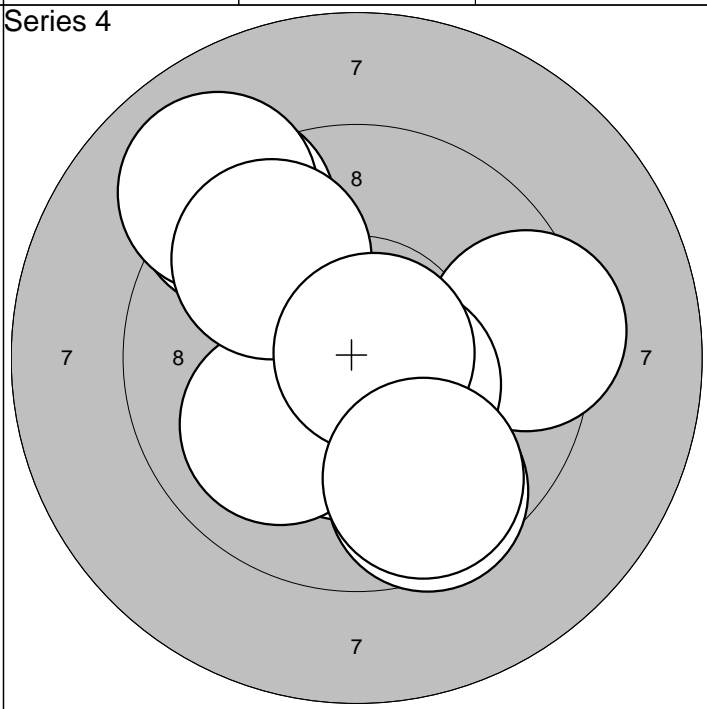

| | | | | |
|------------|------------|-----|-------|------|
| 1: 9,4 → | 6: 10,5* ↘ | | Serie | 94,0 |
| 2: 9,6 ↘ | 7: 10,0 ↙ | | | |
| 3: 9,3 ↗ | 8: 9,8 ↗ | Sum | 368,0 | |
| 4: 9,0 ↗ | 9: 10,8* → | | | |
| 5: 10,4* ↓ | 10: 9,7 ↘ | | | |

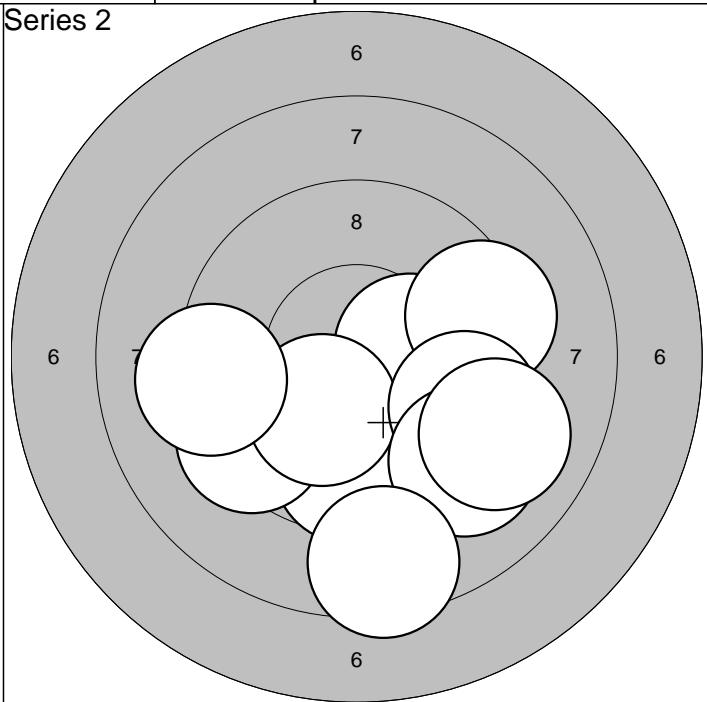
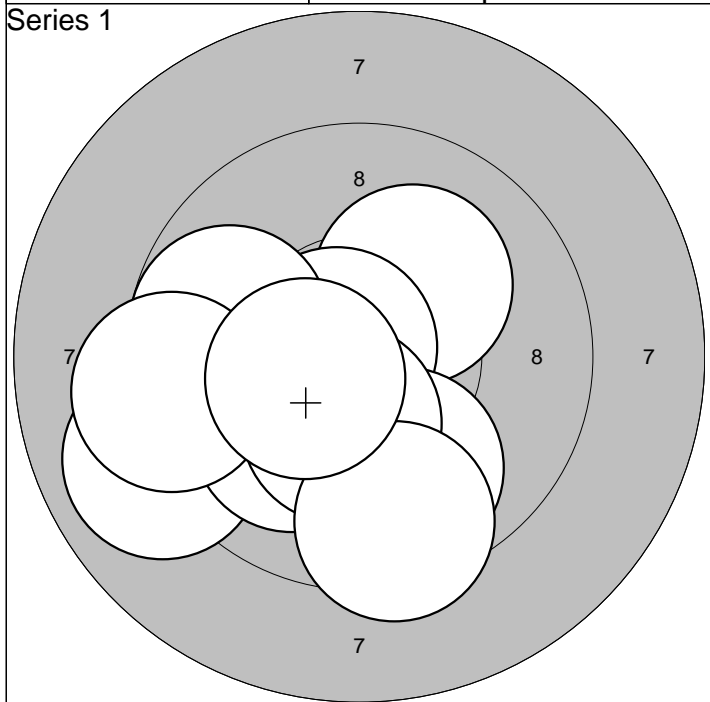

| | | | | | |
|-----------|------------|--|--|-------|------|
| 1:10,1 ↗ | 6: 9,7 ← | | | Serie | 95,0 |
| 2:10,7* ← | 7:10,3* ↓ | | | | |
| 3: 9,9 ↓ | 8: 9,3 ← | | | Sum | 95,0 |
| 4: 9,0 ← | 9: 9,4 ↓ | | | | |
| 5:10,0 ↘ | 10:10,4* ← | | | | |

| | | | | | |
|-----------|-----------|--|--|-------|-------|
| 1:10,3* → | 6: 9,2 ← | | | Serie | 91,0 |
| 2: 9,6 ↓ | 7: 9,6 → | | | | |
| 3: 9,4 ↙ | 8: 9,2 ↓ | | | Sum | 186,0 |
| 4: 9,4 → | 9: 8,5 ↓ | | | | |
| 5:10,2* ↘ | 10: 9,1 ↘ | | | | |

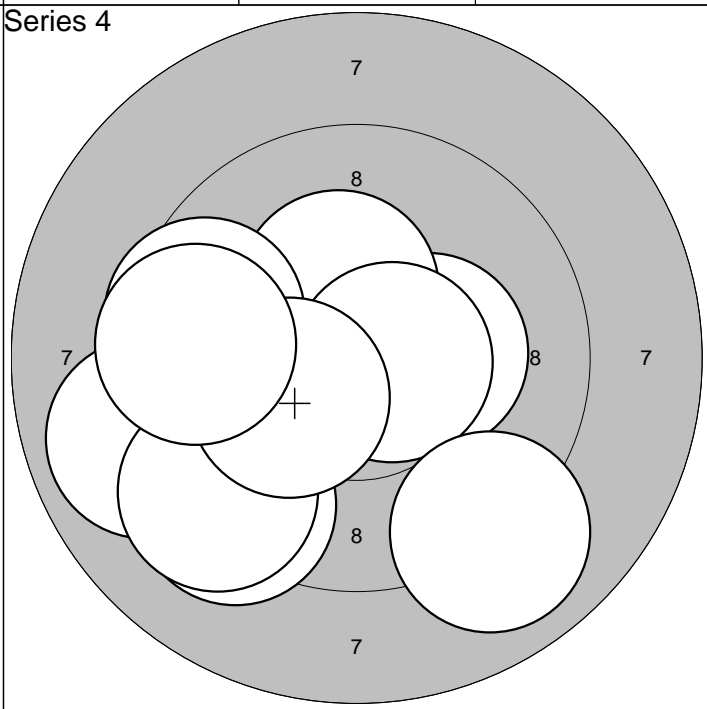
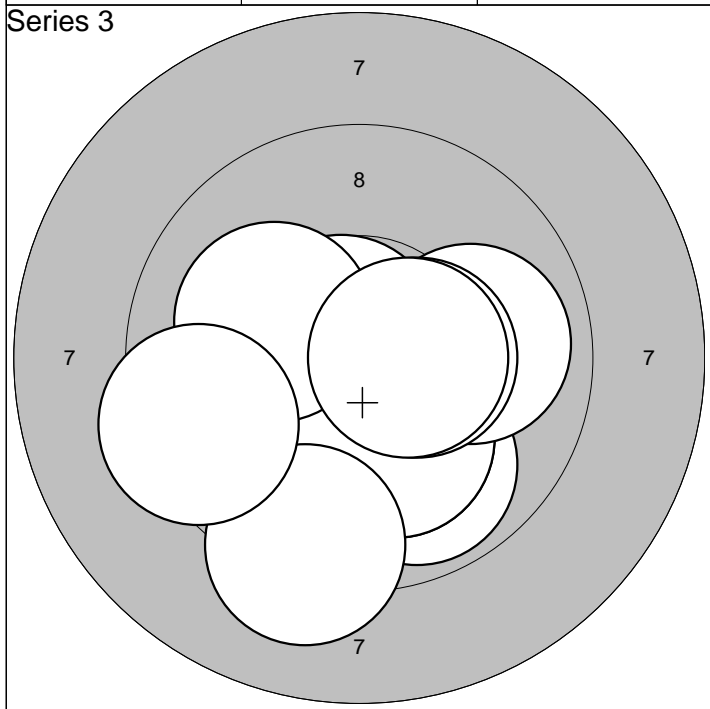

| | | | | | |
|-----------|------------|--|--|-------|-------|
| 1:10,7* ↗ | 6:10,4* → | | | Serie | 97,0 |
| 2: 9,9 ↓ | 7: 9,2 ↓ | | | | |
| 3:10,2* ↘ | 8:10,1 ← | | | Sum | 283,0 |
| 4:10,1 ↘ | 9: 9,4 ← | | | | |
| 5:10,0 → | 10:10,5* → | | | | |

| | | | | | |
|-----------|-----------|--|--|-------|-------|
| 1: 8,9 ← | 6:10,6* → | | | Serie | 93,0 |
| 2: 9,3 ↘ | 7: 9,5 ← | | | | |
| 3:10,3* → | 8:10,2* ← | | | Sum | 376,0 |
| 4:10,3* ↗ | 9: 9,0 ↓ | | | | |
| 5: 9,2 ↙ | 10: 9,5 ← | | | | |

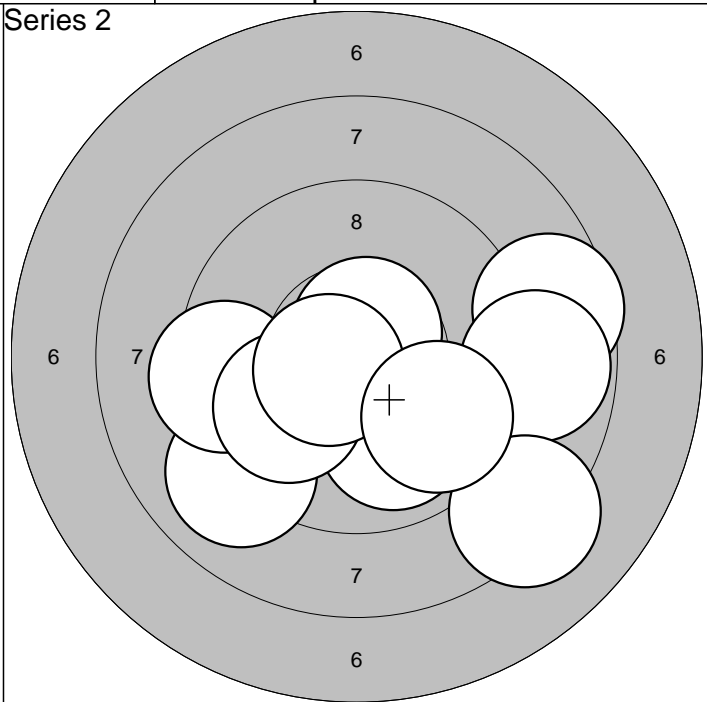
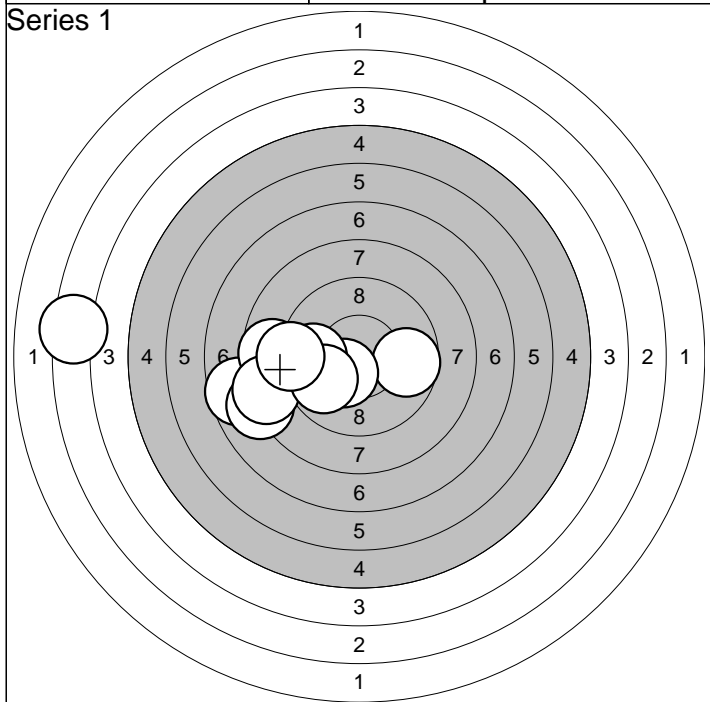

| | | | |
|----------|-----------|-------|------|
| 1: 7,7 ← | 6: 8,3 ← | Serie | 80,0 |
| 2: 3,4 ← | 7:10,4* ↘ | | |
| 3: 8,0 ← | 8: 9,7 ← | Sum | 80,0 |
| 4: 8,7 ← | 9: 9,9 ← | | |
| 5: 9,7 → | 10: 9,2 ← | | |

| | | | |
|----------|-----------|-------|-------|
| 1: 9,0 ↘ | 6:10,6* ↗ | Serie | 89,0 |
| 2: 8,6 → | 7: 8,8 → | | |
| 3: 9,4 ← | 8: 8,2 ↘ | Sum | 169,0 |
| 4: 9,9 ↘ | 9:10,6* ← | | |
| 5: 9,9 ↘ | 10: 9,7 ↘ | | |

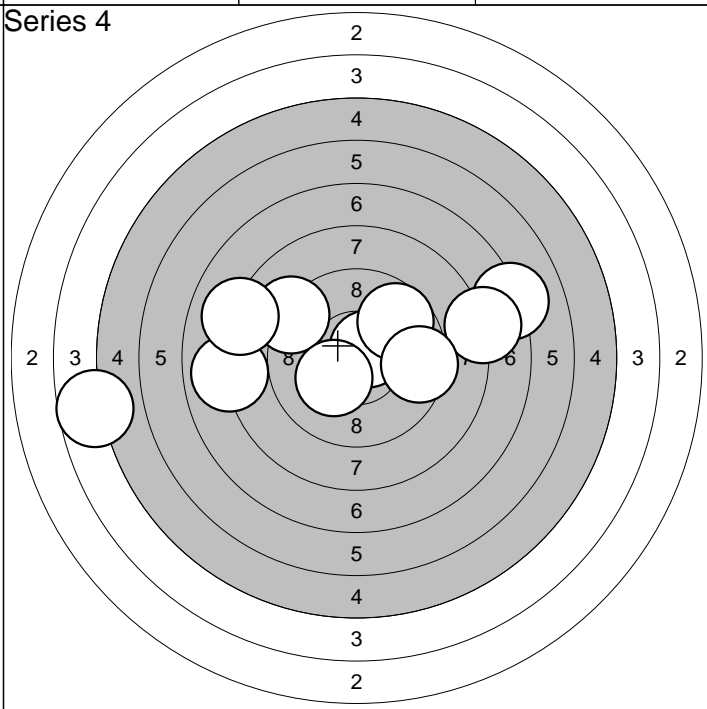
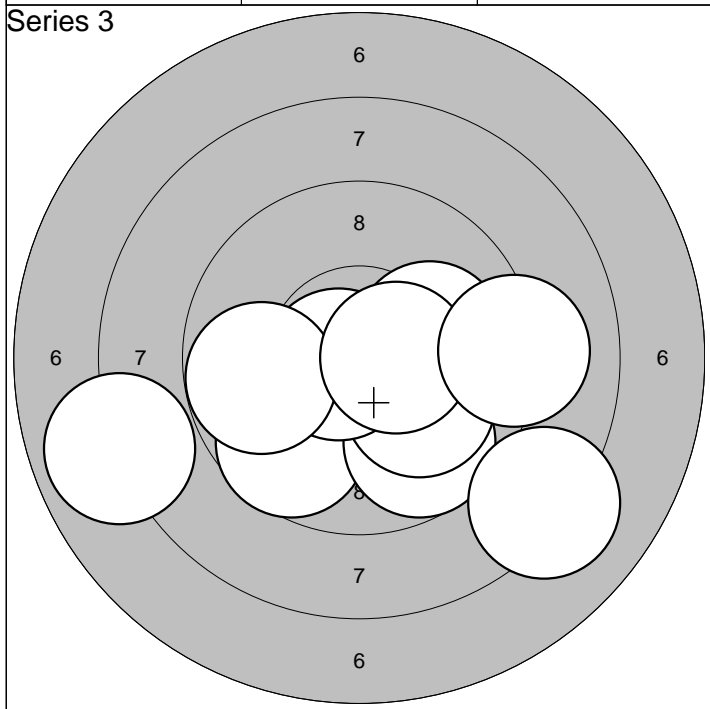

| | | | |
|----------|-----------|-------|-------|
| 1: 9,7 ↘ | 6: 8,2 ↘ | Serie | 91,0 |
| 2: 9,7 ↘ | 7:10,7* ← | | |
| 3:10,1 → | 8: 9,8 ← | Sum | 260,0 |
| 4:10,1 ↘ | 9:10,5* → | | |
| 5: 7,9 ← | 10: 9,1 → | | |

| | | | |
|-----------|-----------|-------|-------|
| 1:10,6* ↗ | 6: 4,7 ← | Serie | 81,0 |
| 2: 9,1 ← | 7: 7,1 → | | |
| 3: 8,0 ← | 8:10,2* ↘ | Sum | 341,0 |
| 4: 8,1 ← | 9: 7,9 → | | |
| 5: 9,7 ↗ | 10: 9,5 → | | |

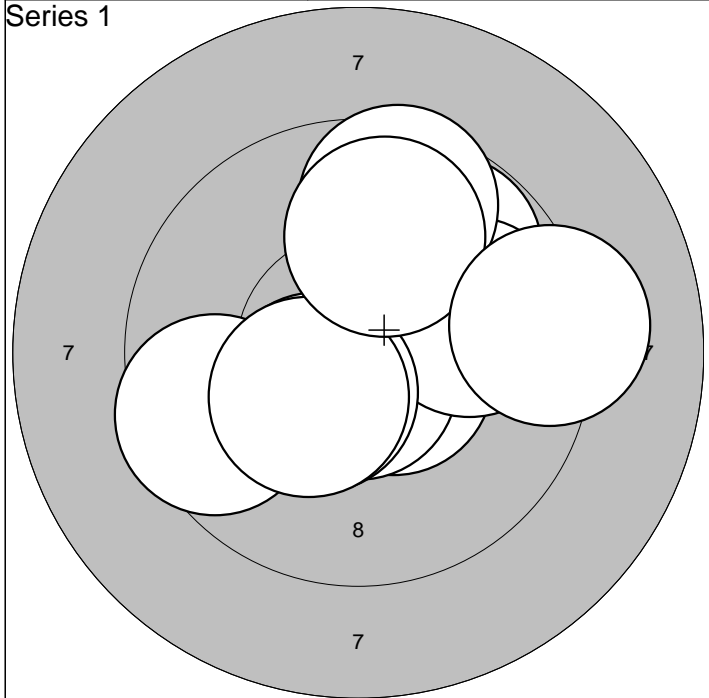

| | | | | | |
|-----------|-----------|-----|------|-------|------|
| 1: 9,8 ↗ | 6: 9,6 ↑ | | | Serie | 94,0 |
| 2: 9,6 ← | 7:10,4* ↙ | | | | |
| 3:10,6* ↘ | 8:10,3* ↙ | Sum | 94,0 | | |
| 4:10,7* ↓ | 9: 9,9 ↑ | | | | |
| 5: 9,9 → | 10: 9,2 → | | | | |

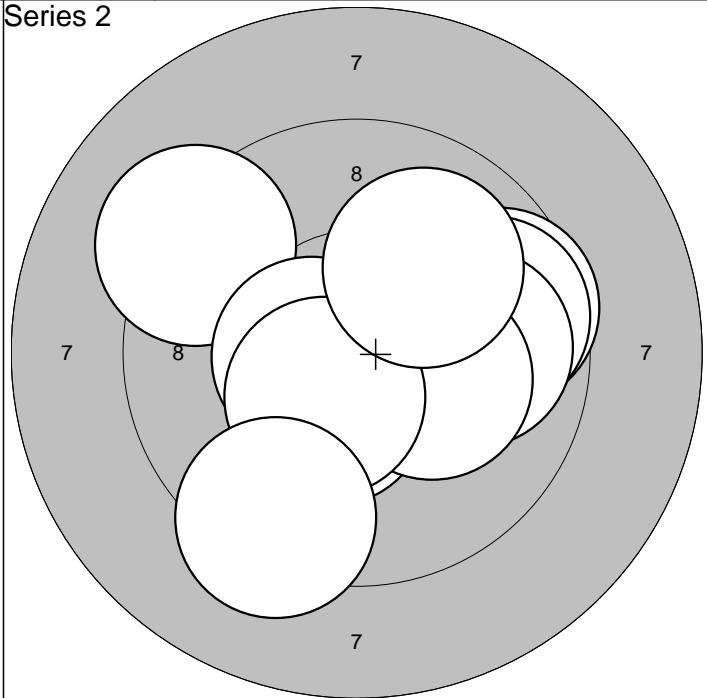

| | | | | | |
|-----------|-----------|-----|-------|-------|------|
| 1: 9,2 ↖ | 6:10,6* ← | | | Serie | 95,0 |
| 2: 9,6 → | 7:10,2* → | | | | |
| 3: 9,7 → | 8:10,5* ↙ | Sum | 189,0 | | |
| 4: 9,9 → | 9:10,0 ↗ | | | | |
| 5:10,4* ↙ | 10: 9,3 ↙ | | | | |

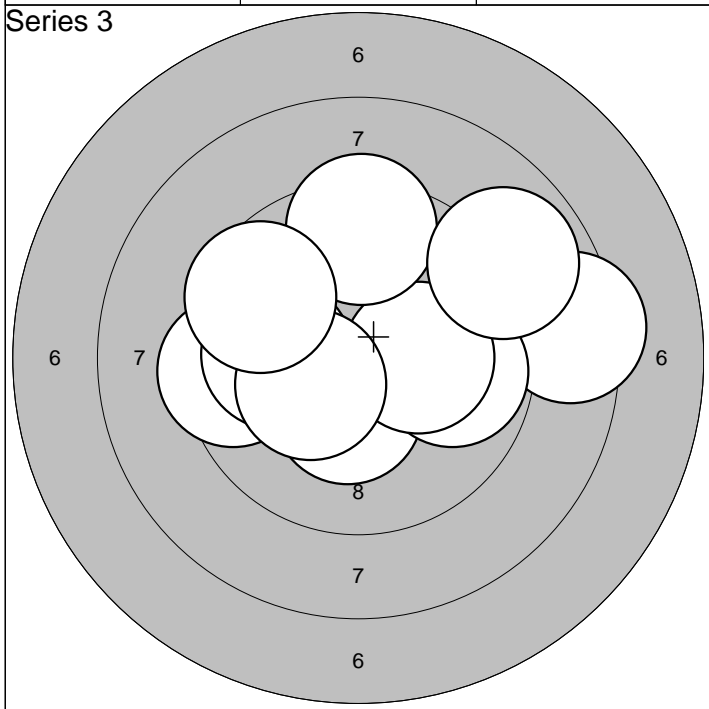

| | | | | | |
|-----------|-----------|-----|-------|-------|------|
| 1: 9,5 ← | 6:10,2* → | | | Serie | 92,0 |
| 2:10,0 ← | 7: 9,4 ↑ | | | | |
| 3: 8,4 → | 8: 8,9 ↗ | Sum | 281,0 | | |
| 4:10,3* ↓ | 9:10,3* ← | | | | |
| 5: 9,8 → | 10: 9,6 ↖ | | | | |

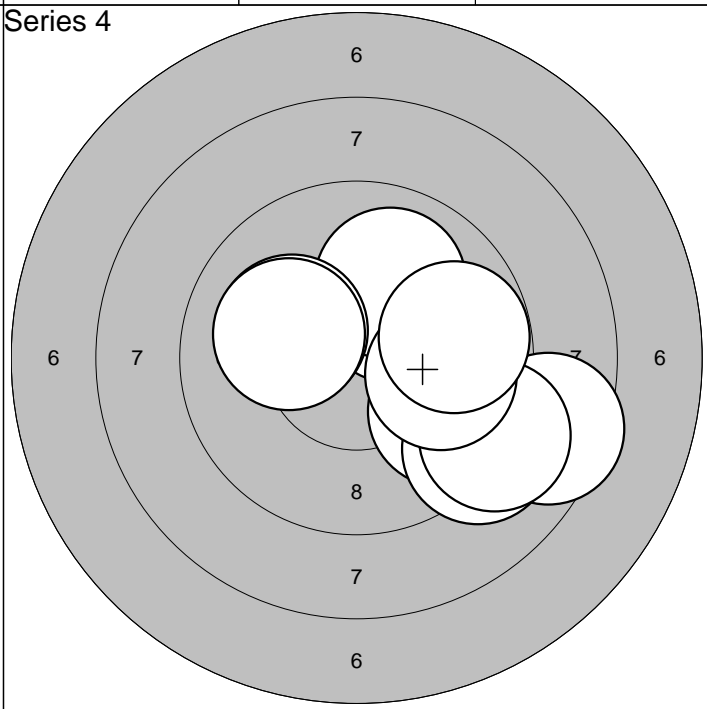

| | | | | | |
|-----------|-----------|-----|-------|-------|------|
| 1:10,2* ↗ | 6: 8,5 → | | | Serie | 93,0 |
| 2:10,0 ↗ | 7: 9,1 ↙ | | | | |
| 3: 9,7 ↘ | 8: 9,1 ↘ | Sum | 374,0 | | |
| 4:10,1 ↖ | 9: 9,9 → | | | | |
| 5:10,1 ↖ | 10: 9,8 → | | | | |

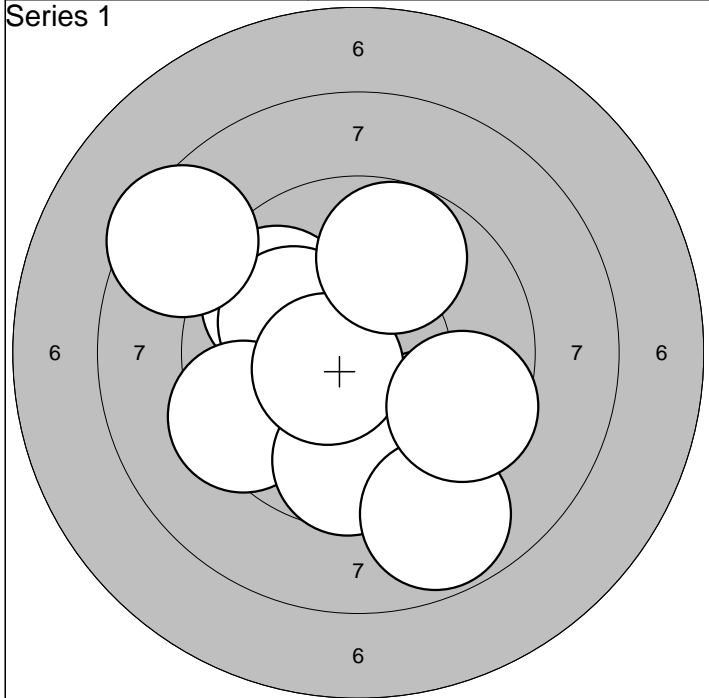

| | | | | |
|----------|-----------|-----|-------|------|
| 1: 9,8 ↘ | 6: 9,7 ↓ | | Serie | 90,0 |
| 2: 9,8 ↗ | 7:10,5* ← | | | |
| 3:10,1 ↗ | 8: 8,8 ↓ | Sum | 90,0 | |
| 4: 8,5 ↗ | 9: 9,6 ↘ | | | |
| 5: 9,4 ↙ | 10: 9,8 ↗ | | | |

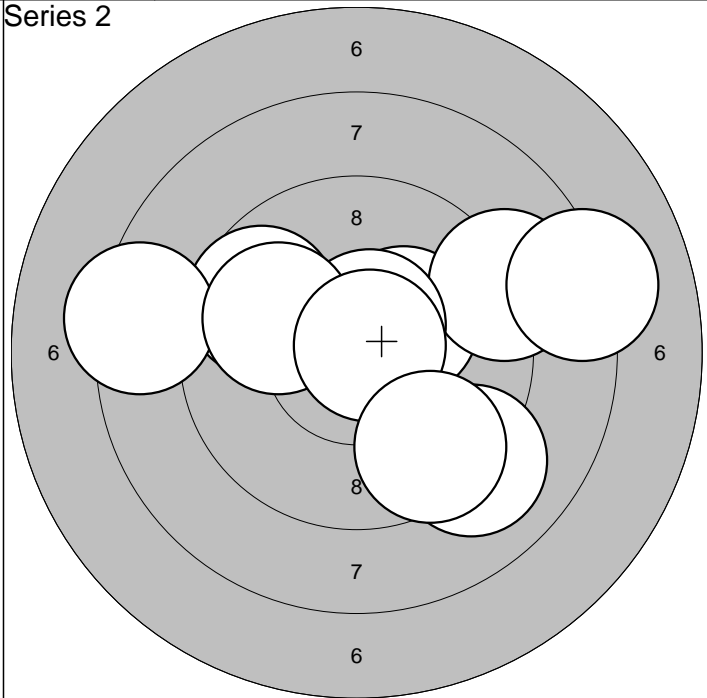

| | | | | |
|-----------|-----------|-----|-------|------|
| 1: 9,7 ↖ | 6: 9,1 ↘ | | Serie | 91,0 |
| 2:10,3* ↗ | 7: 8,2 → | | | |
| 3: 9,0 → | 8: 9,9 ↖ | Sum | 181,0 | |
| 4: 8,4 ← | 9:10,8* → | | | |
| 5:10,6* ↗ | 10: 9,5 ↘ | | | |

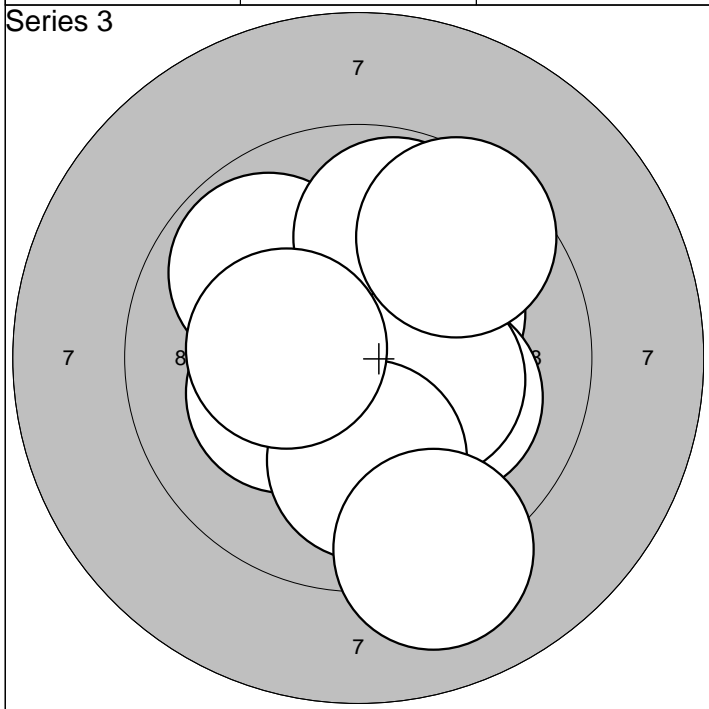

| | | | | |
|-----------|-----------|-----|-------|------|
| 1: 9,8 ↖ | 6:10,3* → | | Serie | 96,0 |
| 2:10,2* ↗ | 7:10,0 ↓ | | | |
| 3:10,2* ↙ | 8: 9,1 ↓ | Sum | 277,0 | |
| 4:10,1 ↘ | 9:10,3* ← | | | |
| 5: 9,8 ↗ | 10: 9,5 ↗ | | | |

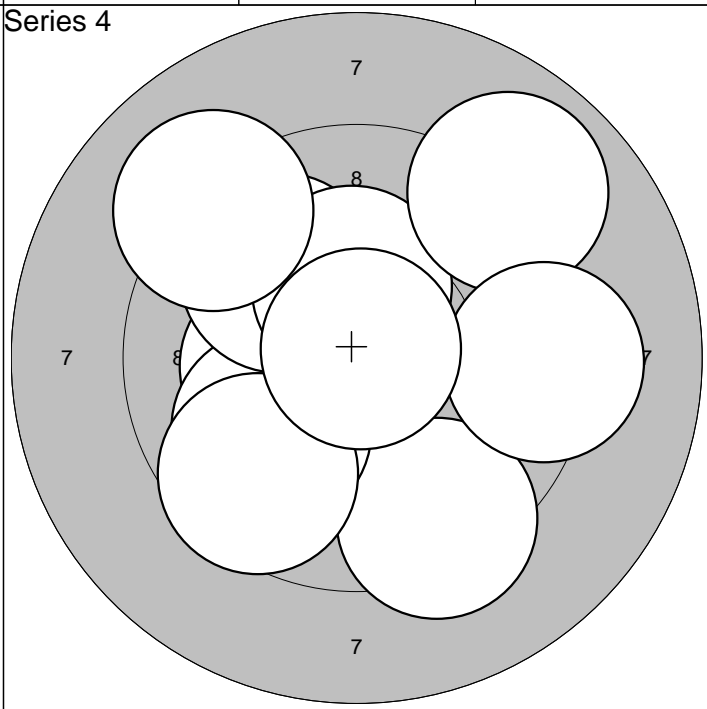

| | | | | |
|-----------|-----------|-----|-------|------|
| 1:10,3* ← | 6: 9,6 ↙ | | Serie | 92,0 |
| 2: 9,4 ↓ | 7: 8,9 ↗ | | | |
| 3: 9,9 ↙ | 8: 9,3 → | Sum | 369,0 | |
| 4: 9,9 ↖ | 9:10,9* ↗ | | | |
| 5:10,3* ↗ | 10: 9,1 ↖ | | | |

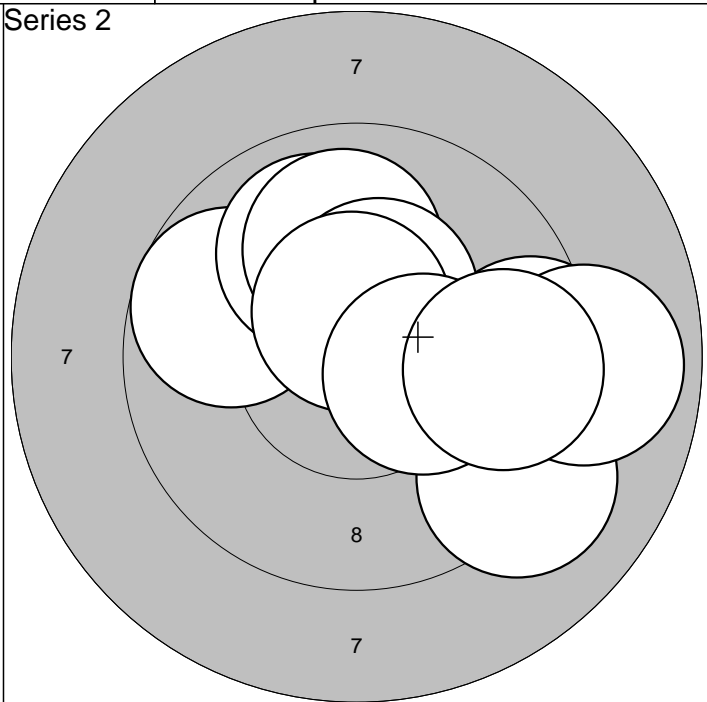
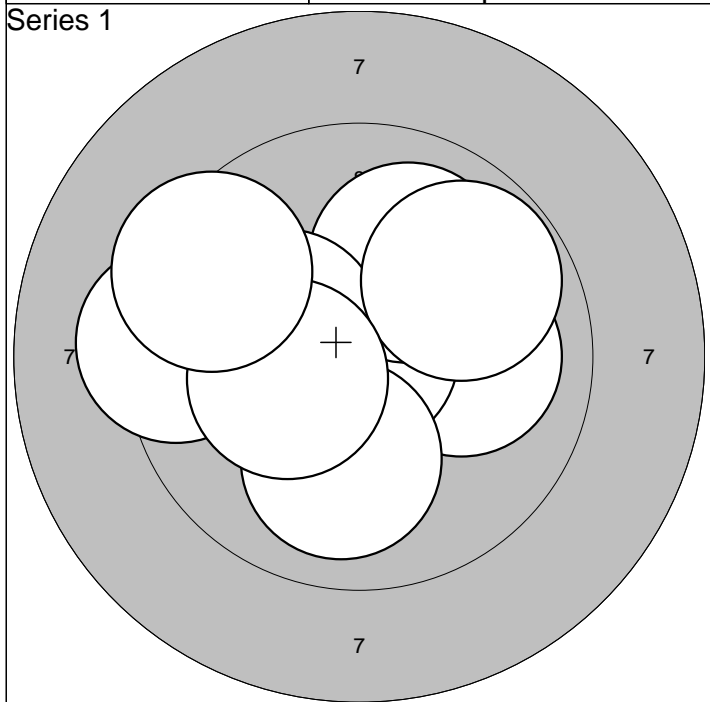

| | | | |
|-----------|-----------|-------|------|
| 1: 9,3 ← | 6:10,0 ↗ | Serie | 97,0 |
| 2:10,7* ↓ | 7:10,2* ← | | |
| 3:10,0 → | 8: 9,8 ↗ | Sum | 97,0 |
| 4:10,9* ↑ | 9:10,3* ← | | |
| 5:10,0 ↓ | 10: 9,4 ↖ | | |

| | | | |
|----------|-----------|-------|-------|
| 1: 9,8 ← | 6:10,0 ↑ | Serie | 93,0 |
| 2: 9,4 → | 7:10,4* ↗ | | |
| 3: 9,1 ↘ | 8:10,5* ↑ | Sum | 190,0 |
| 4: 9,9 ↑ | 9:10,3* → | | |
| 5: 8,9 → | 10: 9,6 → | | |

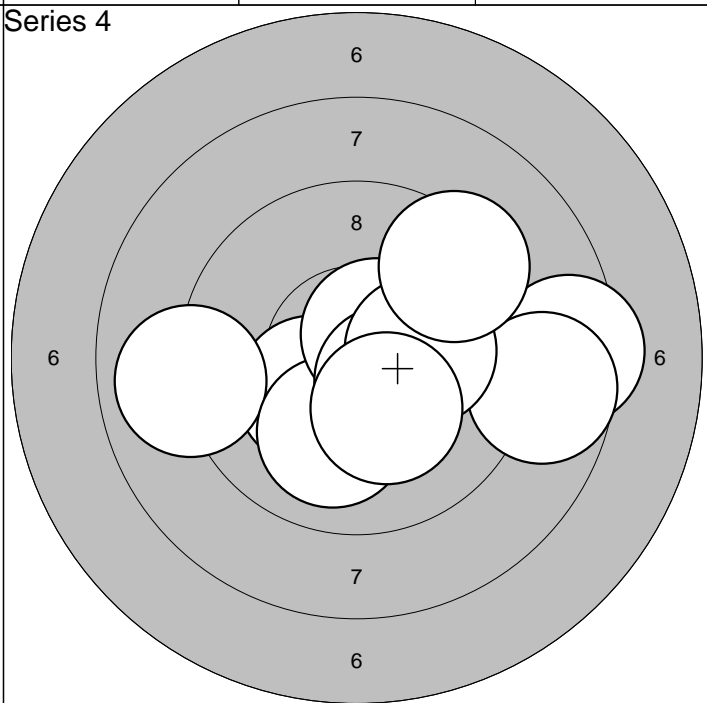
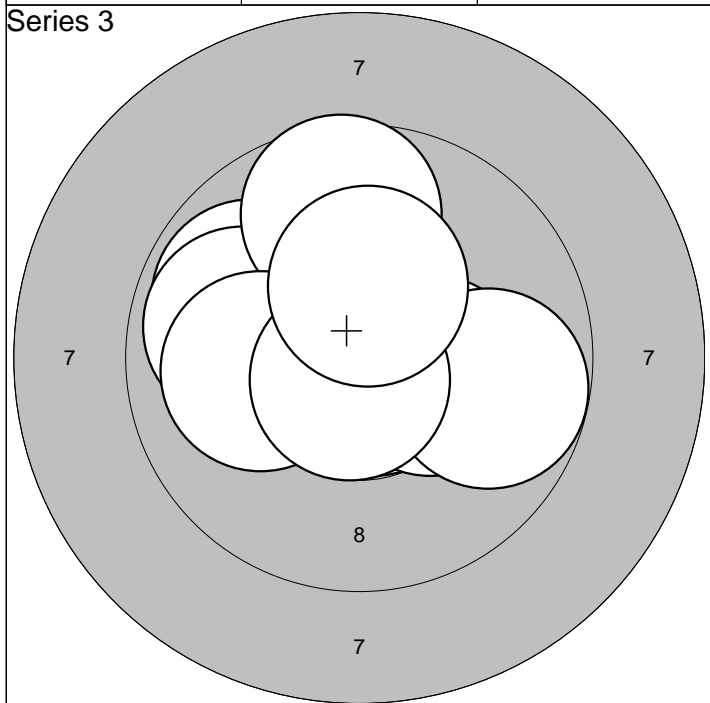

| | | | |
|-----------|------------|-------|-------|
| 1:10,3* ↑ | 6: 9,8 → | Serie | 96,0 |
| 2:10,7* ↘ | 7: 9,7 ↑ | | |
| 3: 9,9 ↖ | 8:10,1 ← | Sum | 286,0 |
| 4:10,3* → | 9:10,7* ↓ | | |
| 5: 9,9 ← | 10:10,3* ↑ | | |

| | | | |
|-----------|-----------|-------|-------|
| 1: 8,4 → | 6:10,5* ↘ | Serie | 94,0 |
| 2:10,3* ↖ | 7: 8,7 → | | |
| 3: 9,0 ← | 8:10,2* → | Sum | 380,0 |
| 4:10,0 ↓ | 9:10,2* ↘ | | |
| 5:10,6* ↗ | 10: 9,4 ↗ | | |

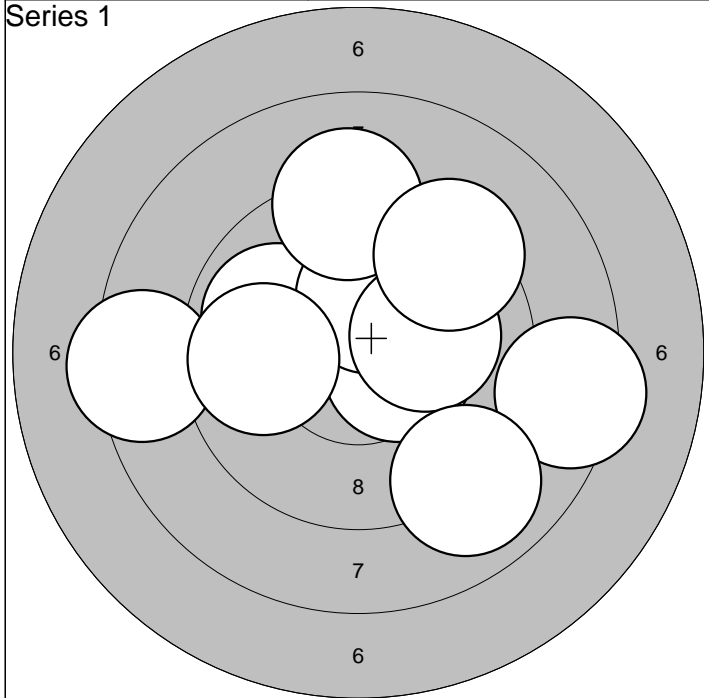

| | | | |
|------------|-----------|-------|------|
| 1: 8,4 → | 6: 9,2 ↑ | Serie | 91,0 |
| 2: 9,9 ← | 7: 9,8 ← | | |
| 3: 10,5* → | 8: 10,1 → | Sum | 91,0 |
| 4: 8,4 ← | 9: 9,4 ↗ | | |
| 5: 10,3* ↑ | 10: 9,0 ↘ | | |

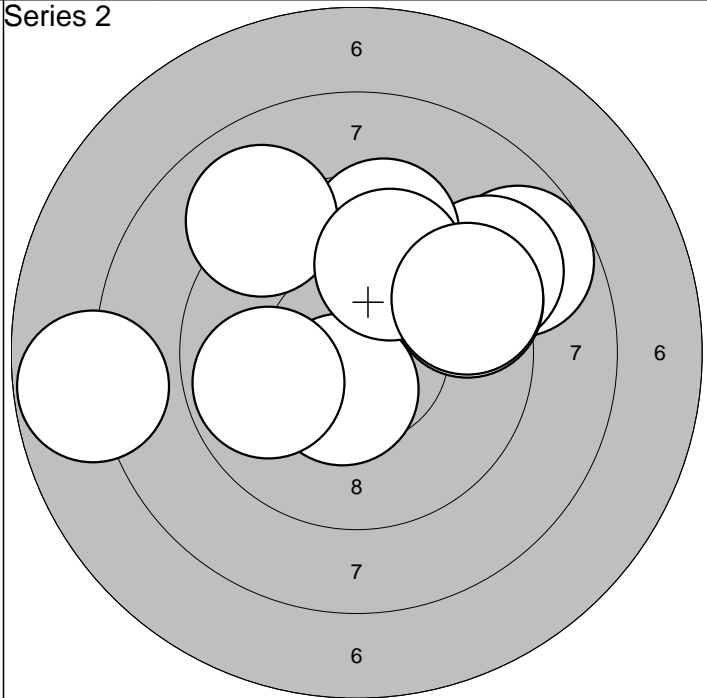

| | | | |
|------------|-----------|-------|-------|
| 1: 8,7 ↗ | 6: 9,0 ↖ | Serie | 88,0 |
| 2: 9,1 ↗ | 7: 9,8 ↑ | | |
| 3: 10,5* ↓ | 8: 9,5 → | Sum | 179,0 |
| 4: 9,5 → | 9: 7,8 ← | | |
| 5: 9,5 ↑ | 10: 9,9 ← | | |

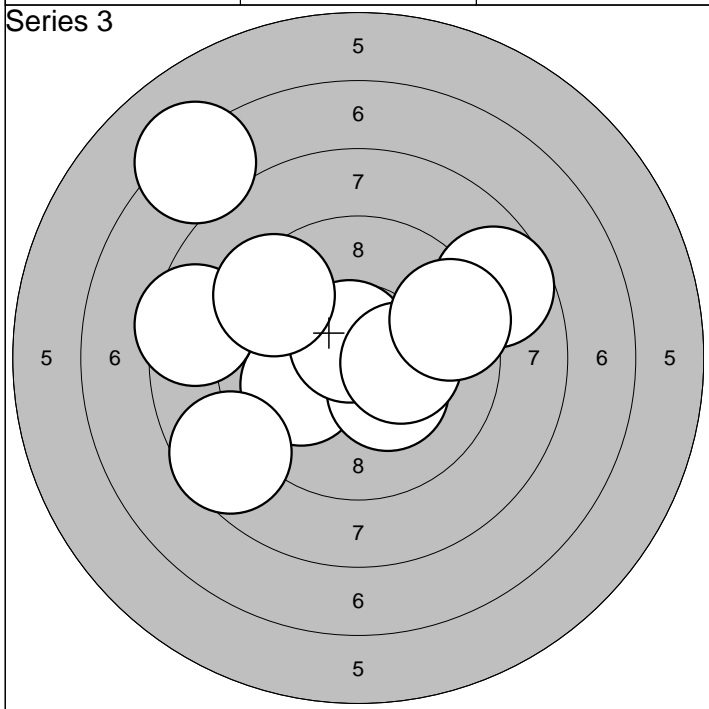

| | | | |
|------------|------------|-------|-------|
| 1: 10,0 ← | 6: 9,4 ↗ | Serie | 89,0 |
| 2: 10,3* ↓ | 7: 7,2 ↗ | | |
| 3: 8,5 ← | 8: 10,3* → | Sum | 268,0 |
| 4: 10,7* ↑ | 9: 8,7 → | | |
| 5: 8,6 ← | 10: 9,5 → | | |

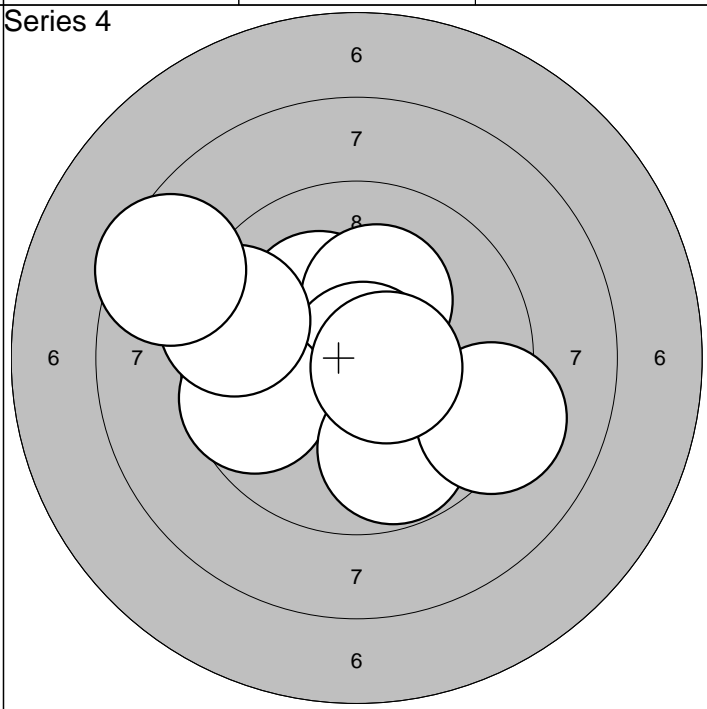

| | | | |
|------------|-------------|-------|-------|
| 1: 10,2* ↗ | 6: 9,5 ← | Serie | 94,0 |
| 2: 10,2* ↑ | 7: 9,8 ↓ | | |
| 3: 10,4* ↓ | 8: 9,2 → | Sum | 362,0 |
| 4: 10,9* → | 9: 8,5 ↖ | | |
| 5: 9,6 ← | 10: 10,6* → | | |

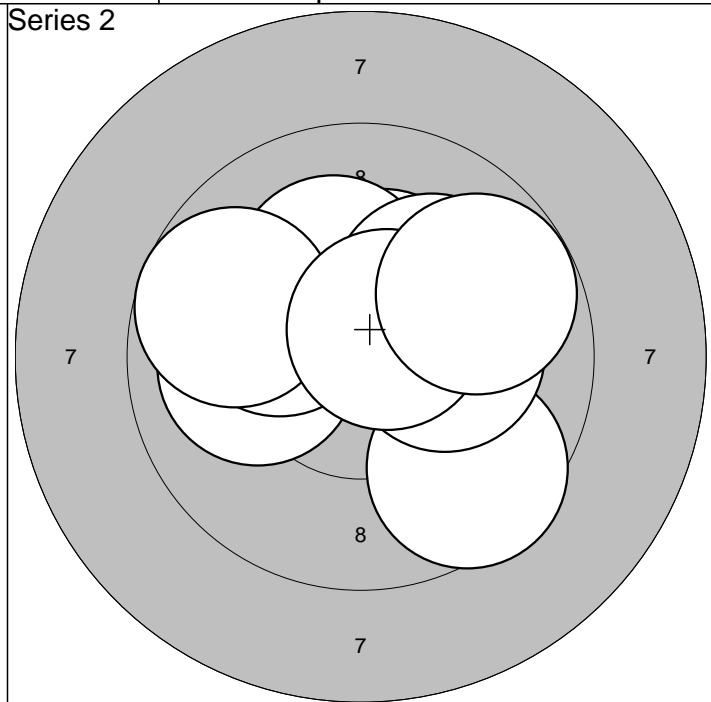
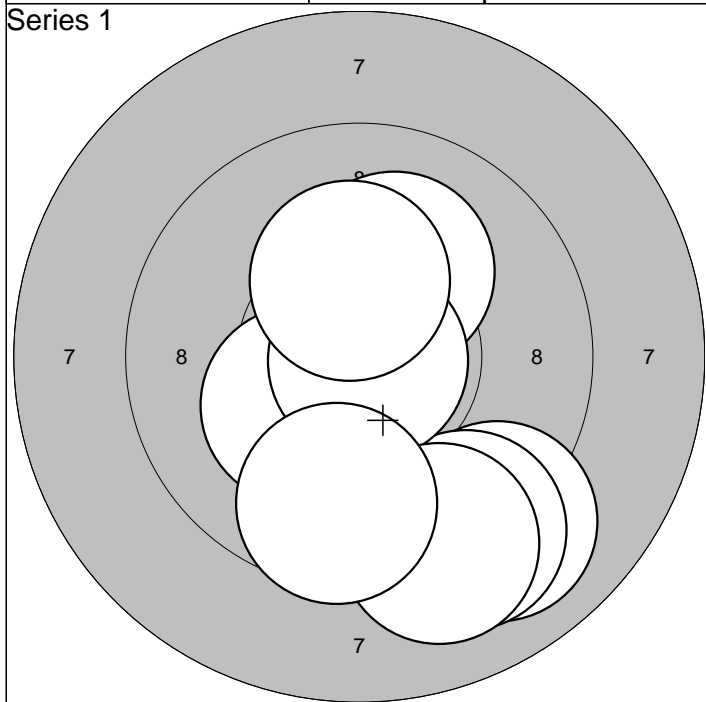

| | | | |
|-----------|------------|-------|------|
| 1: 9,0 ↘ | 6:10,3* ↙ | Serie | 96,0 |
| 2: 9,1 ↘ | 7:10,9* → | | |
| 3:10,1 ↗ | 8: 9,1 ↘ | Sum | 96,0 |
| 4:10,8* ↘ | 9: 9,6 ↘ | | |
| 5:10,3* ↘ | 10:10,3* ↑ | | |

| | | | |
|-----------|-----------|-------|-------|
| 1: 9,6 ↘ | 6:10,2* ↗ | Serie | 97,0 |
| 2:10,2* → | 7: 9,7 ↙ | | |
| 3:10,0 ← | 8:10,1 ↗ | Sum | 193,0 |
| 4:10,1 ↙ | 9:10,6* ↗ | | |
| 5:10,3* ↑ | 10: 9,8 ↗ | | |

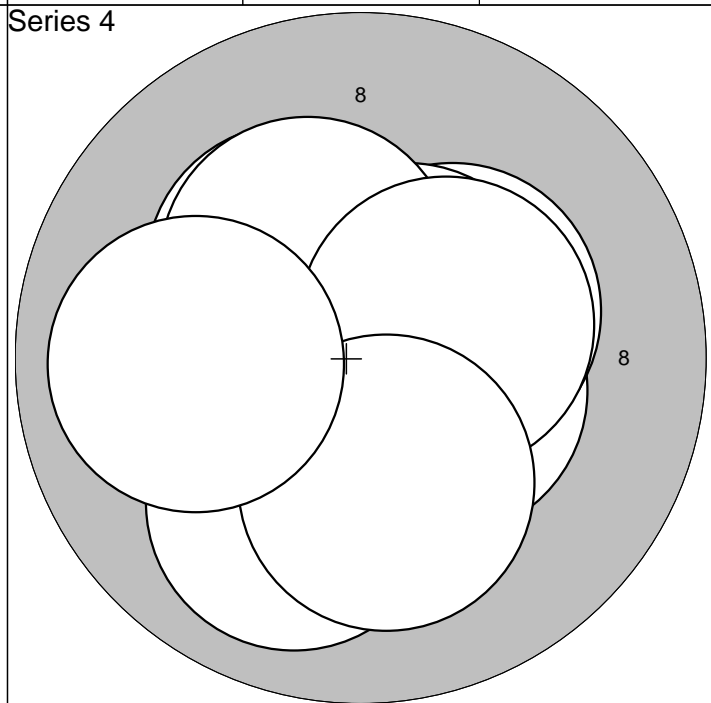
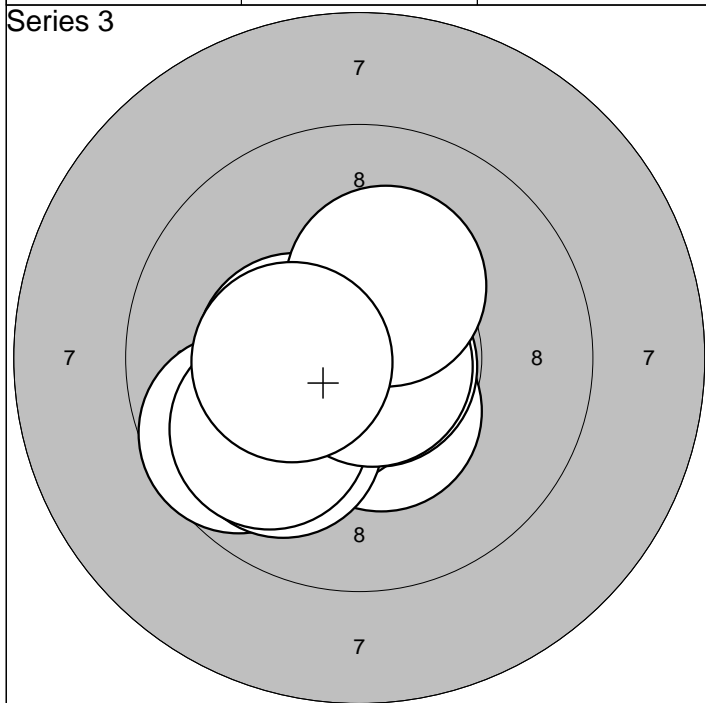

| | | | |
|-----------|------------|-------|-------|
| 1:10,4* ↘ | 6:10,0 ↙ | Serie | 98,0 |
| 2:10,8* → | 7: 9,9 ↙ | | |
| 3: 9,7 ↙ | 8:10,8* → | Sum | 291,0 |
| 4:10,4* ← | 9:10,3* ↗ | | |
| 5:10,6* ↙ | 10:10,4* ← | | |

| | | | |
|-----------|-----------|-------|-------|
| 1:10,4* → | 6:10,3* ↗ | Serie | 100,0 |
| 2:10,3* ↗ | 7:10,4* → | | |
| 3:10,2* ← | 8:10,0 ↘ | Sum | 391,0 |
| 4:10,3* ↗ | 9:10,2* ↘ | | |
| 5:10,5* ↗ | 10:10,0 ← | | |

Lag **2** Skive **41**

Johanna Johansson

Day 1, Rifle SSK Qulan ARJW

3-6.1.2010 Swedish Cup 2010 Swedishcup 10

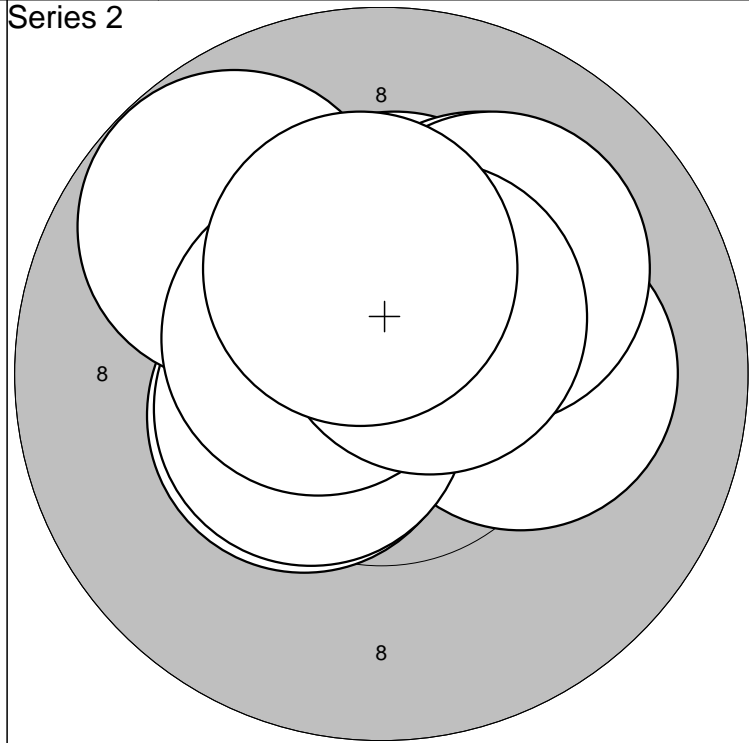
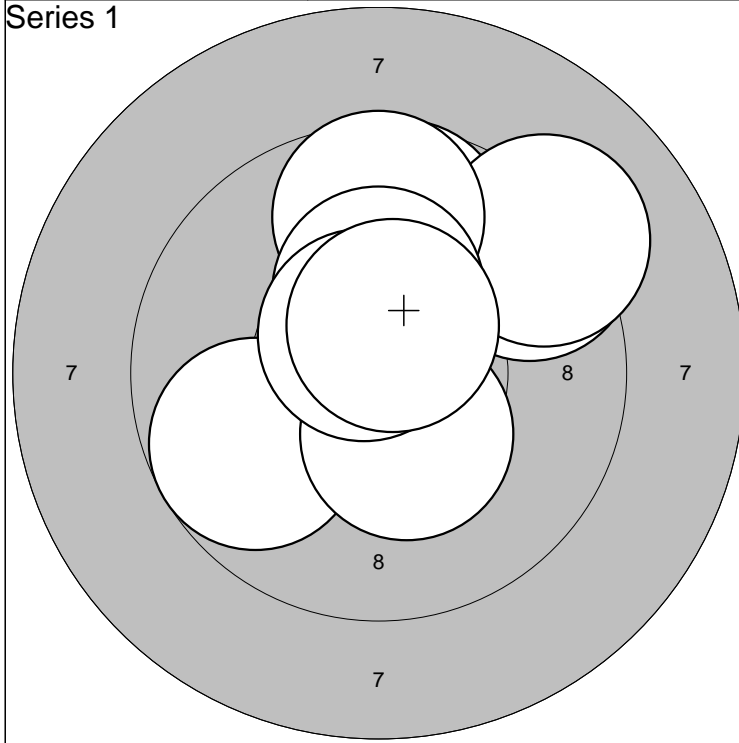

| | | | | | |
|----------|---|-----------|---|-------|------|
| 1: 10,5* | ↑ | 6: 9,6 | ↑ | Serie | 95,0 |
| 2: 9,7 | ↑ | 7: 10,4* | ↓ | | |
| 3: 9,3 | ↗ | 8: 10,3* | ↑ | Sum | 95,0 |
| 4: 9,1 | ↗ | 9: 10,6* | ↖ | | |
| 5: 9,8 | ↖ | 10: 10,5* | ↑ | | |

| | | | | | |
|----------|---|-----------|---|-------|-------|
| 1: 10,5* | ↖ | 6: 10,1 | ↗ | Serie | 99,0 |
| 2: 10,2* | → | 7: 10,5* | ↖ | | |
| 3: 10,5* | ↖ | 8: 10,1 | ↗ | Sum | 194,0 |
| 4: 10,4* | ↑ | 9: 10,5* | ↗ | | |
| 5: 9,8 | ↖ | 10: 10,3* | ↑ | | |

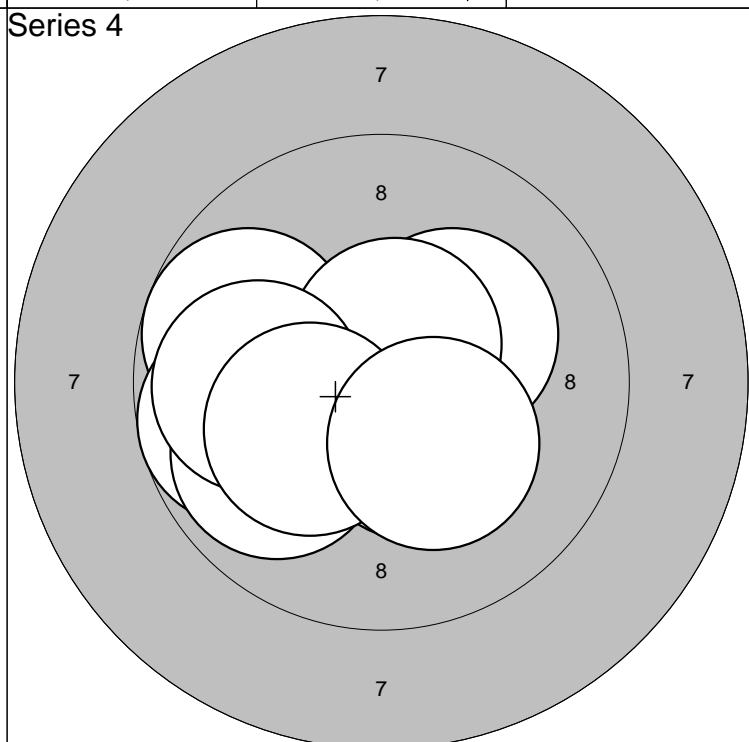
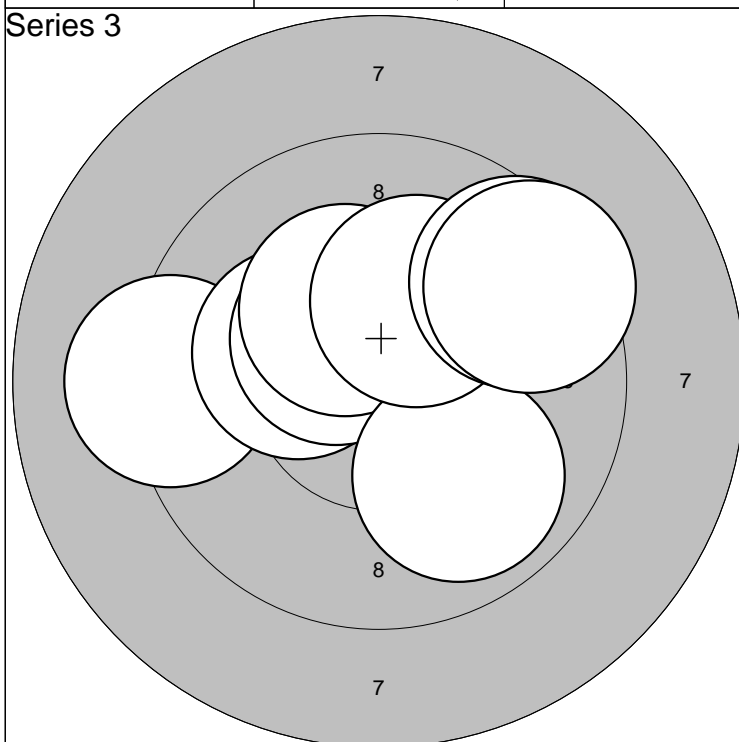

| | | | | | |
|----------|---|----------|---|-------|-------|
| 1: 9,2 | ↖ | 6: 10,3* | ↖ | Serie | 96,0 |
| 2: 10,5* | ↑ | 7: 9,9 | ↓ | | |
| 3: 10,4* | ↖ | 8: 10,2* | ↑ | Sum | 290,0 |
| 4: 10,2* | ↖ | 9: 9,5 | ↗ | | |
| 5: 10,4* | ↖ | 10: 9,4 | ↗ | | |

| | | | | | |
|----------|---|-----------|---|-------|-------|
| 1: 10,3* | ↗ | 6: 9,8 | ↖ | Serie | 96,0 |
| 2: 10,4* | ↖ | 7: 9,9 | ↖ | | |
| 3: 10,4* | ↓ | 8: 9,9 | ↖ | Sum | 386,0 |
| 4: 9,8 | ↖ | 9: 10,2* | ↖ | | |
| 5: 10,6* | ↑ | 10: 10,3* | ↓ | | |

Edman Precision, Morini, Interprodukter Sävsjö kommun, Sävsjö Skytte Center

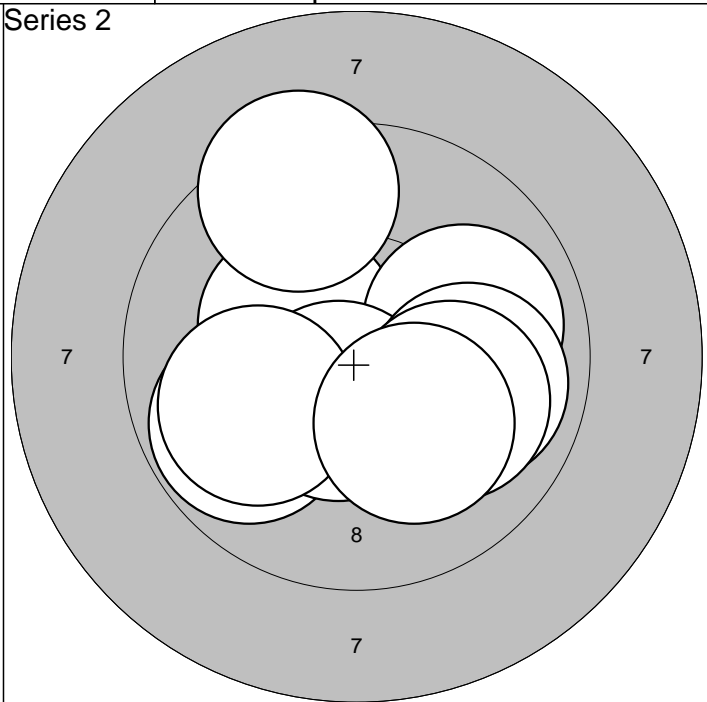
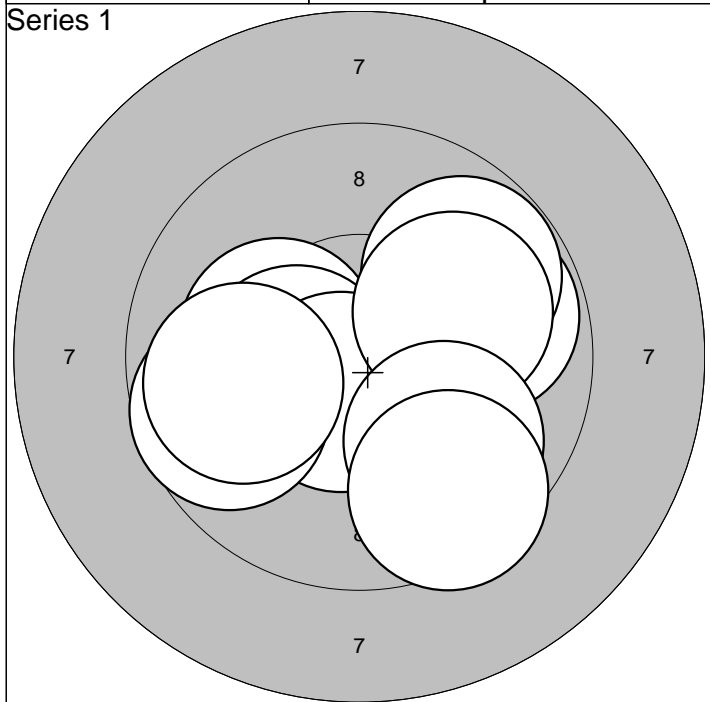

| | | | | | |
|-----------|-----------|--|--|-------|------|
| 1:10,2* ← | 6:10,0 → | | | | |
| 2: 9,8 → | 7: 9,9 ↓ | | | | |
| 3:10,4* ← | 8: 9,5 ↓ | | | Serie | 94,0 |
| 4:10,6* ↓ | 9: 9,7 ← | | | Sum | 94,0 |
| 5: 9,8 ↗ | 10: 9,9 ← | | | | |

| | | | | | |
|-----------|------------|--|--|-------|-------|
| 1:10,4* ← | 6:10,5* ↓ | | | | |
| 2:10,4* ← | 7:10,0 ← | | | | |
| 3: 9,4 ↑ | 8: 9,9 → | | | Serie | 97,0 |
| 4:10,0 → | 9:10,0 → | | | Sum | 191,0 |
| 5: 9,8 ← | 10:10,2* ↓ | | | | |

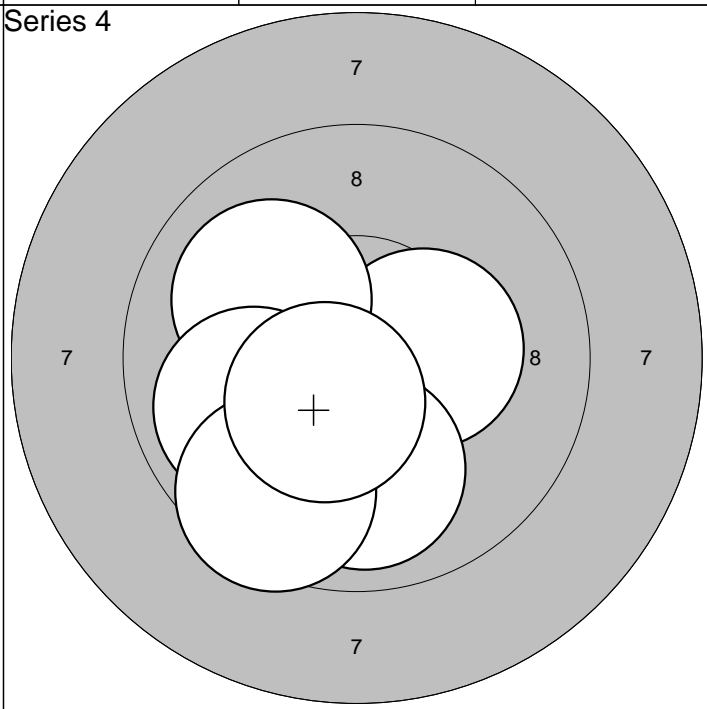
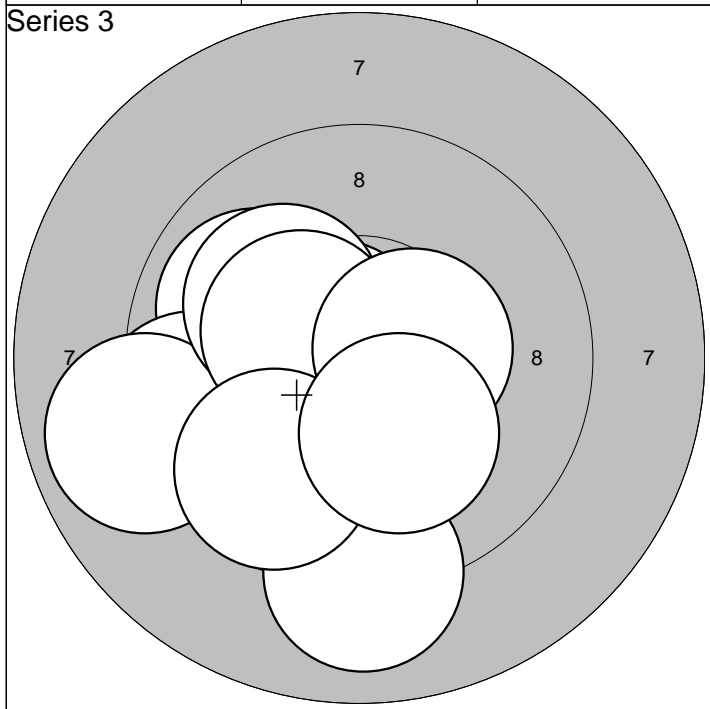

| | | | | | |
|-----------|------------|--|--|-------|-------|
| 1: 9,9 ↖ | 6:10,4* ← | | | | |
| 2: 9,4 ← | 7: 9,0 ↓ | | | | |
| 3:10,7* ↖ | 8: 9,7 ↓ | | | Serie | 94,0 |
| 4: 8,9 ← | 9:10,5* → | | | Sum | 285,0 |
| 5:10,1 ↖ | 10:10,2* ↓ | | | | |

| | | | | | |
|-----------|------------|--|--|-------|-------|
| 1:10,0 ↓ | 6:10,0 ↖ | | | | |
| 2:10,2* ← | 7:10,0 ↓ | | | | |
| 3:10,4* → | 8: 9,9 ← | | | Serie | 98,0 |
| 4:10,1 ↖ | 9: 9,5 ↓ | | | Sum | 383,0 |
| 5:10,3* ← | 10:10,5* ↓ | | | | |

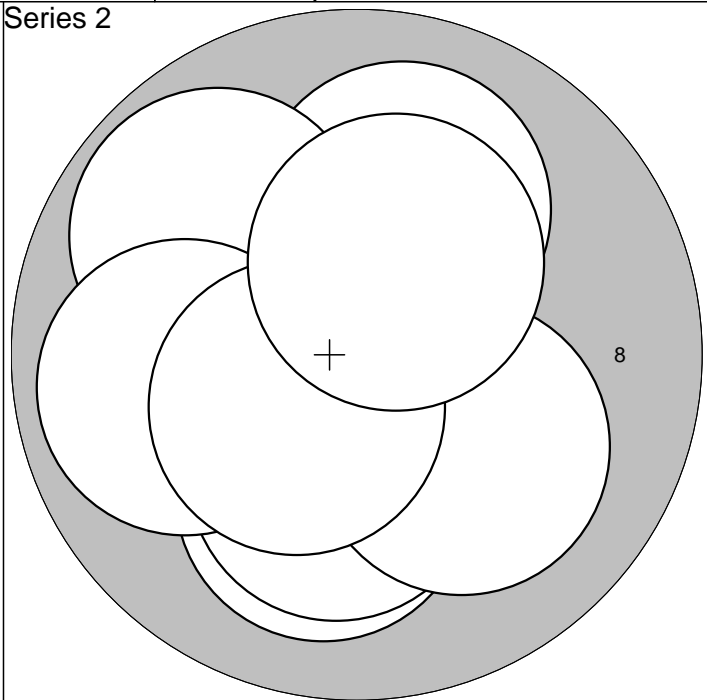
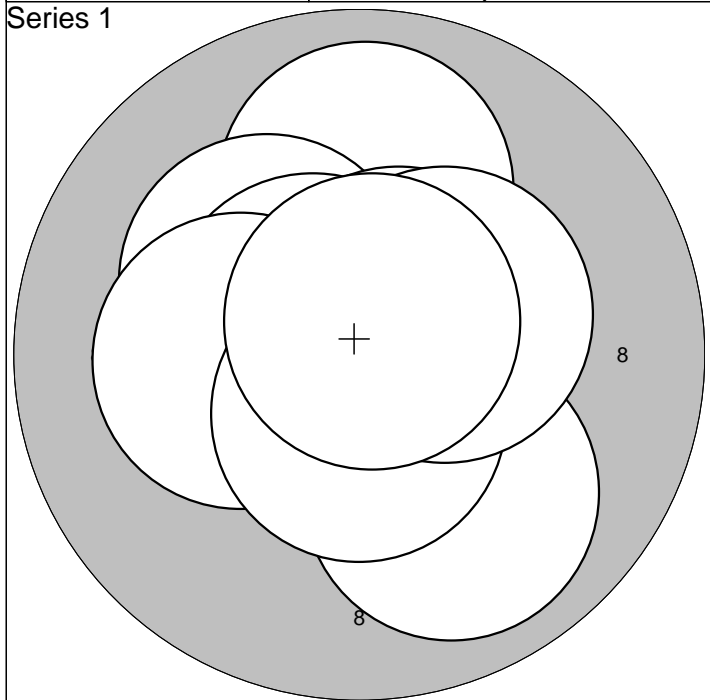

| | | | | | | | |
|---------|---|----------|---|-------|------|--|--|
| 1: 9,9 | ↘ | 6:10,6* | ↗ | | | | |
| 2: 9,9 | ↑ | 7:10,2* | ← | Serie | 98,0 | | |
| 3:10,2* | ↖ | 8:10,6* | ↓ | | | | |
| 4:10,7* | ← | 9:10,4* | ↗ | Sum | 98,0 | | |
| 5:10,6* | ↖ | 10:10,7* | ↑ | | | | |

| | | | | | | | |
|---------|---|----------|---|-------|-------|--|--|
| 1:10,9* | ↖ | 6:10,2* | ↓ | | | | |
| 2:10,5* | ↗ | 7: 9,9 | ← | Serie | 98,0 | | |
| 3:10,0 | ↑ | 8:10,1 | ↘ | | | | |
| 4:10,1 | ↓ | 9:10,5* | ↖ | Sum | 196,0 | | |
| 5: 9,9 | ↖ | 10:10,4* | ↑ | | | | |

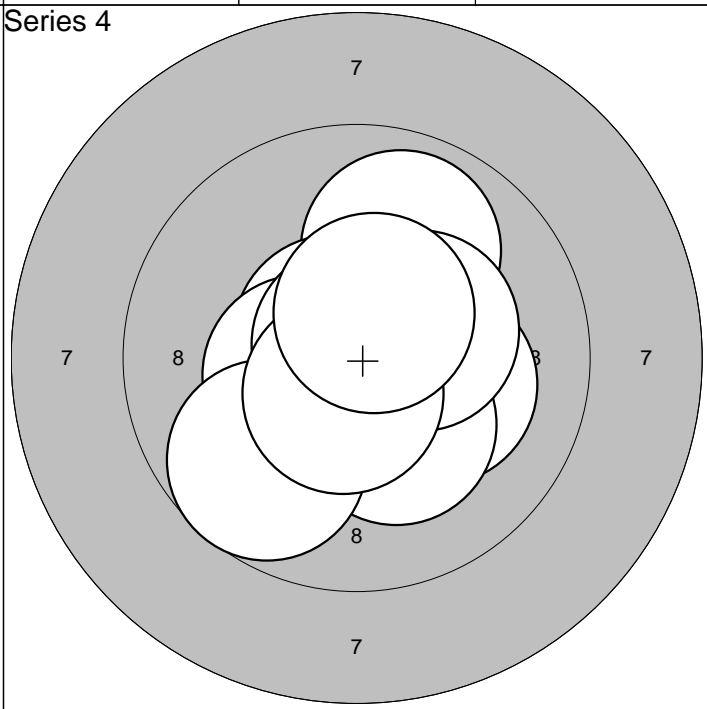
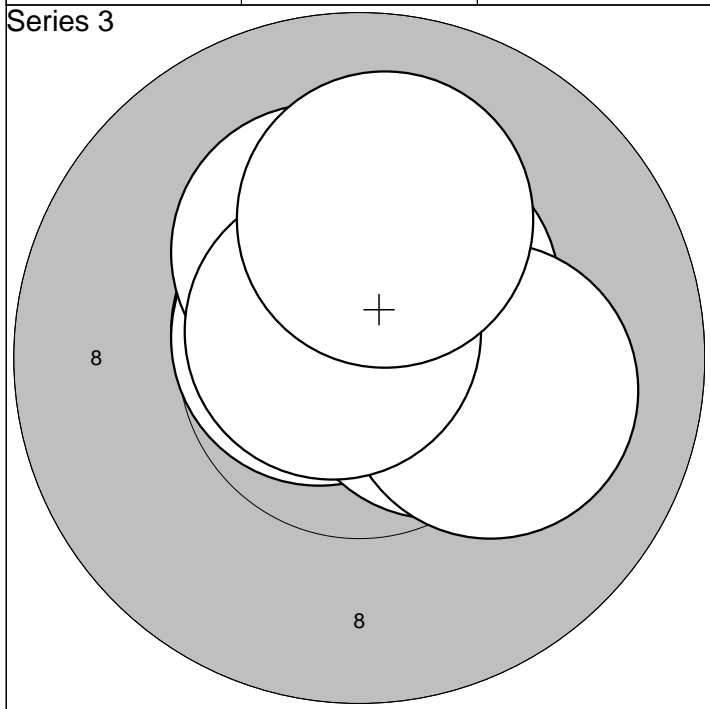

| | | | | | | | |
|---------|---|---------|---|-------|-------|--|--|
| 1:10,5* | ↑ | 6:10,5* | → | | | | |
| 2:10,4* | ↗ | 7:10,3* | ↗ | Serie | 100,0 | | |
| 3:10,7* | ↖ | 8:10,1 | → | | | | |
| 4:10,7* | ↖ | 9:10,7* | ↗ | Sum | 296,0 | | |
| 5:10,4* | ↗ | 10:10,1 | ↑ | | | | |

| | | | | | | | |
|---------|---|----------|---|-------|-------|--|--|
| 1:10,2* | → | 6:10,8* | ↗ | | | | |
| 2: 9,9 | ↑ | 7: 9,7 | ↘ | Serie | 98,0 | | |
| 3:10,3* | ↘ | 8:10,4* | ↗ | | | | |
| 4:10,7* | ↗ | 9:10,6* | ↘ | Sum | 394,0 | | |
| 5:10,4* | ← | 10:10,5* | ↑ | | | | |

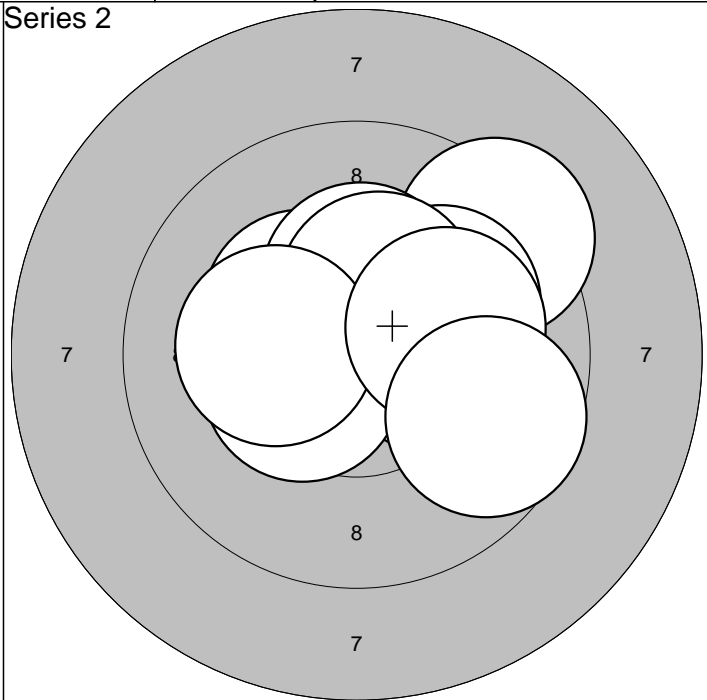
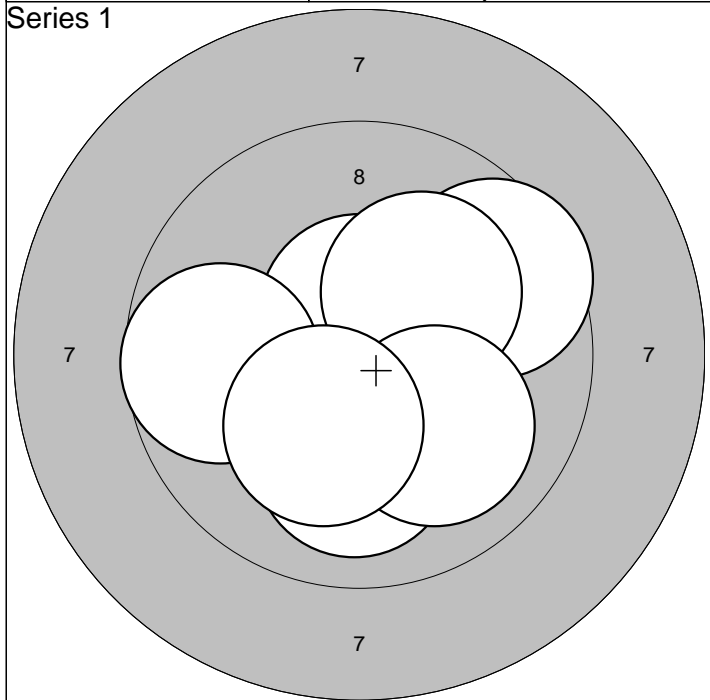

| | | | | | |
|-----------|------------|-----|------|--|--|
| 1:10,8* ↓ | 6: 9,5 ↗ | | | | |
| 2:10,0 ↓ | 7:10,2* ↗ | | | | |
| 3:10,7* ↓ | 8: 9,7 ← | Sum | 98,0 | | |
| 4:10,3* ↓ | 9:10,0 ↓ | | | | |
| 5:10,6* ↑ | 10:10,2* ↓ | | | | |

| | | | | | |
|-----------|-----------|-----|-------|--|--|
| 1:10,3* ↖ | 6:10,2* → | | | | |
| 2: 9,3 ↗ | 7:10,4* ← | | | | |
| 3:10,1 ↗ | 8:10,2* ← | Sum | 196,0 | | |
| 4:10,3* ↑ | 9:10,1 → | | | | |
| 5:10,4* ↑ | 10: 9,7 ↘ | | | | |

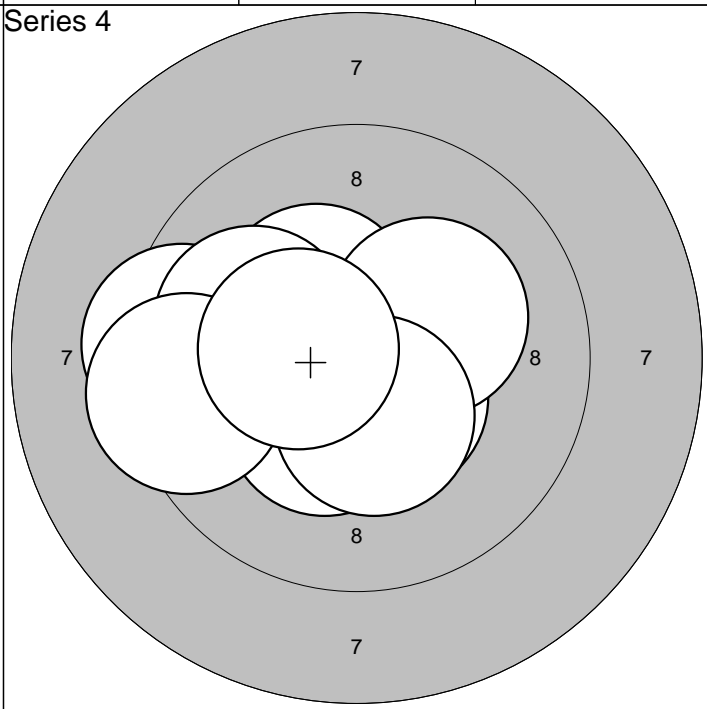
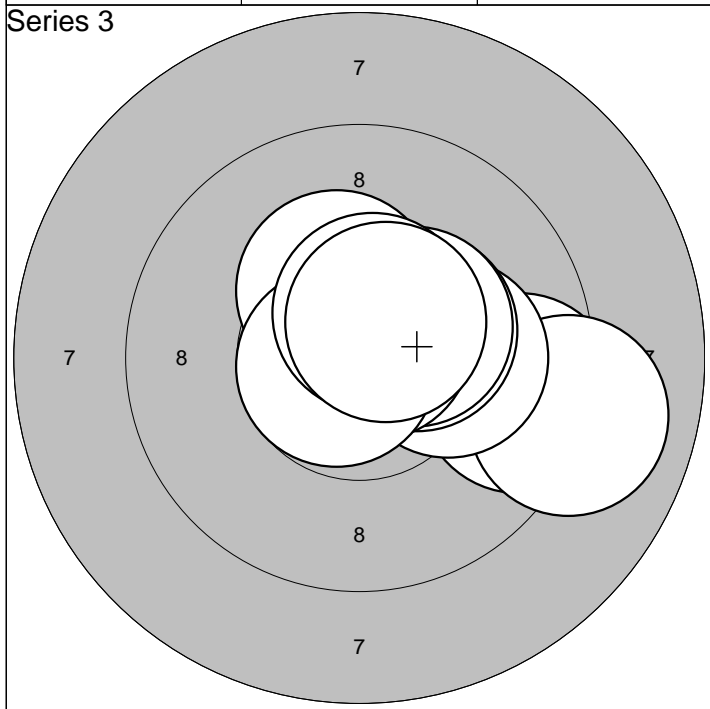

| | | | | | |
|-----------|------------|-----|-------|--|--|
| 1: 9,5 → | 6:10,4* ↗ | | | | |
| 2: 9,0 → | 7:10,8* ↗ | | | | |
| 3:10,1 → | 8:10,7* ← | Sum | 294,0 | | |
| 4:10,3* ↑ | 9:10,5* ↑ | | | | |
| 5:10,4* ↗ | 10:10,6* ↗ | | | | |

| | | | | | |
|-----------|------------|-----|-------|--|--|
| 1:10,4* ↓ | 6: 9,4 ← | | | | |
| 2:10,5* ↓ | 7:10,0 ← | | | | |
| 3:10,3* ↖ | 8:10,4* ↓ | Sum | 392,0 | | |
| 4:10,8* ← | 9: 9,4 ← | | | | |
| 5:10,2* ↗ | 10:10,4* ← | | | | |

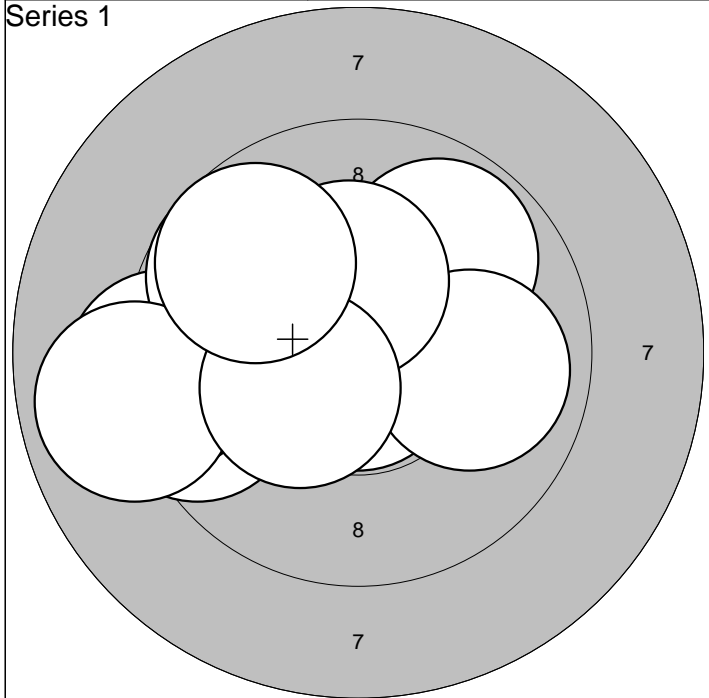

| | | | |
|-----------|-----------|-------|------|
| 1: 9,4 ← | 6:10,3* ↑ | Serie | 92,0 |
| 2:10,8* ↓ | 7: 9,7 ↖ | | |
| 3: 9,2 ← | 8: 8,9 ← | Sum | 92,0 |
| 4: 9,8 ↗ | 9:10,4* ← | | |
| 5: 9,9 → | 10: 9,7 ↖ | | |

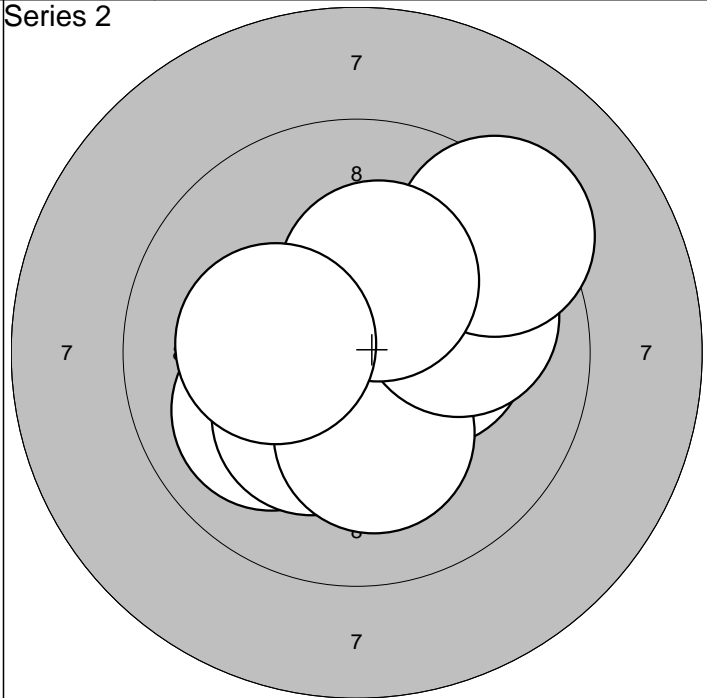

| | | | |
|-----------|------------|-------|-------|
| 1:10,0 ↙ | 6:10,2* ↓ | Serie | 99,0 |
| 2:10,3* → | 7:10,0 → | | |
| 3:10,7* ↘ | 8: 9,3 ↗ | Sum | 191,0 |
| 4:10,6* ↗ | 9:10,3* ↑ | | |
| 5:10,3* ↘ | 10:10,2* ← | | |

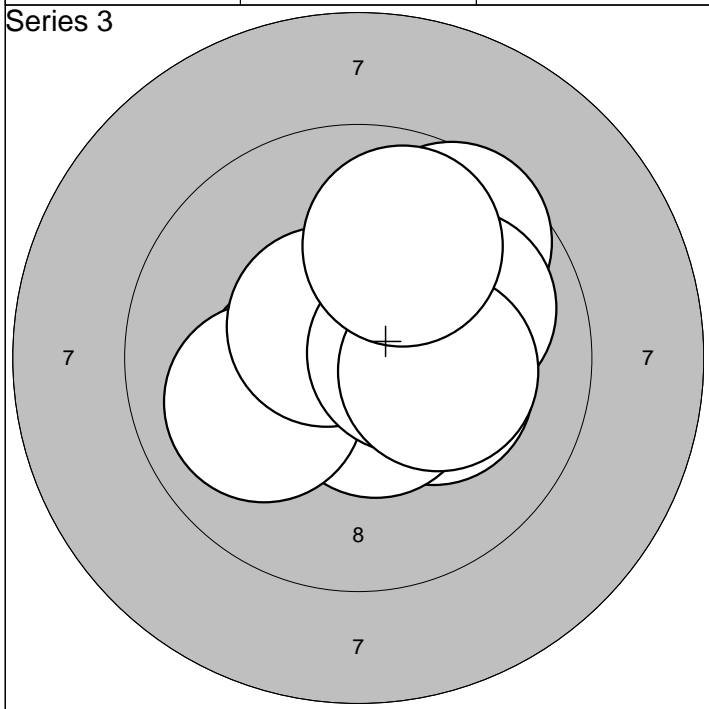

| | | | |
|-----------|-----------|-------|-------|
| 1: 9,6 ↗ | 6:10,0 ← | Serie | 98,0 |
| 2:10,0 → | 7:10,6* ↖ | | |
| 3:10,4* ← | 8:10,5* → | Sum | 289,0 |
| 4:10,2* → | 9:10,2* → | | |
| 5:10,5* ↓ | 10: 9,9 ↑ | | |

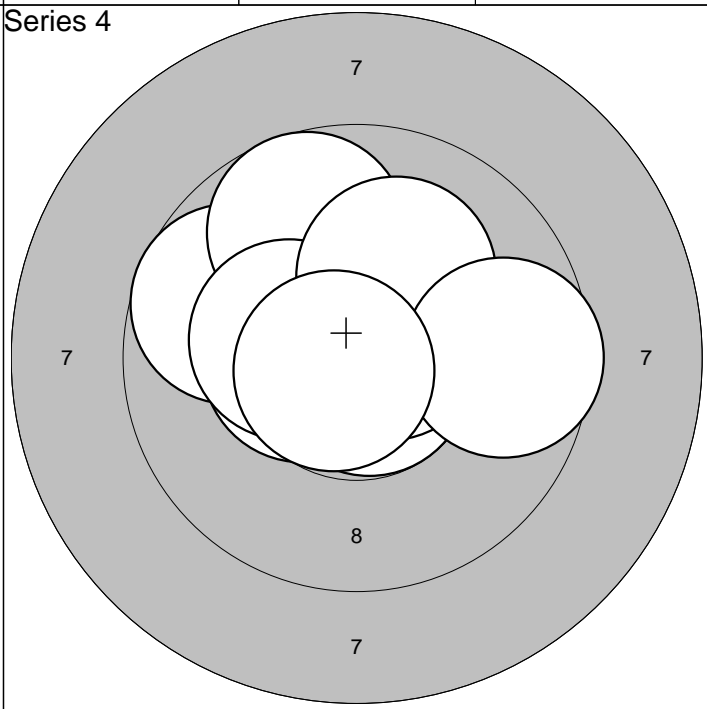

| | | | |
|-----------|------------|-------|-------|
| 1: 9,7 ↖ | 6:10,3* ← | Serie | 97,0 |
| 2:10,7* ← | 7:10,6* → | | |
| 3:10,5* ← | 8:10,1 ↑ | Sum | 386,0 |
| 4:10,7* ↘ | 9: 9,6 → | | |
| 5: 9,8 ↑ | 10:10,7* ← | | |

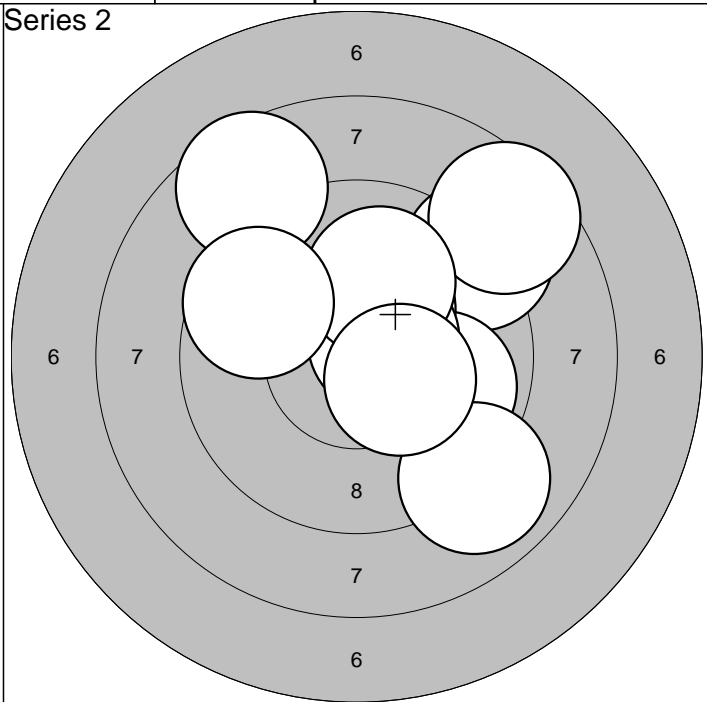
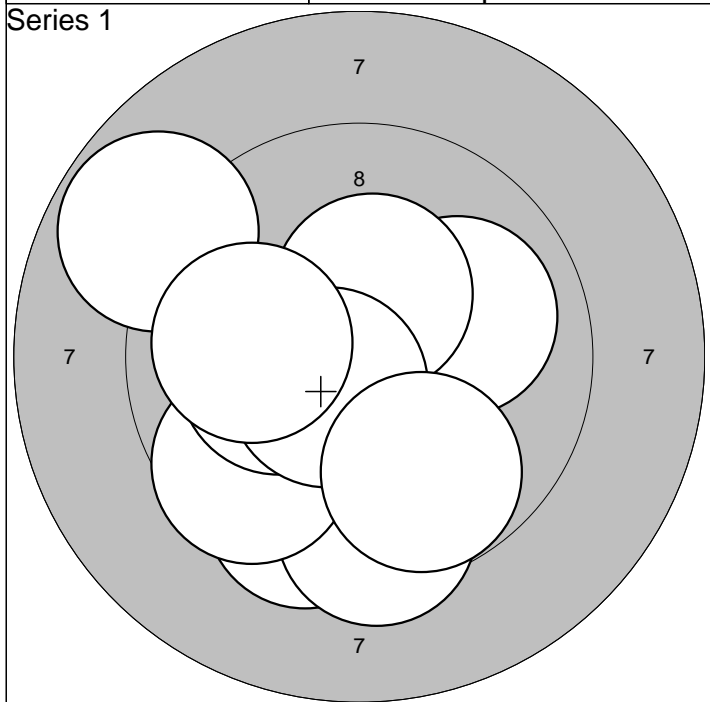

| | | | |
|-----------|-----------|-------|------|
| 1: 9,5 ↓ | 6:10,2* ← | Serie | 94,0 |
| 2:10,0 → | 7:10,6* ↙ | | |
| 3: 9,4 ↓ | 8: 8,8 ↖ | Sum | 94,0 |
| 4: 9,6 ↙ | 9:10,0 ← | | |
| 5:10,4* ↑ | 10: 9,8 ↓ | | |

| | | | |
|-----------|------------|-------|-------|
| 1: 9,1 ↗ | 6:10,6* ↗ | Serie | 91,0 |
| 2: 9,9 → | 7: 8,5 ↗ | | |
| 3:10,3* ↗ | 8:10,0 ↑ | Sum | 185,0 |
| 4: 8,6 ↗ | 9: 9,6 ↖ | | |
| 5: 8,9 ↓ | 10:10,3* ↘ | | |

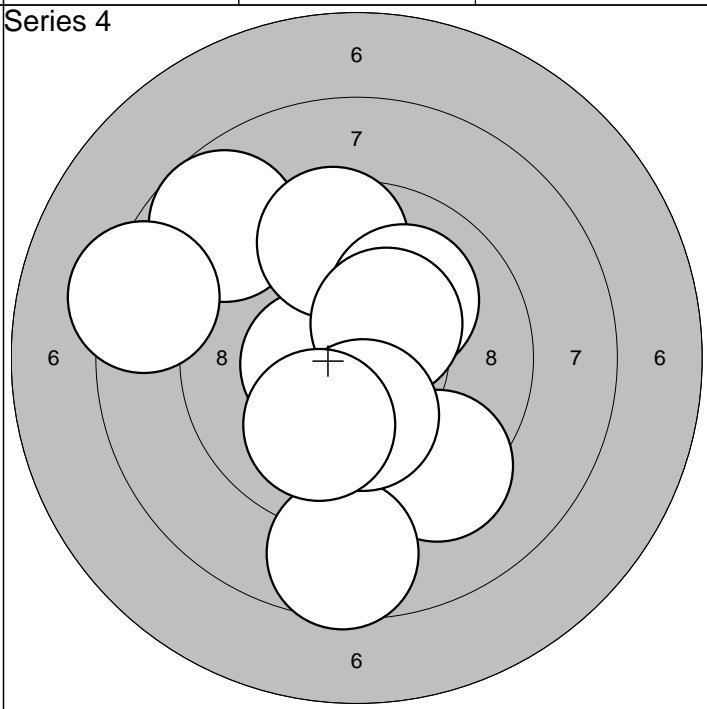
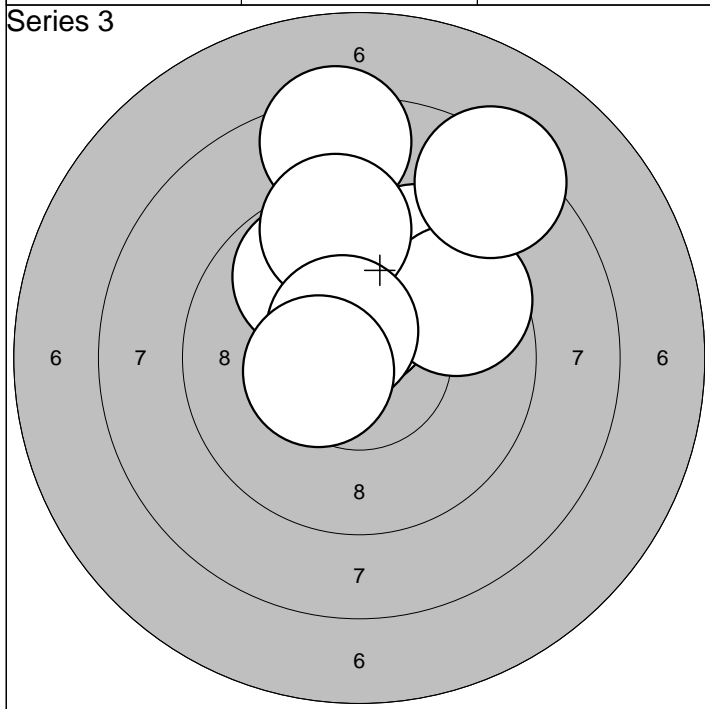

| | | | |
|-----------|------------|-------|-------|
| 1: 9,7 ↗ | 6: 9,6 ↗ | Serie | 91,0 |
| 2: 9,6 ↗ | 7: 9,4 ↑ | | |
| 3:10,4* ↑ | 8: 8,4 ↗ | Sum | 276,0 |
| 4: 9,8 ↖ | 9:10,6* ↖ | | |
| 5: 8,4 ↑ | 10:10,4* ← | | |

| | | | |
|-----------|-----------|-------|-------|
| 1: 8,7 ↖ | 6:10,4* ↗ | Serie | 92,0 |
| 2:10,5* ← | 7: 9,3 ↓ | | |
| 3: 8,3 ← | 8: 8,6 ↓ | Sum | 368,0 |
| 4: 9,6 ↑ | 9:10,3* ↓ | | |
| 5:10,1 ↗ | 10:10,0 ↙ | | |

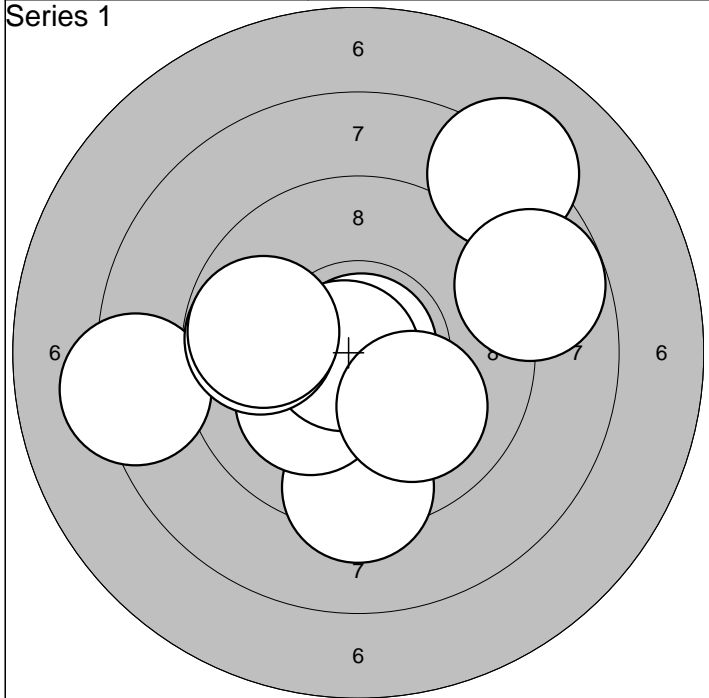

| | | | |
|------------|------------|-------|------|
| 1: 9,3 ↓ | 6: 10,8* ← | Serie | 91,0 |
| 2: 8,2 ↗ | 7: 10,1 ↘ | | |
| 3: 10,9* ↗ | 8: 8,7 → | Sum | 91,0 |
| 4: 8,3 ← | 9: 9,8 ← | | |
| 5: 10,2* ↙ | 10: 9,8 ← | | |

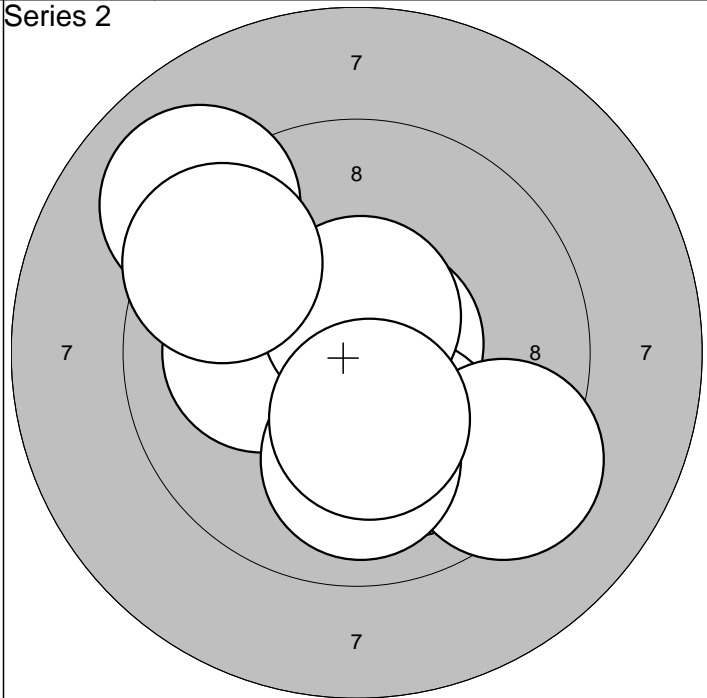

| | | | |
|------------|------------|-------|-------|
| 1: 10,7* → | 6: 10,0 ↓ | Serie | 97,0 |
| 2: 10,7* ↑ | 7: 10,6* ↑ | | |
| 3: 10,1 ← | 8: 10,3* ↓ | Sum | 188,0 |
| 4: 10,1 ↓ | 9: 9,0 ↗ | | |
| 5: 9,3 ↘ | 10: 9,5 ↗ | | |

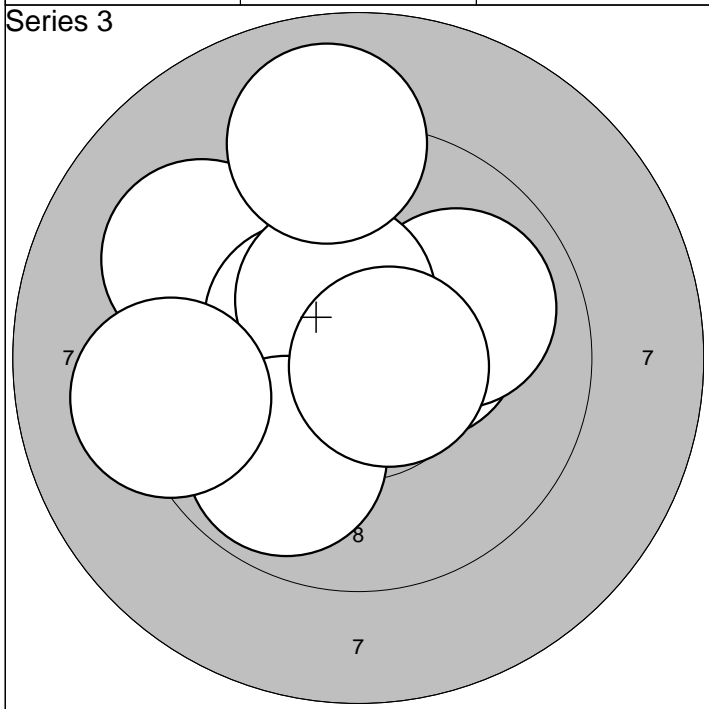

| | | | |
|------------|------------|-------|-------|
| 1: 10,4* → | 6: 10,4* ↑ | Serie | 95,0 |
| 2: 10,0 → | 7: 9,9 ↓ | | |
| 3: 9,8 ↖ | 8: 10,7* → | Sum | 283,0 |
| 4: 9,3 ↖ | 9: 9,2 ← | | |
| 5: 10,4* ↖ | 10: 9,0 ↑ | | |

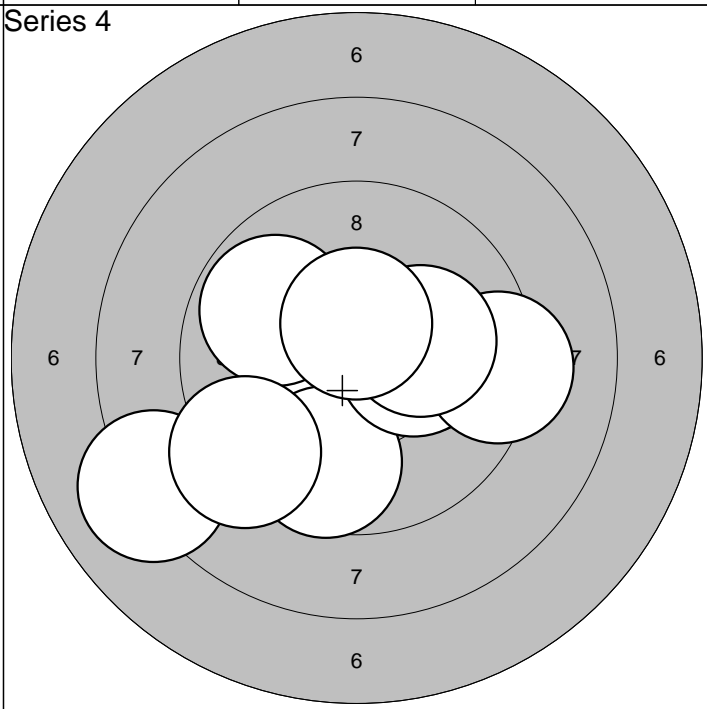

| | | | |
|------------|-------------|-------|-------|
| 1: 9,8 ↓ | 6: 9,8 ↖ | Serie | 93,0 |
| 2: 9,7 ↓ | 7: 9,3 → | | |
| 3: 10,2* → | 8: 9,2 ↙ | Sum | 376,0 |
| 4: 8,1 ← | 9: 10,2* → | | |
| 5: 10,3* → | 10: 10,5* ↑ | | |

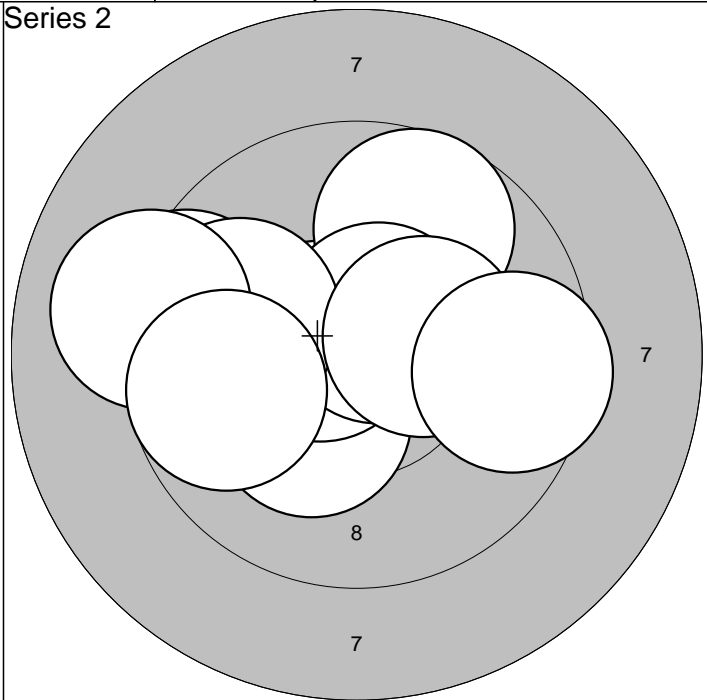
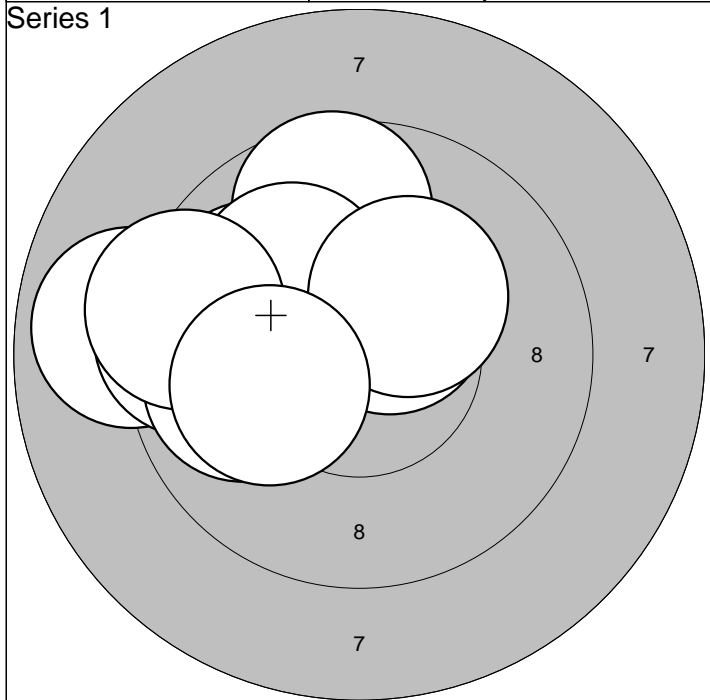

| | | | | | | | |
|----------|---|----------|---|-------|------|--|--|
| 1: 9,7 | ↑ | 6: 10,3* | ↗ | | | | |
| 2: 8,9 | ← | 7: 9,5 | ← | Serie | 93,0 | | |
| 3: 10,5* | ↗ | 8: 9,9 | ← | | | | |
| 4: 9,9 | ↖ | 9: 9,3 | ← | Sum | 93,0 | | |
| 5: 10,1 | ↗ | 10: 10,1 | ← | | | | |

| | | | | | | | |
|----------|---|----------|---|-------|-------|--|--|
| 1: 10,3* | ↘ | 6: 9,9 | ← | | | | |
| 2: 9,4 | ← | 7: 9,1 | ← | Serie | 94,0 | | |
| 3: 10,6* | ↖ | 8: 10,4* | → | | | | |
| 4: 9,7 | ↗ | 9: 9,6 | → | Sum | 187,0 | | |
| 5: 10,6* | ↗ | 10: 9,7 | ← | | | | |

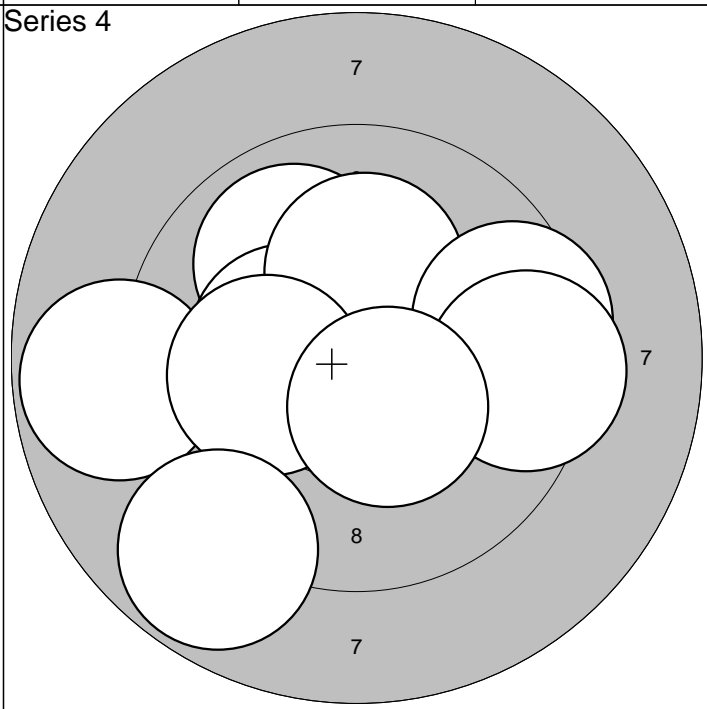
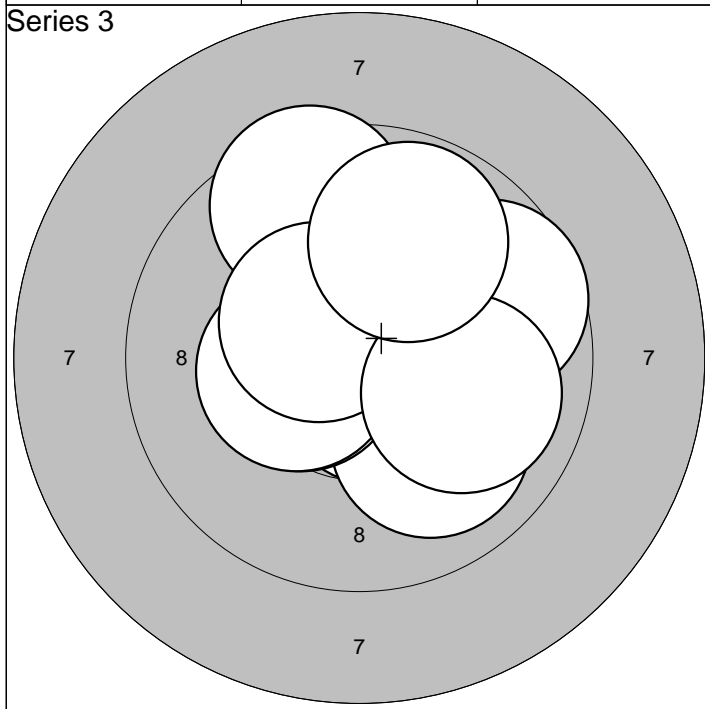

| | | | | | | | |
|----------|---|----------|---|-------|-------|--|--|
| 1: 10,7* | ↘ | 6: 10,4* | ← | | | | |
| 2: 10,4* | → | 7: 9,7 | → | Serie | 97,0 | | |
| 3: 10,0 | ↘ | 8: 10,5* | ↖ | | | | |
| 4: 10,4* | ← | 9: 10,0 | → | Sum | 284,0 | | |
| 5: 9,5 | ↗ | 10: 9,8 | ↗ | | | | |

| | | | | | | | |
|----------|---|----------|---|-------|-------|--|--|
| 1: 10,0 | ↗ | 6: 10,1 | ← | | | | |
| 2: 10,3* | ← | 7: 9,5 | → | Serie | 94,0 | | |
| 3: 10,7* | ← | 8: 9,4 | → | | | | |
| 4: 10,2* | ↗ | 9: 10,4* | ↘ | Sum | 378,0 | | |
| 5: 8,8 | ← | 10: 8,8 | ↘ | | | | |

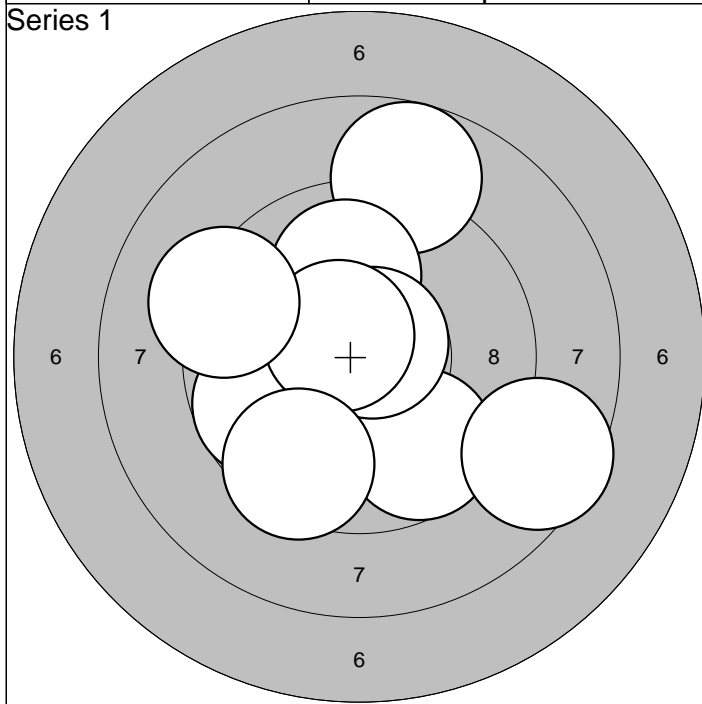

| | | | | | |
|--------|---|---------|---|-------|------|
| 1: 8,8 | ↑ | 6:10,7* | ↗ | Serie | 92,0 |
| 2:10,0 | ↑ | 7: 8,5 | → | | |
| 3: 9,7 | ↘ | 8:10,6* | ↗ | Sum | 92,0 |
| 4:10,0 | ← | 9: 9,5 | ↘ | | |
| 5: 9,7 | ↙ | 10: 9,2 | ← | | |

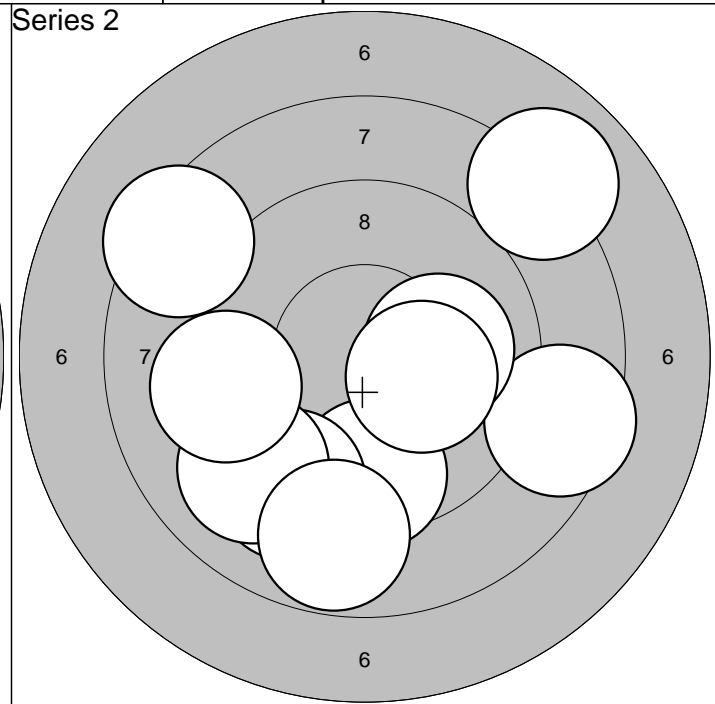

| | | | | | |
|--------|---|----------|---|-------|-------|
| 1: 9,5 | ↓ | 6: 9,3 | ← | Serie | 88,0 |
| 2: 9,2 | ↘ | 7: 8,8 | ↓ | | |
| 3: 9,1 | ↙ | 8:10,1 | → | Sum | 180,0 |
| 4: 8,4 | ↗ | 9: 8,0 | ↗ | | |
| 5: 8,5 | → | 10:10,2* | → | | |

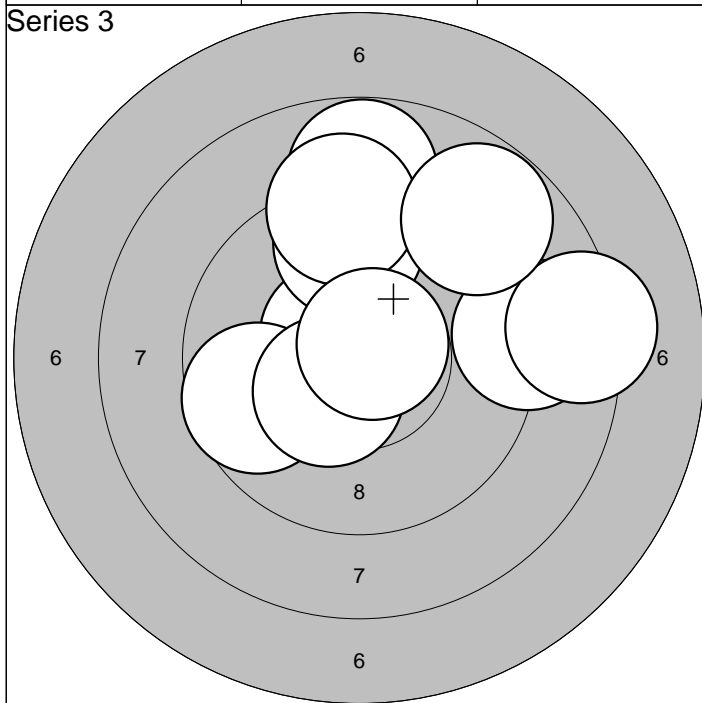

| | | | | | |
|---------|---|----------|---|-------|-------|
| 1:10,6* | ↖ | 6: 8,3 | → | Serie | 89,0 |
| 2: 9,7 | ← | 7: 9,2 | ↑ | | |
| 3: 8,8 | ↑ | 8: 8,8 | ↗ | Sum | 269,0 |
| 4: 9,6 | ↑ | 9:10,4* | ↘ | | |
| 5: 8,9 | → | 10:10,7* | ↗ | | |

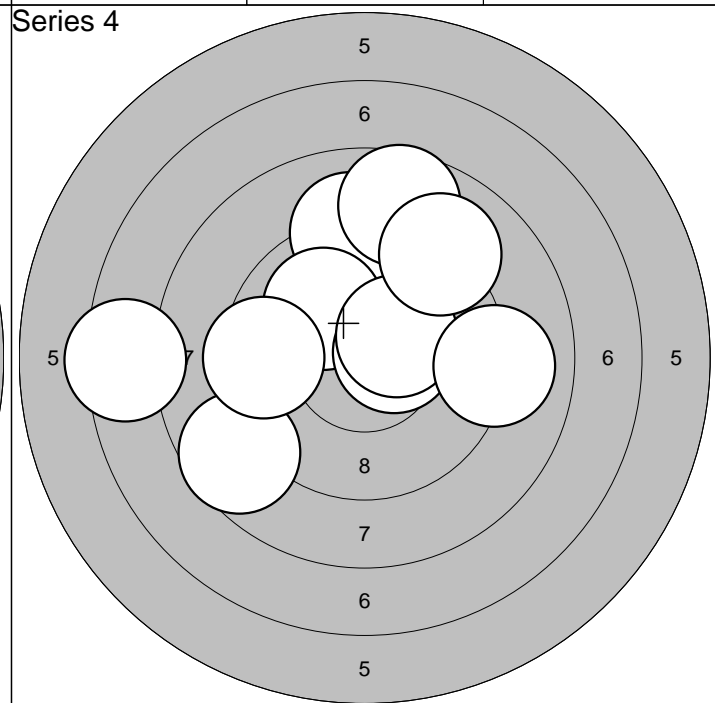

| | | | | | |
|---------|---|---------|---|-------|-------|
| 1: 9,1 | ↑ | 6:10,4* | ↗ | Serie | 89,0 |
| 2:10,0 | ↖ | 7: 7,4 | ← | | |
| 3:10,5* | → | 8: 9,0 | ↗ | Sum | 358,0 |
| 4: 8,7 | ↑ | 9: 9,5 | ← | | |
| 5: 8,6 | ↙ | 10: 9,0 | → | | |

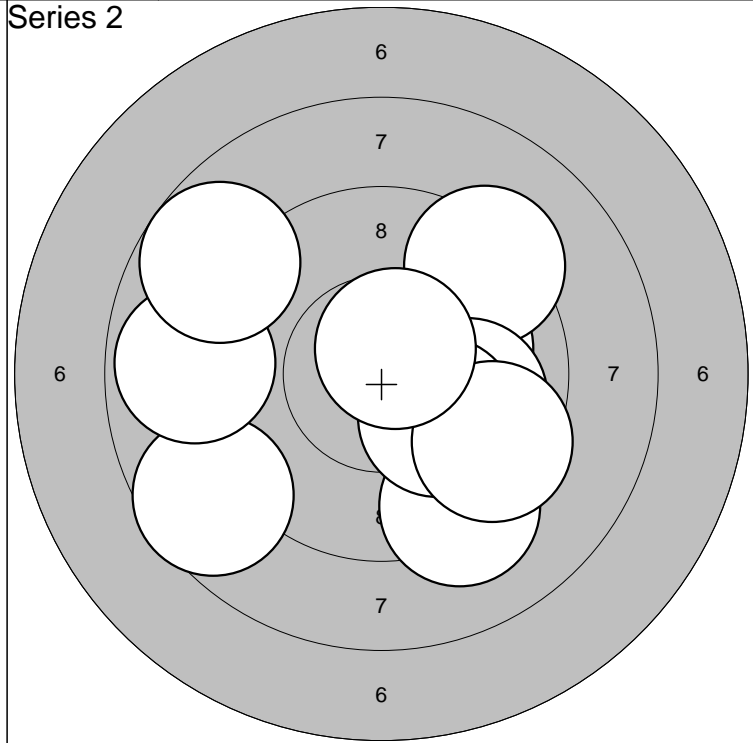

| | | | |
|-----------|------------|-------|------|
| 1:10,3* ↖ | 6: 9,1 ↑ | Serie | 96,0 |
| 2:10,0 → | 7:10,2* → | | |
| 3:10,7* ↖ | 8: 9,2 ← | Sum | 96,0 |
| 4:10,1 ↑ | 9: 8,3 ↖ | | |
| 5:10,5* ← | 10:10,4* ↑ | | |

| | | | |
|----------|------------|-------|-------|
| 1: 8,6 ↙ | 6: 9,2 ↘ | Serie | 91,0 |
| 2:10,1 → | 7:10,0 → | | |
| 3: 8,9 ← | 8:10,2* ↘ | Sum | 187,0 |
| 4: 8,8 ↖ | 9: 9,5 ↘ | | |
| 5: 9,3 ↗ | 10:10,6* ↑ | | |

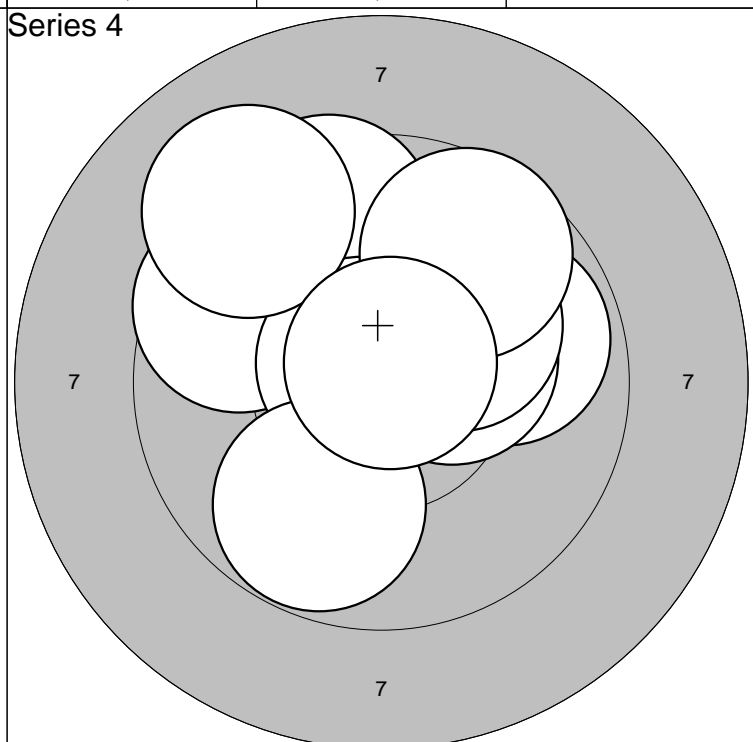
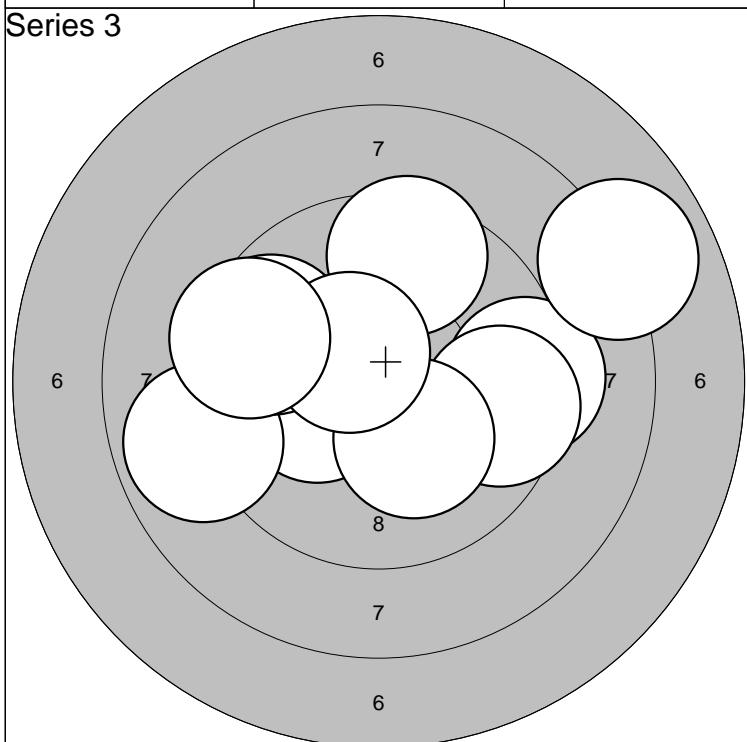

| | | | |
|-----------|-----------|-------|-------|
| 1: 9,3 → | 6:10,2* ↘ | Serie | 91,0 |
| 2: 9,5 ↑ | 7: 8,0 → | | |
| 3:10,2* ← | 8: 9,7 ↖ | Sum | 278,0 |
| 4: 8,9 ← | 9:10,5* ↗ | | |
| 5: 9,6 → | 10: 9,4 ← | | |

| | | | |
|-----------|------------|-------|-------|
| 1: 9,8 → | 6: 9,8 ↘ | Serie | 94,0 |
| 2: 9,6 ↖ | 7:10,1 ↗ | | |
| 3:10,3* → | 8: 9,6 ↗ | Sum | 372,0 |
| 4: 9,5 ↑ | 9: 9,1 ↖ | | |
| 5:10,7* ↖ | 10:10,8* ↗ | | |

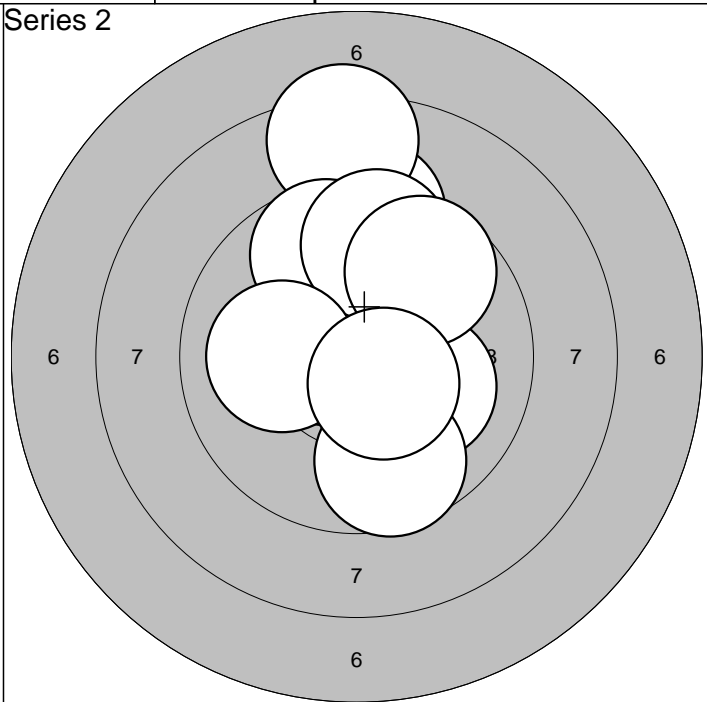
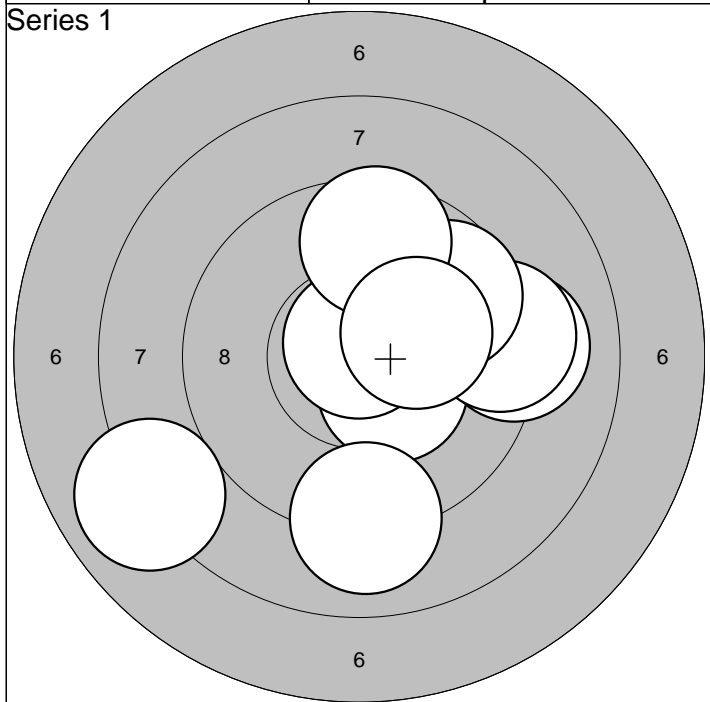

| | | |
|-----------|------------|------------|
| 1:10,4* ↘ | 6:10,8* ↑ | Serie 93,0 |
| 2:10,2* ↗ | 7: 9,7 ↗ | |
| 3: 8,0 ↙ | 8: 9,0 ↓ | Sum 93,0 |
| 4: 9,1 → | 9: 9,6 ↑ | |
| 5: 9,2 → | 10:10,2* ↗ | |

| | | |
|-----------|------------|------------|
| 1: 9,3 ↑ | 6:10,1 ← | Serie 93,0 |
| 2:10,6* ← | 7:10,1 → | |
| 3: 8,4 ↑ | 8: 9,7 ↗ | Sum 186,0 |
| 4: 9,7 ↑ | 9: 9,7 ↓ | |
| 5: 9,6 ↑ | 10:10,5* ↘ | |

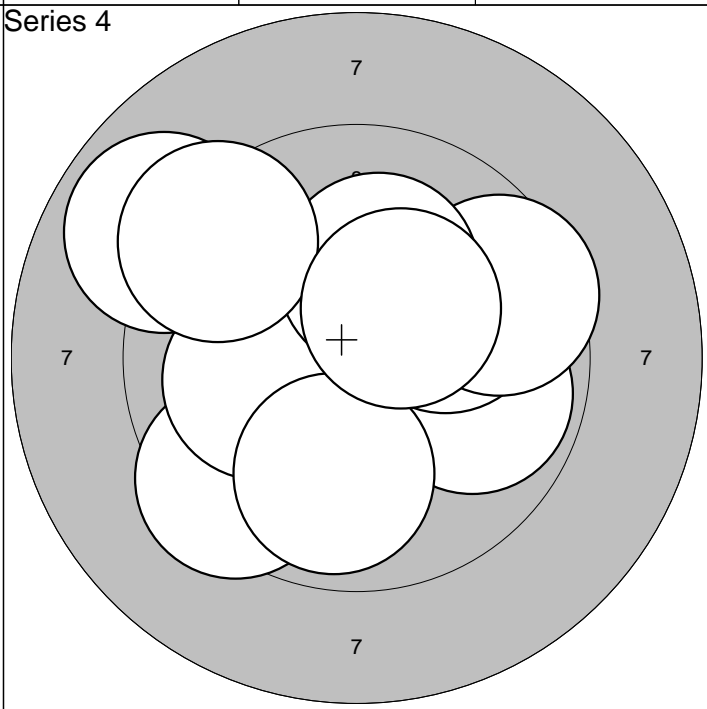
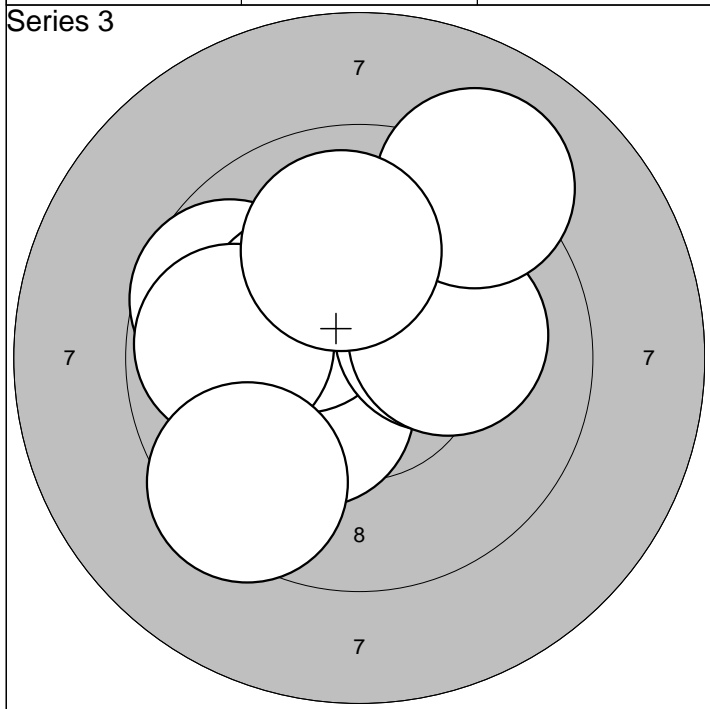

| | | |
|-----------|-----------|------------|
| 1:10,6* ↖ | 6: 9,8 ← | Serie 96,0 |
| 2: 9,7 ↙ | 7: 9,5 ↙ | |
| 3:10,4* ↘ | 8:10,1 → | Sum 282,0 |
| 4:10,3* ↖ | 9: 9,1 ↗ | |
| 5:10,2* → | 10:10,0 ↑ | |

| | | |
|----------|------------|------------|
| 1: 9,4 ↙ | 6: 9,9 ↓ | Serie 93,0 |
| 2:10,1 ← | 7: 9,6 ↗ | |
| 3: 9,9 → | 8:10,2* ↑ | Sum 375,0 |
| 4:10,1 ↗ | 9: 9,4 ↖ | |
| 5: 8,9 ↖ | 10:10,4* ↗ | |

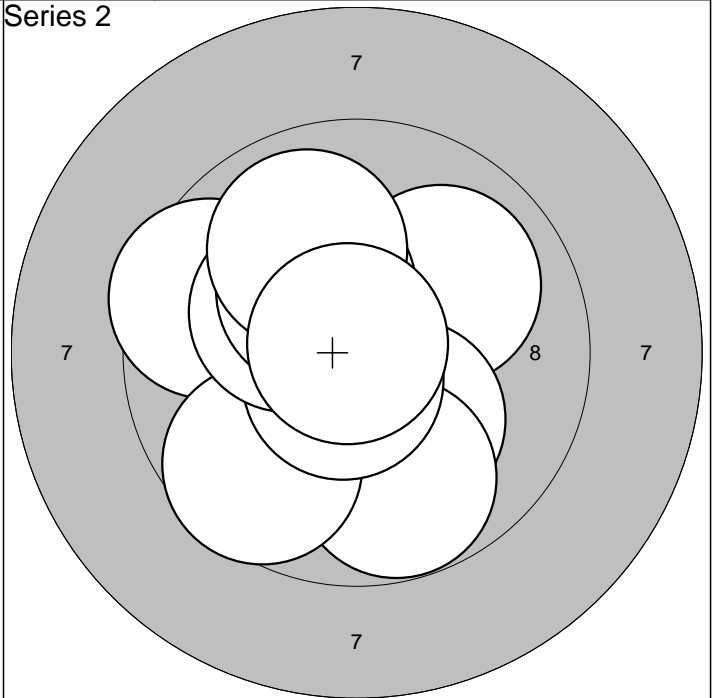
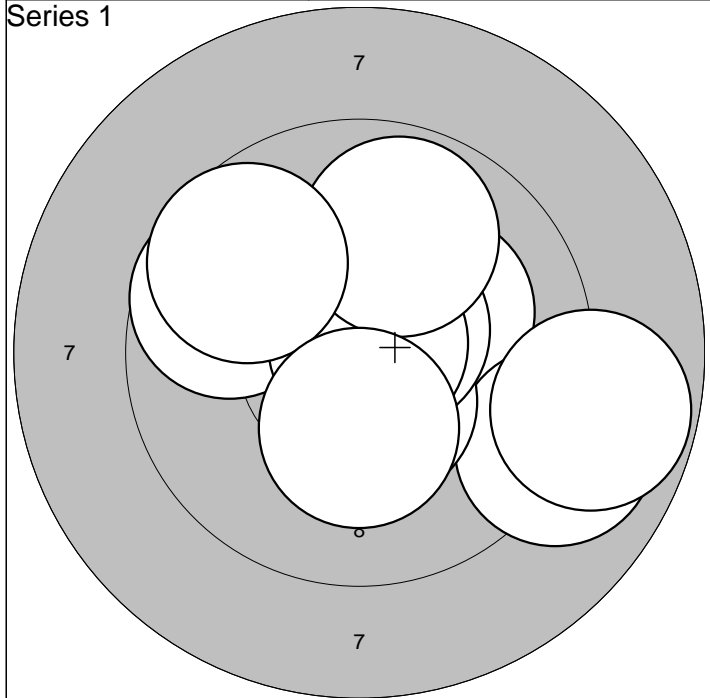

| | | | |
|-----------|-----------|-------|------|
| 1:10,2* ↗ | 6:10,9* ↗ | Serie | 94,0 |
| 2: 9,0 ↘ | 7: 9,8 ↑ | | |
| 3:10,5* ↓ | 8: 9,7 ↖ | Sum | 94,0 |
| 4: 9,7 ↖ | 9:10,3* ↓ | | |
| 5:10,6* ↗ | 10: 8,8 → | | |

| | | | |
|-----------|------------|-------|-------|
| 1:10,0 ↗ | 6:10,7* ↓ | Serie | 96,0 |
| 2: 9,5 ↖ | 7:10,3* ↖ | | |
| 3:10,2* ↓ | 8:10,3* ↗ | Sum | 190,0 |
| 4: 9,8 ↓ | 9: 9,9 ↑ | | |
| 5: 9,7 ↘ | 10:10,8* ↗ | | |

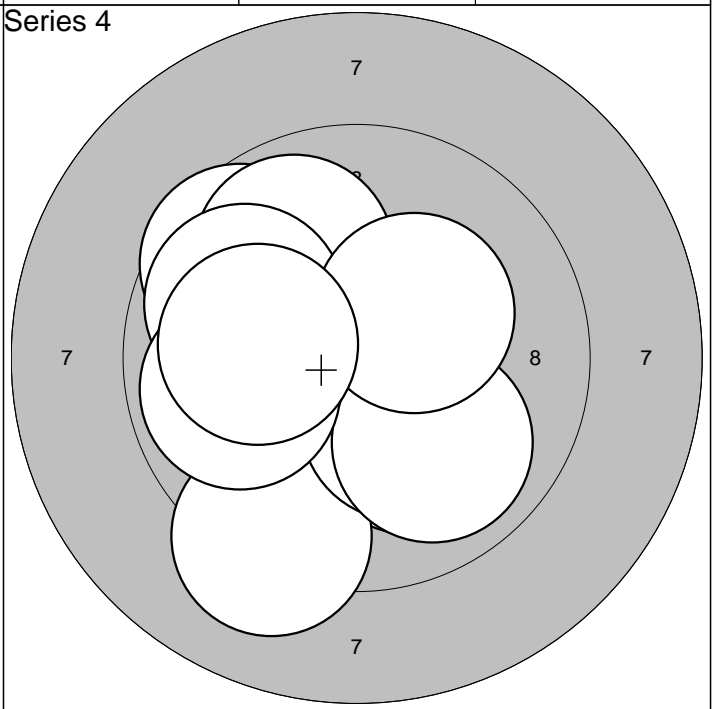
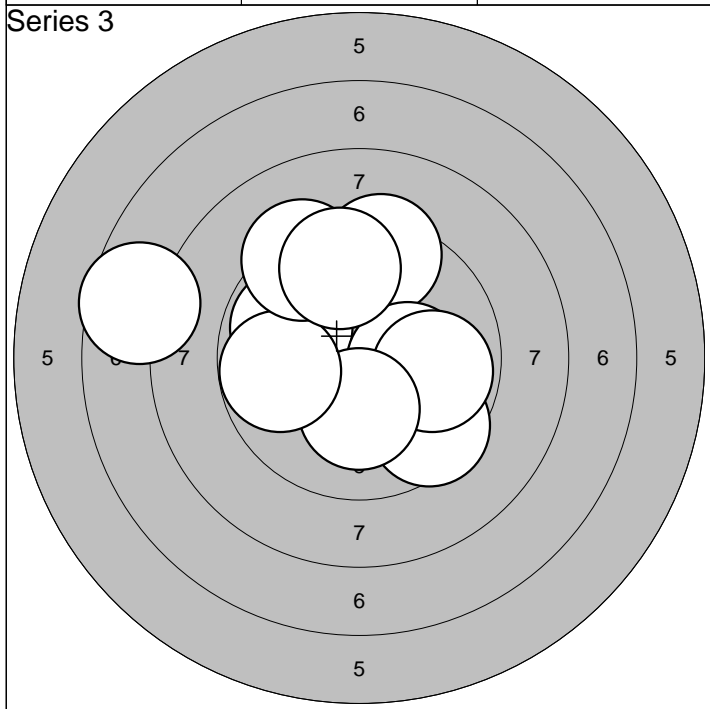

| | | | |
|-----------|-----------|-------|-------|
| 1: 7,6 ↖ | 6: 9,8 → | Serie | 90,0 |
| 2: 9,9 ↖ | 7:10,2* ↓ | | |
| 3: 9,5 ↘ | 8: 9,8 ↖ | Sum | 280,0 |
| 4: 9,4 ↑ | 9: 9,3 ↗ | | |
| 5:10,2* → | 10: 9,6 ↑ | | |

| | | | |
|-----------|-----------|-------|-------|
| 1:10,1 ↓ | 6: 9,9 ↗ | Serie | 94,0 |
| 2: 9,6 ↗ | 7: 9,8 ↖ | | |
| 3: 9,2 ↓ | 8:10,3* ↗ | Sum | 374,0 |
| 4:10,3* ↓ | 9: 9,9 ↖ | | |
| 5: 9,9 ↓ | 10:10,1 ↖ | | |

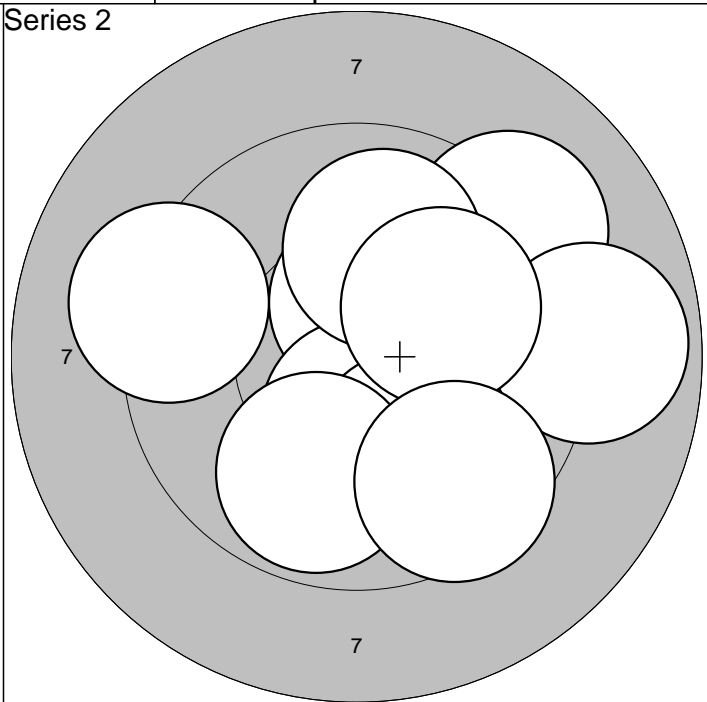
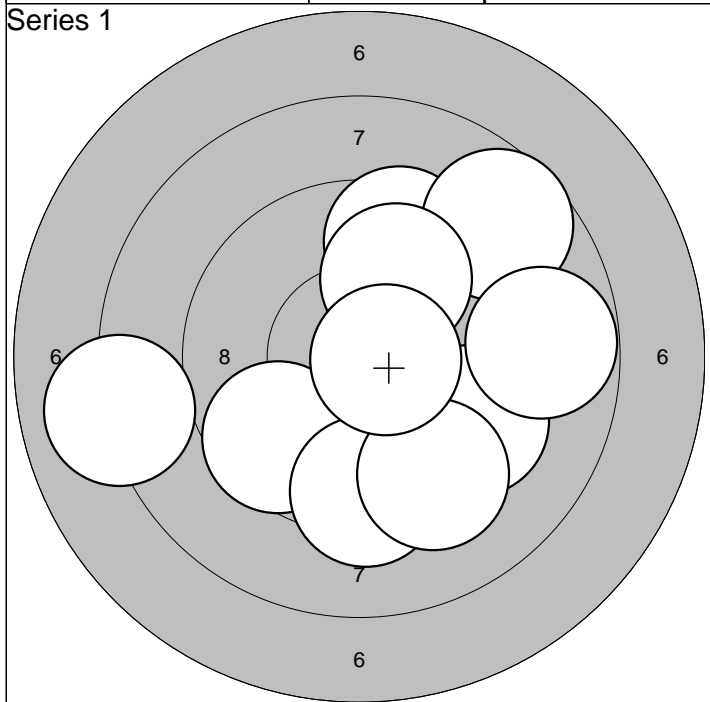

| | | | | |
|----------|------------|-----|-------|------|
| 1: 9,5 ↗ | 6: 9,4 ↘ | | Serie | 88,0 |
| 2: 8,0 ← | 7: 9,3 ↓ | | | |
| 3: 8,7 ↗ | 8: 9,3 ↓ | Sum | 88,0 | |
| 4: 9,9 ↗ | 9: 8,8 → | | | |
| 5: 9,6 ↙ | 10:10,6* → | | | |

| | | | | |
|-----------|-----------|-----|-------|------|
| 1: 9,2 ↗ | 6: 9,2 ← | | Serie | 94,0 |
| 2: 8,9 → | 7:10,0 ↑ | | | |
| 3:10,4* ↑ | 8: 9,9 ↓ | Sum | 182,0 | |
| 4:10,4* ↓ | 9:10,1 ↗ | | | |
| 5:10,0 ↓ | 10: 9,6 ↓ | | | |

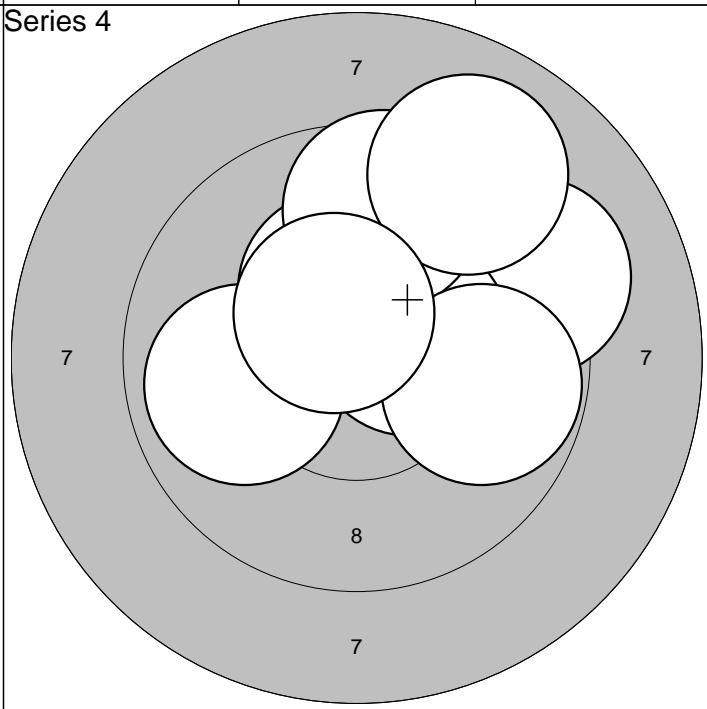
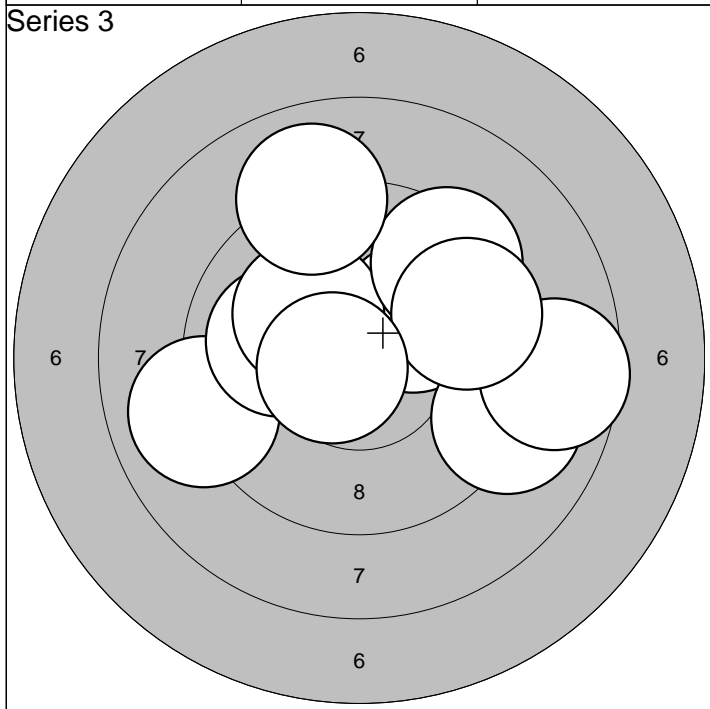

| | | | | |
|-----------|------------|-----|-------|------|
| 1: 9,0 ← | 6: 9,4 ↗ | | Serie | 93,0 |
| 2:10,1 ↗ | 7: 8,6 → | | | |
| 3:10,0 ← | 8: 9,0 ↑ | Sum | 275,0 | |
| 4:10,2* ↗ | 9: 9,6 → | | | |
| 5: 9,1 → | 10:10,6* ← | | | |

| | | | | |
|-----------|------------|-----|-------|------|
| 1:10,2* ↗ | 6:10,3* ↑ | | Serie | 94,0 |
| 2: 9,8 → | 7: 9,6 ↑ | | | |
| 3: 9,2 ↗ | 8: 9,0 ↑ | Sum | 369,0 | |
| 4:10,4* ↗ | 9: 9,8 → | | | |
| 5: 9,9 ← | 10:10,5* ↗ | | | |

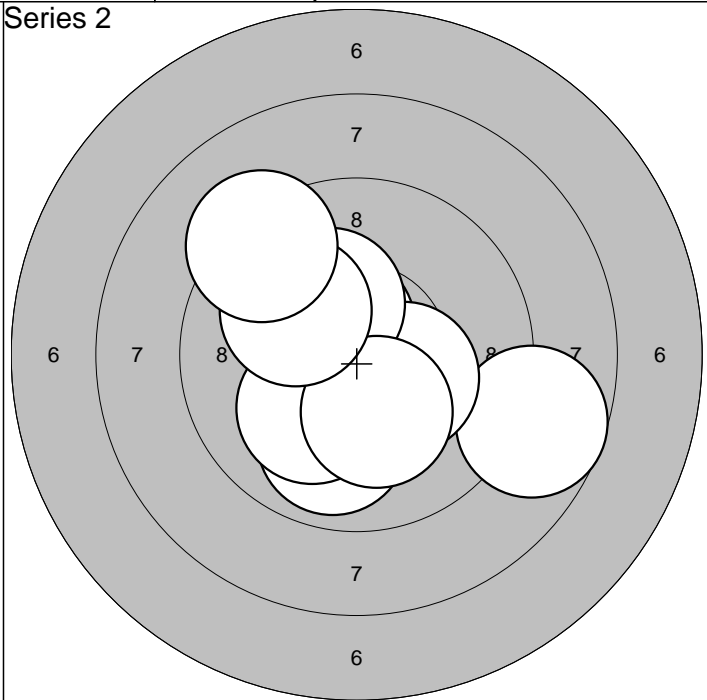
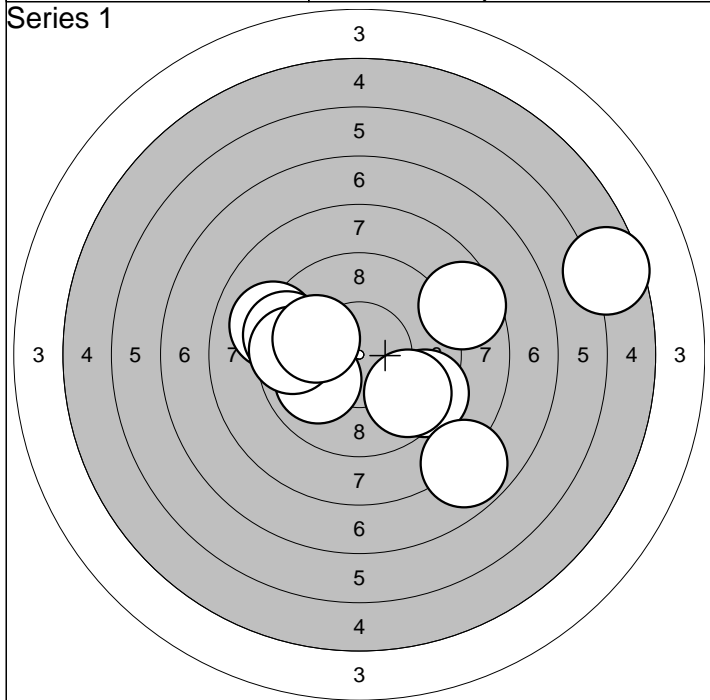

| | | | | |
|----------|-----------|-----|-------|------|
| 1: 9,1 ↙ | 6: 9,7 ↘ | | Serie | 85,0 |
| 2: 5,6 → | 7:10,0 ↙ | | | |
| 3: 9,4 ↘ | 8: 9,6 ↙ | Sum | 85,0 | |
| 4: 8,6 → | 9:10,0 ↙ | | | |
| 5: 9,4 ↙ | 10: 7,8 ↘ | | | |

| | | | | |
|-----------|-----------|-----|-------|------|
| 1: 8,7 → | 6:10,3* ↘ | | Serie | 96,0 |
| 2: 9,9 ↓ | 7:10,3* ↗ | | | |
| 3:10,6* ↗ | 8:10,2* ↘ | Sum | 181,0 | |
| 4:10,5* ↘ | 9:10,1 ↗ | | | |
| 5:10,1 ↘ | 10: 9,2 ↗ | | | |

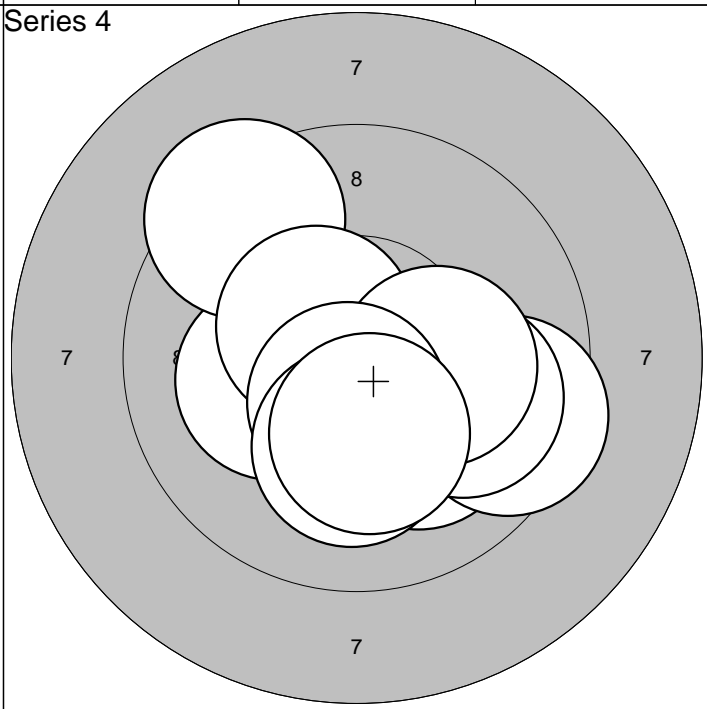
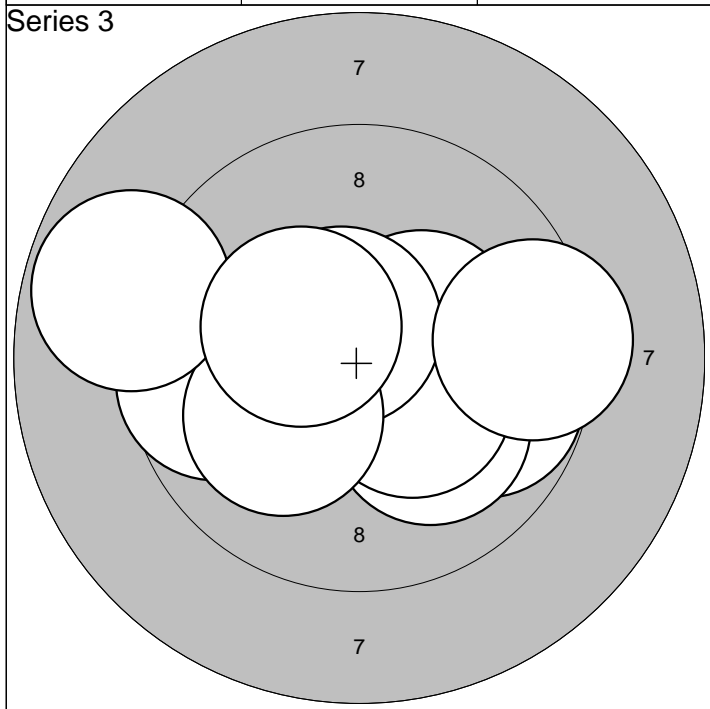

| | | | | |
|-----------|------------|-----|-------|------|
| 1: 9,8 → | 6:10,6* ↗ | | Serie | 95,0 |
| 2:10,3* → | 7: 9,4 → | | | |
| 3:10,1 ↘ | 8:10,1 ↙ | Sum | 276,0 | |
| 4: 9,6 ↙ | 9: 8,8 ↙ | | | |
| 5:10,4* ↘ | 10:10,4* ↗ | | | |

| | | | | |
|-----------|------------|-----|-------|------|
| 1:10,1 ↘ | 6:10,5* ↗ | | Serie | 97,0 |
| 2: 9,5 → | 7:10,2* → | | | |
| 3: 9,9 → | 8:10,5* ↘ | Sum | 373,0 | |
| 4:10,2* ↙ | 9:10,1 ↘ | | | |
| 5: 9,4 ↗ | 10:10,3* ↘ | | | |

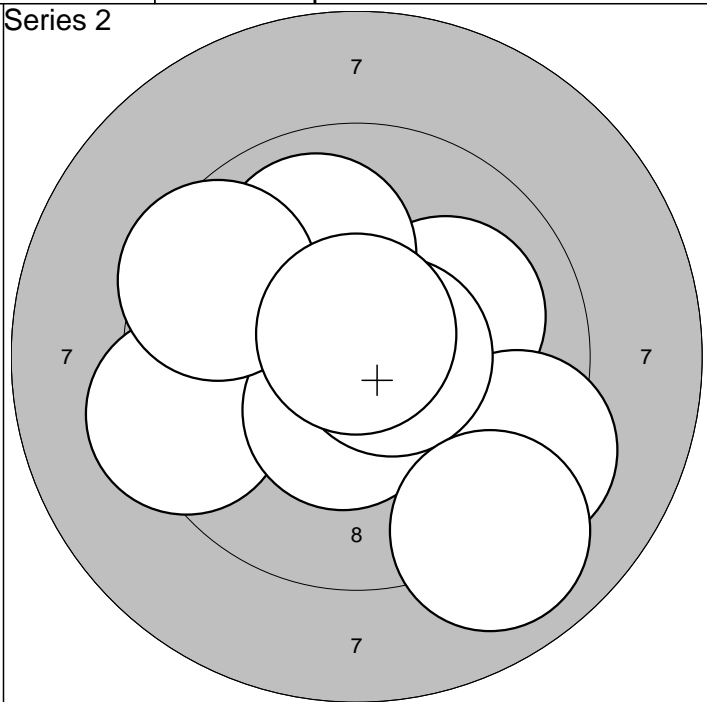
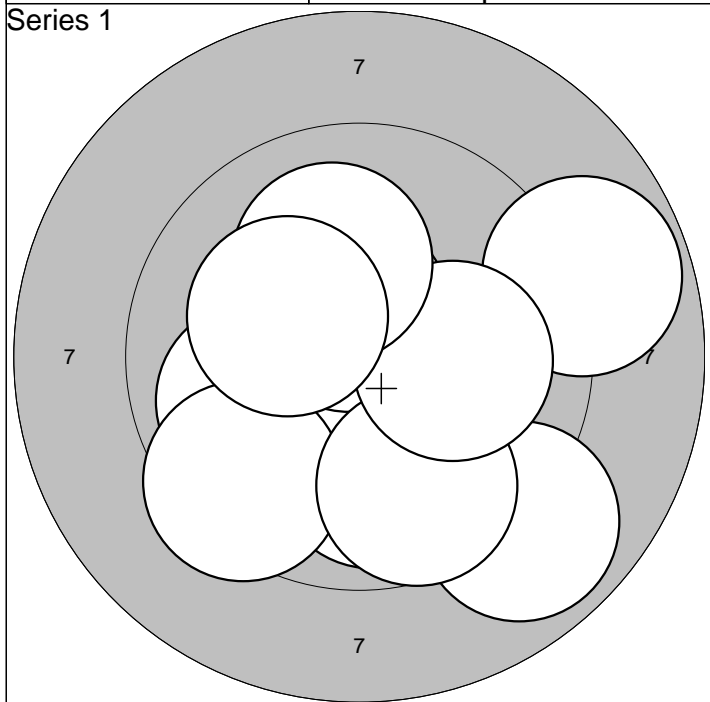

| | | |
|----------|------------|------------|
| 1: 8,9 ↘ | 6:10,5* ↑ | Serie 92,0 |
| 2: 8,8 → | 7: 9,7 ↓ | |
| 3: 9,9 ← | 8:10,1 → | Sum 92,0 |
| 4: 9,9 ↓ | 9:10,1 ↑ | |
| 5: 9,4 ↙ | 10:10,2* ↖ | |

| | | |
|----------|-----------|------------|
| 1:10,1 → | 6:10,5* ↓ | Serie 95,0 |
| 2: 9,3 ↘ | 7: 9,5 ↖ | |
| 3:10,0 ↑ | 8:10,6* → | Sum 187,0 |
| 4: 9,3 ↘ | 9:10,7* ↑ | |
| 5: 9,3 ← | 10: 9,0 ↓ | |

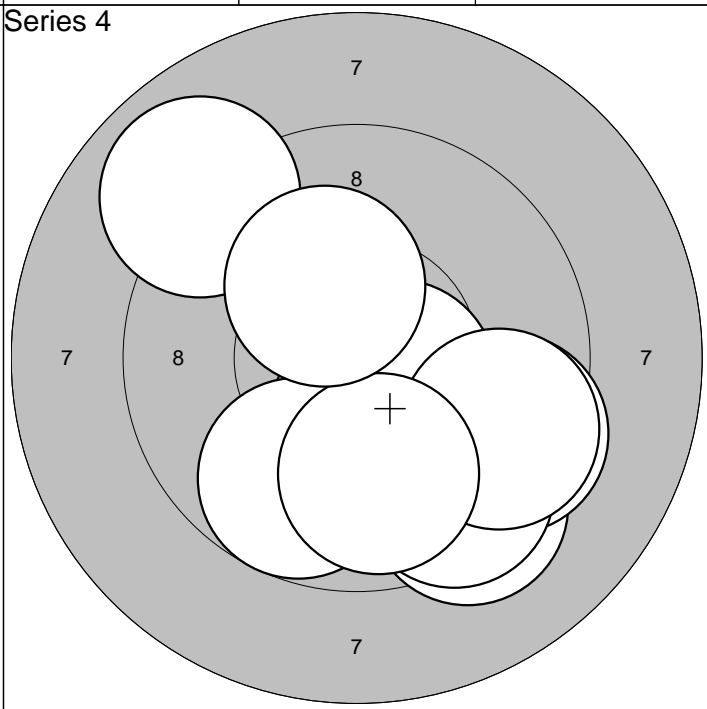
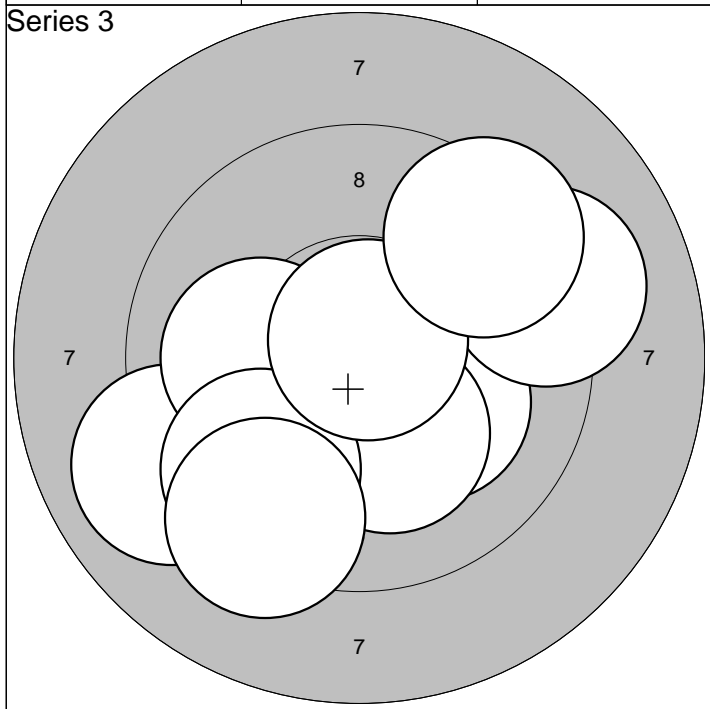

| | | |
|-----------|-----------|------------|
| 1:10,3* ← | 6: 9,6 ↘ | Serie 95,0 |
| 2: 9,0 ← | 7: 9,1 → | |
| 3:10,1 ← | 8:10,8* ↑ | Sum 282,0 |
| 4:10,2* ↘ | 9: 9,3 ↘ | |
| 5:10,2* ↓ | 10: 9,4 ↗ | |

| | | |
|-----------|------------|------------|
| 1:10,4* ↓ | 6: 9,5 ↘ | Serie 92,0 |
| 2: 9,3 ↘ | 7: 9,5 ↘ | |
| 3: 9,4 ↘ | 8: 9,7 ↘ | Sum 374,0 |
| 4:10,5* ↘ | 9: 9,9 ↓ | |
| 5: 8,9 ↗ | 10:10,3* ↑ | |

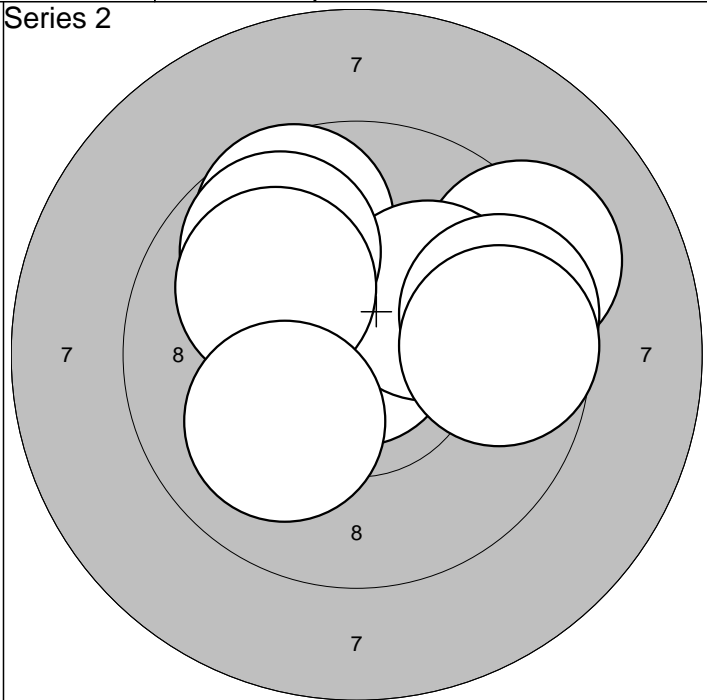
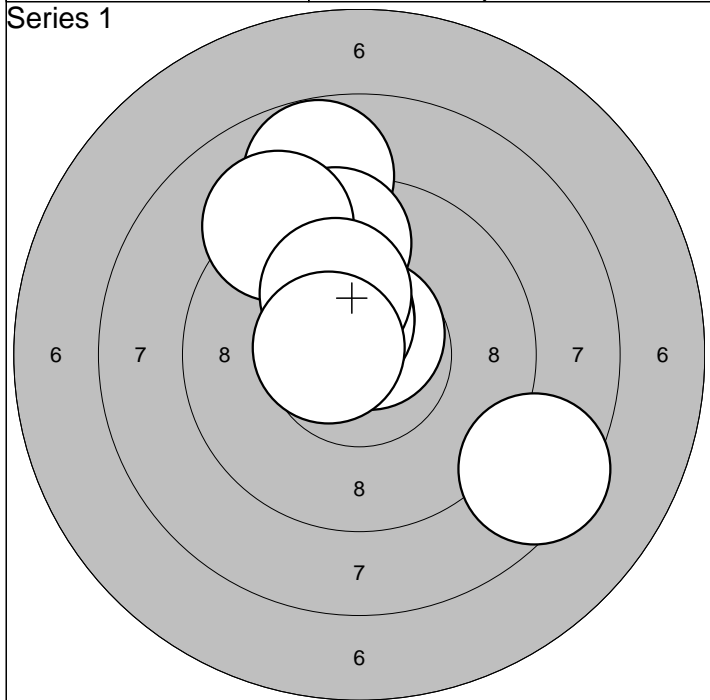

| | | | | | | | |
|---------|---|---------|---|-----|------|-------|------|
| 1: 9,6 | ↑ | 6: 9,2 | ↖ | | | Serie | 93,0 |
| 2: 8,8 | ↑ | 7:10,5* | ↗ | | | | |
| 3:10,7* | ↗ | 8:10,2* | ↗ | Sum | 93,0 | | |
| 4: 9,6 | ↑ | 9:10,6* | ↖ | | | | |
| 5:10,4* | ↖ | 10: 8,5 | ↘ | | | | |

| | | | | | | | |
|---------|---|---------|---|-----|-------|-------|------|
| 1:10,7* | ← | 6: 9,8 | ↖ | | | Serie | 95,0 |
| 2: 9,3 | ↗ | 7: 9,6 | → | | | | |
| 3: 9,7 | ↖ | 8:10,0 | ↖ | Sum | 188,0 | | |
| 4:10,9* | ↑ | 9:10,1 | ↘ | | | | |
| 5:10,1 | ↗ | 10: 9,7 | → | | | | |

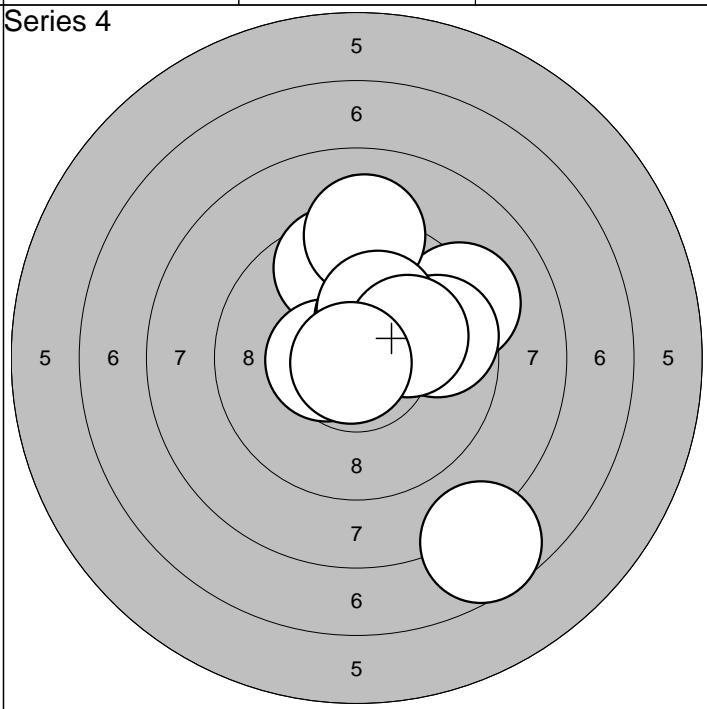
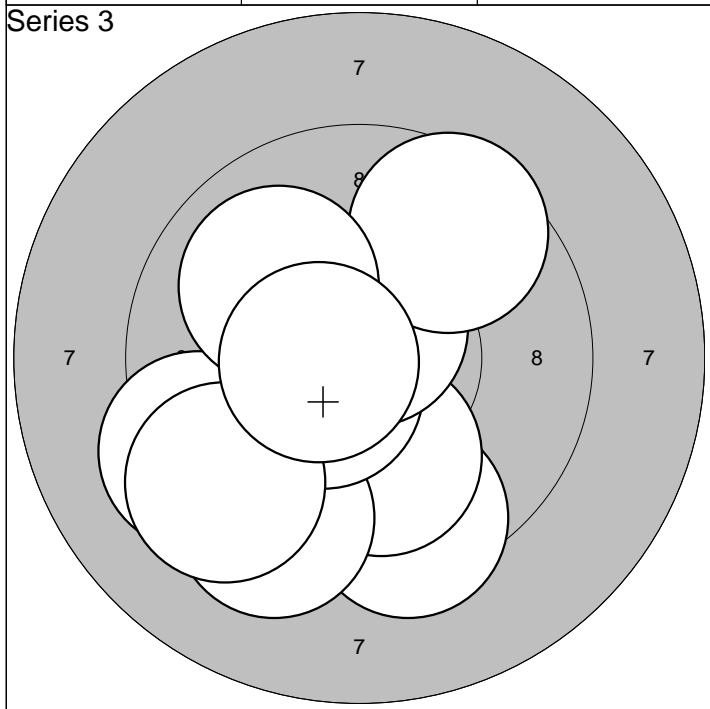

| | | | | | | | |
|---------|---|----------|---|-----|-------|-------|------|
| 1: 9,3 | ↖ | 6:10,7* | ↑ | | | Serie | 95,0 |
| 2: 9,5 | ↘ | 7: 9,6 | ↗ | | | | |
| 3:10,1 | ↘ | 8:10,0 | ↖ | Sum | 283,0 | | |
| 4: 9,3 | ↘ | 9: 9,3 | ↖ | | | | |
| 5:10,5* | ↖ | 10:10,6* | ← | | | | |

| | | | | | | | |
|---------|---|----------|---|-----|-------|-------|------|
| 1: 9,6 | ↑ | 6: 9,7 | → | | | Serie | 93,0 |
| 2: 7,7 | ↘ | 7:10,3* | ↗ | | | | |
| 3: 9,2 | ↗ | 8:10,2* | ↗ | Sum | 376,0 | | |
| 4:10,5* | ← | 9:10,1 | ↗ | | | | |
| 5: 9,2 | ↑ | 10:10,9* | ↘ | | | | |

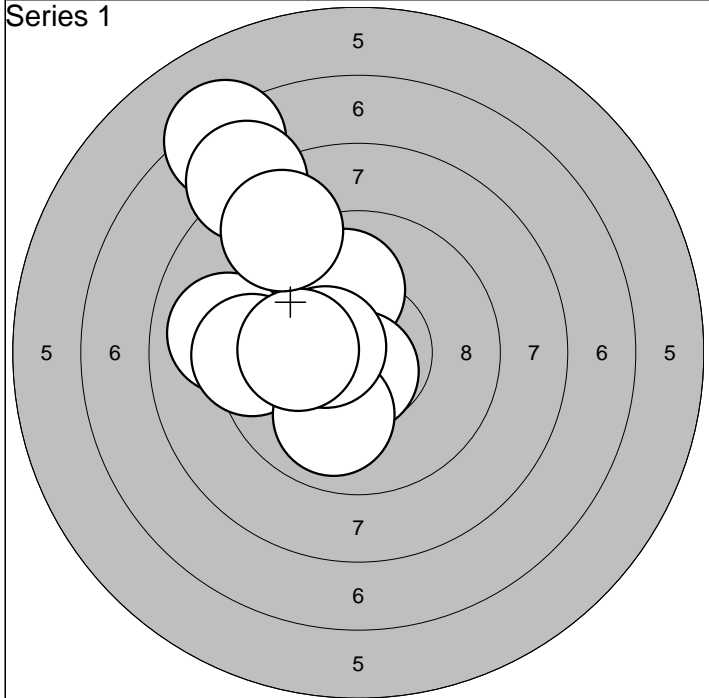

| | | | | | |
|---------|---|---------|---|-------|------|
| 1: 9,0 | ← | 6: 7,3 | ↗ | Serie | 90,0 |
| 2:10,0 | ↑ | 7:10,4* | ← | | |
| 3: 9,4 | ← | 8:10,1 | ← | Sum | 90,0 |
| 4:10,7* | ↓ | 9: 7,9 | ↗ | | |
| 5:10,0 | ↘ | 10: 8,8 | ↗ | | |

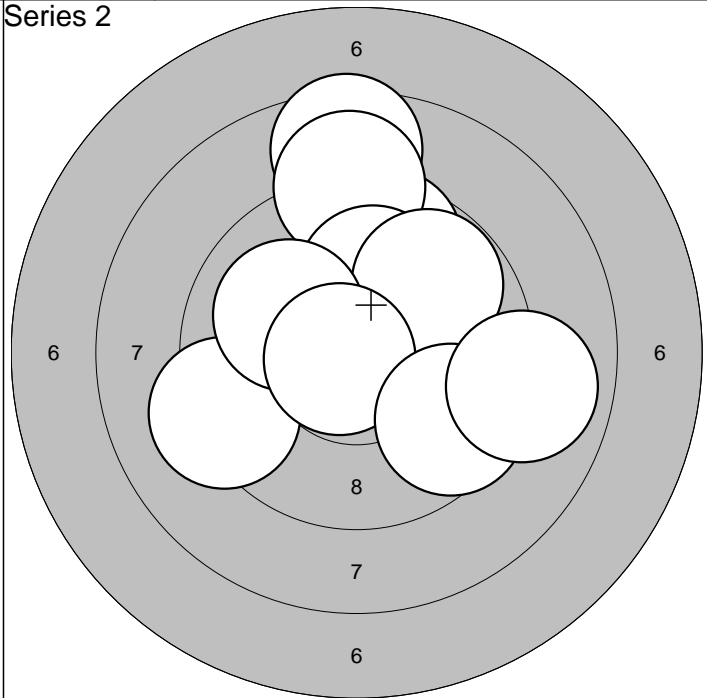

| | | | | | |
|--------|---|---------|---|-------|-------|
| 1: 9,6 | ↑ | 6: 9,8 | ↗ | Serie | 91,0 |
| 2: 8,5 | ↑ | 7:10,1 | ← | | |
| 3: 9,0 | ↑ | 8:10,7* | ← | Sum | 181,0 |
| 4:10,1 | ↑ | 9: 9,6 | ↘ | | |
| 5: 9,2 | ← | 10: 8,9 | → | | |

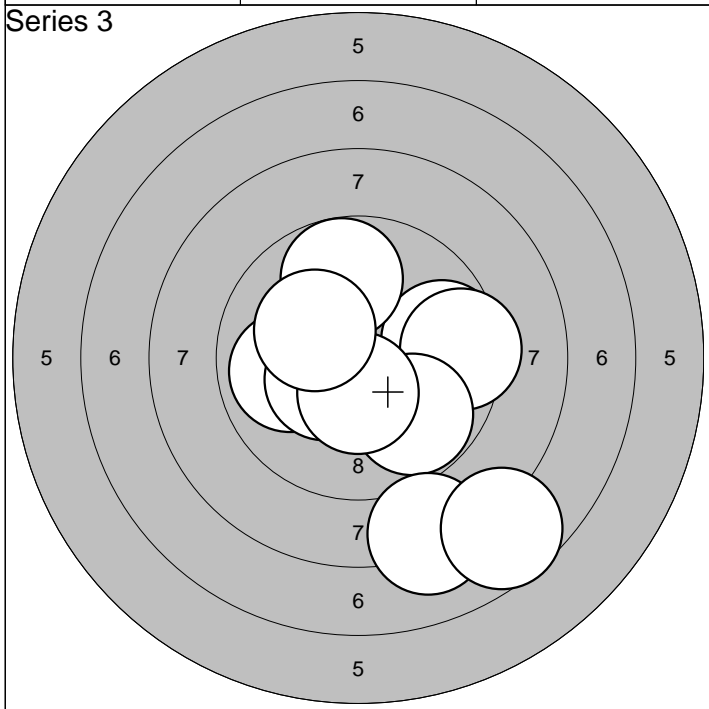

| | | | | | |
|---------|---|----------|---|-------|-------|
| 1: 9,9 | ← | 6: 9,8 | ↘ | Serie | 90,0 |
| 2: 9,7 | → | 7: 8,1 | ↘ | | |
| 3: 9,8 | ↑ | 8:10,4* | ↘ | Sum | 271,0 |
| 4:10,4* | ← | 9: 7,7 | ↘ | | |
| 5: 9,4 | → | 10:10,2* | ↗ | | |

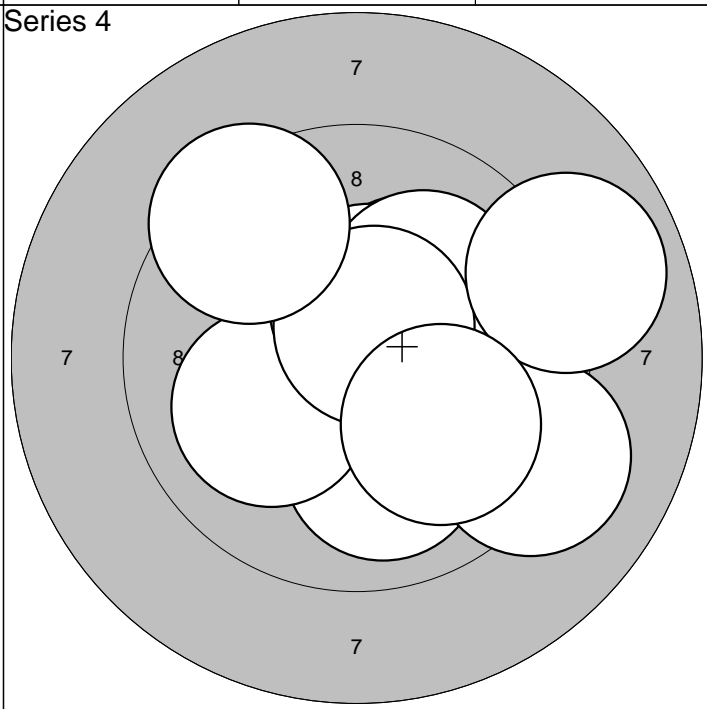

| | | | | | |
|---------|---|---------|---|-------|-------|
| 1:10,0 | ↓ | 6:10,1 | ↗ | Serie | 96,0 |
| 2:10,1 | ← | 7:10,6* | ↑ | | |
| 3:10,2* | ↗ | 8: 8,9 | → | Sum | 367,0 |
| 4:10,4* | ↑ | 9:10,0 | ↘ | | |
| 5: 9,1 | ↘ | 10: 9,4 | ↗ | | |

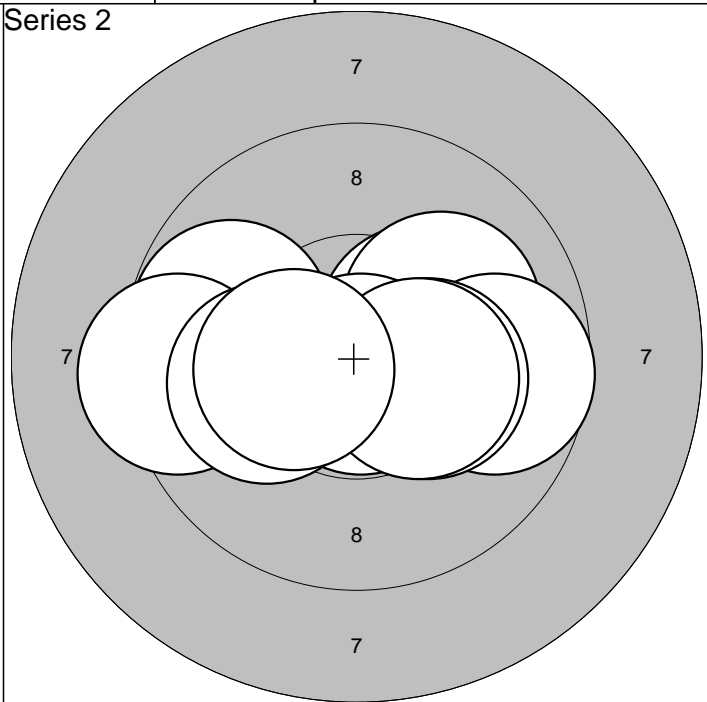
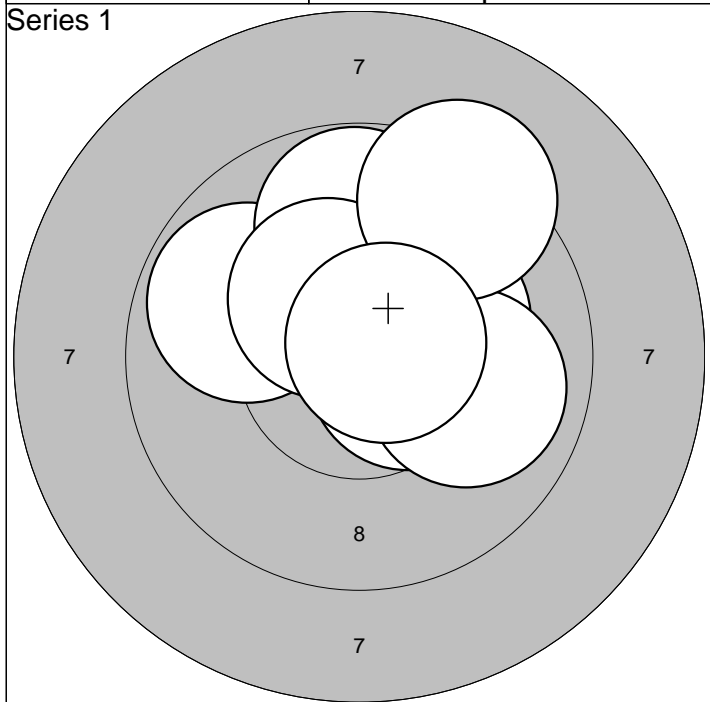

| | | | |
|-----------|------------|-------|------|
| 1:10,4* → | 6: 9,8 ↑ | Serie | 96,0 |
| 2: 9,8 ↙ | 7:10,3* ↗ | | |
| 3:10,3* ↗ | 8: 9,9 → | Sum | 96,0 |
| 4:10,5* → | 9: 9,3 ↗ | | |
| 5:10,3* ↗ | 10:10,7* ↗ | | |

| | | | |
|-----------|------------|-------|-------|
| 1: 9,8 ↙ | 6:10,8* ↓ | Serie | 97,0 |
| 2:10,3* ↗ | 7:10,1 ↙ | | |
| 3:10,1 ↗ | 8:10,3* → | Sum | 193,0 |
| 4: 9,4 ↙ | 9:10,4* → | | |
| 5: 9,7 → | 10:10,4* ↙ | | |

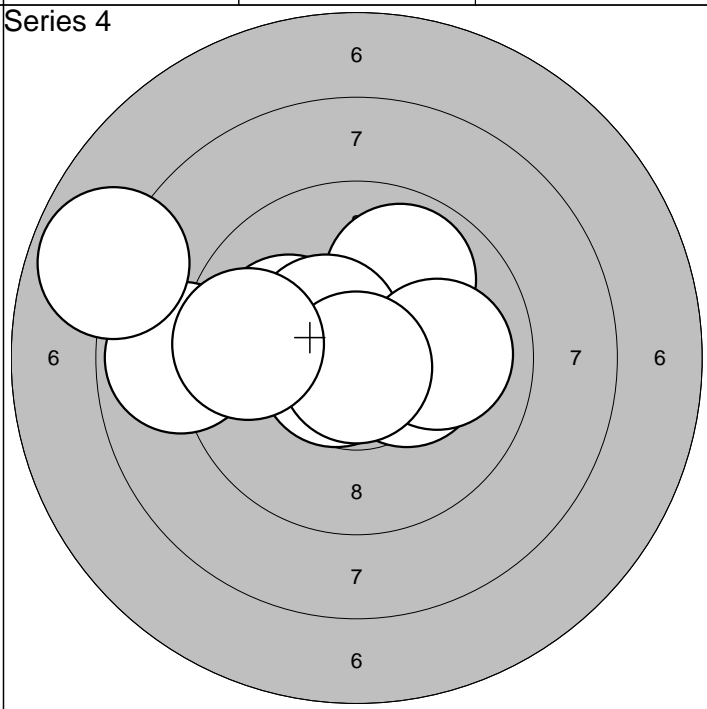
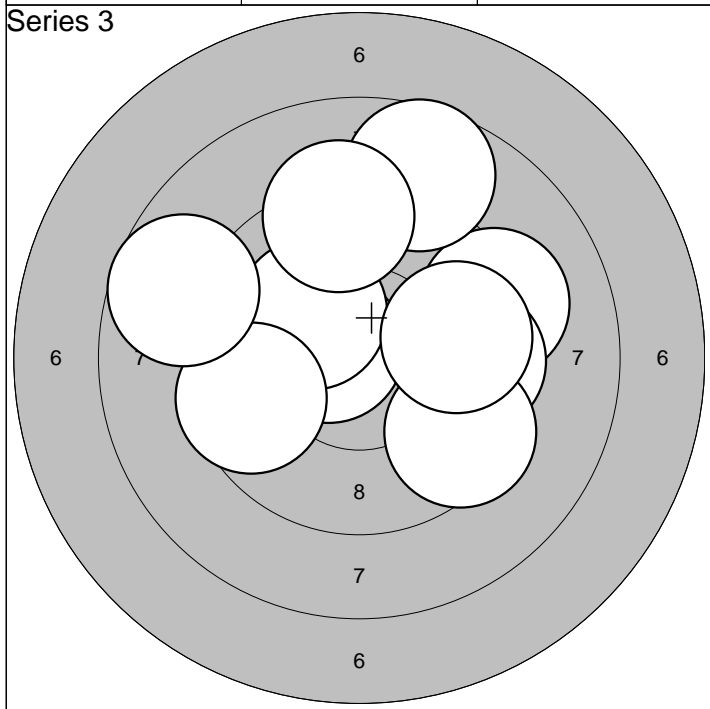

| | | | |
|-----------|-----------|-------|-------|
| 1:10,6* ↙ | 6: 9,6 ↙ | Serie | 90,0 |
| 2: 9,2 → | 7: 8,7 ↑ | | |
| 3: 9,6 → | 8: 8,7 ↙ | Sum | 283,0 |
| 4:10,2* ↗ | 9: 9,3 ↑ | | |
| 5: 9,5 ↘ | 10: 9,8 → | | |

| | | | |
|-----------|-----------|-------|-------|
| 1:10,1 ↙ | 6:10,4* ↗ | Serie | 93,0 |
| 2:10,6* ↙ | 7:10,0 → | | |
| 3: 8,9 ↙ | 8:10,8* ↓ | Sum | 376,0 |
| 4: 9,9 ↗ | 9: 9,7 ↙ | | |
| 5:10,3* → | 10: 7,9 ↙ | | |

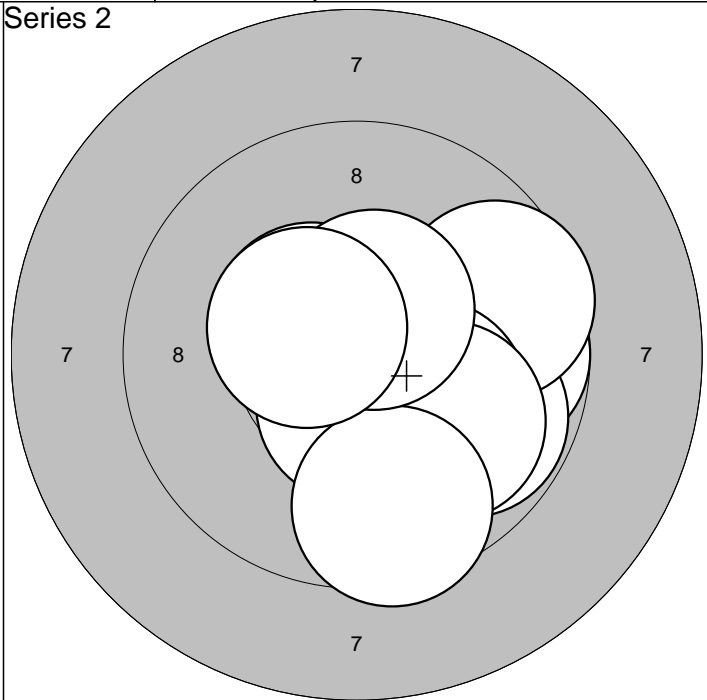
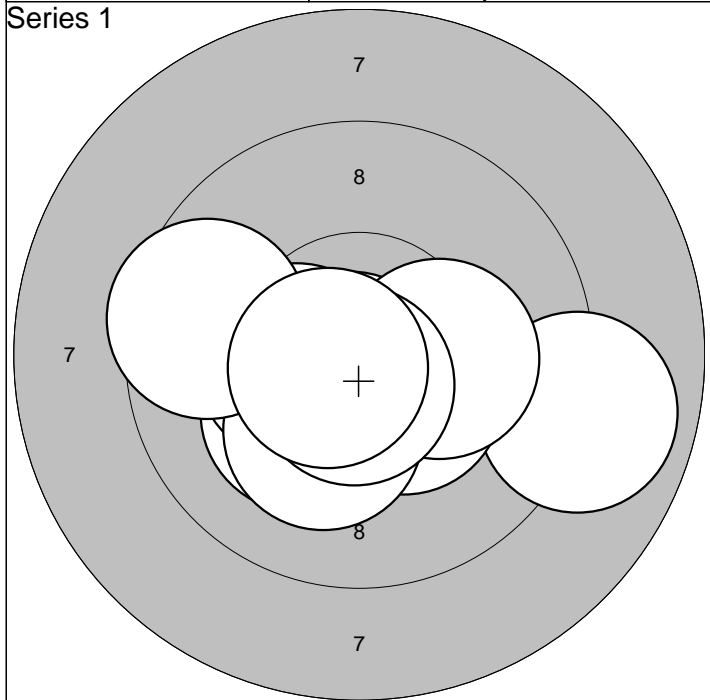

| | | |
|-----------|------------|-------------------|
| 1:10,2* ↙ | 6:10,2* ↓ | Serie 97,0 |
| 2: 8,9 → | 7: 9,5 ← | |
| 3:10,4* ← | 8:10,2* → | Sum 97,0 |
| 4:10,8* ↓ | 9:10,7* ↓ | |
| 5:10,4* ↘ | 10:10,7* ← | |

| | | |
|-----------|------------|-------------------|
| 1: 9,8 → | 6:10,2* ↘ | Serie 95,0 |
| 2:10,5* ↖ | 7: 9,9 ↓ | |
| 3: 9,8 ↘ | 8: 9,5 ↓ | Sum 192,0 |
| 4: 9,6 → | 9:10,5* ↗ | |
| 5:10,5* ↓ | 10:10,5* ↖ | |

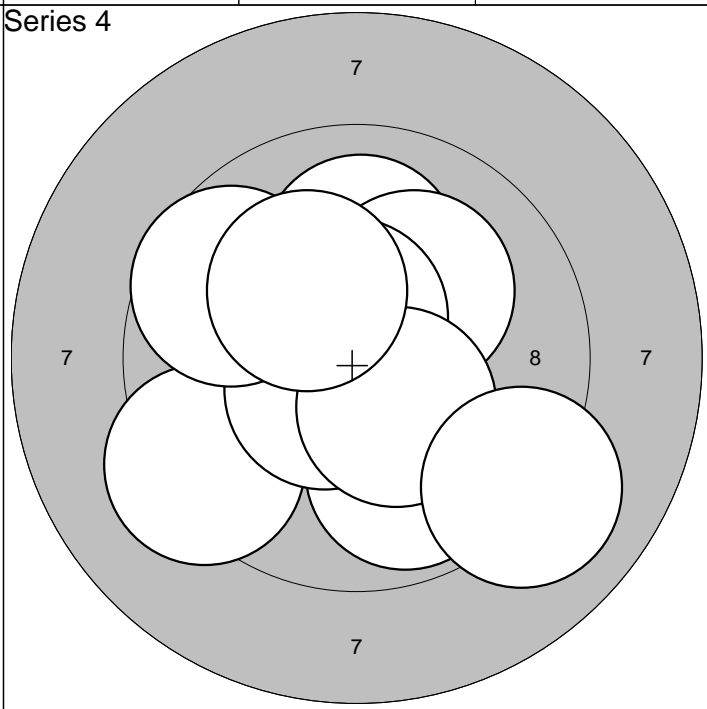
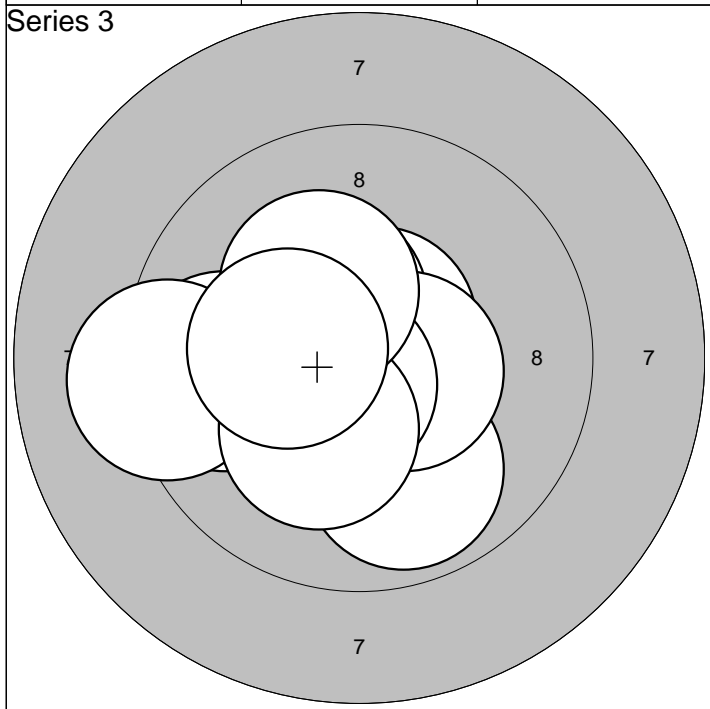

| | | |
|-----------|------------|-------------------|
| 1: 9,9 ↓ | 6: 9,7 ← | Serie 97,0 |
| 2:10,6* ↗ | 7: 9,2 ← | |
| 3:10,4* ↖ | 8:10,2* ↓ | Sum 289,0 |
| 4:10,5* → | 9:10,3* ↗ | |
| 5:10,6* ↘ | 10:10,3* ← | |

| | | |
|-----------|------------|-------------------|
| 1: 9,9 ↓ | 6:10,5* ↘ | Serie 96,0 |
| 2:10,0 ↑ | 7:10,4* ↓ | |
| 3: 9,3 ← | 8: 9,1 ↓ | Sum 385,0 |
| 4:10,2* ↗ | 9: 9,7 ↖ | |
| 5:10,6* ↗ | 10:10,2* ↖ | |

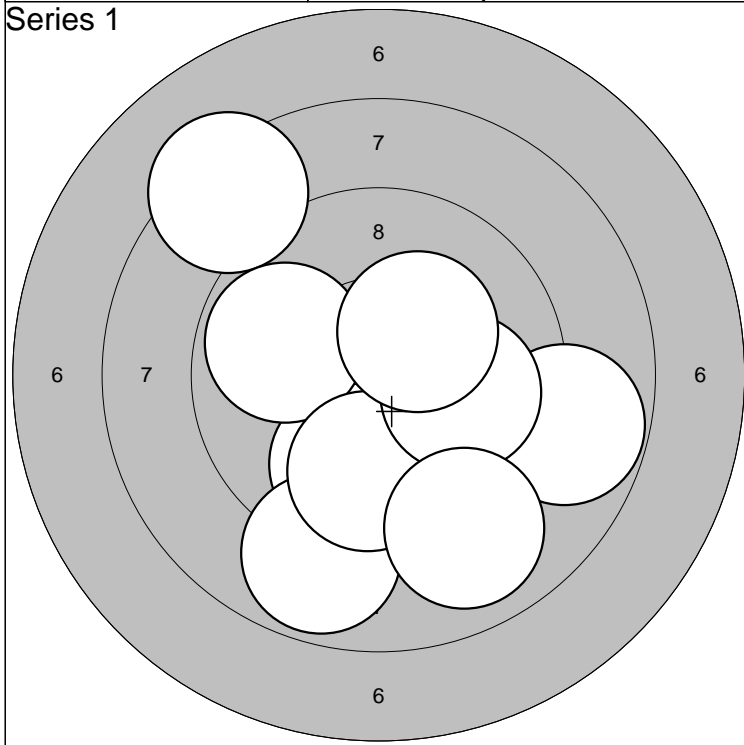

| | | | | | |
|--------|---|----------|---|--------------|-------------|
| 1: 9,9 | ↓ | 6: 8,8 | → | Serie | 89,0 |
| 2: 8,3 | ↗ | 7: 9,8 | ↓ | | |
| 3: 9,9 | → | 8: 10,0 | → | Sum | 89,0 |
| 4: 8,9 | ↓ | 9: 10,3* | ↗ | | |
| 5: 9,8 | ↖ | 10: 9,0 | ↓ | | |

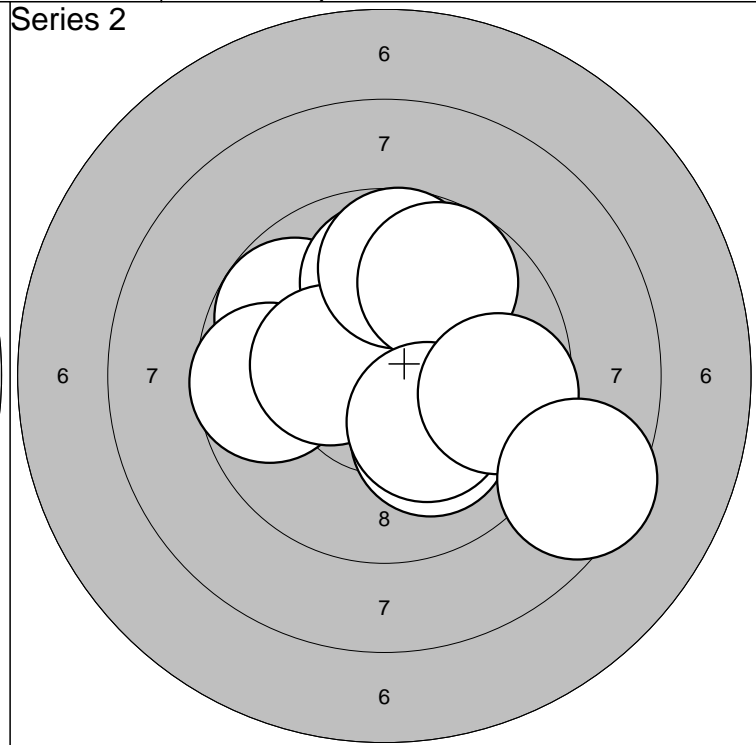

| | | | | | |
|----------|---|----------|---|--------------|--------------|
| 1: 9,8 | ↖ | 6: 9,8 | ↑ | Serie | 92,0 |
| 2: 10,1 | ↓ | 7: 9,7 | ↗ | | |
| 3: 9,9 | ↑ | 8: 10,3* | ↓ | Sum | 181,0 |
| 4: 9,7 | ← | 9: 9,7 | → | | |
| 5: 10,3* | ↖ | 10: 8,5 | ↘ | | |

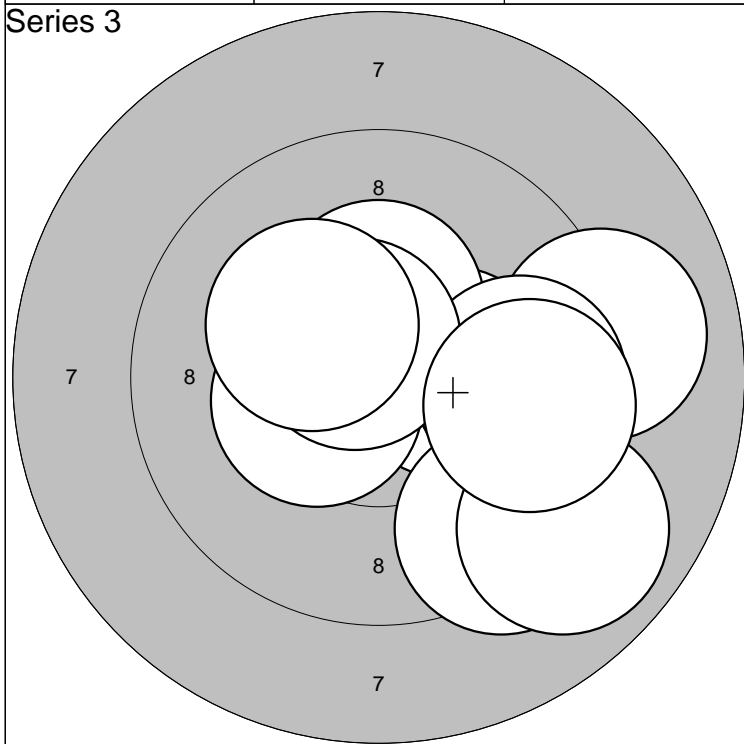

| | | | | | |
|----------|---|----------|---|--------------|--------------|
| 1: 10,4* | → | 6: 9,3 | ↓ | Serie | 94,0 |
| 2: 10,4* | ↑ | 7: 10,6* | ↗ | | |
| 3: 9,0 | → | 8: 8,9 | ↓ | Sum | 275,0 |
| 4: 9,7 | → | 9: 10,2* | ↗ | | |
| 5: 10,4* | ← | 10: 9,6 | → | | |

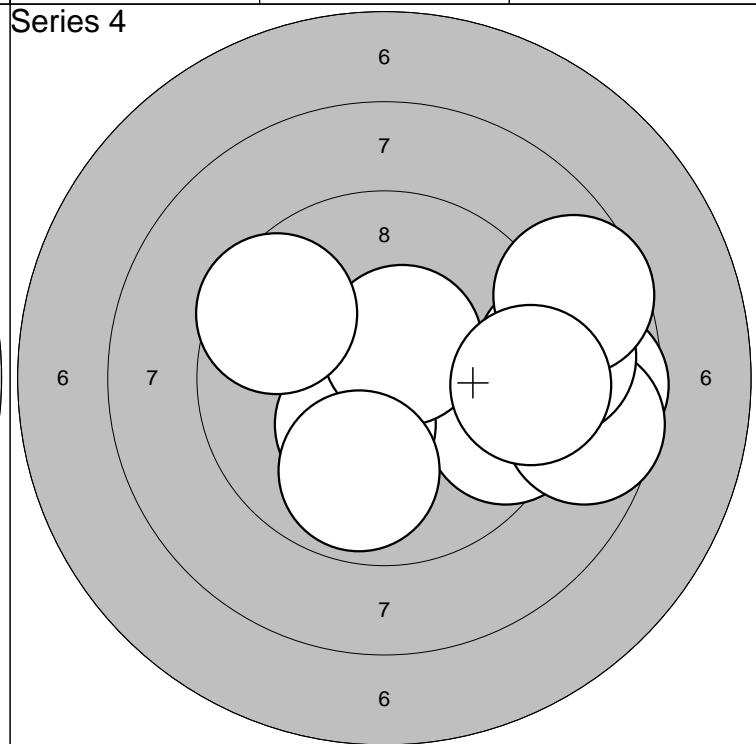

| | | | | | |
|----------|---|---------|---|--------------|--------------|
| 1: 8,7 | → | 6: 9,9 | ↓ | Serie | 89,0 |
| 2: 9,5 | ↘ | 7: 9,0 | → | | |
| 3: 8,6 | → | 8: 9,6 | ↖ | Sum | 364,0 |
| 4: 10,3* | ↘ | 9: 8,7 | ↗ | | |
| 5: 10,5* | ↗ | 10: 9,3 | → | | |

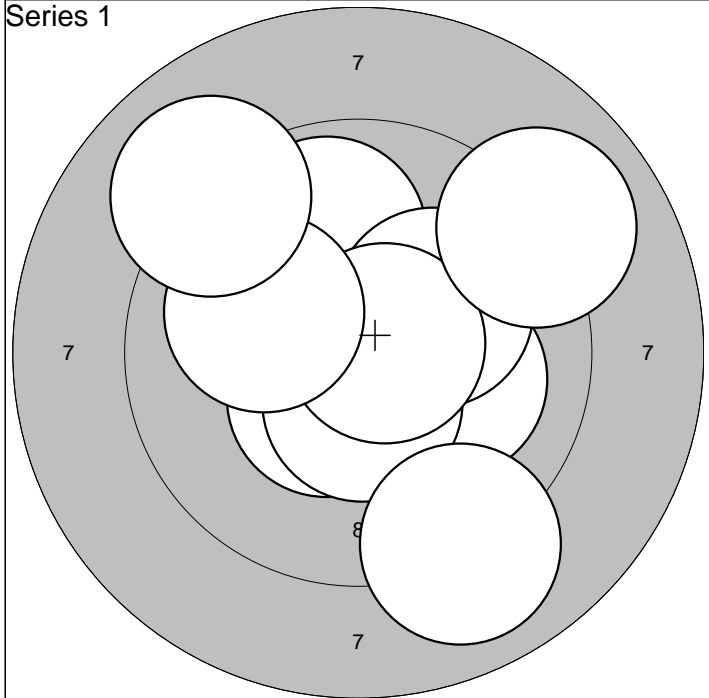

| | | | | |
|-----------|-----------|--|-------|------|
| 1:10,5* ↙ | 6:10,7* → | | Serie | 96,0 |
| 2: 9,9 ↗ | 7:10,1 ↖ | | Sum | 96,0 |
| 3:10,1 → | 8: 9,0 ↗ | | | |
| 4:10,5* ↓ | 9: 9,0 ↓ | | | |
| 5:10,2* ↗ | 10: 9,0 ↗ | | | |

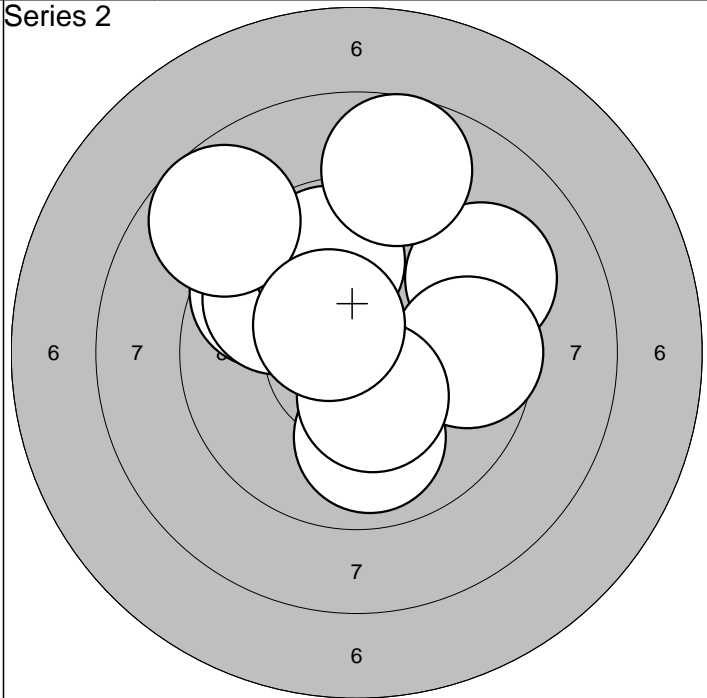

| | | | | |
|----------|------------|--|-------|-------|
| 1: 9,7 ↖ | 6: 9,8 ↗ | | Serie | 90,0 |
| 2: 9,3 ↗ | 7:10,4* ↙ | | Sum | 186,0 |
| 3: 9,8 ↖ | 8: 8,7 ↗ | | | |
| 4: 9,9 ↓ | 9: 8,7 ↗ | | | |
| 5: 9,6 → | 10:10,5* ↗ | | | |

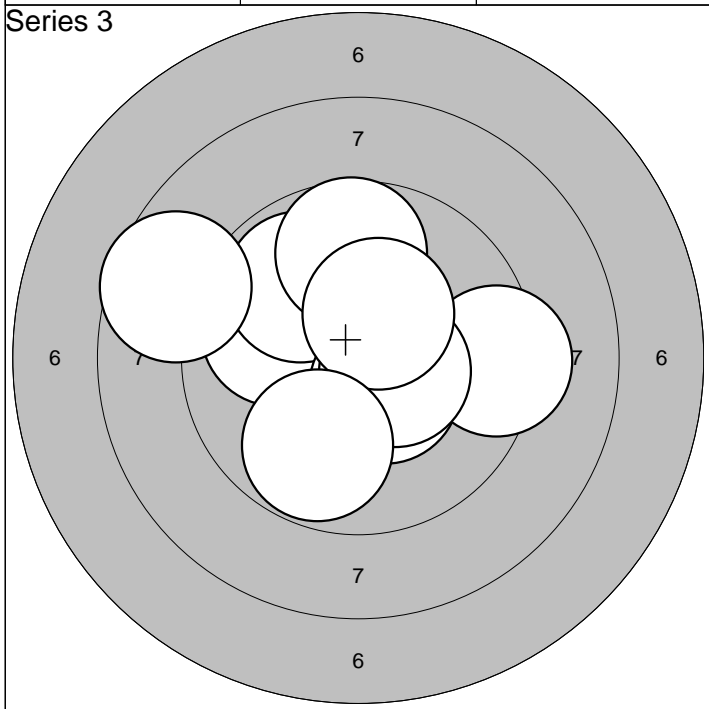

| | | | | |
|-----------|-----------|--|-------|-------|
| 1:10,8* ↗ | 6: 9,3 → | | Serie | 93,0 |
| 2: 9,9 ↖ | 7: 9,7 ↗ | | Sum | 279,0 |
| 3: 9,9 ↗ | 8:10,5* → | | | |
| 4: 8,6 ↖ | 9:10,4* ↗ | | | |
| 5:10,5* ↓ | 10: 9,8 ↓ | | | |

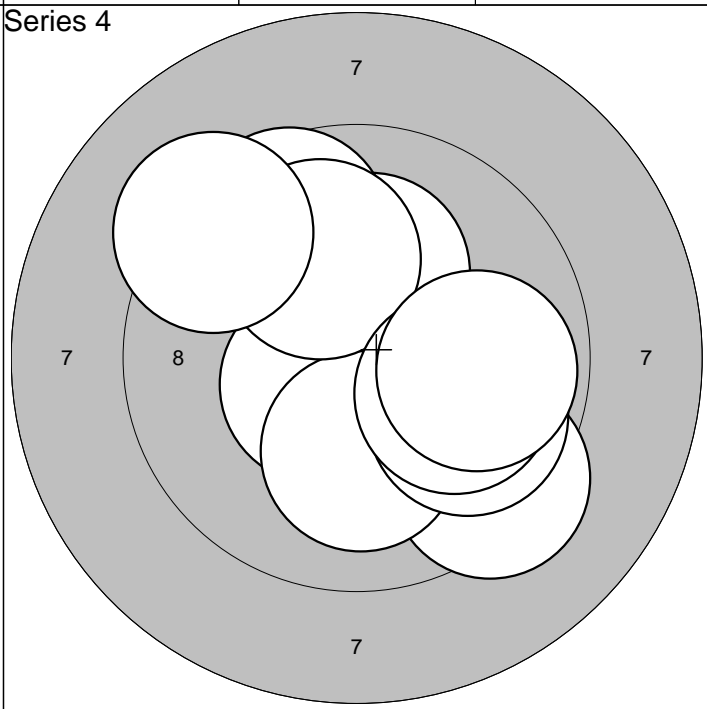

| | | | | |
|-----------|-----------|--|-------|-------|
| 1: 9,3 ↓ | 6: 9,8 ↓ | | Serie | 95,0 |
| 2:10,2* ↗ | 7:10,0 ↗ | | Sum | 374,0 |
| 3: 9,6 ↖ | 8:10,0 → | | | |
| 4:10,5* ↙ | 9: 9,2 ↗ | | | |
| 5:10,1 ↓ | 10: 9,8 → | | | |

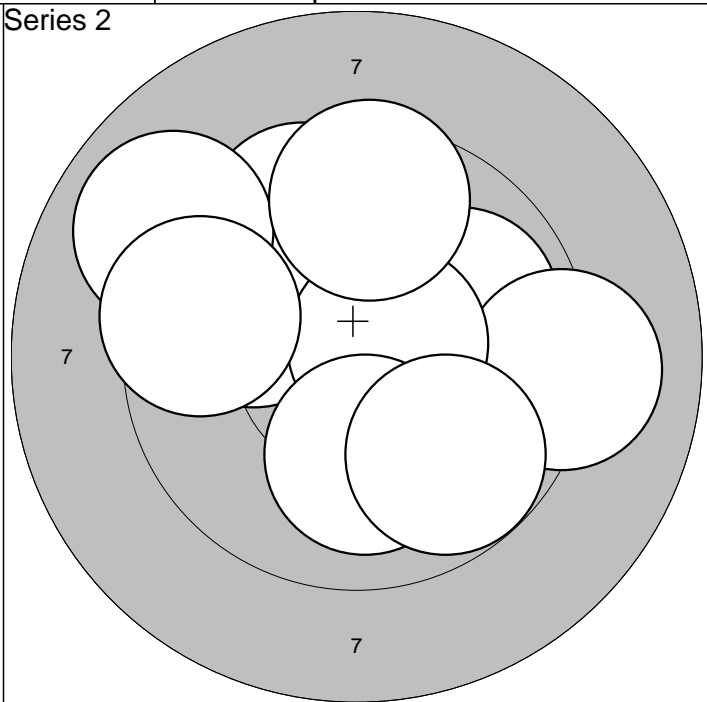
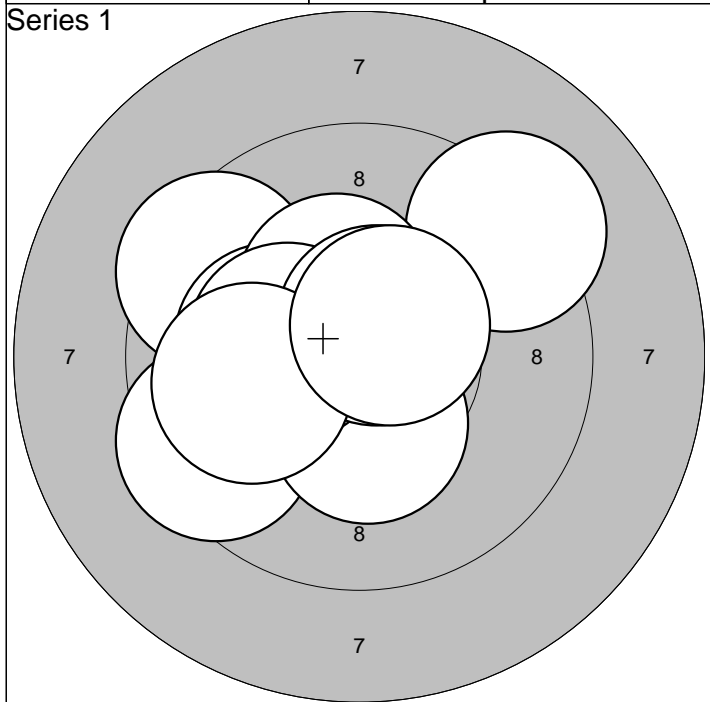

| | | | |
|-----------|------------|-------|------|
| 1: 9,5 ↖ | 6:10,4* ↗ | Serie | 96,0 |
| 2: 9,5 ↙ | 7:10,3* ↖ | | |
| 3: 9,2 ↗ | 8:10,6* ↗ | Sum | 96,0 |
| 4:10,4* ↓ | 9: 9,9 ↖ | | |
| 5:10,2* ↖ | 10:10,5* ↗ | | |

| | | | |
|----------|-----------|-------|-------|
| 1: 9,9 ↖ | 6:10,7* ↗ | Serie | 92,0 |
| 2: 9,9 ↗ | 7: 9,5 ↗ | | |
| 3: 9,7 ↗ | 8:10,1 ↓ | Sum | 188,0 |
| 4: 9,1 → | 9: 9,5 ↖ | | |
| 5: 9,0 ↖ | 10: 9,8 ↓ | | |

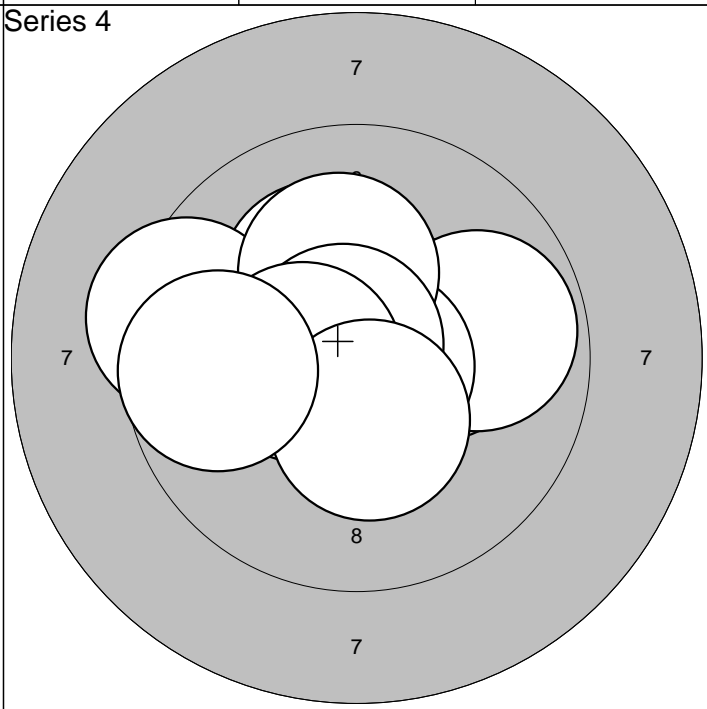
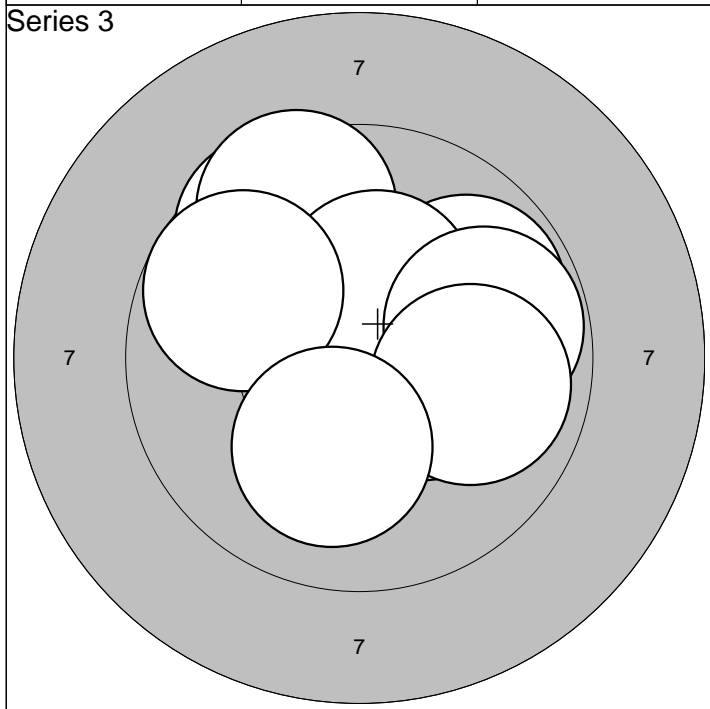

| | | | |
|-----------|-----------|-------|-------|
| 1:10,5* → | 6:10,3* ↗ | Serie | 94,0 |
| 2:10,3* → | 7: 9,8 → | | |
| 3: 9,8 ↗ | 8: 9,9 → | Sum | 282,0 |
| 4: 9,6 ↗ | 9: 9,8 ↖ | | |
| 5: 9,5 ↗ | 10:10,1 ↓ | | |

| | | | |
|-----------|-----------|-------|-------|
| 1:10,2* → | 6:10,2* ↗ | Serie | 97,0 |
| 2:10,2* ↗ | 7:10,8* ↖ | | |
| 3: 9,9 → | 8:10,5* ↖ | Sum | 379,0 |
| 4: 9,4 ↖ | 9:10,4* ↓ | | |
| 5:10,8* → | 10: 9,7 ↖ | | |

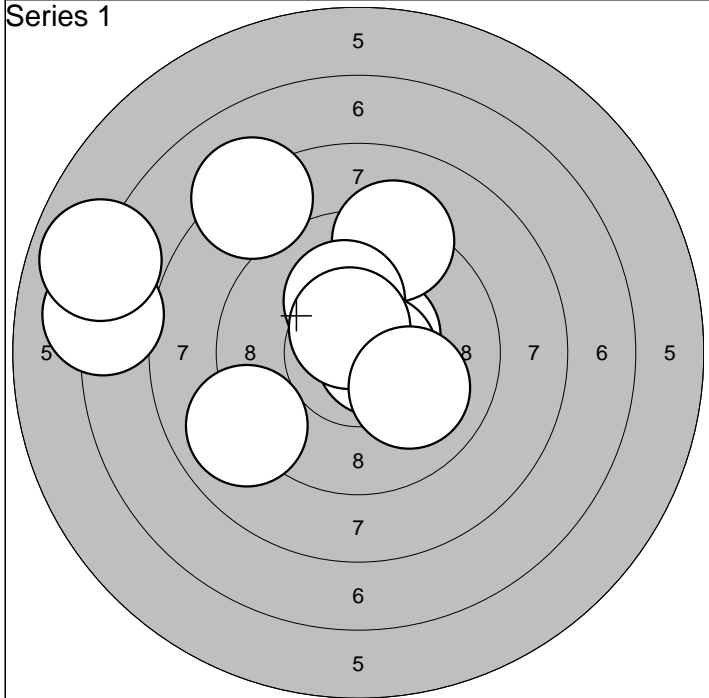

| | | | |
|------------|------------|-------|------|
| 1: 8,2 ↖ | 6: 10,7* → | Serie | 89,0 |
| 2: 10,6* ↗ | 7: 9,0 ↙ | | |
| 3: 7,2 ← | 8: 10,6* ↖ | Sum | 89,0 |
| 4: 9,2 ↗ | 9: 6,9 ↙ | | |
| 5: 10,2* ↗ | 10: 10,0 ↘ | | |

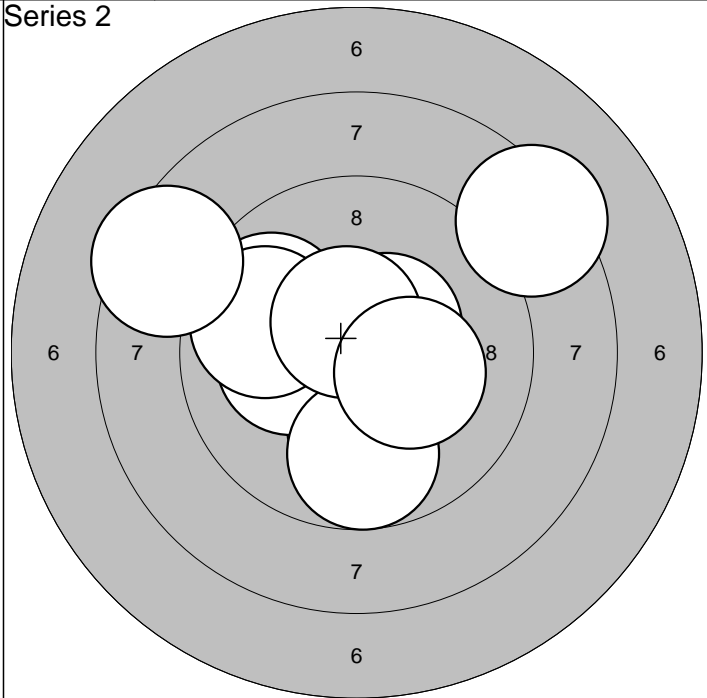

| | | | |
|------------|-------------|-------|-------|
| 1: 8,4 ↗ | 6: 9,8 ↖ | Serie | 93,0 |
| 2: 10,0 ↓ | 7: 8,5 ↖ | | |
| 3: 10,2* ← | 8: 9,7 ↓ | Sum | 182,0 |
| 4: 10,5* ↗ | 9: 10,6* ↖ | | |
| 5: 9,8 ↖ | 10: 10,3* ↗ | | |

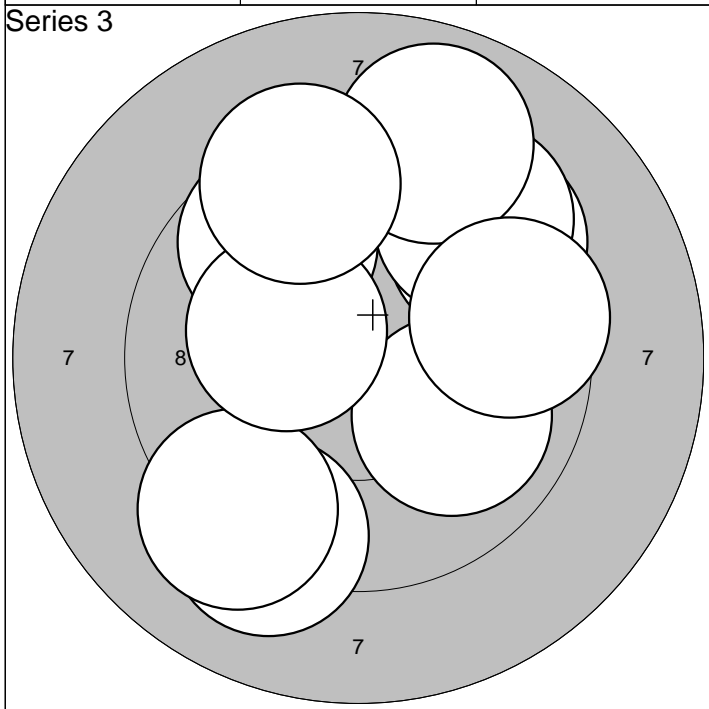

| | | | |
|----------|------------|-------|-------|
| 1: 9,4 ↗ | 6: 10,0 ↘ | Serie | 91,0 |
| 2: 9,2 ↓ | 7: 8,9 ↗ | | |
| 3: 9,3 ↗ | 8: 9,5 → | Sum | 273,0 |
| 4: 9,2 ↓ | 9: 10,3* ↖ | | |
| 5: 9,7 ↖ | 10: 9,3 ↗ | | |

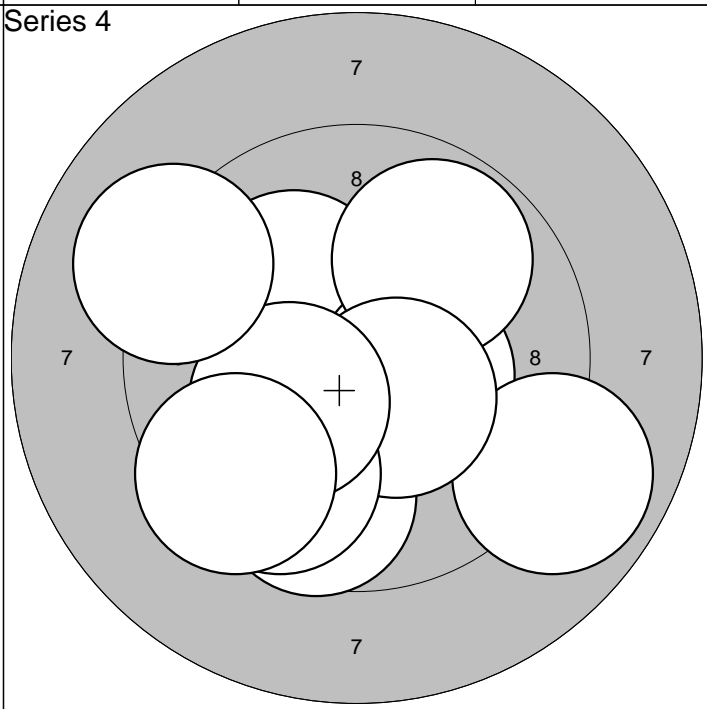

| | | | |
|------------|------------|-------|-------|
| 1: 9,7 ↓ | 6: 10,4* ↘ | Serie | 93,0 |
| 2: 10,1 ↖ | 7: 9,7 ↓ | | |
| 3: 10,4* → | 8: 10,2* ↖ | Sum | 366,0 |
| 4: 9,8 ↗ | 9: 9,5 ↖ | | |
| 5: 8,9 ↘ | 10: 9,1 ↖ | | |

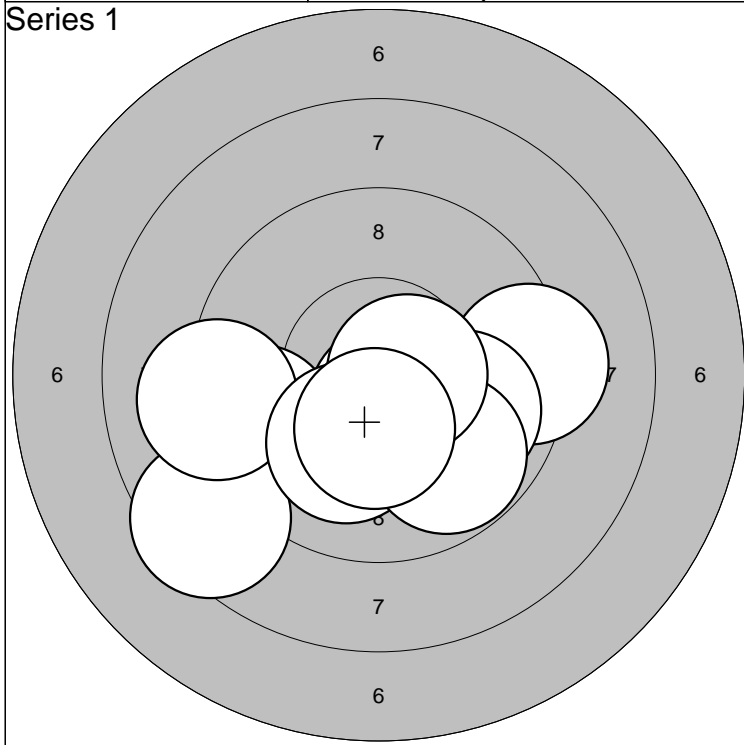

| | | | |
|-----------|------------|-------|------|
| 1: 9,5 ← | 6: 9,3 → | Serie | 93,0 |
| 2:10,6* ↓ | 7: 9,9 → | | |
| 3: 8,5 ↙ | 8: 9,8 ↓ | Sum | 93,0 |
| 4: 9,1 ← | 9:10,6* → | | |
| 5:10,1 ↓ | 10:10,4* ↓ | | |

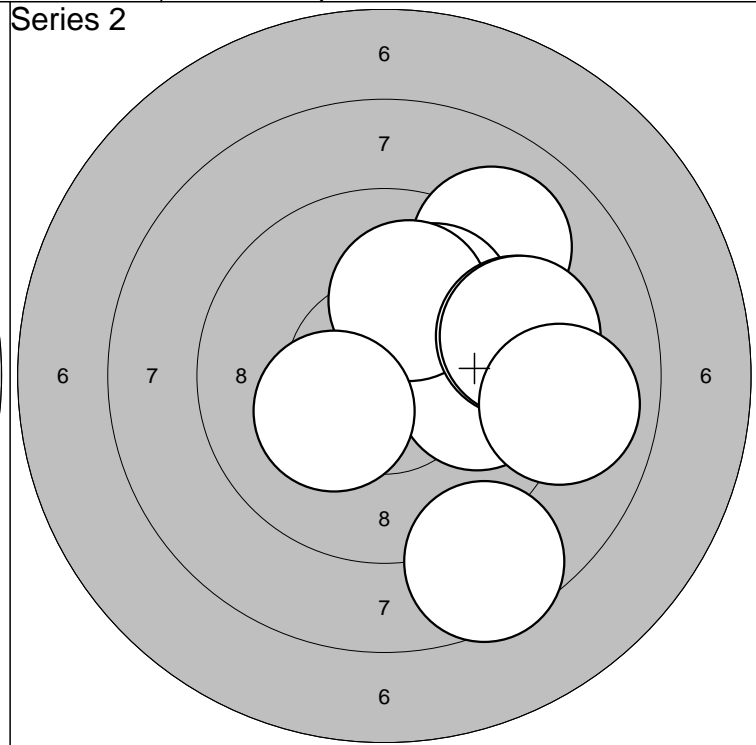

| | | | |
|----------|-----------|-------|-------|
| 1: 9,1 ↗ | 6: 9,4 → | Serie | 92,0 |
| 2:10,0 ↗ | 7: 9,4 → | | |
| 3: 9,5 → | 8:10,3* ↙ | Sum | 185,0 |
| 4: 9,9 → | 9: 8,6 ↓ | | |
| 5:10,1 ↗ | 10: 9,0 → | | |

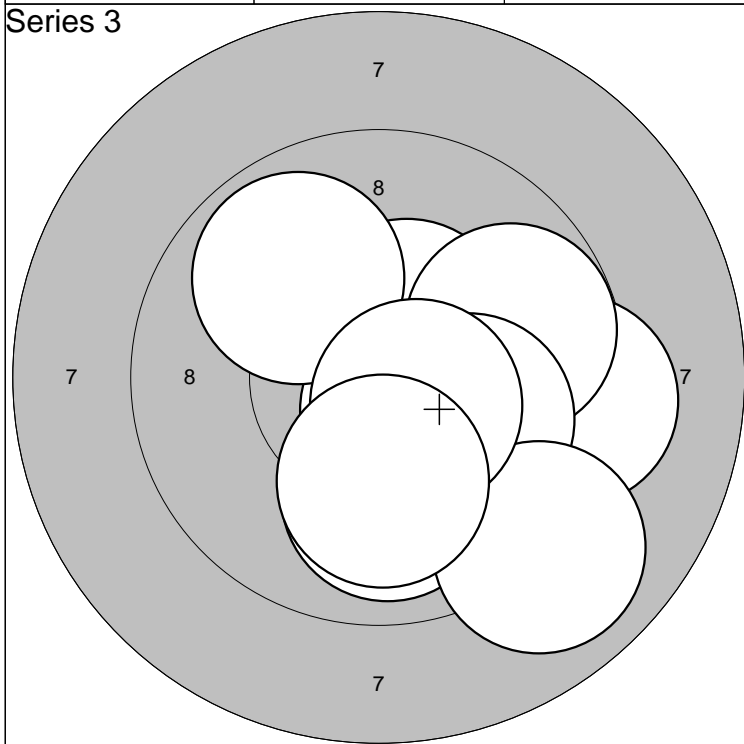

| | | | |
|-----------|-----------|-------|-------|
| 1:10,4* ↗ | 6:10,1 ↓ | Serie | 95,0 |
| 2: 9,9 ↓ | 7: 9,0 ↓ | | |
| 3:10,6* ↓ | 8: 9,9 ↗ | Sum | 280,0 |
| 4: 9,3 → | 9:10,6* ↓ | | |
| 5: 9,8 → | 10:10,1 ↓ | | |

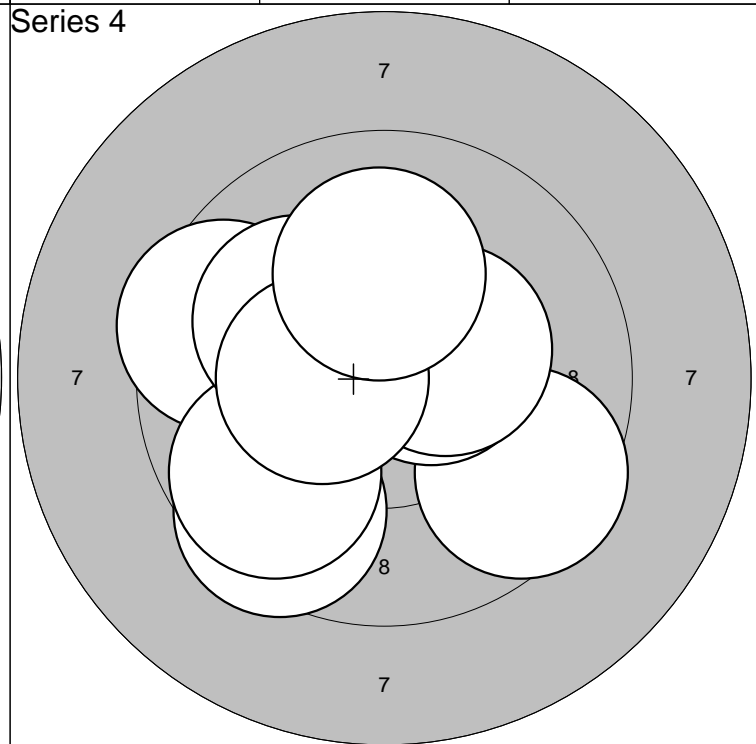

| | | | |
|-----------|-----------|-------|-------|
| 1: 9,5 ↙ | 6:10,5* → | Serie | 96,0 |
| 2: 9,5 ↙ | 7:10,4* → | | |
| 3:10,4* ↗ | 8:10,1 ↙ | Sum | 376,0 |
| 4: 9,5 ← | 9:10,4* ← | | |
| 5: 9,7 ↙ | 10:10,1 ↑ | | |

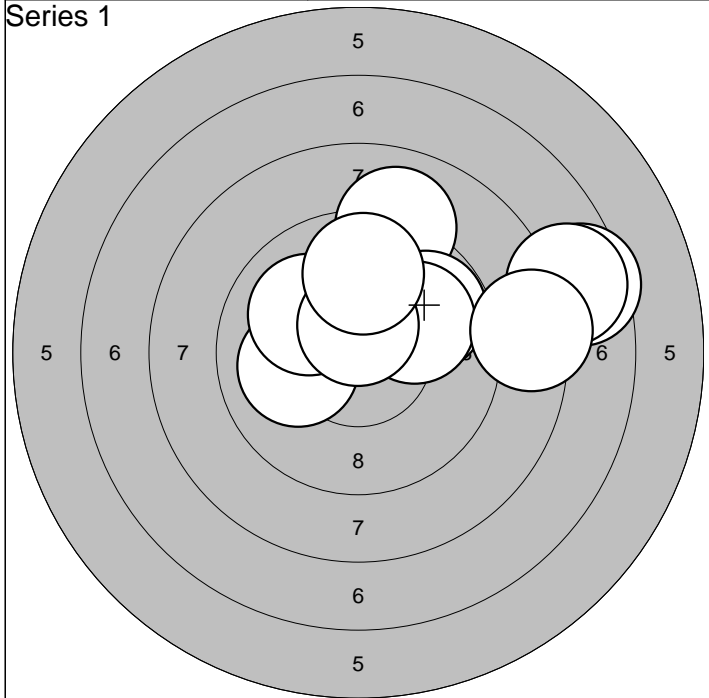

| | | | |
|-----------|------------|-------|------|
| 1: 7,5 → | 6: 10,0 ↖ | Serie | 89,0 |
| 2: 9,0 ↑ | 7: 10,0 → | | |
| 3: 7,7 → | 8: 10,5* ↑ | Sum | 89,0 |
| 4: 9,8 ↗ | 9: 9,8 ↑ | | |
| 5: 10,0 ← | 10: 8,4 → | | |

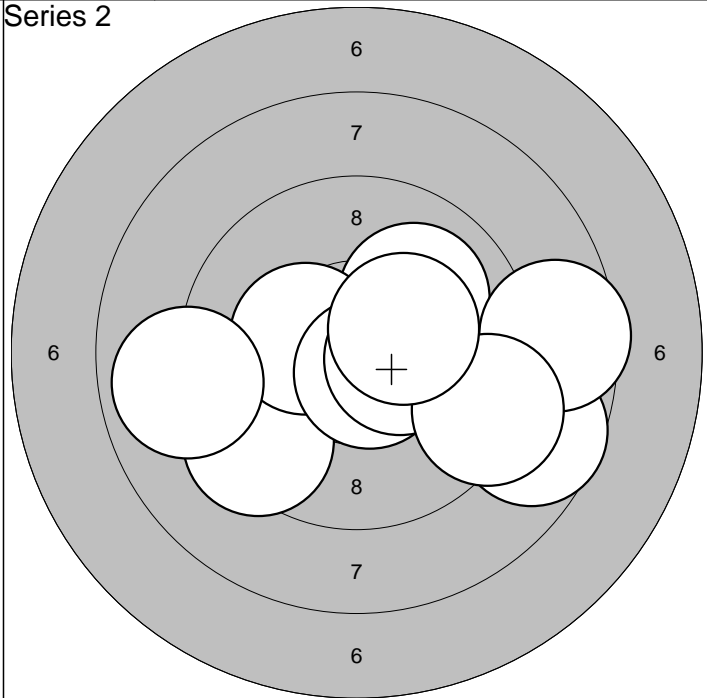

| | | | |
|------------|-------------|-------|-------|
| 1: 9,4 ↙ | 6: 8,9 ← | Serie | 92,0 |
| 2: 8,7 → | 7: 10,7* ↘ | | |
| 3: 10,0 ↗ | 8: 10,4* → | Sum | 181,0 |
| 4: 10,3* ↖ | 9: 9,2 → | | |
| 5: 8,6 → | 10: 10,3* ↗ | | |

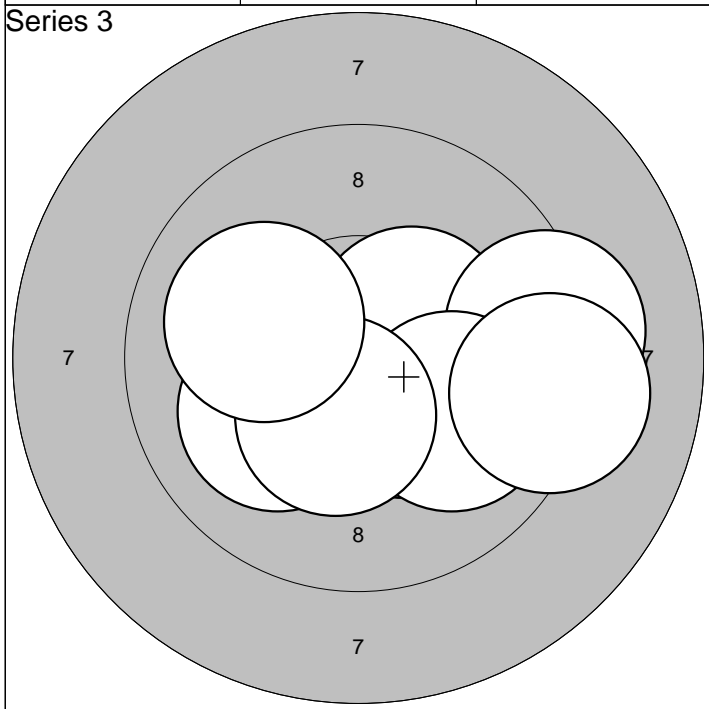

| | | | |
|------------|------------|-------|-------|
| 1: 10,1 ↙ | 6: 9,2 → | Serie | 98,0 |
| 2: 10,4* ↘ | 7: 10,0 → | | |
| 3: 10,6* ↘ | 8: 10,4* ↘ | Sum | 279,0 |
| 4: 10,4* ↘ | 9: 10,0 ↖ | | |
| 5: 10,4* ↗ | 10: 9,2 → | | |

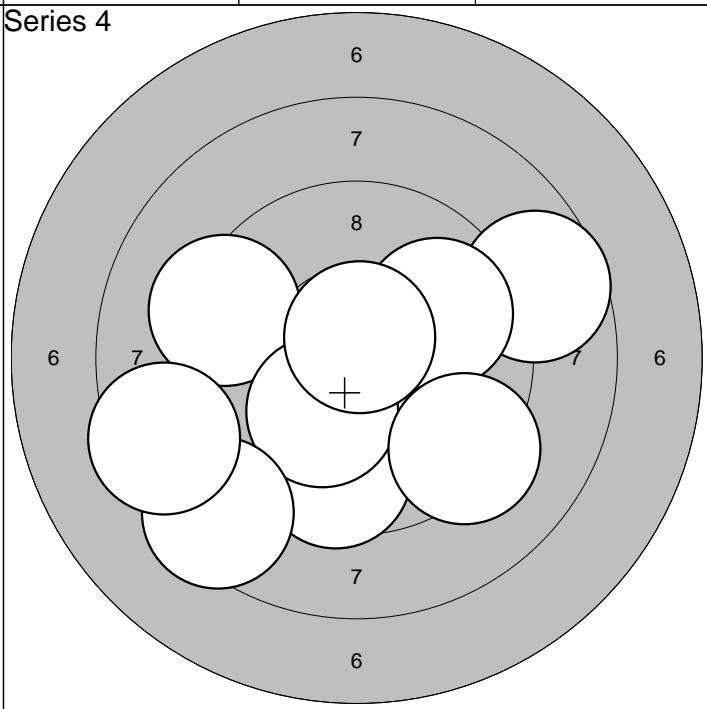

| | | | |
|------------|------------|-------|-------|
| 1: 9,3 ↖ | 6: 9,9 ↗ | Serie | 90,0 |
| 2: 10,5* ↘ | 7: 10,7* ↑ | | |
| 3: 9,6 ↘ | 8: 9,3 ↘ | Sum | 369,0 |
| 4: 10,2* ↙ | 9: 8,5 ↙ | | |
| 5: 8,7 → | 10: 8,5 ↖ | | |

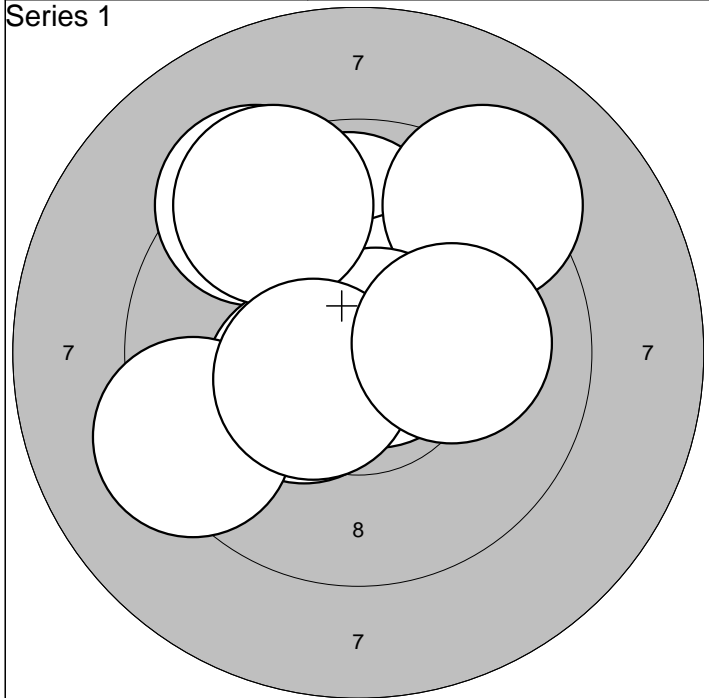

| | | | | | |
|---------|---|---------|---|-------|------|
| 1: 9,9 | ↑ | 6:10,4* | ↙ | Serie | 95,0 |
| 2: 9,4 | ↖ | 7: 9,3 | ↙ | | |
| 3:10,4* | ↗ | 8: 9,4 | ↖ | Sum | 95,0 |
| 4: 9,2 | ↗ | 9:10,5* | ↙ | | |
| 5:10,8* | → | 10:10,1 | → | | |

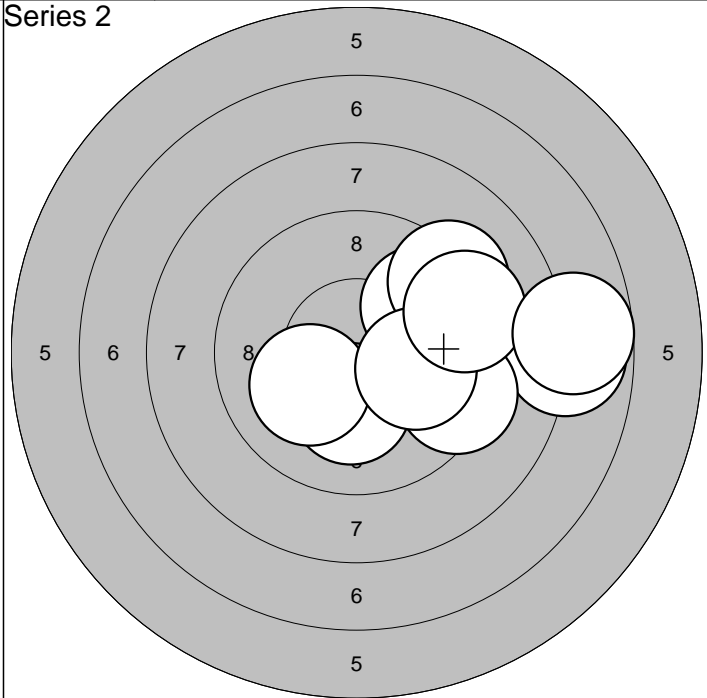

| | | | | | |
|---------|---|---------|---|-------|-------|
| 1: 7,9 | → | 6: 9,8 | ↗ | Serie | 89,0 |
| 2: 9,9 | → | 7: 9,2 | ↗ | | |
| 3:10,2* | ↓ | 8:10,0 | → | Sum | 184,0 |
| 4:10,1 | ↙ | 9: 9,2 | ↗ | | |
| 5: 9,3 | → | 10: 7,7 | → | | |

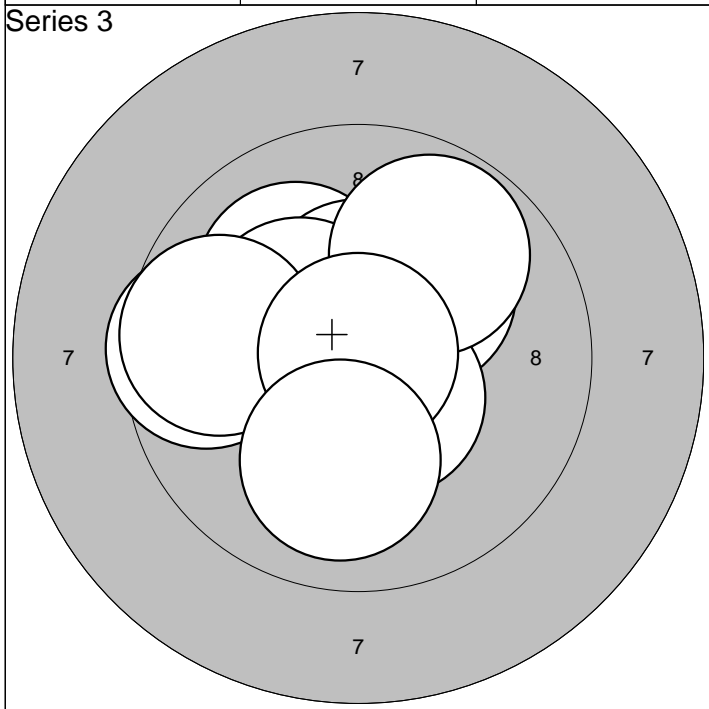

| | | | | | |
|---------|---|---------|---|-------|-------|
| 1:10,2* | ↗ | 6:10,3* | ↖ | Serie | 97,0 |
| 2:10,1 | ↖ | 7: 9,8 | ↗ | | |
| 3:10,5* | ↘ | 8: 9,7 | ↖ | Sum | 281,0 |
| 4:10,4* | ↑ | 9:10,9* | ↑ | | |
| 5: 9,6 | ← | 10:10,0 | ↓ | | |

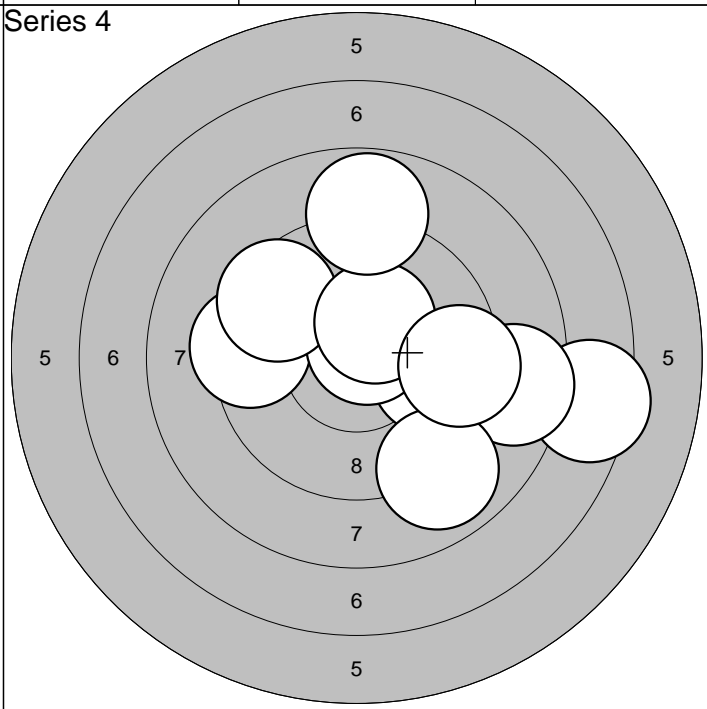

| | | | | | |
|---------|---|---------|---|-------|-------|
| 1: 9,8 | → | 6: 8,6 | → | Serie | 87,0 |
| 2: 9,4 | ← | 7:10,3* | ↗ | | |
| 3: 7,5 | → | 8: 8,9 | ↘ | Sum | 368,0 |
| 4:10,7* | ↗ | 9: 8,8 | ↑ | | |
| 5: 9,5 | ↖ | 10: 9,4 | → | | |

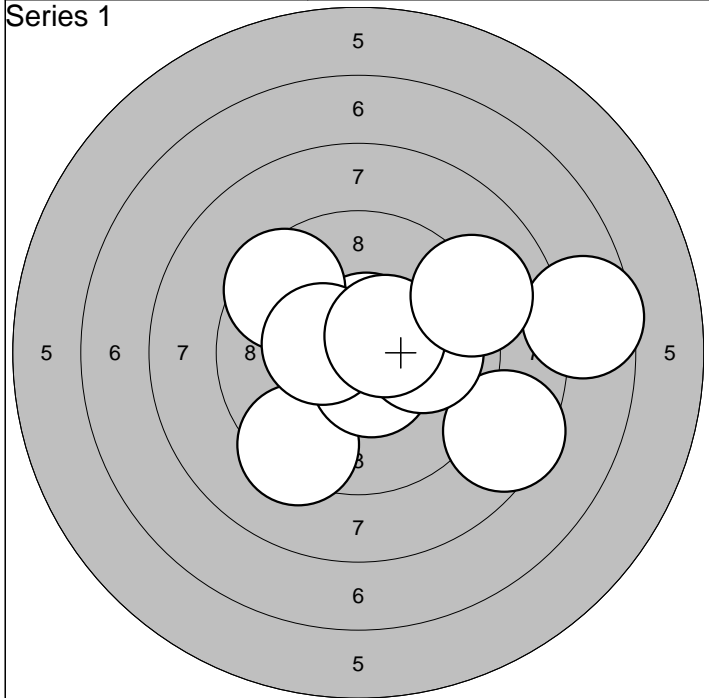

| | | | |
|-----------|-----------|-------|------|
| 1:10,6* ↗ | 6: 8,5 ➡ | Serie | 92,0 |
| 2: 9,3 ↘ | 7:10,4* ← | | |
| 3:10,6* ↘ | 8:10,0 ➡ | Sum | 92,0 |
| 4: 7,6 ➡ | 9:10,5* ↗ | | |
| 5: 9,5 ↖ | 10: 9,1 ➡ | | |

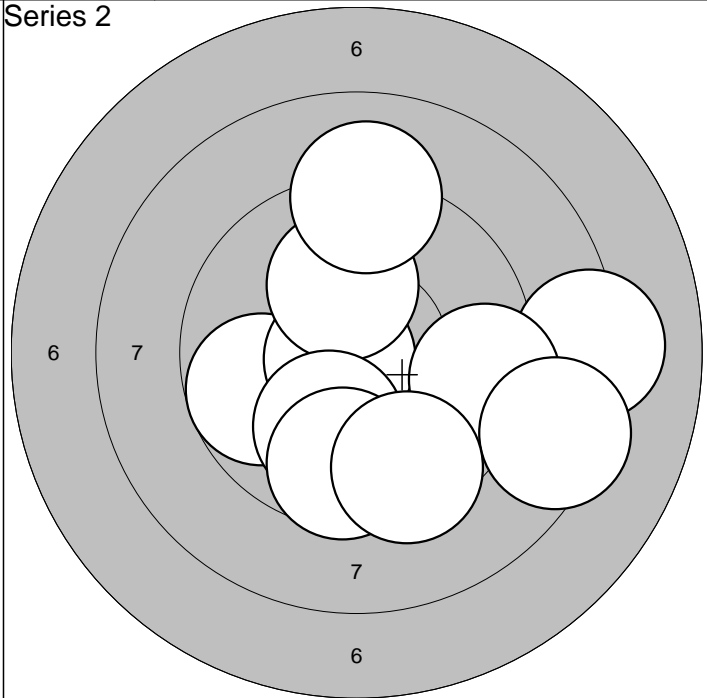

| | | | |
|-----------|-----------|-------|-------|
| 1: 9,8 ← | 6: 9,1 ↑ | Serie | 91,0 |
| 2:10,7* ← | 7: 8,4 ➡ | | |
| 3: 8,2 ➡ | 8:10,0 ↘ | Sum | 183,0 |
| 4: 9,4 ➡ | 9: 9,6 ↘ | | |
| 5:10,1 ↑ | 10: 9,5 ↘ | | |

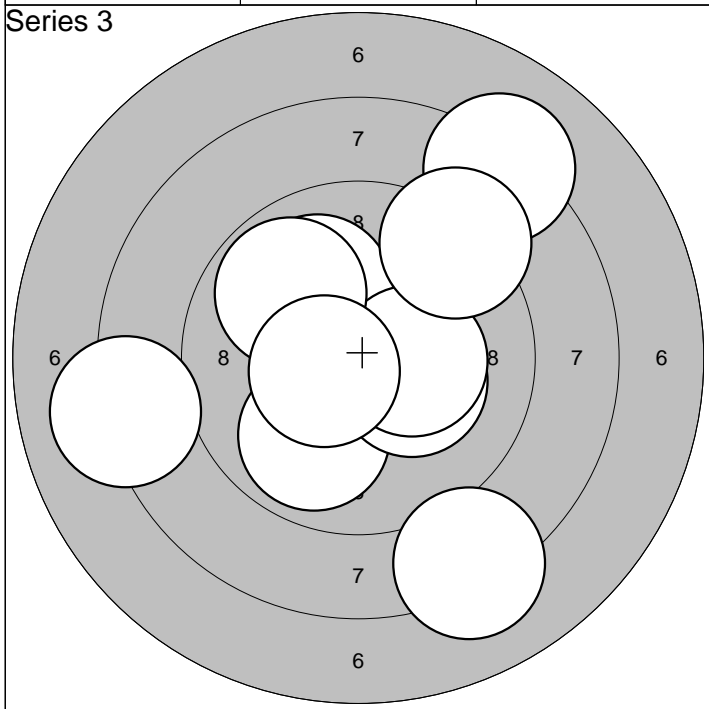

| | | | |
|-----------|------------|-------|-------|
| 1:10,0 ↗ | 6: 8,1 ↗ | Serie | 91,0 |
| 2: 9,9 ↘ | 7: 9,2 ↗ | | |
| 3:10,3* ➡ | 8: 9,8 ↖ | Sum | 274,0 |
| 4: 8,1 ← | 9: 8,2 ↘ | | |
| 5:10,3* ➡ | 10:10,5* ← | | |

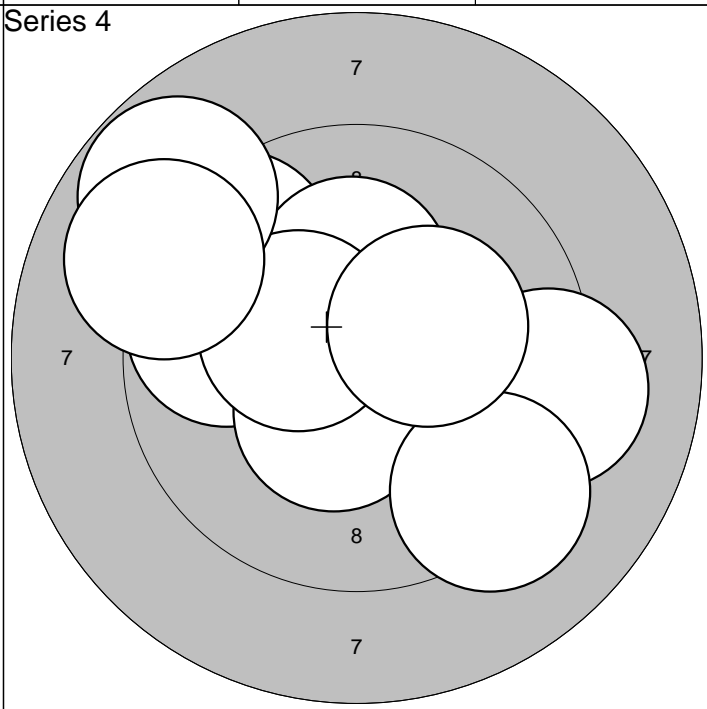

| | | | |
|-----------|------------|-------|-------|
| 1: 9,8 ← | 6: 9,2 ➡ | Serie | 93,0 |
| 2: 9,5 ↖ | 7: 8,8 ↖ | | |
| 3:10,4* ↘ | 8: 9,0 ← | Sum | 367,0 |
| 4:10,2* ↑ | 9: 9,3 ↘ | | |
| 5:10,4* ← | 10:10,2* ➡ | | |

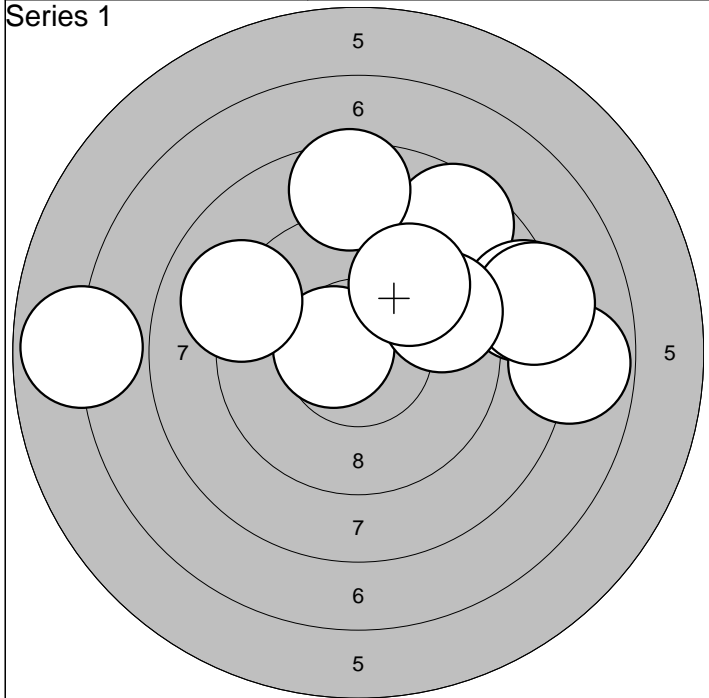

| | | | |
|------------|-----------|-------|------|
| 1: 8,6 ↗ | 6: 9,6 ↗ | Serie | 82,0 |
| 2: 10,6* ← | 7: 8,5 ↑ | | |
| 3: 8,4 → | 8: 9,1 ← | Sum | 82,0 |
| 4: 7,8 → | 9: 6,9 ← | | |
| 5: 8,3 → | 10: 9,7 ↗ | | |

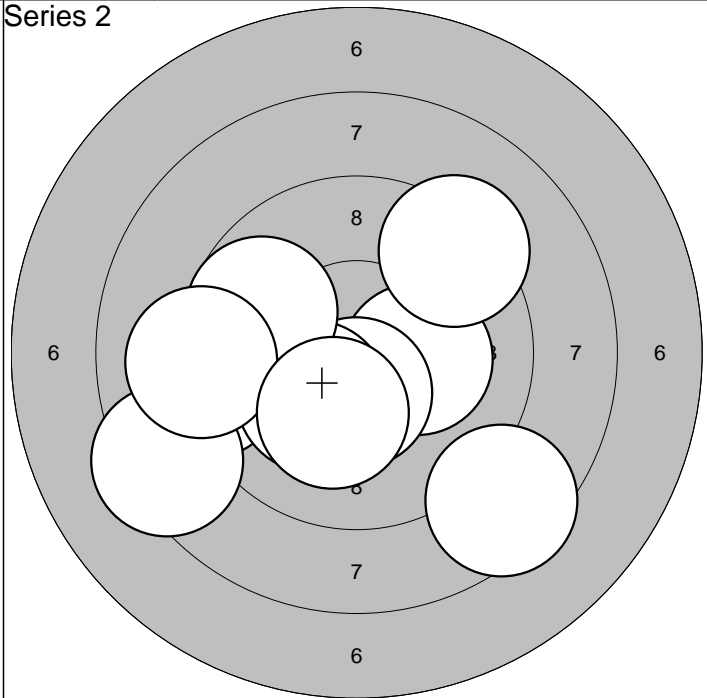

| | | | |
|------------|-------------|-------|-------|
| 1: 9,2 ← | 6: 10,2* ↘ | Serie | 92,0 |
| 2: 8,5 ↘ | 7: 9,7 ← | | |
| 3: 10,2* → | 8: 9,1 ← | Sum | 174,0 |
| 4: 8,4 ← | 9: 9,3 ↗ | | |
| 5: 10,5* ↓ | 10: 10,2* ↘ | | |

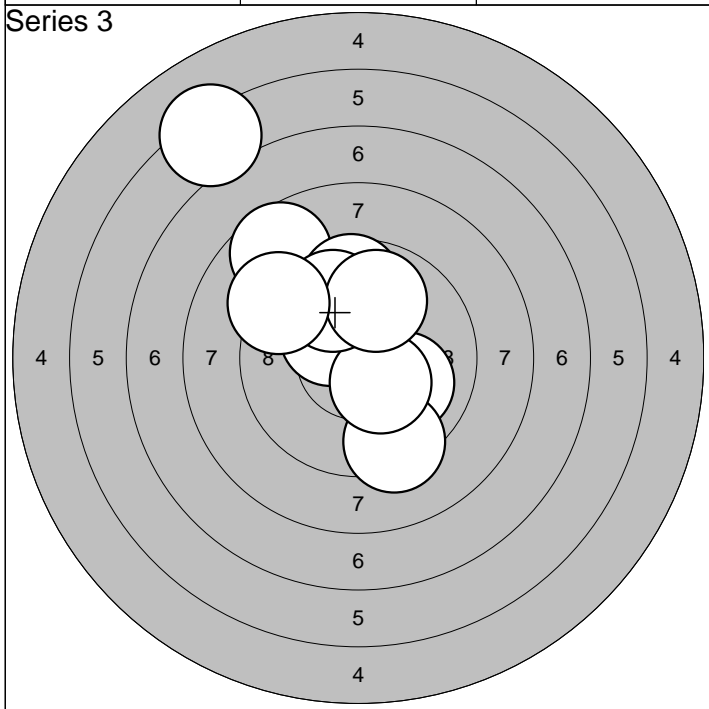

| | | | |
|-----------|------------|-------|-------|
| 1: 6,3 ↗ | 6: 10,3* ↗ | Serie | 89,0 |
| 2: 10,0 ↘ | 7: 10,4* ↘ | | |
| 3: 9,3 ↘ | 8: 9,9 ↗ | Sum | 263,0 |
| 4: 8,7 ↗ | 9: 9,9 ↗ | | |
| 5: 9,6 ↑ | 10: 9,3 ↗ | | |

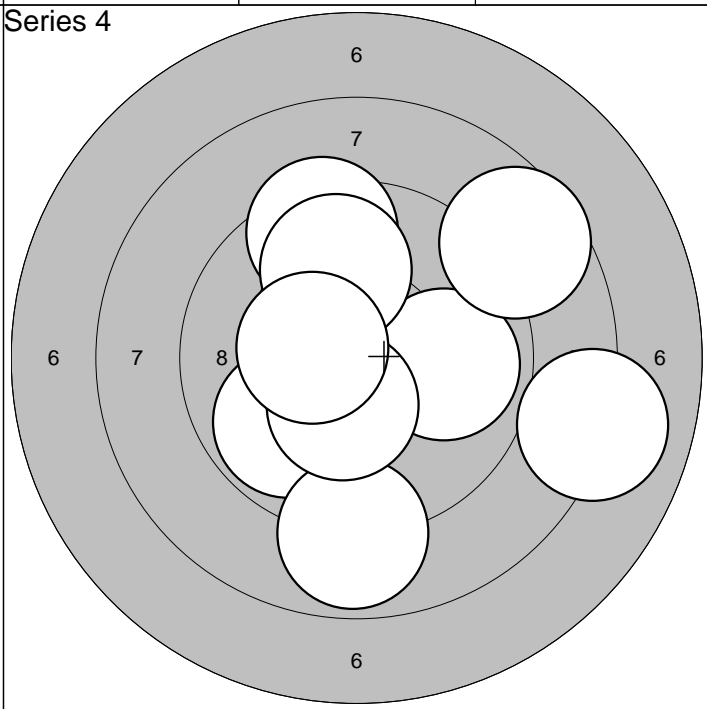

| | | | |
|------------|-------------|-------|-------|
| 1: 10,4* ↗ | 6: 8,9 ↓ | Serie | 90,0 |
| 2: 9,4 ↑ | 7: 10,4* ↘ | | |
| 3: 9,9 ↘ | 8: 8,1 → | Sum | 353,0 |
| 4: 9,9 → | 9: 8,6 ↗ | | |
| 5: 9,9 ↑ | 10: 10,4* ← | | |

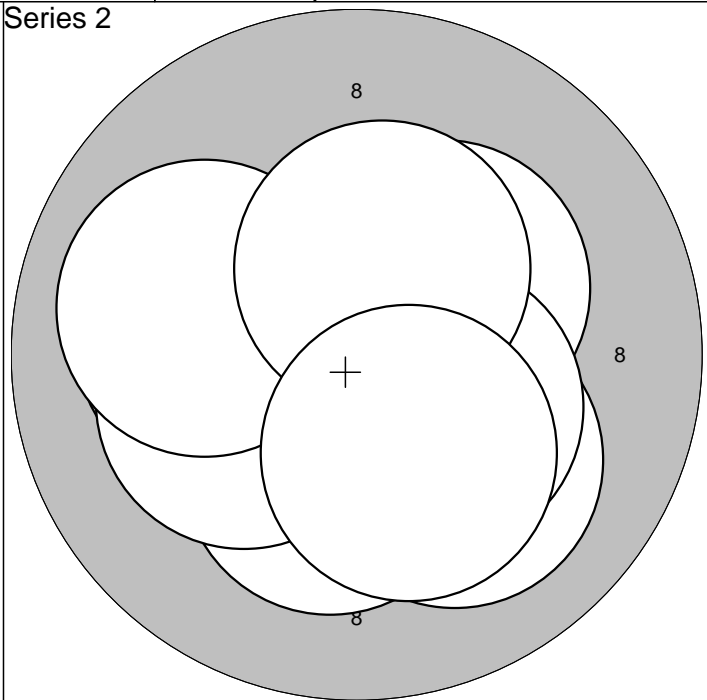
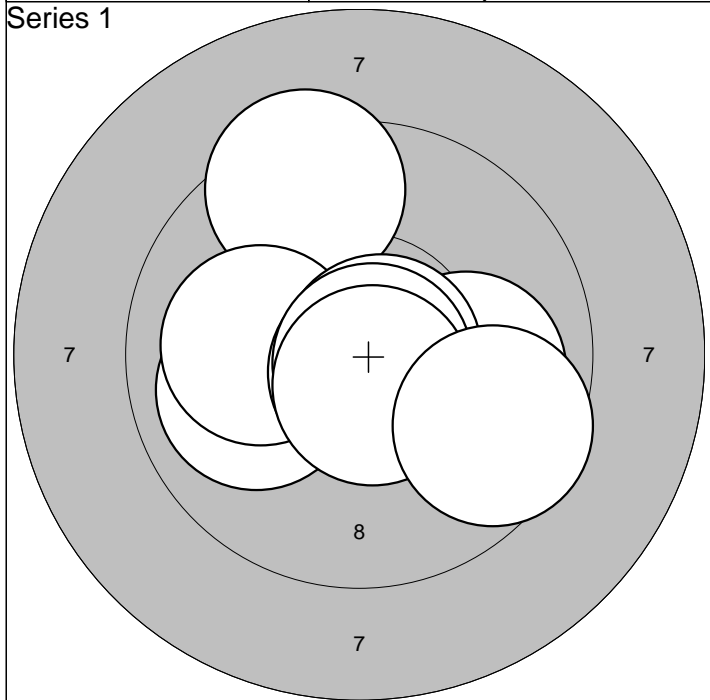

| | | | |
|-----------|-----------|-------|------|
| 1: 9,4 ↗ | 6:10,7* → | Serie | 98,0 |
| 2:10,0 ← | 7:10,8* ↓ | | |
| 3:10,4* → | 8:10,8* ↓ | Sum | 98,0 |
| 4:10,0 → | 9:10,7* ↓ | | |
| 5:10,1 ← | 10: 9,6 ↓ | | |

| | | | |
|-----------|------------|-------|-------|
| 1:10,1 ↓ | 6:10,4* ↓ | Serie | 100,0 |
| 2:10,2* ↓ | 7:10,2* ← | | |
| 3:10,7* ↖ | 8:10,0 ← | Sum | 198,0 |
| 4:10,3* ↗ | 9:10,4* ↑ | | |
| 5:10,2* ← | 10:10,3* ↓ | | |

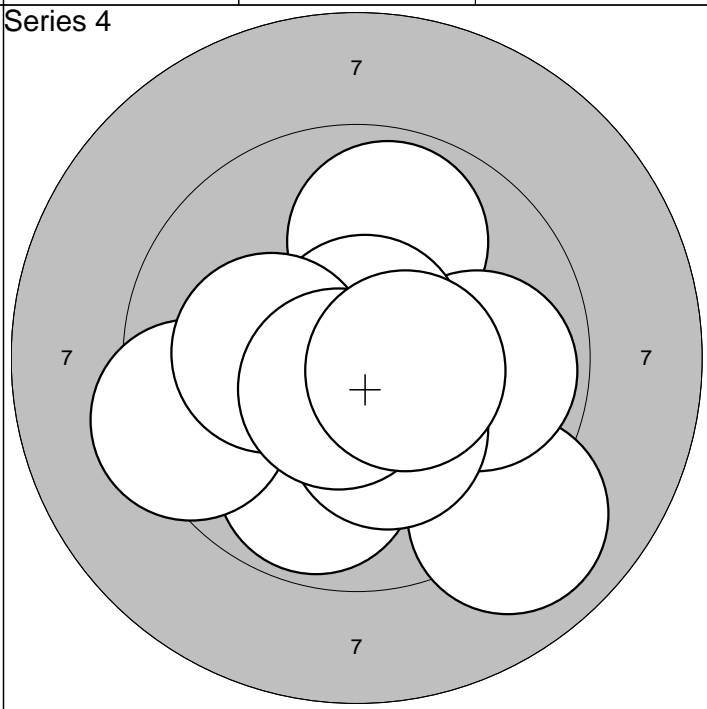
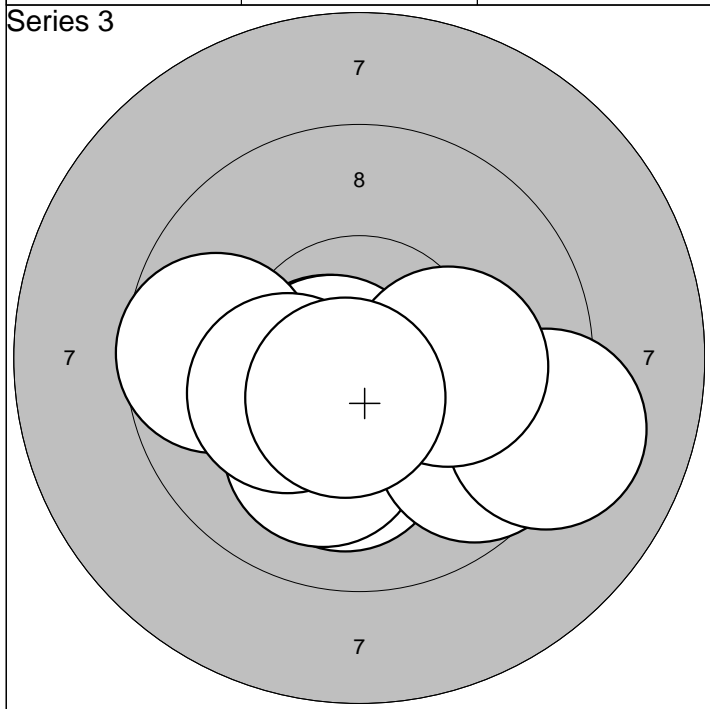

| | | | |
|-----------|------------|-------|-------|
| 1:10,1 ↓ | 6: 9,7 ↓ | Serie | 97,0 |
| 2:10,6* ← | 7: 9,1 → | | |
| 3:10,1 ↓ | 8:10,1 → | Sum | 295,0 |
| 4:10,7* ← | 9:10,2* ← | | |
| 5: 9,7 ← | 10:10,6* ↓ | | |

| | | | |
|-----------|------------|-------|-------|
| 1: 9,9 ↗ | 6: 9,4 ← | Serie | 95,0 |
| 2: 9,8 ↓ | 7:10,7* ↑ | | |
| 3: 9,0 ↓ | 8:10,2* ← | Sum | 390,0 |
| 4: 9,9 → | 9:10,6* ↓ | | |
| 5:10,3* ↓ | 10:10,5* → | | |

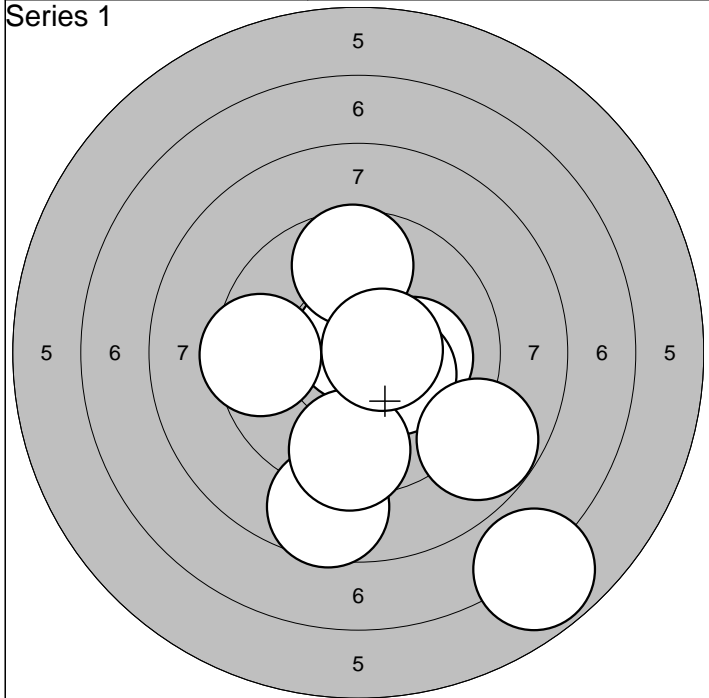

| | | | | |
|-----------|------------|-----|-------|------|
| 1: 6,8 ↘ | 6: 8,6 ↓ | | Serie | 89,0 |
| 2:10,1 → | 7: 9,5 ← | | | |
| 3:10,8* ↑ | 8: 9,7 ↑ | Sum | 89,0 | |
| 4:10,3* ↘ | 9: 9,5 ↓ | | | |
| 5: 8,8 ↘ | 10:10,6* → | | | |

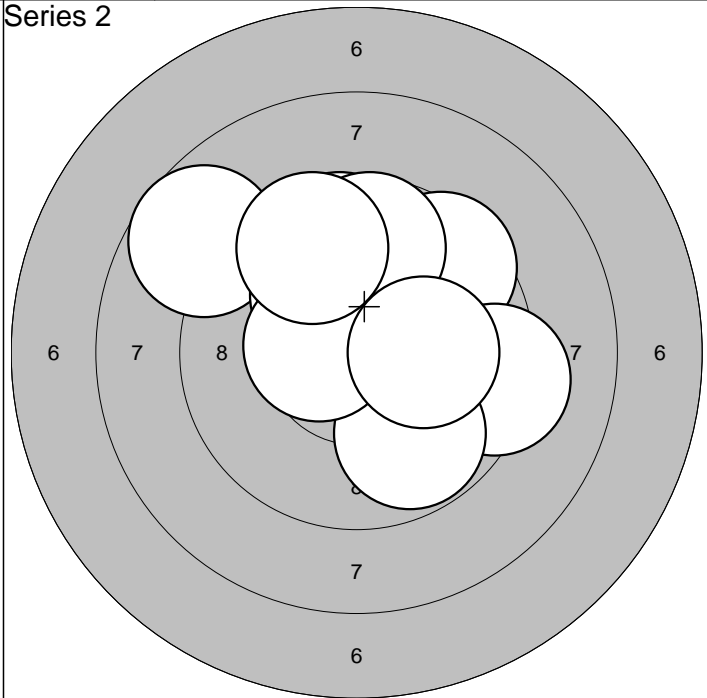

| | | | | |
|-----------|------------|-----|-------|------|
| 1: 9,7 ↑ | 6: 9,8 ↘ | | Serie | 92,0 |
| 2: 9,5 ↗ | 7: 9,7 ↑ | | | |
| 3: 8,7 ↖ | 8:10,5* ← | Sum | 181,0 | |
| 4: 9,3 → | 9: 9,6 ↑ | | | |
| 5:10,2* ↑ | 10:10,2* → | | | |

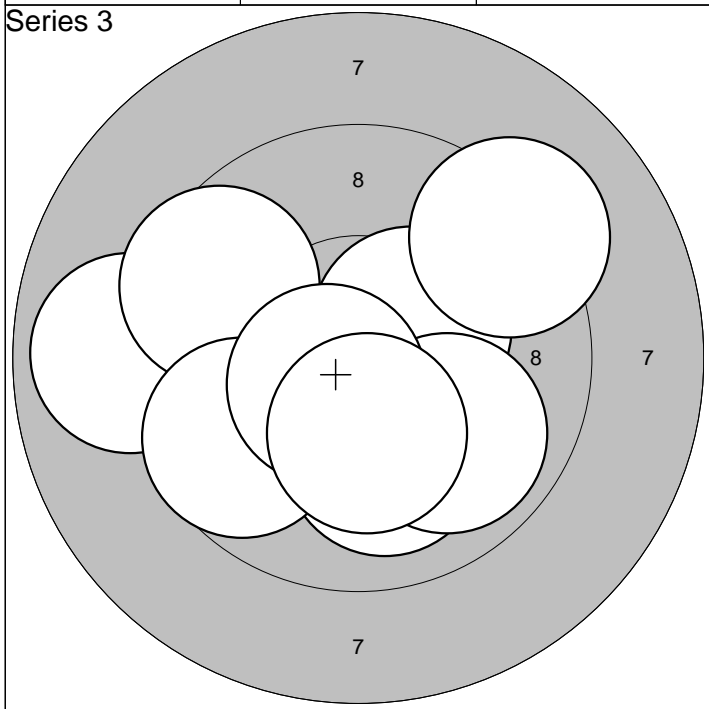

| | | | | |
|-----------|------------|-----|-------|------|
| 1:10,4* ↙ | 6: 9,9 ↘ | | Serie | 94,0 |
| 2: 8,9 ← | 7: 9,7 ↙ | | | |
| 3:10,0 ↓ | 8:10,6* ↙ | Sum | 275,0 | |
| 4:10,4* ↗ | 9: 9,2 ↗ | | | |
| 5: 9,6 ↖ | 10:10,3* ↓ | | | |

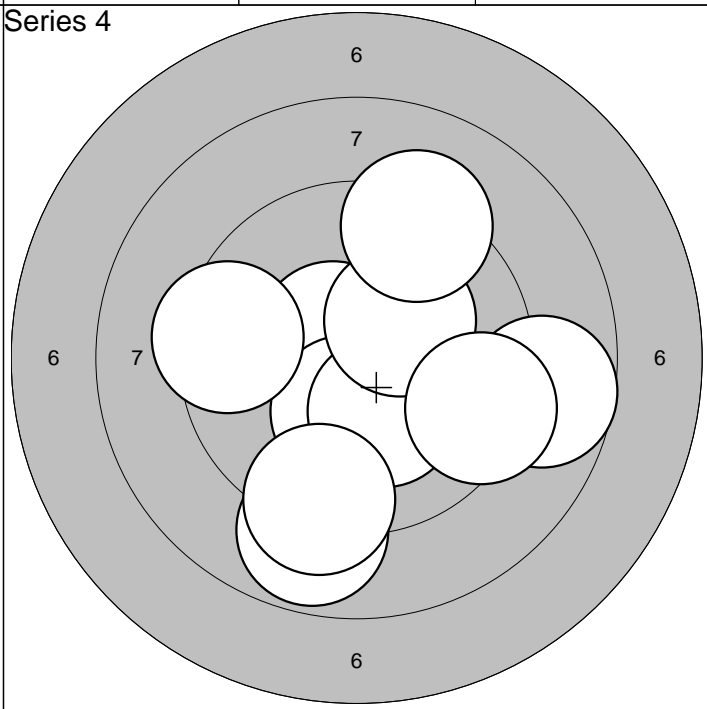

| | | | | |
|-----------|-----------|-----|-------|------|
| 1: 8,7 → | 6:10,3* ↗ | | Serie | 92,0 |
| 2: 8,9 ↓ | 7: 9,2 ↑ | | | |
| 3:10,6* ↖ | 8: 9,4 ← | Sum | 367,0 | |
| 4:10,3* ↓ | 9: 9,2 ↓ | | | |
| 5:10,2* ↘ | 10: 9,4 → | | | |

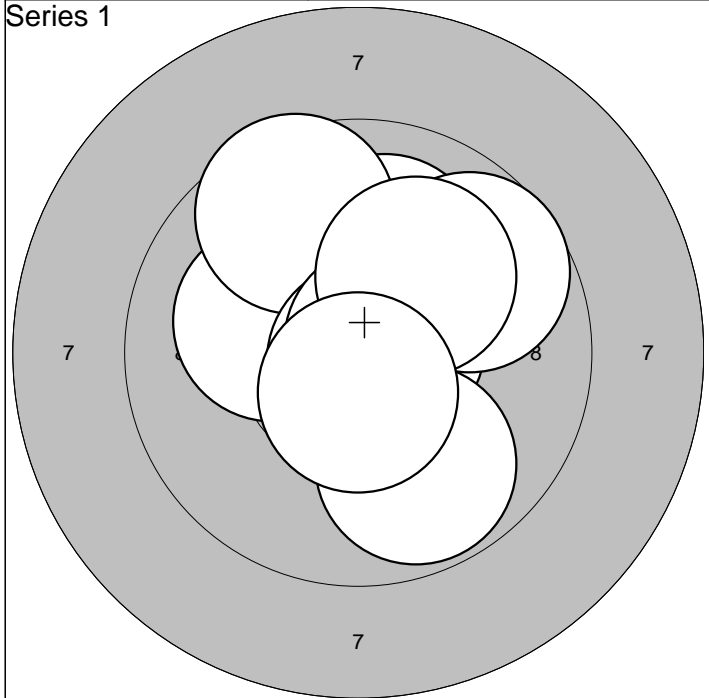

| | | | | |
|-----------|------------|-----|-------|------|
| 1:10,2* ← | 6:10,7* → | | Serie | 97,0 |
| 2:10,1 ← | 7: 9,7 ↗ | | | |
| 3:10,0 ↑ | 8:10,1 ↗ | Sum | 97,0 | |
| 4: 9,6 ↗ | 9: 9,8 ↓ | | | |
| 5:10,9* ↓ | 10:10,6* ↓ | | | |

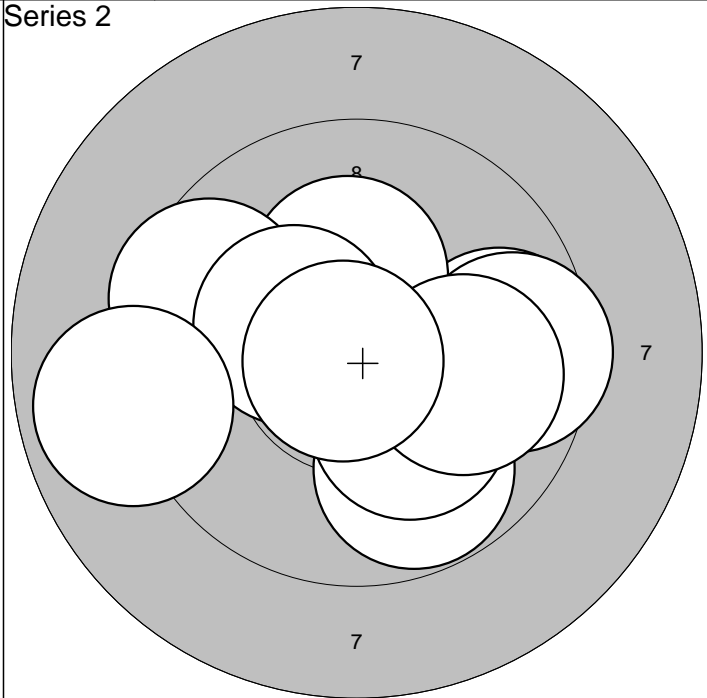

| | | | | |
|-----------|-----------|-----|-------|------|
| 1: 9,8 ↓ | 6:10,2* ↓ | | Serie | 94,0 |
| 2: 9,7 → | 7:10,3* ← | | | |
| 3: 9,5 → | 8:10,0 → | Sum | 191,0 | |
| 4:10,3* ↑ | 9:10,8* ← | | | |
| 5: 9,5 ← | 10: 8,9 ← | | | |

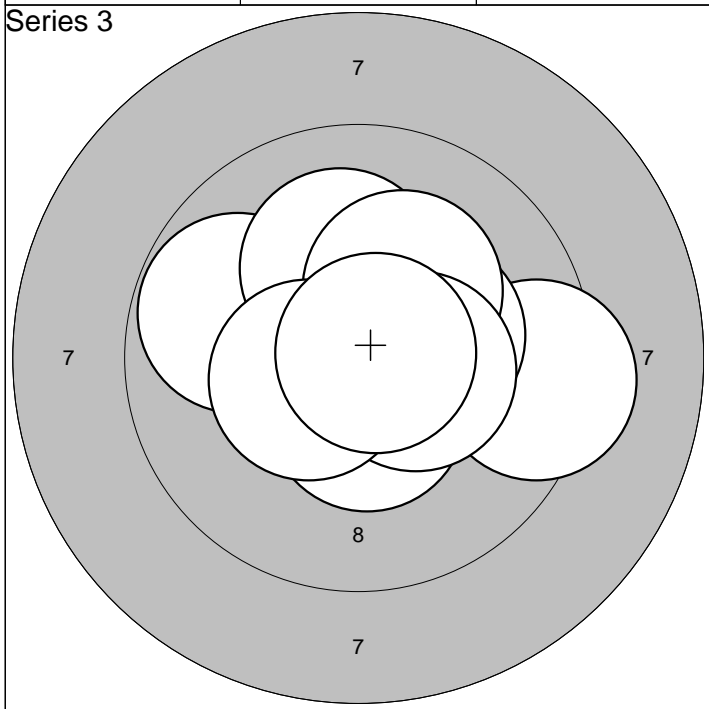

| | | | | |
|-----------|------------|-----|-------|------|
| 1:10,4* ← | 6:10,3* → | | Serie | 98,0 |
| 2: 9,8 ← | 7:10,2* ↗ | | | |
| 3:10,1 ↑ | 8:10,4* → | Sum | 289,0 | |
| 4: 9,3 → | 9:10,5* ← | | | |
| 5:10,4* ↓ | 10:10,8* → | | | |

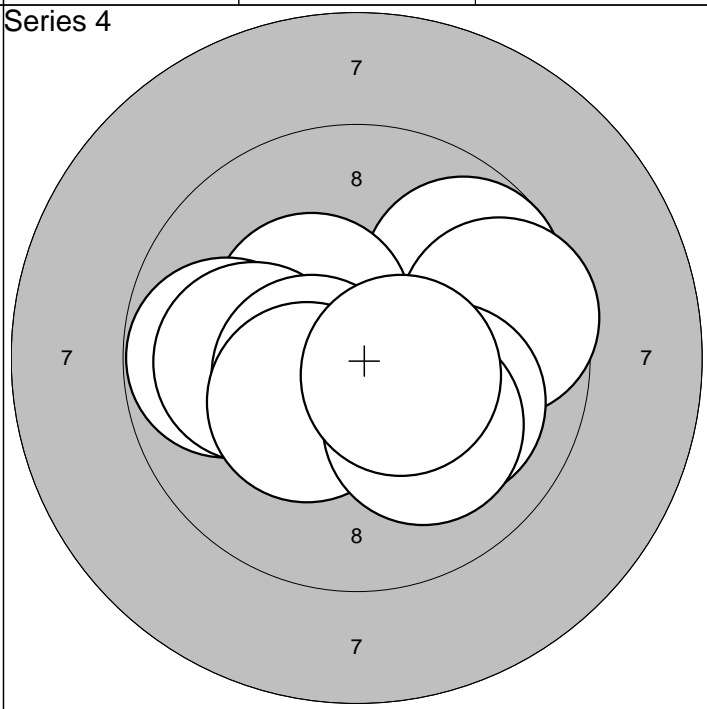

| | | | | |
|-----------|------------|-----|-------|------|
| 1: 9,8 ↗ | 6:10,5* ← | | Serie | 97,0 |
| 2: 9,6 → | 7:10,0 ↘ | | | |
| 3:10,4* ↖ | 8:10,4* ↖ | Sum | 386,0 | |
| 4: 9,8 ← | 9:10,1 ↓ | | | |
| 5:10,0 ← | 10:10,5* → | | | |

Lag **3** Skive **11**

Johanna Lindström

Day 1, Rifle

Forsa Skf

ARJW

3-6.1.2010

Swedish Cup 2010

Swedishcup 10

Series 1

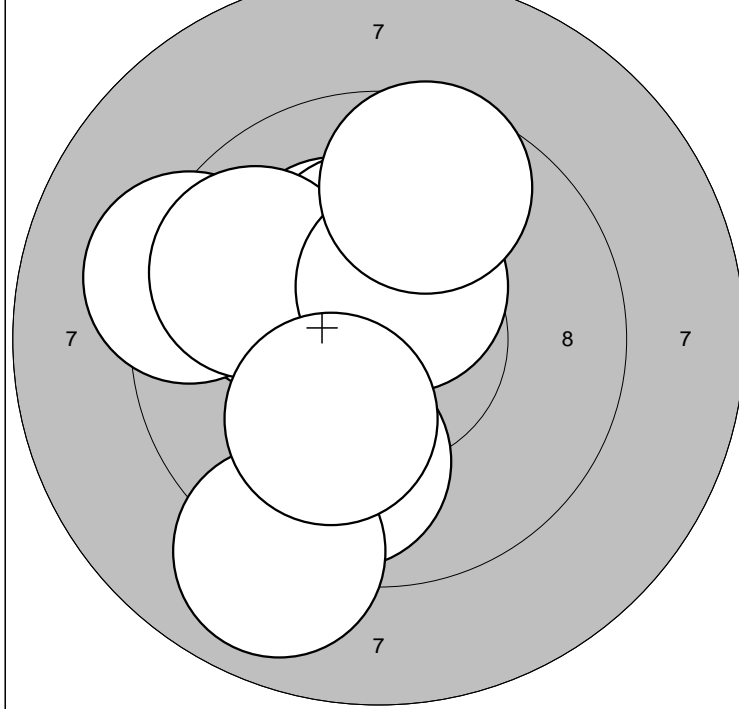

| | | | |
|------------|------------|-------|------|
| 1: 10,1 ↖ | 6: 10,3* ↑ | Serie | 95,0 |
| 2: 9,9 ↓ | 7: 9,8 ↖ | | |
| 3: 9,3 ↖ | 8: 10,5* ↑ | Sum | 95,0 |
| 4: 10,2* ↗ | 9: 10,2* ↓ | | |
| 5: 9,0 ↓ | 10: 9,6 ↑ | | |

Series 2

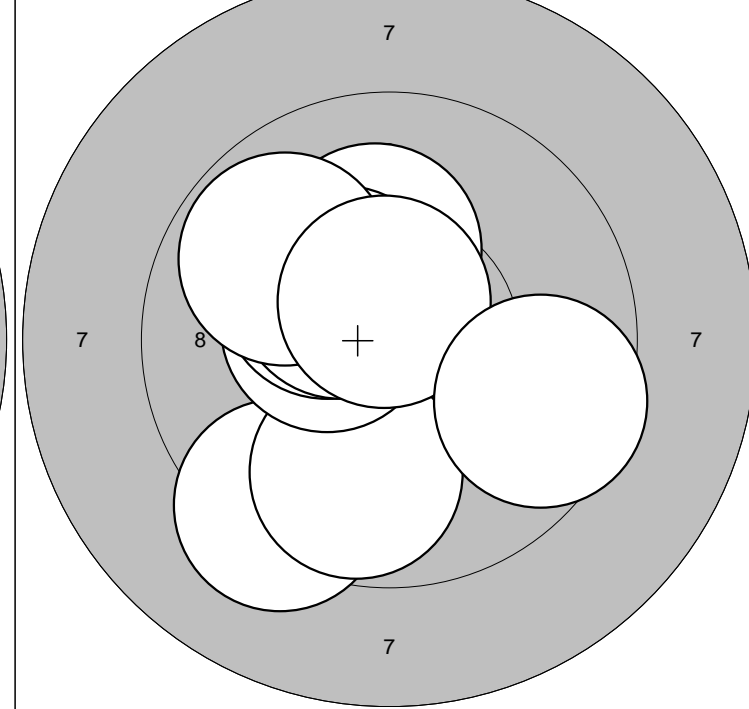

| | | | |
|------------|------------|-------|-------|
| 1: 9,3 ↘ | 6: 10,3* ↗ | Serie | 96,0 |
| 2: 10,5* ↖ | 7: 10,4* ↗ | | |
| 3: 10,2* ↑ | 8: 9,8 ↗ | Sum | 191,0 |
| 4: 9,8 ↓ | 9: 10,6* ↑ | | |
| 5: 10,4* ↖ | 10: 9,6 ↘ | | |

Series 3

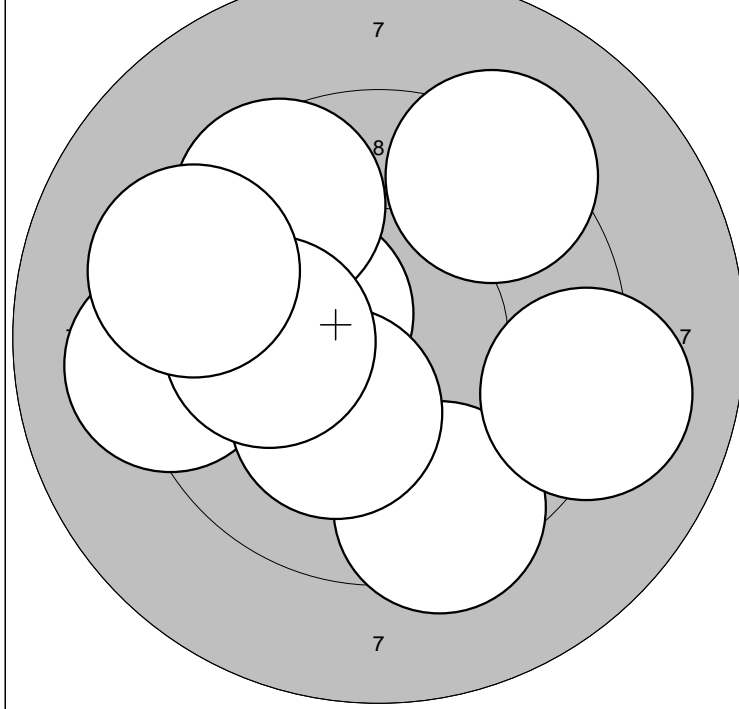

| | | | |
|------------|-----------|-------|-------|
| 1: 9,2 ↖ | 6: 9,3 ↗ | Serie | 93,0 |
| 2: 9,4 ↓ | 7: 9,5 ↗ | | |
| 3: 9,8 ↗ | 8: 9,1 → | Sum | 284,0 |
| 4: 10,3* ↖ | 9: 10,0 ↖ | | |
| 5: 10,2* ↓ | 10: 9,3 ↖ | | |

Series 4

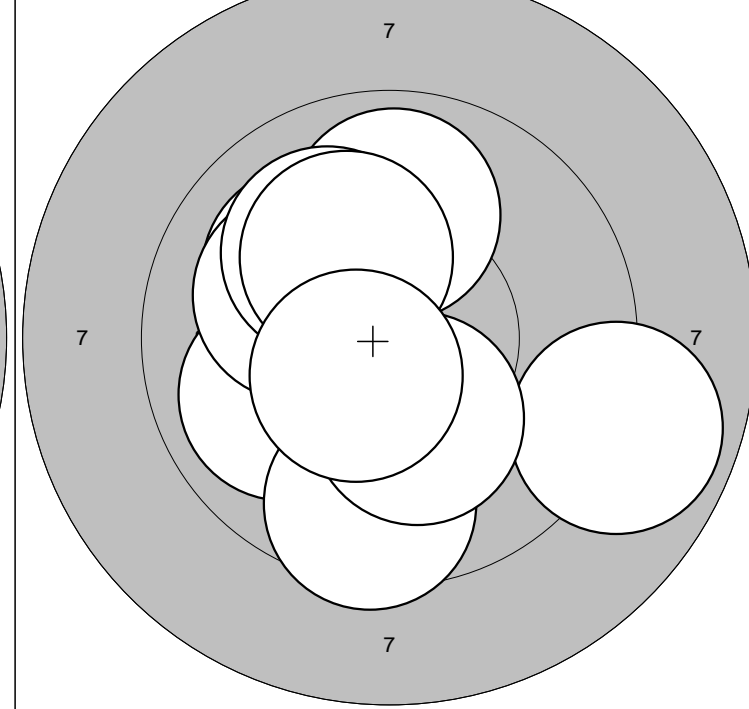

| | | | |
|-----------|-------------|-------|-------|
| 1: 8,9 → | 6: 10,1 ↗ | Serie | 95,0 |
| 2: 9,9 ↖ | 7: 9,5 ↓ | | |
| 3: 10,1 ↖ | 8: 10,2* ↓ | Sum | 379,0 |
| 4: 9,9 ↑ | 9: 10,2* ↗ | | |
| 5: 10,1 ↖ | 10: 10,5* ↓ | | |

Edman Precision, Morini, Interprodukter

Sävsjö kommun, Sävsjö Skytte Center

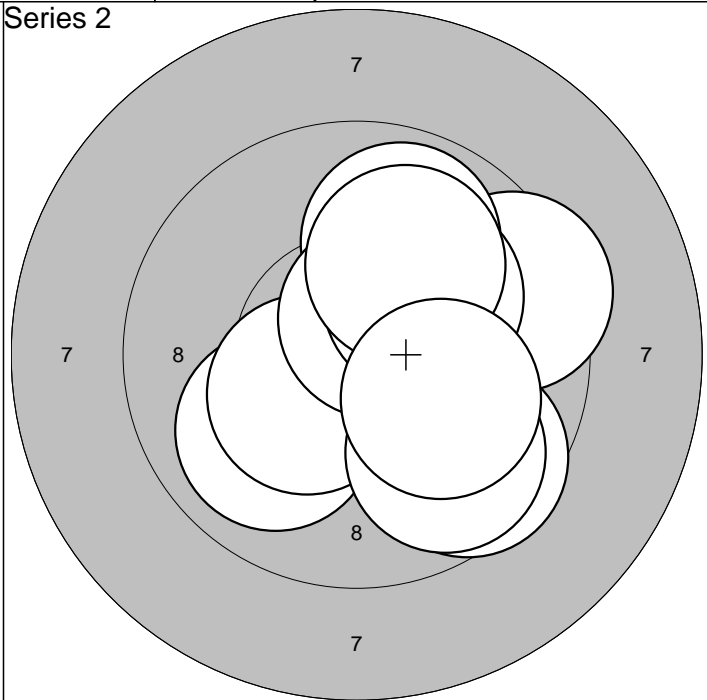
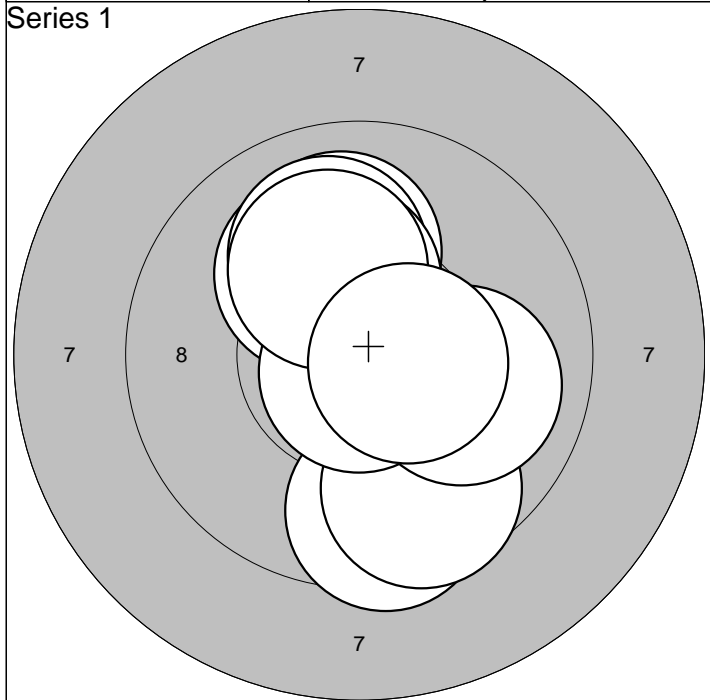

| | | |
|----------|------------|------------|
| 1:10,1 ↗ | 6:10,0 → | Serie 98,0 |
| 2:10,0 ↑ | 7:10,3* ↑ | |
| 3:10,0 ↑ | 8:10,8* ↓ | Sum 98,0 |
| 4: 9,5 ↓ | 9:10,2* ↑ | |
| 5: 9,6 ↓ | 10:10,5* → | |

| | | |
|-----------|-----------|------------|
| 1: 9,9 ↙ | 6: 9,6 ↘ | Serie 95,0 |
| 2:10,4* ↙ | 7:10,2* ↗ | |
| 3: 9,4 → | 8:10,0 ↑ | Sum 193,0 |
| 4: 9,9 ↑ | 9: 9,8 ↓ | |
| 5:10,6* ↗ | 10:10,1 ↘ | |

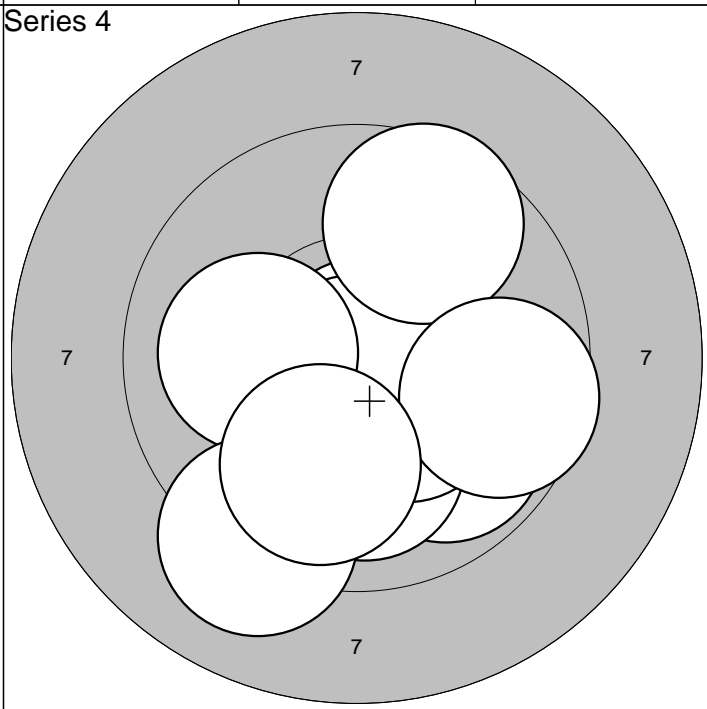
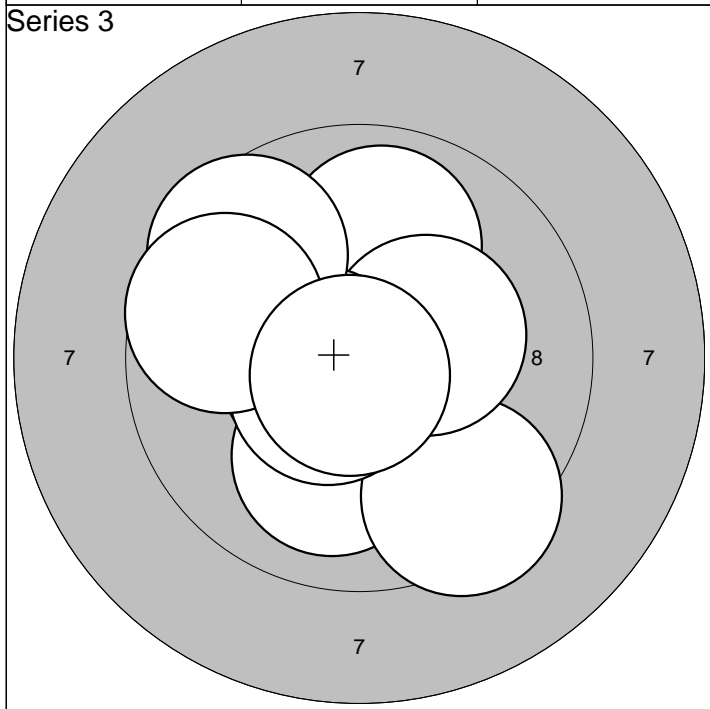

| | | |
|-----------|------------|------------|
| 1:10,0 ↓ | 6:10,6* ← | Serie 96,0 |
| 2:10,0 ← | 7: 9,6 ↗ | |
| 3: 9,9 ↑ | 8:10,6* ↙ | Sum 289,0 |
| 4: 9,4 ↓ | 9: 9,7 ← | |
| 5:10,3* → | 10:10,8* ↓ | |

| | | |
|-----------|-----------|------------|
| 1: 9,9 ↘ | 6:10,0 ← | Serie 95,0 |
| 2:10,0 ↓ | 7: 9,6 ↗ | |
| 3:10,9* → | 8: 9,6 → | Sum 384,0 |
| 4:10,4* ↘ | 9: 9,1 ↓ | |
| 5:10,8* ↓ | 10: 9,9 ↓ | |

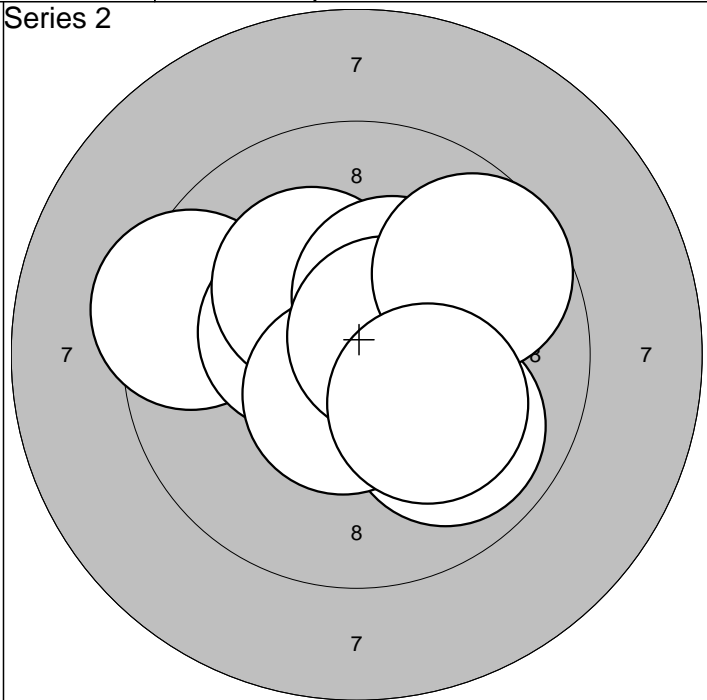
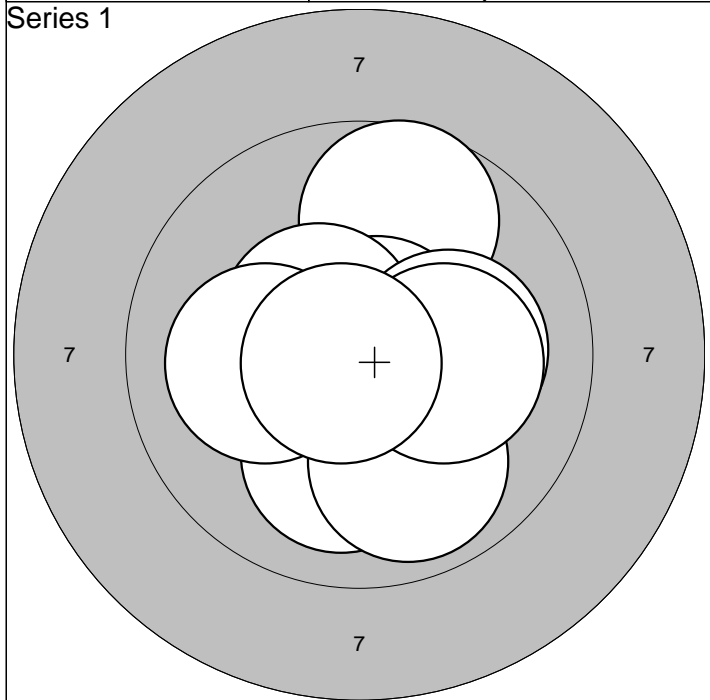

| | | | | | | | |
|---------|---|----------|---|-----|------|-------|------|
| 1: 9,7 | ↑ | 6:10,1 | ← | | | Serie | 98,0 |
| 2:10,7* | ↗ | 7:10,2* | → | | | | |
| 3:10,5* | ↘ | 8: 9,9 | ↓ | Sum | 98,0 | | |
| 4:10,1 | ↓ | 9:10,2* | → | | | | |
| 5:10,5* | ↖ | 10:10,7* | ← | | | | |

| | | | | | | | |
|---------|---|----------|---|-----|-------|-------|------|
| 1: 9,4 | ← | 6:10,3* | ↗ | | | Serie | 97,0 |
| 2:10,6* | ↖ | 7:10,6* | ↓ | | | | |
| 3:10,4* | ↖ | 8:10,6* | ↗ | Sum | 195,0 | | |
| 4:10,2* | ↗ | 9: 9,7 | ↗ | | | | |
| 5: 9,9 | ↘ | 10:10,2* | ↘ | | | | |

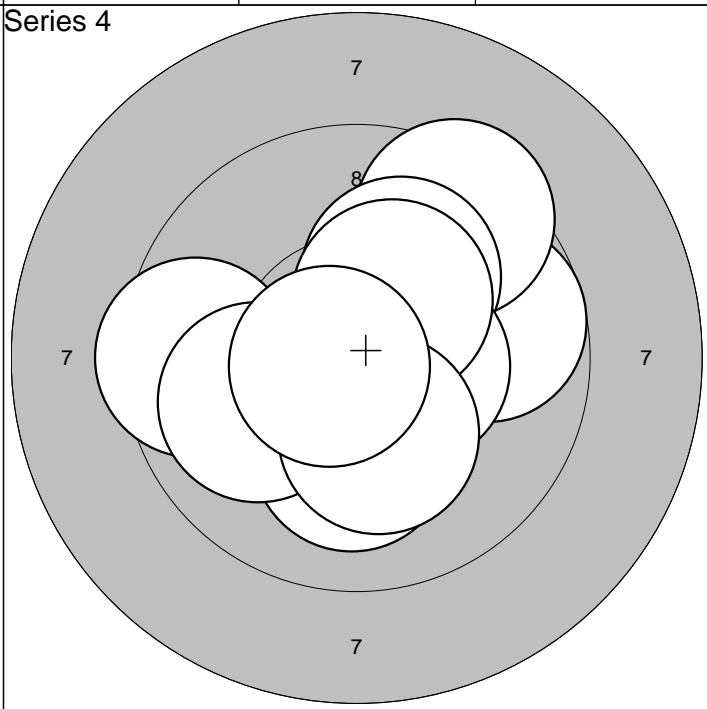
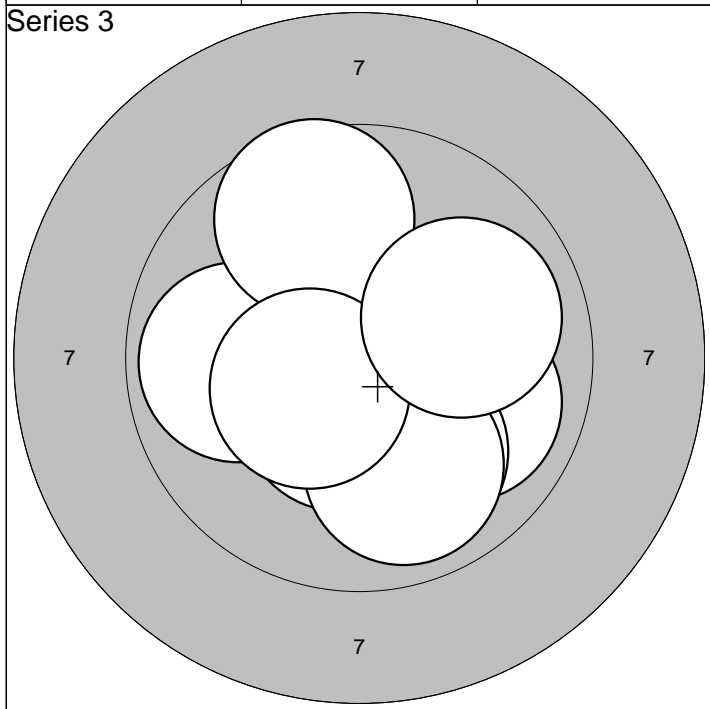

| | | | | | | | |
|---------|---|---------|---|-----|-------|-------|------|
| 1:10,4* | ↓ | 6: 9,9 | ↓ | | | Serie | 97,0 |
| 2:10,1 | ↓ | 7: 9,9 | ← | | | | |
| 3:10,1 | ↓ | 8: 9,6 | ↑ | Sum | 292,0 | | |
| 4:10,0 | ↘ | 9:10,4* | ← | | | | |
| 5:10,0 | ↓ | 10:10,0 | → | | | | |

| | | | | | | | |
|--------|---|----------|---|-----|-------|-------|------|
| 1:10,1 | ↓ | 6:10,1 | ↗ | | | Serie | 97,0 |
| 2: 9,7 | → | 7:10,5* | → | | | | |
| 3: 9,5 | ← | 8:10,3* | ↗ | Sum | 389,0 | | |
| 4:10,0 | ← | 9:10,2* | ↓ | | | | |
| 5: 9,4 | ↗ | 10:10,7* | ← | | | | |

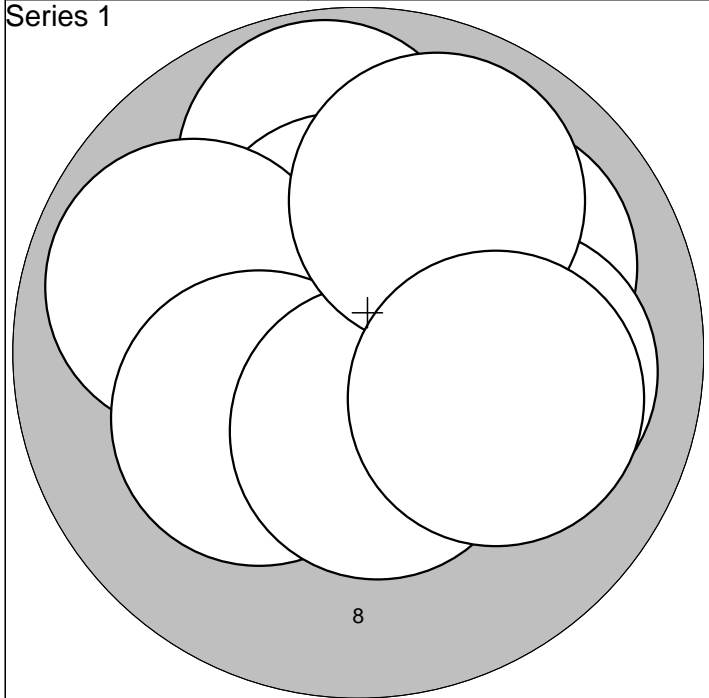

| | | | | | |
|---------|---|---------|---|-------|------|
| 1: 9,8 | ↑ | 6:10,0 | → | Serie | 97,0 |
| 2:10,2* | ← | 7:10,2* | ↙ | | |
| 3:10,4* | ↑ | 8:10,5* | ↓ | Sum | 97,0 |
| 4: 9,9 | ↖ | 9: 9,9 | ↗ | | |
| 5:10,0 | ↗ | 10:10,1 | → | | |

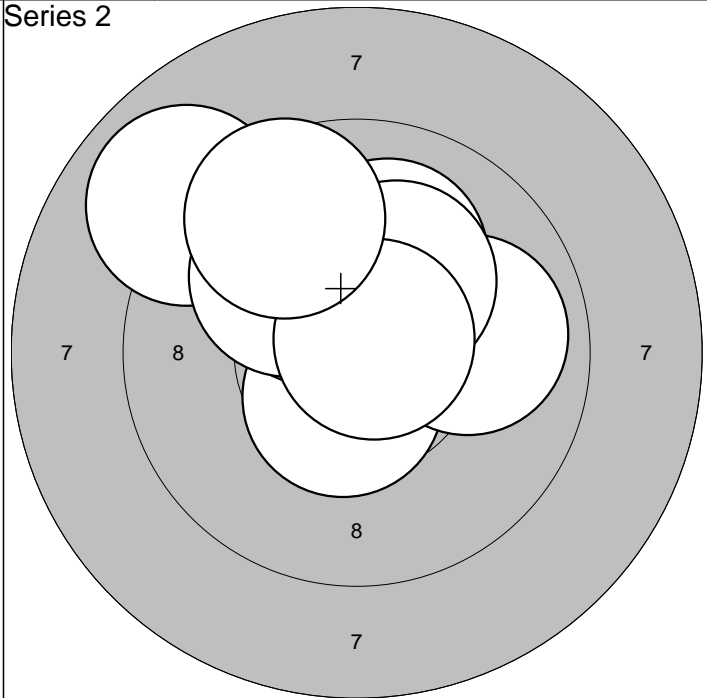

| | | | | | |
|---------|---|---------|---|-------|-------|
| 1:10,0 | ↑ | 6: 9,9 | → | Serie | 97,0 |
| 2:10,5* | ↓ | 7:10,2* | ↗ | | |
| 3:10,2* | ↖ | 8:10,1 | ↖ | Sum | 194,0 |
| 4:10,3* | ↑ | 9:10,7* | ↗ | | |
| 5: 9,0 | ↖ | 10: 9,6 | ↖ | | |

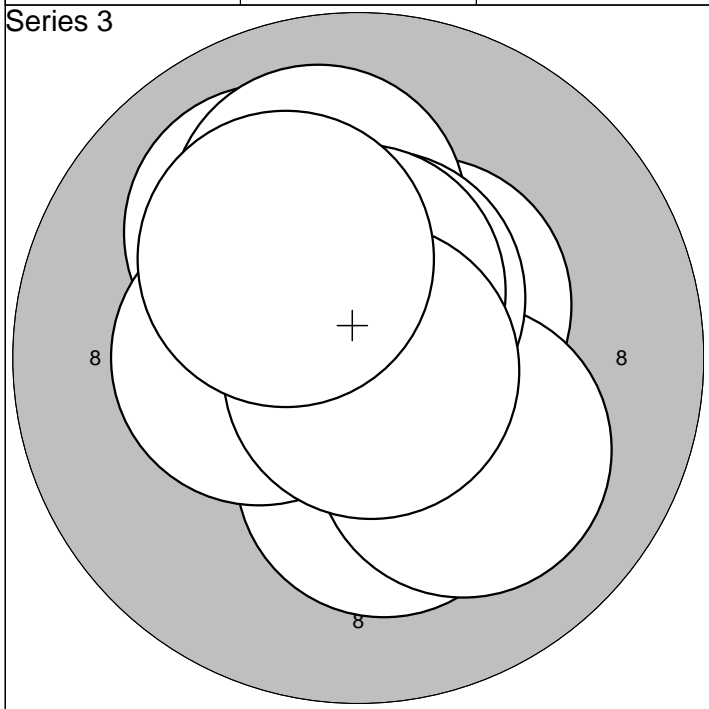

| | | | | | |
|---------|---|----------|---|-------|-------|
| 1:10,4* | ↗ | 6:10,6* | ↑ | Serie | 100,0 |
| 2:10,0 | ↗ | 7:10,5* | ↑ | | |
| 3:10,0 | ↑ | 8:10,4* | ← | Sum | 294,0 |
| 4:10,3* | ↓ | 9:10,8* | ↘ | | |
| 5:10,1 | ↘ | 10:10,2* | ↗ | | |

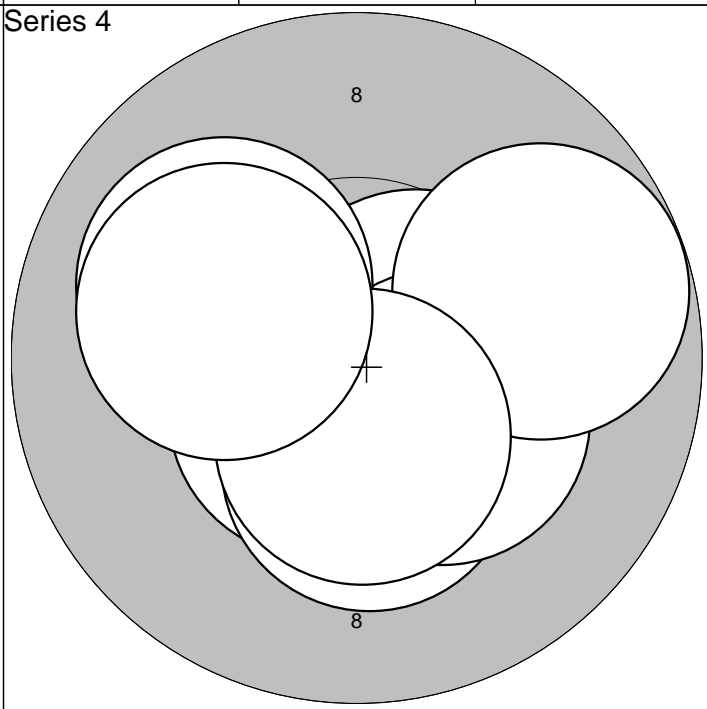

| | | | | | |
|---------|---|---------|---|-------|-------|
| 1:10,6* | ↘ | 6:10,3* | ↘ | Serie | 99,0 |
| 2:10,8* | ← | 7: 9,8 | → | | |
| 3:10,4* | → | 8:10,1 | ↖ | Sum | 393,0 |
| 4:10,3* | ↓ | 9:10,5* | ↓ | | |
| 5:10,6* | → | 10:10,1 | ↖ | | |

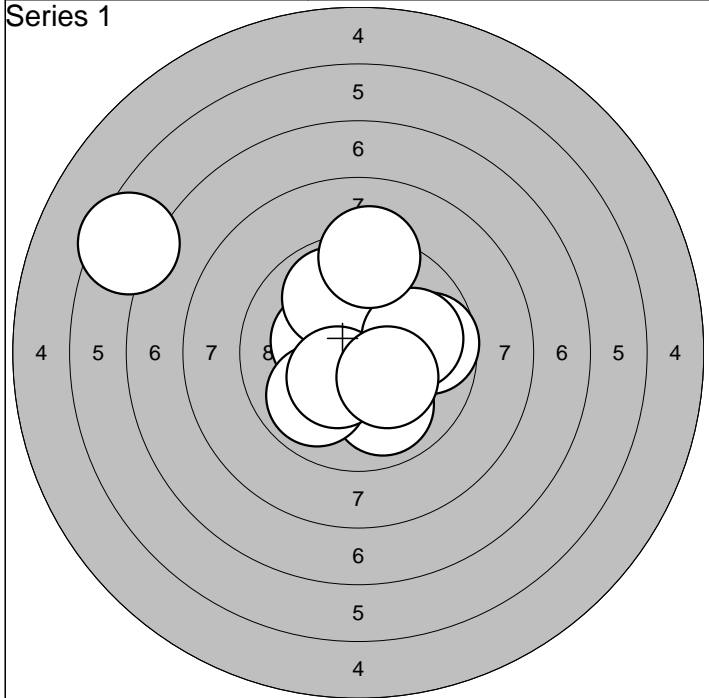

| | | | |
|------------|-------------|-------|------|
| 1: 6,5 ↖ | 6: 9,9 ↗ | Serie | 91,0 |
| 2: 9,7 → | 7: 10,0 → | | |
| 3: 10,3* ↖ | 8: 10,4* ↘ | Sum | 91,0 |
| 4: 9,9 ↘ | 9: 9,2 ↗ | | |
| 5: 9,9 ↙ | 10: 10,3* ↘ | | |

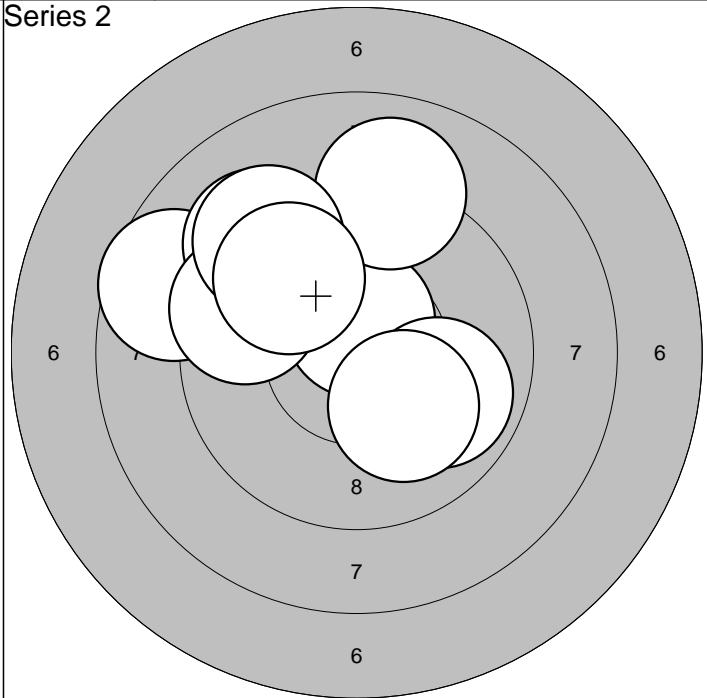

| | | | |
|------------|-----------|-------|-------|
| 1: 10,0 ↗ | 6: 9,2 ↗ | Serie | 92,0 |
| 2: 10,6* ↗ | 7: 10,1 ↘ | | |
| 3: 9,9 ↘ | 8: 9,5 ↖ | Sum | 183,0 |
| 4: 8,7 ↖ | 9: 9,3 ↗ | | |
| 5: 9,0 ↗ | 10: 9,8 ↗ | | |

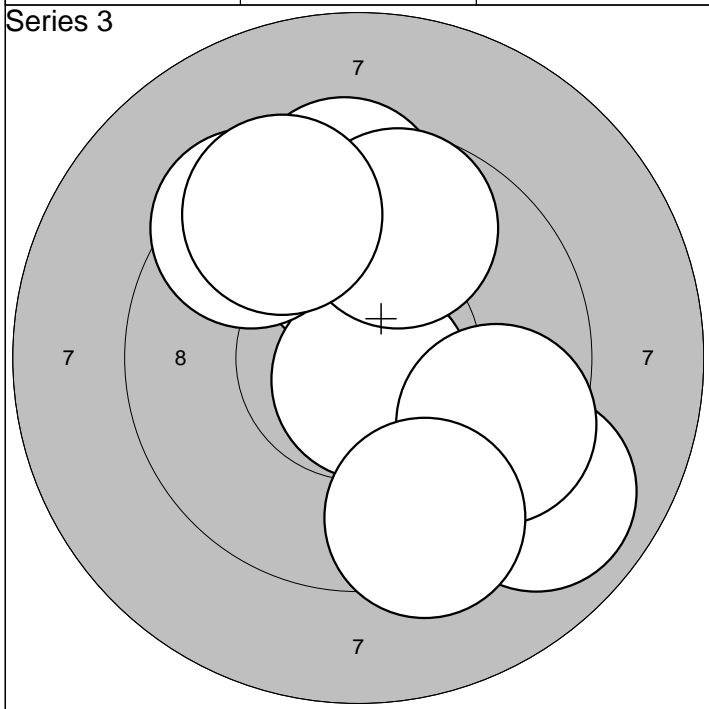

| | | | |
|------------|-----------|-------|-------|
| 1: 9,9 ↗ | 6: 9,7 ↗ | Serie | 91,0 |
| 2: 9,5 ↗ | 7: 9,6 ↘ | | |
| 3: 8,9 ↘ | 8: 9,5 ↗ | Sum | 274,0 |
| 4: 10,0 ↗ | 9: 9,5 ↗ | | |
| 5: 10,7* ↘ | 10: 9,4 ↘ | | |

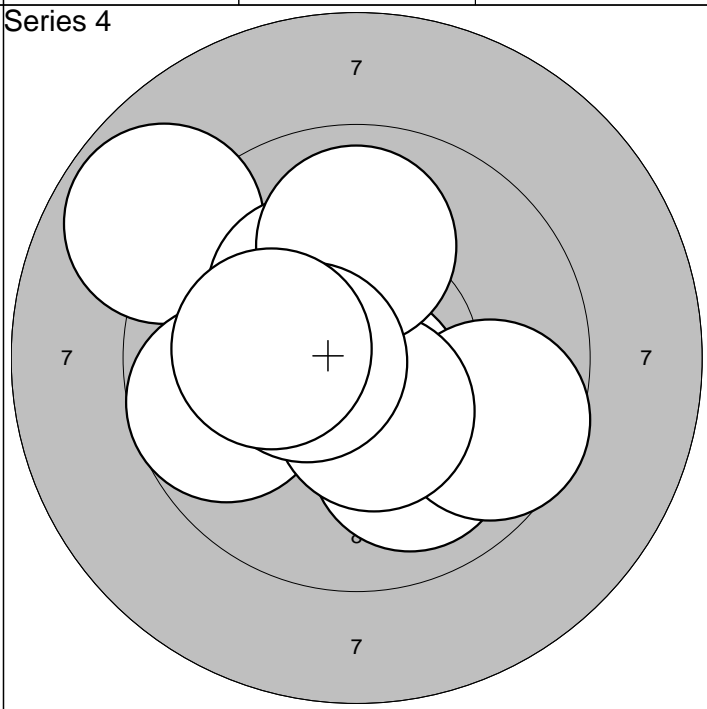

| | | | |
|------------|-------------|-------|-------|
| 1: 8,9 ↖ | 6: 9,6 ↘ | Serie | 96,0 |
| 2: 9,7 ↖ | 7: 10,4* ↘ | | |
| 3: 10,6* ↘ | 8: 10,0 ↗ | Sum | 370,0 |
| 4: 10,0 ↘ | 9: 10,5* ↖ | | |
| 5: 10,2* ↗ | 10: 10,2* ↖ | | |

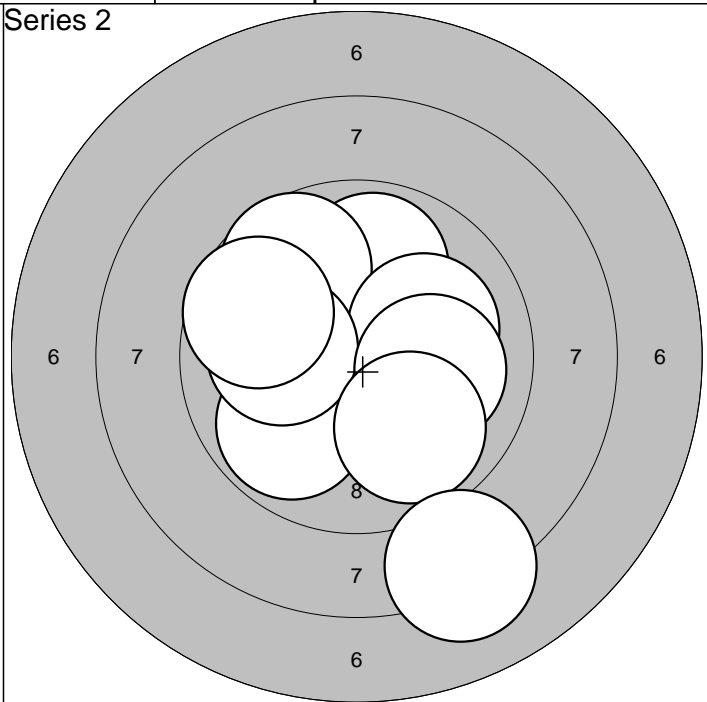
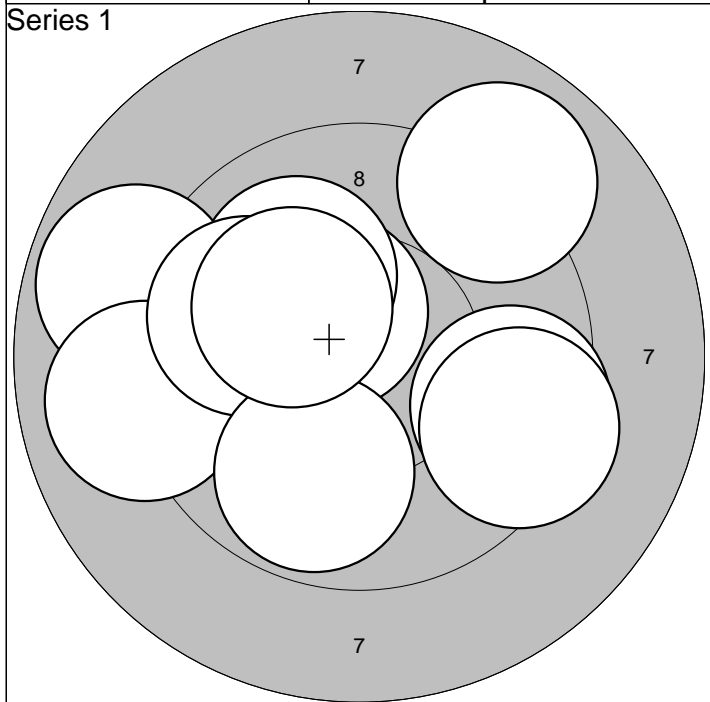

| | | | | | |
|-----------|------------|-------|------|--|--|
| 1: 9,5 → | 6: 9,0 ← | | | | |
| 2:10,4* ↗ | 7: 9,9 ← | | | | |
| 3: 9,4 → | 8: 8,9 ↗ | Serie | 91,0 | | |
| 4:10,0 ↗ | 9: 9,8 ↓ | Sum | 91,0 | | |
| 5: 8,8 ← | 10:10,2* ↖ | | | | |

| | | | | | |
|-----------|-----------|-------|-------|--|--|
| 1: 9,9 ↑ | 6:10,1 ← | | | | |
| 2:10,2* ↓ | 7:10,1 → | | | | |
| 3: 9,9 ↘ | 8: 9,7 ← | Serie | 93,0 | | |
| 4: 9,7 ↗ | 9: 9,9 ↓ | Sum | 184,0 | | |
| 5:10,1 → | 10: 8,2 ↓ | | | | |

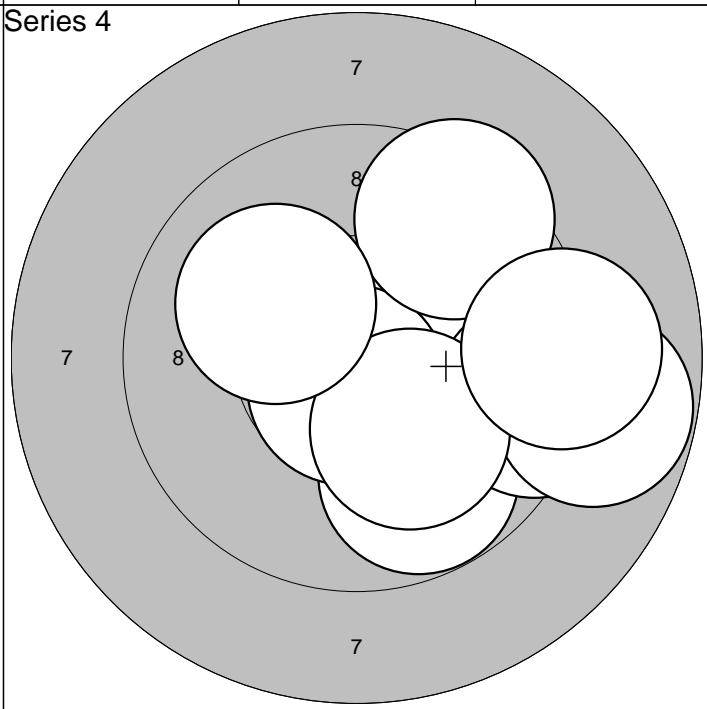
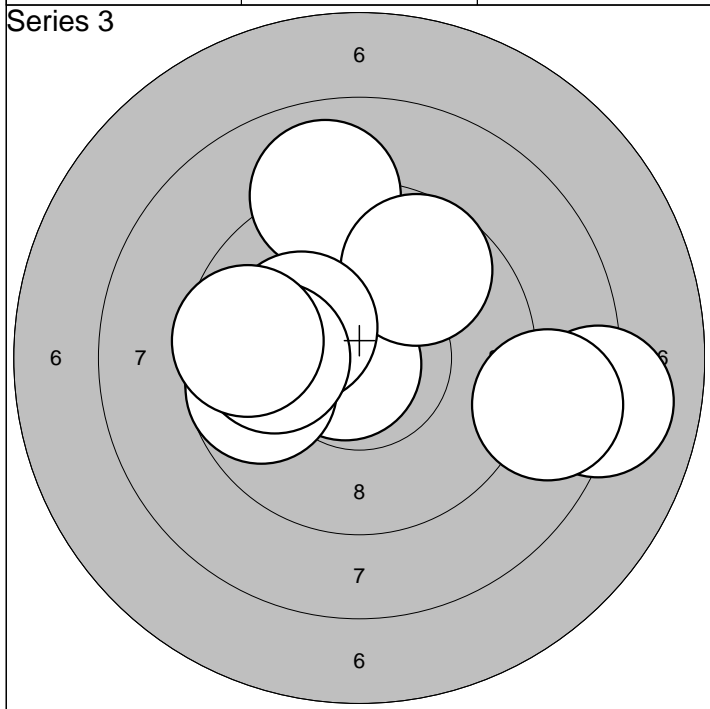

| | | | | | |
|-----------|-----------|-------|-------|--|--|
| 1: 9,0 ↑ | 6:10,2* ← | | | | |
| 2: 8,1 → | 7: 9,7 ← | | | | |
| 3:10,8* ← | 8:10,0 ← | Serie | 91,0 | | |
| 4: 9,8 ← | 9: 8,6 → | Sum | 275,0 | | |
| 5: 9,7 ↗ | 10: 9,6 ← | | | | |

| | | | | | |
|-----------|-----------|-------|-------|--|--|
| 1:10,2* → | 6:10,7* ↓ | | | | |
| 2:10,1 ↗ | 7:10,1 ↓ | | | | |
| 3: 9,8 ↓ | 8: 9,4 ↗ | Serie | 94,0 | | |
| 4: 9,3 → | 9:10,1 ↖ | Sum | 369,0 | | |
| 5: 8,8 → | 10: 9,1 → | | | | |

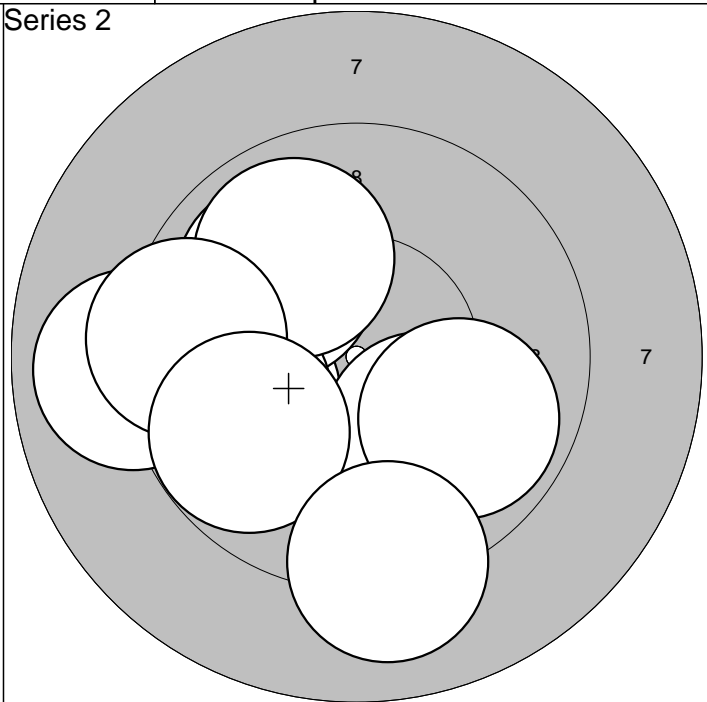
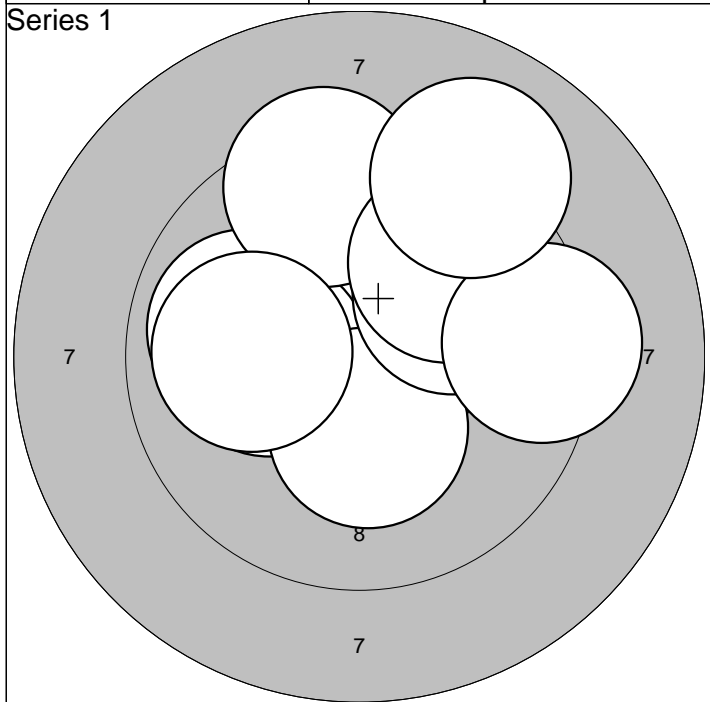

| | | | |
|------------|-----------|-------|------|
| 1: 9,9 ↗ | 6: 9,9 ↗ | Serie | 93,0 |
| 2: 9,9 ← | 7: 9,8 ↗ | | |
| 3: 10,2* ← | 8: 9,3 → | Sum | 93,0 |
| 4: 9,4 ↑ | 9: 10,0 ← | | |
| 5: 10,3* ↓ | 10: 9,1 ↗ | | |

| | | | |
|-----------|-----------|-------|-------|
| 1: 9,9 ← | 6: 9,9 ↘ | Serie | 91,0 |
| 2: 9,9 ↗ | 7: 9,0 ← | | |
| 3: 9,8 ← | 8: 9,4 ← | Sum | 184,0 |
| 4: 9,9 ↗ | 9: 9,8 ↙ | | |
| 5: 10,0 ↘ | 10: 9,1 ↓ | | |

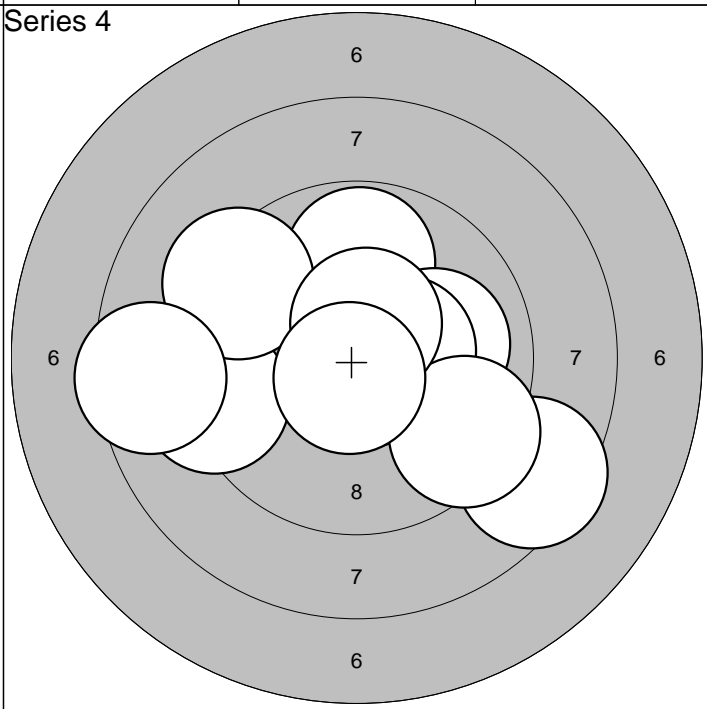
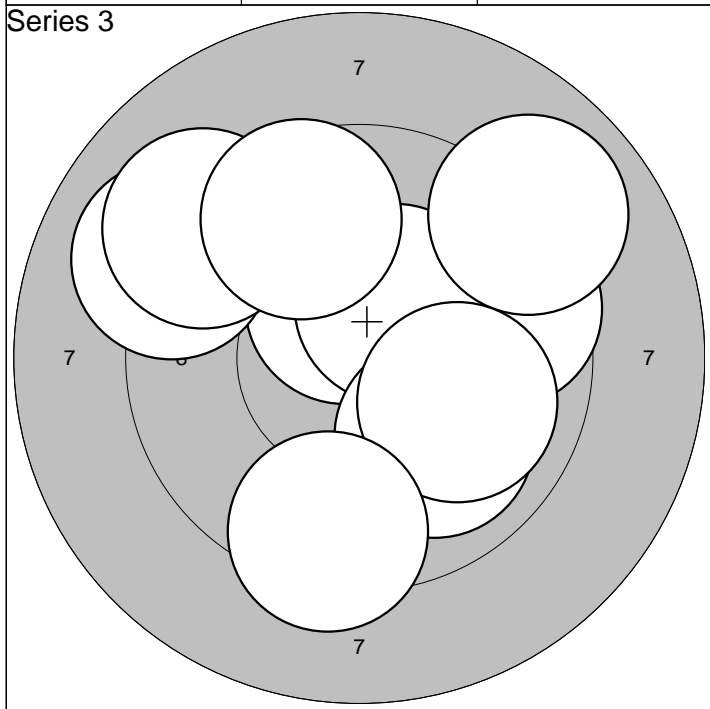

| | | | |
|------------|-----------|-------|-------|
| 1: 10,5* ↑ | 6: 10,0 ↓ | Serie | 93,0 |
| 2: 9,1 ← | 7: 8,9 ↗ | | |
| 3: 9,6 → | 8: 10,0 → | Sum | 277,0 |
| 4: 10,4* ↗ | 9: 9,6 ↗ | | |
| 5: 9,1 ↖ | 10: 9,4 ↓ | | |

| | | | |
|------------|------------|-------|-------|
| 1: 9,2 ← | 6: 8,5 ↘ | Serie | 92,0 |
| 2: 9,8 ↑ | 7: 9,4 ↘ | | |
| 3: 10,0 → | 8: 10,5* ↑ | Sum | 369,0 |
| 4: 10,4* → | 9: 10,7* ↓ | | |
| 5: 9,3 ↖ | 10: 8,5 ← | | |

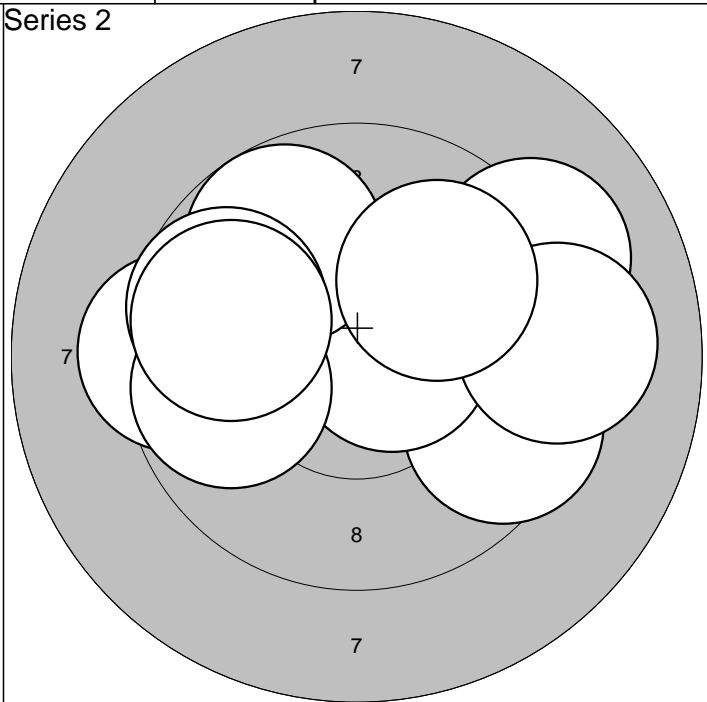
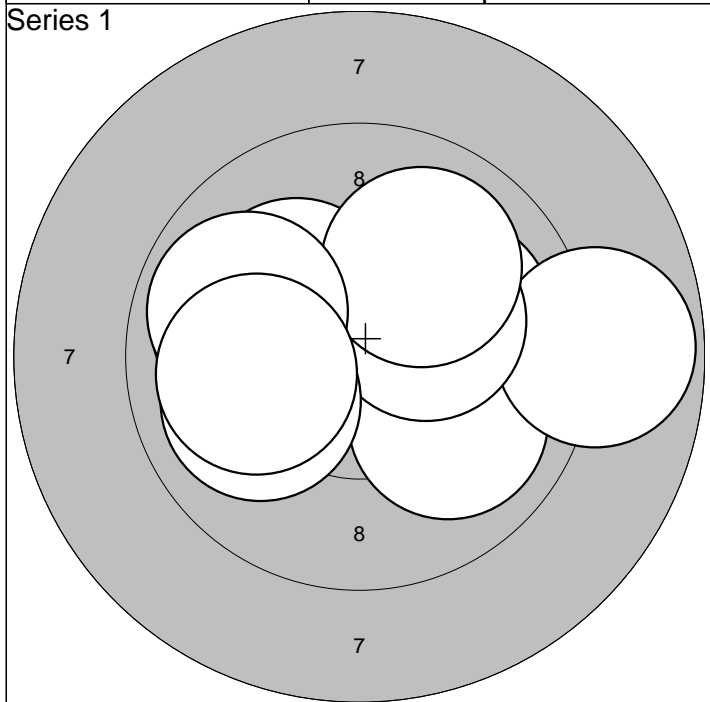

| | | | | | |
|-----------|-----------|--|--|-------|------|
| 1:10,1 → | 6:10,3* → | | | Serie | 96,0 |
| 2:10,2* ↖ | 7:10,0 ← | | | | |
| 3:10,0 ↘ | 8:10,0 ↗ | | | Sum | 96,0 |
| 4: 9,9 ← | 9: 9,9 ← | | | | |
| 5: 8,8 → | 10:10,0 ← | | | | |

| | | | | | |
|-----------|-----------|--|--|-------|-------|
| 1: 9,5 → | 6: 9,7 ↖ | | | Serie | 92,0 |
| 2: 9,2 ↗ | 7: 9,8 ← | | | | |
| 3:10,6* → | 8: 9,8 ← | | | Sum | 188,0 |
| 4: 9,8 ↗ | 9: 9,1 → | | | | |
| 5: 9,3 ← | 10:10,0 ↗ | | | | |

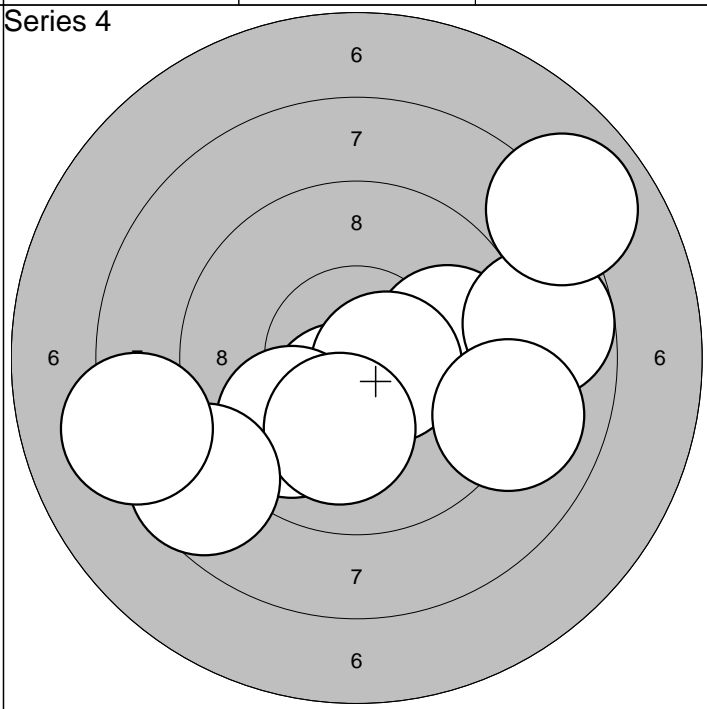
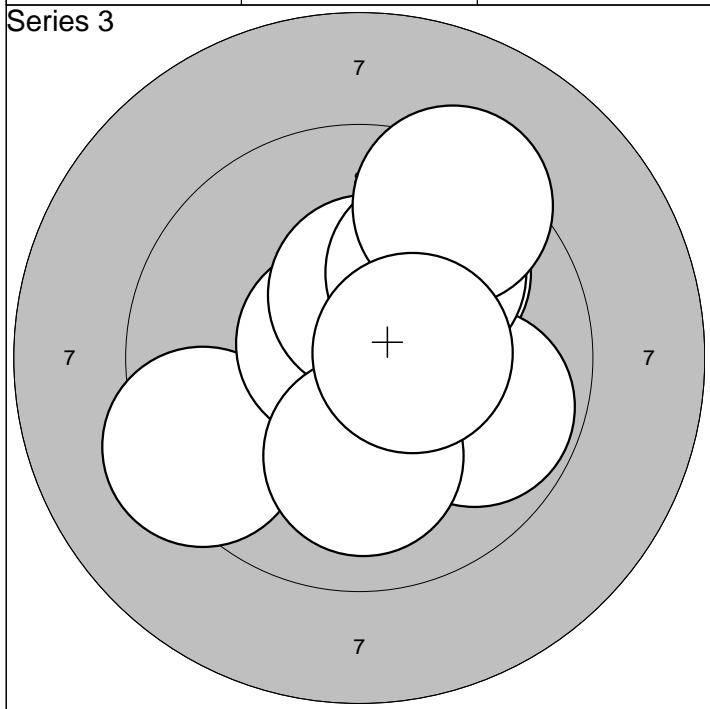

| | | | | | |
|-----------|------------|--|--|-------|-------|
| 1: 9,3 ↖ | 6:10,4* ↑ | | | Serie | 97,0 |
| 2:10,5* → | 7:10,0 ↗ | | | | |
| 3:10,0 ↗ | 8:10,1 ↓ | | | Sum | 285,0 |
| 4:10,7* ↖ | 9: 9,4 ↗ | | | | |
| 5: 9,8 ↘ | 10:10,5* → | | | | |

| | | | | | |
|-----------|-----------|--|--|-------|-------|
| 1: 9,9 → | 6:10,1 ↓ | | | Serie | 88,0 |
| 2:10,4* ↓ | 7: 8,6 ↖ | | | | |
| 3: 8,7 → | 8: 9,0 → | | | Sum | 373,0 |
| 4:10,6* → | 9: 7,9 ↗ | | | | |
| 5: 9,9 ↖ | 10: 8,2 ← | | | | |

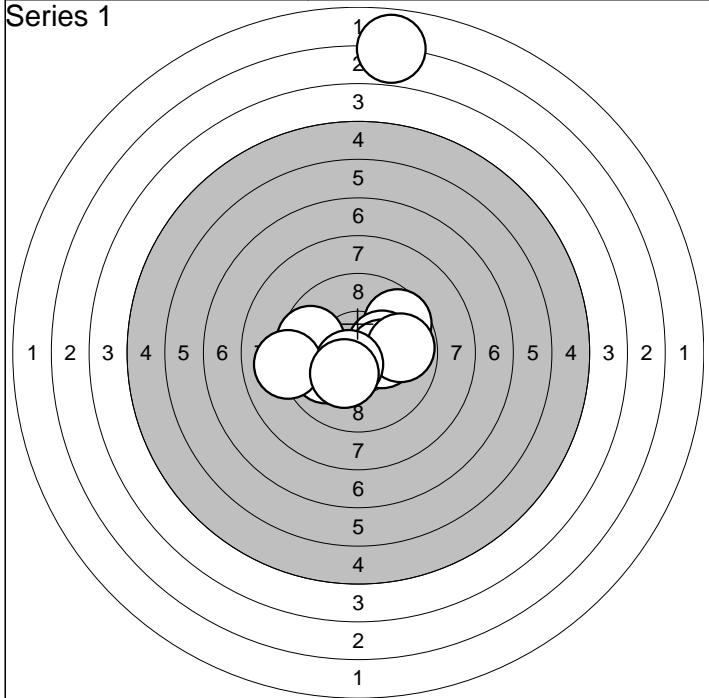

| | | | |
|------------|-------------|-------|------|
| 1: 9,7 ↗ | 6: 9,7 ← | Serie | 88,0 |
| 2: 2,9 ↑ | 7: 9,8 → | | |
| 3: 10,3* → | 8: 10,6* ↘ | Sum | 88,0 |
| 4: 10,3* → | 9: 9,1 ← | | |
| 5: 10,0 ↙ | 10: 10,3* ↘ | | |

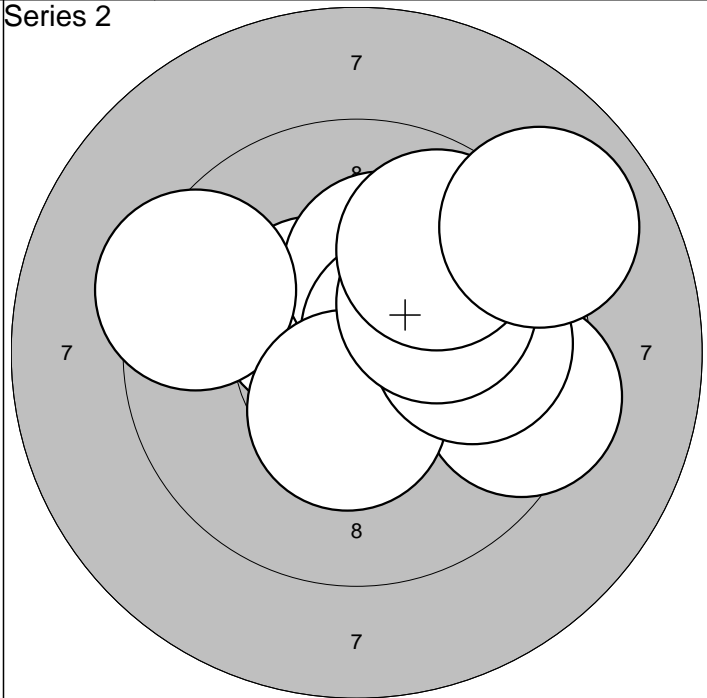

| | | | |
|------------|------------|-------|-------|
| 1: 10,5* ↖ | 6: 10,4* ↓ | Serie | 95,0 |
| 2: 10,2* ↑ | 7: 9,9 → | | |
| 3: 9,4 ↖ | 8: 10,1 ↗ | Sum | 183,0 |
| 4: 10,5* → | 9: 9,8 ↗ | | |
| 5: 9,4 → | 10: 9,0 ↗ | | |

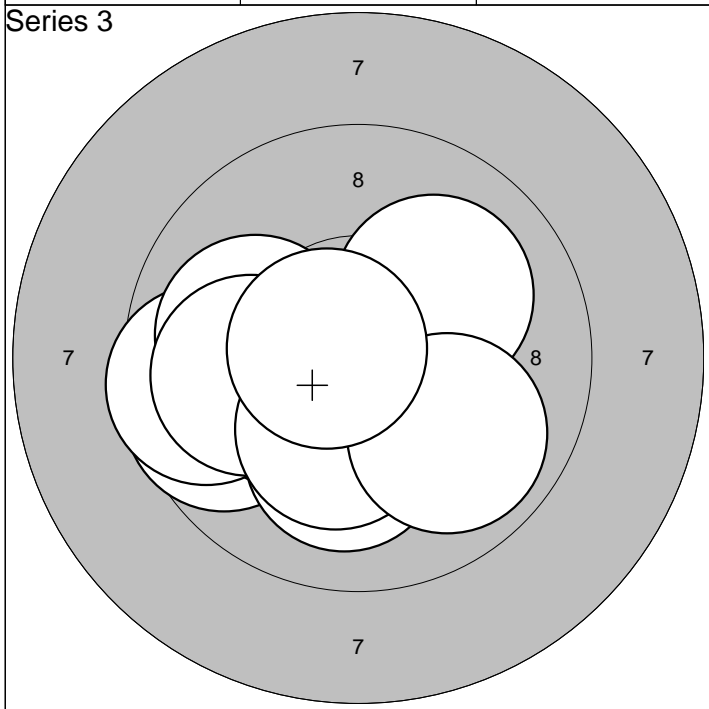

| | | | |
|------------|-------------|-------|-------|
| 1: 10,0 ↗ | 6: 10,0 ← | Serie | 97,0 |
| 2: 9,7 ← | 7: 10,0 ← | | |
| 3: 10,1 ↓ | 8: 10,3* ↓ | Sum | 280,0 |
| 4: 10,3* ← | 9: 9,9 ↘ | | |
| 5: 9,6 ← | 10: 10,7* ← | | |

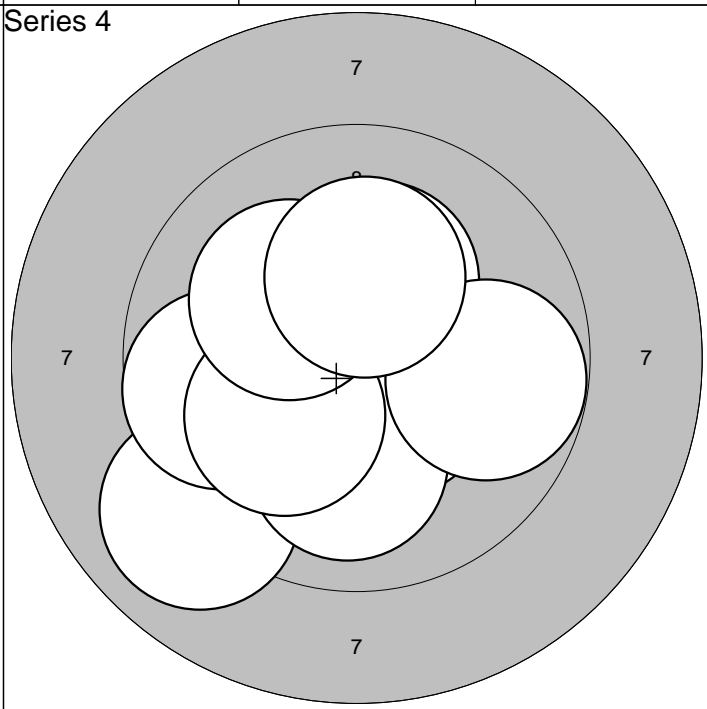

| | | | |
|------------|-------------|-------|-------|
| 1: 9,0 ↙ | 6: 10,0 ↓ | Serie | 97,0 |
| 2: 10,2* ↑ | 7: 9,8 → | | |
| 3: 10,5* ↘ | 8: 10,1 ↖ | Sum | 377,0 |
| 4: 9,7 ← | 9: 10,2* ↖ | | |
| 5: 10,6* → | 10: 10,2* ↑ | | |

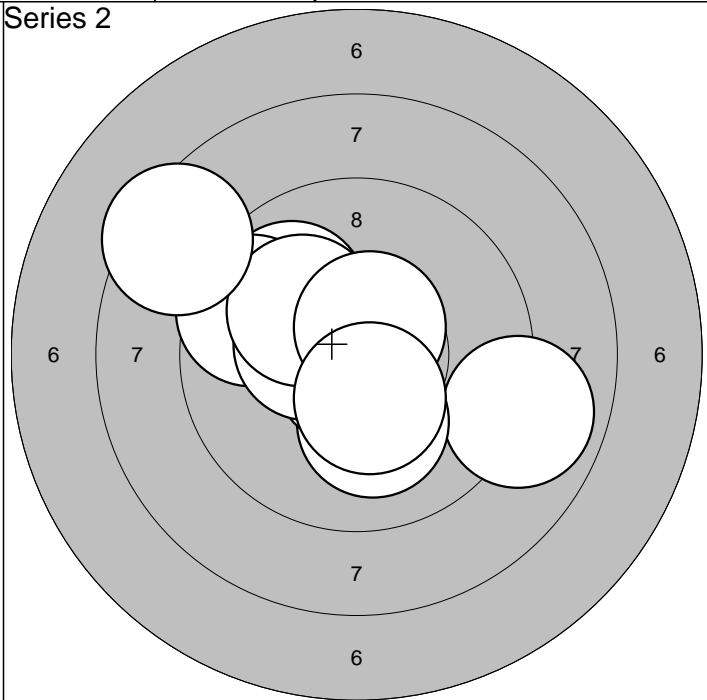
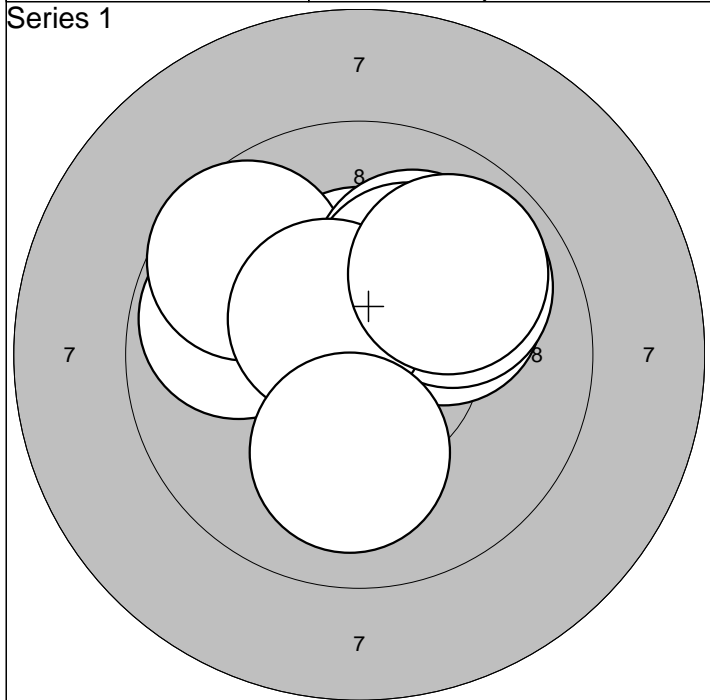

| | | | | | |
|-----------|-----------|-----|------|--|--|
| 1: 9,8 ↙ | 6:10,1 ↗ | | | | |
| 2:10,4* ↑ | 7: 9,9 ↗ | | | | |
| 3: 9,6 ↘ | 8:10,5* ↖ | Sum | 96,0 | | |
| 4:10,1 ↗ | 9:10,1 ↓ | | | | |
| 5:10,2* ↗ | 10: 9,9 ↗ | | | | |

| | | | | | |
|-----------|-----------|-----|-------|--|--|
| 1: 9,9 ↖ | 6:10,4* ↙ | | | | |
| 2: 8,9 ➔ | 7:10,1 ↖ | | | | |
| 3:10,1 ↓ | 8:10,6* ↗ | Sum | 190,0 | | |
| 4:10,7* ↓ | 9:10,4* ↓ | | | | |
| 5: 9,6 ↖ | 10: 8,4 ↖ | | | | |

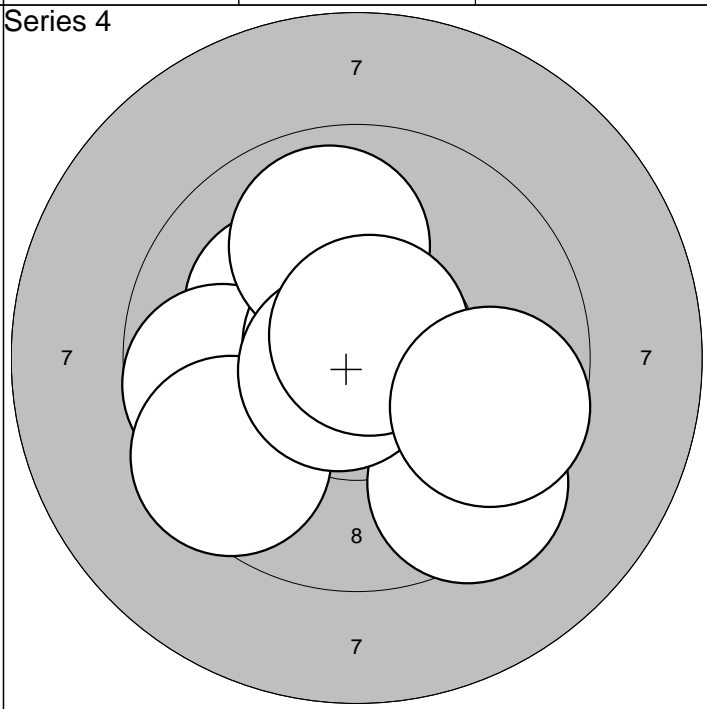
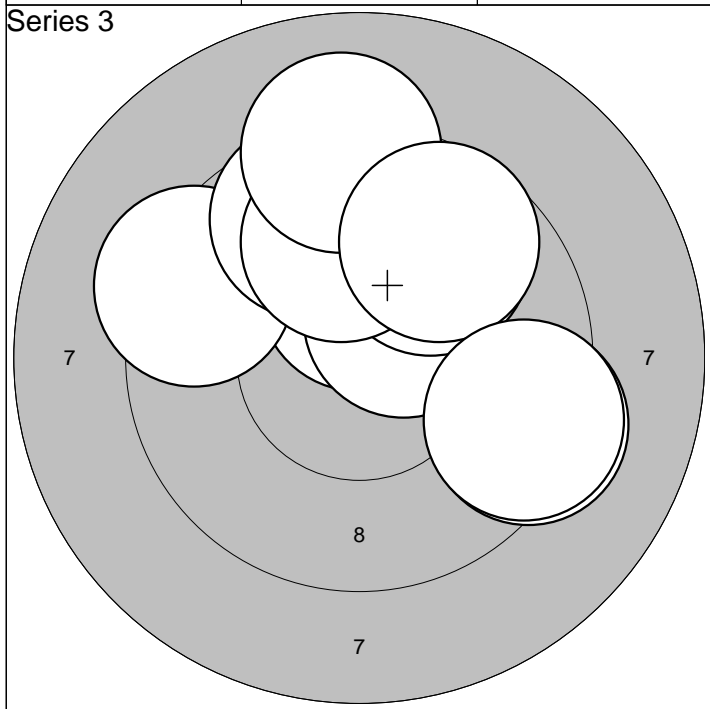

| | | | | | |
|-----------|-----------|-----|-------|--|--|
| 1:10,3* ↑ | 6: 9,9 ↑ | | | | |
| 2:10,4* ↗ | 7: 9,1 ↑ | | | | |
| 3: 9,3 ↙ | 8: 9,7 ↗ | Sum | 282,0 | | |
| 4: 9,7 ↑ | 9: 9,3 ➔ | | | | |
| 5: 9,8 ↗ | 10: 9,4 ➔ | | | | |

| | | | | | |
|-----------|-----------|-----|-------|--|--|
| 1:10,8* ➔ | 6: 9,5 ↙ | | | | |
| 2:10,2* ↖ | 7: 9,9 ↑ | | | | |
| 3: 9,4 ↓ | 8:10,8* ↙ | Sum | 377,0 | | |
| 4: 9,7 ↙ | 9:10,7* ↗ | | | | |
| 5:10,8* ↗ | 10: 9,7 ➔ | | | | |

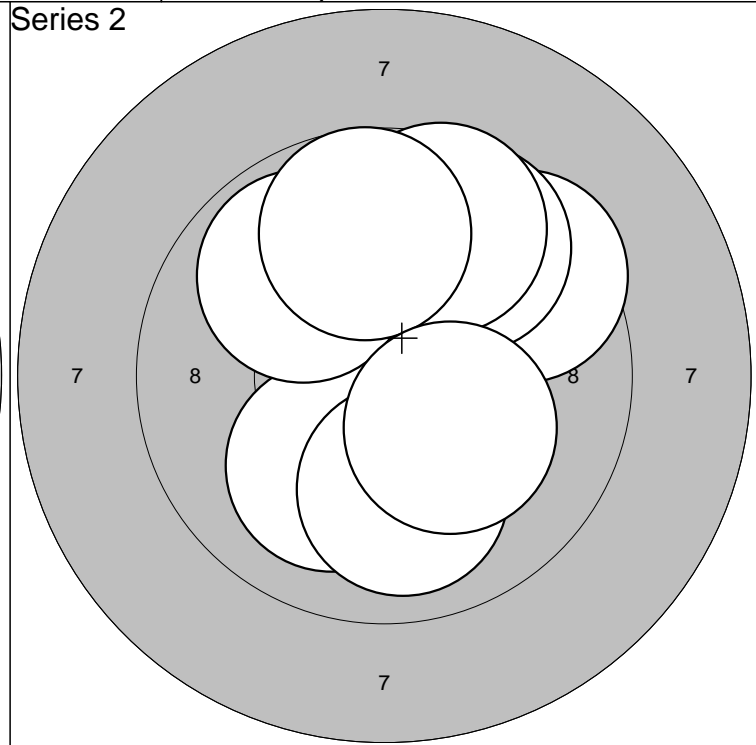
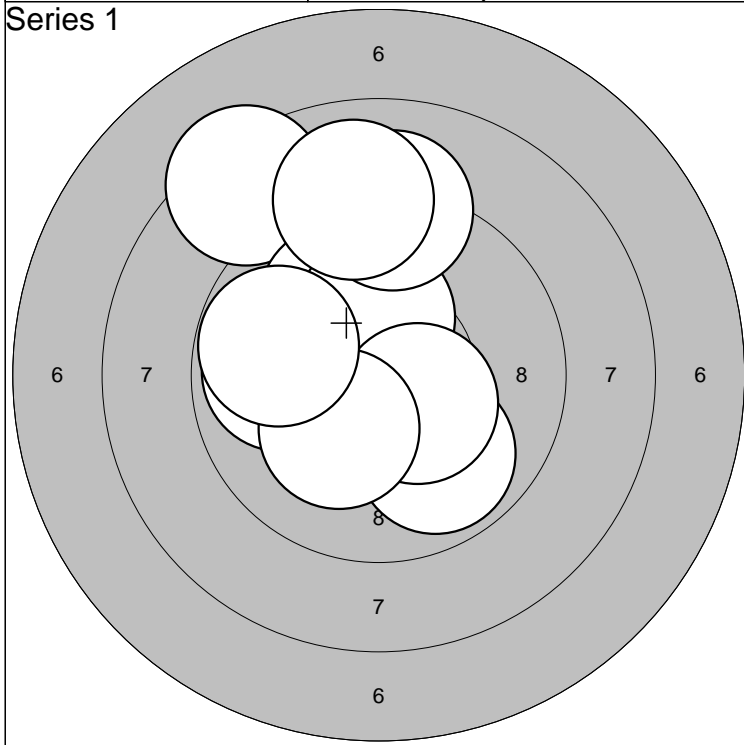

| | | | |
|-----------|-----------|-------|------|
| 1: 8,3 ↗ | 6: 9,9 ↘ | Serie | 93,0 |
| 2: 9,9 ← | 7:10,4* ↘ | | |
| 3:10,0 ↗ | 8: 9,0 ↑ | Sum | 93,0 |
| 4:10,3* ↑ | 9:10,2* ↘ | | |
| 5: 9,1 ↑ | 10: 9,8 ← | | |

| | | | |
|-----------|------------|-------|-------|
| 1:10,5* ↓ | 6: 9,6 ↗ | Serie | 95,0 |
| 2: 9,5 ↗ | 7: 9,9 ↗ | | |
| 3: 9,7 ↗ | 8: 9,7 ↑ | Sum | 188,0 |
| 4:10,3* ↗ | 9:10,0 ↓ | | |
| 5:10,1 ↘ | 10:10,2* ↘ | | |

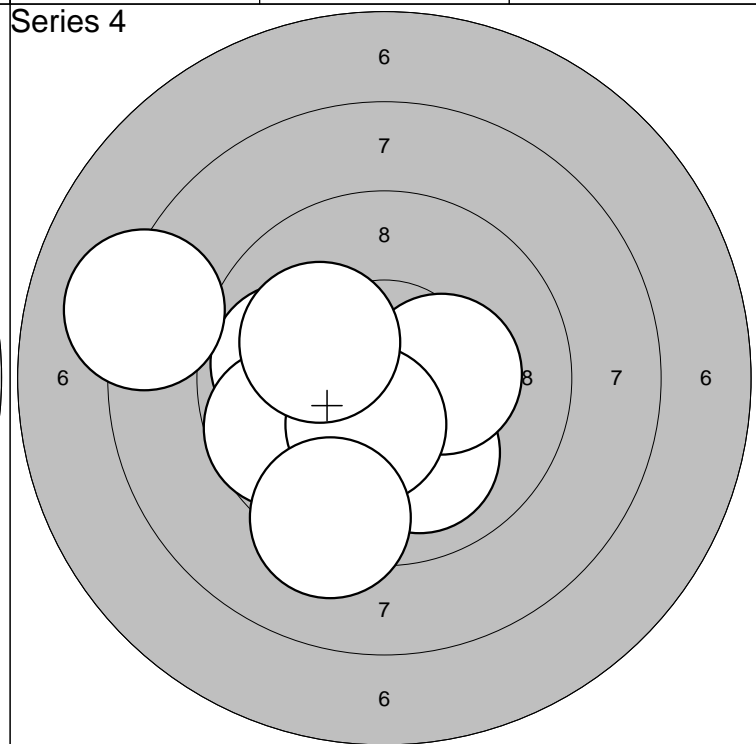
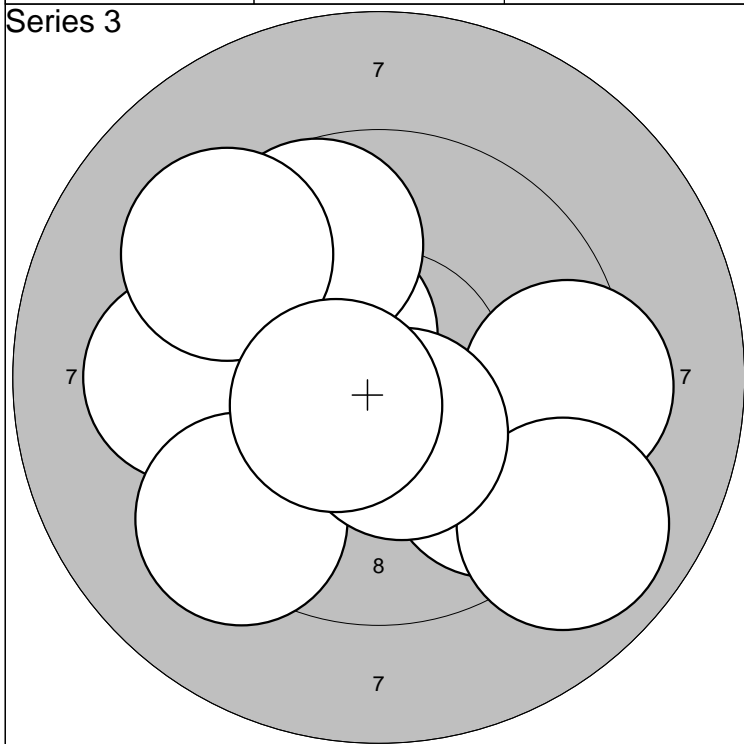

| | | | |
|-----------|------------|-------|-------|
| 1:10,4* ↗ | 6: 9,4 ← | Serie | 93,0 |
| 2: 9,7 ↘ | 7: 9,3 ↘ | | |
| 3: 9,4 → | 8: 9,3 ↗ | Sum | 281,0 |
| 4: 9,0 ↘ | 9:10,4* ↘ | | |
| 5: 9,7 ↗ | 10:10,5* ↘ | | |

| | | | |
|-----------|-----------|-------|-------|
| 1:10,0 ↘ | 6: 9,7 ← | Serie | 95,0 |
| 2:10,0 ↘ | 7:10,4* ↘ | | |
| 3:10,3* → | 8:10,1 ↗ | Sum | 376,0 |
| 4: 9,9 ← | 9: 9,3 ↘ | | |
| 5:10,3* ← | 10: 8,2 ← | | |

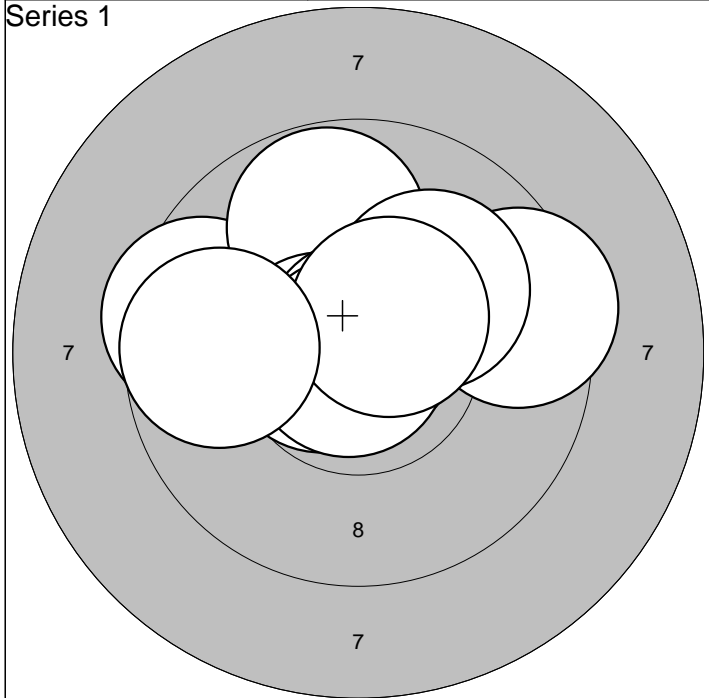

| | | | |
|-----------|-----------|-------|------|
| 1:10,2* ↖ | 6:10,8* ↗ | Serie | 96,0 |
| 2: 9,4 → | 7:10,1 ↗ | | |
| 3: 9,5 ← | 8:10,9* ← | Sum | 96,0 |
| 4: 9,8 ↑ | 9:10,5* ↗ | | |
| 5:10,6* ← | 10: 9,7 ← | | |

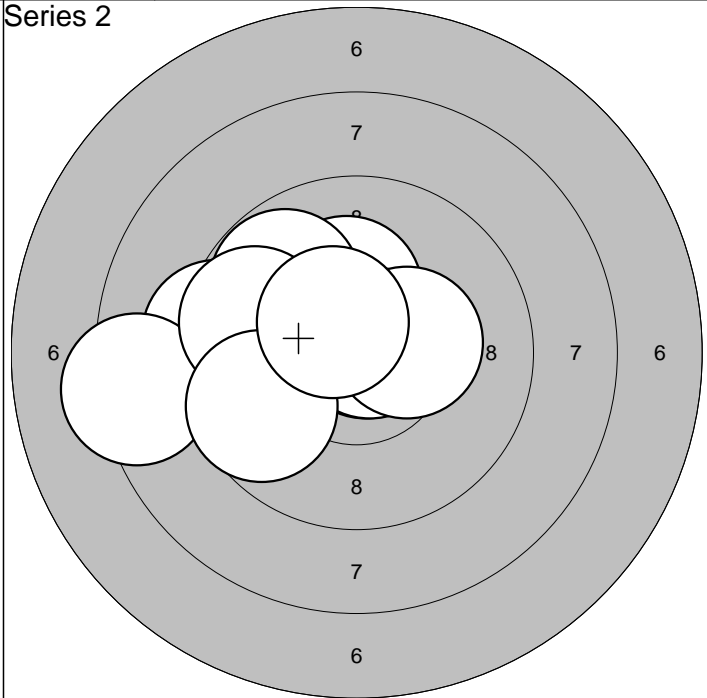

| | | | |
|-----------|------------|-------|-------|
| 1: 9,3 ← | 6: 9,7 ← | Serie | 94,0 |
| 2:10,2* ↑ | 7:10,7* ↗ | | |
| 3:10,8* ↗ | 8:10,3* → | Sum | 190,0 |
| 4: 9,8 ↖ | 9: 9,7 ← | | |
| 5: 8,3 ← | 10:10,5* ↖ | | |

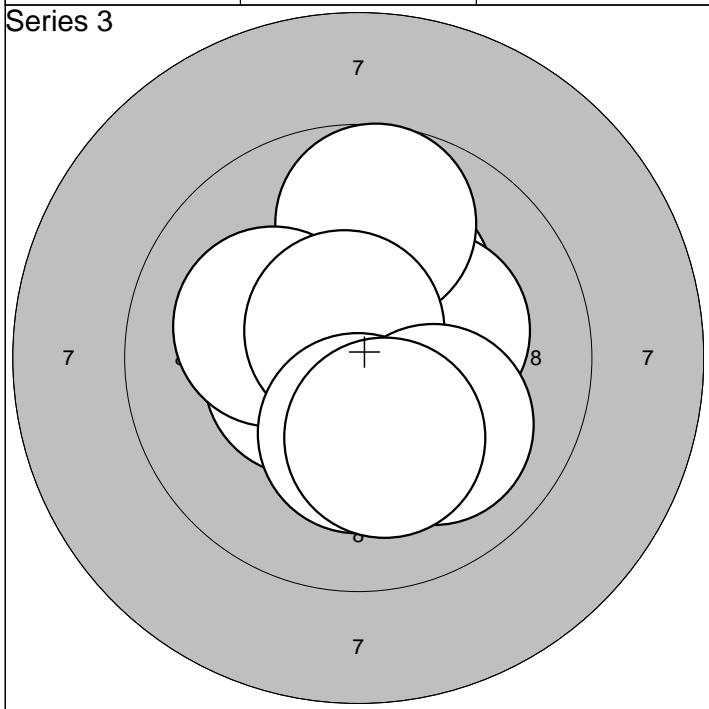

| | | | |
|-----------|------------|-------|-------|
| 1:10,2* ↗ | 6:10,1 ← | Serie | 99,0 |
| 2:10,3* → | 7:10,7* ↗ | | |
| 3:10,4* ← | 8:10,3* ↓ | Sum | 289,0 |
| 4:10,8* ↖ | 9:10,1 ↓ | | |
| 5: 9,7 ↑ | 10:10,2* ↓ | | |

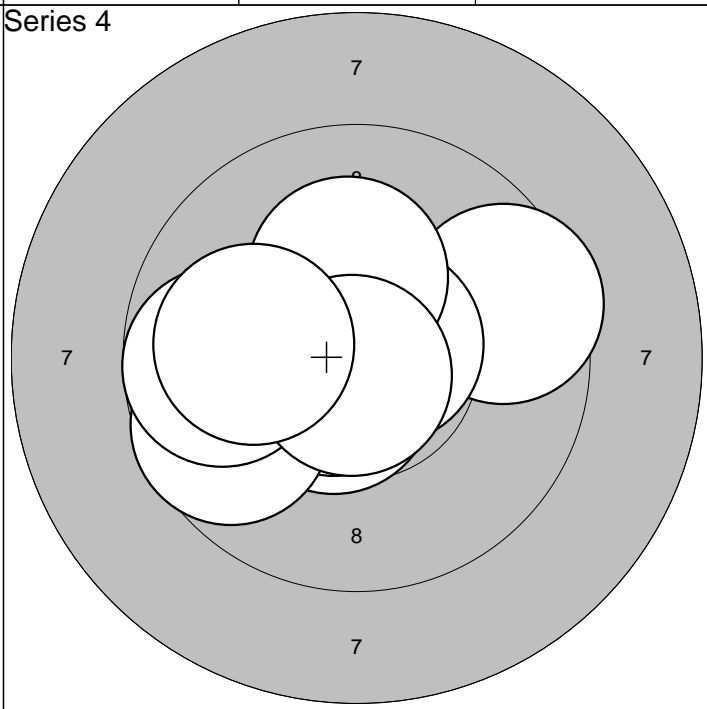

| | | | |
|-----------|-----------|-------|-------|
| 1:10,4* ← | 6: 9,7 ← | Serie | 97,0 |
| 2: 9,6 → | 7: 9,7 ← | | |
| 3:10,6* ↘ | 8:10,2* ↑ | Sum | 386,0 |
| 4:10,7* ↗ | 9:10,8* ↓ | | |
| 5:10,7* ↘ | 10:10,0 ← | | |

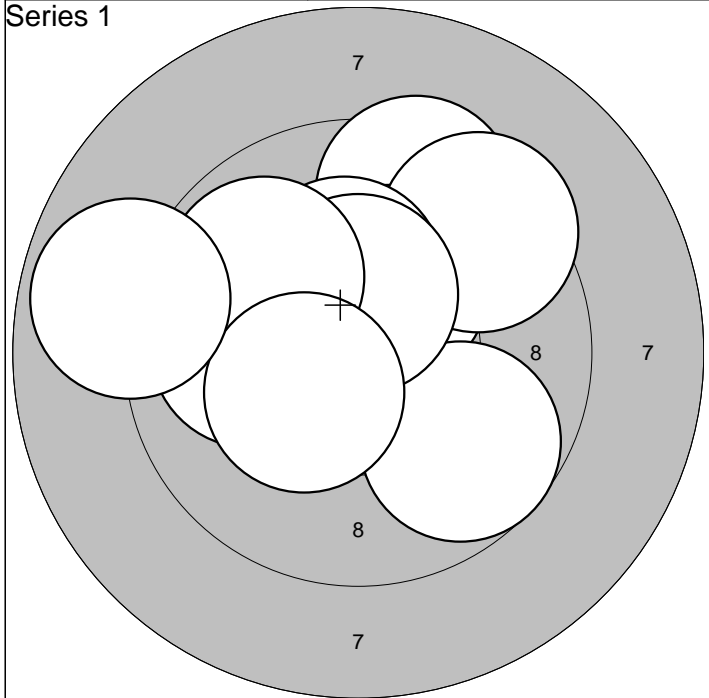

| | | | |
|-----------|-----------|-------|------|
| 1: 9,5 ↗ | 6:10,3* ↗ | Serie | 94,0 |
| 2:10,0 ← | 7:10,4* ↑ | | |
| 3:10,3* ↗ | 8: 9,9 ↘ | Sum | 94,0 |
| 4: 9,4 ↗ | 9:10,3* ↘ | | |
| 5: 9,7 ↘ | 10: 8,9 ← | | |

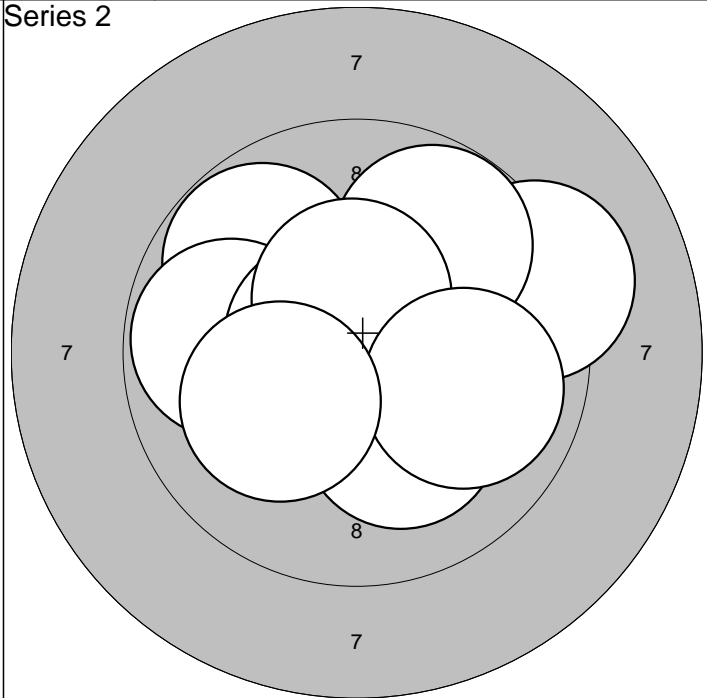

| | | | |
|-----------|-----------|-------|-------|
| 1: 9,8 ↖ | 6: 9,8 ↗ | Serie | 95,0 |
| 2:10,8* ↖ | 7:10,6* ← | | |
| 3: 9,8 ← | 8:10,5* ↑ | Sum | 189,0 |
| 4:10,2* ↘ | 9: 9,9 → | | |
| 5: 9,2 → | 10:10,1 ↙ | | |

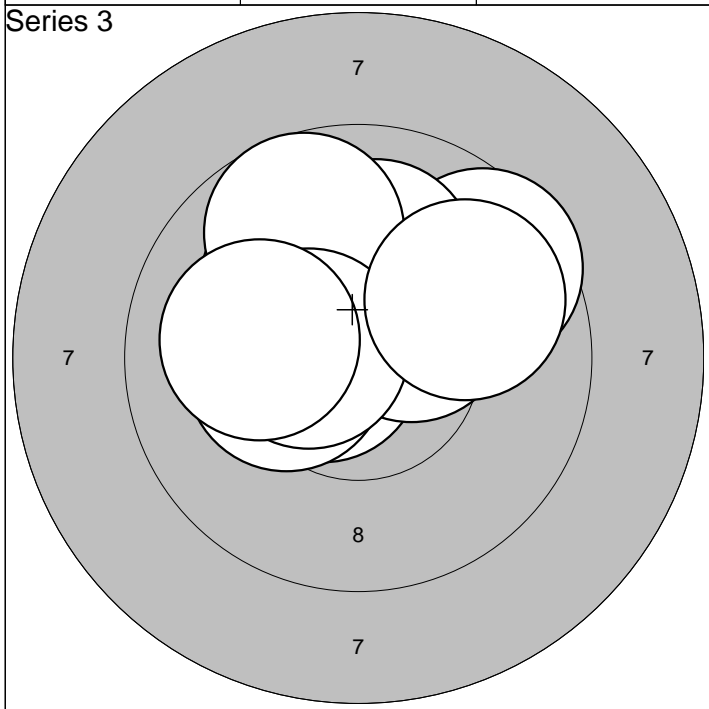

| | | | |
|-----------|-----------|-------|-------|
| 1:10,6* ← | 6:10,3* ← | Serie | 97,0 |
| 2:10,4* ↗ | 7: 9,7 ↗ | | |
| 3:10,1 ↖ | 8:10,5* ← | Sum | 286,0 |
| 4: 9,6 ↗ | 9: 9,9 ↗ | | |
| 5:10,1 ↑ | 10:10,0 ← | | |

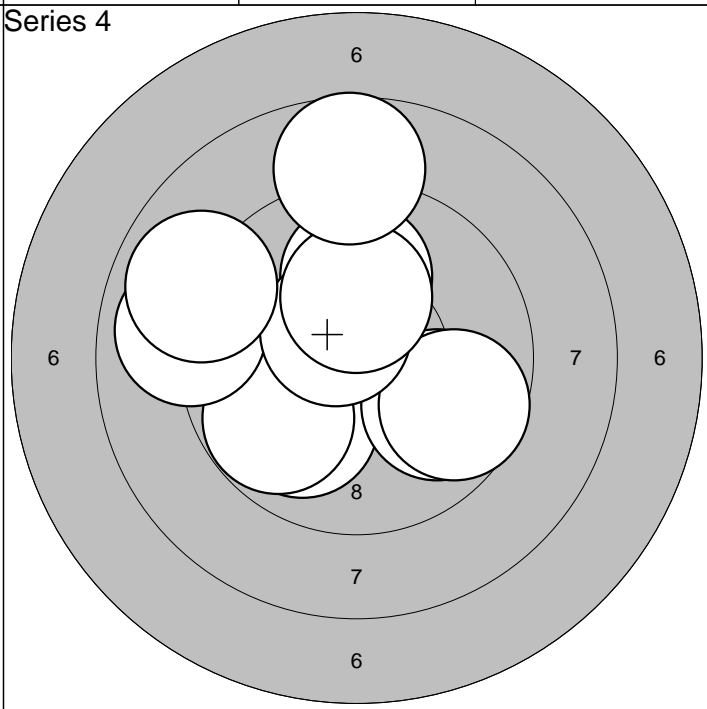

| | | | |
|----------|-----------|-------|-------|
| 1:10,0 ↘ | 6: 9,0 ← | Serie | 92,0 |
| 2: 9,8 → | 7:10,5* ↖ | | |
| 3: 9,7 → | 8: 8,9 ← | Sum | 378,0 |
| 4:10,0 ↑ | 9:10,2* ↑ | | |
| 5: 9,8 ↙ | 10: 8,7 ↑ | | |

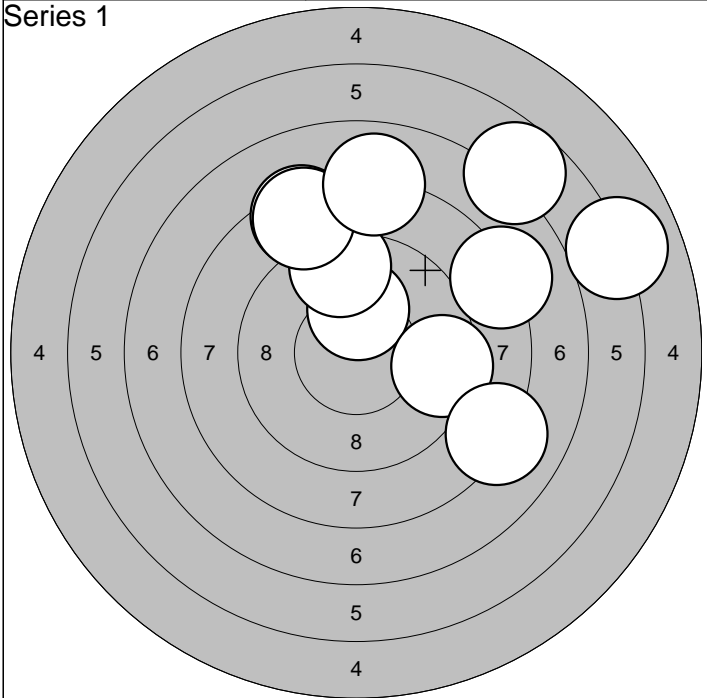

| | | | |
|------------|-----------|-------|------|
| 1: 10,2* ↑ | 6: 6,7 ↗ | Serie | 80,0 |
| 2: 8,4 ↗ | 7: 8,4 ↗ | | |
| 3: 9,4 → | 8: 8,1 → | Sum | 80,0 |
| 4: 8,1 ↗ | 9: 8,0 ↑ | | |
| 5: 9,4 ↑ | 10: 6,0 → | | |

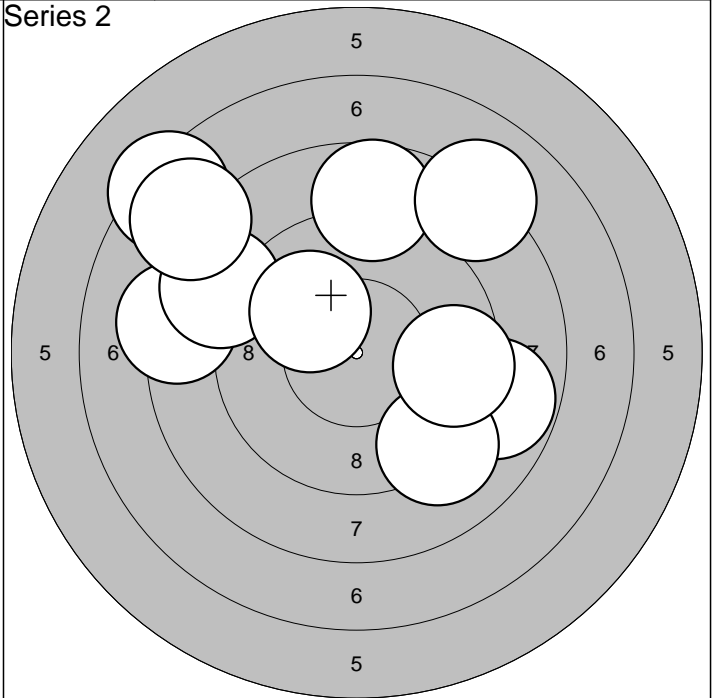

| | | | |
|----------|-----------|-------|-------|
| 1: 8,3 ← | 6: 10,1 ↗ | Serie | 82,0 |
| 2: 8,8 → | 7: 7,3 ↗ | | |
| 3: 8,7 ↗ | 8: 9,1 ↘ | Sum | 162,0 |
| 4: 8,7 ↑ | 9: 9,5 → | | |
| 5: 8,1 ↗ | 10: 7,8 ↗ | | |

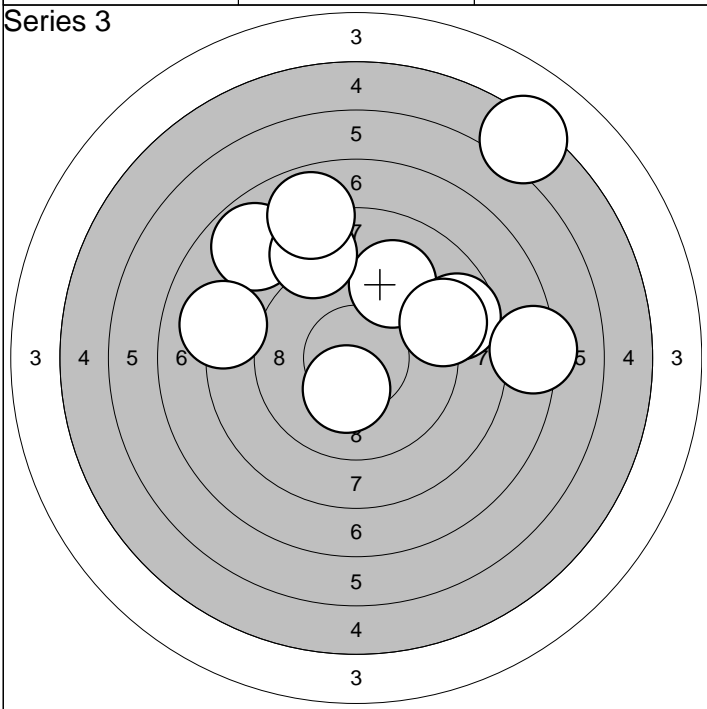

| | | | |
|----------|------------|-------|-------|
| 1: 7,9 ↗ | 6: 5,3 ↗ | Serie | 78,0 |
| 2: 9,2 ↗ | 7: 8,1 ← | | |
| 3: 8,7 → | 8: 10,3* ↓ | Sum | 240,0 |
| 4: 8,7 ↗ | 9: 7,3 → | | |
| 5: 7,9 ↑ | 10: 9,0 → | | |

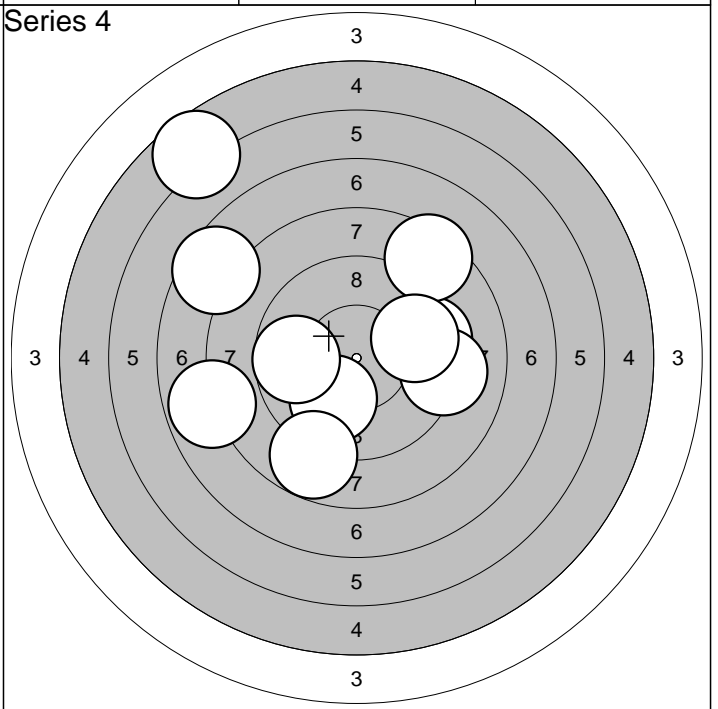

| | | | |
|-----------|-----------|-------|-------|
| 1: 9,4 → | 6: 7,8 ← | Serie | 81,0 |
| 2: 5,7 ↗ | 7: 7,5 ↗ | | |
| 3: 10,0 ↓ | 8: 8,4 ↗ | Sum | 321,0 |
| 4: 8,8 ↓ | 9: 9,7 ← | | |
| 5: 9,1 → | 10: 9,7 → | | |

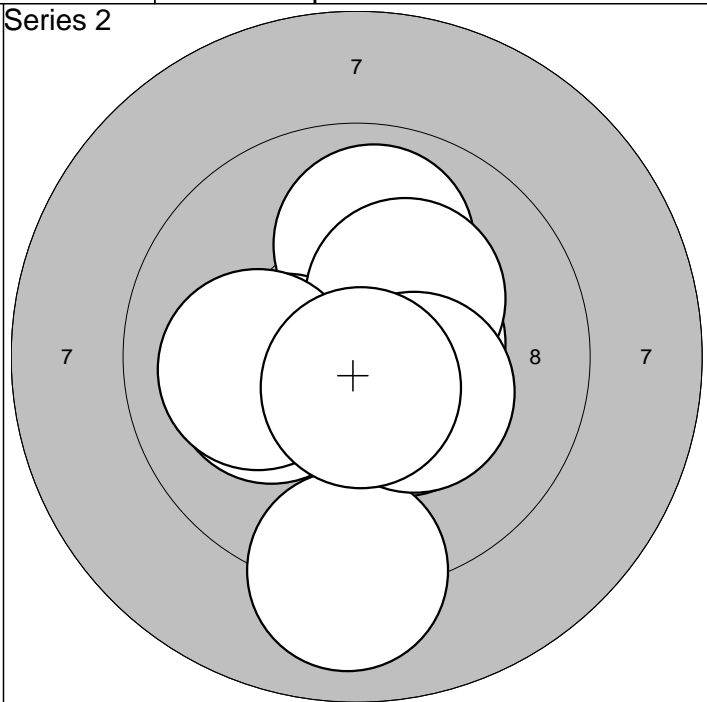
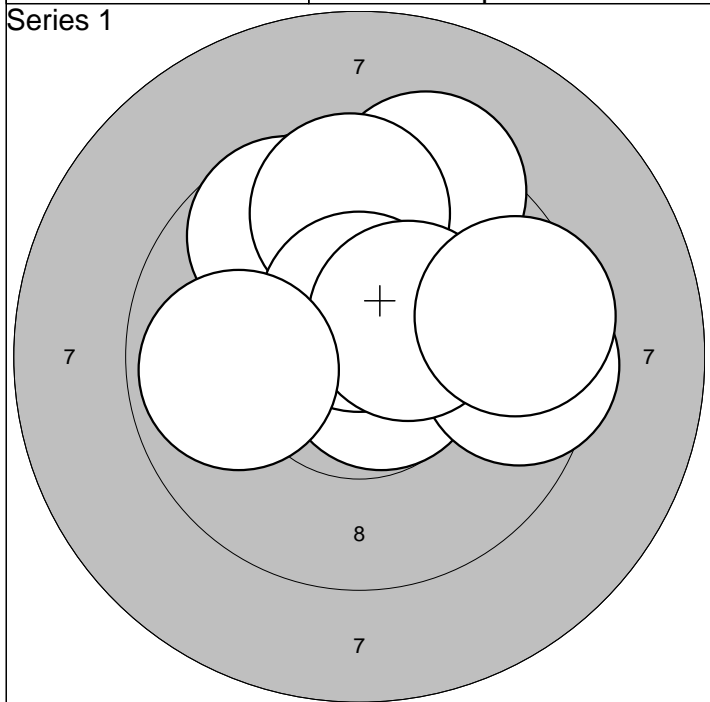

| | | | |
|-----------|-----------|-------|------|
| 1: 9,4 ↗ | 6: 9,5 → | Serie | 94,0 |
| 2:10,3* ↘ | 7:10,6* ↑ | | |
| 3:10,7* ↘ | 8:10,4* ↗ | Sum | 94,0 |
| 4: 9,7 ↗ | 9: 9,9 ← | | |
| 5: 9,7 ↑ | 10: 9,5 → | | |

| | | | |
|-----------|------------|-------|-------|
| 1:10,5* → | 6:10,1 ← | Serie | 98,0 |
| 2: 9,9 ↑ | 7:10,0 ← | | |
| 3:10,3* ← | 8: 9,0 ↓ | Sum | 192,0 |
| 4:10,4* ↘ | 9:10,4* ↘ | | |
| 5:10,3* ↗ | 10:10,7* ↓ | | |

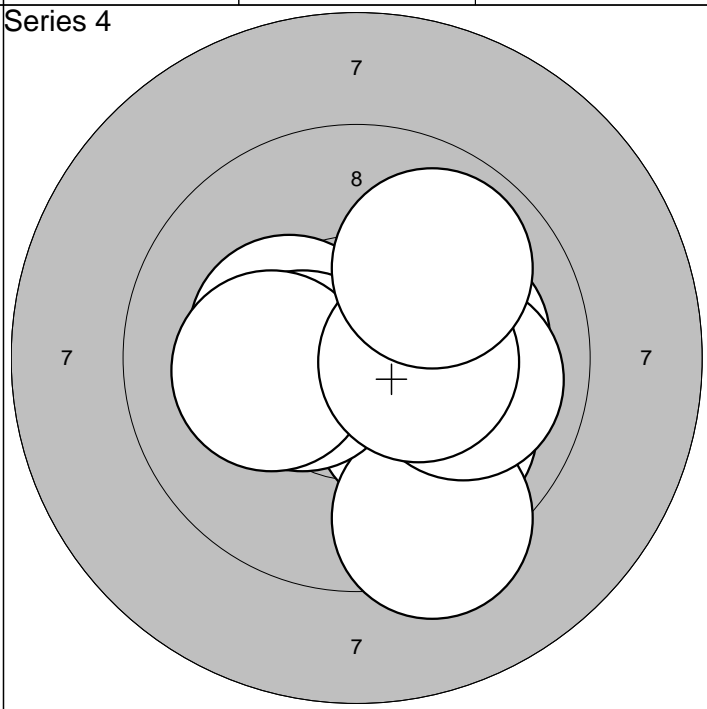
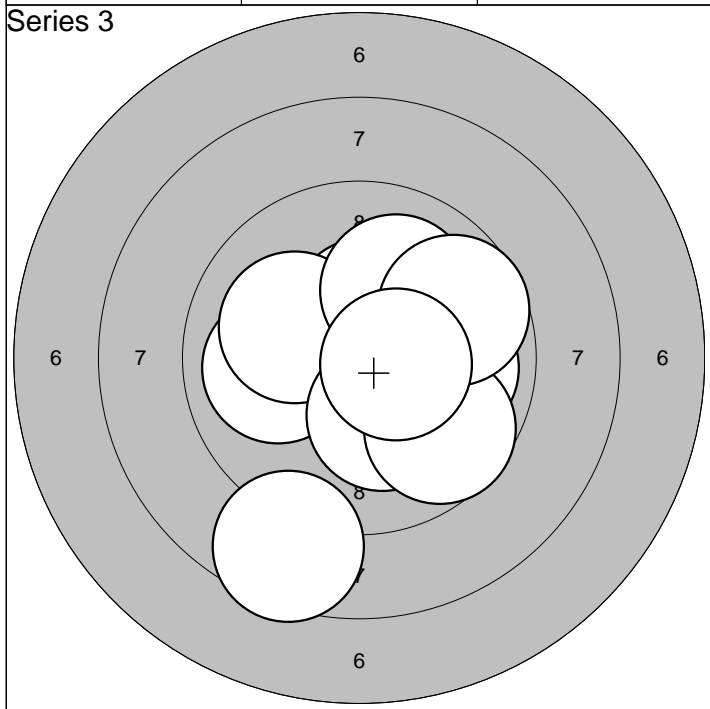

| | | | |
|-----------|------------|-------|-------|
| 1:10,4* ↑ | 6: 9,9 → | Serie | 95,0 |
| 2:10,0 ← | 7: 9,7 ↘ | | |
| 3:10,1 ← | 8: 9,7 ↗ | Sum | 287,0 |
| 4:10,2* ↓ | 9: 8,6 ↓ | | |
| 5:10,0 ↗ | 10:10,5* → | | |

| | | | |
|-----------|-----------|-------|-------|
| 1:10,0 ↘ | 6:10,5* ← | Serie | 98,0 |
| 2:10,1 → | 7:10,2* ← | | |
| 3:10,2* ↘ | 8:10,0 → | Sum | 385,0 |
| 4: 9,4 ↓ | 9:10,4* → | | |
| 5:10,3* ← | 10: 9,9 ↗ | | |

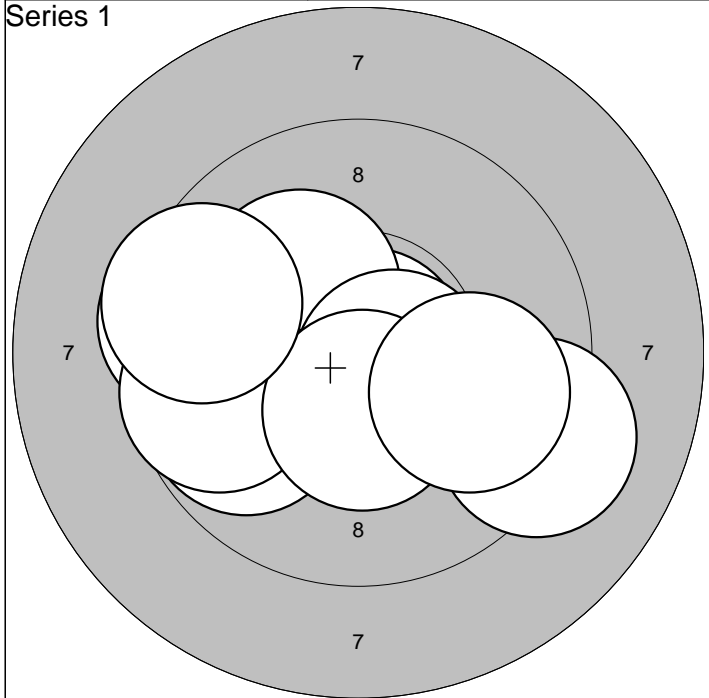

| | | | | | |
|---------|---|---------|---|-------|------|
| 1: 9,5 | ← | 6: 9,7 | ← | Serie | 94,0 |
| 2:10,9* | ↗ | 7: 9,2 | ↘ | | |
| 3:10,2* | ↖ | 8:10,4* | ↓ | Sum | 94,0 |
| 4: 9,8 | ← | 9: 9,5 | ← | | |
| 5:10,6* | ↘ | 10: 9,9 | ↘ | | |

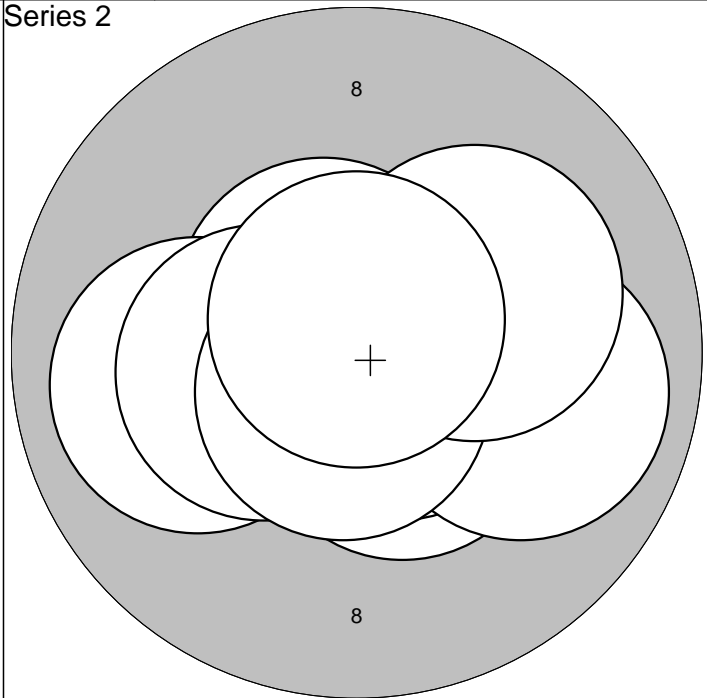

| | | | | | |
|---------|---|----------|---|-------|-------|
| 1:10,6* | ↖ | 6:10,7* | ↘ | Serie | 99,0 |
| 2:10,0 | ← | 7: 9,9 | ↘ | | |
| 3:10,5* | ↘ | 8:10,7* | ↓ | Sum | 193,0 |
| 4:10,6* | ↘ | 9:10,2* | ↗ | | |
| 5:10,4* | ← | 10:10,7* | ↑ | | |

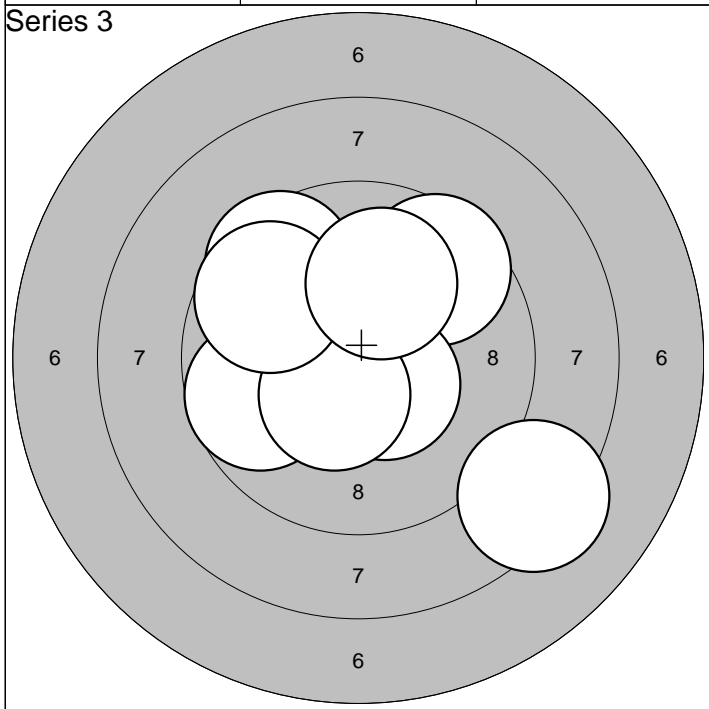

| | | | | | |
|---------|---|---------|---|-------|-------|
| 1:10,7* | ↖ | 6:10,5* | ↘ | Serie | 94,0 |
| 2:10,3* | ↖ | 7:10,4* | ↘ | | |
| 3: 8,3 | ↘ | 8: 9,5 | ↖ | Sum | 287,0 |
| 4: 9,7 | ← | 9: 9,7 | ↖ | | |
| 5: 9,5 | ↖ | 10:10,0 | ↑ | | |

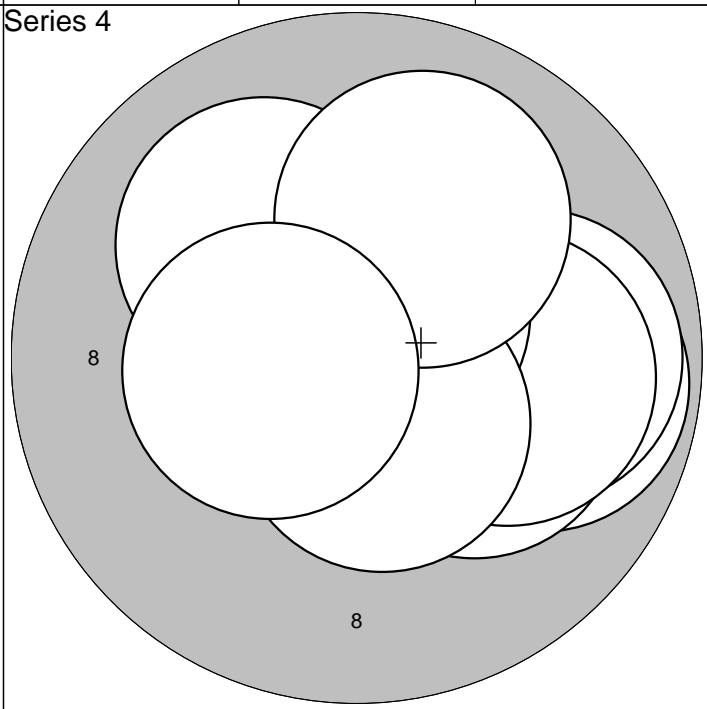

| | | | | | |
|---------|---|----------|---|-------|-------|
| 1: 9,8 | ↘ | 6:10,6* | ↖ | Serie | 98,0 |
| 2:10,5* | ↗ | 7:10,5* | ↘ | | |
| 3:10,1 | ↘ | 8:10,1 | ↖ | Sum | 385,0 |
| 4: 9,9 | ↘ | 9:10,0 | ↖ | | |
| 5:10,0 | ↘ | 10:10,4* | ← | | |

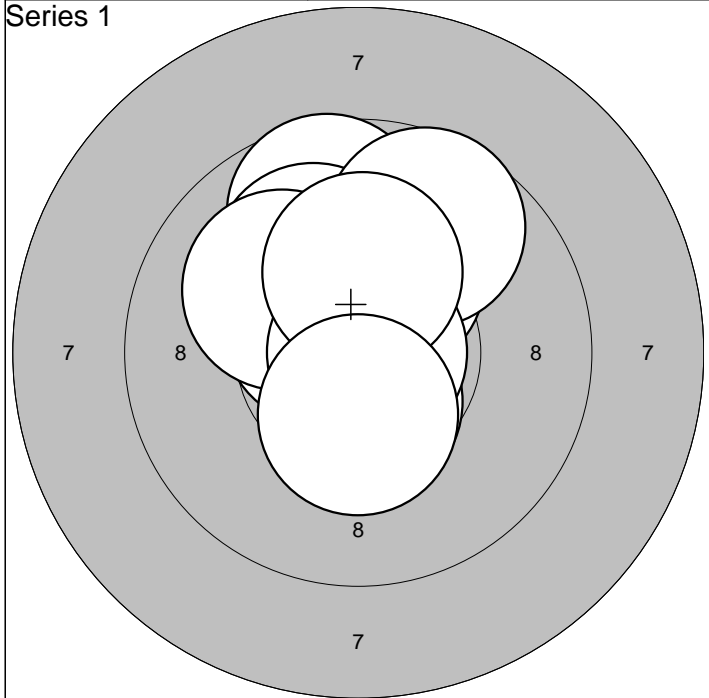

| | | | | | | | |
|---------|---|----------|---|-----|------|-------|------|
| 1: 9,7 | ↑ | 6:10,1 | ↖ | | | Serie | 98,0 |
| 2:10,1 | ↗ | 7: 9,7 | ↗ | | | | |
| 3:10,6* | ↖ | 8:10,9* | → | Sum | 98,0 | | |
| 4:10,2* | ↗ | 9:10,2* | ↑ | | | | |
| 5:10,5* | ↓ | 10:10,4* | ↓ | | | | |

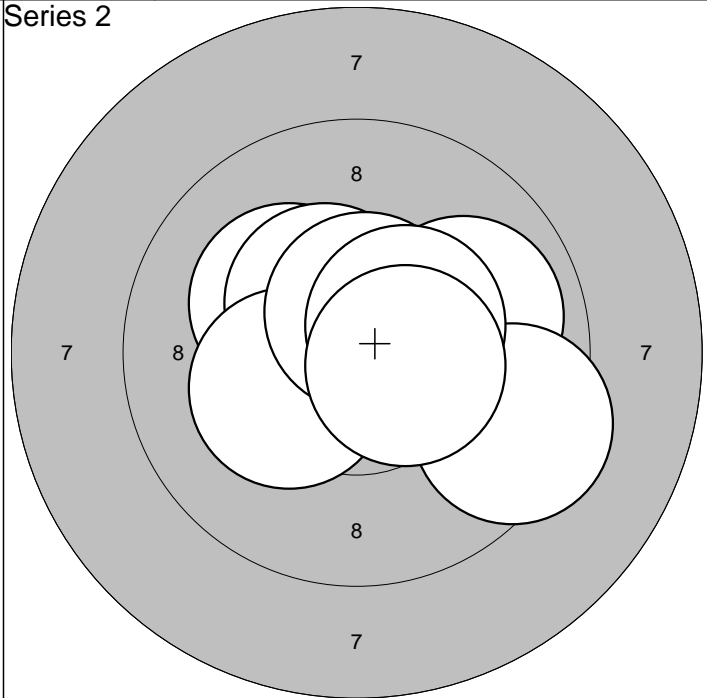

| | | | | | | | |
|---------|---|----------|---|-----|-------|-------|------|
| 1:10,5* | ← | 6:10,3* | ↖ | | | Serie | 98,0 |
| 2: 9,9 | → | 7: 9,4 | ↘ | | | | |
| 3:10,2* | ↖ | 8:10,6* | ↑ | Sum | 196,0 | | |
| 4:10,4* | ↗ | 9:10,4* | ↗ | | | | |
| 5:10,7* | → | 10:10,5* | → | | | | |

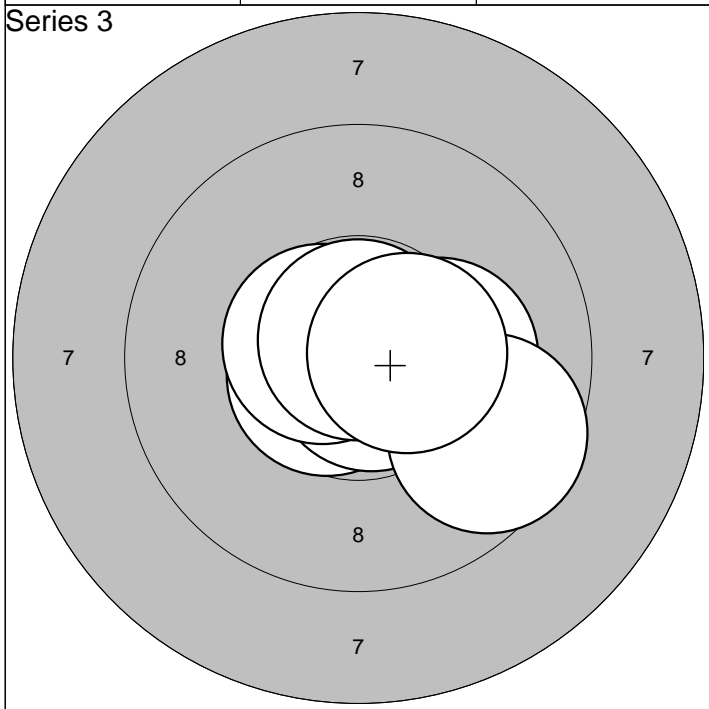

| | | | | | | | |
|---------|---|----------|---|-----|-------|-------|------|
| 1:10,6* | → | 6:10,2* | → | | | Serie | 99,0 |
| 2:10,9* | ↖ | 7:10,6* | ↖ | | | | |
| 3:10,6* | ↖ | 8:10,8* | ↑ | Sum | 295,0 | | |
| 4:10,2* | → | 9: 9,6 | ↘ | | | | |
| 5:10,8* | ↘ | 10:10,5* | → | | | | |

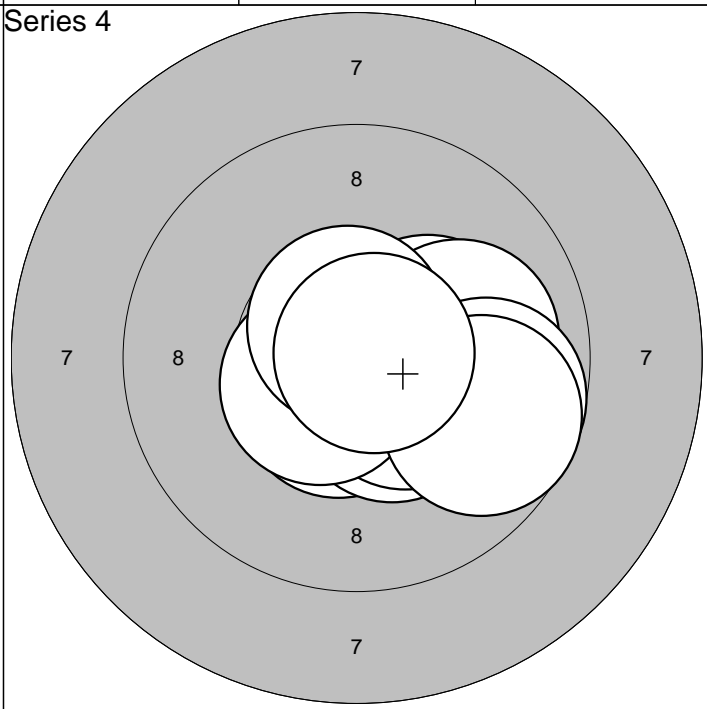

| | | | | | | | |
|---------|---|----------|---|-----|-------|-------|------|
| 1:10,5* | ↓ | 6:10,0 | → | | | Serie | 98,0 |
| 2:10,4* | ↘ | 7: 9,7 | ↘ | | | | |
| 3:10,4* | ↘ | 8:10,7* | ↑ | Sum | 393,0 | | |
| 4:10,6* | ↖ | 9: 9,7 | ↘ | | | | |
| 5:10,3* | → | 10:10,8* | → | | | | |

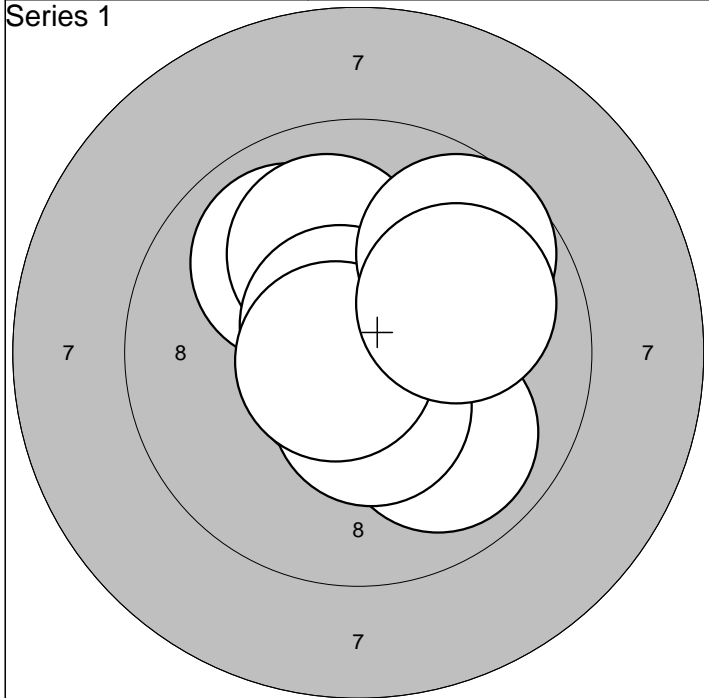

| | | | |
|------------|------------|-------|------|
| 1: 9,9 ↗ | 6: 9,9 ↘ | Serie | 97,0 |
| 2: 10,8* ↘ | 7: 10,5* ↘ | | |
| 3: 10,0 ↗ | 8: 10,7* ← | Sum | 97,0 |
| 4: 10,6* → | 9: 9,7 ↗ | | |
| 5: 10,7* ↗ | 10: 10,0 → | | |

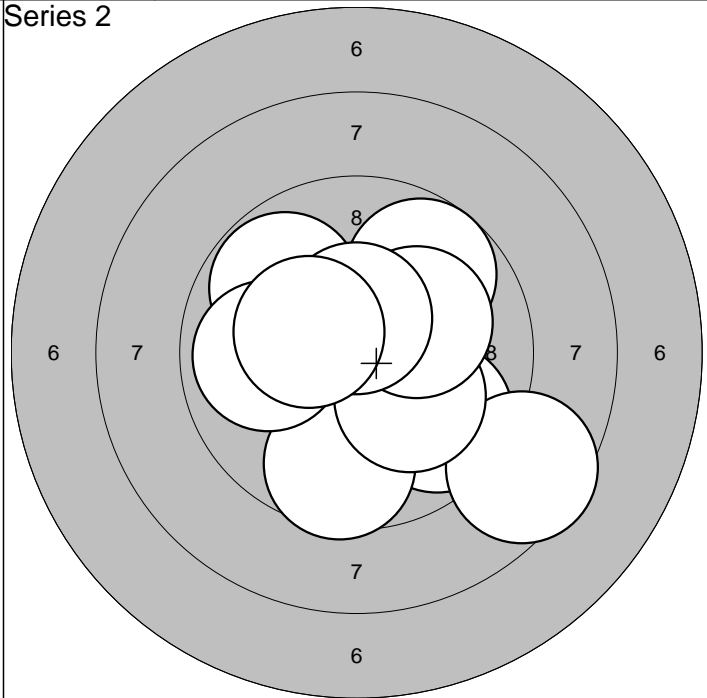

| | | | |
|----------|-------------|-------|-------|
| 1: 9,7 ↘ | 6: 10,1 ↘ | Serie | 93,0 |
| 2: 9,8 ↗ | 7: 10,2* ↗ | | |
| 3: 9,8 ↗ | 8: 9,9 ← | Sum | 190,0 |
| 4: 8,6 ↘ | 9: 10,6* ↑ | | |
| 5: 9,6 ↘ | 10: 10,4* ↖ | | |

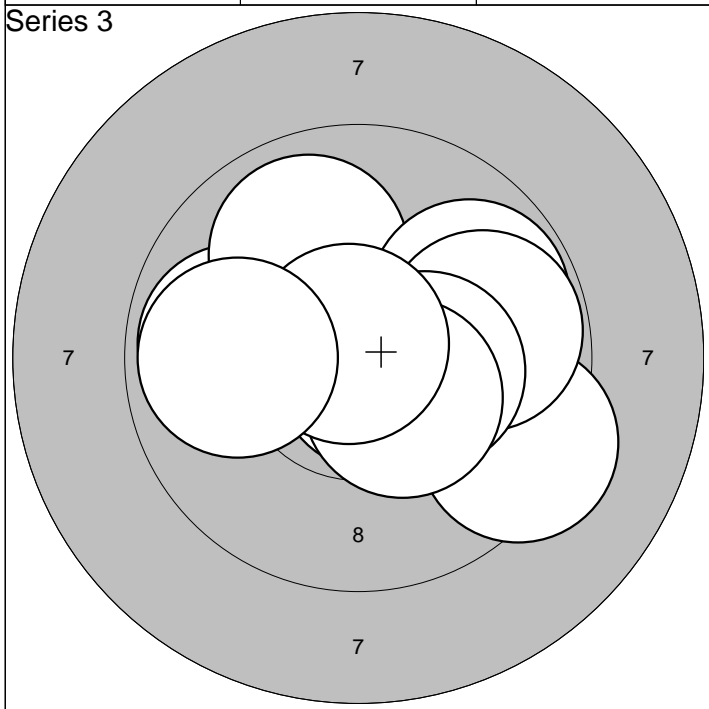

| | | | |
|------------|------------|-------|-------|
| 1: 9,3 ↘ | 6: 9,8 → | Serie | 94,0 |
| 2: 9,9 ← | 7: 10,4* → | | |
| 3: 10,8* ↘ | 8: 10,4* ↘ | Sum | 284,0 |
| 4: 9,9 ↗ | 9: 10,8* ↗ | | |
| 5: 9,8 → | 10: 9,9 ← | | |

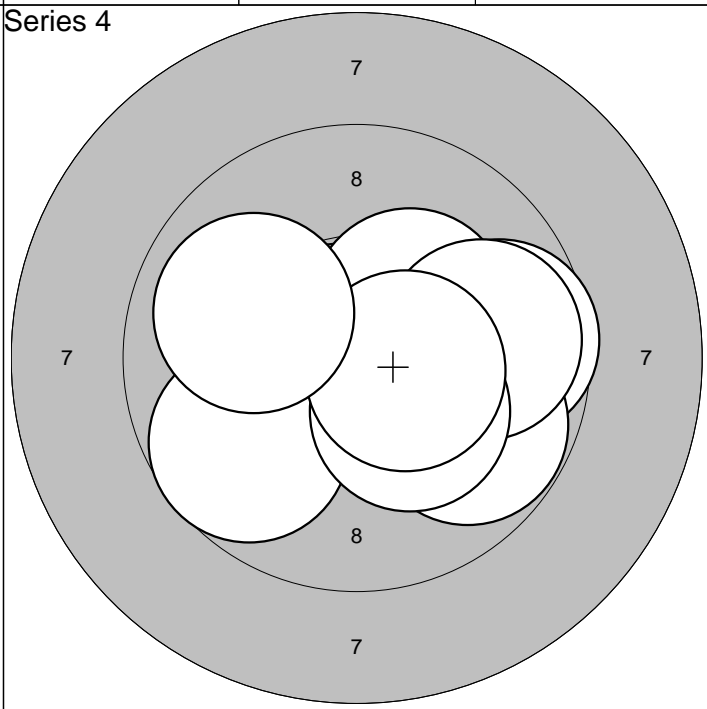

| | | | |
|------------|------------|-------|-------|
| 1: 10,8* ↖ | 6: 9,8 → | Serie | 95,0 |
| 2: 9,7 → | 7: 9,7 ↖ | | |
| 3: 10,3* ↗ | 8: 10,3* ↘ | Sum | 379,0 |
| 4: 9,8 ↘ | 9: 10,5* → | | |
| 5: 10,3* → | 10: 9,9 ↖ | | |

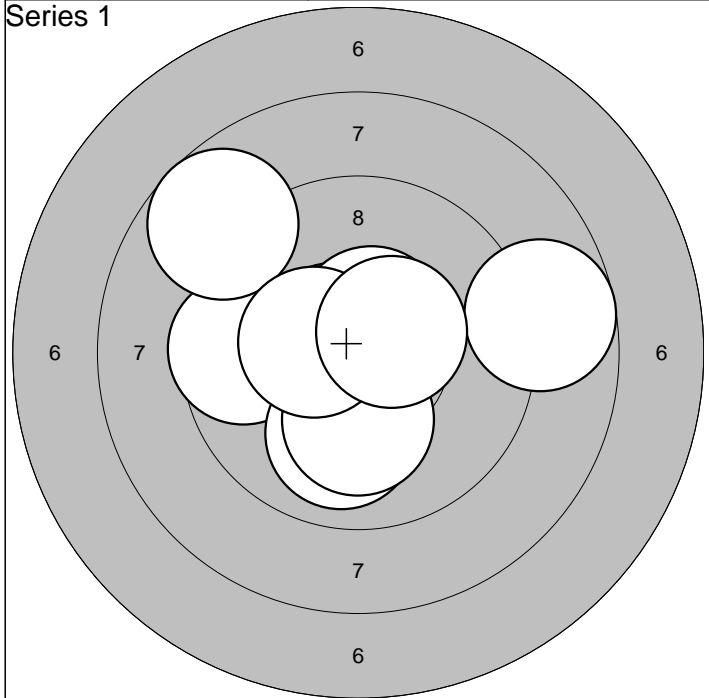

| | | | |
|-----------|------------|-------|------|
| 1: 9,6 ← | 6: 8,7 ↖ | Serie | 95,0 |
| 2:10,6* ↖ | 7:10,7* ← | | |
| 3:10,0 ↓ | 8:10,2* ↓ | Sum | 95,0 |
| 4: 8,7 → | 9:10,4* ← | | |
| 5:10,6* ↗ | 10:10,5* ↗ | | |

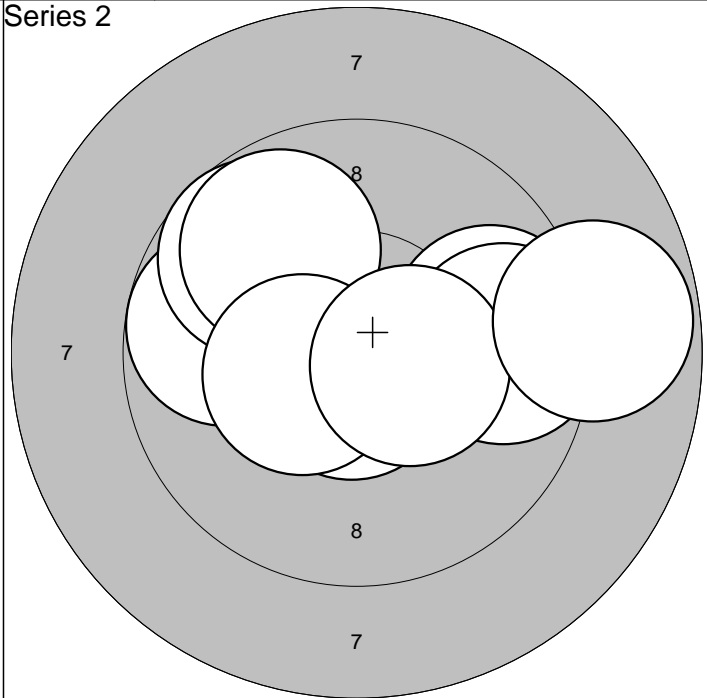

| | | | |
|-----------|-----------|-------|-------|
| 1: 9,8 ← | 6: 9,7 → | Serie | 93,0 |
| 2:10,5* ← | 7: 9,6 → | | |
| 3:10,7* ↓ | 8:10,4* ← | Sum | 188,0 |
| 4: 9,7 ↗ | 9:10,5* → | | |
| 5: 9,8 ↗ | 10: 8,8 → | | |

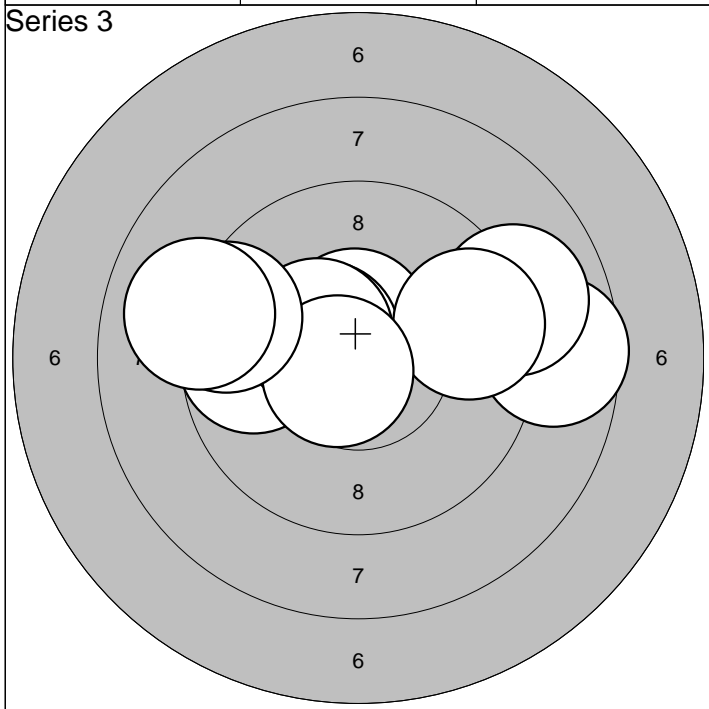

| | | | |
|-----------|-----------|-------|-------|
| 1:10,5* ↑ | 6:10,4* ↖ | Serie | 93,0 |
| 2: 8,6 → | 7: 9,6 → | | |
| 3: 9,0 ↗ | 8:10,7* ↖ | Sum | 281,0 |
| 4:10,5* ↖ | 9: 9,3 ← | | |
| 5: 9,7 ← | 10: 9,0 ← | | |

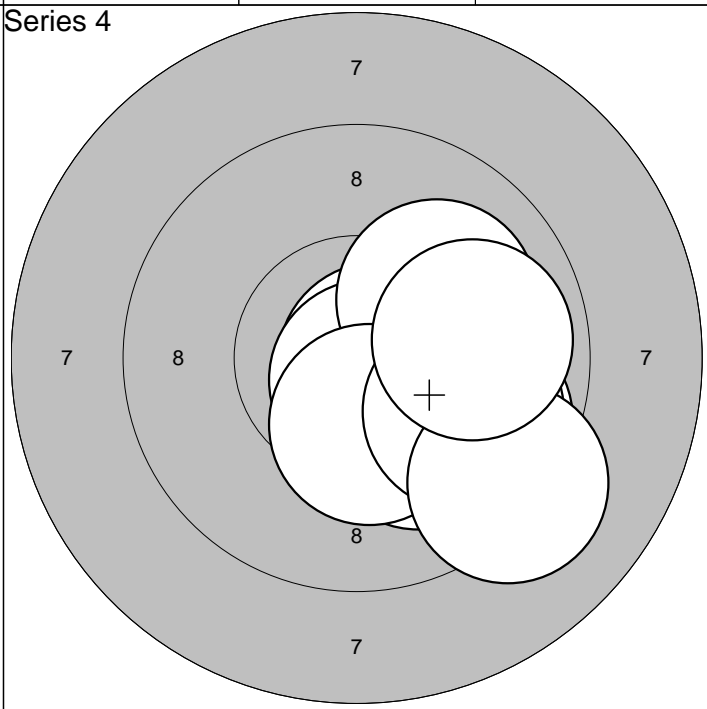

| | | | |
|-----------|-----------|-------|-------|
| 1:10,8* → | 6:10,1 ↗ | Serie | 96,0 |
| 2:10,1 ↘ | 7:10,3* ↓ | | |
| 3: 9,8 ↘ | 8: 9,9 → | Sum | 377,0 |
| 4:10,3* ↘ | 9: 9,2 ↘ | | |
| 5:10,7* ↘ | 10: 9,9 → | | |

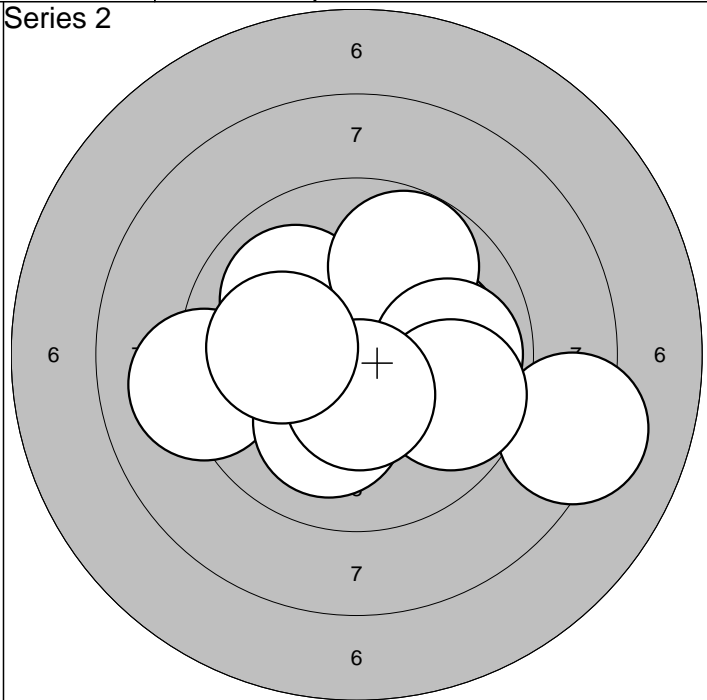
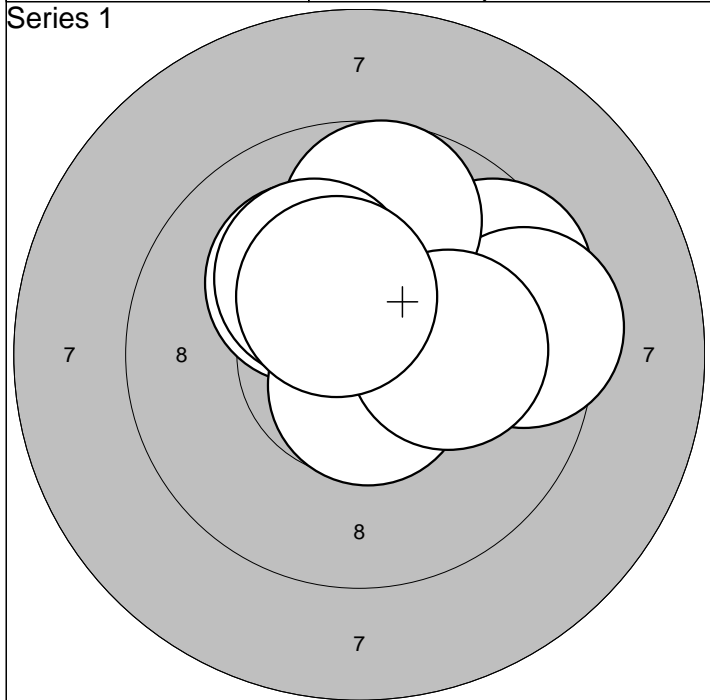

| | | | | | |
|----------|------------|-------|------|--|--|
| 1:10,1 → | 6: 9,8 ↑ | | | | |
| 2:10,0 ↗ | 7:10,7* ↓ | | | | |
| 3: 9,6 → | 8:10,2* ↗ | Serie | 97,0 | | |
| 4:10,1 ↖ | 9:10,2* → | Sum | 97,0 | | |
| 5: 9,5 → | 10:10,4* ↗ | | | | |

| | | | | | |
|----------|-----------|-------|-------|--|--|
| 1:10,1 → | 6: 9,9 → | | | | |
| 2:10,0 ↖ | 7:10,1 ↓ | | | | |
| 3: 8,3 → | 8: 9,7 → | Serie | 94,0 | | |
| 4: 9,1 ← | 9:10,5* ↓ | Sum | 191,0 | | |
| 5: 9,8 ↗ | 10:10,1 ← | | | | |

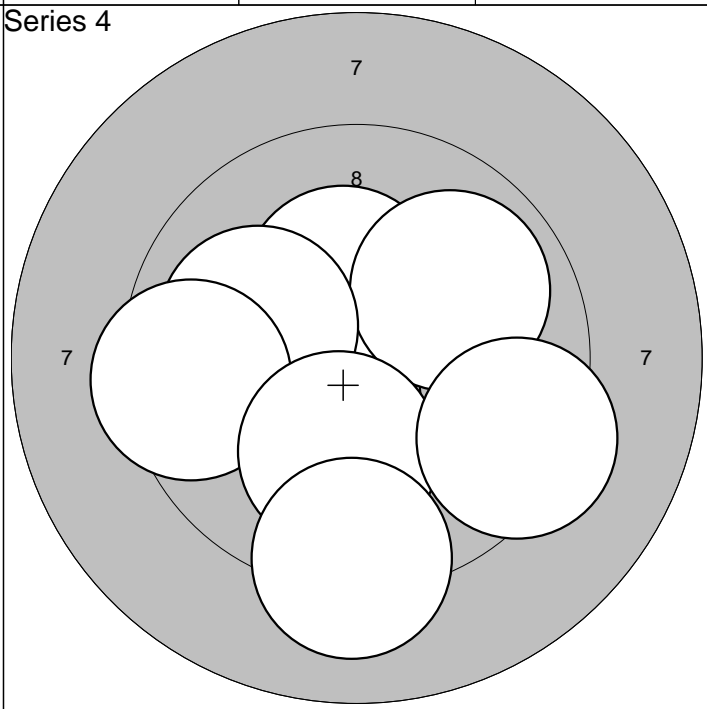
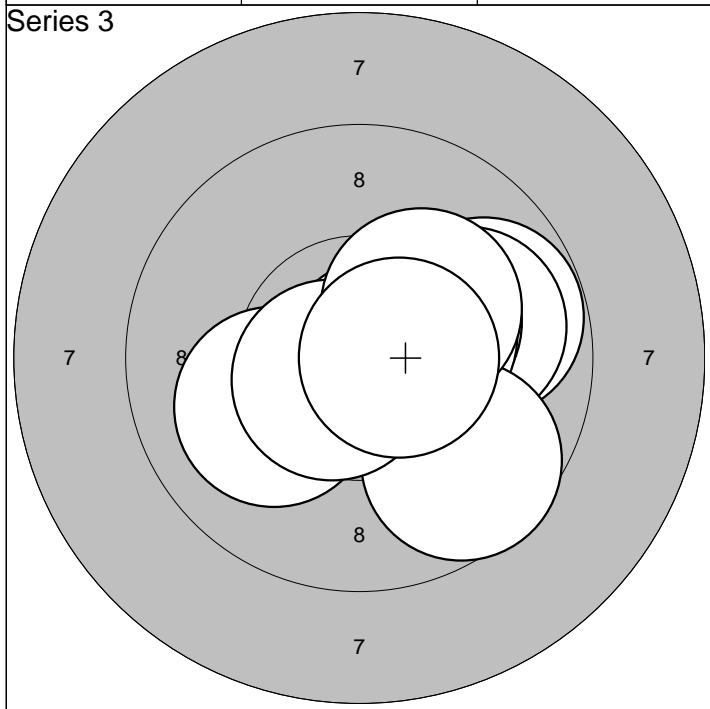

| | | | | | |
|-----------|------------|-------|-------|--|--|
| 1:10,0 ↖ | 6:10,4* → | | | | |
| 2: 9,8 → | 7: 9,6 ↘ | | | | |
| 3: 9,9 → | 8:10,6* ↖ | Serie | 97,0 | | |
| 4:10,7* → | 9:10,2* ↗ | Sum | 288,0 | | |
| 5:10,3* ↗ | 10:10,6* → | | | | |

| | | | | | |
|-----------|-----------|-------|-------|--|--|
| 1:10,7* ↖ | 6:10,0 ↖ | | | | |
| 2:10,4* ↘ | 7: 9,5 ← | | | | |
| 3:10,5* ↖ | 8:10,1 ↓ | Serie | 96,0 | | |
| 4:10,3* ↗ | 9: 9,3 → | Sum | 384,0 | | |
| 5: 9,9 ↗ | 10: 9,2 ↓ | | | | |

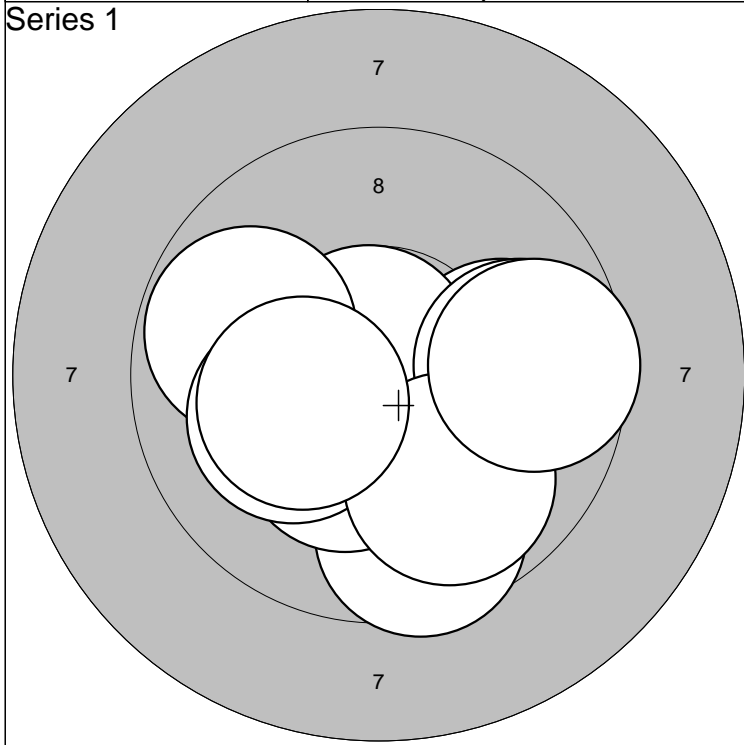

| | | | | | |
|---------|---|---------|---|--------------|-------------|
| 1: 9,6 | ↓ | 6:10,1 | ← | Serie | 94,0 |
| 2: 9,9 | → | 7: 9,8 | → | | |
| 3:10,3* | ↓ | 8: 9,9 | ↓ | Sum | 94,0 |
| 4:10,8* | ↑ | 9:10,3* | ← | | |
| 5: 9,8 | ← | 10: 9,6 | → | | |

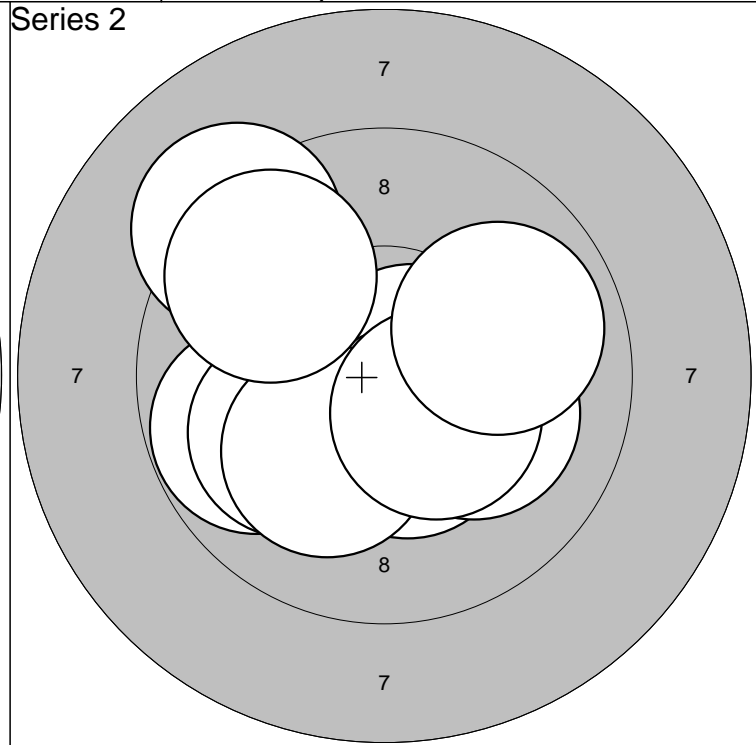

| | | | | | |
|---------|---|---------|---|--------------|--------------|
| 1: 9,8 | ← | 6:10,1 | → | Serie | 96,0 |
| 2:10,7* | → | 7:10,4* | ↓ | | |
| 3:10,0 | ← | 8: 9,9 | → | Sum | 190,0 |
| 4:10,4* | ↓ | 9: 9,2 | ↑ | | |
| 5:10,1 | ↙ | 10: 9,7 | ↑ | | |

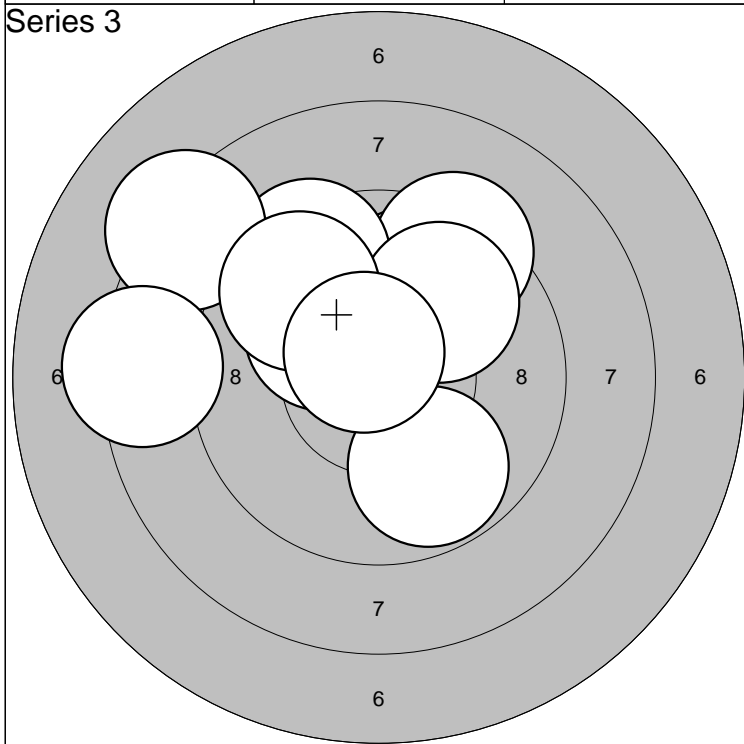

| | | | | | |
|---------|---|----------|---|--------------|--------------|
| 1: 9,9 | ↑ | 6: 8,2 | ↖ | Serie | 90,0 |
| 2: 9,3 | ↑ | 7: 8,3 | ← | | |
| 3: 9,4 | ↑ | 8: 9,9 | ↑ | Sum | 280,0 |
| 4:10,2* | ↑ | 9: 9,6 | ↑ | | |
| 5: 9,8 | ↓ | 10:10,6* | ↑ | | |

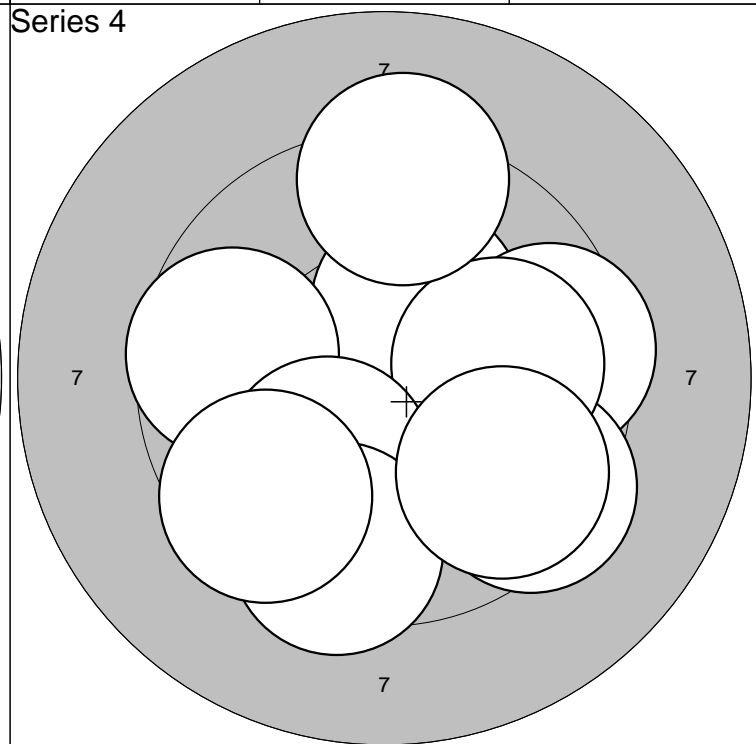

| | | | | | |
|---------|---|---------|---|--------------|--------------|
| 1:10,3* | ↑ | 6:10,1 | ↙ | Serie | 93,0 |
| 2: 9,5 | → | 7: 9,5 | ↓ | | |
| 3: 9,4 | ↘ | 8: 9,5 | ↙ | Sum | 373,0 |
| 4:10,0 | → | 9: 9,3 | ↑ | | |
| 5: 9,7 | ← | 10: 9,7 | ↘ | | |

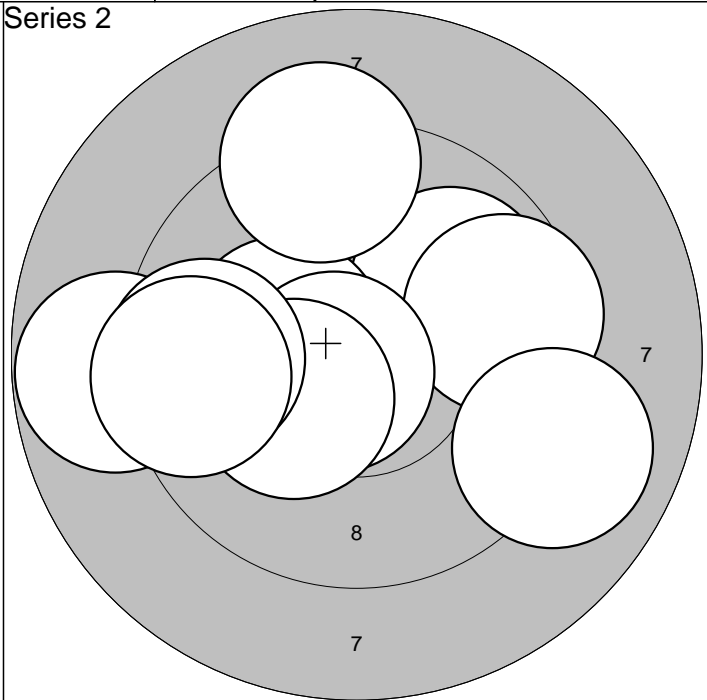
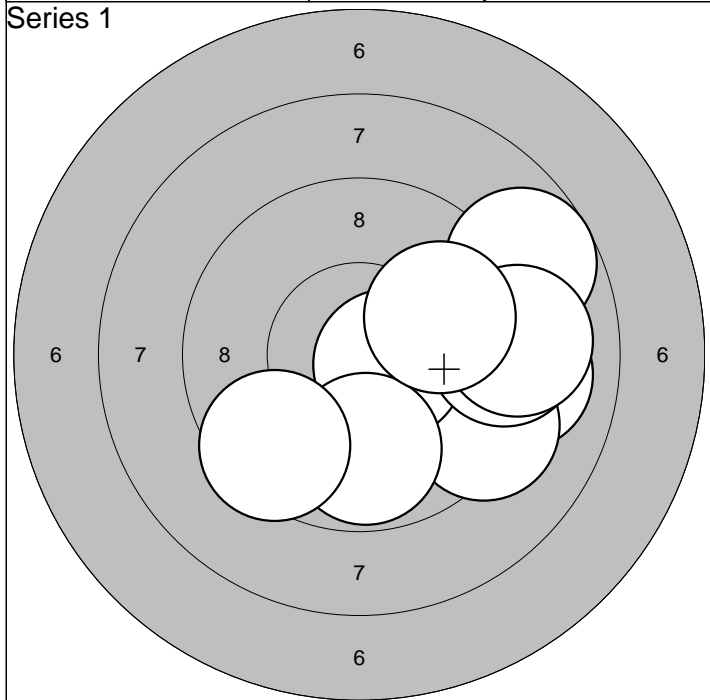

| | | | | |
|-----------|-----------|--|-------|------|
| 1: 9,1 → | 6: 9,5 ↙ | | Serie | 91,0 |
| 2:10,2* → | 7: 8,7 ↗ | | | |
| 3: 9,3 ↘ | 8: 9,2 → | | Sum | 91,0 |
| 4:10,6* → | 9: 9,1 → | | | |
| 5: 9,8 ↓ | 10: 9,9 ↗ | | | |

| | | | | |
|-----------|-----------|--|-------|-------|
| 1: 9,9 ↗ | 6:10,7* ↙ | | Serie | 92,0 |
| 2:10,3* ← | 7:10,3* ↙ | | | |
| 3: 8,8 ← | 8: 9,0 → | | Sum | 183,0 |
| 4: 9,6 → | 9: 9,6 ← | | | |
| 5: 9,2 ↑ | 10: 9,5 ← | | | |

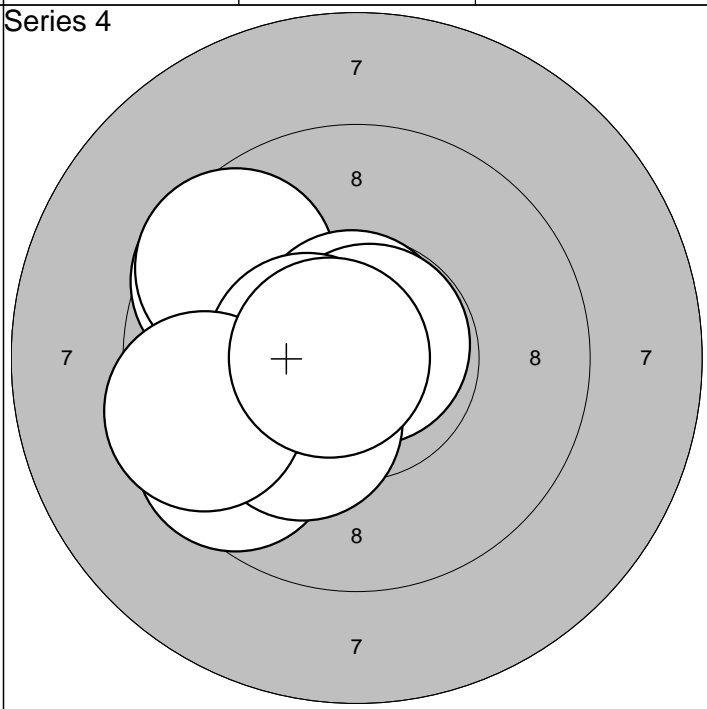
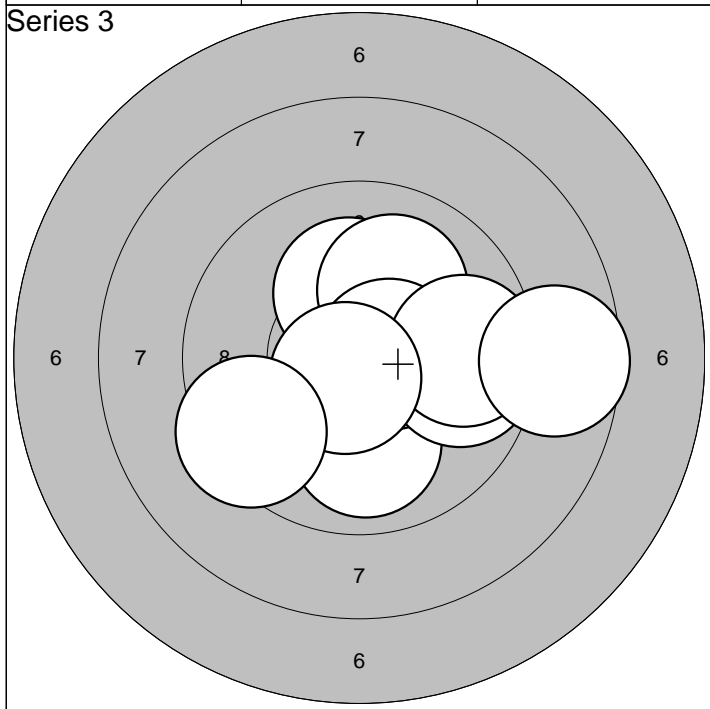

| | | | | |
|-----------|-----------|--|-------|-------|
| 1:10,3* → | 6: 9,7 → | | Serie | 95,0 |
| 2:10,0 ↓ | 7: 9,7 → | | | |
| 3:10,2* ↑ | 8:10,7* ↙ | | Sum | 278,0 |
| 4:10,0 ↗ | 9: 9,4 ↙ | | | |
| 5:10,6* → | 10: 8,6 → | | | |

| | | | | |
|-----------|------------|--|-------|-------|
| 1:10,3* ← | 6:10,8* ↗ | | Serie | 96,0 |
| 2: 9,6 ↖ | 7:10,2* ↙ | | | |
| 3: 9,6 ↙ | 8:10,5* ← | | Sum | 374,0 |
| 4: 9,6 ↖ | 9: 9,5 ← | | | |
| 5:10,7* ↑ | 10:10,7* ← | | | |

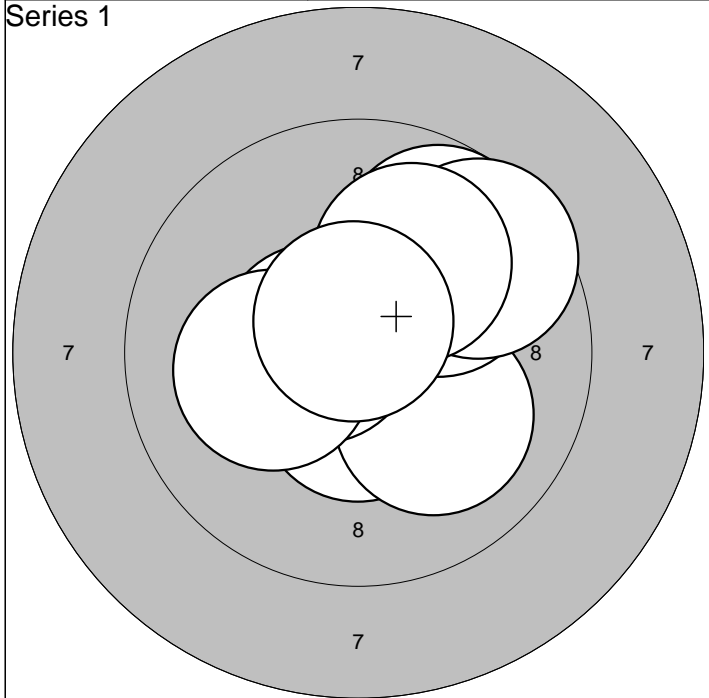

| | | | | |
|-----------|------------|-----|-------|------|
| 1:10,5* ↓ | 6:10,6* ← | | Serie | 97,0 |
| 2: 9,7 ↗ | 7:10,2* ← | | | |
| 3:10,1 ↘ | 8: 9,6 ↗ | Sum | 97,0 | |
| 4:10,0 ↗ | 9:10,0 ↗ | | | |
| 5: 9,7 ↗ | 10:10,7* ↑ | | | |

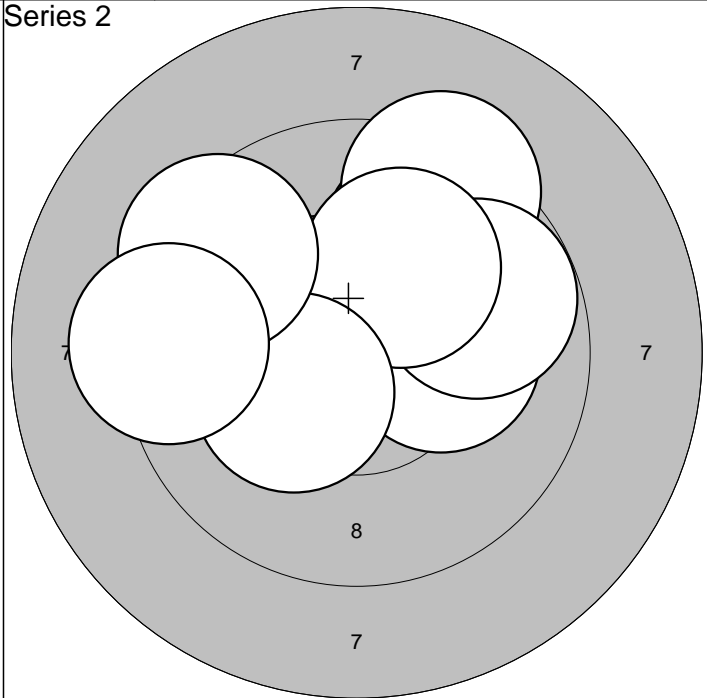

| | | | | |
|-----------|-----------|-----|-------|------|
| 1: 9,8 ↗ | 6:10,3* ↖ | | Serie | 95,0 |
| 2:10,5* ↖ | 7:10,1 ↗ | | | |
| 3:10,2* → | 8:10,3* ↖ | Sum | 192,0 | |
| 4: 9,3 ↗ | 9: 9,4 ↖ | | | |
| 5: 9,8 ↗ | 10: 9,3 ← | | | |

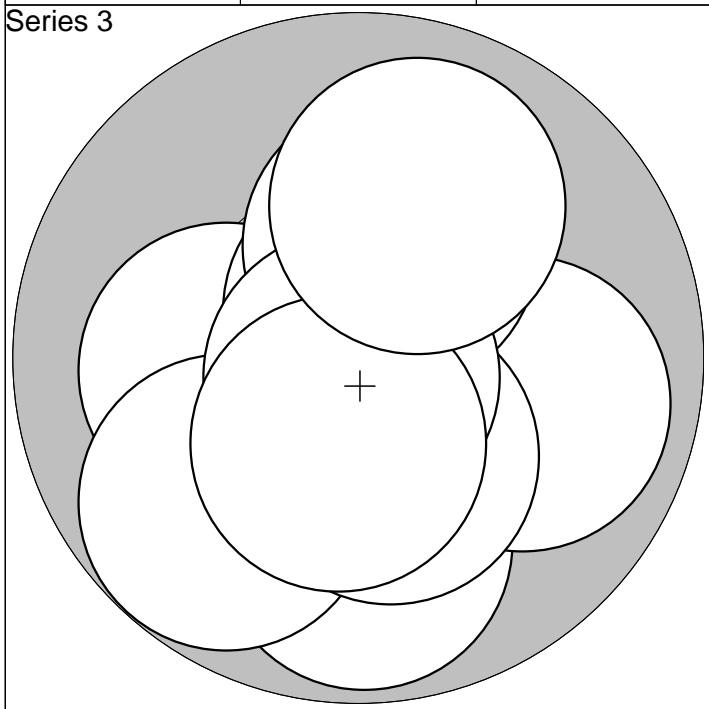

| | | | | |
|-----------|-----------|-----|-------|------|
| 1:10,2* ← | 6:10,3* ↓ | | Serie | 96,0 |
| 2: 9,8 ↓ | 7:10,2* ↑ | | | |
| 3:10,7* ↑ | 8:10,8* ↓ | Sum | 288,0 | |
| 4: 9,8 ↖ | 9:10,4* ↓ | | | |
| 5: 9,9 → | 10: 9,9 ↑ | | | |

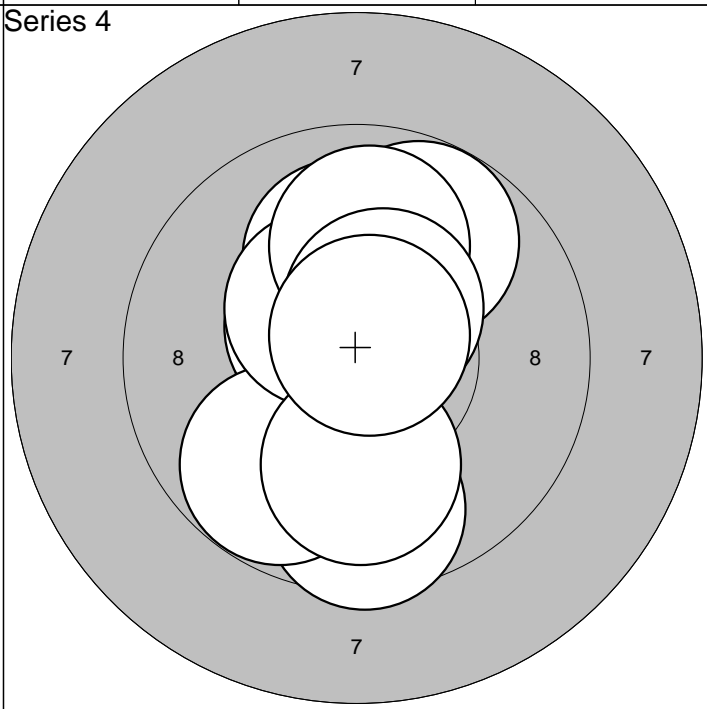

| | | | | |
|-----------|------------|-----|-------|------|
| 1:10,1 ↑ | 6: 9,8 ↗ | | Serie | 97,0 |
| 2:10,5* ↖ | 7:10,0 ↑ | | | |
| 3: 9,6 ↓ | 8:10,0 ↓ | Sum | 385,0 | |
| 4: 9,8 ↖ | 9:10,4* ↗ | | | |
| 5:10,4* ↖ | 10:10,7* ↗ | | | |

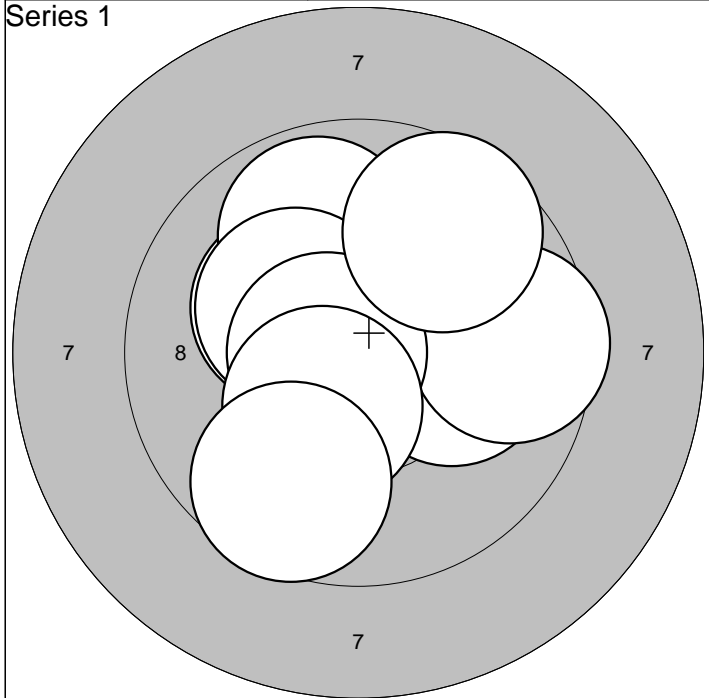

| | | | | | | | |
|-----------|-----------|-----|------|--|--|--|--|
| 1:10,0 ↗ | 6:10,3* ↖ | | | | | | |
| 2:10,1 → | 7:10,7* ← | | | | | | |
| 3: 9,6 → | 8: 9,6 ↗ | | | | | | |
| 4:10,2* ↖ | 9:10,4* ↘ | Sum | 96,0 | | | | |
| 5: 9,8 ↗ | 10: 9,7 ↘ | | | | | | |

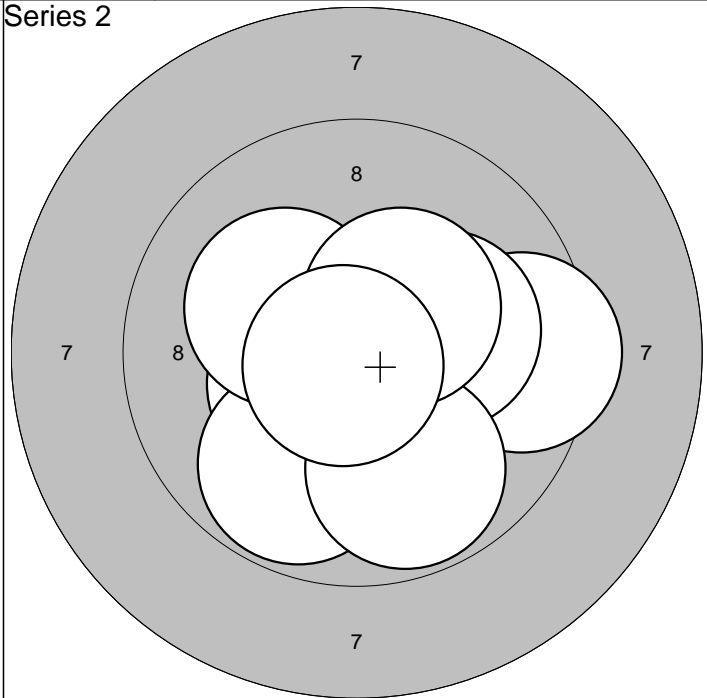

| | | | | | | | |
|-----------|------------|-----|-------|--|--|--|--|
| 1:10,4* ↖ | 6:10,3* ↗ | | | | | | |
| 2: 9,8 ↘ | 7:10,2* → | | | | | | |
| 3:10,2* ↖ | 8: 9,8 ↘ | | | | | | |
| 4:10,7* ↘ | 9:10,4* ↗ | Sum | 193,0 | | | | |
| 5: 9,5 → | 10:10,8* ↖ | | | | | | |

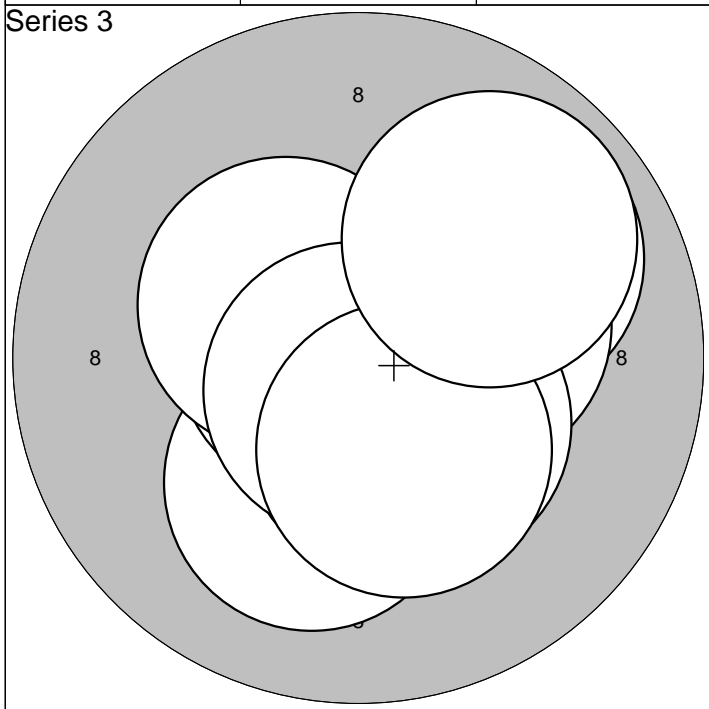

| | | | | | | | |
|-----------|-----------|-----|-------|--|--|--|--|
| 1: 9,9 ↗ | 6:10,4* ↘ | | | | | | |
| 2:10,1 ↘ | 7:10,4* ↖ | | | | | | |
| 3:10,8* ← | 8:10,7* ↘ | | | | | | |
| 4:10,5* ↘ | 9:10,3* ↘ | Sum | 291,0 | | | | |
| 5:10,3* → | 10: 9,9 ↗ | | | | | | |

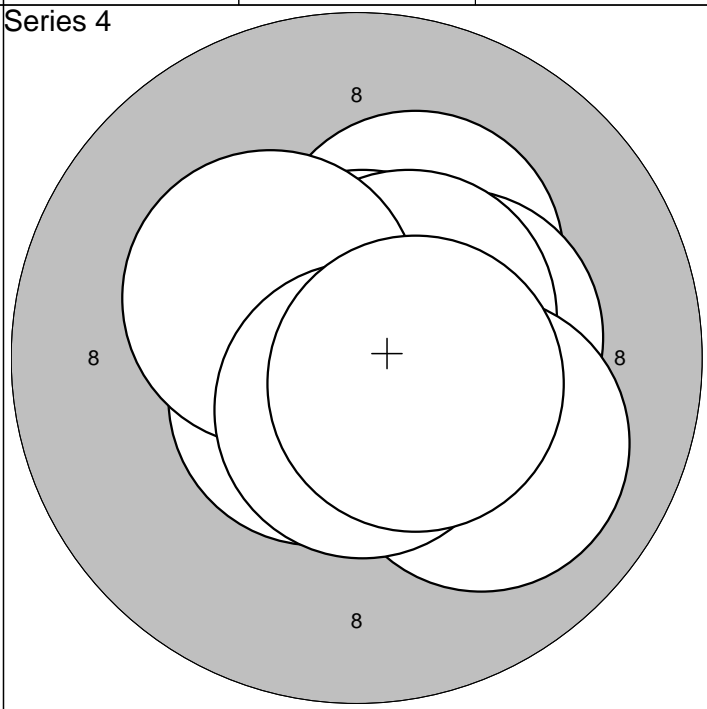

| | | | | | | | |
|-----------|------------|-----|-------|--|--|--|--|
| 1:10,2* ↗ | 6:10,6* ↘ | | | | | | |
| 2:10,7* ↗ | 7:10,0 ↘ | | | | | | |
| 3:10,8* → | 8:10,3* ↖ | | | | | | |
| 4:10,3* → | 9:10,6* ↘ | Sum | 391,0 | | | | |
| 5:10,5* ↗ | 10:10,6* → | | | | | | |

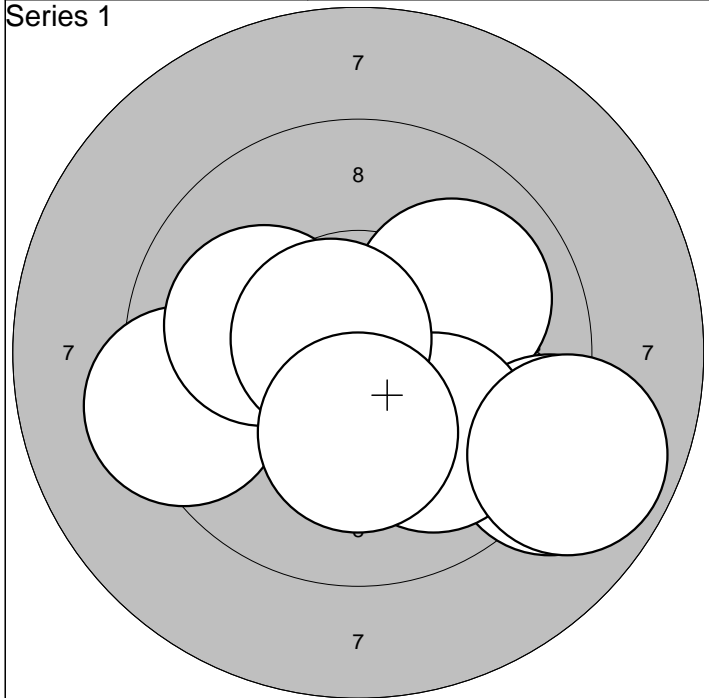

| | | | |
|-----------|-----------|-------|------|
| 1:10,7* ↓ | 6: 9,0 ↘ | Serie | 95,0 |
| 2: 9,3 ← | 7: 9,9 ↘ | | |
| 3:10,3* ↓ | 8:10,7* ↖ | Sum | 95,0 |
| 4:10,0 ↗ | 9:10,2* ↓ | | |
| 5:10,1 ← | 10: 8,9 ↘ | | |

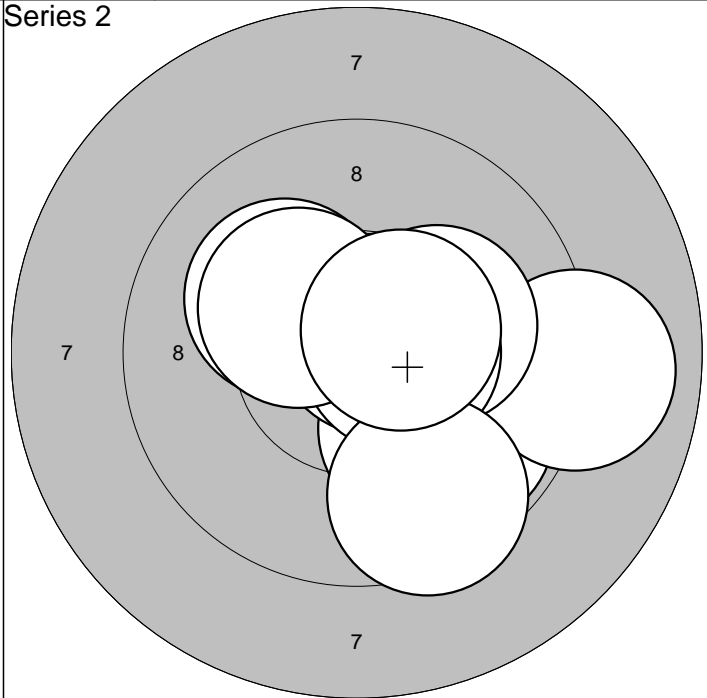

| | | | |
|-----------|------------|-------|-------|
| 1: 9,8 ↘ | 6:10,7* ↗ | Serie | 97,0 |
| 2:10,2* ↗ | 7:10,5* → | | |
| 3:10,1 ↓ | 8: 9,5 ↓ | Sum | 192,0 |
| 4: 9,0 → | 9:10,3* ↖ | | |
| 5:10,2* → | 10:10,5* ↗ | | |

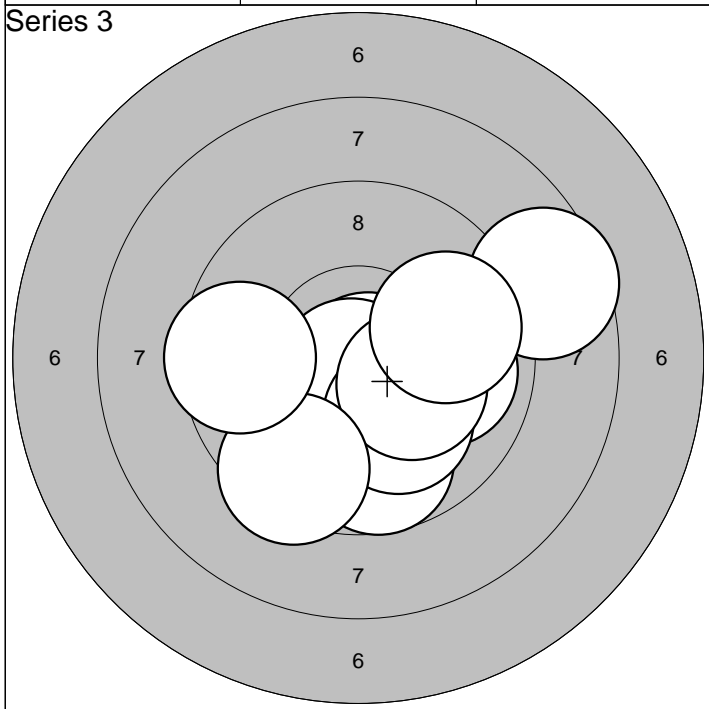

| | | | |
|-----------|-----------|-------|-------|
| 1: 8,6 ↗ | 6:10,1 ↓ | Serie | 93,0 |
| 2: 9,9 → | 7:10,2* ↘ | | |
| 3:10,8* ↘ | 8: 9,8 → | Sum | 285,0 |
| 4: 9,7 ↓ | 9: 9,4 ↘ | | |
| 5:10,7* ↘ | 10: 9,6 ← | | |

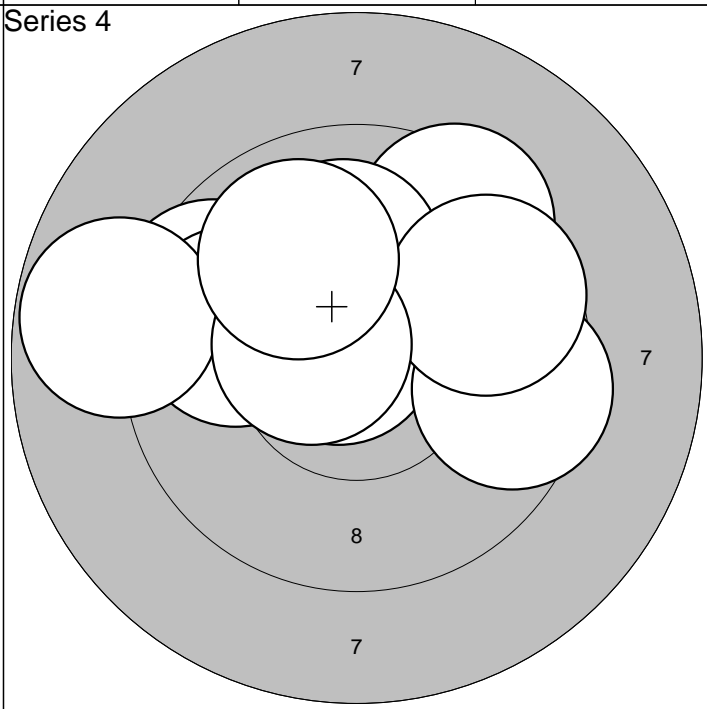

| | | | |
|-----------|-----------|-------|-------|
| 1: 9,6 ← | 6:10,1 ↑ | Serie | 92,0 |
| 2:10,8* ↖ | 7: 9,7 ↗ | | |
| 3: 9,5 ↗ | 8: 8,8 ← | Sum | 377,0 |
| 4: 9,5 → | 9:10,5* ← | | |
| 5: 9,8 ← | 10: 9,9 ↗ | | |

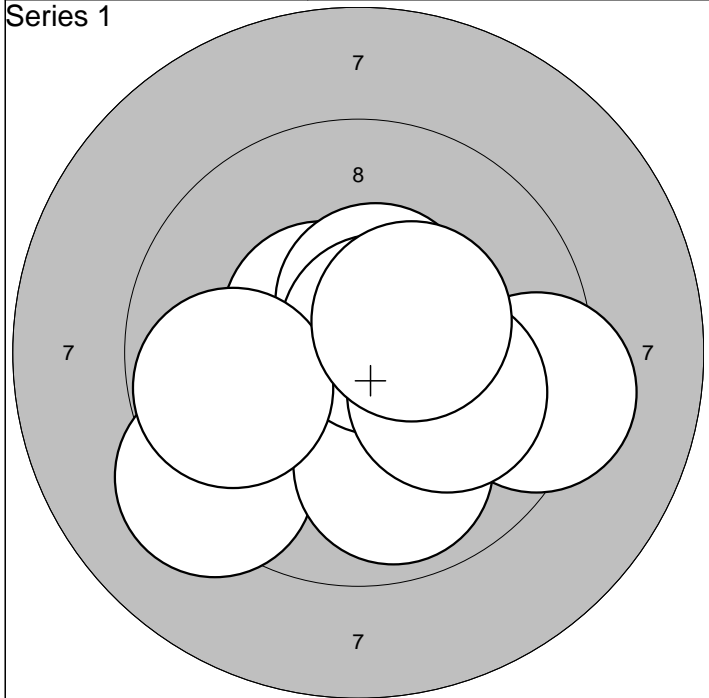

| | | | | |
|-----------|------------|-----|-------|------|
| 1:10,3* ↓ | 6: 9,9 ↓ | | Serie | 96,0 |
| 2: 9,3 → | 7:10,7* ↗ | | | |
| 3:10,5* ↘ | 8: 9,8 ← | | | |
| 4: 9,3 ↙ | 9:10,1 → | Sum | | 96,0 |
| 5:10,5* ↑ | 10:10,4* ↗ | | | |

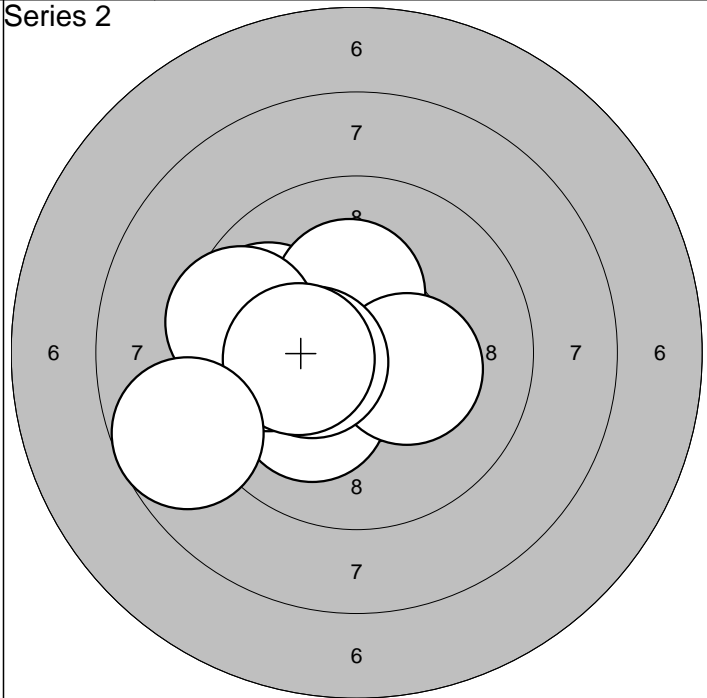

| | | | | |
|-----------|-----------|-----|-------|-------|
| 1: 9,9 ← | 6:10,3* → | | Serie | 95,0 |
| 2:10,5* ↑ | 7:10,4* ← | | | |
| 3:10,1 ↙ | 8: 9,5 ← | | | |
| 4: 9,9 ← | 9:10,3* ← | Sum | | 191,0 |
| 5:10,3* ↑ | 10: 8,7 ↙ | | | |

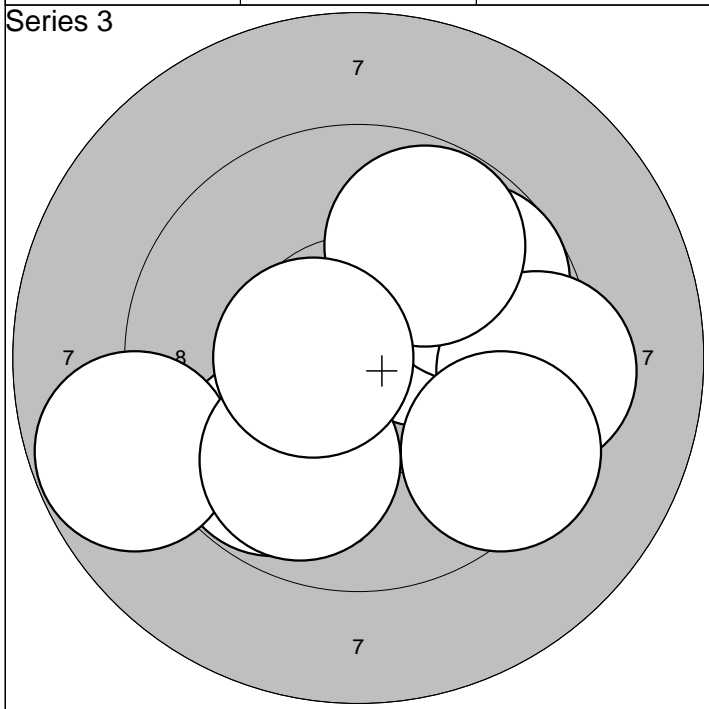

| | | | | |
|-----------|------------|-----|-------|-------|
| 1: 9,8 ↙ | 6: 9,3 → | | Serie | 92,0 |
| 2:10,1 ↗ | 7: 9,4 → | | | |
| 3: 8,8 ← | 8: 9,8 ↗ | | | |
| 4:10,3* → | 9: 9,9 ↙ | Sum | | 283,0 |
| 5: 9,7 ↗ | 10:10,5* ← | | | |

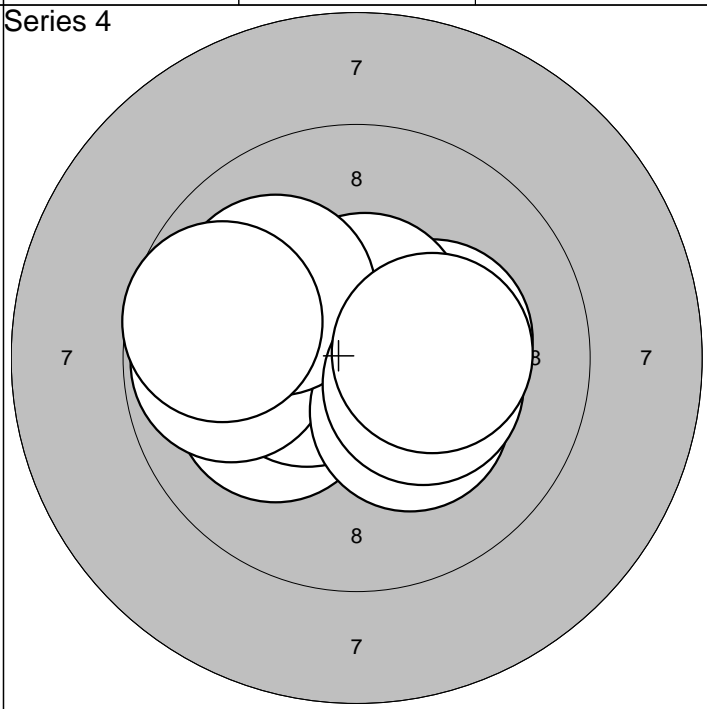

| | | | | |
|-----------|-----------|-----|-------|-------|
| 1:10,3* → | 6:10,3* ↙ | | Serie | 98,0 |
| 2:10,1 ↙ | 7:10,1 ↖ | | | |
| 3:10,6* ↑ | 8:10,3* → | | | |
| 4:10,5* ← | 9:10,3* → | Sum | | 381,0 |
| 5: 9,8 ← | 10: 9,7 ↖ | | | |

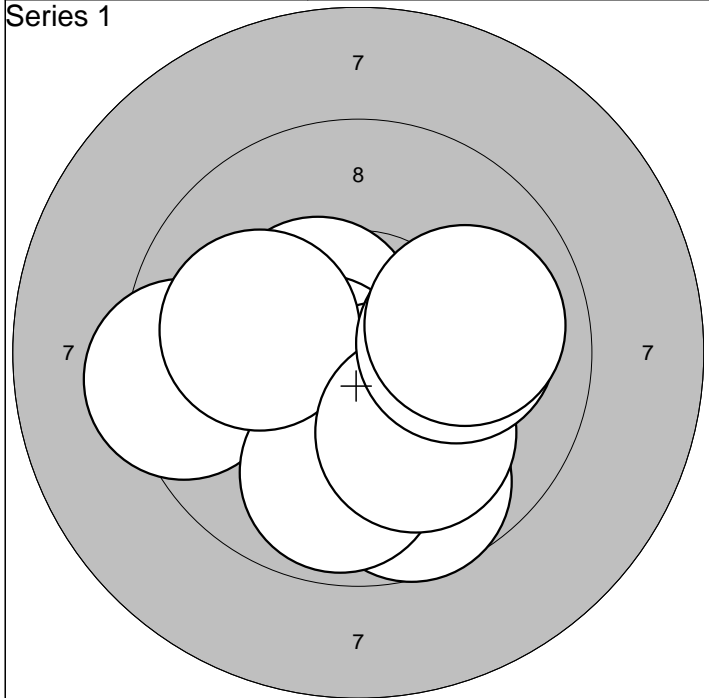

| | | | |
|-----------|-----------|-------|------|
| 1:10,5* ↖ | 6: 9,9 ↓ | Serie | 97,0 |
| 2:10,5* ↙ | 7:10,0 ← | | |
| 3: 9,7 ↓ | 8:10,1 ↓ | Sum | 97,0 |
| 4: 9,4 ← | 9:10,1 → | | |
| 5:10,4* ↓ | 10:10,0 → | | |

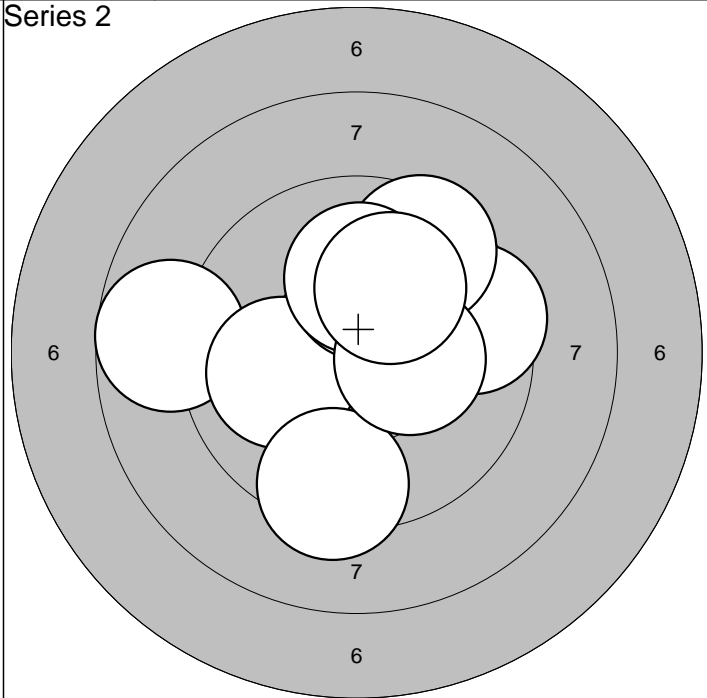

| | | | |
|-----------|-----------|-------|-------|
| 1: 9,5 → | 6: 9,5 ↗ | Serie | 95,0 |
| 2: 8,7 ← | 7:10,1 ↑ | | |
| 3:10,5* ↗ | 8:10,1 ↑ | Sum | 192,0 |
| 4:10,0 ← | 9:10,3* → | | |
| 5: 9,4 ↓ | 10:10,1 ↗ | | |

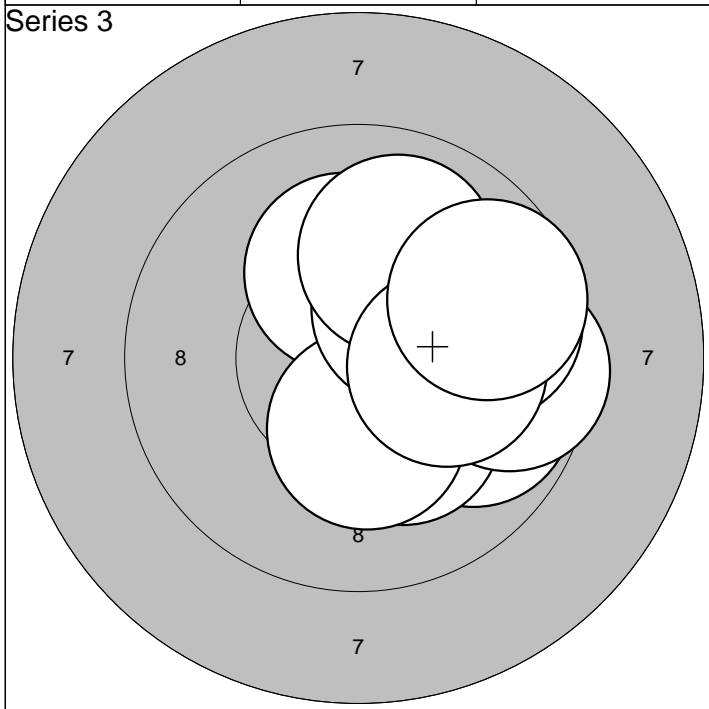

| | | | |
|-----------|-----------|-------|-------|
| 1: 9,8 ↘ | 6: 9,8 → | Serie | 95,0 |
| 2:10,2* ↓ | 7:10,3* ↗ | | |
| 3: 9,6 → | 8: 9,9 ↑ | Sum | 287,0 |
| 4:10,2* ↑ | 9:10,2* → | | |
| 5:10,3* ↓ | 10: 9,7 ↗ | | |

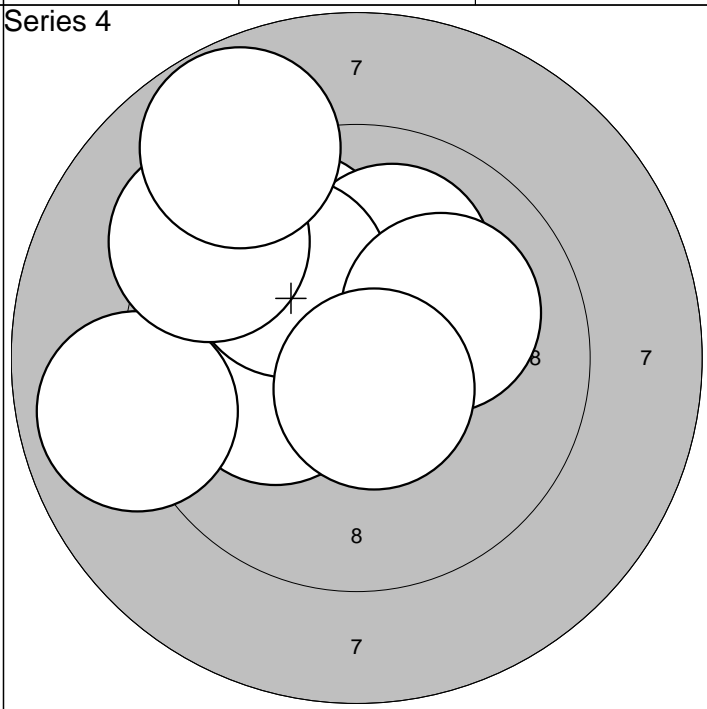

| | | | |
|-----------|-----------|-------|-------|
| 1: 9,8 ↖ | 6: 8,9 ← | Serie | 93,0 |
| 2: 9,9 ↙ | 7:10,1 ↗ | | |
| 3:10,2* ← | 8:10,6* ↓ | Sum | 380,0 |
| 4:10,1 ↑ | 9: 9,3 ↖ | | |
| 5:10,0 ↖ | 10: 8,8 ↗ | | |

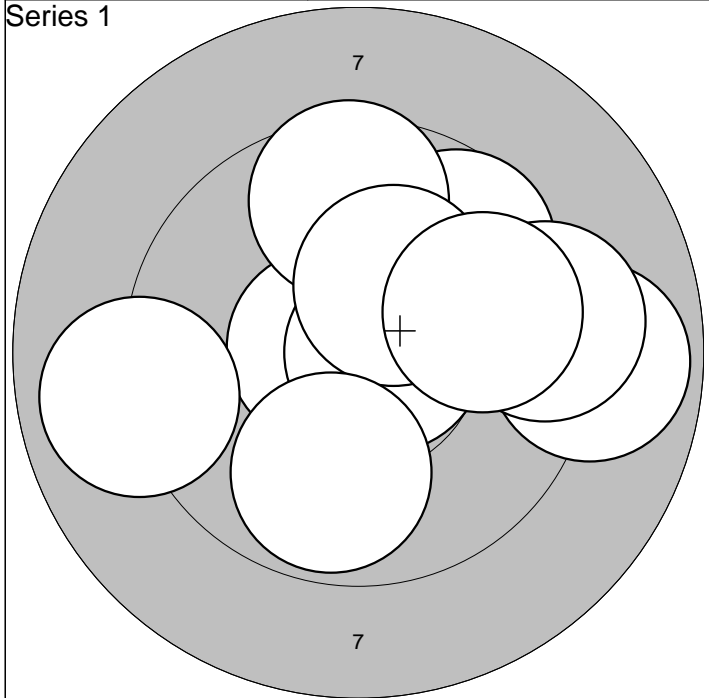

| | | | |
|-----------|-----------|-------|------|
| 1:10,7* ← | 6: 9,6 ↑ | Serie | 91,0 |
| 2: 9,7 ↗ | 7:10,3* ↗ | | |
| 3: 8,9 → | 8: 9,3 → | Sum | 91,0 |
| 4: 8,9 ← | 9: 9,8 ↓ | | |
| 5:10,7* → | 10: 9,8 → | | |

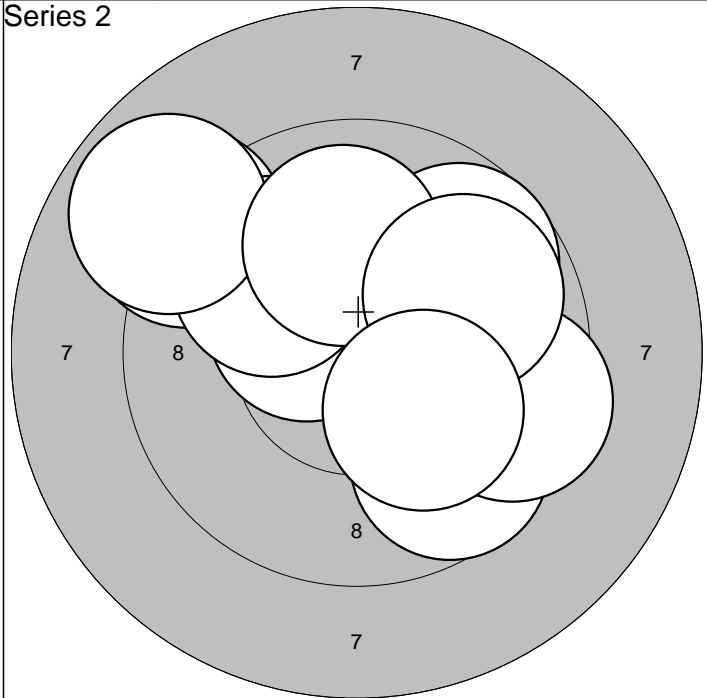

| | | | |
|-----------|-----------|-------|-------|
| 1:10,4* ↖ | 6: 9,9 ↖ | Serie | 92,0 |
| 2: 9,1 ↖ | 7: 8,9 ↖ | | |
| 3: 9,7 ↘ | 8:10,0 ↑ | Sum | 183,0 |
| 4: 9,7 ↗ | 9: 9,8 ↗ | | |
| 5: 9,5 → | 10:10,1 ↘ | | |

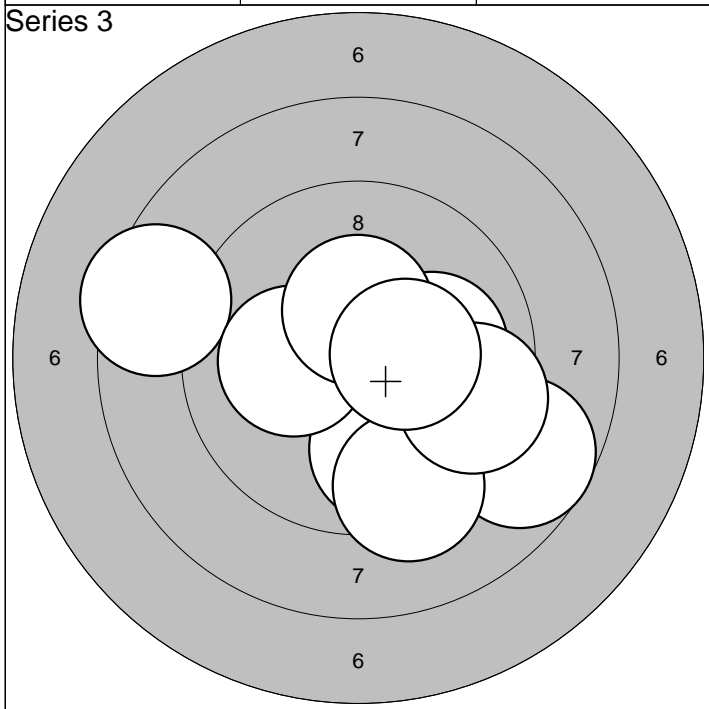

| | | | |
|-----------|------------|-------|-------|
| 1:10,2* → | 6:10,1 → | Serie | 93,0 |
| 2: 9,8 ↓ | 7:10,2* ← | | |
| 3: 8,7 ↘ | 8: 9,5 → | Sum | 276,0 |
| 4: 8,4 ← | 9:10,4* ↑ | | |
| 5: 9,3 ↓ | 10:10,4* → | | |

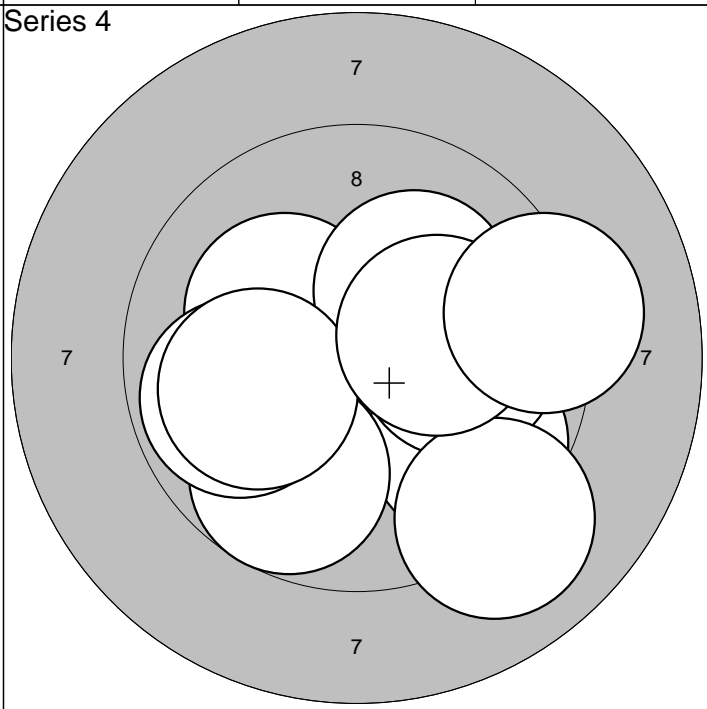

| | | | |
|-----------|-----------|-------|-------|
| 1: 9,7 ↘ | 6:10,2* ↗ | Serie | 95,0 |
| 2:10,0 → | 7: 9,9 ← | | |
| 3:10,2* ↖ | 8:10,0 ← | Sum | 371,0 |
| 4: 9,8 ↓ | 9:10,2* → | | |
| 5: 9,1 ↘ | 10: 9,2 → | | |

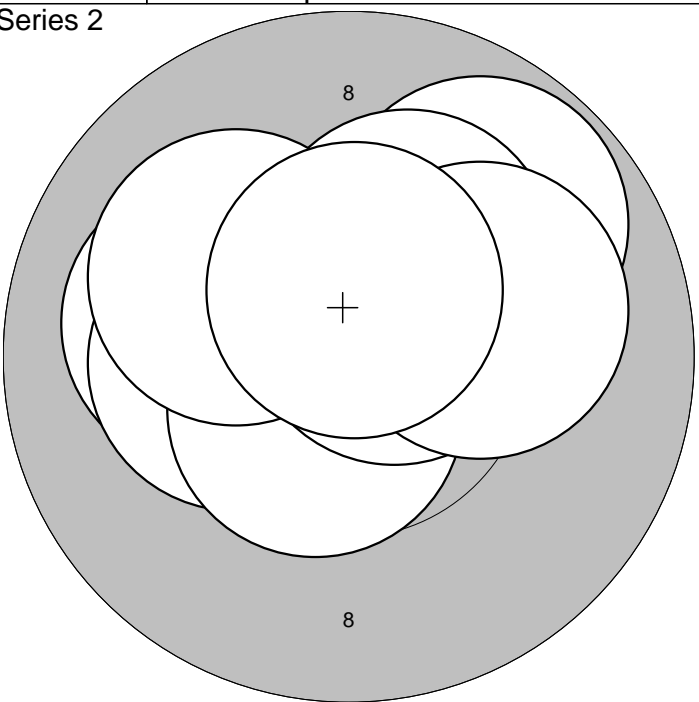
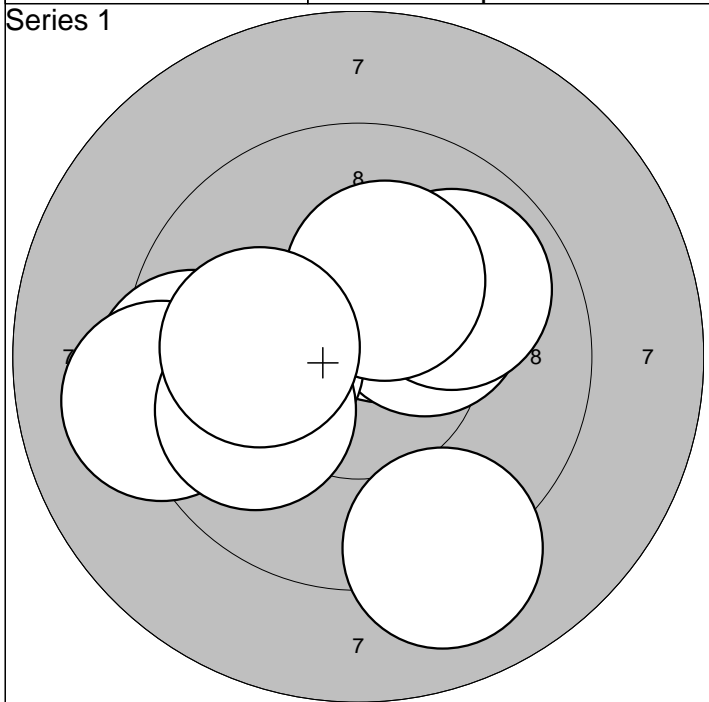

| | | | | |
|-----------|-----------|-----|-------|------|
| 1: 9,5 ← | 6: 9,1 ← | | Serie | 95,0 |
| 2:10,4* ↗ | 7:10,1 ← | | | |
| 3:10,2* ↘ | 8: 9,9 ← | Sum | 95,0 | |
| 4: 9,1 ↓ | 9:10,2* ↗ | | | |
| 5: 9,9 ↘ | 10:10,1 ← | | | |

| | | | | |
|-----------|------------|-----|-------|------|
| 1:10,1 ← | 6:10,6* ↓ | | Serie | 99,0 |
| 2:10,5* ↖ | 7:10,6* ↗ | | | |
| 3: 9,8 ↗ | 8:10,1 → | Sum | 194,0 | |
| 4:10,3* ← | 9:10,1 ↖ | | | |
| 5:10,3* ↗ | 10:10,6* ↑ | | | |

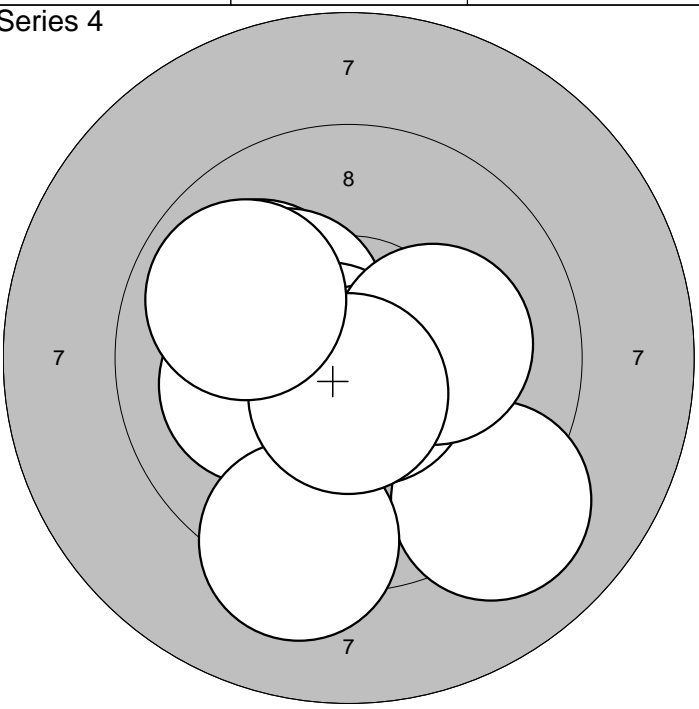
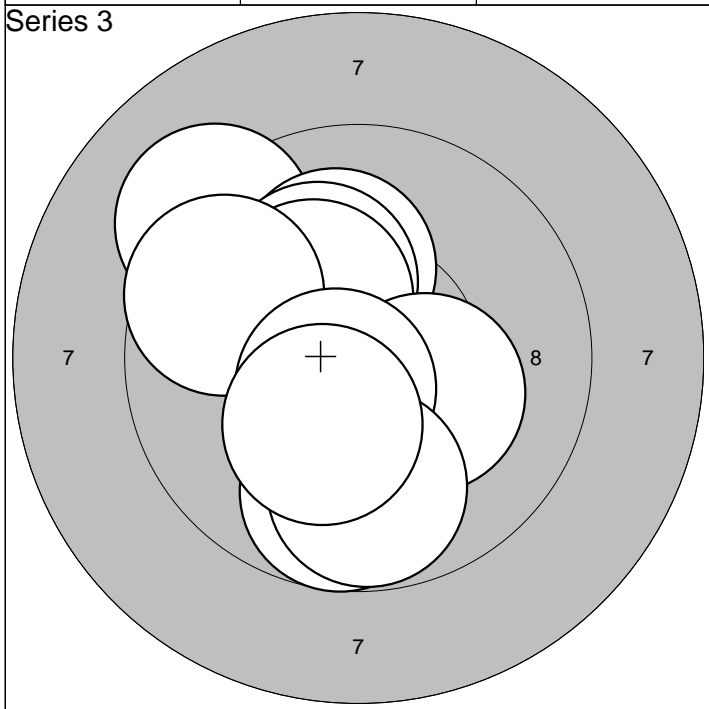

| | | | | |
|-----------|------------|-----|-------|------|
| 1: 9,2 ↗ | 6: 9,7 ↓ | | Serie | 96,0 |
| 2:10,1 ↑ | 7: 9,6 ← | | | |
| 3:10,2* ↗ | 8:10,6* ↓ | Sum | 290,0 | |
| 4:10,3* ↗ | 9: 9,8 ↓ | | | |
| 5:10,3* ↘ | 10:10,3* ↓ | | | |

| | | | | |
|-----------|-----------|-----|-------|------|
| 1:10,0 ↖ | 6:10,6* ↓ | | Serie | 97,0 |
| 2:10,3* ↗ | 7:10,2* → | | | |
| 3: 9,1 ↓ | 8: 9,3 ↓ | Sum | 387,0 | |
| 4:10,7* ← | 9:10,6* ↓ | | | |
| 5:10,1 ← | 10: 9,9 ↖ | | | |

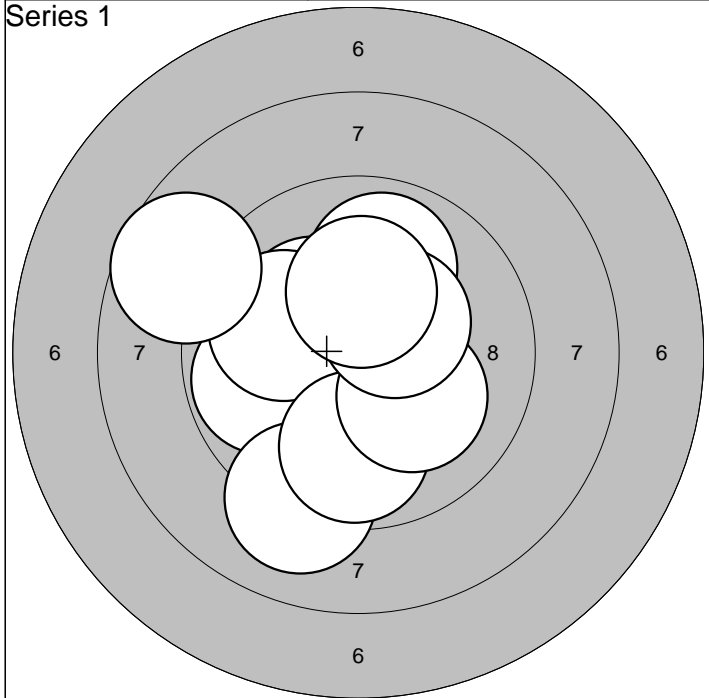

| | | | | | |
|-----------|------------|--|--|-------|------|
| 1: 9,8 ← | 6: 9,9 ↑ | | | Serie | 94,0 |
| 2:10,3* ↖ | 7: 8,7 ← | | | | |
| 3:10,0 ← | 8:10,1 ↘ | | | Sum | 94,0 |
| 4: 9,1 ↓ | 9:10,4* ↗ | | | | |
| 5: 9,8 ↓ | 10:10,2* ↑ | | | | |

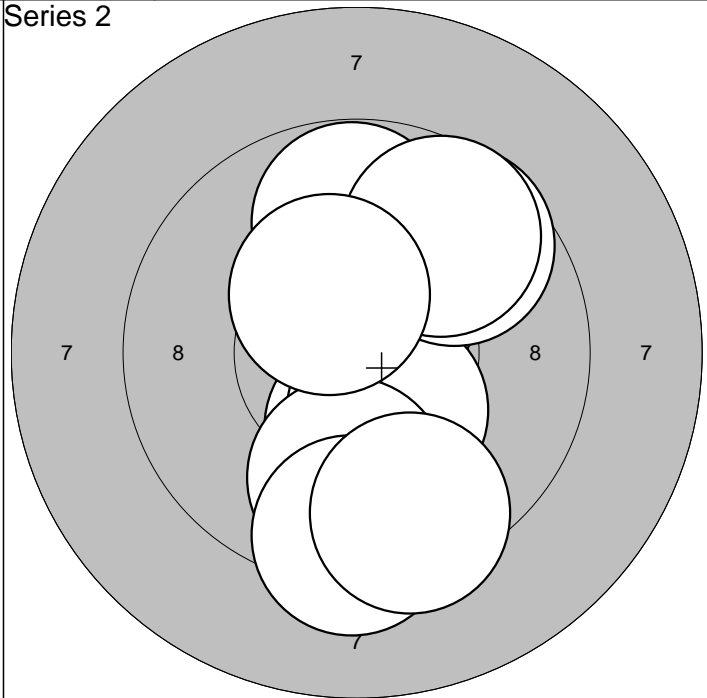

| | | | | | |
|-----------|------------|--|--|-------|-------|
| 1:10,3* ↓ | 6: 9,8 ↓ | | | Serie | 94,0 |
| 2:10,6* ↗ | 7: 9,3 ↓ | | | | |
| 3:10,4* ↘ | 8: 9,4 ↓ | | | Sum | 188,0 |
| 4: 9,6 ↗ | 9: 9,7 ↗ | | | | |
| 5: 9,8 ↑ | 10:10,4* ↖ | | | | |

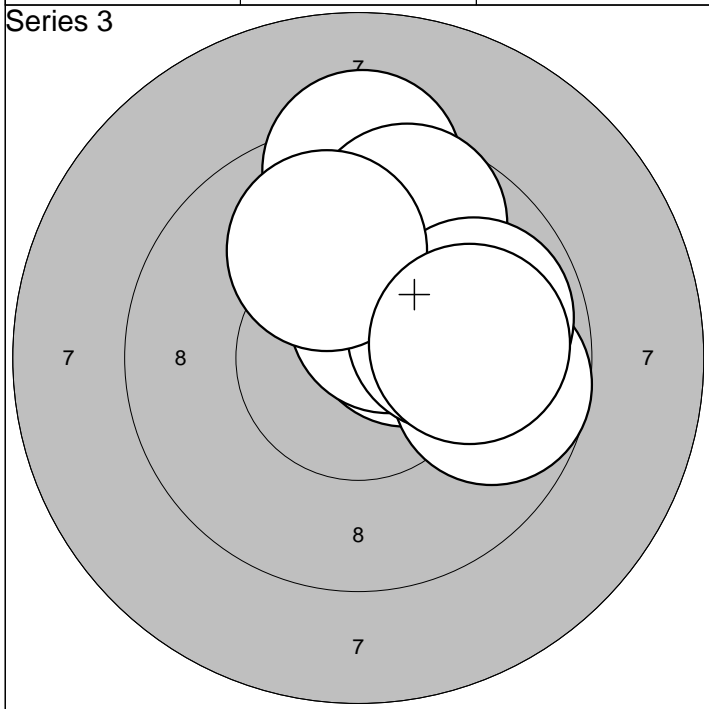

| | | | | | |
|-----------|-----------|--|--|-------|-------|
| 1:10,2* ↑ | 6: 9,7 ↑ | | | Serie | 96,0 |
| 2:10,4* ↗ | 7:10,1 → | | | | |
| 3:10,5* ↗ | 8: 9,8 → | | | Sum | 284,0 |
| 4: 9,3 ↑ | 9:10,0 ↑ | | | | |
| 5: 9,7 → | 10:10,0 → | | | | |

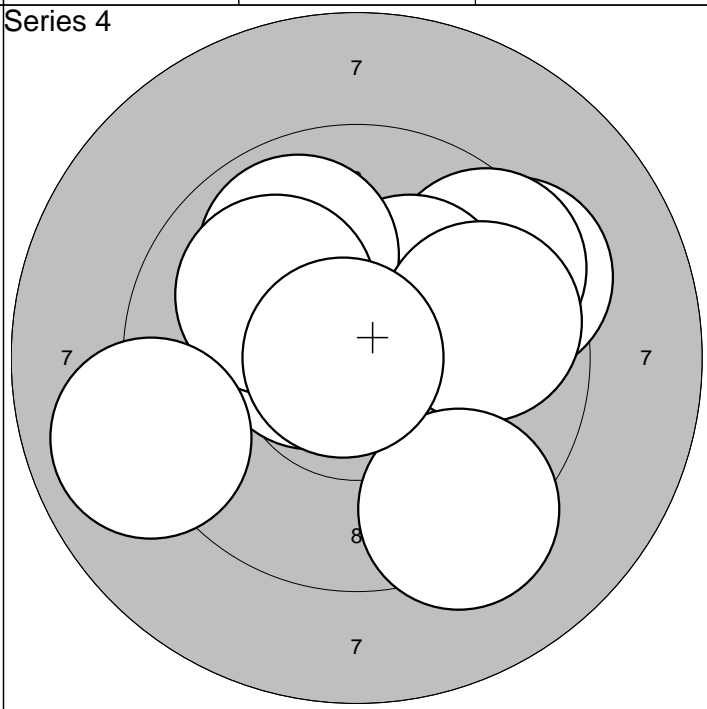

| | | | | | |
|-----------|------------|--|--|-------|-------|
| 1: 9,4 ↗ | 6:10,0 ↖ | | | Serie | 94,0 |
| 2: 9,6 ↗ | 7: 9,8 → | | | | |
| 3:10,5* ← | 8: 9,0 ← | | | Sum | 378,0 |
| 4:10,2* ↗ | 9: 9,3 ↓ | | | | |
| 5: 9,9 ↖ | 10:10,8* ← | | | | |

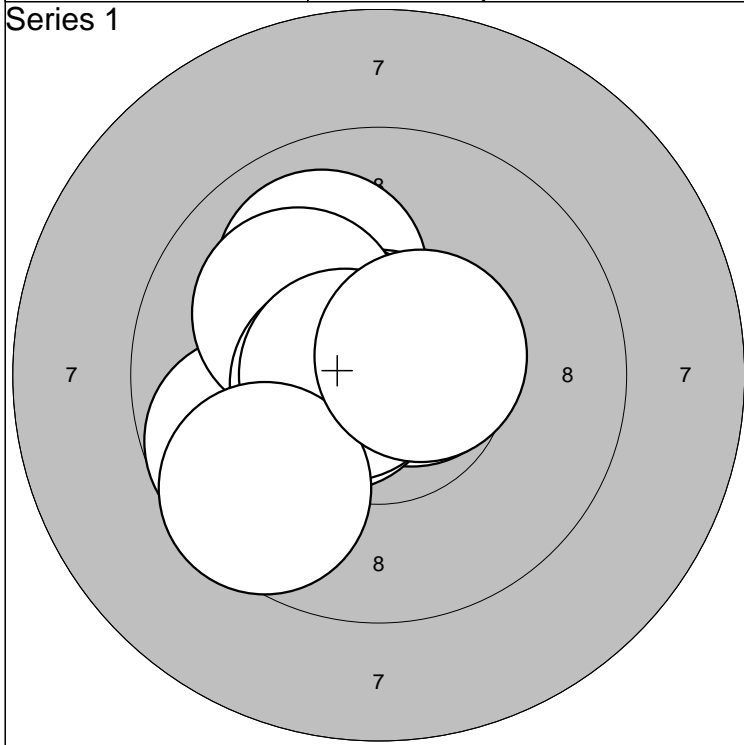

| | | | |
|-----------|------------|-------|------|
| 1:10,0 ↗ | 6:10,1 ↖ | Serie | 98,0 |
| 2:10,8* ↑ | 7:10,6* ← | | |
| 3:10,6* → | 8:10,7* ← | Sum | 98,0 |
| 4:10,5* ↖ | 9: 9,6 ↙ | | |
| 5: 9,7 ↙ | 10:10,6* → | | |

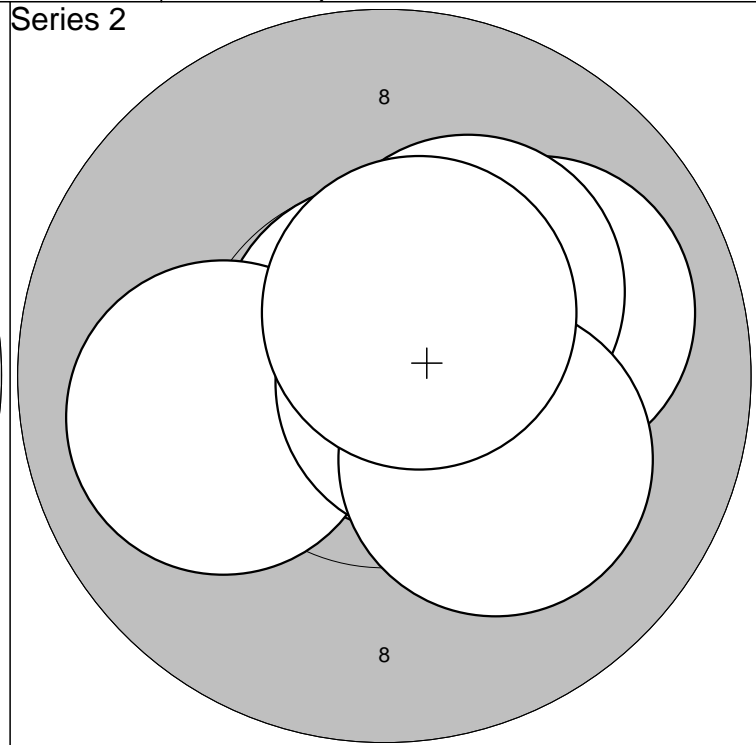

| | | | |
|-----------|------------|-------|-------|
| 1:10,5* → | 6:10,0 ← | Serie | 100,0 |
| 2:10,7* ↑ | 7:10,7* → | | |
| 3:10,8* → | 8:10,3* ↗ | Sum | 198,0 |
| 4:10,0 → | 9:10,2* ↘ | | |
| 5:10,6* → | 10:10,5* ↗ | | |

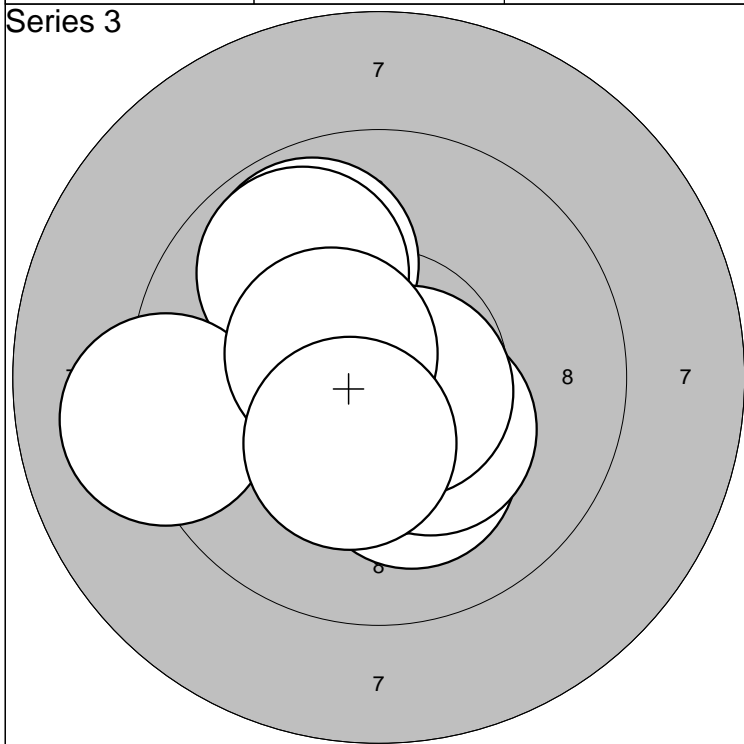

| | | | |
|-----------|------------|-------|-------|
| 1: 9,8 ↗ | 6:10,7* ↘ | Serie | 97,0 |
| 2:10,2* ↘ | 7: 9,8 ↗ | | |
| 3:10,5* ↘ | 8: 9,1 ← | Sum | 295,0 |
| 4:10,6* ↘ | 9:10,5* ↖ | | |
| 5:10,3* ↘ | 10:10,3* ↘ | | |

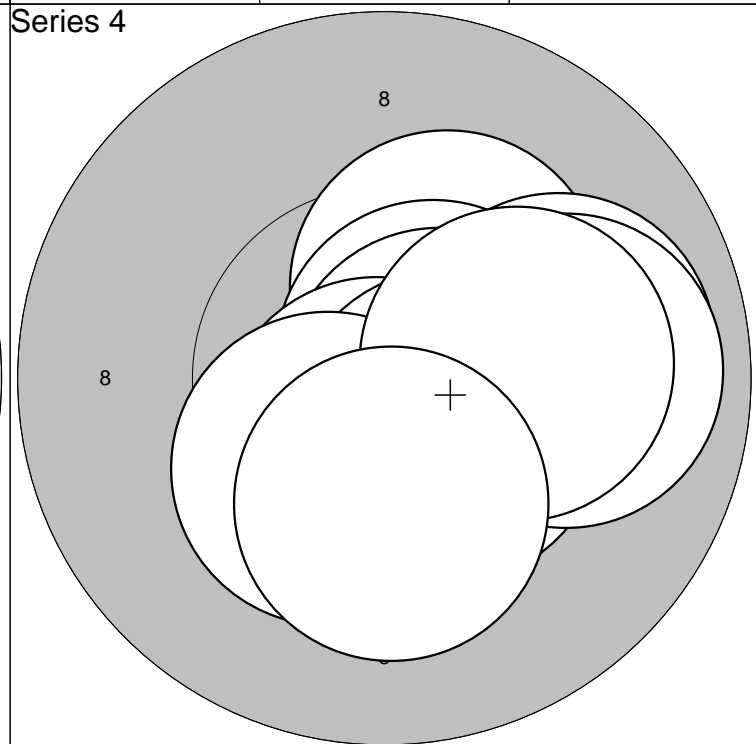

| | | | |
|-----------|------------|-------|-------|
| 1:10,3* ↗ | 6: 9,9 → | Serie | 98,0 |
| 2:10,7* → | 7: 9,9 → | | |
| 3:10,6* → | 8:10,3* ↘ | Sum | 393,0 |
| 4:10,6* ↘ | 9:10,2* → | | |
| 5:10,5* ↘ | 10:10,2* ↘ | | |

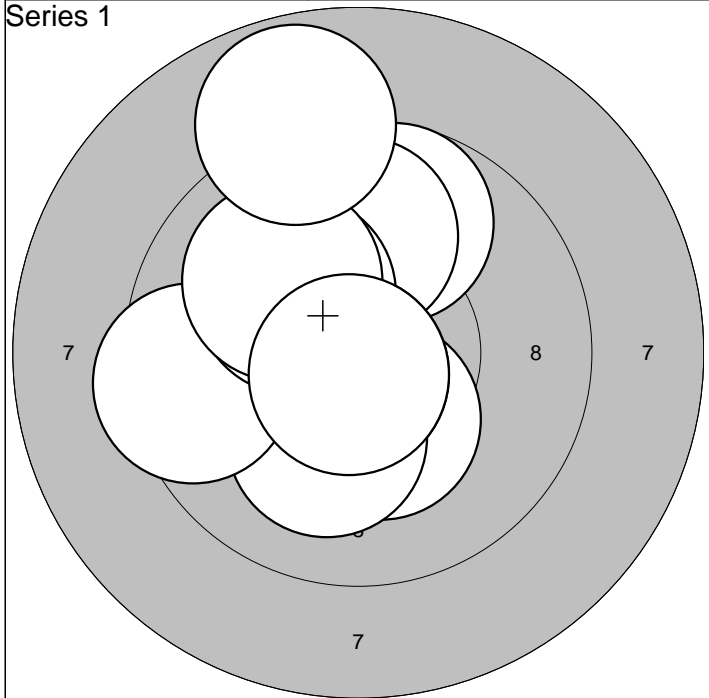

| | | | | |
|--------------|--------------|--|-------|------|
| 1: 9,8 ↗ | 6: 9,5 ← | | Serie | 95,0 |
| 2:10,3* ↓ | 7:10,2* ↖ | | Sum | 95,0 |
| 3: 9,9 ↑ | 8:10,0 ↗ | | | |
| 4:10,7* ↓ | 9:10,7* ↓ | | | |
| 5:10,2* ↓ | 10: 8,8 ↑ | | | |

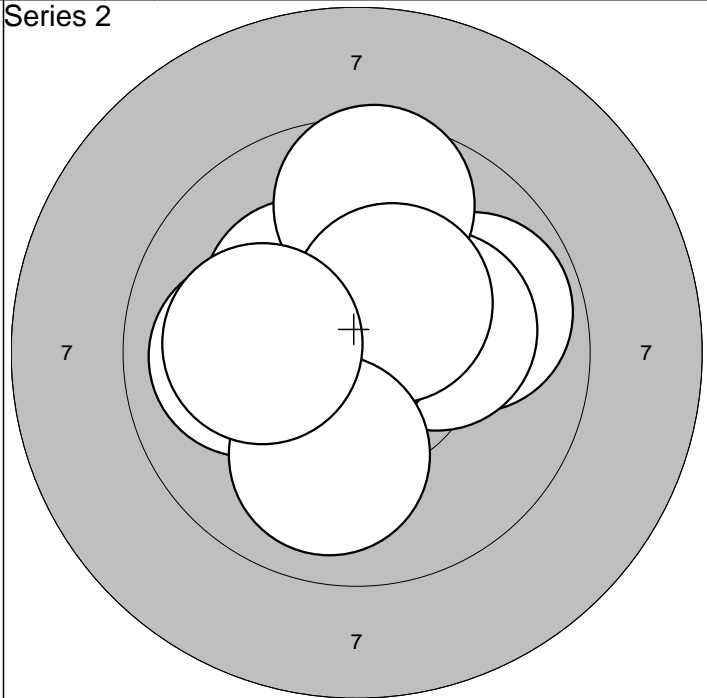

| | | | | |
|--------------|--------------|--|-------|-------|
| 1:10,8* ↗ | 6:10,8* ↖ | | Serie | 98,0 |
| 2:10,3* ↖ | 7: 9,6 ↑ | | Sum | 193,0 |
| 3:10,0 ← | 8:10,4* ↗ | | | |
| 4: 9,9 → | 9:10,0 ↓ | | | |
| 5:10,2* → | 10:10,1 ← | | | |

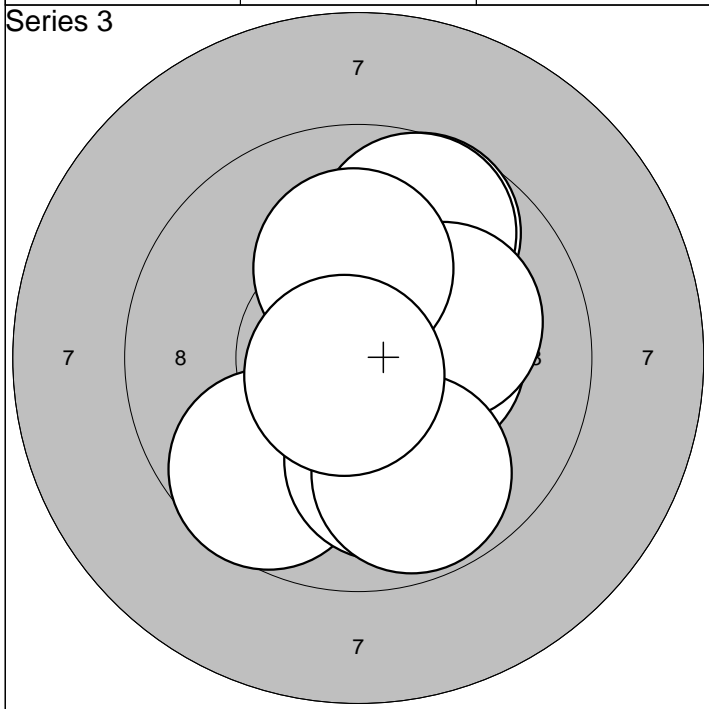

| | | | | |
|--------------|---------------|--|-------|-------|
| 1: 9,7 ↙ | 6:10,8* ↓ | | Serie | 96,0 |
| 2: 9,7 ↗ | 7:10,1 → | | Sum | 289,0 |
| 3:10,0 ↓ | 8: 9,8 ↓ | | | |
| 4:10,4* → | 9:10,1 ↑ | | | |
| 5: 9,7 ↗ | 10:10,8* ↙ | | | |

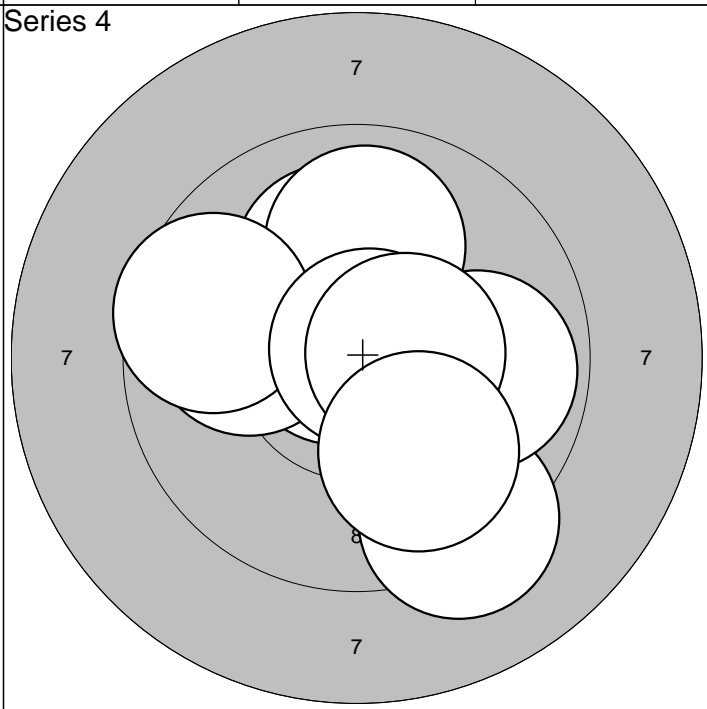

| | | | | |
|--------------|--------------|--|-------|-------|
| 1:10,7* ↖ | 6: 9,6 ← | | Serie | 95,0 |
| 2:10,1 ↑ | 7:10,8* ↗ | | Sum | 384,0 |
| 3: 9,3 ↓ | 8: 9,8 → | | | |
| 4:10,0 ← | 9:10,5* → | | | |
| 5: 9,9 ↑ | 10: 9,9 ↓ | | | |

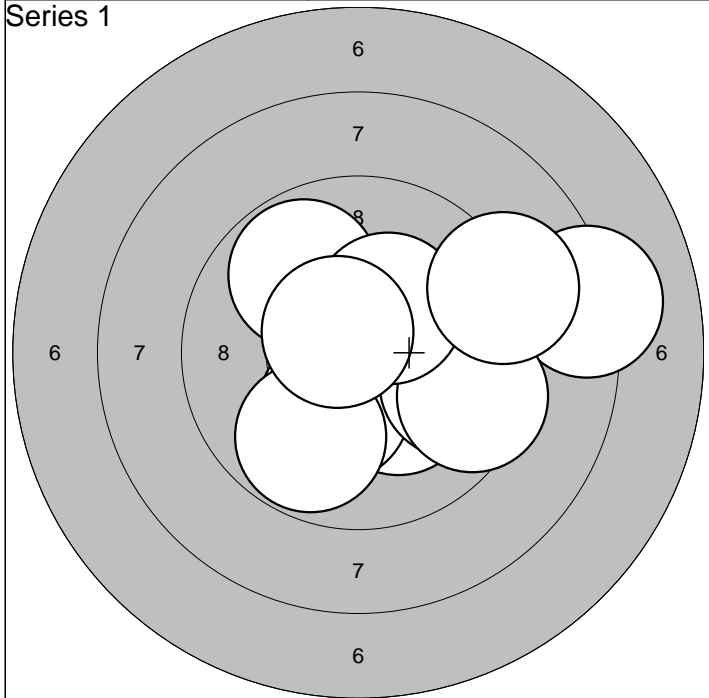

| | | | |
|------------|-------------|-------|------|
| 1: 8,1 → | 6: 9,8 ↓ | Serie | 93,0 |
| 2: 9,8 ↗ | 7: 9,5 → | | |
| 3: 10,2* ↓ | 8: 10,3* ↗ | Sum | 93,0 |
| 4: 10,3* ↓ | 9: 9,1 → | | |
| 5: 9,7 → | 10: 10,6* ↖ | | |

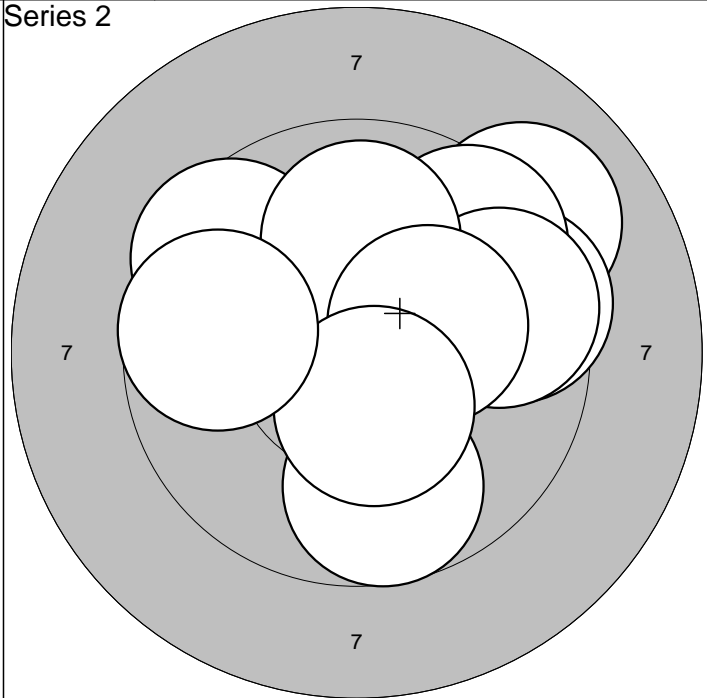

| | | | |
|----------|------------|-------|-------|
| 1: 9,7 ↓ | 6: 9,6 → | Serie | 93,0 |
| 2: 9,1 ↗ | 7: 10,0 ↑ | | |
| 3: 9,5 → | 8: 10,3* → | Sum | 186,0 |
| 4: 9,6 ↗ | 9: 10,4* ↓ | | |
| 5: 9,6 ↖ | 10: 9,7 ← | | |

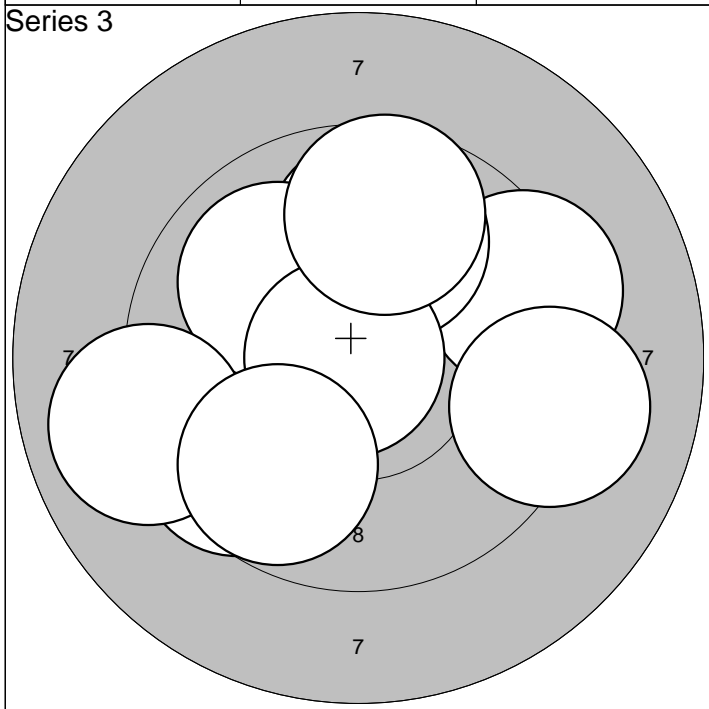

| | | | |
|----------|------------|-------|-------|
| 1: 9,9 ↑ | 6: 10,0 ↖ | Serie | 92,0 |
| 2: 9,6 ↙ | 7: 10,8* ← | | |
| 3: 9,3 → | 8: 9,6 ↑ | Sum | 278,0 |
| 4: 9,9 ↑ | 9: 9,0 ← | | |
| 5: 9,2 → | 10: 9,8 ↓ | | |

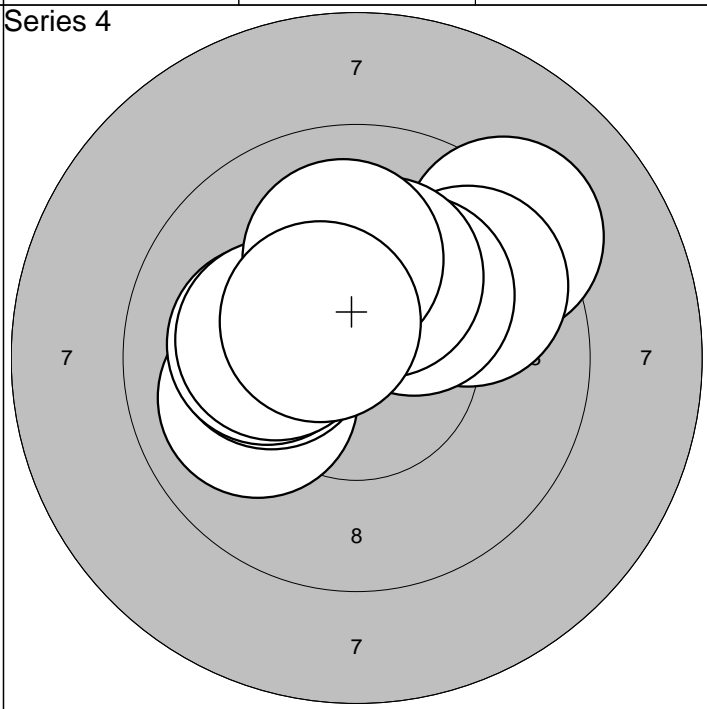

| | | | |
|------------|-------------|-------|-------|
| 1: 9,3 ↗ | 6: 10,2* ← | Serie | 98,0 |
| 2: 10,0 ← | 7: 10,1 ← | | |
| 3: 9,8 ↗ | 8: 10,2* ← | Sum | 376,0 |
| 4: 10,2* ↗ | 9: 10,1 ↑ | | |
| 5: 10,2* ↑ | 10: 10,5* ↖ | | |

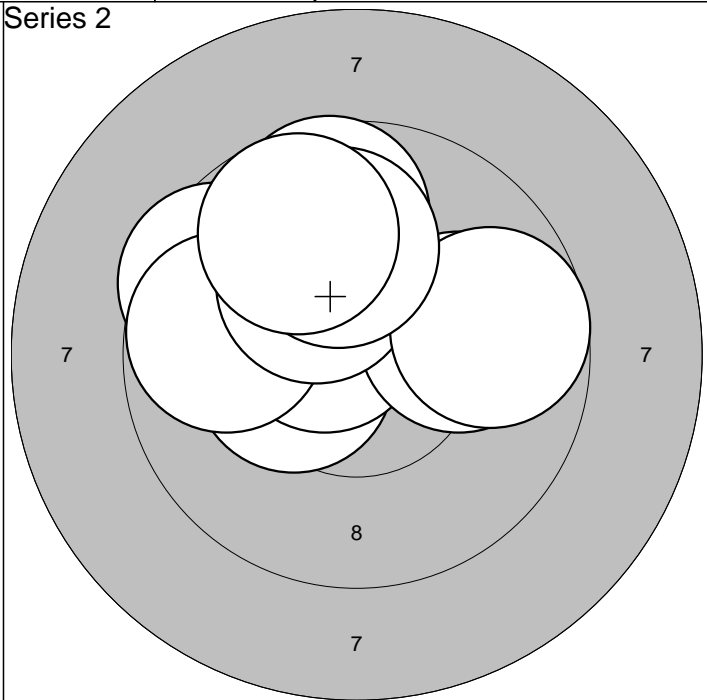
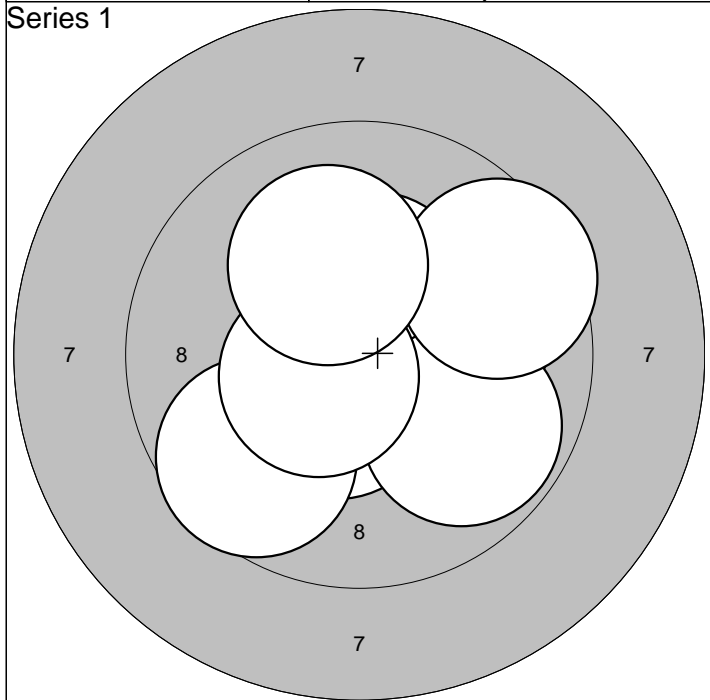

| | | | |
|-----------|-----------|-------|------|
| 1:10,4* ↗ | 6: 9,7 ↙ | Serie | 97,0 |
| 2:10,6* ↘ | 7: 9,8 ➤ | | |
| 3:10,5* ↘ | 8: 9,5 ➤ | Sum | 97,0 |
| 4:10,0 ➤ | 9:10,5* ↙ | | |
| 5:10,4* ↗ | 10:10,1 ↗ | | |

| | | | |
|-----------|-----------|-------|-------|
| 1: 9,6 ↙ | 6:10,0 ➤ | Serie | 95,0 |
| 2:10,4* ↙ | 7:10,2* ↗ | | |
| 3:10,6* ↙ | 8: 9,7 ➤ | Sum | 192,0 |
| 4: 9,7 ↗ | 9:10,0 ↗ | | |
| 5: 9,8 ↙ | 10: 9,8 ↗ | | |

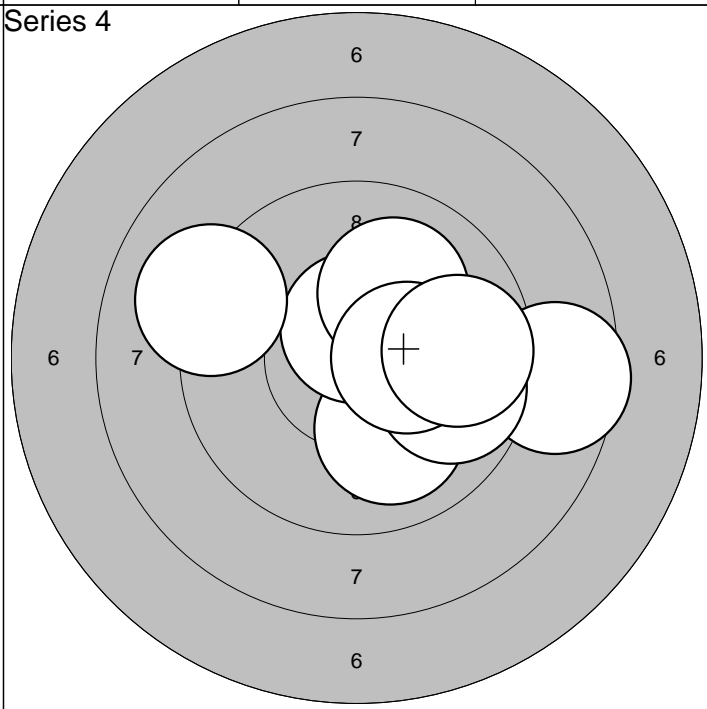
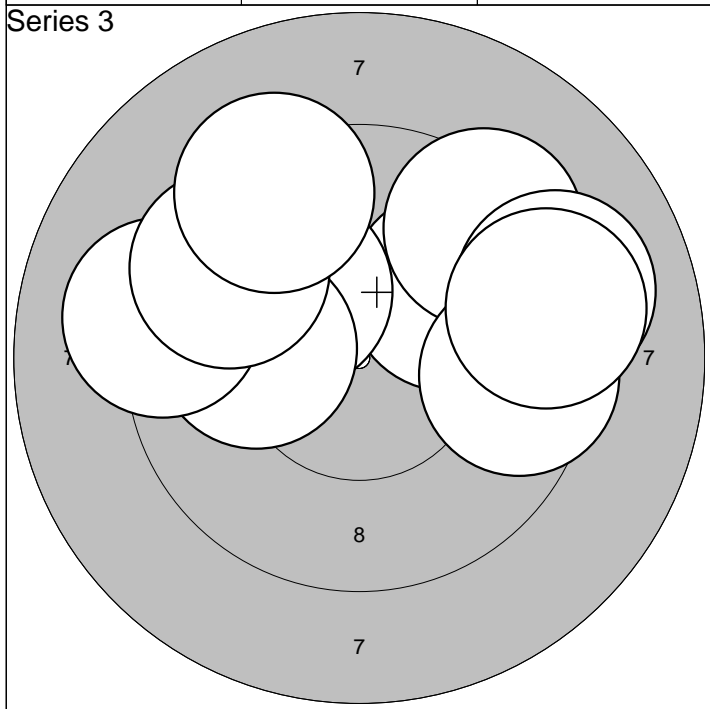

| | | | |
|----------|-----------|-------|-------|
| 1: 9,9 ↗ | 6: 9,6 ↙ | Serie | 92,0 |
| 2: 9,3 ↗ | 7: 9,3 ↗ | | |
| 3:10,1 ↙ | 8: 9,5 ➤ | Sum | 284,0 |
| 4:10,0 ↙ | 9: 9,1 ➤ | | |
| 5: 9,2 ↙ | 10: 9,2 ➤ | | |

| | | | |
|-----------|-----------|-------|-------|
| 1:10,2* ↗ | 6: 8,6 ➤ | Serie | 95,0 |
| 2:10,0 ↘ | 7: 9,8 ➤ | | |
| 3:10,1 ➤ | 8:10,3* ➤ | Sum | 379,0 |
| 4:10,6* ↗ | 9: 9,7 ➤ | | |
| 5:10,0 ↗ | 10: 9,1 ↙ | | |

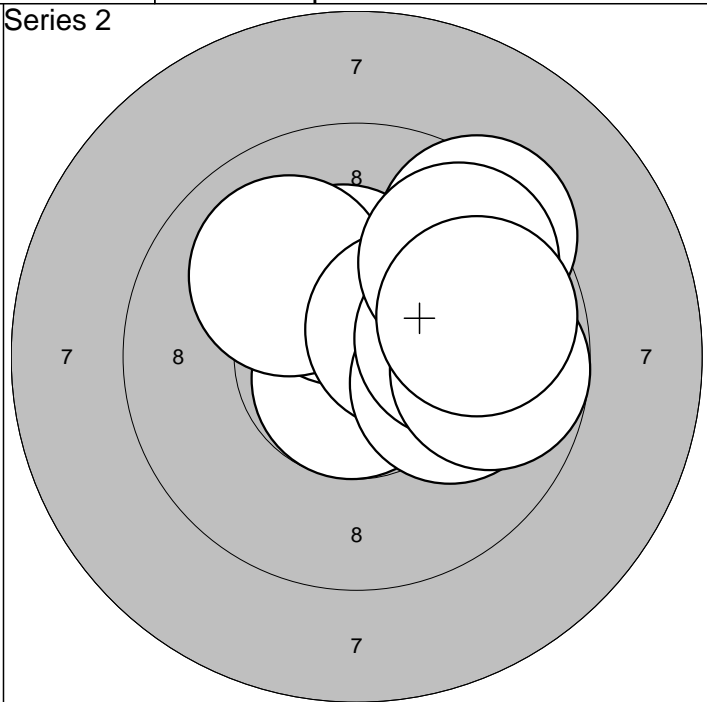
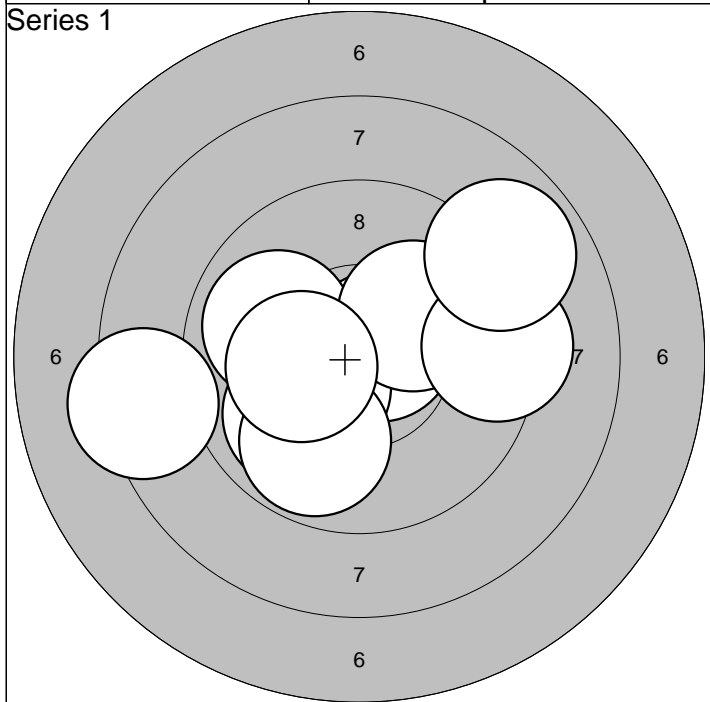

| | | | | | |
|-----------|-----------|-----|------|--|--|
| 1:10,7* ↗ | 6: 9,8 ↓ | | | | |
| 2:10,3* ↙ | 7:10,1 ↗ | | | | |
| 3:10,0 ↙ | 8:10,3* ← | Sum | 93,0 | | |
| 4: 8,3 ← | 9: 9,3 → | | | | |
| 5: 9,9 ↖ | 10: 8,9 ↗ | | | | |

| | | | | | |
|-----------|-----------|-----|-------|--|--|
| 1:10,8* ↓ | 6:10,1 ⇒ | | | | |
| 2:10,3* ↑ | 7:10,1 → | | | | |
| 3:10,0 ↖ | 8: 9,8 → | Sum | 189,0 | | |
| 4: 9,4 ↗ | 9: 9,7 ↗ | | | | |
| 5:10,5* ↗ | 10: 9,8 → | | | | |

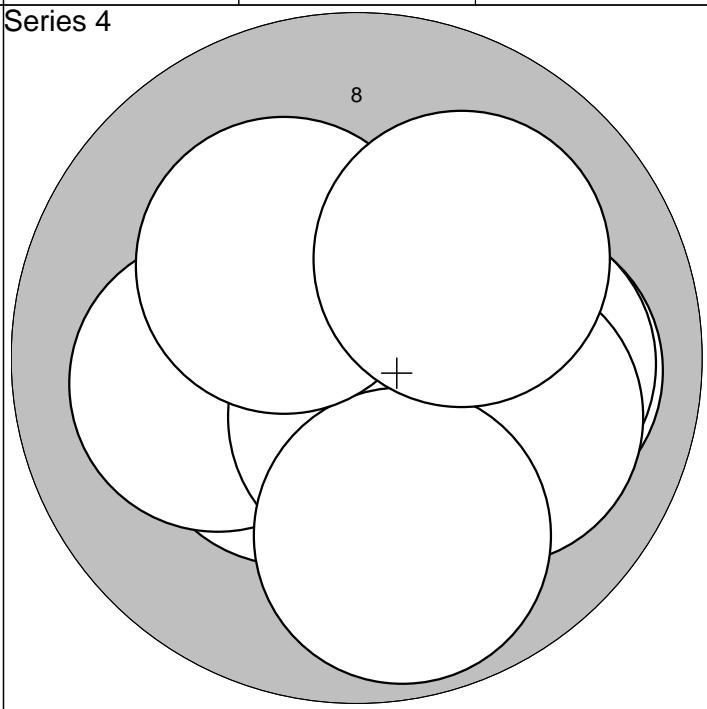
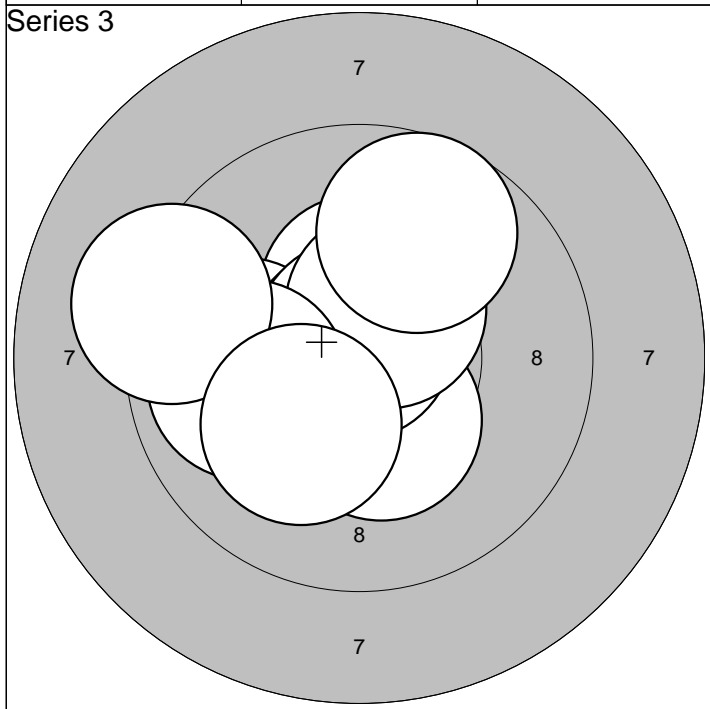

| | | | | | |
|-----------|------------|-----|-------|--|--|
| 1:10,4* ↑ | 6:10,5* ↗ | | | | |
| 2: 9,9 ← | 7: 9,7 ↗ | | | | |
| 3:10,8* ↖ | 8: 9,9 ← | Sum | 285,0 | | |
| 4:10,4* ↓ | 9: 9,2 ← | | | | |
| 5:10,8* ↑ | 10:10,2* ↙ | | | | |

| | | | | | |
|-----------|-----------|-----|-------|--|--|
| 1:10,4* ↙ | 6:10,6* ↓ | | | | |
| 2:10,0 → | 7:10,0 ⇒ | | | | |
| 3:10,5* ↗ | 8: 9,8 ↓ | Sum | 384,0 | | |
| 4:10,1 ← | 9:10,2* ↗ | | | | |
| 5:10,0 → | 10:10,1 ↗ | | | | |

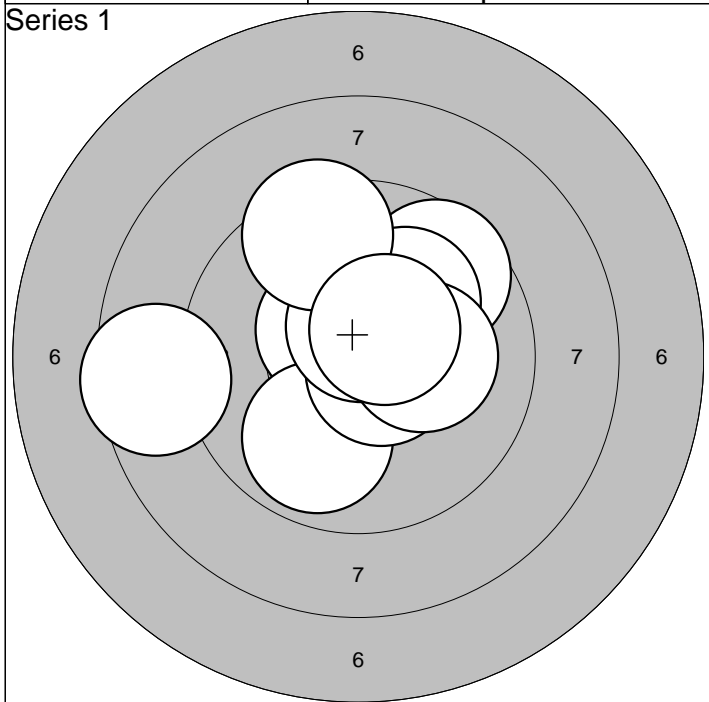

| | | | | | |
|-----------|------------|-----|------|-------|------|
| 1:10,5* ↖ | 6:10,1 ↗ | | | Serie | 95,0 |
| 2: 9,9 ↘ | 7: 8,5 ← | | | | |
| 3:10,6* → | 8: 9,4 ↗ | Sum | 95,0 | | |
| 4:10,6* ↑ | 9:10,2* → | | | | |
| 5: 9,6 ↗ | 10:10,5* ↗ | | | | |

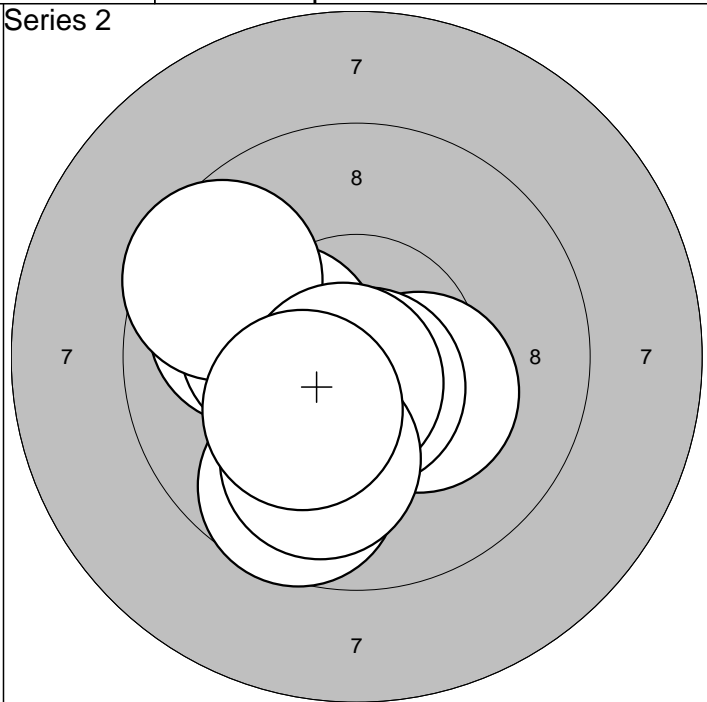

| | | | | | |
|-----------|------------|-----|-------|-------|------|
| 1:10,5* ↓ | 6:10,3* ← | | | Serie | 98,0 |
| 2:10,3* → | 7: 9,6 ↖ | | | | |
| 3:10,6* ↓ | 8:10,7* ↘ | Sum | 193,0 | | |
| 4: 9,7 ↘ | 9:10,0 ↘ | | | | |
| 5:10,0 ← | 10:10,3* ↘ | | | | |

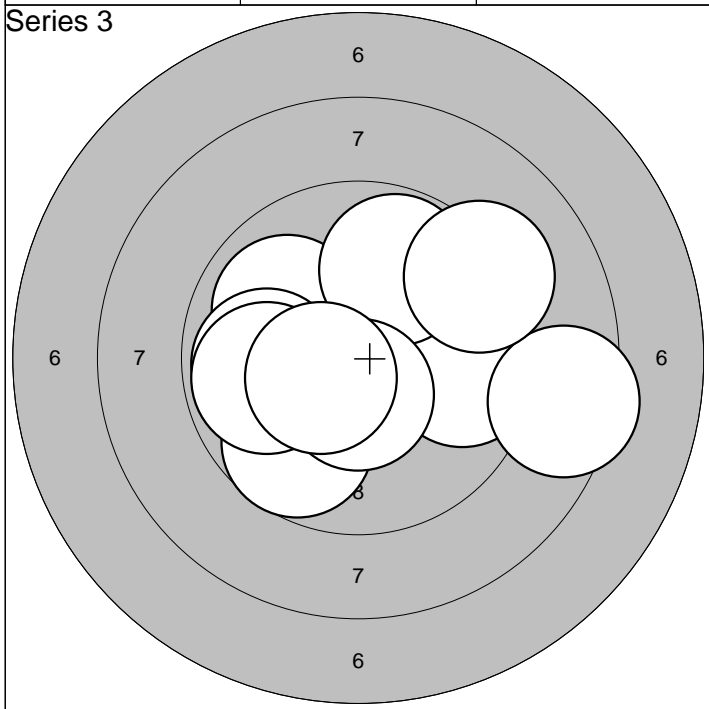

| | | | | | |
|----------|-----------|-----|-------|-------|------|
| 1: 9,7 ↘ | 6: 8,5 → | | | Serie | 91,0 |
| 2: 9,9 ↖ | 7: 9,8 ← | | | | |
| 3: 9,7 → | 8:10,5* ↓ | Sum | 284,0 | | |
| 4: 9,9 ← | 9:10,5* ← | | | | |
| 5: 9,8 ↗ | 10: 9,2 ↗ | | | | |

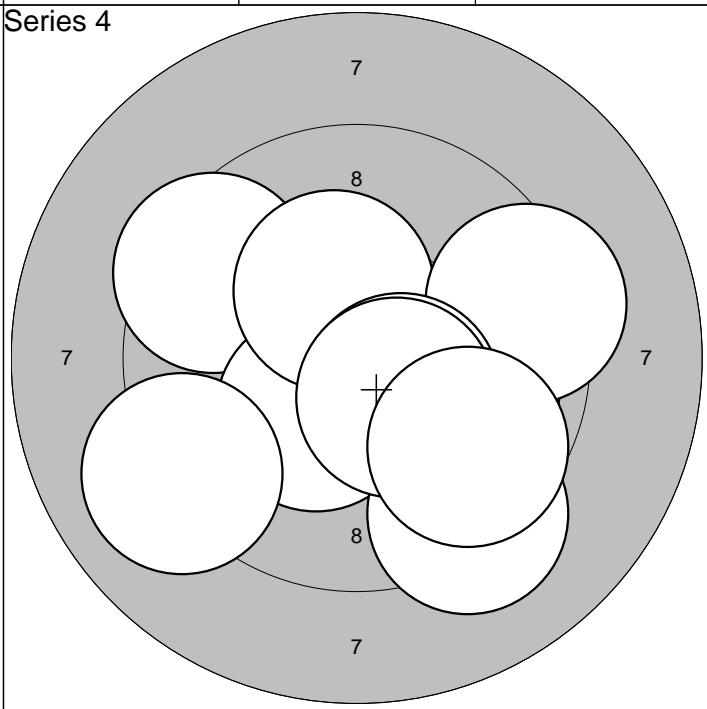

| | | | | | |
|-----------|-----------|-----|-------|-------|------|
| 1: 9,5 ↖ | 6: 9,3 → | | | Serie | 95,0 |
| 2:10,4* ↘ | 7:10,5* ↘ | | | | |
| 3: 9,1 ↖ | 8: 9,2 ↘ | Sum | 379,0 | | |
| 4:10,0 → | 9:10,4* ↘ | | | | |
| 5:10,3* ↑ | 10: 9,7 ↘ | | | | |

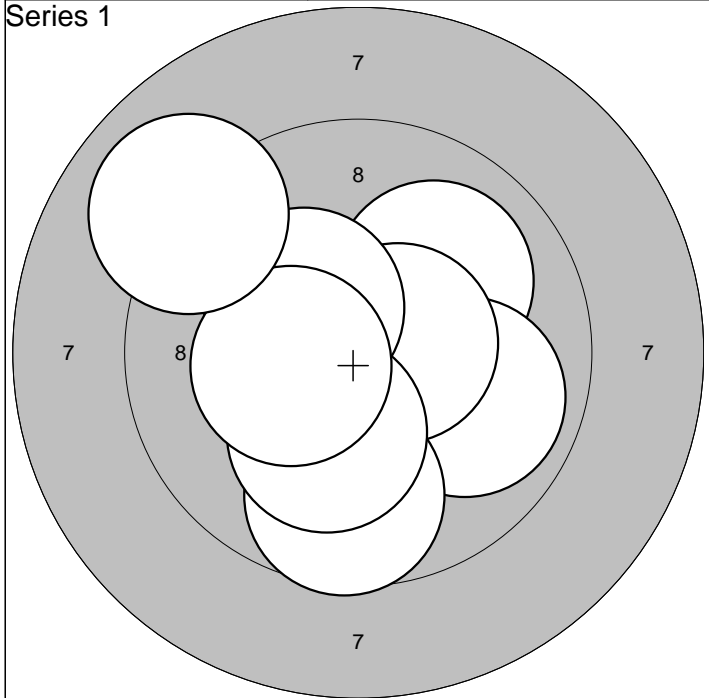

| | | | | | |
|-----------|-----------|-----|------|-------|------|
| 1:10,3* ↓ | 6:10,6* → | | | Serie | 97,0 |
| 2:10,3* ↘ | 7:10,2* ↓ | | | | |
| 3:10,0 ↗ | 8:10,3* ↖ | Sum | 97,0 | | |
| 4: 9,9 ↘ | 9:10,3* ← | | | | |
| 5: 9,7 ↓ | 10: 9,0 ↗ | | | | |

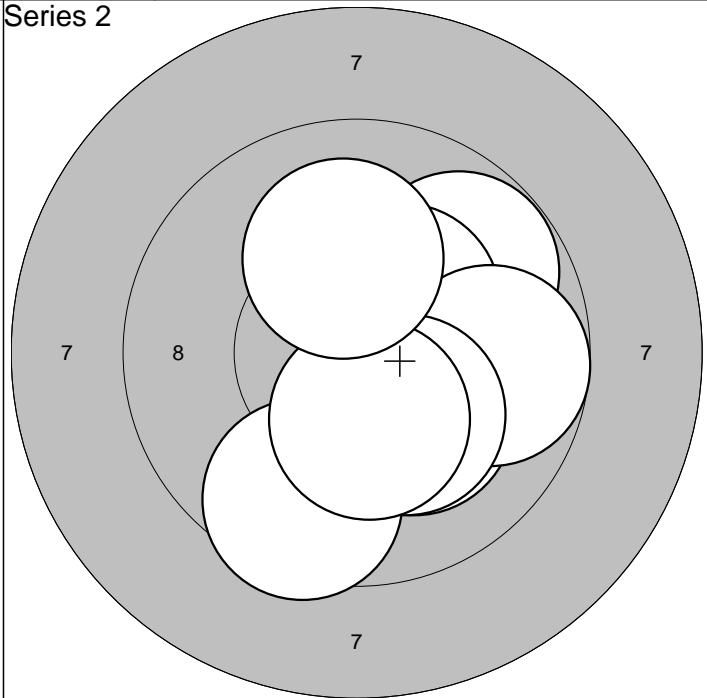

| | | | | | |
|-----------|-----------|-----|-------|-------|------|
| 1: 9,8 ↗ | 6:10,3* ↗ | | | Serie | 97,0 |
| 2:10,4* ↗ | 7: 9,8 → | | | | |
| 3: 9,5 ↓ | 8:10,2* ↓ | Sum | 194,0 | | |
| 4:10,2* ↓ | 9:10,3* ↓ | | | | |
| 5:10,4* → | 10:10,1 ↑ | | | | |

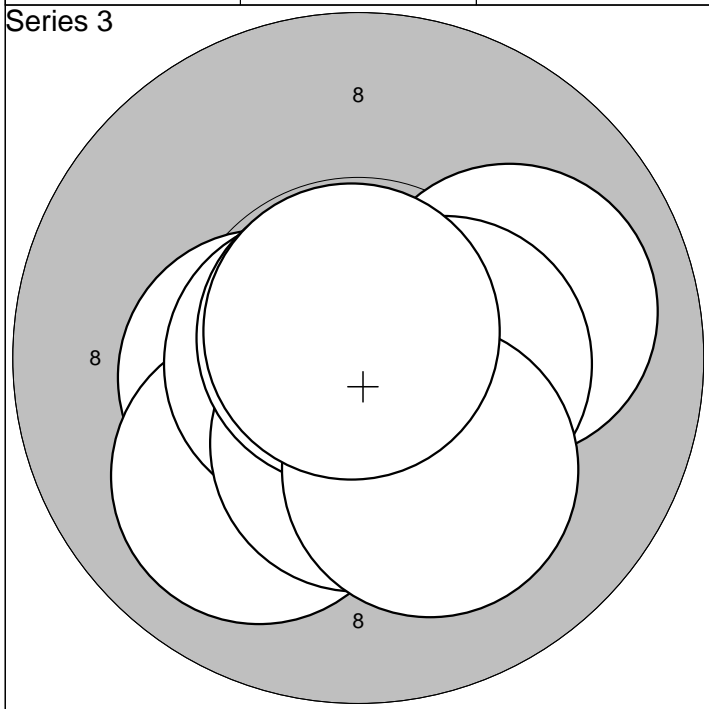

| | | | | | |
|-----------|------------|-----|-------|-------|-------|
| 1:10,0 → | 6:10,4* → | | | Serie | 100,0 |
| 2:10,4* ← | 7:10,4* ↓ | | | | |
| 3:10,0 ↓ | 8:10,8* ↗ | Sum | 294,0 | | |
| 4:10,8* ↓ | 9:10,2* ↓ | | | | |
| 5:10,6* ← | 10:10,8* ↑ | | | | |

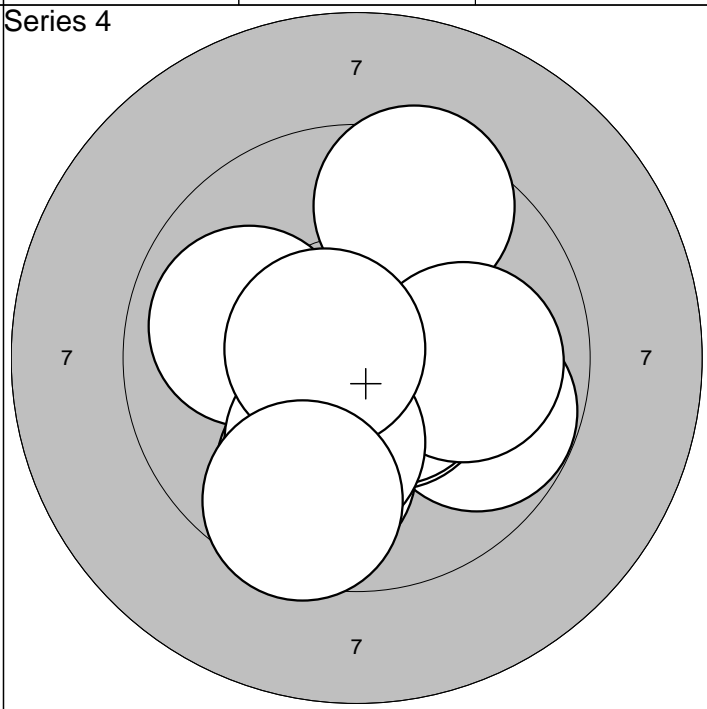

| | | | | | |
|-----------|-----------|-----|-------|-------|------|
| 1: 9,5 ↗ | 6:10,6* ↓ | | | Serie | 96,0 |
| 2: 9,8 ↘ | 7:10,0 → | | | | |
| 3: 9,9 ↓ | 8:10,1 ↓ | Sum | 390,0 | | |
| 4:10,5* ↓ | 9:10,7* ← | | | | |
| 5:10,0 ← | 10: 9,6 ↓ | | | | |

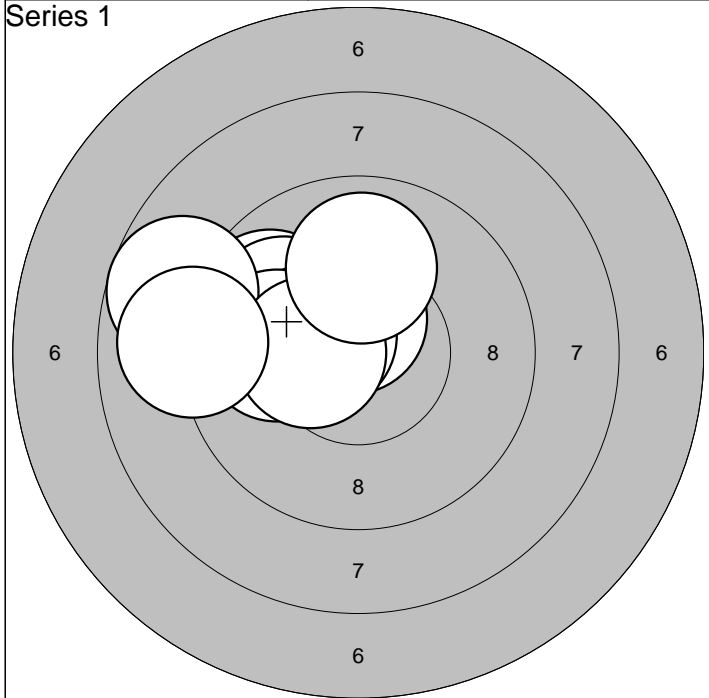

| | | |
|-----------|-----------|------------|
| 1: 9,8 ↖ | 6:10,0 ← | Serie 95,0 |
| 2: 9,9 ↖ | 7: 8,8 ← | |
| 3:10,5* ↑ | 8:10,4* ← | Sum 95,0 |
| 4:10,5* ↖ | 9:10,0 ↑ | |
| 5:10,3* ← | 10: 9,0 ← | |

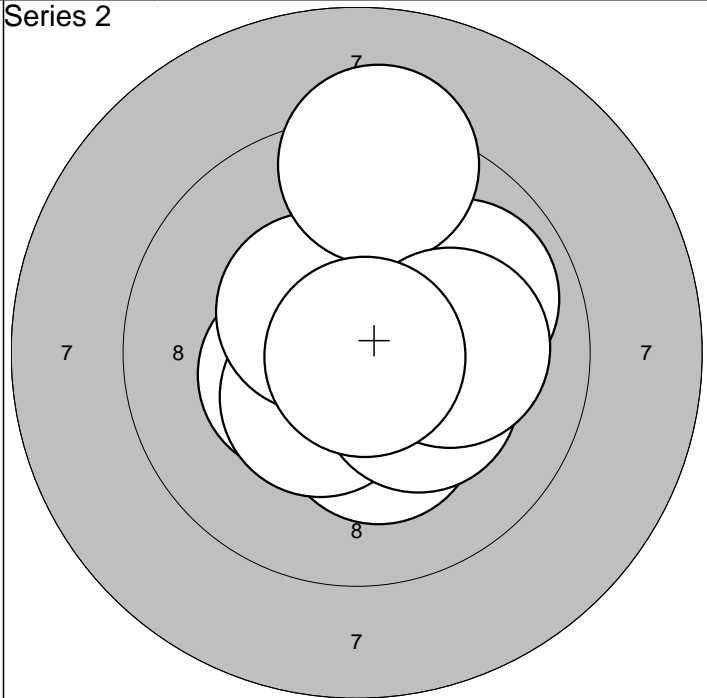

| | | |
|-----------|------------|------------|
| 1:10,4* ← | 6: 9,9 → | Serie 98,0 |
| 2:10,3* ↓ | 7:10,3* ↘ | |
| 3:10,8* ↑ | 8: 9,2 ↑ | Sum 193,0 |
| 4:10,4* ↙ | 9:10,1 → | |
| 5:10,4* ↖ | 10:10,9* ↘ | |

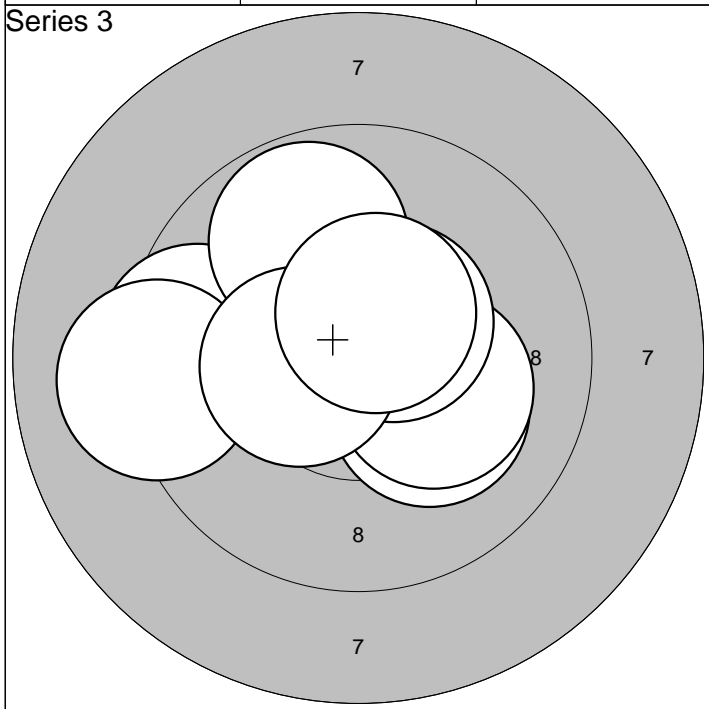

| | | |
|-----------|------------|------------|
| 1: 9,5 ← | 6:10,2* → | Serie 97,0 |
| 2:10,5* ↑ | 7:10,5* ↗ | |
| 3: 9,1 ← | 8: 9,8 ↖ | Sum 290,0 |
| 4:10,2* ↘ | 9:10,4* ← | |
| 5:10,6* ↑ | 10:10,5* ↑ | |

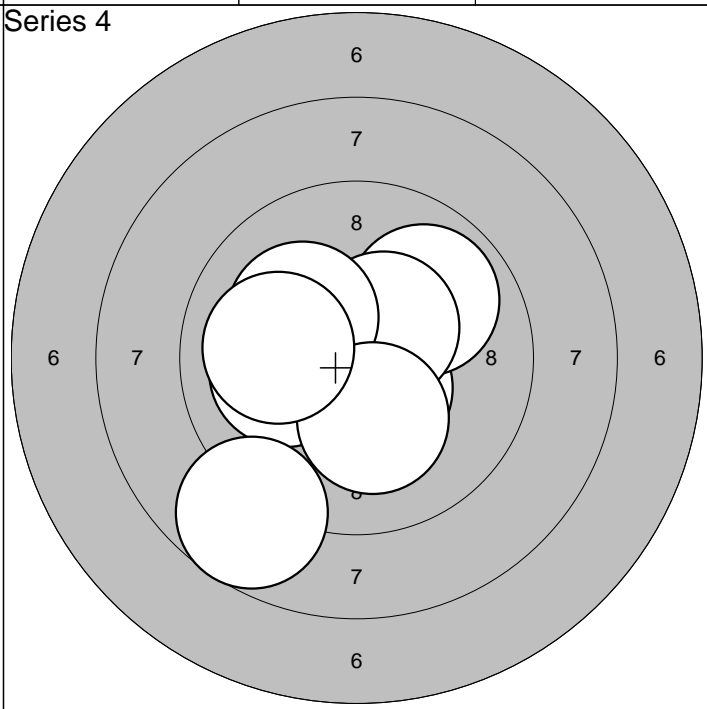

| | | |
|-----------|-----------|------------|
| 1:10,5* ← | 6:10,5* ↗ | Serie 97,0 |
| 2:10,1 ← | 7:10,2* ↖ | |
| 3:10,5* ↓ | 8:10,2* ↓ | Sum 387,0 |
| 4: 9,9 ↗ | 9:10,0 ← | |
| 5:10,7* ↑ | 10: 8,7 ↙ | |

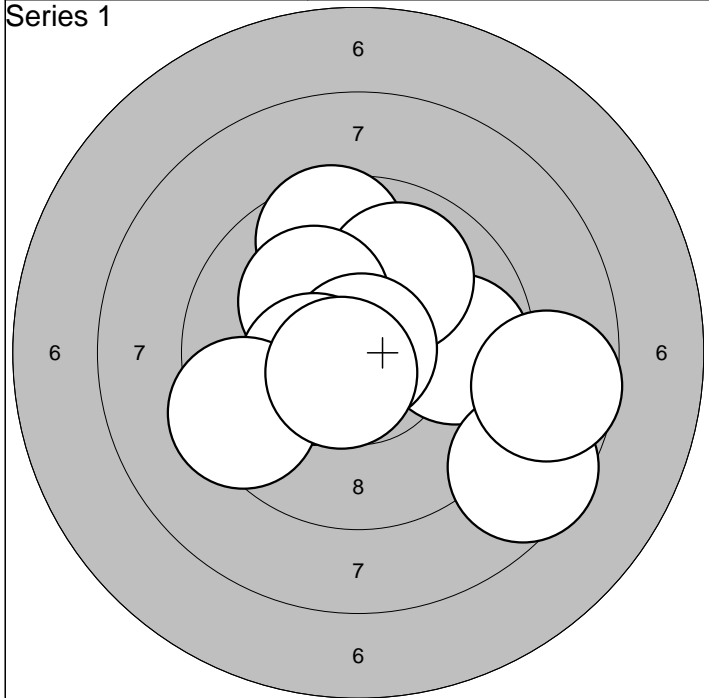

| | | | | | |
|-----------|------------|-----|------|-------|------|
| 1: 9,8 → | 6: 8,7 → | | | Serie | 93,0 |
| 2: 8,6 ↘ | 7:10,9* ↗ | | | | |
| 3: 9,6 ↑ | 8:10,4* ← | Sum | 93,0 | | |
| 4:10,0 ↗ | 9: 9,4 ← | | | | |
| 5:10,2* ↖ | 10:10,7* ↘ | | | | |

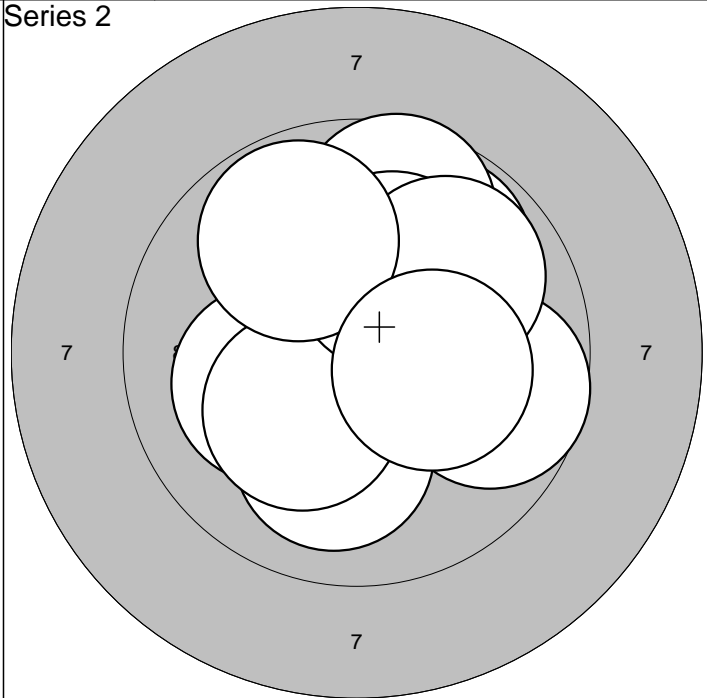

| | | | | | |
|----------|------------|-----|-------|-------|------|
| 1: 9,8 ↗ | 6:10,2* ↘ | | | Serie | 95,0 |
| 2:10,1 ← | 7:10,2* ↑ | | | | |
| 3: 9,7 → | 8: 9,9 ↗ | Sum | 188,0 | | |
| 4: 9,7 ↑ | 9: 9,8 ↖ | | | | |
| 5:10,0 ↓ | 10:10,3* → | | | | |

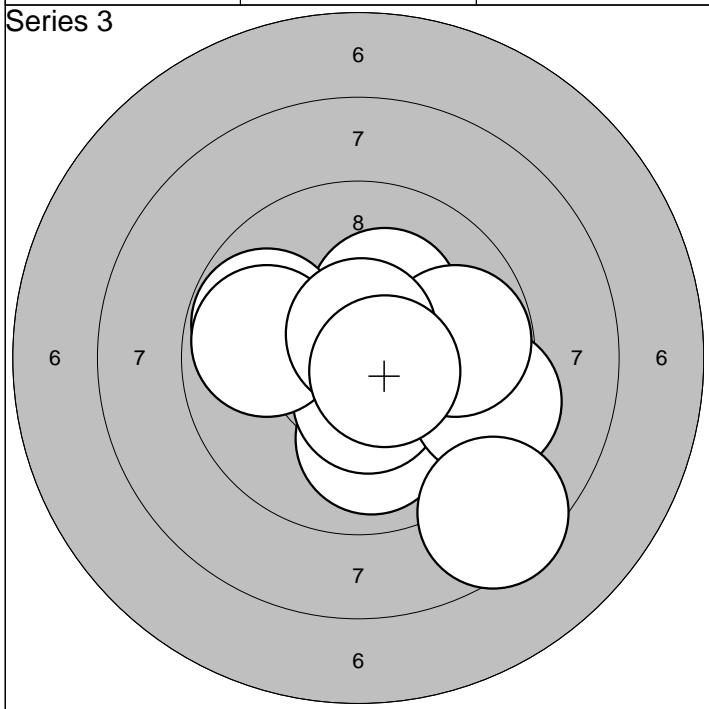

| | | | | | |
|-----------|------------|-----|-------|-------|------|
| 1:10,0 ↓ | 6: 9,3 → | | | Serie | 94,0 |
| 2:10,5* ↓ | 7: 8,5 ↘ | | | | |
| 3:10,2* ↗ | 8: 9,8 → | Sum | 282,0 | | |
| 4: 9,8 ← | 9:10,7* ↑ | | | | |
| 5: 9,9 ← | 10:10,6* ↘ | | | | |

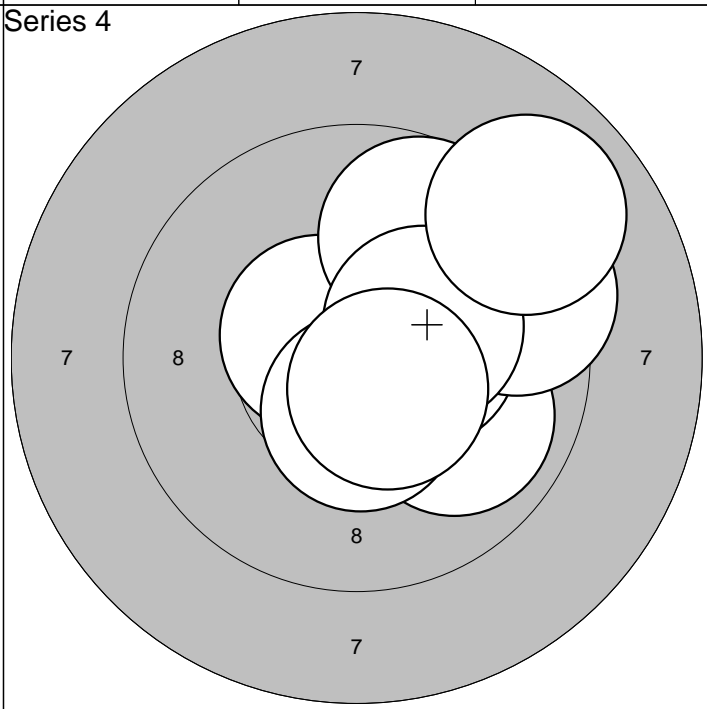

| | | | | | |
|-----------|-----------|-----|-------|-------|------|
| 1: 9,9 → | 6: 9,7 ↗ | | | Serie | 95,0 |
| 2: 9,8 ↗ | 7:10,4* ↓ | | | | |
| 3:10,4* → | 8:10,3* → | Sum | 377,0 | | |
| 4:10,6* ← | 9:10,5* ↘ | | | | |
| 5: 9,4 → | 10: 9,0 ↗ | | | | |

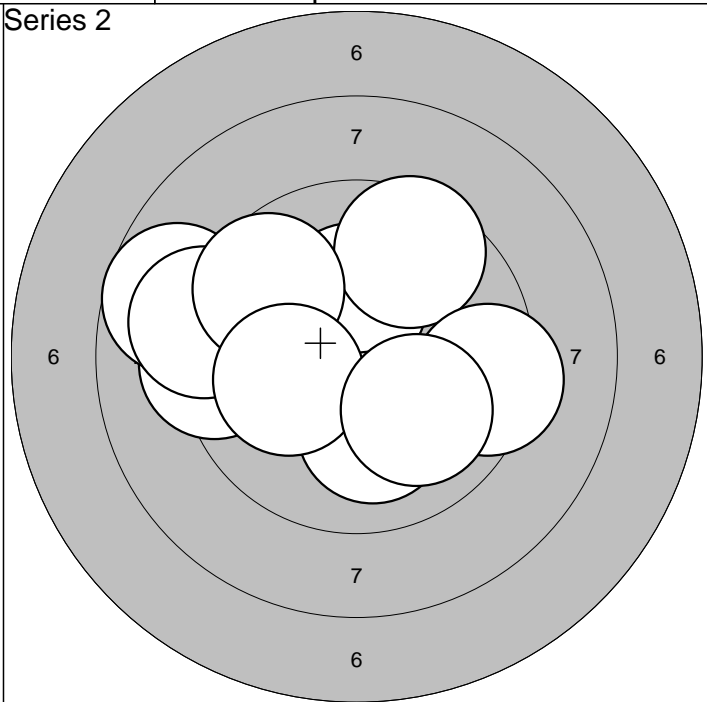
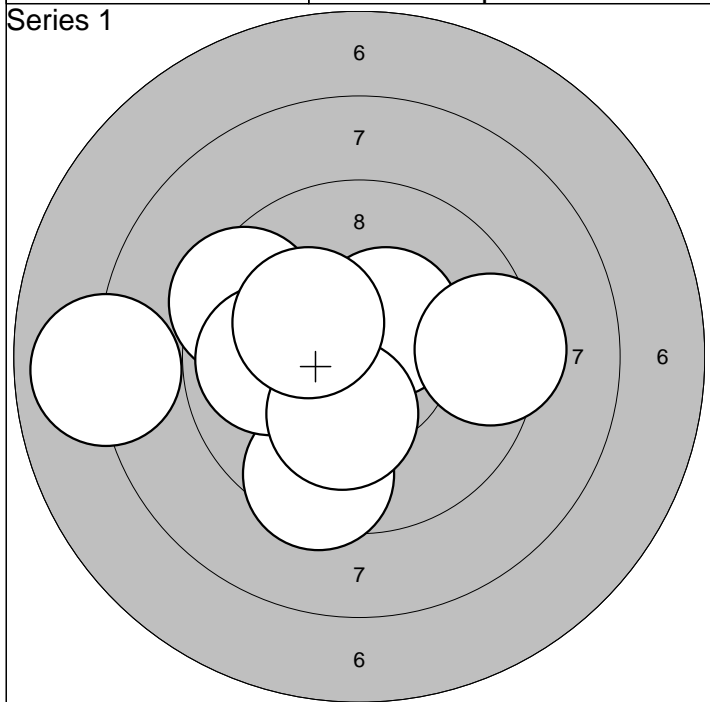

| | | | |
|-----------|------------|-------|------|
| 1:10,8* ↖ | 6:10,5* ↗ | Serie | 93,0 |
| 2:10,3* ↓ | 7:10,3* ↓ | | |
| 3: 9,5 ↓ | 8: 7,9 ← | Sum | 93,0 |
| 4: 9,5 ↖ | 9: 9,4 → | | |
| 5: 9,9 ← | 10:10,2* ↖ | | |

| | | | |
|-----------|-----------|-------|-------|
| 1: 9,2 ← | 6: 9,4 → | Serie | 93,0 |
| 2: 8,7 ↖ | 7: 9,6 ↗ | | |
| 3:10,3* ↑ | 8:10,1 ↓ | Sum | 186,0 |
| 4: 9,1 ↖ | 9:10,1 ← | | |
| 5: 9,6 ↗ | 10:10,0 ↓ | | |

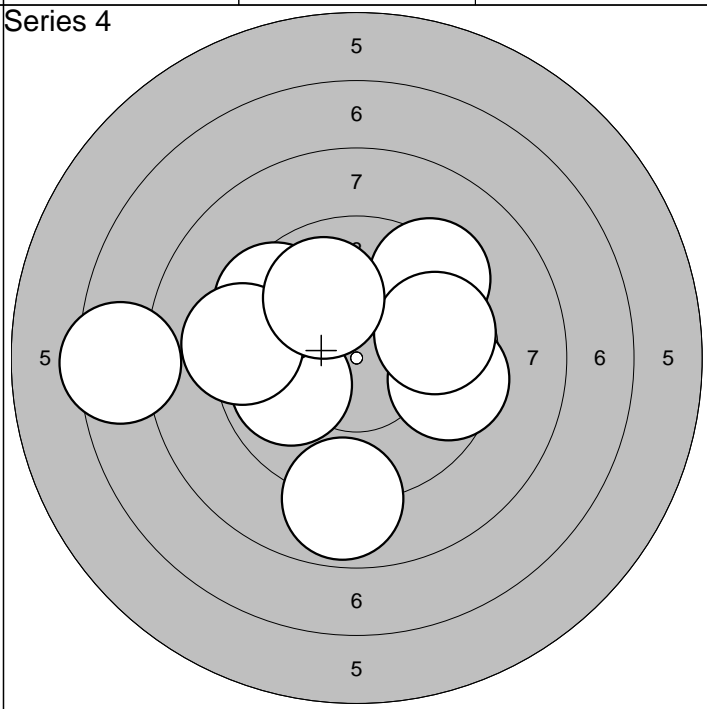
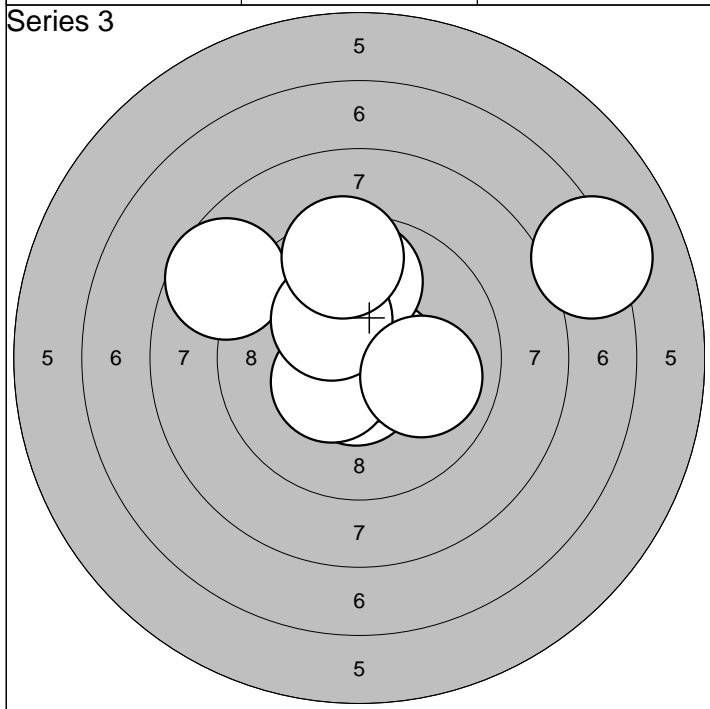

| | | | |
|-----------|-----------|-------|-------|
| 1:10,5* ↓ | 6: 9,8 ↑ | Serie | 92,0 |
| 2: 8,7 ↖ | 7:10,3* ↗ | | |
| 3:10,6* → | 8:10,0 → | Sum | 278,0 |
| 4:10,4* ↖ | 9: 9,4 ↑ | | |
| 5: 9,7 ↑ | 10: 7,2 ↗ | | |

| | | | |
|----------|-----------|-------|-------|
| 1: 9,6 → | 6: 8,9 ↓ | Serie | 88,0 |
| 2: 9,8 ↖ | 7: 9,5 ↖ | | |
| 3: 9,9 ↖ | 8: 9,3 ← | Sum | 366,0 |
| 4: 9,4 ↗ | 9:10,0 ↗ | | |
| 5: 9,8 → | 10: 7,5 ← | | |

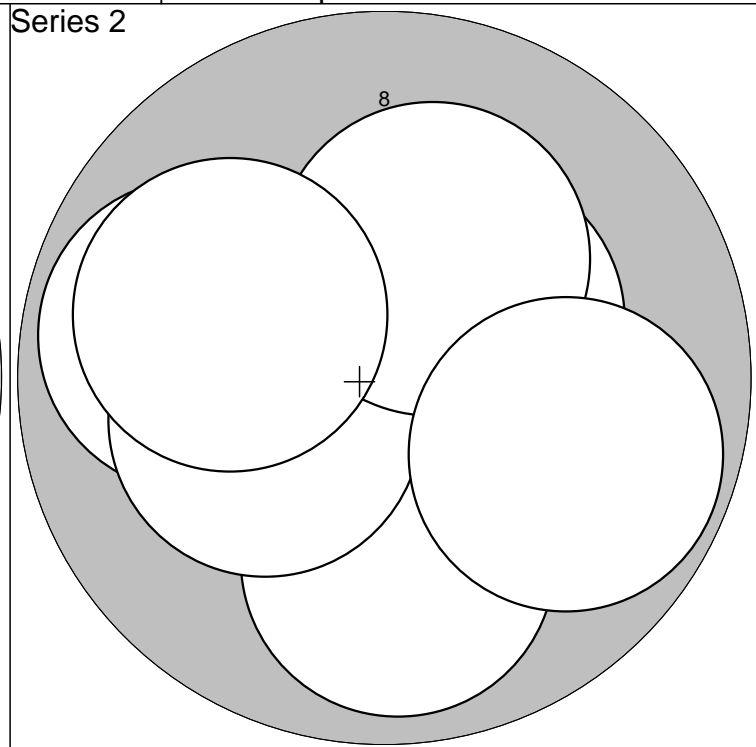
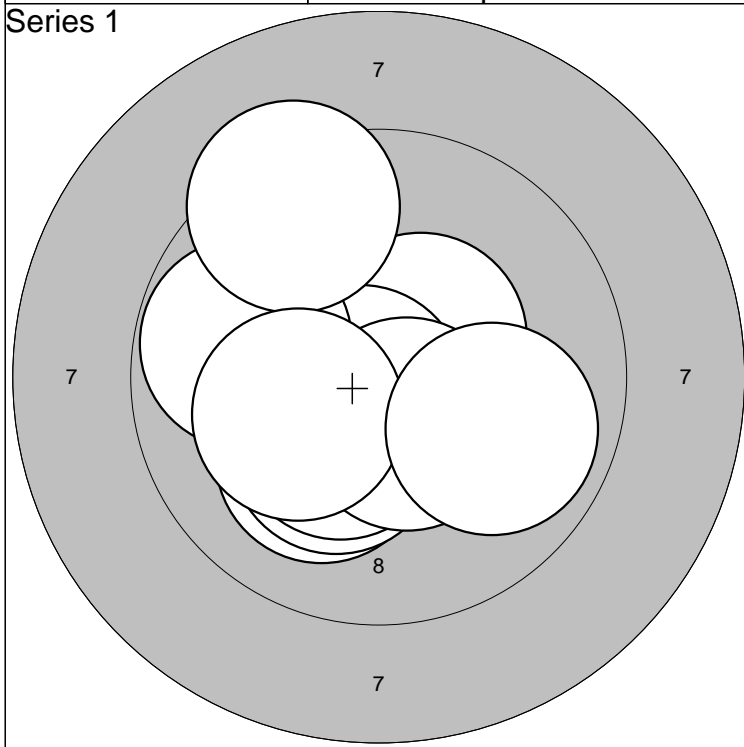

| | | | |
|-----------|-----------|-------|------|
| 1:10,5* ↗ | 6: 9,3 ↗ | Serie | 97,0 |
| 2:10,8* ↖ | 7:10,4* ↘ | | |
| 3: 9,8 ↖ | 8:10,5* ↘ | Sum | 97,0 |
| 4:10,1 ↘ | 9:10,2* ↖ | | |
| 5:10,2* ↘ | 10: 9,9 ↗ | | |

| | | | |
|-----------|-----------|-------|-------|
| 1:10,7* ↘ | 6: 9,9 ↓ | Serie | 97,0 |
| 2: 9,8 ↖ | 7:10,2* ↖ | | |
| 3:10,4* ↗ | 8:10,2* ↗ | Sum | 194,0 |
| 4:10,3* ↖ | 9:10,0 ↖ | | |
| 5:10,6* ↖ | 10: 9,8 ↗ | | |

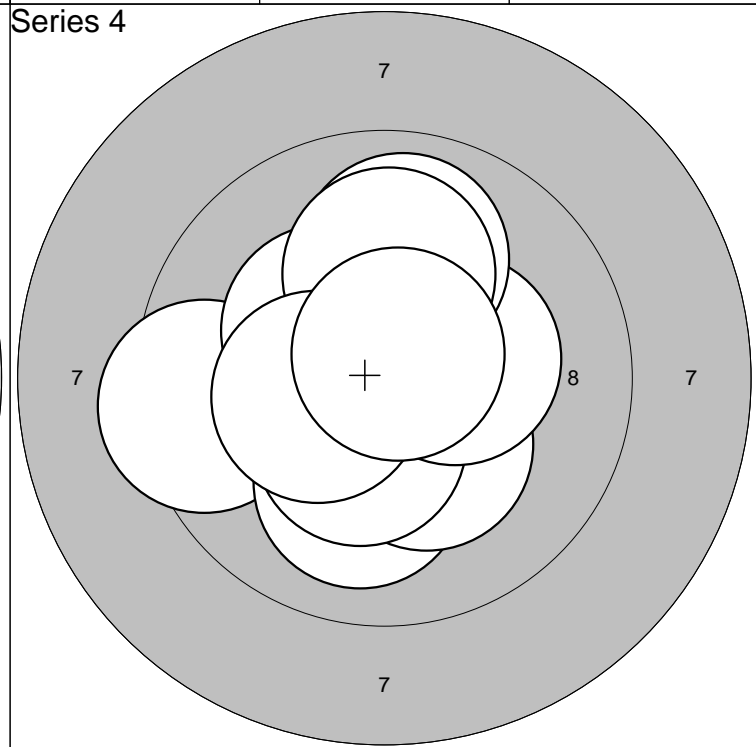
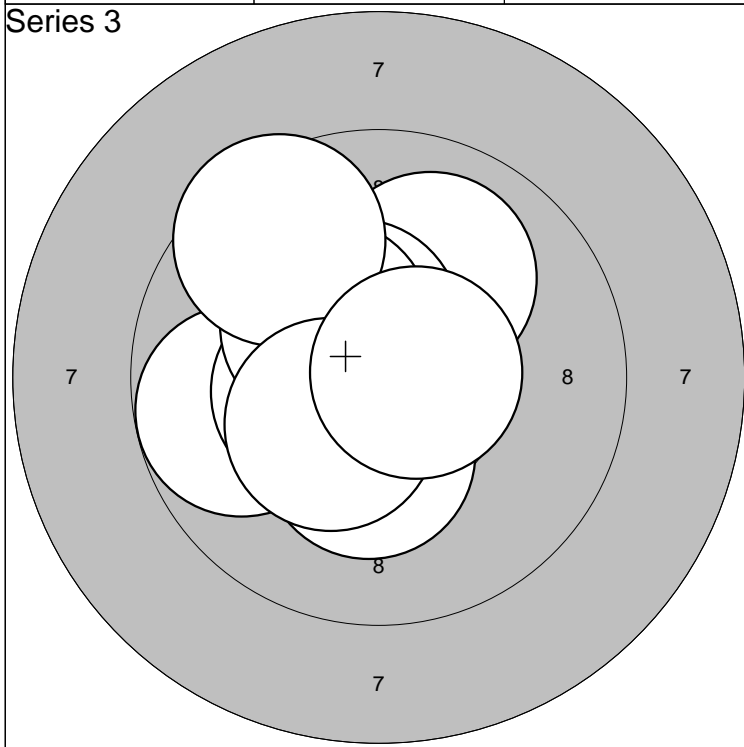

| | | | |
|-----------|------------|-------|-------|
| 1:10,3* ↓ | 6:10,5* ↗ | Serie | 98,0 |
| 2: 9,8 ↖ | 7:10,3* ↗ | | |
| 3:10,4* ↖ | 8: 9,5 ↗ | Sum | 292,0 |
| 4:10,6* ↗ | 9:10,4* ↘ | | |
| 5:10,0 ↗ | 10:10,6* → | | |

| | | | |
|-----------|------------|-------|-------|
| 1: 9,4 ↖ | 6:10,3* → | Serie | 98,0 |
| 2:10,1 ↘ | 7: 9,9 ↗ | | |
| 3:10,3* ↘ | 8:10,1 ↗ | Sum | 390,0 |
| 4:10,3* ↗ | 9:10,4* ↖ | | |
| 5:10,4* ↘ | 10:10,7* ↗ | | |

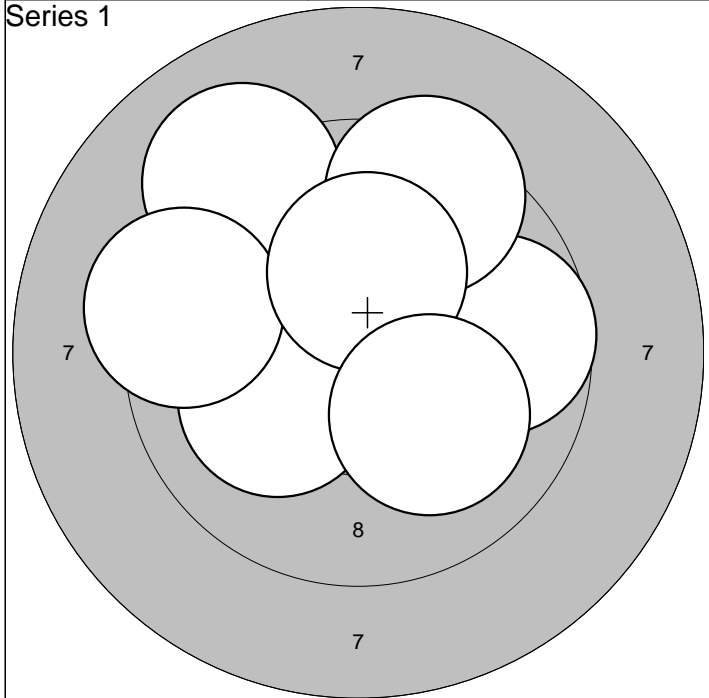

| | | |
|------------|------------|------------|
| 1: 9,1 ↖ | 6: 9,4 ↗ | Serie 96,0 |
| 2: 10,2* ↗ | 7: 10,1 ↖ | |
| 3: 10,7* ↗ | 8: 9,3 ↖ | Sum 96,0 |
| 4: 10,1 → | 9: 10,2* ↗ | |
| 5: 9,7 → | 10: 10,1 ↘ | |

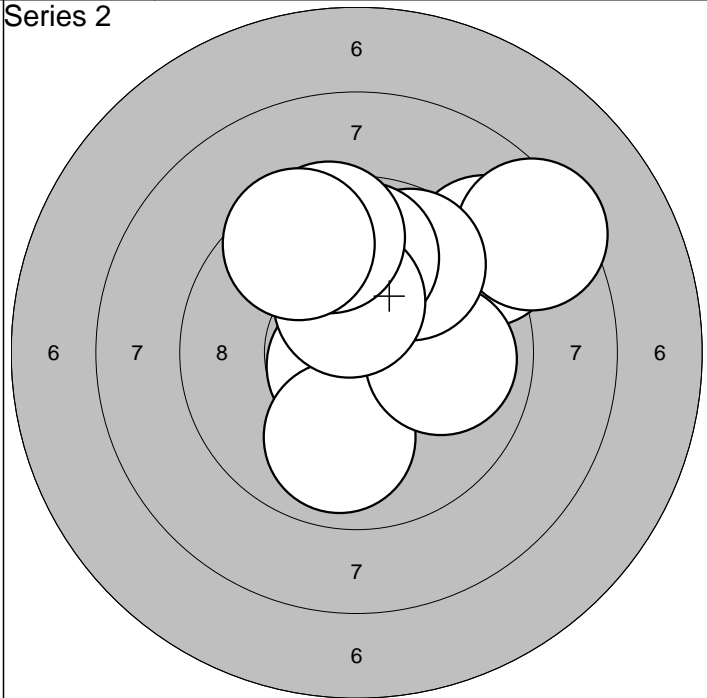

| | | |
|------------|------------|------------|
| 1: 9,0 ↗ | 6: 9,7 ↗ | Serie 91,0 |
| 2: 10,7* ↘ | 7: 9,8 ↗ | |
| 3: 8,5 ↗ | 8: 10,3* ↗ | Sum 187,0 |
| 4: 9,9 ↓ | 9: 9,6 ↗ | |
| 5: 9,9 → | 10: 9,5 ↖ | |

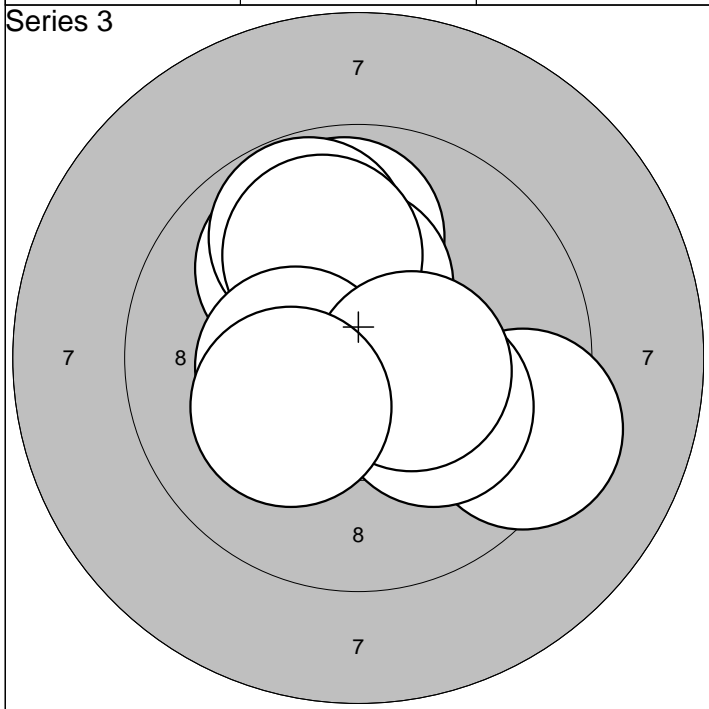

| | | |
|------------|-------------|------------|
| 1: 9,3 → | 6: 10,0 ↗ | Serie 97,0 |
| 2: 10,0 ↗ | 7: 10,4* ↖ | |
| 3: 9,9 ↗ | 8: 10,1 → | Sum 284,0 |
| 4: 10,3* ↗ | 9: 10,5* → | |
| 5: 9,8 ↗ | 10: 10,2* ↖ | |

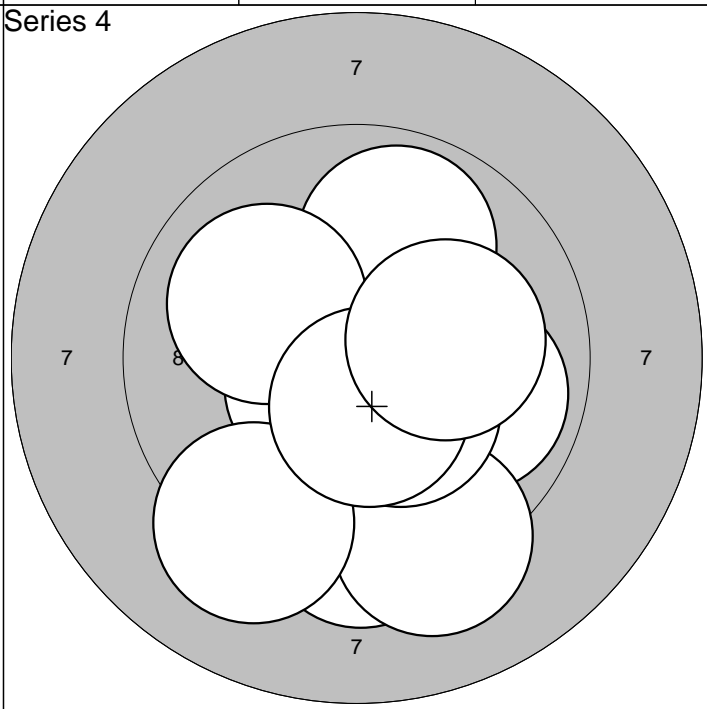

| | | |
|------------|------------|------------|
| 1: 9,9 ↗ | 6: 10,4* ↘ | Serie 95,0 |
| 2: 9,9 → | 7: 9,2 ↘ | |
| 3: 9,4 ↓ | 8: 10,0 ↖ | Sum 379,0 |
| 4: 9,2 ↓ | 9: 10,5* ↓ | |
| 5: 10,6* ↖ | 10: 10,1 → | |

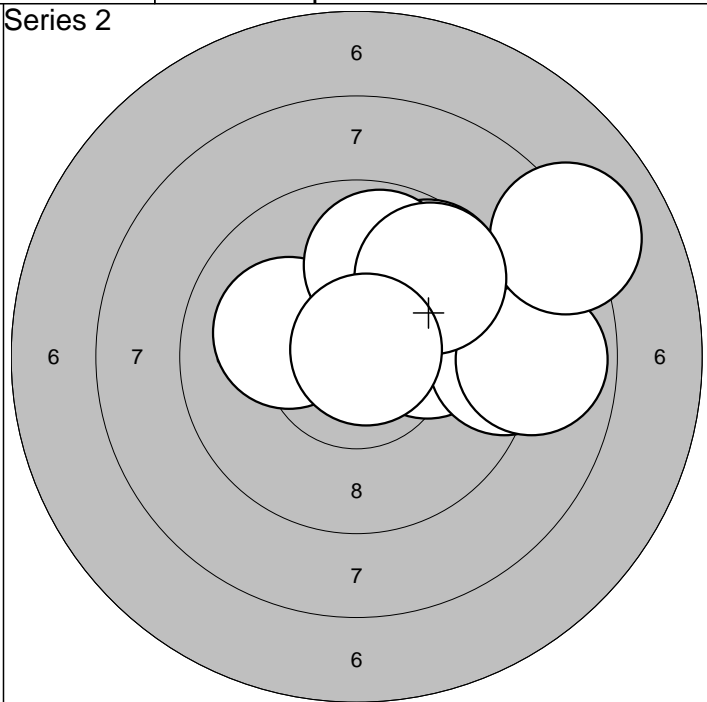
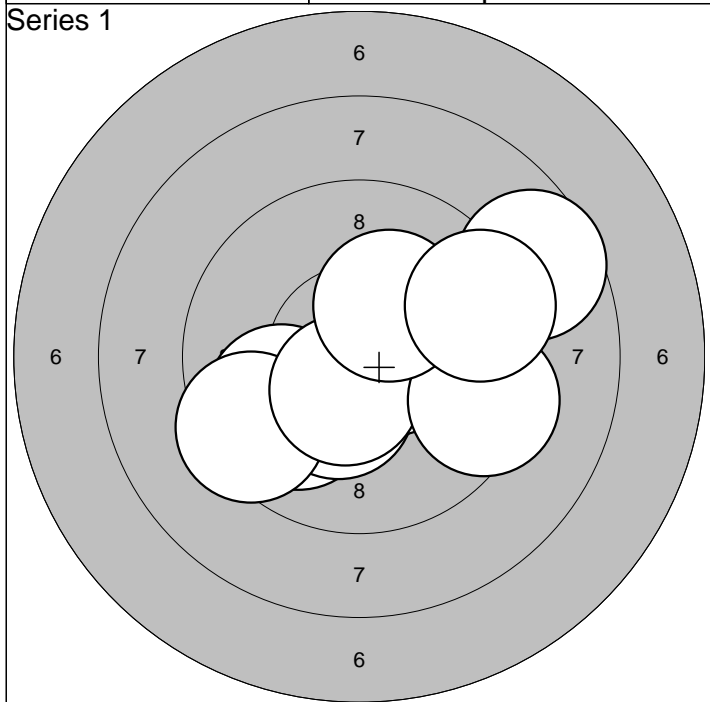

| | | |
|-----------|-----------|------------|
| 1:10,0 ↙ | 6:10,5* → | Serie 94,0 |
| 2: 9,9 ← | 7:10,5* ↓ | |
| 3:10,3* ↓ | 8: 9,4 → | Sum 94,0 |
| 4: 9,4 ← | 9:10,3* ↗ | |
| 5: 8,7 ↗ | 10: 9,4 → | |

| | | |
|-----------|------------|------------|
| 1:10,1 → | 6: 8,9 → | Serie 92,0 |
| 2: 9,2 → | 7: 8,1 ↗ | |
| 3: 9,7 ↗ | 8: 9,8 ↑ | Sum 186,0 |
| 4:10,5* ↑ | 9: 9,7 ↗ | |
| 5:10,1 ← | 10:10,8* ↗ | |

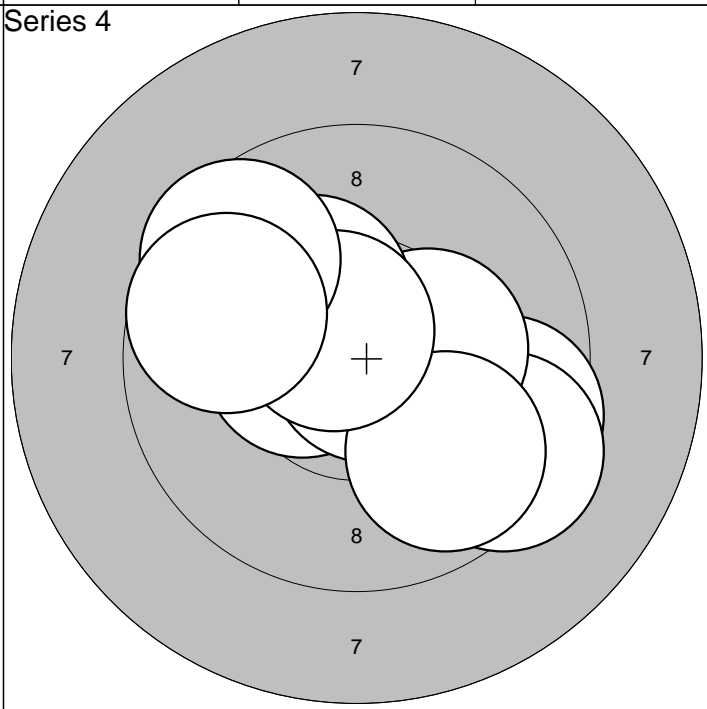
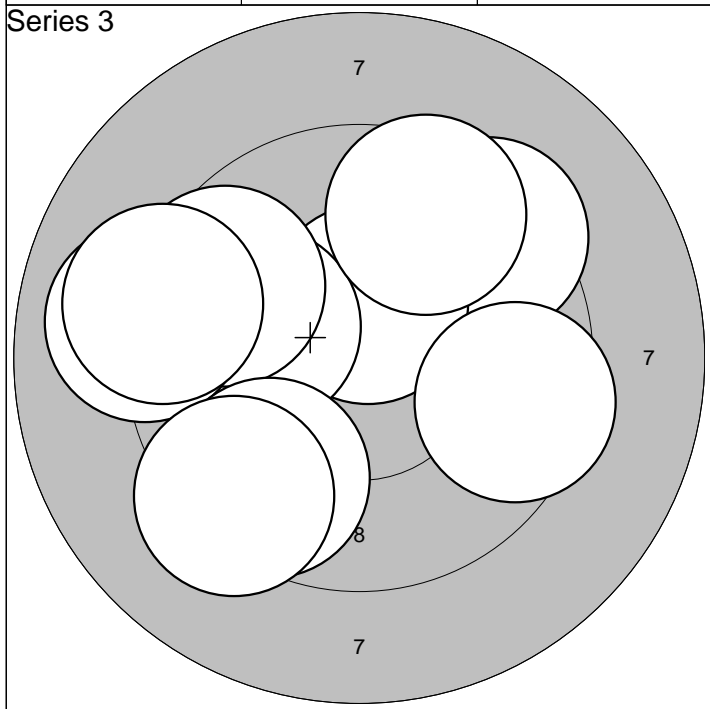

| | | |
|-----------|-----------|------------|
| 1: 9,4 ↗ | 6: 9,6 ↓ | Serie 92,0 |
| 2:10,5* ↑ | 7: 9,3 ↓ | |
| 3:10,0 ← | 8: 9,5 ↑ | Sum 278,0 |
| 4: 9,6 ↖ | 9: 9,1 ← | |
| 5: 9,0 ← | 10: 9,5 → | |

| | | |
|-----------|-----------|------------|
| 1:10,5* ← | 6: 9,8 ↓ | Serie 95,0 |
| 2: 9,5 → | 7:10,3* ↗ | |
| 3: 9,4 ↘ | 8:10,6* ↗ | Sum 373,0 |
| 4:10,8* → | 9: 9,6 ↗ | |
| 5:10,3* → | 10: 9,7 ↖ | |

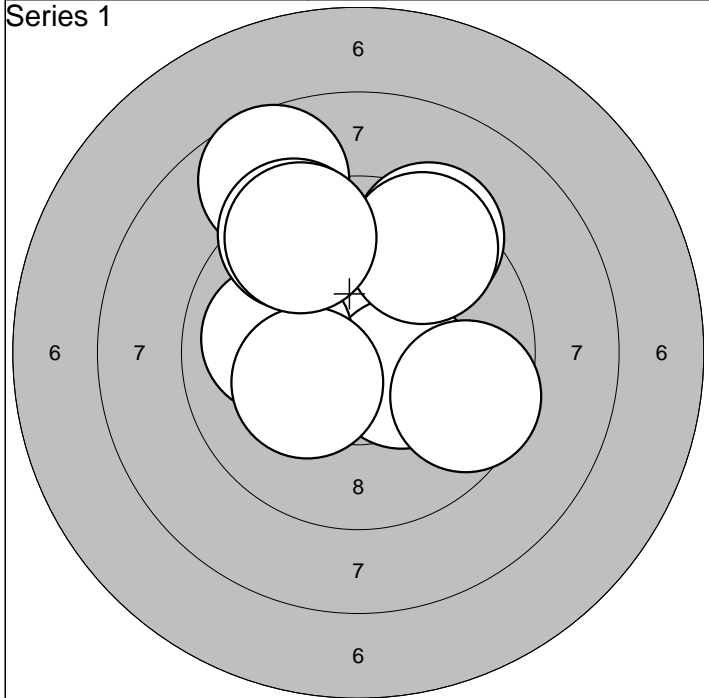

| | | | |
|-----------|-----------|-------|------|
| 1:10,2* ↖ | 6:10,3* ↙ | Serie | 93,0 |
| 2: 9,3 ↗ | 7: 9,6 → | | |
| 3:10,4* → | 8: 9,4 ↗ | Sum | 93,0 |
| 4: 8,7 ↗ | 9: 9,5 ↗ | | |
| 5:10,0 ← | 10: 9,4 ↗ | | |

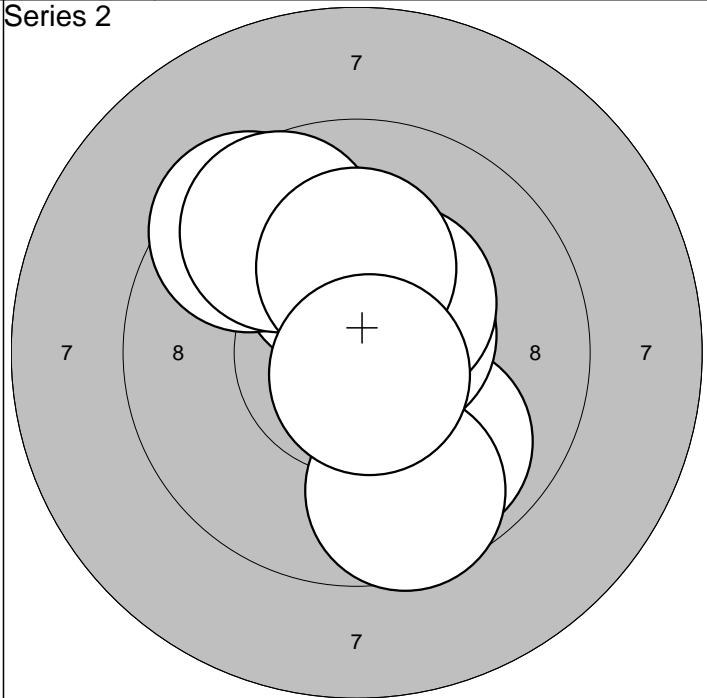

| | | | |
|-----------|------------|-------|-------|
| 1: 9,9 ↘ | 6:10,5* ↗ | Serie | 96,0 |
| 2:10,2* ↗ | 7:10,6* → | | |
| 3: 9,6 ↘ | 8:10,4* ↗ | Sum | 189,0 |
| 4: 9,5 ↗ | 9:10,2* ↑ | | |
| 5: 9,7 ↗ | 10:10,7* ↘ | | |

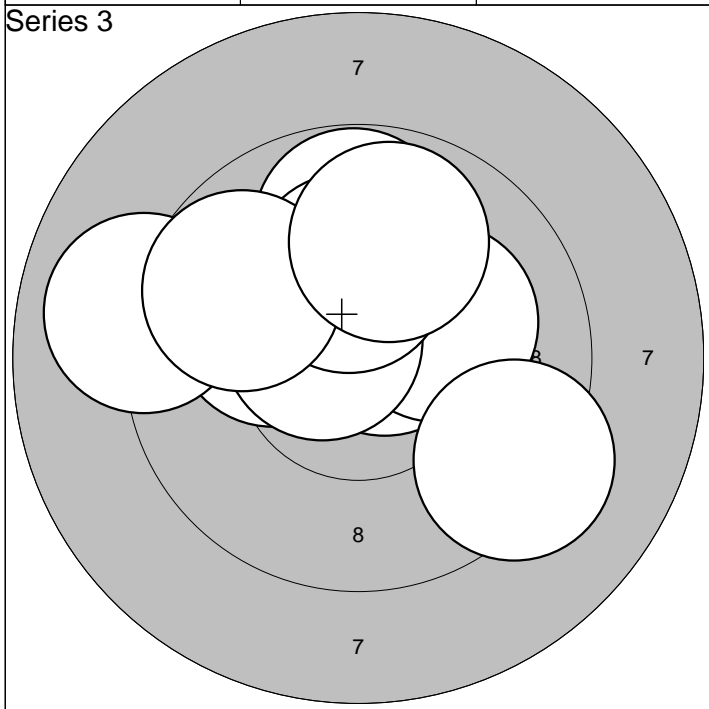

| | | | |
|-----------|-----------|-------|-------|
| 1:10,6* ↗ | 6: 9,3 ↘ | Serie | 95,0 |
| 2:10,2* ↙ | 7:10,6* ↙ | | |
| 3: 9,8 ↑ | 8:10,2* ↑ | Sum | 284,0 |
| 4:10,2* → | 9: 9,7 ↙ | | |
| 5: 9,0 ← | 10: 9,9 ↑ | | |

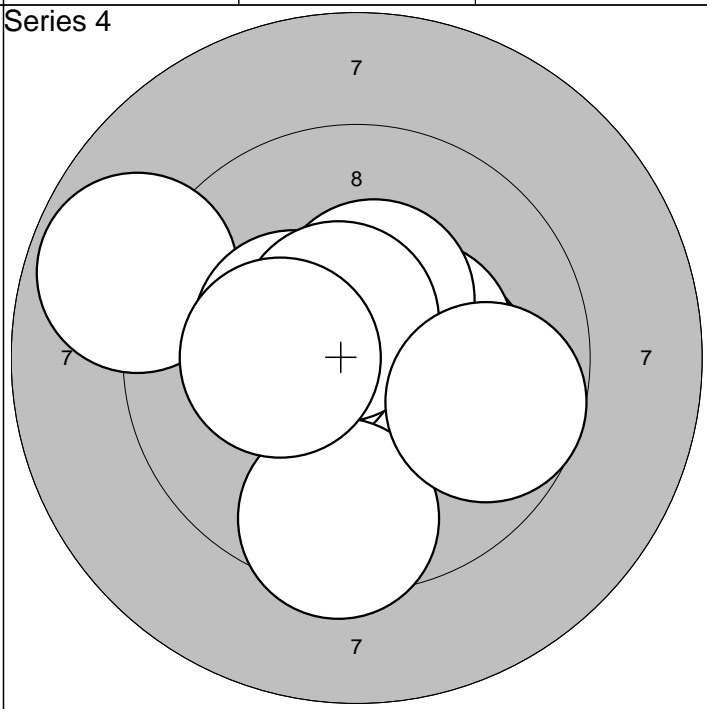

| | | | |
|-----------|-----------|-------|-------|
| 1:10,2* → | 6:10,4* ↑ | Serie | 96,0 |
| 2:10,4* → | 7:10,6* ↗ | | |
| 3:10,5* ← | 8: 9,5 ↘ | Sum | 380,0 |
| 4: 8,8 ↙ | 9:10,3* ← | | |
| 5:10,3* ↙ | 10: 9,7 → | | |

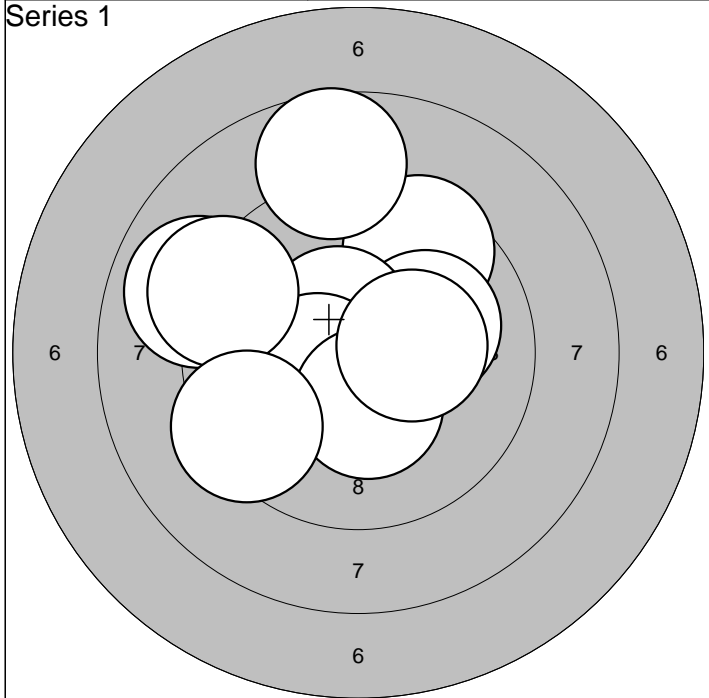

| | | | | | |
|-----------|-----------|-----|------|-------|------|
| 1: 9,5 ↗ | 6:10,3* ↓ | | | Serie | 94,0 |
| 2: 9,0 ↖ | 7: 9,2 ↖ | | | | |
| 3:10,1 → | 8:10,3* → | Sum | 94,0 | | |
| 4:10,5* ↖ | 9: 8,7 ↑ | | | | |
| 5:10,4* ↖ | 10: 9,4 ↖ | | | | |

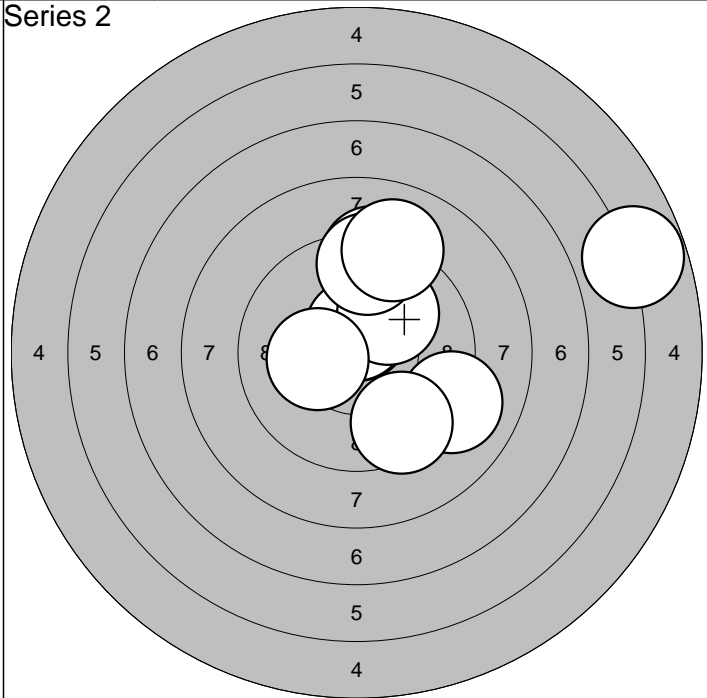

| | | | | | |
|-----------|-----------|-----|-------|-------|------|
| 1:10,5* ↑ | 6: 9,4 ↑ | | | Serie | 90,0 |
| 2: 9,2 ↑ | 7: 9,0 ↑ | | | | |
| 3:10,6* ↑ | 8:10,2* ↖ | Sum | 184,0 | | |
| 4: 9,0 ↘ | 9: 9,5 ↓ | | | | |
| 5:10,1 ↗ | 10: 5,8 → | | | | |

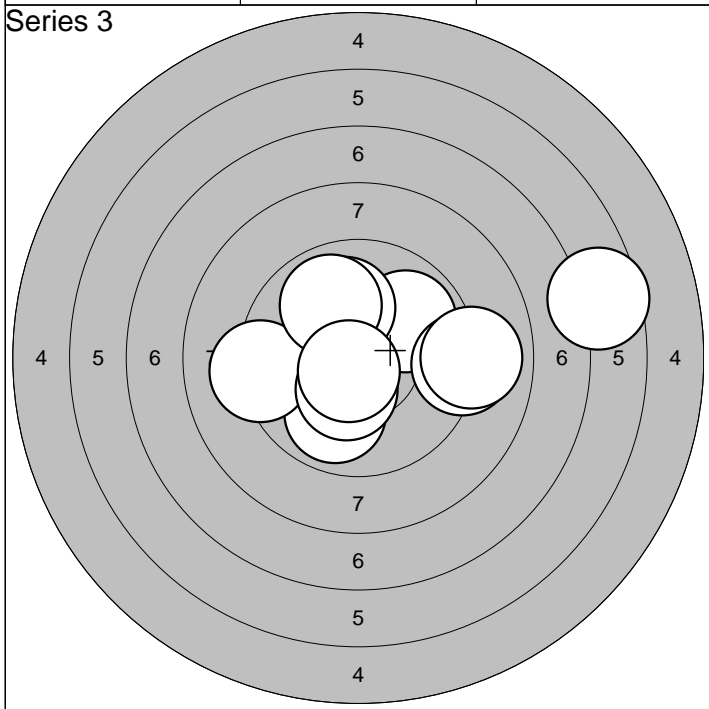

| | | | | | |
|----------|------------|-----|-------|-------|------|
| 1: 9,9 ↗ | 6: 9,2 ↖ | | | Serie | 90,0 |
| 2:10,0 ↑ | 7:10,4* ↓ | | | | |
| 3: 9,1 → | 8: 9,0 → | Sum | 274,0 | | |
| 4: 6,6 → | 9: 9,9 ↑ | | | | |
| 5: 9,9 ↓ | 10:10,7* ↓ | | | | |

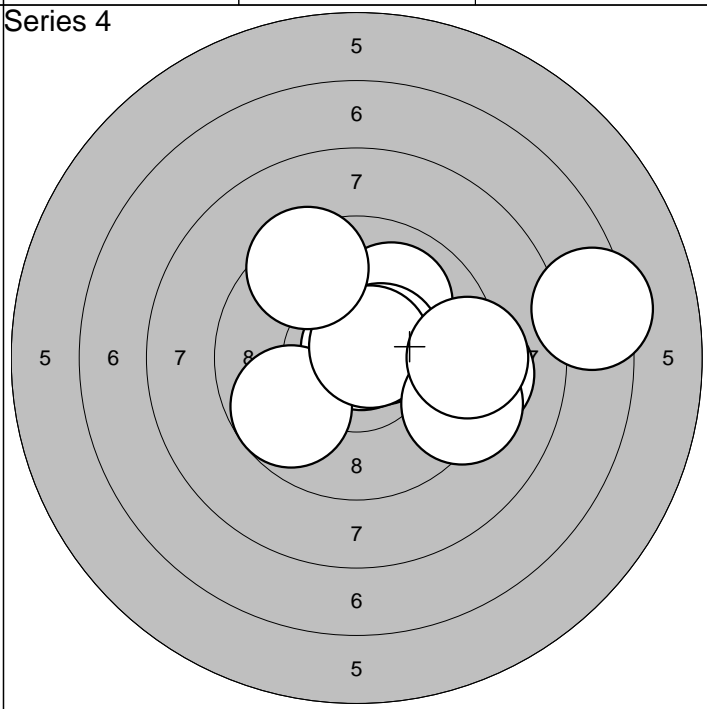

| | | | | | |
|-----------|-----------|-----|-------|-------|------|
| 1:10,8* ↗ | 6:10,7* ↗ | | | Serie | 92,0 |
| 2: 7,4 → | 7: 9,2 → | | | | |
| 3:10,0 ↑ | 8: 9,5 ↑ | Sum | 366,0 | | |
| 4:10,5* ↗ | 9: 9,2 ↘ | | | | |
| 5: 9,7 ↖ | 10: 9,3 → | | | | |

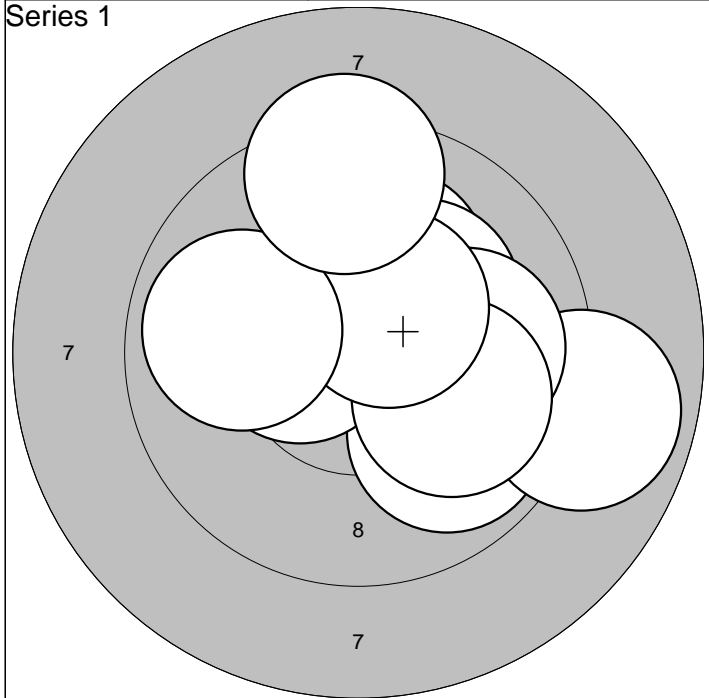

| | | | | | |
|-----------|-----------|-----|------|-------|------|
| 1: 9,9 ↘ | 6:10,0 → | | | Serie | 95,0 |
| 2: 8,9 → | 7:10,0 → | | | | |
| 3:10,1 ↗ | 8:10,5* ↗ | Sum | 95,0 | | |
| 4:10,2* ↗ | 9: 9,9 ← | | | | |
| 5:10,4* ← | 10: 9,3 ↑ | | | | |

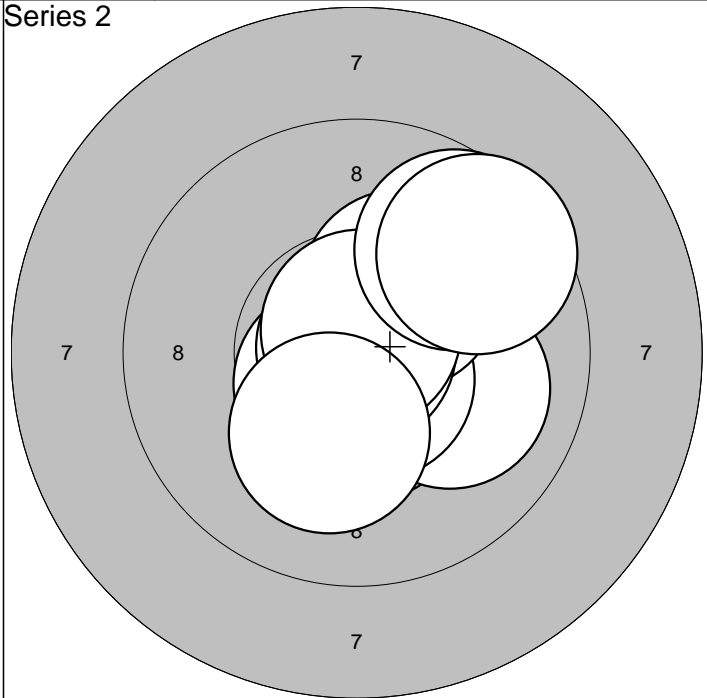

| | | | | | |
|-----------|-----------|-----|-------|-------|------|
| 1:10,5* ↓ | 6:10,9* ↑ | | | Serie | 98,0 |
| 2:10,6* ↘ | 7:10,8* ↑ | | | | |
| 3:10,0 → | 8:10,2* ↘ | Sum | 193,0 | | |
| 4:10,7* ↘ | 9: 9,7 ↗ | | | | |
| 5:10,3* ↗ | 10: 9,6 ↗ | | | | |

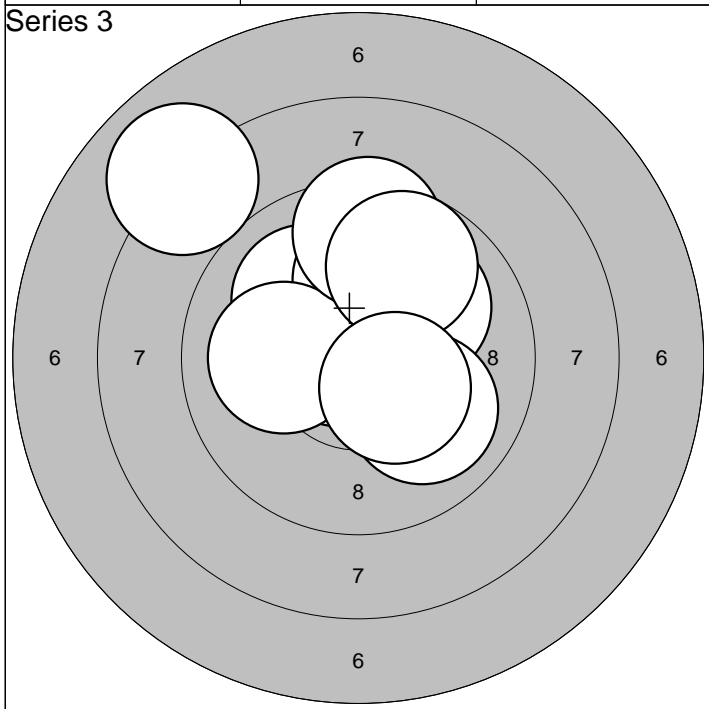

| | | | | | |
|-----------|------------|-----|-------|-------|------|
| 1: 8,0 ↗ | 6:10,0 ↑ | | | Serie | 96,0 |
| 2:10,0 ↗ | 7:10,1 ← | | | | |
| 3:10,7* ← | 8: 9,5 ↑ | Sum | 289,0 | | |
| 4:10,0 ↗ | 9: 9,7 ↗ | | | | |
| 5:10,0 ↘ | 10:10,4* ↘ | | | | |

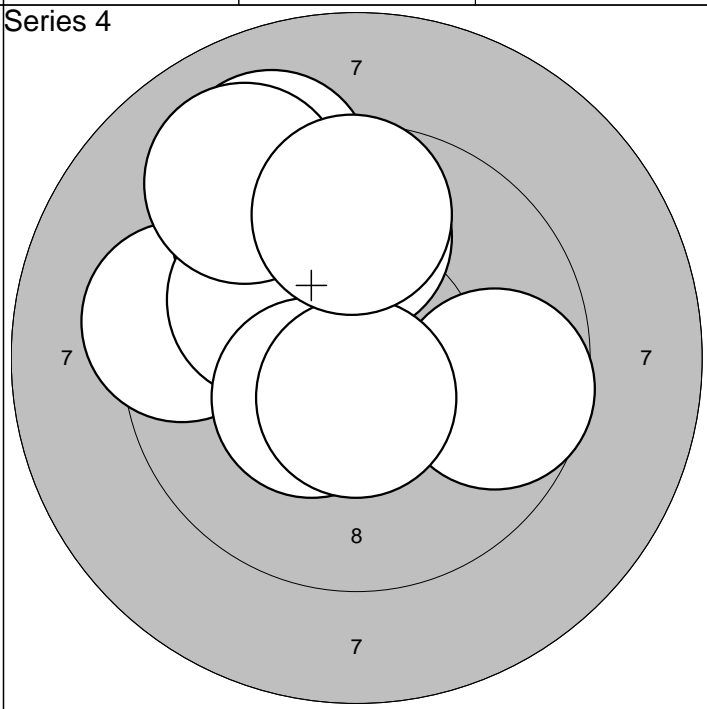

| | | | | | |
|----------|-----------|-----|-------|-------|------|
| 1: 9,1 ↗ | 6:10,0 ↘ | | | Serie | 93,0 |
| 2: 9,7 → | 7:10,4* ↘ | | | | |
| 3: 9,4 ← | 8:10,6* ↓ | Sum | 382,0 | | |
| 4: 9,6 ↗ | 9: 9,1 ↗ | | | | |
| 5: 9,9 ↑ | 10: 9,7 ↑ | | | | |

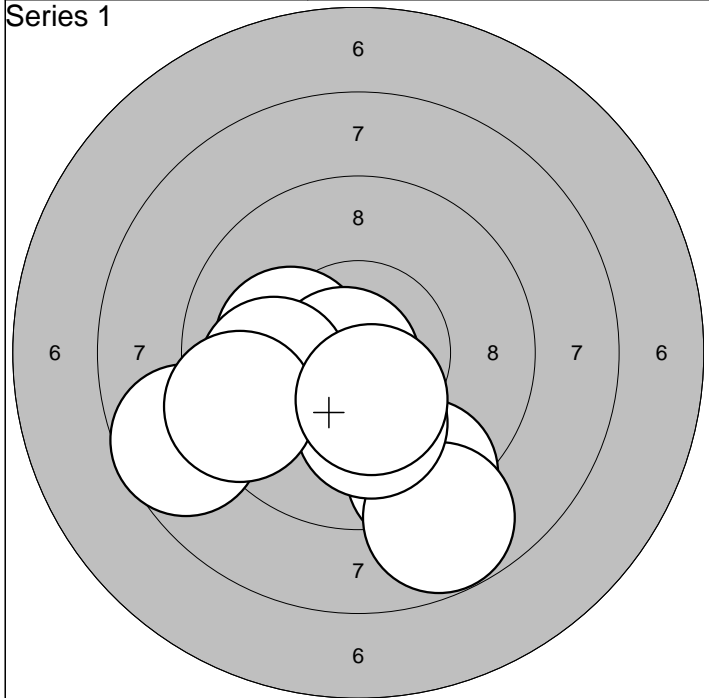

| | | | | | | | | | | | |
|--------|--------|--------|--------|---------|---------|--------|--------|--------|----------|-------|------|
| 1: 9,3 | 2: 8,7 | 3:10,1 | 4: 8,7 | 5:10,5* | 6:10,8* | 7:10,1 | 8: 9,9 | 9: 9,4 | 10:10,4* | | |
| ↘ | ↘ | ← | ← | ↘ | ↙ | ↘ | ← | ← | ↘ | Serie | 93,0 |
| | | | | | | | | | | Sum | 93,0 |

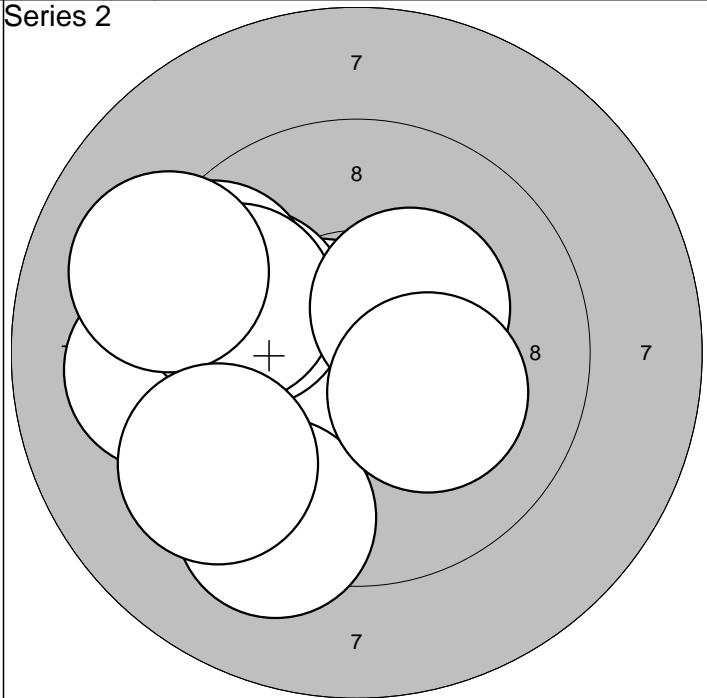

| | | | | | | | | | | | |
|--------|---------|--------|--------|--------|--------|--------|--------|---------|----------|-------|-------|
| 1: 9,2 | 2:10,6* | 3: 9,3 | 4: 9,9 | 5: 9,5 | 6: 9,8 | 7: 9,1 | 8: 9,4 | 9:10,3* | 10:10,2* | | |
| ← | ↙ | ↘ | ↙ | ↙ | ↙ | ↙ | ↘ | ↗ | ↘ | Serie | 93,0 |
| | | | | | | | | | | Sum | 186,0 |

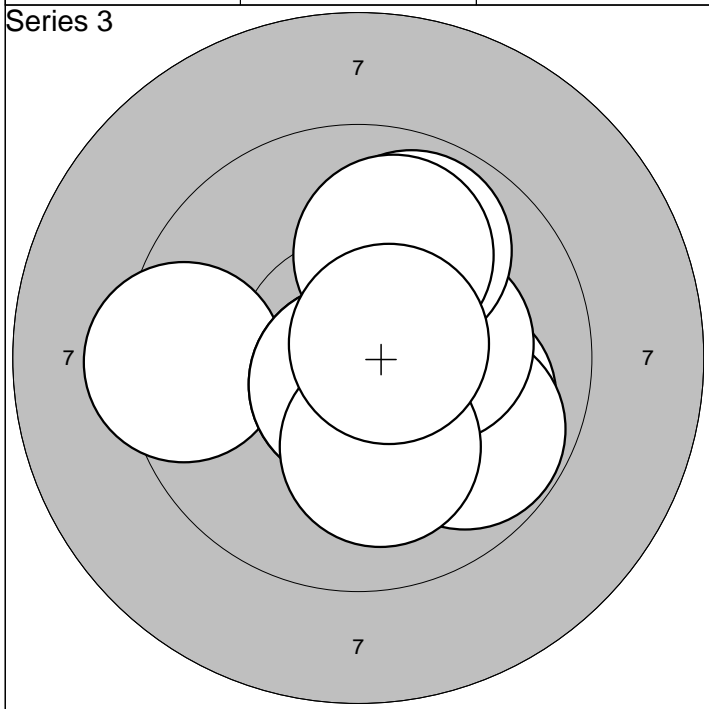

| | | | | | | | | | | | |
|--------|--------|--------|---------|---------|--------|---------|--------|--------|----------|-------|-------|
| 1: 9,4 | 2:10,0 | 3: 9,8 | 4:10,7* | 5:10,2* | 6: 9,9 | 7:10,7* | 8:10,0 | 9:10,1 | 10:10,6* | | |
| ← | → | ↘ | ↘ | → | ↗ | ↘ | ↗ | ↘ | → | Serie | 97,0 |
| | | | | | | | | | | Sum | 283,0 |

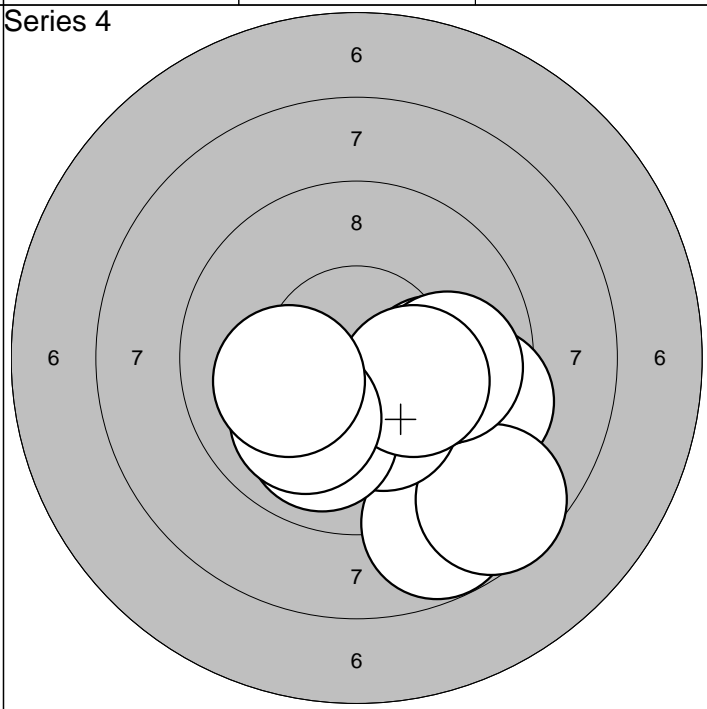

| | | | | | | | | | | | |
|--------|--------|--------|---------|--------|--------|--------|---------|--------|---------|-------|-------|
| 1: 9,4 | 2: 8,8 | 3: 8,6 | 4:10,2* | 5: 9,9 | 6:10,0 | 7: 9,9 | 8:10,2* | 9:10,0 | 10:10,1 | | |
| → | ↘ | ↘ | ↘ | ↘ | → | → | → | ↘ | ← | Serie | 93,0 |
| | | | | | | | | | | Sum | 376,0 |

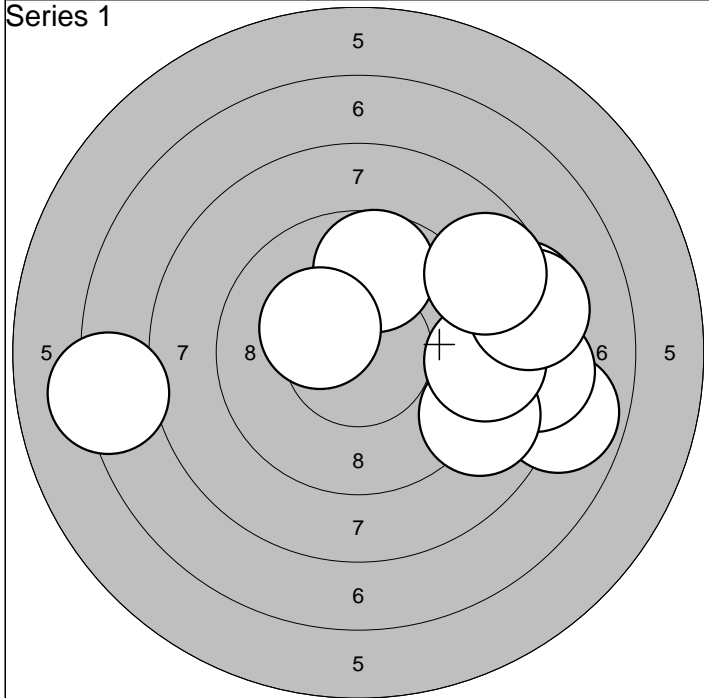

| | | | |
|------------|-----------|-------|------|
| 1: 7,9 → | 6: 8,4 → | Serie | 82,0 |
| 2: 9,7 ↑ | 7: 9,1 → | | |
| 3: 8,3 → | 8: 8,4 → | Sum | 82,0 |
| 4: 10,3* ↖ | 9: 8,7 ↗ | | |
| 5: 8,9 ↘ | 10: 7,2 ← | | |

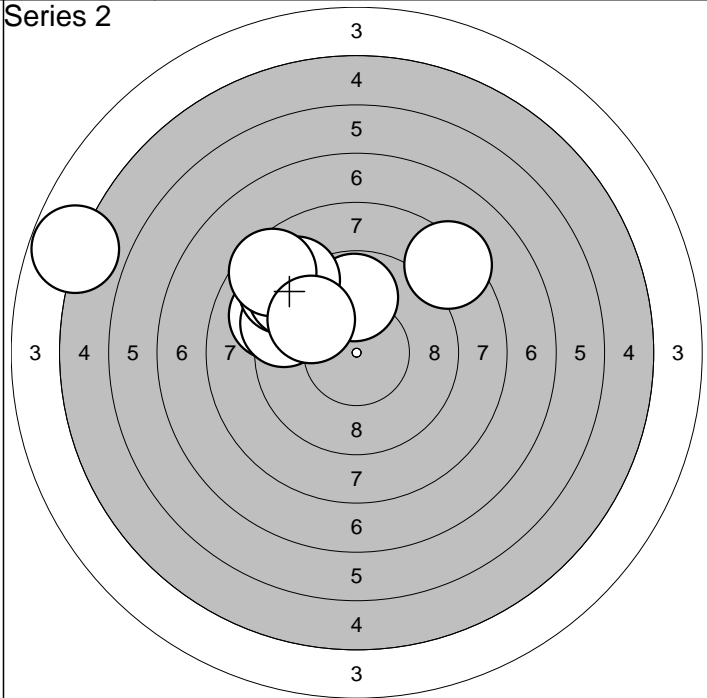

| | | | |
|----------|-----------|-------|-------|
| 1: 9,1 ↖ | 6: 9,2 ↖ | Serie | 83,0 |
| 2: 9,4 ↖ | 7: 9,0 ↗ | | |
| 3: 9,0 ↗ | 8: 8,3 ↗ | Sum | 165,0 |
| 4: 4,8 ↖ | 9: 8,6 ↗ | | |
| 5: 9,8 ↑ | 10: 9,8 ↖ | | |

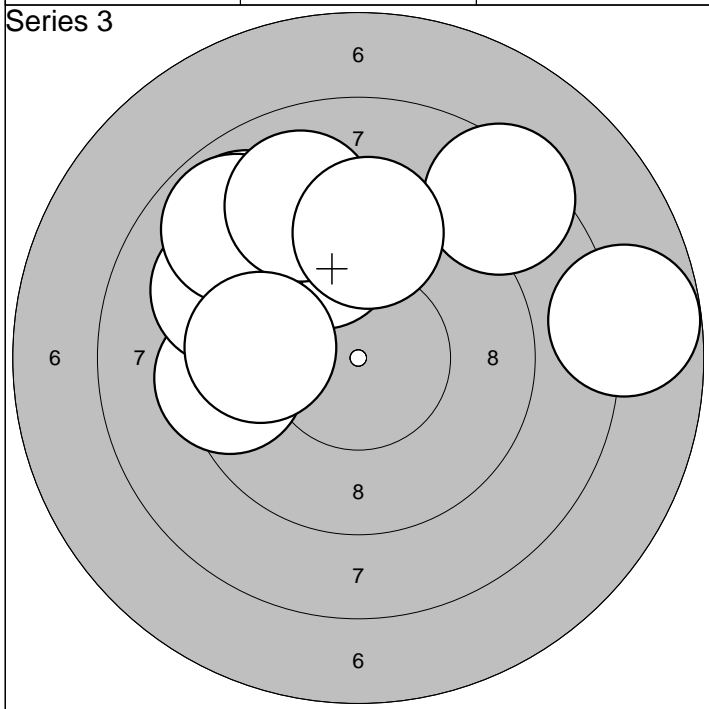

| | | | |
|----------|-----------|-------|-------|
| 1: 8,9 ↖ | 6: 9,0 ↖ | Serie | 85,0 |
| 2: 9,6 ↑ | 7: 8,4 ↗ | | |
| 3: 9,4 ← | 8: 9,5 ↑ | Sum | 250,0 |
| 4: 9,2 ↖ | 9: 7,8 → | | |
| 5: 8,8 ↖ | 10: 9,8 ← | | |

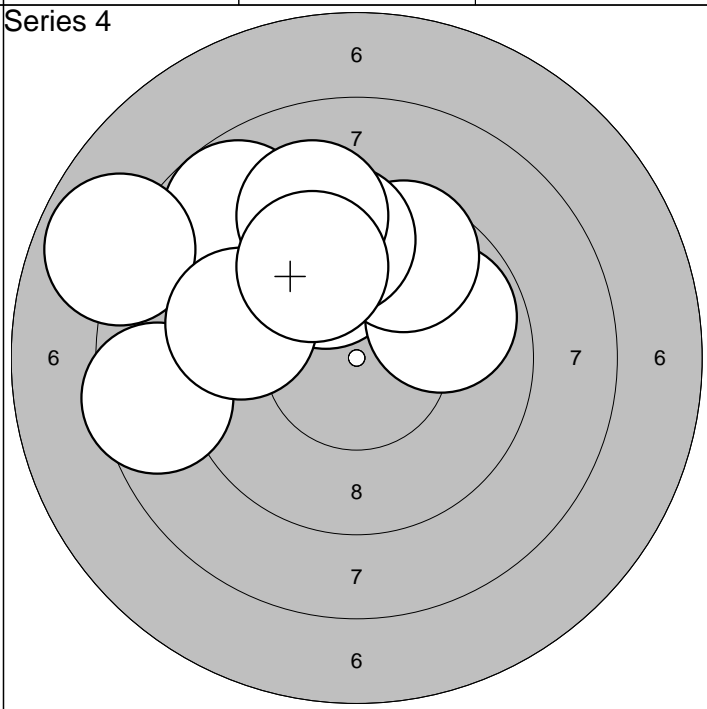

| | | | |
|----------|-----------|-------|-------|
| 1: 8,8 ↖ | 6: 9,6 ↗ | Serie | 86,0 |
| 2: 9,9 ↑ | 7: 9,5 ↑ | | |
| 3: 7,9 ↖ | 8: 9,2 ↑ | Sum | 336,0 |
| 4: 9,9 ↗ | 9: 9,5 ← | | |
| 5: 8,5 ← | 10: 9,8 ↖ | | |

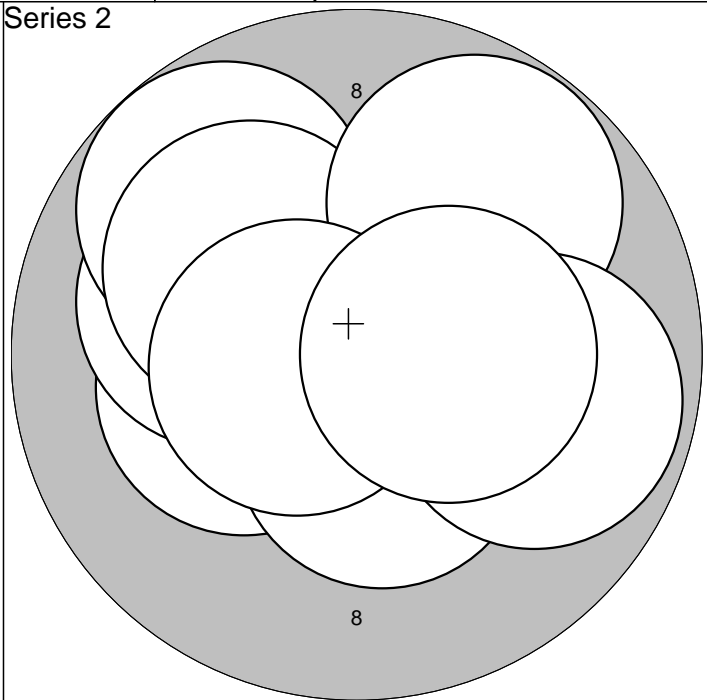
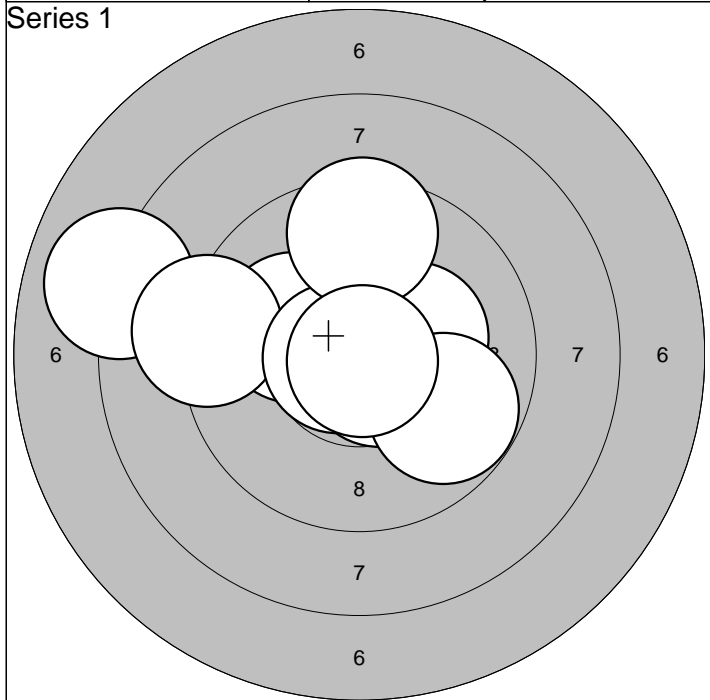

| | | | | | |
|-----------|------------|-----|------|-------|------|
| 1: 8,0 ← | 6:10,3* → | | | Serie | 95,0 |
| 2:10,7* ↑ | 7:10,7* ← | | | | |
| 3:10,6* ↘ | 8: 9,8 ↘ | Sum | 95,0 | | |
| 4:10,1 ↖ | 9: 9,5 ↑ | | | | |
| 5: 9,1 ← | 10:10,9* ↘ | | | | |

| | | | | | |
|-----------|------------|-----|-------|-------|------|
| 1:10,2* ← | 6:10,1 ↖ | | | Serie | 97,0 |
| 2:10,5* ↗ | 7: 9,8 ↗ | | | | |
| 3:10,1 ← | 8:10,6* ← | Sum | 192,0 | | |
| 4:10,4* ↓ | 9: 9,9 → | | | | |
| 5: 9,8 ↗ | 10:10,4* → | | | | |

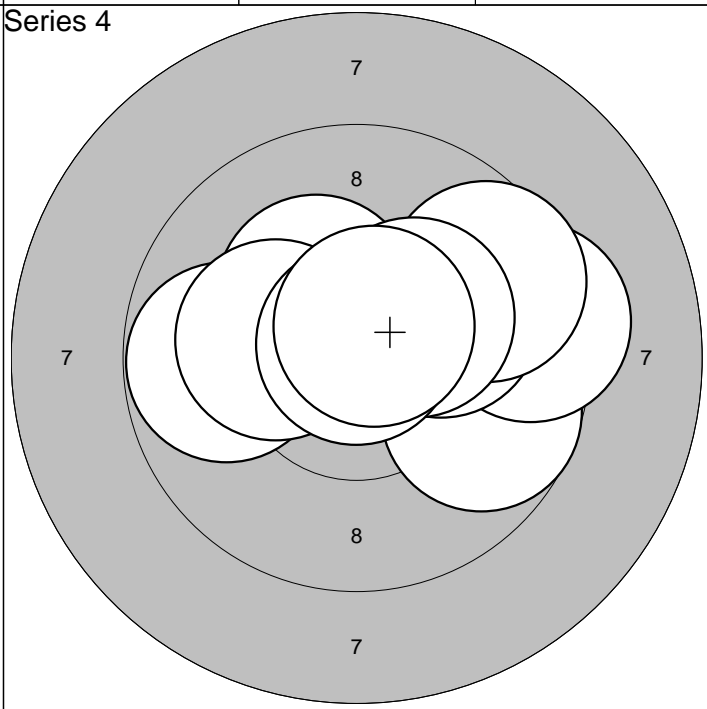
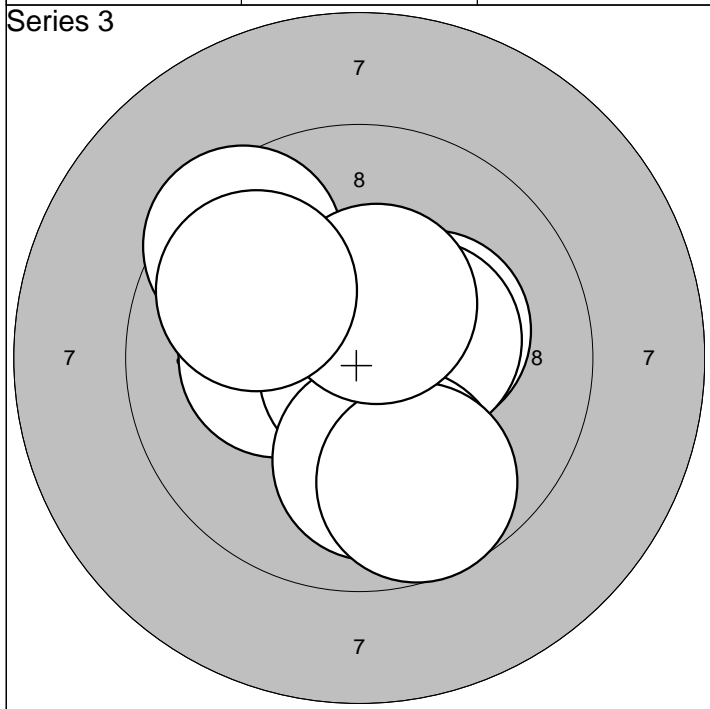

| | | | | | |
|-----------|-----------|-----|-------|-------|------|
| 1:10,2* ← | 6: 9,9 ↓ | | | Serie | 96,0 |
| 2:10,3* → | 7:10,0 ↓ | | | | |
| 3: 9,5 ↖ | 8: 9,7 ↓ | Sum | 288,0 | | |
| 4:10,8* ↓ | 9:10,4* ↑ | | | | |
| 5:10,4* → | 10: 9,9 ↖ | | | | |

| | | | | | |
|----------|------------|-----|-------|-------|------|
| 1: 9,7 → | 6:10,3* ↖ | | | Serie | 96,0 |
| 2: 9,8 ← | 7:10,3* ↗ | | | | |
| 3: 9,4 → | 8:10,2* ← | Sum | 384,0 | | |
| 4:10,1 → | 9:10,8* ↑ | | | | |
| 5: 9,6 → | 10:10,6* ↗ | | | | |

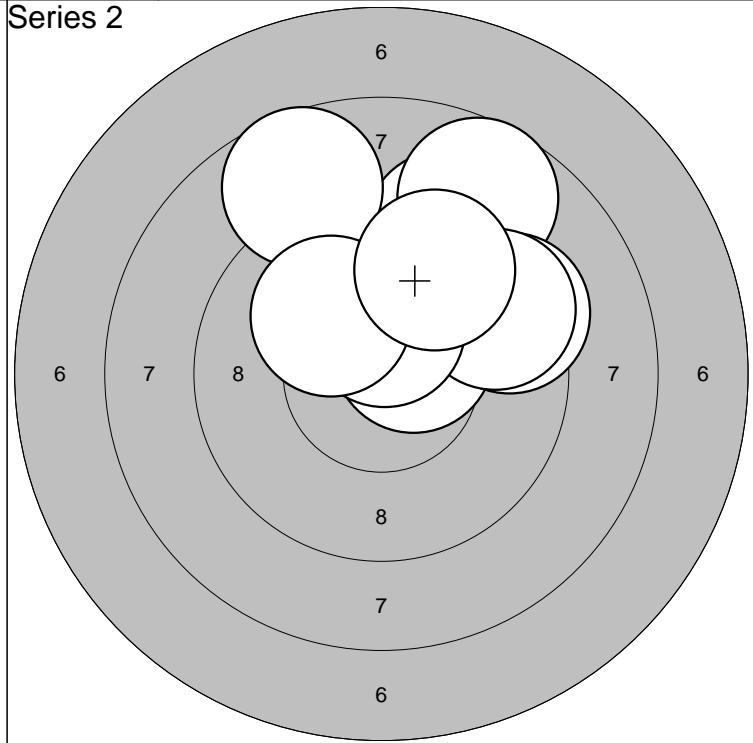
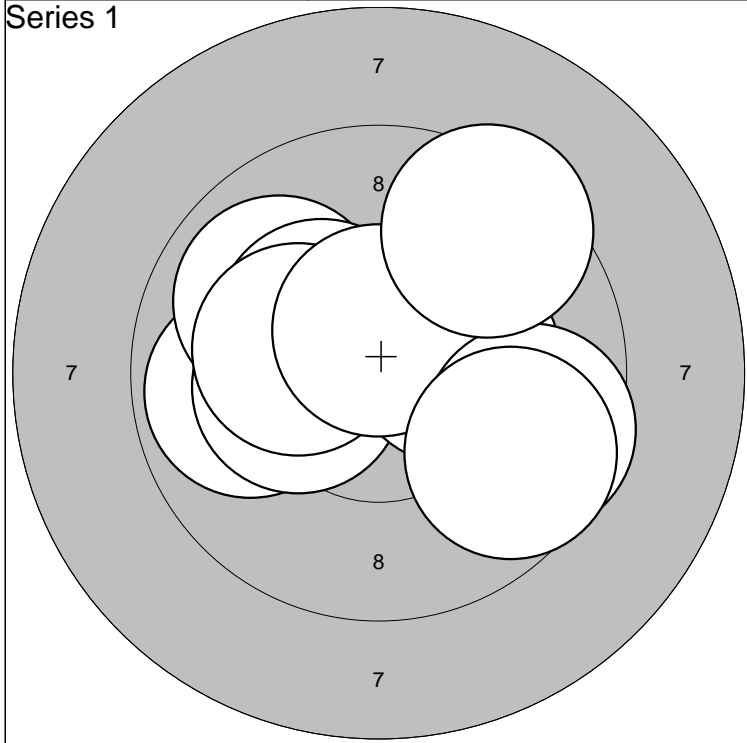

| | | | |
|-----------|-----------|-------|------|
| 1: 9,9 ← | 6:10,2* ← | Serie | 95,0 |
| 2:10,2* ← | 7:10,6* ↑ | | |
| 3: 9,9 ↗ | 8: 9,6 → | Sum | 95,0 |
| 4:10,3* ↗ | 9: 9,6 → | | |
| 5:10,3* → | 10: 9,5 ↗ | | |

| | | | |
|-----------|-----------|-------|-------|
| 1:10,5* ↗ | 6: 9,5 ↗ | Serie | 92,0 |
| 2:10,0 ↑ | 7:10,4* ↑ | | |
| 3: 9,2 ↗ | 8: 8,7 ↗ | Sum | 187,0 |
| 4: 8,7 ↗ | 9:10,1 ↗ | | |
| 5: 9,4 ↗ | 10: 9,6 ↗ | | |

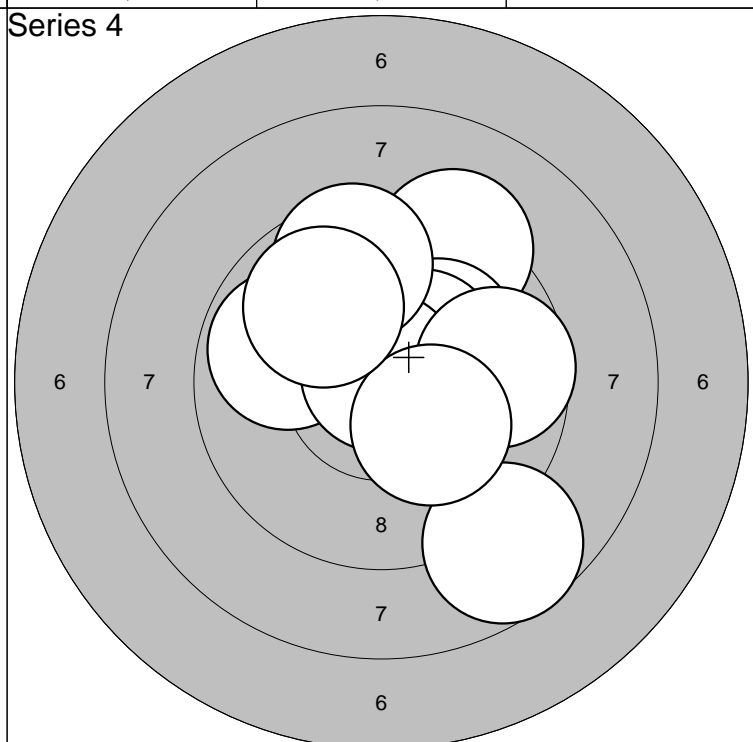
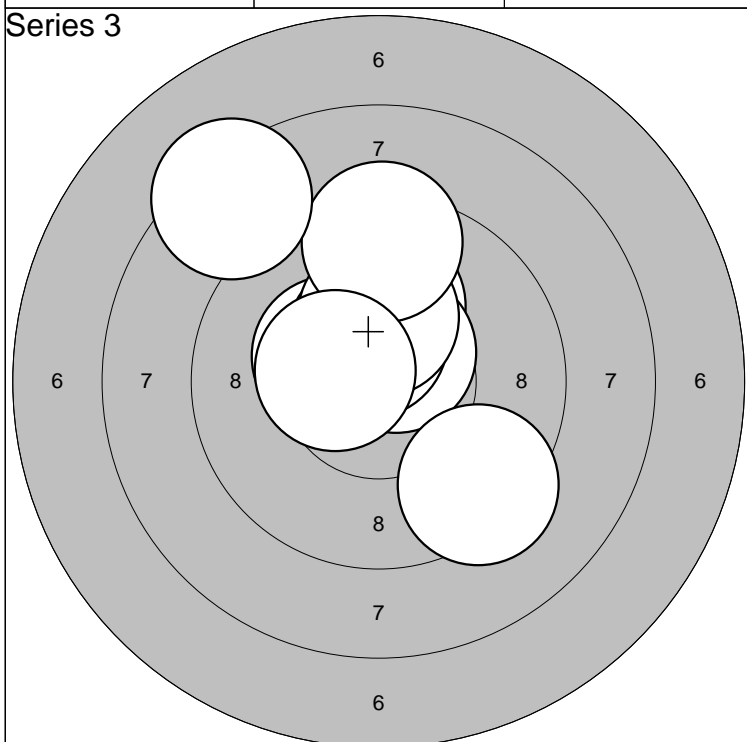

| | | | |
|-----------|-----------|-------|-------|
| 1:10,4* ↗ | 6:10,2* ↑ | Serie | 96,0 |
| 2:10,5* ↑ | 7: 9,4 ↑ | | |
| 3:10,1 ↑ | 8:10,5* ← | Sum | 283,0 |
| 4:10,6* ↗ | 9: 8,4 ↗ | | |
| 5:10,4* ↑ | 10: 9,3 ↘ | | |

| | | | |
|-----------|-----------|-------|-------|
| 1: 9,3 ↗ | 6: 9,6 ↑ | Serie | 93,0 |
| 2:10,1 ↗ | 7: 9,7 → | | |
| 3:10,4* ↗ | 8: 8,7 ↘ | Sum | 376,0 |
| 4: 9,9 ← | 9:10,2* ↘ | | |
| 5:10,8* ↑ | 10: 9,9 ↗ | | |

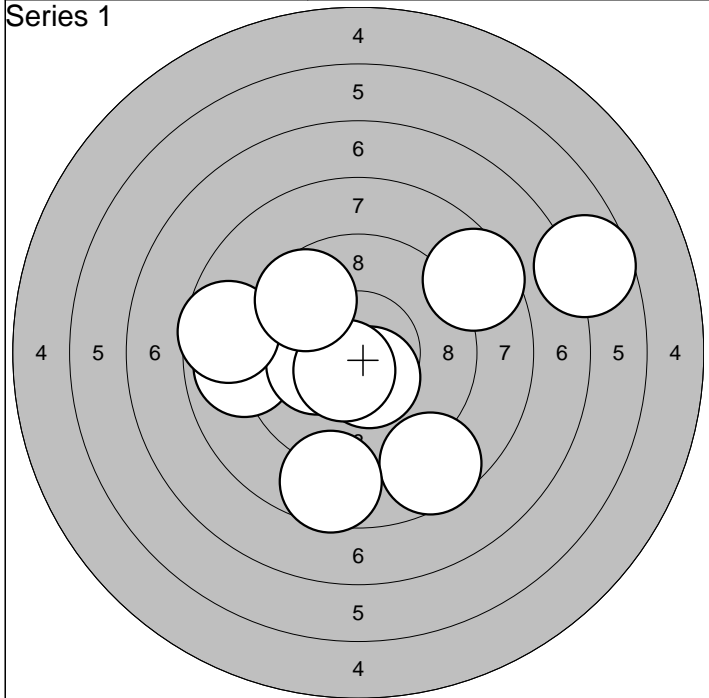

| | | | | |
|------------|------------|-----|-------|------|
| 1: 8,9 ← | 6: 8,7 ← | | Serie | 85,0 |
| 2: 8,6 ↗ | 7: 10,5* ↓ | | | |
| 3: 8,6 ↓ | 8: 6,7 → | Sum | 85,0 | |
| 4: 10,2* ← | 9: 10,6* ↓ | | | |
| 5: 8,6 ↓ | 10: 9,6 ↗ | | | |

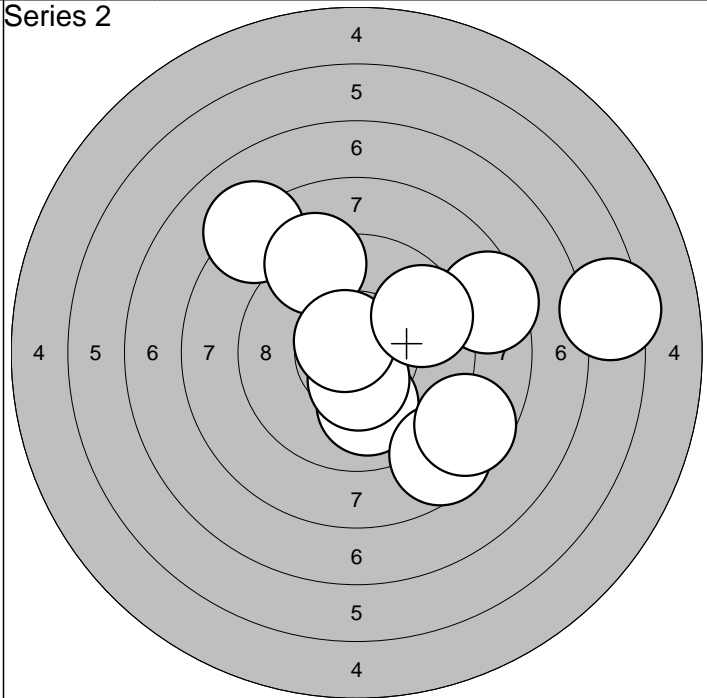

| | | | | |
|-----------|------------|-----|-------|------|
| 1: 10,0 ↓ | 6: 10,5* ↓ | | Serie | 86,0 |
| 2: 6,4 → | 7: 9,2 ↗ | | | |
| 3: 8,6 ↓ | 8: 10,7* ↗ | Sum | 171,0 | |
| 4: 8,2 ↗ | 9: 8,5 → | | | |
| 5: 8,6 ↓ | 10: 9,6 ↗ | | | |

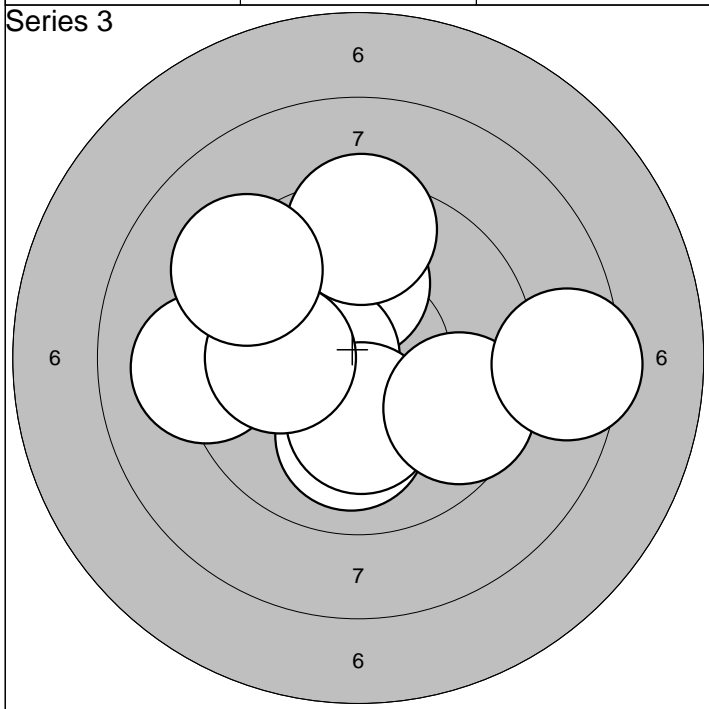

| | | | | |
|------------|-----------|-----|-------|------|
| 1: 10,1 ↑ | 6: 9,4 ↑ | | Serie | 94,0 |
| 2: 10,6* ← | 7: 9,6 → | | | |
| 3: 10,0 ↓ | 8: 8,5 → | Sum | 265,0 | |
| 4: 9,2 ← | 9: 10,0 ← | | | |
| 5: 10,2* ↓ | 10: 9,3 ↗ | | | |

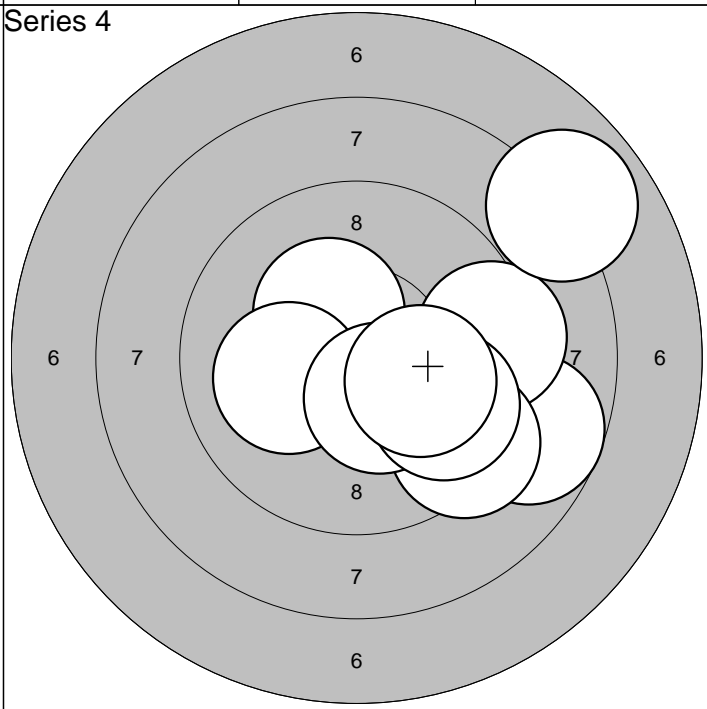

| | | | | |
|------------|------------|-----|-------|------|
| 1: 8,8 → | 6: 7,9 ↗ | | Serie | 92,0 |
| 2: 10,7* ↓ | 7: 10,1 ← | | | |
| 3: 10,3* ↗ | 8: 10,4* ↓ | Sum | 357,0 | |
| 4: 9,4 → | 9: 9,8 → | | | |
| 5: 9,3 ↓ | 10: 10,1 → | | | |

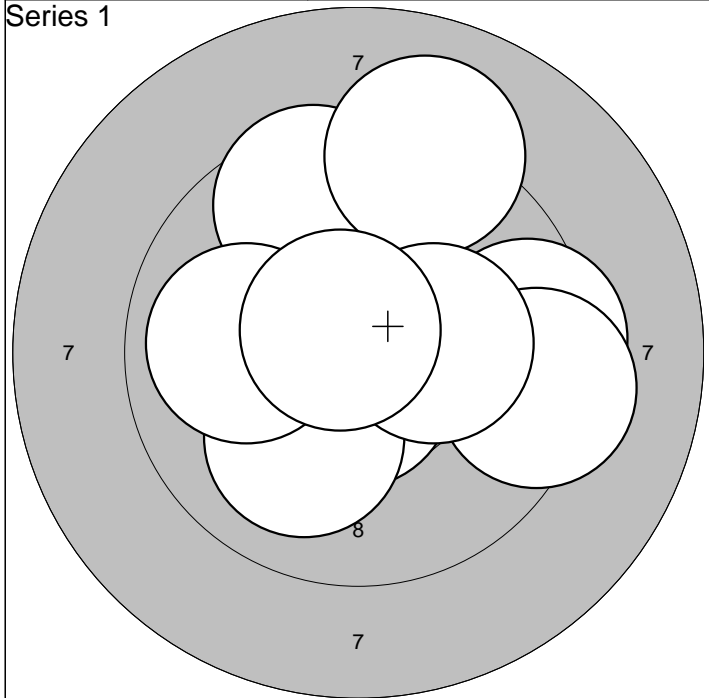

| | | | | | |
|----------|---|-----------|---|-------|------|
| 1: 9,6 | ↑ | 6: 9,1 | ↑ | Serie | 95,0 |
| 2: 10,6* | ↓ | 7: 9,9 | ← | | |
| 3: 9,4 | → | 8: 9,3 | → | Sum | 95,0 |
| 4: 10,5* | ↗ | 9: 10,3* | → | | |
| 5: 10,1 | ↘ | 10: 10,7* | ↖ | | |

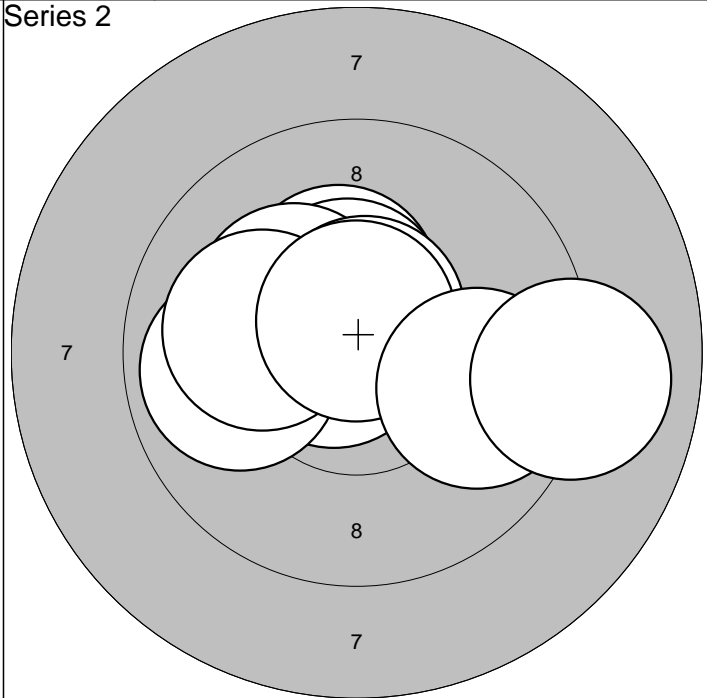

| | | | | | |
|----------|---|----------|---|-------|-------|
| 1: 10,3* | ↑ | 6: 10,6* | ↑ | Serie | 97,0 |
| 2: 10,5* | ↑ | 7: 10,1 | ← | | |
| 3: 10,2* | ↖ | 8: 10,7* | ↑ | Sum | 192,0 |
| 4: 10,7* | ← | 9: 9,8 | → | | |
| 5: 9,9 | ← | 10: 9,0 | → | | |

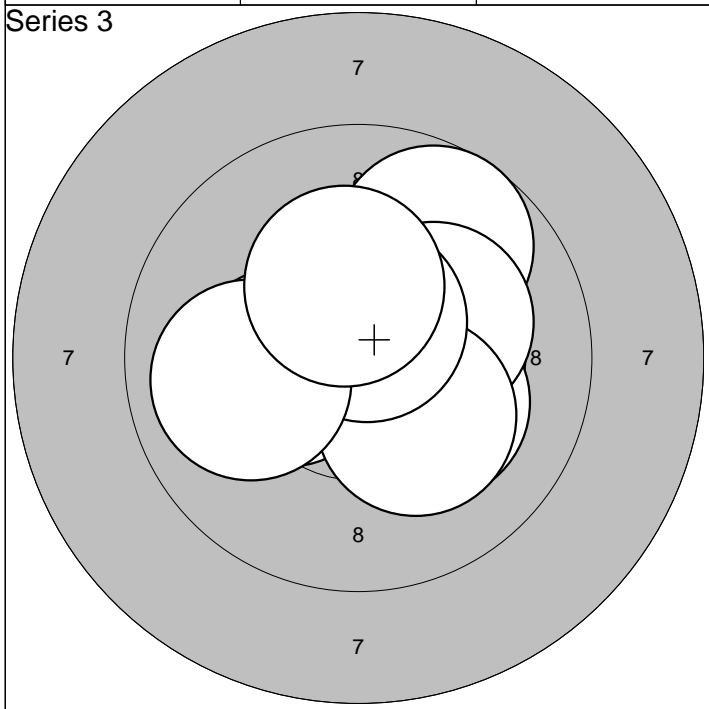

| | | | | | |
|----------|---|-----------|---|-------|-------|
| 1: 10,3* | ↑ | 6: 10,2* | ↗ | Serie | 99,0 |
| 2: 10,3* | → | 7: 10,2* | ↘ | | |
| 3: 10,3* | ← | 8: 10,6* | ↑ | Sum | 291,0 |
| 4: 9,7 | ↗ | 9: 10,0 | ← | | |
| 5: 10,2* | ↘ | 10: 10,3* | ↑ | | |

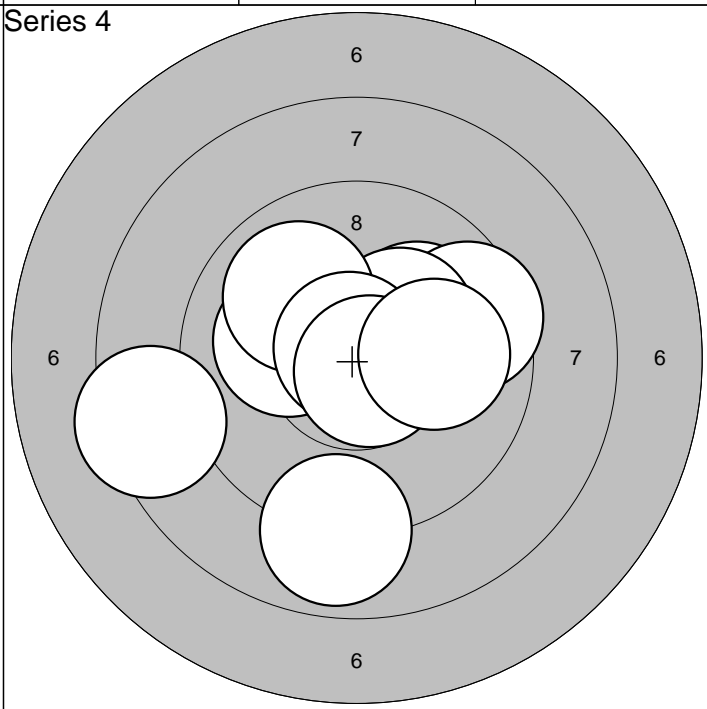

| | | | | | |
|----------|---|----------|---|-------|-------|
| 1: 10,1 | ← | 6: 10,8* | ↖ | Serie | 95,0 |
| 2: 10,1 | ↗ | 7: 10,7* | ↘ | | |
| 3: 9,6 | → | 8: 8,9 | ↓ | Sum | 386,0 |
| 4: 10,3* | ↗ | 9: 10,0 | → | | |
| 5: 10,0 | ↖ | 10: 8,4 | ← | | |

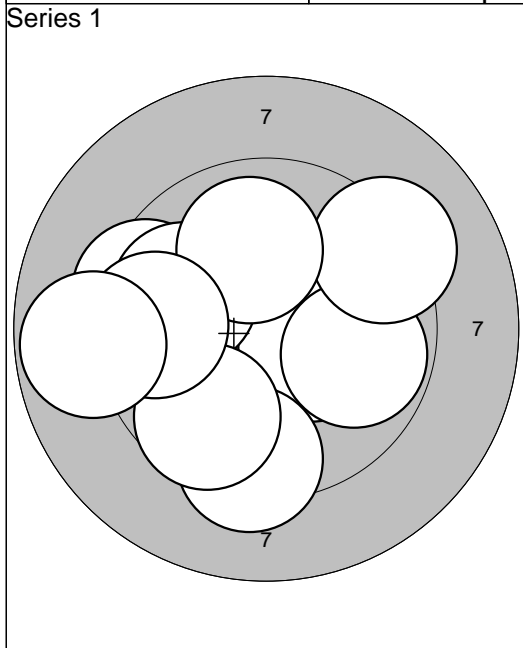

| | |
|-------------------|---|
| 1: 10,3* | → |
| 2: 9,3 | ↓ |
| 3: 9,4 | ↖ |
| 4: 9,9 | ↖ |
| 5: 9,8 | → |
| 6: 9,2 | ↗ |
| 7: 9,6 | ↙ |
| 8: 10,0 | ↑ |
| 9: 9,6 | ← |
| 10: 8,8 | ← |
| Serie 91,0 | |
| Sum 91,0 | |

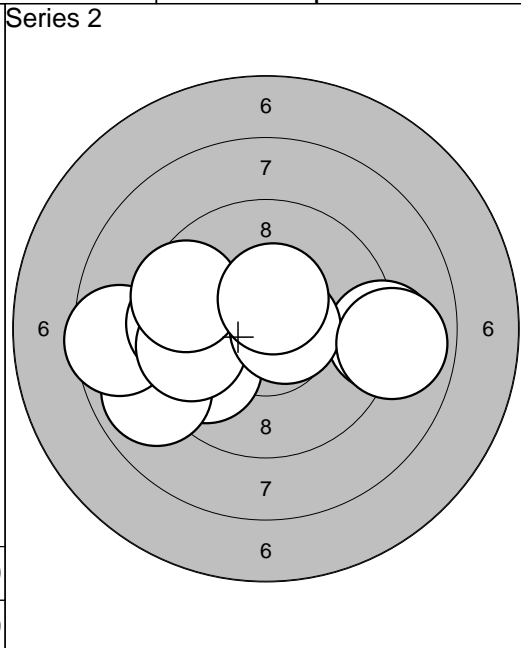

| | |
|-------------------|---|
| 1: 9,1 | → |
| 2: 9,8 | ↙ |
| 3: 8,9 | ↙ |
| 4: 8,6 | ← |
| 5: 9,6 | ← |
| 6: 9,7 | ← |
| 7: 10,6* | → |
| 8: 9,6 | ↖ |
| 9: 10,5* | ↑ |
| 10: 8,9 | → |
| Serie 89,0 | |
| Sum 180,0 | |

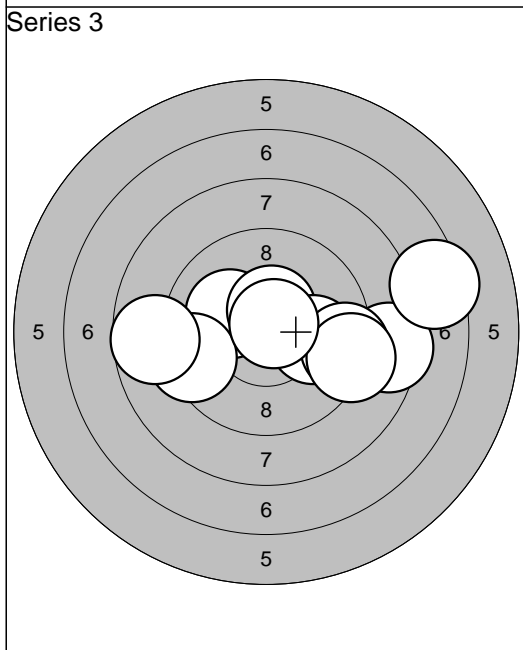

| | |
|-------------------|---|
| 1: 8,5 | → |
| 2: 10,1 | ↖ |
| 3: 10,5* | ↑ |
| 4: 9,4 | ← |
| 5: 10,0 | → |
| 6: 8,7 | ← |
| 7: 9,3 | → |
| 8: 7,4 | → |
| 9: 9,2 | → |
| 10: 10,7* | ↗ |
| Serie 90,0 | |
| Sum 270,0 | |

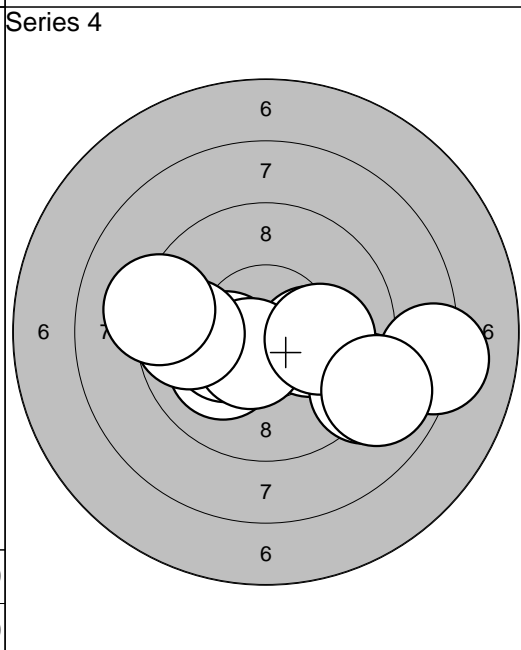

| | |
|-------------------|---|
| 1: 10,2* | → |
| 2: 9,1 | ↘ |
| 3: 10,1 | ↙ |
| 4: 10,3* | ← |
| 5: 10,5* | ↙ |
| 6: 9,7 | ← |
| 7: 8,2 | → |
| 8: 10,1 | → |
| 9: 9,2 | ← |
| 10: 8,9 | ↘ |
| Serie 93,0 | |
| Sum 363,0 | |

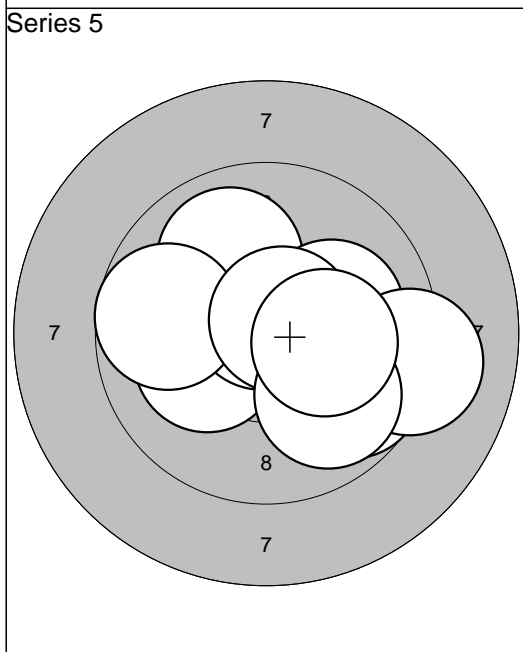

| | |
|-------------------|---|
| 1: 9,7 | ↘ |
| 2: 10,2* | ← |
| 3: 10,7* | ↑ |
| 4: 9,9 | ↗ |
| 5: 10,1 | → |
| 6: 9,2 | → |
| 7: 9,7 | ← |
| 8: 10,7* | ↗ |
| 9: 9,9 | ↘ |
| 10: 10,2* | → |
| Serie 95,0 | |
| Sum 458,0 | |

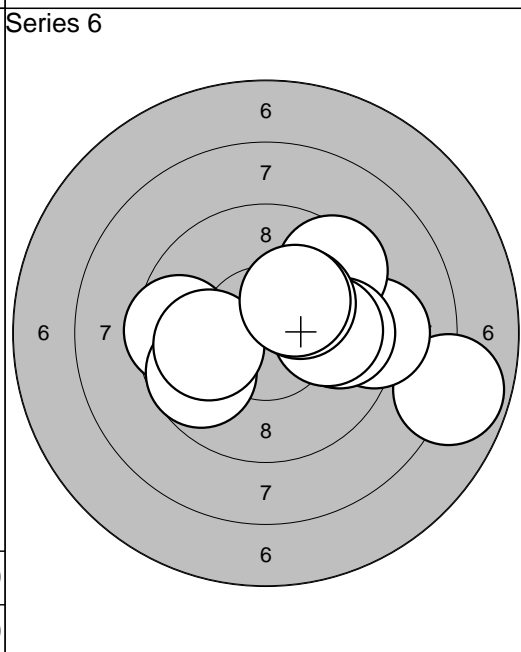

| | |
|-------------------|---|
| 1: 9,5 | ← |
| 2: 7,8 | → |
| 3: 9,2 | → |
| 4: 9,5 | ↗ |
| 5: 9,8 | → |
| 6: 9,7 | ↙ |
| 7: 9,9 | → |
| 8: 10,0 | ← |
| 9: 10,2* | ↗ |
| 10: 10,2* | ↗ |
| Serie 91,0 | |
| Sum 549,0 | |

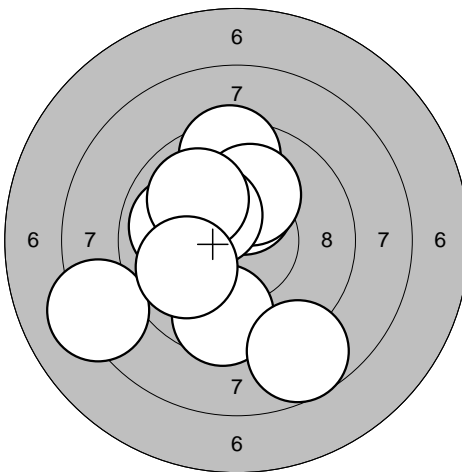
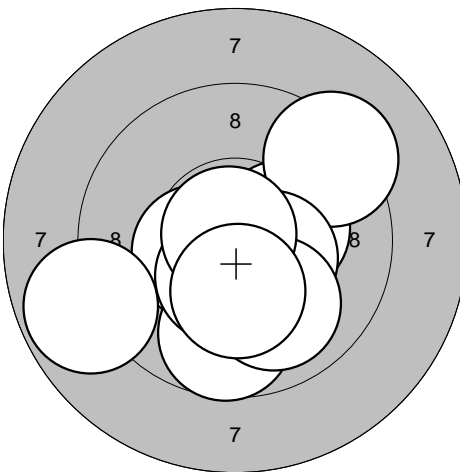
| | | | |
|--|---|--|---|
| <p>Series 1</p>  | <p>1: 9,4 ↑</p> <p>2: 9,9 ←</p> <p>3: 10,3* ↑</p> <p>4: 10,1 ↑</p> <p>5: 10,3* ↗</p> <p>6: 8,2 ←</p> <p>7: 9,9 ↗</p> <p>8: 9,6 ↓</p> <p>9: 9,9 ←</p> <p>10: 8,7 ↓</p> | <p>Series 2</p>  | <p>1: 10,3* →</p> <p>2: 10,4* ←</p> <p>3: 8,8 ←</p> <p>4: 9,7 ↓</p> <p>5: 9,3 ↗</p> <p>6: 10,4* →</p> <p>7: 10,0 ↓</p> <p>8: 10,5* ↓</p> <p>9: 10,8* ↗</p> <p>10: 10,2* ↓</p> |
| Serie 91,0 | Serie 96,0 | Serie 96,0 | Serie 96,0 |
| Sum 91,0 | Sum 187,0 | Sum 187,0 | Sum 187,0 |

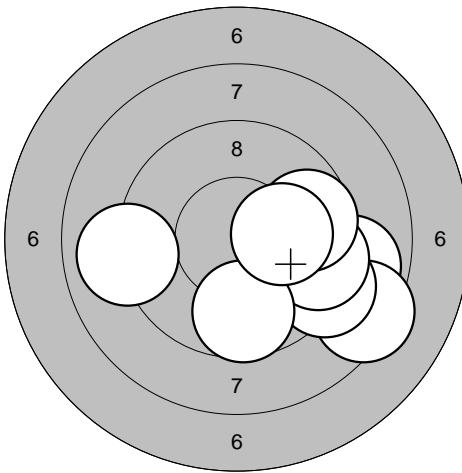
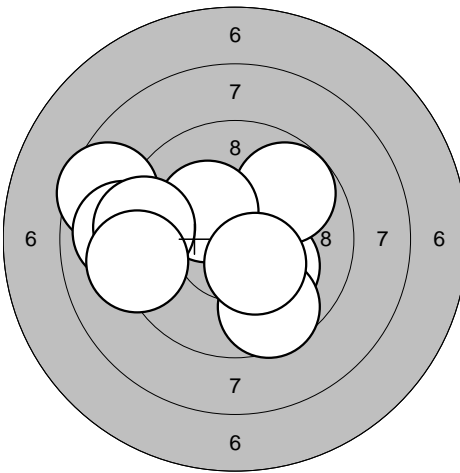
| | | | |
|---|---|---|--|
| <p>Series 3</p>  | <p>1: 9,8 →</p> <p>2: 9,9 →</p> <p>3: 8,9 →</p> <p>4: 8,4 →</p> <p>5: 9,0 ←</p> <p>6: 9,2 →</p> <p>7: 9,5 →</p> <p>8: 9,7 ↓</p> <p>9: 9,7 →</p> <p>10: 10,1 →</p> | <p>Series 4</p>  | <p>1: 8,6 ←</p> <p>2: 10,2* ↓</p> <p>3: 9,7 ↗</p> <p>4: 10,3* ↗</p> <p>5: 9,3 ←</p> <p>6: 9,0 ←</p> <p>7: 9,6 ↓</p> <p>8: 9,3 ←</p> <p>9: 9,2 ←</p> <p>10: 10,4* ↓</p> |
| Serie 89,0 | Serie 92,0 | Serie 92,0 | Serie 92,0 |
| Sum 276,0 | Sum 368,0 | Sum 368,0 | Sum 368,0 |

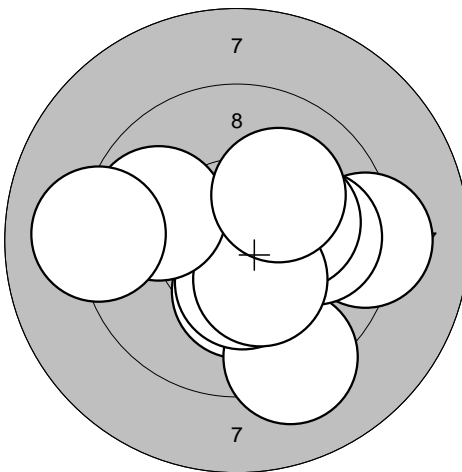
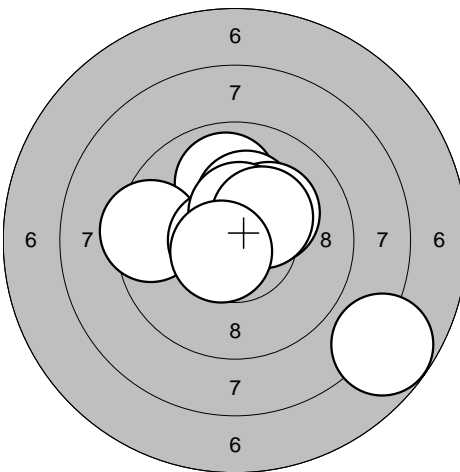
| | | | |
|--|---|--|--|
| <p>Series 5</p>  | <p>1: 9,2 →</p> <p>2: 10,3* ↓</p> <p>3: 9,2 ↓</p> <p>4: 10,4* ↓</p> <p>5: 9,9 →</p> <p>6: 10,2* →</p> <p>7: 10,3* ↓</p> <p>8: 9,8 ←</p> <p>9: 10,1 ↗</p> <p>10: 9,1 ←</p> | <p>Series 6</p>  | <p>1: 10,5* ↖</p> <p>2: 9,9 ↑</p> <p>3: 7,8 ↓</p> <p>4: 10,3* ↑</p> <p>5: 9,5 ←</p> <p>6: 10,2* ↗</p> <p>7: 10,7* ←</p> <p>8: 10,4* ↑</p> <p>9: 10,3* ↗</p> <p>10: 10,7* ←</p> |
| Serie 95,0 | Serie 95,0 | Serie 95,0 | Serie 95,0 |
| Sum 463,0 | Sum 558,0 | Sum 558,0 | Sum 558,0 |

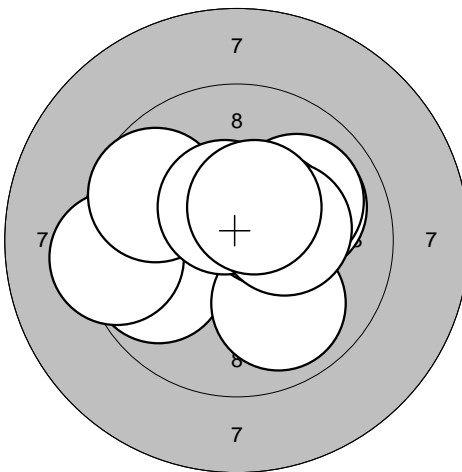
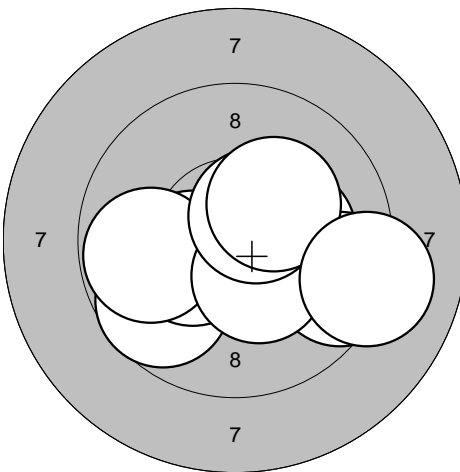
| | | | |
|--|--|--|--|
| <p>Series 1</p>  | <p>1: 9,8 ←</p> <p>2: 9,3 ←</p> <p>3: 10,0 →</p> <p>4: 10,0 →</p> <p>5: 9,7 ←</p> <p>6: 9,9 ↓</p> <p>7: 10,4* →</p> <p>8: 10,5* ↑</p> <p>9: 10,3* →</p> <p>10: 10,5* ↑</p> | <p>Series 2</p>  | <p>1: 10,7* ↓</p> <p>2: 9,7 ←</p> <p>3: 10,2* →</p> <p>4: 10,3* ←</p> <p>5: 9,8 ←</p> <p>6: 9,5 →</p> <p>7: 10,4* ↓</p> <p>8: 10,5* ↑</p> <p>9: 10,3* ↑</p> <p>10: 9,1 →</p> |
| Serie 96,0 | | Serie 96,0 | |
| Sum 96,0 | | Sum 192,0 | |

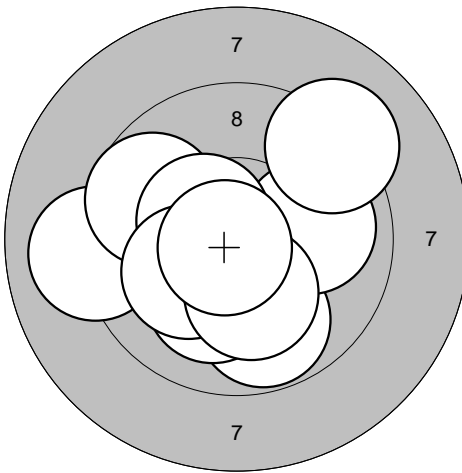
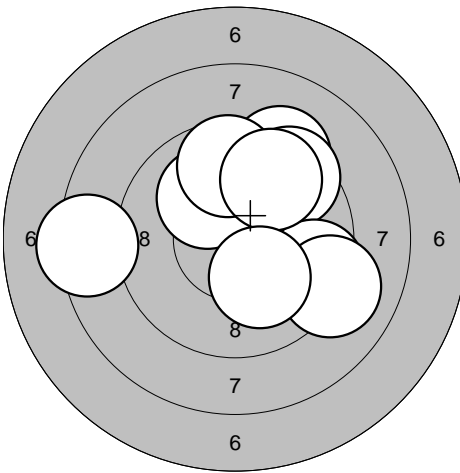
| | | | |
|---|--|---|---|
| <p>Series 3</p>  | <p>1: 9,8 ↓</p> <p>2: 10,0 →</p> <p>3: 10,1 ↓</p> <p>4: 9,1 ←</p> <p>5: 9,7 ←</p> <p>6: 10,4* ↑</p> <p>7: 9,2 →</p> <p>8: 10,2* ←</p> <p>9: 10,2* ↓</p> <p>10: 10,7* ←</p> | <p>Series 4</p>  | <p>1: 9,3 ↑</p> <p>2: 8,3 ←</p> <p>3: 9,5 ↑</p> <p>4: 10,1 ↑</p> <p>5: 10,1 ↑</p> <p>6: 9,7 ↑</p> <p>7: 9,4 →</p> <p>8: 9,1 →</p> <p>9: 9,7 ↑</p> <p>10: 10,1 ↓</p> |
| Serie 96,0 | | Serie 92,0 | |
| Sum 288,0 | | Sum 380,0 | |

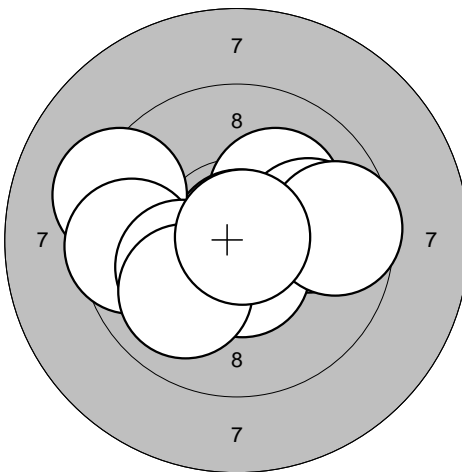
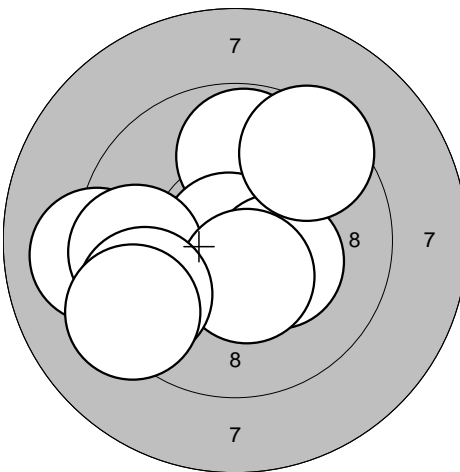
| | | | |
|--|---|--|---|
| <p>Series 5</p>  | <p>1: 10,2* ↑</p> <p>2: 10,0 →</p> <p>3: 10,9* ↑</p> <p>4: 10,6* ↓</p> <p>5: 9,3 ←</p> <p>6: 9,6 ←</p> <p>7: 9,6 →</p> <p>8: 10,1 ←</p> <p>9: 10,0 ↓</p> <p>10: 10,9* →</p> | <p>Series 6</p>  | <p>1: 9,1 ←</p> <p>2: 9,8 ↑</p> <p>3: 10,0 ←</p> <p>4: 10,9* ←</p> <p>5: 9,6 ←</p> <p>6: 10,3* →</p> <p>7: 10,4* ↓</p> <p>8: 9,5 ←</p> <p>9: 9,3 ←</p> <p>10: 9,5 ↑</p> |
| Serie 97,0 | | Serie 94,0 | |
| Sum 477,0 | | Sum 571,0 | |

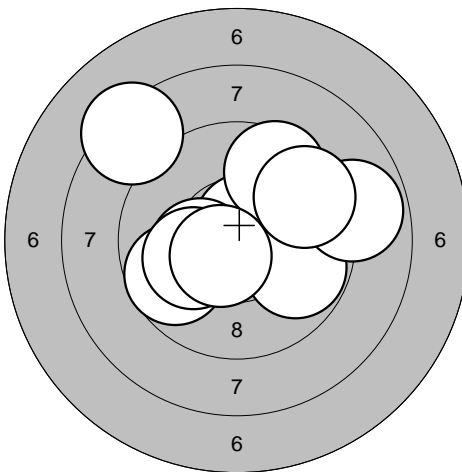
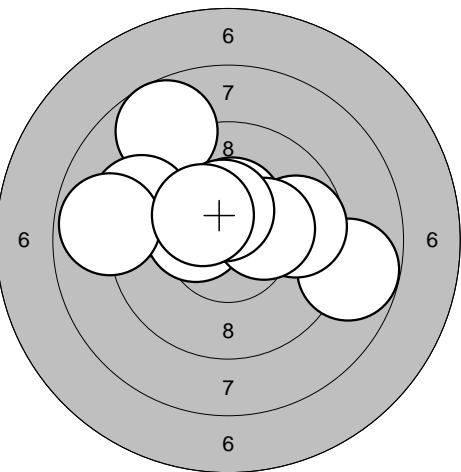
| | | | | | | | | | | | |
|--|---|-------|------|-----|------|--|---|-------|------|-----|-------|
| <p>Series 1</p>  | <p>1: 10,6* ↗ 2: 9,8 → 3: 9,7 ↙ 4: 10,3* ← 5: 10,1 ← 6: 8,8 → 7: 9,6 ↗ 8: 8,3 ↖ 9: 10,6* ↙ 10: 9,5 ↗</p> <table border="1" style="width:100%; border-collapse: collapse;"> <tr><td>Serie</td><td style="text-align: right;">92,0</td></tr> <tr><td>Sum</td><td style="text-align: right;">92,0</td></tr> </table> | Serie | 92,0 | Sum | 92,0 | <p>Series 2</p>  | <p>1: 8,7 ↗ 2: 8,8 → 3: 9,3 ↙ 4: 10,4* ← 5: 8,9 ← 6: 9,7 → 7: 10,4* ↑ 8: 10,3* → 9: 10,4* ↑ 10: 10,3* ↖</p> <table border="1" style="width:100%; border-collapse: collapse;"> <tr><td>Serie</td><td style="text-align: right;">92,0</td></tr> <tr><td>Sum</td><td style="text-align: right;">184,0</td></tr> </table> | Serie | 92,0 | Sum | 184,0 |
| Serie | 92,0 | | | | | | | | | | |
| Sum | 92,0 | | | | | | | | | | |
| Serie | 92,0 | | | | | | | | | | |
| Sum | 184,0 | | | | | | | | | | |

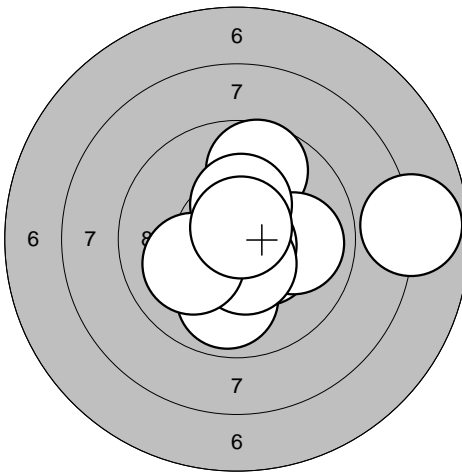
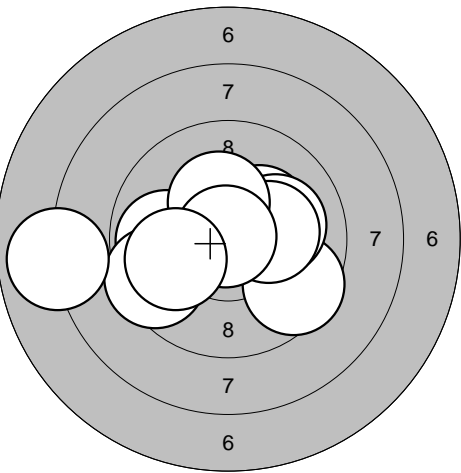
| | | | | | | | | | | | |
|---|---|-------|------|-----|-------|---|---|-------|------|-----|-------|
| <p>Series 3</p>  | <p>1: 9,9 ↓ 2: 9,7 ↗ 3: 10,4* → 4: 10,0 → 5: 7,9 → 6: 10,3* ↑ 7: 10,7* → 8: 10,5* ↓ 9: 10,1 ↙ 10: 10,7* ↗</p> <table border="1" style="width:100%; border-collapse: collapse;"> <tr><td>Serie</td><td style="text-align: right;">95,0</td></tr> <tr><td>Sum</td><td style="text-align: right;">279,0</td></tr> </table> | Serie | 95,0 | Sum | 279,0 | <p>Series 4</p>  | <p>1: 9,9 ← 2: 9,6 ↘ 3: 10,3* ↗ 4: 10,1 → 5: 9,5 ↙ 6: 10,2* → 7: 10,3* ↑ 8: 7,9 ← 9: 10,9* ↗ 10: 10,0 ←</p> <table border="1" style="width:100%; border-collapse: collapse;"> <tr><td>Serie</td><td style="text-align: right;">94,0</td></tr> <tr><td>Sum</td><td style="text-align: right;">373,0</td></tr> </table> | Serie | 94,0 | Sum | 373,0 |
| Serie | 95,0 | | | | | | | | | | |
| Sum | 279,0 | | | | | | | | | | |
| Serie | 94,0 | | | | | | | | | | |
| Sum | 373,0 | | | | | | | | | | |

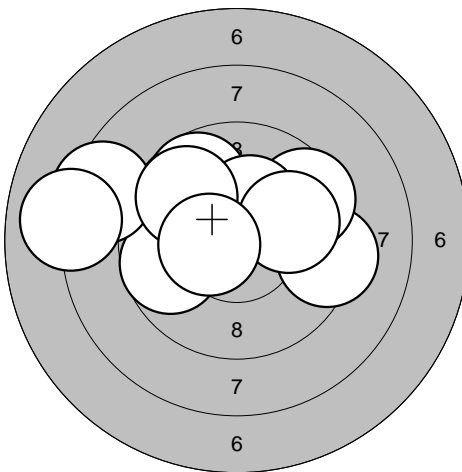
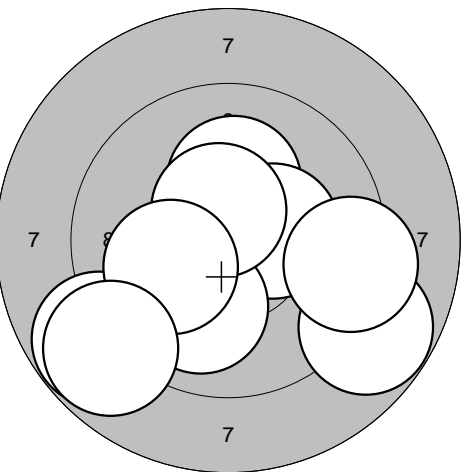
| | | | | | | | | | | | |
|--|--|-------|------|-----|-------|--|--|-------|------|-----|-------|
| <p>Series 5</p>  | <p>1: 9,7 ← 2: 9,3 → 3: 8,4 ↙ 4: 9,6 ↗ 5: 9,7 ↗ 6: 10,3* ↑ 7: 8,0 ← 8: 9,8 ↗ 9: 10,0 → 10: 10,5* ←</p> <table border="1" style="width:100%; border-collapse: collapse;"> <tr><td>Serie</td><td style="text-align: right;">91,0</td></tr> <tr><td>Sum</td><td style="text-align: right;">464,0</td></tr> </table> | Serie | 91,0 | Sum | 464,0 | <p>Series 6</p>  | <p>1: 10,0 ↙ 2: 10,2* ↑ 3: 10,3* → 4: 10,0 ↓ 5: 10,5* ↑ 6: 8,8 ↙ 7: 10,1 ↙ 8: 8,8 ↘ 9: 9,3 → 10: 8,8 ↙</p> <table border="1" style="width:100%; border-collapse: collapse;"> <tr><td>Serie</td><td style="text-align: right;">93,0</td></tr> <tr><td>Sum</td><td style="text-align: right;">557,0</td></tr> </table> | Serie | 93,0 | Sum | 557,0 |
| Serie | 91,0 | | | | | | | | | | |
| Sum | 464,0 | | | | | | | | | | |
| Serie | 93,0 | | | | | | | | | | |
| Sum | 557,0 | | | | | | | | | | |

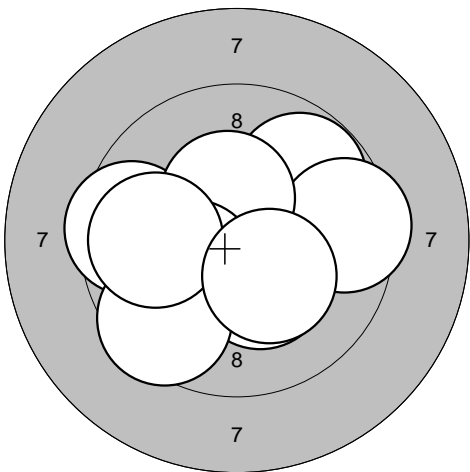
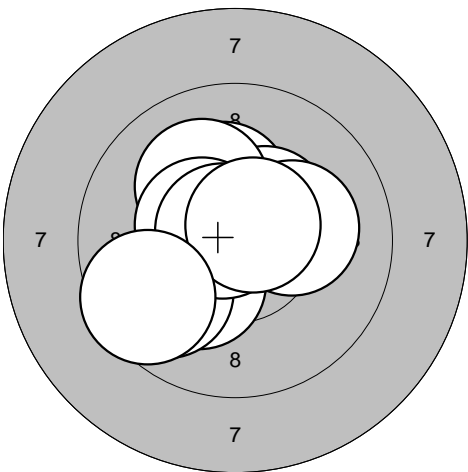
| | | | | | | | | | | | |
|--|---|-------|------|-----|------|--|---|-------|------|-----|-------|
| <p>Series 1</p>  | <p>1: 9,5 ←</p> <p>2: 9,8 ↗</p> <p>3: 9,5 →</p> <p>4: 10,3* ↙</p> <p>5: 10,3* ↘</p> <p>6: 10,4* ↑</p> <p>7: 10,3* ↙</p> <p>8: 9,5 ↙</p> <p>9: 9,9 ←</p> <p>10: 10,3* ↘</p> <table border="1" style="width:100%; border-collapse: collapse;"> <tr><td>Serie</td><td style="text-align: right;">95,0</td></tr> <tr><td>Sum</td><td style="text-align: right;">95,0</td></tr> </table> | Serie | 95,0 | Sum | 95,0 | <p>Series 2</p>  | <p>1: 10,3* ↑</p> <p>2: 10,2* ↙</p> <p>3: 10,4* ↗</p> <p>4: 9,8 ↙</p> <p>5: 10,2* →</p> <p>6: 10,1 ↗</p> <p>7: 10,5* ↙</p> <p>8: 10,8* ↖</p> <p>9: 10,6* ↗</p> <p>10: 9,6 ↙</p> <table border="1" style="width:100%; border-collapse: collapse;"> <tr><td>Serie</td><td style="text-align: right;">98,0</td></tr> <tr><td>Sum</td><td style="text-align: right;">193,0</td></tr> </table> | Serie | 98,0 | Sum | 193,0 |
| Serie | 95,0 | | | | | | | | | | |
| Sum | 95,0 | | | | | | | | | | |
| Serie | 98,0 | | | | | | | | | | |
| Sum | 193,0 | | | | | | | | | | |

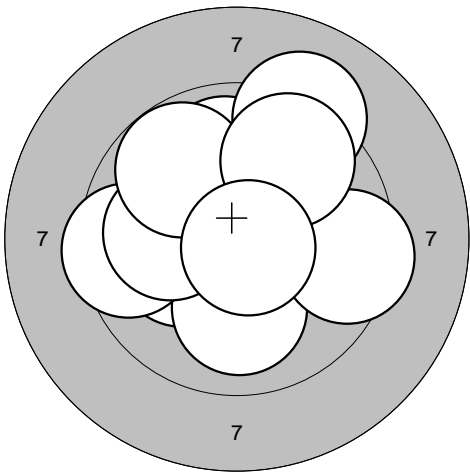
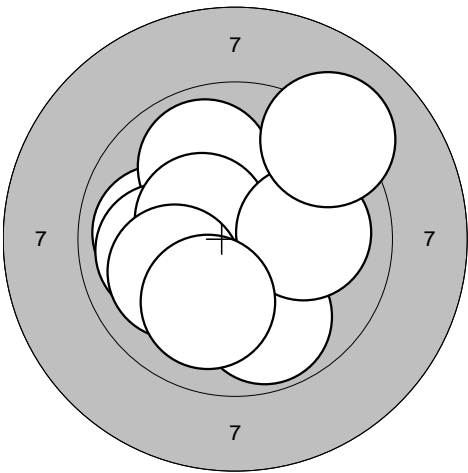
| | | | | | | | | | | | |
|---|---|-------|------|-----|-------|---|---|-------|------|-----|-------|
| <p>Series 3</p>  | <p>1: 10,2* ←</p> <p>2: 10,0 ↓</p> <p>3: 10,0 ↑</p> <p>4: 9,5 ←</p> <p>5: 10,1 ←</p> <p>6: 9,5 →</p> <p>7: 9,8 ↗</p> <p>8: 9,1 ↗</p> <p>9: 9,7 ↗</p> <p>10: 10,8* ↘</p> <table border="1" style="width:100%; border-collapse: collapse;"> <tr><td>Serie</td><td style="text-align: right;">95,0</td></tr> <tr><td>Sum</td><td style="text-align: right;">288,0</td></tr> </table> | Serie | 95,0 | Sum | 288,0 | <p>Series 4</p>  | <p>1: 10,0 ←</p> <p>2: 9,9 ↑</p> <p>3: 10,5* ↙</p> <p>4: 10,0 ←</p> <p>5: 10,4* ↖</p> <p>6: 10,0 ↙</p> <p>7: 9,8 ↓</p> <p>8: 10,0 →</p> <p>9: 10,0 ↓</p> <p>10: 9,1 ↗</p> <table border="1" style="width:100%; border-collapse: collapse;"> <tr><td>Serie</td><td style="text-align: right;">97,0</td></tr> <tr><td>Sum</td><td style="text-align: right;">385,0</td></tr> </table> | Serie | 97,0 | Sum | 385,0 |
| Serie | 95,0 | | | | | | | | | | |
| Sum | 288,0 | | | | | | | | | | |
| Serie | 97,0 | | | | | | | | | | |
| Sum | 385,0 | | | | | | | | | | |

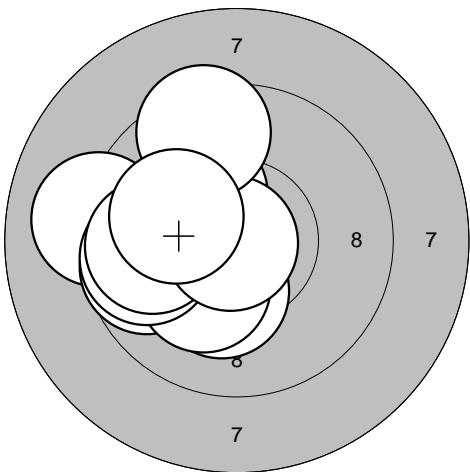
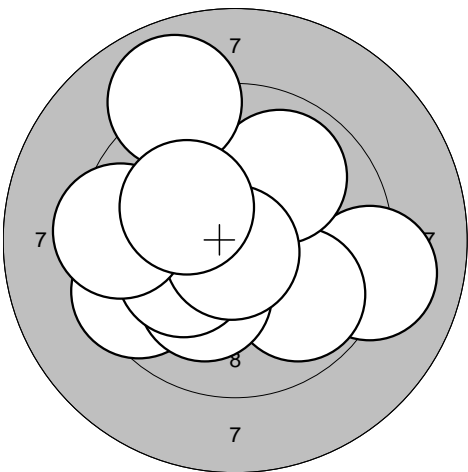
| | | | | | | | | | | | |
|--|---|-------|------|-----|-------|--|--|-------|------|-----|-------|
| <p>Series 5</p>  | <p>1: 9,1 ←</p> <p>2: 10,2* ↓</p> <p>3: 9,7 ←</p> <p>4: 10,2* ↙</p> <p>5: 9,7 ←</p> <p>6: 10,2* ↗</p> <p>7: 9,8 ←</p> <p>8: 10,9* ↙</p> <p>9: 9,5 ↑</p> <p>10: 10,1 ↙</p> <table border="1" style="width:100%; border-collapse: collapse;"> <tr><td>Serie</td><td style="text-align: right;">95,0</td></tr> <tr><td>Sum</td><td style="text-align: right;">480,0</td></tr> </table> | Serie | 95,0 | Sum | 480,0 | <p>Series 6</p>  | <p>1: 9,1 →</p> <p>2: 9,5 ↙</p> <p>3: 9,8 ↘</p> <p>4: 10,1 ↙</p> <p>5: 10,1 ↙</p> <p>6: 9,9 ↗</p> <p>7: 10,8* ↘</p> <p>8: 8,9 ↑</p> <p>9: 9,4 ←</p> <p>10: 10,2* ↖</p> <table border="1" style="width:100%; border-collapse: collapse;"> <tr><td>Serie</td><td style="text-align: right;">93,0</td></tr> <tr><td>Sum</td><td style="text-align: right;">573,0</td></tr> </table> | Serie | 93,0 | Sum | 573,0 |
| Serie | 95,0 | | | | | | | | | | |
| Sum | 480,0 | | | | | | | | | | |
| Serie | 93,0 | | | | | | | | | | |
| Sum | 573,0 | | | | | | | | | | |

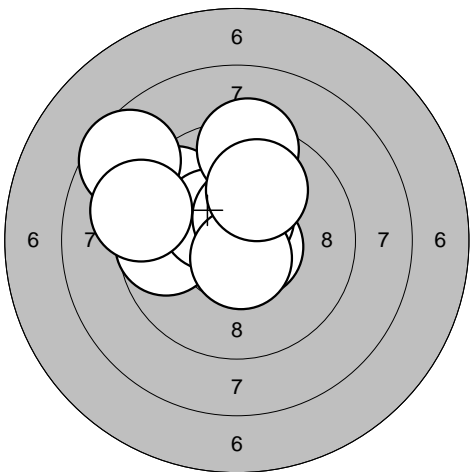
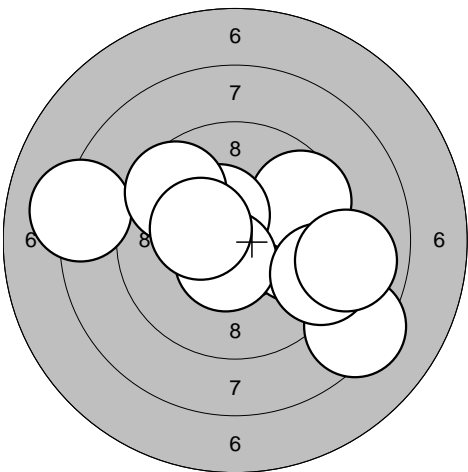
| | | | |
|--|---|--|--|
| <p>Series 1</p>  | <p>1: 9,7 ←</p> <p>2: 10,6* →</p> <p>3: 9,6 ↗</p> <p>4: 10,4* ↗</p> <p>5: 8,6 ↗</p> <p>6: 10,5* ↗</p> <p>7: 9,3 ↗</p> <p>8: 10,6* ↓</p> <p>9: 10,0 ↗</p> <p>10: 9,2 ←</p> | <p>Series 2</p>  | <p>1: 9,9 →</p> <p>2: 9,6 ↗</p> <p>3: 10,4* ↗</p> <p>4: 10,5* ↓</p> <p>5: 8,4 ↓</p> <p>6: 8,2 ←</p> <p>7: 9,3 →</p> <p>8: 9,6 ↗</p> <p>9: 9,0 →</p> <p>10: 10,3* ←</p> |
| Serie 94,0 | Serie 91,0 | Serie 91,0 | Serie 91,0 |
| Sum 94,0 | Sum 94,0 | Sum 185,0 | Sum 185,0 |

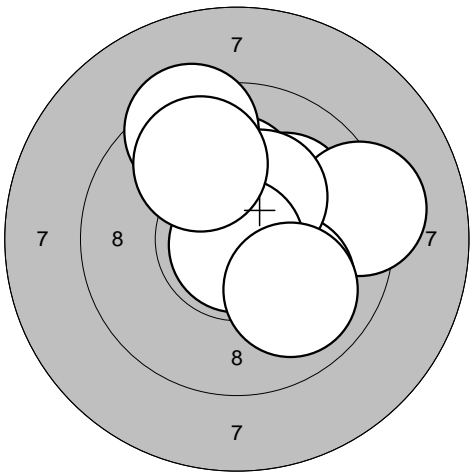
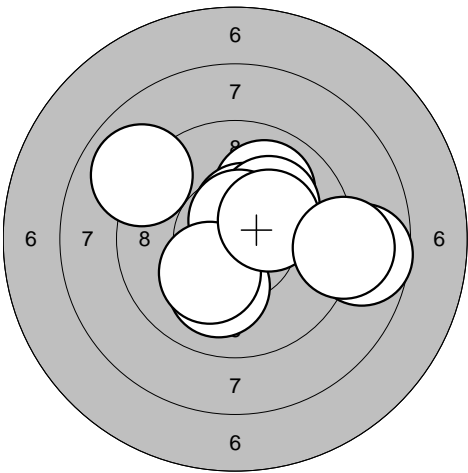
| | | | |
|---|---|---|---|
| <p>Series 3</p>  | <p>1: 10,1 ↗</p> <p>2: 9,3 →</p> <p>3: 10,2* ↑</p> <p>4: 10,1 ↓</p> <p>5: 10,3* ↑</p> <p>6: 10,3* ↗</p> <p>7: 10,9* ↓</p> <p>8: 9,4 ↗</p> <p>9: 10,0 ↓</p> <p>10: 9,8 ↗</p> | <p>Series 4</p>  | <p>1: 9,0 ↖</p> <p>2: 10,0 ↗</p> <p>3: 10,5* ↑</p> <p>4: 10,1 ↗</p> <p>5: 10,1 ↓</p> <p>6: 10,6* ↑</p> <p>7: 10,2* ↓</p> <p>8: 8,7 →</p> <p>9: 10,3* ↗</p> <p>10: 9,0 →</p> |
| Serie 97,0 | Serie 97,0 | Serie 96,0 | Serie 96,0 |
| Sum 282,0 | Sum 282,0 | Sum 378,0 | Sum 378,0 |

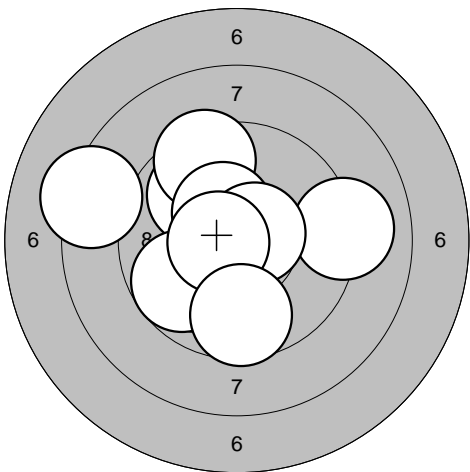
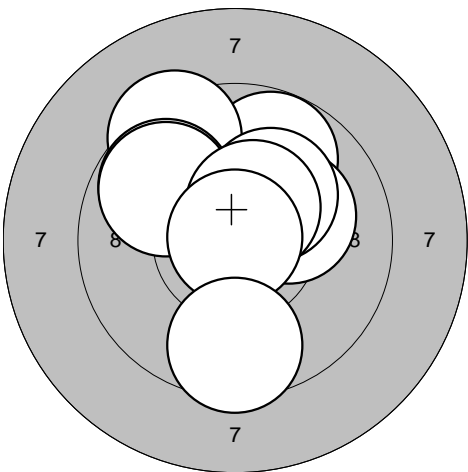
| | | | |
|--|---|--|--|
| <p>Series 5</p>  | <p>1: 9,9 ↗</p> <p>2: 9,4 ↗</p> <p>3: 10,0 ↓</p> <p>4: 8,3 ←</p> <p>5: 9,1 →</p> <p>6: 10,4* ↗</p> <p>7: 10,6* →</p> <p>8: 9,7 ←</p> <p>9: 10,6* ←</p> <p>10: 9,6 ↓</p> | <p>Series 6</p>  | <p>1: 9,8 ↗</p> <p>2: 9,4 ↖</p> <p>3: 10,6* ↗</p> <p>4: 9,8 ↖</p> <p>5: 10,2* →</p> <p>6: 10,2* ↗</p> <p>7: 9,8 ↖</p> <p>8: 10,5* ↗</p> <p>9: 10,9* ↑</p> <p>10: 9,5 ↓</p> |
| Serie 93,0 | Serie 93,0 | Serie 95,0 | Serie 95,0 |
| Sum 471,0 | Sum 471,0 | Sum 566,0 | Sum 566,0 |

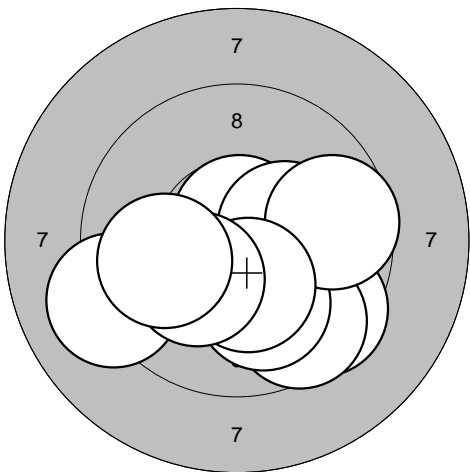
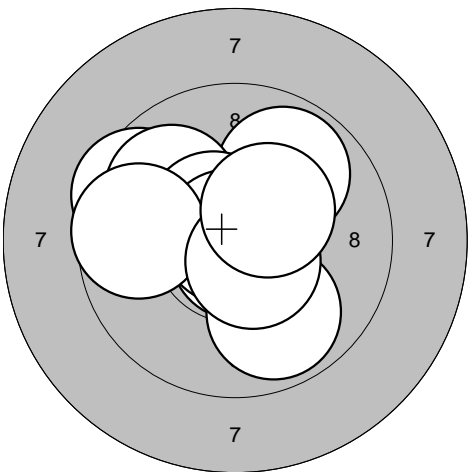
| | | | | | | | | | | | |
|--|--|-------|------|-----|------|--|--|-------|------|-----|-------|
| <p>Series 1</p>  | <p>1: 10,7* ↑</p> <p>2: 9,5 ↘</p> <p>3: 9,6 ↘</p> <p>4: 9,1 ↙</p> <p>5: 10,3* →</p> <p>6: 10,0 ↘</p> <p>7: 9,6 →</p> <p>8: 10,3* ↘</p> <p>9: 10,2* ↙</p> <p>10: 9,9 ←</p> <table border="1" style="width:100%; border-collapse: collapse;"> <tr><td>Serie</td><td style="text-align: right;">95,0</td></tr> <tr><td>Sum</td><td style="text-align: right;">95,0</td></tr> </table> | Serie | 95,0 | Sum | 95,0 | <p>Series 2</p>  | <p>1: 9,5 ↖</p> <p>2: 9,9 ↗</p> <p>3: 10,8* ↓</p> <p>4: 9,9 ↗</p> <p>5: 10,6* ↗</p> <p>6: 9,8 ↓</p> <p>7: 10,9* ↖</p> <p>8: 9,7 ←</p> <p>9: 10,6* ↘</p> <p>10: 10,4* ↗</p> <table border="1" style="width:100%; border-collapse: collapse;"> <tr><td>Serie</td><td style="text-align: right;">95,0</td></tr> <tr><td>Sum</td><td style="text-align: right;">190,0</td></tr> </table> | Serie | 95,0 | Sum | 190,0 |
| Serie | 95,0 | | | | | | | | | | |
| Sum | 95,0 | | | | | | | | | | |
| Serie | 95,0 | | | | | | | | | | |
| Sum | 190,0 | | | | | | | | | | |

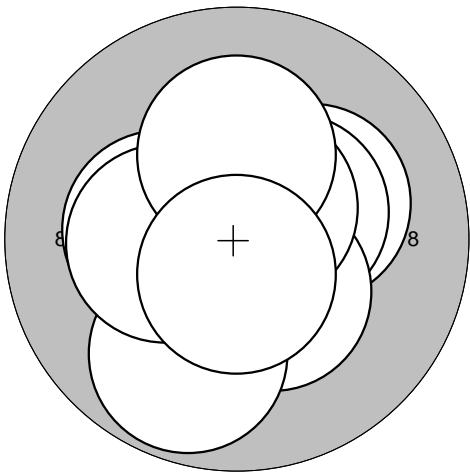
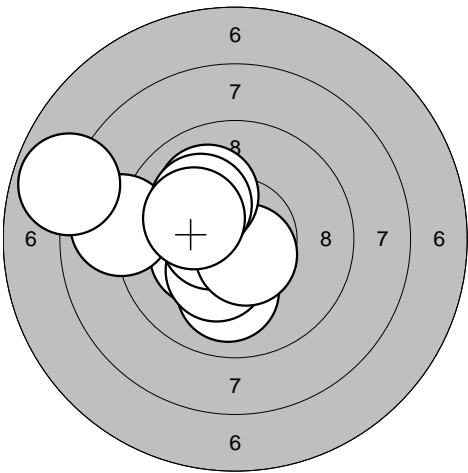
| | | | | | | | | | | | |
|---|--|-------|------|-----|-------|---|---|-------|------|-----|-------|
| <p>Series 3</p>  | <p>1: 10,2* →</p> <p>2: 10,4* →</p> <p>3: 10,3* ↘</p> <p>4: 9,8 ↘</p> <p>5: 10,3* ←</p> <p>6: 10,7* ←</p> <p>7: 10,3* ←</p> <p>8: 10,6* ↗</p> <p>9: 10,2* ↑</p> <p>10: 10,6* ↓</p> <table border="1" style="width:100%; border-collapse: collapse;"> <tr><td>Serie</td><td style="text-align: right;">99,0</td></tr> <tr><td>Sum</td><td style="text-align: right;">289,0</td></tr> </table> | Serie | 99,0 | Sum | 289,0 | <p>Series 4</p>  | <p>1: 10,0 ↓</p> <p>2: 10,3* ↙</p> <p>3: 8,9 ←</p> <p>4: 10,3* ↘</p> <p>5: 10,5* ←</p> <p>6: 10,6* ↘</p> <p>7: 7,9 ↙</p> <p>8: 10,1 ↗</p> <p>9: 10,1 ↗</p> <p>10: 10,2* ↖</p> <table border="1" style="width:100%; border-collapse: collapse;"> <tr><td>Serie</td><td style="text-align: right;">95,0</td></tr> <tr><td>Sum</td><td style="text-align: right;">384,0</td></tr> </table> | Serie | 95,0 | Sum | 384,0 |
| Serie | 99,0 | | | | | | | | | | |
| Sum | 289,0 | | | | | | | | | | |
| Serie | 95,0 | | | | | | | | | | |
| Sum | 384,0 | | | | | | | | | | |

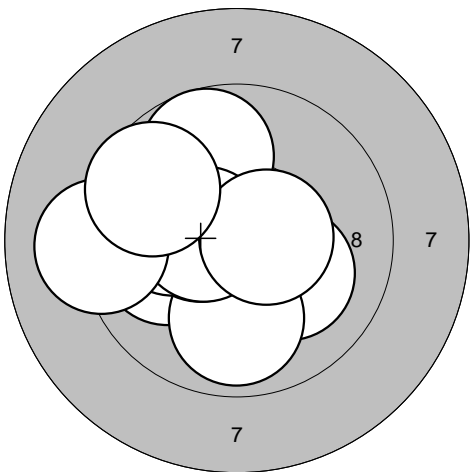
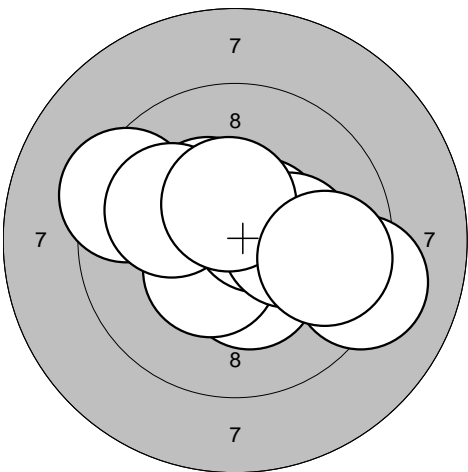
| | | | | | | | | | | | |
|--|---|-------|------|-----|-------|--|---|-------|------|-----|-------|
| <p>Series 5</p>  | <p>1: 9,8 ↑</p> <p>2: 10,1 ↘</p> <p>3: 10,0 ←</p> <p>4: 9,9 ↓</p> <p>5: 10,4* ←</p> <p>6: 10,1 ←</p> <p>7: 10,5* ←</p> <p>8: 9,1 ←</p> <p>9: 10,6* →</p> <p>10: 9,6 ↖</p> <table border="1" style="width:100%; border-collapse: collapse;"> <tr><td>Serie</td><td style="text-align: right;">96,0</td></tr> <tr><td>Sum</td><td style="text-align: right;">480,0</td></tr> </table> | Serie | 96,0 | Sum | 480,0 | <p>Series 6</p>  | <p>1: 10,4* ↓</p> <p>2: 10,3* ↗</p> <p>3: 9,2 →</p> <p>4: 10,4* ↘</p> <p>5: 9,4 ↖</p> <p>6: 10,6* ↗</p> <p>7: 10,2* →</p> <p>8: 10,0 ↖</p> <p>9: 10,4* ↑</p> <p>10: 9,7 →</p> <table border="1" style="width:100%; border-collapse: collapse;"> <tr><td>Serie</td><td style="text-align: right;">97,0</td></tr> <tr><td>Sum</td><td style="text-align: right;">577,0</td></tr> </table> | Serie | 97,0 | Sum | 577,0 |
| Serie | 96,0 | | | | | | | | | | |
| Sum | 480,0 | | | | | | | | | | |
| Serie | 97,0 | | | | | | | | | | |
| Sum | 577,0 | | | | | | | | | | |

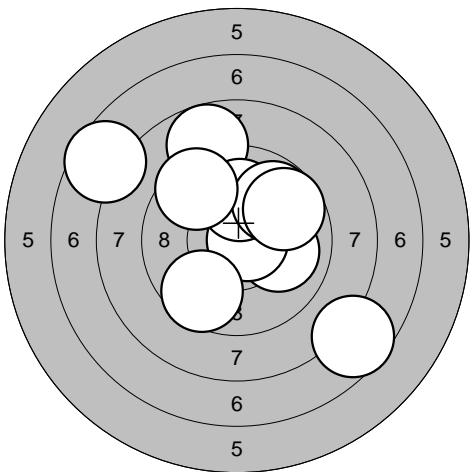
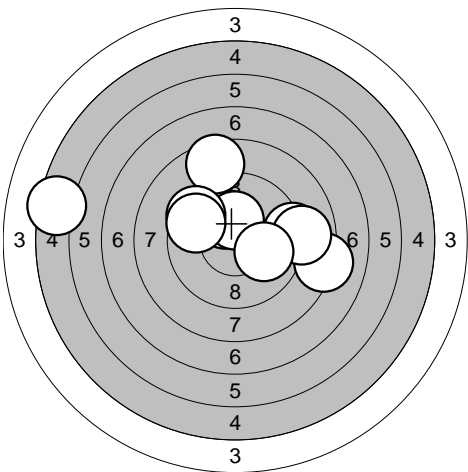
| | | | |
|---|--|---|---|
| <p>Series 1</p>  | <p>1: 10,0 →</p> <p>2: 10,7* →</p> <p>3: 8,8 ↑</p> <p>4: 7,6 ↖</p> <p>5: 9,6 ↙</p> <p>6: 10,1 ↑</p> <p>7: 7,6 ↘</p> <p>8: 9,8 ↗</p> <p>9: 9,5 ↖</p> <p>10: 9,7 ↗</p> | <p>Series 2</p>  | <p>1: 10,2* ↖</p> <p>2: 5,4 ←</p> <p>3: 10,4* ↑</p> <p>4: 8,1 →</p> <p>5: 8,6 ↑</p> <p>6: 9,2 →</p> <p>7: 9,5 ↖</p> <p>8: 8,9 →</p> <p>9: 10,0 →</p> <p>10: 9,6 ←</p> |
| Serie 88,0 | | Serie 86,0 | |
| Sum 88,0 | | Sum 174,0 | |

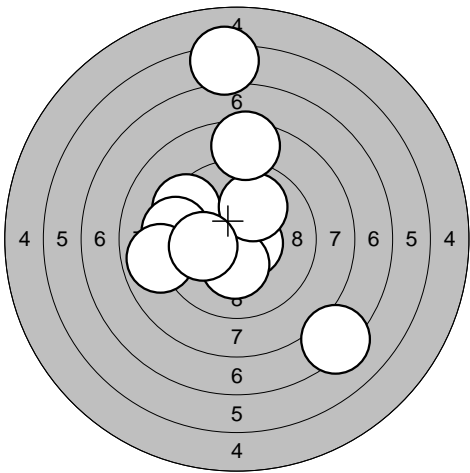
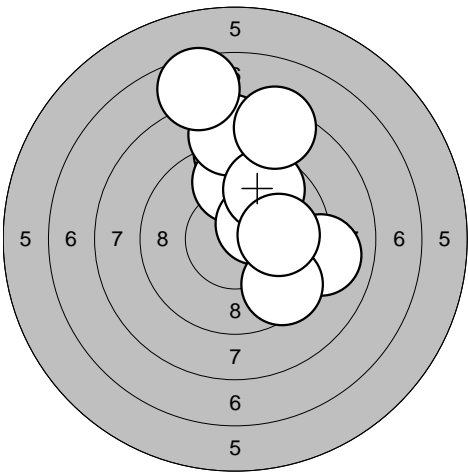
| | | | |
|--|--|--|---|
| <p>Series 3</p>  | <p>1: 9,4 ↖</p> <p>2: 9,3 ←</p> <p>3: 6,3 ↑</p> <p>4: 10,6* →</p> <p>5: 10,3* ↓</p> <p>6: 10,0 ↑</p> <p>7: 7,3 ↘</p> <p>8: 8,5 ↑</p> <p>9: 8,9 ←</p> <p>10: 10,1 ←</p> | <p>Series 4</p>  | <p>1: 9,0 →</p> <p>2: 9,1 ↑</p> <p>3: 9,7 ↑</p> <p>4: 10,4* ↗</p> <p>5: 8,7 ↑</p> <p>6: 9,5 ↘</p> <p>7: 9,7 ↗</p> <p>8: 8,4 ↑</p> <p>9: 10,0 →</p> <p>10: 7,6 ↑</p> |
| Serie 87,0 | | Serie 88,0 | |
| Sum 261,0 | | Sum 349,0 | |

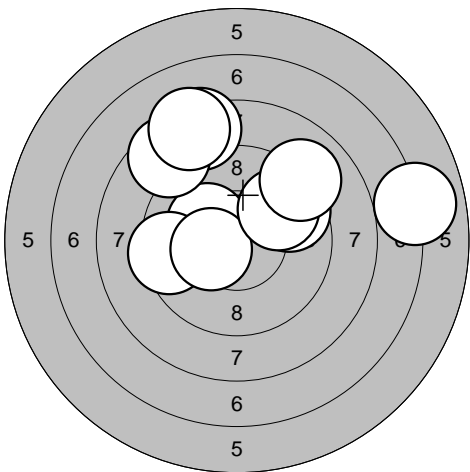
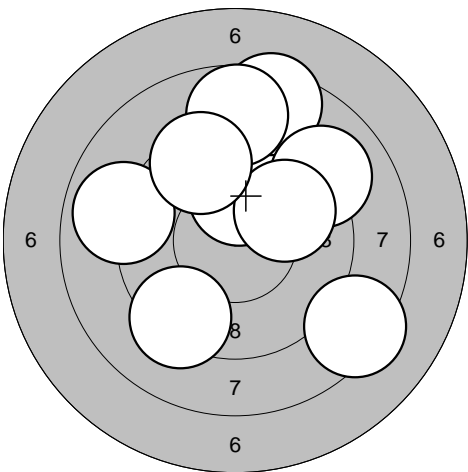
| | | | |
|---|--|---|---|
| <p>Series 5</p>  | <p>1: 10,2* ↖</p> <p>2: 8,4 ↑</p> <p>3: 9,6 →</p> <p>4: 9,4 ←</p> <p>5: 8,6 ↖</p> <p>6: 7,0 →</p> <p>7: 10,4* ←</p> <p>8: 9,8 ↗</p> <p>9: 8,3 ↖</p> <p>10: 9,0 ↗</p> | <p>Series 6</p>  | <p>1: 10,1 ↑</p> <p>2: 9,1 ↑</p> <p>3: 8,5 ↑</p> <p>4: 8,9 ←</p> <p>5: 9,3 ↙</p> <p>6: 8,3 ↘</p> <p>7: 8,8 ↑</p> <p>8: 9,1 ↗</p> <p>9: 9,9 ↗</p> <p>10: 9,5 ↖</p> |
| Serie 87,0 | | Serie 87,0 | |
| Sum 436,0 | | Sum 523,0 | |

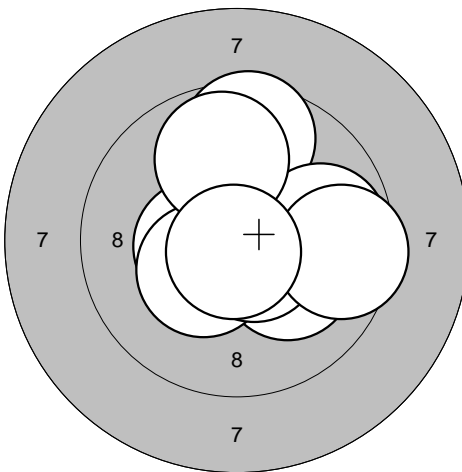
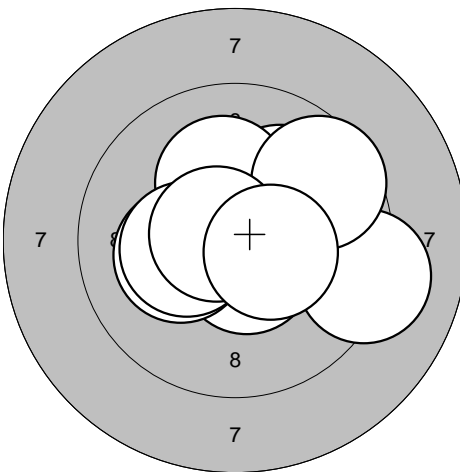
| | | | | | | | | | | | |
|--|--|-------|------|-----|------|--|---|-------|------|-----|-------|
| <p>Series 1</p>  | <p>1: 10,5* ←</p> <p>2: 10,4* →</p> <p>3: 10,1 →</p> <p>4: 9,6 ↑</p> <p>5: 10,3* ↙</p> <p>6: 10,7* ↘</p> <p>7: 9,8 →</p> <p>8: 9,5 →</p> <p>9: 9,8 ↑</p> <p>10: 10,8* ↓</p> <table border="1" style="width:100%; border-collapse: collapse;"> <tr> <td style="text-align: right;">Serie</td> <td style="text-align: right;">96,0</td> </tr> <tr> <td style="text-align: right;">Sum</td> <td style="text-align: right;">96,0</td> </tr> </table> | Serie | 96,0 | Sum | 96,0 | <p>Series 2</p>  | <p>1: 10,1 ↗</p> <p>2: 10,6* ←</p> <p>3: 9,2 →</p> <p>4: 10,6* ↓</p> <p>5: 10,2* ←</p> <p>6: 10,2* ↑</p> <p>7: 9,6 ↗</p> <p>8: 10,3* ←</p> <p>9: 10,7* ←</p> <p>10: 10,4* →</p> <table border="1" style="width:100%; border-collapse: collapse;"> <tr> <td style="text-align: right;">Serie</td> <td style="text-align: right;">98,0</td> </tr> <tr> <td style="text-align: right;">Sum</td> <td style="text-align: right;">194,0</td> </tr> </table> | Serie | 98,0 | Sum | 194,0 |
| Serie | 96,0 | | | | | | | | | | |
| Sum | 96,0 | | | | | | | | | | |
| Serie | 98,0 | | | | | | | | | | |
| Sum | 194,0 | | | | | | | | | | |

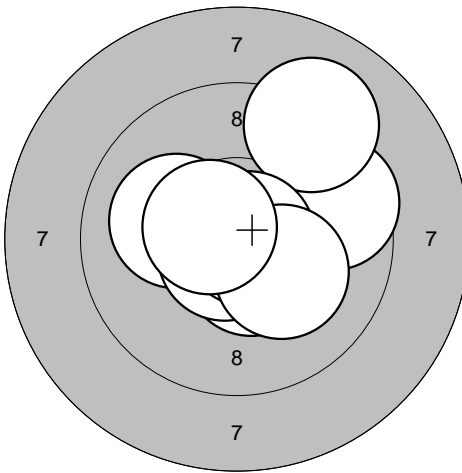
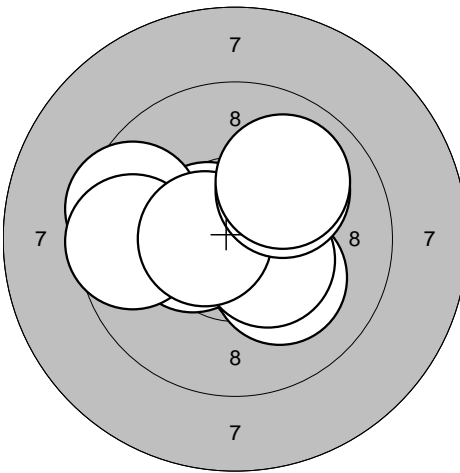
| | | | | | | | | | | | |
|---|---|-------|------|-----|-------|---|--|-------|------|-----|-------|
| <p>Series 3</p>  | <p>1: 10,5* ↓</p> <p>2: 10,6* ←</p> <p>3: 10,5* →</p> <p>4: 9,6 →</p> <p>5: 10,1 ←</p> <p>6: 10,7* ↙</p> <p>7: 9,1 ↗</p> <p>8: 10,8* →</p> <p>9: 10,2* ↓</p> <p>10: 10,5* ←</p> <table border="1" style="width:100%; border-collapse: collapse;"> <tr> <td style="text-align: right;">Serie</td> <td style="text-align: right;">98,0</td> </tr> <tr> <td style="text-align: right;">Sum</td> <td style="text-align: right;">292,0</td> </tr> </table> | Serie | 98,0 | Sum | 292,0 | <p>Series 4</p>  | <p>1: 10,4* ↘</p> <p>2: 10,6* ←</p> <p>3: 10,4* ←</p> <p>4: 9,5 ←</p> <p>5: 9,6 ←</p> <p>6: 10,2* ↘</p> <p>7: 10,4* ↘</p> <p>8: 10,6* ←</p> <p>9: 10,0 ↗</p> <p>10: 10,0 ↗</p> <table border="1" style="width:100%; border-collapse: collapse;"> <tr> <td style="text-align: right;">Serie</td> <td style="text-align: right;">98,0</td> </tr> <tr> <td style="text-align: right;">Sum</td> <td style="text-align: right;">390,0</td> </tr> </table> | Serie | 98,0 | Sum | 390,0 |
| Serie | 98,0 | | | | | | | | | | |
| Sum | 292,0 | | | | | | | | | | |
| Serie | 98,0 | | | | | | | | | | |
| Sum | 390,0 | | | | | | | | | | |

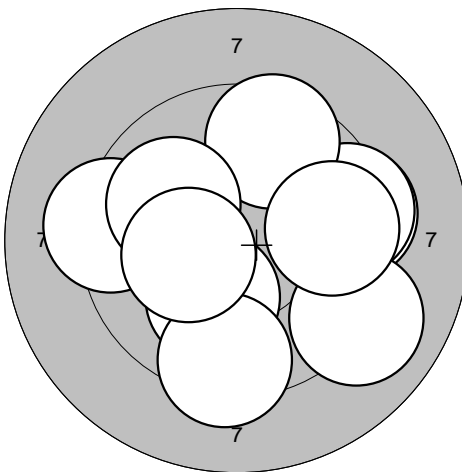
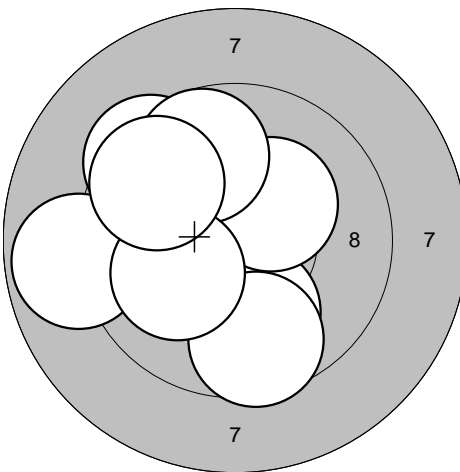
| | | | | | | | | | | | |
|--|--|-------|------|-----|-------|--|--|-------|------|-----|-------|
| <p>Series 5</p>  | <p>1: 10,1 ↓</p> <p>2: 9,4 →</p> <p>3: 9,4 →</p> <p>4: 9,0 ↓</p> <p>5: 9,3 ←</p> <p>6: 9,6 ↑</p> <p>7: 9,4 ↓</p> <p>8: 10,0 ↗</p> <p>9: 10,3* ←</p> <p>10: 9,6 →</p> <table border="1" style="width:100%; border-collapse: collapse;"> <tr> <td style="text-align: right;">Serie</td> <td style="text-align: right;">93,0</td> </tr> <tr> <td style="text-align: right;">Sum</td> <td style="text-align: right;">483,0</td> </tr> </table> | Serie | 93,0 | Sum | 483,0 | <p>Series 6</p>  | <p>1: 10,8* ←</p> <p>2: 10,0 ←</p> <p>3: 9,9 ↓</p> <p>4: 10,3* ↗</p> <p>5: 8,9 ←</p> <p>6: 9,6 ↓</p> <p>7: 9,4 ↗</p> <p>8: 9,7 ↑</p> <p>9: 10,1 ←</p> <p>10: 9,7 ↗</p> <table border="1" style="width:100%; border-collapse: collapse;"> <tr> <td style="text-align: right;">Serie</td> <td style="text-align: right;">93,0</td> </tr> <tr> <td style="text-align: right;">Sum</td> <td style="text-align: right;">576,0</td> </tr> </table> | Serie | 93,0 | Sum | 576,0 |
| Serie | 93,0 | | | | | | | | | | |
| Sum | 483,0 | | | | | | | | | | |
| Serie | 93,0 | | | | | | | | | | |
| Sum | 576,0 | | | | | | | | | | |

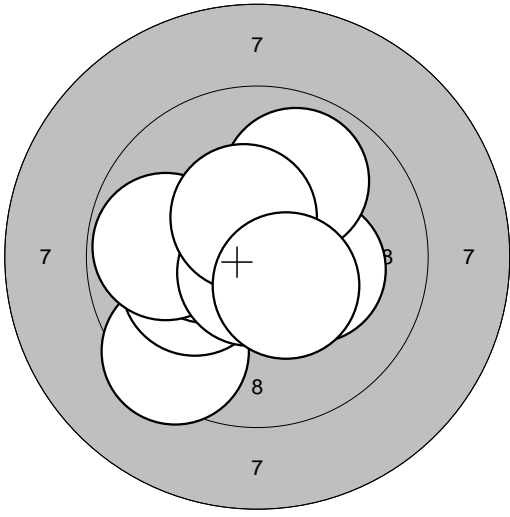
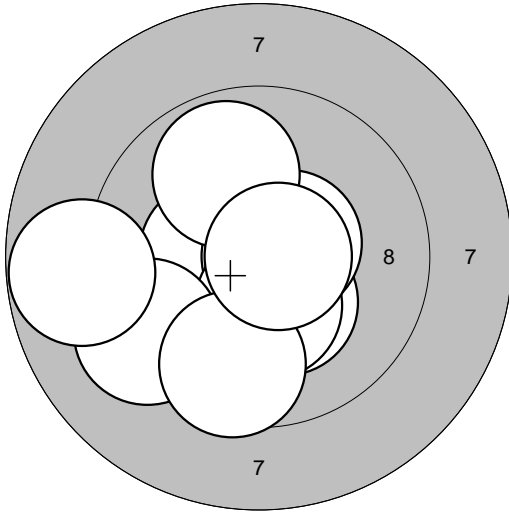
| | | |
|---|--|--|
| <p>Series 1</p>  | <p>Series 2</p>  | |
| <p>1: 10,3* →</p> <p>2: 9,4 ↘</p> <p>3: 10,6* ←</p> <p>4: 10,1 ←</p> <p>5: 10,3* ←</p> <p>6: 9,8 ←</p> <p>7: 10,7* ↘</p> <p>8: 9,9 ↗</p> <p>9: 10,5* ↗</p> <p>10: 10,4* ↘</p> | <p>1: 10,4* ←</p> <p>2: 10,8* →</p> <p>3: 10,3* ↘</p> <p>4: 10,3* ↘</p> <p>5: 9,3 ↘</p> <p>6: 10,6* →</p> <p>7: 9,9 ↗</p> <p>8: 8,8 ←</p> <p>9: 9,6 ↘</p> <p>10: 10,7* →</p> | |
| Serie 97,0 | Serie 95,0 | |
| Sum 97,0 | Sum 192,0 | |

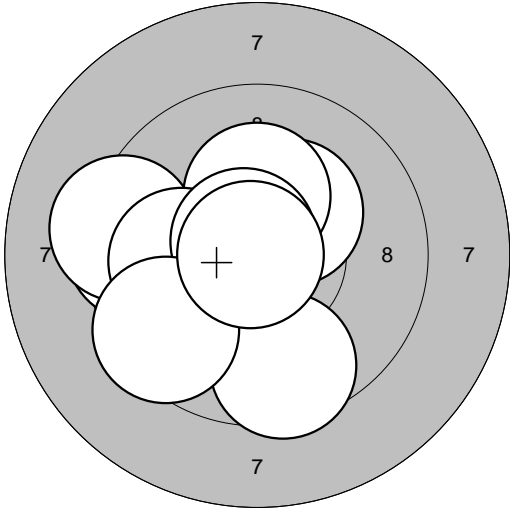
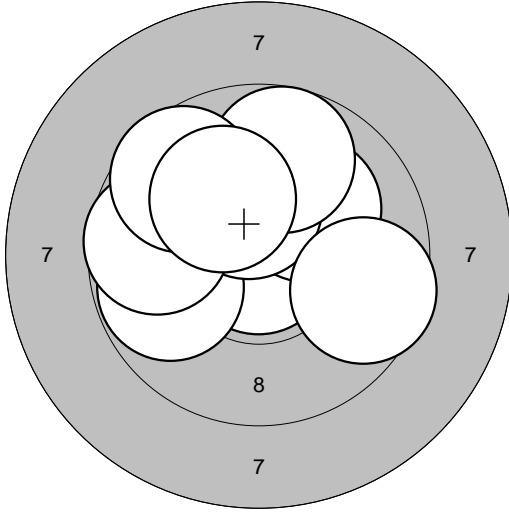
| | | |
|---|--|--|
| <p>Series 3</p>  | <p>Series 4</p>  | |
| <p>1: 10,3* ↘</p> <p>2: 9,6 ↘</p> <p>3: 10,3* ↗</p> <p>4: 10,2* ↑</p> <p>5: 9,5 ←</p> <p>6: 9,3 ←</p> <p>7: 10,0 ←</p> <p>8: 10,7* ↗</p> <p>9: 9,5 ↘</p> <p>10: 10,9* ←</p> | <p>1: 10,9* ↓</p> <p>2: 10,1 ↗</p> <p>3: 10,2* ↗</p> <p>4: 9,8 ←</p> <p>5: 10,4* ↑</p> <p>6: 9,7 ↗</p> <p>7: 9,6 →</p> <p>8: 9,7 ←</p> <p>9: 9,7 ↗</p> <p>10: 10,1 ↗</p> | |
| Serie 96,0 | Serie 95,0 | |
| Sum 288,0 | Sum 383,0 | |

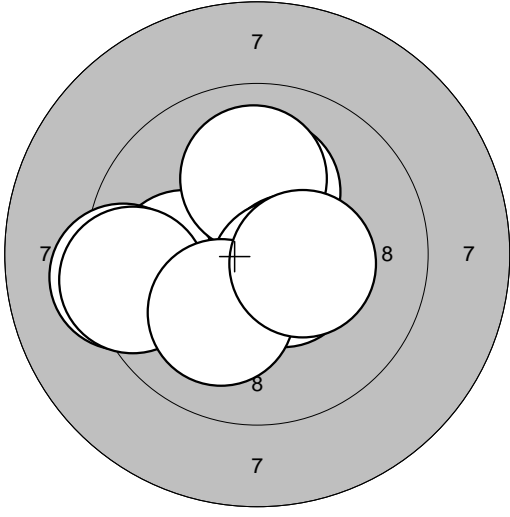
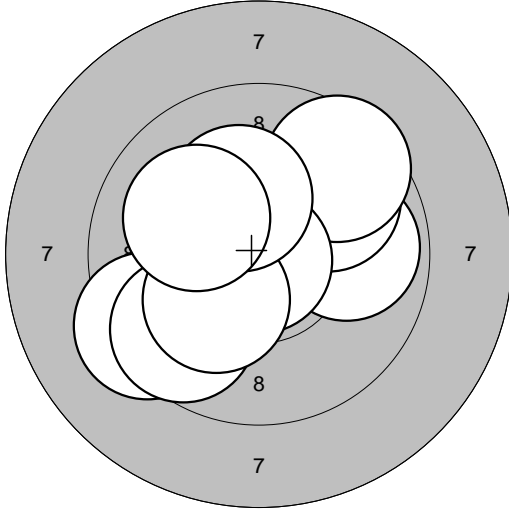
| | | |
|---|---|--|
| <p>Series 5</p>  | <p>Series 6</p>  | |
| <p>1: 10,0 ←</p> <p>2: 9,3 ←</p> <p>3: 10,2* ↑</p> <p>4: 9,4 ←</p> <p>5: 10,7* →</p> <p>6: 10,0 ↑</p> <p>7: 10,5* →</p> <p>8: 10,5* ↘</p> <p>9: 10,1 ↘</p> <p>10: 10,4* →</p> | <p>1: 9,8 →</p> <p>2: 10,9* ↖</p> <p>3: 9,3 ↘</p> <p>4: 9,9 ↗</p> <p>5: 9,6 ↘</p> <p>6: 9,5 ↗</p> <p>7: 10,9* ↓</p> <p>8: 10,2* ↘</p> <p>9: 10,2* ↗</p> <p>10: 10,1 ↖</p> | |
| Serie 98,0 | Serie 95,0 | |
| Sum 481,0 | Sum 576,0 | |

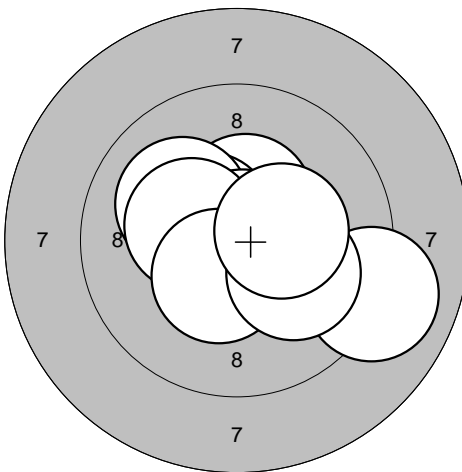
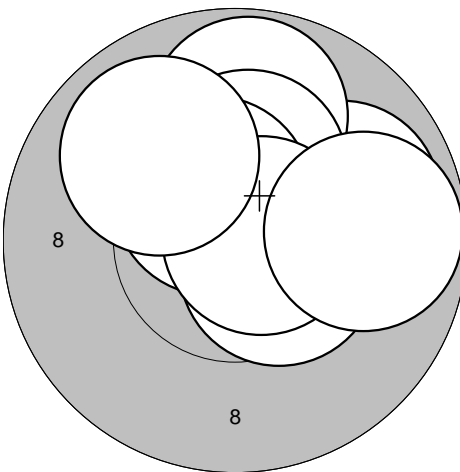
| | | | |
|--|--|--|--|
| <p>Series 1</p>  | <p>1: 10,4* ↗</p> <p>2: 10,5* ↗</p> <p>3: 9,0 →</p> <p>4: 10,1 ↗</p> <p>5: 10,4* ↘</p> <p>6: 10,9* →</p> <p>7: 10,3* ↖</p> <p>8: 10,4* ↘</p> <p>9: 10,1 ↘</p> <p>10: 10,3* →</p> | <p>Series 2</p>  | <p>1: 9,9 →</p> <p>2: 10,3* ↑</p> <p>3: 9,8 ↑</p> <p>4: 10,7* ↗</p> <p>5: 10,5* ↘</p> <p>6: 10,3* ↑</p> <p>7: 10,5* ↗</p> <p>8: 10,7* →</p> <p>9: 9,8 →</p> <p>10: 9,9 ↖</p> |
| Serie 99,0 | Serie 96,0 | Serie 96,0 | Serie 96,0 |
| Sum 99,0 | Sum 99,0 | Sum 195,0 | Sum 195,0 |

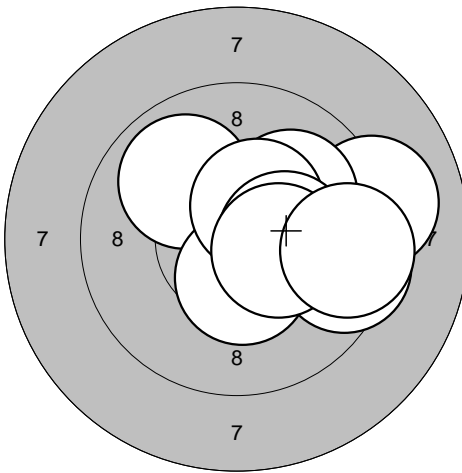
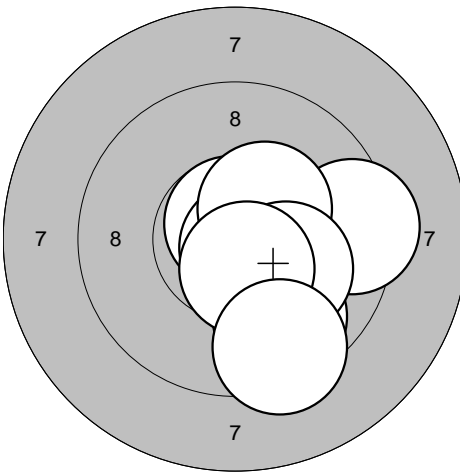
| | | | |
|---|---|---|--|
| <p>Series 3</p>  | <p>1: 9,1 →</p> <p>2: 10,6* ↗</p> <p>3: 9,9 ↗</p> <p>4: 10,4* ↘</p> <p>5: 10,1 ↗</p> <p>6: 10,4* ↗</p> <p>7: 10,3* →</p> <p>8: 9,5 →</p> <p>9: 10,4* →</p> <p>10: 9,5 →</p> | <p>Series 4</p>  | <p>1: 10,2* ↘</p> <p>2: 9,8 ↘</p> <p>3: 10,5* →</p> <p>4: 9,4 →</p> <p>5: 10,8* ↑</p> <p>6: 10,8* ↘</p> <p>7: 10,4* ↗</p> <p>8: 10,2* ↘</p> <p>9: 10,5* ↘</p> <p>10: 9,4 ↘</p> |
| Serie 96,0 | Serie 97,0 | Serie 97,0 | Serie 97,0 |
| Sum 291,0 | Sum 388,0 | Sum 388,0 | Sum 388,0 |

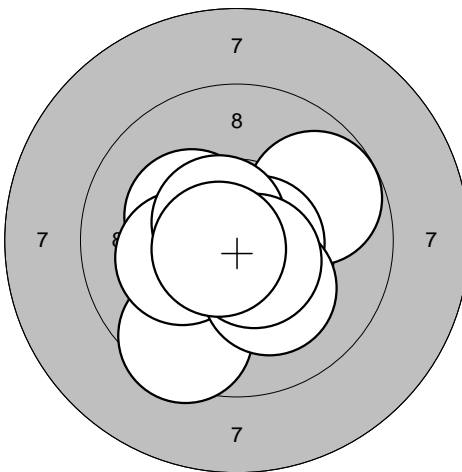
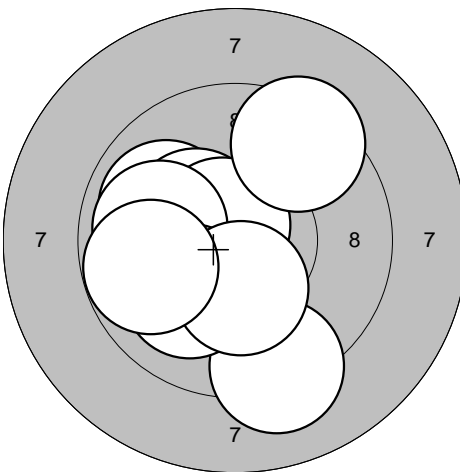
| | | | |
|--|--|--|---|
| <p>Series 5</p>  | <p>1: 10,3* ↖</p> <p>2: 9,5 ↘</p> <p>3: 10,2* ↖</p> <p>4: 10,5* ↘</p> <p>5: 9,8 →</p> <p>6: 10,7* →</p> <p>7: 10,6* ↗</p> <p>8: 10,2* ↘</p> <p>9: 10,6* ↘</p> <p>10: 10,7* ↖</p> | <p>Series 6</p>  | <p>1: 9,2 ↘</p> <p>2: 9,9 ↖</p> <p>3: 10,6* ↘</p> <p>4: 10,3* ↖</p> <p>5: 10,7* ↗</p> <p>6: 9,9 ↖</p> <p>7: 10,0 ↘</p> <p>8: 10,3* ↘</p> <p>9: 9,4 ↗</p> <p>10: 9,8 ↖</p> |
| Serie 98,0 | Serie 95,0 | Serie 95,0 | Serie 95,0 |
| Sum 486,0 | Sum 581,0 | Sum 581,0 | Sum 581,0 |

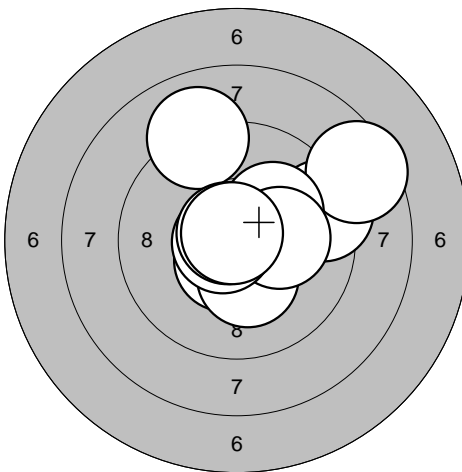
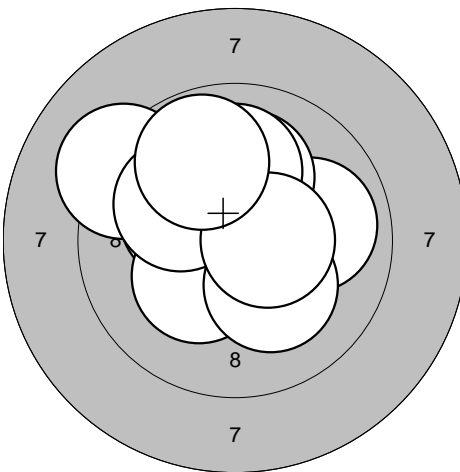
| | | |
|--|--|--|
| <p>Series 1</p>  | <p>Series 2</p>  | <p>Series 2</p> <p>1: 9,9 → 2: 10,2* ↖ 3: 9,2 ↖ 4: 10,3* ↙ 5: 10,1 ↖ 6: 10,2* ↘ 7: 10,1 ↑ 8: 10,0 ↑ 9: 10,5* → 10: 9,8 ↖</p> |
| Serie 96,0 | Serie 97,0 | |
| Sum 96,0 | Sum 193,0 | |

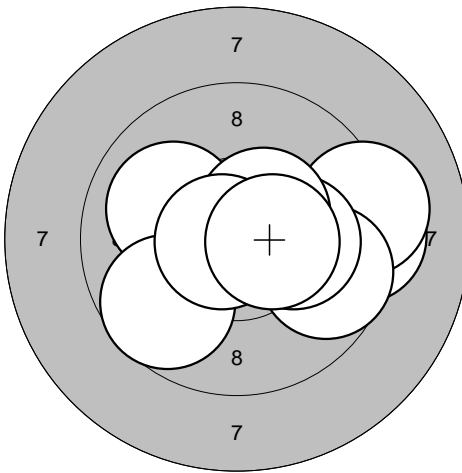
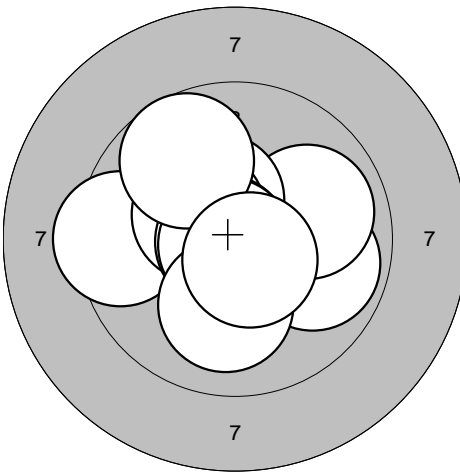
| | | |
|---|---|--|
| <p>Series 3</p>  | <p>Series 4</p>  | <p>Series 4</p> <p>1: 9,9 → 2: 9,9 → 3: 10,4* ↗ 4: 9,4 ← 5: 10,4* ↖ 6: 10,8* ← 7: 10,8* ↙ 8: 9,8 ↗ 9: 10,1 ↓ 10: 10,6* ↘</p> |
| Serie 96,0 | Serie 96,0 | |
| Sum 289,0 | Sum 385,0 | |

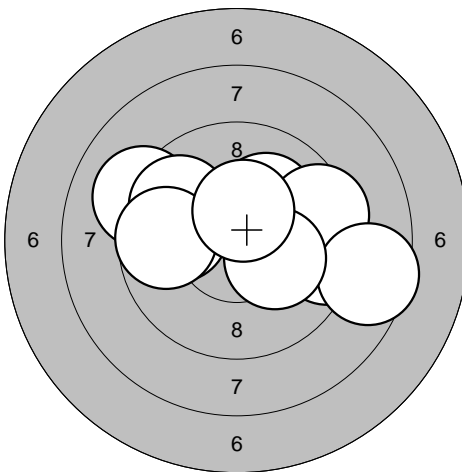
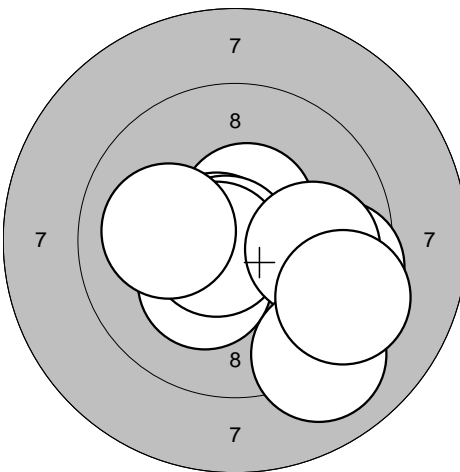
| | | |
|--|--|--|
| <p>Series 5</p>  | <p>Series 6</p>  | <p>Series 6</p> <p>1: 10,5* ↗ 2: 10,7* ← 3: 10,8* ← 4: 10,3* ↙ 5: 10,7* ← 6: 9,5 → 7: 9,9 → 8: 10,1 ← 9: 9,1 ↘ 10: 9,3 ↘</p> |
| Serie 92,0 | Serie 96,0 | |
| Sum 477,0 | Sum 573,0 | |

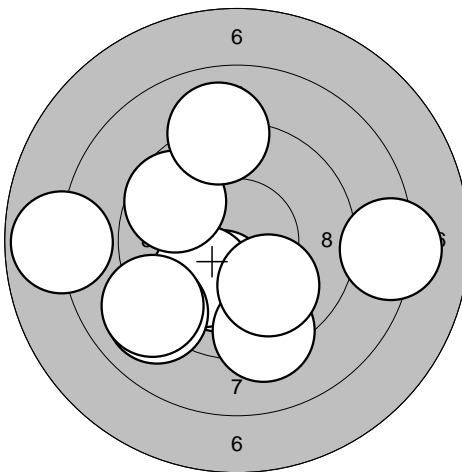
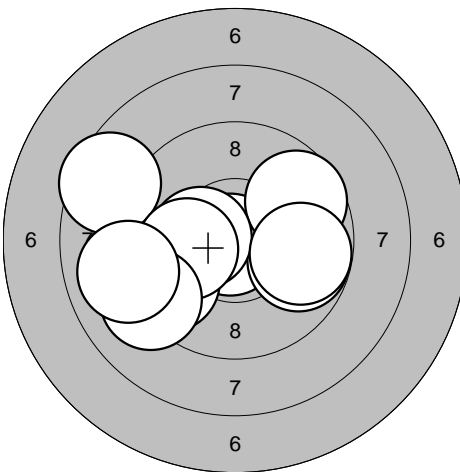
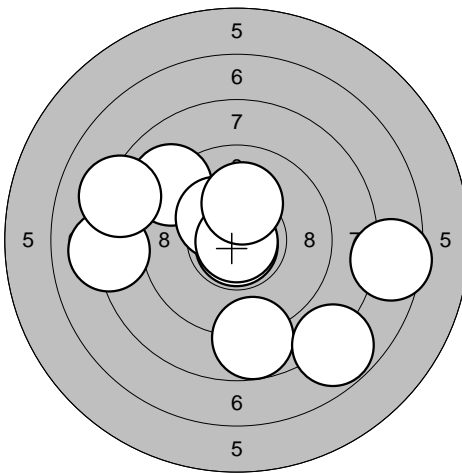
| | | |
|--|--|---|
| <p>Series 1</p>  | <p>Series 2</p>  | <p>Series 3</p>  |
| Serie 90,0 | Serie 92,0 | Serie 87,0 |
| Sum 90,0 | Sum 182,0 | Sum 269,0 |

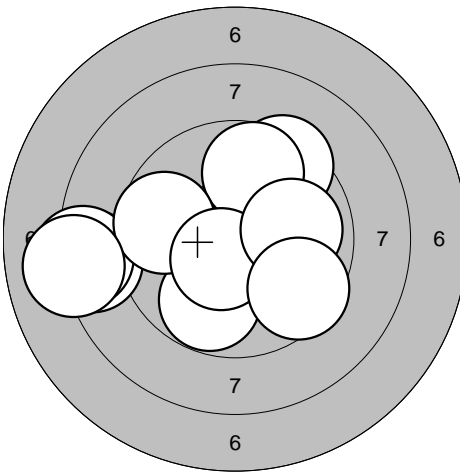
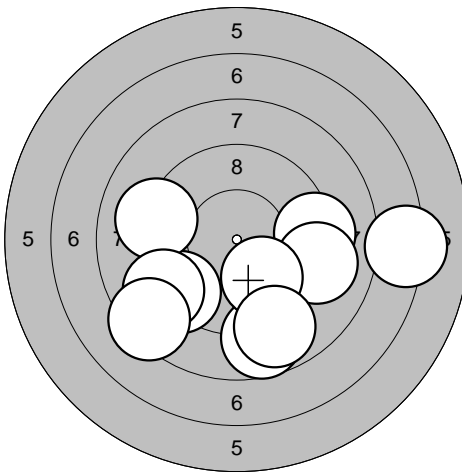
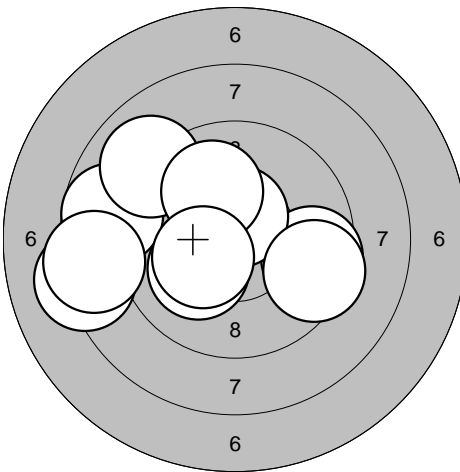
| | | |
|---|--|--|
| <p>Series 4</p>  | <p>Series 5</p>  | <p>Series 6</p>  |
| Serie 89,0 | Serie 85,0 | Serie 91,0 |
| Sum 358,0 | Sum 443,0 | Sum 534,0 |

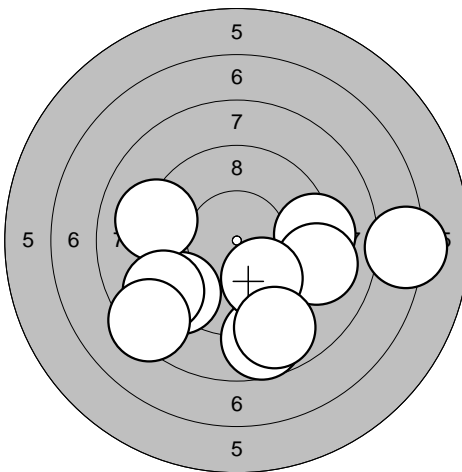
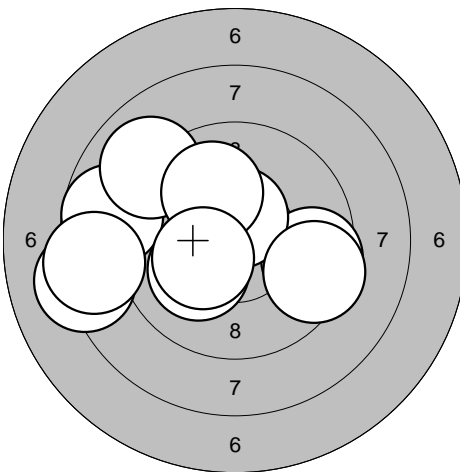
| | |
|--|--|
| <p>Series 5</p>  | <p>Series 6</p>  |
| Serie 85,0 | Serie 91,0 |
| Sum 443,0 | Sum 534,0 |

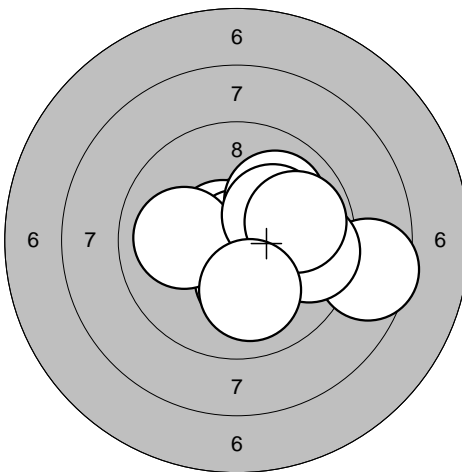
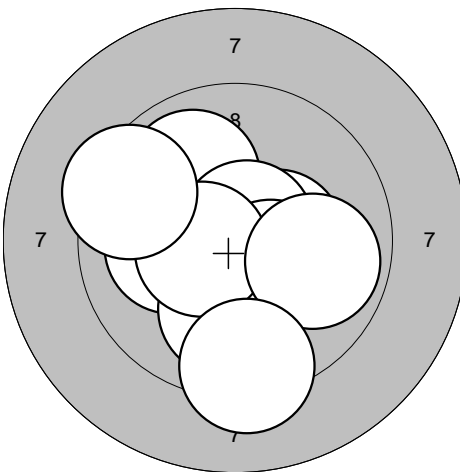
| | | | | | | | | | | | |
|--|---|-------|------|-----|------|--|---|-------|------|-----|-------|
| <p>Series 1</p>  | <p>1: 10,7* ↖ 2: 8,6 → 3: 10,3* ↓ 4: 10,9* → 5: 10,0 ← 6: 10,0 ↗ 7: 9,6 → 8: 10,2* ↗ 9: 9,9 → 10: 10,0 ↓</p> <table border="1" style="width:100%; border-collapse: collapse;"> <tr><td>Serie</td><td style="text-align: right;">96,0</td></tr> <tr><td>Sum</td><td style="text-align: right;">96,0</td></tr> </table> | Serie | 96,0 | Sum | 96,0 | <p>Series 2</p>  | <p>1: 9,9 ↖ 2: 10,4* → 3: 10,1 ← 4: 10,0 ↓ 5: 10,7* ↗ 6: 10,4* ↓ 7: 10,5* ← 8: 9,9 → 9: 9,4 ↖ 10: 9,3 ↓</p> <table border="1" style="width:100%; border-collapse: collapse;"> <tr><td>Serie</td><td style="text-align: right;">96,0</td></tr> <tr><td>Sum</td><td style="text-align: right;">192,0</td></tr> </table> | Serie | 96,0 | Sum | 192,0 |
| Serie | 96,0 | | | | | | | | | | |
| Sum | 96,0 | | | | | | | | | | |
| Serie | 96,0 | | | | | | | | | | |
| Sum | 192,0 | | | | | | | | | | |

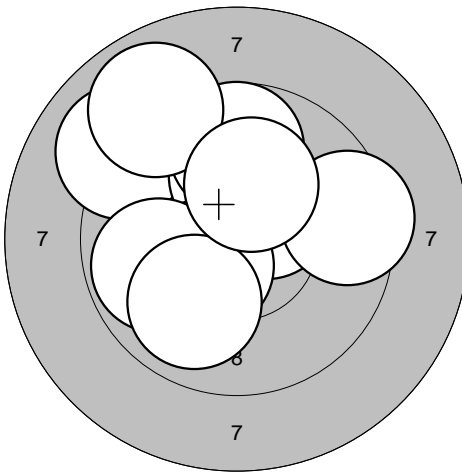
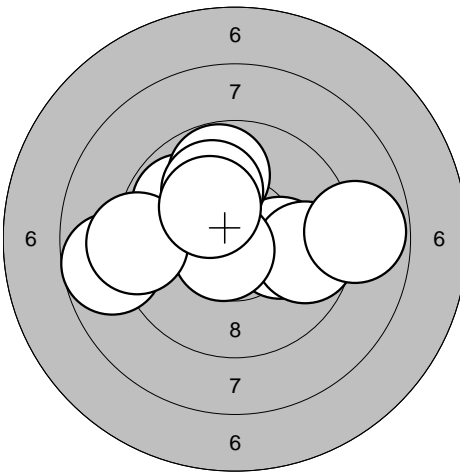
| | | | | | | | | | | | |
|---|--|-------|------|-----|-------|---|---|-------|------|-----|-------|
| <p>Series 3</p>  | <p>1: 9,0 ↖ 2: 10,4* ↗ 3: 10,1 ↑ 4: 10,4* ↖ 5: 9,8 ↑ 6: 8,9 ↗ 7: 9,9 ← 8: 9,5 → 9: 9,9 ↖ 10: 10,2* ↑</p> <table border="1" style="width:100%; border-collapse: collapse;"> <tr><td>Serie</td><td style="text-align: right;">93,0</td></tr> <tr><td>Sum</td><td style="text-align: right;">285,0</td></tr> </table> | Serie | 93,0 | Sum | 285,0 | <p>Series 4</p>  | <p>1: 10,1 → 2: 9,8 ↖ 3: 8,7 ← 4: 9,7 → 5: 10,7* ↖ 6: 8,8 → 7: 9,2 ← 8: 9,8 ↑ 9: 10,0 ↗ 10: 10,2* ↖</p> <table border="1" style="width:100%; border-collapse: collapse;"> <tr><td>Serie</td><td style="text-align: right;">92,0</td></tr> <tr><td>Sum</td><td style="text-align: right;">377,0</td></tr> </table> | Serie | 92,0 | Sum | 377,0 |
| Serie | 93,0 | | | | | | | | | | |
| Sum | 285,0 | | | | | | | | | | |
| Serie | 92,0 | | | | | | | | | | |
| Sum | 377,0 | | | | | | | | | | |

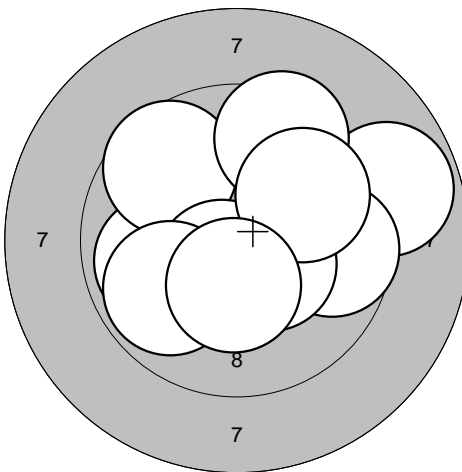
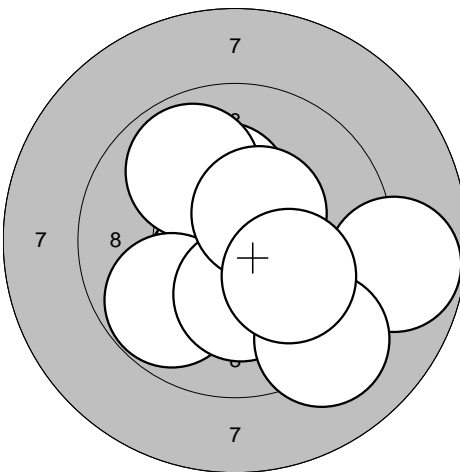
| | | | | | | | | | | | |
|--|---|-------|------|-----|-------|--|--|-------|------|-----|-------|
| <p>Series 5</p>  | <p>1: 9,9 ← 2: 8,8 → 3: 9,7 → 4: 10,4* ↓ 5: 9,6 ↗ 6: 10,5* ↓ 7: 9,9 ← 8: 9,5 ↗ 9: 9,9 ↗ 10: 10,4* ↓</p> <table border="1" style="width:100%; border-collapse: collapse;"> <tr><td>Serie</td><td style="text-align: right;">92,0</td></tr> <tr><td>Sum</td><td style="text-align: right;">469,0</td></tr> </table> | Serie | 92,0 | Sum | 469,0 | <p>Series 6</p>  | <p>1: 10,2* ↑ 2: 10,4* ↖ 3: 8,8 → 4: 10,6* ↖ 5: 9,9 ↗ 6: 9,8 ↖ 7: 10,2* ↓ 8: 10,5* ↗ 9: 9,2 ↓ 10: 10,1 ↓</p> <table border="1" style="width:100%; border-collapse: collapse;"> <tr><td>Serie</td><td style="text-align: right;">95,0</td></tr> <tr><td>Sum</td><td style="text-align: right;">564,0</td></tr> </table> | Serie | 95,0 | Sum | 564,0 |
| Serie | 92,0 | | | | | | | | | | |
| Sum | 469,0 | | | | | | | | | | |
| Serie | 95,0 | | | | | | | | | | |
| Sum | 564,0 | | | | | | | | | | |

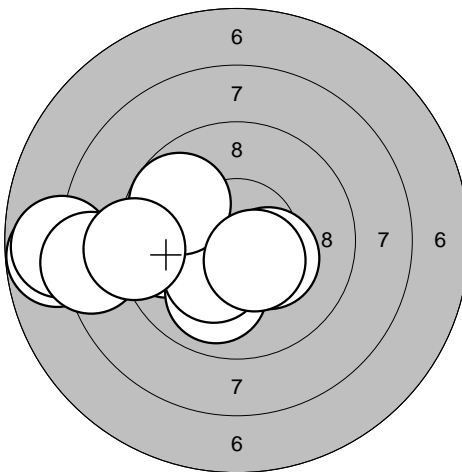
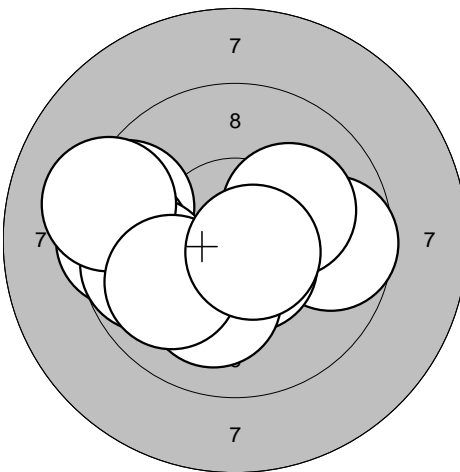
| | | | |
|--|--|--|---|
| <p>Series 1</p>  | <p>1: 9,8 ←</p> <p>2: 9,9 ↓</p> <p>3: 7,8 ←</p> <p>4: 10,3* →</p> <p>5: 7,9 ←</p> <p>6: 10,3* ↓</p> <p>7: 8,4 ←</p> <p>8: 9,8 ↗</p> <p>9: 9,1 ←</p> <p>10: 10,5* ↓</p> | <p>Series 2</p>  | <p>1: 9,7 →</p> <p>2: 9,4 ←</p> <p>3: 9,5 ←</p> <p>4: 10,6* ↓</p> <p>5: 9,8 ←</p> <p>6: 10,1 ↗</p> <p>7: 10,1 ↓</p> <p>8: 9,2 ←</p> <p>9: 10,0 ←</p> <p>10: 10,6* ↓</p> |
| Serie 88,0 | Serie 95,0 | | |
| Sum 88,0 | Sum 183,0 | | |

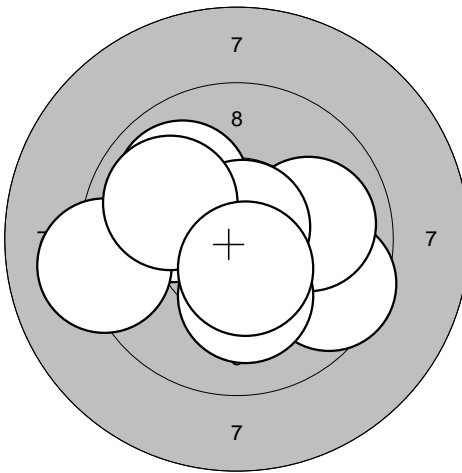
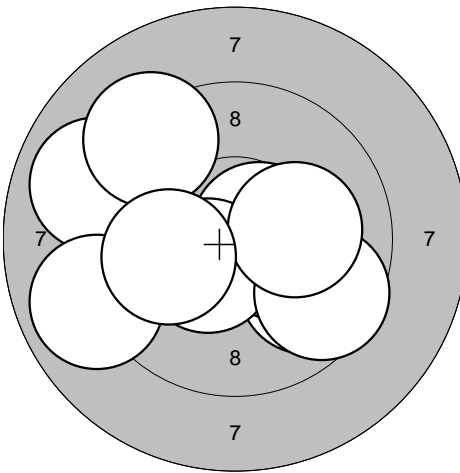
| | | | |
|---|--|---|--|
| <p>Series 3</p>  | <p>1: 10,3* ↓</p> <p>2: 10,1 ↗</p> <p>3: 9,6 →</p> <p>4: 10,0 ↗</p> <p>5: 10,0 →</p> <p>6: 10,2* ↓</p> <p>7: 9,2 ←</p> <p>8: 10,8* ↗</p> <p>9: 10,0 ↗</p> <p>10: 10,5* ↓</p> | <p>Series 4</p>  | <p>1: 9,8 ↘</p> <p>2: 9,0 ←</p> <p>3: 8,9 ←</p> <p>4: 10,3* →</p> <p>5: 9,2 ↗</p> <p>6: 10,6* →</p> <p>7: 10,4* ↓</p> <p>8: 9,6 ↘</p> <p>9: 10,1 →</p> <p>10: 10,0 ←</p> |
| Serie 98,0 | Serie 94,0 | | |
| Sum 281,0 | Sum 375,0 | | |

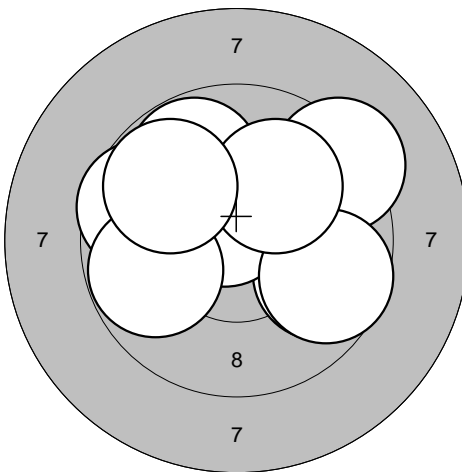
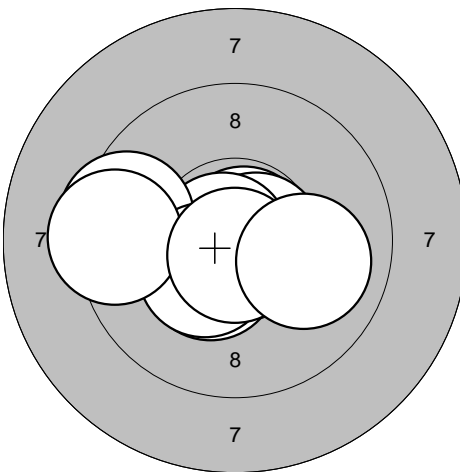
| | | | |
|--|---|--|---|
| <p>Series 5</p>  | <p>1: 10,3* ↗</p> <p>2: 9,8 ↗</p> <p>3: 9,8 →</p> <p>4: 9,3 ↗</p> <p>5: 10,6* ↗</p> <p>6: 9,6 ←</p> <p>7: 9,7 →</p> <p>8: 9,8 ←</p> <p>9: 10,0 ↗</p> <p>10: 9,8 ↗</p> | <p>Series 6</p>  | <p>1: 10,7* ↘</p> <p>2: 10,8* ↗</p> <p>3: 10,4* ↓</p> <p>4: 10,7* →</p> <p>5: 10,8* ←</p> <p>6: 9,5 ←</p> <p>7: 10,4* ↓</p> <p>8: 9,4 ←</p> <p>9: 10,7* ↓</p> <p>10: 10,0 →</p> |
| Serie 93,0 | Serie 98,0 | | |
| Sum 468,0 | Sum 566,0 | | |

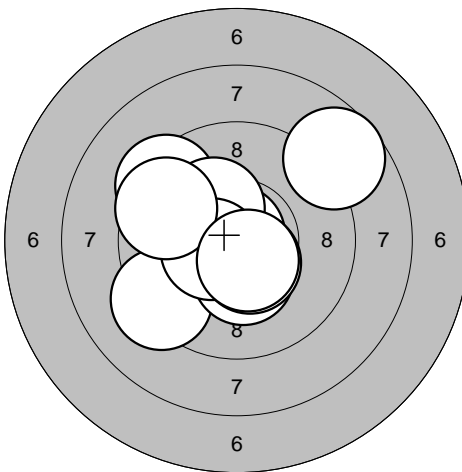
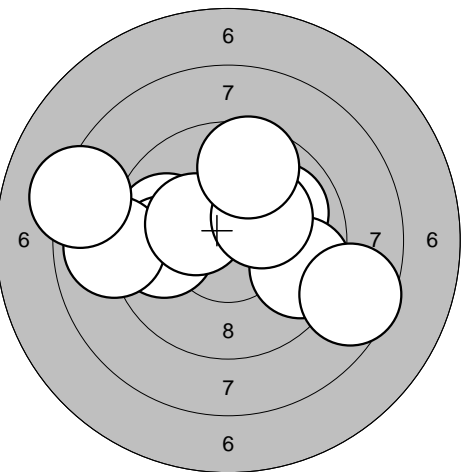
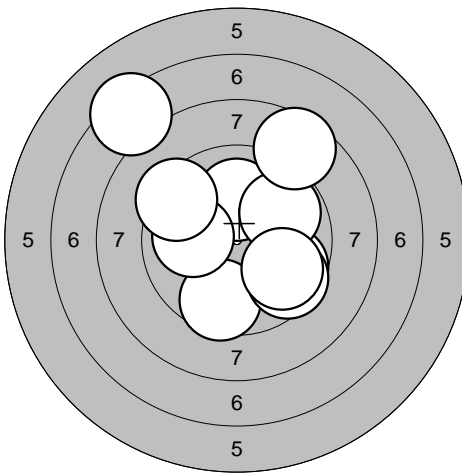
| | | |
|---|--|--|
| <p>Series 1</p>  | <p>Series 2</p>  | <p>Series 3</p>  |
| 1: 9,4 ↖ 2: 10,9* ↗ 3: 9,3 ↙ 4: 10,4* ↓ 5: 10,5* ↓ 6: 10,3* ↗ 7: 8,7 ↗ 8: 10,5* ← 9: 9,6 ↖ 10: 10,5* ↓ | 1: 9,8 ← 2: 9,8 ← 3: 9,0 ← 4: 10,0 ↗ 5: 10,3* ↖ 6: 8,2 ← 7: 9,6 → 8: 10,2* ↗ 9: 8,6 → 10: 9,6 ↑ | 1: 9,4 ↗ 2: 10,1 ↖ 3: 8,1 ↗ 4: 9,7 ↗ 5: 8,6 ↑ 6: 9,9 ↗ 7: 10,3* ← 8: 9,8 ↓ 9: 7,2 ↓ 10: 8,3 ↗ |
| Serie 95,0 Sum 95,0 | Serie 91,0 Sum 186,0 | Serie 89,0 Sum 275,0 |

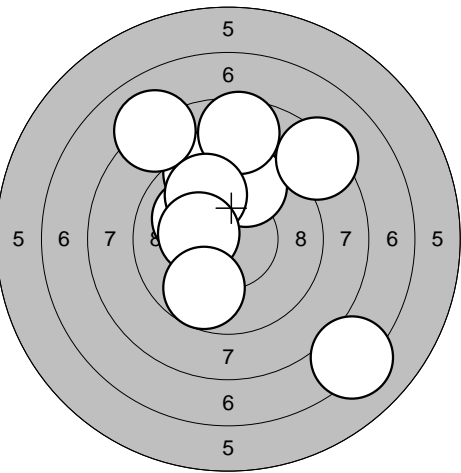
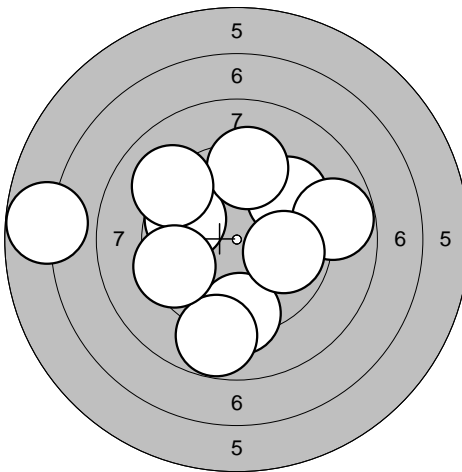
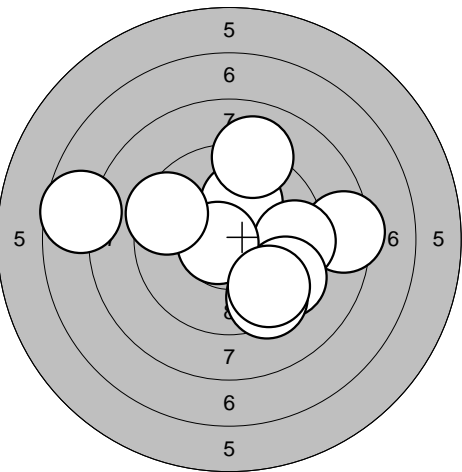
| | | |
|---|---|--|
| <p>Series 4</p>  | <p>Series 5</p>  | <p>Series 6</p>  |
| 1: 9,6 ↓ 2: 10,1 ↑ 3: 7,3 ↗ 4: 9,7 → 5: 9,6 ↓ 6: 10,0 ← 7: 9,8 ↗ 8: 8,6 ↗ 9: 9,3 ↗ 10: 9,8 ↓ | 1: 9,5 ↗ 2: 9,7 ← 3: 9,3 ↓ 4: 6,8 ← 5: 9,4 ↑ 6: 9,1 ↗ 7: 8,8 → 8: 8,8 ↓ 9: 9,9 → 10: 9,5 ← | 1: 10,1 ↗ 2: 8,4 → 3: 9,5 → 4: 9,4 ↙ 5: 7,7 ← 6: 10,7* ← 7: 9,5 ← 8: 9,4 ↓ 9: 9,1 ↑ 10: 9,6 ↓ |
| Serie 89,0 Sum 275,0 | Serie 85,0 Sum 447,0 | Serie 89,0 Sum 536,0 |

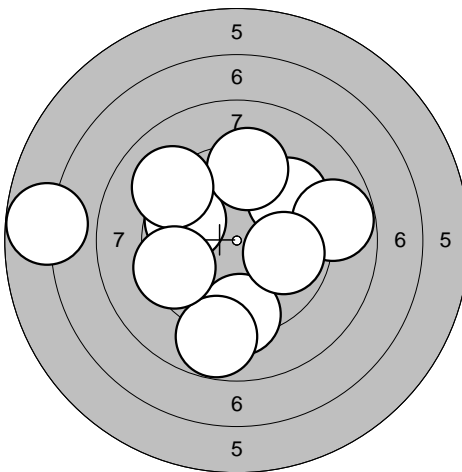
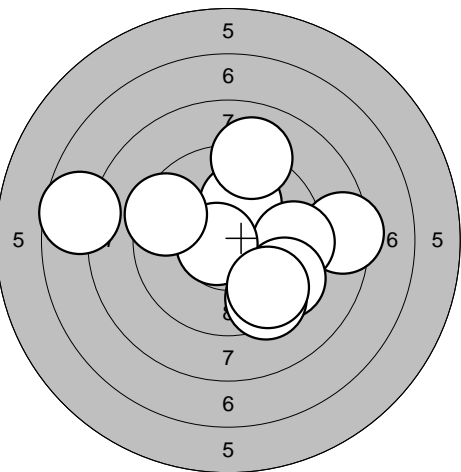
| | |
|--|--|
| <p>Series 5</p>  | <p>Series 6</p>  |
| Serie 85,0 Sum 447,0 | Serie 89,0 Sum 536,0 |

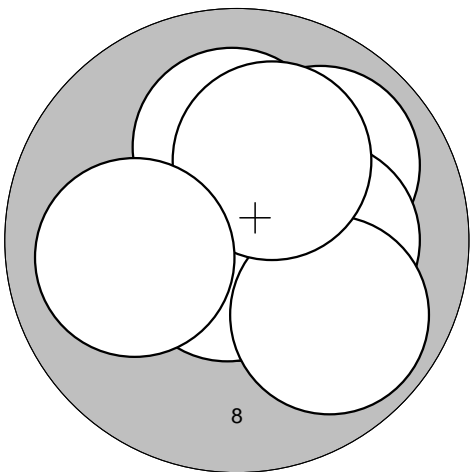
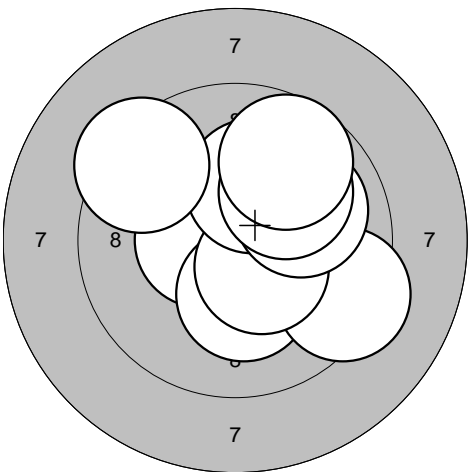
| | | | | | | | | | | | |
|--|--|-------|------|-----|------|--|---|-------|------|-----|-------|
| <p>Series 1</p>  | <p>1: 9,9 ↗ 2: 10,2* ↑ 3: 10,7* ↗ 4: 10,8* → 5: 10,2* → 6: 10,1 ↑ 7: 10,7* ↓ 8: 9,9 ↘ 9: 10,2* ↑ 10: 10,0 ←</p> <table border="1" style="width:100%; border-collapse: collapse;"> <tr><td>Serie</td><td style="text-align: right;">98,0</td></tr> <tr><td>Sum</td><td style="text-align: right;">98,0</td></tr> </table> | Serie | 98,0 | Sum | 98,0 | <p>Series 2</p>  | <p>1: 10,9* ↖ 2: 10,5* ← 3: 10,2* ↓ 4: 9,3 ↘ 5: 10,4* ↘ 6: 10,2* ↑ 7: 10,0 → 8: 10,0 ↗ 9: 9,4 ↖ 10: 9,7 ↗</p> <table border="1" style="width:100%; border-collapse: collapse;"> <tr><td>Serie</td><td style="text-align: right;">97,0</td></tr> <tr><td>Sum</td><td style="text-align: right;">195,0</td></tr> </table> | Serie | 97,0 | Sum | 195,0 |
| Serie | 98,0 | | | | | | | | | | |
| Sum | 98,0 | | | | | | | | | | |
| Serie | 97,0 | | | | | | | | | | |
| Sum | 195,0 | | | | | | | | | | |

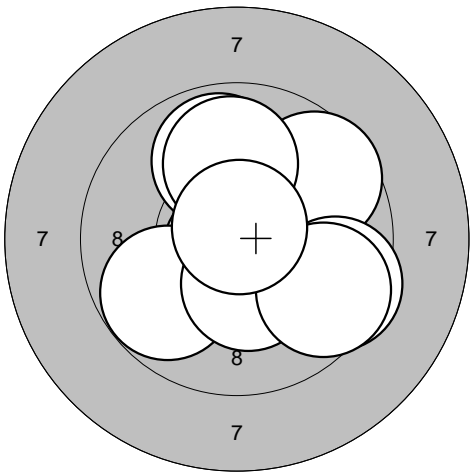
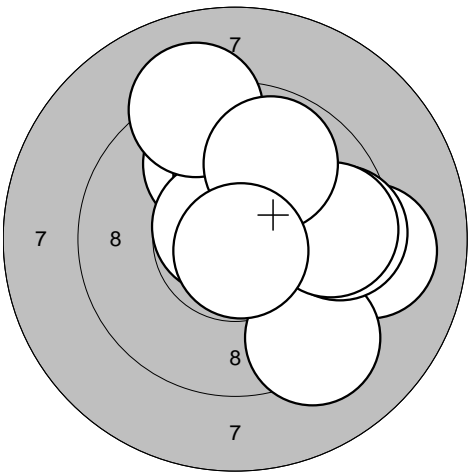
| | | | | | | | | | | | |
|---|---|-------|------|-----|-------|---|--|-------|------|-----|-------|
| <p>Series 3</p>  | <p>1: 10,7* → 2: 10,8* ↓ 3: 9,8 ↖ 4: 9,6 ↗ 5: 9,9 ↑ 6: 10,3* ↓ 7: 9,9 ↑ 8: 9,5 ↘ 9: 9,6 ↘ 10: 10,8* ↑</p> <table border="1" style="width:100%; border-collapse: collapse;"> <tr><td>Serie</td><td style="text-align: right;">94,0</td></tr> <tr><td>Sum</td><td style="text-align: right;">289,0</td></tr> </table> | Serie | 94,0 | Sum | 289,0 | <p>Series 4</p>  | <p>1: 9,1 → 2: 9,3 ↘ 3: 9,9 ↑ 4: 10,1 ↑ 5: 9,6 → 6: 9,7 → 7: 10,7* ↖ 8: 9,2 ↑ 9: 9,9 ↑ 10: 10,8* ↓</p> <table border="1" style="width:100%; border-collapse: collapse;"> <tr><td>Serie</td><td style="text-align: right;">93,0</td></tr> <tr><td>Sum</td><td style="text-align: right;">382,0</td></tr> </table> | Serie | 93,0 | Sum | 382,0 |
| Serie | 94,0 | | | | | | | | | | |
| Sum | 289,0 | | | | | | | | | | |
| Serie | 93,0 | | | | | | | | | | |
| Sum | 382,0 | | | | | | | | | | |

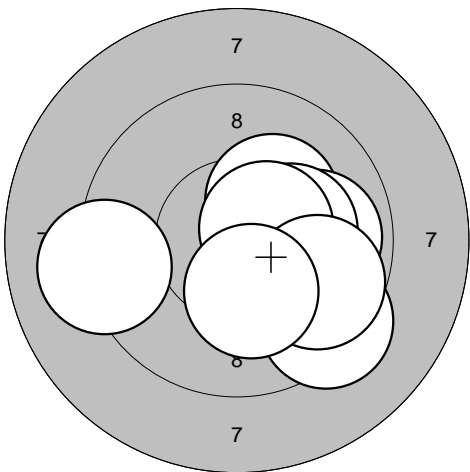
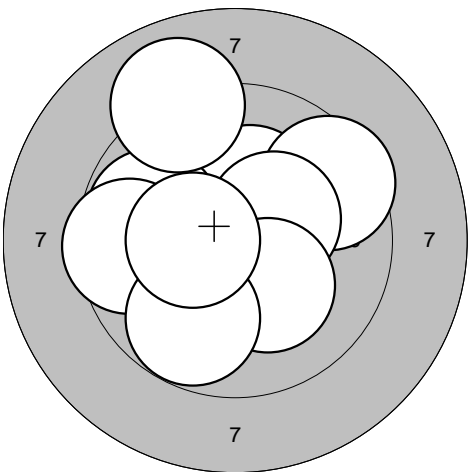
| | | | | | | | | | | | |
|--|---|-------|------|-----|-------|--|--|-------|------|-----|-------|
| <p>Series 5</p>  | <p>1: 10,2* ↗ 2: 10,3* ↘ 3: 9,9 → 4: 9,3 ↘ 5: 10,3* → 6: 10,2* → 7: 10,5* → 8: 9,7 ↘ 9: 9,2 ← 10: 10,2* ↓</p> <table border="1" style="width:100%; border-collapse: collapse;"> <tr><td>Serie</td><td style="text-align: right;">96,0</td></tr> <tr><td>Sum</td><td style="text-align: right;">478,0</td></tr> </table> | Serie | 96,0 | Sum | 478,0 | <p>Series 6</p>  | <p>1: 10,3* ↑ 2: 10,0 ← 3: 9,8 ← 4: 9,5 ↗ 5: 10,4* ↗ 6: 9,5 ← 7: 10,2* ↓ 8: 9,0 ↑ 9: 9,8 ↓ 10: 10,4* ←</p> <table border="1" style="width:100%; border-collapse: collapse;"> <tr><td>Serie</td><td style="text-align: right;">95,0</td></tr> <tr><td>Sum</td><td style="text-align: right;">573,0</td></tr> </table> | Serie | 95,0 | Sum | 573,0 |
| Serie | 96,0 | | | | | | | | | | |
| Sum | 478,0 | | | | | | | | | | |
| Serie | 95,0 | | | | | | | | | | |
| Sum | 573,0 | | | | | | | | | | |

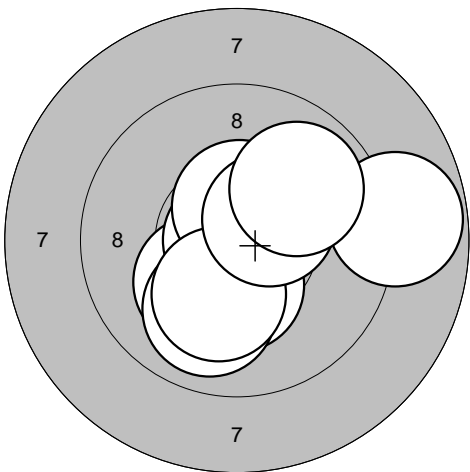
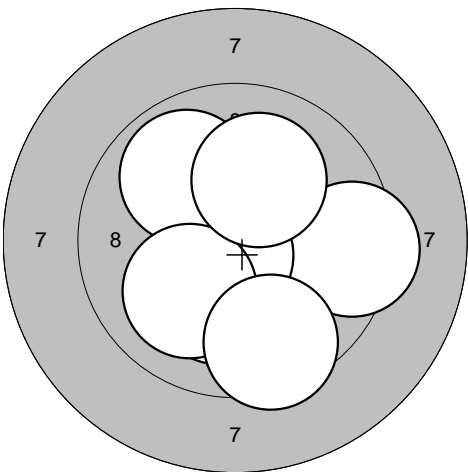
| | | | | | | | | | | | |
|--|--|-------|------|-----|------|--|--|-------|------|-----|-------|
| <p>Series 1</p>  | <p>1: 10,2* ↙ 2: 10,3* ↓ 3: 10,5* ↗ 4: 10,0 ↓ 5: 8,8 → 6: 10,9* ← 7: 10,5* ↑ 8: 10,2* ↓ 9: 10,4* ↗ 10: 9,9 ↗</p> <table border="1" style="width:100%; border-collapse: collapse;"> <tr><td>Serie</td><td style="text-align: right;">97,0</td></tr> <tr><td>Sum</td><td style="text-align: right;">97,0</td></tr> </table> | Serie | 97,0 | Sum | 97,0 | <p>Series 2</p>  | <p>1: 10,7* ↑ 2: 10,5* ↘ 3: 10,2* ↓ 4: 10,5* ↓ 5: 9,4 → 6: 10,7* ↓ 7: 9,9 ↖ 8: 10,1 ↘ 9: 9,5 ↓ 10: 10,1 ↑</p> <table border="1" style="width:100%; border-collapse: collapse;"> <tr><td>Serie</td><td style="text-align: right;">97,0</td></tr> <tr><td>Sum</td><td style="text-align: right;">194,0</td></tr> </table> | Serie | 97,0 | Sum | 194,0 |
| Serie | 97,0 | | | | | | | | | | |
| Sum | 97,0 | | | | | | | | | | |
| Serie | 97,0 | | | | | | | | | | |
| Sum | 194,0 | | | | | | | | | | |

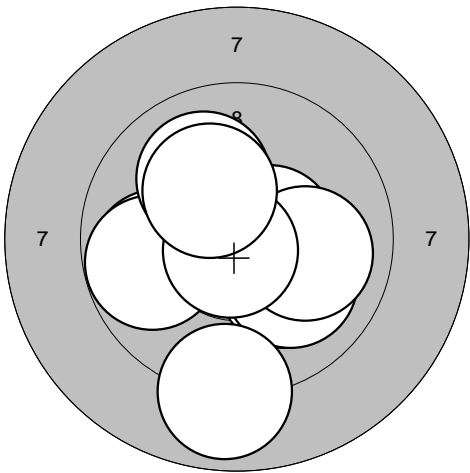
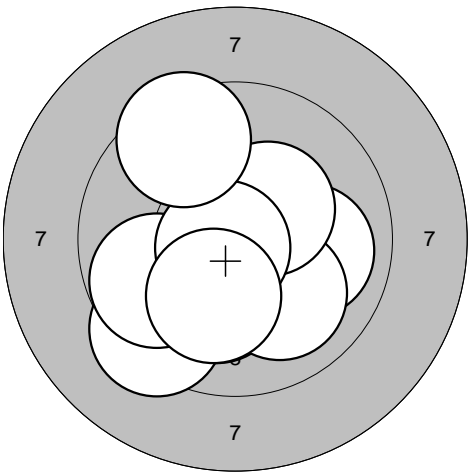
| | | | | | | | | | | | |
|---|--|-------|------|-----|-------|---|---|-------|------|-----|-------|
| <p>Series 3</p>  | <p>1: 10,1 ↘ 2: 10,0 ↘ 3: 9,9 ← 4: 9,8 ← 5: 10,5* → 6: 10,0 ↗ 7: 10,0 → 8: 8,9 ↓ 9: 10,8* ↓ 10: 10,2* ↖</p> <table border="1" style="width:100%; border-collapse: collapse;"> <tr><td>Serie</td><td style="text-align: right;">96,0</td></tr> <tr><td>Sum</td><td style="text-align: right;">290,0</td></tr> </table> | Serie | 96,0 | Sum | 290,0 | <p>Series 4</p>  | <p>1: 10,5* ↓ 2: 10,2* ↓ 3: 9,4 ↘ 4: 10,0 → 5: 9,8 ← 6: 10,0 ↘ 7: 10,4* ↗ 8: 10,8* ← 9: 9,5 ↖ 10: 10,1 ↓</p> <table border="1" style="width:100%; border-collapse: collapse;"> <tr><td>Serie</td><td style="text-align: right;">97,0</td></tr> <tr><td>Sum</td><td style="text-align: right;">387,0</td></tr> </table> | Serie | 97,0 | Sum | 387,0 |
| Serie | 96,0 | | | | | | | | | | |
| Sum | 290,0 | | | | | | | | | | |
| Serie | 97,0 | | | | | | | | | | |
| Sum | 387,0 | | | | | | | | | | |

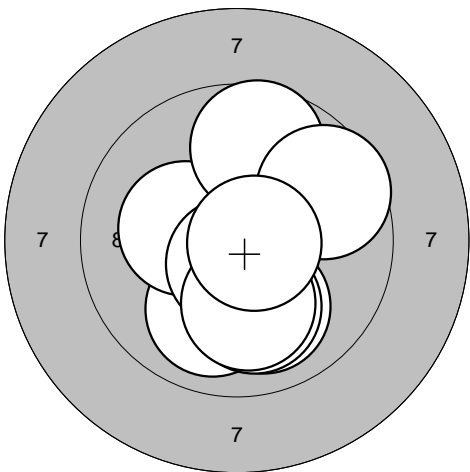
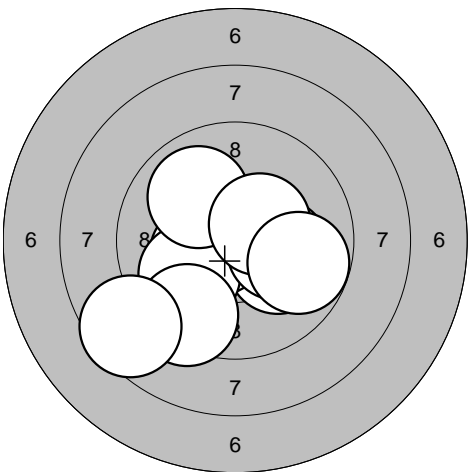
| | | | | | | | | | | | |
|--|--|-------|------|-----|-------|--|--|-------|------|-----|-------|
| <p>Series 5</p>  | <p>1: 10,6* ← 2: 10,0 ↓ 3: 10,0 ↓ 4: 10,3* ← 5: 9,7 ↑ 6: 10,0 ↓ 7: 9,6 ↗ 8: 10,6* ↓ 9: 10,1 ↓ 10: 10,7* →</p> <table border="1" style="width:100%; border-collapse: collapse;"> <tr><td>Serie</td><td style="text-align: right;">98,0</td></tr> <tr><td>Sum</td><td style="text-align: right;">485,0</td></tr> </table> | Serie | 98,0 | Sum | 485,0 | <p>Series 6</p>  | <p>1: 10,1 ↘ 2: 10,3* ← 3: 10,6* ← 4: 10,0 ↘ 5: 9,4 ↓ 6: 10,2* → 7: 9,9 ↖ 8: 10,4* ↗ 9: 8,6 ↘ 10: 9,7 →</p> <table border="1" style="width:100%; border-collapse: collapse;"> <tr><td>Serie</td><td style="text-align: right;">95,0</td></tr> <tr><td>Sum</td><td style="text-align: right;">580,0</td></tr> </table> | Serie | 95,0 | Sum | 580,0 |
| Serie | 98,0 | | | | | | | | | | |
| Sum | 485,0 | | | | | | | | | | |
| Serie | 95,0 | | | | | | | | | | |
| Sum | 580,0 | | | | | | | | | | |

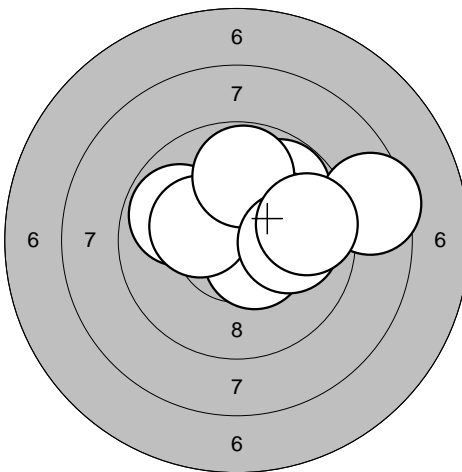
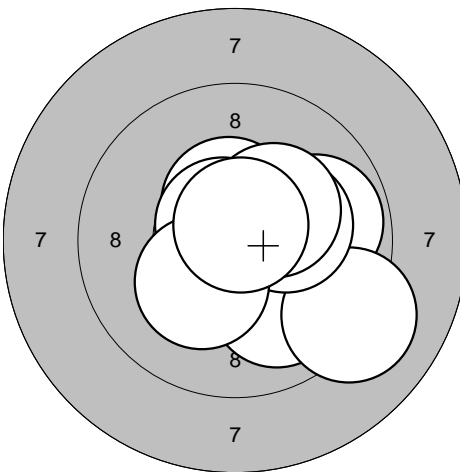
| | | | | | | | | | | | |
|--|--|-------|------|-----|------|--|--|-------|------|-----|-------|
| <p>Series 1</p>  | <p>1: 9,8 ↗ 2: 10,0 → 3: 10,3* ↗ 4: 8,5 → 5: 10,5* ↘ 6: 9,9 ↗ 7: 10,2* ← 8: 9,8 ↑ 9: 10,0 → 10: 9,7 →</p> <table border="1" style="width:100%; border-collapse: collapse;"> <tr><td>Serie</td><td style="text-align: right;">94,0</td></tr> <tr><td>Sum</td><td style="text-align: right;">94,0</td></tr> </table> | Serie | 94,0 | Sum | 94,0 | <p>Series 2</p>  | <p>1: 9,9 → 2: 10,8* ↓ 3: 10,5* ↑ 4: 10,0 ↓ 5: 9,2 ↘ 6: 10,7* ↗ 7: 10,2* → 8: 10,3* ↗ 9: 10,2* ↘ 10: 10,7* ↑</p> <table border="1" style="width:100%; border-collapse: collapse;"> <tr><td>Serie</td><td style="text-align: right;">98,0</td></tr> <tr><td>Sum</td><td style="text-align: right;">192,0</td></tr> </table> | Serie | 98,0 | Sum | 192,0 |
| Serie | 94,0 | | | | | | | | | | |
| Sum | 94,0 | | | | | | | | | | |
| Serie | 98,0 | | | | | | | | | | |
| Sum | 192,0 | | | | | | | | | | |

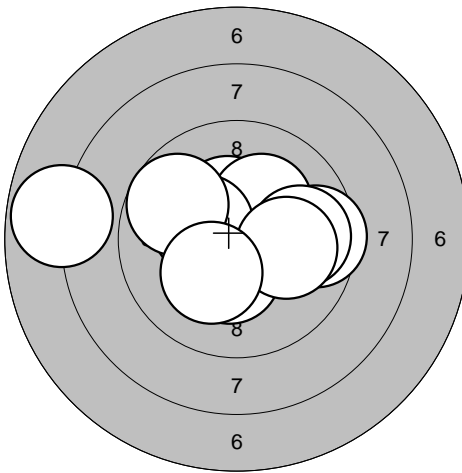
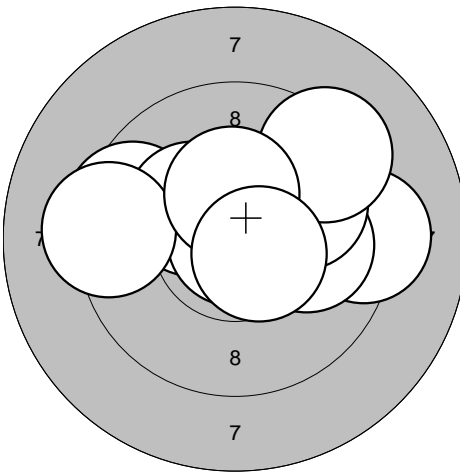
| | | | | | | | | | | | |
|---|--|-------|------|-----|-------|---|--|-------|------|-----|-------|
| <p>Series 3</p>  | <p>1: 9,5 → 2: 10,3* ↓ 3: 10,4* ↑ 4: 10,2* ↗ 5: 9,8 → 6: 10,3* ← 7: 10,0 → 8: 7,8 ← 9: 9,7 ↗ 10: 10,2* ↘</p> <table border="1" style="width:100%; border-collapse: collapse;"> <tr><td>Serie</td><td style="text-align: right;">94,0</td></tr> <tr><td>Sum</td><td style="text-align: right;">286,0</td></tr> </table> | Serie | 94,0 | Sum | 286,0 | <p>Series 4</p>  | <p>1: 9,5 ← 2: 9,2 → 3: 10,0 → 4: 9,9 ↗ 5: 10,2* ↖ 6: 10,9* 7: 9,3 ← 8: 9,3 ↗ 9: 10,4* ↑ 10: 10,6* ↘</p> <table border="1" style="width:100%; border-collapse: collapse;"> <tr><td>Serie</td><td style="text-align: right;">95,0</td></tr> <tr><td>Sum</td><td style="text-align: right;">381,0</td></tr> </table> | Serie | 95,0 | Sum | 381,0 |
| Serie | 94,0 | | | | | | | | | | |
| Sum | 286,0 | | | | | | | | | | |
| Serie | 95,0 | | | | | | | | | | |
| Sum | 381,0 | | | | | | | | | | |

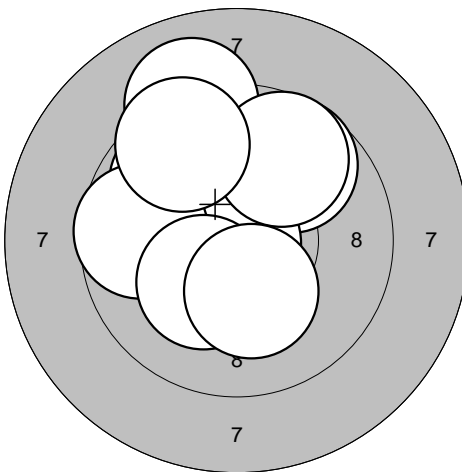
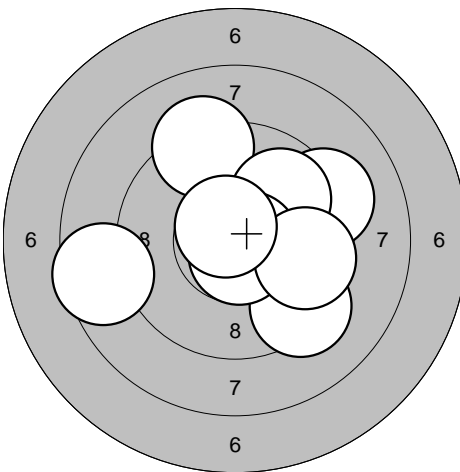
| | | | | | | | | | | | |
|--|---|-------|------|-----|-------|--|---|-------|------|-----|-------|
| <p>Series 5</p>  | <p>1: 9,7 ↗ 2: 10,3* ← 3: 9,8 ↗ 4: 9,1 ↗ 5: 10,9* ↘ 6: 9,7 ← 7: 9,7 ↗ 8: 10,2* ↘ 9: 9,5 ↗ 10: 10,2* ↘</p> <table border="1" style="width:100%; border-collapse: collapse;"> <tr><td>Serie</td><td style="text-align: right;">94,0</td></tr> <tr><td>Sum</td><td style="text-align: right;">475,0</td></tr> </table> | Serie | 94,0 | Sum | 475,0 | <p>Series 6</p>  | <p>1: 8,5 ← 2: 9,3 ↗ 3: 10,6* ↑ 4: 9,2 ↑ 5: 9,9 ↗ 6: 10,7* → 7: 9,3 ↓ 8: 10,7* ↓ 9: 9,7 → 10: 10,7* ↗</p> <table border="1" style="width:100%; border-collapse: collapse;"> <tr><td>Serie</td><td style="text-align: right;">93,0</td></tr> <tr><td>Sum</td><td style="text-align: right;">568,0</td></tr> </table> | Serie | 93,0 | Sum | 568,0 |
| Serie | 94,0 | | | | | | | | | | |
| Sum | 475,0 | | | | | | | | | | |
| Serie | 93,0 | | | | | | | | | | |
| Sum | 568,0 | | | | | | | | | | |

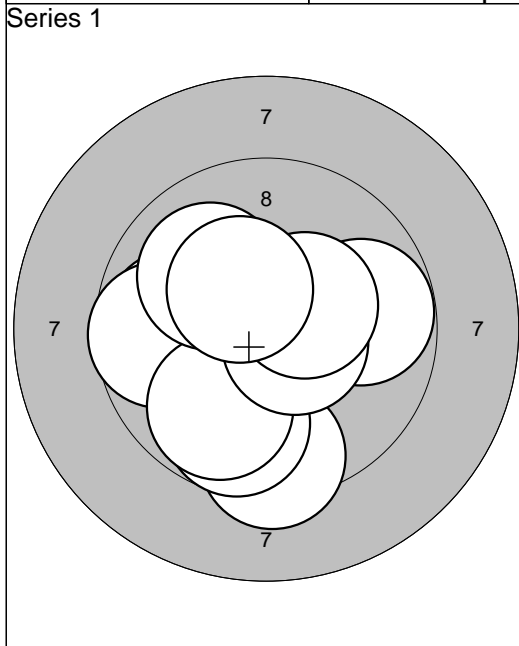

| | |
|------------|---|
| 1: 9,4 | ↓ |
| 2: 9,7 | ↓ |
| 3: 9,9 | ← |
| 4: 9,8 | → |
| 5: 9,7 | ← |
| 6: 9,8 | ↓ |
| 7: 10,6* | → |
| 8: 10,4* | ↗ |
| 9: 10,0 | ↗ |
| 10: 10,4* | ↗ |
| Serie 94,0 | |
| Sum 94,0 | |

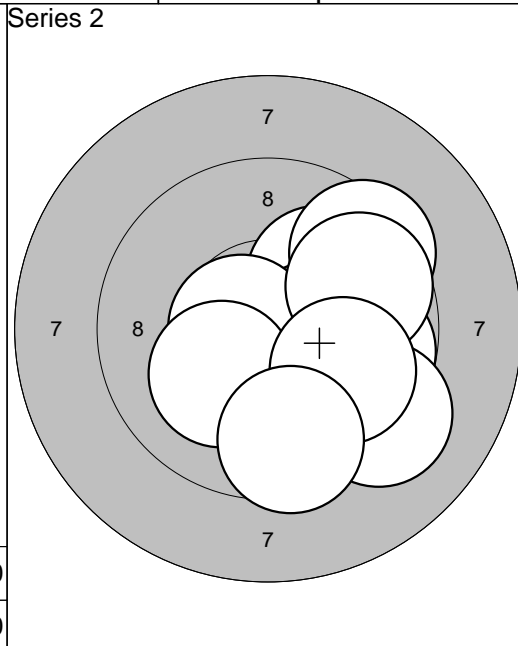

| | |
|------------|---|
| 1: 9,7 | → |
| 2: 10,1 | ↗ |
| 3: 9,5 | ↗ |
| 4: 9,3 | ↓ |
| 5: 10,4* | → |
| 6: 10,6* | ← |
| 7: 10,1 | ↓ |
| 8: 9,7 | ↗ |
| 9: 9,9 | ↘ |
| 10: 9,6 | ↓ |
| Serie 94,0 | |
| Sum 188,0 | |

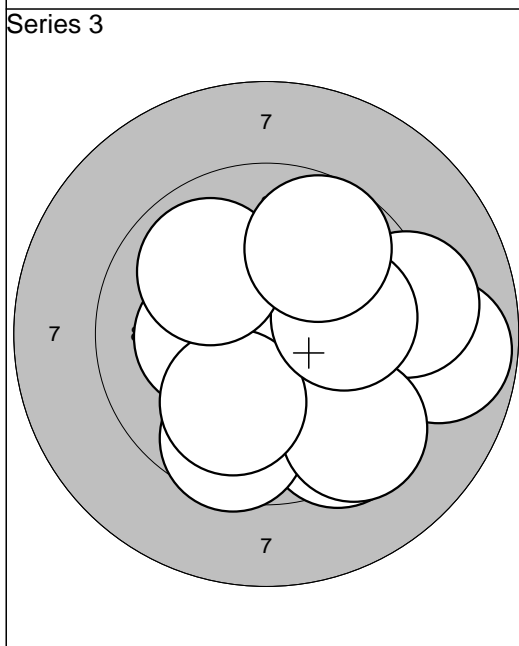

| | |
|------------|---|
| 1: 8,8 | → |
| 2: 10,2* | ← |
| 3: 9,4 | ↓ |
| 4: 9,6 | ↓ |
| 5: 9,2 | → |
| 6: 9,3 | ↓ |
| 7: 10,0 | ↓ |
| 8: 10,0 | → |
| 9: 9,9 | ↗ |
| 10: 9,7 | ↗ |
| Serie 92,0 | |
| Sum 280,0 | |

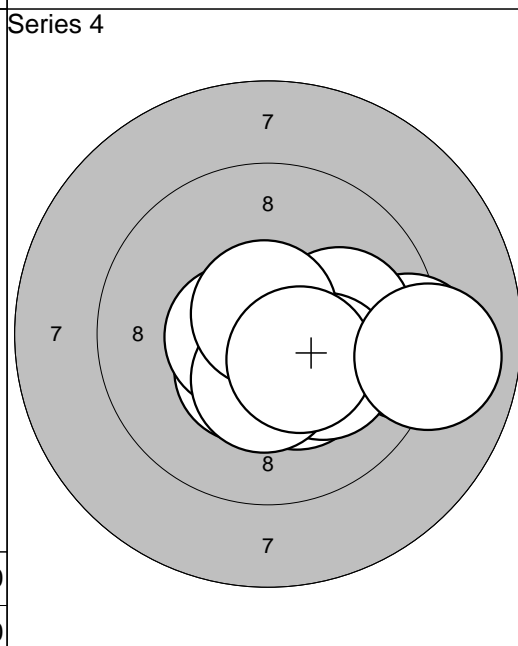

| | |
|------------|---|
| 1: 10,4* | ↓ |
| 2: 9,2 | → |
| 3: 10,3* | ↓ |
| 4: 10,1 | → |
| 5: 10,6* | ← |
| 6: 10,1 | ↘ |
| 7: 10,4* | ↓ |
| 8: 10,7* | ↑ |
| 9: 10,4* | ↓ |
| 10: 9,0 | → |
| Serie 98,0 | |
| Sum 378,0 | |

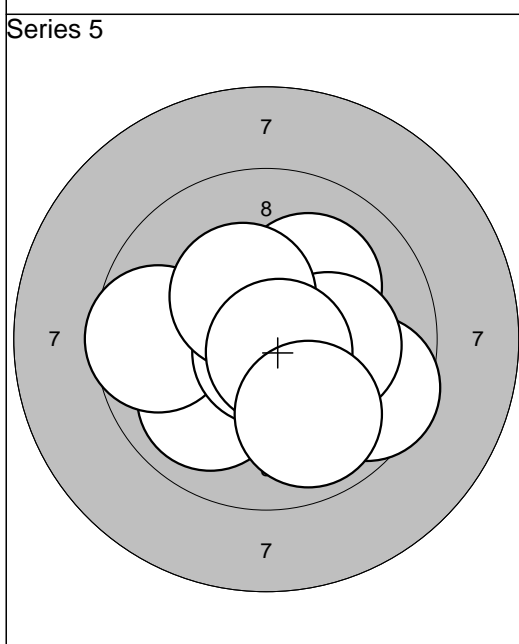

| | |
|------------|---|
| 1: 10,4* | → |
| 2: 10,1 | ↗ |
| 3: 9,6 | ↘ |
| 4: 10,2* | → |
| 5: 10,0 | ↓ |
| 6: 9,6 | ← |
| 7: 10,8* | ↓ |
| 8: 10,4* | ↗ |
| 9: 10,7* | ↓ |
| 10: 9,9 | ↓ |
| Serie 97,0 | |
| Sum 475,0 | |

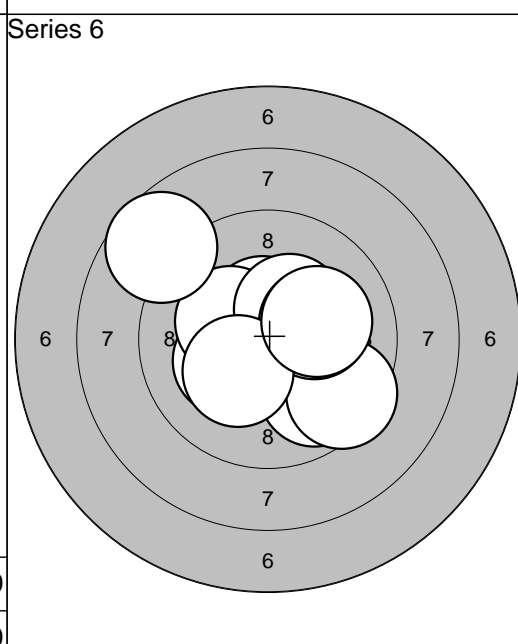

| | |
|------------|---|
| 1: 10,2* | ↙ |
| 2: 10,5* | ↑ |
| 3: 10,3* | ↙ |
| 4: 10,3* | ↗ |
| 5: 9,8 | ↓ |
| 6: 8,7 | ↗ |
| 7: 9,5 | ↘ |
| 8: 10,2* | → |
| 9: 10,2* | ↓ |
| 10: 10,1 | ↗ |
| Serie 96,0 | |
| Sum 571,0 | |

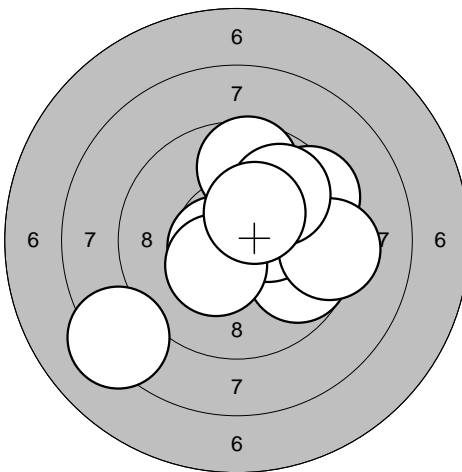
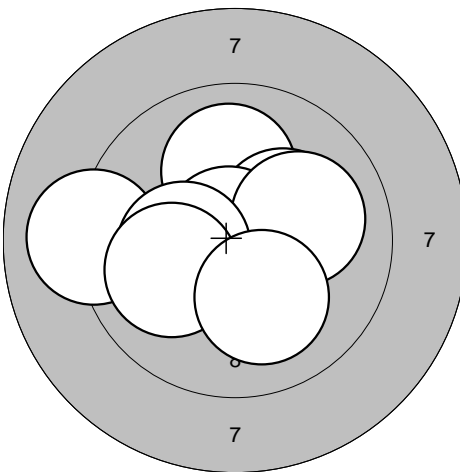
| | | | | | | | | | | | |
|--|--|-------|------|-----|------|--|---|-------|------|-----|-------|
| <p>Series 1</p>  | <p>1: 9,7 ↘ 2: 10,3* → 3: 10,6* ← 4: 9,7 ↑ 5: 10,4* ↙ 6: 9,5 → 7: 9,3 → 8: 8,2 ↙ 9: 9,8 ↗ 10: 10,4* ↗</p> <table border="1" style="width:100%; border-collapse: collapse;"> <tr><td>Serie</td><td style="text-align: right;">93,0</td></tr> <tr><td>Sum</td><td style="text-align: right;">93,0</td></tr> </table> | Serie | 93,0 | Sum | 93,0 | <p>Series 2</p>  | <p>1: 10,6* ↓ 2: 10,4* ↗ 3: 10,0 ↑ 4: 10,2* ↗ 5: 10,8* ↖ 6: 9,1 ← 7: 10,1 → 8: 10,2* ← 9: 10,0 ← 10: 10,1 ↓</p> <table border="1" style="width:100%; border-collapse: collapse;"> <tr><td>Serie</td><td style="text-align: right;">99,0</td></tr> <tr><td>Sum</td><td style="text-align: right;">192,0</td></tr> </table> | Serie | 99,0 | Sum | 192,0 |
| Serie | 93,0 | | | | | | | | | | |
| Sum | 93,0 | | | | | | | | | | |
| Serie | 99,0 | | | | | | | | | | |
| Sum | 192,0 | | | | | | | | | | |

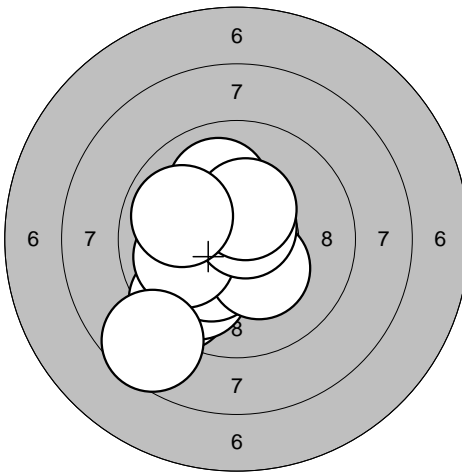
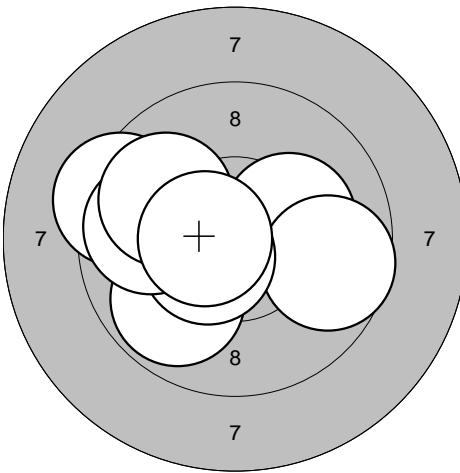
| | | | | | | | | | | | |
|---|---|-------|------|-----|-------|---|--|-------|------|-----|-------|
| <p>Series 3</p>  | <p>1: 10,0 ↑ 2: 9,5 ↙ 3: 9,8 ↙ 4: 10,2* ↙ 5: 10,3* ↙ 6: 10,0 ← 7: 10,7* ↗ 8: 10,4* ↑ 9: 8,6 ↙ 10: 9,9 ←</p> <table border="1" style="width:100%; border-collapse: collapse;"> <tr><td>Serie</td><td style="text-align: right;">95,0</td></tr> <tr><td>Sum</td><td style="text-align: right;">287,0</td></tr> </table> | Serie | 95,0 | Sum | 287,0 | <p>Series 4</p>  | <p>1: 10,2* ← 2: 10,2* → 3: 9,7 → 4: 9,8 ↙ 5: 9,4 ← 6: 10,0 ← 7: 10,5* ↙ 8: 9,8 ← 9: 9,9 ↖ 10: 10,6* ←</p> <table border="1" style="width:100%; border-collapse: collapse;"> <tr><td>Serie</td><td style="text-align: right;">95,0</td></tr> <tr><td>Sum</td><td style="text-align: right;">382,0</td></tr> </table> | Serie | 95,0 | Sum | 382,0 |
| Serie | 95,0 | | | | | | | | | | |
| Sum | 287,0 | | | | | | | | | | |
| Serie | 95,0 | | | | | | | | | | |
| Sum | 382,0 | | | | | | | | | | |

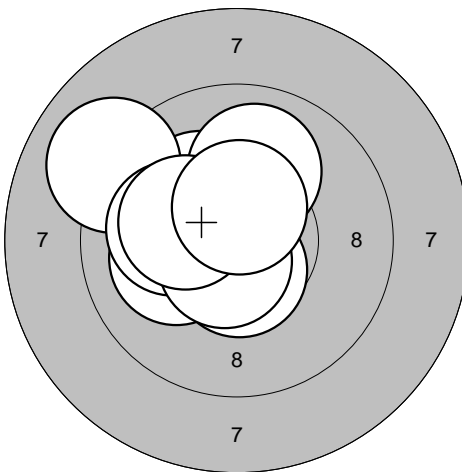
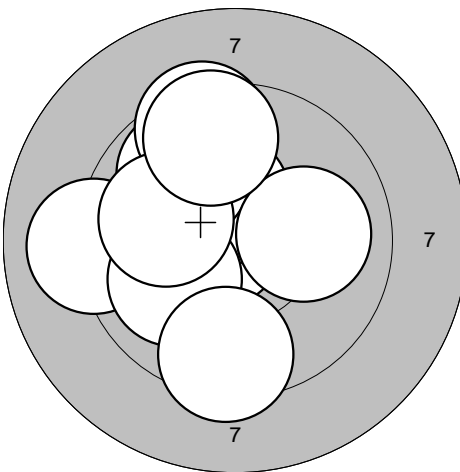
| | | | | | | | | | | | |
|--|--|-------|------|-----|-------|--|--|-------|------|-----|-------|
| <p>Series 5</p>  | <p>1: 10,5* ↓ 2: 10,2* ↗ 3: 10,1 ← 4: 9,0 ↖ 5: 10,4* ← 6: 10,0 ↑ 7: 10,1 ← 8: 10,6* ↙ 9: 10,2* ← 10: 10,5* ↑</p> <table border="1" style="width:100%; border-collapse: collapse;"> <tr><td>Serie</td><td style="text-align: right;">99,0</td></tr> <tr><td>Sum</td><td style="text-align: right;">481,0</td></tr> </table> | Serie | 99,0 | Sum | 481,0 | <p>Series 6</p>  | <p>1: 9,1 ← 2: 10,7* ← 3: 10,4* ↑ 4: 10,0 ↙ 5: 9,4 ↓ 6: 9,9 ↗ 7: 9,4 ↑ 8: 10,0 → 9: 10,0 ← 10: 9,5 ↑</p> <table border="1" style="width:100%; border-collapse: collapse;"> <tr><td>Serie</td><td style="text-align: right;">95,0</td></tr> <tr><td>Sum</td><td style="text-align: right;">576,0</td></tr> </table> | Serie | 95,0 | Sum | 576,0 |
| Serie | 99,0 | | | | | | | | | | |
| Sum | 481,0 | | | | | | | | | | |
| Serie | 95,0 | | | | | | | | | | |
| Sum | 576,0 | | | | | | | | | | |

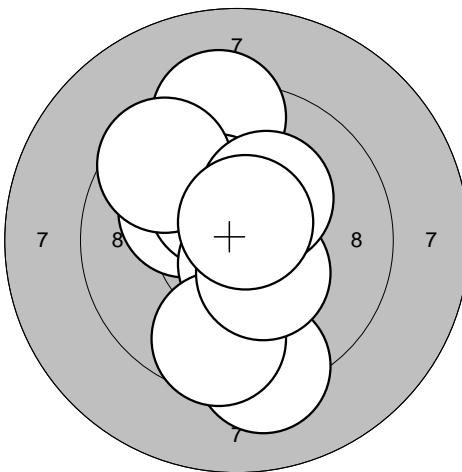
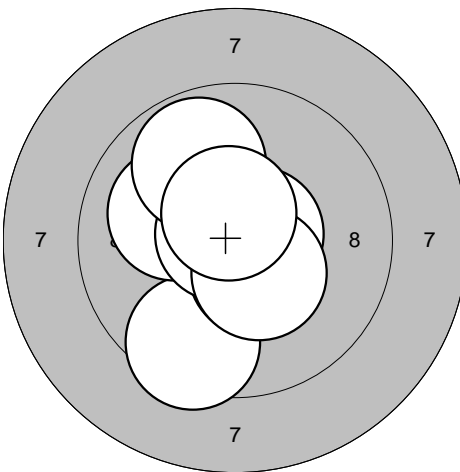
| | | | |
|---|---|---|---|
| Series 1  | 1: 10,2* ↖ 2: 9,3 ↑ 3: 10,3* ↗ 4: 10,6* ↓ 5: 9,2 ↓ 6: 9,6 ↗ 7: 9,6 ↓ 8: 10,4* ↓ 9: 10,3* ↗ 10: 10,7* ↗ <hr/> Serie 96,0 Sum 96,0 | Series 2  | 1: 9,5 ↓ 2: 10,5* ↓ 3: 10,2* ↗ 4: 10,1 ↖ 5: 10,8* ↖ 6: 10,7* → 7: 10,6* → 8: 9,9 ↗ 9: 10,4* ↓ 10: 10,6* ↑ <hr/> Serie 98,0 Sum 194,0 |
|---|---|---|---|

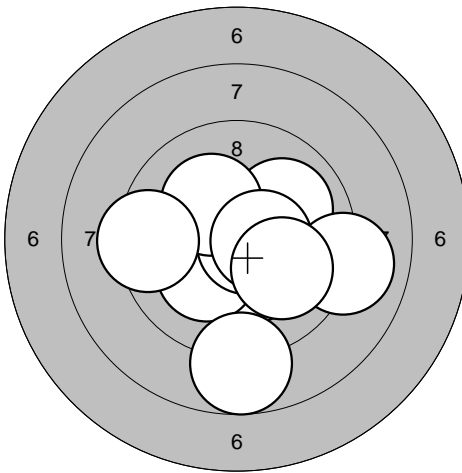
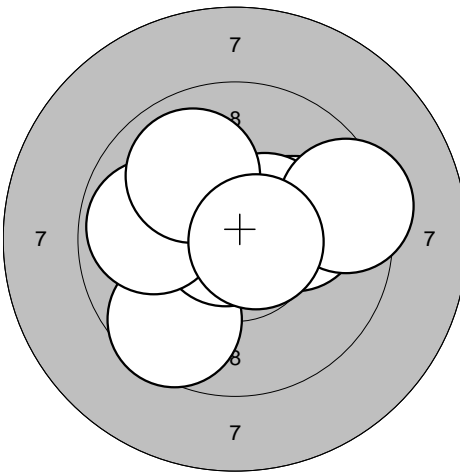
| | | | |
|--|--|--|---|
| Series 3  | 1: 10,0 ↗ 2: 10,3* ↓ 3: 10,2* ↖ 4: 10,7* → 5: 10,2* ↗ 6: 9,0 → 7: 9,4 ← 8: 10,5* → 9: 10,0 ↓ 10: 8,8 ↓ <hr/> Serie 96,0 Sum 290,0 | Series 4  | 1: 10,3* ↖ 2: 10,2* → 3: 10,1 → 4: 10,5* ↗ 5: 9,6 ↓ 6: 10,8* ← 7: 9,4 → 8: 9,9 ← 9: 9,9 ↗ 10: 10,6* → <hr/> Serie 96,0 Sum 386,0 |
|--|--|--|---|

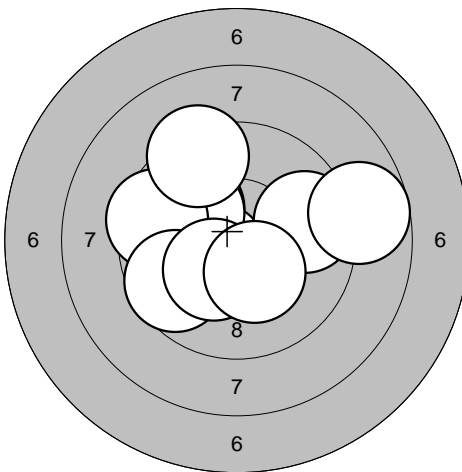
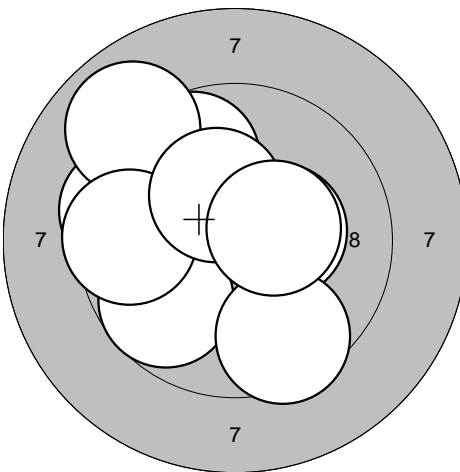
| | | | |
|---|--|---|--|
| Series 5  | 1: 10,0 ↖ 2: 10,5* ↖ 3: 10,1 ↗ 4: 9,5 ↖ 5: 9,7 → 6: 9,6 ↖ 7: 10,3* ↖ 8: 10,3* ↓ 9: 9,3 ↗ 10: 8,7 → <hr/> Serie 94,0 Sum 480,0 | Series 6  | 1: 9,7 ↗ 2: 9,5 ← 3: 10,3* → 4: 9,7 ↗ 5: 9,7 ↖ 6: 8,9 ↗ 7: 9,6 ← 8: 9,5 ↓ 9: 10,3* ↗ 10: 10,4* → <hr/> Serie 92,0 Sum 572,0 |
|---|--|---|--|

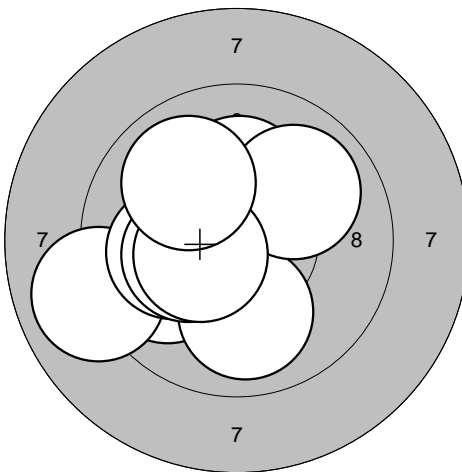
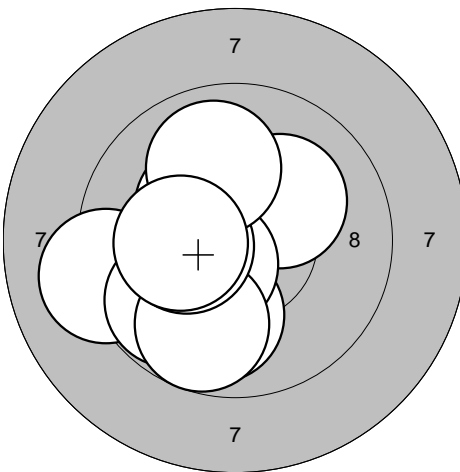
| | | | | | | | | | | | |
|--|--|-------|------|-----|------|--|--|-------|------|-----|-------|
| <p>Series 1</p>  | <p>1: 9,9 ↙ 2: 10,2* ↑ 3: 10,0 ↓ 4: 9,0 ← 5: 10,1 ← 6: 10,4* ← 7: 10,0 ↗ 8: 10,3* ← 9: 10,4* ← 10: 10,0 ↖</p> <table border="1" style="width:100%; border-collapse: collapse;"> <tr><td>Serie</td><td style="text-align: right;">98,0</td></tr> <tr><td>Sum</td><td style="text-align: right;">98,0</td></tr> </table> | Serie | 98,0 | Sum | 98,0 | <p>Series 2</p>  | <p>1: 9,9 ↓ 2: 9,2 ← 3: 10,3* ↖ 4: 10,2* ↗ 5: 9,8 ↙ 6: 10,5* ↙ 7: 9,8 ↓ 8: 10,3* ← 9: 10,0 ↑ 10: 10,2* ←</p> <table border="1" style="width:100%; border-collapse: collapse;"> <tr><td>Serie</td><td style="text-align: right;">96,0</td></tr> <tr><td>Sum</td><td style="text-align: right;">194,0</td></tr> </table> | Serie | 96,0 | Sum | 194,0 |
| Serie | 98,0 | | | | | | | | | | |
| Sum | 98,0 | | | | | | | | | | |
| Serie | 96,0 | | | | | | | | | | |
| Sum | 194,0 | | | | | | | | | | |

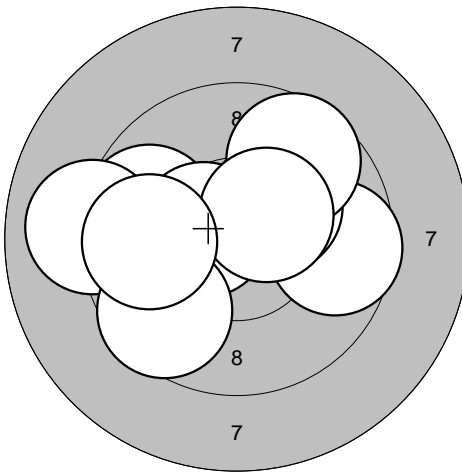
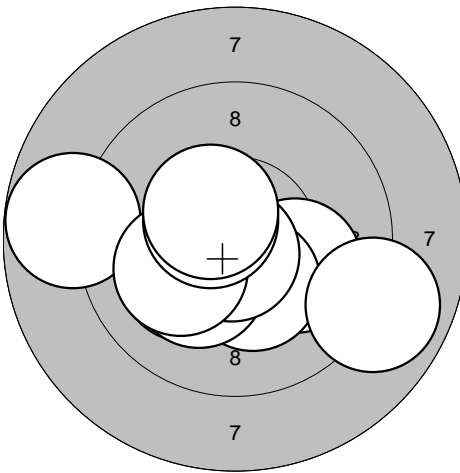
| | | | | | | | | | | | |
|---|---|-------|------|-----|-------|---|--|-------|------|-----|-------|
| <p>Series 3</p>  | <p>1: 9,6 → 2: 10,3* ↗ 3: 9,6 ← 4: 9,7 ↗ 5: 9,7 ← 6: 10,5* ← 7: 9,0 ← 8: 9,6 ↙ 9: 10,4* ↗ 10: 9,8 ←</p> <table border="1" style="width:100%; border-collapse: collapse;"> <tr><td>Serie</td><td style="text-align: right;">93,0</td></tr> <tr><td>Sum</td><td style="text-align: right;">287,0</td></tr> </table> | Serie | 93,0 | Sum | 287,0 | <p>Series 4</p>  | <p>1: 10,1 ↘ 2: 8,8 ← 3: 10,3* ↓ 4: 10,1 ↙ 5: 10,2* ↙ 6: 10,8* ↓ 7: 10,1 ↙ 8: 8,9 ↘ 9: 10,5* ↗ 10: 10,5* ↖</p> <table border="1" style="width:100%; border-collapse: collapse;"> <tr><td>Serie</td><td style="text-align: right;">96,0</td></tr> <tr><td>Sum</td><td style="text-align: right;">383,0</td></tr> </table> | Serie | 96,0 | Sum | 383,0 |
| Serie | 93,0 | | | | | | | | | | |
| Sum | 287,0 | | | | | | | | | | |
| Serie | 96,0 | | | | | | | | | | |
| Sum | 383,0 | | | | | | | | | | |

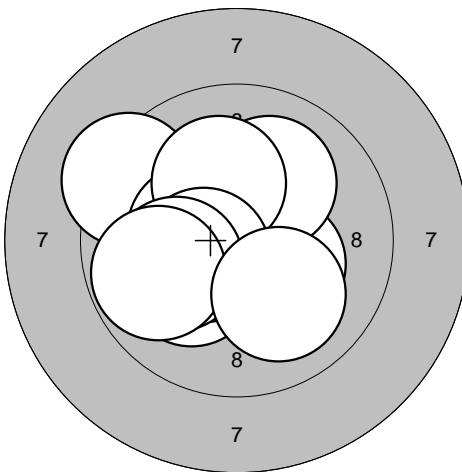
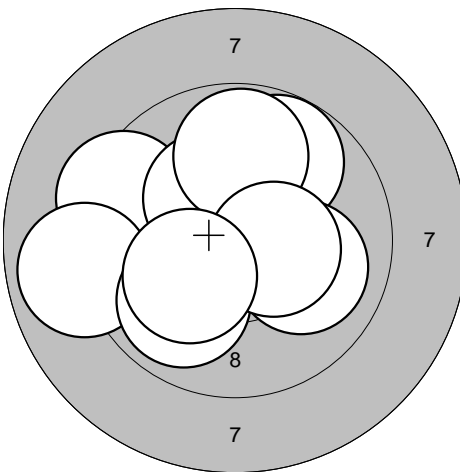
| | | | | | | | | | | | |
|--|--|-------|------|-----|-------|--|--|-------|------|-----|-------|
| <p>Series 5</p>  | <p>1: 10,2* ↙ 2: 10,3* ↘ 3: 10,1 ↗ 4: 9,3 ↖ 5: 10,4* ← 6: 10,2* ↑ 7: 10,4* ← 8: 10,1 ← 9: 9,8 ← 10: 10,0 ↓</p> <table border="1" style="width:100%; border-collapse: collapse;"> <tr><td>Serie</td><td style="text-align: right;">98,0</td></tr> <tr><td>Sum</td><td style="text-align: right;">481,0</td></tr> </table> | Serie | 98,0 | Sum | 481,0 | <p>Series 6</p>  | <p>1: 10,3* ↙ 2: 9,4 ← 3: 10,3* ↖ 4: 8,9 ← 5: 9,9 ↙ 6: 9,8 ↗ 7: 9,8 ↑ 8: 10,0 ↘ 9: 10,4* → 10: 10,2* ↙</p> <table border="1" style="width:100%; border-collapse: collapse;"> <tr><td>Serie</td><td style="text-align: right;">94,0</td></tr> <tr><td>Sum</td><td style="text-align: right;">575,0</td></tr> </table> | Serie | 94,0 | Sum | 575,0 |
| Serie | 98,0 | | | | | | | | | | |
| Sum | 481,0 | | | | | | | | | | |
| Serie | 94,0 | | | | | | | | | | |
| Sum | 575,0 | | | | | | | | | | |

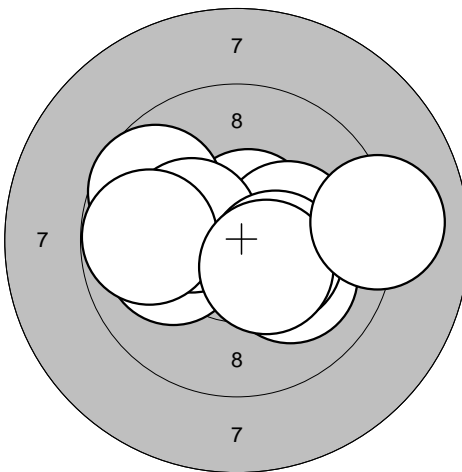
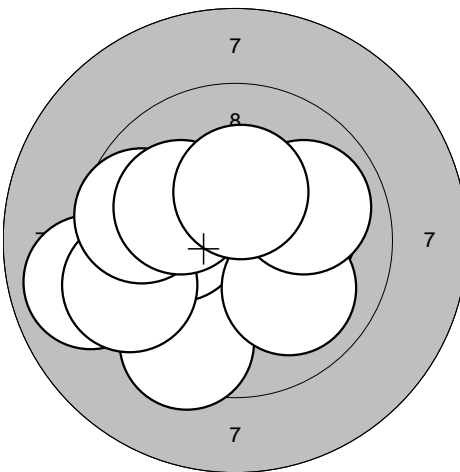
| | | | |
|--|--|--|---|
| <p>Series 1</p>  | <p>1: 10,1 ↘ 2: 10,6* ↗ 3: 10,1 ← 4: 9,7 ↖ 5: 10,2* → 6: 10,3* ↖ 7: 9,8 ← 8: 10,4* ↘ 9: 10,4* ↘ 10: 9,1 →</p> <p>Serie 97,0 Sum 97,0</p> | <p>Series 2</p>  | <p>1: 8,9 ← 2: 9,4 ↓ 3: 10,2* ← 4: 10,2* → 5: 10,0 ↘ 6: 9,4 ← 7: 9,7 ← 8: 10,1 ↖ 9: 9,9 → 10: 10,3* ↑</p> <p>Serie 94,0 Sum 191,0</p> |
|--|--|--|---|

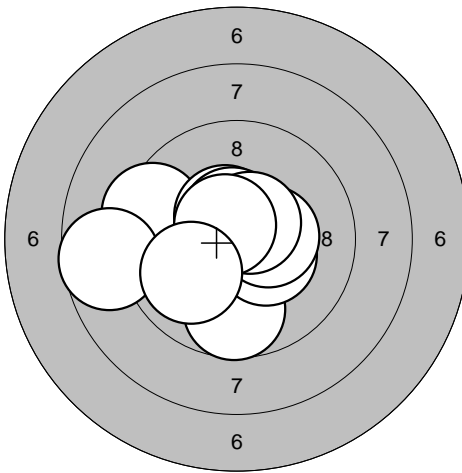
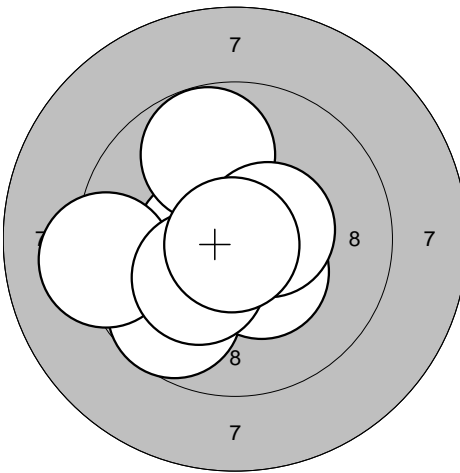
| | | | |
|---|---|---|---|
| <p>Series 3</p>  | <p>1: 9,4 ← 2: 10,5* ↗ 3: 8,7 ← 4: 9,7 ↓ 5: 10,4* ↘ 6: 10,4* → 7: 10,6* ↗ 8: 10,6* ↗ 9: 10,7* ↗ 10: 9,9 ↘</p> <p>Serie 95,0 Sum 286,0</p> | <p>Series 4</p>  | <p>1: 10,7* ↑ 2: 10,5* ← 3: 10,7* → 4: 9,7 ↘ 5: 9,2 ← 6: 9,8 ↑ 7: 10,4* ↘ 8: 10,5* → 9: 10,2* ↘ 10: 10,9* ↘</p> <p>Serie 97,0 Sum 383,0</p> |
|---|---|---|---|

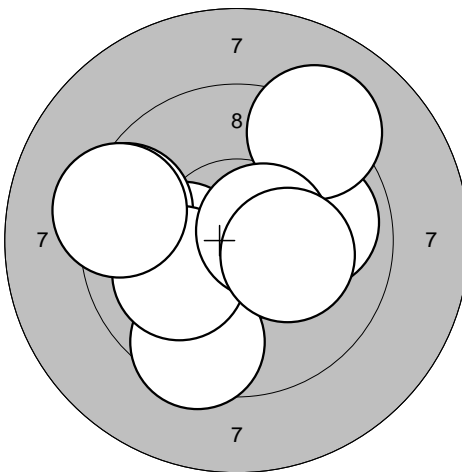
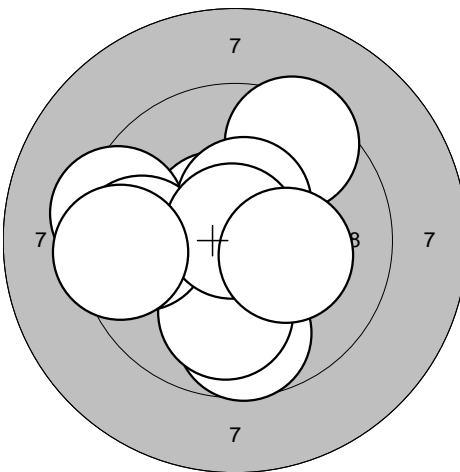
| | | | |
|--|--|--|--|
| <p>Series 5</p>  | <p>1: 10,2* ← 2: 9,4 ← 3: 10,3* ↘ 4: 9,9 → 5: 9,5 ↓ 6: 10,1 ← 7: 9,2 ↗ 8: 10,6* → 9: 9,4 ← 10: 10,2* →</p> <p>Serie 95,0 Sum 478,0</p> | <p>Series 6</p>  | <p>1: 10,6* ↖ 2: 9,5 ↗ 3: 9,7 ↓ 4: 10,0 ↓ 5: 9,4 ← 6: 10,5* ↑ 7: 9,7 ← 8: 10,8* ↑ 9: 10,2* → 10: 9,4 ←</p> <p>Serie 95,0 Sum 573,0</p> |
|--|--|--|--|

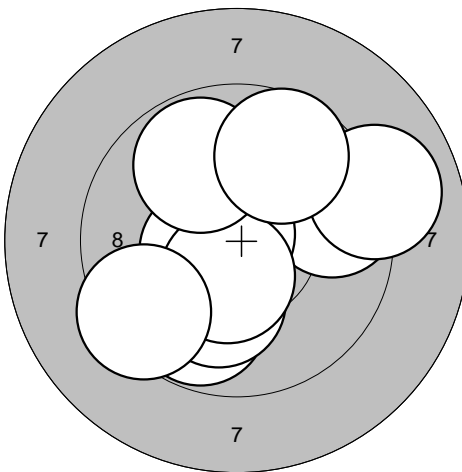
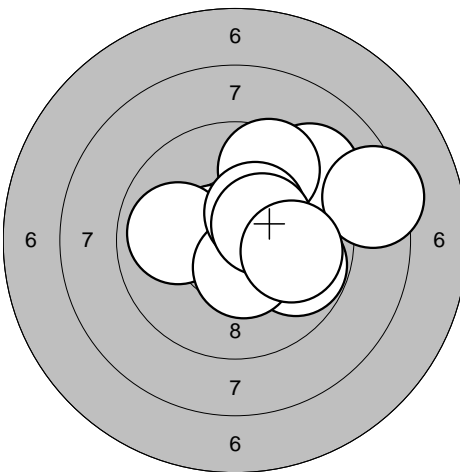
| | | | |
|--|---|--|---|
| <p>Series 1</p>  | <p>1: 9,6 →</p> <p>2: 9,8 ↓</p> <p>3: 10,8* ↖</p> <p>4: 10,1 ↓</p> <p>5: 10,5* ←</p> <p>6: 10,4* ↓</p> <p>7: 9,9 ↑</p> <p>8: 9,0 →</p> <p>9: 9,4 ←</p> <p>10: 9,7 ↗</p> | <p>Series 2</p>  | <p>1: 10,6* ←</p> <p>2: 10,0 ←</p> <p>3: 9,8 →</p> <p>4: 9,2 ↗</p> <p>5: 9,6 ↗</p> <p>6: 10,5* ↓</p> <p>7: 10,4* ↗</p> <p>8: 10,4* ↗</p> <p>9: 8,4 →</p> <p>10: 9,9 →</p> |
| Serie 94,0 | | Serie 94,0 | |
| Sum 94,0 | | Sum 188,0 | |

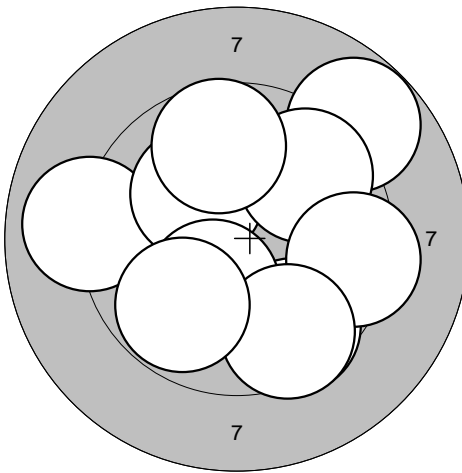
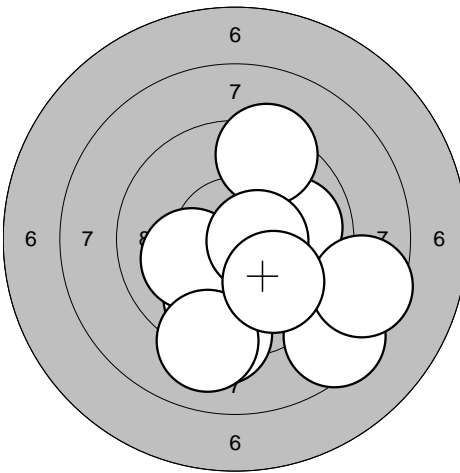
| | | | |
|---|--|---|---|
| <p>Series 3</p>  | <p>1: 9,5 ↓</p> <p>2: 9,0 ←</p> <p>3: 10,2* ↗</p> <p>4: 10,2* ↓</p> <p>5: 8,8 ↗</p> <p>6: 9,7 ↗</p> <p>7: 9,4 →</p> <p>8: 9,5 ↓</p> <p>9: 9,8 ↖</p> <p>10: 9,7 ↑</p> | <p>Series 4</p>  | <p>1: 9,8 ↓</p> <p>2: 9,3 ↓</p> <p>3: 9,9 →</p> <p>4: 9,4 ↗</p> <p>5: 10,1 ←</p> <p>6: 8,5 ↓</p> <p>7: 8,5 →</p> <p>8: 9,1 ↓</p> <p>9: 10,5* →</p> <p>10: 9,9 ↓</p> |
| Serie 91,0 | | Serie 90,0 | |
| Sum 279,0 | | Sum 369,0 | |

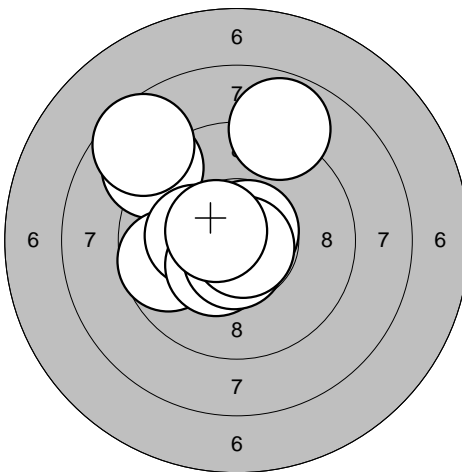
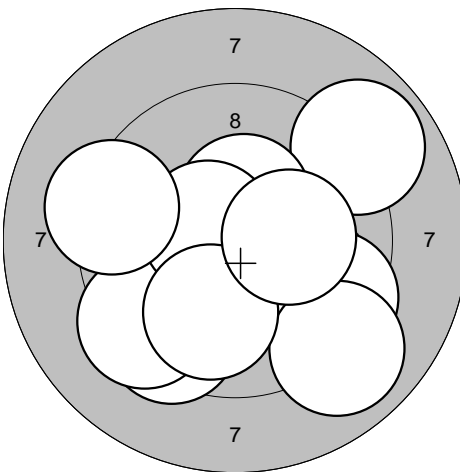
| | | | |
|--|--|--|---|
| <p>Series 5</p>  | <p>1: 8,9 ↗</p> <p>2: 9,0 ↖</p> <p>3: 9,7 ←</p> <p>4: 10,2* ←</p> <p>5: 10,7* ↗</p> <p>6: 10,4* ↓</p> <p>7: 8,6 ↗</p> <p>8: 10,6* ↓</p> <p>9: 10,8* ↓</p> <p>10: 10,5* ↖</p> | <p>Series 6</p>  | <p>1: 9,4 ↓</p> <p>2: 9,3 ↖</p> <p>3: 8,9 ↗</p> <p>4: 10,4* ↗</p> <p>5: 9,4 ↘</p> <p>6: 9,0 ↘</p> <p>7: 10,6* ↖</p> <p>8: 9,2 ←</p> <p>9: 10,0 ↓</p> <p>10: 10,2* →</p> |
| Serie 94,0 | | Serie 93,0 | |
| Sum 463,0 | | Sum 556,0 | |

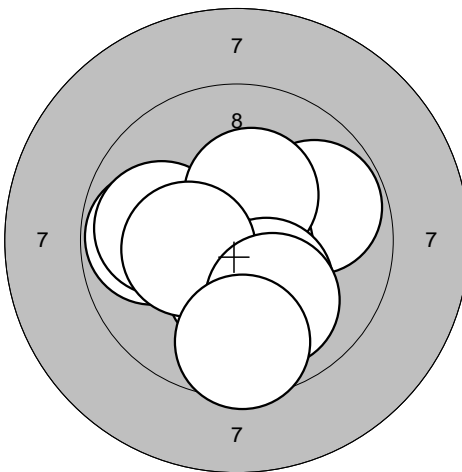
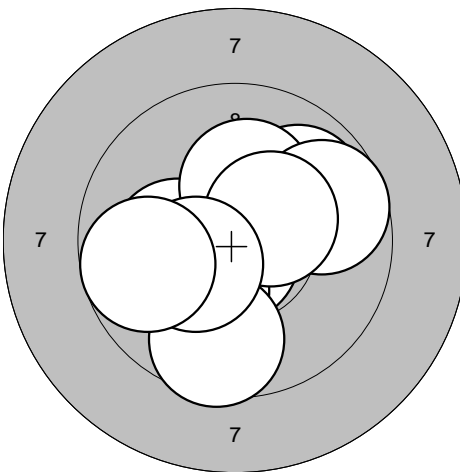
| | | | | | | | | | | | |
|--|--|-------|------|-----|------|--|---|-------|------|-----|-------|
| <p>Series 1</p>  | <p>1: 9,8 ←</p> <p>2: 9,9 ←</p> <p>3: 9,8 →</p> <p>4: 10,8* ↘</p> <p>5: 10,3* ↑</p> <p>6: 10,3* ↓</p> <p>7: 10,2* ↘</p> <p>8: 10,3* ←</p> <p>9: 10,0 ↓</p> <p>10: 9,6 ↓</p> <table border="1" style="width:100%; border-collapse: collapse;"> <tr><td>Serie</td><td style="text-align: right;">96,0</td></tr> <tr><td>Sum</td><td style="text-align: right;">96,0</td></tr> </table> | Serie | 96,0 | Sum | 96,0 | <p>Series 2</p>  | <p>1: 9,9 ↗</p> <p>2: 10,2* ←</p> <p>3: 10,8* ↓</p> <p>4: 10,1 ↘</p> <p>5: 9,6 ↓</p> <p>6: 10,2* ↑</p> <p>7: 9,7 →</p> <p>8: 10,4* ↗</p> <p>9: 10,3* ←</p> <p>10: 9,7 ←</p> <table border="1" style="width:100%; border-collapse: collapse;"> <tr><td>Serie</td><td style="text-align: right;">96,0</td></tr> <tr><td>Sum</td><td style="text-align: right;">192,0</td></tr> </table> | Serie | 96,0 | Sum | 192,0 |
| Serie | 96,0 | | | | | | | | | | |
| Sum | 96,0 | | | | | | | | | | |
| Serie | 96,0 | | | | | | | | | | |
| Sum | 192,0 | | | | | | | | | | |

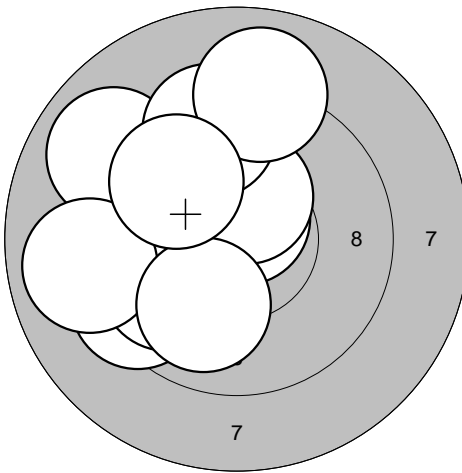
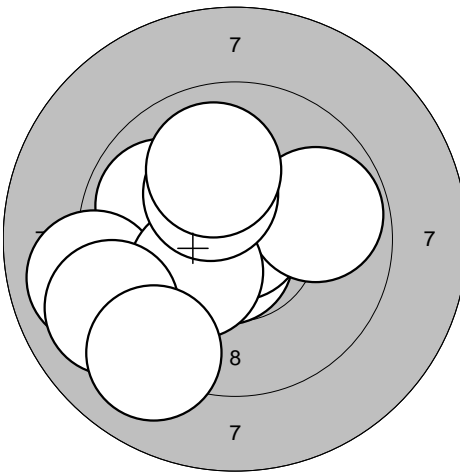
| | | | | | | | | | | | |
|---|---|-------|------|-----|-------|---|---|-------|------|-----|-------|
| <p>Series 3</p>  | <p>1: 9,0 ↖</p> <p>2: 9,4 ↙</p> <p>3: 10,7* ↑</p> <p>4: 9,9 ↙</p> <p>5: 10,4* ↑</p> <p>6: 9,5 ↑</p> <p>7: 8,9 ←</p> <p>8: 9,0 ↑</p> <p>9: 10,0 ↘</p> <p>10: 9,8 ↗</p> <table border="1" style="width:100%; border-collapse: collapse;"> <tr><td>Serie</td><td style="text-align: right;">92,0</td></tr> <tr><td>Sum</td><td style="text-align: right;">284,0</td></tr> </table> | Serie | 92,0 | Sum | 284,0 | <p>Series 4</p>  | <p>1: 10,7* ↓</p> <p>2: 10,9* ↗</p> <p>3: 9,9 ↖</p> <p>4: 9,0 ←</p> <p>5: 9,8 →</p> <p>6: 10,3* ↙</p> <p>7: 10,3* ↗</p> <p>8: 10,0 ↑</p> <p>9: 9,1 ↙</p> <p>10: 9,1 ↘</p> <table border="1" style="width:100%; border-collapse: collapse;"> <tr><td>Serie</td><td style="text-align: right;">95,0</td></tr> <tr><td>Sum</td><td style="text-align: right;">379,0</td></tr> </table> | Serie | 95,0 | Sum | 379,0 |
| Serie | 92,0 | | | | | | | | | | |
| Sum | 284,0 | | | | | | | | | | |
| Serie | 95,0 | | | | | | | | | | |
| Sum | 379,0 | | | | | | | | | | |

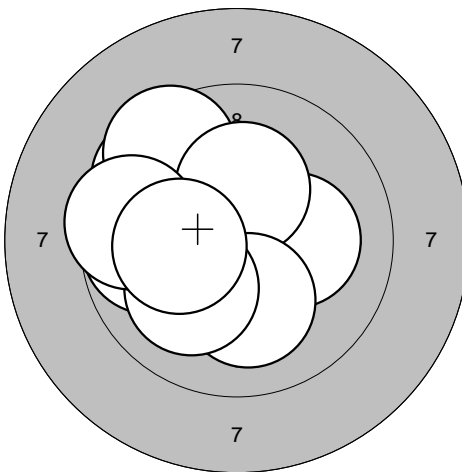
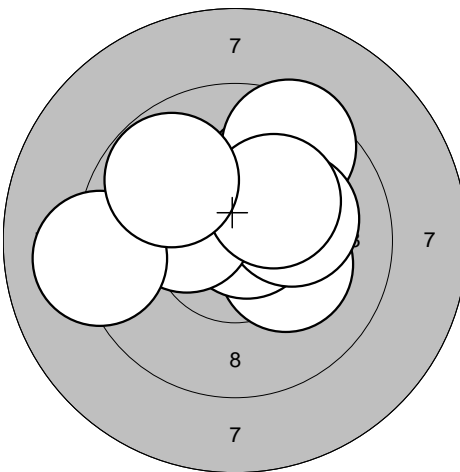
| | | | | | | | | | | | |
|--|--|-------|------|-----|-------|--|--|-------|------|-----|-------|
| <p>Series 5</p>  | <p>1: 9,6 ↗</p> <p>2: 10,4* ↖</p> <p>3: 9,5 ↗</p> <p>4: 10,2* →</p> <p>5: 10,3* ↑</p> <p>6: 9,8 ←</p> <p>7: 10,1 ↓</p> <p>8: 10,1 ↙</p> <p>9: 9,5 ←</p> <p>10: 10,2* ←</p> <table border="1" style="width:100%; border-collapse: collapse;"> <tr><td>Serie</td><td style="text-align: right;">96,0</td></tr> <tr><td>Sum</td><td style="text-align: right;">475,0</td></tr> </table> | Serie | 96,0 | Sum | 475,0 | <p>Series 6</p>  | <p>1: 10,2* ↘</p> <p>2: 10,7* ↗</p> <p>3: 10,0 ↗</p> <p>4: 9,5 ↗</p> <p>5: 10,1 →</p> <p>6: 10,3* ↖</p> <p>7: 10,3* ←</p> <p>8: 9,1 ←</p> <p>9: 10,2* ↗</p> <p>10: 9,8 ↖</p> <table border="1" style="width:100%; border-collapse: collapse;"> <tr><td>Serie</td><td style="text-align: right;">97,0</td></tr> <tr><td>Sum</td><td style="text-align: right;">572,0</td></tr> </table> | Serie | 97,0 | Sum | 572,0 |
| Serie | 96,0 | | | | | | | | | | |
| Sum | 475,0 | | | | | | | | | | |
| Serie | 97,0 | | | | | | | | | | |
| Sum | 572,0 | | | | | | | | | | |

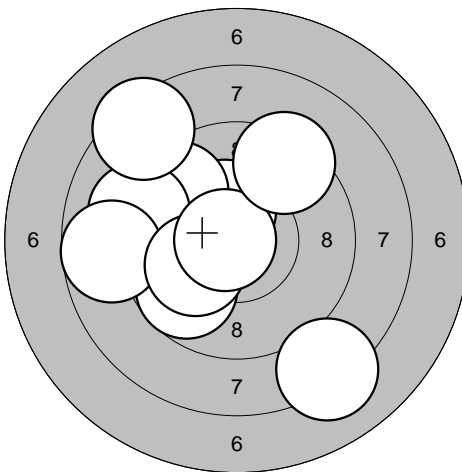
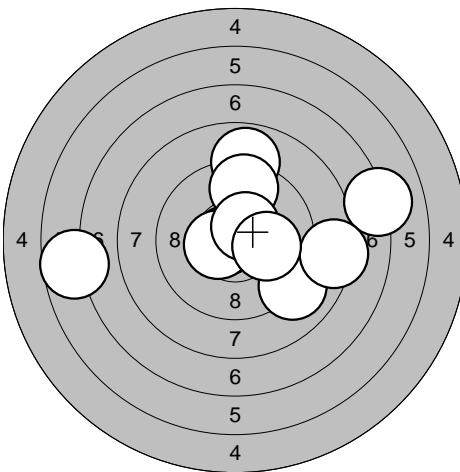
| | | | |
|--|--|---|---|
| <p>Series 1</p>  | <p>Series 2</p>  | <p>1: 10,4* ↗</p> <p>2: 9,6 ↗</p> <p>3: 9,1 ←</p> <p>4: 9,7 ↘</p> <p>5: 8,8 ←</p> <p>6: 8,4 ↗</p> <p>7: 10,1 ↘</p> <p>8: 10,8* ←</p> <p>9: 8,2 ↘</p> <p>10: 9,4 ↗</p> | <p>1: 9,0 ↘</p> <p>2: 10,8* ←</p> <p>3: 8,9 ↑</p> <p>4: 7,0 →</p> <p>5: 10,5* ←</p> <p>6: 8,3 →</p> <p>7: 9,6 ↑</p> <p>8: 6,7 ←</p> <p>9: 10,5* ↗</p> <p>10: 10,1 →</p> |
| Serie 90,0 | Serie 87,0 | | |
| Sum 90,0 | Sum 177,0 | | |

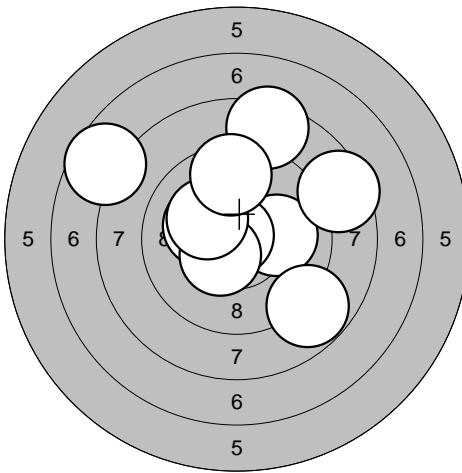
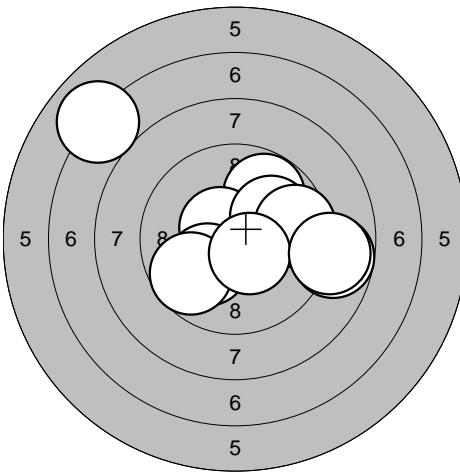
| | | | |
|---|---|---|--|
| <p>Series 3</p>  | <p>Series 4</p>  | <p>1: 7,7 ↗</p> <p>2: 10,2* ↗</p> <p>3: 10,1 →</p> <p>4: 10,9* ↗</p> <p>5: 10,5* ↘</p> <p>6: 10,2* ↗</p> <p>7: 8,4 ↑</p> <p>8: 9,5 ↑</p> <p>9: 8,5 →</p> <p>10: 8,8 ↘</p> | <p>1: 9,8 ↗</p> <p>2: 7,0 ↗</p> <p>3: 10,6* ↗</p> <p>4: 10,1 ↘</p> <p>5: 9,7 ↘</p> <p>6: 10,0 →</p> <p>7: 8,8 →</p> <p>8: 9,6 →</p> <p>9: 10,5* ↘</p> <p>10: 8,9 →</p> |
| Serie 90,0 | Serie 90,0 | | |
| Sum 267,0 | Sum 357,0 | | |

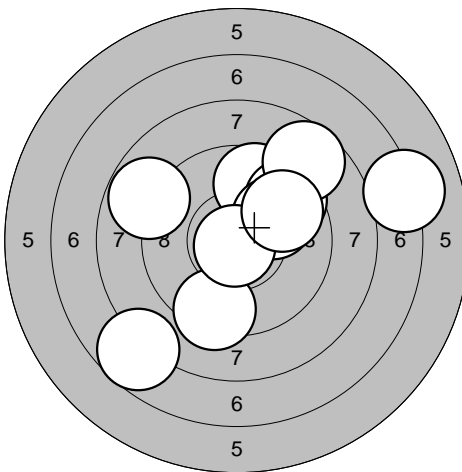
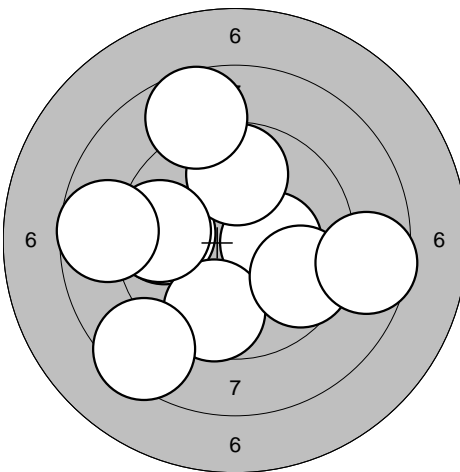
| | | | |
|--|--|---|--|
| <p>Series 5</p>  | <p>Series 6</p>  | <p>1: 8,8 ↗</p> <p>2: 9,7 ↑</p> <p>3: 9,5 ↗</p> <p>4: 9,3 ↘</p> <p>5: 7,7 ↘</p> <p>6: 8,7 ↗</p> <p>7: 7,1 →</p> <p>8: 10,0 →</p> <p>9: 10,8* ↘</p> <p>10: 9,8 ↗</p> | <p>1: 10,3* →</p> <p>2: 9,7 ←</p> <p>3: 9,7 ↘</p> <p>4: 9,6 ↘</p> <p>5: 9,8 ↑</p> <p>6: 9,6 ←</p> <p>7: 8,6 →</p> <p>8: 8,7 ←</p> <p>9: 8,4 ↘</p> <p>10: 8,7 ↑</p> |
| Serie 86,0 | Serie 87,0 | | |
| Sum 443,0 | Sum 530,0 | | |

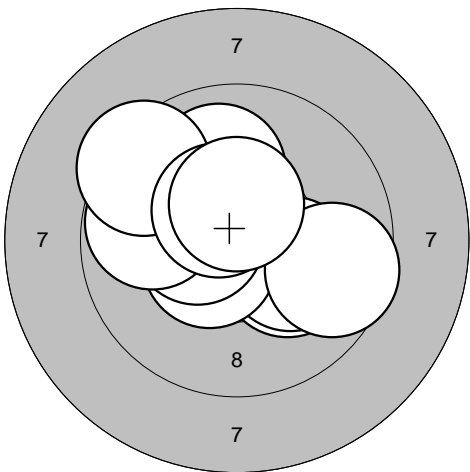
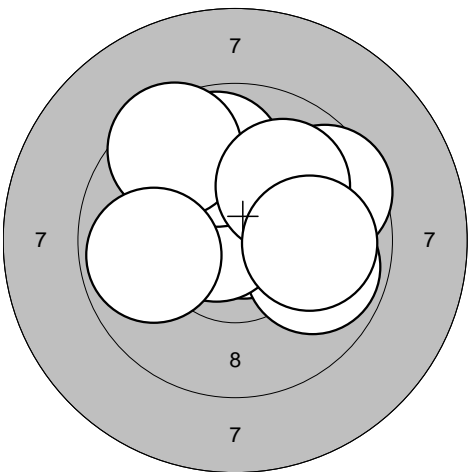
| | | | | | | | | | | | |
|--|---|-------|------|-----|------|--|--|-------|------|-----|-------|
| <p>Series 1</p>  | <p>1: 10,2* ↘ 2: 10,1 → 3: 10,5* ↙ 4: 10,4* ← 5: 9,6 → 6: 10,0 ↑ 7: 9,8 ← 8: 9,4 ↗ 9: 10,5* ↗ 10: 10,5* ↑</p> <table border="1" style="width:100%; border-collapse: collapse;"> <tr><td>Serie</td><td style="text-align: right;">97,0</td></tr> <tr><td>Sum</td><td style="text-align: right;">97,0</td></tr> </table> | Serie | 97,0 | Sum | 97,0 | <p>Series 2</p>  | <p>1: 10,4* ← 2: 10,8* ↗ 3: 9,9 → 4: 10,7* ← 5: 9,9 ↑ 6: 9,6 ↗ 7: 9,5 ↗ 8: 9,8 ← 9: 10,0 ↗ 10: 10,0 →</p> <table border="1" style="width:100%; border-collapse: collapse;"> <tr><td>Serie</td><td style="text-align: right;">95,0</td></tr> <tr><td>Sum</td><td style="text-align: right;">192,0</td></tr> </table> | Serie | 95,0 | Sum | 192,0 |
| Serie | 97,0 | | | | | | | | | | |
| Sum | 97,0 | | | | | | | | | | |
| Serie | 95,0 | | | | | | | | | | |
| Sum | 192,0 | | | | | | | | | | |

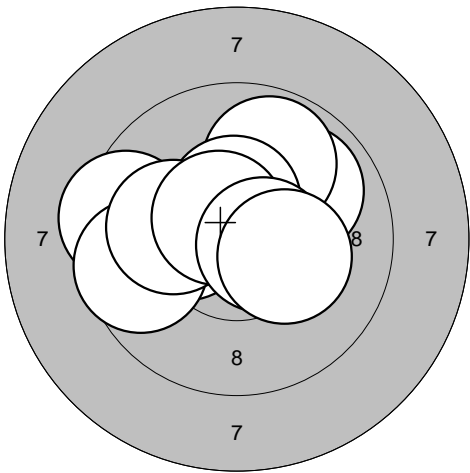
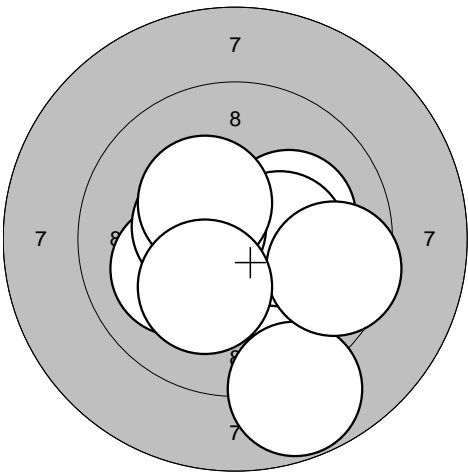
| | | | | | | | | | | | |
|---|---|-------|------|-----|-------|---|---|-------|------|-----|-------|
| <p>Series 3</p>  | <p>1: 9,9 ↗ 2: 9,9 ↗ 3: 10,3* ← 4: 9,5 ← 5: 9,6 ← 6: 10,5* ↑ 7: 10,1 ← 8: 10,6* ↗ 9: 10,6* → 10: 10,3* →</p> <table border="1" style="width:100%; border-collapse: collapse;"> <tr><td>Serie</td><td style="text-align: right;">96,0</td></tr> <tr><td>Sum</td><td style="text-align: right;">288,0</td></tr> </table> | Serie | 96,0 | Sum | 288,0 | <p>Series 4</p>  | <p>1: 10,5* ↘ 2: 10,2* → 3: 10,4* ↘ 4: 10,3* → 5: 8,8 ↘ 6: 9,6 → 7: 10,1 ← 8: 10,4* ← 9: 10,3* ↗ 10: 10,2* ↘</p> <table border="1" style="width:100%; border-collapse: collapse;"> <tr><td>Serie</td><td style="text-align: right;">97,0</td></tr> <tr><td>Sum</td><td style="text-align: right;">385,0</td></tr> </table> | Serie | 97,0 | Sum | 385,0 |
| Serie | 96,0 | | | | | | | | | | |
| Sum | 288,0 | | | | | | | | | | |
| Serie | 97,0 | | | | | | | | | | |
| Sum | 385,0 | | | | | | | | | | |

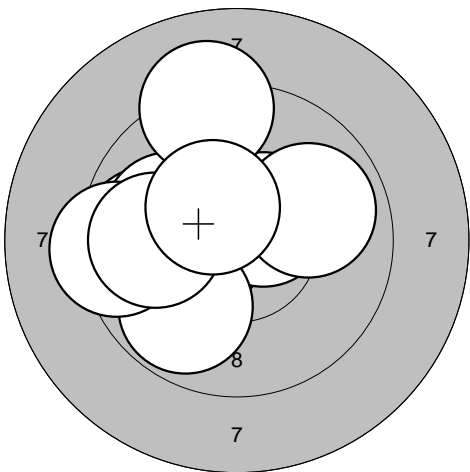
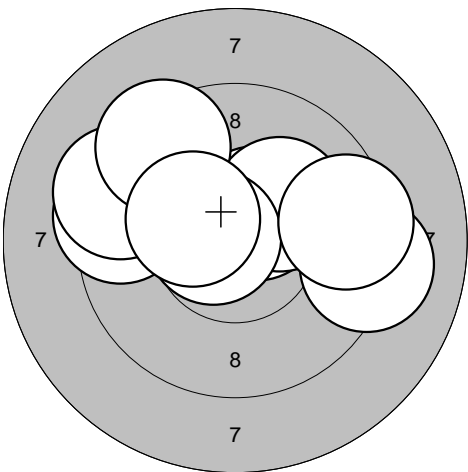
| | | | | | | | | | | | |
|--|---|-------|------|-----|-------|--|--|-------|------|-----|-------|
| <p>Series 5</p>  | <p>1: 10,6* ← 2: 9,8 ← 3: 10,5* ↗ 4: 9,9 ↘ 5: 10,0 ← 6: 9,3 ← 7: 9,9 → 8: 9,1 ↑ 9: 9,9 ← 10: 10,4* ↗</p> <table border="1" style="width:100%; border-collapse: collapse;"> <tr><td>Serie</td><td style="text-align: right;">94,0</td></tr> <tr><td>Sum</td><td style="text-align: right;">479,0</td></tr> </table> | Serie | 94,0 | Sum | 479,0 | <p>Series 6</p>  | <p>1: 9,6 ↙ 2: 10,5* ↗ 3: 9,4 ← 4: 9,3 ← 5: 10,2* ↗ 6: 9,2 → 7: 10,7* ← 8: 9,5 → 9: 9,4 ↗ 10: 10,3* ←</p> <table border="1" style="width:100%; border-collapse: collapse;"> <tr><td>Serie</td><td style="text-align: right;">94,0</td></tr> <tr><td>Sum</td><td style="text-align: right;">573,0</td></tr> </table> | Serie | 94,0 | Sum | 573,0 |
| Serie | 94,0 | | | | | | | | | | |
| Sum | 479,0 | | | | | | | | | | |
| Serie | 94,0 | | | | | | | | | | |
| Sum | 573,0 | | | | | | | | | | |

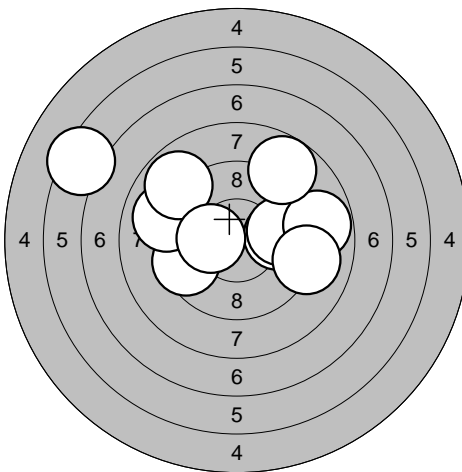
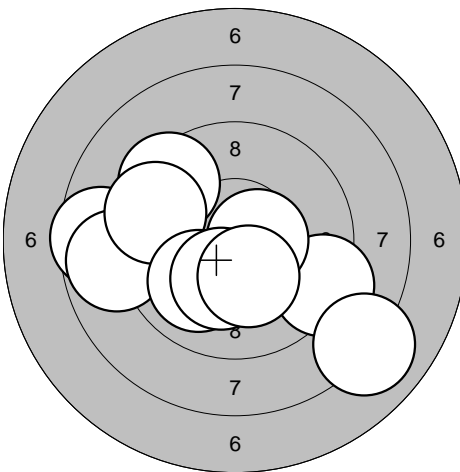
| | | | | | | | | | | | |
|--|---|-------|------|-----|------|--|---|-------|------|-----|-------|
| <p>Series 1</p>  | <p>1: 9,9 →</p> <p>2: 9,5 ←</p> <p>3: 6,4 ↗</p> <p>4: 9,8 →</p> <p>5: 9,0 ←</p> <p>6: 8,8 →</p> <p>7: 9,1 →</p> <p>8: 8,8 ↗</p> <p>9: 10,3* ←</p> <p>10: 8,8 ↗</p> <table border="1" style="width:100%; border-collapse: collapse;"> <tr> <td style="text-align: right;">Serie</td> <td style="text-align: right;">85,0</td> </tr> <tr> <td style="text-align: right;">Sum</td> <td style="text-align: right;">85,0</td> </tr> </table> | Serie | 85,0 | Sum | 85,0 | <p>Series 2</p>  | <p>1: 9,4 ↖</p> <p>2: 8,6 ←</p> <p>3: 8,8 ←</p> <p>4: 9,2 ↘</p> <p>5: 8,0 ↘</p> <p>6: 9,5 ←</p> <p>7: 10,0 ↘</p> <p>8: 10,6* →</p> <p>9: 10,2* ↘</p> <p>10: 10,3* ↘</p> <table border="1" style="width:100%; border-collapse: collapse;"> <tr> <td style="text-align: right;">Serie</td> <td style="text-align: right;">91,0</td> </tr> <tr> <td style="text-align: right;">Sum</td> <td style="text-align: right;">176,0</td> </tr> </table> | Serie | 91,0 | Sum | 176,0 |
| Serie | 85,0 | | | | | | | | | | |
| Sum | 85,0 | | | | | | | | | | |
| Serie | 91,0 | | | | | | | | | | |
| Sum | 176,0 | | | | | | | | | | |

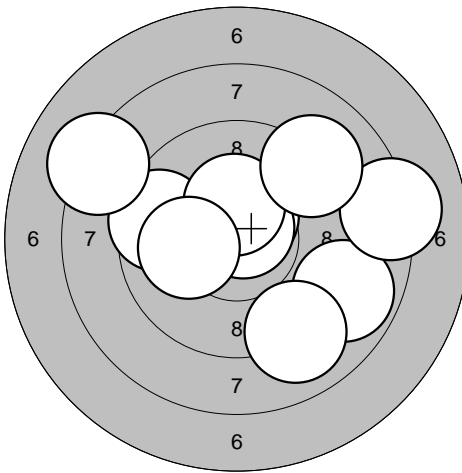
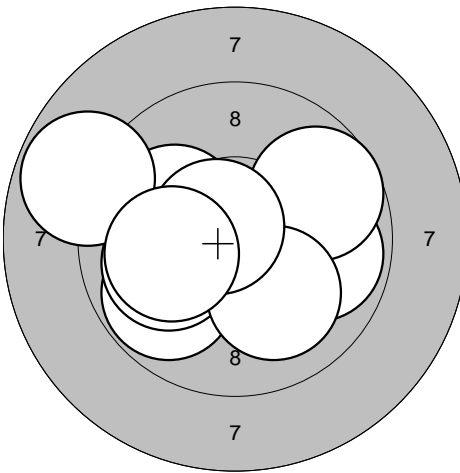
| | | | | | | | | | | | |
|---|---|-------|------|-----|-------|---|--|-------|------|-----|-------|
| <p>Series 3</p>  | <p>1: 10,5* ↗</p> <p>2: 9,6 ←</p> <p>3: 10,7* ↗</p> <p>4: 10,4* ↑</p> <p>5: 8,8 →</p> <p>6: 8,2 →</p> <p>7: 9,0 ↘</p> <p>8: 8,2 ↗</p> <p>9: 10,1 ←</p> <p>10: 9,1 ↗</p> <table border="1" style="width:100%; border-collapse: collapse;"> <tr> <td style="text-align: right;">Serie</td> <td style="text-align: right;">91,0</td> </tr> <tr> <td style="text-align: right;">Sum</td> <td style="text-align: right;">267,0</td> </tr> </table> | Serie | 91,0 | Sum | 267,0 | <p>Series 4</p>  | <p>1: 10,2* ↘</p> <p>2: 9,8 ←</p> <p>3: 9,8 →</p> <p>4: 10,0 ←</p> <p>5: 9,7 ↗</p> <p>6: 10,1 ↘</p> <p>7: 10,1 ↖</p> <p>8: 8,8 ↖</p> <p>9: 10,7* ↗</p> <p>10: 10,1 ←</p> <table border="1" style="width:100%; border-collapse: collapse;"> <tr> <td style="text-align: right;">Serie</td> <td style="text-align: right;">95,0</td> </tr> <tr> <td style="text-align: right;">Sum</td> <td style="text-align: right;">362,0</td> </tr> </table> | Serie | 95,0 | Sum | 362,0 |
| Serie | 91,0 | | | | | | | | | | |
| Sum | 267,0 | | | | | | | | | | |
| Serie | 95,0 | | | | | | | | | | |
| Sum | 362,0 | | | | | | | | | | |

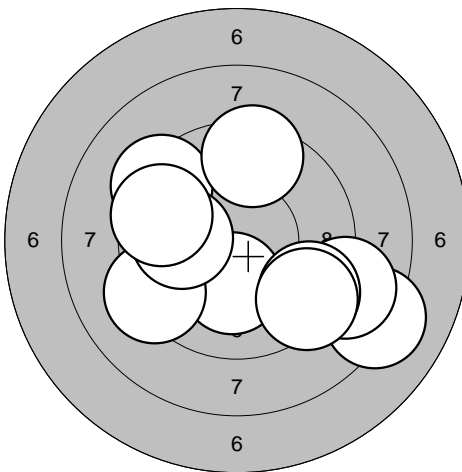
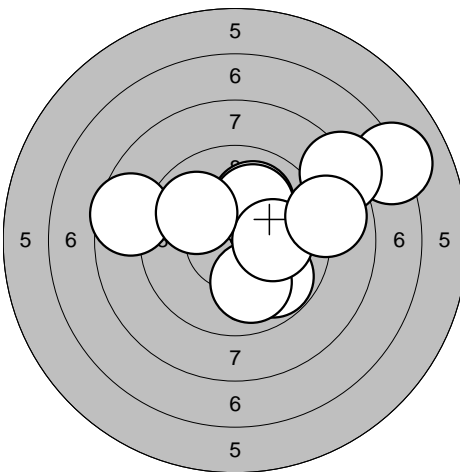
| | | | | | | | | | | | |
|--|---|-------|------|-----|-------|--|---|-------|------|-----|-------|
| <p>Series 5</p>  | <p>1: 10,2* ↓</p> <p>2: 9,3 ←</p> <p>3: 8,1 →</p> <p>4: 9,3 ↗</p> <p>5: 8,8 →</p> <p>6: 9,4 ↘</p> <p>7: 10,0 ←</p> <p>8: 9,4 ↑</p> <p>9: 9,6 ←</p> <p>10: 9,3 ↘</p> <table border="1" style="width:100%; border-collapse: collapse;"> <tr> <td style="text-align: right;">Serie</td> <td style="text-align: right;">90,0</td> </tr> <tr> <td style="text-align: right;">Sum</td> <td style="text-align: right;">452,0</td> </tr> </table> | Serie | 90,0 | Sum | 452,0 | <p>Series 6</p>  | <p>1: 8,6 ←</p> <p>2: 9,8 ↘</p> <p>3: 9,9 ↘</p> <p>4: 10,0 ↗</p> <p>5: 10,1 ↗</p> <p>6: 7,1 →</p> <p>7: 10,1 →</p> <p>8: 9,9 ↖</p> <p>9: 8,2 ↗</p> <p>10: 8,9 →</p> <table border="1" style="width:100%; border-collapse: collapse;"> <tr> <td style="text-align: right;">Serie</td> <td style="text-align: right;">88,0</td> </tr> <tr> <td style="text-align: right;">Sum</td> <td style="text-align: right;">540,0</td> </tr> </table> | Serie | 88,0 | Sum | 540,0 |
| Serie | 90,0 | | | | | | | | | | |
| Sum | 452,0 | | | | | | | | | | |
| Serie | 88,0 | | | | | | | | | | |
| Sum | 540,0 | | | | | | | | | | |

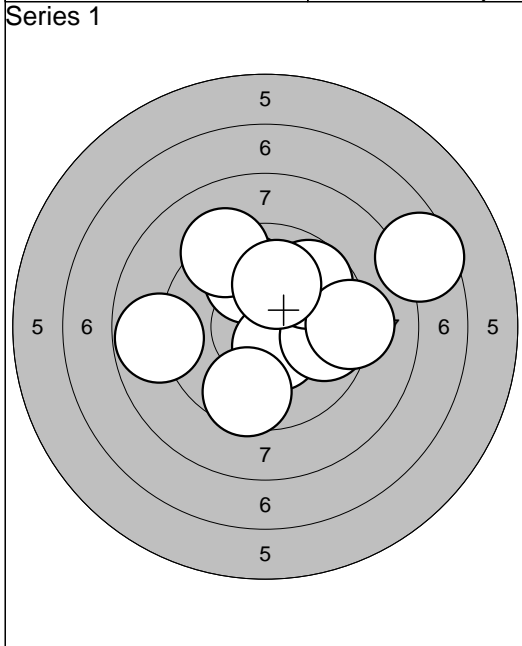

| | |
|-------------------|---|
| 1: 9,9 | ↖ |
| 2: 10,5* | ↘ |
| 3: 9,6 | ↘ |
| 4: 9,7 | → |
| 5: 8,8 | ← |
| 6: 9,8 | ↗ |
| 7: 9,3 | ↖ |
| 8: 7,5 | ↗ |
| 9: 9,2 | → |
| 10: 10,1 | ↗ |
| Serie 89,0 | |
| Sum 89,0 | |

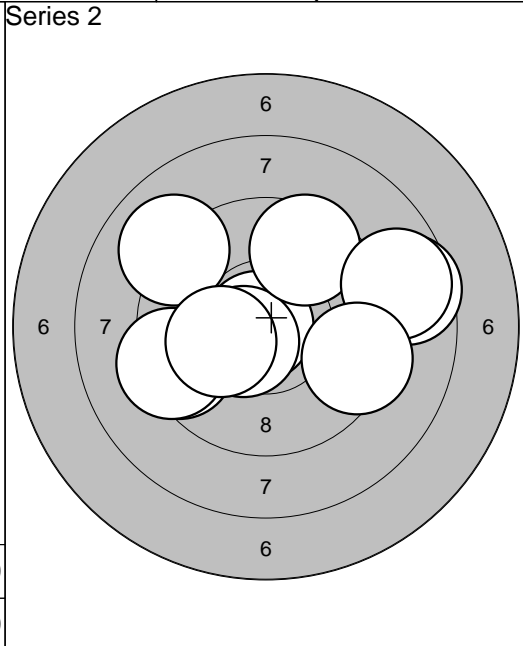

| | |
|-------------------|---|
| 1: 10,8* | ← |
| 2: 8,6 | → |
| 3: 9,4 | ← |
| 4: 9,3 | ← |
| 5: 10,5* | ↙ |
| 6: 9,0 | ↗ |
| 7: 9,5 | ↗ |
| 8: 8,7 | → |
| 9: 9,4 | → |
| 10: 10,2* | ← |
| Serie 91,0 | |
| Sum 180,0 | |

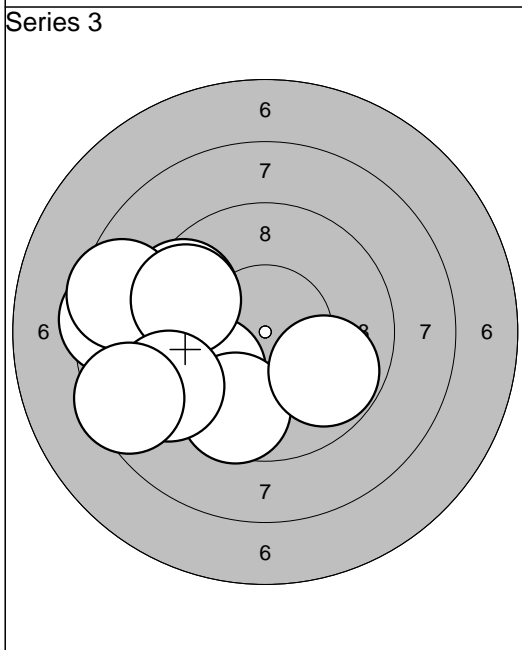

| | |
|-------------------|---|
| 1: 9,5 | ↙ |
| 2: 8,5 | ← |
| 3: 9,4 | ← |
| 4: 9,9 | ↙ |
| 5: 9,6 | ↘ |
| 6: 8,6 | ← |
| 7: 9,6 | ↙ |
| 8: 9,2 | ↙ |
| 9: 8,5 | ↙ |
| 10: 9,8 | ↘ |
| Serie 87,0 | |
| Sum 267,0 | |

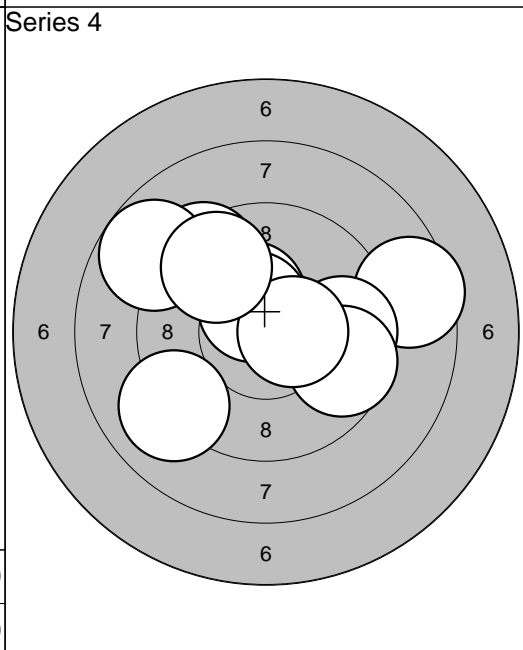

| | |
|-------------------|---|
| 1: 10,4* | ↖ |
| 2: 8,6 | → |
| 3: 9,7 | → |
| 4: 9,6 | → |
| 5: 9,4 | ↗ |
| 6: 10,5* | ↗ |
| 7: 9,0 | ↙ |
| 8: 10,5* | → |
| 9: 8,8 | ↗ |
| 10: 9,6 | ↗ |
| Serie 91,0 | |
| Sum 358,0 | |

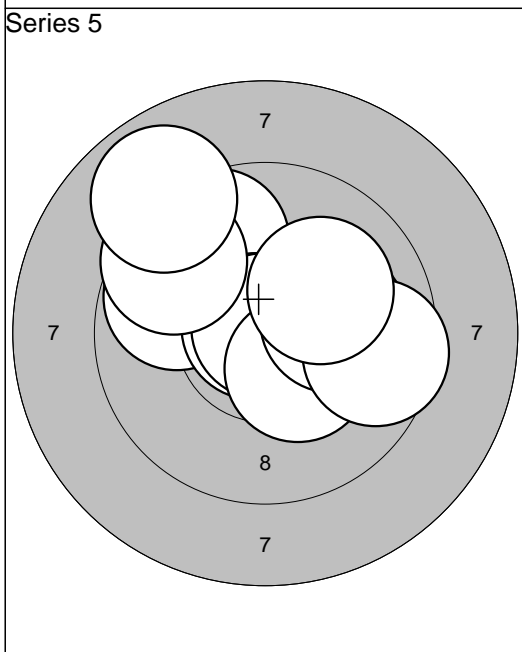

| | |
|-------------------|---|
| 1: 9,8 | ↙ |
| 2: 9,7 | ↗ |
| 3: 10,8* | ↙ |
| 4: 10,9* | ↖ |
| 5: 9,5 | ↗ |
| 6: 10,3* | ↘ |
| 7: 10,1 | → |
| 8: 9,6 | → |
| 9: 8,9 | ↖ |
| 10: 10,1 | ↗ |
| Serie 94,0 | |
| Sum 452,0 | |

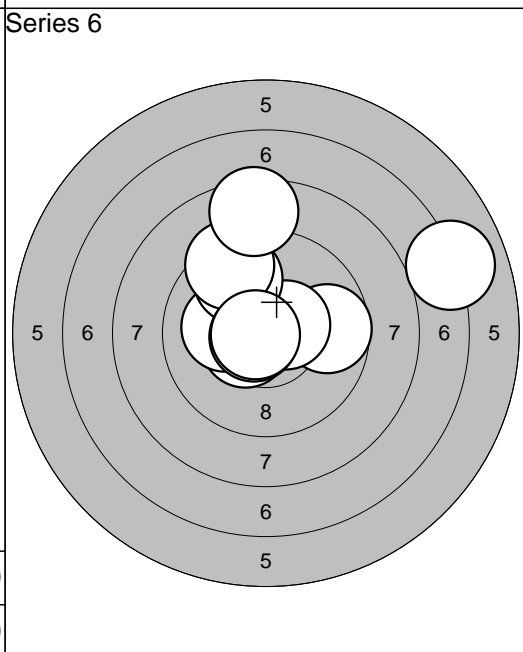

| | |
|-------------------|---|
| 1: 10,5* | ↙ |
| 2: 9,7 | → |
| 3: 10,1 | ← |
| 4: 10,5* | → |
| 5: 9,7 | ↗ |
| 6: 10,7* | ← |
| 7: 9,4 | ↖ |
| 8: 10,8* | ← |
| 9: 8,5 | ↖ |
| 10: 7,0 | → |
| Serie 92,0 | |
| Sum 544,0 | |

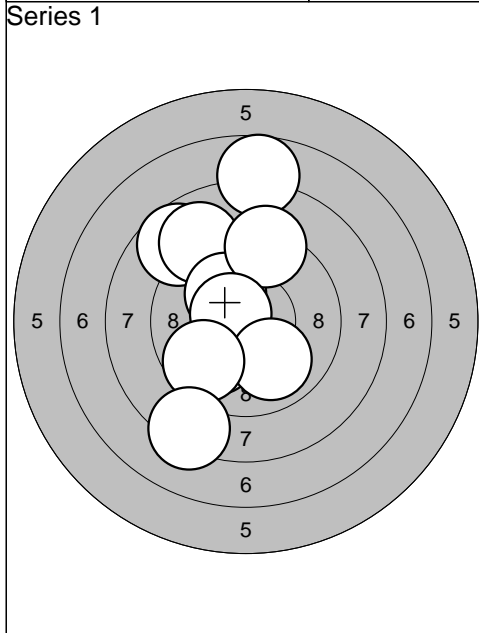

| | |
|----------|------|
| 1: 8,7 | ↖ |
| 2: 9,0 | ↖ |
| 3: 10,2* | ↖ |
| 4: 10,0 | ↙ |
| 5: 7,8 | ↑ |
| 6: 9,3 | ↑ |
| 7: 10,6* | ↖ |
| 8: 10,0 | ↙ |
| 9: 9,7 | ↙ |
| 10: 8,3 | ↙ |
| Serie | 90,0 |
| Sum | 90,0 |

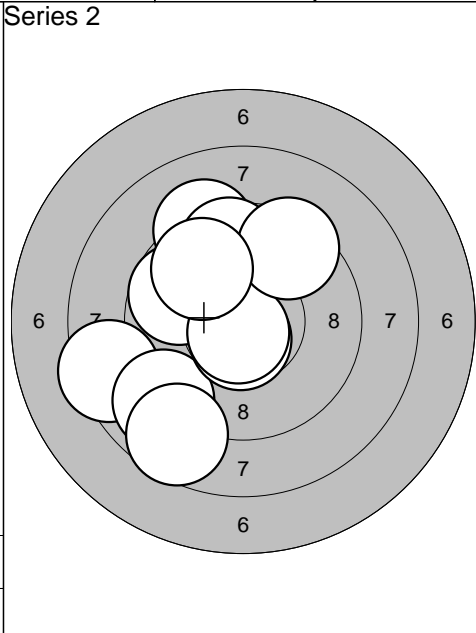

| | |
|----------|-------|
| 1: 8,4 | ↙ |
| 2: 9,0 | ↙ |
| 3: 9,7 | ↙ |
| 4: 10,6* | ↓ |
| 5: 9,2 | ↑ |
| 6: 9,6 | ↑ |
| 7: 10,7* | ↙ |
| 8: 9,5 | ↗ |
| 9: 9,8 | ↗ |
| 10: 8,6 | ↙ |
| Serie | 90,0 |
| Sum | 180,0 |

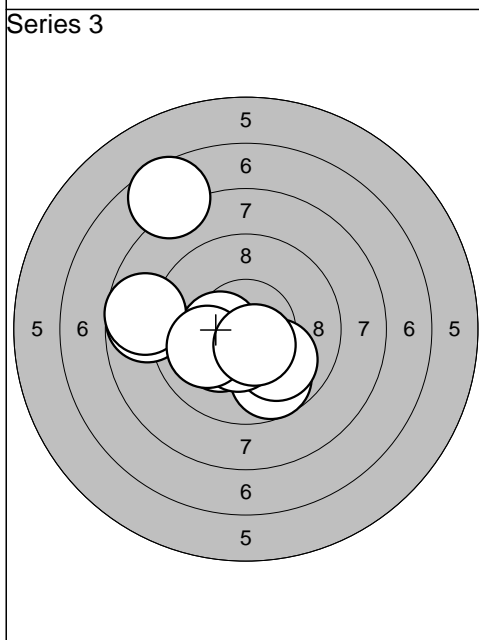

| | |
|-----------|-------|
| 1: 9,7 | ↙ |
| 2: 10,2* | ↙ |
| 3: 7,6 | ↗ |
| 4: 10,0 | ↙ |
| 5: 8,8 | ← |
| 6: 10,4* | ↙ |
| 7: 10,4* | ← |
| 8: 8,7 | ← |
| 9: 10,0 | ← |
| 10: 10,5* | ↙ |
| Serie | 92,0 |
| Sum | 272,0 |

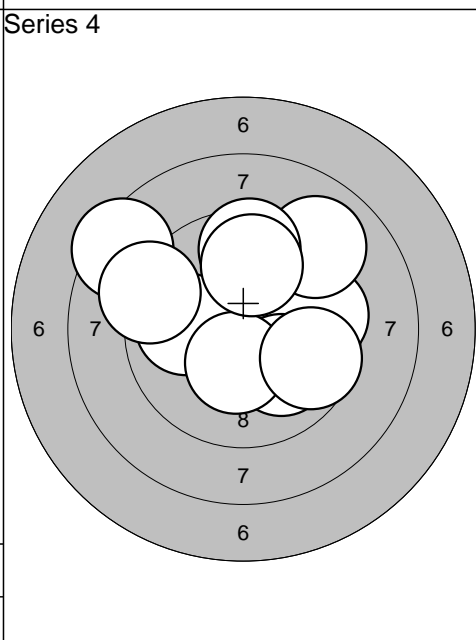

| | |
|----------|-------|
| 1: 9,6 | → |
| 2: 9,9 | ← |
| 3: 10,0 | ↙ |
| 4: 8,4 | ↖ |
| 5: 9,0 | ↗ |
| 6: 10,3* | ↓ |
| 7: 9,6 | → |
| 8: 9,5 | ↑ |
| 9: 9,8 | ↑ |
| 10: 9,2 | ↖ |
| Serie | 91,0 |
| Sum | 363,0 |

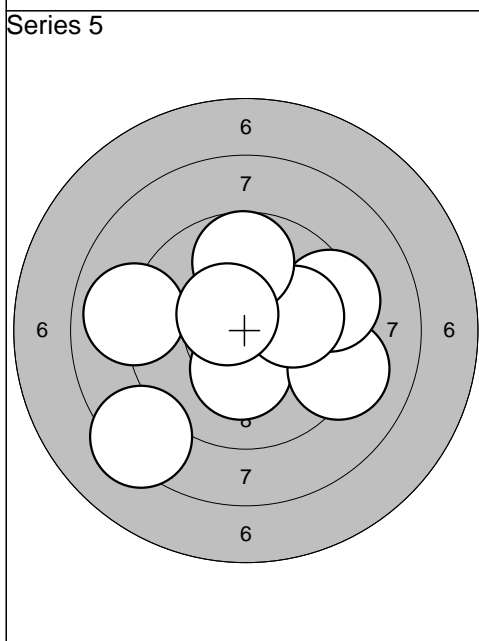

| | |
|-----------|-------|
| 1: 10,8* | ← |
| 2: 10,3* | ↓ |
| 3: 10,2* | ↑ |
| 4: 9,2 | → |
| 5: 9,4 | → |
| 6: 10,1 | → |
| 7: 9,7 | ↑ |
| 8: 9,0 | ← |
| 9: 8,3 | ↙ |
| 10: 10,5* | ↖ |
| Serie | 94,0 |
| Sum | 457,0 |

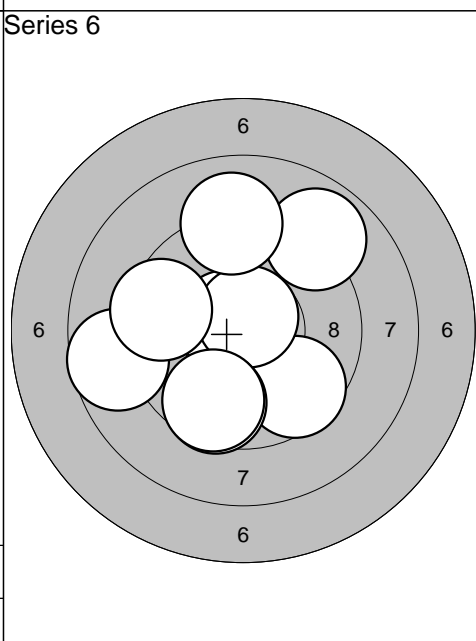

| | |
|----------|-------|
| 1: 10,0 | ↓ |
| 2: 8,9 | ↗ |
| 3: 10,6* | ↖ |
| 4: 9,6 | ↙ |
| 5: 10,7* | ↑ |
| 6: 8,7 | ← |
| 7: 9,1 | ↑ |
| 8: 9,5 | ← |
| 9: 9,6 | ↙ |
| 10: 9,6 | ↙ |
| Serie | 91,0 |
| Sum | 548,0 |

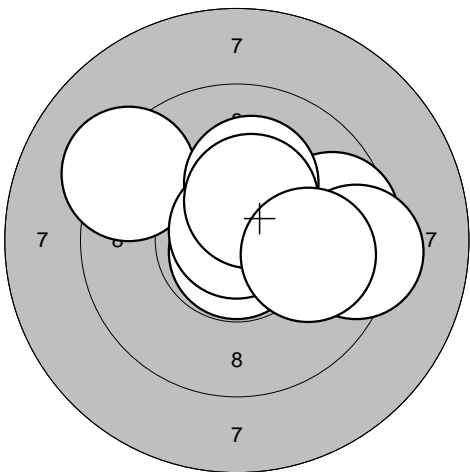
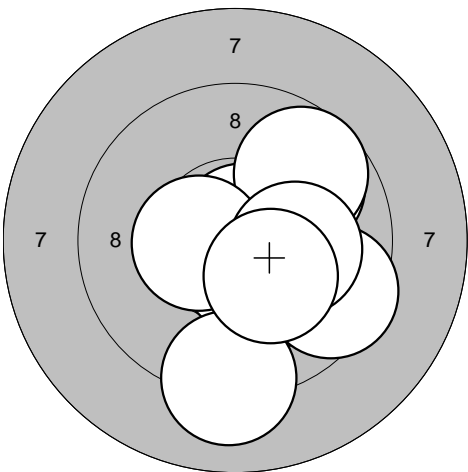
| | | | |
|--|---|--|--|
| <p>Series 1</p>  | <p>1: 10,5* ↗ 2: 10,8* ↓ 3: 10,5* ↗ 4: 9,3 ↖ 5: 9,7 → 6: 10,2* ↗ 7: 10,8* ↗ 8: 9,3 → 9: 10,4* ↗ 10: 10,0 →</p> <p>Serie 97,0 Sum 97,0</p> | <p>Series 2</p>  | <p>1: 9,8 ↗ 2: 10,8* ↗ 3: 10,2* ↘ 4: 10,6* ↓ 5: 9,7 ↗ 6: 9,5 ↘ 7: 10,5* ← 8: 10,1 → 9: 9,1 ↓ 10: 10,3* ↘</p> <p>Serie 96,0 Sum 193,0</p> |
|--|---|--|--|

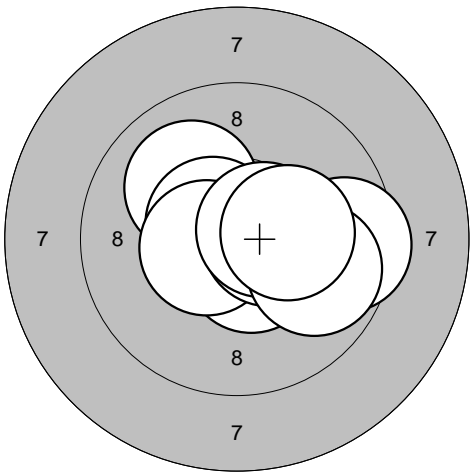
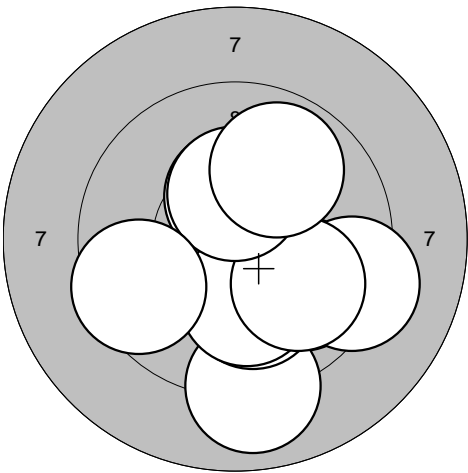
| | | | |
|---|--|---|---|
| <p>Series 3</p>  | <p>1: 10,1 ↗ 2: 10,6* ↗ 3: 10,7* → 4: 9,5 → 5: 10,5* ↘ 6: 10,5* ← 7: 10,5* → 8: 10,6* → 9: 9,8 ↘ 10: 10,3* →</p> <p>Serie 98,0 Sum 291,0</p> | <p>Series 4</p>  | <p>1: 9,9 ↘ 2: 10,4* ↑ 3: 9,0 ↓ 4: 9,3 ↘ 5: 10,1 ↓ 6: 10,1 ↓ 7: 9,9 ↘ 8: 10,3* ↑ 9: 9,9 ↗ 10: 9,5 ←</p> <p>Serie 94,0 Sum 385,0</p> |
|---|--|---|---|

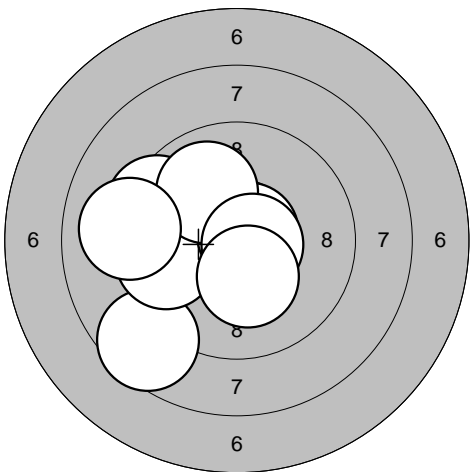
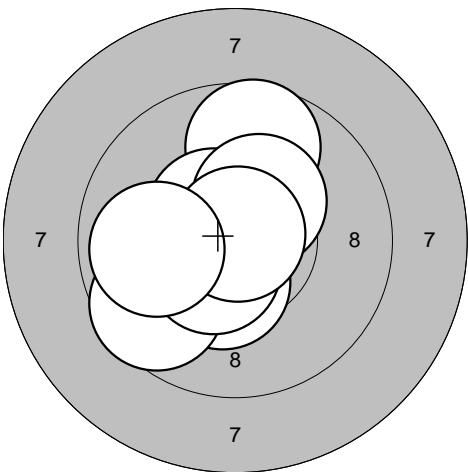
| | | | |
|--|---|--|---|
| <p>Series 5</p>  | <p>1: 8,6 ↘ 2: 10,1 ← 3: 10,8* ↗ 4: 9,4 ↖ 5: 9,7 ← 6: 10,7* → 7: 10,0 ↗ 8: 10,7* → 9: 9,0 ← 10: 10,3* ↘</p> <p>Serie 95,0 Sum 480,0</p> | <p>Series 6</p>  | <p>1: 10,4* ↑ 2: 9,7 ↑ 3: 10,7* ← 4: 10,5* ↖ 5: 10,4* ↓ 6: 9,6 ← 7: 10,3* ↗ 8: 10,5* ↘ 9: 10,9* ↗ 10: 9,9 ←</p> <p>Serie 97,0 Sum 577,0</p> |
|--|---|--|---|

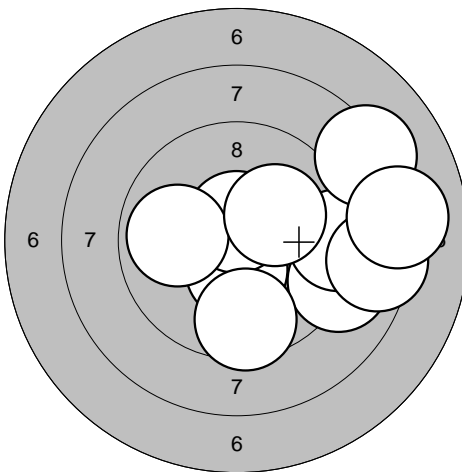
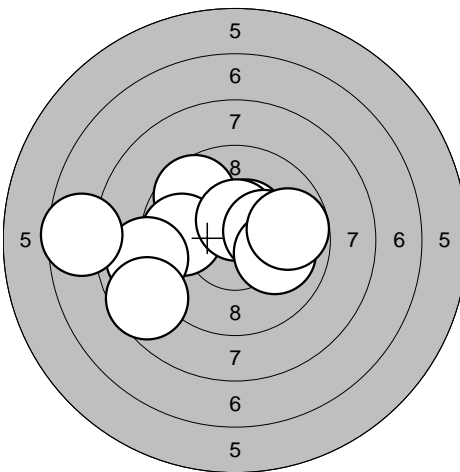
| | | | |
|--|--|--|---|
| <p>Series 1</p>  | <p>1: 9,0 →</p> <p>2: 10,4* ↓</p> <p>3: 9,1 →</p> <p>4: 10,6* ↑</p> <p>5: 8,2 ↗</p> <p>6: 9,9 ←</p> <p>7: 9,6 ↓</p> <p>8: 8,5 →</p> <p>9: 10,2* ↗</p> <p>10: 8,1 →</p> | <p>Series 2</p>  | <p>1: 9,6 ↖</p> <p>2: 9,8 ←</p> <p>3: 10,4* ↗</p> <p>4: 9,0 ←</p> <p>5: 10,5* ↑</p> <p>6: 10,3* →</p> <p>7: 10,0 →</p> <p>8: 8,6 ↖</p> <p>9: 9,8 →</p> <p>10: 7,6 ←</p> |
| Serie 90,0 | Serie 91,0 | Serie 91,0 | Serie 91,0 |
| Sum 90,0 | Sum 181,0 | Sum 181,0 | Sum 181,0 |

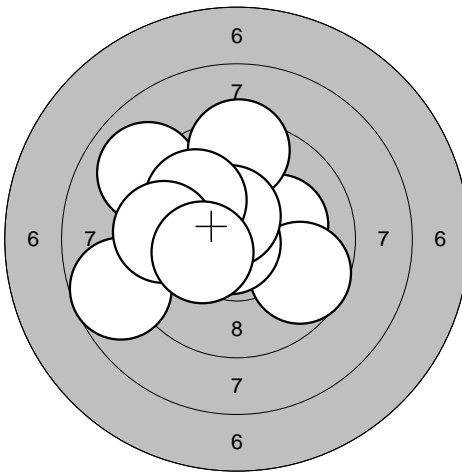
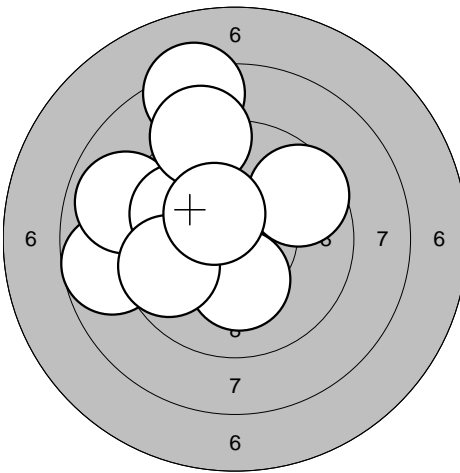
| | | | |
|---|---|---|--|
| <p>Series 3</p>  | <p>1: 8,7 ←</p> <p>2: 9,0 ↖</p> <p>3: 10,2* →</p> <p>4: 9,4 ↑</p> <p>5: 9,7 ↘</p> <p>6: 10,8* ↖</p> <p>7: 10,5* ↑</p> <p>8: 10,0 ↗</p> <p>9: 9,6 ←</p> <p>10: 10,3* ↖</p> | <p>Series 4</p>  | <p>1: 9,6 ↗</p> <p>2: 9,6 ←</p> <p>3: 8,7 ←</p> <p>4: 10,2* ↓</p> <p>5: 8,9 ↖</p> <p>6: 8,3 ↑</p> <p>7: 9,9 ↖</p> <p>8: 9,7 ↖</p> <p>9: 9,1 ↑</p> <p>10: 10,4* ↖</p> |
| Serie 94,0 | Serie 89,0 | Serie 89,0 | Serie 89,0 |
| Sum 275,0 | Sum 364,0 | Sum 364,0 | Sum 364,0 |

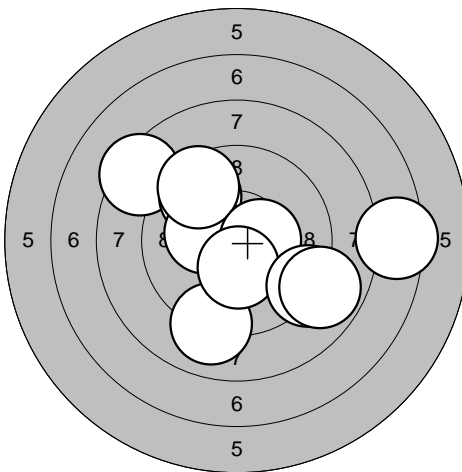
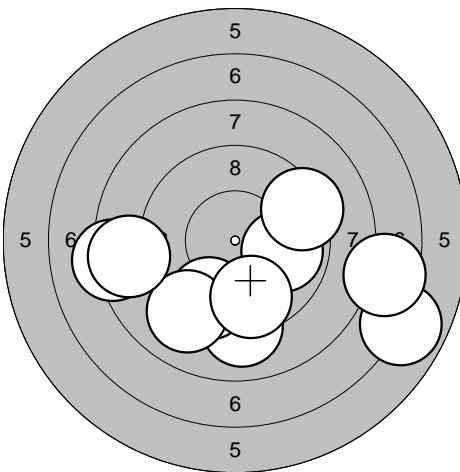
| | | | |
|--|--|--|--|
| <p>Series 5</p>  | <p>1: 8,4 ↖</p> <p>2: 9,7 ↗</p> <p>3: 10,3* ↖</p> <p>4: 9,5 ↗</p> <p>5: 9,0 ↓</p> <p>6: 10,4* →</p> <p>7: 10,3* ↓</p> <p>8: 9,1 ↘</p> <p>9: 8,8 ↘</p> <p>10: 7,4 →</p> | <p>Series 6</p>  | <p>1: 9,9 →</p> <p>2: 8,3 ←</p> <p>3: 9,0 ↓</p> <p>4: 9,5 ↘</p> <p>5: 9,1 ↘</p> <p>6: 6,9 ↘</p> <p>7: 9,7 ↓</p> <p>8: 7,6 →</p> <p>9: 8,6 ←</p> <p>10: 9,3 ↗</p> |
| Serie 89,0 | Serie 83,0 | Serie 83,0 | Serie 83,0 |
| Sum 453,0 | Sum 536,0 | Sum 536,0 | Sum 536,0 |

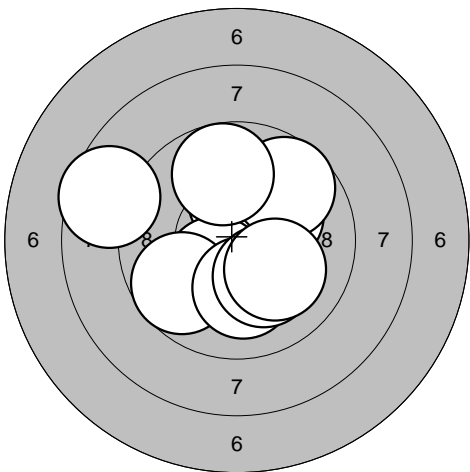
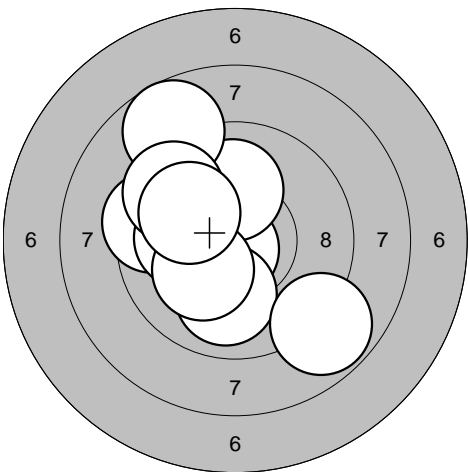
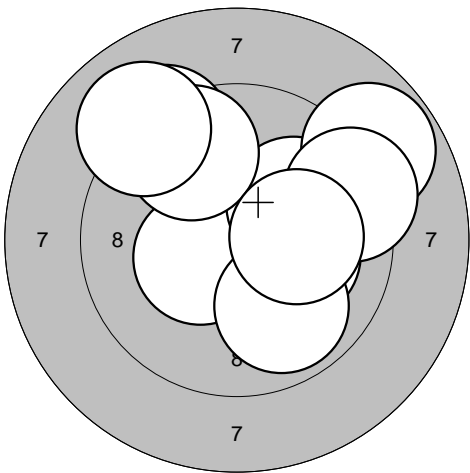
| | | |
|--|---|--|
| <p>Series 1</p>  | <p>Series 2</p>  | <p>Series 3</p>  |
| <p>1: 10,2* ↗ 2: 10,2* ↑ 3: 10,3* ↘ 4: 9,7 ↘ 5: 10,1 ↓ 6: 9,7 ↗ 7: 10,1 ↘ 8: 9,8 ↑ 9: 8,6 ← 10: 10,1 ↘</p> | <p>1: 10,7* ↘ 2: 10,1 ↑ 3: 9,5 ← 4: 10,1 ← 5: 8,7 ↗ 6: 10,0 ↓ 7: 10,2* ↘ 8: 9,6 ↗ 9: 8,8 ↘ 10: 10,0 ↖</p> | <p>1: 10,2* → 2: 10,4* ↖ 3: 9,2 ↗ 4: 10,1 ↗ 5: 9,9 ↘ 6: 9,6 ↗ 7: 9,0 ↗ 8: 8,8 ↗ 9: 9,3 → 10: 10,2* →</p> |
| Serie 95,0 | Serie 94,0 | Serie 93,0 |
| Sum 95,0 | Sum 189,0 | Sum 282,0 |

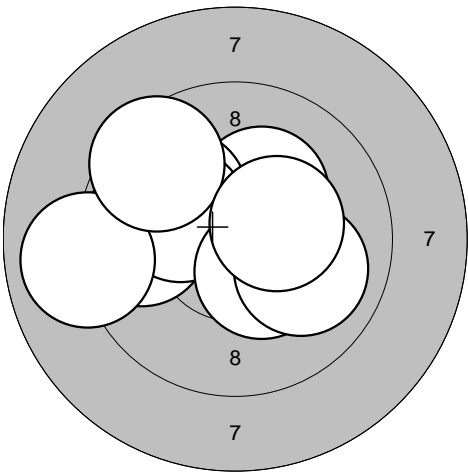
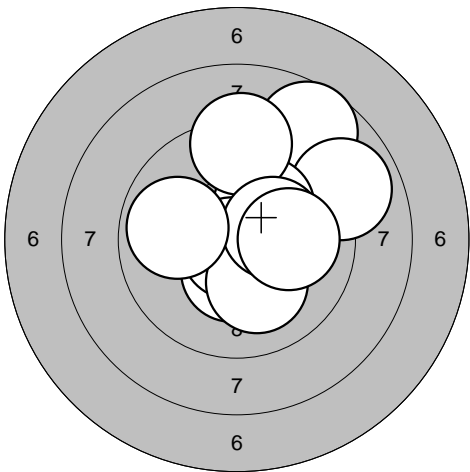
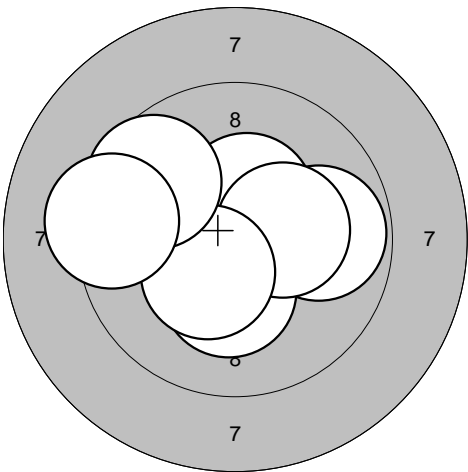
| | | |
|--|---|--|
| <p>Series 4</p>  | <p>Series 5</p>  | <p>Series 6</p>  |
| <p>1: 10,5* → 2: 9,7 ← 3: 10,3* ↗ 4: 10,1 ↗ 5: 10,1 ↖ 6: 10,4* ↘ 7: 9,0 ← 8: 9,5 ↗ 9: 10,0 ↘ 10: 10,4* →</p> | <p>1: 8,7 ↗ 2: 8,9 → 3: 10,4* ↓ 4: 10,2* ↗ 5: 9,3 ↑ 6: 10,8* ↘ 7: 10,1 ↘ 8: 10,3* → 9: 10,0 → 10: 9,9 ←</p> | <p>1: 10,0 ← 2: 10,2* ← 3: 10,3* → 4: 9,8 → 5: 10,4* ↗ 6: 10,2* ↓ 7: 10,3* → 8: 10,4* ↘ 9: 9,6 ↖ 10: 9,3 ←</p> |
| Serie 97,0 | Serie 94,0 | Serie 97,0 |
| Sum 379,0 | Sum 473,0 | Sum 570,0 |

| | |
|---|-------------------------------------|
| Edman Precision, Morini, Interprodukter | Sävsjö kommun, Sävsjö Skytte Center |
|---|-------------------------------------|

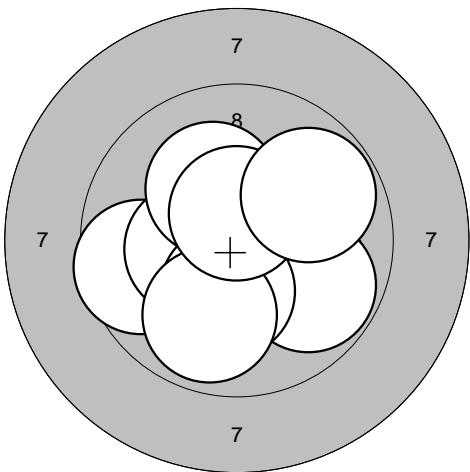
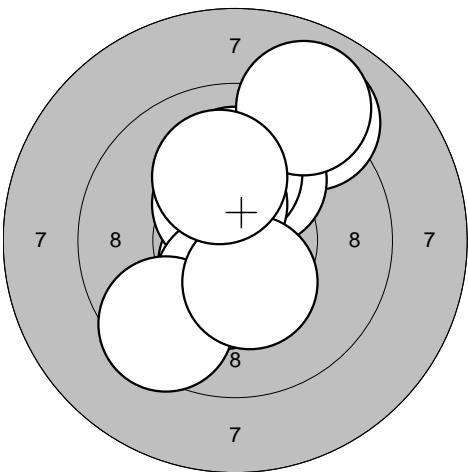
| | | | |
|--|--|--|---|
| <p>Series 1</p>  | <p>1: 10,3* ↓</p> <p>2: 9,6 ←</p> <p>3: 10,9* ↑</p> <p>4: 10,3* ←</p> <p>5: 9,8 →</p> <p>6: 10,3* ↓</p> <p>7: 9,9 ↓</p> <p>8: 10,2* ↑</p> <p>9: 10,6* ↑</p> <p>10: 9,8 ↗</p> | <p>Series 2</p>  | <p>1: 10,6* ↓</p> <p>2: 9,1 ↗</p> <p>3: 10,1 ↗</p> <p>4: 10,1 ↑</p> <p>5: 10,4* ↗</p> <p>6: 10,4* ↓</p> <p>7: 9,0 ↗</p> <p>8: 9,5 ↙</p> <p>9: 10,4* ↓</p> <p>10: 10,1 ↑</p> |
| Serie 96,0 | | Serie 97,0 | |
| Sum 96,0 | | Sum 193,0 | |

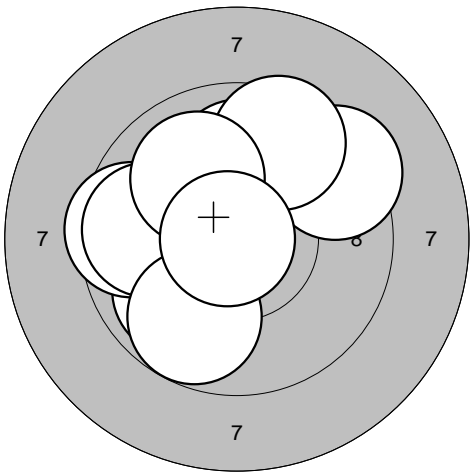
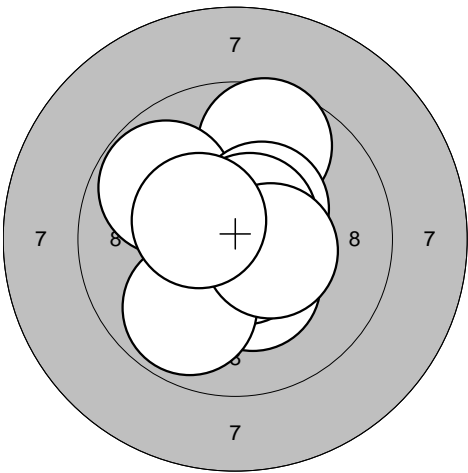
| | | | |
|---|--|---|--|
| <p>Series 3</p>  | <p>1: 10,0 ↙</p> <p>2: 10,1 ↗</p> <p>3: 9,5 ←</p> <p>4: 10,0 ↑</p> <p>5: 9,8 ←</p> <p>6: 9,8 ↓</p> <p>7: 9,4 ↗</p> <p>8: 9,6 ↑</p> <p>9: 10,0 ↑</p> <p>10: 10,8* ←</p> | <p>Series 4</p>  | <p>1: 9,7 ↑</p> <p>2: 10,3* ↓</p> <p>3: 10,7* →</p> <p>4: 10,7* ↓</p> <p>5: 9,8 ↗</p> <p>6: 10,4* ↗</p> <p>7: 10,6* ↗</p> <p>8: 9,9 ↓</p> <p>9: 10,4* →</p> <p>10: 10,4* ↙</p> |
| Serie 95,0 | | Serie 97,0 | |
| Sum 288,0 | | Sum 385,0 | |

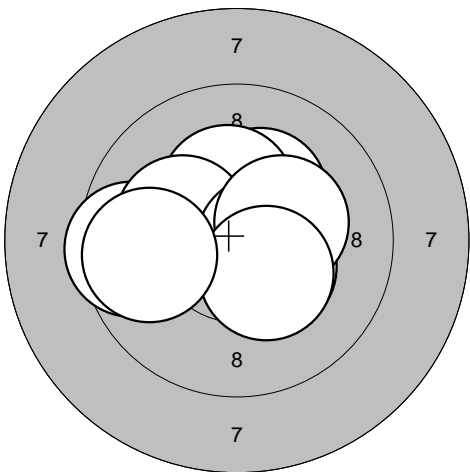
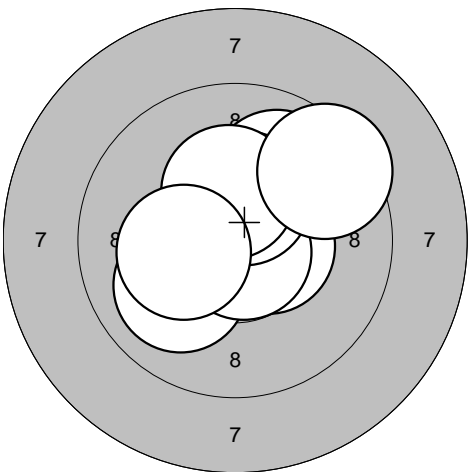
| | | | |
|--|--|--|---|
| <p>Series 5</p>  | <p>1: 10,4* ↓</p> <p>2: 10,2* ↑</p> <p>3: 10,8* →</p> <p>4: 9,5 ←</p> <p>5: 10,3* ↑</p> <p>6: 10,2* ←</p> <p>7: 10,6* →</p> <p>8: 10,3* →</p> <p>9: 10,3* ↓</p> <p>10: 9,8 ←</p> | <p>Series 6</p>  | <p>1: 10,6* ↗</p> <p>2: 9,9 ↗</p> <p>3: 10,6* ↑</p> <p>4: 10,5* →</p> <p>5: 10,0 ↙</p> <p>6: 10,8* ↓</p> <p>7: 10,4* ↑</p> <p>8: 10,3* ↑</p> <p>9: 9,4 ↗</p> <p>10: 10,3* ←</p> |
| Serie 98,0 | | Serie 98,0 | |
| Sum 483,0 | | Sum 581,0 | |

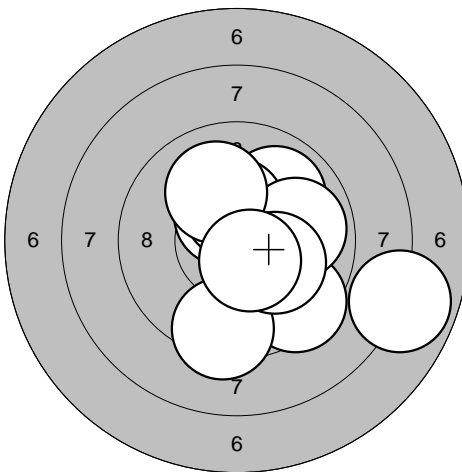
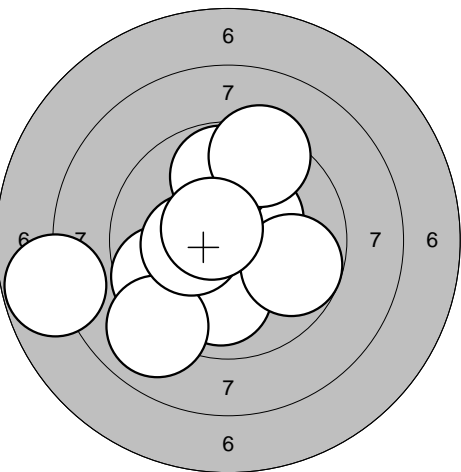
| | | | | | | | | | | | |
|--|--|-------|------|-----|------|--|---|-------|------|-----|-------|
| <p>Series 1</p>  | <p>1: 10,5* ↗</p> <p>2: 9,4 ↘</p> <p>3: 9,9 ↗</p> <p>4: 10,4* ↑</p> <p>5: 9,9 →</p> <p>6: 10,0 ↑</p> <p>7: 7,9 →</p> <p>8: 9,4 ↓</p> <p>9: 10,2* ↘</p> <p>10: 10,5* ↘</p> <table border="1" style="width:100%; border-collapse: collapse;"> <tr><td>Serie</td><td style="text-align: right;">93,0</td></tr> <tr><td>Sum</td><td style="text-align: right;">93,0</td></tr> </table> | Serie | 93,0 | Sum | 93,0 | <p>Series 2</p>  | <p>1: 9,6 ↙</p> <p>2: 10,0 ↓</p> <p>3: 10,4* ↗</p> <p>4: 9,8 →</p> <p>5: 9,8 ↑</p> <p>6: 9,4 ↑</p> <p>7: 9,0 ↘</p> <p>8: 10,3* ←</p> <p>9: 7,8 ←</p> <p>10: 10,6* ↙</p> <table border="1" style="width:100%; border-collapse: collapse;"> <tr><td>Serie</td><td style="text-align: right;">92,0</td></tr> <tr><td>Sum</td><td style="text-align: right;">185,0</td></tr> </table> | Serie | 92,0 | Sum | 185,0 |
| Serie | 93,0 | | | | | | | | | | |
| Sum | 93,0 | | | | | | | | | | |
| Serie | 92,0 | | | | | | | | | | |
| Sum | 185,0 | | | | | | | | | | |

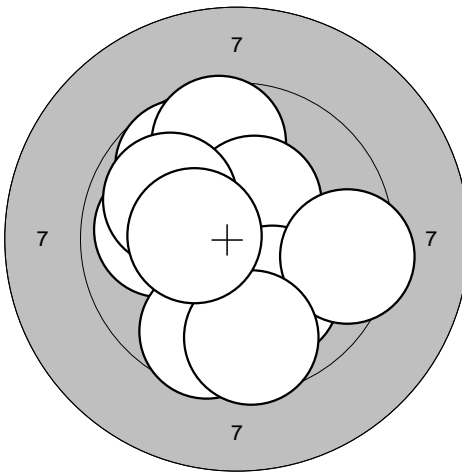
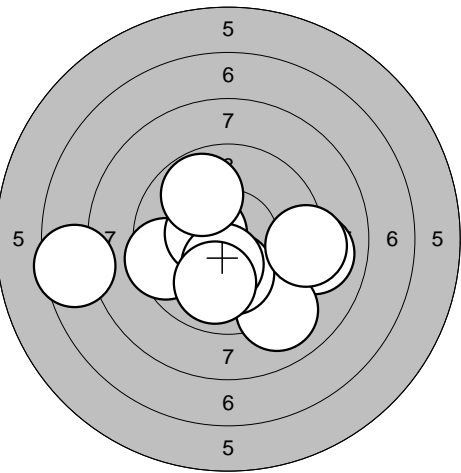
| | | | | | | | | | | | |
|---|---|-------|------|-----|-------|---|--|-------|------|-----|-------|
| <p>Series 3</p>  | <p>1: 9,7 ↗</p> <p>2: 9,6 ↑</p> <p>3: 10,4* ↗</p> <p>4: 9,9 ←</p> <p>5: 9,9 ↗</p> <p>6: 10,1 ↘</p> <p>7: 9,4 →</p> <p>8: 9,6 ↓</p> <p>9: 9,6 ↓</p> <p>10: 10,4* ←</p> <table border="1" style="width:100%; border-collapse: collapse;"> <tr><td>Serie</td><td style="text-align: right;">93,0</td></tr> <tr><td>Sum</td><td style="text-align: right;">278,0</td></tr> </table> | Serie | 93,0 | Sum | 278,0 | <p>Series 4</p>  | <p>1: 9,1 →</p> <p>2: 9,0 ↘</p> <p>3: 10,2* ↓</p> <p>4: 9,5 ←</p> <p>5: 10,4* ←</p> <p>6: 10,4* ↓</p> <p>7: 9,9 ↓</p> <p>8: 9,8 ↗</p> <p>9: 7,5 ←</p> <p>10: 9,2 →</p> <table border="1" style="width:100%; border-collapse: collapse;"> <tr><td>Serie</td><td style="text-align: right;">91,0</td></tr> <tr><td>Sum</td><td style="text-align: right;">369,0</td></tr> </table> | Serie | 91,0 | Sum | 369,0 |
| Serie | 93,0 | | | | | | | | | | |
| Sum | 278,0 | | | | | | | | | | |
| Serie | 91,0 | | | | | | | | | | |
| Sum | 369,0 | | | | | | | | | | |

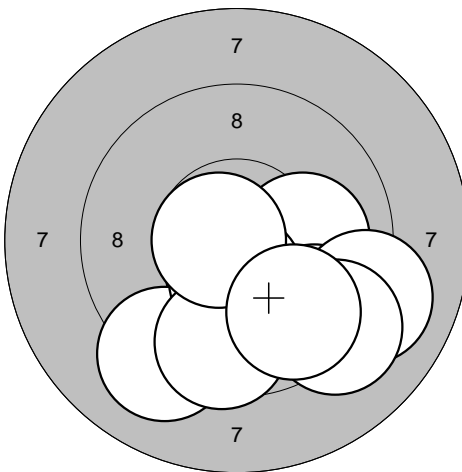
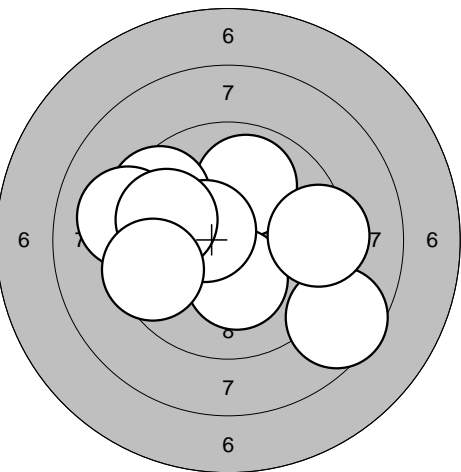
| | | | | | | | | | | | |
|--|---|-------|------|-----|-------|--|--|-------|------|-----|-------|
| <p>Series 5</p>  | <p>1: 10,5* ↓</p> <p>2: 10,1 →</p> <p>3: 9,5 ↘</p> <p>4: 9,1 →</p> <p>5: 9,2 ↘</p> <p>6: 9,2 ↘</p> <p>7: 10,4* ↓</p> <p>8: 9,6 ↓</p> <p>9: 10,7* ←</p> <p>10: 9,7 ↘</p> <table border="1" style="width:100%; border-collapse: collapse;"> <tr><td>Serie</td><td style="text-align: right;">94,0</td></tr> <tr><td>Sum</td><td style="text-align: right;">463,0</td></tr> </table> | Serie | 94,0 | Sum | 463,0 | <p>Series 6</p>  | <p>1: 9,8 ←</p> <p>2: 9,9 ↑</p> <p>3: 10,3* ↓</p> <p>4: 9,5 ↗</p> <p>5: 9,2 ←</p> <p>6: 8,6 ↘</p> <p>7: 10,5* ←</p> <p>8: 9,8 ←</p> <p>9: 9,3 →</p> <p>10: 9,6 ←</p> <table border="1" style="width:100%; border-collapse: collapse;"> <tr><td>Serie</td><td style="text-align: right;">91,0</td></tr> <tr><td>Sum</td><td style="text-align: right;">554,0</td></tr> </table> | Serie | 91,0 | Sum | 554,0 |
| Serie | 94,0 | | | | | | | | | | |
| Sum | 463,0 | | | | | | | | | | |
| Serie | 91,0 | | | | | | | | | | |
| Sum | 554,0 | | | | | | | | | | |

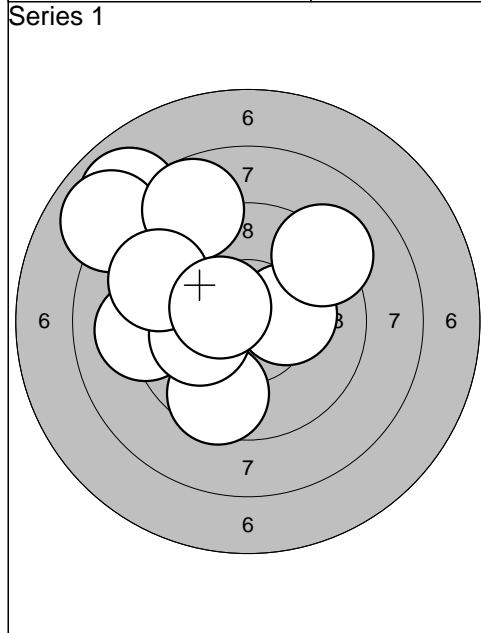

| | |
|-----------|------|
| 1: 8,0 | ↗ |
| 2: 8,0 | ↗ |
| 3: 8,8 | ↗ |
| 4: 9,1 | ↖ |
| 5: 9,6 | ↘ |
| 6: 10,3* | → |
| 7: 10,1 | ↖ |
| 8: 9,2 | ↗ |
| 9: 9,2 | ↗ |
| 10: 10,4* | ↖ |
| Serie | 90,0 |
| Sum | 90,0 |

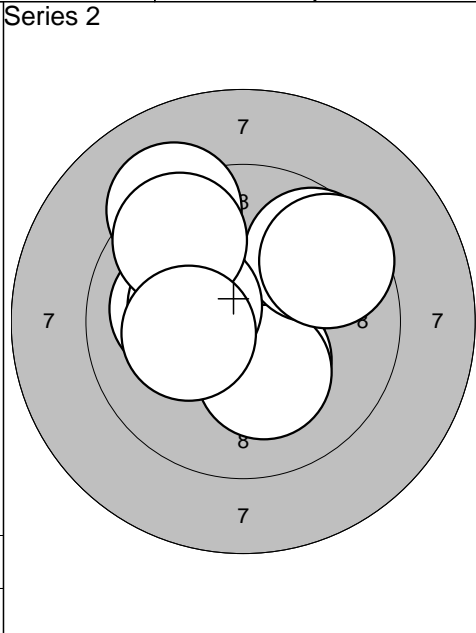

| | |
|-----------|-------|
| 1: 10,4* | ↘ |
| 2: 10,7* | ↘ |
| 3: 10,2* | ↘ |
| 4: 9,7 | ↗ |
| 5: 10,1 | ↖ |
| 6: 10,3* | ↖ |
| 7: 9,2 | ↗ |
| 8: 9,6 | ↗ |
| 9: 9,6 | ↗ |
| 10: 10,2* | ↖ |
| Serie | 96,0 |
| Sum | 186,0 |

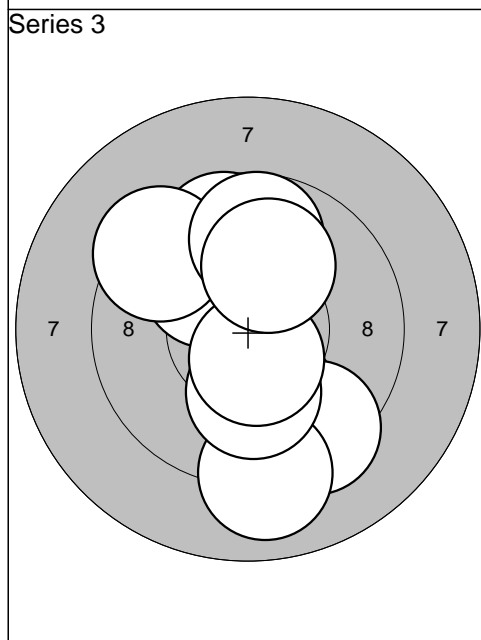

| | |
|----------|-------|
| 1: 9,7 | ↗ |
| 2: 10,0 | ↘ |
| 3: 10,1 | ↗ |
| 4: 9,4 | ↗ |
| 5: 9,4 | ↘ |
| 6: 9,0 | ↘ |
| 7: 10,1 | ↘ |
| 8: 9,8 | ↗ |
| 9: 10,5* | ↘ |
| 10: 10,1 | ↗ |
| Serie | 95,0 |
| Sum | 281,0 |

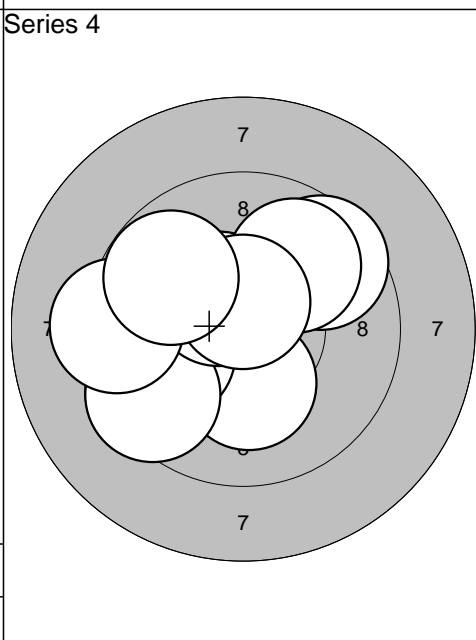

| | |
|----------|-------|
| 1: 9,6 | ↗ |
| 2: 9,5 | ↖ |
| 3: 10,2* | ↘ |
| 4: 9,9 | ↖ |
| 5: 9,5 | ↖ |
| 6: 10,4* | ↗ |
| 7: 9,9 | ↗ |
| 8: 10,6* | ↑ |
| 9: 9,3 | ↖ |
| 10: 9,8 | ↖ |
| Serie | 93,0 |
| Sum | 374,0 |

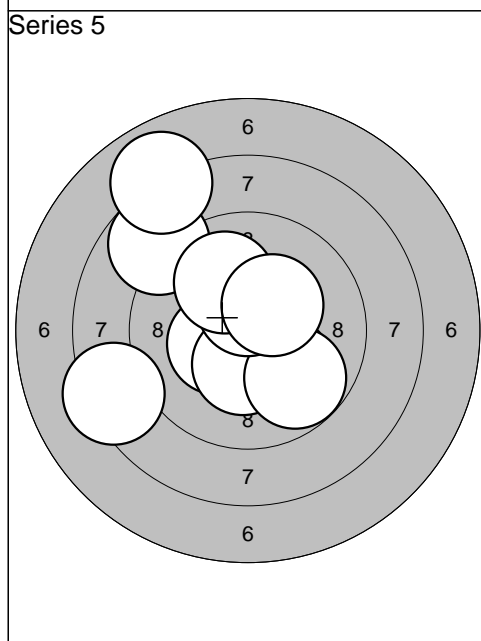

| | |
|----------|-------|
| 1: 10,1 | ↘ |
| 2: 10,4* | ↖ |
| 3: 10,3* | ↘ |
| 4: 9,8 | ↘ |
| 5: 8,8 | ↗ |
| 6: 10,5* | ↗ |
| 7: 10,0 | ↗ |
| 8: 8,3 | ↖ |
| 9: 10,3* | ↗ |
| 10: 8,0 | ↗ |
| Serie | 93,0 |
| Sum | 467,0 |

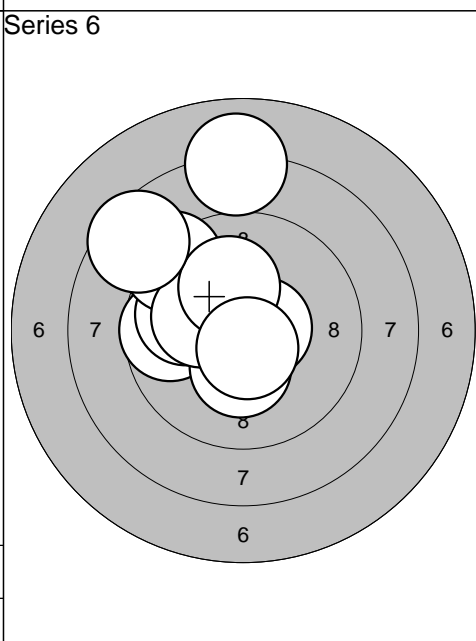

| | |
|----------|-------|
| 1: 9,7 | ↖ |
| 2: 9,9 | ↖ |
| 3: 8,0 | ↑ |
| 4: 10,6* | → |
| 5: 10,3* | ↘ |
| 6: 9,2 | ↗ |
| 7: 10,2* | ↖ |
| 8: 10,1 | ↗ |
| 9: 10,6* | ↘ |
| 10: 8,5 | ↖ |
| Serie | 93,0 |
| Sum | 560,0 |

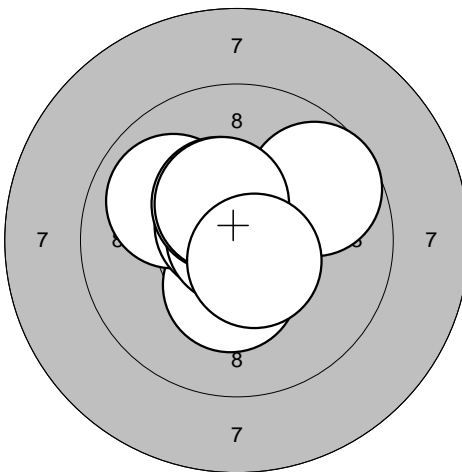
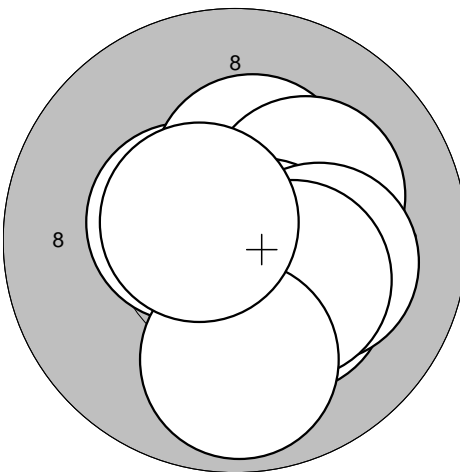
| | | | |
|--|---|--|---|
| <p>Series 1</p>  | <p>1: 10,4* ↓</p> <p>2: 10,6* ↗</p> <p>3: 10,6* ↑</p> <p>4: 10,0 ↗</p> <p>5: 10,7* ↗</p> <p>6: 10,9* ↗</p> <p>7: 9,7 ↗</p> <p>8: 10,4* ↗</p> <p>9: 10,4* ↗</p> <p>10: 10,6* ↓</p> | <p>Series 2</p>  | <p>1: 10,5* ↖</p> <p>2: 10,3* ↘</p> <p>3: 10,6* →</p> <p>4: 10,3* ↑</p> <p>5: 10,2* ↗</p> <p>6: 10,6* ↘</p> <p>7: 10,1 →</p> <p>8: 10,3* ↘</p> <p>9: 9,9 ↓</p> <p>10: 10,6* ↖</p> |
| | Serie 99,0 | | Serie 99,0 |
| | Sum 99,0 | | Sum 198,0 |

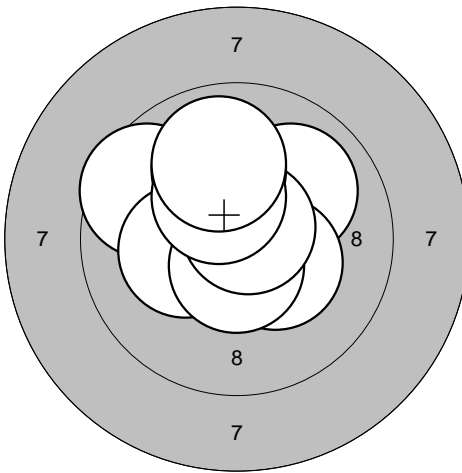
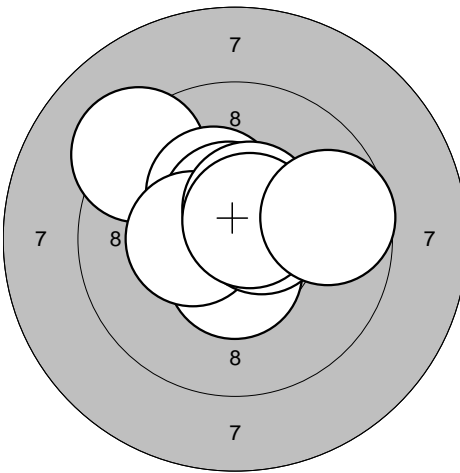
| | | | |
|---|--|---|--|
| <p>Series 3</p>  | <p>1: 10,0 ↗</p> <p>2: 10,4* ↖</p> <p>3: 10,3* ↘</p> <p>4: 9,6 ↗</p> <p>5: 10,3* ←</p> <p>6: 10,6* ↓</p> <p>7: 10,7* ↗</p> <p>8: 10,0 ↑</p> <p>9: 10,3* ↗</p> <p>10: 9,9 ↑</p> | <p>Series 4</p>  | <p>1: 9,2 ↖</p> <p>2: 10,7* ↖</p> <p>3: 10,3* ↗</p> <p>4: 10,5* ↑</p> <p>5: 10,5* ↓</p> <p>6: 10,4* ←</p> <p>7: 10,5* ↗</p> <p>8: 10,5* →</p> <p>9: 10,6* ↗</p> <p>10: 9,7 →</p> |
| | Serie 98,0 | | Serie 98,0 |
| | Sum 296,0 | | Sum 394,0 |

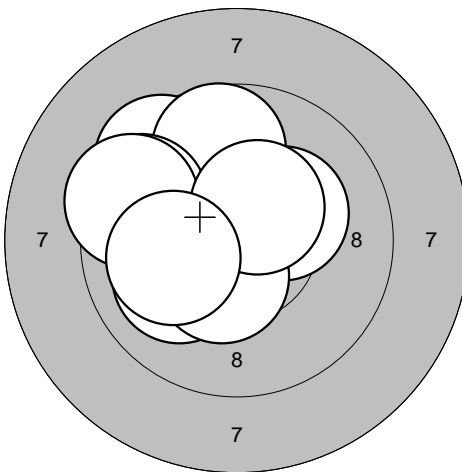
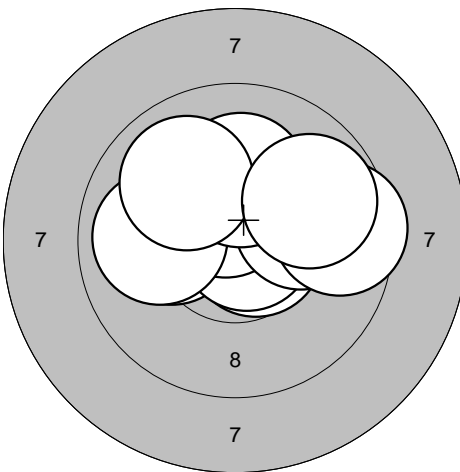
| | | | |
|--|--|--|--|
| <p>Series 5</p>  | <p>1: 10,2* ↗</p> <p>2: 9,5 ↗</p> <p>3: 10,6* ↗</p> <p>4: 9,7 ↗</p> <p>5: 9,6 ↖</p> <p>6: 10,1 ↖</p> <p>7: 10,4* ↓</p> <p>8: 9,5 ↖</p> <p>9: 10,4* ↗</p> <p>10: 10,1 ←</p> | <p>Series 6</p>  | <p>1: 10,1 ←</p> <p>2: 10,6* →</p> <p>3: 10,8* →</p> <p>4: 10,5* ↑</p> <p>5: 10,0 ←</p> <p>6: 10,1 →</p> <p>7: 10,2* ↑</p> <p>8: 10,0 ↖</p> <p>9: 9,5 →</p> <p>10: 9,8 ↗</p> |
| | Serie 96,0 | | Serie 98,0 |
| | Sum 490,0 | | Sum 588,0 |

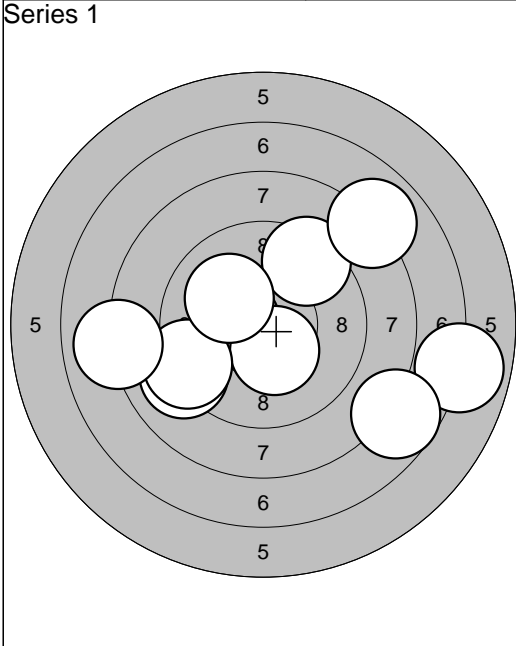

| | |
|-------------------|---|
| 1: 10,4* | ← |
| 2: 6,9 | → |
| 3: 9,4 | ↗ |
| 4: 10,4* | ↓ |
| 5: 9,1 | ↙ |
| 6: 8,0 | ↗ |
| 7: 9,2 | ← |
| 8: 7,7 | ↓ |
| 9: 8,0 | ← |
| 10: 10,1 | ↖ |
| Serie 86,0 | |
| Sum 86,0 | |

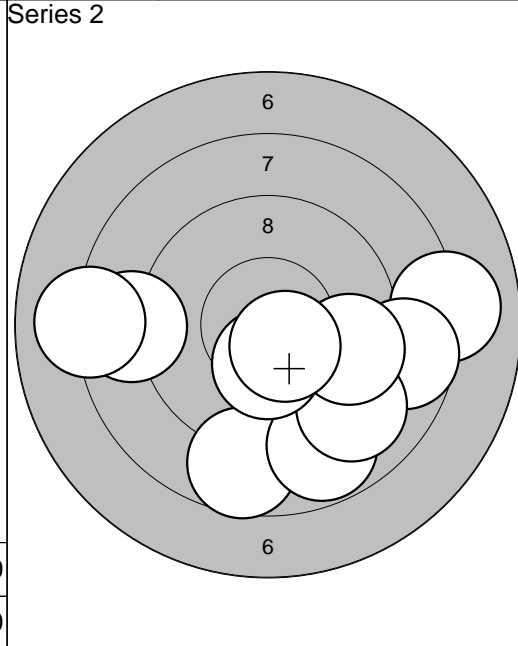

| | |
|-------------------|---|
| 1: 8,7 | ↓ |
| 2: 8,8 | ← |
| 3: 8,0 | → |
| 4: 8,7 | → |
| 5: 8,8 | ↓ |
| 6: 9,0 | ↓ |
| 7: 9,6 | → |
| 8: 8,1 | ← |
| 9: 10,3* | ↓ |
| 10: 10,5* | ↓ |
| Serie 86,0 | |
| Sum 172,0 | |

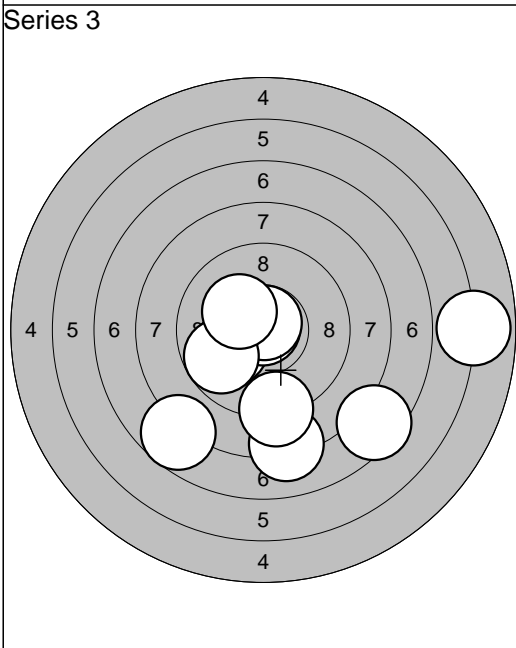

| | |
|-------------------|---|
| 1: 8,1 | ↓ |
| 2: 10,1 | ↙ |
| 3: 9,0 | ↓ |
| 4: 7,7 | ↙ |
| 5: 10,9* | ↑ |
| 6: 10,8* | ↑ |
| 7: 9,8 | ↙ |
| 8: 7,5 | ↘ |
| 9: 5,9 | → |
| 10: 10,2* | ↖ |
| Serie 85,0 | |
| Sum 257,0 | |

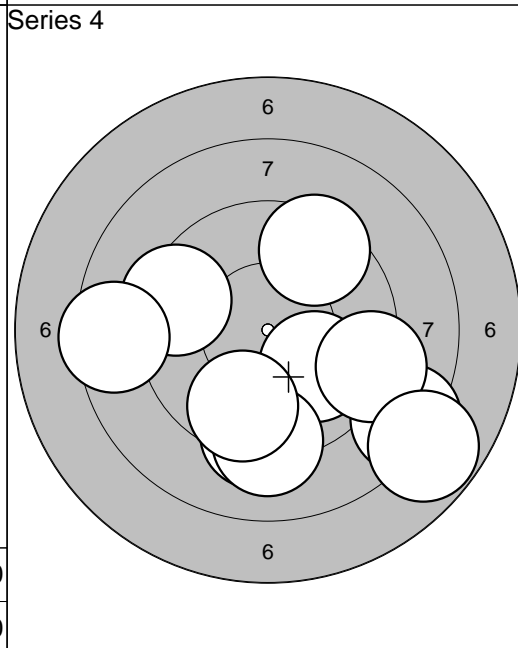

| | |
|-------------------|---|
| 1: 10,0 | ↘ |
| 2: 8,3 | ↘ |
| 3: 9,2 | → |
| 4: 9,5 | ↗ |
| 5: 9,3 | ↓ |
| 6: 9,2 | ↓ |
| 7: 9,4 | ← |
| 8: 8,5 | ← |
| 9: 9,7 | ↓ |
| 10: 7,8 | ↘ |
| Serie 87,0 | |
| Sum 344,0 | |

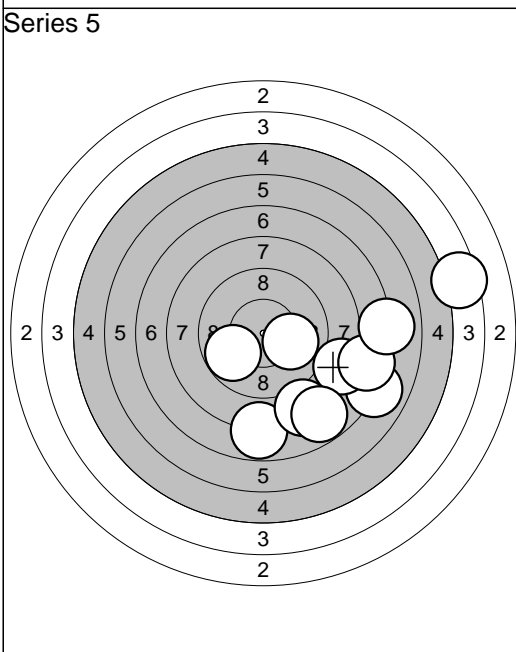

| | |
|-------------------|---|
| 1: 4,4 | → |
| 2: 7,8 | ↓ |
| 3: 7,0 | ↘ |
| 4: 8,2 | → |
| 5: 8,2 | ↓ |
| 6: 9,8 | ↙ |
| 7: 7,5 | → |
| 8: 7,8 | ↓ |
| 9: 10,0 | → |
| 10: 7,0 | → |
| Serie 74,0 | |
| Sum 418,0 | |

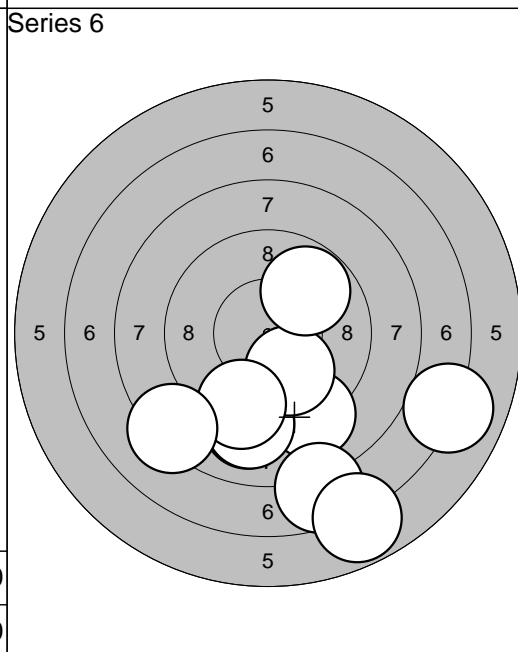

| | |
|-------------------|---|
| 1: 9,1 | ↓ |
| 2: 9,1 | ↓ |
| 3: 7,7 | ↓ |
| 4: 6,8 | ↓ |
| 5: 9,1 | ↓ |
| 6: 7,0 | → |
| 7: 10,1 | ↓ |
| 8: 9,8 | ↗ |
| 9: 9,4 | ↓ |
| 10: 8,2 | ↙ |
| Serie 83,0 | |
| Sum 501,0 | |

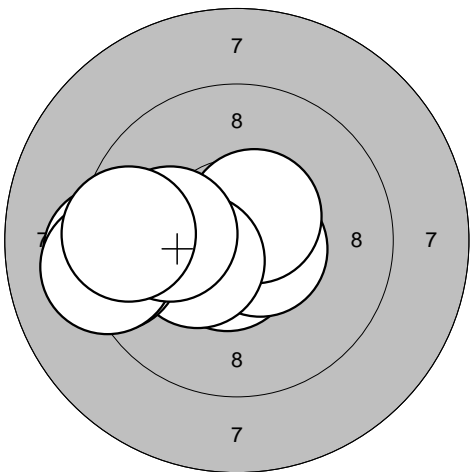
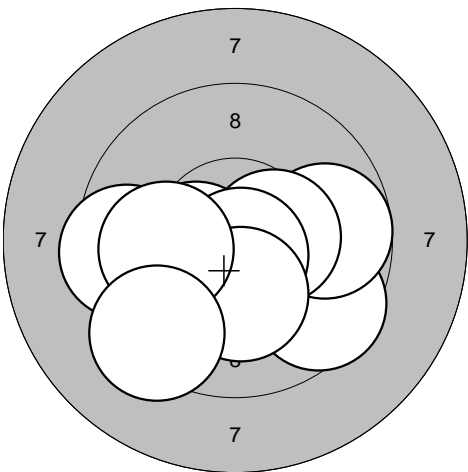
| | | |
|---|---|--|
| <p>Series 1</p>  | <p>Series 2</p>  | |
| <p>1: 10,4* ←</p> <p>2: 10,6* ↓</p> <p>3: 10,6* →</p> <p>4: 10,5* ↗</p> <p>5: 9,3 ←</p> <p>6: 10,4* ←</p> <p>7: 9,3 ←</p> <p>8: 9,2 ←</p> <p>9: 10,1 ←</p> <p>10: 9,5 ←</p> | <p>1: 9,5 ←</p> <p>2: 9,6 ↘</p> <p>3: 9,7 →</p> <p>4: 10,4* →</p> <p>5: 9,9 ↘</p> <p>6: 10,4* ←</p> <p>7: 10,7* ↓</p> <p>8: 10,2* ↓</p> <p>9: 10,0 ←</p> <p>10: 9,3 ↘</p> | |
| Serie 96,0 | Serie 95,0 | |
| Sum 96,0 | Sum 191,0 | |

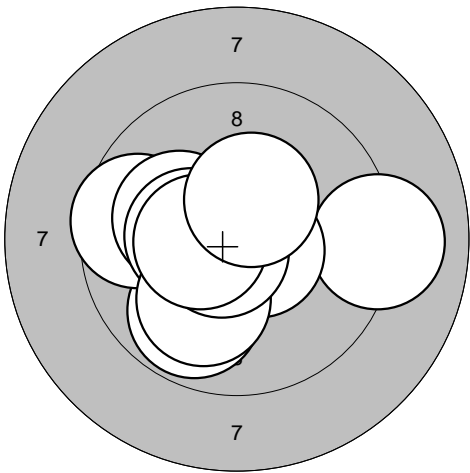
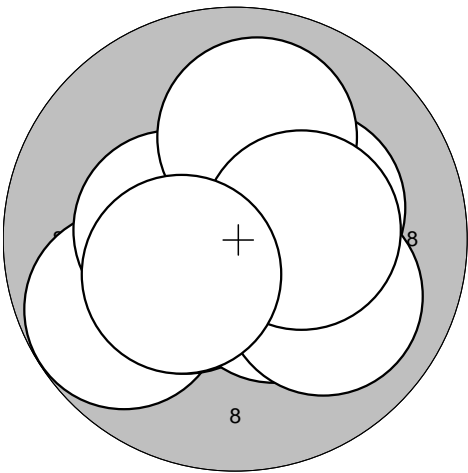
| | | |
|--|--|--|
| <p>Series 3</p>  | <p>Series 4</p>  | |
| <p>1: 9,1 →</p> <p>2: 10,6* ↘</p> <p>3: 9,8 ↓</p> <p>4: 9,6 ←</p> <p>5: 10,1 ↖</p> <p>6: 10,3* ←</p> <p>7: 10,0 ↓</p> <p>8: 10,7* ↘</p> <p>9: 10,5* ←</p> <p>10: 10,4* ↗</p> | <p>1: 10,2* ↗</p> <p>2: 9,8 ↖</p> <p>3: 10,4* ↖</p> <p>4: 10,4* ↘</p> <p>5: 10,4* ←</p> <p>6: 10,3* →</p> <p>7: 10,0 ↗</p> <p>8: 10,0 ↘</p> <p>9: 10,3* →</p> <p>10: 10,4* ↖</p> | |
| Serie 97,0 | Serie 99,0 | |
| Sum 288,0 | Sum 387,0 | |

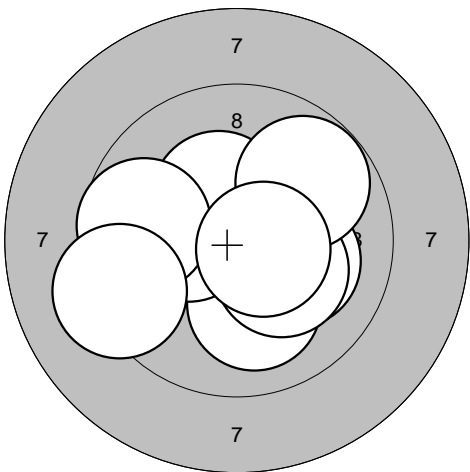
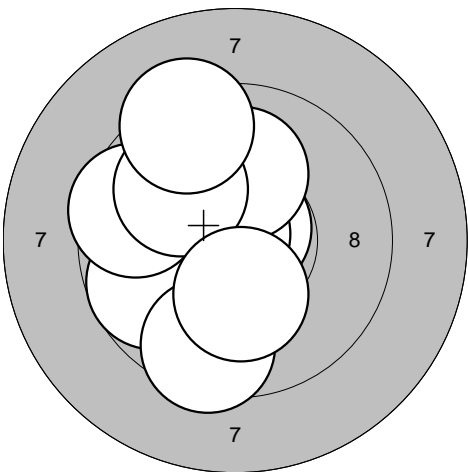
| | | |
|--|--|--|
| <p>Series 5</p>  | <p>Series 6</p>  | |
| <p>1: 10,4* ←</p> <p>2: 10,1 ↓</p> <p>3: 10,1 →</p> <p>4: 10,2* ↘</p> <p>5: 10,3* ←</p> <p>6: 10,3* ↗</p> <p>7: 9,8 ↗</p> <p>8: 9,7 ←</p> <p>9: 10,6* →</p> <p>10: 9,2 ←</p> | <p>1: 9,9 ↗</p> <p>2: 10,8* ↗</p> <p>3: 10,8* ↖</p> <p>4: 10,0 ↗</p> <p>5: 9,7 ↖</p> <p>6: 9,6 ↖</p> <p>7: 9,5 ↓</p> <p>8: 10,0 ↖</p> <p>9: 9,3 ↗</p> <p>10: 10,2* ↓</p> | |
| Serie 97,0 | Serie 95,0 | |
| Sum 484,0 | Sum 579,0 | |

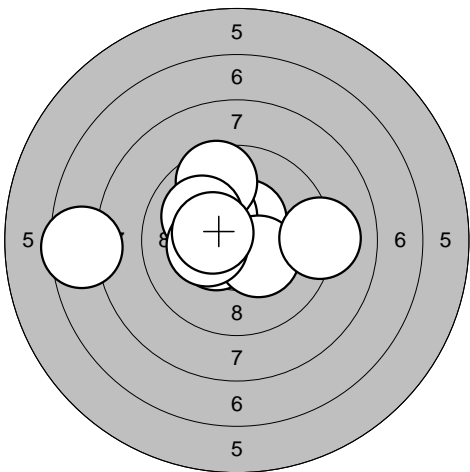
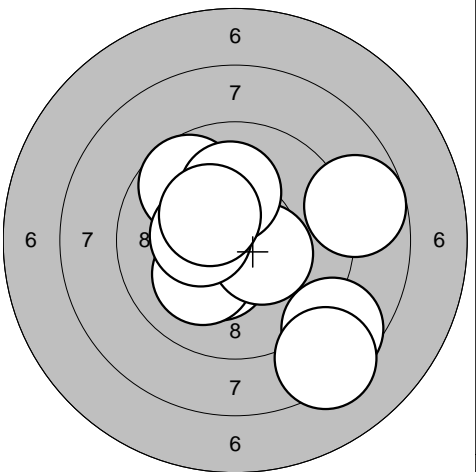
| | | | | | | | | | | | |
|--|--|-------|------|-----|------|--|--|-------|------|-----|-------|
| <p>Series 1</p>  | <p>1: 10,5* ↗</p> <p>2: 10,3* ↗</p> <p>3: 10,5* ↖</p> <p>4: 9,6 ↗</p> <p>5: 7,5 ↖</p> <p>6: 10,0 ↗</p> <p>7: 10,3* ↘</p> <p>8: 9,1 →</p> <p>9: 10,3* ↖</p> <p>10: 10,4* ↖</p> <table border="1" style="width:100%; border-collapse: collapse;"> <tr> <td>Serie</td> <td style="text-align: right;">95,0</td> </tr> <tr> <td>Sum</td> <td style="text-align: right;">95,0</td> </tr> </table> | Serie | 95,0 | Sum | 95,0 | <p>Series 2</p>  | <p>1: 10,4* ↘</p> <p>2: 9,7 ↗</p> <p>3: 10,1 ↘</p> <p>4: 8,6 ↘</p> <p>5: 10,4* ↘</p> <p>6: 10,3* ↖</p> <p>7: 8,3 ↘</p> <p>8: 10,1 ↑</p> <p>9: 10,3* ↗</p> <p>10: 8,8 →</p> <table border="1" style="width:100%; border-collapse: collapse;"> <tr> <td>Serie</td> <td style="text-align: right;">93,0</td> </tr> <tr> <td>Sum</td> <td style="text-align: right;">188,0</td> </tr> </table> | Serie | 93,0 | Sum | 188,0 |
| Serie | 95,0 | | | | | | | | | | |
| Sum | 95,0 | | | | | | | | | | |
| Serie | 93,0 | | | | | | | | | | |
| Sum | 188,0 | | | | | | | | | | |

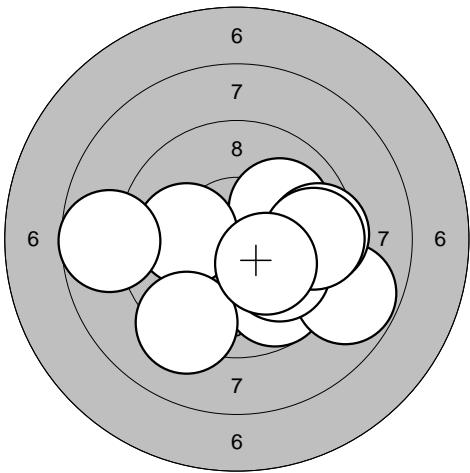
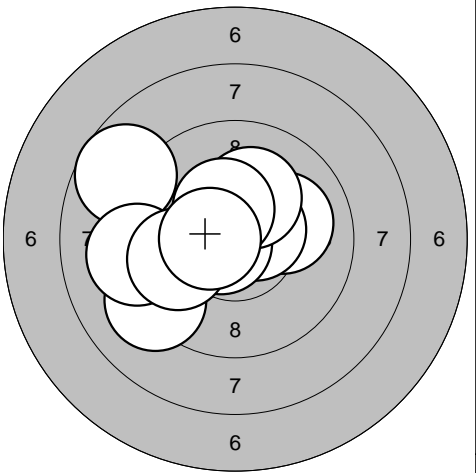
| | | | | | | | | | | | |
|---|---|-------|------|-----|-------|---|---|-------|------|-----|-------|
| <p>Series 3</p>  | <p>1: 9,7 ↘</p> <p>2: 10,0 ↗</p> <p>3: 10,1 ↖</p> <p>4: 8,8 ↘</p> <p>5: 10,0 ↘</p> <p>6: 9,5 →</p> <p>7: 9,2 ↘</p> <p>8: 9,6 →</p> <p>9: 8,7 ↖</p> <p>10: 10,3* ↘</p> <table border="1" style="width:100%; border-collapse: collapse;"> <tr> <td>Serie</td> <td style="text-align: right;">92,0</td> </tr> <tr> <td>Sum</td> <td style="text-align: right;">280,0</td> </tr> </table> | Serie | 92,0 | Sum | 280,0 | <p>Series 4</p>  | <p>1: 10,0 →</p> <p>2: 8,7 ↖</p> <p>3: 10,6* →</p> <p>4: 9,2 ↖</p> <p>5: 9,2 ↖</p> <p>6: 10,7* ↖</p> <p>7: 9,9 ↖</p> <p>8: 10,2* ↑</p> <p>9: 10,4* ↑</p> <p>10: 10,5* ↖</p> <table border="1" style="width:100%; border-collapse: collapse;"> <tr> <td>Serie</td> <td style="text-align: right;">95,0</td> </tr> <tr> <td>Sum</td> <td style="text-align: right;">375,0</td> </tr> </table> | Serie | 95,0 | Sum | 375,0 |
| Serie | 92,0 | | | | | | | | | | |
| Sum | 280,0 | | | | | | | | | | |
| Serie | 95,0 | | | | | | | | | | |
| Sum | 375,0 | | | | | | | | | | |

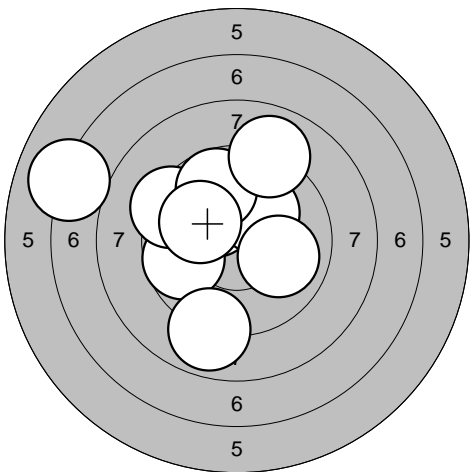
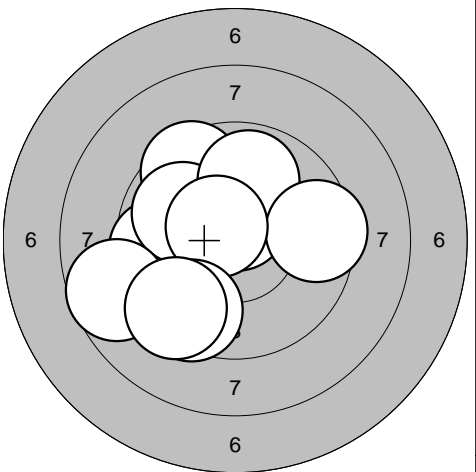
| | | | | | | | | | | | |
|--|--|-------|------|-----|-------|--|--|-------|------|-----|-------|
| <p>Series 5</p>  | <p>1: 7,1 ↖</p> <p>2: 10,2* ↗</p> <p>3: 10,2* ↗</p> <p>4: 10,0 →</p> <p>5: 9,7 ↖</p> <p>6: 9,3 ↗</p> <p>7: 9,7 ↗</p> <p>8: 8,9 ↘</p> <p>9: 10,1 ↗</p> <p>10: 9,0 ↗</p> <table border="1" style="width:100%; border-collapse: collapse;"> <tr> <td>Serie</td> <td style="text-align: right;">91,0</td> </tr> <tr> <td>Sum</td> <td style="text-align: right;">466,0</td> </tr> </table> | Serie | 91,0 | Sum | 466,0 | <p>Series 6</p>  | <p>1: 10,6* ↑</p> <p>2: 9,6 ↖</p> <p>3: 9,5 ↗</p> <p>4: 9,9 ↖</p> <p>5: 9,9 ↑</p> <p>6: 9,5 →</p> <p>7: 8,7 ↖</p> <p>8: 10,6* ↖</p> <p>9: 9,5 ↘</p> <p>10: 9,3 ↘</p> <table border="1" style="width:100%; border-collapse: collapse;"> <tr> <td>Serie</td> <td style="text-align: right;">91,0</td> </tr> <tr> <td>Sum</td> <td style="text-align: right;">557,0</td> </tr> </table> | Serie | 91,0 | Sum | 557,0 |
| Serie | 91,0 | | | | | | | | | | |
| Sum | 466,0 | | | | | | | | | | |
| Serie | 91,0 | | | | | | | | | | |
| Sum | 557,0 | | | | | | | | | | |

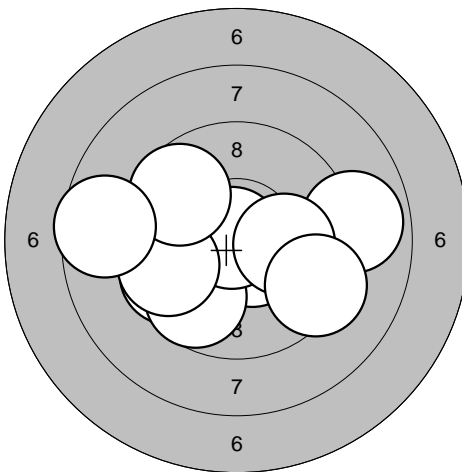
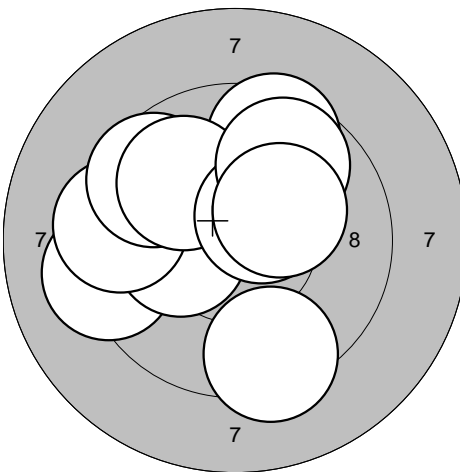
| | | | | | | | | | | | |
|--|---|-------|------|-----|------|--|---|-------|------|-----|-------|
| <p>Series 1</p>  | <p>1: 10,6* ↘ 2: 9,7 ← 3: 9,7 ↘ 4: 8,9 → 5: 10,8* ↗ 6: 10,1 → 7: 9,7 ← 8: 9,7 ↗ 9: 9,3 ↘ 10: 8,6 ←</p> <table border="1" style="width:100%; border-collapse: collapse;"> <tr><td>Serie</td><td style="text-align: right;">91,0</td></tr> <tr><td>Sum</td><td style="text-align: right;">91,0</td></tr> </table> | Serie | 91,0 | Sum | 91,0 | <p>Series 2</p>  | <p>1: 9,2 ← 2: 9,6 ↗ 3: 10,2* ← 4: 9,4 ← 5: 9,4 ↘ 6: 9,6 ↗ 7: 9,9 ↗ 8: 10,5* ↗ 9: 9,8 ↗ 10: 10,2* ↗</p> <table border="1" style="width:100%; border-collapse: collapse;"> <tr><td>Serie</td><td style="text-align: right;">93,0</td></tr> <tr><td>Sum</td><td style="text-align: right;">184,0</td></tr> </table> | Serie | 93,0 | Sum | 184,0 |
| Serie | 91,0 | | | | | | | | | | |
| Sum | 91,0 | | | | | | | | | | |
| Serie | 93,0 | | | | | | | | | | |
| Sum | 184,0 | | | | | | | | | | |

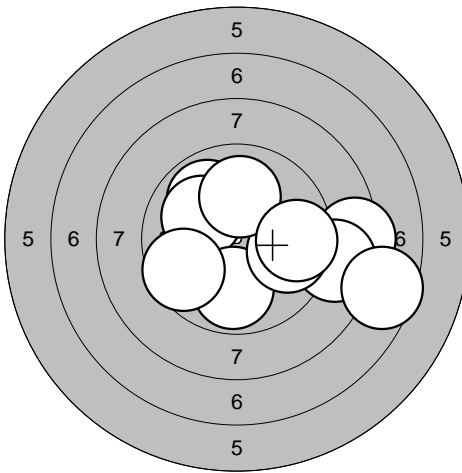
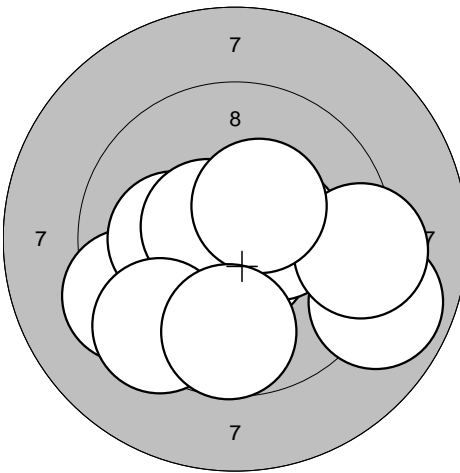
| | | | | | | | | | | | |
|---|---|-------|------|-----|-------|---|--|-------|------|-----|-------|
| <p>Series 3</p>  | <p>1: 8,4 → 2: 9,9 ↗ 3: 10,1 ↗ 4: 9,9 ↘ 5: 9,6 ← 6: 8,7 → 7: 9,8 → 8: 10,0 ↑ 9: 9,6 → 10: 7,6 →</p> <table border="1" style="width:100%; border-collapse: collapse;"> <tr><td>Serie</td><td style="text-align: right;">88,0</td></tr> <tr><td>Sum</td><td style="text-align: right;">272,0</td></tr> </table> | Serie | 88,0 | Sum | 272,0 | <p>Series 4</p>  | <p>1: 10,7* ↘ 2: 8,9 → 3: 9,4 ← 4: 10,4* → 5: 10,1 ← 6: 10,6* ← 7: 9,4 ↘ 8: 9,3 → 9: 10,4* ↗ 10: 9,7 ↘</p> <table border="1" style="width:100%; border-collapse: collapse;"> <tr><td>Serie</td><td style="text-align: right;">94,0</td></tr> <tr><td>Sum</td><td style="text-align: right;">366,0</td></tr> </table> | Serie | 94,0 | Sum | 366,0 |
| Serie | 88,0 | | | | | | | | | | |
| Sum | 272,0 | | | | | | | | | | |
| Serie | 94,0 | | | | | | | | | | |
| Sum | 366,0 | | | | | | | | | | |

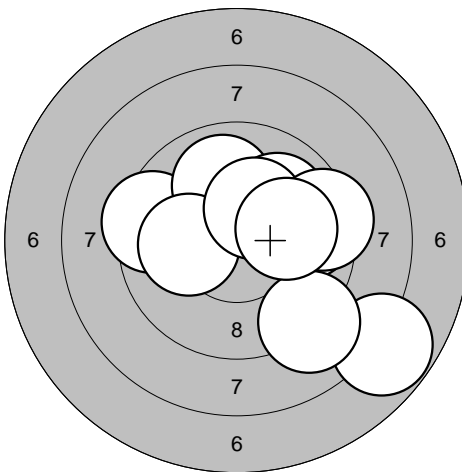
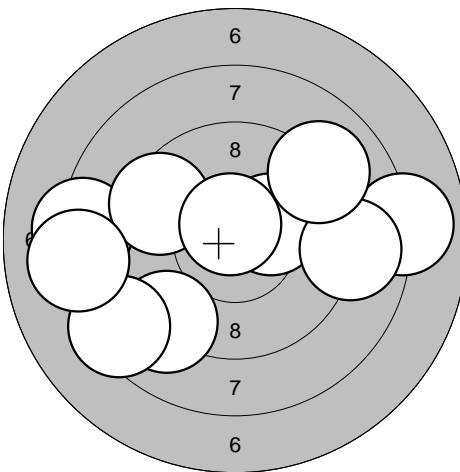
| | | | | | | | | | | | |
|--|---|-------|------|-----|-------|--|---|-------|------|-----|-------|
| <p>Series 5</p>  | <p>1: 9,4 ← 2: 10,0 ↑ 3: 9,7 → 4: 10,1 ← 5: 7,8 ↘ 6: 10,0 ↗ 7: 10,3* ↗ 8: 9,4 → 9: 9,0 ↘ 10: 10,1 →</p> <table border="1" style="width:100%; border-collapse: collapse;"> <tr><td>Serie</td><td style="text-align: right;">93,0</td></tr> <tr><td>Sum</td><td style="text-align: right;">459,0</td></tr> </table> | Serie | 93,0 | Sum | 459,0 | <p>Series 6</p>  | <p>1: 8,0 → 2: 10,2* → 3: 8,3 ← 4: 9,1 ↘ 5: 8,4 ← 6: 8,9 → 7: 9,5 ← 8: 8,2 ← 9: 9,0 ↗ 10: 10,7* ↑</p> <table border="1" style="width:100%; border-collapse: collapse;"> <tr><td>Serie</td><td style="text-align: right;">87,0</td></tr> <tr><td>Sum</td><td style="text-align: right;">546,0</td></tr> </table> | Serie | 87,0 | Sum | 546,0 |
| Serie | 93,0 | | | | | | | | | | |
| Sum | 459,0 | | | | | | | | | | |
| Serie | 87,0 | | | | | | | | | | |
| Sum | 546,0 | | | | | | | | | | |

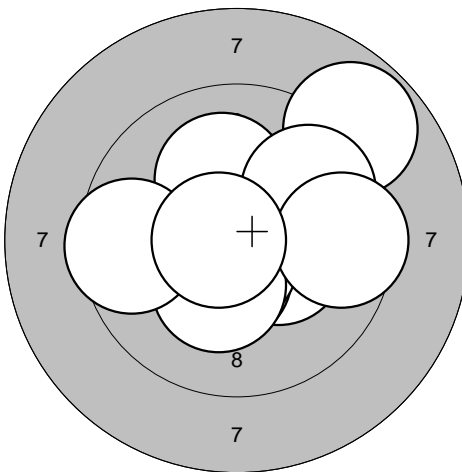
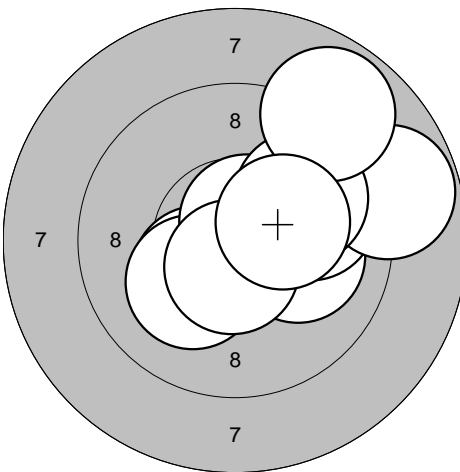
| | | | |
|--|---|--|---|
| <p>Series 1</p>  | <p>1: 10,4* →</p> <p>2: 10,4* ↓</p> <p>3: 10,1 ↑</p> <p>4: 8,8 ↗</p> <p>5: 9,8 ↗</p> <p>6: 10,7* ↓</p> <p>7: 10,3* ↓</p> <p>8: 9,6 →</p> <p>9: 9,6 ←</p> <p>10: 10,7* ←</p> | <p>Series 2</p>  | <p>1: 10,3* ↙</p> <p>2: 10,2* ↙</p> <p>3: 10,1 →</p> <p>4: 9,9 →</p> <p>5: 8,8 →</p> <p>6: 10,7* ↗</p> <p>7: 9,9 ↗</p> <p>8: 10,6* ↓</p> <p>9: 8,9 ↗</p> <p>10: 10,3* →</p> |
| Serie 95,0 | Serie 94,0 | Serie 94,0 | Serie 94,0 |
| Sum 95,0 | Sum 189,0 | Sum 189,0 | Sum 189,0 |

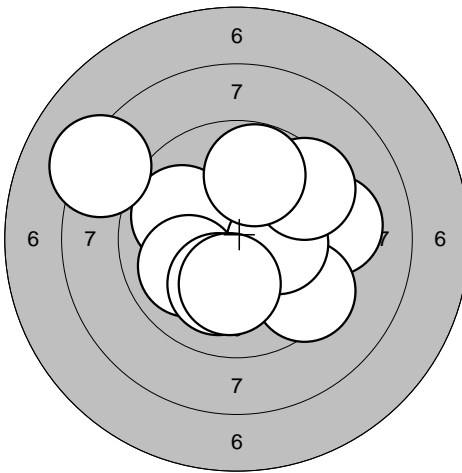
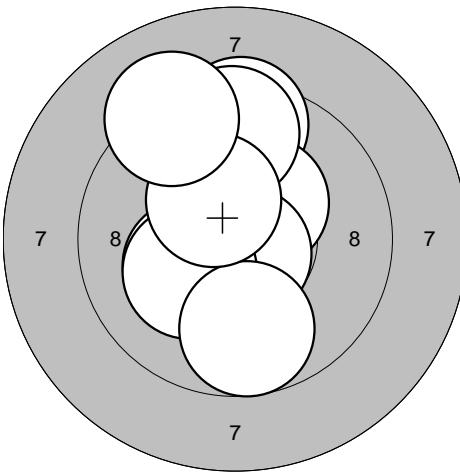
| | | | |
|---|---|---|--|
| <p>Series 3</p>  | <p>1: 9,2 →</p> <p>2: 9,9 ↖</p> <p>3: 8,2 ↗</p> <p>4: 10,0 ↖</p> <p>5: 9,4 ↘</p> <p>6: 10,2* →</p> <p>7: 10,1 ↓</p> <p>8: 9,5 ↗</p> <p>9: 10,1 ↓</p> <p>10: 9,8 ↑</p> | <p>Series 4</p>  | <p>1: 10,5* ↓</p> <p>2: 10,3* ↖</p> <p>3: 9,4 ↑</p> <p>4: 10,3* ↗</p> <p>5: 10,7* ↘</p> <p>6: 9,5 ↑</p> <p>7: 10,2* ↖</p> <p>8: 9,7 ↓</p> <p>9: 10,4* ↗</p> <p>10: 9,2 ↗</p> |
| Serie 93,0 | Serie 96,0 | Serie 96,0 | Serie 96,0 |
| Sum 282,0 | Sum 378,0 | Sum 378,0 | Sum 378,0 |

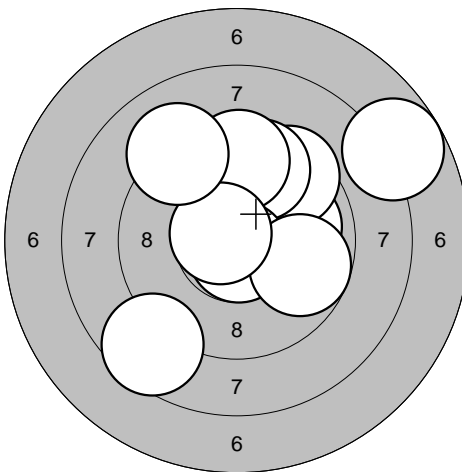
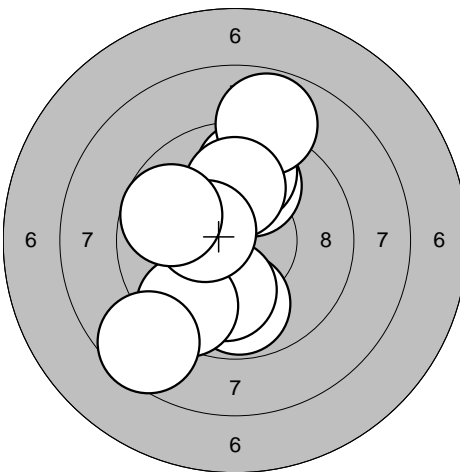
| | | | |
|--|---|--|---|
| <p>Series 5</p>  | <p>1: 10,0 →</p> <p>2: 9,5 ↗</p> <p>3: 8,6 ↖</p> <p>4: 9,7 ↑</p> <p>5: 10,8* ↓</p> <p>6: 9,6 ↑</p> <p>7: 9,8 →</p> <p>8: 10,7* ↖</p> <p>9: 9,1 ↗</p> <p>10: 7,8 ↗</p> | <p>Series 6</p>  | <p>1: 9,8 ↓</p> <p>2: 10,0 ↓</p> <p>3: 9,5 ↖</p> <p>4: 10,0 ↑</p> <p>5: 9,7 ↑</p> <p>6: 8,8 ↑</p> <p>7: 8,6 ↖</p> <p>8: 10,0 ↑</p> <p>9: 10,4* ↖</p> <p>10: 9,8 ↖</p> |
| Serie 90,0 | Serie 92,0 | Serie 92,0 | Serie 92,0 |
| Sum 468,0 | Sum 560,0 | Sum 560,0 | Sum 560,0 |

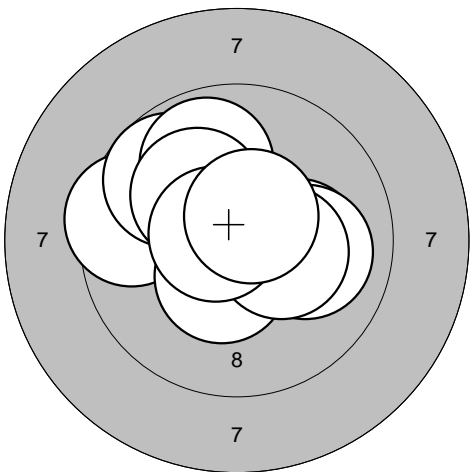
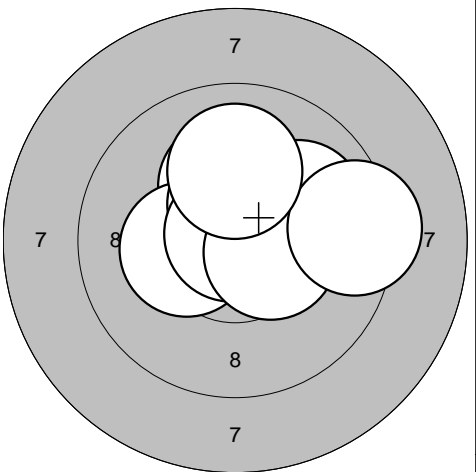
| | | | |
|--|---|--|--|
| <p>Series 1</p>  | <p>1: 9,5 ←</p> <p>2: 10,4* ↓</p> <p>3: 9,8 ↗</p> <p>4: 10,2* →</p> <p>5: 9,8 ↗</p> <p>6: 10,2* ↗</p> <p>7: 10,0 →</p> <p>8: 10,3* →</p> <p>9: 10,7* ←</p> <p>10: 10,6* ↗</p> | <p>Series 2</p>  | <p>1: 10,3* ↗</p> <p>2: 10,2* ↑</p> <p>3: 10,4* →</p> <p>4: 10,3* ←</p> <p>5: 10,5* ↑</p> <p>6: 10,0 ↗</p> <p>7: 10,9* ↗</p> <p>8: 10,4* →</p> <p>9: 9,3 →</p> <p>10: 10,0 ↑</p> |
| Serie 97,0 | Serie 99,0 | Serie 99,0 | Serie 99,0 |
| Sum 97,0 | Sum 97,0 | Sum 196,0 | Sum 196,0 |

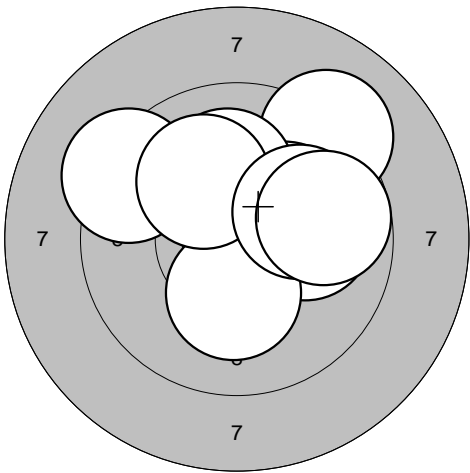
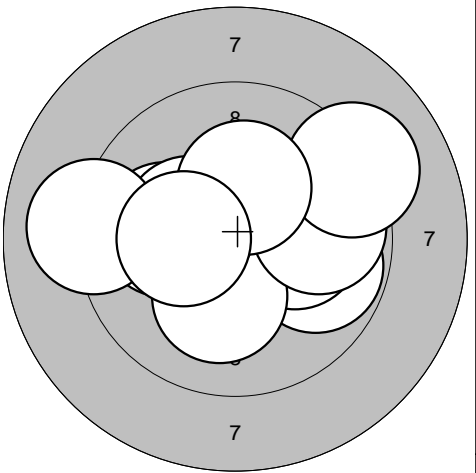
| | | | |
|---|--|---|---|
| <p>Series 3</p>  | <p>1: 9,1 ↗</p> <p>2: 10,2* ↗</p> <p>3: 10,0 →</p> <p>4: 10,7* ↗</p> <p>5: 10,1 ↑</p> <p>6: 9,3 ↗</p> <p>7: 10,2* ↓</p> <p>8: 10,1 ↗</p> <p>9: 10,0 →</p> <p>10: 9,8 →</p> | <p>Series 4</p>  | <p>1: 9,8 →</p> <p>2: 10,2* →</p> <p>3: 10,2* ↓</p> <p>4: 10,0 ←</p> <p>5: 10,3* ←</p> <p>6: 9,8 →</p> <p>7: 9,1 ←</p> <p>8: 9,2 ↗</p> <p>9: 10,2* ↑</p> <p>10: 10,3* ←</p> |
| Serie 97,0 | Serie 97,0 | Serie 96,0 | Serie 96,0 |
| Sum 293,0 | Sum 293,0 | Sum 389,0 | Sum 389,0 |

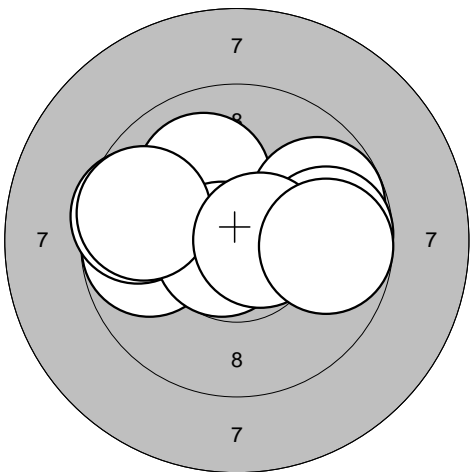
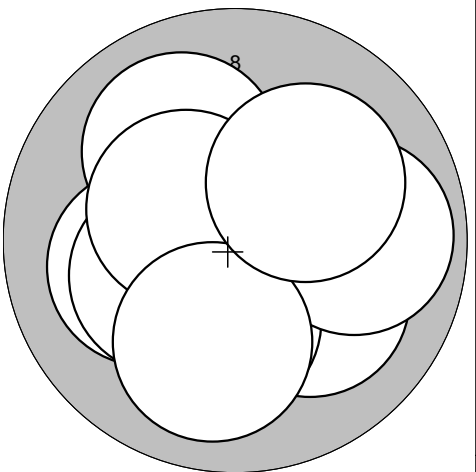
| | | | |
|--|---|--|---|
| <p>Series 5</p>  | <p>1: 9,8 ←</p> <p>2: 10,8* ↗</p> <p>3: 10,0 ↗</p> <p>4: 9,6 ←</p> <p>5: 10,7* ←</p> <p>6: 9,7 ←</p> <p>7: 9,8 →</p> <p>8: 9,8 →</p> <p>9: 10,6* →</p> <p>10: 9,7 →</p> | <p>Series 6</p>  | <p>1: 10,0 ↗</p> <p>2: 10,1 ↘</p> <p>3: 10,2* ↓</p> <p>4: 10,5* ←</p> <p>5: 9,9 →</p> <p>6: 10,1 ←</p> <p>7: 10,3* ←</p> <p>8: 10,4* ↗</p> <p>9: 10,0 ↓</p> <p>10: 10,1 ↗</p> |
| Serie 94,0 | Serie 94,0 | Serie 99,0 | Serie 99,0 |
| Sum 483,0 | Sum 483,0 | Sum 582,0 | Sum 582,0 |

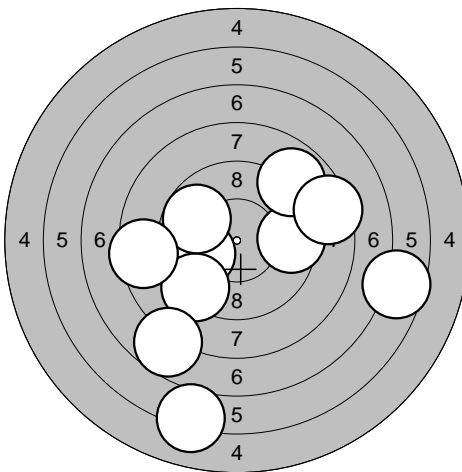
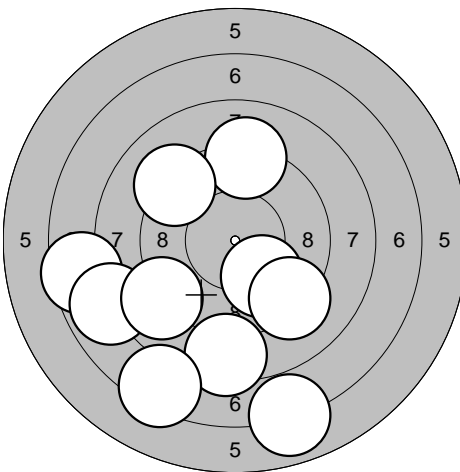
| | | | |
|--|---|--|---|
| <p>Series 1</p>  | <p>1: 10,0 ←</p> <p>2: 9,5 →</p> <p>3: 6,6 →</p> <p>4: 8,9 ↗</p> <p>5: 9,3 ↙</p> <p>6: 9,8 ↗</p> <p>7: 8,5 ←</p> <p>8: 8,4 →</p> <p>9: 7,7 ↙</p> <p>10: 6,1 ↓</p> | <p>Series 2</p>  | <p>1: 10,0 ↓</p> <p>2: 9,2 ↓</p> <p>3: 6,9 ↓</p> <p>4: 8,4 ↓</p> <p>5: 9,1 ↑</p> <p>6: 9,2 ↗</p> <p>7: 7,5 ←</p> <p>8: 7,9 ↙</p> <p>9: 7,3 ↓</p> <p>10: 8,9 ↙</p> |
| Serie | 80,0 | Serie | 80,0 |
| Sum | 80,0 | Sum | 160,0 |

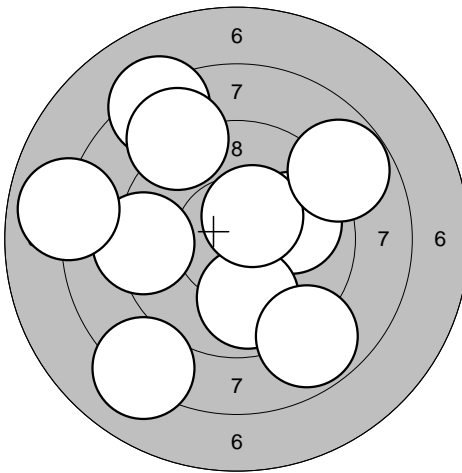
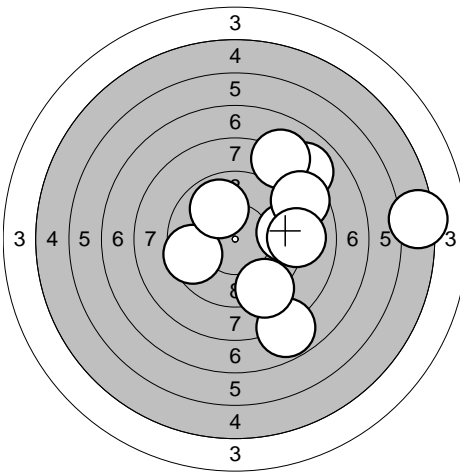
| | | | |
|---|--|---|--|
| <p>Series 3</p>  | <p>1: 9,3 ←</p> <p>2: 9,9 →</p> <p>3: 9,9 ↓</p> <p>4: 8,1 ↙</p> <p>5: 8,8 ↙</p> <p>6: 8,3 ↗</p> <p>7: 10,4* ↗</p> <p>8: 8,9 ↗</p> <p>9: 7,9 ←</p> <p>10: 8,8 ↗</p> | <p>Series 4</p>  | <p>1: 8,0 ↗</p> <p>2: 8,1 ↗</p> <p>3: 7,8 ↓</p> <p>4: 9,4 →</p> <p>5: 9,6 ←</p> <p>6: 8,6 ↗</p> <p>7: 9,1 →</p> <p>8: 9,9 ↗</p> <p>9: 9,2 ↓</p> <p>10: 5,3 →</p> |
| Serie | 84,0 | Serie | 81,0 |
| Sum | 244,0 | Sum | 325,0 |

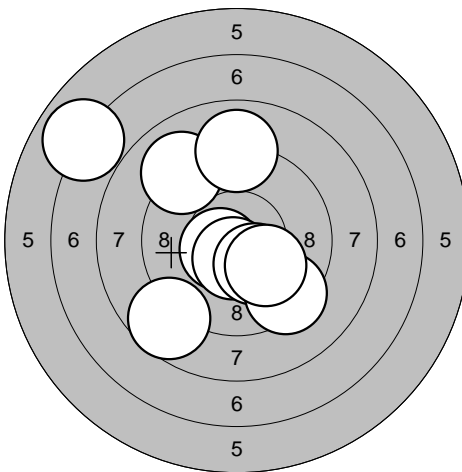
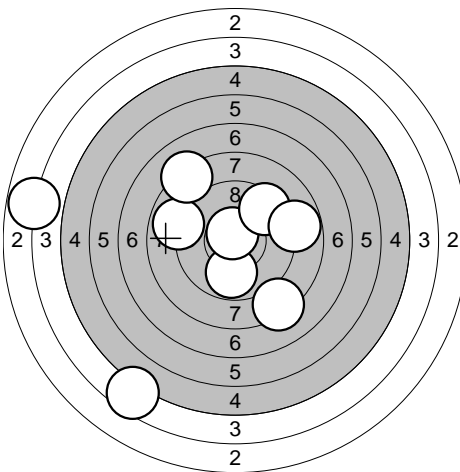
| | | | |
|--|---|--|--|
| <p>Series 5</p>  | <p>1: 9,1 ↗</p> <p>2: 10,5* ←</p> <p>3: 9,0 ↑</p> <p>4: 10,5* ↓</p> <p>5: 8,7 ↙</p> <p>6: 6,9 ↗</p> <p>7: 10,3* ↓</p> <p>8: 9,4 ↙</p> <p>9: 0,0 ←</p> <p>10: 10,1 ↓</p> | <p>Series 6</p>  | <p>1: 9,8 ↓</p> <p>2: 10,7* ↑</p> <p>3: 8,9 ←</p> <p>4: 9,5 ↗</p> <p>5: 8,2 ↓</p> <p>6: 3,8 ←</p> <p>7: 8,8 →</p> <p>8: 4,5 ↙</p> <p>9: 0,0 ←</p> <p>10: 8,2 ↗</p> |
| Serie | 81,0 | Serie | 67,0 |
| Sum | 406,0 | Sum | 473,0 |

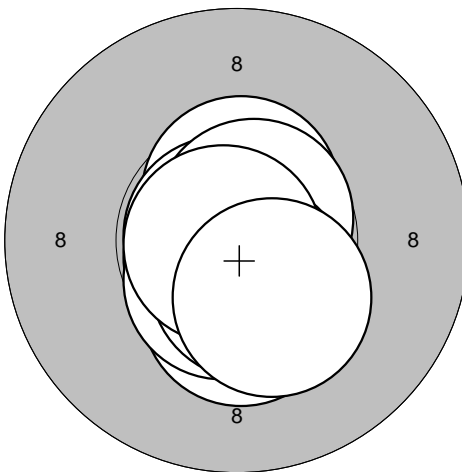
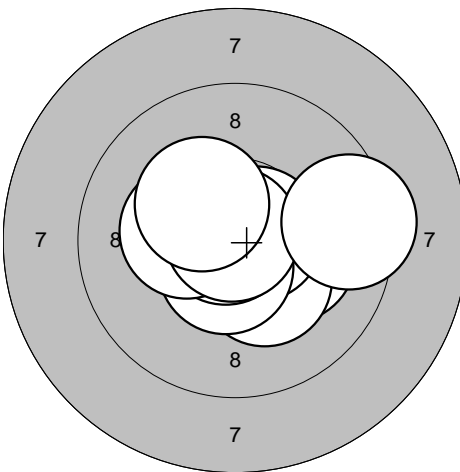
| | | | | | | | | | | | |
|--|--|-------|-------|-----|-------|--|---|-------|------|-----|-------|
| <p>Series 1</p>  | <p>1: 10,8* ↙ 2: 10,5* ↓ 3: 10,6* ↑ 4: 10,8* ← 5: 10,3* ↓ 6: 10,6* ↓ 7: 10,7* ↗ 8: 10,6* ↓ 9: 10,8* ← 10: 10,4* ↓</p> <table border="1" style="width:100%; border-collapse: collapse;"> <tr><td style="text-align: right;">Serie</td><td style="text-align: right;">100,0</td></tr> <tr><td style="text-align: right;">Sum</td><td style="text-align: right;">100,0</td></tr> </table> | Serie | 100,0 | Sum | 100,0 | <p>Series 2</p>  | <p>1: 10,2* → 2: 10,6* ↓ 3: 10,3* ↘ 4: 10,7* → 5: 10,6* ↓ 6: 10,8* ← 7: 10,3* ← 8: 10,9* ↗ 9: 10,3* ↗ 10: 9,4 →</p> <table border="1" style="width:100%; border-collapse: collapse;"> <tr><td style="text-align: right;">Serie</td><td style="text-align: right;">99,0</td></tr> <tr><td style="text-align: right;">Sum</td><td style="text-align: right;">199,0</td></tr> </table> | Serie | 99,0 | Sum | 199,0 |
| Serie | 100,0 | | | | | | | | | | |
| Sum | 100,0 | | | | | | | | | | |
| Serie | 99,0 | | | | | | | | | | |
| Sum | 199,0 | | | | | | | | | | |

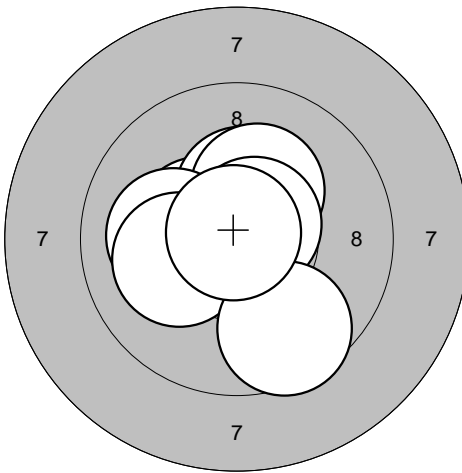
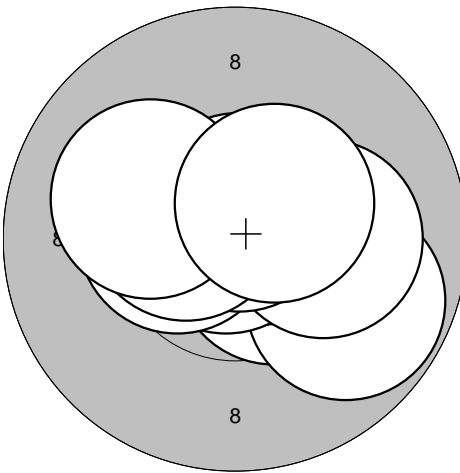
| | | | | | | | | | | | |
|---|---|-------|------|-----|-------|---|--|-------|------|-----|-------|
| <p>Series 3</p>  | <p>1: 10,5* ↑ 2: 10,4* ← 3: 10,4* ↑ 4: 10,4* ↑ 5: 10,2* ↑ 6: 10,1 ← 7: 10,1 ← 8: 10,6* ↗ 9: 9,6 ↓ 10: 10,9* ↗</p> <table border="1" style="width:100%; border-collapse: collapse;"> <tr><td style="text-align: right;">Serie</td><td style="text-align: right;">99,0</td></tr> <tr><td style="text-align: right;">Sum</td><td style="text-align: right;">298,0</td></tr> </table> | Serie | 99,0 | Sum | 298,0 | <p>Series 4</p>  | <p>1: 10,5* ↘ 2: 9,8 ↘ 3: 10,7* ↗ 4: 10,9* ← 5: 10,4* ← 6: 10,2* → 7: 10,7* ↑ 8: 10,5* ← 9: 10,1 ← 10: 10,5* ↗</p> <table border="1" style="width:100%; border-collapse: collapse;"> <tr><td style="text-align: right;">Serie</td><td style="text-align: right;">99,0</td></tr> <tr><td style="text-align: right;">Sum</td><td style="text-align: right;">397,0</td></tr> </table> | Serie | 99,0 | Sum | 397,0 |
| Serie | 99,0 | | | | | | | | | | |
| Sum | 298,0 | | | | | | | | | | |
| Serie | 99,0 | | | | | | | | | | |
| Sum | 397,0 | | | | | | | | | | |

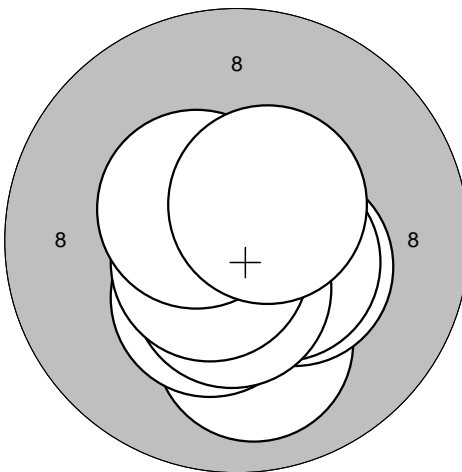
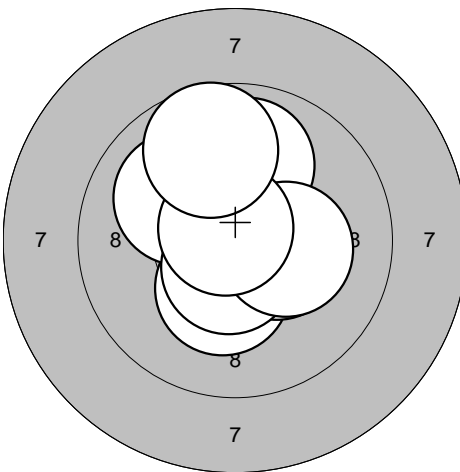
| | | | | | | | | | | | |
|--|---|-------|-------|-----|-------|--|--|-------|------|-----|-------|
| <p>Series 5</p>  | <p>1: 10,0 ↓ 2: 10,7* → 3: 10,4* → 4: 10,8* ↓ 5: 10,4* ↓ 6: 10,5* → 7: 10,5* ↓ 8: 10,6* ← 9: 10,5* ↗ 10: 10,5* ↗</p> <table border="1" style="width:100%; border-collapse: collapse;"> <tr><td style="text-align: right;">Serie</td><td style="text-align: right;">100,0</td></tr> <tr><td style="text-align: right;">Sum</td><td style="text-align: right;">497,0</td></tr> </table> | Serie | 100,0 | Sum | 497,0 | <p>Series 6</p>  | <p>1: 10,8* ↑ 2: 10,3* ↓ 3: 10,2* ↑ 4: 9,9 ↑ 5: 10,0 ↗ 6: 10,4* → 7: 10,6* ↓ 8: 10,2* → 9: 10,7* ↗ 10: 9,7 ↑</p> <table border="1" style="width:100%; border-collapse: collapse;"> <tr><td style="text-align: right;">Serie</td><td style="text-align: right;">98,0</td></tr> <tr><td style="text-align: right;">Sum</td><td style="text-align: right;">595,0</td></tr> </table> | Serie | 98,0 | Sum | 595,0 |
| Serie | 100,0 | | | | | | | | | | |
| Sum | 497,0 | | | | | | | | | | |
| Serie | 98,0 | | | | | | | | | | |
| Sum | 595,0 | | | | | | | | | | |

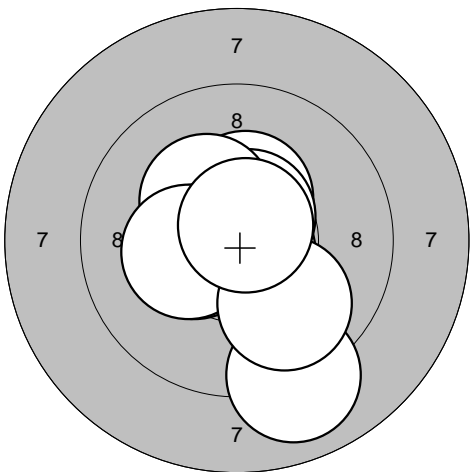
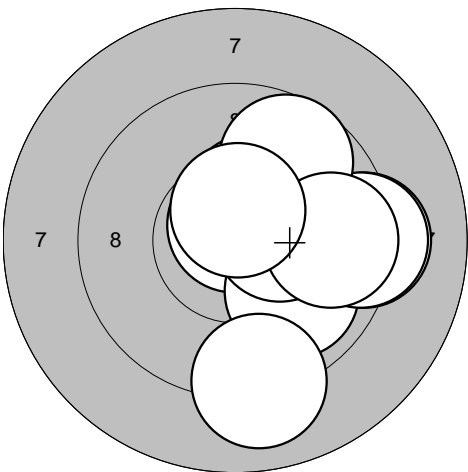
| | | | |
|--|--|--|--|
| <p>Series 1</p>  | <p>1: 10,4* ↑</p> <p>2: 10,7* ↘</p> <p>3: 10,4* ↑</p> <p>4: 10,6* ↗</p> <p>5: 10,3* ↗</p> <p>6: 9,0 ↘</p> <p>7: 10,4* ←</p> <p>8: 10,3* ←</p> <p>9: 9,9 ↘</p> <p>10: 10,7* ↗</p> | <p>Series 2</p>  | <p>1: 10,8* ↑</p> <p>2: 9,9 ↘</p> <p>3: 9,2 →</p> <p>4: 10,4* ↗</p> <p>5: 10,3* →</p> <p>6: 9,3 →</p> <p>7: 9,7 ↗</p> <p>8: 9,7 →</p> <p>9: 10,5* ↑</p> <p>10: 9,0 ↘</p> |
| Serie 98,0 | Serie 94,0 | Serie 94,0 | Serie 94,0 |
| Sum 98,0 | Sum 192,0 | Sum 192,0 | Sum 192,0 |

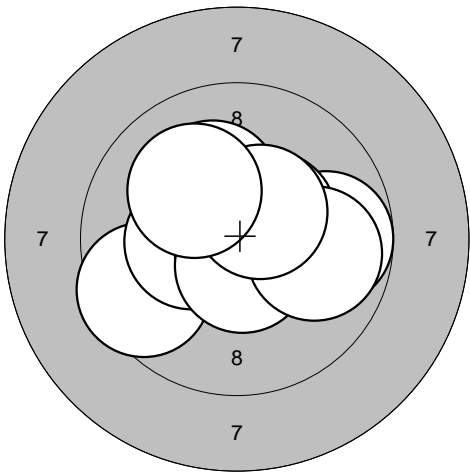
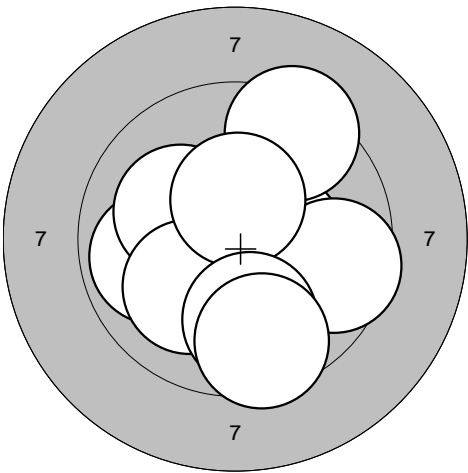
| | | | |
|---|---|---|--|
| <p>Series 3</p>  | <p>1: 9,5 ←</p> <p>2: 9,8 →</p> <p>3: 10,4* ↗</p> <p>4: 10,4* ←</p> <p>5: 10,7* ↘</p> <p>6: 10,6* ↘</p> <p>7: 10,2* ↗</p> <p>8: 9,9 →</p> <p>9: 10,4* ↗</p> <p>10: 10,1 ↗</p> | <p>Series 4</p>  | <p>1: 10,9* ↖</p> <p>2: 9,9 ←</p> <p>3: 10,1 ↖</p> <p>4: 10,4* →</p> <p>5: 10,1 ↖</p> <p>6: 9,4 ↗</p> <p>7: 9,6 →</p> <p>8: 10,4* ↑</p> <p>9: 9,8 ↘</p> <p>10: 9,5 ↘</p> |
| Serie 97,0 | Serie 95,0 | Serie 95,0 | Serie 95,0 |
| Sum 289,0 | Sum 384,0 | Sum 384,0 | Sum 384,0 |

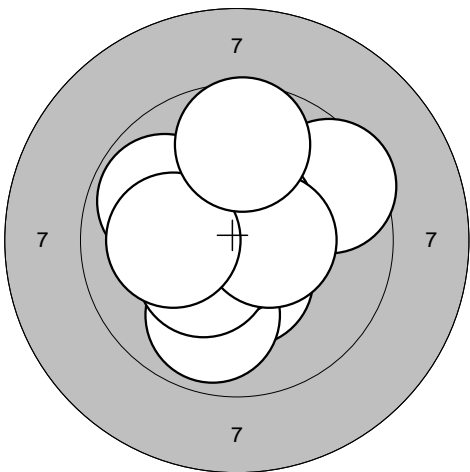
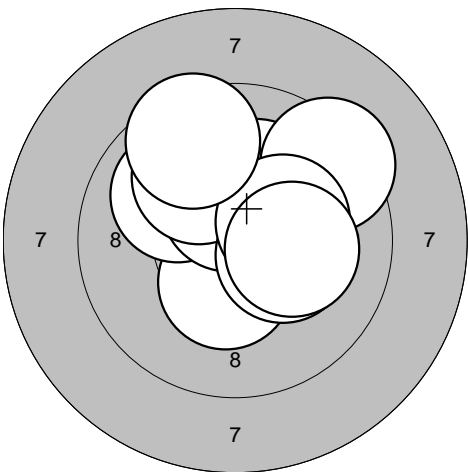
| | | | |
|--|---|--|--|
| <p>Series 5</p>  | <p>1: 10,4* ↘</p> <p>2: 9,9 ↘</p> <p>3: 10,8* ↖</p> <p>4: 9,8 ↖</p> <p>5: 10,3* ↖</p> <p>6: 9,5 →</p> <p>7: 10,6* ↗</p> <p>8: 10,5* →</p> <p>9: 10,1 ←</p> <p>10: 9,7 ↑</p> | <p>Series 6</p>  | <p>1: 10,4* ↘</p> <p>2: 10,0 ↖</p> <p>3: 10,5* ↑</p> <p>4: 10,2* ↗</p> <p>5: 10,0 ↖</p> <p>6: 9,4 ↗</p> <p>7: 10,3* →</p> <p>8: 10,3* →</p> <p>9: 9,5 ↗</p> <p>10: 10,2* →</p> |
| Serie 96,0 | Serie 98,0 | Serie 98,0 | Serie 98,0 |
| Sum 480,0 | Sum 578,0 | Sum 578,0 | Sum 578,0 |

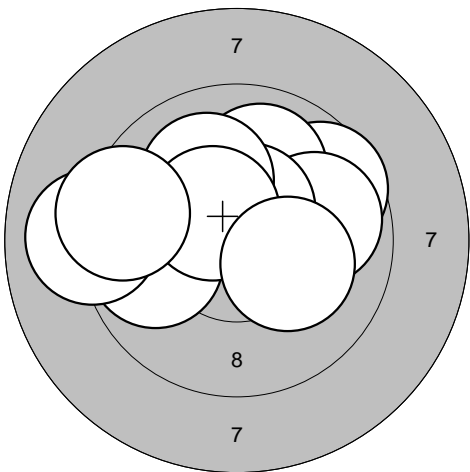
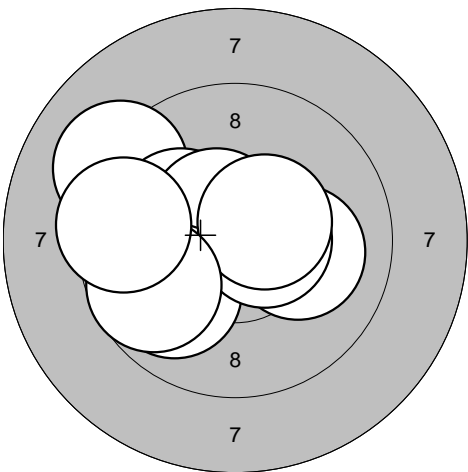
| | | | |
|--|--|--|--|
| <p>Series 1</p>  | <p>1: 9,7 ↗</p> <p>2: 9,8 ←</p> <p>3: 10,0 ↑</p> <p>4: 9,9 →</p> <p>5: 10,5* ↑</p> <p>6: 10,0 ↑</p> <p>7: 10,5* ↑</p> <p>8: 10,2* ↘</p> <p>9: 9,0 ←</p> <p>10: 9,4 ←</p> <hr/> <p>Serie 95,0</p> <hr/> <p>Sum 95,0</p> | <p>Series 2</p>  | <p>1: 10,4* ↖</p> <p>2: 9,2 ↗</p> <p>3: 10,2* ↖</p> <p>4: 10,1 →</p> <p>5: 10,6* ↗</p> <p>6: 9,9 ↘</p> <p>7: 10,5* →</p> <p>8: 10,5* ↗</p> <p>9: 9,7 ←</p> <p>10: 9,5 ←</p> <hr/> <p>Serie 96,0</p> <hr/> <p>Sum 191,0</p> |
|--|--|--|--|

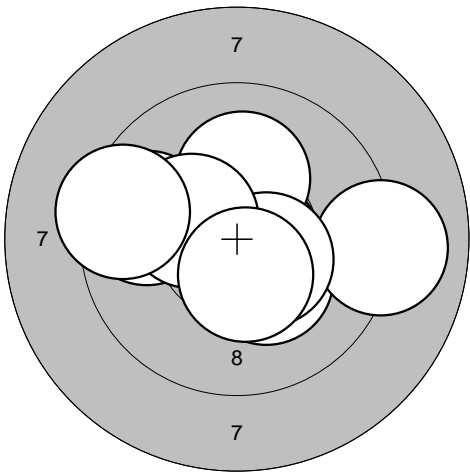
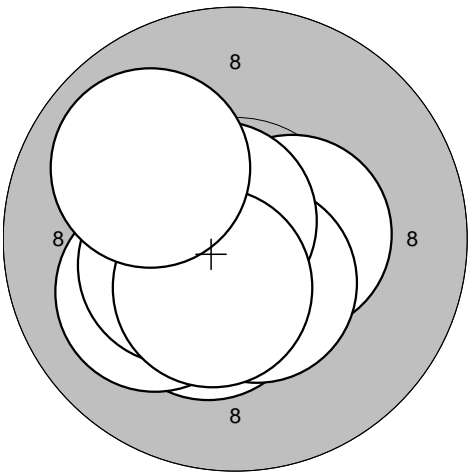
| | | | |
|---|--|---|--|
| <p>Series 3</p>  | <p>1: 10,7* ↘</p> <p>2: 10,7* →</p> <p>3: 10,3* ↘</p> <p>4: 10,1 ↑</p> <p>5: 9,7 ←</p> <p>6: 9,0 →</p> <p>7: 10,5* ↘</p> <p>8: 10,3* ↖</p> <p>9: 10,5* ↘</p> <p>10: 9,4 ←</p> <hr/> <p>Serie 97,0</p> <hr/> <p>Sum 288,0</p> | <p>Series 4</p>  | <p>1: 10,8* ↖</p> <p>2: 10,4* ↘</p> <p>3: 10,4* →</p> <p>4: 10,1 ↖</p> <p>5: 10,8* ←</p> <p>6: 10,4* ←</p> <p>7: 10,5* ↘</p> <p>8: 10,7* ↗</p> <p>9: 10,5* ↘</p> <p>10: 10,0 ↗</p> <hr/> <p>Serie 100,0</p> <hr/> <p>Sum 388,0</p> |
|---|--|---|--|

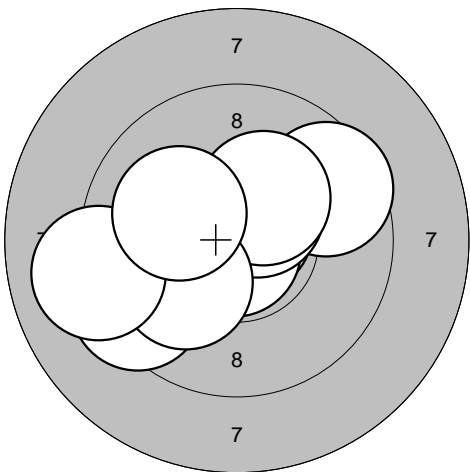
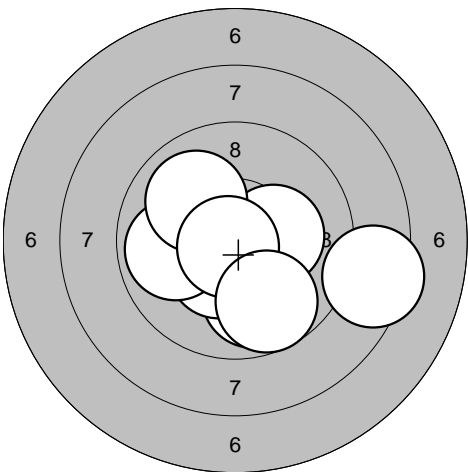
| | | | |
|--|---|--|--|
| <p>Series 5</p>  | <p>1: 9,6 ↗</p> <p>2: 10,7* ↗</p> <p>3: 10,8* ←</p> <p>4: 10,8* ↘</p> <p>5: 9,4 ←</p> <p>6: 10,5* ↗</p> <p>7: 10,3* ↗</p> <p>8: 10,1 ↖</p> <p>9: 9,1 ←</p> <p>10: 10,1 ↖</p> <hr/> <p>Serie 97,0</p> <hr/> <p>Sum 485,0</p> | <p>Series 6</p>  | <p>1: 10,2* ↖</p> <p>2: 8,4 →</p> <p>3: 9,9 ↘</p> <p>4: 10,4* ↘</p> <p>5: 10,4* ↖</p> <p>6: 10,3* →</p> <p>7: 9,9 ←</p> <p>8: 10,0 ↗</p> <p>9: 10,8* ↘</p> <p>10: 9,7 ↘</p> <hr/> <p>Serie 95,0</p> <hr/> <p>Sum 580,0</p> |
|--|---|--|--|

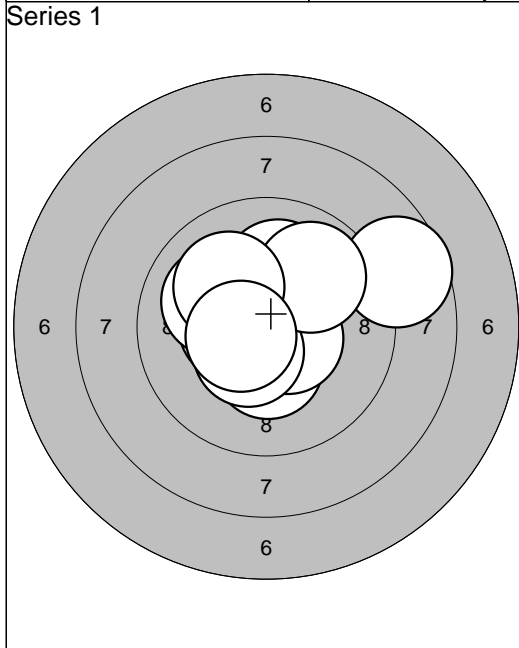

| | |
|-----------|------|
| 1: 10,4* | ← |
| 2: 10,1 | ↑ |
| 3: 10,3* | ↓ |
| 4: 10,5* | → |
| 5: 8,7 | → |
| 6: 10,5* | ↓ |
| 7: 10,0 | ← |
| 8: 9,9 | ↗ |
| 9: 10,1 | ↖ |
| 10: 10,5* | ← |
| Serie | 97,0 |
| Sum | 97,0 |

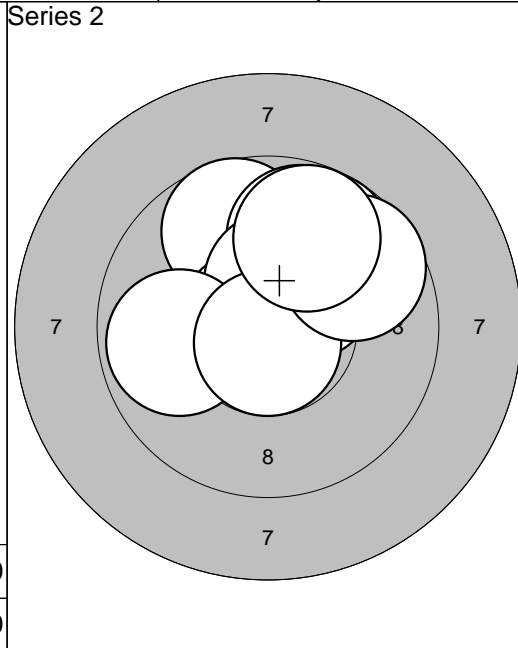

| | |
|----------|-------|
| 1: 9,7 | ↖ |
| 2: 9,8 | ↖ |
| 3: 10,3* | ↗ |
| 4: 9,8 | ↗ |
| 5: 10,8* | ← |
| 6: 10,4* | ↑ |
| 7: 9,9 | ← |
| 8: 10,7* | ↓ |
| 9: 9,7 | ↗ |
| 10: 9,8 | ↖ |
| Serie | 94,0 |
| Sum | 191,0 |

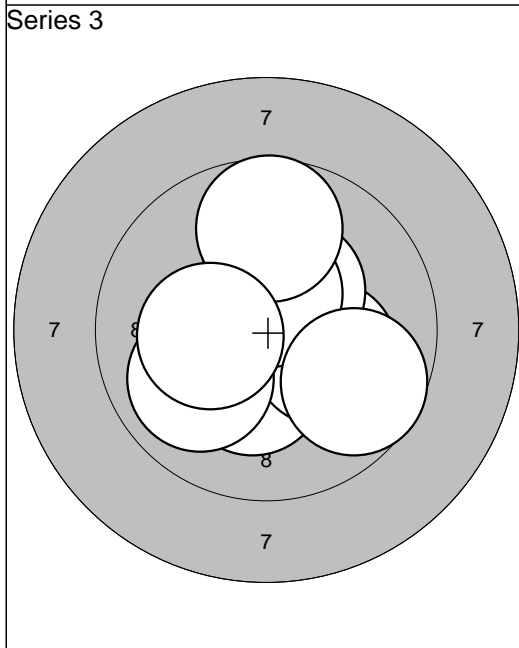

| | |
|----------|-------|
| 1: 10,5* | ↖ |
| 2: 10,9* | ↓ |
| 3: 10,3* | ↓ |
| 4: 10,2* | → |
| 5: 10,0 | ← |
| 6: 10,4* | ↗ |
| 7: 10,5* | ↑ |
| 8: 9,7 | ↑ |
| 9: 10,3* | ← |
| 10: 9,7 | ↘ |
| Serie | 98,0 |
| Sum | 289,0 |

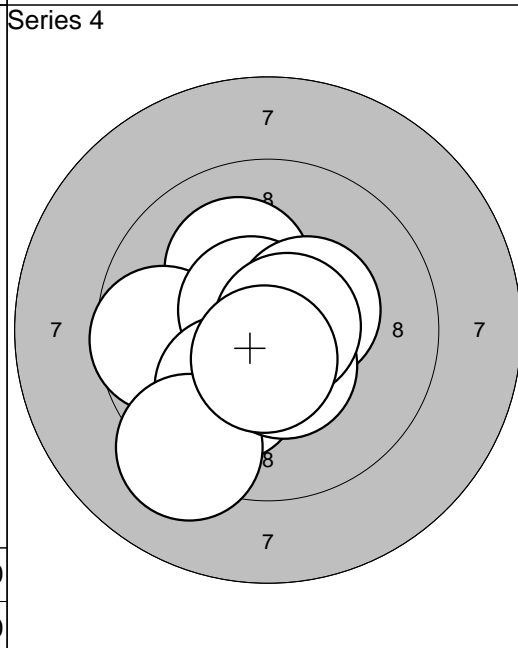

| | |
|-----------|-------|
| 1: 10,1 | ↖ |
| 2: 9,7 | ← |
| 3: 10,6* | ↖ |
| 4: 10,1 | ↓ |
| 5: 9,2 | ↓ |
| 6: 10,5* | ↓ |
| 7: 10,4* | ↗ |
| 8: 10,5* | ↓ |
| 9: 10,7* | → |
| 10: 10,6* | ↓ |
| Serie | 98,0 |
| Sum | 387,0 |

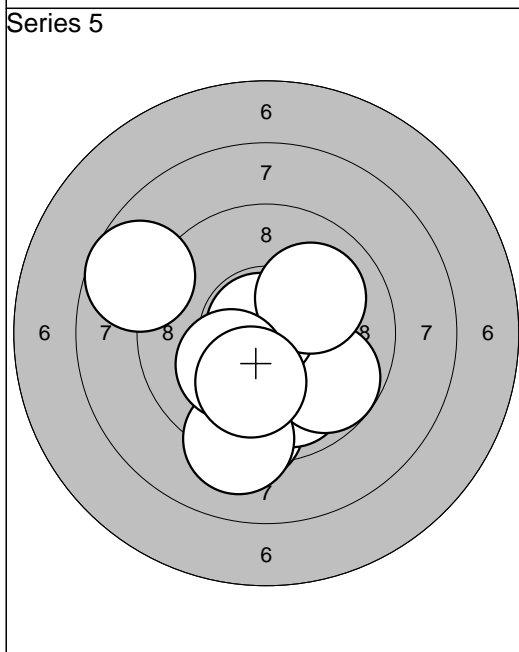

| | |
|----------|-------|
| 1: 10,5* | ↖ |
| 2: 9,4 | ↓ |
| 3: 9,9 | ↓ |
| 4: 9,7 | ↘ |
| 5: 8,7 | ↖ |
| 6: 9,2 | ↓ |
| 7: 10,8* | ↖ |
| 8: 10,0 | ↗ |
| 9: 10,2* | ↖ |
| 10: 10,1 | ↓ |
| Serie | 94,0 |
| Sum | 481,0 |

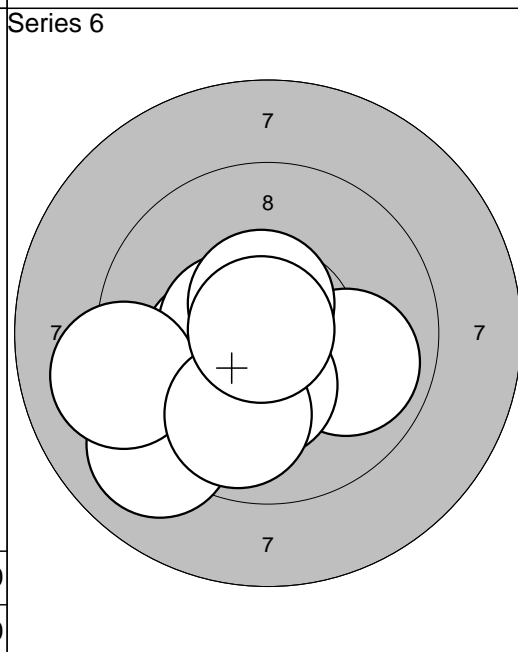

| | |
|-----------|-------|
| 1: 10,3* | ← |
| 2: 9,9 | ↖ |
| 3: 9,1 | ↖ |
| 4: 10,5* | ← |
| 5: 9,1 | ← |
| 6: 9,9 | → |
| 7: 10,6* | ↑ |
| 8: 10,3* | ↓ |
| 9: 9,9 | ↓ |
| 10: 10,9* | ↖ |
| Serie | 95,0 |
| Sum | 576,0 |

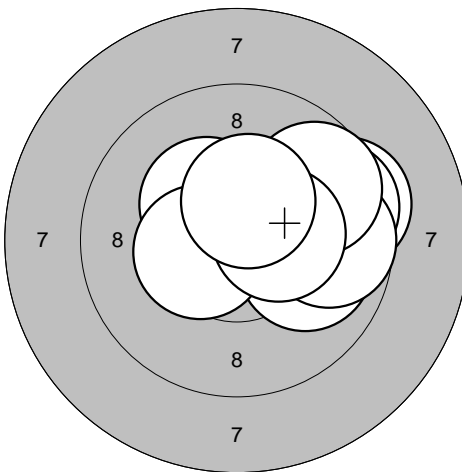
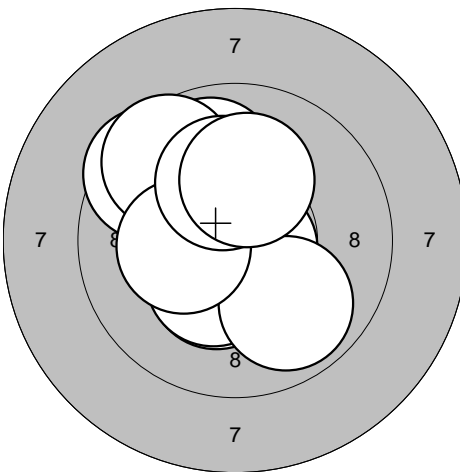
| | | | |
|--|---|--|---|
| <p>Series 1</p>  | <p>1: 9,4 →</p> <p>2: 10,3* ↗</p> <p>3: 10,0 →</p> <p>4: 10,3* →</p> <p>5: 9,6 →</p> <p>6: 9,7 →</p> <p>7: 9,7 ↗</p> <p>8: 10,4* ←</p> <p>9: 10,4* →</p> <p>10: 10,4* ↑</p> | <p>Series 2</p>  | <p>1: 9,9 ↑</p> <p>2: 10,7* ↘</p> <p>3: 9,5 ↗</p> <p>4: 9,6 ↗</p> <p>5: 10,4* ↓</p> <p>6: 10,4* ↓</p> <p>7: 9,9 ↓</p> <p>8: 10,3* ←</p> <p>9: 10,2* ↑</p> <p>10: 10,1 ↑</p> |
| Serie 96,0 | Serie 96,0 | Serie 96,0 | Serie 96,0 |
| Sum 96,0 | Sum 96,0 | Sum 192,0 | Sum 192,0 |

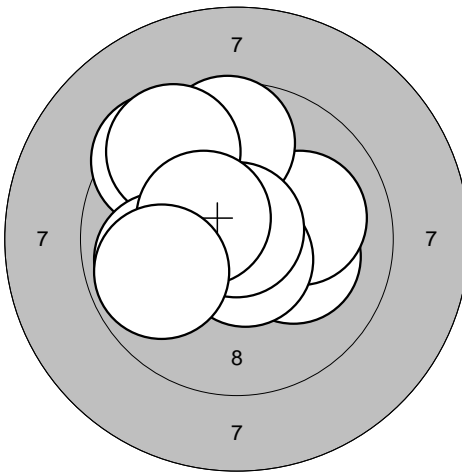
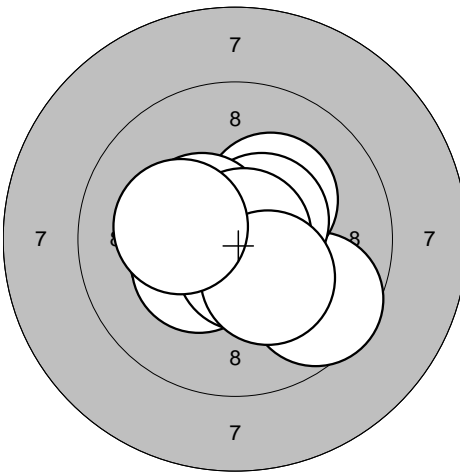
| | | | |
|---|---|---|--|
| <p>Series 3</p>  | <p>1: 10,2* →</p> <p>2: 10,1 →</p> <p>3: 9,5 ↗</p> <p>4: 9,7 ↑</p> <p>5: 10,7* ↓</p> <p>6: 9,5 ↗</p> <p>7: 9,9 ←</p> <p>8: 10,8* ↑</p> <p>9: 10,4* ↗</p> <p>10: 9,8 ←</p> | <p>Series 4</p>  | <p>1: 9,6 ↘</p> <p>2: 10,3* ↗</p> <p>3: 10,5* ↗</p> <p>4: 10,4* ↖</p> <p>5: 10,4* ←</p> <p>6: 10,3* ↖</p> <p>7: 10,6* ↓</p> <p>8: 10,8* →</p> <p>9: 10,3* ↘</p> <p>10: 10,2* ←</p> |
| Serie 95,0 | Serie 95,0 | Serie 99,0 | Serie 99,0 |
| Sum 287,0 | Sum 287,0 | Sum 386,0 | Sum 386,0 |

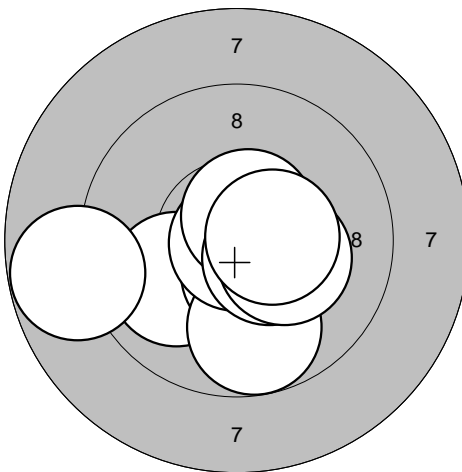
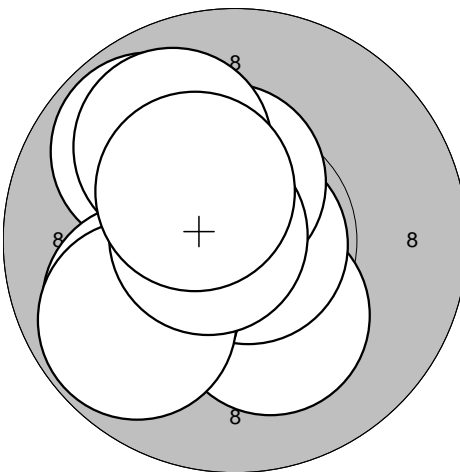
| | | | |
|--|---|--|--|
| <p>Series 5</p>  | <p>1: 10,5* ↘</p> <p>2: 10,0 ↖</p> <p>3: 10,5* ↓</p> <p>4: 9,8 ↓</p> <p>5: 10,9* ↓</p> <p>6: 8,8 ←</p> <p>7: 10,6* ↗</p> <p>8: 10,5* ↘</p> <p>9: 10,3* →</p> <p>10: 10,5* →</p> | <p>Series 6</p>  | <p>1: 10,7* ↑</p> <p>2: 9,9 ↗</p> <p>3: 10,2* ↓</p> <p>4: 10,8* →</p> <p>5: 10,4* ↑</p> <p>6: 9,9 ↖</p> <p>7: 9,8 ↖</p> <p>8: 10,7* ←</p> <p>9: 9,9 ↗</p> <p>10: 10,4* ↗</p> |
| Serie 97,0 | Serie 97,0 | Serie 96,0 | Serie 96,0 |
| Sum 483,0 | Sum 483,0 | Sum 579,0 | Sum 579,0 |

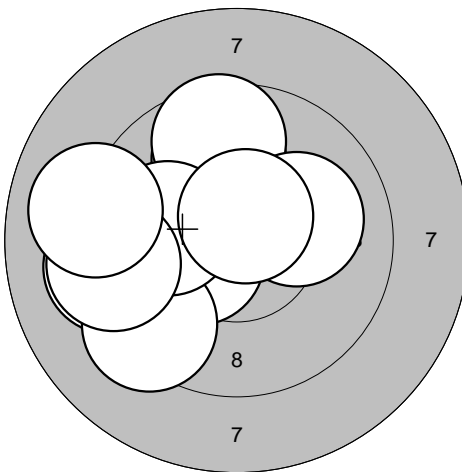
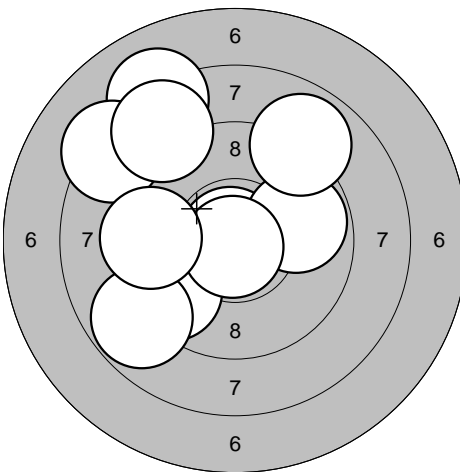
| | | | |
|--|--|--|--|
| <p>Series 1</p>  | <p>1: 9,8 ↑</p> <p>2: 9,2 ←</p> <p>3: 9,6 ↑</p> <p>4: 10,4* ←</p> <p>5: 9,3 ↙</p> <p>6: 10,0 ←</p> <p>7: 9,3 ←</p> <p>8: 10,1 →</p> <p>9: 9,0 ←</p> <p>10: 10,6* ↑</p> | <p>Series 2</p>  | <p>1: 10,9* ↖</p> <p>2: 9,8 →</p> <p>3: 8,9 ↗</p> <p>4: 8,1 ↖</p> <p>5: 9,5 ↙</p> <p>6: 8,8 ↙</p> <p>7: 8,3 ↖</p> <p>8: 8,6 ↗</p> <p>9: 10,8* ↓</p> <p>10: 9,5 ←</p> |
| Serie 94,0 | Serie 87,0 | | |
| Sum 94,0 | Sum 181,0 | | |

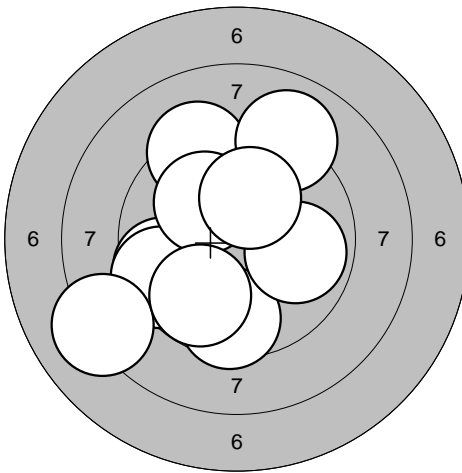
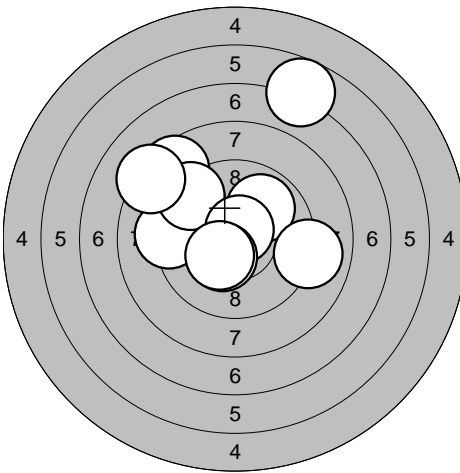
| | | | |
|---|---|---|---|
| <p>Series 3</p>  | <p>1: 9,6 ←</p> <p>2: 9,3 ↗</p> <p>3: 9,5 ←</p> <p>4: 10,1 ↖</p> <p>5: 9,6 ↓</p> <p>6: 8,1 ←</p> <p>7: 9,8 ↙</p> <p>8: 9,9 →</p> <p>9: 9,0 ↗</p> <p>10: 10,2* ↑</p> | <p>Series 4</p>  | <p>1: 9,2 ←</p> <p>2: 8,6 ↖</p> <p>3: 9,9 ↗</p> <p>4: 9,4 ↖</p> <p>5: 6,8 ↗</p> <p>6: 9,0 →</p> <p>7: 8,3 ↖</p> <p>8: 10,7* ↗</p> <p>9: 10,4* ↙</p> <p>10: 10,4* ↙</p> |
| Serie 91,0 | Serie 88,0 | | |
| Sum 272,0 | Sum 360,0 | | |

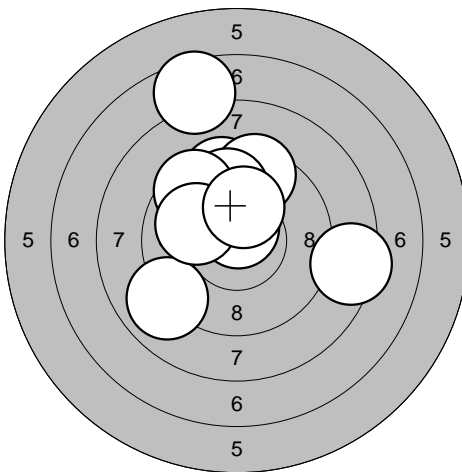
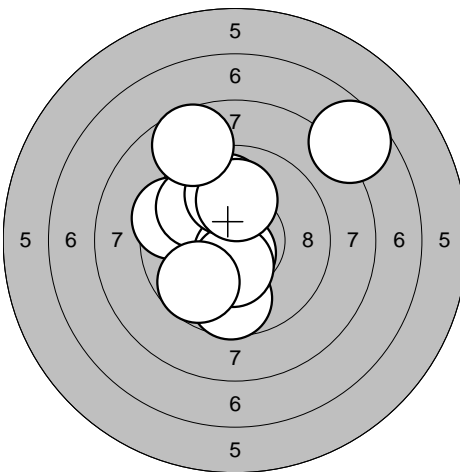
| | | | |
|--|--|--|--|
| <p>Series 5</p>  | <p>1: 9,6 ↑</p> <p>2: 10,7* ↑</p> <p>3: 9,5 ↑</p> <p>4: 9,8 ↑</p> <p>5: 9,0 ↙</p> <p>6: 9,5 ↗</p> <p>7: 7,6 ↑</p> <p>8: 10,0 ←</p> <p>9: 10,2* ↑</p> <p>10: 8,4 →</p> | <p>Series 6</p>  | <p>1: 9,5 ↖</p> <p>2: 9,8 ↖</p> <p>3: 9,7 ↓</p> <p>4: 10,7* ↓</p> <p>5: 10,4* ↓</p> <p>6: 9,9 ↑</p> <p>7: 10,1 ↑</p> <p>8: 8,7 ↖</p> <p>9: 9,7 ↙</p> <p>10: 7,6 ↗</p> |
| Serie 90,0 | Serie 90,0 | | |
| Sum 450,0 | Sum 540,0 | | |

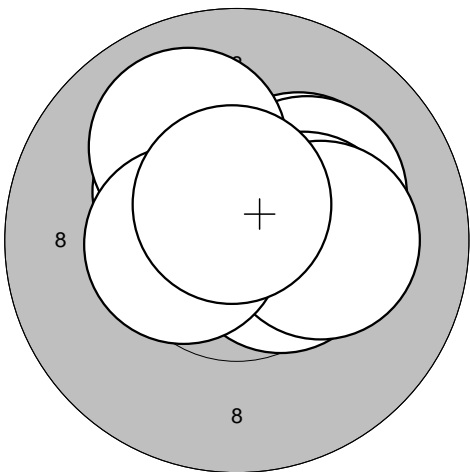
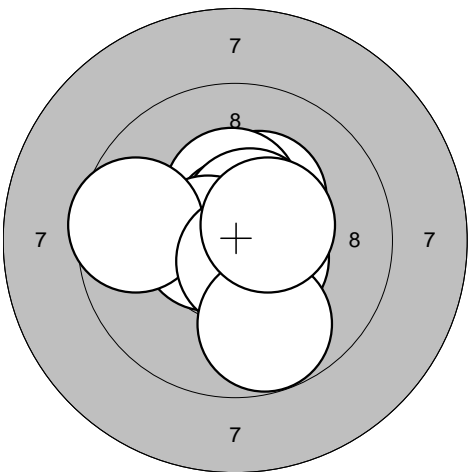
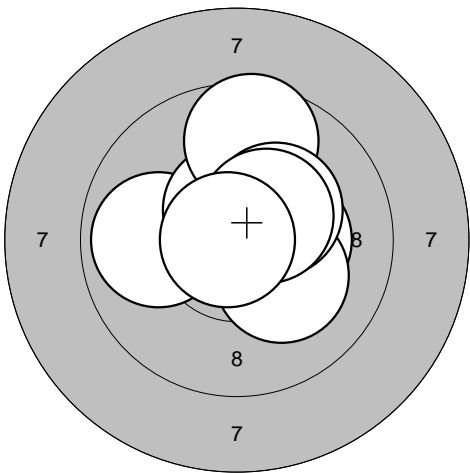
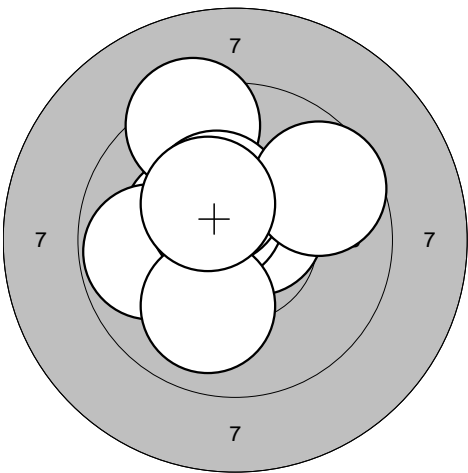
| | | | |
|--|--|---|---|
| <p>Series 1</p>  | <p>Series 2</p>  | <p>Series 3</p>  | <p>Series 4</p>  |
| Serie 100,0 | Serie 98,0 | Serie 98,0 | Serie 97,0 |
| Sum 100,0 | Sum 198,0 | Sum 296,0 | Sum 393,0 |

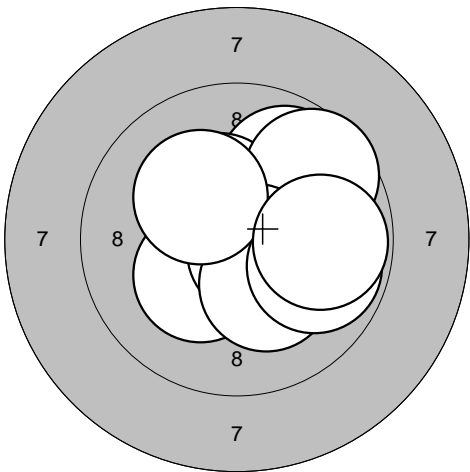
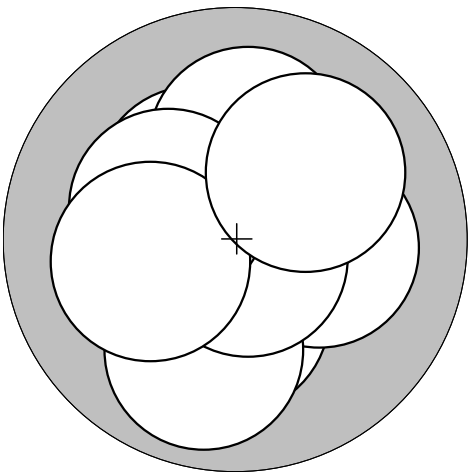
| | |
|--|--|
| <p>Series 5</p>  | <p>Series 6</p>  |
| Serie 96,0 | Serie 99,0 |
| Sum 489,0 | Sum 588,0 |

| | |
|---|-------------------------------------|
| Edman Precision, Morini, Interprodukter | Sävsjö kommun, Sävsjö Skytte Center |
|---|-------------------------------------|

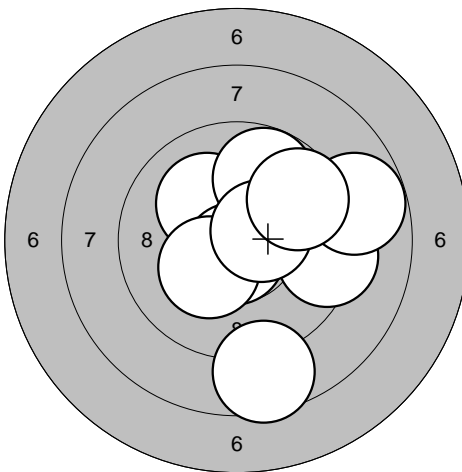
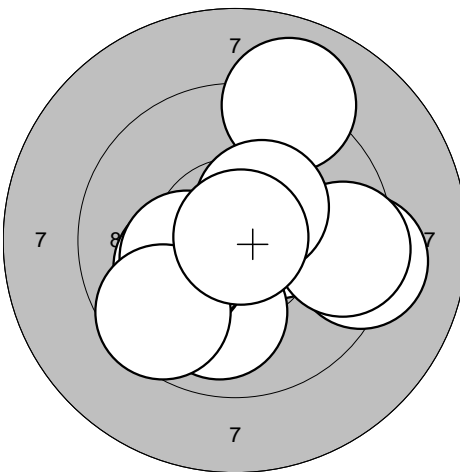
| | | | |
|--|---|--|---|
| <p>Series 1</p>  | <p>1: 10,4* ↗</p> <p>2: 9,3 →</p> <p>3: 10,1 ↗</p> <p>4: 8,6 ↓</p> <p>5: 9,8 ↗</p> <p>6: 10,7* ↓</p> <p>7: 10,3* ↙</p> <p>8: 8,8 →</p> <p>9: 10,5* →</p> <p>10: 9,6 ↗</p> | <p>Series 2</p>  | <p>1: 9,2 →</p> <p>2: 9,0 ↗</p> <p>3: 10,4* →</p> <p>4: 9,9 ↓</p> <p>5: 9,5 →</p> <p>6: 10,4* ↗</p> <p>7: 10,1 ←</p> <p>8: 10,3* ←</p> <p>9: 9,6 ↙</p> <p>10: 10,9* ↗</p> |
| Serie 93,0 | Serie 95,0 | Serie 95,0 | Serie 95,0 |
| Sum 93,0 | Sum 188,0 | Sum 188,0 | Sum 188,0 |

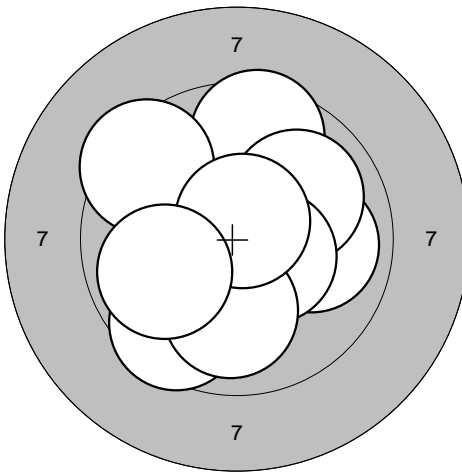
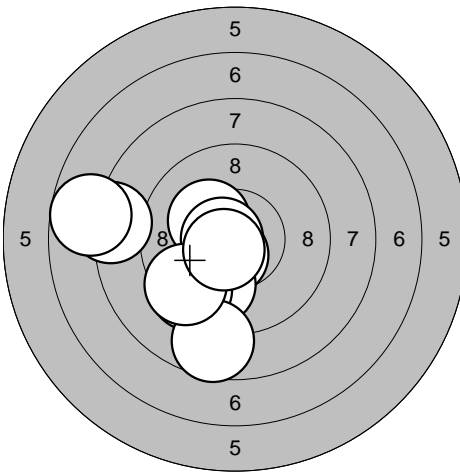
| | | | |
|---|--|---|--|
| <p>Series 3</p>  | <p>1: 10,4* ↓</p> <p>2: 9,6 ↗</p> <p>3: 9,9 →</p> <p>4: 10,0 ↗</p> <p>5: 9,6 ↙</p> <p>6: 10,5* →</p> <p>7: 10,0 ↓</p> <p>8: 9,4 ↗</p> <p>9: 10,7* ↗</p> <p>10: 9,9 ←</p> | <p>Series 4</p>  | <p>1: 8,2 ←</p> <p>2: 10,5* ↓</p> <p>3: 9,9 ↓</p> <p>4: 9,5 ↙</p> <p>5: 7,7 ←</p> <p>6: 10,3* ↗</p> <p>7: 10,7* ←</p> <p>8: 8,7 ↓</p> <p>9: 9,5 ↙</p> <p>10: 10,6* ↙</p> |
| Serie 95,0 | Serie 90,0 | Serie 90,0 | Serie 90,0 |
| Sum 283,0 | Sum 373,0 | Sum 373,0 | Sum 373,0 |

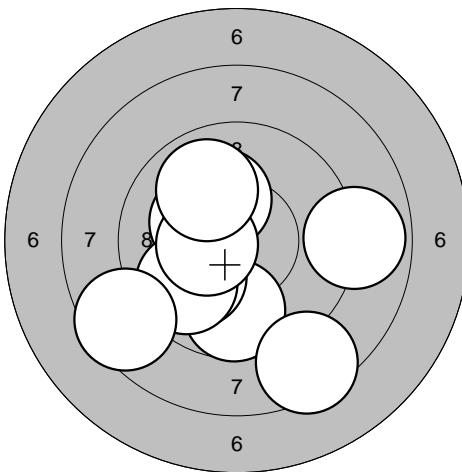
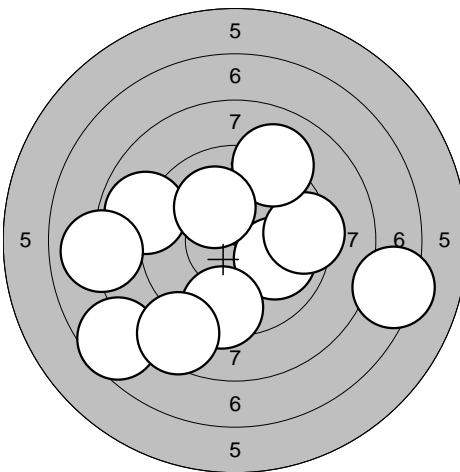
| | | | |
|--|---|--|--|
| <p>Series 5</p>  | <p>1: 10,2* ↙</p> <p>2: 9,7 ↓</p> <p>3: 10,0 ↙</p> <p>4: 8,9 →</p> <p>5: 10,2* ↗</p> <p>6: 8,5 ↓</p> <p>7: 9,8 ↙</p> <p>8: 10,4* ←</p> <p>9: 8,6 ↙</p> <p>10: 9,9 ↗</p> | <p>Series 6</p>  | <p>1: 10,0 →</p> <p>2: 7,6 ↙</p> <p>3: 8,9 ←</p> <p>4: 9,4 →</p> <p>5: 9,4 ↓</p> <p>6: 9,1 ↗</p> <p>7: 10,1 ↗</p> <p>8: 7,3 →</p> <p>9: 8,0 ←</p> <p>10: 8,5 ↙</p> |
| Serie 91,0 | Serie 85,0 | Serie 85,0 | Serie 85,0 |
| Sum 464,0 | Sum 549,0 | Sum 549,0 | Sum 549,0 |

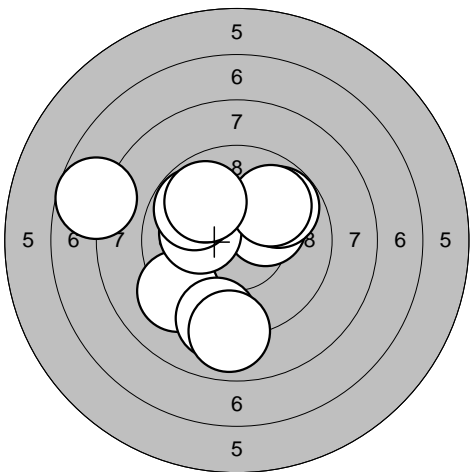
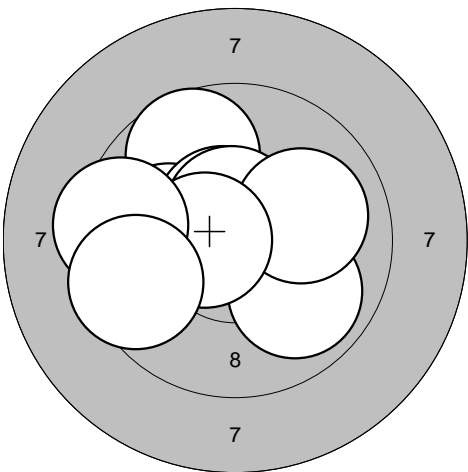
| | | | | | | | | | | | |
|--|---|-------|------|-----|------|--|---|-------|------|-----|-------|
| <p>Series 1</p>  | <p>1: 9,2 ↙ 2: 10,2* → 3: 9,2 ↓ 4: 7,8 ← 5: 9,8 → 6: 10,1 ← 7: 8,9 ↓ 8: 9,8 ↗ 9: 9,9 ↗ 10: 9,9 ↗</p> <table border="1" style="width:100%; border-collapse: collapse;"> <tr><td>Serie</td><td style="text-align: right;">89,0</td></tr> <tr><td>Sum</td><td style="text-align: right;">89,0</td></tr> </table> | Serie | 89,0 | Sum | 89,0 | <p>Series 2</p>  | <p>1: 9,7 ↗ 2: 10,7* ← 3: 9,9 ↓ 4: 10,1 ← 5: 10,6* ↗ 6: 10,6* ↑ 7: 10,0 → 8: 10,5* ← 9: 9,4 ← 10: 9,5 ←</p> <table border="1" style="width:100%; border-collapse: collapse;"> <tr><td>Serie</td><td style="text-align: right;">96,0</td></tr> <tr><td>Sum</td><td style="text-align: right;">185,0</td></tr> </table> | Serie | 96,0 | Sum | 185,0 |
| Serie | 89,0 | | | | | | | | | | |
| Sum | 89,0 | | | | | | | | | | |
| Serie | 96,0 | | | | | | | | | | |
| Sum | 185,0 | | | | | | | | | | |

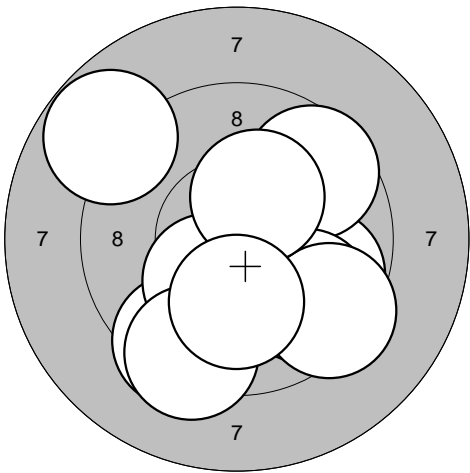
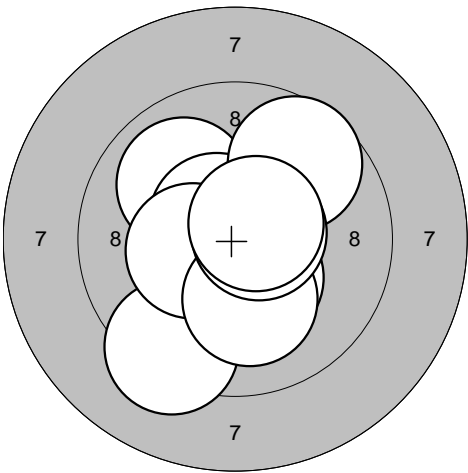
| | | | | | | | | | | | |
|---|--|-------|------|-----|-------|---|---|-------|------|-----|-------|
| <p>Series 3</p>  | <p>1: 9,4 ↓ 2: 9,8 → 3: 9,6 ↗ 4: 8,8 ↗ 5: 9,7 ↓ 6: 9,4 ↓ 7: 10,3* ↓ 8: 10,3* ↗ 9: 9,3 ↓ 10: 10,1 ↓</p> <table border="1" style="width:100%; border-collapse: collapse;"> <tr><td>Serie</td><td style="text-align: right;">92,0</td></tr> <tr><td>Sum</td><td style="text-align: right;">277,0</td></tr> </table> | Serie | 92,0 | Sum | 277,0 | <p>Series 4</p>  | <p>1: 10,6* ↗ 2: 10,0 ↗ 3: 10,6* ↗ 4: 9,3 ↓ 5: 9,7 ↗ 6: 10,4* ↓ 7: 10,4* ← 8: 10,1 ↓ 9: 10,6* → 10: 10,6* ↗</p> <table border="1" style="width:100%; border-collapse: collapse;"> <tr><td>Serie</td><td style="text-align: right;">98,0</td></tr> <tr><td>Sum</td><td style="text-align: right;">375,0</td></tr> </table> | Serie | 98,0 | Sum | 375,0 |
| Serie | 92,0 | | | | | | | | | | |
| Sum | 277,0 | | | | | | | | | | |
| Serie | 98,0 | | | | | | | | | | |
| Sum | 375,0 | | | | | | | | | | |

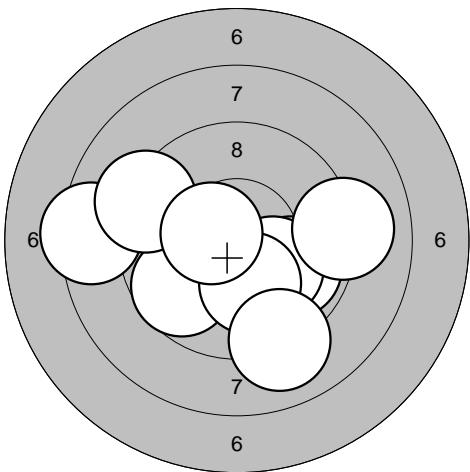
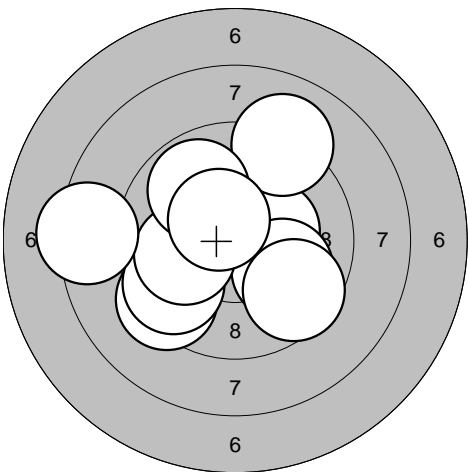
| | | | | | | | | | | | |
|--|--|-------|------|-----|-------|--|---|-------|------|-----|-------|
| <p>Series 5</p>  | <p>1: 9,9 → 2: 10,1 ↓ 3: 8,4 ← 4: 10,3* ← 5: 9,7 ↙ 6: 9,1 → 7: 10,2* ↓ 8: 9,0 ↓ 9: 9,2 ↗ 10: 10,5* ←</p> <table border="1" style="width:100%; border-collapse: collapse;"> <tr><td>Serie</td><td style="text-align: right;">93,0</td></tr> <tr><td>Sum</td><td style="text-align: right;">468,0</td></tr> </table> | Serie | 93,0 | Sum | 468,0 | <p>Series 6</p>  | <p>1: 10,3* → 2: 9,4 ↙ 3: 9,6 ↙ 4: 9,1 ↗ 5: 10,0 ↘ 6: 10,1 ← 7: 9,9 ↗ 8: 9,6 ↘ 9: 8,3 ← 10: 10,5* ↗</p> <table border="1" style="width:100%; border-collapse: collapse;"> <tr><td>Serie</td><td style="text-align: right;">93,0</td></tr> <tr><td>Sum</td><td style="text-align: right;">561,0</td></tr> </table> | Serie | 93,0 | Sum | 561,0 |
| Serie | 93,0 | | | | | | | | | | |
| Sum | 468,0 | | | | | | | | | | |
| Serie | 93,0 | | | | | | | | | | |
| Sum | 561,0 | | | | | | | | | | |

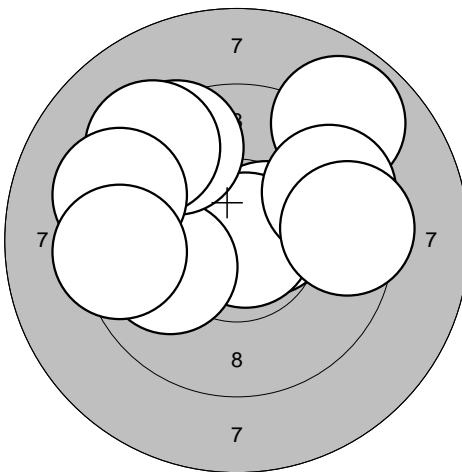
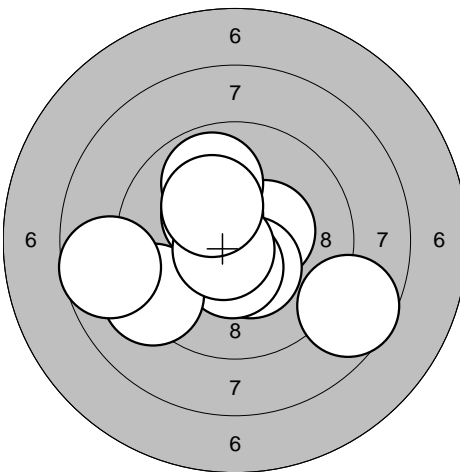
| | | | | | | | | | | | |
|--|--|-------|------|-----|------|--|--|-------|------|-----|-------|
| <p>Series 1</p>  | <p>1: 10,5* →</p> <p>2: 10,8* →</p> <p>3: 10,0 ←</p> <p>4: 8,9 ↗</p> <p>5: 9,5 ↗</p> <p>6: 9,5 →</p> <p>7: 9,3 ↗</p> <p>8: 9,3 ←</p> <p>9: 9,4 →</p> <p>10: 9,4 ←</p> <table border="1" style="width:100%; border-collapse: collapse;"> <tr><td>Serie</td><td style="text-align: right;">92,0</td></tr> <tr><td>Sum</td><td style="text-align: right;">92,0</td></tr> </table> | Serie | 92,0 | Sum | 92,0 | <p>Series 2</p>  | <p>1: 10,4* →</p> <p>2: 10,4* ↓</p> <p>3: 10,5* ↓</p> <p>4: 8,6 ↘</p> <p>5: 10,3* ↗</p> <p>6: 9,2 ←</p> <p>7: 9,9 ↗</p> <p>8: 8,7 ←</p> <p>9: 10,7* ↘</p> <p>10: 10,2* ↗</p> <table border="1" style="width:100%; border-collapse: collapse;"> <tr><td>Serie</td><td style="text-align: right;">94,0</td></tr> <tr><td>Sum</td><td style="text-align: right;">186,0</td></tr> </table> | Serie | 94,0 | Sum | 186,0 |
| Serie | 92,0 | | | | | | | | | | |
| Sum | 92,0 | | | | | | | | | | |
| Serie | 94,0 | | | | | | | | | | |
| Sum | 186,0 | | | | | | | | | | |

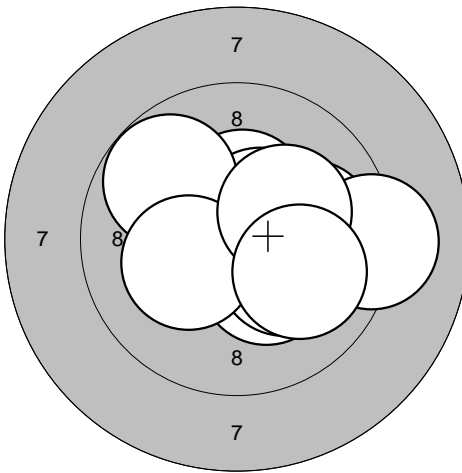
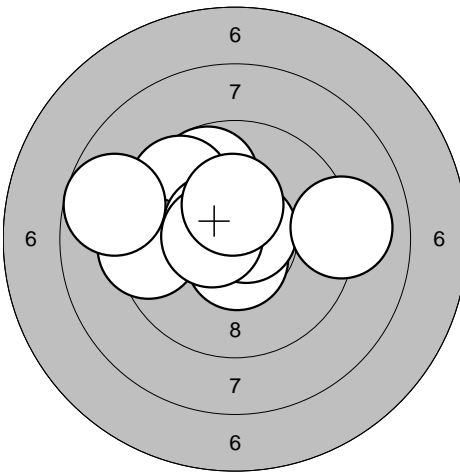
| | | | | | | | | | | | |
|---|--|-------|------|-----|-------|---|--|-------|------|-----|-------|
| <p>Series 3</p>  | <p>1: 10,0 →</p> <p>2: 10,4* ↑</p> <p>3: 10,5* ↗</p> <p>4: 10,3* ↓</p> <p>5: 10,2* ↓</p> <p>6: 9,2 →</p> <p>7: 9,8 ↗</p> <p>8: 10,2* ←</p> <p>9: 10,2* ↗</p> <p>10: 10,0 ↘</p> <table border="1" style="width:100%; border-collapse: collapse;"> <tr><td>Serie</td><td style="text-align: right;">98,0</td></tr> <tr><td>Sum</td><td style="text-align: right;">284,0</td></tr> </table> | Serie | 98,0 | Sum | 284,0 | <p>Series 4</p>  | <p>1: 9,8 ↗</p> <p>2: 9,6 ↗</p> <p>3: 9,4 ←</p> <p>4: 10,5* ↗</p> <p>5: 10,6* ↓</p> <p>6: 10,7* ↗</p> <p>7: 8,7 ←</p> <p>8: 10,6* ←</p> <p>9: 10,4* ↑</p> <p>10: 9,1 →</p> <table border="1" style="width:100%; border-collapse: collapse;"> <tr><td>Serie</td><td style="text-align: right;">94,0</td></tr> <tr><td>Sum</td><td style="text-align: right;">378,0</td></tr> </table> | Serie | 94,0 | Sum | 378,0 |
| Serie | 98,0 | | | | | | | | | | |
| Sum | 284,0 | | | | | | | | | | |
| Serie | 94,0 | | | | | | | | | | |
| Sum | 378,0 | | | | | | | | | | |

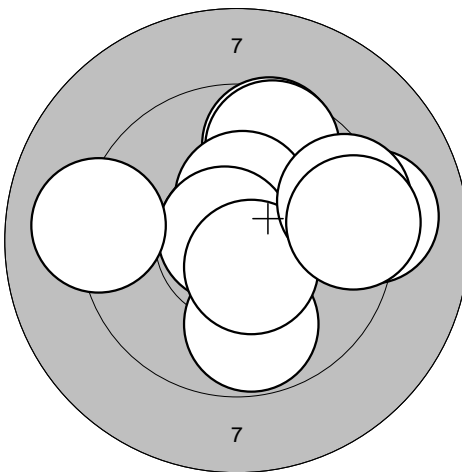
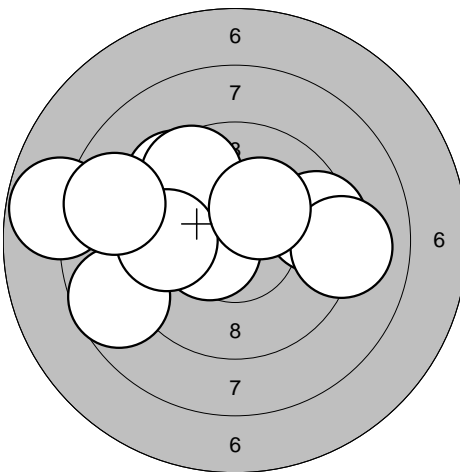
| | | | | | | | | | | | |
|--|--|-------|------|-----|-------|--|--|-------|------|-----|-------|
| <p>Series 5</p>  | <p>1: 9,1 →</p> <p>2: 9,6 ↑</p> <p>3: 9,6 ↑</p> <p>4: 9,8 ↓</p> <p>5: 10,4* ↑</p> <p>6: 10,8* ←</p> <p>7: 10,5* ↓</p> <p>8: 9,4 →</p> <p>9: 9,4 →</p> <p>10: 9,1 ←</p> <table border="1" style="width:100%; border-collapse: collapse;"> <tr><td>Serie</td><td style="text-align: right;">93,0</td></tr> <tr><td>Sum</td><td style="text-align: right;">471,0</td></tr> </table> | Serie | 93,0 | Sum | 471,0 | <p>Series 6</p>  | <p>1: 8,7 ←</p> <p>2: 10,5* ←</p> <p>3: 9,5 ↗</p> <p>4: 9,6 ↗</p> <p>5: 9,8 ←</p> <p>6: 7,8 ←</p> <p>7: 8,7 ←</p> <p>8: 9,5 →</p> <p>9: 9,1 →</p> <p>10: 10,2* ↗</p> <table border="1" style="width:100%; border-collapse: collapse;"> <tr><td>Serie</td><td style="text-align: right;">88,0</td></tr> <tr><td>Sum</td><td style="text-align: right;">559,0</td></tr> </table> | Serie | 88,0 | Sum | 559,0 |
| Serie | 93,0 | | | | | | | | | | |
| Sum | 471,0 | | | | | | | | | | |
| Serie | 88,0 | | | | | | | | | | |
| Sum | 559,0 | | | | | | | | | | |

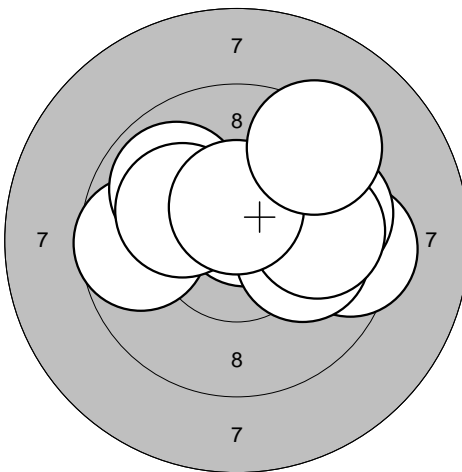
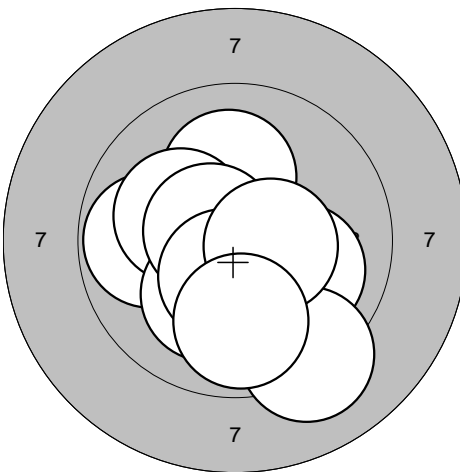
| | | | | | | | | | | | |
|--|---|-------|------|-----|------|--|---|-------|------|-----|-------|
| <p>Series 1</p>  | <p>1: 9,7 ←</p> <p>2: 9,9 ↗</p> <p>3: 9,4 →</p> <p>4: 10,7* ↗</p> <p>5: 10,1 →</p> <p>6: 10,1 ↗</p> <p>7: 9,7 →</p> <p>8: 9,9 →</p> <p>9: 10,5* ↑</p> <p>10: 9,3 ↗</p> <table border="1" style="width:100%; border-collapse: collapse;"> <tr><td>Serie</td><td style="text-align: right;">94,0</td></tr> <tr><td>Sum</td><td style="text-align: right;">94,0</td></tr> </table> | Serie | 94,0 | Sum | 94,0 | <p>Series 2</p>  | <p>1: 10,1 ↑</p> <p>2: 9,8 ←</p> <p>3: 10,2* ↖</p> <p>4: 10,0 →</p> <p>5: 9,2 ↓</p> <p>6: 10,1 ↓</p> <p>7: 10,6* ↖</p> <p>8: 10,5* ↓</p> <p>9: 10,5* →</p> <p>10: 9,9 ↓</p> <table border="1" style="width:100%; border-collapse: collapse;"> <tr><td>Serie</td><td style="text-align: right;">97,0</td></tr> <tr><td>Sum</td><td style="text-align: right;">191,0</td></tr> </table> | Serie | 97,0 | Sum | 191,0 |
| Serie | 94,0 | | | | | | | | | | |
| Sum | 94,0 | | | | | | | | | | |
| Serie | 97,0 | | | | | | | | | | |
| Sum | 191,0 | | | | | | | | | | |

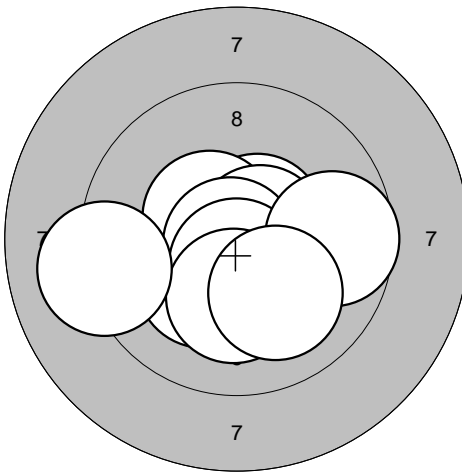
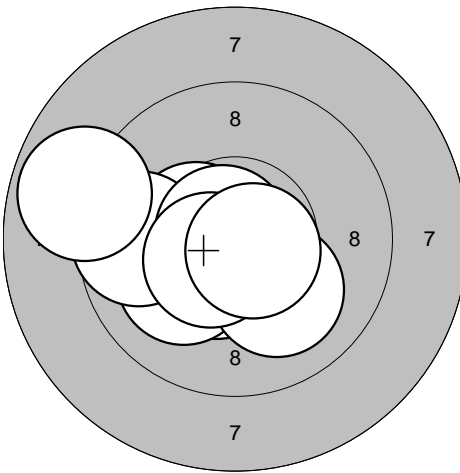
| | | | | | | | | | | | |
|---|---|-------|------|-----|-------|---|--|-------|------|-----|-------|
| <p>Series 3</p>  | <p>1: 10,6* ↗</p> <p>2: 10,2* ↘</p> <p>3: 10,5* ↗</p> <p>4: 10,6* →</p> <p>5: 10,8* ↘</p> <p>6: 10,6* ↓</p> <p>7: 10,2* ↓</p> <p>8: 9,7 →</p> <p>9: 9,1 ←</p> <p>10: 10,0 ↓</p> <table border="1" style="width:100%; border-collapse: collapse;"> <tr><td>Serie</td><td style="text-align: right;">98,0</td></tr> <tr><td>Sum</td><td style="text-align: right;">289,0</td></tr> </table> | Serie | 98,0 | Sum | 289,0 | <p>Series 4</p>  | <p>1: 10,7* ↓</p> <p>2: 10,4* ↓</p> <p>3: 10,1 ↖</p> <p>4: 10,4* ↖</p> <p>5: 9,7 ←</p> <p>6: 10,8* ↖</p> <p>7: 10,1 ↓</p> <p>8: 10,5* ↖</p> <p>9: 8,9 ←</p> <p>10: 10,7* ↘</p> <table border="1" style="width:100%; border-collapse: collapse;"> <tr><td>Serie</td><td style="text-align: right;">97,0</td></tr> <tr><td>Sum</td><td style="text-align: right;">386,0</td></tr> </table> | Serie | 97,0 | Sum | 386,0 |
| Serie | 98,0 | | | | | | | | | | |
| Sum | 289,0 | | | | | | | | | | |
| Serie | 97,0 | | | | | | | | | | |
| Sum | 386,0 | | | | | | | | | | |

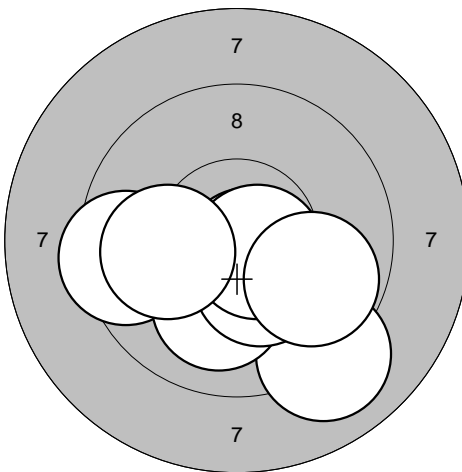
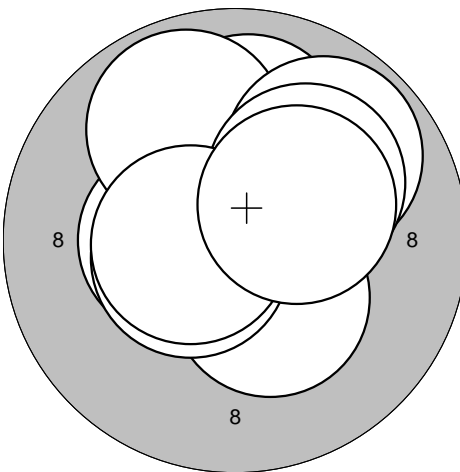
| | | | | | | | | | | | |
|--|--|-------|------|-----|-------|--|--|-------|------|-----|-------|
| <p>Series 5</p>  | <p>1: 10,4* ↓</p> <p>2: 10,5* ↓</p> <p>3: 9,4 ←</p> <p>4: 9,1 ↓</p> <p>5: 10,7* ↓</p> <p>6: 10,1 ↓</p> <p>7: 10,3* ↓</p> <p>8: 10,6* ↓</p> <p>9: 10,0 ←</p> <p>10: 9,8 →</p> <table border="1" style="width:100%; border-collapse: collapse;"> <tr><td>Serie</td><td style="text-align: right;">97,0</td></tr> <tr><td>Sum</td><td style="text-align: right;">483,0</td></tr> </table> | Serie | 97,0 | Sum | 483,0 | <p>Series 6</p>  | <p>1: 10,0 ↑</p> <p>2: 10,6* →</p> <p>3: 10,4* ←</p> <p>4: 10,3* ↓</p> <p>5: 10,5* ↖</p> <p>6: 9,8 ↗</p> <p>7: 9,8 ↗</p> <p>8: 10,1 ↗</p> <p>9: 10,5* ←</p> <p>10: 10,3* ↗</p> <table border="1" style="width:100%; border-collapse: collapse;"> <tr><td>Serie</td><td style="text-align: right;">98,0</td></tr> <tr><td>Sum</td><td style="text-align: right;">581,0</td></tr> </table> | Serie | 98,0 | Sum | 581,0 |
| Serie | 97,0 | | | | | | | | | | |
| Sum | 483,0 | | | | | | | | | | |
| Serie | 98,0 | | | | | | | | | | |
| Sum | 581,0 | | | | | | | | | | |

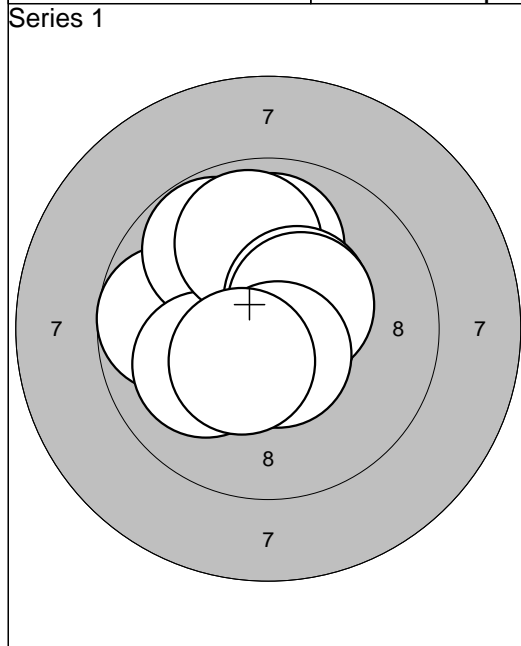

| | |
|-----------|------|
| 1: 9,9 | ↑ |
| 2: 9,7 | ← |
| 3: 10,5* | ↗ |
| 4: 9,8 | ↘ |
| 5: 10,1 | ← |
| 6: 9,9 | ↑ |
| 7: 10,4* | ↗ |
| 8: 10,5* | ↗ |
| 9: 10,6* | ↓ |
| 10: 10,4* | ↘ |
| Serie | 96,0 |
| Sum | 96,0 |

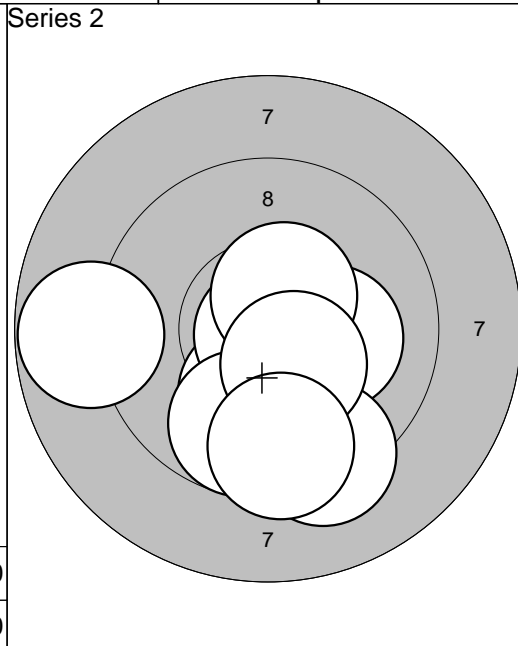

| | |
|----------|-------|
| 1: 10,1 | ↓ |
| 2: 10,2* | → |
| 3: 9,3 | ↓ |
| 4: 10,1 | ↓ |
| 5: 10,9* | ↓ |
| 6: 10,5* | ↗ |
| 7: 9,8 | ↓ |
| 8: 8,8 | ← |
| 9: 10,4* | ↓ |
| 10: 9,5 | ↓ |
| Serie | 95,0 |
| Sum | 191,0 |

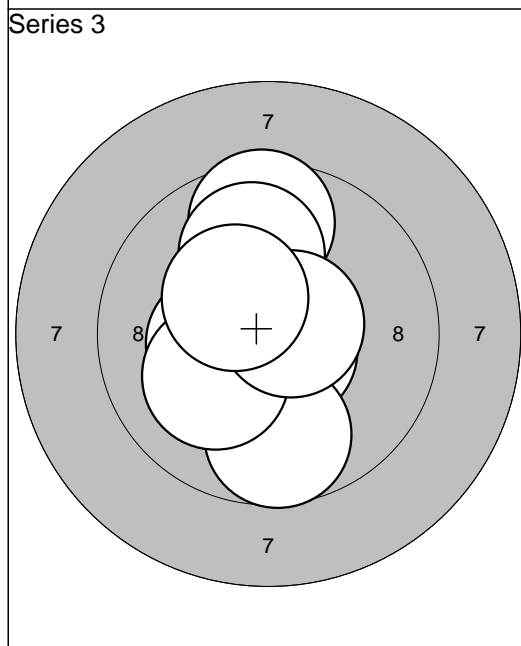

| | |
|-----------|-------|
| 1: 10,3* | ← |
| 2: 10,9* | ↑ |
| 3: 9,6 | ↑ |
| 4: 10,7* | ↖ |
| 5: 10,7* | ↘ |
| 6: 10,0 | ↑ |
| 7: 9,7 | ↓ |
| 8: 10,1 | ↖ |
| 9: 10,6* | ↗ |
| 10: 10,4* | ↖ |
| Serie | 98,0 |
| Sum | 289,0 |

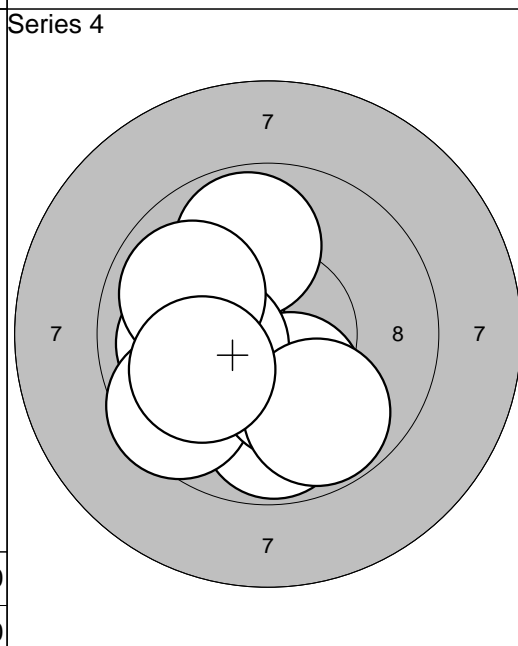

| | |
|----------|-------|
| 1: 10,0 | ← |
| 2: 10,2* | ← |
| 3: 9,8 | ↓ |
| 4: 9,6 | ↘ |
| 5: 10,3* | ↓ |
| 6: 9,8 | ↑ |
| 7: 10,3* | ← |
| 8: 9,9 | ↖ |
| 9: 9,8 | ↓ |
| 10: 10,0 | ↖ |
| Serie | 95,0 |
| Sum | 384,0 |

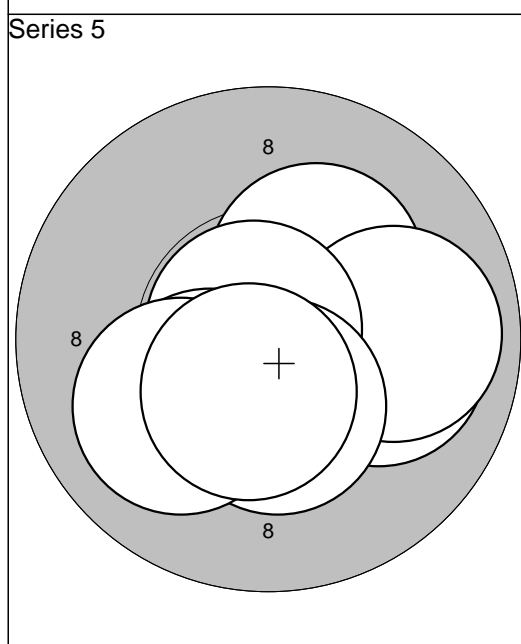

| | |
|-----------|-------|
| 1: 10,8* | ↓ |
| 2: 10,6* | ↓ |
| 3: 10,0 | → |
| 4: 10,3* | ↗ |
| 5: 9,9 | → |
| 6: 10,8* | ↖ |
| 7: 10,3* | ↖ |
| 8: 10,4* | ↓ |
| 9: 10,0 | ↖ |
| 10: 10,5* | ↓ |
| Serie | 99,0 |
| Sum | 483,0 |

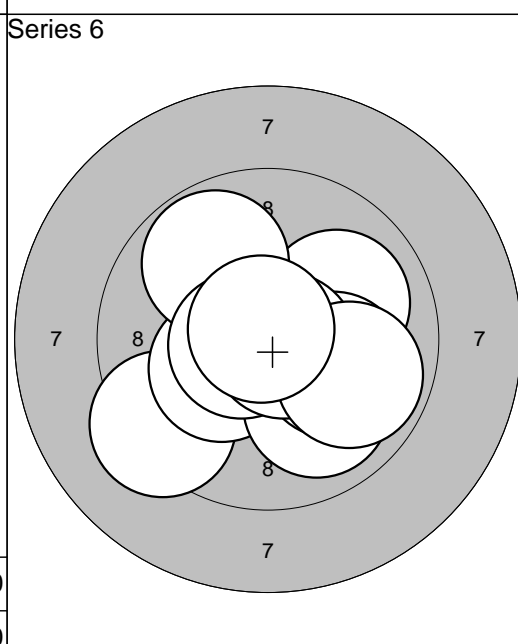

| | |
|-----------|-------|
| 1: 9,3 | ↖ |
| 2: 10,3* | ↖ |
| 3: 9,9 | ↓ |
| 4: 10,0 | ↗ |
| 5: 9,8 | ↗ |
| 6: 10,1 | ↘ |
| 7: 10,6* | ← |
| 8: 10,8* | ↘ |
| 9: 9,8 | ↘ |
| 10: 10,8* | ↗ |
| Serie | 96,0 |
| Sum | 579,0 |

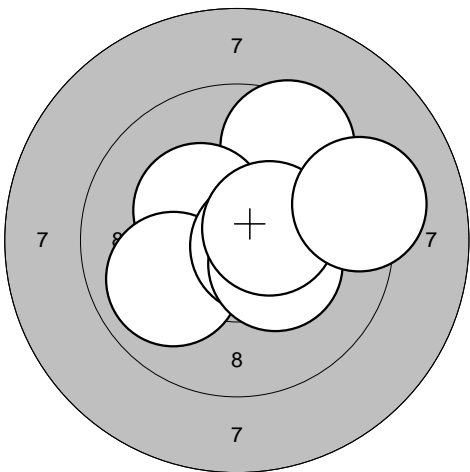
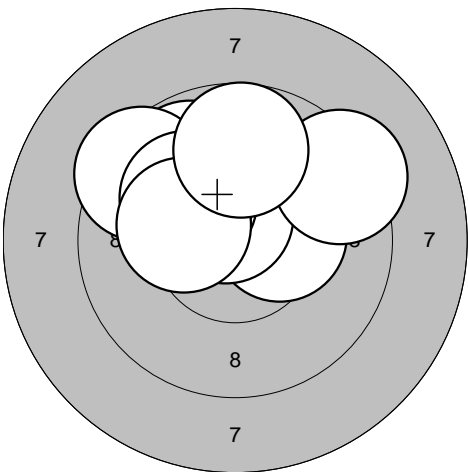
| | | | |
|--|---|--|--|
| <p>Series 1</p>  | <p>1: 10,4* ↖</p> <p>2: 10,5* ←</p> <p>3: 10,3* ↗</p> <p>4: 9,5 ↗</p> <p>5: 10,3* ↗</p> <p>6: 10,0 ←</p> <p>7: 10,6* →</p> <p>8: 10,3* ↘</p> <p>9: 10,5* →</p> <p>10: 9,3 →</p> | <p>Series 2</p>  | <p>1: 10,1 ↖</p> <p>2: 10,4* →</p> <p>3: 10,6* ↑</p> <p>4: 9,3 ↗</p> <p>5: 9,8 ↗</p> <p>6: 10,2* ↗</p> <p>7: 9,4 ↖</p> <p>8: 10,1 ↖</p> <p>9: 10,3* ←</p> <p>10: 9,7 ↑</p> |
| Serie 98,0 | Serie 96,0 | Serie 96,0 | Serie 96,0 |
| Sum 98,0 | Sum 194,0 | Sum 194,0 | Sum 194,0 |

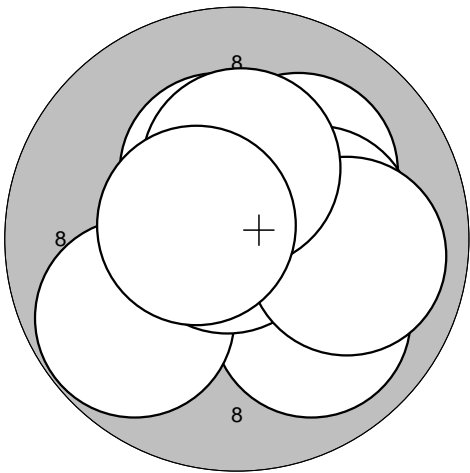
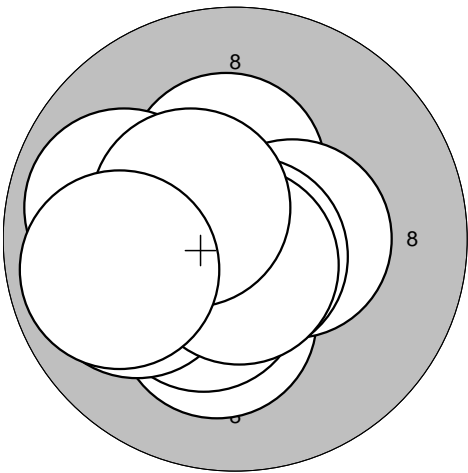
| | | | |
|---|---|---|---|
| <p>Series 3</p>  | <p>1: 10,0 ↘</p> <p>2: 10,3* ↑</p> <p>3: 10,3* ↗</p> <p>4: 10,1 ↗</p> <p>5: 10,2* →</p> <p>6: 9,8 ←</p> <p>7: 10,9* ↖</p> <p>8: 10,0 →</p> <p>9: 10,3* ↑</p> <p>10: 10,6* ←</p> | <p>Series 4</p>  | <p>1: 10,4* ↑</p> <p>2: 10,2* ↓</p> <p>3: 10,4* ↘</p> <p>4: 10,4* →</p> <p>5: 10,8* ↘</p> <p>6: 10,0 ←</p> <p>7: 9,9 ←</p> <p>8: 10,7* ↓</p> <p>9: 10,5* ↗</p> <p>10: 9,9 ←</p> |
| Serie 99,0 | Serie 98,0 | Serie 98,0 | Serie 98,0 |
| Sum 293,0 | Sum 391,0 | Sum 391,0 | Sum 391,0 |

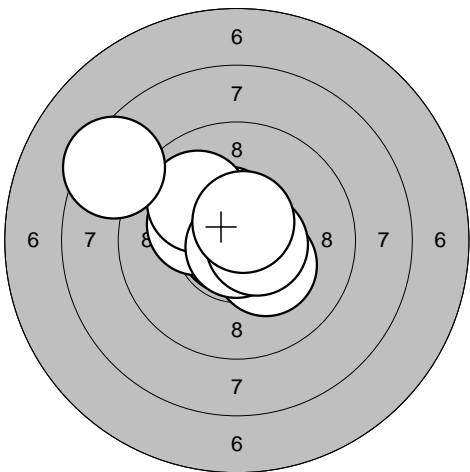
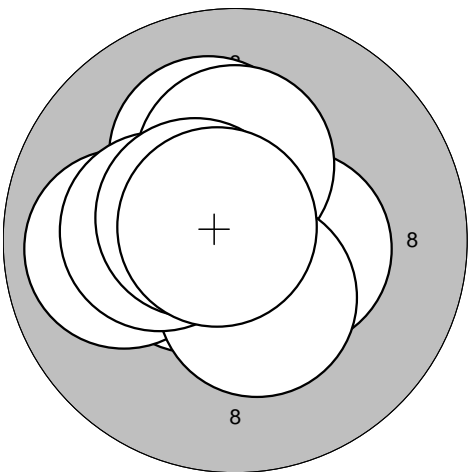
| | | | |
|--|---|--|---|
| <p>Series 5</p>  | <p>1: 10,5* ↑</p> <p>2: 10,3* ↘</p> <p>3: 10,8* ↑</p> <p>4: 10,8* ←</p> <p>5: 10,2* ↖</p> <p>6: 10,0 ↗</p> <p>7: 10,8* ↓</p> <p>8: 10,6* →</p> <p>9: 10,6* ↑</p> <p>10: 8,4 ↖</p> | <p>Series 6</p>  | <p>1: 10,8* →</p> <p>2: 10,2* ↑</p> <p>3: 10,6* ←</p> <p>4: 10,0 ←</p> <p>5: 10,4* →</p> <p>6: 10,3* ↑</p> <p>7: 10,4* ↓</p> <p>8: 10,2* ←</p> <p>9: 10,5* ↖</p> <p>10: 10,8* ↖</p> |
| Serie 98,0 | Serie 100,0 | Serie 100,0 | Serie 100,0 |
| Sum 489,0 | Sum 589,0 | Sum 589,0 | Sum 589,0 |

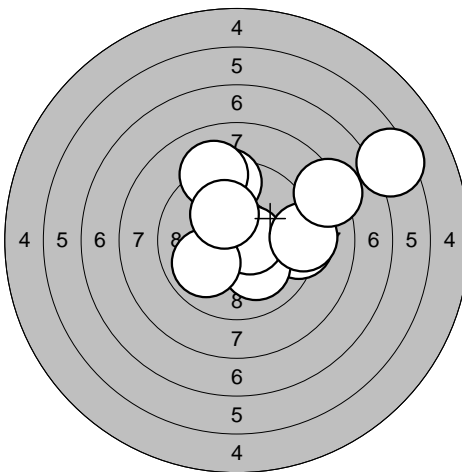
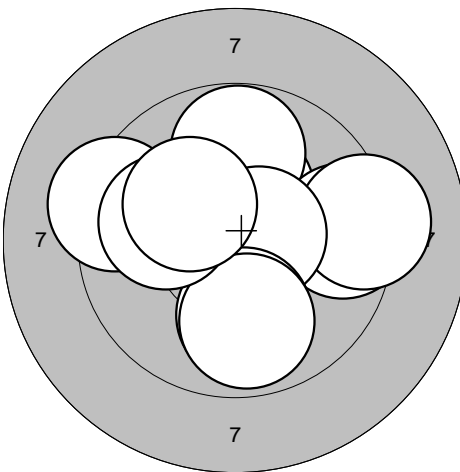
| | | | |
|--|--|--|---|
| <p>Series 1</p>  | <p>1: 9,3 →</p> <p>2: 9,4 ↑</p> <p>3: 10,1 ↓</p> <p>4: 9,1 ↑</p> <p>5: 10,6* →</p> <p>6: 10,0 ←</p> <p>7: 9,2 →</p> <p>8: 10,2* ↑</p> <p>9: 6,4 ↗</p> <p>10: 8,2 ↗</p> | <p>Series 2</p>  | <p>1: 10,3* ↑</p> <p>2: 9,8 ↑</p> <p>3: 9,5 →</p> <p>4: 9,2 →</p> <p>5: 10,6* →</p> <p>6: 9,9 ↓</p> <p>7: 9,3 ←</p> <p>8: 9,9 ↓</p> <p>9: 10,0 ←</p> <p>10: 10,2* ↖</p> |
| Serie 90,0 | Serie 90,0 | Serie 94,0 | Serie 94,0 |
| Sum 90,0 | Sum 90,0 | Sum 184,0 | Sum 184,0 |

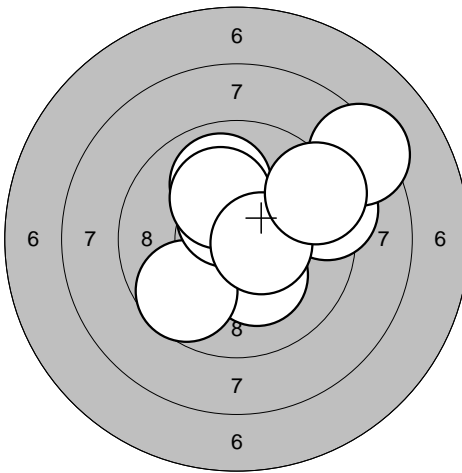
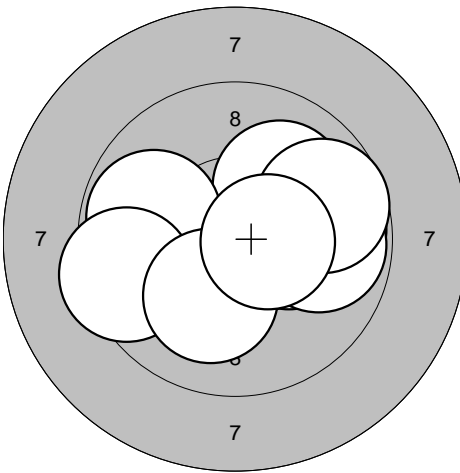
| | | | |
|---|---|---|--|
| <p>Series 3</p>  | <p>1: 10,4* ↑</p> <p>2: 10,2* ↓</p> <p>3: 9,7 ↙</p> <p>4: 9,3 →</p> <p>5: 8,3 ↗</p> <p>6: 10,5* ↑</p> <p>7: 10,0 ↑</p> <p>8: 10,2* ↑</p> <p>9: 10,5* →</p> <p>10: 9,4 ↗</p> | <p>Series 4</p>  | <p>1: 10,8* ↙</p> <p>2: 10,0 ↗</p> <p>3: 9,8 ←</p> <p>4: 10,2* →</p> <p>5: 9,8 →</p> <p>6: 9,4 ←</p> <p>7: 9,8 →</p> <p>8: 9,7 ↗</p> <p>9: 10,1 ↓</p> <p>10: 10,5* →</p> |
| Serie 95,0 | Serie 95,0 | Serie 95,0 | Serie 95,0 |
| Sum 279,0 | Sum 279,0 | Sum 374,0 | Sum 374,0 |

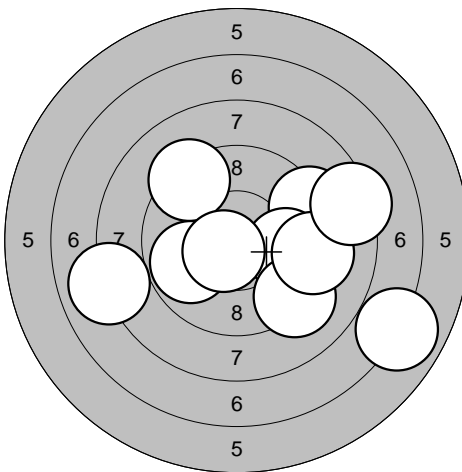
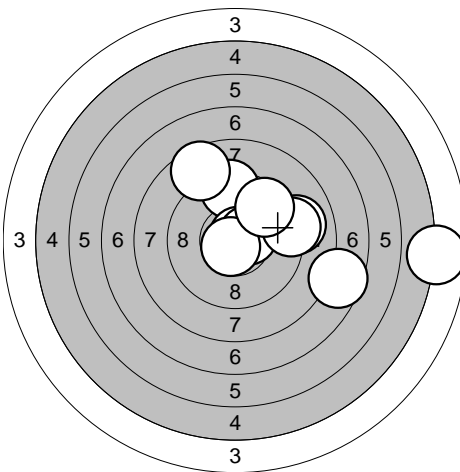
| | | | |
|--|--|--|--|
| <p>Series 5</p>  | <p>1: 9,2 ↗</p> <p>2: 9,9 →</p> <p>3: 9,9 ←</p> <p>4: 9,3 ↗</p> <p>5: 8,0 ←</p> <p>6: 9,1 ↓</p> <p>7: 9,3 →</p> <p>8: 6,9 ↘</p> <p>9: 10,6* ↙</p> <p>10: 8,3 →</p> | <p>Series 6</p>  | <p>1: 9,4 ↑</p> <p>2: 10,8* ↗</p> <p>3: 4,8 →</p> <p>4: 7,6 →</p> <p>5: 10,5* ↗</p> <p>6: 9,0 →</p> <p>7: 9,2 →</p> <p>8: 10,7* ↙</p> <p>9: 8,6 ↖</p> <p>10: 9,6 ↗</p> |
| Serie 86,0 | Serie 86,0 | Serie 85,0 | Serie 85,0 |
| Sum 460,0 | Sum 460,0 | Sum 545,0 | Sum 545,0 |

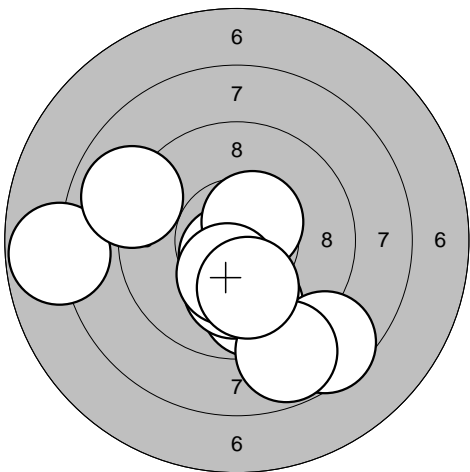
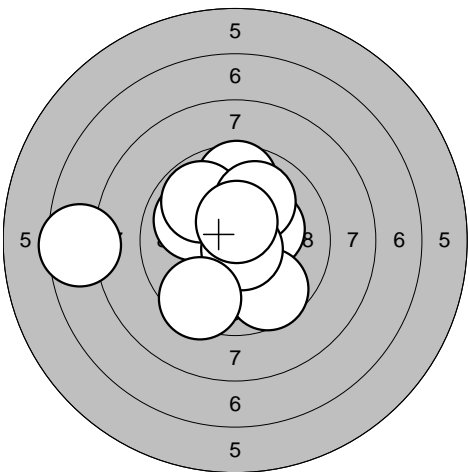
| | | | |
|--|--|--|--|
| <p>Series 1</p>  | <p>1: 9,8 ↓</p> <p>2: 10,6* ↓</p> <p>3: 10,5* ↗</p> <p>4: 7,8 ←</p> <p>5: 10,1 ↓</p> <p>6: 9,0 ↗</p> <p>7: 8,6 ↓</p> <p>8: 8,8 ↓</p> <p>9: 10,3* ↓</p> <p>10: 10,1 ↓</p> <hr/> <p>Serie 91,0</p> <hr/> <p>Sum 91,0</p> | <p>Series 2</p>  | <p>1: 9,7 ↑</p> <p>2: 10,3* →</p> <p>3: 9,9 ↖</p> <p>4: 9,9 ↗</p> <p>5: 10,0 ↗</p> <p>6: 9,6 ↓</p> <p>7: 10,7* ↓</p> <p>8: 9,5 ↓</p> <p>9: 7,6 ←</p> <p>10: 10,5* ↑</p> <hr/> <p>Serie 92,0</p> <hr/> <p>Sum 183,0</p> |
|--|--|--|--|

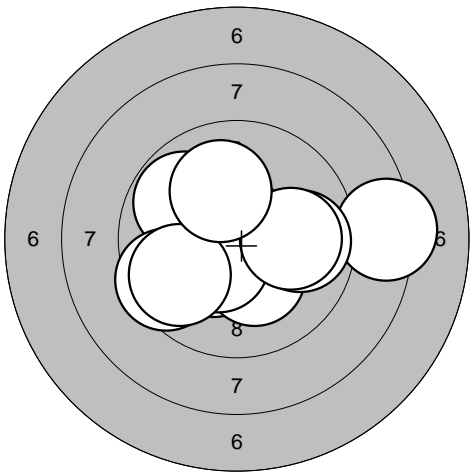
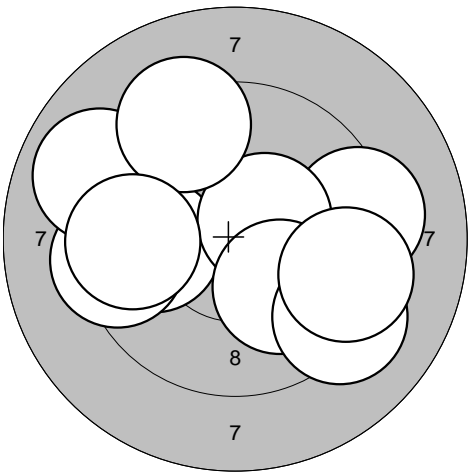
| | | | |
|---|---|---|--|
| <p>Series 3</p>  | <p>1: 10,3* ↓</p> <p>2: 10,2* ↓</p> <p>3: 9,8 ↗</p> <p>4: 8,3 →</p> <p>5: 10,5* ↓</p> <p>6: 9,5 ←</p> <p>7: 9,8 →</p> <p>8: 9,8 ←</p> <p>9: 10,0 →</p> <p>10: 10,1 ↑</p> <hr/> <p>Serie 94,0</p> <hr/> <p>Sum 277,0</p> | <p>Series 4</p>  | <p>1: 9,9 ←</p> <p>2: 9,4 ←</p> <p>3: 9,3 →</p> <p>4: 9,0 ↖</p> <p>5: 10,5* ↗</p> <p>6: 10,1 ↓</p> <p>7: 9,2 ↓</p> <p>8: 9,4 →</p> <p>9: 9,3 ↗</p> <p>10: 9,6 ←</p> <hr/> <p>Serie 92,0</p> <hr/> <p>Sum 369,0</p> |
|---|---|---|--|

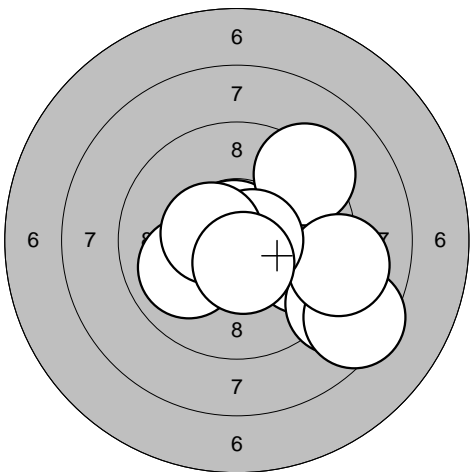
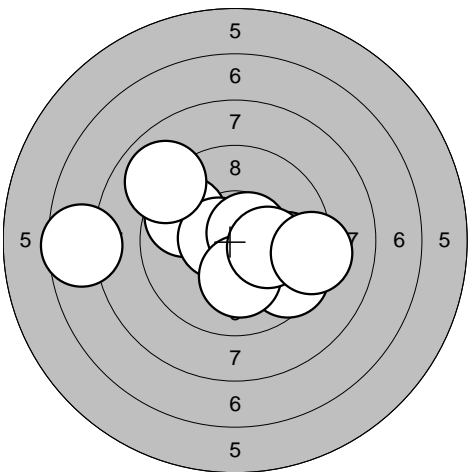
| | | | |
|--|--|--|--|
| <p>Series 5</p>  | <p>1: 9,7 →</p> <p>2: 8,9 ↓</p> <p>3: 10,8* ↑</p> <p>4: 8,5 ↓</p> <p>5: 10,0 ←</p> <p>6: 9,3 ↗</p> <p>7: 9,1 →</p> <p>8: 10,7* →</p> <p>9: 10,5* ←</p> <p>10: 10,5* ↓</p> <hr/> <p>Serie 93,0</p> <hr/> <p>Sum 462,0</p> | <p>Series 6</p>  | <p>1: 9,8 →</p> <p>2: 9,5 ↓</p> <p>3: 9,8 ↖</p> <p>4: 10,6* ←</p> <p>5: 10,6* ↗</p> <p>6: 7,6 ←</p> <p>7: 10,1 ↓</p> <p>8: 10,2* →</p> <p>9: 9,2 →</p> <p>10: 9,0 ↗</p> <hr/> <p>Serie 92,0</p> <hr/> <p>Sum 554,0</p> |
|--|--|--|--|

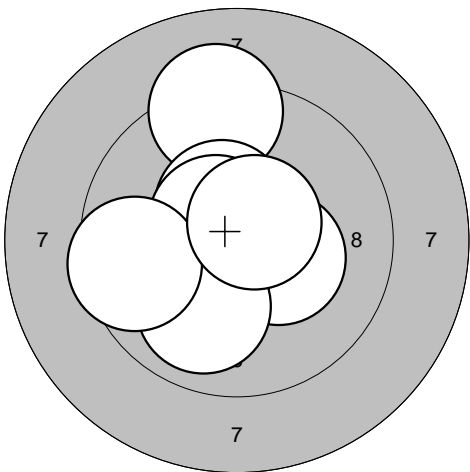
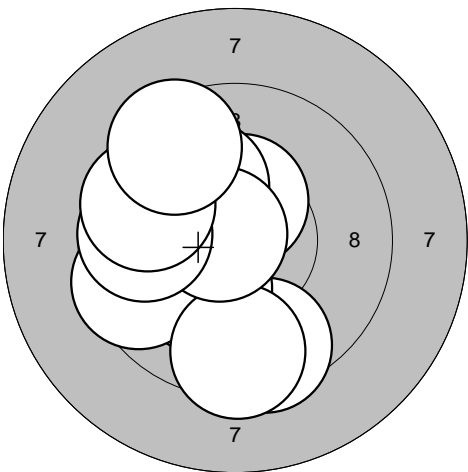
| | | | |
|--|---|--|---|
| <p>Series 1</p>  | <p>1: 9,2 ↗</p> <p>2: 10,5* ↘</p> <p>3: 10,5* ↗</p> <p>4: 10,6* ↗</p> <p>5: 10,8* ↗</p> <p>6: 10,4* ↘</p> <p>7: 10,6* ↗</p> <p>8: 10,0 ↘</p> <p>9: 9,5 ←</p> <p>10: 10,6* ↗</p> | <p>Series 2</p>  | <p>1: 9,5 ↘</p> <p>2: 10,4* ↗</p> <p>3: 10,1 ↗</p> <p>4: 10,2* ↘</p> <p>5: 9,6 ←</p> <p>6: 9,5 ↘</p> <p>7: 10,7* ←</p> <p>8: 9,8 ←</p> <p>9: 9,7 ←</p> <p>10: 9,5 ↗</p> |
| Serie 98,0 | Serie 94,0 | Serie 94,0 | Serie 94,0 |
| Sum 98,0 | Sum 98,0 | Sum 192,0 | Sum 192,0 |

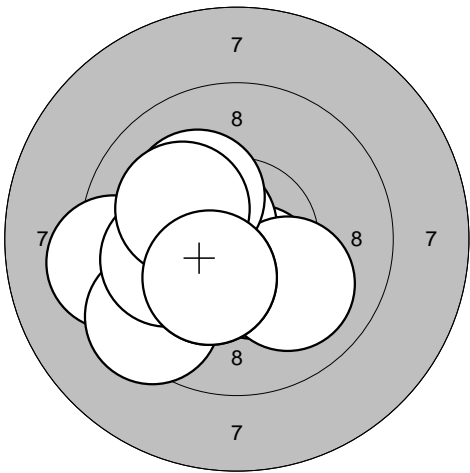
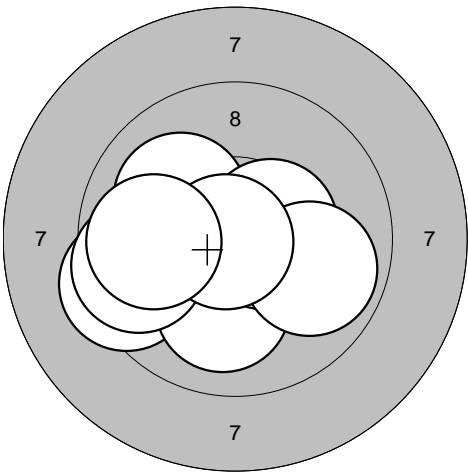
| | | | |
|---|---|---|---|
| <p>Series 3</p>  | <p>1: 10,4* ↘</p> <p>2: 9,3 ←</p> <p>3: 10,6* ↗</p> <p>4: 10,1 ↘</p> <p>5: 9,4 ↘</p> <p>6: 10,3* ↘</p> <p>7: 10,2* ↗</p> <p>8: 10,0 ←</p> <p>9: 10,1 ↗</p> <p>10: 10,3* ↘</p> | <p>Series 4</p>  | <p>1: 9,4 ←</p> <p>2: 10,1 ↘</p> <p>3: 10,1 ←</p> <p>4: 9,6 ←</p> <p>5: 10,5* →</p> <p>6: 10,1 ↗</p> <p>7: 10,5* →</p> <p>8: 9,9 →</p> <p>9: 10,8* ←</p> <p>10: 9,8 ←</p> |
| Serie 98,0 | Serie 98,0 | Serie 96,0 | Serie 96,0 |
| Sum 290,0 | Sum 290,0 | Sum 386,0 | Sum 386,0 |

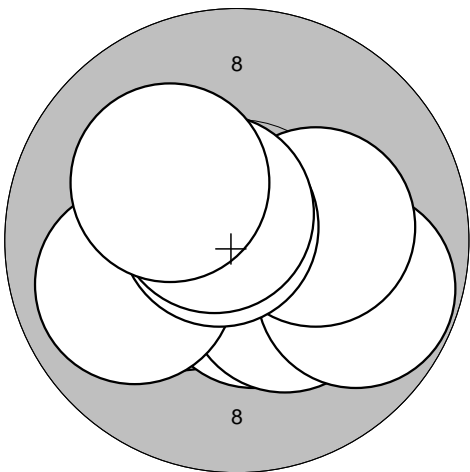
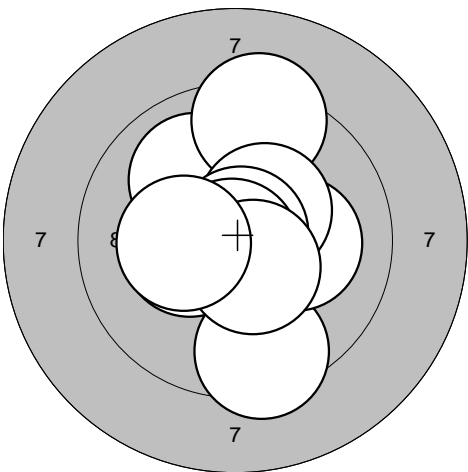
| | | | |
|--|--|--|--|
| <p>Series 5</p>  | <p>1: 10,4* ←</p> <p>2: 10,5* ↘</p> <p>3: 10,3* ↘</p> <p>4: 10,3* ↗</p> <p>5: 9,8 ↘</p> <p>6: 9,9 ←</p> <p>7: 10,2* →</p> <p>8: 10,7* ↗</p> <p>9: 10,6* ↗</p> <p>10: 10,2* ↗</p> | <p>Series 6</p>  | <p>1: 10,3* ←</p> <p>2: 10,0 ↗</p> <p>3: 9,4 ↘</p> <p>4: 9,3 ↗</p> <p>5: 10,1 →</p> <p>6: 10,4* ↗</p> <p>7: 10,8* ↗</p> <p>8: 10,9* ↘</p> <p>9: 10,5* ↘</p> <p>10: 10,3* ←</p> |
| Serie 98,0 | Serie 98,0 | Serie 98,0 | Serie 98,0 |
| Sum 484,0 | Sum 484,0 | Sum 582,0 | Sum 582,0 |

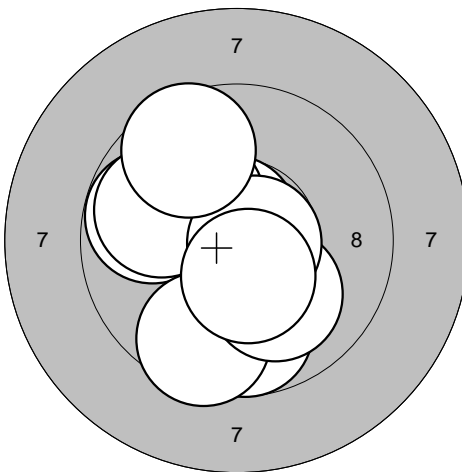
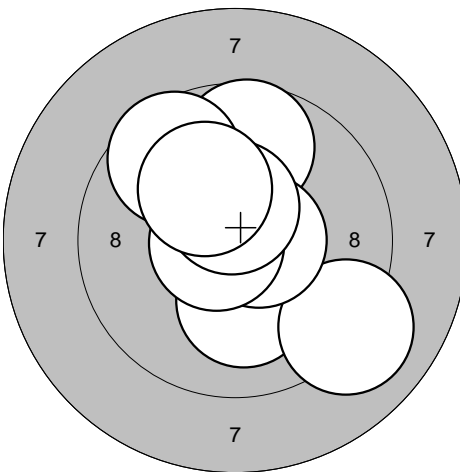
| | | | | | | | | | | | |
|--|--|-------|------|-----|------|--|---|-------|------|-----|-------|
| <p>Series 1</p>  | <p>1: 9,8 ←</p> <p>2: 9,8 ↓</p> <p>3: 10,7* ↑</p> <p>4: 9,6 ↓</p> <p>5: 10,1 ↓</p> <p>6: 10,2* ↑</p> <p>7: 9,9 ↑</p> <p>8: 10,7* →</p> <p>9: 10,4* ↓</p> <p>10: 9,6 ↑</p> <table border="1" style="width:100%; border-collapse: collapse;"> <tr><td>Serie</td><td style="text-align: right;">95,0</td></tr> <tr><td>Sum</td><td style="text-align: right;">95,0</td></tr> </table> | Serie | 95,0 | Sum | 95,0 | <p>Series 2</p>  | <p>1: 10,7* →</p> <p>2: 10,8* ↑</p> <p>3: 10,1 ↓</p> <p>4: 9,7 ↑</p> <p>5: 9,1 ↘</p> <p>6: 10,6* →</p> <p>7: 10,7* ←</p> <p>8: 10,5* ↑</p> <p>9: 9,6 ↑</p> <p>10: 10,2* ↑</p> <table border="1" style="width:100%; border-collapse: collapse;"> <tr><td>Serie</td><td style="text-align: right;">97,0</td></tr> <tr><td>Sum</td><td style="text-align: right;">192,0</td></tr> </table> | Serie | 97,0 | Sum | 192,0 |
| Serie | 95,0 | | | | | | | | | | |
| Sum | 95,0 | | | | | | | | | | |
| Serie | 97,0 | | | | | | | | | | |
| Sum | 192,0 | | | | | | | | | | |

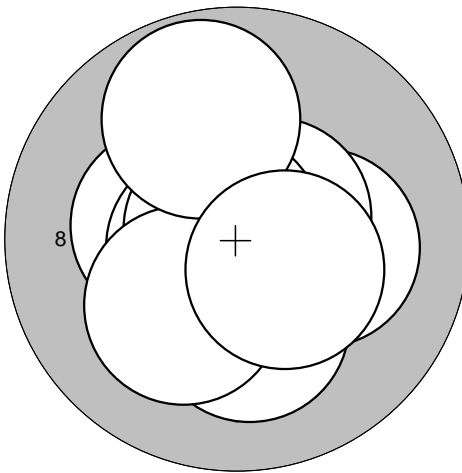
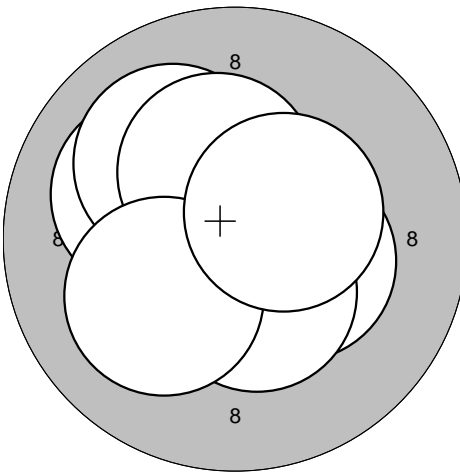
| | | | | | | | | | | | |
|---|--|-------|------|-----|-------|---|--|-------|-------|-----|-------|
| <p>Series 3</p>  | <p>1: 10,2* ↓</p> <p>2: 10,2* →</p> <p>3: 10,4* ←</p> <p>4: 10,6* ←</p> <p>5: 10,8* ↑</p> <p>6: 10,6* →</p> <p>7: 10,8* ↑</p> <p>8: 10,2* ↓</p> <p>9: 9,8 ↑</p> <p>10: 10,4* ↓</p> <table border="1" style="width:100%; border-collapse: collapse;"> <tr><td>Serie</td><td style="text-align: right;">99,0</td></tr> <tr><td>Sum</td><td style="text-align: right;">291,0</td></tr> </table> | Serie | 99,0 | Sum | 291,0 | <p>Series 4</p>  | <p>1: 10,4* →</p> <p>2: 10,6* ↑</p> <p>3: 10,8* ↑</p> <p>4: 10,4* ↓</p> <p>5: 10,3* ↑</p> <p>6: 10,1 ←</p> <p>7: 10,1 ↑</p> <p>8: 10,3* ↑</p> <p>9: 10,1 ↓</p> <p>10: 10,4* →</p> <table border="1" style="width:100%; border-collapse: collapse;"> <tr><td>Serie</td><td style="text-align: right;">100,0</td></tr> <tr><td>Sum</td><td style="text-align: right;">391,0</td></tr> </table> | Serie | 100,0 | Sum | 391,0 |
| Serie | 99,0 | | | | | | | | | | |
| Sum | 291,0 | | | | | | | | | | |
| Serie | 100,0 | | | | | | | | | | |
| Sum | 391,0 | | | | | | | | | | |

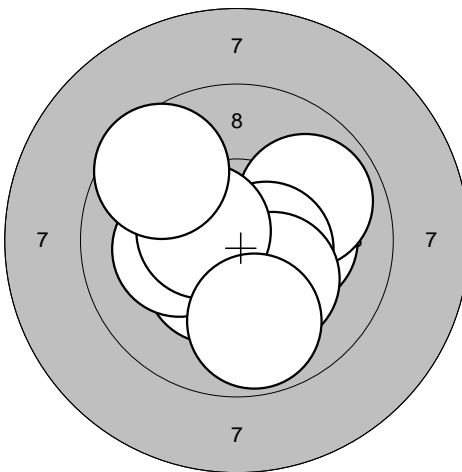
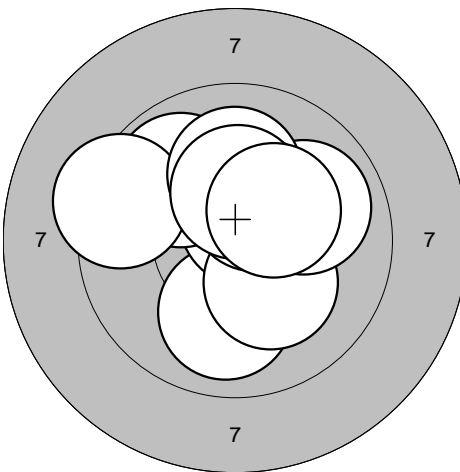
| | | | | | | | | | | | |
|--|--|-------|------|-----|-------|--|--|-------|------|-----|-------|
| <p>Series 5</p>  | <p>1: 10,5* ↓</p> <p>2: 10,2* →</p> <p>3: 9,9 →</p> <p>4: 10,5* →</p> <p>5: 10,4* ↓</p> <p>6: 10,2* ↓</p> <p>7: 10,2* ←</p> <p>8: 10,5* ←</p> <p>9: 9,9 ↓</p> <p>10: 9,6 ↑</p> <table border="1" style="width:100%; border-collapse: collapse;"> <tr><td>Serie</td><td style="text-align: right;">97,0</td></tr> <tr><td>Sum</td><td style="text-align: right;">488,0</td></tr> </table> | Serie | 97,0 | Sum | 488,0 | <p>Series 6</p>  | <p>1: 10,0 ↓</p> <p>2: 10,6* ↑</p> <p>3: 10,2* ↓</p> <p>4: 9,9 →</p> <p>5: 9,9 ↑</p> <p>6: 9,3 ←</p> <p>7: 10,1 ↑</p> <p>8: 10,4* ↑</p> <p>9: 10,3* ↑</p> <p>10: 10,3* →</p> <table border="1" style="width:100%; border-collapse: collapse;"> <tr><td>Serie</td><td style="text-align: right;">97,0</td></tr> <tr><td>Sum</td><td style="text-align: right;">585,0</td></tr> </table> | Serie | 97,0 | Sum | 585,0 |
| Serie | 97,0 | | | | | | | | | | |
| Sum | 488,0 | | | | | | | | | | |
| Serie | 97,0 | | | | | | | | | | |
| Sum | 585,0 | | | | | | | | | | |

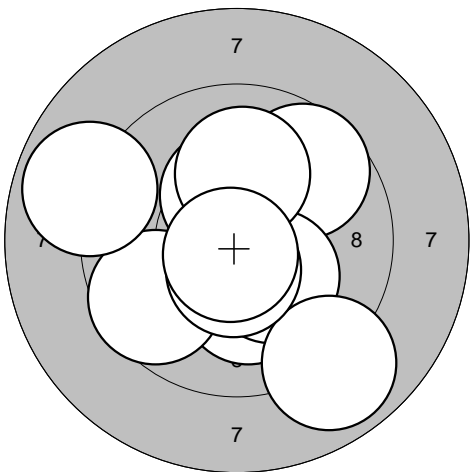
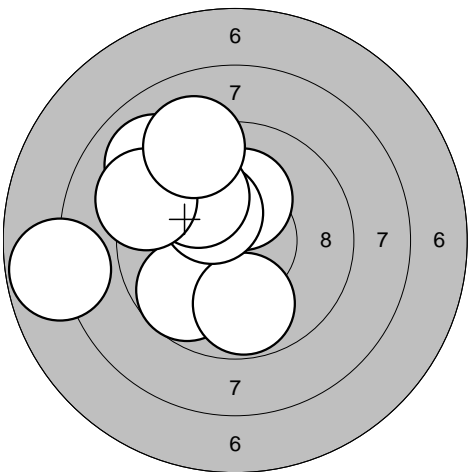
| | | | | | | | | | | | |
|--|---|-------|------|-----|------|--|---|-------|------|-----|-------|
| <p>Series 1</p>  | <p>1: 9,7 ↗ 2: 10,2* ↓ 3: 10,3* ↑ 4: 9,6 ↙ 5: 10,3* ↘ 6: 10,1 ↑ 7: 8,9 ↓ 8: 8,9 ← 9: 10,6* ↓ 10: 10,7* ↓</p> <table border="1" style="width:100%; border-collapse: collapse;"> <tr><td>Serie</td><td style="text-align: right;">94,0</td></tr> <tr><td>Sum</td><td style="text-align: right;">94,0</td></tr> </table> | Serie | 94,0 | Sum | 94,0 | <p>Series 2</p>  | <p>1: 9,7 ↙ 2: 10,2* ↑ 3: 9,8 ↓ 4: 7,8 ← 5: 10,0 ↗ 6: 9,0 ↗ 7: 10,3* ↗ 8: 10,0 ↗ 9: 9,2 ↙ 10: 9,2 ↗</p> <table border="1" style="width:100%; border-collapse: collapse;"> <tr><td>Serie</td><td style="text-align: right;">92,0</td></tr> <tr><td>Sum</td><td style="text-align: right;">186,0</td></tr> </table> | Serie | 92,0 | Sum | 186,0 |
| Serie | 94,0 | | | | | | | | | | |
| Sum | 94,0 | | | | | | | | | | |
| Serie | 92,0 | | | | | | | | | | |
| Sum | 186,0 | | | | | | | | | | |

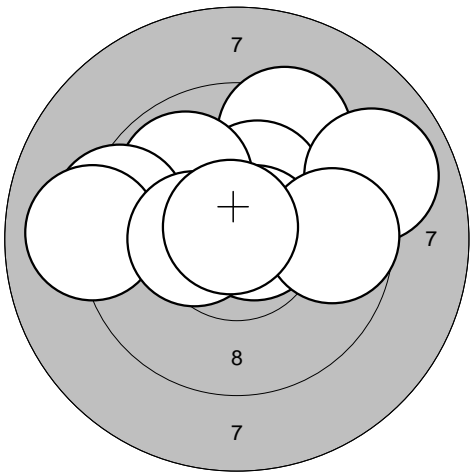
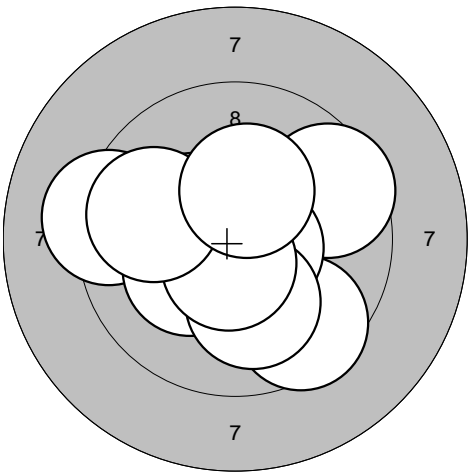
| | | | | | | | | | | | |
|---|---|-------|------|-----|-------|---|--|-------|------|-----|-------|
| <p>Series 3</p>  | <p>1: 9,4 ↗ 2: 10,2* ↑ 3: 10,7* → 4: 9,9 ↗ 5: 9,3 ← 6: 9,0 ← 7: 9,0 → 8: 10,4* ← 9: 9,7 → 10: 10,8* ↗</p> <table border="1" style="width:100%; border-collapse: collapse;"> <tr><td>Serie</td><td style="text-align: right;">94,0</td></tr> <tr><td>Sum</td><td style="text-align: right;">280,0</td></tr> </table> | Serie | 94,0 | Sum | 280,0 | <p>Series 4</p>  | <p>1: 9,6 ↗ 2: 9,3 ← 3: 10,3* ↙ 4: 9,5 ↓ 5: 10,6* → 6: 10,2* ↙ 7: 10,1 ↓ 8: 10,6* ↓ 9: 9,8 ← 10: 10,3* ↑</p> <table border="1" style="width:100%; border-collapse: collapse;"> <tr><td>Serie</td><td style="text-align: right;">96,0</td></tr> <tr><td>Sum</td><td style="text-align: right;">376,0</td></tr> </table> | Serie | 96,0 | Sum | 376,0 |
| Serie | 94,0 | | | | | | | | | | |
| Sum | 280,0 | | | | | | | | | | |
| Serie | 96,0 | | | | | | | | | | |
| Sum | 376,0 | | | | | | | | | | |

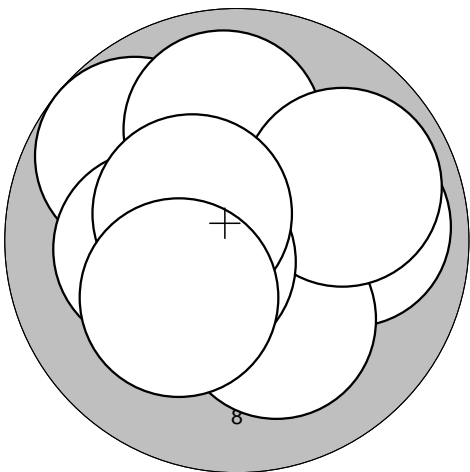
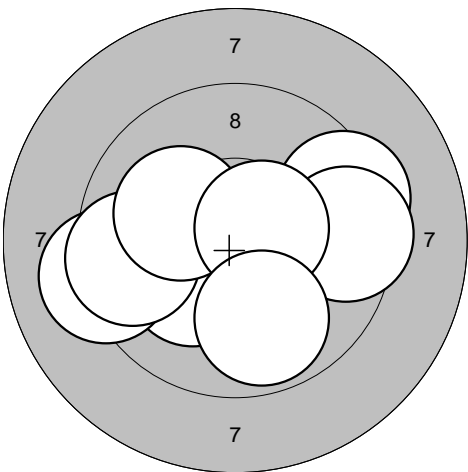
| | | | | | | | | | | | |
|--|--|-------|------|-----|-------|--|--|-------|------|-----|-------|
| <p>Series 5</p>  | <p>1: 10,2* ↗ 2: 9,8 ↗ 3: 10,2* ← 4: 9,9 ↑ 5: 9,9 → 6: 10,1 ↓ 7: 9,9 → 8: 10,5* ← 9: 10,5* ↗ 10: 10,2* ↙</p> <table border="1" style="width:100%; border-collapse: collapse;"> <tr><td>Serie</td><td style="text-align: right;">96,0</td></tr> <tr><td>Sum</td><td style="text-align: right;">472,0</td></tr> </table> | Serie | 96,0 | Sum | 472,0 | <p>Series 6</p>  | <p>1: 10,6* ↙ 2: 10,7* → 3: 10,2* ↙ 4: 9,2 ← 5: 9,6 ← 6: 10,1 ↙ 7: 9,4 → 8: 9,5 → 9: 10,6* → 10: 9,8 ↓</p> <table border="1" style="width:100%; border-collapse: collapse;"> <tr><td>Serie</td><td style="text-align: right;">95,0</td></tr> <tr><td>Sum</td><td style="text-align: right;">567,0</td></tr> </table> | Serie | 95,0 | Sum | 567,0 |
| Serie | 96,0 | | | | | | | | | | |
| Sum | 472,0 | | | | | | | | | | |
| Serie | 95,0 | | | | | | | | | | |
| Sum | 567,0 | | | | | | | | | | |

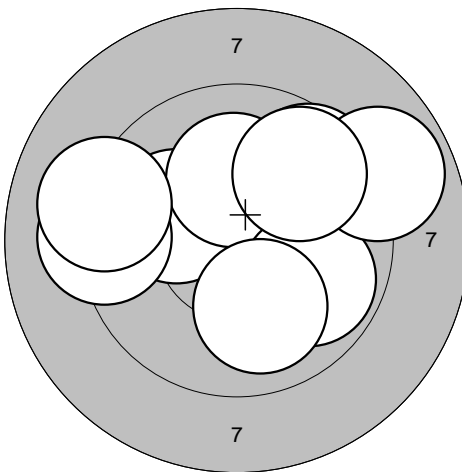
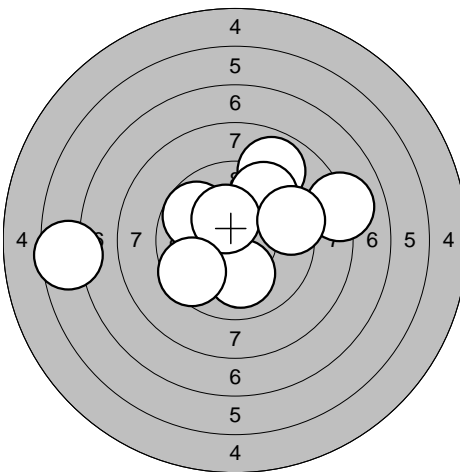
| | | | | | | | | | | | |
|--|---|-------|------|-----|------|--|--|-------|------|-----|-------|
| <p>Series 1</p>  | <p>1: 9,6 ↗ 2: 10,1 ↖ 3: 10,2* ↗ 4: 10,1 ↑ 5: 9,9 → 6: 8,9 → 7: 9,2 ← 8: 10,0 ↓ 9: 9,7 ↗ 10: 9,1 ←</p> <table border="1" style="width:100%; border-collapse: collapse;"> <tr><td>Serie</td><td style="text-align: right;">93,0</td></tr> <tr><td>Sum</td><td style="text-align: right;">93,0</td></tr> </table> | Serie | 93,0 | Sum | 93,0 | <p>Series 2</p>  | <p>1: 8,9 ↗ 2: 10,3* ↖ 3: 8,0 → 4: 9,8 ↖ 5: 9,6 ↗ 6: 10,1 ↓ 7: 10,4* ↗ 8: 6,6 ← 9: 9,4 → 10: 9,5 ↖</p> <table border="1" style="width:100%; border-collapse: collapse;"> <tr><td>Serie</td><td style="text-align: right;">88,0</td></tr> <tr><td>Sum</td><td style="text-align: right;">181,0</td></tr> </table> | Serie | 88,0 | Sum | 181,0 |
| Serie | 93,0 | | | | | | | | | | |
| Sum | 93,0 | | | | | | | | | | |
| Serie | 88,0 | | | | | | | | | | |
| Sum | 181,0 | | | | | | | | | | |

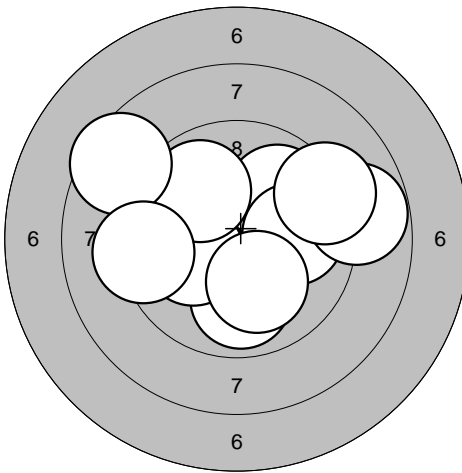
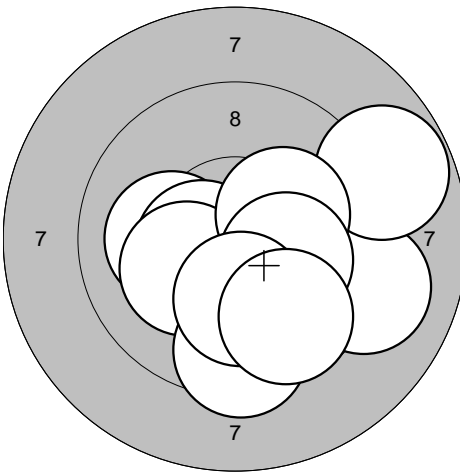
| | | | | | | | | | | | |
|---|--|-------|------|-----|-------|---|--|-------|------|-----|-------|
| <p>Series 3</p>  | <p>1: 9,9 ↓ 2: 10,1 ← 3: 9,9 ↗ 4: 9,9 ↗ 5: 8,5 ↖ 6: 10,0 → 7: 9,3 ← 8: 8,8 → 9: 9,2 → 10: 10,1 ↓</p> <table border="1" style="width:100%; border-collapse: collapse;"> <tr><td>Serie</td><td style="text-align: right;">91,0</td></tr> <tr><td>Sum</td><td style="text-align: right;">272,0</td></tr> </table> | Serie | 91,0 | Sum | 272,0 | <p>Series 4</p>  | <p>1: 10,1 ← 2: 10,5* ← 3: 10,2* ↖ 4: 9,1 → 5: 8,8 → 6: 10,2* → 7: 9,5 ↓ 8: 10,2* → 9: 10,2* ↓ 10: 9,7 ↓</p> <table border="1" style="width:100%; border-collapse: collapse;"> <tr><td>Serie</td><td style="text-align: right;">95,0</td></tr> <tr><td>Sum</td><td style="text-align: right;">367,0</td></tr> </table> | Serie | 95,0 | Sum | 367,0 |
| Serie | 91,0 | | | | | | | | | | |
| Sum | 272,0 | | | | | | | | | | |
| Serie | 95,0 | | | | | | | | | | |
| Sum | 367,0 | | | | | | | | | | |

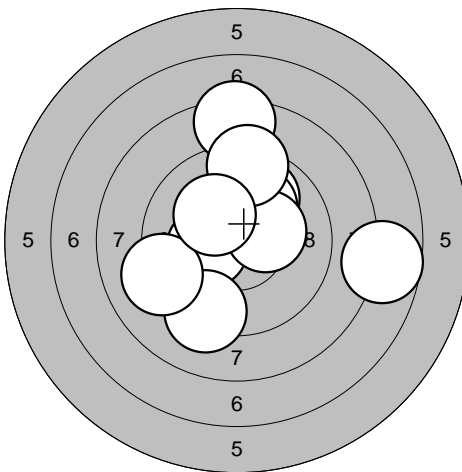
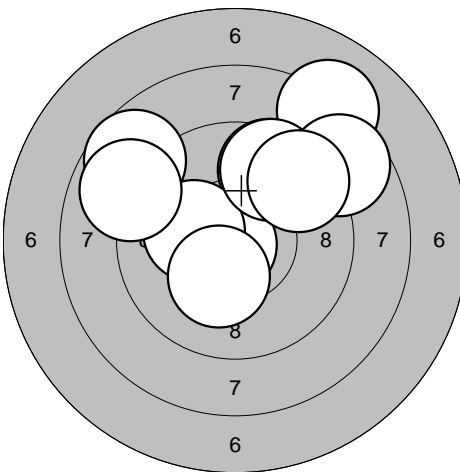
| | | | | | | | | | | | |
|--|--|-------|------|-----|-------|--|---|-------|------|-----|-------|
| <p>Series 5</p>  | <p>1: 9,9 ↗ 2: 10,3* ← 3: 7,7 → 4: 10,1 ↗ 5: 9,2 ↓ 6: 9,1 ← 7: 8,3 ↑ 8: 10,3* → 9: 9,3 ↑ 10: 10,2* ↖</p> <table border="1" style="width:100%; border-collapse: collapse;"> <tr><td>Serie</td><td style="text-align: right;">91,0</td></tr> <tr><td>Sum</td><td style="text-align: right;">458,0</td></tr> </table> | Serie | 91,0 | Sum | 458,0 | <p>Series 6</p>  | <p>1: 9,6 ↗ 2: 10,8* ↖ 3: 8,7 ↖ 4: 10,2* ← 5: 8,9 ↖ 6: 8,1 ↗ 7: 8,7 ↗ 8: 10,2* ↓ 9: 9,6 ↗ 10: 9,4 ↗</p> <table border="1" style="width:100%; border-collapse: collapse;"> <tr><td>Serie</td><td style="text-align: right;">89,0</td></tr> <tr><td>Sum</td><td style="text-align: right;">547,0</td></tr> </table> | Serie | 89,0 | Sum | 547,0 |
| Serie | 91,0 | | | | | | | | | | |
| Sum | 458,0 | | | | | | | | | | |
| Serie | 89,0 | | | | | | | | | | |
| Sum | 547,0 | | | | | | | | | | |

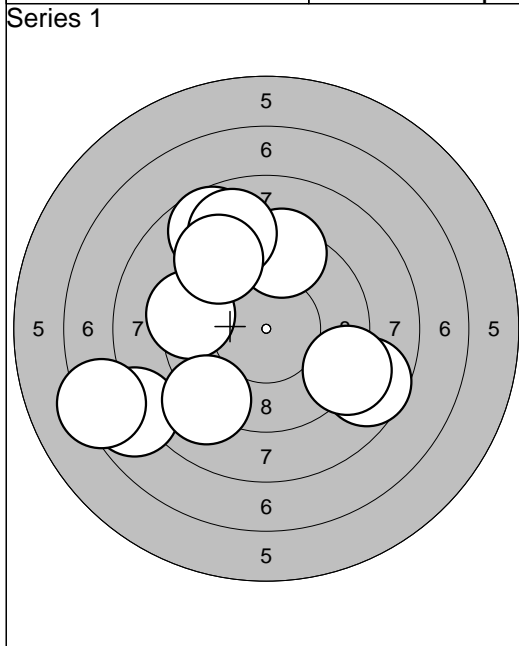

| | | |
|--------------|-----|-------------|
| 1: | 8,7 | ↖ |
| 2: | 9,4 | ↑ |
| 3: | 8,9 | ↗ |
| 4: | 9,4 | ← |
| 5: | 9,3 | ↗ |
| 6: | 7,8 | ↙ |
| 7: | 7,3 | ← |
| 8: | 9,1 | ↘ |
| 9: | 8,6 | ↘ |
| 10: | 9,1 | ↘ |
| Serie | | 83,0 |
| Sum | | 83,0 |

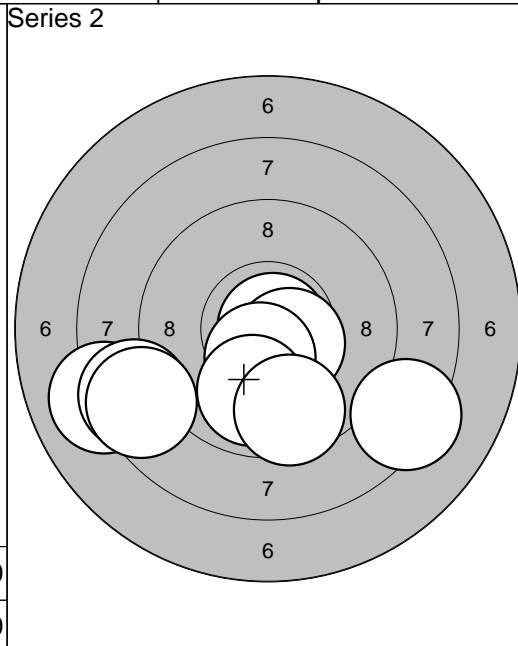

| | | |
|--------------|-------|--------------|
| 1: | 8,3 | ↘ |
| 2: | 10,9* | → |
| 3: | 8,1 | ↙ |
| 4: | 8,5 | ↙ |
| 5: | 10,5* | ↘ |
| 6: | 10,5* | ↘ |
| 7: | 8,6 | ↙ |
| 8: | 10,5* | ↘ |
| 9: | 9,9 | ↘ |
| 10: | 9,6 | ↘ |
| Serie | | 90,0 |
| Sum | | 173,0 |

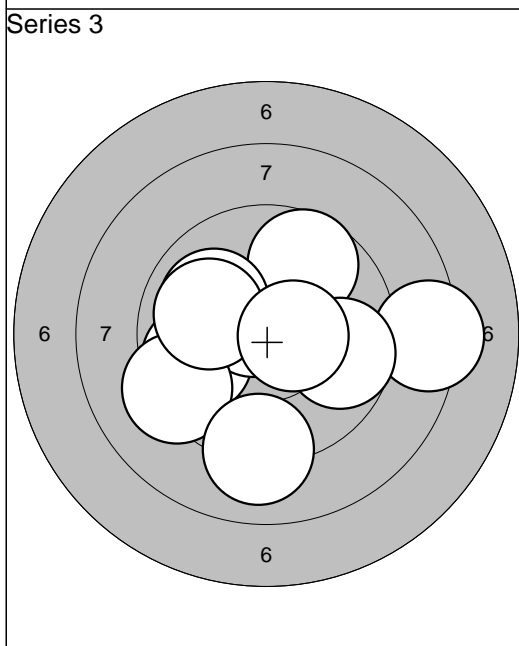

| | | |
|--------------|-------|--------------|
| 1: | 9,8 | ← |
| 2: | 8,3 | → |
| 3: | 10,7* | ↖ |
| 4: | 9,7 | ↗ |
| 5: | 10,0 | ↖ |
| 6: | 9,3 | ← |
| 7: | 9,7 | → |
| 8: | 9,1 | ↓ |
| 9: | 10,0 | ← |
| 10: | 10,5* | → |
| Serie | | 93,0 |
| Sum | | 266,0 |

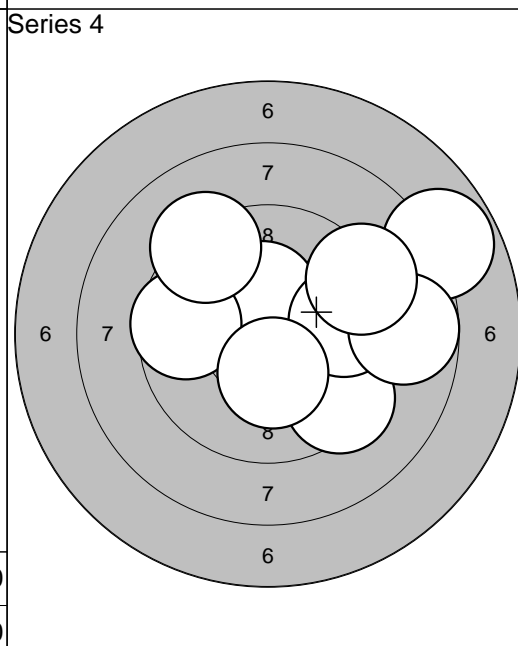

| | | |
|--------------|-------|--------------|
| 1: | 9,4 | ↘ |
| 2: | 9,6 | → |
| 3: | 10,3* | ↑ |
| 4: | 9,6 | ← |
| 5: | 7,8 | ↗ |
| 6: | 9,7 | → |
| 7: | 9,2 | ↗ |
| 8: | 8,8 | → |
| 9: | 9,2 | ↗ |
| 10: | 10,3* | ↓ |
| Serie | | 89,0 |
| Sum | | 355,0 |

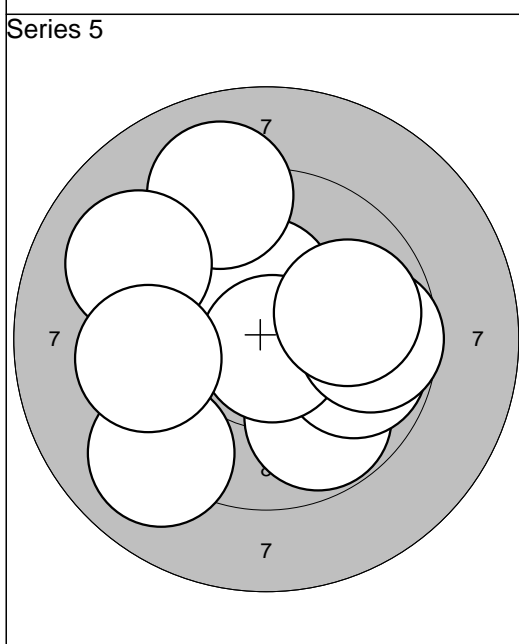

| | | |
|--------------|-------|--------------|
| 1: | 9,8 | ↘ |
| 2: | 10,4* | ↑ |
| 3: | 9,8 | → |
| 4: | 9,1 | ↑ |
| 5: | 10,8* | ↘ |
| 6: | 9,7 | → |
| 7: | 9,1 | ↗ |
| 8: | 9,1 | ↘ |
| 9: | 9,5 | ← |
| 10: | 9,9 | → |
| Serie | | 92,0 |
| Sum | | 447,0 |

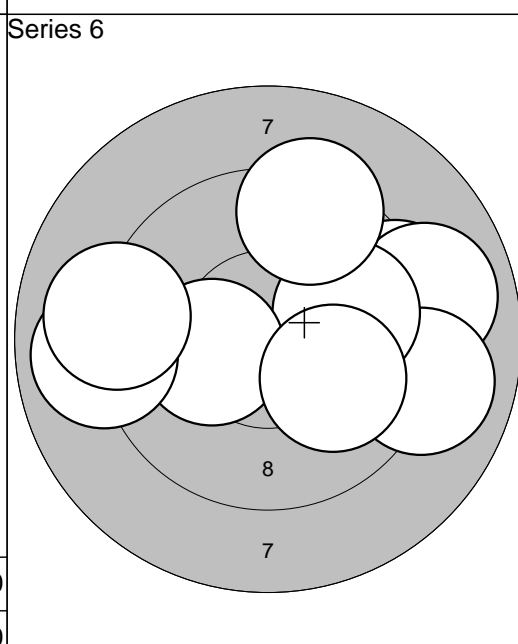

| | | |
|--------------|-------|--------------|
| 1: | 9,5 | → |
| 2: | 9,3 | → |
| 3: | 8,9 | → |
| 4: | 9,0 | → |
| 5: | 10,0 | → |
| 6: | 10,3* | ← |
| 7: | 10,0 | ↘ |
| 8: | 8,9 | ← |
| 9: | 9,3 | ↑ |
| 10: | 9,1 | ← |
| Serie | | 91,0 |
| Sum | | 538,0 |

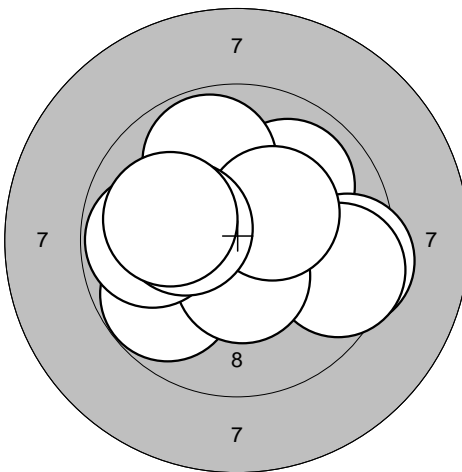
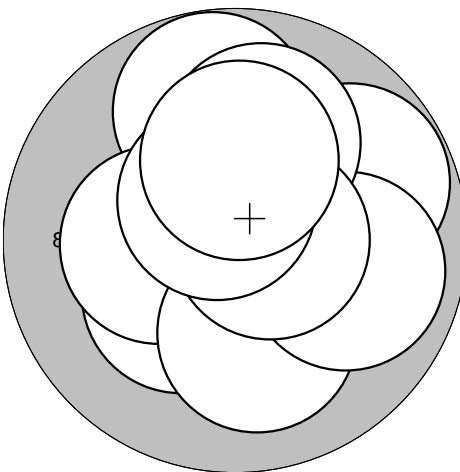
| | | | | | | | | | | | |
|--|--|-------|------|-----|------|--|---|-------|------|-----|-------|
| <p>Series 1</p>  | <p>1: 10,0 ↗ 2: 9,9 ↑ 3: 9,4 → 4: 9,5 → 5: 9,8 ↙ 6: 10,5* ↓ 7: 10,3* ↗ 8: 9,8 ← 9: 10,3* ← 10: 10,0 ←</p> <table border="1" style="width:100%; border-collapse: collapse;"> <tr><td>Serie</td><td style="text-align: right;">95,0</td></tr> <tr><td>Sum</td><td style="text-align: right;">95,0</td></tr> </table> | Serie | 95,0 | Sum | 95,0 | <p>Series 2</p>  | <p>1: 10,3* ↙ 2: 9,8 ↑ 3: 10,3* ← 4: 9,8 ↗ 5: 10,1 ↓ 6: 9,9 → 7: 10,1 ↑ 8: 10,6* → 9: 10,5* ↑ 10: 10,2* ↑</p> <table border="1" style="width:100%; border-collapse: collapse;"> <tr><td>Serie</td><td style="text-align: right;">97,0</td></tr> <tr><td>Sum</td><td style="text-align: right;">192,0</td></tr> </table> | Serie | 97,0 | Sum | 192,0 |
| Serie | 95,0 | | | | | | | | | | |
| Sum | 95,0 | | | | | | | | | | |
| Serie | 97,0 | | | | | | | | | | |
| Sum | 192,0 | | | | | | | | | | |

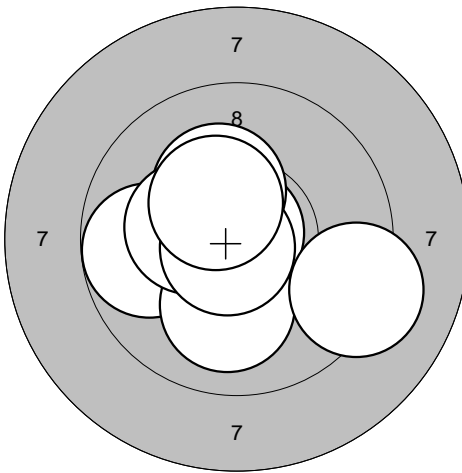
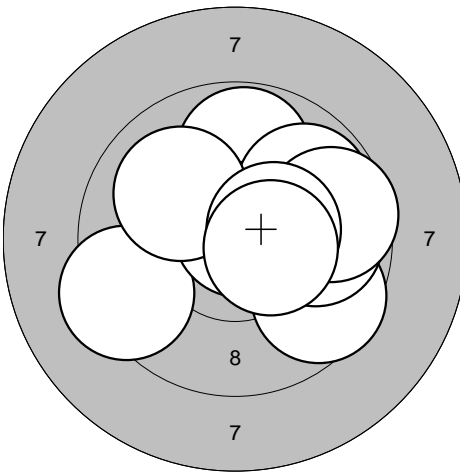
| | | | | | | | | | | | |
|---|--|-------|------|-----|-------|---|--|-------|------|-----|-------|
| <p>Series 3</p>  | <p>1: 10,9* ↑ 2: 10,2* ↑ 3: 10,6* ← 4: 10,5* ↙ 5: 9,8 ← 6: 10,1 ↓ 7: 10,3* ← 8: 10,8* ↙ 9: 10,4* ↑ 10: 9,2 →</p> <table border="1" style="width:100%; border-collapse: collapse;"> <tr><td>Serie</td><td style="text-align: right;">98,0</td></tr> <tr><td>Sum</td><td style="text-align: right;">290,0</td></tr> </table> | Serie | 98,0 | Sum | 290,0 | <p>Series 4</p>  | <p>1: 9,8 ↑ 2: 9,6 ↘ 3: 9,9 → 4: 9,3 ↙ 5: 10,8* ↗ 6: 9,8 ↗ 7: 9,6 → 8: 10,0 ↙ 9: 10,4* → 10: 10,4* →</p> <table border="1" style="width:100%; border-collapse: collapse;"> <tr><td>Serie</td><td style="text-align: right;">94,0</td></tr> <tr><td>Sum</td><td style="text-align: right;">384,0</td></tr> </table> | Serie | 94,0 | Sum | 384,0 |
| Serie | 98,0 | | | | | | | | | | |
| Sum | 290,0 | | | | | | | | | | |
| Serie | 94,0 | | | | | | | | | | |
| Sum | 384,0 | | | | | | | | | | |

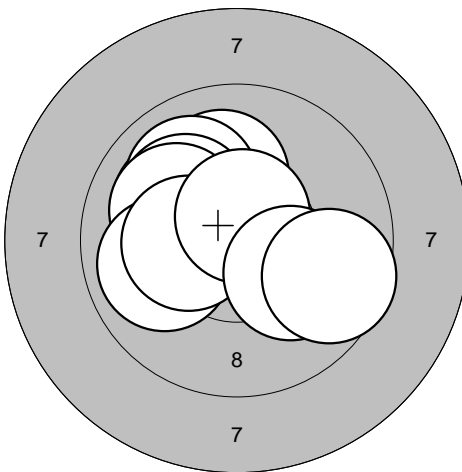
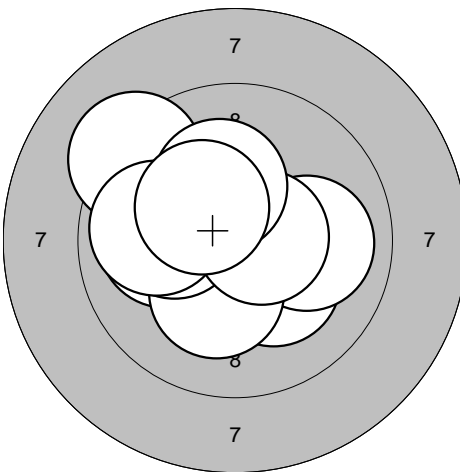
| | | | | | | | | | | | |
|--|---|-------|------|-----|-------|--|--|-------|------|-----|-------|
| <p>Series 5</p>  | <p>1: 10,1 ↑ 2: 10,0 ↗ 3: 10,0 ↗ 4: 10,1 ↗ 5: 10,0 ↗ 6: 9,9 ← 7: 10,3* ← 8: 10,6* ↑ 9: 10,1 ↘ 10: 9,6 →</p> <table border="1" style="width:100%; border-collapse: collapse;"> <tr><td>Serie</td><td style="text-align: right;">98,0</td></tr> <tr><td>Sum</td><td style="text-align: right;">482,0</td></tr> </table> | Serie | 98,0 | Sum | 482,0 | <p>Series 6</p>  | <p>1: 10,0 ← 2: 10,2* ↘ 3: 10,0 → 4: 10,2* ↓ 5: 10,1 ← 6: 10,6* → 7: 9,3 ↗ 8: 9,9 ← 9: 10,2* ↑ 10: 10,3* ↙</p> <table border="1" style="width:100%; border-collapse: collapse;"> <tr><td>Serie</td><td style="text-align: right;">98,0</td></tr> <tr><td>Sum</td><td style="text-align: right;">580,0</td></tr> </table> | Serie | 98,0 | Sum | 580,0 |
| Serie | 98,0 | | | | | | | | | | |
| Sum | 482,0 | | | | | | | | | | |
| Serie | 98,0 | | | | | | | | | | |
| Sum | 580,0 | | | | | | | | | | |

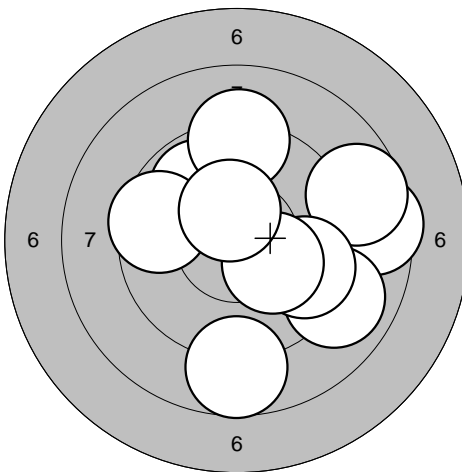
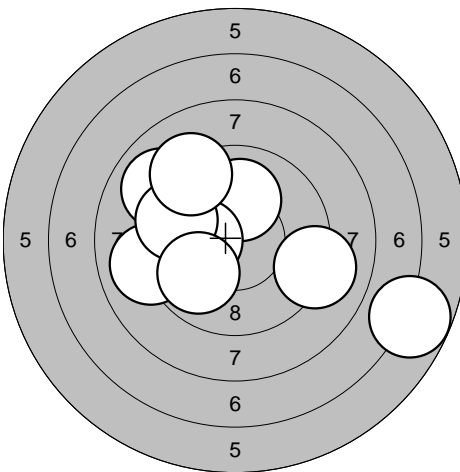
| | | | | | | | | | | | |
|--|---|-------|------|-----|------|--|--|-------|------|-----|-------|
| <p>Series 1</p>  | <p>1: 8,5 →</p> <p>2: 9,0 ↘</p> <p>3: 9,9 ↗</p> <p>4: 8,7 →</p> <p>5: 9,6 ↘</p> <p>6: 9,2 ↑</p> <p>7: 9,6 ←</p> <p>8: 8,7 ↓</p> <p>9: 10,2* ↘</p> <p>10: 10,4* ↑</p> <table border="1" style="width:100%; border-collapse: collapse;"> <tr> <td style="text-align: right;">Serie</td> <td style="text-align: right;">89,0</td> </tr> <tr> <td style="text-align: right;">Sum</td> <td style="text-align: right;">89,0</td> </tr> </table> | Serie | 89,0 | Sum | 89,0 | <p>Series 2</p>  | <p>1: 10,1 ←</p> <p>2: 10,1 ↑</p> <p>3: 9,0 ↗</p> <p>4: 9,0 ←</p> <p>5: 10,2* ←</p> <p>6: 6,8 ↘</p> <p>7: 9,1 →</p> <p>8: 9,6 ←</p> <p>9: 9,9 ↙</p> <p>10: 9,2 ↗</p> <table border="1" style="width:100%; border-collapse: collapse;"> <tr> <td style="text-align: right;">Serie</td> <td style="text-align: right;">90,0</td> </tr> <tr> <td style="text-align: right;">Sum</td> <td style="text-align: right;">179,0</td> </tr> </table> | Serie | 90,0 | Sum | 179,0 |
| Serie | 89,0 | | | | | | | | | | |
| Sum | 89,0 | | | | | | | | | | |
| Serie | 90,0 | | | | | | | | | | |
| Sum | 179,0 | | | | | | | | | | |

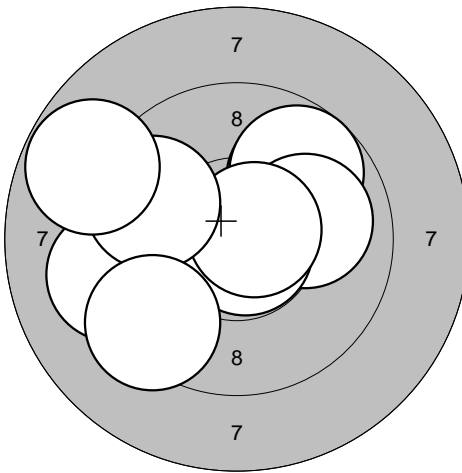
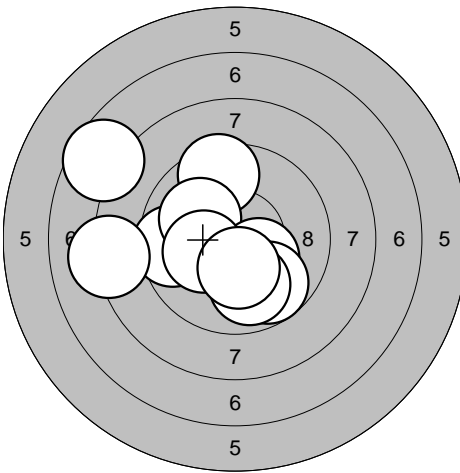
| | | | | | | | | | | | |
|---|---|-------|------|-----|-------|---|---|-------|------|-----|-------|
| <p>Series 3</p>  | <p>1: 9,9 ↗</p> <p>2: 9,8 ↗</p> <p>3: 9,7 ↗</p> <p>4: 10,0 →</p> <p>5: 10,8* ↘</p> <p>6: 10,7* →</p> <p>7: 9,2 ←</p> <p>8: 9,7 ←</p> <p>9: 8,8 ↗</p> <p>10: 9,4 ↙</p> <table border="1" style="width:100%; border-collapse: collapse;"> <tr> <td style="text-align: right;">Serie</td> <td style="text-align: right;">92,0</td> </tr> <tr> <td style="text-align: right;">Sum</td> <td style="text-align: right;">271,0</td> </tr> </table> | Serie | 92,0 | Sum | 271,0 | <p>Series 4</p>  | <p>1: 7,6 ↖</p> <p>2: 9,6 ←</p> <p>3: 9,5 ↑</p> <p>4: 10,1 ↖</p> <p>5: 10,3* ↘</p> <p>6: 9,7 ↘</p> <p>7: 9,9 ↘</p> <p>8: 10,2* ←</p> <p>9: 8,2 ←</p> <p>10: 10,3* ↓</p> <table border="1" style="width:100%; border-collapse: collapse;"> <tr> <td style="text-align: right;">Serie</td> <td style="text-align: right;">91,0</td> </tr> <tr> <td style="text-align: right;">Sum</td> <td style="text-align: right;">362,0</td> </tr> </table> | Serie | 91,0 | Sum | 362,0 |
| Serie | 92,0 | | | | | | | | | | |
| Sum | 271,0 | | | | | | | | | | |
| Serie | 91,0 | | | | | | | | | | |
| Sum | 362,0 | | | | | | | | | | |

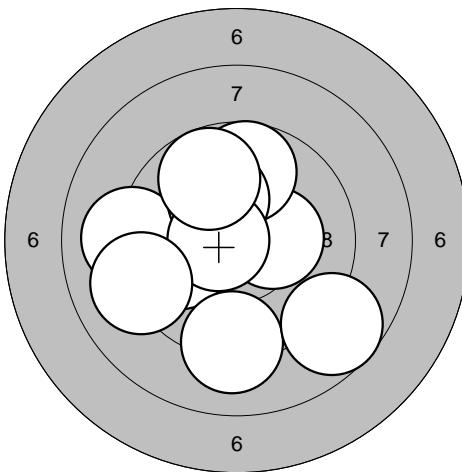
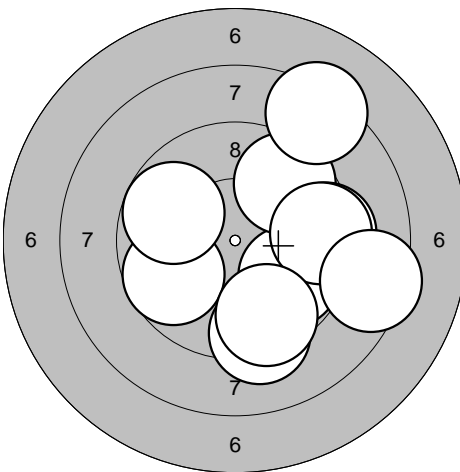
| | | | | | | | | | | | |
|--|---|-------|------|-----|-------|--|--|-------|------|-----|-------|
| <p>Series 5</p>  | <p>1: 10,3* →</p> <p>2: 9,9 ←</p> <p>3: 9,1 ←</p> <p>4: 9,8 ↑</p> <p>5: 10,1 ↗</p> <p>6: 9,2 ↓</p> <p>7: 10,6* ←</p> <p>8: 9,1 ←</p> <p>9: 9,8 ↗</p> <p>10: 8,7 ↘</p> <table border="1" style="width:100%; border-collapse: collapse;"> <tr> <td style="text-align: right;">Serie</td> <td style="text-align: right;">92,0</td> </tr> <tr> <td style="text-align: right;">Sum</td> <td style="text-align: right;">454,0</td> </tr> </table> | Serie | 92,0 | Sum | 454,0 | <p>Series 6</p>  | <p>1: 9,8 ↘</p> <p>2: 9,6 ↗</p> <p>3: 9,3 →</p> <p>4: 9,3 ↓</p> <p>5: 8,3 ↗</p> <p>6: 9,7 ←</p> <p>7: 9,4 →</p> <p>8: 9,5 ↓</p> <p>9: 8,4 →</p> <p>10: 9,8 ←</p> <table border="1" style="width:100%; border-collapse: collapse;"> <tr> <td style="text-align: right;">Serie</td> <td style="text-align: right;">88,0</td> </tr> <tr> <td style="text-align: right;">Sum</td> <td style="text-align: right;">542,0</td> </tr> </table> | Serie | 88,0 | Sum | 542,0 |
| Serie | 92,0 | | | | | | | | | | |
| Sum | 454,0 | | | | | | | | | | |
| Serie | 88,0 | | | | | | | | | | |
| Sum | 542,0 | | | | | | | | | | |

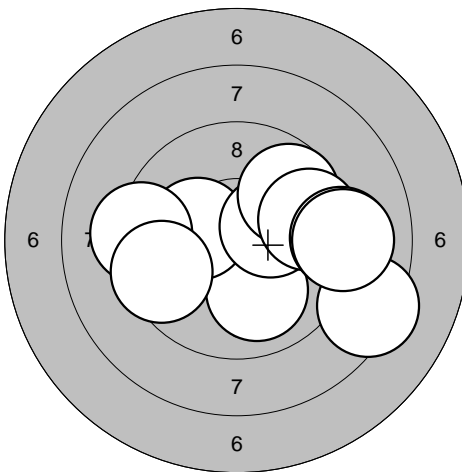
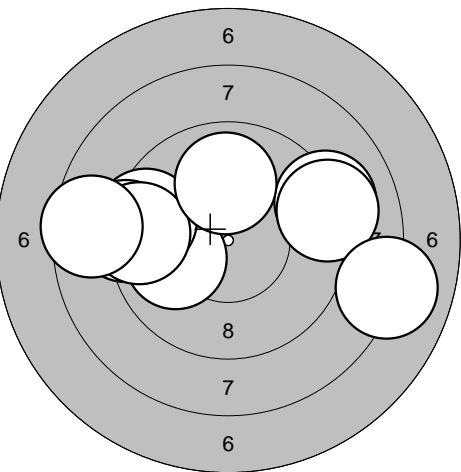
| | | | | | | | | | | | |
|--|---|-------|------|-----|------|--|---|-------|------|-----|-------|
| <p>Series 1</p>  | <p>1: 10,0 ↘ 2: 10,2* ← 3: 10,3* → 4: 9,2 ← 5: 9,7 ↗ 6: 9,6 → 7: 9,5 ← 8: 8,4 ↘ 9: 9,1 → 10: 9,1 →</p> <table border="1" style="width:100%; border-collapse: collapse;"> <tr><td>Serie</td><td style="text-align: right;">92,0</td></tr> <tr><td>Sum</td><td style="text-align: right;">92,0</td></tr> </table> | Serie | 92,0 | Sum | 92,0 | <p>Series 2</p>  | <p>1: 9,6 ← 2: 9,1 → 3: 10,0 ← 4: 9,4 ← 5: 9,1 → 6: 9,1 ← 7: 9,4 ← 8: 8,0 → 9: 8,5 ← 10: 10,0 ↑</p> <table border="1" style="width:100%; border-collapse: collapse;"> <tr><td>Serie</td><td style="text-align: right;">90,0</td></tr> <tr><td>Sum</td><td style="text-align: right;">182,0</td></tr> </table> | Serie | 90,0 | Sum | 182,0 |
| Serie | 92,0 | | | | | | | | | | |
| Sum | 92,0 | | | | | | | | | | |
| Serie | 90,0 | | | | | | | | | | |
| Sum | 182,0 | | | | | | | | | | |

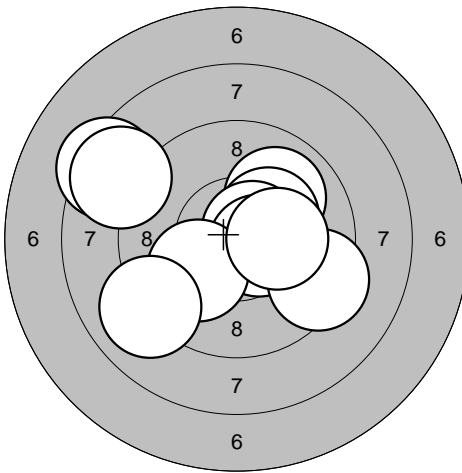
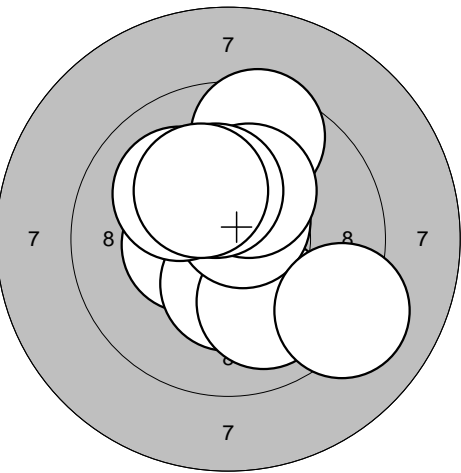
| | | | | | | | | | | | |
|---|---|-------|------|-----|-------|---|---|-------|------|-----|-------|
| <p>Series 3</p>  | <p>1: 8,3 ← 2: 10,0 ↗ 3: 10,3* → 4: 10,7* → 5: 10,5* → 6: 10,1 ← 7: 9,3 ↘ 8: 9,0 ← 9: 10,2* → 10: 8,6 ↖</p> <table border="1" style="width:100%; border-collapse: collapse;"> <tr><td>Serie</td><td style="text-align: right;">94,0</td></tr> <tr><td>Sum</td><td style="text-align: right;">276,0</td></tr> </table> | Serie | 94,0 | Sum | 276,0 | <p>Series 4</p>  | <p>1: 10,4* ← 2: 9,5 ↑ 3: 10,4* ↓ 4: 10,0 ↓ 5: 10,7* ↗ 6: 10,3* ↑ 7: 10,1 ↖ 8: 10,3* ↑ 9: 10,2* ↗ 10: 9,2 ↘</p> <table border="1" style="width:100%; border-collapse: collapse;"> <tr><td>Serie</td><td style="text-align: right;">98,0</td></tr> <tr><td>Sum</td><td style="text-align: right;">374,0</td></tr> </table> | Serie | 98,0 | Sum | 374,0 |
| Serie | 94,0 | | | | | | | | | | |
| Sum | 276,0 | | | | | | | | | | |
| Serie | 98,0 | | | | | | | | | | |
| Sum | 374,0 | | | | | | | | | | |

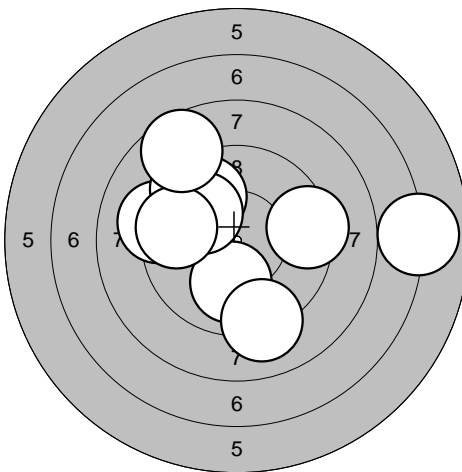
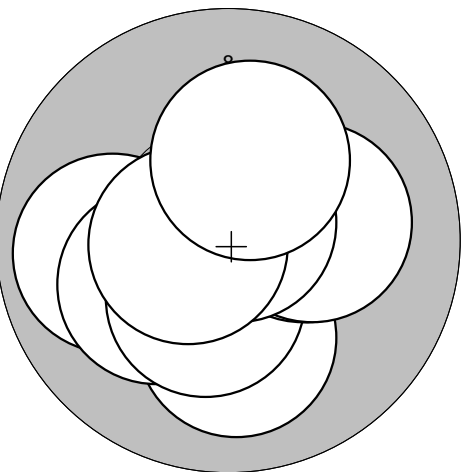
| | | | | | | | | | | | |
|--|---|-------|------|-----|-------|--|--|-------|------|-----|-------|
| <p>Series 5</p>  | <p>1: 9,4 → 2: 9,2 ← 3: 9,4 ↗ 4: 9,8 ↗ 5: 10,0 ↓ 6: 10,0 ↗ 7: 6,9 → 8: 9,1 ↓ 9: 9,6 ← 10: 8,7 ↗</p> <table border="1" style="width:100%; border-collapse: collapse;"> <tr><td>Serie</td><td style="text-align: right;">88,0</td></tr> <tr><td>Sum</td><td style="text-align: right;">462,0</td></tr> </table> | Serie | 88,0 | Sum | 462,0 | <p>Series 6</p>  | <p>1: 10,1 ↓ 2: 9,9 ← 3: 10,2* → 4: 10,2* ← 5: 10,4* ↓ 6: 10,3* → 7: 10,2* → 8: 10,8* ↑ 9: 10,6* ← 10: 10,2* ↑</p> <table border="1" style="width:100%; border-collapse: collapse;"> <tr><td>Serie</td><td style="text-align: right;">99,0</td></tr> <tr><td>Sum</td><td style="text-align: right;">561,0</td></tr> </table> | Serie | 99,0 | Sum | 561,0 |
| Serie | 88,0 | | | | | | | | | | |
| Sum | 462,0 | | | | | | | | | | |
| Serie | 99,0 | | | | | | | | | | |
| Sum | 561,0 | | | | | | | | | | |

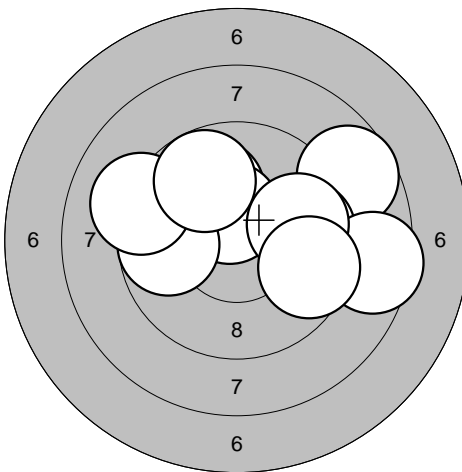
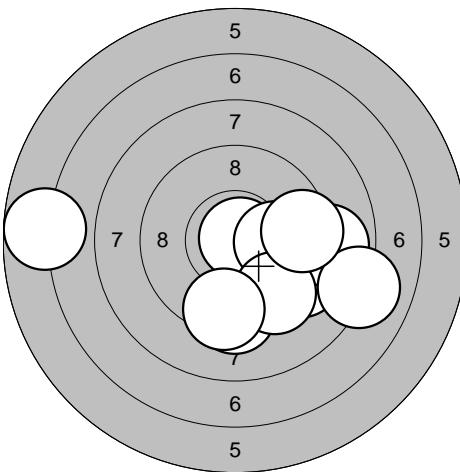
| | | | | | | | | | | | |
|--|---|-------|------|-----|------|--|--|-------|------|-----|-------|
| <p>Series 1</p>  | <p>1: 8,7 ↗ 2: 10,0 ↗ 3: 10,5* ↗ 4: 9,7 → 5: 8,5 → 6: 9,7 ← 7: 9,8 → 8: 9,1 ↖ 9: 9,6 → 10: 9,8 ↗</p> <table border="1" style="width:100%; border-collapse: collapse;"> <tr><td>Serie</td><td style="text-align: right;">90,0</td></tr> <tr><td>Sum</td><td style="text-align: right;">90,0</td></tr> </table> | Serie | 90,0 | Sum | 90,0 | <p>Series 2</p>  | <p>1: 10,8* → 2: 10,0 → 3: 9,3 ↓ 4: 9,3 ↘ 5: 8,9 → 6: 8,0 → 7: 9,5 ↓ 8: 9,4 ↓ 9: 6,8 ← 10: 9,5 →</p> <table border="1" style="width:100%; border-collapse: collapse;"> <tr><td>Serie</td><td style="text-align: right;">87,0</td></tr> <tr><td>Sum</td><td style="text-align: right;">177,0</td></tr> </table> | Serie | 87,0 | Sum | 177,0 |
| Serie | 90,0 | | | | | | | | | | |
| Sum | 90,0 | | | | | | | | | | |
| Serie | 87,0 | | | | | | | | | | |
| Sum | 177,0 | | | | | | | | | | |

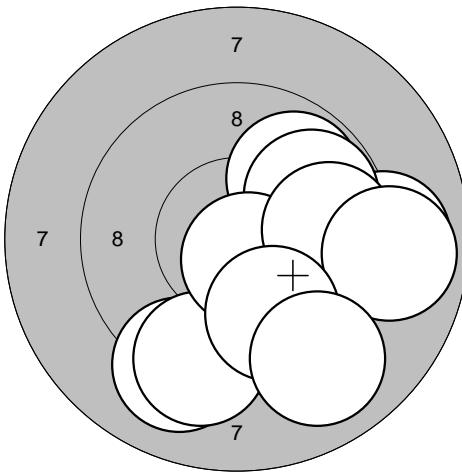
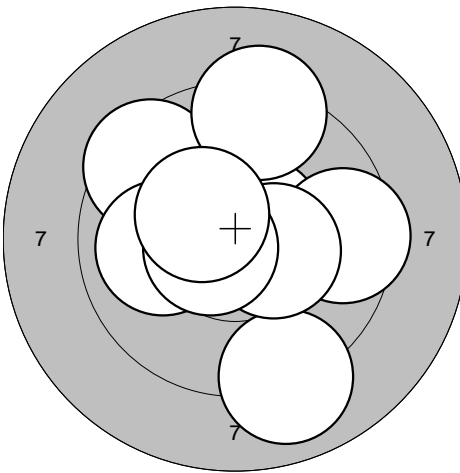
| | | | | | | | | | | | |
|---|---|-------|------|-----|-------|---|--|-------|------|-----|-------|
| <p>Series 3</p>  | <p>1: 9,9 ↗ 2: 9,0 → 3: 9,1 ↓ 4: 9,8 ↗ 5: 9,3 ↓ 6: 10,6* ↓ 7: 9,7 → 8: 8,9 → 9: 9,8 ↓ 10: 9,0 ↓</p> <table border="1" style="width:100%; border-collapse: collapse;"> <tr><td>Serie</td><td style="text-align: right;">90,0</td></tr> <tr><td>Sum</td><td style="text-align: right;">267,0</td></tr> </table> | Serie | 90,0 | Sum | 267,0 | <p>Series 4</p>  | <p>1: 10,2* ↖ 2: 10,6* ↗ 3: 9,5 → 4: 9,5 ↗ 5: 9,0 ↓ 6: 10,4* → 7: 10,0 ← 8: 10,6* ← 9: 9,2 ↑ 10: 10,4* ↖</p> <table border="1" style="width:100%; border-collapse: collapse;"> <tr><td>Serie</td><td style="text-align: right;">96,0</td></tr> <tr><td>Sum</td><td style="text-align: right;">363,0</td></tr> </table> | Serie | 96,0 | Sum | 363,0 |
| Serie | 90,0 | | | | | | | | | | |
| Sum | 267,0 | | | | | | | | | | |
| Serie | 96,0 | | | | | | | | | | |
| Sum | 363,0 | | | | | | | | | | |

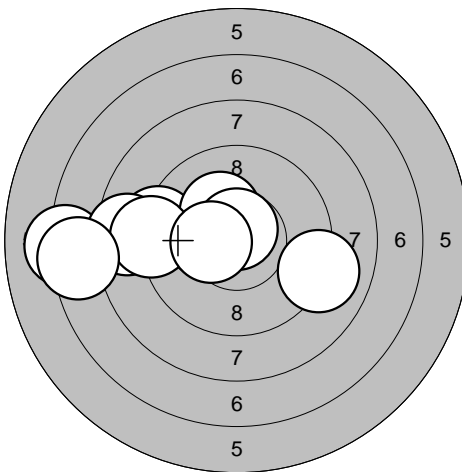
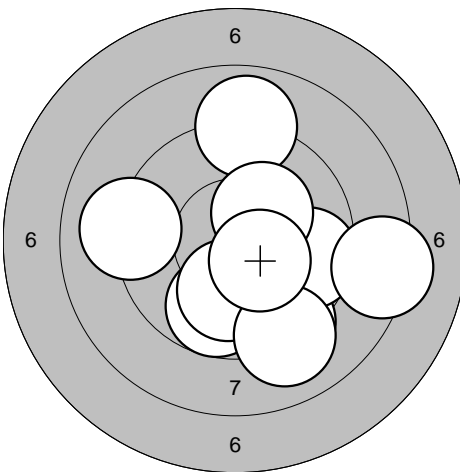
| | | | | | | | | | | | |
|--|---|-------|------|-----|-------|--|--|-------|------|-----|-------|
| <p>Series 5</p>  | <p>1: 10,3* ← 2: 9,0 → 3: 9,2 ← 4: 7,2 ← 5: 10,3* ↗ 6: 8,6 ← 7: 9,1 ← 8: 10,7* ↑ 9: 10,4* ← 10: 7,4 ←</p> <table border="1" style="width:100%; border-collapse: collapse;"> <tr><td>Serie</td><td style="text-align: right;">89,0</td></tr> <tr><td>Sum</td><td style="text-align: right;">452,0</td></tr> </table> | Serie | 89,0 | Sum | 452,0 | <p>Series 6</p>  | <p>1: 9,3 ↓ 2: 9,6 → 3: 9,7 ↓ 4: 8,9 ↑ 5: 10,0 ↓ 6: 10,3* ↗ 7: 9,1 ↓ 8: 8,3 → 9: 10,4* ↘ 10: 9,1 ←</p> <table border="1" style="width:100%; border-collapse: collapse;"> <tr><td>Serie</td><td style="text-align: right;">91,0</td></tr> <tr><td>Sum</td><td style="text-align: right;">543,0</td></tr> </table> | Serie | 91,0 | Sum | 543,0 |
| Serie | 89,0 | | | | | | | | | | |
| Sum | 452,0 | | | | | | | | | | |
| Serie | 91,0 | | | | | | | | | | |
| Sum | 543,0 | | | | | | | | | | |

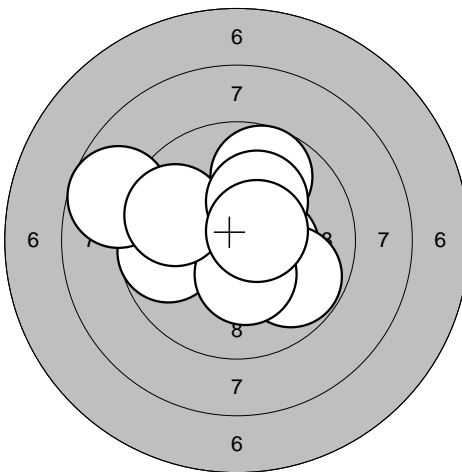
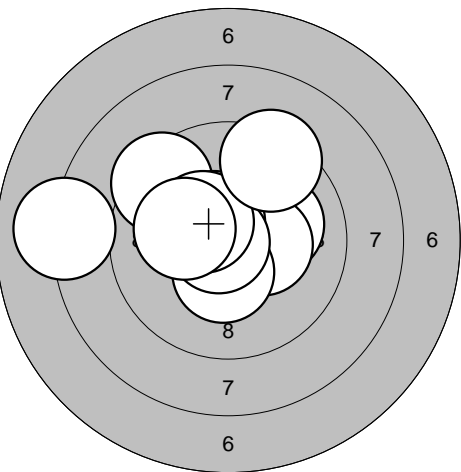
| | | | |
|--|--|--|---|
| <p>Series 1</p>  | <p>1: 9,7 ←</p> <p>2: 10,4* →</p> <p>3: 10,9* →</p> <p>4: 9,7 ↗</p> <p>5: 9,8 ↘</p> <p>6: 10,3* ↓</p> <p>7: 8,7 ←</p> <p>8: 9,8 ←</p> <p>9: 10,2* ↗</p> <p>10: 10,5* →</p> | <p>Series 2</p>  | <p>1: 10,1 →</p> <p>2: 9,4 ↖</p> <p>3: 8,0 ←</p> <p>4: 10,3* →</p> <p>5: 10,4* ↓</p> <p>6: 10,6* ↗</p> <p>7: 10,8* ←</p> <p>8: 10,4* ↖</p> <p>9: 9,4 ↗</p> <p>10: 10,2* ←</p> |
| Serie 94,0 | | Serie 96,0 | |
| Sum 94,0 | | Sum 190,0 | |

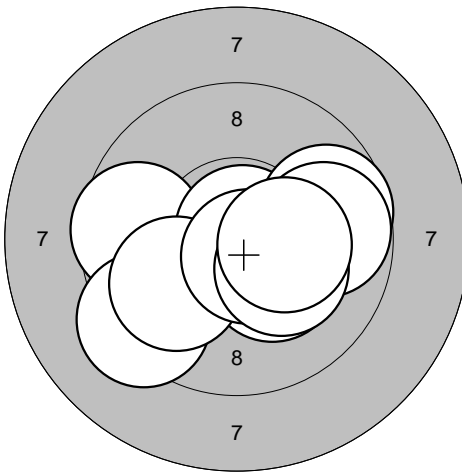
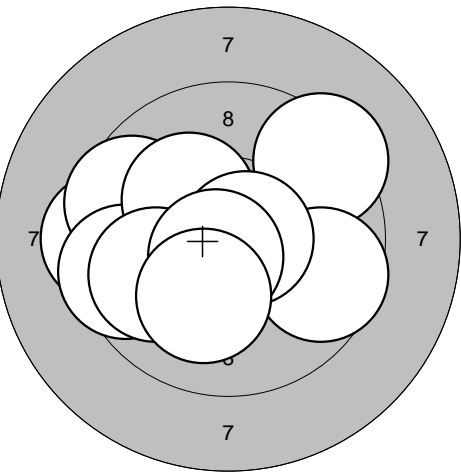
| | | | |
|---|---|---|---|
| <p>Series 3</p>  | <p>1: 9,6 ←</p> <p>2: 9,3 ↙</p> <p>3: 10,3* ↓</p> <p>4: 10,8* ↗</p> <p>5: 10,0 ←</p> <p>6: 9,7 →</p> <p>7: 10,7* ↓</p> <p>8: 9,8 →</p> <p>9: 10,2* ↓</p> <p>10: 10,3* →</p> | <p>Series 4</p>  | <p>1: 9,3 ↗</p> <p>2: 9,6 →</p> <p>3: 9,4 ←</p> <p>4: 9,6 ←</p> <p>5: 9,5 ←</p> <p>6: 10,2* ↗</p> <p>7: 9,9 ←</p> <p>8: 10,7* →</p> <p>9: 10,7* ↓</p> <p>10: 10,1 ↓</p> |
| Serie 96,0 | | Serie 94,0 | |
| Sum 286,0 | | Sum 380,0 | |

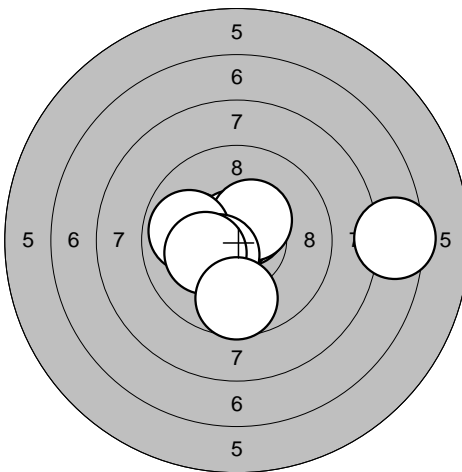
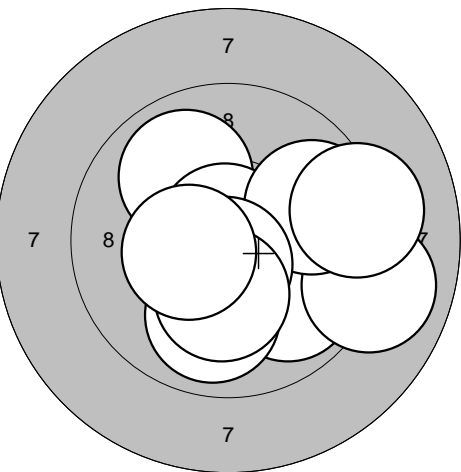
| | | | |
|--|---|--|--|
| <p>Series 5</p>  | <p>1: 10,6* ↗</p> <p>2: 10,0 ←</p> <p>3: 10,4* ←</p> <p>4: 10,7* ↗</p> <p>5: 10,4* ↗</p> <p>6: 9,9 ←</p> <p>7: 10,4* ↙</p> <p>8: 10,2* ←</p> <p>9: 7,5 →</p> <p>10: 9,7 ↓</p> | <p>Series 6</p>  | <p>1: 9,9 ↘</p> <p>2: 9,9 ↗</p> <p>3: 10,8* ↗</p> <p>4: 9,0 →</p> <p>5: 9,8 →</p> <p>6: 9,9 ↓</p> <p>7: 9,2 →</p> <p>8: 10,6* ↓</p> <p>9: 10,2* ↓</p> <p>10: 10,4* ←</p> |
| Serie 95,0 | | Serie 94,0 | |
| Sum 475,0 | | Sum 569,0 | |

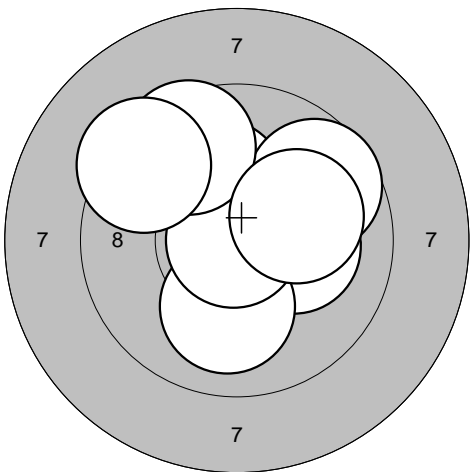
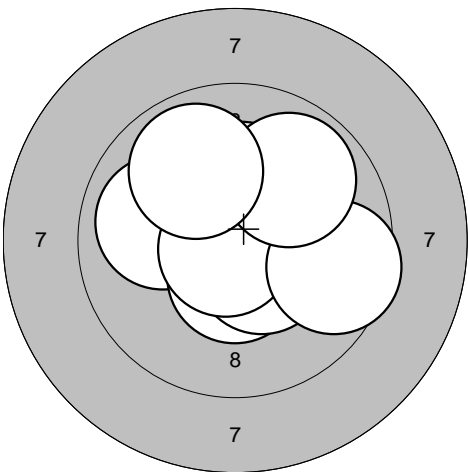
| | | | |
|--|--|--|--|
| <p>Series 1</p>  | <p>1: 10,2* ↗</p> <p>2: 10,7* →</p> <p>3: 10,8* →</p> <p>4: 10,2* →</p> <p>5: 9,7 ↗</p> <p>6: 10,1 ↓</p> <p>7: 10,9* ←</p> <p>8: 9,6 ↗</p> <p>9: 9,3 ↗</p> <p>10: 10,1 →</p> | <p>Series 2</p>  | <p>1: 10,3* ↖</p> <p>2: 10,0 ←</p> <p>3: 10,1 →</p> <p>4: 10,5* ↓</p> <p>5: 10,3* ↑</p> <p>6: 10,4* ↘</p> <p>7: 10,8* ↙</p> <p>8: 9,6 →</p> <p>9: 9,9 ↗</p> <p>10: 9,9 ↗</p> |
| Serie 97,0 | | Serie 97,0 | |
| Sum 97,0 | | Sum 194,0 | |

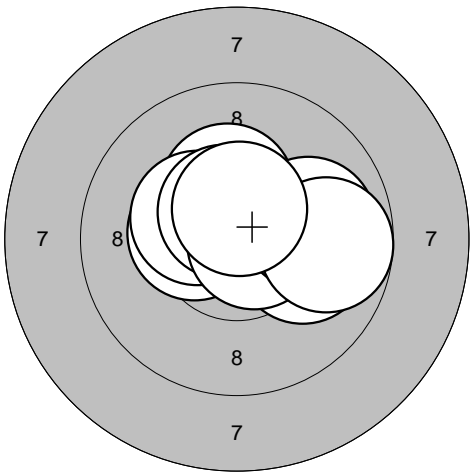
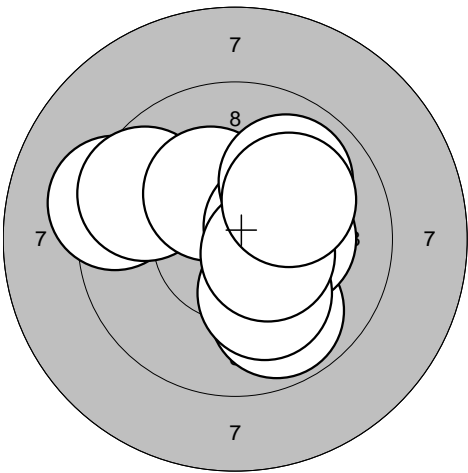
| | | | |
|---|--|---|---|
| <p>Series 3</p>  | <p>1: 10,3* ↗</p> <p>2: 10,4* ←</p> <p>3: 10,1 →</p> <p>4: 10,8* ↗</p> <p>5: 10,4* ↖</p> <p>6: 10,6* ↗</p> <p>7: 10,7* →</p> <p>8: 10,0 →</p> <p>9: 9,7 →</p> <p>10: 10,5* ↑</p> | <p>Series 4</p>  | <p>1: 9,3 ↖</p> <p>2: 9,6 ↖</p> <p>3: 9,8 ↘</p> <p>4: 10,2* →</p> <p>5: 10,3* ↗</p> <p>6: 10,1 ↓</p> <p>7: 10,4* →</p> <p>8: 10,5* ↘</p> <p>9: 10,0 ↗</p> <p>10: 10,1 ↗</p> |
| Serie 99,0 | | Serie 97,0 | |
| Sum 293,0 | | Sum 390,0 | |

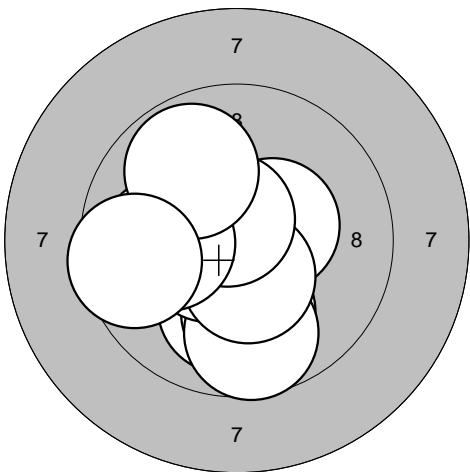
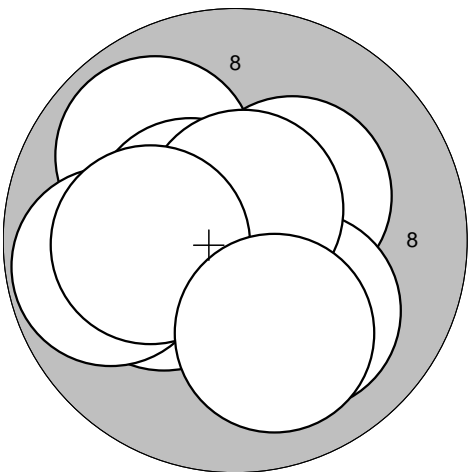
| | | | |
|--|---|--|--|
| <p>Series 5</p>  | <p>1: 10,0 ↓</p> <p>2: 10,0 ↓</p> <p>3: 9,7 ↓</p> <p>4: 10,4* →</p> <p>5: 10,5* ←</p> <p>6: 10,4* ↓</p> <p>7: 10,6* ↗</p> <p>8: 10,0 ←</p> <p>9: 9,9 ↗</p> <p>10: 9,6 ←</p> | <p>Series 6</p>  | <p>1: 9,9 ↖</p> <p>2: 10,3* ↗</p> <p>3: 10,2* ←</p> <p>4: 10,1 ↓</p> <p>5: 10,6* ←</p> <p>6: 9,8 ←</p> <p>7: 10,5* ↖</p> <p>8: 10,6* ↑</p> <p>9: 10,2* ←</p> <p>10: 10,0 ↓</p> |
| Serie 97,0 | | Serie 98,0 | |
| Sum 487,0 | | Sum 585,0 | |

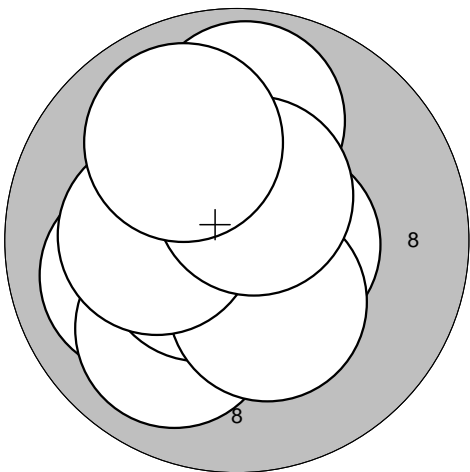
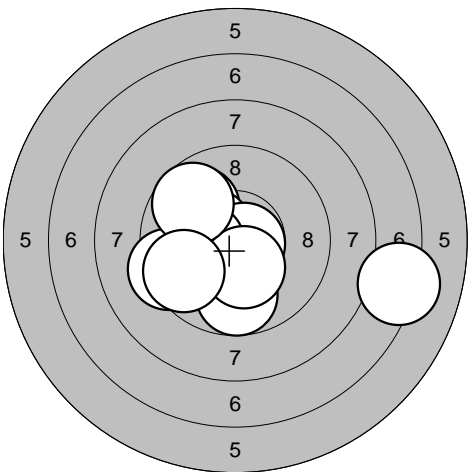
| | | | |
|--|---|--|--|
| <p>Series 1</p>  | <p>1: 10,0 ←</p> <p>2: 10,0 ↑</p> <p>3: 10,0 ↘</p> <p>4: 10,6* ↙</p> <p>5: 10,5* →</p> <p>6: 10,3* ↘</p> <p>7: 10,2* ←</p> <p>8: 9,9 ↑</p> <p>9: 10,5* ↗</p> <p>10: 9,9 ↖</p> | <p>Series 2</p>  | <p>1: 9,9 ↗</p> <p>2: 10,4* ↖</p> <p>3: 10,7* →</p> <p>4: 10,3* ←</p> <p>5: 7,2 →</p> <p>6: 9,4 ←</p> <p>7: 9,8 ↓</p> <p>8: 10,3* ↘</p> <p>9: 9,7 ↗</p> <p>10: 9,6 ↙</p> |
| Serie 98,0 | | Serie 92,0 | |
| Sum 98,0 | | Sum 190,0 | |

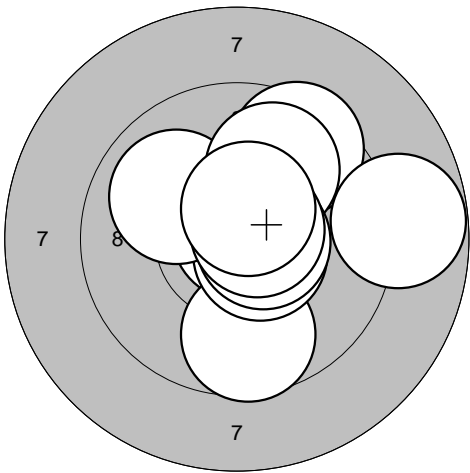
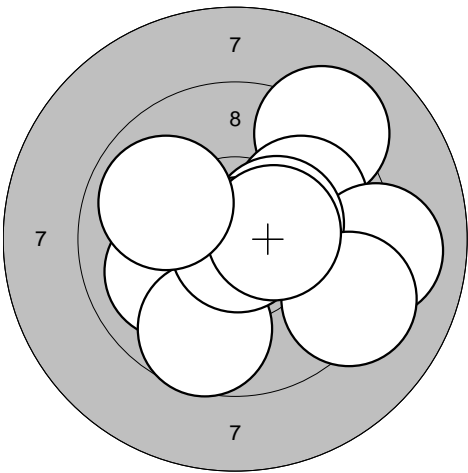
| | | | |
|---|---|---|---|
| <p>Series 3</p>  | <p>1: 10,9* ↗</p> <p>2: 9,7 ↘</p> <p>3: 9,5 ↗</p> <p>4: 10,6* ↘</p> <p>5: 8,8 →</p> <p>6: 10,0 ↗</p> <p>7: 9,9 ↗</p> <p>8: 10,6* →</p> <p>9: 10,7* →</p> <p>10: 10,5* ↗</p> | <p>Series 4</p>  | <p>1: 9,1 ↗</p> <p>2: 9,9 ↗</p> <p>3: 9,0 →</p> <p>4: 10,4* →</p> <p>5: 9,2 ↘</p> <p>6: 10,0 ←</p> <p>7: 9,7 ↘</p> <p>8: 10,9* ↘</p> <p>9: 10,4* →</p> <p>10: 9,9 ↖</p> |
| Serie 95,0 | | Serie 94,0 | |
| Sum 285,0 | | Sum 379,0 | |

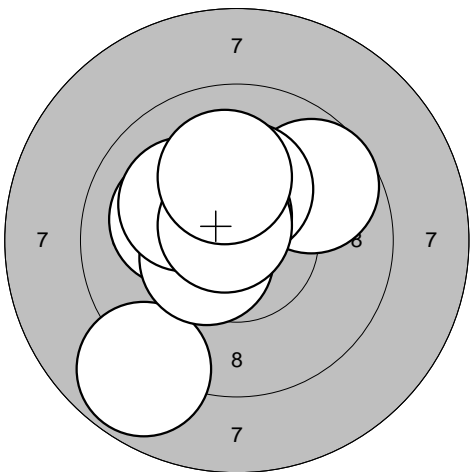
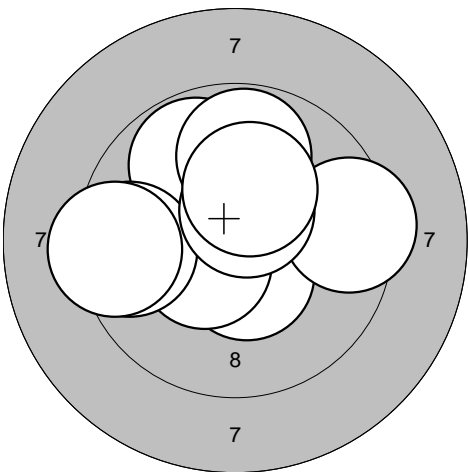
| | | | |
|--|---|--|--|
| <p>Series 5</p>  | <p>1: 10,1 ←</p> <p>2: 9,7 ↗</p> <p>3: 10,3* ↑</p> <p>4: 10,6* ↗</p> <p>5: 8,8 ↘</p> <p>6: 10,4* ↗</p> <p>7: 10,5* ↙</p> <p>8: 10,1 ↗</p> <p>9: 10,7* ↗</p> <p>10: 10,1 ↑</p> | <p>Series 6</p>  | <p>1: 10,5* ↘</p> <p>2: 10,5* ↙</p> <p>3: 10,4* ↑</p> <p>4: 9,8 ↗</p> <p>5: 9,4 →</p> <p>6: 9,5 ←</p> <p>7: 9,8 ↑</p> <p>8: 9,4 ←</p> <p>9: 10,5* ↗</p> <p>10: 10,2* ↑</p> |
| Serie 97,0 | | Serie 95,0 | |
| Sum 476,0 | | Sum 571,0 | |

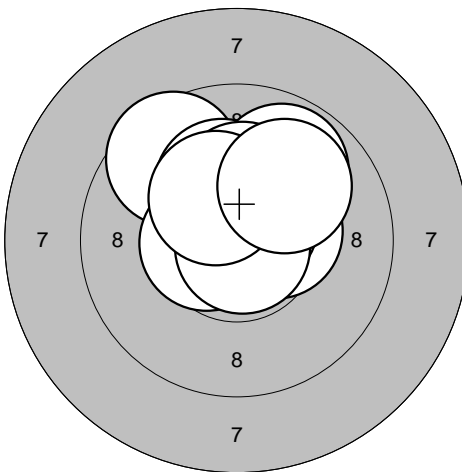
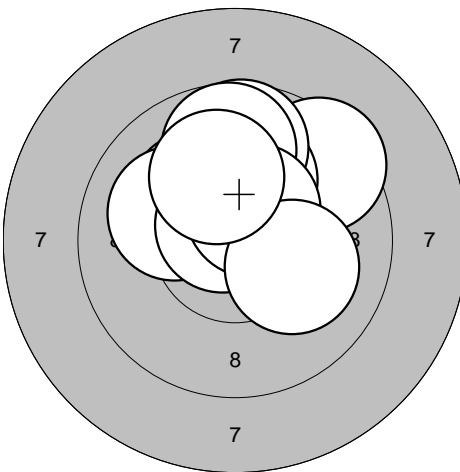
| | | | |
|--|---|--|--|
| <p>Series 1</p>  | <p>1: 10,4* →</p> <p>2: 9,6 ↖</p> <p>3: 10,2* ↑</p> <p>4: 9,9 ↗</p> <p>5: 10,5* ←</p> <p>6: 10,6* ↗</p> <p>7: 10,3* ↑</p> <p>8: 10,8* ↘</p> <p>9: 10,3* ↑</p> <p>10: 10,0 ↗</p> | <p>Series 2</p>  | <p>1: 10,2* ↖</p> <p>2: 10,1 ↖</p> <p>3: 9,5 ↗</p> <p>4: 10,1 ↑</p> <p>5: 9,7 ↑</p> <p>6: 10,7* ↖</p> <p>7: 9,7 ↑</p> <p>8: 10,5* ↗</p> <p>9: 10,1 →</p> <p>10: 10,1 ↑</p> |
| Serie 98,0 | Serie 97,0 | Serie 97,0 | Serie 97,0 |
| Sum 98,0 | Sum 195,0 | Sum 195,0 | Sum 195,0 |

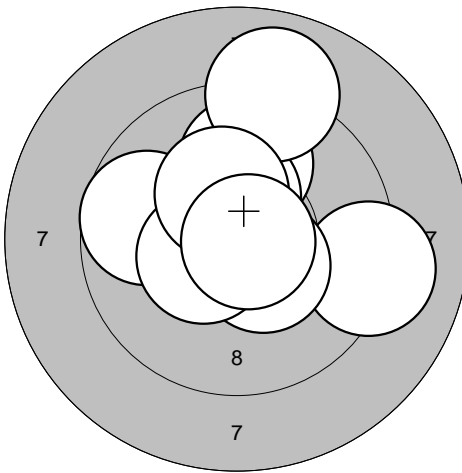
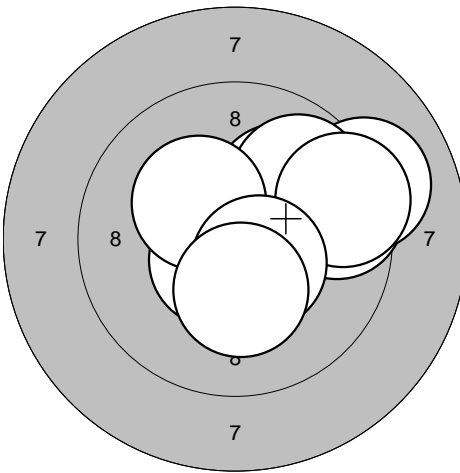
| | | | |
|---|---|---|---|
| <p>Series 3</p>  | <p>1: 9,1 →</p> <p>2: 9,7 ←</p> <p>3: 10,5* ↑</p> <p>4: 10,4* ↘</p> <p>5: 10,0 ↑</p> <p>6: 10,4* ↑</p> <p>7: 9,0 ↑</p> <p>8: 10,4* ←</p> <p>9: 10,3* ↑</p> <p>10: 10,8* →</p> | <p>Series 4</p>  | <p>1: 10,1 ↗</p> <p>2: 9,7 ↗</p> <p>3: 9,6 →</p> <p>4: 9,1 →</p> <p>5: 10,6* ↘</p> <p>6: 9,8 ↗</p> <p>7: 10,3* ↖</p> <p>8: 9,4 →</p> <p>9: 10,5* ↘</p> <p>10: 10,3* ↓</p> |
| Serie 97,0 | Serie 95,0 | Serie 95,0 | Serie 95,0 |
| Sum 292,0 | Sum 387,0 | Sum 387,0 | Sum 387,0 |

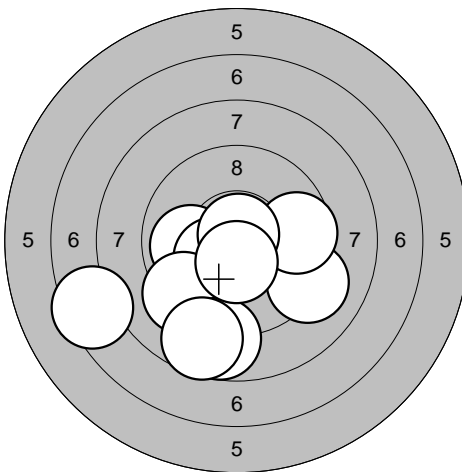
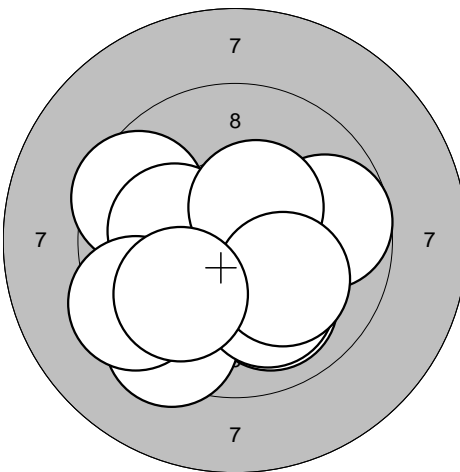
| | | | |
|--|--|--|---|
| <p>Series 5</p>  | <p>1: 9,1 ↘</p> <p>2: 7,5 ←</p> <p>3: 9,9 ←</p> <p>4: 9,6 →</p> <p>5: 10,3* ↖</p> <p>6: 9,3 ↖</p> <p>7: 8,8 ↓</p> <p>8: 10,8* ↑</p> <p>9: 10,5* ↓</p> <p>10: 8,6 ↓</p> | <p>Series 6</p>  | <p>1: 9,6 ↖</p> <p>2: 9,7 →</p> <p>3: 10,2* ←</p> <p>4: 10,0 ↓</p> <p>5: 9,4 ↘</p> <p>6: 9,4 ↖</p> <p>7: 10,0 ↓</p> <p>8: 10,4* ↗</p> <p>9: 10,1 ↘</p> <p>10: 9,9 ↖</p> |
| Serie 89,0 | Serie 95,0 | Serie 95,0 | Serie 95,0 |
| Sum 476,0 | Sum 571,0 | Sum 571,0 | Sum 571,0 |

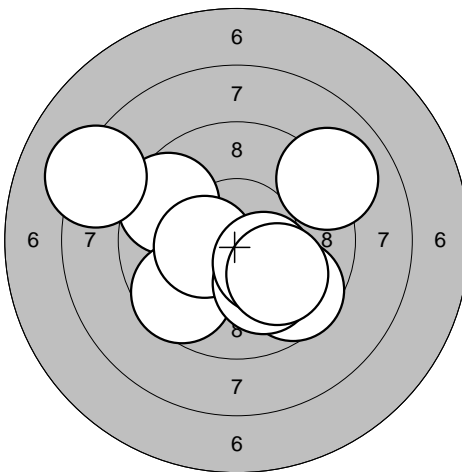
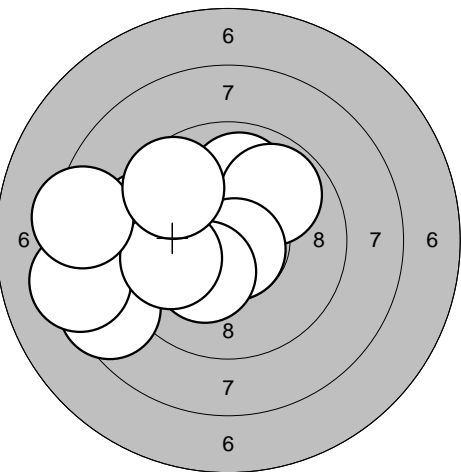
| | | | | | | | | | | | |
|--|--|-------|------|-----|------|--|---|-------|------|-----|-------|
| <p>Series 1</p>  | <p>1: 9,6 ↘ 2: 9,0 ↗ 3: 9,6 ↗ 4: 8,2 ↗ 5: 9,6 ↘ 6: 10,3* ↘ 7: 10,4* ← 8: 10,0 ↘ 9: 10,3* ↘ 10: 10,0 ↘</p> <table border="1" style="width:100%; border-collapse: collapse;"> <tr><td>Serie</td><td style="text-align: right;">94,0</td></tr> <tr><td>Sum</td><td style="text-align: right;">94,0</td></tr> </table> | Serie | 94,0 | Sum | 94,0 | <p>Series 2</p>  | <p>1: 9,5 ← 2: 9,9 ↑ 3: 9,8 ↗ 4: 8,6 ↖ 5: 10,7* ↘ 6: 10,2* ↘ 7: 8,3 ← 8: 9,9 ← 9: 8,4 ← 10: 9,6 ↗</p> <table border="1" style="width:100%; border-collapse: collapse;"> <tr><td>Serie</td><td style="text-align: right;">89,0</td></tr> <tr><td>Sum</td><td style="text-align: right;">183,0</td></tr> </table> | Serie | 89,0 | Sum | 183,0 |
| Serie | 94,0 | | | | | | | | | | |
| Sum | 94,0 | | | | | | | | | | |
| Serie | 89,0 | | | | | | | | | | |
| Sum | 183,0 | | | | | | | | | | |

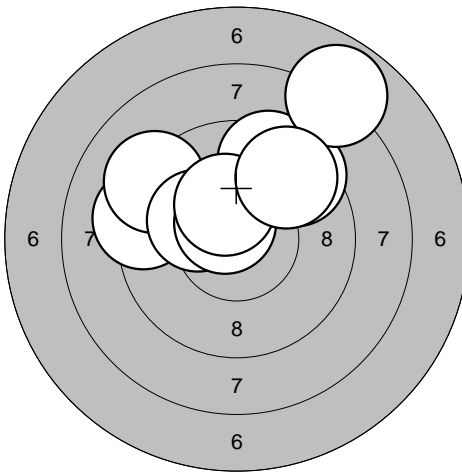
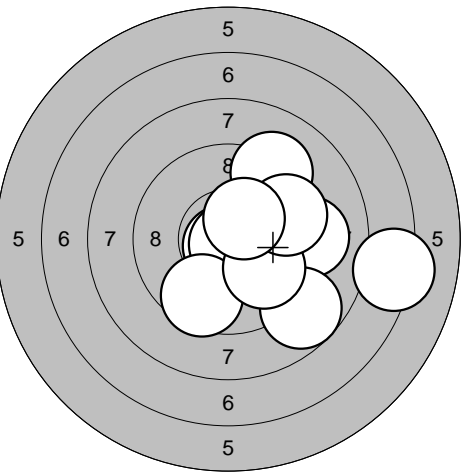
| | | | | | | | | | | | |
|---|---|-------|------|-----|-------|---|---|-------|------|-----|-------|
| <p>Series 3</p>  | <p>1: 9,3 ← 2: 10,4* ↗ 3: 9,4 ↗ 4: 9,5 ↗ 5: 9,2 ↗ 6: 10,2* ↗ 7: 10,6* ↗ 8: 7,9 ↗ 9: 10,3* ↗ 10: 9,5 ↗</p> <table border="1" style="width:100%; border-collapse: collapse;"> <tr><td>Serie</td><td style="text-align: right;">92,0</td></tr> <tr><td>Sum</td><td style="text-align: right;">275,0</td></tr> </table> | Serie | 92,0 | Sum | 275,0 | <p>Series 4</p>  | <p>1: 10,8* ↘ 2: 7,2 → 3: 10,8* ↘ 4: 9,6 ↘ 5: 9,2 ↗ 6: 9,2 → 7: 8,7 ↘ 8: 9,9 ↘ 9: 9,6 → 10: 10,4* ↗</p> <table border="1" style="width:100%; border-collapse: collapse;"> <tr><td>Serie</td><td style="text-align: right;">90,0</td></tr> <tr><td>Sum</td><td style="text-align: right;">365,0</td></tr> </table> | Serie | 90,0 | Sum | 365,0 |
| Serie | 92,0 | | | | | | | | | | |
| Sum | 275,0 | | | | | | | | | | |
| Serie | 90,0 | | | | | | | | | | |
| Sum | 365,0 | | | | | | | | | | |

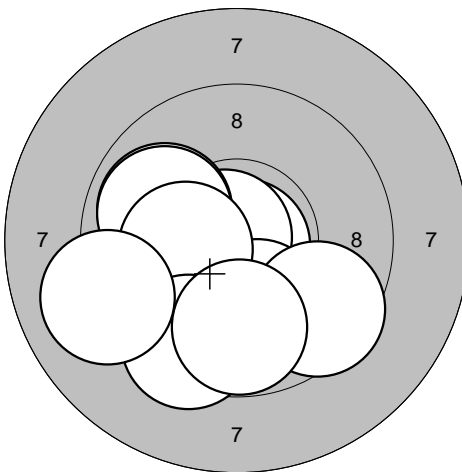
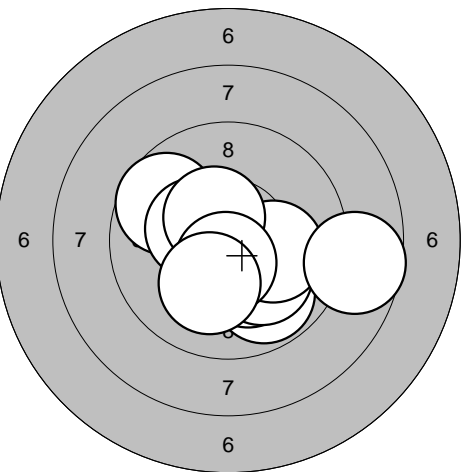
| | | | | | | | | | | | |
|--|--|-------|------|-----|-------|--|--|-------|------|-----|-------|
| <p>Series 5</p>  | <p>1: 10,8* ↘ 2: 10,8* ← 3: 9,9 ↗ 4: 9,9 ↗ 5: 10,0 ↘ 6: 9,5 ↘ 7: 10,3* ← 8: 9,4 ↘ 9: 9,8 ↘ 10: 9,1 ←</p> <table border="1" style="width:100%; border-collapse: collapse;"> <tr><td>Serie</td><td style="text-align: right;">94,0</td></tr> <tr><td>Sum</td><td style="text-align: right;">459,0</td></tr> </table> | Serie | 94,0 | Sum | 459,0 | <p>Series 6</p>  | <p>1: 9,7 ↖ 2: 9,8 ↘ 3: 10,3* ↖ 4: 10,2* ↘ 5: 10,1 ↘ 6: 10,1 → 7: 10,5* ↗ 8: 10,6* ↘ 9: 8,7 → 10: 10,1 ↘</p> <table border="1" style="width:100%; border-collapse: collapse;"> <tr><td>Serie</td><td style="text-align: right;">96,0</td></tr> <tr><td>Sum</td><td style="text-align: right;">555,0</td></tr> </table> | Serie | 96,0 | Sum | 555,0 |
| Serie | 94,0 | | | | | | | | | | |
| Sum | 459,0 | | | | | | | | | | |
| Serie | 96,0 | | | | | | | | | | |
| Sum | 555,0 | | | | | | | | | | |

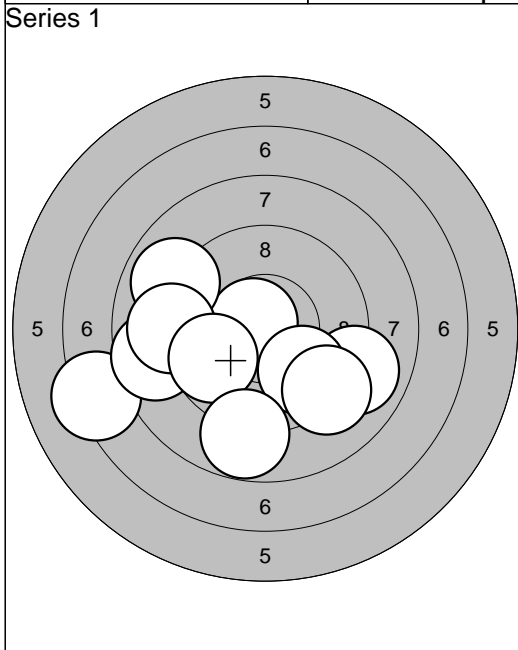

| | |
|-------------------|---|
| 1: 7,3 | ← |
| 2: 10,7* | ↖ |
| 3: 8,9 | ↖ |
| 4: 9,0 | → |
| 5: 8,7 | ← |
| 6: 9,8 | ↘ |
| 7: 9,1 | ← |
| 8: 9,8 | ← |
| 9: 9,2 | ↘ |
| 10: 8,8 | ↓ |
| Serie 86,0 | |
| Sum 86,0 | |

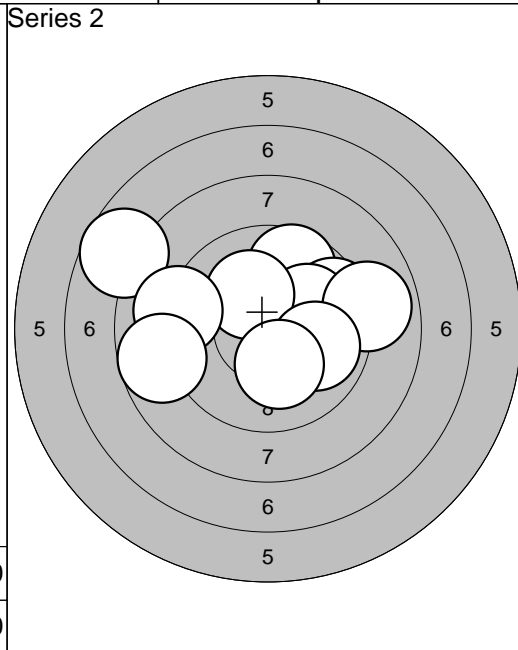

| | |
|-------------------|---|
| 1: 9,7 | ↗ |
| 2: 9,6 | → |
| 3: 7,7 | ↖ |
| 4: 10,1 | → |
| 5: 10,2* | ↗ |
| 6: 8,9 | → |
| 7: 9,1 | ← |
| 8: 8,7 | ← |
| 9: 9,9 | → |
| 10: 10,2* | ↓ |
| Serie 89,0 | |
| Sum 175,0 | |

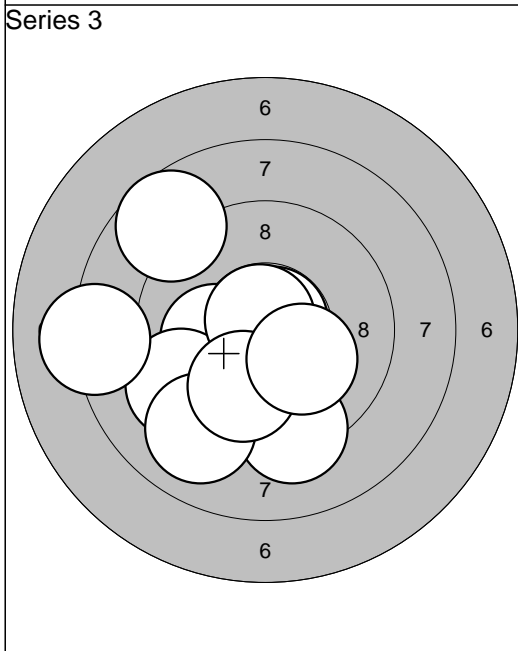

| | |
|-------------------|---|
| 1: 10,1 | ← |
| 2: 9,3 | ↓ |
| 3: 9,3 | ← |
| 4: 8,2 | ← |
| 5: 10,8* | ↗ |
| 6: 10,8* | ↗ |
| 7: 9,1 | ↘ |
| 8: 10,0 | ↓ |
| 9: 8,7 | ↗ |
| 10: 10,2* | ↘ |
| Serie 93,0 | |
| Sum 268,0 | |

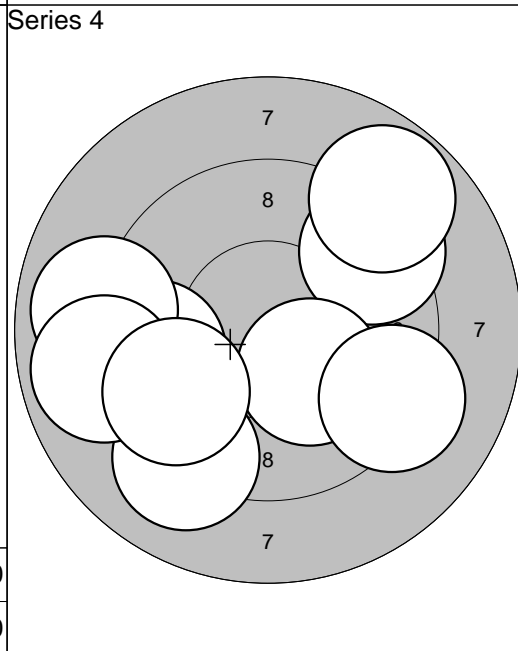

| | |
|-------------------|---|
| 1: 9,3 | ↗ |
| 2: 9,1 | ↓ |
| 3: 9,1 | ← |
| 4: 9,5 | ← |
| 5: 8,9 | ← |
| 6: 8,9 | ← |
| 7: 10,2* | ↘ |
| 8: 9,2 | → |
| 9: 9,6 | ↖ |
| 10: 8,8 | ↗ |
| Serie 88,0 | |
| Sum 356,0 | |

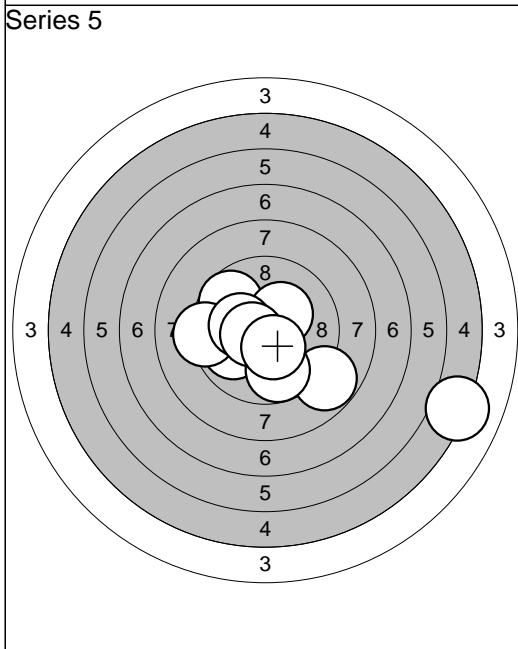

| | |
|-------------------|---|
| 1: 5,1 | → |
| 2: 9,7 | ↗ |
| 3: 10,0 | ← |
| 4: 10,3* | ↗ |
| 5: 8,8 | ↘ |
| 6: 9,3 | ← |
| 7: 10,3* | ← |
| 8: 9,8 | ↓ |
| 9: 10,6* | ← |
| 10: 10,4* | ↓ |
| Serie 90,0 | |
| Sum 446,0 | |

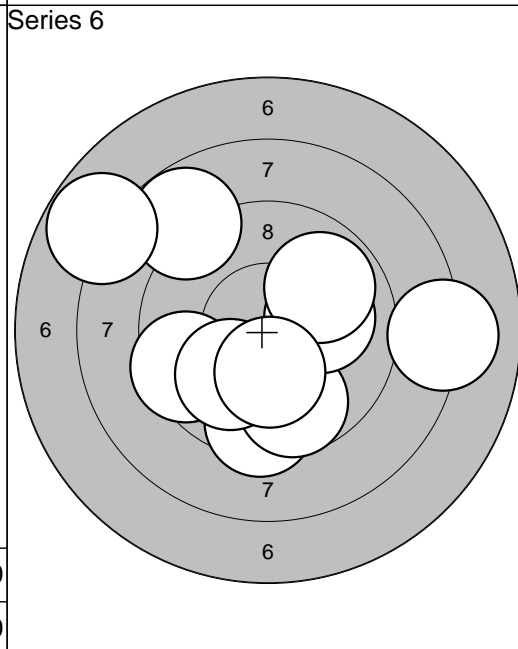

| | |
|-------------------|---|
| 1: 9,5 | ↓ |
| 2: 9,7 | ↓ |
| 3: 8,8 | ↖ |
| 4: 10,1 | → |
| 5: 9,5 | ← |
| 6: 9,9 | ↗ |
| 7: 8,1 | → |
| 8: 7,8 | ↖ |
| 9: 10,0 | ↘ |
| 10: 10,3* | ↓ |
| Serie 89,0 | |
| Sum 535,0 | |

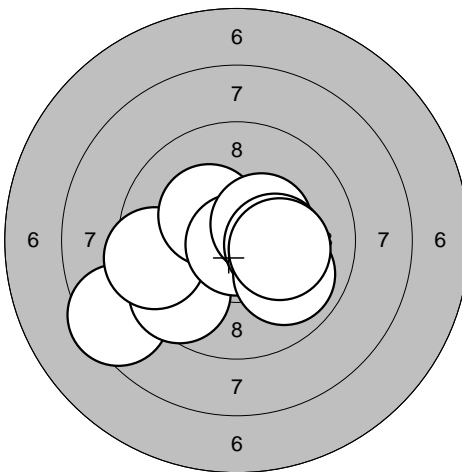
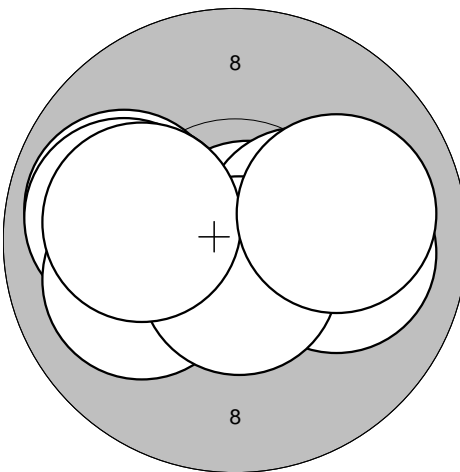
| | | | | | | | | | | | |
|--|--|-------|------|-----|------|--|--|-------|------|-----|-------|
| <p>Series 1</p>  | <p>1: 8,5 ↙ 2: 9,6 ↙ 3: 9,5 ← 4: 10,3* ↗ 5: 10,2* → 6: 10,9* ↓ 7: 10,4* ↗ 8: 10,3* → 9: 9,9 ↘ 10: 10,2* →</p> <table border="1" style="width:100%; border-collapse: collapse;"> <tr><td>Serie</td><td style="text-align: right;">95,0</td></tr> <tr><td>Sum</td><td style="text-align: right;">95,0</td></tr> </table> | Serie | 95,0 | Sum | 95,0 | <p>Series 2</p>  | <p>1: 10,1 ← 2: 9,9 ← 3: 10,8* → 4: 10,3* → 5: 10,0 → 6: 9,9 ← 7: 10,0 ← 8: 10,6* ↓ 9: 10,1 ← 10: 10,0 →</p> <table border="1" style="width:100%; border-collapse: collapse;"> <tr><td>Serie</td><td style="text-align: right;">98,0</td></tr> <tr><td>Sum</td><td style="text-align: right;">193,0</td></tr> </table> | Serie | 98,0 | Sum | 193,0 |
| Serie | 95,0 | | | | | | | | | | |
| Sum | 95,0 | | | | | | | | | | |
| Serie | 98,0 | | | | | | | | | | |
| Sum | 193,0 | | | | | | | | | | |

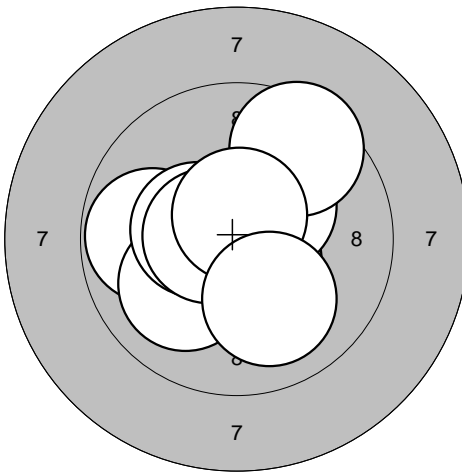
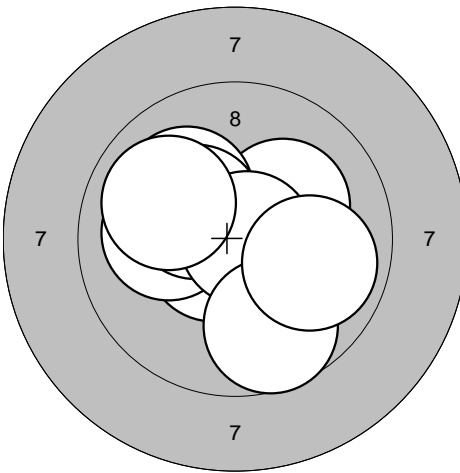
| | | | | | | | | | | | |
|---|---|-------|------|-----|-------|---|---|-------|------|-----|-------|
| <p>Series 3</p>  | <p>1: 10,6* ↘ 2: 10,8* ↑ 3: 9,8 ← 4: 10,0 ↙ 5: 10,4* ← 6: 10,6* ← 7: 10,3* ↗ 8: 9,5 ↗ 9: 10,6* ↑ 10: 10,0 ↘</p> <table border="1" style="width:100%; border-collapse: collapse;"> <tr><td>Serie</td><td style="text-align: right;">98,0</td></tr> <tr><td>Sum</td><td style="text-align: right;">291,0</td></tr> </table> | Serie | 98,0 | Sum | 291,0 | <p>Series 4</p>  | <p>1: 10,7* ↙ 2: 10,2* ↗ 3: 10,6* ↙ 4: 10,1 ↗ 5: 10,1 ← 6: 10,3* ↗ 7: 10,8* → 8: 9,7 ↓ 9: 9,9 → 10: 9,9 ↙</p> <table border="1" style="width:100%; border-collapse: collapse;"> <tr><td>Serie</td><td style="text-align: right;">97,0</td></tr> <tr><td>Sum</td><td style="text-align: right;">388,0</td></tr> </table> | Serie | 97,0 | Sum | 388,0 |
| Serie | 98,0 | | | | | | | | | | |
| Sum | 291,0 | | | | | | | | | | |
| Serie | 97,0 | | | | | | | | | | |
| Sum | 388,0 | | | | | | | | | | |

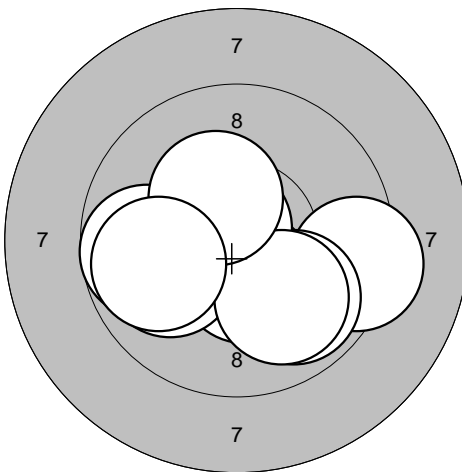
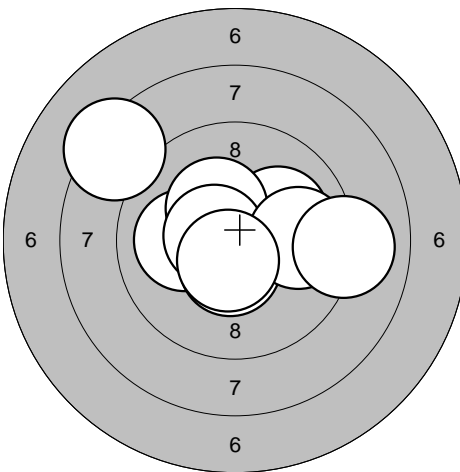
| | | | | | | | | | | | |
|--|---|-------|------|-----|-------|--|--|-------|------|-----|-------|
| <p>Series 5</p>  | <p>1: 10,5* ↓ 2: 9,3 → 3: 10,7* ← 4: 10,0 ↙ 5: 9,9 ↘ 6: 10,7* ↗ 7: 10,0 ↘ 8: 9,7 ← 9: 10,3* ↗ 10: 9,9 ←</p> <table border="1" style="width:100%; border-collapse: collapse;"> <tr><td>Serie</td><td style="text-align: right;">96,0</td></tr> <tr><td>Sum</td><td style="text-align: right;">484,0</td></tr> </table> | Serie | 96,0 | Sum | 484,0 | <p>Series 6</p>  | <p>1: 8,3 ↗ 2: 10,0 → 3: 10,1 ← 4: 10,1 ↗ 5: 10,3* ↗ 6: 10,6* ← 7: 10,5* ↓ 8: 9,8 → 9: 10,6* ↓ 10: 9,0 →</p> <table border="1" style="width:100%; border-collapse: collapse;"> <tr><td>Serie</td><td style="text-align: right;">96,0</td></tr> <tr><td>Sum</td><td style="text-align: right;">580,0</td></tr> </table> | Serie | 96,0 | Sum | 580,0 |
| Serie | 96,0 | | | | | | | | | | |
| Sum | 484,0 | | | | | | | | | | |
| Serie | 96,0 | | | | | | | | | | |
| Sum | 580,0 | | | | | | | | | | |

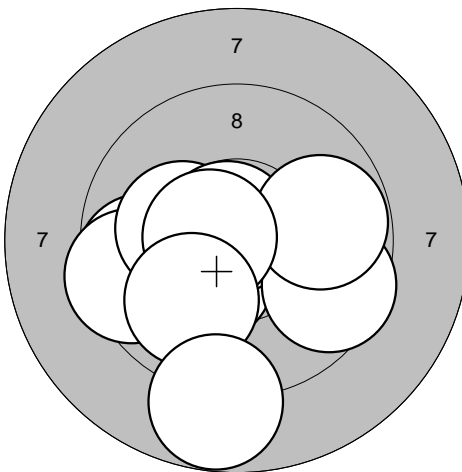
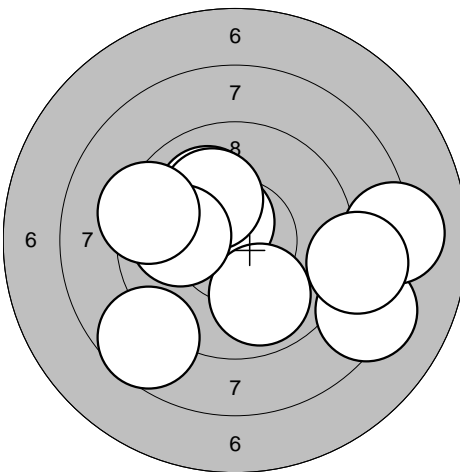
| | | | |
|--|--|--|---|
| <p>Series 1</p>  | <p>1: 9,7 ←</p> <p>2: 10,3* ↘</p> <p>3: 9,5 ←</p> <p>4: 10,2* ←</p> <p>5: 10,7* ↗</p> <p>6: 9,6 →</p> <p>7: 9,8 →</p> <p>8: 10,6* ←</p> <p>9: 9,9 ↘</p> <p>10: 8,8 ↓</p> | <p>Series 2</p>  | <p>1: 8,3 ↘</p> <p>2: 10,6* ↗</p> <p>3: 10,1 ↗</p> <p>4: 8,1 →</p> <p>5: 9,9 ↘</p> <p>6: 10,1 ↗</p> <p>7: 8,7 ↘</p> <p>8: 8,8 →</p> <p>9: 10,0 ←</p> <p>10: 9,3 ←</p> |
| Serie 93,0 | Serie 90,0 | Serie 90,0 | Serie 90,0 |
| Sum 93,0 | Sum 93,0 | Sum 183,0 | Sum 183,0 |

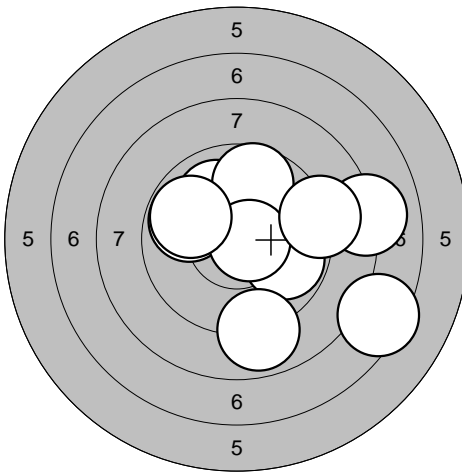
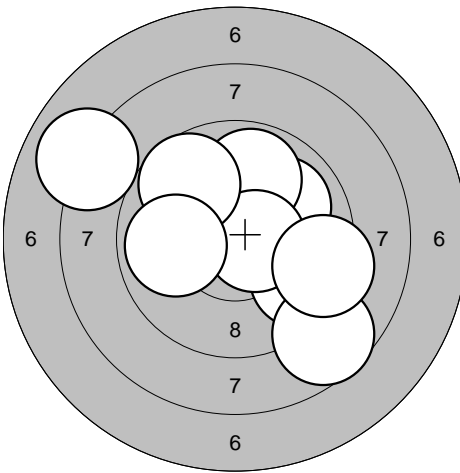
| | | | |
|---|---|---|---|
| <p>Series 3</p>  | <p>1: 8,1 →</p> <p>2: 9,8 →</p> <p>3: 10,0 ↗</p> <p>4: 9,9 ←</p> <p>5: 9,7 ↗</p> <p>6: 8,9 ↘</p> <p>7: 7,4 ↘</p> <p>8: 10,7* →</p> <p>9: 9,9 ↗</p> <p>10: 9,0 →</p> | <p>Series 4</p>  | <p>1: 10,5* →</p> <p>2: 9,6 ↘</p> <p>3: 10,0 ↗</p> <p>4: 9,9 ↗</p> <p>5: 10,6* →</p> <p>6: 9,7 ↗</p> <p>7: 8,6 ↘</p> <p>8: 8,0 ↗</p> <p>9: 9,3 →</p> <p>10: 9,9 ←</p> |
| Serie 88,0 | Serie 88,0 | Serie 91,0 | Serie 91,0 |
| Sum 271,0 | Sum 271,0 | Sum 362,0 | Sum 362,0 |

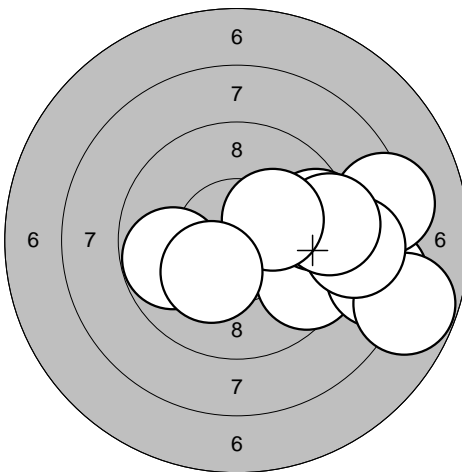
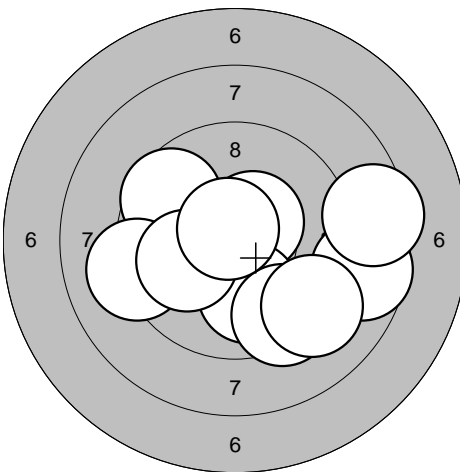
| | | | |
|--|--|--|--|
| <p>Series 5</p>  | <p>1: 9,5 ↘</p> <p>2: 8,4 →</p> <p>3: 7,8 →</p> <p>4: 9,8 ←</p> <p>5: 8,3 →</p> <p>6: 9,5 →</p> <p>7: 8,9 →</p> <p>8: 9,3 →</p> <p>9: 10,2* ↗</p> <p>10: 10,2* ↘</p> | <p>Series 6</p>  | <p>1: 8,6 →</p> <p>2: 9,6 ↗</p> <p>3: 8,5 →</p> <p>4: 10,5* ↗</p> <p>5: 10,0 ↘</p> <p>6: 9,1 ←</p> <p>7: 10,0 ←</p> <p>8: 9,4 ↘</p> <p>9: 10,7* ↗</p> <p>10: 9,2 ↘</p> |
| Serie 87,0 | Serie 87,0 | Serie 92,0 | Serie 92,0 |
| Sum 449,0 | Sum 449,0 | Sum 541,0 | Sum 541,0 |

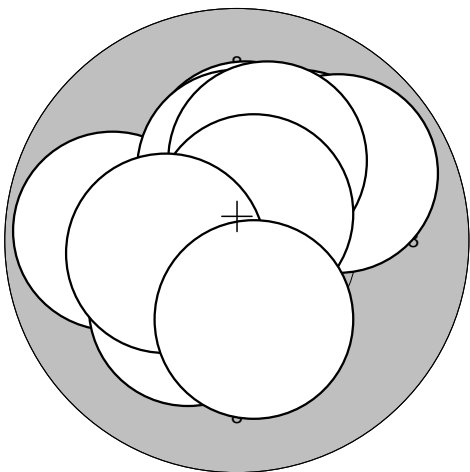
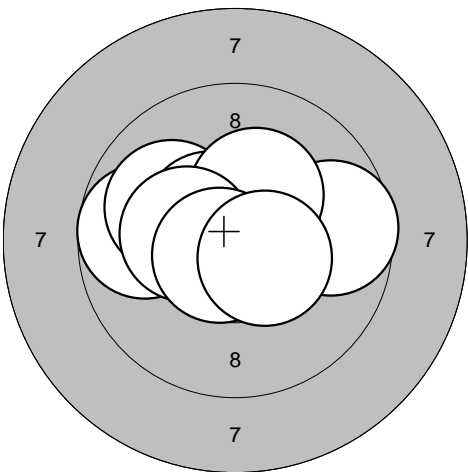
| | | | |
|--|---|--|--|
| <p>Series 1</p>  | <p>1: 10,1 ↗ 2: 9,8 ← 3: 9,8 ↗ 4: 10,2* ↑ 5: 10,2* ↘ 6: 10,3* ↑ 7: 10,2* ↗ 8: 10,7* ↗ 9: 10,3* ← 10: 10,2* ↓</p> <p>Serie 98,0 Sum 98,0</p> | <p>Series 2</p>  | <p>1: 9,7 ← 2: 10,5* ← 3: 10,0 ↖ 4: 10,8* ↓ 5: 10,5* ↗ 6: 9,6 → 7: 10,3* ↗ 8: 10,3* ← 9: 10,7* ↘ 10: 10,5* ↘</p> <p>Serie 98,0 Sum 196,0</p> |
|--|---|--|--|

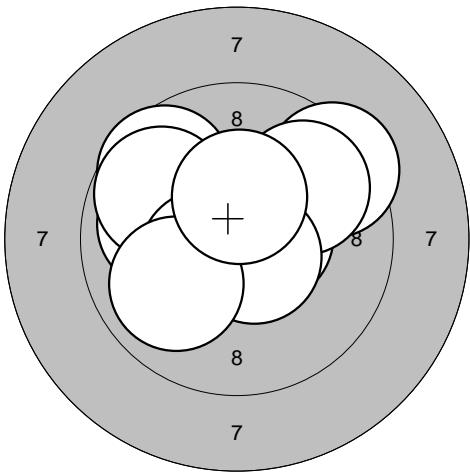
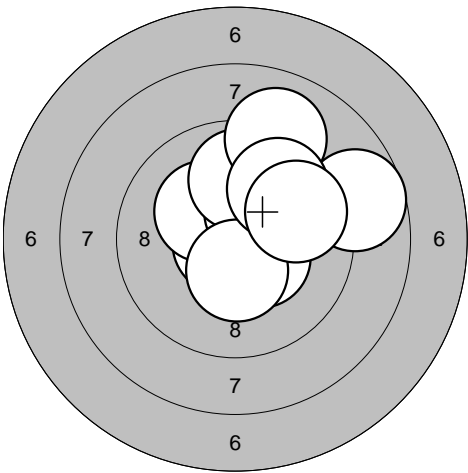
| | | | |
|---|--|---|---|
| <p>Series 3</p>  | <p>1: 10,5* → 2: 9,4 ↗ 3: 10,0 ← 4: 9,7 ↗ 5: 9,8 ↖ 6: 10,5* ← 7: 9,8 ↗ 8: 10,6* ↘ 9: 9,9 ← 10: 10,4* ↑</p> <p>Serie 95,0 Sum 291,0</p> | <p>Series 4</p>  | <p>1: 10,7* ← 2: 10,3* ↖ 3: 10,4* ↗ 4: 10,4* ↘ 5: 9,9 ↑ 6: 9,1 ↗ 7: 10,4* ↓ 8: 8,7 → 9: 9,8 ↗ 10: 9,8 →</p> <p>Serie 94,0 Sum 385,0</p> |
|---|--|---|---|

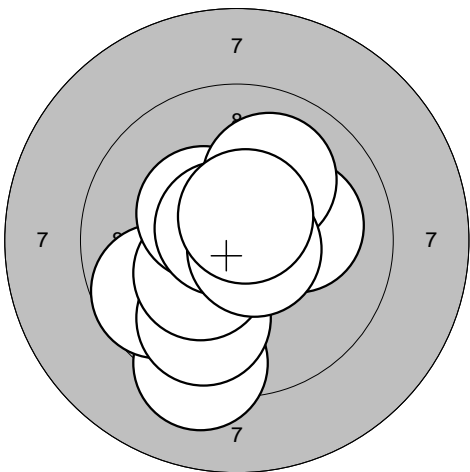
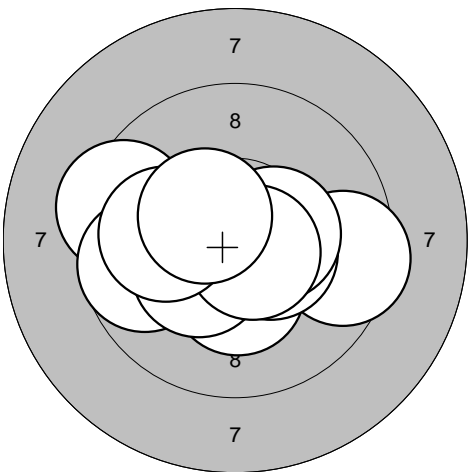
| | | | |
|--|---|--|--|
| <p>Series 5</p>  | <p>1: 9,3 ↓ 2: 9,7 ← 3: 9,8 ↓ 4: 10,1 → 5: 10,3* ← 6: 10,4* ↗ 7: 10,1 ↗ 8: 10,7* ↗ 9: 10,7* → 10: 10,6* ↑</p> <p>Serie 97,0 Sum 482,0</p> | <p>Series 6</p>  | <p>1: 9,4 ← 2: 9,7 ← 3: 10,3* ↓ 4: 9,5 → 5: 10,5* → 6: 10,3* ← 7: 10,4* → 8: 10,7* ↘ 9: 10,0 ← 10: 10,4* ↖</p> <p>Serie 97,0 Sum 579,0</p> |
|--|---|--|--|

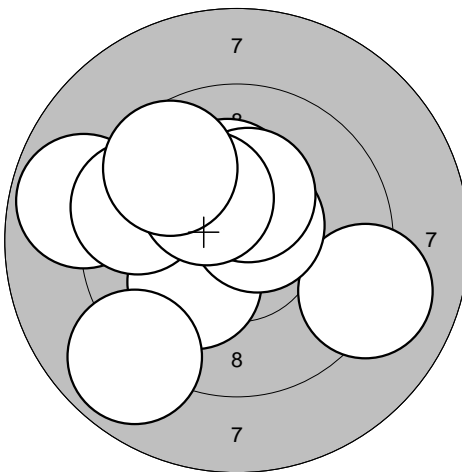
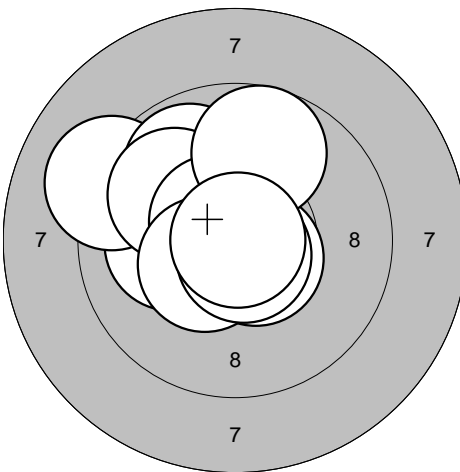
| | | | | | | | | | | | |
|--|---|-------|------|-----|------|--|---|-------|------|-----|-------|
| <p>Series 1</p>  | <p>1: 8,9 ←</p> <p>2: 10,2* ↙</p> <p>3: 9,1 →</p> <p>4: 10,2* ↑</p> <p>5: 10,6* ↗</p> <p>6: 10,3* ↑</p> <p>7: 9,6 ←</p> <p>8: 10,3* ↑</p> <p>9: 9,6 ↗</p> <p>10: 8,9 ↙</p> <table border="1" style="width:100%; border-collapse: collapse;"> <tr><td>Serie</td><td style="text-align: right;">93,0</td></tr> <tr><td>Sum</td><td style="text-align: right;">93,0</td></tr> </table> | Serie | 93,0 | Sum | 93,0 | <p>Series 2</p>  | <p>1: 10,1 ←</p> <p>2: 9,1 ↙</p> <p>3: 9,8 ↗</p> <p>4: 9,9 ↗</p> <p>5: 10,6* ↘</p> <p>6: 10,6* ↗</p> <p>7: 10,4* ↙</p> <p>8: 10,7* ↘</p> <p>9: 9,7 ↑</p> <p>10: 10,9* →</p> <table border="1" style="width:100%; border-collapse: collapse;"> <tr><td>Serie</td><td style="text-align: right;">96,0</td></tr> <tr><td>Sum</td><td style="text-align: right;">189,0</td></tr> </table> | Serie | 96,0 | Sum | 189,0 |
| Serie | 93,0 | | | | | | | | | | |
| Sum | 93,0 | | | | | | | | | | |
| Serie | 96,0 | | | | | | | | | | |
| Sum | 189,0 | | | | | | | | | | |

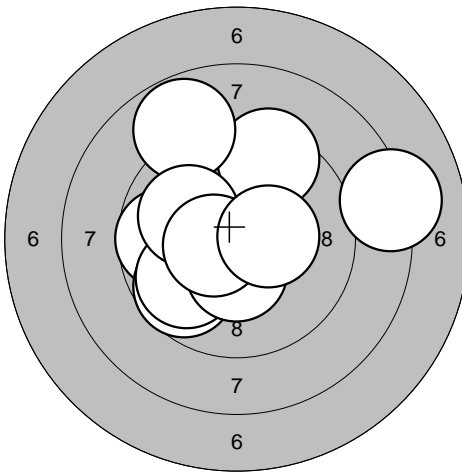
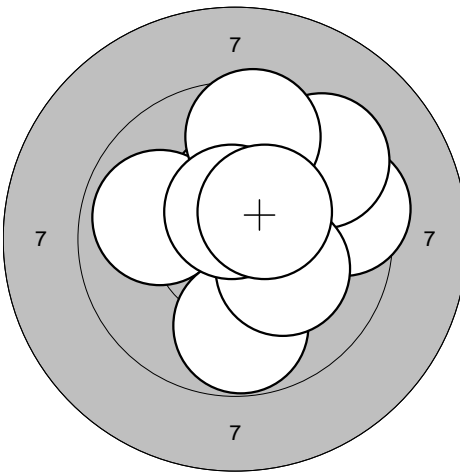
| | | | | | | | | | | | |
|---|---|-------|------|-----|-------|---|--|-------|------|-----|-------|
| <p>Series 3</p>  | <p>1: 9,5 ↑</p> <p>2: 9,7 ←</p> <p>3: 9,7 ↙</p> <p>4: 9,8 ↙</p> <p>5: 8,8 ↑</p> <p>6: 8,1 →</p> <p>7: 10,4* ↓</p> <p>8: 10,0 ↙</p> <p>9: 10,5* ←</p> <p>10: 10,4* →</p> <table border="1" style="width:100%; border-collapse: collapse;"> <tr><td>Serie</td><td style="text-align: right;">92,0</td></tr> <tr><td>Sum</td><td style="text-align: right;">281,0</td></tr> </table> | Serie | 92,0 | Sum | 281,0 | <p>Series 4</p>  | <p>1: 10,4* ↑</p> <p>2: 9,9 ←</p> <p>3: 9,4 →</p> <p>4: 10,4* ↗</p> <p>5: 9,4 ↗</p> <p>6: 9,8 ↓</p> <p>7: 9,6 ↑</p> <p>8: 10,2* ↘</p> <p>9: 10,6* ↑</p> <p>10: 10,4* ↗</p> <table border="1" style="width:100%; border-collapse: collapse;"> <tr><td>Serie</td><td style="text-align: right;">95,0</td></tr> <tr><td>Sum</td><td style="text-align: right;">376,0</td></tr> </table> | Serie | 95,0 | Sum | 376,0 |
| Serie | 92,0 | | | | | | | | | | |
| Sum | 281,0 | | | | | | | | | | |
| Serie | 95,0 | | | | | | | | | | |
| Sum | 376,0 | | | | | | | | | | |

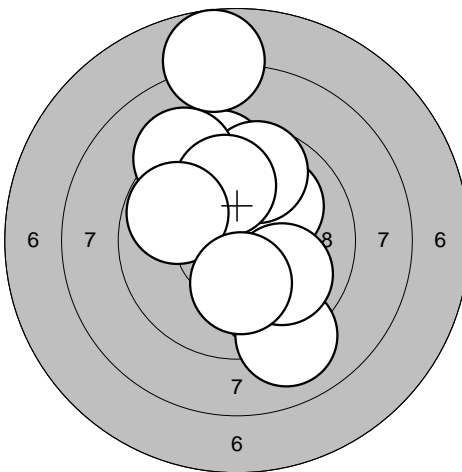
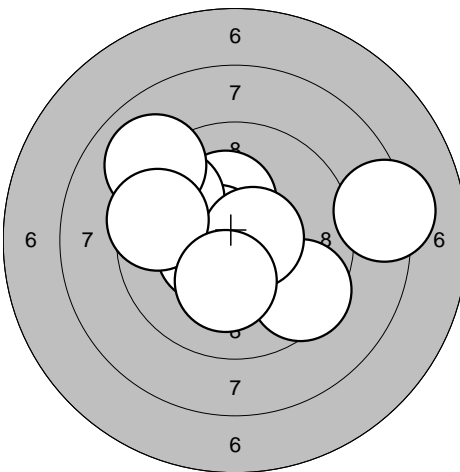
| | | | | | | | | | | | |
|--|--|-------|------|-----|-------|--|--|-------|------|-----|-------|
| <p>Series 5</p>  | <p>1: 9,5 ↑</p> <p>2: 10,1 ↗</p> <p>3: 7,8 ↑</p> <p>4: 9,7 ↑</p> <p>5: 9,0 ↘</p> <p>6: 9,3 ↗</p> <p>7: 10,0 ↑</p> <p>8: 9,9 ↘</p> <p>9: 9,8 ↗</p> <p>10: 10,2* ↓</p> <table border="1" style="width:100%; border-collapse: collapse;"> <tr><td>Serie</td><td style="text-align: right;">91,0</td></tr> <tr><td>Sum</td><td style="text-align: right;">467,0</td></tr> </table> | Serie | 91,0 | Sum | 467,0 | <p>Series 6</p>  | <p>1: 10,4* ↙</p> <p>2: 10,3* ↑</p> <p>3: 9,5 ↘</p> <p>4: 10,6* ←</p> <p>5: 8,3 →</p> <p>6: 9,7 ↗</p> <p>7: 9,0 ↗</p> <p>8: 10,6* →</p> <p>9: 9,5 ←</p> <p>10: 10,2* ↓</p> <table border="1" style="width:100%; border-collapse: collapse;"> <tr><td>Serie</td><td style="text-align: right;">94,0</td></tr> <tr><td>Sum</td><td style="text-align: right;">561,0</td></tr> </table> | Serie | 94,0 | Sum | 561,0 |
| Serie | 91,0 | | | | | | | | | | |
| Sum | 467,0 | | | | | | | | | | |
| Serie | 94,0 | | | | | | | | | | |
| Sum | 561,0 | | | | | | | | | | |

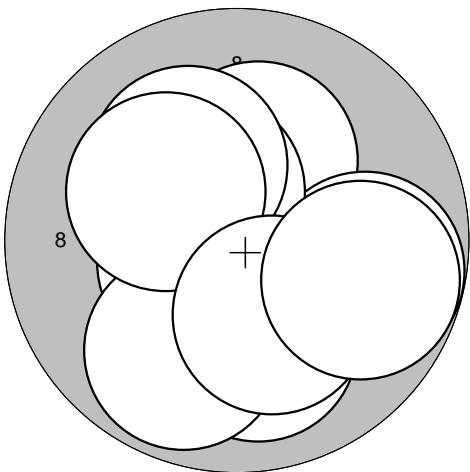
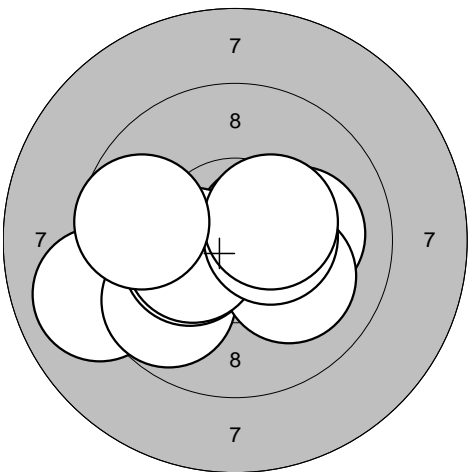
| | | | |
|--|--|--|--|
| <p>Series 1</p>  | <p>1: 10,2* ↗</p> <p>2: 10,0 ↘</p> <p>3: 9,7 →</p> <p>4: 10,5* ↙</p> <p>5: 10,4* ↗</p> <p>6: 9,9 ↘</p> <p>7: 10,1 ↗</p> <p>8: 10,2* ↗</p> <p>9: 10,2* ↘</p> <p>10: 9,8 →</p> | <p>Series 2</p>  | <p>1: 10,6* →</p> <p>2: 9,0 ←</p> <p>3: 9,8 ↙</p> <p>4: 10,1 →</p> <p>5: 10,3* ←</p> <p>6: 10,1 ↘</p> <p>7: 10,3* ←</p> <p>8: 10,5* →</p> <p>9: 10,4* ↗</p> <p>10: 9,7 ←</p> |
| Serie 97,0 | Serie 97,0 | Serie 97,0 | Serie 97,0 |
| Sum 97,0 | Sum 97,0 | Sum 194,0 | Sum 194,0 |

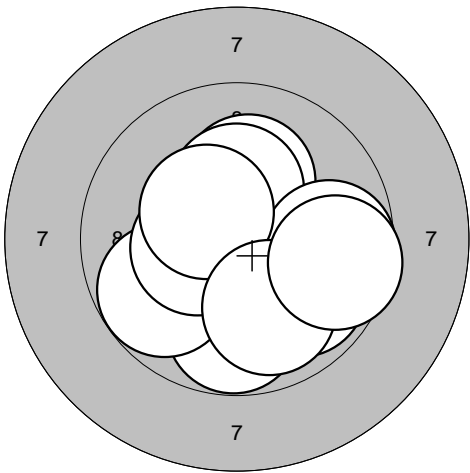
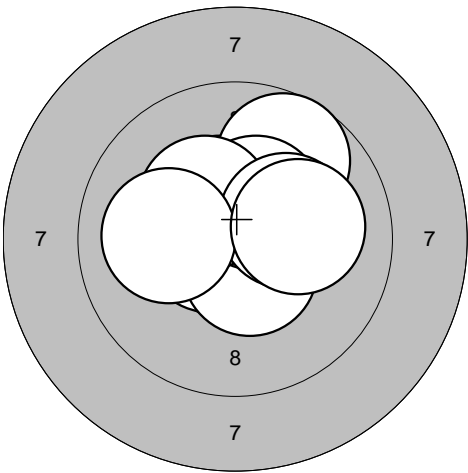
| | | | |
|---|--|---|--|
| <p>Series 3</p>  | <p>1: 9,8 ↘</p> <p>2: 9,9 ↘</p> <p>3: 9,8 ↙</p> <p>4: 10,4* ←</p> <p>5: 10,2* ↗</p> <p>6: 10,3* ↗</p> <p>7: 9,7 →</p> <p>8: 10,4* ↗</p> <p>9: 9,9 ↘</p> <p>10: 9,6 →</p> | <p>Series 4</p>  | <p>1: 10,4* ←</p> <p>2: 10,4* ↗</p> <p>3: 9,7 ↗</p> <p>4: 10,6* ←</p> <p>5: 10,5* ↘</p> <p>6: 10,4* ↗</p> <p>7: 10,3* ↗</p> <p>8: 10,2* →</p> <p>9: 10,1 ←</p> <p>10: 10,1 →</p> |
| Serie 94,0 | Serie 99,0 | Serie 99,0 | Serie 99,0 |
| Sum 288,0 | Sum 387,0 | Sum 387,0 | Sum 387,0 |

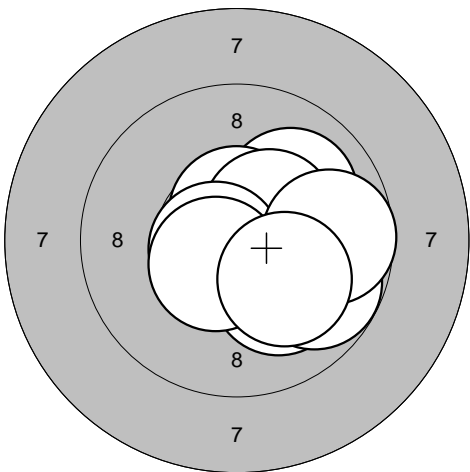
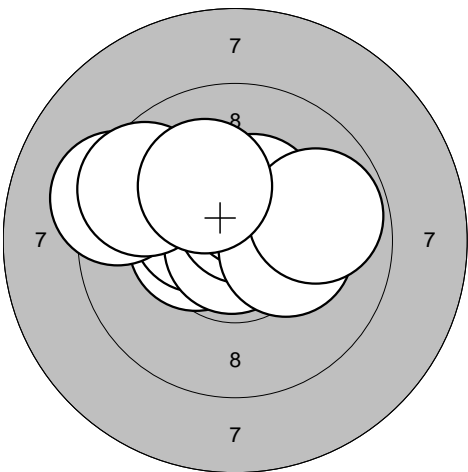
| | | | |
|--|---|--|---|
| <p>Series 5</p>  | <p>1: 10,1 ↘</p> <p>2: 10,7* ↘</p> <p>3: 10,0 ↗</p> <p>4: 10,6* ↗</p> <p>5: 10,4* ↗</p> <p>6: 9,8 →</p> <p>7: 10,7* ←</p> <p>8: 9,7 →</p> <p>9: 10,5* ↙</p> <p>10: 10,1 ↘</p> | <p>Series 6</p>  | <p>1: 10,4* ←</p> <p>2: 10,4* ←</p> <p>3: 10,9* ↘</p> <p>4: 10,6* ↗</p> <p>5: 10,4* ↗</p> <p>6: 10,3* →</p> <p>7: 9,8 →</p> <p>8: 9,3 ←</p> <p>9: 9,6 ↙</p> <p>10: 10,1 ↗</p> |
| Serie 98,0 | Serie 97,0 | Serie 97,0 | Serie 97,0 |
| Sum 485,0 | Sum 582,0 | Sum 582,0 | Sum 582,0 |

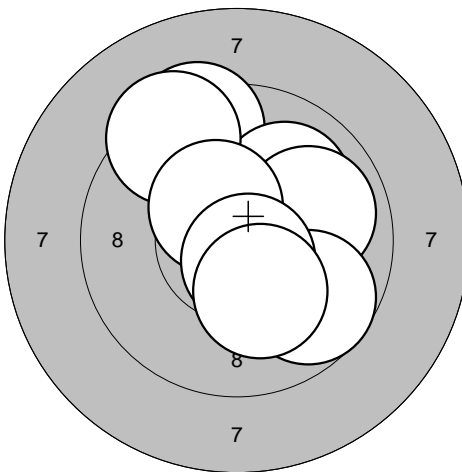
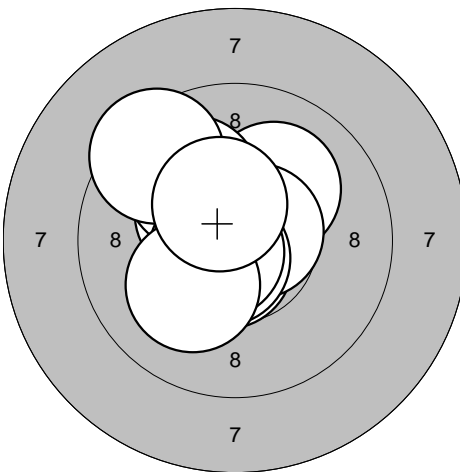
| | | | |
|--|---|--|--|
| <p>Series 1</p>  | <p>1: 9,4 ↗ 2: 10,5* ↑ 3: 10,0 ↗ 4: 10,7* ↗ 5: 9,4 ↑ 6: 9,9 → 7: 9,7 ↘ 8: 10,4* ↑ 9: 10,6* ↘ 10: 10,2* ↘</p> <p>Serie 96,0 Sum 96,0</p> | <p>Series 2</p>  | <p>1: 10,4* ↖ 2: 10,1 ↗ 3: 10,0 ↗ 4: 9,4 ↖ 5: 10,6* ↘ 6: 10,6* → 7: 10,7* ↘ 8: 10,7* ↖ 9: 10,1 ↘ 10: 10,4* ↗</p> <p>Serie 99,0 Sum 195,0</p> |
|--|---|--|--|

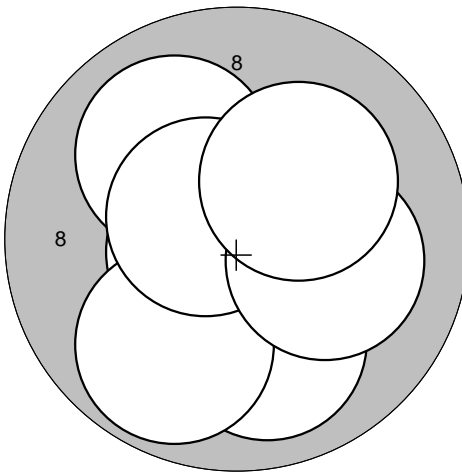
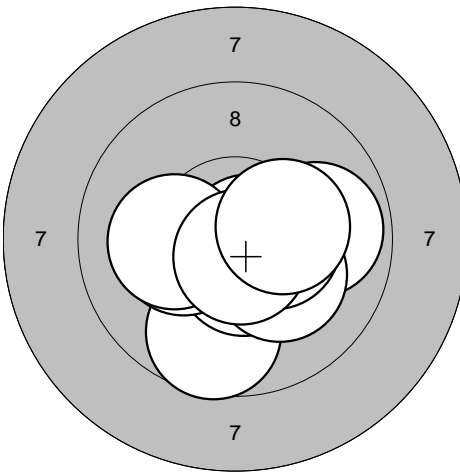
| | | | |
|---|--|---|--|
| <p>Series 3</p>  | <p>1: 10,3* ↘ 2: 10,6* ↖ 3: 10,7* ↘ 4: 10,0 ↘ 5: 10,0 ↗ 6: 10,8* ↗ 7: 9,8 ↘ 8: 10,6* ↗ 9: 10,1 → 10: 10,2* ↗</p> <p>Serie 99,0 Sum 294,0</p> | <p>Series 4</p>  | <p>1: 9,7 ↘ 2: 9,9 → 3: 10,5* ↘ 4: 10,2* ↘ 5: 10,3* ↖ 6: 10,4* → 7: 10,7* → 8: 10,1 ↖ 9: 10,7* ↘ 10: 10,3* →</p> <p>Serie 98,0 Sum 392,0</p> |
|---|--|---|--|

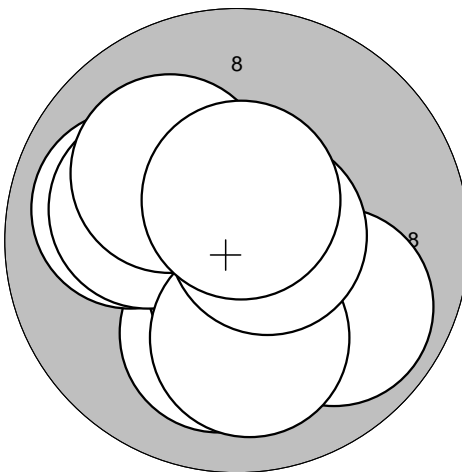
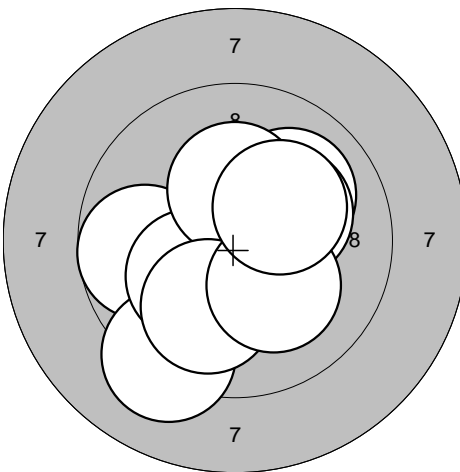
| | | | |
|--|--|--|---|
| <p>Series 5</p>  | <p>1: 10,1 ↘ 2: 10,6* ↘ 3: 9,9 ↘ 4: 10,0 ↖ 5: 10,7* ↘ 6: 10,1 ↖ 7: 10,1 ↘ 8: 10,7* → 9: 10,1 ↗ 10: 10,6* ↑</p> <p>Serie 99,0 Sum 491,0</p> | <p>Series 6</p>  | <p>1: 10,7* ↗ 2: 9,7 ↖ 3: 9,2 ↘ 4: 10,2* ↖ 5: 10,0 ↗ 6: 10,2* → 7: 10,3* ↑ 8: 10,0 ↘ 9: 10,2* ↘ 10: 10,2* ↗</p> <p>Serie 98,0 Sum 589,0</p> |
|--|--|--|---|

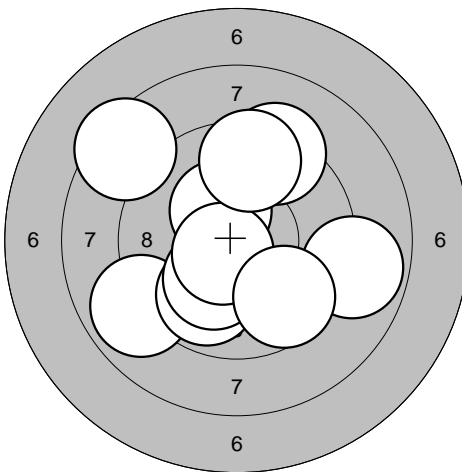
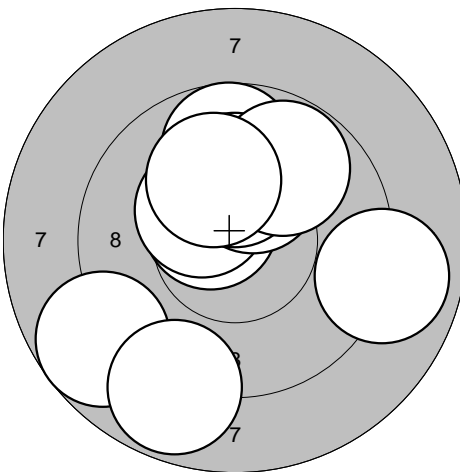
| | | | | | | | | | | | |
|--|--|-------|------|-----|------|--|---|-------|------|-----|-------|
| <p>Series 1</p>  | <p>1: 8,9 ↙ 2: 9,9 ↓ 3: 10,4* ↗ 4: 8,9 → 5: 10,2* ↓ 6: 9,3 ↗ 7: 10,6* ↙ 8: 9,7 ↓ 9: 8,4 ↗ 10: 9,5 ↑</p> <table border="1" style="width:100%; border-collapse: collapse;"> <tr><td>Serie</td><td style="text-align: right;">90,0</td></tr> <tr><td>Sum</td><td style="text-align: right;">90,0</td></tr> </table> | Serie | 90,0 | Sum | 90,0 | <p>Series 2</p>  | <p>1: 9,7 ↑ 2: 10,5* ↖ 3: 8,8 ↙ 4: 10,4* ↖ 5: 10,2* ↑ 6: 8,8 ↓ 7: 10,1 ↑ 8: 9,8 ↗ 9: 10,1 ↑ 10: 8,9 →</p> <table border="1" style="width:100%; border-collapse: collapse;"> <tr><td>Serie</td><td style="text-align: right;">92,0</td></tr> <tr><td>Sum</td><td style="text-align: right;">182,0</td></tr> </table> | Serie | 92,0 | Sum | 182,0 |
| Serie | 90,0 | | | | | | | | | | |
| Sum | 90,0 | | | | | | | | | | |
| Serie | 92,0 | | | | | | | | | | |
| Sum | 182,0 | | | | | | | | | | |

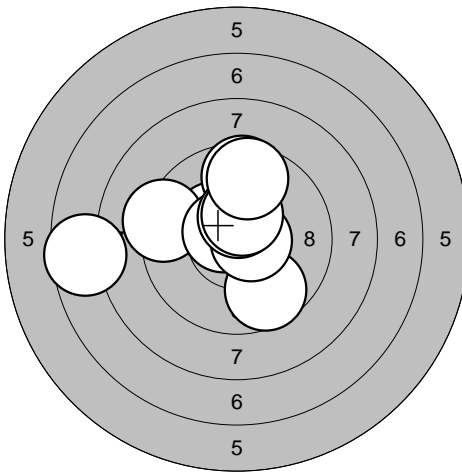
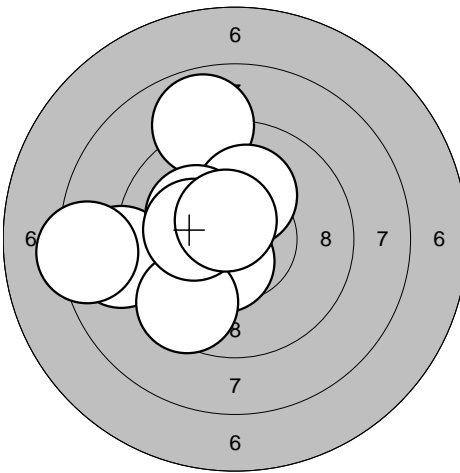
| | | | | | | | | | | | |
|---|---|-------|------|-----|-------|---|--|-------|------|-----|-------|
| <p>Series 3</p>  | <p>1: 9,7 ↓ 2: 10,4* ↗ 3: 9,3 ← 4: 7,6 ← 5: 9,6 ↑ 6: 10,6* ↗ 7: 10,6* → 8: 10,5* ↑ 9: 10,4* ↑ 10: 9,6 ↑</p> <table border="1" style="width:100%; border-collapse: collapse;"> <tr><td>Serie</td><td style="text-align: right;">93,0</td></tr> <tr><td>Sum</td><td style="text-align: right;">275,0</td></tr> </table> | Serie | 93,0 | Sum | 275,0 | <p>Series 4</p>  | <p>1: 10,3* ← 2: 8,9 ← 3: 8,9 ↑ 4: 10,5* ↓ 5: 9,6 ↓ 6: 10,1 ↑ 7: 10,2* ↖ 8: 10,2* ← 9: 10,6* ↗ 10: 8,4 ←</p> <table border="1" style="width:100%; border-collapse: collapse;"> <tr><td>Serie</td><td style="text-align: right;">93,0</td></tr> <tr><td>Sum</td><td style="text-align: right;">368,0</td></tr> </table> | Serie | 93,0 | Sum | 368,0 |
| Serie | 93,0 | | | | | | | | | | |
| Sum | 275,0 | | | | | | | | | | |
| Serie | 93,0 | | | | | | | | | | |
| Sum | 368,0 | | | | | | | | | | |

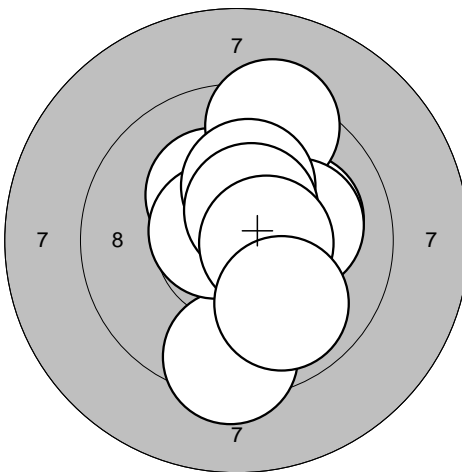
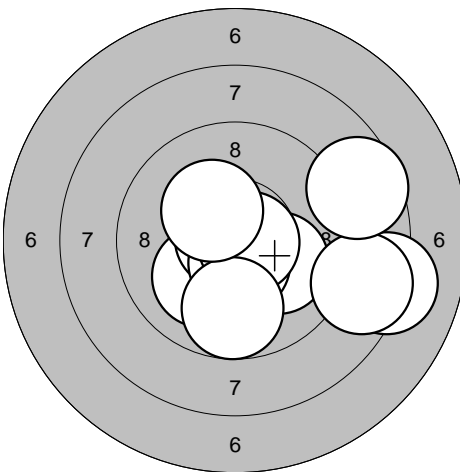
| | | | | | | | | | | | |
|--|---|-------|------|-----|-------|--|---|-------|------|-----|-------|
| <p>Series 5</p>  | <p>1: 9,4 ↓ 2: 10,3* ↗ 3: 10,1 → 4: 10,7* ↖ 5: 9,3 ↑ 6: 10,1 → 7: 10,2* ↑ 8: 10,5* ↗ 9: 10,5* → 10: 9,9 ↓</p> <table border="1" style="width:100%; border-collapse: collapse;"> <tr><td>Serie</td><td style="text-align: right;">97,0</td></tr> <tr><td>Sum</td><td style="text-align: right;">465,0</td></tr> </table> | Serie | 97,0 | Sum | 465,0 | <p>Series 6</p>  | <p>1: 10,1 ↙ 2: 10,1 ↘ 3: 8,2 → 4: 10,8* ← 5: 10,5* ↓ 6: 10,7* → 7: 9,7 ↓ 8: 8,6 → 9: 10,3* ↗ 10: 8,6 →</p> <table border="1" style="width:100%; border-collapse: collapse;"> <tr><td>Serie</td><td style="text-align: right;">93,0</td></tr> <tr><td>Sum</td><td style="text-align: right;">558,0</td></tr> </table> | Serie | 93,0 | Sum | 558,0 |
| Serie | 97,0 | | | | | | | | | | |
| Sum | 465,0 | | | | | | | | | | |
| Serie | 93,0 | | | | | | | | | | |
| Sum | 558,0 | | | | | | | | | | |

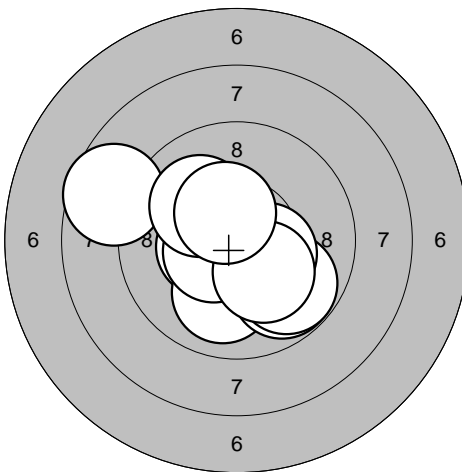
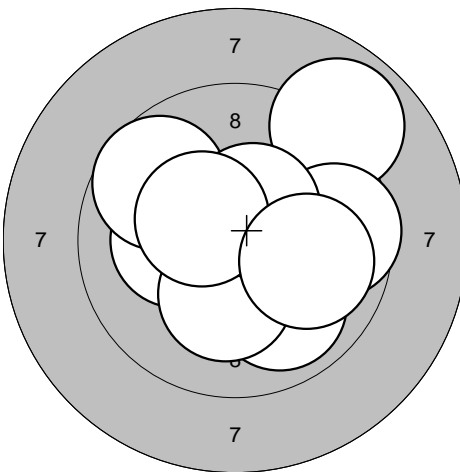
| | | | | | | | | | | | |
|--|---|-------|------|-----|------|--|---|-------|------|-----|-------|
| <p>Series 1</p>  | <p>1: 10,4* ←</p> <p>2: 10,0 ↓</p> <p>3: 9,8 ↓</p> <p>4: 10,5* ←</p> <p>5: 9,8 ↓</p> <p>6: 8,7 ↗</p> <p>7: 10,4* →</p> <p>8: 10,1 ↗</p> <p>9: 10,2* ↓</p> <p>10: 10,4* ↗</p> <table border="1" style="width:100%; border-collapse: collapse;"> <tr><td>Serie</td><td style="text-align: right;">96,0</td></tr> <tr><td>Sum</td><td style="text-align: right;">96,0</td></tr> </table> | Serie | 96,0 | Sum | 96,0 | <p>Series 2</p>  | <p>1: 10,3* ←</p> <p>2: 8,9 ↗</p> <p>3: 10,2* ←</p> <p>4: 9,9 ↓</p> <p>5: 9,7 ↗</p> <p>6: 10,2* ↓</p> <p>7: 9,6 →</p> <p>8: 10,5* ↗</p> <p>9: 10,4* ↗</p> <p>10: 10,0 →</p> <table border="1" style="width:100%; border-collapse: collapse;"> <tr><td>Serie</td><td style="text-align: right;">95,0</td></tr> <tr><td>Sum</td><td style="text-align: right;">191,0</td></tr> </table> | Serie | 95,0 | Sum | 191,0 |
| Serie | 96,0 | | | | | | | | | | |
| Sum | 96,0 | | | | | | | | | | |
| Serie | 95,0 | | | | | | | | | | |
| Sum | 191,0 | | | | | | | | | | |

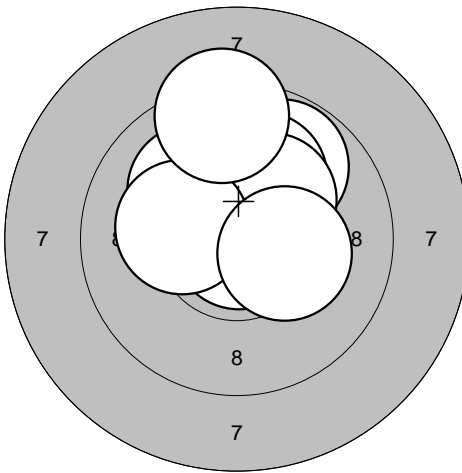
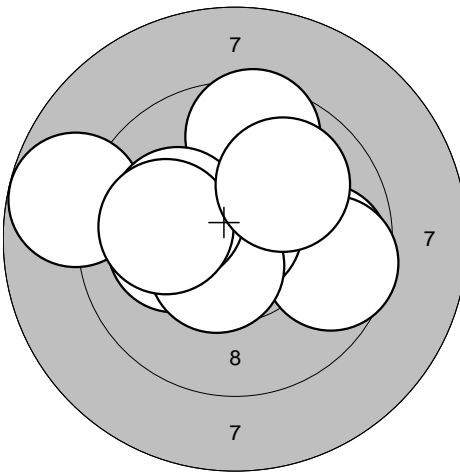
| | | | | | | | | | | | |
|---|--|-------|------|-----|-------|---|--|-------|------|-----|-------|
| <p>Series 3</p>  | <p>1: 10,4* ↗</p> <p>2: 10,6* ↗</p> <p>3: 9,8 ↗</p> <p>4: 10,1 ↗</p> <p>5: 10,9* ↓</p> <p>6: 10,1 ↗</p> <p>7: 10,3* ↗</p> <p>8: 10,2* ←</p> <p>9: 10,3* →</p> <p>10: 9,3 ↑</p> <table border="1" style="width:100%; border-collapse: collapse;"> <tr><td>Serie</td><td style="text-align: right;">98,0</td></tr> <tr><td>Sum</td><td style="text-align: right;">289,0</td></tr> </table> | Serie | 98,0 | Sum | 289,0 | <p>Series 4</p>  | <p>1: 8,8 ←</p> <p>2: 10,1 ←</p> <p>3: 9,8 →</p> <p>4: 9,6 →</p> <p>5: 10,8* ↑</p> <p>6: 10,5* ↓</p> <p>7: 9,6 ↑</p> <p>8: 10,1 ←</p> <p>9: 10,0 ←</p> <p>10: 10,0 ↗</p> <table border="1" style="width:100%; border-collapse: collapse;"> <tr><td>Serie</td><td style="text-align: right;">95,0</td></tr> <tr><td>Sum</td><td style="text-align: right;">384,0</td></tr> </table> | Serie | 95,0 | Sum | 384,0 |
| Serie | 98,0 | | | | | | | | | | |
| Sum | 289,0 | | | | | | | | | | |
| Serie | 95,0 | | | | | | | | | | |
| Sum | 384,0 | | | | | | | | | | |

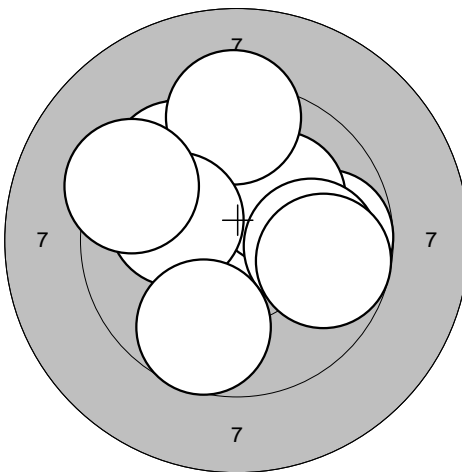
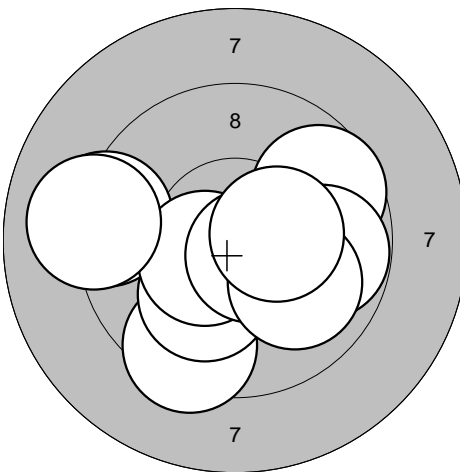
| | | | | | | | | | | | |
|--|--|-------|------|-----|-------|--|--|-------|------|-----|-------|
| <p>Series 5</p>  | <p>1: 9,7 ↗</p> <p>2: 9,8 →</p> <p>3: 10,6* ←</p> <p>4: 10,1 ↗</p> <p>5: 9,3 ↑</p> <p>6: 9,9 →</p> <p>7: 10,1 ↗</p> <p>8: 9,7 ↓</p> <p>9: 9,8 →</p> <p>10: 9,4 ↗</p> <table border="1" style="width:100%; border-collapse: collapse;"> <tr><td>Serie</td><td style="text-align: right;">93,0</td></tr> <tr><td>Sum</td><td style="text-align: right;">477,0</td></tr> </table> | Serie | 93,0 | Sum | 477,0 | <p>Series 6</p>  | <p>1: 9,6 ↗</p> <p>2: 9,2 ←</p> <p>3: 9,5 ↓</p> <p>4: 10,1 ↓</p> <p>5: 10,5* ←</p> <p>6: 10,6* ↓</p> <p>7: 9,8 →</p> <p>8: 9,1 ←</p> <p>9: 10,0 ↓</p> <p>10: 10,4* →</p> <table border="1" style="width:100%; border-collapse: collapse;"> <tr><td>Serie</td><td style="text-align: right;">95,0</td></tr> <tr><td>Sum</td><td style="text-align: right;">572,0</td></tr> </table> | Serie | 95,0 | Sum | 572,0 |
| Serie | 93,0 | | | | | | | | | | |
| Sum | 477,0 | | | | | | | | | | |
| Serie | 95,0 | | | | | | | | | | |
| Sum | 572,0 | | | | | | | | | | |

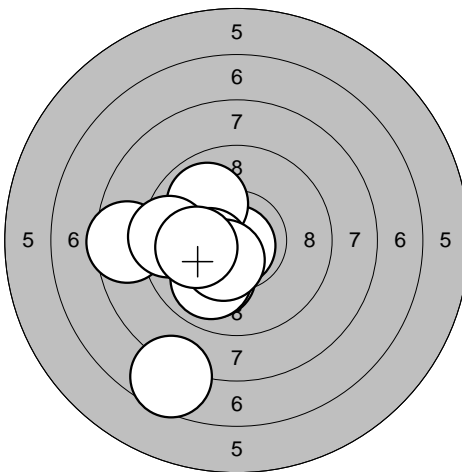
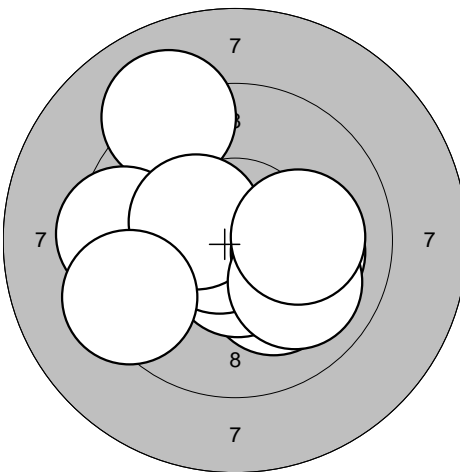
| | | | | | | | | | | | |
|--|---|-------|------|-----|------|--|---|-------|------|-----|-------|
| <p>Series 1</p>  | <p>1: 10,0 ↘ 2: 8,5 ← 3: 10,8* ↘ 4: 10,0 ↘ 5: 9,9 ↗ 6: 10,3* ← 7: 10,4* ↘ 8: 7,6 ↘ 9: 9,5 ← 10: 10,1 ←</p> <table border="1" style="width:100%; border-collapse: collapse;"> <tr><td>Serie</td><td style="text-align: right;">93,0</td></tr> <tr><td>Sum</td><td style="text-align: right;">93,0</td></tr> </table> | Serie | 93,0 | Sum | 93,0 | <p>Series 2</p>  | <p>1: 10,1 ↘ 2: 10,5* ↘ 3: 9,1 ↗ 4: 10,8* ← 5: 9,5 ← 6: 10,4* ↖ 7: 10,1 → 8: 10,0 ↘ 9: 9,4 ← 10: 10,1 →</p> <table border="1" style="width:100%; border-collapse: collapse;"> <tr><td>Serie</td><td style="text-align: right;">97,0</td></tr> <tr><td>Sum</td><td style="text-align: right;">190,0</td></tr> </table> | Serie | 97,0 | Sum | 190,0 |
| Serie | 93,0 | | | | | | | | | | |
| Sum | 93,0 | | | | | | | | | | |
| Serie | 97,0 | | | | | | | | | | |
| Sum | 190,0 | | | | | | | | | | |

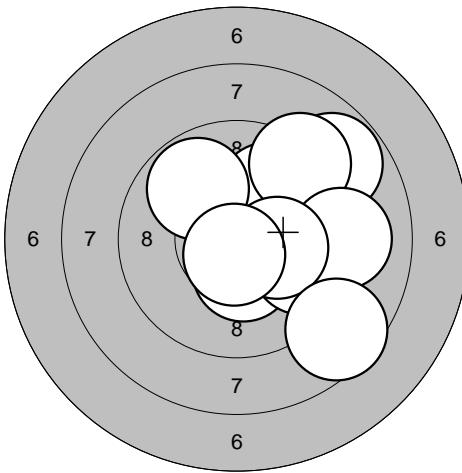
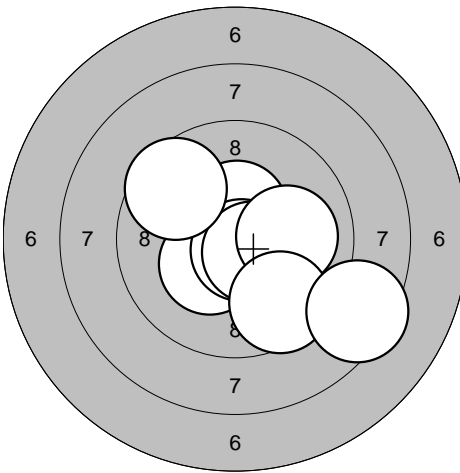
| | | | | | | | | | | | |
|---|--|-------|------|-----|-------|---|--|-------|------|-----|-------|
| <p>Series 3</p>  | <p>1: 10,0 ↗ 2: 10,4* ↘ 3: 9,8 ↗ 4: 9,7 → 5: 8,8 ↗ 6: 9,2 ↗ 7: 9,1 → 8: 10,2* → 9: 10,7* ↘ 10: 8,6 ↘</p> <table border="1" style="width:100%; border-collapse: collapse;"> <tr><td>Serie</td><td style="text-align: right;">92,0</td></tr> <tr><td>Sum</td><td style="text-align: right;">282,0</td></tr> </table> | Serie | 92,0 | Sum | 282,0 | <p>Series 4</p>  | <p>1: 10,5* ↗ 2: 10,3* ↘ 3: 10,2* → 4: 10,5* ↑ 5: 10,7* ↘ 6: 10,6* ↘ 7: 10,0 → 8: 9,6 ↗ 9: 9,6 ↘ 10: 8,5 ↘</p> <table border="1" style="width:100%; border-collapse: collapse;"> <tr><td>Serie</td><td style="text-align: right;">96,0</td></tr> <tr><td>Sum</td><td style="text-align: right;">378,0</td></tr> </table> | Serie | 96,0 | Sum | 378,0 |
| Serie | 92,0 | | | | | | | | | | |
| Sum | 282,0 | | | | | | | | | | |
| Serie | 96,0 | | | | | | | | | | |
| Sum | 378,0 | | | | | | | | | | |

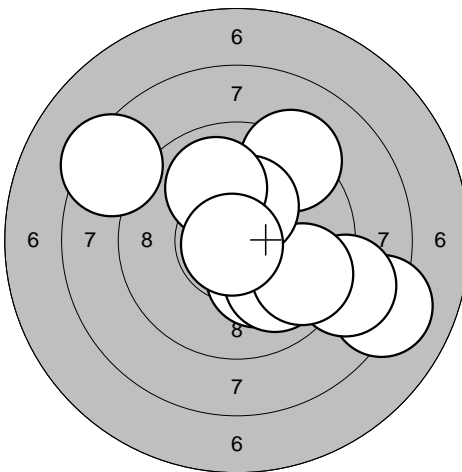
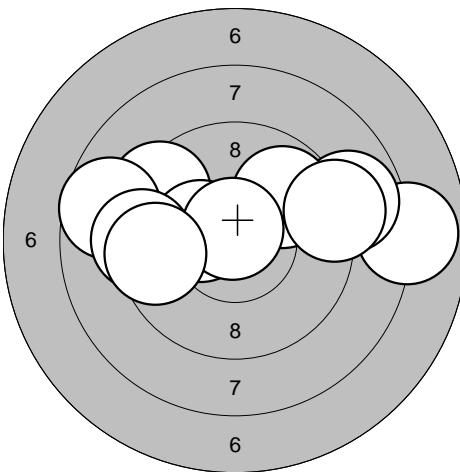
| | | | | | | | | | | | |
|--|--|-------|------|-----|-------|--|---|-------|------|-----|-------|
| <p>Series 5</p>  | <p>1: 10,2* ↘ 2: 8,1 ↘ 3: 9,9 ↘ 4: 8,9 → 5: 9,6 ↘ 6: 9,3 ↗ 7: 10,3* ↗ 8: 10,0 ↗ 9: 8,4 ↗ 10: 10,9* ↘</p> <table border="1" style="width:100%; border-collapse: collapse;"> <tr><td>Serie</td><td style="text-align: right;">91,0</td></tr> <tr><td>Sum</td><td style="text-align: right;">469,0</td></tr> </table> | Serie | 91,0 | Sum | 469,0 | <p>Series 6</p>  | <p>1: 7,9 → 2: 9,4 ↗ 3: 10,3* ← 4: 8,7 ← 5: 9,3 ← 6: 8,8 → 7: 9,8 ↗ 8: 10,7* ↑ 9: 9,5 ← 10: 9,1 →</p> <table border="1" style="width:100%; border-collapse: collapse;"> <tr><td>Serie</td><td style="text-align: right;">88,0</td></tr> <tr><td>Sum</td><td style="text-align: right;">557,0</td></tr> </table> | Serie | 88,0 | Sum | 557,0 |
| Serie | 91,0 | | | | | | | | | | |
| Sum | 469,0 | | | | | | | | | | |
| Serie | 88,0 | | | | | | | | | | |
| Sum | 557,0 | | | | | | | | | | |

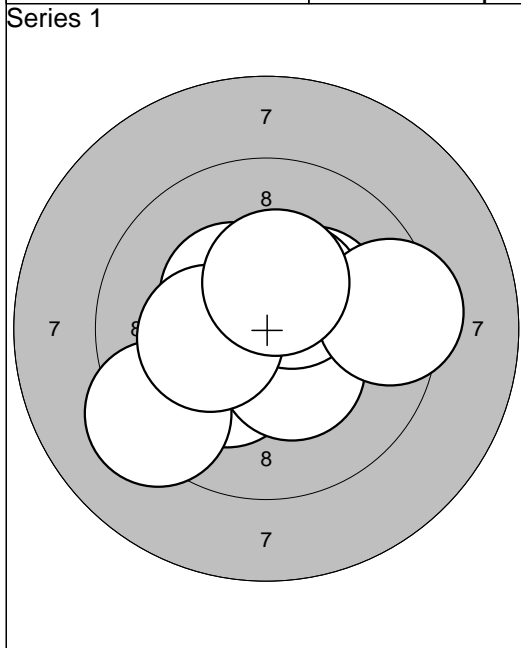

| | |
|-------------------|---|
| 1: 10,3* | ➔ |
| 2: 10,8* | ➔ |
| 3: 10,2* | ↙ |
| 4: 10,4* | ↖ |
| 5: 10,4* | ↘ |
| 6: 10,4* | ↗ |
| 7: 9,2 | ↙ |
| 8: 9,4 | ➔ |
| 9: 10,3* | ↖ |
| 10: 10,4* | ↗ |
| Serie 98,0 | |
| Sum 98,0 | |

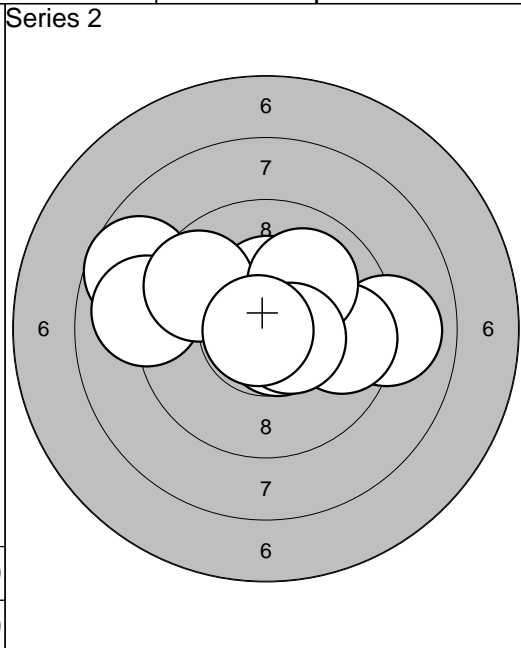

| | |
|-------------------|---|
| 1: 9,0 | ➔ |
| 2: 10,7* | ↘ |
| 3: 10,3* | ↗ |
| 4: 8,7 | ↖ |
| 5: 9,0 | ↖ |
| 6: 9,7 | ➔ |
| 7: 9,6 | ↗ |
| 8: 10,0 | ↗ |
| 9: 10,5* | ➔ |
| 10: 10,8* | ↖ |
| Serie 94,0 | |
| Sum 192,0 | |

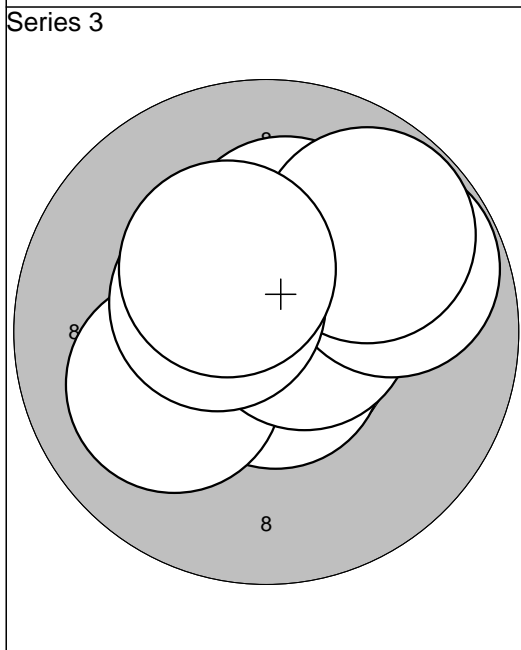

| | |
|-------------------|---|
| 1: 10,5* | ↗ |
| 2: 10,3* | ↗ |
| 3: 10,7* | ↘ |
| 4: 10,2* | ↗ |
| 5: 10,1 | ↖ |
| 6: 10,6* | ➔ |
| 7: 9,8 | ➔ |
| 8: 9,8 | ↗ |
| 9: 10,5* | ↖ |
| 10: 10,4* | ↗ |
| Serie 98,0 | |
| Sum 290,0 | |

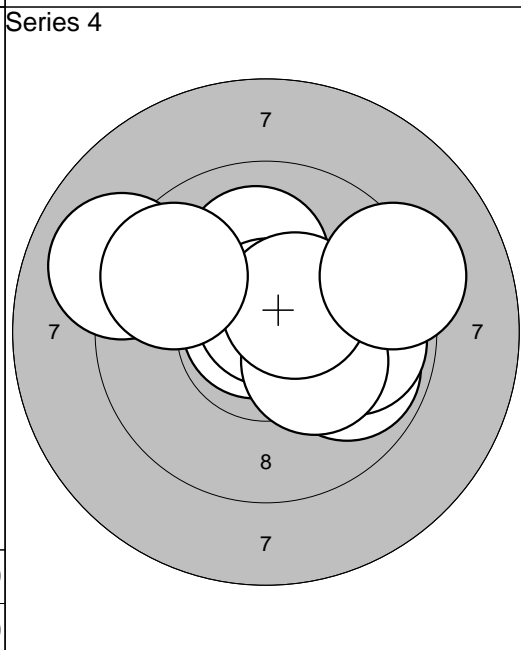

| | |
|-------------------|---|
| 1: 9,9 | ➔ |
| 2: 10,8* | ↖ |
| 3: 10,1 | ↗ |
| 4: 10,7* | ↗ |
| 5: 9,9 | ➔ |
| 6: 10,2* | ↘ |
| 7: 10,5* | ↗ |
| 8: 9,0 | ↖ |
| 9: 9,3 | ➔ |
| 10: 9,7 | ↖ |
| Serie 95,0 | |
| Sum 385,0 | |

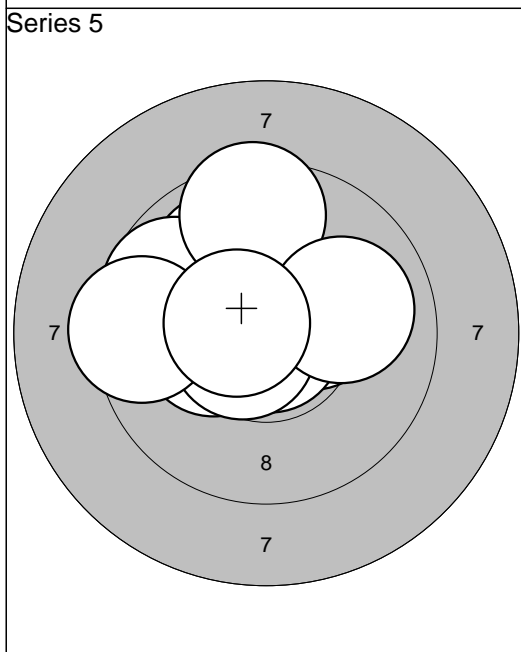

| | |
|-------------------|---|
| 1: 10,3* | ➔ |
| 2: 10,0 | ↗ |
| 3: 10,9* | ↘ |
| 4: 10,3* | ↖ |
| 5: 9,7 | ↖ |
| 6: 10,6* | ↖ |
| 7: 9,5 | ↗ |
| 8: 9,4 | ↖ |
| 9: 10,0 | ➔ |
| 10: 10,6* | ↖ |
| Serie 97,0 | |
| Sum 482,0 | |

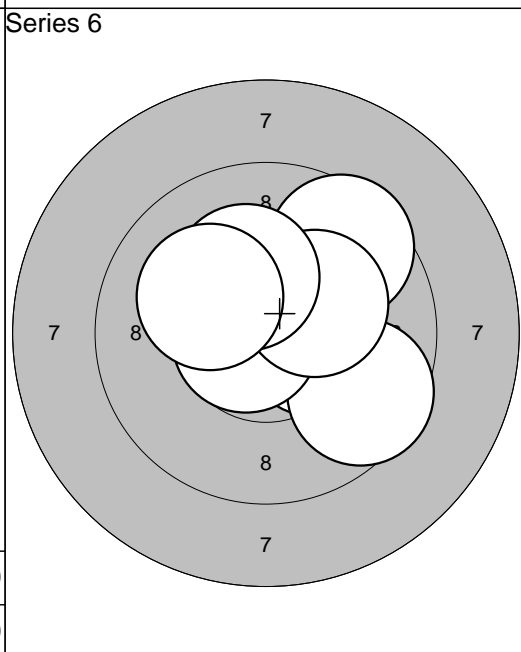

| | |
|-------------------|---|
| 1: 9,6 | ↗ |
| 2: 10,8* | ↗ |
| 3: 10,3* | ↗ |
| 4: 10,3* | ➔ |
| 5: 9,6 | ↘ |
| 6: 10,7* | ↗ |
| 7: 10,7* | ↖ |
| 8: 10,2* | ➔ |
| 9: 10,2* | ↗ |
| 10: 10,2* | ↖ |
| Serie 98,0 | |
| Sum 580,0 | |

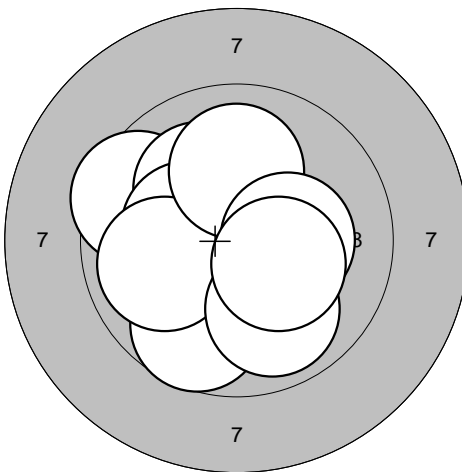
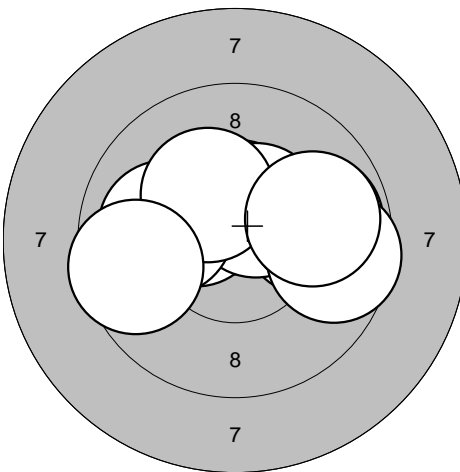
| | | | | | | | | | | | |
|--|--|-------|------|-----|------|--|---|-------|------|-----|-------|
| <p>Series 1</p>  | <p>1: 10,2* ←</p> <p>2: 9,5 ↖</p> <p>3: 10,1 ↗</p> <p>4: 9,7 ↓</p> <p>5: 10,3* ←</p> <p>6: 10,0 ←</p> <p>7: 10,0 ↑</p> <p>8: 10,3* →</p> <p>9: 9,9 ↓</p> <p>10: 10,3* ↘</p> <table border="1" style="width:100%; border-collapse: collapse;"> <tr> <td style="text-align: right;">Serie</td> <td style="text-align: right;">97,0</td> </tr> <tr> <td style="text-align: right;">Sum</td> <td style="text-align: right;">97,0</td> </tr> </table> | Serie | 97,0 | Sum | 97,0 | <p>Series 2</p>  | <p>1: 10,5* ↑</p> <p>2: 10,4* ↖</p> <p>3: 9,9 →</p> <p>4: 10,5* ↗</p> <p>5: 10,0 ←</p> <p>6: 9,9 →</p> <p>7: 10,2* ↗</p> <p>8: 9,6 ←</p> <p>9: 9,6 →</p> <p>10: 9,9 →</p> <table border="1" style="width:100%; border-collapse: collapse;"> <tr> <td style="text-align: right;">Serie</td> <td style="text-align: right;">95,0</td> </tr> <tr> <td style="text-align: right;">Sum</td> <td style="text-align: right;">192,0</td> </tr> </table> | Serie | 95,0 | Sum | 192,0 |
| Serie | 97,0 | | | | | | | | | | |
| Sum | 97,0 | | | | | | | | | | |
| Serie | 95,0 | | | | | | | | | | |
| Sum | 192,0 | | | | | | | | | | |

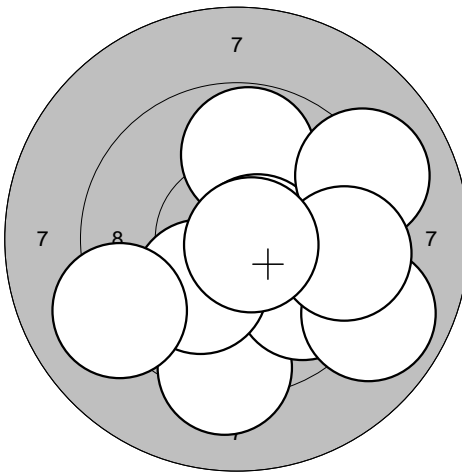
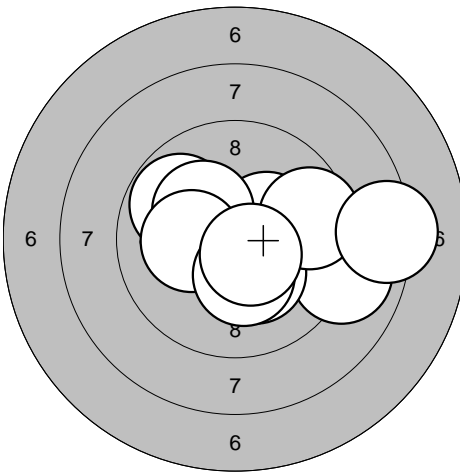
| | | | | | | | | | | | |
|---|---|-------|------|-----|-------|---|--|-------|------|-----|-------|
| <p>Series 3</p>  | <p>1: 9,2 ↓</p> <p>2: 9,8 ↑</p> <p>3: 10,7* →</p> <p>4: 9,8 ↓</p> <p>5: 9,1 ↗</p> <p>6: 8,9 ↘</p> <p>7: 10,1 ↓</p> <p>8: 9,1 ←</p> <p>9: 9,5 →</p> <p>10: 10,7* ↘</p> <table border="1" style="width:100%; border-collapse: collapse;"> <tr> <td style="text-align: right;">Serie</td> <td style="text-align: right;">92,0</td> </tr> <tr> <td style="text-align: right;">Sum</td> <td style="text-align: right;">284,0</td> </tr> </table> | Serie | 92,0 | Sum | 284,0 | <p>Series 4</p>  | <p>1: 9,0 →</p> <p>2: 10,2* ↓</p> <p>3: 9,8 ↗</p> <p>4: 10,3* ↗</p> <p>5: 10,2* ↗</p> <p>6: 10,2* ←</p> <p>7: 9,6 →</p> <p>8: 8,3 →</p> <p>9: 10,3* ↓</p> <p>10: 10,6* ↘</p> <table border="1" style="width:100%; border-collapse: collapse;"> <tr> <td style="text-align: right;">Serie</td> <td style="text-align: right;">95,0</td> </tr> <tr> <td style="text-align: right;">Sum</td> <td style="text-align: right;">379,0</td> </tr> </table> | Serie | 95,0 | Sum | 379,0 |
| Serie | 92,0 | | | | | | | | | | |
| Sum | 284,0 | | | | | | | | | | |
| Serie | 95,0 | | | | | | | | | | |
| Sum | 379,0 | | | | | | | | | | |

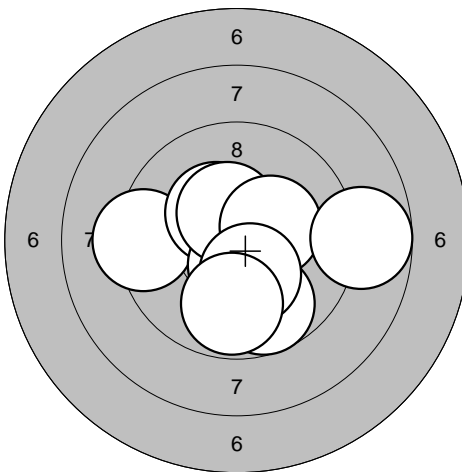
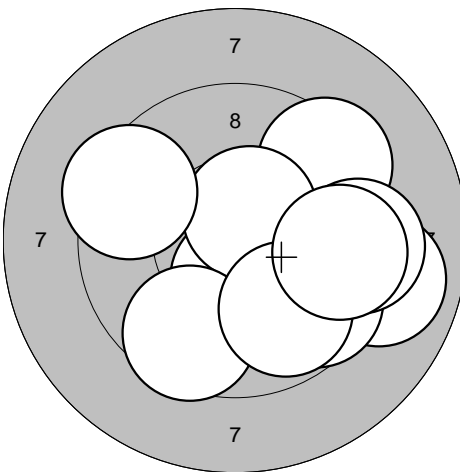
| | | | | | | | | | | | |
|--|--|-------|------|-----|-------|--|--|-------|------|-----|-------|
| <p>Series 5</p>  | <p>1: 9,3 ←</p> <p>2: 10,7* ↗</p> <p>3: 9,7 ↓</p> <p>4: 10,4* ↗</p> <p>5: 10,5* ↓</p> <p>6: 10,4* ↗</p> <p>7: 10,3* →</p> <p>8: 10,3* ↓</p> <p>9: 9,8 ↓</p> <p>10: 8,8 →</p> <table border="1" style="width:100%; border-collapse: collapse;"> <tr> <td style="text-align: right;">Serie</td> <td style="text-align: right;">95,0</td> </tr> <tr> <td style="text-align: right;">Sum</td> <td style="text-align: right;">474,0</td> </tr> </table> | Serie | 95,0 | Sum | 474,0 | <p>Series 6</p>  | <p>1: 9,4 ↗</p> <p>2: 10,4* ↓</p> <p>3: 10,6* ↗</p> <p>4: 9,4 ←</p> <p>5: 9,6 ↓</p> <p>6: 9,0 →</p> <p>7: 9,6 ↓</p> <p>8: 9,3 →</p> <p>9: 9,8 ↓</p> <p>10: 9,5 →</p> <table border="1" style="width:100%; border-collapse: collapse;"> <tr> <td style="text-align: right;">Serie</td> <td style="text-align: right;">92,0</td> </tr> <tr> <td style="text-align: right;">Sum</td> <td style="text-align: right;">566,0</td> </tr> </table> | Serie | 92,0 | Sum | 566,0 |
| Serie | 95,0 | | | | | | | | | | |
| Sum | 474,0 | | | | | | | | | | |
| Serie | 92,0 | | | | | | | | | | |
| Sum | 566,0 | | | | | | | | | | |

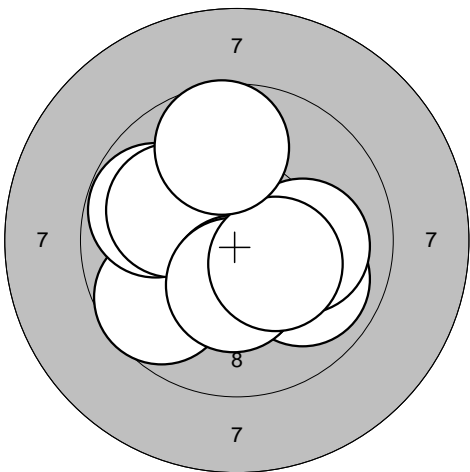
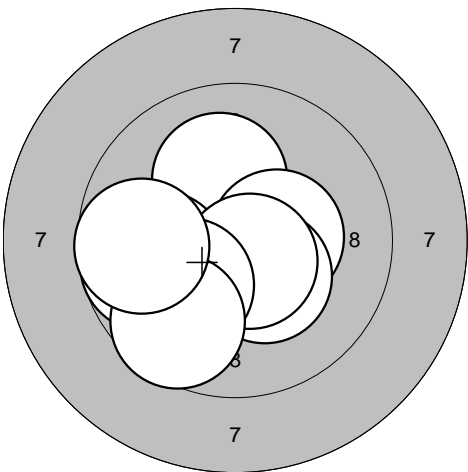
| | | | | | | | | | | | |
|--|---|-------|------|-----|------|--|---|-------|------|-----|-------|
| <p>Series 1</p>  | <p>1: 10,4* →</p> <p>2: 9,9 ↘</p> <p>3: 10,1 →</p> <p>4: 9,7 ↙</p> <p>5: 9,8 ↗</p> <p>6: 10,0 ↗</p> <p>7: 10,4* ↓</p> <p>8: 10,4* ↓</p> <p>9: 10,3* ↘</p> <p>10: 9,7 ↑</p> <table border="1" style="width:100%; border-collapse: collapse;"> <tr> <td style="text-align: right;">Serie</td> <td style="text-align: right;">96,0</td> </tr> <tr> <td style="text-align: right;">Sum</td> <td style="text-align: right;">96,0</td> </tr> </table> | Serie | 96,0 | Sum | 96,0 | <p>Series 2</p>  | <p>1: 10,0 ↘</p> <p>2: 10,1 ↑</p> <p>3: 9,9 ←</p> <p>4: 10,4* →</p> <p>5: 10,3* ↘</p> <p>6: 9,8 ←</p> <p>7: 10,6* ↘</p> <p>8: 10,1 ↙</p> <p>9: 9,6 ↘</p> <p>10: 9,7 ←</p> <table border="1" style="width:100%; border-collapse: collapse;"> <tr> <td style="text-align: right;">Serie</td> <td style="text-align: right;">96,0</td> </tr> <tr> <td style="text-align: right;">Sum</td> <td style="text-align: right;">192,0</td> </tr> </table> | Serie | 96,0 | Sum | 192,0 |
| Serie | 96,0 | | | | | | | | | | |
| Sum | 96,0 | | | | | | | | | | |
| Serie | 96,0 | | | | | | | | | | |
| Sum | 192,0 | | | | | | | | | | |

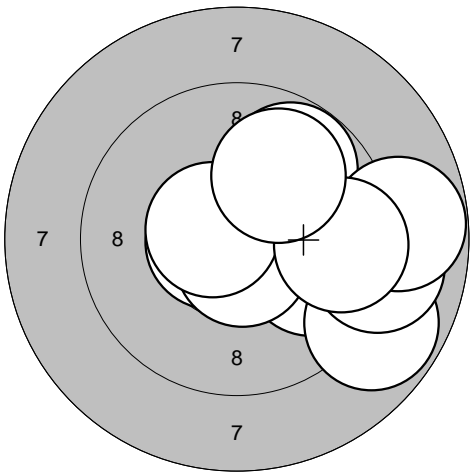
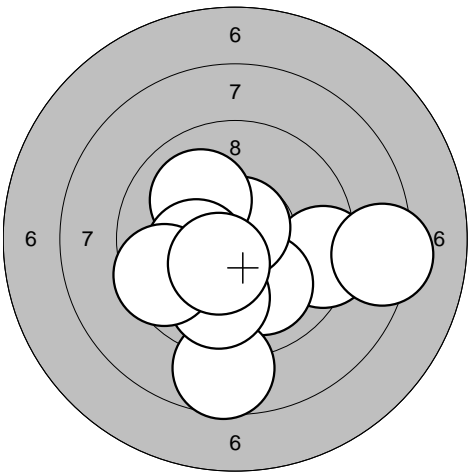
| | | | | | | | | | | | |
|---|--|-------|------|-----|-------|---|--|-------|------|-----|-------|
| <p>Series 3</p>  | <p>1: 9,9 ↘</p> <p>2: 9,8 ↗</p> <p>3: 8,8 ↘</p> <p>4: 10,6* ←</p> <p>5: 9,0 →</p> <p>6: 8,8 →</p> <p>7: 10,6* ↓</p> <p>8: 10,6* ↗</p> <p>9: 9,6 →</p> <p>10: 9,9 ↗</p> <table border="1" style="width:100%; border-collapse: collapse;"> <tr> <td style="text-align: right;">Serie</td> <td style="text-align: right;">91,0</td> </tr> <tr> <td style="text-align: right;">Sum</td> <td style="text-align: right;">283,0</td> </tr> </table> | Serie | 91,0 | Sum | 283,0 | <p>Series 4</p>  | <p>1: 9,4 →</p> <p>2: 10,0 ↘</p> <p>3: 10,7* ↗</p> <p>4: 8,7 ↓</p> <p>5: 9,9 ↓</p> <p>6: 10,0 ↗</p> <p>7: 10,2* ←</p> <p>8: 9,5 ←</p> <p>9: 8,3 →</p> <p>10: 10,4* ↘</p> <table border="1" style="width:100%; border-collapse: collapse;"> <tr> <td style="text-align: right;">Serie</td> <td style="text-align: right;">93,0</td> </tr> <tr> <td style="text-align: right;">Sum</td> <td style="text-align: right;">376,0</td> </tr> </table> | Serie | 93,0 | Sum | 376,0 |
| Serie | 91,0 | | | | | | | | | | |
| Sum | 283,0 | | | | | | | | | | |
| Serie | 93,0 | | | | | | | | | | |
| Sum | 376,0 | | | | | | | | | | |

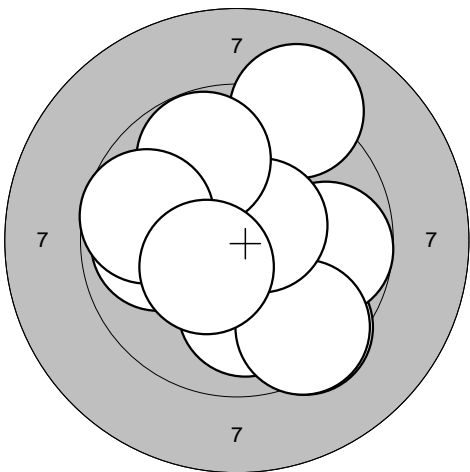
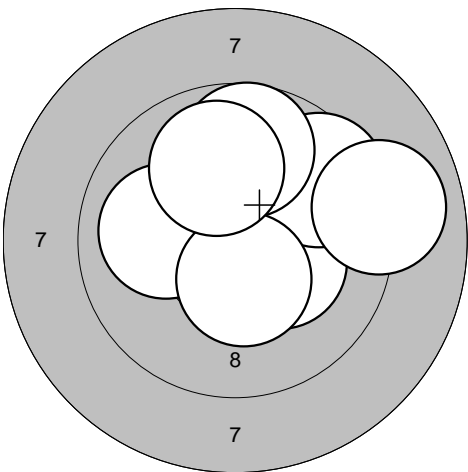
| | | | | | | | | | | | |
|--|---|-------|------|-----|-------|--|---|-------|------|-----|-------|
| <p>Series 5</p>  | <p>1: 9,5 ↘</p> <p>2: 10,0 ↓</p> <p>3: 9,8 →</p> <p>4: 9,0 ↗</p> <p>5: 9,5 ↘</p> <p>6: 10,5* ↗</p> <p>7: 9,8 ↗</p> <p>8: 9,9 ←</p> <p>9: 9,7 ←</p> <p>10: 10,4* ↙</p> <table border="1" style="width:100%; border-collapse: collapse;"> <tr> <td style="text-align: right;">Serie</td> <td style="text-align: right;">93,0</td> </tr> <tr> <td style="text-align: right;">Sum</td> <td style="text-align: right;">469,0</td> </tr> </table> | Serie | 93,0 | Sum | 469,0 | <p>Series 6</p>  | <p>1: 10,6* ↗</p> <p>2: 9,9 ↑</p> <p>3: 10,3* ↘</p> <p>4: 10,0 ↑</p> <p>5: 10,0 ←</p> <p>6: 9,6 ↗</p> <p>7: 9,7 ↑</p> <p>8: 10,4* ↓</p> <p>9: 10,0 ↑</p> <p>10: 9,0 →</p> <table border="1" style="width:100%; border-collapse: collapse;"> <tr> <td style="text-align: right;">Serie</td> <td style="text-align: right;">96,0</td> </tr> <tr> <td style="text-align: right;">Sum</td> <td style="text-align: right;">565,0</td> </tr> </table> | Serie | 96,0 | Sum | 565,0 |
| Serie | 93,0 | | | | | | | | | | |
| Sum | 469,0 | | | | | | | | | | |
| Serie | 96,0 | | | | | | | | | | |
| Sum | 565,0 | | | | | | | | | | |

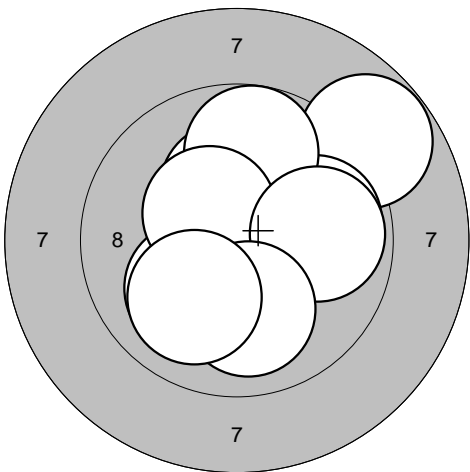
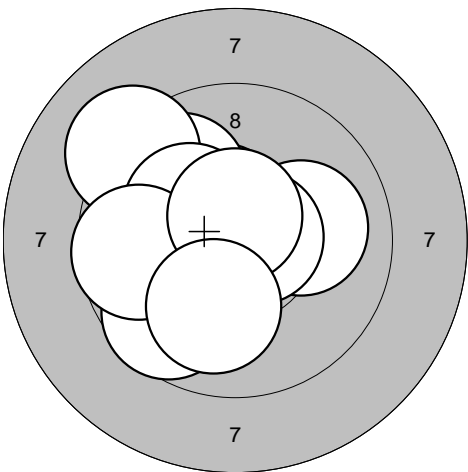
| | | | | | | | | | | | |
|--|---|-------|------|-----|------|--|---|-------|------|-----|-------|
| <p>Series 1</p>  | <p>1: 8,8 ↗ 2: 10,3* ↑ 3: 9,9 → 4: 10,1 ↘ 5: 10,5* → 6: 9,8 ↑ 7: 10,4* ↗ 8: 9,9 → 9: 10,0 ↓ 10: 10,0 ↘</p> <table border="1" style="width:100%; border-collapse: collapse;"> <tr><td>Serie</td><td style="text-align: right;">95,0</td></tr> <tr><td>Sum</td><td style="text-align: right;">95,0</td></tr> </table> | Serie | 95,0 | Sum | 95,0 | <p>Series 2</p>  | <p>1: 10,1 → 2: 10,5* ↗ 3: 9,8 ↗ 4: 9,2 ↘ 5: 9,6 ↘ 6: 10,2* ↖ 7: 9,7 ← 8: 10,7* → 9: 10,6* ↑ 10: 10,0 ↓</p> <table border="1" style="width:100%; border-collapse: collapse;"> <tr><td>Serie</td><td style="text-align: right;">96,0</td></tr> <tr><td>Sum</td><td style="text-align: right;">191,0</td></tr> </table> | Serie | 96,0 | Sum | 191,0 |
| Serie | 95,0 | | | | | | | | | | |
| Sum | 95,0 | | | | | | | | | | |
| Serie | 96,0 | | | | | | | | | | |
| Sum | 191,0 | | | | | | | | | | |

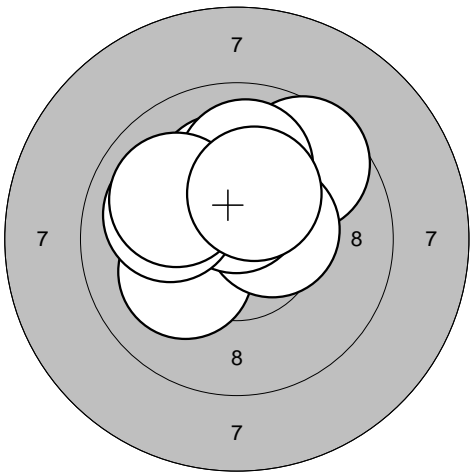
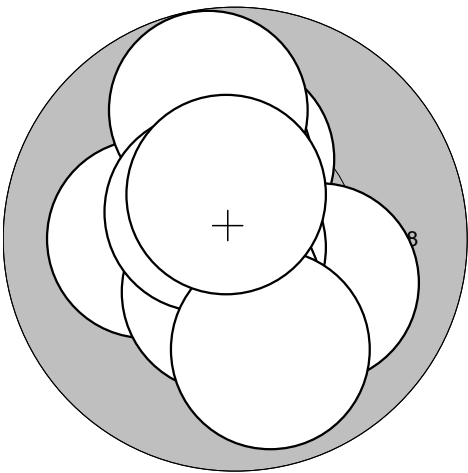
| | | | | | | | | | | | |
|---|--|-------|------|-----|-------|---|--|-------|------|-----|-------|
| <p>Series 3</p>  | <p>1: 10,4* ↖ 2: 9,6 ↗ 3: 10,1 ↖ 4: 10,4* → 5: 10,1 ↑ 6: 10,5* ↑ 7: 10,0 ↖ 8: 10,0 ↑ 9: 10,0 ↖ 10: 10,3* ↗</p> <table border="1" style="width:100%; border-collapse: collapse;"> <tr><td>Serie</td><td style="text-align: right;">99,0</td></tr> <tr><td>Sum</td><td style="text-align: right;">290,0</td></tr> </table> | Serie | 99,0 | Sum | 290,0 | <p>Series 4</p>  | <p>1: 10,2* ↑ 2: 10,1 → 3: 10,3* ↑ 4: 10,8* ↘ 5: 10,2* ← 6: 9,8 ↑ 7: 10,4* ↘ 8: 10,6* ↖ 9: 9,9 ↓ 10: 10,5* ↑</p> <table border="1" style="width:100%; border-collapse: collapse;"> <tr><td>Serie</td><td style="text-align: right;">98,0</td></tr> <tr><td>Sum</td><td style="text-align: right;">388,0</td></tr> </table> | Serie | 98,0 | Sum | 388,0 |
| Serie | 99,0 | | | | | | | | | | |
| Sum | 290,0 | | | | | | | | | | |
| Serie | 98,0 | | | | | | | | | | |
| Sum | 388,0 | | | | | | | | | | |

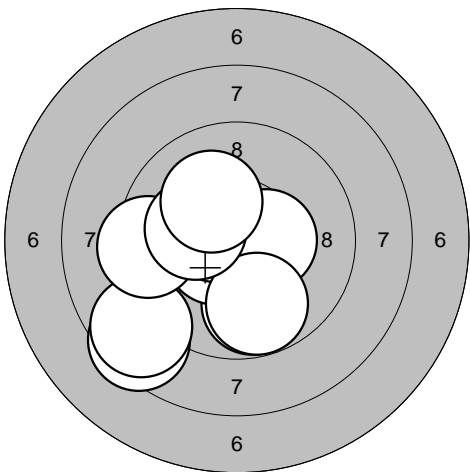
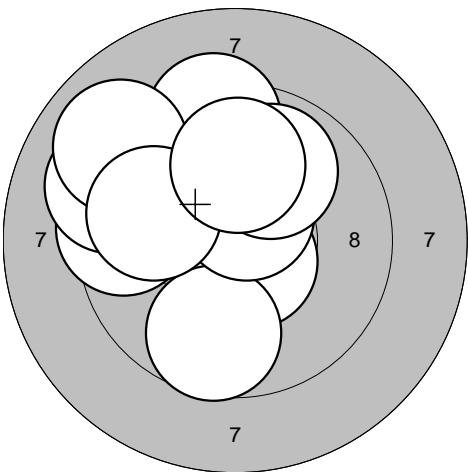
| | | | | | | | | | | | |
|--|--|-------|------|-----|-------|--|---|-------|------|-----|-------|
| <p>Series 5</p>  | <p>1: 9,8 ↓ 2: 10,5* ↖ 3: 8,5 ↖ 4: 8,7 ↖ 5: 10,5* ↖ 6: 9,4 ← 7: 10,4* → 8: 9,8 ↓ 9: 10,2* ← 10: 10,1 ↗</p> <table border="1" style="width:100%; border-collapse: collapse;"> <tr><td>Serie</td><td style="text-align: right;">93,0</td></tr> <tr><td>Sum</td><td style="text-align: right;">481,0</td></tr> </table> | Serie | 93,0 | Sum | 481,0 | <p>Series 6</p>  | <p>1: 10,6* ↘ 2: 9,7 ↓ 3: 10,6* ↗ 4: 9,3 ↑ 5: 9,5 ← 6: 9,9 ↗ 7: 9,1 ↖ 8: 9,0 ↖ 9: 9,8 ← 10: 9,9 ↑</p> <table border="1" style="width:100%; border-collapse: collapse;"> <tr><td>Serie</td><td style="text-align: right;">92,0</td></tr> <tr><td>Sum</td><td style="text-align: right;">573,0</td></tr> </table> | Serie | 92,0 | Sum | 573,0 |
| Serie | 93,0 | | | | | | | | | | |
| Sum | 481,0 | | | | | | | | | | |
| Serie | 92,0 | | | | | | | | | | |
| Sum | 573,0 | | | | | | | | | | |

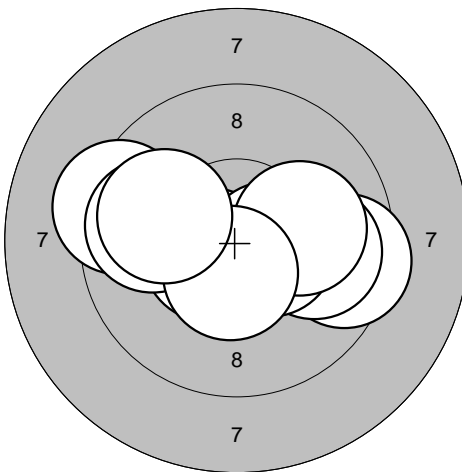
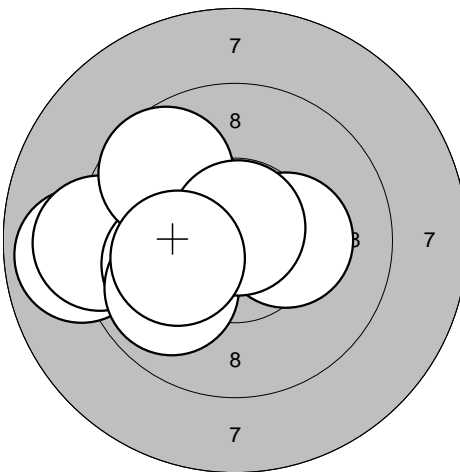
| | | | |
|--|---|--|---|
| <p>Series 1</p>  | <p>1: 10,5* ↓</p> <p>2: 10,5* ↙</p> <p>3: 9,5 →</p> <p>4: 9,9 →</p> <p>5: 9,3 ↖</p> <p>6: 10,5* →</p> <p>7: 9,8 ↖</p> <p>8: 10,1 →</p> <p>9: 10,5* ↓</p> <p>10: 9,9 ↖</p> | <p>Series 2</p>  | <p>1: 10,0 ↖</p> <p>2: 10,3* →</p> <p>3: 9,8 ↖</p> <p>4: 8,9 ↖</p> <p>5: 9,2 ↖</p> <p>6: 10,0 ↖</p> <p>7: 9,7 ↖</p> <p>8: 9,9 ↖</p> <p>9: 10,8* ↑</p> <p>10: 10,1 ↖</p> |
| Serie 95,0 | Serie 94,0 | Serie 94,0 | Serie 94,0 |
| Sum 95,0 | Sum 189,0 | Sum 189,0 | Sum 189,0 |

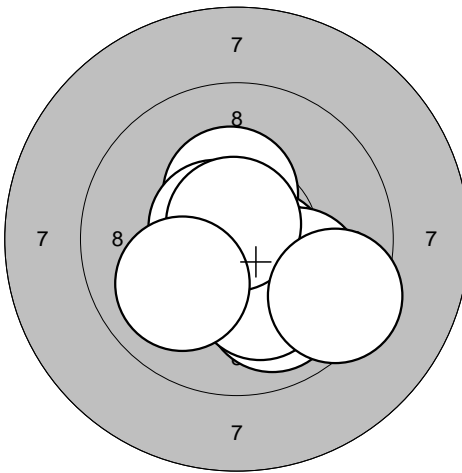
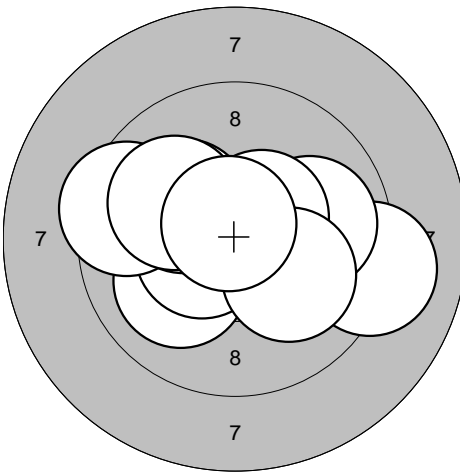
| | | | |
|---|---|---|---|
| <p>Series 3</p>  | <p>1: 10,3* ↑</p> <p>2: 9,9 ↓</p> <p>3: 10,5* ↓</p> <p>4: 10,4* ↓</p> <p>5: 10,0 ↓</p> <p>6: 10,6* ↗</p> <p>7: 10,1 ↓</p> <p>8: 10,8* ↑</p> <p>9: 10,0 ↖</p> <p>10: 9,4 ↘</p> | <p>Series 4</p>  | <p>1: 10,1 ↖</p> <p>2: 9,1 →</p> <p>3: 10,5* ↖</p> <p>4: 9,5 ↖</p> <p>5: 10,2* ↖</p> <p>6: 9,9 →</p> <p>7: 10,5* ↗</p> <p>8: 10,0 ↖</p> <p>9: 10,1 ↘</p> <p>10: 10,7* ↑</p> |
| Serie 98,0 | Serie 97,0 | Serie 97,0 | Serie 97,0 |
| Sum 287,0 | Sum 384,0 | Sum 384,0 | Sum 384,0 |

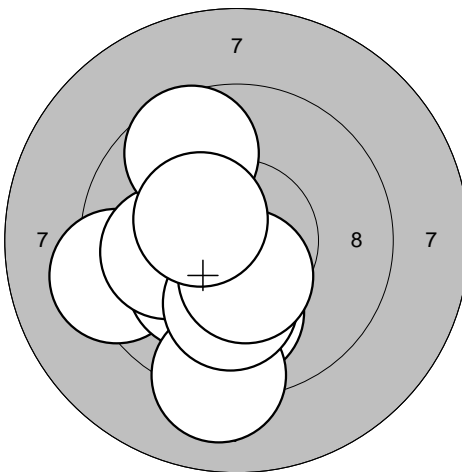
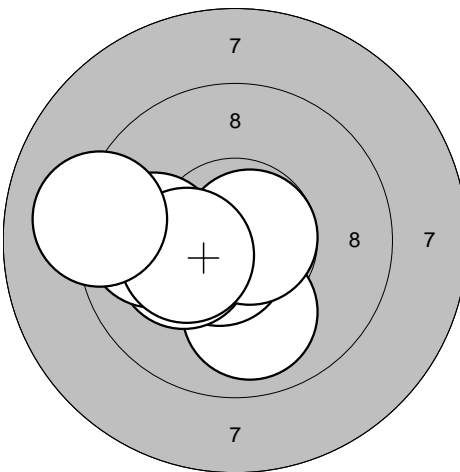
| | | | |
|--|--|--|---|
| <p>Series 5</p>  | <p>1: 10,0 ↓</p> <p>2: 10,0 ↓</p> <p>3: 9,3 ↖</p> <p>4: 10,2* ↖</p> <p>5: 10,0 ↖</p> <p>6: 9,1 ↓</p> <p>7: 10,1 ↓</p> <p>8: 10,5* ↓</p> <p>9: 9,6 ↗</p> <p>10: 10,4* ↖</p> | <p>Series 6</p>  | <p>1: 10,5* ↖</p> <p>2: 10,7* ↓</p> <p>3: 10,5* ↓</p> <p>4: 10,0 ↓</p> <p>5: 10,6* ↖</p> <p>6: 10,2* ↖</p> <p>7: 10,7* →</p> <p>8: 9,9 ↖</p> <p>9: 10,3* ↖</p> <p>10: 9,1 ↖</p> |
| Serie 97,0 | Serie 98,0 | Serie 98,0 | Serie 98,0 |
| Sum 481,0 | Sum 579,0 | Sum 579,0 | Sum 579,0 |

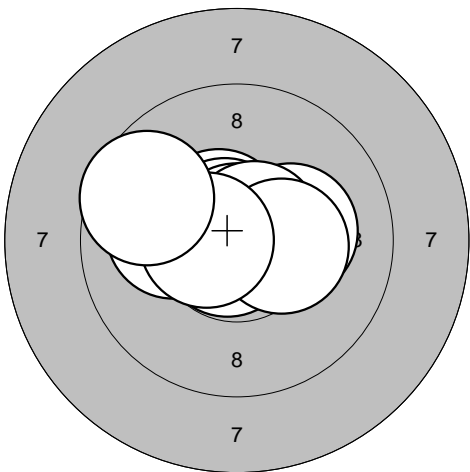
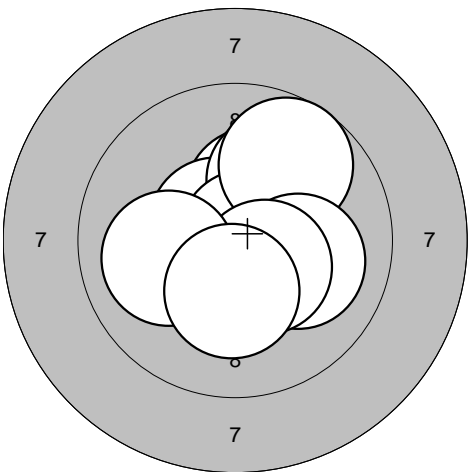
| | | | | | | | | | | | |
|--|---|-------|------|-----|------|--|--|-------|------|-----|-------|
| <p>Series 1</p>  | <p>1: 10,5* ↖ 2: 10,8* ↙ 3: 10,7* ↗ 4: 10,2* → 5: 10,8* ↑ 6: 10,1 ← 7: 10,7* ↗ 8: 10,3* → 9: 10,5* ← 10: 9,6 ↖</p> <table border="1" style="width:100%; border-collapse: collapse;"> <tr><td>Serie</td><td style="text-align: right;">99,0</td></tr> <tr><td>Sum</td><td style="text-align: right;">99,0</td></tr> </table> | Serie | 99,0 | Sum | 99,0 | <p>Series 2</p>  | <p>1: 10,3* ↗ 2: 10,8* ↓ 3: 10,6* ↖ 4: 10,0 ↗ 5: 10,8* → 6: 9,7 ↗ 7: 10,1 → 8: 10,4* ↘ 9: 10,0 ← 10: 10,3* ↓</p> <table border="1" style="width:100%; border-collapse: collapse;"> <tr><td>Serie</td><td style="text-align: right;">99,0</td></tr> <tr><td>Sum</td><td style="text-align: right;">198,0</td></tr> </table> | Serie | 99,0 | Sum | 198,0 |
| Serie | 99,0 | | | | | | | | | | |
| Sum | 99,0 | | | | | | | | | | |
| Serie | 99,0 | | | | | | | | | | |
| Sum | 198,0 | | | | | | | | | | |

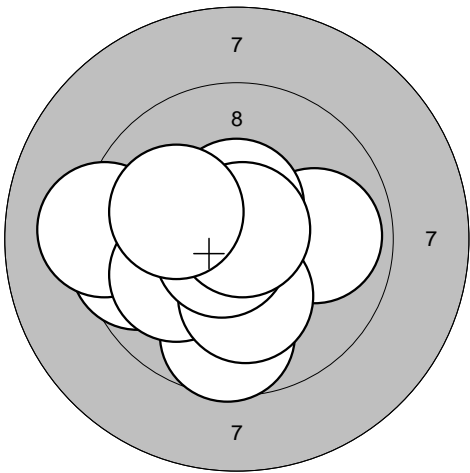
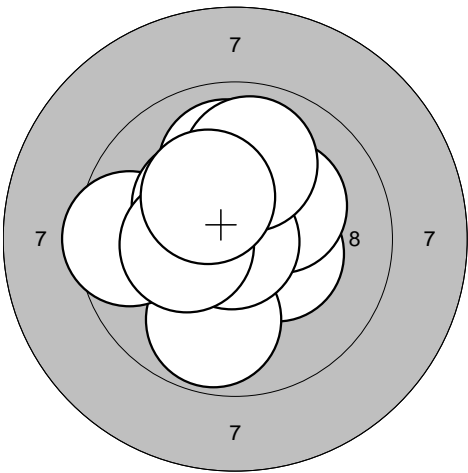
| | | | | | | | | | | | |
|---|---|-------|------|-----|-------|---|--|-------|------|-----|-------|
| <p>Series 3</p>  | <p>1: 9,7 ↓ 2: 9,6 ← 3: 9,2 ← 4: 10,0 ← 5: 9,9 → 6: 10,2* ↓ 7: 10,7* ↙ 8: 10,5* ↑ 9: 10,8* ↗ 10: 10,1 ↖</p> <table border="1" style="width:100%; border-collapse: collapse;"> <tr><td>Serie</td><td style="text-align: right;">96,0</td></tr> <tr><td>Sum</td><td style="text-align: right;">294,0</td></tr> </table> | Serie | 96,0 | Sum | 294,0 | <p>Series 4</p>  | <p>1: 10,4* → 2: 10,2* ↗ 3: 9,9 ↓ 4: 9,5 ← 5: 10,0 ↑ 6: 10,3* ↖ 7: 10,9* ↙ 8: 10,3* ← 9: 9,9 ↑ 10: 10,3* ↖</p> <table border="1" style="width:100%; border-collapse: collapse;"> <tr><td>Serie</td><td style="text-align: right;">97,0</td></tr> <tr><td>Sum</td><td style="text-align: right;">391,0</td></tr> </table> | Serie | 97,0 | Sum | 391,0 |
| Serie | 96,0 | | | | | | | | | | |
| Sum | 294,0 | | | | | | | | | | |
| Serie | 97,0 | | | | | | | | | | |
| Sum | 391,0 | | | | | | | | | | |

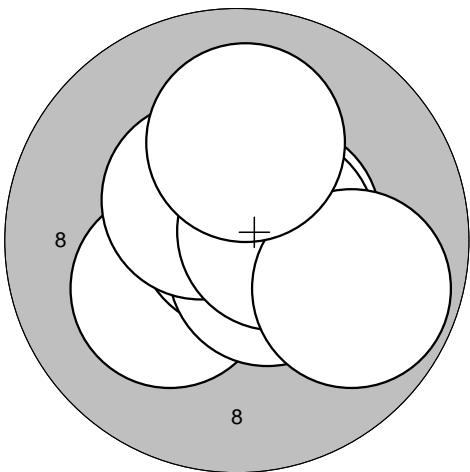
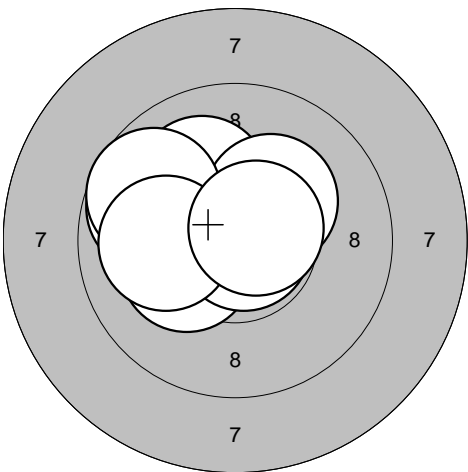
| | | | | | | | | | | | |
|--|--|-------|------|-----|-------|--|---|-------|------|-----|-------|
| <p>Series 5</p>  | <p>1: 10,2* ↙ 2: 10,6* → 3: 10,5* → 4: 10,7* ↗ 5: 10,9* ↑ 6: 10,6* ↘ 7: 10,5* ↗ 8: 10,6* → 9: 9,8 → 10: 10,1 ↑</p> <table border="1" style="width:100%; border-collapse: collapse;"> <tr><td>Serie</td><td style="text-align: right;">99,0</td></tr> <tr><td>Sum</td><td style="text-align: right;">490,0</td></tr> </table> | Serie | 99,0 | Sum | 490,0 | <p>Series 6</p>  | <p>1: 9,8 ↖ 2: 10,8* ↗ 3: 10,1 ↖ 4: 10,5* ← 5: 10,2* ↖ 6: 10,8* → 7: 10,2* ↗ 8: 9,7 ↖ 9: 10,0 ← 10: 10,6* ↗</p> <table border="1" style="width:100%; border-collapse: collapse;"> <tr><td>Serie</td><td style="text-align: right;">98,0</td></tr> <tr><td>Sum</td><td style="text-align: right;">588,0</td></tr> </table> | Serie | 98,0 | Sum | 588,0 |
| Serie | 99,0 | | | | | | | | | | |
| Sum | 490,0 | | | | | | | | | | |
| Serie | 98,0 | | | | | | | | | | |
| Sum | 588,0 | | | | | | | | | | |

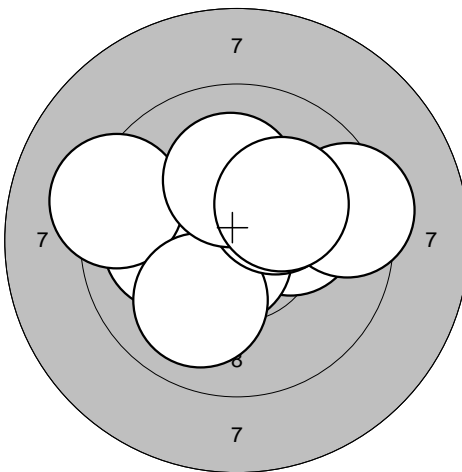
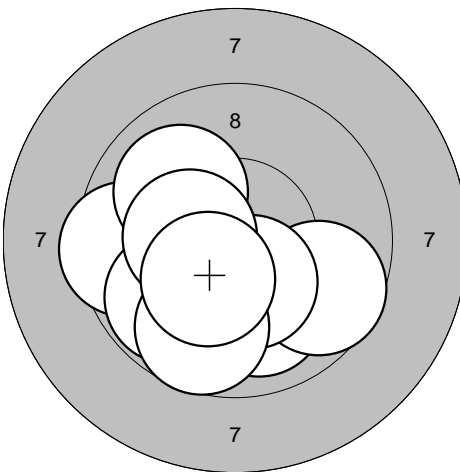
| | | | |
|--|--|--|---|
| <p>Series 1</p>  | <p>1: 10,1 ←</p> <p>2: 10,2* →</p> <p>3: 10,1 ←</p> <p>4: 10,7* ↓</p> <p>5: 9,3 ←</p> <p>6: 9,4 →</p> <p>7: 10,0 ↓</p> <p>8: 10,3* ↗</p> <p>9: 10,1 ↑</p> <p>10: 10,2* ↗</p> | <p>Series 2</p>  | <p>1: 10,0 ↘</p> <p>2: 9,5 ←</p> <p>3: 10,0 ↓</p> <p>4: 9,8 ↘</p> <p>5: 9,7 ↘</p> <p>6: 10,3* ↓</p> <p>7: 9,7 ↓</p> <p>8: 10,0 ↗</p> <p>9: 10,3* ←</p> <p>10: 10,3* ↓</p> |
| Serie 98,0 | | Serie 96,0 | |
| Sum 98,0 | | Sum 194,0 | |

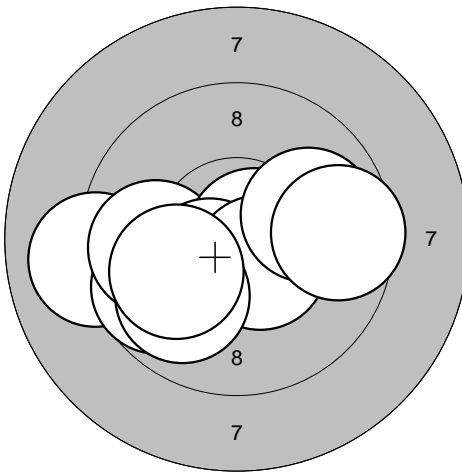
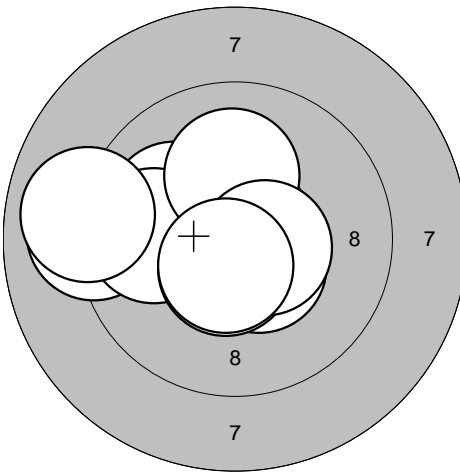
| | | | |
|---|---|---|--|
| <p>Series 3</p>  | <p>1: 9,1 ←</p> <p>2: 9,7 ↘</p> <p>3: 9,8 ←</p> <p>4: 10,7* →</p> <p>5: 10,4* ↘</p> <p>6: 10,5* ↘</p> <p>7: 9,9 ↘</p> <p>8: 9,9 →</p> <p>9: 10,0 ←</p> <p>10: 9,6 →</p> | <p>Series 4</p>  | <p>1: 10,7* ←</p> <p>2: 9,1 ←</p> <p>3: 10,5* ↘</p> <p>4: 10,0 ↗</p> <p>5: 9,9 ←</p> <p>6: 8,9 ←</p> <p>7: 10,1 ↑</p> <p>8: 10,6* ↓</p> <p>9: 10,5* →</p> <p>10: 10,6* ↓</p> |
| Serie 94,0 | | Serie 96,0 | |
| Sum 288,0 | | Sum 384,0 | |

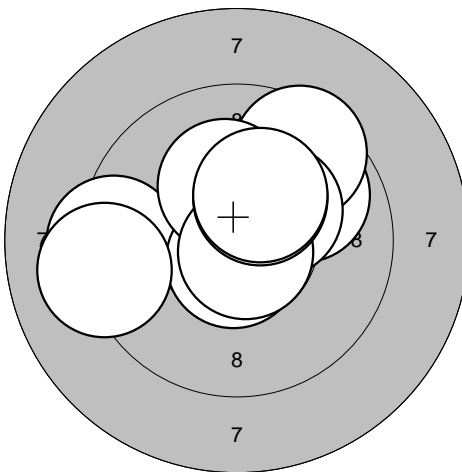
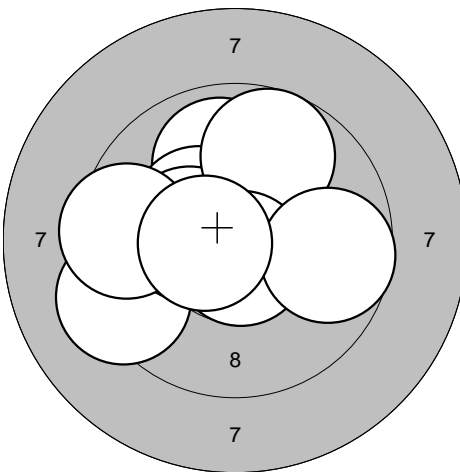
| | | | |
|--|--|--|--|
| <p>Series 5</p>  | <p>1: 9,9 ↗</p> <p>2: 9,5 ↗</p> <p>3: 9,3 ←</p> <p>4: 10,3* ↗</p> <p>5: 10,7* ↓</p> <p>6: 10,2* ↑</p> <p>7: 10,7* ↓</p> <p>8: 10,3* ↗</p> <p>9: 9,1 ←</p> <p>10: 10,3* ↗</p> | <p>Series 6</p>  | <p>1: 9,9 ↑</p> <p>2: 9,3 ↘</p> <p>3: 10,3* ↗</p> <p>4: 10,5* ↗</p> <p>5: 10,4* ←</p> <p>6: 9,7 ↗</p> <p>7: 9,5 ←</p> <p>8: 10,7* ↓</p> <p>9: 9,7 →</p> <p>10: 10,5* ←</p> |
| Serie 96,0 | | Serie 95,0 | |
| Sum 480,0 | | Sum 575,0 | |

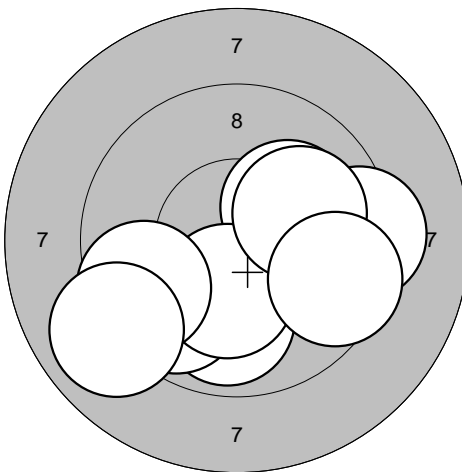
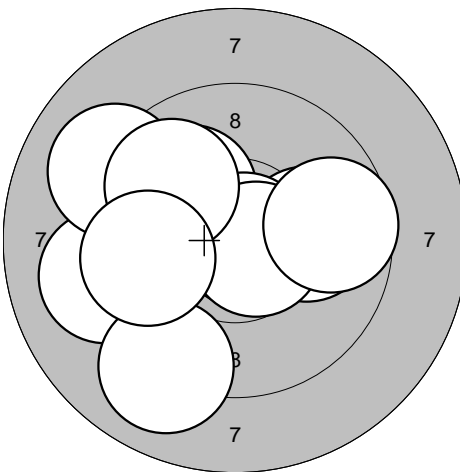
| | | | |
|--|---|--|--|
| <p>Series 1</p>  | <p>1: 9,9 ↓</p> <p>2: 10,1 ↗</p> <p>3: 9,8 ↙</p> <p>4: 10,1 →</p> <p>5: 10,3* ↓</p> <p>6: 9,6 ←</p> <p>7: 9,3 →</p> <p>8: 10,0 ↗</p> <p>9: 9,5 →</p> <p>10: 8,9 ↙</p> | <p>Series 2</p>  | <p>1: 10,0 →</p> <p>2: 9,2 ←</p> <p>3: 10,1 ↗</p> <p>4: 10,8* →</p> <p>5: 10,7* →</p> <p>6: 9,0 ↙</p> <p>7: 9,7 →</p> <p>8: 9,1 ↗</p> <p>9: 9,9 ↗</p> <p>10: 9,7 ←</p> |
| Serie 93,0 | Serie 94,0 | Serie 94,0 | Serie 94,0 |
| Sum 93,0 | Sum 187,0 | Sum 187,0 | Sum 187,0 |

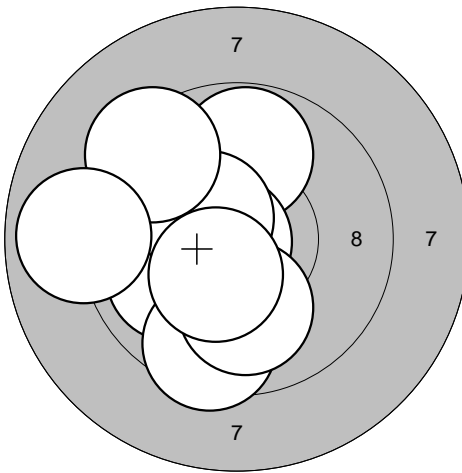
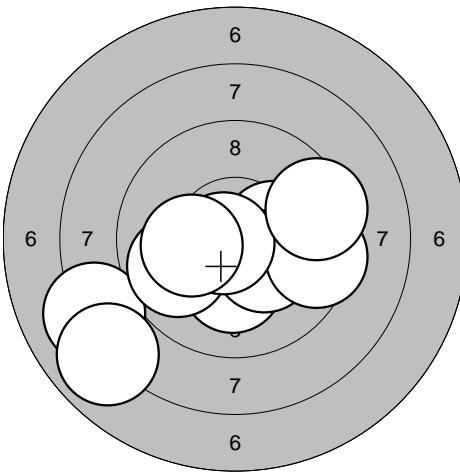
| | | | |
|---|--|---|--|
| <p>Series 3</p>  | <p>1: 9,8 ↑</p> <p>2: 10,2* ↙</p> <p>3: 10,0 ←</p> <p>4: 10,8* ←</p> <p>5: 9,5 ↓</p> <p>6: 10,5* ↗</p> <p>7: 10,0 ↓</p> <p>8: 9,4 ↗</p> <p>9: 10,4* ↙</p> <p>10: 8,9 ←</p> | <p>Series 4</p>  | <p>1: 10,2* →</p> <p>2: 10,2* ↓</p> <p>3: 10,3* →</p> <p>4: 8,2 ←</p> <p>5: 9,8 ←</p> <p>6: 9,5 →</p> <p>7: 10,7* ←</p> <p>8: 7,9 ↙</p> <p>9: 10,2* ←</p> <p>10: 9,4 →</p> |
| Serie 95,0 | Serie 92,0 | Serie 92,0 | Serie 92,0 |
| Sum 282,0 | Sum 374,0 | Sum 374,0 | Sum 374,0 |

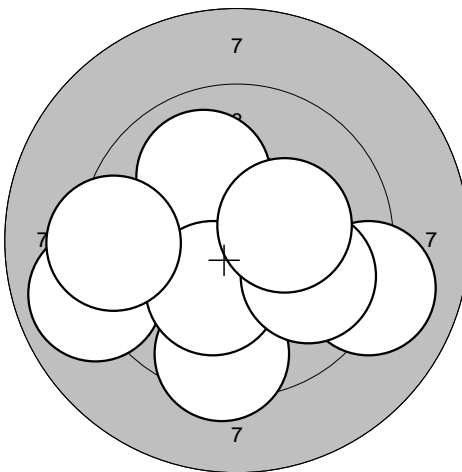
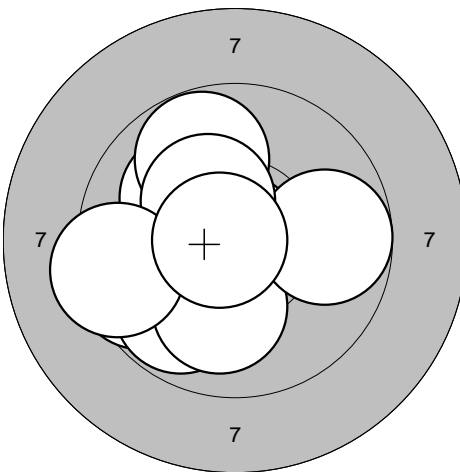
| | | | |
|--|---|--|--|
| <p>Series 5</p>  | <p>1: 10,2* ←</p> <p>2: 9,4 ↓</p> <p>3: 10,7* ↑</p> <p>4: 8,9 ←</p> <p>5: 9,1 →</p> <p>6: 10,0 ↗</p> <p>7: 10,2* ↙</p> <p>8: 9,3 ←</p> <p>9: 9,9 →</p> <p>10: 10,3* →</p> | <p>Series 6</p>  | <p>1: 9,6 ←</p> <p>2: 9,8 ↙</p> <p>3: 10,1 ↗</p> <p>4: 9,8 ↗</p> <p>5: 10,9* →</p> <p>6: 10,1 ↓</p> <p>7: 9,7 →</p> <p>8: 10,3* ↗</p> <p>9: 9,4 ←</p> <p>10: 10,8* ←</p> |
| Serie 94,0 | Serie 95,0 | Serie 95,0 | Serie 95,0 |
| Sum 468,0 | Sum 563,0 | Sum 563,0 | Sum 563,0 |

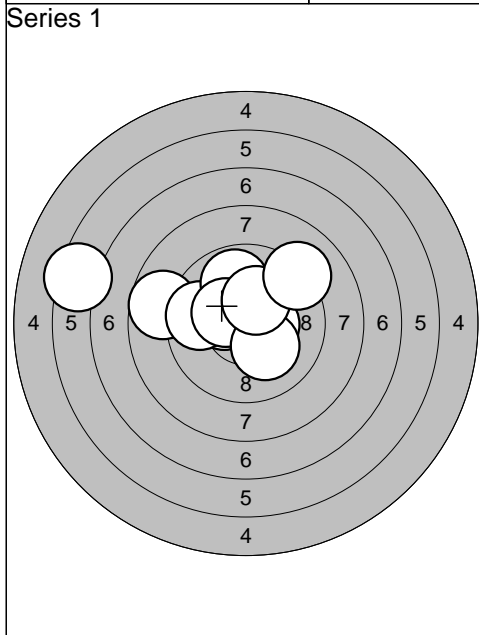

| | |
|----------|---|
| 1: 8,7 | ← |
| 2: 10,3* | ← |
| 3: 9,7 | ← |
| 4: 10,4* | → |
| 5: 9,9 | ↑ |
| 6: 6,4 | ← |
| 7: 10,4* | ↖ |
| 8: 10,2* | ↘ |
| 9: 10,3* | ↗ |
| 10: 9,1 | ↗ |

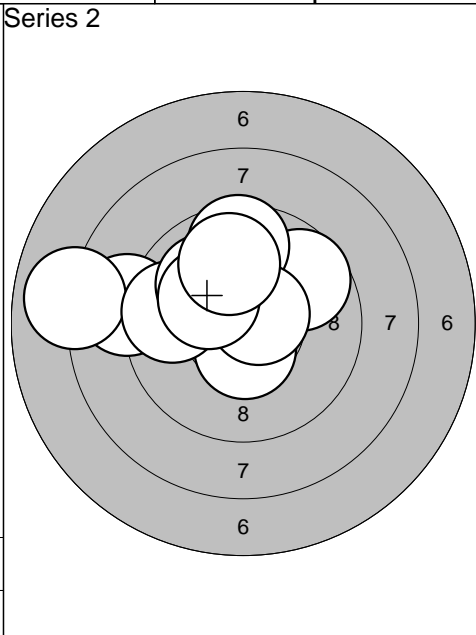

| | |
|----------|---|
| 1: 8,9 | ← |
| 2: 9,7 | ↗ |
| 3: 9,6 | ↑ |
| 4: 10,5* | ↓ |
| 5: 10,6* | ↗ |
| 6: 8,0 | ← |
| 7: 9,7 | ← |
| 8: 10,0 | ↖ |
| 9: 10,2* | ↖ |
| 10: 9,9 | ↑ |

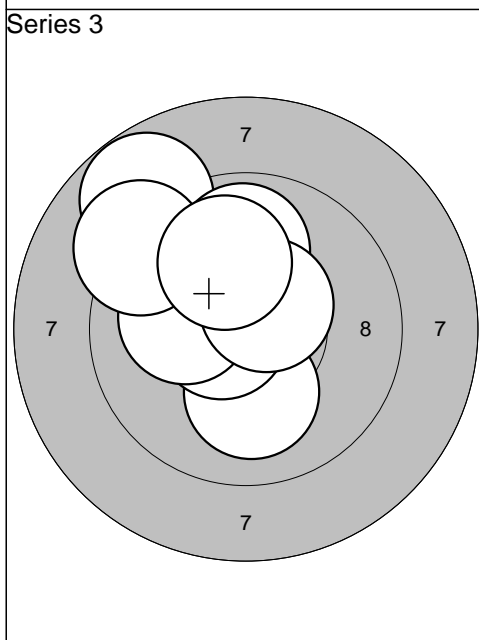

| | |
|----------|---|
| 1: 8,8 | ↖ |
| 2: 10,1 | ↓ |
| 3: 10,1 | ↖ |
| 4: 10,6* | ↖ |
| 5: 10,6* | ← |
| 6: 10,1 | ← |
| 7: 9,2 | ↖ |
| 8: 9,9 | ↑ |
| 9: 10,5* | ↗ |
| 10: 10,0 | ↑ |

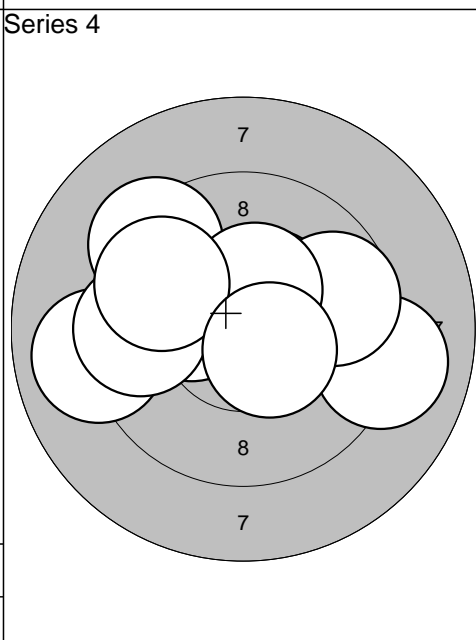

| | |
|-----------|---|
| 1: 9,1 | → |
| 2: 9,3 | ↖ |
| 3: 10,2* | ← |
| 4: 9,0 | ← |
| 5: 10,4* | ↗ |
| 6: 9,7 | → |
| 7: 10,4* | ↑ |
| 8: 9,6 | ← |
| 9: 9,7 | ↖ |
| 10: 10,5* | ↘ |

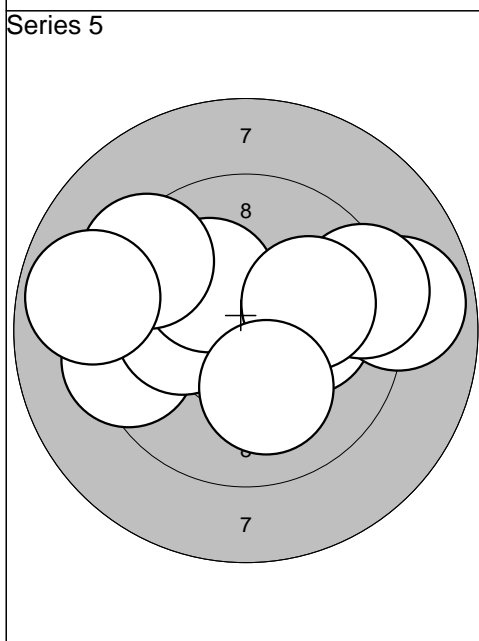

| | |
|----------|---|
| 1: 10,1 | → |
| 2: 9,3 | ← |
| 3: 10,1 | ← |
| 4: 10,2* | ↖ |
| 5: 9,3 | ↖ |
| 6: 8,9 | → |
| 7: 8,9 | ← |
| 8: 9,3 | → |
| 9: 10,0 | → |
| 10: 10,1 | ↓ |

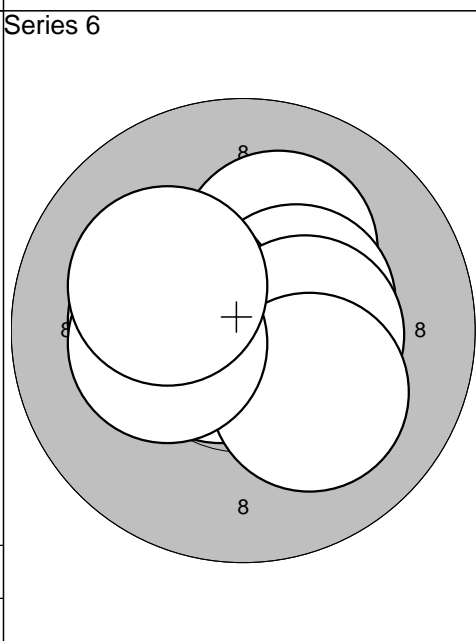

| | |
|-----------|---|
| 1: 10,3* | ← |
| 2: 10,5* | ↗ |
| 3: 10,2* | ↗ |
| 4: 10,7* | ← |
| 5: 10,4* | ↗ |
| 6: 10,3* | ← |
| 7: 10,4* | → |
| 8: 10,1 | ↘ |
| 9: 10,2* | ← |
| 10: 10,2* | ↖ |

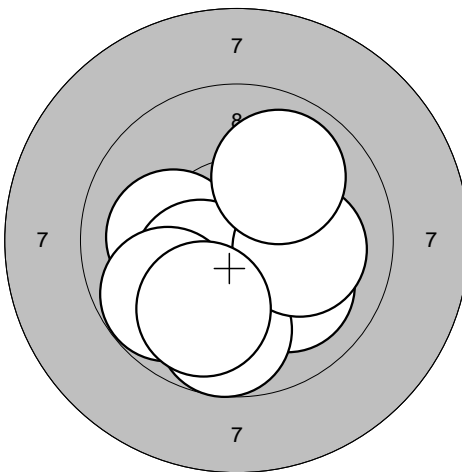
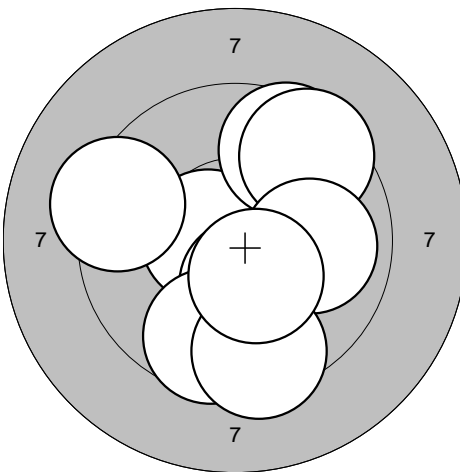
| | | | | | | | | | | | |
|--|--|-------|------|-----|------|--|--|-------|------|-----|-------|
| <p>Series 1</p>  | <p>1: 10,0 ↙ 2: 10,5* → 3: 10,1 ← 4: 10,0 ↘ 5: 9,7 ↓ 6: 10,3* ↙ 7: 10,1 → 8: 9,8 ↙ 9: 9,9 ↗ 10: 9,9 ↓</p> <table border="1" style="width:100%; border-collapse: collapse;"> <tr><td>Serie</td><td style="text-align: right;">96,0</td></tr> <tr><td>Sum</td><td style="text-align: right;">96,0</td></tr> </table> | Serie | 96,0 | Sum | 96,0 | <p>Series 2</p>  | <p>1: 10,7* → 2: 10,6* ← 3: 9,3 ← 4: 9,6 ↗ 5: 9,5 ↗ 6: 10,3* ↓ 7: 9,6 ↓ 8: 10,0 → 9: 9,5 ↓ 10: 10,4* ↓</p> <table border="1" style="width:100%; border-collapse: collapse;"> <tr><td>Serie</td><td style="text-align: right;">95,0</td></tr> <tr><td>Sum</td><td style="text-align: right;">191,0</td></tr> </table> | Serie | 95,0 | Sum | 191,0 |
| Serie | 96,0 | | | | | | | | | | |
| Sum | 96,0 | | | | | | | | | | |
| Serie | 95,0 | | | | | | | | | | |
| Sum | 191,0 | | | | | | | | | | |

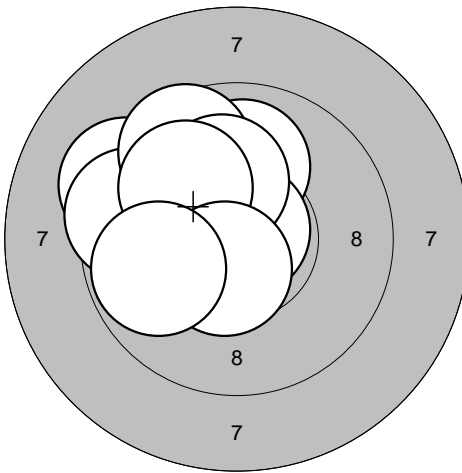
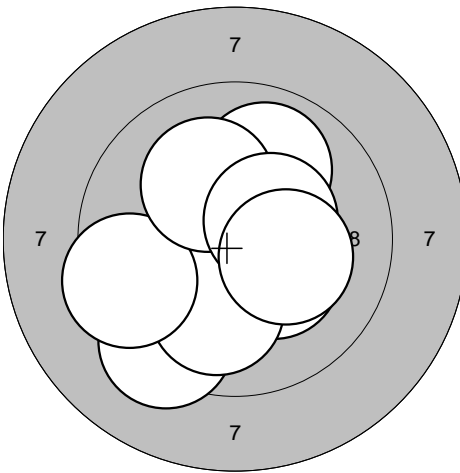
| | | | | | | | | | | | |
|---|---|-------|------|-----|-------|---|--|-------|------|-----|-------|
| <p>Series 3</p>  | <p>1: 10,0 ↑ 2: 10,8* ↗ 3: 9,3 ↙ 4: 9,5 ← 5: 9,6 ↗ 6: 10,3* ↗ 7: 10,2* ↗ 8: 10,0 ↗ 9: 10,5* ↓ 10: 9,8 ←</p> <table border="1" style="width:100%; border-collapse: collapse;"> <tr><td>Serie</td><td style="text-align: right;">96,0</td></tr> <tr><td>Sum</td><td style="text-align: right;">287,0</td></tr> </table> | Serie | 96,0 | Sum | 287,0 | <p>Series 4</p>  | <p>1: 10,8* ↙ 2: 9,3 ↘ 3: 10,5* ↗ 4: 10,3* ↘ 5: 10,0 ↓ 6: 9,5 ← 7: 9,9 ↗ 8: 10,2* ↗ 9: 10,4* ↗ 10: 10,2* →</p> <table border="1" style="width:100%; border-collapse: collapse;"> <tr><td>Serie</td><td style="text-align: right;">97,0</td></tr> <tr><td>Sum</td><td style="text-align: right;">384,0</td></tr> </table> | Serie | 97,0 | Sum | 384,0 |
| Serie | 96,0 | | | | | | | | | | |
| Sum | 287,0 | | | | | | | | | | |
| Serie | 97,0 | | | | | | | | | | |
| Sum | 384,0 | | | | | | | | | | |

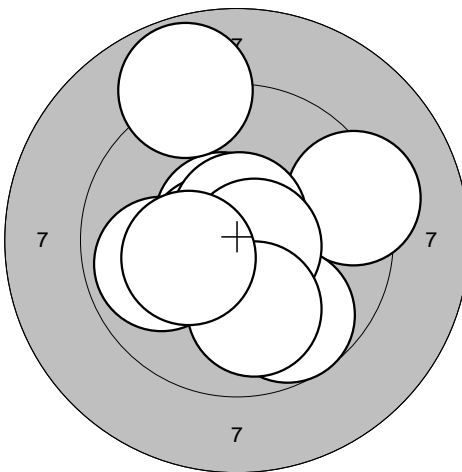
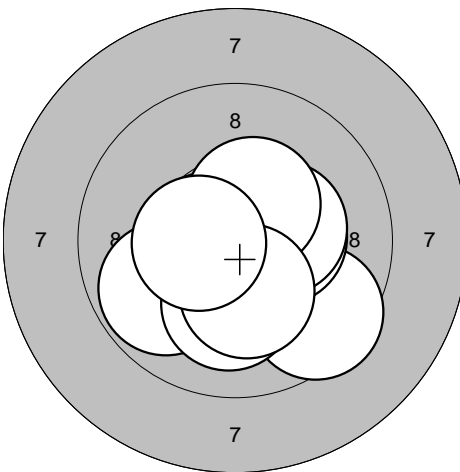
| | | | | | | | | | | | |
|--|--|-------|------|-----|-------|--|--|-------|------|-----|-------|
| <p>Series 5</p>  | <p>1: 10,6* ↗ 2: 9,9 ← 3: 10,6* ← 4: 8,8 ↑ 5: 9,3 → 6: 9,7 ↘ 7: 10,7* ↑ 8: 10,7* → 9: 10,0 ↓ 10: 10,3* ←</p> <table border="1" style="width:100%; border-collapse: collapse;"> <tr><td>Serie</td><td style="text-align: right;">95,0</td></tr> <tr><td>Sum</td><td style="text-align: right;">479,0</td></tr> </table> | Serie | 95,0 | Sum | 479,0 | <p>Series 6</p>  | <p>1: 10,6* ← 2: 9,5 ↘ 3: 10,3* → 4: 10,7* ← 5: 9,8 ← 6: 10,3* → 7: 10,1 ↓ 8: 10,4* ↗ 9: 10,2* ↓ 10: 10,5* ←</p> <table border="1" style="width:100%; border-collapse: collapse;"> <tr><td>Serie</td><td style="text-align: right;">98,0</td></tr> <tr><td>Sum</td><td style="text-align: right;">577,0</td></tr> </table> | Serie | 98,0 | Sum | 577,0 |
| Serie | 95,0 | | | | | | | | | | |
| Sum | 479,0 | | | | | | | | | | |
| Serie | 98,0 | | | | | | | | | | |
| Sum | 577,0 | | | | | | | | | | |

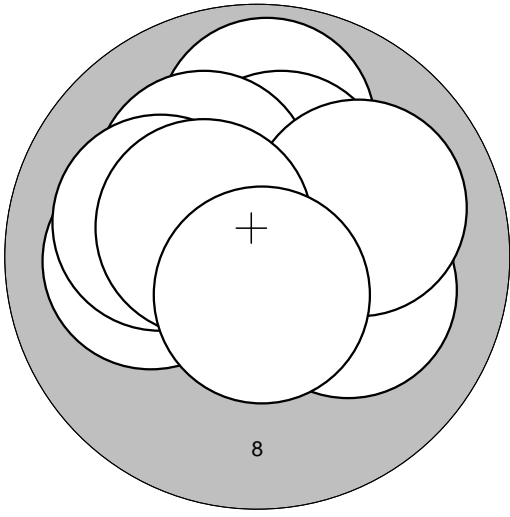
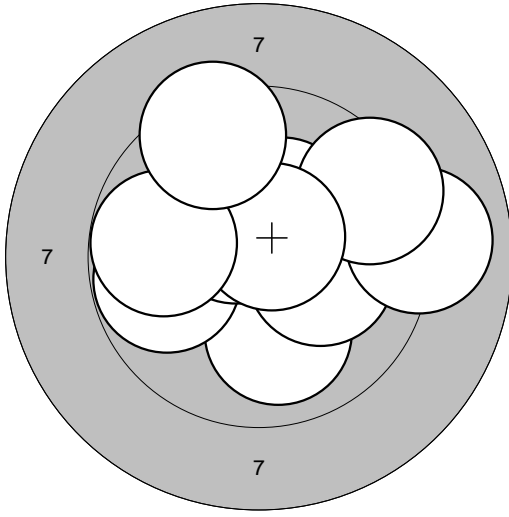
| | | | |
|--|--|--|---|
| <p>Series 1</p>  | <p>1: 9,9 ↑</p> <p>2: 10,3* ↑</p> <p>3: 10,2* ↗</p> <p>4: 10,7* ↓</p> <p>5: 10,1 →</p> <p>6: 10,1 ←</p> <p>7: 10,1 ←</p> <p>8: 10,0 →</p> <p>9: 10,5* ↖</p> <p>10: 10,6* ↓</p> | <p>Series 2</p>  | <p>1: 10,0 ↓</p> <p>2: 10,3* ↗</p> <p>3: 9,8 ←</p> <p>4: 10,2* →</p> <p>5: 9,0 →</p> <p>6: 9,4 ↗</p> <p>7: 10,5* ↖</p> <p>8: 10,7* ↗</p> <p>9: 9,8 ←</p> <p>10: 9,4 ↑</p> |
| | <p>Serie 99,0</p> <p>Sum 99,0</p> | | <p>Serie 95,0</p> <p>Sum 194,0</p> |

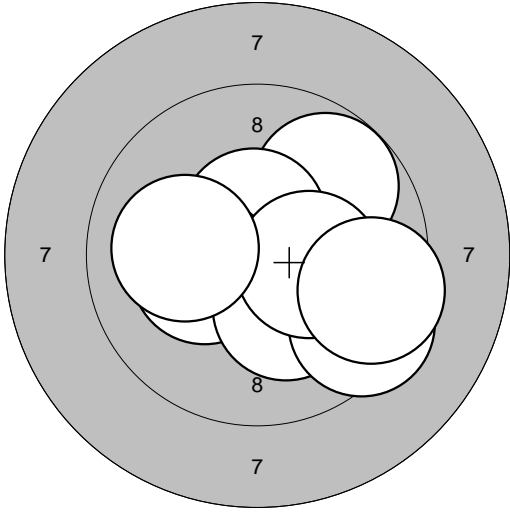
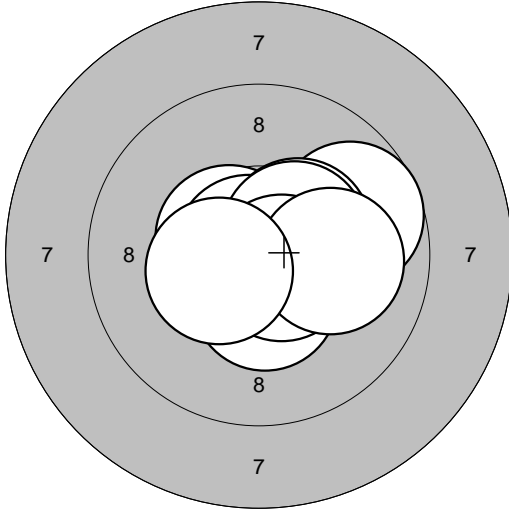
| | | | |
|---|---|---|--|
| <p>Series 3</p>  | <p>1: 10,4* →</p> <p>2: 9,8 ↗</p> <p>3: 10,5* →</p> <p>4: 10,6* ↑</p> <p>5: 10,3* ←</p> <p>6: 10,2* ↓</p> <p>7: 9,4 ↓</p> <p>8: 10,3* →</p> <p>9: 9,5 →</p> <p>10: 10,1 ←</p> | <p>Series 4</p>  | <p>1: 9,7 →</p> <p>2: 10,1 →</p> <p>3: 10,5* ↖</p> <p>4: 10,4* ↗</p> <p>5: 10,8* ↖</p> <p>6: 10,5* ↗</p> <p>7: 10,4* ↓</p> <p>8: 10,6* ↘</p> <p>9: 10,1 →</p> <p>10: 10,5* ←</p> |
| | <p>Serie 97,0</p> <p>Sum 291,0</p> | | <p>Serie 99,0</p> <p>Sum 390,0</p> |

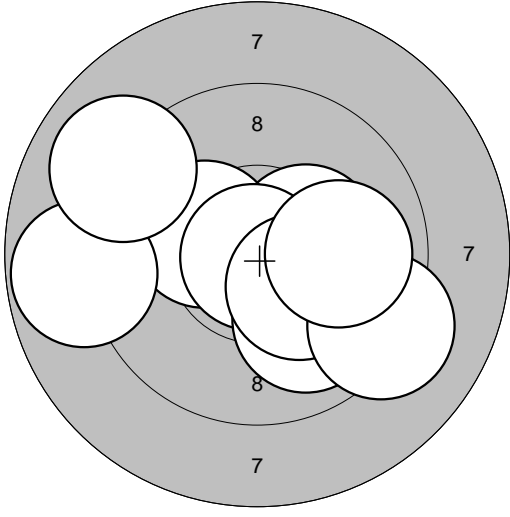
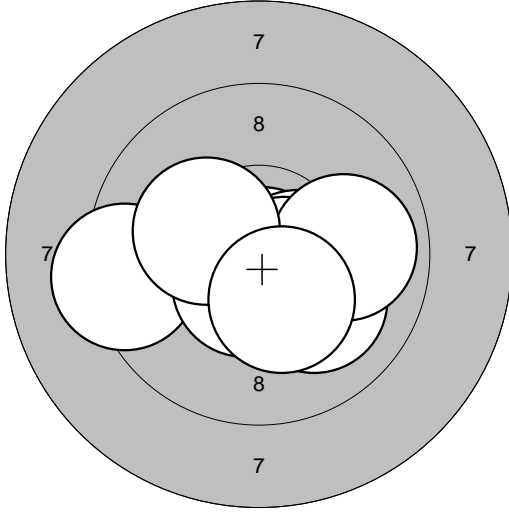
| | | | |
|--|---|--|---|
| <p>Series 5</p>  | <p>1: 10,4* →</p> <p>2: 10,3* →</p> <p>3: 10,3* ←</p> <p>4: 10,9* ↖</p> <p>5: 9,9 ↓</p> <p>6: 8,8 ←</p> <p>7: 9,0 ↗</p> <p>8: 10,3* ↓</p> <p>9: 9,2 ↓</p> <p>10: 10,0 →</p> | <p>Series 6</p>  | <p>1: 10,9* ↓</p> <p>2: 10,9* ↓</p> <p>3: 10,4* →</p> <p>4: 10,1 ↘</p> <p>5: 9,3 ←</p> <p>6: 10,6* ↘</p> <p>7: 10,6* ↓</p> <p>8: 9,9 →</p> <p>9: 10,2* ↖</p> <p>10: 10,3* ↓</p> |
| | <p>Serie 95,0</p> <p>Sum 485,0</p> | | <p>Serie 98,0</p> <p>Sum 583,0</p> |

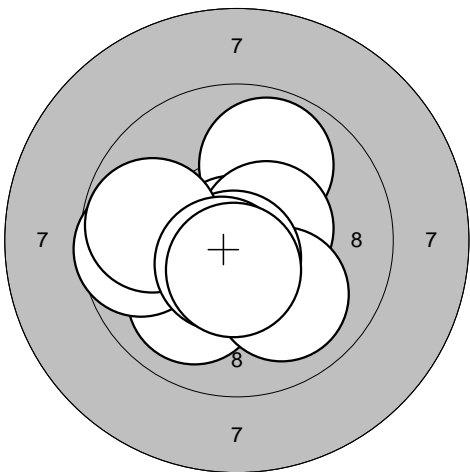
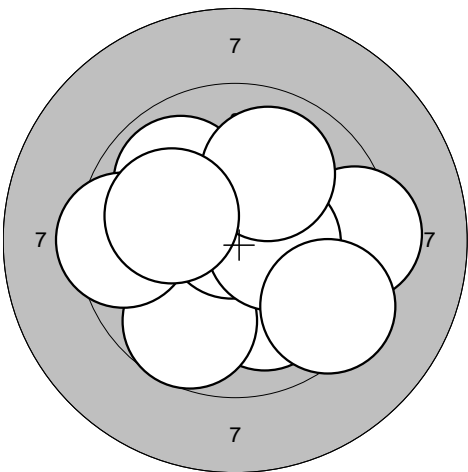
| | | | |
|--|--|--|--|
| <p>Series 1</p>  | <p>1: 9,9 ↗ 2: 10,0 ↘ 3: 9,7 ← 4: 10,9* ↘ 5: 10,5* → 6: 10,0 ↘ 7: 10,7* ↓ 8: 9,8 ← 9: 10,6* ↘ 10: 10,5* ↓</p> <p>Serie 97,0 Sum 97,0</p> | <p>Series 2</p>  | <p>1: 9,9 ↗ 2: 10,0 ↘ 3: 9,7 ↘ 4: 9,5 ← 5: 10,8* ↗ 6: 9,4 → 7: 10,4* → 8: 9,4 ↘ 9: 10,0 ↗ 10: 10,1 ←</p> <p>Serie 95,0 Sum 192,0</p> |
|--|--|--|--|

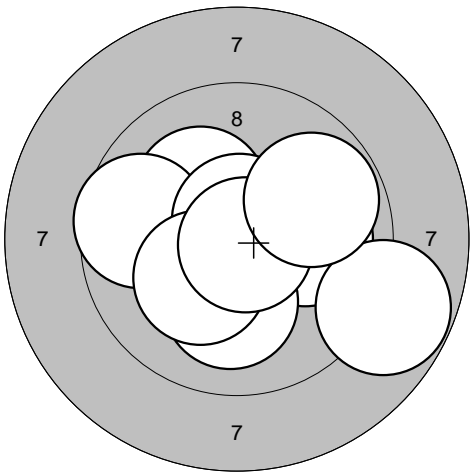
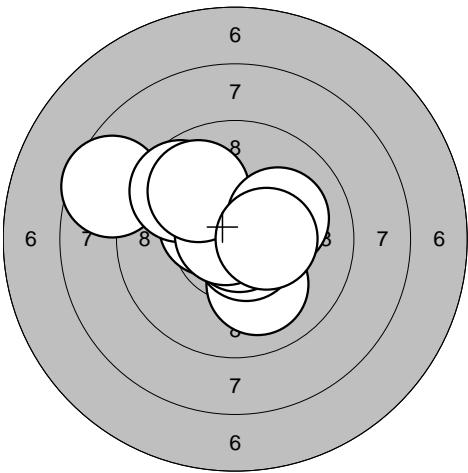
| | | | |
|---|---|---|---|
| <p>Series 3</p>  | <p>1: 10,2* ↗ 2: 10,4* → 3: 9,6 ← 4: 10,0 → 5: 10,1 ↓ 6: 10,7* ↗ 7: 8,8 → 8: 10,2* ↘ 9: 10,8* ↘ 10: 9,8 →</p> <p>Serie 96,0 Sum 288,0</p> | <p>Series 4</p>  | <p>1: 10,0 ↓ 2: 8,6 ↗ 3: 10,5* ↗ 4: 9,7 ↗ 5: 10,6* ↘ 6: 10,8* ↘ 7: 10,8* ↗ 8: 9,9 ↗ 9: 10,1 → 10: 10,4* →</p> <p>Serie 96,0 Sum 384,0</p> |
|---|---|---|---|

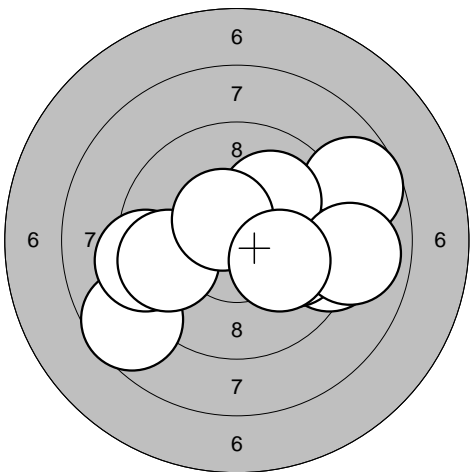
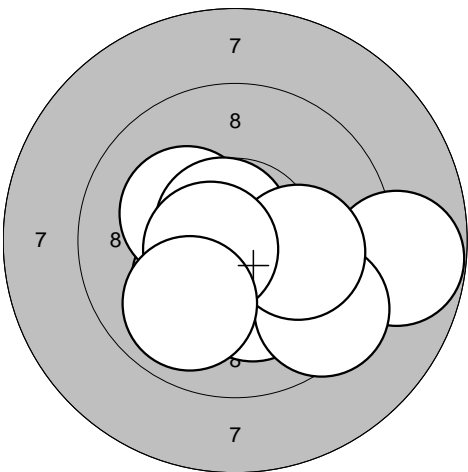
| | | | |
|--|---|--|--|
| <p>Series 5</p>  | <p>1: 8,7 → 2: 9,3 → 3: 9,9 → 4: 10,1 ↗ 5: 8,7 ↘ 6: 9,3 ← 7: 9,7 ← 8: 8,9 → 9: 10,5* ↗ 10: 10,1 →</p> <p>Serie 90,0 Sum 474,0</p> | <p>Series 6</p>  | <p>1: 8,8 → 2: 10,4* ↘ 3: 10,2* ↘ 4: 10,2* ↗ 5: 10,2* ↘ 6: 10,7* ↗ 7: 9,5 ↘ 8: 10,1 → 9: 10,6* ← 10: 9,9 ↘</p> <p>Serie 96,0 Sum 570,0</p> |
|--|---|--|--|

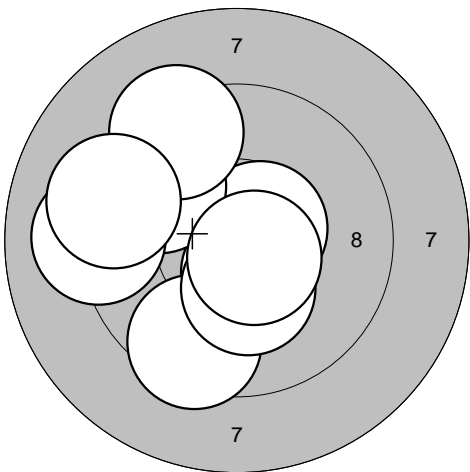
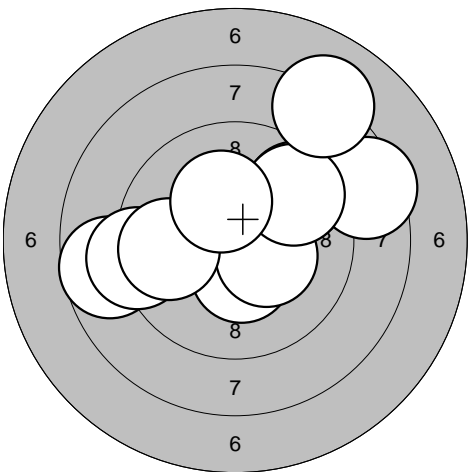
| | | | | | | | | | | | | | | | | | | | | | | | | | | | | | | | | | | | | | | | | | | | | | | | | | | | |
|--|--|----------|---|--------|---|--------|---|----------|---|----------|---|--------|---|----------|---|--------|---|--------|---|---------|---|-------|------|-----|------|--|---|--------|---|----------|---|--------|---|--------|---|--------|---|----------|---|--------|---|--------|---|--------|---|-----------|---|-------|------|-----|-------|
| <p>Series 1</p>  | <table style="width:100%; border-collapse: collapse;"> <tr><td>1: 10,5*</td><td>↘</td></tr> <tr><td>2: 9,5</td><td>↘</td></tr> <tr><td>3: 9,7</td><td>↗</td></tr> <tr><td>4: 10,6*</td><td>↗</td></tr> <tr><td>5: 10,3*</td><td>↘</td></tr> <tr><td>6: 9,7</td><td>↗</td></tr> <tr><td>7: 10,6*</td><td>↘</td></tr> <tr><td>8: 9,3</td><td>↗</td></tr> <tr><td>9: 9,1</td><td>←</td></tr> <tr><td>10: 9,2</td><td>←</td></tr> <tr style="border-top: 1px solid black;"><td style="text-align: right;">Serie</td><td style="text-align: right;">94,0</td></tr> <tr style="border-top: 1px solid black;"><td style="text-align: right;">Sum</td><td style="text-align: right;">94,0</td></tr> </table> | 1: 10,5* | ↘ | 2: 9,5 | ↘ | 3: 9,7 | ↗ | 4: 10,6* | ↗ | 5: 10,3* | ↘ | 6: 9,7 | ↗ | 7: 10,6* | ↘ | 8: 9,3 | ↗ | 9: 9,1 | ← | 10: 9,2 | ← | Serie | 94,0 | Sum | 94,0 | <p>Series 2</p>  | <table style="width:100%; border-collapse: collapse;"> <tr><td>1: 9,6</td><td>↗</td></tr> <tr><td>2: 10,4*</td><td>↘</td></tr> <tr><td>3: 8,7</td><td>←</td></tr> <tr><td>4: 9,2</td><td>←</td></tr> <tr><td>5: 8,5</td><td>↗</td></tr> <tr><td>6: 10,3*</td><td>↘</td></tr> <tr><td>7: 9,6</td><td>↗</td></tr> <tr><td>8: 8,1</td><td>↗</td></tr> <tr><td>9: 9,8</td><td>←</td></tr> <tr><td>10: 10,2*</td><td>↗</td></tr> <tr style="border-top: 1px solid black;"><td style="text-align: right;">Serie</td><td style="text-align: right;">90,0</td></tr> <tr style="border-top: 1px solid black;"><td style="text-align: right;">Sum</td><td style="text-align: right;">184,0</td></tr> </table> | 1: 9,6 | ↗ | 2: 10,4* | ↘ | 3: 8,7 | ← | 4: 9,2 | ← | 5: 8,5 | ↗ | 6: 10,3* | ↘ | 7: 9,6 | ↗ | 8: 8,1 | ↗ | 9: 9,8 | ← | 10: 10,2* | ↗ | Serie | 90,0 | Sum | 184,0 |
| 1: 10,5* | ↘ | | | | | | | | | | | | | | | | | | | | | | | | | | | | | | | | | | | | | | | | | | | | | | | | | | |
| 2: 9,5 | ↘ | | | | | | | | | | | | | | | | | | | | | | | | | | | | | | | | | | | | | | | | | | | | | | | | | | |
| 3: 9,7 | ↗ | | | | | | | | | | | | | | | | | | | | | | | | | | | | | | | | | | | | | | | | | | | | | | | | | | |
| 4: 10,6* | ↗ | | | | | | | | | | | | | | | | | | | | | | | | | | | | | | | | | | | | | | | | | | | | | | | | | | |
| 5: 10,3* | ↘ | | | | | | | | | | | | | | | | | | | | | | | | | | | | | | | | | | | | | | | | | | | | | | | | | | |
| 6: 9,7 | ↗ | | | | | | | | | | | | | | | | | | | | | | | | | | | | | | | | | | | | | | | | | | | | | | | | | | |
| 7: 10,6* | ↘ | | | | | | | | | | | | | | | | | | | | | | | | | | | | | | | | | | | | | | | | | | | | | | | | | | |
| 8: 9,3 | ↗ | | | | | | | | | | | | | | | | | | | | | | | | | | | | | | | | | | | | | | | | | | | | | | | | | | |
| 9: 9,1 | ← | | | | | | | | | | | | | | | | | | | | | | | | | | | | | | | | | | | | | | | | | | | | | | | | | | |
| 10: 9,2 | ← | | | | | | | | | | | | | | | | | | | | | | | | | | | | | | | | | | | | | | | | | | | | | | | | | | |
| Serie | 94,0 | | | | | | | | | | | | | | | | | | | | | | | | | | | | | | | | | | | | | | | | | | | | | | | | | | |
| Sum | 94,0 | | | | | | | | | | | | | | | | | | | | | | | | | | | | | | | | | | | | | | | | | | | | | | | | | | |
| 1: 9,6 | ↗ | | | | | | | | | | | | | | | | | | | | | | | | | | | | | | | | | | | | | | | | | | | | | | | | | | |
| 2: 10,4* | ↘ | | | | | | | | | | | | | | | | | | | | | | | | | | | | | | | | | | | | | | | | | | | | | | | | | | |
| 3: 8,7 | ← | | | | | | | | | | | | | | | | | | | | | | | | | | | | | | | | | | | | | | | | | | | | | | | | | | |
| 4: 9,2 | ← | | | | | | | | | | | | | | | | | | | | | | | | | | | | | | | | | | | | | | | | | | | | | | | | | | |
| 5: 8,5 | ↗ | | | | | | | | | | | | | | | | | | | | | | | | | | | | | | | | | | | | | | | | | | | | | | | | | | |
| 6: 10,3* | ↘ | | | | | | | | | | | | | | | | | | | | | | | | | | | | | | | | | | | | | | | | | | | | | | | | | | |
| 7: 9,6 | ↗ | | | | | | | | | | | | | | | | | | | | | | | | | | | | | | | | | | | | | | | | | | | | | | | | | | |
| 8: 8,1 | ↗ | | | | | | | | | | | | | | | | | | | | | | | | | | | | | | | | | | | | | | | | | | | | | | | | | | |
| 9: 9,8 | ← | | | | | | | | | | | | | | | | | | | | | | | | | | | | | | | | | | | | | | | | | | | | | | | | | | |
| 10: 10,2* | ↗ | | | | | | | | | | | | | | | | | | | | | | | | | | | | | | | | | | | | | | | | | | | | | | | | | | |
| Serie | 90,0 | | | | | | | | | | | | | | | | | | | | | | | | | | | | | | | | | | | | | | | | | | | | | | | | | | |
| Sum | 184,0 | | | | | | | | | | | | | | | | | | | | | | | | | | | | | | | | | | | | | | | | | | | | | | | | | | |

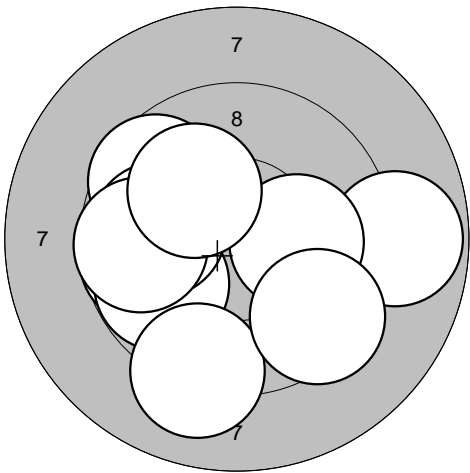
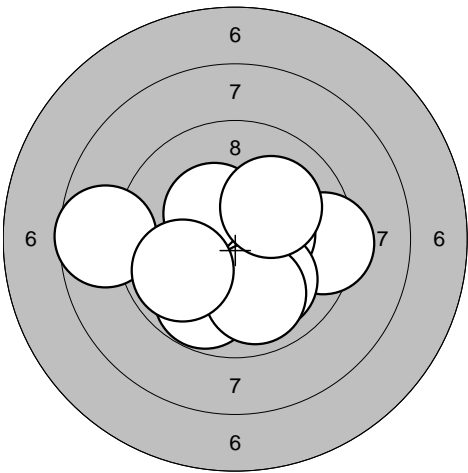
| | | | | | | | | | | | | | | | | | | | | | | | | | | | | | | | | | | | | | | | | | | | | | | | | | | | |
|---|--|--------|---|--------|---|--------|---|--------|---|----------|---|--------|---|--------|---|--------|---|---------|---|---------|---|-------|------|-----|-------|---|---|----------|---|--------|---|--------|---|----------|---|--------|---|----------|---|---------|---|--------|---|--------|---|----------|---|-------|------|-----|-------|
| <p>Series 3</p>  | <table style="width:100%; border-collapse: collapse;"> <tr><td>1: 9,7</td><td>←</td></tr> <tr><td>2: 9,8</td><td>↙</td></tr> <tr><td>3: 9,6</td><td>↗</td></tr> <tr><td>4: 8,8</td><td>→</td></tr> <tr><td>5: 10,2*</td><td>→</td></tr> <tr><td>6: 9,9</td><td>←</td></tr> <tr><td>7: 9,7</td><td>←</td></tr> <tr><td>8: 9,1</td><td>↘</td></tr> <tr><td>9: 10,1</td><td>↗</td></tr> <tr><td>10: 9,5</td><td>↘</td></tr> <tr style="border-top: 1px solid black;"><td style="text-align: right;">Serie</td><td style="text-align: right;">91,0</td></tr> <tr style="border-top: 1px solid black;"><td style="text-align: right;">Sum</td><td style="text-align: right;">275,0</td></tr> </table> | 1: 9,7 | ← | 2: 9,8 | ↙ | 3: 9,6 | ↗ | 4: 8,8 | → | 5: 10,2* | → | 6: 9,9 | ← | 7: 9,7 | ← | 8: 9,1 | ↘ | 9: 10,1 | ↗ | 10: 9,5 | ↘ | Serie | 91,0 | Sum | 275,0 | <p>Series 4</p>  | <table style="width:100%; border-collapse: collapse;"> <tr><td>1: 10,6*</td><td>↗</td></tr> <tr><td>2: 9,4</td><td>→</td></tr> <tr><td>3: 8,7</td><td>←</td></tr> <tr><td>4: 10,4*</td><td>→</td></tr> <tr><td>5: 9,8</td><td>↘</td></tr> <tr><td>6: 10,4*</td><td>↗</td></tr> <tr><td>7: 10,0</td><td>↘</td></tr> <tr><td>8: 9,9</td><td>↘</td></tr> <tr><td>9: 9,9</td><td>←</td></tr> <tr><td>10: 10,1</td><td>↗</td></tr> <tr style="border-top: 1px solid black;"><td style="text-align: right;">Serie</td><td style="text-align: right;">94,0</td></tr> <tr style="border-top: 1px solid black;"><td style="text-align: right;">Sum</td><td style="text-align: right;">369,0</td></tr> </table> | 1: 10,6* | ↗ | 2: 9,4 | → | 3: 8,7 | ← | 4: 10,4* | → | 5: 9,8 | ↘ | 6: 10,4* | ↗ | 7: 10,0 | ↘ | 8: 9,9 | ↘ | 9: 9,9 | ← | 10: 10,1 | ↗ | Serie | 94,0 | Sum | 369,0 |
| 1: 9,7 | ← | | | | | | | | | | | | | | | | | | | | | | | | | | | | | | | | | | | | | | | | | | | | | | | | | | |
| 2: 9,8 | ↙ | | | | | | | | | | | | | | | | | | | | | | | | | | | | | | | | | | | | | | | | | | | | | | | | | | |
| 3: 9,6 | ↗ | | | | | | | | | | | | | | | | | | | | | | | | | | | | | | | | | | | | | | | | | | | | | | | | | | |
| 4: 8,8 | → | | | | | | | | | | | | | | | | | | | | | | | | | | | | | | | | | | | | | | | | | | | | | | | | | | |
| 5: 10,2* | → | | | | | | | | | | | | | | | | | | | | | | | | | | | | | | | | | | | | | | | | | | | | | | | | | | |
| 6: 9,9 | ← | | | | | | | | | | | | | | | | | | | | | | | | | | | | | | | | | | | | | | | | | | | | | | | | | | |
| 7: 9,7 | ← | | | | | | | | | | | | | | | | | | | | | | | | | | | | | | | | | | | | | | | | | | | | | | | | | | |
| 8: 9,1 | ↘ | | | | | | | | | | | | | | | | | | | | | | | | | | | | | | | | | | | | | | | | | | | | | | | | | | |
| 9: 10,1 | ↗ | | | | | | | | | | | | | | | | | | | | | | | | | | | | | | | | | | | | | | | | | | | | | | | | | | |
| 10: 9,5 | ↘ | | | | | | | | | | | | | | | | | | | | | | | | | | | | | | | | | | | | | | | | | | | | | | | | | | |
| Serie | 91,0 | | | | | | | | | | | | | | | | | | | | | | | | | | | | | | | | | | | | | | | | | | | | | | | | | | |
| Sum | 275,0 | | | | | | | | | | | | | | | | | | | | | | | | | | | | | | | | | | | | | | | | | | | | | | | | | | |
| 1: 10,6* | ↗ | | | | | | | | | | | | | | | | | | | | | | | | | | | | | | | | | | | | | | | | | | | | | | | | | | |
| 2: 9,4 | → | | | | | | | | | | | | | | | | | | | | | | | | | | | | | | | | | | | | | | | | | | | | | | | | | | |
| 3: 8,7 | ← | | | | | | | | | | | | | | | | | | | | | | | | | | | | | | | | | | | | | | | | | | | | | | | | | | |
| 4: 10,4* | → | | | | | | | | | | | | | | | | | | | | | | | | | | | | | | | | | | | | | | | | | | | | | | | | | | |
| 5: 9,8 | ↘ | | | | | | | | | | | | | | | | | | | | | | | | | | | | | | | | | | | | | | | | | | | | | | | | | | |
| 6: 10,4* | ↗ | | | | | | | | | | | | | | | | | | | | | | | | | | | | | | | | | | | | | | | | | | | | | | | | | | |
| 7: 10,0 | ↘ | | | | | | | | | | | | | | | | | | | | | | | | | | | | | | | | | | | | | | | | | | | | | | | | | | |
| 8: 9,9 | ↘ | | | | | | | | | | | | | | | | | | | | | | | | | | | | | | | | | | | | | | | | | | | | | | | | | | |
| 9: 9,9 | ← | | | | | | | | | | | | | | | | | | | | | | | | | | | | | | | | | | | | | | | | | | | | | | | | | | |
| 10: 10,1 | ↗ | | | | | | | | | | | | | | | | | | | | | | | | | | | | | | | | | | | | | | | | | | | | | | | | | | |
| Serie | 94,0 | | | | | | | | | | | | | | | | | | | | | | | | | | | | | | | | | | | | | | | | | | | | | | | | | | |
| Sum | 369,0 | | | | | | | | | | | | | | | | | | | | | | | | | | | | | | | | | | | | | | | | | | | | | | | | | | |

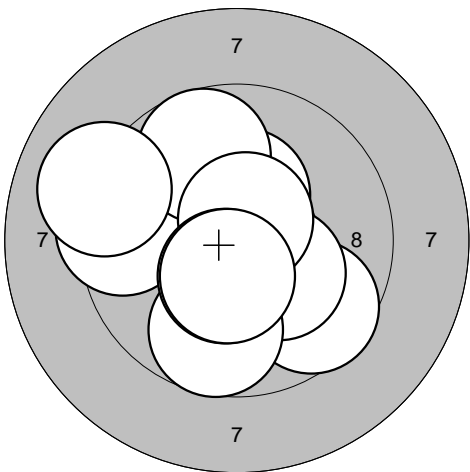
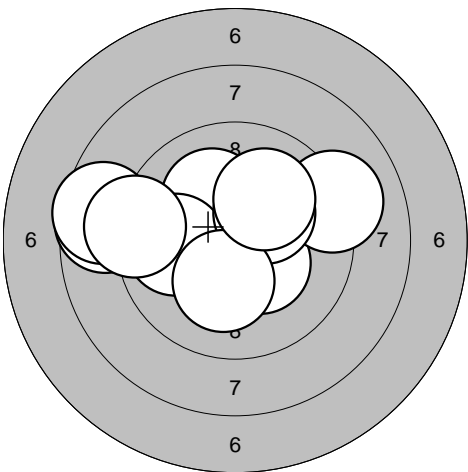
| | | | | | | | | | | | | | | | | | | | | | | | | | | | | | | | | | | | | | | | | | | | | | | | | | | | |
|--|---|----------|---|--------|---|--------|---|----------|---|--------|---|--------|---|----------|---|--------|---|----------|---|-----------|---|-------|------|-----|-------|--|---|--------|---|----------|---|---------|---|--------|---|--------|---|--------|---|----------|---|--------|---|----------|---|----------|---|-------|------|-----|-------|
| <p>Series 5</p>  | <table style="width:100%; border-collapse: collapse;"> <tr><td>1: 10,3*</td><td>↑</td></tr> <tr><td>2: 9,6</td><td>↘</td></tr> <tr><td>3: 9,4</td><td>←</td></tr> <tr><td>4: 10,3*</td><td>↘</td></tr> <tr><td>5: 9,7</td><td>↘</td></tr> <tr><td>6: 9,7</td><td>↗</td></tr> <tr><td>7: 10,6*</td><td>↗</td></tr> <tr><td>8: 9,1</td><td>←</td></tr> <tr><td>9: 10,4*</td><td>↘</td></tr> <tr><td>10: 10,4*</td><td>↘</td></tr> <tr style="border-top: 1px solid black;"><td style="text-align: right;">Serie</td><td style="text-align: right;">95,0</td></tr> <tr style="border-top: 1px solid black;"><td style="text-align: right;">Sum</td><td style="text-align: right;">464,0</td></tr> </table> | 1: 10,3* | ↑ | 2: 9,6 | ↘ | 3: 9,4 | ← | 4: 10,3* | ↘ | 5: 9,7 | ↘ | 6: 9,7 | ↗ | 7: 10,6* | ↗ | 8: 9,1 | ← | 9: 10,4* | ↘ | 10: 10,4* | ↘ | Serie | 95,0 | Sum | 464,0 | <p>Series 6</p>  | <table style="width:100%; border-collapse: collapse;"> <tr><td>1: 8,6</td><td>←</td></tr> <tr><td>2: 10,4*</td><td>↘</td></tr> <tr><td>3: 10,1</td><td>↗</td></tr> <tr><td>4: 9,1</td><td>↗</td></tr> <tr><td>5: 8,6</td><td>←</td></tr> <tr><td>6: 9,9</td><td>←</td></tr> <tr><td>7: 10,2*</td><td>↗</td></tr> <tr><td>8: 9,2</td><td>←</td></tr> <tr><td>9: 10,2*</td><td>↘</td></tr> <tr><td>10: 10,1</td><td>↗</td></tr> <tr style="border-top: 1px solid black;"><td style="text-align: right;">Serie</td><td style="text-align: right;">93,0</td></tr> <tr style="border-top: 1px solid black;"><td style="text-align: right;">Sum</td><td style="text-align: right;">557,0</td></tr> </table> | 1: 8,6 | ← | 2: 10,4* | ↘ | 3: 10,1 | ↗ | 4: 9,1 | ↗ | 5: 8,6 | ← | 6: 9,9 | ← | 7: 10,2* | ↗ | 8: 9,2 | ← | 9: 10,2* | ↘ | 10: 10,1 | ↗ | Serie | 93,0 | Sum | 557,0 |
| 1: 10,3* | ↑ | | | | | | | | | | | | | | | | | | | | | | | | | | | | | | | | | | | | | | | | | | | | | | | | | | |
| 2: 9,6 | ↘ | | | | | | | | | | | | | | | | | | | | | | | | | | | | | | | | | | | | | | | | | | | | | | | | | | |
| 3: 9,4 | ← | | | | | | | | | | | | | | | | | | | | | | | | | | | | | | | | | | | | | | | | | | | | | | | | | | |
| 4: 10,3* | ↘ | | | | | | | | | | | | | | | | | | | | | | | | | | | | | | | | | | | | | | | | | | | | | | | | | | |
| 5: 9,7 | ↘ | | | | | | | | | | | | | | | | | | | | | | | | | | | | | | | | | | | | | | | | | | | | | | | | | | |
| 6: 9,7 | ↗ | | | | | | | | | | | | | | | | | | | | | | | | | | | | | | | | | | | | | | | | | | | | | | | | | | |
| 7: 10,6* | ↗ | | | | | | | | | | | | | | | | | | | | | | | | | | | | | | | | | | | | | | | | | | | | | | | | | | |
| 8: 9,1 | ← | | | | | | | | | | | | | | | | | | | | | | | | | | | | | | | | | | | | | | | | | | | | | | | | | | |
| 9: 10,4* | ↘ | | | | | | | | | | | | | | | | | | | | | | | | | | | | | | | | | | | | | | | | | | | | | | | | | | |
| 10: 10,4* | ↘ | | | | | | | | | | | | | | | | | | | | | | | | | | | | | | | | | | | | | | | | | | | | | | | | | | |
| Serie | 95,0 | | | | | | | | | | | | | | | | | | | | | | | | | | | | | | | | | | | | | | | | | | | | | | | | | | |
| Sum | 464,0 | | | | | | | | | | | | | | | | | | | | | | | | | | | | | | | | | | | | | | | | | | | | | | | | | | |
| 1: 8,6 | ← | | | | | | | | | | | | | | | | | | | | | | | | | | | | | | | | | | | | | | | | | | | | | | | | | | |
| 2: 10,4* | ↘ | | | | | | | | | | | | | | | | | | | | | | | | | | | | | | | | | | | | | | | | | | | | | | | | | | |
| 3: 10,1 | ↗ | | | | | | | | | | | | | | | | | | | | | | | | | | | | | | | | | | | | | | | | | | | | | | | | | | |
| 4: 9,1 | ↗ | | | | | | | | | | | | | | | | | | | | | | | | | | | | | | | | | | | | | | | | | | | | | | | | | | |
| 5: 8,6 | ← | | | | | | | | | | | | | | | | | | | | | | | | | | | | | | | | | | | | | | | | | | | | | | | | | | |
| 6: 9,9 | ← | | | | | | | | | | | | | | | | | | | | | | | | | | | | | | | | | | | | | | | | | | | | | | | | | | |
| 7: 10,2* | ↗ | | | | | | | | | | | | | | | | | | | | | | | | | | | | | | | | | | | | | | | | | | | | | | | | | | |
| 8: 9,2 | ← | | | | | | | | | | | | | | | | | | | | | | | | | | | | | | | | | | | | | | | | | | | | | | | | | | |
| 9: 10,2* | ↘ | | | | | | | | | | | | | | | | | | | | | | | | | | | | | | | | | | | | | | | | | | | | | | | | | | |
| 10: 10,1 | ↗ | | | | | | | | | | | | | | | | | | | | | | | | | | | | | | | | | | | | | | | | | | | | | | | | | | |
| Serie | 93,0 | | | | | | | | | | | | | | | | | | | | | | | | | | | | | | | | | | | | | | | | | | | | | | | | | | |
| Sum | 557,0 | | | | | | | | | | | | | | | | | | | | | | | | | | | | | | | | | | | | | | | | | | | | | | | | | | |

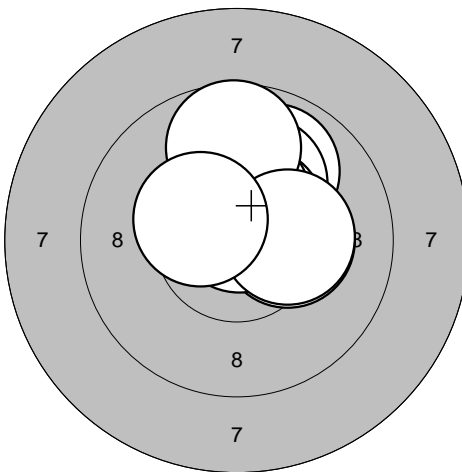
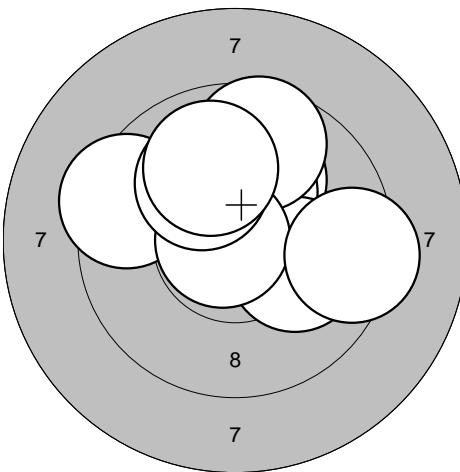
| | | | | | | | | | | | |
|--|---|-------|------|-----|------|--|--|-------|------|-----|-------|
| <p>Series 1</p>  | <p>1: 9,9 ↗ 2: 10,3* → 3: 10,6* ↑ 4: 10,1 ↗ 5: 10,5* ↗ 6: 10,7* ↑ 7: 10,4* ↑ 8: 9,7 ↑ 9: 10,3* → 10: 10,4* ↖</p> <table border="1" style="width:100%; border-collapse: collapse;"> <tr><td>Serie</td><td style="text-align: right;">98,0</td></tr> <tr><td>Sum</td><td style="text-align: right;">98,0</td></tr> </table> | Serie | 98,0 | Sum | 98,0 | <p>Series 2</p>  | <p>1: 10,1 ↗ 2: 10,3* ↑ 3: 10,6* ↑ 4: 10,1 → 5: 9,6 ↑ 6: 9,4 ↖ 7: 10,8* ← 8: 10,1 ↗ 9: 9,9 ↑ 10: 9,4 →</p> <table border="1" style="width:100%; border-collapse: collapse;"> <tr><td>Serie</td><td style="text-align: right;">96,0</td></tr> <tr><td>Sum</td><td style="text-align: right;">194,0</td></tr> </table> | Serie | 96,0 | Sum | 194,0 |
| Serie | 98,0 | | | | | | | | | | |
| Sum | 98,0 | | | | | | | | | | |
| Serie | 96,0 | | | | | | | | | | |
| Sum | 194,0 | | | | | | | | | | |

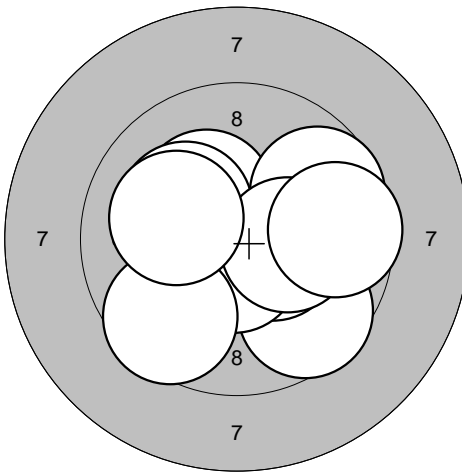
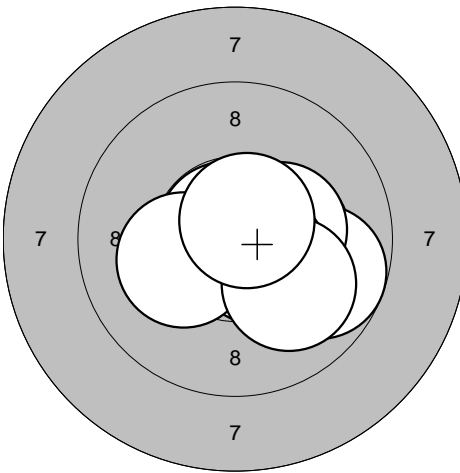
| | | | | | | | | | | | |
|---|--|-------|------|-----|-------|---|--|-------|------|-----|-------|
| <p>Series 3</p>  | <p>1: 9,6 ↘ 2: 10,3* ↑ 3: 9,7 → 4: 10,4* → 5: 10,2* ↗ 6: 10,6* ↓ 7: 10,3* → 8: 9,6 → 9: 9,6 ↘ 10: 10,1 ↖</p> <table border="1" style="width:100%; border-collapse: collapse;"> <tr><td>Serie</td><td style="text-align: right;">96,0</td></tr> <tr><td>Sum</td><td style="text-align: right;">290,0</td></tr> </table> | Serie | 96,0 | Sum | 290,0 | <p>Series 4</p>  | <p>1: 10,7* ↗ 2: 10,8* ↑ 3: 10,3* → 4: 9,7 → 5: 10,4* → 6: 10,8* ↗ 7: 10,6* ↘ 8: 10,2* ← 9: 10,0 ↘ 10: 10,7* ↗</p> <table border="1" style="width:100%; border-collapse: collapse;"> <tr><td>Serie</td><td style="text-align: right;">99,0</td></tr> <tr><td>Sum</td><td style="text-align: right;">389,0</td></tr> </table> | Serie | 99,0 | Sum | 389,0 |
| Serie | 96,0 | | | | | | | | | | |
| Sum | 290,0 | | | | | | | | | | |
| Serie | 99,0 | | | | | | | | | | |
| Sum | 389,0 | | | | | | | | | | |

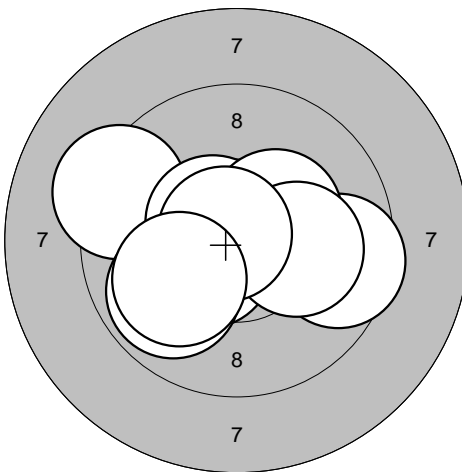
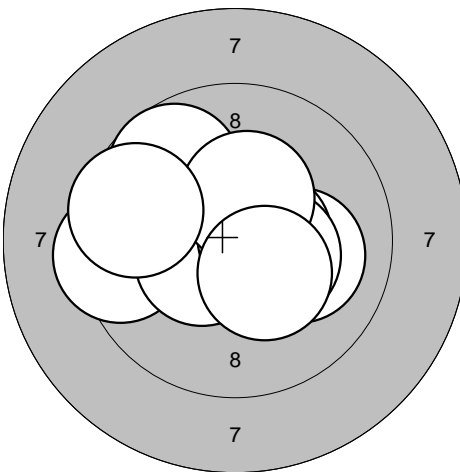
| | | | | | | | | | | | |
|--|---|-------|------|-----|-------|--|--|-------|------|-----|-------|
| <p>Series 5</p>  | <p>1: 9,6 → 2: 10,7* ← 3: 9,3 ↖ 4: 10,4* ↖ 5: 10,6* ↗ 6: 10,3* ↗ 7: 10,1 → 8: 10,8* ↖ 9: 9,9 ↘ 10: 10,0 ↖</p> <table border="1" style="width:100%; border-collapse: collapse;"> <tr><td>Serie</td><td style="text-align: right;">97,0</td></tr> <tr><td>Sum</td><td style="text-align: right;">486,0</td></tr> </table> | Serie | 97,0 | Sum | 486,0 | <p>Series 6</p>  | <p>1: 10,8* ↓ 2: 9,4 ← 3: 10,5* ↖ 4: 9,7 ↗ 5: 10,1 → 6: 10,6* → 7: 10,4* → 8: 10,4* ↑ 9: 9,6 ← 10: 10,3* ↘</p> <table border="1" style="width:100%; border-collapse: collapse;"> <tr><td>Serie</td><td style="text-align: right;">97,0</td></tr> <tr><td>Sum</td><td style="text-align: right;">583,0</td></tr> </table> | Serie | 97,0 | Sum | 583,0 |
| Serie | 97,0 | | | | | | | | | | |
| Sum | 486,0 | | | | | | | | | | |
| Serie | 97,0 | | | | | | | | | | |
| Sum | 583,0 | | | | | | | | | | |

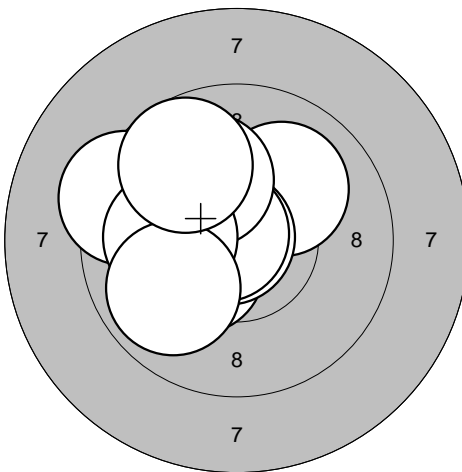
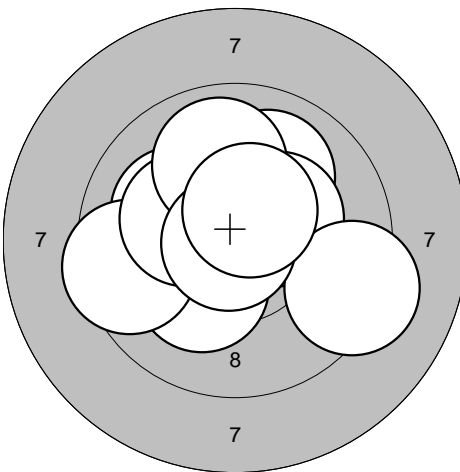
| | | | | | | | | | | | |
|--|--|-------|------|-----|------|--|---|-------|------|-----|-------|
| <p>Series 1</p>  | <p>1: 9,4 ↙ 2: 10,3* ↙ 3: 10,1 ↗ 4: 10,0 ↗ 5: 10,8* ↙ 6: 10,7* ↙ 7: 10,1 ↗ 8: 10,1 ↙ 9: 9,9 ↙ 10: 9,8 ↗</p> <table border="1" style="width:100%; border-collapse: collapse;"> <tr><td>Serie</td><td style="text-align: right;">97,0</td></tr> <tr><td>Sum</td><td style="text-align: right;">97,0</td></tr> </table> | Serie | 97,0 | Sum | 97,0 | <p>Series 2</p>  | <p>1: 10,2* ↘ 2: 10,0 ↗ 3: 10,1 ↙ 4: 9,5 ↙ 5: 10,3* ↗ 6: 10,3* ↙ 7: 9,3 ↘ 8: 9,9 ↗ 9: 10,9* ↙ 10: 10,5* ↗</p> <table border="1" style="width:100%; border-collapse: collapse;"> <tr><td>Serie</td><td style="text-align: right;">97,0</td></tr> <tr><td>Sum</td><td style="text-align: right;">194,0</td></tr> </table> | Serie | 97,0 | Sum | 194,0 |
| Serie | 97,0 | | | | | | | | | | |
| Sum | 97,0 | | | | | | | | | | |
| Serie | 97,0 | | | | | | | | | | |
| Sum | 194,0 | | | | | | | | | | |

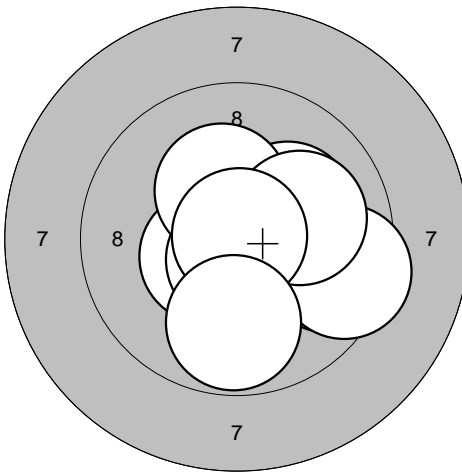
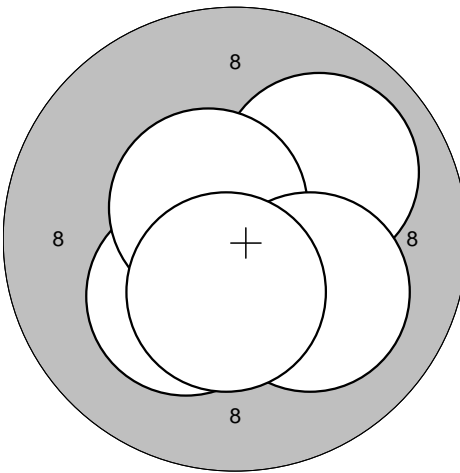
| | | | | | | | | | | | |
|---|---|-------|------|-----|-------|---|--|-------|-------|-----|-------|
| <p>Series 3</p>  | <p>1: 10,1 ↗ 2: 10,5* ↗ 3: 10,5* ↙ 4: 10,7* ↘ 5: 9,7 ↘ 6: 9,5 ↘ 7: 10,3* ↗ 8: 10,1 ↗ 9: 10,9* ↗ 10: 9,8 ↘</p> <table border="1" style="width:100%; border-collapse: collapse;"> <tr><td>Serie</td><td style="text-align: right;">97,0</td></tr> <tr><td>Sum</td><td style="text-align: right;">291,0</td></tr> </table> | Serie | 97,0 | Sum | 291,0 | <p>Series 4</p>  | <p>1: 10,7* ↘ 2: 10,7* ↗ 3: 10,7* ↗ 4: 10,7* ↙ 5: 10,8* ↗ 6: 10,0 ↗ 7: 10,3* ↙ 8: 10,6* ↙ 9: 10,1 ↘ 10: 10,5* ↘</p> <table border="1" style="width:100%; border-collapse: collapse;"> <tr><td>Serie</td><td style="text-align: right;">100,0</td></tr> <tr><td>Sum</td><td style="text-align: right;">391,0</td></tr> </table> | Serie | 100,0 | Sum | 391,0 |
| Serie | 97,0 | | | | | | | | | | |
| Sum | 291,0 | | | | | | | | | | |
| Serie | 100,0 | | | | | | | | | | |
| Sum | 391,0 | | | | | | | | | | |

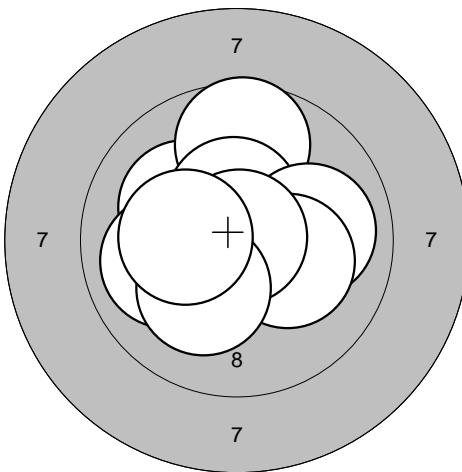
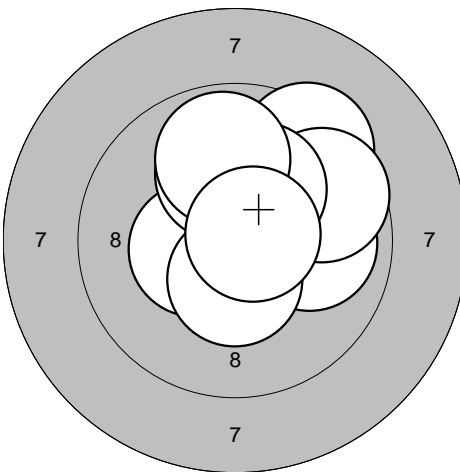
| | | | | | | | | | | | |
|--|---|-------|------|-----|-------|--|--|-------|------|-----|-------|
| <p>Series 5</p>  | <p>1: 10,2* ↙ 2: 10,0 ↙ 3: 10,7* ↙ 4: 9,7 ↗ 5: 10,5* ↗ 6: 10,0 ↗ 7: 10,2* ↗ 8: 10,9* ↗ 9: 10,2* ↙ 10: 10,3* ↙</p> <table border="1" style="width:100%; border-collapse: collapse;"> <tr><td>Serie</td><td style="text-align: right;">99,0</td></tr> <tr><td>Sum</td><td style="text-align: right;">490,0</td></tr> </table> | Serie | 99,0 | Sum | 490,0 | <p>Series 6</p>  | <p>1: 10,4* ↙ 2: 10,0 ↗ 3: 9,9 ↘ 4: 10,4* ↗ 5: 9,4 ↗ 6: 10,4* ↘ 7: 9,6 ↗ 8: 10,2* ↗ 9: 9,9 ↗ 10: 10,7* ↗</p> <table border="1" style="width:100%; border-collapse: collapse;"> <tr><td>Serie</td><td style="text-align: right;">96,0</td></tr> <tr><td>Sum</td><td style="text-align: right;">586,0</td></tr> </table> | Serie | 96,0 | Sum | 586,0 |
| Serie | 99,0 | | | | | | | | | | |
| Sum | 490,0 | | | | | | | | | | |
| Serie | 96,0 | | | | | | | | | | |
| Sum | 586,0 | | | | | | | | | | |

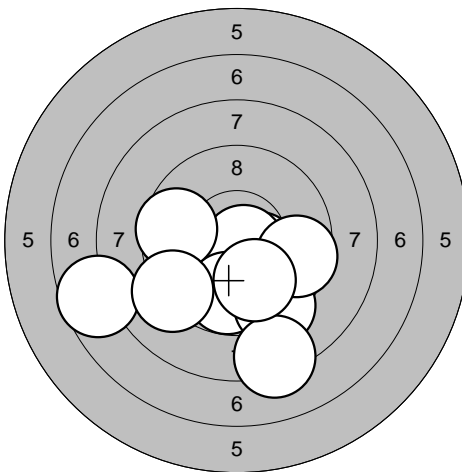
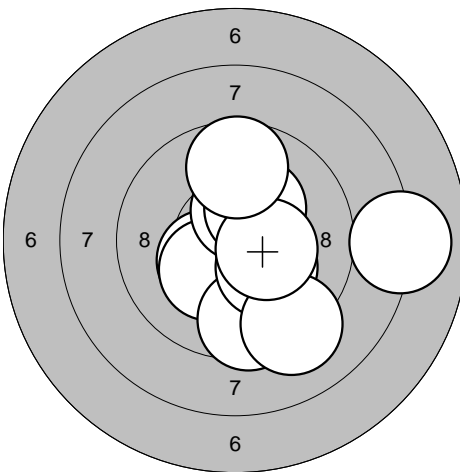
| | | | | | | | | | | | |
|--|---|-------|------|-----|------|--|---|-------|------|-----|-------|
| <p>Series 1</p>  | <p>1: 10,4* ↘ 2: 10,8* ↘ 3: 7,7 ← 4: 9,8 ↓ 5: 9,3 ↘ 6: 9,6 ← 7: 9,6 → 8: 8,2 ↓ 9: 10,0 ↓ 10: 9,2 ↙</p> <table border="1" style="width:100%; border-collapse: collapse;"> <tr><td>Serie</td><td style="text-align: right;">90,0</td></tr> <tr><td>Sum</td><td style="text-align: right;">90,0</td></tr> </table> | Serie | 90,0 | Sum | 90,0 | <p>Series 2</p>  | <p>1: 10,4* ↘ 2: 10,3* ↘ 3: 10,4* ↑ 4: 9,5 ↓ 5: 10,2* ↘ 6: 9,2 ↘ 7: 10,3* ↗ 8: 8,0 → 9: 10,4* → 10: 9,7 ↑</p> <table border="1" style="width:100%; border-collapse: collapse;"> <tr><td>Serie</td><td style="text-align: right;">95,0</td></tr> <tr><td>Sum</td><td style="text-align: right;">185,0</td></tr> </table> | Serie | 95,0 | Sum | 185,0 |
| Serie | 90,0 | | | | | | | | | | |
| Sum | 90,0 | | | | | | | | | | |
| Serie | 95,0 | | | | | | | | | | |
| Sum | 185,0 | | | | | | | | | | |

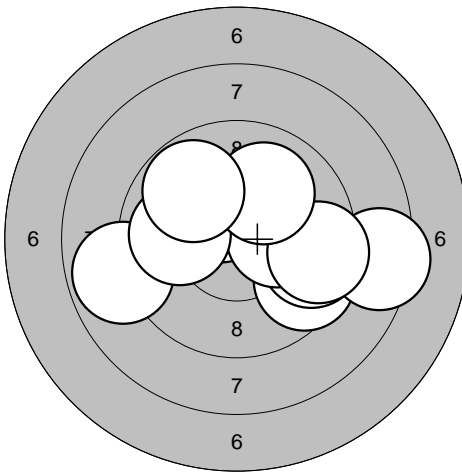
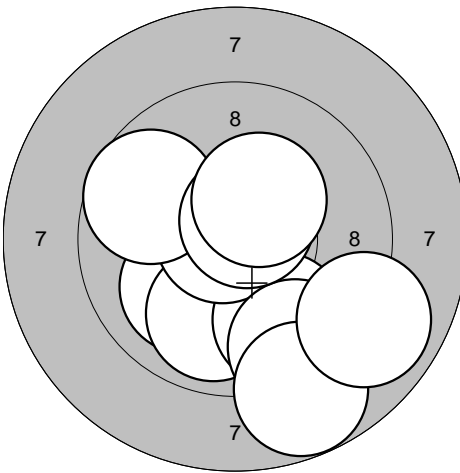
| | | | | | | | | | | | |
|---|--|-------|------|-----|-------|---|--|-------|------|-----|-------|
| <p>Series 3</p>  | <p>1: 8,8 ← 2: 9,6 ↘ 3: 10,4* ↗ 4: 8,4 → 5: 9,6 → 6: 10,2* → 7: 9,9 ← 8: 9,5 → 9: 10,0 ↗ 10: 9,8 ↗</p> <table border="1" style="width:100%; border-collapse: collapse;"> <tr><td>Serie</td><td style="text-align: right;">91,0</td></tr> <tr><td>Sum</td><td style="text-align: right;">276,0</td></tr> </table> | Serie | 91,0 | Sum | 276,0 | <p>Series 4</p>  | <p>1: 10,0 ↘ 2: 9,9 ↓ 3: 9,7 ↘ 4: 10,8* ← 5: 9,3 ↓ 6: 8,8 ↓ 7: 9,7 ↖ 8: 10,7* ↗ 9: 10,4* ↗ 10: 8,9 ↘</p> <table border="1" style="width:100%; border-collapse: collapse;"> <tr><td>Serie</td><td style="text-align: right;">92,0</td></tr> <tr><td>Sum</td><td style="text-align: right;">368,0</td></tr> </table> | Serie | 92,0 | Sum | 368,0 |
| Serie | 91,0 | | | | | | | | | | |
| Sum | 276,0 | | | | | | | | | | |
| Serie | 92,0 | | | | | | | | | | |
| Sum | 368,0 | | | | | | | | | | |

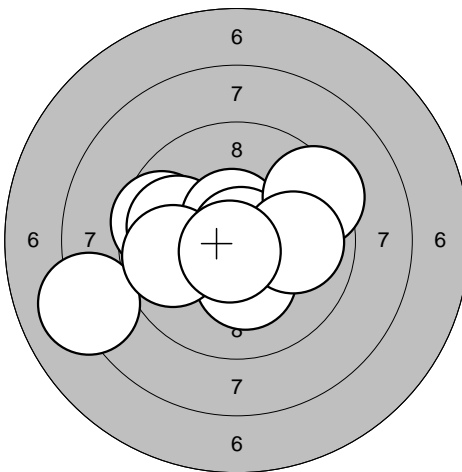
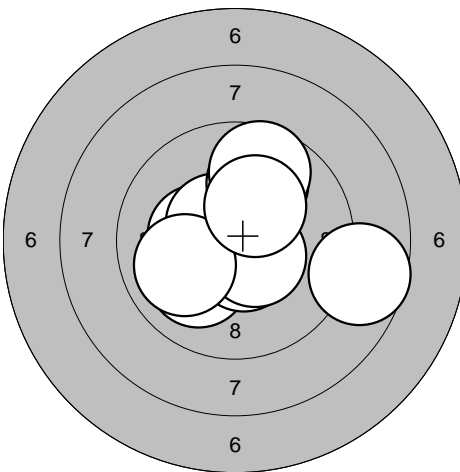
| | | | | | | | | | | | |
|--|---|-------|------|-----|-------|--|---|-------|------|-----|-------|
| <p>Series 5</p>  | <p>1: 9,6 ← 2: 8,1 ← 3: 10,2* ↓ 4: 9,9 ← 5: 10,6* ↑ 6: 10,9* → 7: 9,4 ↗ 8: 9,8 ← 9: 9,9 → 10: 10,7* ↘</p> <table border="1" style="width:100%; border-collapse: collapse;"> <tr><td>Serie</td><td style="text-align: right;">93,0</td></tr> <tr><td>Sum</td><td style="text-align: right;">461,0</td></tr> </table> | Serie | 93,0 | Sum | 461,0 | <p>Series 6</p>  | <p>1: 10,0 ↘ 2: 10,3* ← 3: 10,6* ↓ 4: 10,5* ↗ 5: 9,9 ↑ 6: 10,5* ↘ 7: 10,0 ← 8: 9,7 ↑ 9: 10,2* ↗ 10: 8,7 →</p> <table border="1" style="width:100%; border-collapse: collapse;"> <tr><td>Serie</td><td style="text-align: right;">96,0</td></tr> <tr><td>Sum</td><td style="text-align: right;">557,0</td></tr> </table> | Serie | 96,0 | Sum | 557,0 |
| Serie | 93,0 | | | | | | | | | | |
| Sum | 461,0 | | | | | | | | | | |
| Serie | 96,0 | | | | | | | | | | |
| Sum | 557,0 | | | | | | | | | | |

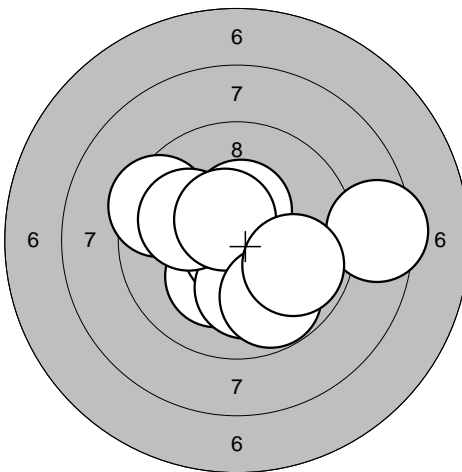
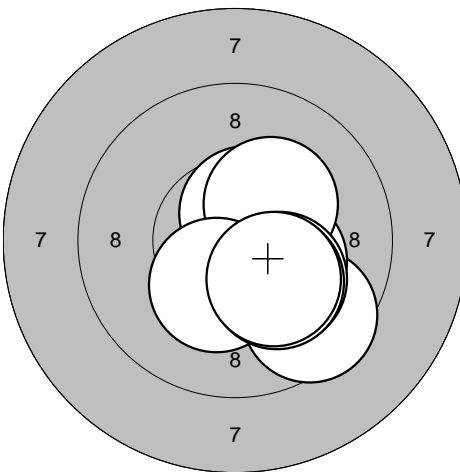
| | | | | | | | | | | | |
|--|--|-------|------|-----|------|--|--|-------|------|-----|-------|
| <p>Series 1</p>  | <p>1: 10,2* ↙ 2: 10,8* ↙ 3: 9,5 ↖ 4: 10,4* ↑ 5: 8,5 → 6: 10,1 ↙ 7: 10,0 ↖ 8: 10,5* ↗ 9: 9,8 ↙ 10: 9,8 →</p> <table border="1" style="width:100%; border-collapse: collapse;"> <tr><td>Serie</td><td style="text-align: right;">95,0</td></tr> <tr><td>Sum</td><td style="text-align: right;">95,0</td></tr> </table> | Serie | 95,0 | Sum | 95,0 | <p>Series 2</p>  | <p>1: 9,6 ↘ 2: 10,3* ↘ 3: 10,6* ↗ 4: 10,5* → 5: 10,6* ↑ 6: 10,3* ↗ 7: 10,2* ↘ 8: 10,3* ↙ 9: 10,1 ↘ 10: 10,2* ↘</p> <table border="1" style="width:100%; border-collapse: collapse;"> <tr><td>Serie</td><td style="text-align: right;">99,0</td></tr> <tr><td>Sum</td><td style="text-align: right;">194,0</td></tr> </table> | Serie | 99,0 | Sum | 194,0 |
| Serie | 95,0 | | | | | | | | | | |
| Sum | 95,0 | | | | | | | | | | |
| Serie | 99,0 | | | | | | | | | | |
| Sum | 194,0 | | | | | | | | | | |

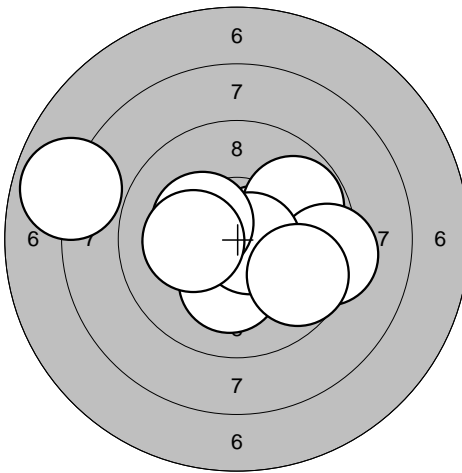
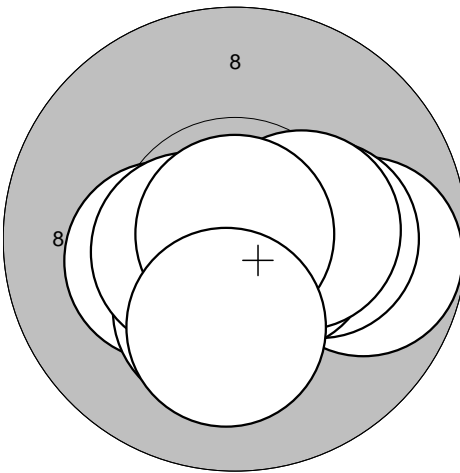
| | | | | | | | | | | | |
|---|---|-------|------|-----|-------|---|--|-------|------|-----|-------|
| <p>Series 3</p>  | <p>1: 10,6* → 2: 9,8 ↗ 3: 7,9 ↖ 4: 9,3 → 5: 10,6* ↘ 6: 10,2* ↙ 7: 10,7* → 8: 10,3* ↗ 9: 10,2* ← 10: 9,7 ↘</p> <table border="1" style="width:100%; border-collapse: collapse;"> <tr><td>Serie</td><td style="text-align: right;">94,0</td></tr> <tr><td>Sum</td><td style="text-align: right;">288,0</td></tr> </table> | Serie | 94,0 | Sum | 288,0 | <p>Series 4</p>  | <p>1: 9,8 → 2: 10,4* → 3: 10,3* ← 4: 10,2* → 5: 10,6* → 6: 10,3* ↙ 7: 10,5* ← 8: 10,3* → 9: 10,9* ↑ 10: 10,1 ↘</p> <table border="1" style="width:100%; border-collapse: collapse;"> <tr><td>Serie</td><td style="text-align: right;">99,0</td></tr> <tr><td>Sum</td><td style="text-align: right;">387,0</td></tr> </table> | Serie | 99,0 | Sum | 387,0 |
| Serie | 94,0 | | | | | | | | | | |
| Sum | 288,0 | | | | | | | | | | |
| Serie | 99,0 | | | | | | | | | | |
| Sum | 387,0 | | | | | | | | | | |

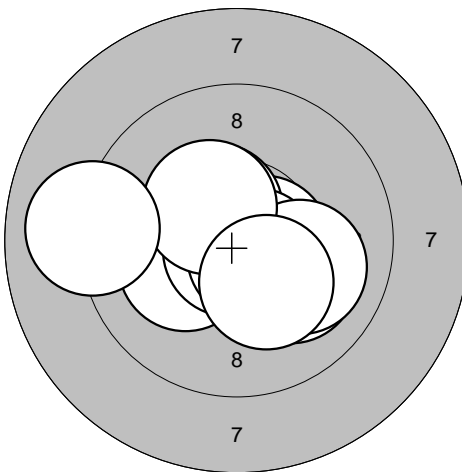
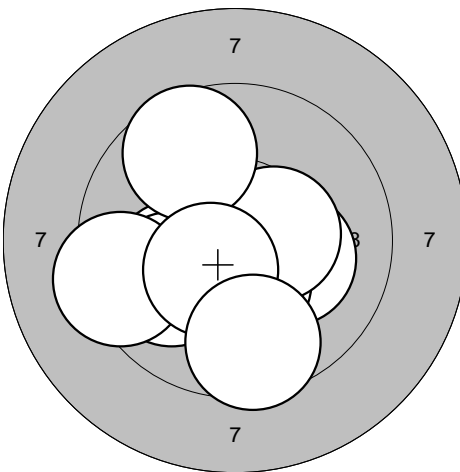
| | | | | | | | | | | | |
|--|---|-------|------|-----|-------|--|---|-------|------|-----|-------|
| <p>Series 5</p>  | <p>1: 10,6* → 2: 10,5* ↗ 3: 10,2* ← 4: 10,8* ↙ 5: 10,1 ↘ 6: 10,6* ↘ 7: 10,0 → 8: 10,4* ↗ 9: 10,3* ↘ 10: 9,0 ←</p> <table border="1" style="width:100%; border-collapse: collapse;"> <tr><td>Serie</td><td style="text-align: right;">99,0</td></tr> <tr><td>Sum</td><td style="text-align: right;">486,0</td></tr> </table> | Serie | 99,0 | Sum | 486,0 | <p>Series 6</p>  | <p>1: 10,4* ↙ 2: 10,2* → 3: 10,1 ← 4: 10,0 ← 5: 9,3 ← 6: 10,4* ↙ 7: 10,4* → 8: 9,7 ↗ 9: 10,4* ↙ 10: 9,6 ↘</p> <table border="1" style="width:100%; border-collapse: collapse;"> <tr><td>Serie</td><td style="text-align: right;">97,0</td></tr> <tr><td>Sum</td><td style="text-align: right;">583,0</td></tr> </table> | Serie | 97,0 | Sum | 583,0 |
| Serie | 99,0 | | | | | | | | | | |
| Sum | 486,0 | | | | | | | | | | |
| Serie | 97,0 | | | | | | | | | | |
| Sum | 583,0 | | | | | | | | | | |

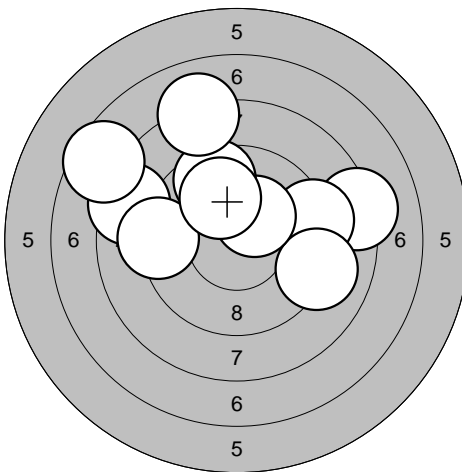
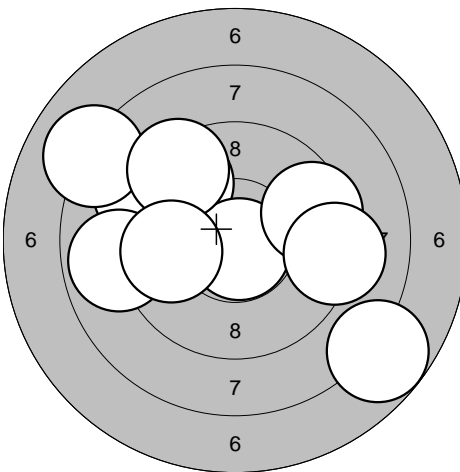
| | | | |
|--|---|--|--|
| <p>Series 1</p>  | <p>1: 8,2 →</p> <p>2: 9,2 →</p> <p>3: 9,1 →</p> <p>4: 8,5 ←</p> <p>5: 10,3* ↗</p> <p>6: 9,5 ↗</p> <p>7: 8,1 ↗</p> <p>8: 9,2 ←</p> <p>9: 7,6 ↗</p> <p>10: 10,0 ↗</p> | <p>Series 2</p>  | <p>1: 9,6 ↗</p> <p>2: 10,8* ↓</p> <p>3: 9,1 ↗</p> <p>4: 7,7 ↓</p> <p>5: 9,5 →</p> <p>6: 9,2 →</p> <p>7: 8,1 ↗</p> <p>8: 9,4 ↗</p> <p>9: 8,9 ←</p> <p>10: 9,8 ←</p> |
| Serie 87,0 | Serie 87,0 | Serie 87,0 | Serie 87,0 |
| Sum 87,0 | Sum 87,0 | Sum 174,0 | Sum 174,0 |

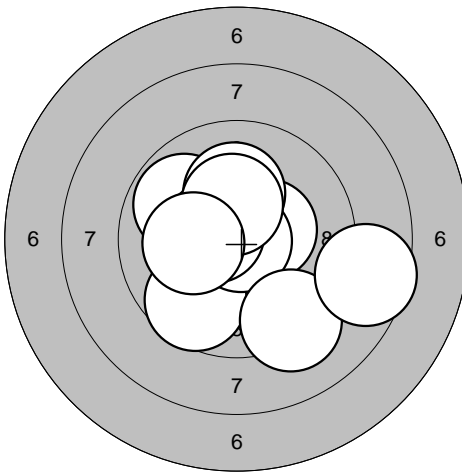
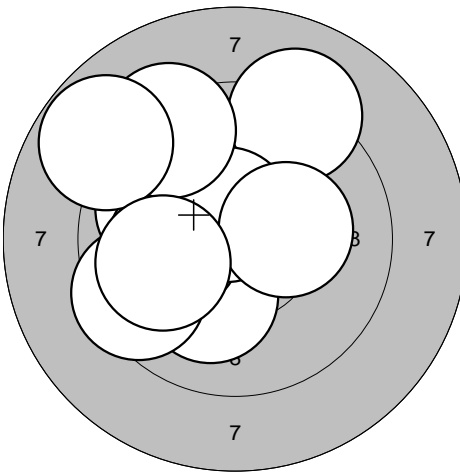
| | | | |
|---|---|---|--|
| <p>Series 3</p>  | <p>1: 9,7 ↓</p> <p>2: 10,4* →</p> <p>3: 10,9* →</p> <p>4: 9,2 ↓</p> <p>5: 9,9 ↗</p> <p>6: 10,1 ↗</p> <p>7: 10,5* ←</p> <p>8: 10,3* ↗</p> <p>9: 8,6 →</p> <p>10: 10,2* ←</p> | <p>Series 4</p>  | <p>1: 9,1 ↗</p> <p>2: 9,9 ←</p> <p>3: 10,1 ↓</p> <p>4: 10,1 ←</p> <p>5: 9,5 ←</p> <p>6: 10,6* ↗</p> <p>7: 9,3 ↗</p> <p>8: 10,3* →</p> <p>9: 8,8 ↗</p> <p>10: 9,9 ←</p> |
| Serie 95,0 | Serie 95,0 | Serie 93,0 | Serie 93,0 |
| Sum 269,0 | Sum 269,0 | Sum 362,0 | Sum 362,0 |

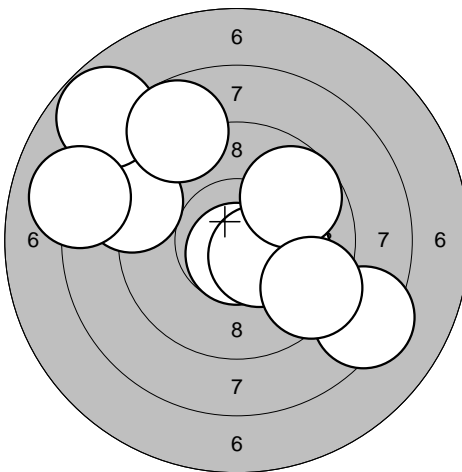
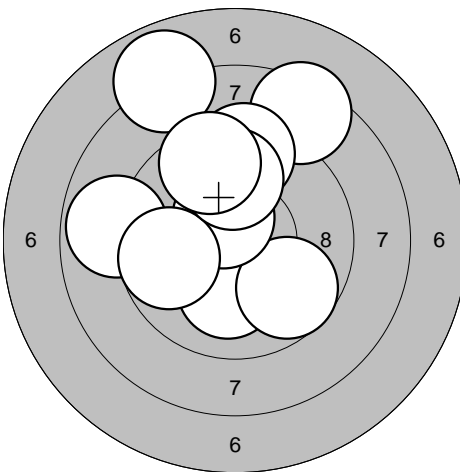
| | | | |
|--|--|--|---|
| <p>Series 5</p>  | <p>1: 9,0 ←</p> <p>2: 8,3 ↓</p> <p>3: 7,8 ↗</p> <p>4: 10,2* →</p> <p>5: 10,7* ↓</p> <p>6: 10,5* ↓</p> <p>7: 8,8 ↗</p> <p>8: 9,7 ↗</p> <p>9: 9,4 ↓</p> <p>10: 8,1 ←</p> | <p>Series 6</p>  | <p>1: 7,9 ↗</p> <p>2: 10,1 ↓</p> <p>3: 8,4 ↗</p> <p>4: 9,7 ↓</p> <p>5: 10,5* ↗</p> <p>6: 8,8 ←</p> <p>7: 9,4 ↗</p> <p>8: 9,7 ←</p> <p>9: 9,9 ↗</p> <p>10: 9,5 ↗</p> |
| Serie 88,0 | Serie 88,0 | Serie 88,0 | Serie 88,0 |
| Sum 450,0 | Sum 450,0 | Sum 538,0 | Sum 538,0 |

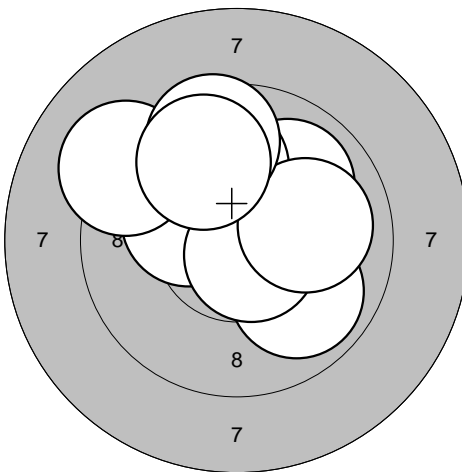
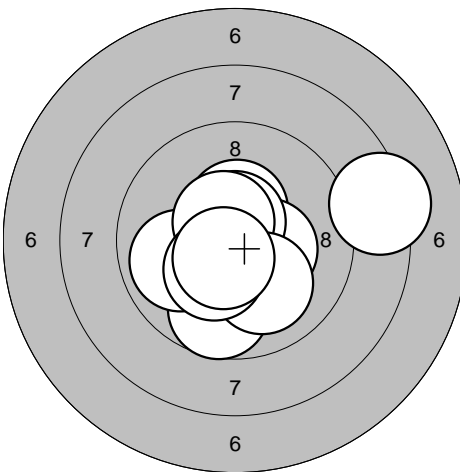
| | | | |
|--|---|--|--|
| <p>Series 1</p>  | <p>1: 10,5* ↗ 2: 9,9 ↗ 3: 10,0 ↑ 4: 9,9 ↘ 5: 10,3* ↗ 6: 10,7* ↘ 7: 10,0 → 8: 9,2 ↗ 9: 9,6 ↑ 10: 9,8 ↑</p> | <p>Series 2</p>  | <p>1: 10,4* ↑ 2: 9,7 ↓ 3: 10,4* → 4: 9,9 ← 5: 10,6* ↑ 6: 10,6* ↗ 7: 10,0 ↓ 8: 10,3* ↘ 9: 8,3 → 10: 10,6* ↘</p> |
| | Serie 95,0 | | Serie 96,0 |
| | Sum 95,0 | | Sum 191,0 |

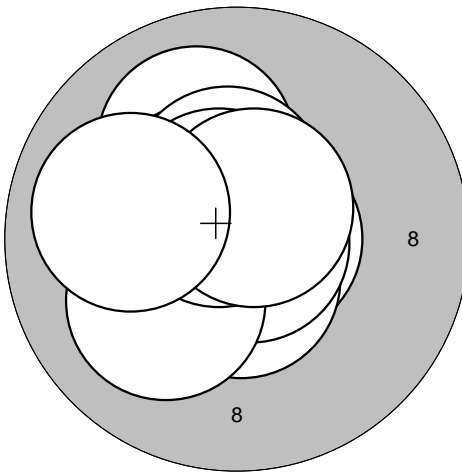
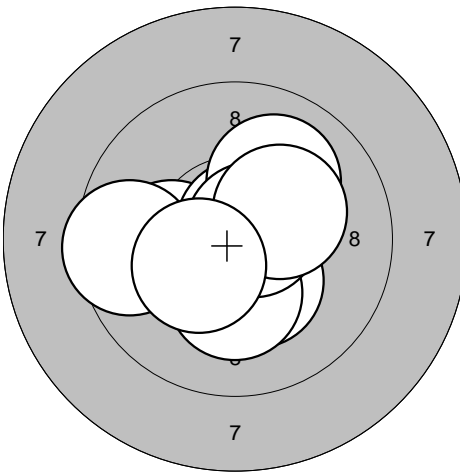
| | | | |
|---|---|---|---|
| <p>Series 3</p>  | <p>1: 10,7* → 2: 10,0 ↑ 3: 10,6* ↓ 4: 10,5* ↗ 5: 10,8* → 6: 10,1 ↖ 7: 10,5* ↑ 8: 10,6* ↗ 9: 10,6* ↗ 10: 9,9 ←</p> | <p>Series 4</p>  | <p>1: 10,1 ← 2: 10,7* ↗ 3: 10,0 ↗ 4: 9,5 ← 5: 10,4* ↓ 6: 10,3* ↓ 7: 10,2* ↓ 8: 10,7* ↗ 9: 10,3* ↗ 10: 10,4* ↖</p> |
| | Serie 99,0 | | Serie 99,0 |
| | Sum 290,0 | | Sum 389,0 |

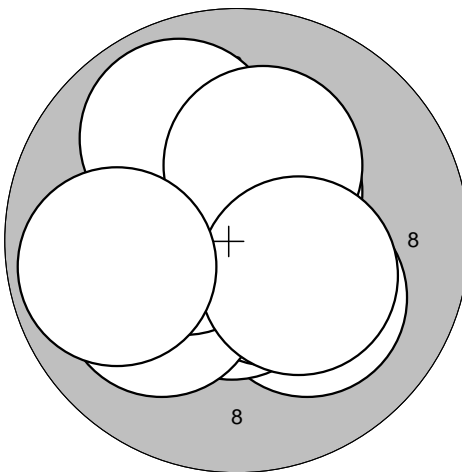
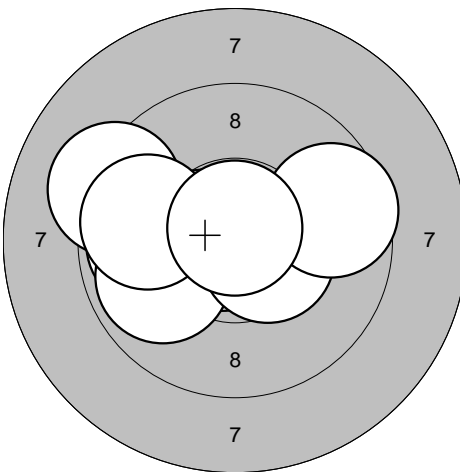
| | | | |
|--|---|--|---|
| <p>Series 5</p>  | <p>1: 10,1 ↘ 2: 10,6* ↓ 3: 10,5* ↘ 4: 10,1 ↖ 5: 10,5* ↗ 6: 10,5* ← 7: 9,9 ↗ 8: 10,2* ↗ 9: 10,3* ↘ 10: 9,9 ←</p> | <p>Series 6</p>  | <p>1: 10,8* ← 2: 10,6* ← 3: 9,2 ← 4: 10,5* ← 5: 9,9 ← 6: 9,9 ← 7: 10,5* → 8: 9,8 ← 9: 9,6 → 10: 10,8* ↑</p> |
| | Serie 98,0 | | Serie 95,0 |
| | Sum 487,0 | | Sum 582,0 |

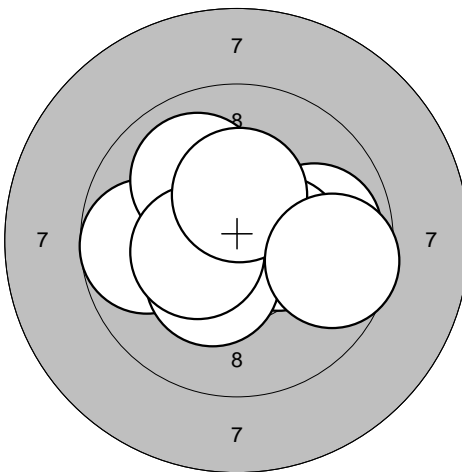
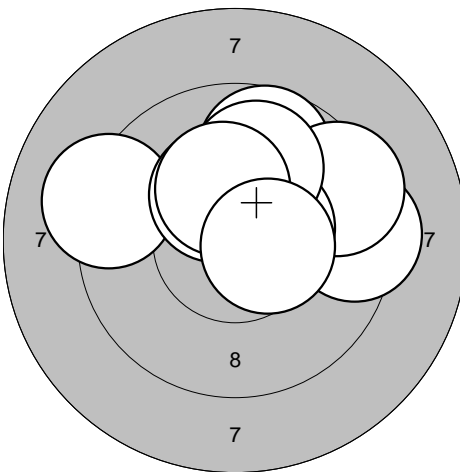
| | | | |
|--|---|--|---|
| <p>Series 1</p>  | <p>1: 10,8* ↗</p> <p>2: 9,9 →</p> <p>3: 10,2* ↗</p> <p>4: 9,8 ←</p> <p>5: 10,4* →</p> <p>6: 10,3* ↘</p> <p>7: 10,0 ↗</p> <p>8: 10,4* ←</p> <p>9: 10,3* ↑</p> <p>10: 9,6 →</p> | <p>Series 2</p>  | <p>1: 9,2 ←</p> <p>2: 10,3* ↗</p> <p>3: 9,7 ↑</p> <p>4: 9,4 →</p> <p>5: 9,4 ↗</p> <p>6: 10,5* →</p> <p>7: 10,0 ↑</p> <p>8: 10,3* ↗</p> <p>9: 10,3* ↑</p> <p>10: 10,5* →</p> |
| Serie 97,0 | Serie 96,0 | | |
| Sum 97,0 | Sum 193,0 | | |

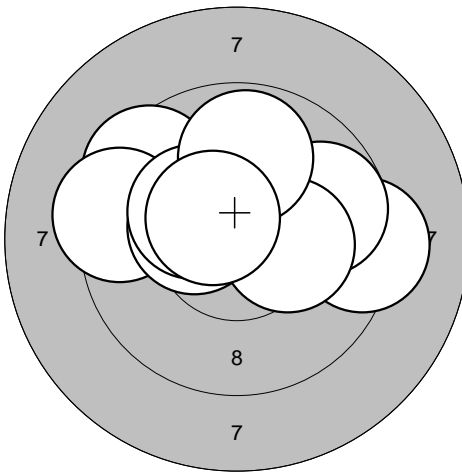
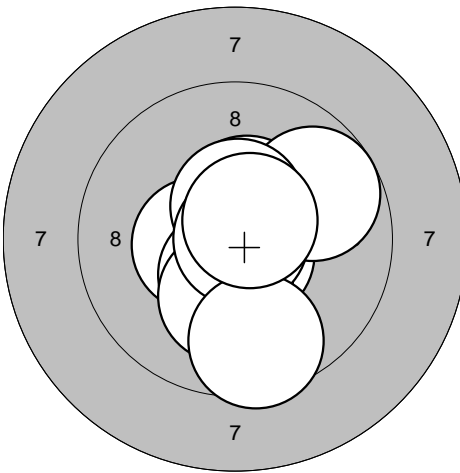
| | | | |
|---|--|---|--|
| <p>Series 3</p>  | <p>1: 10,6* ↗</p> <p>2: 9,5 ↗</p> <p>3: 9,3 →</p> <p>4: 9,3 ←</p> <p>5: 10,4* ←</p> <p>6: 10,3* ↗</p> <p>7: 9,8 →</p> <p>8: 10,2* →</p> <p>9: 9,9 ↑</p> <p>10: 10,5* ↗</p> | <p>Series 4</p>  | <p>1: 10,5* ←</p> <p>2: 10,5* ↑</p> <p>3: 10,7* ↘</p> <p>4: 10,5* ↘</p> <p>5: 9,7 ↗</p> <p>6: 10,5* ↑</p> <p>7: 10,2* ↘</p> <p>8: 10,9* →</p> <p>9: 9,6 ↘</p> <p>10: 10,6* ↗</p> |
| Serie 95,0 | Serie 98,0 | | |
| Sum 288,0 | Sum 386,0 | | |

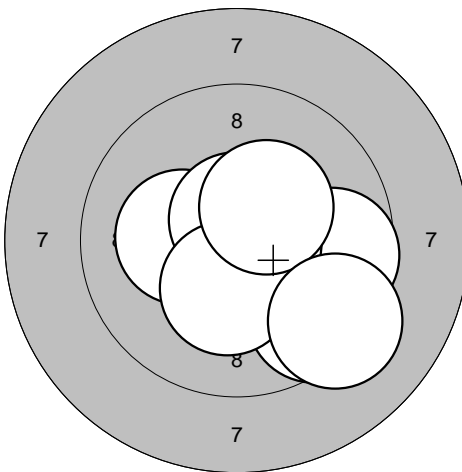
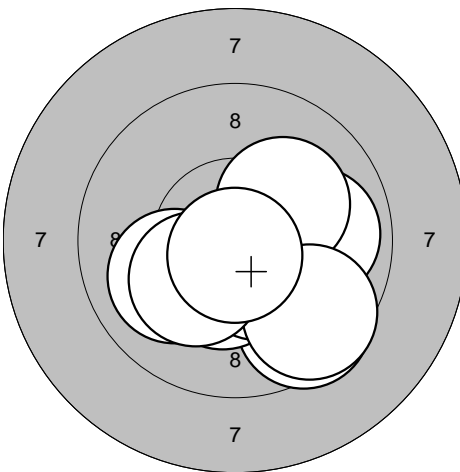
| | | | |
|--|---|--|--|
| <p>Series 5</p>  | <p>1: 10,2* ←</p> <p>2: 10,3* →</p> <p>3: 10,1 →</p> <p>4: 9,5 ↘</p> <p>5: 9,7 →</p> <p>6: 10,7* →</p> <p>7: 10,7* ↑</p> <p>8: 10,3* ↘</p> <p>9: 10,4* ↗</p> <p>10: 9,3 ↘</p> | <p>Series 6</p>  | <p>1: 9,5 ↘</p> <p>2: 10,4* ↘</p> <p>3: 9,9 →</p> <p>4: 10,0 ←</p> <p>5: 10,4* ↘</p> <p>6: 10,4* ↘</p> <p>7: 10,1 ↗</p> <p>8: 9,6 ↘</p> <p>9: 10,2* ↘</p> <p>10: 10,8* ↘</p> |
| Serie 97,0 | Serie 97,0 | | |
| Sum 483,0 | Sum 580,0 | | |

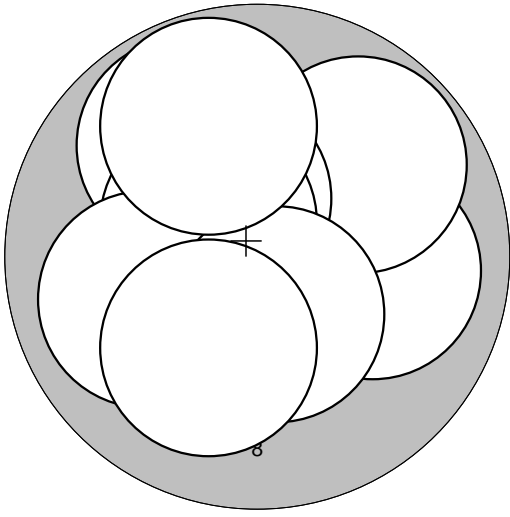
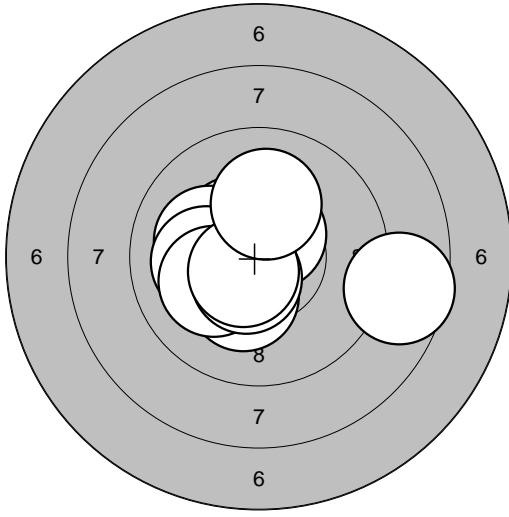
| | | | | |
|--|--|--|--|--|
| <p>Series 1</p>  | <p>1: 10,0 →</p> <p>2: 9,8 ↗</p> <p>3: 10,5* ↓</p> <p>4: 10,4* ↗</p> <p>5: 9,9 ↗</p> <p>6: 10,5* ↗</p> <p>7: 9,9 ←</p> <p>8: 10,4* ↓</p> <p>9: 9,8 ↑</p> <p>10: 10,1 ↓</p> | <p>Series 2</p>  | | <p>1: 10,4* ↖</p> <p>2: 10,6* ↗</p> <p>3: 10,1 ←</p> <p>4: 10,1 ←</p> <p>5: 10,3* ↓</p> <p>6: 10,1 ←</p> <p>7: 8,6 →</p> <p>8: 10,6* ↓</p> <p>9: 10,6* ↖</p> <p>10: 10,1 ↑</p> |
| | Serie 96,0 | | | Serie 98,0 |
| | Sum 96,0 | | | Sum 194,0 |

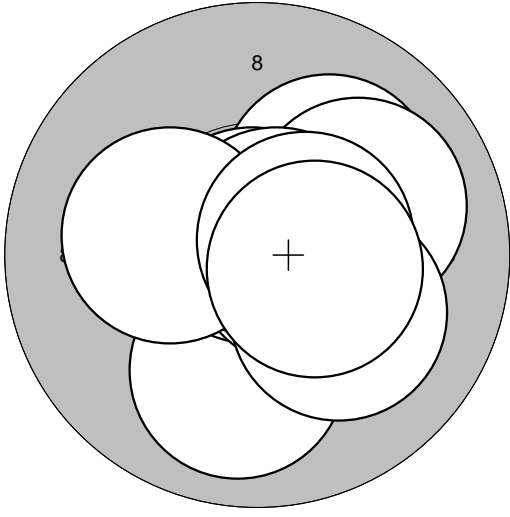
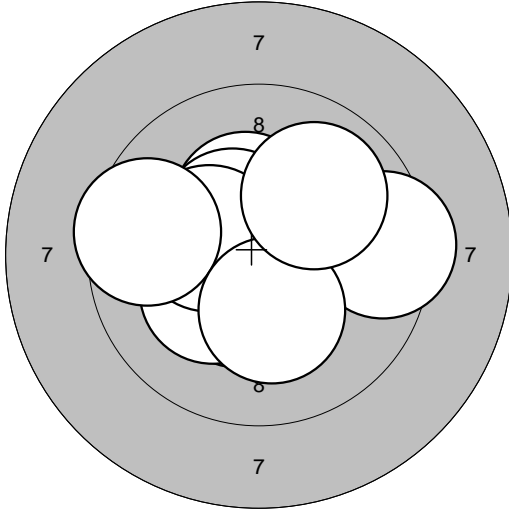
| | | | | |
|---|--|---|--|---|
| <p>Series 3</p>  | <p>1: 10,0 ↓</p> <p>2: 10,1 ↗</p> <p>3: 10,8* ↑</p> <p>4: 10,6* →</p> <p>5: 10,0 →</p> <p>6: 10,7* ↗</p> <p>7: 10,1 ↓</p> <p>8: 10,2* ←</p> <p>9: 10,5* →</p> <p>10: 10,5* →</p> | <p>Series 4</p>  | | <p>1: 9,4 →</p> <p>2: 10,4* ↓</p> <p>3: 10,9* ←</p> <p>4: 10,3* ↑</p> <p>5: 10,4* ↗</p> <p>6: 10,2* ↖</p> <p>7: 10,3* ←</p> <p>8: 9,5 ←</p> <p>9: 10,2* ↓</p> <p>10: 10,0 ↗</p> |
| | Serie 100,0 | | | Serie 98,0 |
| | Sum 294,0 | | | Sum 392,0 |

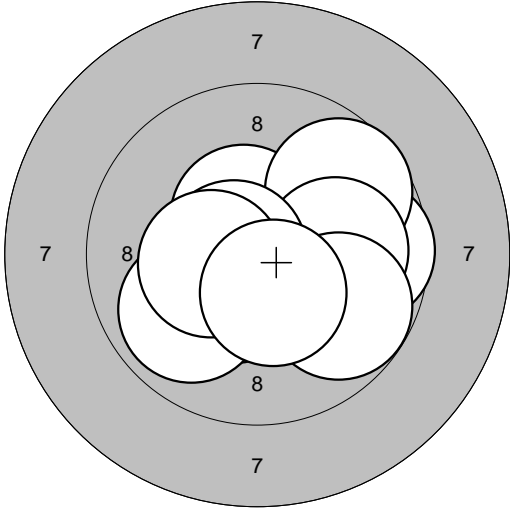
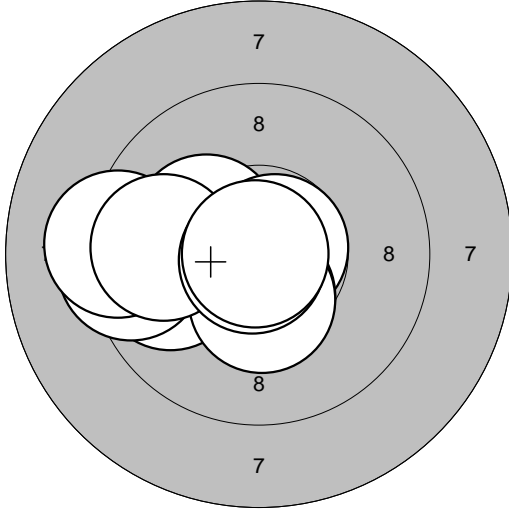
| | | | | |
|--|---|--|--|--|
| <p>Series 5</p>  | <p>1: 10,5* ↑</p> <p>2: 9,7 →</p> <p>3: 9,7 ↗</p> <p>4: 10,4* ↓</p> <p>5: 9,9 ↖</p> <p>6: 10,0 →</p> <p>7: 9,8 ↘</p> <p>8: 10,7* ←</p> <p>9: 10,4* ←</p> <p>10: 10,4* ↓</p> | <p>Series 6</p>  | | <p>1: 10,2* ↖</p> <p>2: 10,7* →</p> <p>3: 9,8 ←</p> <p>4: 10,4* ↓</p> <p>5: 10,4* ↓</p> <p>6: 9,4 ←</p> <p>7: 9,2 ←</p> <p>8: 9,8 ←</p> <p>9: 10,9* ↖</p> <p>10: 10,9* ←</p> |
| | Serie 96,0 | | | Serie 96,0 |
| | Sum 488,0 | | | Sum 584,0 |

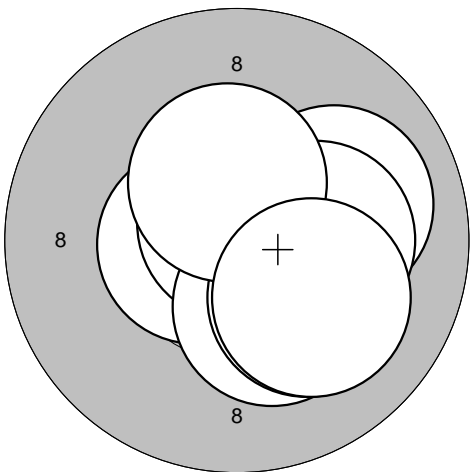
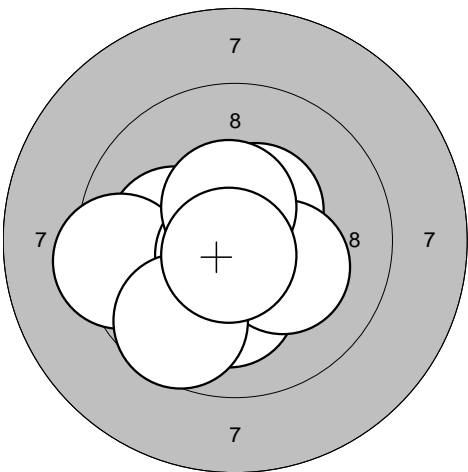
| | | | | | | | | | | | |
|--|--|-------|-------|-----|-------|--|---|-------|------|-----|-------|
| <p>Series 1</p>  | <p>1: 10,3* →</p> <p>2: 10,6* ←</p> <p>3: 10,7* →</p> <p>4: 10,0 →</p> <p>5: 10,8* ↑</p> <p>6: 10,3* ↓</p> <p>7: 10,2* →</p> <p>8: 10,1 ↓</p> <p>9: 10,4* ↑</p> <p>10: 10,1 ↓</p> <table border="1" style="width:100%; border-collapse: collapse;"> <tr> <td style="text-align: right;">Serie</td> <td style="text-align: right;">100,0</td> </tr> <tr> <td style="text-align: right;">Sum</td> <td style="text-align: right;">100,0</td> </tr> </table> | Serie | 100,0 | Sum | 100,0 | <p>Series 2</p>  | <p>1: 10,5* ↗</p> <p>2: 10,7* ↓</p> <p>3: 10,2* ↓</p> <p>4: 10,1 ←</p> <p>5: 9,4 ←</p> <p>6: 10,7* ↘</p> <p>7: 10,2* ↘</p> <p>8: 10,5* ↑</p> <p>9: 9,7 ↓</p> <p>10: 10,7* ↓</p> <table border="1" style="width:100%; border-collapse: collapse;"> <tr> <td style="text-align: right;">Serie</td> <td style="text-align: right;">98,0</td> </tr> <tr> <td style="text-align: right;">Sum</td> <td style="text-align: right;">198,0</td> </tr> </table> | Serie | 98,0 | Sum | 198,0 |
| Serie | 100,0 | | | | | | | | | | |
| Sum | 100,0 | | | | | | | | | | |
| Serie | 98,0 | | | | | | | | | | |
| Sum | 198,0 | | | | | | | | | | |

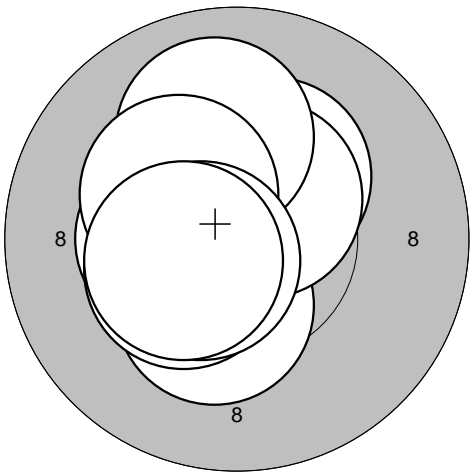
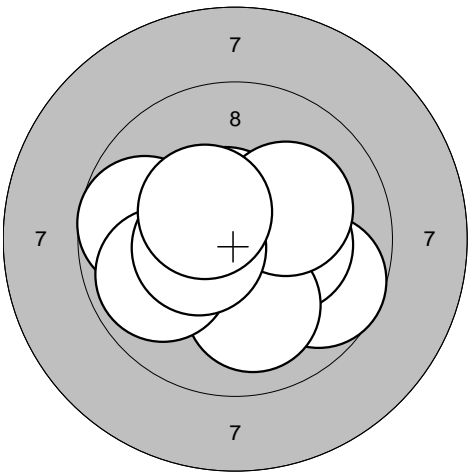
| | | | | | | | | | | | |
|---|--|-------|-------|-----|-------|---|---|-------|------|-----|-------|
| <p>Series 3</p>  | <p>1: 10,5* ↗</p> <p>2: 10,3* ↗</p> <p>3: 10,3* ↓</p> <p>4: 10,5* ↗</p> <p>5: 10,4* ←</p> <p>6: 10,4* ←</p> <p>7: 10,0 ↑</p> <p>8: 10,3* ↗</p> <p>9: 10,6* ←</p> <p>10: 10,4* ←</p> <table border="1" style="width:100%; border-collapse: collapse;"> <tr> <td style="text-align: right;">Serie</td> <td style="text-align: right;">100,0</td> </tr> <tr> <td style="text-align: right;">Sum</td> <td style="text-align: right;">298,0</td> </tr> </table> | Serie | 100,0 | Sum | 298,0 | <p>Series 4</p>  | <p>1: 10,7* ↓</p> <p>2: 9,7 ←</p> <p>3: 9,7 →</p> <p>4: 10,3* →</p> <p>5: 10,6* ↑</p> <p>6: 10,0 ↓</p> <p>7: 9,9 ←</p> <p>8: 10,2* ↗</p> <p>9: 10,5* ←</p> <p>10: 10,4* ↖</p> <table border="1" style="width:100%; border-collapse: collapse;"> <tr> <td style="text-align: right;">Serie</td> <td style="text-align: right;">97,0</td> </tr> <tr> <td style="text-align: right;">Sum</td> <td style="text-align: right;">395,0</td> </tr> </table> | Serie | 97,0 | Sum | 395,0 |
| Serie | 100,0 | | | | | | | | | | |
| Sum | 298,0 | | | | | | | | | | |
| Serie | 97,0 | | | | | | | | | | |
| Sum | 395,0 | | | | | | | | | | |

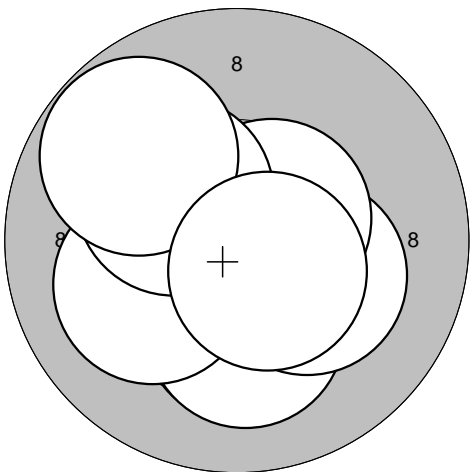
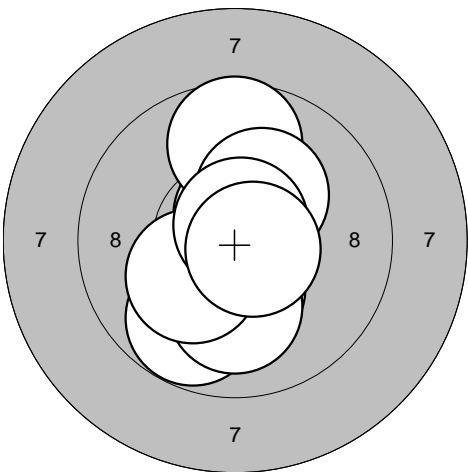
| | | | | | | | | | | | |
|--|---|-------|------|-----|-------|--|---|-------|------|-----|-------|
| <p>Series 5</p>  | <p>1: 10,3* ↘</p> <p>2: 10,2* ↓</p> <p>3: 10,6* ↓</p> <p>4: 10,2* ↓</p> <p>5: 10,1 ←</p> <p>6: 10,2* →</p> <p>7: 10,6* ↗</p> <p>8: 10,3* ↗</p> <p>9: 9,8 ↗</p> <p>10: 10,5* ↓</p> <table border="1" style="width:100%; border-collapse: collapse;"> <tr> <td style="text-align: right;">Serie</td> <td style="text-align: right;">99,0</td> </tr> <tr> <td style="text-align: right;">Sum</td> <td style="text-align: right;">494,0</td> </tr> </table> | Serie | 99,0 | Sum | 494,0 | <p>Series 6</p>  | <p>1: 10,6* ↑</p> <p>2: 9,7 ↑</p> <p>3: 10,8* →</p> <p>4: 10,2* ↗</p> <p>5: 10,3* ↓</p> <p>6: 9,8 ↓</p> <p>7: 10,1 ↓</p> <p>8: 10,2* ←</p> <p>9: 10,7* ↗</p> <p>10: 10,7* →</p> <table border="1" style="width:100%; border-collapse: collapse;"> <tr> <td style="text-align: right;">Serie</td> <td style="text-align: right;">98,0</td> </tr> <tr> <td style="text-align: right;">Sum</td> <td style="text-align: right;">592,0</td> </tr> </table> | Serie | 98,0 | Sum | 592,0 |
| Serie | 99,0 | | | | | | | | | | |
| Sum | 494,0 | | | | | | | | | | |
| Serie | 98,0 | | | | | | | | | | |
| Sum | 592,0 | | | | | | | | | | |

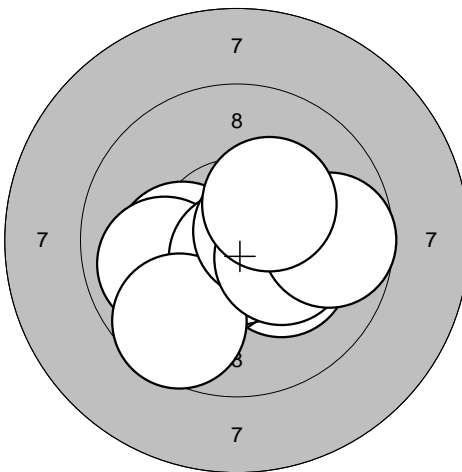
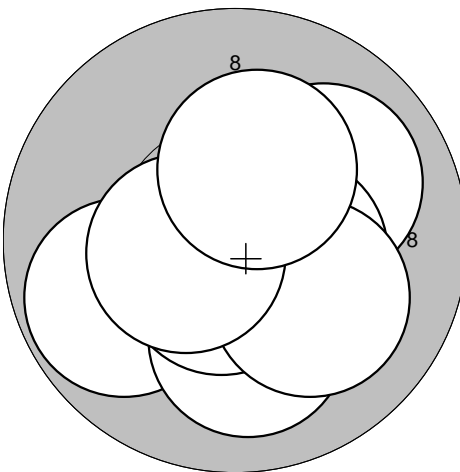
| | | | | | | | | | | | |
|---|---|-------|------|-----|------|---|---|-------|------|-----|-------|
| <p>Series 1</p>  | <p>1: 10,2* ↘ 2: 10,2* ← 3: 10,4* ↙ 4: 9,9 ← 5: 10,7* ↓ 6: 9,6 ↙ 7: 10,6* → 8: 10,3* → 9: 9,7 → 10: 10,3* ↗</p> <table border="1" style="width:100%; border-collapse: collapse;"> <tr><td>Serie</td><td style="text-align: right;">97,0</td></tr> <tr><td>Sum</td><td style="text-align: right;">97,0</td></tr> </table> | Serie | 97,0 | Sum | 97,0 | <p>Series 2</p>  | <p>1: 9,8 ↙ 2: 10,0 ↗ 3: 10,7* → 4: 10,5* → 5: 10,6* ↓ 6: 10,1 ↓ 7: 10,6* ↓ 8: 10,1 ↘ 9: 10,5* ← 10: 10,3* ↗</p> <table border="1" style="width:100%; border-collapse: collapse;"> <tr><td>Serie</td><td style="text-align: right;">99,0</td></tr> <tr><td>Sum</td><td style="text-align: right;">196,0</td></tr> </table> | Serie | 99,0 | Sum | 196,0 |
| Serie | 97,0 | | | | | | | | | | |
| Sum | 97,0 | | | | | | | | | | |
| Serie | 99,0 | | | | | | | | | | |
| Sum | 196,0 | | | | | | | | | | |

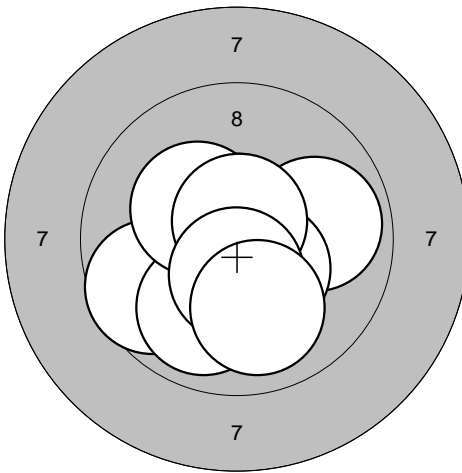
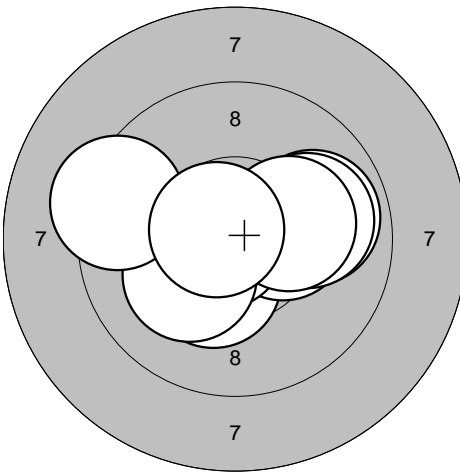
| | | | | | | | | | | | |
|--|---|-------|------|-----|-------|--|---|-------|------|-----|-------|
| <p>Series 3</p>  | <p>1: 10,5* → 2: 9,9 → 3: 10,4* ↘ 4: 10,7* ↑ 5: 9,6 ← 6: 9,9 ↙ 7: 10,3* ↖ 8: 10,7* ↑ 9: 10,5* ↓ 10: 10,0 ↓</p> <table border="1" style="width:100%; border-collapse: collapse;"> <tr><td>Serie</td><td style="text-align: right;">97,0</td></tr> <tr><td>Sum</td><td style="text-align: right;">293,0</td></tr> </table> | Serie | 97,0 | Sum | 293,0 | <p>Series 4</p>  | <p>1: 10,3* ↓ 2: 10,2* → 3: 10,3* → 4: 9,9 → 5: 10,7* ← 6: 10,0 → 7: 10,2* → 8: 10,2* ↙ 9: 9,3 ← 10: 10,7* ↖</p> <table border="1" style="width:100%; border-collapse: collapse;"> <tr><td>Serie</td><td style="text-align: right;">98,0</td></tr> <tr><td>Sum</td><td style="text-align: right;">391,0</td></tr> </table> | Serie | 98,0 | Sum | 391,0 |
| Serie | 97,0 | | | | | | | | | | |
| Sum | 293,0 | | | | | | | | | | |
| Serie | 98,0 | | | | | | | | | | |
| Sum | 391,0 | | | | | | | | | | |

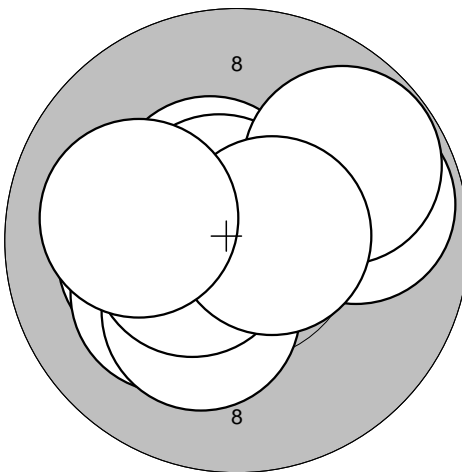
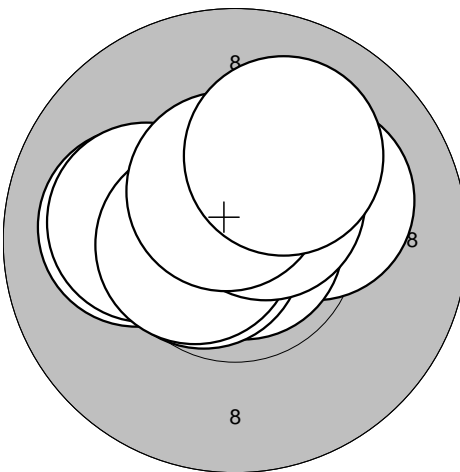
| | | | | | | | | | | | |
|---|---|-------|------|-----|-------|---|--|-------|-------|-----|-------|
| <p>Series 5</p>  | <p>1: 9,8 → 2: 10,5* ↗ 3: 10,2* ← 4: 10,6* ↗ 5: 10,2* ↙ 6: 9,8 → 7: 10,2* ↙ 8: 10,5* ← 9: 10,6* → 10: 10,0 ←</p> <table border="1" style="width:100%; border-collapse: collapse;"> <tr><td>Serie</td><td style="text-align: right;">98,0</td></tr> <tr><td>Sum</td><td style="text-align: right;">489,0</td></tr> </table> | Serie | 98,0 | Sum | 489,0 | <p>Series 6</p>  | <p>1: 10,7* ← 2: 10,2* ↗ 3: 10,9* → 4: 10,6* ← 5: 10,1 ← 6: 10,1 ← 7: 10,6* ← 8: 10,5* ↗ 9: 10,5* ↑ 10: 10,1 ↗</p> <table border="1" style="width:100%; border-collapse: collapse;"> <tr><td>Serie</td><td style="text-align: right;">100,0</td></tr> <tr><td>Sum</td><td style="text-align: right;">589,0</td></tr> </table> | Serie | 100,0 | Sum | 589,0 |
| Serie | 98,0 | | | | | | | | | | |
| Sum | 489,0 | | | | | | | | | | |
| Serie | 100,0 | | | | | | | | | | |
| Sum | 589,0 | | | | | | | | | | |

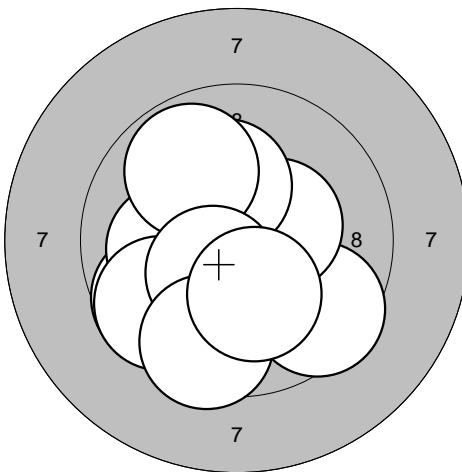
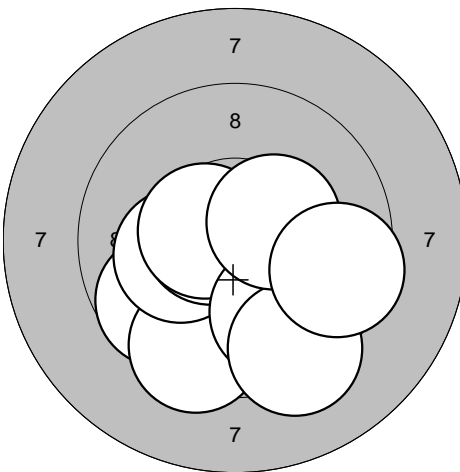
| | | | | | | | | | | | |
|--|---|-------|------|-----|------|--|--|-------|------|-----|-------|
| <p>Series 1</p>  | <p>1: 9,5 ↘ 2: 10,4* → 3: 10,2* ↑ 4: 9,7 ↙ 5: 10,1 ← 6: 9,6 ↙ 7: 9,8 ↗ 8: 10,4* ↘ 9: 9,5 ↓ 10: 10,2* ↘</p> <table border="1" style="width:100%; border-collapse: collapse;"> <tr><td>Serie</td><td style="text-align: right;">95,0</td></tr> <tr><td>Sum</td><td style="text-align: right;">95,0</td></tr> </table> | Serie | 95,0 | Sum | 95,0 | <p>Series 2</p>  | <p>1: 10,1 ↙ 2: 9,7 ↙ 3: 9,5 ↓ 4: 10,2* ← 5: 10,6* ← 6: 10,5* ← 7: 9,8 ↓ 8: 9,3 ↓ 9: 10,4* → 10: 9,5 →</p> <table border="1" style="width:100%; border-collapse: collapse;"> <tr><td>Serie</td><td style="text-align: right;">95,0</td></tr> <tr><td>Sum</td><td style="text-align: right;">190,0</td></tr> </table> | Serie | 95,0 | Sum | 190,0 |
| Serie | 95,0 | | | | | | | | | | |
| Sum | 95,0 | | | | | | | | | | |
| Serie | 95,0 | | | | | | | | | | |
| Sum | 190,0 | | | | | | | | | | |

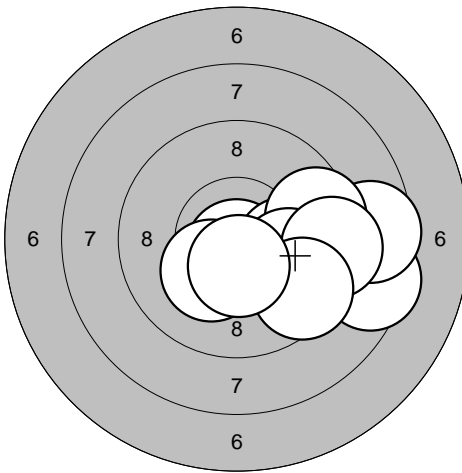
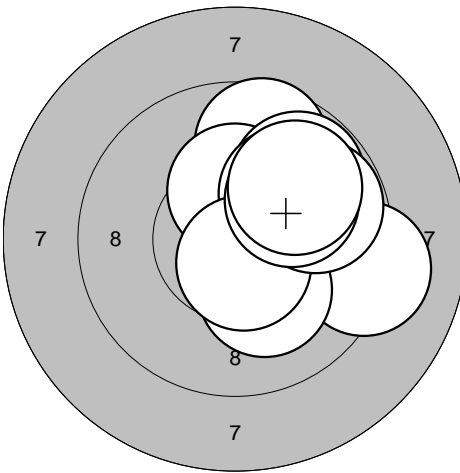
| | | | | | | | | | | | |
|---|---|-------|------|-----|-------|---|---|-------|------|-----|-------|
| <p>Series 3</p>  | <p>1: 10,7* ↓ 2: 8,5 → 3: 10,0 → 4: 8,6 → 5: 9,5 → 6: 10,0 → 7: 9,3 → 8: 10,2* ↙ 9: 9,5 ↓ 10: 10,5* ↓</p> <table border="1" style="width:100%; border-collapse: collapse;"> <tr><td>Serie</td><td style="text-align: right;">93,0</td></tr> <tr><td>Sum</td><td style="text-align: right;">283,0</td></tr> </table> | Serie | 93,0 | Sum | 283,0 | <p>Series 4</p>  | <p>1: 9,7 ↑ 2: 10,3* ↑ 3: 9,2 → 4: 9,8 ↗ 5: 10,2* ↘ 6: 10,0 ↗ 7: 10,6* ↘ 8: 9,8 → 9: 10,0 ↗ 10: 9,9 ↗</p> <table border="1" style="width:100%; border-collapse: collapse;"> <tr><td>Serie</td><td style="text-align: right;">95,0</td></tr> <tr><td>Sum</td><td style="text-align: right;">378,0</td></tr> </table> | Serie | 95,0 | Sum | 378,0 |
| Serie | 93,0 | | | | | | | | | | |
| Sum | 283,0 | | | | | | | | | | |
| Serie | 95,0 | | | | | | | | | | |
| Sum | 378,0 | | | | | | | | | | |

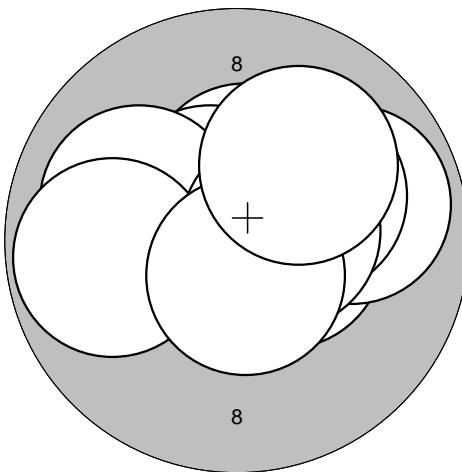
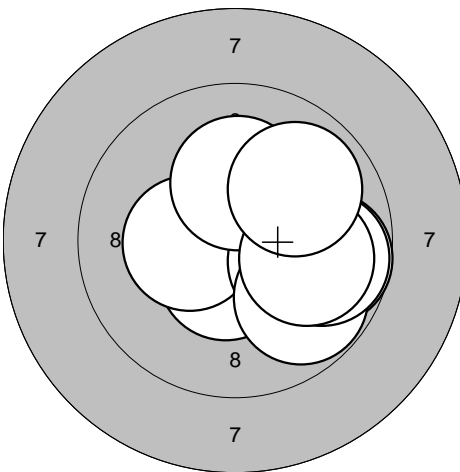
| | | | | | | | | | | | |
|--|---|-------|------|-----|-------|--|--|-------|------|-----|-------|
| <p>Series 5</p>  | <p>1: 10,4* ↑ 2: 10,6* ↗ 3: 10,5* → 4: 10,0 ↙ 5: 9,9 → 6: 10,2* ↗ 7: 9,8 ← 8: 10,5* → 9: 10,6* ↓ 10: 10,1 ↗</p> <table border="1" style="width:100%; border-collapse: collapse;"> <tr><td>Serie</td><td style="text-align: right;">98,0</td></tr> <tr><td>Sum</td><td style="text-align: right;">476,0</td></tr> </table> | Serie | 98,0 | Sum | 476,0 | <p>Series 6</p>  | <p>1: 9,7 → 2: 10,5* ↓ 3: 10,3* ← 4: 10,1 ↗ 5: 10,1 → 6: 9,8 ↘ 7: 10,2* ↑ 8: 9,7 → 9: 10,0 → 10: 9,9 ↗</p> <table border="1" style="width:100%; border-collapse: collapse;"> <tr><td>Serie</td><td style="text-align: right;">96,0</td></tr> <tr><td>Sum</td><td style="text-align: right;">572,0</td></tr> </table> | Serie | 96,0 | Sum | 572,0 |
| Serie | 98,0 | | | | | | | | | | |
| Sum | 476,0 | | | | | | | | | | |
| Serie | 96,0 | | | | | | | | | | |
| Sum | 572,0 | | | | | | | | | | |

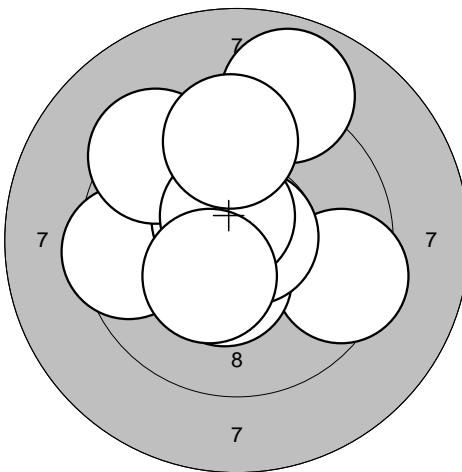
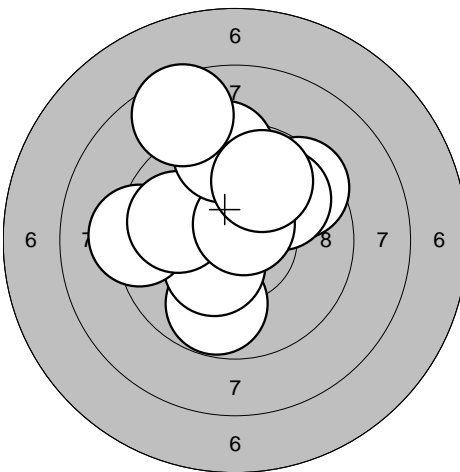
| | | | |
|--|--|--|--|
| <p>Series 1</p>  | <p>1: 8,9 ↗</p> <p>2: 9,5 ←</p> <p>3: 9,5 →</p> <p>4: 10,4* ↓</p> <p>5: 10,6* ↗</p> <p>6: 9,4 ↗</p> <p>7: 10,7* →</p> <p>8: 10,6* ↗</p> <p>9: 9,6 ↑</p> <p>10: 10,3* ↘</p> | <p>Series 2</p>  | <p>1: 9,8 ↓</p> <p>2: 10,4* ↘</p> <p>3: 9,5 ↗</p> <p>4: 9,3 ←</p> <p>5: 9,9 ←</p> <p>6: 9,9 ↗</p> <p>7: 10,6* ↗</p> <p>8: 9,4 ↑</p> <p>9: 8,6 ↗</p> <p>10: 9,8 ↗</p> |
| Serie 94,0 | | Serie 91,0 | |
| Sum 94,0 | | Sum 185,0 | |

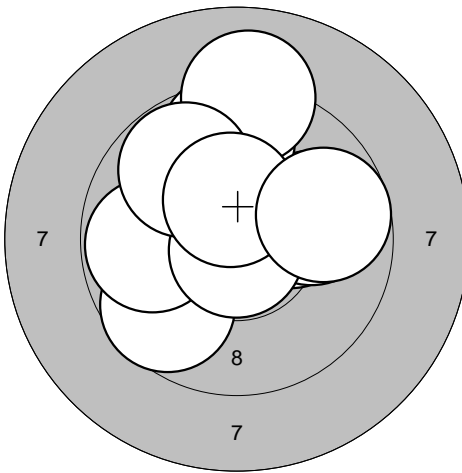
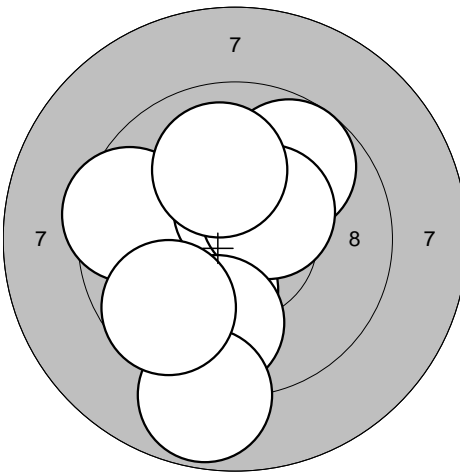
| | | | |
|---|--|---|---|
| <p>Series 3</p>  | <p>1: 10,2* →</p> <p>2: 9,9 →</p> <p>3: 9,7 ↘</p> <p>4: 9,8 ←</p> <p>5: 9,6 ↑</p> <p>6: 9,1 ↑</p> <p>7: 10,8* ↓</p> <p>8: 9,8 ↗</p> <p>9: 10,4* ↑</p> <p>10: 9,7 →</p> | <p>Series 4</p>  | <p>1: 10,2* ↓</p> <p>2: 10,4* ↑</p> <p>3: 9,5 ←</p> <p>4: 9,7 ↗</p> <p>5: 10,5* ↑</p> <p>6: 10,4* ↗</p> <p>7: 10,0 ↑</p> <p>8: 9,8 ↓</p> <p>9: 8,8 ↓</p> <p>10: 9,7 ↘</p> |
| Serie 93,0 | | Serie 94,0 | |
| Sum 278,0 | | Sum 372,0 | |

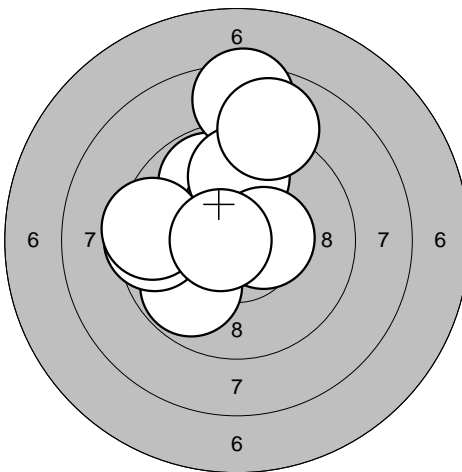
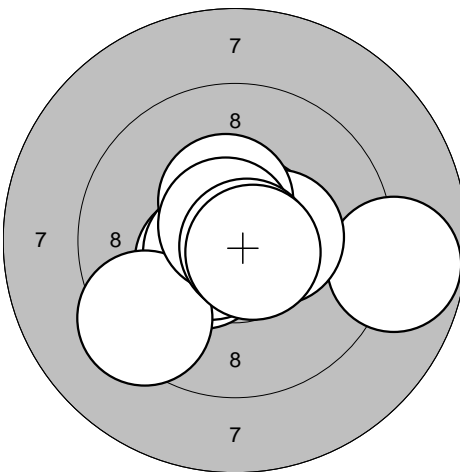
| | | | |
|--|--|--|--|
| <p>Series 5</p>  | <p>1: 9,8 ↗</p> <p>2: 8,5 ↑</p> <p>3: 10,4* ↑</p> <p>4: 9,8 ↑</p> <p>5: 8,9 ↑</p> <p>6: 9,8 ↘</p> <p>7: 10,5* →</p> <p>8: 9,5 ←</p> <p>9: 9,4 ←</p> <p>10: 10,7* ←</p> | <p>Series 6</p>  | <p>1: 10,4* ↘</p> <p>2: 10,6* ↘</p> <p>3: 9,4 ↘</p> <p>4: 8,8 →</p> <p>5: 10,7* ↗</p> <p>6: 10,4* →</p> <p>7: 10,4* ↑</p> <p>8: 10,7* ↗</p> <p>9: 10,8* ↘</p> <p>10: 10,7* ↘</p> |
| Serie 91,0 | | Serie 97,0 | |
| Sum 463,0 | | Sum 560,0 | |

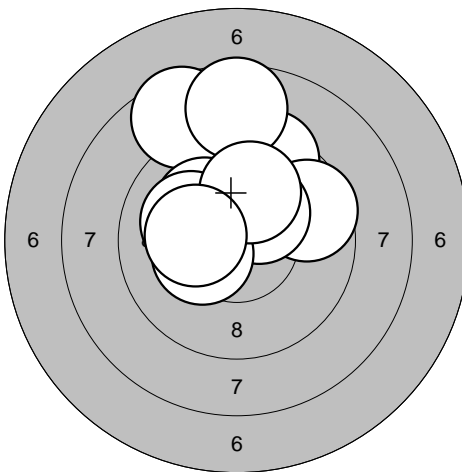
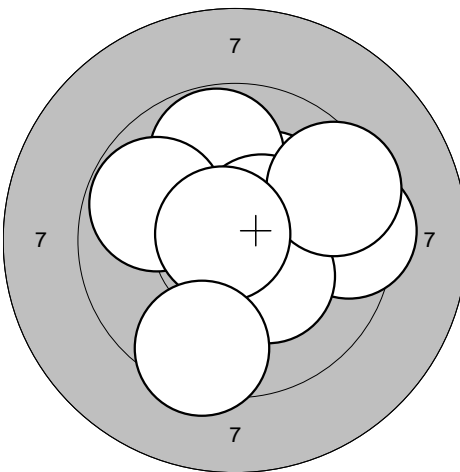
| | | | | | | | | | | | |
|--|--|-------|------|-----|------|--|---|-------|------|-----|-------|
| <p>Series 1</p>  | <p>1: 9,4 ↗ 2: 9,6 → 3: 10,3* ↗ 4: 8,6 ↖ 5: 10,3* ← 6: 10,2* ↖ 7: 10,1 ← 8: 8,6 ↑ 9: 10,1 ↑ 10: 10,2* ←</p> <table border="1" style="width:100%; border-collapse: collapse;"> <tr><td>Serie</td><td style="text-align: right;">94,0</td></tr> <tr><td>Sum</td><td style="text-align: right;">94,0</td></tr> </table> | Serie | 94,0 | Sum | 94,0 | <p>Series 2</p>  | <p>1: 10,2* ↗ 2: 10,4* → 3: 9,8 ↑ 4: 9,4 → 5: 9,8 ↖ 6: 10,5* ↗ 7: 10,3* ↘ 8: 9,5 → 9: 10,8* ↖ 10: 9,4 ↓</p> <table border="1" style="width:100%; border-collapse: collapse;"> <tr><td>Serie</td><td style="text-align: right;">95,0</td></tr> <tr><td>Sum</td><td style="text-align: right;">189,0</td></tr> </table> | Serie | 95,0 | Sum | 189,0 |
| Serie | 94,0 | | | | | | | | | | |
| Sum | 94,0 | | | | | | | | | | |
| Serie | 95,0 | | | | | | | | | | |
| Sum | 189,0 | | | | | | | | | | |

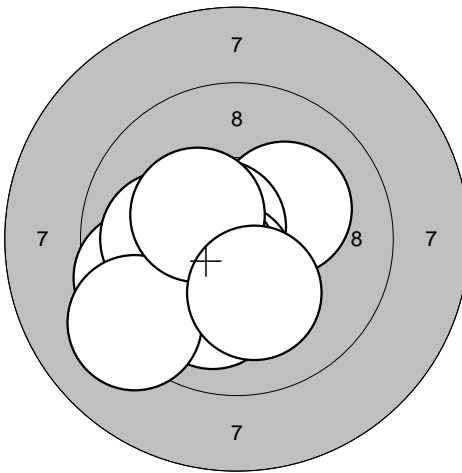
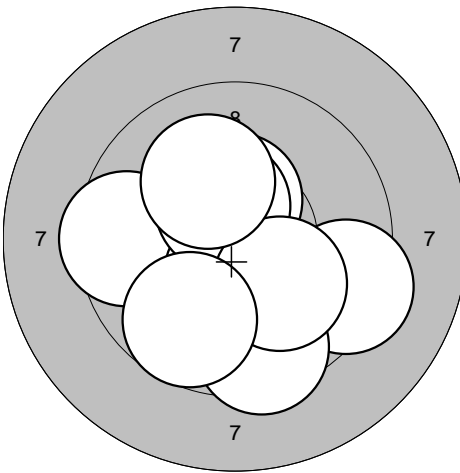
| | | | | | | | | | | | |
|---|---|-------|------|-----|-------|---|---|-------|------|-----|-------|
| <p>Series 3</p>  | <p>1: 10,2* → 2: 10,7* ↖ 3: 10,5* ↓ 4: 10,1 ↓ 5: 9,6 ← 6: 10,0 ← 7: 10,5* ↖ 8: 9,2 ↖ 9: 10,3* ↖ 10: 10,2* ↓</p> <table border="1" style="width:100%; border-collapse: collapse;"> <tr><td>Serie</td><td style="text-align: right;">98,0</td></tr> <tr><td>Sum</td><td style="text-align: right;">287,0</td></tr> </table> | Serie | 98,0 | Sum | 287,0 | <p>Series 4</p>  | <p>1: 10,3* ↘ 2: 9,4 → 3: 10,4* ↑ 4: 9,5 ← 5: 10,5* ↓ 6: 9,5 ↓ 7: 10,5* ↑ 8: 10,1 ↘ 9: 9,7 ↘ 10: 10,1 ↑</p> <table border="1" style="width:100%; border-collapse: collapse;"> <tr><td>Serie</td><td style="text-align: right;">96,0</td></tr> <tr><td>Sum</td><td style="text-align: right;">383,0</td></tr> </table> | Serie | 96,0 | Sum | 383,0 |
| Serie | 98,0 | | | | | | | | | | |
| Sum | 287,0 | | | | | | | | | | |
| Serie | 96,0 | | | | | | | | | | |
| Sum | 383,0 | | | | | | | | | | |

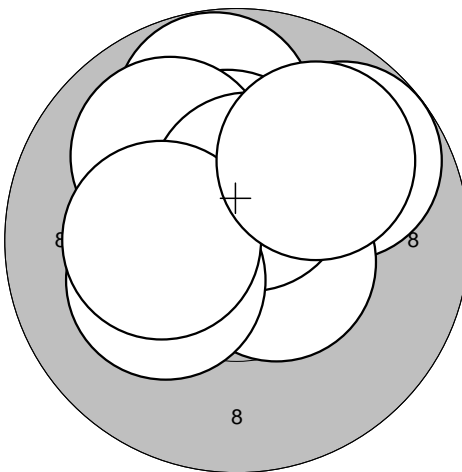
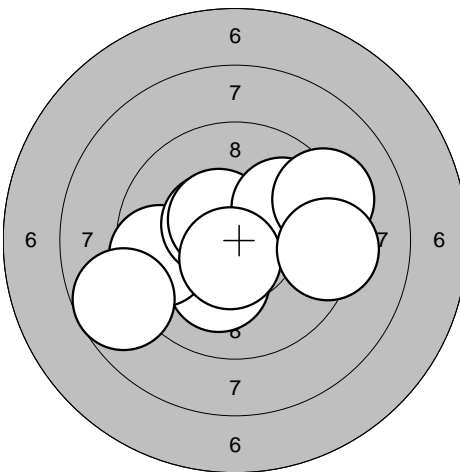
| | | | | | | | | | | | |
|--|--|-------|------|-----|-------|--|---|-------|------|-----|-------|
| <p>Series 5</p>  | <p>1: 9,8 ↑ 2: 10,3* ↑ 3: 10,8* ← 4: 9,8 ↗ 5: 10,5* → 6: 10,0 ↗ 7: 10,5* ↑ 8: 10,2* ↖ 9: 10,3* ← 10: 9,9 ↗</p> <table border="1" style="width:100%; border-collapse: collapse;"> <tr><td>Serie</td><td style="text-align: right;">97,0</td></tr> <tr><td>Sum</td><td style="text-align: right;">480,0</td></tr> </table> | Serie | 97,0 | Sum | 480,0 | <p>Series 6</p>  | <p>1: 10,2* ↓ 2: 9,6 ← 3: 10,5* ↖ 4: 9,8 → 5: 10,5* ↖ 6: 8,7 ← 7: 9,9 ↗ 8: 9,2 → 9: 10,6* ↓ 10: 9,3 →</p> <table border="1" style="width:100%; border-collapse: collapse;"> <tr><td>Serie</td><td style="text-align: right;">93,0</td></tr> <tr><td>Sum</td><td style="text-align: right;">573,0</td></tr> </table> | Serie | 93,0 | Sum | 573,0 |
| Serie | 97,0 | | | | | | | | | | |
| Sum | 480,0 | | | | | | | | | | |
| Serie | 93,0 | | | | | | | | | | |
| Sum | 573,0 | | | | | | | | | | |

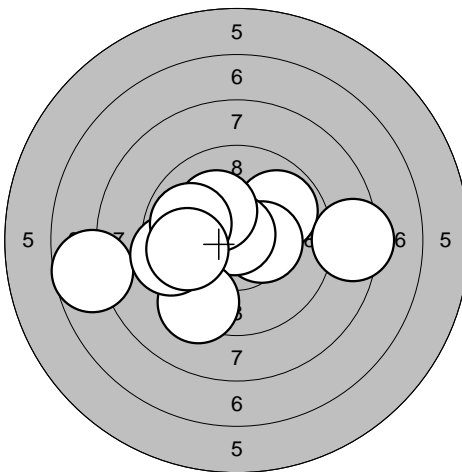
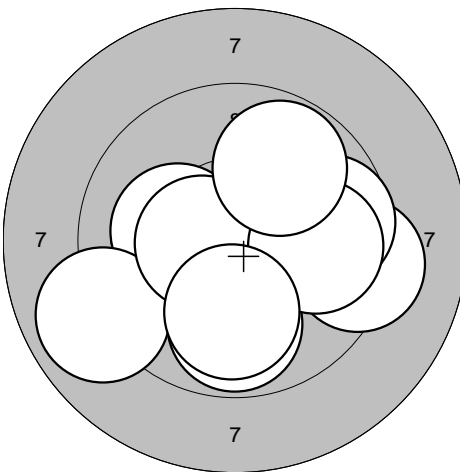
| | | | |
|--|--|--|---|
| <p>Series 1</p>  | <p>1: 9,9 ↗</p> <p>2: 10,4* →</p> <p>3: 10,8* ↑</p> <p>4: 7,7 ←</p> <p>5: 9,4 ↓</p> <p>6: 9,5 ←</p> <p>7: 10,2* ↑</p> <p>8: 9,9 ←</p> <p>9: 9,8 ←</p> <p>10: 8,4 →</p> | <p>Series 2</p>  | <p>1: 9,3 →</p> <p>2: 9,7 →</p> <p>3: 10,5* ←</p> <p>4: 10,2* ←</p> <p>5: 8,9 ↙</p> <p>6: 9,8 ↓</p> <p>7: 10,5* ←</p> <p>8: 9,9 →</p> <p>9: 10,0 ↓</p> <p>10: 9,8 ↗</p> |
| Serie 90,0 | Serie 93,0 | | |
| Sum 90,0 | Sum 183,0 | | |

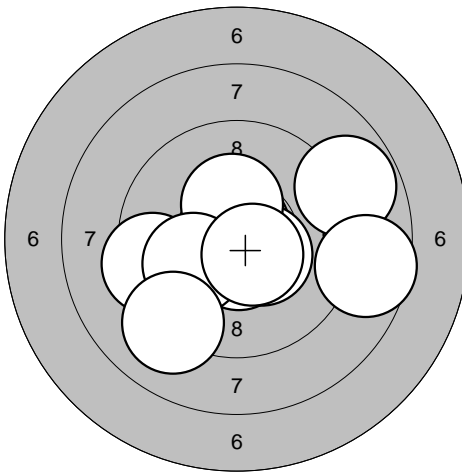
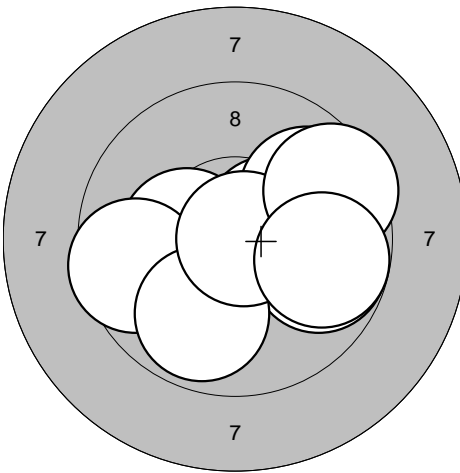
| | | | |
|---|---|---|--|
| <p>Series 3</p>  | <p>1: 10,7* ↑</p> <p>2: 10,4* →</p> <p>3: 10,6* ↓</p> <p>4: 9,4 ←</p> <p>5: 10,3* ↑</p> <p>6: 10,1 ←</p> <p>7: 9,1 ↓</p> <p>8: 8,8 →</p> <p>9: 10,6* ↓</p> <p>10: 8,6 →</p> | <p>Series 4</p>  | <p>1: 9,8 →</p> <p>2: 10,3* ←</p> <p>3: 10,2* →</p> <p>4: 9,6 ←</p> <p>5: 9,8 ↓</p> <p>6: 10,4* →</p> <p>7: 9,8 ↗</p> <p>8: 10,8* →</p> <p>9: 9,5 ↗</p> <p>10: 9,8 →</p> |
| Serie 94,0 | Serie 94,0 | | |
| Sum 277,0 | Sum 371,0 | | |

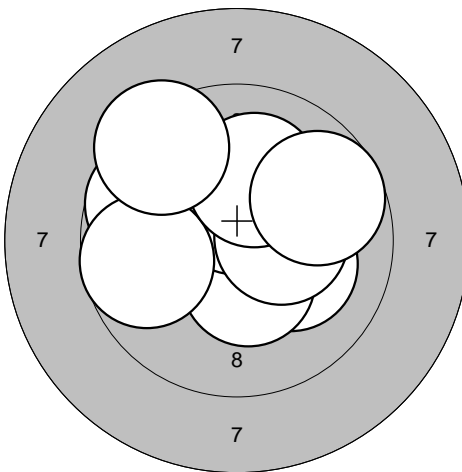
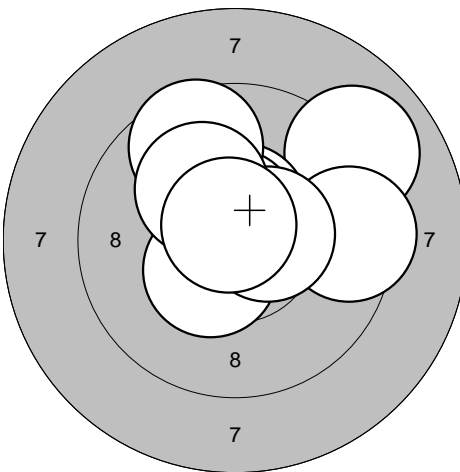
| | | | |
|--|--|--|---|
| <p>Series 5</p>  | <p>1: 10,1 →</p> <p>2: 9,7 ←</p> <p>3: 10,4* →</p> <p>4: 10,4* ↓</p> <p>5: 10,5* ↑</p> <p>6: 9,7 ←</p> <p>7: 10,3* →</p> <p>8: 10,1 ↑</p> <p>9: 9,8 →</p> <p>10: 9,3 ↖</p> | <p>Series 6</p>  | <p>1: 9,0 ↗</p> <p>2: 10,5* ↑</p> <p>3: 10,5* ↖</p> <p>4: 10,4* ↙</p> <p>5: 10,6* ↑</p> <p>6: 9,6 ↖</p> <p>7: 9,4 →</p> <p>8: 10,5* →</p> <p>9: 10,1 ↖</p> <p>10: 10,7* ↖</p> |
| Serie 96,0 | Serie 97,0 | | |
| Sum 467,0 | Sum 564,0 | | |

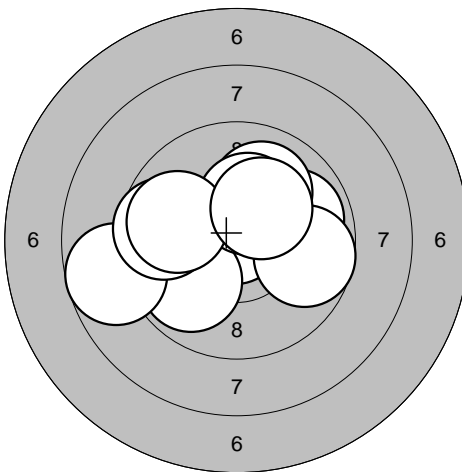
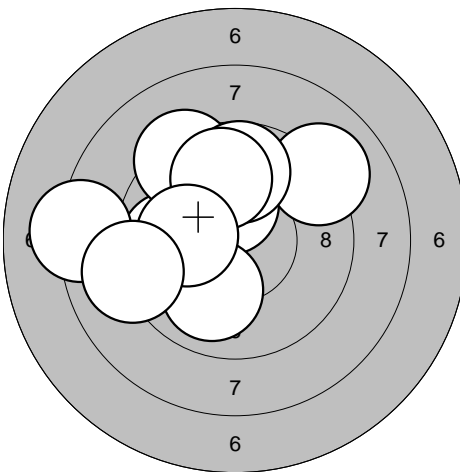
| | | | |
|--|---|--|--|
| <p>Series 1</p>  | <p>1: 10,8* ↗</p> <p>2: 9,9 →</p> <p>3: 9,9 ↙</p> <p>4: 8,7 ←</p> <p>5: 9,7 ←</p> <p>6: 10,0 ↗</p> <p>7: 10,3* ↗</p> <p>8: 9,9 ←</p> <p>9: 9,7 →</p> <p>10: 10,2* ↗</p> | <p>Series 2</p>  | <p>1: 10,3* ↑</p> <p>2: 9,8 ←</p> <p>3: 9,3 ↗</p> <p>4: 10,0 ↘</p> <p>5: 9,1 ↗</p> <p>6: 8,2 ←</p> <p>7: 9,8 ↑</p> <p>8: 9,8 ↑</p> <p>9: 10,1 ←</p> <p>10: 9,1 ←</p> |
| Serie 93,0 | Serie 92,0 | Serie 92,0 | Serie 92,0 |
| Sum 93,0 | Sum 185,0 | Sum 185,0 | Sum 185,0 |

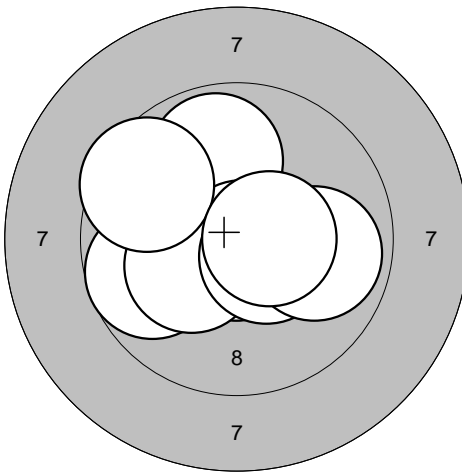
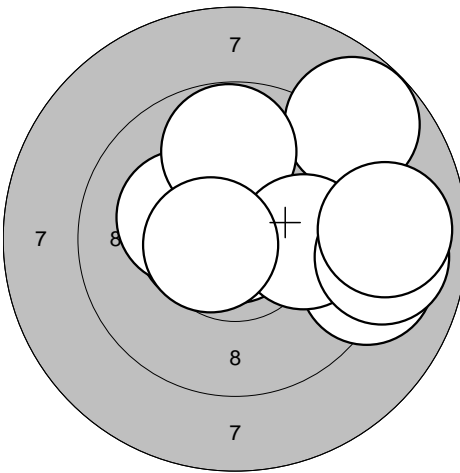
| | | | |
|---|---|---|---|
| <p>Series 3</p>  | <p>1: 10,8* ↓</p> <p>2: 9,8 ←</p> <p>3: 10,1 ↗</p> <p>4: 9,9 ↗</p> <p>5: 10,8* ↘</p> <p>6: 10,3* ↙</p> <p>7: 10,5* ↘</p> <p>8: 9,6 ↗</p> <p>9: 9,9 →</p> <p>10: 10,5* →</p> | <p>Series 4</p>  | <p>1: 10,9* ↑</p> <p>2: 9,1 →</p> <p>3: 10,5* ←</p> <p>4: 8,8 ↗</p> <p>5: 10,2* ↙</p> <p>6: 9,8 ↑</p> <p>7: 10,0 →</p> <p>8: 9,0 →</p> <p>9: 9,0 →</p> <p>10: 10,6* ←</p> |
| Serie 96,0 | Serie 94,0 | Serie 94,0 | Serie 94,0 |
| Sum 281,0 | Sum 375,0 | Sum 375,0 | Sum 375,0 |

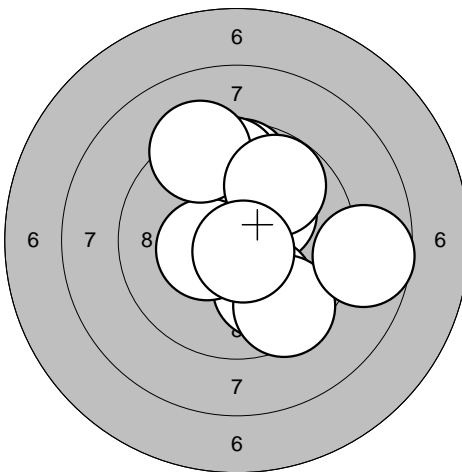
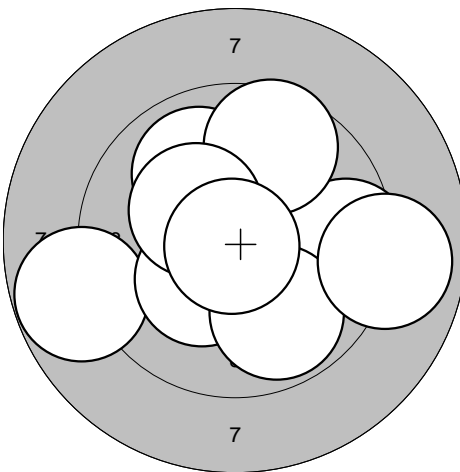
| | | | |
|--|---|--|--|
| <p>Series 5</p>  | <p>1: 10,2* ↗</p> <p>2: 10,0 ↘</p> <p>3: 9,5 ↘</p> <p>4: 8,7 →</p> <p>5: 9,7 ↑</p> <p>6: 9,7 ↑</p> <p>7: 10,4* ←</p> <p>8: 9,3 ↑</p> <p>9: 9,8 ↗</p> <p>10: 10,7* ↘</p> | <p>Series 6</p>  | <p>1: 9,5 →</p> <p>2: 10,4* ↘</p> <p>3: 9,9 ↗</p> <p>4: 8,8 ←</p> <p>5: 10,3* ↙</p> <p>6: 9,6 ↑</p> <p>7: 9,8 ↘</p> <p>8: 10,3* ↗</p> <p>9: 10,9* ↘</p> <p>10: 8,9 →</p> |
| Serie 93,0 | Serie 92,0 | Serie 92,0 | Serie 92,0 |
| Sum 468,0 | Sum 560,0 | Sum 560,0 | Sum 560,0 |

Series 1

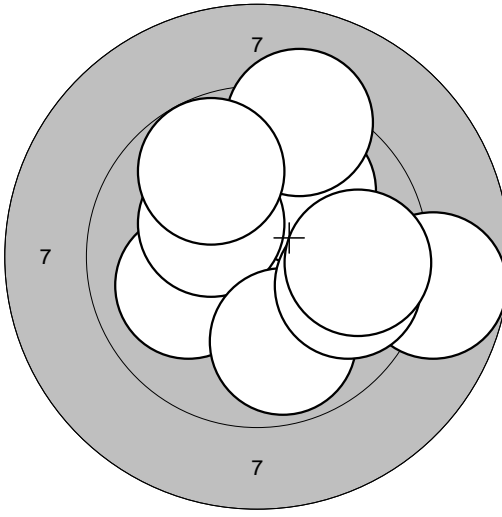

| | |
|-------------------|---|
| 1: 10,0 | ↙ |
| 2: 8,8 | → |
| 3: 10,3* | ↑ |
| 4: 10,0 | ↗ |
| 5: 10,3* | ↗ |
| 6: 9,9 | ↓ |
| 7: 9,8 | → |
| 8: 9,2 | ↑ |
| 9: 9,7 | → |
| 10: 9,8 | ↗ |
| Serie 93,0 | |
| Sum 93,0 | |

Series 2

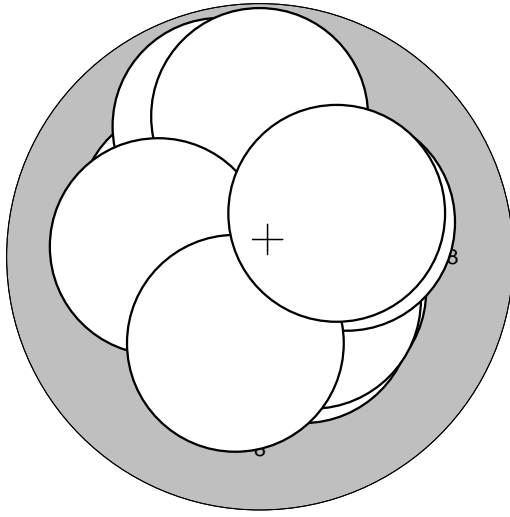

| | |
|-------------------|---|
| 1: 10,2* | ↖ |
| 2: 10,4* | ↘ |
| 3: 10,3* | ↘ |
| 4: 9,8 | ↑ |
| 5: 10,4* | ↘ |
| 6: 9,8 | ↑ |
| 7: 10,1 | ← |
| 8: 10,2* | → |
| 9: 10,2* | ↓ |
| 10: 10,2* | ↗ |
| Serie 98,0 | |
| Sum 191,0 | |

Series 3

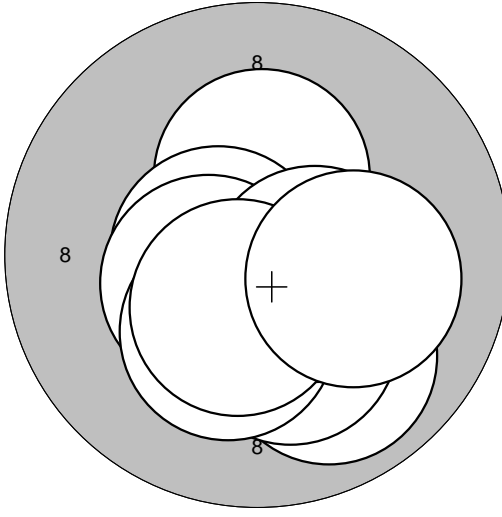

| | |
|-------------------|---|
| 1: 10,8* | ↘ |
| 2: 10,3* | ↑ |
| 3: 10,6* | ← |
| 4: 9,9 | ↘ |
| 5: 10,2* | ↘ |
| 6: 10,5* | ← |
| 7: 10,3* | ↘ |
| 8: 10,5* | → |
| 9: 10,5* | ↘ |
| 10: 10,1 | → |
| Serie 99,0 | |
| Sum 290,0 | |

Series 4

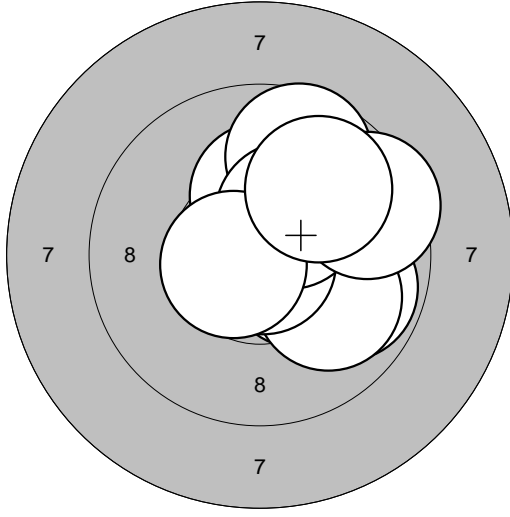

| | |
|-------------------|---|
| 1: 9,9 | → |
| 2: 10,4* | ↘ |
| 3: 9,9 | ↘ |
| 4: 10,8* | ↘ |
| 5: 10,2* | ↑ |
| 6: 9,6 | ↑ |
| 7: 10,4* | ↗ |
| 8: 9,5 | → |
| 9: 10,6* | ← |
| 10: 9,9 | ↗ |
| Serie 95,0 | |
| Sum 385,0 | |

Series 5

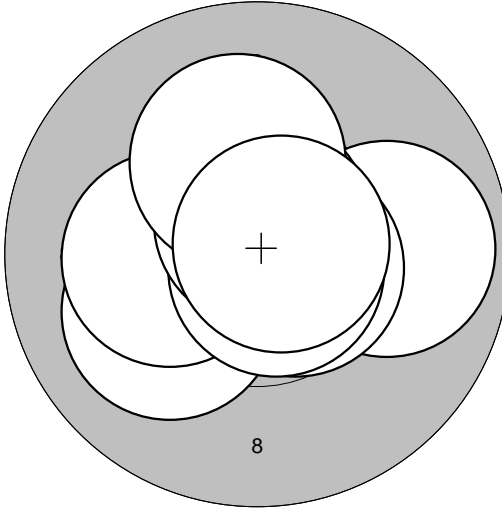

| | |
|-------------------|---|
| 1: 10,9* | ↙ |
| 2: 10,7* | ↗ |
| 3: 9,9 | → |
| 4: 10,1 | ← |
| 5: 10,6* | → |
| 6: 10,2* | ← |
| 7: 10,7* | ↘ |
| 8: 10,7* | ↑ |
| 9: 10,2* | ↑ |
| 10: 10,7* | ↗ |
| Serie 99,0 | |
| Sum 484,0 | |

Series 6

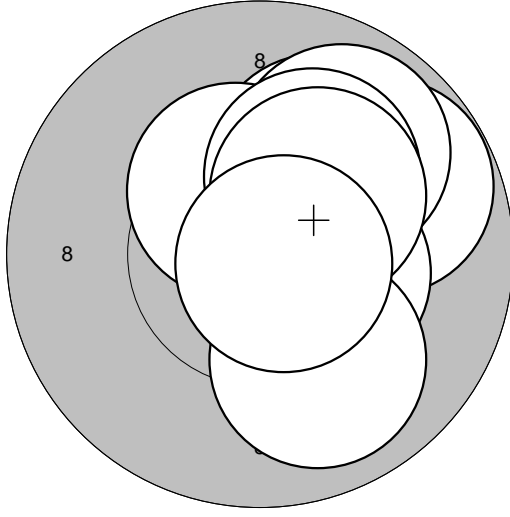

| | |
|-------------------|---|
| 1: 10,1 | ↗ |
| 2: 10,6* | → |
| 3: 10,4* | ↖ |
| 4: 9,8 | → |
| 5: 9,9 | ↗ |
| 6: 10,2* | ↗ |
| 7: 10,4* | → |
| 8: 9,9 | ↘ |
| 9: 10,3* | ↗ |
| 10: 10,7* | ↘ |
| Serie 97,0 | |
| Sum 581,0 | |

| | | | | | | | | | | | |
|-----------------|---|-------|------|-----|------|-----------------|--|-------|------|-----|-------|
| <p>Series 1</p> | <p>1: 10,2* ↗ 2: 10,3* ← 3: 10,2* ↗ 4: 10,2* ↗ 5: 10,8* ↘ 6: 10,0 ↘ 7: 10,3* ↗ 8: 10,3* ↗ 9: 9,9 → 10: 10,0 ↖</p> <table border="1" style="width:100%; border-collapse: collapse;"> <tr> <td style="text-align: right;">Serie</td> <td style="text-align: right;">99,0</td> </tr> <tr> <td style="text-align: right;">Sum</td> <td style="text-align: right;">99,0</td> </tr> </table> | Serie | 99,0 | Sum | 99,0 | <p>Series 2</p> | <p>1: 10,5* ↖ 2: 10,5* ↖ 3: 9,2 → 4: 9,9 → 5: 10,6* ↗ 6: 10,0 → 7: 10,2* ↖ 8: 10,1 → 9: 10,4* ↘ 10: 10,5* ↘</p> <table border="1" style="width:100%; border-collapse: collapse;"> <tr> <td style="text-align: right;">Serie</td> <td style="text-align: right;">98,0</td> </tr> <tr> <td style="text-align: right;">Sum</td> <td style="text-align: right;">197,0</td> </tr> </table> | Serie | 98,0 | Sum | 197,0 |
| Serie | 99,0 | | | | | | | | | | |
| Sum | 99,0 | | | | | | | | | | |
| Serie | 98,0 | | | | | | | | | | |
| Sum | 197,0 | | | | | | | | | | |

| | | | | | | | | | | | |
|-----------------|--|-------|------|-----|-------|-----------------|---|-------|------|-----|-------|
| <p>Series 3</p> | <p>1: 10,6* ↑ 2: 10,7* ← 3: 10,2* ↑ 4: 10,5* ↖ 5: 9,9 ↑ 6: 10,2* ← 7: 10,5* → 8: 10,4* ↗ 9: 10,2* ↘ 10: 10,8* →</p> <table border="1" style="width:100%; border-collapse: collapse;"> <tr> <td style="text-align: right;">Serie</td> <td style="text-align: right;">99,0</td> </tr> <tr> <td style="text-align: right;">Sum</td> <td style="text-align: right;">296,0</td> </tr> </table> | Serie | 99,0 | Sum | 296,0 | <p>Series 4</p> | <p>1: 10,4* ↖ 2: 10,6* ↘ 3: 10,7* ↘ 4: 10,5* ↗ 5: 10,4* ↗ 6: 10,6* → 7: 9,9 ↗ 8: 10,4* ↗ 9: 10,6* → 10: 10,0 ↗</p> <table border="1" style="width:100%; border-collapse: collapse;"> <tr> <td style="text-align: right;">Serie</td> <td style="text-align: right;">99,0</td> </tr> <tr> <td style="text-align: right;">Sum</td> <td style="text-align: right;">395,0</td> </tr> </table> | Serie | 99,0 | Sum | 395,0 |
| Serie | 99,0 | | | | | | | | | | |
| Sum | 296,0 | | | | | | | | | | |
| Serie | 99,0 | | | | | | | | | | |
| Sum | 395,0 | | | | | | | | | | |

| | | | | | | | | | | | |
|-----------------|---|-------|------|-----|-------|-----------------|---|-------|------|-----|-------|
| <p>Series 5</p> | <p>1: 10,6* ↗ 2: 9,7 → 3: 10,7* ↘ 4: 10,6* ← 5: 10,8* ← 6: 10,2* ↘ 7: 10,0 ← 8: 10,1 ↘ 9: 10,4* ↗ 10: 10,0 ↖</p> <table border="1" style="width:100%; border-collapse: collapse;"> <tr> <td style="text-align: right;">Serie</td> <td style="text-align: right;">99,0</td> </tr> <tr> <td style="text-align: right;">Sum</td> <td style="text-align: right;">494,0</td> </tr> </table> | Serie | 99,0 | Sum | 494,0 | <p>Series 6</p> | <p>1: 10,1 ↖ 2: 10,3* ↖ 3: 10,1 ↘ 4: 10,1 ↖ 5: 10,4* ↘ 6: 9,8 ↗ 7: 9,0 → 8: 9,4 ← 9: 9,1 → 10: 10,7* ↗</p> <table border="1" style="width:100%; border-collapse: collapse;"> <tr> <td style="text-align: right;">Serie</td> <td style="text-align: right;">96,0</td> </tr> <tr> <td style="text-align: right;">Sum</td> <td style="text-align: right;">590,0</td> </tr> </table> | Serie | 96,0 | Sum | 590,0 |
| Serie | 99,0 | | | | | | | | | | |
| Sum | 494,0 | | | | | | | | | | |
| Serie | 96,0 | | | | | | | | | | |
| Sum | 590,0 | | | | | | | | | | |

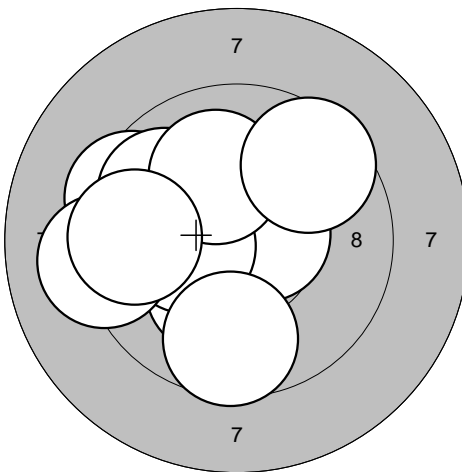
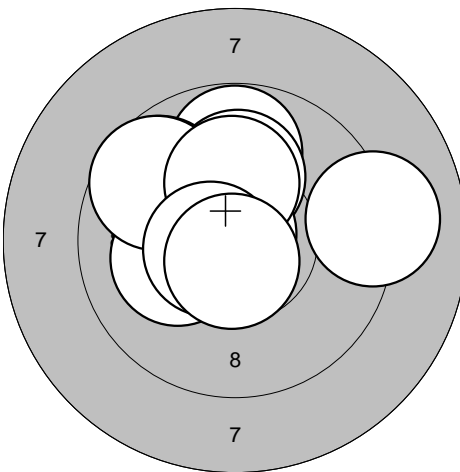
| | | | | | | | | | | | |
|--|---|-------|------|-----|------|--|---|-------|------|-----|-------|
| <p>Series 1</p>  | <p>1: 9,4 ↙ 2: 10,2* ↓ 3: 9,8 ↗ 4: 10,6* → 5: 10,3* ← 6: 10,1 ↑ 7: 9,6 ↗ 8: 9,2 ← 9: 9,6 ↓ 10: 9,6 ←</p> <table border="1" style="width:100%; border-collapse: collapse;"> <tr><td>Serie</td><td style="text-align: right;">94,0</td></tr> <tr><td>Sum</td><td style="text-align: right;">94,0</td></tr> </table> | Serie | 94,0 | Sum | 94,0 | <p>Series 2</p>  | <p>1: 9,1 → 2: 9,8 ↑ 3: 10,1 ← 4: 10,1 ↑ 5: 10,8* ↗ 6: 9,7 ↗ 7: 9,7 ↗ 8: 10,2* ↑ 9: 10,6* ← 10: 10,7* ↓</p> <table border="1" style="width:100%; border-collapse: collapse;"> <tr><td>Serie</td><td style="text-align: right;">96,0</td></tr> <tr><td>Sum</td><td style="text-align: right;">190,0</td></tr> </table> | Serie | 96,0 | Sum | 190,0 |
| Serie | 94,0 | | | | | | | | | | |
| Sum | 94,0 | | | | | | | | | | |
| Serie | 96,0 | | | | | | | | | | |
| Sum | 190,0 | | | | | | | | | | |

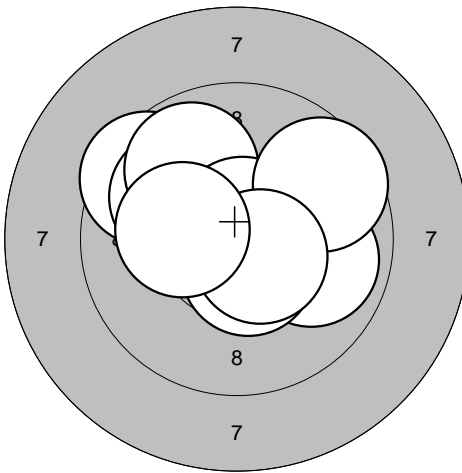
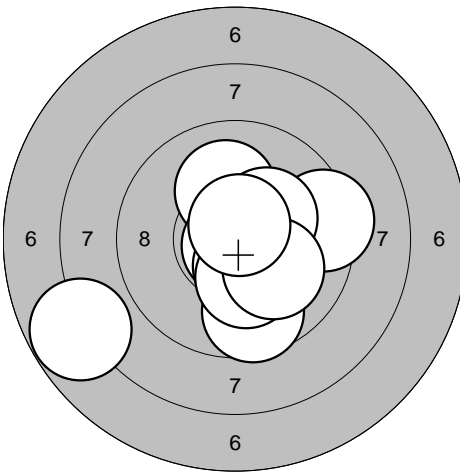
| | | | | | | | | | | | |
|---|--|-------|------|-----|-------|---|---|-------|------|-----|-------|
| <p>Series 3</p>  | <p>1: 9,5 ↗ 2: 10,0 ↗ 3: 9,9 ↗ 4: 10,7* → 5: 9,9 → 6: 10,5* ↓ 7: 10,7* ↑ 8: 9,6 ↗ 9: 10,6* ↓ 10: 10,2* ←</p> <table border="1" style="width:100%; border-collapse: collapse;"> <tr><td>Serie</td><td style="text-align: right;">96,0</td></tr> <tr><td>Sum</td><td style="text-align: right;">286,0</td></tr> </table> | Serie | 96,0 | Sum | 286,0 | <p>Series 4</p>  | <p>1: 7,8 ↙ 2: 9,6 ↓ 3: 10,1 ↑ 4: 9,4 → 5: 10,8* ↓ 6: 10,5* ↓ 7: 10,3* ↓ 8: 10,3* ↗ 9: 10,1 ↘ 10: 10,7* ↑</p> <table border="1" style="width:100%; border-collapse: collapse;"> <tr><td>Serie</td><td style="text-align: right;">95,0</td></tr> <tr><td>Sum</td><td style="text-align: right;">381,0</td></tr> </table> | Serie | 95,0 | Sum | 381,0 |
| Serie | 96,0 | | | | | | | | | | |
| Sum | 286,0 | | | | | | | | | | |
| Serie | 95,0 | | | | | | | | | | |
| Sum | 381,0 | | | | | | | | | | |

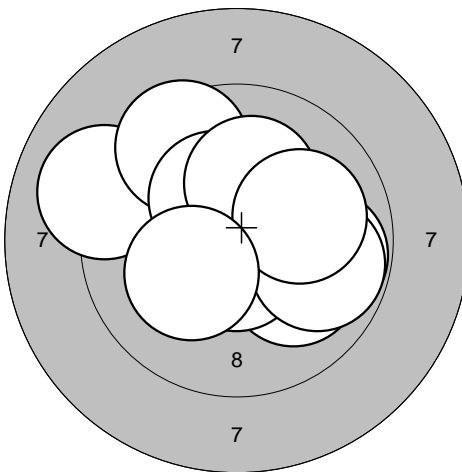
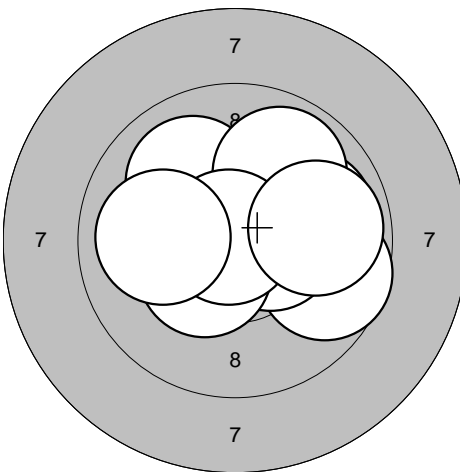
| | | | | | | | | | | | |
|--|---|-------|------|-----|-------|--|---|-------|------|-----|-------|
| <p>Series 5</p>  | <p>1: 10,0 ↓ 2: 9,1 ← 3: 9,5 ↗ 4: 9,8 → 5: 10,6* ↓ 6: 10,3* ↗ 7: 10,2* ↑ 8: 9,8 → 9: 10,1 → 10: 10,2* ↙</p> <table border="1" style="width:100%; border-collapse: collapse;"> <tr><td>Serie</td><td style="text-align: right;">96,0</td></tr> <tr><td>Sum</td><td style="text-align: right;">477,0</td></tr> </table> | Serie | 96,0 | Sum | 477,0 | <p>Series 6</p>  | <p>1: 9,7 → 2: 10,2* ↗ 3: 10,5* → 4: 10,4* ↙ 5: 10,0 ↗ 6: 9,9 → 7: 9,9 ↗ 8: 10,9* ↙ 9: 10,0 ← 10: 9,9 →</p> <table border="1" style="width:100%; border-collapse: collapse;"> <tr><td>Serie</td><td style="text-align: right;">96,0</td></tr> <tr><td>Sum</td><td style="text-align: right;">573,0</td></tr> </table> | Serie | 96,0 | Sum | 573,0 |
| Serie | 96,0 | | | | | | | | | | |
| Sum | 477,0 | | | | | | | | | | |
| Serie | 96,0 | | | | | | | | | | |
| Sum | 573,0 | | | | | | | | | | |

| | | | |
|-----------------|---|-----------------|--|
| <p>Series 1</p> | <p>1: 10,0 ←</p> <p>2: 10,3* ↑</p> <p>3: 9,8 →</p> <p>4: 9,5 ←</p> <p>5: 10,2* →</p> <p>6: 10,5* ←</p> <p>7: 10,5* ↑</p> <p>8: 10,1 ↑</p> <p>9: 10,0 ↑</p> <p>10: 10,6* ↑</p> | <p>Series 2</p> | <p>1: 10,7* ↗</p> <p>2: 10,2* →</p> <p>3: 10,5* ↓</p> <p>4: 10,7* ↓</p> <p>5: 10,9* ←</p> <p>6: 9,9 ←</p> <p>7: 10,2* →</p> <p>8: 10,2* →</p> <p>9: 10,7* →</p> <p>10: 9,9 ↑</p> |
| Serie 98,0 | Serie 98,0 | Serie 98,0 | Serie 98,0 |
| Sum 98,0 | Sum 98,0 | Sum 196,0 | Sum 196,0 |

| | | | |
|-----------------|--|-----------------|--|
| <p>Series 3</p> | <p>1: 10,7* ↘</p> <p>2: 10,5* ↓</p> <p>3: 10,8* ←</p> <p>4: 10,8* →</p> <p>5: 9,9 ↗</p> <p>6: 9,6 ↗</p> <p>7: 10,2* ↘</p> <p>8: 10,0 →</p> <p>9: 10,0 →</p> <p>10: 9,6 ↙</p> | <p>Series 4</p> | <p>1: 10,0 ↑</p> <p>2: 10,5* ↘</p> <p>3: 10,6* ↘</p> <p>4: 10,9* →</p> <p>5: 10,3* ←</p> <p>6: 10,4* ↓</p> <p>7: 9,9 ↓</p> <p>8: 10,7* ↘</p> <p>9: 10,2* →</p> <p>10: 10,1 →</p> |
| Serie 97,0 | Serie 97,0 | Serie 99,0 | Serie 99,0 |
| Sum 293,0 | Sum 293,0 | Sum 392,0 | Sum 392,0 |

| | | | |
|-----------------|---|-----------------|---|
| <p>Series 5</p> | <p>1: 9,8 ↘</p> <p>2: 10,5* ←</p> <p>3: 10,3* ↗</p> <p>4: 10,7* →</p> <p>5: 10,0 →</p> <p>6: 10,0 ↘</p> <p>7: 10,6* ↗</p> <p>8: 10,7* ←</p> <p>9: 10,8* ←</p> <p>10: 10,0 ↓</p> | <p>Series 6</p> | <p>1: 10,0 ↙</p> <p>2: 10,1 ↙</p> <p>3: 9,9 →</p> <p>4: 9,9 ↓</p> <p>5: 10,6* ↗</p> <p>6: 10,6* ↘</p> <p>7: 9,7 ↓</p> <p>8: 10,0 →</p> <p>9: 10,2* ↘</p> <p>10: 10,3* ↙</p> |
| Serie 99,0 | Serie 99,0 | Serie 97,0 | Serie 97,0 |
| Sum 491,0 | Sum 491,0 | Sum 588,0 | Sum 588,0 |

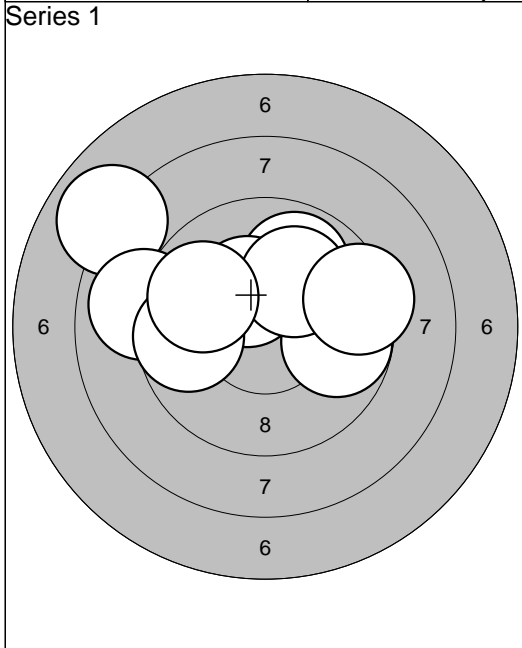

| | |
|----------|------|
| 1: 9,9 | ➔ |
| 2: 9,8 | ➔ |
| 3: 9,9 | ↗ |
| 4: 10,3* | ↗ |
| 5: 7,9 | ↗ |
| 6: 10,1 | ↗ |
| 7: 9,0 | ↖ |
| 8: 9,7 | ↖ |
| 9: 9,9 | ↖ |
| 10: 9,3 | ➔ |
| Serie | 90,0 |
| Sum | 90,0 |

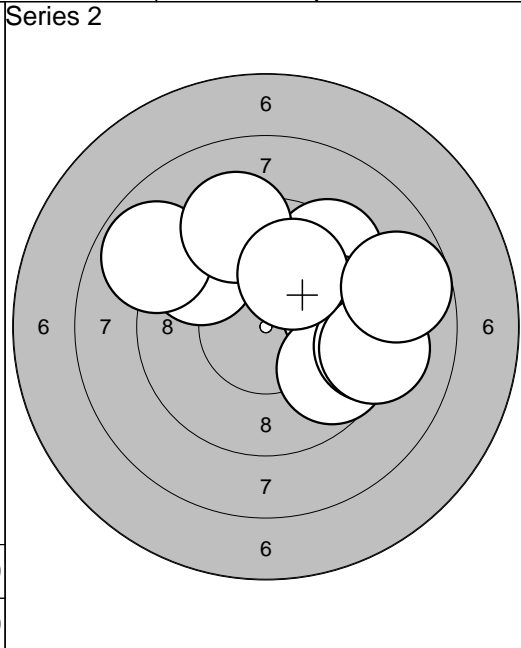

| | |
|---------|-------|
| 1: 9,6 | ↖ |
| 2: 9,4 | ↗ |
| 3: 8,9 | ↖ |
| 4: 9,8 | ➔ |
| 5: 9,7 | ↘ |
| 6: 9,2 | ➔ |
| 7: 9,2 | ➔ |
| 8: 9,3 | ↗ |
| 9: 10,0 | ↗ |
| 10: 8,7 | ➔ |
| Serie | 89,0 |
| Sum | 179,0 |

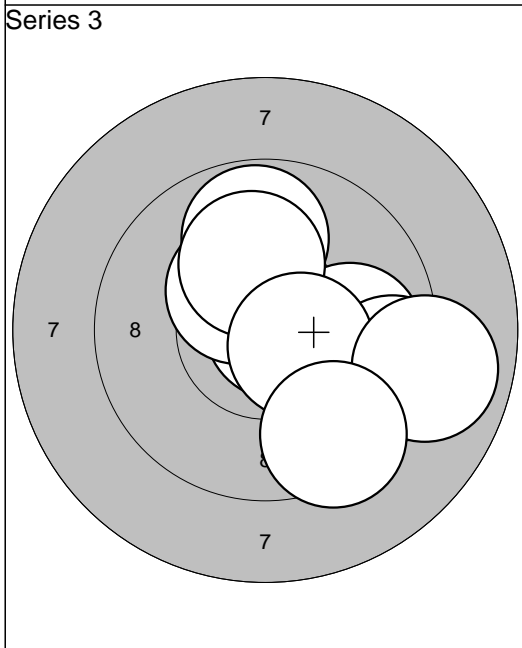

| | |
|----------|-------|
| 1: 10,8* | ➔ |
| 2: 10,4* | ↗ |
| 3: 10,3* | ↘ |
| 4: 9,9 | ➔ |
| 5: 9,8 | ↗ |
| 6: 10,1 | ↗ |
| 7: 9,3 | ↘ |
| 8: 10,5* | ↘ |
| 9: 8,9 | ➔ |
| 10: 9,4 | ↘ |
| Serie | 94,0 |
| Sum | 273,0 |

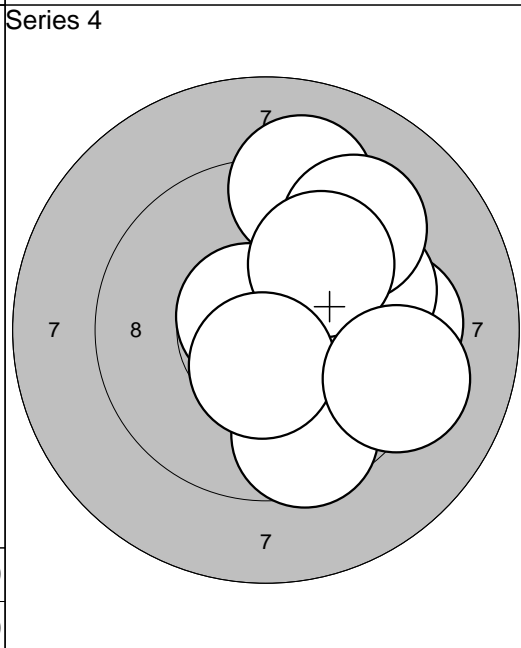

| | |
|----------|-------|
| 1: 9,7 | ↗ |
| 2: 10,7* | ↖ |
| 3: 9,2 | ↗ |
| 4: 9,4 | ➔ |
| 5: 9,6 | ↘ |
| 6: 9,7 | ➔ |
| 7: 9,3 | ↗ |
| 8: 9,9 | ↗ |
| 9: 10,5* | ↘ |
| 10: 9,2 | ➔ |
| Serie | 92,0 |
| Sum | 365,0 |

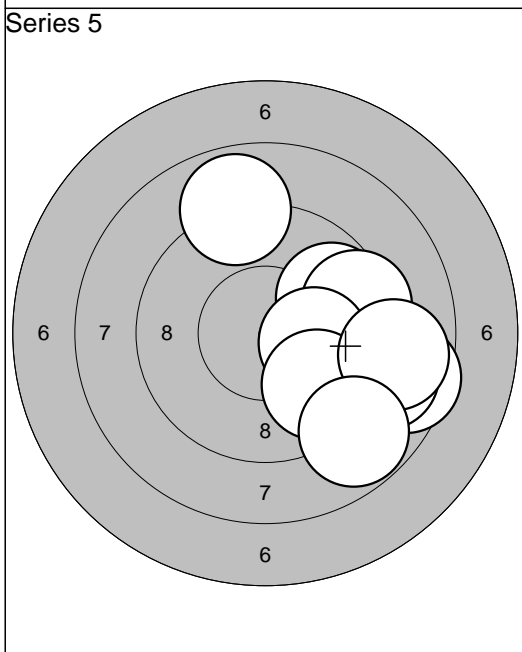

| | |
|----------|-------|
| 1: 8,6 | ➔ |
| 2: 9,7 | ↗ |
| 3: 9,1 | ↘ |
| 4: 8,9 | ➔ |
| 5: 8,9 | ↗ |
| 6: 9,4 | ➔ |
| 7: 10,2* | ➔ |
| 8: 9,8 | ↘ |
| 9: 8,9 | ➔ |
| 10: 8,8 | ↘ |
| Serie | 86,0 |
| Sum | 451,0 |

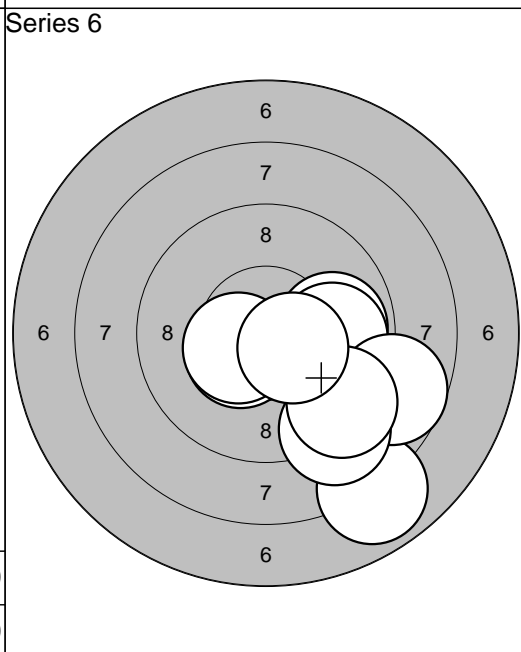

| | |
|-----------|-------|
| 1: 9,8 | ➔ |
| 2: 10,4* | ↖ |
| 3: 7,9 | ↘ |
| 4: 9,7 | ➔ |
| 5: 10,5* | ↖ |
| 6: 9,9 | ➔ |
| 7: 8,7 | ➔ |
| 8: 9,0 | ↘ |
| 9: 9,3 | ↘ |
| 10: 10,4* | ↘ |
| Serie | 90,0 |
| Sum | 541,0 |

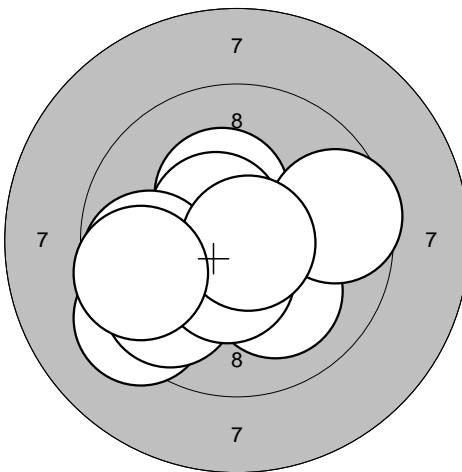
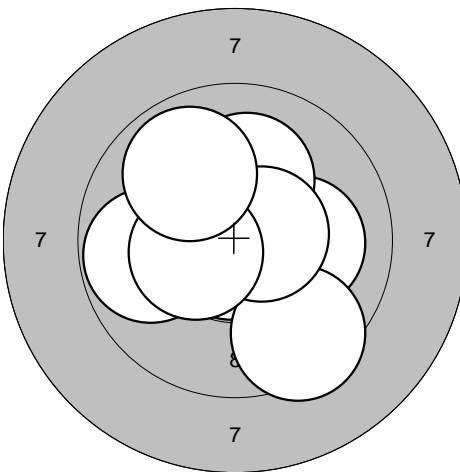
| | | | |
|--|---|--|--|
| <p>Series 1</p>  | <p>1: 10,3* ↗</p> <p>2: 9,3 ↘</p> <p>3: 10,6* ↗</p> <p>4: 9,8 ↘</p> <p>5: 10,1 ↘</p> <p>6: 9,8 ←</p> <p>7: 9,6 →</p> <p>8: 10,5* ↘</p> <p>9: 10,8* →</p> <p>10: 9,6 ←</p> | <p>Series 2</p>  | <p>1: 10,5* ↗</p> <p>2: 10,5* ←</p> <p>3: 10,1 →</p> <p>4: 10,1 ↑</p> <p>5: 9,8 ←</p> <p>6: 10,8* ↘</p> <p>7: 9,5 ↘</p> <p>8: 10,6* →</p> <p>9: 10,4* ←</p> <p>10: 9,9 ↗</p> |
| Serie 95,0 | Serie 97,0 | Serie 97,0 | Serie 97,0 |
| Sum 95,0 | Sum 192,0 | Sum 192,0 | Sum 192,0 |

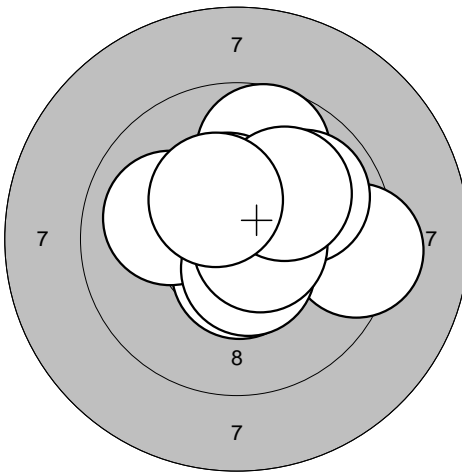
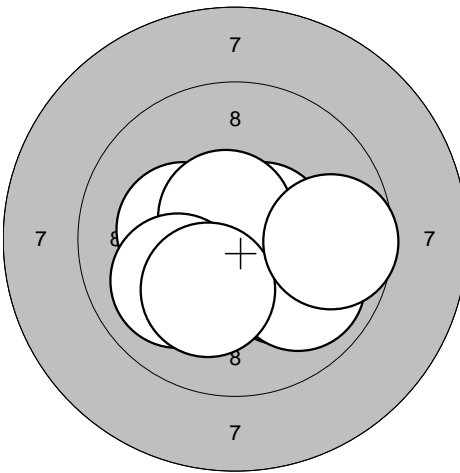
| | | | |
|---|--|---|--|
| <p>Series 3</p>  | <p>1: 9,7 ↗</p> <p>2: 9,3 →</p> <p>3: 10,4* ↗</p> <p>4: 10,5* ↘</p> <p>5: 10,0 ←</p> <p>6: 10,5* ↘</p> <p>7: 9,9 ↗</p> <p>8: 10,6* →</p> <p>9: 10,1 ↗</p> <p>10: 10,4* ↗</p> | <p>Series 4</p>  | <p>1: 10,6* →</p> <p>2: 10,6* ←</p> <p>3: 10,8* ↗</p> <p>4: 10,1 ↘</p> <p>5: 10,3* ←</p> <p>6: 9,9 ↘</p> <p>7: 10,7* ↗</p> <p>8: 10,0 ←</p> <p>9: 10,2* ↘</p> <p>10: 9,7 →</p> |
| Serie 97,0 | Serie 98,0 | Serie 98,0 | Serie 98,0 |
| Sum 289,0 | Sum 387,0 | Sum 387,0 | Sum 387,0 |

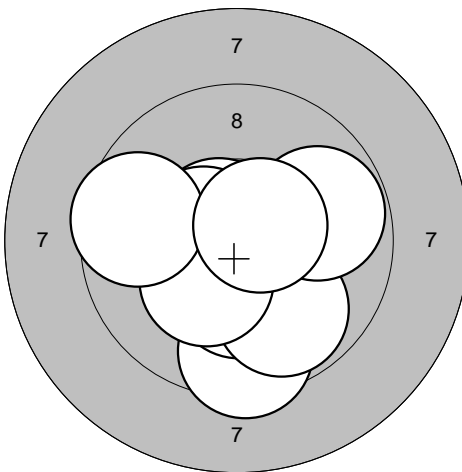
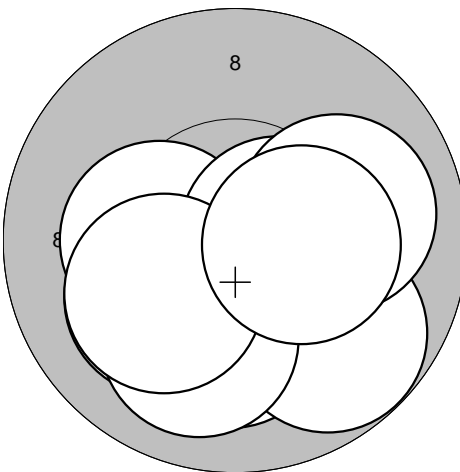
| | | | |
|--|--|--|---|
| <p>Series 5</p>  | <p>1: 10,6* ↗</p> <p>2: 9,5 ↘</p> <p>3: 10,7* ←</p> <p>4: 10,5* ←</p> <p>5: 10,3* ↘</p> <p>6: 9,9 ↘</p> <p>7: 10,3* ↘</p> <p>8: 9,8 →</p> <p>9: 9,6 ←</p> <p>10: 10,6* ↗</p> | <p>Series 6</p>  | <p>1: 10,1 ↘</p> <p>2: 10,3* ←</p> <p>3: 10,3* ↘</p> <p>4: 10,6* →</p> <p>5: 9,7 ↘</p> <p>6: 10,0 →</p> <p>7: 10,1 ←</p> <p>8: 10,0 ↘</p> <p>9: 10,1 ←</p> <p>10: 10,4* →</p> |
| Serie 96,0 | Serie 99,0 | Serie 99,0 | Serie 99,0 |
| Sum 483,0 | Sum 582,0 | Sum 582,0 | Sum 582,0 |

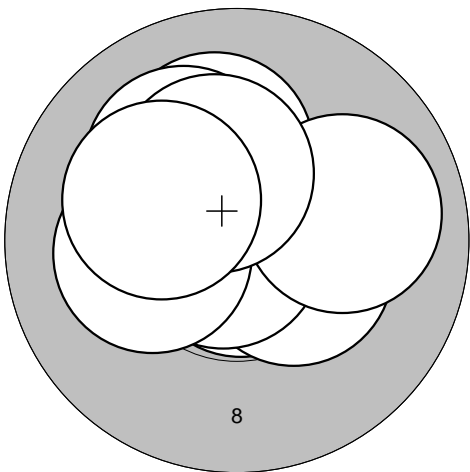
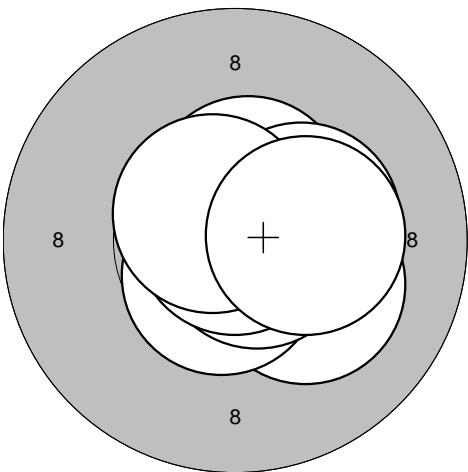
| | | | | | | | | | | | |
|--|--|-------|-------|-----|-------|--|---|-------|-------|-----|-------|
| <p>Series 1</p>  | <p>1: 10,2* ↗ 2: 10,8* ↓ 3: 10,4* → 4: 10,1 ↗ 5: 10,8* ↖ 6: 10,1 ↗ 7: 10,2* ← 8: 10,0 → 9: 10,3* ↗ 10: 10,2* ↖</p> <table border="1" style="width:100%; border-collapse: collapse;"> <tr> <td style="width:50%;">Serie</td> <td style="width:50%; text-align: right;">100,0</td> </tr> <tr> <td>Sum</td> <td style="text-align: right;">100,0</td> </tr> </table> | Serie | 100,0 | Sum | 100,0 | <p>Series 2</p>  | <p>1: 10,2* ↘ 2: 10,6* ↓ 3: 10,8* ↗ 4: 10,4* → 5: 10,5* ↗ 6: 10,8* → 7: 10,9* ↗ 8: 10,3* → 9: 10,7* ↗ 10: 10,3* →</p> <table border="1" style="width:100%; border-collapse: collapse;"> <tr> <td style="width:50%;">Serie</td> <td style="width:50%; text-align: right;">100,0</td> </tr> <tr> <td>Sum</td> <td style="text-align: right;">200,0</td> </tr> </table> | Serie | 100,0 | Sum | 200,0 |
| Serie | 100,0 | | | | | | | | | | |
| Sum | 100,0 | | | | | | | | | | |
| Serie | 100,0 | | | | | | | | | | |
| Sum | 200,0 | | | | | | | | | | |

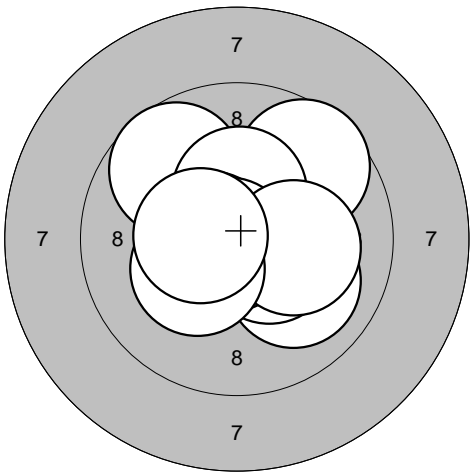
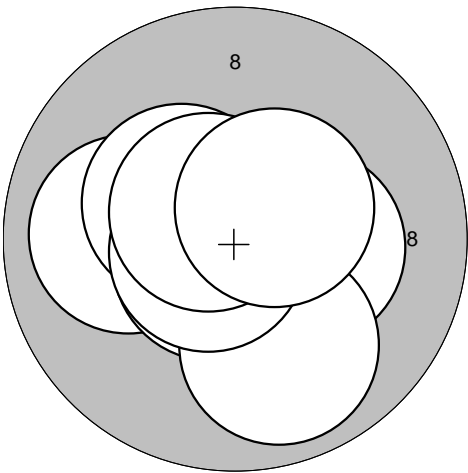
| | | | | | | | | | | | |
|---|---|-------|------|-----|-------|---|---|-------|------|-----|-------|
| <p>Series 3</p>  | <p>1: 9,6 ↗ 2: 9,7 ↗ 3: 10,3* ↗ 4: 10,0 ↓ 5: 10,6* ← 6: 10,4* → 7: 10,8* ↖ 8: 10,2* → 9: 10,3* ↖ 10: 10,5* ←</p> <table border="1" style="width:100%; border-collapse: collapse;"> <tr> <td style="width:50%;">Serie</td> <td style="width:50%; text-align: right;">98,0</td> </tr> <tr> <td>Sum</td> <td style="text-align: right;">298,0</td> </tr> </table> | Serie | 98,0 | Sum | 298,0 | <p>Series 4</p>  | <p>1: 10,0 ← 2: 10,7* ↖ 3: 10,4* → 4: 10,3* → 5: 9,9 ↓ 6: 10,8* ↗ 7: 10,4* ↖ 8: 10,7* ↖ 9: 10,6* ↗ 10: 10,5* ↗</p> <table border="1" style="width:100%; border-collapse: collapse;"> <tr> <td style="width:50%;">Serie</td> <td style="width:50%; text-align: right;">99,0</td> </tr> <tr> <td>Sum</td> <td style="text-align: right;">397,0</td> </tr> </table> | Serie | 99,0 | Sum | 397,0 |
| Serie | 98,0 | | | | | | | | | | |
| Sum | 298,0 | | | | | | | | | | |
| Serie | 99,0 | | | | | | | | | | |
| Sum | 397,0 | | | | | | | | | | |

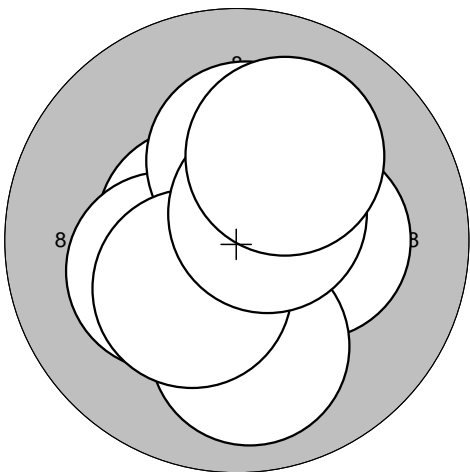
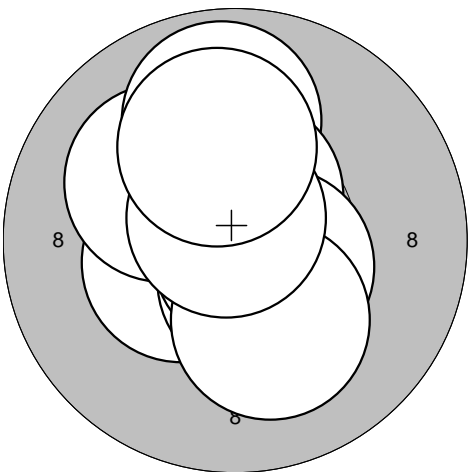
| | | | | | | | | | | | |
|--|---|-------|-------|-----|-------|--|---|-------|------|-----|-------|
| <p>Series 5</p>  | <p>1: 10,3* → 2: 10,6* ← 3: 10,5* ↓ 4: 10,7* ↖ 5: 10,2* ↖ 6: 10,2* ↗ 7: 10,0 ↓ 8: 10,3* ↖ 9: 10,6* ↗ 10: 10,1 ↗</p> <table border="1" style="width:100%; border-collapse: collapse;"> <tr> <td style="width:50%;">Serie</td> <td style="width:50%; text-align: right;">100,0</td> </tr> <tr> <td>Sum</td> <td style="text-align: right;">497,0</td> </tr> </table> | Serie | 100,0 | Sum | 497,0 | <p>Series 6</p>  | <p>1: 10,4* ↖ 2: 10,5* ↓ 3: 10,1 ↗ 4: 9,9 ↗ 5: 10,6* ↗ 6: 10,7* ↘ 7: 10,5* ↘ 8: 10,1 ↓ 9: 10,7* ↗ 10: 10,1 ↗</p> <table border="1" style="width:100%; border-collapse: collapse;"> <tr> <td style="width:50%;">Serie</td> <td style="width:50%; text-align: right;">99,0</td> </tr> <tr> <td>Sum</td> <td style="text-align: right;">596,0</td> </tr> </table> | Serie | 99,0 | Sum | 596,0 |
| Serie | 100,0 | | | | | | | | | | |
| Sum | 497,0 | | | | | | | | | | |
| Serie | 99,0 | | | | | | | | | | |
| Sum | 596,0 | | | | | | | | | | |

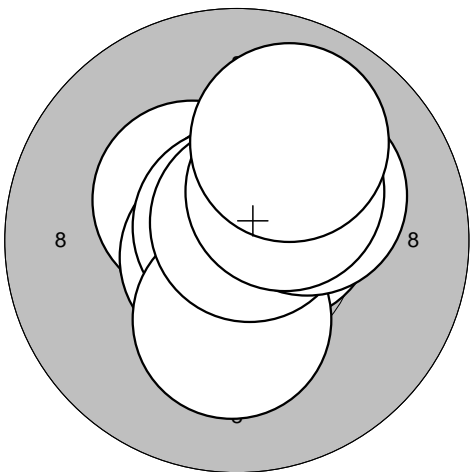
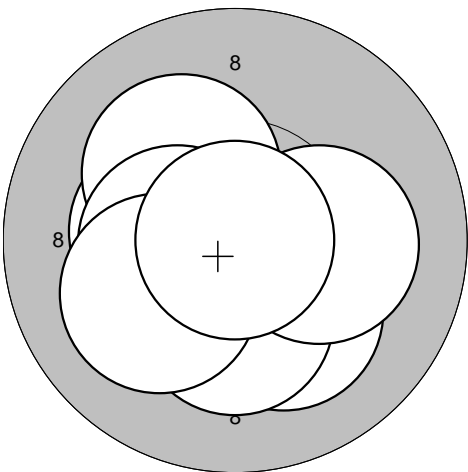
| | | | | | | | | | | | |
|--|---|-------|-------|-----|-------|--|---|-------|-------|-----|-------|
| <p>Series 1</p>  | <p>1: 10,4* ↖ 2: 10,7* ↙ 3: 10,7* ↗ 4: 10,8* ↗ 5: 10,6* → 6: 10,2* ↓ 7: 10,7* ↗ 8: 10,2* → 9: 10,3* ↗ 10: 10,0 ↗</p> <table border="1" style="width:100%; border-collapse: collapse;"> <tr> <td style="width:50%;">Serie</td> <td style="text-align: right;">100,0</td> </tr> <tr> <td>Sum</td> <td style="text-align: right;">100,0</td> </tr> </table> | Serie | 100,0 | Sum | 100,0 | <p>Series 2</p>  | <p>1: 10,6* ↖ 2: 10,2* ↘ 3: 10,7* ← 4: 10,3* ← 5: 10,3* ↓ 6: 10,2* ↗ 7: 10,4* ← 8: 10,1 ↖ 9: 10,2* → 10: 10,9*</p> <table border="1" style="width:100%; border-collapse: collapse;"> <tr> <td style="width:50%;">Serie</td> <td style="text-align: right;">100,0</td> </tr> <tr> <td>Sum</td> <td style="text-align: right;">200,0</td> </tr> </table> | Serie | 100,0 | Sum | 200,0 |
| Serie | 100,0 | | | | | | | | | | |
| Sum | 100,0 | | | | | | | | | | |
| Serie | 100,0 | | | | | | | | | | |
| Sum | 200,0 | | | | | | | | | | |

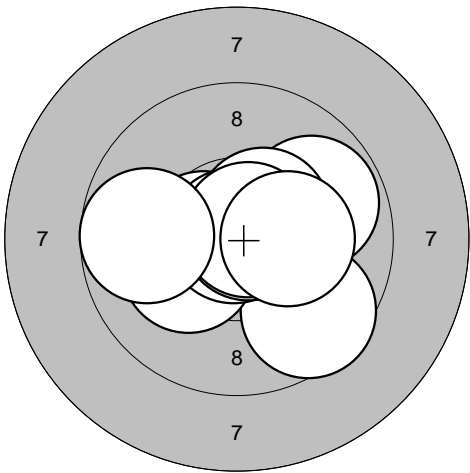
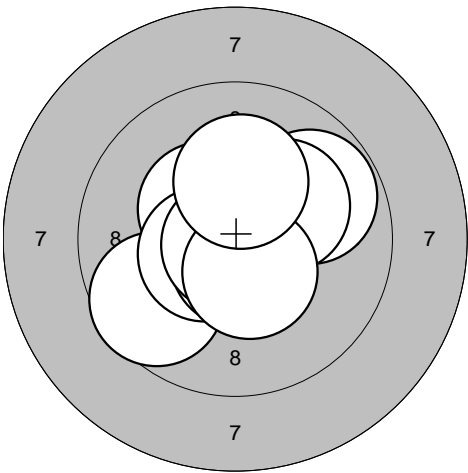
| | | | | | | | | | | | |
|---|---|-------|------|-----|-------|---|---|-------|------|-----|-------|
| <p>Series 3</p>  | <p>1: 10,5* ← 2: 9,6 ↘ 3: 10,2* ← 4: 10,9* ↖ 5: 10,8* → 6: 9,8 → 7: 10,5* ↗ 8: 10,7* ↗ 9: 10,3* → 10: 9,8 ←</p> <table border="1" style="width:100%; border-collapse: collapse;"> <tr> <td style="width:50%;">Serie</td> <td style="text-align: right;">97,0</td> </tr> <tr> <td>Sum</td> <td style="text-align: right;">297,0</td> </tr> </table> | Serie | 97,0 | Sum | 297,0 | <p>Series 4</p>  | <p>1: 10,4* ↖ 2: 9,6 ↖ 3: 10,5* ← 4: 10,6* ↗ 5: 9,8 → 6: 10,7* ↓ 7: 10,2* ↗ 8: 10,9* ↖ 9: 10,5* ↘ 10: 10,2* ↗</p> <table border="1" style="width:100%; border-collapse: collapse;"> <tr> <td style="width:50%;">Serie</td> <td style="text-align: right;">98,0</td> </tr> <tr> <td>Sum</td> <td style="text-align: right;">395,0</td> </tr> </table> | Serie | 98,0 | Sum | 395,0 |
| Serie | 97,0 | | | | | | | | | | |
| Sum | 297,0 | | | | | | | | | | |
| Serie | 98,0 | | | | | | | | | | |
| Sum | 395,0 | | | | | | | | | | |

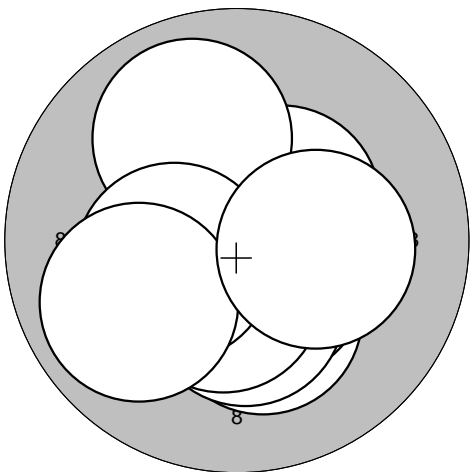
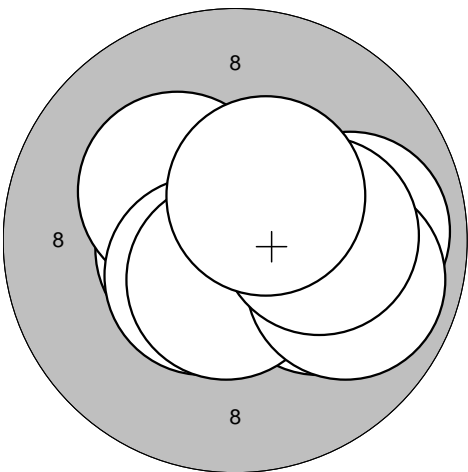
| | | | | | | | | | | | |
|--|---|-------|------|-----|-------|--|--|-------|------|-----|-------|
| <p>Series 5</p>  | <p>1: 10,8* ↗ 2: 10,2* ↓ 3: 10,4* ↗ 4: 10,5* ↘ 5: 10,3* ↓ 6: 9,9 ↗ 7: 10,5* ↓ 8: 10,4* ← 9: 9,9 ↖ 10: 10,2* →</p> <table border="1" style="width:100%; border-collapse: collapse;"> <tr> <td style="width:50%;">Serie</td> <td style="text-align: right;">98,0</td> </tr> <tr> <td>Sum</td> <td style="text-align: right;">493,0</td> </tr> </table> | Serie | 98,0 | Sum | 493,0 | <p>Series 6</p>  | <p>1: 10,1 → 2: 9,9 → 3: 10,6* ← 4: 10,3* → 5: 10,3* ↖ 6: 10,5* ↖ 7: 10,6* ↓ 8: 9,9 → 9: 10,2* → 10: 10,5* ↗</p> <table border="1" style="width:100%; border-collapse: collapse;"> <tr> <td style="width:50%;">Serie</td> <td style="text-align: right;">98,0</td> </tr> <tr> <td>Sum</td> <td style="text-align: right;">591,0</td> </tr> </table> | Serie | 98,0 | Sum | 591,0 |
| Serie | 98,0 | | | | | | | | | | |
| Sum | 493,0 | | | | | | | | | | |
| Serie | 98,0 | | | | | | | | | | |
| Sum | 591,0 | | | | | | | | | | |

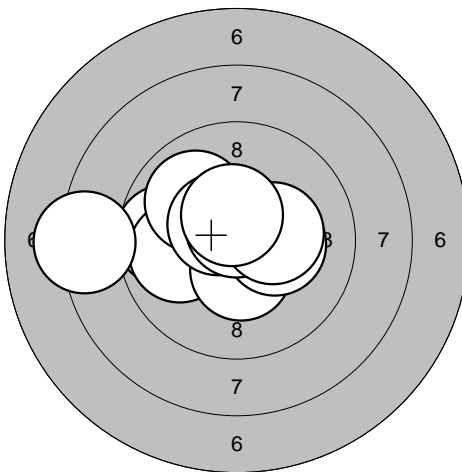
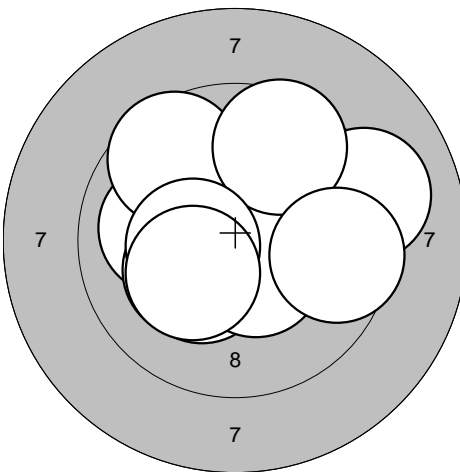
| | | | | | | | | | | | |
|--|---|-------|------|-----|------|--|---|-------|------|-----|-------|
| <p>Series 1</p>  | <p>1: 9,7 ←</p> <p>2: 9,9 ←</p> <p>3: 10,4* ↓</p> <p>4: 10,3* →</p> <p>5: 9,9 ↗</p> <p>6: 10,5* ↗</p> <p>7: 8,3 ←</p> <p>8: 10,7* ↑</p> <p>9: 10,3* →</p> <p>10: 10,5* ↑</p> <table border="1" style="width:100%; border-collapse: collapse;"> <tr><td>Serie</td><td style="text-align: right;">95,0</td></tr> <tr><td>Sum</td><td style="text-align: right;">95,0</td></tr> </table> | Serie | 95,0 | Sum | 95,0 | <p>Series 2</p>  | <p>1: 10,0 ←</p> <p>2: 9,6 ↖</p> <p>3: 10,2* ↖</p> <p>4: 10,3* ↖</p> <p>5: 9,1 →</p> <p>6: 10,5* ↘</p> <p>7: 9,6 ↗</p> <p>8: 10,4* ←</p> <p>9: 10,2* ↖</p> <p>10: 9,6 →</p> <table border="1" style="width:100%; border-collapse: collapse;"> <tr><td>Serie</td><td style="text-align: right;">96,0</td></tr> <tr><td>Sum</td><td style="text-align: right;">191,0</td></tr> </table> | Serie | 96,0 | Sum | 191,0 |
| Serie | 95,0 | | | | | | | | | | |
| Sum | 95,0 | | | | | | | | | | |
| Serie | 96,0 | | | | | | | | | | |
| Sum | 191,0 | | | | | | | | | | |

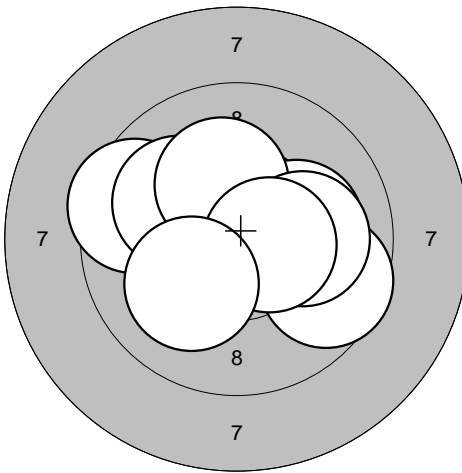
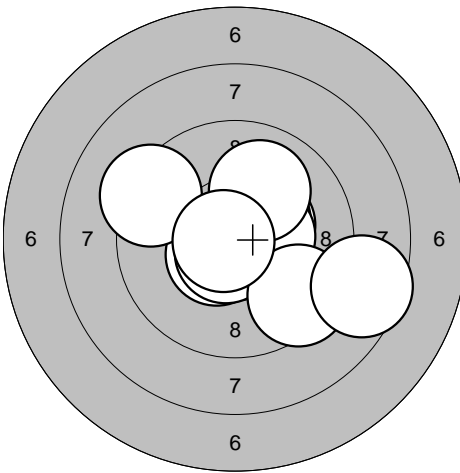
| | | | | | | | | | | | |
|---|--|-------|------|-----|-------|---|---|-------|------|-----|-------|
| <p>Series 3</p>  | <p>1: 10,7* ↑</p> <p>2: 9,6 →</p> <p>3: 10,6* ↗</p> <p>4: 10,1 →</p> <p>5: 9,5 ←</p> <p>6: 10,1 ↗</p> <p>7: 10,2* ↗</p> <p>8: 10,1 →</p> <p>9: 10,5* →</p> <p>10: 10,1 ↘</p> <table border="1" style="width:100%; border-collapse: collapse;"> <tr><td>Serie</td><td style="text-align: right;">98,0</td></tr> <tr><td>Sum</td><td style="text-align: right;">289,0</td></tr> </table> | Serie | 98,0 | Sum | 289,0 | <p>Series 4</p>  | <p>1: 10,4* ↗</p> <p>2: 10,4* ↗</p> <p>3: 10,5* ↖</p> <p>4: 10,7* ↘</p> <p>5: 10,4* →</p> <p>6: 9,3 ↖</p> <p>7: 9,5 ↘</p> <p>8: 10,0 ↗</p> <p>9: 8,6 →</p> <p>10: 10,8* ←</p> <table border="1" style="width:100%; border-collapse: collapse;"> <tr><td>Serie</td><td style="text-align: right;">96,0</td></tr> <tr><td>Sum</td><td style="text-align: right;">385,0</td></tr> </table> | Serie | 96,0 | Sum | 385,0 |
| Serie | 98,0 | | | | | | | | | | |
| Sum | 289,0 | | | | | | | | | | |
| Serie | 96,0 | | | | | | | | | | |
| Sum | 385,0 | | | | | | | | | | |

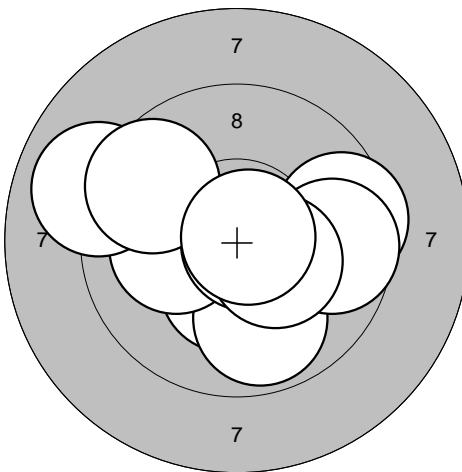
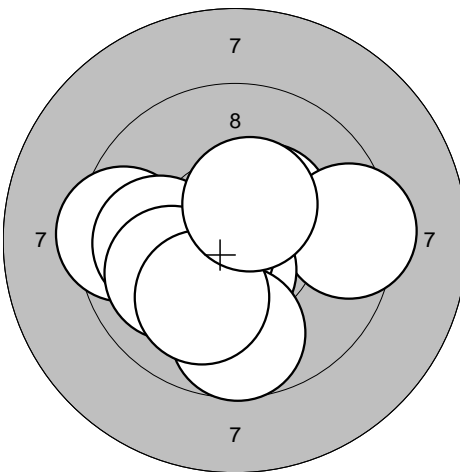
| | | | | | | | | | | | |
|--|---|-------|------|-----|-------|--|---|-------|------|-----|-------|
| <p>Series 5</p>  | <p>1: 10,3* ↓</p> <p>2: 9,5 →</p> <p>3: 9,9 ↓</p> <p>4: 10,1 ←</p> <p>5: 9,0 ↖</p> <p>6: 10,8* →</p> <p>7: 9,6 ↗</p> <p>8: 9,7 →</p> <p>9: 10,4* ↘</p> <p>10: 10,8* →</p> <table border="1" style="width:100%; border-collapse: collapse;"> <tr><td>Serie</td><td style="text-align: right;">95,0</td></tr> <tr><td>Sum</td><td style="text-align: right;">480,0</td></tr> </table> | Serie | 95,0 | Sum | 480,0 | <p>Series 6</p>  | <p>1: 10,4* ↗</p> <p>2: 9,5 ←</p> <p>3: 9,4 →</p> <p>4: 10,6* ↓</p> <p>5: 10,6* ←</p> <p>6: 10,0 ←</p> <p>7: 10,0 ↖</p> <p>8: 9,7 ↓</p> <p>9: 10,1 ↘</p> <p>10: 10,4* ↗</p> <table border="1" style="width:100%; border-collapse: collapse;"> <tr><td>Serie</td><td style="text-align: right;">97,0</td></tr> <tr><td>Sum</td><td style="text-align: right;">577,0</td></tr> </table> | Serie | 97,0 | Sum | 577,0 |
| Serie | 95,0 | | | | | | | | | | |
| Sum | 480,0 | | | | | | | | | | |
| Serie | 97,0 | | | | | | | | | | |
| Sum | 577,0 | | | | | | | | | | |

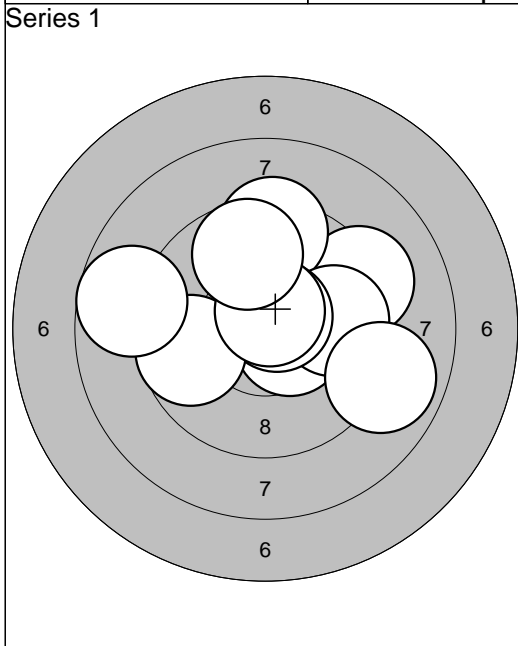

| | |
|-------------------|---|
| 1: 9,2 | ↗ |
| 2: 10,5* | ↘ |
| 3: 9,4 | ↑ |
| 4: 9,8 | → |
| 5: 10,7* | ↗ |
| 6: 9,7 | ← |
| 7: 8,7 | ← |
| 8: 10,6* | ↑ |
| 9: 8,9 | ↘ |
| 10: 9,7 | ↑ |
| Serie 91,0 | |
| Sum 91,0 | |

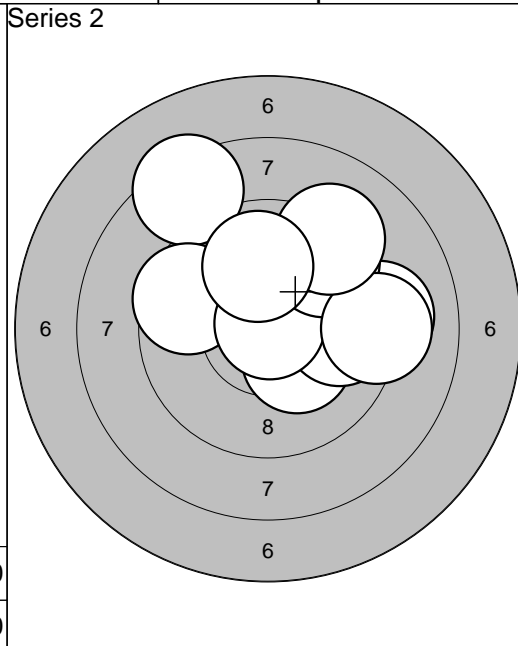

| | |
|-------------------|---|
| 1: 8,3 | ↖ |
| 2: 9,1 | → |
| 3: 10,3* | ↘ |
| 4: 9,8 | → |
| 5: 9,6 | ← |
| 6: 10,9* | ↗ |
| 7: 9,5 | ↗ |
| 8: 9,2 | → |
| 9: 9,2 | ↗ |
| 10: 9,9 | ↑ |
| Serie 91,0 | |
| Sum 182,0 | |

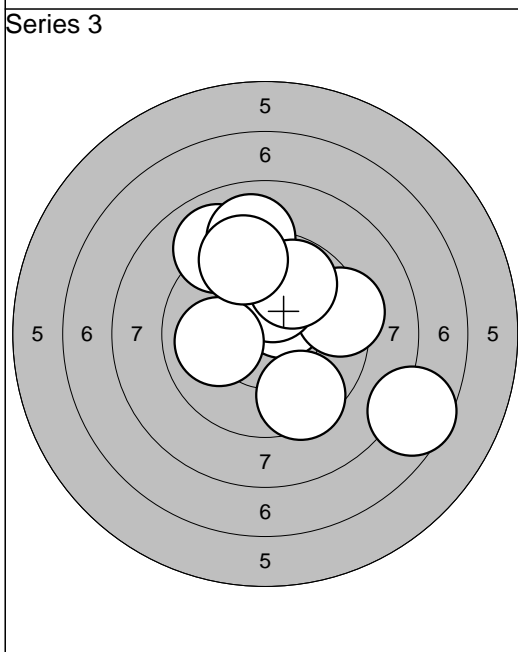

| | |
|-------------------|---|
| 1: 10,4* | ↗ |
| 2: 9,4 | → |
| 3: 9,5 | ↘ |
| 4: 9,0 | ↗ |
| 5: 9,0 | ↑ |
| 6: 10,2* | ↑ |
| 7: 7,6 | ↘ |
| 8: 9,8 | ↗ |
| 9: 10,0 | ← |
| 10: 9,4 | ↑ |
| Serie 91,0 | |
| Sum 273,0 | |

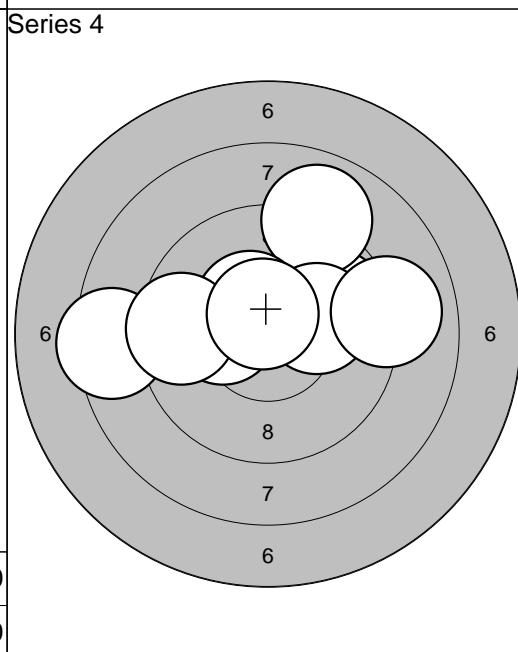

| | |
|-------------------|---|
| 1: 10,2* | ← |
| 2: 8,4 | ← |
| 3: 9,8 | ↗ |
| 4: 10,6* | ↑ |
| 5: 8,9 | ↗ |
| 6: 10,1 | ↗ |
| 7: 10,5* | ↗ |
| 8: 9,5 | ← |
| 9: 9,0 | → |
| 10: 10,6* | ↑ |
| Serie 93,0 | |
| Sum 366,0 | |

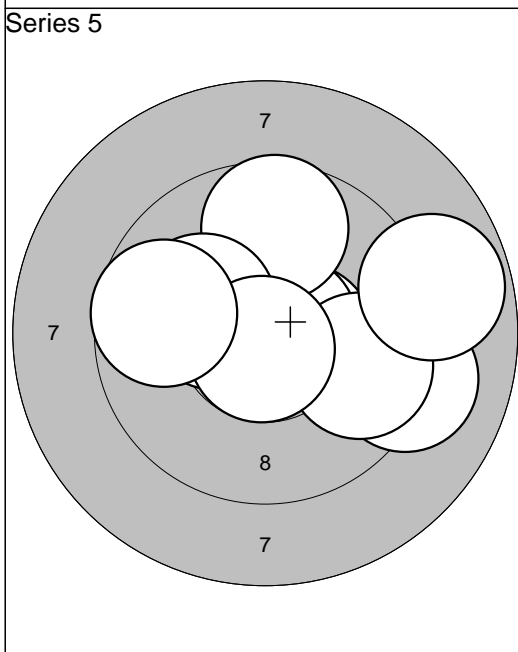

| | |
|-------------------|---|
| 1: 10,5* | → |
| 2: 9,1 | ↘ |
| 3: 10,7* | → |
| 4: 9,7 | ↘ |
| 5: 10,3* | ← |
| 6: 9,7 | ↑ |
| 7: 10,1 | ← |
| 8: 8,8 | → |
| 9: 10,8* | ↘ |
| 10: 9,7 | ← |
| Serie 94,0 | |
| Sum 460,0 | |

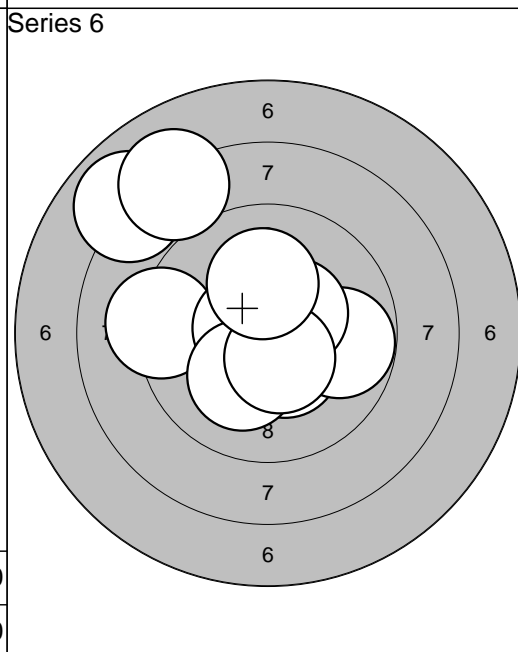

| | |
|-------------------|---|
| 1: 7,9 | ↖ |
| 2: 9,2 | ← |
| 3: 8,1 | ↗ |
| 4: 10,6* | ← |
| 5: 10,4* | ↘ |
| 6: 10,2* | ↘ |
| 7: 9,8 | → |
| 8: 10,4* | ↗ |
| 9: 10,5* | ↘ |
| 10: 10,2* | ↑ |
| Serie 93,0 | |
| Sum 553,0 | |

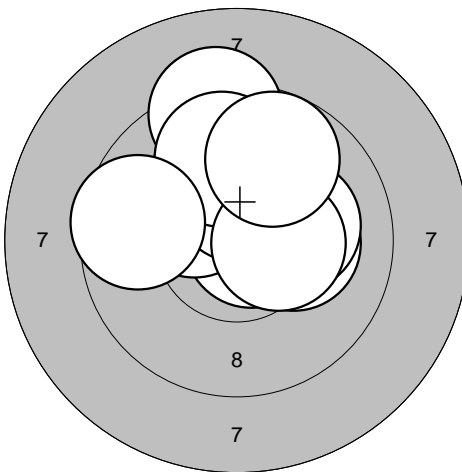
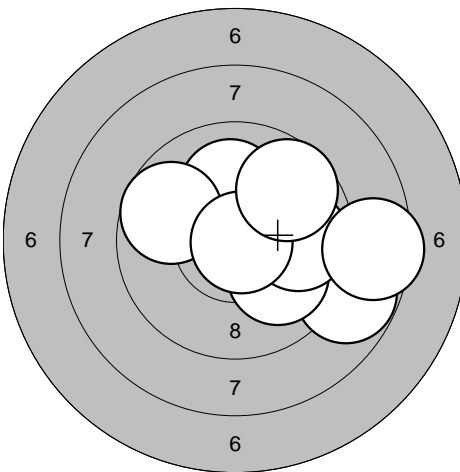

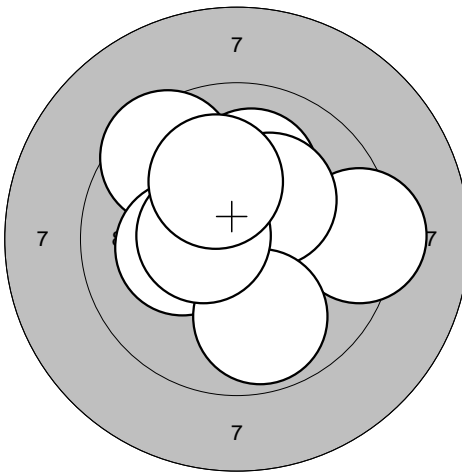
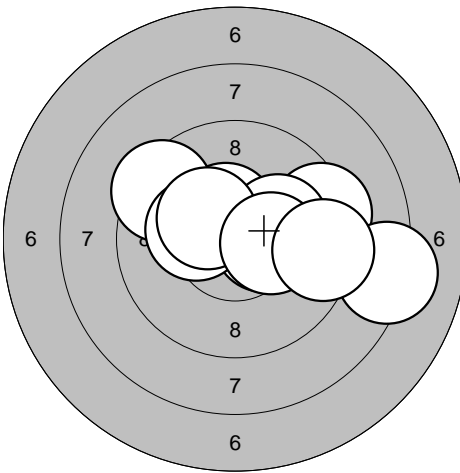
| | | | |
|--|--|--|--|
| <p>Series 1</p>  | <p>1: 10,2* →</p> <p>2: 10,7* →</p> <p>3: 10,2* ↗</p> <p>4: 10,2* →</p> <p>5: 10,3* ↑</p> <p>6: 9,3 ↑</p> <p>7: 9,9 ↑</p> <p>8: 10,4* →</p> <p>9: 9,8 ↗</p> <p>10: 9,6 ←</p> | <p>Series 2</p>  | <p>1: 10,3* ↗</p> <p>2: 9,8 →</p> <p>3: 10,1 ↑</p> <p>4: 8,8 ↘</p> <p>5: 10,0 ↘</p> <p>6: 9,8 →</p> <p>7: 9,7 ↖</p> <p>8: 8,5 →</p> <p>9: 10,8* →</p> <p>10: 9,7 ↗</p> |
| Serie 96,0 | Serie 92,0 | Serie 92,0 | Serie 92,0 |
| Sum 96,0 | Sum 188,0 | Sum 188,0 | Sum 188,0 |

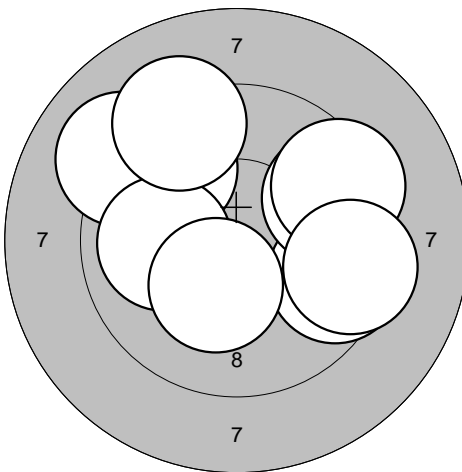
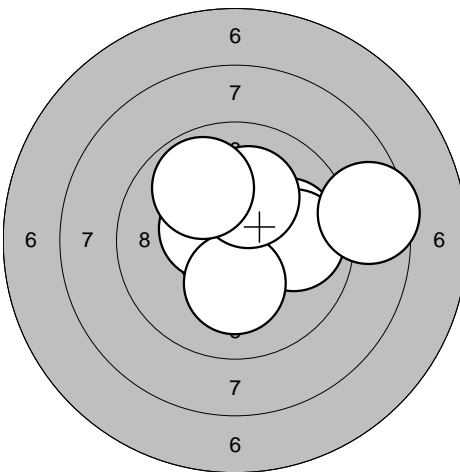
| | | | |
|---|--|---|--|
| <p>Series 3</p>  | <p>1: 10,1 ↖</p> <p>2: 10,5* ↖</p> <p>3: 10,1 ↑</p> <p>4: 9,5 ↖</p> <p>5: 9,3 →</p> <p>6: 10,2* ←</p> <p>7: 10,3* ↗</p> <p>8: 9,8 ↓</p> <p>9: 10,5* ←</p> <p>10: 10,2* ↑</p> | <p>Series 4</p>  | <p>1: 10,5* ↖</p> <p>2: 9,4 →</p> <p>3: 9,4 ↖</p> <p>4: 10,4* →</p> <p>5: 10,3* ←</p> <p>6: 8,2 →</p> <p>7: 10,2* →</p> <p>8: 10,4* ↖</p> <p>9: 10,3* →</p> <p>10: 9,4 →</p> |
| Serie 97,0 | Serie 95,0 | Serie 95,0 | Serie 95,0 |
| Sum 285,0 | Sum 380,0 | Sum 380,0 | Sum 380,0 |

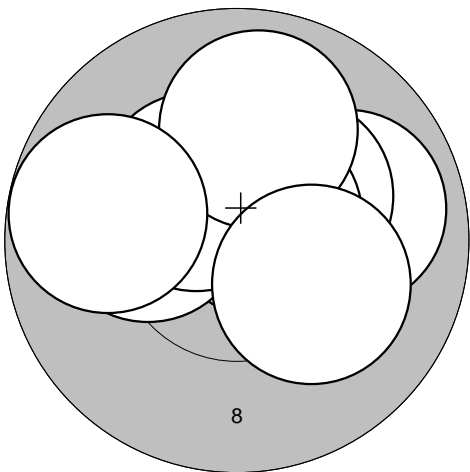
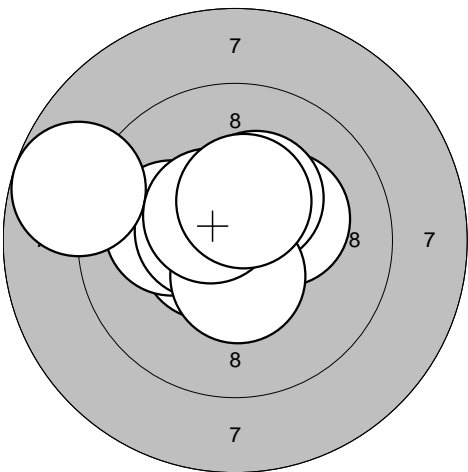
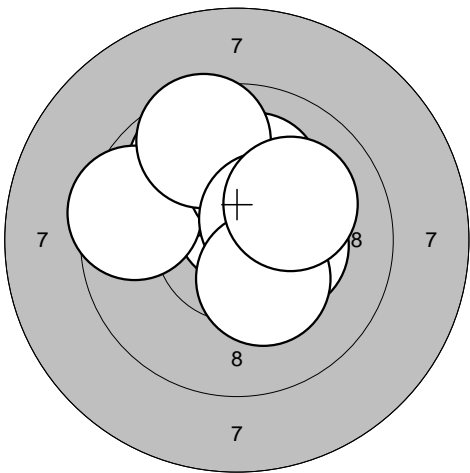
| | | | |
|--|---|--|--|
| <p>Series 5</p>  | <p>1: 9,3 ↖</p> <p>2: 9,5 →</p> <p>3: 9,6 →</p> <p>4: 9,7 ↖</p> <p>5: 9,1 ↖</p> <p>6: 9,4 →</p> <p>7: 10,0 ←</p> <p>8: 10,3* ↘</p> <p>9: 9,2 ↖</p> <p>10: 9,4 →</p> | <p>Series 6</p>  | <p>1: 10,0 →</p> <p>2: 10,4* ↗</p> <p>3: 10,5* →</p> <p>4: 10,8* ↖</p> <p>5: 9,9 →</p> <p>6: 8,6 →</p> <p>7: 10,5* ↖</p> <p>8: 10,2* ↓</p> <p>9: 10,1 ↑</p> <p>10: 9,9 ↖</p> |
| Serie 92,0 | Serie 96,0 | Serie 96,0 | Serie 96,0 |
| Sum 472,0 | Sum 568,0 | Sum 568,0 | Sum 568,0 |

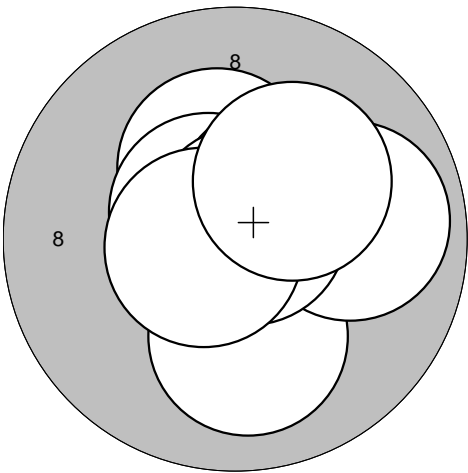
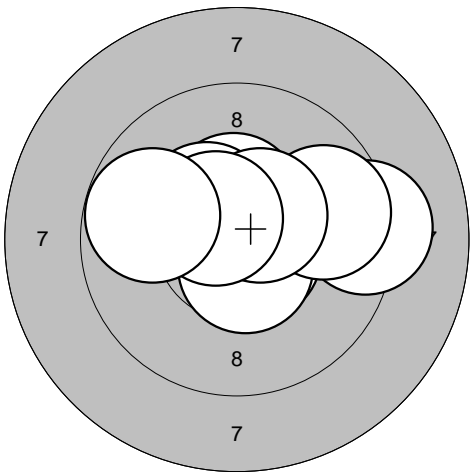
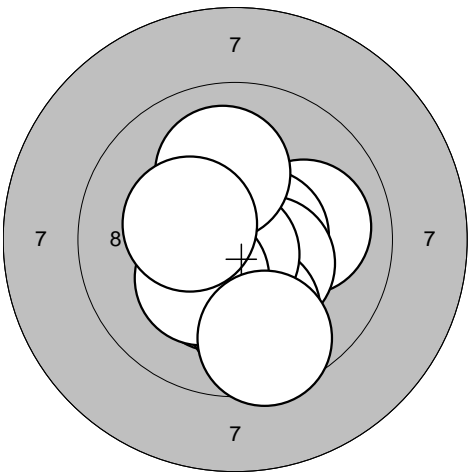
| | | |
|--|--|--|
| <p>Series 1</p>  | <p>Series 2</p>  | <p>Series 3</p>  |
| <p>1: 10,7* ↗ 2: 9,9 → 3: 10,3* ↗ 4: 10,6* ↗ 5: 10,5* ↑ 6: 10,1 ← 7: 10,4* ↗ 8: 9,9 ↑ 9: 9,8 ← 10: 10,2* ↘</p> | <p>1: 10,6* ← 2: 10,1 ← 3: 10,2* → 4: 10,3* ↗ 5: 10,8* ← 6: 10,5* ← 7: 8,8 ← 8: 10,5* ↓ 9: 10,5* ↗ 10: 10,4* ↑</p> | <p>1: 10,6* ↗ 2: 10,8* ↑ 3: 10,3* ↑ 4: 10,1 ↓ 5: 10,6* ↗ 6: 10,5* ↗ 7: 9,9 → 8: 10,8* ↗ 9: 10,7* ← 10: 10,2* ↗</p> |
| Serie 97,0 | Serie 98,0 | Serie 99,0 |
| Sum 97,0 | Sum 195,0 | Sum 391,0 |

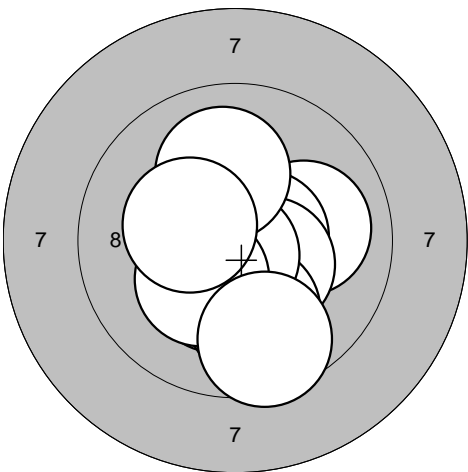
| | | |
|--|---|--|
| <p>Series 4</p>  | <p>Series 5</p>  | <p>Series 6</p>  |
| <p>1: 10,6* ↑ 2: 10,1 ↑ 3: 9,9 ↗ 4: 9,6 ← 5: 10,1 ↑ 6: 9,6 ↑ 7: 10,4* → 8: 10,5* ↗ 9: 10,3* ↓ 10: 10,1 ↗</p> | <p>1: 10,4* ↑ 2: 9,2 → 3: 10,6* ↘ 4: 10,6* ↘ 5: 10,6* ↘ 6: 10,4* ↗ 7: 9,7 → 8: 10,5* ↗ 9: 10,6* ↗ 10: 9,8 ←</p> | <p>1: 10,0 → 2: 10,6* → 3: 10,3* ↓ 4: 10,4* ↘ 5: 10,0 ↓ 6: 10,7* ↓ 7: 10,3* ↘ 8: 10,1 ↑ 9: 10,3* ← 10: 9,6 ↓</p> |
| Serie 97,0 | Serie 97,0 | Serie 99,0 |
| Sum 292,0 | Sum 488,0 | Sum 587,0 |

| | | |
|--|--|--|
| <p>Series 6</p>  | <p>Series 7</p>  | <p>Series 8</p>  |
| Serie 97,0 | Serie 97,0 | Serie 99,0 |
| Sum 488,0 | Sum 488,0 | Sum 587,0 |

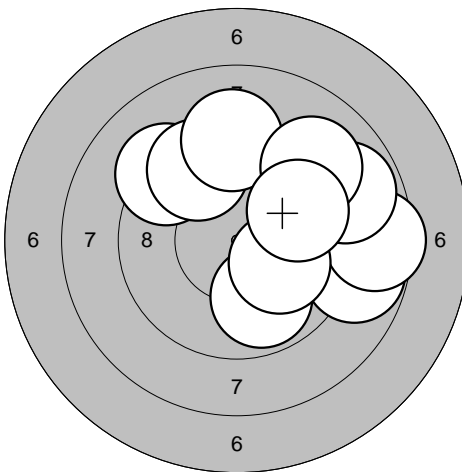
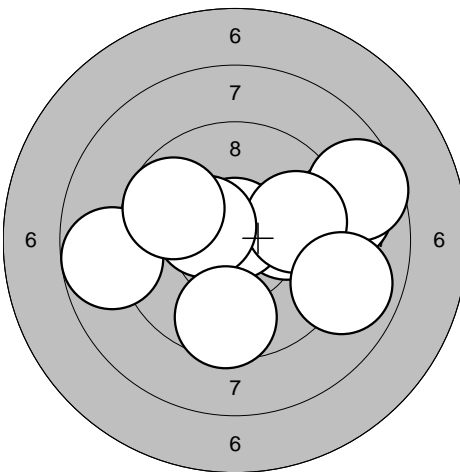
| | | | |
|--|---|--|--|
| <p>Series 1</p>  | <p>1: 8,8 →</p> <p>2: 9,9 ↓</p> <p>3: 9,2 ↗</p> <p>4: 8,5 →</p> <p>5: 10,1 ↘</p> <p>6: 9,6 ↗</p> <p>7: 9,2 ↑</p> <p>8: 8,9 →</p> <p>9: 9,1 ↗</p> <p>10: 9,7 →</p> <hr/> <p>Serie 88,0</p> <hr/> <p>Sum 88,0</p> | <p>Series 2</p>  | <p>1: 10,0 →</p> <p>2: 9,0 →</p> <p>3: 10,7* ↑</p> <p>4: 8,6 →</p> <p>5: 9,8 →</p> <p>6: 10,4* ↖</p> <p>7: 8,9 →</p> <p>8: 8,8 ←</p> <p>9: 9,7 ↖</p> <p>10: 9,6 ↓</p> <hr/> <p>Serie 90,0</p> <hr/> <p>Sum 178,0</p> |
|--|---|--|--|

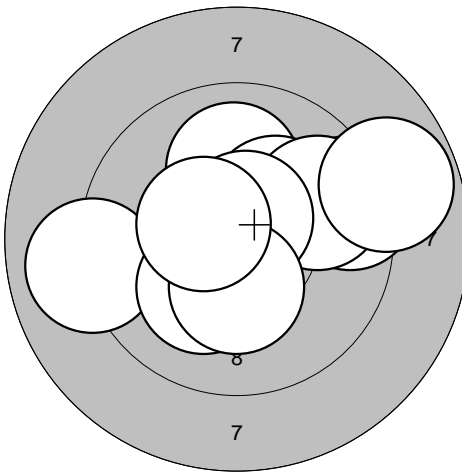
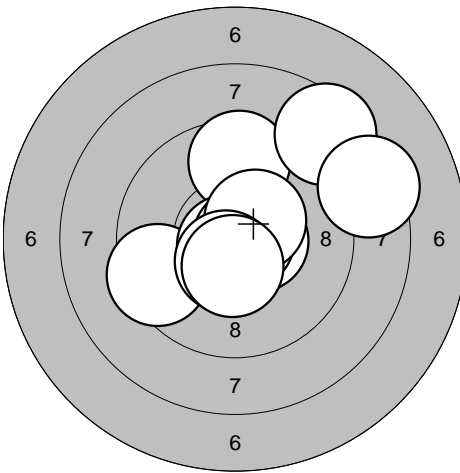
| | | | |
|---|--|---|---|
| <p>Series 3</p>  | <p>1: 10,0 ↑</p> <p>2: 9,0 ←</p> <p>3: 10,2* ↓</p> <p>4: 9,4 →</p> <p>5: 10,2* ↗</p> <p>6: 9,8 →</p> <p>7: 8,8 →</p> <p>8: 10,6* ↑</p> <p>9: 10,3* ↓</p> <p>10: 10,5* ↖</p> <hr/> <p>Serie 95,0</p> <hr/> <p>Sum 273,0</p> | <p>Series 4</p>  | <p>1: 9,6 ↑</p> <p>2: 10,6* →</p> <p>3: 8,5 ↗</p> <p>4: 9,4 ←</p> <p>5: 10,8* ↘</p> <p>6: 8,4 →</p> <p>7: 10,8* →</p> <p>8: 10,5* ↗</p> <p>9: 10,5* ↓</p> <p>10: 10,5* ↓</p> <hr/> <p>Serie 94,0</p> <hr/> <p>Sum 367,0</p> |
|---|--|---|---|

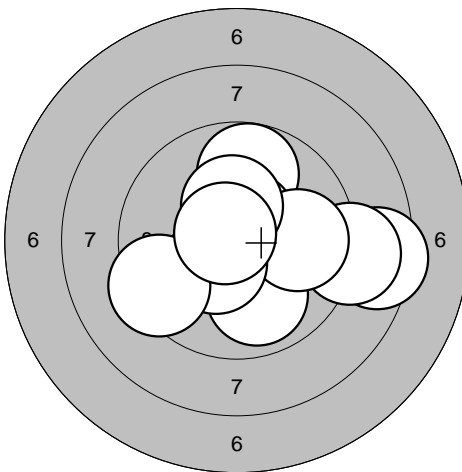
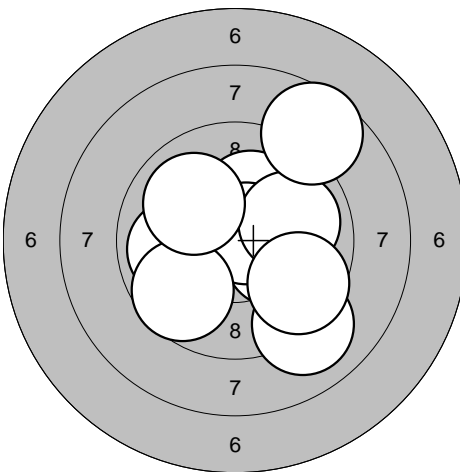
| | | | |
|--|---|--|---|
| <p>Series 5</p>  | <p>1: 9,9 ↓</p> <p>2: 9,8 ↑</p> <p>3: 10,6* ↗</p> <p>4: 8,5 →</p> <p>5: 9,0 →</p> <p>6: 9,9 →</p> <p>7: 10,4* ↘</p> <p>8: 10,4* ↑</p> <p>9: 9,4 ←</p> <p>10: 10,7* ↖</p> <hr/> <p>Serie 93,0</p> <hr/> <p>Sum 460,0</p> | <p>Series 6</p>  | <p>1: 10,2* ↗</p> <p>2: 9,9 ←</p> <p>3: 9,0 ↓</p> <p>4: 10,2* →</p> <p>5: 10,7* ↗</p> <p>6: 9,7 ↘</p> <p>7: 10,0 →</p> <p>8: 9,6 →</p> <p>9: 10,0 ↖</p> <p>10: 8,6 ↗</p> <hr/> <p>Serie 94,0</p> <hr/> <p>Sum 554,0</p> |
|--|---|--|---|

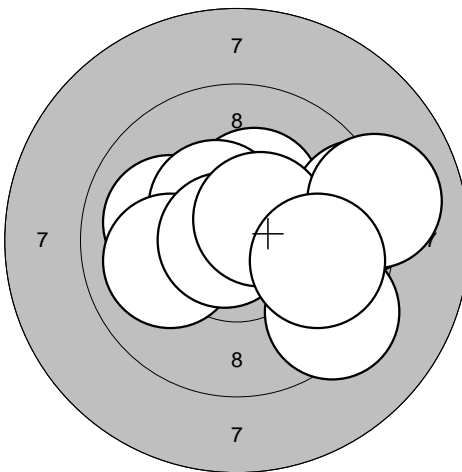
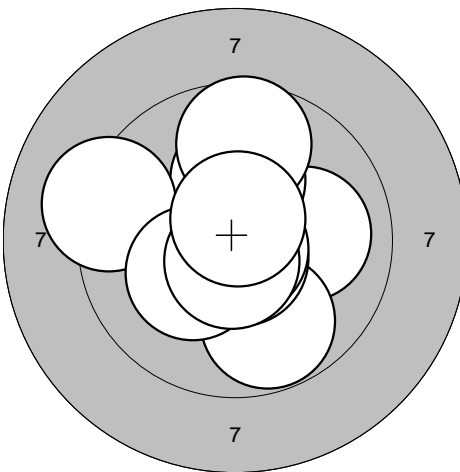
| | | | | | | | | | | | |
|--|---|-------|------|-----|------|--|--|-------|------|-----|-------|
| <p>Series 1</p>  | <p>1: 10,0 ←</p> <p>2: 9,4 ↘</p> <p>3: 10,3* ↗</p> <p>4: 9,2 →</p> <p>5: 10,4* ↗</p> <p>6: 10,0 ←</p> <p>7: 10,8* ←</p> <p>8: 10,5* ↗</p> <p>9: 9,0 →</p> <p>10: 9,8 →</p> <table border="1" style="width:100%; border-collapse: collapse;"> <tr> <td style="width:50%;">Serie</td> <td style="width:50%; text-align: right;">96,0</td> </tr> <tr> <td>Sum</td> <td style="text-align: right;">96,0</td> </tr> </table> | Serie | 96,0 | Sum | 96,0 | <p>Series 2</p>  | <p>1: 10,0 →</p> <p>2: 10,1 ↑</p> <p>3: 9,2 ←</p> <p>4: 9,8 ↓</p> <p>5: 10,2* ↙</p> <p>6: 10,7* ↓</p> <p>7: 10,8* ↓</p> <p>8: 9,7 ↑</p> <p>9: 10,7* ↓</p> <p>10: 10,7* ↑</p> <table border="1" style="width:100%; border-collapse: collapse;"> <tr> <td style="width:50%;">Serie</td> <td style="width:50%; text-align: right;">97,0</td> </tr> <tr> <td>Sum</td> <td style="text-align: right;">193,0</td> </tr> </table> | Serie | 97,0 | Sum | 193,0 |
| Serie | 96,0 | | | | | | | | | | |
| Sum | 96,0 | | | | | | | | | | |
| Serie | 97,0 | | | | | | | | | | |
| Sum | 193,0 | | | | | | | | | | |

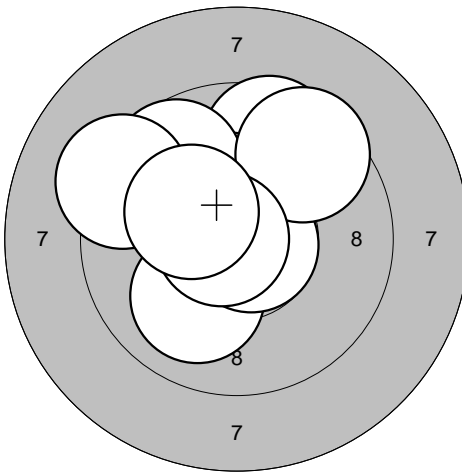
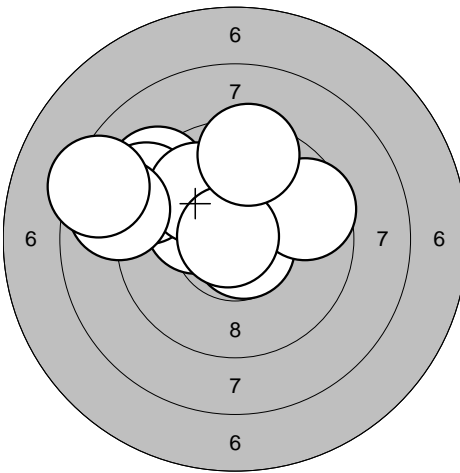
| | | | | | | | | | | | |
|---|---|-------|------|-----|-------|---|--|-------|------|-----|-------|
| <p>Series 3</p>  | <p>1: 10,3* ↖</p> <p>2: 9,6 ↗</p> <p>3: 10,4* ↗</p> <p>4: 10,0 ↘</p> <p>5: 9,7 ↗</p> <p>6: 9,2 ↗</p> <p>7: 10,7* →</p> <p>8: 9,5 ↗</p> <p>9: 10,8* ←</p> <p>10: 10,2* ↖</p> <table border="1" style="width:100%; border-collapse: collapse;"> <tr> <td style="width:50%;">Serie</td> <td style="width:50%; text-align: right;">96,0</td> </tr> <tr> <td>Sum</td> <td style="text-align: right;">289,0</td> </tr> </table> | Serie | 96,0 | Sum | 289,0 | <p>Series 4</p>  | <p>1: 10,7* ↘</p> <p>2: 10,2* ↖</p> <p>3: 9,6 →</p> <p>4: 9,2 ↗</p> <p>5: 9,2 ↗</p> <p>6: 9,9 ↗</p> <p>7: 8,8 ←</p> <p>8: 10,8* ←</p> <p>9: 9,5 ↑</p> <p>10: 8,4 ↖</p> <table border="1" style="width:100%; border-collapse: collapse;"> <tr> <td style="width:50%;">Serie</td> <td style="width:50%; text-align: right;">91,0</td> </tr> <tr> <td>Sum</td> <td style="text-align: right;">380,0</td> </tr> </table> | Serie | 91,0 | Sum | 380,0 |
| Serie | 96,0 | | | | | | | | | | |
| Sum | 289,0 | | | | | | | | | | |
| Serie | 91,0 | | | | | | | | | | |
| Sum | 380,0 | | | | | | | | | | |

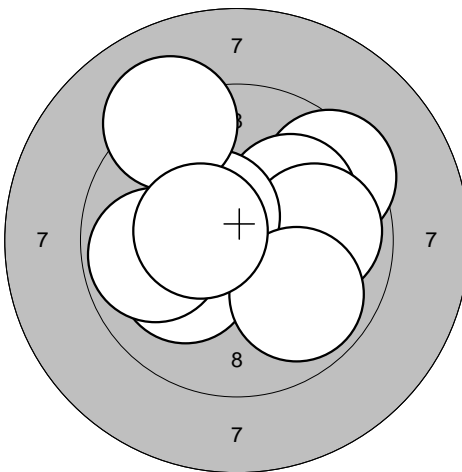
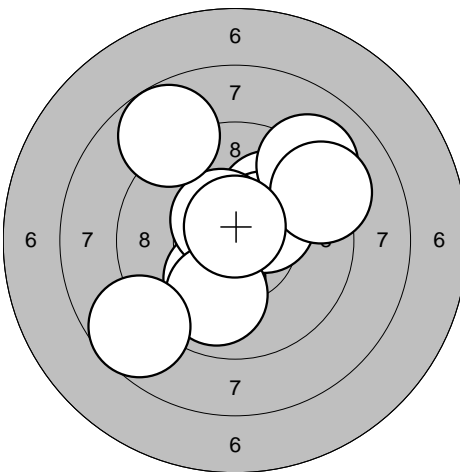
| | | | | | | | | | | | |
|--|--|-------|------|-----|-------|--|---|-------|------|-----|-------|
| <p>Series 5</p>  | <p>1: 9,4 ↗</p> <p>2: 10,8* ↑</p> <p>3: 10,1 ↗</p> <p>4: 10,1 ↖</p> <p>5: 9,9 →</p> <p>6: 10,5* ↗</p> <p>7: 9,9 ↘</p> <p>8: 9,9 ←</p> <p>9: 9,2 ↗</p> <p>10: 10,5* ←</p> <table border="1" style="width:100%; border-collapse: collapse;"> <tr> <td style="width:50%;">Serie</td> <td style="width:50%; text-align: right;">95,0</td> </tr> <tr> <td>Sum</td> <td style="text-align: right;">475,0</td> </tr> </table> | Serie | 95,0 | Sum | 475,0 | <p>Series 6</p>  | <p>1: 10,1 ↗</p> <p>2: 10,2* ↘</p> <p>3: 10,4* ↗</p> <p>4: 9,1 ↗</p> <p>5: 9,2 ↗</p> <p>6: 10,5* ↖</p> <p>7: 9,9 ↓</p> <p>8: 10,7* ↑</p> <p>9: 8,8 ↖</p> <p>10: 8,7 ↖</p> <table border="1" style="width:100%; border-collapse: collapse;"> <tr> <td style="width:50%;">Serie</td> <td style="width:50%; text-align: right;">93,0</td> </tr> <tr> <td>Sum</td> <td style="text-align: right;">568,0</td> </tr> </table> | Serie | 93,0 | Sum | 568,0 |
| Serie | 95,0 | | | | | | | | | | |
| Sum | 475,0 | | | | | | | | | | |
| Serie | 93,0 | | | | | | | | | | |
| Sum | 568,0 | | | | | | | | | | |

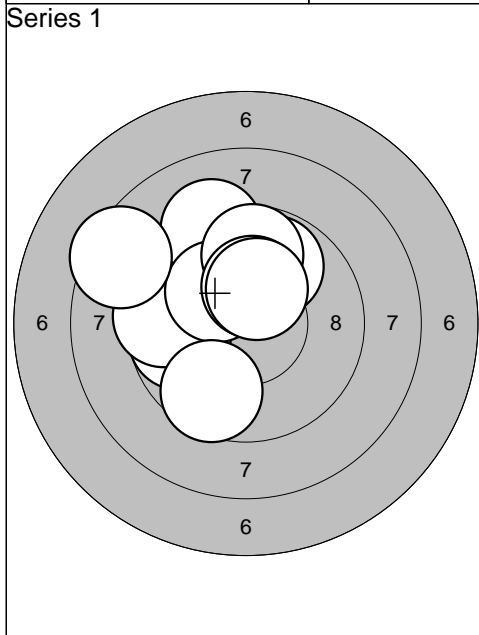

| | |
|----------|---|
| 1: 9,8 | ← |
| 2: 9,2 | ↑ |
| 3: 9,5 | ← |
| 4: 10,2* | ↖ |
| 5: 9,8 | ↗ |
| 6: 9,7 | ↑ |
| 7: 10,3* | ↑ |
| 8: 8,4 | ↖ |
| 9: 10,3* | ↑ |
| 10: 9,6 | ↘ |

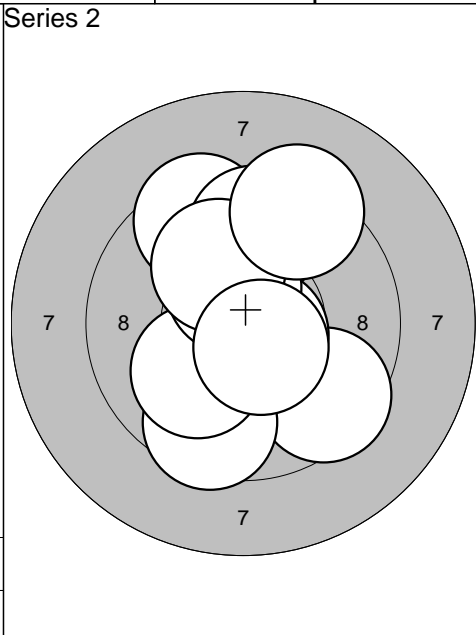

| | |
|-----------|---|
| 1: 9,5 | ↘ |
| 2: 9,5 | ↓ |
| 3: 10,7* | ↘ |
| 4: 9,5 | ↗ |
| 5: 10,1 | ↙ |
| 6: 9,7 | ↑ |
| 7: 10,4* | ↑ |
| 8: 10,1 | ↗ |
| 9: 9,3 | ↗ |
| 10: 10,6* | ↘ |

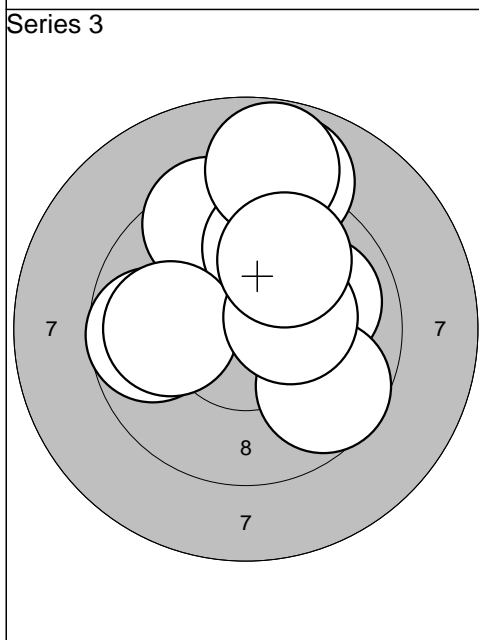

| | |
|----------|---|
| 1: 10,0 | → |
| 2: 9,5 | ↖ |
| 3: 8,9 | ↑ |
| 4: 9,8 | ↑ |
| 5: 9,7 | ← |
| 6: 9,7 | ↘ |
| 7: 9,9 | ← |
| 8: 8,8 | ↑ |
| 9: 10,3* | → |
| 10: 9,9 | ↗ |

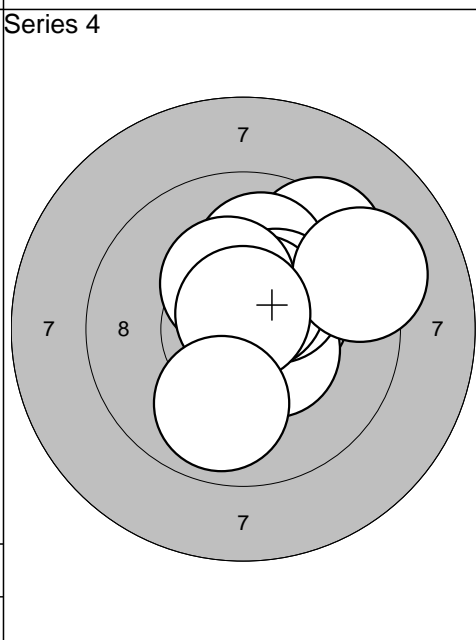

| | |
|----------|---|
| 1: 10,4* | → |
| 2: 9,5 | ↗ |
| 3: 10,0 | ↑ |
| 4: 10,5* | ↘ |
| 5: 10,4* | ↗ |
| 6: 10,5* | ↗ |
| 7: 10,3* | ↑ |
| 8: 9,2 | → |
| 9: 10,7* | ↑ |
| 10: 9,9 | ↓ |

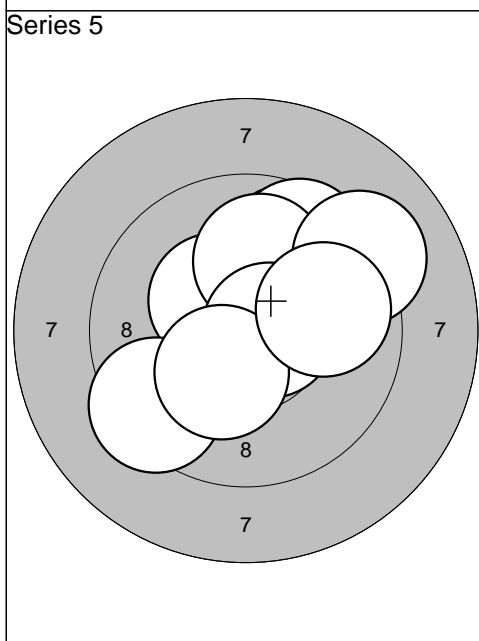

| | |
|----------|---|
| 1: 10,4* | ↖ |
| 2: 9,7 | ↗ |
| 3: 9,7 | ↗ |
| 4: 9,6 | ↗ |
| 5: 9,4 | ↙ |
| 6: 10,0 | ↑ |
| 7: 9,2 | ↗ |
| 8: 10,6* | → |
| 9: 10,3* | ↘ |
| 10: 9,9 | → |

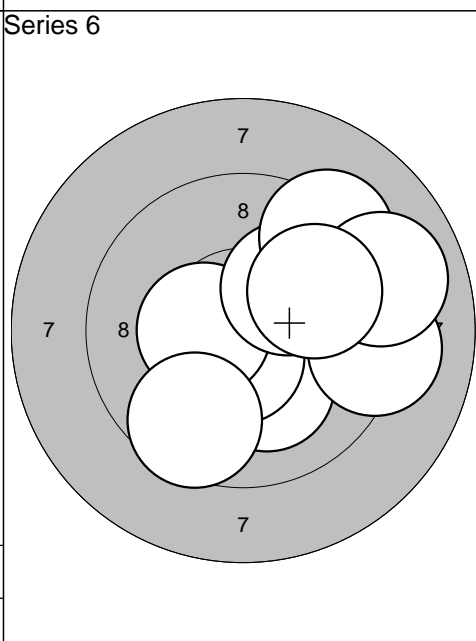

| | |
|----------|---|
| 1: 9,9 | ↗ |
| 2: 10,2* | ↘ |
| 3: 10,6* | ↓ |
| 4: 9,2 | → |
| 5: 10,4* | ← |
| 6: 10,1 | ↗ |
| 7: 9,6 | ↘ |
| 8: 9,3 | ↗ |
| 9: 9,0 | → |
| 10: 9,9 | ↗ |

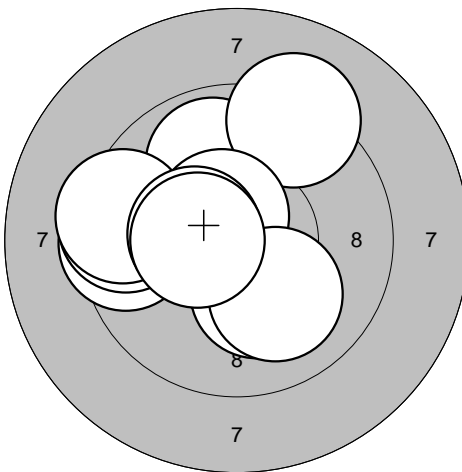
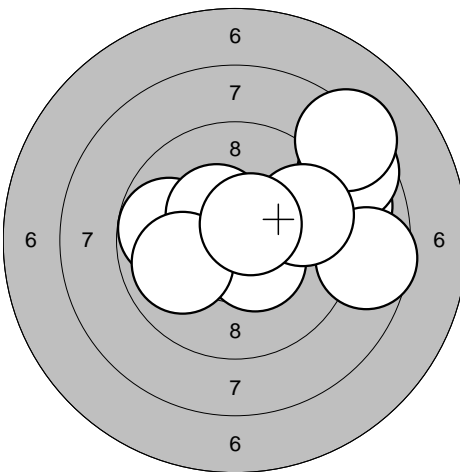
| | | | |
|--|---|--|--|
| <p>Series 1</p>  | <p>1: 9,9 ↗</p> <p>2: 9,5 ←</p> <p>3: 9,2 ↗</p> <p>4: 10,2* ↓</p> <p>5: 9,5 ←</p> <p>6: 10,6* ↗</p> <p>7: 9,4 ←</p> <p>8: 10,4* ←</p> <p>9: 10,1 ↓</p> <p>10: 10,4* ←</p> <hr/> <p>Serie 95,0</p> <hr/> <p>Sum 95,0</p> | <p>Series 2</p>  | <p>1: 9,8 ←</p> <p>2: 9,0 →</p> <p>3: 10,4* ↗</p> <p>4: 8,6 →</p> <p>5: 8,3 ↗</p> <p>6: 8,6 →</p> <p>7: 10,4* ↓</p> <p>8: 9,7 →</p> <p>9: 10,0 ←</p> <p>10: 10,6* ↗</p> <hr/> <p>Serie 91,0</p> <hr/> <p>Sum 186,0</p> |
|--|---|--|--|

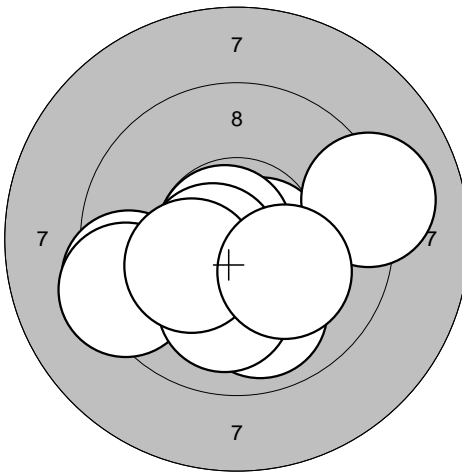
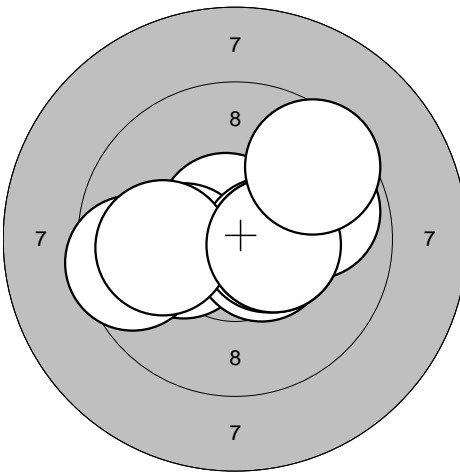
| | | | |
|---|--|---|--|
| <p>Series 3</p>  | <p>1: 9,9 ↓</p> <p>2: 9,4 ←</p> <p>3: 10,6* →</p> <p>4: 9,3 ←</p> <p>5: 10,1 ↓</p> <p>6: 9,1 →</p> <p>7: 10,8* ↗</p> <p>8: 10,6* ←</p> <p>9: 10,2* ←</p> <p>10: 10,2* →</p> <hr/> <p>Serie 96,0</p> <hr/> <p>Sum 282,0</p> | <p>Series 4</p>  | <p>1: 10,7* ↗</p> <p>2: 10,3* ←</p> <p>3: 10,5* →</p> <p>4: 10,5* →</p> <p>5: 9,6 ←</p> <p>6: 10,4* →</p> <p>7: 9,8 →</p> <p>8: 10,0 ←</p> <p>9: 10,4* →</p> <p>10: 9,5 ↗</p> <hr/> <p>Serie 97,0</p> <hr/> <p>Sum 379,0</p> |
|---|--|---|--|

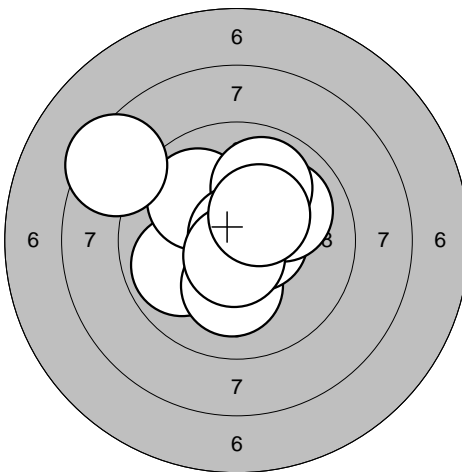
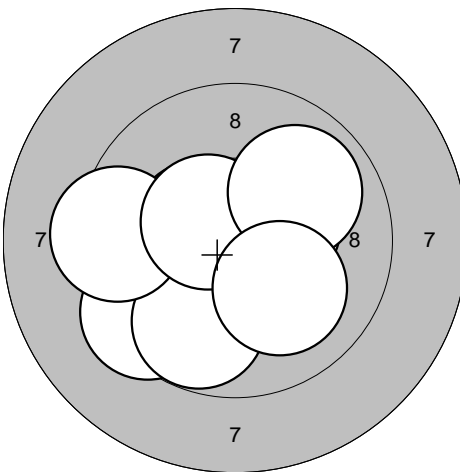
| | | | |
|--|---|--|--|
| <p>Series 5</p>  | <p>1: 9,9 ←</p> <p>2: 10,2* ↓</p> <p>3: 10,6* →</p> <p>4: 10,0 ↗</p> <p>5: 10,0 ↗</p> <p>6: 8,4 ↗</p> <p>7: 9,9 ↗</p> <p>8: 10,9* ↗</p> <p>9: 10,7* ↓</p> <p>10: 10,4* ↗</p> <hr/> <p>Serie 96,0</p> <hr/> <p>Sum 475,0</p> | <p>Series 6</p>  | <p>1: 10,4* ←</p> <p>2: 10,4* →</p> <p>3: 10,6* ↓</p> <p>4: 9,4 ←</p> <p>5: 10,7* ↗</p> <p>6: 9,8 ↓</p> <p>7: 9,4 ←</p> <p>8: 10,5* ↗</p> <p>9: 9,9 ↗</p> <p>10: 10,1 ↓</p> <hr/> <p>Serie 96,0</p> <hr/> <p>Sum 571,0</p> |
|--|---|--|--|

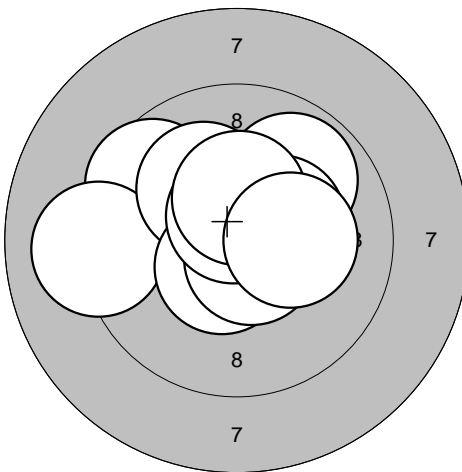
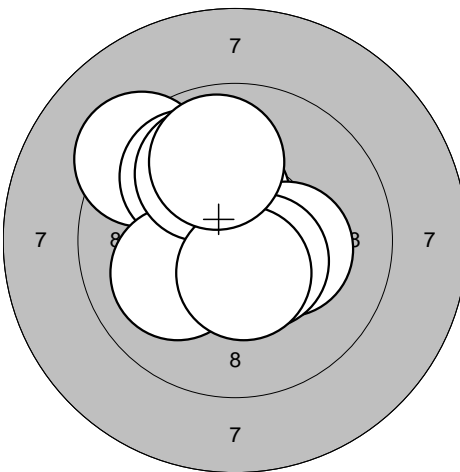
| | | | | | | | | | | | |
|--|---|-------|------|-----|------|--|---|-------|------|-----|-------|
| <p>Series 1</p>  | <p>1: 9,6 ↖ 2: 9,9 ↗ 3: 9,1 ← 4: 10,3* → 5: 10,1 ↗ 6: 10,5* ↓ 7: 10,6* ↓ 8: 10,6* ↑ 9: 10,4* ↑ 10: 10,2* →</p> <table border="1" style="width:100%; border-collapse: collapse;"> <tr><td>Serie</td><td style="text-align: right;">97,0</td></tr> <tr><td>Sum</td><td style="text-align: right;">97,0</td></tr> </table> | Serie | 97,0 | Sum | 97,0 | <p>Series 2</p>  | <p>1: 10,4* ↑ 2: 10,3* → 3: 10,7* ↓ 4: 9,3 ↗ 5: 10,5* ↓ 6: 9,9 ↗ 7: 10,1 ← 8: 10,0 ↗ 9: 10,5* ↓ 10: 9,9 ↑</p> <table border="1" style="width:100%; border-collapse: collapse;"> <tr><td>Serie</td><td style="text-align: right;">97,0</td></tr> <tr><td>Sum</td><td style="text-align: right;">194,0</td></tr> </table> | Serie | 97,0 | Sum | 194,0 |
| Serie | 97,0 | | | | | | | | | | |
| Sum | 97,0 | | | | | | | | | | |
| Serie | 97,0 | | | | | | | | | | |
| Sum | 194,0 | | | | | | | | | | |

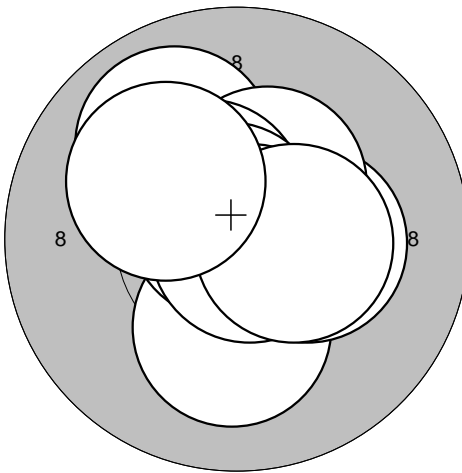
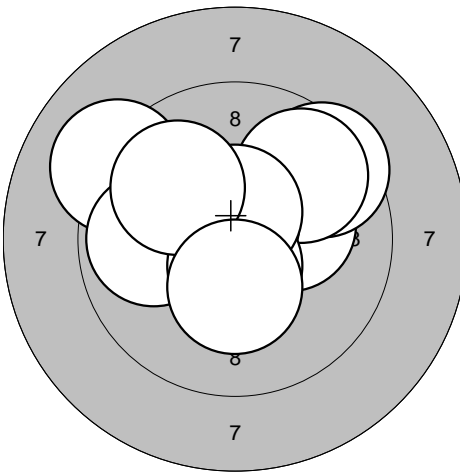
| | | | | | | | | | | | |
|---|--|-------|------|-----|-------|---|---|-------|------|-----|-------|
| <p>Series 3</p>  | <p>1: 10,0 ↗ 2: 10,1 ↓ 3: 10,3* → 4: 9,9 ↗ 5: 10,4* ↗ 6: 10,5* ↗ 7: 10,8* ↗ 8: 10,8* → 9: 10,4* → 10: 10,1 ↗</p> <table border="1" style="width:100%; border-collapse: collapse;"> <tr><td>Serie</td><td style="text-align: right;">99,0</td></tr> <tr><td>Sum</td><td style="text-align: right;">293,0</td></tr> </table> | Serie | 99,0 | Sum | 293,0 | <p>Series 4</p>  | <p>1: 10,2* → 2: 9,1 ↖ 3: 9,9 ← 4: 9,5 ↗ 5: 9,7 ↗ 6: 10,7* ↑ 7: 10,6* ↓ 8: 10,6* ↑ 9: 9,9 ↖ 10: 10,3* ↓</p> <table border="1" style="width:100%; border-collapse: collapse;"> <tr><td>Serie</td><td style="text-align: right;">95,0</td></tr> <tr><td>Sum</td><td style="text-align: right;">388,0</td></tr> </table> | Serie | 95,0 | Sum | 388,0 |
| Serie | 99,0 | | | | | | | | | | |
| Sum | 293,0 | | | | | | | | | | |
| Serie | 95,0 | | | | | | | | | | |
| Sum | 388,0 | | | | | | | | | | |

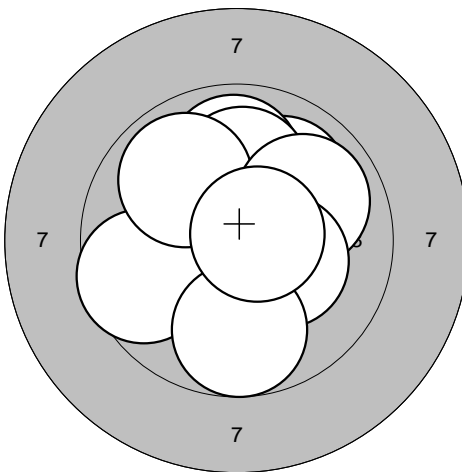
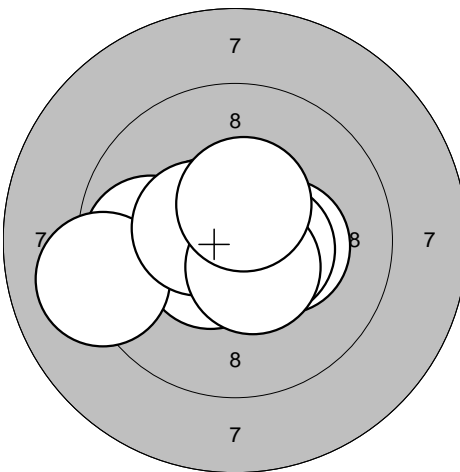
| | | | | | | | | | | | |
|--|---|-------|------|-----|-------|--|---|-------|------|-----|-------|
| <p>Series 5</p>  | <p>1: 10,7* ↗ 2: 10,0 ↗ 3: 9,9 ↑ 4: 10,0 ↑ 5: 9,6 ← 6: 9,9 ↗ 7: 9,9 ↗ 8: 10,3* → 9: 9,8 ↓ 10: 10,7* →</p> <table border="1" style="width:100%; border-collapse: collapse;"> <tr><td>Serie</td><td style="text-align: right;">95,0</td></tr> <tr><td>Sum</td><td style="text-align: right;">483,0</td></tr> </table> | Serie | 95,0 | Sum | 483,0 | <p>Series 6</p>  | <p>1: 10,6* ← 2: 9,8 ← 3: 10,6* ↖ 4: 10,5* ↖ 5: 9,1 ← 6: 10,3* → 7: 10,5* ← 8: 10,5* → 9: 10,5* ↓ 10: 10,5* ↑</p> <table border="1" style="width:100%; border-collapse: collapse;"> <tr><td>Serie</td><td style="text-align: right;">98,0</td></tr> <tr><td>Sum</td><td style="text-align: right;">581,0</td></tr> </table> | Serie | 98,0 | Sum | 581,0 |
| Serie | 95,0 | | | | | | | | | | |
| Sum | 483,0 | | | | | | | | | | |
| Serie | 98,0 | | | | | | | | | | |
| Sum | 581,0 | | | | | | | | | | |

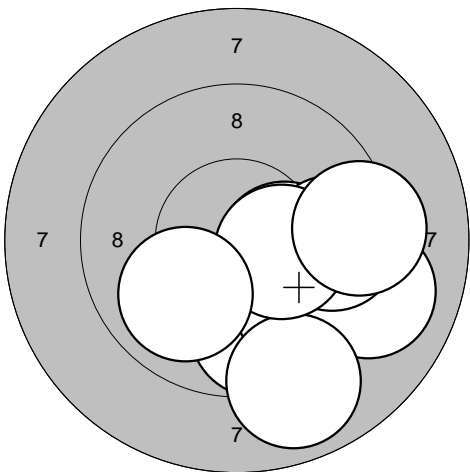
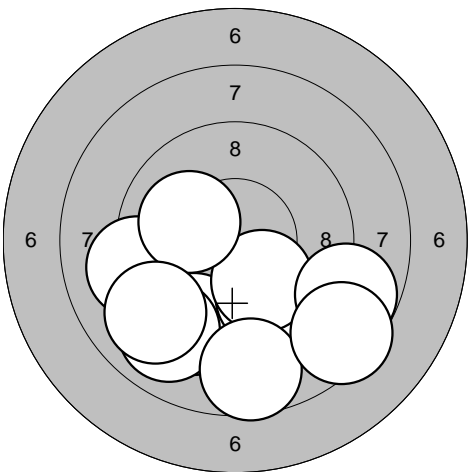
| | | | |
|--|--|--|---|
| <p>Series 1</p>  | <p>1: 9,5 ↘ 2: 9,7 ↘ 3: 10,3* → 4: 9,7 ↘ 5: 9,1 → 6: 9,7 → 7: 8,9 ↘ 8: 10,3* → 9: 9,9 ↙ 10: 9,3 →</p> <p>Serie 91,0 Sum 91,0</p> | <p>Series 2</p>  | <p>1: 9,2 ← 2: 9,3 ↘ 3: 9,8 ↘ 4: 9,0 ↘ 5: 10,1 ↘ 6: 8,7 ↘ 7: 10,1 ↖ 8: 8,8 → 9: 8,5 ↘ 10: 9,1 ↙</p> <p>Serie 89,0 Sum 180,0</p> |
|--|--|--|---|

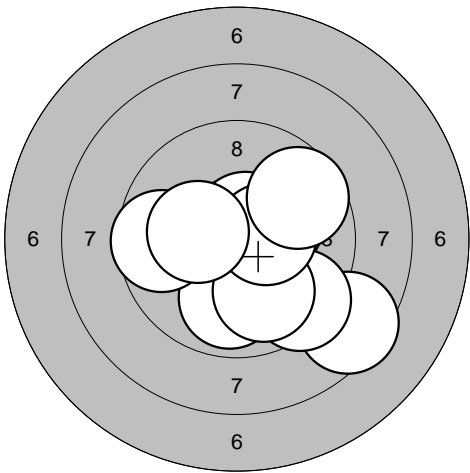
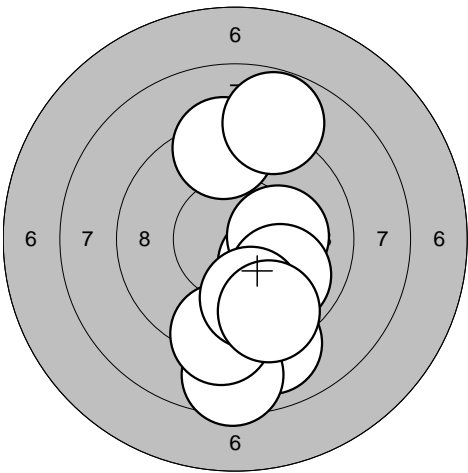
| | | | |
|---|---|---|---|
| <p>Series 3</p>  | <p>1: 10,2* → 2: 8,5 ↘ 3: 9,4 ↘ 4: 9,9 ↘ 5: 10,6* ↗ 6: 9,9 ↘ 7: 10,4* → 8: 9,6 ← 9: 9,7 → 10: 10,3* ←</p> <p>Serie 93,0 Sum 273,0</p> | <p>Series 4</p>  | <p>1: 9,0 ↘ 2: 9,4 ↑ 3: 10,2* ↘ 4: 8,5 ↘ 5: 9,3 ↘ 6: 10,2* → 7: 9,9 ↘ 8: 9,9 ↘ 9: 9,6 ↘ 10: 8,8 ↑</p> <p>Serie 90,0 Sum 363,0</p> |
|---|---|---|---|

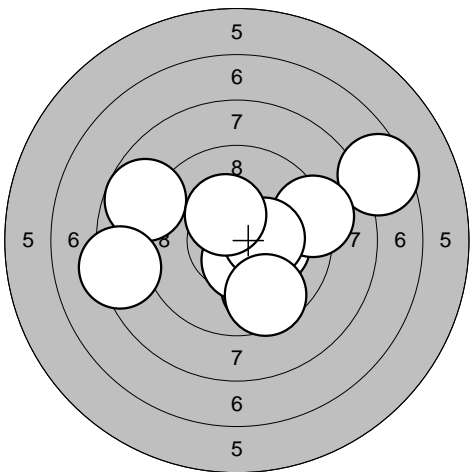
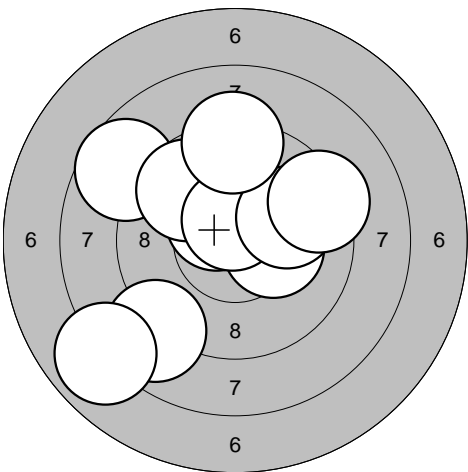
| | | | |
|--|---|--|---|
| <p>Series 5</p>  | <p>1: 9,8 ↘ 2: 10,2* → 3: 8,8 ↖ 4: 10,5* ↘ 5: 7,5 → 6: 8,3 ← 7: 9,2 → 8: 10,4* → 9: 9,6 ↘ 10: 10,3* ↗</p> <p>Serie 90,0 Sum 453,0</p> | <p>Series 6</p>  | <p>1: 10,3* → 2: 8,7 ↖ 3: 10,5* ↗ 4: 9,7 ↗ 5: 10,6* ↑ 6: 8,8 ↘ 7: 9,9 → 8: 9,2 ↑ 9: 7,9 ↙ 10: 9,3 →</p> <p>Serie 89,0 Sum 542,0</p> |
|--|---|--|---|

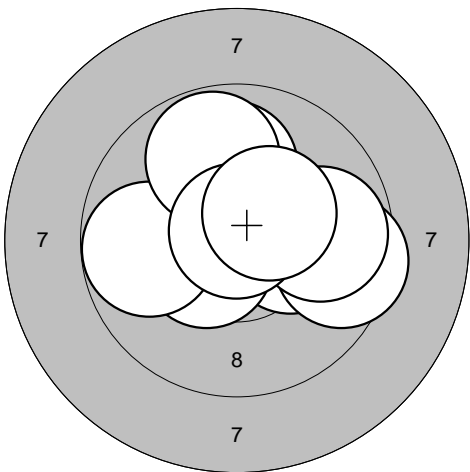
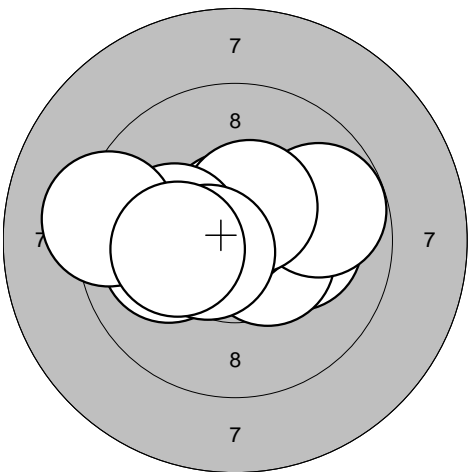
| | | | | | |
|----------|--|--|------------|--|---|
| Series 1 |  | 1: 10,6* ↖ 2: 10,0 ↑ 3: 10,2* → 4: 9,5 → 5: 10,5* ↖ 6: 9,8 ← 7: 9,8 ↑ 8: 9,8 → 9: 10,8* ↑ 10: 10,4* ↗ | Series 2 |  | 1: 10,1 → 2: 10,5* ↘ 3: 10,1 ← 4: 9,7 → 5: 10,7* ↑ 6: 10,5* ↗ 7: 10,2* ← 8: 9,3 ← 9: 10,6* ← 10: 10,2* ← |
| | Serie 96,0 | | Serie 98,0 | | |
| | Sum 96,0 | | Sum 194,0 | | |

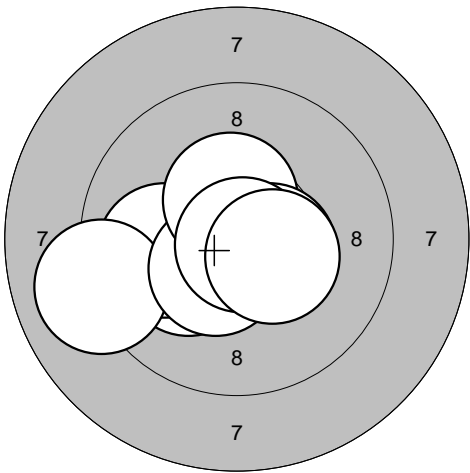
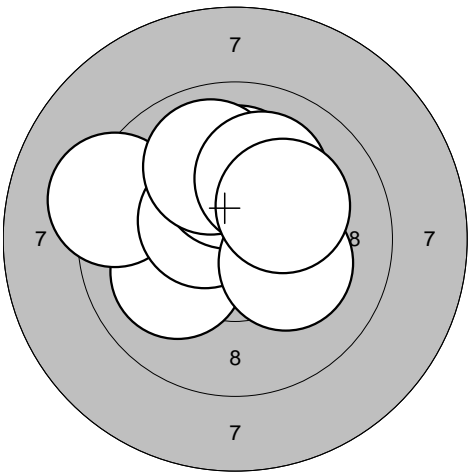
| | | | | | |
|----------|---|--|------------|---|---|
| Series 3 |  | 1: 10,8* ↑ 2: 10,2* ↖ 3: 10,6* ↖ 4: 10,0 ← 5: 9,0 ← 6: 10,5* ↖ 7: 10,4* ↑ 8: 10,5* → 9: 10,8* ↘ 10: 10,4* → | Series 4 |  | 1: 10,1 ↖ 2: 9,3 ← 3: 10,1 ↑ 4: 10,6* ↑ 5: 10,5* ↖ 6: 10,2* ↑ 7: 10,0 ↑ 8: 10,1 ↗ 9: 10,2* ↘ 10: 10,2* ↗ |
| | Serie 99,0 | | Serie 99,0 | | |
| | Sum 293,0 | | Sum 392,0 | | |

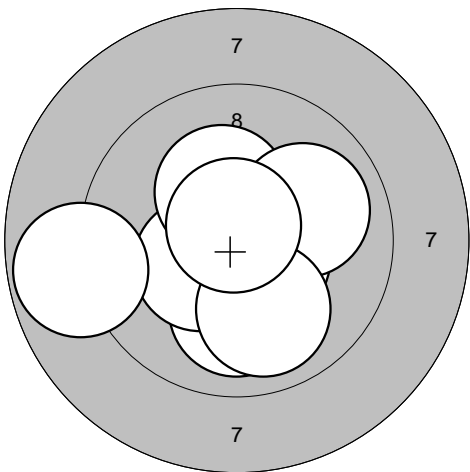
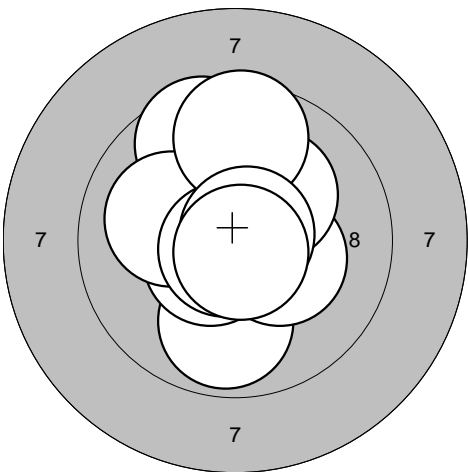
| | | | | | |
|----------|--|---|------------|--|--|
| Series 5 |  | 1: 10,6* ↗ 2: 10,7* ↓ 3: 10,0 ↓ 4: 10,4* ↖ 5: 10,5* ↘ 6: 10,3* ↑ 7: 8,8 ← 8: 10,0 → 9: 9,9 ↓ 10: 10,7* ↑ | Series 6 |  | 1: 9,6 ↖ 2: 9,9 ↓ 3: 10,3* ↘ 4: 10,5* ↖ 5: 10,1 ← 6: 10,2* ↗ 7: 10,8* ↖ 8: 9,6 ↑ 9: 10,8* ↗ 10: 10,8* ↓ |
| | Serie 97,0 | | Serie 97,0 | | |
| | Sum 489,0 | | Sum 586,0 | | |

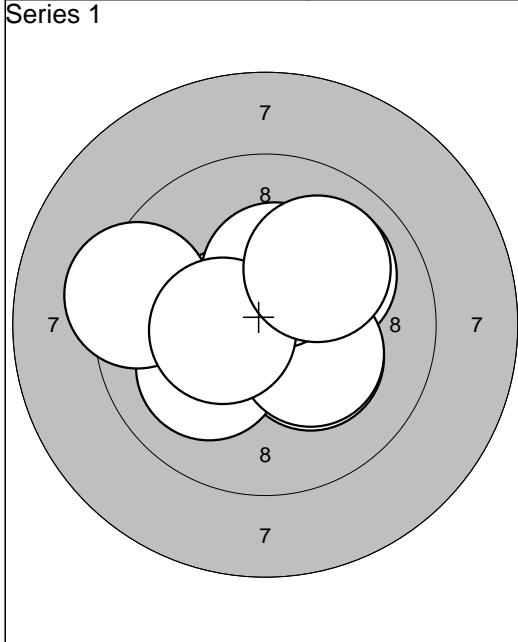

| | |
|-------------------|---|
| 1: 10,3* | ↘ |
| 2: 10,7* | ← |
| 3: 10,1 | ↙ |
| 4: 10,6* | ← |
| 5: 10,0 | ↗ |
| 6: 10,3* | ↘ |
| 7: 9,3 | ← |
| 8: 10,4* | ↑ |
| 9: 10,4* | ← |
| 10: 10,0 | ↗ |
| Serie 99,0 | |
| Sum 99,0 | |

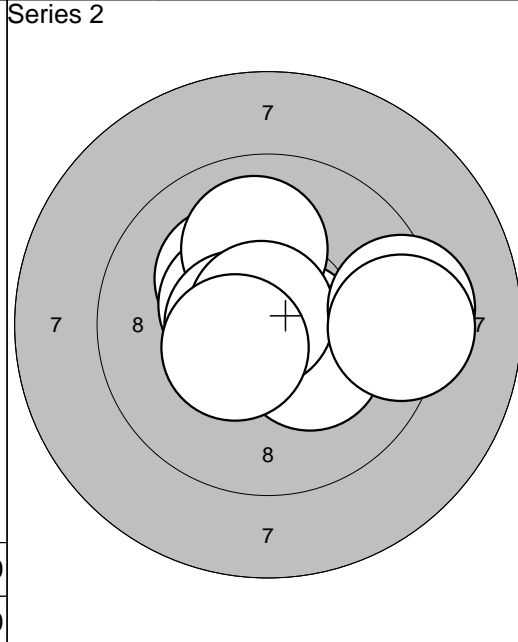

| | |
|-------------------|---|
| 1: 10,6* | ↘ |
| 2: 10,2* | ↗ |
| 3: 10,4* | ↙ |
| 4: 10,0 | ↑ |
| 5: 10,6* | ← |
| 6: 10,3* | ↘ |
| 7: 10,8* | ↗ |
| 8: 10,4* | ↙ |
| 9: 9,3 | → |
| 10: 9,3 | → |
| Serie 98,0 | |
| Sum 197,0 | |

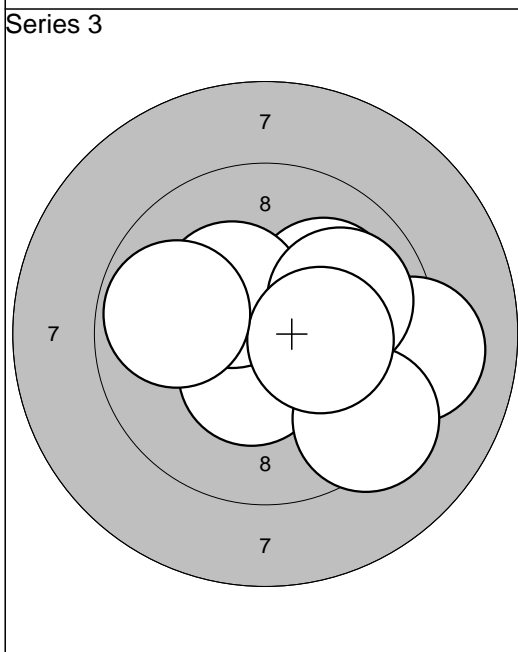

| | |
|-------------------|---|
| 1: 10,4* | ← |
| 2: 9,2 | → |
| 3: 10,8* | ↗ |
| 4: 10,1 | ↗ |
| 5: 10,4* | ↓ |
| 6: 9,3 | ↘ |
| 7: 10,3* | ↗ |
| 8: 9,9 | ↗ |
| 9: 10,3* | → |
| 10: 9,8 | ← |
| Serie 96,0 | |
| Sum 293,0 | |

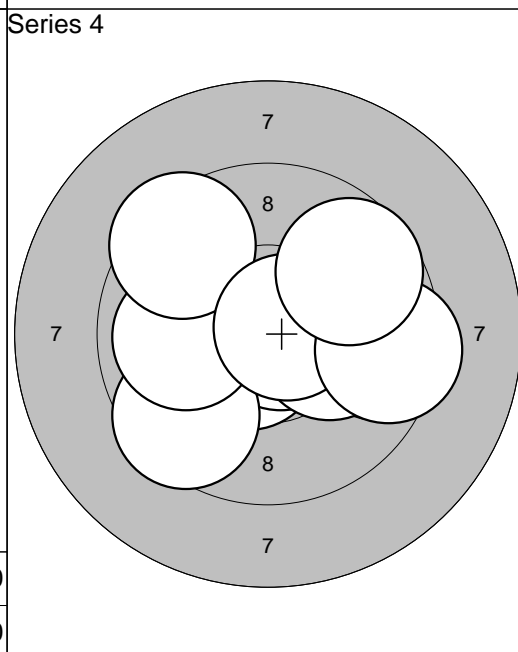

| | |
|-------------------|---|
| 1: 10,6* | ↙ |
| 2: 9,6 | → |
| 3: 10,8* | → |
| 4: 9,5 | ↙ |
| 5: 9,9 | ← |
| 6: 9,4 | ↗ |
| 7: 10,2* | → |
| 8: 10,7* | → |
| 9: 9,5 | → |
| 10: 9,7 | ↗ |
| Serie 94,0 | |
| Sum 387,0 | |

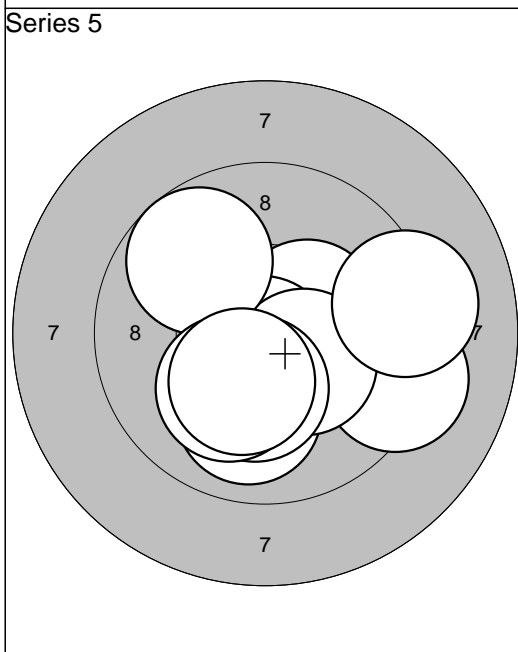

| | |
|-------------------|---|
| 1: 10,4* | ↗ |
| 2: 10,0 | ↓ |
| 3: 10,7* | ↓ |
| 4: 9,3 | → |
| 5: 10,3* | ↘ |
| 6: 9,8 | ↗ |
| 7: 10,3* | ↓ |
| 8: 9,2 | → |
| 9: 10,1 | ↓ |
| 10: 10,3* | ↓ |
| Serie 97,0 | |
| Sum 484,0 | |

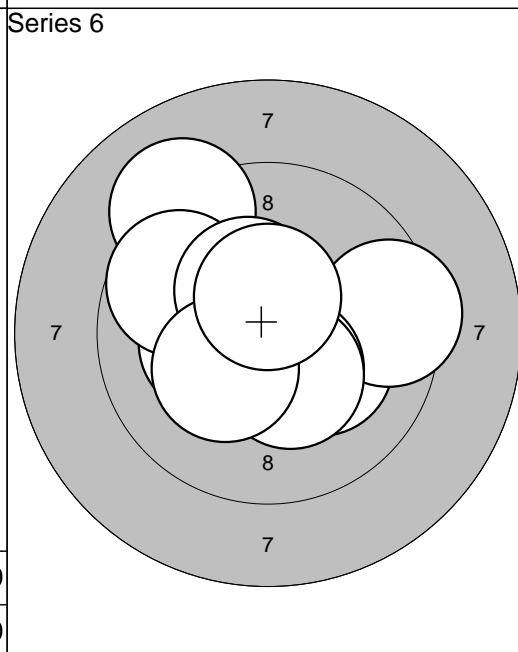

| | |
|-------------------|---|
| 1: 9,1 | ↗ |
| 2: 10,2* | ↘ |
| 3: 9,5 | → |
| 4: 10,4* | ↘ |
| 5: 10,2* | ← |
| 6: 9,7 | ↙ |
| 7: 10,4* | ↗ |
| 8: 10,4* | ↘ |
| 9: 10,3* | ↙ |
| 10: 10,5* | ↑ |
| Serie 97,0 | |
| Sum 581,0 | |

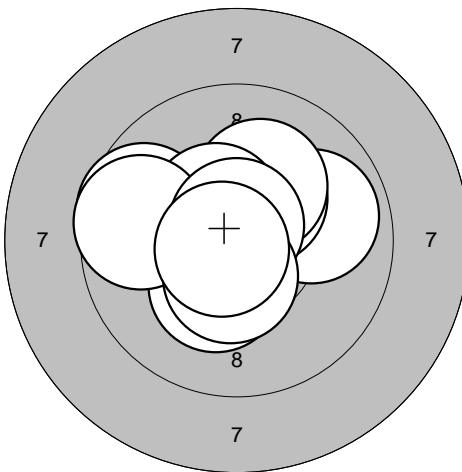
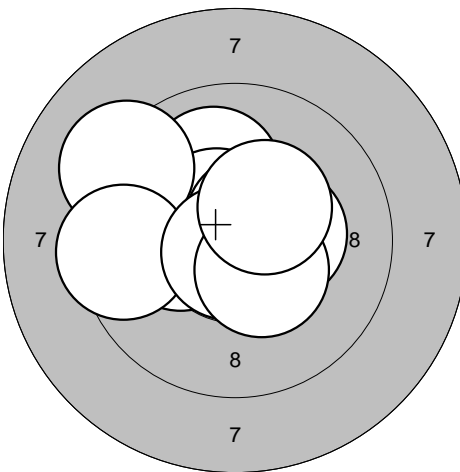
| | | | |
|--|--|--|---|
| <p>Series 1</p>  | <p>1: 9,9 →</p> <p>2: 10,3* ↓</p> <p>3: 10,3* ↗</p> <p>4: 10,2* ↗</p> <p>5: 9,7 ←</p> <p>6: 10,4* ↗</p> <p>7: 9,7 ←</p> <p>8: 10,8* ↑</p> <p>9: 10,5* ↓</p> <p>10: 10,7* ↙</p> | <p>Series 2</p>  | <p>1: 10,0 ↑</p> <p>2: 10,3* →</p> <p>3: 10,2* ←</p> <p>4: 10,6* ↗</p> <p>5: 9,2 ↖</p> <p>6: 9,5 ←</p> <p>7: 10,6* ↗</p> <p>8: 10,8* ↓</p> <p>9: 10,4* ↘</p> <p>10: 10,3* ↗</p> |
| Serie 97,0 | Serie 98,0 | Serie 98,0 | Serie 98,0 |
| Sum 97,0 | Sum 97,0 | Sum 195,0 | Sum 195,0 |

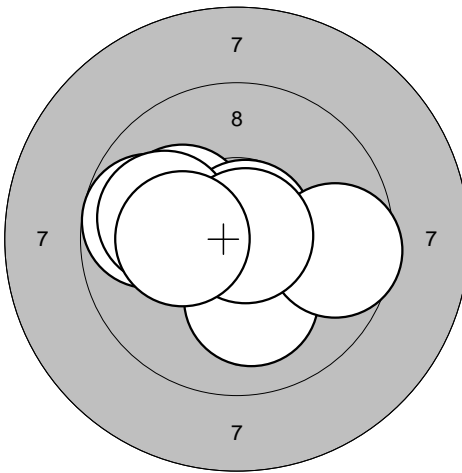
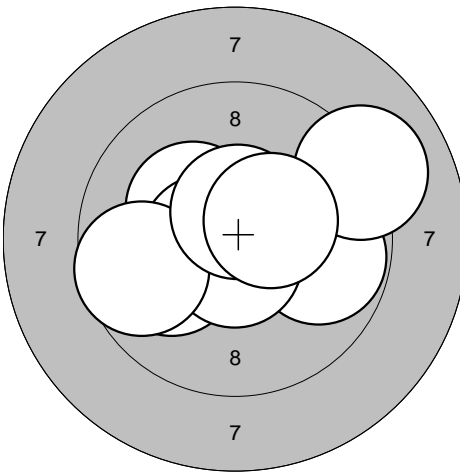
| | | | |
|---|--|---|---|
| <p>Series 3</p>  | <p>1: 10,8* ↖</p> <p>2: 10,8* ↓</p> <p>3: 10,1 ↖</p> <p>4: 9,8 ←</p> <p>5: 10,7* ↗</p> <p>6: 9,9 ←</p> <p>7: 10,1 ↓</p> <p>8: 9,6 →</p> <p>9: 10,8* →</p> <p>10: 10,2* ←</p> | <p>Series 4</p>  | <p>1: 9,8 →</p> <p>2: 10,8* ↗</p> <p>3: 9,1 →</p> <p>4: 10,2* ↖</p> <p>5: 10,0 ←</p> <p>6: 10,6* ←</p> <p>7: 10,7* ↓</p> <p>8: 9,6 ←</p> <p>9: 10,6* ↑</p> <p>10: 10,4* →</p> |
| Serie 97,0 | Serie 97,0 | Serie 97,0 | Serie 97,0 |
| Sum 292,0 | Sum 292,0 | Sum 389,0 | Sum 389,0 |

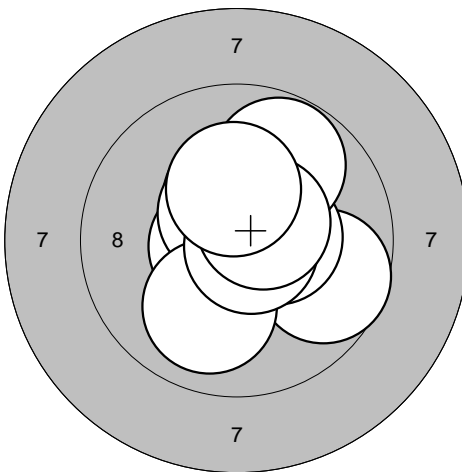
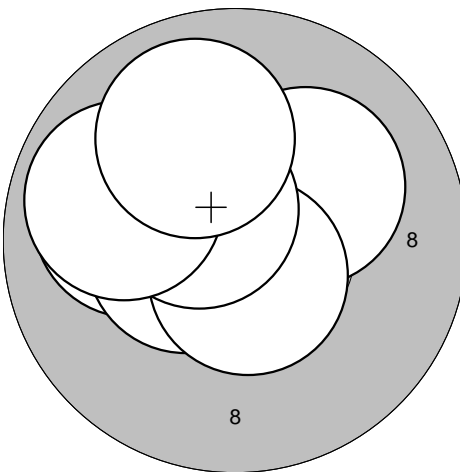
| | | | |
|--|---|--|--|
| <p>Series 5</p>  | <p>1: 10,7* ←</p> <p>2: 9,7 →</p> <p>3: 10,4* →</p> <p>4: 10,4* ↑</p> <p>5: 10,6* ↗</p> <p>6: 10,0 ↓</p> <p>7: 9,8 ↗</p> <p>8: 10,7* →</p> <p>9: 10,5* ↗</p> <p>10: 10,3* ↑</p> | <p>Series 6</p>  | <p>1: 10,0 ←</p> <p>2: 10,4* ↗</p> <p>3: 10,5* ↖</p> <p>4: 10,5* ↑</p> <p>5: 10,2* ↗</p> <p>6: 10,5* ←</p> <p>7: 10,6* ↓</p> <p>8: 10,5* ↖</p> <p>9: 9,9 ←</p> <p>10: 10,0 ↑</p> |
| Serie 98,0 | Serie 99,0 | Serie 99,0 | Serie 99,0 |
| Sum 487,0 | Sum 487,0 | Sum 586,0 | Sum 586,0 |

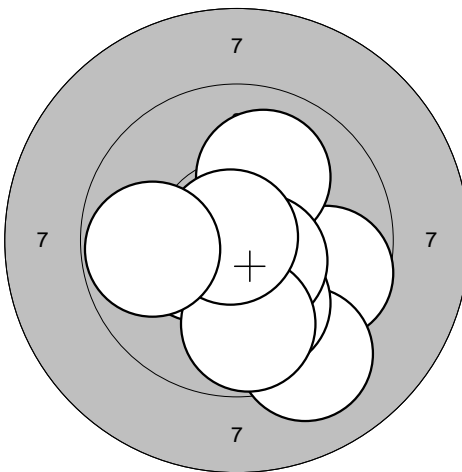
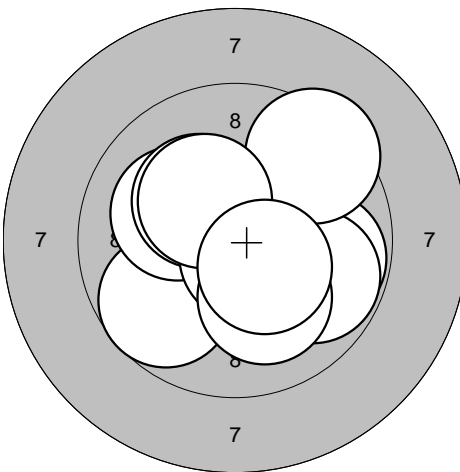
| | | | |
|--|--|--|--|
| <p>Series 1</p>  | <p>1: 9,7 →</p> <p>2: 10,4* ←</p> <p>3: 9,2 ↓</p> <p>4: 10,7* ↗</p> <p>5: 10,0 ↓</p> <p>6: 10,0 ↗</p> <p>7: 10,5* ↓</p> <p>8: 9,8 ↓</p> <p>9: 10,8* ↗</p> <p>10: 9,8 ←</p> | <p>Series 2</p>  | <p>1: 9,7 ↙</p> <p>2: 9,8 →</p> <p>3: 10,1 ↖</p> <p>4: 9,8 ↘</p> <p>5: 10,3* ↗</p> <p>6: 10,7* ↓</p> <p>7: 10,1 ↓</p> <p>8: 9,4 ↗</p> <p>9: 10,3* ↗</p> <p>10: 10,4* ↓</p> |
| Serie 96,0 | Serie 96,0 | Serie 96,0 | Serie 96,0 |
| Sum 96,0 | Sum 96,0 | Sum 192,0 | Sum 192,0 |

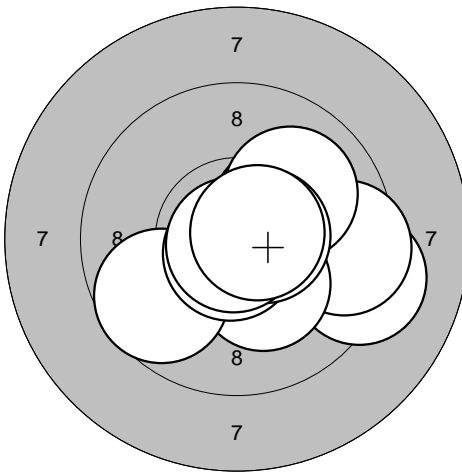
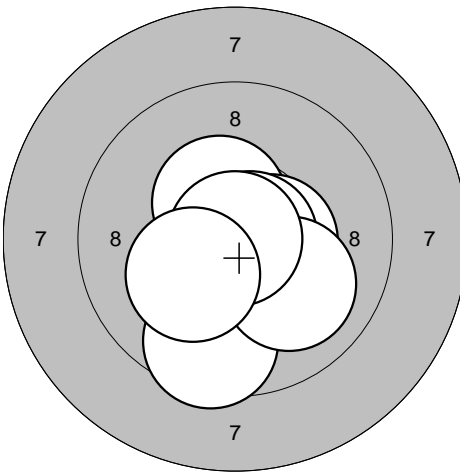
| | | | |
|---|---|---|---|
| <p>Series 3</p>  | <p>1: 10,3* ↗</p> <p>2: 9,2 →</p> <p>3: 9,5 →</p> <p>4: 10,0 ↗</p> <p>5: 10,2* ↓</p> <p>6: 9,7 ↙</p> <p>7: 10,7* ↓</p> <p>8: 10,6* →</p> <p>9: 10,9* ↓</p> <p>10: 10,7* →</p> | <p>Series 4</p>  | <p>1: 10,4* ↓</p> <p>2: 10,8* ↗</p> <p>3: 9,6 ↓</p> <p>4: 10,7* ↓</p> <p>5: 10,4* ↗</p> <p>6: 10,5* →</p> <p>7: 10,8* →</p> <p>8: 10,0 ↓</p> <p>9: 10,9*</p> <p>10: 10,2* ↙</p> |
| Serie 97,0 | Serie 97,0 | Serie 99,0 | Serie 99,0 |
| Sum 289,0 | Sum 289,0 | Sum 388,0 | Sum 388,0 |

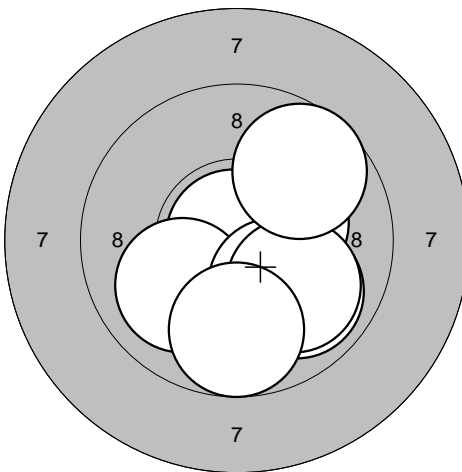
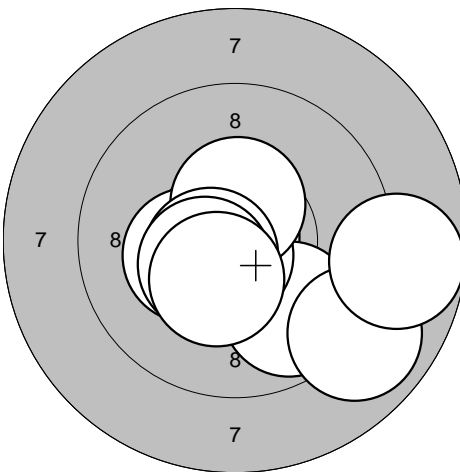
| | | | |
|--|--|--|--|
| <p>Series 5</p>  | <p>1: 10,5* ↓</p> <p>2: 10,2* ↓</p> <p>3: 10,3* →</p> <p>4: 10,9* ↗</p> <p>5: 10,0 ↙</p> <p>6: 9,9 ↙</p> <p>7: 10,2* ↓</p> <p>8: 10,0 ↓</p> <p>9: 9,8 ↓</p> <p>10: 9,7 ↗</p> | <p>Series 6</p>  | <p>1: 10,3* ↙</p> <p>2: 10,9* ↗</p> <p>3: 9,8 ↓</p> <p>4: 10,7* ↓</p> <p>5: 8,9 ↘</p> <p>6: 8,8 →</p> <p>7: 10,5* ↑</p> <p>8: 10,6* ↙</p> <p>9: 10,5* ↙</p> <p>10: 10,4* ↓</p> |
| Serie 97,0 | Serie 97,0 | Serie 95,0 | Serie 95,0 |
| Sum 485,0 | Sum 485,0 | Sum 580,0 | Sum 580,0 |

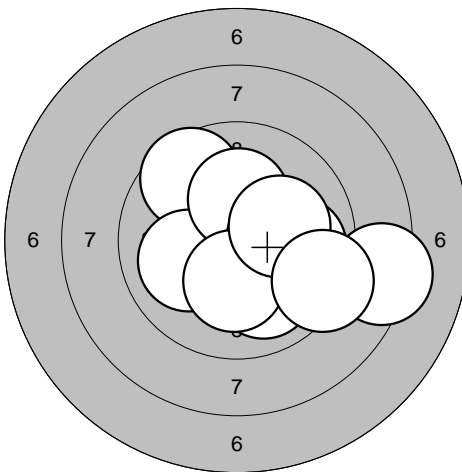
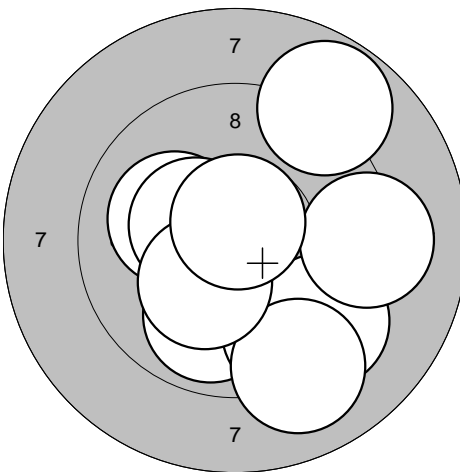
| | | | | | | | | | | | | | | | | | | | | | | | | | | | | | | | | | | | | | | | | | | | | | | | | | | | |
|--|--|--------|---|--------|---|---------|---|---------|---|----------|---|----------|---|--------|---|----------|---|---------|---|---------|---|-------|------|-----|------|--|---|--------|---|---------|---|--------|---|--------|---|--------|---|----------|---|--------|---|----------|---|--------|---|-----------|---|-------|------|-----|-------|
| <p>Series 1</p>  | <table style="width:100%; border-collapse: collapse;"> <tr><td>1: 9,9</td><td>→</td></tr> <tr><td>2: 9,6</td><td>↗</td></tr> <tr><td>3: 10,0</td><td>↓</td></tr> <tr><td>4: 10,0</td><td>←</td></tr> <tr><td>5: 10,2*</td><td>↑</td></tr> <tr><td>6: 10,2*</td><td>→</td></tr> <tr><td>7: 8,3</td><td>→</td></tr> <tr><td>8: 10,2*</td><td>↓</td></tr> <tr><td>9: 10,1</td><td>→</td></tr> <tr><td>10: 9,3</td><td>↘</td></tr> <tr style="border-top: 1px solid black;"><td style="border-top: 1px solid black;">Serie</td><td style="border-top: 1px solid black;">95,0</td></tr> <tr><td>Sum</td><td>95,0</td></tr> </table> | 1: 9,9 | → | 2: 9,6 | ↗ | 3: 10,0 | ↓ | 4: 10,0 | ← | 5: 10,2* | ↑ | 6: 10,2* | → | 7: 8,3 | → | 8: 10,2* | ↓ | 9: 10,1 | → | 10: 9,3 | ↘ | Serie | 95,0 | Sum | 95,0 | <p>Series 2</p>  | <table style="width:100%; border-collapse: collapse;"> <tr><td>1: 9,9</td><td>↓</td></tr> <tr><td>2: 10,1</td><td>↖</td></tr> <tr><td>3: 9,6</td><td>↓</td></tr> <tr><td>4: 9,4</td><td>↘</td></tr> <tr><td>5: 9,2</td><td>→</td></tr> <tr><td>6: 10,4*</td><td>↖</td></tr> <tr><td>7: 9,1</td><td>↓</td></tr> <tr><td>8: 10,3*</td><td>↘</td></tr> <tr><td>9: 8,8</td><td>↗</td></tr> <tr><td>10: 10,7*</td><td>↑</td></tr> <tr style="border-top: 1px solid black;"><td style="border-top: 1px solid black;">Serie</td><td style="border-top: 1px solid black;">93,0</td></tr> <tr><td>Sum</td><td>188,0</td></tr> </table> | 1: 9,9 | ↓ | 2: 10,1 | ↖ | 3: 9,6 | ↓ | 4: 9,4 | ↘ | 5: 9,2 | → | 6: 10,4* | ↖ | 7: 9,1 | ↓ | 8: 10,3* | ↘ | 9: 8,8 | ↗ | 10: 10,7* | ↑ | Serie | 93,0 | Sum | 188,0 |
| 1: 9,9 | → | | | | | | | | | | | | | | | | | | | | | | | | | | | | | | | | | | | | | | | | | | | | | | | | | | |
| 2: 9,6 | ↗ | | | | | | | | | | | | | | | | | | | | | | | | | | | | | | | | | | | | | | | | | | | | | | | | | | |
| 3: 10,0 | ↓ | | | | | | | | | | | | | | | | | | | | | | | | | | | | | | | | | | | | | | | | | | | | | | | | | | |
| 4: 10,0 | ← | | | | | | | | | | | | | | | | | | | | | | | | | | | | | | | | | | | | | | | | | | | | | | | | | | |
| 5: 10,2* | ↑ | | | | | | | | | | | | | | | | | | | | | | | | | | | | | | | | | | | | | | | | | | | | | | | | | | |
| 6: 10,2* | → | | | | | | | | | | | | | | | | | | | | | | | | | | | | | | | | | | | | | | | | | | | | | | | | | | |
| 7: 8,3 | → | | | | | | | | | | | | | | | | | | | | | | | | | | | | | | | | | | | | | | | | | | | | | | | | | | |
| 8: 10,2* | ↓ | | | | | | | | | | | | | | | | | | | | | | | | | | | | | | | | | | | | | | | | | | | | | | | | | | |
| 9: 10,1 | → | | | | | | | | | | | | | | | | | | | | | | | | | | | | | | | | | | | | | | | | | | | | | | | | | | |
| 10: 9,3 | ↘ | | | | | | | | | | | | | | | | | | | | | | | | | | | | | | | | | | | | | | | | | | | | | | | | | | |
| Serie | 95,0 | | | | | | | | | | | | | | | | | | | | | | | | | | | | | | | | | | | | | | | | | | | | | | | | | | |
| Sum | 95,0 | | | | | | | | | | | | | | | | | | | | | | | | | | | | | | | | | | | | | | | | | | | | | | | | | | |
| 1: 9,9 | ↓ | | | | | | | | | | | | | | | | | | | | | | | | | | | | | | | | | | | | | | | | | | | | | | | | | | |
| 2: 10,1 | ↖ | | | | | | | | | | | | | | | | | | | | | | | | | | | | | | | | | | | | | | | | | | | | | | | | | | |
| 3: 9,6 | ↓ | | | | | | | | | | | | | | | | | | | | | | | | | | | | | | | | | | | | | | | | | | | | | | | | | | |
| 4: 9,4 | ↘ | | | | | | | | | | | | | | | | | | | | | | | | | | | | | | | | | | | | | | | | | | | | | | | | | | |
| 5: 9,2 | → | | | | | | | | | | | | | | | | | | | | | | | | | | | | | | | | | | | | | | | | | | | | | | | | | | |
| 6: 10,4* | ↖ | | | | | | | | | | | | | | | | | | | | | | | | | | | | | | | | | | | | | | | | | | | | | | | | | | |
| 7: 9,1 | ↓ | | | | | | | | | | | | | | | | | | | | | | | | | | | | | | | | | | | | | | | | | | | | | | | | | | |
| 8: 10,3* | ↘ | | | | | | | | | | | | | | | | | | | | | | | | | | | | | | | | | | | | | | | | | | | | | | | | | | |
| 9: 8,8 | ↗ | | | | | | | | | | | | | | | | | | | | | | | | | | | | | | | | | | | | | | | | | | | | | | | | | | |
| 10: 10,7* | ↑ | | | | | | | | | | | | | | | | | | | | | | | | | | | | | | | | | | | | | | | | | | | | | | | | | | |
| Serie | 93,0 | | | | | | | | | | | | | | | | | | | | | | | | | | | | | | | | | | | | | | | | | | | | | | | | | | |
| Sum | 188,0 | | | | | | | | | | | | | | | | | | | | | | | | | | | | | | | | | | | | | | | | | | | | | | | | | | |

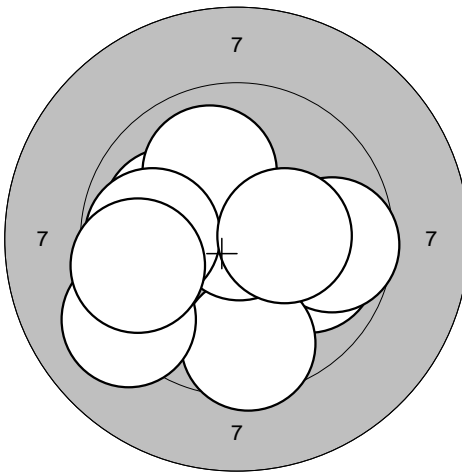
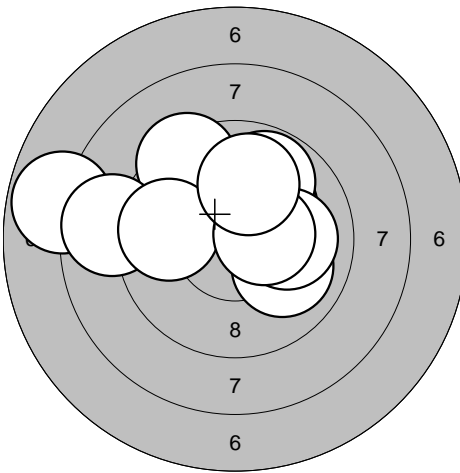
| | | | | | | | | | | | | | | | | | | | | | | | | | | | | | | | | | | | | | | | | | | | | | | | | | | | |
|---|--|--------|---|---------|---|--------|---|--------|---|----------|---|---------|---|--------|---|--------|---|--------|---|-----------|---|-------|------|-----|-------|---|---|---------|---|--------|---|----------|---|--------|---|--------|---|--------|---|--------|---|---------|---|----------|---|----------|---|-------|------|-----|-------|
| <p>Series 3</p>  | <table style="width:100%; border-collapse: collapse;"> <tr><td>1: 9,9</td><td>↘</td></tr> <tr><td>2: 10,0</td><td>↖</td></tr> <tr><td>3: 9,7</td><td>→</td></tr> <tr><td>4: 9,5</td><td>↓</td></tr> <tr><td>5: 10,9*</td><td>↗</td></tr> <tr><td>6: 10,0</td><td>↑</td></tr> <tr><td>7: 9,8</td><td>←</td></tr> <tr><td>8: 9,2</td><td>↙</td></tr> <tr><td>9: 9,6</td><td>←</td></tr> <tr><td>10: 10,3*</td><td>→</td></tr> <tr style="border-top: 1px solid black;"><td style="border-top: 1px solid black;">Serie</td><td style="border-top: 1px solid black;">94,0</td></tr> <tr><td>Sum</td><td>282,0</td></tr> </table> | 1: 9,9 | ↘ | 2: 10,0 | ↖ | 3: 9,7 | → | 4: 9,5 | ↓ | 5: 10,9* | ↗ | 6: 10,0 | ↑ | 7: 9,8 | ← | 8: 9,2 | ↙ | 9: 9,6 | ← | 10: 10,3* | → | Serie | 94,0 | Sum | 282,0 | <p>Series 4</p>  | <table style="width:100%; border-collapse: collapse;"> <tr><td>1: 10,0</td><td>↘</td></tr> <tr><td>2: 9,4</td><td>↖</td></tr> <tr><td>3: 10,2*</td><td>↗</td></tr> <tr><td>4: 7,8</td><td>←</td></tr> <tr><td>5: 8,8</td><td>←</td></tr> <tr><td>6: 9,8</td><td>←</td></tr> <tr><td>7: 9,8</td><td>↗</td></tr> <tr><td>8: 10,0</td><td>→</td></tr> <tr><td>9: 10,4*</td><td>→</td></tr> <tr><td>10: 10,0</td><td>↑</td></tr> <tr style="border-top: 1px solid black;"><td style="border-top: 1px solid black;">Serie</td><td style="border-top: 1px solid black;">92,0</td></tr> <tr><td>Sum</td><td>374,0</td></tr> </table> | 1: 10,0 | ↘ | 2: 9,4 | ↖ | 3: 10,2* | ↗ | 4: 7,8 | ← | 5: 8,8 | ← | 6: 9,8 | ← | 7: 9,8 | ↗ | 8: 10,0 | → | 9: 10,4* | → | 10: 10,0 | ↑ | Serie | 92,0 | Sum | 374,0 |
| 1: 9,9 | ↘ | | | | | | | | | | | | | | | | | | | | | | | | | | | | | | | | | | | | | | | | | | | | | | | | | | |
| 2: 10,0 | ↖ | | | | | | | | | | | | | | | | | | | | | | | | | | | | | | | | | | | | | | | | | | | | | | | | | | |
| 3: 9,7 | → | | | | | | | | | | | | | | | | | | | | | | | | | | | | | | | | | | | | | | | | | | | | | | | | | | |
| 4: 9,5 | ↓ | | | | | | | | | | | | | | | | | | | | | | | | | | | | | | | | | | | | | | | | | | | | | | | | | | |
| 5: 10,9* | ↗ | | | | | | | | | | | | | | | | | | | | | | | | | | | | | | | | | | | | | | | | | | | | | | | | | | |
| 6: 10,0 | ↑ | | | | | | | | | | | | | | | | | | | | | | | | | | | | | | | | | | | | | | | | | | | | | | | | | | |
| 7: 9,8 | ← | | | | | | | | | | | | | | | | | | | | | | | | | | | | | | | | | | | | | | | | | | | | | | | | | | |
| 8: 9,2 | ↙ | | | | | | | | | | | | | | | | | | | | | | | | | | | | | | | | | | | | | | | | | | | | | | | | | | |
| 9: 9,6 | ← | | | | | | | | | | | | | | | | | | | | | | | | | | | | | | | | | | | | | | | | | | | | | | | | | | |
| 10: 10,3* | → | | | | | | | | | | | | | | | | | | | | | | | | | | | | | | | | | | | | | | | | | | | | | | | | | | |
| Serie | 94,0 | | | | | | | | | | | | | | | | | | | | | | | | | | | | | | | | | | | | | | | | | | | | | | | | | | |
| Sum | 282,0 | | | | | | | | | | | | | | | | | | | | | | | | | | | | | | | | | | | | | | | | | | | | | | | | | | |
| 1: 10,0 | ↘ | | | | | | | | | | | | | | | | | | | | | | | | | | | | | | | | | | | | | | | | | | | | | | | | | | |
| 2: 9,4 | ↖ | | | | | | | | | | | | | | | | | | | | | | | | | | | | | | | | | | | | | | | | | | | | | | | | | | |
| 3: 10,2* | ↗ | | | | | | | | | | | | | | | | | | | | | | | | | | | | | | | | | | | | | | | | | | | | | | | | | | |
| 4: 7,8 | ← | | | | | | | | | | | | | | | | | | | | | | | | | | | | | | | | | | | | | | | | | | | | | | | | | | |
| 5: 8,8 | ← | | | | | | | | | | | | | | | | | | | | | | | | | | | | | | | | | | | | | | | | | | | | | | | | | | |
| 6: 9,8 | ← | | | | | | | | | | | | | | | | | | | | | | | | | | | | | | | | | | | | | | | | | | | | | | | | | | |
| 7: 9,8 | ↗ | | | | | | | | | | | | | | | | | | | | | | | | | | | | | | | | | | | | | | | | | | | | | | | | | | |
| 8: 10,0 | → | | | | | | | | | | | | | | | | | | | | | | | | | | | | | | | | | | | | | | | | | | | | | | | | | | |
| 9: 10,4* | → | | | | | | | | | | | | | | | | | | | | | | | | | | | | | | | | | | | | | | | | | | | | | | | | | | |
| 10: 10,0 | ↑ | | | | | | | | | | | | | | | | | | | | | | | | | | | | | | | | | | | | | | | | | | | | | | | | | | |
| Serie | 92,0 | | | | | | | | | | | | | | | | | | | | | | | | | | | | | | | | | | | | | | | | | | | | | | | | | | |
| Sum | 374,0 | | | | | | | | | | | | | | | | | | | | | | | | | | | | | | | | | | | | | | | | | | | | | | | | | | |

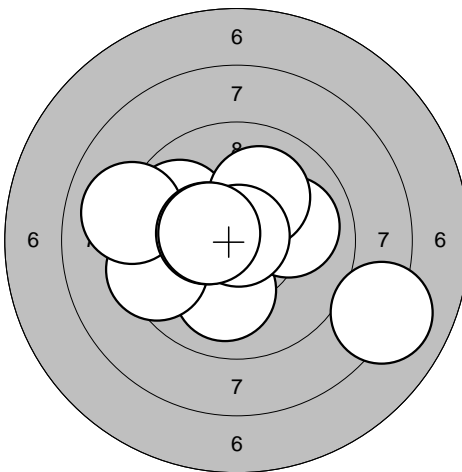
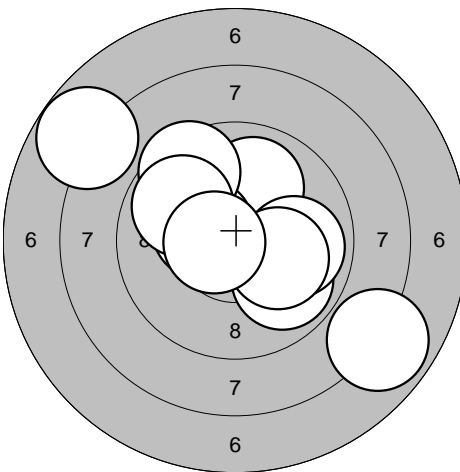
| | | | | | | | | | | | | | | | | | | | | | | | | | | | | | | | | | | | | | | | | | | | | | | | | | | | |
|--|---|--------|---|---------|---|--------|---|--------|---|--------|---|---------|---|---------|---|----------|---|----------|---|-----------|---|-------|------|-----|-------|--|--|--------|---|--------|---|---------|---|----------|---|--------|---|--------|---|--------|---|---------|---|----------|---|---------|---|-------|------|-----|-------|
| <p>Series 5</p>  | <table style="width:100%; border-collapse: collapse;"> <tr><td>1: 9,8</td><td>↖</td></tr> <tr><td>2: 10,0</td><td>↓</td></tr> <tr><td>3: 8,1</td><td>→</td></tr> <tr><td>4: 9,4</td><td>←</td></tr> <tr><td>5: 9,0</td><td>←</td></tr> <tr><td>6: 10,0</td><td>→</td></tr> <tr><td>7: 10,1</td><td>↗</td></tr> <tr><td>8: 10,9*</td><td>↗</td></tr> <tr><td>9: 10,4*</td><td>←</td></tr> <tr><td>10: 10,4*</td><td>←</td></tr> <tr style="border-top: 1px solid black;"><td style="border-top: 1px solid black;">Serie</td><td style="border-top: 1px solid black;">95,0</td></tr> <tr><td>Sum</td><td>469,0</td></tr> </table> | 1: 9,8 | ↖ | 2: 10,0 | ↓ | 3: 8,1 | → | 4: 9,4 | ← | 5: 9,0 | ← | 6: 10,0 | → | 7: 10,1 | ↗ | 8: 10,9* | ↗ | 9: 10,4* | ← | 10: 10,4* | ← | Serie | 95,0 | Sum | 469,0 | <p>Series 6</p>  | <table style="width:100%; border-collapse: collapse;"> <tr><td>1: 9,9</td><td>↘</td></tr> <tr><td>2: 7,8</td><td>↖</td></tr> <tr><td>3: 10,0</td><td>↑</td></tr> <tr><td>4: 10,3*</td><td>←</td></tr> <tr><td>5: 9,9</td><td>→</td></tr> <tr><td>6: 9,5</td><td>↗</td></tr> <tr><td>7: 9,9</td><td>↗</td></tr> <tr><td>8: 10,1</td><td>↘</td></tr> <tr><td>9: 10,6*</td><td>←</td></tr> <tr><td>10: 7,9</td><td>↘</td></tr> <tr style="border-top: 1px solid black;"><td style="border-top: 1px solid black;">Serie</td><td style="border-top: 1px solid black;">90,0</td></tr> <tr><td>Sum</td><td>559,0</td></tr> </table> | 1: 9,9 | ↘ | 2: 7,8 | ↖ | 3: 10,0 | ↑ | 4: 10,3* | ← | 5: 9,9 | → | 6: 9,5 | ↗ | 7: 9,9 | ↗ | 8: 10,1 | ↘ | 9: 10,6* | ← | 10: 7,9 | ↘ | Serie | 90,0 | Sum | 559,0 |
| 1: 9,8 | ↖ | | | | | | | | | | | | | | | | | | | | | | | | | | | | | | | | | | | | | | | | | | | | | | | | | | |
| 2: 10,0 | ↓ | | | | | | | | | | | | | | | | | | | | | | | | | | | | | | | | | | | | | | | | | | | | | | | | | | |
| 3: 8,1 | → | | | | | | | | | | | | | | | | | | | | | | | | | | | | | | | | | | | | | | | | | | | | | | | | | | |
| 4: 9,4 | ← | | | | | | | | | | | | | | | | | | | | | | | | | | | | | | | | | | | | | | | | | | | | | | | | | | |
| 5: 9,0 | ← | | | | | | | | | | | | | | | | | | | | | | | | | | | | | | | | | | | | | | | | | | | | | | | | | | |
| 6: 10,0 | → | | | | | | | | | | | | | | | | | | | | | | | | | | | | | | | | | | | | | | | | | | | | | | | | | | |
| 7: 10,1 | ↗ | | | | | | | | | | | | | | | | | | | | | | | | | | | | | | | | | | | | | | | | | | | | | | | | | | |
| 8: 10,9* | ↗ | | | | | | | | | | | | | | | | | | | | | | | | | | | | | | | | | | | | | | | | | | | | | | | | | | |
| 9: 10,4* | ← | | | | | | | | | | | | | | | | | | | | | | | | | | | | | | | | | | | | | | | | | | | | | | | | | | |
| 10: 10,4* | ← | | | | | | | | | | | | | | | | | | | | | | | | | | | | | | | | | | | | | | | | | | | | | | | | | | |
| Serie | 95,0 | | | | | | | | | | | | | | | | | | | | | | | | | | | | | | | | | | | | | | | | | | | | | | | | | | |
| Sum | 469,0 | | | | | | | | | | | | | | | | | | | | | | | | | | | | | | | | | | | | | | | | | | | | | | | | | | |
| 1: 9,9 | ↘ | | | | | | | | | | | | | | | | | | | | | | | | | | | | | | | | | | | | | | | | | | | | | | | | | | |
| 2: 7,8 | ↖ | | | | | | | | | | | | | | | | | | | | | | | | | | | | | | | | | | | | | | | | | | | | | | | | | | |
| 3: 10,0 | ↑ | | | | | | | | | | | | | | | | | | | | | | | | | | | | | | | | | | | | | | | | | | | | | | | | | | |
| 4: 10,3* | ← | | | | | | | | | | | | | | | | | | | | | | | | | | | | | | | | | | | | | | | | | | | | | | | | | | |
| 5: 9,9 | → | | | | | | | | | | | | | | | | | | | | | | | | | | | | | | | | | | | | | | | | | | | | | | | | | | |
| 6: 9,5 | ↗ | | | | | | | | | | | | | | | | | | | | | | | | | | | | | | | | | | | | | | | | | | | | | | | | | | |
| 7: 9,9 | ↗ | | | | | | | | | | | | | | | | | | | | | | | | | | | | | | | | | | | | | | | | | | | | | | | | | | |
| 8: 10,1 | ↘ | | | | | | | | | | | | | | | | | | | | | | | | | | | | | | | | | | | | | | | | | | | | | | | | | | |
| 9: 10,6* | ← | | | | | | | | | | | | | | | | | | | | | | | | | | | | | | | | | | | | | | | | | | | | | | | | | | |
| 10: 7,9 | ↘ | | | | | | | | | | | | | | | | | | | | | | | | | | | | | | | | | | | | | | | | | | | | | | | | | | |
| Serie | 90,0 | | | | | | | | | | | | | | | | | | | | | | | | | | | | | | | | | | | | | | | | | | | | | | | | | | |
| Sum | 559,0 | | | | | | | | | | | | | | | | | | | | | | | | | | | | | | | | | | | | | | | | | | | | | | | | | | |

Series 1

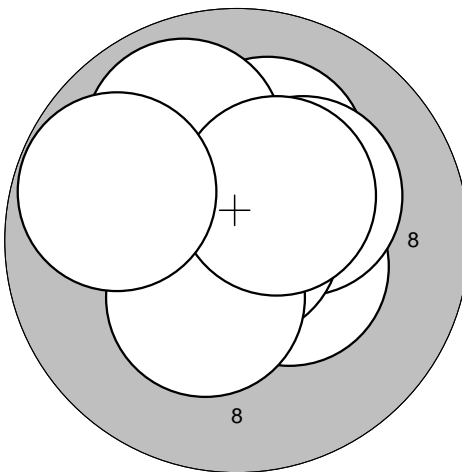

| | |
|----------|------|
| 1: 10,8* | ↖ |
| 2: 10,4* | ↑ |
| 3: 10,2* | ↑ |
| 4: 10,4* | ↘ |
| 5: 9,9 | ↑ |
| 6: 10,2* | ↗ |
| 7: 10,9* | → |
| 8: 10,4* | ↓ |
| 9: 10,4* | ↗ |
| 10: 9,8 | ↖ |
| Serie | 98,0 |
| Sum | 98,0 |

Series 2

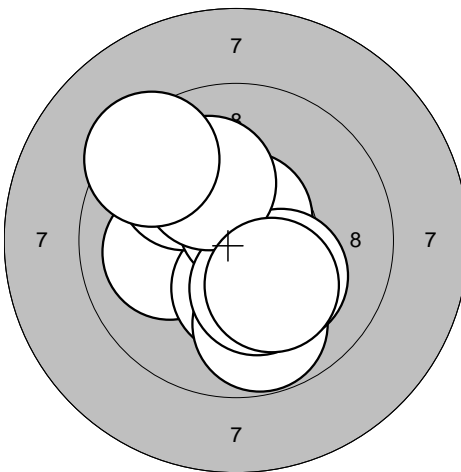

| | |
|----------|-------|
| 1: 10,0 | ↖ |
| 2: 10,3* | ↓ |
| 3: 9,9 | ↗ |
| 4: 10,7* | ↑ |
| 5: 9,8 | ↓ |
| 6: 10,2* | ↘ |
| 7: 10,3* | ↓ |
| 8: 10,1 | ↗ |
| 9: 10,2* | ↘ |
| 10: 9,4 | ↗ |
| Serie | 97,0 |
| Sum | 195,0 |

Series 3

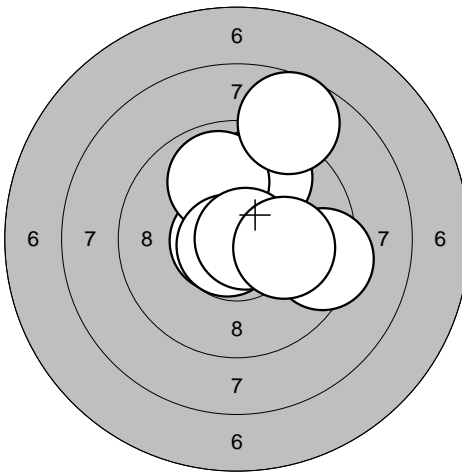

| | |
|----------|-------|
| 1: 10,9* | |
| 2: 9,4 | → |
| 3: 10,1 | ↑ |
| 4: 9,8 | ↑ |
| 5: 10,7* | ↖ |
| 6: 9,9 | ↑ |
| 7: 10,7* | ↖ |
| 8: 8,7 | ↑ |
| 9: 10,8* | → |
| 10: 10,1 | → |
| Serie | 95,0 |
| Sum | 290,0 |

Series 4

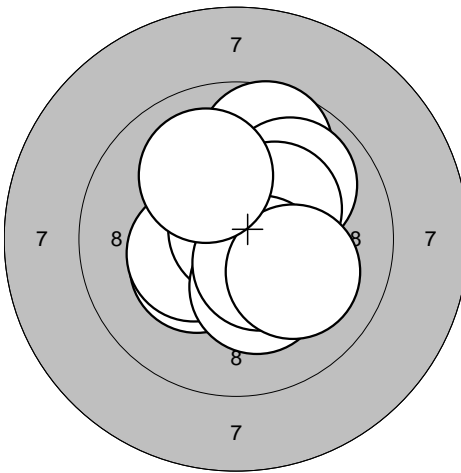

| | |
|----------|-------|
| 1: 10,3* | ↖ |
| 2: 10,3* | ↖ |
| 3: 10,8* | ↑ |
| 4: 9,7 | ↑ |
| 5: 9,9 | ↗ |
| 6: 10,3* | ↗ |
| 7: 10,3* | ↓ |
| 8: 10,5* | ↘ |
| 9: 10,1 | ↘ |
| 10: 10,0 | ↗ |
| Serie | 98,0 |
| Sum | 388,0 |

Series 5

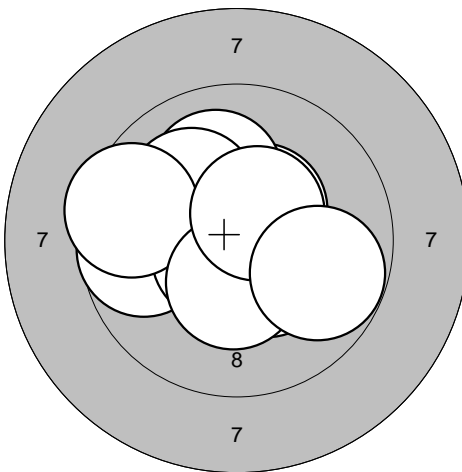

| | |
|----------|-------|
| 1: 10,4* | ↘ |
| 2: 9,7 | ↖ |
| 3: 10,4* | ↗ |
| 4: 10,1 | ↑ |
| 5: 10,1 | ↗ |
| 6: 10,6* | ↖ |
| 7: 9,5 | ↖ |
| 8: 10,4* | ↓ |
| 9: 10,5* | ↗ |
| 10: 9,8 | → |
| Serie | 97,0 |
| Sum | 485,0 |

Series 6

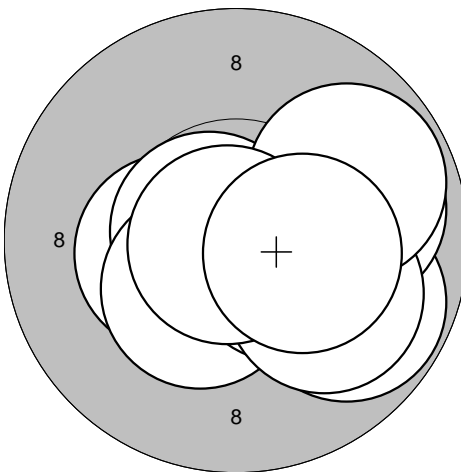

| | |
|-----------|-------|
| 1: 10,4* | ↖ |
| 2: 10,7* | ↖ |
| 3: 9,8 | ↘ |
| 4: 9,9 | → |
| 5: 10,4* | ↘ |
| 6: 10,5* | ↘ |
| 7: 10,0 | ↘ |
| 8: 9,8 | ↗ |
| 9: 10,8* | ↖ |
| 10: 10,3* | → |
| Serie | 97,0 |
| Sum | 582,0 |

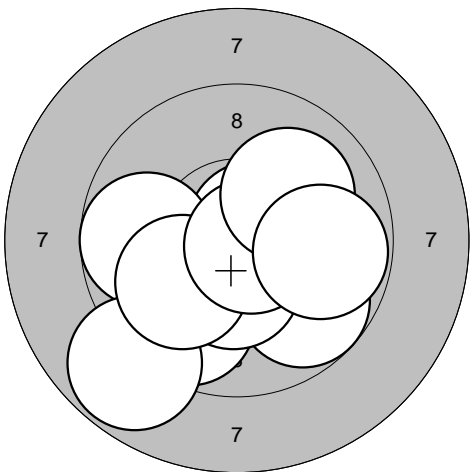
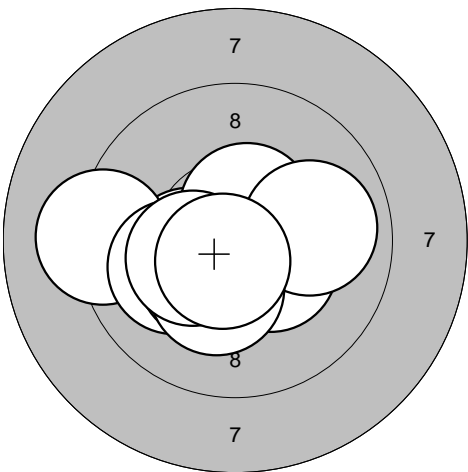
| | | | | | | | | | | | |
|---|--|-------|------|-----|------|---|--|-------|------|-----|-------|
| <p>Series 1</p>  | <p>1: 9,8 ↘ 2: 10,7* ↗ 3: 9,7 ↙ 4: 9,8 ← 5: 8,8 ↙ 6: 10,4* ↓ 7: 10,1 ↙ 8: 10,7* ↘ 9: 10,0 ↗ 10: 9,8 →</p> <table border="1" style="width:100%; border-collapse: collapse;"> <tr><td style="text-align: right;">Serie</td><td style="text-align: right;">94,0</td></tr> <tr><td style="text-align: right;">Sum</td><td style="text-align: right;">94,0</td></tr> </table> | Serie | 94,0 | Sum | 94,0 | <p>Series 2</p>  | <p>1: 10,3* ← 2: 9,2 ← 3: 10,4* ↘ 4: 10,5* ↗ 5: 10,1 ← 6: 9,9 → 7: 10,3* ↙ 8: 10,3* ↓ 9: 10,3* ← 10: 10,6* ↙</p> <table border="1" style="width:100%; border-collapse: collapse;"> <tr><td style="text-align: right;">Serie</td><td style="text-align: right;">98,0</td></tr> <tr><td style="text-align: right;">Sum</td><td style="text-align: right;">192,0</td></tr> </table> | Serie | 98,0 | Sum | 192,0 |
| Serie | 94,0 | | | | | | | | | | |
| Sum | 94,0 | | | | | | | | | | |
| Serie | 98,0 | | | | | | | | | | |
| Sum | 192,0 | | | | | | | | | | |

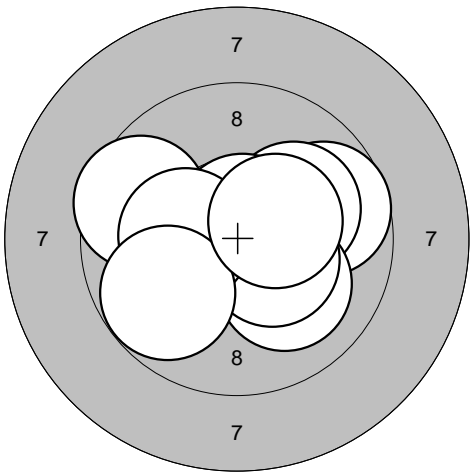
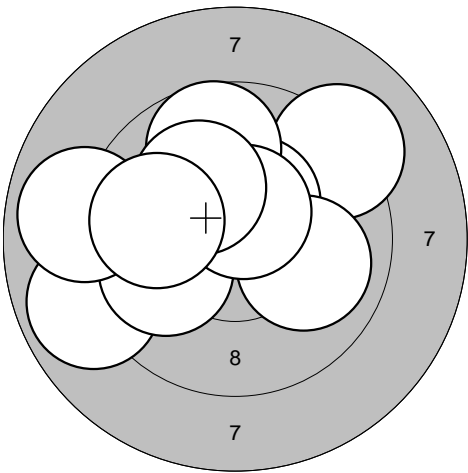
| | | | | | | | | | | | |
|--|---|-------|------|-----|-------|--|---|-------|------|-----|-------|
| <p>Series 3</p>  | <p>1: 9,6 ← 2: 9,7 → 3: 10,1 → 4: 10,1 ↘ 5: 10,7* ↗ 6: 10,3* ← 7: 10,4* ↘ 8: 10,3* ← 9: 9,8 ↙ 10: 10,4* →</p> <table border="1" style="width:100%; border-collapse: collapse;"> <tr><td style="text-align: right;">Serie</td><td style="text-align: right;">97,0</td></tr> <tr><td style="text-align: right;">Sum</td><td style="text-align: right;">289,0</td></tr> </table> | Serie | 97,0 | Sum | 289,0 | <p>Series 4</p>  | <p>1: 9,2 ↗ 2: 10,4* ↗ 3: 9,7 ↗ 4: 8,9 ← 5: 9,9 ← 6: 10,0 → 7: 10,5* ↗ 8: 8,9 ← 9: 10,1 ↗ 10: 9,9 ←</p> <table border="1" style="width:100%; border-collapse: collapse;"> <tr><td style="text-align: right;">Serie</td><td style="text-align: right;">92,0</td></tr> <tr><td style="text-align: right;">Sum</td><td style="text-align: right;">381,0</td></tr> </table> | Serie | 92,0 | Sum | 381,0 |
| Serie | 97,0 | | | | | | | | | | |
| Sum | 289,0 | | | | | | | | | | |
| Serie | 92,0 | | | | | | | | | | |
| Sum | 381,0 | | | | | | | | | | |

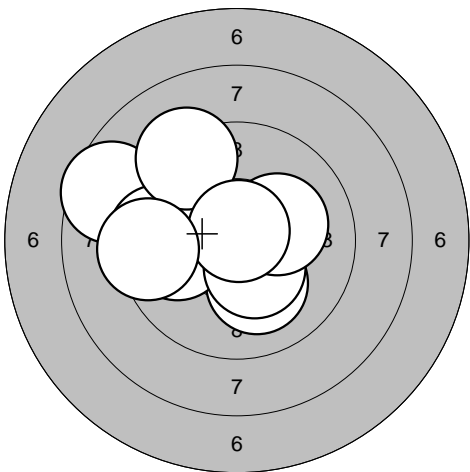
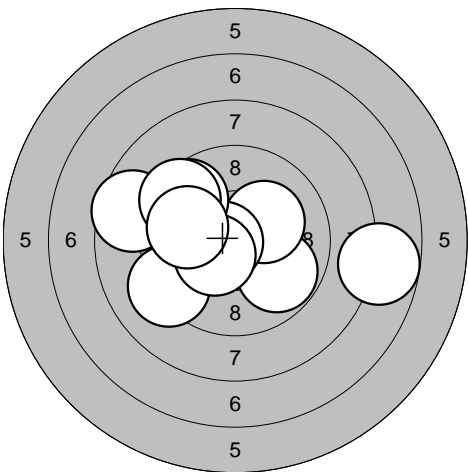
| | | | | | | | | | | | |
|---|--|-------|------|-----|-------|---|---|-------|------|-----|-------|
| <p>Series 5</p>  | <p>1: 8,6 ← 2: 9,6 ← 3: 10,1 ↘ 4: 10,3* ← 5: 9,9 ← 6: 9,2 ↗ 7: 10,4* ↘ 8: 10,2* → 9: 10,8* ↗ 10: 9,4 ←</p> <table border="1" style="width:100%; border-collapse: collapse;"> <tr><td style="text-align: right;">Serie</td><td style="text-align: right;">94,0</td></tr> <tr><td style="text-align: right;">Sum</td><td style="text-align: right;">475,0</td></tr> </table> | Serie | 94,0 | Sum | 475,0 | <p>Series 6</p>  | <p>1: 9,2 ← 2: 9,8 ↘ 3: 8,6 ← 4: 10,2* ↗ 5: 10,7* ← 6: 9,6 ↗ 7: 10,4* ↙ 8: 9,5 ↗ 9: 7,8 → 10: 9,9 ←</p> <table border="1" style="width:100%; border-collapse: collapse;"> <tr><td style="text-align: right;">Serie</td><td style="text-align: right;">90,0</td></tr> <tr><td style="text-align: right;">Sum</td><td style="text-align: right;">565,0</td></tr> </table> | Serie | 90,0 | Sum | 565,0 |
| Serie | 94,0 | | | | | | | | | | |
| Sum | 475,0 | | | | | | | | | | |
| Serie | 90,0 | | | | | | | | | | |
| Sum | 565,0 | | | | | | | | | | |

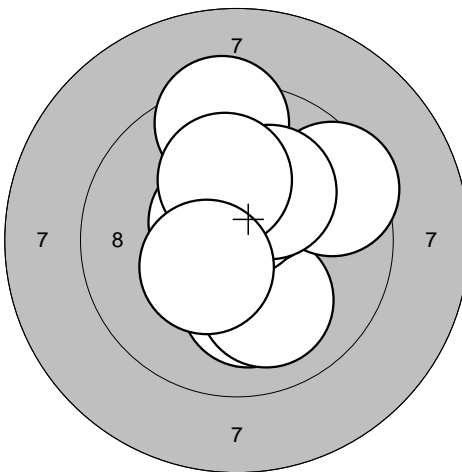
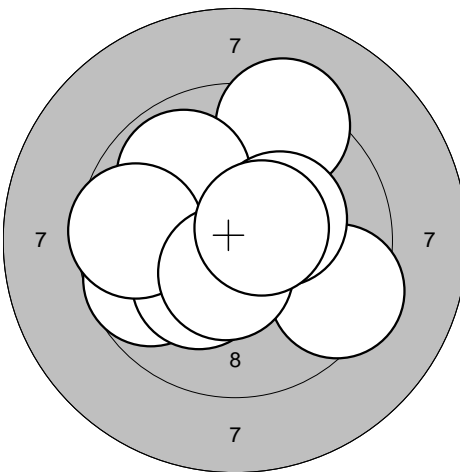
| | | | | | | | | | | | |
|--|--|-------|------|-----|------|--|---|-------|------|-----|-------|
| <p>Series 1</p>  | <p>1: 10,2* ↓ 2: 10,1 ↓ 3: 10,3* ↑ 4: 9,4 ↑ 5: 10,6* ↑ 6: 9,5 → 7: 10,6* ← 8: 10,2* ↑ 9: 10,1 ↑ 10: 10,4* ↙</p> <table border="1" style="width:100%; border-collapse: collapse;"> <tr><td>Serie</td><td style="text-align: right;">98,0</td></tr> <tr><td>Sum</td><td style="text-align: right;">98,0</td></tr> </table> | Serie | 98,0 | Sum | 98,0 | <p>Series 2</p>  | <p>1: 9,3 ↑ 2: 10,8* ← 3: 9,7 ← 4: 9,9 ↗ 5: 10,2* ↘ 6: 9,4 ↘ 7: 10,3* → 8: 9,6 ← 9: 10,5* ↓ 10: 10,6* →</p> <table border="1" style="width:100%; border-collapse: collapse;"> <tr><td>Serie</td><td style="text-align: right;">95,0</td></tr> <tr><td>Sum</td><td style="text-align: right;">193,0</td></tr> </table> | Serie | 95,0 | Sum | 193,0 |
| Serie | 98,0 | | | | | | | | | | |
| Sum | 98,0 | | | | | | | | | | |
| Serie | 95,0 | | | | | | | | | | |
| Sum | 193,0 | | | | | | | | | | |

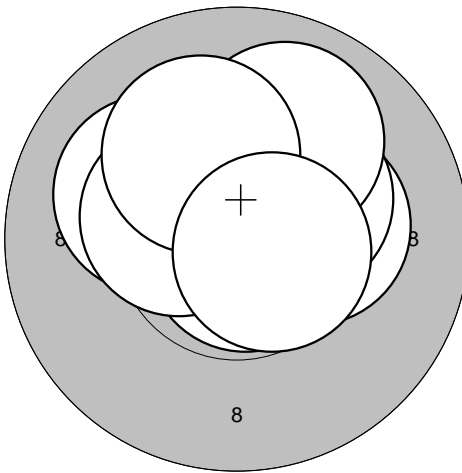
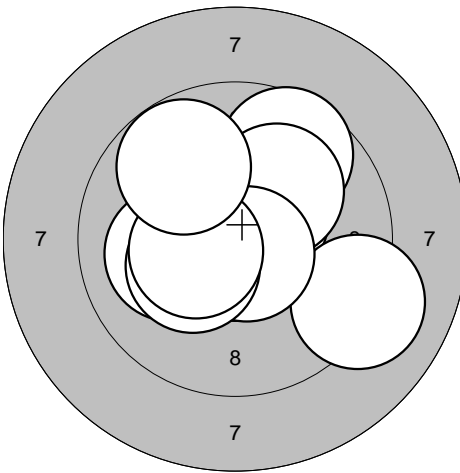
| | | | | | | | | | | | |
|---|---|-------|------|-----|-------|---|---|-------|------|-----|-------|
| <p>Series 3</p>  | <p>1: 10,3* ↑ 2: 10,1 ← 3: 10,8* ↓ 4: 10,5* ↑ 5: 10,2* → 6: 10,3* → 7: 10,4* ← 8: 9,9 ↑ 9: 10,1 ↑ 10: 10,6* →</p> <table border="1" style="width:100%; border-collapse: collapse;"> <tr><td>Serie</td><td style="text-align: right;">99,0</td></tr> <tr><td>Sum</td><td style="text-align: right;">292,0</td></tr> </table> | Serie | 99,0 | Sum | 292,0 | <p>Series 4</p>  | <p>1: 10,2* ↑ 2: 10,5* → 3: 9,6 ↑ 4: 10,1 ↗ 5: 9,1 ↘ 6: 10,7* ↘ 7: 10,1 ← 8: 10,3* ← 9: 10,4* ← 10: 9,8 ↗</p> <table border="1" style="width:100%; border-collapse: collapse;"> <tr><td>Serie</td><td style="text-align: right;">97,0</td></tr> <tr><td>Sum</td><td style="text-align: right;">389,0</td></tr> </table> | Serie | 97,0 | Sum | 389,0 |
| Serie | 99,0 | | | | | | | | | | |
| Sum | 292,0 | | | | | | | | | | |
| Serie | 97,0 | | | | | | | | | | |
| Sum | 389,0 | | | | | | | | | | |

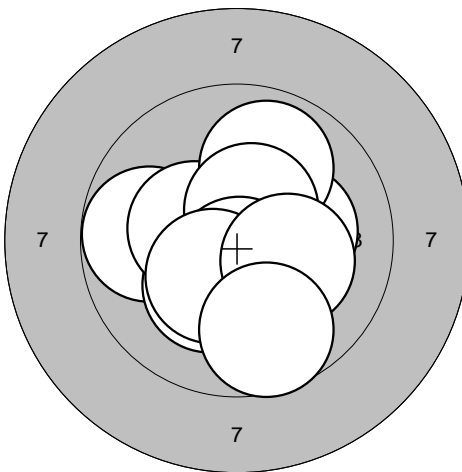
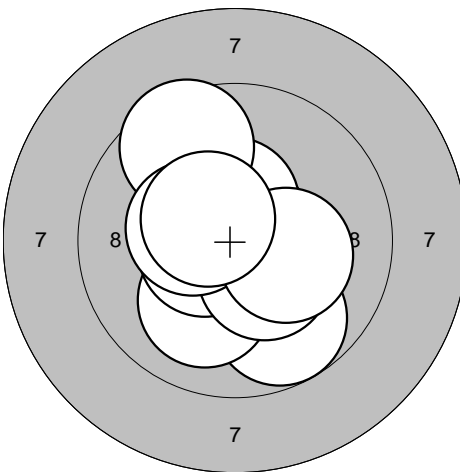
| | | | | | | | | | | | |
|--|---|-------|------|-----|-------|--|--|-------|------|-----|-------|
| <p>Series 5</p>  | <p>1: 9,8 ← 2: 10,3* ↘ 3: 10,4* ← 4: 10,2* → 5: 9,9 ↑ 6: 10,5* ↑ 7: 10,6* ↓ 8: 10,4* ↘ 9: 10,2* → 10: 9,7 ↓</p> <table border="1" style="width:100%; border-collapse: collapse;"> <tr><td>Serie</td><td style="text-align: right;">97,0</td></tr> <tr><td>Sum</td><td style="text-align: right;">486,0</td></tr> </table> | Serie | 97,0 | Sum | 486,0 | <p>Series 6</p>  | <p>1: 9,7 ↓ 2: 10,0 ↘ 3: 10,7* ↑ 4: 10,5* ↑ 5: 9,5 ↗ 6: 10,5* ← 7: 10,4* ↘ 8: 10,4* ← 9: 10,2* → 10: 10,5* ↗</p> <table border="1" style="width:100%; border-collapse: collapse;"> <tr><td>Serie</td><td style="text-align: right;">98,0</td></tr> <tr><td>Sum</td><td style="text-align: right;">584,0</td></tr> </table> | Serie | 98,0 | Sum | 584,0 |
| Serie | 97,0 | | | | | | | | | | |
| Sum | 486,0 | | | | | | | | | | |
| Serie | 98,0 | | | | | | | | | | |
| Sum | 584,0 | | | | | | | | | | |

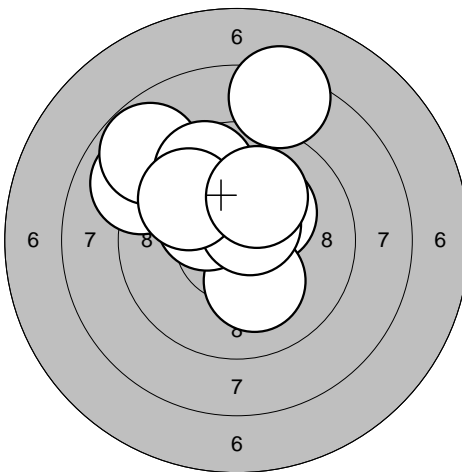
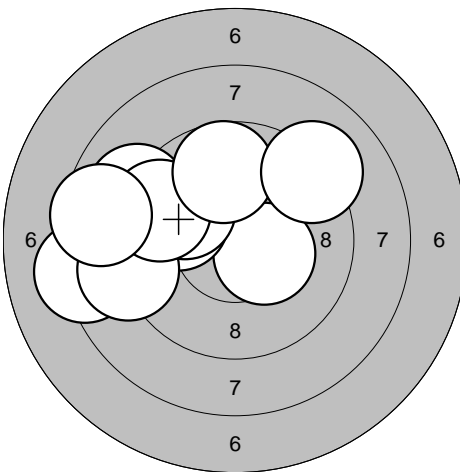
| | | | |
|--|---|--|--|
| <p>Series 1</p>  | <p>1: 10,3* ↗</p> <p>2: 9,0 ↗</p> <p>3: 10,2* ↓</p> <p>4: 8,8 ↗</p> <p>5: 9,6 ↗</p> <p>6: 10,3* ↗</p> <p>7: 8,3 ↗</p> <p>8: 10,6* ↗</p> <p>9: 9,8 ↗</p> <p>10: 10,1 ↗</p> | <p>Series 2</p>  | <p>1: 8,2 ←</p> <p>2: 10,4* →</p> <p>3: 9,9 ←</p> <p>4: 9,0 ←</p> <p>5: 9,9 ↗</p> <p>6: 9,0 ↗</p> <p>7: 9,5 ←</p> <p>8: 8,6 ←</p> <p>9: 9,7 ↑</p> <p>10: 9,1 ↗</p> |
| Serie 93,0 | Serie 89,0 | Serie 93,0 | Serie 89,0 |
| Sum 93,0 | Sum 182,0 | Sum 93,0 | Sum 182,0 |

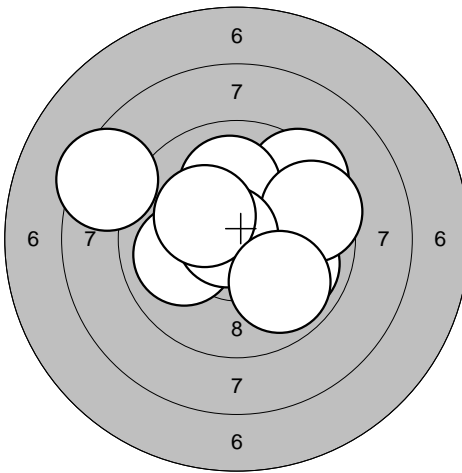
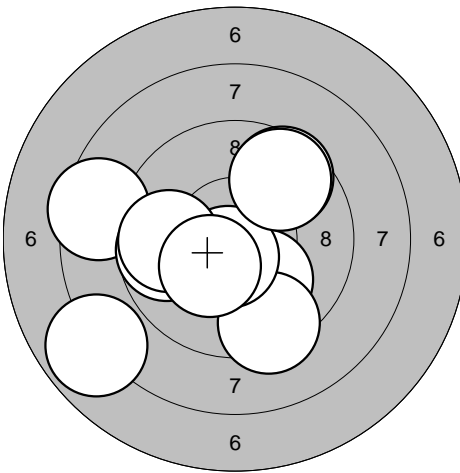
| | | | |
|---|---|---|---|
| <p>Series 3</p>  | <p>1: 9,9 →</p> <p>2: 10,1 →</p> <p>3: 9,4 ↗</p> <p>4: 10,0 ↑</p> <p>5: 9,5 →</p> <p>6: 10,0 ←</p> <p>7: 8,4 ↗</p> <p>8: 10,8* ←</p> <p>9: 10,3* ↗</p> <p>10: 9,9 ↓</p> | <p>Series 4</p>  | <p>1: 10,1 ↓</p> <p>2: 7,9 ←</p> <p>3: 9,6 ↗</p> <p>4: 9,4 ↓</p> <p>5: 8,5 ←</p> <p>6: 9,7 ←</p> <p>7: 10,6* ↓</p> <p>8: 9,8 ←</p> <p>9: 9,7 ↗</p> <p>10: 10,3* ↙</p> |
| Serie 94,0 | Serie 90,0 | Serie 94,0 | Serie 90,0 |
| Sum 276,0 | Sum 366,0 | Sum 276,0 | Sum 366,0 |

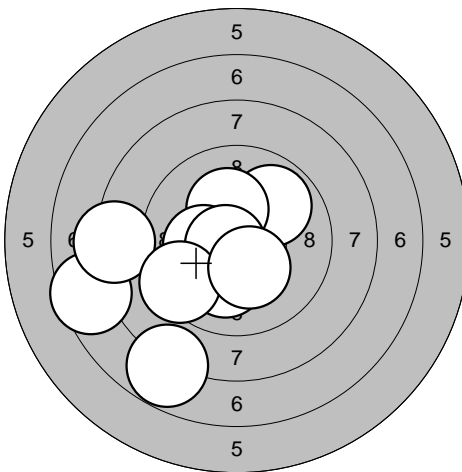
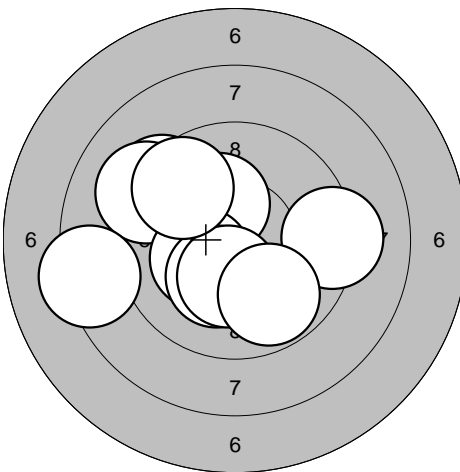
| | | | |
|--|---|--|--|
| <p>Series 5</p>  | <p>1: 9,9 ↗</p> <p>2: 10,1 ↓</p> <p>3: 10,2* ↑</p> <p>4: 10,2* ←</p> <p>5: 7,6 ←</p> <p>6: 7,8 ↓</p> <p>7: 8,3 ←</p> <p>8: 10,7* ←</p> <p>9: 9,4 ←</p> <p>10: 10,3* ↓</p> | <p>Series 6</p>  | <p>1: 9,3 ↗</p> <p>2: 10,2* ↑</p> <p>3: 9,2 ↗</p> <p>4: 9,2 →</p> <p>5: 10,3* ←</p> <p>6: 8,3 ←</p> <p>7: 10,2* ↓</p> <p>8: 10,3* ↓</p> <p>9: 9,6 ↗</p> <p>10: 9,8 ↓</p> |
| Serie 90,0 | Serie 93,0 | Serie 90,0 | Serie 93,0 |
| Sum 456,0 | Sum 549,0 | Sum 456,0 | Sum 549,0 |

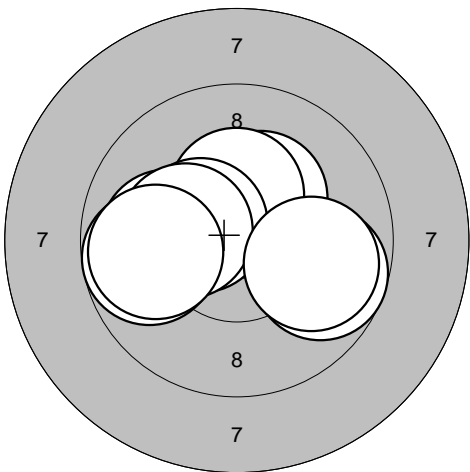
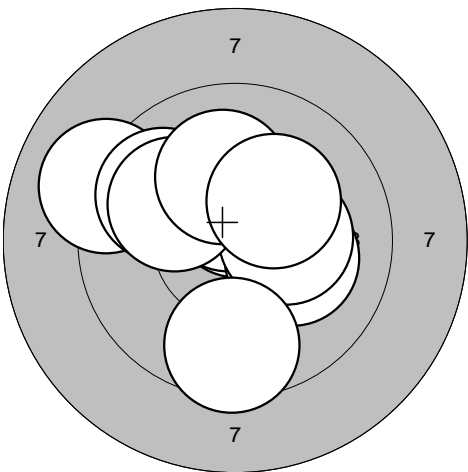
| | | | | | | | | | | | |
|--|--|-------|------|-----|------|--|---|-------|------|-----|-------|
| <p>Series 1</p>  | <p>1: 10,0 ←</p> <p>2: 10,5* ↑</p> <p>3: 10,3* ↗</p> <p>4: 10,4* ↑</p> <p>5: 10,4* ↖</p> <p>6: 9,7 →</p> <p>7: 9,8 ←</p> <p>8: 10,3* ←</p> <p>9: 9,9 →</p> <p>10: 9,9 ←</p> <table border="1" style="width:100%; border-collapse: collapse;"> <tr><td>Serie</td><td style="text-align: right;">96,0</td></tr> <tr><td>Sum</td><td style="text-align: right;">96,0</td></tr> </table> | Serie | 96,0 | Sum | 96,0 | <p>Series 2</p>  | <p>1: 9,1 ↖</p> <p>2: 10,6* ↑</p> <p>3: 10,4* ↑</p> <p>4: 10,1 →</p> <p>5: 10,3* →</p> <p>6: 9,8 ↖</p> <p>7: 10,0 ↖</p> <p>8: 10,1 ↑</p> <p>9: 9,5 ↓</p> <p>10: 10,2* ↗</p> <table border="1" style="width:100%; border-collapse: collapse;"> <tr><td>Serie</td><td style="text-align: right;">97,0</td></tr> <tr><td>Sum</td><td style="text-align: right;">193,0</td></tr> </table> | Serie | 97,0 | Sum | 193,0 |
| Serie | 96,0 | | | | | | | | | | |
| Sum | 96,0 | | | | | | | | | | |
| Serie | 97,0 | | | | | | | | | | |
| Sum | 193,0 | | | | | | | | | | |

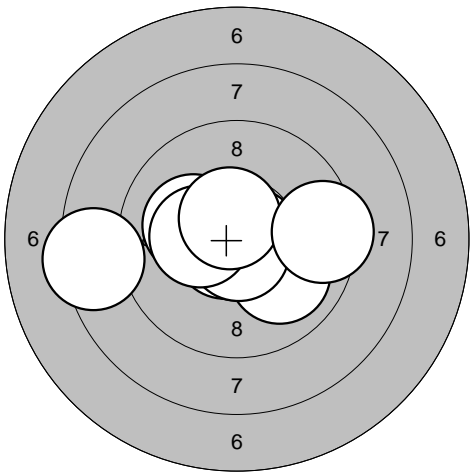
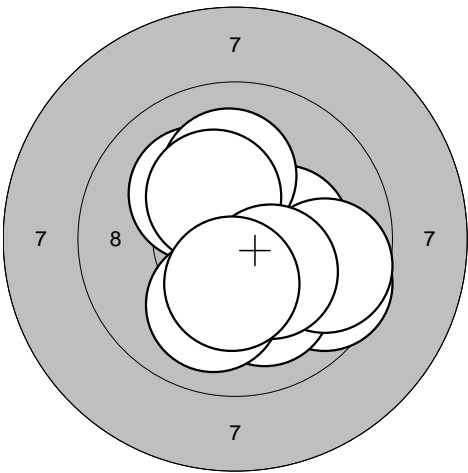
| | | | | | | | | | | | |
|---|--|-------|------|-----|-------|---|--|-------|------|-----|-------|
| <p>Series 3</p>  | <p>1: 10,7* ↖</p> <p>2: 8,4 ←</p> <p>3: 10,1 ↖</p> <p>4: 10,7* ↗</p> <p>5: 10,7* →</p> <p>6: 10,0 ↘</p> <p>7: 10,8* ↘</p> <p>8: 10,3* ←</p> <p>9: 10,6* ↑</p> <p>10: 9,4 →</p> <table border="1" style="width:100%; border-collapse: collapse;"> <tr><td>Serie</td><td style="text-align: right;">97,0</td></tr> <tr><td>Sum</td><td style="text-align: right;">290,0</td></tr> </table> | Serie | 97,0 | Sum | 290,0 | <p>Series 4</p>  | <p>1: 9,6 ↘</p> <p>2: 10,1 ↗</p> <p>3: 10,3* →</p> <p>4: 10,1 ↑</p> <p>5: 10,1 ↘</p> <p>6: 10,3* ↗</p> <p>7: 9,7 →</p> <p>8: 10,3* ↘</p> <p>9: 10,0 ↘</p> <p>10: 10,3* ↓</p> <table border="1" style="width:100%; border-collapse: collapse;"> <tr><td>Serie</td><td style="text-align: right;">98,0</td></tr> <tr><td>Sum</td><td style="text-align: right;">388,0</td></tr> </table> | Serie | 98,0 | Sum | 388,0 |
| Serie | 97,0 | | | | | | | | | | |
| Sum | 290,0 | | | | | | | | | | |
| Serie | 98,0 | | | | | | | | | | |
| Sum | 388,0 | | | | | | | | | | |

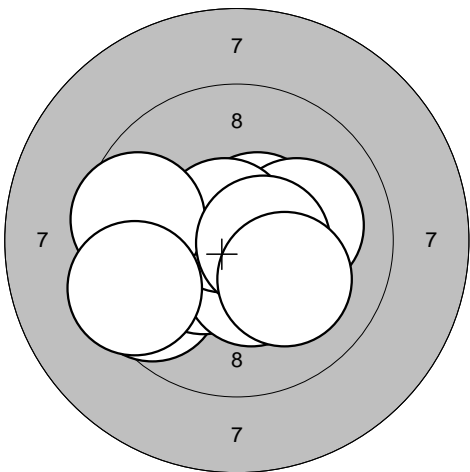
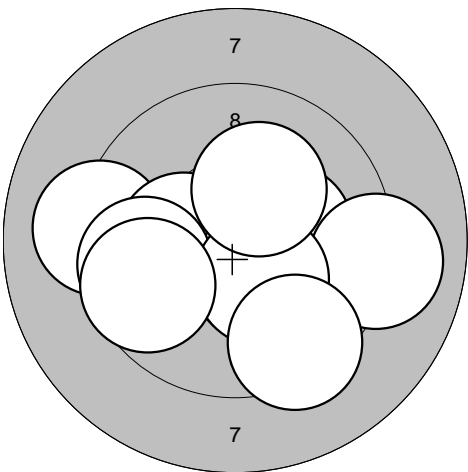
| | | | | | | | | | | | |
|--|--|-------|------|-----|-------|--|--|-------|------|-----|-------|
| <p>Series 5</p>  | <p>1: 9,6 ↖</p> <p>2: 10,5* ↗</p> <p>3: 10,4* ↖</p> <p>4: 10,4* ↘</p> <p>5: 10,1 →</p> <p>6: 10,7* ↗</p> <p>7: 9,6 ←</p> <p>8: 10,6* →</p> <p>9: 10,1 ↘</p> <p>10: 9,5 ←</p> <table border="1" style="width:100%; border-collapse: collapse;"> <tr><td>Serie</td><td style="text-align: right;">97,0</td></tr> <tr><td>Sum</td><td style="text-align: right;">485,0</td></tr> </table> | Serie | 97,0 | Sum | 485,0 | <p>Series 6</p>  | <p>1: 9,2 ←</p> <p>2: 10,3* ←</p> <p>3: 10,4* ↘</p> <p>4: 9,7 ←</p> <p>5: 10,3* →</p> <p>6: 9,0 →</p> <p>7: 10,3* ↘</p> <p>8: 10,2* ↗</p> <p>9: 9,4 ↘</p> <p>10: 9,6 ↖</p> <table border="1" style="width:100%; border-collapse: collapse;"> <tr><td>Serie</td><td style="text-align: right;">95,0</td></tr> <tr><td>Sum</td><td style="text-align: right;">580,0</td></tr> </table> | Serie | 95,0 | Sum | 580,0 |
| Serie | 97,0 | | | | | | | | | | |
| Sum | 485,0 | | | | | | | | | | |
| Serie | 95,0 | | | | | | | | | | |
| Sum | 580,0 | | | | | | | | | | |

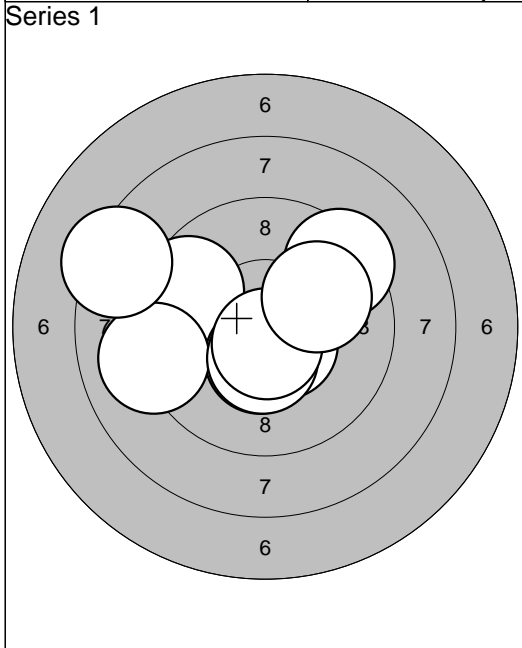

| | |
|-------------------|---|
| 1: 9,3 | ← |
| 2: 9,6 | ↖ |
| 3: 10,4* | ↓ |
| 4: 9,4 | ↗ |
| 5: 10,6* | ↘ |
| 6: 9,1 | ← |
| 7: 10,4* | ↓ |
| 8: 10,7* | ↓ |
| 9: 10,0 | ↗ |
| 10: 8,4 | ↖ |
| Serie 94,0 | |
| Sum 94,0 | |

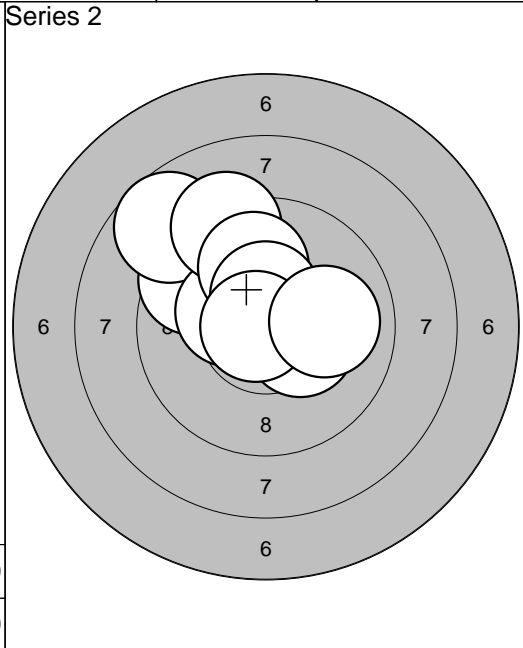

| | |
|-------------------|---|
| 1: 9,6 | ↖ |
| 2: 10,3* | ↗ |
| 3: 8,7 | ↗ |
| 4: 10,3* | ↖ |
| 5: 9,2 | ↗ |
| 6: 10,0 | ↑ |
| 7: 10,5* | ↑ |
| 8: 10,3* | → |
| 9: 10,8* | ← |
| 10: 10,0 | → |
| Serie 96,0 | |
| Sum 190,0 | |

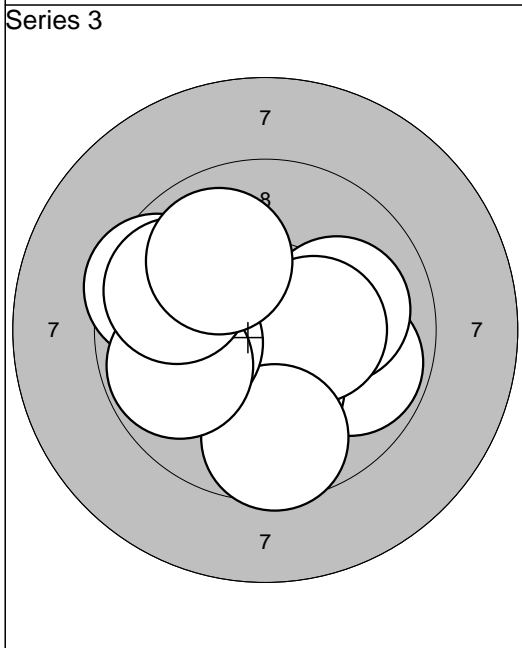

| | |
|-------------------|---|
| 1: 9,8 | → |
| 2: 10,0 | → |
| 3: 10,2* | ↓ |
| 4: 10,3* | → |
| 5: 9,6 | ↓ |
| 6: 10,0 | ← |
| 7: 9,5 | ↖ |
| 8: 9,8 | ← |
| 9: 9,8 | ↖ |
| 10: 9,9 | ↗ |
| Serie 94,0 | |
| Sum 284,0 | |

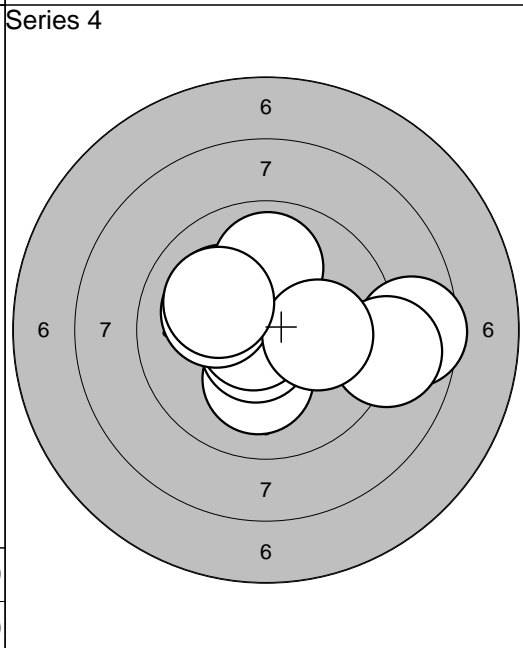

| | |
|-------------------|---|
| 1: 10,1 | ↓ |
| 2: 10,6* | ↘ |
| 3: 10,7* | ← |
| 4: 10,1 | ↖ |
| 5: 8,6 | → |
| 6: 9,9 | ↑ |
| 7: 10,1 | ↖ |
| 8: 9,0 | → |
| 9: 10,1 | → |
| 10: 10,1 | ↖ |
| Serie 96,0 | |
| Sum 380,0 | |

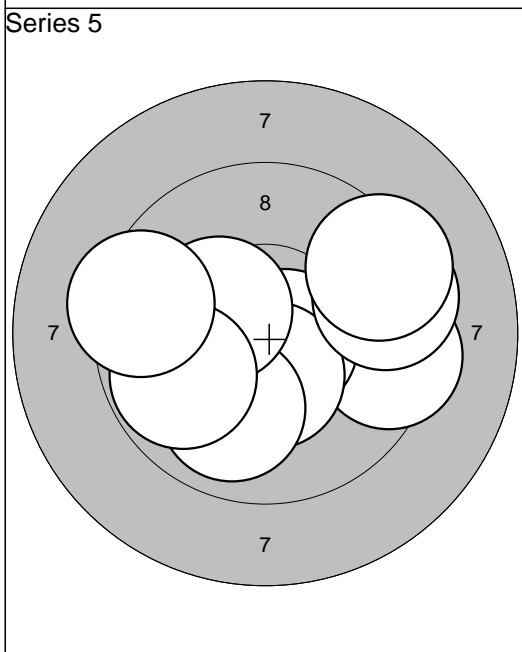

| | |
|-------------------|---|
| 1: 10,2* | ← |
| 2: 9,4 | → |
| 3: 10,7* | ↘ |
| 4: 10,4* | ↓ |
| 5: 10,0 | ↘ |
| 6: 10,3* | ↖ |
| 7: 9,4 | → |
| 8: 9,3 | ↗ |
| 9: 9,8 | ← |
| 10: 9,4 | ← |
| Serie 95,0 | |
| Sum 475,0 | |

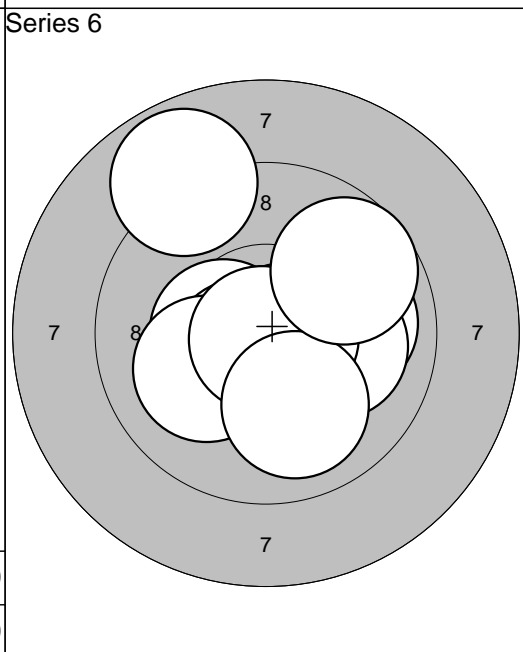

| | |
|-------------------|---|
| 1: 10,4* | ← |
| 2: 10,6* | ↘ |
| 3: 8,9 | ↗ |
| 4: 10,0 | → |
| 5: 10,1 | → |
| 6: 10,1 | ↖ |
| 7: 10,7* | → |
| 8: 10,9* | ↘ |
| 9: 10,0 | ↓ |
| 10: 9,7 | ↗ |
| Serie 97,0 | |
| Sum 572,0 | |

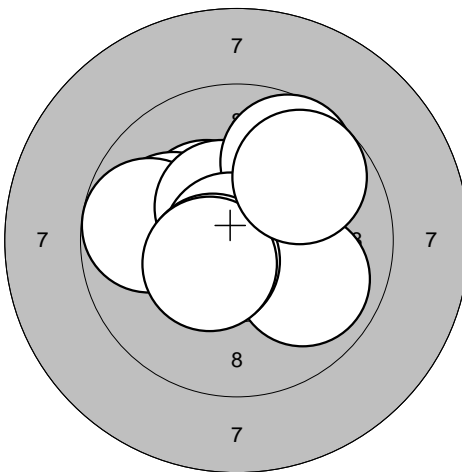
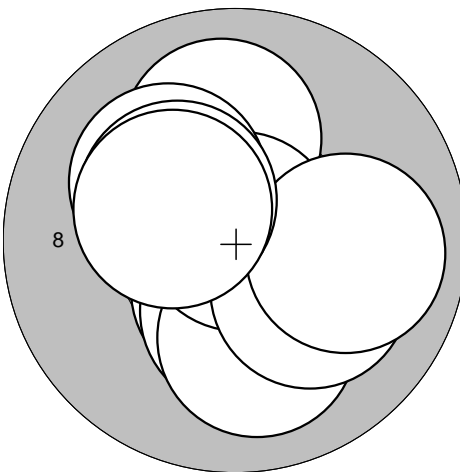
| | | | | | | | | | | | |
|--|---|-------|------|-----|------|--|---|-------|------|-----|-------|
| <p>Series 1</p>  | <p>1: 10,4* ↗ 2: 10,1 ← 3: 9,8 ← 4: 10,5* ↗ 5: 9,7 ↗ 6: 10,9* ← 7: 9,9 → 8: 10,5* ↙ 9: 10,5* ↙ 10: 9,8 ↗</p> <table border="1" style="width:100%; border-collapse: collapse;"> <tr><td>Serie</td><td style="text-align: right;">96,0</td></tr> <tr><td>Sum</td><td style="text-align: right;">96,0</td></tr> </table> | Serie | 96,0 | Sum | 96,0 | <p>Series 2</p>  | <p>1: 10,5* ↓ 2: 10,0 ↑ 3: 10,3* ↓ 4: 10,1 ↓ 5: 10,9* ↗ 6: 10,1 ↗ 7: 10,1 ↓ 8: 9,9 → 9: 10,3* ↗ 10: 10,3* ↖</p> <table border="1" style="width:100%; border-collapse: collapse;"> <tr><td>Serie</td><td style="text-align: right;">99,0</td></tr> <tr><td>Sum</td><td style="text-align: right;">195,0</td></tr> </table> | Serie | 99,0 | Sum | 195,0 |
| Serie | 96,0 | | | | | | | | | | |
| Sum | 96,0 | | | | | | | | | | |
| Serie | 99,0 | | | | | | | | | | |
| Sum | 195,0 | | | | | | | | | | |

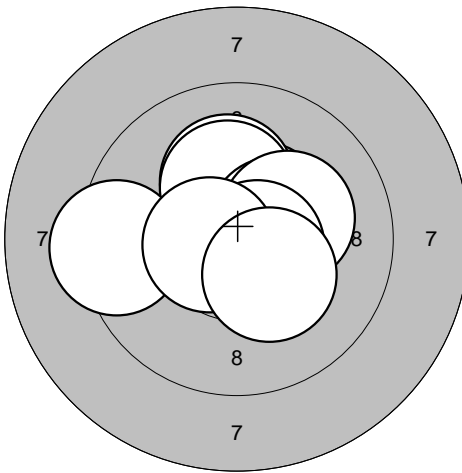
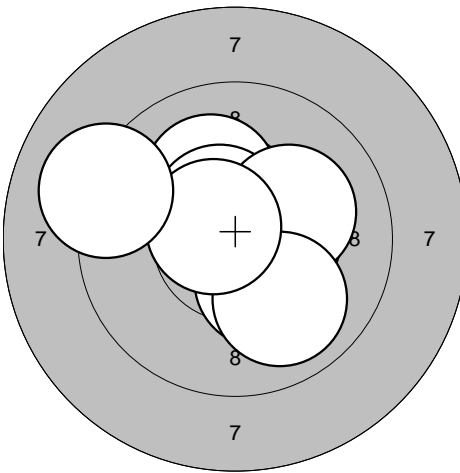
| | | | | | | | | | | | |
|---|---|-------|------|-----|-------|---|---|-------|------|-----|-------|
| <p>Series 3</p>  | <p>1: 10,7* ↗ 2: 10,4* ↗ 3: 10,2* ↑ 4: 10,2* ↑ 5: 10,4* → 6: 10,2* → 7: 10,7* → 8: 9,3 ← 9: 10,6* ← 10: 10,3* ↓</p> <table border="1" style="width:100%; border-collapse: collapse;"> <tr><td>Serie</td><td style="text-align: right;">99,0</td></tr> <tr><td>Sum</td><td style="text-align: right;">294,0</td></tr> </table> | Serie | 99,0 | Sum | 294,0 | <p>Series 4</p>  | <p>1: 10,4* ↓ 2: 10,3* ↓ 3: 10,4* ↑ 4: 10,1 ↑ 5: 10,5* ↗ 6: 10,4* → 7: 10,2* ↗ 8: 10,0 ↓ 9: 10,6* ↗ 10: 9,1 ↖</p> <table border="1" style="width:100%; border-collapse: collapse;"> <tr><td>Serie</td><td style="text-align: right;">99,0</td></tr> <tr><td>Sum</td><td style="text-align: right;">393,0</td></tr> </table> | Serie | 99,0 | Sum | 393,0 |
| Serie | 99,0 | | | | | | | | | | |
| Sum | 294,0 | | | | | | | | | | |
| Serie | 99,0 | | | | | | | | | | |
| Sum | 393,0 | | | | | | | | | | |

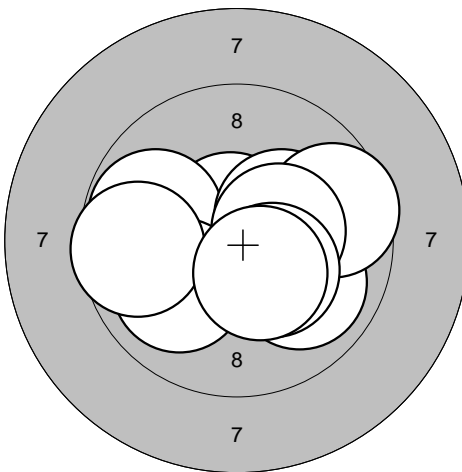
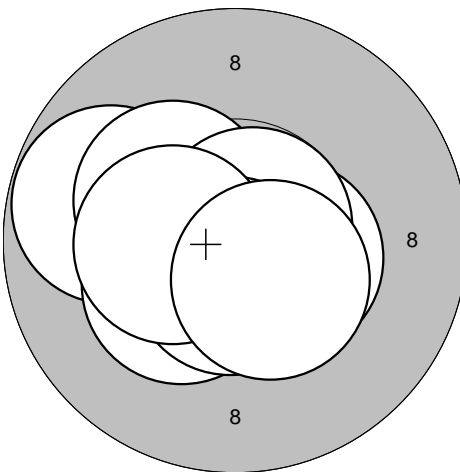
| | | | | | | | | | | | |
|--|--|-------|------|-----|-------|--|---|-------|------|-----|-------|
| <p>Series 5</p>  | <p>1: 10,7* ↗ 2: 9,8 ← 3: 9,9 ↓ 4: 10,3* ↗ 5: 9,6 → 6: 10,4* → 7: 10,0 ← 8: 10,3* ↙ 9: 9,6 ← 10: 10,4* ↓</p> <table border="1" style="width:100%; border-collapse: collapse;"> <tr><td>Serie</td><td style="text-align: right;">96,0</td></tr> <tr><td>Sum</td><td style="text-align: right;">489,0</td></tr> </table> | Serie | 96,0 | Sum | 489,0 | <p>Series 6</p>  | <p>1: 9,8 ← 2: 10,6* ← 3: 10,4* ← 4: 10,3* ↖ 5: 10,3* ↙ 6: 10,5* → 7: 10,8* ↗ 8: 10,6* ↓ 9: 10,4* ← 10: 10,5* ↓</p> <table border="1" style="width:100%; border-collapse: collapse;"> <tr><td>Serie</td><td style="text-align: right;">99,0</td></tr> <tr><td>Sum</td><td style="text-align: right;">588,0</td></tr> </table> | Serie | 99,0 | Sum | 588,0 |
| Serie | 96,0 | | | | | | | | | | |
| Sum | 489,0 | | | | | | | | | | |
| Serie | 99,0 | | | | | | | | | | |
| Sum | 588,0 | | | | | | | | | | |

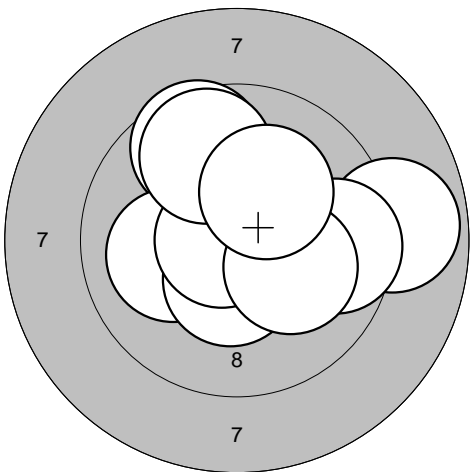
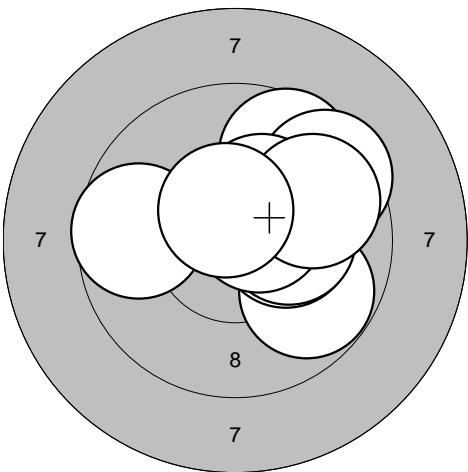
| | | | | | | | | | | | |
|--|--|-------|------|-----|------|--|---|-------|------|-----|-------|
| <p>Series 1</p>  | <p>1: 10,4* ↘ 2: 8,8 → 3: 9,6 ↑ 4: 10,1 ← 5: 10,4* ↓ 6: 10,8* ← 7: 9,6 → 8: 10,1 ↘ 9: 9,7 ↑ 10: 10,2* ↗</p> <table border="1" style="width:100%; border-collapse: collapse;"> <tr><td>Serie</td><td style="text-align: right;">95,0</td></tr> <tr><td>Sum</td><td style="text-align: right;">95,0</td></tr> </table> | Serie | 95,0 | Sum | 95,0 | <p>Series 2</p>  | <p>1: 9,6 ↗ 2: 9,5 ↗ 3: 9,8 ↘ 4: 10,3* → 5: 10,2* → 6: 10,3* ↗ 7: 9,7 ← 8: 10,6* ↗ 9: 9,8 ↗ 10: 10,5* ↗</p> <table border="1" style="width:100%; border-collapse: collapse;"> <tr><td>Serie</td><td style="text-align: right;">95,0</td></tr> <tr><td>Sum</td><td style="text-align: right;">190,0</td></tr> </table> | Serie | 95,0 | Sum | 190,0 |
| Serie | 95,0 | | | | | | | | | | |
| Sum | 95,0 | | | | | | | | | | |
| Serie | 95,0 | | | | | | | | | | |
| Sum | 190,0 | | | | | | | | | | |

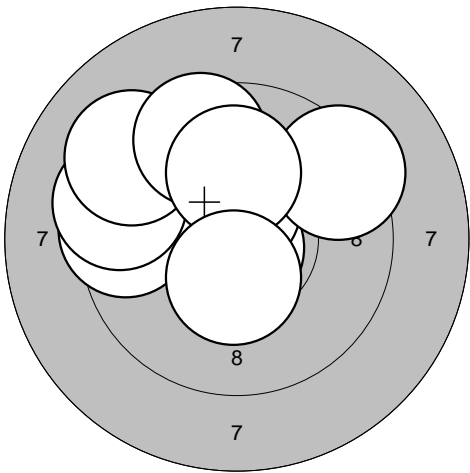
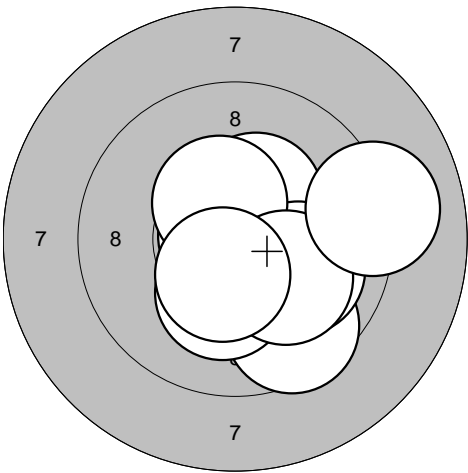
| | | | | | | | | | | | |
|---|---|-------|------|-----|-------|---|---|-------|------|-----|-------|
| <p>Series 3</p>  | <p>1: 10,8* ↓ 2: 10,5* ↑ 3: 9,3 ↗ 4: 10,1 ↗ 5: 9,5 ← 6: 9,3 ← 7: 9,2 ↗ 8: 9,6 ↑ 9: 10,1 ↑ 10: 10,4* ↓</p> <table border="1" style="width:100%; border-collapse: collapse;"> <tr><td>Serie</td><td style="text-align: right;">95,0</td></tr> <tr><td>Sum</td><td style="text-align: right;">285,0</td></tr> </table> | Serie | 95,0 | Sum | 285,0 | <p>Series 4</p>  | <p>1: 10,4* → 2: 10,3* ↗ 3: 9,6 ↘ 4: 10,2* ↓ 5: 10,8* ← 6: 10,0 ↘ 7: 10,4* ↗ 8: 10,1 ↘ 9: 10,5* ↓ 10: 9,1 →</p> <table border="1" style="width:100%; border-collapse: collapse;"> <tr><td>Serie</td><td style="text-align: right;">98,0</td></tr> <tr><td>Sum</td><td style="text-align: right;">383,0</td></tr> </table> | Serie | 98,0 | Sum | 383,0 |
| Serie | 95,0 | | | | | | | | | | |
| Sum | 285,0 | | | | | | | | | | |
| Serie | 98,0 | | | | | | | | | | |
| Sum | 383,0 | | | | | | | | | | |

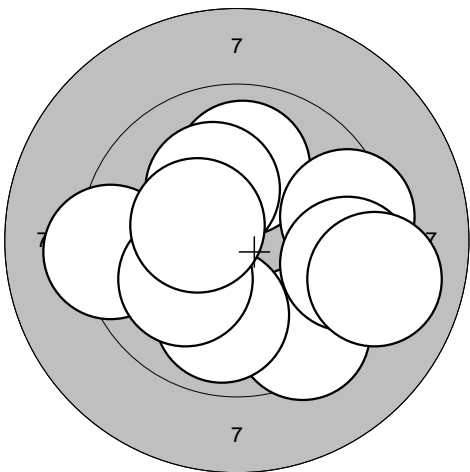
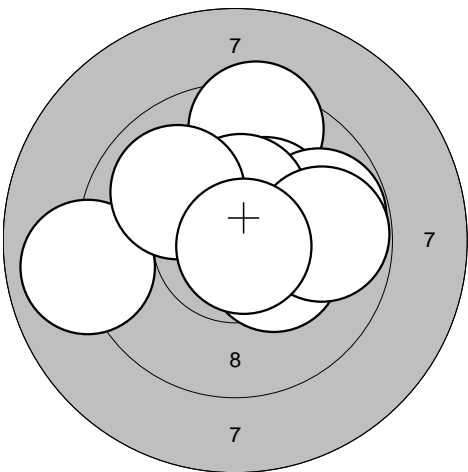
| | | | | | | | | | | | |
|--|---|-------|------|-----|-------|--|---|-------|------|-----|-------|
| <p>Series 5</p>  | <p>1: 9,3 ← 2: 10,0 ↑ 3: 9,4 ↘ 4: 9,9 ↓ 5: 9,4 → 6: 9,4 → 7: 9,0 → 8: 10,1 ← 9: 10,2* ↑ 10: 10,4* ←</p> <table border="1" style="width:100%; border-collapse: collapse;"> <tr><td>Serie</td><td style="text-align: right;">94,0</td></tr> <tr><td>Sum</td><td style="text-align: right;">477,0</td></tr> </table> | Serie | 94,0 | Sum | 477,0 | <p>Series 6</p>  | <p>1: 9,0 ← 2: 9,4 ↑ 3: 10,5* ↗ 4: 10,3* ↗ 5: 9,8 → 6: 10,3* ↘ 7: 10,4* ↑ 8: 9,9 ↗ 9: 9,8 → 10: 10,8* ↘</p> <table border="1" style="width:100%; border-collapse: collapse;"> <tr><td>Serie</td><td style="text-align: right;">95,0</td></tr> <tr><td>Sum</td><td style="text-align: right;">572,0</td></tr> </table> | Serie | 95,0 | Sum | 572,0 |
| Serie | 94,0 | | | | | | | | | | |
| Sum | 477,0 | | | | | | | | | | |
| Serie | 95,0 | | | | | | | | | | |
| Sum | 572,0 | | | | | | | | | | |

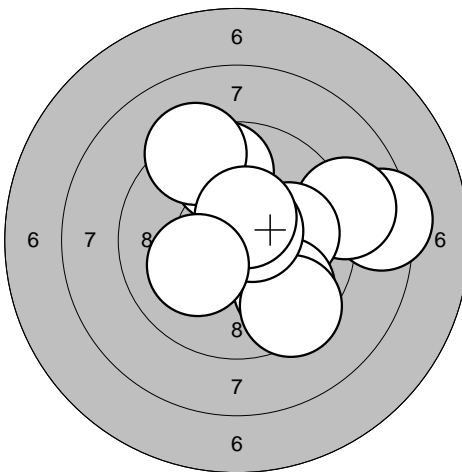
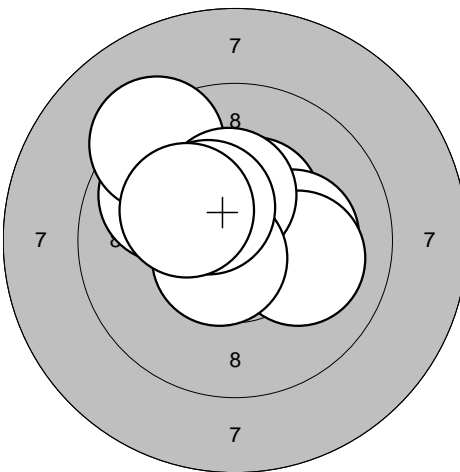
| | | | |
|--|--|--|---|
| <p>Series 1</p>  | <p>1: 8,4 →</p> <p>2: 9,7 ↑</p> <p>3: 8,9 →</p> <p>4: 10,0 →</p> <p>5: 9,3 ↑</p> <p>6: 9,7 ↓</p> <p>7: 9,4 ↓</p> <p>8: 10,6* ↗</p> <p>9: 10,5* ↑</p> <p>10: 10,1 ↙</p> | <p>Series 2</p>  | <p>1: 9,8 ↖</p> <p>2: 10,4* ↖</p> <p>3: 10,4* ↗</p> <p>4: 10,2* →</p> <p>5: 10,1 →</p> <p>6: 9,3 ↗</p> <p>7: 10,4* ↑</p> <p>8: 10,6* ↙</p> <p>9: 10,4* ↗</p> <p>10: 10,2* ↖</p> |
| Serie 92,0 | | Serie 98,0 | |
| Sum 92,0 | | Sum 190,0 | |

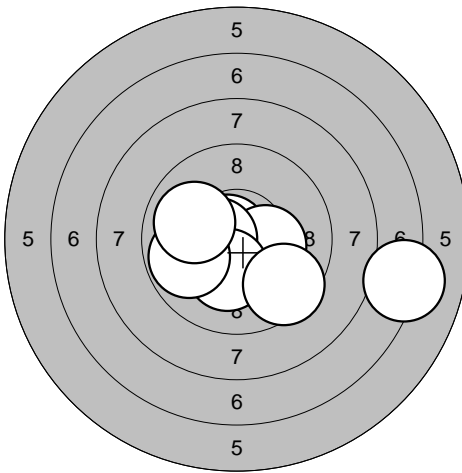
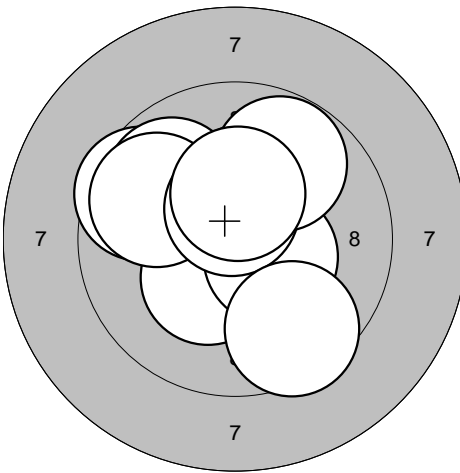
| | | | |
|---|--|---|--|
| <p>Series 3</p>  | <p>1: 10,4* ←</p> <p>2: 10,7* ↖</p> <p>3: 10,3* →</p> <p>4: 10,2* ←</p> <p>5: 10,5* ←</p> <p>6: 10,3* ↓</p> <p>7: 7,2 →</p> <p>8: 9,8 ←</p> <p>9: 9,9 ↖</p> <p>10: 9,5 ↓</p> | <p>Series 4</p>  | <p>1: 10,3* ↙</p> <p>2: 9,6 ↖</p> <p>3: 10,3* ↑</p> <p>4: 9,9 ↗</p> <p>5: 10,4* →</p> <p>6: 9,8 ↖</p> <p>7: 10,5* ↑</p> <p>8: 9,8 ↗</p> <p>9: 9,5 ↓</p> <p>10: 10,4* ↑</p> |
| Serie 94,0 | | Serie 95,0 | |
| Sum 284,0 | | Sum 379,0 | |

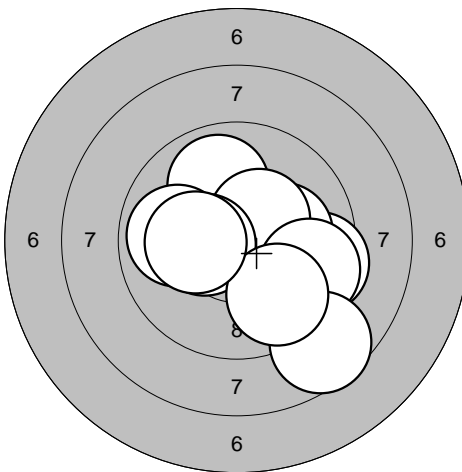
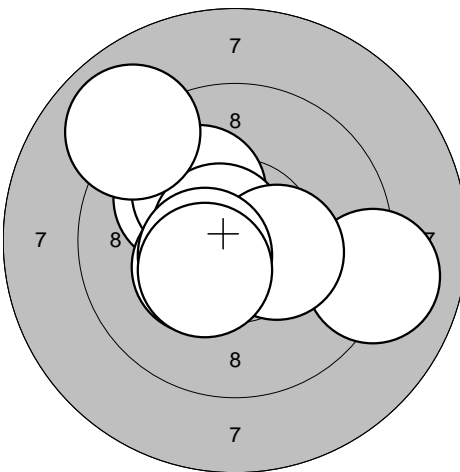
| | | | |
|--|---|--|--|
| <p>Series 5</p>  | <p>1: 9,4 →</p> <p>2: 10,1 →</p> <p>3: 9,9 ↑</p> <p>4: 10,4* ↗</p> <p>5: 9,6 →</p> <p>6: 9,9 ←</p> <p>7: 10,4* ←</p> <p>8: 8,6 ↓</p> <p>9: 9,7 ↓</p> <p>10: 10,2* ←</p> | <p>Series 6</p>  | <p>1: 9,1 →</p> <p>2: 10,8* ↓</p> <p>3: 10,0 ↖</p> <p>4: 10,1 ↗</p> <p>5: 10,7* ↖</p> <p>6: 10,3* ↙</p> <p>7: 10,4* →</p> <p>8: 10,5* ←</p> <p>9: 10,4* ↙</p> <p>10: 9,0 ↖</p> |
| Serie 93,0 | | Serie 98,0 | |
| Sum 472,0 | | Sum 570,0 | |

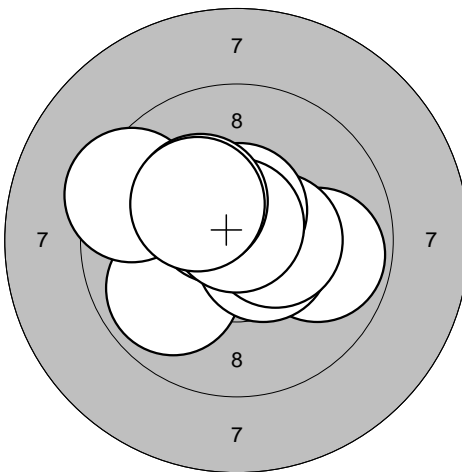
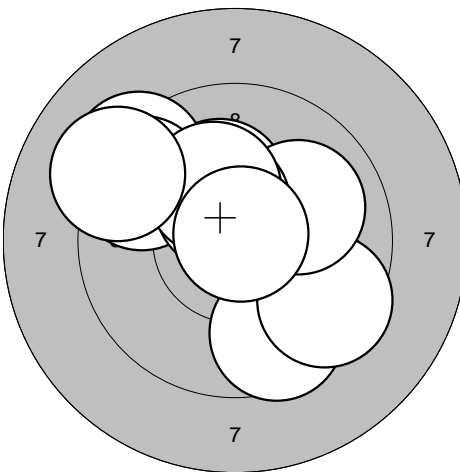
| | | | |
|--|--|--|--|
| <p>Series 1</p>  | <p>1: 9,9 →</p> <p>2: 9,9 ↙</p> <p>3: 10,6* ↗</p> <p>4: 10,5* ↘</p> <p>5: 10,4* →</p> <p>6: 10,6* ↑</p> <p>7: 9,4 ←</p> <p>8: 10,7* ↑</p> <p>9: 10,2* ↗</p> <p>10: 10,2* ↖</p> <hr/> <p>Serie 97,0</p> <hr/> <p>Sum 97,0</p> | <p>Series 2</p>  | <p>1: 9,6 ↓</p> <p>2: 10,2* ↑</p> <p>3: 9,3 ↗</p> <p>4: 9,5 ↘</p> <p>5: 9,5 ↗</p> <p>6: 10,0 →</p> <p>7: 10,4* ↑</p> <p>8: 10,2* ↑</p> <p>9: 9,2 ↖</p> <p>10: 10,8* ↗</p> <hr/> <p>Serie 95,0</p> <hr/> <p>Sum 192,0</p> |
|--|--|--|--|

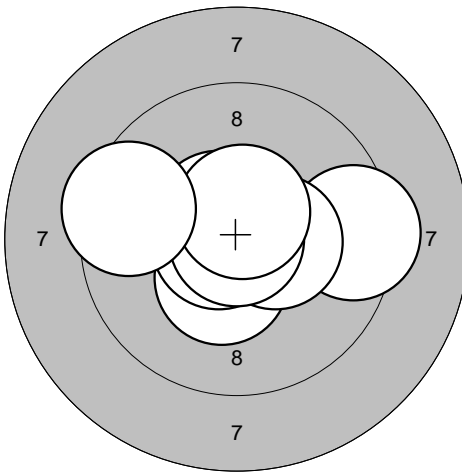
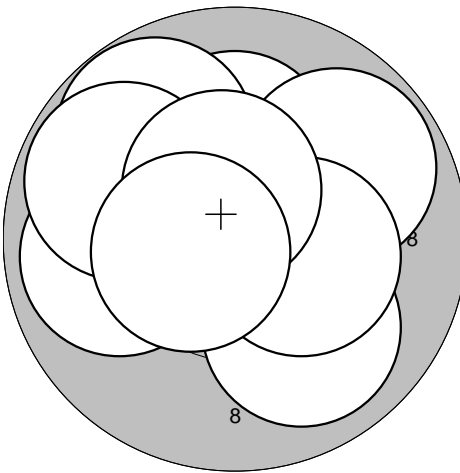
| | | | |
|---|---|---|---|
| <p>Series 3</p>  | <p>1: 10,7* ↖</p> <p>2: 10,8* ↙</p> <p>3: 10,6* ↗</p> <p>4: 10,4* ↘</p> <p>5: 9,4 →</p> <p>6: 10,7* ←</p> <p>7: 10,4* →</p> <p>8: 10,9*</p> <p>9: 10,6* ↑</p> <p>10: 9,5 ←</p> <hr/> <p>Serie 98,0</p> <hr/> <p>Sum 290,0</p> | <p>Series 4</p>  | <p>1: 10,1 ↑</p> <p>2: 9,8 ↖</p> <p>3: 9,9 ←</p> <p>4: 9,8 →</p> <p>5: 10,7* ↗</p> <p>6: 10,0 ↓</p> <p>7: 10,3* →</p> <p>8: 9,8 ↖</p> <p>9: 10,5* ↑</p> <p>10: 10,5* ←</p> <hr/> <p>Serie 96,0</p> <hr/> <p>Sum 386,0</p> |
|---|---|---|---|

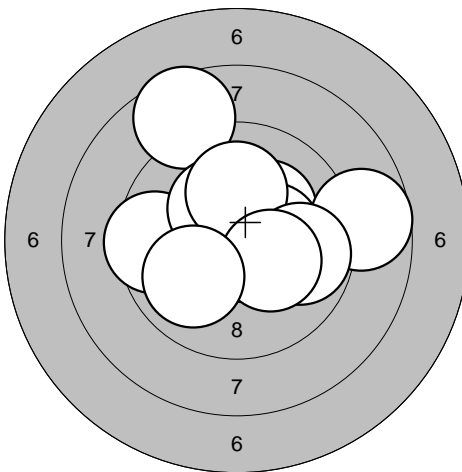
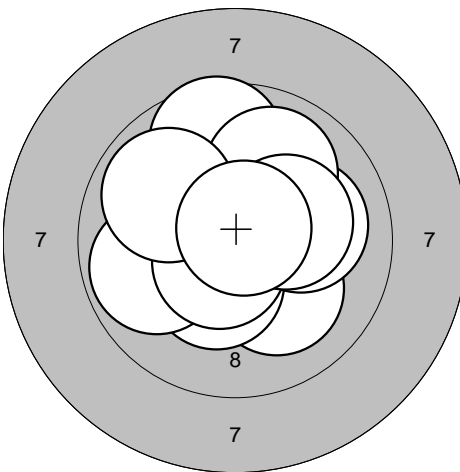
| | | | |
|--|---|--|--|
| <p>Series 5</p>  | <p>1: 10,2* ↗</p> <p>2: 9,5 ←</p> <p>3: 8,6 ↑</p> <p>4: 10,3* ↗</p> <p>5: 10,3* →</p> <p>6: 8,7 →</p> <p>7: 10,1 ↑</p> <p>8: 9,8 →</p> <p>9: 10,3* ↘</p> <p>10: 10,0 ↙</p> <hr/> <p>Serie 94,0</p> <hr/> <p>Sum 480,0</p> | <p>Series 6</p>  | <p>1: 10,1 ↓</p> <p>2: 10,4* ↘</p> <p>3: 9,6 ↑</p> <p>4: 9,9 ←</p> <p>5: 10,0 →</p> <p>6: 10,0 ↑</p> <p>7: 10,6* ↘</p> <p>8: 10,2* →</p> <p>9: 9,9 ↖</p> <p>10: 10,8* ↗</p> <hr/> <p>Serie 97,0</p> <hr/> <p>Sum 577,0</p> |
|--|---|--|--|

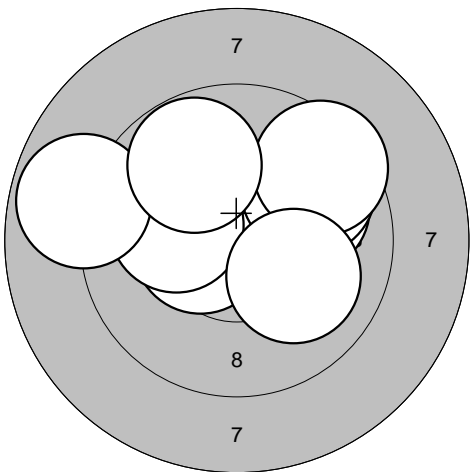
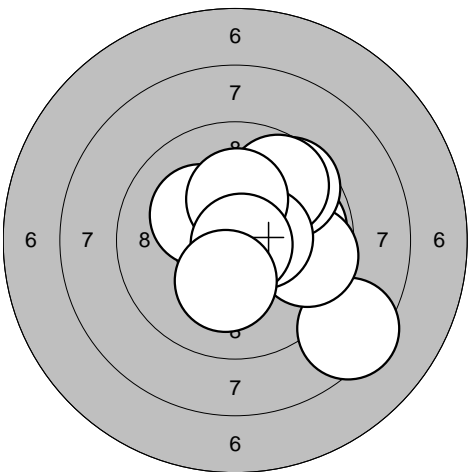
| | | | |
|--|---|--|--|
| <p>Series 1</p>  | <p>1: 10,0 →</p> <p>2: 10,4* →</p> <p>3: 10,4* ↖</p> <p>4: 10,5* ←</p> <p>5: 9,8 ↗</p> <p>6: 10,1 ←</p> <p>7: 9,5 ↗</p> <p>8: 8,9 ←</p> <p>9: 9,8 ↗</p> <p>10: 10,1 ↘</p> | <p>Series 2</p>  | <p>1: 9,8 →</p> <p>2: 10,2* ↖</p> <p>3: 8,4 ↘</p> <p>4: 9,6 →</p> <p>5: 9,6 ↗</p> <p>6: 9,7 ↗</p> <p>7: 10,5* →</p> <p>8: 10,2* ↑</p> <p>9: 10,8* ↘</p> <p>10: 10,2* ↓</p> |
| Serie 95,0 | Serie 95,0 | Serie 94,0 | Serie 94,0 |
| Sum 95,0 | Sum 95,0 | Sum 189,0 | Sum 189,0 |

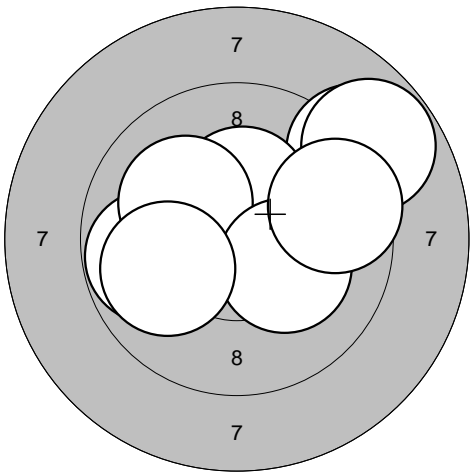
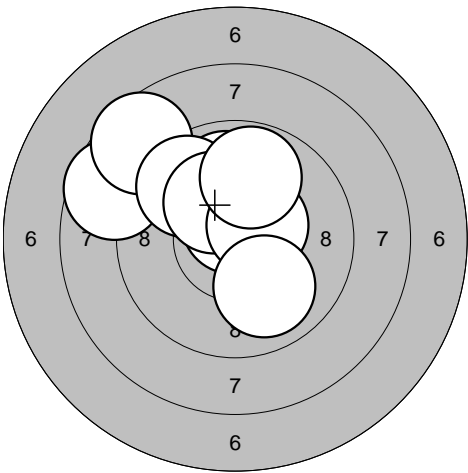
| | | | |
|---|--|---|--|
| <p>Series 3</p>  | <p>1: 10,2* →</p> <p>2: 9,8 →</p> <p>3: 9,8 ←</p> <p>4: 9,0 ↗</p> <p>5: 10,3* ↑</p> <p>6: 10,1 ↖</p> <p>7: 10,2* ↘</p> <p>8: 8,8 ↗</p> <p>9: 9,6 →</p> <p>10: 10,0 ←</p> | <p>Series 4</p>  | <p>1: 8,6 ↖</p> <p>2: 10,0 ↑</p> <p>3: 10,5* ↗</p> <p>4: 8,6 ↖</p> <p>5: 10,7* ↑</p> <p>6: 9,7 ↗</p> <p>7: 10,2* ↗</p> <p>8: 10,5* ↗</p> <p>9: 10,0 ↘</p> <p>10: 9,8 ↑</p> |
| Serie 94,0 | Serie 94,0 | Serie 94,0 | Serie 94,0 |
| Sum 283,0 | Sum 283,0 | Sum 377,0 | Sum 377,0 |

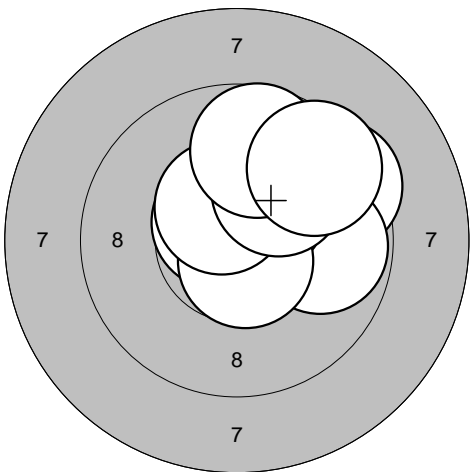
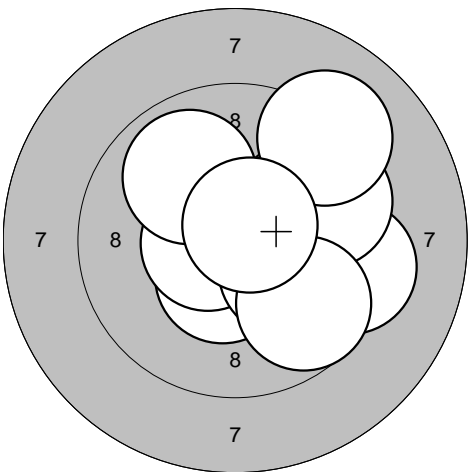
| | | | |
|--|---|--|---|
| <p>Series 5</p>  | <p>1: 10,6* ↖</p> <p>2: 9,4 ↗</p> <p>3: 9,8 →</p> <p>4: 10,4* ↗</p> <p>5: 9,8 ↑</p> <p>6: 10,6* ↘</p> <p>7: 10,5* ↗</p> <p>8: 10,1 ↗</p> <p>9: 9,7 ↑</p> <p>10: 9,5 ↗</p> | <p>Series 6</p>  | <p>1: 10,4* ↓</p> <p>2: 10,6* ←</p> <p>3: 10,1 ↘</p> <p>4: 9,9 ↗</p> <p>5: 9,4 →</p> <p>6: 9,9 ↗</p> <p>7: 9,6 ↗</p> <p>8: 9,7 ↘</p> <p>9: 9,1 ↗</p> <p>10: 10,7* ↗</p> |
| Serie 95,0 | Serie 95,0 | Serie 94,0 | Serie 94,0 |
| Sum 472,0 | Sum 472,0 | Sum 566,0 | Sum 566,0 |

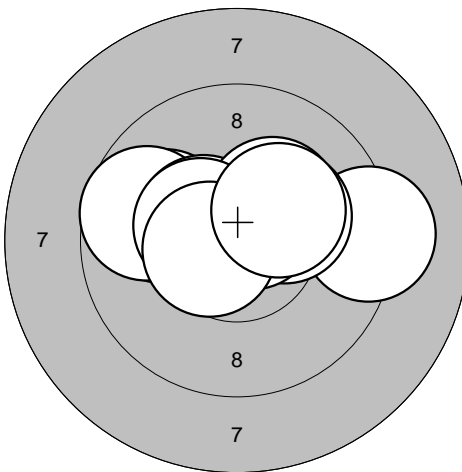
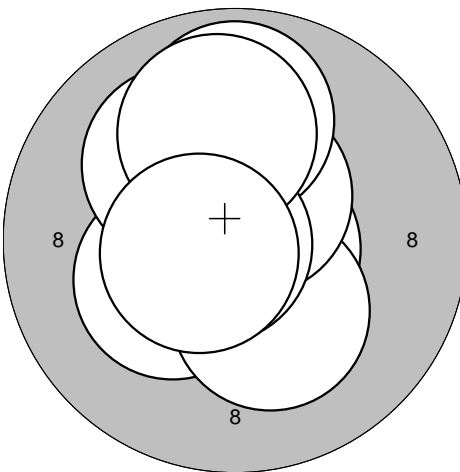
| | | | | | | | | | | | |
|--|---|-------|------|-----|------|--|--|-------|------|-----|-------|
| <p>Series 1</p>  | <p>1: 9,9 ←</p> <p>2: 9,2 →</p> <p>3: 9,7 ←</p> <p>4: 10,4* ↖</p> <p>5: 10,3* →</p> <p>6: 10,6* ↗</p> <p>7: 10,3* ↗</p> <p>8: 10,4* ↖</p> <p>9: 10,6* ←</p> <p>10: 10,3* ↗</p> <table border="1" style="width:100%; border-collapse: collapse;"> <tr><td style="text-align: right;">Serie</td><td style="text-align: right;">97,0</td></tr> <tr><td style="text-align: right;">Sum</td><td style="text-align: right;">97,0</td></tr> </table> | Serie | 97,0 | Sum | 97,0 | <p>Series 2</p>  | <p>1: 10,3* ↖</p> <p>2: 10,8* ↑</p> <p>3: 10,7* →</p> <p>4: 10,2* ↓</p> <p>5: 10,5* ↗</p> <p>6: 9,9 ↑</p> <p>7: 10,1 ↖</p> <p>8: 10,7* ←</p> <p>9: 10,0 ↑</p> <p>10: 10,6* ↖</p> <table border="1" style="width:100%; border-collapse: collapse;"> <tr><td style="text-align: right;">Serie</td><td style="text-align: right;">99,0</td></tr> <tr><td style="text-align: right;">Sum</td><td style="text-align: right;">196,0</td></tr> </table> | Serie | 99,0 | Sum | 196,0 |
| Serie | 97,0 | | | | | | | | | | |
| Sum | 97,0 | | | | | | | | | | |
| Serie | 99,0 | | | | | | | | | | |
| Sum | 196,0 | | | | | | | | | | |

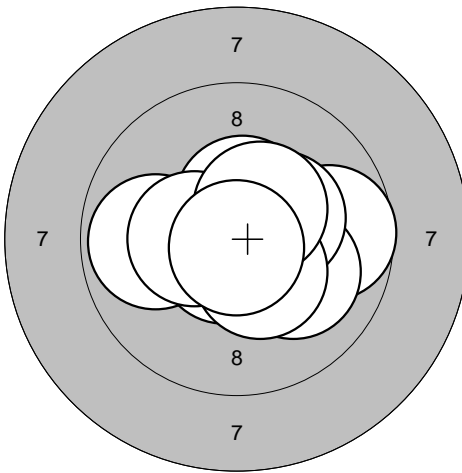
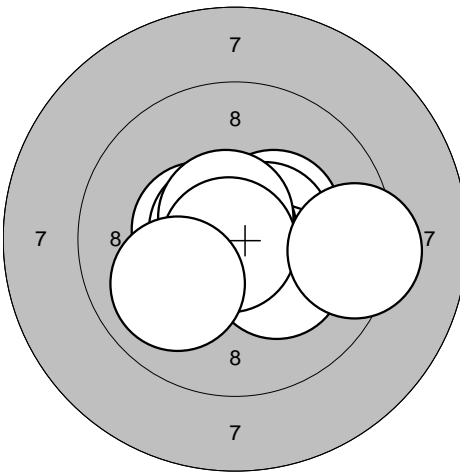
| | | | | | | | | | | | |
|---|---|-------|------|-----|-------|---|---|-------|------|-----|-------|
| <p>Series 3</p>  | <p>1: 9,9 ←</p> <p>2: 9,7 →</p> <p>3: 10,7* ↙</p> <p>4: 10,5* ↑</p> <p>5: 10,4* ←</p> <p>6: 10,1 →</p> <p>7: 10,3* →</p> <p>8: 10,4* ↘</p> <p>9: 10,4* ↗</p> <p>10: 10,8* ↓</p> <table border="1" style="width:100%; border-collapse: collapse;"> <tr><td style="text-align: right;">Serie</td><td style="text-align: right;">98,0</td></tr> <tr><td style="text-align: right;">Sum</td><td style="text-align: right;">294,0</td></tr> </table> | Serie | 98,0 | Sum | 294,0 | <p>Series 4</p>  | <p>1: 10,4* ↗</p> <p>2: 10,5* →</p> <p>3: 10,2* ↘</p> <p>4: 10,5* ←</p> <p>5: 10,7* ↖</p> <p>6: 10,8* ↗</p> <p>7: 10,6* ↗</p> <p>8: 10,9* ↙</p> <p>9: 10,0 ↙</p> <p>10: 9,3 →</p> <table border="1" style="width:100%; border-collapse: collapse;"> <tr><td style="text-align: right;">Serie</td><td style="text-align: right;">99,0</td></tr> <tr><td style="text-align: right;">Sum</td><td style="text-align: right;">393,0</td></tr> </table> | Serie | 99,0 | Sum | 393,0 |
| Serie | 98,0 | | | | | | | | | | |
| Sum | 294,0 | | | | | | | | | | |
| Serie | 99,0 | | | | | | | | | | |
| Sum | 393,0 | | | | | | | | | | |

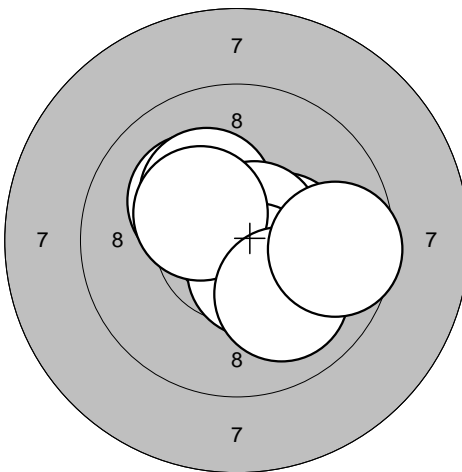
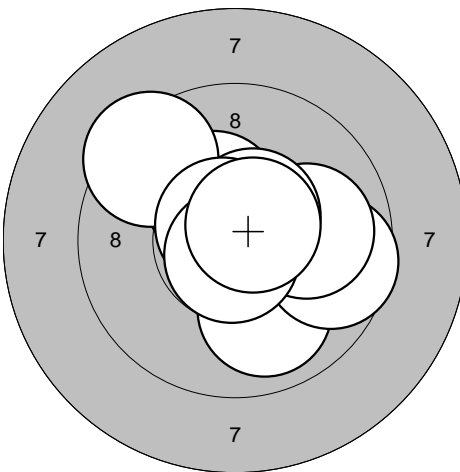
| | | | | | | | | | | | |
|--|---|-------|------|-----|-------|--|---|-------|------|-----|-------|
| <p>Series 5</p>  | <p>1: 10,6* ↘</p> <p>2: 10,2* ↗</p> <p>3: 10,2* ↗</p> <p>4: 10,3* →</p> <p>5: 10,8* ↗</p> <p>6: 10,7* ↗</p> <p>7: 10,5* ↘</p> <p>8: 10,3* ↗</p> <p>9: 10,0 ↘</p> <p>10: 9,6 →</p> <table border="1" style="width:100%; border-collapse: collapse;"> <tr><td style="text-align: right;">Serie</td><td style="text-align: right;">99,0</td></tr> <tr><td style="text-align: right;">Sum</td><td style="text-align: right;">492,0</td></tr> </table> | Serie | 99,0 | Sum | 492,0 | <p>Series 6</p>  | <p>1: 10,3* ↗</p> <p>2: 9,4 ↖</p> <p>3: 10,6* ↗</p> <p>4: 9,9 ↓</p> <p>5: 9,6 →</p> <p>6: 10,0 →</p> <p>7: 10,5* ↗</p> <p>8: 10,7* ↖</p> <p>9: 10,7* ↓</p> <p>10: 10,6* ↗</p> <table border="1" style="width:100%; border-collapse: collapse;"> <tr><td style="text-align: right;">Serie</td><td style="text-align: right;">97,0</td></tr> <tr><td style="text-align: right;">Sum</td><td style="text-align: right;">589,0</td></tr> </table> | Serie | 97,0 | Sum | 589,0 |
| Serie | 99,0 | | | | | | | | | | |
| Sum | 492,0 | | | | | | | | | | |
| Serie | 97,0 | | | | | | | | | | |
| Sum | 589,0 | | | | | | | | | | |

| | | | |
|-----------------|---|-----------------|---|
| <p>Series 1</p> | <p>1: 10,2* →</p> <p>2: 10,0 ↓</p> <p>3: 10,3* ↗</p> <p>4: 9,9 →</p> <p>5: 9,8 →</p> <p>6: 9,5 ←</p> <p>7: 10,6* ↓</p> <p>8: 10,3* ←</p> <p>9: 10,5* ←</p> <p>10: 9,9 ↖</p> | <p>Series 2</p> | <p>1: 10,2* ↓</p> <p>2: 10,8* ↑</p> <p>3: 10,6* ←</p> <p>4: 10,4* ↗</p> <p>5: 10,1 ↗</p> <p>6: 10,6* ←</p> <p>7: 10,3* ↙</p> <p>8: 10,4* ↗</p> <p>9: 10,6* ←</p> <p>10: 10,7* ↓</p> |
| Serie 96,0 | Serie 100,0 | Serie 100,0 | Serie 100,0 |
| Sum 96,0 | Sum 196,0 | Sum 196,0 | Sum 196,0 |

| | | | |
|-----------------|--|-----------------|---|
| <p>Series 3</p> | <p>1: 10,4* ↓</p> <p>2: 9,8 ↗</p> <p>3: 9,9 ←</p> <p>4: 10,5* ↑</p> <p>5: 9,9 ↓</p> <p>6: 10,4* ←</p> <p>7: 10,6* ↑</p> <p>8: 10,3* ↓</p> <p>9: 10,2* ←</p> <p>10: 10,5* ↙</p> | <p>Series 4</p> | <p>1: 10,3* ←</p> <p>2: 10,7* ↗</p> <p>3: 9,7 →</p> <p>4: 10,3* ←</p> <p>5: 10,4* ↓</p> <p>6: 9,4 ↗</p> <p>7: 10,7* ↓</p> <p>8: 10,0 →</p> <p>9: 10,3* ↑</p> <p>10: 10,6* ↓</p> |
| Serie 97,0 | Serie 98,0 | Serie 98,0 | Serie 98,0 |
| Sum 293,0 | Sum 391,0 | Sum 391,0 | Sum 391,0 |

| | | | |
|-----------------|--|-----------------|--|
| <p>Series 5</p> | <p>1: 9,2 ↓</p> <p>2: 10,4* ↙</p> <p>3: 9,4 →</p> <p>4: 10,7* ↑</p> <p>5: 9,9 ↗</p> <p>6: 10,3* ↗</p> <p>7: 10,4* →</p> <p>8: 10,4* →</p> <p>9: 9,8 ←</p> <p>10: 10,2* ↑</p> | <p>Series 6</p> | <p>1: 10,3* ↗</p> <p>2: 10,0 ↗</p> <p>3: 10,5* ↗</p> <p>4: 10,4* ↙</p> <p>5: 10,4* →</p> <p>6: 10,5* ↗</p> <p>7: 10,1 →</p> <p>8: 10,2* ↑</p> <p>9: 10,3* →</p> <p>10: 10,7* →</p> |
| Serie 96,0 | Serie 100,0 | Serie 100,0 | Serie 100,0 |
| Sum 487,0 | Sum 587,0 | Sum 587,0 | Sum 587,0 |

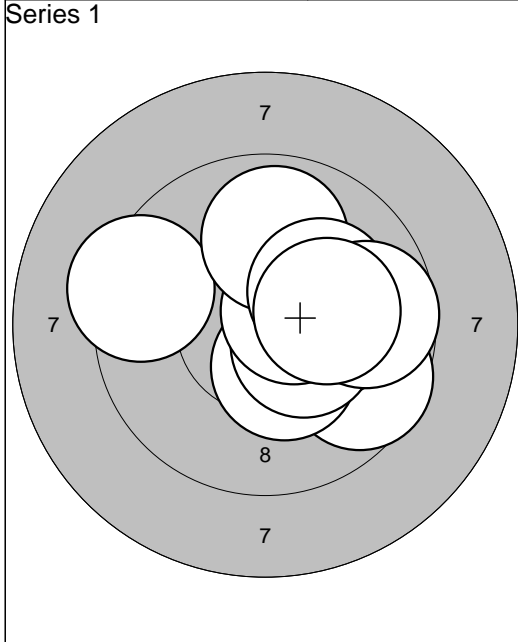

| | |
|-------------------|-------------|
| 1: 9,6 | ↘ |
| 2: 10,2* | → |
| 3: 10,4* | ↘ |
| 4: 9,4 | ← |
| 5: 10,4* | ↘ |
| 6: 10,5* | → |
| 7: 9,9 | ↑ |
| 8: 10,2* | ↗ |
| 9: 9,7 | → |
| 10: 10,2* | → |
| Serie 96,0 | |
| Sum | 96,0 |

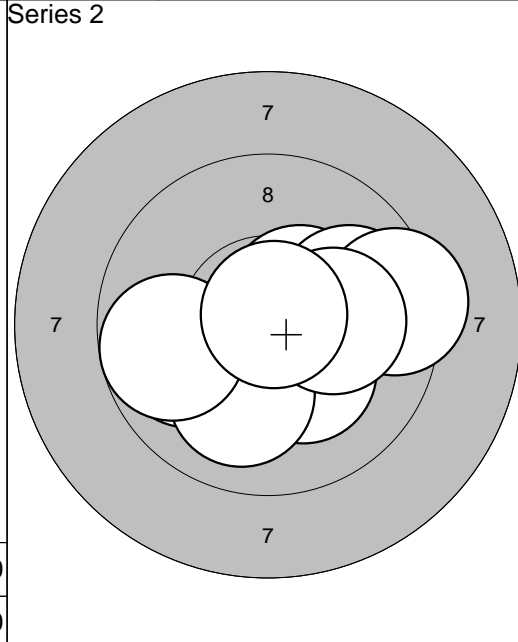

| | |
|-------------------|--------------|
| 1: 10,4* | ↗ |
| 2: 9,9 | → |
| 3: 9,4 | → |
| 4: 10,4* | ↘ |
| 5: 10,2* | ↘ |
| 6: 9,9 | ← |
| 7: 10,0 | ↓ |
| 8: 9,8 | ← |
| 9: 10,1 | → |
| 10: 10,8* | ↗ |
| Serie 96,0 | |
| Sum | 192,0 |

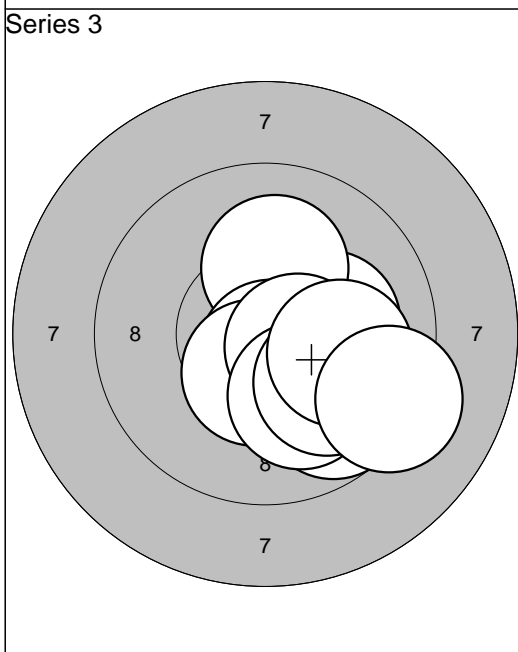

| | |
|-------------------|--------------|
| 1: 10,2* | → |
| 2: 10,1 | ↑ |
| 3: 10,7* | ↘ |
| 4: 10,4* | ↘ |
| 5: 9,7 | ↘ |
| 6: 10,5* | → |
| 7: 10,1 | ↘ |
| 8: 10,0 | ↘ |
| 9: 10,0 | → |
| 10: 9,2 | ↘ |
| Serie 98,0 | |
| Sum | 290,0 |

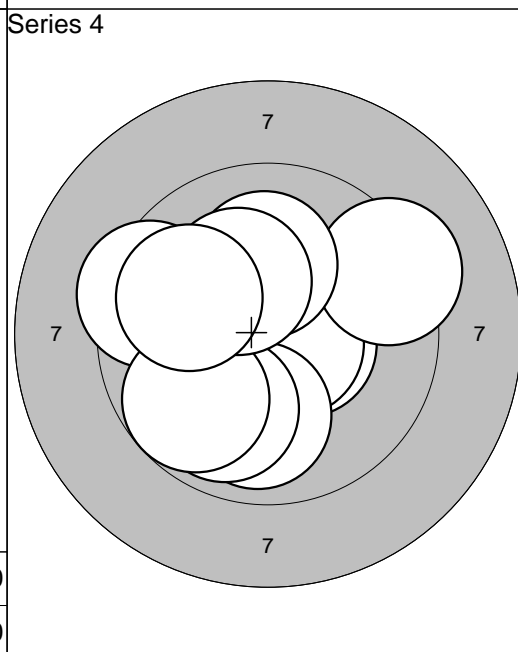

| | |
|-------------------|--------------|
| 1: 10,5* | → |
| 2: 10,6* | → |
| 3: 9,9 | ↓ |
| 4: 9,9 | ↘ |
| 5: 9,4 | ← |
| 6: 9,3 | ↗ |
| 7: 10,1 | ↑ |
| 8: 9,8 | ↘ |
| 9: 10,2* | ↗ |
| 10: 9,9 | ← |
| Serie 94,0 | |
| Sum | 384,0 |

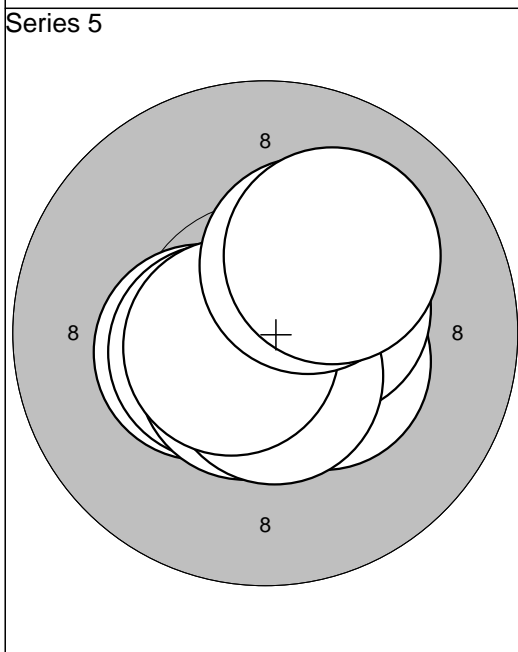

| | |
|--------------------|--------------|
| 1: 10,4* | ← |
| 2: 10,6* | ↘ |
| 3: 10,5* | ← |
| 4: 10,4* | → |
| 5: 10,6* | ↘ |
| 6: 10,4* | → |
| 7: 10,6* | ↘ |
| 8: 10,6* | ← |
| 9: 10,3* | ↗ |
| 10: 10,1 | ↗ |
| Serie 100,0 | |
| Sum | 484,0 |

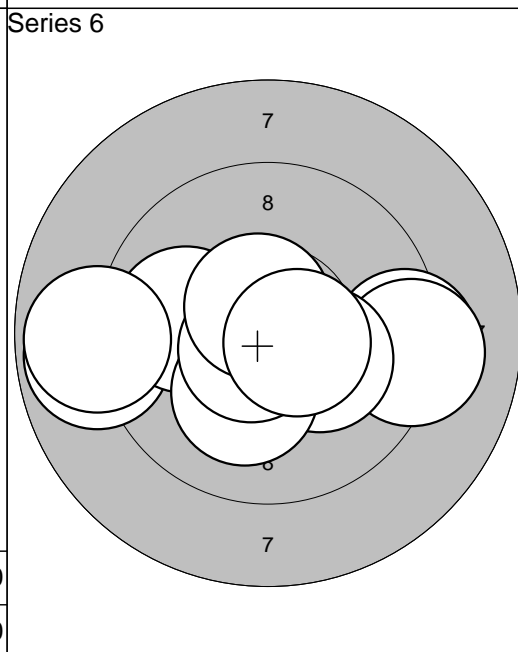

| | |
|-------------------|--------------|
| 1: 8,9 | ← |
| 2: 10,0 | ← |
| 3: 9,3 | → |
| 4: 8,9 | ← |
| 5: 9,2 | → |
| 6: 10,2* | ↘ |
| 7: 10,2* | ↘ |
| 8: 10,7* | ↘ |
| 9: 10,6* | ↗ |
| 10: 10,6* | → |
| Serie 94,0 | |
| Sum | 578,0 |

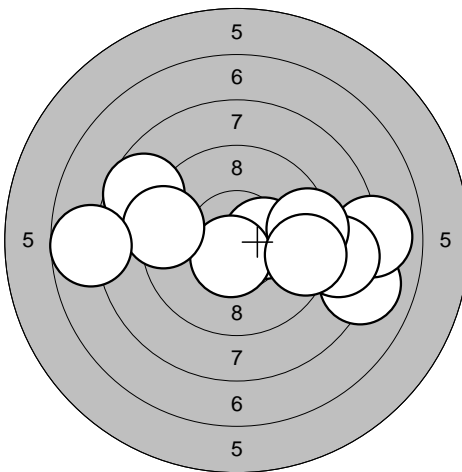
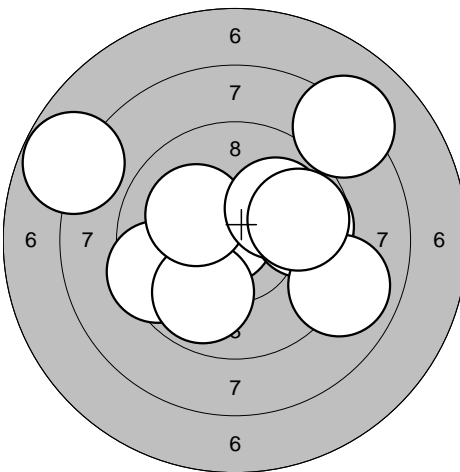
| | | | |
|--|--|--|--|
| <p>Series 1</p>  | <p>1: 10,4* →</p> <p>2: 8,1 →</p> <p>3: 8,0 →</p> <p>4: 8,7 →</p> <p>5: 10,6* ↓</p> <p>6: 8,7 ↗</p> <p>7: 9,4 →</p> <p>8: 9,4 →</p> <p>9: 9,3 ←</p> <p>10: 7,7 ←</p> | <p>Series 2</p>  | <p>1: 8,2 ↗</p> <p>2: 10,7* ↖</p> <p>3: 9,5 ←</p> <p>4: 9,9 ↓</p> <p>5: 7,8 ↖</p> <p>6: 10,1 ↖</p> <p>7: 9,7 →</p> <p>8: 10,0 ↗</p> <p>9: 9,0 →</p> <p>10: 9,8 →</p> |
| Serie 86,0 | Serie 90,0 | Serie 90,0 | Serie 90,0 |
| Sum 86,0 | Sum 86,0 | Sum 176,0 | Sum 176,0 |

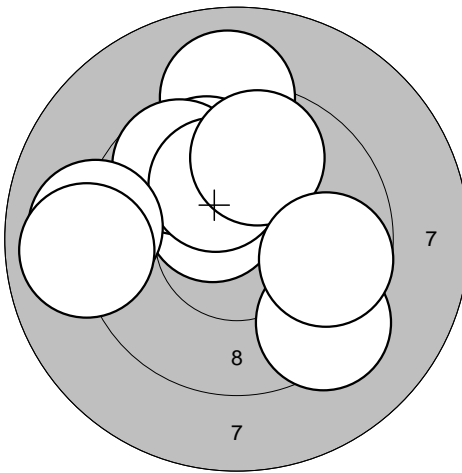
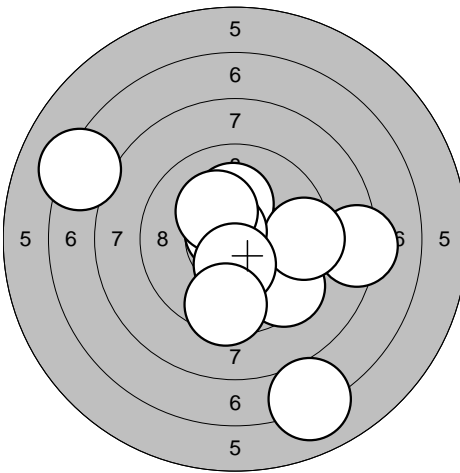
| | | | |
|---|--|---|--|
| <p>Series 3</p>  | <p>1: 9,1 ↑</p> <p>2: 10,5* ↗</p> <p>3: 9,4 ↓</p> <p>4: 9,9 ↗</p> <p>5: 9,7 ↗</p> <p>6: 10,2* ↗</p> <p>7: 9,1 ←</p> <p>8: 9,0 ←</p> <p>9: 9,8 ↑</p> <p>10: 9,7 →</p> | <p>Series 4</p>  | <p>1: 10,2* ↑</p> <p>2: 7,1 ↓</p> <p>3: 8,3 →</p> <p>4: 9,4 ↓</p> <p>5: 9,4 →</p> <p>6: 10,7* ↗</p> <p>7: 7,2 ↖</p> <p>8: 10,2* ↗</p> <p>9: 10,4* ↓</p> <p>10: 9,5 ↓</p> |
| Serie 92,0 | Serie 92,0 | Serie 89,0 | Serie 89,0 |
| Sum 268,0 | Sum 268,0 | Sum 357,0 | Sum 357,0 |

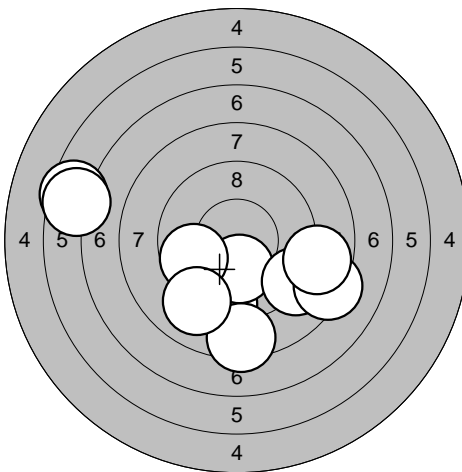
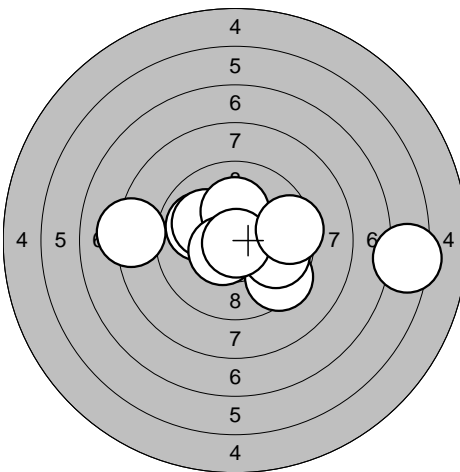
| | | | |
|--|--|--|--|
| <p>Series 5</p>  | <p>1: 9,2 ↓</p> <p>2: 10,2* ↓</p> <p>3: 9,1 ↓</p> <p>4: 9,7 ←</p> <p>5: 8,3 →</p> <p>6: 6,5 ↖</p> <p>7: 8,4 ↓</p> <p>8: 8,8 →</p> <p>9: 6,6 ←</p> <p>10: 9,1 ↓</p> | <p>Series 6</p>  | <p>1: 9,4 ↓</p> <p>2: 10,0 ↖</p> <p>3: 9,8 →</p> <p>4: 10,1 ↖</p> <p>5: 10,2* ↑</p> <p>6: 6,4 →</p> <p>7: 10,5* ↖</p> <p>8: 10,9* ↓</p> <p>9: 9,5 →</p> <p>10: 8,2 ←</p> |
| Serie 82,0 | Serie 82,0 | Serie 91,0 | Serie 91,0 |
| Sum 439,0 | Sum 439,0 | Sum 530,0 | Sum 530,0 |

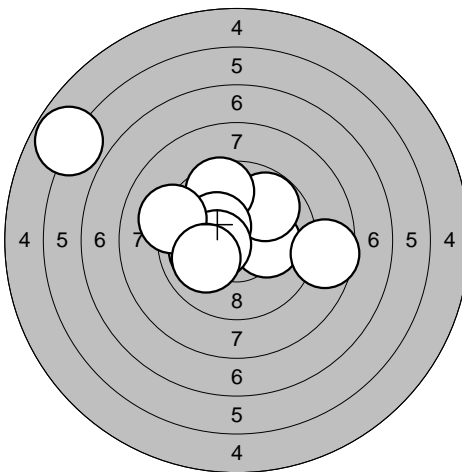
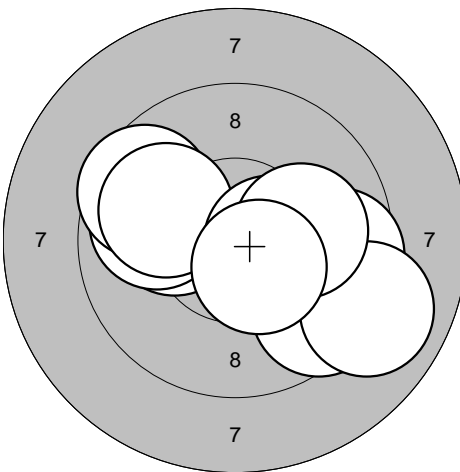
| | | |
|--|---|--|
| <p>Series 1</p>  | <p>Series 2</p>  | |
| 1: 10,1 → 2: 5,8 ↗ 3: 9,8 ↗ 4: 9,6 ↗ 5: 10,3* ↗ 6: 8,6 → 7: 10,0 ← 8: 10,4* ← 9: 9,2 ← 10: 10,0 ↙ | 1: 10,1 ← 2: 9,5 ↘ 3: 9,9 ← 4: 9,6 ↗ 5: 9,9 ↗ 6: 10,5* → 7: 9,6 → 8: 9,0 ↘ 9: 10,0 → 10: 10,5* ↘ | |
| Serie 90,0 | Serie 94,0 | |
| Sum 90,0 | Sum 184,0 | |

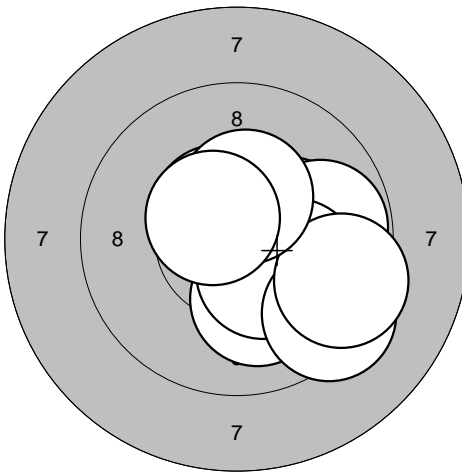
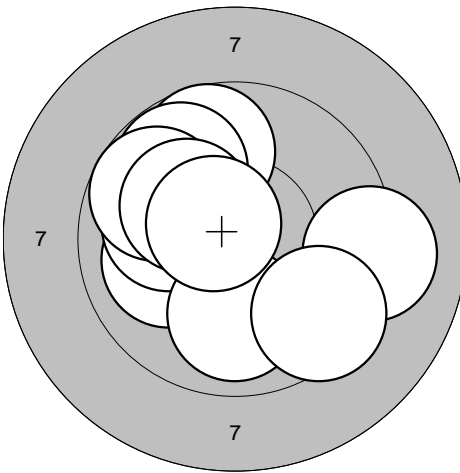
| | | |
|---|---|--|
| <p>Series 3</p>  | <p>Series 4</p>  | |
| 1: 10,3* → 2: 10,5* ↗ 3: 9,8 → 4: 10,1 ↘ 5: 10,1 ↘ 6: 10,4* ↘ 7: 9,4 ↘ 8: 9,4 ↘ 9: 10,4* ↗ 10: 10,5* ↗ | 1: 10,0 ← 2: 9,7 ↗ 3: 9,8 ↗ 4: 10,1 ← 5: 9,1 → 6: 9,7 ↗ 7: 9,9 ↓ 8: 10,2* ↗ 9: 10,6* ↗ 10: 9,5 ↘ | |
| Serie 97,0 | Serie 94,0 | |
| Sum 281,0 | Sum 375,0 | |

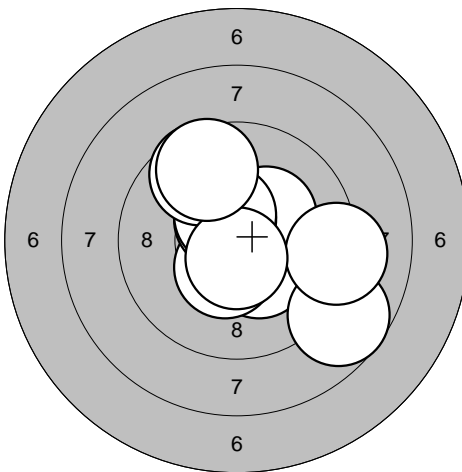
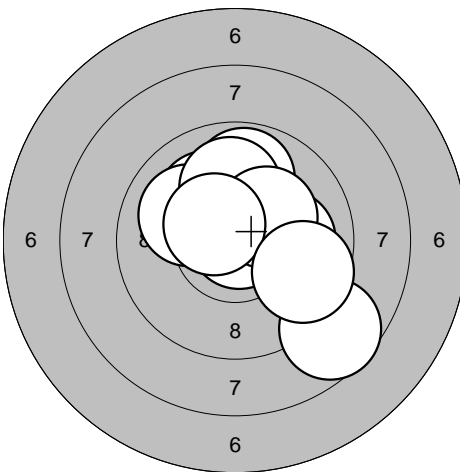
| | | |
|---|---|--|
| <p>Series 5</p>  | <p>Series 6</p>  | |
| 1: 10,3* ↘ 2: 10,3* ↗ 3: 10,4* ↘ 4: 10,5* ↗ 5: 8,7 ↘ 6: 10,5* ↗ 7: 9,6 ↗ 8: 9,2 → 9: 10,6* ↘ 10: 9,6 ↗ | 1: 9,9 ↑ 2: 10,1 → 3: 8,7 ↘ 4: 10,8* ↗ 5: 10,1 ↗ 6: 10,0 ← 7: 10,0 ↑ 8: 10,3* ↗ 9: 10,5* ↗ 10: 9,6 ↘ | |
| Serie 95,0 | Serie 96,0 | |
| Sum 470,0 | Sum 566,0 | |

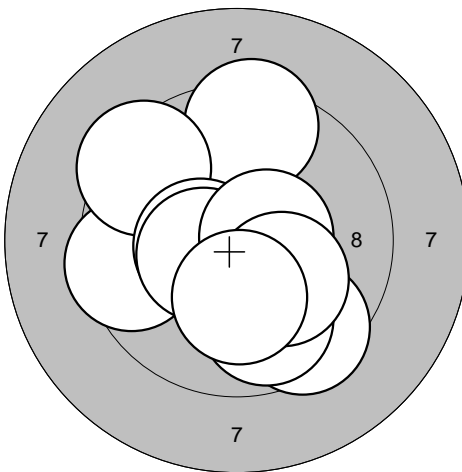
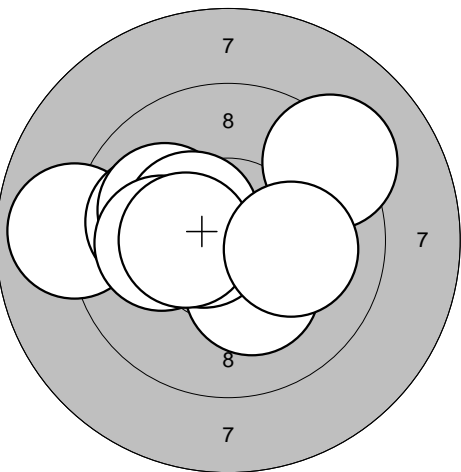
| | | | | | | | | | | | |
|--|--|-------|------|-----|------|--|---|-------|------|-----|-------|
| <p>Series 1</p>  | <p>1: 9,4 ↗</p> <p>2: 9,5 ↘</p> <p>3: 9,8 ↘</p> <p>4: 9,5 ←</p> <p>5: 9,4 ↗</p> <p>6: 10,5* ←</p> <p>7: 10,5* ←</p> <p>8: 10,6* →</p> <p>9: 10,2* ↘</p> <p>10: 10,2* ↓</p> <table border="1" style="width:100%; border-collapse: collapse;"> <tr><td>Serie</td><td style="text-align: right;">95,0</td></tr> <tr><td>Sum</td><td style="text-align: right;">95,0</td></tr> </table> | Serie | 95,0 | Sum | 95,0 | <p>Series 2</p>  | <p>1: 8,9 ←</p> <p>2: 9,9 ←</p> <p>3: 10,2* ↘</p> <p>4: 10,0 ↗</p> <p>5: 10,6* ←</p> <p>6: 10,4* ↗</p> <p>7: 9,2 ↗</p> <p>8: 10,1 ←</p> <p>9: 10,4* ←</p> <p>10: 10,1 →</p> <table border="1" style="width:100%; border-collapse: collapse;"> <tr><td>Serie</td><td style="text-align: right;">96,0</td></tr> <tr><td>Sum</td><td style="text-align: right;">191,0</td></tr> </table> | Serie | 96,0 | Sum | 191,0 |
| Serie | 95,0 | | | | | | | | | | |
| Sum | 95,0 | | | | | | | | | | |
| Serie | 96,0 | | | | | | | | | | |
| Sum | 191,0 | | | | | | | | | | |

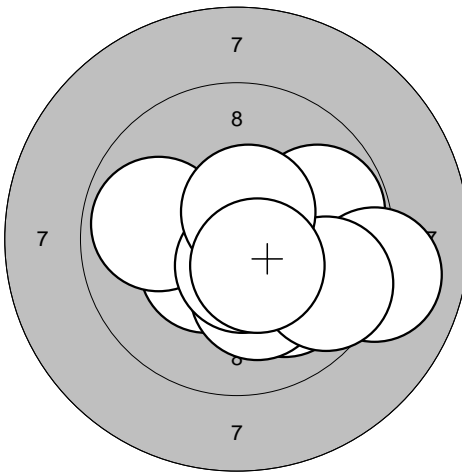
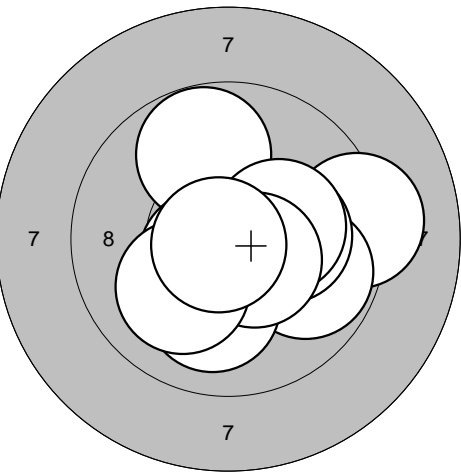
| | | | | | | | | | | | |
|---|--|-------|------|-----|-------|---|---|-------|------|-----|-------|
| <p>Series 3</p>  | <p>1: 9,8 →</p> <p>2: 10,4* ↘</p> <p>3: 10,0 ↘</p> <p>4: 10,2* ↘</p> <p>5: 9,1 →</p> <p>6: 9,6 ↘</p> <p>7: 9,9 ←</p> <p>8: 10,6* ↘</p> <p>9: 10,6* ↗</p> <p>10: 10,5* ↘</p> <table border="1" style="width:100%; border-collapse: collapse;"> <tr><td>Serie</td><td style="text-align: right;">96,0</td></tr> <tr><td>Sum</td><td style="text-align: right;">287,0</td></tr> </table> | Serie | 96,0 | Sum | 287,0 | <p>Series 4</p>  | <p>1: 9,2 →</p> <p>2: 9,8 ↑</p> <p>3: 9,8 →</p> <p>4: 10,0 ↓</p> <p>5: 10,2* →</p> <p>6: 10,6* ↘</p> <p>7: 10,2* →</p> <p>8: 10,5* ↘</p> <p>9: 10,1 ↘</p> <p>10: 10,8* ←</p> <table border="1" style="width:100%; border-collapse: collapse;"> <tr><td>Serie</td><td style="text-align: right;">97,0</td></tr> <tr><td>Sum</td><td style="text-align: right;">384,0</td></tr> </table> | Serie | 97,0 | Sum | 384,0 |
| Serie | 96,0 | | | | | | | | | | |
| Sum | 287,0 | | | | | | | | | | |
| Serie | 97,0 | | | | | | | | | | |
| Sum | 384,0 | | | | | | | | | | |

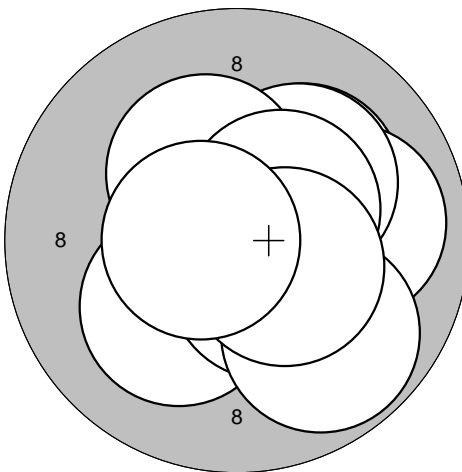
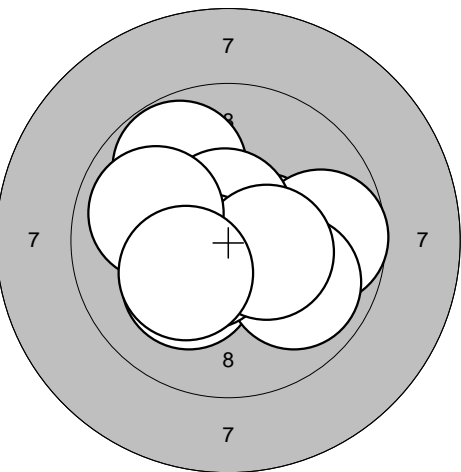
| | | | | | | | | | | | |
|--|--|-------|------|-----|-------|--|--|-------|------|-----|-------|
| <p>Series 5</p>  | <p>1: 10,1 ↗</p> <p>2: 10,2* ↘</p> <p>3: 9,9 →</p> <p>4: 10,5* ↘</p> <p>5: 10,2* ↗</p> <p>6: 10,3* ↗</p> <p>7: 10,5* ↗</p> <p>8: 9,8 ↘</p> <p>9: 10,4* ↘</p> <p>10: 10,6* ←</p> <table border="1" style="width:100%; border-collapse: collapse;"> <tr><td>Serie</td><td style="text-align: right;">98,0</td></tr> <tr><td>Sum</td><td style="text-align: right;">482,0</td></tr> </table> | Serie | 98,0 | Sum | 482,0 | <p>Series 6</p>  | <p>1: 9,8 ↗</p> <p>2: 10,5* →</p> <p>3: 9,7 →</p> <p>4: 10,2* ↘</p> <p>5: 10,6* ↑</p> <p>6: 9,9 ↘</p> <p>7: 10,5* ↘</p> <p>8: 10,4* →</p> <p>9: 9,9 ←</p> <p>10: 10,2* ↘</p> <table border="1" style="width:100%; border-collapse: collapse;"> <tr><td>Serie</td><td style="text-align: right;">96,0</td></tr> <tr><td>Sum</td><td style="text-align: right;">578,0</td></tr> </table> | Serie | 96,0 | Sum | 578,0 |
| Serie | 98,0 | | | | | | | | | | |
| Sum | 482,0 | | | | | | | | | | |
| Serie | 96,0 | | | | | | | | | | |
| Sum | 578,0 | | | | | | | | | | |

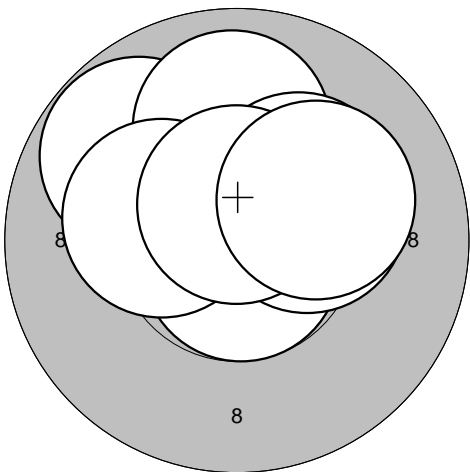
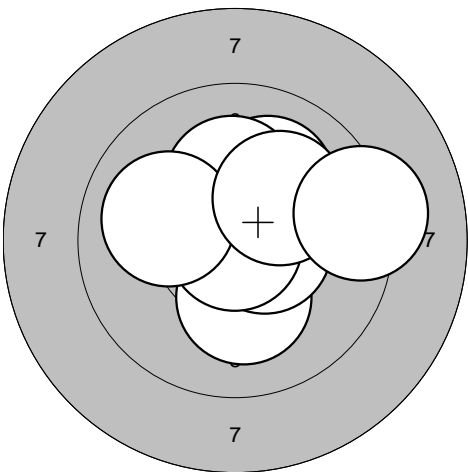
| | | | |
|--|---|--|---|
| <p>Series 1</p>  | <p>1: 10,4* ↗</p> <p>2: 10,4* ↖</p> <p>3: 10,7* ↓</p> <p>4: 10,3* →</p> <p>5: 9,8 ↗</p> <p>6: 10,0 ↑</p> <p>7: 10,2* ←</p> <p>8: 10,2* ↗</p> <p>9: 10,6* ↑</p> <p>10: 10,2* ↗</p> | <p>Series 2</p>  | <p>1: 10,2* ↓</p> <p>2: 10,7* ↗</p> <p>3: 10,2* ↗</p> <p>4: 10,6* →</p> <p>5: 10,1 ↗</p> <p>6: 10,2* ↑</p> <p>7: 10,9* ↓</p> <p>8: 10,0 ←</p> <p>9: 10,1 ↗</p> <p>10: 9,2 →</p> |
| Serie 99,0 | Serie 99,0 | Serie 99,0 | Serie 99,0 |
| Sum 99,0 | Sum 99,0 | Sum 198,0 | Sum 198,0 |

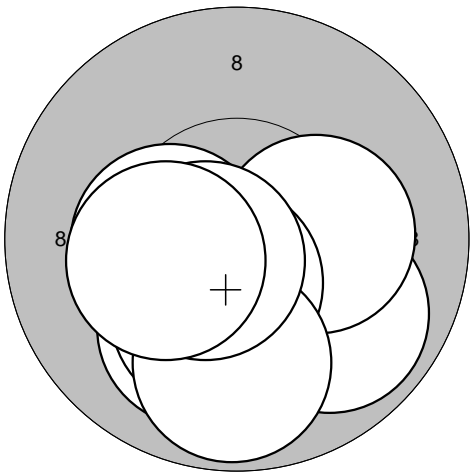
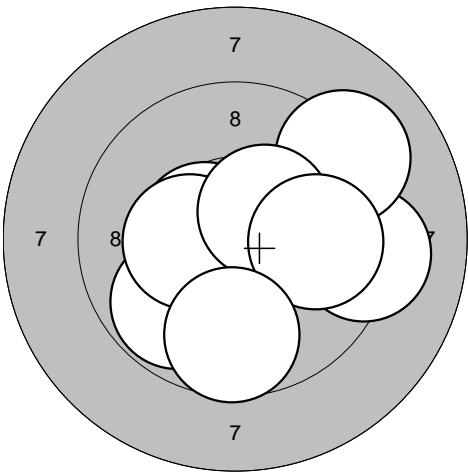
| | | | |
|---|---|---|--|
| <p>Series 3</p>  | <p>1: 9,9 ↘</p> <p>2: 10,3* ↓</p> <p>3: 10,1 ↓</p> <p>4: 10,3* ←</p> <p>5: 10,2* ↓</p> <p>6: 10,2* →</p> <p>7: 10,5* ↓</p> <p>8: 9,8 ↓</p> <p>9: 10,6* ↙</p> <p>10: 10,3* ←</p> | <p>Series 4</p>  | <p>1: 10,5* ↓</p> <p>2: 9,8 ↙</p> <p>3: 10,5* ←</p> <p>4: 9,2 →</p> <p>5: 10,4* →</p> <p>6: 9,1 ↗</p> <p>7: 10,4* ←</p> <p>8: 10,4* ↗</p> <p>9: 9,9 →</p> <p>10: 9,7 ↓</p> |
| Serie 98,0 | Serie 95,0 | Serie 95,0 | Serie 95,0 |
| Sum 296,0 | Sum 391,0 | Sum 391,0 | Sum 391,0 |

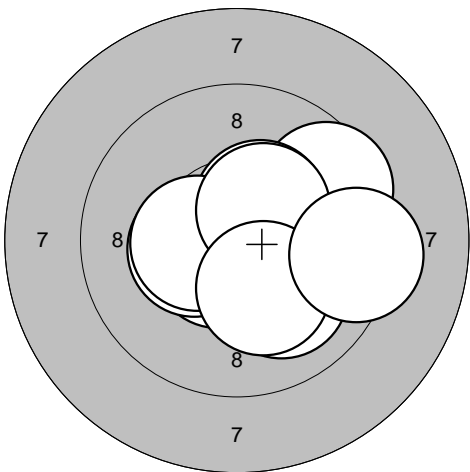
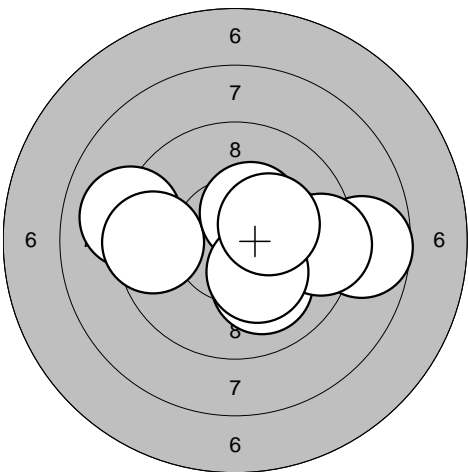
| | | | |
|--|---|--|---|
| <p>Series 5</p>  | <p>1: 10,6* ↙</p> <p>2: 10,4* ←</p> <p>3: 9,6 ↗</p> <p>4: 10,4* ↗</p> <p>5: 10,1 ↓</p> <p>6: 10,6* →</p> <p>7: 10,4* ←</p> <p>8: 10,4* ↗</p> <p>9: 10,2* ↓</p> <p>10: 9,4 →</p> | <p>Series 6</p>  | <p>1: 8,7 →</p> <p>2: 10,4* →</p> <p>3: 10,1 ↓</p> <p>4: 9,1 ←</p> <p>5: 9,5 ←</p> <p>6: 10,2* →</p> <p>7: 10,4* ↗</p> <p>8: 9,4 →</p> <p>9: 10,3* ↓</p> <p>10: 10,3* ↗</p> |
| Serie 98,0 | Serie 95,0 | Serie 95,0 | Serie 95,0 |
| Sum 489,0 | Sum 584,0 | Sum 584,0 | Sum 584,0 |

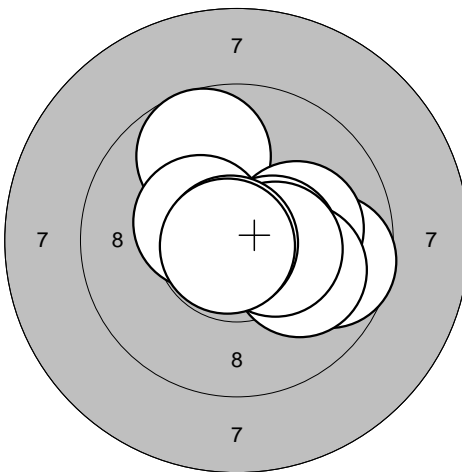
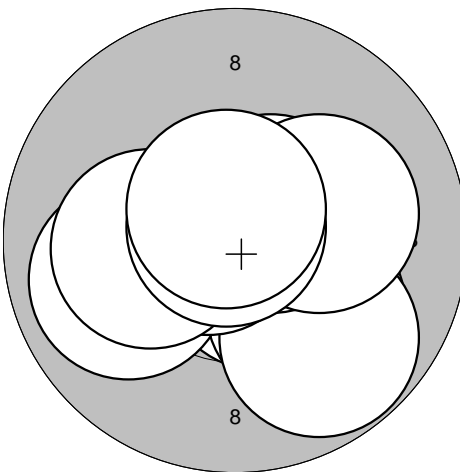
| | | | | | | | | | | | |
|--|---|-------|------|-----|------|--|---|-------|------|-----|-------|
| <p>Series 1</p>  | <p>1: 9,7 →</p> <p>2: 10,5* ↗</p> <p>3: 9,8 ↗</p> <p>4: 10,1 →</p> <p>5: 10,5* →</p> <p>6: 10,4* ↗</p> <p>7: 10,0 →</p> <p>8: 10,4* →</p> <p>9: 10,8* ←</p> <p>10: 10,8* ←</p> <table border="1" style="width:100%; border-collapse: collapse;"> <tr><td>Serie</td><td style="text-align: right;">98,0</td></tr> <tr><td>Sum</td><td style="text-align: right;">98,0</td></tr> </table> | Serie | 98,0 | Sum | 98,0 | <p>Series 2</p>  | <p>1: 10,6* ↘</p> <p>2: 10,1 ↘</p> <p>3: 9,8 ↘</p> <p>4: 9,9 ←</p> <p>5: 10,6* ↗</p> <p>6: 10,2* →</p> <p>7: 10,7* ←</p> <p>8: 10,2* ←</p> <p>9: 10,8* ↗</p> <p>10: 10,7* ↗</p> <table border="1" style="width:100%; border-collapse: collapse;"> <tr><td>Serie</td><td style="text-align: right;">98,0</td></tr> <tr><td>Sum</td><td style="text-align: right;">196,0</td></tr> </table> | Serie | 98,0 | Sum | 196,0 |
| Serie | 98,0 | | | | | | | | | | |
| Sum | 98,0 | | | | | | | | | | |
| Serie | 98,0 | | | | | | | | | | |
| Sum | 196,0 | | | | | | | | | | |

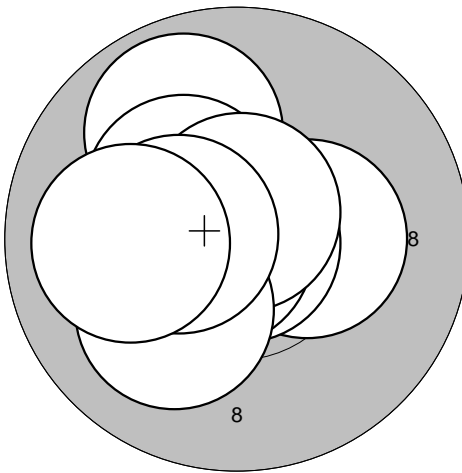
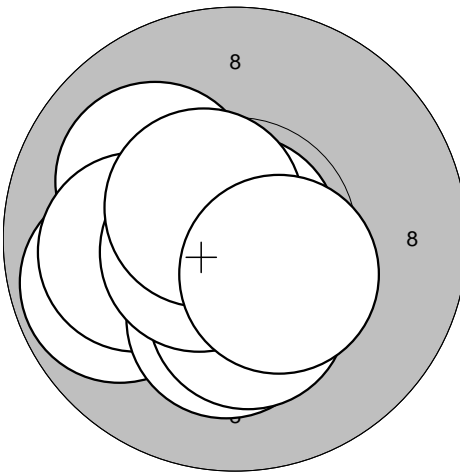
| | | | | | | | | | | | |
|---|--|-------|------|-----|-------|---|--|-------|------|-----|-------|
| <p>Series 3</p>  | <p>1: 10,3* →</p> <p>2: 10,4* ←</p> <p>3: 10,9* ↘</p> <p>4: 10,7* ←</p> <p>5: 9,9 ↗</p> <p>6: 10,3* ↗</p> <p>7: 10,7* ↗</p> <p>8: 10,1 ↘</p> <p>9: 10,4* ←</p> <p>10: 10,0 ←</p> <table border="1" style="width:100%; border-collapse: collapse;"> <tr><td>Serie</td><td style="text-align: right;">99,0</td></tr> <tr><td>Sum</td><td style="text-align: right;">295,0</td></tr> </table> | Serie | 99,0 | Sum | 295,0 | <p>Series 4</p>  | <p>1: 10,1 ↗</p> <p>2: 10,6* ←</p> <p>3: 9,8 ←</p> <p>4: 10,0 ←</p> <p>5: 10,2* ↓</p> <p>6: 10,9* ↗</p> <p>7: 10,3* ↓</p> <p>8: 10,6* ←</p> <p>9: 10,6* ↗</p> <p>10: 10,4* ↘</p> <table border="1" style="width:100%; border-collapse: collapse;"> <tr><td>Serie</td><td style="text-align: right;">99,0</td></tr> <tr><td>Sum</td><td style="text-align: right;">394,0</td></tr> </table> | Serie | 99,0 | Sum | 394,0 |
| Serie | 99,0 | | | | | | | | | | |
| Sum | 295,0 | | | | | | | | | | |
| Serie | 99,0 | | | | | | | | | | |
| Sum | 394,0 | | | | | | | | | | |

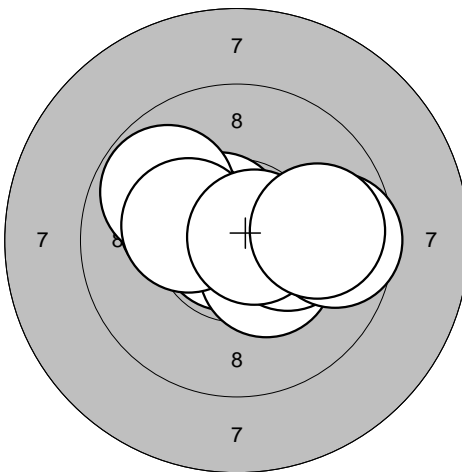
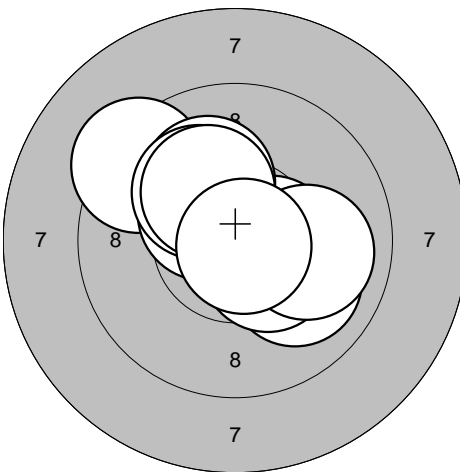
| | | | | | | | | | | | |
|--|--|-------|------|-----|-------|--|--|-------|------|-----|-------|
| <p>Series 5</p>  | <p>1: 10,6* ↗</p> <p>2: 10,8* ←</p> <p>3: 10,4* ↘</p> <p>4: 10,2* ↗</p> <p>5: 10,3* →</p> <p>6: 9,8 ↗</p> <p>7: 10,3* ↗</p> <p>8: 10,7* →</p> <p>9: 9,6 →</p> <p>10: 9,9 →</p> <table border="1" style="width:100%; border-collapse: collapse;"> <tr><td>Serie</td><td style="text-align: right;">97,0</td></tr> <tr><td>Sum</td><td style="text-align: right;">491,0</td></tr> </table> | Serie | 97,0 | Sum | 491,0 | <p>Series 6</p>  | <p>1: 10,0 ↘</p> <p>2: 9,3 ↗</p> <p>3: 10,4* ↗</p> <p>4: 10,5* →</p> <p>5: 10,4* ↘</p> <p>6: 10,1 ↗</p> <p>7: 10,1 ↗</p> <p>8: 10,0 →</p> <p>9: 10,2* ↗</p> <p>10: 10,8* ↘</p> <table border="1" style="width:100%; border-collapse: collapse;"> <tr><td>Serie</td><td style="text-align: right;">99,0</td></tr> <tr><td>Sum</td><td style="text-align: right;">590,0</td></tr> </table> | Serie | 99,0 | Sum | 590,0 |
| Serie | 97,0 | | | | | | | | | | |
| Sum | 491,0 | | | | | | | | | | |
| Serie | 99,0 | | | | | | | | | | |
| Sum | 590,0 | | | | | | | | | | |

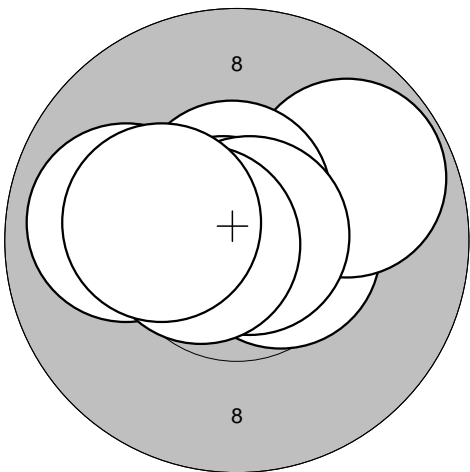
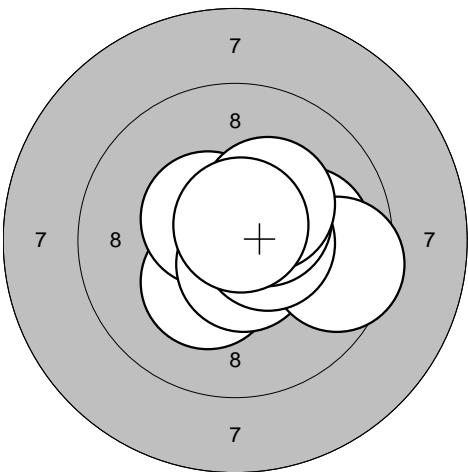
| | | | |
|--|--|--|---|
| <p>Series 1</p>  | <p>1: 10,5* →</p> <p>2: 10,5* →</p> <p>3: 9,9 ←</p> <p>4: 9,8 ↗</p> <p>5: 10,7* ←</p> <p>6: 10,6* ↑</p> <p>7: 10,8* ←</p> <p>8: 10,8* →</p> <p>9: 10,6* ←</p> <p>10: 10,3* ←</p> | <p>Series 2</p>  | <p>1: 10,3* ↘</p> <p>2: 10,5* ↖</p> <p>3: 10,0 →</p> <p>4: 10,6* ↘</p> <p>5: 10,6* ↗</p> <p>6: 9,6 →</p> <p>7: 10,5* →</p> <p>8: 10,5* ↗</p> <p>9: 10,3* ↗</p> <p>10: 10,7* ↗</p> |
| Serie 98,0 | | Serie 99,0 | |
| Sum 98,0 | | Sum 197,0 | |

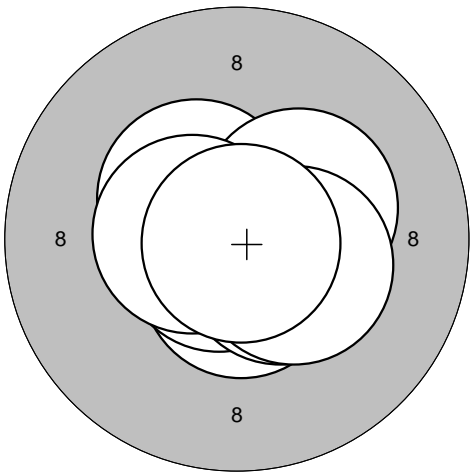
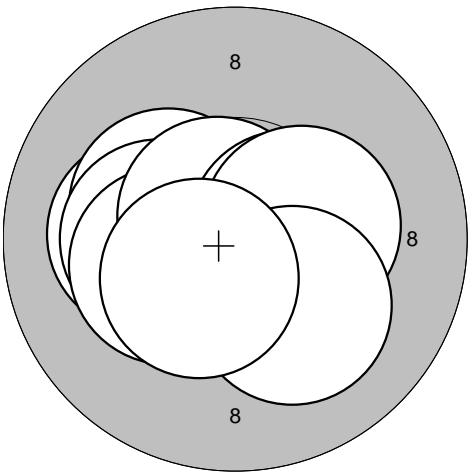
| | | | |
|---|--|---|--|
| <p>Series 3</p>  | <p>1: 10,4* ↖</p> <p>2: 10,6* ↘</p> <p>3: 10,8* ↘</p> <p>4: 10,7* →</p> <p>5: 10,8* ↖</p> <p>6: 10,5* ↘</p> <p>7: 10,3* ↗</p> <p>8: 10,4* →</p> <p>9: 10,5* ←</p> <p>10: 10,9* ↘</p> | <p>Series 4</p>  | <p>1: 10,2* ←</p> <p>2: 10,8* ↘</p> <p>3: 10,3* ↖</p> <p>4: 10,3* ←</p> <p>5: 10,3* ←</p> <p>6: 10,7* ↗</p> <p>7: 10,5* →</p> <p>8: 10,4* →</p> <p>9: 10,2* ↘</p> <p>10: 10,5* ↘</p> |
| Serie 100,0 | | Serie 100,0 | |
| Sum 297,0 | | Sum 397,0 | |

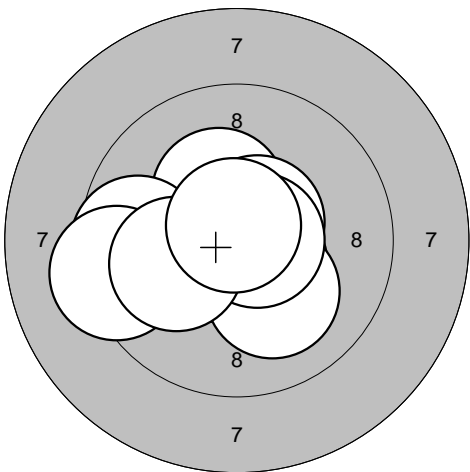
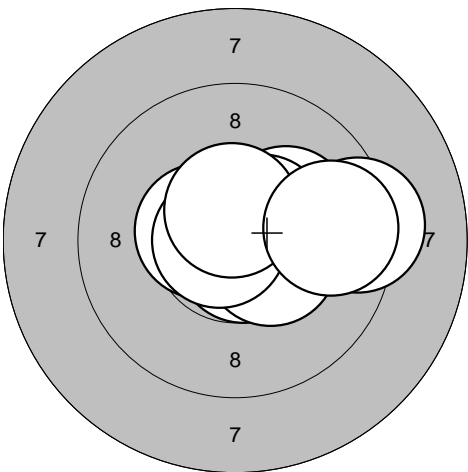
| | | | |
|--|--|--|--|
| <p>Series 5</p>  | <p>1: 10,3* ↗</p> <p>2: 10,6* ↗</p> <p>3: 10,6* ↖</p> <p>4: 9,6 ←</p> <p>5: 9,3 ←</p> <p>6: 10,5* ↘</p> <p>7: 10,1 ↘</p> <p>8: 10,7* →</p> <p>9: 10,1 ←</p> <p>10: 10,7* ↗</p> | <p>Series 6</p>  | <p>1: 9,3 →</p> <p>2: 10,5* ←</p> <p>3: 10,6* →</p> <p>4: 10,2* ↗</p> <p>5: 10,5* ↗</p> <p>6: 10,7* ↘</p> <p>7: 10,4* ↘</p> <p>8: 10,7* ←</p> <p>9: 10,5* ↑</p> <p>10: 9,7 →</p> |
| Serie 98,0 | | Serie 98,0 | |
| Sum 495,0 | | Sum 593,0 | |

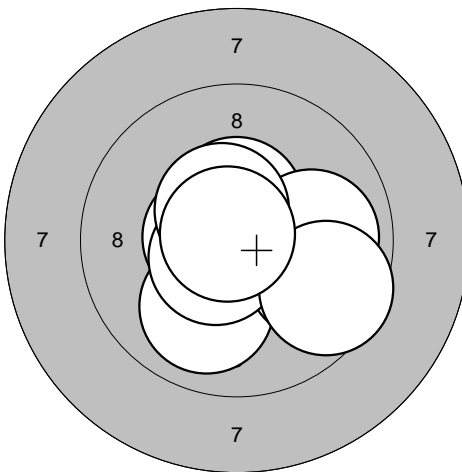
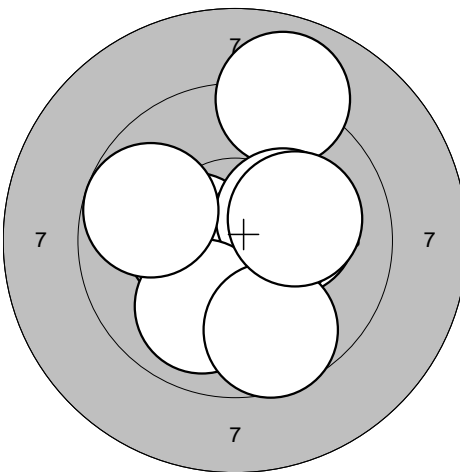
| | | | | | | | | | | | |
|--|---|-------|------|-----|------|--|---|-------|------|-----|-------|
| <p>Series 1</p>  | <p>1: 10,2* →</p> <p>2: 10,6* ←</p> <p>3: 10,0 ↓</p> <p>4: 10,5* ↑</p> <p>5: 9,8 →</p> <p>6: 10,6* ←</p> <p>7: 10,0 →</p> <p>8: 10,5* ↑</p> <p>9: 9,6 →</p> <p>10: 10,8* ↖</p> <table border="1" style="width:100%; border-collapse: collapse;"> <tr> <td style="text-align: right;">Serie</td> <td style="text-align: right;">98,0</td> </tr> <tr> <td style="text-align: right;">Sum</td> <td style="text-align: right;">98,0</td> </tr> </table> | Serie | 98,0 | Sum | 98,0 | <p>Series 2</p>  | <p>1: 10,5* ←</p> <p>2: 10,4* ←</p> <p>3: 10,2* →</p> <p>4: 9,0 ↑</p> <p>5: 10,5* →</p> <p>6: 10,2* ↗</p> <p>7: 9,9 ↓</p> <p>8: 9,7 ↓</p> <p>9: 9,8 ←</p> <p>10: 10,1 →</p> <table border="1" style="width:100%; border-collapse: collapse;"> <tr> <td style="text-align: right;">Serie</td> <td style="text-align: right;">96,0</td> </tr> <tr> <td style="text-align: right;">Sum</td> <td style="text-align: right;">194,0</td> </tr> </table> | Serie | 96,0 | Sum | 194,0 |
| Serie | 98,0 | | | | | | | | | | |
| Sum | 98,0 | | | | | | | | | | |
| Serie | 96,0 | | | | | | | | | | |
| Sum | 194,0 | | | | | | | | | | |

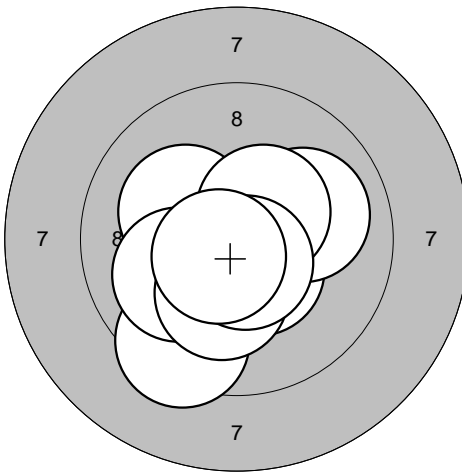
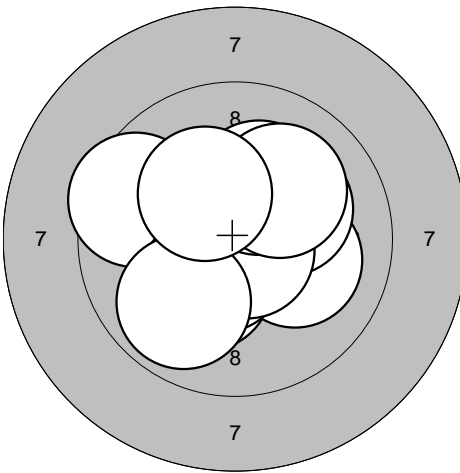
| | | | | | | | | | | | |
|---|--|-------|------|-----|-------|---|--|-------|------|-----|-------|
| <p>Series 3</p>  | <p>1: 10,5* ↓</p> <p>2: 10,2* ↖</p> <p>3: 10,0 →</p> <p>4: 9,4 ↓</p> <p>5: 10,7* ↓</p> <p>6: 10,5* ↗</p> <p>7: 10,0 ←</p> <p>8: 10,2* ↓</p> <p>9: 10,6* ↓</p> <p>10: 10,6* ↙</p> <table border="1" style="width:100%; border-collapse: collapse;"> <tr> <td style="text-align: right;">Serie</td> <td style="text-align: right;">99,0</td> </tr> <tr> <td style="text-align: right;">Sum</td> <td style="text-align: right;">293,0</td> </tr> </table> | Serie | 99,0 | Sum | 293,0 | <p>Series 4</p>  | <p>1: 9,5 ←</p> <p>2: 10,2* ↓</p> <p>3: 10,1 →</p> <p>4: 10,2* ↗</p> <p>5: 10,5* ↓</p> <p>6: 10,7* ↘</p> <p>7: 10,2* ↗</p> <p>8: 10,1 ↗</p> <p>9: 9,9 ↓</p> <p>10: 10,2* ↖</p> <table border="1" style="width:100%; border-collapse: collapse;"> <tr> <td style="text-align: right;">Serie</td> <td style="text-align: right;">98,0</td> </tr> <tr> <td style="text-align: right;">Sum</td> <td style="text-align: right;">391,0</td> </tr> </table> | Serie | 98,0 | Sum | 391,0 |
| Serie | 99,0 | | | | | | | | | | |
| Sum | 293,0 | | | | | | | | | | |
| Serie | 98,0 | | | | | | | | | | |
| Sum | 391,0 | | | | | | | | | | |

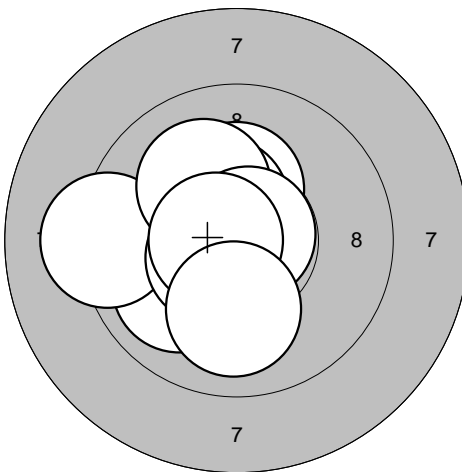
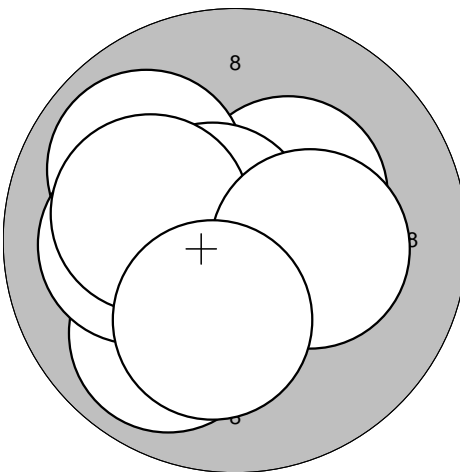
| | | | | | | | | | | | |
|--|---|-------|------|-----|-------|--|--|-------|------|-----|-------|
| <p>Series 5</p>  | <p>1: 10,0 ↙</p> <p>2: 10,3* ↑</p> <p>3: 10,5* ↖</p> <p>4: 9,2 ←</p> <p>5: 10,4* ↗</p> <p>6: 10,1 ↗</p> <p>7: 10,7* →</p> <p>8: 10,5* ←</p> <p>9: 10,7* ←</p> <p>10: 10,0 ↓</p> <table border="1" style="width:100%; border-collapse: collapse;"> <tr> <td style="text-align: right;">Serie</td> <td style="text-align: right;">99,0</td> </tr> <tr> <td style="text-align: right;">Sum</td> <td style="text-align: right;">490,0</td> </tr> </table> | Serie | 99,0 | Sum | 490,0 | <p>Series 6</p>  | <p>1: 10,3* ↗</p> <p>2: 10,5* ←</p> <p>3: 9,9 ↖</p> <p>4: 10,7* ↖</p> <p>5: 9,9 ↓</p> <p>6: 10,5* ←</p> <p>7: 10,1 ←</p> <p>8: 10,1 ←</p> <p>9: 10,2* →</p> <p>10: 10,2* ↓</p> <table border="1" style="width:100%; border-collapse: collapse;"> <tr> <td style="text-align: right;">Serie</td> <td style="text-align: right;">98,0</td> </tr> <tr> <td style="text-align: right;">Sum</td> <td style="text-align: right;">588,0</td> </tr> </table> | Serie | 98,0 | Sum | 588,0 |
| Serie | 99,0 | | | | | | | | | | |
| Sum | 490,0 | | | | | | | | | | |
| Serie | 98,0 | | | | | | | | | | |
| Sum | 588,0 | | | | | | | | | | |

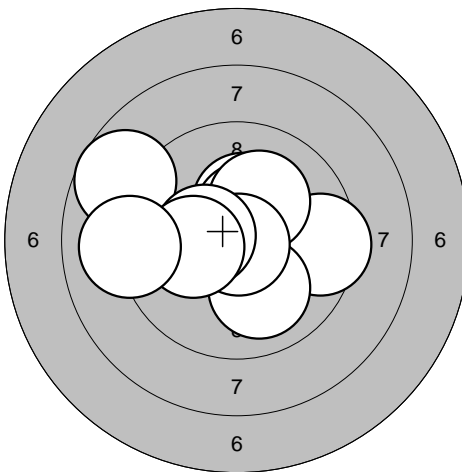
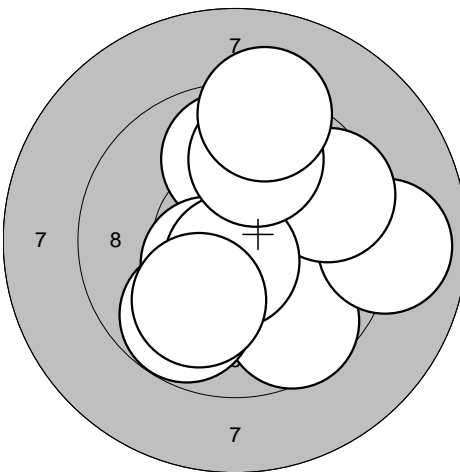
| | | | |
|--|---|--|---|
| <p>Series 1</p>  | <p>1: 9,5 →</p> <p>2: 10,3* ↑</p> <p>3: 10,4* ↑</p> <p>4: 8,8 ↖</p> <p>5: 10,0 ↓</p> <p>6: 10,2* ↑</p> <p>7: 10,8* ↓</p> <p>8: 10,4* ←</p> <p>9: 10,2* ←</p> <p>10: 9,1 ←</p> | <p>Series 2</p>  | <p>1: 9,6 ↓</p> <p>2: 9,0 →</p> <p>3: 9,6 ↗</p> <p>4: 9,9 ↑</p> <p>5: 9,8 ↓</p> <p>6: 10,5* ↖</p> <p>7: 10,7* ↓</p> <p>8: 9,8 ↑</p> <p>9: 9,2 ↑</p> <p>10: 10,0 ↓</p> |
| Serie 96,0 | | Serie 93,0 | |
| Sum 96,0 | | Sum 189,0 | |

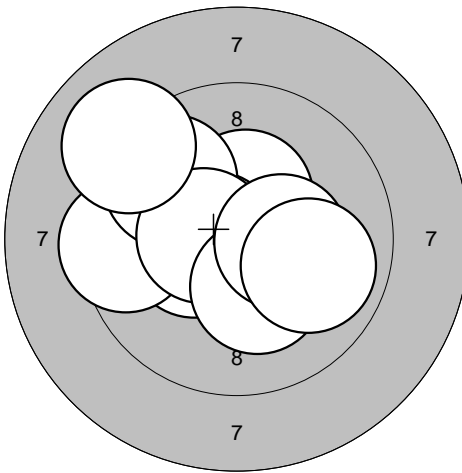
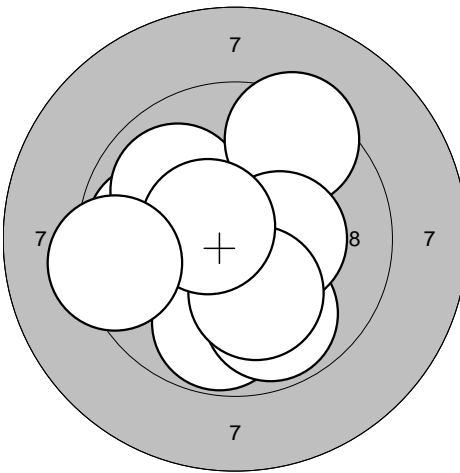
| | | | |
|---|--|---|---|
| <p>Series 3</p>  | <p>1: 10,4* ↑</p> <p>2: 10,6* ←</p> <p>3: 10,4* ←</p> <p>4: 9,5 ←</p> <p>5: 9,8 ↗</p> <p>6: 10,5* ←</p> <p>7: 10,3* ↓</p> <p>8: 10,4* →</p> <p>9: 9,9 ↗</p> <p>10: 9,0 ↗</p> | <p>Series 4</p>  | <p>1: 9,9 ←</p> <p>2: 10,5* ↖</p> <p>3: 10,0 ↗</p> <p>4: 9,8 ↓</p> <p>5: 9,8 ↓</p> <p>6: 9,4 ↗</p> <p>7: 10,3* →</p> <p>8: 10,2* ↓</p> <p>9: 10,6* ↖</p> <p>10: 9,3 ←</p> |
| Serie 96,0 | | Serie 95,0 | |
| Sum 285,0 | | Sum 380,0 | |

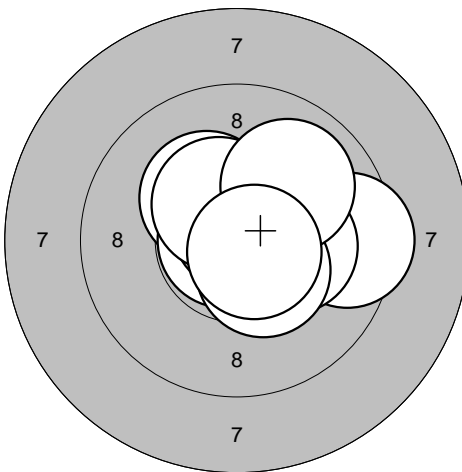
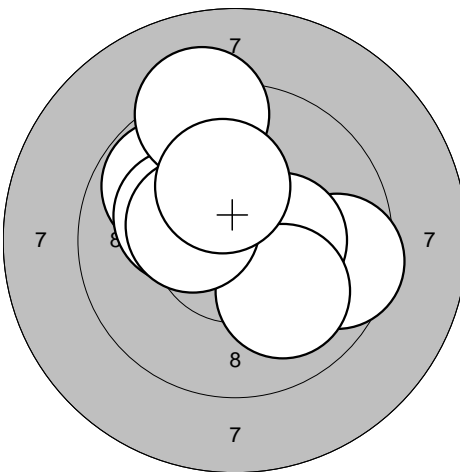
| | | | |
|--|---|--|---|
| <p>Series 5</p>  | <p>1: 10,3* ↗</p> <p>2: 10,8* ←</p> <p>3: 9,5 →</p> <p>4: 10,7* ↑</p> <p>5: 10,5* →</p> <p>6: 10,4* ↗</p> <p>7: 10,2* →</p> <p>8: 10,4* ↓</p> <p>9: 10,0 ↗</p> <p>10: 10,7* ↓</p> | <p>Series 6</p>  | <p>1: 10,7* ↑</p> <p>2: 9,6 →</p> <p>3: 10,3* →</p> <p>4: 9,8 ↗</p> <p>5: 10,2* ↗</p> <p>6: 10,2* ↖</p> <p>7: 9,2 ↑</p> <p>8: 10,0 ↓</p> <p>9: 10,4* ↖</p> <p>10: 10,2* ↑</p> |
| Serie 99,0 | | Serie 97,0 | |
| Sum 479,0 | | Sum 576,0 | |

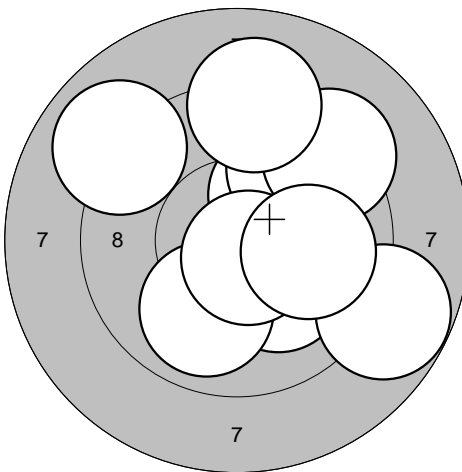
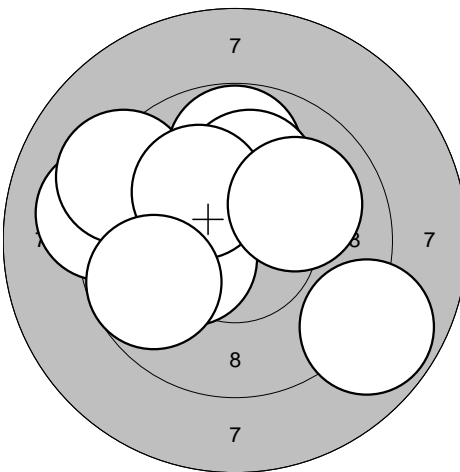
| | | | | | | | | | | | |
|--|---|-------|------|-----|------|--|--|-------|------|-----|-------|
| <p>Series 1</p>  | <p>1: 10,1 ↘ 2: 10,2* ↗ 3: 9,7 ↗ 4: 10,0 ↓ 5: 9,3 ↗ 6: 10,6* ↓ 7: 9,1 ↑ 8: 9,0 ↗ 9: 8,8 → 10: 10,0 →</p> <table border="1" style="width:100%; border-collapse: collapse;"> <tr><td>Serie</td><td style="text-align: right;">94,0</td></tr> <tr><td>Sum</td><td style="text-align: right;">94,0</td></tr> </table> | Serie | 94,0 | Sum | 94,0 | <p>Series 2</p>  | <p>1: 9,7 ↖ 2: 9,1 ← 3: 8,9 ↘ 4: 10,3* ← 5: 9,8 ↑ 6: 10,1 ↑ 7: 9,2 ↖ 8: 10,1 ↗ 9: 9,7 ← 10: 10,0 ↗</p> <table border="1" style="width:100%; border-collapse: collapse;"> <tr><td>Serie</td><td style="text-align: right;">93,0</td></tr> <tr><td>Sum</td><td style="text-align: right;">187,0</td></tr> </table> | Serie | 93,0 | Sum | 187,0 |
| Serie | 94,0 | | | | | | | | | | |
| Sum | 94,0 | | | | | | | | | | |
| Serie | 93,0 | | | | | | | | | | |
| Sum | 187,0 | | | | | | | | | | |

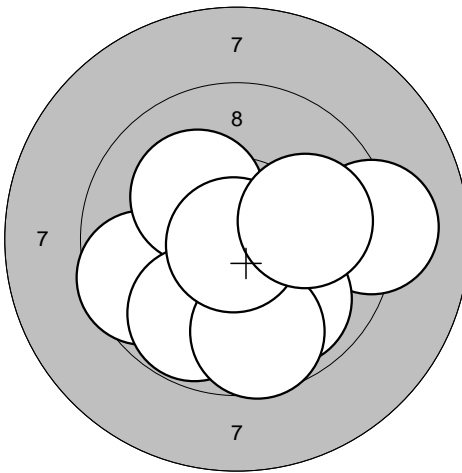
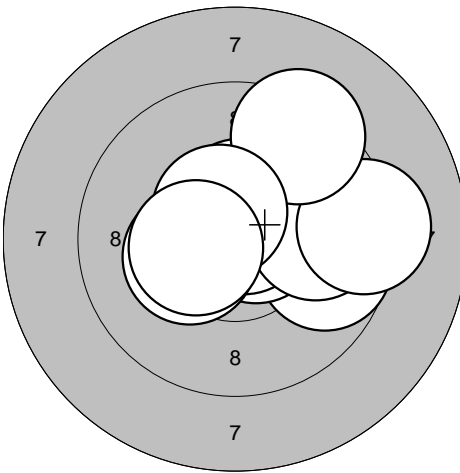
| | | | | | | | | | | | |
|---|--|-------|------|-----|-------|---|---|-------|------|-----|-------|
| <p>Series 3</p>  | <p>1: 10,7* ↓ 2: 10,6* ↓ 3: 9,1 → 4: 9,6 ← 5: 10,2* ↗ 6: 9,8 ↓ 7: 9,9 ↓ 8: 9,7 ↓ 9: 10,9* ↓ 10: 10,0 →</p> <table border="1" style="width:100%; border-collapse: collapse;"> <tr><td>Serie</td><td style="text-align: right;">95,0</td></tr> <tr><td>Sum</td><td style="text-align: right;">282,0</td></tr> </table> | Serie | 95,0 | Sum | 282,0 | <p>Series 4</p>  | <p>1: 9,7 → 2: 10,7* → 3: 10,5* ↑ 4: 10,8* ↗ 5: 9,9 → 6: 9,2 → 7: 9,3 ↗ 8: 10,5* ↗ 9: 10,3* ← 10: 10,4* ←</p> <table border="1" style="width:100%; border-collapse: collapse;"> <tr><td>Serie</td><td style="text-align: right;">96,0</td></tr> <tr><td>Sum</td><td style="text-align: right;">378,0</td></tr> </table> | Serie | 96,0 | Sum | 378,0 |
| Serie | 95,0 | | | | | | | | | | |
| Sum | 282,0 | | | | | | | | | | |
| Serie | 96,0 | | | | | | | | | | |
| Sum | 378,0 | | | | | | | | | | |

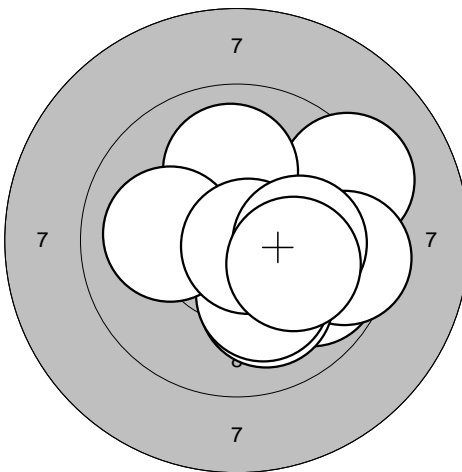
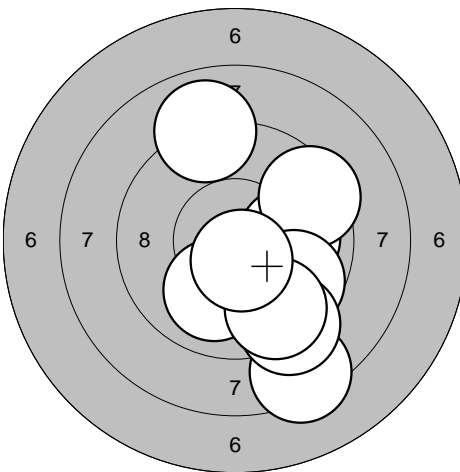
| | | | | | | | | | | | |
|--|--|-------|------|-----|-------|--|---|-------|------|-----|-------|
| <p>Series 5</p>  | <p>1: 9,3 ↗ 2: 9,8 → 3: 10,0 ↑ 4: 9,5 → 5: 10,1 ↓ 6: 10,2* ↓ 7: 10,1 ← 8: 10,8* → 9: 10,1 → 10: 10,1 →</p> <table border="1" style="width:100%; border-collapse: collapse;"> <tr><td>Serie</td><td style="text-align: right;">97,0</td></tr> <tr><td>Sum</td><td style="text-align: right;">475,0</td></tr> </table> | Serie | 97,0 | Sum | 475,0 | <p>Series 6</p>  | <p>1: 10,5* ↓ 2: 9,0 ↑ 3: 10,0 → 4: 9,4 ↗ 5: 9,7 ↘ 6: 10,0 ↓ 7: 8,4 ↓ 8: 9,2 ↓ 9: 9,5 ↓ 10: 10,6* ↓</p> <table border="1" style="width:100%; border-collapse: collapse;"> <tr><td>Serie</td><td style="text-align: right;">93,0</td></tr> <tr><td>Sum</td><td style="text-align: right;">568,0</td></tr> </table> | Serie | 93,0 | Sum | 568,0 |
| Serie | 97,0 | | | | | | | | | | |
| Sum | 475,0 | | | | | | | | | | |
| Serie | 93,0 | | | | | | | | | | |
| Sum | 568,0 | | | | | | | | | | |

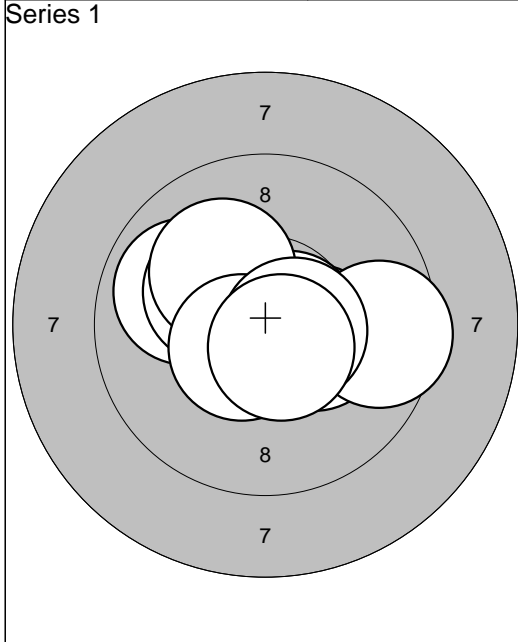

| | |
|-----------|------|
| 1: 10,3* | ↖ |
| 2: 9,9 | ↖ |
| 3: 10,2* | ↗ |
| 4: 10,3* | → |
| 5: 10,7* | → |
| 6: 10,1 | ↗ |
| 7: 9,5 | → |
| 8: 10,6* | ↙ |
| 9: 10,6* | → |
| 10: 10,6* | ↘ |
| Serie | 98,0 |
| Sum | 98,0 |

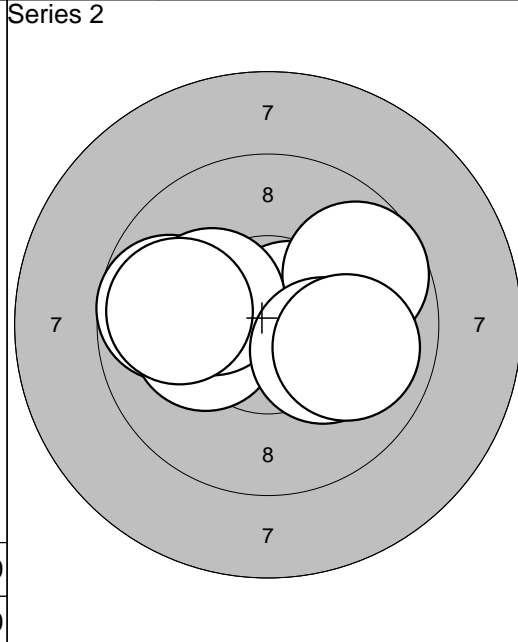

| | |
|----------|-------|
| 1: 10,3* | → |
| 2: 10,3* | ← |
| 3: 9,7 | ← |
| 4: 10,6* | ↗ |
| 5: 10,2* | ← |
| 6: 9,7 | ↗ |
| 7: 10,2* | ← |
| 8: 9,9 | ← |
| 9: 10,2* | ↗ |
| 10: 10,0 | → |
| Serie | 97,0 |
| Sum | 195,0 |

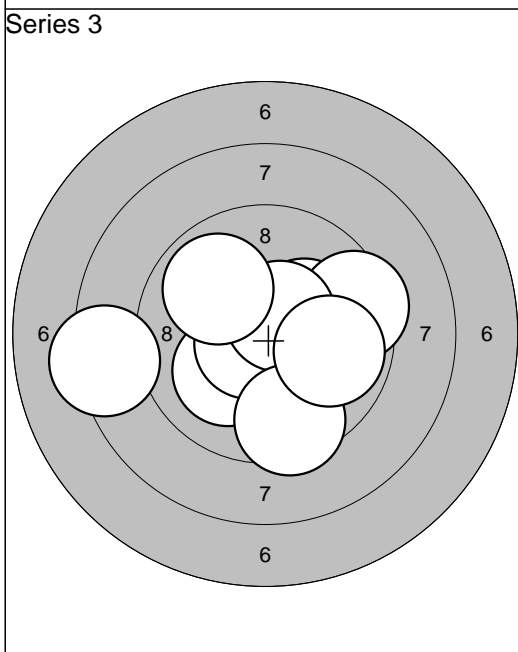

| | |
|----------|-------|
| 1: 10,0 | → |
| 2: 10,1 | ↙ |
| 3: 10,2* | ↗ |
| 4: 8,3 | ← |
| 5: 9,4 | → |
| 6: 10,7* | ← |
| 7: 10,6* | ↗ |
| 8: 9,9 | ↗ |
| 9: 9,5 | ↘ |
| 10: 9,9 | → |
| Serie | 94,0 |
| Sum | 289,0 |

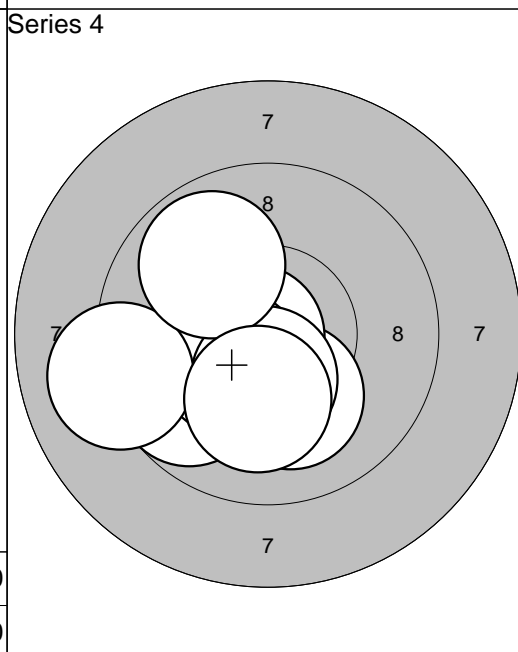

| | |
|-----------|-------|
| 1: 10,4* | ↙ |
| 2: 10,3* | ↘ |
| 3: 9,7 | ↙ |
| 4: 10,1 | ↘ |
| 5: 10,7* | ← |
| 6: 10,4* | ↙ |
| 7: 10,4* | ↘ |
| 8: 9,1 | ← |
| 9: 9,9 | ↗ |
| 10: 10,2* | ↘ |
| Serie | 97,0 |
| Sum | 386,0 |

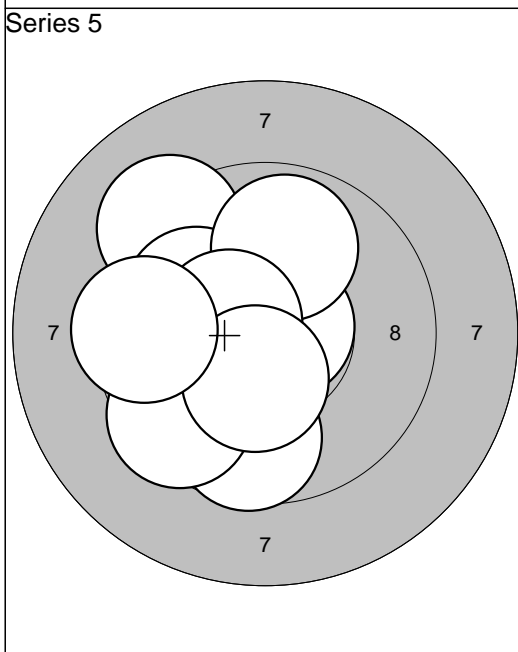

| | |
|----------|-------|
| 1: 10,5* | ↘ |
| 2: 9,7 | ↘ |
| 3: 9,5 | ↙ |
| 4: 9,2 | ↗ |
| 5: 10,0 | ↖ |
| 6: 10,7* | → |
| 7: 9,9 | ↗ |
| 8: 10,5* | ← |
| 9: 10,4* | ↘ |
| 10: 9,5 | ← |
| Serie | 95,0 |
| Sum | 481,0 |

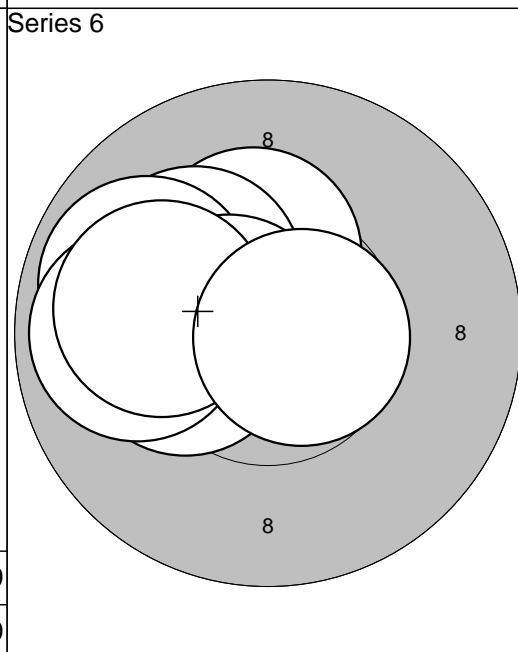

| | |
|-----------|-------|
| 1: 10,0 | ← |
| 2: 10,4* | ← |
| 3: 10,3* | ↗ |
| 4: 10,2* | ↗ |
| 5: 9,9 | ← |
| 6: 10,6* | ← |
| 7: 10,2* | ← |
| 8: 9,9 | ← |
| 9: 10,1 | ← |
| 10: 10,7* | → |
| Serie | 98,0 |
| Sum | 579,0 |

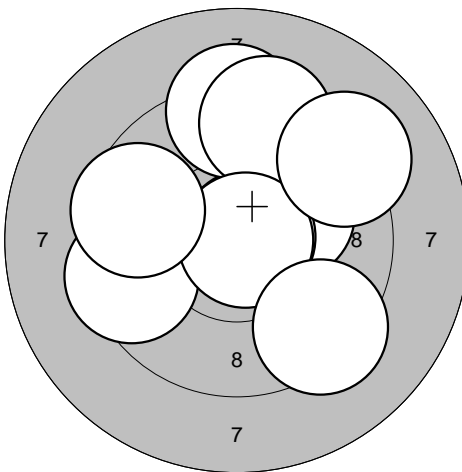
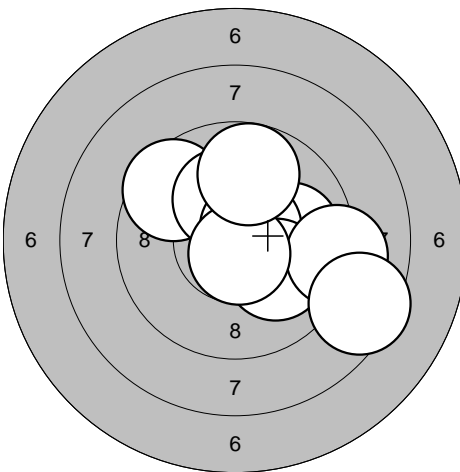
| | | | | | | | | | | | |
|--|--|-------|------|-----|------|--|--|-------|------|-----|-------|
| <p>Series 1</p>  | <p>1: 9,6 ↗ 2: 10,2* → 3: 10,8* → 4: 9,5 ← 5: 9,2 ↑ 6: 9,4 ↑ 7: 10,8* → 8: 9,2 ↗ 9: 9,3 ↘ 10: 9,6 ←</p> <table border="1" style="width:100%; border-collapse: collapse;"> <tr><td>Serie</td><td style="text-align: right;">93,0</td></tr> <tr><td>Sum</td><td style="text-align: right;">93,0</td></tr> </table> | Serie | 93,0 | Sum | 93,0 | <p>Series 2</p>  | <p>1: 9,6 ↖ 2: 10,2* ↑ 3: 10,1 → 4: 10,0 → 5: 10,6* ↗ 6: 10,1 ↘ 7: 9,1 → 8: 10,7* ↘ 9: 9,8 ↑ 10: 8,5 ↘</p> <table border="1" style="width:100%; border-collapse: collapse;"> <tr><td>Serie</td><td style="text-align: right;">95,0</td></tr> <tr><td>Sum</td><td style="text-align: right;">188,0</td></tr> </table> | Serie | 95,0 | Sum | 188,0 |
| Serie | 93,0 | | | | | | | | | | |
| Sum | 93,0 | | | | | | | | | | |
| Serie | 95,0 | | | | | | | | | | |
| Sum | 188,0 | | | | | | | | | | |

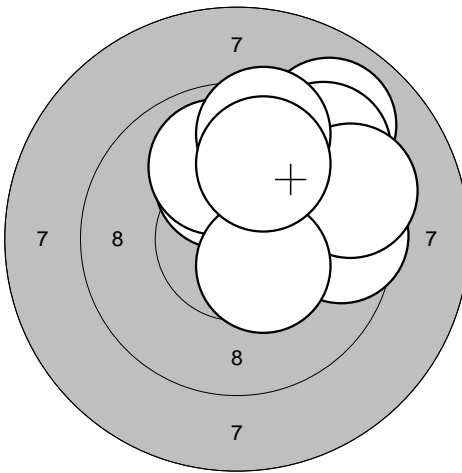
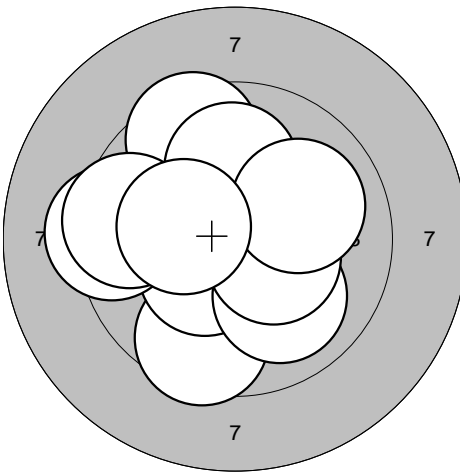
| | | | | | | | | | | | |
|---|---|-------|------|-----|-------|---|--|-------|------|-----|-------|
| <p>Series 3</p>  | <p>1: 9,0 ↗ 2: 9,6 → 3: 10,2* ↑ 4: 9,9 ↑ 5: 9,4 ↗ 6: 9,3 ↗ 7: 9,3 → 8: 9,5 ↑ 9: 10,5* ↘ 10: 9,9 ↑</p> <table border="1" style="width:100%; border-collapse: collapse;"> <tr><td>Serie</td><td style="text-align: right;">92,0</td></tr> <tr><td>Sum</td><td style="text-align: right;">280,0</td></tr> </table> | Serie | 92,0 | Sum | 280,0 | <p>Series 4</p>  | <p>1: 9,6 ↓ 2: 10,4* ↖ 3: 10,0 ↘ 4: 10,4* ↘ 5: 9,3 ← 6: 9,5 ↑ 7: 10,0 ↑ 8: 10,0 ↗ 9: 9,5 ← 10: 10,3* ←</p> <table border="1" style="width:100%; border-collapse: collapse;"> <tr><td>Serie</td><td style="text-align: right;">96,0</td></tr> <tr><td>Sum</td><td style="text-align: right;">376,0</td></tr> </table> | Serie | 96,0 | Sum | 376,0 |
| Serie | 92,0 | | | | | | | | | | |
| Sum | 280,0 | | | | | | | | | | |
| Serie | 96,0 | | | | | | | | | | |
| Sum | 376,0 | | | | | | | | | | |

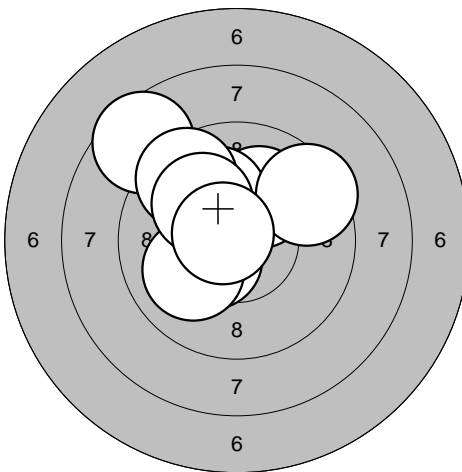
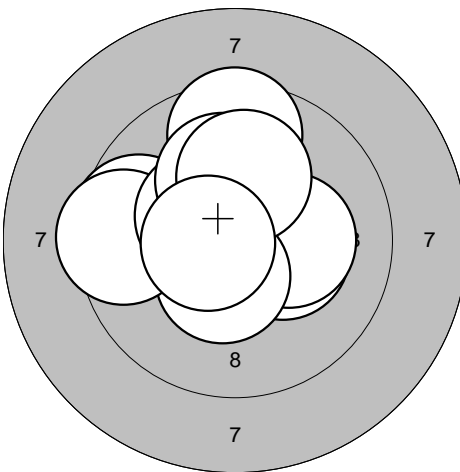
| | | | | | | | | | | | |
|--|---|-------|------|-----|-------|--|---|-------|------|-----|-------|
| <p>Series 5</p>  | <p>1: 10,3* ↑ 2: 10,1 ↗ 3: 10,1 ↗ 4: 10,4* ↖ 5: 8,6 ↗ 6: 9,5 ↗ 7: 9,5 ↗ 8: 10,0 ↖ 9: 10,1 ↗ 10: 10,7* ↖</p> <table border="1" style="width:100%; border-collapse: collapse;"> <tr><td>Serie</td><td style="text-align: right;">96,0</td></tr> <tr><td>Sum</td><td style="text-align: right;">472,0</td></tr> </table> | Serie | 96,0 | Sum | 472,0 | <p>Series 6</p>  | <p>1: 10,3* → 2: 10,2* → 3: 10,4* ↘ 4: 9,6 ← 5: 9,6 ↑ 6: 9,5 ← 7: 10,4* ↖ 8: 10,1 ↑ 9: 10,1 ↑ 10: 10,6* ←</p> <table border="1" style="width:100%; border-collapse: collapse;"> <tr><td>Serie</td><td style="text-align: right;">97,0</td></tr> <tr><td>Sum</td><td style="text-align: right;">569,0</td></tr> </table> | Serie | 97,0 | Sum | 569,0 |
| Serie | 96,0 | | | | | | | | | | |
| Sum | 472,0 | | | | | | | | | | |
| Serie | 97,0 | | | | | | | | | | |
| Sum | 569,0 | | | | | | | | | | |

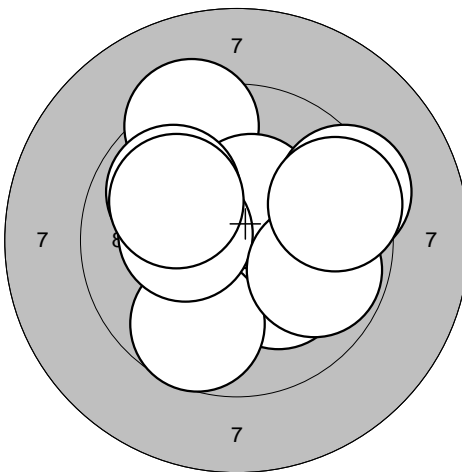
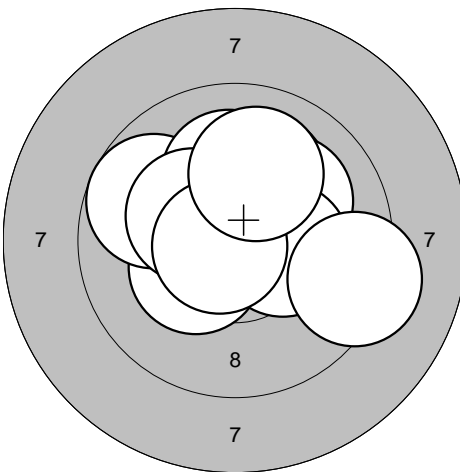
| | | | | | | | | | | | |
|--|---|-------|------|-----|------|--|---|-------|------|-----|-------|
| <p>Series 1</p>  | <p>1: 10,2* ↘ 2: 9,7 ↙ 3: 9,3 ↗ 4: 10,4* ↗ 5: 9,4 → 6: 10,3* ← 7: 9,8 → 8: 9,9 ↗ 9: 9,6 → 10: 10,0 ↖</p> <table border="1" style="width:100%; border-collapse: collapse;"> <tr><td>Serie</td><td style="text-align: right;">94,0</td></tr> <tr><td>Sum</td><td style="text-align: right;">94,0</td></tr> </table> | Serie | 94,0 | Sum | 94,0 | <p>Series 2</p>  | <p>1: 10,1 ↗ 2: 10,1 ↗ 3: 10,3* ↖ 4: 10,3* → 5: 9,8 ↖ 6: 9,3 → 7: 10,1 ↑ 8: 10,3* ↖ 9: 10,8* ↖ 10: 10,0 ↑</p> <table border="1" style="width:100%; border-collapse: collapse;"> <tr><td>Serie</td><td style="text-align: right;">98,0</td></tr> <tr><td>Sum</td><td style="text-align: right;">192,0</td></tr> </table> | Serie | 98,0 | Sum | 192,0 |
| Serie | 94,0 | | | | | | | | | | |
| Sum | 94,0 | | | | | | | | | | |
| Serie | 98,0 | | | | | | | | | | |
| Sum | 192,0 | | | | | | | | | | |

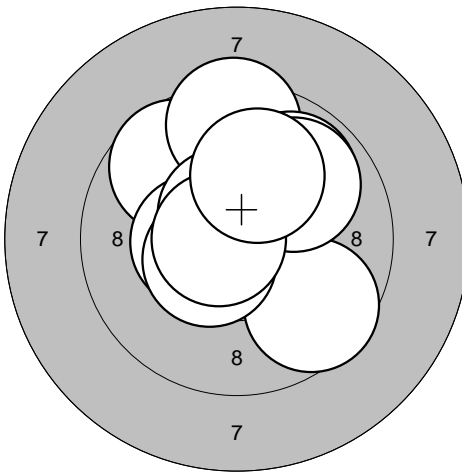
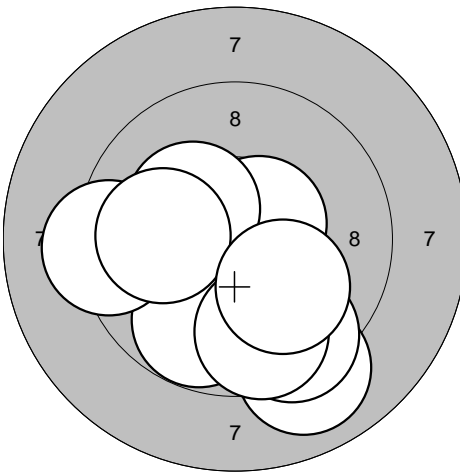
| | | | | | | | | | | | |
|---|--|-------|------|-----|-------|---|---|-------|------|-----|-------|
| <p>Series 3</p>  | <p>1: 9,7 ↖ 2: 10,4* ← 3: 9,4 ↗ 4: 9,9 ↗ 5: 10,6* ↗ 6: 9,6 ↘ 7: 9,9 ↗ 8: 10,5* ↖ 9: 10,7* ← 10: 10,1 ↗</p> <table border="1" style="width:100%; border-collapse: collapse;"> <tr><td>Serie</td><td style="text-align: right;">95,0</td></tr> <tr><td>Sum</td><td style="text-align: right;">287,0</td></tr> </table> | Serie | 95,0 | Sum | 287,0 | <p>Series 4</p>  | <p>1: 9,0 ↘ 2: 9,9 ↘ 3: 10,6* ↗ 4: 9,5 ↘ 5: 9,8 ↘ 6: 9,3 ← 7: 10,2* ↖ 8: 9,7 ↘ 9: 10,0 ← 10: 10,0 ↘</p> <table border="1" style="width:100%; border-collapse: collapse;"> <tr><td>Serie</td><td style="text-align: right;">94,0</td></tr> <tr><td>Sum</td><td style="text-align: right;">381,0</td></tr> </table> | Serie | 94,0 | Sum | 381,0 |
| Serie | 95,0 | | | | | | | | | | |
| Sum | 287,0 | | | | | | | | | | |
| Serie | 94,0 | | | | | | | | | | |
| Sum | 381,0 | | | | | | | | | | |

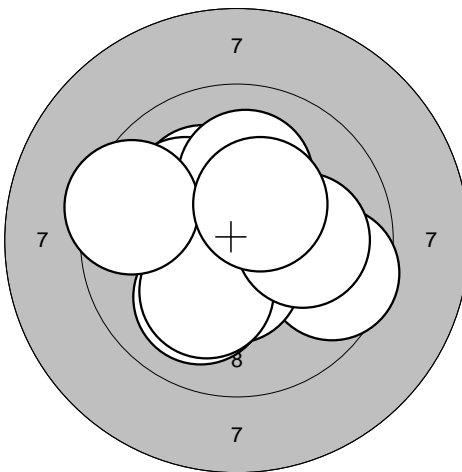
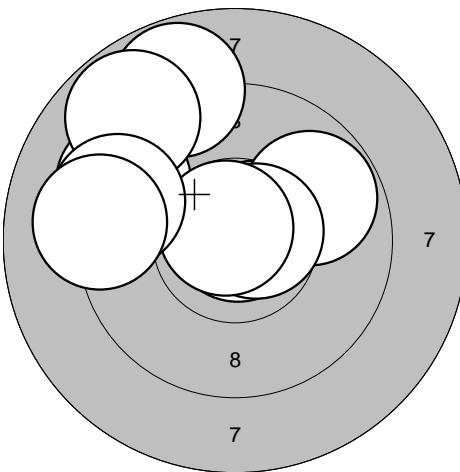
| | | | | | | | | | | | |
|--|---|-------|------|-----|-------|--|---|-------|------|-----|-------|
| <p>Series 5</p>  | <p>1: 10,2* ↗ 2: 9,6 → 3: 10,1 ↗ 4: 10,1 ↑ 5: 10,5* ↘ 6: 10,1 ↘ 7: 10,2* ↘ 8: 10,1 → 9: 9,5 ← 10: 10,4* ↗</p> <table border="1" style="width:100%; border-collapse: collapse;"> <tr><td>Serie</td><td style="text-align: right;">98,0</td></tr> <tr><td>Sum</td><td style="text-align: right;">479,0</td></tr> </table> | Serie | 98,0 | Sum | 479,0 | <p>Series 6</p>  | <p>1: 9,3 ↖ 2: 10,6* ↗ 3: 9,8 ↗ 4: 10,9* ↗ 5: 8,8 ↗ 6: 10,6* → 7: 10,8* ↗ 8: 8,8 ↗ 9: 9,3 ← 10: 9,1 ←</p> <table border="1" style="width:100%; border-collapse: collapse;"> <tr><td>Serie</td><td style="text-align: right;">92,0</td></tr> <tr><td>Sum</td><td style="text-align: right;">571,0</td></tr> </table> | Serie | 92,0 | Sum | 571,0 |
| Serie | 98,0 | | | | | | | | | | |
| Sum | 479,0 | | | | | | | | | | |
| Serie | 92,0 | | | | | | | | | | |
| Sum | 571,0 | | | | | | | | | | |

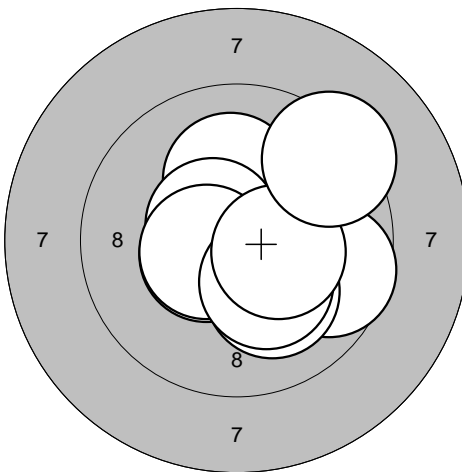
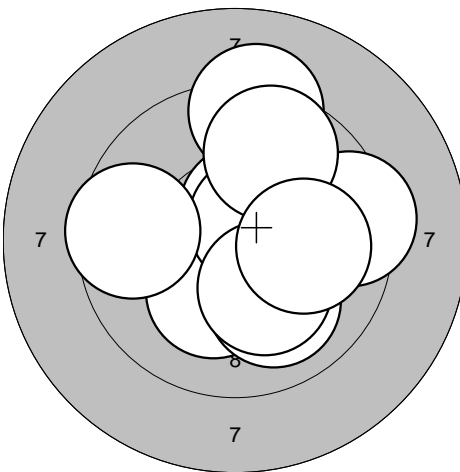
| | | | |
|--|---|--|--|
| <p>Series 1</p>  | <p>1: 10,2* ↑</p> <p>2: 10,5* ↙</p> <p>3: 10,2* ↘</p> <p>4: 9,7 →</p> <p>5: 10,1 ↘</p> <p>6: 10,6* ↗</p> <p>7: 10,5* ↙</p> <p>8: 10,3* ↘</p> <p>9: 10,4* →</p> <p>10: 9,3 ↗</p> | <p>Series 2</p>  | <p>1: 10,5* ↗</p> <p>2: 10,2* ↘</p> <p>3: 9,2 ↑</p> <p>4: 10,6* ↗</p> <p>5: 9,4 →</p> <p>6: 10,0 ↘</p> <p>7: 9,7 ↑</p> <p>8: 10,2* ↘</p> <p>9: 9,6 ←</p> <p>10: 10,0 →</p> |
| Serie 98,0 | Serie 96,0 | Serie 96,0 | Serie 96,0 |
| Sum 98,0 | Sum 194,0 | Sum 194,0 | Sum 194,0 |

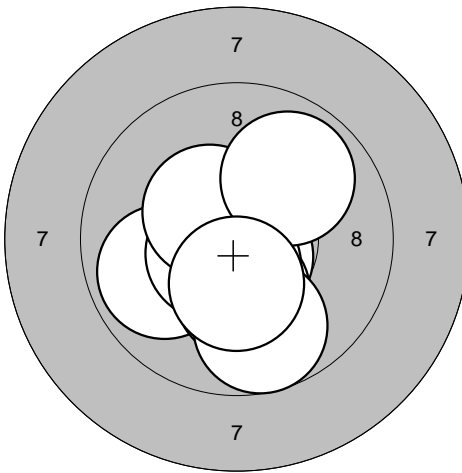
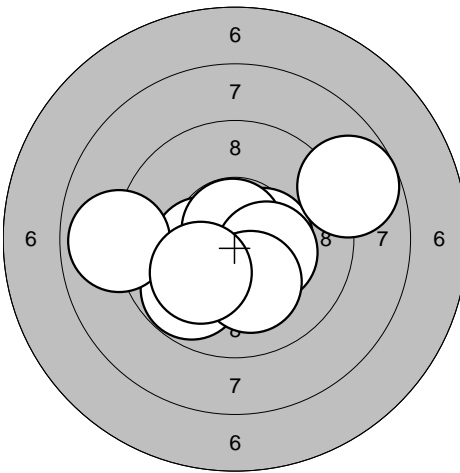
| | | | |
|---|--|---|--|
| <p>Series 3</p>  | <p>1: 10,7* ↘</p> <p>2: 9,9 ↙</p> <p>3: 10,2* ↘</p> <p>4: 10,6* ↘</p> <p>5: 10,7* ↑</p> <p>6: 10,6* ↙</p> <p>7: 10,4* ↗</p> <p>8: 9,7 ↘</p> <p>9: 9,9 ↗</p> <p>10: 10,4* ↘</p> | <p>Series 4</p>  | <p>1: 10,5* →</p> <p>2: 10,4* ↙</p> <p>3: 10,5* →</p> <p>4: 9,8 ↘</p> <p>5: 10,8* ↑</p> <p>6: 8,7 ↗</p> <p>7: 10,4* →</p> <p>8: 10,1 ↘</p> <p>9: 8,9 ←</p> <p>10: 10,1 ↙</p> |
| Serie 97,0 | Serie 95,0 | Serie 95,0 | Serie 95,0 |
| Sum 291,0 | Sum 386,0 | Sum 386,0 | Sum 386,0 |

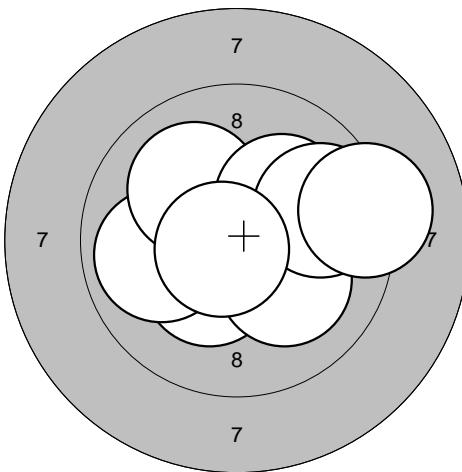
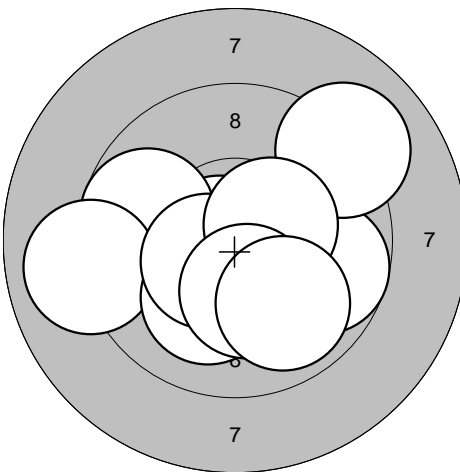
| | | | |
|--|--|--|---|
| <p>Series 5</p>  | <p>1: 10,3* ↙</p> <p>2: 10,3* ↘</p> <p>3: 10,6* ↙</p> <p>4: 10,1 ↘</p> <p>5: 9,9 ↙</p> <p>6: 10,1 ↗</p> <p>7: 10,2* ↗</p> <p>8: 9,8 →</p> <p>9: 9,2 →</p> <p>10: 10,7* ↙</p> | <p>Series 6</p>  | <p>1: 10,8* ↙</p> <p>2: 9,8 ↙</p> <p>3: 9,7 →</p> <p>4: 9,0 ↙</p> <p>5: 9,1 ↗</p> <p>6: 10,1 ↘</p> <p>7: 10,5* ↙</p> <p>8: 10,4* →</p> <p>9: 10,2* ↘</p> <p>10: 9,9 ↘</p> |
| Serie 97,0 | Serie 95,0 | Serie 95,0 | Serie 95,0 |
| Sum 483,0 | Sum 578,0 | Sum 578,0 | Sum 578,0 |

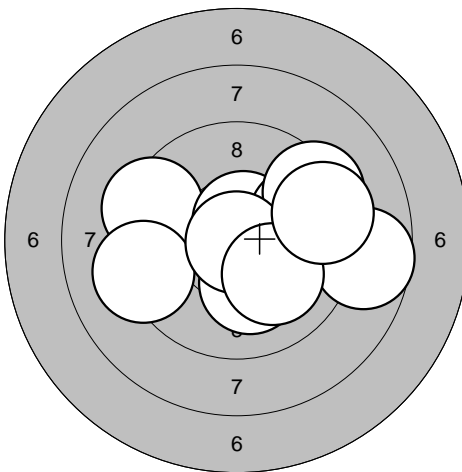
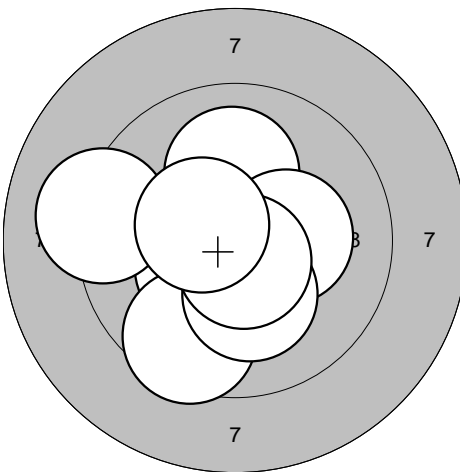
| | | | |
|--|--|--|---|
| <p>Series 1</p>  | <p>1: 9,4 ←</p> <p>2: 10,6* ↑</p> <p>3: 9,2 ←</p> <p>4: 10,1 ↓</p> <p>5: 9,8 →</p> <p>6: 9,3 →</p> <p>7: 10,9* ↓</p> <p>8: 8,7 →</p> <p>9: 10,1 ↓</p> <p>10: 9,4 →</p> | <p>Series 2</p>  | <p>1: 10,7* ↗</p> <p>2: 10,1 ↑</p> <p>3: 10,4* ↓</p> <p>4: 10,4* ↙</p> <p>5: 9,2 ←</p> <p>6: 10,3* →</p> <p>7: 9,6 ↓</p> <p>8: 10,2* ↓</p> <p>9: 10,7* ↓</p> <p>10: 10,5* ↙</p> |
| Serie 93,0 | | Serie 98,0 | |
| Sum 93,0 | | Sum 191,0 | |

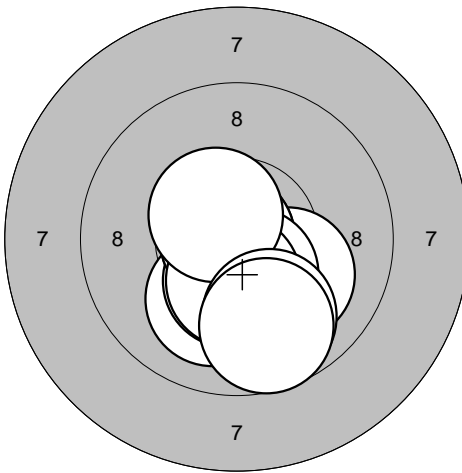
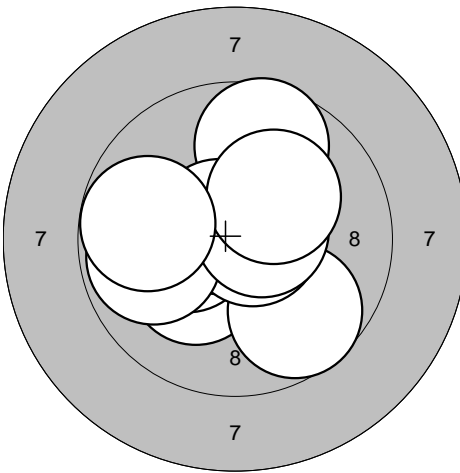
| | | | |
|---|--|---|--|
| <p>Series 3</p>  | <p>1: 10,1 ↓</p> <p>2: 10,1 ↘</p> <p>3: 10,8* ←</p> <p>4: 10,4* ↓</p> <p>5: 10,8* ←</p> <p>6: 10,4* ↓</p> <p>7: 10,4* ↓</p> <p>8: 10,5* ↗</p> <p>9: 9,8 ↓</p> <p>10: 9,7 ↓</p> | <p>Series 4</p>  | <p>1: 9,7 ↑</p> <p>2: 10,2* ↙</p> <p>3: 10,3* ←</p> <p>4: 10,7* ↗</p> <p>5: 9,7 ↓</p> <p>6: 10,7* →</p> <p>7: 9,8 ←</p> <p>8: 10,6* →</p> <p>9: 10,2* ↗</p> <p>10: 9,8 ←</p> |
| Serie 98,0 | | Serie 96,0 | |
| Sum 289,0 | | Sum 385,0 | |

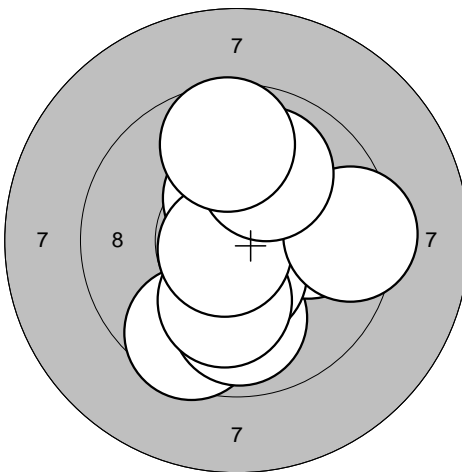
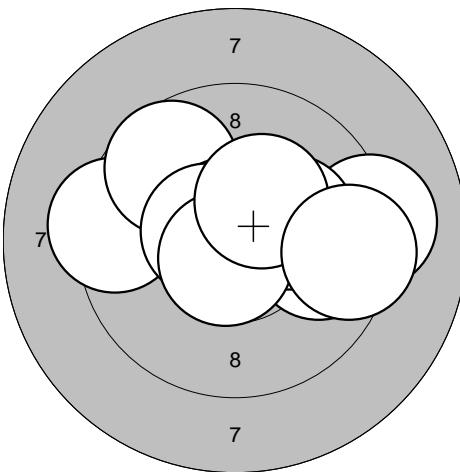
| | | | |
|--|---|--|--|
| <p>Series 5</p>  | <p>1: 10,4* ↑</p> <p>2: 9,6 ↓</p> <p>3: 9,9 ↓</p> <p>4: 10,0 →</p> <p>5: 10,5* ↓</p> <p>6: 10,1 ↓</p> <p>7: 10,7* ↙</p> <p>8: 9,4 →</p> <p>9: 10,0 ↗</p> <p>10: 9,7 ↑</p> | <p>Series 6</p>  | <p>1: 9,3 ←</p> <p>2: 9,7 ↗</p> <p>3: 9,1 →</p> <p>4: 9,8 →</p> <p>5: 10,2* →</p> <p>6: 10,8* ↗</p> <p>7: 10,6* ↙</p> <p>8: 10,7* ↓</p> <p>9: 10,3* ↗</p> <p>10: 9,4 →</p> |
| Serie 96,0 | | Serie 95,0 | |
| Sum 481,0 | | Sum 576,0 | |

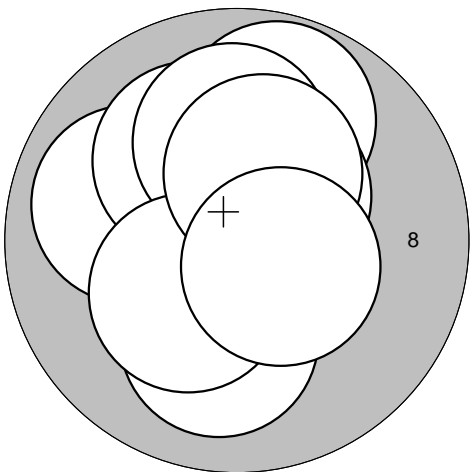
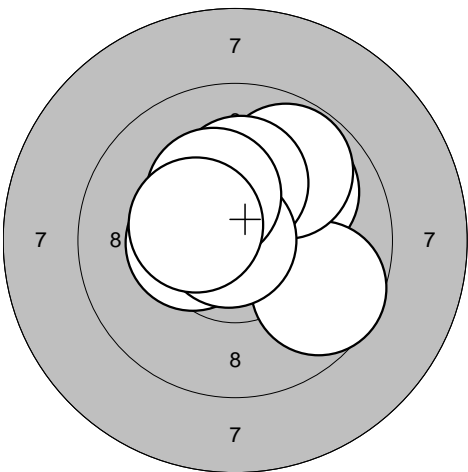
| | | | | | | | | | | | |
|--|--|-------|------|-----|------|--|---|-------|------|-----|-------|
| <p>Series 1</p>  | <p>1: 10,1 ↓ 2: 10,3* ↖ 3: 10,0 ↖ 4: 9,8 ↑ 5: 10,4* ↗ 6: 10,1 ↑ 7: 10,1 ↑ 8: 10,3* ↙ 9: 10,3* ↗ 10: 10,5* ↘</p> <table border="1" style="width:100%; border-collapse: collapse;"> <tr><td>Serie</td><td style="text-align: right;">99,0</td></tr> <tr><td>Sum</td><td style="text-align: right;">99,0</td></tr> </table> | Serie | 99,0 | Sum | 99,0 | <p>Series 2</p>  | <p>1: 10,4* ← 2: 9,9 ↗ 3: 10,6* ↗ 4: 9,7 ↘ 5: 9,8 ↗ 6: 10,7* ↖ 7: 10,2* ↑ 8: 10,9* ← 9: 10,3* ↖ 10: 10,4* ←</p> <table border="1" style="width:100%; border-collapse: collapse;"> <tr><td>Serie</td><td style="text-align: right;">97,0</td></tr> <tr><td>Sum</td><td style="text-align: right;">196,0</td></tr> </table> | Serie | 97,0 | Sum | 196,0 |
| Serie | 99,0 | | | | | | | | | | |
| Sum | 99,0 | | | | | | | | | | |
| Serie | 97,0 | | | | | | | | | | |
| Sum | 196,0 | | | | | | | | | | |

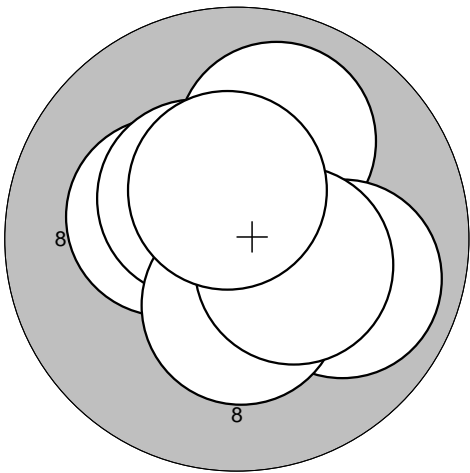
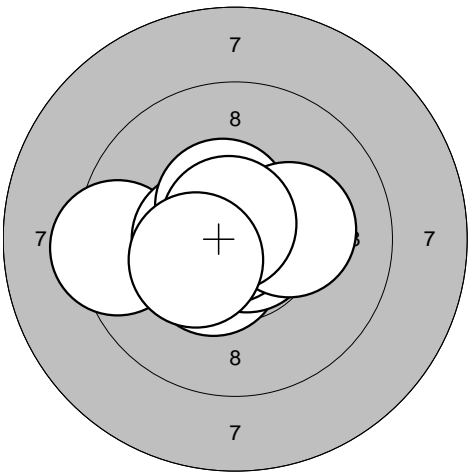
| | | | | | | | | | | | |
|---|--|-------|------|-----|-------|---|---|-------|------|-----|-------|
| <p>Series 3</p>  | <p>1: 10,4* → 2: 10,3* ↖ 3: 10,9* ↗ 4: 10,0 ↑ 5: 10,6* ↘ 6: 10,4* ↗ 7: 9,9 → 8: 10,4* ↘ 9: 10,4* → 10: 10,5* ↑</p> <table border="1" style="width:100%; border-collapse: collapse;"> <tr><td>Serie</td><td style="text-align: right;">99,0</td></tr> <tr><td>Sum</td><td style="text-align: right;">295,0</td></tr> </table> | Serie | 99,0 | Sum | 295,0 | <p>Series 4</p>  | <p>1: 10,8* ↑ 2: 10,5* ↘ 3: 9,4 ← 4: 10,8* ↘ 5: 10,5* ← 6: 10,5* ↑ 7: 10,8* ↖ 8: 10,2* → 9: 10,7* ↖ 10: 10,3* ↖</p> <table border="1" style="width:100%; border-collapse: collapse;"> <tr><td>Serie</td><td style="text-align: right;">99,0</td></tr> <tr><td>Sum</td><td style="text-align: right;">394,0</td></tr> </table> | Serie | 99,0 | Sum | 394,0 |
| Serie | 99,0 | | | | | | | | | | |
| Sum | 295,0 | | | | | | | | | | |
| Serie | 99,0 | | | | | | | | | | |
| Sum | 394,0 | | | | | | | | | | |

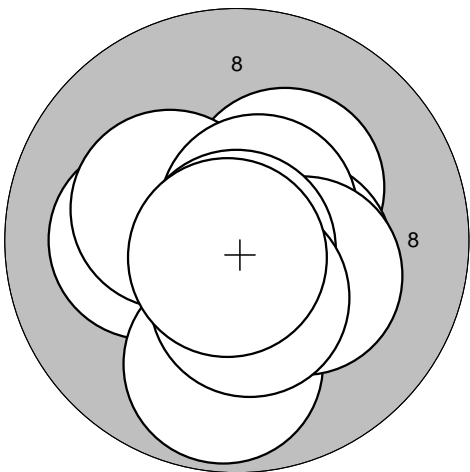
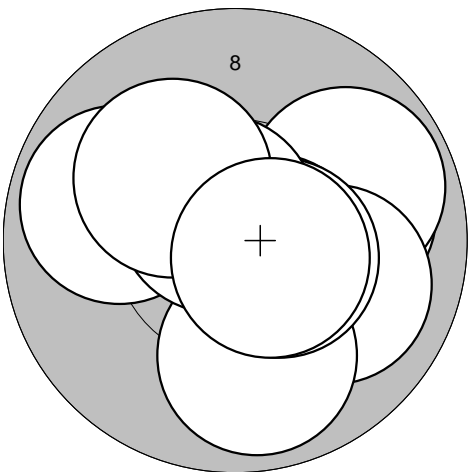
| | | | | | | | | | | | |
|--|--|-------|------|-----|-------|--|--|-------|------|-----|-------|
| <p>Series 5</p>  | <p>1: 10,3* ↗ 2: 10,1 ← 3: 9,8 ↓ 4: 10,3* ↖ 5: 10,4* → 6: 10,6* ↗ 7: 10,3* → 8: 10,9* ↓ 9: 10,4* ↓ 10: 10,8* ↘</p> <table border="1" style="width:100%; border-collapse: collapse;"> <tr><td>Serie</td><td style="text-align: right;">99,0</td></tr> <tr><td>Sum</td><td style="text-align: right;">493,0</td></tr> </table> | Serie | 99,0 | Sum | 493,0 | <p>Series 6</p>  | <p>1: 10,0 → 2: 9,8 ↗ 3: 10,0 ↘ 4: 10,6* ↘ 5: 9,9 ↖ 6: 9,9 ↓ 7: 10,5* ↘ 8: 10,7* ↗ 9: 10,1 ↗ 10: 10,6* ↘</p> <table border="1" style="width:100%; border-collapse: collapse;"> <tr><td>Serie</td><td style="text-align: right;">97,0</td></tr> <tr><td>Sum</td><td style="text-align: right;">590,0</td></tr> </table> | Serie | 97,0 | Sum | 590,0 |
| Serie | 99,0 | | | | | | | | | | |
| Sum | 493,0 | | | | | | | | | | |
| Serie | 97,0 | | | | | | | | | | |
| Sum | 590,0 | | | | | | | | | | |

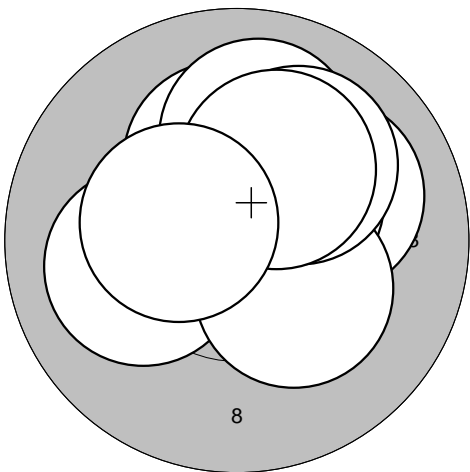
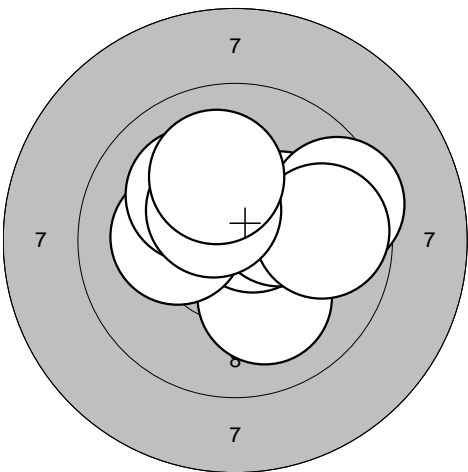
| | | | |
|--|--|--|---|
| <p>Series 1</p>  | <p>1: 10,1 →</p> <p>2: 10,2* ↑</p> <p>3: 10,0 ↑</p> <p>4: 10,4* ↗</p> <p>5: 10,1 ←</p> <p>6: 10,7* ↑</p> <p>7: 10,3* ↘</p> <p>8: 10,1 ↗</p> <p>9: 10,2* ↗</p> <p>10: 10,4* ←</p> | <p>Series 2</p>  | <p>1: 10,1 ↓</p> <p>2: 10,3* ←</p> <p>3: 10,6* ↗</p> <p>4: 10,3* ↗</p> <p>5: 10,2* ←</p> <p>6: 9,5 →</p> <p>7: 9,8 →</p> <p>8: 10,1 ↖</p> <p>9: 10,5* ↖</p> <p>10: 10,1 ↑</p> |
| Serie 100,0 | Serie 98,0 | Serie 98,0 | Serie 98,0 |
| Sum 100,0 | Sum 198,0 | Sum 198,0 | Sum 198,0 |

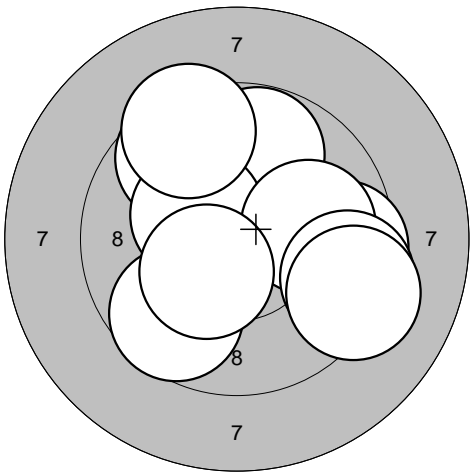
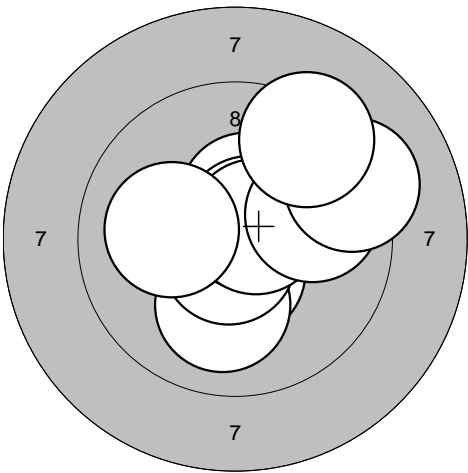
| | | | |
|---|---|---|--|
| <p>Series 3</p>  | <p>1: 9,7 ↖</p> <p>2: 9,8 ↑</p> <p>3: 10,4* ↖</p> <p>4: 9,4 ↑</p> <p>5: 9,6 ↘</p> <p>6: 9,5 →</p> <p>7: 10,0 →</p> <p>8: 9,4 →</p> <p>9: 9,2 ↘</p> <p>10: 10,3* ↘</p> | <p>Series 4</p>  | <p>1: 10,5* ↓</p> <p>2: 10,0 ↓</p> <p>3: 10,4* ↑</p> <p>4: 10,7* ↘</p> <p>5: 10,7* ↗</p> <p>6: 10,6* ↗</p> <p>7: 9,9 →</p> <p>8: 9,2 →</p> <p>9: 9,3 ↗</p> <p>10: 10,1 ←</p> |
| Serie 93,0 | Serie 97,0 | Serie 97,0 | Serie 97,0 |
| Sum 291,0 | Sum 388,0 | Sum 388,0 | Sum 388,0 |

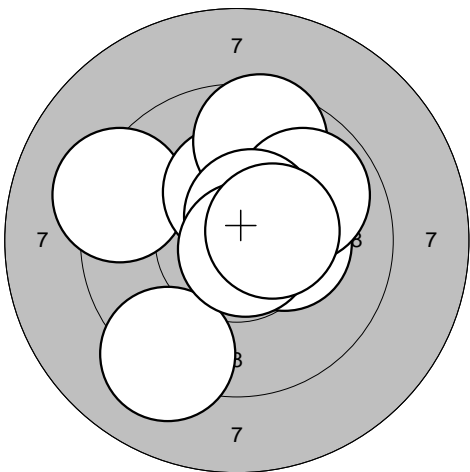
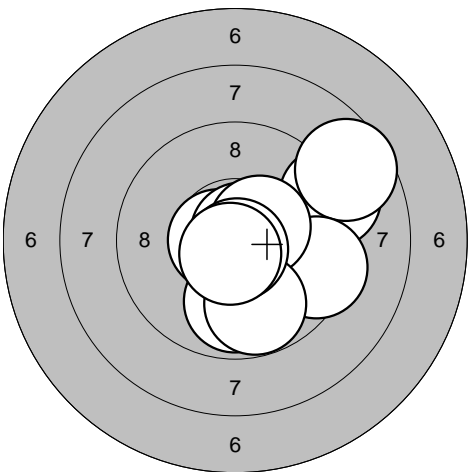
| | | | |
|--|--|--|--|
| <p>Series 5</p>  | <p>1: 9,3 ←</p> <p>2: 10,3* ↑</p> <p>3: 10,3* →</p> <p>4: 9,2 ↘</p> <p>5: 10,5* →</p> <p>6: 9,6 ↑</p> <p>7: 9,9 ↗</p> <p>8: 10,6* ↗</p> <p>9: 10,8* ↘</p> <p>10: 10,5* →</p> | <p>Series 6</p>  | <p>1: 9,9 ↓</p> <p>2: 9,1 →</p> <p>3: 8,6 ↗</p> <p>4: 9,4 →</p> <p>5: 10,7* ←</p> <p>6: 10,8* ↗</p> <p>7: 10,4* ↗</p> <p>8: 9,8 ↓</p> <p>9: 10,8* ↓</p> <p>10: 10,7* ↓</p> |
| Serie 96,0 | Serie 94,0 | Serie 94,0 | Serie 94,0 |
| Sum 484,0 | Sum 578,0 | Sum 578,0 | Sum 578,0 |

| | | | | | | | | | | | |
|-----------------|--|-------|------|-----|------|-----------------|---|-------|------|-----|-------|
| <p>Series 1</p> | <p>1: 10,8* →</p> <p>2: 10,4* →</p> <p>3: 10,0 ↙</p> <p>4: 10,8* →</p> <p>5: 9,6 ↙</p> <p>6: 10,4* ↑</p> <p>7: 10,1 ↓</p> <p>8: 9,5 →</p> <p>9: 10,0 ↓</p> <p>10: 10,2* ←</p> <table border="1" style="width:100%; border-collapse: collapse;"> <tr><td>Serie</td><td style="text-align: right;">98,0</td></tr> <tr><td>Sum</td><td style="text-align: right;">98,0</td></tr> </table> | Serie | 98,0 | Sum | 98,0 | <p>Series 2</p> | <p>1: 10,4* ↖</p> <p>2: 10,0 ↑</p> <p>3: 10,6* ↗</p> <p>4: 10,0 ↓</p> <p>5: 10,4* ↘</p> <p>6: 10,0 ←</p> <p>7: 10,5* ↙</p> <p>8: 9,8 ↙</p> <p>9: 10,5* ←</p> <p>10: 10,4* ↗</p> <table border="1" style="width:100%; border-collapse: collapse;"> <tr><td>Serie</td><td style="text-align: right;">99,0</td></tr> <tr><td>Sum</td><td style="text-align: right;">197,0</td></tr> </table> | Serie | 99,0 | Sum | 197,0 |
| Serie | 98,0 | | | | | | | | | | |
| Sum | 98,0 | | | | | | | | | | |
| Serie | 99,0 | | | | | | | | | | |
| Sum | 197,0 | | | | | | | | | | |

| | | | | | | | | | | | |
|-----------------|---|-------|-------|-----|-------|-----------------|---|-------|-------|-----|-------|
| <p>Series 3</p> | <p>1: 10,6* ↗</p> <p>2: 10,6* →</p> <p>3: 10,1 ↓</p> <p>4: 10,2* →</p> <p>5: 10,1 ↓</p> <p>6: 10,8* ↓</p> <p>7: 10,5* ↑</p> <p>8: 10,2* ←</p> <p>9: 10,6* ↗</p> <p>10: 10,4* ↑</p> <table border="1" style="width:100%; border-collapse: collapse;"> <tr><td>Serie</td><td style="text-align: right;">100,0</td></tr> <tr><td>Sum</td><td style="text-align: right;">297,0</td></tr> </table> | Serie | 100,0 | Sum | 297,0 | <p>Series 4</p> | <p>1: 10,2* ↘</p> <p>2: 10,5* ↓</p> <p>3: 10,2* ↓</p> <p>4: 10,6* ↘</p> <p>5: 10,9* ↑</p> <p>6: 10,1 ↓</p> <p>7: 10,3* ↘</p> <p>8: 10,4* ↑</p> <p>9: 10,3* ←</p> <p>10: 10,1 ↗</p> <table border="1" style="width:100%; border-collapse: collapse;"> <tr><td>Serie</td><td style="text-align: right;">100,0</td></tr> <tr><td>Sum</td><td style="text-align: right;">397,0</td></tr> </table> | Serie | 100,0 | Sum | 397,0 |
| Serie | 100,0 | | | | | | | | | | |
| Sum | 297,0 | | | | | | | | | | |
| Serie | 100,0 | | | | | | | | | | |
| Sum | 397,0 | | | | | | | | | | |

| | | | | | | | | | | | |
|-----------------|--|-------|------|-----|-------|-----------------|---|-------|------|-----|-------|
| <p>Series 5</p> | <p>1: 10,0 →</p> <p>2: 9,6 →</p> <p>3: 10,0 →</p> <p>4: 10,5* ↗</p> <p>5: 10,3* ↙</p> <p>6: 10,3* ↓</p> <p>7: 10,2* ←</p> <p>8: 10,4* ↑</p> <p>9: 9,9 ↓</p> <p>10: 10,6* ↘</p> <table border="1" style="width:100%; border-collapse: collapse;"> <tr><td>Serie</td><td style="text-align: right;">98,0</td></tr> <tr><td>Sum</td><td style="text-align: right;">495,0</td></tr> </table> | Serie | 98,0 | Sum | 495,0 | <p>Series 6</p> | <p>1: 10,6* ←</p> <p>2: 10,1 ↗</p> <p>3: 10,3* ↖</p> <p>4: 10,6* →</p> <p>5: 9,3 ↗</p> <p>6: 10,7* ↗</p> <p>7: 10,3* ↗</p> <p>8: 10,5* ↘</p> <p>9: 10,8* ↘</p> <p>10: 10,5* →</p> <table border="1" style="width:100%; border-collapse: collapse;"> <tr><td>Serie</td><td style="text-align: right;">99,0</td></tr> <tr><td>Sum</td><td style="text-align: right;">594,0</td></tr> </table> | Serie | 99,0 | Sum | 594,0 |
| Serie | 98,0 | | | | | | | | | | |
| Sum | 495,0 | | | | | | | | | | |
| Serie | 99,0 | | | | | | | | | | |
| Sum | 594,0 | | | | | | | | | | |

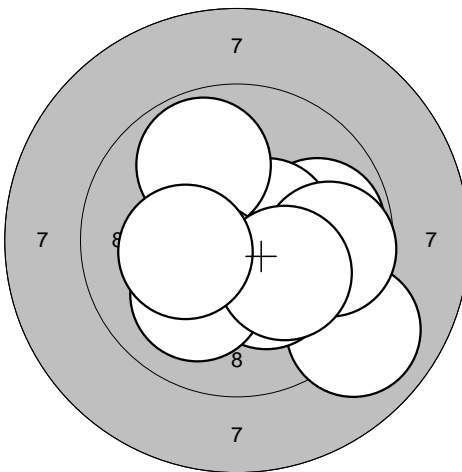
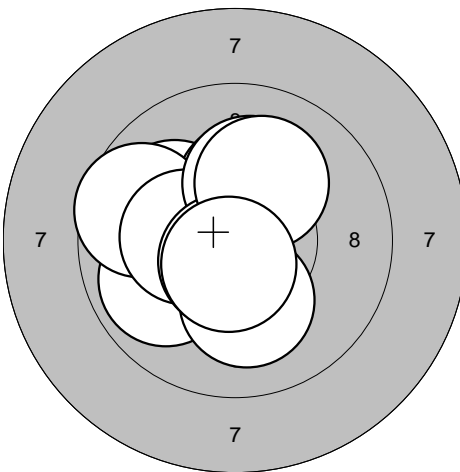
| | | | |
|--|---|--|---|
| <p>Series 1</p>  | <p>1: 9,9 →</p> <p>2: 10,5* →</p> <p>3: 9,0 ↓</p> <p>4: 9,9 ↑</p> <p>5: 9,7 →</p> <p>6: 10,3* ↓</p> <p>7: 10,4* ↓</p> <p>8: 10,1 ↓</p> <p>9: 10,2* ↓</p> <p>10: 10,2* ←</p> | <p>Series 2</p>  | <p>1: 10,1 ↖</p> <p>2: 9,9 ↙</p> <p>3: 10,3* ↑</p> <p>4: 10,1 ↓</p> <p>5: 9,7 ↖</p> <p>6: 10,3* ←</p> <p>7: 10,2* ↑</p> <p>8: 10,6* ↓</p> <p>9: 10,1 ↗</p> <p>10: 10,6* ↓</p> |
| Serie 96,0 | Serie 98,0 | Serie 98,0 | Serie 98,0 |
| Sum 96,0 | Sum 194,0 | Sum 194,0 | Sum 194,0 |

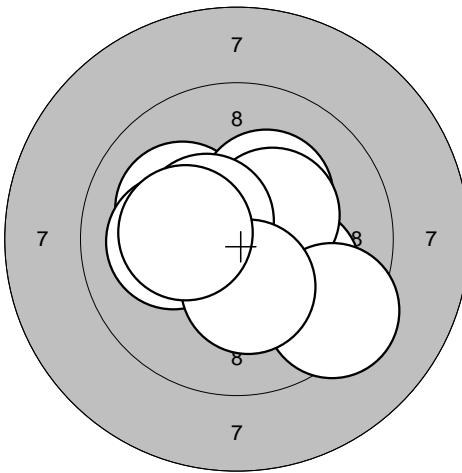
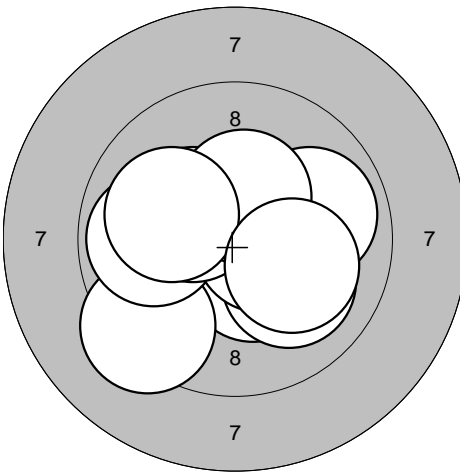
| | | | |
|---|---|---|---|
| <p>Series 3</p>  | <p>1: 10,1 ↖</p> <p>2: 10,1 ←</p> <p>3: 10,3* ↓</p> <p>4: 10,1 →</p> <p>5: 10,3* ↗</p> <p>6: 10,4* ↗</p> <p>7: 10,5* ↗</p> <p>8: 9,4 ↓</p> <p>9: 10,3* ↓</p> <p>10: 10,3* ←</p> | <p>Series 4</p>  | <p>1: 10,4* ↓</p> <p>2: 9,3 ↙</p> <p>3: 10,0 ↓</p> <p>4: 9,9 ←</p> <p>5: 10,6* →</p> <p>6: 9,9 →</p> <p>7: 10,3* ↖</p> <p>8: 10,4* ↑</p> <p>9: 10,0 ←</p> <p>10: 10,1 →</p> |
| Serie 99,0 | Serie 97,0 | Serie 97,0 | Serie 97,0 |
| Sum 293,0 | Sum 390,0 | Sum 390,0 | Sum 390,0 |

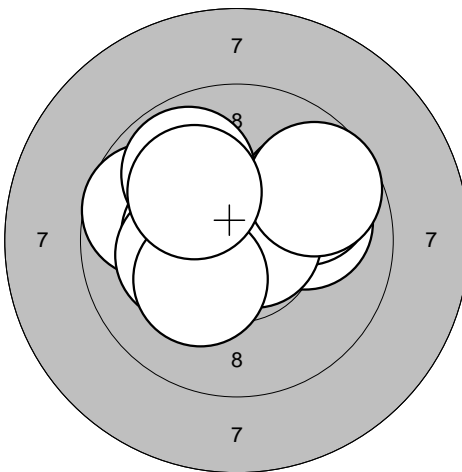
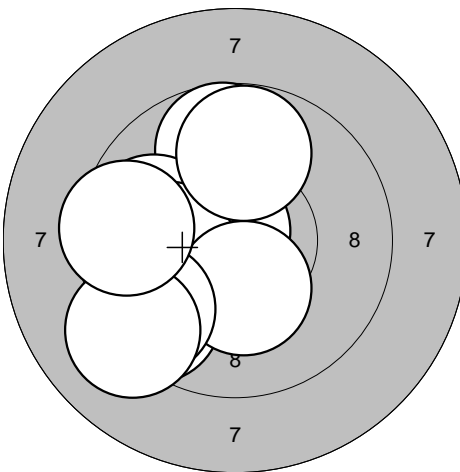
| | | | |
|--|--|--|---|
| <p>Series 5</p>  | <p>1: 10,0 →</p> <p>2: 9,9 →</p> <p>3: 9,7 ←</p> <p>4: 10,3* ←</p> <p>5: 10,2* ←</p> <p>6: 10,7* →</p> <p>7: 10,2* ↓</p> <p>8: 9,9 ↑</p> <p>9: 9,7 →</p> <p>10: 10,1 ↗</p> | <p>Series 6</p>  | <p>1: 9,5 ↙</p> <p>2: 9,7 ↑</p> <p>3: 10,7* ↖</p> <p>4: 9,9 ←</p> <p>5: 10,1 ←</p> <p>6: 10,3* ↓</p> <p>7: 9,5 ↙</p> <p>8: 9,1 ↙</p> <p>9: 9,5 ←</p> <p>10: 9,8 ↑</p> |
| Serie 96,0 | Serie 93,0 | Serie 93,0 | Serie 93,0 |
| Sum 486,0 | Sum 579,0 | Sum 579,0 | Sum 579,0 |