

1: 10.0	↑
2: 10.3*	↗
3: 10.7*	↘
4: 8.1	↗
5: 9.3	↘
6: 10.4*	↗
7: 10.1	←
8: 10.4*	↘
9: 9.6	→
10: 10.4*	↘
Series	96.0
Total	96.0

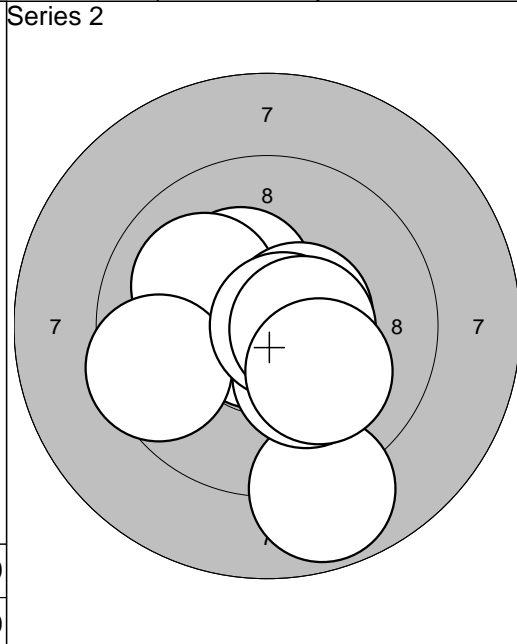

1: 10.8*	↙
2: 10.3*	↗
3: 10.0	↖
4: 8.8	↘
5: 10.2*	↘
6: 10.5*	→
7: 9.5	←
8: 10.8*	→
9: 10.5*	→
10: 10.1	↘
Series	97.0
Total	193.0

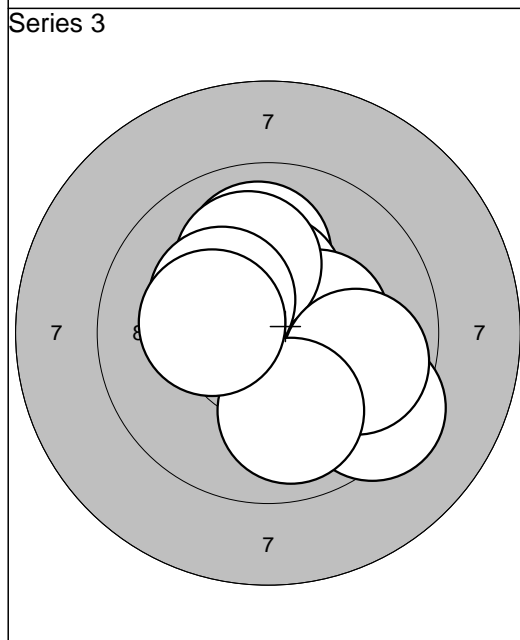

1: 10.5*	→
2: 10.0	↑
3: 10.4*	↑
4: 10.3*	→
5: 10.1	↑
6: 10.3*	↗
7: 9.4	↘
8: 9.8	→
9: 10.0	↘
10: 10.2*	←
Series	98.0
Total	291.0

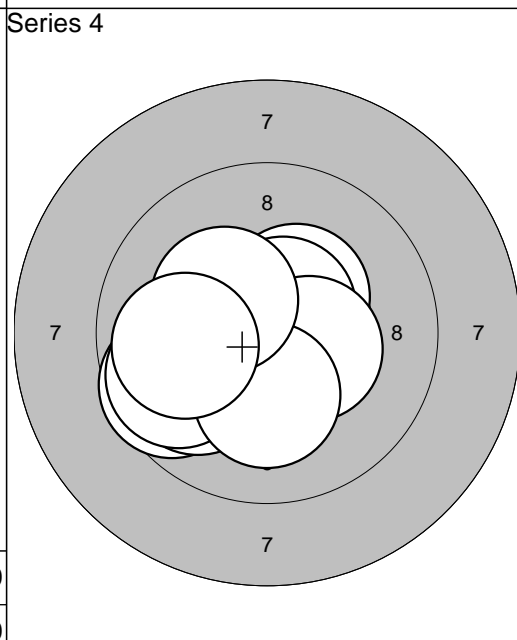

1: 10.5*	→
2: 9.6	↙
3: 10.4*	↗
4: 9.9	↙
5: 10.6*	↗
6: 10.4*	→
7: 9.7	↙
8: 10.2*	↓
9: 10.3*	↗
10: 9.9	←
Series	96.0
Total	387.0

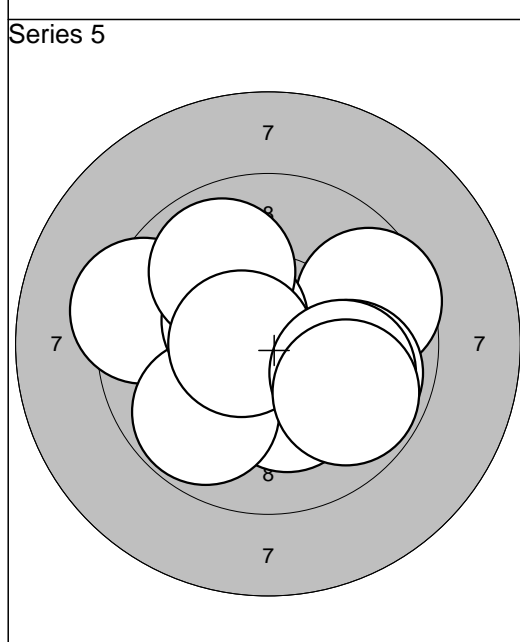

1: 9.4	←
2: 9.6	→
3: 10.2*	↘
4: 9.8	↘
5: 10.5*	↗
6: 9.9	↗
7: 10.6*	←
8: 9.9	→
9: 10.0	→
10: 9.8	↘
Series	94.0
Total	481.0

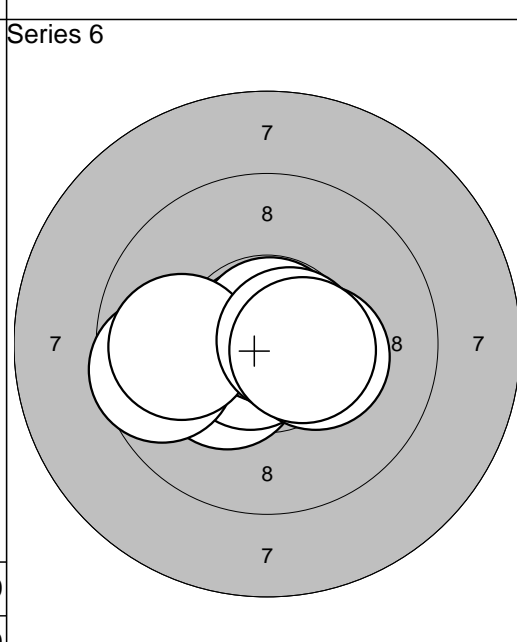

1: 10.8*	↗
2: 10.3*	↙
3: 10.8*	←
4: 10.7*	↙
5: 10.3*	→
6: 10.8*	↑
7: 9.6	←
8: 9.9	←
9: 10.7*	→
10: 10.5*	→
Series	98.0
Total	579.0

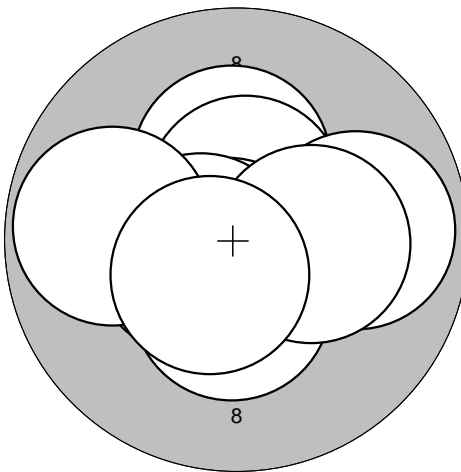
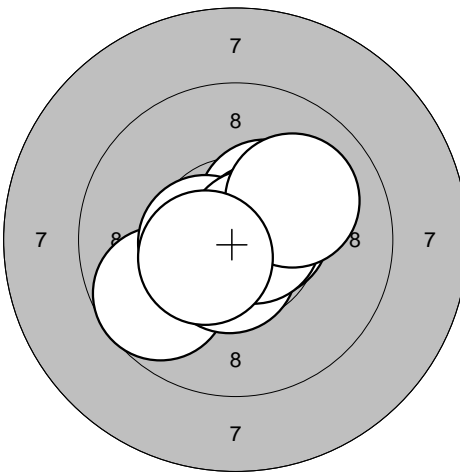
<p>Series 1</p> 	<p>1: 10.3* ↑</p> <p>2: 10.5* ↑</p> <p>3: 10.8* ↓</p> <p>4: 10.4* ↓</p> <p>5: 10.5* ←</p> <p>6: 9.9 →</p> <p>7: 10.6* ←</p> <p>8: 10.3* →</p> <p>9: 9.8 ←</p> <p>10: 10.5* ↓</p>	<p>Series 2</p> 	<p>1: 10.4* ↗</p> <p>2: 10.7* ↓</p> <p>3: 9.7 ↙</p> <p>4: 10.5* ↙</p> <p>5: 10.5* ←</p> <p>6: 10.6* →</p> <p>7: 10.6* ↓</p> <p>8: 10.7* →</p> <p>9: 10.0 ↗</p> <p>10: 10.5* ↙</p>
Series 98.0	Series 99.0		
Total 98.0	Total 197.0		

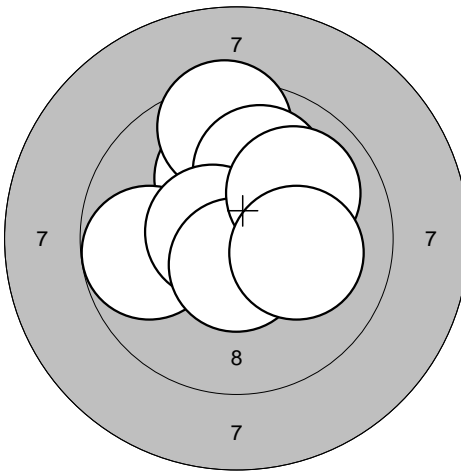
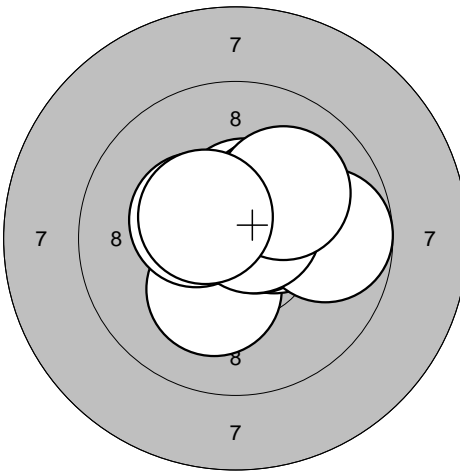
<p>Series 3</p> 	<p>1: 10.1 ↑</p> <p>2: 9.5 ↑</p> <p>3: 10.4* ↗</p> <p>4: 10.0 ↑</p> <p>5: 9.8 ←</p> <p>6: 10.4* →</p> <p>7: 10.6* ←</p> <p>8: 10.6* ↓</p> <p>9: 10.0 ↗</p> <p>10: 10.1 →</p>	<p>Series 4</p> 	<p>1: 10.5* ↑</p> <p>2: 10.2* ↓</p> <p>3: 10.4* →</p> <p>4: 10.6* ↗</p> <p>5: 10.3* ↗</p> <p>6: 9.7 →</p> <p>7: 10.4* ↙</p> <p>8: 10.7* ↗</p> <p>9: 10.1 ↗</p> <p>10: 10.5* ↙</p>
Series 98.0	Series 99.0		
Total 295.0	Total 394.0		

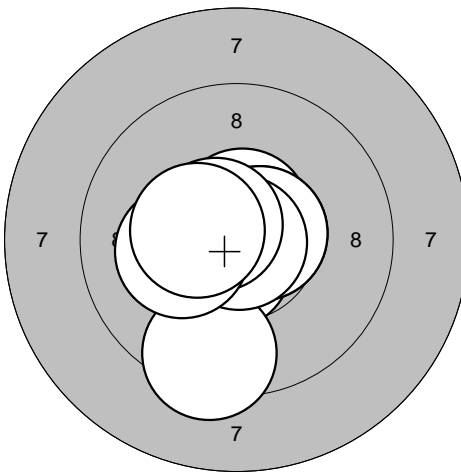
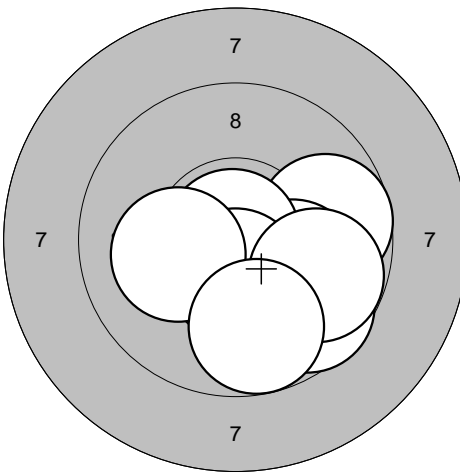
<p>Series 5</p> 	<p>1: 10.4* ↙</p> <p>2: 10.6* ↓</p> <p>3: 10.6* ↑</p> <p>4: 10.6* →</p> <p>5: 9.4 ↓</p> <p>6: 10.6* →</p> <p>7: 10.9* ↓</p> <p>8: 10.6* ↗</p> <p>9: 10.2* ←</p> <p>10: 10.4* ←</p>	<p>Series 6</p> 	<p>1: 9.7 →</p> <p>2: 9.6 ↘</p> <p>3: 10.6* ↓</p> <p>4: 10.8* ↓</p> <p>5: 10.1 →</p> <p>6: 10.9* ↗</p> <p>7: 10.5* ↓</p> <p>8: 9.8 →</p> <p>9: 10.2* ←</p> <p>10: 9.7 ↓</p>
Series 99.0	Series 96.0		
Total 493.0	Total 589.0		

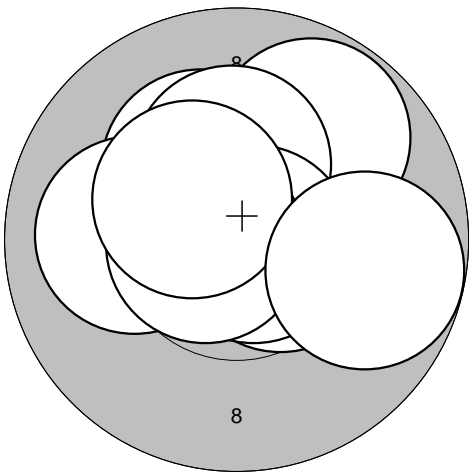
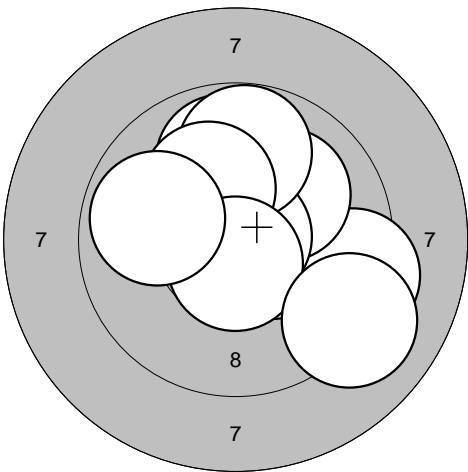
<p>Series 1</p> 	<p>1: 10.2* ↗</p> <p>2: 10.5* →</p> <p>3: 10.0 ←</p> <p>4: 10.8* ↗</p> <p>5: 9.8 ↗</p> <p>6: 10.3* ↑</p> <p>7: 10.8* →</p> <p>8: 10.7* ←</p> <p>9: 10.4* ↗</p> <p>10: 9.8 →</p>	<p>Series 2</p> 	<p>1: 9.9 ↑</p> <p>2: 10.4* →</p> <p>3: 9.3 →</p> <p>4: 10.1 ↗</p> <p>5: 10.8* →</p> <p>6: 9.8 ↑</p> <p>7: 10.2* ↗</p> <p>8: 10.6* ↓</p> <p>9: 9.1 ↘</p> <p>10: 9.9 ←</p>
Series 98.0		Series 95.0	
Total 98.0		Total 193.0	

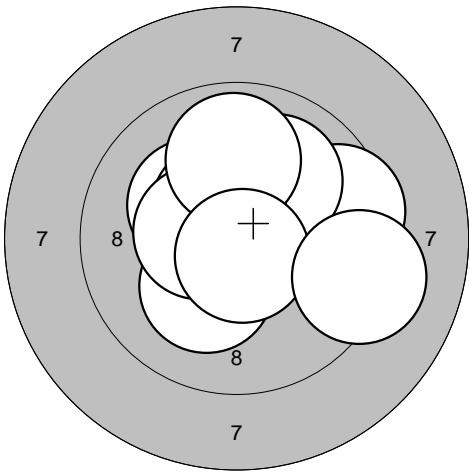
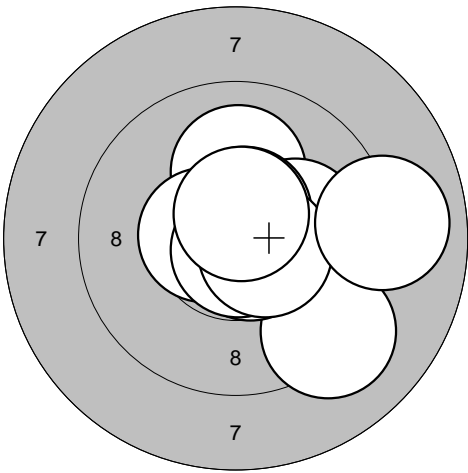
<p>Series 3</p> 	<p>1: 10.3* ↗</p> <p>2: 10.4* ↗</p> <p>3: 10.2* ↘</p> <p>4: 9.5 →</p> <p>5: 10.0 ↗</p> <p>6: 10.5* ↗</p> <p>7: 10.5* ←</p> <p>8: 9.9 ↑</p> <p>9: 10.7* ↘</p> <p>10: 9.2 →</p>	<p>Series 4</p> 	<p>1: 10.0 ↑</p> <p>2: 10.5* ←</p> <p>3: 10.1 →</p> <p>4: 9.2 ↘</p> <p>5: 10.7* ↘</p> <p>6: 10.6* ↑</p> <p>7: 10.8* ↘</p> <p>8: 10.5* →</p> <p>9: 9.0 →</p> <p>10: 10.6* ↑</p>
Series 97.0		Series 98.0	
Total 290.0		Total 388.0	

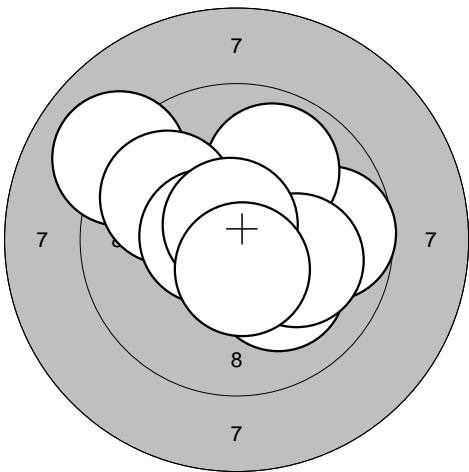
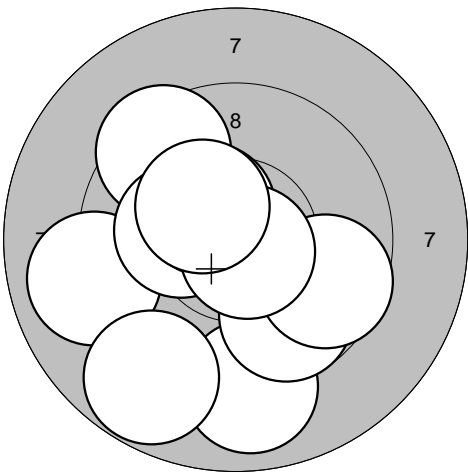
<p>Series 5</p> 	<p>1: 9.7 →</p> <p>2: 10.4* →</p> <p>3: 9.9 ↗</p> <p>4: 9.0 ↗</p> <p>5: 9.9 ↗</p> <p>6: 10.1 ↘</p> <p>7: 10.5* ←</p> <p>8: 10.1 →</p> <p>9: 10.7* ↗</p> <p>10: 10.5* ↘</p>	<p>Series 6</p> 	<p>1: 9.0 ←</p> <p>2: 9.0 ↓</p> <p>3: 9.7 ↘</p> <p>4: 9.4 ↗</p> <p>5: 8.8 ↘</p> <p>6: 10.2* ←</p> <p>7: 10.4* ↗</p> <p>8: 9.6 ↘</p> <p>9: 10.7* ↘</p> <p>10: 10.3* ↗</p>
Series 96.0		Series 93.0	
Total 484.0		Total 577.0	

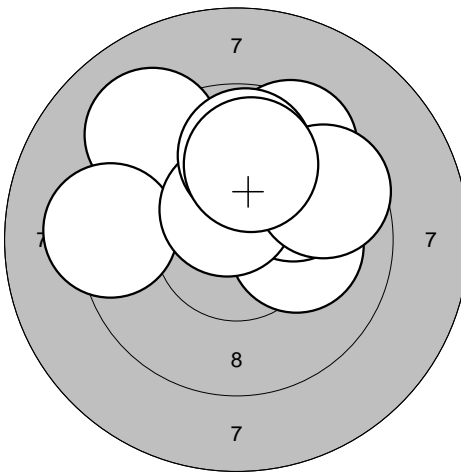
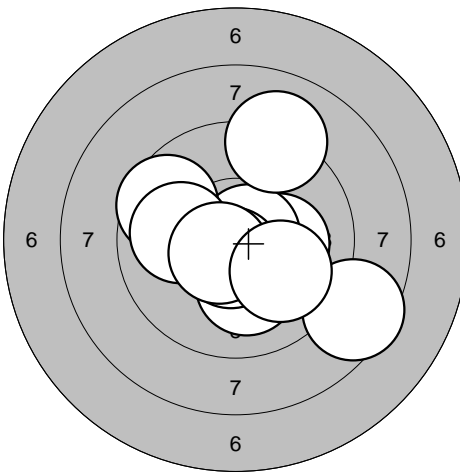
<p>Series 1</p> 	<p>1: 10.3* →</p> <p>2: 9.2 ↗</p> <p>3: 9.3 ←</p> <p>4: 9.5 ↗</p> <p>5: 10.1 →</p> <p>6: 10.0 ↗</p> <p>7: 10.5* ↗</p> <p>8: 9.6 ↗</p> <p>9: 9.8 ↑</p> <p>10: 9.9 ↑</p>	<p>Series 2</p> 	<p>1: 10.2* →</p> <p>2: 10.7* →</p> <p>3: 9.6 ↖</p> <p>4: 10.1 ↓</p> <p>5: 10.6* ↓</p> <p>6: 8.5 ↘</p> <p>7: 10.0 ←</p> <p>8: 10.6* ↙</p> <p>9: 10.0 ↘</p> <p>10: 9.1 ↗</p>
Series 94.0	Series 96.0	Series 96.0	Series 96.0
Total 94.0	Total 190.0	Total 190.0	Total 190.0

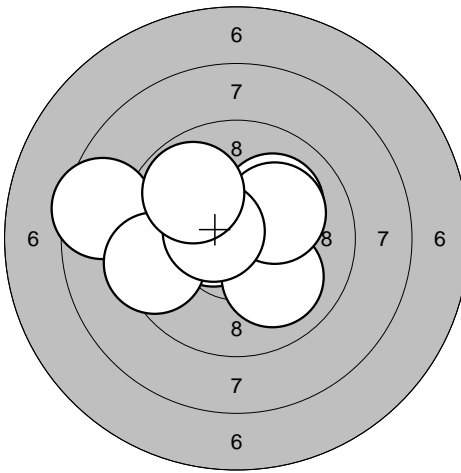
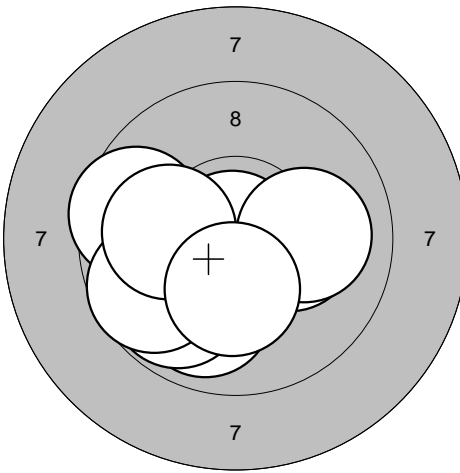
<p>Series 3</p> 	<p>1: 10.0 ←</p> <p>2: 10.1 ↗</p> <p>3: 10.5* ←</p> <p>4: 8.5 ←</p> <p>5: 10.5* →</p> <p>6: 10.0 ↘</p> <p>7: 10.1 ↗</p> <p>8: 9.4 ←</p> <p>9: 10.5* ←</p> <p>10: 9.9 ↗</p>	<p>Series 4</p> 	<p>1: 10.2* →</p> <p>2: 9.9 ↓</p> <p>3: 10.1 ←</p> <p>4: 10.9* ←</p> <p>5: 9.6 ←</p> <p>6: 9.8 ↙</p> <p>7: 9.7 ↙</p> <p>8: 10.0 →</p> <p>9: 10.1 ←</p> <p>10: 10.3* ↓</p>
Series 96.0	Series 96.0	Series 96.0	Series 96.0
Total 286.0	Total 382.0	Total 382.0	Total 382.0

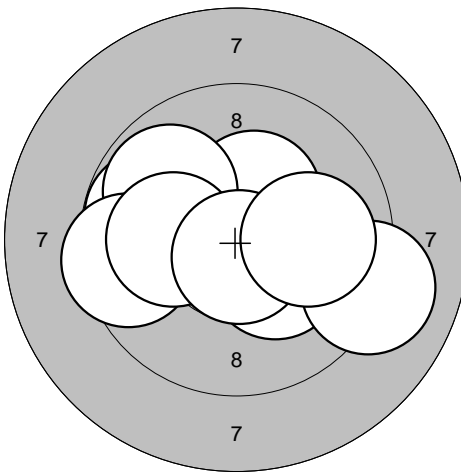
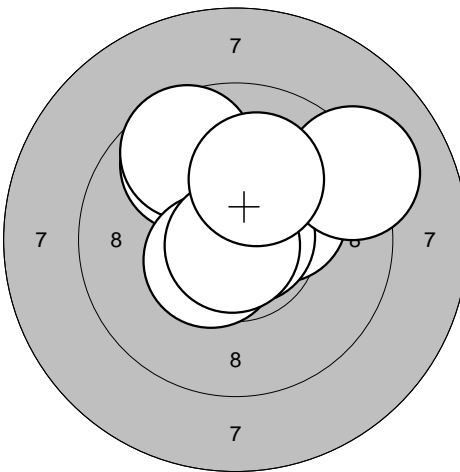
<p>Series 5</p> 	<p>1: 9.8 ←</p> <p>2: 10.4* ↗</p> <p>3: 9.9 ↗</p> <p>4: 9.5 ←</p> <p>5: 10.3* ↘</p> <p>6: 10.1 ←</p> <p>7: 10.3* ↘</p> <p>8: 9.1 ↘</p> <p>9: 10.7* ↘</p> <p>10: 10.0 →</p>	<p>Series 6</p> 	<p>1: 9.8 ↖</p> <p>2: 10.7* ↗</p> <p>3: 10.3* ↗</p> <p>4: 10.8* →</p> <p>5: 10.5* ↑</p> <p>6: 9.2 ↗</p> <p>7: 9.6 ↖</p> <p>8: 10.5* ↙</p> <p>9: 10.9* ↘</p> <p>10: 10.1 ↗</p>
Series 96.0	Series 97.0	Series 97.0	Series 97.0
Total 478.0	Total 575.0	Total 575.0	Total 575.0

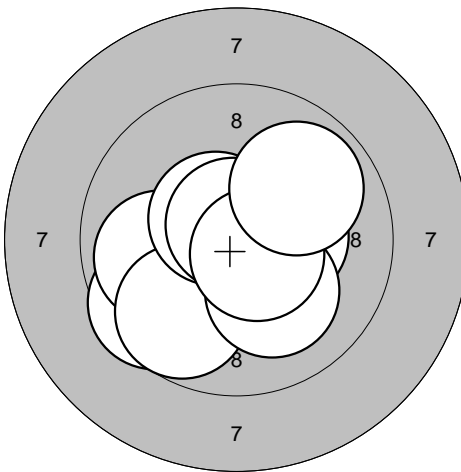
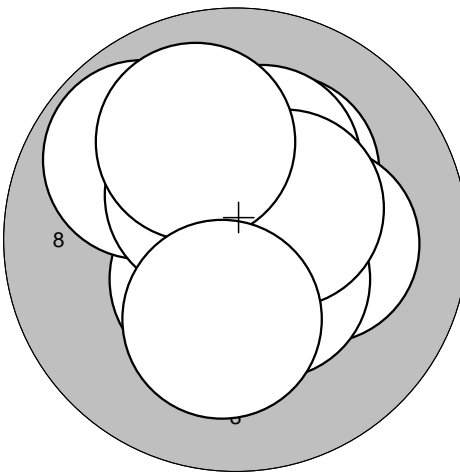
<p>Series 1</p> 	<p>1: 10.8* ↗ 2: 10.4* → 3: 9.6 ↙ 4: 9.9 ← 5: 9.8 ↙ 6: 10.6* ↗ 7: 10.8* ↗ 8: 10.1 ↘ 9: 10.6* ↘ 10: 9.9 ↗</p> <p>Series 96.0 Total 96.0</p>	<p>Series 2</p>  <p>1: 10.2* ↗ 2: 10.5* ↘ 3: 9.9 ↖ 4: 10.5* ↗ 5: 10.2* → 6: 10.5* ↘ 7: 10.2* ↗ 8: 10.4* ↗ 9: 10.0 ↗ 10: 10.2* ↘</p> <p>Series 99.0 Total 195.0</p>
--	--	--

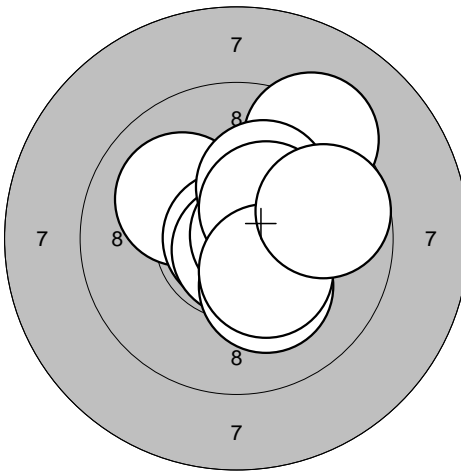
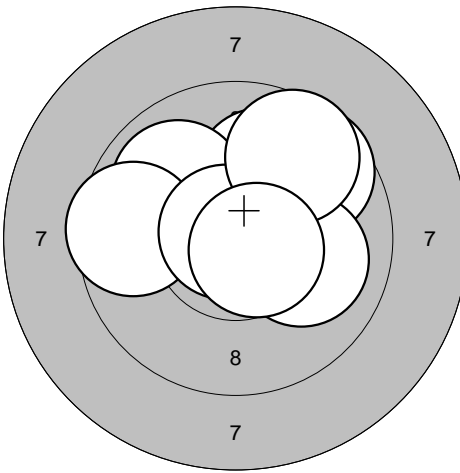
<p>Series 3</p> 	<p>1: 10.1 ↖ 2: 10.9* ← 3: 10.8* ↘ 4: 10.2* ↘ 5: 10.7* → 6: 9.3 ↗ 7: 10.2* ↗ 8: 10.4* ↗ 9: 10.4* ↘ 10: 9.8 →</p> <p>Series 98.0 Total 293.0</p>	<p>Series 4</p>  <p>1: 10.0 ↗ 2: 9.7 ↗ 3: 10.4* ↗ 4: 9.9 ↖ 5: 9.6 ← 6: 10.4* → 7: 10.0 → 8: 10.8* ↖ 9: 9.6 ↗ 10: 10.6* ↘</p> <p>Series 96.0 Total 389.0</p>
---	---	--

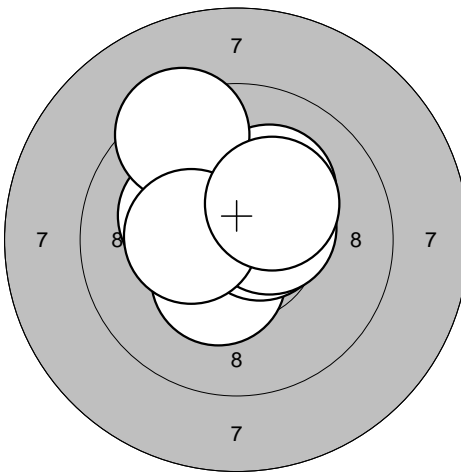
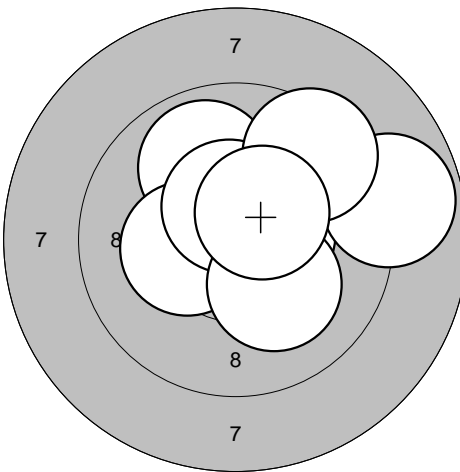
<p>Series 5</p> 	<p>1: 10.5* ↗ 2: 10.5* ↗ 3: 10.4* ↘ 4: 10.6* → 5: 10.2* ↗ 6: 10.2* ↖ 7: 10.5* → 8: 9.4 ↗ 9: 10.3* ← 10: 10.3* ↗</p> <p>Series 99.0 Total 488.0</p>	<p>Series 6</p>  <p>1: 10.5* → 2: 10.6* ↖ 3: 9.9 ↗ 4: 10.5* → 5: 10.3* ← 6: 8.9 → 7: 10.5* ↗ 8: 9.4 ↗ 9: 10.1 ↘ 10: 10.4* ↗</p> <p>Series 96.0 Total 584.0</p>
--	--	--

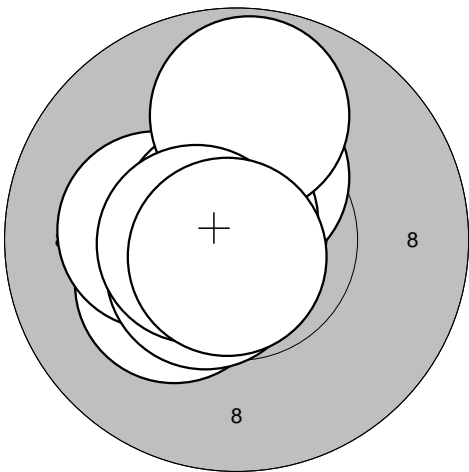
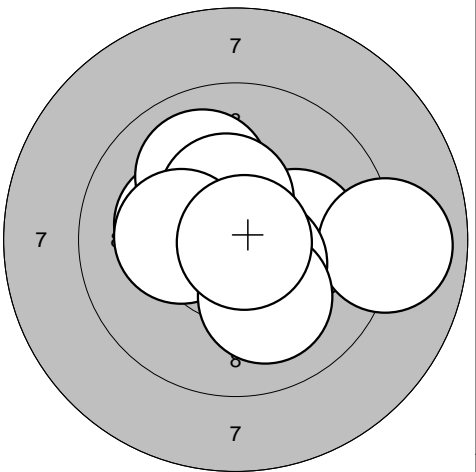
<p>Series 1</p> 	<p>1: 10.9* ↖ 2: 10.8* ↗ 3: 10.4* ↑ 4: 10.3* ↙ 5: 10.2* ← 6: 10.7* ↗ 7: 10.5* ↙ 8: 9.8 ↑ 9: 10.6* ← 10: 10.8* ↙</p>	<p>Series 2</p> 	<p>1: 10.2* ↖ 2: 10.6* ↑ 3: 10.1 → 4: 9.0 → 5: 10.0 ↗ 6: 10.4* ↑ 7: 10.2* ← 8: 10.5* ↘ 9: 10.1 ↘ 10: 10.8* →</p>
Series 99.0	Series 99.0	Series 99.0	Series 99.0
Total 99.0	Total 99.0	Total 198.0	Total 198.0

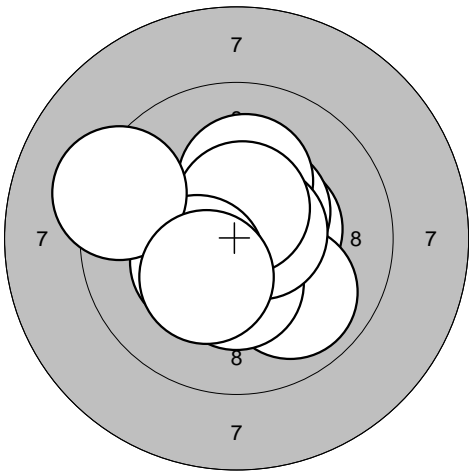
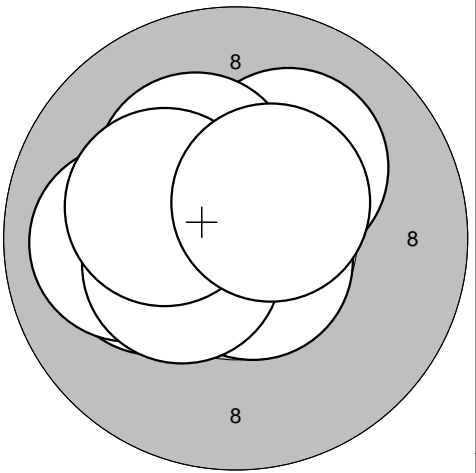
<p>Series 3</p> 	<p>1: 10.4* → 2: 10.4* ↗ 3: 9.9 ↘ 4: 10.2* ↑ 5: 10.3* ↘ 6: 10.6* → 7: 10.5* ↑ 8: 10.4* ↙ 9: 9.3 ← 10: 10.3* ↙</p>	<p>Series 4</p> 	<p>1: 10.7* ↘ 2: 10.5* ↗ 3: 10.1 ↗ 4: 10.2* ← 5: 10.2* ↗ 6: 10.3* ← 7: 10.0 ← 8: 10.4* ↙ 9: 10.3* ↙ 10: 10.5* ↗</p>
Series 98.0	Series 98.0	Series 100.0	Series 100.0
Total 296.0	Total 296.0	Total 396.0	Total 396.0

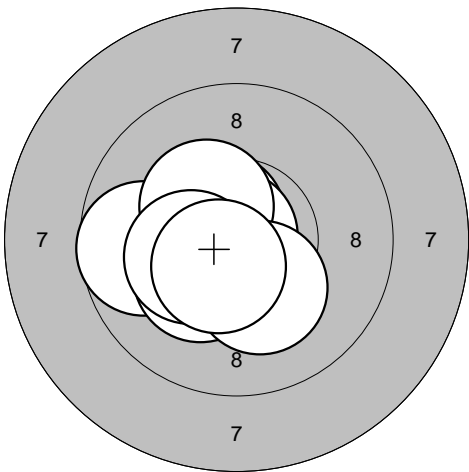
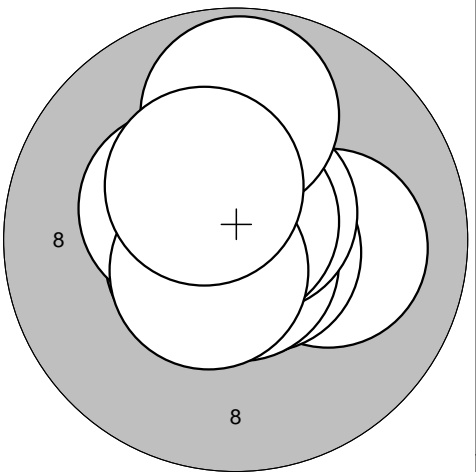
<p>Series 5</p> 	<p>1: 10.7* ↘ 2: 10.8* ← 3: 9.7 ← 4: 10.6* ↗ 5: 10.3* ↙ 6: 10.9* ↗ 7: 10.3* ↗ 8: 10.2* ↘ 9: 10.3* ← 10: 10.5* ↙</p>	<p>Series 6</p> 	<p>1: 10.6* ↖ 2: 10.1 → 3: 10.7* ↘ 4: 10.8* ↘ 5: 10.6* ↗ 6: 10.4* ↖ 7: 10.8* ↑ 8: 9.8 ↑ 9: 10.6* ↙ 10: 10.4* ↗</p>
Series 99.0	Series 99.0	Series 99.0	Series 99.0
Total 495.0	Total 495.0	Total 594.0	Total 594.0

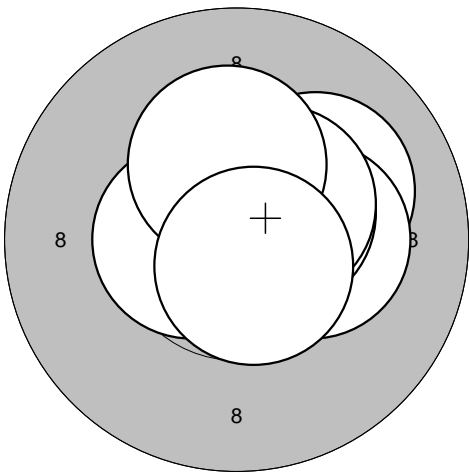
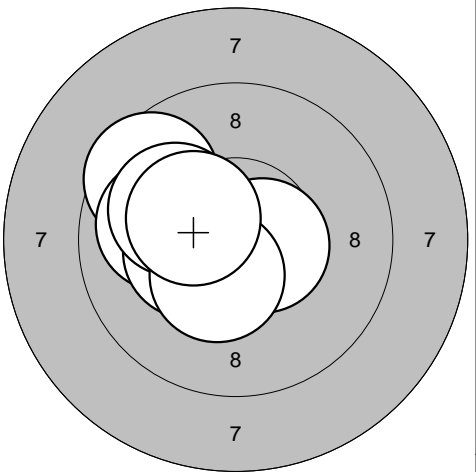
<p>Series 1</p> 	<p>1: 10.4* →</p> <p>2: 10.1 ↗</p> <p>3: 10.3* →</p> <p>4: 10.7* ↗</p> <p>5: 10.5* ↗</p> <p>6: 10.5* ↑</p> <p>7: 10.5* ↗</p> <p>8: 10.5* ←</p> <p>9: 10.3* ↑</p> <p>10: 10.7* ↘</p>	<p>Series 2</p> 	<p>1: 10.1 ←</p> <p>2: 10.1 ←</p> <p>3: 9.6 ↖</p> <p>4: 10.6* ↓</p> <p>5: 10.0 ←</p> <p>6: 10.3* ←</p> <p>7: 10.6* →</p> <p>8: 10.0 ↖</p> <p>9: 10.4* ↓</p> <p>10: 10.3* ↖</p>
Series 100.0	Series 99.0		
Total 100.0	Total 199.0		

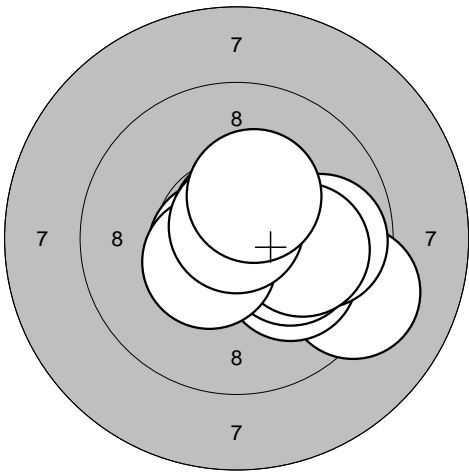
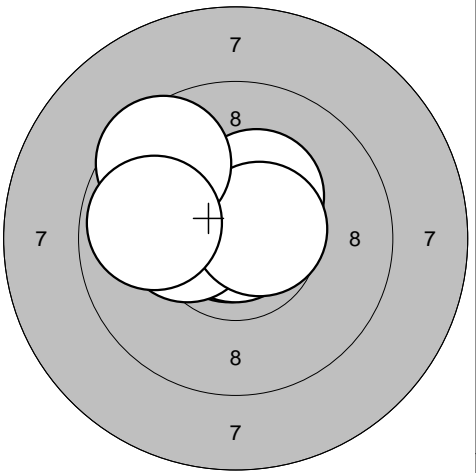
<p>Series 3</p> 	<p>1: 10.7* ←</p> <p>2: 9.2 →</p> <p>3: 10.7* ↑</p> <p>4: 10.1 →</p> <p>5: 10.2* →</p> <p>6: 9.8 →</p> <p>7: 10.1 →</p> <p>8: 10.5* ↖</p> <p>9: 10.8* ↑</p> <p>10: 10.3* ↑</p>	<p>Series 4</p> 	<p>1: 10.9* ↖</p> <p>2: 10.8* ↗</p> <p>3: 10.2* ↖</p> <p>4: 10.3* ↗</p> <p>5: 10.9* ↑</p> <p>6: 10.0 ←</p> <p>7: 10.3* ←</p> <p>8: 10.6* →</p> <p>9: 9.6 ↗</p> <p>10: 9.9 ←</p>
Series 98.0	Series 98.0		
Total 297.0	Total 395.0		

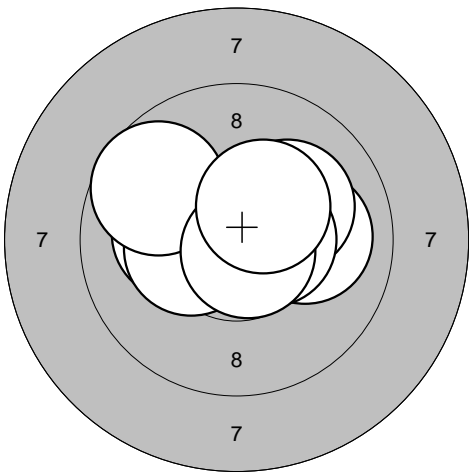
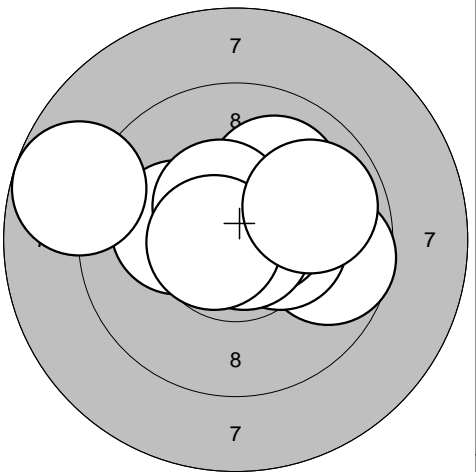
<p>Series 5</p> 	<p>1: 10.3* ↗</p> <p>2: 10.0 →</p> <p>3: 10.9* →</p> <p>4: 10.2* ←</p> <p>5: 10.1 ↗</p> <p>6: 10.3* ←</p> <p>7: 10.5* →</p> <p>8: 9.7 ↖</p> <p>9: 10.7* ↘</p> <p>10: 10.4* ↗</p>	<p>Series 6</p> 	<p>1: 10.0 ↗</p> <p>2: 9.7 →</p> <p>3: 10.2* ←</p> <p>4: 10.3* →</p> <p>5: 8.8 ←</p> <p>6: 10.6* →</p> <p>7: 10.8* →</p> <p>8: 10.5* ↗</p> <p>9: 10.7* ←</p> <p>10: 9.9 →</p>
Series 99.0	Series 96.0		
Total 494.0	Total 590.0		

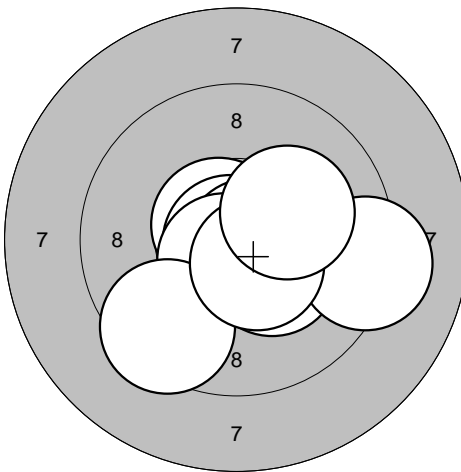
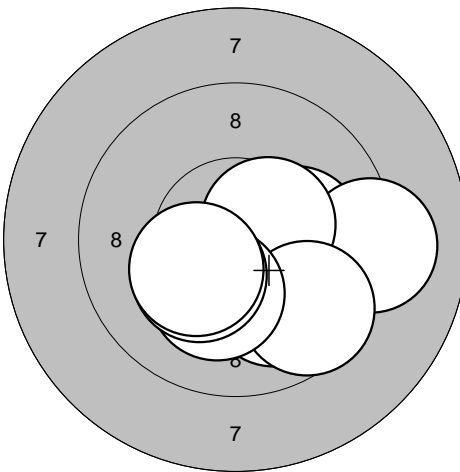
<p>Series 1</p> 	<p>1: 10.3* ↘ 2: 10.6* ↗ 3: 10.5* ↘ 4: 10.9* ↙ 5: 10.7* ↘ 6: 10.6* ↘ 7: 9.5 ↘ 8: 9.2 → 9: 10.5* ↘ 10: 10.2* ↗</p>	<p>Series 2</p> 	<p>1: 10.2* ↘ 2: 10.2* → 3: 10.1 → 4: 10.0 ↘ 5: 9.1 → 6: 10.5* ↗ 7: 9.6 ↘ 8: 10.2* ↘ 9: 10.3* ↘ 10: 10.3* ↙</p>
Series 98.0	Series 98.0	Series 98.0	Series 98.0
Total 98.0	Total 98.0	Total 196.0	Total 196.0

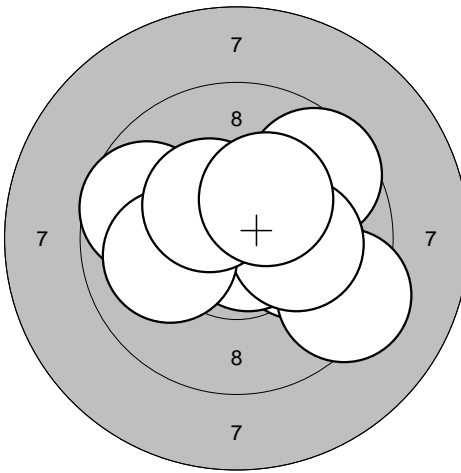
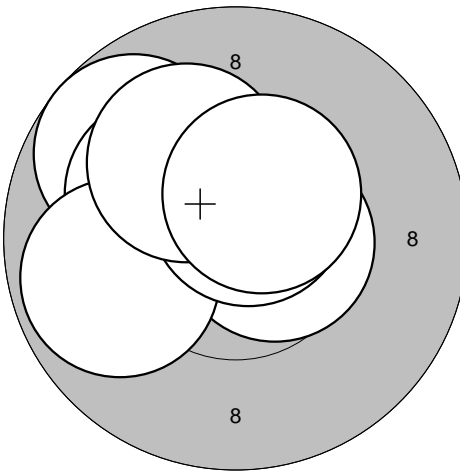
<p>Series 3</p> 	<p>1: 9.7 ↙ 2: 10.1 → 3: 9.3 ↘ 4: 10.4* ↗ 5: 9.6 ↗ 6: 10.8* ↘ 7: 10.2* → 8: 10.0 ↙ 9: 10.4* ↗ 10: 10.3* ↗</p>	<p>Series 4</p> 	<p>1: 10.6* ↗ 2: 10.6* ↗ 3: 9.8 ↗ 4: 10.2* ↗ 5: 10.2* ↗ 6: 10.6* → 7: 9.9 ↙ 8: 10.6* ↗ 9: 10.2* ↗ 10: 10.5* ↗</p>
Series 97.0	Series 97.0	Series 98.0	Series 98.0
Total 293.0	Total 293.0	Total 391.0	Total 391.0

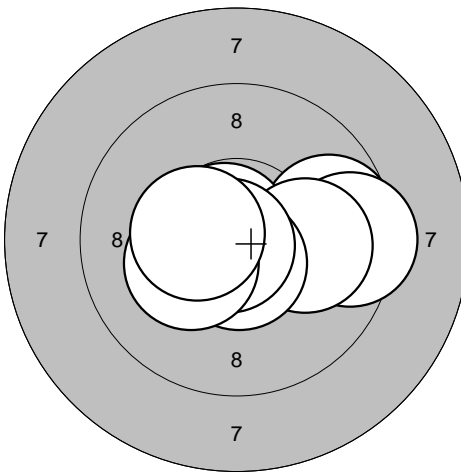
<p>Series 5</p> 	<p>1: 9.7 → 2: 9.4 → 3: 10.7* ↙ 4: 10.7* ↗ 5: 10.0 → 6: 10.8* ↘ 7: 10.6* ↘ 8: 10.8* ↙ 9: 10.3* ↙ 10: 10.4* ↙</p>	<p>Series 6</p> 	<p>1: 9.6 → 2: 10.3* ↙ 3: 10.7* ↗ 4: 10.5* → 5: 10.5* ↘ 6: 10.1 ↙ 7: 10.5* ↙ 8: 10.6* ↗ 9: 10.4* → 10: 9.6 ↘</p>
Series 98.0	Series 98.0	Series 98.0	Series 98.0
Total 489.0	Total 489.0	Total 587.0	Total 587.0

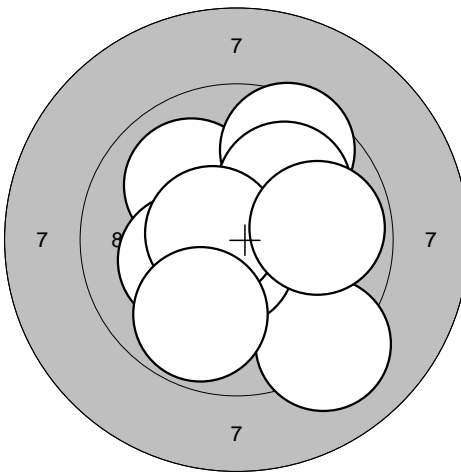
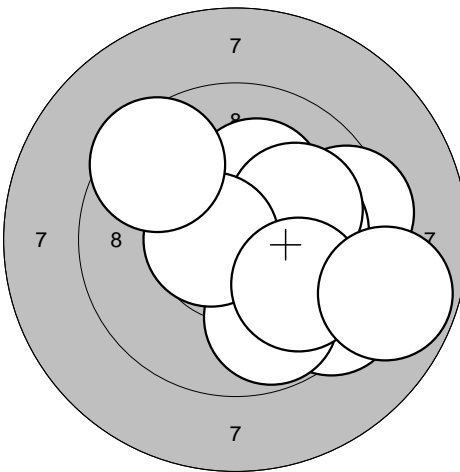
<p>Series 1</p> 	<p>1: 10.7* ↖ 2: 10.0 ↗ 3: 9.6 ↗ 4: 10.0 ↗ 5: 10.2* ↖ 6: 9.1 ↘ 7: 10.6* ↘ 8: 10.6* ↖ 9: 9.9 → 10: 9.8 ↘</p> <p>Series 96.0 Total 96.0</p>	<p>Series 2</p> 	<p>1: 9.4 → 2: 10.1 → 3: 10.2* ↗ 4: 9.4 ↘ 5: 9.8 ↘ 6: 10.1 ↗ 7: 10.6* ↖ 8: 9.9 ↘ 9: 8.8 → 10: 9.5 ↗</p> <p>Series 93.0 Total 189.0</p>
--	---	--	--

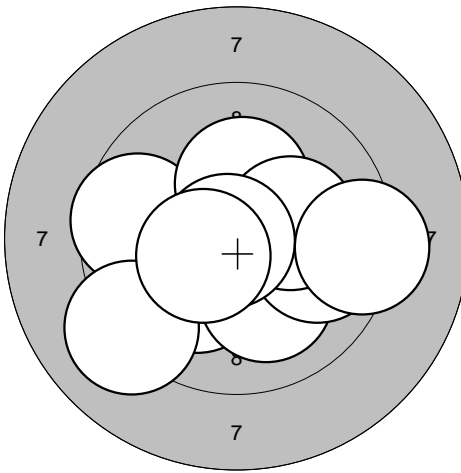
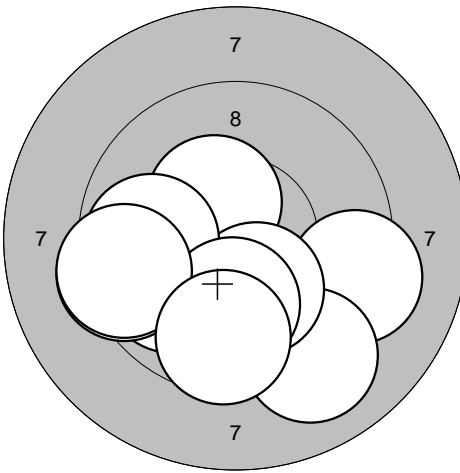
<p>Series 3</p> 	<p>1: 10.1 ↘ 2: 9.6 ↖ 3: 9.1 ↖ 4: 10.1 ↘ 5: 10.2* ↗ 6: 9.8 → 7: 10.2* → 8: 10.8* ↖ 9: 10.4* ↖ 10: 9.3 →</p> <p>Series 96.0 Total 285.0</p>	<p>Series 4</p> 	<p>1: 9.3 → 2: 9.9 ↖ 3: 9.1 ↘ 4: 10.4* ↗ 5: 9.4 ↖ 6: 10.2* ↘ 7: 9.8 ↖ 8: 10.1 ↘ 9: 9.4 ↖ 10: 9.6 ↘</p> <p>Series 93.0 Total 378.0</p>
---	--	---	---

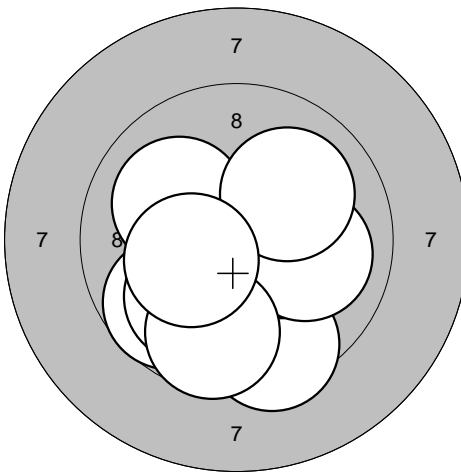
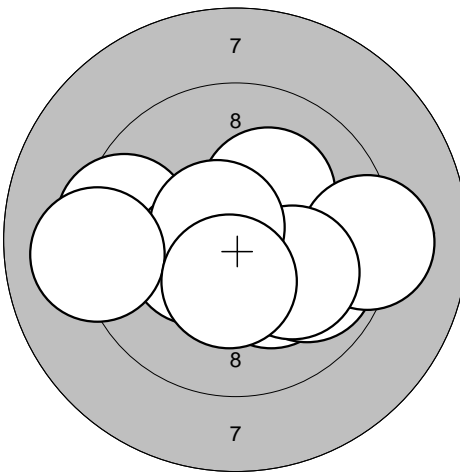
<p>Series 5</p> 	<p>1: 10.3* ↘ 2: 9.5 ↘ 3: 10.3* → 4: 9.7 ↖ 5: 10.0 ↘ 6: 10.0 ↗ 7: 10.0 → 8: 10.1 ↗ 9: 9.7 ↘ 10: 10.3* ↖</p> <p>Series 97.0 Total 475.0</p>	<p>Series 6</p> 	<p>1: 10.2* ↘ 2: 10.2* ↗ 3: 9.9 ↘ 4: 9.2 → 5: 10.1 ↘ 6: 9.5 ↖ 7: 10.4* ↖ 8: 10.7* ↖ 9: 9.1 ↖ 10: 10.4* ↘</p> <p>Series 96.0 Total 571.0</p>
--	--	--	---

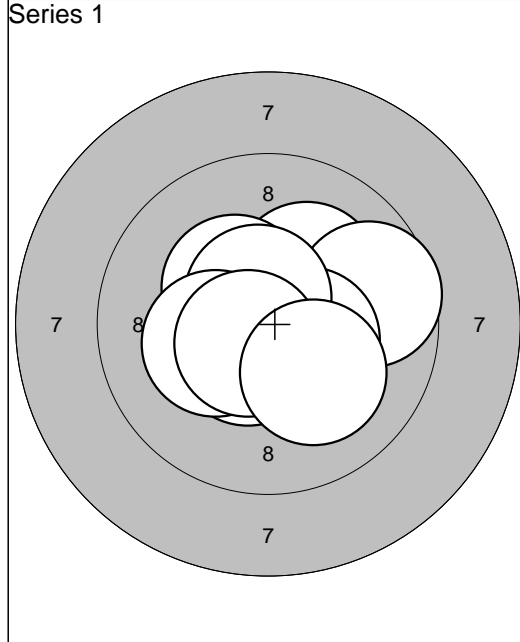

1: 10.2*	↗
2: 9.6	→
3: 10.5*	↘
4: 10.3*	↖
5: 10.4*	→
6: 10.8*	←
7: 10.6*	↑
8: 10.3*	←
9: 10.6*	↘
10: 10.1	↘
Series	99.0
Total	99.0

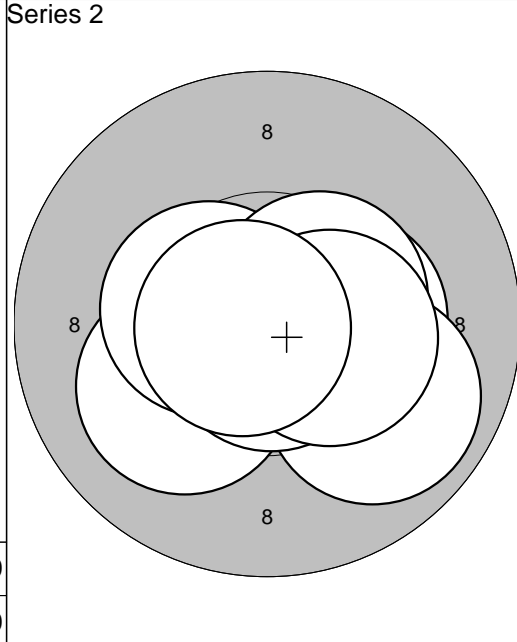

1: 10.4*	→
2: 10.1	↙
3: 10.8*	→
4: 10.4*	←
5: 9.9	↘
6: 10.6*	→
7: 10.8*	↘
8: 10.5*	↗
9: 10.4*	→
10: 10.8*	←
Series	99.0
Total	198.0

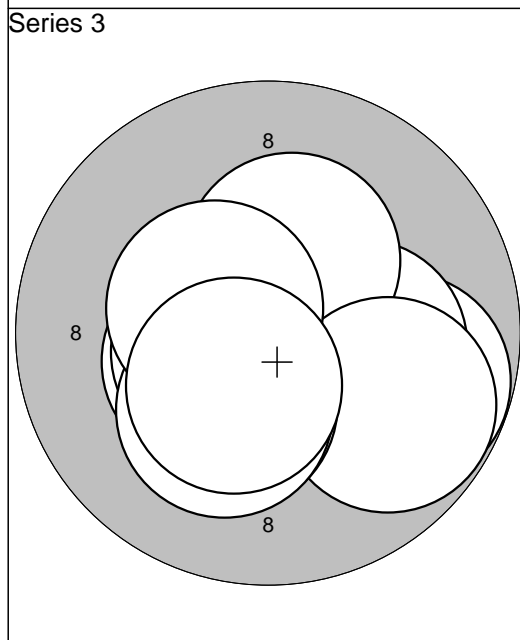

1: 10.4*	←
2: 10.5*	←
3: 9.8	→
4: 10.2*	→
5: 10.3*	↑
6: 9.8	↘
7: 10.3*	↘
8: 10.2*	↘
9: 10.5*	←
10: 10.4*	↘
Series	98.0
Total	296.0

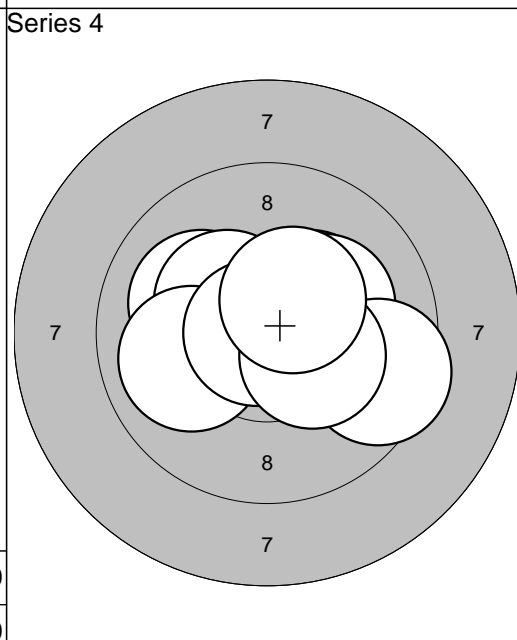

1: 10.1	↙
2: 10.3*	↖
3: 10.4*	↗
4: 10.3*	↗
5: 10.0	←
6: 10.8*	←
7: 10.2*	↗
8: 9.5	→
9: 10.3*	↘
10: 10.4*	↗
Series	99.0
Total	395.0

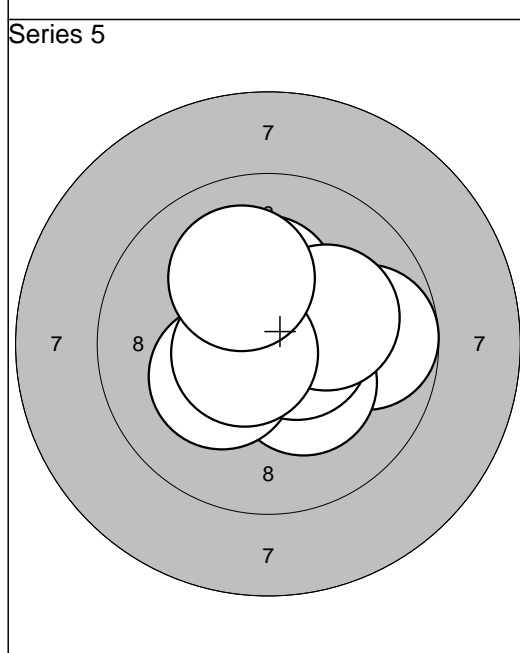

1: 10.6*	↗
2: 10.3*	↑
3: 9.8	→
4: 10.3*	↘
5: 10.3*	↙
6: 10.5*	↑
7: 10.6*	→
8: 10.2*	↗
9: 10.6*	←
10: 10.1	↑
Series	99.0
Total	494.0

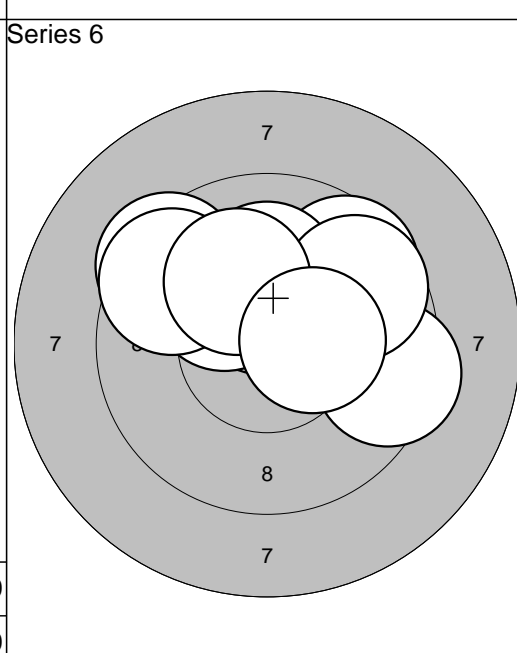

1: 10.4*	↑
2: 9.4	→
3: 9.6	↗
4: 9.4	↖
5: 10.1	↑
6: 10.2*	↗
7: 9.6	↖
8: 9.7	↗
9: 10.1	↑
10: 10.4*	→
Series	95.0
Total	589.0

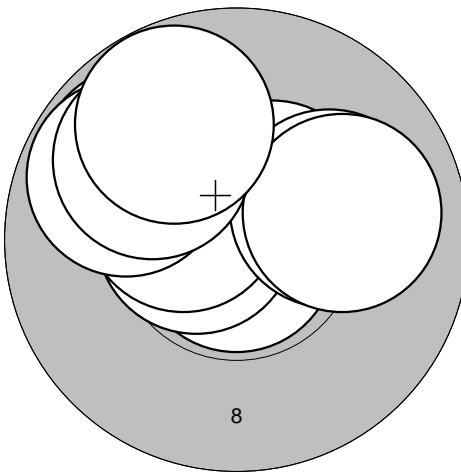
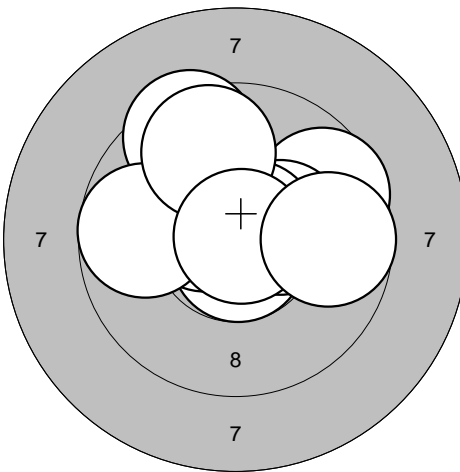
<p>Series 1</p> 	<p>1: 10.5* ↗ 2: 10.8* ↓ 3: 10.6* ← 4: 10.4* ↗ 5: 10.1 → 6: 10.0 → 7: 9.8 ↗ 8: 9.8 ↗ 9: 9.9 ↗ 10: 9.8 ↗</p> <p style="text-align: right;">Series 96.0 Total 96.0</p>	<p>Series 2</p> 	<p>1: 9.6 ↗ 2: 10.8* ↓ 3: 9.5 ↗ 4: 10.5* ↖ 5: 10.3* → 6: 9.8 ← 7: 10.7* ↗ 8: 9.7 ↗ 9: 10.9* ↗ 10: 9.7 →</p> <p style="text-align: right;">Series 95.0 Total 191.0</p>
--	--	--	---

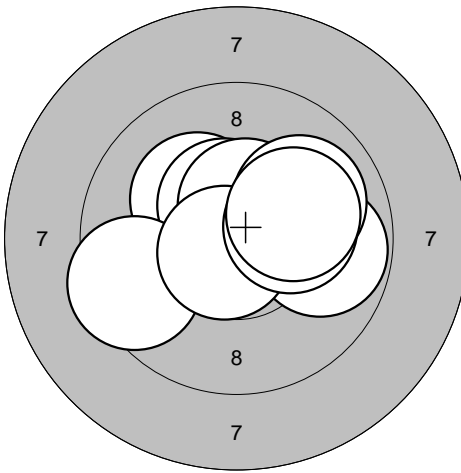
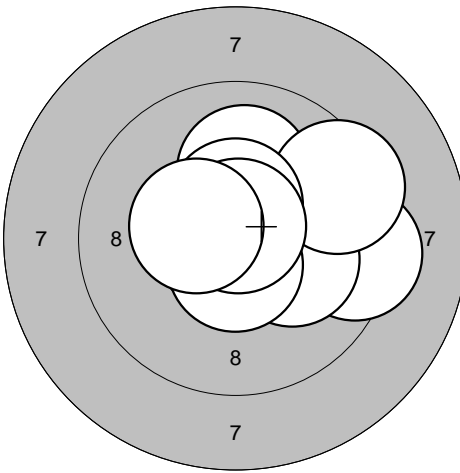
<p>Series 3</p> 	<p>1: 9.8 → 2: 10.8* ↗ 3: 10.2* ↗ 4: 10.5* ↗ 5: 10.5* ↗ 6: 10.0 → 7: 9.5 ← 8: 10.7* ↘ 9: 10.2* → 10: 10.1 →</p> <p style="text-align: right;">Series 98.0 Total 289.0</p>	<p>Series 4</p> 	<p>1: 10.5* ↑ 2: 9.3 → 3: 10.6* ↘ 4: 10.0 ↑ 5: 10.1 → 6: 10.6* ↓ 7: 9.4 ↗ 8: 10.5* ↑ 9: 10.8* ↑ 10: 10.4* ←</p> <p style="text-align: right;">Series 98.0 Total 387.0</p>
---	---	---	---

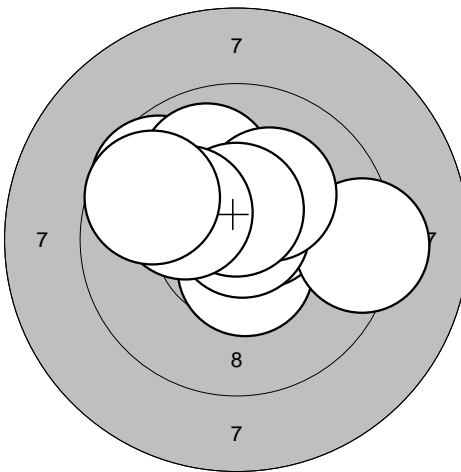
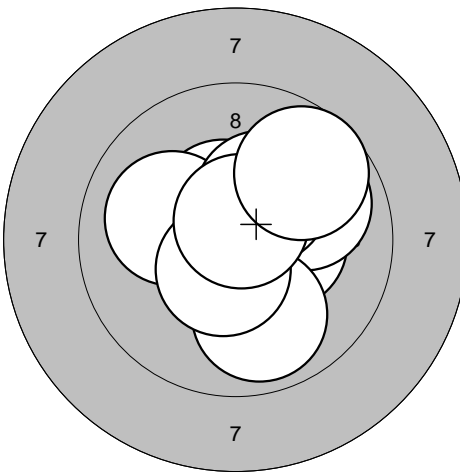
<p>Series 5</p> 	<p>1: 10.5* ↓ 2: 9.7 ↖ 3: 10.5* ↗ 4: 9.3 → 5: 10.8* ↗ 6: 10.0 ↗ 7: 10.2* ↗ 8: 10.5* ↑ 9: 10.2* ↖ 10: 9.7 ↖</p> <p style="text-align: right;">Series 97.0 Total 484.0</p>	<p>Series 6</p> 	<p>1: 10.3* → 2: 9.9 ↗ 3: 9.9 ↗ 4: 9.9 ↓ 5: 10.5* ↗ 6: 10.0 ← 7: 10.5* ↘ 8: 10.3* ↗ 9: 10.7* ↗ 10: 9.7 ↗</p> <p style="text-align: right;">Series 96.0 Total 580.0</p>
--	--	--	--

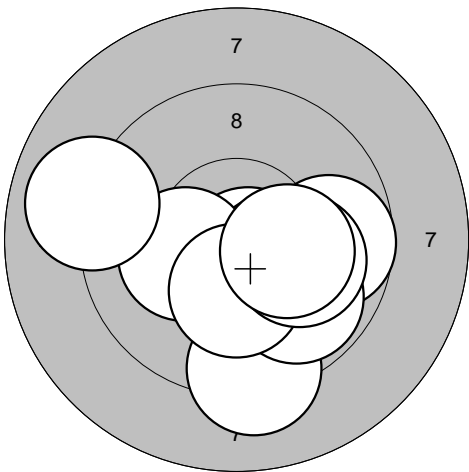
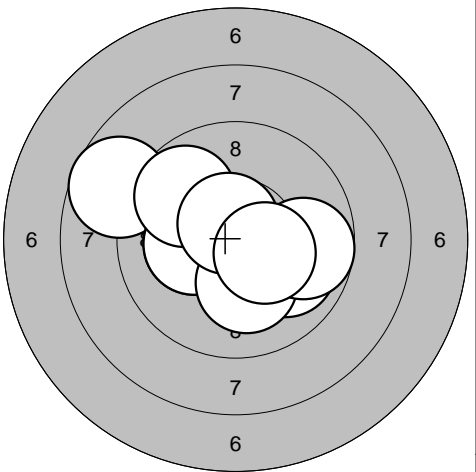
<p>Series 1</p> 	<p>1: 10.7* ↘ 2: 10.4* → 3: 10.2* ← 4: 9.2 ↓ 5: 9.0 ← 6: 9.7 → 7: 9.8 ↘ 8: 10.3* ↓ 9: 10.1 → 10: 10.2* →</p>	<p>Series 2</p> 	<p>1: 8.7 ↖ 2: 10.7* ↗ 3: 10.2* ← 4: 10.2* ← 5: 9.9 ↘ 6: 10.1 ↓ 7: 9.8 ↗ 8: 9.7 → 9: 10.7* ↗ 10: 10.4* ↘</p>
	Series 96.0		Series 95.0
	Total 96.0		Total 191.0

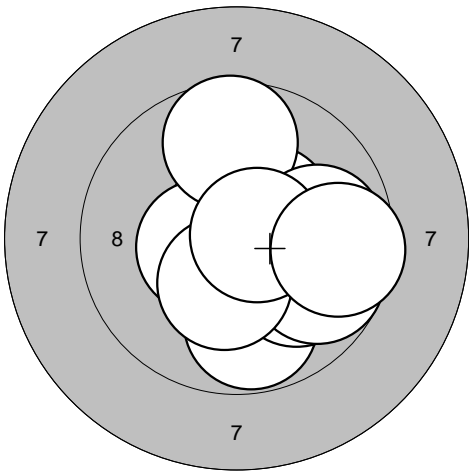
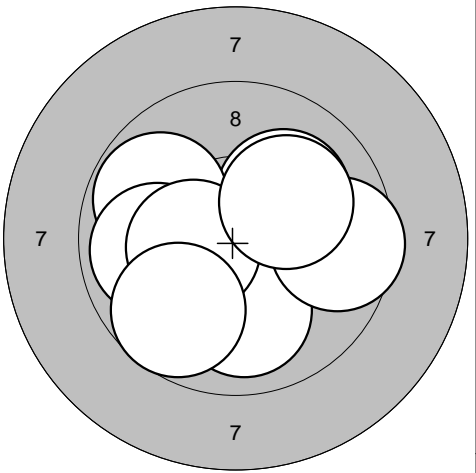
<p>Series 3</p> 	<p>1: 10.5* ← 2: 10.4* ↗ 3: 9.6 ↑ 4: 9.8 ↓ 5: 10.0 ↘ 6: 9.8 → 7: 10.3* ↓ 8: 9.9 → 9: 10.7* → 10: 9.6 →</p>	<p>Series 4</p> 	<p>1: 10.1 ↗ 2: 10.5* ← 3: 9.8 ↖ 4: 9.9 ← 5: 10.5* → 6: 10.0 ↓ 7: 9.6 → 8: 10.4* ← 9: 10.1 ↗ 10: 9.7 ↘</p>
	Series 95.0		Series 96.0
	Total 286.0		Total 382.0

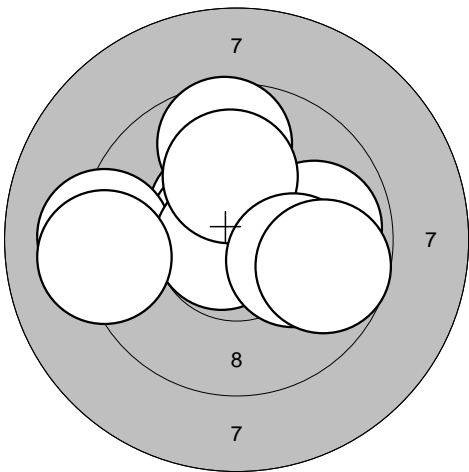
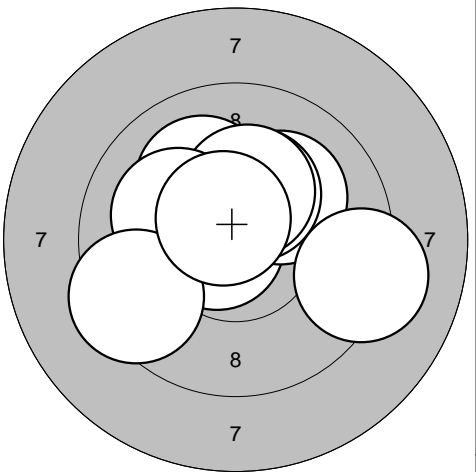
<p>Series 5</p> 	<p>1: 9.6 ↑ 2: 9.9 → 3: 10.5* ↗ 4: 10.7* ↖ 5: 9.2 ← 6: 10.8* ← 7: 9.2 ← 8: 10.1 ↑ 9: 10.2* → 10: 9.7 →</p>	<p>Series 6</p> 	<p>1: 10.5* ↖ 2: 10.7* ← 3: 10.1 ↗ 4: 10.1 ↗ 5: 10.3* ↗ 6: 10.3* ↗ 7: 10.1 ↖ 8: 9.2 → 9: 9.4 ↖ 10: 10.6* ↗</p>
	Series 95.0		Series 98.0
	Total 477.0		Total 575.0

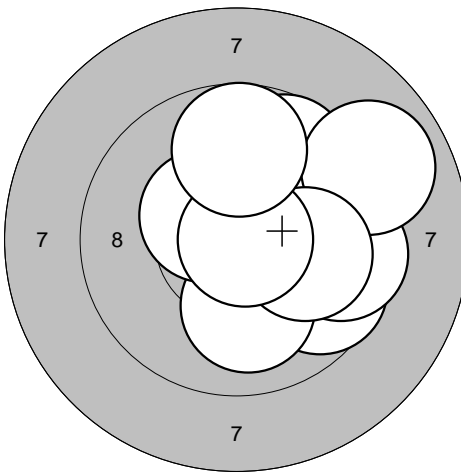
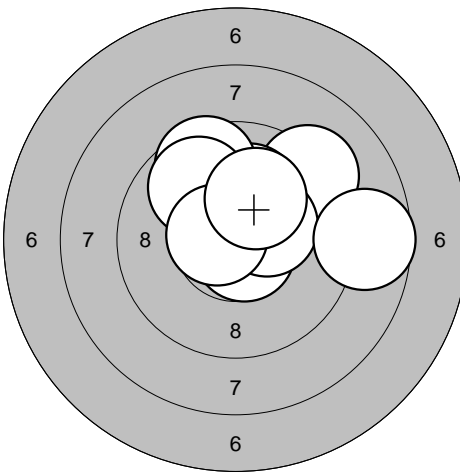
<p>Series 1</p> 	<p>1: 10.5* ↘ 2: 9.7 ↘ 3: 9.7 ↗ 4: 10.0 ↘ 5: 10.4* ↗ 6: 9.5 → 7: 8.9 ↗ 8: 10.0 → 9: 10.8* → 10: 9.7 ↑</p> <p>Series 94.0 Total 94.0</p>	<p>Series 2</p> 	<p>1: 10.7* ↘ 2: 10.4* ↑ 3: 9.2 ↗ 4: 10.1 ↑ 5: 9.6 ↑ 6: 9.8 ↗ 7: 10.4* → 8: 8.7 → 9: 10.6* ← 10: 10.1 ↗</p> <p>Series 95.0 Total 189.0</p>
--	---	--	--

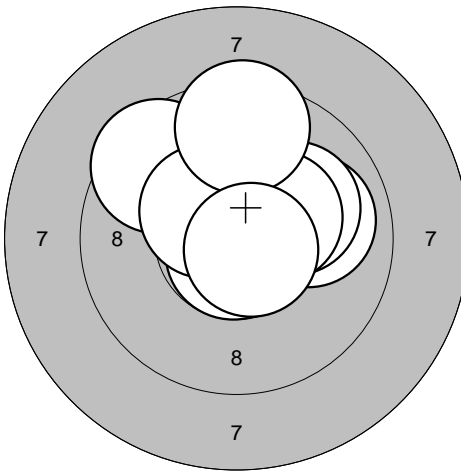
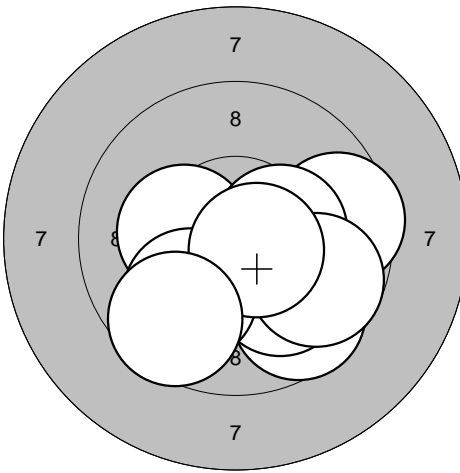
<p>Series 3</p> 	<p>1: 9.5 ↖ 2: 10.0 → 3: 10.5* ↑ 4: 10.5* ↗ 5: 10.1 ↗ 6: 10.3* → 7: 10.7* ↓ 8: 10.4* ↖ 9: 9.5 ↑ 10: 10.7* ↘</p> <p>Series 98.0 Total 287.0</p>	<p>Series 4</p> 	<p>1: 9.6 → 2: 10.3* ← 3: 10.3* → 4: 9.7 ↘ 5: 10.6* ↘ 6: 10.1 ↘ 7: 9.7 ↘ 8: 10.0 ↘ 9: 10.6* ↘ 10: 9.6 ↘</p> <p>Series 96.0 Total 383.0</p>
---	--	---	--

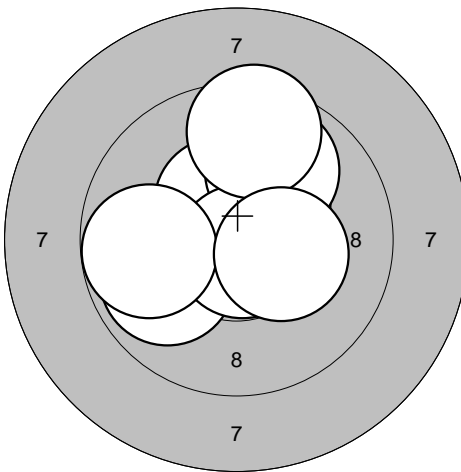
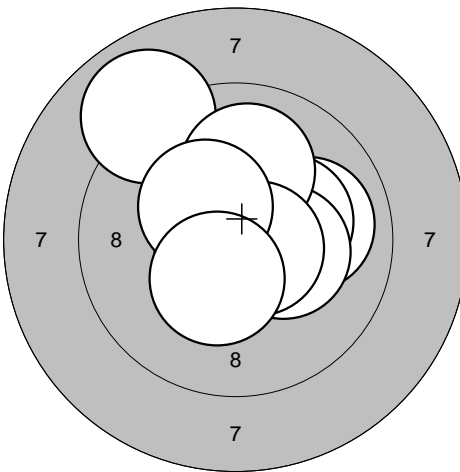
<p>Series 5</p> 	<p>1: 10.5* ↗ 2: 10.2* ↑ 3: 10.3* ↗ 4: 10.4* ↑ 5: 9.9 ↗ 6: 9.9 ← 7: 10.8* ↓ 8: 9.8 ← 9: 9.5 ↑ 10: 10.3* →</p> <p>Series 96.0 Total 479.0</p>	<p>Series 6</p> 	<p>1: 10.7* ↘ 2: 10.0 → 3: 8.9 ↗ 4: 10.2* → 5: 10.5* ↗ 6: 10.3* → 7: 10.0 ↑ 8: 10.7* ↘ 9: 10.3* ↗ 10: 10.4* ↘</p> <p>Series 98.0 Total 577.0</p>
--	--	--	--

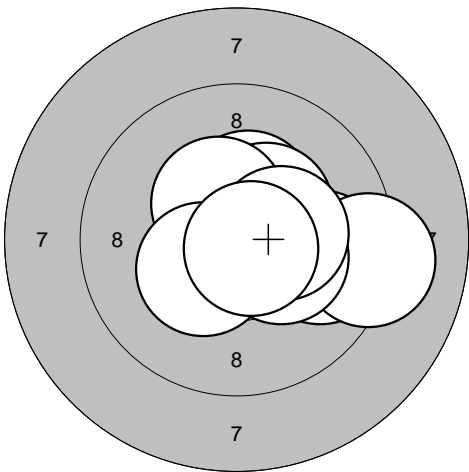
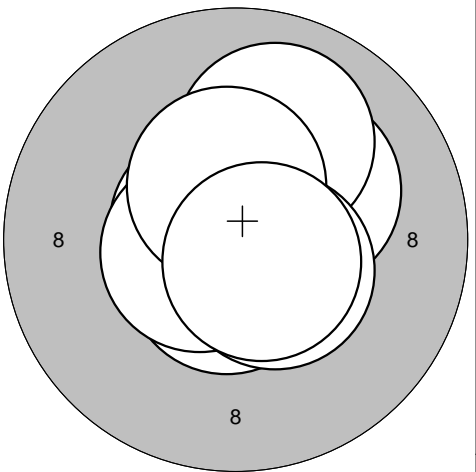
<p>Series 1</p> 	<p>1: 10.4* ↗</p> <p>2: 9.8 →</p> <p>3: 9.2 →</p> <p>4: 10.7* ↘</p> <p>5: 10.3* →</p> <p>6: 10.4* ↗</p> <p>7: 10.4* ↗</p> <p>8: 10.4* →</p> <p>9: 10.4* ↙</p> <p>10: 10.7* ↘</p>	<p>Series 2</p> 	<p>1: 10.2* ↗</p> <p>2: 10.7* ↖</p> <p>3: 10.5* ↑</p> <p>4: 10.6* ↓</p> <p>5: 10.6* ↑</p> <p>6: 10.0 ↗</p> <p>7: 10.6* ↖</p> <p>8: 10.5* ↘</p> <p>9: 10.5* ↑</p> <p>10: 10.7* ↘</p>
Series 98.0	Series 100.0		
Total 98.0	Total 198.0		

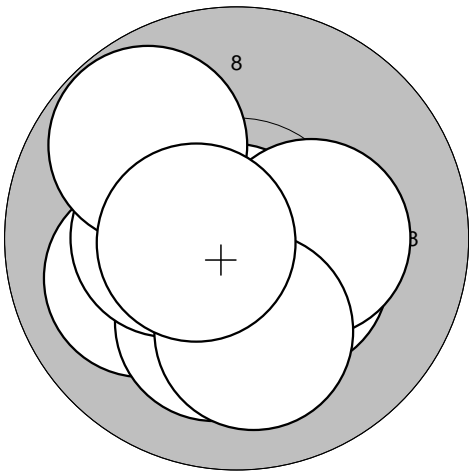
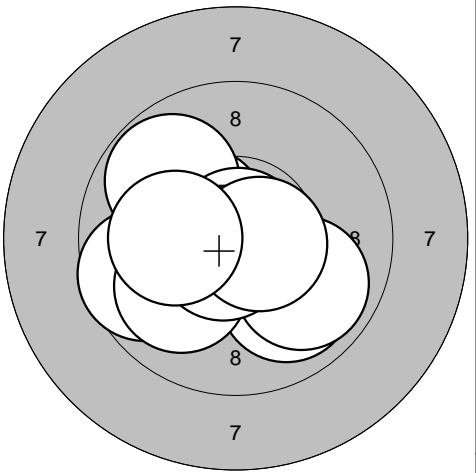
<p>Series 3</p> 	<p>1: 10.0 ↖</p> <p>2: 10.4* ↘</p> <p>3: 10.9* ↙</p> <p>4: 10.2* ↓</p> <p>5: 10.3* ←</p> <p>6: 10.5* ↓</p> <p>7: 9.8 ↗</p> <p>8: 10.3* →</p> <p>9: 10.1 ↓</p> <p>10: 10.6* ←</p>	<p>Series 4</p> 	<p>1: 9.7 ↖</p> <p>2: 9.9 ↘</p> <p>3: 10.4* ↗</p> <p>4: 9.8 ↗</p> <p>5: 9.9 ↘</p> <p>6: 10.9* ↗</p> <p>7: 10.0 ↖</p> <p>8: 10.7* ↘</p> <p>9: 10.6* →</p> <p>10: 10.2* ←</p>
Series 99.0	Series 96.0		
Total 297.0	Total 393.0		

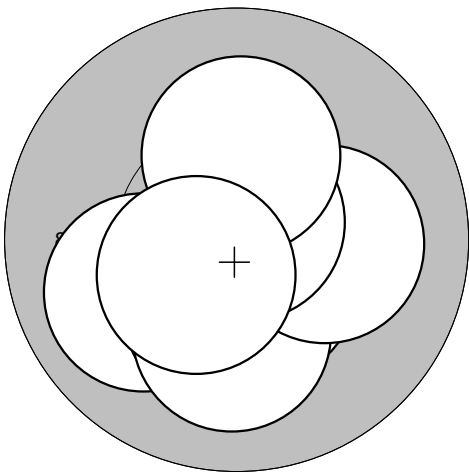
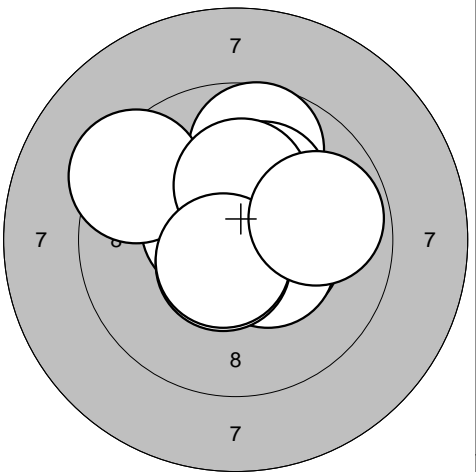
<p>Series 5</p> 	<p>1: 10.0 ↖</p> <p>2: 10.4* ↓</p> <p>3: 10.6* ↗</p> <p>4: 10.5* ↓</p> <p>5: 10.3* ↓</p> <p>6: 10.1 ↓</p> <p>7: 10.2* →</p> <p>8: 10.7* ↗</p> <p>9: 10.2* ↑</p> <p>10: 10.5* ↙</p>	<p>Series 6</p> 	<p>1: 10.4* →</p> <p>2: 9.7 ↑</p> <p>3: 10.5* ↖</p> <p>4: 10.4* ↘</p> <p>5: 10.2* ↗</p> <p>6: 9.4 ↖</p> <p>7: 10.2* ↑</p> <p>8: 10.6* ↓</p> <p>9: 10.6* ↓</p> <p>10: 9.8 →</p>
Series 100.0	Series 97.0		
Total 493.0	Total 590.0		

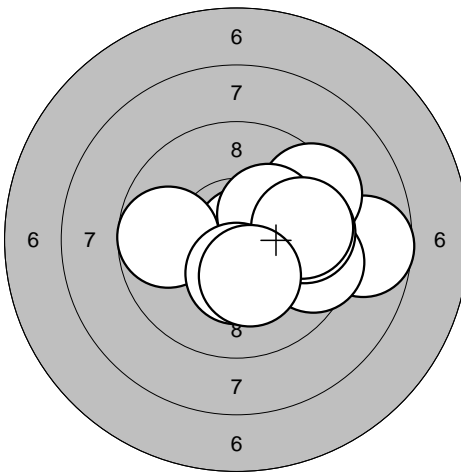
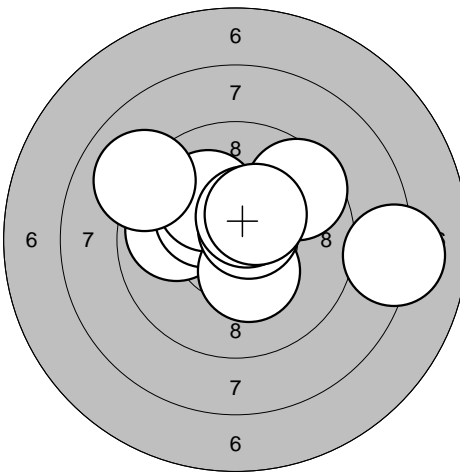
<p>Series 1</p> 	<p>1: 8.7 →</p> <p>2: 9.5 →</p> <p>3: 10.8* →</p> <p>4: 9.4 ↗</p> <p>5: 9.8 →</p> <p>6: 10.2* ↗</p> <p>7: 9.8 →</p> <p>8: 9.7 ←</p> <p>9: 10.4* ↓</p> <p>10: 10.3* ↓</p>	<p>Series 2</p> 	<p>1: 9.6 ↗</p> <p>2: 9.9 ←</p> <p>3: 10.3* ↗</p> <p>4: 10.1 ↗</p> <p>5: 9.0 ↗</p> <p>6: 8.1 →</p> <p>7: 10.3* ↓</p> <p>8: 10.6* ↗</p> <p>9: 10.5* ↗</p> <p>10: 10.4* ↗</p>
Series 93.0	Series 95.0	Series 95.0	Series 95.0
Total 93.0	Total 188.0	Total 188.0	Total 188.0

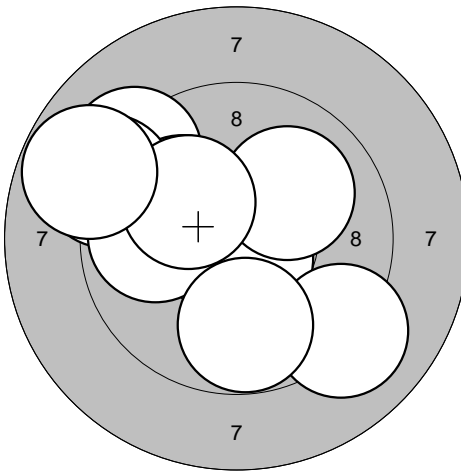
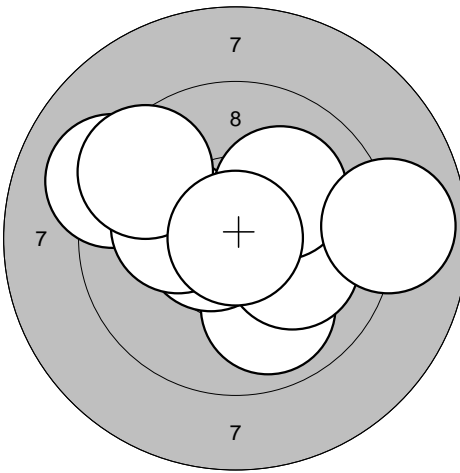
<p>Series 3</p> 	<p>1: 9.2 ↗</p> <p>2: 10.1 ↗</p> <p>3: 10.6* ↓</p> <p>4: 10.0 ↗</p> <p>5: 9.1 ↗</p> <p>6: 9.9 ←</p> <p>7: 9.1 ↓</p> <p>8: 10.1 ↗</p> <p>9: 8.8 ↗</p> <p>10: 9.8 ↓</p>	<p>Series 4</p> 	<p>1: 10.4* →</p> <p>2: 9.1 ↗</p> <p>3: 9.9 ↓</p> <p>4: 10.6* ←</p> <p>5: 10.1 →</p> <p>6: 10.2* ←</p> <p>7: 10.1 ↗</p> <p>8: 9.5 ↗</p> <p>9: 8.9 →</p> <p>10: 10.9*</p>
Series 93.0	Series 95.0	Series 95.0	Series 95.0
Total 281.0	Total 376.0	Total 376.0	Total 376.0

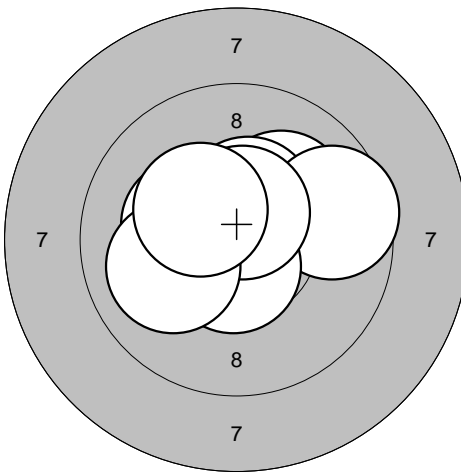
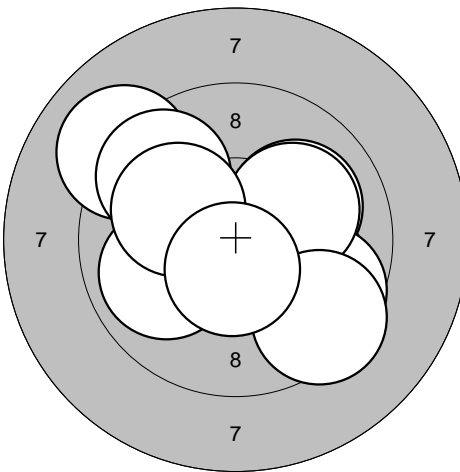
<p>Series 5</p> 	<p>1: 10.6* ↗</p> <p>2: 10.1 ↗</p> <p>3: 10.7* ↗</p> <p>4: 10.4* ↗</p> <p>5: 9.6 →</p> <p>6: 10.3* ←</p> <p>7: 10.6* ↓</p> <p>8: 10.6* ↗</p> <p>9: 10.0 ←</p> <p>10: 10.3* ↗</p>	<p>Series 6</p> 	<p>1: 9.1 ↗</p> <p>2: 9.7 ↗</p> <p>3: 9.9 ←</p> <p>4: 10.1 ↗</p> <p>5: 9.6 →</p> <p>6: 10.5* ↓</p> <p>7: 10.1 ↗</p> <p>8: 10.1 ↗</p> <p>9: 9.4 ↓</p> <p>10: 10.5* ↓</p>
Series 99.0	Series 95.0	Series 95.0	Series 95.0
Total 475.0	Total 570.0	Total 570.0	Total 570.0

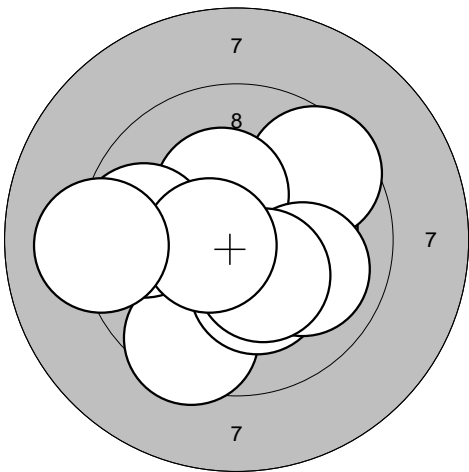
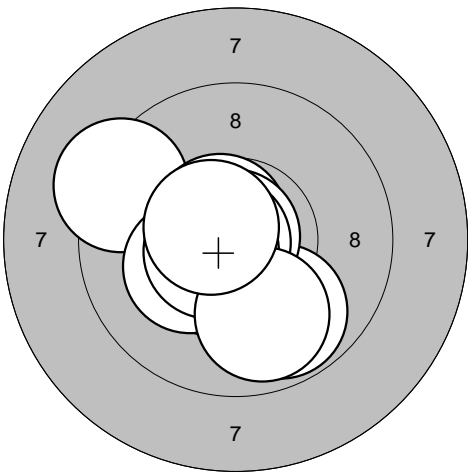
Series 1		1: 10.2* → 2: 9.6 ↗ 3: 10.3* ↑ 4: 9.5 ↓ 5: 10.3* ↓ 6: 10.0 → 7: 10.4* ↓ 8: 9.7 ← 9: 10.6* ← 10: 9.2 ←	Series 2		1: 9.3 ↖ 2: 9.8 ↓ 3: 10.6* ↗ 4: 10.5* ↓ 5: 10.9* ↗ 6: 10.3* ↖ 7: 10.8* ← 8: 10.6* ↖ 9: 9.9 ↓ 10: 10.6* ↖
	Series 96.0		Series 97.0		
	Total 96.0		Total 193.0		

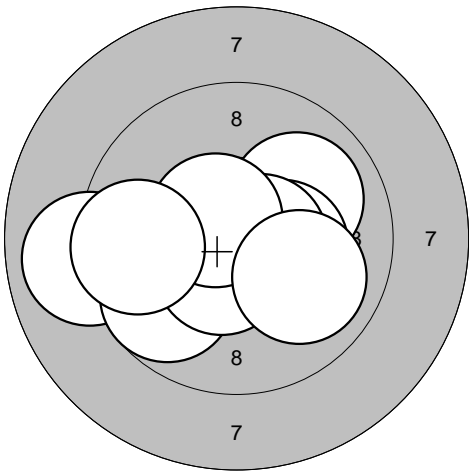
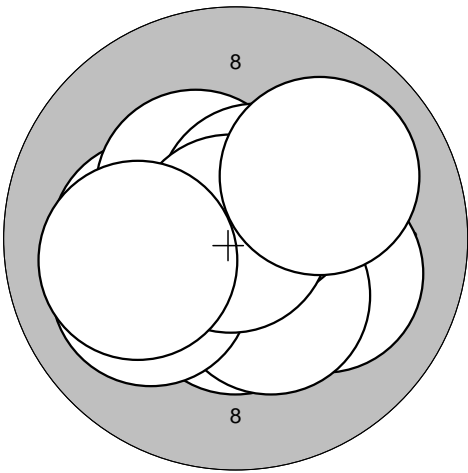
Series 3		1: 10.3* ← 2: 10.0 ↗ 3: 10.3* → 4: 9.0 ← 5: 10.6* → 6: 9.8 ↖ 7: 10.5* ↓ 8: 10.6* ↗ 9: 9.9 ↘ 10: 9.6 ←	Series 4		1: 10.1 → 2: 10.4* ↓ 3: 10.2* ← 4: 10.4* ↗ 5: 10.3* ↓ 6: 10.6* ↗ 7: 10.1 ↖ 8: 10.9* ↗ 9: 10.1 ← 10: 10.0 ↗
	Series 96.0		Series 100.0		
	Total 289.0		Total 389.0		

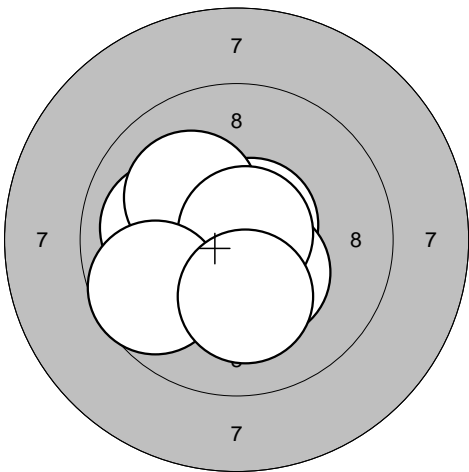
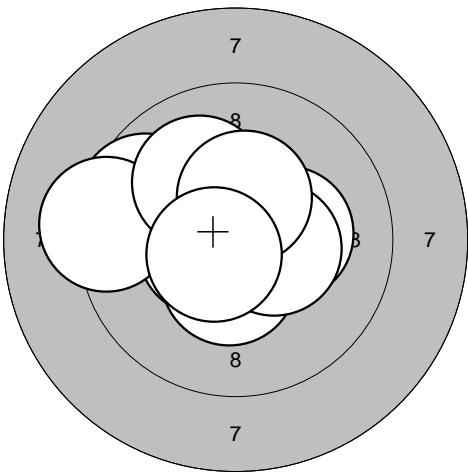
Series 5		1: 10.0 ← 2: 10.6* ↗ 3: 10.2* ← 4: 10.6* ↖ 5: 10.8* ← 6: 10.1 ↗ 7: 10.4* ↓ 8: 10.8* ↗ 9: 9.7 ↖ 10: 10.2* ↓	Series 6		1: 10.5* ↖ 2: 10.3* → 3: 10.4* ↓ 4: 9.6 ↖ 5: 10.7* ← 6: 9.2 ↖ 7: 10.1 ↗ 8: 10.4* → 9: 10.4* ↑ 10: 10.6* ↖
	Series 99.0		Series 98.0		
	Total 488.0		Total 586.0		

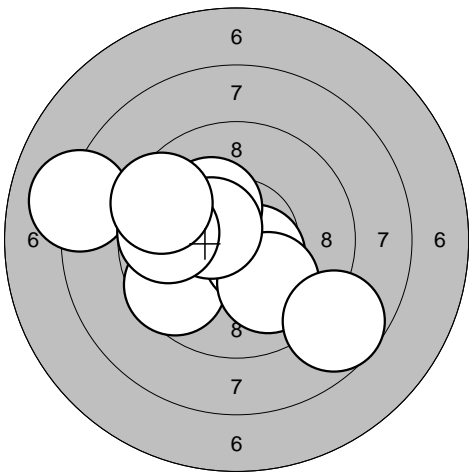
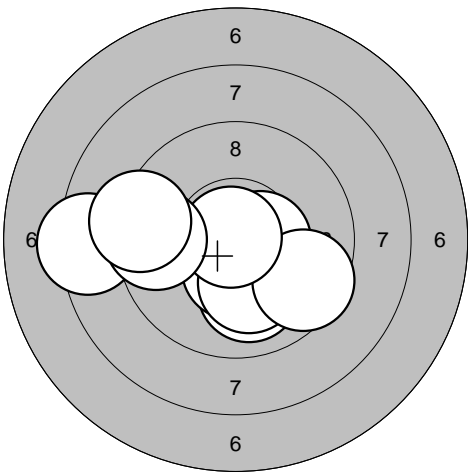
<p>Series 1</p> 	<p>1: 8.1 ↙ 2: 9.6 ↙ 3: 10.5* ↘ 4: 9.8 ↗ 5: 10.0 ↘ 6: 10.3* ↗ 7: 10.5* ↗ 8: 9.7 ← 9: 8.7 ↘ 10: 9.5 ↗</p> <p>Series 92.0 Total 92.0</p>	<p>Series 2</p>  <p>1: 10.0 ↓ 2: 10.5* ↘ 3: 10.5* → 4: 10.4* ↓ 5: 10.2* ↓ 6: 9.6 ↘ 7: 10.9* ↗ 8: 8.3 ← 9: 9.5 ← 10: 9.3 ←</p> <p>Series 95.0 Total 187.0</p>
---	--	---

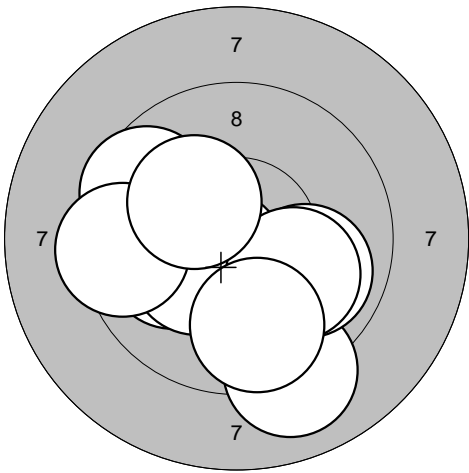
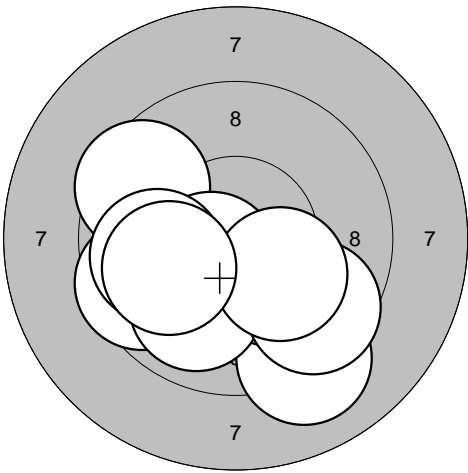
<p>Series 3</p> 	<p>1: 9.6 ↗ 2: 9.0 ↓ 3: 10.0 ← 4: 10.6* ↘ 5: 9.9 ↘ 6: 10.3* ↘ 7: 10.1 ↘ 8: 9.7 ↓ 9: 9.4 ← 10: 10.2* ↗</p> <p>Series 95.0 Total 282.0</p>	<p>Series 4</p>  <p>1: 9.5 ↗ 2: 9.6 ← 3: 9.1 ↓ 4: 10.2* ↘ 5: 10.5* ↘ 6: 9.9 ← 7: 9.9 ↓ 8: 9.6 ↘ 9: 10.2* ↘ 10: 10.0 ←</p> <p>Series 94.0 Total 376.0</p>
--	--	--

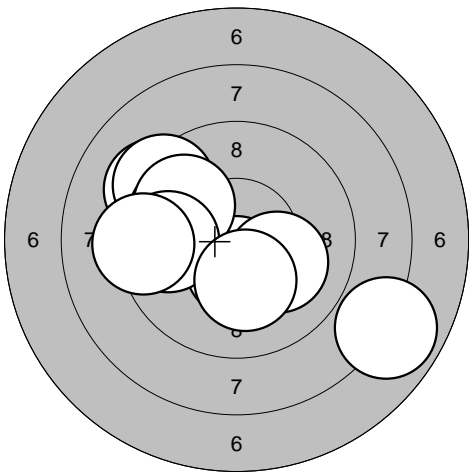
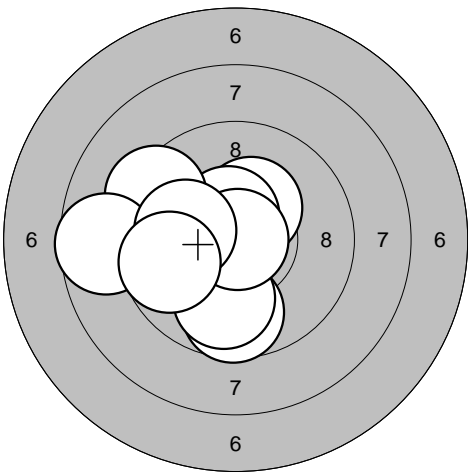
<p>Series 5</p> 	<p>1: 10.5* ↓ 2: 9.3 ↗ 3: 9.4 ↗ 4: 10.1 ↘ 5: 9.9 ↗ 6: 9.9 ↗ 7: 7.9 ↓ 8: 9.7 ← 9: 10.2* ↓ 10: 9.3 ←</p> <p>Series 91.0 Total 467.0</p>	<p>Series 6</p>  <p>1: 10.3* ↗ 2: 10.0 ← 3: 9.7 ↓ 4: 10.5* ↗ 5: 9.4 ↗ 6: 8.7 ← 7: 9.9 ↓ 8: 10.9* → 9: 10.1 ← 10: 9.7 ←</p> <p>Series 94.0 Total 561.0</p>
---	---	--

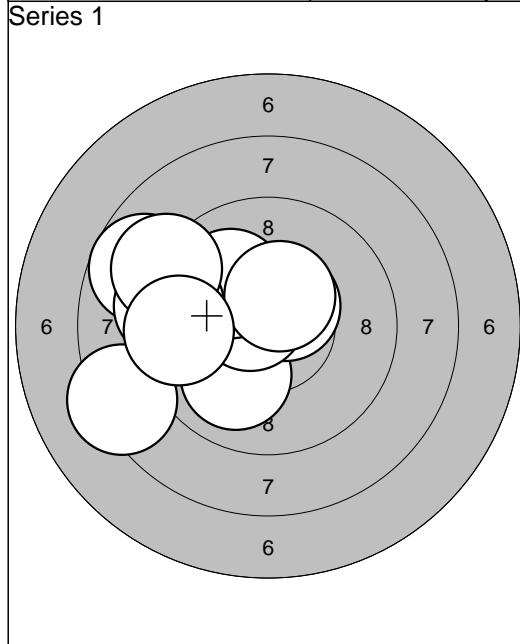

1: 8.3	↙
2: 10.0	↘
3: 8.8	↙
4: 10.5*	↗
5: 10.6*	↖
6: 10.1	↗
7: 9.3	↙
8: 10.4*	↗
9: 9.1	↙
10: 9.5	↙
Series	93.0
Total	93.0

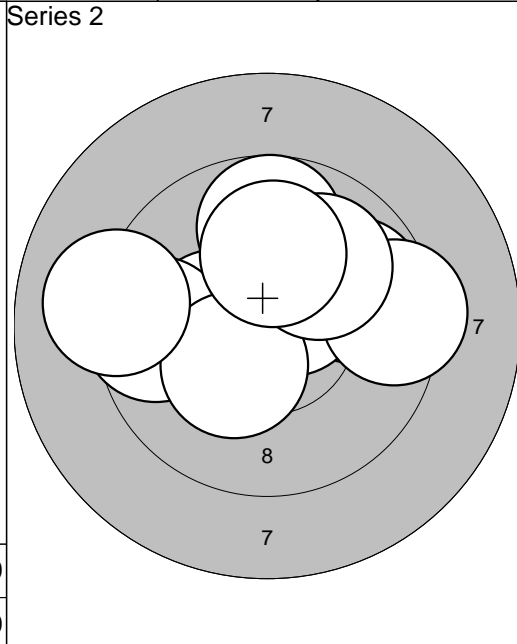

1: 9.8	↗
2: 10.6*	↗
3: 10.3*	↙
4: 9.6	↙
5: 9.4	→
6: 10.3*	↘
7: 9.7	↑
8: 9.1	↙
9: 10.0	↗
10: 10.1	↑
Series	95.0
Total	188.0

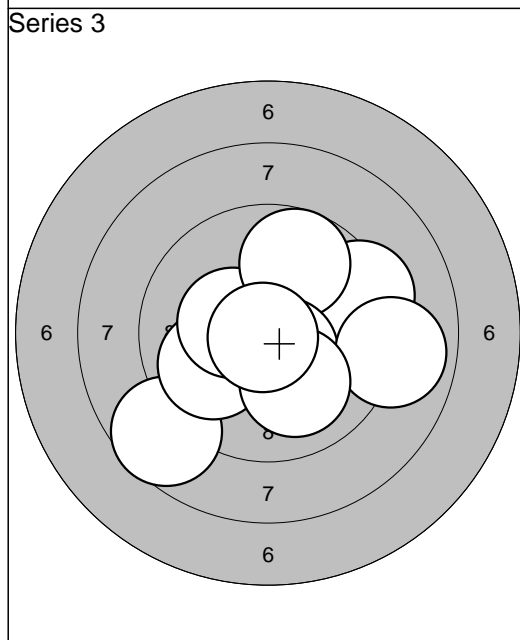

1: 8.7	↘
2: 10.5*	→
3: 9.3	→
4: 9.9	↙
5: 10.4*	↙
6: 9.8	↗
7: 10.5*	↘
8: 8.9	→
9: 10.1	↘
10: 10.8*	↘
Series	93.0
Total	281.0

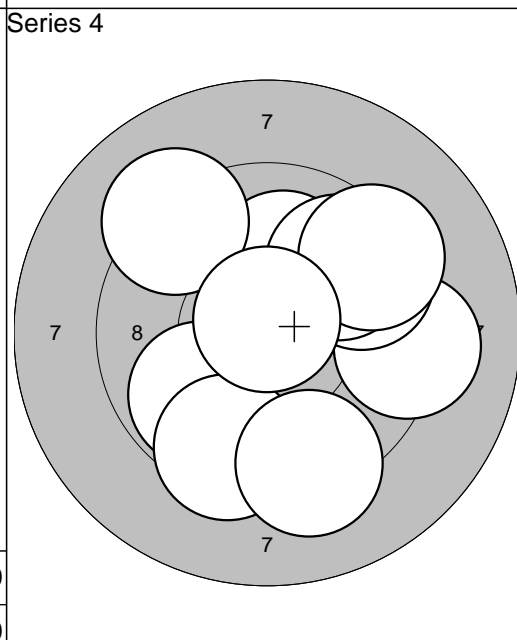

1: 9.8	↘
2: 10.1	↑
3: 9.2	→
4: 9.6	↗
5: 9.2	↖
6: 9.8	↗
7: 9.5	↘
8: 9.3	↘
9: 9.4	↗
10: 10.8*	↑
Series	92.0
Total	373.0

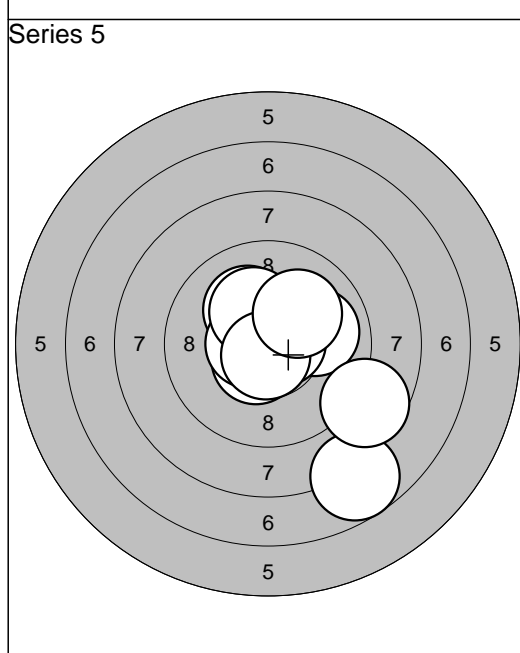

1: 10.1	↖
2: 10.0	→
3: 10.6*	↘
4: 10.6*	↙
5: 10.7*	→
6: 7.7	↘
7: 8.7	↘
8: 10.2*	↗
9: 10.7*	↘
10: 10.1	↗
Series	95.0
Total	468.0

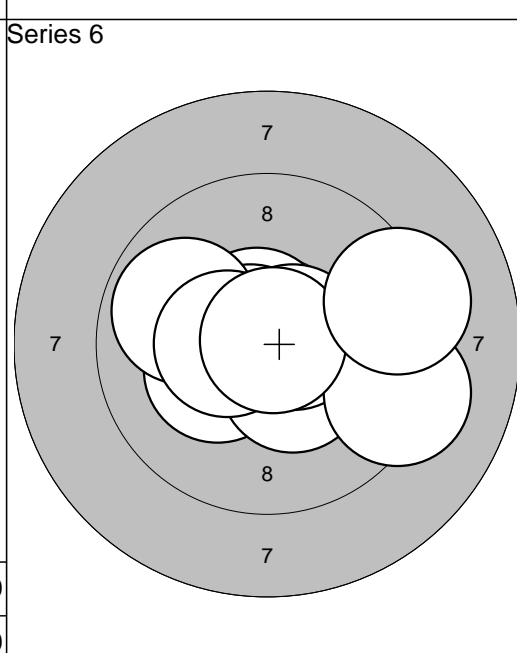

1: 10.6*	↖
2: 10.2*	↙
3: 10.4*	↘
4: 10.6*	→
5: 9.2	→
6: 10.7*	↙
7: 9.9	↙
8: 10.5*	↙
9: 10.8*	↗
10: 9.3	→
Series	97.0
Total	565.0

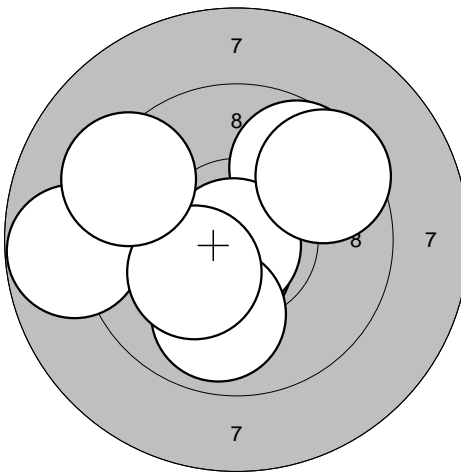
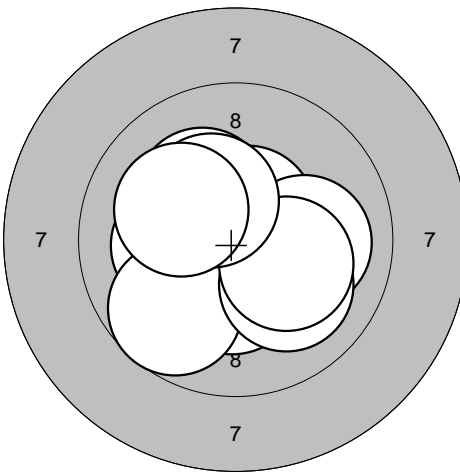
<p>Series 1</p> 	<p>1: 10.6* ↘ 2: 10.3* ↘ 3: 10.1 ↘ 4: 9.7 ↗ 5: 10.9* ↘ 6: 8.8 ← 7: 9.9 ↘ 8: 10.2* ↙ 9: 9.5 ↗ 10: 9.3 ↖</p> <p>Series 94.0 Total 94.0</p>	<p>Series 2</p> 	<p>1: 10.6* ↗ 2: 10.2* ← 3: 10.3* ↓ 4: 9.7 ↙ 5: 10.0 → 6: 10.0 ↘ 7: 10.2* ↘ 8: 10.2* ↗ 9: 10.3* ↗ 10: 10.1 ↖</p> <p>Series 99.0 Total 193.0</p>
--	--	--	---

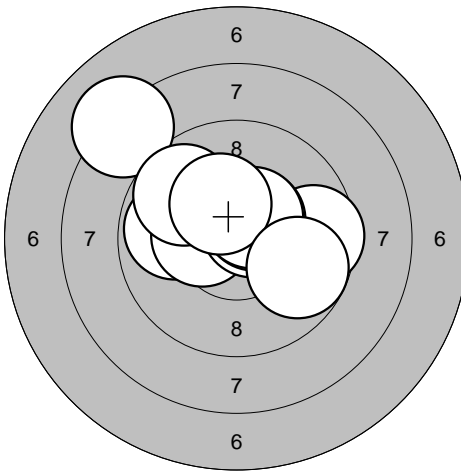
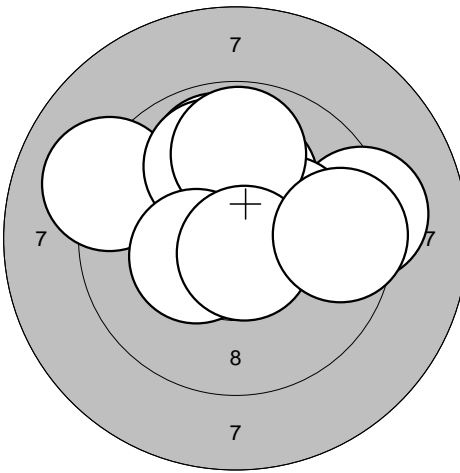
<p>Series 3</p> 	<p>1: 9.9 ← 2: 9.6 → 3: 8.1 ↗ 4: 10.3* ← 5: 10.6* ↗ 6: 10.5* ↗ 7: 9.7 ↗ 8: 10.5* ↗ 9: 10.3* ↗ 10: 9.8 →</p> <p>Series 94.0 Total 287.0</p>	<p>Series 4</p> 	<p>1: 9.1 ↖ 2: 10.1 ↗ 3: 9.9 ↗ 4: 9.3 → 5: 9.9 ↗ 6: 10.2* → 7: 9.8 ↗ 8: 10.4* ← 9: 10.7* ↓ 10: 9.6 →</p> <p>Series 94.0 Total 381.0</p>
---	--	---	---

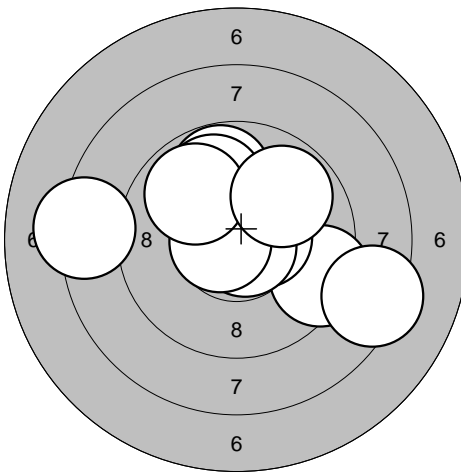
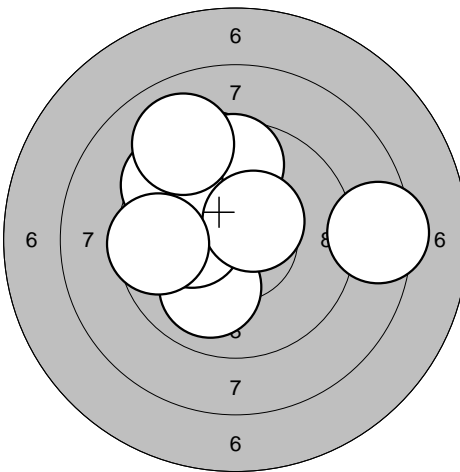
<p>Series 5</p> 	<p>1: 9.8 ↗ 2: 9.3 → 3: 10.5* → 4: 10.7* ↘ 5: 9.9 ↗ 6: 10.7* ← 7: 8.3 ← 8: 9.9 ↗ 9: 8.3 → 10: 9.8 ↗</p> <p>Series 91.0 Total 472.0</p>	<p>Series 6</p> 	<p>1: 9.5 ↗ 2: 8.4 → 3: 9.6 ↗ 4: 10.0 ↘ 5: 10.2* ← 6: 10.2* ← 7: 9.5 ↗ 8: 10.5* ↗ 9: 9.6 ← 10: 9.0 ↗</p> <p>Series 93.0 Total 565.0</p>
--	--	--	---

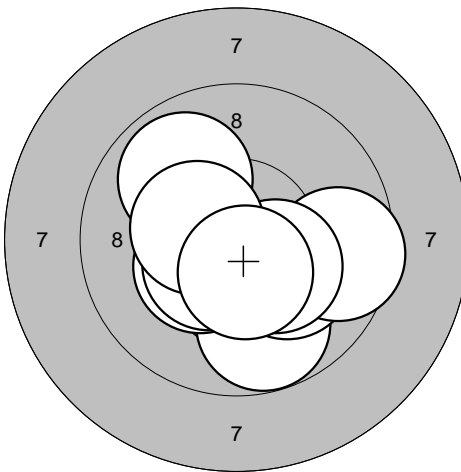
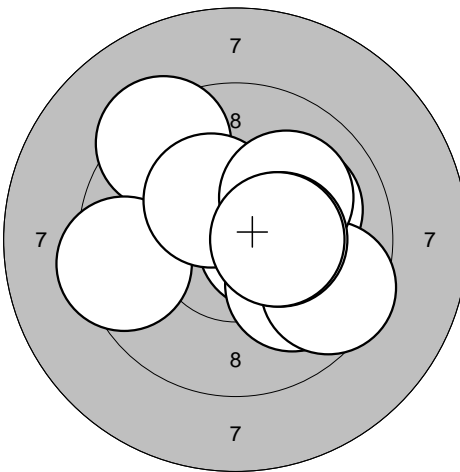
<p>Series 1</p> 	<p>1: 10.4* ↓</p> <p>2: 9.8 ↓</p> <p>3: 10.4* ↙</p> <p>4: 10.5* ↙</p> <p>5: 10.1 ↘</p> <p>6: 9.9 ↗</p> <p>7: 9.6 →</p> <p>8: 10.3* ↘</p> <p>9: 10.4* ↖</p> <p>10: 10.5* ↓</p>	<p>Series 2</p> 	<p>1: 10.6* →</p> <p>2: 9.4 ↗</p> <p>3: 10.0 ↘</p> <p>4: 10.0 ↗</p> <p>5: 9.5 ←</p> <p>6: 10.4* ↗</p> <p>7: 9.6 ↘</p> <p>8: 10.1 ↗</p> <p>9: 10.4* →</p> <p>10: 10.4* →</p>
Series 97.0	Series 97.0	Series 97.0	Series 97.0
Total 97.0	Total 97.0	Total 194.0	Total 194.0

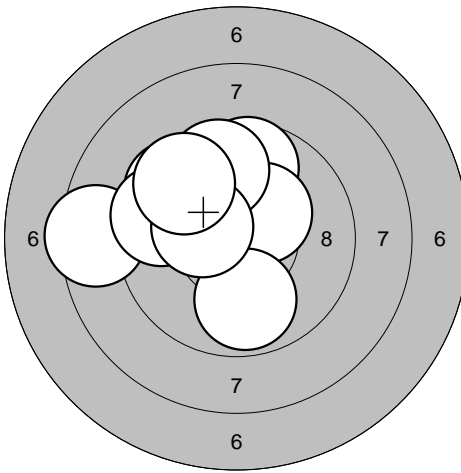
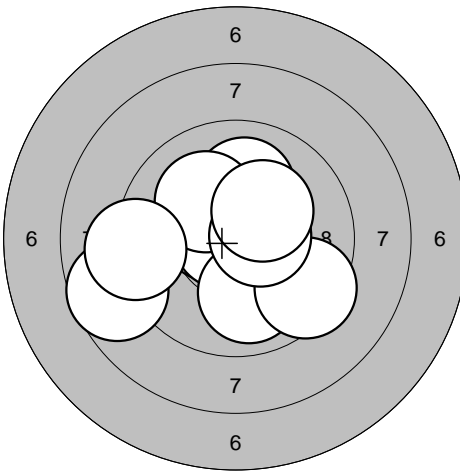
<p>Series 3</p> 	<p>1: 9.6 ↖</p> <p>2: 10.5* ↑</p> <p>3: 9.7 ↑</p> <p>4: 10.3* ↗</p> <p>5: 8.5 ←</p> <p>6: 9.6 ↖</p> <p>7: 9.7 ↑</p> <p>8: 9.8 ↓</p> <p>9: 10.3* ↖</p> <p>10: 9.6 ↗</p>	<p>Series 4</p> 	<p>1: 10.1 ↑</p> <p>2: 8.7 ↖</p> <p>3: 10.5* ↖</p> <p>4: 10.8* ←</p> <p>5: 10.1 ↗</p> <p>6: 10.0 ↓</p> <p>7: 9.4 ↘</p> <p>8: 10.5* →</p> <p>9: 9.2 ←</p> <p>10: 10.3* ↗</p>
Series 92.0	Series 96.0	Series 96.0	Series 96.0
Total 286.0	Total 382.0	Total 382.0	Total 382.0

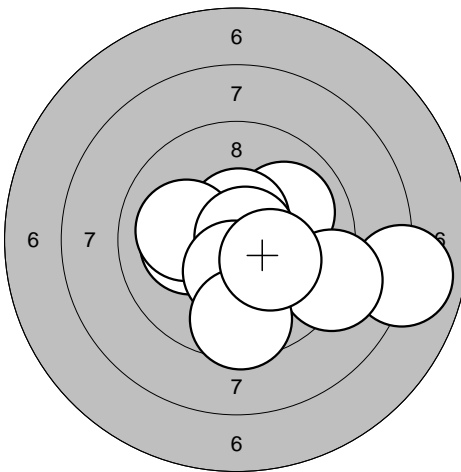
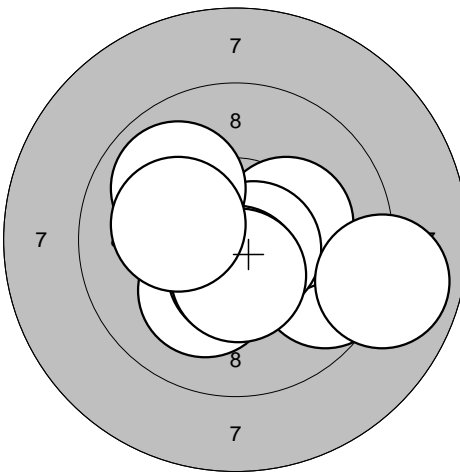
<p>Series 5</p> 	<p>1: 8.0 →</p> <p>2: 10.0 ↗</p> <p>3: 10.2* ←</p> <p>4: 9.1 →</p> <p>5: 10.6* ↑</p> <p>6: 10.1 ↖</p> <p>7: 10.8* →</p> <p>8: 10.4* ↓</p> <p>9: 9.5 ↓</p> <p>10: 10.2* ↘</p>	<p>Series 6</p> 	<p>1: 10.5* ↖</p> <p>2: 9.6 ↘</p> <p>3: 10.3* →</p> <p>4: 10.7* ↘</p> <p>5: 10.1 ↘</p> <p>6: 10.5* ↓</p> <p>7: 10.5* ↓</p> <p>8: 9.9 ↗</p> <p>9: 10.2* ↖</p> <p>10: 8.9 →</p>
Series 96.0	Series 96.0	Series 96.0	Series 96.0
Total 478.0	Total 574.0	Total 574.0	Total 574.0

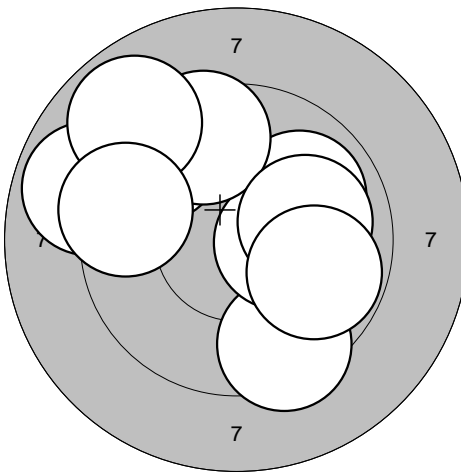
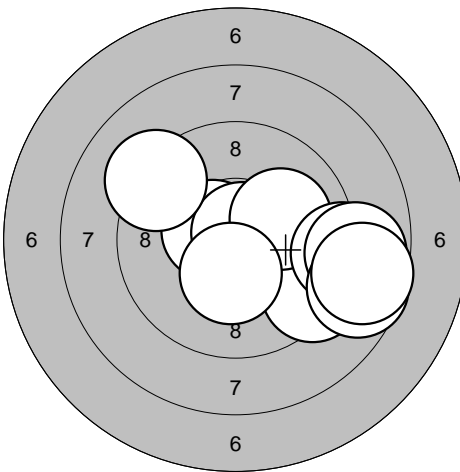
<p>Series 1</p> 	<p>1: 9.9 ↗</p> <p>2: 9.4 ↘</p> <p>3: 10.4* →</p> <p>4: 9.4 ↗</p> <p>5: 8.9 ↗</p> <p>6: 9.5 ↗</p> <p>7: 8.9 ↗</p> <p>8: 10.0 →</p> <p>9: 9.4 ←</p> <p>10: 9.8 ↘</p>	<p>Series 2</p> 	<p>1: 10.5* ↖</p> <p>2: 10.8* ↗</p> <p>3: 9.3 ↘</p> <p>4: 9.2 ↖</p> <p>5: 10.1 ↗</p> <p>6: 9.0 →</p> <p>7: 8.8 →</p> <p>8: 8.6 ↘</p> <p>9: 10.3* ↓</p> <p>10: 8.6 →</p>
Series 90.0	Series 91.0	Series 91.0	Series 91.0
Total 90.0	Total 181.0	Total 181.0	Total 181.0

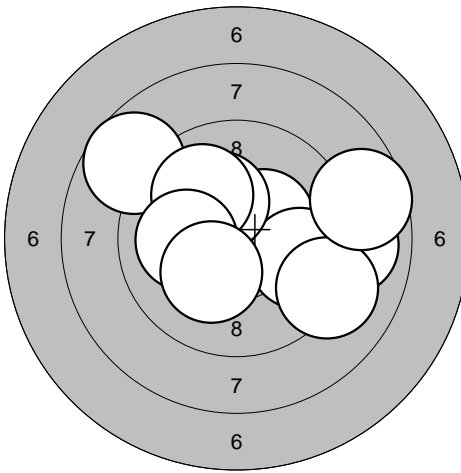
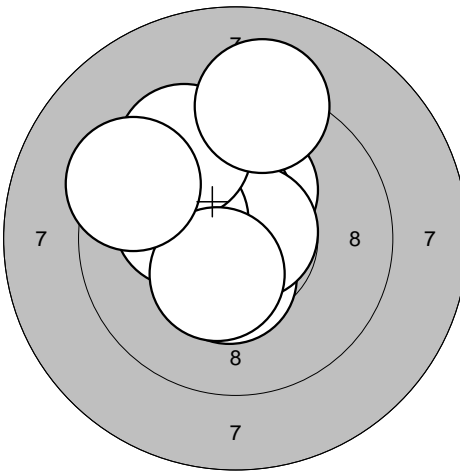
<p>Series 3</p> 	<p>1: 10.4* ↗</p> <p>2: 8.7 ↗</p> <p>3: 9.0 →</p> <p>4: 9.8 →</p> <p>5: 9.1 ↘</p> <p>6: 10.2* ↗</p> <p>7: 10.0 ↗</p> <p>8: 10.1 ←</p> <p>9: 8.6 →</p> <p>10: 10.2* ↘</p>	<p>Series 4</p> 	<p>1: 10.4* ↓</p> <p>2: 10.3* ↗</p> <p>3: 10.5* ↗</p> <p>4: 9.8 ↖</p> <p>5: 10.7* ↗</p> <p>6: 10.2* ↖</p> <p>7: 9.6 ↗</p> <p>8: 9.2 ↗</p> <p>9: 10.4* ↘</p> <p>10: 9.4 ↖</p>
Series 93.0	Series 96.0	Series 96.0	Series 96.0
Total 274.0	Total 370.0	Total 370.0	Total 370.0

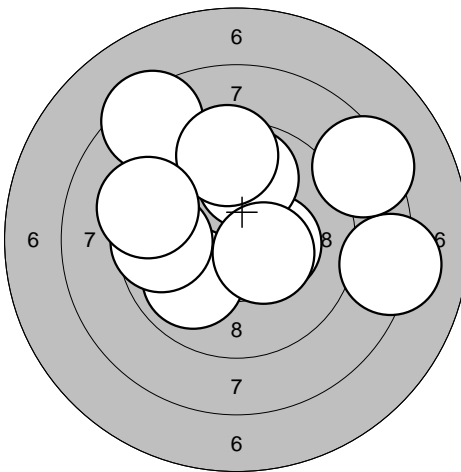
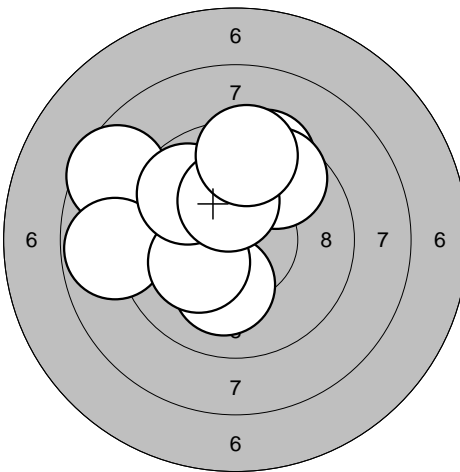
<p>Series 5</p> 	<p>1: 10.4* →</p> <p>2: 8.4 ↗</p> <p>3: 9.9 ↗</p> <p>4: 9.9 ↘</p> <p>5: 8.2 →</p> <p>6: 9.6 ←</p> <p>7: 9.4 ↗</p> <p>8: 9.3 ↖</p> <p>9: 8.4 ↗</p> <p>10: 10.4* ↘</p>	<p>Series 6</p> 	<p>1: 8.6 ↖</p> <p>2: 8.8 ←</p> <p>3: 10.1 ↓</p> <p>4: 9.6 ↗</p> <p>5: 10.2* ↖</p> <p>6: 9.5 ↗</p> <p>7: 9.6 ↗</p> <p>8: 9.8 ↖</p> <p>9: 10.2* ↗</p> <p>10: 9.5 ↗</p>
Series 89.0	Series 91.0	Series 91.0	Series 91.0
Total 459.0	Total 550.0	Total 550.0	Total 550.0

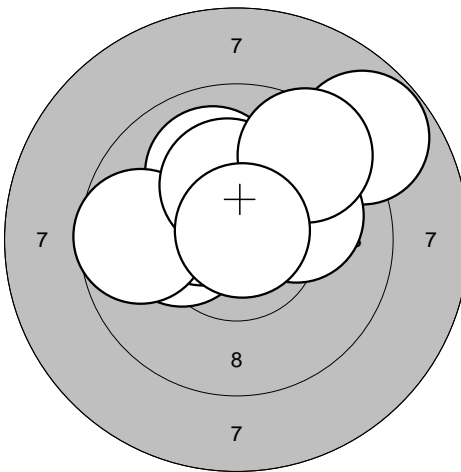
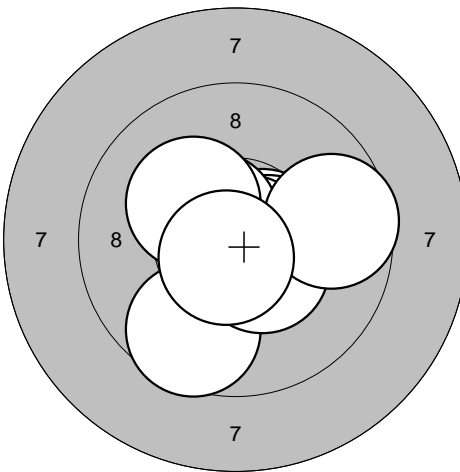
<p>Series 1</p> 	<p>1: 10.3* ↑</p> <p>2: 8.8 ↗</p> <p>3: 10.2* ←</p> <p>4: 10.4* ↖</p> <p>5: 10.0 ↑</p> <p>6: 9.7 ←</p> <p>7: 10.2* ↑</p> <p>8: 10.1 ↗</p> <p>9: 9.5 ↗</p> <p>10: 10.8* ↗</p>	<p>Series 2</p> 	<p>1: 9.6 ↓</p> <p>2: 10.6* →</p> <p>3: 10.8* ↓</p> <p>4: 10.5* →</p> <p>5: 10.8* →</p> <p>6: 10.4* ↓</p> <p>7: 10.5* ↗</p> <p>8: 10.2* ↗</p> <p>9: 9.7 →</p> <p>10: 10.7* ↓</p>
Series 96.0	Series 98.0	Series 98.0	
Total 96.0	Total 194.0	Total 194.0	

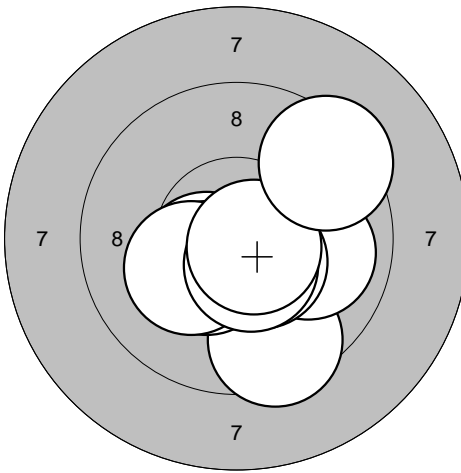
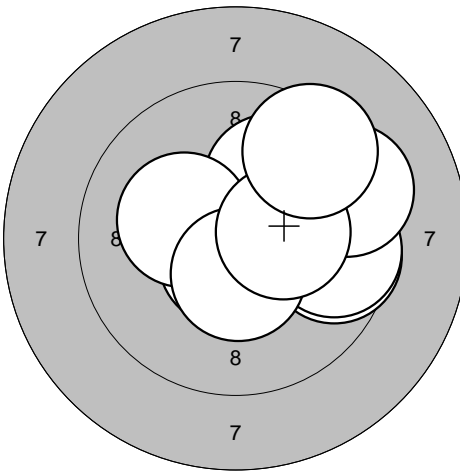
<p>Series 3</p> 	<p>1: 10.2* →</p> <p>2: 9.5 ↓</p> <p>3: 10.5* ↖</p> <p>4: 10.4* ↖</p> <p>5: 10.0 →</p> <p>6: 10.5* ↓</p> <p>7: 10.2* ↖</p> <p>8: 10.6* ↓</p> <p>9: 10.7* →</p> <p>10: 9.4 ↗</p>	<p>Series 4</p> 	<p>1: 9.6 →</p> <p>2: 10.0 →</p> <p>3: 9.6 →</p> <p>4: 10.6* ↓</p> <p>5: 9.4 →</p> <p>6: 10.1 ↗</p> <p>7: 10.2* ↖</p> <p>8: 10.5* ↓</p> <p>9: 10.3* →</p> <p>10: 9.4 ↗</p>
Series 98.0	Series 96.0	Series 96.0	
Total 292.0	Total 388.0	Total 388.0	

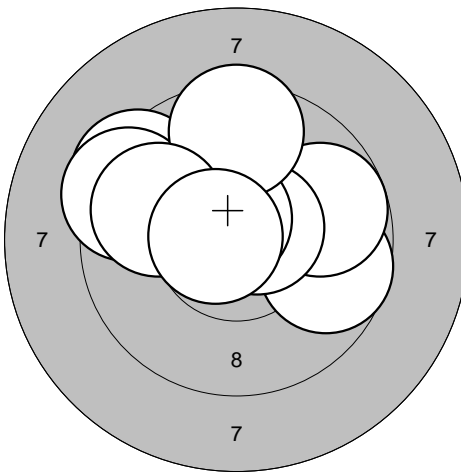
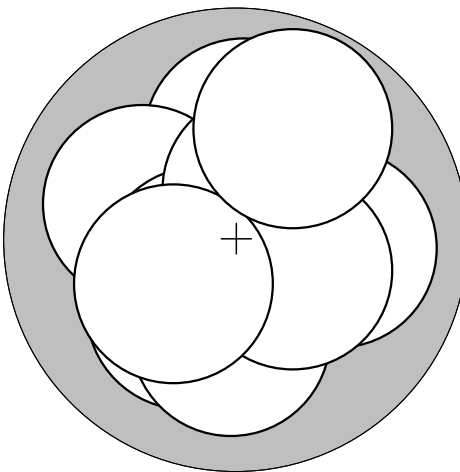
<p>Series 5</p> 	<p>1: 10.6* ↗</p> <p>2: 9.7 →</p> <p>3: 9.8 →</p> <p>4: 10.6* ↗</p> <p>5: 9.4 ↖</p> <p>6: 10.6* ↗</p> <p>7: 9.4 ↖</p> <p>8: 9.5 ↑</p> <p>9: 9.8 ↖</p> <p>10: 10.7* ↖</p>	<p>Series 6</p> 	<p>1: 10.2* ↓</p> <p>2: 10.0 ↑</p> <p>3: 10.1 ↖</p> <p>4: 10.0 →</p> <p>5: 10.1 ↓</p> <p>6: 10.5* ↖</p> <p>7: 10.4* ↗</p> <p>8: 10.4* ↖</p> <p>9: 10.2* ↖</p> <p>10: 9.8 ↗</p>
Series 94.0	Series 99.0	Series 99.0	
Total 482.0	Total 581.0	Total 581.0	

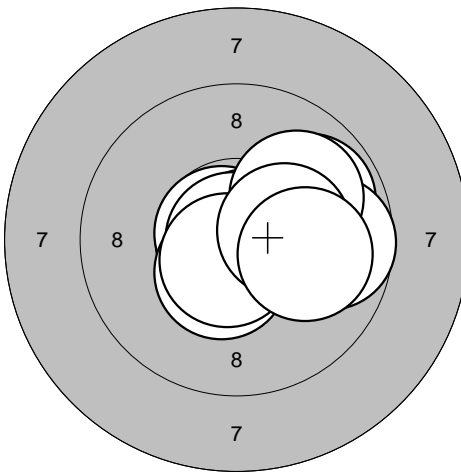
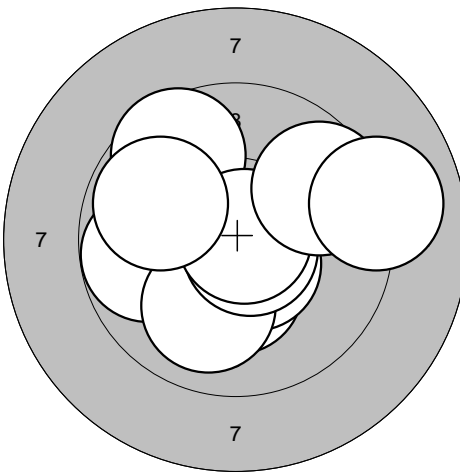
<p>Series 1</p> 	<p>1: 9.9 →</p> <p>2: 10.7* ←</p> <p>3: 10.8* →</p> <p>4: 9.7 →</p> <p>5: 10.5* ↓</p> <p>6: 10.9* ←</p> <p>7: 10.0 ↗</p> <p>8: 10.6* ↓</p> <p>9: 10.3* →</p> <p>10: 10.0 →</p>	<p>Series 2</p> 	<p>1: 10.3* ↓</p> <p>2: 10.5* ↓</p> <p>3: 9.6 ↗</p> <p>4: 9.8 ←</p> <p>5: 10.0 ↓</p> <p>6: 10.7* ↓</p> <p>7: 10.8* →</p> <p>8: 9.6 ↗</p> <p>9: 9.9 ←</p> <p>10: 9.0 →</p>
Series 98.0	Series 95.0		
Total 98.0	Total 193.0		

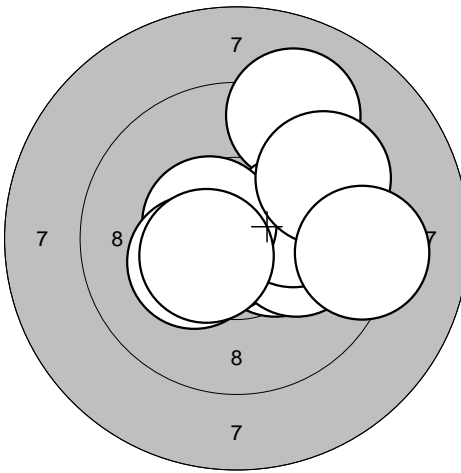
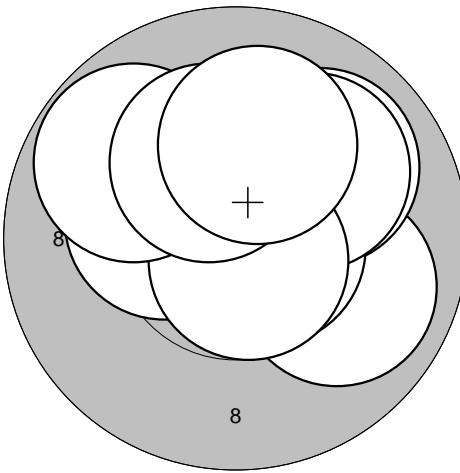
<p>Series 3</p> 	<p>1: 10.4* →</p> <p>2: 9.1 ↗</p> <p>3: 10.7* ←</p> <p>4: 10.1 →</p> <p>5: 10.2* →</p> <p>6: 10.5* ↗</p> <p>7: 9.6 ↗</p> <p>8: 10.3* ←</p> <p>9: 10.5* ←</p> <p>10: 9.2 →</p>	<p>Series 4</p> 	<p>1: 9.9 ↘</p> <p>2: 10.6* ↑</p> <p>3: 10.3* ←</p> <p>4: 9.9 ↗</p> <p>5: 10.7* →</p> <p>6: 10.1 ↗</p> <p>7: 10.7* ↓</p> <p>8: 9.8 ↗</p> <p>9: 10.2* ↗</p> <p>10: 10.1 ↑</p>
Series 97.0	Series 97.0		
Total 290.0	Total 387.0		

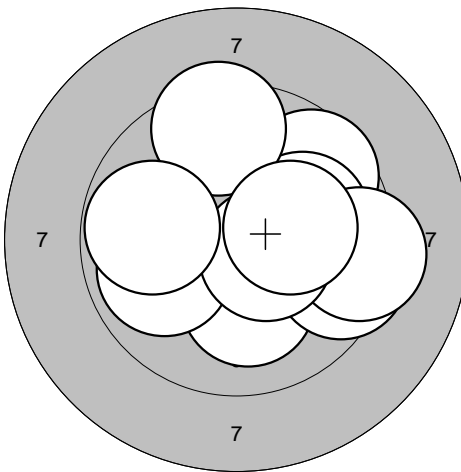
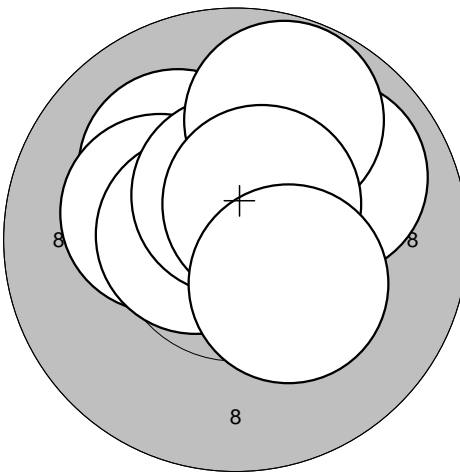
<p>Series 5</p> 	<p>1: 10.1 ↓</p> <p>2: 9.9 ←</p> <p>3: 9.5 →</p> <p>4: 9.7 ↗</p> <p>5: 10.0 →</p> <p>6: 9.5 ↑</p> <p>7: 9.3 →</p> <p>8: 10.5* ↘</p> <p>9: 10.2* →</p> <p>10: 9.8 ←</p>	<p>Series 6</p> 	<p>1: 10.5* ←</p> <p>2: 10.1 ↗</p> <p>3: 10.2* ←</p> <p>4: 10.2* ↗</p> <p>5: 10.6* ←</p> <p>6: 9.9 ↗</p> <p>7: 10.5* ↑</p> <p>8: 9.8 ↗</p> <p>9: 10.6* ↗</p> <p>10: 10.3* ↓</p>
Series 94.0	Series 98.0		
Total 481.0	Total 579.0		

Relay 1	Lane 28	Henrik Lindström
-------------------	-------------------	-------------------------

Day 2, Rifle	Forsa Skf	ARM
--------------	-----------	-----

3-6.1.2010	Swedish Cup 2010	Swedishcup 10
------------	------------------	---------------

Series 1

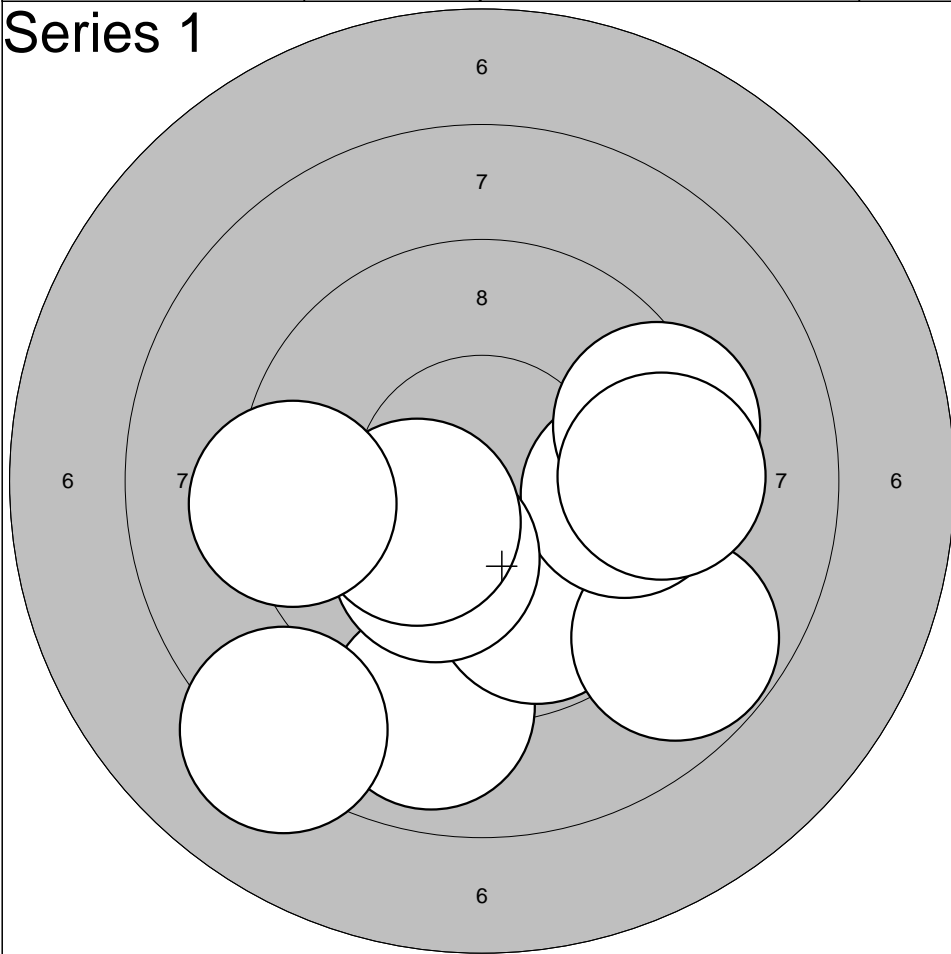

1: 8.9	↓
2: 9.8	↓
3: 8.8	↘
4: 9.7	→
5: 8.2	↙
6: 10.2*	↓
7: 10.3*	↙
8: 9.3	→
9: 9.3	←
10: 9.4	→

Series	89.0
--------	------

Total	89.0
-------	------

Series 2

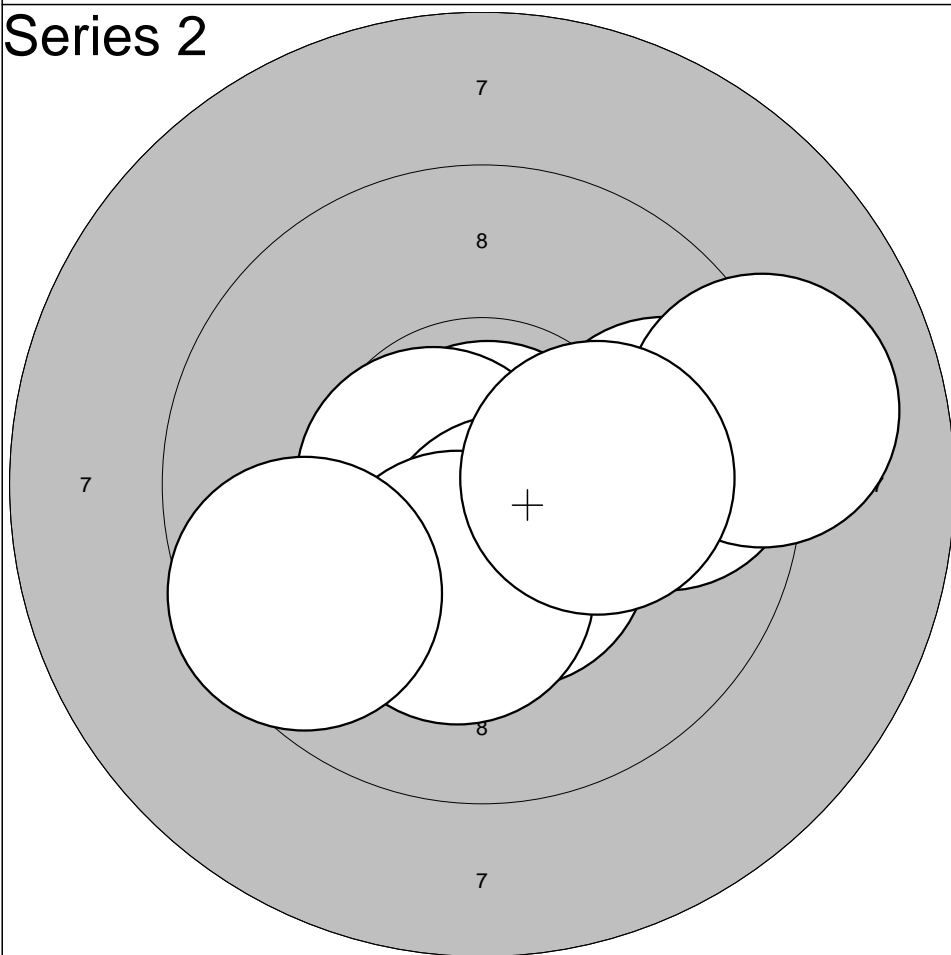

1: 10.9*	↗
2: 9.7	→
3: 10.6*	←
4: 9.0	→
5: 10.5*	↓
6: 10.2*	↓
7: 9.6	↙
8: 10.2*	→

Series	77.0
--------	------

Total	166.0
-------	-------

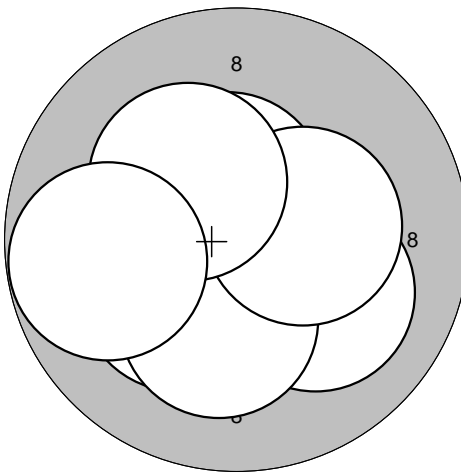
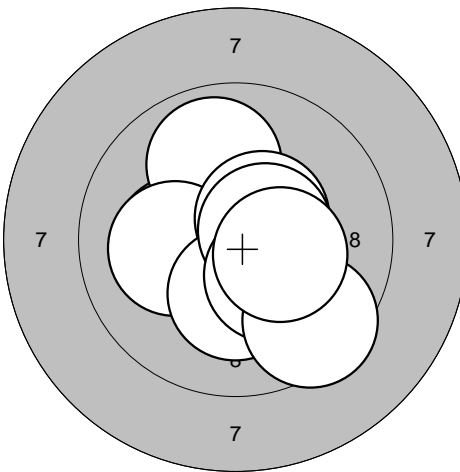
<p>Series 1</p> 	<p>1: 10.4* ←</p> <p>2: 10.4* ←</p> <p>3: 10.2* ↙</p> <p>4: 10.5* ↗</p> <p>5: 10.5* ↗</p> <p>6: 10.1 ↘</p> <p>7: 10.2* ↓</p> <p>8: 10.3* →</p> <p>9: 10.3* ↗</p> <p>10: 9.8 ←</p>	<p>Series 2</p> 	<p>1: 10.9* ↙</p> <p>2: 10.2* ←</p> <p>3: 9.9 ↑</p> <p>4: 10.1 ←</p> <p>5: 10.5* ↗</p> <p>6: 10.2* ↓</p> <p>7: 10.5* →</p> <p>8: 10.3* ↘</p> <p>9: 9.5 ↓</p> <p>10: 10.3* →</p>
Series 99.0	Series 98.0	Series 98.0	Series 98.0
Total 99.0	Total 99.0	Total 197.0	Total 197.0

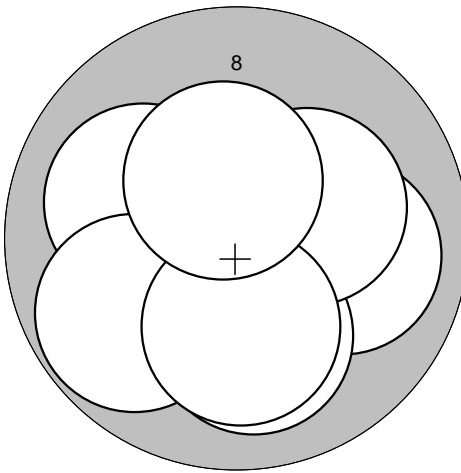
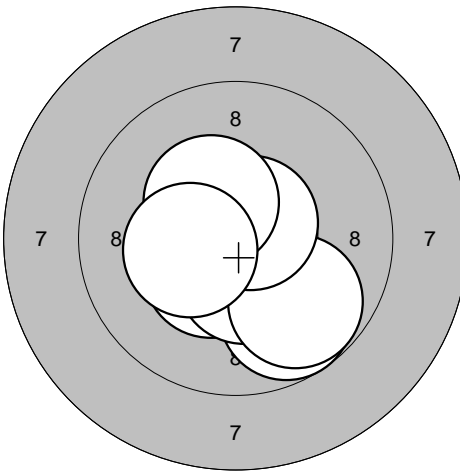
<p>Series 3</p> 	<p>1: 10.7* ↙</p> <p>2: 10.0 →</p> <p>3: 10.6* ↓</p> <p>4: 10.9* ↗</p> <p>5: 10.0 ↓</p> <p>6: 10.3* →</p> <p>7: 10.1 ←</p> <p>8: 9.8 ←</p> <p>9: 10.2* ↓</p> <p>10: 10.4* ↗</p>	<p>Series 4</p> 	<p>1: 9.7 ↓</p> <p>2: 10.6* ↙</p> <p>3: 10.8* →</p> <p>4: 10.9* ↙</p> <p>5: 10.4* ↙</p> <p>6: 10.4* ↓</p> <p>7: 9.8 ↓</p> <p>8: 10.7* ↗</p> <p>9: 10.4* ↗</p> <p>10: 10.3* ←</p>
Series 99.0	Series 98.0	Series 98.0	Series 98.0
Total 296.0	Total 296.0	Total 394.0	Total 394.0

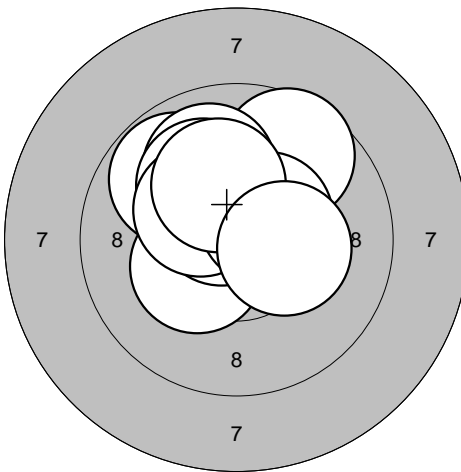
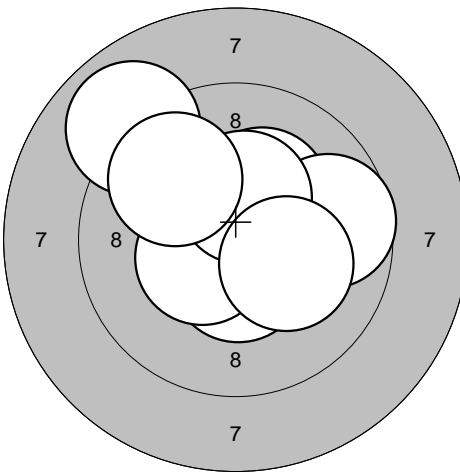
<p>Series 5</p> 	<p>1: 10.3* ↙</p> <p>2: 9.8 ↗</p> <p>3: 9.6 ↗</p> <p>4: 10.0 ↗</p> <p>5: 10.6* ↗</p> <p>6: 10.1 ↗</p> <p>7: 10.3* ↗</p> <p>8: 10.5* ↗</p> <p>9: 10.2* ↗</p> <p>10: 10.3* →</p>	<p>Series 6</p> 	<p>1: 10.8* ↓</p> <p>2: 10.9* ↓</p> <p>3: 10.5* ↓</p> <p>4: 9.0 ↗</p> <p>5: 10.4* ←</p> <p>6: 10.2* ↗</p> <p>7: 9.7 →</p> <p>8: 10.4* ↑</p> <p>9: 10.2* ↘</p> <p>10: 9.8 ↗</p>
Series 98.0	Series 97.0	Series 97.0	Series 97.0
Total 492.0	Total 492.0	Total 589.0	Total 589.0

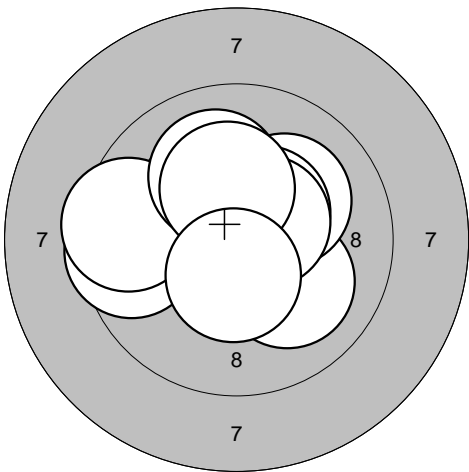
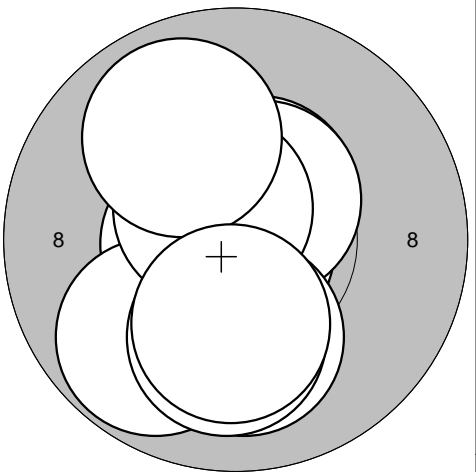
<p>Series 1</p> 	<p>1: 10.3* ↗ 2: 9.5 ← 3: 10.1 ↘ 4: 10.1 ↗ 5: 9.5 ← 6: 10.1 ↗ 7: 10.4* ↗ 8: 10.5* ↗ 9: 10.2* ↗ 10: 10.5* ↓</p>	<p>Series 2</p> 	<p>1: 10.5* ↗ 2: 10.9* ↓ 3: 10.5* ↗ 4: 10.6* ← 5: 10.1 ↓ 6: 9.8 ↘ 7: 10.6* ↗ 8: 9.9 ↗ 9: 10.1 ↓ 10: 10.2* ↓</p>
Series 98.0	Series 98.0	Series 98.0	Series 98.0
Total 98.0	Total 98.0	Total 196.0	Total 196.0

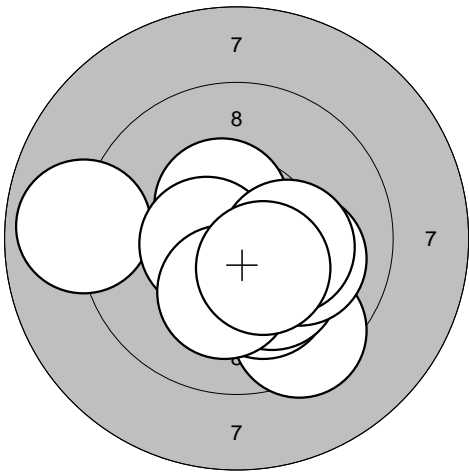
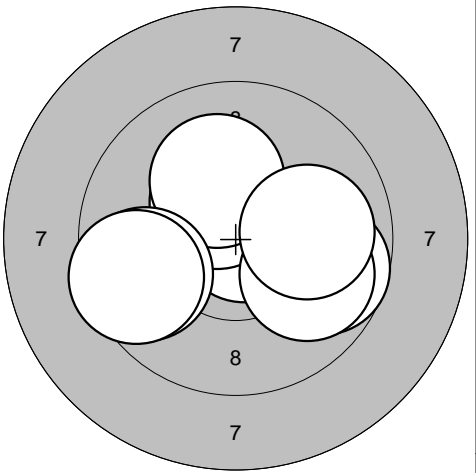
<p>Series 3</p> 	<p>1: 9.5 ↘ 2: 10.5* ↗ 3: 8.9 ← 4: 10.1 ↘ 5: 10.2* ↘ 6: 10.6* ← 7: 10.2* ↘ 8: 10.1 → 9: 10.3* → 10: 10.4* ↘</p>	<p>Series 4</p> 	<p>1: 10.8* ↗ 2: 10.7* ↗ 3: 10.8* → 4: 10.4* ↗ 5: 10.1 ↗ 6: 9.7 → 7: 9.7 ← 8: 9.5 ← 9: 9.9 ↘ 10: 10.0 →</p>
Series 97.0	Series 96.0	Series 96.0	Series 96.0
Total 293.0	Total 293.0	Total 389.0	Total 389.0

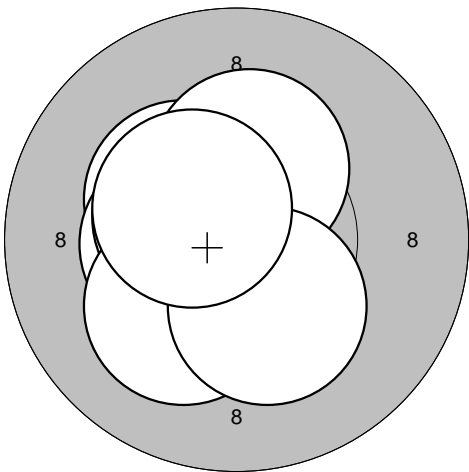
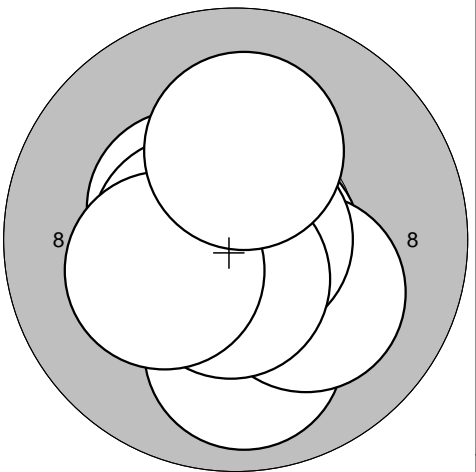
<p>Series 5</p> 	<p>1: 10.3* ↗ 2: 10.5* ← 3: 10.4* ← 4: 10.5* ↘ 5: 10.5* ↗ 6: 10.3* ↗ 7: 10.4* ↘ 8: 10.2* ↘ 9: 10.3* ↘ 10: 10.5* ↗</p>	<p>Series 6</p> 	<p>1: 10.4* ↗ 2: 9.9 ↓ 3: 10.6* ← 4: 10.7* → 5: 10.6* ← 6: 10.1 ↘ 7: 10.8* → 8: 10.6* ↓ 9: 10.3* ← 10: 10.2* ↗</p>
Series 100.0	Series 99.0	Series 99.0	Series 99.0
Total 489.0	Total 489.0	Total 588.0	Total 588.0

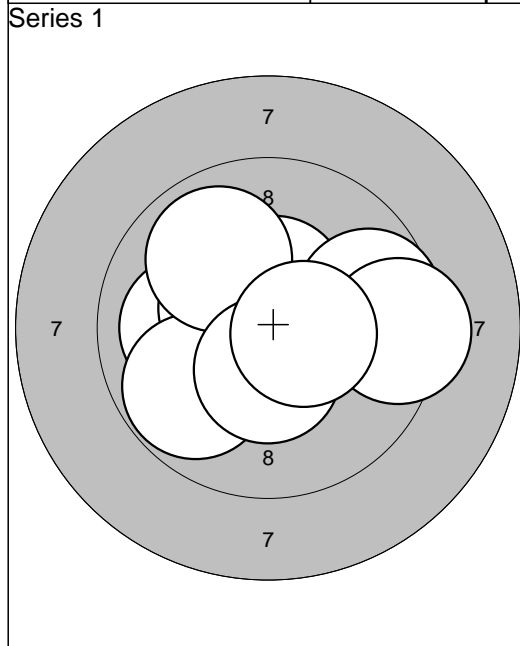

1: 10.0	←
2: 10.8*	→
3: 10.5*	↑
4: 10.5*	↖
5: 9.7	→
6: 9.8	↖
7: 9.3	→
8: 9.9	↗
9: 10.4*	↓
10: 10.5*	→
Series	96.0
Total	96.0

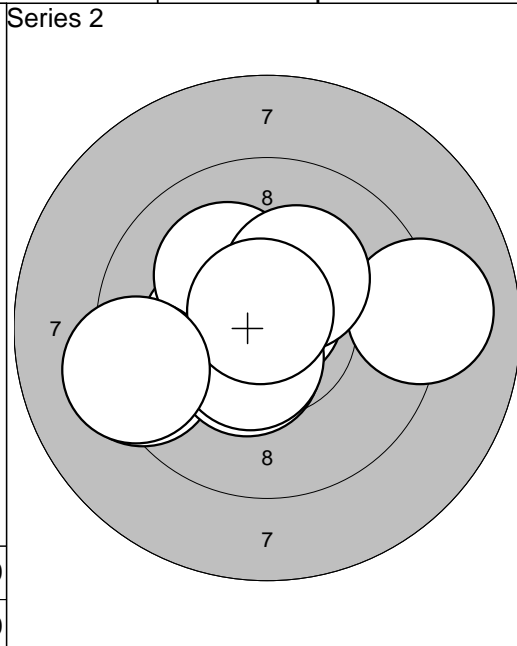

1: 10.3*	←
2: 10.1	↖
3: 9.3	←
4: 10.7*	↑
5: 10.4*	↘
6: 9.1	→
7: 10.5*	↘
8: 10.3*	↗
9: 10.7*	↗
10: 9.3	←
Series	97.0
Total	193.0

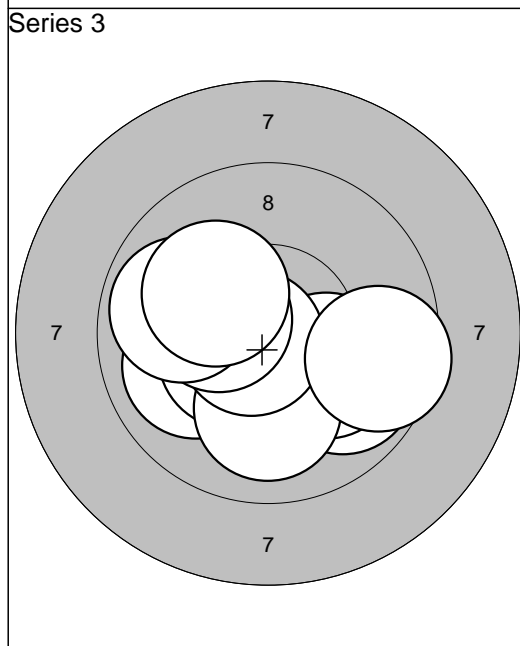

1: 10.0	←
2: 9.9	↘
3: 10.1	↘
4: 10.4*	↖
5: 10.0	↓
6: 10.7*	←
7: 10.3*	←
8: 9.9	←
9: 10.1	↗
10: 9.6	→
Series	97.0
Total	290.0

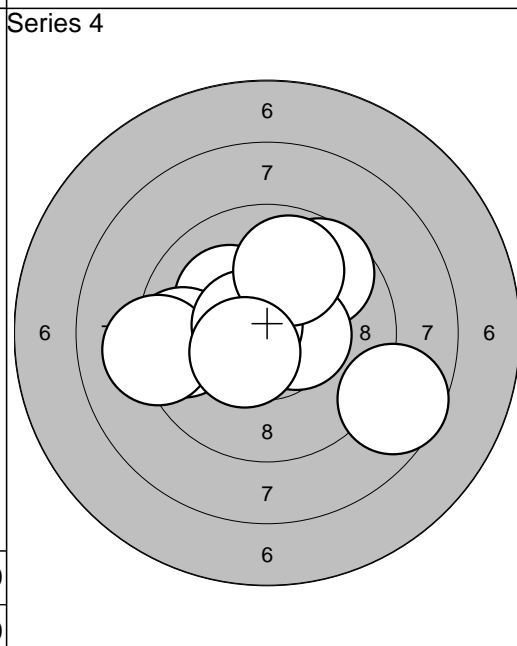

1: 9.8	↗
2: 10.2*	↖
3: 9.7	↗
4: 9.6	←
5: 10.5*	→
6: 9.1	←
7: 10.6*	←
8: 9.9	↗
9: 10.4*	↖
10: 8.7	↘
Series	93.0
Total	383.0

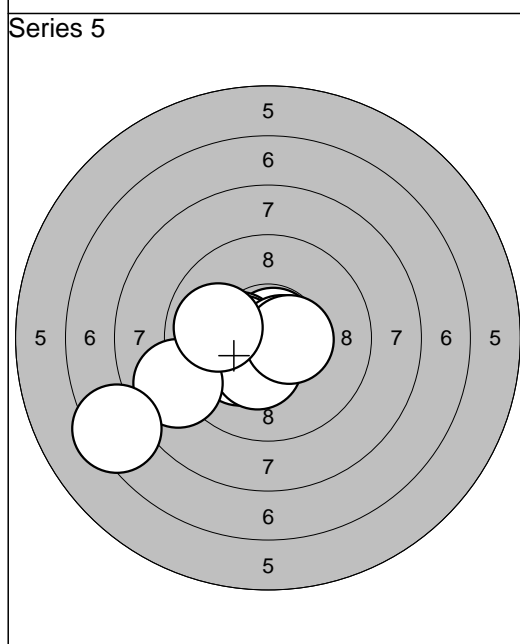

1: 10.2*	↖
2: 10.8*	↗
3: 10.3*	←
4: 10.4*	←
5: 10.7*	→
6: 10.4*	↘
7: 8.9	←
8: 10.5*	→
9: 7.4	←
10: 9.9	←
Series	94.0
Total	477.0

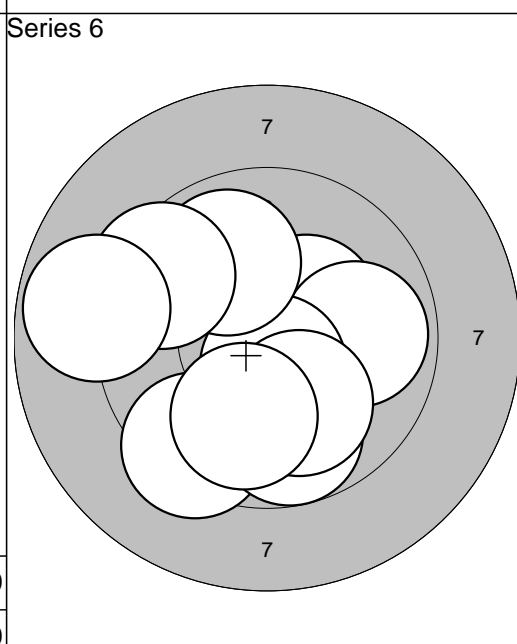

1: 9.3	↘
2: 10.4*	↗
3: 9.9	→
4: 9.8	↘
5: 10.6*	↘
6: 9.9	↗
7: 9.5	↗
8: 10.0	↘
9: 9.9	↘
10: 8.8	←
Series	92.0
Total	569.0

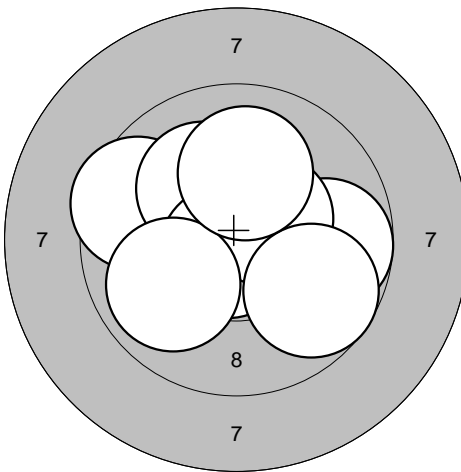
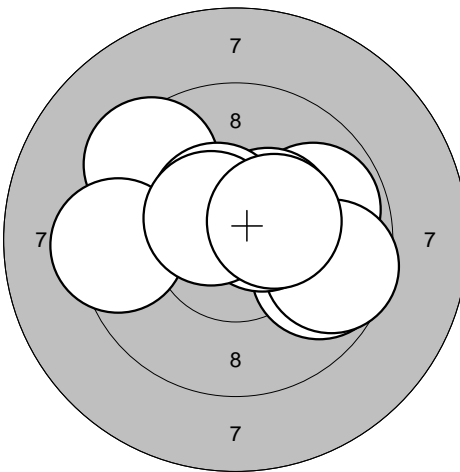
<p>Series 1</p> 	<p>1: 10.0 ↖</p> <p>2: 10.5* →</p> <p>3: 9.6 ↖</p> <p>4: 10.1 ↗</p> <p>5: 10.8* ↘</p> <p>6: 9.7 →</p> <p>7: 10.5* ↗</p> <p>8: 9.9 ↖</p> <p>9: 9.7 ↘</p> <p>10: 10.1 ↑</p>	<p>Series 2</p> 	<p>1: 9.8 →</p> <p>2: 9.5 ↗</p> <p>3: 9.7 →</p> <p>4: 9.4 ←</p> <p>5: 10.4* ↗</p> <p>6: 9.6 →</p> <p>7: 10.5* ↗</p> <p>8: 10.5* ↗</p> <p>9: 10.5* ↗</p> <p>10: 10.4* →</p>
Series 96.0	Series 95.0		
Total 96.0	Total 191.0		

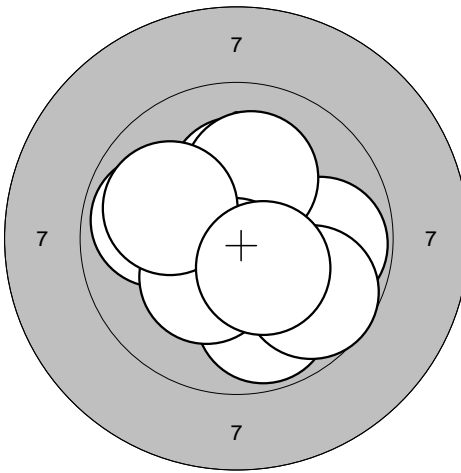
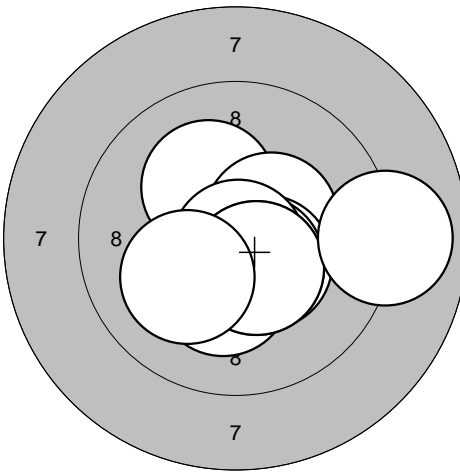
<p>Series 3</p> 	<p>1: 9.8 →</p> <p>2: 9.9 ↘</p> <p>3: 9.9 ↖</p> <p>4: 10.2* ↑</p> <p>5: 10.1 ↑</p> <p>6: 10.6* ↘</p> <p>7: 9.7 ↘</p> <p>8: 10.3* ↘</p> <p>9: 10.0 ↖</p> <p>10: 10.4* ↘</p>	<p>Series 4</p> 	<p>1: 10.2* ↗</p> <p>2: 10.4* ↗</p> <p>3: 10.4* ↘</p> <p>4: 10.2* ↘</p> <p>5: 10.5* ↘</p> <p>6: 10.8* ↘</p> <p>7: 10.5* ↘</p> <p>8: 10.5* ↘</p> <p>9: 10.1 ↖</p> <p>10: 9.0 →</p>
Series 96.0	Series 99.0		
Total 287.0	Total 386.0		

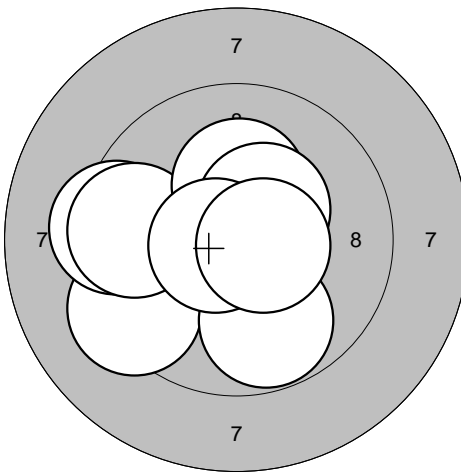
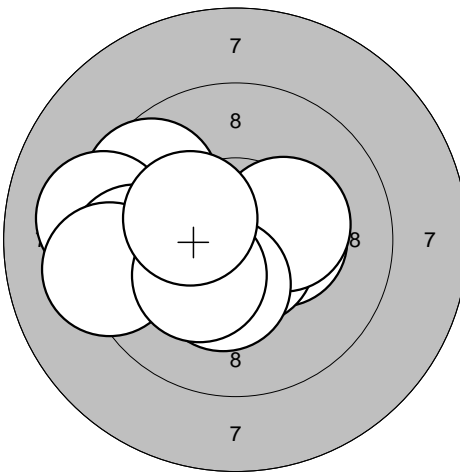
<p>Series 5</p> 	<p>1: 10.4* ←</p> <p>2: 9.3 ↖</p> <p>3: 9.3 ↖</p> <p>4: 10.5* ↘</p> <p>5: 9.6 ←</p> <p>6: 10.2* ↑</p> <p>7: 9.8 ↘</p> <p>8: 10.4* ↗</p> <p>9: 10.6* ←</p> <p>10: 10.6* →</p>	<p>Series 6</p> 	<p>1: 10.4* →</p> <p>2: 10.7* ↘</p> <p>3: 9.6 ↗</p> <p>4: 9.2 ←</p> <p>5: 9.6 ←</p> <p>6: 10.3* →</p> <p>7: 9.2 ←</p> <p>8: 10.3* ↘</p> <p>9: 10.3* ↘</p> <p>10: 10.3* ↖</p>
Series 96.0	Series 96.0		
Total 482.0	Total 578.0		

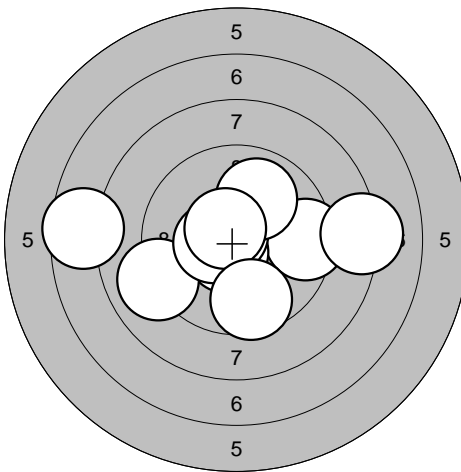
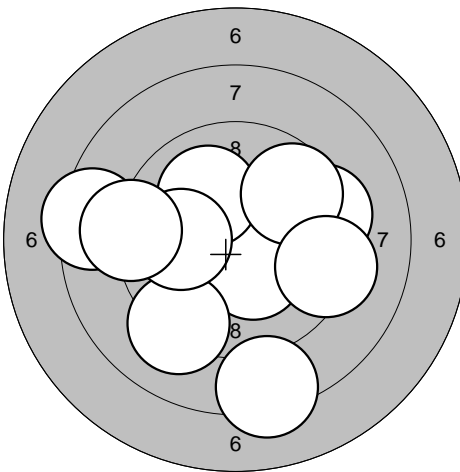
<p>Series 1</p> 	<p>1: 9.4 →</p> <p>2: 10.6* ↘</p> <p>3: 7.6 ←</p> <p>4: 8.2 →</p> <p>5: 9.0 ←</p> <p>6: 10.7* ↗</p> <p>7: 10.4* ←</p> <p>8: 10.0 ↗</p> <p>9: 10.6* ↗</p> <p>10: 9.6 ↘</p>	<p>Series 2</p> 	<p>1: 10.4* ↘</p> <p>2: 9.2 ↘</p> <p>3: 8.4 ←</p> <p>4: 10.1 ↗</p> <p>5: 10.0 ←</p> <p>6: 8.3 ↘</p> <p>7: 9.4 →</p> <p>8: 9.7 ↗</p> <p>9: 9.3 →</p> <p>10: 9.1 ←</p>
Series 92.0	Series 91.0	Series 91.0	Series 91.0
Total 92.0	Total 183.0	Total 183.0	Total 183.0

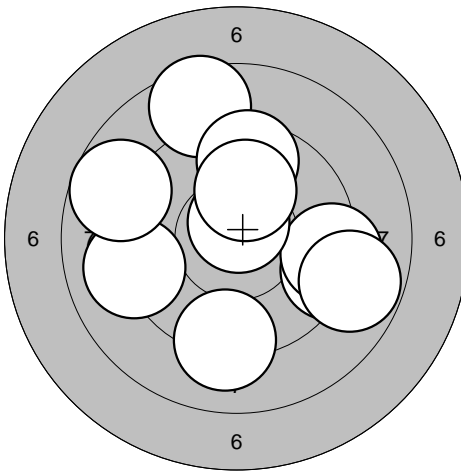
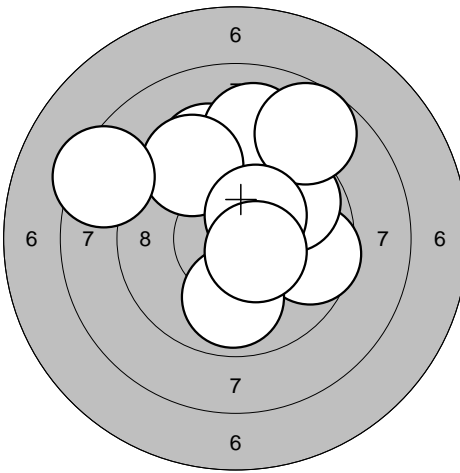
<p>Series 3</p> 	<p>1: 9.1 ↘</p> <p>2: 9.2 →</p> <p>3: 9.3 →</p> <p>4: 8.5 ↗</p> <p>5: 9.6 ↗</p> <p>6: 9.1 ←</p> <p>7: 8.8 →</p> <p>8: 10.7* ↗</p> <p>9: 10.1 ↗</p> <p>10: 8.7 ←</p>	<p>Series 4</p> 	<p>1: 9.4 ↗</p> <p>2: 9.6 →</p> <p>3: 9.9 ↘</p> <p>4: 9.8 ↗</p> <p>5: 9.1 ↗</p> <p>6: 9.5 ↗</p> <p>7: 8.4 ←</p> <p>8: 8.7 ↗</p> <p>9: 10.4* ↗</p> <p>10: 10.5* ↘</p>
Series 89.0	Series 90.0	Series 90.0	Series 90.0
Total 272.0	Total 362.0	Total 362.0	Total 362.0

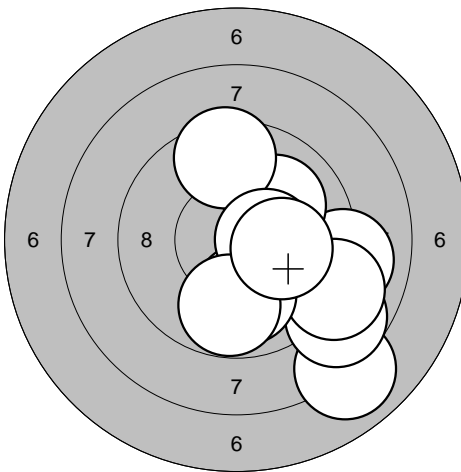
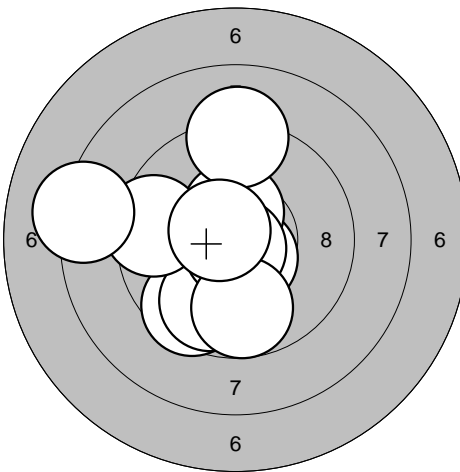
<p>Series 5</p> 	<p>1: 9.0 →</p> <p>2: 10.1 ↗</p> <p>3: 8.0 ↘</p> <p>4: 8.7 ↘</p> <p>5: 9.0 ↘</p> <p>6: 10.0 ↘</p> <p>7: 9.5 ↗</p> <p>8: 10.4* →</p> <p>9: 9.8 ↘</p> <p>10: 10.1 →</p>	<p>Series 6</p> 	<p>1: 10.6* ↘</p> <p>2: 10.5* ↗</p> <p>3: 9.6 ↘</p> <p>4: 9.8 ↘</p> <p>5: 9.5 ←</p> <p>6: 10.8* ↘</p> <p>7: 8.2 ←</p> <p>8: 9.1 ↗</p> <p>9: 9.7 ↘</p> <p>10: 10.6* ↗</p>
Series 92.0	Series 93.0	Series 93.0	Series 93.0
Total 454.0	Total 547.0	Total 547.0	Total 547.0

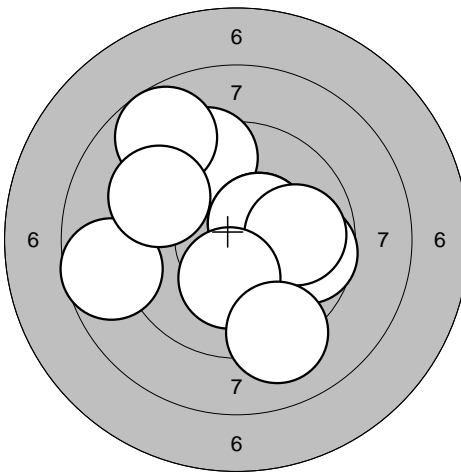
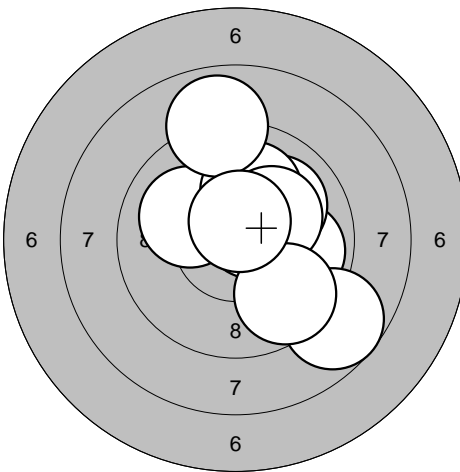
<p>Series 1</p> 	<p>1: 9.4 ↗ 2: 10.5* ↘ 3: 8.8 ↗ 4: 9.7 → 5: 10.5* ↘ 6: 8.7 ← 7: 9.4 ↗ 8: 9.9 → 9: 10.3* ↓ 10: 9.2 ↓</p> <p>Series 91.0 Total 91.0</p>	<p>Series 2</p> 	<p>1: 10.6* ↗ 2: 9.9 → 3: 10.0 ↖ 4: 10.0 ↗ 5: 10.1 ↑ 6: 10.2* ↗ 7: 8.7 ↘ 8: 9.6 ↘ 9: 8.9 ↑ 10: 10.6* ↑</p> <p>Series 94.0 Total 185.0</p>
---	---	---	---

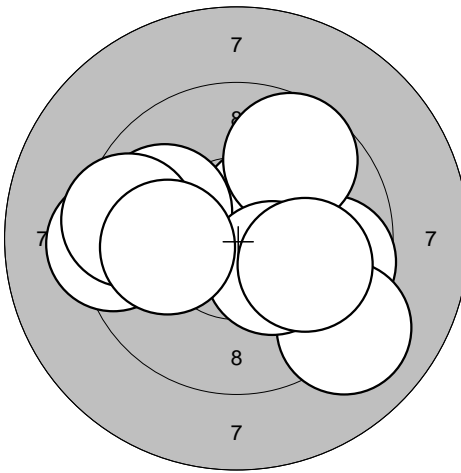
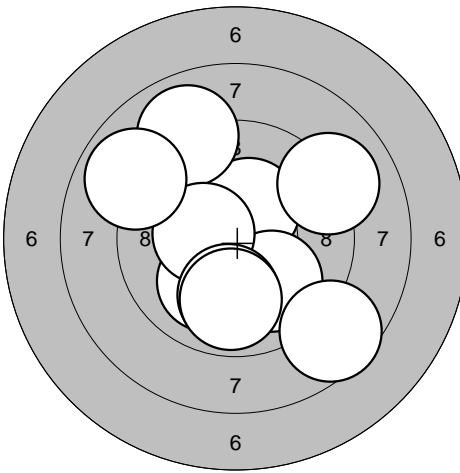
<p>Series 3</p> 	<p>1: 9.3 ← 2: 9.7 → 3: 10.4* ↗ 4: 9.7 ↗ 5: 9.9 ↖ 6: 9.5 ← 7: 9.1 ↘ 8: 10.3* ↘ 9: 10.0 → 10: 10.0 ←</p> <p>Series 94.0 Total 279.0</p>	<p>Series 4</p> 	<p>1: 10.4* ↗ 2: 9.0 ↗ 3: 9.9 ↘ 4: 9.0 ↗ 5: 10.1 ↘ 6: 10.4* ← 7: 9.9 ↘ 8: 8.9 ↖ 9: 9.9 ↓ 10: 8.6 ↘</p> <p>Series 91.0 Total 370.0</p>
--	--	--	---

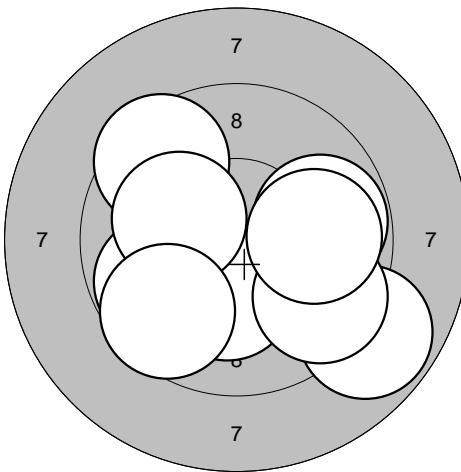
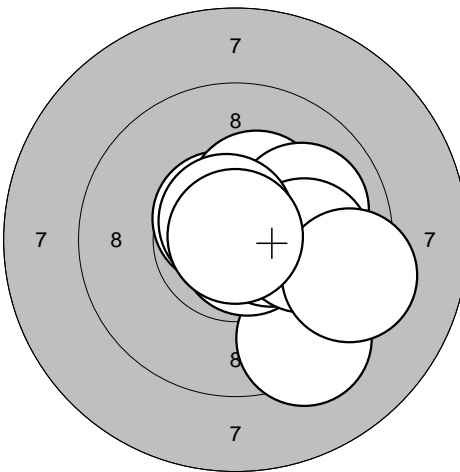
<p>Series 5</p> 	<p>1: 9.8 ↖ 2: 10.3* ↓ 3: 9.5 ↗ 4: 9.8 → 5: 10.2* ↓ 6: 8.8 ↘ 7: 10.1 ↖ 8: 9.6 ↘ 9: 9.6 ↖ 10: 9.9 →</p> <p>Series 92.0 Total 462.0</p>	<p>Series 6</p> 	<p>1: 10.6* ↗ 2: 9.3 ↘ 3: 10.7* ↘ 4: 10.3* ↗ 5: 10.5* → 6: 10.0 ↗ 7: 10.0 → 8: 10.7* ↗ 9: 9.4 → 10: 10.9* ↑</p> <p>Series 98.0 Total 560.0</p>
---	---	---	--

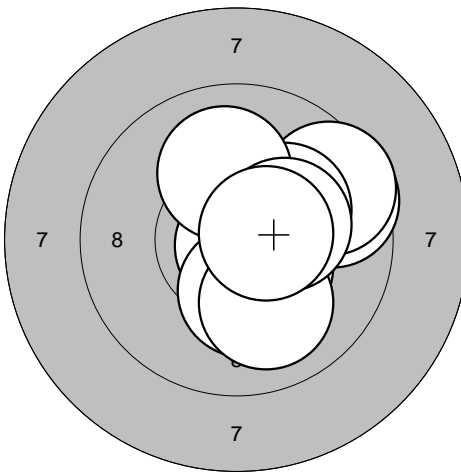
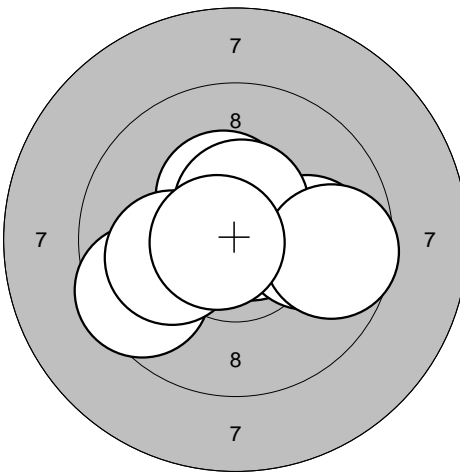
<p>Series 1</p> 	<p>1: 10.4* ↘ 2: 10.8* ↘ 3: 10.2* ↓ 4: 10.0 ↓ 5: 9.5 → 6: 9.5 → 7: 10.2* → 8: 10.1 ↑ 9: 10.3* → 10: 10.5* →</p>	<p>Series 2</p> 	<p>1: 9.5 ↙ 2: 10.7* → 3: 10.7* ↗ 4: 10.6* ↗ 5: 10.4* ↑ 6: 10.0 → 7: 10.5* ↑ 8: 9.6 → 9: 10.1 ← 10: 10.7* ←</p>
	Series 98.0		Series 98.0
	Total 98.0		Total 196.0

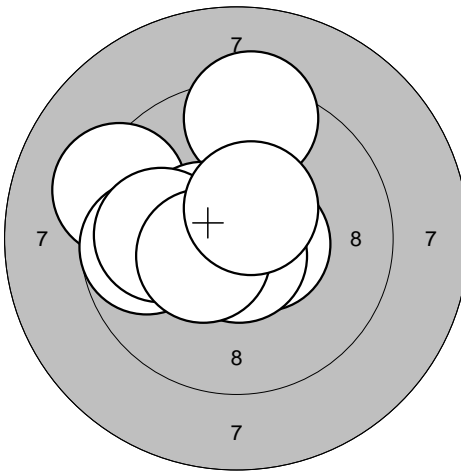
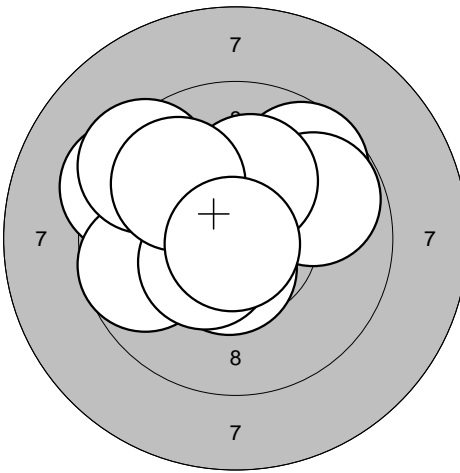
<p>Series 3</p> 	<p>1: 9.3 ↙ 2: 9.3 ↑ 3: 10.9* ↗ 4: 10.5* ↙ 5: 10.6* → 6: 10.7* ↓ 7: 9.7 ← 8: 10.0 ← 9: 10.4* ↙ 10: 10.5* ↗</p>	<p>Series 4</p> 	<p>1: 9.4 ↙ 2: 9.7 ↙ 3: 9.7 ↗ 4: 9.8 → 5: 10.2* ↑ 6: 9.4 ↙ 7: 10.5* ↓ 8: 10.4* ↙ 9: 9.9 ↗ 10: 10.8* ↓</p>
	Series 97.0		Series 94.0
	Total 293.0		Total 387.0

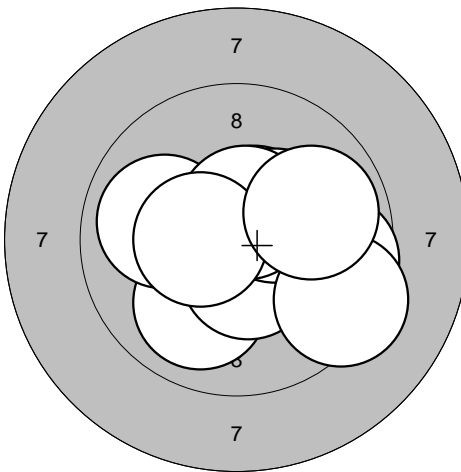
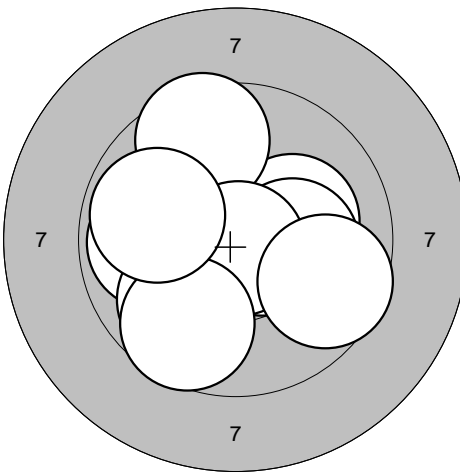
<p>Series 5</p> 	<p>1: 10.0 ↓ 2: 9.6 → 3: 10.5* ↓ 4: 10.0 ↙ 5: 10.5* ↗ 6: 10.4* → 7: 10.6* ↗ 8: 9.3 ↘ 9: 10.5* ← 10: 9.9 →</p>	<p>Series 6</p> 	<p>1: 10.6* → 2: 9.9 ← 3: 10.1 → 4: 9.5 ↑ 5: 9.9 ↙ 6: 10.2* → 7: 10.8* ↓ 8: 9.7 ↙ 9: 9.6 ↘ 10: 9.8 ←</p>
	Series 97.0		Series 94.0
	Total 484.0		Total 578.0

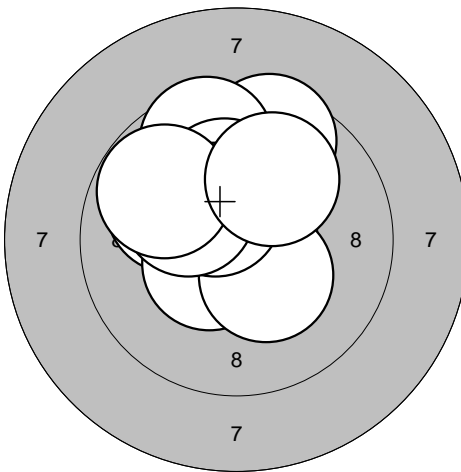
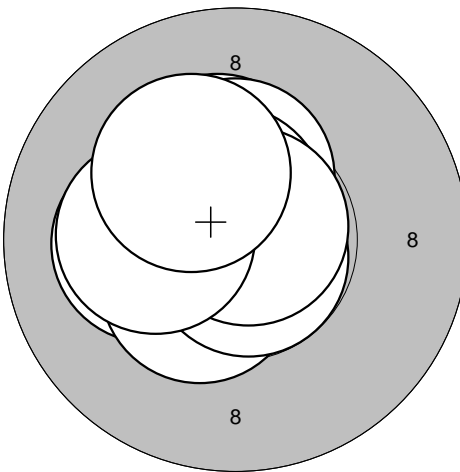
<p>Series 1</p> 	<p>1: 10.0 ↖ 2: 9.6 ↑ 3: 10.5* ↙ 4: 9.6 ↑ 5: 10.3* ↘ 6: 10.2* ↑ 7: 10.4* ↑ 8: 10.2* ↗ 9: 9.8 ↗ 10: 10.0 ↗</p>	<p>Series 2</p> 	<p>1: 10.3* ↑ 2: 10.4* ↑ 3: 10.2* ← 4: 10.8* ↖ 5: 10.4* ↘ 6: 10.8* ↘ 7: 10.6* ↑ 8: 10.8* ↗ 9: 10.2* ← 10: 10.2* ↖</p>
Series 97.0	Series 100.0		
Total 97.0	Total 197.0		

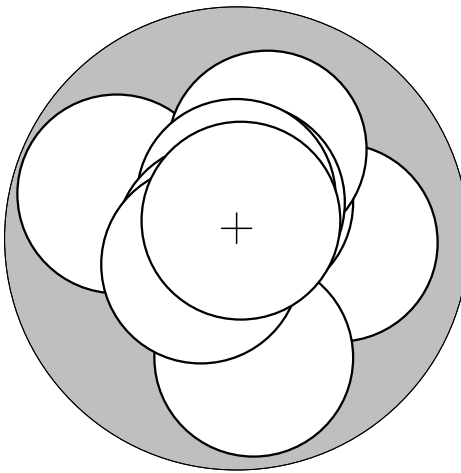
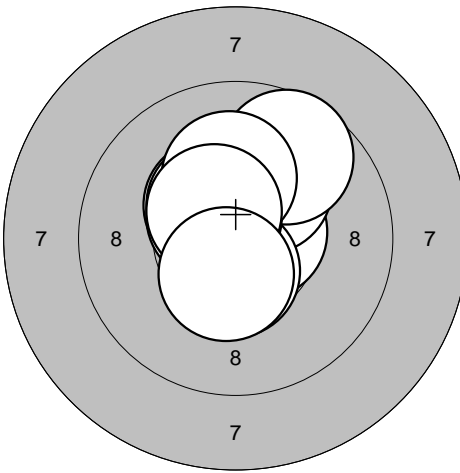
<p>Series 3</p> 	<p>1: 9.8 ↖ 2: 10.0 → 3: 10.6* ↑ 4: 10.1 ↑ 5: 9.9 ↓ 6: 10.6* ↑ 7: 10.6* ↑ 8: 10.7* ← 9: 10.6* ↙ 10: 10.8* ↑</p>	<p>Series 4</p> 	<p>1: 10.6* → 2: 10.2* ↗ 3: 10.4* ↗ 4: 10.5* ↓ 5: 9.7 ↗ 6: 10.6* ↗ 7: 10.4* ↗ 8: 10.1 ↑ 9: 10.5* ↗ 10: 10.5* ↓</p>
Series 98.0	Series 99.0		
Total 295.0	Total 394.0		

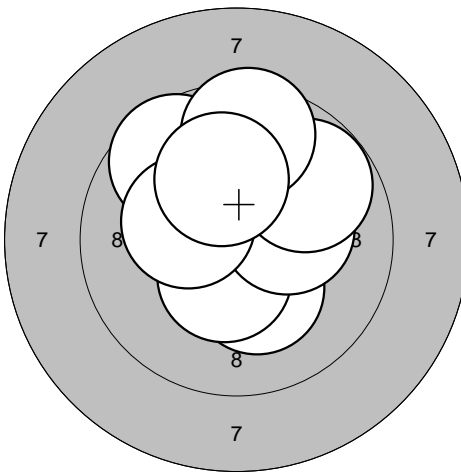
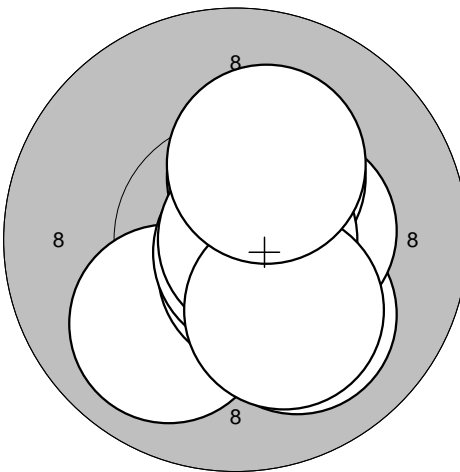
<p>Series 5</p> 	<p>1: 10.3* ↓ 2: 10.1 ↑ 3: 10.2* ↑ 4: 10.4* ↓ 5: 10.2* → 6: 9.6 ↗ 7: 10.3* ↖ 8: 9.8 ↗ 9: 9.5 ↑ 10: 10.1 ↑</p>	<p>Series 6</p> 	<p>1: 10.0 ↙ 2: 10.1 ↘ 3: 10.4* → 4: 10.6* ↘ 5: 10.7* ↘ 6: 10.4* → 7: 10.3* ↗ 8: 10.7* → 9: 10.2* ↘ 10: 10.2* ↗</p>
Series 97.0	Series 100.0		
Total 491.0	Total 591.0		

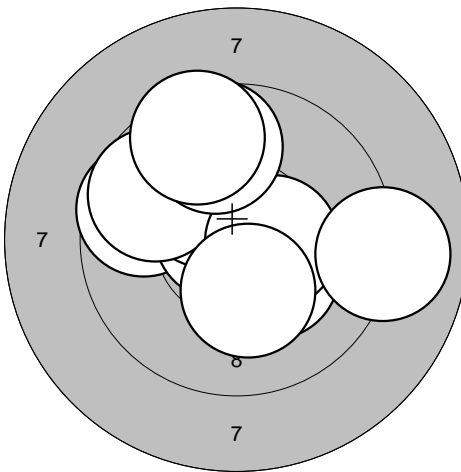
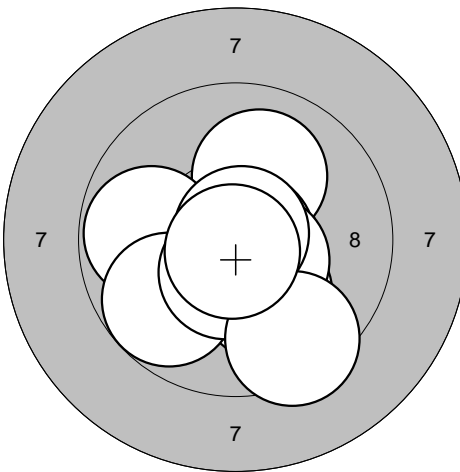
<p>Series 1</p> 	<p>1: 9.6 ↖</p> <p>2: 10.7* ↖</p> <p>3: 10.3* ↗</p> <p>4: 10.3* ↘</p> <p>5: 9.7 ↗</p> <p>6: 10.5* →</p> <p>7: 9.7 ↗</p> <p>8: 9.0 →</p> <p>9: 10.3* ↘</p> <p>10: 9.5 ↗</p>	<p>Series 2</p> 	<p>1: 10.0 ↗</p> <p>2: 10.1 ↘</p> <p>3: 10.8* →</p> <p>4: 9.8 ←</p> <p>5: 10.5* ↘</p> <p>6: 9.8 ↙</p> <p>7: 10.8* ↗</p> <p>8: 10.5* ↘</p> <p>9: 9.4 ↘</p> <p>10: 10.8* ↘</p>
Series 95.0	Series 97.0	Series 97.0	Series 97.0
Total 95.0	Total 192.0	Total 192.0	Total 192.0

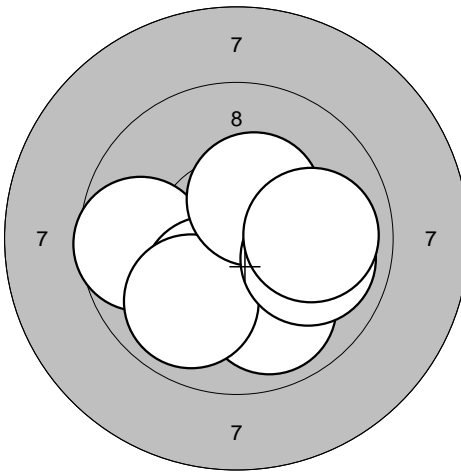
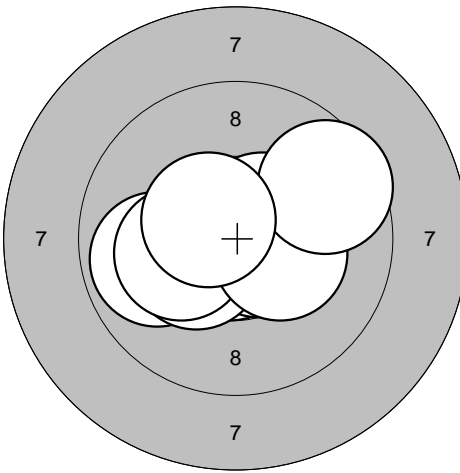
<p>Series 3</p> 	<p>1: 10.4* ↘</p> <p>2: 9.7 ←</p> <p>3: 10.2* ↘</p> <p>4: 10.3* ↘</p> <p>5: 10.3* ↘</p> <p>6: 9.9 ↘</p> <p>7: 9.9 ↘</p> <p>8: 10.4* ↗</p> <p>9: 10.0 →</p> <p>10: 9.9 →</p>	<p>Series 4</p> 	<p>1: 10.7* ↘</p> <p>2: 10.4* →</p> <p>3: 9.9 ←</p> <p>4: 10.6* ↘</p> <p>5: 10.5* ↗</p> <p>6: 10.3* ↙</p> <p>7: 10.2* ←</p> <p>8: 10.3* →</p> <p>9: 9.6 ↗</p> <p>10: 10.5* ↖</p>
Series 96.0	Series 98.0	Series 98.0	Series 98.0
Total 288.0	Total 386.0	Total 386.0	Total 386.0

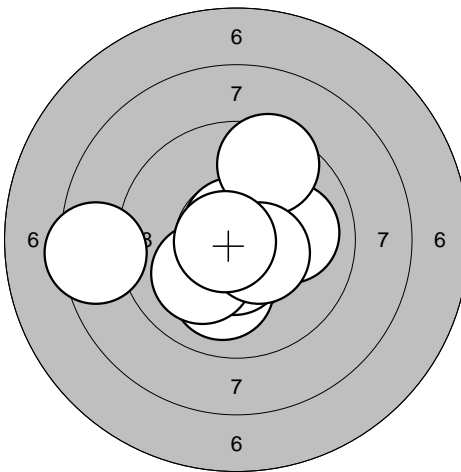
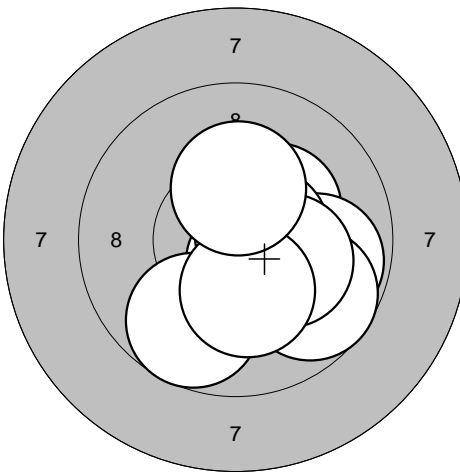
<p>Series 5</p> 	<p>1: 10.6* ↘</p> <p>2: 10.0 ↘</p> <p>3: 10.7* ↗</p> <p>4: 10.0 →</p> <p>5: 10.5* ↘</p> <p>6: 9.5 ↗</p> <p>7: 8.5 ←</p> <p>8: 10.1 ↙</p> <p>9: 10.5* ↘</p> <p>10: 10.8* ←</p>	<p>Series 6</p> 	<p>1: 10.6* ↘</p> <p>2: 10.3* ↗</p> <p>3: 9.9 →</p> <p>4: 10.4* ↘</p> <p>5: 9.8 ↘</p> <p>6: 10.6* →</p> <p>7: 9.7 ↘</p> <p>8: 10.2* →</p> <p>9: 10.3* ↘</p> <p>10: 10.3* ↗</p>
Series 97.0	Series 97.0	Series 97.0	Series 97.0
Total 483.0	Total 580.0	Total 580.0	Total 580.0

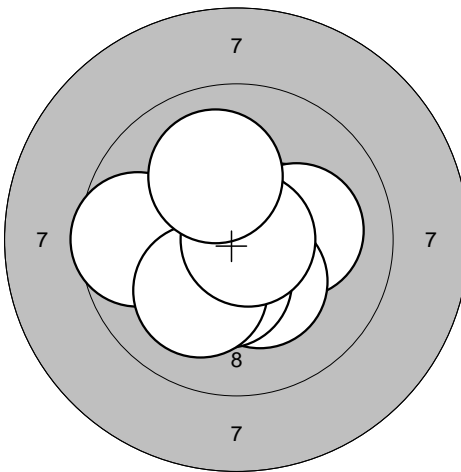
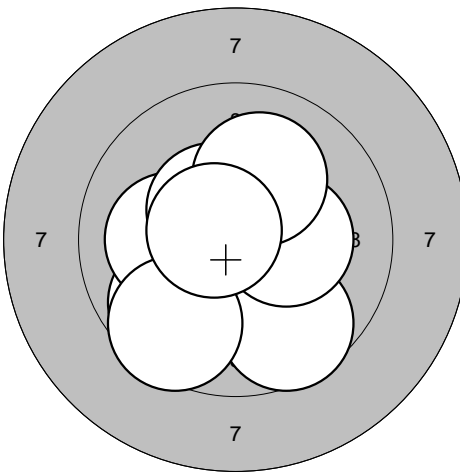
<p>Series 1</p> 	<p>1: 10.4* →</p> <p>2: 10.1 →</p> <p>3: 10.3* ↓</p> <p>4: 10.5* ↙</p> <p>5: 10.8* ↑</p> <p>6: 9.6 ←</p> <p>7: 10.4* ↓</p> <p>8: 10.1 ↙</p> <p>9: 10.8* →</p> <p>10: 10.1 ↗</p>	<p>Series 2</p> 	<p>1: 10.4* ↘</p> <p>2: 9.8 ↘</p> <p>3: 10.1 ←</p> <p>4: 10.4* ↘</p> <p>5: 9.6 ↘</p> <p>6: 10.3* →</p> <p>7: 9.6 ↘</p> <p>8: 10.4* ↗</p> <p>9: 10.1 ↑</p> <p>10: 10.7* ↖</p>
Series 99.0	Series 97.0		
Total 99.0	Total 196.0		

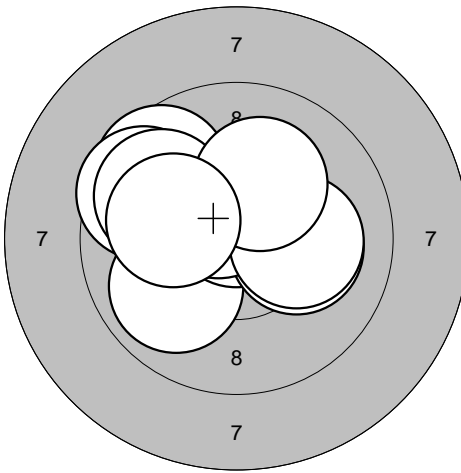
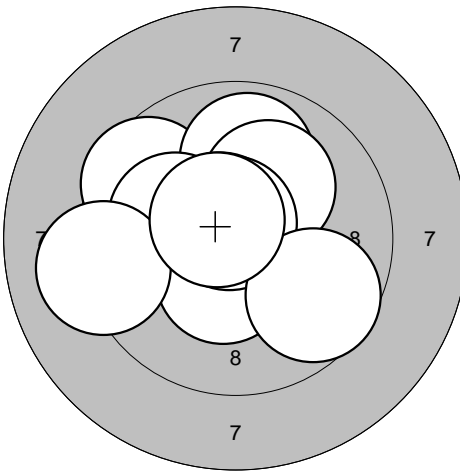
<p>Series 3</p> 	<p>1: 9.9 ↙</p> <p>2: 9.6 ↗</p> <p>3: 9.6 ↗</p> <p>4: 10.7* ↑</p> <p>5: 10.2* →</p> <p>6: 10.5* ↗</p> <p>7: 10.1 →</p> <p>8: 9.8 ↗</p> <p>9: 10.2* ↗</p> <p>10: 10.1 ←</p>	<p>Series 4</p> 	<p>1: 9.6 ↖</p> <p>2: 9.9 ↑</p> <p>3: 10.2* ↗</p> <p>4: 10.1 ←</p> <p>5: 10.4* ↓</p> <p>6: 10.6* ↗</p> <p>7: 10.7* ↗</p> <p>8: 9.1 ←</p> <p>9: 9.7 ↘</p> <p>10: 10.6* ↗</p>
Series 96.0	Series 96.0		
Total 292.0	Total 388.0		

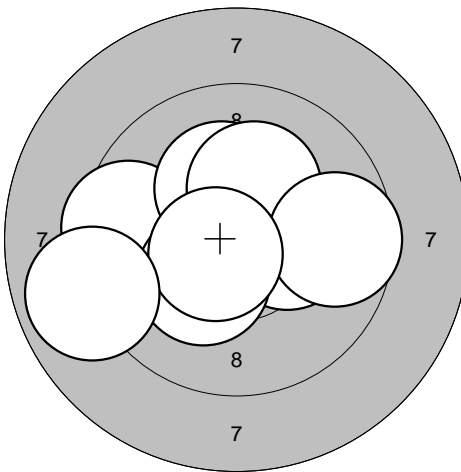
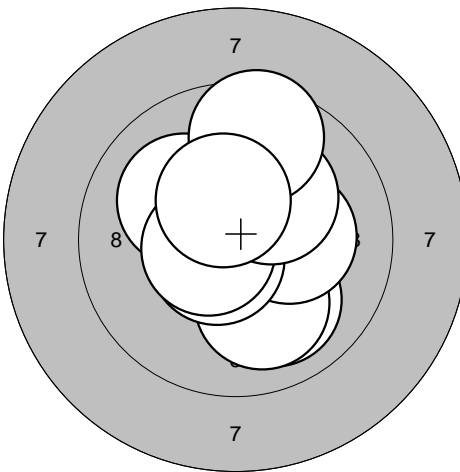
<p>Series 5</p> 	<p>1: 9.5 ←</p> <p>2: 10.7* ↙</p> <p>3: 10.6* ↑</p> <p>4: 10.2* ↑</p> <p>5: 10.3* →</p> <p>6: 10.2* ↑</p> <p>7: 10.3* ↙</p> <p>8: 9.6 →</p> <p>9: 10.6* ↙</p> <p>10: 8.9 ←</p>	<p>Series 6</p> 	<p>1: 10.8* ↙</p> <p>2: 10.1 ↗</p> <p>3: 10.0 ↘</p> <p>4: 10.0 ↘</p> <p>5: 10.2* →</p> <p>6: 10.6* ↙</p> <p>7: 10.6* ←</p> <p>8: 10.2* ↗</p> <p>9: 9.6 ↑</p> <p>10: 10.4* ↗</p>
Series 96.0	Series 99.0		
Total 484.0	Total 583.0		

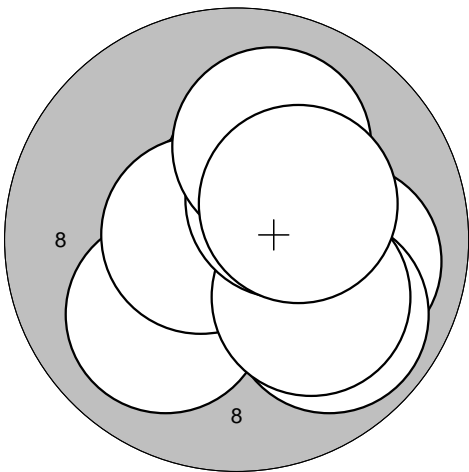
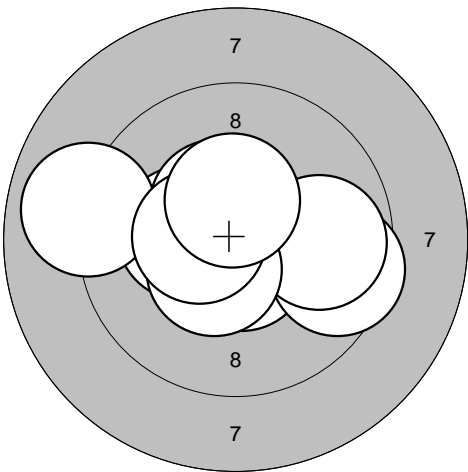
<p>Series 1</p> 	<table style="width:100%; border-collapse: collapse;"> <tr><td>1: 10.0</td><td style="text-align: right;">→</td></tr> <tr><td>2: 9.9</td><td style="text-align: right;">↘</td></tr> <tr><td>3: 10.4*</td><td style="text-align: right;">↗</td></tr> <tr><td>4: 10.4*</td><td style="text-align: right;">↗</td></tr> <tr><td>5: 10.0</td><td style="text-align: right;">↙</td></tr> <tr><td>6: 10.6*</td><td style="text-align: right;">←</td></tr> <tr><td>7: 10.1</td><td style="text-align: right;">↘</td></tr> <tr><td>8: 10.4*</td><td style="text-align: right;">↗</td></tr> <tr><td>9: 10.1</td><td style="text-align: right;">↗</td></tr> <tr><td>10: 10.3*</td><td style="text-align: right;">↗</td></tr> <tr style="border-top: 1px solid black;"><td style="text-align: right;">Series</td><td style="text-align: right;">99.0</td></tr> <tr style="border-top: 1px solid black;"><td style="text-align: right;">Total</td><td style="text-align: right;">99.0</td></tr> </table>	1: 10.0	→	2: 9.9	↘	3: 10.4*	↗	4: 10.4*	↗	5: 10.0	↙	6: 10.6*	←	7: 10.1	↘	8: 10.4*	↗	9: 10.1	↗	10: 10.3*	↗	Series	99.0	Total	99.0	<p>Series 2</p> 	<table style="width:100%; border-collapse: collapse;"> <tr><td>1: 10.3*</td><td style="text-align: right;">←</td></tr> <tr><td>2: 10.7*</td><td style="text-align: right;">↗</td></tr> <tr><td>3: 9.0</td><td style="text-align: right;">←</td></tr> <tr><td>4: 10.6*</td><td style="text-align: right;">↘</td></tr> <tr><td>5: 9.5</td><td style="text-align: right;">→</td></tr> <tr><td>6: 9.8</td><td style="text-align: right;">→</td></tr> <tr><td>7: 10.5*</td><td style="text-align: right;">↘</td></tr> <tr><td>8: 10.5*</td><td style="text-align: right;">↖</td></tr> <tr><td>9: 10.5*</td><td style="text-align: right;">←</td></tr> <tr><td>10: 10.4*</td><td style="text-align: right;">↑</td></tr> <tr style="border-top: 1px solid black;"><td style="text-align: right;">Series</td><td style="text-align: right;">97.0</td></tr> <tr style="border-top: 1px solid black;"><td style="text-align: right;">Total</td><td style="text-align: right;">196.0</td></tr> </table>	1: 10.3*	←	2: 10.7*	↗	3: 9.0	←	4: 10.6*	↘	5: 9.5	→	6: 9.8	→	7: 10.5*	↘	8: 10.5*	↖	9: 10.5*	←	10: 10.4*	↑	Series	97.0	Total	196.0
1: 10.0	→																																																		
2: 9.9	↘																																																		
3: 10.4*	↗																																																		
4: 10.4*	↗																																																		
5: 10.0	↙																																																		
6: 10.6*	←																																																		
7: 10.1	↘																																																		
8: 10.4*	↗																																																		
9: 10.1	↗																																																		
10: 10.3*	↗																																																		
Series	99.0																																																		
Total	99.0																																																		
1: 10.3*	←																																																		
2: 10.7*	↗																																																		
3: 9.0	←																																																		
4: 10.6*	↘																																																		
5: 9.5	→																																																		
6: 9.8	→																																																		
7: 10.5*	↘																																																		
8: 10.5*	↖																																																		
9: 10.5*	←																																																		
10: 10.4*	↑																																																		
Series	97.0																																																		
Total	196.0																																																		

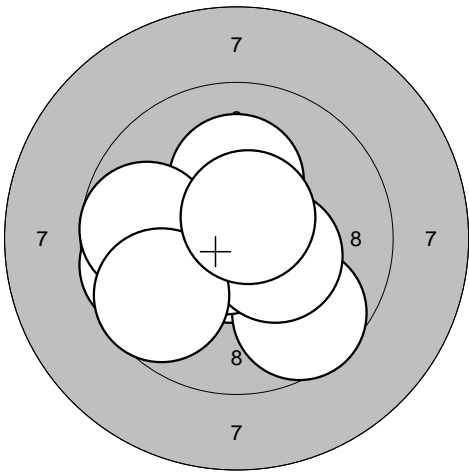
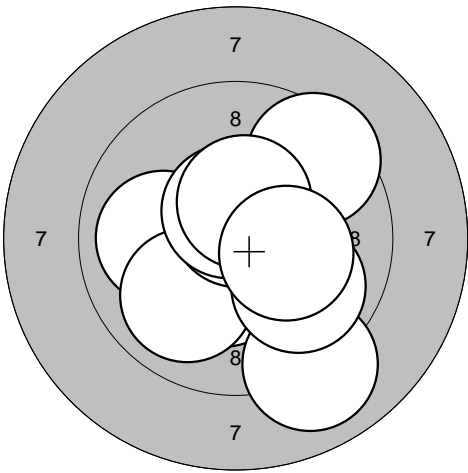
<p>Series 3</p> 	<table style="width:100%; border-collapse: collapse;"> <tr><td>1: 10.2*</td><td style="text-align: right;">←</td></tr> <tr><td>2: 10.7*</td><td style="text-align: right;">↘</td></tr> <tr><td>3: 10.2*</td><td style="text-align: right;">↑</td></tr> <tr><td>4: 9.7</td><td style="text-align: right;">←</td></tr> <tr><td>5: 9.7</td><td style="text-align: right;">↘</td></tr> <tr><td>6: 10.8*</td><td style="text-align: right;">↙</td></tr> <tr><td>7: 10.4*</td><td style="text-align: right;">→</td></tr> <tr><td>8: 9.8</td><td style="text-align: right;">←</td></tr> <tr><td>9: 9.7</td><td style="text-align: right;">↙</td></tr> <tr><td>10: 10.6*</td><td style="text-align: right;">↗</td></tr> <tr style="border-top: 1px solid black;"><td style="text-align: right;">Series</td><td style="text-align: right;">96.0</td></tr> <tr style="border-top: 1px solid black;"><td style="text-align: right;">Total</td><td style="text-align: right;">292.0</td></tr> </table>	1: 10.2*	←	2: 10.7*	↘	3: 10.2*	↑	4: 9.7	←	5: 9.7	↘	6: 10.8*	↙	7: 10.4*	→	8: 9.8	←	9: 9.7	↙	10: 10.6*	↗	Series	96.0	Total	292.0	<p>Series 4</p> 	<table style="width:100%; border-collapse: collapse;"> <tr><td>1: 10.4*</td><td style="text-align: right;">↘</td></tr> <tr><td>2: 9.5</td><td style="text-align: right;">↗</td></tr> <tr><td>3: 10.0</td><td style="text-align: right;">←</td></tr> <tr><td>4: 10.0</td><td style="text-align: right;">↙</td></tr> <tr><td>5: 10.7*</td><td style="text-align: right;">↑</td></tr> <tr><td>6: 9.0</td><td style="text-align: right;">↘</td></tr> <tr><td>7: 10.6*</td><td style="text-align: right;">↑</td></tr> <tr><td>8: 9.9</td><td style="text-align: right;">↘</td></tr> <tr><td>9: 10.4*</td><td style="text-align: right;">↑</td></tr> <tr><td>10: 10.2*</td><td style="text-align: right;">→</td></tr> <tr style="border-top: 1px solid black;"><td style="text-align: right;">Series</td><td style="text-align: right;">97.0</td></tr> <tr style="border-top: 1px solid black;"><td style="text-align: right;">Total</td><td style="text-align: right;">389.0</td></tr> </table>	1: 10.4*	↘	2: 9.5	↗	3: 10.0	←	4: 10.0	↙	5: 10.7*	↑	6: 9.0	↘	7: 10.6*	↑	8: 9.9	↘	9: 10.4*	↑	10: 10.2*	→	Series	97.0	Total	389.0
1: 10.2*	←																																																		
2: 10.7*	↘																																																		
3: 10.2*	↑																																																		
4: 9.7	←																																																		
5: 9.7	↘																																																		
6: 10.8*	↙																																																		
7: 10.4*	→																																																		
8: 9.8	←																																																		
9: 9.7	↙																																																		
10: 10.6*	↗																																																		
Series	96.0																																																		
Total	292.0																																																		
1: 10.4*	↘																																																		
2: 9.5	↗																																																		
3: 10.0	←																																																		
4: 10.0	↙																																																		
5: 10.7*	↑																																																		
6: 9.0	↘																																																		
7: 10.6*	↑																																																		
8: 9.9	↘																																																		
9: 10.4*	↑																																																		
10: 10.2*	→																																																		
Series	97.0																																																		
Total	389.0																																																		

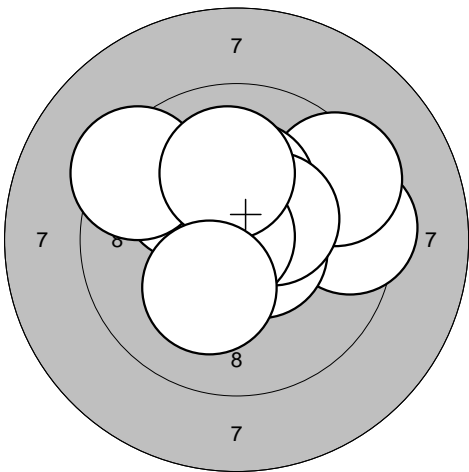
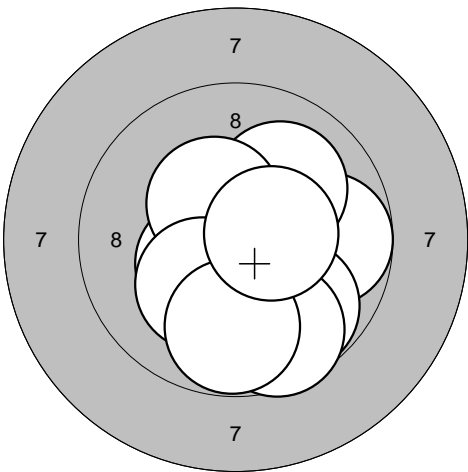
<p>Series 5</p> 	<table style="width:100%; border-collapse: collapse;"> <tr><td>1: 9.4</td><td style="text-align: right;">→</td></tr> <tr><td>2: 9.4</td><td style="text-align: right;">↗</td></tr> <tr><td>3: 10.3*</td><td style="text-align: right;">↑</td></tr> <tr><td>4: 10.6*</td><td style="text-align: right;">→</td></tr> <tr><td>5: 10.4*</td><td style="text-align: right;">↗</td></tr> <tr><td>6: 10.8*</td><td style="text-align: right;">←</td></tr> <tr><td>7: 10.1</td><td style="text-align: right;">↗</td></tr> <tr><td>8: 9.4</td><td style="text-align: right;">↗</td></tr> <tr><td>9: 10.1</td><td style="text-align: right;">↑</td></tr> <tr><td>10: 10.2*</td><td style="text-align: right;">↘</td></tr> <tr style="border-top: 1px solid black;"><td style="text-align: right;">Series</td><td style="text-align: right;">97.0</td></tr> <tr style="border-top: 1px solid black;"><td style="text-align: right;">Total</td><td style="text-align: right;">486.0</td></tr> </table>	1: 9.4	→	2: 9.4	↗	3: 10.3*	↑	4: 10.6*	→	5: 10.4*	↗	6: 10.8*	←	7: 10.1	↗	8: 9.4	↗	9: 10.1	↑	10: 10.2*	↘	Series	97.0	Total	486.0	<p>Series 6</p> 	<table style="width:100%; border-collapse: collapse;"> <tr><td>1: 10.4*</td><td style="text-align: right;">↙</td></tr> <tr><td>2: 9.7</td><td style="text-align: right;">→</td></tr> <tr><td>3: 9.8</td><td style="text-align: right;">↘</td></tr> <tr><td>4: 10.6*</td><td style="text-align: right;">↘</td></tr> <tr><td>5: 10.0</td><td style="text-align: right;">↗</td></tr> <tr><td>6: 10.4*</td><td style="text-align: right;">↗</td></tr> <tr><td>7: 9.6</td><td style="text-align: right;">↘</td></tr> <tr><td>8: 10.2*</td><td style="text-align: right;">↙</td></tr> <tr><td>9: 9.8</td><td style="text-align: right;">↘</td></tr> <tr><td>10: 10.5*</td><td style="text-align: right;">→</td></tr> <tr style="border-top: 1px solid black;"><td style="text-align: right;">Series</td><td style="text-align: right;">96.0</td></tr> <tr style="border-top: 1px solid black;"><td style="text-align: right;">Total</td><td style="text-align: right;">582.0</td></tr> </table>	1: 10.4*	↙	2: 9.7	→	3: 9.8	↘	4: 10.6*	↘	5: 10.0	↗	6: 10.4*	↗	7: 9.6	↘	8: 10.2*	↙	9: 9.8	↘	10: 10.5*	→	Series	96.0	Total	582.0
1: 9.4	→																																																		
2: 9.4	↗																																																		
3: 10.3*	↑																																																		
4: 10.6*	→																																																		
5: 10.4*	↗																																																		
6: 10.8*	←																																																		
7: 10.1	↗																																																		
8: 9.4	↗																																																		
9: 10.1	↑																																																		
10: 10.2*	↘																																																		
Series	97.0																																																		
Total	486.0																																																		
1: 10.4*	↙																																																		
2: 9.7	→																																																		
3: 9.8	↘																																																		
4: 10.6*	↘																																																		
5: 10.0	↗																																																		
6: 10.4*	↗																																																		
7: 9.6	↘																																																		
8: 10.2*	↙																																																		
9: 9.8	↘																																																		
10: 10.5*	→																																																		
Series	96.0																																																		
Total	582.0																																																		

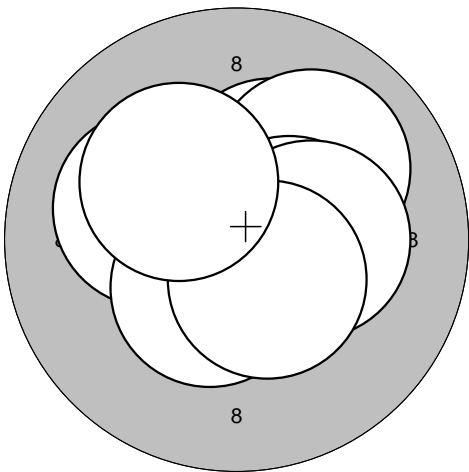
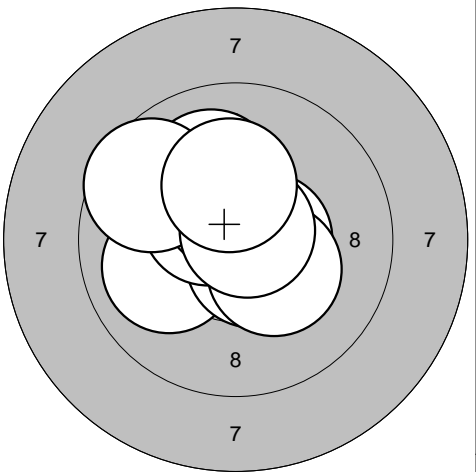
<p>Series 1</p> 	<p>1: 10.7* ↘ 2: 10.2* ↖ 3: 10.7* ↗ 4: 10.3* ↗ 5: 10.0 ↗ 6: 10.5* → 7: 10.5* ↘ 8: 10.3* → 9: 10.5* ↘ 10: 10.2* ↗</p> <table border="1" style="width:100%; border-collapse: collapse;"> <tr><td>Series</td><td style="text-align: right;">100.0</td></tr> <tr><td>Total</td><td style="text-align: right;">100.0</td></tr> </table>	Series	100.0	Total	100.0	<p>Series 2</p> 	<p>1: 10.0 ← 2: 10.6* ↘ 3: 10.5* ↗ 4: 10.5* ↑ 5: 10.1 ↑ 6: 9.6 ↖ 7: 10.5* → 8: 10.3* ↘ 9: 10.7* ↗ 10: 10.2* ↑</p> <table border="1" style="width:100%; border-collapse: collapse;"> <tr><td>Series</td><td style="text-align: right;">99.0</td></tr> <tr><td>Total</td><td style="text-align: right;">199.0</td></tr> </table>	Series	99.0	Total	199.0
Series	100.0										
Total	100.0										
Series	99.0										
Total	199.0										

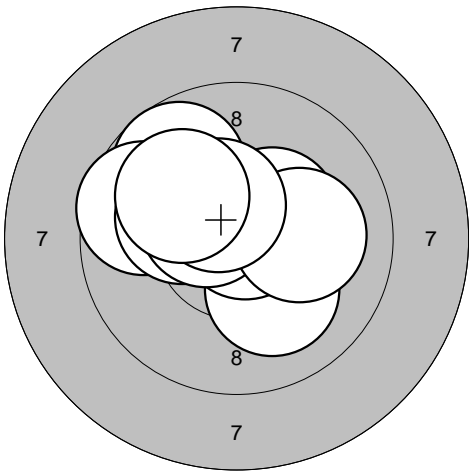
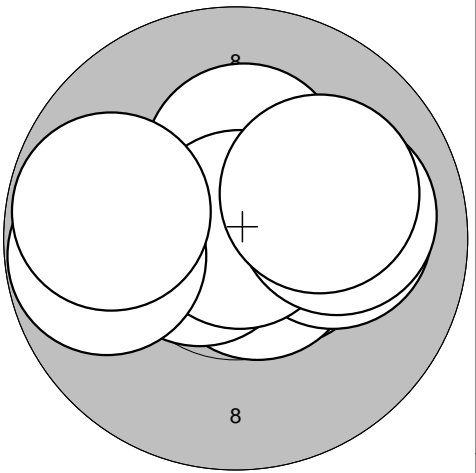
<p>Series 3</p> 	<p>1: 9.8 ↗ 2: 10.1 ↘ 3: 9.7 ↖ 4: 10.4* ↗ 5: 10.8* ↗ 6: 10.2* ↖ 7: 10.5* ↗ 8: 10.1 → 9: 10.5* ↗ 10: 10.0 ↗</p> <table border="1" style="width:100%; border-collapse: collapse;"> <tr><td>Series</td><td style="text-align: right;">98.0</td></tr> <tr><td>Total</td><td style="text-align: right;">297.0</td></tr> </table>	Series	98.0	Total	297.0	<p>Series 4</p> 	<p>1: 10.6* → 2: 10.7* ↘ 3: 10.6* ← 4: 10.3* ↑ 5: 10.1 → 6: 10.8* ↗ 7: 9.8 ← 8: 9.8 ← 9: 10.0 → 10: 10.1 ↗</p> <table border="1" style="width:100%; border-collapse: collapse;"> <tr><td>Series</td><td style="text-align: right;">98.0</td></tr> <tr><td>Total</td><td style="text-align: right;">395.0</td></tr> </table>	Series	98.0	Total	395.0
Series	98.0										
Total	297.0										
Series	98.0										
Total	395.0										

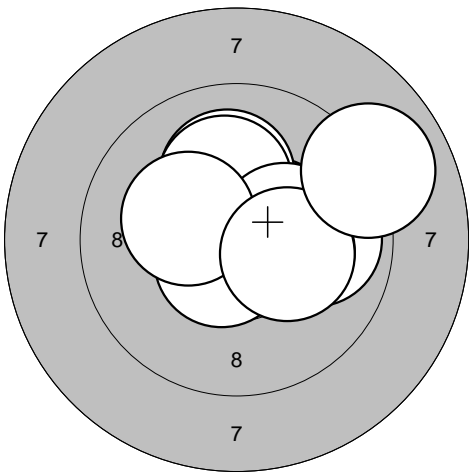
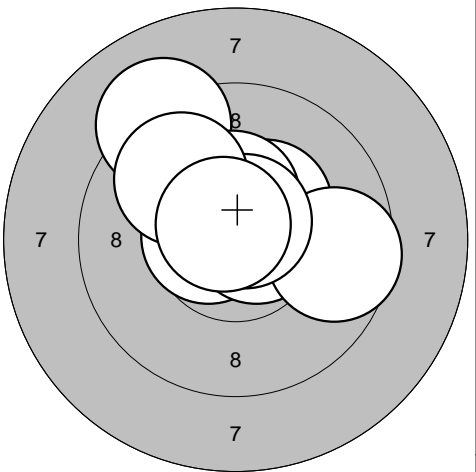
<p>Series 5</p> 	<p>1: 10.6* ↘ 2: 9.9 → 3: 10.4* → 4: 10.1 ↑ 5: 10.2* ↑ 6: 10.3* → 7: 10.3* → 8: 10.3* ↖ 9: 10.2* → 10: 9.0 ↗</p> <table border="1" style="width:100%; border-collapse: collapse;"> <tr><td>Series</td><td style="text-align: right;">98.0</td></tr> <tr><td>Total</td><td style="text-align: right;">493.0</td></tr> </table>	Series	98.0	Total	493.0	<p>Series 6</p> 	<p>1: 10.6* ← 2: 10.7* → 3: 10.4* ↗ 4: 10.4* ↗ 5: 9.2 ↖ 6: 9.6 → 7: 10.4* ↑ 8: 10.7* ↗ 9: 9.9 ↖ 10: 10.7* ↖</p> <table border="1" style="width:100%; border-collapse: collapse;"> <tr><td>Series</td><td style="text-align: right;">97.0</td></tr> <tr><td>Total</td><td style="text-align: right;">590.0</td></tr> </table>	Series	97.0	Total	590.0
Series	98.0										
Total	493.0										
Series	97.0										
Total	590.0										

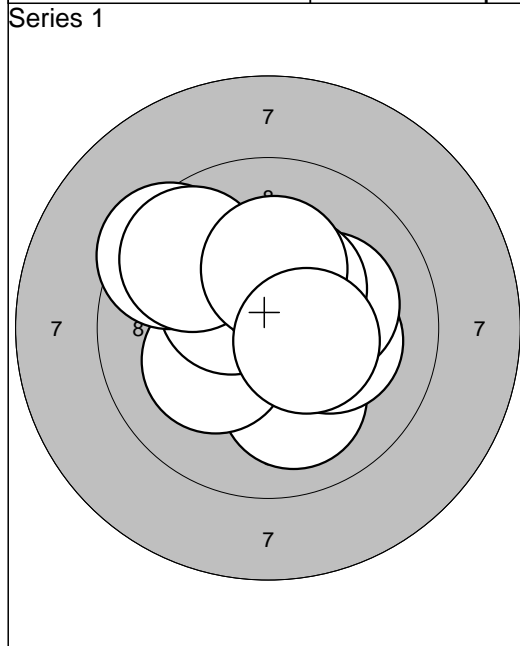

1: 10.0	↘
2: 10.2*	→
3: 10.2*	↙
4: 10.4*	↗
5: 9.5	↗
6: 10.2*	→
7: 10.4*	↗
8: 9.7	↗
9: 10.2*	↑
10: 10.4*	→
Series	98.0
Total	98.0

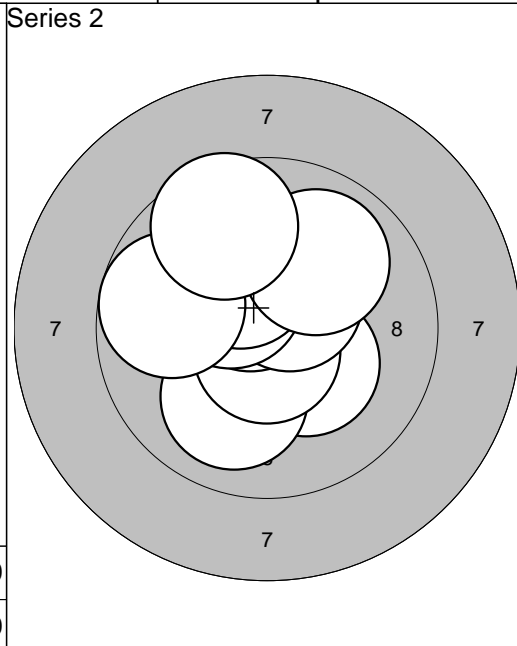

1: 10.3*	↘
2: 10.0	↙
3: 10.7*	↓
4: 10.5*	↗
5: 10.5*	↗
6: 10.4*	↗
7: 10.2*	↗
8: 9.8	←
9: 10.0	↗
10: 9.6	↗
Series	98.0
Total	196.0

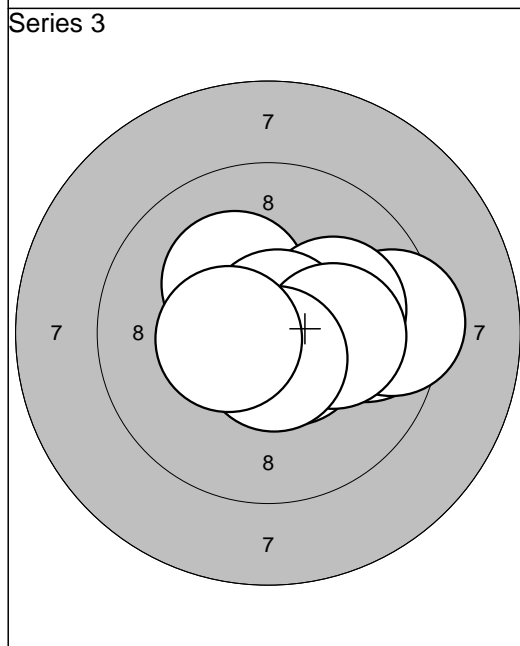

1: 9.7	→
2: 9.4	→
3: 10.3*	→
4: 10.2*	↗
5: 10.6*	↘
6: 10.1	→
7: 10.8*	↗
8: 10.1	→
9: 10.6*	↘
10: 10.5*	←
Series	98.0
Total	294.0

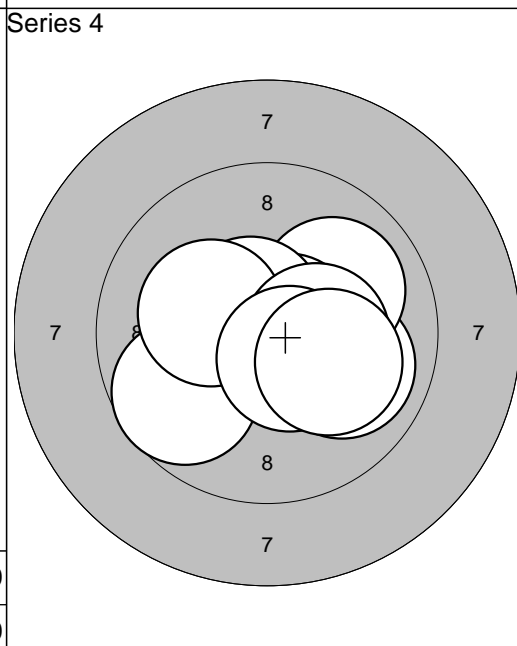

1: 10.0	→
2: 10.4*	→
3: 10.0	↗
4: 10.7*	→
5: 9.7	↙
6: 10.6*	↗
7: 10.2*	↙
8: 10.3*	→
9: 10.5*	↘
10: 10.1	↘
Series	99.0
Total	393.0

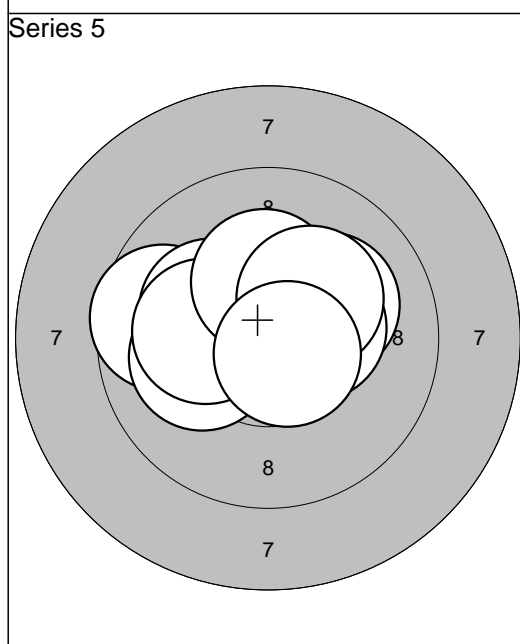

1: 9.7	←
2: 10.2*	↙
3: 10.1	←
4: 10.5*	↗
5: 10.1	↗
6: 10.2*	←
7: 10.4*	→
8: 10.3*	↑
9: 10.2*	↗
10: 10.6*	↘
Series	99.0
Total	492.0

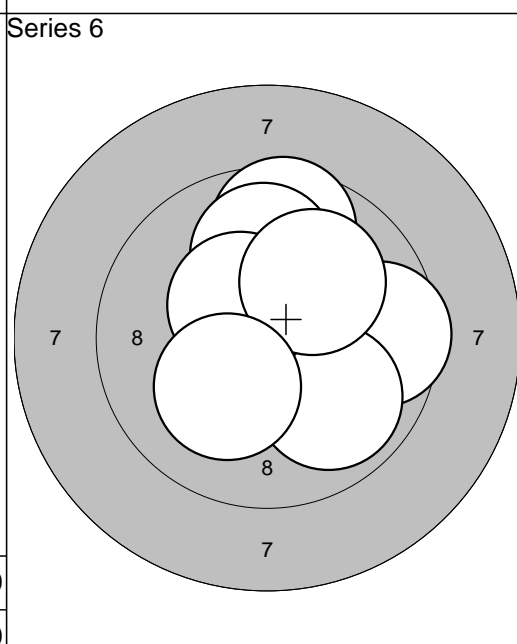

1: 9.6	↑
2: 10.9*	
3: 10.3*	↑
4: 9.9	↑
5: 9.6	→
6: 10.3*	↘
7: 9.9	↘
8: 10.4*	↗
9: 10.1	↗
10: 10.2*	↘
Series	96.0
Total	588.0

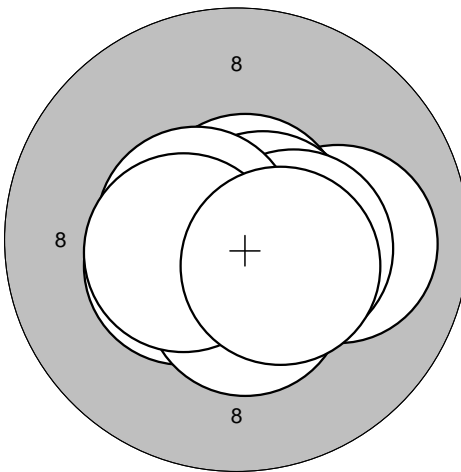
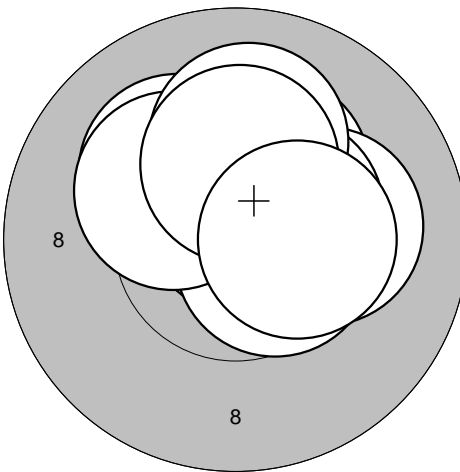
<p>Series 1</p> 	<p>1: 10.7* ↘ 2: 10.4* ← 3: 10.0 → 4: 10.7* ↑ 5: 10.4* ↓ 6: 10.7* → 7: 10.4* → 8: 10.6* ← 9: 10.5* ← 10: 10.5* ↘</p> <table border="1" style="width:100%; border-collapse: collapse;"> <tr><td>Series</td><td style="text-align: right;">100.0</td></tr> <tr><td>Total</td><td style="text-align: right;">100.0</td></tr> </table>	Series	100.0	Total	100.0	<p>Series 2</p> 	<p>1: 10.3* ↗ 2: 10.1 → 3: 10.7* ↗ 4: 10.5* ↘ 5: 10.5* ↗ 6: 10.2* ↗ 7: 10.2* ↖ 8: 10.1 ↑ 9: 10.3* ↑ 10: 10.4* →</p> <table border="1" style="width:100%; border-collapse: collapse;"> <tr><td>Series</td><td style="text-align: right;">100.0</td></tr> <tr><td>Total</td><td style="text-align: right;">200.0</td></tr> </table>	Series	100.0	Total	200.0
Series	100.0										
Total	100.0										
Series	100.0										
Total	200.0										

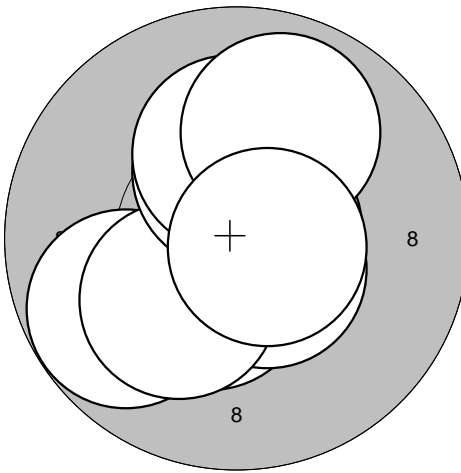
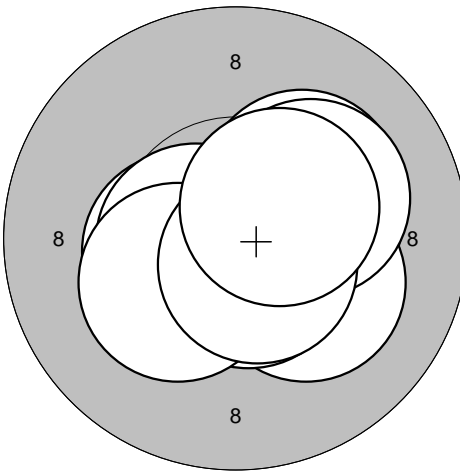
<p>Series 3</p> 	<p>1: 10.4* ↘ 2: 10.7* → 3: 9.7 ← 4: 10.6* ↘ 5: 10.9* ↓ 6: 10.2* ↖ 7: 10.3* ↑ 8: 10.2* ↑ 9: 9.9 ↗ 10: 10.7* →</p> <table border="1" style="width:100%; border-collapse: collapse;"> <tr><td>Series</td><td style="text-align: right;">98.0</td></tr> <tr><td>Total</td><td style="text-align: right;">298.0</td></tr> </table>	Series	98.0	Total	298.0	<p>Series 4</p> 	<p>1: 10.3* → 2: 10.2* ↘ 3: 10.6* ↓ 4: 10.5* ← 5: 10.2* ↗ 6: 10.2* ↗ 7: 10.6* ← 8: 10.3* ↖ 9: 10.6* ↘ 10: 10.5* ↗</p> <table border="1" style="width:100%; border-collapse: collapse;"> <tr><td>Series</td><td style="text-align: right;">100.0</td></tr> <tr><td>Total</td><td style="text-align: right;">398.0</td></tr> </table>	Series	100.0	Total	398.0
Series	98.0										
Total	298.0										
Series	100.0										
Total	398.0										

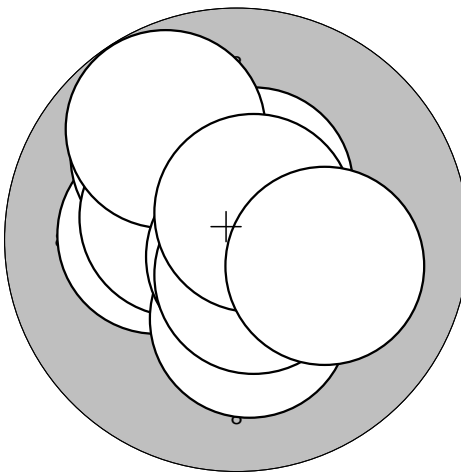
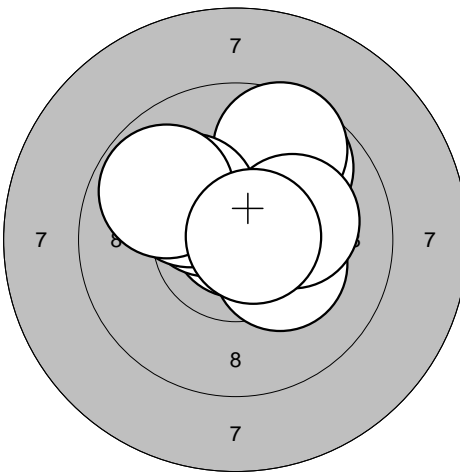
<p>Series 5</p> 	<p>1: 10.4* ↑ 2: 10.2* ← 3: 10.0 ↗ 4: 10.4* ↖ 5: 10.2* ↓ 6: 9.8 ↗ 7: 10.8* ↓ 8: 10.6* ↓ 9: 10.7* ↗ 10: 10.1 →</p> <table border="1" style="width:100%; border-collapse: collapse;"> <tr><td>Series</td><td style="text-align: right;">99.0</td></tr> <tr><td>Total</td><td style="text-align: right;">497.0</td></tr> </table>	Series	99.0	Total	497.0	<p>Series 6</p> 	<p>1: 10.8* ↗ 2: 10.2* ↗ 3: 10.4* ↖ 4: 10.3* ↘ 5: 9.8 ↗ 6: 9.6 ↗ 7: 10.2* ↖ 8: 9.8 ↖ 9: 10.1 → 10: 10.7* →</p> <table border="1" style="width:100%; border-collapse: collapse;"> <tr><td>Series</td><td style="text-align: right;">97.0</td></tr> <tr><td>Total</td><td style="text-align: right;">594.0</td></tr> </table>	Series	97.0	Total	594.0
Series	99.0										
Total	497.0										
Series	97.0										
Total	594.0										

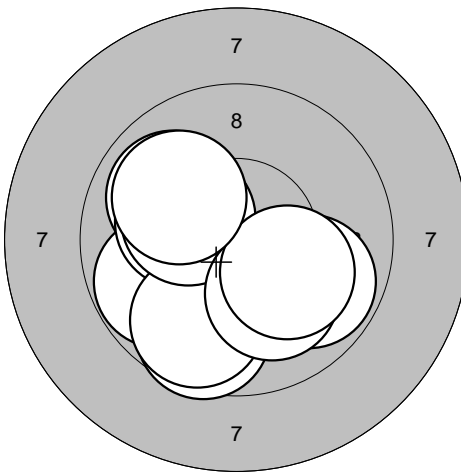
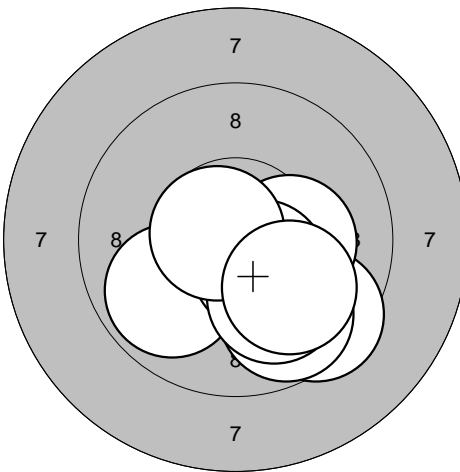
<p>Series 1</p> 	<p>1: 9.8 ↘ 2: 9.9 ↗ 3: 9.8 ↙ 4: 9.6 ↓ 5: 10.2* ↖ 6: 9.8 ↓ 7: 10.2* ↖ 8: 10.1 ↓ 9: 10.1 ↓ 10: 10.0 ↗</p> <p>Series 95.0 Total 95.0</p>	<p>Series 2</p> 	<p>1: 9.5 ↘ 2: 10.8* ↙ 3: 10.4* ↙ 4: 9.9 ↙ 5: 10.2* → 6: 9.7 ↓ 7: 10.5* ↓ 8: 10.0 ↓ 9: 10.7* ↖ 10: 10.0 ↓</p> <p>Series 97.0 Total 192.0</p>
---	--	---	--

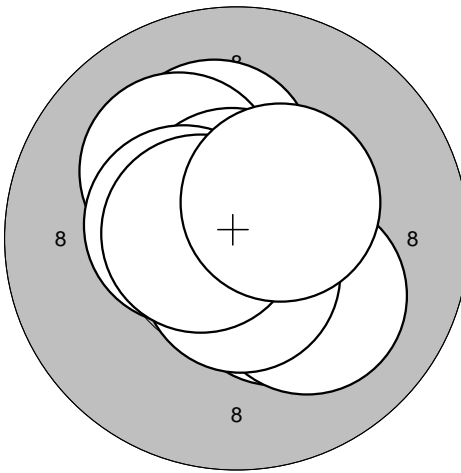
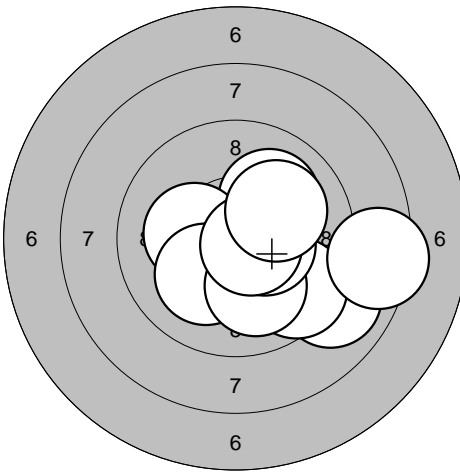
<p>Series 3</p> 	<p>1: 10.4* ↘ 2: 10.1 ↘ 3: 10.2* ↗ 4: 10.2* ↗ 5: 10.7* ↖ 6: 10.7* ↗ 7: 10.4* ↖ 8: 10.6* ↓ 9: 10.6* ↖ 10: 10.4* ↗</p> <p>Series 100.0 Total 292.0</p>	<p>Series 4</p> 	<p>1: 9.0 ↘ 2: 9.6 ↘ 3: 10.0 ↗ 4: 10.2* ↖ 5: 10.1 ↘ 6: 10.1 ↓ 7: 8.4 → 8: 10.4* → 9: 10.6* → 10: 10.1 ↗</p> <p>Series 96.0 Total 388.0</p>
--	--	--	--

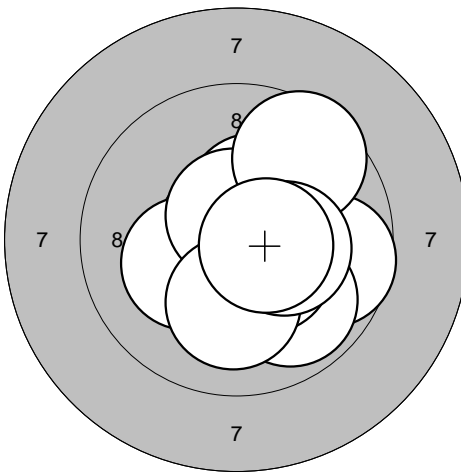
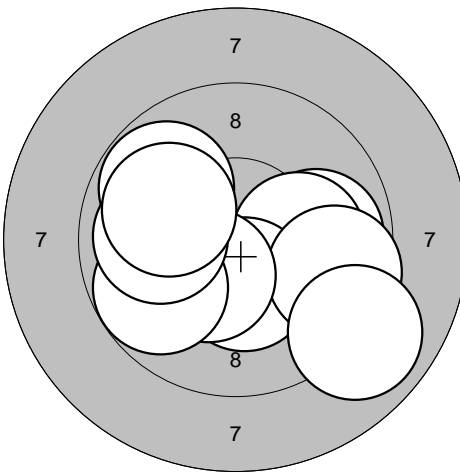
<p>Series 5</p> 	<p>1: 9.7 → 2: 9.9 ↓ 3: 10.2* ↖ 4: 10.4* ↓ 5: 10.4* ↗ 6: 10.6* ↗ 7: 9.6 ↗ 8: 10.1 ↓ 9: 10.3* → 10: 10.5* →</p> <p>Series 97.0 Total 485.0</p>	<p>Series 6</p> 	<p>1: 9.9 → 2: 10.1 → 3: 10.3* ↓ 4: 9.6 → 5: 8.9 ↓ 6: 10.4* ↓ 7: 9.8 ↖ 8: 9.8 ↗ 9: 10.0 ↖ 10: 10.0 ↖</p> <p>Series 94.0 Total 579.0</p>
---	---	---	---

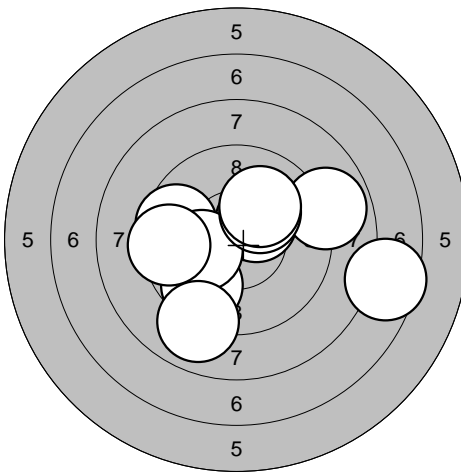
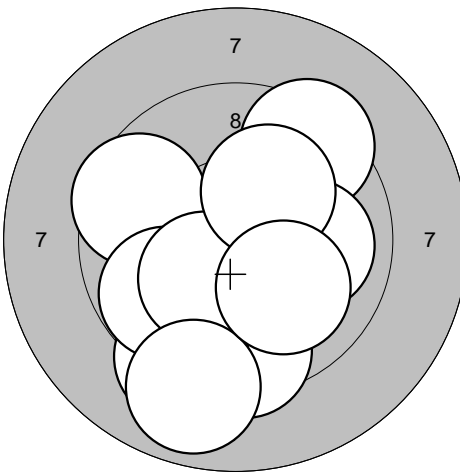
<p>Series 1</p> 	<p>1: 10.4* ↗ 2: 7.6 → 3: 9.6 ← 4: 8.9 → 5: 9.7 ↓ 6: 10.2* ← 7: 9.5 ← 8: 10.2* ↗ 9: 10.1 ↗ 10: 9.0 ↓</p> <p>Series 91.0 Total 91.0</p>	<p>Series 2</p> 	<p>1: 9.6 ↖ 2: 9.4 ↗ 3: 9.5 ↓ 4: 9.2 ↓ 5: 9.8 ↖ 6: 10.0 → 7: 10.3* ↖ 8: 8.9 ↓ 9: 10.2* ↗ 10: 10.0 ↘</p> <p>Series 93.0 Total 184.0</p>
--	--	--	--

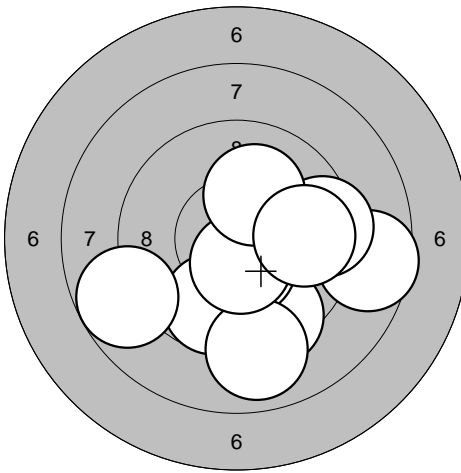
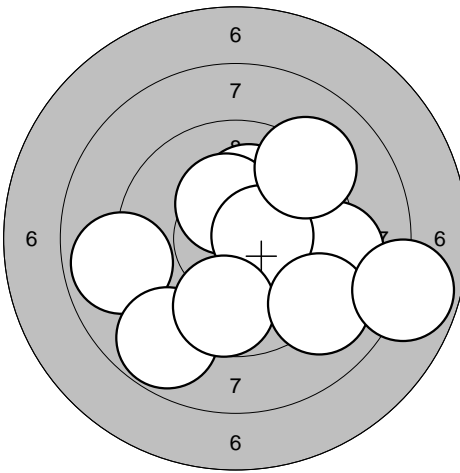
<p>Series 3</p> 	<p>1: 9.4 ↓ 2: 8.6 → 3: 10.4* ↓ 4: 9.7 ↓ 5: 9.4 → 6: 9.0 ↓ 7: 8.8 ← 8: 10.5* ↓ 9: 10.1 ↗ 10: 9.8 →</p> <p>Series 91.0 Total 275.0</p>	<p>Series 4</p> 	<p>1: 8.9 ← 2: 10.1 ↗ 3: 10.3* ↗ 4: 9.2 → 5: 10.5* → 6: 8.8 ↓ 7: 9.7 ↓ 8: 9.1 ↘ 9: 9.2 ↗ 10: 7.8 →</p> <p>Series 89.0 Total 364.0</p>
---	---	---	---

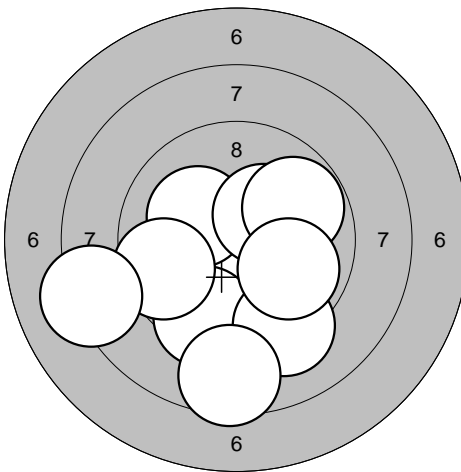
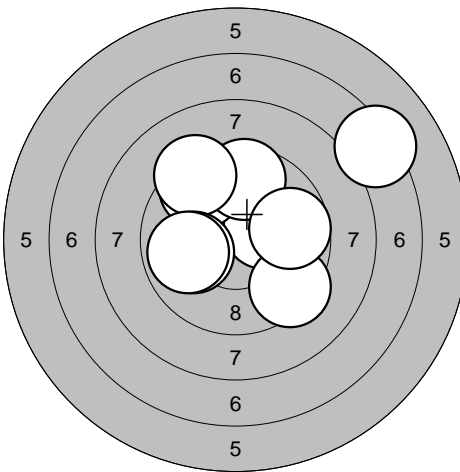
<p>Series 5</p> 	<p>1: 9.9 ↖ 2: 10.2* ↖ 3: 9.5 ↓ 4: 9.2 ↓ 5: 9.6 ← 6: 10.3* ↗ 7: 9.8 ↗ 8: 9.9 → 9: 8.5 ↓ 10: 8.2 ←</p> <p>Series 90.0 Total 454.0</p>	<p>Series 6</p> 	<p>1: 10.0 ↗ 2: 10.3* → 3: 9.6 ↗ 4: 9.6 ↗ 5: 9.3 ↗ 6: 9.4 ↘ 7: 9.7 → 8: 7.3 ↗ 9: 10.0 ← 10: 9.9 ←</p> <p>Series 91.0 Total 545.0</p>
--	--	--	--

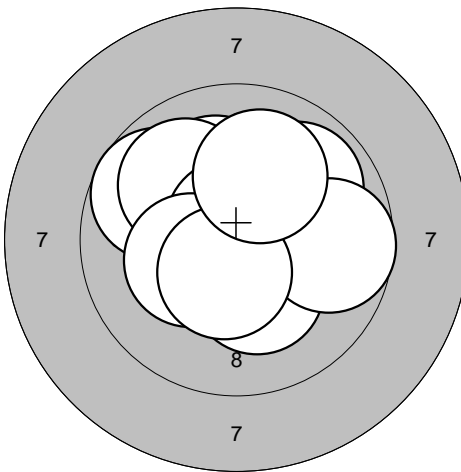
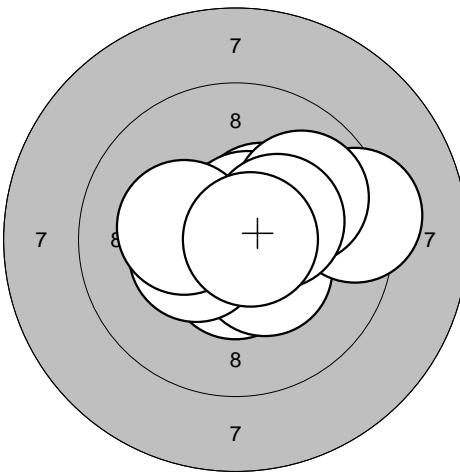
<p>Series 1</p> 	<p>1: 9.8 ↖</p> <p>2: 10.1 ↗</p> <p>3: 10.0 ↖</p> <p>4: 9.9 ↗</p> <p>5: 10.7* ↗</p> <p>6: 10.2* ↘</p> <p>7: 10.3* ↖</p> <p>8: 9.7 →</p> <p>9: 10.5* ↘</p> <p>10: 10.1 ↗</p>	<p>Series 2</p> 	<p>1: 10.5* ↓</p> <p>2: 10.4* ↘</p> <p>3: 9.3 →</p> <p>4: 10.4* ↗</p> <p>5: 10.6* ↗</p> <p>6: 10.4* ↖</p> <p>7: 10.3* ↖</p> <p>8: 9.9 ↗</p> <p>9: 10.3* →</p> <p>10: 10.7* →</p>
Series 97.0	Series 98.0		
Total 97.0	Total 195.0		

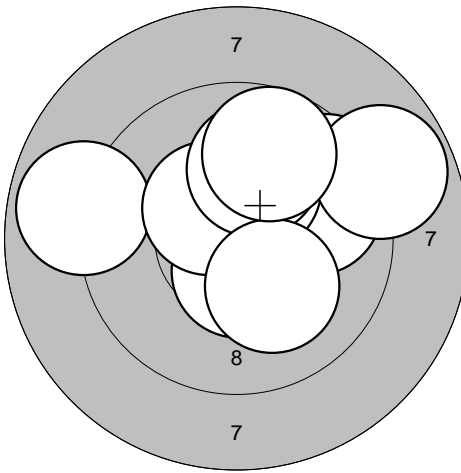
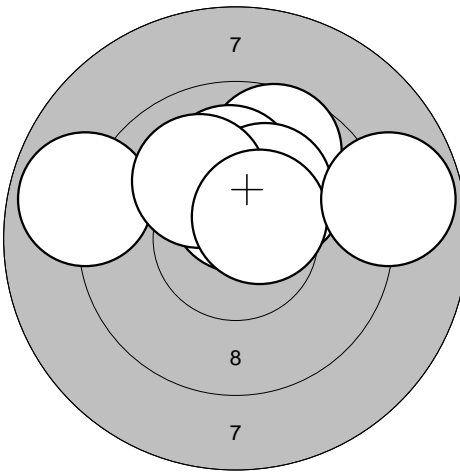
<p>Series 3</p> 	<p>1: 9.5 ↗</p> <p>2: 9.8 →</p> <p>3: 8.9 ↖</p> <p>4: 10.2* ↗</p> <p>5: 10.5* ↘</p> <p>6: 10.4* ↖</p> <p>7: 8.8 →</p> <p>8: 10.0 ↗</p> <p>9: 10.2* ↘</p> <p>10: 9.8 ↗</p>	<p>Series 4</p> 	<p>1: 10.5* ↑</p> <p>2: 10.1 ↗</p> <p>3: 10.1 ↑</p> <p>4: 8.9 ↖</p> <p>5: 9.7 ↗</p> <p>6: 10.1 ↑</p> <p>7: 10.2* ↗</p> <p>8: 10.1 ↖</p> <p>9: 10.5* ↗</p> <p>10: 8.8 →</p>
Series 93.0	Series 95.0		
Total 288.0	Total 383.0		

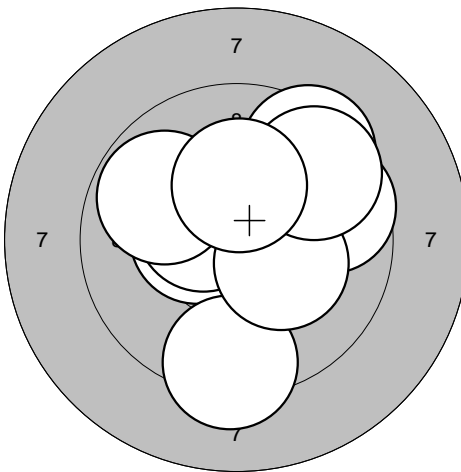
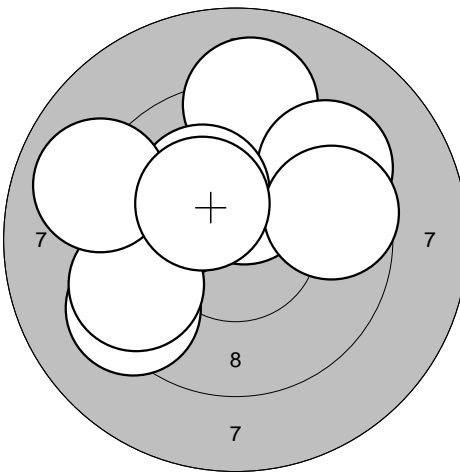
<p>Series 5</p> 	<p>1: 10.4* ↑</p> <p>2: 10.4* ↖</p> <p>3: 9.5 ↗</p> <p>4: 9.6 →</p> <p>5: 10.5* ↖</p> <p>6: 9.3 ↘</p> <p>7: 10.3* ↘</p> <p>8: 9.6 ↗</p> <p>9: 9.8 ↖</p> <p>10: 10.2* ↑</p>	<p>Series 6</p> 	<p>1: 9.3 ↖</p> <p>2: 10.4* ↑</p> <p>3: 10.0 ↖</p> <p>4: 9.1 ↑</p> <p>5: 9.4 ↗</p> <p>6: 9.5 ↖</p> <p>7: 10.2* ↗</p> <p>8: 9.0 ↖</p> <p>9: 9.6 →</p> <p>10: 10.3* ↖</p>
Series 95.0	Series 94.0		
Total 478.0	Total 572.0		

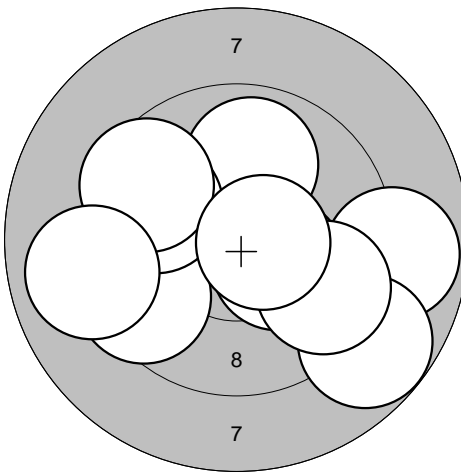
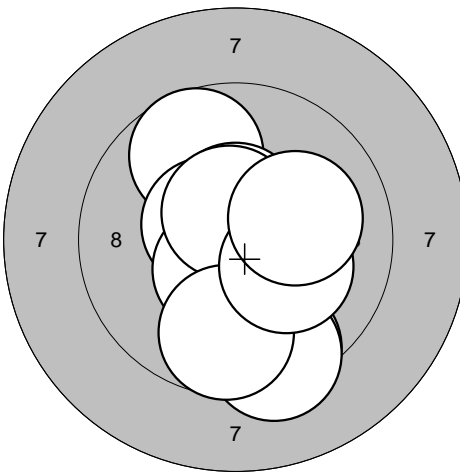
<p>Series 1</p> 	<p>1: 8.9 →</p> <p>2: 10.3* ↘</p> <p>3: 9.9 ↑</p> <p>4: 9.5 ↙</p> <p>5: 8.8 ↘</p> <p>6: 9.8 ↗</p> <p>7: 9.5 ↗</p> <p>8: 9.0 ↙</p> <p>9: 9.6 ↘</p> <p>10: 10.6* →</p>	<p>Series 2</p> 	<p>1: 9.7 ↗</p> <p>2: 9.4 ↘</p> <p>3: 10.5* ↑</p> <p>4: 10.5* ↘</p> <p>5: 9.3 ↘</p> <p>6: 10.5* ↘</p> <p>7: 10.6* ↑</p> <p>8: 9.7 ↘</p> <p>9: 10.2* ↘</p> <p>10: 10.1 →</p>
Series 90.0	Series 96.0	Series 96.0	Series 96.0
Total 90.0	Total 186.0	Total 186.0	Total 186.0

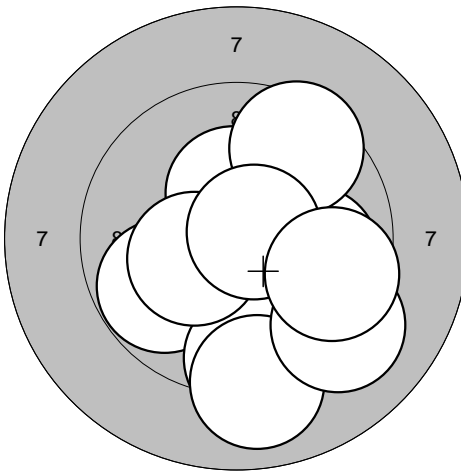
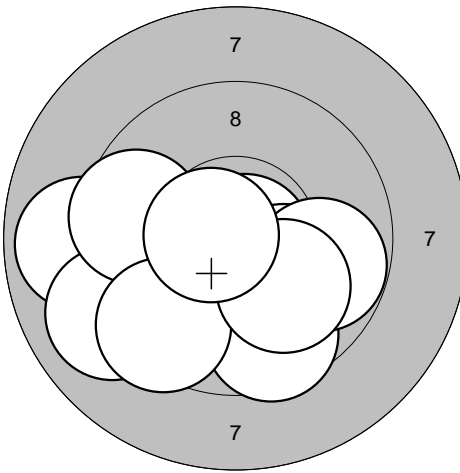
<p>Series 3</p> 	<p>1: 9.8 ↙</p> <p>2: 9.9 →</p> <p>3: 10.4* ↑</p> <p>4: 9.3 ↘</p> <p>5: 9.0 ↘</p> <p>6: 9.5 ↗</p> <p>7: 9.2 ↘</p> <p>8: 10.3* ↙</p> <p>9: 10.7* →</p> <p>10: 9.6 →</p>	<p>Series 4</p> 	<p>1: 8.9 ↙</p> <p>2: 10.8* →</p> <p>3: 10.2* ↘</p> <p>4: 9.6 ↘</p> <p>5: 9.0 ↙</p> <p>6: 9.6 ↙</p> <p>7: 9.8 →</p> <p>8: 9.5 ↘</p> <p>9: 10.0 ↘</p> <p>10: 10.6* ↙</p>
Series 93.0	Series 93.0	Series 93.0	Series 93.0
Total 279.0	Total 372.0	Total 372.0	Total 372.0

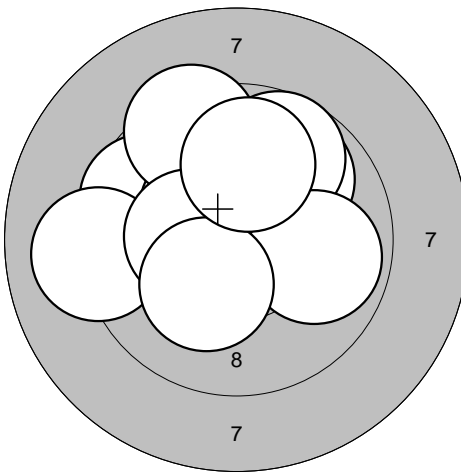
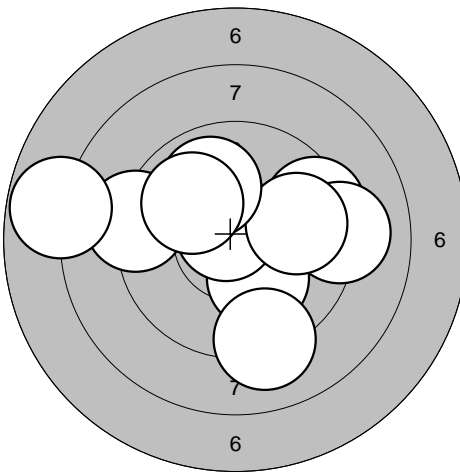
<p>Series 5</p> 	<p>1: 9.6 ↙</p> <p>2: 10.4* ↗</p> <p>3: 9.9 ↗</p> <p>4: 9.7 ↗</p> <p>5: 9.4 ↗</p> <p>6: 9.1 ↙</p> <p>7: 10.3* ↙</p> <p>8: 9.9 →</p> <p>9: 10.2* ↘</p> <p>10: 9.9 ↑</p>	<p>Series 6</p> 	<p>1: 10.2* ↘</p> <p>2: 9.4 →</p> <p>3: 9.1 →</p> <p>4: 9.1 ↘</p> <p>5: 10.7* ↗</p> <p>6: 9.8 →</p> <p>7: 9.2 ↙</p> <p>8: 9.9 ↗</p> <p>9: 7.8 ↙</p> <p>10: 9.9 ↗</p>
Series 93.0	Series 90.0	Series 90.0	Series 90.0
Total 465.0	Total 555.0	Total 555.0	Total 555.0

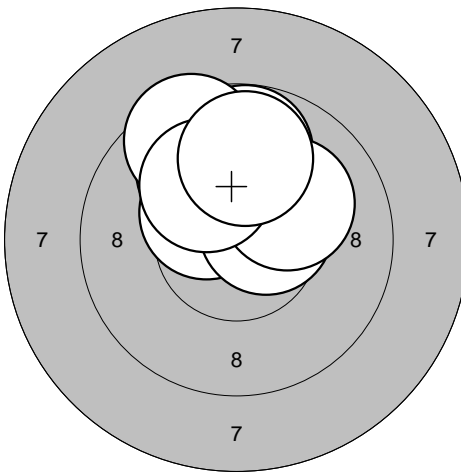
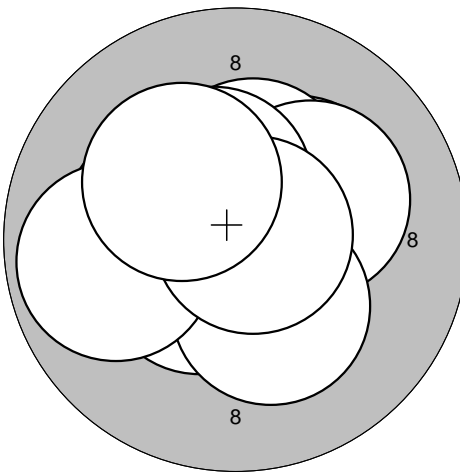
<p>Series 1</p> 	<p>1: 10.4* ↖</p> <p>2: 9.8 ↑</p> <p>3: 9.9 ↖</p> <p>4: 10.4* ↑</p> <p>5: 10.4* ↖</p> <p>6: 10.5* →</p> <p>7: 9.5 ↖</p> <p>8: 10.1 ↗</p> <p>9: 10.1 ↖</p> <p>10: 9.9 ↑</p>	<p>Series 2</p> 	<p>1: 10.5* ↘</p> <p>2: 10.3* ↗</p> <p>3: 10.4* ↑</p> <p>4: 10.2* ↗</p> <p>5: 10.4* ↖</p> <p>6: 10.3* ↘</p> <p>7: 10.3* ←</p> <p>8: 9.8 ←</p> <p>9: 10.8* →</p> <p>10: 10.2* ↖</p>
	Series 96.0		Series 99.0
	Total 96.0		Total 195.0

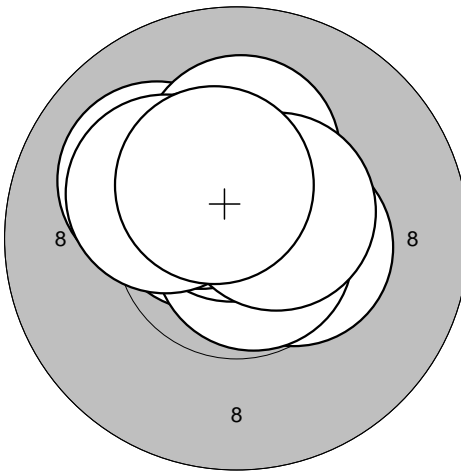
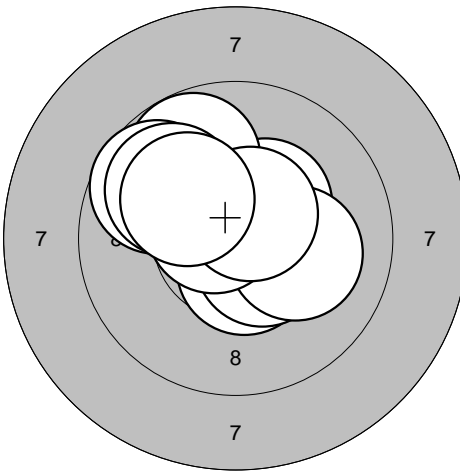
<p>Series 3</p> 	<p>1: 10.0 ↖</p> <p>2: 10.4* →</p> <p>3: 10.6* ↗</p> <p>4: 10.7* ↘</p> <p>5: 10.2* ↑</p> <p>6: 10.6* ↑</p> <p>7: 10.4* ↖</p> <p>8: 10.2* ↖</p> <p>9: 10.5* ↗</p> <p>10: 10.4* ↖</p>	<p>Series 4</p> 	<p>1: 10.4* ↗</p> <p>2: 9.8 ↖</p> <p>3: 10.5* ↘</p> <p>4: 10.5* ↘</p> <p>5: 10.1 →</p> <p>6: 9.7 ↖</p> <p>7: 9.9 ↖</p> <p>8: 10.6* ↖</p> <p>9: 10.6* ↗</p> <p>10: 10.1 ↖</p>
	Series 100.0		Series 97.0
	Total 295.0		Total 392.0

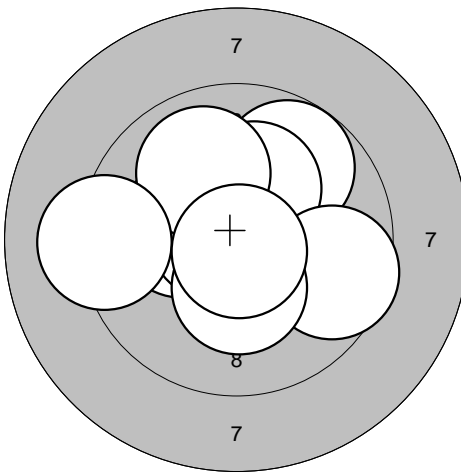
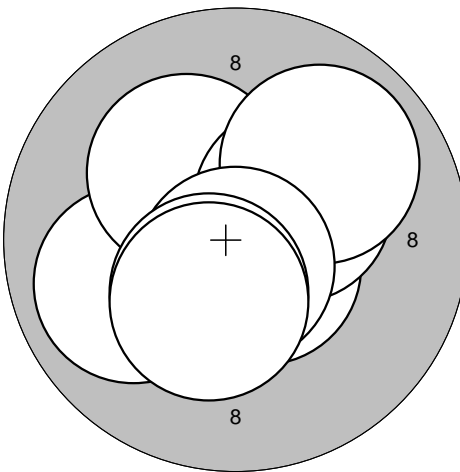
<p>Series 5</p> 	<p>1: 9.8 ↗</p> <p>2: 10.2* ←</p> <p>3: 10.8* ↘</p> <p>4: 10.2* ↑</p> <p>5: 10.7* ←</p> <p>6: 10.0 ↖</p> <p>7: 9.2 ←</p> <p>8: 9.6 →</p> <p>9: 10.3* ↘</p> <p>10: 10.8* ↘</p>	<p>Series 6</p> 	<p>1: 10.7* ←</p> <p>2: 10.6* ↘</p> <p>3: 10.5* ↖</p> <p>4: 9.9 ←</p> <p>5: 10.2* ↖</p> <p>6: 10.3* ↗</p> <p>7: 9.9 ↖</p> <p>8: 10.7* ↘</p> <p>9: 10.4* ↘</p> <p>10: 10.3* ↘</p>
	Series 97.0		Series 98.0
	Total 489.0		Total 587.0

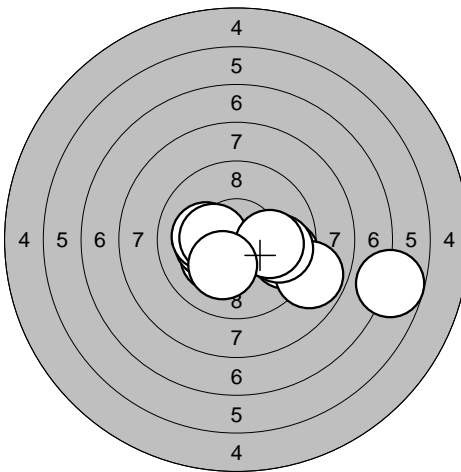
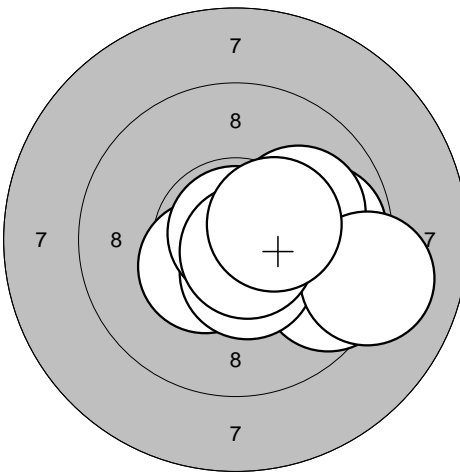
<p>Series 1</p> 	<p>1: 9.6 →</p> <p>2: 8.8 →</p> <p>3: 10.2* ↙</p> <p>4: 10.2* ←</p> <p>5: 10.1 ←</p> <p>6: 9.8 →</p> <p>7: 10.3* ←</p> <p>8: 10.1 →</p> <p>9: 6.7 →</p> <p>10: 10.2* ↘</p>	<p>Series 2</p> 	<p>1: 10.4* ↙</p> <p>2: 9.8 →</p> <p>3: 10.6* ↘</p> <p>4: 9.6 →</p> <p>5: 10.5* ↘</p> <p>6: 10.9* ↑</p> <p>7: 10.0 →</p> <p>8: 9.1 →</p> <p>9: 10.7* ↘</p> <p>10: 10.4* →</p>
Series 92.0	Series 97.0	Series 97.0	Series 97.0
Total 92.0	Total 189.0	Total 189.0	Total 189.0

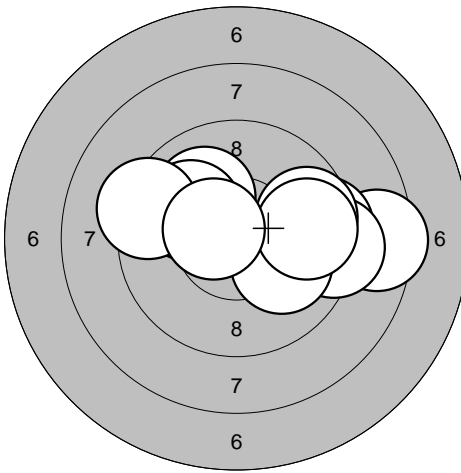
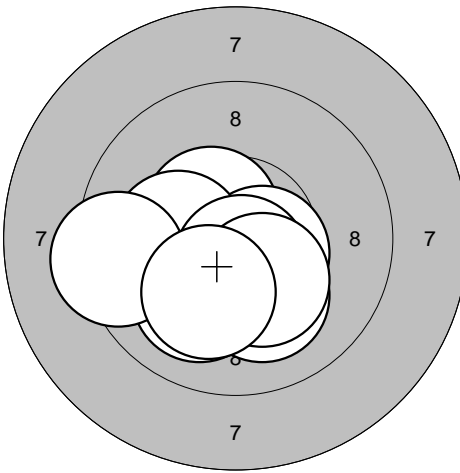
<p>Series 3</p> 	<p>1: 8.5 →</p> <p>2: 9.4 →</p> <p>3: 9.2 →</p> <p>4: 9.7 →</p> <p>5: 10.0 ↗</p> <p>6: 10.0 ↘</p> <p>7: 9.7 →</p> <p>8: 10.0 ↗</p> <p>9: 9.3 ←</p> <p>10: 10.5* ↗</p>	<p>Series 4</p> 	<p>1: 10.4* ↘</p> <p>2: 10.5* ↗</p> <p>3: 10.5* ↘</p> <p>4: 10.2* ←</p> <p>5: 10.6* ↘</p> <p>6: 10.1 ↘</p> <p>7: 9.4 ←</p> <p>8: 10.1 ↘</p> <p>9: 10.3* ↘</p> <p>10: 10.1 ↘</p>
Series 93.0	Series 99.0	Series 99.0	Series 99.0
Total 282.0	Total 381.0	Total 381.0	Total 381.0

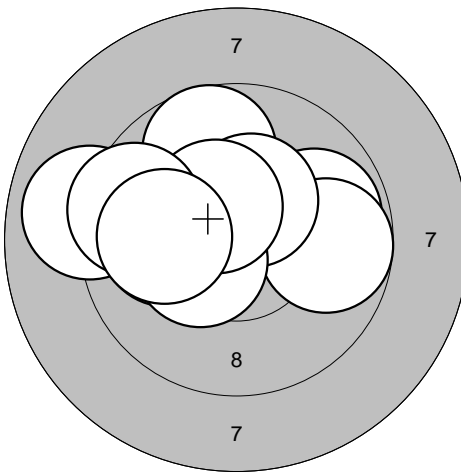
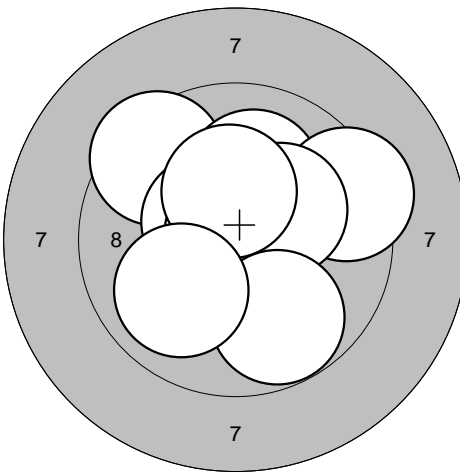
<p>Series 5</p> 	<p>1: 9.9 →</p> <p>2: 10.0 ←</p> <p>3: 9.7 →</p> <p>4: 9.7 ↗</p> <p>5: 8.9 ←</p> <p>6: 10.4* ↗</p> <p>7: 10.4* ←</p> <p>8: 10.5* ↗</p> <p>9: 9.5 ←</p> <p>10: 10.0 ←</p>	<p>Series 6</p> 	<p>1: 9.5 ↗</p> <p>2: 10.8* ↘</p> <p>3: 10.5* ↗</p> <p>4: 10.1 ↗</p> <p>5: 9.3 →</p> <p>6: 10.8* ↗</p> <p>7: 10.2* ↗</p> <p>8: 10.3* ↑</p> <p>9: 9.8 ↘</p> <p>10: 10.0 ↙</p>
Series 94.0	Series 97.0	Series 97.0	Series 97.0
Total 475.0	Total 572.0	Total 572.0	Total 572.0

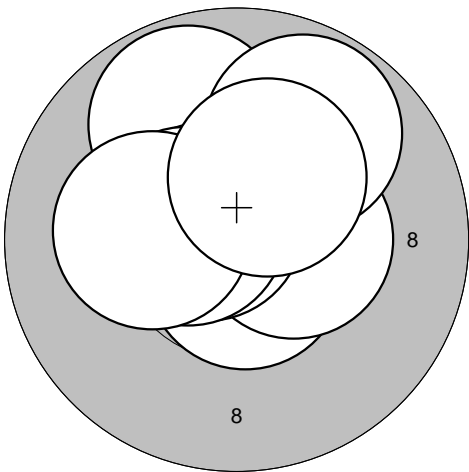
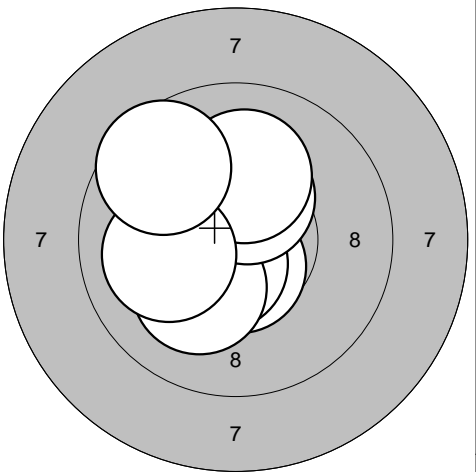
<p>Series 1</p> 	<p>1: 10.7* ↗</p> <p>2: 10.6* ↓</p> <p>3: 10.6* →</p> <p>4: 9.8 ↗</p> <p>5: 10.4* →</p> <p>6: 9.8 ↗</p> <p>7: 10.6* ↗</p> <p>8: 10.5* ←</p> <p>9: 10.2* ←</p> <p>10: 10.3* ↗</p>	<p>Series 2</p> 	<p>1: 10.6* ←</p> <p>2: 10.6* ↓</p> <p>3: 10.5* ↗</p> <p>4: 10.6* ↓</p> <p>5: 10.4* ↑</p> <p>6: 10.1 ↓</p> <p>7: 10.3* ↑</p> <p>8: 10.1 ↑</p> <p>9: 10.1 ←</p> <p>10: 9.6 ↗</p>
Series 98.0	Series 99.0		
Total 98.0	Total 197.0		

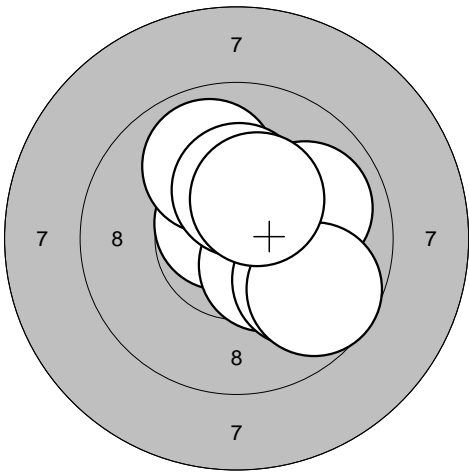
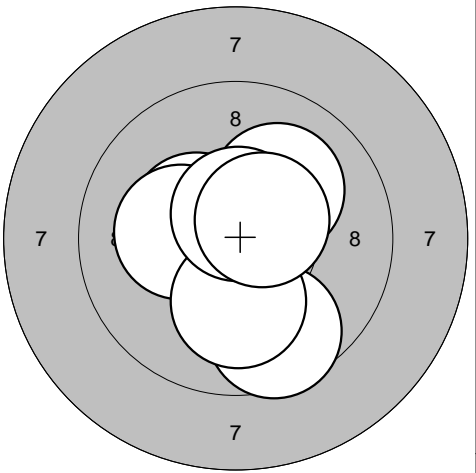
<p>Series 3</p> 	<p>1: 9.9 ↘</p> <p>2: 10.7* ↗</p> <p>3: 10.4* ↘</p> <p>4: 10.4* ↘</p> <p>5: 9.9 ↘</p> <p>6: 10.0 →</p> <p>7: 9.7 ↘</p> <p>8: 9.9 ↗</p> <p>9: 10.3* ↑</p> <p>10: 10.4* ↗</p>	<p>Series 4</p> 	<p>1: 10.9* ↑</p> <p>2: 10.3* ↗</p> <p>3: 9.6 ↓</p> <p>4: 10.4* ←</p> <p>5: 10.7* ↑</p> <p>6: 10.1 ↗</p> <p>7: 10.2* ←</p> <p>8: 10.1 ↓</p> <p>9: 10.6* ↑</p> <p>10: 10.5* ↗</p>
Series 96.0	Series 99.0		
Total 293.0	Total 392.0		

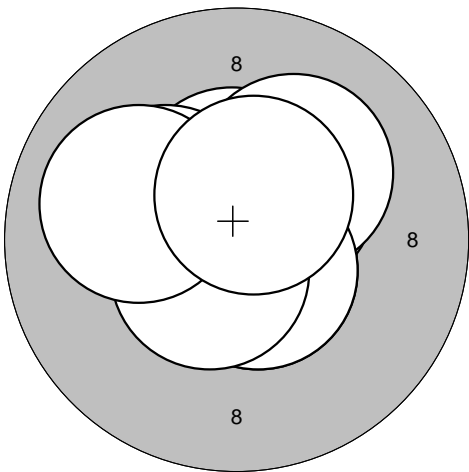
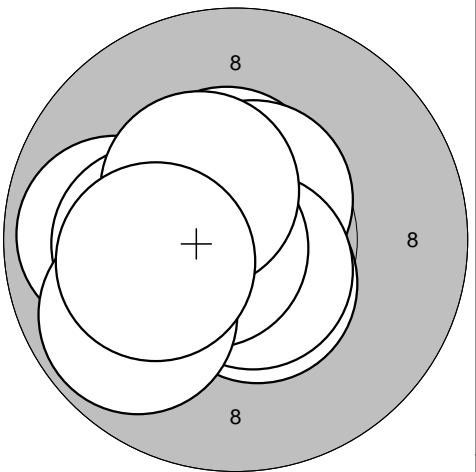
<p>Series 5</p> 	<p>1: 10.6* ↘</p> <p>2: 10.4* ↗</p> <p>3: 10.5* ↑</p> <p>4: 10.2* ↗</p> <p>5: 10.2* ←</p> <p>6: 10.9* ↑</p> <p>7: 10.6* ↘</p> <p>8: 10.6* ↘</p> <p>9: 10.0 ←</p> <p>10: 10.5* ↗</p>	<p>Series 6</p> 	<p>1: 9.9 ←</p> <p>2: 10.2* ←</p> <p>3: 10.5* ↑</p> <p>4: 10.5* ↗</p> <p>5: 10.5* ↓</p> <p>6: 10.6* ↓</p> <p>7: 10.7* ←</p> <p>8: 10.4* ↗</p> <p>9: 9.8 ↘</p> <p>10: 10.2* ←</p>
Series 100.0	Series 98.0		
Total 492.0	Total 590.0		

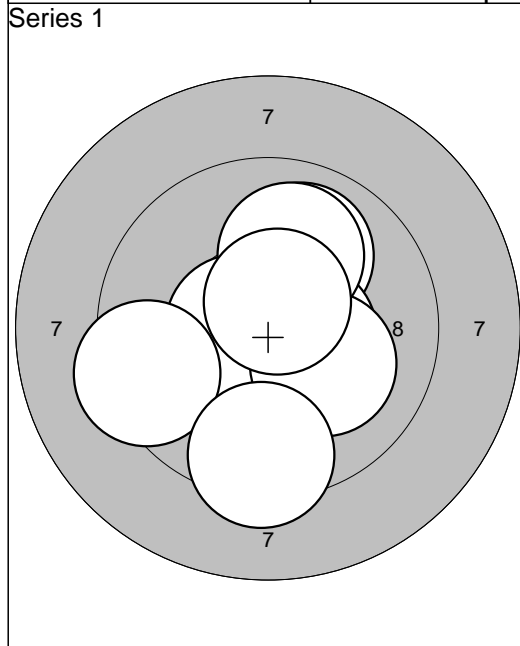

1: 10.0	↗
2: 10.5*	→
3: 10.4*	↓
4: 10.8*	→
5: 10.6*	←
6: 10.1	↘
7: 10.0	↑
8: 9.4	←
9: 10.6*	↑
10: 9.4	↓
Series	98.0
Total	98.0

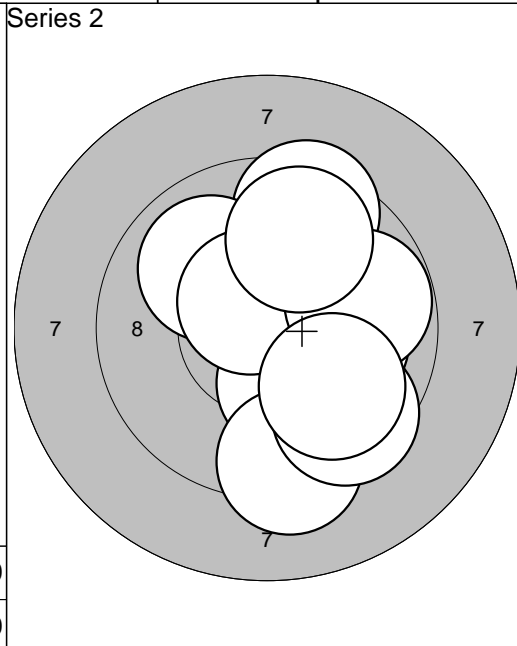

1: 10.2*	↘
2: 10.1	→
3: 9.5	↑
4: 10.0	↗
5: 9.3	↓
6: 10.6*	↗
7: 9.8	→
8: 9.6	↘
9: 9.8	↑
10: 9.9	↘
Series	94.0
Total	192.0

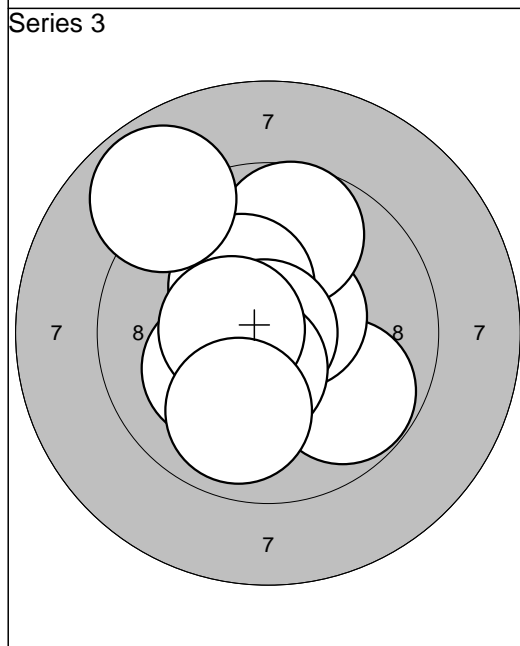

1: 10.2*	↖
2: 9.8	↘
3: 10.6*	↗
4: 9.7	↑
5: 10.3*	↗
6: 8.9	↗
7: 10.9*	←
8: 10.5*	↓
9: 10.5*	←
10: 9.9	↘
Series	95.0
Total	287.0

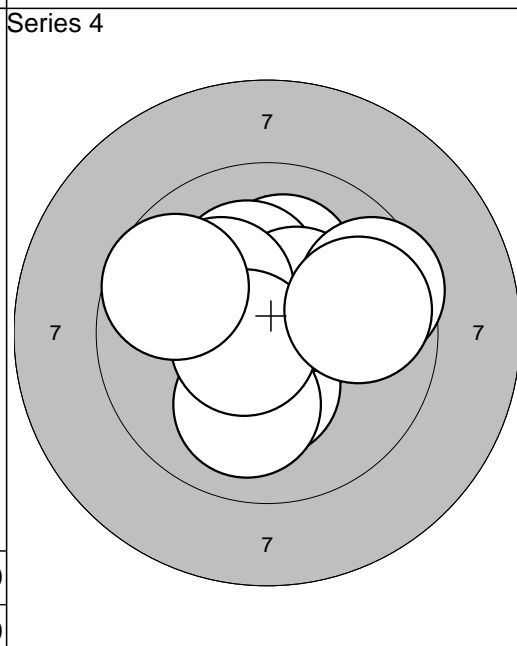

1: 10.1	↑
2: 10.3*	↓
3: 10.2*	↑
4: 10.0	↓
5: 10.4*	↗
6: 9.6	→
7: 10.2*	↖
8: 10.7*	←
9: 9.7	↖
10: 9.8	→
Series	97.0
Total	384.0

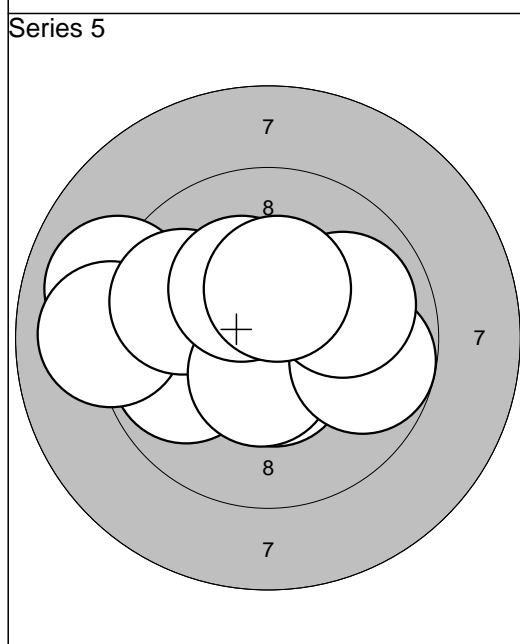

1: 9.0	←
2: 9.9	←
3: 10.5*	↓
4: 9.0	←
5: 9.8	↖
6: 10.5*	↓
7: 9.8	→
8: 9.9	→
9: 10.3*	↗
10: 10.3*	↑
Series	94.0
Total	478.0

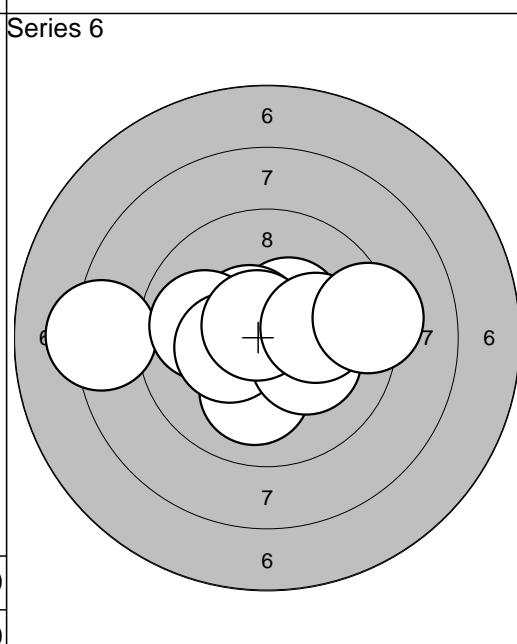

1: 10.4*	↗
2: 10.6*	↖
3: 8.3	←
4: 10.1	↓
5: 10.0	←
6: 10.3*	←
7: 10.2*	↘
8: 10.7*	↗
9: 10.1	→
10: 9.3	→
Series	97.0
Total	575.0

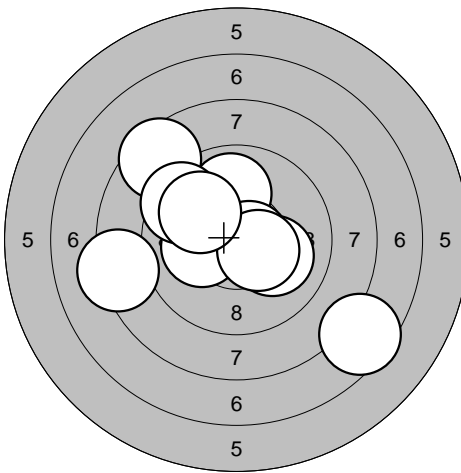
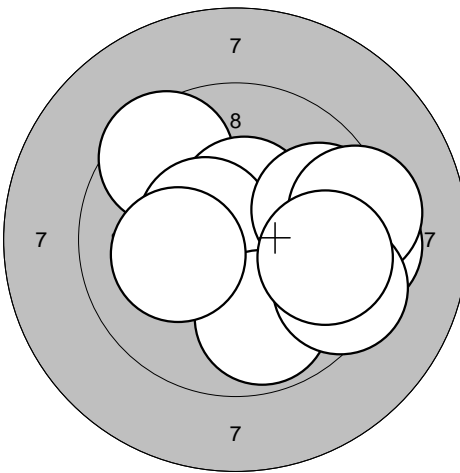
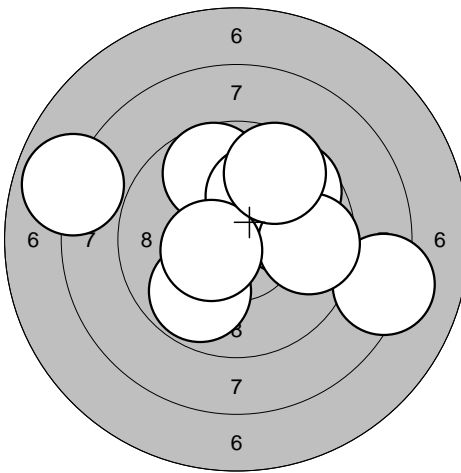
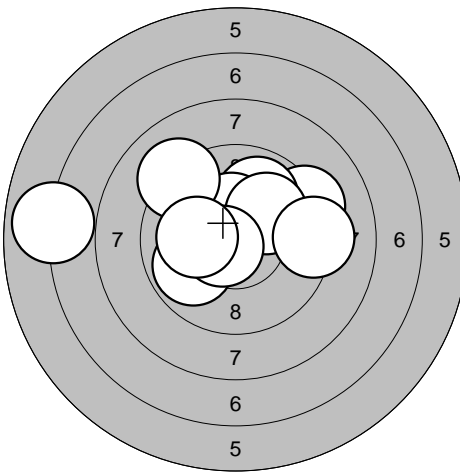
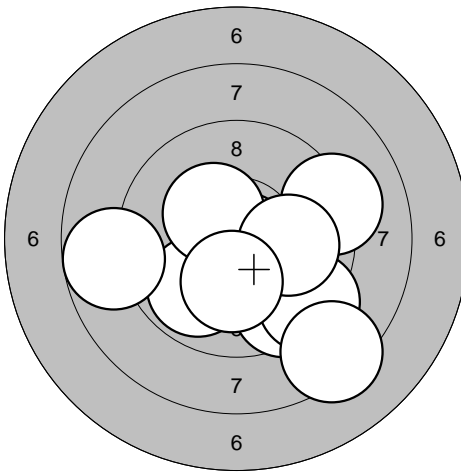
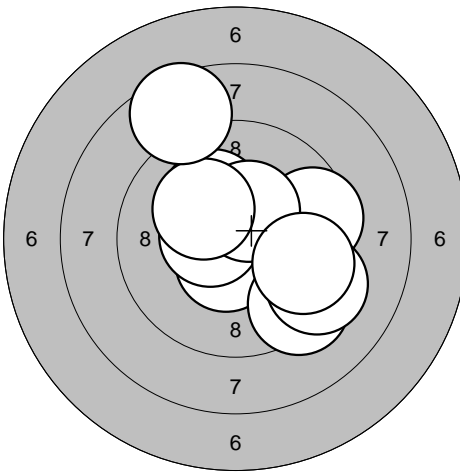
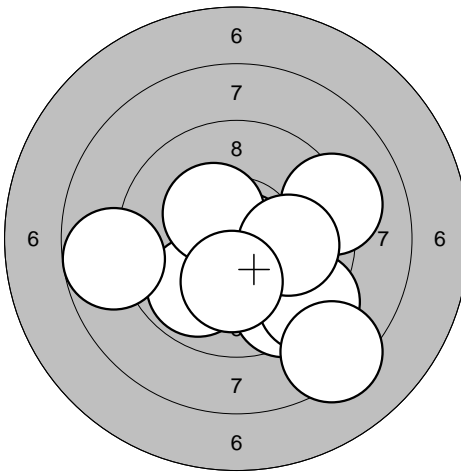
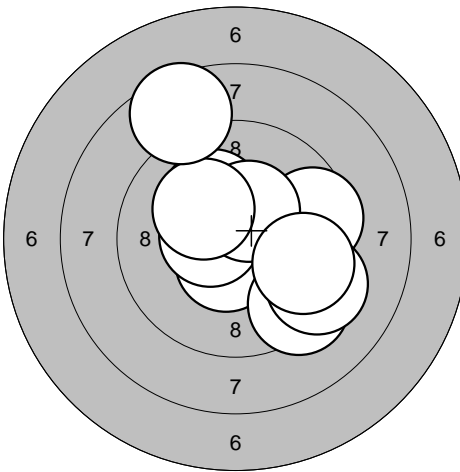
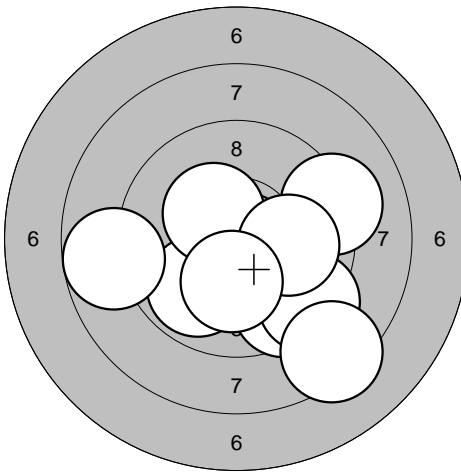
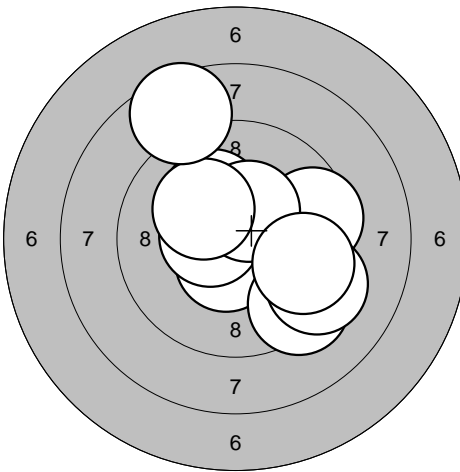
<p>Series 1</p> 	<p>Series 2</p> 	<table border="1" style="width:100%; border-collapse: collapse;"> <tr><td>1: 10.0</td><td style="text-align: right;">↑</td></tr> <tr><td>2: 10.1</td><td style="text-align: right;">↘</td></tr> <tr><td>3: 8.5</td><td style="text-align: right;">↗</td></tr> <tr><td>4: 8.3</td><td style="text-align: right;">←</td></tr> <tr><td>5: 10.6*</td><td style="text-align: right;">→</td></tr> <tr><td>6: 7.5</td><td style="text-align: right;">↘</td></tr> <tr><td>7: 10.2*</td><td style="text-align: right;">←</td></tr> <tr><td>8: 9.5</td><td style="text-align: right;">↗</td></tr> <tr><td>9: 10.4*</td><td style="text-align: right;">↘</td></tr> <tr><td>10: 9.9</td><td style="text-align: right;">↗</td></tr> <tr><td>Series</td><td style="text-align: right;">91.0</td></tr> <tr><td>Total</td><td style="text-align: right;">91.0</td></tr> </table>	1: 10.0	↑	2: 10.1	↘	3: 8.5	↗	4: 8.3	←	5: 10.6*	→	6: 7.5	↘	7: 10.2*	←	8: 9.5	↗	9: 10.4*	↘	10: 9.9	↗	Series	91.0	Total	91.0
1: 10.0	↑																									
2: 10.1	↘																									
3: 8.5	↗																									
4: 8.3	←																									
5: 10.6*	→																									
6: 7.5	↘																									
7: 10.2*	←																									
8: 9.5	↗																									
9: 10.4*	↘																									
10: 9.9	↗																									
Series	91.0																									
Total	91.0																									
<p>Series 3</p> 	<p>Series 4</p> 	<table border="1" style="width:100%; border-collapse: collapse;"> <tr><td>1: 9.5</td><td style="text-align: right;">↖</td></tr> <tr><td>2: 10.5*</td><td style="text-align: right;">↑</td></tr> <tr><td>3: 10.5*</td><td style="text-align: right;">↖</td></tr> <tr><td>4: 9.3</td><td style="text-align: right;">→</td></tr> <tr><td>5: 9.7</td><td style="text-align: right;">↗</td></tr> <tr><td>6: 9.8</td><td style="text-align: right;">↘</td></tr> <tr><td>7: 9.3</td><td style="text-align: right;">→</td></tr> <tr><td>8: 10.2*</td><td style="text-align: right;">←</td></tr> <tr><td>9: 9.4</td><td style="text-align: right;">↘</td></tr> <tr><td>10: 9.7</td><td style="text-align: right;">→</td></tr> <tr><td>Series</td><td style="text-align: right;">93.0</td></tr> <tr><td>Total</td><td style="text-align: right;">184.0</td></tr> </table>	1: 9.5	↖	2: 10.5*	↑	3: 10.5*	↖	4: 9.3	→	5: 9.7	↗	6: 9.8	↘	7: 9.3	→	8: 10.2*	←	9: 9.4	↘	10: 9.7	→	Series	93.0	Total	184.0
1: 9.5	↖																									
2: 10.5*	↑																									
3: 10.5*	↖																									
4: 9.3	→																									
5: 9.7	↗																									
6: 9.8	↘																									
7: 9.3	→																									
8: 10.2*	←																									
9: 9.4	↘																									
10: 9.7	→																									
Series	93.0																									
Total	184.0																									
<p>Series 5</p> 	<p>Series 6</p> 	<table border="1" style="width:100%; border-collapse: collapse;"> <tr><td>1: 9.7</td><td style="text-align: right;">↑</td></tr> <tr><td>2: 9.8</td><td style="text-align: right;">↘</td></tr> <tr><td>3: 8.2</td><td style="text-align: right;">→</td></tr> <tr><td>4: 10.0</td><td style="text-align: right;">→</td></tr> <tr><td>5: 10.1</td><td style="text-align: right;">↑</td></tr> <tr><td>6: 9.7</td><td style="text-align: right;">↗</td></tr> <tr><td>7: 9.7</td><td style="text-align: right;">→</td></tr> <tr><td>8: 10.5*</td><td style="text-align: right;">←</td></tr> <tr><td>9: 9.6</td><td style="text-align: right;">↗</td></tr> <tr><td>10: 7.9</td><td style="text-align: right;">←</td></tr> <tr><td>Series</td><td style="text-align: right;">90.0</td></tr> <tr><td>Total</td><td style="text-align: right;">274.0</td></tr> </table>	1: 9.7	↑	2: 9.8	↘	3: 8.2	→	4: 10.0	→	5: 10.1	↑	6: 9.7	↗	7: 9.7	→	8: 10.5*	←	9: 9.6	↗	10: 7.9	←	Series	90.0	Total	274.0
1: 9.7	↑																									
2: 9.8	↘																									
3: 8.2	→																									
4: 10.0	→																									
5: 10.1	↑																									
6: 9.7	↗																									
7: 9.7	→																									
8: 10.5*	←																									
9: 9.6	↗																									
10: 7.9	←																									
Series	90.0																									
Total	274.0																									
<p>Series 5</p> 	<p>Series 6</p> 	<table border="1" style="width:100%; border-collapse: collapse;"> <tr><td>1: 9.2</td><td style="text-align: right;">→</td></tr> <tr><td>2: 9.9</td><td style="text-align: right;">↘</td></tr> <tr><td>3: 9.5</td><td style="text-align: right;">↘</td></tr> <tr><td>4: 8.8</td><td style="text-align: right;">←</td></tr> <tr><td>5: 10.8*</td><td style="text-align: right;">↘</td></tr> <tr><td>6: 10.4*</td><td style="text-align: right;">↗</td></tr> <tr><td>7: 9.3</td><td style="text-align: right;">↘</td></tr> <tr><td>8: 10.0</td><td style="text-align: right;">→</td></tr> <tr><td>9: 10.2*</td><td style="text-align: right;">↘</td></tr> <tr><td>10: 8.3</td><td style="text-align: right;">↘</td></tr> <tr><td>Series</td><td style="text-align: right;">92.0</td></tr> <tr><td>Total</td><td style="text-align: right;">457.0</td></tr> </table>	1: 9.2	→	2: 9.9	↘	3: 9.5	↘	4: 8.8	←	5: 10.8*	↘	6: 10.4*	↗	7: 9.3	↘	8: 10.0	→	9: 10.2*	↘	10: 8.3	↘	Series	92.0	Total	457.0
1: 9.2	→																									
2: 9.9	↘																									
3: 9.5	↘																									
4: 8.8	←																									
5: 10.8*	↘																									
6: 10.4*	↗																									
7: 9.3	↘																									
8: 10.0	→																									
9: 10.2*	↘																									
10: 8.3	↘																									
Series	92.0																									
Total	457.0																									
<p>Series 5</p> 	<p>Series 6</p> 	<table border="1" style="width:100%; border-collapse: collapse;"> <tr><td>1: 10.2*</td><td style="text-align: right;">↗</td></tr> <tr><td>2: 9.6</td><td style="text-align: right;">→</td></tr> <tr><td>3: 10.5*</td><td style="text-align: right;">↘</td></tr> <tr><td>4: 10.5*</td><td style="text-align: right;">←</td></tr> <tr><td>5: 9.3</td><td style="text-align: right;">↘</td></tr> <tr><td>6: 9.3</td><td style="text-align: right;">↘</td></tr> <tr><td>7: 10.4*</td><td style="text-align: right;">↗</td></tr> <tr><td>8: 9.7</td><td style="text-align: right;">→</td></tr> <tr><td>9: 10.2*</td><td style="text-align: right;">↗</td></tr> <tr><td>10: 8.6</td><td style="text-align: right;">↑</td></tr> <tr><td>Series</td><td style="text-align: right;">94.0</td></tr> <tr><td>Total</td><td style="text-align: right;">551.0</td></tr> </table>	1: 10.2*	↗	2: 9.6	→	3: 10.5*	↘	4: 10.5*	←	5: 9.3	↘	6: 9.3	↘	7: 10.4*	↗	8: 9.7	→	9: 10.2*	↗	10: 8.6	↑	Series	94.0	Total	551.0
1: 10.2*	↗																									
2: 9.6	→																									
3: 10.5*	↘																									
4: 10.5*	←																									
5: 9.3	↘																									
6: 9.3	↘																									
7: 10.4*	↗																									
8: 9.7	→																									
9: 10.2*	↗																									
10: 8.6	↑																									
Series	94.0																									
Total	551.0																									

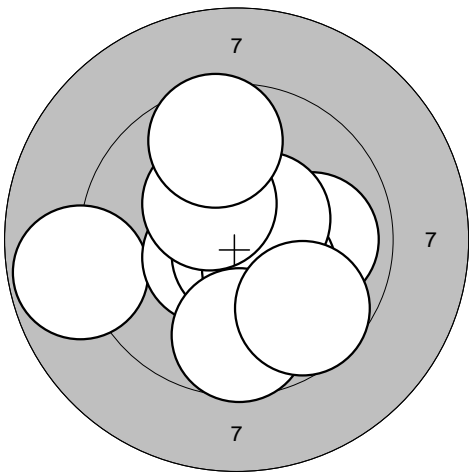
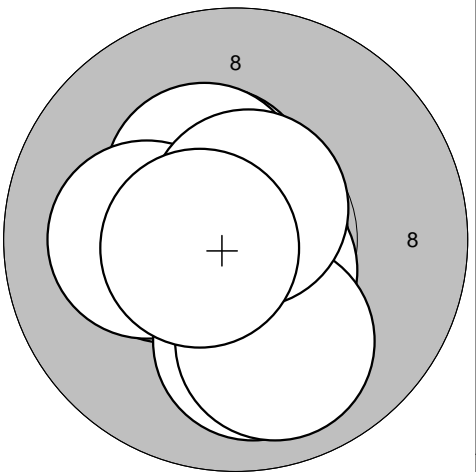
<p>Series 1</p> 	<p>Series 2</p> 	<p>Series 1</p> <p>1: 8.8 ←</p> <p>2: 10.5* ↙</p> <p>3: 10.7* ↓</p> <p>4: 9.9 →</p> <p>5: 10.4* ↘</p> <p>6: 10.5* ↗</p> <p>7: 9.7 ↓</p> <p>8: 9.7 ↘</p> <p>9: 10.4* ↗</p> <p>10: 9.6 ↑</p> <hr/> <p>Series 94.0</p> <hr/> <p>Total 94.0</p>	<p>Series 2</p> <p>1: 10.4* ←</p> <p>2: 10.4* ↗</p> <p>3: 10.4* ↗</p> <p>4: 10.2* ←</p> <p>5: 10.8* →</p> <p>6: 10.6* ↘</p> <p>7: 10.0 ↓</p> <p>8: 9.9 ↓</p> <p>9: 10.7* ↗</p> <p>10: 10.6* ←</p> <hr/> <p>Series 99.0</p> <hr/> <p>Total 193.0</p>
--	--	---	---

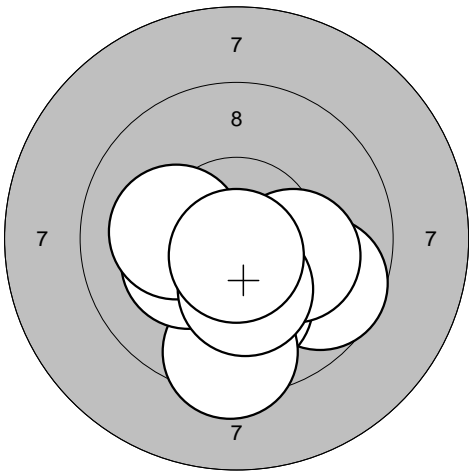
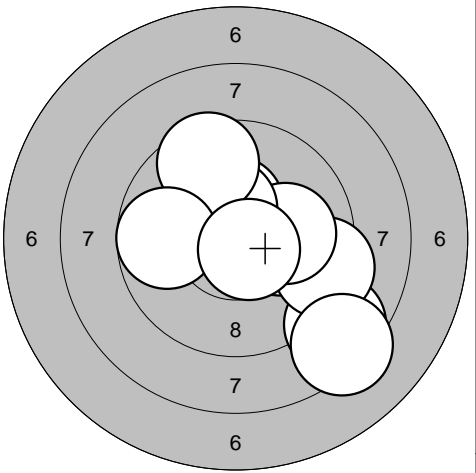
<p>Series 3</p> 	<p>Series 4</p> 	<p>Series 3</p> <p>1: 10.5* ↘</p> <p>2: 10.1 ↓</p> <p>3: 9.7 →</p> <p>4: 10.1 ↓</p> <p>5: 9.4 ↓</p> <p>6: 10.2* ←</p> <p>7: 10.2* ←</p> <p>8: 10.2* →</p> <p>9: 10.3* ↓</p> <p>10: 10.7* ↓</p> <hr/> <p>Series 98.0</p> <hr/> <p>Total 291.0</p>	<p>Series 4</p> <p>1: 10.2* →</p> <p>2: 10.4* ↑</p> <p>3: 8.6 ↘</p> <p>4: 9.3 →</p> <p>5: 10.1 →</p> <p>6: 10.4* ↑</p> <p>7: 8.3 ↘</p> <p>8: 9.5 ↑</p> <p>9: 9.8 ←</p> <p>10: 10.6* ↘</p> <hr/> <p>Series 93.0</p> <hr/> <p>Total 384.0</p>
---	---	--	---

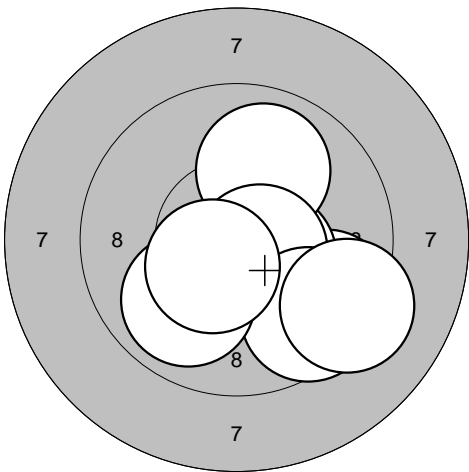
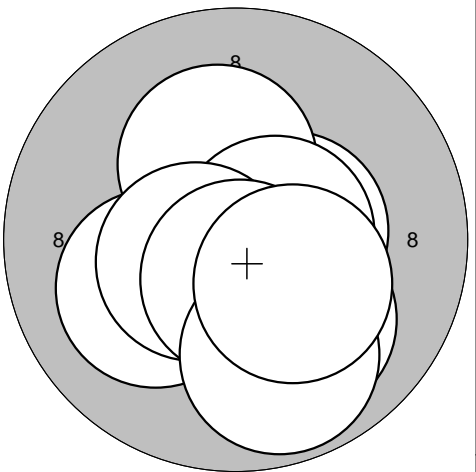
<p>Series 5</p> 	<p>Series 6</p> 	<p>Series 5</p> <p>1: 9.5 ↘</p> <p>2: 10.5* ↘</p> <p>3: 10.5* →</p> <p>4: 10.0 ↑</p> <p>5: 10.6* →</p> <p>6: 10.3* ↘</p> <p>7: 9.5 ↘</p> <p>8: 9.9 ↘</p> <p>9: 9.2 ↘</p> <p>10: 10.5* ↘</p> <hr/> <p>Series 96.0</p> <hr/> <p>Total 480.0</p>	<p>Series 6</p> <p>1: 10.7* ↑</p> <p>2: 10.0 ↘</p> <p>3: 10.1 ←</p> <p>4: 10.5* →</p> <p>5: 10.3* ↑</p> <p>6: 10.6* →</p> <p>7: 10.5* ↙</p> <p>8: 10.6* ↓</p> <p>9: 9.8 ↓</p> <p>10: 10.3* ↘</p> <hr/> <p>Series 99.0</p> <hr/> <p>Total 579.0</p>
--	--	---	--

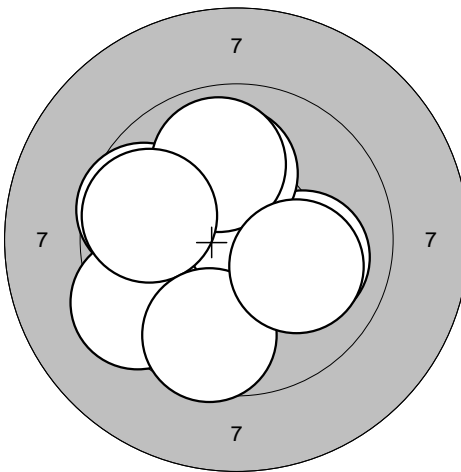
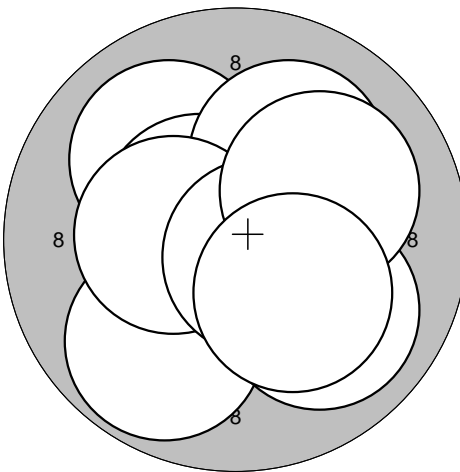
<p>Series 1</p> 	<table border="0" style="width:100%;"> <tr><td>1: 10.0</td><td>➔</td></tr> <tr><td>2: 10.3*</td><td>↖</td></tr> <tr><td>3: 10.1</td><td>↑</td></tr> <tr><td>4: 9.7</td><td>↖</td></tr> <tr><td>5: 10.6*</td><td>↓</td></tr> <tr><td>6: 9.4</td><td>↖</td></tr> <tr><td>7: 9.9</td><td>↑</td></tr> <tr><td>8: 9.8</td><td>↖</td></tr> <tr><td>9: 9.6</td><td>↓</td></tr> <tr><td>10: 10.1</td><td>➔</td></tr> </table> <table border="1" style="width:100%; border-collapse: collapse; margin-top: 5px;"> <tr><td style="text-align: right;">Series</td><td style="text-align: left;">95.0</td></tr> <tr><td style="text-align: right;">Total</td><td style="text-align: left;">95.0</td></tr> </table>	1: 10.0	➔	2: 10.3*	↖	3: 10.1	↑	4: 9.7	↖	5: 10.6*	↓	6: 9.4	↖	7: 9.9	↑	8: 9.8	↖	9: 9.6	↓	10: 10.1	➔	Series	95.0	Total	95.0	<p>Series 2</p> 	<table border="0" style="width:100%;"> <tr><td>1: 10.0</td><td>↖</td></tr> <tr><td>2: 10.2*</td><td>↗</td></tr> <tr><td>3: 10.5*</td><td>↖</td></tr> <tr><td>4: 10.1</td><td>↗</td></tr> <tr><td>5: 9.8</td><td>↘</td></tr> <tr><td>6: 10.0</td><td>↘</td></tr> <tr><td>7: 10.4*</td><td>↖</td></tr> <tr><td>8: 10.7*</td><td>↘</td></tr> <tr><td>9: 10.1</td><td>↗</td></tr> <tr><td>10: 10.3*</td><td>↘</td></tr> </table> <table border="1" style="width:100%; border-collapse: collapse; margin-top: 5px;"> <tr><td style="text-align: right;">Series</td><td style="text-align: left;">99.0</td></tr> <tr><td style="text-align: right;">Total</td><td style="text-align: left;">194.0</td></tr> </table>	1: 10.0	↖	2: 10.2*	↗	3: 10.5*	↖	4: 10.1	↗	5: 9.8	↘	6: 10.0	↘	7: 10.4*	↖	8: 10.7*	↘	9: 10.1	↗	10: 10.3*	↘	Series	99.0	Total	194.0
1: 10.0	➔																																																		
2: 10.3*	↖																																																		
3: 10.1	↑																																																		
4: 9.7	↖																																																		
5: 10.6*	↓																																																		
6: 9.4	↖																																																		
7: 9.9	↑																																																		
8: 9.8	↖																																																		
9: 9.6	↓																																																		
10: 10.1	➔																																																		
Series	95.0																																																		
Total	95.0																																																		
1: 10.0	↖																																																		
2: 10.2*	↗																																																		
3: 10.5*	↖																																																		
4: 10.1	↗																																																		
5: 9.8	↘																																																		
6: 10.0	↘																																																		
7: 10.4*	↖																																																		
8: 10.7*	↘																																																		
9: 10.1	↗																																																		
10: 10.3*	↘																																																		
Series	99.0																																																		
Total	194.0																																																		

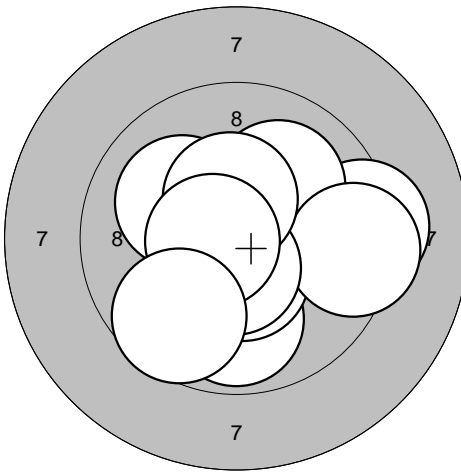
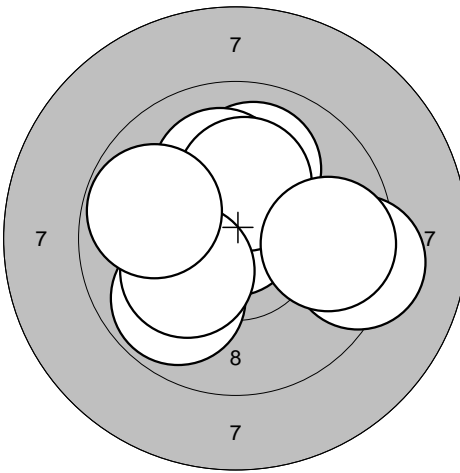
<p>Series 3</p> 	<table border="0" style="width:100%;"> <tr><td>1: 9.9</td><td>↓</td></tr> <tr><td>2: 10.5*</td><td>↓</td></tr> <tr><td>3: 9.3</td><td>➔</td></tr> <tr><td>4: 10.1</td><td>↗</td></tr> <tr><td>5: 9.4</td><td>➔</td></tr> <tr><td>6: 10.5*</td><td>↓</td></tr> <tr><td>7: 10.1</td><td>↖</td></tr> <tr><td>8: 10.4*</td><td>↑</td></tr> <tr><td>9: 10.6*</td><td>↖</td></tr> <tr><td>10: 9.6</td><td>↘</td></tr> </table> <table border="1" style="width:100%; border-collapse: collapse; margin-top: 5px;"> <tr><td style="text-align: right;">Series</td><td style="text-align: left;">96.0</td></tr> <tr><td style="text-align: right;">Total</td><td style="text-align: left;">290.0</td></tr> </table>	1: 9.9	↓	2: 10.5*	↓	3: 9.3	➔	4: 10.1	↗	5: 9.4	➔	6: 10.5*	↓	7: 10.1	↖	8: 10.4*	↑	9: 10.6*	↖	10: 9.6	↘	Series	96.0	Total	290.0	<p>Series 4</p> 	<table border="0" style="width:100%;"> <tr><td>1: 10.6*</td><td>↗</td></tr> <tr><td>2: 9.8</td><td>↘</td></tr> <tr><td>3: 9.3</td><td>➔</td></tr> <tr><td>4: 10.0</td><td>↑</td></tr> <tr><td>5: 10.1</td><td>↑</td></tr> <tr><td>6: 10.8*</td><td>↑</td></tr> <tr><td>7: 10.2*</td><td>↑</td></tr> <tr><td>8: 9.7</td><td>➔</td></tr> <tr><td>9: 10.2*</td><td>↖</td></tr> <tr><td>10: 9.8</td><td>↖</td></tr> </table> <table border="1" style="width:100%; border-collapse: collapse; margin-top: 5px;"> <tr><td style="text-align: right;">Series</td><td style="text-align: left;">96.0</td></tr> <tr><td style="text-align: right;">Total</td><td style="text-align: left;">386.0</td></tr> </table>	1: 10.6*	↗	2: 9.8	↘	3: 9.3	➔	4: 10.0	↑	5: 10.1	↑	6: 10.8*	↑	7: 10.2*	↑	8: 9.7	➔	9: 10.2*	↖	10: 9.8	↖	Series	96.0	Total	386.0
1: 9.9	↓																																																		
2: 10.5*	↓																																																		
3: 9.3	➔																																																		
4: 10.1	↗																																																		
5: 9.4	➔																																																		
6: 10.5*	↓																																																		
7: 10.1	↖																																																		
8: 10.4*	↑																																																		
9: 10.6*	↖																																																		
10: 9.6	↘																																																		
Series	96.0																																																		
Total	290.0																																																		
1: 10.6*	↗																																																		
2: 9.8	↘																																																		
3: 9.3	➔																																																		
4: 10.0	↑																																																		
5: 10.1	↑																																																		
6: 10.8*	↑																																																		
7: 10.2*	↑																																																		
8: 9.7	➔																																																		
9: 10.2*	↖																																																		
10: 9.8	↖																																																		
Series	96.0																																																		
Total	386.0																																																		

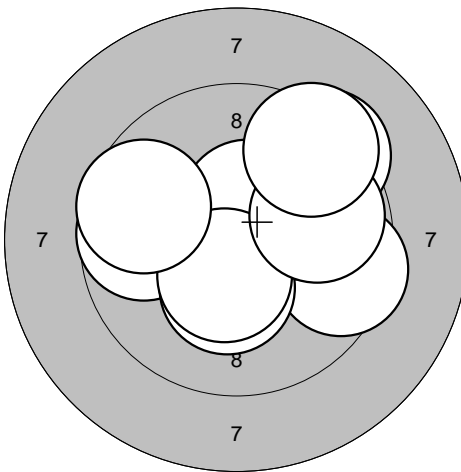
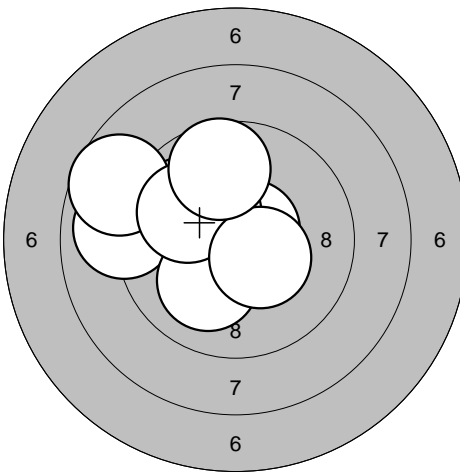
<p>Series 5</p> 	<table border="0" style="width:100%;"> <tr><td>1: 9.5</td><td>➔</td></tr> <tr><td>2: 10.1</td><td>↗</td></tr> <tr><td>3: 10.5*</td><td>↑</td></tr> <tr><td>4: 9.7</td><td>↖</td></tr> <tr><td>5: 10.3*</td><td>↓</td></tr> <tr><td>6: 9.3</td><td>↗</td></tr> <tr><td>7: 10.4*</td><td>↓</td></tr> <tr><td>8: 9.8</td><td>➔</td></tr> <tr><td>9: 9.6</td><td>↖</td></tr> <tr><td>10: 9.4</td><td>↗</td></tr> </table> <table border="1" style="width:100%; border-collapse: collapse; margin-top: 5px;"> <tr><td style="text-align: right;">Series</td><td style="text-align: left;">94.0</td></tr> <tr><td style="text-align: right;">Total</td><td style="text-align: left;">480.0</td></tr> </table>	1: 9.5	➔	2: 10.1	↗	3: 10.5*	↑	4: 9.7	↖	5: 10.3*	↓	6: 9.3	↗	7: 10.4*	↓	8: 9.8	➔	9: 9.6	↖	10: 9.4	↗	Series	94.0	Total	480.0	<p>Series 6</p> 	<table border="0" style="width:100%;"> <tr><td>1: 10.7*</td><td>↖</td></tr> <tr><td>2: 10.6*</td><td>↗</td></tr> <tr><td>3: 9.9</td><td>↖</td></tr> <tr><td>4: 9.0</td><td>↖</td></tr> <tr><td>5: 8.7</td><td>↖</td></tr> <tr><td>6: 10.3*</td><td>↗</td></tr> <tr><td>7: 10.1</td><td>↘</td></tr> <tr><td>8: 10.0</td><td>↖</td></tr> <tr><td>9: 10.4*</td><td>↘</td></tr> <tr><td>10: 9.7</td><td>↑</td></tr> </table> <table border="1" style="width:100%; border-collapse: collapse; margin-top: 5px;"> <tr><td style="text-align: right;">Series</td><td style="text-align: left;">95.0</td></tr> <tr><td style="text-align: right;">Total</td><td style="text-align: left;">575.0</td></tr> </table>	1: 10.7*	↖	2: 10.6*	↗	3: 9.9	↖	4: 9.0	↖	5: 8.7	↖	6: 10.3*	↗	7: 10.1	↘	8: 10.0	↖	9: 10.4*	↘	10: 9.7	↑	Series	95.0	Total	575.0
1: 9.5	➔																																																		
2: 10.1	↗																																																		
3: 10.5*	↑																																																		
4: 9.7	↖																																																		
5: 10.3*	↓																																																		
6: 9.3	↗																																																		
7: 10.4*	↓																																																		
8: 9.8	➔																																																		
9: 9.6	↖																																																		
10: 9.4	↗																																																		
Series	94.0																																																		
Total	480.0																																																		
1: 10.7*	↖																																																		
2: 10.6*	↗																																																		
3: 9.9	↖																																																		
4: 9.0	↖																																																		
5: 8.7	↖																																																		
6: 10.3*	↗																																																		
7: 10.1	↘																																																		
8: 10.0	↖																																																		
9: 10.4*	↘																																																		
10: 9.7	↑																																																		
Series	95.0																																																		
Total	575.0																																																		

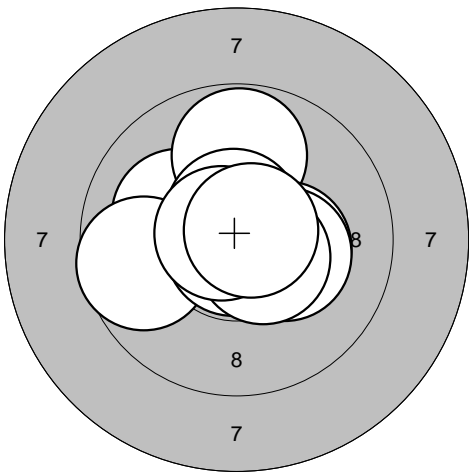
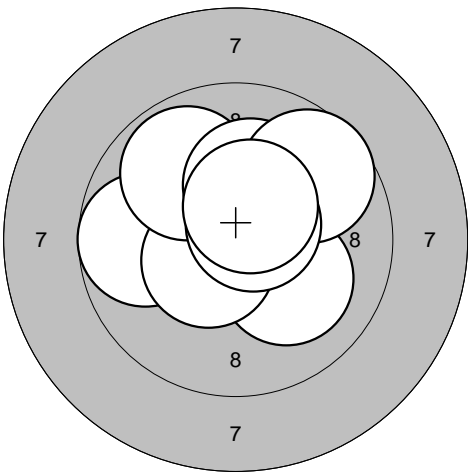
<p>Series 1</p> 	<p>1: 10.1 ←</p> <p>2: 9.7 ←←</p> <p>3: 9.8 ↑</p> <p>4: 10.8* ↓</p> <p>5: 10.3* →</p> <p>6: 10.3* →</p> <p>7: 10.6* ↑</p> <p>8: 10.5* ↓</p> <p>9: 10.7* ←</p> <p>10: 10.7* ↗</p>	<p>Series 2</p> 	<p>1: 9.8 ←</p> <p>2: 10.8* ↓</p> <p>3: 10.1 ↓</p> <p>4: 10.6* ↗</p> <p>5: 10.5* ↙</p> <p>6: 9.8 ↗</p> <p>7: 10.2* ↑</p> <p>8: 9.7 ↗</p> <p>9: 10.6* ↗</p> <p>10: 10.5* ↑</p>
Series 98.0	Series 97.0		
Total 98.0	Total 195.0		

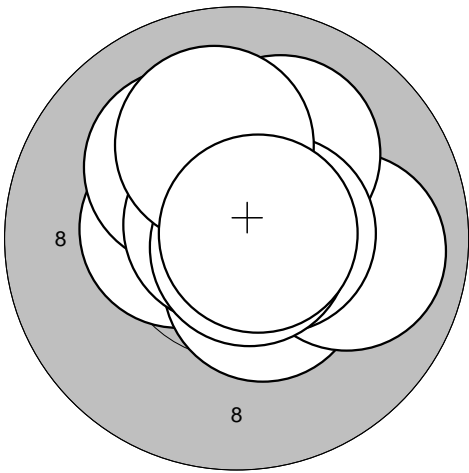
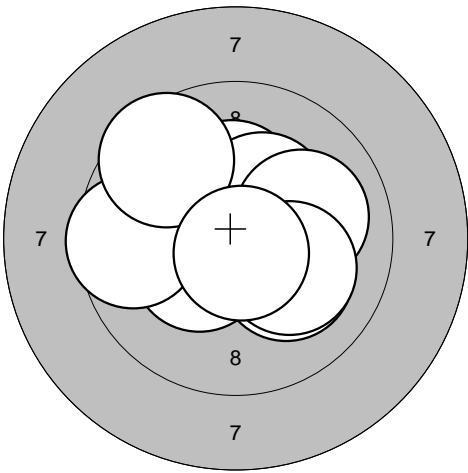
<p>Series 3</p> 	<p>1: 10.4* ←</p> <p>2: 10.1 ↗</p> <p>3: 10.5* ↓</p> <p>4: 9.9 →</p> <p>5: 10.1 ↗</p> <p>6: 10.8* ↗</p> <p>7: 10.6* →</p> <p>8: 10.8* ↓</p> <p>9: 10.1 ↑</p> <p>10: 10.8* →</p>	<p>Series 4</p> 	<p>1: 10.2* ←</p> <p>2: 10.3* ↑</p> <p>3: 10.4* ↙</p> <p>4: 9.6 ←</p> <p>5: 10.3* ↗</p> <p>6: 9.6 ↗</p> <p>7: 10.0 →</p> <p>8: 10.1 ↓</p> <p>9: 10.1 ↓</p> <p>10: 10.7* ↓</p>
Series 99.0	Series 98.0		
Total 294.0	Total 392.0		

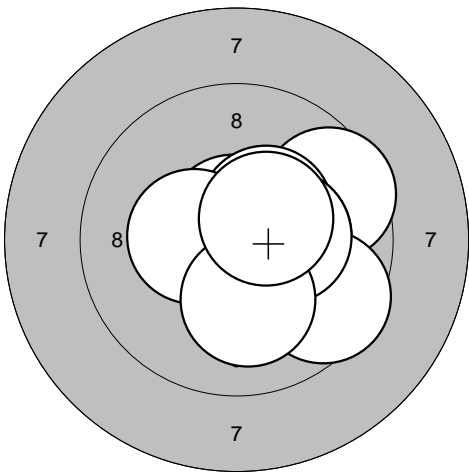
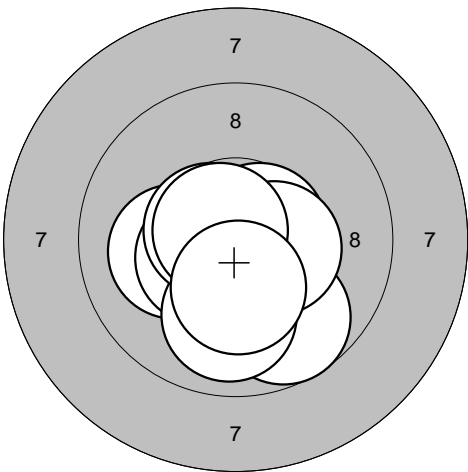
<p>Series 5</p> 	<p>1: 10.3* ↓</p> <p>2: 10.7* ↑</p> <p>3: 9.6 →</p> <p>4: 10.4* ↗</p> <p>5: 10.3* →</p> <p>6: 10.4* ←</p> <p>7: 9.6 ↓</p> <p>8: 10.3* →</p> <p>9: 10.2* ↓</p> <p>10: 10.4* ↗</p>	<p>Series 6</p> 	<p>1: 10.8* ↓</p> <p>2: 10.1 ←</p> <p>3: 10.6* →</p> <p>4: 10.4* ↙</p> <p>5: 9.7 ↓</p> <p>6: 10.4* →</p> <p>7: 9.9 ↓</p> <p>8: 10.6* ←</p> <p>9: 10.7* ↙</p> <p>10: 10.3* ↓</p>
Series 98.0	Series 98.0		
Total 490.0	Total 588.0		

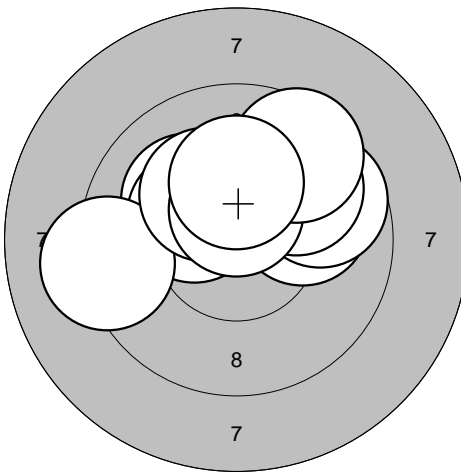
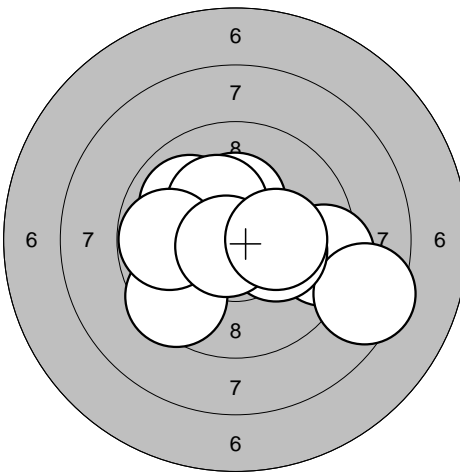
<p>Series 1</p> 	<p>1: 10.1 ↖</p> <p>2: 10.3* ↖</p> <p>3: 9.2 ←</p> <p>4: 10.0 →</p> <p>5: 9.7 →</p> <p>6: 9.9 ↗</p> <p>7: 10.2* ↖</p> <p>8: 10.6* ↑</p> <p>9: 9.6 ↗</p> <p>10: 10.2* ↑</p>	<p>Series 2</p> 	<p>1: 9.9 ↖</p> <p>2: 9.5 ↙</p> <p>3: 9.4 →</p> <p>4: 10.3* ↑</p> <p>5: 8.5 →</p> <p>6: 10.2* →</p> <p>7: 10.3* ↗</p> <p>8: 9.8 ←</p> <p>9: 10.7* ↙</p> <p>10: 10.2* →</p>
Series 96.0	Series 94.0		
Total 96.0	Total 190.0		

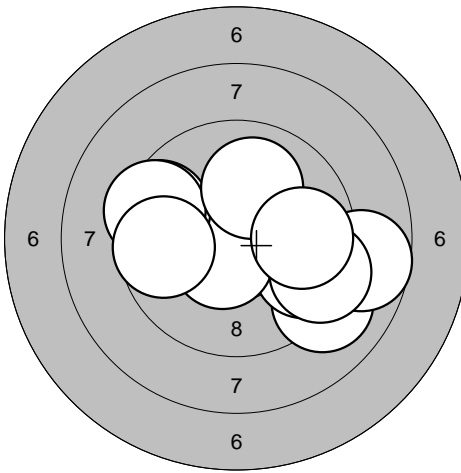
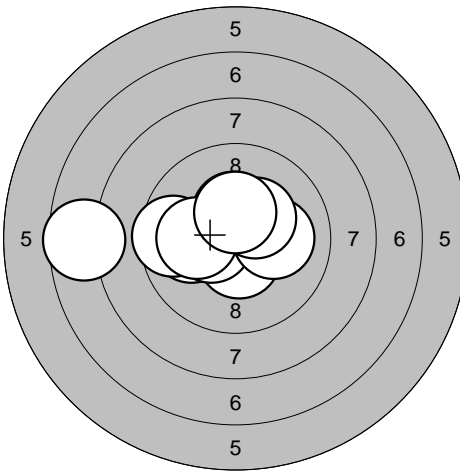
<p>Series 3</p> 	<p>1: 9.0 ↘</p> <p>2: 9.6 →</p> <p>3: 10.5* ↙</p> <p>4: 9.5 ↖</p> <p>5: 9.4 ↖</p> <p>6: 8.7 →</p> <p>7: 9.4 →</p> <p>8: 10.0 ↑</p> <p>9: 9.8 →</p> <p>10: 9.6 ←</p>	<p>Series 4</p> 	<p>1: 10.5* ↓</p> <p>2: 10.0 ←</p> <p>3: 10.4* ↑</p> <p>4: 10.4* ←</p> <p>5: 9.6 ←</p> <p>6: 10.1 →</p> <p>7: 10.1 ←</p> <p>8: 7.6 ←</p> <p>9: 10.4* ↗</p> <p>10: 10.4* ↑</p>
Series 91.0	Series 96.0		
Total 281.0	Total 377.0		

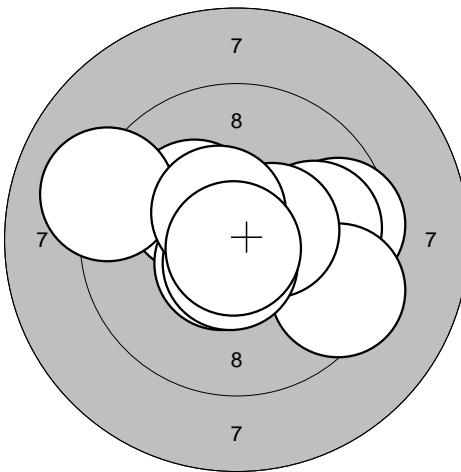
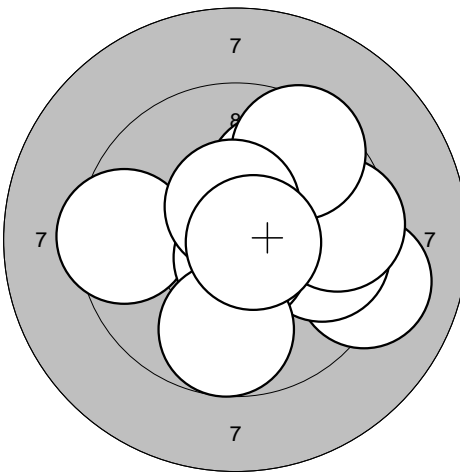
<p>Series 5</p> 	<p>1: 9.6 →</p> <p>2: 10.2* ↖</p> <p>3: 9.9 →</p> <p>4: 9.4 →</p> <p>5: 10.6* ↙</p> <p>6: 9.1 ↖</p> <p>7: 10.4* →</p> <p>8: 10.6* ↙</p> <p>9: 10.5* ↖</p> <p>10: 10.8* ↙</p>	<p>Series 6</p> 	<p>1: 9.5 ←</p> <p>2: 10.0 ↗</p> <p>3: 9.1 →</p> <p>4: 9.8 →</p> <p>5: 10.7* ↙</p> <p>6: 9.6 →</p> <p>7: 9.5 ↗</p> <p>8: 9.8 ↓</p> <p>9: 10.5* ↑</p> <p>10: 10.7* →</p>
Series 96.0	Series 94.0		
Total 473.0	Total 567.0		

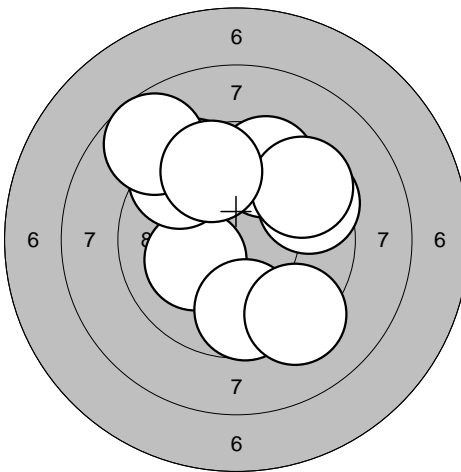
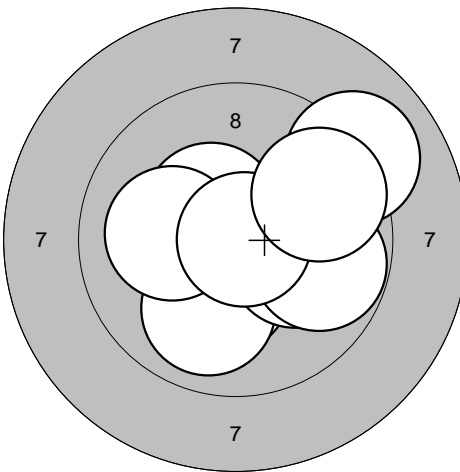
Series 1 	1: 9.5 → 2: 9.5 ↗ 3: 10.1 ↖ 4: 9.6 ↗ 5: 9.5 ↗ 6: 9.7 ↓ 7: 9.5 ↗ 8: 8.7 ↗ 9: 9.7 ↗ 10: 9.3 ↓ <hr/> Series 90.0 Total 90.0	Series 2 	1: 10.3* ↓ 2: 10.0 ↓ 3: 10.4* ↗ 4: 10.1 → 5: 10.1 → 6: 10.1 ← 7: 9.1 ↗ 8: 9.8 → 9: 10.8* → 10: 9.7 ↗ <hr/> Series 97.0 Total 187.0
---	---	---	---

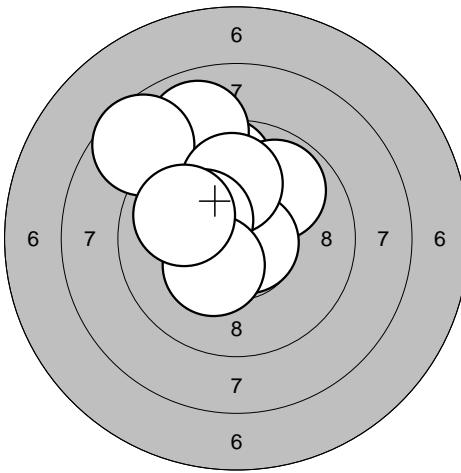
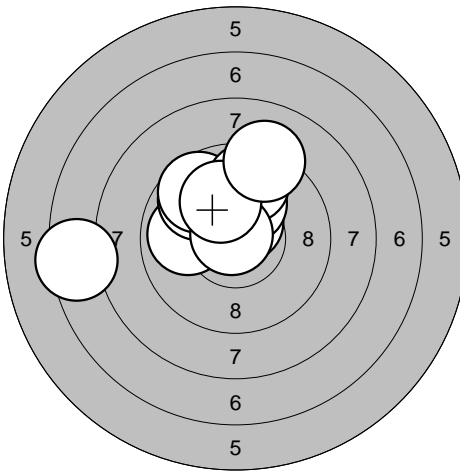
Series 3 	1: 9.7 ↗ 2: 10.7* ← 3: 8.9 ↗ 4: 9.9 ↗ 5: 10.7* → 6: 8.6 ↗ 7: 10.0 ↗ 8: 10.3* ↗ 9: 10.3* ↖ 10: 10.0 ↖ <hr/> Series 94.0 Total 281.0	Series 4 	1: 9.9 ← 2: 9.8 ↗ 3: 10.6* ↗ 4: 10.2* ↗ 5: 9.7 ↗ 6: 9.7 ↗ 7: 10.8* ↗ 8: 10.1 ↗ 9: 9.1 ↗ 10: 7.4 ← <hr/> Series 92.0 Total 373.0
--	---	--	--

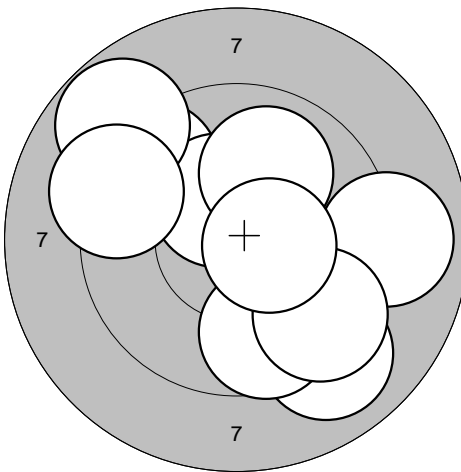
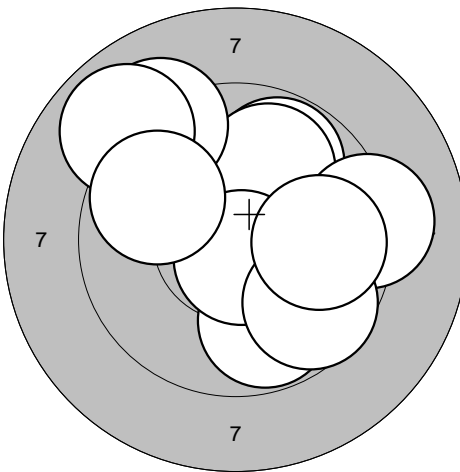
Series 5 	1: 9.5 ↗ 2: 9.0 → 3: 9.0 ↓ 4: 9.7 ↓ 5: 10.4* ↗ 6: 9.5 ↓ 7: 10.0 ↗ 8: 10.5* → 9: 8.8 ↗ 10: 9.2 ↗ <hr/> Series 92.0 Total 465.0	Series 6 	1: 9.8 ↗ 2: 9.9 ↗ 3: 9.8 ↓ 4: 10.7* ↓ 5: 9.1 ↗ 6: 8.9 ↗ 7: 9.2 → 8: 9.6 ↓ 9: 9.8 → 10: 9.8 ↖ <hr/> Series 90.0 Total 555.0
---	--	---	---

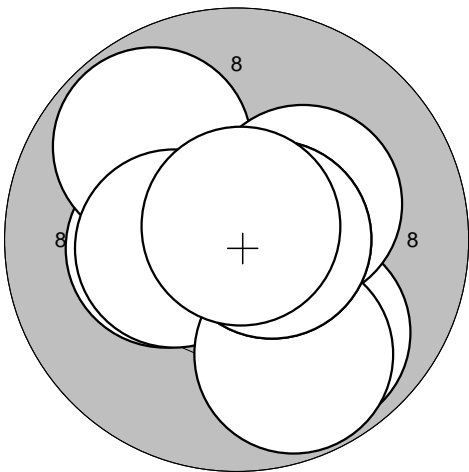
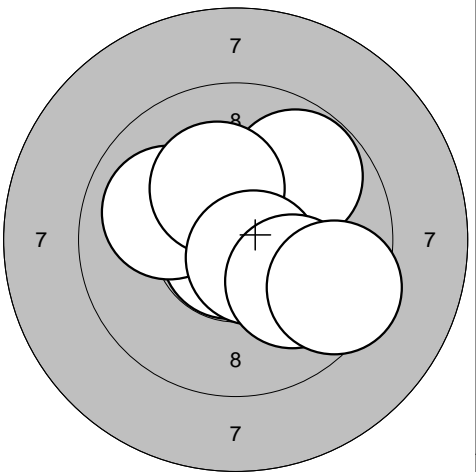
<p>Series 1</p> 	<p>1: 10.3* ←</p> <p>2: 10.9* →</p> <p>3: 9.8 ↗</p> <p>4: 9.9 ↘</p> <p>5: 10.3* ↗</p> <p>6: 10.4* ←</p> <p>7: 9.8 ↘</p> <p>8: 10.6* →</p> <p>9: 10.6* →</p> <p>10: 10.8* ↗</p>	<p>Series 2</p> 	<p>1: 10.5* →</p> <p>2: 10.4* ↗</p> <p>3: 10.8* ↗</p> <p>4: 9.8 ↗</p> <p>5: 10.8* ↘</p> <p>6: 10.0 ←</p> <p>7: 10.2* ↗</p> <p>8: 10.6* ↘</p> <p>9: 10.0 ↘</p> <p>10: 9.5 →</p>
Series 97.0	Series 98.0	Series 98.0	Series 98.0
Total 97.0	Total 195.0	Total 195.0	Total 195.0

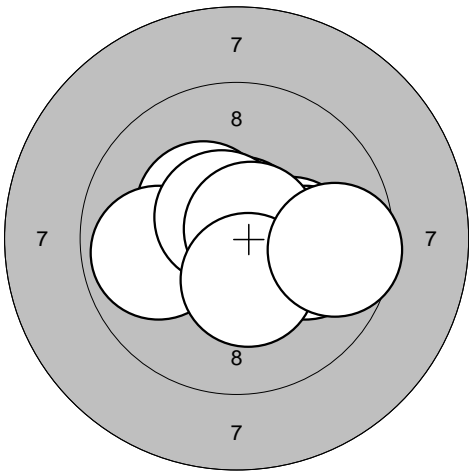
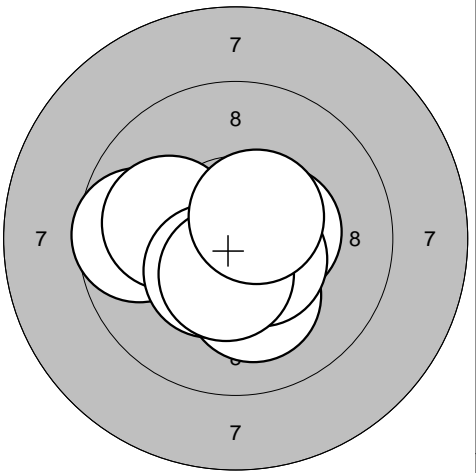
<p>Series 3</p> 	<p>1: 10.4* ↗</p> <p>2: 10.9* ↗</p> <p>3: 9.9 ←</p> <p>4: 10.2* →</p> <p>5: 10.0 →</p> <p>6: 10.8* ↗</p> <p>7: 10.6* ↗</p> <p>8: 10.7* ↗</p> <p>9: 10.4* ↘</p> <p>10: 9.6 →</p>	<p>Series 4</p> 	<p>1: 9.7 ←</p> <p>2: 10.5* ↘</p> <p>3: 10.6* ↗</p> <p>4: 10.0 ←</p> <p>5: 10.2* ↘</p> <p>6: 10.4* ↘</p> <p>7: 10.4* →</p> <p>8: 10.5* ↘</p> <p>9: 10.4* ↘</p> <p>10: 10.6* ↗</p>
Series 98.0	Series 99.0	Series 99.0	Series 99.0
Total 293.0	Total 392.0	Total 392.0	Total 392.0

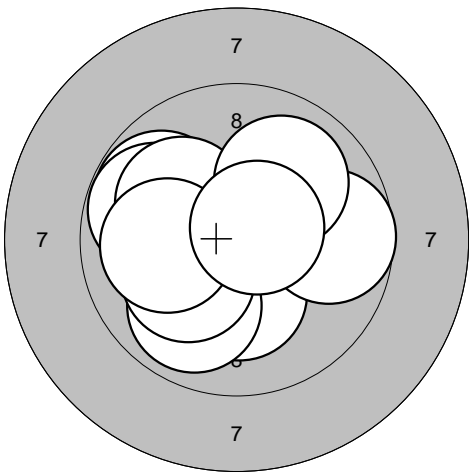
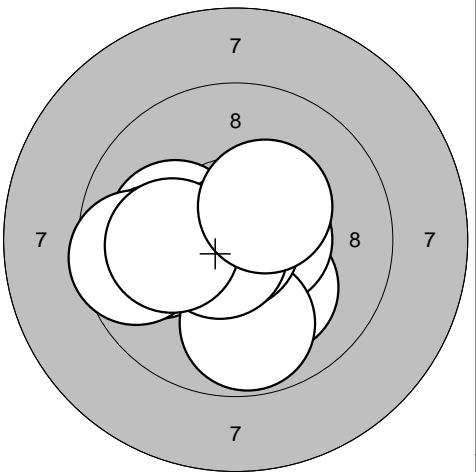
<p>Series 5</p> 	<p>1: 9.8 ↗</p> <p>2: 10.2* ↘</p> <p>3: 9.9 ↘</p> <p>4: 9.8 ←</p> <p>5: 9.7 →</p> <p>6: 10.1 ←</p> <p>7: 10.1 ↗</p> <p>8: 10.0 ↗</p> <p>9: 10.0 ←</p> <p>10: 10.6* ↗</p>	<p>Series 6</p> 	<p>1: 10.2* ↘</p> <p>2: 10.1 ←</p> <p>3: 10.6* →</p> <p>4: 9.9 ←</p> <p>5: 9.8 ↘</p> <p>6: 9.6 ←</p> <p>7: 10.9* ↘</p> <p>8: 10.7* ↘</p> <p>9: 10.1 ←</p> <p>10: 10.4* ↗</p>
Series 96.0	Series 97.0	Series 97.0	Series 97.0
Total 488.0	Total 585.0	Total 585.0	Total 585.0

Relay 1	Lane 60	Are Hansen
-------------------	-------------------	-------------------

Day 2, Rifle	Krapforss SSL	ARM
--------------	---------------	-----

3-6.1.2010	Swedish Cup 2010	Swedishcup 10
------------	------------------	---------------

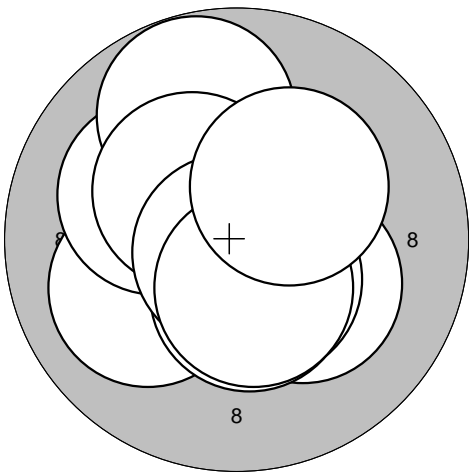
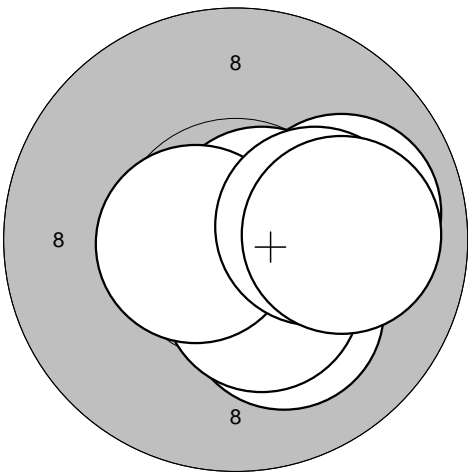
Series 1		1: 10.2* ↘ 2: 10.5* ↘ 3: 10.0 ← 4: 10.1 ↗ 5: 10.4* ↘ 6: 9.8 ↗ 7: 10.3* ↗ 8: 10.8* ↘ 9: 10.5* ↘ 10: 10.3* ↗ Series 99.0 Total 99.0	Series 2		1: 10.0 → 2: 10.8* ← 3: 10.6* → 4: 10.7* ← 5: 10.7* ↗ 6: 10.2* ↘ 7: 10.4* ↘ 8: 10.6* ← 9: 10.2* → 10: 10.0 → Series 100.0 Total 199.0
----------	--	--	----------	--	--

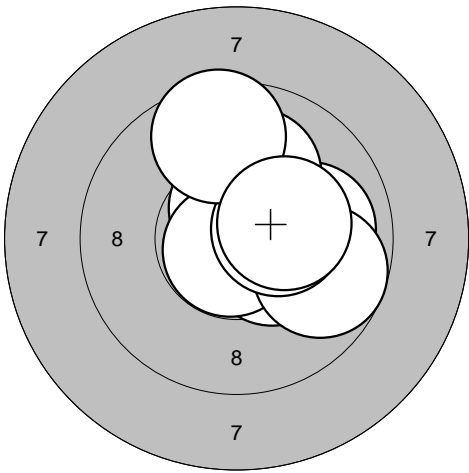
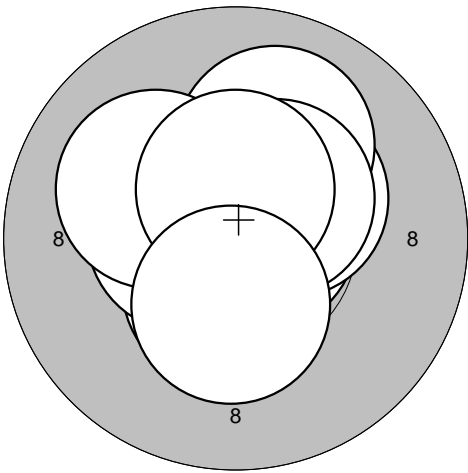
Series 3		1: 10.0 → 2: 10.6* ↑ 3: 10.4* ↘ 4: 10.0 → 5: 10.1 ↑ 6: 10.8* ↘ 7: 9.7 → 8: 10.4* → 9: 9.6 ↑ 10: 10.3* → Series 98.0 Total 297.0	Series 4		1: 10.5* ↓ 2: 10.7* → 3: 10.5* ← 4: 10.4* ↗ 5: 10.6* ↗ 6: 10.0 ↑ 7: 10.1 ↖ 8: 10.4* ↗ 9: 10.5* ↑ 10: 10.4* ↓ Series 100.0 Total 397.0
----------	---	--	----------	---	--

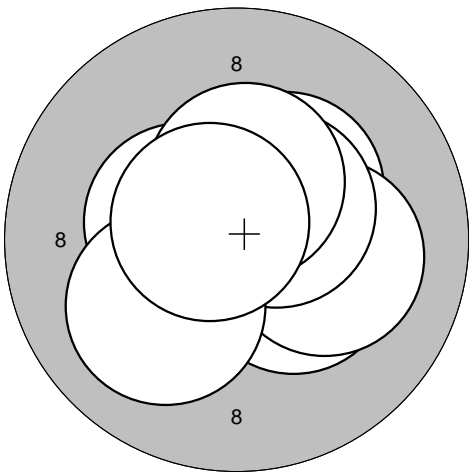
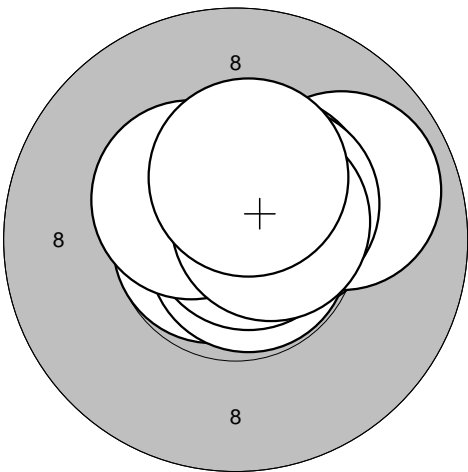
Series 5		1: 10.4* ← 2: 10.7* ↑ 3: 10.8* ↘ 4: 10.3* ↗ 5: 10.3* ↘ 6: 10.1 → 7: 10.5* ↗ 8: 10.1 ← 9: 10.4* ↑ 10: 10.6* ↖ Series 100.0 Total 497.0	Series 6		1: 10.8* ← 2: 10.4* ↗ 3: 9.9 → 4: 10.8* ↘ 5: 10.4* ↗ 6: 10.4* ↗ 7: 10.8* ↗ 8: 10.4* ↖ 9: 10.6* → 10: 10.4* ↑ Series 99.0 Total 596.0
----------	--	--	----------	--	---

Edman Precision, Morini, Interprodukter	Sävsjö kommun, Sävsjö Skytte Center
---	-------------------------------------

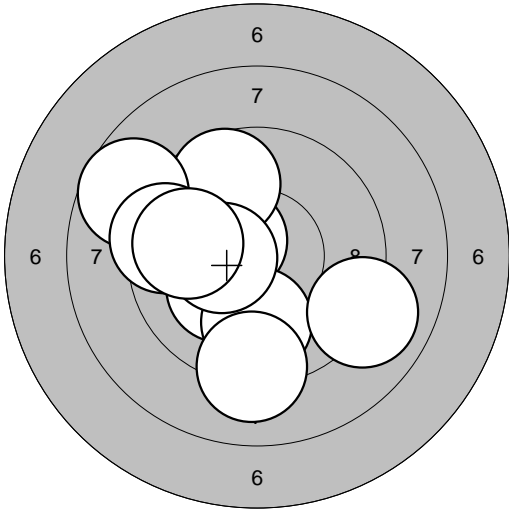
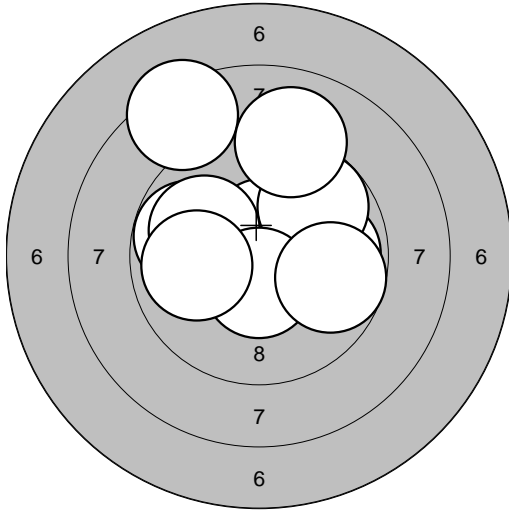
<p>Series 1</p> 	<table style="width:100%; border-collapse: collapse;"> <tr><td>1: 10.5*</td><td>↖</td></tr> <tr><td>2: 10.2*</td><td>↙</td></tr> <tr><td>3: 9.7</td><td>↗</td></tr> <tr><td>4: 8.7</td><td>↘</td></tr> <tr><td>5: 9.4</td><td>←</td></tr> <tr><td>6: 9.9</td><td>↓</td></tr> <tr><td>7: 10.4*</td><td>←</td></tr> <tr><td>8: 9.1</td><td>↓</td></tr> <tr><td>9: 9.8</td><td>←</td></tr> <tr><td>10: 9.0</td><td>↘</td></tr> <tr style="border-top: 1px solid black;"><td style="text-align: right;">Series</td><td style="text-align: right;">92.0</td></tr> <tr><td style="text-align: right;">Total</td><td style="text-align: right;">92.0</td></tr> </table>	1: 10.5*	↖	2: 10.2*	↙	3: 9.7	↗	4: 8.7	↘	5: 9.4	←	6: 9.9	↓	7: 10.4*	←	8: 9.1	↓	9: 9.8	←	10: 9.0	↘	Series	92.0	Total	92.0	<p>Series 2</p> 	<table style="width:100%; border-collapse: collapse;"> <tr><td>1: 8.4</td><td>↗</td></tr> <tr><td>2: 10.6*</td><td>↑</td></tr> <tr><td>3: 9.9</td><td>→</td></tr> <tr><td>4: 9.8</td><td>←</td></tr> <tr><td>5: 9.7</td><td>↗</td></tr> <tr><td>6: 10.0</td><td>↖</td></tr> <tr><td>7: 10.5*</td><td>↓</td></tr> <tr><td>8: 9.7</td><td>→</td></tr> <tr><td>9: 9.0</td><td>↑</td></tr> <tr><td>10: 9.9</td><td>←</td></tr> <tr style="border-top: 1px solid black;"><td style="text-align: right;">Series</td><td style="text-align: right;">92.0</td></tr> <tr><td style="text-align: right;">Total</td><td style="text-align: right;">184.0</td></tr> </table>	1: 8.4	↗	2: 10.6*	↑	3: 9.9	→	4: 9.8	←	5: 9.7	↗	6: 10.0	↖	7: 10.5*	↓	8: 9.7	→	9: 9.0	↑	10: 9.9	←	Series	92.0	Total	184.0
1: 10.5*	↖																																																		
2: 10.2*	↙																																																		
3: 9.7	↗																																																		
4: 8.7	↘																																																		
5: 9.4	←																																																		
6: 9.9	↓																																																		
7: 10.4*	←																																																		
8: 9.1	↓																																																		
9: 9.8	←																																																		
10: 9.0	↘																																																		
Series	92.0																																																		
Total	92.0																																																		
1: 8.4	↗																																																		
2: 10.6*	↑																																																		
3: 9.9	→																																																		
4: 9.8	←																																																		
5: 9.7	↗																																																		
6: 10.0	↖																																																		
7: 10.5*	↓																																																		
8: 9.7	→																																																		
9: 9.0	↑																																																		
10: 9.9	←																																																		
Series	92.0																																																		
Total	184.0																																																		

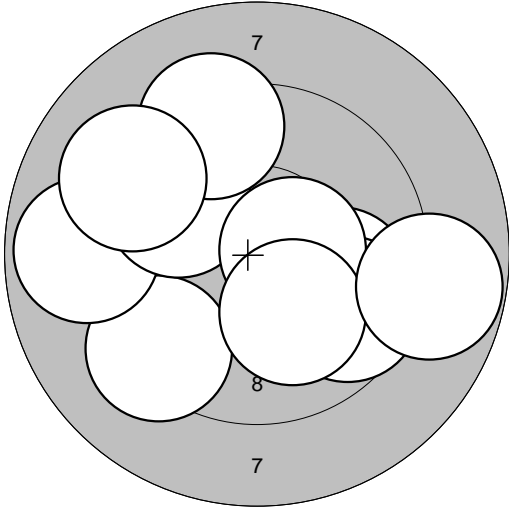
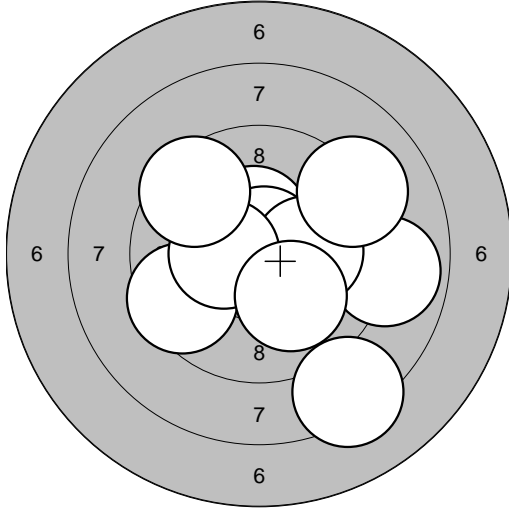
<p>Series 3</p> 	<table style="width:100%; border-collapse: collapse;"> <tr><td>1: 9.3</td><td>↙</td></tr> <tr><td>2: 9.9</td><td>→</td></tr> <tr><td>3: 9.6</td><td>↘</td></tr> <tr><td>4: 8.9</td><td>←</td></tr> <tr><td>5: 9.8</td><td>↗</td></tr> <tr><td>6: 9.3</td><td>↗</td></tr> <tr><td>7: 10.5*</td><td>→</td></tr> <tr><td>8: 10.1</td><td>↘</td></tr> <tr><td>9: 9.2</td><td>↗</td></tr> <tr><td>10: 8.8</td><td>→</td></tr> <tr style="border-top: 1px solid black;"><td style="text-align: right;">Series</td><td style="text-align: right;">90.0</td></tr> <tr><td style="text-align: right;">Total</td><td style="text-align: right;">274.0</td></tr> </table>	1: 9.3	↙	2: 9.9	→	3: 9.6	↘	4: 8.9	←	5: 9.8	↗	6: 9.3	↗	7: 10.5*	→	8: 10.1	↘	9: 9.2	↗	10: 8.8	→	Series	90.0	Total	274.0	<p>Series 4</p> 	<table style="width:100%; border-collapse: collapse;"> <tr><td>1: 10.4*</td><td>↑</td></tr> <tr><td>2: 8.3</td><td>↘</td></tr> <tr><td>3: 10.7*</td><td>↑</td></tr> <tr><td>4: 8.9</td><td>→</td></tr> <tr><td>5: 10.1</td><td>→</td></tr> <tr><td>6: 9.1</td><td>↗</td></tr> <tr><td>7: 9.5</td><td>↖</td></tr> <tr><td>8: 10.4*</td><td>←</td></tr> <tr><td>9: 10.1</td><td>↘</td></tr> <tr><td>10: 9.5</td><td>↗</td></tr> <tr style="border-top: 1px solid black;"><td style="text-align: right;">Series</td><td style="text-align: right;">93.0</td></tr> <tr><td style="text-align: right;">Total</td><td style="text-align: right;">367.0</td></tr> </table>	1: 10.4*	↑	2: 8.3	↘	3: 10.7*	↑	4: 8.9	→	5: 10.1	→	6: 9.1	↗	7: 9.5	↖	8: 10.4*	←	9: 10.1	↘	10: 9.5	↗	Series	93.0	Total	367.0
1: 9.3	↙																																																		
2: 9.9	→																																																		
3: 9.6	↘																																																		
4: 8.9	←																																																		
5: 9.8	↗																																																		
6: 9.3	↗																																																		
7: 10.5*	→																																																		
8: 10.1	↘																																																		
9: 9.2	↗																																																		
10: 8.8	→																																																		
Series	90.0																																																		
Total	274.0																																																		
1: 10.4*	↑																																																		
2: 8.3	↘																																																		
3: 10.7*	↑																																																		
4: 8.9	→																																																		
5: 10.1	→																																																		
6: 9.1	↗																																																		
7: 9.5	↖																																																		
8: 10.4*	←																																																		
9: 10.1	↘																																																		
10: 9.5	↗																																																		
Series	93.0																																																		
Total	367.0																																																		

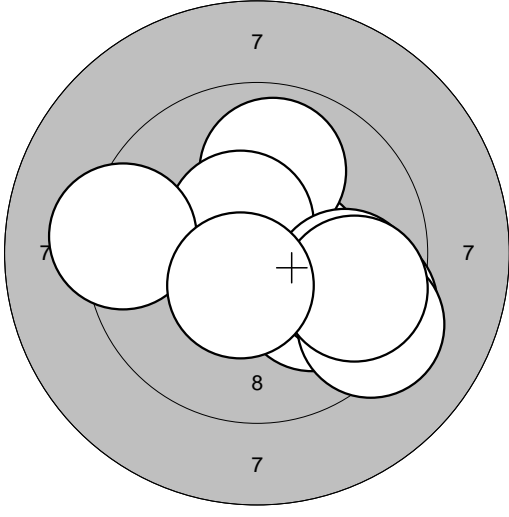
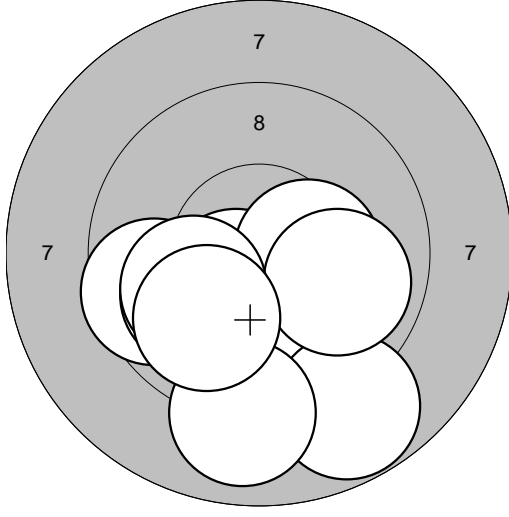
<p>Series 5</p> 	<table style="width:100%; border-collapse: collapse;"> <tr><td>1: 10.5*</td><td>→</td></tr> <tr><td>2: 9.5</td><td>↘</td></tr> <tr><td>3: 10.1</td><td>↘</td></tr> <tr><td>4: 9.9</td><td>↑</td></tr> <tr><td>5: 10.5*</td><td>↗</td></tr> <tr><td>6: 9.3</td><td>←</td></tr> <tr><td>7: 9.8</td><td>→</td></tr> <tr><td>8: 9.3</td><td>↘</td></tr> <tr><td>9: 9.7</td><td>→</td></tr> <tr><td>10: 10.5*</td><td>↘</td></tr> <tr style="border-top: 1px solid black;"><td style="text-align: right;">Series</td><td style="text-align: right;">94.0</td></tr> <tr><td style="text-align: right;">Total</td><td style="text-align: right;">461.0</td></tr> </table>	1: 10.5*	→	2: 9.5	↘	3: 10.1	↘	4: 9.9	↑	5: 10.5*	↗	6: 9.3	←	7: 9.8	→	8: 9.3	↘	9: 9.7	→	10: 10.5*	↘	Series	94.0	Total	461.0	<p>Series 6</p> 	<table style="width:100%; border-collapse: collapse;"> <tr><td>1: 10.5*</td><td>↘</td></tr> <tr><td>2: 9.6</td><td>←</td></tr> <tr><td>3: 10.3*</td><td>→</td></tr> <tr><td>4: 10.0</td><td>↖</td></tr> <tr><td>5: 9.5</td><td>↓</td></tr> <tr><td>6: 8.8</td><td>↘</td></tr> <tr><td>7: 9.0</td><td>↓</td></tr> <tr><td>8: 9.9</td><td>→</td></tr> <tr><td>9: 10.0</td><td>↖</td></tr> <tr><td>10: 9.9</td><td>↘</td></tr> <tr style="border-top: 1px solid black;"><td style="text-align: right;">Series</td><td style="text-align: right;">93.0</td></tr> <tr><td style="text-align: right;">Total</td><td style="text-align: right;">554.0</td></tr> </table>	1: 10.5*	↘	2: 9.6	←	3: 10.3*	→	4: 10.0	↖	5: 9.5	↓	6: 8.8	↘	7: 9.0	↓	8: 9.9	→	9: 10.0	↖	10: 9.9	↘	Series	93.0	Total	554.0
1: 10.5*	→																																																		
2: 9.5	↘																																																		
3: 10.1	↘																																																		
4: 9.9	↑																																																		
5: 10.5*	↗																																																		
6: 9.3	←																																																		
7: 9.8	→																																																		
8: 9.3	↘																																																		
9: 9.7	→																																																		
10: 10.5*	↘																																																		
Series	94.0																																																		
Total	461.0																																																		
1: 10.5*	↘																																																		
2: 9.6	←																																																		
3: 10.3*	→																																																		
4: 10.0	↖																																																		
5: 9.5	↓																																																		
6: 8.8	↘																																																		
7: 9.0	↓																																																		
8: 9.9	→																																																		
9: 10.0	↖																																																		
10: 9.9	↘																																																		
Series	93.0																																																		
Total	554.0																																																		

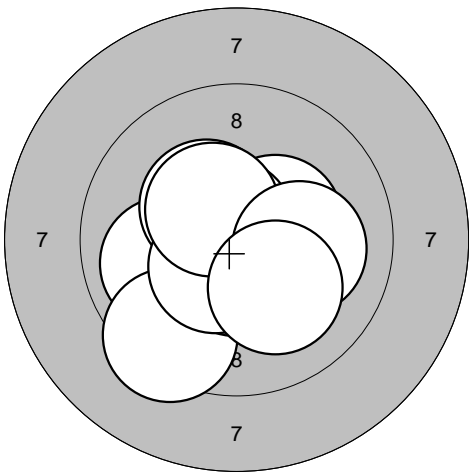
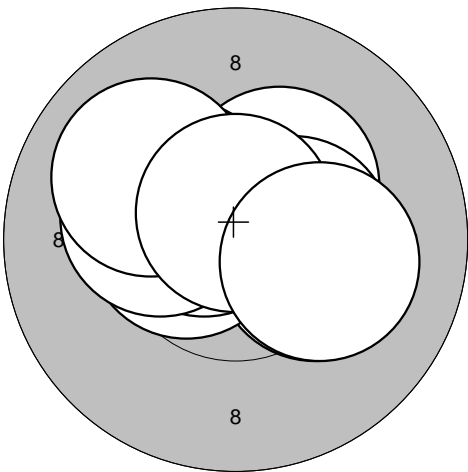
<p>Series 1</p> 	<p>1: 10.4* ↗ 2: 10.0 ← 3: 9.4 ↘ 4: 10.7* ↗ 5: 10.5* ↘ 6: 10.3* ↗ 7: 10.5* ↘ 8: 10.4* ↗ 9: 10.1 → 10: 10.1 ↘</p>	<p>Series 2</p> 	<p>1: 10.3* ↗ 2: 10.2* → 3: 10.4* → 4: 10.5* ← 5: 10.6* ↗ 6: 10.4* ↗ 7: 10.2* ← 8: 10.0 ↗ 9: 10.7* ↑ 10: 10.2* →</p>
Series 99.0	Series 100.0	Series 100.0	Series 100.0
Total 99.0	Total 99.0	Total 199.0	Total 199.0

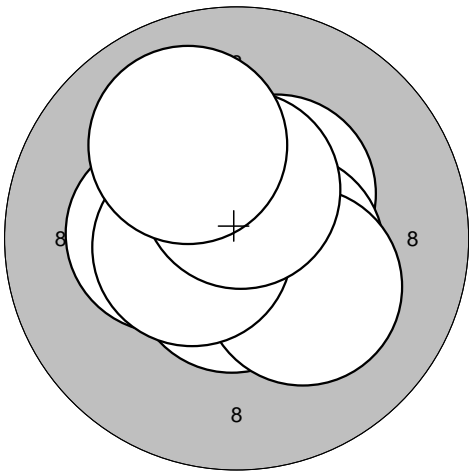
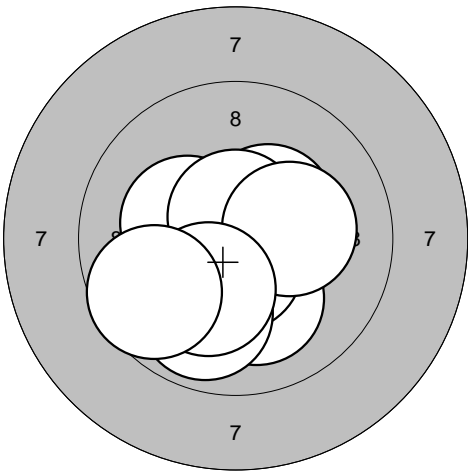
<p>Series 3</p> 	<p>1: 10.4* ↗ 2: 10.6* ↑ 3: 10.3* ← 4: 10.5* → 5: 10.6* ↘ 6: 10.7* ← 7: 10.2* ↘ 8: 10.5* ← 9: 10.5* ↑ 10: 10.0 ↗</p>	<p>Series 4</p> 	<p>1: 10.0 ← 2: 10.1 ↘ 3: 10.6* ↘ 4: 10.4* ↗ 5: 10.3* ← 6: 10.7* ↑ 7: 9.9 ↘ 8: 10.2* → 9: 10.2* ↘ 10: 9.7 ←</p>
Series 100.0	Series 100.0	Series 98.0	Series 98.0
Total 299.0	Total 299.0	Total 397.0	Total 397.0

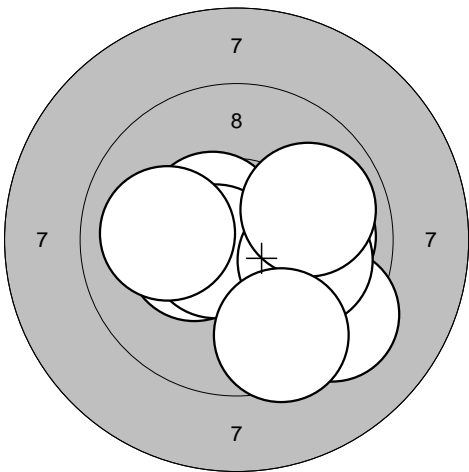
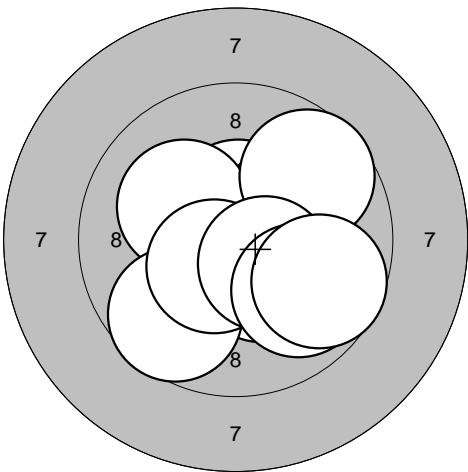
<p>Series 5</p> 	<p>1: 10.5* ↗ 2: 9.3 ↘ 3: 10.4* ← 4: 10.0 → 5: 10.1 → 6: 10.6* ← 7: 10.0 → 8: 9.9 → 9: 10.0 ← 10: 9.5 ↘</p>	<p>Series 6</p> 	<p>1: 10.5* ↑ 2: 10.1 ↗ 3: 10.2* ↗ 4: 9.7 ↗ 5: 10.4* ↘ 6: 9.7 ↘ 7: 10.5* ↘ 8: 10.4* ↘ 9: 9.9 ↘ 10: 9.7 →</p>
Series 97.0	Series 97.0	Series 96.0	Series 96.0
Total 494.0	Total 494.0	Total 590.0	Total 590.0

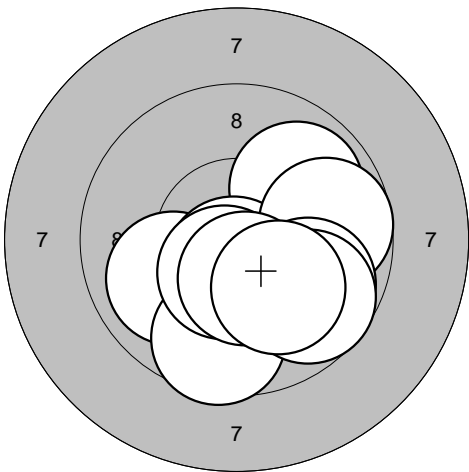
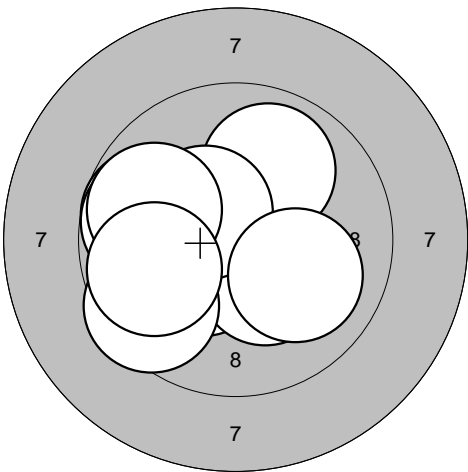
<p>Series 1</p> 	<p>1: 9.9 ↙ 2: 9.6 ↓ 3: 9.9 ↗ 4: 10.6* ↓ 5: 9.7 → 6: 10.5* ↓ 7: 9.8 ↘ 8: 10.4* ↓ 9: 9.7 ↓ 10: 10.1 ↓</p> <p>Series 94.0 Total 94.0</p>	<p>Series 2</p> 	<p>1: 9.8 ↙ 2: 10.3* ↙ 3: 10.0 ↗ 4: 10.3* ↓ 5: 9.8 ← 6: 10.4* ↗ 7: 10.0 ↘ 8: 9.8 ← 9: 9.5 ↙ 10: 9.8 ←</p> <p>Series 95.0 Total 189.0</p>
--	--	--	--

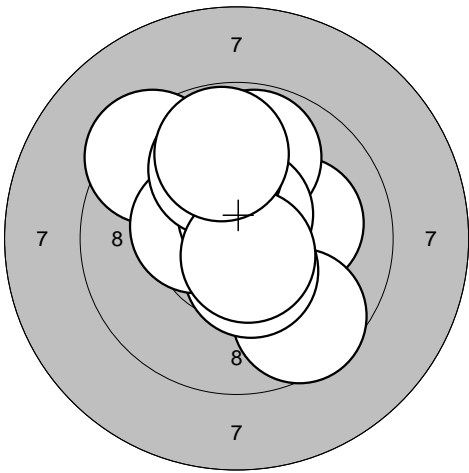
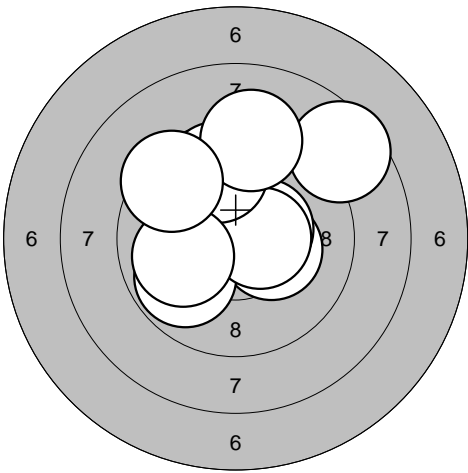
<p>Series 3</p> 	<p>1: 10.1 → 2: 9.6 ↓ 3: 10.5* ↓ 4: 9.4 ↗ 5: 9.8 ↗ 6: 10.4* ← 7: 10.6* ↗ 8: 10.0 ↗ 9: 10.6* ↓ 10: 9.8 ↗</p> <p>Series 96.0 Total 285.0</p>	<p>Series 4</p> 	<p>1: 10.0 ↗ 2: 8.6 ↗ 3: 10.3* → 4: 9.8 ↙ 5: 10.4* → 6: 10.5* → 7: 9.8 ↗ 8: 9.2 ↗ 9: 10.0 ← 10: 9.4 ↙</p> <p>Series 94.0 Total 379.0</p>
---	--	---	--

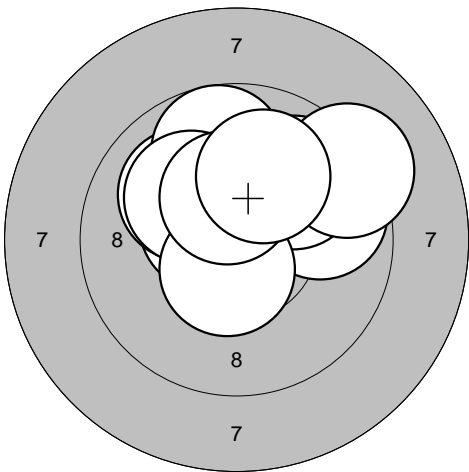
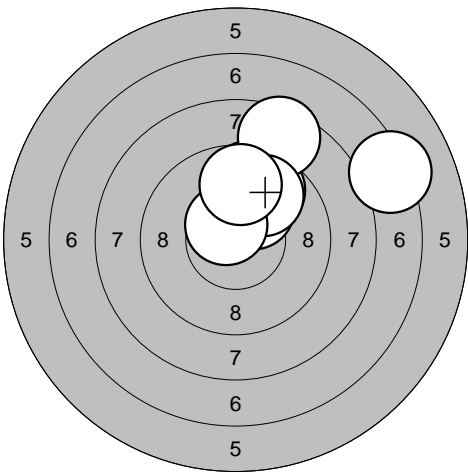
<p>Series 5</p> 	<p>1: 9.8 → 2: 10.5* ↙ 3: 10.1 ↗ 4: 9.9 ↗ 5: 9.8 ↗ 6: 10.1 ↗ 7: 10.5* ↓ 8: 10.4* ↗ 9: 9.2 ↗ 10: 10.0 ↗</p> <p>Series 96.0 Total 475.0</p>	<p>Series 6</p> 	<p>1: 9.6 ↗ 2: 9.7 ↗ 3: 8.5 ↗ 4: 10.0 ↗ 5: 10.5* ↗ 6: 10.2* ↗ 7: 9.8 ↗ 8: 10.6* ↙ 9: 7.3 → 10: 9.8 ↗</p> <p>Series 91.0 Total 566.0</p>
--	---	--	---

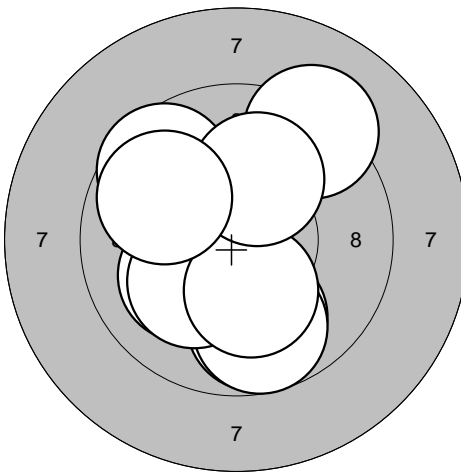
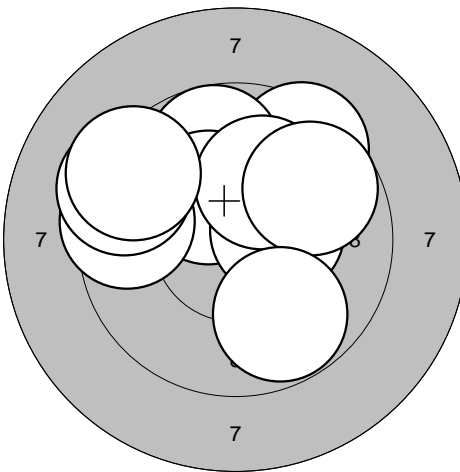
<p>Series 1</p> 	1: 10.1 ↙ 2: 9.8 ↓ 3: 9.6 ↗ 4: 9.9 ↓ 5: 9.7 ↓ 6: 10.1 ↙ 7: 10.2* ↓ 8: 9.2 ↗ 9: 10.1 ↗ 10: 9.8 ↖	<p>Series 2</p> 	1: 9.5 ↗ 2: 9.7 ↑ 3: 10.3* ↗ 4: 10.4* → 5: 10.1 ↗ 6: 9.5 ← 7: 9.3 ↖ 8: 9.8 ↗ 9: 9.8 ↓ 10: 9.3 ↖
Series 94.0		Series 93.0	
Total 94.0		Total 187.0	

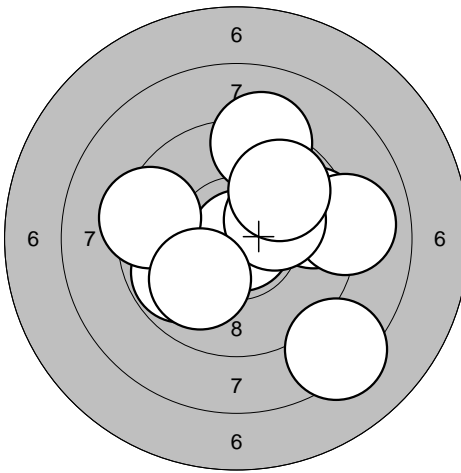
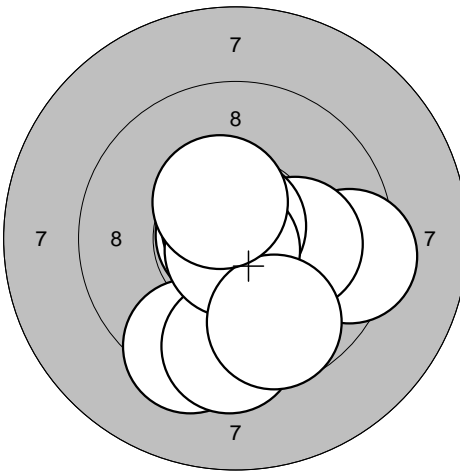
<p>Series 3</p> 	1: 9.8 ↙ 2: 10.8* → 3: 9.2 ↑ 4: 9.5 → 5: 9.0 → 6: 10.2* → 7: 8.3 ↓ 8: 9.4 ← 9: 10.0 ↙ 10: 9.8 ↗	<p>Series 4</p> 	1: 10.8* ← 2: 10.8* ↗ 3: 9.4 → 4: 10.1 → 5: 9.4 ↓ 6: 10.8* ↑ 7: 9.5 ↓ 8: 10.8* ↓ 9: 9.7 ↓ 10: 10.4* ↗
Series 92.0		Series 96.0	
Total 279.0		Total 375.0	

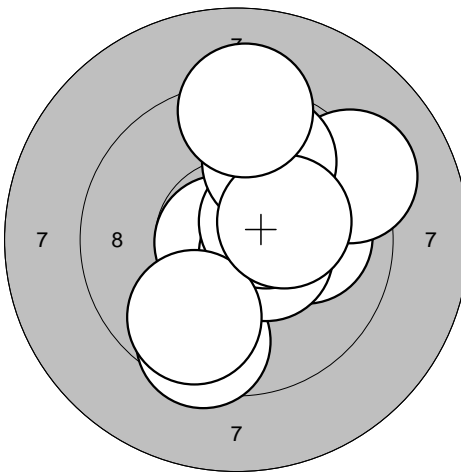
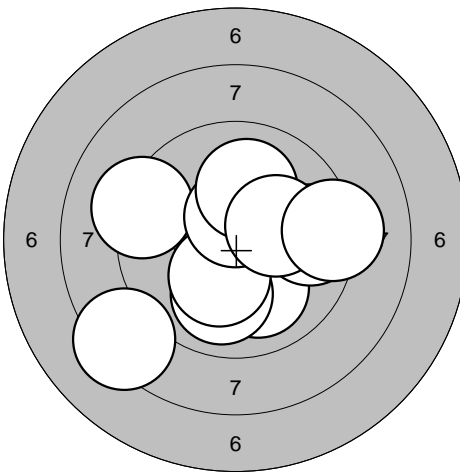
<p>Series 5</p> 	1: 10.7* ← 2: 10.0 → 3: 9.5 ↓ 4: 10.5* → 5: 10.5* ↗ 6: 9.2 → 7: 9.8 ↓ 8: 9.8 ↑ 9: 10.3* → 10: 9.2 ↑	<p>Series 6</p> 	1: 9.2 ↖ 2: 10.0 ↓ 3: 10.0 ↓ 4: 8.3 ↖ 5: 9.6 → 6: 10.3* ↓ 7: 10.5* ↑ 8: 10.0 ↑ 9: 10.2* → 10: 9.2 →
Series 95.0		Series 95.0	
Total 470.0		Total 565.0	

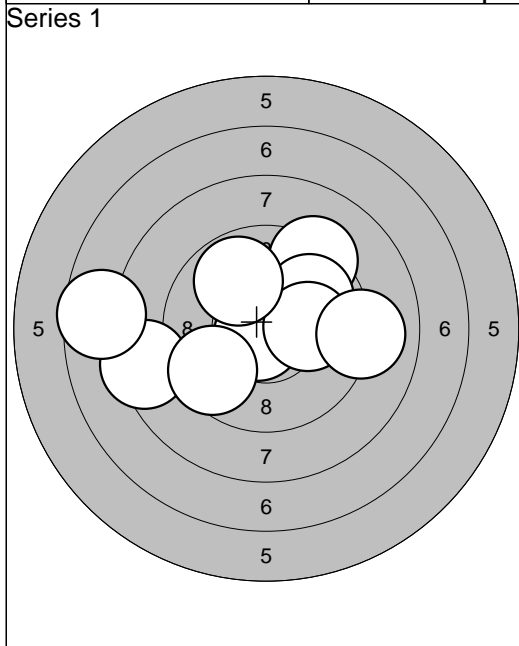

1: 10,7*	↙
2: 9,3	↗
3: 10,0	→
4: 9,9	↗
5: 10,1	→
6: 9,8	↗
7: 8,4	←
8: 9,0	→
9: 9,6	↙
10: 7,6	←
Serie	90,0
Sum	90,0

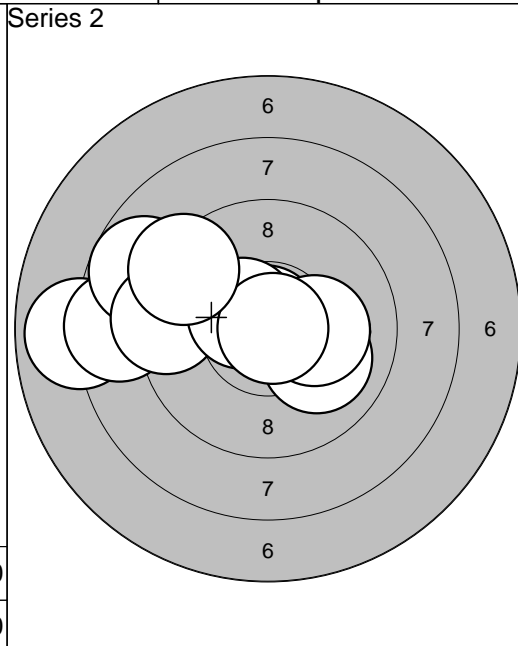

1: 7,9	←
2: 10,0	↘
3: 8,5	←
4: 10,8*	↗
5: 8,8	↖
6: 9,3	←
7: 10,2*	→
8: 10,5*	↖
9: 10,9*	→
10: 9,3	↖
Serie	91,0
Sum	181,0

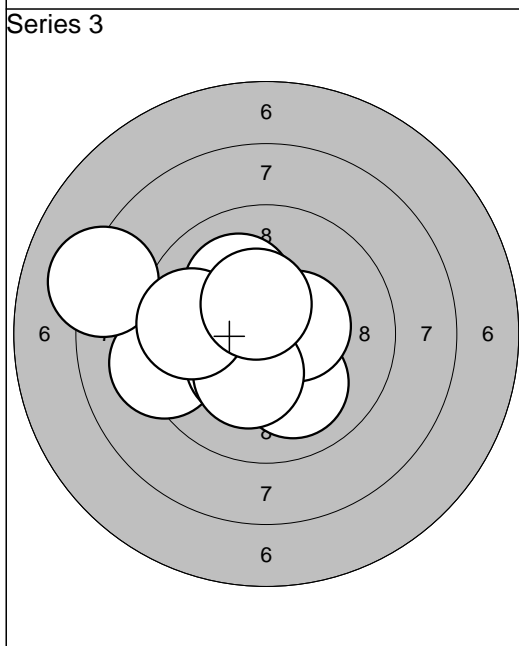

1: 10,6*	↙
2: 10,1	↗
3: 10,0	↘
4: 10,4*	→
5: 9,3	←
6: 10,3*	↙
7: 10,3*	↘
8: 8,2	←
9: 9,7	←
10: 10,5*	↗
Serie	96,0
Sum	277,0

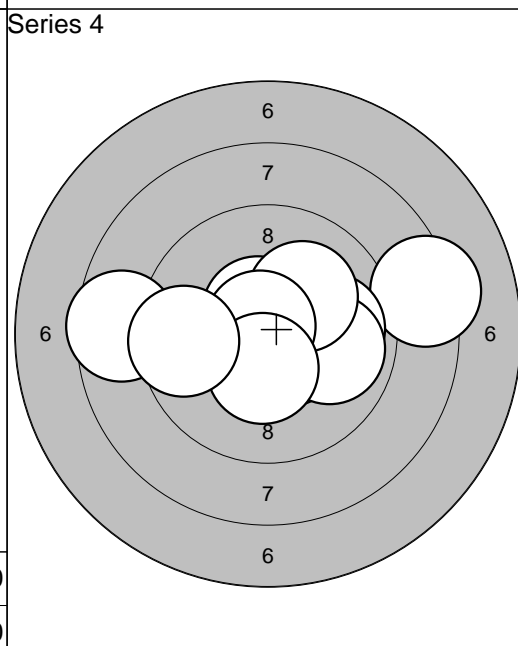

1: 8,3	→
2: 10,6*	↗
3: 9,9	→
4: 10,5*	↘
5: 8,6	←
6: 9,9	→
7: 10,1	↗
8: 10,8*	↖
9: 10,4*	↘
10: 9,6	←
Serie	93,0
Sum	370,0

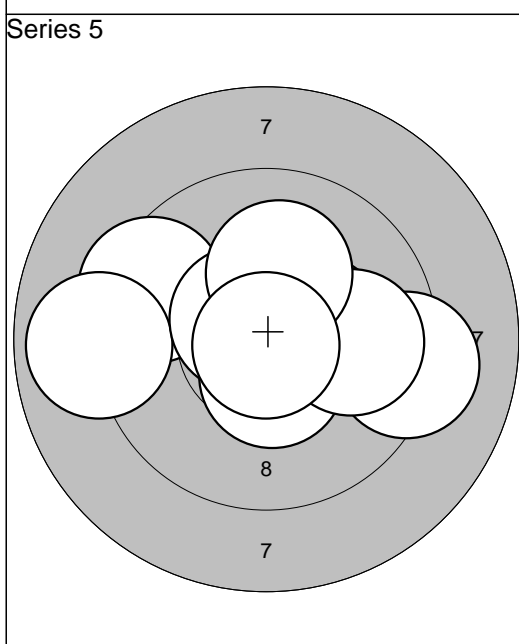

1: 9,4	←
2: 10,6*	↗
3: 8,9	←
4: 9,2	→
5: 10,3*	→
6: 10,6*	↗
7: 10,5*	↘
8: 9,9	→
9: 10,1	↗
10: 10,9*	↘
Serie	95,0
Sum	465,0

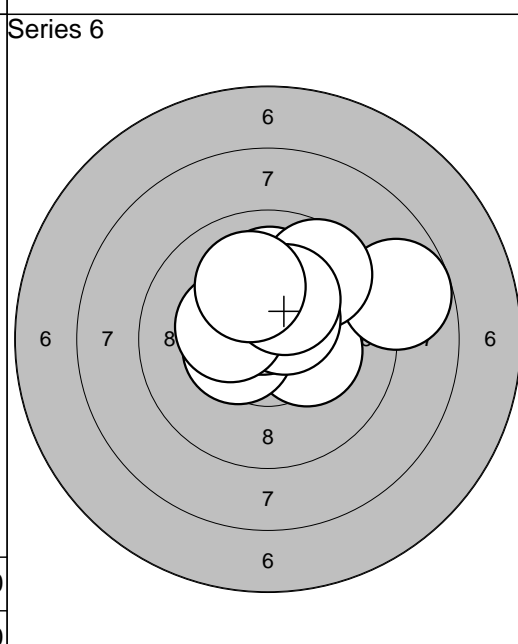

1: 10,0	↗
2: 10,3*	↘
3: 8,8	→
4: 10,4*	←
5: 10,6*	↗
6: 9,6	↗
7: 10,5*	↗
8: 10,3*	←
9: 10,3*	↗
10: 10,1	↗
Serie	97,0
Sum	562,0

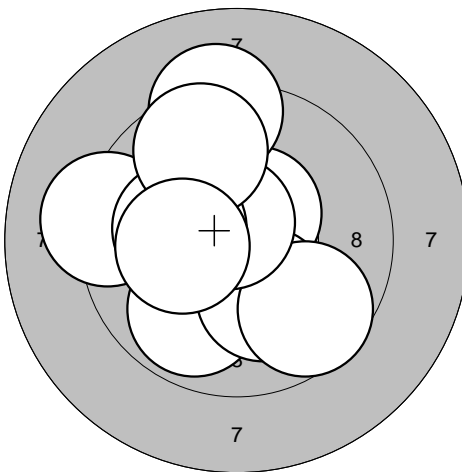
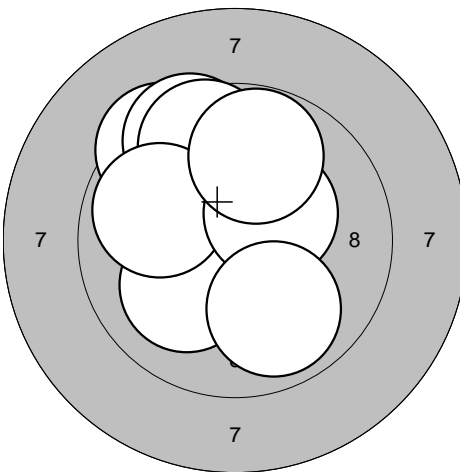
<p>Series 1</p> 	<p>1: 9,9 ↘ 2: 10,5* ↗ 3: 9,2 ← 4: 10,2* ↘ 5: 9,7 ↘ 6: 9,2 ↗ 7: 10,7* ↗ 8: 10,2* ← 9: 9,7 ↗ 10: 10,2* ←</p> <table border="1" style="width:100%; border-collapse: collapse;"> <tr><td>Serie</td><td style="text-align: right;">95,0</td></tr> <tr><td>Sum</td><td style="text-align: right;">95,0</td></tr> </table>	Serie	95,0	Sum	95,0	<p>Series 2</p> 	<p>1: 10,5* ↗ 2: 9,4 ↗ 3: 10,3* ↗ 4: 9,5 ↗ 5: 10,1 ↘ 6: 9,6 ↗ 7: 9,9 ← 8: 10,3* ↗ 9: 9,9 ↘ 10: 9,8 ↗</p> <table border="1" style="width:100%; border-collapse: collapse;"> <tr><td>Serie</td><td style="text-align: right;">94,0</td></tr> <tr><td>Sum</td><td style="text-align: right;">189,0</td></tr> </table>	Serie	94,0	Sum	189,0
Serie	95,0										
Sum	95,0										
Serie	94,0										
Sum	189,0										

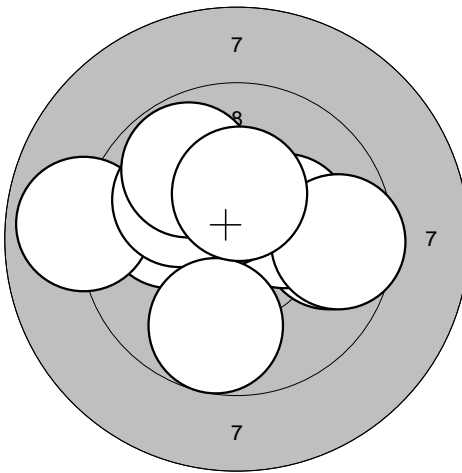
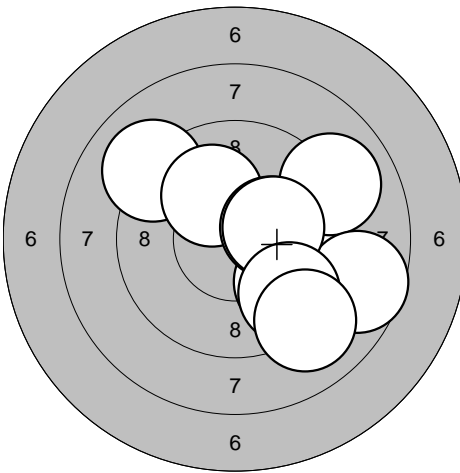
<p>Series 3</p> 	<p>1: 9,7 → 2: 10,0 ← 3: 10,3* → 4: 10,4* ↗ 5: 8,9 ← 6: 10,0 ↗ 7: 9,8 ↘ 8: 9,8 ↗ 9: 9,6 → 10: 10,3* ↗</p> <table border="1" style="width:100%; border-collapse: collapse;"> <tr><td>Serie</td><td style="text-align: right;">94,0</td></tr> <tr><td>Sum</td><td style="text-align: right;">283,0</td></tr> </table>	Serie	94,0	Sum	283,0	<p>Series 4</p> 	<p>1: 9,8 → 2: 9,1 ↗ 3: 9,0 → 4: 10,1 ↗ 5: 9,8 ↘ 6: 10,3* → 7: 8,7 → 8: 10,2* → 9: 9,6 ↘ 10: 9,0 ↘</p> <table border="1" style="width:100%; border-collapse: collapse;"> <tr><td>Serie</td><td style="text-align: right;">92,0</td></tr> <tr><td>Sum</td><td style="text-align: right;">375,0</td></tr> </table>	Serie	92,0	Sum	375,0
Serie	94,0										
Sum	283,0										
Serie	92,0										
Sum	375,0										

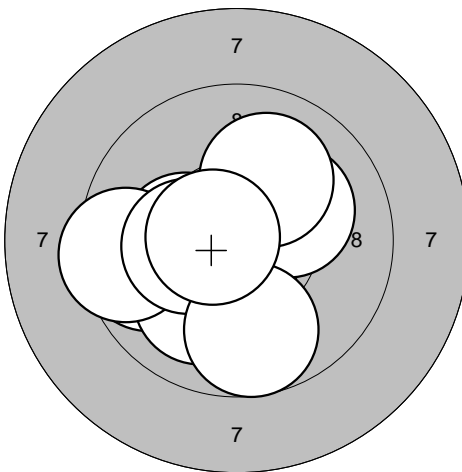
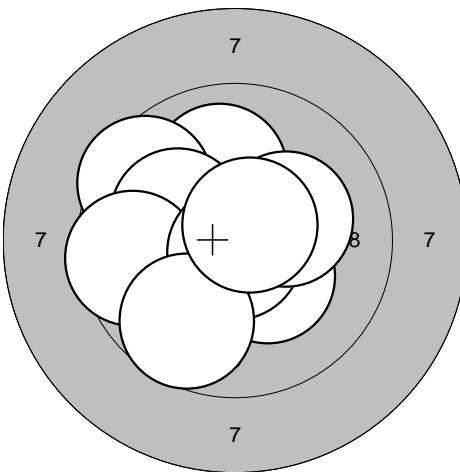
<p>Series 5</p> 	<p>1: 10,9* ↘ 2: 10,3* ← 3: 9,7 ← 4: 10,2* ↗ 5: 10,0 ↘ 6: 9,4 ← 7: 10,1 ↗ 8: 10,3* ← 9: 9,7 ↘ 10: 10,6* ←</p> <table border="1" style="width:100%; border-collapse: collapse;"> <tr><td>Serie</td><td style="text-align: right;">97,0</td></tr> <tr><td>Sum</td><td style="text-align: right;">472,0</td></tr> </table>	Serie	97,0	Sum	472,0	<p>Series 6</p> 	<p>1: 10,5* ↘ 2: 10,0 ↗ 3: 9,5 ↗ 4: 10,3* ↘ 5: 10,1 ↗ 6: 9,6 ← 7: 10,8* ↘ 8: 9,7 ↘ 9: 10,2* → 10: 10,7* ↗</p> <table border="1" style="width:100%; border-collapse: collapse;"> <tr><td>Serie</td><td style="text-align: right;">97,0</td></tr> <tr><td>Sum</td><td style="text-align: right;">569,0</td></tr> </table>	Serie	97,0	Sum	569,0
Serie	97,0										
Sum	472,0										
Serie	97,0										
Sum	569,0										

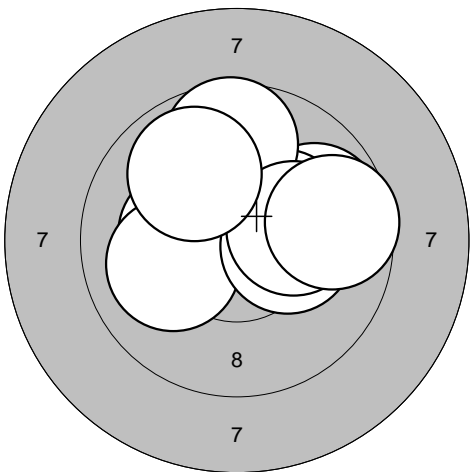
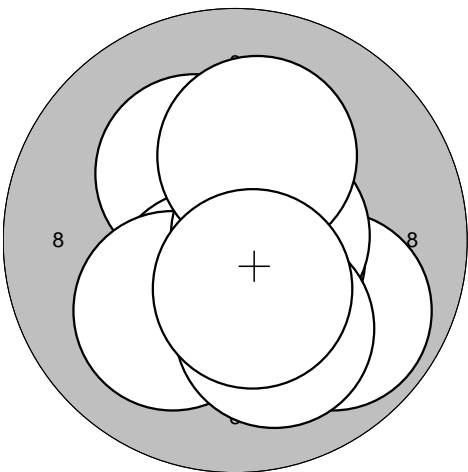
<p>Series 1</p> 	<p>1: 9,8 →</p> <p>2: 10,4* ↗</p> <p>3: 10,3* ↗</p> <p>4: 10,3* ←</p> <p>5: 10,0 ←</p> <p>6: 10,3* →</p> <p>7: 9,7 ↑</p> <p>8: 10,2* →</p> <p>9: 9,6 →</p> <p>10: 9,9 ↗</p>	<p>Series 2</p> 	<p>1: 10,2* ↗</p> <p>2: 10,4* ↘</p> <p>3: 10,0 ↘</p> <p>4: 9,9 ↘</p> <p>5: 10,6* ↘</p> <p>6: 10,1 ↘</p> <p>7: 10,6* →</p> <p>8: 10,1 ↘</p> <p>9: 10,2* ↑</p> <p>10: 10,5* ↘</p>
Serie 96,0	Serie 99,0	Serie 99,0	Serie 99,0
Sum 96,0	Sum 96,0	Sum 195,0	Sum 195,0

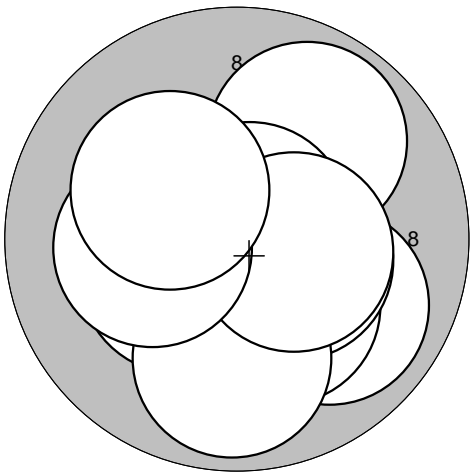
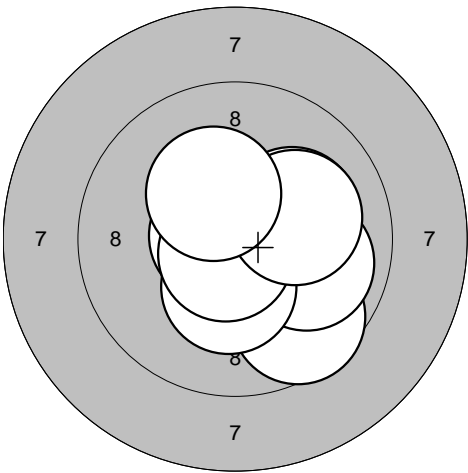
<p>Series 3</p> 	<p>1: 9,9 ↘</p> <p>2: 9,8 ↗</p> <p>3: 10,3* ←</p> <p>4: 10,2* ↘</p> <p>5: 10,4* →</p> <p>6: 9,9 ↓</p> <p>7: 10,8* ↗</p> <p>8: 10,4* →</p> <p>9: 10,2* ←</p> <p>10: 10,2* ↗</p>	<p>Series 4</p> 	<p>1: 10,4* ↘</p> <p>2: 10,9* ←</p> <p>3: 9,6 ↘</p> <p>4: 10,7* ←</p> <p>5: 9,9 →</p> <p>6: 10,1 →</p> <p>7: 10,3* ↓</p> <p>8: 10,7* ↘</p> <p>9: 10,1 →</p> <p>10: 10,3* ↗</p>
Serie 97,0	Serie 97,0	Serie 98,0	Serie 98,0
Sum 292,0	Sum 292,0	Sum 390,0	Sum 390,0

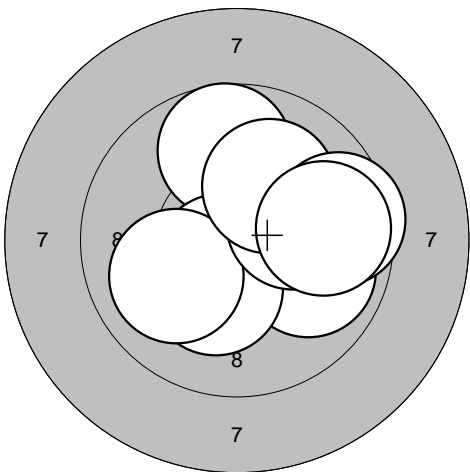
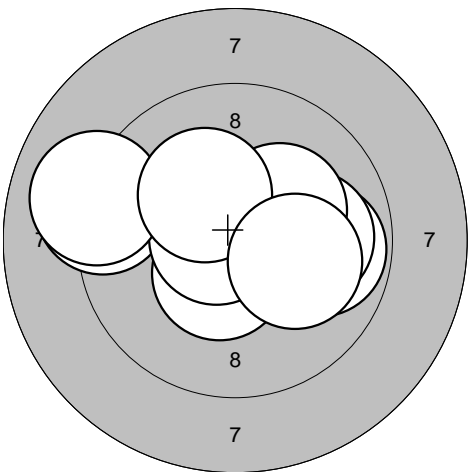
<p>Series 5</p> 	<p>1: 9,8 ↑</p> <p>2: 10,1 →</p> <p>3: 9,9 →</p> <p>4: 10,6* ↘</p> <p>5: 10,2* ↘</p> <p>6: 10,0 ←</p> <p>7: 10,2* →</p> <p>8: 10,1 ↗</p> <p>9: 9,6 →</p> <p>10: 9,8 →</p>	<p>Series 6</p> 	<p>1: 9,1 ←</p> <p>2: 9,8 →</p> <p>3: 10,5* ↘</p> <p>4: 10,7* ↗</p> <p>5: 10,0 →</p> <p>6: 10,7* ←</p> <p>7: 10,2* ↗</p> <p>8: 9,0 ←</p> <p>9: 10,2* ↗</p> <p>10: 10,1 →</p>
Serie 96,0	Serie 96,0	Serie 97,0	Serie 97,0
Sum 486,0	Sum 486,0	Sum 583,0	Sum 583,0

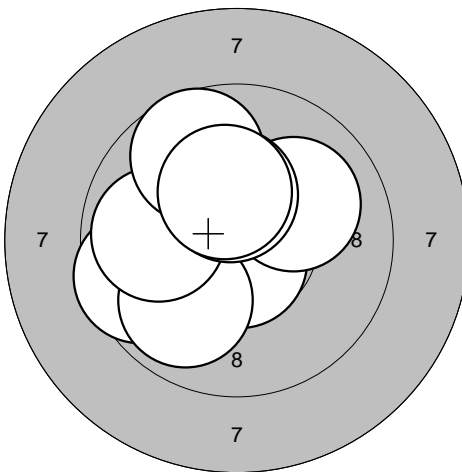
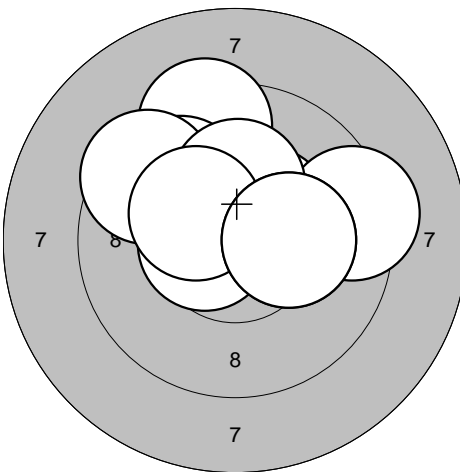
<p>Series 1</p> 	<p>1: 10,8* ↓</p> <p>2: 10,0 ←</p> <p>3: 10,7* ↓</p> <p>4: 9,6 ←</p> <p>5: 9,9 ↙</p> <p>6: 10,1 ↗</p> <p>7: 9,9 ←</p> <p>8: 10,3* ↑</p> <p>9: 9,7 ↗</p> <p>10: 10,3* ↑</p> <table border="1" style="width:100%; border-collapse: collapse;"> <tr> <td style="width:80%;">Serie</td> <td style="width:20%; text-align: right;">96,0</td> </tr> <tr> <td>Sum</td> <td style="text-align: right;">96,0</td> </tr> </table>	Serie	96,0	Sum	96,0	<p>Series 2</p> 	<p>1: 9,4 ↑</p> <p>2: 9,9 ↗</p> <p>3: 10,5* ←</p> <p>4: 10,4* ↗</p> <p>5: 9,4 →</p> <p>6: 9,5 ↗</p> <p>7: 10,2* ↑</p> <p>8: 10,3* ↗</p> <p>9: 10,2* →</p> <p>10: 10,2* →</p> <table border="1" style="width:100%; border-collapse: collapse;"> <tr> <td style="width:80%;">Serie</td> <td style="width:20%; text-align: right;">96,0</td> </tr> <tr> <td>Sum</td> <td style="text-align: right;">192,0</td> </tr> </table>	Serie	96,0	Sum	192,0
Serie	96,0										
Sum	96,0										
Serie	96,0										
Sum	192,0										

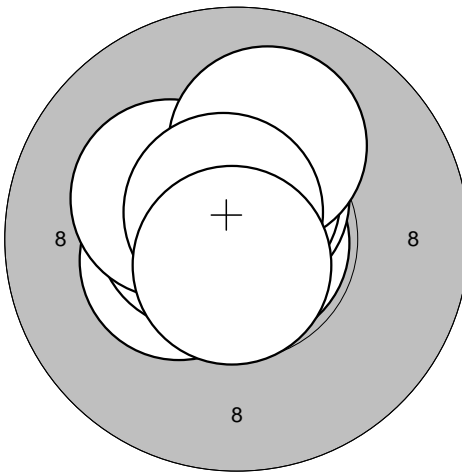
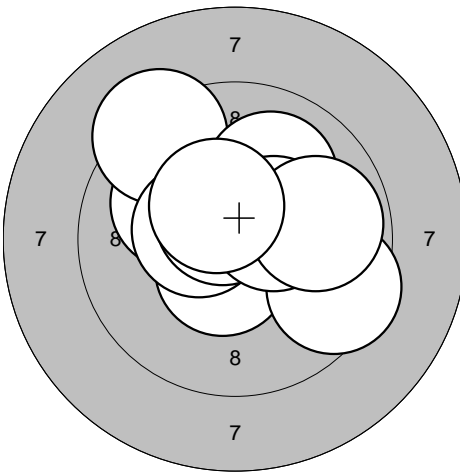
<p>Series 3</p> 	<p>1: 10,8* →</p> <p>2: 10,4* ←</p> <p>3: 10,6* ←</p> <p>4: 10,5* ↑</p> <p>5: 10,6* ↑</p> <p>6: 10,6* ↑</p> <p>7: 10,3* ↖</p> <p>8: 10,1 ↑</p> <p>9: 10,7* ↗</p> <p>10: 10,7* ↓</p> <table border="1" style="width:100%; border-collapse: collapse;"> <tr> <td style="width:80%;">Serie</td> <td style="width:20%; text-align: right;">100,0</td> </tr> <tr> <td>Sum</td> <td style="text-align: right;">292,0</td> </tr> </table>	Serie	100,0	Sum	292,0	<p>Series 4</p> 	<p>1: 10,1 ↖</p> <p>2: 9,3 ↗</p> <p>3: 10,5* ↓</p> <p>4: 10,5* ←</p> <p>5: 10,0 ↗</p> <p>6: 10,6* ↗</p> <p>7: 9,5 ↘</p> <p>8: 10,4* →</p> <p>9: 9,8 →</p> <p>10: 10,4* ↗</p> <table border="1" style="width:100%; border-collapse: collapse;"> <tr> <td style="width:80%;">Serie</td> <td style="width:20%; text-align: right;">97,0</td> </tr> <tr> <td>Sum</td> <td style="text-align: right;">389,0</td> </tr> </table>	Serie	97,0	Sum	389,0
Serie	100,0										
Sum	292,0										
Serie	97,0										
Sum	389,0										

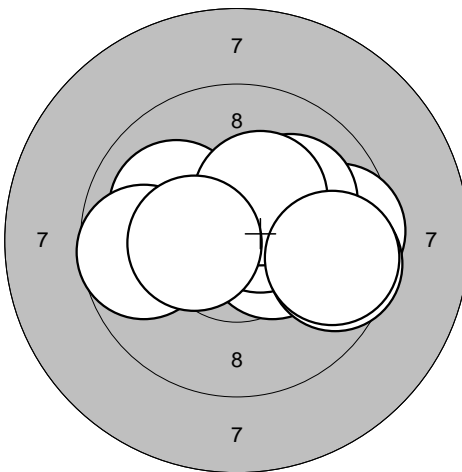
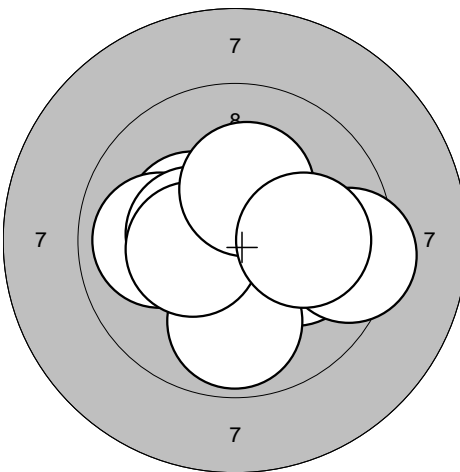
<p>Series 5</p> 	<p>1: 9,6 →</p> <p>2: 10,0 ↗</p> <p>3: 10,0 ↖</p> <p>4: 10,4* →</p> <p>5: 10,6* ↗</p> <p>6: 9,6 →</p> <p>7: 10,3* ↗</p> <p>8: 9,7 ←</p> <p>9: 10,4* ←</p> <p>10: 9,7 →</p> <table border="1" style="width:100%; border-collapse: collapse;"> <tr> <td style="width:80%;">Serie</td> <td style="width:20%; text-align: right;">96,0</td> </tr> <tr> <td>Sum</td> <td style="text-align: right;">485,0</td> </tr> </table>	Serie	96,0	Sum	485,0	<p>Series 6</p> 	<p>1: 10,5* ↓</p> <p>2: 10,3* ↖</p> <p>3: 10,0 ←</p> <p>4: 10,4* ←</p> <p>5: 10,1 →</p> <p>6: 9,4 →</p> <p>7: 9,9 ↓</p> <p>8: 10,4* ←</p> <p>9: 10,3* ↑</p> <p>10: 10,0 →</p> <table border="1" style="width:100%; border-collapse: collapse;"> <tr> <td style="width:80%;">Serie</td> <td style="width:20%; text-align: right;">98,0</td> </tr> <tr> <td>Sum</td> <td style="text-align: right;">583,0</td> </tr> </table>	Serie	98,0	Sum	583,0
Serie	96,0										
Sum	485,0										
Serie	98,0										
Sum	583,0										

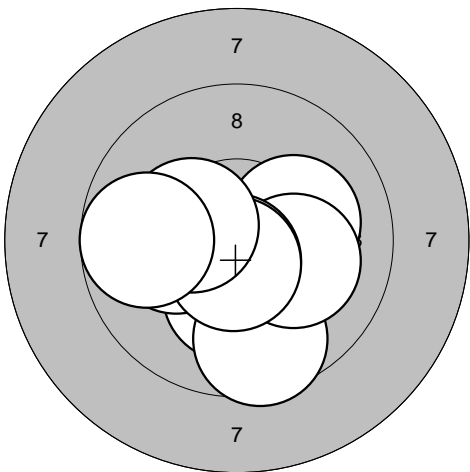
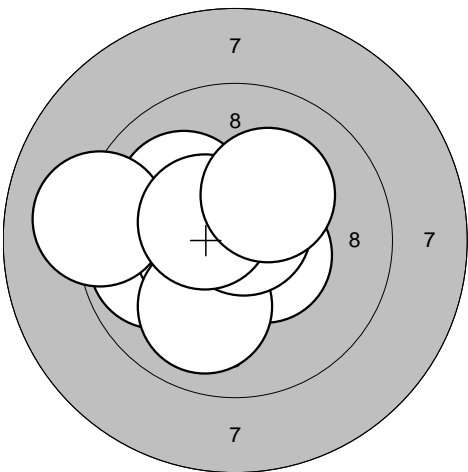
<p>Series 1</p> 	<p>1: 10,2* ↓ 2: 10,3* → 3: 10,1 → 4: 9,6 ↓ 5: 10,1 → 6: 10,7* ↓ 7: 10,2* ← 8: 10,6* ↓ 9: 10,3* ← 10: 9,8 ←</p> <table border="1" style="width:100%; border-collapse: collapse;"> <tr><td>Serie</td><td style="text-align: right;">98,0</td></tr> <tr><td>Sum</td><td style="text-align: right;">98,0</td></tr> </table>	Serie	98,0	Sum	98,0	<p>Series 2</p>  <p>1: 9,9 ← 2: 10,5* ↓ 3: 10,5* → 4: 10,5* ← 5: 10,0 ↓ 6: 10,1 ↗ 7: 10,7* ↗ 8: 9,1 ← 9: 10,5* ↗ 10: 10,2* ↗</p> <table border="1" style="width:100%; border-collapse: collapse;"> <tr><td>Serie</td><td style="text-align: right;">98,0</td></tr> <tr><td>Sum</td><td style="text-align: right;">196,0</td></tr> </table>	Serie	98,0	Sum	196,0
Serie	98,0									
Sum	98,0									
Serie	98,0									
Sum	196,0									

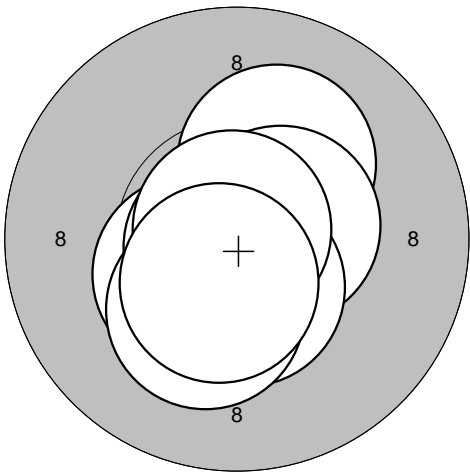
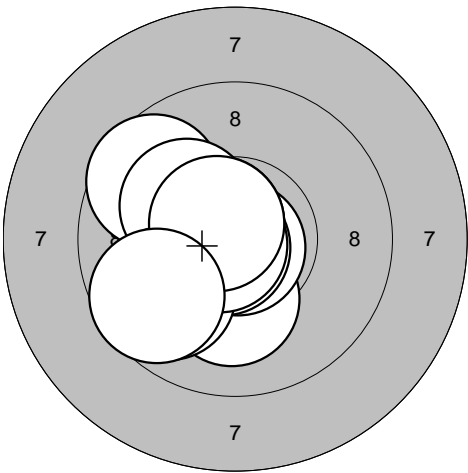
<p>Series 3</p> 	<p>1: 10,2* ↗ 2: 10,7* ↓ 3: 10,4* ↙ 4: 10,8* ↙ 5: 10,8* → 6: 10,5* → 7: 10,5* ↓ 8: 10,2* ↓ 9: 10,9* ↗ 10: 10,5* ↓</p> <table border="1" style="width:100%; border-collapse: collapse;"> <tr><td>Serie</td><td style="text-align: right;">100,0</td></tr> <tr><td>Sum</td><td style="text-align: right;">296,0</td></tr> </table>	Serie	100,0	Sum	296,0	<p>Series 4</p>  <p>1: 10,2* ↓ 2: 9,6 ↖ 3: 10,8* ↓ 4: 10,6* ↖ 5: 10,8* ↙ 6: 10,2* ↖ 7: 9,8 ↙ 8: 10,7* ↙ 9: 10,6* ↖ 10: 9,7 ↙</p> <table border="1" style="width:100%; border-collapse: collapse;"> <tr><td>Serie</td><td style="text-align: right;">97,0</td></tr> <tr><td>Sum</td><td style="text-align: right;">393,0</td></tr> </table>	Serie	97,0	Sum	393,0
Serie	100,0									
Sum	296,0									
Serie	97,0									
Sum	393,0									

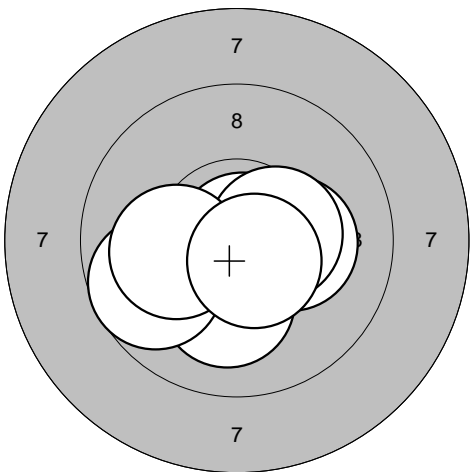
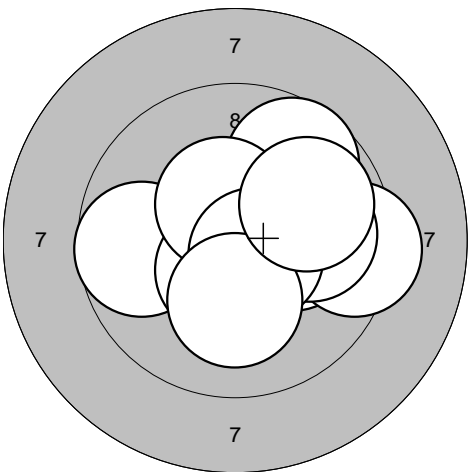
<p>Series 5</p> 	<p>1: 10,6* ↓ 2: 10,3* ← 3: 10,2* → 4: 10,6* ↓ 5: 10,1 ↓ 6: 10,9* → 7: 10,4* → 8: 9,7 ← 9: 10,1 ← 10: 10,6* ↓</p> <table border="1" style="width:100%; border-collapse: collapse;"> <tr><td>Serie</td><td style="text-align: right;">99,0</td></tr> <tr><td>Sum</td><td style="text-align: right;">492,0</td></tr> </table>	Serie	99,0	Sum	492,0	<p>Series 6</p>  <p>1: 9,7 ↗ 2: 9,7 ← 3: 10,5* ↓ 4: 10,2* → 5: 9,3 → 6: 9,9 → 7: 10,4* ↗ 8: 10,6* ↘ 9: 10,2* ↓ 10: 9,9 ↗</p> <table border="1" style="width:100%; border-collapse: collapse;"> <tr><td>Serie</td><td style="text-align: right;">95,0</td></tr> <tr><td>Sum</td><td style="text-align: right;">587,0</td></tr> </table>	Serie	95,0	Sum	587,0
Serie	99,0									
Sum	492,0									
Serie	95,0									
Sum	587,0									

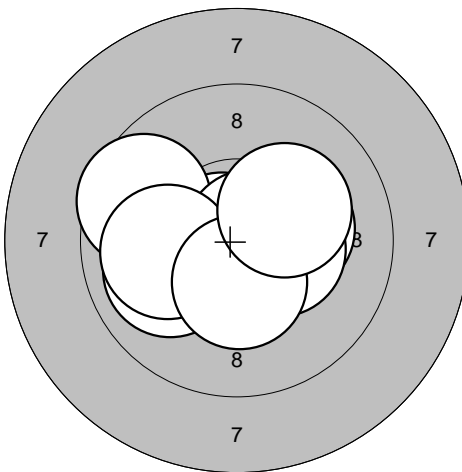
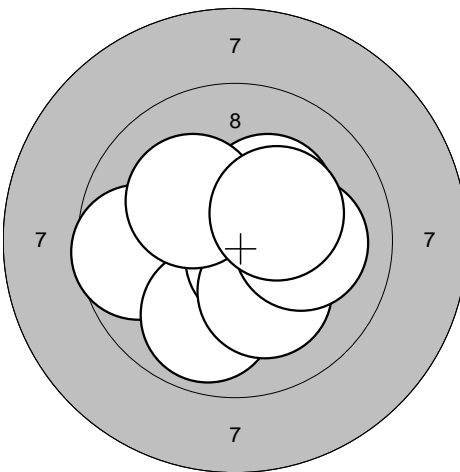
<p>Series 1</p> 	<p>1: 10,7* ←</p> <p>2: 10,3* →</p> <p>3: 9,6 ↖</p> <p>4: 10,7* ↘</p> <p>5: 10,0 ←</p> <p>6: 10,7* →</p> <p>7: 10,0 ←</p> <p>8: 10,4* →</p> <p>9: 10,4* ↓</p> <p>10: 10,2* ↗</p> <table border="1" style="width:100%; border-collapse: collapse;"> <tr><td style="text-align: right;">Serie</td><td style="text-align: right;">99,0</td></tr> <tr><td style="text-align: right;">Sum</td><td style="text-align: right;">99,0</td></tr> </table>	Serie	99,0	Sum	99,0	<p>Series 2</p> 	<p>1: 10,4* ↘</p> <p>2: 9,6 ←</p> <p>3: 10,8* ↓</p> <p>4: 9,9 ↓</p> <p>5: 10,6* ↘</p> <p>6: 10,2* ↓</p> <p>7: 10,1 →</p> <p>8: 10,3* ↗</p> <p>9: 10,2* ↗</p> <p>10: 10,3* ↗</p> <table border="1" style="width:100%; border-collapse: collapse;"> <tr><td style="text-align: right;">Serie</td><td style="text-align: right;">98,0</td></tr> <tr><td style="text-align: right;">Sum</td><td style="text-align: right;">197,0</td></tr> </table>	Serie	98,0	Sum	197,0
Serie	99,0										
Sum	99,0										
Serie	98,0										
Sum	197,0										

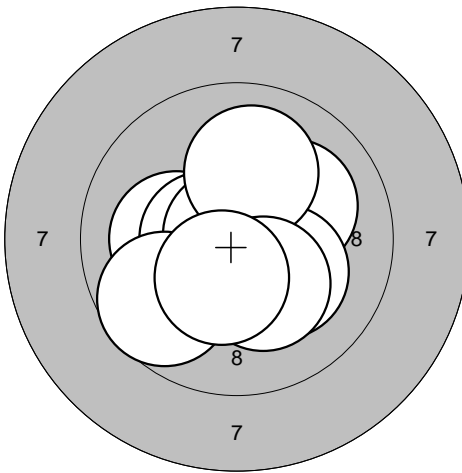
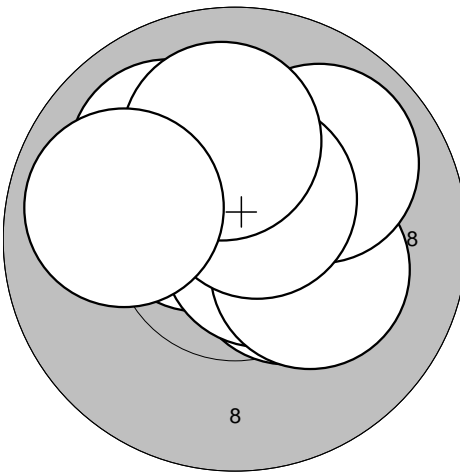
<p>Series 3</p> 	<p>1: 10,6* ←</p> <p>2: 10,1 ←</p> <p>3: 10,5* ←</p> <p>4: 10,1 ↗</p> <p>5: 10,9* ↖</p> <p>6: 10,2* ↘</p> <p>7: 10,0 ↑</p> <p>8: 9,7 ↖</p> <p>9: 10,3* ↘</p> <p>10: 10,4* ↓</p> <table border="1" style="width:100%; border-collapse: collapse;"> <tr><td style="text-align: right;">Serie</td><td style="text-align: right;">99,0</td></tr> <tr><td style="text-align: right;">Sum</td><td style="text-align: right;">296,0</td></tr> </table>	Serie	99,0	Sum	296,0	<p>Series 4</p> 	<p>1: 10,6* →</p> <p>2: 10,5* ↗</p> <p>3: 10,4* ↘</p> <p>4: 10,7* →</p> <p>5: 10,0 ↗</p> <p>6: 10,2* →</p> <p>7: 9,9 ↗</p> <p>8: 10,5* ↗</p> <p>9: 10,1 ↑</p> <p>10: 9,9 ←</p> <table border="1" style="width:100%; border-collapse: collapse;"> <tr><td style="text-align: right;">Serie</td><td style="text-align: right;">98,0</td></tr> <tr><td style="text-align: right;">Sum</td><td style="text-align: right;">394,0</td></tr> </table>	Serie	98,0	Sum	394,0
Serie	99,0										
Sum	296,0										
Serie	98,0										
Sum	394,0										

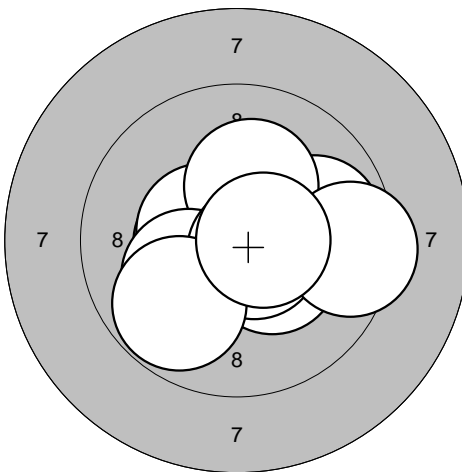
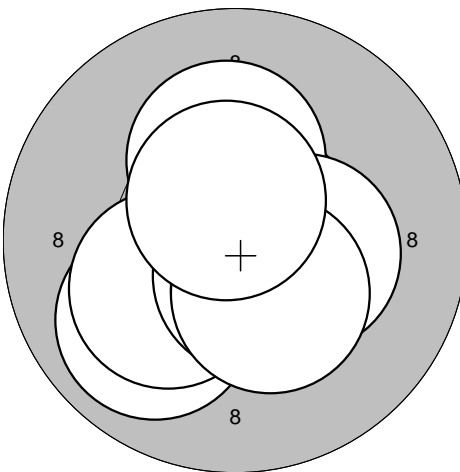
<p>Series 5</p> 	<p>1: 9,9 →</p> <p>2: 10,5* ←</p> <p>3: 10,5* ←</p> <p>4: 10,2* ↑</p> <p>5: 10,4* ↘</p> <p>6: 10,2* ↖</p> <p>7: 10,7* ↘</p> <p>8: 9,8 ↖</p> <p>9: 9,4 →</p> <p>10: 10,6* →</p> <table border="1" style="width:100%; border-collapse: collapse;"> <tr><td style="text-align: right;">Serie</td><td style="text-align: right;">97,0</td></tr> <tr><td style="text-align: right;">Sum</td><td style="text-align: right;">491,0</td></tr> </table>	Serie	97,0	Sum	491,0	<p>Series 6</p> 	<p>1: 9,9 ↖</p> <p>2: 10,2* ↖</p> <p>3: 10,7* ↗</p> <p>4: 10,2* ↑</p> <p>5: 10,6* →</p> <p>6: 10,6* ↘</p> <p>7: 10,4* ↘</p> <p>8: 10,3* →</p> <p>9: 10,4* ↘</p> <p>10: 10,6* ↑</p> <table border="1" style="width:100%; border-collapse: collapse;"> <tr><td style="text-align: right;">Serie</td><td style="text-align: right;">99,0</td></tr> <tr><td style="text-align: right;">Sum</td><td style="text-align: right;">590,0</td></tr> </table>	Serie	99,0	Sum	590,0
Serie	97,0										
Sum	491,0										
Serie	99,0										
Sum	590,0										

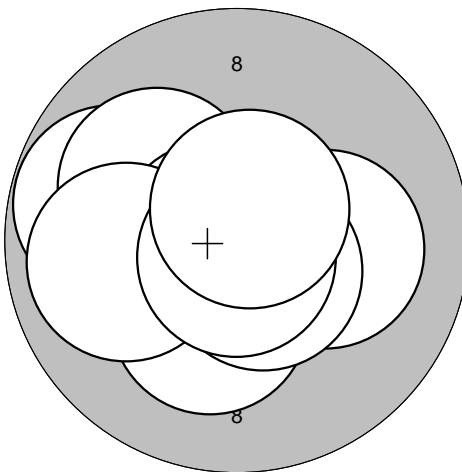
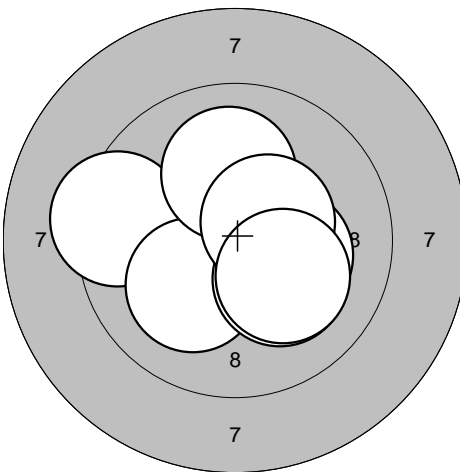
<p>Series 1</p> 	<p>1: 10,2* ↘ 2: 9,8 ← 3: 10,3* ← 4: 10,1 ↗ 5: 10,1 → 6: 10,8* ← 7: 10,6* ↘ 8: 9,9 ← 9: 10,8* ↓ 10: 10,6* ↗</p> <table border="1" style="width:100%; border-collapse: collapse;"> <tr><td style="text-align: right;">Serie</td><td style="text-align: right;">98,0</td></tr> <tr><td style="text-align: right;">Sum</td><td style="text-align: right;">98,0</td></tr> </table>	Serie	98,0	Sum	98,0	<p>Series 2</p> 	<p>1: 10,4* ↗ 2: 10,4* ↑ 3: 10,6* → 4: 9,4 ← 5: 10,1 ↘ 6: 10,2* ↘ 7: 10,2* → 8: 10,1 ↑ 9: 10,5* ↗ 10: 10,2* ↘</p> <table border="1" style="width:100%; border-collapse: collapse;"> <tr><td style="text-align: right;">Serie</td><td style="text-align: right;">99,0</td></tr> <tr><td style="text-align: right;">Sum</td><td style="text-align: right;">197,0</td></tr> </table>	Serie	99,0	Sum	197,0
Serie	98,0										
Sum	98,0										
Serie	99,0										
Sum	197,0										

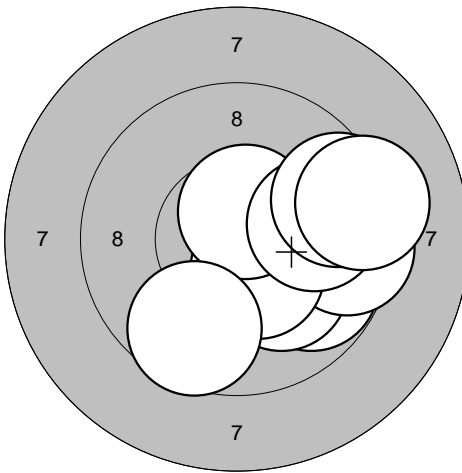
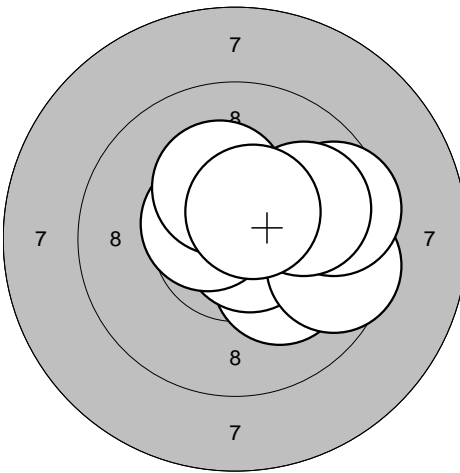
<p>Series 3</p> 	<p>1: 10,5* ↘ 2: 9,8 ↘ 3: 10,1 ↘ 4: 9,5 → 5: 10,4* ↘ 6: 10,6* ↗ 7: 9,6 ↘ 8: 9,9 → 9: 9,5 → 10: 9,2 →</p> <table border="1" style="width:100%; border-collapse: collapse;"> <tr><td style="text-align: right;">Serie</td><td style="text-align: right;">94,0</td></tr> <tr><td style="text-align: right;">Sum</td><td style="text-align: right;">291,0</td></tr> </table>	Serie	94,0	Sum	291,0	<p>Series 4</p> 	<p>1: 10,7* ↑ 2: 10,6* ↗ 3: 10,2* ↘ 4: 10,7* ↘ 5: 10,5* ↗ 6: 9,6 → 7: 9,6 → 8: 10,2* ↑ 9: 9,9 → 10: 10,5* ↗</p> <table border="1" style="width:100%; border-collapse: collapse;"> <tr><td style="text-align: right;">Serie</td><td style="text-align: right;">97,0</td></tr> <tr><td style="text-align: right;">Sum</td><td style="text-align: right;">388,0</td></tr> </table>	Serie	97,0	Sum	388,0
Serie	94,0										
Sum	291,0										
Serie	97,0										
Sum	388,0										

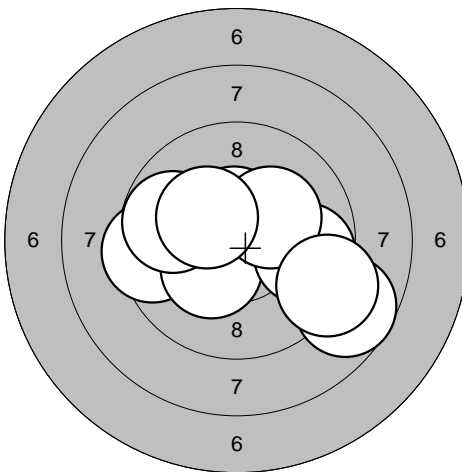
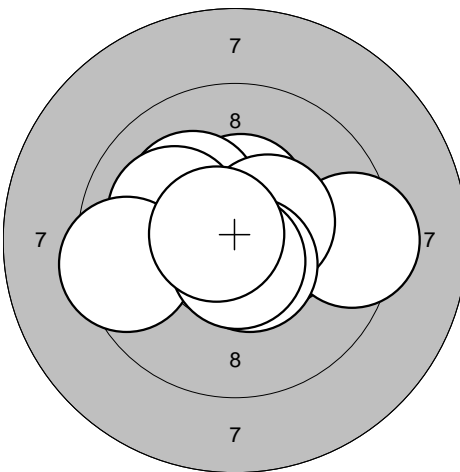
<p>Series 5</p> 	<p>1: 10,8* ← 2: 9,5 ← 3: 10,6* ↑ 4: 8,7 ↘ 5: 10,3* ↘ 6: 9,7 → 7: 9,8 ← 8: 10,2* ↗ 9: 9,2 ↘ 10: 10,3* ↗</p> <table border="1" style="width:100%; border-collapse: collapse;"> <tr><td style="text-align: right;">Serie</td><td style="text-align: right;">94,0</td></tr> <tr><td style="text-align: right;">Sum</td><td style="text-align: right;">482,0</td></tr> </table>	Serie	94,0	Sum	482,0	<p>Series 6</p> 	<p>1: 10,4* ↑ 2: 10,4* → 3: 9,4 → 4: 10,2* ↗ 5: 10,5* ↗ 6: 10,6* ↘ 7: 10,1 ← 8: 9,5 ← 9: 10,7* ↓ 10: 10,7* ←</p> <table border="1" style="width:100%; border-collapse: collapse;"> <tr><td style="text-align: right;">Serie</td><td style="text-align: right;">98,0</td></tr> <tr><td style="text-align: right;">Sum</td><td style="text-align: right;">580,0</td></tr> </table>	Serie	98,0	Sum	580,0
Serie	94,0										
Sum	482,0										
Serie	98,0										
Sum	580,0										

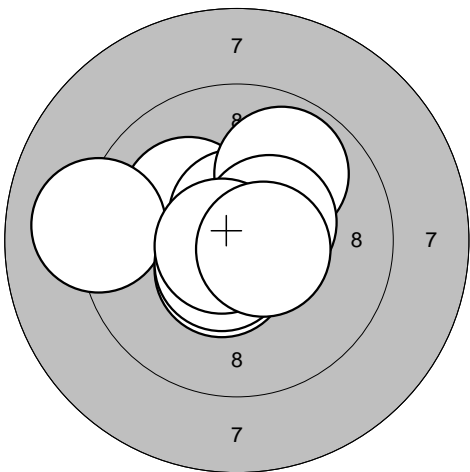
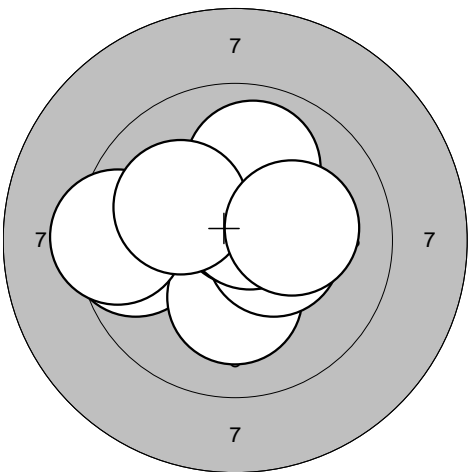
<p>Series 1</p> 	<p>1: 10,7* →</p> <p>2: 10,1 ↖</p> <p>3: 10,6* ↑</p> <p>4: 10,5* ↓</p> <p>5: 9,1 ←</p> <p>6: 9,9 ↗</p> <p>7: 10,5* →</p> <p>8: 10,6* ↓</p> <p>9: 10,7* ←</p> <p>10: 10,6* →</p>	<p>Series 2</p> 	<p>1: 9,6 ←</p> <p>2: 10,4* ↑</p> <p>3: 10,2* ↓</p> <p>4: 10,4* →</p> <p>5: 10,6* ↗</p> <p>6: 9,4 ←</p> <p>7: 10,7* ↗</p> <p>8: 9,9 ↑</p> <p>9: 10,1 ↖</p> <p>10: 10,2* →</p>
Serie 98,0	Serie 97,0	Serie 97,0	Serie 97,0
Sum 98,0	Sum 98,0	Sum 195,0	Sum 195,0

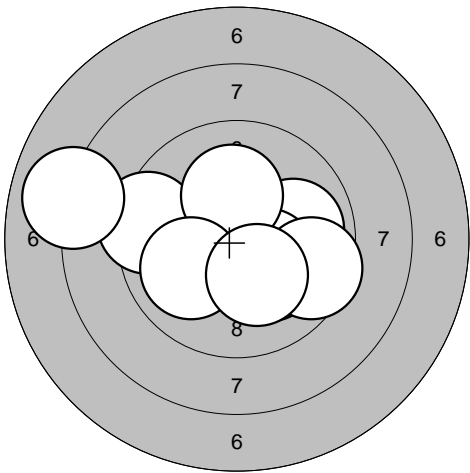
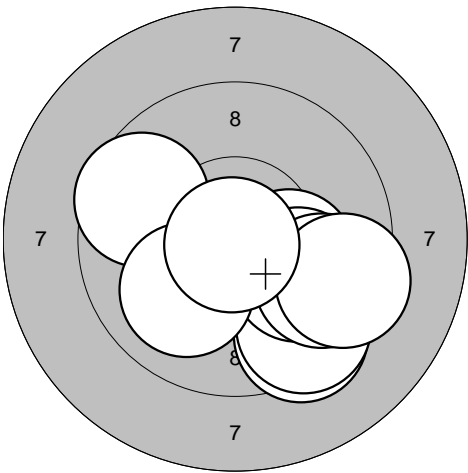
<p>Series 3</p> 	<p>1: 9,4 ←</p> <p>2: 10,2* ↓</p> <p>3: 10,8* ↓</p> <p>4: 8,0 ←</p> <p>5: 10,0 →</p> <p>6: 10,3* ↓</p> <p>7: 10,2* ↑</p> <p>8: 10,0 ←</p> <p>9: 9,5 →</p> <p>10: 10,2* ↓</p>	<p>Series 4</p> 	<p>1: 9,4 ↓</p> <p>2: 10,7* ↓</p> <p>3: 10,2* →</p> <p>4: 9,5 ↓</p> <p>5: 9,6 ↖</p> <p>6: 10,0 ↓</p> <p>7: 9,7 →</p> <p>8: 10,0 ↓</p> <p>9: 9,4 →</p> <p>10: 10,9* ↓</p>
Serie 96,0	Serie 96,0	Serie 95,0	Serie 95,0
Sum 291,0	Sum 291,0	Sum 386,0	Sum 386,0

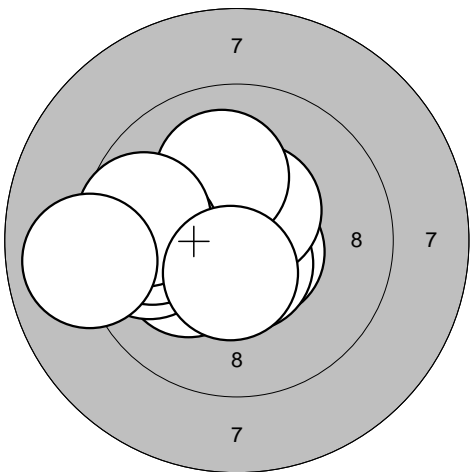
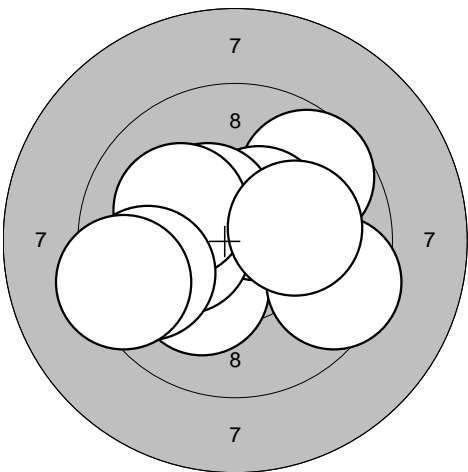
<p>Series 5</p> 	<p>1: 10,2* ←</p> <p>2: 10,6* →</p> <p>3: 9,8 ←</p> <p>4: 10,6* ↓</p> <p>5: 10,5* ↗</p> <p>6: 10,1 ↑</p> <p>7: 9,8 ←</p> <p>8: 9,7 ←</p> <p>9: 10,5* ↓</p> <p>10: 9,0 ←</p>	<p>Series 6</p> 	<p>1: 9,7 ↗</p> <p>2: 10,2* ↓</p> <p>3: 10,5* ↗</p> <p>4: 9,5 →</p> <p>5: 10,4* ↖</p> <p>6: 10,2* ←</p> <p>7: 10,1 ↖</p> <p>8: 10,1 →</p> <p>9: 9,7 ←</p> <p>10: 9,4 ←</p>
Serie 96,0	Serie 96,0	Serie 96,0	Serie 96,0
Sum 482,0	Sum 482,0	Sum 578,0	Sum 578,0

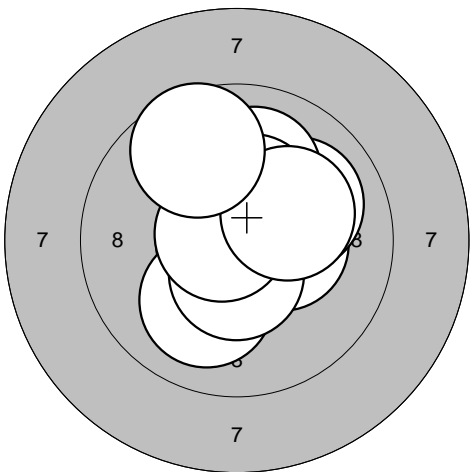
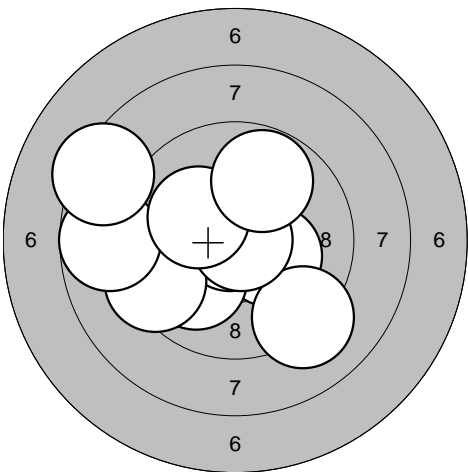
<p>Series 1</p> 	<p>1: 10,2* ↑</p> <p>2: 10,4* →</p> <p>3: 10,0 ↓</p> <p>4: 10,5* ↓</p> <p>5: 10,0 ↗</p> <p>6: 10,1 ↑</p> <p>7: 10,4* ↑</p> <p>8: 10,7* ↖</p> <p>9: 10,2* ↗</p> <p>10: 9,6 ↑</p>	<p>Series 2</p> 	<p>1: 10,3* →</p> <p>2: 9,1 ↓</p> <p>3: 10,0 ↙</p> <p>4: 10,9* ←</p> <p>5: 9,4 ↖</p> <p>6: 10,8* →</p> <p>7: 8,7 ←</p> <p>8: 10,2* ↖</p> <p>9: 8,4 ↖</p> <p>10: 9,8 ↑</p>
Serie 99,0	Serie 93,0	Serie 93,0	Serie 93,0
Sum 99,0	Sum 192,0	Sum 192,0	Sum 192,0

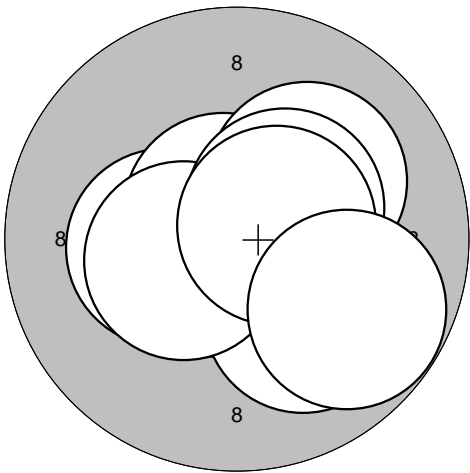
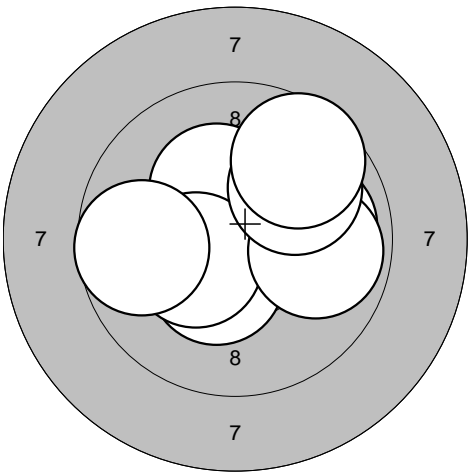
<p>Series 3</p> 	<p>1: 10,8* ↑</p> <p>2: 10,0 ↓</p> <p>3: 10,7* ↗</p> <p>4: 10,3* ←</p> <p>5: 10,7* ↑</p> <p>6: 10,1 ↗</p> <p>7: 10,4* ←</p> <p>8: 10,4* ↗</p> <p>9: 10,6* →</p> <p>10: 9,8 ↓</p>	<p>Series 4</p> 	<p>1: 10,0 →</p> <p>2: 10,4* ↗</p> <p>3: 10,5* ↖</p> <p>4: 10,3* ↑</p> <p>5: 10,4* ↓</p> <p>6: 10,3* ←</p> <p>7: 9,9 →</p> <p>8: 9,9 ↗</p> <p>9: 9,7 ←</p> <p>10: 9,6 ↗</p>
Serie 99,0	Serie 96,0	Serie 96,0	Serie 96,0
Sum 291,0	Sum 387,0	Sum 387,0	Sum 387,0

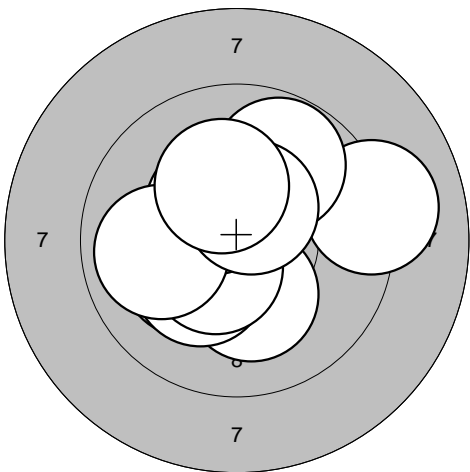
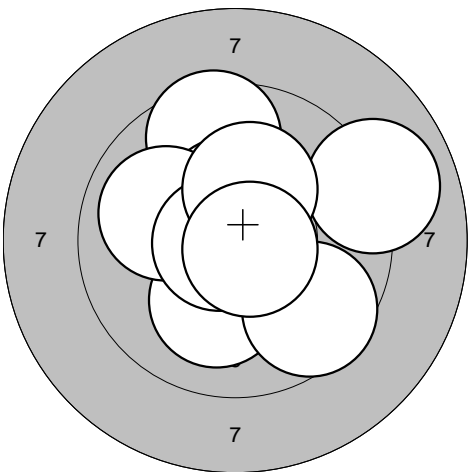
<p>Series 5</p> 	<p>1: 9,1 →</p> <p>2: 9,8 ↑</p> <p>3: 10,2* ↖</p> <p>4: 10,2* ↓</p> <p>5: 10,2* ↙</p> <p>6: 10,5* ↙</p> <p>7: 10,4* ↑</p> <p>8: 9,9 ←</p> <p>9: 10,5* ↑</p> <p>10: 10,2* ↑</p>	<p>Series 6</p> 	<p>1: 9,0 →</p> <p>2: 10,3* ↖</p> <p>3: 9,6 ↑</p> <p>4: 10,4* ↑</p> <p>5: 10,1 ↓</p> <p>6: 9,6 ↓</p> <p>7: 10,0 ↖</p> <p>8: 10,8* ←</p> <p>9: 10,3* ↑</p> <p>10: 10,7* ↓</p>
Serie 97,0	Serie 97,0	Serie 97,0	Serie 97,0
Sum 484,0	Sum 581,0	Sum 581,0	Sum 581,0

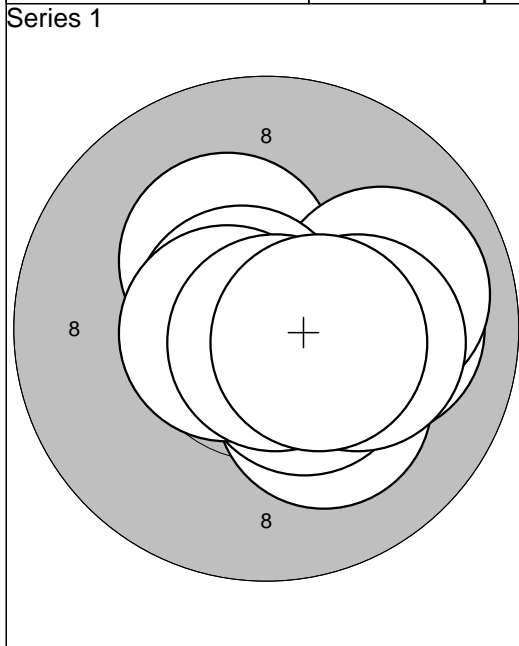

1: 10,2*	↘
2: 10,3*	↗
3: 10,0	→
4: 10,5*	↘
5: 9,9	→
6: 10,7*	↗
7: 10,6*	←
8: 10,8*	↘
9: 10,2*	→
10: 10,5*	↗
Serie	99,0
Sum	99,0

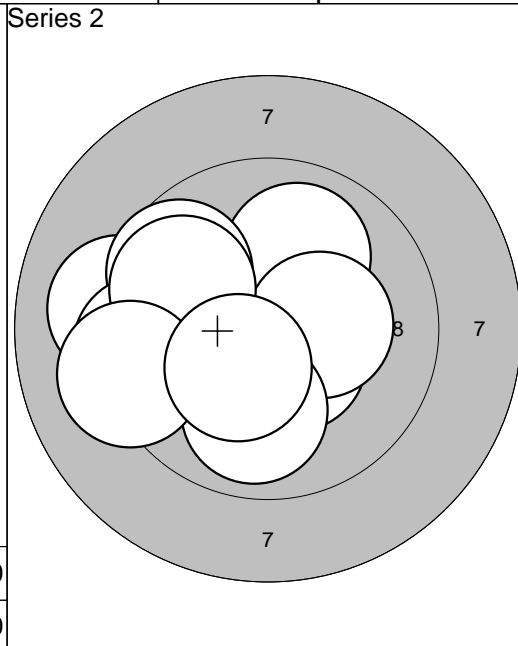

1: 9,1	←
2: 10,5*	↘
3: 10,0	↗
4: 9,7	↖
5: 10,3*	→
6: 9,9	↘
7: 9,5	←
8: 9,8	↖
9: 9,2	←
10: 10,4*	↘
Serie	94,0
Sum	193,0

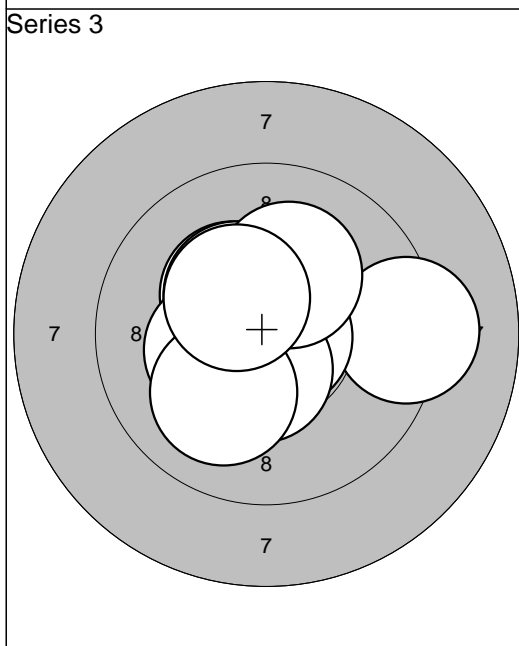

1: 9,2	→
2: 10,5*	←
3: 10,8*	→
4: 10,3*	↗
5: 10,3*	←
6: 10,5*	↘
7: 10,3*	↗
8: 10,0	↘
9: 10,2*	↗
10: 10,4*	↗
Serie	99,0
Sum	292,0

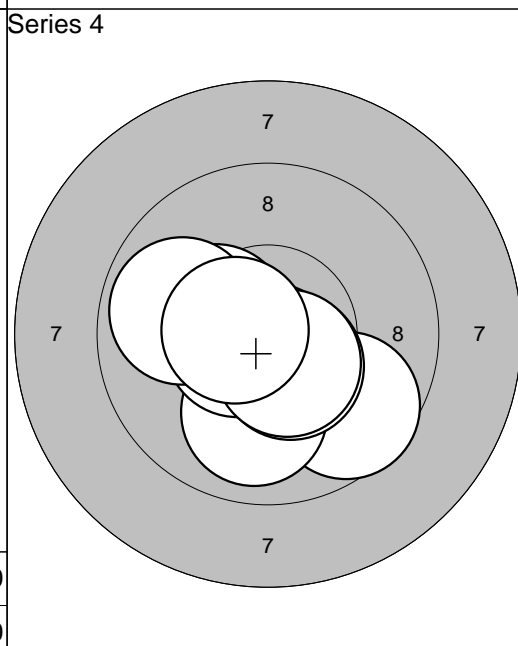

1: 10,5*	←
2: 10,7*	↘
3: 9,7	↘
4: 10,3*	←
5: 10,0	↘
6: 10,6*	←
7: 10,5*	↘
8: 10,5*	↘
9: 9,9	←
10: 10,5*	←
Serie	98,0
Sum	390,0

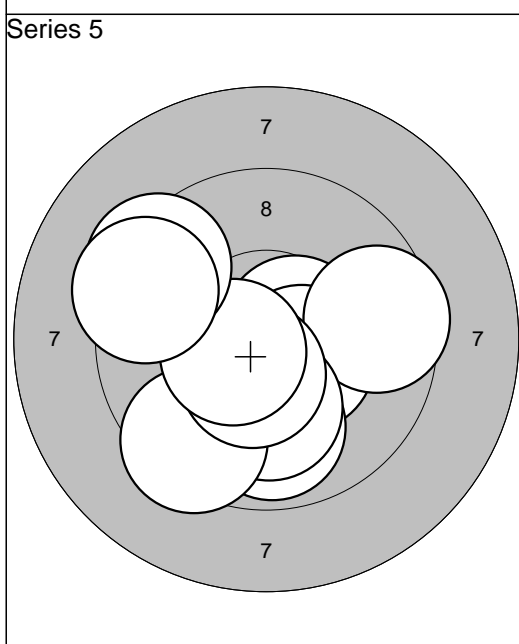

1: 10,6*	→
2: 10,5*	↘
3: 9,9	↘
4: 9,6	→
5: 10,1	↘
6: 9,4	↘
7: 10,5*	↘
8: 10,5*	←
9: 9,4	↖
10: 9,4	↖
Serie	95,0
Sum	485,0

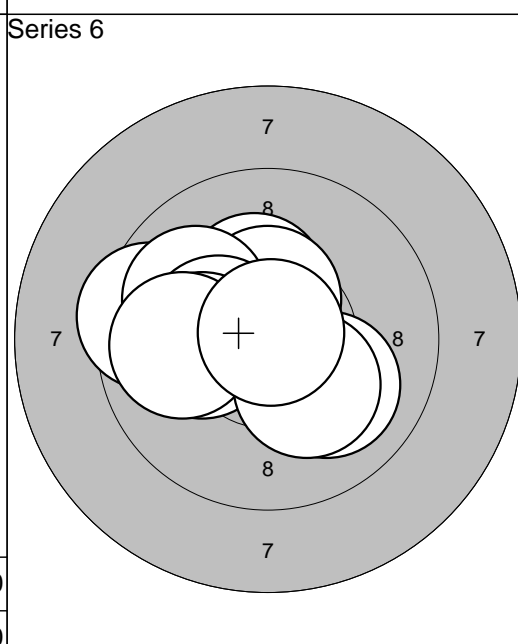

1: 9,5	←
2: 10,0	↘
3: 10,3*	↗
4: 10,5*	↗
5: 9,9	↖
6: 10,3*	←
7: 10,2*	←
8: 9,9	←
9: 10,2*	↘
10: 10,9*	↗
Serie	97,0
Sum	582,0

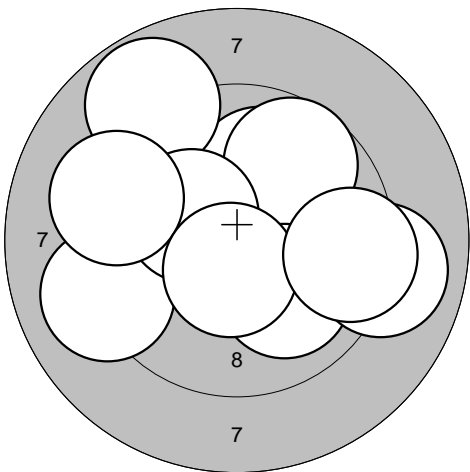
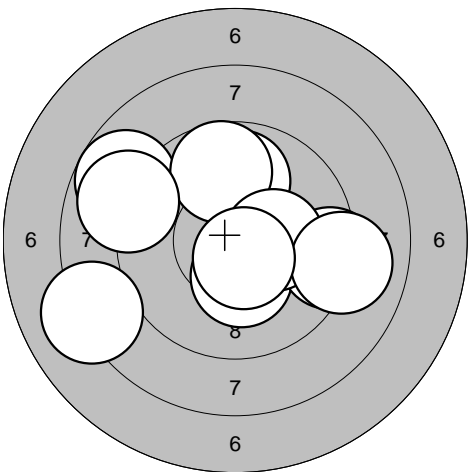
<p>Series 1</p> 	<p>1: 10,0 ↗</p> <p>2: 9,1 ←</p> <p>3: 8,8 ↗</p> <p>4: 9,7 ↗</p> <p>5: 10,3* ↗</p> <p>6: 10,0 ↘</p> <p>7: 9,3 ↗</p> <p>8: 9,0 →</p> <p>9: 10,5* ↘</p> <p>10: 9,4 →</p>	<p>Series 2</p> 	<p>1: 8,8 ↖</p> <p>2: 10,3* ↓</p> <p>3: 9,9 ↑</p> <p>4: 9,2 →</p> <p>5: 9,7 ↑</p> <p>6: 8,1 ←</p> <p>7: 10,3* →</p> <p>8: 9,0 →</p> <p>9: 9,0 ↖</p> <p>10: 10,6* ↘</p>
Serie 93,0	Serie 91,0	Serie 91,0	Serie 91,0
Sum 93,0	Sum 184,0	Sum 184,0	Sum 184,0

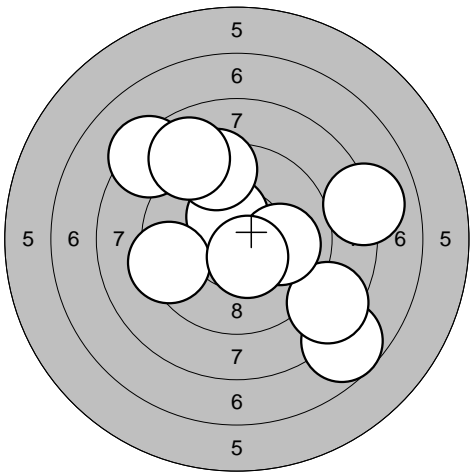
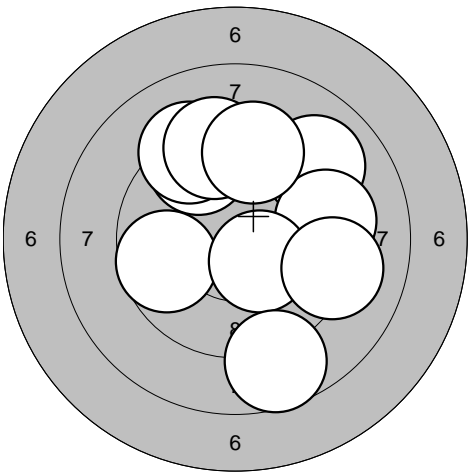
<p>Series 3</p> 	<p>1: 8,1 →</p> <p>2: 10,4* ↗</p> <p>3: 7,7 ↘</p> <p>4: 8,3 ↗</p> <p>5: 9,4 ↗</p> <p>6: 8,5 ↘</p> <p>7: 9,4 ←</p> <p>8: 8,9 ↗</p> <p>9: 10,0 →</p> <p>10: 10,5* ↘</p>	<p>Series 4</p> 	<p>1: 9,5 ↗</p> <p>2: 9,2 ↗</p> <p>3: 9,7 ←</p> <p>4: 9,1 ↗</p> <p>5: 9,3 →</p> <p>6: 9,3 ↑</p> <p>7: 10,4* ↘</p> <p>8: 9,2 →</p> <p>9: 9,4 ↑</p> <p>10: 8,7 ↘</p>
Serie 87,0	Serie 87,0	Serie 90,0	Serie 90,0
Sum 271,0	Sum 271,0	Sum 361,0	Sum 361,0

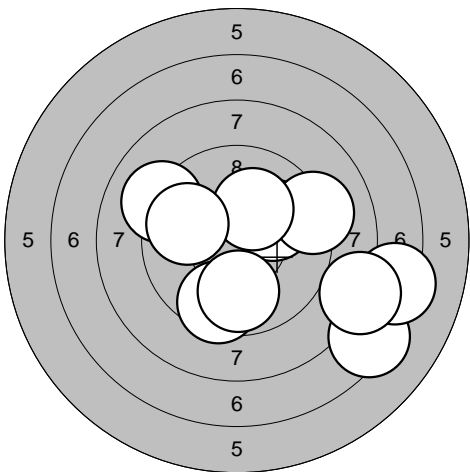
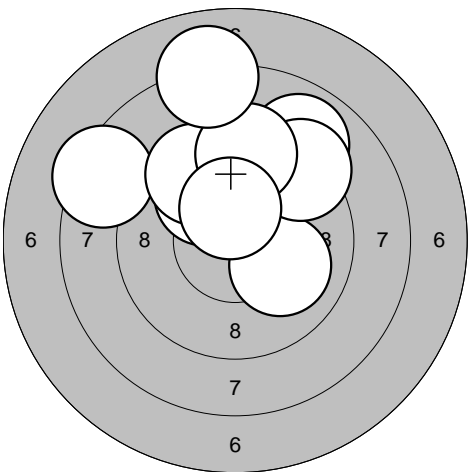
<p>Series 5</p> 	<p>1: 7,3 ↘</p> <p>2: 9,1 ↗</p> <p>3: 10,0 →</p> <p>4: 9,5 ↘</p> <p>5: 9,8 ↘</p> <p>6: 7,3 →</p> <p>7: 9,2 →</p> <p>8: 8,0 →</p> <p>9: 10,2* ↗</p> <p>10: 9,8 ←</p>	<p>Series 6</p> 	<p>1: 8,4 ↖</p> <p>2: 9,7 ↑</p> <p>3: 10,0 ↗</p> <p>4: 10,1 ↘</p> <p>5: 9,0 ↗</p> <p>6: 9,2 ↗</p> <p>7: 9,6 ↗</p> <p>8: 9,4 ↑</p> <p>9: 10,4* ↑</p> <p>10: 8,0 ↑</p>
Serie 87,0	Serie 87,0	Serie 91,0	Serie 91,0
Sum 448,0	Sum 448,0	Sum 539,0	Sum 539,0

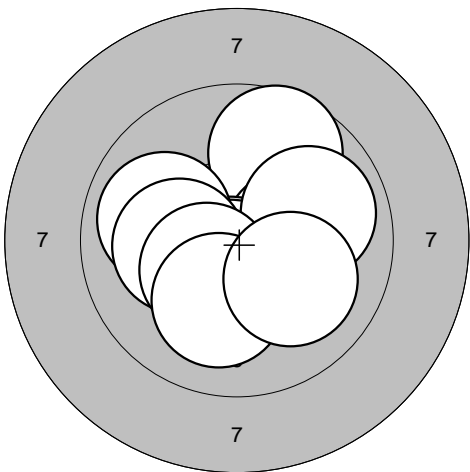
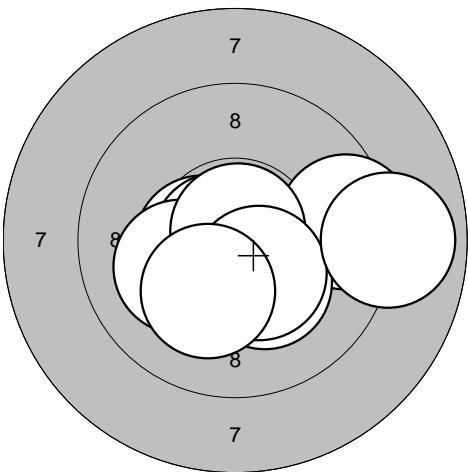
<p>Series 1</p> 	<p>1: 9,7 ↗ 2: 10,2* → 3: 10,6* ↓ 4: 10,6* ↓ 5: 9,9 → 6: 9,9 ← 7: 10,2* ← 8: 10,4* ↙ 9: 10,1 ↓ 10: 10,1 ↘</p> <table border="1" style="width:100%; border-collapse: collapse;"> <tr><td>Serie</td><td style="text-align: right;">97,0</td></tr> <tr><td>Sum</td><td style="text-align: right;">97,0</td></tr> </table>	Serie	97,0	Sum	97,0	<p>Series 2</p> 	<p>1: 10,5* ← 2: 9,4 → 3: 10,6* ↓ 4: 10,8* ← 5: 10,2* ← 6: 10,8* ↑ 7: 10,3* ↓ 8: 10,4* ↓ 9: 8,9 → 10: 10,2* ↓</p> <table border="1" style="width:100%; border-collapse: collapse;"> <tr><td>Serie</td><td style="text-align: right;">97,0</td></tr> <tr><td>Sum</td><td style="text-align: right;">194,0</td></tr> </table>	Serie	97,0	Sum	194,0
Serie	97,0										
Sum	97,0										
Serie	97,0										
Sum	194,0										

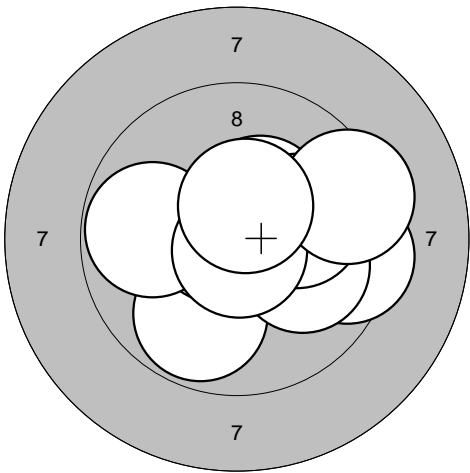
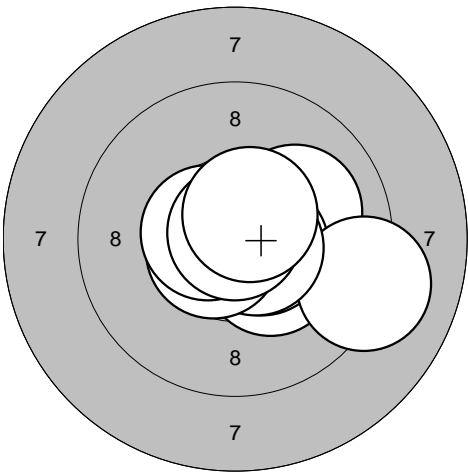
<p>Series 3</p> 	<p>1: 9,9 ↓ 2: 9,5 → 3: 10,0 → 4: 10,7* ← 5: 10,4* ↗ 6: 9,8 ← 7: 10,1 → 8: 10,8* ↓ 9: 9,4 → 10: 10,5* ↑</p> <table border="1" style="width:100%; border-collapse: collapse;"> <tr><td>Serie</td><td style="text-align: right;">96,0</td></tr> <tr><td>Sum</td><td style="text-align: right;">290,0</td></tr> </table>	Serie	96,0	Sum	290,0	<p>Series 4</p> 	<p>1: 10,6* ↗ 2: 10,1 → 3: 10,3* ↘ 4: 10,6* → 5: 9,1 → 6: 10,6* → 7: 10,6* ← 8: 10,6* ← 9: 10,9* ↑ 10: 10,6* ↗</p> <table border="1" style="width:100%; border-collapse: collapse;"> <tr><td>Serie</td><td style="text-align: right;">99,0</td></tr> <tr><td>Sum</td><td style="text-align: right;">389,0</td></tr> </table>	Serie	99,0	Sum	389,0
Serie	96,0										
Sum	290,0										
Serie	99,0										
Sum	389,0										

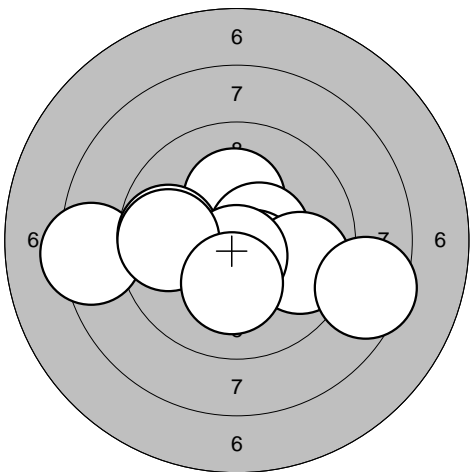
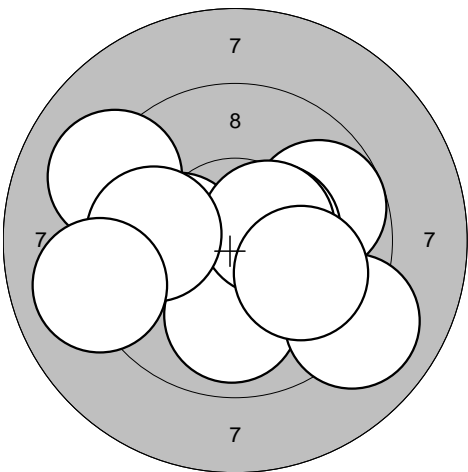
<p>Series 5</p> 	<p>1: 10,2* ↑ 2: 8,4 ← 3: 10,5* → 4: 10,5* ↓ 5: 9,8 ← 6: 9,8 → 7: 8,5 → 8: 10,7* ↓ 9: 9,7 ← 10: 10,2* ↓</p> <table border="1" style="width:100%; border-collapse: collapse;"> <tr><td>Serie</td><td style="text-align: right;">93,0</td></tr> <tr><td>Sum</td><td style="text-align: right;">482,0</td></tr> </table>	Serie	93,0	Sum	482,0	<p>Series 6</p> 	<p>1: 9,8 → 2: 10,2* ← 3: 9,9 ↓ 4: 9,2 ↙ 5: 10,4* → 6: 10,5* → 7: 9,1 ↘ 8: 9,8 ← 9: 9,0 ← 10: 10,0 ↘</p> <table border="1" style="width:100%; border-collapse: collapse;"> <tr><td>Serie</td><td style="text-align: right;">94,0</td></tr> <tr><td>Sum</td><td style="text-align: right;">576,0</td></tr> </table>	Serie	94,0	Sum	576,0
Serie	93,0										
Sum	482,0										
Serie	94,0										
Sum	576,0										

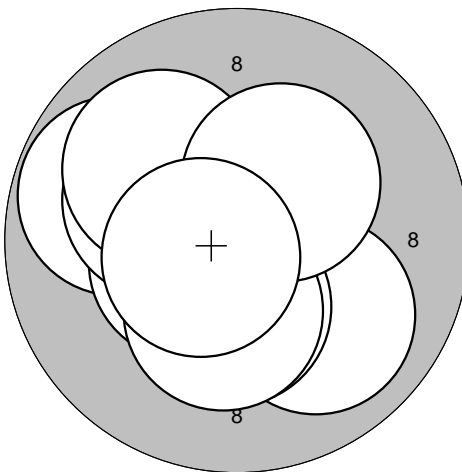
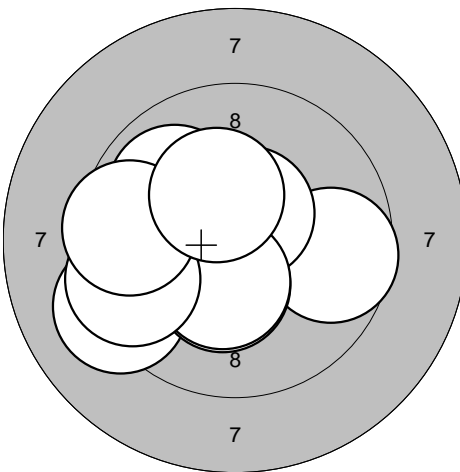
<p>Series 1</p> 	<p>1: 10,8* ↙ 2: 10,0 ↘ 3: 9,8 ↗ 4: 10,5* ↖ 5: 10,3* ↓ 6: 10,2* ↗ 7: 10,0 ↗ 8: 10,3* ↓ 9: 10,3* ↗ 10: 10,6* ↖</p> <table border="1" style="width:100%; border-collapse: collapse;"> <tr> <td style="text-align: right;">Serie</td> <td style="text-align: right;">99,0</td> </tr> <tr> <td style="text-align: right;">Sum</td> <td style="text-align: right;">99,0</td> </tr> </table>	Serie	99,0	Sum	99,0	<p>Series 2</p> 	<p>1: 9,7 → 2: 9,2 ↖ 3: 10,5* ↖ 4: 10,6* ↗ 5: 10,3* ↓ 6: 10,4* ↓ 7: 9,5 ← 8: 9,9 ↖ 9: 9,6 ← 10: 10,3* ↗</p> <table border="1" style="width:100%; border-collapse: collapse;"> <tr> <td style="text-align: right;">Serie</td> <td style="text-align: right;">95,0</td> </tr> <tr> <td style="text-align: right;">Sum</td> <td style="text-align: right;">194,0</td> </tr> </table>	Serie	95,0	Sum	194,0
Serie	99,0										
Sum	99,0										
Serie	95,0										
Sum	194,0										

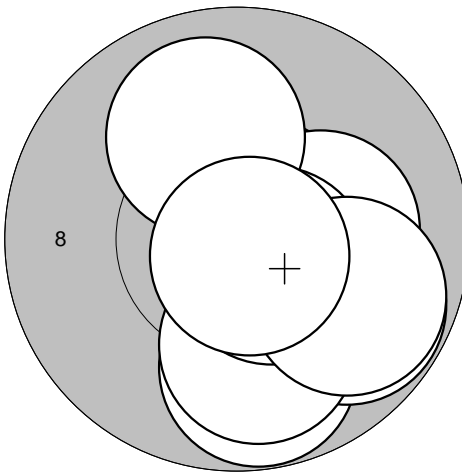
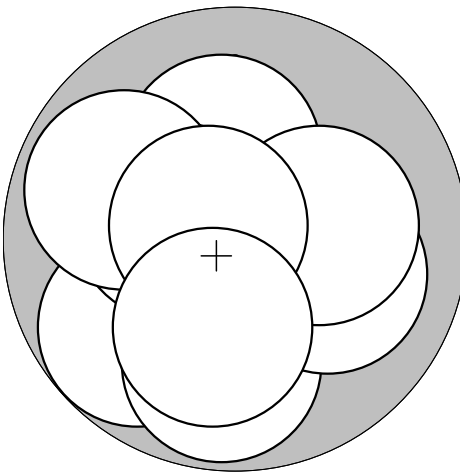
<p>Series 3</p> 	<p>1: 9,8 ↓ 2: 10,1 → 3: 9,8 → 4: 10,7* ↗ 5: 10,0 ↓ 6: 10,2* → 7: 10,5* ↓ 8: 10,0 ↗ 9: 9,8 → 10: 10,7* ↓</p> <table border="1" style="width:100%; border-collapse: collapse;"> <tr> <td style="text-align: right;">Serie</td> <td style="text-align: right;">97,0</td> </tr> <tr> <td style="text-align: right;">Sum</td> <td style="text-align: right;">291,0</td> </tr> </table>	Serie	97,0	Sum	291,0	<p>Series 4</p> 	<p>1: 10,7* ↖ 2: 10,2* ↑ 3: 9,7 ↖ 4: 9,8 ↓ 5: 10,1 → 6: 10,2* → 7: 10,4* ↖ 8: 9,9 ↖ 9: 10,7* ↖ 10: 10,1 ↓</p> <table border="1" style="width:100%; border-collapse: collapse;"> <tr> <td style="text-align: right;">Serie</td> <td style="text-align: right;">97,0</td> </tr> <tr> <td style="text-align: right;">Sum</td> <td style="text-align: right;">388,0</td> </tr> </table>	Serie	97,0	Sum	388,0
Serie	97,0										
Sum	291,0										
Serie	97,0										
Sum	388,0										

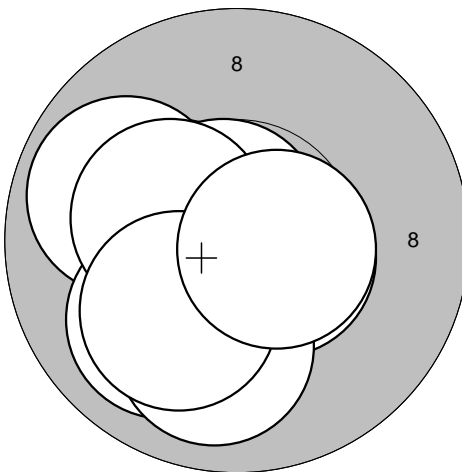
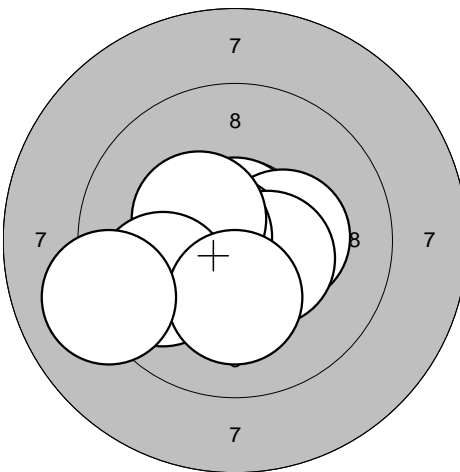
<p>Series 5</p> 	<p>1: 10,3* ↖ 2: 9,9 ↖ 3: 10,7* ↗ 4: 10,6* → 5: 10,0 ↘ 6: 10,6* ↖ 7: 10,0 ↓ 8: 10,3* ↖ 9: 10,1 ↘ 10: 10,6* →</p> <table border="1" style="width:100%; border-collapse: collapse;"> <tr> <td style="text-align: right;">Serie</td> <td style="text-align: right;">99,0</td> </tr> <tr> <td style="text-align: right;">Sum</td> <td style="text-align: right;">487,0</td> </tr> </table>	Serie	99,0	Sum	487,0	<p>Series 6</p> 	<p>1: 10,8* ↑ 2: 10,3* → 3: 10,5* ↖ 4: 10,8* ↖ 5: 10,4* ↘ 6: 10,6* ↖ 7: 10,4* ↖ 8: 9,9 ↖ 9: 10,2* ↓ 10: 9,1 ↖</p> <table border="1" style="width:100%; border-collapse: collapse;"> <tr> <td style="text-align: right;">Serie</td> <td style="text-align: right;">98,0</td> </tr> <tr> <td style="text-align: right;">Sum</td> <td style="text-align: right;">585,0</td> </tr> </table>	Serie	98,0	Sum	585,0
Serie	99,0										
Sum	487,0										
Serie	98,0										
Sum	585,0										

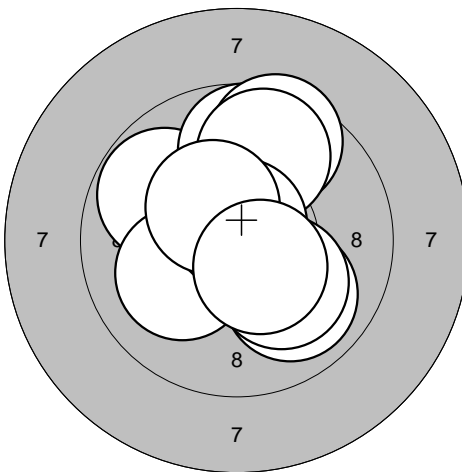
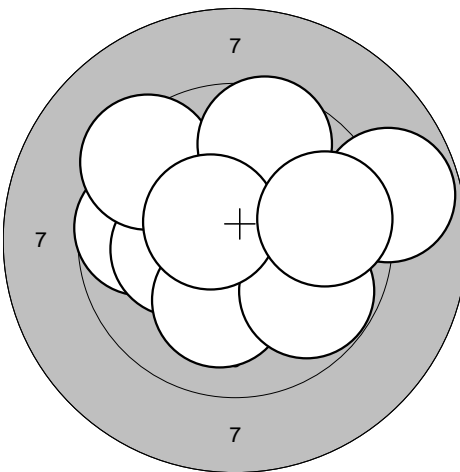
<p>Series 1</p> 	<p>1: 9,9 ↘ 2: 9,8 ↗ 3: 9,7 ↑ 4: 9,5 ↗ 5: 10,1 ↘ 6: 9,8 ↑ 7: 10,1 ↙ 8: 10,8* ↑ 9: 10,4* ↗ 10: 10,5* ↘</p> <table border="1" style="width:100%; border-collapse: collapse;"> <tr><td>Serie</td><td style="text-align: right;">95,0</td></tr> <tr><td>Sum</td><td style="text-align: right;">95,0</td></tr> </table>	Serie	95,0	Sum	95,0	<p>Series 2</p> 	<p>1: 8,8 → 2: 9,7 ← 3: 10,6* ↗ 4: 10,2* ← 5: 9,4 ↗ 6: 10,1 ↓ 7: 9,8 ↘ 8: 9,6 ↑ 9: 10,5* ↗ 10: 9,7 →</p> <table border="1" style="width:100%; border-collapse: collapse;"> <tr><td>Serie</td><td style="text-align: right;">93,0</td></tr> <tr><td>Sum</td><td style="text-align: right;">188,0</td></tr> </table>	Serie	93,0	Sum	188,0
Serie	95,0										
Sum	95,0										
Serie	93,0										
Sum	188,0										

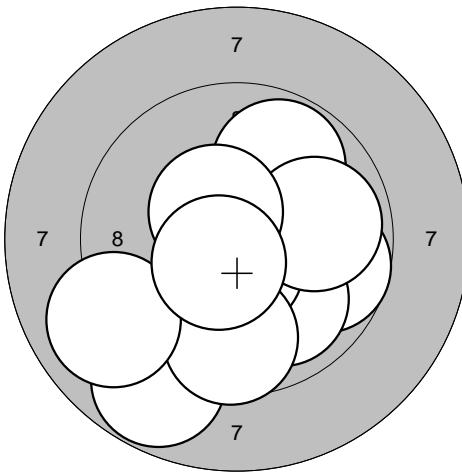
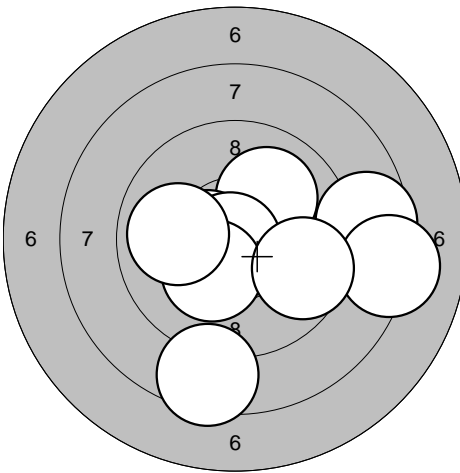
<p>Series 3</p> 	<p>1: 9,7 → 2: 10,0 ↘ 3: 9,8 ↗ 4: 10,6* ↓ 5: 8,8 ↘ 6: 9,9 → 7: 9,6 ↓ 8: 9,0 ↙ 9: 10,5* ↗ 10: 10,5* ↘</p> <table border="1" style="width:100%; border-collapse: collapse;"> <tr><td>Serie</td><td style="text-align: right;">93,0</td></tr> <tr><td>Sum</td><td style="text-align: right;">281,0</td></tr> </table>	Serie	93,0	Sum	281,0	<p>Series 4</p> 	<p>1: 8,6 → 2: 10,5* ← 3: 8,5 ↓ 4: 8,2 → 5: 10,0 ↗ 6: 10,5* ← 7: 10,8* ↙ 8: 10,3* ↘ 9: 9,9 ← 10: 9,6 →</p> <table border="1" style="width:100%; border-collapse: collapse;"> <tr><td>Serie</td><td style="text-align: right;">92,0</td></tr> <tr><td>Sum</td><td style="text-align: right;">373,0</td></tr> </table>	Serie	92,0	Sum	373,0
Serie	93,0										
Sum	281,0										
Serie	92,0										
Sum	373,0										

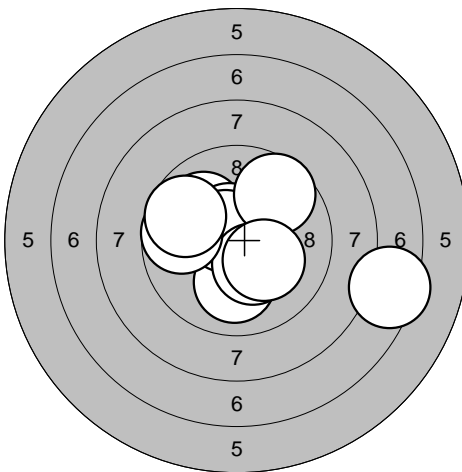
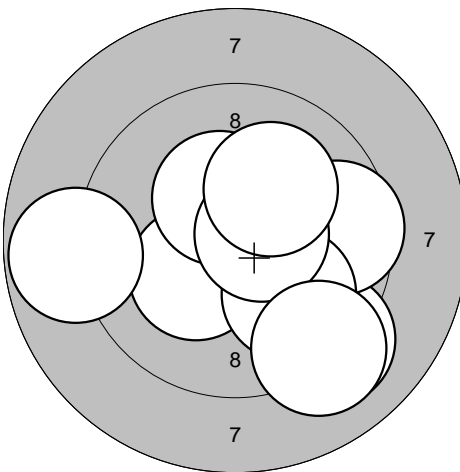
<p>Series 5</p> 	<p>1: 10,0 ↓ 2: 10,0 ↗ 3: 10,6* ↗ 4: 10,6* ↗ 5: 9,6 ↗ 6: 10,3* ↘ 7: 9,7 ← 8: 7,4 → 9: 10,2* ↘ 10: 9,7 ↗</p> <table border="1" style="width:100%; border-collapse: collapse;"> <tr><td>Serie</td><td style="text-align: right;">94,0</td></tr> <tr><td>Sum</td><td style="text-align: right;">467,0</td></tr> </table>	Serie	94,0	Sum	467,0	<p>Series 6</p> 	<p>1: 9,1 ↘ 2: 10,7* ↗ 3: 9,6 → 4: 10,3* ↙ 5: 10,4* ↗ 6: 9,9 ↘ 7: 10,6* → 8: 9,1 ↘ 9: 8,8 ← 10: 10,1 ↗</p> <table border="1" style="width:100%; border-collapse: collapse;"> <tr><td>Serie</td><td style="text-align: right;">94,0</td></tr> <tr><td>Sum</td><td style="text-align: right;">561,0</td></tr> </table>	Serie	94,0	Sum	561,0
Serie	94,0										
Sum	467,0										
Serie	94,0										
Sum	561,0										

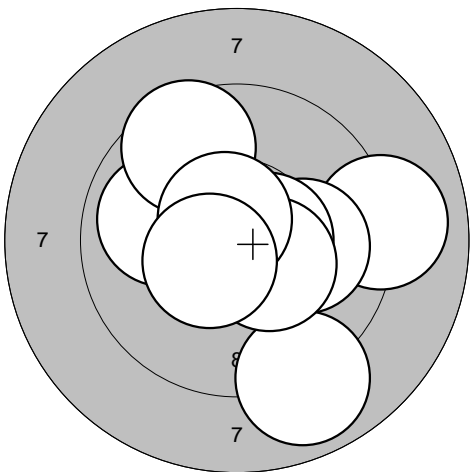
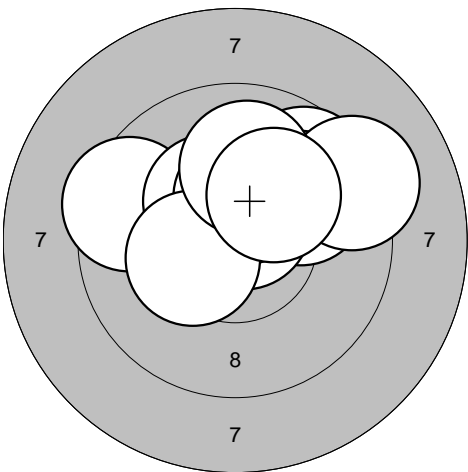
<p>Series 1</p> 	<p>1: 10,0 ←</p> <p>2: 9,0 →</p> <p>3: 10,0 →</p> <p>4: 10,7* ↙</p> <p>5: 8,9 ↘</p> <p>6: 10,5* →</p> <p>7: 9,6 ↗</p> <p>8: 10,4* ↘</p> <p>9: 10,6* ↗</p> <p>10: 10,5* ↙</p>	<p>Series 2</p> 	<p>1: 9,7 ↗</p> <p>2: 9,9 ↗</p> <p>3: 10,7* ↗</p> <p>4: 9,5 ↙</p> <p>5: 9,2 →</p> <p>6: 10,3* ↖</p> <p>7: 10,4* ↑</p> <p>8: 10,3* ↙</p> <p>9: 10,0 ↑</p> <p>10: 10,1 ↗</p>
Serie 96,0		Serie 96,0	
Sum 96,0		Sum 192,0	

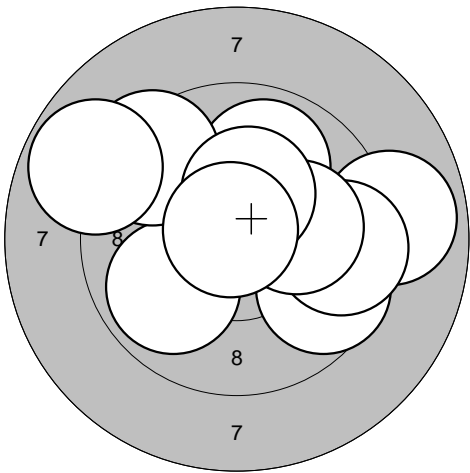
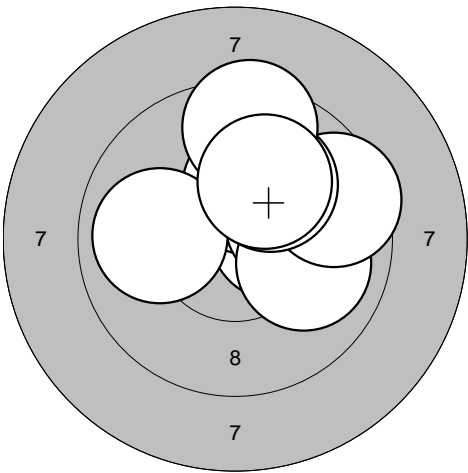
<p>Series 3</p> 	<p>1: 9,6 ↘</p> <p>2: 8,9 →</p> <p>3: 9,5 →</p> <p>4: 9,9 ↙</p> <p>5: 9,9 ↗</p> <p>6: 9,4 ↗</p> <p>7: 10,1 →</p> <p>8: 10,3* ↑</p> <p>9: 10,8* ↗</p> <p>10: 8,8 ↙</p>	<p>Series 4</p> 	<p>1: 10,4* →</p> <p>2: 10,1 ↗</p> <p>3: 10,2* ↑</p> <p>4: 10,2* →</p> <p>5: 10,0 →</p> <p>6: 9,5 →</p> <p>7: 10,1 ↗</p> <p>8: 9,4 ↑</p> <p>9: 10,0 ←</p> <p>10: 10,1 ↗</p>
Serie 91,0		Serie 98,0	
Sum 283,0		Sum 381,0	

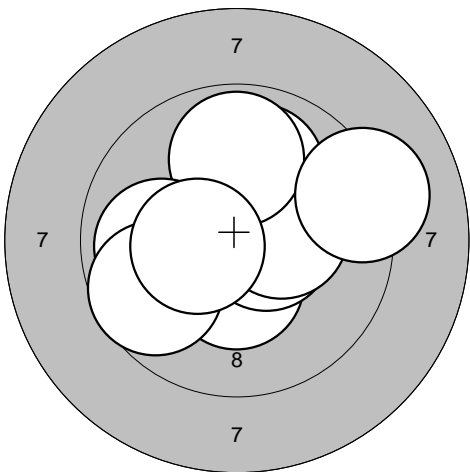
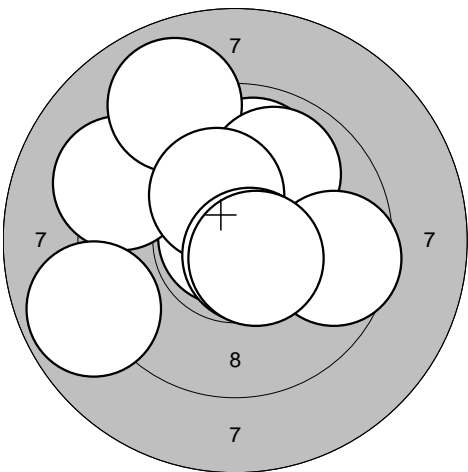
<p>Series 5</p> 	<p>1: 10,4* ↓</p> <p>2: 10,5* →</p> <p>3: 10,1 ←</p> <p>4: 10,0 ↑</p> <p>5: 10,3* →</p> <p>6: 9,9 ↑</p> <p>7: 10,0 ←</p> <p>8: 9,7 ↙</p> <p>9: 9,2 →</p> <p>10: 10,4* ←</p>	<p>Series 6</p> 	<p>1: 10,8* ↙</p> <p>2: 9,3 ↙</p> <p>3: 9,9 ↑</p> <p>4: 9,0 ↖</p> <p>5: 9,9 ↗</p> <p>6: 10,3* ↖</p> <p>7: 9,6 →</p> <p>8: 10,7* ↘</p> <p>9: 8,9 ↙</p> <p>10: 10,6* ↘</p>
Serie 97,0		Serie 93,0	
Sum 478,0		Sum 571,0	

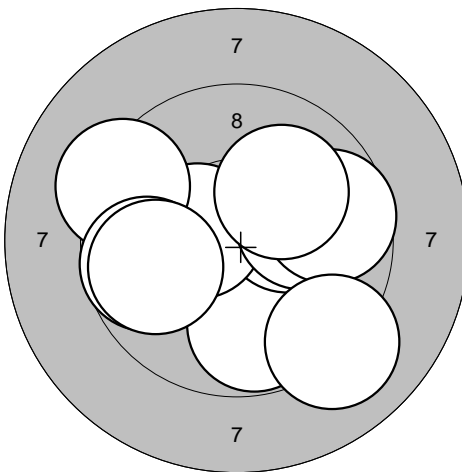
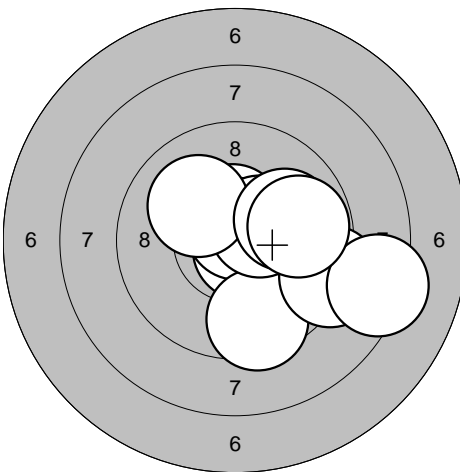
<p>Series 1</p> 	<p>1: 9,8 ↘ 2: 10,2* → 3: 10,4* ← 4: 10,1 → 5: 9,3 ↖ 6: 9,7 → 7: 10,1 ↗ 8: 9,7 ← 9: 9,1 ↘ 10: 9,8 ←</p> <table border="1" style="width:100%; border-collapse: collapse;"> <tr><td>Serie</td><td style="text-align: right;">94,0</td></tr> <tr><td>Sum</td><td style="text-align: right;">94,0</td></tr> </table>	Serie	94,0	Sum	94,0	<p>Series 2</p> 	<p>1: 10,7* ↘ 2: 10,5* ↑ 3: 10,7* ↑ 4: 9,5 ↘ 5: 9,1 → 6: 10,4* ↗ 7: 10,1 ↗ 8: 10,0 → 9: 8,3 → 10: 9,8 →</p> <table border="1" style="width:100%; border-collapse: collapse;"> <tr><td>Serie</td><td style="text-align: right;">95,0</td></tr> <tr><td>Sum</td><td style="text-align: right;">189,0</td></tr> </table>	Serie	95,0	Sum	189,0
Serie	94,0										
Sum	94,0										
Serie	95,0										
Sum	189,0										

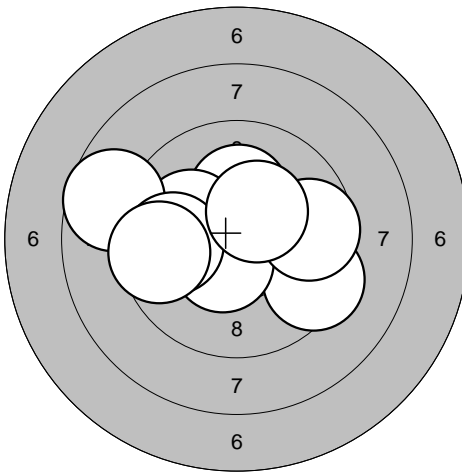
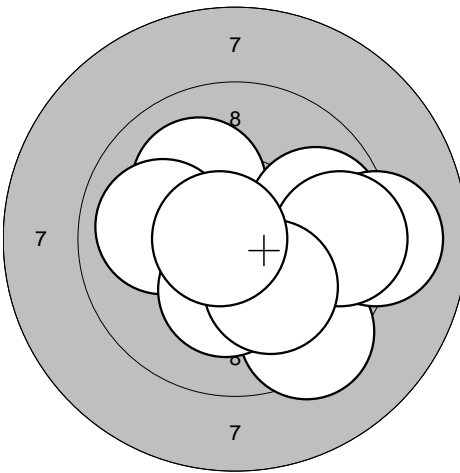
<p>Series 3</p> 	<p>1: 10,2* ↑ 2: 10,3* → 3: 10,1 ← 4: 9,4 → 5: 10,5* ↘ 6: 8,7 ← 7: 9,7 → 8: 9,8 ← 9: 9,6 ← 10: 10,4* ↗</p> <table border="1" style="width:100%; border-collapse: collapse;"> <tr><td>Serie</td><td style="text-align: right;">94,0</td></tr> <tr><td>Sum</td><td style="text-align: right;">283,0</td></tr> </table>	Serie	94,0	Sum	283,0	<p>Series 4</p> 	<p>1: 9,4 ↘ 2: 10,1 ↗ 3: 9,8 → 4: 9,1 → 5: 10,7* ↘ 6: 10,0 ← 7: 10,3* ↘ 8: 9,5 → 9: 10,2* ↘ 10: 10,8* ←</p> <table border="1" style="width:100%; border-collapse: collapse;"> <tr><td>Serie</td><td style="text-align: right;">96,0</td></tr> <tr><td>Sum</td><td style="text-align: right;">379,0</td></tr> </table>	Serie	96,0	Sum	379,0
Serie	94,0										
Sum	283,0										
Serie	96,0										
Sum	379,0										

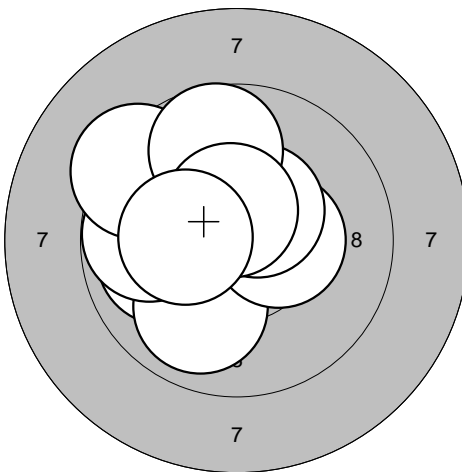
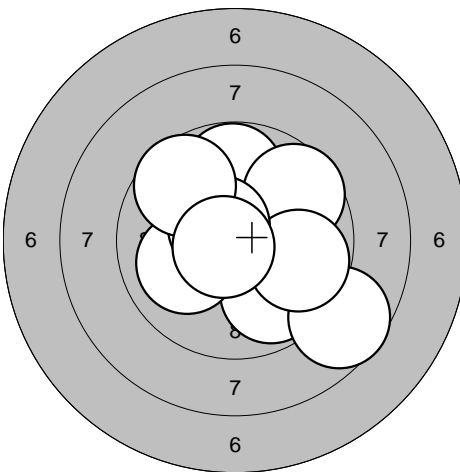
<p>Series 5</p> 	<p>1: 10,2* ↗ 2: 10,0 ← 3: 9,9 ↘ 4: 9,8 ← 5: 10,4* → 6: 9,3 ↗ 7: 10,5* ↗ 8: 9,7 ↑ 9: 10,5* ↑ 10: 10,3* ←</p> <table border="1" style="width:100%; border-collapse: collapse;"> <tr><td>Serie</td><td style="text-align: right;">96,0</td></tr> <tr><td>Sum</td><td style="text-align: right;">475,0</td></tr> </table>	Serie	96,0	Sum	475,0	<p>Series 6</p> 	<p>1: 10,1 ↗ 2: 9,8 ↑ 3: 9,6 ↗ 4: 9,9 ↘ 5: 8,7 ↘ 6: 10,0 ← 7: 9,8 → 8: 10,6* ↗ 9: 9,7 ↗ 10: 10,7* ←</p> <table border="1" style="width:100%; border-collapse: collapse;"> <tr><td>Serie</td><td style="text-align: right;">93,0</td></tr> <tr><td>Sum</td><td style="text-align: right;">568,0</td></tr> </table>	Serie	93,0	Sum	568,0
Serie	96,0										
Sum	475,0										
Serie	93,0										
Sum	568,0										

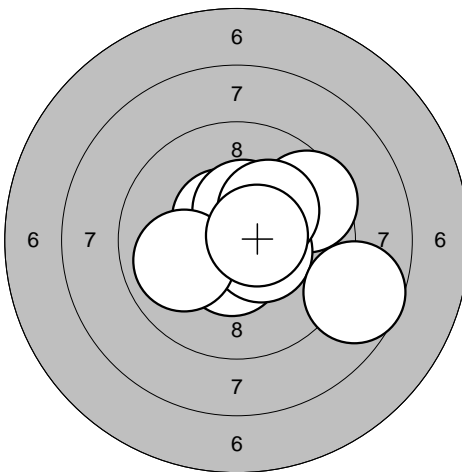
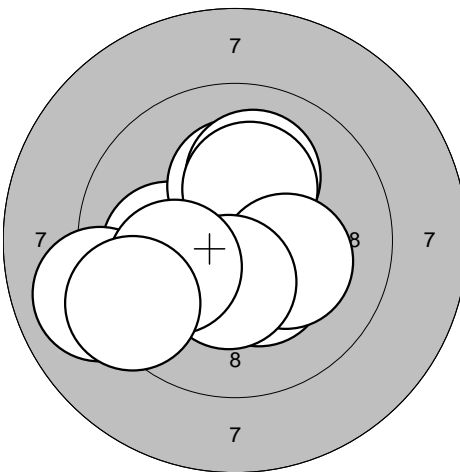
<p>Series 1</p> 	<p>1: 10,8* ↗</p> <p>2: 9,5 →</p> <p>3: 10,5* ↗</p> <p>4: 10,5* ↓</p> <p>5: 10,4* ↑</p> <p>6: 10,5* →</p> <p>7: 10,0 ←</p> <p>8: 10,2* ↗</p> <p>9: 8,7 →</p> <p>10: 10,6* →</p>	<p>Series 2</p> 	<p>1: 10,1 ←</p> <p>2: 10,2* ↑</p> <p>3: 10,4* ↓</p> <p>4: 10,1 ↑</p> <p>5: 10,2* ↑</p> <p>6: 10,2* →</p> <p>7: 10,4* ↓</p> <p>8: 9,0 ←</p> <p>9: 10,1 ←</p> <p>10: 9,3 ←</p>
Serie 97,0	Serie 98,0	Serie 98,0	Serie 98,0
Sum 97,0	Sum 97,0	Sum 195,0	Sum 195,0

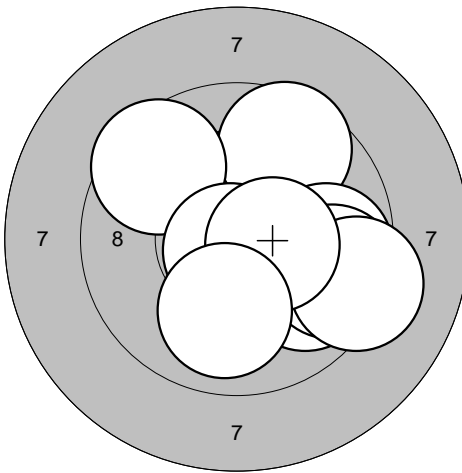
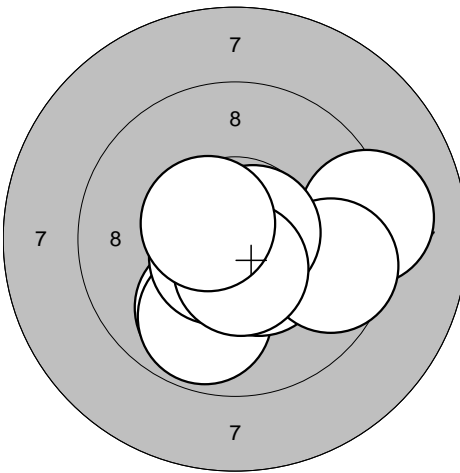
<p>Series 3</p> 	<p>1: 10,4* ↑</p> <p>2: 9,9 →</p> <p>3: 9,6 ↗</p> <p>4: 9,6 ↗</p> <p>5: 9,7 →</p> <p>6: 9,6 →</p> <p>7: 10,8* ↓</p> <p>8: 9,2 →</p> <p>9: 10,5* →</p> <p>10: 10,0 ↓</p>	<p>Series 4</p> 	<p>1: 9,9 ↓</p> <p>2: 10,8* ↓</p> <p>3: 9,8 ↓</p> <p>4: 9,2 →</p> <p>5: 10,4* ↓</p> <p>6: 9,6 →</p> <p>7: 10,6* ↙</p> <p>8: 10,7* →</p> <p>9: 10,5* ↓</p> <p>10: 10,5* ↙</p>
Serie 94,0	Serie 96,0	Serie 96,0	Serie 96,0
Sum 289,0	Sum 289,0	Sum 385,0	Sum 385,0

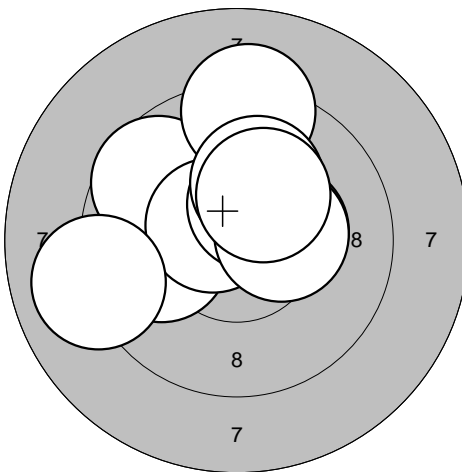
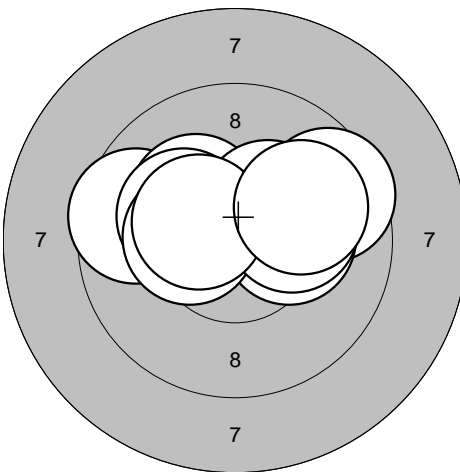
<p>Series 5</p> 	<p>1: 9,9 ←</p> <p>2: 9,6 ↗</p> <p>3: 10,3* →</p> <p>4: 10,6* ↗</p> <p>5: 10,4* ↗</p> <p>6: 9,2 ↑</p> <p>7: 10,3* →</p> <p>8: 10,2* ↑</p> <p>9: 10,3* ↗</p> <p>10: 9,0 ←</p>	<p>Series 6</p> 	<p>1: 9,6 →</p> <p>2: 9,6 ←</p> <p>3: 10,2* →</p> <p>4: 10,2* ↗</p> <p>5: 10,2* ↗</p> <p>6: 10,3* ↗</p> <p>7: 10,4* ←</p> <p>8: 10,2* →</p> <p>9: 10,4* ↙</p> <p>10: 10,0 →</p>
Serie 96,0	Serie 98,0	Serie 98,0	Serie 98,0
Sum 481,0	Sum 481,0	Sum 579,0	Sum 579,0

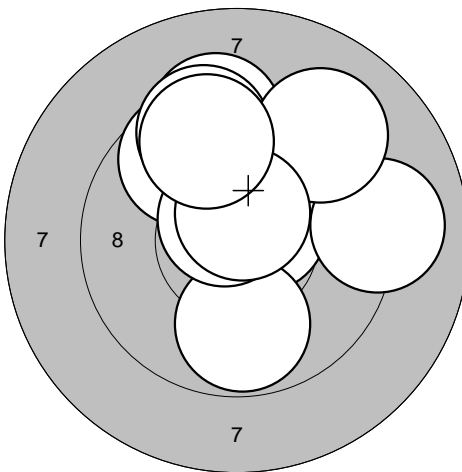
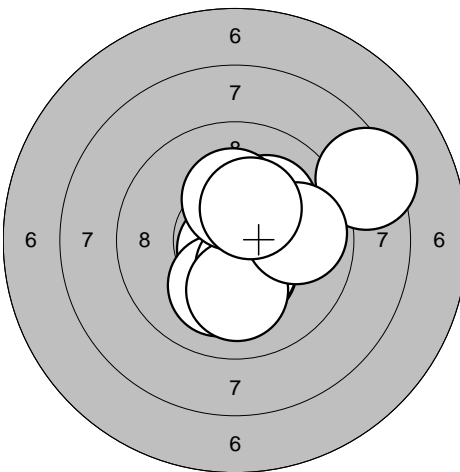
<p>Series 1</p> 	<p>1: 9,7 ↖ 2: 9,3 ↑ 3: 9,4 ↑ 4: 10,6* ↗ 5: 9,8 ↓ 6: 9,1 → 7: 9,2 ↗ 8: 10,6* ↖ 9: 10,6* ↑ 10: 9,6 ↑</p> <table border="1" style="width:100%; border-collapse: collapse;"> <tr><td>Serie</td><td style="text-align: right;">93,0</td></tr> <tr><td>Sum</td><td style="text-align: right;">93,0</td></tr> </table>	Serie	93,0	Sum	93,0	<p>Series 2</p> 	<p>1: 10,4* ↓ 2: 10,8* ↙ 3: 10,1 ↓ 4: 8,4 ↗ 5: 10,4* ↓ 6: 10,1 ↓ 7: 10,1 ↗ 8: 9,9 → 9: 10,2* ↑ 10: 10,3* ↗</p> <table border="1" style="width:100%; border-collapse: collapse;"> <tr><td>Serie</td><td style="text-align: right;">97,0</td></tr> <tr><td>Sum</td><td style="text-align: right;">190,0</td></tr> </table>	Serie	97,0	Sum	190,0
Serie	93,0										
Sum	93,0										
Serie	97,0										
Sum	190,0										

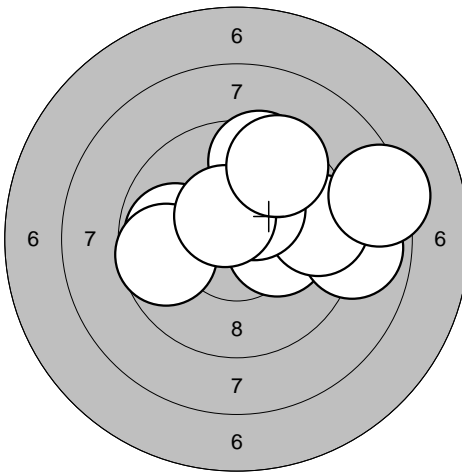
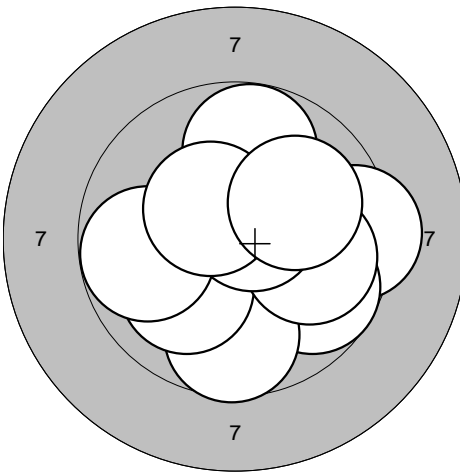
<p>Series 3</p> 	<p>1: 10,2* → 2: 9,8 ← 3: 9,5 ↑ 4: 8,9 → 5: 9,5 → 6: 9,7 ← 7: 8,3 → 8: 10,4* ↗ 9: 10,5* ↖ 10: 9,5 ↗</p> <table border="1" style="width:100%; border-collapse: collapse;"> <tr><td>Serie</td><td style="text-align: right;">91,0</td></tr> <tr><td>Sum</td><td style="text-align: right;">281,0</td></tr> </table>	Serie	91,0	Sum	281,0	<p>Series 4</p> 	<p>1: 9,3 → 2: 9,7 ↘ 3: 9,8 ↑ 4: 9,7 ↓ 5: 10,0 ↙ 6: 9,9 → 7: 9,8 ← 8: 10,6* ↗ 9: 10,4* ↖ 10: 10,0 ↗</p> <table border="1" style="width:100%; border-collapse: collapse;"> <tr><td>Serie</td><td style="text-align: right;">94,0</td></tr> <tr><td>Sum</td><td style="text-align: right;">375,0</td></tr> </table>	Serie	94,0	Sum	375,0
Serie	91,0										
Sum	281,0										
Serie	94,0										
Sum	375,0										

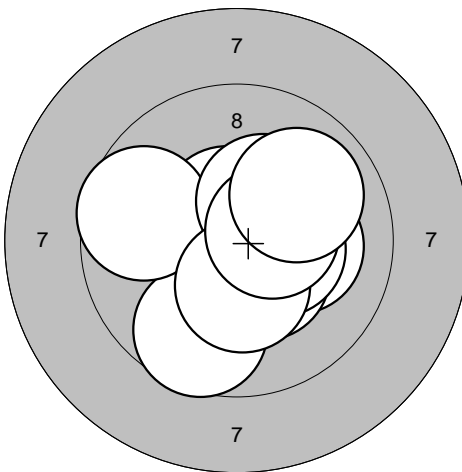
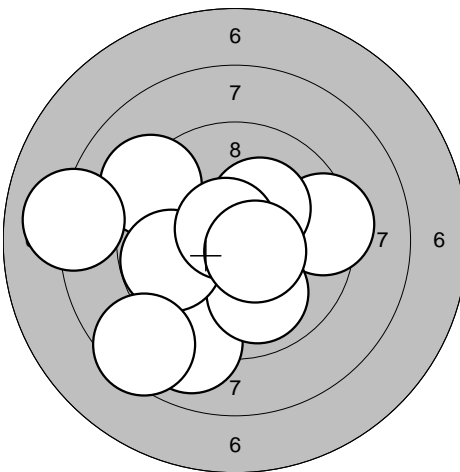
<p>Series 5</p> 	<p>1: 10,1 → 2: 10,6* ↑ 3: 9,7 ↓ 4: 10,4* ↓ 5: 10,4* → 6: 9,7 ← 7: 10,3* ↗ 8: 10,4* ↓ 9: 10,4* → 10: 10,0 ↗</p> <table border="1" style="width:100%; border-collapse: collapse;"> <tr><td>Serie</td><td style="text-align: right;">98,0</td></tr> <tr><td>Sum</td><td style="text-align: right;">473,0</td></tr> </table>	Serie	98,0	Sum	473,0	<p>Series 6</p> 	<p>1: 9,0 ↓ 2: 9,4 → 3: 9,2 ↖ 4: 10,0 ↓ 5: 9,8 ← 6: 8,5 ↙ 7: 8,1 ← 8: 10,2* ↗ 9: 10,7* ↖ 10: 10,5* ↘</p> <table border="1" style="width:100%; border-collapse: collapse;"> <tr><td>Serie</td><td style="text-align: right;">92,0</td></tr> <tr><td>Sum</td><td style="text-align: right;">565,0</td></tr> </table>	Serie	92,0	Sum	565,0
Serie	98,0										
Sum	473,0										
Serie	92,0										
Sum	565,0										

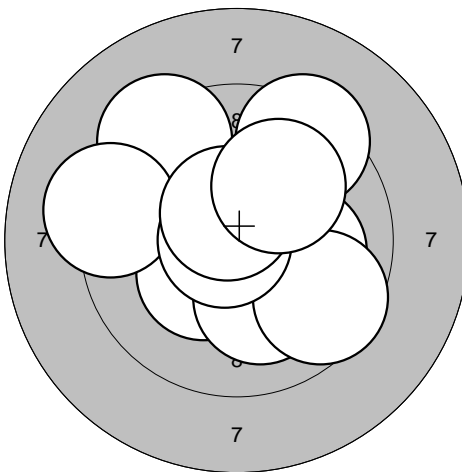
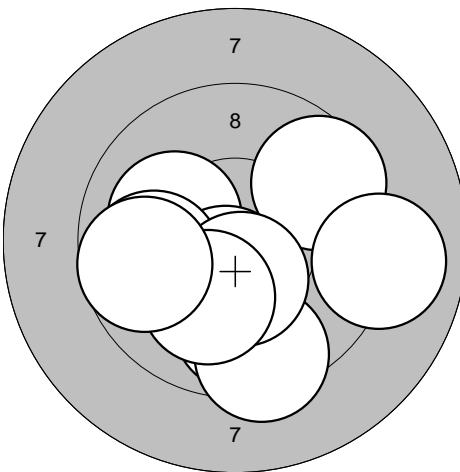
<p>Series 1</p> 	<p>1: 9,4 ↗ 2: 10,3* ↘ 3: 9,3 ↗ 4: 10,1 → 5: 10,1 ↘ 6: 9,2 ← 7: 9,6 ↘ 8: 10,8* ← 9: 10,6* ↗ 10: 10,0 ↗</p> <p>Serie 96,0 Sum 96,0</p>	<p>Series 2</p> 	<p>1: 9,8 ↓ 2: 9,4 ↓ 3: 9,6 ↗ 4: 10,1 ← 5: 10,5* ↓ 6: 9,0 → 7: 9,8 ← 8: 10,4* ↓ 9: 10,1 ↘ 10: 9,7 ←</p> <p>Serie 94,0 Sum 190,0</p>
--	---	--	---

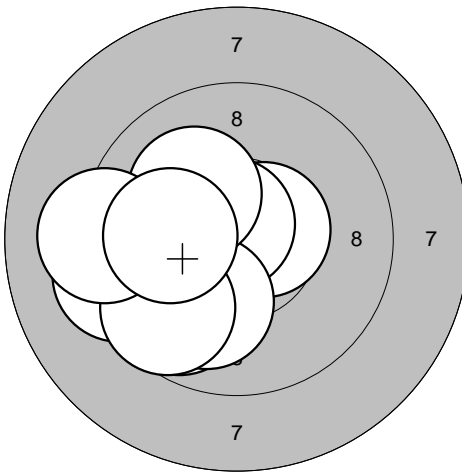
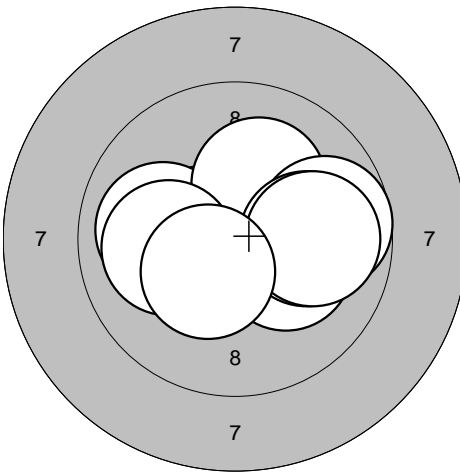
<p>Series 3</p> 	<p>1: 9,7 ↘ 2: 10,6* → 3: 10,1 ↘ 4: 9,3 ← 5: 10,7* ↗ 6: 10,0 ↘ 7: 9,7 ↘ 8: 10,1 ↗ 9: 9,2 ← 10: 10,1 ←</p> <p>Serie 96,0 Sum 286,0</p>	<p>Series 4</p> 	<p>1: 10,6* ← 2: 10,2* → 3: 10,6* ↗ 4: 10,0 ← 5: 10,2* ↗ 6: 9,7 → 7: 10,0 → 8: 9,9 → 9: 10,1 ← 10: 10,4* ↘</p> <p>Serie 98,0 Sum 384,0</p>
---	---	---	--

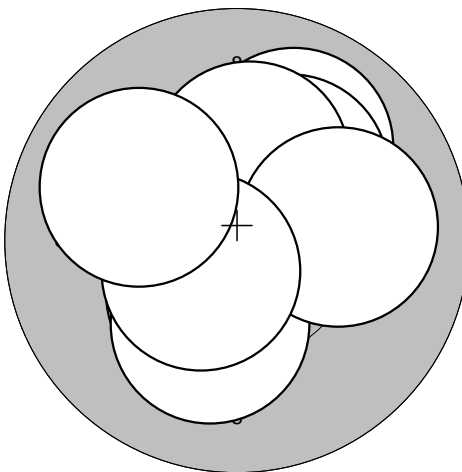
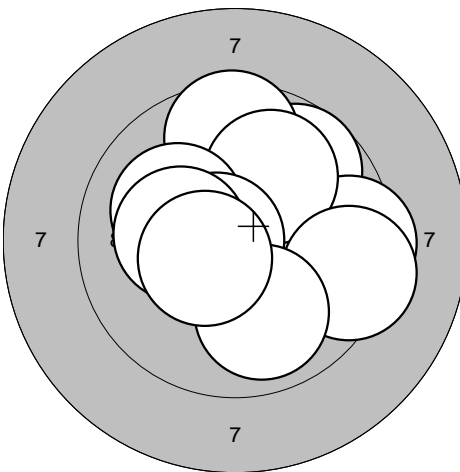
<p>Series 5</p> 	<p>1: 10,8* ↗ 2: 10,4* ↘ 3: 10,2* ↘ 4: 9,9 ↗ 5: 10,2* ↗ 6: 10,8* ← 7: 10,2* ↗ 8: 10,0 → 9: 10,5* ↘ 10: 9,9 ↗</p> <p>Serie 98,0 Sum 482,0</p>	<p>Series 6</p> 	<p>1: 9,7 ↗ 2: 9,4 → 3: 9,6 ↑ 4: 10,0 ↗ 5: 10,1 ← 6: 10,7* ← 7: 9,4 → 8: 10,2* ← 9: 9,9 ↓ 10: 10,5* ↗</p> <p>Serie 95,0 Sum 577,0</p>
--	--	--	---

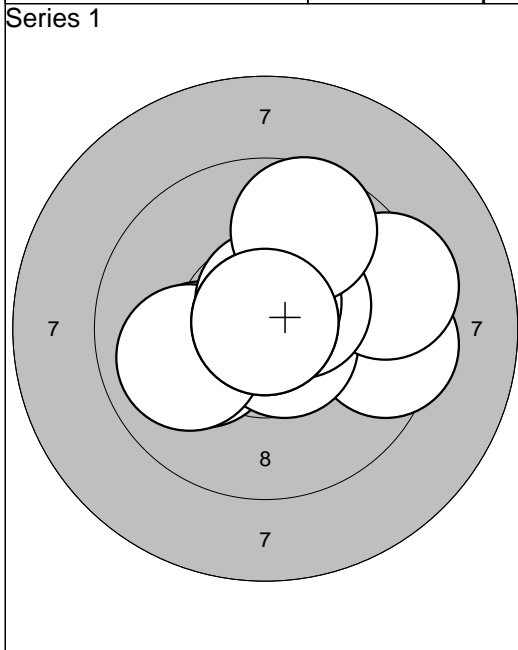

1: 10,1	←
2: 9,5	→
3: 10,7*	↘
4: 9,4	→
5: 10,0	←
6: 10,5*	↗
7: 10,6*	↑
8: 10,9*	↑
9: 9,7	↗
10: 10,9*	↑
Serie 97,0	
Sum 97,0	

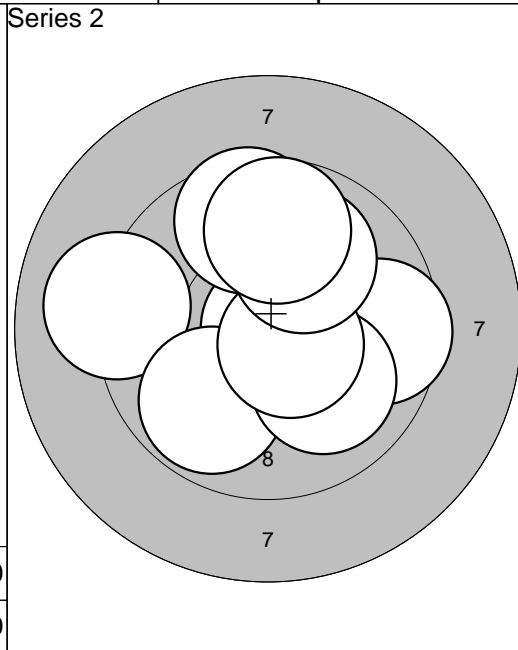

1: 10,7*	→
2: 9,1	←
3: 9,6	→
4: 10,9*	→
5: 9,9	↘
6: 10,0	↘
7: 9,6	↑
8: 10,6*	↘
9: 10,0	↗
10: 9,7	↑
Serie 95,0	
Sum 192,0	

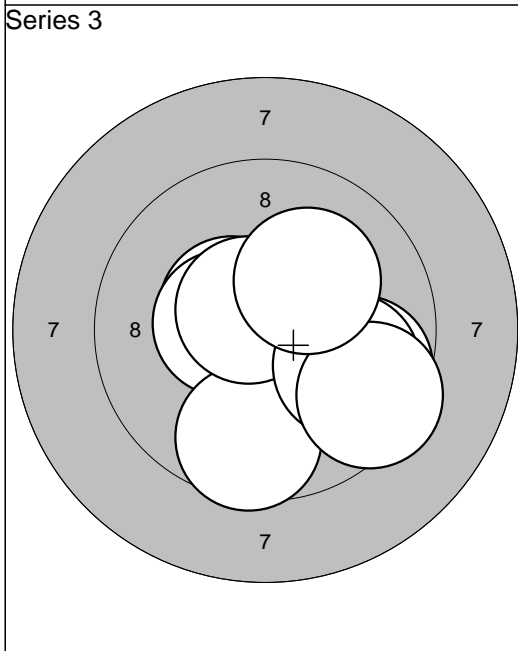

1: 10,5*	↖
2: 10,5*	←
3: 10,5*	→
4: 10,5*	↘
5: 9,6	↓
6: 9,7	↘
7: 10,6*	↗
8: 9,8	↘
9: 9,4	↘
10: 10,2*	↗
Serie 96,0	
Sum 288,0	

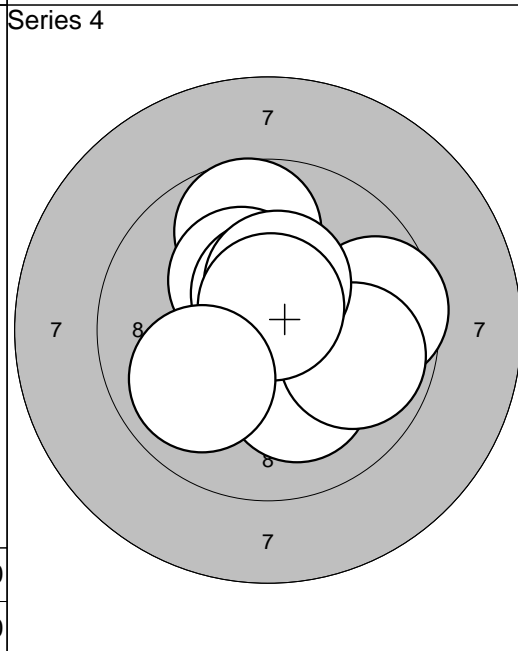

1: 9,7	↑
2: 10,2*	↘
3: 10,3*	↗
4: 9,6	→
5: 10,5*	↑
6: 10,1	↘
7: 9,9	→
8: 10,4*	↑
9: 10,7*	↑
10: 9,9	↘
Serie 96,0	
Sum 384,0	

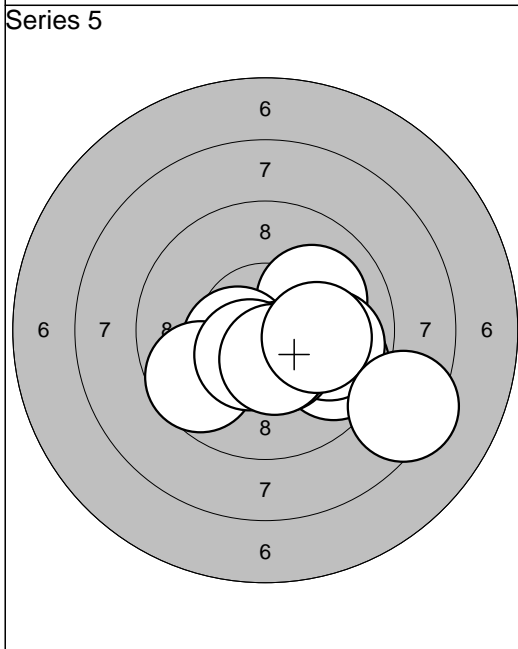

1: 10,1	↗
2: 9,7	↘
3: 10,5*	←
4: 9,6	←
5: 9,9	→
6: 10,4*	↘
7: 10,5*	↘
8: 10,4*	↘
9: 10,1	→
10: 8,4	↘
Serie 95,0	
Sum 479,0	

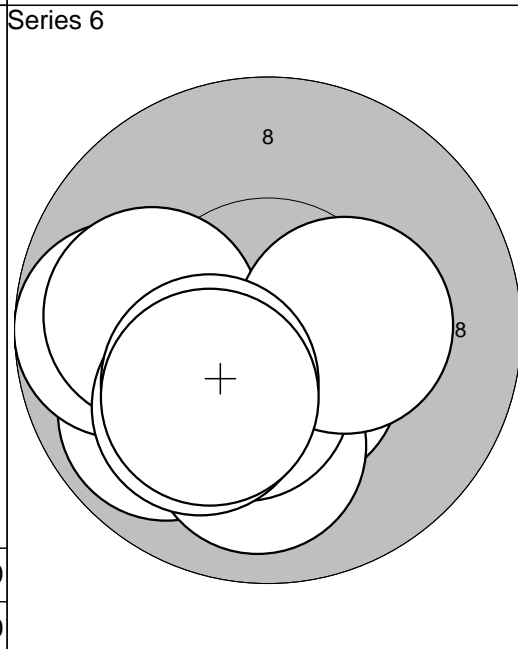

1: 9,9	↘
2: 10,5*	↘
3: 9,7	←
4: 10,0	←
5: 10,0	↓
6: 10,4*	↘
7: 10,1	↘
8: 10,3*	→
9: 10,3*	↘
10: 10,2*	↘
Serie 98,0	
Sum 577,0	

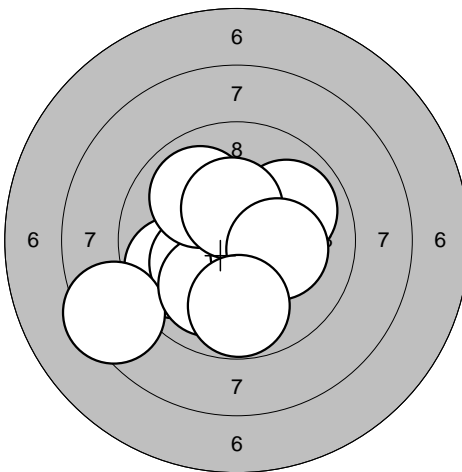
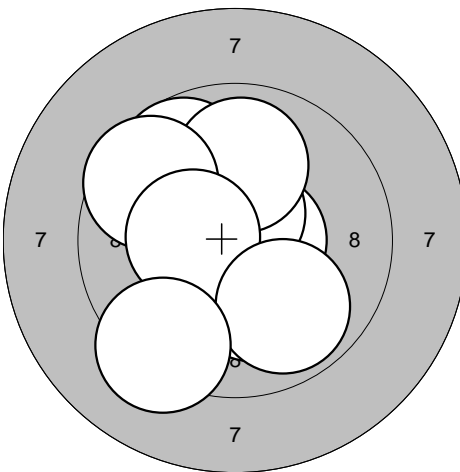
<p>Series 1</p> 	<p>1: 9,8 ↙</p> <p>2: 10,2* ↙</p> <p>3: 10,0 ↗</p> <p>4: 8,4 ↙</p> <p>5: 10,0 ↘</p> <p>6: 10,4* ↗</p> <p>7: 10,0 ↗</p> <p>8: 10,4* ↗</p> <p>9: 10,2* ↗</p> <p>10: 9,8 ↘</p> <table border="1" style="width:100%; border-collapse: collapse;"> <tr> <td style="text-align: right;">Serie</td> <td style="text-align: right;">96,0</td> </tr> <tr> <td style="text-align: right;">Sum</td> <td style="text-align: right;">96,0</td> </tr> </table>	Serie	96,0	Sum	96,0	<p>Series 2</p> 	<p>1: 10,8* ↗</p> <p>2: 10,2* ↘</p> <p>3: 10,6* →</p> <p>4: 10,6* ↑</p> <p>5: 9,8 ↗</p> <p>6: 10,0 ↑</p> <p>7: 9,6 ↗</p> <p>8: 10,4* ←</p> <p>9: 9,9 ↘</p> <p>10: 9,2 ↘</p> <table border="1" style="width:100%; border-collapse: collapse;"> <tr> <td style="text-align: right;">Serie</td> <td style="text-align: right;">96,0</td> </tr> <tr> <td style="text-align: right;">Sum</td> <td style="text-align: right;">192,0</td> </tr> </table>	Serie	96,0	Sum	192,0
Serie	96,0										
Sum	96,0										
Serie	96,0										
Sum	192,0										

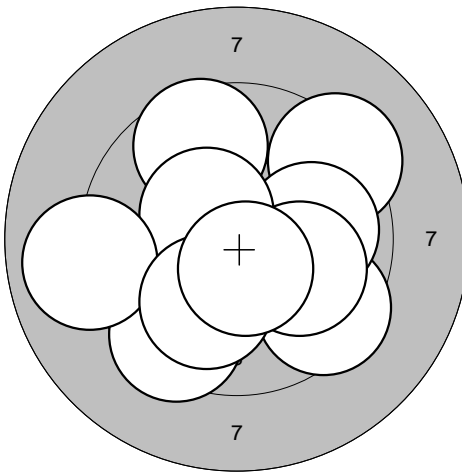
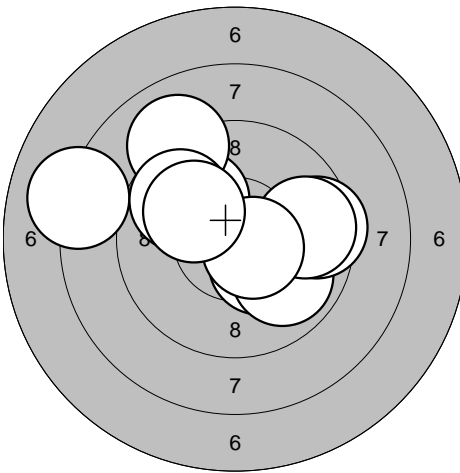
<p>Series 3</p> 	<p>1: 9,6 ↗</p> <p>2: 9,5 ↘</p> <p>3: 9,2 ↗</p> <p>4: 9,9 →</p> <p>5: 9,5 ↘</p> <p>6: 10,0 ↗</p> <p>7: 10,4* ↗</p> <p>8: 9,0 ←</p> <p>9: 10,0 ↘</p> <p>10: 10,5* ↘</p> <table border="1" style="width:100%; border-collapse: collapse;"> <tr> <td style="text-align: right;">Serie</td> <td style="text-align: right;">94,0</td> </tr> <tr> <td style="text-align: right;">Sum</td> <td style="text-align: right;">286,0</td> </tr> </table>	Serie	94,0	Sum	286,0	<p>Series 4</p> 	<p>1: 10,3* ↘</p> <p>2: 9,9 ↘</p> <p>3: 10,0 ↗</p> <p>4: 8,1 ←</p> <p>5: 9,5 →</p> <p>6: 9,7 →</p> <p>7: 9,0 ↗</p> <p>8: 9,8 ↗</p> <p>9: 10,6* ↘</p> <p>10: 10,1 ↗</p> <table border="1" style="width:100%; border-collapse: collapse;"> <tr> <td style="text-align: right;">Serie</td> <td style="text-align: right;">93,0</td> </tr> <tr> <td style="text-align: right;">Sum</td> <td style="text-align: right;">379,0</td> </tr> </table>	Serie	93,0	Sum	379,0
Serie	94,0										
Sum	286,0										
Serie	93,0										
Sum	379,0										

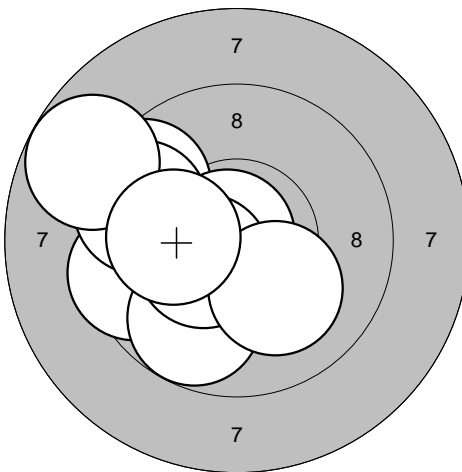
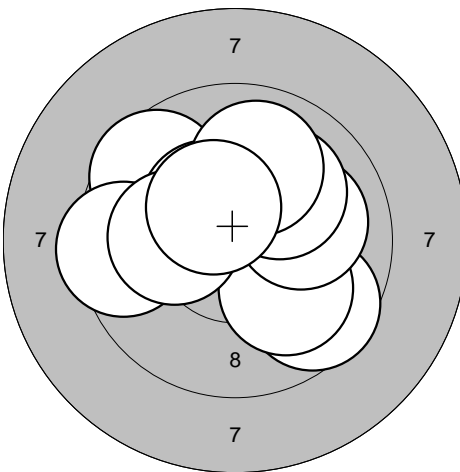
<p>Series 5</p> 	<p>1: 10,0 ←</p> <p>2: 9,5 ←</p> <p>3: 9,5 ↗</p> <p>4: 9,6 ↗</p> <p>5: 10,8* ↗</p> <p>6: 9,8 ↘</p> <p>7: 10,4* ↗</p> <p>8: 10,1 ↘</p> <p>9: 8,8 ↗</p> <p>10: 10,1 ←</p> <table border="1" style="width:100%; border-collapse: collapse;"> <tr> <td style="text-align: right;">Serie</td> <td style="text-align: right;">94,0</td> </tr> <tr> <td style="text-align: right;">Sum</td> <td style="text-align: right;">473,0</td> </tr> </table>	Serie	94,0	Sum	473,0	<p>Series 6</p> 	<p>1: 9,6 ↗</p> <p>2: 9,5 ←</p> <p>3: 10,4* ↗</p> <p>4: 9,6 ↘</p> <p>5: 10,0 ↘</p> <p>6: 10,0 →</p> <p>7: 10,1 ↗</p> <p>8: 10,1 ←</p> <p>9: 10,0 ↑</p> <p>10: 10,4* ↗</p> <table border="1" style="width:100%; border-collapse: collapse;"> <tr> <td style="text-align: right;">Serie</td> <td style="text-align: right;">97,0</td> </tr> <tr> <td style="text-align: right;">Sum</td> <td style="text-align: right;">570,0</td> </tr> </table>	Serie	97,0	Sum	570,0
Serie	94,0										
Sum	473,0										
Serie	97,0										
Sum	570,0										

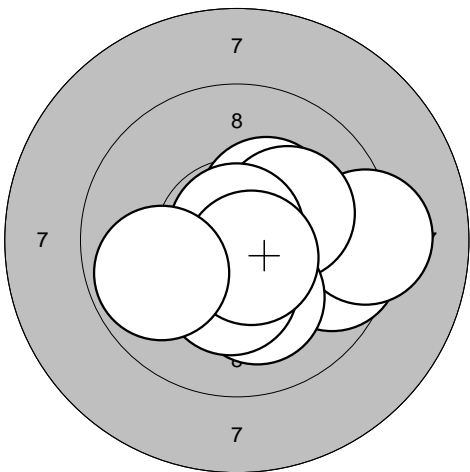
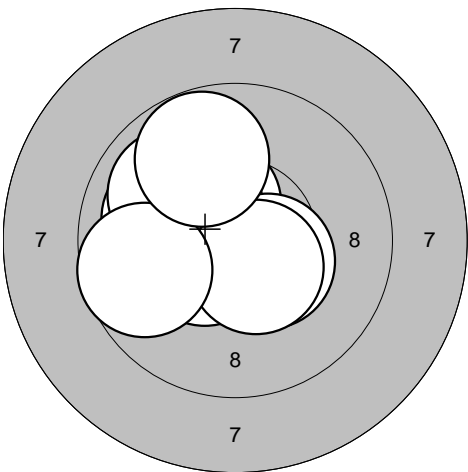
<p>Series 1</p> 	<p>1: 9,6 →</p> <p>2: 10,2* ↓</p> <p>3: 9,2 →</p> <p>4: 10,3* ↗</p> <p>5: 10,2* ↗</p> <p>6: 10,8* ↑</p> <p>7: 10,1 ↓</p> <p>8: 10,3* ↓</p> <p>9: 10,6* ↓</p> <p>10: 9,8 ←</p>	<p>Series 2</p> 	<p>1: 10,0 ←</p> <p>2: 10,4* ↗</p> <p>3: 10,6* ←</p> <p>4: 10,3* ↗</p> <p>5: 10,0 ↗</p> <p>6: 10,5* ←</p> <p>7: 10,4* ↘</p> <p>8: 10,5* ↓</p> <p>9: 9,7 ←</p> <p>10: 9,8 ↗</p>
Serie 97,0	Serie 98,0	Serie 98,0	Serie 98,0
Sum 97,0	Sum 195,0	Sum 195,0	Sum 195,0

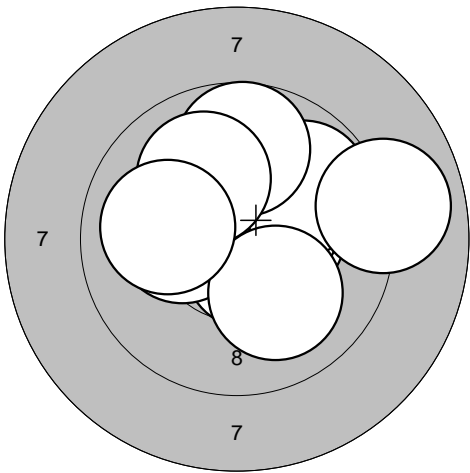
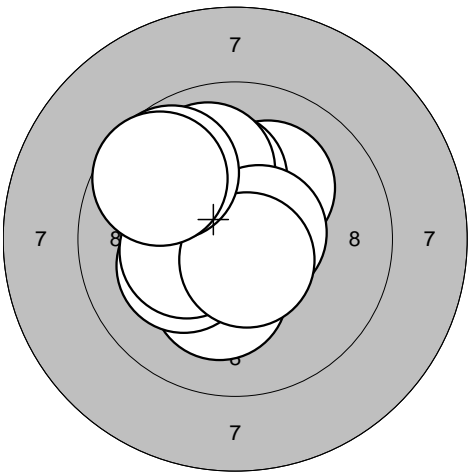
<p>Series 3</p> 	<p>1: 10,4* →</p> <p>2: 10,4* →</p> <p>3: 10,6* ↓</p> <p>4: 9,8 ↗</p> <p>5: 10,2* ←</p> <p>6: 10,1 ↓</p> <p>7: 9,7 ↑</p> <p>8: 8,9 →</p> <p>9: 10,0 ↗</p> <p>10: 10,0 ←</p>	<p>Series 4</p> 	<p>1: 10,2* ↓</p> <p>2: 10,2* ↗</p> <p>3: 10,1 ↑</p> <p>4: 9,9 ↗</p> <p>5: 10,2* ←</p> <p>6: 10,3* ←</p> <p>7: 10,6* →</p> <p>8: 10,6* ↓</p> <p>9: 9,7 ↗</p> <p>10: 9,7 ↗</p>
Serie 96,0	Serie 97,0	Serie 97,0	Serie 97,0
Sum 291,0	Sum 388,0	Sum 388,0	Sum 388,0

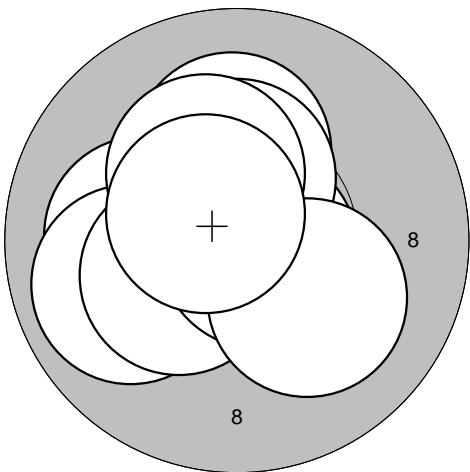
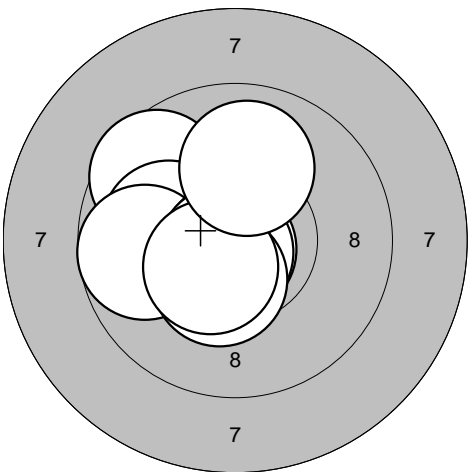
<p>Series 5</p> 	<p>1: 10,1 ←</p> <p>2: 9,9 ←</p> <p>3: 10,2* ↑</p> <p>4: 10,5* ↗</p> <p>5: 10,3* ←</p> <p>6: 10,7* →</p> <p>7: 10,4* ↑</p> <p>8: 10,1 ↓</p> <p>9: 10,3* ↗</p> <p>10: 10,6* ↗</p>	<p>Series 6</p> 	<p>1: 10,2* ↗</p> <p>2: 10,3* ←</p> <p>3: 9,6 ↗</p> <p>4: 10,0 ←</p> <p>5: 9,7 ←</p> <p>6: 10,8* ↓</p> <p>7: 10,7* ↓</p> <p>8: 10,4* ↓</p> <p>9: 10,5* ←</p> <p>10: 10,0 ↑</p>
Serie 99,0	Serie 98,0	Serie 98,0	Serie 98,0
Sum 487,0	Sum 585,0	Sum 585,0	Sum 585,0

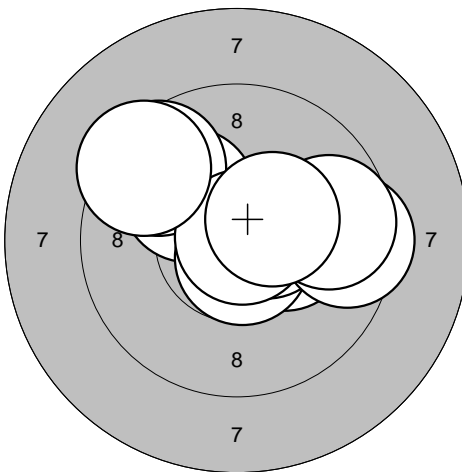
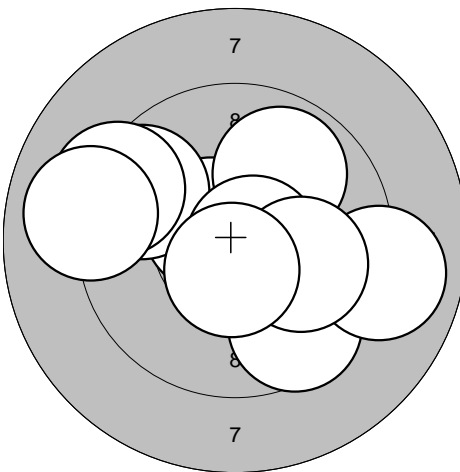
<p>Series 1</p> 	<p>1: 10,1 ↖</p> <p>2: 10,3* →</p> <p>3: 10,7* ↓</p> <p>4: 10,5* →</p> <p>5: 9,5 →</p> <p>6: 9,5 ↖</p> <p>7: 9,7 →</p> <p>8: 10,9* →</p> <p>9: 9,4 ↖</p> <p>10: 10,4* ↗</p>	<p>Series 2</p> 	<p>1: 9,6 ↓</p> <p>2: 10,6* ↖</p> <p>3: 9,0 →</p> <p>4: 9,5 ↖</p> <p>5: 9,9 ↗</p> <p>6: 10,7* →</p> <p>7: 10,0 →</p> <p>8: 10,5* ↓</p> <p>9: 9,3 ↖</p> <p>10: 9,0 ←</p>
Serie 96,0	Serie 94,0	Serie 94,0	Serie 94,0
Sum 96,0	Sum 190,0	Sum 190,0	Sum 190,0

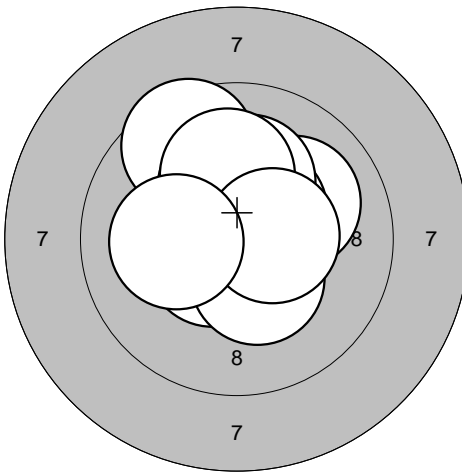
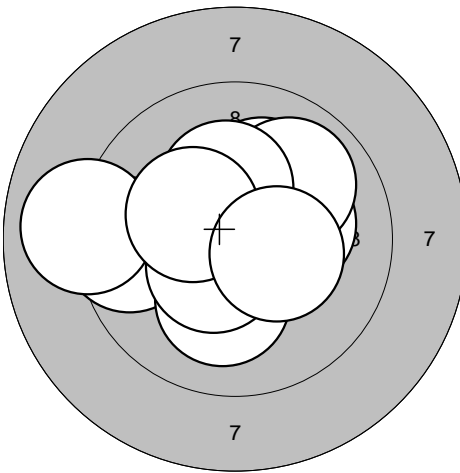
<p>Series 3</p> 	<p>1: 10,5* ↖</p> <p>2: 9,5 ↖</p> <p>3: 10,3* ↓</p> <p>4: 10,2* ↑</p> <p>5: 10,0 ↗</p> <p>6: 10,5* ↗</p> <p>7: 10,2* ↑</p> <p>8: 10,1 ↑</p> <p>9: 10,5* →</p> <p>10: 10,2* ←</p>	<p>Series 4</p> 	<p>1: 10,2* ↗</p> <p>2: 10,2* →</p> <p>3: 9,9 ↗</p> <p>4: 10,3* ↑</p> <p>5: 9,5 ←</p> <p>6: 10,1 ↓</p> <p>7: 9,0 ←</p> <p>8: 10,5* ↓</p> <p>9: 10,3* ↖</p> <p>10: 10,4* →</p>
Serie 99,0	Serie 97,0	Serie 97,0	Serie 97,0
Sum 289,0	Sum 386,0	Sum 386,0	Sum 386,0

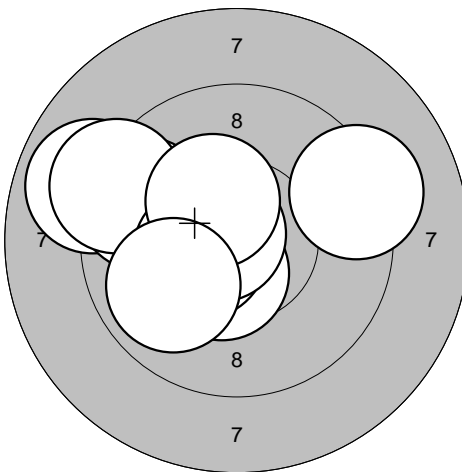
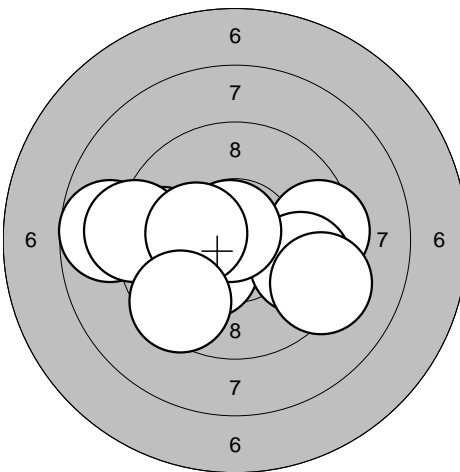
<p>Series 5</p> 	<p>1: 10,5* ↓</p> <p>2: 8,9 ↖</p> <p>3: 9,2 →</p> <p>4: 9,6 ↖</p> <p>5: 10,3* ↗</p> <p>6: 9,2 ↖</p> <p>7: 10,5* ←</p> <p>8: 10,7* ↖</p> <p>9: 10,4* ↗</p> <p>10: 9,9 ↖</p>	<p>Series 6</p> 	<p>1: 9,5 →</p> <p>2: 10,3* ↖</p> <p>3: 8,7 ←</p> <p>4: 9,7 →</p> <p>5: 10,8* ↗</p> <p>6: 9,7 ←</p> <p>7: 9,2 →</p> <p>8: 9,2 ←</p> <p>9: 10,3* ←</p> <p>10: 9,5 ↖</p>
Serie 94,0	Serie 92,0	Serie 92,0	Serie 92,0
Sum 480,0	Sum 572,0	Sum 572,0	Sum 572,0

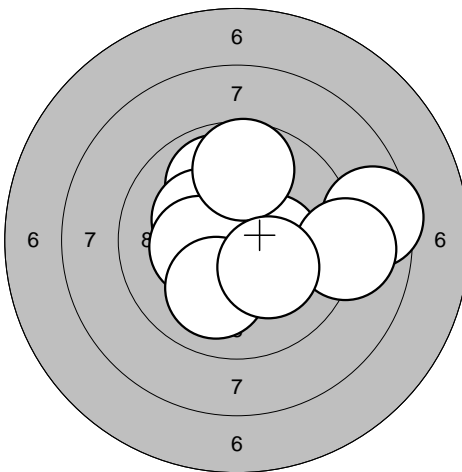
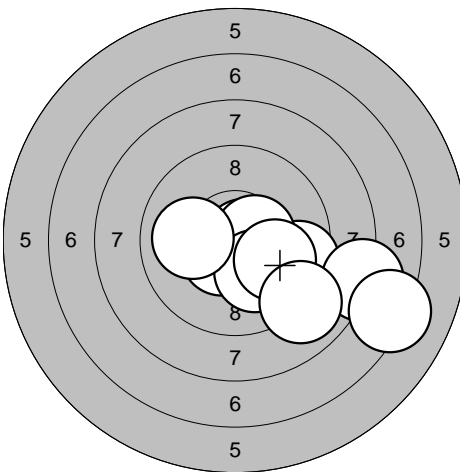
<p>Series 1</p> 	<p>1: 10,4* ↘ 2: 9,9 ↗ 3: 8,5 → 4: 10,3* ↗ 5: 10,3* → 6: 10,3* ← 7: 9,0 → 8: 9,7 ↗ 9: 10,0 ↘ 10: 10,2* ↘</p> <table border="1" style="width:100%; border-collapse: collapse;"> <tr><td>Serie</td><td style="text-align: right;">95,0</td></tr> <tr><td>Sum</td><td style="text-align: right;">95,0</td></tr> </table>	Serie	95,0	Sum	95,0	<p>Series 2</p> 	<p>1: 10,7* → 2: 9,5 ↘ 3: 10,5* ↘ 4: 10,5* → 5: 10,1 ↘ 6: 8,0 → 7: 9,9 ↘ 8: 10,0 ← 9: 9,0 ↘ 10: 7,2 ↘</p> <table border="1" style="width:100%; border-collapse: collapse;"> <tr><td>Serie</td><td style="text-align: right;">92,0</td></tr> <tr><td>Sum</td><td style="text-align: right;">187,0</td></tr> </table>	Serie	92,0	Sum	187,0
Serie	95,0										
Sum	95,0										
Serie	92,0										
Sum	187,0										

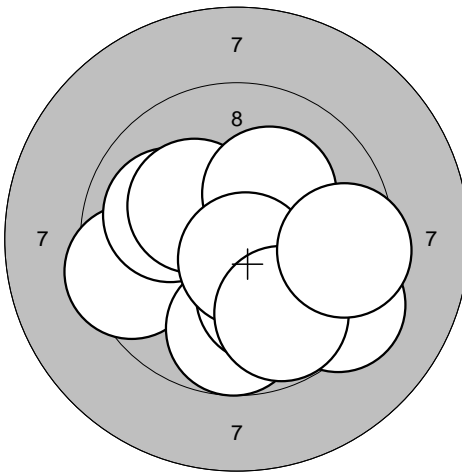
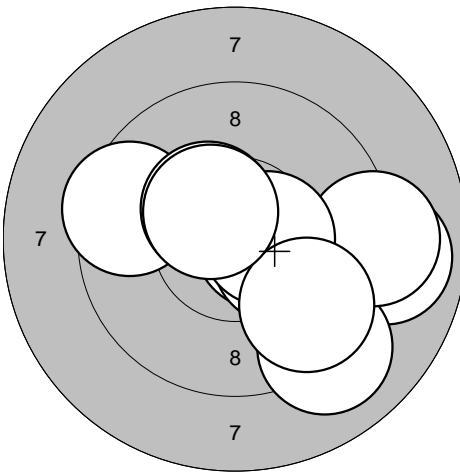
<p>Series 3</p> 	<p>1: 9,5 ← 2: 10,0 ↗ 3: 10,2* ↗ 4: 10,2* ↗ 5: 9,8 ↘ 6: 10,1 ↘ 7: 9,3 ↘ 8: 10,7* ↘ 9: 9,8 ↘ 10: 9,5 →</p> <table border="1" style="width:100%; border-collapse: collapse;"> <tr><td>Serie</td><td style="text-align: right;">95,0</td></tr> <tr><td>Sum</td><td style="text-align: right;">282,0</td></tr> </table>	Serie	95,0	Sum	282,0	<p>Series 4</p> 	<p>1: 8,9 → 2: 9,5 ← 3: 10,6* → 4: 10,3* ↘ 5: 9,1 ↘ 6: 9,1 → 7: 10,4* ↗ 8: 10,5* → 9: 9,7 ↘ 10: 10,4* ↗</p> <table border="1" style="width:100%; border-collapse: collapse;"> <tr><td>Serie</td><td style="text-align: right;">94,0</td></tr> <tr><td>Sum</td><td style="text-align: right;">376,0</td></tr> </table>	Serie	94,0	Sum	376,0
Serie	95,0										
Sum	282,0										
Serie	94,0										
Sum	376,0										

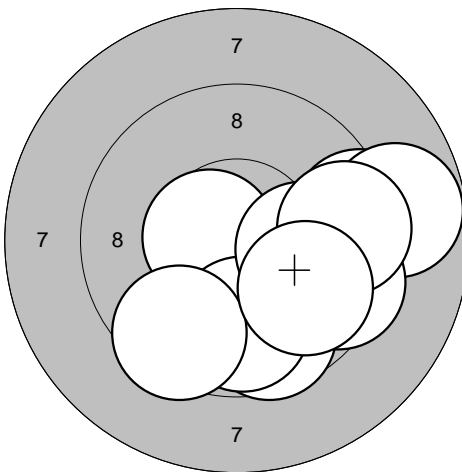
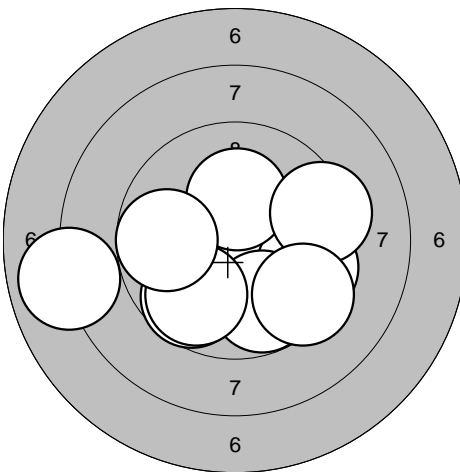
<p>Series 5</p> 	<p>1: 9,3 → 2: 10,6* ← 3: 8,8 → 4: 9,6 ↘ 5: 9,8 ↘ 6: 9,5 ↘ 7: 9,5 ↘ 8: 10,1 → 9: 9,5 → 10: 9,8 ↘</p> <table border="1" style="width:100%; border-collapse: collapse;"> <tr><td>Serie</td><td style="text-align: right;">91,0</td></tr> <tr><td>Sum</td><td style="text-align: right;">467,0</td></tr> </table>	Serie	91,0	Sum	467,0	<p>Series 6</p> 	<p>1: 9,7 ↘ 2: 10,6* ← 3: 9,6 ↘ 4: 10,2* ↑ 5: 9,8 ↘ 6: 8,0 ← 7: 9,7 ↘ 8: 9,3 → 9: 9,8 ← 10: 9,4 ↘</p> <table border="1" style="width:100%; border-collapse: collapse;"> <tr><td>Serie</td><td style="text-align: right;">91,0</td></tr> <tr><td>Sum</td><td style="text-align: right;">558,0</td></tr> </table>	Serie	91,0	Sum	558,0
Serie	91,0										
Sum	467,0										
Serie	91,0										
Sum	558,0										

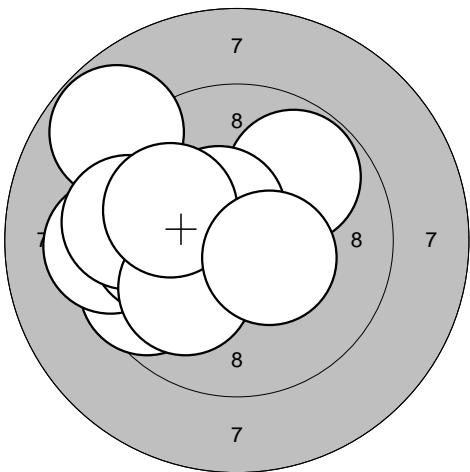
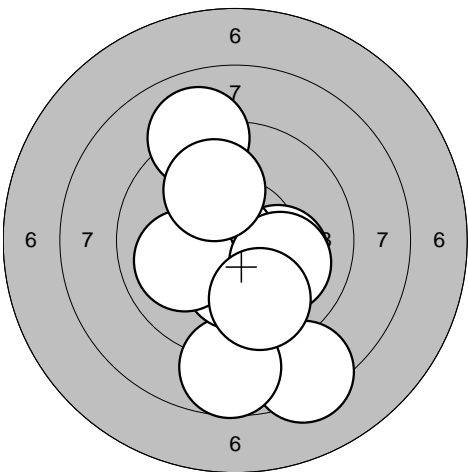
<p>Series 1</p> 	<p>1: 8,8 ↖</p> <p>2: 9,8 ↗</p> <p>3: 9,6 ↙</p> <p>4: 9,3 ←</p> <p>5: 9,9 ←</p> <p>6: 10,5* ↗</p> <p>7: 9,5 ←</p> <p>8: 10,0 ↙</p> <p>9: 10,0 ↗</p> <p>10: 10,5* ↘</p>	<p>Series 2</p> 	<p>1: 8,3 ↓</p> <p>2: 8,7 ↓</p> <p>3: 10,3* ↓</p> <p>4: 10,1 →</p> <p>5: 10,8* ←</p> <p>6: 10,0 ←</p> <p>7: 9,0 ↗</p> <p>8: 10,1 ↘</p> <p>9: 10,0 ↗</p> <p>10: 9,8 ↓</p>
Serie 93,0		Serie 94,0	
Sum 93,0		Sum 187,0	

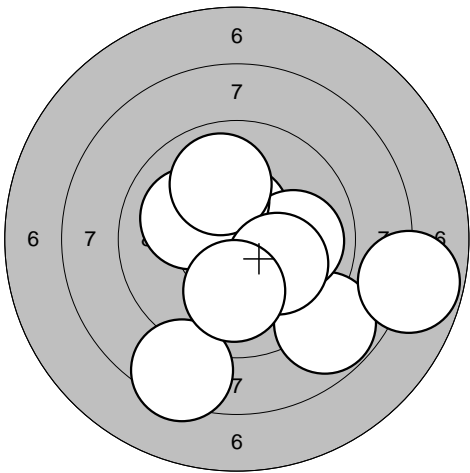
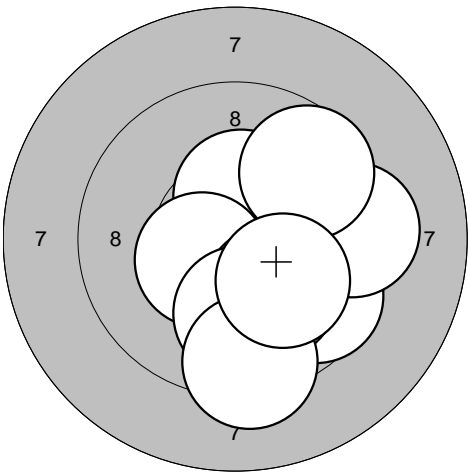
<p>Series 3</p> 	<p>1: 10,5* ↑</p> <p>2: 8,8 ↓</p> <p>3: 10,0 →</p> <p>4: 10,2* ↗</p> <p>5: 10,1 ↗</p> <p>6: 9,9 ↗</p> <p>7: 10,1 ↘</p> <p>8: 8,4 ↓</p> <p>9: 10,0 ↓</p> <p>10: 7,8 →</p>	<p>Series 4</p> 	<p>1: 9,6 ↘</p> <p>2: 10,1 →</p> <p>3: 10,4* ↑</p> <p>4: 10,4* ↙</p> <p>5: 9,4 →</p> <p>6: 10,1 ↓</p> <p>7: 9,9 ↓</p> <p>8: 9,6 ↗</p> <p>9: 9,3 ↓</p> <p>10: 10,1 ↘</p>
Serie 92,0		Serie 95,0	
Sum 279,0		Sum 374,0	

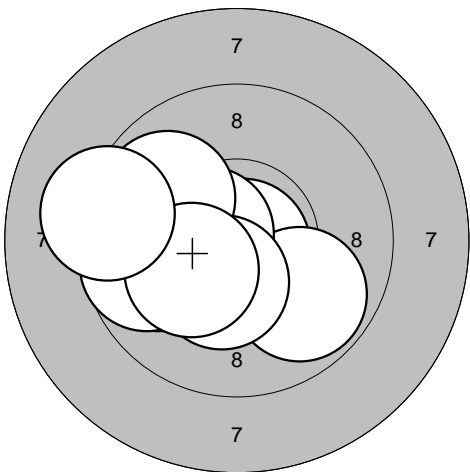
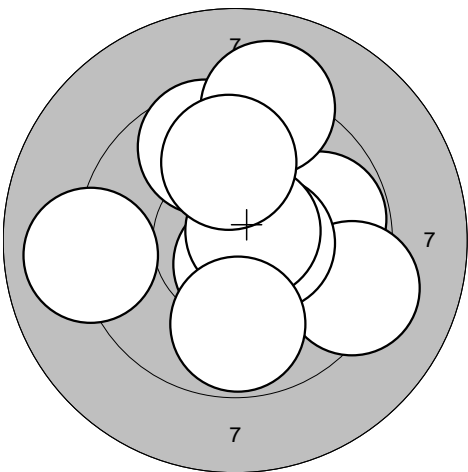
<p>Series 5</p> 	<p>1: 10,8* ↓</p> <p>2: 9,9 ↓</p> <p>3: 10,5* ←</p> <p>4: 9,9 ←</p> <p>5: 10,0 ←</p> <p>6: 9,7 ←</p> <p>7: 10,4* ↓</p> <p>8: 9,9 ↗</p> <p>9: 10,2* ↙</p> <p>10: 9,2 ←</p>	<p>Series 6</p> 	<p>1: 10,6* ↓</p> <p>2: 9,8 →</p> <p>3: 9,3 ↘</p> <p>4: 10,5* →</p> <p>5: 9,6 ↗</p> <p>6: 10,7* ↗</p> <p>7: 9,0 ←</p> <p>8: 9,8 ↓</p> <p>9: 9,1 ↗</p> <p>10: 9,9 ↗</p>
Serie 95,0		Serie 93,0	
Sum 469,0		Sum 562,0	

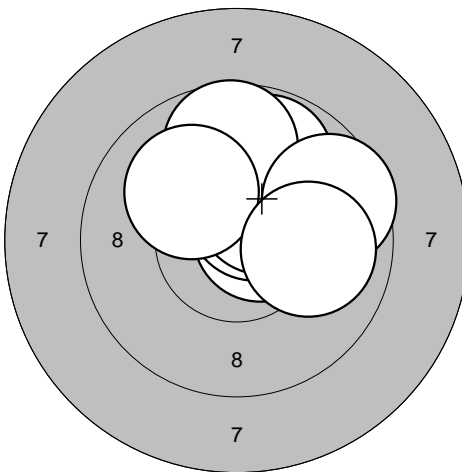
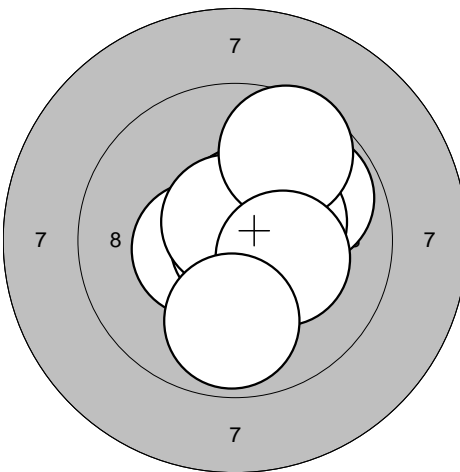
<p>Series 1</p> 	<p>1: 10,0 ↑</p> <p>2: 10,6* →</p> <p>3: 9,9 ↑</p> <p>4: 10,2* ↗</p> <p>5: 10,5* ↗</p> <p>6: 10,4* ↗</p> <p>7: 9,7 ↑</p> <p>8: 10,1 ↖</p> <p>9: 9,6 →</p> <p>10: 10,0 →</p>	<p>Series 2</p> 	<p>1: 9,8 ↗</p> <p>2: 10,6* ↑</p> <p>3: 10,5* ←</p> <p>4: 10,3* →</p> <p>5: 10,6* ↑</p> <p>6: 10,9* ↘</p> <p>7: 10,7* ↑</p> <p>8: 9,6 ↑</p> <p>9: 10,3* →</p> <p>10: 9,9 ↓</p>
Serie	97,0	Serie	97,0
Sum	97,0	Sum	194,0

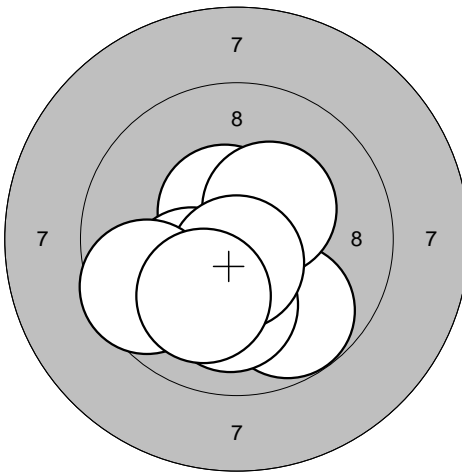
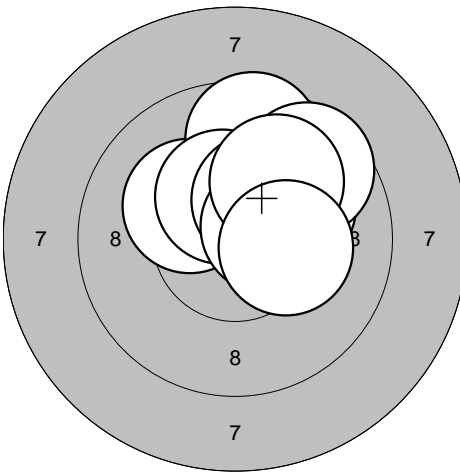
<p>Series 3</p> 	<p>1: 10,7* ↘</p> <p>2: 10,7* ↘</p> <p>3: 9,8 ↘</p> <p>4: 10,1 ↘</p> <p>5: 10,6* ↑</p> <p>6: 10,3* ↗</p> <p>7: 10,2* ↖</p> <p>8: 10,6* ↓</p> <p>9: 9,6 ↖</p> <p>10: 10,1 ↘</p>	<p>Series 4</p> 	<p>1: 10,2* ↖</p> <p>2: 9,6 ↑</p> <p>3: 10,4* ↑</p> <p>4: 10,3* ↗</p> <p>5: 10,1 ↗</p> <p>6: 10,4* ↑</p> <p>7: 9,6 ↗</p> <p>8: 10,5* →</p> <p>9: 10,0 ↑</p> <p>10: 10,3* →</p>
Serie	98,0	Serie	98,0
Sum	292,0	Sum	390,0

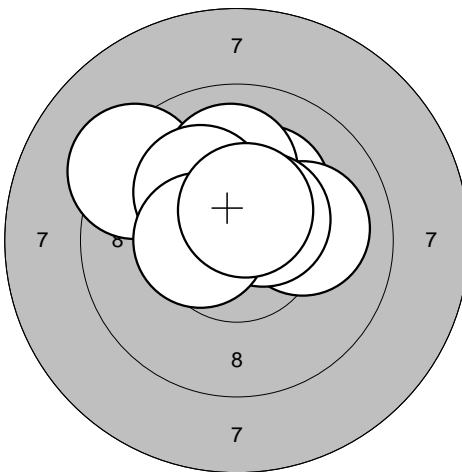
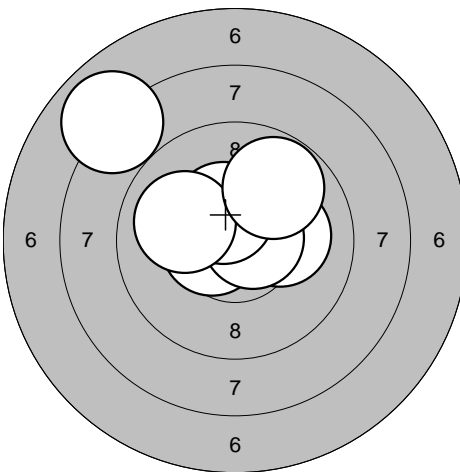
<p>Series 5</p> 	<p>1: 10,2* ↗</p> <p>2: 10,1 →</p> <p>3: 10,5* ↖</p> <p>4: 9,3 ↖</p> <p>5: 10,0 ↑</p> <p>6: 10,5* ↗</p> <p>7: 10,5* ↗</p> <p>8: 10,1 ↑</p> <p>9: 10,5* ←</p> <p>10: 10,5* ↑</p>	<p>Series 6</p> 	<p>1: 10,6* ↗</p> <p>2: 10,7* ↑</p> <p>3: 8,0 ↖</p> <p>4: 10,6* ↖</p> <p>5: 10,6* ←</p> <p>6: 10,1 →</p> <p>7: 10,6* →</p> <p>8: 10,4* ↑</p> <p>9: 10,0 ←</p> <p>10: 9,8 ↑</p>
Serie	99,0	Serie	97,0
Sum	489,0	Sum	586,0

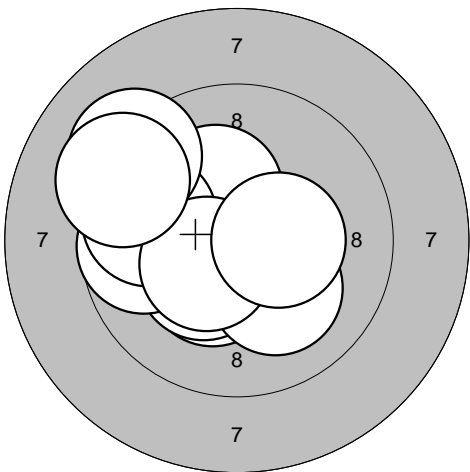
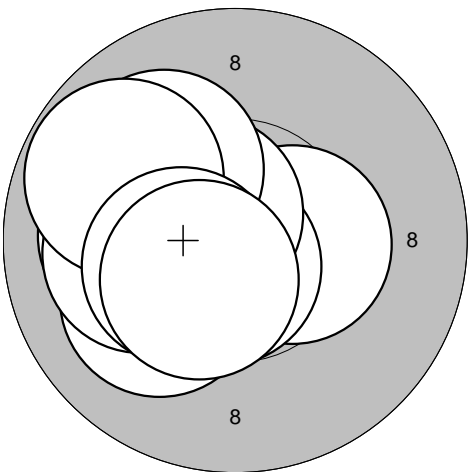
<p>Series 1</p> 	<p>1: 10,3* ↙ 2: 10,3* ↙ 3: 10,1 ↘ 4: 10,2* ↗ 5: 9,7 ← 6: 9,8 ← 7: 9,2 ↗ 8: 10,4* ↙ 9: 10,4* → 10: 9,2 ↖</p> <table border="1" style="width:100%; border-collapse: collapse;"> <tr><td>Serie</td><td style="text-align: right;">96,0</td></tr> <tr><td>Sum</td><td style="text-align: right;">96,0</td></tr> </table>	Serie	96,0	Sum	96,0	<p>Series 2</p> 	<p>1: 10,1 ← 2: 10,4* → 3: 10,1 ↙ 4: 10,7* ↘ 5: 10,6* ↗ 6: 10,1 ← 7: 10,1 ↗ 8: 9,8 ↖ 9: 10,4* ↙ 10: 10,5* ↘</p> <table border="1" style="width:100%; border-collapse: collapse;"> <tr><td>Serie</td><td style="text-align: right;">99,0</td></tr> <tr><td>Sum</td><td style="text-align: right;">195,0</td></tr> </table>	Serie	99,0	Sum	195,0
Serie	96,0										
Sum	96,0										
Serie	99,0										
Sum	195,0										

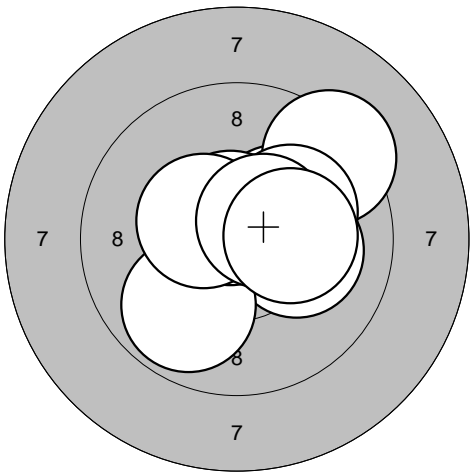
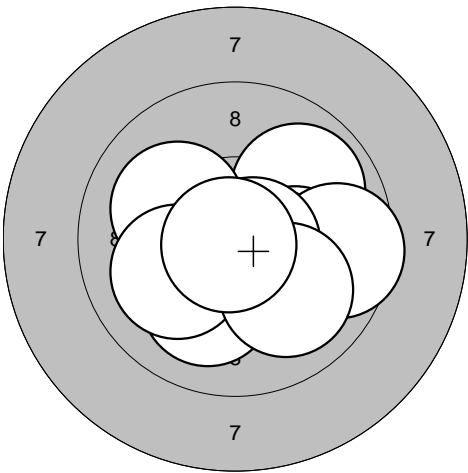
<p>Series 3</p> 	<p>1: 10,6* → 2: 10,3* ↗ 3: 9,3 ↗ 4: 10,1 → 5: 9,9 ↘ 6: 10,7* ↗ 7: 10,2* ↗ 8: 10,5* ↖ 9: 10,5* ↗ 10: 10,2* →</p> <table border="1" style="width:100%; border-collapse: collapse;"> <tr><td>Serie</td><td style="text-align: right;">98,0</td></tr> <tr><td>Sum</td><td style="text-align: right;">293,0</td></tr> </table>	Serie	98,0	Sum	293,0	<p>Series 4</p> 	<p>1: 9,9 ↗ 2: 10,1 ↖ 3: 10,1 ↘ 4: 10,1 → 5: 10,4* ↘ 6: 10,1 ← 7: 9,6 → 8: 10,7* ↘ 9: 10,0 ↘ 10: 10,8* ↙</p> <table border="1" style="width:100%; border-collapse: collapse;"> <tr><td>Serie</td><td style="text-align: right;">98,0</td></tr> <tr><td>Sum</td><td style="text-align: right;">391,0</td></tr> </table>	Serie	98,0	Sum	391,0
Serie	98,0										
Sum	293,0										
Serie	98,0										
Sum	391,0										

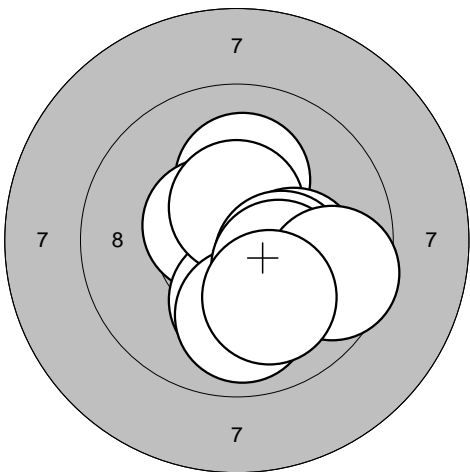
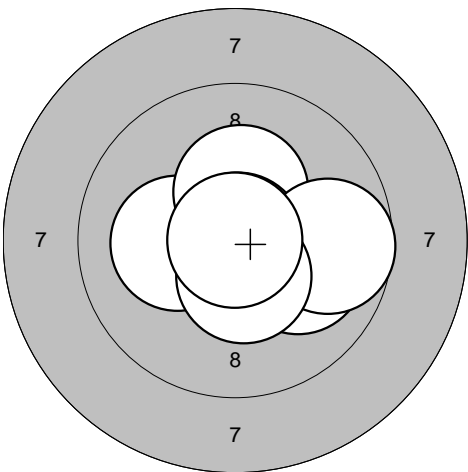
<p>Series 5</p> 	<p>1: 10,2* ↑ 2: 10,5* ↖ 3: 10,1 ↘ 4: 10,5* ↑ 5: 10,0 ↘ 6: 10,2* → 7: 10,3* → 8: 10,3* ↘ 9: 9,6 → 10: 10,1 ↘</p> <table border="1" style="width:100%; border-collapse: collapse;"> <tr><td>Serie</td><td style="text-align: right;">99,0</td></tr> <tr><td>Sum</td><td style="text-align: right;">490,0</td></tr> </table>	Serie	99,0	Sum	490,0	<p>Series 6</p> 	<p>1: 10,7* ↗ 2: 10,2* ← 3: 10,3* ↑ 4: 10,9* → 5: 10,0 ↘ 6: 10,7* ↘ 7: 10,6* ↘ 8: 9,7 → 9: 10,5* ↘ 10: 10,9*</p> <table border="1" style="width:100%; border-collapse: collapse;"> <tr><td>Serie</td><td style="text-align: right;">99,0</td></tr> <tr><td>Sum</td><td style="text-align: right;">589,0</td></tr> </table>	Serie	99,0	Sum	589,0
Serie	99,0										
Sum	490,0										
Serie	99,0										
Sum	589,0										

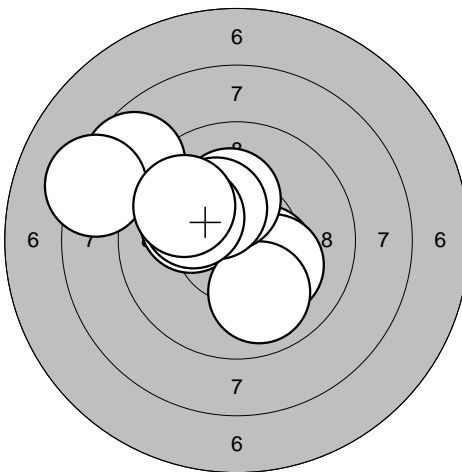
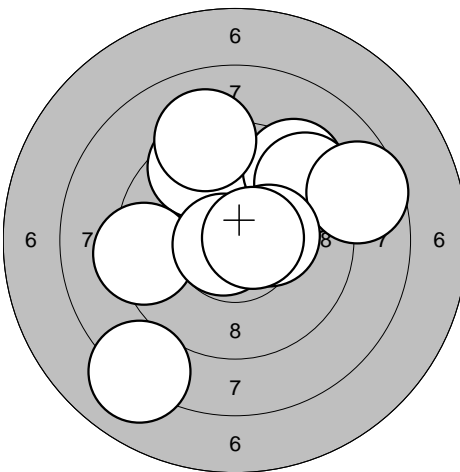
<p>Series 1</p> 	<p>1: 8,7 ↖</p> <p>2: 10,4* ↘</p> <p>3: 10,2* ↘</p> <p>4: 10,1 ↖</p> <p>5: 10,0 ↘</p> <p>6: 10,2* ↖</p> <p>7: 8,3 ↖</p> <p>8: 10,3* ↖</p> <p>9: 10,1 ↖</p> <p>10: 9,9 ↖</p>	<p>Series 2</p> 	<p>1: 9,5 ↖</p> <p>2: 9,3 ↗</p> <p>3: 8,1 ↘</p> <p>4: 9,4 ↗</p> <p>5: 8,6 →</p> <p>6: 10,4* →</p> <p>7: 9,3 ←</p> <p>8: 10,7* ←</p> <p>9: 9,1 ↑</p> <p>10: 10,6* →</p>
Serie 95,0	Serie 91,0	Serie 91,0	Serie 91,0
Sum 95,0	Sum 186,0	Sum 186,0	Sum 186,0

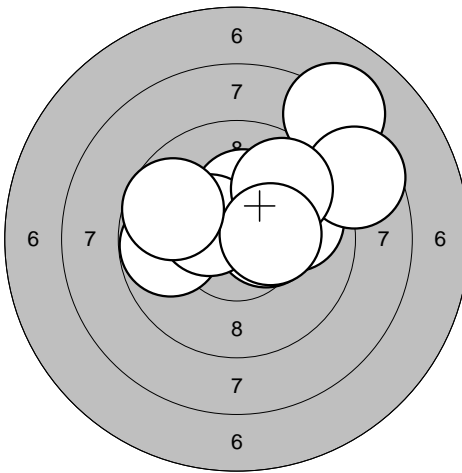
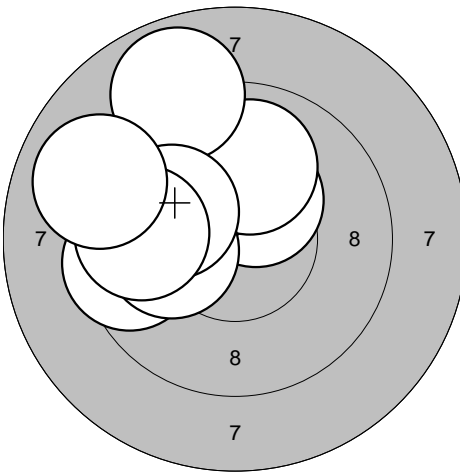
<p>Series 3</p> 	<p>1: 10,4* →</p> <p>2: 8,2 ↗</p> <p>3: 9,9 →</p> <p>4: 9,8 ←</p> <p>5: 10,3* ↑</p> <p>6: 8,6 →</p> <p>7: 10,4* ↖</p> <p>8: 9,8 ↗</p> <p>9: 10,4* →</p> <p>10: 9,7 ↖</p>	<p>Series 4</p> 	<p>1: 9,5 ←</p> <p>2: 10,4* ↗</p> <p>3: 10,1 ↖</p> <p>4: 10,0 ↑</p> <p>5: 8,9 ↗</p> <p>6: 9,9 ←</p> <p>7: 10,1 ←</p> <p>8: 10,1 ↖</p> <p>9: 9,7 ←</p> <p>10: 9,0 ↖</p>
Serie 92,0	Serie 94,0	Serie 94,0	Serie 94,0
Sum 278,0	Sum 372,0	Sum 372,0	Sum 372,0

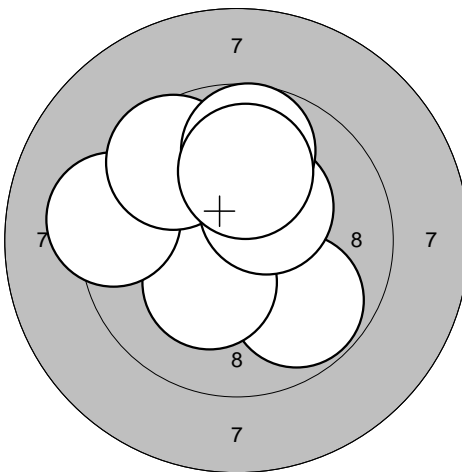
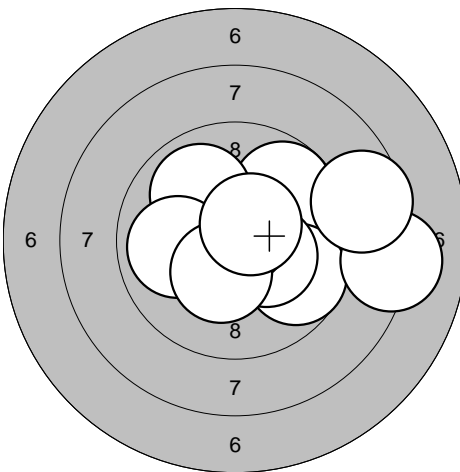
<p>Series 5</p> 	<p>1: 10,4* ↖</p> <p>2: 10,3* ↖</p> <p>3: 10,3* ↖</p> <p>4: 9,8 ↘</p> <p>5: 10,3* ↘</p> <p>6: 9,3 ←</p> <p>7: 9,6 ↖</p> <p>8: 10,3* ↖</p> <p>9: 9,7 ↑</p> <p>10: 10,0 ↑</p>	<p>Series 6</p> 	<p>1: 9,8 ↗</p> <p>2: 9,7 ↘</p> <p>3: 10,3* ↘</p> <p>4: 10,8* ↗</p> <p>5: 8,1 →</p> <p>6: 10,0 ↖</p> <p>7: 9,9 ←</p> <p>8: 10,3* ↘</p> <p>9: 8,6 →</p> <p>10: 10,6* ↗</p>
Serie 96,0	Serie 93,0	Serie 93,0	Serie 93,0
Sum 468,0	Sum 561,0	Sum 561,0	Sum 561,0

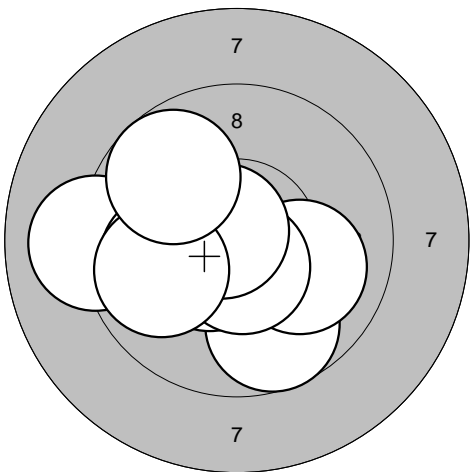
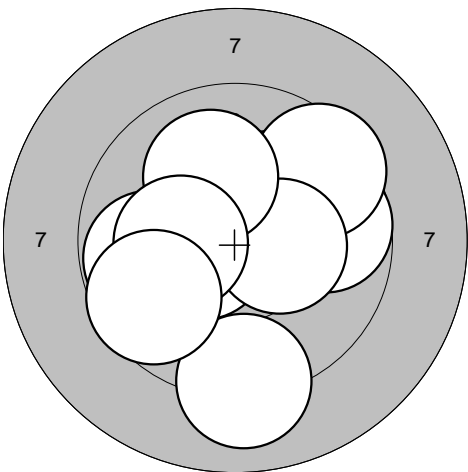
<p>Series 1</p> 	<p>1: 9,7 ↘ 2: 10,0 → 3: 9,1 ← 4: 10,0 ← 5: 10,3* ← 6: 10,5* ↘ 7: 10,6* ↘ 8: 10,7* ↗ 9: 9,9 ← 10: 9,8 ↗</p> <table border="1" style="width:100%; border-collapse: collapse;"> <tr><td>Serie</td><td style="text-align: right;">96,0</td></tr> <tr><td>Sum</td><td style="text-align: right;">96,0</td></tr> </table>	Serie	96,0	Sum	96,0	<p>Series 2</p> 	<p>1: 9,7 → 2: 10,2* ↗ 3: 9,5 ↗ 4: 10,5* ← 5: 9,1 ↓ 6: 10,4* → 7: 10,1 ↗ 8: 9,8 ← 9: 10,2* ← 10: 9,6 ↘</p> <table border="1" style="width:100%; border-collapse: collapse;"> <tr><td>Serie</td><td style="text-align: right;">95,0</td></tr> <tr><td>Sum</td><td style="text-align: right;">191,0</td></tr> </table>	Serie	95,0	Sum	191,0
Serie	96,0										
Sum	96,0										
Serie	95,0										
Sum	191,0										

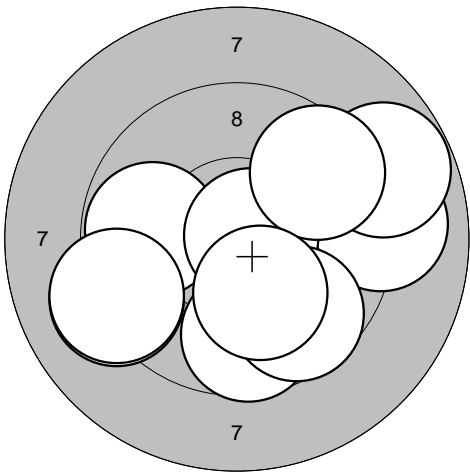
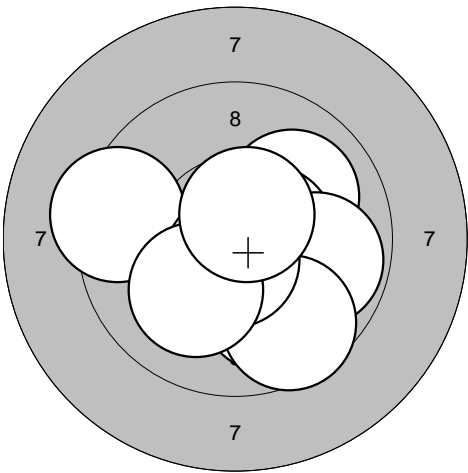
<p>Series 3</p> 	<p>1: 9,0 → 2: 9,7 ↘ 3: 9,2 ← 4: 9,8 ← 5: 10,7* → 6: 8,8 → 7: 9,5 ↗ 8: 9,7 ↘ 9: 9,2 ← 10: 10,2* ↘</p> <table border="1" style="width:100%; border-collapse: collapse;"> <tr><td>Serie</td><td style="text-align: right;">91,0</td></tr> <tr><td>Sum</td><td style="text-align: right;">282,0</td></tr> </table>	Serie	91,0	Sum	282,0	<p>Series 4</p> 	<p>1: 10,7* ↗ 2: 10,0 ↘ 3: 10,0 ↗ 4: 10,5* → 5: 9,4 ← 6: 9,8 → 7: 9,6 ↘ 8: 10,7* ↘ 9: 10,1 ↘ 10: 10,6* ↗</p> <table border="1" style="width:100%; border-collapse: collapse;"> <tr><td>Serie</td><td style="text-align: right;">97,0</td></tr> <tr><td>Sum</td><td style="text-align: right;">379,0</td></tr> </table>	Serie	97,0	Sum	379,0
Serie	91,0										
Sum	282,0										
Serie	97,0										
Sum	379,0										

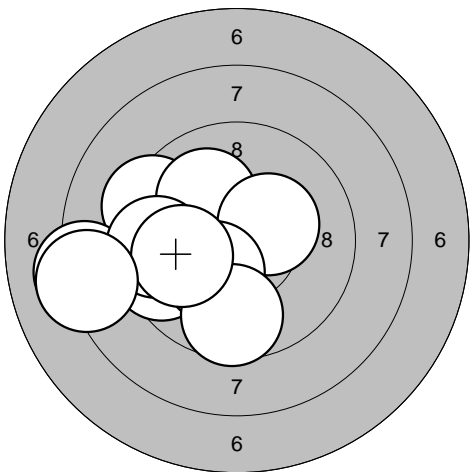
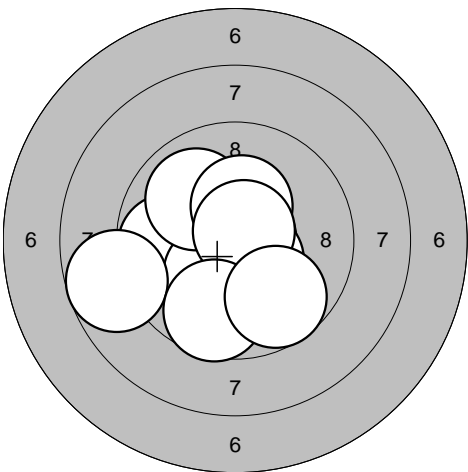
<p>Series 5</p> 	<p>1: 9,3 ← 2: 8,2 ← 3: 9,5 ← 4: 10,1 ↗ 5: 10,3* ↗ 6: 9,5 ← 7: 10,3* ↘ 8: 9,6 ↓ 9: 10,0 ← 10: 8,2 ←</p> <table border="1" style="width:100%; border-collapse: collapse;"> <tr><td>Serie</td><td style="text-align: right;">92,0</td></tr> <tr><td>Sum</td><td style="text-align: right;">471,0</td></tr> </table>	Serie	92,0	Sum	471,0	<p>Series 6</p> 	<p>1: 10,5* ↘ 2: 10,6* ↘ 3: 9,8 ← 4: 10,2* ↘ 5: 8,7 ← 6: 10,0 ↗ 7: 10,3* ↗ 8: 10,7* ↗ 9: 9,7 ↘ 10: 9,7 ↘</p> <table border="1" style="width:100%; border-collapse: collapse;"> <tr><td>Serie</td><td style="text-align: right;">95,0</td></tr> <tr><td>Sum</td><td style="text-align: right;">566,0</td></tr> </table>	Serie	95,0	Sum	566,0
Serie	92,0										
Sum	471,0										
Serie	95,0										
Sum	566,0										

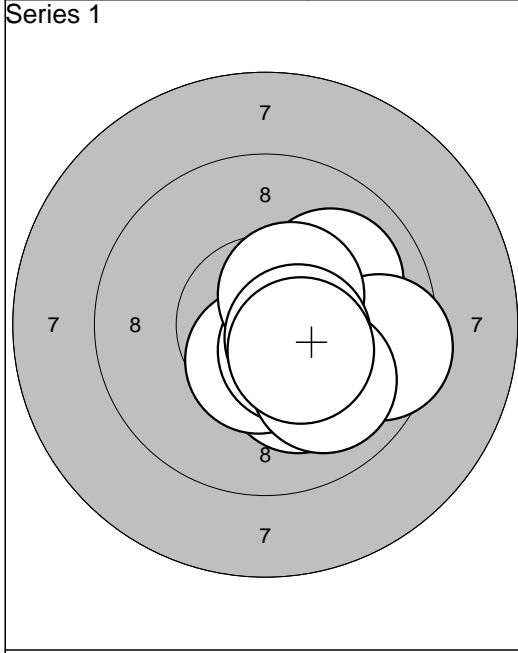

1: 10,0	→
2: 10,0	↗
3: 10,2*	↓
4: 10,5*	↓
5: 10,5*	↓
6: 9,5	→
7: 10,5*	↗
8: 10,0	↓
9: 10,5*	→
10: 10,4*	↘
Serie 99,0	
Sum	99,0

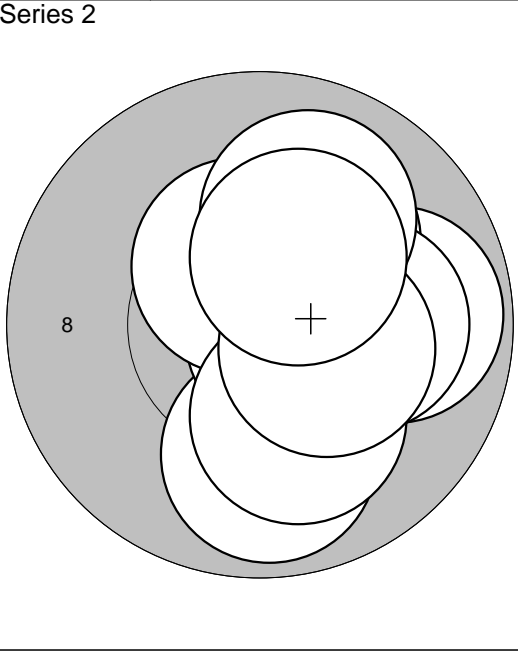

1: 9,9	↓
2: 10,7*	→
3: 9,8	→
4: 10,2*	↗
5: 10,5*	↗
6: 10,1	→
7: 10,1	↓
8: 10,0	↗
9: 10,3*	→
10: 10,3*	↗
Serie 98,0	
Sum	197,0

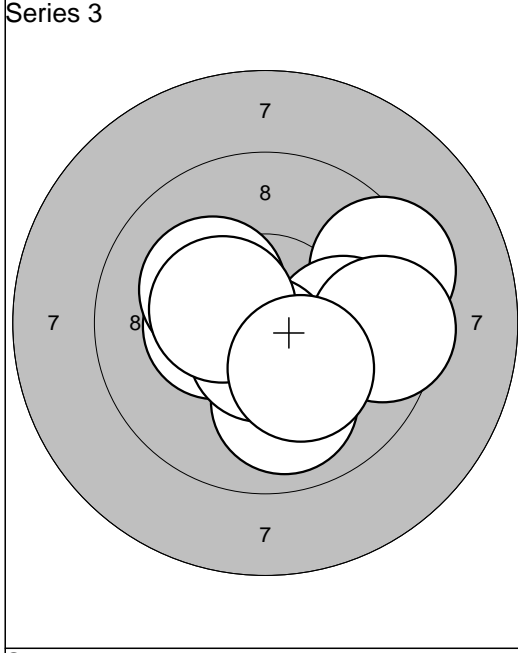

1: 10,4*	←
2: 9,4	↗
3: 10,4*	↓
4: 10,0	↓
5: 10,2*	↗
6: 10,0	→
7: 9,5	→
8: 10,6*	↓
9: 10,4*	←
10: 10,2*	↘
Serie 98,0	
Sum	295,0

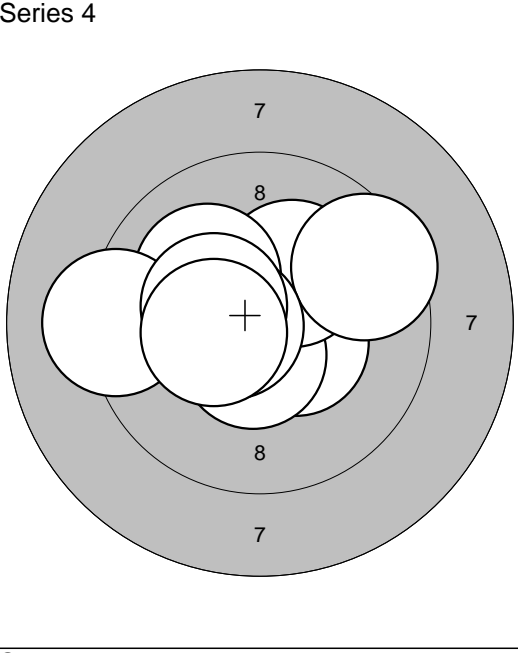

1: 10,7*	↓
2: 10,4*	↘
3: 10,5*	↓
4: 10,2*	↗
5: 10,1	↖
6: 9,5	↗
7: 10,6*	←
8: 9,2	←
9: 10,4*	←
10: 10,4*	←
Serie 98,0	
Sum	393,0

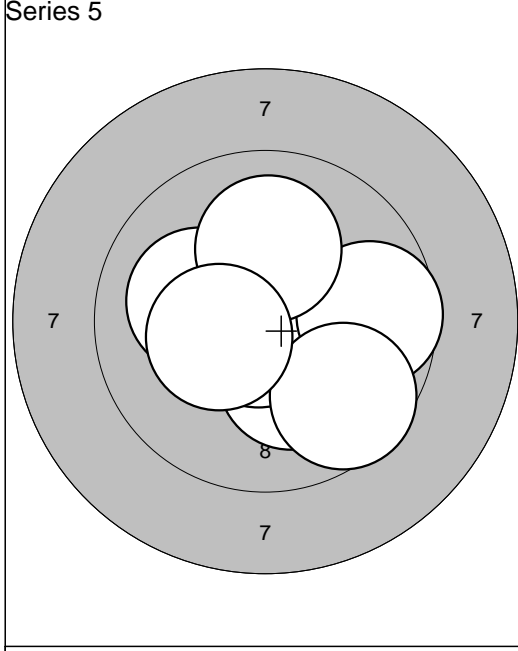

1: 10,7*	↓
2: 10,1	→
3: 10,2*	↓
4: 10,9*	↑
5: 10,8*	↓
6: 9,7	→
7: 9,6	↘
8: 10,1	←
9: 10,1	↑
10: 10,3*	←
Serie 98,0	
Sum	491,0

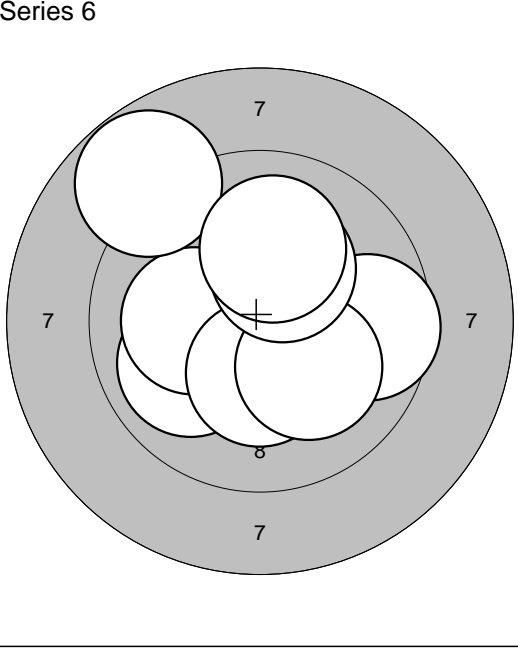

1: 10,0	↖
2: 10,4*	↘
3: 10,7*	←
4: 10,1	←
5: 10,3*	↓
6: 9,6	→
7: 8,8	↗
8: 10,1	↘
9: 10,3*	↗
10: 10,0	↑
Serie 97,0	
Sum	588,0

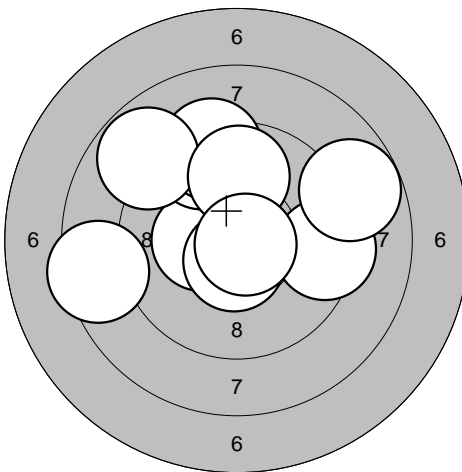
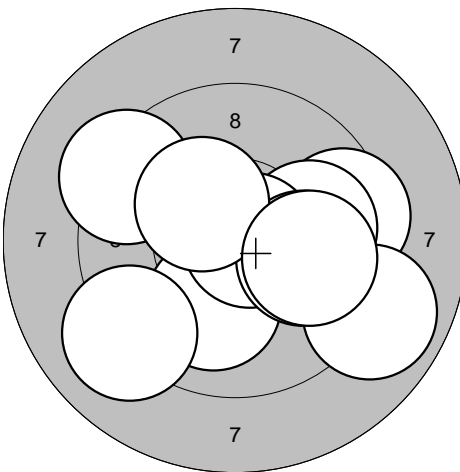
<p>Series 1</p> 	<p>1: 10,4* ←</p> <p>2: 8,4 ←</p> <p>3: 9,4 ↗</p> <p>4: 10,6* ↓</p> <p>5: 9,3 ↗</p> <p>6: 8,8 ↗</p> <p>7: 9,4 →</p> <p>8: 8,8 →</p> <p>9: 9,8 ↑</p> <p>10: 10,8* →</p>	<p>Series 2</p> 	<p>1: 9,5 →</p> <p>2: 10,1 ↓</p> <p>3: 9,1 ↙</p> <p>4: 9,9 →</p> <p>5: 10,7* →</p> <p>6: 9,3 ↙</p> <p>7: 10,0 →</p> <p>8: 10,3* ↗</p> <p>9: 8,9 ↘</p> <p>10: 9,9 →</p>
Serie	90,0	Serie	93,0
Sum	90,0	Sum	183,0

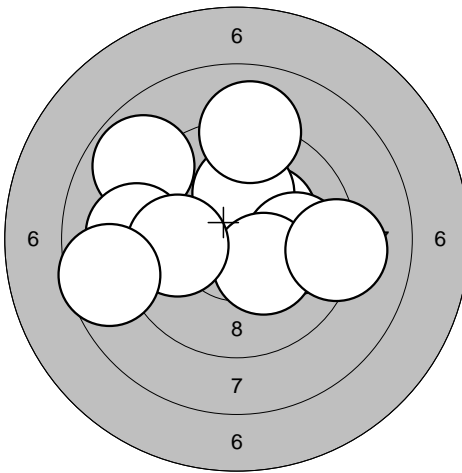
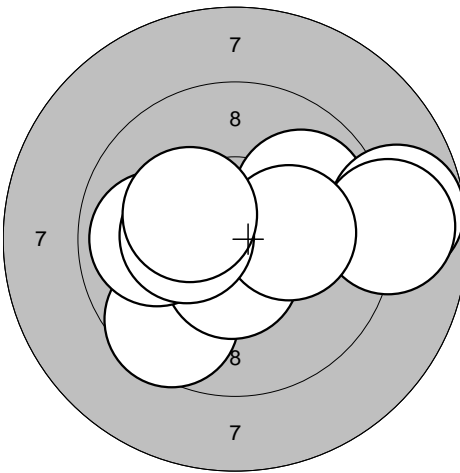
<p>Series 3</p> 	<p>1: 10,3* ↗</p> <p>2: 10,1 ↑</p> <p>3: 8,9 ↙</p> <p>4: 9,2 ←</p> <p>5: 9,1 ↑</p> <p>6: 9,9 →</p> <p>7: 10,3* ↘</p> <p>8: 9,2 →</p> <p>9: 9,9 ←</p> <p>10: 8,6 ←</p>	<p>Series 4</p> 	<p>1: 10,1 ←</p> <p>2: 9,9 ↗</p> <p>3: 8,7 →</p> <p>4: 9,6 ↙</p> <p>5: 10,5* ↓</p> <p>6: 8,9 →</p> <p>7: 9,9 ←</p> <p>8: 10,2* →</p> <p>9: 10,3* ←</p> <p>10: 10,3* ↙</p>
Serie	91,0	Serie	93,0
Sum	274,0	Sum	367,0

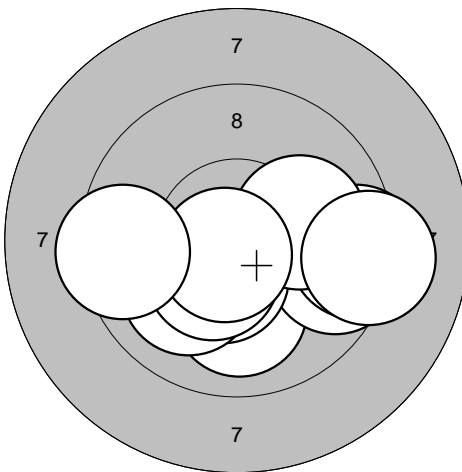
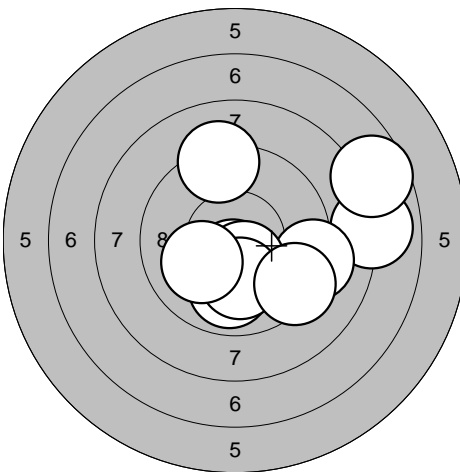
<p>Series 5</p> 	<p>1: 10,0 ↓</p> <p>2: 9,6 →</p> <p>3: 10,4* ↓</p> <p>4: 10,0 ↙</p> <p>5: 9,4 →</p> <p>6: 10,4* ↙</p> <p>7: 10,1 →</p> <p>8: 10,7* ↙</p> <p>9: 9,4 ←</p> <p>10: 9,2 →</p>	<p>Series 6</p> 	<p>1: 7,9 →</p> <p>2: 10,5* ↓</p> <p>3: 9,2 →</p> <p>4: 10,4* ↓</p> <p>5: 9,9 ↓</p> <p>6: 10,1 ↓</p> <p>7: 9,2 ↑</p> <p>8: 7,7 ↗</p> <p>9: 9,3 ↘</p> <p>10: 10,1 ↙</p>
Serie	96,0	Serie	90,0
Sum	463,0	Sum	553,0

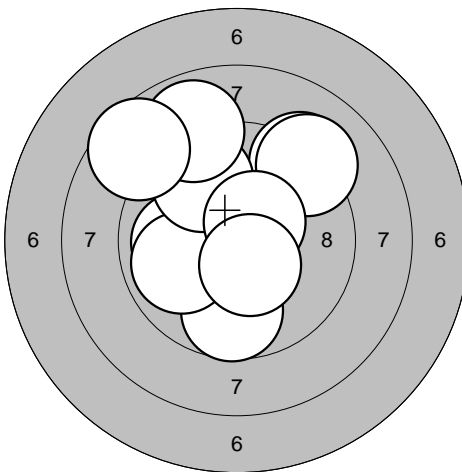
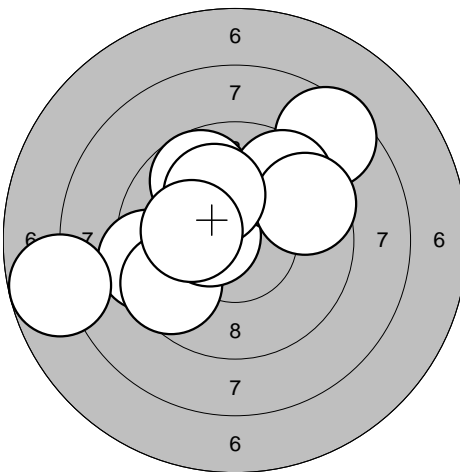
<p>Series 1</p> 	<p>1: 9,7 ↓</p> <p>2: 9,2 ↗</p> <p>3: 9,1 ↗</p> <p>4: 10,0 ←</p> <p>5: 9,9 ←</p> <p>6: 9,8 ↗</p> <p>7: 10,5* ↗</p> <p>8: 8,9 ↗</p> <p>9: 10,4* ↓</p> <p>10: 8,6 ↗</p>	<p>Series 2</p> 	<p>1: 9,7 ↗</p> <p>2: 9,4 ←</p> <p>3: 7,8 ←</p> <p>4: 9,6 ←</p> <p>5: 10,5* ←</p> <p>6: 8,5 ↗</p> <p>7: 9,6 ↗</p> <p>8: 9,6 ↗</p> <p>9: 10,1 ↗</p> <p>10: 10,2* ←</p>
Serie 91,0	Serie 90,0	Serie 90,0	Serie 90,0
Sum 91,0	Sum 181,0	Sum 181,0	Sum 181,0

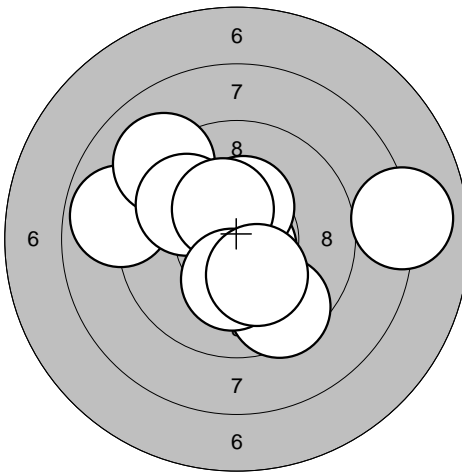
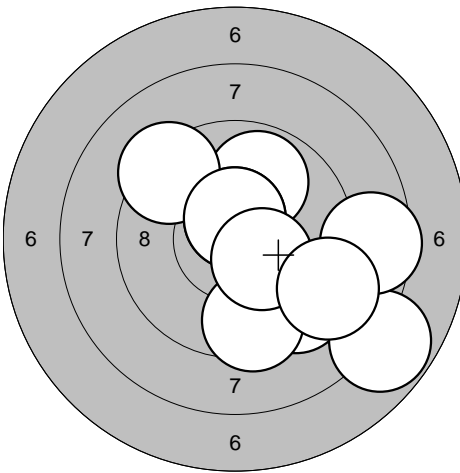
<p>Series 3</p> 	<p>1: 10,7* ↓</p> <p>2: 8,9 ←</p> <p>3: 9,1 ↗</p> <p>4: 9,9 ↗</p> <p>5: 9,5 ↓</p> <p>6: 8,0 →</p> <p>7: 10,4* ↗</p> <p>8: 10,4* ↗</p> <p>9: 10,2* ↓</p> <p>10: 10,2* ↓</p>	<p>Series 4</p> 	<p>1: 9,4 ↓</p> <p>2: 9,5 ↓</p> <p>3: 7,8 ↓</p> <p>4: 9,9 ↗</p> <p>5: 10,6* ↑</p> <p>6: 9,3 ↗</p> <p>7: 8,6 →</p> <p>8: 10,6* ↑</p> <p>9: 10,3* ↓</p> <p>10: 9,1 ↓</p>
Serie 93,0	Serie 90,0	Serie 90,0	Serie 90,0
Sum 274,0	Sum 364,0	Sum 364,0	Sum 364,0

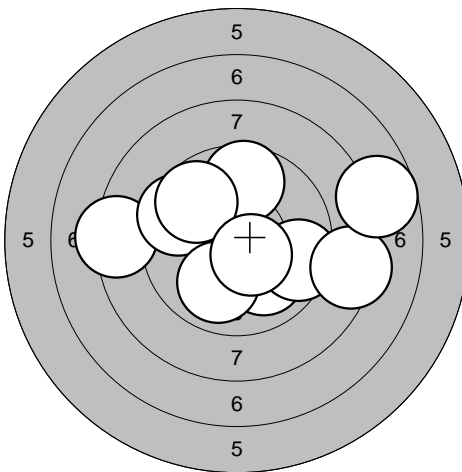
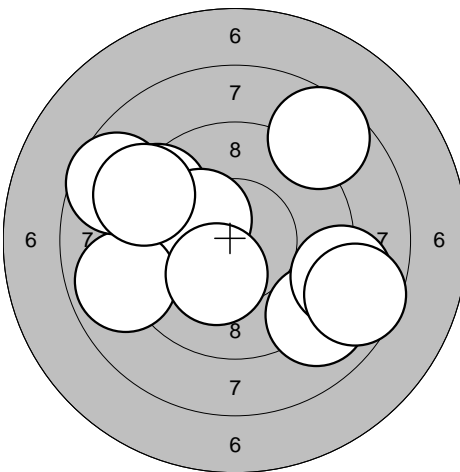
<p>Series 5</p> 	<p>1: 8,3 ←</p> <p>2: 10,0 ↓</p> <p>3: 9,5 ↗</p> <p>4: 9,5 →</p> <p>5: 8,4 →</p> <p>6: 9,7 ↗</p> <p>7: 9,7 ↗</p> <p>8: 7,7 →</p> <p>9: 10,0 ↓</p> <p>10: 10,5* ↓</p>	<p>Series 6</p> 	<p>1: 9,0 ↓</p> <p>2: 9,4 ↗</p> <p>3: 10,3* ↗</p> <p>4: 9,0 →</p> <p>5: 8,9 ←</p> <p>6: 8,6 ↗</p> <p>7: 8,6 ←</p> <p>8: 10,3* ↓</p> <p>9: 9,2 ←</p> <p>10: 8,6 →</p>
Serie 89,0	Serie 88,0	Serie 88,0	Serie 88,0
Sum 453,0	Sum 541,0	Sum 541,0	Sum 541,0

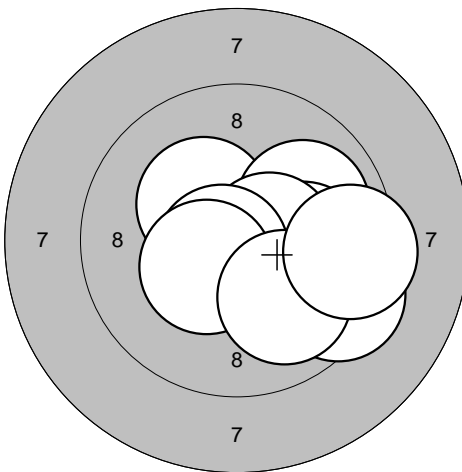
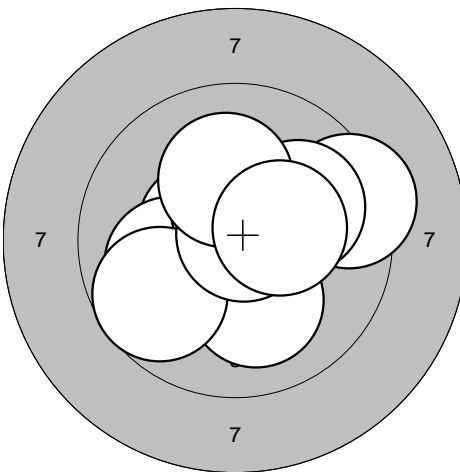
<p>Series 1</p> 	<p>1: 10,3* ↗</p> <p>2: 10,0 →</p> <p>3: 10,1 ↓</p> <p>4: 10,0 →</p> <p>5: 10,5* →</p> <p>6: 9,4 ↓</p> <p>7: 10,7* ↙</p> <p>8: 10,4* ↙</p> <p>9: 10,0 ↓</p> <p>10: 9,4 →</p>	<p>Series 2</p> 	<p>1: 9,3 →</p> <p>2: 10,5* ↖</p> <p>3: 10,1 ↖</p> <p>4: 10,0 →</p> <p>5: 10,1 ↓</p> <p>6: 10,5* ↑</p> <p>7: 9,7 ↖</p> <p>8: 10,8* ↗</p> <p>9: 10,1 ↑</p> <p>10: 10,3* →</p>
Serie 98,0	Serie 98,0	Serie 98,0	Serie 98,0
Sum 98,0	Sum 98,0	Sum 196,0	Sum 196,0

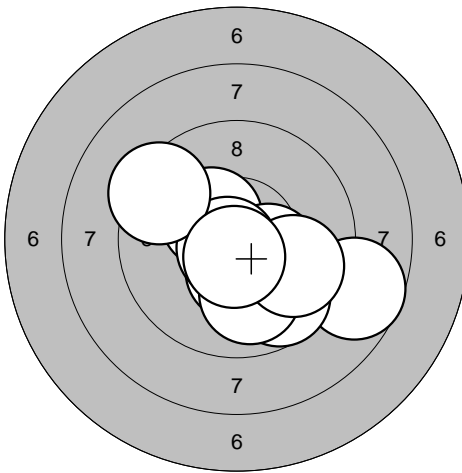
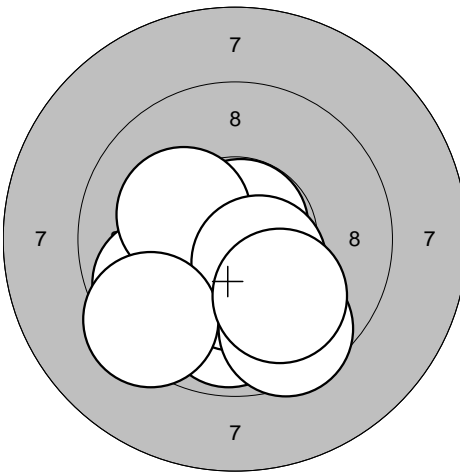
<p>Series 3</p> 	<p>1: 8,7 ↘</p> <p>2: 10,4* ↗</p> <p>3: 10,3* ↘</p> <p>4: 10,4* ↓</p> <p>5: 9,7 ↓</p> <p>6: 10,7* ↙</p> <p>7: 10,0 ↓</p> <p>8: 9,8 ↘</p> <p>9: 9,4 ↗</p> <p>10: 10,6* ↓</p>	<p>Series 4</p> 	<p>1: 10,8* ↗</p> <p>2: 9,9 ↓</p> <p>3: 10,4* ↓</p> <p>4: 9,8 ↖</p> <p>5: 10,3* ↓</p> <p>6: 9,6 ↓</p> <p>7: 10,2* ↖</p> <p>8: 10,5* ↘</p> <p>9: 9,4 ↖</p> <p>10: 10,0 ↓</p>
Serie 95,0	Serie 95,0	Serie 96,0	Serie 96,0
Sum 291,0	Sum 291,0	Sum 387,0	Sum 387,0

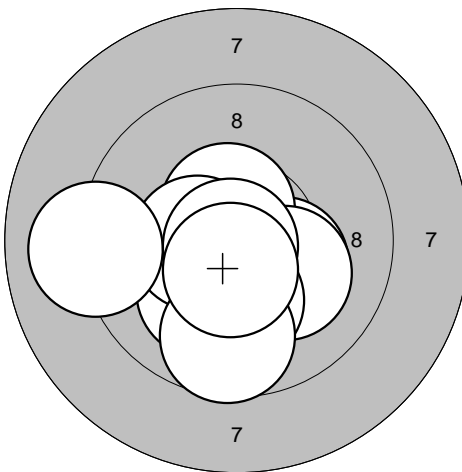
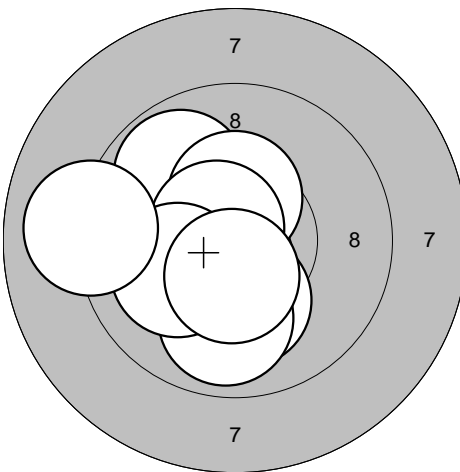
<p>Series 5</p> 	<p>1: 10,3* ↘</p> <p>2: 10,5* ↗</p> <p>3: 10,2* ↘</p> <p>4: 10,1 ↙</p> <p>5: 10,1 ↓</p> <p>6: 10,4* ↖</p> <p>7: 9,1 ↖</p> <p>8: 10,9* ↙</p> <p>9: 9,7 ↓</p> <p>10: 10,5* ↓</p>	<p>Series 6</p> 	<p>1: 10,3* ↖</p> <p>2: 10,1 ↓</p> <p>3: 10,6* ↘</p> <p>4: 9,9 ↗</p> <p>5: 10,4* ↑</p> <p>6: 9,9 ↓</p> <p>7: 10,7* ↖</p> <p>8: 10,1 ↖</p> <p>9: 9,0 ↖</p> <p>10: 10,5* ↓</p>
Serie 98,0	Serie 98,0	Serie 97,0	Serie 97,0
Sum 485,0	Sum 485,0	Sum 582,0	Sum 582,0

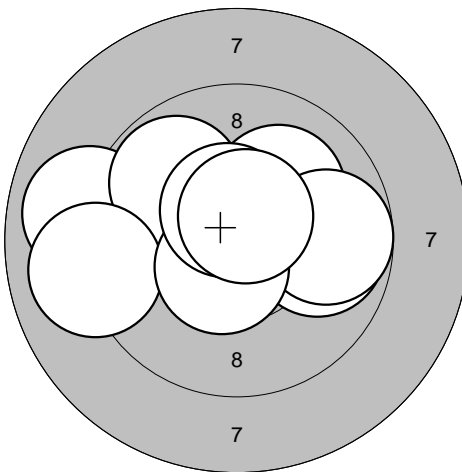
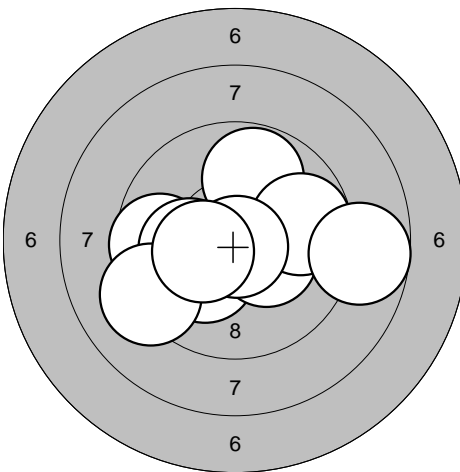
<p>Series 1</p> 	<p>1: 10,1 ↗</p> <p>2: 10,7* ←</p> <p>3: 8,9 ←</p> <p>4: 9,8 ↗</p> <p>5: 9,0 ←</p> <p>6: 9,8 →</p> <p>7: 9,7 →</p> <p>8: 10,6* ↘</p> <p>9: 10,5* ↗</p> <p>10: 10,6* ↗</p>	<p>Series 2</p> 	<p>1: 10,2* ↘</p> <p>2: 10,3* ↘</p> <p>3: 9,6 ←</p> <p>4: 9,8 ↗</p> <p>5: 10,1 ←</p> <p>6: 9,7 →</p> <p>7: 8,7 →</p> <p>8: 10,8* ↘</p> <p>9: 9,2 ↘</p> <p>10: 10,3* ←</p>
Serie 94,0		Serie 94,0	
Sum 94,0		Sum 188,0	

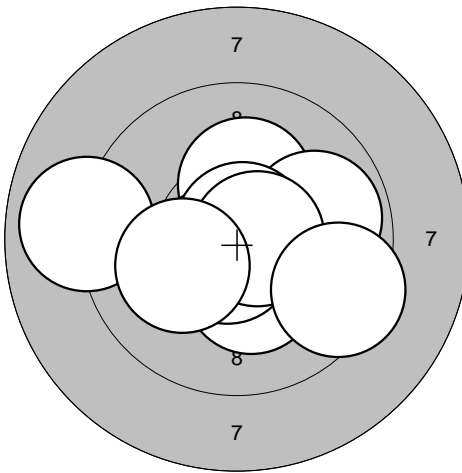
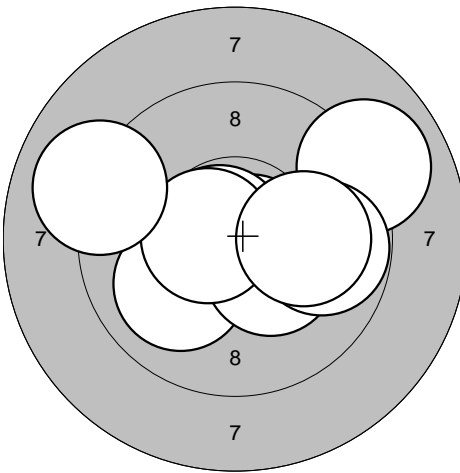
<p>Series 3</p> 	<p>1: 10,2* ↗</p> <p>2: 10,6* ↘</p> <p>3: 10,3* ↘</p> <p>4: 9,9 →</p> <p>5: 10,7* ↘</p> <p>6: 10,8* ↗</p> <p>7: 8,9 ←</p> <p>8: 10,7* →</p> <p>9: 10,2* ↘</p> <p>10: 9,4 ↘</p>	<p>Series 4</p> 	<p>1: 10,8* →</p> <p>2: 10,5* ↘</p> <p>3: 10,7* ↘</p> <p>4: 10,0 ↘</p> <p>5: 9,0 ↗</p> <p>6: 10,3* ↘</p> <p>7: 10,6* ←</p> <p>8: 9,8 →</p> <p>9: 10,0 →</p> <p>10: 9,0 ←</p>
Serie 96,0		Serie 97,0	
Sum 284,0		Sum 381,0	

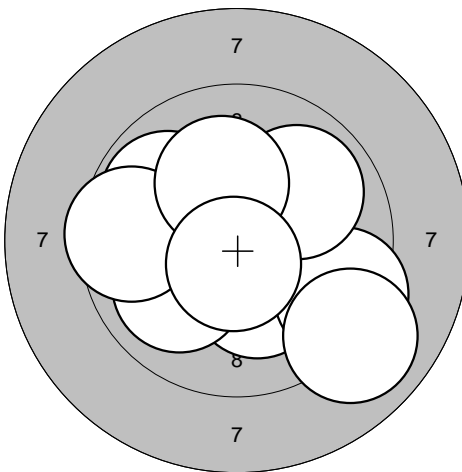
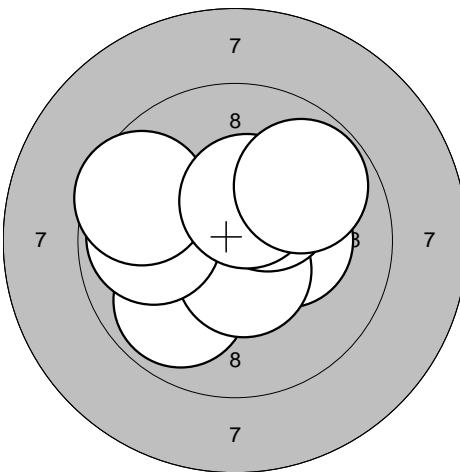
<p>Series 5</p> 	<p>1: 9,9 ↘</p> <p>2: 10,2* ↘</p> <p>3: 10,4* ←</p> <p>4: 9,4 →</p> <p>5: 9,0 ↘</p> <p>6: 10,0 ↘</p> <p>7: 9,5 ←</p> <p>8: 9,9 ↗</p> <p>9: 10,2* ↗</p> <p>10: 10,6* ↘</p>	<p>Series 6</p> 	<p>1: 10,3* ↘</p> <p>2: 9,9 ↘</p> <p>3: 10,3* →</p> <p>4: 10,8* ↘</p> <p>5: 10,5* ↘</p> <p>6: 9,9 ←</p> <p>7: 10,3* ↗</p> <p>8: 9,6 ↘</p> <p>9: 10,4* ↗</p> <p>10: 9,8 ↗</p>
Serie 95,0		Serie 96,0	
Sum 476,0		Sum 572,0	

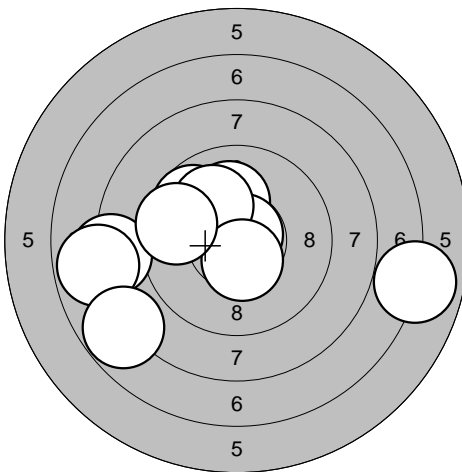
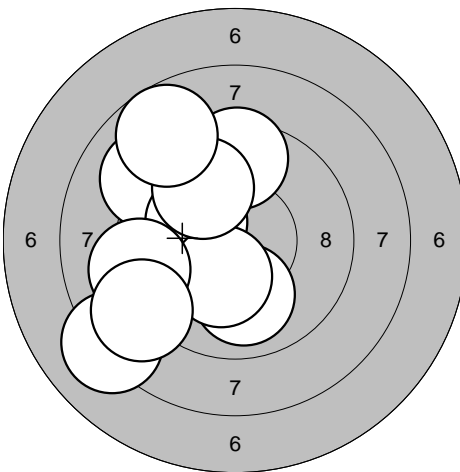
<p>Series 1</p> 	<p>1: 8,2 ←</p> <p>2: 9,7 ↗</p> <p>3: 7,9 ←</p> <p>4: 10,1 ↑</p> <p>5: 10,8* ↗</p> <p>6: 10,0 ↑</p> <p>7: 7,8 ↙</p> <p>8: 6,9 →</p> <p>9: 10,5* ↓</p> <p>10: 9,6 ←</p> <hr/> <p>Serie 86,0</p> <hr/> <p>Sum 86,0</p>	<p>Series 2</p> 	<p>1: 10,0 ↓</p> <p>2: 9,1 ↗</p> <p>3: 9,5 ↑</p> <p>4: 10,2* ↙</p> <p>5: 10,3* ↓</p> <p>6: 8,1 ↙</p> <p>7: 9,2 ←</p> <p>8: 9,9 ↗</p> <p>9: 8,8 ↗</p> <p>10: 8,9 ↙</p> <hr/> <p>Serie 90,0</p> <hr/> <p>Sum 176,0</p>
--	--	--	--

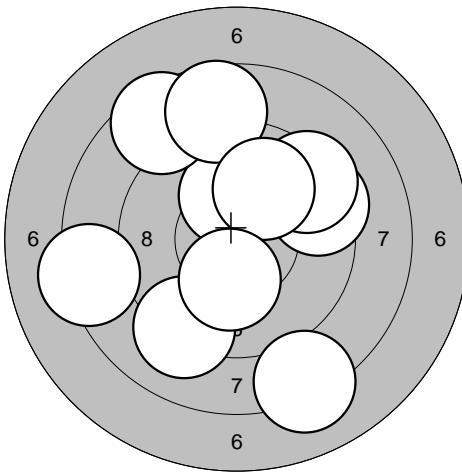
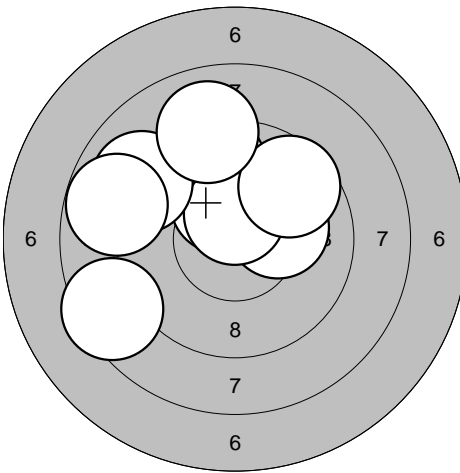
<p>Series 3</p> 	<p>1: 10,2* ↑</p> <p>2: 9,1 ↓</p> <p>3: 8,2 ↓</p> <p>4: 8,5 ↗</p> <p>5: 9,4 →</p> <p>6: 8,3 ←</p> <p>7: 9,4 ↗</p> <p>8: 8,7 ↑</p> <p>9: 9,9 ↗</p> <p>10: 10,2* ↓</p> <hr/> <p>Serie 88,0</p> <hr/> <p>Sum 264,0</p>	<p>Series 4</p> 	<p>1: 8,5 ↙</p> <p>2: 10,2* ↑</p> <p>3: 9,6 ↑</p> <p>4: 10,2* →</p> <p>5: 10,3* ↑</p> <p>6: 10,5* ↑</p> <p>7: 9,6 ↗</p> <p>8: 9,0 ↙</p> <p>9: 9,0 ↑</p> <p>10: 8,8 ←</p> <hr/> <p>Serie 92,0</p> <hr/> <p>Sum 356,0</p>
---	---	---	---

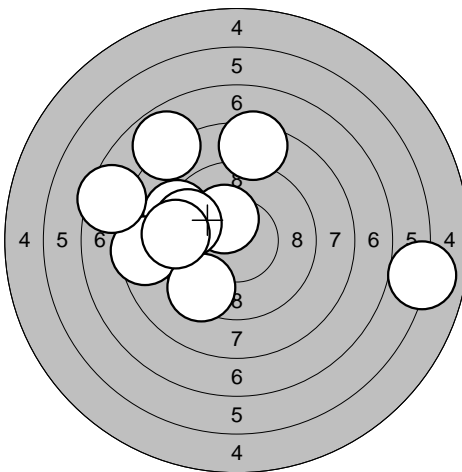
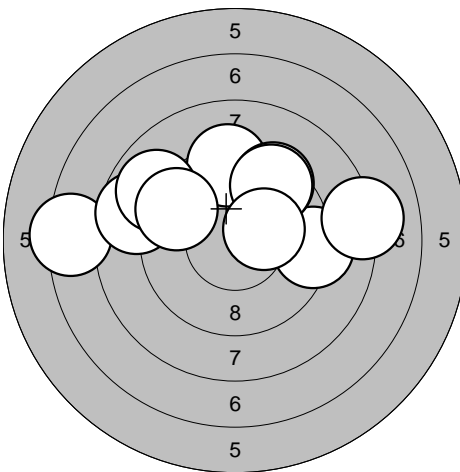
<p>Series 5</p> 	<p>1: 9,2 ↙</p> <p>2: 6,0 →</p> <p>3: 8,5 ←</p> <p>4: 9,4 ↙</p> <p>5: 7,5 ←</p> <p>6: 10,3* ↑</p> <p>7: 9,6 ↙</p> <p>8: 9,3 ←</p> <p>9: 8,4 ↑</p> <p>10: 7,9 ↗</p> <hr/> <p>Serie 82,0</p> <hr/> <p>Sum 438,0</p>	<p>Series 6</p> 	<p>1: 7,4 ←</p> <p>2: 9,2 →</p> <p>3: 9,3 ↑</p> <p>4: 9,5 ↗</p> <p>5: 8,7 ←</p> <p>6: 9,5 ↗</p> <p>7: 8,1 →</p> <p>8: 10,3* →</p> <p>9: 8,9 ↙</p> <p>10: 9,5 ↙</p> <hr/> <p>Serie 86,0</p> <hr/> <p>Sum 524,0</p>
--	---	--	---

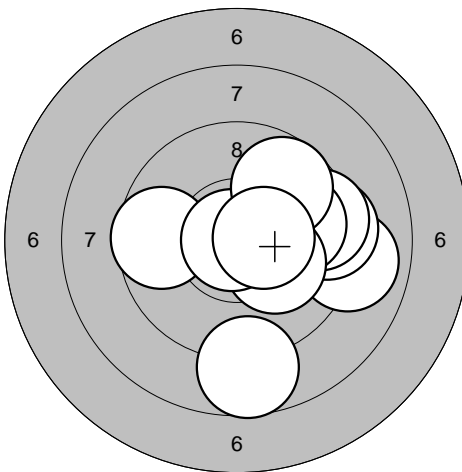
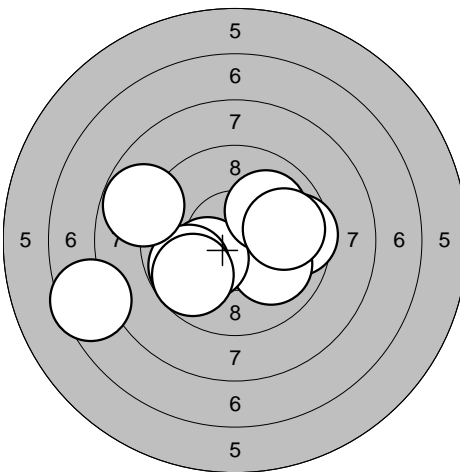
<p>Series 1</p> 	<p>1: 9,0 →</p> <p>2: 9,3 →</p> <p>3: 9,5 →</p> <p>4: 9,6 ←</p> <p>5: 9,9 →</p> <p>6: 10,2* →</p> <p>7: 10,9* ←</p> <p>8: 8,7 ↓</p> <p>9: 9,7 ↗</p> <p>10: 10,5* →</p>	<p>Series 2</p> 	<p>1: 10,0 →</p> <p>2: 9,6 →</p> <p>3: 10,0 →</p> <p>4: 10,2* ←</p> <p>5: 7,5 ←</p> <p>6: 9,8 ←</p> <p>7: 9,8 ←</p> <p>8: 8,8 ←</p> <p>9: 10,0 ↗</p> <p>10: 9,8 →</p>
Serie 92,0	Serie 91,0	Serie 91,0	Serie 91,0
Sum 92,0	Sum 183,0	Sum 183,0	Sum 183,0

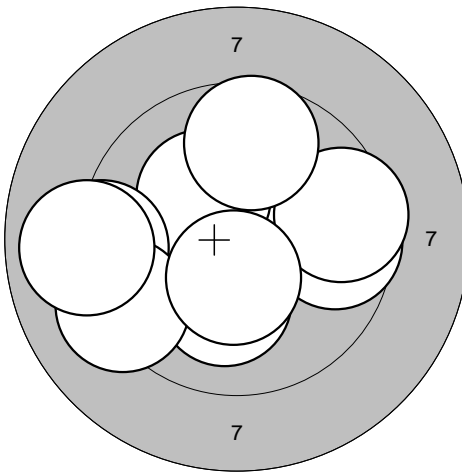
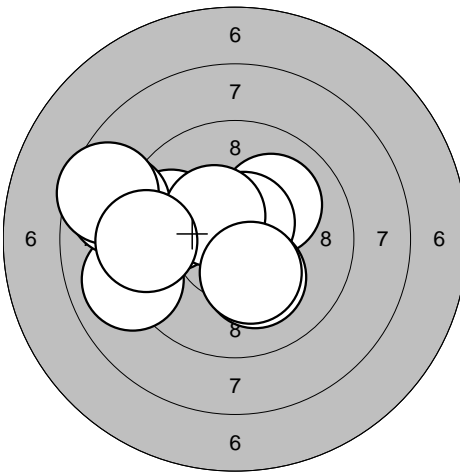
<p>Series 3</p> 	<p>1: 9,6 →</p> <p>2: 10,8* ↑</p> <p>3: 10,1 ↓</p> <p>4: 10,2* ↗</p> <p>5: 9,2 ←</p> <p>6: 9,5 →</p> <p>7: 9,2 ←</p> <p>8: 9,0 ←</p> <p>9: 9,7 ↑</p> <p>10: 10,4* ↓</p>	<p>Series 4</p> 	<p>1: 10,1 ↗</p> <p>2: 9,0 ←</p> <p>3: 9,8 ←</p> <p>4: 8,8 ←</p> <p>5: 10,6* ↗</p> <p>6: 8,6 ←</p> <p>7: 10,2* ↓</p> <p>8: 10,4* ↗</p> <p>9: 10,3* ↓</p> <p>10: 9,4 ←</p>
Serie 94,0	Serie 93,0	Serie 93,0	Serie 93,0
Sum 277,0	Sum 370,0	Sum 370,0	Sum 370,0

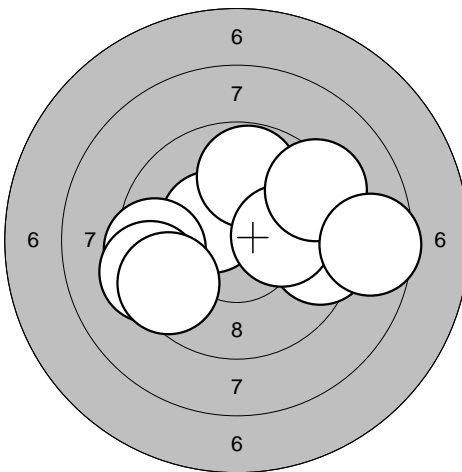
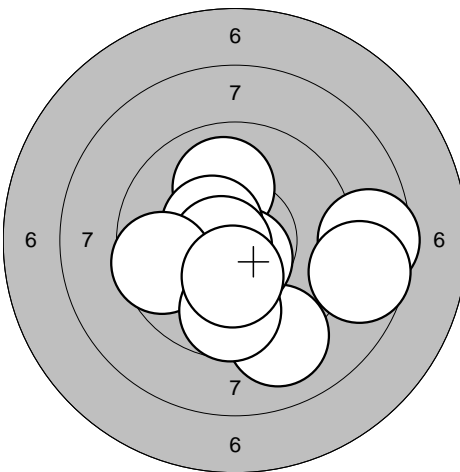
<p>Series 5</p> 	<p>1: 10,4* ↖</p> <p>2: 9,7 →</p> <p>3: 9,5 ←</p> <p>4: 9,3 ←</p> <p>5: 9,8 ↑</p> <p>6: 9,4 →</p> <p>7: 10,1 →</p> <p>8: 9,5 ←</p> <p>9: 9,3 ↗</p> <p>10: 8,6 →</p>	<p>Series 6</p> 	<p>1: 10,0 ↑</p> <p>2: 9,1 ↓</p> <p>3: 10,6* ↓</p> <p>4: 10,5* ↖</p> <p>5: 10,7* ←</p> <p>6: 9,6 ←</p> <p>7: 8,6 →</p> <p>8: 9,7 ↓</p> <p>9: 8,7 →</p> <p>10: 10,3* ↓</p>
Serie 91,0	Serie 93,0	Serie 93,0	Serie 93,0
Sum 461,0	Sum 554,0	Sum 554,0	Sum 554,0

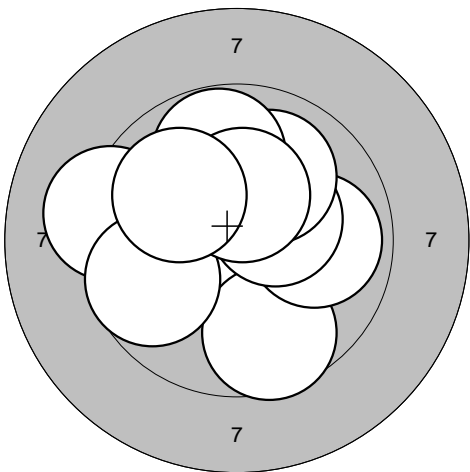
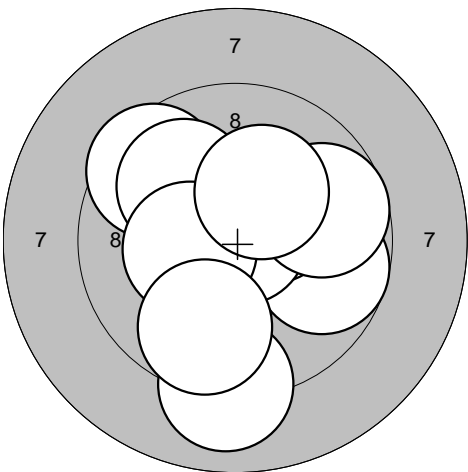
<p>Series 1</p> 	<p>1: 10,9* ↙ 2: 9,2 ← 3: 9,6 ↓ 4: 9,9 → 5: 10,3* ↗ 6: 10,0 ↗ 7: 9,8 ↑ 8: 9,7 ← 9: 10,3* ↑ 10: 10,0 ↙</p> <table border="1" style="width:100%; border-collapse: collapse;"> <tr><td>Serie</td><td style="text-align: right;">95,0</td></tr> <tr><td>Sum</td><td style="text-align: right;">95,0</td></tr> </table>	Serie	95,0	Sum	95,0	<p>Series 2</p> 	<p>1: 9,5 ↖ 2: 9,0 ↓ 3: 9,7 → 4: 9,9 ↗ 5: 10,4* ↗ 6: 10,9* ↗ 7: 9,7 → 8: 10,3* ← 9: 10,2* ↗ 10: 9,7 ↓</p> <table border="1" style="width:100%; border-collapse: collapse;"> <tr><td>Serie</td><td style="text-align: right;">94,0</td></tr> <tr><td>Sum</td><td style="text-align: right;">189,0</td></tr> </table>	Serie	94,0	Sum	189,0
Serie	95,0										
Sum	95,0										
Serie	94,0										
Sum	189,0										

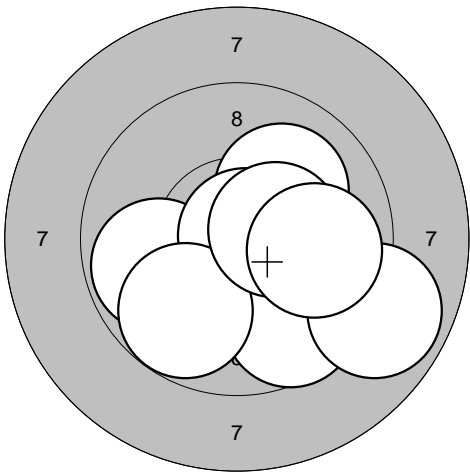
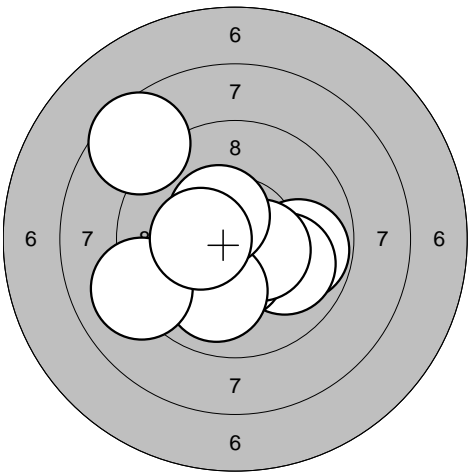
<p>Series 3</p> 	<p>1: 10,1 ↗ 2: 10,7* ↓ 3: 9,9 ← 4: 10,2* → 5: 10,8* → 6: 9,7 ↓ 7: 9,8 ↓ 8: 10,4* → 9: 8,9 ↓ 10: 9,9 →</p> <table border="1" style="width:100%; border-collapse: collapse;"> <tr><td>Serie</td><td style="text-align: right;">94,0</td></tr> <tr><td>Sum</td><td style="text-align: right;">283,0</td></tr> </table>	Serie	94,0	Sum	283,0	<p>Series 4</p> 	<p>1: 8,6 ↖ 2: 9,8 → 3: 10,0 → 4: 10,8* ↙ 5: 10,4* ↓ 6: 10,5* → 7: 10,0 ↓ 8: 10,5* ↖ 9: 9,1 ← 10: 10,4* ←</p> <table border="1" style="width:100%; border-collapse: collapse;"> <tr><td>Serie</td><td style="text-align: right;">96,0</td></tr> <tr><td>Sum</td><td style="text-align: right;">379,0</td></tr> </table>	Serie	96,0	Sum	379,0
Serie	94,0										
Sum	283,0										
Serie	96,0										
Sum	379,0										

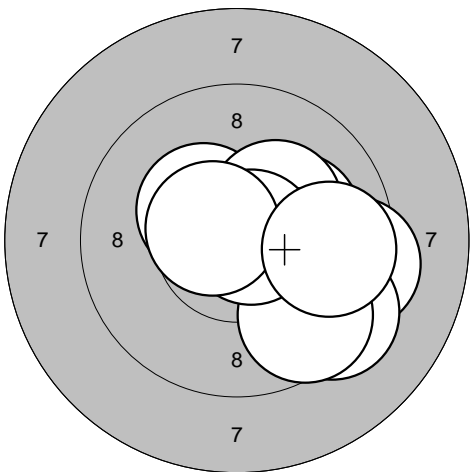
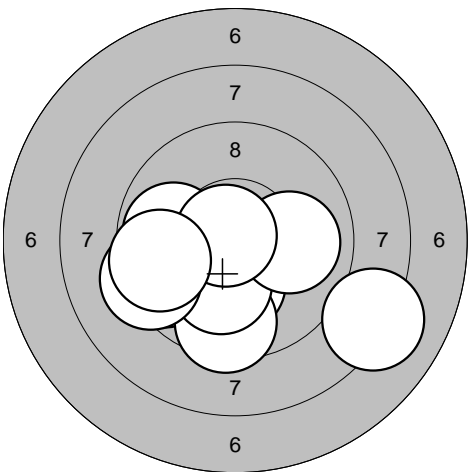
<p>Series 5</p> 	<p>1: 9,4 → 2: 10,1 → 3: 10,4* ↗ 4: 9,4 ↓ 5: 10,3* ↗ 6: 10,2* → 7: 9,6 ↓ 8: 10,8* → 9: 10,6* ↗ 10: 9,7 →</p> <table border="1" style="width:100%; border-collapse: collapse;"> <tr><td>Serie</td><td style="text-align: right;">96,0</td></tr> <tr><td>Sum</td><td style="text-align: right;">475,0</td></tr> </table>	Serie	96,0	Sum	475,0	<p>Series 6</p> 	<p>1: 9,6 ↖ 2: 10,2* ↓ 3: 9,5 ↓ 4: 10,1 ↓ 5: 9,9 ← 6: 9,3 ← 7: 8,2 ↘ 8: 10,0 → 9: 10,8* ↖ 10: 9,6 ←</p> <table border="1" style="width:100%; border-collapse: collapse;"> <tr><td>Serie</td><td style="text-align: right;">93,0</td></tr> <tr><td>Sum</td><td style="text-align: right;">568,0</td></tr> </table>	Serie	93,0	Sum	568,0
Serie	96,0										
Sum	475,0										
Serie	93,0										
Sum	568,0										

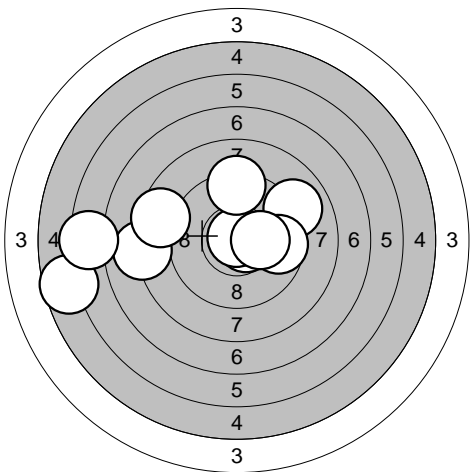
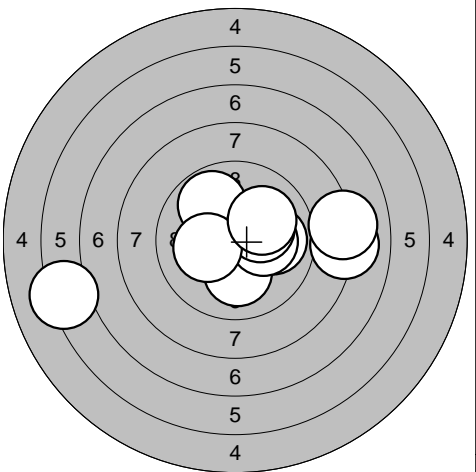
<p>Series 1</p> 	<p>1: 9,0 →</p> <p>2: 8,0 ←</p> <p>3: 5,6 ←</p> <p>4: 10,7* →</p> <p>5: 10,9* ↑</p> <p>6: 6,4 ←</p> <p>7: 9,7 →</p> <p>8: 9,3 ↑</p> <p>9: 10,2* →</p> <p>10: 8,5 ←</p>	<p>Series 2</p> 	<p>1: 10,1 ↓</p> <p>2: 9,9 →</p> <p>3: 8,1 →</p> <p>4: 6,2 ←</p> <p>5: 9,9 ↗</p> <p>6: 10,2* →</p> <p>7: 8,1 →</p> <p>8: 10,2* ↗</p> <p>9: 10,2* ←</p> <p>10: 10,1 ↗</p>
Serie 84,0	Serie 90,0	Serie 90,0	Serie 90,0
Sum 84,0	Sum 84,0	Sum 174,0	Sum 174,0

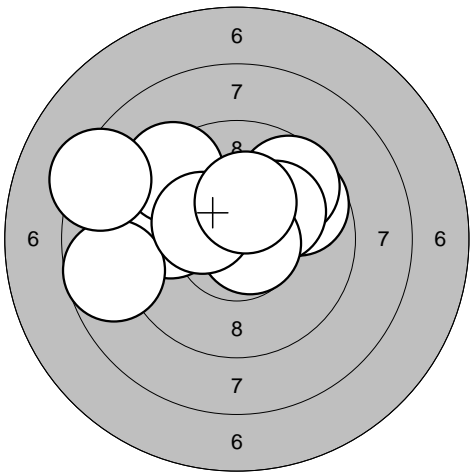
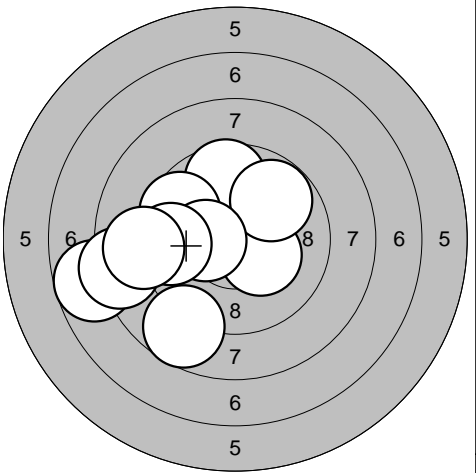
<p>Series 3</p> 	<p>1: 9,7 →</p> <p>2: 9,8 ←</p> <p>3: 8,7 ←</p> <p>4: 9,4 ↗</p> <p>5: 9,6 ↗</p> <p>6: 10,1 ↗</p> <p>7: 8,3 ←</p> <p>8: 10,7* →</p> <p>9: 10,3* ↗</p> <p>10: 10,3* ↑</p>	<p>Series 4</p> 	<p>1: 7,7 ←</p> <p>2: 9,6 ↑</p> <p>3: 9,6 ←</p> <p>4: 8,4 ←</p> <p>5: 10,3* ↘</p> <p>6: 8,7 ↘</p> <p>7: 9,8 ↗</p> <p>8: 10,3* ←</p> <p>9: 9,5 ←</p> <p>10: 8,9 ←</p>
Serie 92,0	Serie 87,0	Serie 87,0	Serie 87,0
Sum 266,0	Sum 266,0	Sum 353,0	Sum 353,0

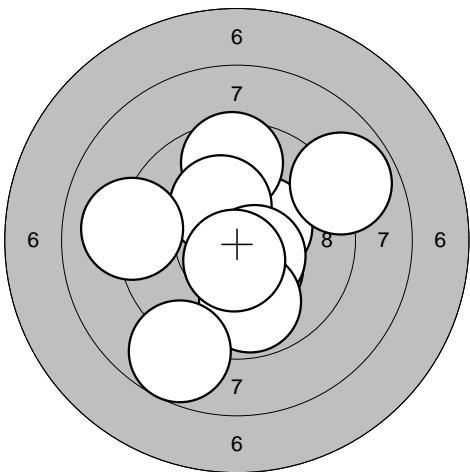
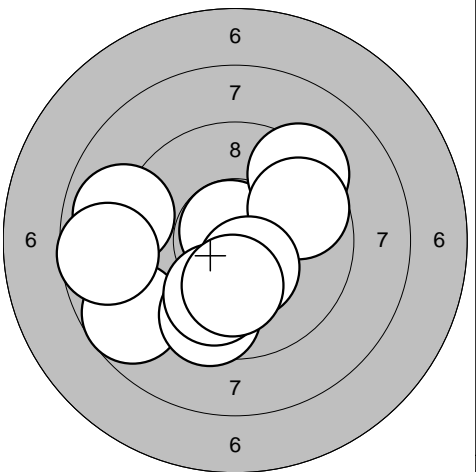
<p>Series 5</p> 	<p>1: 10,5* →</p> <p>2: 10,4* ↓</p> <p>3: 9,6 ↑</p> <p>4: 10,3* ↗</p> <p>5: 10,5* ↘</p> <p>6: 8,8 →</p> <p>7: 9,8 ↓</p> <p>8: 9,1 ←</p> <p>9: 10,6* ↓</p> <p>10: 8,8 ↓</p>	<p>Series 6</p> 	<p>1: 8,7 ↙</p> <p>2: 9,6 ↓</p> <p>3: 8,9 ←</p> <p>4: 10,8* ↗</p> <p>5: 9,3 ↗</p> <p>6: 9,9 ↓</p> <p>7: 9,7 ↗</p> <p>8: 8,7 ←</p> <p>9: 10,4* ↓</p> <p>10: 10,2* ↓</p>
Serie 93,0	Serie 90,0	Serie 90,0	Serie 90,0
Sum 446,0	Sum 446,0	Sum 536,0	Sum 536,0

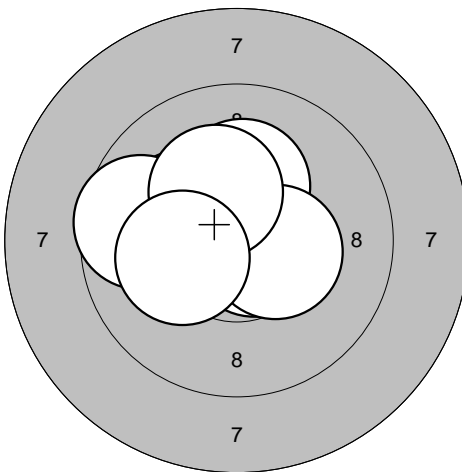
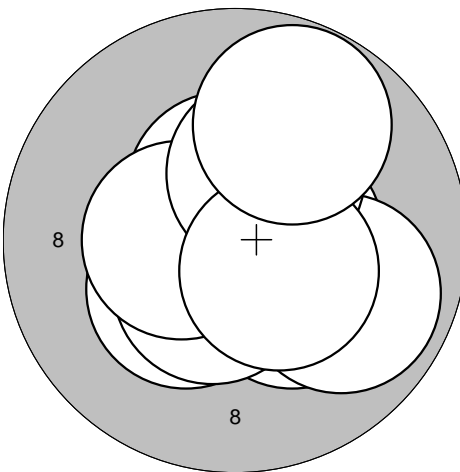
<p>Series 1</p> 	<p>1: 10,5* ↖</p> <p>2: 10,6* ↗</p> <p>3: 10,2* ↑</p> <p>4: 10,5* ↗</p> <p>5: 10,2* ↗</p> <p>6: 10,7* ↘</p> <p>7: 9,7 ←</p> <p>8: 10,4* ↘</p> <p>9: 10,3* ↑</p> <p>10: 10,2* ←</p>	<p>Series 2</p> 	<p>1: 10,3* ↘</p> <p>2: 10,3* ↘</p> <p>3: 10,5* ↘</p> <p>4: 10,5* →</p> <p>5: 10,5* ↑</p> <p>6: 9,9 ↘</p> <p>7: 10,5* ←</p> <p>8: 10,3* ↗</p> <p>9: 10,5* ↘</p> <p>10: 9,8 ↗</p>
Serie 99,0		Serie 98,0	
Sum 99,0		Sum 197,0	

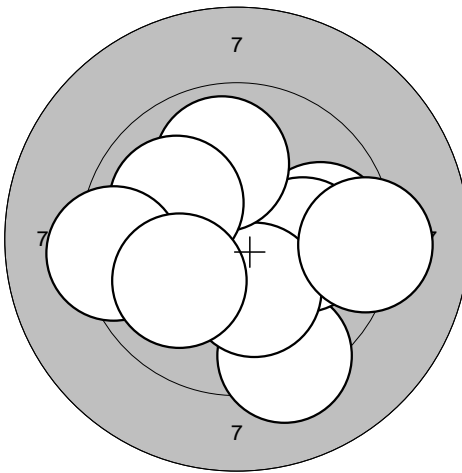
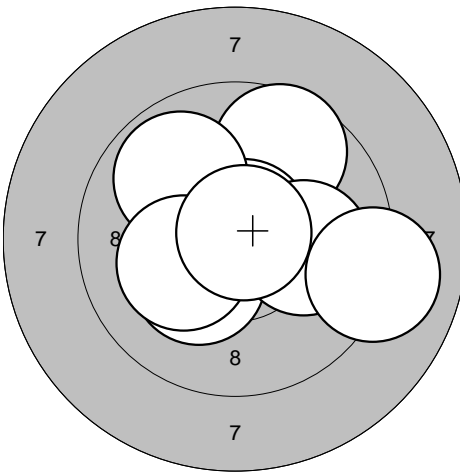
<p>Series 3</p> 	<p>1: 9,8 →</p> <p>2: 10,3* ↘</p> <p>3: 9,3 ↘</p> <p>4: 10,1 →</p> <p>5: 10,2* ↘</p> <p>6: 9,9 ↑</p> <p>7: 9,2 →</p> <p>8: 10,0 ↗</p> <p>9: 9,3 ←</p> <p>10: 10,0 ↘</p>	<p>Series 4</p> 	<p>1: 10,2* ↘</p> <p>2: 10,6* ↗</p> <p>3: 10,6* →</p> <p>4: 9,7 ↗</p> <p>5: 10,7* ↗</p> <p>6: 9,9 ↗</p> <p>7: 10,0 →</p> <p>8: 9,0 →</p> <p>9: 10,2* ←</p> <p>10: 10,8* ↗</p>
Serie 95,0		Serie 97,0	
Sum 292,0		Sum 389,0	

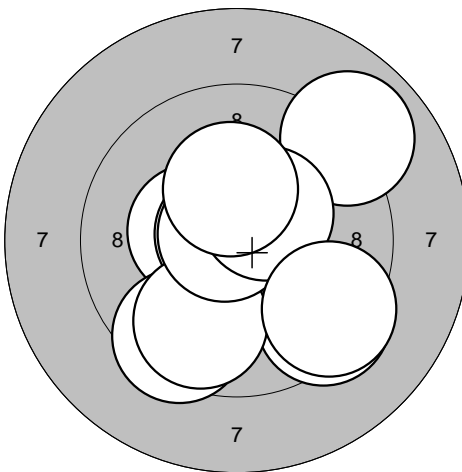
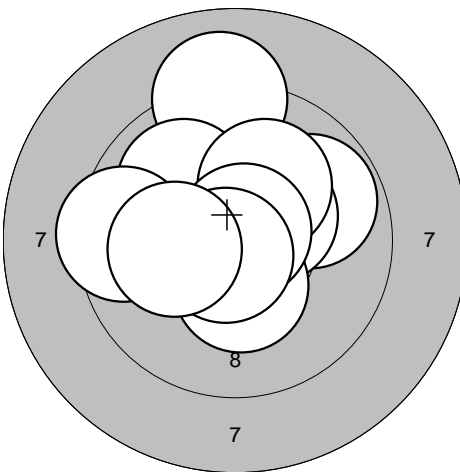
<p>Series 5</p> 	<p>1: 10,4* ←</p> <p>2: 10,7* ←</p> <p>3: 9,5 ↘</p> <p>4: 9,4 ↘</p> <p>5: 9,8 ↘</p> <p>6: 10,8* ↗</p> <p>7: 9,0 ↗</p> <p>8: 10,4* ↗</p> <p>9: 10,3* ↑</p> <p>10: 9,4 ↘</p>	<p>Series 6</p> 	<p>1: 9,8 ↗</p> <p>2: 10,4* ↗</p> <p>3: 9,1 ↑</p> <p>4: 10,0 ↗</p> <p>5: 10,1 ↗</p> <p>6: 10,4* ↘</p> <p>7: 10,8* ↗</p> <p>8: 9,5 ←</p> <p>9: 10,7* ↘</p> <p>10: 10,1 ←</p>
Serie 95,0		Serie 97,0	
Sum 484,0		Sum 581,0	

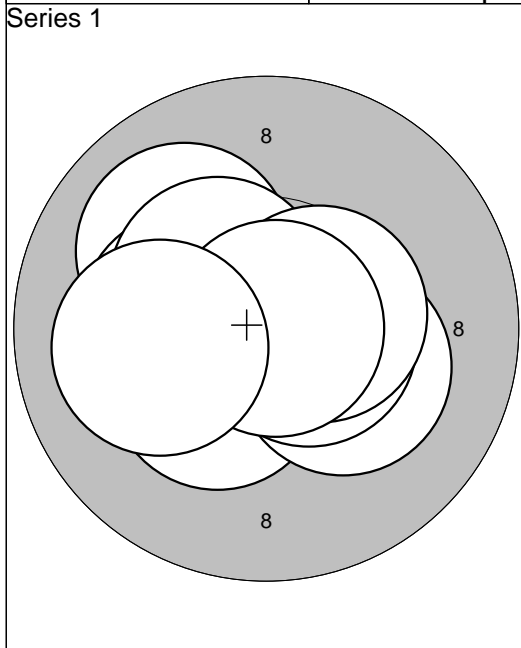

1: 10,0	↗
2: 10,8*	↗
3: 10,4*	↘
4: 10,2*	↘
5: 10,6*	→
6: 10,3*	←
7: 10,4*	↗
8: 10,5*	→
9: 10,9*	→
10: 10,1	←
<hr/>	
Serie	100,0
Sum	100,0

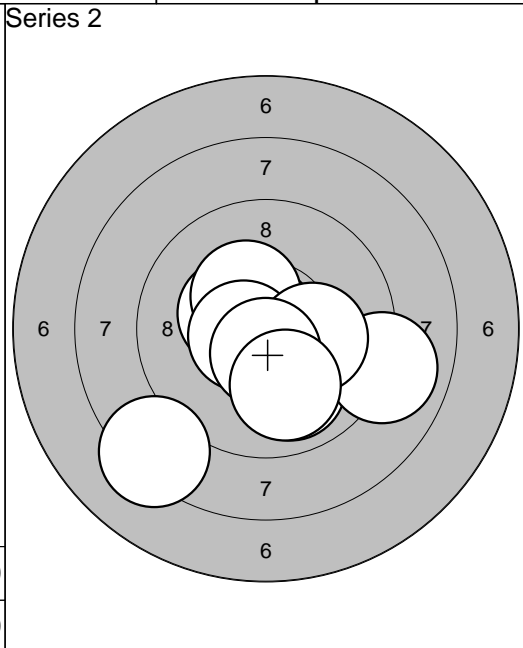

1: 10,0	↘
2: 10,9*	↗
3: 8,3	↘
4: 10,4*	↖
5: 10,3*	↗
6: 8,9	→
7: 10,6*	←
8: 10,2*	→
9: 10,5*	↘
10: 10,0	↘
<hr/>	
Serie	96,0
Sum	196,0

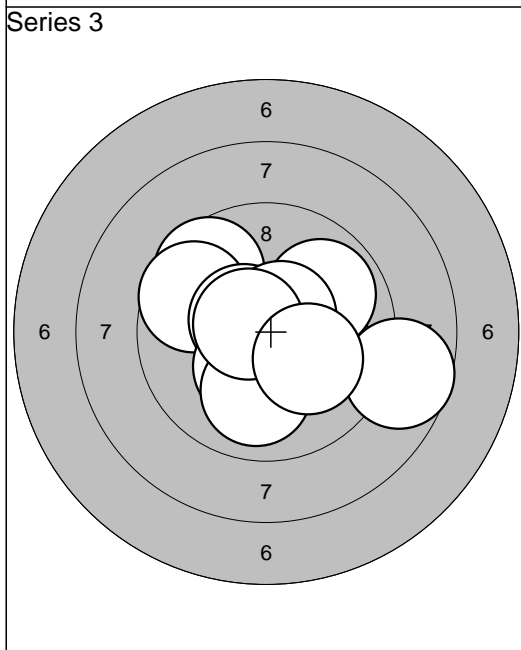

1: 9,6	↗
2: 9,6	↖
3: 10,5*	↖
4: 9,9	↗
5: 10,3*	↘
6: 10,6*	↗
7: 8,7	→
8: 10,0	↘
9: 10,7*	↖
10: 10,1	↘
<hr/>	
Serie	95,0
Sum	291,0

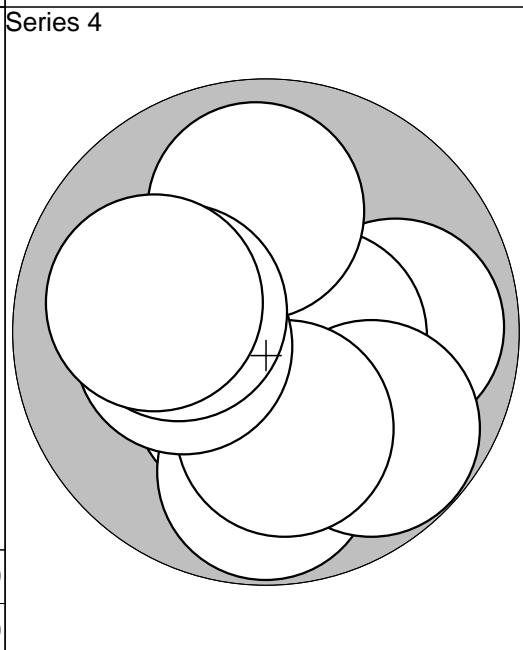

1: 9,9	→
2: 10,4*	↘
3: 10,5*	→
4: 9,8	↘
5: 9,8	↘
6: 10,1	↘
7: 10,3*	←
8: 9,9	↑
9: 10,2*	←
10: 10,0	←
<hr/>	
Serie	96,0
Sum	387,0

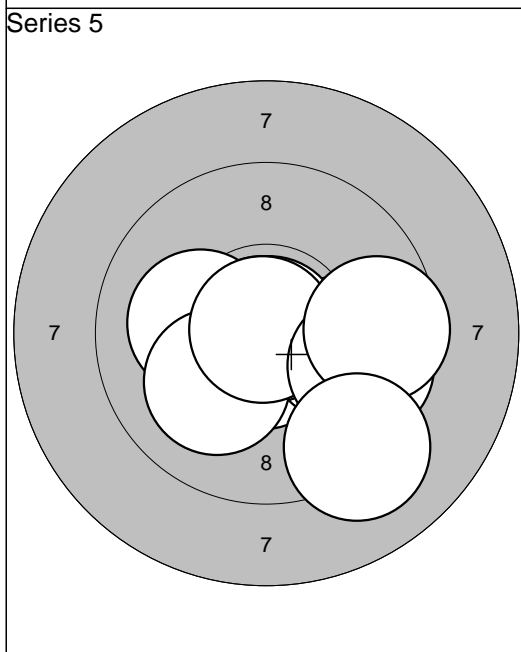

1: 10,9*	↖
2: 10,2*	←
3: 10,7*	↘
4: 10,0	→
5: 10,9*	↗
6: 10,1	↖
7: 10,9*	↗
8: 9,7	→
9: 9,6	→
10: 9,2	↘
<hr/>	
Serie	97,0
Sum	484,0

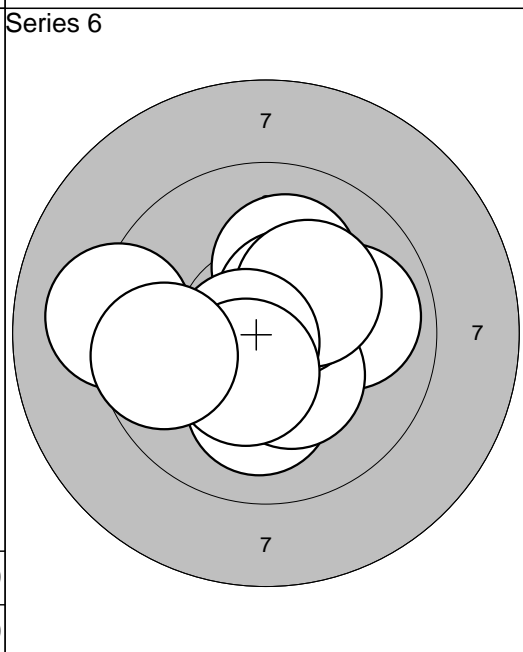

1: 9,9	→
2: 10,1	↗
3: 10,1	↘
4: 10,3*	↘
5: 10,5*	↗
6: 10,2*	↗
7: 10,7*	←
8: 10,4*	↘
9: 9,1	←
10: 9,7	←
<hr/>	
Serie	97,0
Sum	581,0

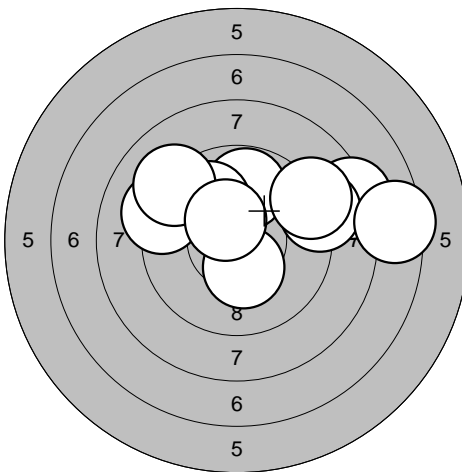
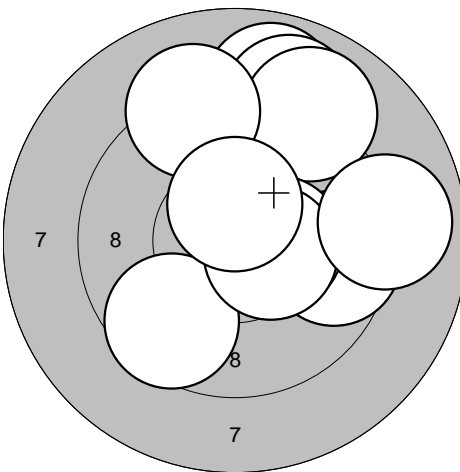
<p>Series 1</p> 	<p>1: 10,3* ↓</p> <p>2: 8,3 →</p> <p>3: 9,8 ↑</p> <p>4: 9,9 ↗</p> <p>5: 9,2 ↖</p> <p>6: 9,0 →</p> <p>7: 7,4 →</p> <p>8: 9,1 ↗</p> <p>9: 9,1 →</p> <p>10: 10,5* ↗</p> <hr/> <p>Serie 89,0</p> <hr/> <p>Sum 89,0</p>	<p>Series 2</p> 	<p>1: 9,6 →</p> <p>2: 9,6 ↘</p> <p>3: 8,9 ↑</p> <p>4: 9,0 ↗</p> <p>5: 9,0 ↗</p> <p>6: 9,2 ↑</p> <p>7: 10,4* →</p> <p>8: 10,4* →</p> <p>9: 10,5* ↑</p> <p>10: 8,9 →</p> <hr/> <p>Serie 91,0</p> <hr/> <p>Sum 180,0</p>
--	--	--	---

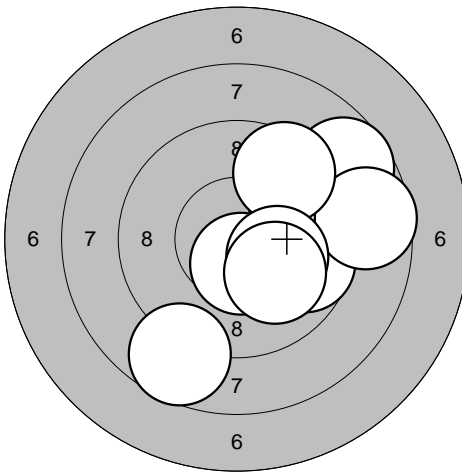
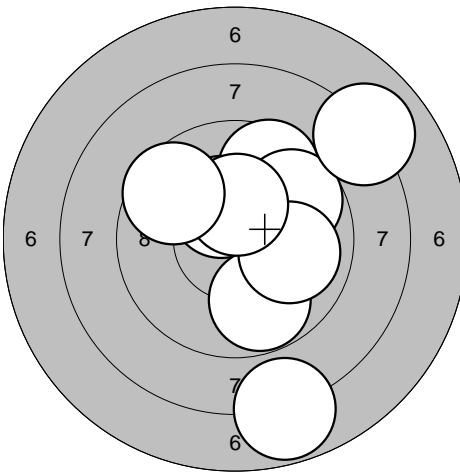
<p>Series 3</p> 	<p>1: 9,8 →</p> <p>2: 9,7 ↗</p> <p>3: 9,7 →</p> <p>4: 8,7 ↗</p> <p>5: 8,6 →</p> <p>6: 9,5 ↗</p> <p>7: 10,5* ↓</p> <p>8: 10,2* →</p> <p>9: 10,0 ↓</p> <p>10: 8,7 ↓</p> <hr/> <p>Serie 90,0</p> <hr/> <p>Sum 270,0</p>	<p>Series 4</p> 	<p>1: 9,6 ↗</p> <p>2: 7,8 ↓</p> <p>3: 10,4* ↗</p> <p>4: 10,3* ↖</p> <p>5: 9,7 ↗</p> <p>6: 9,8 ↓</p> <p>7: 10,0 →</p> <p>8: 10,4* ↑</p> <p>9: 9,6 ↖</p> <p>10: 8,0 ↗</p> <hr/> <p>Serie 91,0</p> <hr/> <p>Sum 361,0</p>
---	--	---	--

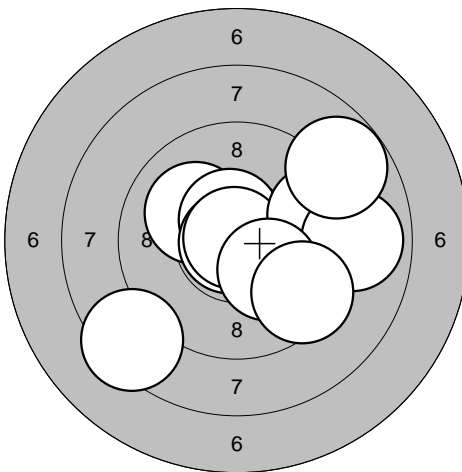
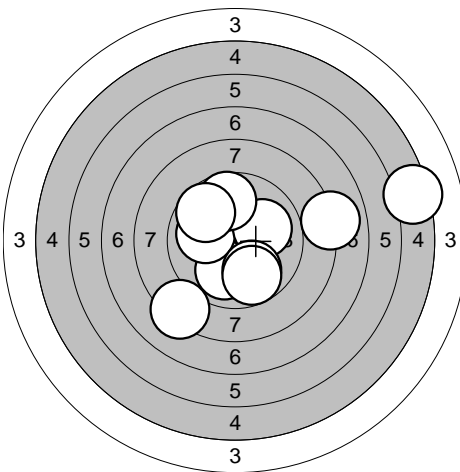
<p>Series 5</p> 	<p>1: 10,1 ↖</p> <p>2: 10,6* ↑</p> <p>3: 10,8* ↖</p> <p>4: 10,9* ↗</p> <p>5: 9,4 →</p> <p>6: 8,9 →</p> <p>7: 10,2* ↓</p> <p>8: 8,4 ↖</p> <p>9: 8,8 ↗</p> <p>10: 9,5 ↓</p> <hr/> <p>Serie 92,0</p> <hr/> <p>Sum 453,0</p>	<p>Series 6</p> 	<p>1: 10,0 ↓</p> <p>2: 8,2 ↘</p> <p>3: 10,0 ↖</p> <p>4: 10,0 →</p> <p>5: 9,7 ↑</p> <p>6: 9,7 ↗</p> <p>7: 9,9 ↓</p> <p>8: 8,0 →</p> <p>9: 5,3 →</p> <p>10: 9,8 ↓</p> <hr/> <p>Serie 87,0</p> <hr/> <p>Sum 540,0</p>
--	--	--	--

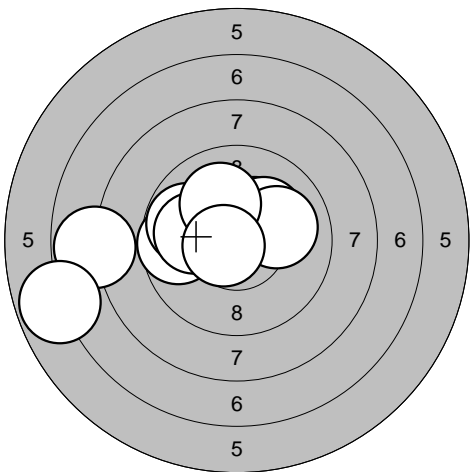
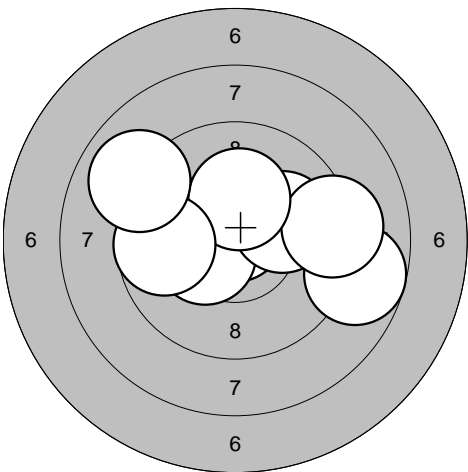
<p>Series 1</p> 	<p>1: 9,6 ←</p> <p>2: 7,8 ←</p> <p>3: 9,8 ←</p> <p>4: 10,3* ↗</p> <p>5: 6,8 ←</p> <p>6: 10,2* ↗</p> <p>7: 10,0 ←</p> <p>8: 10,0 →</p> <p>9: 10,1 ↗</p> <p>10: 10,7* ←</p>	<p>Series 2</p> 	<p>1: 10,5* ↖</p> <p>2: 8,7 →</p> <p>3: 10,5* ↑</p> <p>4: 10,8* ↑</p> <p>5: 10,4* ←</p> <p>6: 10,0 →</p> <p>7: 9,2 →</p> <p>8: 10,2* ↑</p> <p>9: 9,7 ←</p> <p>10: 9,0 ↖</p>
Serie	91,0	Serie	95,0
Sum	91,0	Sum	186,0

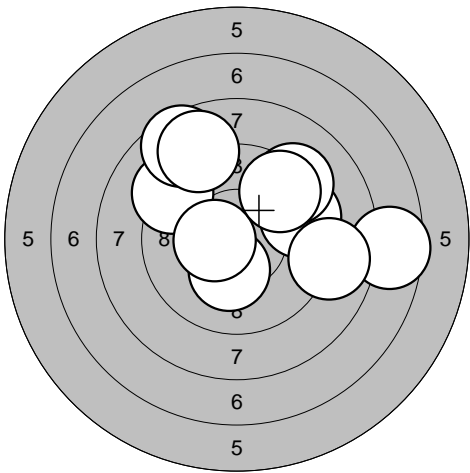
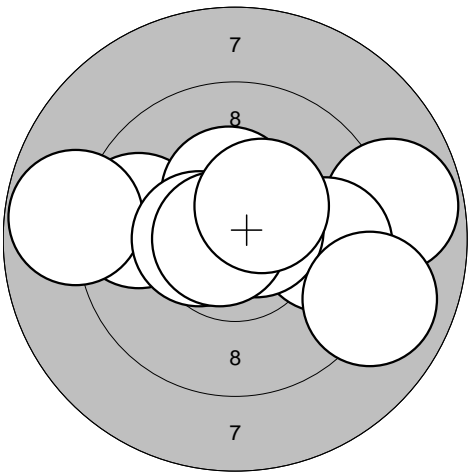
<p>Series 3</p> 	<p>1: 10,2* ↓</p> <p>2: 9,5 →</p> <p>3: 9,2 ↗</p> <p>4: 10,5* ←</p> <p>5: 8,6 ↗</p> <p>6: 7,6 →</p> <p>7: 8,9 ↗</p> <p>8: 8,9 →</p> <p>9: 9,2 ↗</p> <p>10: 9,5 ↗</p>	<p>Series 4</p> 	<p>1: 8,8 →</p> <p>2: 9,7 ←</p> <p>3: 9,8 →</p> <p>4: 10,3* ↑</p> <p>5: 10,6* →</p> <p>6: 8,8 ←</p> <p>7: 10,5* ←</p> <p>8: 9,0 →</p> <p>9: 10,8* ←</p> <p>10: 10,4* ↗</p>
Serie	87,0	Serie	93,0
Sum	273,0	Sum	366,0

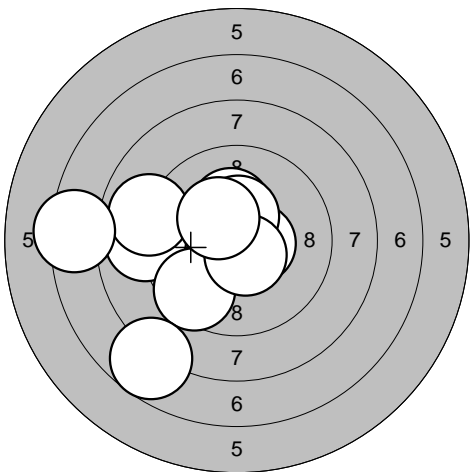
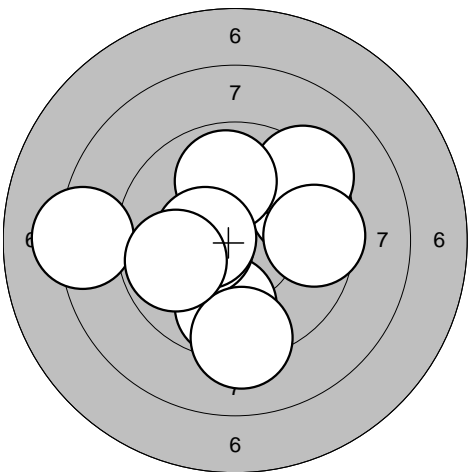
<p>Series 5</p> 	<p>1: 10,3* ↑</p> <p>2: 10,5* →</p> <p>3: 9,0 ←</p> <p>4: 8,9 ←</p> <p>5: 9,5 ↘</p> <p>6: 7,7 ↘</p> <p>7: 10,4* ↑</p> <p>8: 10,6* ↘</p> <p>9: 10,3* ↗</p> <p>10: 7,4 ←</p>	<p>Series 6</p> 	<p>1: 9,7 ↗</p> <p>2: 9,3 ↗</p> <p>3: 9,5 →</p> <p>4: 9,8 ↓</p> <p>5: 9,9 ↑</p> <p>6: 10,4* ←</p> <p>7: 10,4* ←</p> <p>8: 9,2 ↓</p> <p>9: 8,3 ←</p> <p>10: 9,8 ←</p>
Serie	90,0	Serie	91,0
Sum	456,0	Sum	547,0

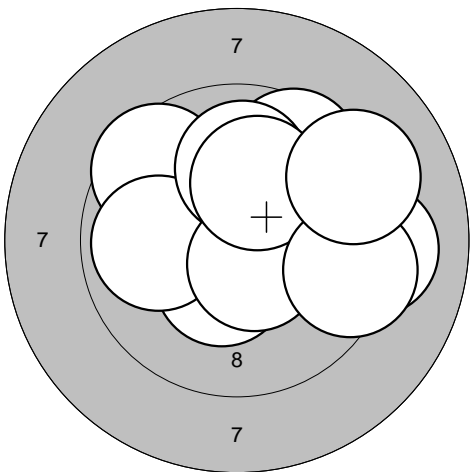
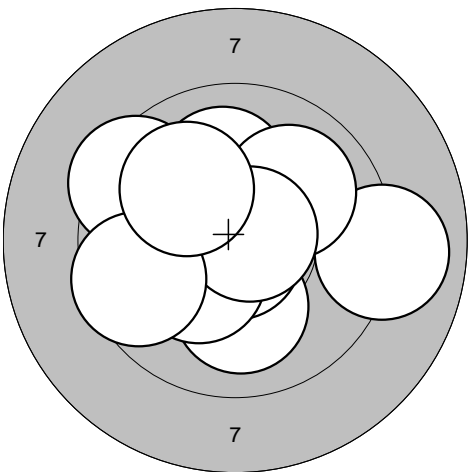
<p>Series 1</p> 	<p>1: 9,6 ↖ 2: 10,4* ↓ 3: 9,9 ← 4: 9,6 ↗ 5: 10,0 ↑ 6: 9,1 → 7: 10,5* ↓ 8: 10,1 ↑ 9: 9,4 → 10: 9,2 ↗</p> <table border="1" style="width:100%; border-collapse: collapse;"> <tr><td>Serie</td><td style="text-align: right;">94,0</td></tr> <tr><td>Sum</td><td style="text-align: right;">94,0</td></tr> </table>	Serie	94,0	Sum	94,0	<p>Series 2</p> 	<p>1: 10,1 ↓ 2: 10,1 ↑ 3: 9,0 → 4: 10,8* ↓ 5: 10,3* ↙ 6: 10,0 ↗ 7: 10,7* → 8: 9,4 ↖ 9: 9,6 ← 10: 10,0 ↖</p> <table border="1" style="width:100%; border-collapse: collapse;"> <tr><td>Serie</td><td style="text-align: right;">97,0</td></tr> <tr><td>Sum</td><td style="text-align: right;">191,0</td></tr> </table>	Serie	97,0	Sum	191,0
Serie	94,0										
Sum	94,0										
Serie	97,0										
Sum	191,0										

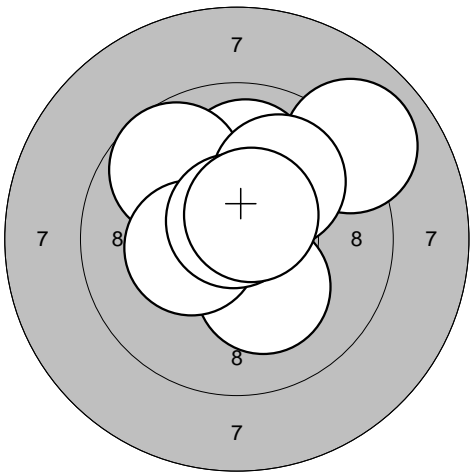
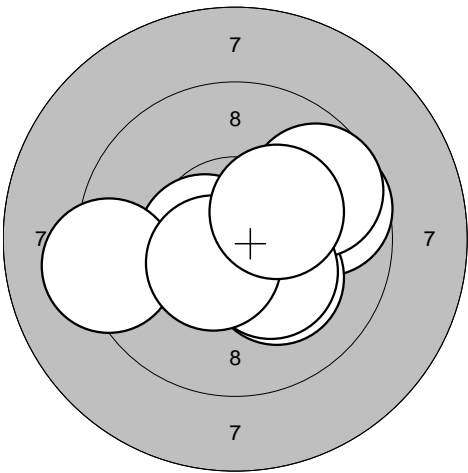
<p>Series 3</p> 	<p>1: 9,0 ↗ 2: 10,4* ↖ 3: 10,1 ↗ 4: 10,2* ↓ 5: 10,0 ↑ 6: 9,7 ↗ 7: 10,0 ↗ 8: 10,4* ← 9: 10,7* ↑ 10: 10,6* ↗</p> <table border="1" style="width:100%; border-collapse: collapse;"> <tr><td>Serie</td><td style="text-align: right;">98,0</td></tr> <tr><td>Sum</td><td style="text-align: right;">289,0</td></tr> </table>	Serie	98,0	Sum	289,0	<p>Series 4</p> 	<p>1: 10,8* → 2: 10,4* ↓ 3: 9,7 → 4: 10,5* ← 5: 9,2 ← 6: 10,2* ↓ 7: 9,7 ↗ 8: 10,3* ↓ 9: 10,5* ↙ 10: 10,3* ↗</p> <table border="1" style="width:100%; border-collapse: collapse;"> <tr><td>Serie</td><td style="text-align: right;">97,0</td></tr> <tr><td>Sum</td><td style="text-align: right;">386,0</td></tr> </table>	Serie	97,0	Sum	386,0
Serie	98,0										
Sum	289,0										
Serie	97,0										
Sum	386,0										

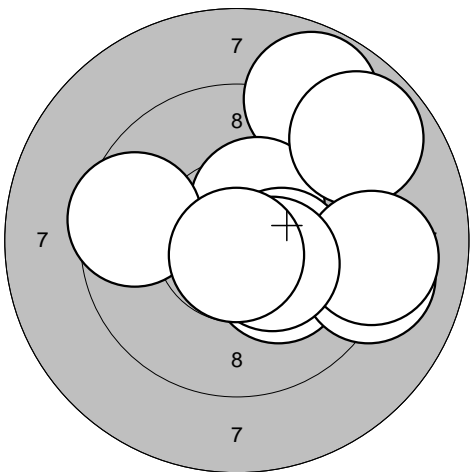
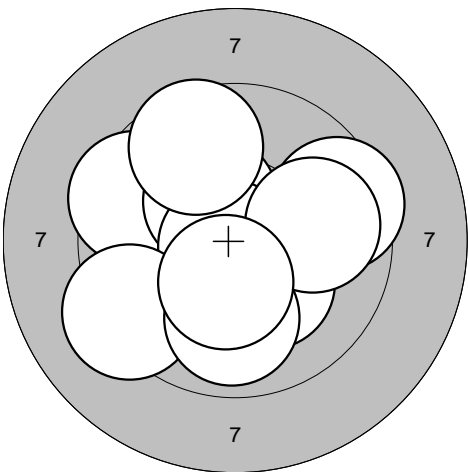
<p>Series 5</p> 	<p>1: 8,8 ↗ 2: 10,2* ↓ 3: 10,4* ↗ 4: 9,1 → 5: 8,9 ↗ 6: 10,3* → 7: 9,1 → 8: 9,6 ← 9: 10,4* ↓ 10: 10,7* ↓</p> <table border="1" style="width:100%; border-collapse: collapse;"> <tr><td>Serie</td><td style="text-align: right;">93,0</td></tr> <tr><td>Sum</td><td style="text-align: right;">479,0</td></tr> </table>	Serie	93,0	Sum	479,0	<p>Series 6</p> 	<p>1: 9,5 ↖ 2: 10,3* ↖ 3: 10,8* ↖ 4: 9,5 → 5: 10,3* ↓ 6: 9,3 ↖ 7: 9,9 ↓ 8: 9,9 → 9: 10,4* ↓ 10: 9,6 ↑</p> <table border="1" style="width:100%; border-collapse: collapse;"> <tr><td>Serie</td><td style="text-align: right;">94,0</td></tr> <tr><td>Sum</td><td style="text-align: right;">573,0</td></tr> </table>	Serie	94,0	Sum	573,0
Serie	93,0										
Sum	479,0										
Serie	94,0										
Sum	573,0										

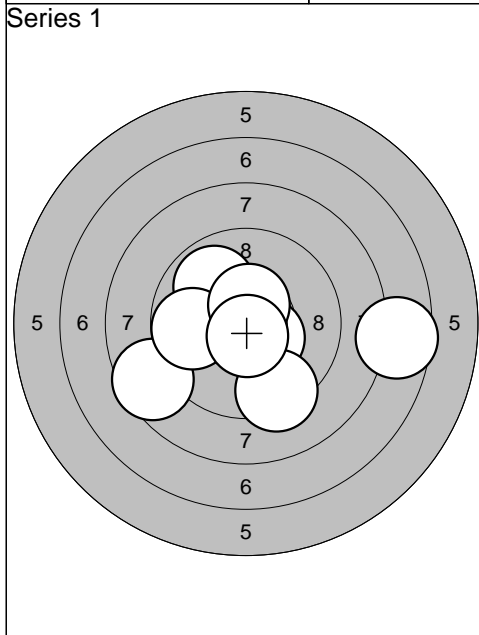

1: 7,6	→
2: 10,5*	↗
3: 8,6	↙
4: 10,5*	↘
5: 9,9	↗
6: 10,9*	↓
7: 9,8	←
8: 10,6*	↗
9: 9,3	↘
10: 10,7*	↓
Serie 92,0	
Sum 92,0	

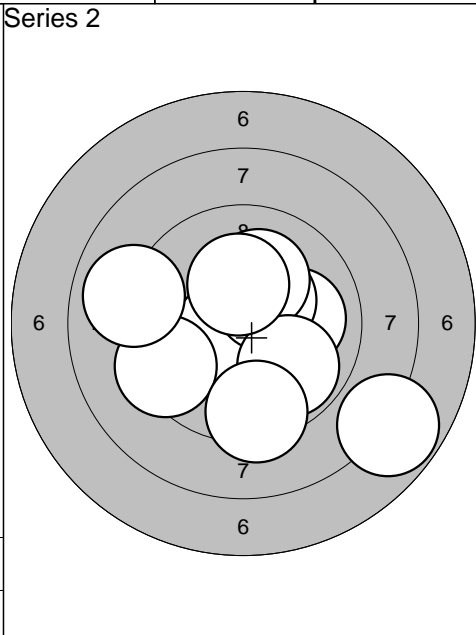

1: 10,0	→
2: 10,6*	↙
3: 10,4*	↗
4: 9,4	↙
5: 10,1	↗
6: 7,8	↘
7: 9,0	←
8: 9,8	↘
9: 9,4	↓
10: 10,3*	↗
Serie 93,0	
Sum 185,0	

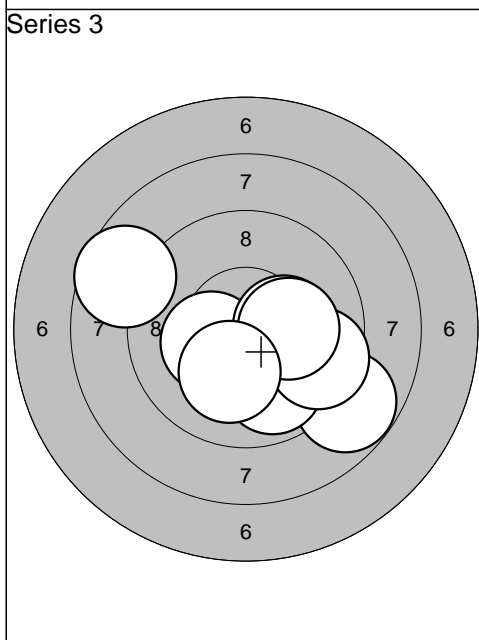

1: 8,8	↘
2: 10,0	↘
3: 10,3*	↘
4: 9,9	↘
5: 10,3*	↙
6: 10,3*	→
7: 9,6	↗
8: 10,2*	→
9: 10,1	↘
10: 8,6	↙
Serie 94,0	
Sum 279,0	

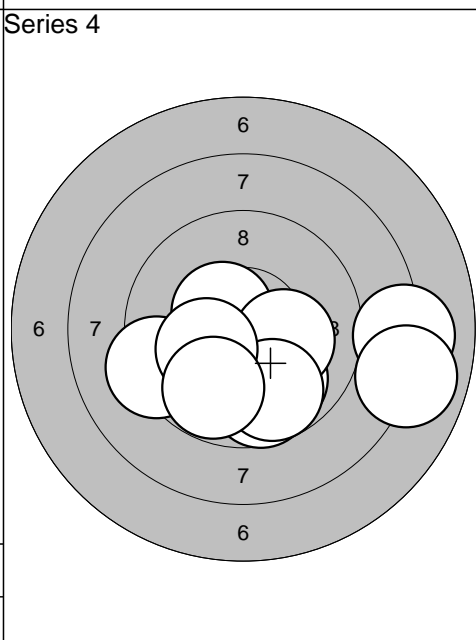

1: 9,9	↘
2: 10,5*	↗
3: 9,7	↘
4: 10,2*	→
5: 8,1	→
6: 9,7	↘
7: 7,9	→
8: 9,3	↙
9: 10,2*	↙
10: 9,8	↘
Serie 90,0	
Sum 369,0	

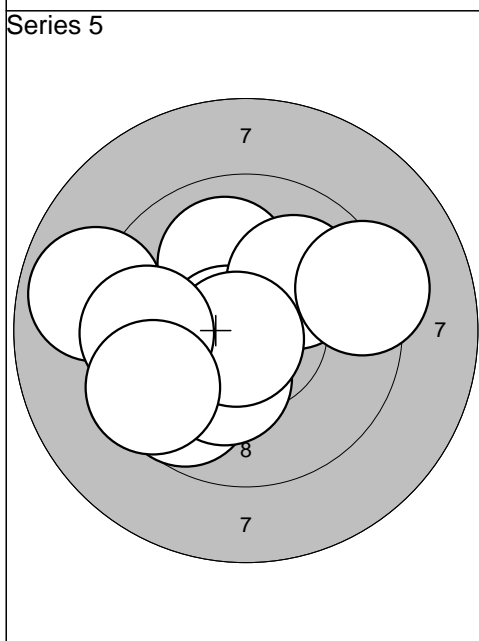

1: 10,0	↗
2: 9,7	↙
3: 10,2*	↘
4: 10,7*	←
5: 10,1	↗
6: 10,8*	↙
7: 9,3	→
8: 8,9	←
9: 9,6	←
10: 9,5	↙
Serie 94,0	
Sum 463,0	

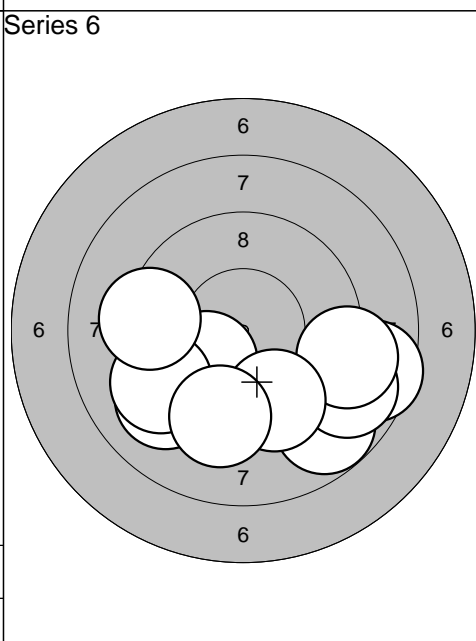

1: 8,8	↘
2: 8,6	→
3: 8,9	↘
4: 10,1	↙
5: 9,1	→
6: 9,6	↘
7: 9,1	↙
8: 9,2	↙
9: 9,3	←
10: 9,4	↘
Serie 88,0	
Sum 551,0	

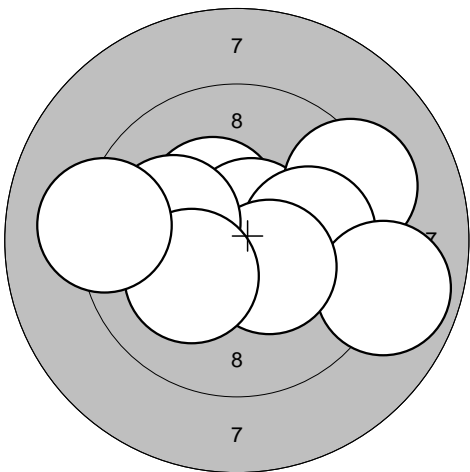
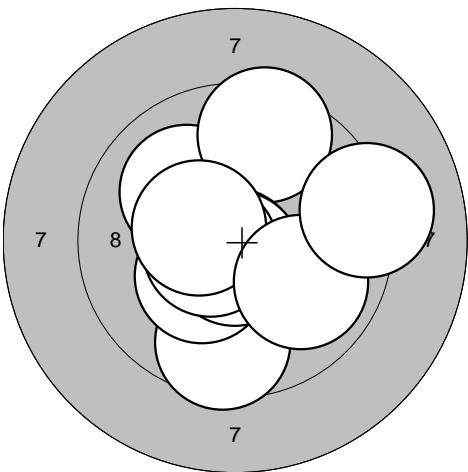
<p>Series 1</p> 	<p>1: 10,7* ↗</p> <p>2: 10,4* ↗</p> <p>3: 10,7* ↗</p> <p>4: 9,3 →</p> <p>5: 10,0 →</p> <p>6: 8,9 →</p> <p>7: 10,4* ↘</p> <p>8: 10,1 ←</p> <p>9: 10,2* ↘</p> <p>10: 9,2 ←</p>	<p>Series 2</p> 	<p>1: 10,0 ↖</p> <p>2: 9,6 ↓</p> <p>3: 9,5 ↑</p> <p>4: 10,3* ↘</p> <p>5: 10,8* ↓</p> <p>6: 10,7* ↓</p> <p>7: 10,6* ←</p> <p>8: 10,4* ←</p> <p>9: 9,9 ↘</p> <p>10: 9,1 →</p>
Serie 96,0	Serie 96,0	Serie 96,0	Serie 96,0
Sum 96,0	Sum 96,0	Sum 192,0	Sum 192,0

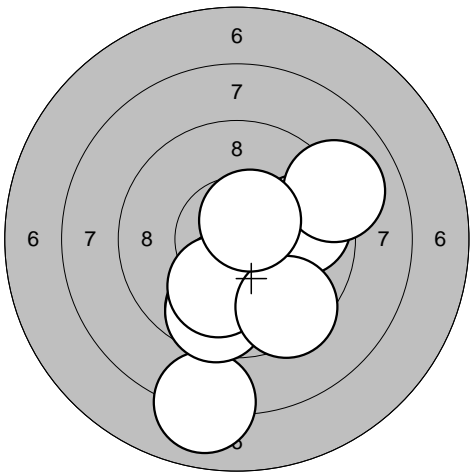
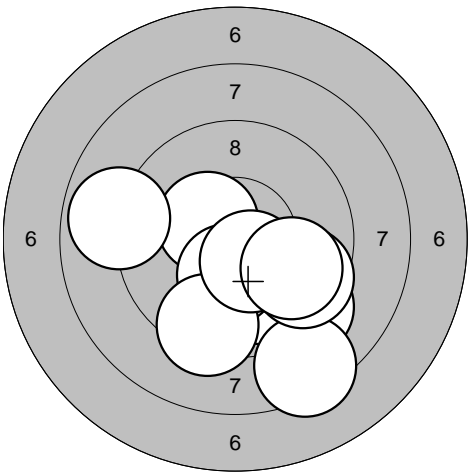
<p>Series 3</p> 	<p>1: 9,6 ↓</p> <p>2: 8,0 ↓</p> <p>3: 10,5* ↘</p> <p>4: 10,2* ↓</p> <p>5: 9,8 →</p> <p>6: 9,6 ↓</p> <p>7: 10,0 ↓</p> <p>8: 9,0 →</p> <p>9: 9,5 ↓</p> <p>10: 10,6* ↗</p>	<p>Series 4</p> 	<p>1: 10,4* ↖</p> <p>2: 8,9 ←</p> <p>3: 9,2 ↘</p> <p>4: 9,9 ↘</p> <p>5: 8,4 ↓</p> <p>6: 10,3* ↓</p> <p>7: 9,6 ↘</p> <p>8: 9,4 ↓</p> <p>9: 10,5* ↘</p> <p>10: 9,8 ↘</p>
Serie 93,0	Serie 91,0	Serie 91,0	Serie 91,0
Sum 285,0	Sum 376,0	Sum 376,0	Sum 376,0

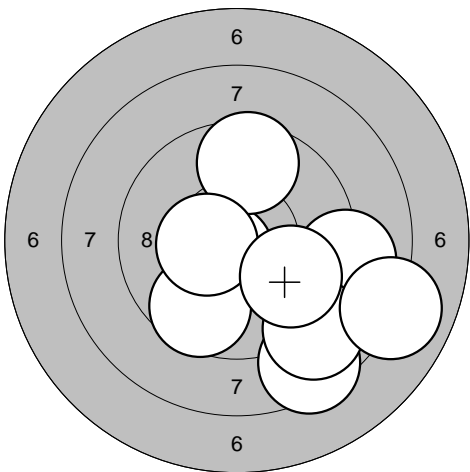
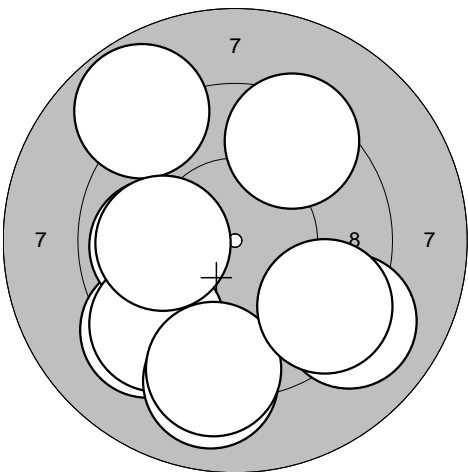
<p>Series 5</p> 	<p>1: 10,6* ↘</p> <p>2: 9,6 ↓</p> <p>3: 8,4 ↓</p> <p>4: 8,9 ↓</p> <p>5: 9,0 →</p> <p>6: 9,6 ↑</p> <p>7: 10,4* ←</p> <p>8: 8,9 ↓</p> <p>9: 9,8 ↓</p> <p>10: 8,0 →</p>	<p>Series 6</p> 	<p>1: 9,3 ↘</p> <p>2: 9,9 ←</p> <p>3: 9,4 ↗</p> <p>4: 9,4 ↘</p> <p>5: 8,8 ↗</p> <p>6: 9,1 ↓</p> <p>7: 10,0 ←</p> <p>8: 9,1 ↘</p> <p>9: 9,2 ↓</p> <p>10: 9,5 ↘</p>
Serie 88,0	Serie 90,0	Serie 90,0	Serie 90,0
Sum 464,0	Sum 554,0	Sum 554,0	Sum 554,0

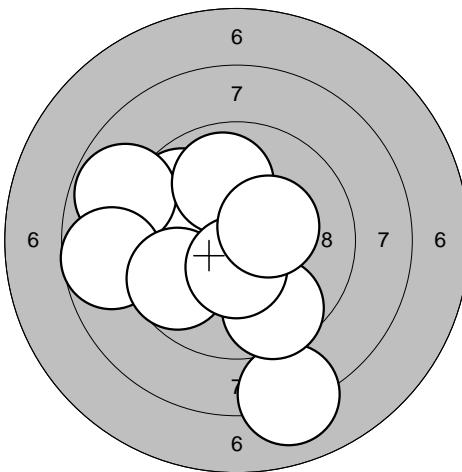
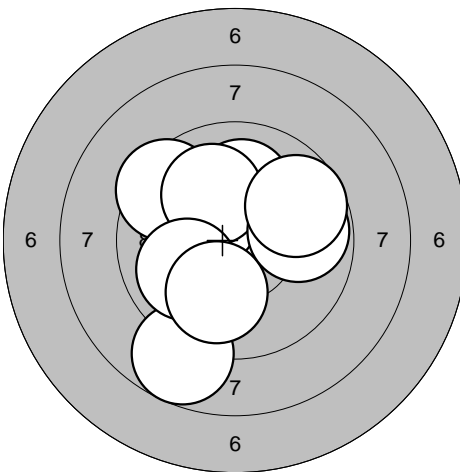
<p>Series 1</p> 	<p>1: 8,1 ↘ 2: 9,7 ↗ 3: 10,3* ← 4: 8,8 ↗ 5: 8,7 ← 6: 9,7 ↙ 7: 9,9 ↑ 8: 9,6 ↘ 9: 10,5* ↘ 10: 10,4* →</p> <table border="1" style="width:100%; border-collapse: collapse;"> <tr><td>Serie</td><td style="text-align: right;">90,0</td></tr> <tr><td>Sum</td><td style="text-align: right;">90,0</td></tr> </table>	Serie	90,0	Sum	90,0	<p>Series 2</p> 	<p>1: 10,4* ↙ 2: 8,7 ↘ 3: 10,1 ↑ 4: 10,3* ↗ 5: 9,5 ↗ 6: 10,0 ↗ 7: 9,9 ↙ 8: 10,0 ↘ 9: 9,8 → 10: 9,7 ↗</p> <table border="1" style="width:100%; border-collapse: collapse;"> <tr><td>Serie</td><td style="text-align: right;">94,0</td></tr> <tr><td>Sum</td><td style="text-align: right;">184,0</td></tr> </table>	Serie	94,0	Sum	184,0
Serie	90,0										
Sum	90,0										
Serie	94,0										
Sum	184,0										

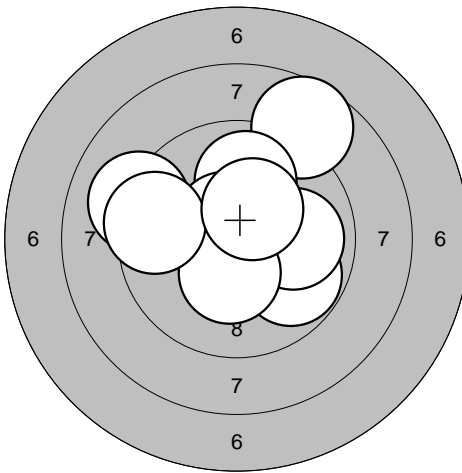
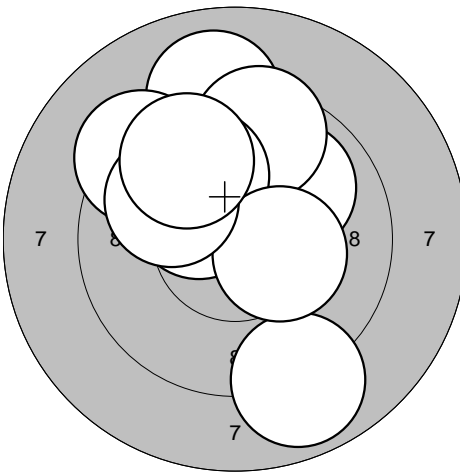
<p>Series 3</p> 	<p>1: 8,7 ↗ 2: 10,4* → 3: 9,1 ↙ 4: 9,8 ↘ 5: 10,0 ↑ 6: 10,0 → 7: 10,6* ↗ 8: 10,3* ↘ 9: 9,5 ← 10: 10,4* ↗</p> <table border="1" style="width:100%; border-collapse: collapse;"> <tr><td>Serie</td><td style="text-align: right;">95,0</td></tr> <tr><td>Sum</td><td style="text-align: right;">279,0</td></tr> </table>	Serie	95,0	Sum	279,0	<p>Series 4</p> 	<p>1: 10,4* ↙ 2: 9,0 ↑ 3: 10,0 ↗ 4: 9,5 ↑ 5: 9,3 ↗ 6: 10,0 ↗ 7: 8,9 ↘ 8: 10,3* → 9: 9,9 ↗ 10: 9,7 ↗</p> <table border="1" style="width:100%; border-collapse: collapse;"> <tr><td>Serie</td><td style="text-align: right;">93,0</td></tr> <tr><td>Sum</td><td style="text-align: right;">372,0</td></tr> </table>	Serie	93,0	Sum	372,0
Serie	95,0										
Sum	279,0										
Serie	93,0										
Sum	372,0										

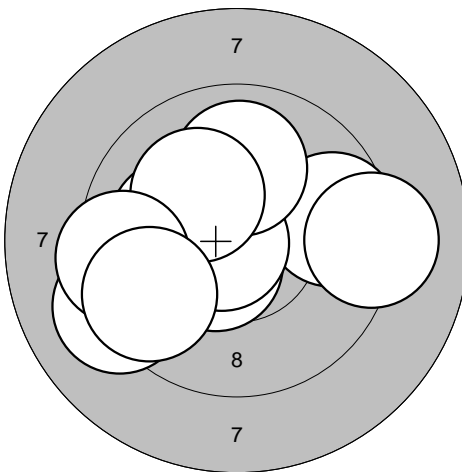
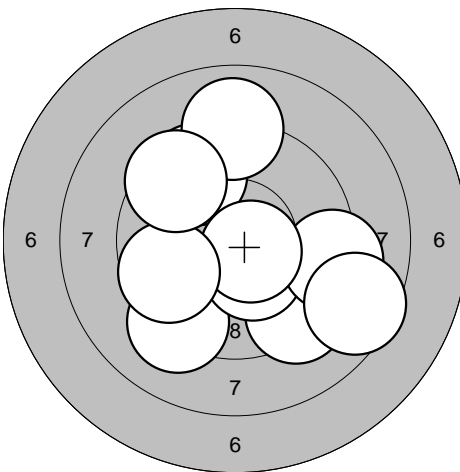
<p>Series 5</p> 	<p>1: 9,6 → 2: 9,2 → 3: 10,5* ↘ 4: 10,1 ← 5: 10,8* ← 6: 10,0 ↑ 7: 9,1 ↙ 8: 10,2* ↗ 9: 9,4 ← 10: 9,6 ↙</p> <table border="1" style="width:100%; border-collapse: collapse;"> <tr><td>Serie</td><td style="text-align: right;">95,0</td></tr> <tr><td>Sum</td><td style="text-align: right;">467,0</td></tr> </table>	Serie	95,0	Sum	467,0	<p>Series 6</p> 	<p>1: 9,6 ↗ 2: 9,2 ↘ 3: 9,2 ↘ 4: 10,3* ↘ 5: 9,0 ↑ 6: 9,2 → 7: 10,6* ↘ 8: 8,6 ↘ 9: 9,7 ↙ 10: 9,5 ↗</p> <table border="1" style="width:100%; border-collapse: collapse;"> <tr><td>Serie</td><td style="text-align: right;">91,0</td></tr> <tr><td>Sum</td><td style="text-align: right;">558,0</td></tr> </table>	Serie	91,0	Sum	558,0
Serie	95,0										
Sum	467,0										
Serie	91,0										
Sum	558,0										

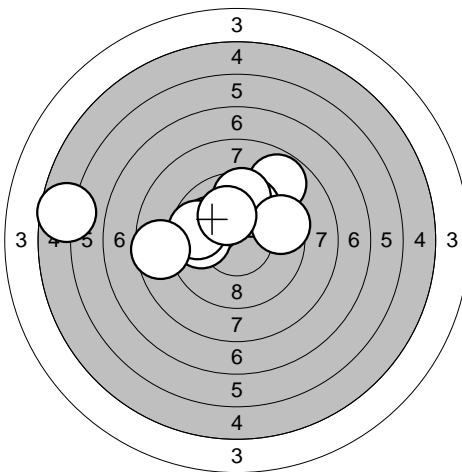
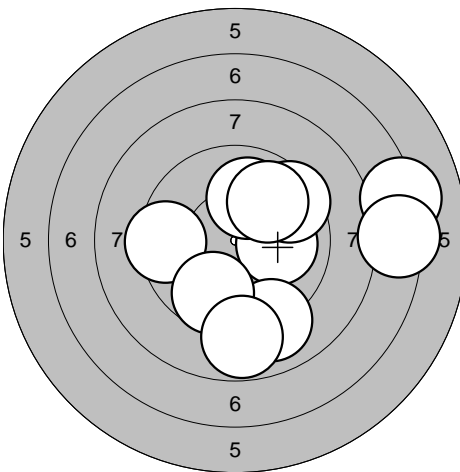
<p>Series 1</p> 	<p>1: 5,7 ←</p> <p>2: 10,0 ↖</p> <p>3: 8,8 ↗</p> <p>4: 9,9 ←</p> <p>5: 9,7 ←</p> <p>6: 9,9 ↗</p> <p>7: 9,6 ↑</p> <p>8: 9,5 →</p> <p>9: 10,2* ↑</p> <p>10: 8,6 ←</p> <hr/> <p>Serie 86,0</p> <hr/> <p>Sum 86,0</p>	<p>Series 2</p> 	<p>1: 9,4 ←</p> <p>2: 7,2 →</p> <p>3: 7,4 →</p> <p>4: 10,0 →</p> <p>5: 9,5 ↗</p> <p>6: 10,0 ↑</p> <p>7: 9,8 ↗</p> <p>8: 9,0 ↓</p> <p>9: 9,7 ↓</p> <p>10: 8,8 ↓</p> <hr/> <p>Serie 87,0</p> <hr/> <p>Sum 173,0</p>
--	---	--	---

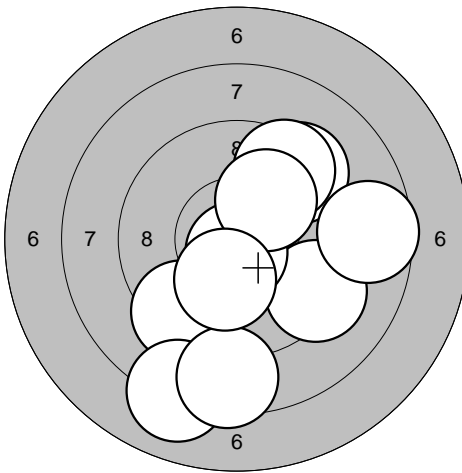
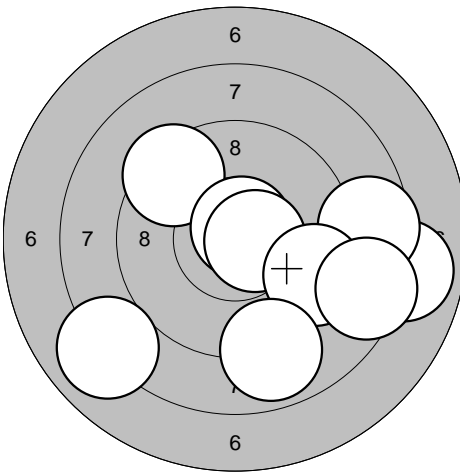
<p>Series 3</p> 	<p>1: 9,3 ↘</p> <p>2: 10,7* ↓</p> <p>3: 9,4 ↗</p> <p>4: 9,4 ↙</p> <p>5: 8,1 ↓</p> <p>6: 8,5 ↓</p> <p>7: 9,5 ↗</p> <p>8: 10,1 ↗</p> <p>9: 10,2* ↓</p> <p>10: 8,6 →</p> <hr/> <p>Serie 90,0</p> <hr/> <p>Sum 263,0</p>	<p>Series 4</p> 	<p>1: 8,5 ↘</p> <p>2: 9,4 ↖</p> <p>3: 7,9 →</p> <p>4: 10,7* ↗</p> <p>5: 10,6* →</p> <p>6: 8,6 →</p> <p>7: 9,4 ↘</p> <p>8: 8,0 ↙</p> <p>9: 8,5 ↘</p> <p>10: 8,9 ↓</p> <hr/> <p>Serie 85,0</p> <hr/> <p>Sum 348,0</p>
---	--	---	---

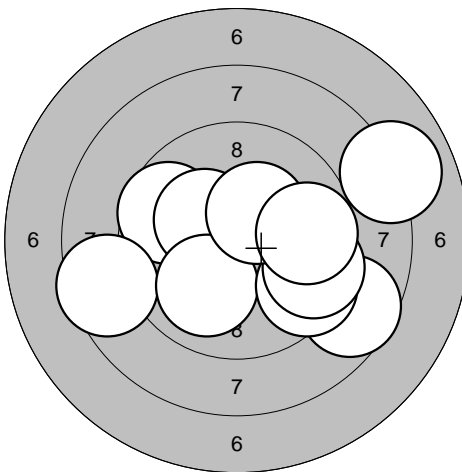
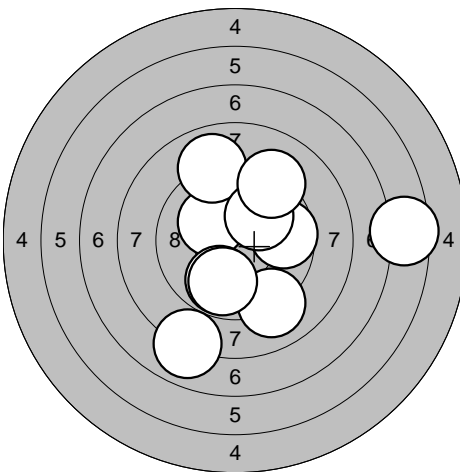
<p>Series 5</p> 	<p>1: 8,6 ↘</p> <p>2: 8,0 →</p> <p>3: 9,7 ↖</p> <p>4: 10,3* ↗</p> <p>5: 8,5 ←</p> <p>6: 10,0 ↓</p> <p>7: 9,5 ↘</p> <p>8: 9,5 →</p> <p>9: 10,3* ↗</p> <p>10: 9,7 →</p> <hr/> <p>Serie 90,0</p> <hr/> <p>Sum 438,0</p>	<p>Series 6</p> 	<p>1: 10,2* ↖</p> <p>2: 9,1 ↓</p> <p>3: 9,0 ↑</p> <p>4: 6,5 →</p> <p>5: 9,7 →</p> <p>6: 10,0 ↗</p> <p>7: 8,0 ↓</p> <p>8: 9,9 ↓</p> <p>9: 9,8 ↓</p> <p>10: 9,2 ↗</p> <hr/> <p>Serie 88,0</p> <hr/> <p>Sum 526,0</p>
--	--	--	--

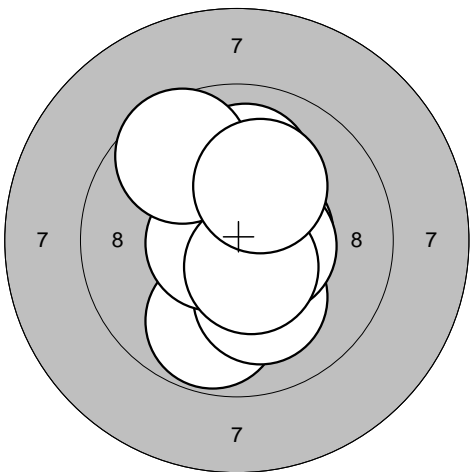
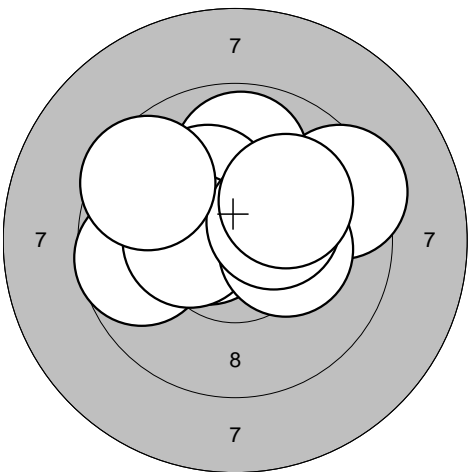
<p>Series 1</p> 	<p>1: 10,5* →</p> <p>2: 9,8 ↓</p> <p>3: 10,1 ↓</p> <p>4: 10,8* ←</p> <p>5: 10,5* →</p> <p>6: 10,6* ←</p> <p>7: 10,0 ↑</p> <p>8: 10,5* ↓</p> <p>9: 9,6 ↗</p> <p>10: 10,1 ↗</p> <table border="1" style="width:100%; border-collapse: collapse;"> <tr><td>Serie</td><td style="text-align: right;">98,0</td></tr> <tr><td>Sum</td><td style="text-align: right;">98,0</td></tr> </table>	Serie	98,0	Sum	98,0	<p>Series 2</p> 	<p>1: 9,4 →</p> <p>2: 9,7 ←</p> <p>3: 10,6* ←</p> <p>4: 9,9 ↑</p> <p>5: 10,2* ↗</p> <p>6: 10,4* ←</p> <p>7: 10,2* →</p> <p>8: 10,4* →</p> <p>9: 10,1 ↗</p> <p>10: 9,6 ↖</p> <table border="1" style="width:100%; border-collapse: collapse;"> <tr><td>Serie</td><td style="text-align: right;">96,0</td></tr> <tr><td>Sum</td><td style="text-align: right;">194,0</td></tr> </table>	Serie	96,0	Sum	194,0
Serie	98,0										
Sum	98,0										
Serie	96,0										
Sum	194,0										

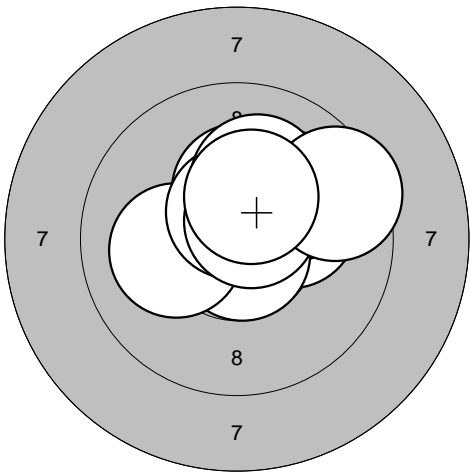
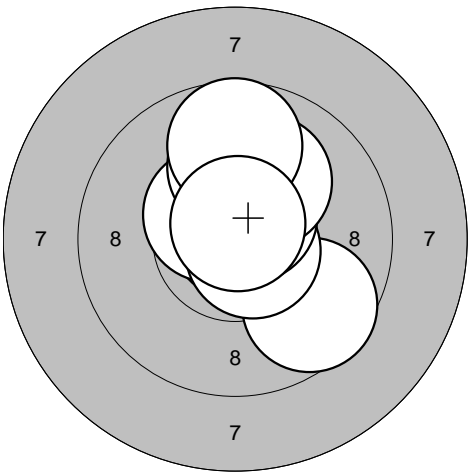
<p>Series 3</p> 	<p>1: 10,2* →</p> <p>2: 10,3* ↑</p> <p>3: 10,1 ↗</p> <p>4: 10,7* ↓</p> <p>5: 10,1 ←</p> <p>6: 10,6* ↑</p> <p>7: 10,1 ↑</p> <p>8: 10,6* ↗</p> <p>9: 9,5 →</p> <p>10: 10,3* ↑</p> <table border="1" style="width:100%; border-collapse: collapse;"> <tr><td>Serie</td><td style="text-align: right;">99,0</td></tr> <tr><td>Sum</td><td style="text-align: right;">293,0</td></tr> </table>	Serie	99,0	Sum	293,0	<p>Series 4</p> 	<p>1: 9,6 ↘</p> <p>2: 10,8* →</p> <p>3: 10,9* ↑</p> <p>4: 10,5* ↖</p> <p>5: 10,7* ↘</p> <p>6: 10,0 ↑</p> <p>7: 10,6* ↗</p> <p>8: 10,1 ↗</p> <p>9: 9,7 ↑</p> <p>10: 10,7* ↑</p> <table border="1" style="width:100%; border-collapse: collapse;"> <tr><td>Serie</td><td style="text-align: right;">98,0</td></tr> <tr><td>Sum</td><td style="text-align: right;">391,0</td></tr> </table>	Serie	98,0	Sum	391,0
Serie	99,0										
Sum	293,0										
Serie	98,0										
Sum	391,0										

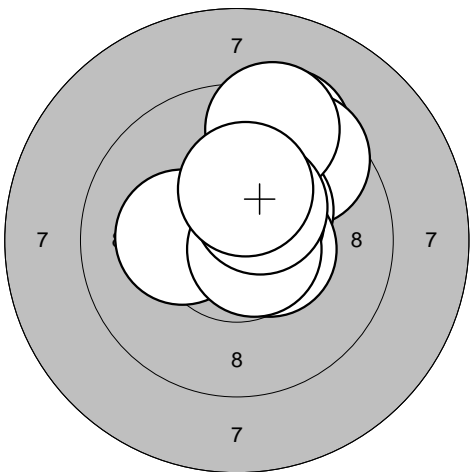
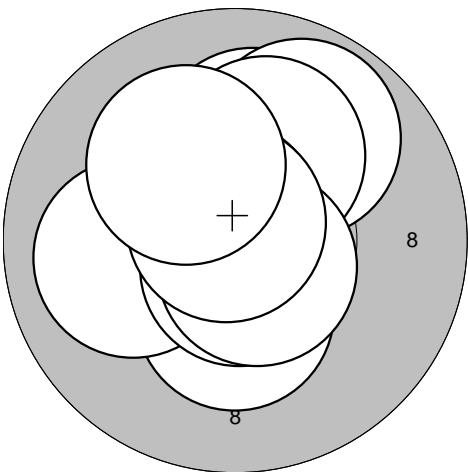
<p>Series 5</p> 	<p>1: 9,4 ↗</p> <p>2: 9,6 ↗</p> <p>3: 10,4* ↗</p> <p>4: 10,5* →</p> <p>5: 10,2* ←</p> <p>6: 10,6* ↗</p> <p>7: 9,4 ↑</p> <p>8: 10,7* →</p> <p>9: 10,4* ↗</p> <p>10: 10,2* ↑</p> <table border="1" style="width:100%; border-collapse: collapse;"> <tr><td>Serie</td><td style="text-align: right;">97,0</td></tr> <tr><td>Sum</td><td style="text-align: right;">488,0</td></tr> </table>	Serie	97,0	Sum	488,0	<p>Series 6</p> 	<p>1: 10,1 ↑</p> <p>2: 10,3* ↓</p> <p>3: 9,9 ↗</p> <p>4: 10,1 ↑</p> <p>5: 10,7* ↖</p> <p>6: 10,0 ←</p> <p>7: 10,7* ↓</p> <p>8: 10,6* ↘</p> <p>9: 10,8* ↗</p> <p>10: 10,1 ↖</p> <table border="1" style="width:100%; border-collapse: collapse;"> <tr><td>Serie</td><td style="text-align: right;">99,0</td></tr> <tr><td>Sum</td><td style="text-align: right;">587,0</td></tr> </table>	Serie	99,0	Sum	587,0
Serie	97,0										
Sum	488,0										
Serie	99,0										
Sum	587,0										

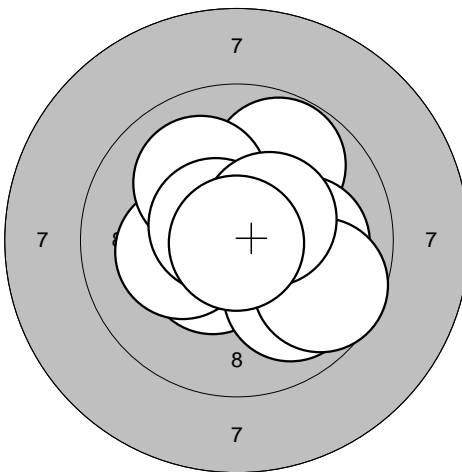
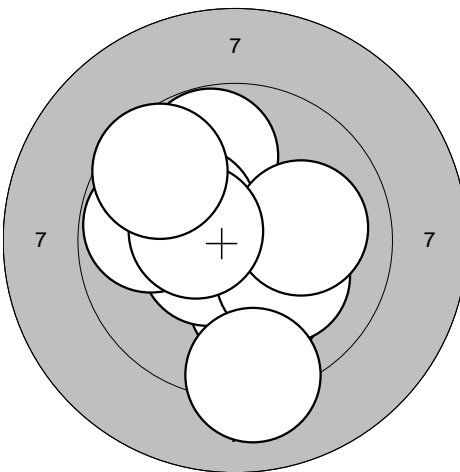
<p>Series 1</p> 	<p>Series 2</p> 	
<p>1: 10,5* ↙ 2: 9,8 ↗ 3: 10,2* ← 4: 9,9 ↘ 5: 10,1 → 6: 9,7 ↘ 7: 10,0 ↗ 8: 10,6* ↗ 9: 10,4* ↗ 10: 10,9* ↓</p>	<p>1: 9,8 ↑ 2: 10,3* ↖ 3: 10,1 ↓ 4: 10,5* ↖ 5: 9,8 ← 6: 10,2* ↘ 7: 10,1 → 8: 10,4* ← 9: 9,1 ↓ 10: 9,6 ↗</p>	
Serie 97,0	Serie 96,0	
Sum 97,0	Sum 193,0	

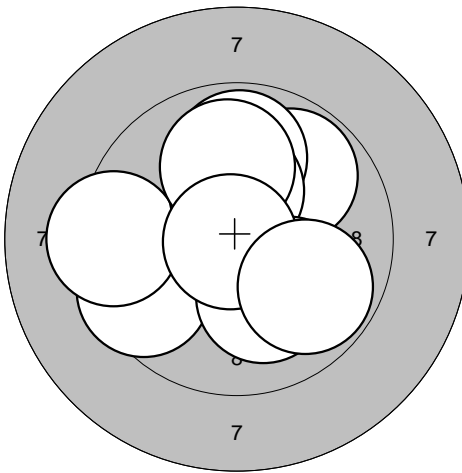
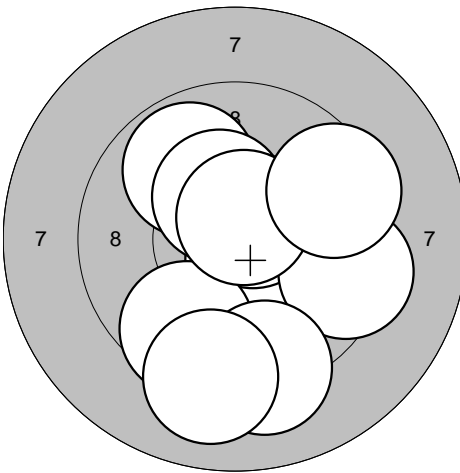
<p>Series 3</p> 	<p>Series 4</p> 	
<p>1: 9,5 ↖ 2: 9,3 ← 3: 9,9 ↗ 4: 9,9 ↑ 5: 10,3* ↑ 6: 10,1 ↘ 7: 10,0 ↑ 8: 10,1 ↘ 9: 10,9* ↖ 10: 9,8 ↘</p>	<p>1: 9,8 ↗ 2: 10,6* ↘ 3: 10,3* ↗ 4: 10,6* ↗ 5: 9,4 → 6: 9,6 ↘ 7: 10,6* ↗ 8: 9,2 ↓ 9: 9,5 ↗ 10: 9,1 ↓</p>	
Serie 95,0	Serie 94,0	
Sum 288,0	Sum 382,0	

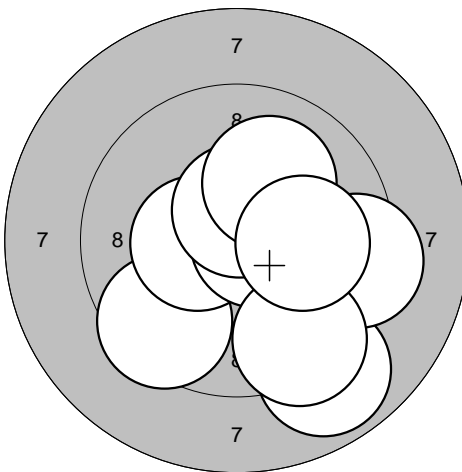
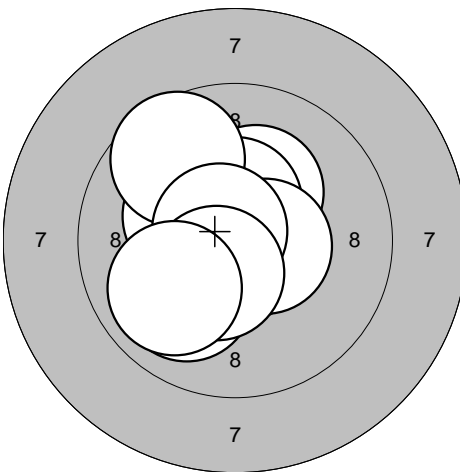
<p>Series 5</p> 	<p>Series 6</p> 	
<p>1: 8,9 ↘ 2: 9,5 ↘ 3: 10,3* → 4: 10,4* ← 5: 9,3 → 6: 10,7* → 7: 9,4 ↘ 8: 10,5* ↑ 9: 10,1 ↗ 10: 10,1 →</p>	<p>1: 10,4* ↗ 2: 10,2* ↗ 3: 10,3* ↖ 4: 10,0 ↘ 5: 10,5* ↑ 6: 9,6 ↗ 7: 10,5* → 8: 10,7* ↖ 9: 10,5* ↘ 10: 9,9 ↖</p>	
Serie 95,0	Serie 98,0	
Sum 477,0	Sum 575,0	

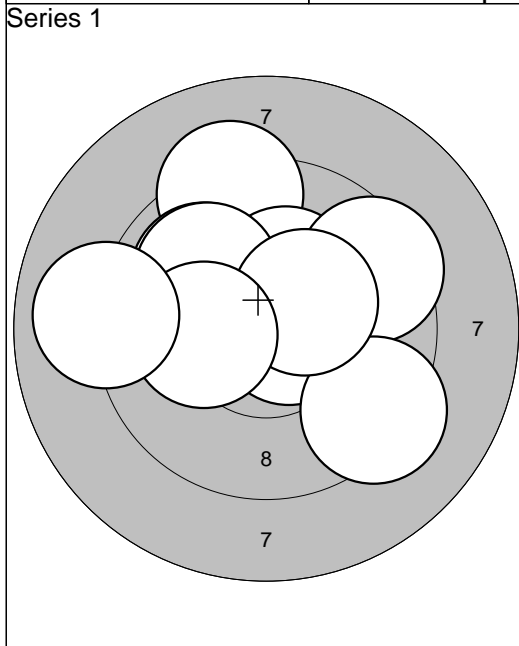

1: 10,7*	→
2: 9,3	↑
3: 10,3*	↗
4: 10,0	↘
5: 9,5	↗
6: 10,0	↗
7: 9,3	↘
8: 10,4*	↗
9: 10,2*	←
10: 9,0	←
Serie 96,0	
Sum 96,0	

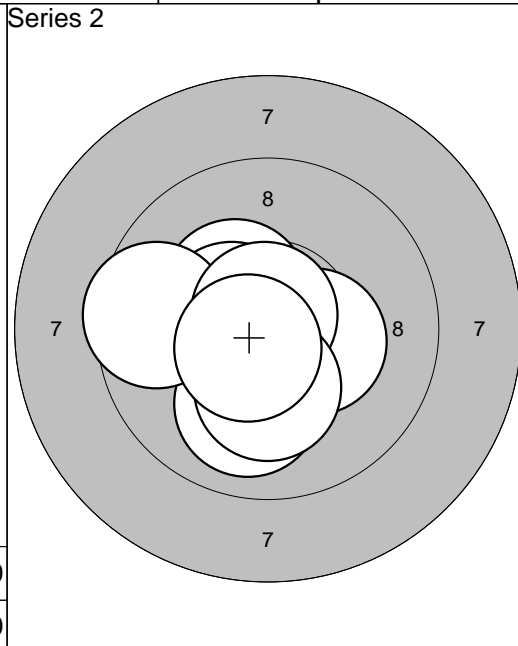

1: 10,0	↓
2: 10,9*	↗
3: 10,3*	↗
4: 10,4*	→
5: 10,5*	↖
6: 10,7*	←
7: 9,6	←
8: 10,8*	↑
9: 10,2*	↓
10: 10,6*	↙
Serie 99,0	
Sum 195,0	

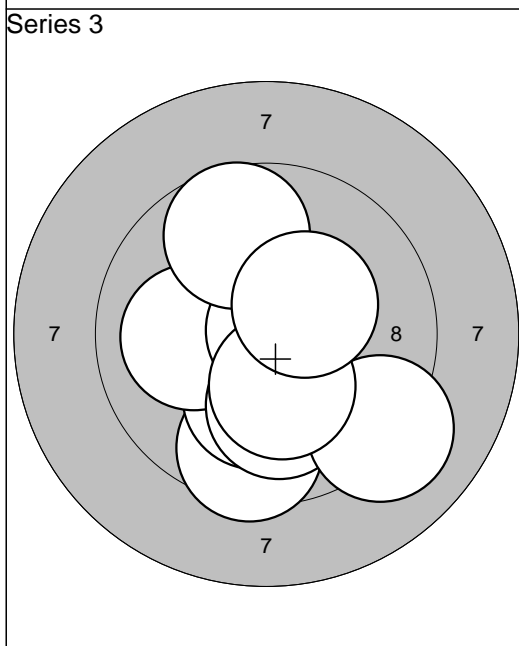

1: 9,5	↓
2: 10,6*	↗
3: 10,2*	↓
4: 10,1	←
5: 10,1	↓
6: 10,8*	→
7: 9,1	↘
8: 10,3*	↓
9: 9,7	↑
10: 10,3*	↗
Serie 97,0	
Sum 292,0	

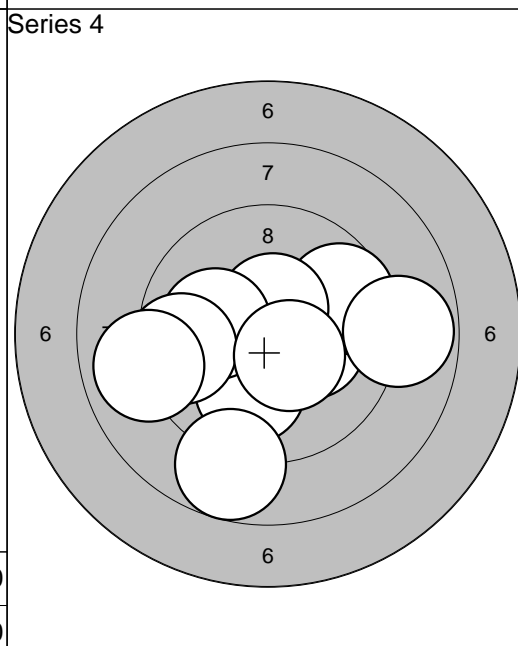

1: 10,2*	→
2: 10,0	↓
3: 9,6	↗
4: 10,5*	↑
5: 10,1	←
6: 9,5	←
7: 8,8	→
8: 8,7	↓
9: 10,4*	↘
10: 9,0	←
Serie 93,0	
Sum 385,0	

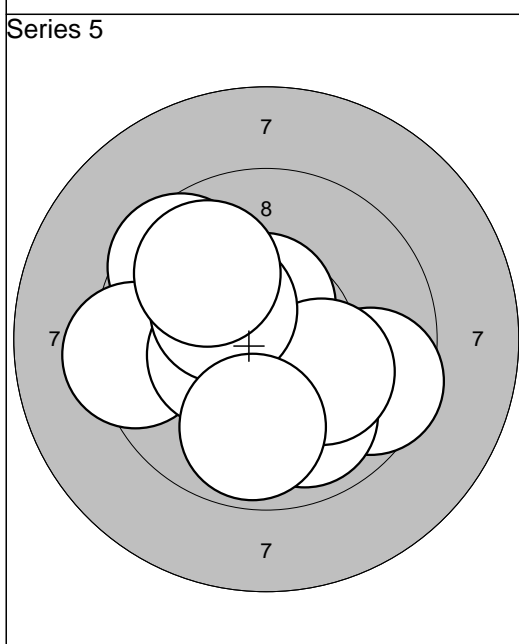

1: 9,6	↘
2: 9,6	↗
3: 9,9	↓
4: 9,4	←
5: 10,4*	←
6: 10,5*	↑
7: 10,1	↘
8: 10,3*	↗
9: 9,9	↓
10: 9,9	↗
Serie 94,0	
Sum 479,0	

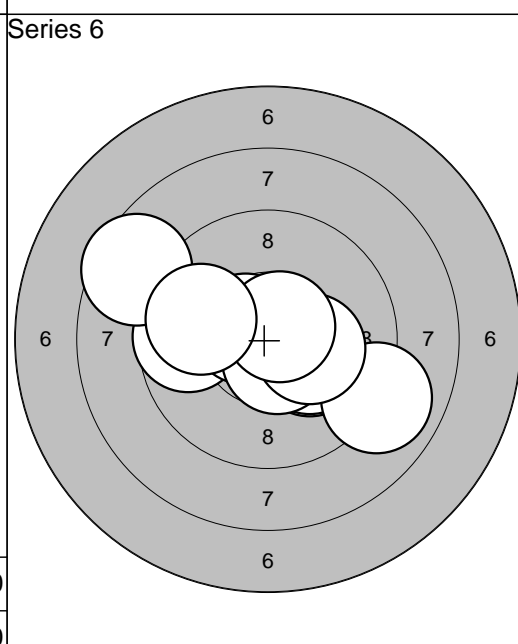

1: 9,7	←
2: 10,6*	↖
3: 8,6	↖
4: 10,2*	↘
5: 10,2*	↘
6: 10,6*	↓
7: 8,9	↘
8: 10,2*	→
9: 10,7*	↗
10: 9,8	←
Serie 94,0	
Sum 573,0	

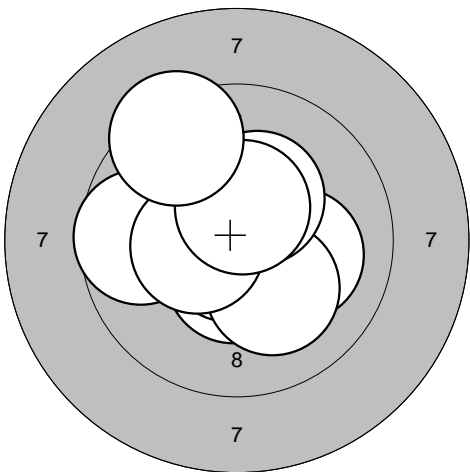
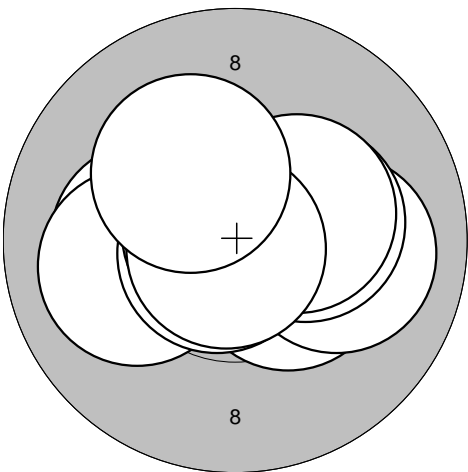
<p>Series 1</p> 	<p>1: 10,5* ↓</p> <p>2: 10,1 →</p> <p>3: 10,8* →</p> <p>4: 9,7 ←</p> <p>5: 10,7* ↓</p> <p>6: 10,2* ↓</p> <p>7: 10,3* ↗</p> <p>8: 10,4* ←</p> <p>9: 10,5* ↗</p> <p>10: 9,4 ↗</p>	<p>Series 2</p> 	<p>1: 10,4* ↘</p> <p>2: 10,2* ←</p> <p>3: 10,0 →</p> <p>4: 10,0 ←</p> <p>5: 10,8* ↙</p> <p>6: 10,8* ↖</p> <p>7: 10,3* →</p> <p>8: 10,3* ↗</p> <p>9: 10,8* ↙</p> <p>10: 10,2* ↖</p>
Serie 98,0		Serie 100,0	
Sum 98,0		Sum 198,0	

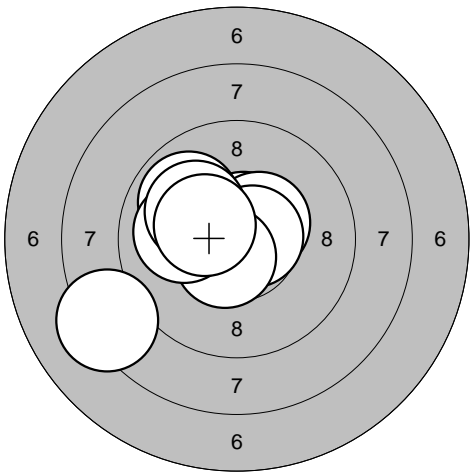
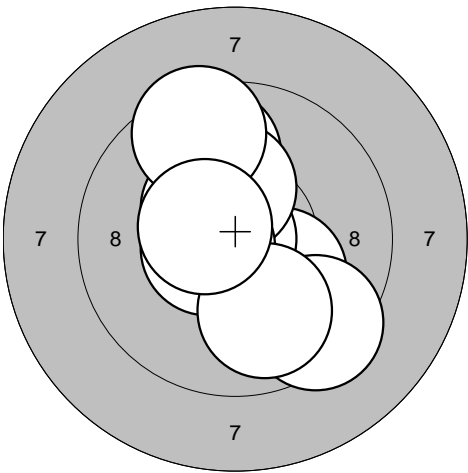
<p>Series 3</p> 	<p>1: 8,3 ↙</p> <p>2: 10,7* ↗</p> <p>3: 10,6* ↙</p> <p>4: 9,9 ↖</p> <p>5: 10,5* ↗</p> <p>6: 10,7* →</p> <p>7: 10,6* ↓</p> <p>8: 10,0 ←</p> <p>9: 10,1 ↗</p> <p>10: 10,4* ↖</p>	<p>Series 4</p> 	<p>1: 9,8 ↗</p> <p>2: 10,2* ↘</p> <p>3: 10,9* ←</p> <p>4: 10,4* ↗</p> <p>5: 10,3* ↗</p> <p>6: 9,5 ↗</p> <p>7: 9,4 ↘</p> <p>8: 10,6* ←</p> <p>9: 9,9 ↓</p> <p>10: 10,5* ↖</p>
Serie 97,0		Serie 96,0	
Sum 295,0		Sum 391,0	

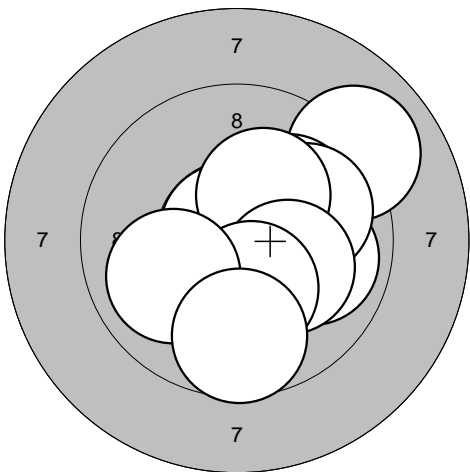
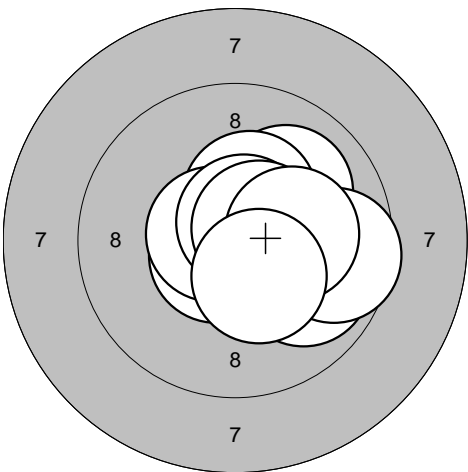
<p>Series 5</p> 	<p>1: 9,0 ↗</p> <p>2: 10,8* ↖</p> <p>3: 9,9 →</p> <p>4: 10,1 ↗</p> <p>5: 9,9 ↗</p> <p>6: 10,2* ↗</p> <p>7: 10,2* →</p> <p>8: 10,3* ↓</p> <p>9: 10,0 ←</p> <p>10: 9,7 ↓</p>	<p>Series 6</p> 	<p>1: 10,0 ↗</p> <p>2: 10,4* ↗</p> <p>3: 10,6* ↙</p> <p>4: 9,9 ↘</p> <p>5: 9,6 →</p> <p>6: 10,7* ←</p> <p>7: 10,7* ↗</p> <p>8: 10,6* ↗</p> <p>9: 10,2* →</p> <p>10: 10,4* ↘</p>
Serie 96,0		Serie 98,0	
Sum 487,0		Sum 585,0	

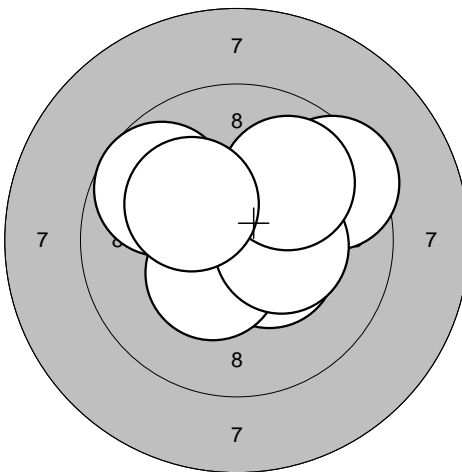
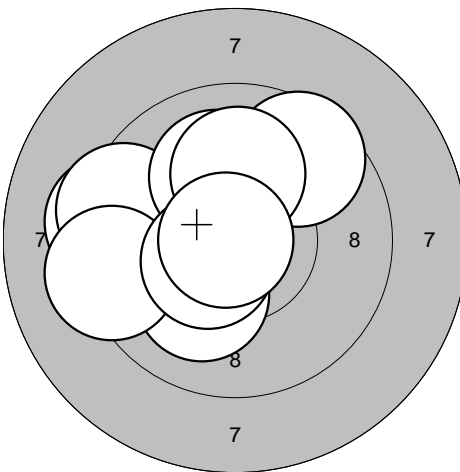
<p>Series 1</p> 	<p>1: 10,5* →</p> <p>2: 9,5 ↗</p> <p>3: 10,4* ↗</p> <p>4: 9,7 ↖</p> <p>5: 10,4* ↘</p> <p>6: 10,6* ↗</p> <p>7: 10,4* ↙</p> <p>8: 10,4* →</p> <p>9: 9,9 ↗</p> <p>10: 10,2* ↖</p>	<p>Series 2</p> 	<p>1: 10,1 ↘</p> <p>2: 9,6 ↗</p> <p>3: 9,3 ←</p> <p>4: 10,7* ↖</p> <p>5: 9,4 ←</p> <p>6: 10,1 ↑</p> <p>7: 9,2 ←</p> <p>8: 10,5* ↙</p> <p>9: 10,1 ↑</p> <p>10: 10,8* ←</p>
Serie 97,0	Serie 96,0	Serie 96,0	Serie 96,0
Sum 97,0	Sum 193,0	Sum 193,0	Sum 193,0

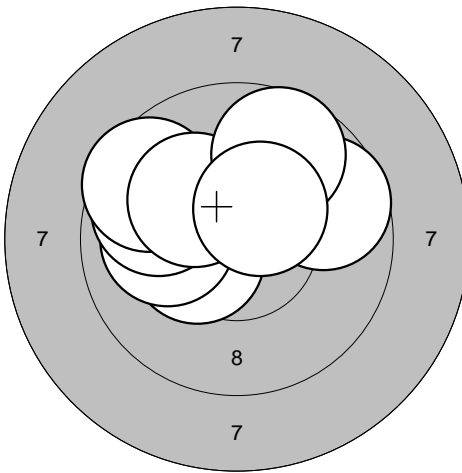
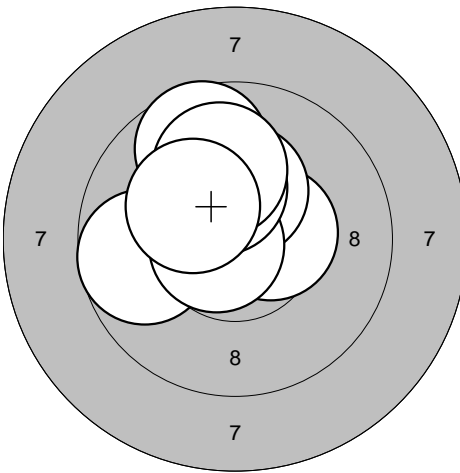
<p>Series 3</p> 	<p>1: 10,0 ↖</p> <p>2: 9,7 ↗</p> <p>3: 10,5* ↗</p> <p>4: 10,4* ↖</p> <p>5: 10,0 ←</p> <p>6: 9,8 ↖</p> <p>7: 9,6 ↗</p> <p>8: 10,2* ↗</p> <p>9: 9,7 ↗</p> <p>10: 10,4* ↗</p>	<p>Series 4</p> 	<p>1: 10,5* →</p> <p>2: 10,2* ↖</p> <p>3: 10,4* ↖</p> <p>4: 9,7 ↗</p> <p>5: 10,3* ↑</p> <p>6: 9,7 ←</p> <p>7: 10,7* ↖</p> <p>8: 10,2* ↑</p> <p>9: 10,0 ↑</p> <p>10: 10,3* ↖</p>
Serie 96,0	Serie 98,0	Serie 98,0	Serie 98,0
Sum 289,0	Sum 387,0	Sum 387,0	Sum 387,0

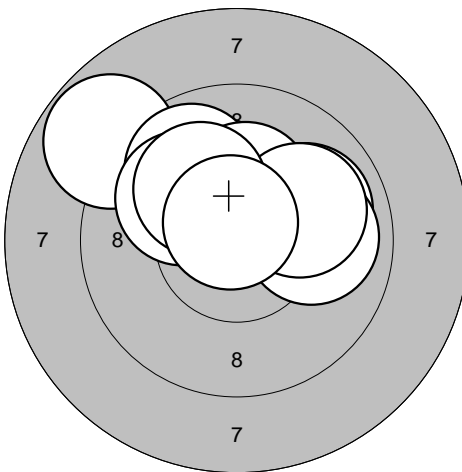
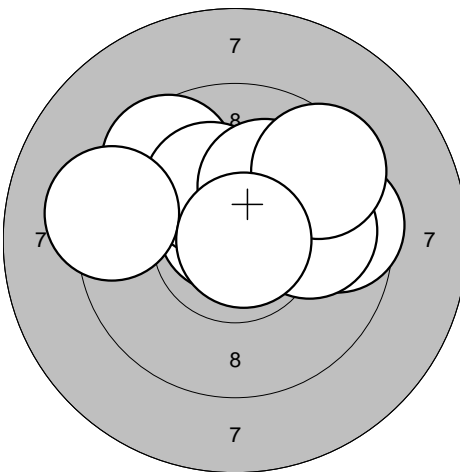
<p>Series 5</p> 	<p>1: 10,1 ↗</p> <p>2: 8,8 ↖</p> <p>3: 9,9 ↗</p> <p>4: 10,3* ↑</p> <p>5: 9,9 →</p> <p>6: 10,0 →</p> <p>7: 10,0 ↖</p> <p>8: 10,0 ↗</p> <p>9: 10,1 ↗</p> <p>10: 10,7* ↗</p>	<p>Series 6</p> 	<p>1: 9,6 →</p> <p>2: 10,7* ↖</p> <p>3: 10,1 ↗</p> <p>4: 9,6 ↖</p> <p>5: 10,2* ↖</p> <p>6: 10,1 ↗</p> <p>7: 10,0 →</p> <p>8: 9,5 ↗</p> <p>9: 9,3 ←</p> <p>10: 10,8* →</p>
Serie 96,0	Serie 96,0	Serie 96,0	Serie 96,0
Sum 483,0	Sum 579,0	Sum 579,0	Sum 579,0

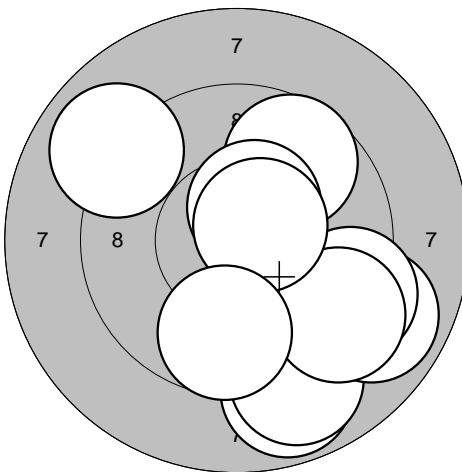
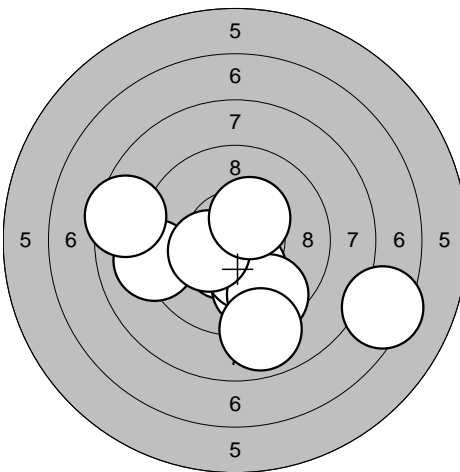
<p>Series 1</p> 	<p>1: 9,7 ↗ 2: 10,5* ↗ 3: 8,9 ↓ 4: 8,9 ↓ 5: 8,9 → 6: 9,3 → 7: 9,3 ↓ 8: 8,9 ↗ 9: 10,6* ↗ 10: 9,7 ↓</p> <p>Serie 88,0 Sum 88,0</p>	<p>Series 2</p> 	<p>1: 10,5* ↓ 2: 9,1 ← 3: 9,8 ↓ 4: 8,5 ← 5: 10,3* ↓ 6: 9,5 ↓ 7: 10,3* ← 8: 10,4* ↗ 9: 8,9 ↓ 10: 7,4 →</p> <p>Serie 90,0 Sum 178,0</p>
--	--	--	---

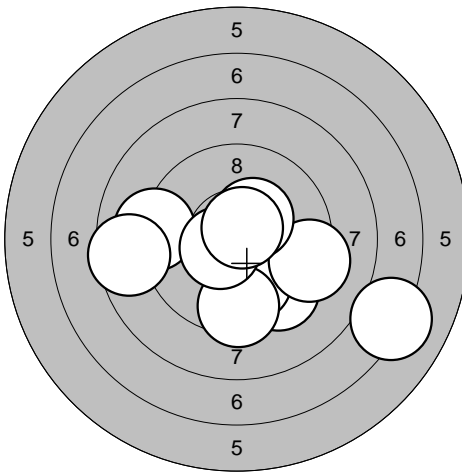
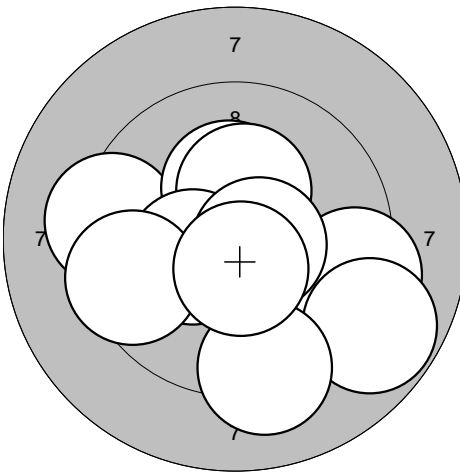
<p>Series 3</p> 	<p>1: 9,5 ↓ 2: 10,0 ↓ 3: 9,5 ↓ 4: 7,1 → 5: 9,1 ← 6: 9,3 → 7: 8,6 ← 8: 10,5* ← 9: 10,4* ↗ 10: 10,7* ↗</p> <p>Serie 91,0 Sum 269,0</p>	<p>Series 4</p> 	<p>1: 9,3 ← 2: 10,2* ↑ 3: 10,3* ↑ 4: 9,3 → 5: 10,3* ← 6: 8,8 ↓ 7: 9,5 ← 8: 9,2 ↓ 9: 10,6* → 10: 10,5* ↓</p> <p>Serie 94,0 Sum 363,0</p>
---	--	---	---

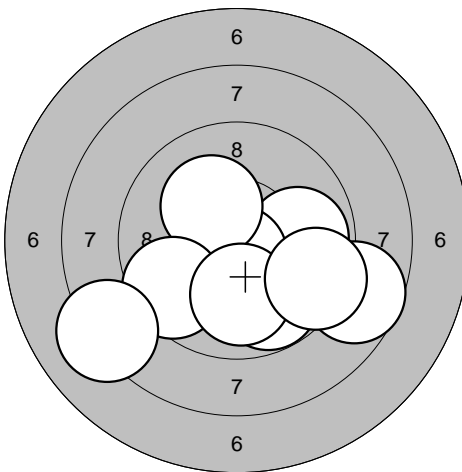
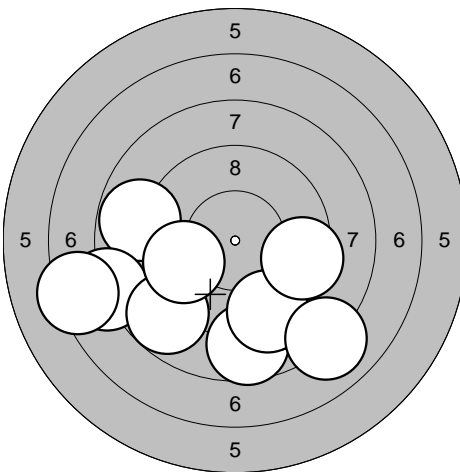
<p>Series 5</p> 	<p>1: 9,9 → 2: 9,8 ↓ 3: 10,1 ↓ 4: 10,7* ↓ 5: 10,2* ↗ 6: 9,5 ← 7: 8,2 ← 8: 8,7 → 9: 10,0 ↓ 10: 9,4 →</p> <p>Serie 92,0 Sum 455,0</p>	<p>Series 6</p> 	<p>1: 8,8 ← 2: 8,6 ↓ 3: 9,2 ↓ 4: 9,2 ↓ 5: 7,9 ← 6: 9,4 → 7: 7,3 ← 8: 8,0 ↓ 9: 8,8 ↓ 10: 9,7 ←</p> <p>Serie 82,0 Sum 537,0</p>
--	---	--	---

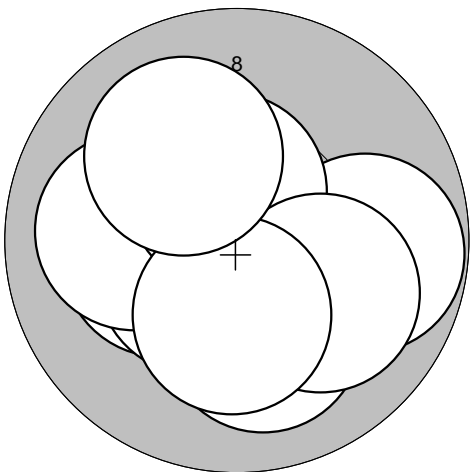
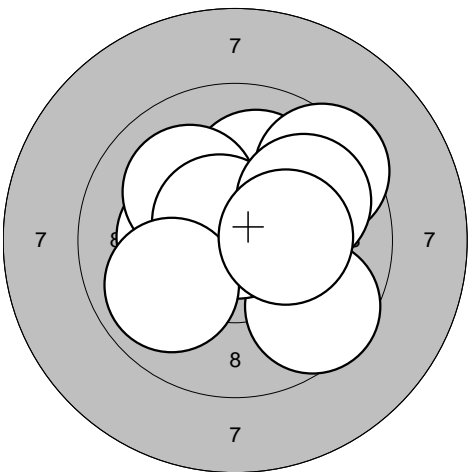
<p>Series 1</p> 	<p>1: 10,2* ← 2: 10,8* → 3: 10,5* ↙ 4: 9,8 → 5: 10,0 ← 6: 10,5* ↑ 7: 10,1 ↓ 8: 10,0 ↘ 9: 10,3* ↓ 10: 10,1 ↑</p> <table border="1" style="width:100%; border-collapse: collapse;"> <tr><td>Serie</td><td style="text-align: right;">99,0</td></tr> <tr><td>Sum</td><td style="text-align: right;">99,0</td></tr> </table>	Serie	99,0	Sum	99,0	<p>Series 2</p> 	<p>1: 10,1 ↑ 2: 9,6 ↘ 3: 9,5 ↗ 4: 10,3* ← 5: 10,1 ↖ 6: 10,8* ↑ 7: 10,6* ↖ 8: 9,9 ↙ 9: 9,9 ↗ 10: 10,3* →</p> <table border="1" style="width:100%; border-collapse: collapse;"> <tr><td>Serie</td><td style="text-align: right;">96,0</td></tr> <tr><td>Sum</td><td style="text-align: right;">195,0</td></tr> </table>	Serie	96,0	Sum	195,0
Serie	99,0										
Sum	99,0										
Serie	96,0										
Sum	195,0										

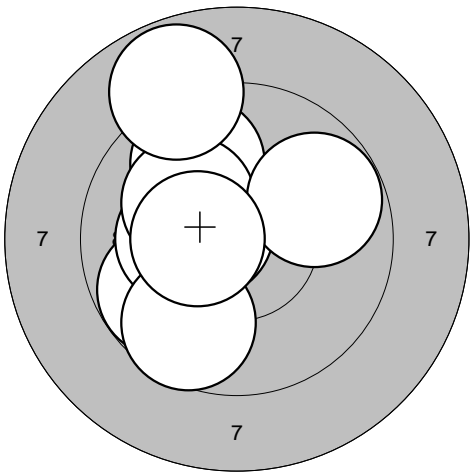
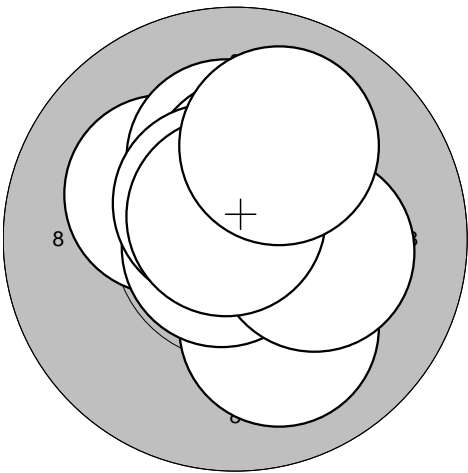
<p>Series 3</p> 	<p>1: 10,5* ← 2: 9,8 ↑ 3: 9,9 ↙ 4: 9,8 ↙ 5: 10,2* ← 6: 10,1 ↗ 7: 8,8 ↑ 8: 9,8 → 9: 9,7 ↙ 10: 10,4* ←</p> <table border="1" style="width:100%; border-collapse: collapse;"> <tr><td>Serie</td><td style="text-align: right;">93,0</td></tr> <tr><td>Sum</td><td style="text-align: right;">288,0</td></tr> </table>	Serie	93,0	Sum	288,0	<p>Series 4</p> 	<p>1: 10,2* ↖ 2: 10,6* ↑ 3: 10,2* ↑ 4: 10,1 ↘ 5: 10,4* ↑ 6: 10,8* ↙ 7: 10,2* → 8: 10,6* ↖ 9: 10,7* ↗ 10: 10,0 ↑</p> <table border="1" style="width:100%; border-collapse: collapse;"> <tr><td>Serie</td><td style="text-align: right;">100,0</td></tr> <tr><td>Sum</td><td style="text-align: right;">388,0</td></tr> </table>	Serie	100,0	Sum	388,0
Serie	93,0										
Sum	288,0										
Serie	100,0										
Sum	388,0										

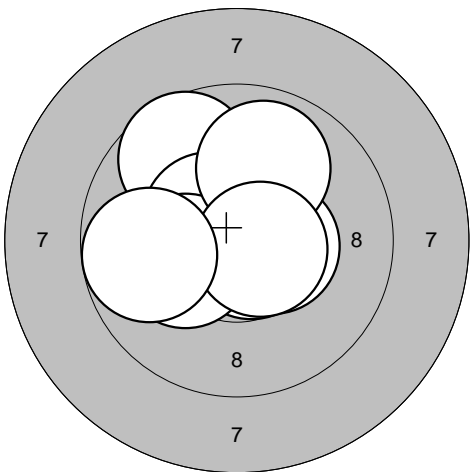
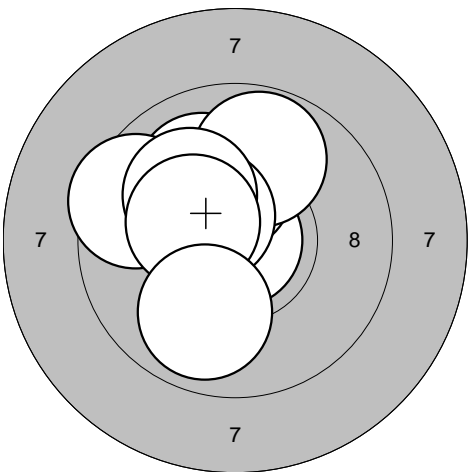
<p>Series 5</p> 	<p>1: 10,7* ↗ 2: 10,8* ↖ 3: 10,5* → 4: 10,7* ↘ 5: 9,7 ↗ 6: 10,5* ↗ 7: 10,2* ← 8: 9,9 ↑ 9: 10,6* → 10: 9,8 ←</p> <table border="1" style="width:100%; border-collapse: collapse;"> <tr><td>Serie</td><td style="text-align: right;">97,0</td></tr> <tr><td>Sum</td><td style="text-align: right;">485,0</td></tr> </table>	Serie	97,0	Sum	485,0	<p>Series 6</p> 	<p>1: 10,3* ↖ 2: 10,9* ↖ 3: 10,2* ↑ 4: 10,0 ↗ 5: 9,8 ↑ 6: 10,5* ↖ 7: 9,5 ← 8: 10,1 ↖ 9: 10,3* ← 10: 9,9 ↘</p> <table border="1" style="width:100%; border-collapse: collapse;"> <tr><td>Serie</td><td style="text-align: right;">97,0</td></tr> <tr><td>Sum</td><td style="text-align: right;">582,0</td></tr> </table>	Serie	97,0	Sum	582,0
Serie	97,0										
Sum	485,0										
Serie	97,0										
Sum	582,0										

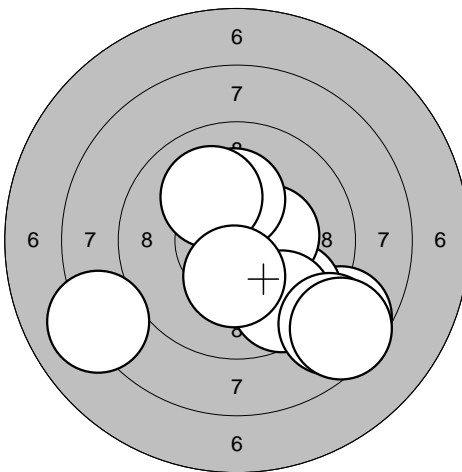
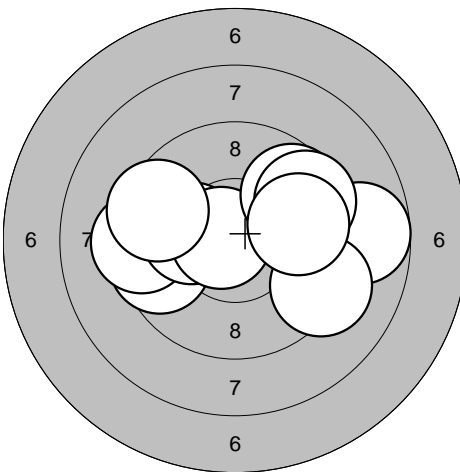
<p>Series 1</p> 	<p>1: 8,7 ↘ 2: 9,6 ↘ 3: 8,1 ↙ 4: 10,4* → 5: 9,6 ↘ 6: 10,2* ↑ 7: 8,8 ↘ 8: 10,1 ↗ 9: 8,6 ↘ 10: 10,3* ↓</p> <table border="1" style="width:100%; border-collapse: collapse;"> <tr><td>Serie</td><td style="text-align: right;">90,0</td></tr> <tr><td>Sum</td><td style="text-align: right;">90,0</td></tr> </table>	Serie	90,0	Sum	90,0	<p>Series 2</p> 	<p>1: 9,6 ← 2: 9,3 ← 3: 10,2* ← 4: 8,7 → 5: 9,2 ↘ 6: 10,7* ← 7: 9,7 ↗ 8: 9,5 ↗ 9: 9,8 → 10: 9,5 ←</p> <table border="1" style="width:100%; border-collapse: collapse;"> <tr><td>Serie</td><td style="text-align: right;">91,0</td></tr> <tr><td>Sum</td><td style="text-align: right;">181,0</td></tr> </table>	Serie	91,0	Sum	181,0
Serie	90,0										
Sum	90,0										
Serie	91,0										
Sum	181,0										

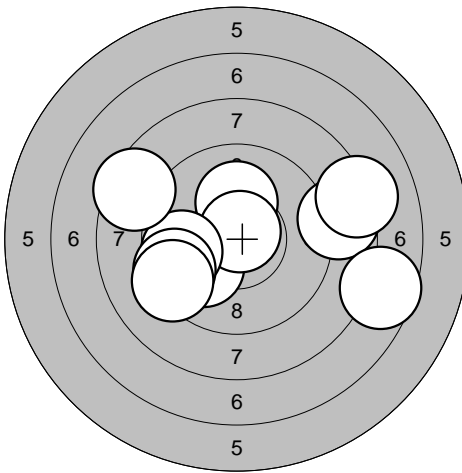
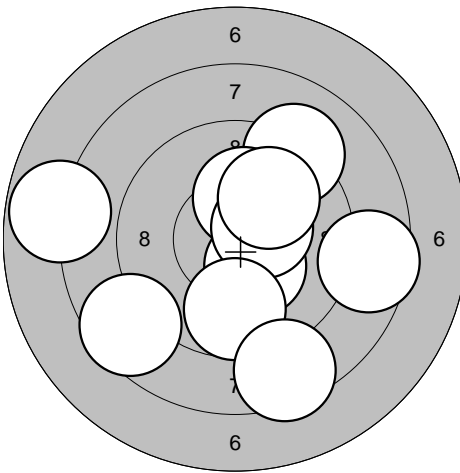
<p>Series 3</p> 	<p>1: 8,7 → 2: 10,2* ↑ 3: 10,0 ↙ 4: 8,2 → 5: 10,8* ↗ 6: 7,6 → 7: 9,7 ← 8: 9,4 ← 9: 9,3 ← 10: 8,5 ↙</p> <table border="1" style="width:100%; border-collapse: collapse;"> <tr><td>Serie</td><td style="text-align: right;">88,0</td></tr> <tr><td>Sum</td><td style="text-align: right;">269,0</td></tr> </table>	Serie	88,0	Sum	269,0	<p>Series 4</p> 	<p>1: 10,4* ↓ 2: 9,1 ↗ 3: 10,2* ↑ 4: 10,4* → 5: 8,5 → 6: 10,0 ↗ 7: 9,7 ↓ 8: 8,6 ↙ 9: 8,5 ↓ 10: 7,8 ←</p> <table border="1" style="width:100%; border-collapse: collapse;"> <tr><td>Serie</td><td style="text-align: right;">89,0</td></tr> <tr><td>Sum</td><td style="text-align: right;">358,0</td></tr> </table>	Serie	89,0	Sum	358,0
Serie	88,0										
Sum	269,0										
Serie	89,0										
Sum	358,0										

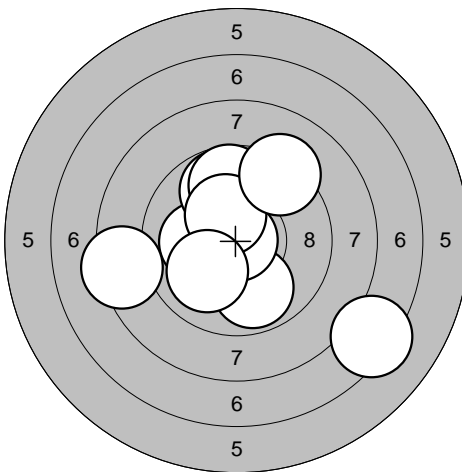
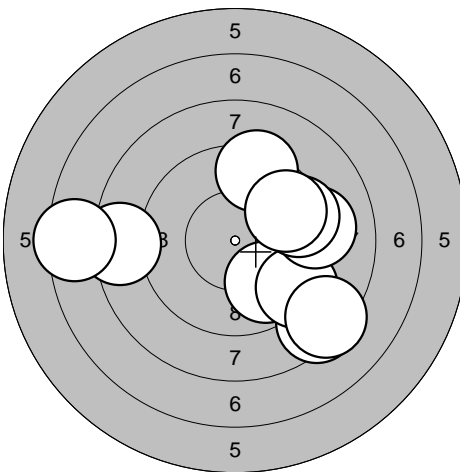
<p>Series 5</p> 	<p>1: 10,2* ← 2: 8,4 ← 3: 9,8 ↑ 4: 7,3 ↘ 5: 9,8 ↘ 6: 10,9* → 7: 9,7 ↑ 8: 10,3* ↑ 9: 9,2 ↗ 10: 10,0 ↙</p> <table border="1" style="width:100%; border-collapse: collapse;"> <tr><td>Serie</td><td style="text-align: right;">91,0</td></tr> <tr><td>Sum</td><td style="text-align: right;">449,0</td></tr> </table>	Serie	91,0	Sum	449,0	<p>Series 6</p> 	<p>1: 8,4 ↘ 2: 9,4 ↑ 3: 9,8 ↘ 4: 9,2 ↘ 5: 9,2 → 6: 9,4 → 7: 8,4 ← 8: 7,4 ← 9: 8,3 ↘ 10: 9,7 ↗</p> <table border="1" style="width:100%; border-collapse: collapse;"> <tr><td>Serie</td><td style="text-align: right;">85,0</td></tr> <tr><td>Sum</td><td style="text-align: right;">534,0</td></tr> </table>	Serie	85,0	Sum	534,0
Serie	91,0										
Sum	449,0										
Serie	85,0										
Sum	534,0										

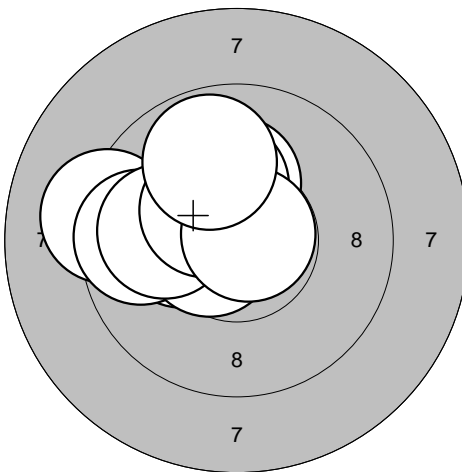
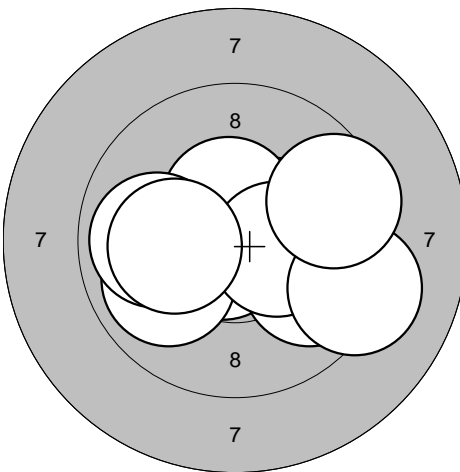
<p>Series 1</p> 	<p>1: 10,2* ←</p> <p>2: 9,2 ←</p> <p>3: 9,7 ←</p> <p>4: 10,6* ←</p> <p>5: 10,2* ↑</p> <p>6: 10,0 ←</p> <p>7: 10,2* ↑</p> <p>8: 10,4* ↗</p> <p>9: 10,8* →</p> <p>10: 9,9 ↑</p>	<p>Series 2</p> 	<p>1: 10,7* ↘</p> <p>2: 9,9 ↘</p> <p>3: 10,5* →</p> <p>4: 9,8 ↘</p> <p>5: 10,5* ↑</p> <p>6: 9,9 ←</p> <p>7: 10,4* →</p> <p>8: 10,1 ←</p> <p>9: 9,2 ↘</p> <p>10: 9,5 →</p>
Serie 97,0	Serie 95,0	Serie 95,0	Serie 95,0
Sum 97,0	Sum 97,0	Sum 192,0	Sum 192,0

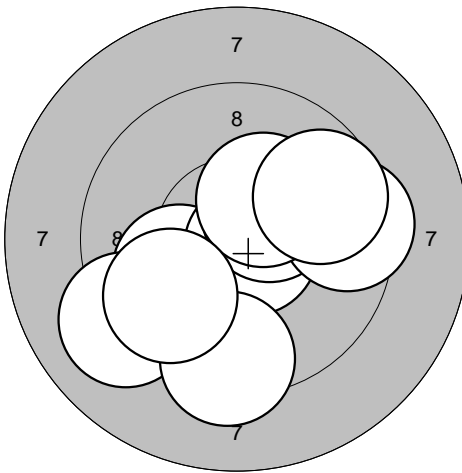
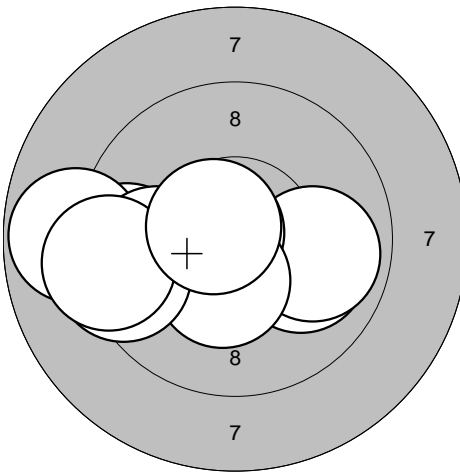
<p>Series 3</p> 	<p>1: 10,1 ↘</p> <p>2: 10,7* ↘</p> <p>3: 9,7 →</p> <p>4: 9,1 ↘</p> <p>5: 10,4* ↗</p> <p>6: 9,5 →</p> <p>7: 10,3* ↗</p> <p>8: 9,3 ↓</p> <p>9: 9,7 →</p> <p>10: 9,8 ↘</p>	<p>Series 4</p> 	<p>1: 10,0 ↘</p> <p>2: 9,9 →</p> <p>3: 9,5 ←</p> <p>4: 10,7* ↘</p> <p>5: 8,8 ←</p> <p>6: 9,9 ←</p> <p>7: 10,4* ↓</p> <p>8: 9,4 ←</p> <p>9: 9,2 ←</p> <p>10: 10,6* ↖</p>
Serie 94,0	Serie 94,0	Serie 93,0	Serie 93,0
Sum 286,0	Sum 286,0	Sum 379,0	Sum 379,0

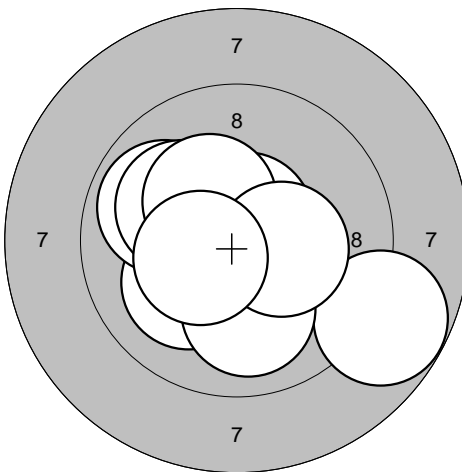
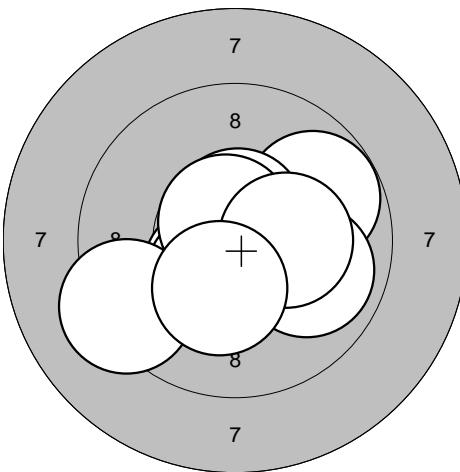
<p>Series 5</p> 	<p>1: 10,6* ↑</p> <p>2: 10,1 ↘</p> <p>3: 10,6* ←</p> <p>4: 9,9 ↖</p> <p>5: 8,8 ↘</p> <p>6: 10,1 ↗</p> <p>7: 10,0 ↓</p> <p>8: 10,3* ↗</p> <p>9: 10,3* →</p> <p>10: 10,4* ↖</p>	<p>Series 6</p> 	<p>1: 10,4* →</p> <p>2: 10,4* ↘</p> <p>3: 10,4* ↘</p> <p>4: 9,3 ↖</p> <p>5: 9,8 ↗</p> <p>6: 10,6* ↑</p> <p>7: 9,9 ↘</p> <p>8: 10,7* ↖</p> <p>9: 10,3* →</p> <p>10: 10,3* ↓</p>
Serie 97,0	Serie 97,0	Serie 97,0	Serie 97,0
Sum 476,0	Sum 476,0	Sum 573,0	Sum 573,0

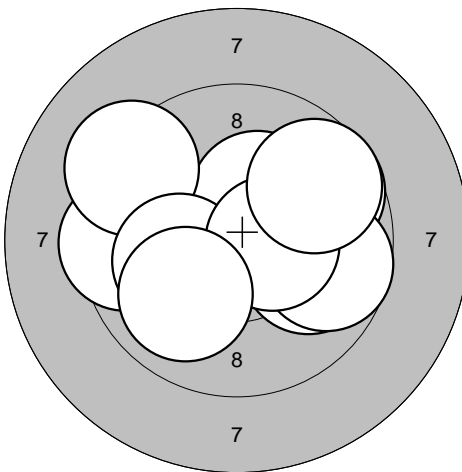
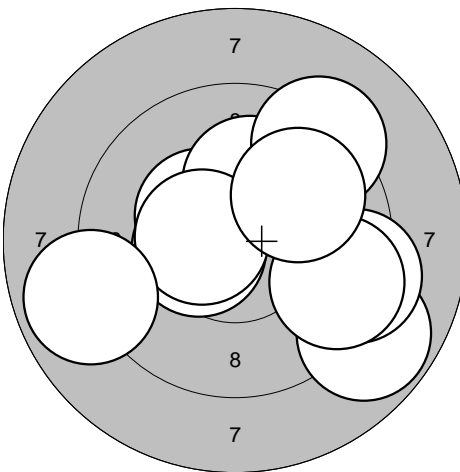
<p>Series 1</p> 	<p>1: 10,3* ↗</p> <p>2: 9,5 ←</p> <p>3: 9,3 ↖</p> <p>4: 9,7 ↗</p> <p>5: 9,9 →</p> <p>6: 9,7 →</p> <p>7: 10,1 ←</p> <p>8: 10,5* →</p> <p>9: 9,7 ↗</p> <p>10: 10,0 ↙</p>	<p>Series 2</p> 	<p>1: 10,4* ←</p> <p>2: 10,4* ↖</p> <p>3: 10,2* ↗</p> <p>4: 8,8 ↘</p> <p>5: 9,3 ↗</p> <p>6: 10,5* ←</p> <p>7: 9,3 →</p> <p>8: 9,5 →</p> <p>9: 9,9 ↗</p> <p>10: 8,9 ←</p>
Serie 94,0		Serie 92,0	
Sum 94,0		Sum 186,0	

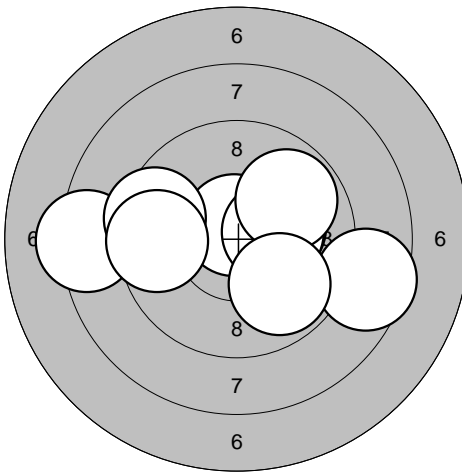
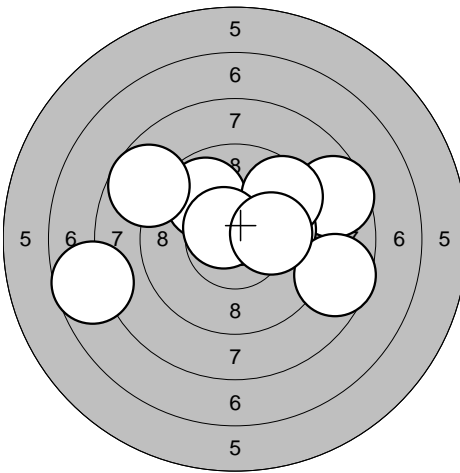
<p>Series 3</p> 	<p>1: 10,4* →</p> <p>2: 10,2* →</p> <p>3: 10,7* ↗</p> <p>4: 10,3* →</p> <p>5: 8,6 →</p> <p>6: 8,3 ←</p> <p>7: 9,5 ←</p> <p>8: 9,5 ←</p> <p>9: 9,8 ↗</p> <p>10: 9,8 ↘</p>	<p>Series 4</p> 	<p>1: 10,6* ↗</p> <p>2: 9,9 ↖</p> <p>3: 7,7 ←</p> <p>4: 8,6 →</p> <p>5: 10,1 →</p> <p>6: 9,6 ↗</p> <p>7: 10,6* ↗</p> <p>8: 8,6 →</p> <p>9: 8,7 ↖</p> <p>10: 10,1 →</p>
Serie 92,0		Serie 89,0	
Sum 278,0		Sum 367,0	

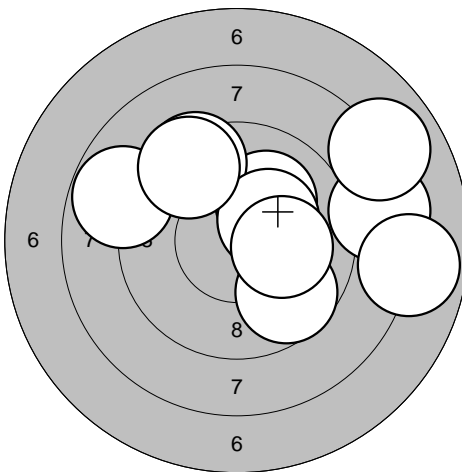
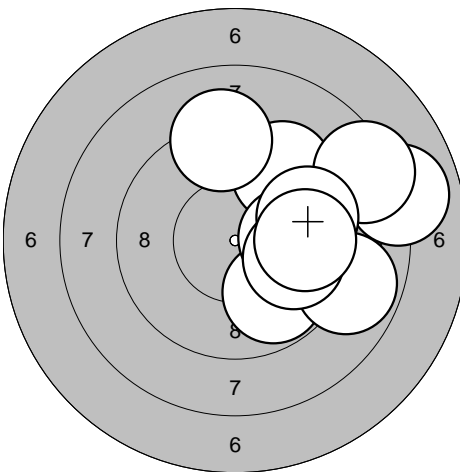
<p>Series 5</p> 	<p>1: 8,8 ←</p> <p>2: 9,7 ↘</p> <p>3: 10,1 ↗</p> <p>4: 9,4 ↗</p> <p>5: 8,4 →</p> <p>6: 7,9 →</p> <p>7: 10,3* ↗</p> <p>8: 8,0 ↗</p> <p>9: 10,1 →</p> <p>10: 9,4 ↗</p>	<p>Series 6</p> 	<p>1: 8,0 →</p> <p>2: 9,5 ↗</p> <p>3: 9,8 ↘</p> <p>4: 8,4 →</p> <p>5: 8,9 →</p> <p>6: 10,0 →</p> <p>7: 9,8 →</p> <p>8: 9,2 ↗</p> <p>9: 9,6 →</p> <p>10: 9,7 →</p>
Serie 88,0		Serie 88,0	
Sum 455,0		Sum 543,0	

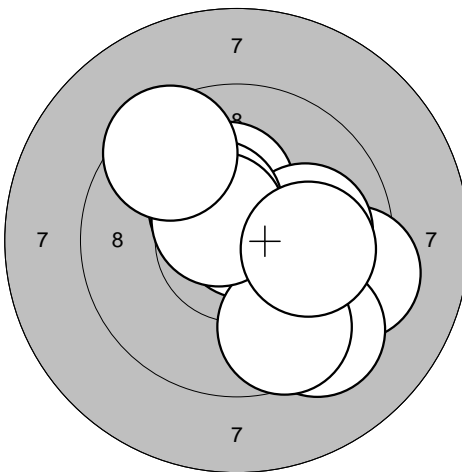
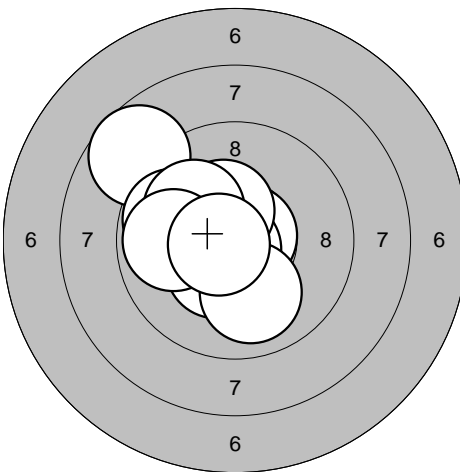
<p>Series 1</p> 	<p>1: 9,3 →</p> <p>2: 9,3 ↘</p> <p>3: 10,8* ↗</p> <p>4: 9,6 ↘</p> <p>5: 10,3* ↗</p> <p>6: 10,0 →</p> <p>7: 10,4* ↗</p> <p>8: 10,6* ↗</p> <p>9: 9,5 ↗</p> <p>10: 10,0 →</p>	<p>Series 2</p> 	<p>1: 10,7* →</p> <p>2: 8,7 ↖</p> <p>3: 10,4* ↘</p> <p>4: 10,8* ↘</p> <p>5: 10,4* ↗</p> <p>6: 10,0 ↘</p> <p>7: 9,8 ←</p> <p>8: 10,1 ↖</p> <p>9: 9,9 ←</p> <p>10: 10,7* ←</p>
Serie 96,0	Serie 96,0	Serie 96,0	Serie 96,0
Sum 96,0	Sum 96,0	Sum 192,0	Sum 192,0

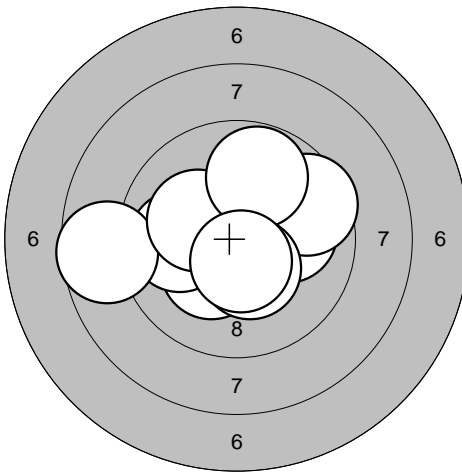
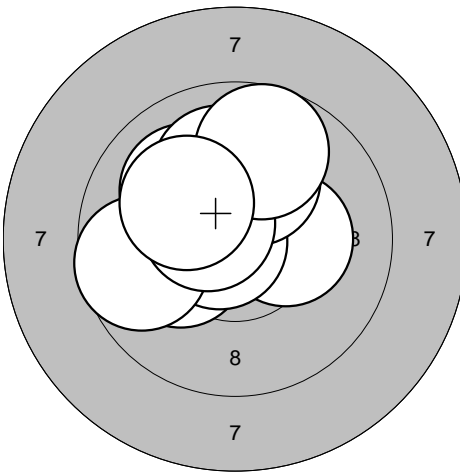
<p>Series 3</p> 	<p>1: 10,5* ↘</p> <p>2: 10,3* ↘</p> <p>3: 9,9 ←</p> <p>4: 8,7 ←</p> <p>5: 10,2* ↖</p> <p>6: 10,1 →</p> <p>7: 9,6 →</p> <p>8: 9,8 ↗</p> <p>9: 10,4* ↘</p> <p>10: 10,6* ↘</p>	<p>Series 4</p> 	<p>1: 10,3* →</p> <p>2: 10,2* ←</p> <p>3: 10,0 ↗</p> <p>4: 10,1 ↗</p> <p>5: 10,7* ←</p> <p>6: 10,1 ↗</p> <p>7: 9,7 ←</p> <p>8: 10,5* ↖</p> <p>9: 9,8 ↗</p> <p>10: 10,2* ↖</p>
Serie 95,0	Serie 95,0	Serie 98,0	Serie 98,0
Sum 287,0	Sum 287,0	Sum 385,0	Sum 385,0

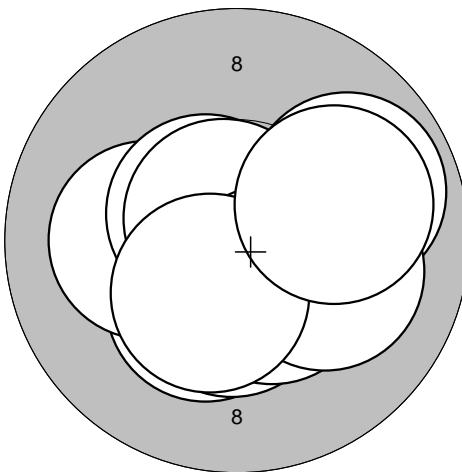
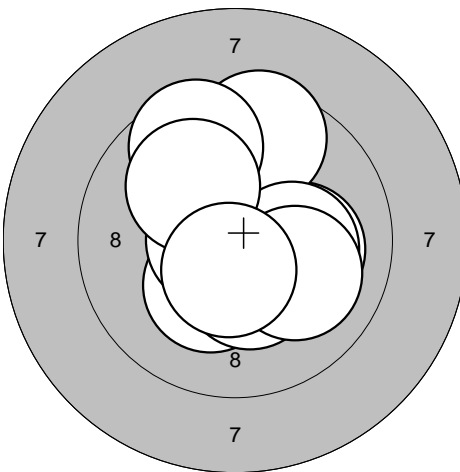
<p>Series 5</p> 	<p>1: 10,3* ↘</p> <p>2: 10,1 ←</p> <p>3: 10,4* ↘</p> <p>4: 10,6* ↗</p> <p>5: 10,7* ↗</p> <p>6: 9,9 →</p> <p>7: 10,4* ↘</p> <p>8: 10,1 →</p> <p>9: 10,4* ↘</p> <p>10: 10,0 →</p>	<p>Series 6</p> 	<p>1: 10,3* ↘</p> <p>2: 10,1 →</p> <p>3: 9,6 ↗</p> <p>4: 10,4* ↘</p> <p>5: 9,6 ↗</p> <p>6: 10,7* ←</p> <p>7: 10,2* →</p> <p>8: 10,0 ↘</p> <p>9: 10,0 ↗</p> <p>10: 10,6* ↘</p>
Serie 99,0	Serie 99,0	Serie 98,0	Serie 98,0
Sum 484,0	Sum 484,0	Sum 582,0	Sum 582,0

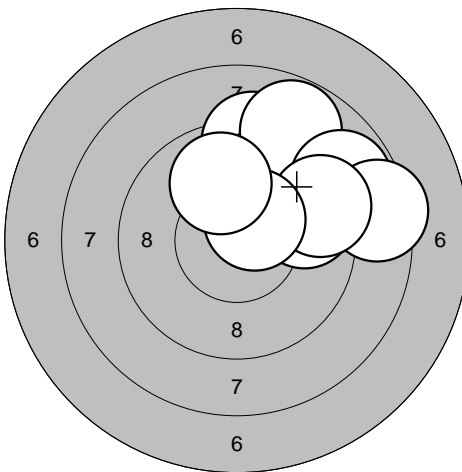
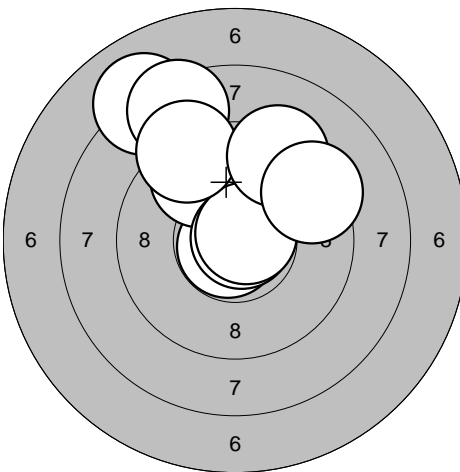
<p>Series 1</p> 	<p>1: 9,0 →</p> <p>2: 9,7 →</p> <p>3: 9,2 ↑</p> <p>4: 9,6 ↗</p> <p>5: 8,8 ↗</p> <p>6: 8,8 →</p> <p>7: 8,4 →</p> <p>8: 9,4 →</p> <p>9: 10,5* ↗</p> <p>10: 9,9 ↑</p> <hr/> <p>Serie 88,0</p> <hr/> <p>Sum 88,0</p>	<p>Series 2</p> 	<p>1: 10,8* ↘</p> <p>2: 10,4* ↑</p> <p>3: 9,7 ↖</p> <p>4: 10,8* →</p> <p>5: 8,1 ↖</p> <p>6: 8,5 ↑</p> <p>7: 10,7* →</p> <p>8: 9,2 ↖</p> <p>9: 9,3 ↑</p> <p>10: 9,4 ↗</p> <hr/> <p>Serie 92,0</p> <hr/> <p>Sum 180,0</p>
--	--	--	---

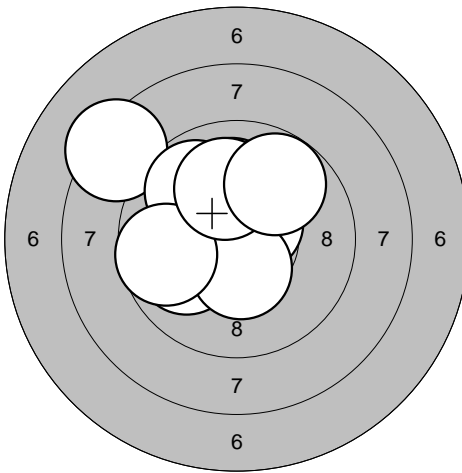
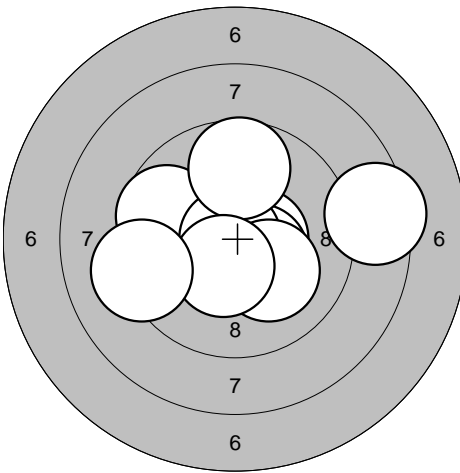
<p>Series 3</p> 	<p>1: 10,5* ↖</p> <p>2: 10,6* ↗</p> <p>3: 10,0 ←</p> <p>4: 8,3 ↖</p> <p>5: 10,1 ↑</p> <p>6: 9,9 ↗</p> <p>7: 10,4* ↓</p> <p>8: 9,7 ←</p> <p>9: 10,0 ↑</p> <p>10: 9,8 ↗</p> <hr/> <p>Serie 95,0</p> <hr/> <p>Sum 275,0</p>	<p>Series 4</p> 	<p>1: 10,5* →</p> <p>2: 10,5* ↙</p> <p>3: 9,7 ←</p> <p>4: 10,5* ↘</p> <p>5: 10,9* ←</p> <p>6: 10,1 ↘</p> <p>7: 8,4 →</p> <p>8: 9,7 ↑</p> <p>9: 10,4* ↓</p> <p>10: 9,2 ←</p> <hr/> <p>Serie 95,0</p> <hr/> <p>Sum 370,0</p>
---	--	---	--

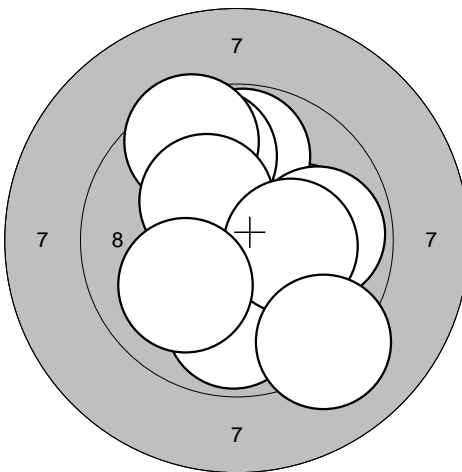
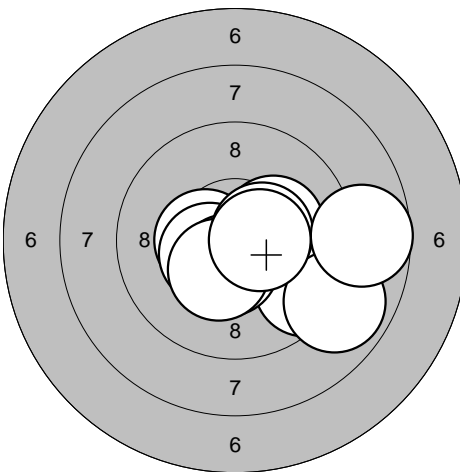
<p>Series 5</p> 	<p>1: 10,1 →</p> <p>2: 9,8 ↑</p> <p>3: 9,8 ↗</p> <p>4: 9,9 →</p> <p>5: 9,5 ↗</p> <p>6: 10,3* ↗</p> <p>7: 9,9 ↓</p> <p>8: 10,2* →</p> <p>9: 9,2 ↘</p> <p>10: 10,0 ↙</p> <hr/> <p>Serie 94,0</p> <hr/> <p>Sum 464,0</p>	<p>Series 6</p> 	<p>1: 9,5 ↘</p> <p>2: 10,4* ←</p> <p>3: 10,5* ↙</p> <p>4: 10,5* ↓</p> <p>5: 10,2* →</p> <p>6: 8,9 ↘</p> <p>7: 10,4* ↘</p> <p>8: 10,4* →</p> <p>9: 8,7 →</p> <p>10: 10,5* →</p> <hr/> <p>Serie 95,0</p> <hr/> <p>Sum 559,0</p>
--	---	--	---

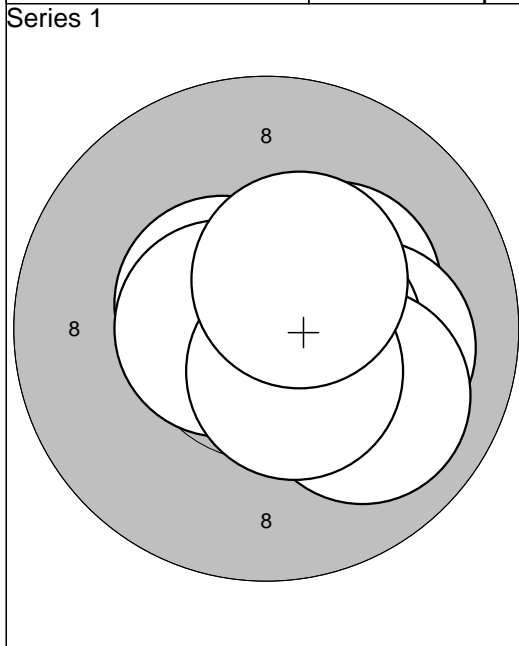

1: 10,6*	↖
2: 10,8*	→
3: 10,3*	↗
4: 10,4*	→
5: 10,6*	←
6: 10,1	→
7: 10,6*	→
8: 10,0	↘
9: 10,5*	↘
10: 10,5*	↗
Serie	100,0
Sum	100,0

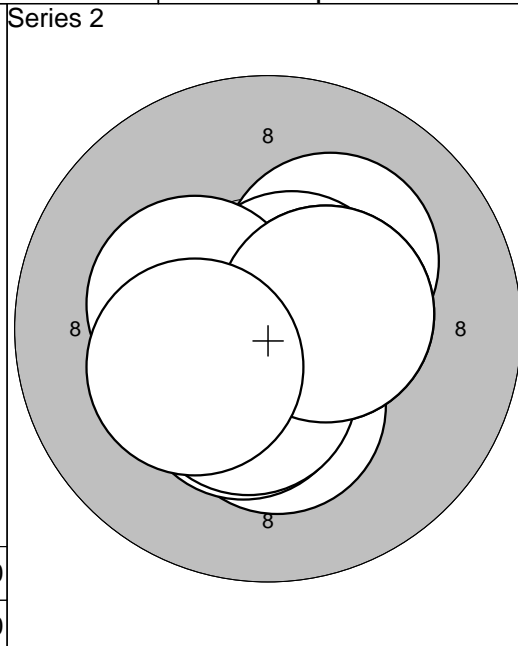

1: 10,2*	↗
2: 10,6*	↘
3: 10,6*	↗
4: 10,3*	↘
5: 10,5*	→
6: 10,3*	↖
7: 10,4*	↘
8: 10,5*	↘
9: 10,5*	→
10: 10,3*	↖
Serie	100,0
Sum	200,0

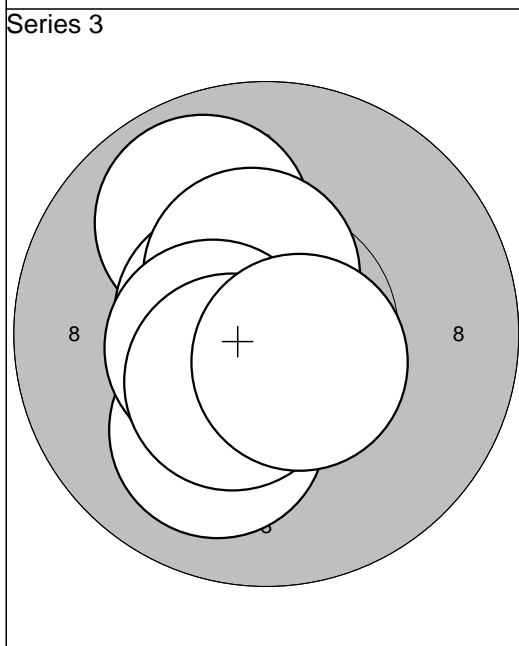

1: 9,9	↗
2: 10,5*	↘
3: 10,9*	→
4: 10,0	↘
5: 10,5*	↖
6: 10,5*	↖
7: 10,5*	↗
8: 10,5*	↖
9: 10,4*	↘
10: 10,6*	↘
Serie	99,0
Sum	299,0

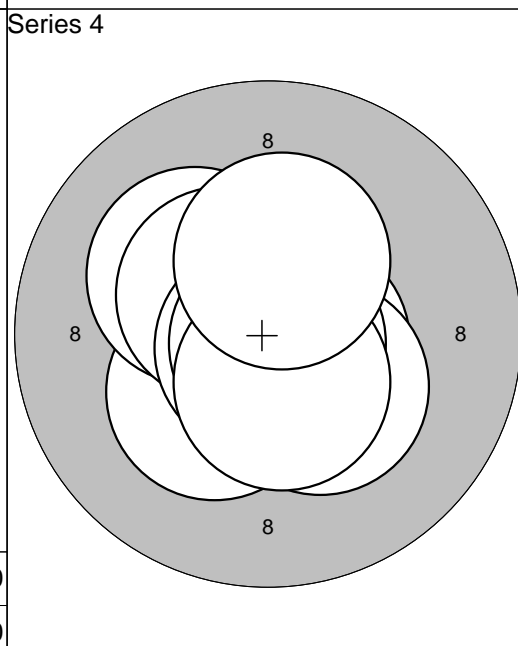

1: 10,7*	→
2: 10,3*	↘
3: 10,8*	↖
4: 10,3*	↘
5: 10,2*	↗
6: 10,5*	↗
7: 10,8*	↘
8: 10,8*	↘
9: 10,5*	↘
10: 10,3*	↗
Serie	100,0
Sum	399,0

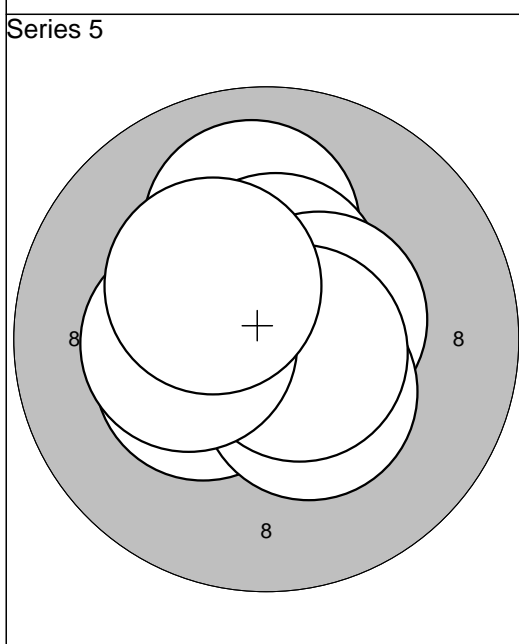

1: 10,0	↑
2: 10,7*	↖
3: 10,4*	↖
4: 10,7*	↑
5: 10,5*	↑
6: 10,5*	→
7: 10,4*	↘
8: 10,7*	→
9: 10,3*	←
10: 10,3*	↗
Serie	100,0
Sum	499,0

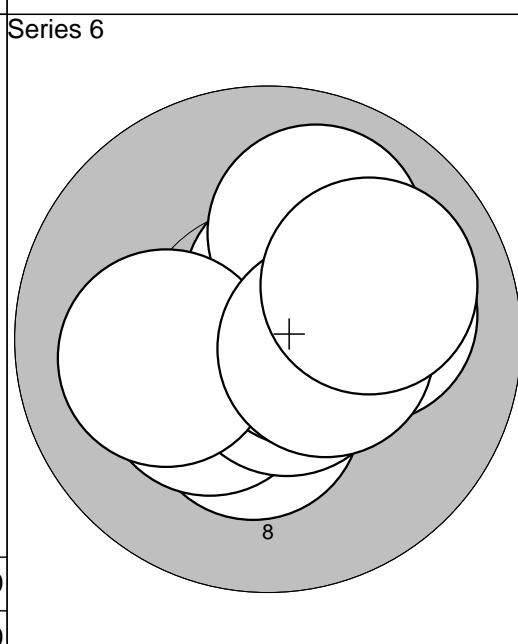

1: 10,1	→
2: 10,3*	↘
3: 10,3*	↖
4: 10,6*	↘
5: 10,6*	→
6: 10,5*	↗
7: 10,0	↗
8: 10,1	←
9: 10,4*	→
10: 10,0	↗
Serie	100,0
Sum	599,0

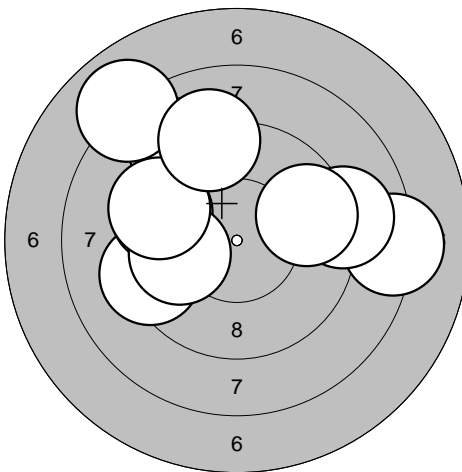
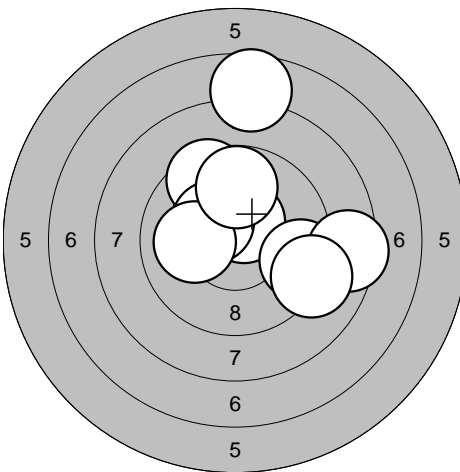
<p>Series 1</p> 	<p>1: 9,3 ←</p> <p>2: 8,2 →</p> <p>3: 9,6 ←</p> <p>4: 9,9 ←</p> <p>5: 9,1 ↗</p> <p>6: 8,0 ↗</p> <p>7: 9,5 ←</p> <p>8: 9,1 ↗</p> <p>9: 9,0 →</p> <p>10: 9,6 →</p> <hr/> <p>Serie 88,0</p> <hr/> <p>Sum 88,0</p>	<p>Series 2</p> 	<p>1: 10,0 ↗</p> <p>2: 10,5* ↗</p> <p>3: 9,5 ↗</p> <p>4: 10,3* ↗</p> <p>5: 10,1 ←</p> <p>6: 9,4 →</p> <p>7: 8,4 →</p> <p>8: 7,7 ↑</p> <p>9: 9,8 ↑</p> <p>10: 9,1 ↘</p> <hr/> <p>Serie 91,0</p> <hr/> <p>Sum 179,0</p>
--	--	--	---

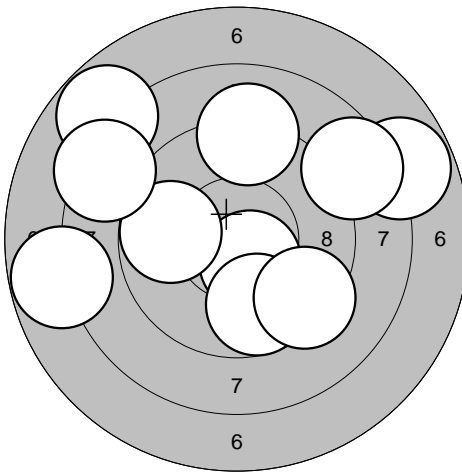
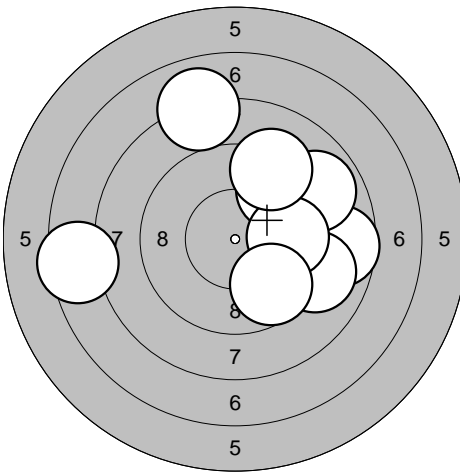
<p>Series 3</p> 	<p>1: 10,5* ↓</p> <p>2: 7,8 ↗</p> <p>3: 7,8 →</p> <p>4: 9,1 ↑</p> <p>5: 8,6 ↗</p> <p>6: 9,8 ←</p> <p>7: 7,8 ←</p> <p>8: 9,7 ↓</p> <p>9: 9,4 ↓</p> <p>10: 8,3 ↗</p> <hr/> <p>Serie 83,0</p> <hr/> <p>Sum 262,0</p>	<p>Series 4</p> 	<p>1: 9,5 ↗</p> <p>2: 9,1 →</p> <p>3: 8,7 →</p> <p>4: 9,1 ↘</p> <p>5: 7,5 ←</p> <p>6: 8,9 ↗</p> <p>7: 9,8 →</p> <p>8: 9,2 ↗</p> <p>9: 9,7 ↓</p> <p>10: 8,0 ↑</p> <hr/> <p>Serie 85,0</p> <hr/> <p>Sum 347,0</p>
---	---	---	---

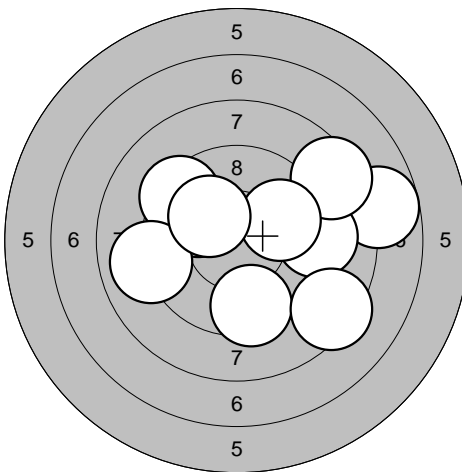
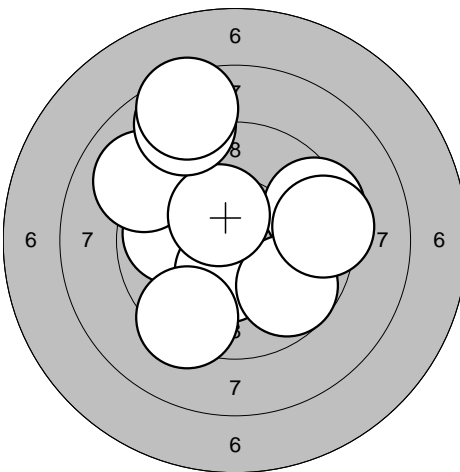
<p>Series 5</p> 	<p>1: 9,5 ↓</p> <p>2: 7,8 →</p> <p>3: 9,2 →</p> <p>4: 9,9 ↗</p> <p>5: 8,4 ↘</p> <p>6: 8,5 ↗</p> <p>7: 9,4 ↗</p> <p>8: 9,9 →</p> <p>9: 9,0 ←</p> <p>10: 10,2* ↗</p> <hr/> <p>Serie 87,0</p> <hr/> <p>Sum 434,0</p>	<p>Series 6</p> 	<p>1: 9,9 ←</p> <p>2: 10,4* ↓</p> <p>3: 9,4 ↓</p> <p>4: 9,4 →</p> <p>5: 9,7 ↘</p> <p>6: 9,0 ↗</p> <p>7: 10,4* ↗</p> <p>8: 9,4 →</p> <p>9: 8,7 ↗</p> <p>10: 8,5 ↑</p> <hr/> <p>Serie 90,0</p> <hr/> <p>Sum 524,0</p>
--	---	--	---

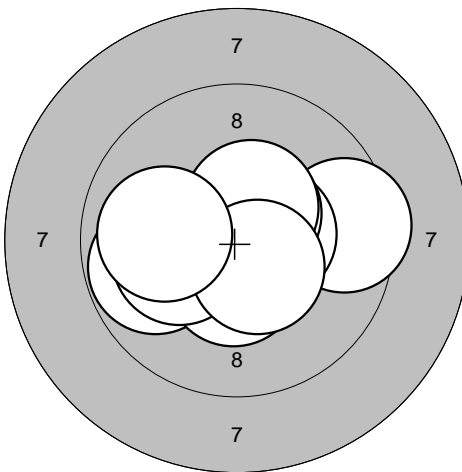
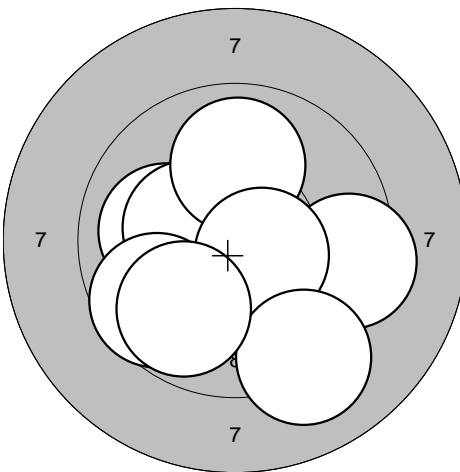
<p>Series 1</p> 	<p>1: 9,5 →</p> <p>2: 10,5* →</p> <p>3: 9,8 ←</p> <p>4: 10,7* ↓</p> <p>5: 10,4* ↓</p> <p>6: 10,5* ↗</p> <p>7: 10,5* ↗</p> <p>8: 10,2* ←</p> <p>9: 10,5* ↓</p> <p>10: 10,0 ←</p>	<p>Series 2</p> 	<p>1: 9,4 →</p> <p>2: 10,0 ←</p> <p>3: 10,4* ←</p> <p>4: 10,3* ↑</p> <p>5: 10,3* ←</p> <p>6: 9,9 ↑</p> <p>7: 10,6* ↘</p> <p>8: 9,6 ←</p> <p>9: 9,1 ↓</p> <p>10: 9,8 ↘</p>
Serie 98,0	Serie 95,0	Serie 95,0	Serie 95,0
Sum 98,0	Sum 98,0	Sum 193,0	Sum 193,0

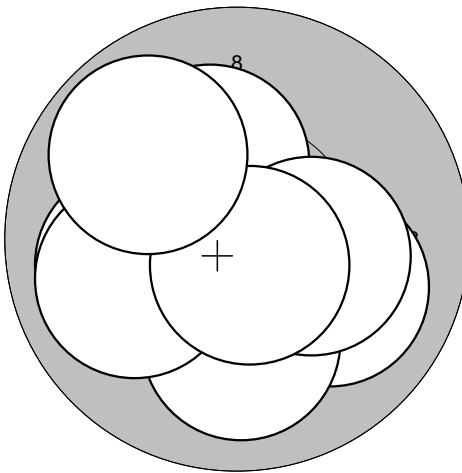
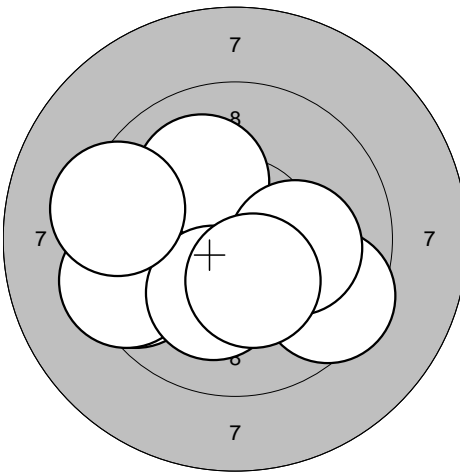
<p>Series 3</p> 	<p>1: 10,0 ←</p> <p>2: 10,0 →</p> <p>3: 10,2* ↑</p> <p>4: 10,4* ↓</p> <p>5: 10,4* ←</p> <p>6: 10,0 ↓</p> <p>7: 10,3* →</p> <p>8: 10,0 ←</p> <p>9: 10,7* ↓</p> <p>10: 9,8 ↗</p>	<p>Series 4</p> 	<p>1: 10,6* ↓</p> <p>2: 9,5 ↘</p> <p>3: 10,4* ←</p> <p>4: 10,1 ↗</p> <p>5: 10,1 →</p> <p>6: 9,5 ←</p> <p>7: 9,4 ←</p> <p>8: 10,2* ↓</p> <p>9: 9,4 ←</p> <p>10: 10,4* ↓</p>
Serie 99,0	Serie 99,0	Serie 96,0	Serie 96,0
Sum 292,0	Sum 292,0	Sum 388,0	Sum 388,0

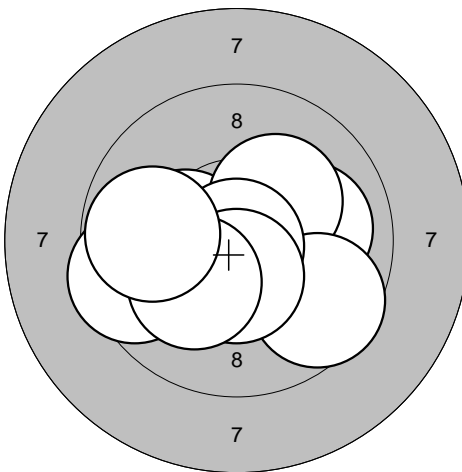
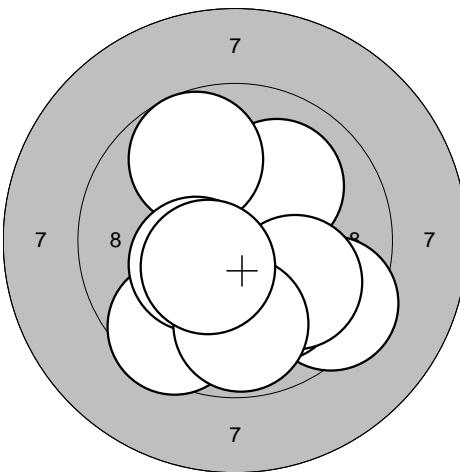
<p>Series 5</p> 	<p>1: 10,3* ←</p> <p>2: 10,0 →</p> <p>3: 10,6* ↓</p> <p>4: 10,2* ↗</p> <p>5: 9,6 ↘</p> <p>6: 9,5 ←</p> <p>7: 10,9* ↓</p> <p>8: 10,5* ↓</p> <p>9: 10,2* ↘</p> <p>10: 9,8 ←</p>	<p>Series 6</p> 	<p>1: 10,1 ↓</p> <p>2: 9,5 ↘</p> <p>3: 9,4 ↘</p> <p>4: 10,1 ↓</p> <p>5: 10,0 ↗</p> <p>6: 9,8 ↗</p> <p>7: 10,4* ←</p> <p>8: 10,0 ↘</p> <p>9: 9,8 ↓</p> <p>10: 10,4* ↘</p>
Serie 97,0	Serie 97,0	Serie 96,0	Serie 96,0
Sum 485,0	Sum 485,0	Sum 581,0	Sum 581,0

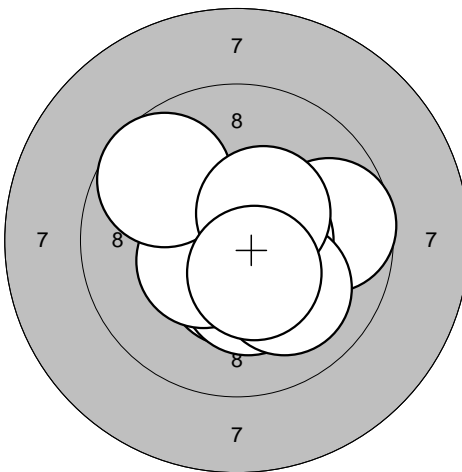
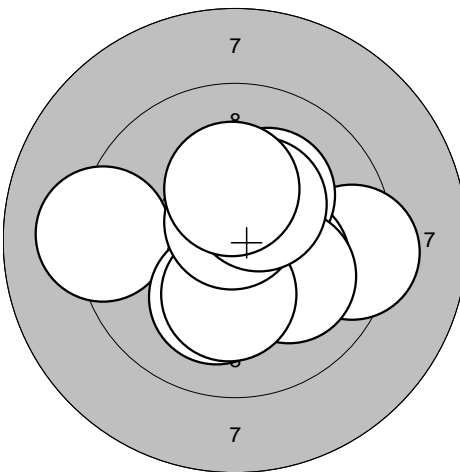
<p>Series 1</p> 	<p>1: 10,4* ↓</p> <p>2: 9,7 →</p> <p>3: 10,3* ↓</p> <p>4: 10,5* →</p> <p>5: 10,4* ←</p> <p>6: 10,5* ↓</p> <p>7: 10,0 ↓</p> <p>8: 9,7 ↗</p> <p>9: 10,4* ↗</p> <p>10: 10,5* ↓</p> <table border="1" style="width:100%; border-collapse: collapse;"> <tr> <td style="width:60%;">Serie</td> <td style="text-align: right;">98,0</td> </tr> <tr> <td>Sum</td> <td style="text-align: right;">98,0</td> </tr> </table>	Serie	98,0	Sum	98,0	<p>Series 2</p> 	<p>1: 9,4 →</p> <p>2: 10,3* →</p> <p>3: 9,2 ←</p> <p>4: 10,2* ↗</p> <p>5: 10,1 ↓</p> <p>6: 10,1 →</p> <p>7: 10,2* ↓</p> <p>8: 10,7* ↑</p> <p>9: 10,4* ↗</p> <p>10: 10,3* ↑</p> <table border="1" style="width:100%; border-collapse: collapse;"> <tr> <td style="width:60%;">Serie</td> <td style="text-align: right;">98,0</td> </tr> <tr> <td>Sum</td> <td style="text-align: right;">196,0</td> </tr> </table>	Serie	98,0	Sum	196,0
Serie	98,0										
Sum	98,0										
Serie	98,0										
Sum	196,0										

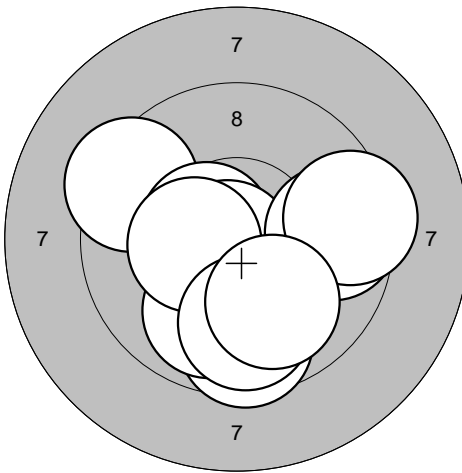
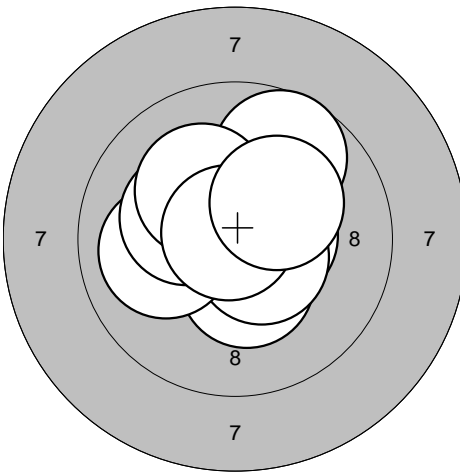
<p>Series 3</p> 	<p>1: 9,6 ↓</p> <p>2: 9,4 ↗</p> <p>3: 10,6* ↗</p> <p>4: 10,8* ↙</p> <p>5: 9,7 →</p> <p>6: 9,9 ↓</p> <p>7: 9,4 →</p> <p>8: 10,4* ←</p> <p>9: 9,8 ↓</p> <p>10: 10,0 ↓</p> <table border="1" style="width:100%; border-collapse: collapse;"> <tr> <td style="width:60%;">Serie</td> <td style="text-align: right;">94,0</td> </tr> <tr> <td>Sum</td> <td style="text-align: right;">290,0</td> </tr> </table>	Serie	94,0	Sum	290,0	<p>Series 4</p> 	<p>1: 10,4* ↓</p> <p>2: 10,5* →</p> <p>3: 9,7 ↗</p> <p>4: 10,7* →</p> <p>5: 10,5* ↙</p> <p>6: 10,0 ←</p> <p>7: 10,2* ←</p> <p>8: 10,2* ↗</p> <p>9: 10,8* ↗</p> <p>10: 10,2* ↗</p> <table border="1" style="width:100%; border-collapse: collapse;"> <tr> <td style="width:60%;">Serie</td> <td style="text-align: right;">99,0</td> </tr> <tr> <td>Sum</td> <td style="text-align: right;">389,0</td> </tr> </table>	Serie	99,0	Sum	389,0
Serie	94,0										
Sum	290,0										
Serie	99,0										
Sum	389,0										

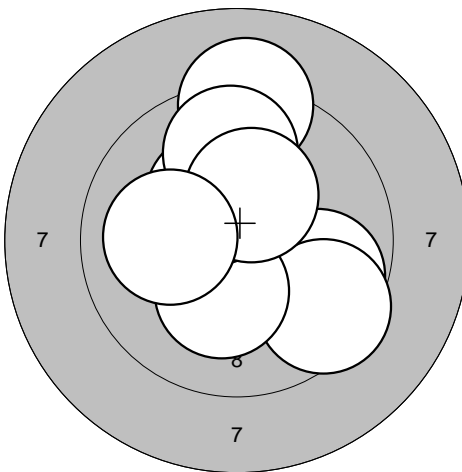
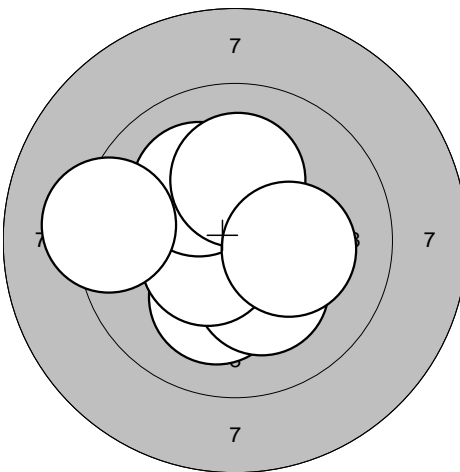
<p>Series 5</p> 	<p>1: 10,5* ↗</p> <p>2: 9,8 →</p> <p>3: 9,1 ↑</p> <p>4: 9,5 ↓</p> <p>5: 10,5* ←</p> <p>6: 10,2* ↓</p> <p>7: 10,3* ↗</p> <p>8: 9,8 ↑</p> <p>9: 10,3* ↗</p> <p>10: 10,1 ←</p> <table border="1" style="width:100%; border-collapse: collapse;"> <tr> <td style="width:60%;">Serie</td> <td style="text-align: right;">96,0</td> </tr> <tr> <td>Sum</td> <td style="text-align: right;">485,0</td> </tr> </table>	Serie	96,0	Sum	485,0	<p>Series 6</p> 	<p>1: 10,2* ↓</p> <p>2: 10,5* →</p> <p>3: 10,3* ↗</p> <p>4: 10,3* ↗</p> <p>5: 10,2* ↓</p> <p>6: 10,5* ←</p> <p>7: 10,1 ↗</p> <p>8: 10,2* ↑</p> <p>9: 10,2* →</p> <p>10: 9,2 ←</p> <table border="1" style="width:100%; border-collapse: collapse;"> <tr> <td style="width:60%;">Serie</td> <td style="text-align: right;">99,0</td> </tr> <tr> <td>Sum</td> <td style="text-align: right;">584,0</td> </tr> </table>	Serie	99,0	Sum	584,0
Serie	96,0										
Sum	485,0										
Serie	99,0										
Sum	584,0										

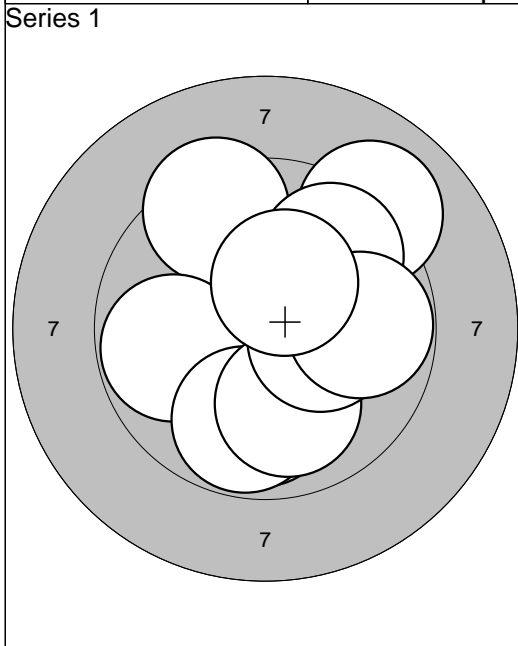

1: 9,9	↓
2: 9,4	↖
3: 9,0	↗
4: 9,8	←
5: 9,8	↗
6: 9,8	↓
7: 10,0	↓
8: 10,3*	→
9: 9,8	→
10: 10,4*	↗
Serie 93,0	
Sum 93,0	

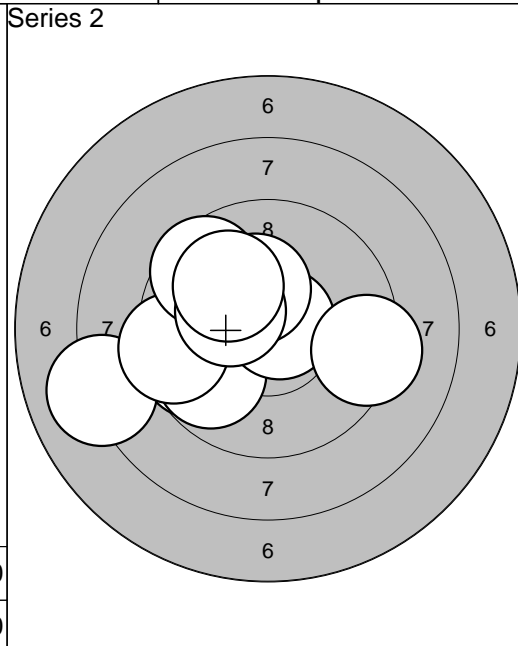

1: 9,7	↖
2: 9,8	↖
3: 10,7*	↗
4: 10,3*	↗
5: 8,1	←
6: 9,4	←
7: 9,6	↗
8: 9,3	→
9: 10,3*	↖
10: 10,0	↖
Serie 93,0	
Sum 186,0	

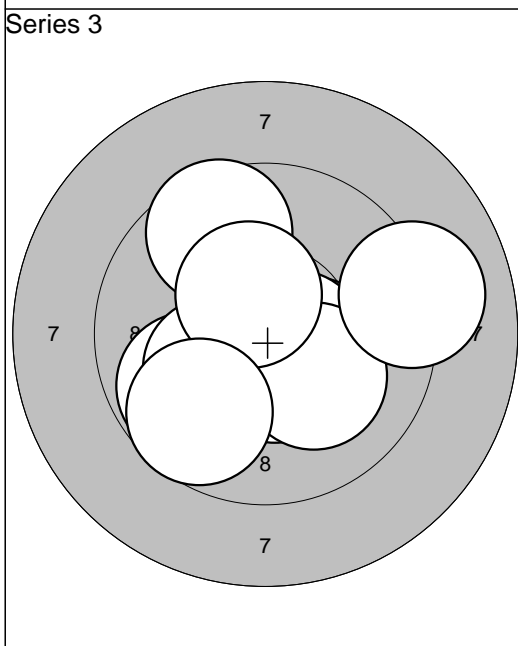

1: 10,4*	→
2: 9,8	↖
3: 9,6	↗
4: 10,6*	→
5: 10,2*	↖
6: 10,5*	↓
7: 10,2*	↘
8: 10,4*	↗
9: 9,1	→
10: 9,7	↘
Serie 96,0	
Sum 282,0	

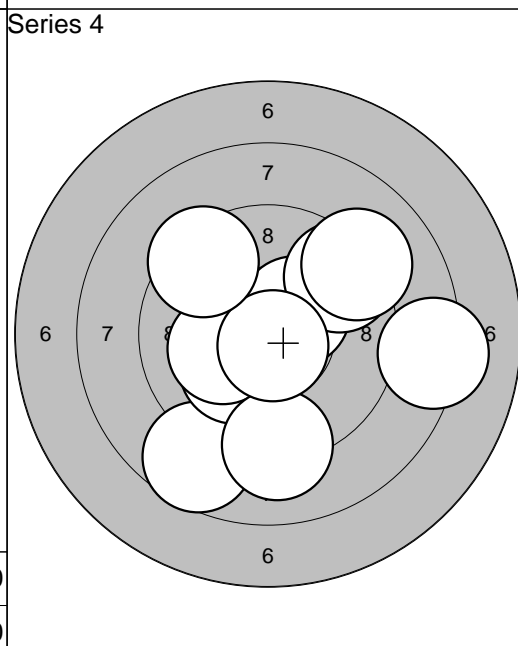

1: 10,4*	↗
2: 9,5	↗
3: 8,7	↘
4: 10,2*	↖
5: 10,2*	←
6: 9,2	↓
7: 8,3	→
8: 9,1	↗
9: 10,7*	↘
10: 9,4	↖
Serie 92,0	
Sum 374,0	

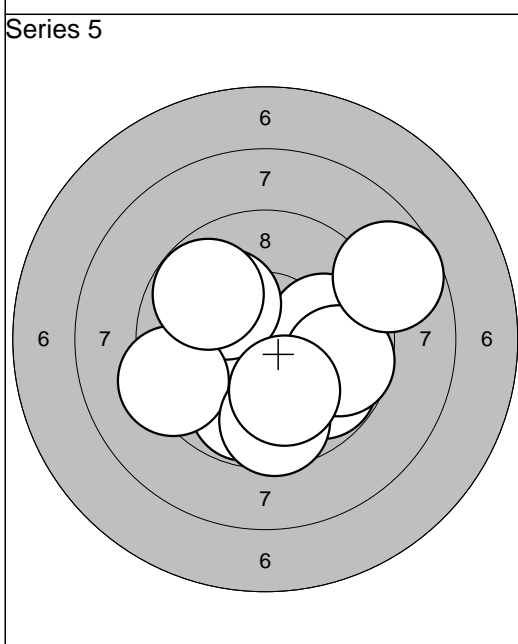

1: 10,0	→
2: 9,8	↘
3: 9,7	→
4: 9,8	↓
5: 10,1	↗
6: 9,3	↖
7: 9,6	↓
8: 10,1	↓
9: 8,7	↗
10: 9,8	↖
Serie 92,0	
Sum 466,0	

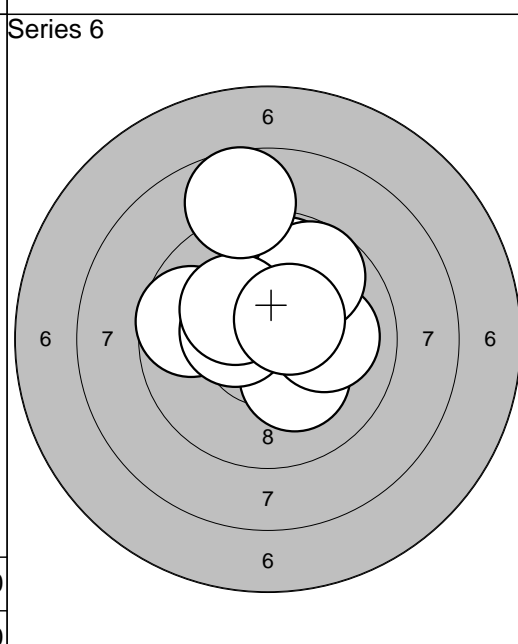

1: 9,8	↗
2: 10,1	↗
3: 10,2*	↘
4: 9,7	←
5: 10,0	→
6: 10,4*	←
7: 9,8	↗
8: 10,2*	↖
9: 8,7	↗
10: 10,5*	↗
Serie 95,0	
Sum 561,0	

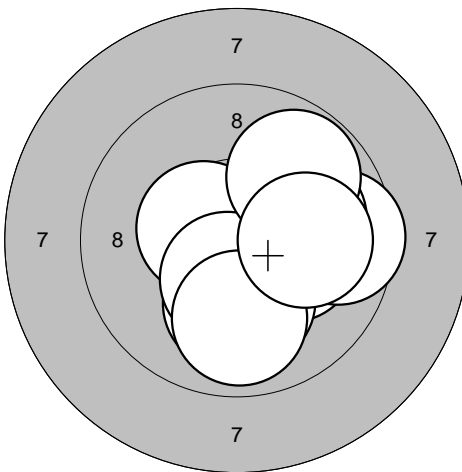
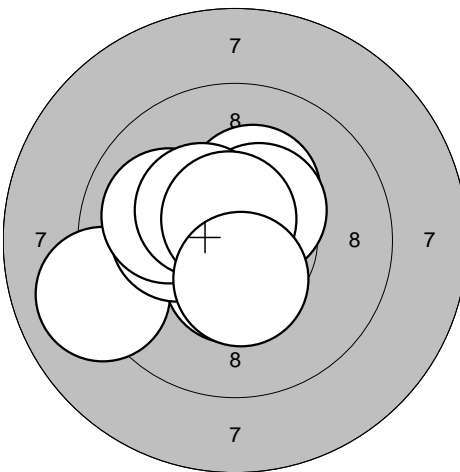
<p>Series 1</p> 	<p>1: 10,2* →</p> <p>2: 9,6 →</p> <p>3: 10,1 →</p> <p>4: 10,1 ↓</p> <p>5: 10,1 ↓</p> <p>6: 10,5* ←</p> <p>7: 10,4* ↓</p> <p>8: 9,8 ↗</p> <p>9: 9,9 ↓</p> <p>10: 10,0 →</p>	<p>Series 2</p> 	<p>1: 10,3* ↑</p> <p>2: 10,2* ←</p> <p>3: 9,0 ←</p> <p>4: 10,5* ↗</p> <p>5: 10,5* ↓</p> <p>6: 10,2* ←</p> <p>7: 10,0 ←</p> <p>8: 10,4* ↖</p> <p>9: 10,7* ↑</p> <p>10: 10,4* ↓</p>
Serie 97,0	Serie 99,0	Serie 99,0	Serie 99,0
Sum 97,0	Sum 196,0	Sum 196,0	Sum 196,0

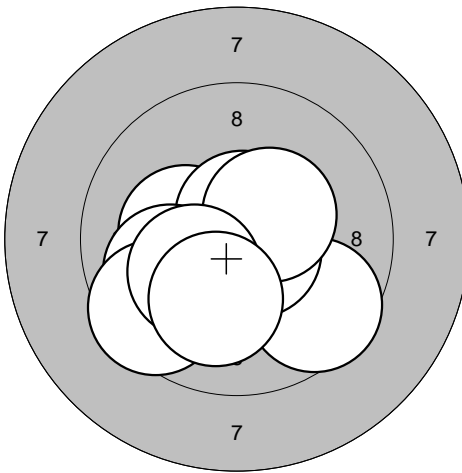
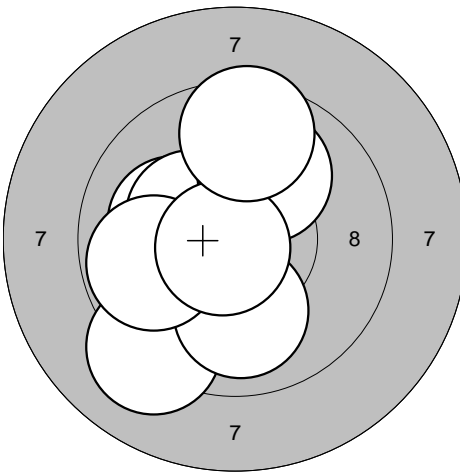
<p>Series 3</p> 	<p>1: 10,3* ←</p> <p>2: 10,6* ↗</p> <p>3: 10,7* ↑</p> <p>4: 9,6 ↓</p> <p>5: 10,7* →</p> <p>6: 10,0 ←</p> <p>7: 9,5 ←</p> <p>8: 10,4* ↗</p> <p>9: 10,2* ←</p> <p>10: 10,1 ↓</p>	<p>Series 4</p> 	<p>1: 10,6* ↖</p> <p>2: 10,1 ←</p> <p>3: 10,0 ←</p> <p>4: 10,3* ↖</p> <p>5: 9,1 ↓</p> <p>6: 10,0 ↑</p> <p>7: 10,0 ↓</p> <p>8: 9,8 ←</p> <p>9: 10,7* ↖</p> <p>10: 9,5 ↑</p>
Serie 98,0	Serie 97,0	Serie 97,0	Serie 97,0
Sum 294,0	Sum 391,0	Sum 391,0	Sum 391,0

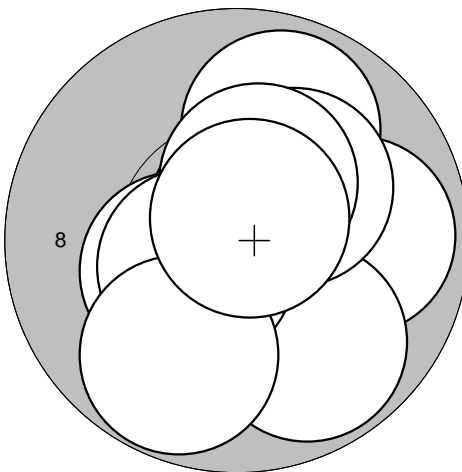
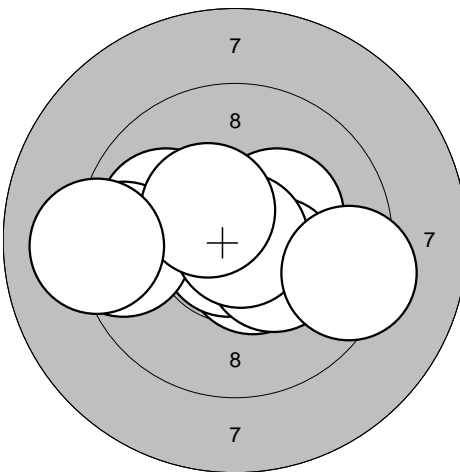
<p>Series 5</p> 	<p>1: 10,4* ↖</p> <p>2: 9,9 →</p> <p>3: 9,8 ↓</p> <p>4: 10,7* ↑</p> <p>5: 9,9 ↑</p> <p>6: 10,5* ←</p> <p>7: 10,2* ↗</p> <p>8: 9,8 ↓</p> <p>9: 10,4* ↑</p> <p>10: 10,7* ↗</p>	<p>Series 6</p> 	<p>1: 10,3* ↗</p> <p>2: 10,5* ↓</p> <p>3: 10,0 ←</p> <p>4: 10,8* ↘</p> <p>5: 10,3* ↘</p> <p>6: 9,5 ←</p> <p>7: 10,9* →</p> <p>8: 10,4* ↗</p> <p>9: 9,1 ←</p> <p>10: 9,4 →</p>
Serie 96,0	Serie 97,0	Serie 97,0	Serie 97,0
Sum 487,0	Sum 584,0	Sum 584,0	Sum 584,0

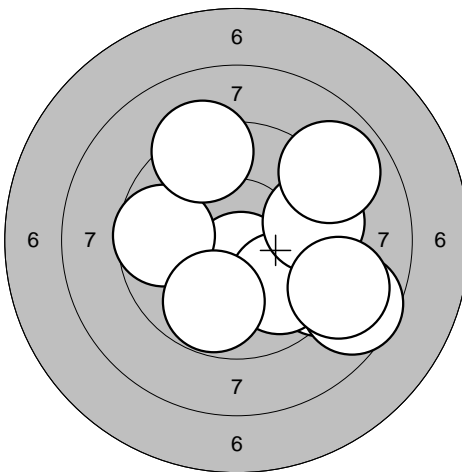
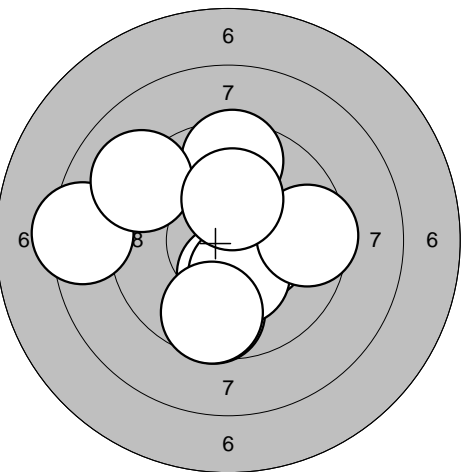
<p>Series 1</p> 	<p>1: 9,3 ↘ 2: 10,5* ↓ 3: 8,6 → 4: 9,9 ↘ 5: 9,5 → 6: 9,7 ← 7: 9,0 → 8: 8,9 ↗ 9: 9,3 ↑ 10: 9,8 ↓</p> <table border="1" style="width:100%; border-collapse: collapse;"> <tr><td>Serie</td><td style="text-align: right;">89,0</td></tr> <tr><td>Sum</td><td style="text-align: right;">89,0</td></tr> </table>	Serie	89,0	Sum	89,0	<p>Series 2</p> 	<p>1: 9,6 ↓ 2: 9,6 ↑ 3: 10,4* → 4: 10,3* ↓ 5: 10,3* ↓ 6: 8,4 ← 7: 9,6 → 8: 9,6 ↓ 9: 9,1 ↖ 10: 10,2* ↑</p> <table border="1" style="width:100%; border-collapse: collapse;"> <tr><td>Serie</td><td style="text-align: right;">93,0</td></tr> <tr><td>Sum</td><td style="text-align: right;">182,0</td></tr> </table>	Serie	93,0	Sum	182,0
Serie	89,0										
Sum	89,0										
Serie	93,0										
Sum	182,0										

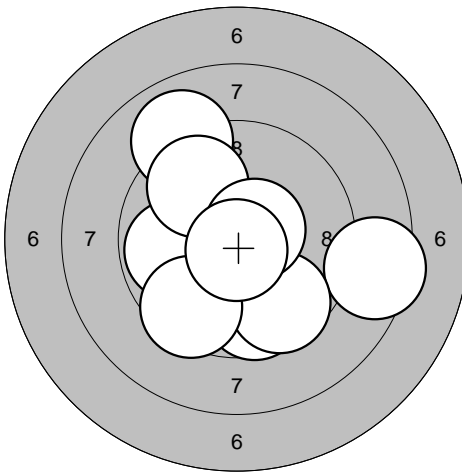
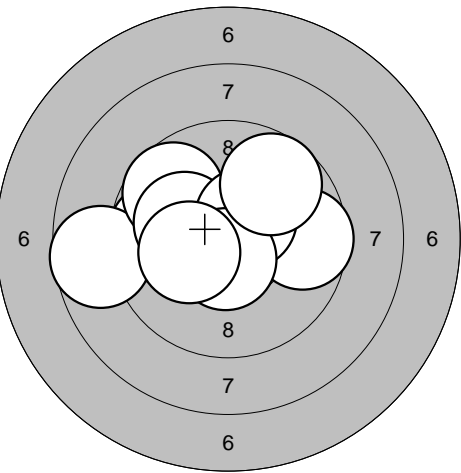
<p>Series 3</p> 	<p>1: 8,5 → 2: 10,9* ↗ 3: 9,9 ← 4: 9,7 ↓ 5: 9,6 ↓ 6: 9,5 ↓ 7: 9,0 ↗ 8: 9,8 ↗ 9: 10,6* ↗ 10: 10,7* ↓</p> <table border="1" style="width:100%; border-collapse: collapse;"> <tr><td>Serie</td><td style="text-align: right;">92,0</td></tr> <tr><td>Sum</td><td style="text-align: right;">274,0</td></tr> </table>	Serie	92,0	Sum	274,0	<p>Series 4</p> 	<p>1: 9,8 ← 2: 10,2* ← 3: 8,7 ← 4: 9,6 → 5: 9,7 ↖ 6: 10,1 ← 7: 10,5* ↗ 8: 10,6* ↓ 9: 10,2* ← 10: 9,7 ↗</p> <table border="1" style="width:100%; border-collapse: collapse;"> <tr><td>Serie</td><td style="text-align: right;">94,0</td></tr> <tr><td>Sum</td><td style="text-align: right;">368,0</td></tr> </table>	Serie	94,0	Sum	368,0
Serie	92,0										
Sum	274,0										
Serie	94,0										
Sum	368,0										

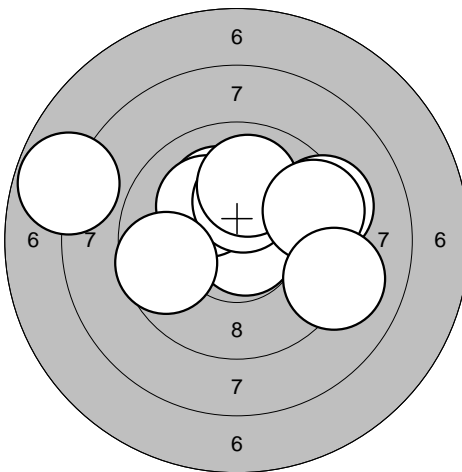
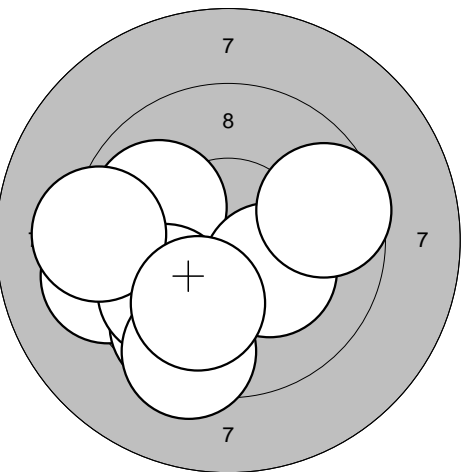
<p>Series 5</p> 	<p>1: 7,8 ← 2: 9,3 → 3: 10,1 ↑ 4: 10,8* → 5: 10,2* ↗ 6: 10,3* ↑ 7: 10,0 ↑ 8: 9,7 ← 9: 9,5 → 10: 9,1 →</p> <table border="1" style="width:100%; border-collapse: collapse;"> <tr><td>Serie</td><td style="text-align: right;">93,0</td></tr> <tr><td>Sum</td><td style="text-align: right;">461,0</td></tr> </table>	Serie	93,0	Sum	461,0	<p>Series 6</p> 	<p>1: 9,3 ← 2: 10,0 ↓ 3: 9,6 ↓ 4: 9,9 ← 5: 10,3* ↘ 6: 9,6 → 7: 9,9 ← 8: 9,2 ← 9: 9,4 ↓ 10: 10,0 ↓</p> <table border="1" style="width:100%; border-collapse: collapse;"> <tr><td>Serie</td><td style="text-align: right;">93,0</td></tr> <tr><td>Sum</td><td style="text-align: right;">554,0</td></tr> </table>	Serie	93,0	Sum	554,0
Serie	93,0										
Sum	461,0										
Serie	93,0										
Sum	554,0										

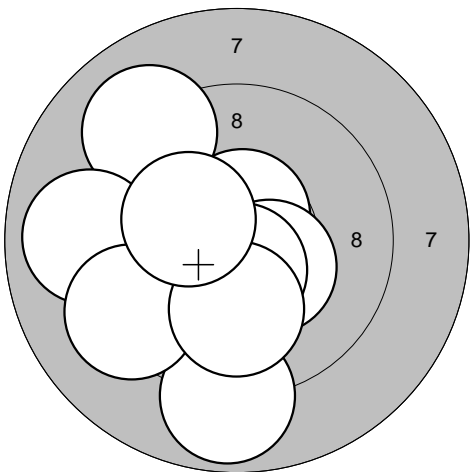
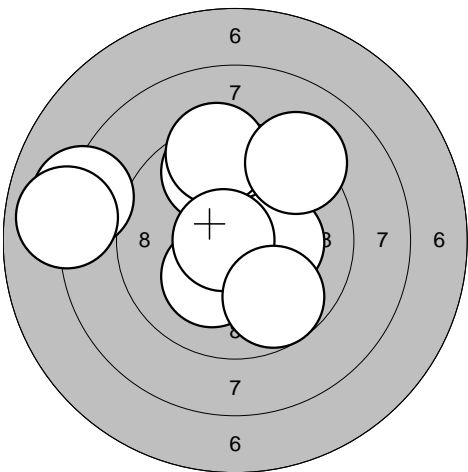
<p>Series 1</p> 	<p>1: 9,1 ↖</p> <p>2: 10,6* ↑</p> <p>3: 10,4* ↘</p> <p>4: 9,0 ←</p> <p>5: 10,1 ↙</p> <p>6: 8,9 ↓</p> <p>7: 10,6* ↓</p> <p>8: 9,2 ↙</p> <p>9: 10,0 ↓</p> <p>10: 10,3* ↖</p>	<p>Series 2</p> 	<p>1: 9,7 ↑</p> <p>2: 10,3* →</p> <p>3: 9,4 ↑</p> <p>4: 8,2 ←</p> <p>5: 9,2 ↗</p> <p>6: 8,0 ←</p> <p>7: 10,4* ↓</p> <p>8: 10,2* ↙</p> <p>9: 10,7* ←</p> <p>10: 9,7 ↓</p>
Serie 95,0	Serie 92,0	Serie 92,0	Serie 92,0
Sum 95,0	Sum 95,0	Sum 187,0	Sum 187,0

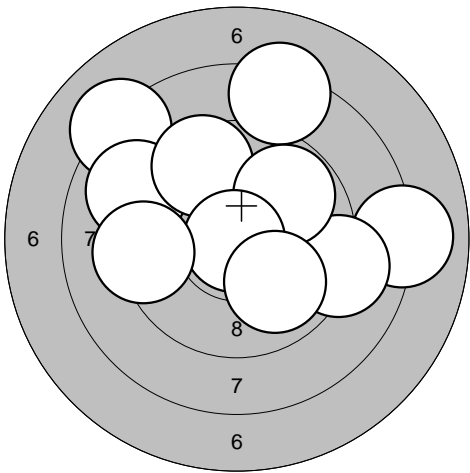
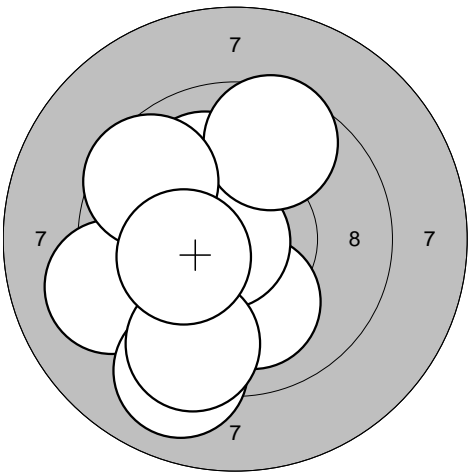
<p>Series 3</p> 	<p>1: 8,1 ↖</p> <p>2: 8,0 →</p> <p>3: 9,0 ↖</p> <p>4: 9,5 ↗</p> <p>5: 9,1 →</p> <p>6: 8,3 ↗</p> <p>7: 9,8 ↗</p> <p>8: 10,9* ↙</p> <p>9: 9,3 ←</p> <p>10: 9,9 ↓</p>	<p>Series 4</p> 	<p>1: 10,1 ←</p> <p>2: 9,2 ←</p> <p>3: 9,1 ↓</p> <p>4: 10,1 ↗</p> <p>5: 10,1 ↓</p> <p>6: 10,8* ←</p> <p>7: 9,5 ↓</p> <p>8: 9,6 ↗</p> <p>9: 9,6 ↖</p> <p>10: 10,2* ←</p>
Serie 88,0	Serie 88,0	Serie 95,0	Serie 95,0
Sum 275,0	Sum 275,0	Sum 370,0	Sum 370,0

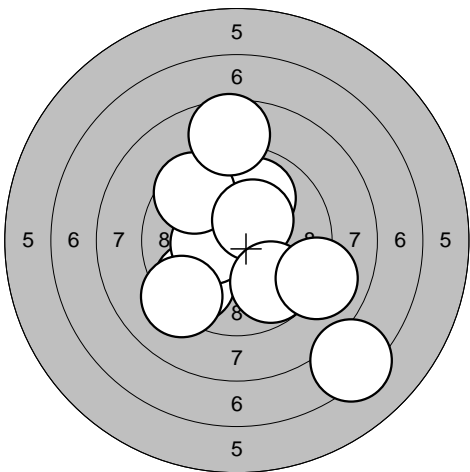
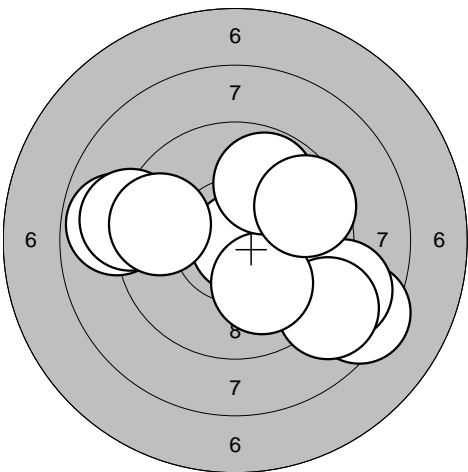
<p>Series 5</p> 	<p>1: 9,7 ↙</p> <p>2: 9,9 ↑</p> <p>3: 10,4* ←</p> <p>4: 9,6 ↗</p> <p>5: 10,4* ↗</p> <p>6: 7,3 ↓</p> <p>7: 8,6 ↑</p> <p>8: 9,7 ↓</p> <p>9: 9,2 ↙</p> <p>10: 9,0 →</p>	<p>Series 6</p> 	<p>1: 8,9 ←</p> <p>2: 8,4 ↘</p> <p>3: 9,1 ←</p> <p>4: 10,8* →</p> <p>5: 8,9 ↘</p> <p>6: 8,9 ↘</p> <p>7: 9,6 ←</p> <p>8: 10,1 ↓</p> <p>9: 9,8 ↗</p> <p>10: 9,6 →</p>
Serie 89,0	Serie 89,0	Serie 88,0	Serie 88,0
Sum 459,0	Sum 459,0	Sum 547,0	Sum 547,0

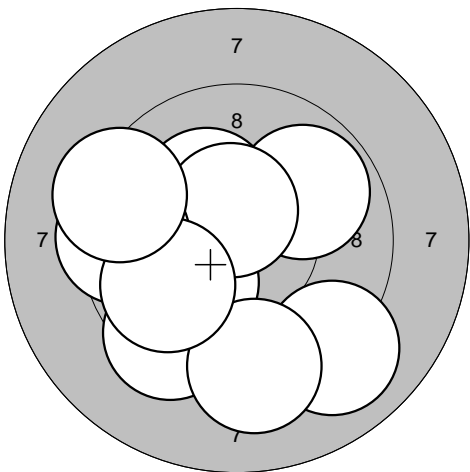
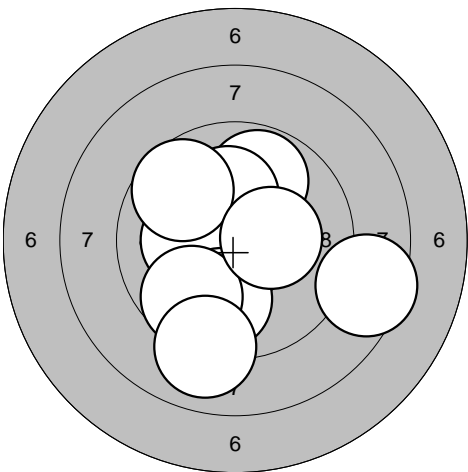
<p>Series 1</p> 	<p>1: 9,0 ↘ 2: 9,9 ↗ 3: 9,4 ↘ 4: 10,1 ↘ 5: 10,2* ↗ 6: 10,5* ↗ 7: 9,3 ↘ 8: 9,4 ← 9: 9,9 ↘ 10: 9,3 ↖</p> <table border="1" style="width:100%; border-collapse: collapse;"> <tr><td>Serie</td><td style="text-align: right;">93,0</td></tr> <tr><td>Sum</td><td style="text-align: right;">93,0</td></tr> </table>	Serie	93,0	Sum	93,0	<p>Series 2</p> 	<p>1: 9,8 ↗ 2: 10,4* ↖ 3: 10,2* ↗ 4: 10,2* ↖ 5: 9,7 ↘ 6: 9,9 ↘ 7: 9,7 ↘ 8: 9,0 ↘ 9: 10,3* → 10: 8,5 →</p> <table border="1" style="width:100%; border-collapse: collapse;"> <tr><td>Serie</td><td style="text-align: right;">93,0</td></tr> <tr><td>Sum</td><td style="text-align: right;">186,0</td></tr> </table>	Serie	93,0	Sum	186,0
Serie	93,0										
Sum	93,0										
Serie	93,0										
Sum	186,0										

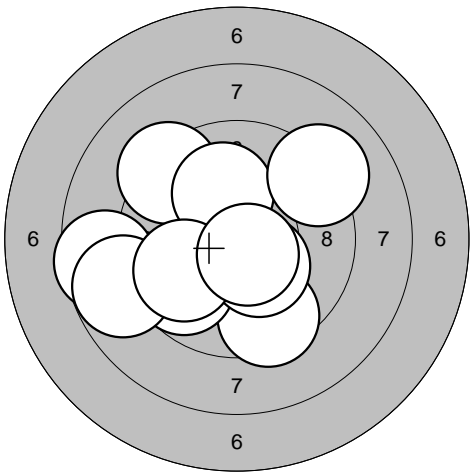
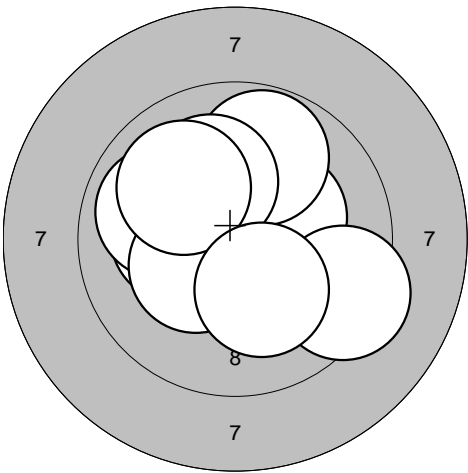
<p>Series 3</p> 	<p>1: 8,6 ← 2: 9,3 ↗ 3: 9,5 ↘ 4: 10,1 ↗ 5: 9,7 ↘ 6: 10,3* ↘ 7: 8,8 ← 8: 9,1 ↗ 9: 9,9 ← 10: 10,6* ↘</p> <table border="1" style="width:100%; border-collapse: collapse;"> <tr><td>Serie</td><td style="text-align: right;">91,0</td></tr> <tr><td>Sum</td><td style="text-align: right;">277,0</td></tr> </table>	Serie	91,0	Sum	277,0	<p>Series 4</p> 	<p>1: 10,4* ↗ 2: 10,2* ← 3: 10,3* → 4: 9,3 ↘ 5: 9,9 ↖ 6: 9,8 ↗ 7: 10,3* ↖ 8: 10,1 ↗ 9: 10,0 ↗ 10: 10,2* ↘</p> <table border="1" style="width:100%; border-collapse: collapse;"> <tr><td>Serie</td><td style="text-align: right;">97,0</td></tr> <tr><td>Sum</td><td style="text-align: right;">374,0</td></tr> </table>	Serie	97,0	Sum	374,0
Serie	91,0										
Sum	277,0										
Serie	97,0										
Sum	374,0										

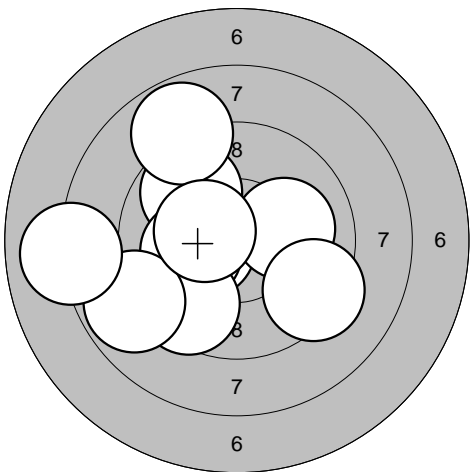
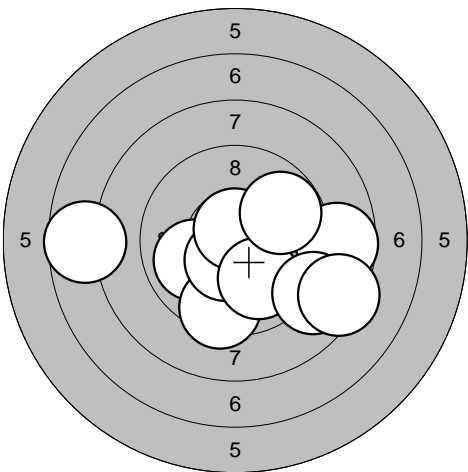
<p>Series 5</p> 	<p>1: 9,8 ↗ 2: 10,4* ← 3: 10,1 ← 4: 9,5 ↘ 5: 8,9 ↖ 6: 8,8 ↗ 7: 10,1 → 8: 10,4* ← 9: 9,3 ↘ 10: 8,0 ←</p> <table border="1" style="width:100%; border-collapse: collapse;"> <tr><td>Serie</td><td style="text-align: right;">91,0</td></tr> <tr><td>Sum</td><td style="text-align: right;">465,0</td></tr> </table>	Serie	91,0	Sum	465,0	<p>Series 6</p> 	<p>1: 7,7 ← 2: 10,0 ↖ 3: 9,4 ↘ 4: 10,5* ↘ 5: 10,7* ↗ 6: 10,0 ↘ 7: 8,7 → 8: 9,8 ↗ 9: 8,9 ↘ 10: 8,4 ↘</p> <table border="1" style="width:100%; border-collapse: collapse;"> <tr><td>Serie</td><td style="text-align: right;">89,0</td></tr> <tr><td>Sum</td><td style="text-align: right;">554,0</td></tr> </table>	Serie	89,0	Sum	554,0
Serie	91,0										
Sum	465,0										
Serie	89,0										
Sum	554,0										

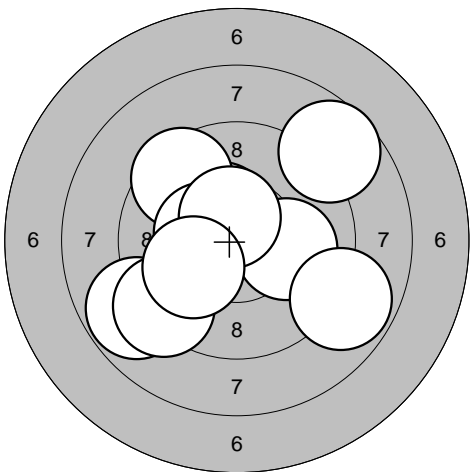
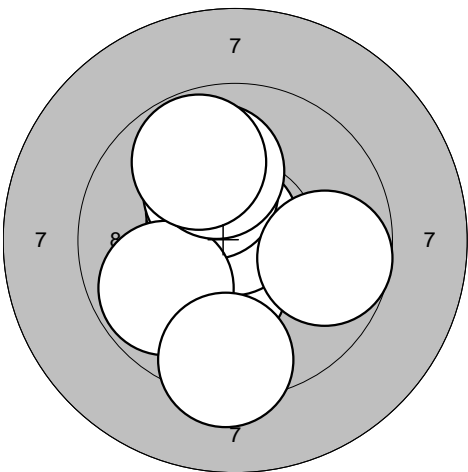
<p>Series 1</p> 	<p>1: 10,4* ↗</p> <p>2: 8,7 ↗</p> <p>3: 9,5 ↗</p> <p>4: 10,4* ←</p> <p>5: 10,1 →</p> <p>6: 8,8 ↘</p> <p>7: 10,5* ↗</p> <p>8: 8,8 ↙</p> <p>9: 9,2 ↙</p> <p>10: 10,0 ↙</p>	<p>Series 2</p> 	<p>1: 10,6* ↖</p> <p>2: 10,5* ↗</p> <p>3: 10,3* ↘</p> <p>4: 10,8* ↗</p> <p>5: 10,2* ↗</p> <p>6: 9,7 →</p> <p>7: 9,8 ↖</p> <p>8: 10,0 ↗</p> <p>9: 9,3 ↘</p> <p>10: 9,8 ↗</p>
Serie 92,0		Serie 96,0	
Sum 92,0		Sum 188,0	

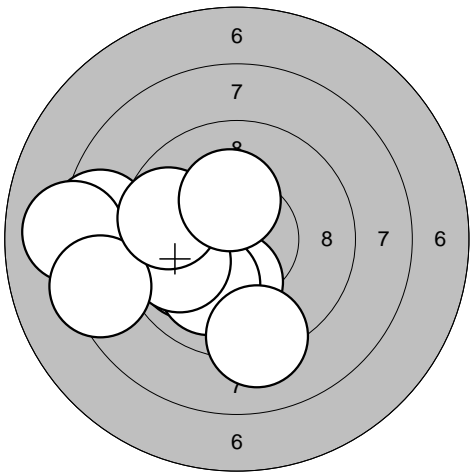
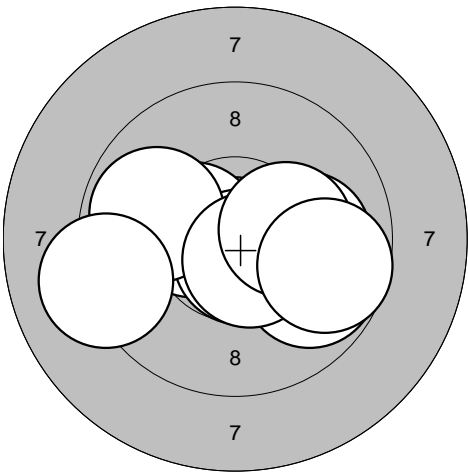
<p>Series 3</p> 	<p>1: 10,2* ↘</p> <p>2: 8,5 ←</p> <p>3: 10,0 ↙</p> <p>4: 8,1 ←</p> <p>5: 10,0 ↘</p> <p>6: 9,9 ←</p> <p>7: 8,4 ←</p> <p>8: 9,2 ↘</p> <p>9: 9,7 ←</p> <p>10: 10,2* ↗</p>	<p>Series 4</p> 	<p>1: 10,9* ↘</p> <p>2: 10,0 →</p> <p>3: 9,8 ↘</p> <p>4: 10,4* ←</p> <p>5: 10,7* ↘</p> <p>6: 9,9 ←</p> <p>7: 10,6* ↘</p> <p>8: 10,2* →</p> <p>9: 9,1 ←</p> <p>10: 9,7 →</p>
Serie 91,0		Serie 96,0	
Sum 279,0		Sum 375,0	

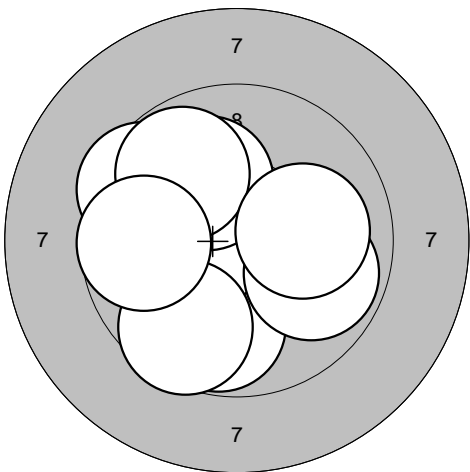
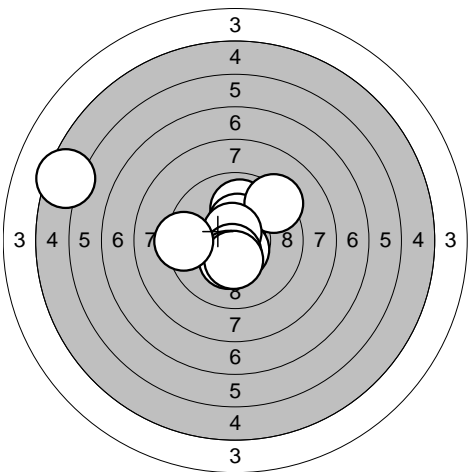
<p>Series 5</p> 	<p>1: 9,8 ↘</p> <p>2: 10,7* ↗</p> <p>3: 10,5* ←</p> <p>4: 9,5 ↗</p> <p>5: 9,6 ↘</p> <p>6: 10,1 ↗</p> <p>7: 9,9 ↘</p> <p>8: 9,8 ↗</p> <p>9: 9,7 ←</p> <p>10: 10,1 →</p>	<p>Series 6</p> 	<p>1: 10,0 ↗</p> <p>2: 10,4* ↗</p> <p>3: 5,5 ↖</p> <p>4: 9,3 ↗</p> <p>5: 10,6* ↘</p> <p>6: 10,7* ↗</p> <p>7: 10,5* ↘</p> <p>8: 10,3* ↘</p> <p>9: 10,4* ↘</p> <p>10: 9,4 ←</p>
Serie 94,0		Serie 93,0	
Sum 469,0		Sum 562,0	

<p>Series 1</p>	<p>1: 10,3* ↗ 2: 10,2* ↗ 3: 10,4* ← 4: 10,1 ← 5: 10,4* ↗ 6: 10,7* ↑ 7: 10,3* ↑ 8: 10,7* ↗ 9: 10,2* ↑ 10: 10,6* ←</p> <table border="1" style="width:100%; border-collapse: collapse;"> <tr> <td style="text-align: right;">Serie</td> <td style="text-align: right;">100,0</td> </tr> <tr> <td style="text-align: right;">Sum</td> <td style="text-align: right;">100,0</td> </tr> </table>	Serie	100,0	Sum	100,0	<p>Series 2</p>	<p>1: 10,4* ← 2: 10,5* ← 3: 10,5* → 4: 10,4* ↗ 5: 9,8 ↗ 6: 10,4* ↗ 7: 10,7* ↓ 8: 10,6* ← 9: 10,4* → 10: 10,7* ↑</p> <table border="1" style="width:100%; border-collapse: collapse;"> <tr> <td style="text-align: right;">Serie</td> <td style="text-align: right;">99,0</td> </tr> <tr> <td style="text-align: right;">Sum</td> <td style="text-align: right;">199,0</td> </tr> </table>	Serie	99,0	Sum	199,0
Serie	100,0										
Sum	100,0										
Serie	99,0										
Sum	199,0										

<p>Series 3</p>	<p>1: 10,6* ↗ 2: 10,0 ↗ 3: 10,2* ↗ 4: 10,7* ↓ 5: 9,7 ↑ 6: 10,3* → 7: 10,4* ↗ 8: 10,5* ↗ 9: 10,4* ↑ 10: 9,7 →</p> <table border="1" style="width:100%; border-collapse: collapse;"> <tr> <td style="text-align: right;">Serie</td> <td style="text-align: right;">98,0</td> </tr> <tr> <td style="text-align: right;">Sum</td> <td style="text-align: right;">297,0</td> </tr> </table>	Serie	98,0	Sum	297,0	<p>Series 4</p>	<p>1: 10,7* ↓ 2: 9,3 ↑ 3: 10,3* ↘ 4: 9,8 ↑ 5: 9,7 ↓ 6: 9,7 ↗ 7: 10,0 ↓ 8: 10,2* ↗ 9: 9,7 ↑ 10: 10,4* →</p> <table border="1" style="width:100%; border-collapse: collapse;"> <tr> <td style="text-align: right;">Serie</td> <td style="text-align: right;">95,0</td> </tr> <tr> <td style="text-align: right;">Sum</td> <td style="text-align: right;">392,0</td> </tr> </table>	Serie	95,0	Sum	392,0
Serie	98,0										
Sum	297,0										
Serie	95,0										
Sum	392,0										

<p>Series 5</p>	<p>1: 9,4 ↘ 2: 9,9 → 3: 9,5 ← 4: 9,9 ↓ 5: 10,6* ↘ 6: 10,5* ↗ 7: 10,3* ↑ 8: 9,6 → 9: 9,4 ↗ 10: 10,5* ↓</p> <table border="1" style="width:100%; border-collapse: collapse;"> <tr> <td style="text-align: right;">Serie</td> <td style="text-align: right;">94,0</td> </tr> <tr> <td style="text-align: right;">Sum</td> <td style="text-align: right;">486,0</td> </tr> </table>	Serie	94,0	Sum	486,0	<p>Series 6</p>	<p>1: 10,1 ← 2: 10,5* ← 3: 9,8 ↓ 4: 10,4* ↗ 5: 9,9 ← 6: 9,5 ↓ 7: 9,8 ↗ 8: 9,9 → 9: 10,5* ← 10: 10,7* ↑</p> <table border="1" style="width:100%; border-collapse: collapse;"> <tr> <td style="text-align: right;">Serie</td> <td style="text-align: right;">95,0</td> </tr> <tr> <td style="text-align: right;">Sum</td> <td style="text-align: right;">581,0</td> </tr> </table>	Serie	95,0	Sum	581,0
Serie	94,0										
Sum	486,0										
Serie	95,0										
Sum	581,0										

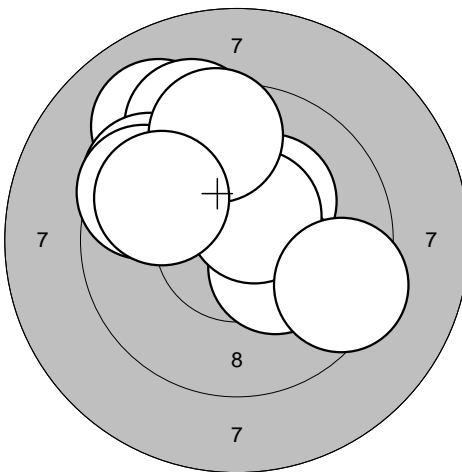
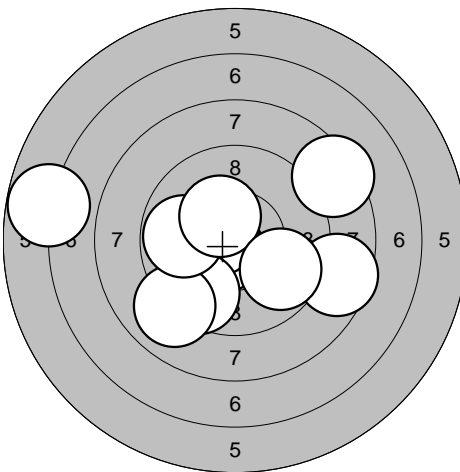
<p>Series 1</p> 	<p>1: 9,1 ↗ 2: 9,3 ↗ 3: 10,3* ↗ 4: 10,3* ↘ 5: 10,6* ↗ 6: 9,5 ↗ 7: 9,4 ↘ 8: 9,6 ↗ 9: 9,5 ↗ 10: 9,8 ↗</p> <table border="1" style="width:100%; border-collapse: collapse;"> <tr><td>Serie</td><td style="text-align: right;">93,0</td></tr> <tr><td>Sum</td><td style="text-align: right;">93,0</td></tr> </table>	Serie	93,0	Sum	93,0	<p>Series 2</p> 	<p>1: 10,6* ↘ 2: 8,4 ↗ 3: 10,5* ↖ 4: 9,5 ↘ 5: 9,0 ↘ 6: 9,8 ↖ 7: 10,3* ↗ 8: 6,8 ↖ 9: 8,6 ↘ 10: 9,8 ↘</p> <table border="1" style="width:100%; border-collapse: collapse;"> <tr><td>Serie</td><td style="text-align: right;">88,0</td></tr> <tr><td>Sum</td><td style="text-align: right;">181,0</td></tr> </table>	Serie	88,0	Sum	181,0
Serie	93,0										
Sum	93,0										
Serie	88,0										
Sum	181,0										

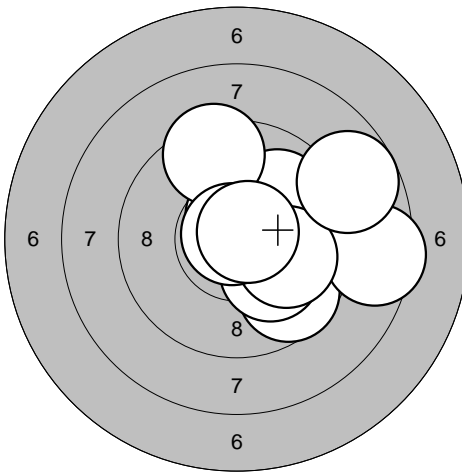
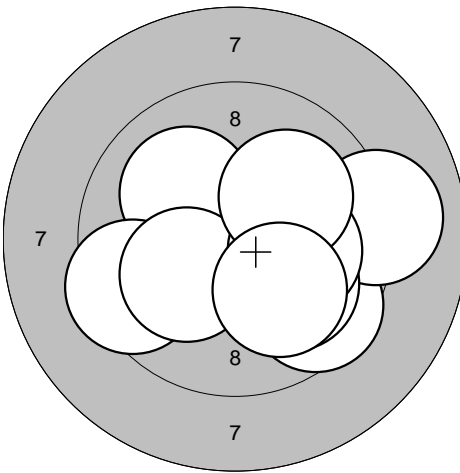
<p>Series 3</p> 	<p>1: 9,7 ↘ 2: 10,6* ↑ 3: 10,1 ↘ 4: 8,5 → 5: 10,0 ↗ 6: 9,4 ↗ 7: 10,0 ↘ 8: 10,8* ↗ 9: 10,7* ↗ 10: 8,8 ↗</p> <table border="1" style="width:100%; border-collapse: collapse;"> <tr><td>Serie</td><td style="text-align: right;">94,0</td></tr> <tr><td>Sum</td><td style="text-align: right;">275,0</td></tr> </table>	Serie	94,0	Sum	275,0	<p>Series 4</p> 	<p>1: 10,5* ↗ 2: 9,6 ↘ 3: 10,1 ↗ 4: 9,1 → 5: 9,4 ↖ 6: 10,0 ↘ 7: 10,2* ↖ 8: 10,1 → 9: 10,1 ↗ 10: 10,0 ↘</p> <table border="1" style="width:100%; border-collapse: collapse;"> <tr><td>Serie</td><td style="text-align: right;">97,0</td></tr> <tr><td>Sum</td><td style="text-align: right;">372,0</td></tr> </table>	Serie	97,0	Sum	372,0
Serie	94,0										
Sum	275,0										
Serie	97,0										
Sum	372,0										

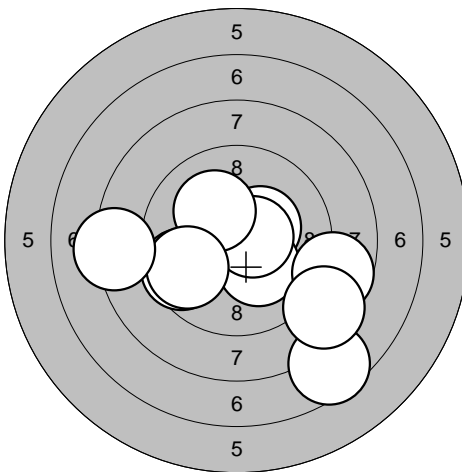
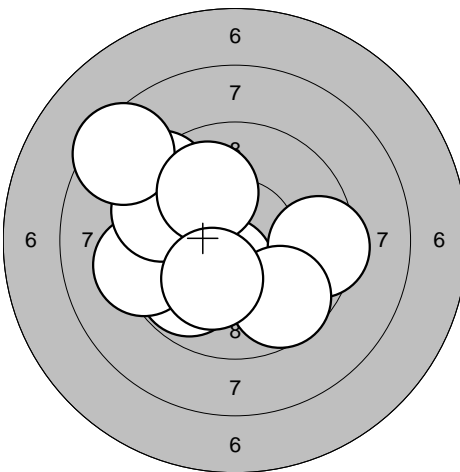
<p>Series 5</p> 	<p>1: 10,4* ↗ 2: 10,2* ↘ 3: 7,6 ↘ 4: 10,6* → 5: 8,7 ↘ 6: 10,2* ↗ 7: 9,6 ↖ 8: 9,7 ↖ 9: 8,5 ↘ 10: 8,2 ↖</p> <table border="1" style="width:100%; border-collapse: collapse;"> <tr><td>Serie</td><td style="text-align: right;">89,0</td></tr> <tr><td>Sum</td><td style="text-align: right;">461,0</td></tr> </table>	Serie	89,0	Sum	461,0	<p>Series 6</p> 	<p>1: 10,4* ↘ 2: 9,3 ↗ 3: 9,8 ↘ 4: 9,5 → 5: 9,3 ↖ 6: 9,5 ↖ 7: 9,7 ↘ 8: 8,5 ↗ 9: 10,0 ↗ 10: 10,1 ↘</p> <table border="1" style="width:100%; border-collapse: collapse;"> <tr><td>Serie</td><td style="text-align: right;">92,0</td></tr> <tr><td>Sum</td><td style="text-align: right;">553,0</td></tr> </table>	Serie	92,0	Sum	553,0
Serie	89,0										
Sum	461,0										
Serie	92,0										
Sum	553,0										

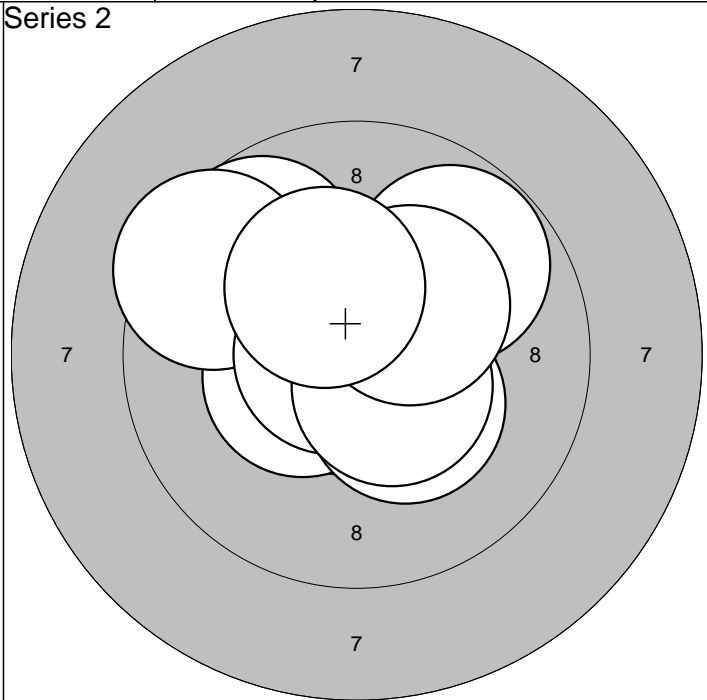
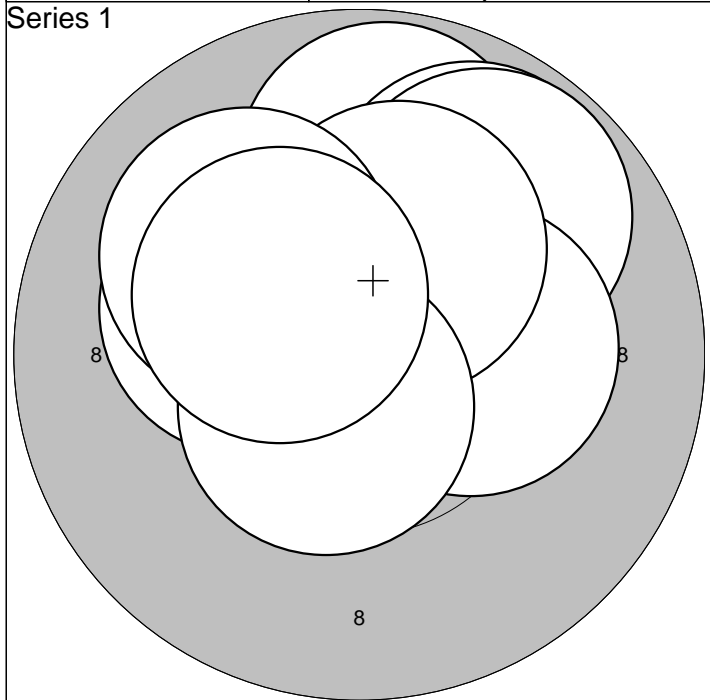

1: 9,8	↑	6:10,3*	→	Serie	97,0
2: 9,9	↗	7:10,3*	↑		
3:10,6*	→	8:10,6*	↘		
4:10,2*	↖	9:10,1	↗		
5: 9,8	↗	10:10,3*	↖		
Sum				97,0	

1:10,4*	↖	6:10,3*	↘	Serie	97,0
2:10,6*	↑	7: 9,8	↗		
3: 9,7	↗	8:10,5*	↘		
4: 9,5	↖	9:10,3*	↗		
5:10,8*	←	10:10,3*	↑		
Sum				194,0	

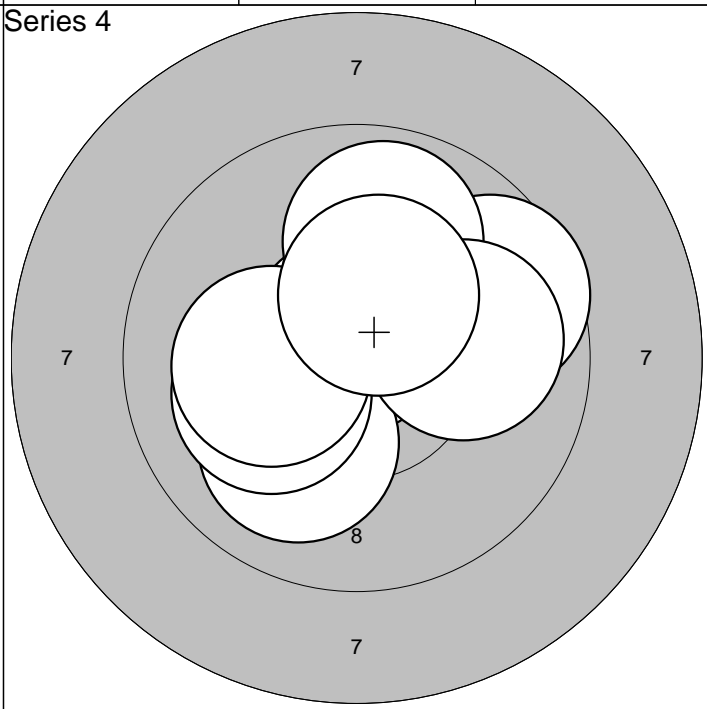
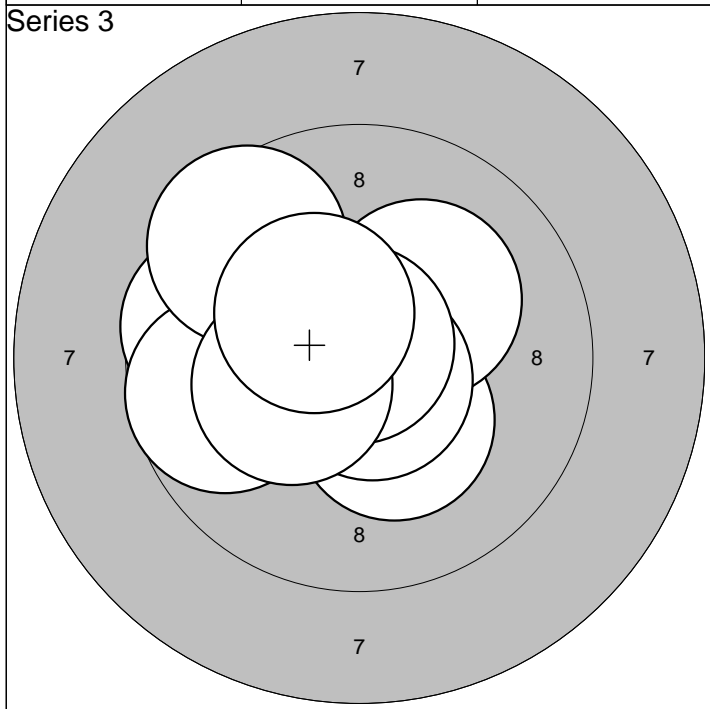

1:10,3*	↘	6:10,7*	↘	Serie	96,0
2: 9,9	←	7: 9,6	↗		
3:10,2*	↗	8:10,8*	↑		
4: 9,7	←	9:10,3*	←		
5: 9,7	←	10:10,4*	↗		
Sum				290,0	

1:10,1	→	6:10,2*	↑	Serie	98,0
2:10,7*	↗	7:10,2*	←		
3: 9,6	↗	8: 9,9	↑		
4:10,0	↘	9:10,0	→		
5:10,1	←	10:10,4*	↑		
Sum				388,0	

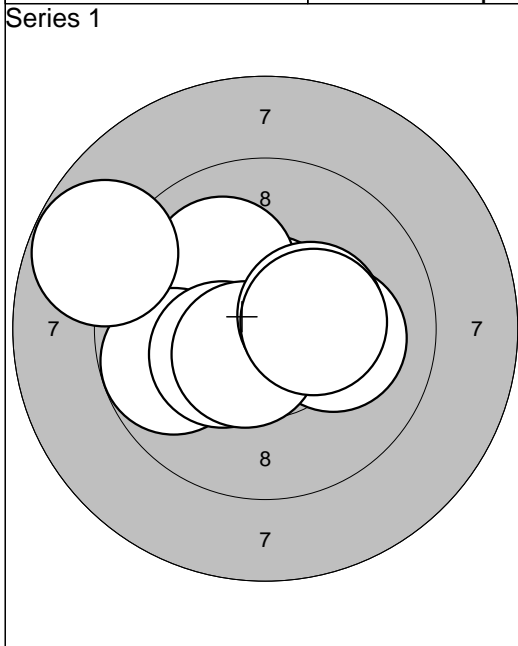

1: 10,7*	↑
2: 10,1	→
3: 10,1	↗
4: 10,0	↗
5: 9,8	←
6: 8,8	↖
7: 10,3*	↖
8: 10,6*	↘
9: 10,4*	→
10: 10,3*	→
Serie	97,0
Sum	97,0

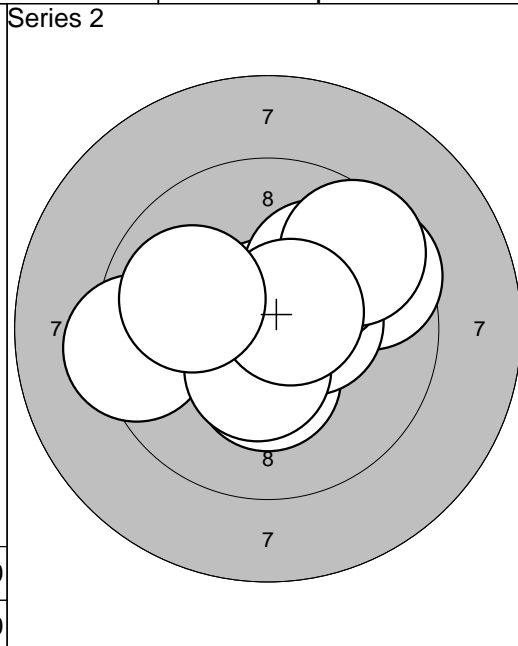

1: 10,7*	↑
2: 10,3*	↓
3: 9,3	←
4: 9,6	↗
5: 10,4*	→
6: 10,0	↗
7: 9,6	↗
8: 10,5*	↓
9: 10,6*	↗
10: 10,0	↖
Serie	97,0
Sum	194,0

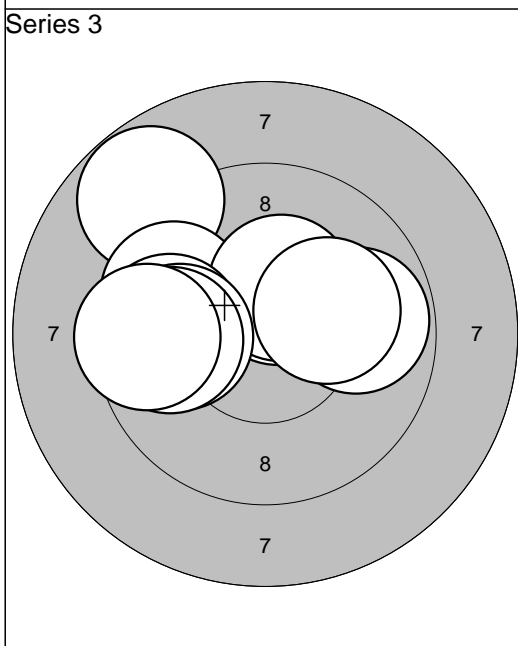

1: 10,4*	↑
2: 8,8	↖
3: 9,7	←
4: 9,8	→
5: 10,4*	↑
6: 9,8	←
7: 9,9	←
8: 9,8	←
9: 10,1	→
10: 9,5	←
Serie	92,0
Sum	286,0

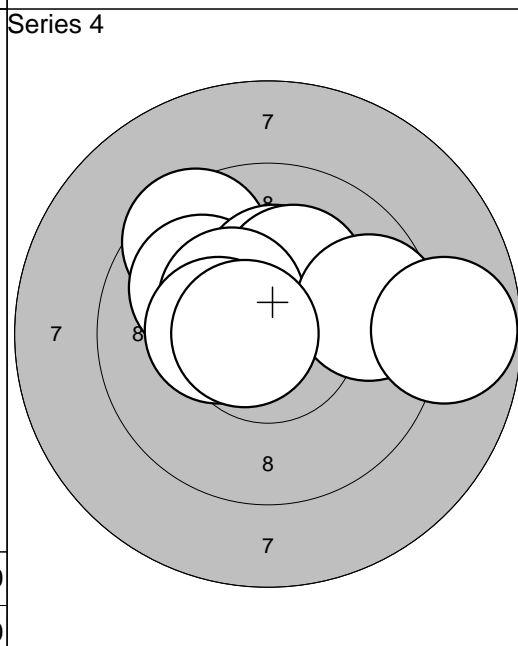

1: 9,5	↖
2: 10,7*	↖
3: 10,0	↖
4: 10,3*	↑
5: 10,2*	↑
6: 10,4*	↖
7: 10,3*	←
8: 9,7	→
9: 10,7*	←
10: 8,8	→
Serie	96,0
Sum	382,0

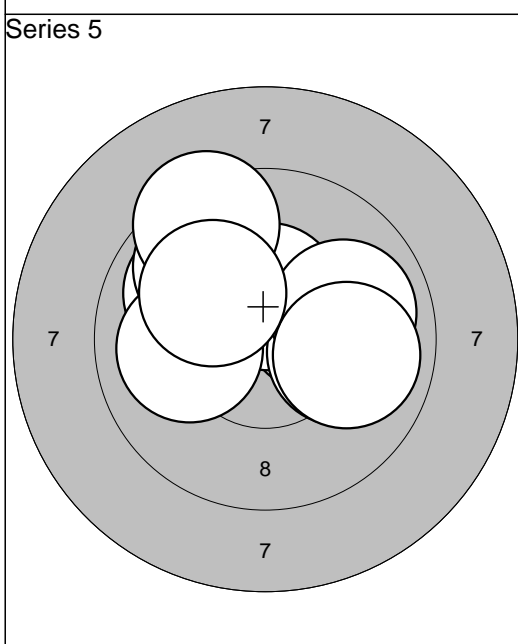

1: 10,0	↖
2: 9,8	↗
3: 10,3*	→
4: 10,4*	↑
5: 9,4	↗
6: 10,0	→
7: 10,0	→
8: 9,9	→
9: 10,0	←
10: 10,1	↖
Serie	97,0
Sum	479,0

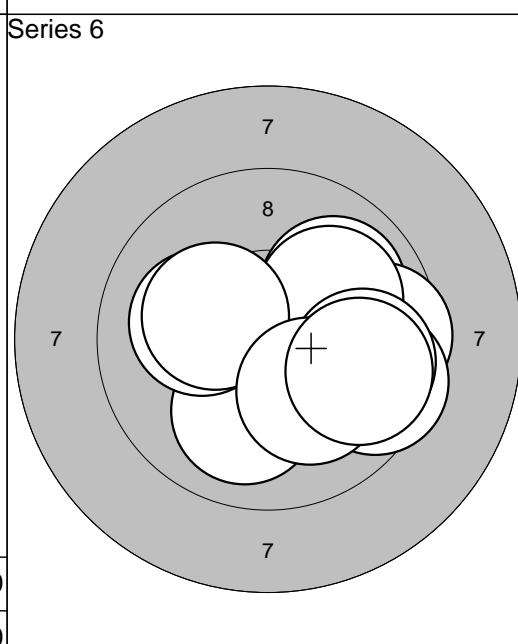

1: 10,0	↗
2: 9,6	→
3: 10,1	↗
4: 10,0	↓
5: 10,1	←
6: 9,5	↘
7: 10,3*	↖
8: 9,7	→
9: 10,1	↓
10: 9,7	↘
Serie	96,0
Sum	575,0

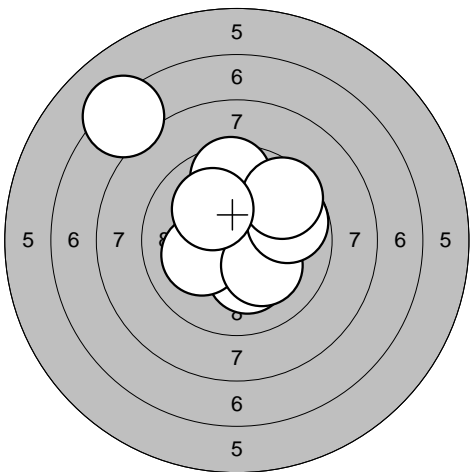
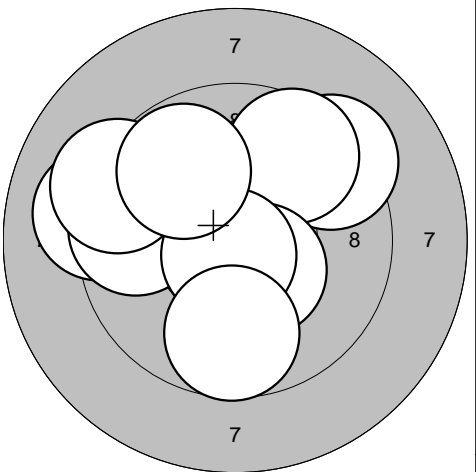
<p>Series 1</p> 	<p>1: 10,2* ↓ 2: 7,3 ↗ 3: 10,6* ↑ 4: 10,1 ← 5: 10,1 ↑ 6: 10,1 ↓ 7: 9,8 → 8: 9,6 ↑ 9: 9,6 ↗ 10: 10,1 ↖</p> <table border="1" style="width:100%; border-collapse: collapse;"> <tr><td>Serie</td><td style="text-align: right;">94,0</td></tr> <tr><td>Sum</td><td style="text-align: right;">94,0</td></tr> </table>	Serie	94,0	Sum	94,0	<p>Series 2</p> 	<p>1: 10,5* ↓ 2: 9,3 ↗ 3: 9,1 ← 4: 9,6 ↗ 5: 10,4* ↓ 6: 9,6 ← 7: 10,7* ↓ 8: 9,2 ↖ 9: 9,8 ↗ 10: 9,7 ↓</p> <table border="1" style="width:100%; border-collapse: collapse;"> <tr><td>Serie</td><td style="text-align: right;">93,0</td></tr> <tr><td>Sum</td><td style="text-align: right;">187,0</td></tr> </table>	Serie	93,0	Sum	187,0
Serie	94,0										
Sum	94,0										
Serie	93,0										
Sum	187,0										

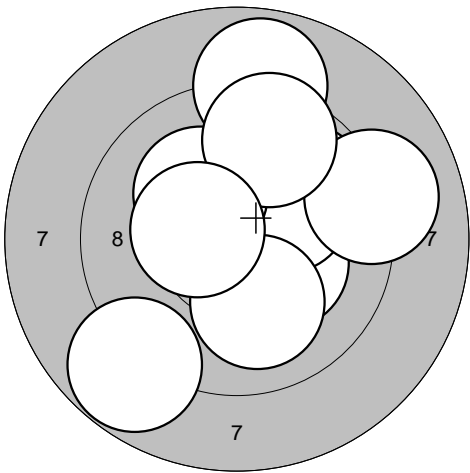
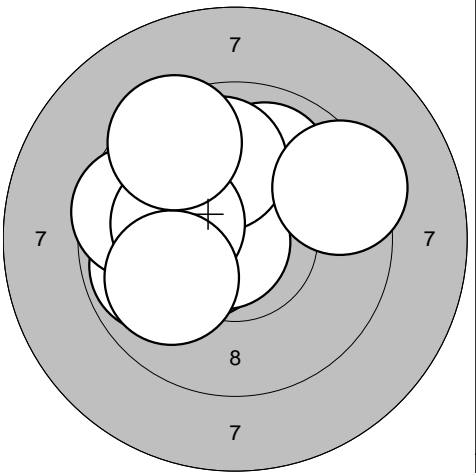
<p>Series 3</p> 	<p>1: 10,3* ↘ 2: 9,9 ↗ 3: 10,2* ↗ 4: 9,1 → 5: 8,9 ↑ 6: 10,2* ↖ 7: 9,6 ↑ 8: 10,1 ↓ 9: 10,4* ← 10: 8,8 ↘</p> <table border="1" style="width:100%; border-collapse: collapse;"> <tr><td>Serie</td><td style="text-align: right;">93,0</td></tr> <tr><td>Sum</td><td style="text-align: right;">280,0</td></tr> </table>	Serie	93,0	Sum	280,0	<p>Series 4</p> 	<p>1: 9,9 ← 2: 9,9 ↗ 3: 10,5* ← 4: 10,8* ← 5: 9,6 ← 6: 9,9 ↑ 7: 10,2* ← 8: 10,0 ← 9: 9,4 → 10: 9,4 ↖</p> <table border="1" style="width:100%; border-collapse: collapse;"> <tr><td>Serie</td><td style="text-align: right;">94,0</td></tr> <tr><td>Sum</td><td style="text-align: right;">374,0</td></tr> </table>	Serie	94,0	Sum	374,0
Serie	93,0										
Sum	280,0										
Serie	94,0										
Sum	374,0										

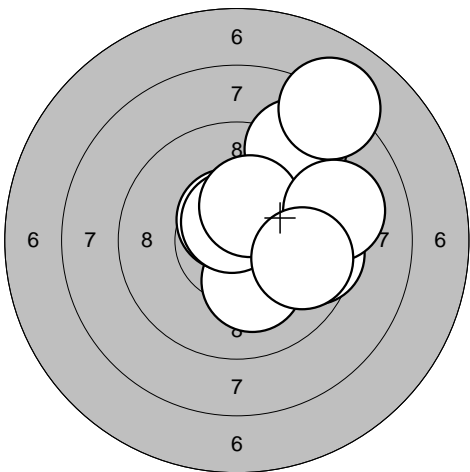
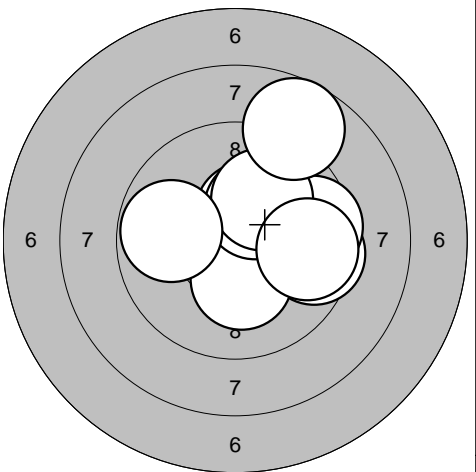
<p>Series 5</p> 	<p>1: 9,1 ↗ 2: 10,3* ↘ 3: 10,2* ↓ 4: 10,5* ↗ 5: 10,6* ↗ 6: 9,6 → 7: 10,3* ↗ 8: 8,1 ↗ 9: 9,1 → 10: 9,7 →</p> <table border="1" style="width:100%; border-collapse: collapse;"> <tr><td>Serie</td><td style="text-align: right;">94,0</td></tr> <tr><td>Sum</td><td style="text-align: right;">468,0</td></tr> </table>	Serie	94,0	Sum	468,0	<p>Series 6</p> 	<p>1: 9,5 → 2: 10,7* ↓ 3: 10,4* ↗ 4: 10,3* ↓ 5: 9,6 → 6: 10,3* ↗ 7: 10,1 ↗ 8: 9,8 ← 9: 8,7 ↗ 10: 9,7 →</p> <table border="1" style="width:100%; border-collapse: collapse;"> <tr><td>Serie</td><td style="text-align: right;">94,0</td></tr> <tr><td>Sum</td><td style="text-align: right;">562,0</td></tr> </table>	Serie	94,0	Sum	562,0
Serie	94,0										
Sum	468,0										
Serie	94,0										
Sum	562,0										

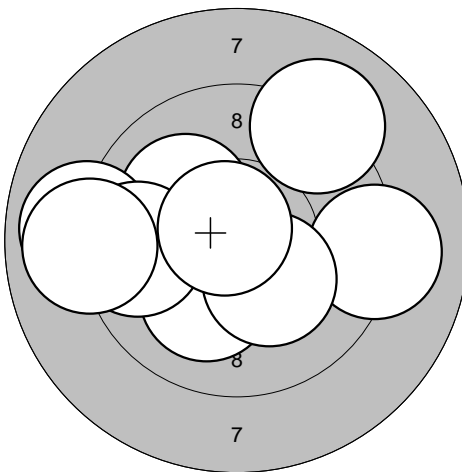
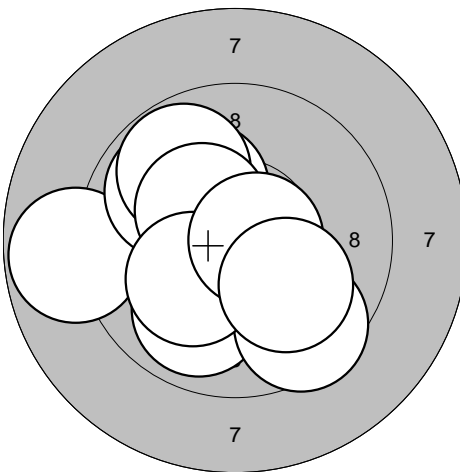
<p>Series 1</p> 	<p>1: 10,4* ↖</p> <p>2: 10,1 ↗</p> <p>3: 9,1 ↗</p> <p>4: 9,0 ←</p> <p>5: 9,1 →</p> <p>6: 10,1 ↘</p> <p>7: 10,3* ↘</p> <p>8: 9,6 ←</p> <p>9: 9,0 ←</p> <p>10: 10,7* ↗</p>	<p>Series 2</p> 	<p>1: 8,8 ←</p> <p>2: 10,2* ↗</p> <p>3: 9,9 ↗</p> <p>4: 9,8 ↗</p> <p>5: 10,4* ↗</p> <p>6: 9,9 ↘</p> <p>7: 9,5 ↘</p> <p>8: 10,2* ↖</p> <p>9: 10,7* →</p> <p>10: 10,0 ↘</p>
Serie 95,0	Serie 94,0	Serie 94,0	Serie 94,0
Sum 95,0	Sum 189,0	Sum 189,0	Sum 189,0

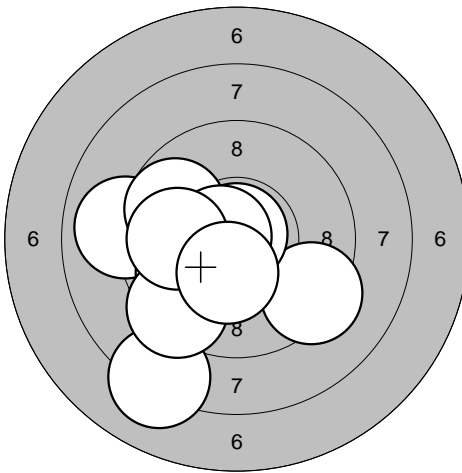
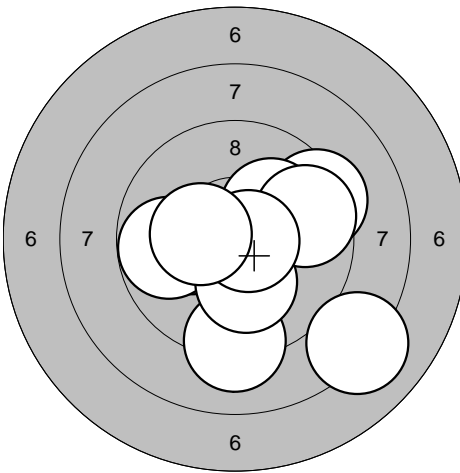
<p>Series 3</p> 	<p>1: 9,0 ←</p> <p>2: 9,3 ↘</p> <p>3: 9,9 ↖</p> <p>4: 8,2 ↘</p> <p>5: 10,9* ↑</p> <p>6: 9,4 ↘</p> <p>7: 9,8 ↖</p> <p>8: 10,7* ←</p> <p>9: 9,9 ←</p> <p>10: 10,4* ↘</p>	<p>Series 4</p> 	<p>1: 9,1 ↓</p> <p>2: 10,2* ←</p> <p>3: 9,4 →</p> <p>4: 9,8 ←</p> <p>5: 10,1 ↗</p> <p>6: 10,2* ↓</p> <p>7: 9,7 →</p> <p>8: 8,1 ↘</p> <p>9: 10,7* →</p> <p>10: 10,3* ←</p>
Serie 92,0	Serie 94,0	Serie 94,0	Serie 94,0
Sum 281,0	Sum 375,0	Sum 375,0	Sum 375,0

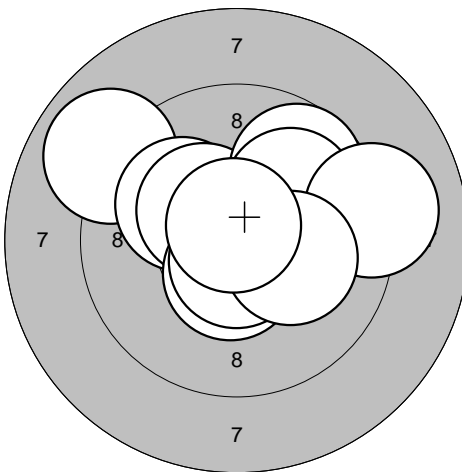
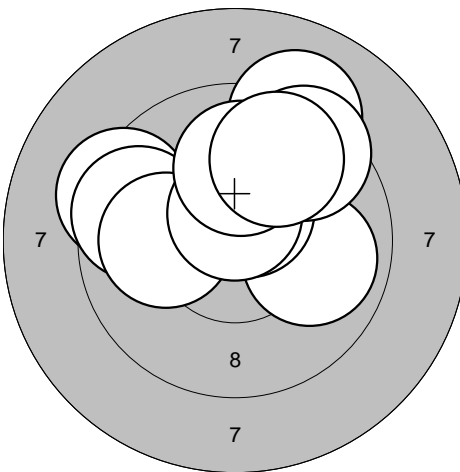
<p>Series 5</p> 	<p>1: 8,9 ↖</p> <p>2: 10,1 ↗</p> <p>3: 10,4* ↗</p> <p>4: 10,5* ↘</p> <p>5: 9,7 ↗</p> <p>6: 10,7* ↘</p> <p>7: 10,0 ↗</p> <p>8: 9,1 →</p> <p>9: 10,2* →</p> <p>10: 10,7* ↑</p>	<p>Series 6</p> 	<p>1: 9,4 ↖</p> <p>2: 9,9 →</p> <p>3: 10,5* ↗</p> <p>4: 9,1 ↗</p> <p>5: 9,6 ←</p> <p>6: 9,5 ↗</p> <p>7: 10,0 ←</p> <p>8: 10,6* ↑</p> <p>9: 10,0 ↑</p> <p>10: 9,7 ↗</p>
Serie 96,0	Serie 94,0	Serie 94,0	Serie 94,0
Sum 471,0	Sum 565,0	Sum 565,0	Sum 565,0

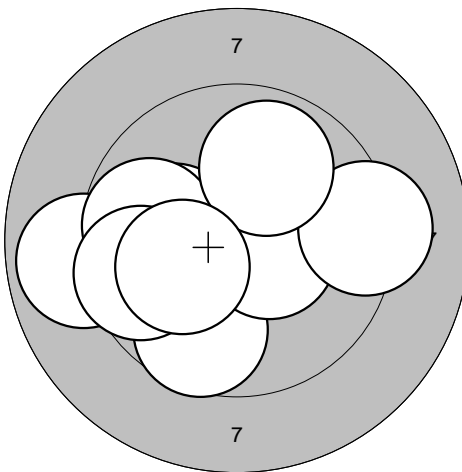
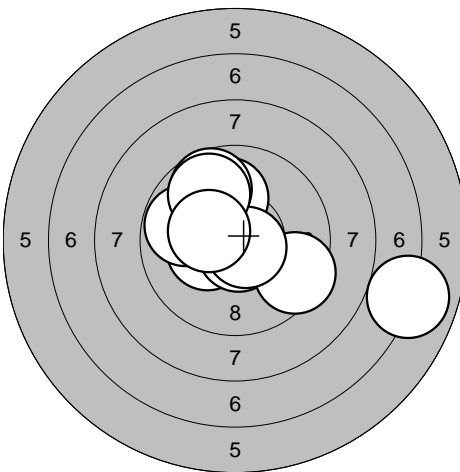
<p>Series 1</p> 	<p>1: 10,8* ↗</p> <p>2: 9,7 ↓</p> <p>3: 10,1 ←</p> <p>4: 8,9 ←</p> <p>5: 10,5* →</p> <p>6: 9,2 →</p> <p>7: 9,8 ←</p> <p>8: 9,9 ↗</p> <p>9: 9,6 ←</p> <p>10: 10,1 ↙</p>	<p>Series 2</p> 	<p>1: 10,3* ↙</p> <p>2: 9,8 ↙</p> <p>3: 10,0 ↗</p> <p>4: 10,7* ↓</p> <p>5: 9,7 ↗</p> <p>6: 9,4 ↓</p> <p>7: 6,9 →</p> <p>8: 10,7* ↘</p> <p>9: 9,8 ↗</p> <p>10: 10,4* ↙</p>
Serie 93,0		Serie 92,0	
Sum 93,0		Sum 185,0	

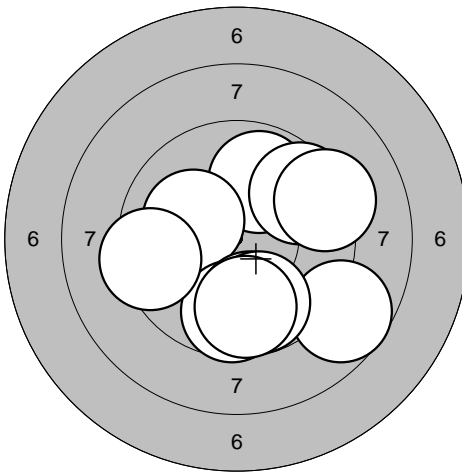
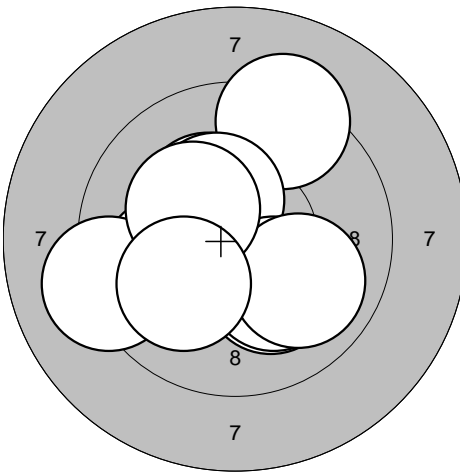
<p>Series 3</p> 	<p>1: 9,9 ↗</p> <p>2: 10,1 ↙</p> <p>3: 8,7 ↘</p> <p>4: 9,7 ↓</p> <p>5: 9,4 ←</p> <p>6: 9,8 ↓</p> <p>7: 9,8 ↓</p> <p>8: 9,8 ↓</p> <p>9: 9,6 ↗</p> <p>10: 9,2 →</p>	<p>Series 4</p> 	<p>1: 10,0 ↙</p> <p>2: 10,1 ↓</p> <p>3: 9,3 ↗</p> <p>4: 10,3* ↗</p> <p>5: 9,2 ←</p> <p>6: 10,4* ↗</p> <p>7: 10,1 ↓</p> <p>8: 9,9 ↓</p> <p>9: 10,3* ↗</p> <p>10: 10,1 ↙</p>
Serie 90,0		Serie 97,0	
Sum 275,0		Sum 372,0	

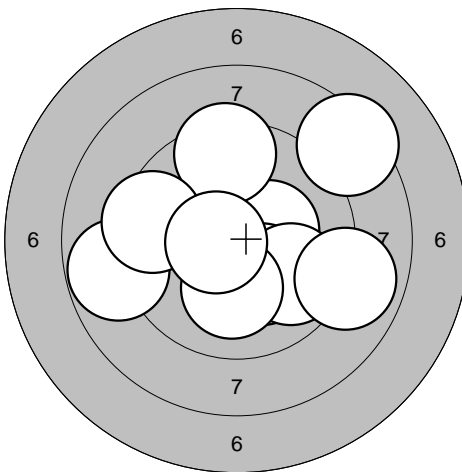
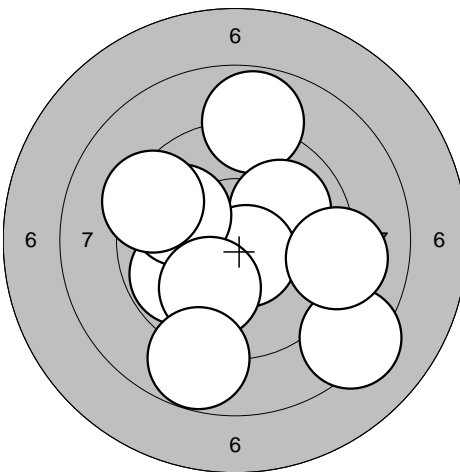
<p>Series 5</p> 	<p>1: 8,8 ←</p> <p>2: 10,4* →</p> <p>3: 10,2* ↓</p> <p>4: 9,8 ↘</p> <p>5: 8,4 ↗</p> <p>6: 9,4 ↗</p> <p>7: 10,1 ↓</p> <p>8: 9,4 ←</p> <p>9: 8,9 →</p> <p>10: 10,6* ←</p>	<p>Series 6</p> 	<p>1: 8,9 ↗</p> <p>2: 10,0 ↗</p> <p>3: 9,8 ↙</p> <p>4: 10,6* ↓</p> <p>5: 9,9 ↙</p> <p>6: 8,3 ↓</p> <p>7: 9,3 ↙</p> <p>8: 10,0 ↓</p> <p>9: 8,8 ↓</p> <p>10: 9,1 →</p>
Serie 91,0		Serie 90,0	
Sum 463,0		Sum 553,0	

Series 1

1: 10,1	↖
2: 10,4*	↖
3: 9,2	↙
4: 9,8	↗
5: 9,9	←
6: 9,7	↗
7: 10,3*	↙
8: 10,3*	↘
9: 9,7	↗
10: 9,9	↗
Serie 94,0	
Sum 94,0	

Series 2

1: 10,0	↗
2: 10,7*	↗
3: 9,8	↘
4: 10,4*	↙
5: 8,9	↖
6: 9,6	↙
7: 9,6	→
8: 9,3	←
9: 10,5*	↗
10: 10,3*	↗
Serie 94,0	
Sum 188,0	

Series 3

1: 10,0	↘
2: 9,7	→
3: 8,5	→
4: 8,5	↘
5: 8,2	←
6: 9,0	←
7: 10,7*	→
8: 9,4	↗
9: 10,2*	↗
10: 10,0	↙
Serie 91,0	
Sum 279,0	

Series 4

1: 9,7	↙
2: 10,4*	↘
3: 10,0	↗
4: 9,1	↖
5: 10,0	←
6: 10,4*	↗
7: 9,1	←
8: 9,1	↗
9: 10,7*	→
10: 10,4*	←
Serie 96,0	
Sum 375,0	

Series 5

1: 10,5*	→
2: 10,7*	↙
3: 9,4	↗
4: 10,7*	→
5: 10,3*	↗
6: 10,3*	↗
7: 10,2*	↗
8: 10,4*	↗
9: 10,5*	↗
10: 9,6	→
Serie 98,0	
Sum 473,0	

Series 6

1: 9,9	←
2: 8,3	←
3: 9,8	↗
4: 10,7*	↘
5: 10,3*	←
6: 10,1	↗
7: 10,6*	↗
8: 10,3*	↗
9: 10,1	↙
10: 9,6	↗
Serie 95,0	
Sum 568,0	

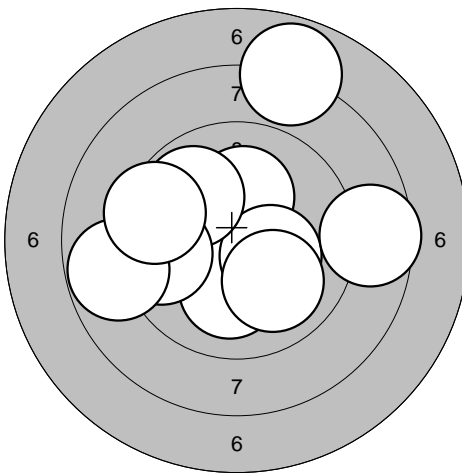
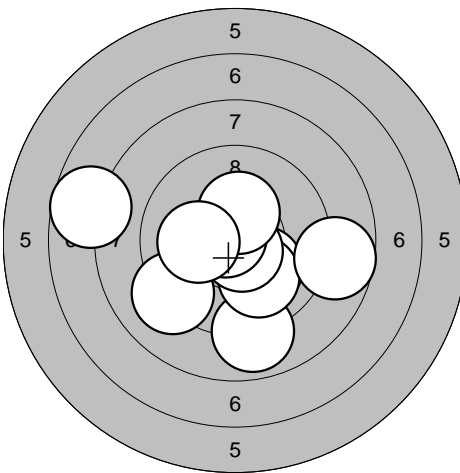
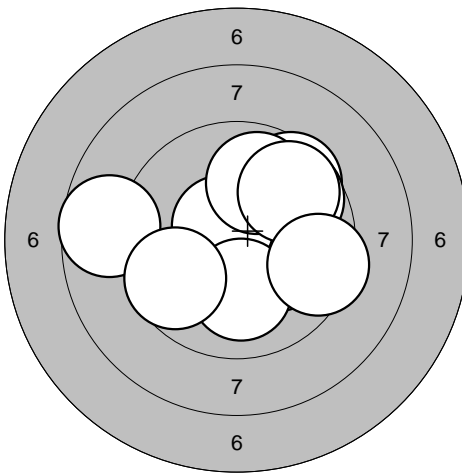
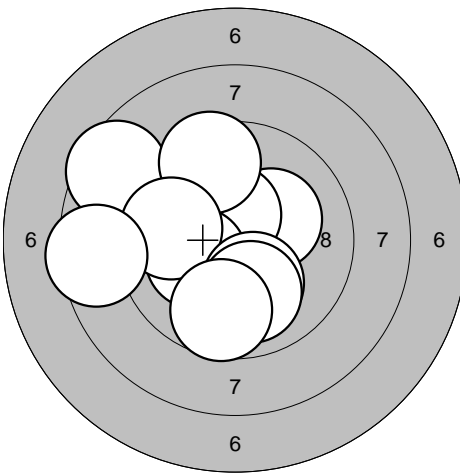
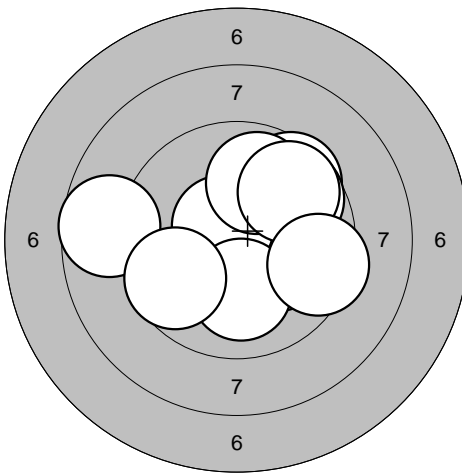
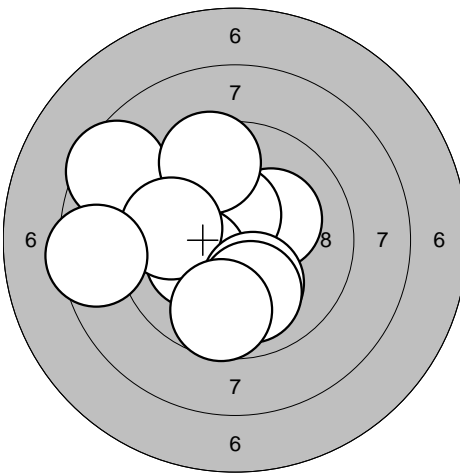
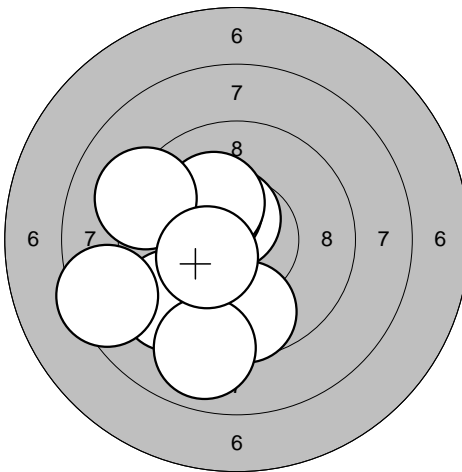
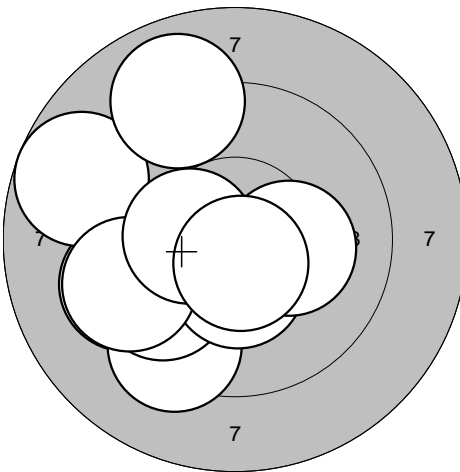
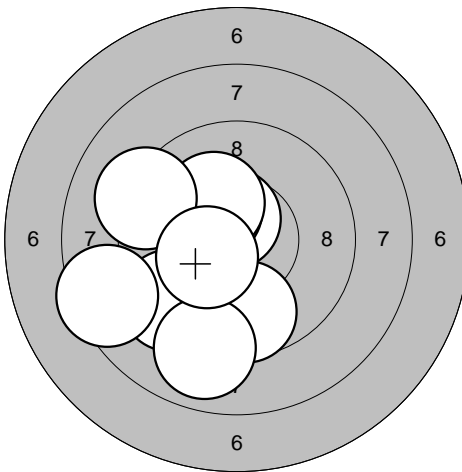
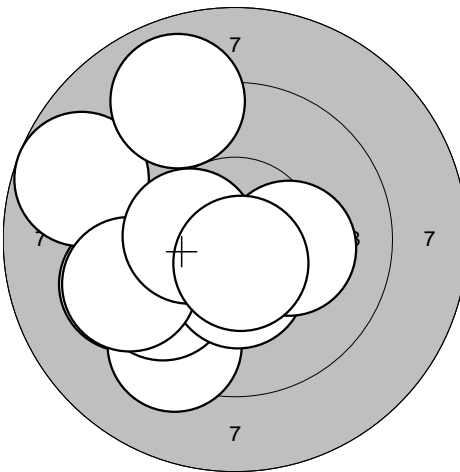
<p>Series 1</p> 	<p>Series 2</p> 	<table style="width:100%; border-collapse: collapse;"> <tr><td>1: 10,2*</td><td style="text-align: right;">↑</td></tr> <tr><td>2: 10,1</td><td style="text-align: right;">↓</td></tr> <tr><td>3: 10,3*</td><td style="text-align: right;">→</td></tr> <tr><td>4: 10,0</td><td style="text-align: right;">↓</td></tr> <tr><td>5: 9,9</td><td style="text-align: right;">↗</td></tr> <tr><td>6: 8,6</td><td style="text-align: right;">→</td></tr> <tr><td>7: 9,6</td><td style="text-align: right;">←</td></tr> <tr><td>8: 7,9</td><td style="text-align: right;">↑</td></tr> <tr><td>9: 8,8</td><td style="text-align: right;">←</td></tr> <tr><td>10: 9,4</td><td style="text-align: right;">↙</td></tr> <tr><td colspan="2"><hr/></td></tr> <tr><td>Serie</td><td style="text-align: right;">90,0</td></tr> <tr><td colspan="2"><hr/></td></tr> <tr><td>Sum</td><td style="text-align: right;">90,0</td></tr> </table>	1: 10,2*	↑	2: 10,1	↓	3: 10,3*	→	4: 10,0	↓	5: 9,9	↗	6: 8,6	→	7: 9,6	←	8: 7,9	↑	9: 8,8	←	10: 9,4	↙	<hr/>		Serie	90,0	<hr/>		Sum	90,0
1: 10,2*	↑																													
2: 10,1	↓																													
3: 10,3*	→																													
4: 10,0	↓																													
5: 9,9	↗																													
6: 8,6	→																													
7: 9,6	←																													
8: 7,9	↑																													
9: 8,8	←																													
10: 9,4	↙																													
<hr/>																														
Serie	90,0																													
<hr/>																														
Sum	90,0																													
<p>Series 3</p> 	<p>Series 4</p> 	<table style="width:100%; border-collapse: collapse;"> <tr><td>1: 10,1</td><td style="text-align: right;">↘</td></tr> <tr><td>2: 8,9</td><td style="text-align: right;">↓</td></tr> <tr><td>3: 10,0</td><td style="text-align: right;">↘</td></tr> <tr><td>4: 8,7</td><td style="text-align: right;">→</td></tr> <tr><td>5: 10,7*</td><td style="text-align: right;">↘</td></tr> <tr><td>6: 7,7</td><td style="text-align: right;">←</td></tr> <tr><td>7: 9,2</td><td style="text-align: right;">↙</td></tr> <tr><td>8: 10,7*</td><td style="text-align: right;">↙</td></tr> <tr><td>9: 10,4*</td><td style="text-align: right;">↑</td></tr> <tr><td>10: 10,2*</td><td style="text-align: right;">←</td></tr> <tr><td colspan="2"><hr/></td></tr> <tr><td>Serie</td><td style="text-align: right;">92,0</td></tr> <tr><td colspan="2"><hr/></td></tr> <tr><td>Sum</td><td style="text-align: right;">182,0</td></tr> </table>	1: 10,1	↘	2: 8,9	↓	3: 10,0	↘	4: 8,7	→	5: 10,7*	↘	6: 7,7	←	7: 9,2	↙	8: 10,7*	↙	9: 10,4*	↑	10: 10,2*	←	<hr/>		Serie	92,0	<hr/>		Sum	182,0
1: 10,1	↘																													
2: 8,9	↓																													
3: 10,0	↘																													
4: 8,7	→																													
5: 10,7*	↘																													
6: 7,7	←																													
7: 9,2	↙																													
8: 10,7*	↙																													
9: 10,4*	↑																													
10: 10,2*	←																													
<hr/>																														
Serie	92,0																													
<hr/>																														
Sum	182,0																													
<p>Series 3</p> 	<p>Series 4</p> 	<table style="width:100%; border-collapse: collapse;"> <tr><td>1: 9,6</td><td style="text-align: right;">↗</td></tr> <tr><td>2: 8,7</td><td style="text-align: right;">←</td></tr> <tr><td>3: 9,7</td><td style="text-align: right;">↗</td></tr> <tr><td>4: 10,1</td><td style="text-align: right;">→</td></tr> <tr><td>5: 10,6*</td><td style="text-align: right;">↗</td></tr> <tr><td>6: 9,9</td><td style="text-align: right;">↑</td></tr> <tr><td>7: 10,1</td><td style="text-align: right;">↓</td></tr> <tr><td>8: 9,7</td><td style="text-align: right;">↙</td></tr> <tr><td>9: 9,7</td><td style="text-align: right;">↗</td></tr> <tr><td>10: 9,5</td><td style="text-align: right;">→</td></tr> <tr><td colspan="2"><hr/></td></tr> <tr><td>Serie</td><td style="text-align: right;">92,0</td></tr> <tr><td colspan="2"><hr/></td></tr> <tr><td>Sum</td><td style="text-align: right;">274,0</td></tr> </table>	1: 9,6	↗	2: 8,7	←	3: 9,7	↗	4: 10,1	→	5: 10,6*	↗	6: 9,9	↑	7: 10,1	↓	8: 9,7	↙	9: 9,7	↗	10: 9,5	→	<hr/>		Serie	92,0	<hr/>		Sum	274,0
1: 9,6	↗																													
2: 8,7	←																													
3: 9,7	↗																													
4: 10,1	→																													
5: 10,6*	↗																													
6: 9,9	↑																													
7: 10,1	↓																													
8: 9,7	↙																													
9: 9,7	↗																													
10: 9,5	→																													
<hr/>																														
Serie	92,0																													
<hr/>																														
Sum	274,0																													
<p>Series 5</p> 	<p>Series 6</p> 	<table style="width:100%; border-collapse: collapse;"> <tr><td>1: 9,9</td><td style="text-align: right;">↘</td></tr> <tr><td>2: 9,4</td><td style="text-align: right;">↙</td></tr> <tr><td>3: 10,6*</td><td style="text-align: right;">↑</td></tr> <tr><td>4: 9,7</td><td style="text-align: right;">↓</td></tr> <tr><td>5: 10,3*</td><td style="text-align: right;">↗</td></tr> <tr><td>6: 10,2*</td><td style="text-align: right;">↗</td></tr> <tr><td>7: 8,9</td><td style="text-align: right;">↓</td></tr> <tr><td>8: 9,2</td><td style="text-align: right;">↙</td></tr> <tr><td>9: 10,3*</td><td style="text-align: right;">↙</td></tr> <tr><td>10: 8,5</td><td style="text-align: right;">←</td></tr> <tr><td colspan="2"><hr/></td></tr> <tr><td>Serie</td><td style="text-align: right;">92,0</td></tr> <tr><td colspan="2"><hr/></td></tr> <tr><td>Sum</td><td style="text-align: right;">459,0</td></tr> </table>	1: 9,9	↘	2: 9,4	↙	3: 10,6*	↑	4: 9,7	↓	5: 10,3*	↗	6: 10,2*	↗	7: 8,9	↓	8: 9,2	↙	9: 10,3*	↙	10: 8,5	←	<hr/>		Serie	92,0	<hr/>		Sum	459,0
1: 9,9	↘																													
2: 9,4	↙																													
3: 10,6*	↑																													
4: 9,7	↓																													
5: 10,3*	↗																													
6: 10,2*	↗																													
7: 8,9	↓																													
8: 9,2	↙																													
9: 10,3*	↙																													
10: 8,5	←																													
<hr/>																														
Serie	92,0																													
<hr/>																														
Sum	459,0																													
<p>Series 5</p> 	<p>Series 6</p> 	<table style="width:100%; border-collapse: collapse;"> <tr><td>1: 9,4</td><td style="text-align: right;">↙</td></tr> <tr><td>2: 9,3</td><td style="text-align: right;">↘</td></tr> <tr><td>3: 8,8</td><td style="text-align: right;">↙</td></tr> <tr><td>4: 9,7</td><td style="text-align: right;">↙</td></tr> <tr><td>5: 10,4*</td><td style="text-align: right;">↓</td></tr> <tr><td>6: 8,9</td><td style="text-align: right;">↗</td></tr> <tr><td>7: 10,2*</td><td style="text-align: right;">→</td></tr> <tr><td>8: 9,4</td><td style="text-align: right;">←</td></tr> <tr><td>9: 10,4*</td><td style="text-align: right;">←</td></tr> <tr><td>10: 10,6*</td><td style="text-align: right;">↓</td></tr> <tr><td colspan="2"><hr/></td></tr> <tr><td>Serie</td><td style="text-align: right;">92,0</td></tr> <tr><td colspan="2"><hr/></td></tr> <tr><td>Sum</td><td style="text-align: right;">551,0</td></tr> </table>	1: 9,4	↙	2: 9,3	↘	3: 8,8	↙	4: 9,7	↙	5: 10,4*	↓	6: 8,9	↗	7: 10,2*	→	8: 9,4	←	9: 10,4*	←	10: 10,6*	↓	<hr/>		Serie	92,0	<hr/>		Sum	551,0
1: 9,4	↙																													
2: 9,3	↘																													
3: 8,8	↙																													
4: 9,7	↙																													
5: 10,4*	↓																													
6: 8,9	↗																													
7: 10,2*	→																													
8: 9,4	←																													
9: 10,4*	←																													
10: 10,6*	↓																													
<hr/>																														
Serie	92,0																													
<hr/>																														
Sum	551,0																													

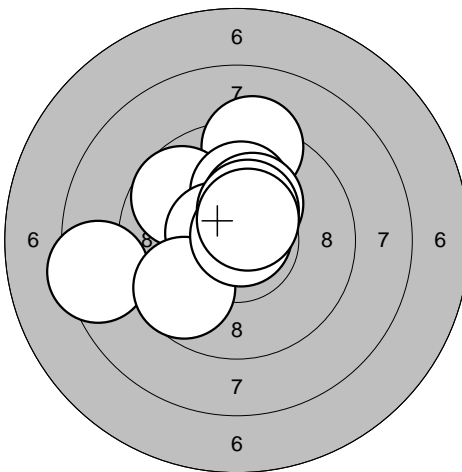
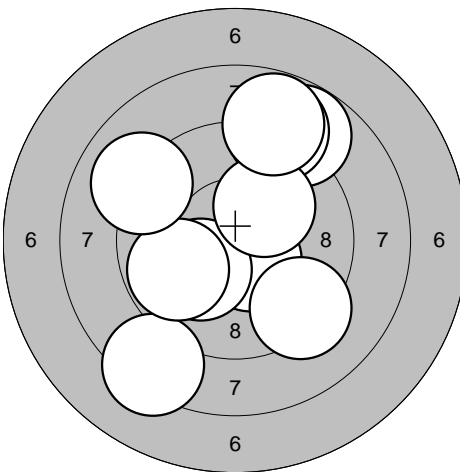
<p>Series 1</p> 	<p>1: 9,3 ↗</p> <p>2: 9,7 ↖</p> <p>3: 8,4 ←</p> <p>4: 10,1 ↗</p> <p>5: 10,6* ↖</p> <p>6: 10,3* ↗</p> <p>7: 9,7 ↖</p> <p>8: 10,4* ↗</p> <p>9: 10,8* ↗</p> <p>10: 10,5* ↗</p>	<p>Series 2</p> 	<p>1: 8,8 ↗</p> <p>2: 10,5* ↖</p> <p>3: 10,2* ↖</p> <p>4: 9,3 ↖</p> <p>5: 8,3 ↖</p> <p>6: 9,8 ↖</p> <p>7: 8,9 ↗</p> <p>8: 9,0 ↖</p> <p>9: 10,2* ↗</p> <p>10: 8,8 ↗</p>
Serie 95,0	Serie 89,0	Serie 89,0	Serie 89,0
Sum 95,0	Sum 184,0	Sum 184,0	Sum 184,0

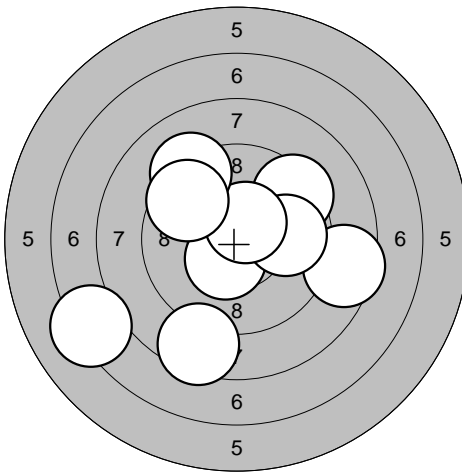
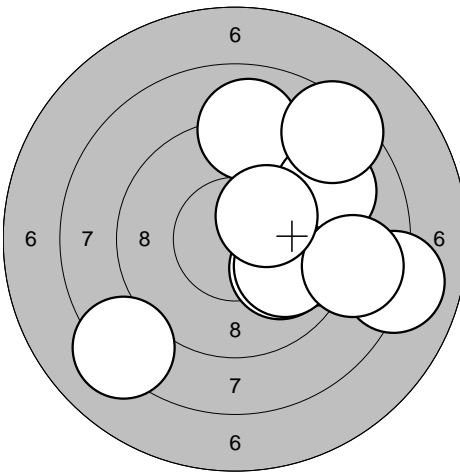
<p>Series 3</p> 	<p>1: 10,2* →</p> <p>2: 8,5 →</p> <p>3: 10,4* ↖</p> <p>4: 8,5 ↖</p> <p>5: 9,4 ↗</p> <p>6: 7,2 ←</p> <p>7: 9,9 →</p> <p>8: 10,5* ↗</p> <p>9: 9,2 ↗</p> <p>10: 9,6 ↖</p>	<p>Series 4</p> 	<p>1: 9,5 →</p> <p>2: 9,0 ↗</p> <p>3: 10,0 ↖</p> <p>4: 8,0 →</p> <p>5: 8,2 ↖</p> <p>6: 9,1 ↗</p> <p>7: 9,9 ↖</p> <p>8: 8,8 →</p> <p>9: 8,4 ↗</p> <p>10: 10,3* ↗</p>
Serie 89,0	Serie 88,0	Serie 88,0	Serie 88,0
Sum 273,0	Sum 361,0	Sum 361,0	Sum 361,0

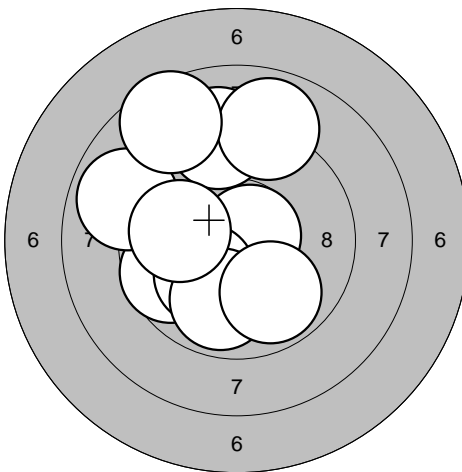
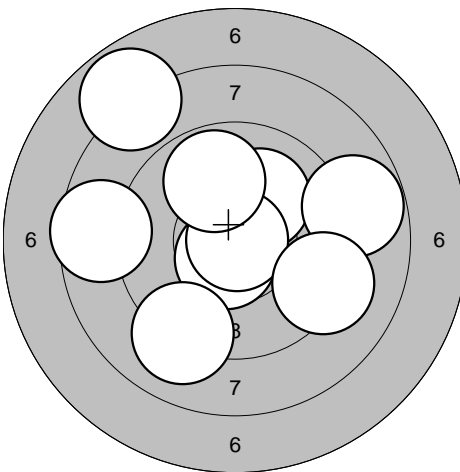
<p>Series 5</p> 	<p>1: 9,1 ↗</p> <p>2: 9,6 ↖</p> <p>3: 10,7* →</p> <p>4: 8,9 ↖</p> <p>5: 10,1 ↖</p> <p>6: 8,9 ↗</p> <p>7: 8,6 ↗</p> <p>8: 9,9 ↖</p> <p>9: 9,9 ↖</p> <p>10: 9,9 ←</p>	<p>Series 6</p> 	<p>1: 10,3* ↗</p> <p>2: 10,1 ↗</p> <p>3: 8,8 →</p> <p>4: 8,6 ←</p> <p>5: 10,6* ↖</p> <p>6: 9,1 ↖</p> <p>7: 10,9* →</p> <p>8: 9,9 ↗</p> <p>9: 7,9 ↗</p> <p>10: 9,2 ↖</p>
Serie 89,0	Serie 90,0	Serie 90,0	Serie 90,0
Sum 450,0	Sum 540,0	Sum 540,0	Sum 540,0

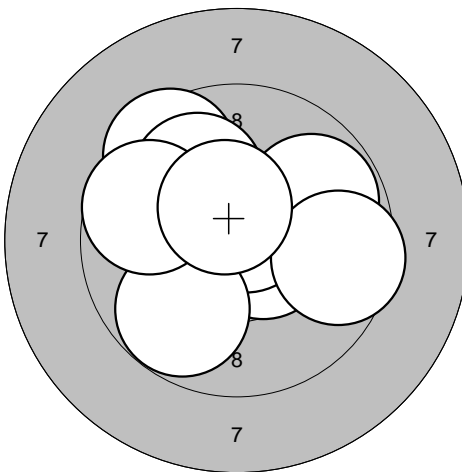
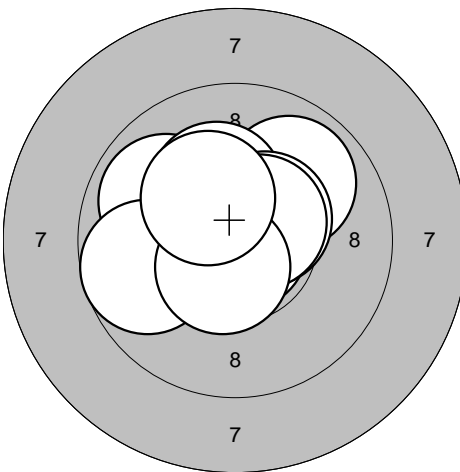
<p>Series 1</p> 	<p>1: 10,0 ↗</p> <p>2: 10,6* ➤</p> <p>3: 10,7* ↗</p> <p>4: 9,5 ↗</p> <p>5: 10,0 ↗</p> <p>6: 9,8 ↘</p> <p>7: 9,7 ↖</p> <p>8: 9,8 ➤</p> <p>9: 9,6 ➤</p> <p>10: 10,5* ↗</p>	<p>Series 2</p> 	<p>1: 10,9* ➤</p> <p>2: 10,3* ↗</p> <p>3: 9,9 ↗</p> <p>4: 9,9 ↖</p> <p>5: 9,8 ↖</p> <p>6: 10,2* ↗</p> <p>7: 10,5* ↗</p> <p>8: 10,5* ↗</p> <p>9: 10,6* ↘</p> <p>10: 10,3* ↖</p>
Serie 95,0	Serie 97,0	Serie 97,0	Serie 97,0
Sum 95,0	Sum 192,0	Sum 192,0	Sum 192,0

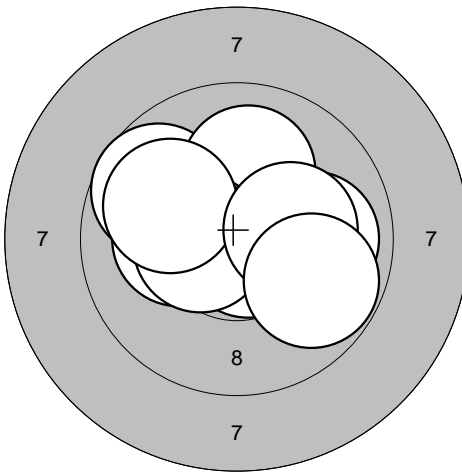
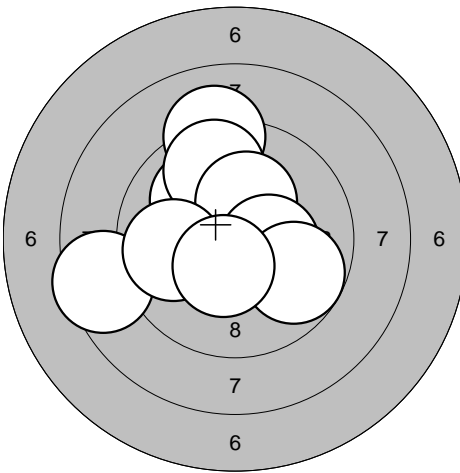
<p>Series 3</p> 	<p>1: 10,7* ↘</p> <p>2: 10,2* ↖</p> <p>3: 9,7 ↗</p> <p>4: 10,1 ↗</p> <p>5: 10,5* ↖</p> <p>6: 10,0 ➤</p> <p>7: 10,5* ↖</p> <p>8: 10,0 ↗</p> <p>9: 10,2* ➤</p> <p>10: 9,8 ➤</p>	<p>Series 4</p> 	<p>1: 10,3* ↖</p> <p>2: 8,5 ↖</p> <p>3: 9,1 ↗</p> <p>4: 10,0 ↖</p> <p>5: 9,7 ↗</p> <p>6: 10,3* ↗</p> <p>7: 10,4* ➤</p> <p>8: 9,8 ➤</p> <p>9: 9,8 ↖</p> <p>10: 10,4* ↘</p>
Serie 98,0	Serie 94,0	Serie 94,0	Serie 94,0
Sum 290,0	Sum 384,0	Sum 384,0	Sum 384,0

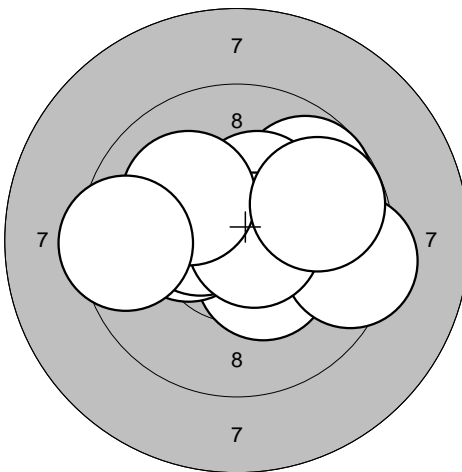
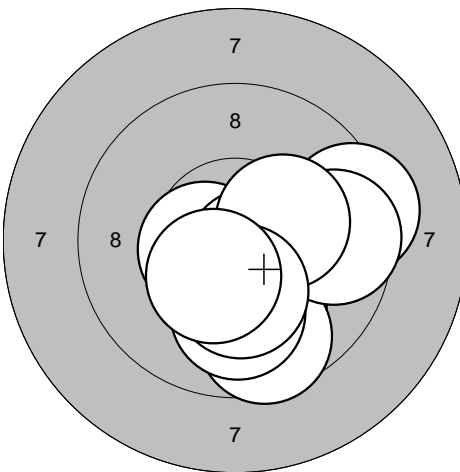
<p>Series 5</p> 	<p>1: 9,8 ↗</p> <p>2: 10,4* ↘</p> <p>3: 10,3* ↖</p> <p>4: 10,4* ↖</p> <p>5: 10,3* ↗</p> <p>6: 9,4 ➤</p> <p>7: 10,7* ➤</p> <p>8: 10,1 ↗</p> <p>9: 9,5 ↖</p> <p>10: 9,8 ➤</p>	<p>Series 6</p> 	<p>1: 10,0 ↘</p> <p>2: 10,5* ↖</p> <p>3: 10,6* ↘</p> <p>4: 9,6 ↘</p> <p>5: 9,3 ➤</p> <p>6: 9,6 ➤</p> <p>7: 10,3* ➤</p> <p>8: 10,0 ↘</p> <p>9: 10,3* ↘</p> <p>10: 10,4* ↘</p>
Serie 96,0	Serie 97,0	Serie 97,0	Serie 97,0
Sum 480,0	Sum 577,0	Sum 577,0	Sum 577,0

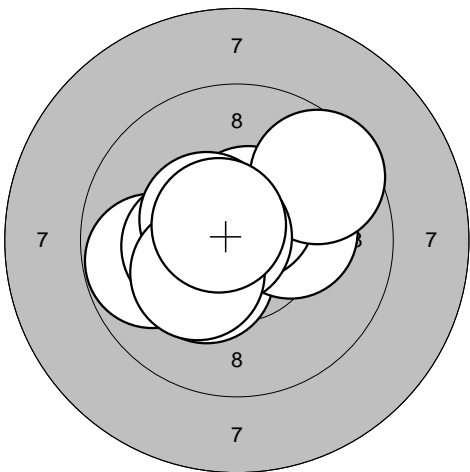
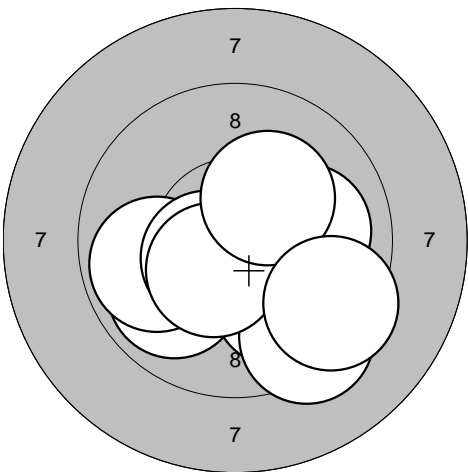
<p>Series 1</p> 	<p>1: 10,3* ↙ 2: 9,8 ← 3: 10,2* → 4: 10,6* ↗ 5: 10,3* ← 6: 9,6 ↗ 7: 10,8* ← 8: 10,5* ↗ 9: 10,3* ↙ 10: 10,6* ↖</p> <table border="1" style="width:100%; border-collapse: collapse;"> <tr><td>Serie</td><td style="text-align: right;">98,0</td></tr> <tr><td>Sum</td><td style="text-align: right;">98,0</td></tr> </table>	Serie	98,0	Sum	98,0	<p>Series 2</p> 	<p>1: 9,9 ↙ 2: 10,7* ↘ 3: 9,9 ← 4: 10,0 ↘ 5: 10,5* ↙ 6: 10,0 → 7: 9,3 ↘ 8: 10,5* ↘ 9: 10,2* ↗ 10: 9,4 ↘</p> <table border="1" style="width:100%; border-collapse: collapse;"> <tr><td>Serie</td><td style="text-align: right;">96,0</td></tr> <tr><td>Sum</td><td style="text-align: right;">194,0</td></tr> </table>	Serie	96,0	Sum	194,0
Serie	98,0										
Sum	98,0										
Serie	96,0										
Sum	194,0										

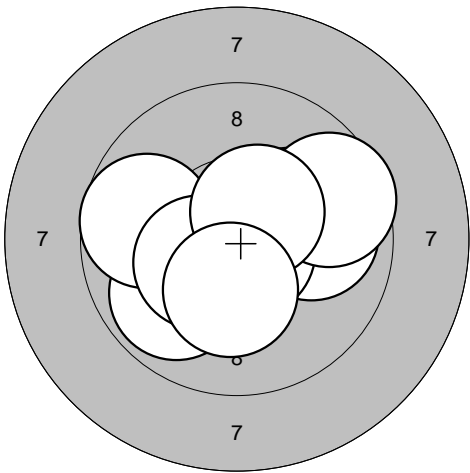
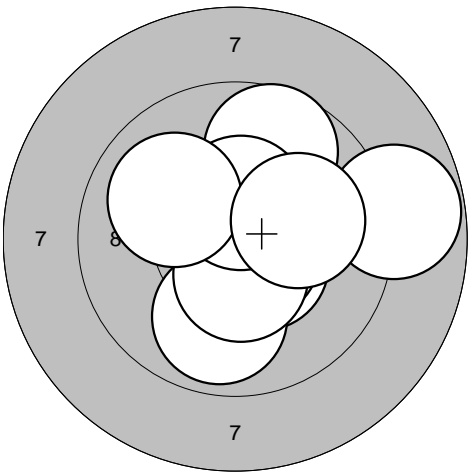
<p>Series 3</p> 	<p>1: 9,9 ↙ 2: 10,2* → 3: 10,5* ↙ 4: 9,9 → 5: 9,7 ← 6: 10,7* ↘ 7: 9,6 → 8: 10,4* ↙ 9: 10,5* ↗ 10: 10,3* ↘</p> <table border="1" style="width:100%; border-collapse: collapse;"> <tr><td>Serie</td><td style="text-align: right;">96,0</td></tr> <tr><td>Sum</td><td style="text-align: right;">290,0</td></tr> </table>	Serie	96,0	Sum	290,0	<p>Series 4</p> 	<p>1: 10,5* ↘ 2: 8,8 → 3: 10,6* → 4: 9,7 ↗ 5: 9,9 ↘ 6: 10,6* ↘ 7: 10,5* ↘ 8: 10,4* ↗ 9: 10,0 ↖ 10: 10,1 →</p> <table border="1" style="width:100%; border-collapse: collapse;"> <tr><td>Serie</td><td style="text-align: right;">96,0</td></tr> <tr><td>Sum</td><td style="text-align: right;">386,0</td></tr> </table>	Serie	96,0	Sum	386,0
Serie	96,0										
Sum	290,0										
Serie	96,0										
Sum	386,0										

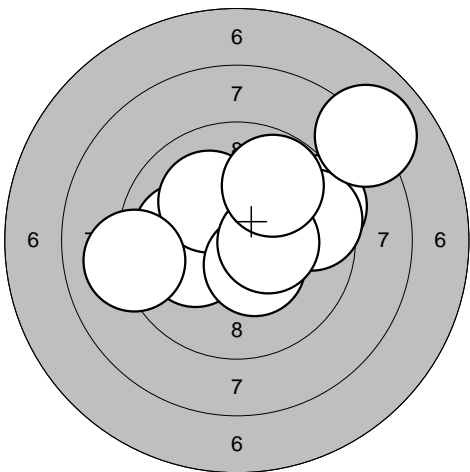
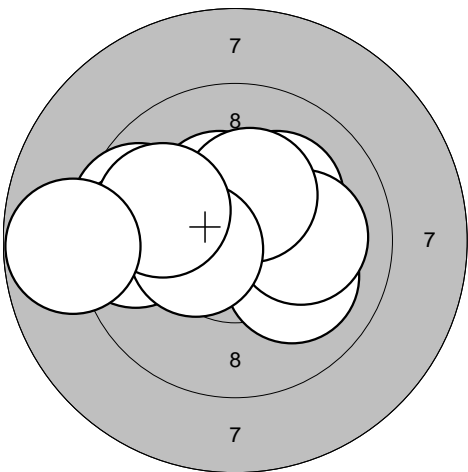
<p>Series 5</p> 	<p>1: 10,0 ← 2: 10,2* ← 3: 10,1 ↗ 4: 9,4 → 5: 10,4* ↘ 6: 9,6 → 7: 10,4* → 8: 9,8 ↗ 9: 9,1 ← 10: 8,0 ↗</p> <table border="1" style="width:100%; border-collapse: collapse;"> <tr><td>Serie</td><td style="text-align: right;">94,0</td></tr> <tr><td>Sum</td><td style="text-align: right;">480,0</td></tr> </table>	Serie	94,0	Sum	480,0	<p>Series 6</p> 	<p>1: 10,4* ↗ 2: 10,0 ↘ 3: 10,2* ↗ 4: 10,1 → 5: 9,6 ← 6: 10,3* ↗ 7: 9,6 ← 8: 10,4* ← 9: 9,9 ↙ 10: 8,8 ←</p> <table border="1" style="width:100%; border-collapse: collapse;"> <tr><td>Serie</td><td style="text-align: right;">95,0</td></tr> <tr><td>Sum</td><td style="text-align: right;">575,0</td></tr> </table>	Serie	95,0	Sum	575,0
Serie	94,0										
Sum	480,0										
Serie	95,0										
Sum	575,0										

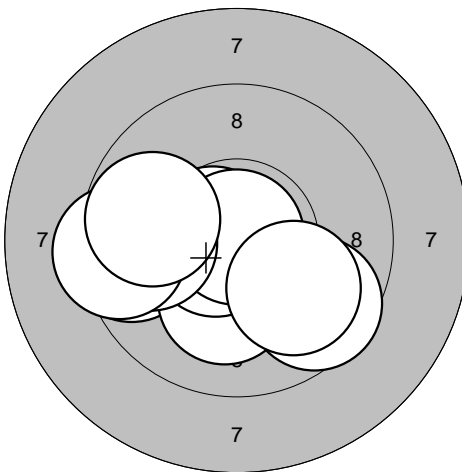
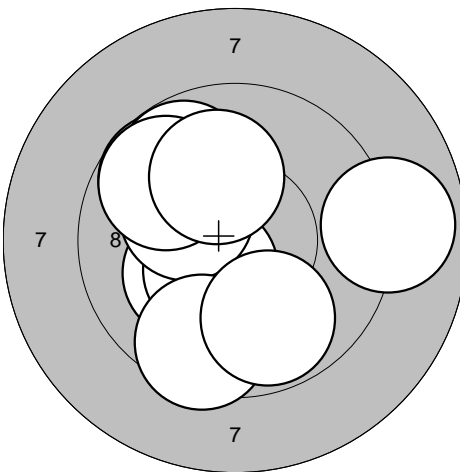
<p>Series 1</p> 	<p>1: 10,6* ←</p> <p>2: 9,6 ↘</p> <p>3: 9,5 ←</p> <p>4: 10,2* ↓</p> <p>5: 10,7* ←</p> <p>6: 10,9* ↑</p> <p>7: 9,8 ←</p> <p>8: 9,4 ←</p> <p>9: 9,9 ↘</p> <p>10: 9,8 ←</p> <hr/> <p>Serie 94,0</p> <hr/> <p>Sum 94,0</p>	<p>Series 2</p> 	<p>1: 8,9 →</p> <p>2: 10,2* ↙</p> <p>3: 10,4* ↘</p> <p>4: 10,2* ↙</p> <p>5: 9,5 ↓</p> <p>6: 9,8 ↓</p> <p>7: 9,7 ↗</p> <p>8: 9,8 ↗</p> <p>9: 9,8 ↗</p> <p>10: 10,1 ↑</p> <hr/> <p>Serie 93,0</p> <hr/> <p>Sum 187,0</p>
--	--	--	--

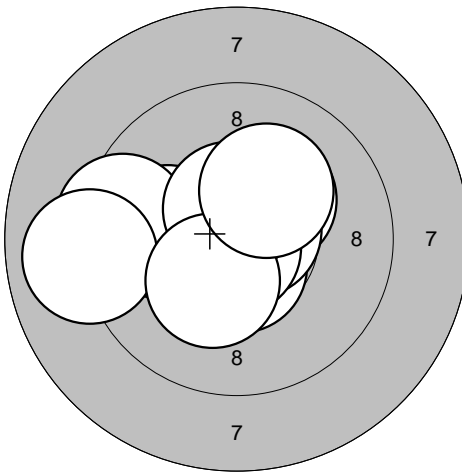
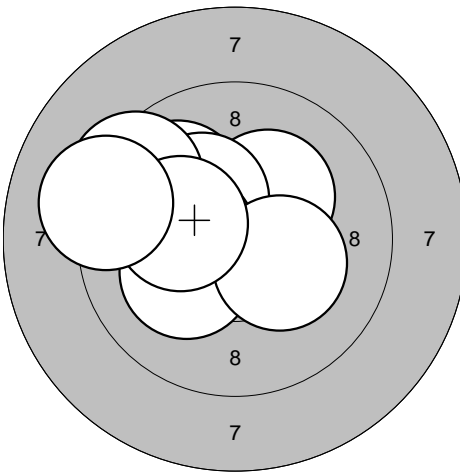
<p>Series 3</p> 	<p>1: 10,3* ↗</p> <p>2: 10,6* ↓</p> <p>3: 10,0 ←</p> <p>4: 10,7* ↗</p> <p>5: 10,8* ↓</p> <p>6: 9,4 ←</p> <p>7: 10,5* ↑</p> <p>8: 9,0 ←</p> <p>9: 10,3* ↘</p> <p>10: 10,2* ↗</p> <hr/> <p>Serie 98,0</p> <hr/> <p>Sum 285,0</p>	<p>Series 4</p> 	<p>1: 10,6* ←</p> <p>2: 10,2* ↗</p> <p>3: 9,9 ↗</p> <p>4: 10,3* ↗</p> <p>5: 10,4* ←</p> <p>6: 9,4 ↗</p> <p>7: 10,2* ↙</p> <p>8: 10,3* ↘</p> <p>9: 10,2* ←</p> <p>10: 9,2 ←</p> <hr/> <p>Serie 97,0</p> <hr/> <p>Sum 382,0</p>
---	--	---	---

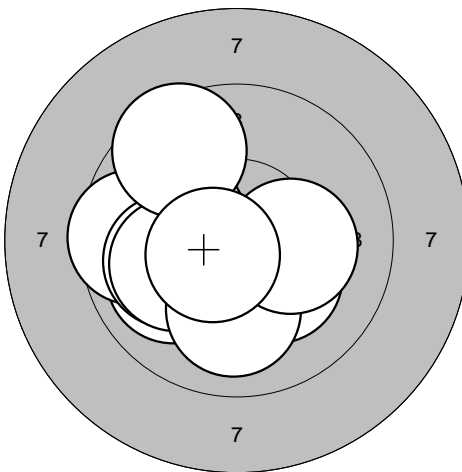
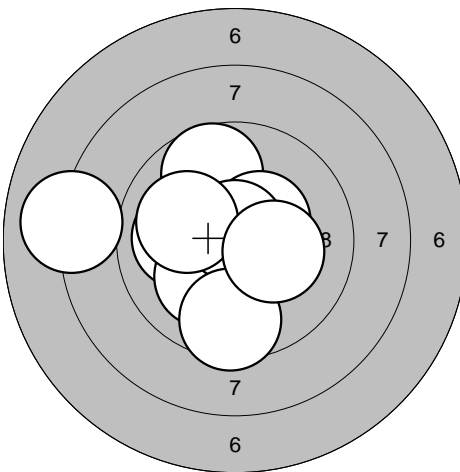
<p>Series 5</p> 	<p>1: 10,1 ←</p> <p>2: 10,0 ↙</p> <p>3: 9,6 ←</p> <p>4: 10,2* ↘</p> <p>5: 10,0 ←</p> <p>6: 10,1 ←</p> <p>7: 10,0 ↓</p> <p>8: 9,5 ↗</p> <p>9: 10,2* →</p> <p>10: 10,6* ↙</p> <hr/> <p>Serie 98,0</p> <hr/> <p>Sum 480,0</p>	<p>Series 6</p> 	<p>1: 10,4* ↗</p> <p>2: 9,7 ↑</p> <p>3: 10,0 ←</p> <p>4: 10,4* ↗</p> <p>5: 10,1 ↘</p> <p>6: 10,8* ↑</p> <p>7: 10,1 ←</p> <p>8: 9,6 ↓</p> <p>9: 10,2* →</p> <p>10: 8,1 ←</p> <hr/> <p>Serie 96,0</p> <hr/> <p>Sum 576,0</p>
--	--	--	--

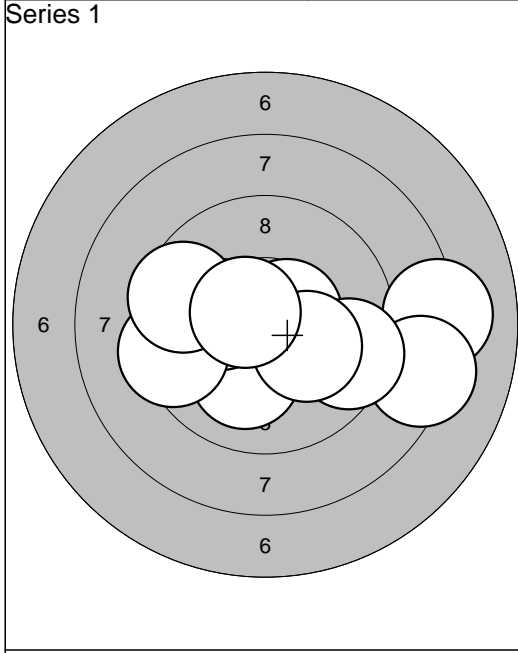

1: 8,2	→
2: 10,5*	→
3: 8,3	→
4: 9,5	→
5: 10,1	↓
6: 10,2*	→
7: 10,2*	←
8: 9,4	←
9: 9,6	←
10: 10,6*	↖
Serie	93,0
Sum	93,0

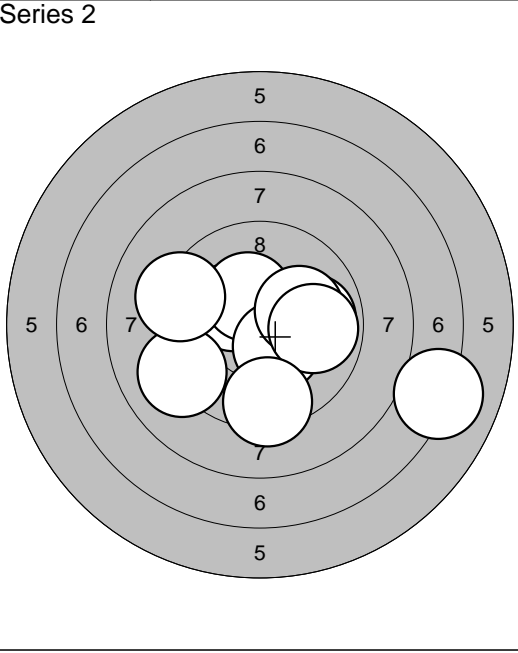

1: 10,3*	↖
2: 9,9	→
3: 9,1	↙
4: 10,4*	↗
5: 7,1	→
6: 10,4*	↘
7: 10,1	→
8: 9,9	→
9: 9,3	←
10: 9,4	↓
Serie	92,0
Sum	185,0

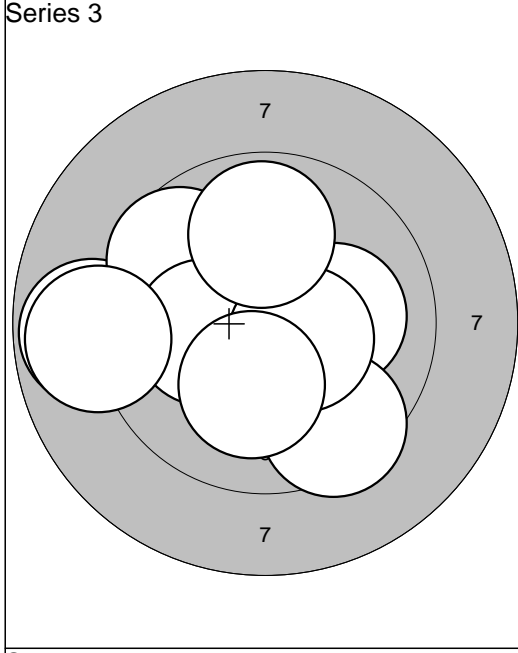

1: 10,2*	↗
2: 8,8	←
3: 10,1	→
4: 9,7	↗
5: 9,5	↓
6: 10,2*	←
7: 8,9	←
8: 10,5*	→
9: 10,2*	↓
10: 9,9	↑
Serie	93,0
Sum	278,0

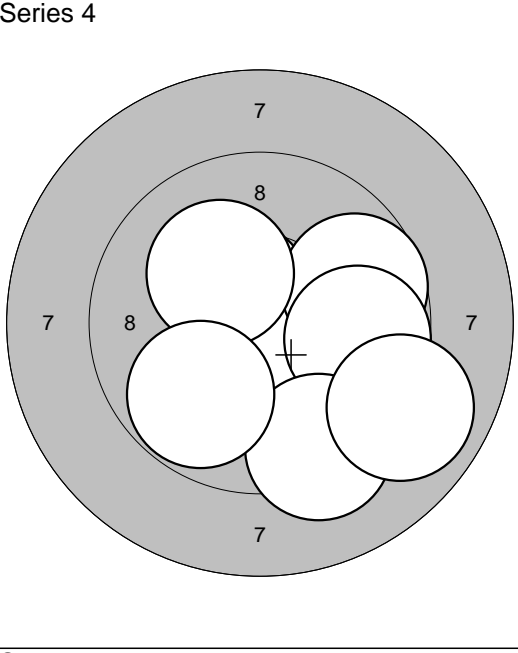

1: 10,0	↓
2: 10,6*	↓
3: 10,5*	↗
4: 10,3*	↓
5: 9,7	→
6: 10,2*	↗
7: 9,7	→
8: 9,3	↓
9: 9,8	↓
10: 8,9	↘
Serie	94,0
Sum	372,0

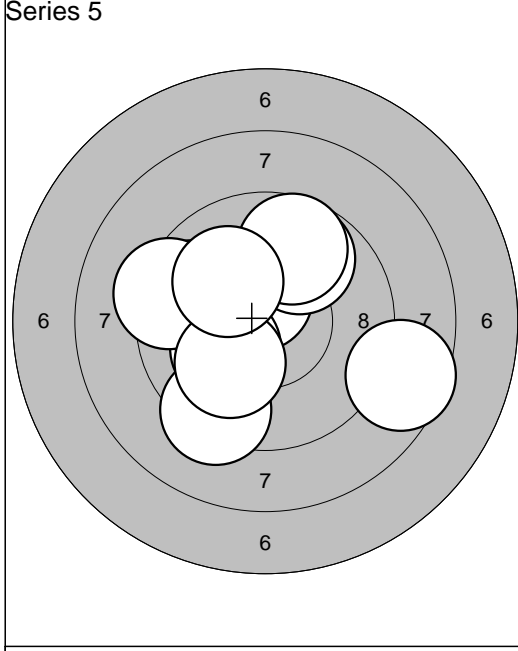

1: 9,3	↘
2: 10,5*	↗
3: 10,2*	↙
4: 9,8	↗
5: 9,7	↗
6: 9,7	←
7: 9,3	←
8: 10,1	↘
9: 8,6	→
10: 10,1	↗
Serie	93,0
Sum	465,0

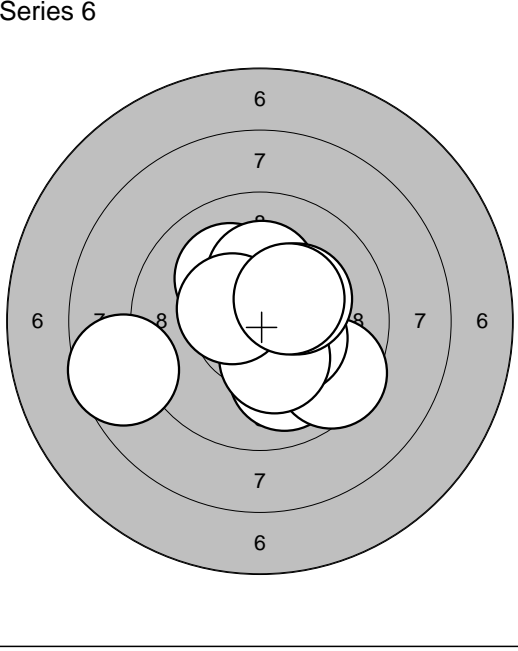

1: 10,1	↗
2: 10,0	↓
3: 9,5	↘
4: 10,2*	↑
5: 8,6	←
6: 10,4*	↘
7: 10,3*	↓
8: 10,3*	↗
9: 10,5*	←
10: 10,4*	↗
Serie	97,0
Sum	562,0

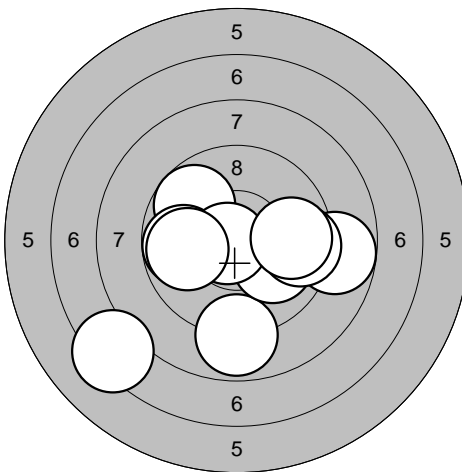
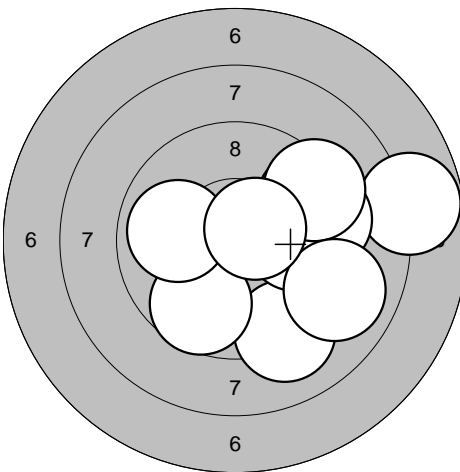
<p>Series 1</p> 	<p>Series 2</p> 	
1: 9,8 ↖ 2: 7,3 ↙ 3: 8,9 ↓ 4: 10,0 ↘ 5: 8,8 → 6: 9,5 → 7: 9,8 ← 8: 10,7* ← 9: 9,7 → 10: 9,9 ←	1: 9,1 ↓ 2: 9,9 → 3: 9,5 ↗ 4: 9,7 ↓ 5: 7,8 → 6: 9,4 → 7: 9,9 ← 8: 9,3 ↗ 9: 9,0 ↘ 10: 10,6* ↗	
Serie 88,0	Serie 89,0	
Sum 88,0	Sum 177,0	

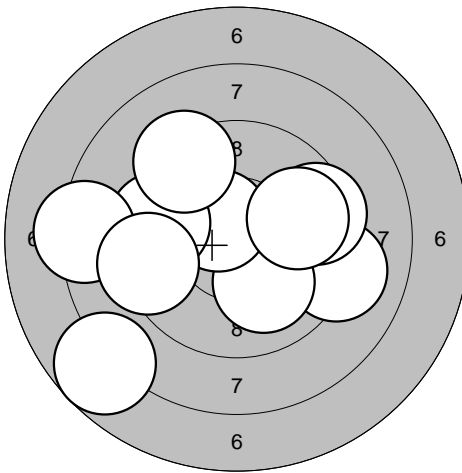
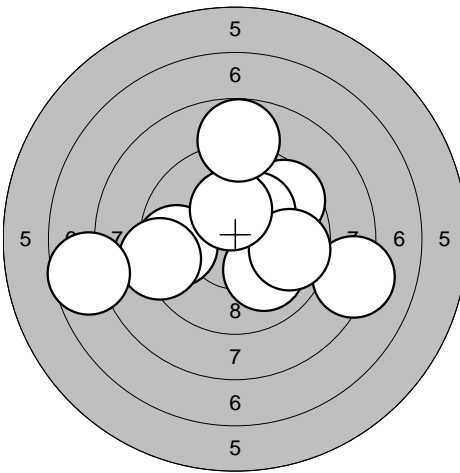
<p>Series 3</p> 	<p>Series 4</p> 	
1: 7,7 ↙ 2: 9,1 → 3: 10,0 ↓ 4: 10,5* ↗ 5: 9,5 → 6: 9,6 ← 7: 8,3 ← 8: 9,3 ← 9: 9,8 → 10: 9,3 ↗	1: 9,6 ↗ 2: 8,2 → 3: 9,6 ← 4: 10,2* ↗ 5: 10,0 ↓ 6: 9,3 ← 7: 7,7 ← 8: 9,7 → 9: 10,3* ↑ 10: 8,8 ↑	
Serie 89,0	Serie 89,0	
Sum 266,0	Sum 355,0	

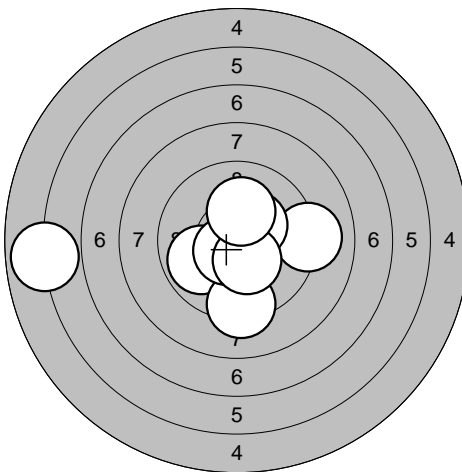
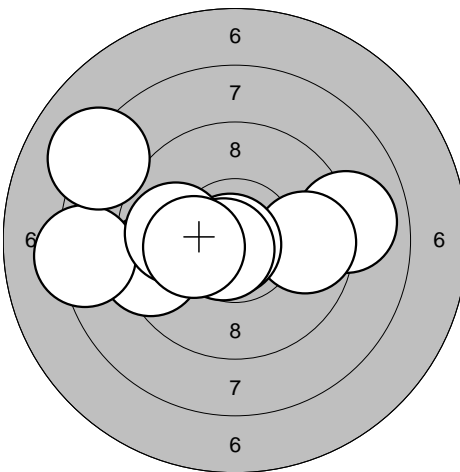
<p>Series 5</p> 	<p>Series 6</p> 	
1: 10,5* → 2: 5,9 ← 3: 9,1 → 4: 10,4* ↓ 5: 9,9 ← 6: 10,4* ↗ 7: 9,2 ↓ 8: 10,6* ↙ 9: 10,4* ↓ 10: 10,2* ↑	1: 9,0 → 2: 9,7 → 3: 10,8* ↙ 4: 9,9 ← 5: 10,7* ↙ 6: 9,4 ← 7: 8,3 ← 8: 9,9 ← 9: 10,2* ← 10: 8,2 ↖	
Serie 92,0	Serie 91,0	
Sum 447,0	Sum 538,0	

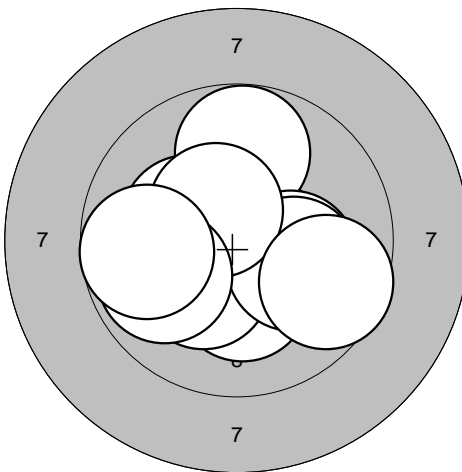
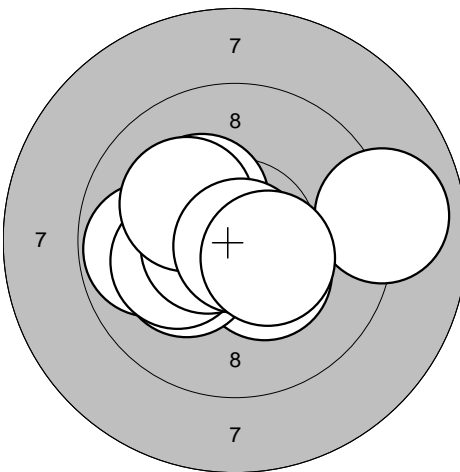
<p>Series 1</p> 	<p>Series 2</p> 	
1: 10,2* ↓ 2: 9,8 ↑ 3: 10,2* → 4: 10,3* ↙ 5: 10,1 → 6: 10,3* ↗ 7: 10,4* ↗ 8: 9,9 ← 9: 9,8 ← 10: 9,6 →	1: 10,3* ↗ 2: 9,8 ← 3: 9,0 → 4: 10,4* ↙ 5: 10,2* ↙ 6: 10,1 ← 7: 10,6* ← 8: 10,2* ↗ 9: 10,8* ↙ 10: 10,5* ↙	
Serie 96,0	Serie 98,0	
Sum 96,0	Sum 194,0	

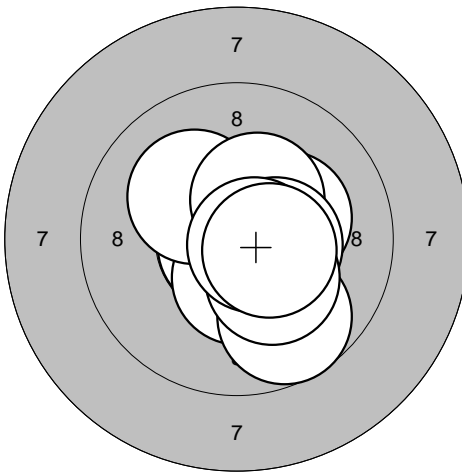
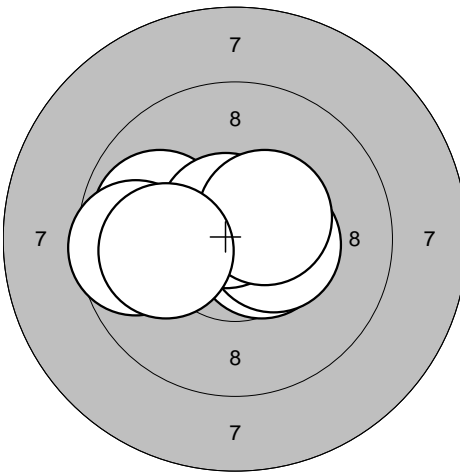
<p>Series 3</p> 	<p>Series 4</p> 	
1: 10,8* ← 2: 10,3* → 3: 10,4* ↓ 4: 10,2* ↗ 5: 10,4* ↗ 6: 9,7 ↙ 7: 10,4* → 8: 10,2* ↙ 9: 10,7* → 10: 10,5* →	1: 9,9 ← 2: 10,8* ↗ 3: 10,7* → 4: 10,6* → 5: 10,5* ↙ 6: 10,4* → 7: 10,7* ↗ 8: 9,6 ← 9: 10,5* ↗ 10: 10,0 ←	
Serie 99,0	Serie 98,0	
Sum 293,0	Sum 391,0	

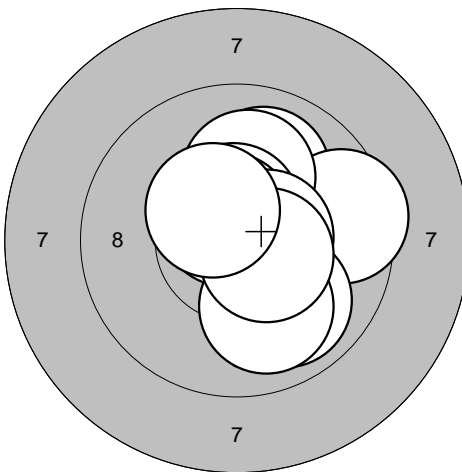
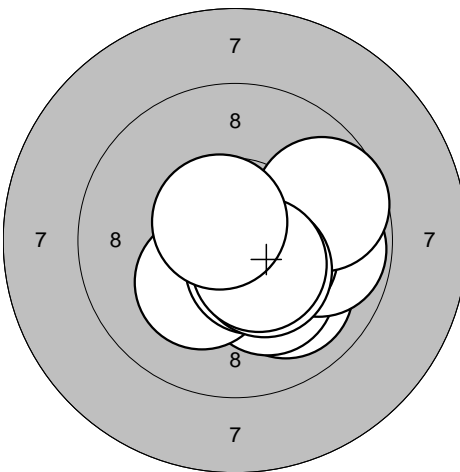
<p>Series 5</p> 	<p>Series 6</p> 	
1: 10,0 ↗ 2: 9,5 → 3: 10,1 ↑ 4: 10,5* ↑ 5: 10,6* ↗ 6: 10,5* → 7: 9,9 ↙ 8: 10,0 ↙ 9: 10,5* ↙ 10: 10,4* ↗	1: 10,0 ↙ 2: 10,2* ↙ 3: 10,2* ↙ 4: 9,8 → 5: 10,4* ↙ 6: 9,7 → 7: 10,5* ↙ 8: 10,4* ↙ 9: 10,5* ↙ 10: 10,6* ↗	
Serie 98,0	Serie 98,0	
Sum 489,0	Sum 587,0	

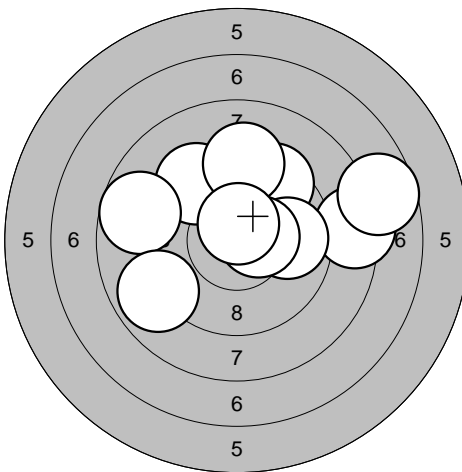
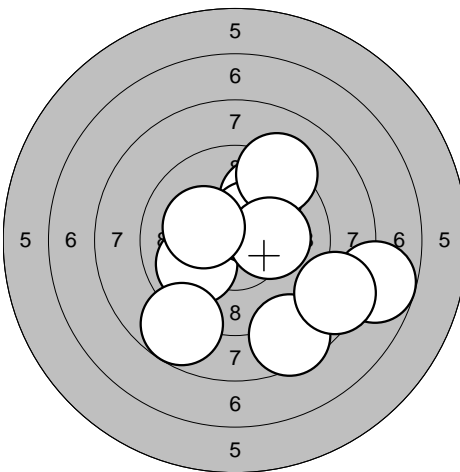
<p>Series 1</p> 	<p>1: 9,5 ↗ 2: 9,4 ↗ 3: 8,3 → 4: 8,8 ← 5: 7,7 → 6: 9,8 → 7: 10,5* → 8: 9,3 ↑ 9: 10,6* ↑ 10: 8,9 ↙</p> <table border="1" style="width:100%; border-collapse: collapse;"> <tr><td>Serie</td><td style="text-align: right;">87,0</td></tr> <tr><td>Sum</td><td style="text-align: right;">87,0</td></tr> </table>	Serie	87,0	Sum	87,0	<p>Series 2</p> 	<p>1: 10,0 ↖ 2: 9,9 ↗ 3: 7,8 → 4: 10,4* ↗ 5: 8,6 ↘ 6: 8,5 ↘ 7: 9,2 ↗ 8: 10,2* → 9: 8,8 ↘ 10: 10,2* ↖</p> <table border="1" style="width:100%; border-collapse: collapse;"> <tr><td>Serie</td><td style="text-align: right;">89,0</td></tr> <tr><td>Sum</td><td style="text-align: right;">176,0</td></tr> </table>	Serie	89,0	Sum	176,0
Serie	87,0										
Sum	87,0										
Serie	89,0										
Sum	176,0										

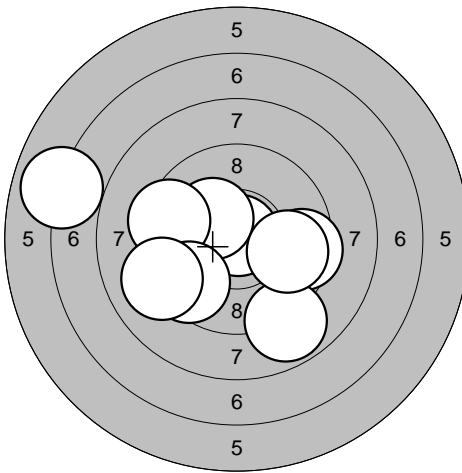
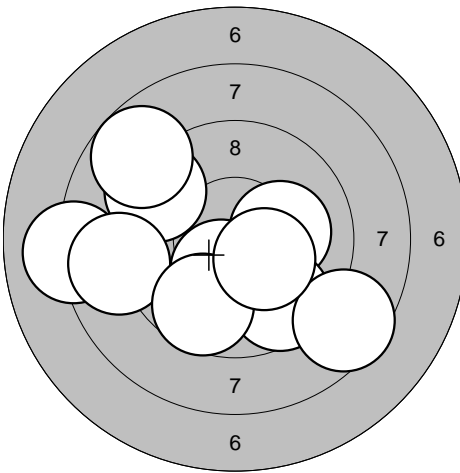
<p>Series 3</p> 	<p>1: 10,3* ↖ 2: 10,8* ↗ 3: 10,3* ↗ 4: 7,0 ← 5: 9,4 ← 6: 9,5 → 7: 8,8 ↘ 8: 9,8 → 9: 9,5 ↘ 10: 9,1 ↙</p> <table border="1" style="width:100%; border-collapse: collapse;"> <tr><td>Serie</td><td style="text-align: right;">90,0</td></tr> <tr><td>Sum</td><td style="text-align: right;">266,0</td></tr> </table>	Serie	90,0	Sum	266,0	<p>Series 4</p> 	<p>1: 10,4* ↘ 2: 10,2* → 3: 9,6 ↘ 4: 8,1 ← 5: 8,5 ↘ 6: 9,3 ↗ 7: 8,8 ↗ 8: 8,9 ← 9: 9,6 ↘ 10: 10,3* ↘</p> <table border="1" style="width:100%; border-collapse: collapse;"> <tr><td>Serie</td><td style="text-align: right;">89,0</td></tr> <tr><td>Sum</td><td style="text-align: right;">355,0</td></tr> </table>	Serie	89,0	Sum	355,0
Serie	90,0										
Sum	266,0										
Serie	89,0										
Sum	355,0										

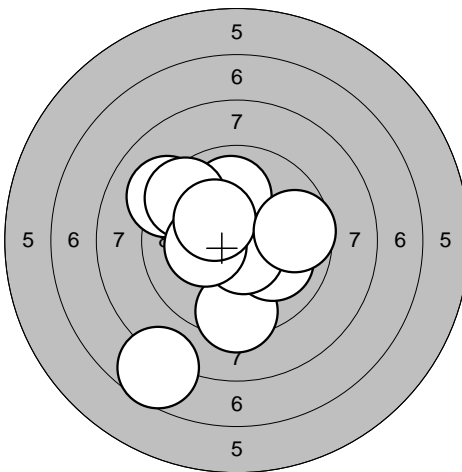
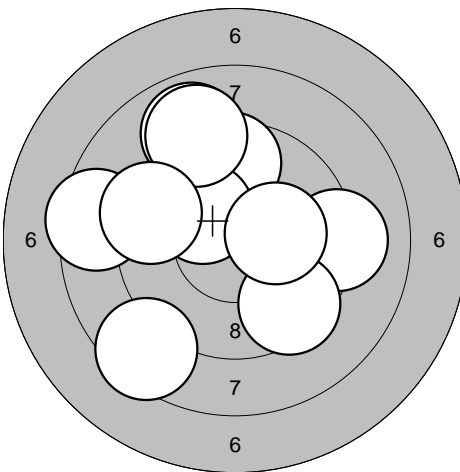
<p>Series 5</p> 	<p>1: 9,2 ↖ 2: 7,7 ↘ 3: 10,0 ↑ 4: 9,5 ↗ 5: 9,4 ↘ 6: 10,0 ↘ 7: 10,6* ↘ 8: 10,3* ← 9: 10,3* ↗ 10: 9,7 →</p> <table border="1" style="width:100%; border-collapse: collapse;"> <tr><td>Serie</td><td style="text-align: right;">93,0</td></tr> <tr><td>Sum</td><td style="text-align: right;">448,0</td></tr> </table>	Serie	93,0	Sum	448,0	<p>Series 6</p> 	<p>1: 8,5 ← 2: 8,5 ↘ 3: 9,6 ↑ 4: 9,1 → 5: 9,5 ↘ 6: 8,9 ↗ 7: 10,2* ↗ 8: 9,0 ↗ 9: 9,0 → 10: 9,4 ←</p> <table border="1" style="width:100%; border-collapse: collapse;"> <tr><td>Serie</td><td style="text-align: right;">89,0</td></tr> <tr><td>Sum</td><td style="text-align: right;">537,0</td></tr> </table>	Serie	89,0	Sum	537,0
Serie	93,0										
Sum	448,0										
Serie	89,0										
Sum	537,0										

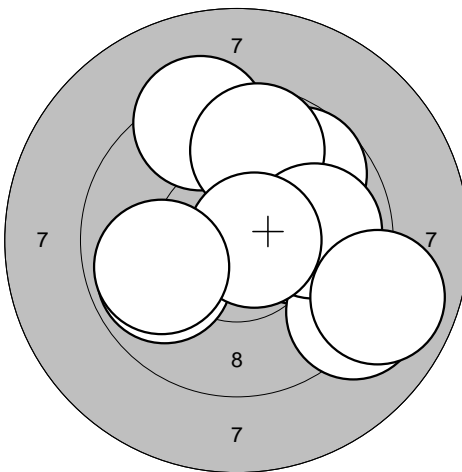
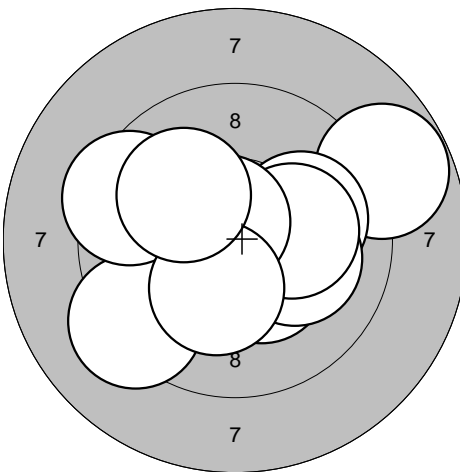
<p>Series 1</p> 	<p>1: 9,9 ↙ 2: 9,3 ↗ 3: 9,7 ↗ 4: 10,1 → 5: 9,7 ↗ 6: 9,1 ↘ 7: 9,9 → 8: 10,7* → 9: 9,9 ↙ 10: 8,9 ↘</p> <table border="1" style="width:100%; border-collapse: collapse;"> <tr><td>Serie</td><td style="text-align: right;">91,0</td></tr> <tr><td>Sum</td><td style="text-align: right;">91,0</td></tr> </table>	Serie	91,0	Sum	91,0	<p>Series 2</p> 	<p>1: 8,8 ↗ 2: 10,4* ↘ 3: 10,0 → 4: 10,1 ↘ 5: 10,2* → 6: 10,7* ↗ 7: 9,2 ↙ 8: 9,4 ↙ 9: 10,3* ↘ 10: 10,0 ↗</p> <table border="1" style="width:100%; border-collapse: collapse;"> <tr><td>Serie</td><td style="text-align: right;">96,0</td></tr> <tr><td>Sum</td><td style="text-align: right;">187,0</td></tr> </table>	Serie	96,0	Sum	187,0
Serie	91,0										
Sum	91,0										
Serie	96,0										
Sum	187,0										

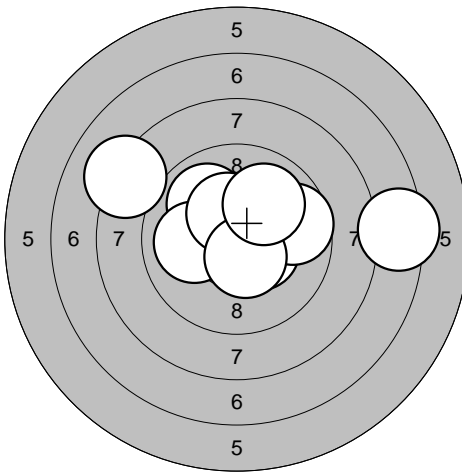
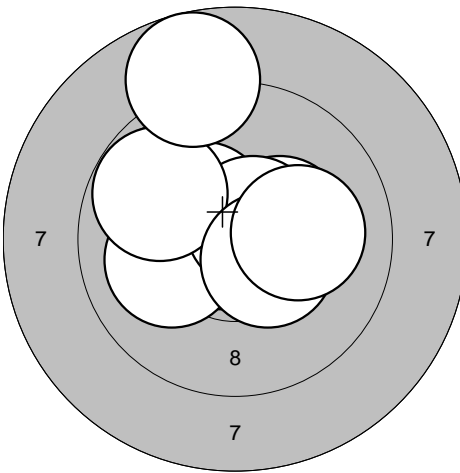
<p>Series 3</p> 	<p>1: 7,4 → 2: 10,4* ↘ 3: 10,5* ↗ 4: 10,0 ↗ 5: 10,0 ↙ 6: 10,4* ↗ 7: 9,7 → 8: 10,5* ↘ 9: 8,1 ↗ 10: 10,0 ↗</p> <table border="1" style="width:100%; border-collapse: collapse;"> <tr><td>Serie</td><td style="text-align: right;">94,0</td></tr> <tr><td>Sum</td><td style="text-align: right;">281,0</td></tr> </table>	Serie	94,0	Sum	281,0	<p>Series 4</p> 	<p>1: 9,8 ↙ 2: 10,4* ↙ 3: 10,3* → 4: 10,8* ↙ 5: 10,1 ↙ 6: 10,6* ↗ 7: 9,8 ↙ 8: 8,8 ↗ 9: 10,4* ↘ 10: 10,1 →</p> <table border="1" style="width:100%; border-collapse: collapse;"> <tr><td>Serie</td><td style="text-align: right;">96,0</td></tr> <tr><td>Sum</td><td style="text-align: right;">377,0</td></tr> </table>	Serie	96,0	Sum	377,0
Serie	94,0										
Sum	281,0										
Serie	96,0										
Sum	377,0										

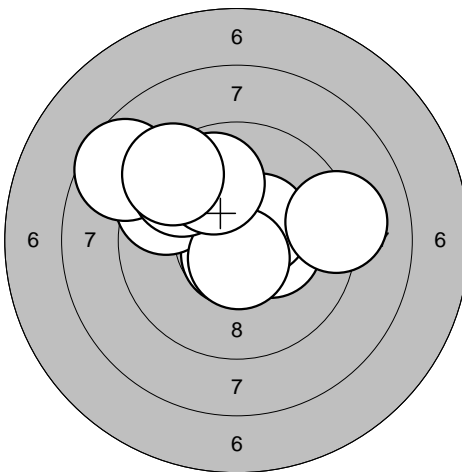
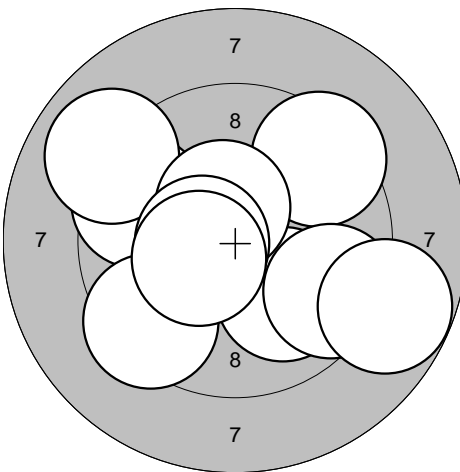
<p>Series 5</p> 	<p>1: 10,3* → 2: 10,7* ↘ 3: 10,5* ↗ 4: 9,2 → 5: 9,6 ↗ 6: 8,6 ↗ 7: 10,6* ↘ 8: 9,6 ↗ 9: 9,9 ↗ 10: 9,3 ↗</p> <table border="1" style="width:100%; border-collapse: collapse;"> <tr><td>Serie</td><td style="text-align: right;">93,0</td></tr> <tr><td>Sum</td><td style="text-align: right;">470,0</td></tr> </table>	Serie	93,0	Sum	470,0	<p>Series 6</p> 	<p>1: 9,4 ↗ 2: 9,6 ↙ 3: 10,0 ↘ 4: 9,4 ↙ 5: 9,0 ↗ 6: 9,5 ↘ 7: 10,5* ↗ 8: 10,5* ↙ 9: 10,4* ↙ 10: 8,8 ↘</p> <table border="1" style="width:100%; border-collapse: collapse;"> <tr><td>Serie</td><td style="text-align: right;">93,0</td></tr> <tr><td>Sum</td><td style="text-align: right;">563,0</td></tr> </table>	Serie	93,0	Sum	563,0
Serie	93,0										
Sum	470,0										
Serie	93,0										
Sum	563,0										

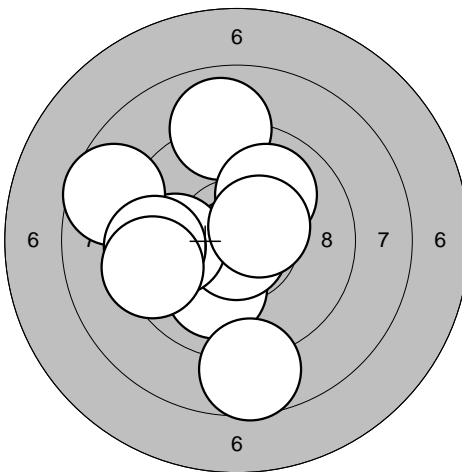
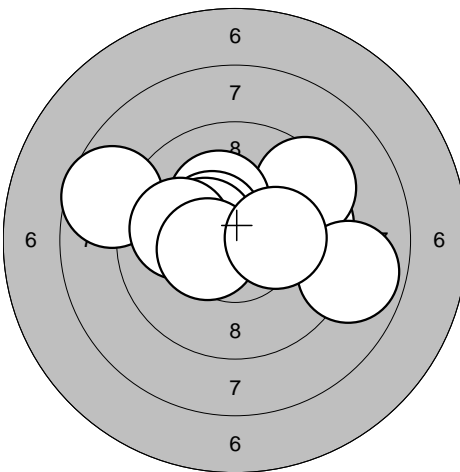
<p>Series 1</p> 	<p>1: 10,0 ↘ 2: 9,0 ↗ 3: 10,8* ↘ 4: 9,9 ← 5: 10,0 ↗ 6: 10,5* ↗ 7: 8,7 ↘ 8: 8,6 ↖ 9: 9,5 ← 10: 9,4 ←</p> <table border="1" style="width:100%; border-collapse: collapse;"> <tr><td>Serie</td><td style="text-align: right;">92,0</td></tr> <tr><td>Sum</td><td style="text-align: right;">92,0</td></tr> </table>	Serie	92,0	Sum	92,0	<p>Series 2</p> 	<p>1: 9,7 → 2: 8,6 ↖ 3: 9,4 ↗ 4: 10,2* ↗ 5: 10,4* ↗ 6: 8,9 → 7: 10,4* ↖ 8: 10,0 ← 9: 10,4* ← 10: 10,2* →</p> <table border="1" style="width:100%; border-collapse: collapse;"> <tr><td>Serie</td><td style="text-align: right;">94,0</td></tr> <tr><td>Sum</td><td style="text-align: right;">186,0</td></tr> </table>	Serie	94,0	Sum	186,0
Serie	92,0										
Sum	92,0										
Serie	94,0										
Sum	186,0										

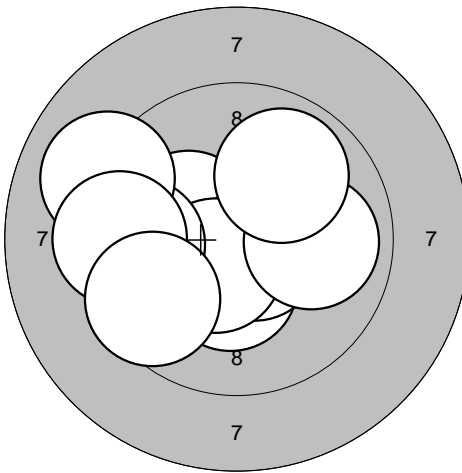
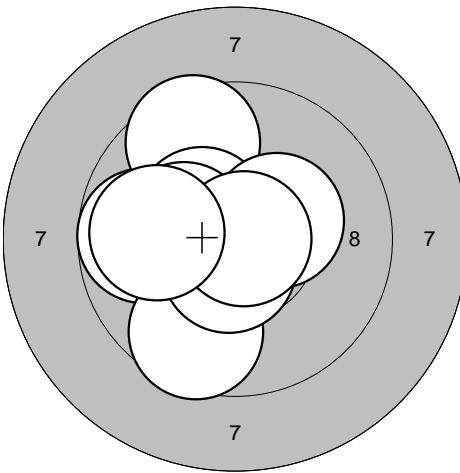
<p>Series 3</p> 	<p>1: 10,3* ↘ 2: 10,2* ↖ 3: 10,7* ↘ 4: 10,5* ↘ 5: 9,6 ← 6: 10,0 → 7: 9,1 ↖ 8: 9,4 ← 9: 9,6 ↘ 10: 9,9 ↗</p> <table border="1" style="width:100%; border-collapse: collapse;"> <tr><td>Serie</td><td style="text-align: right;">95,0</td></tr> <tr><td>Sum</td><td style="text-align: right;">281,0</td></tr> </table>	Serie	95,0	Sum	281,0	<p>Series 4</p> 	<p>1: 9,8 ← 2: 10,3* ↖ 3: 9,5 ↗ 4: 10,4* ↖ 5: 10,3* ↖ 6: 9,6 ↘ 7: 10,3* ↗ 8: 10,6* ↘ 9: 10,8* → 10: 9,9 ←</p> <table border="1" style="width:100%; border-collapse: collapse;"> <tr><td>Serie</td><td style="text-align: right;">96,0</td></tr> <tr><td>Sum</td><td style="text-align: right;">377,0</td></tr> </table>	Serie	96,0	Sum	377,0
Serie	95,0										
Sum	281,0										
Serie	96,0										
Sum	377,0										

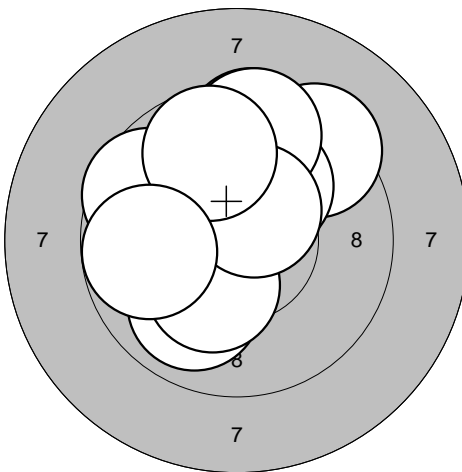
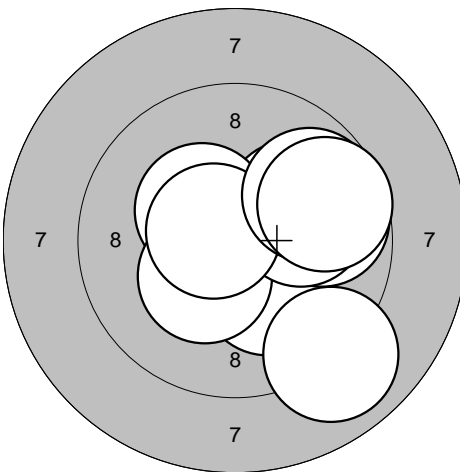
<p>Series 5</p> 	<p>1: 9,9 ↘ 2: 9,7 ↖ 3: 9,4 ↗ 4: 10,1 ↗ 5: 9,6 ↗ 6: 9,5 ↗ 7: 10,3* ↘ 8: 10,5* ↗ 9: 9,7 ↗ 10: 9,8 ←</p> <table border="1" style="width:100%; border-collapse: collapse;"> <tr><td>Serie</td><td style="text-align: right;">93,0</td></tr> <tr><td>Sum</td><td style="text-align: right;">470,0</td></tr> </table>	Serie	93,0	Sum	470,0	<p>Series 6</p> 	<p>1: 10,1 ↗ 2: 10,3* ↖ 3: 10,2* ↘ 4: 9,0 ↘ 5: 10,3* ↘ 6: 9,8 → 7: 10,0 → 8: 10,6* ↖ 9: 9,8 ↗ 10: 9,7 ↗</p> <table border="1" style="width:100%; border-collapse: collapse;"> <tr><td>Serie</td><td style="text-align: right;">96,0</td></tr> <tr><td>Sum</td><td style="text-align: right;">566,0</td></tr> </table>	Serie	96,0	Sum	566,0
Serie	93,0										
Sum	470,0										
Serie	96,0										
Sum	566,0										

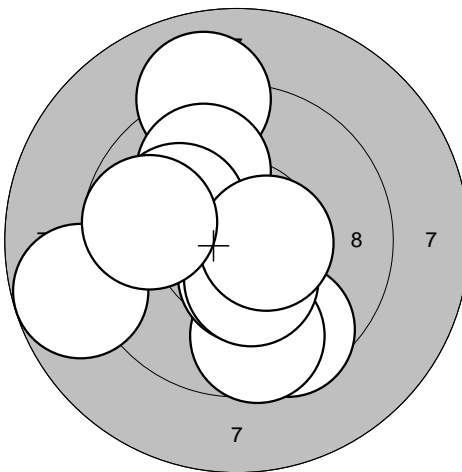
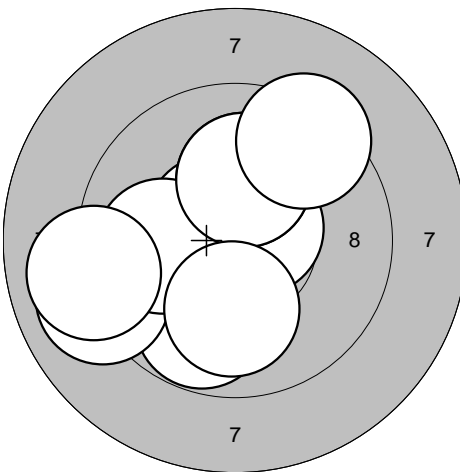
<p>Series 1</p> 	<p>1: 9,5 ↘ 2: 9,7 ↘ 3: 9,0 ↗ 4: 9,9 ↗ 5: 10,1 ↗ 6: 10,4* ↘ 7: 8,8 ← 8: 10,4* ↘ 9: 10,5* → 10: 9,8 ←</p> <p>Serie 93,0 Sum 93,0</p>	<p>Series 2</p> 	<p>1: 9,8 ↘ 2: 10,6* ↖ 3: 10,6* ↗ 4: 10,1 ↑ 5: 9,1 ← 6: 10,0 ← 7: 10,1 ↑ 8: 9,4 ↗ 9: 9,0 ← 10: 10,0 ↓</p> <p>Serie 96,0 Sum 189,0</p>
--	---	--	---

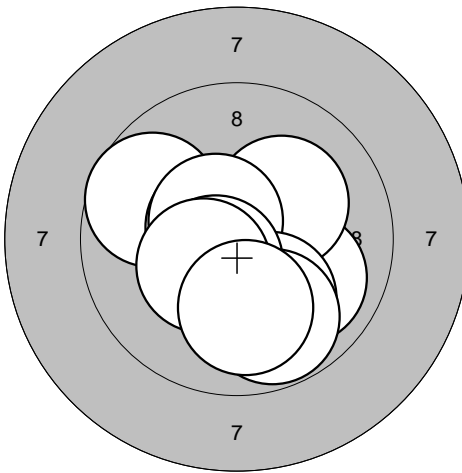
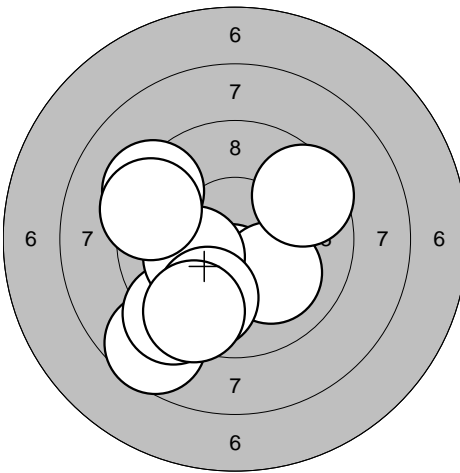
<p>Series 3</p> 	<p>1: 10,0 ↘ 2: 9,7 ↖ 3: 10,6* ↗ 4: 10,2* ↗ 5: 10,6* ↗ 6: 10,0 ↘ 7: 10,5* ↘ 8: 10,4* ↖ 9: 9,8 ↘ 10: 10,0 ↓</p> <p>Serie 98,0 Sum 287,0</p>	<p>Series 4</p> 	<p>1: 10,3* ↓ 2: 8,6 ↘ 3: 10,1 ↘ 4: 9,2 ↘ 5: 9,5 ↗ 6: 10,2* ← 7: 9,8 ↘ 8: 9,5 ↘ 9: 9,3 ↖ 10: 9,4 ↖</p> <p>Serie 92,0 Sum 379,0</p>
---	--	---	--

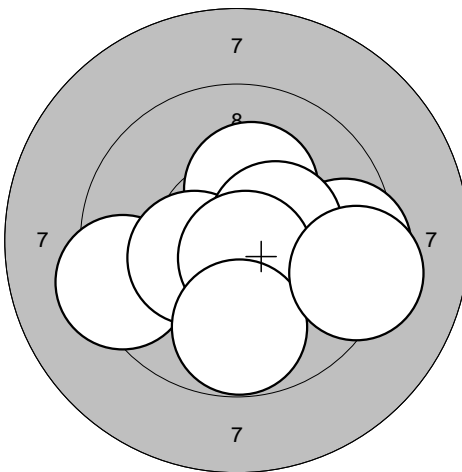
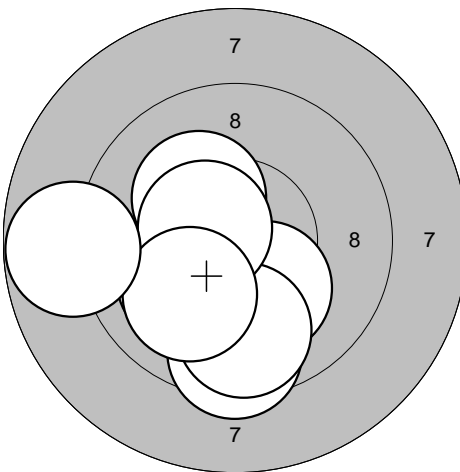
<p>Series 5</p> 	<p>1: 9,3 ← 2: 10,2* → 3: 10,2* ↗ 4: 9,5 → 5: 10,3* → 6: 10,4* ← 7: 10,4* → 8: 10,7* ↘ 9: 9,8 ↘ 10: 9,3 →</p> <p>Serie 96,0 Sum 475,0</p>	<p>Series 6</p> 	<p>1: 10,2* ↓ 2: 10,5* ← 3: 10,2* ↘ 4: 9,5 ↓ 5: 10,1 ← 6: 10,2* ↗ 7: 9,7 ↓ 8: 10,5* ↖ 9: 10,0 ↘ 10: 8,8 ←</p> <p>Serie 96,0 Sum 571,0</p>
--	---	--	---

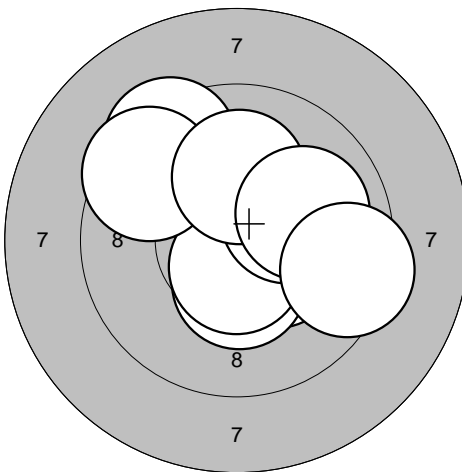
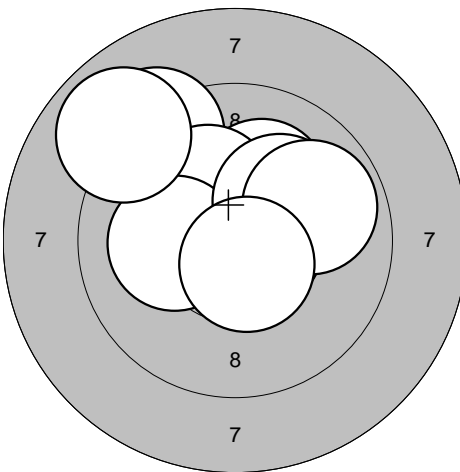
<p>Series 1</p> 	<p>1: 10,4* →</p> <p>2: 9,4 ↗</p> <p>3: 10,4* ↓</p> <p>4: 10,8* ↗</p> <p>5: 10,6* ↓</p> <p>6: 9,5 ↗</p> <p>7: 10,2* →</p> <p>8: 10,1 ↑</p> <p>9: 10,0 →</p> <p>10: 9,4 →</p>	<p>Series 2</p> 	<p>1: 10,6* →</p> <p>2: 10,7* →</p> <p>3: 10,1 ↗</p> <p>4: 9,2 ↗</p> <p>5: 10,2* ↗</p> <p>6: 10,2* ←</p> <p>7: 10,2* ↗</p> <p>8: 8,9 ↗</p> <p>9: 9,8 →</p> <p>10: 10,6* ↓</p>
Serie 97,0	Serie 96,0	Serie 96,0	Serie 96,0
Sum 97,0	Sum 97,0	Sum 193,0	Sum 193,0

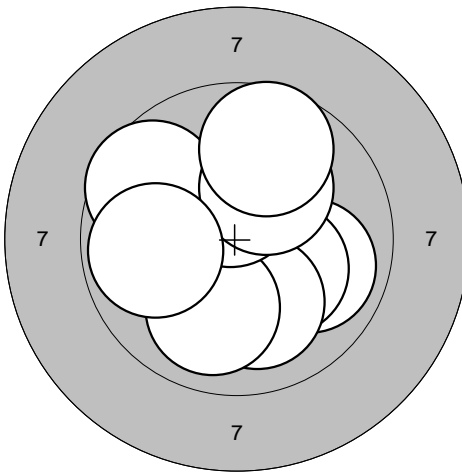
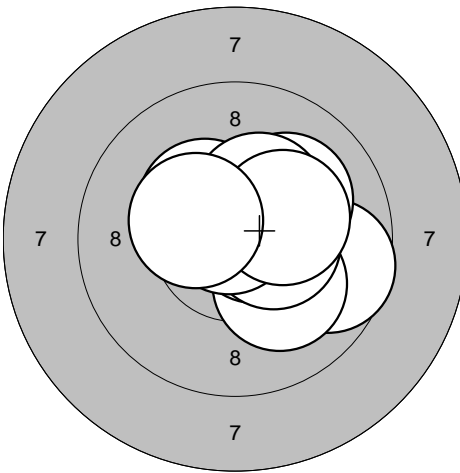
<p>Series 3</p> 	<p>1: 9,9 →</p> <p>2: 10,3* ↘</p> <p>3: 10,2* ↘</p> <p>4: 10,1 ↓</p> <p>5: 10,0 ↓</p> <p>6: 10,4* ↑</p> <p>7: 9,6 ↖</p> <p>8: 10,2* ↗</p> <p>9: 9,7 ↑</p> <p>10: 9,9 ←</p>	<p>Series 4</p> 	<p>1: 9,7 →</p> <p>2: 10,1 ↘</p> <p>3: 10,7* →</p> <p>4: 10,1 ↗</p> <p>5: 10,4* →</p> <p>6: 10,8* ↗</p> <p>7: 10,4* ↗</p> <p>8: 10,3* ↗</p> <p>9: 10,3* →</p> <p>10: 10,4* ←</p>
Serie 96,0	Serie 99,0	Serie 99,0	Serie 99,0
Sum 289,0	Sum 388,0	Sum 388,0	Sum 388,0

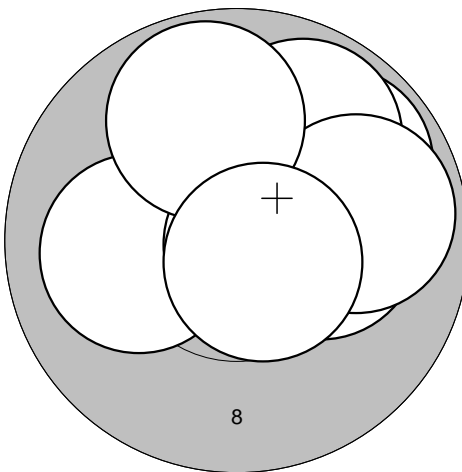
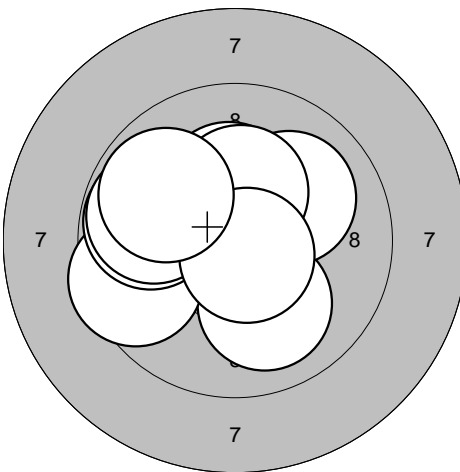
<p>Series 5</p> 	<p>1: 9,8 ↗</p> <p>2: 10,0 ↗</p> <p>3: 10,1 ←</p> <p>4: 10,7* →</p> <p>5: 10,1 ↗</p> <p>6: 10,2* →</p> <p>7: 9,8 ↗</p> <p>8: 9,8 →</p> <p>9: 9,8 ↑</p> <p>10: 10,6* ↓</p>	<p>Series 6</p> 	<p>1: 10,0 ↓</p> <p>2: 10,0 ↗</p> <p>3: 9,6 ←</p> <p>4: 9,8 ←</p> <p>5: 10,3* ↑</p> <p>6: 10,2* ↖</p> <p>7: 10,3* ↑</p> <p>8: 9,8 ←</p> <p>9: 10,7* ↓</p> <p>10: 9,9 ↖</p>
Serie 96,0	Serie 96,0	Serie 96,0	Serie 96,0
Sum 484,0	Sum 484,0	Sum 580,0	Sum 580,0

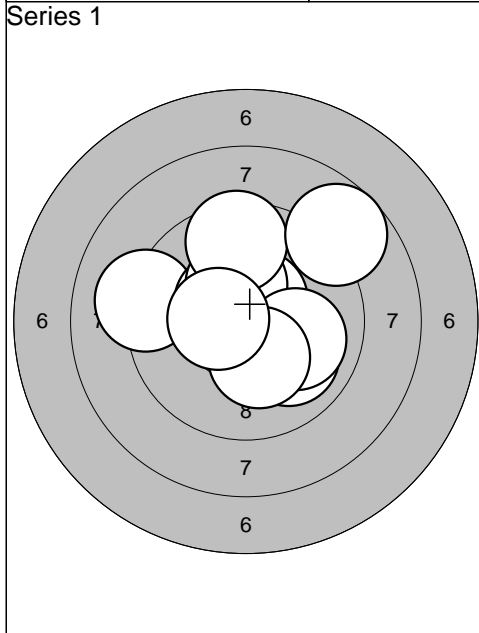

1: 10,6*	↗
2: 9,1	←
3: 10,5*	↗
4: 10,0	↘
5: 10,3*	↑
6: 10,0	→
7: 10,3*	↘
8: 9,5	↑
9: 10,5*	←
10: 8,7	↗
Serie	96,0
Sum	96,0

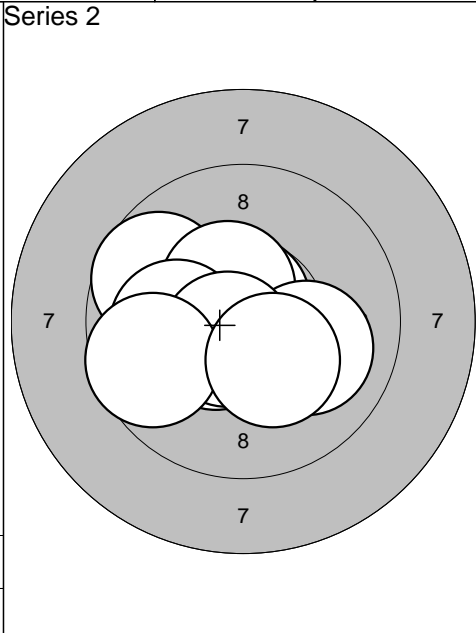

1: 10,4*	↖
2: 10,7*	↑
3: 9,7	↖
4: 10,5*	↗
5: 10,5*	↙
6: 10,1	←
7: 10,0	→
8: 10,6*	↙
9: 9,6	←
10: 10,3*	↘
Serie	98,0
Sum	194,0

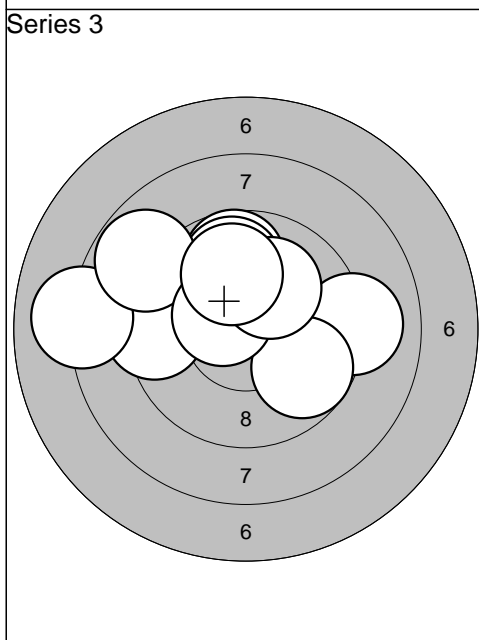

1: 9,3	←
2: 8,1	←
3: 9,7	↑
4: 9,1	→
5: 9,8	↑
6: 9,7	↘
7: 8,8	↗
8: 10,5*	↗
9: 10,1	↗
10: 10,0	↑
Serie	91,0
Sum	285,0

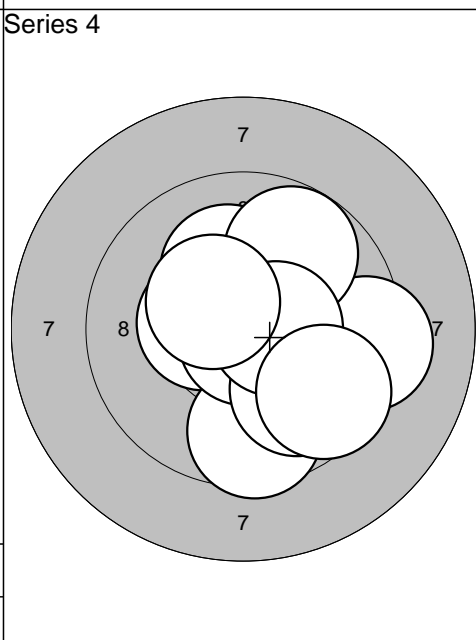

1: 10,2*	↑
2: 9,3	→
3: 10,4*	←
4: 9,7	↗
5: 9,6	↘
6: 10,8*	↘
7: 9,8	↘
8: 10,5*	→
9: 10,4*	↗
10: 9,6	↘
Serie	95,0
Sum	380,0

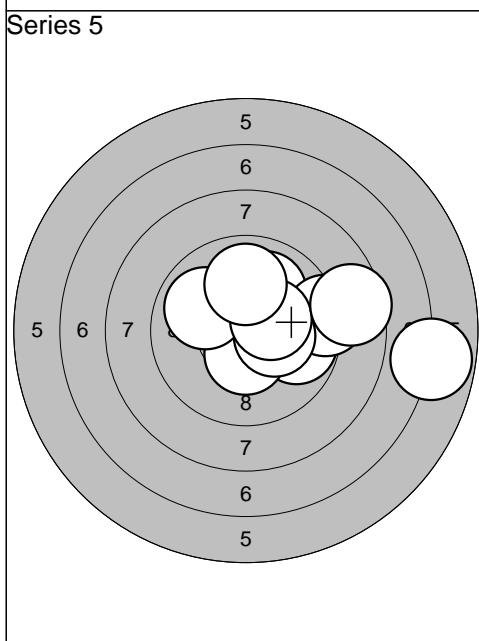

1: 9,8	→
2: 10,4*	↘
3: 10,0	↗
4: 9,2	→
5: 10,3*	→
6: 10,0	↗
7: 10,3*	→
8: 6,8	→
9: 8,6	→
10: 9,9	↑
Serie	91,0
Sum	471,0

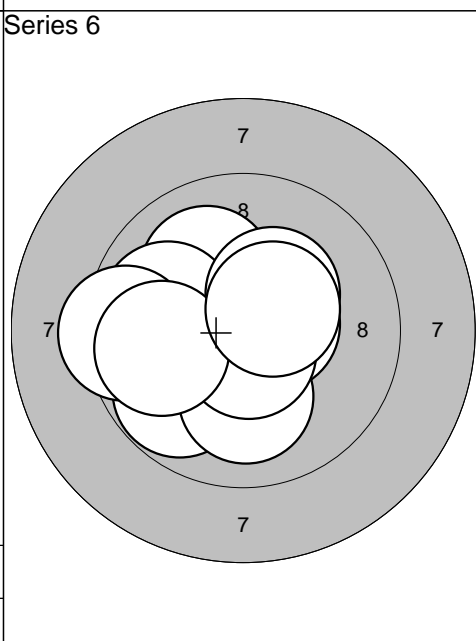

1: 10,1	↗
2: 9,8	↖
3: 10,1	↘
4: 10,5*	→
5: 10,7*	↘
6: 9,9	←
7: 9,4	←
8: 10,3*	↗
9: 9,8	←
10: 10,5*	↗
Serie	96,0
Sum	567,0

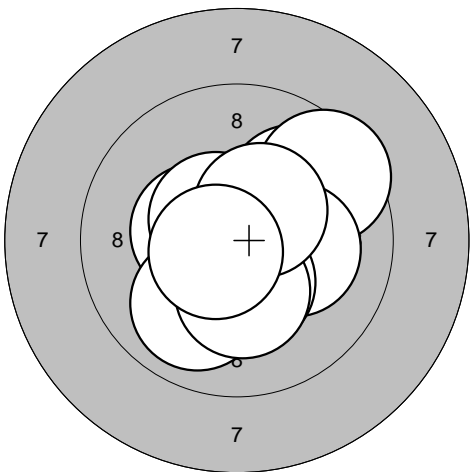
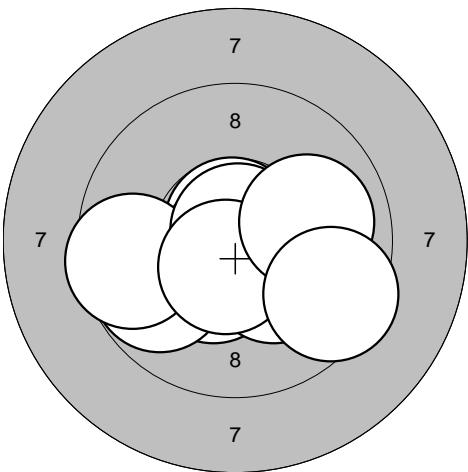
<p>Series 1</p> 	<p>1: 10,0 ↗</p> <p>2: 10,4* ←</p> <p>3: 9,5 ↗</p> <p>4: 10,2* →</p> <p>5: 9,9 ↓</p> <p>6: 10,6* ↗</p> <p>7: 10,4* ↓</p> <p>8: 10,3* ↓</p> <p>9: 10,5* ↗</p> <p>10: 10,6* ←</p>	<p>Series 2</p> 	<p>1: 10,4* ↓</p> <p>2: 10,7* ↑</p> <p>3: 9,8 ←</p> <p>4: 10,8* ↓</p> <p>5: 10,2* ↘</p> <p>6: 9,6 ←</p> <p>7: 10,8* ↑</p> <p>8: 10,6* ↓</p> <p>9: 10,0 →</p> <p>10: 9,5 ↘</p>
Serie 98,0	Serie 97,0	Serie 97,0	Serie 97,0
Sum 98,0	Sum 98,0	Sum 195,0	Sum 195,0

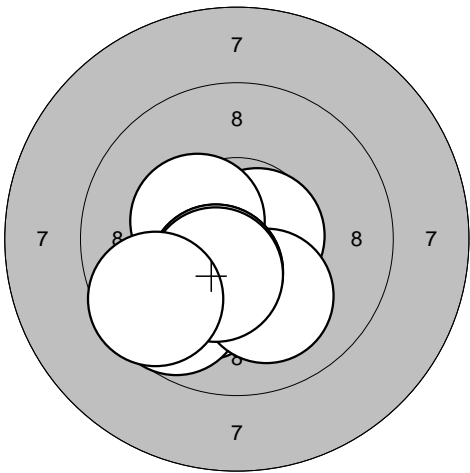
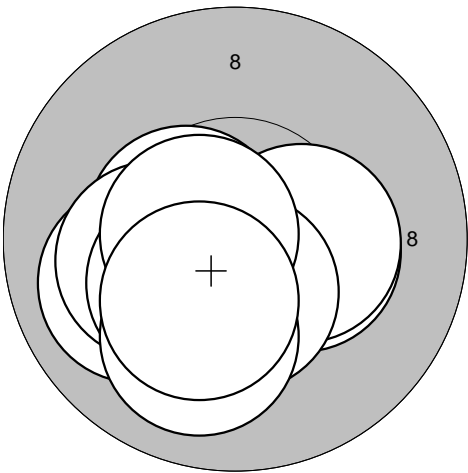
<p>Series 3</p> 	<p>1: 10,0 ↓</p> <p>2: 10,7* →</p> <p>3: 10,4* ←</p> <p>4: 10,1 ↓</p> <p>5: 9,7 ↓</p> <p>6: 10,1 ↓</p> <p>7: 10,4* ↓</p> <p>8: 10,4* ↓</p> <p>9: 10,4* ↓</p> <p>10: 9,6 ←</p>	<p>Series 4</p> 	<p>1: 10,4* →</p> <p>2: 10,5* ←</p> <p>3: 10,0 ←</p> <p>4: 10,2* ←</p> <p>5: 10,3* →</p> <p>6: 10,5* ↓</p> <p>7: 10,4* ↓</p> <p>8: 10,0 ↓</p> <p>9: 10,6* ←</p> <p>10: 10,3* ↓</p>
Serie 98,0	Serie 98,0	Serie 100,0	Serie 100,0
Sum 293,0	Sum 293,0	Sum 393,0	Sum 393,0

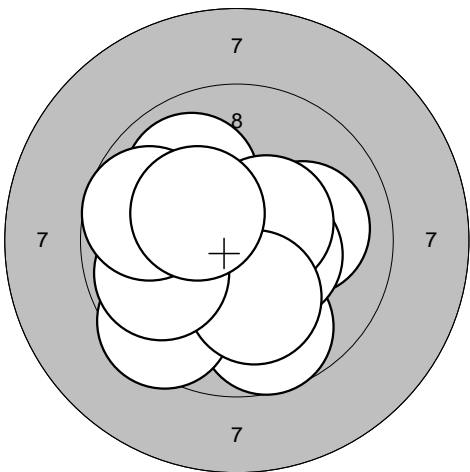
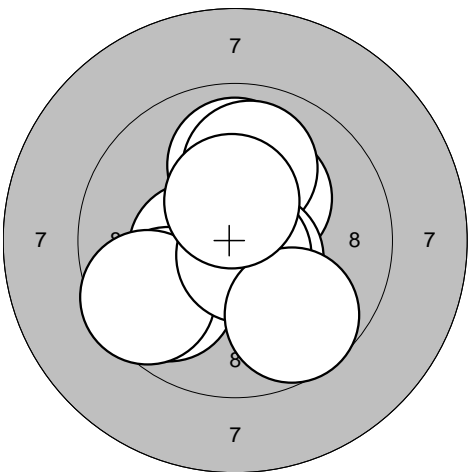
<p>Series 5</p> 	<p>1: 9,7 ↓</p> <p>2: 10,1 →</p> <p>3: 9,5 ↓</p> <p>4: 10,4* →</p> <p>5: 10,0 ↗</p> <p>6: 10,5* →</p> <p>7: 10,2* ↓</p> <p>8: 9,9 ←</p> <p>9: 9,7 ←</p> <p>10: 10,3* ↗</p>	<p>Series 6</p> 	<p>1: 9,9 ↑</p> <p>2: 10,2* ↗</p> <p>3: 10,4* ←</p> <p>4: 10,0 ↑</p> <p>5: 9,8 ←</p> <p>6: 10,6* ↘</p> <p>7: 9,6 ←</p> <p>8: 10,7* ↓</p> <p>9: 9,7 ↓</p> <p>10: 10,4* ↑</p>
Serie 96,0	Serie 96,0	Serie 96,0	Serie 96,0
Sum 489,0	Sum 489,0	Sum 585,0	Sum 585,0

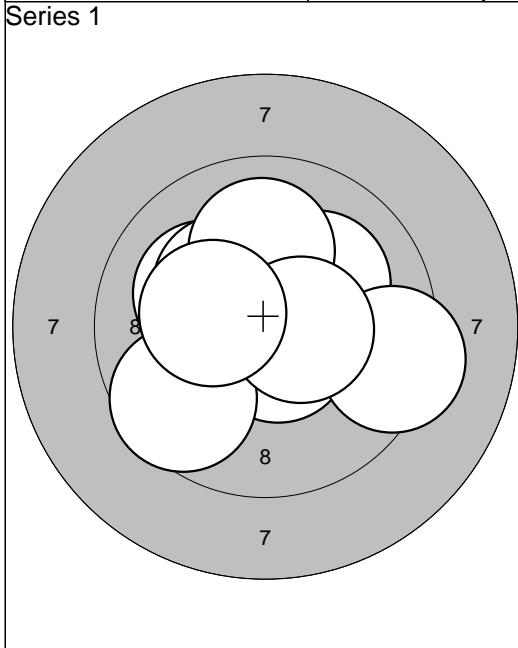

1: 10,4*	↖
2: 10,1	↗
3: 10,6*	↘
4: 9,4	→
5: 10,1	↖
6: 10,3*	↗
7: 10,0	↑
8: 9,6	↙
9: 10,5*	→
10: 10,3*	↖
Serie	98,0
Sum	98,0

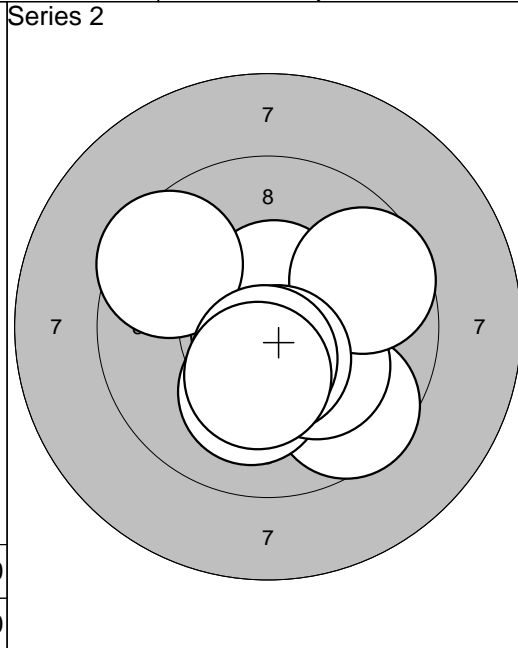

1: 9,6	↘
2: 10,1	↘
3: 10,9*	↙
4: 10,5*	↑
5: 10,2*	↘
6: 9,6	→
7: 9,5	↖
8: 10,5*	↘
9: 10,6*	↘
10: 10,3*	↘
Serie	97,0
Sum	195,0

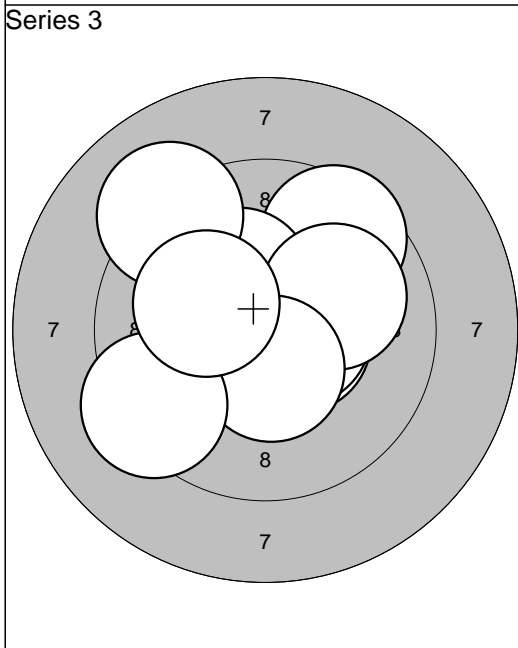

1: 10,5*	→
2: 10,3*	↖
3: 9,6	↗
4: 10,6*	→
5: 10,3*	↗
6: 10,0	→
7: 10,5*	↘
8: 9,3	↙
9: 9,1	↗
10: 10,2*	↖
Serie	97,0
Sum	292,0

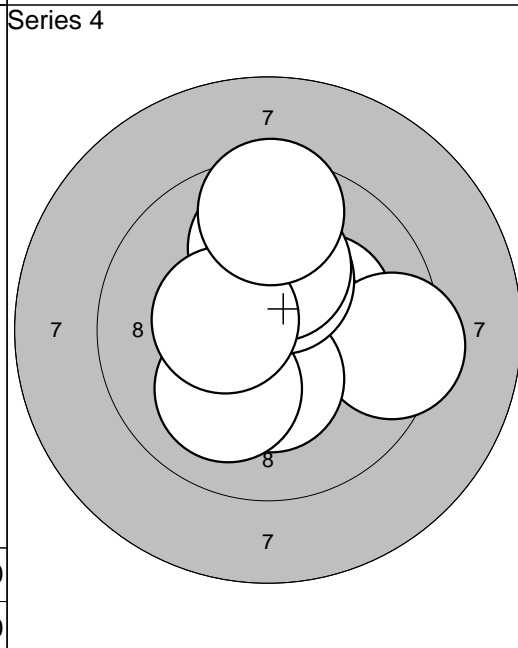

1: 9,9	↑
2: 10,3*	↗
3: 10,5*	→
4: 9,4	→
5: 10,3*	↘
6: 10,1	↙
7: 10,3*	↑
8: 10,2*	↑
9: 10,4*	↖
10: 9,5	↑
Serie	97,0
Sum	389,0

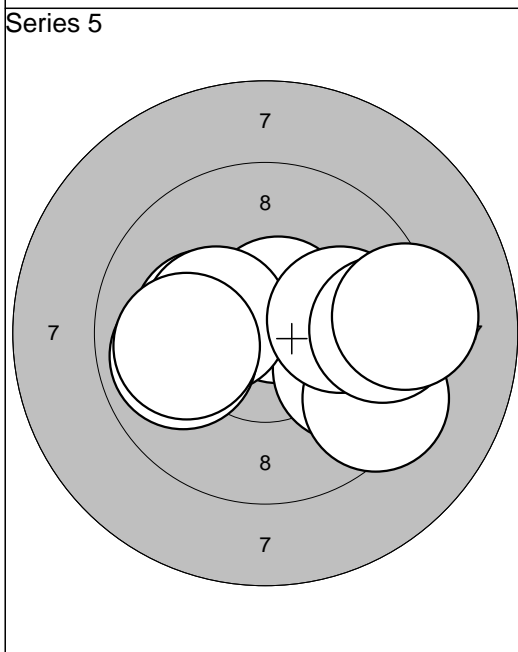

1: 10,6*	↗
2: 9,8	↘
3: 10,2*	↖
4: 9,4	↘
5: 10,3*	↖
6: 9,9	↖
7: 10,0	→
8: 10,0	↖
9: 9,5	→
10: 9,2	→
Serie	95,0
Sum	484,0

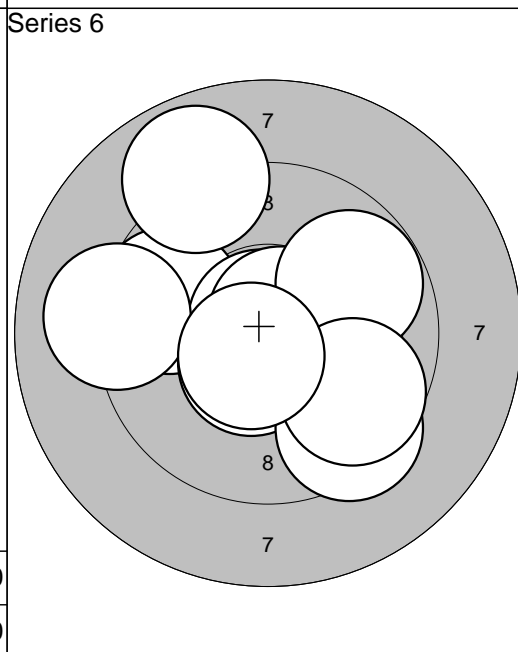

1: 9,7	↖
2: 10,8*	↗
3: 10,7*	↗
4: 9,8	↗
5: 10,5*	↘
6: 9,4	↘
7: 9,7	↘
8: 8,9	↗
9: 9,1	↖
10: 10,6*	↘
Serie	93,0
Sum	577,0

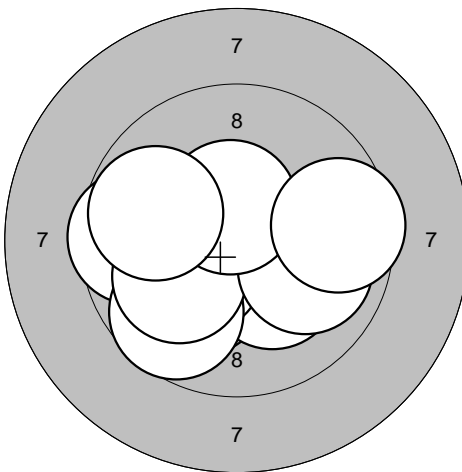
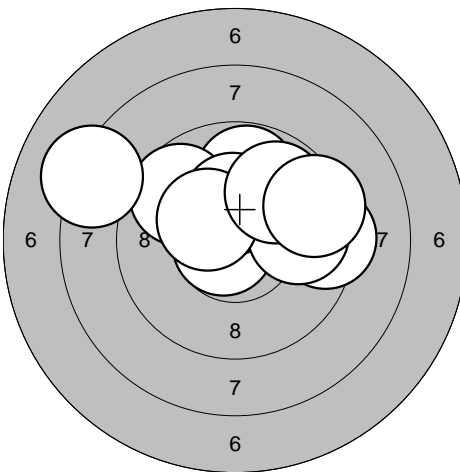
<p>Series 1</p> 	<p>1: 10,2* ↙ 2: 10,2* ↘ 3: 9,6 ← 4: 10,3* ↙ 5: 9,7 ↘ 6: 10,1 ↙ 7: 10,0 → 8: 10,5* ↑ 9: 9,6 → 10: 9,8 ←</p> <table border="1" style="width:100%; border-collapse: collapse;"> <tr><td>Serie</td><td style="text-align: right;">96,0</td></tr> <tr><td>Sum</td><td style="text-align: right;">96,0</td></tr> </table>	Serie	96,0	Sum	96,0	<p>Series 2</p> 	<p>1: 9,4 → 2: 9,8 ↑ 3: 9,7 ↖ 4: 10,7* ↙ 5: 10,3* ↑ 6: 9,8 → 7: 10,4* ↖ 8: 9,9 ↗ 9: 8,2 ↖ 10: 9,4 →</p> <table border="1" style="width:100%; border-collapse: collapse;"> <tr><td>Serie</td><td style="text-align: right;">92,0</td></tr> <tr><td>Sum</td><td style="text-align: right;">188,0</td></tr> </table>	Serie	92,0	Sum	188,0
Serie	96,0										
Sum	96,0										
Serie	92,0										
Sum	188,0										

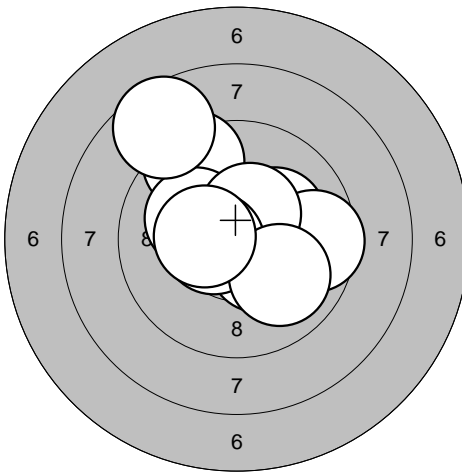
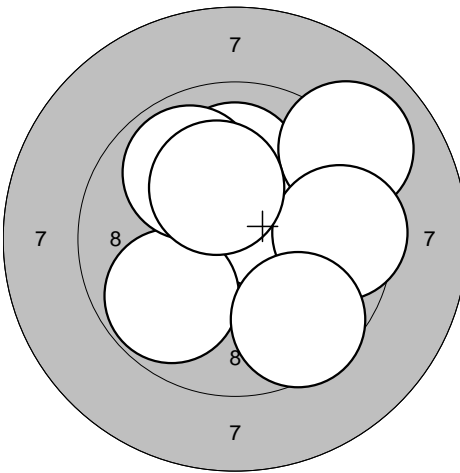
<p>Series 3</p> 	<p>1: 9,4 ↑ 2: 10,4* ↘ 3: 10,2* → 4: 9,6 → 5: 10,2* ↖ 6: 10,4* ↗ 7: 10,5* ← 8: 10,0 ↘ 9: 8,6 ↗ 10: 10,4* ←</p> <table border="1" style="width:100%; border-collapse: collapse;"> <tr><td>Serie</td><td style="text-align: right;">96,0</td></tr> <tr><td>Sum</td><td style="text-align: right;">284,0</td></tr> </table>	Serie	96,0	Sum	284,0	<p>Series 4</p> 	<p>1: 10,1 → 2: 10,5* ↘ 3: 10,5* ↗ 4: 10,0 ↑ 5: 9,8 ↙ 6: 9,1 ↗ 7: 9,5 → 8: 9,6 ↘ 9: 9,9 ↗ 10: 10,2* ↑</p> <table border="1" style="width:100%; border-collapse: collapse;"> <tr><td>Serie</td><td style="text-align: right;">95,0</td></tr> <tr><td>Sum</td><td style="text-align: right;">379,0</td></tr> </table>	Serie	95,0	Sum	379,0
Serie	96,0										
Sum	284,0										
Serie	95,0										
Sum	379,0										

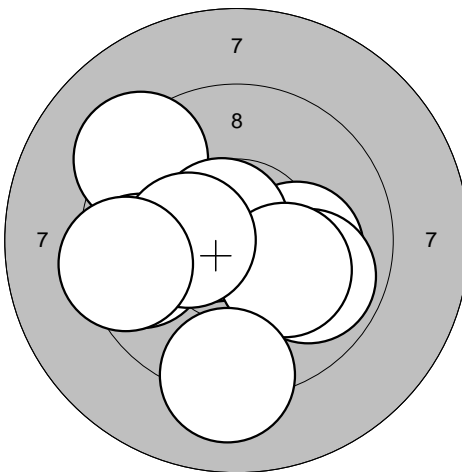
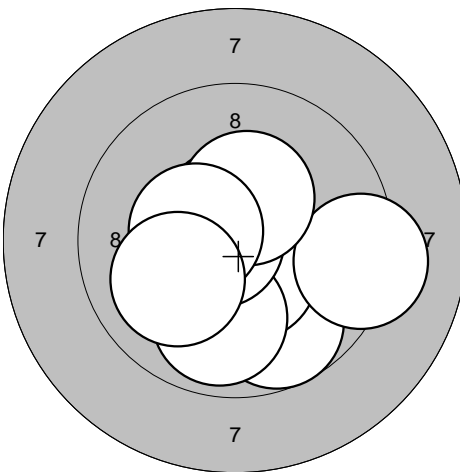
<p>Series 5</p> 	<p>1: 9,3 ↗ 2: 9,6 ← 3: 10,1 → 4: 10,6* ↙ 5: 9,9 ↘ 6: 10,7* ↗ 7: 10,2* ↘ 8: 10,3* ← 9: 9,1 ↓ 10: 9,4 ←</p> <table border="1" style="width:100%; border-collapse: collapse;"> <tr><td>Serie</td><td style="text-align: right;">95,0</td></tr> <tr><td>Sum</td><td style="text-align: right;">474,0</td></tr> </table>	Serie	95,0	Sum	474,0	<p>Series 6</p> 	<p>1: 9,7 ↘ 2: 10,6* ↑ 3: 10,5* ↘ 4: 10,5* ↙ 5: 9,2 → 6: 9,9 ↓ 7: 10,7* ← 8: 10,4* ↑ 9: 10,4* ← 10: 10,0 ↙</p> <table border="1" style="width:100%; border-collapse: collapse;"> <tr><td>Serie</td><td style="text-align: right;">97,0</td></tr> <tr><td>Sum</td><td style="text-align: right;">571,0</td></tr> </table>	Serie	97,0	Sum	571,0
Serie	95,0										
Sum	474,0										
Serie	97,0										
Sum	571,0										

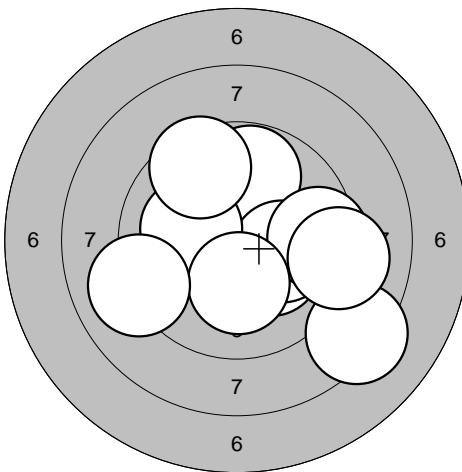
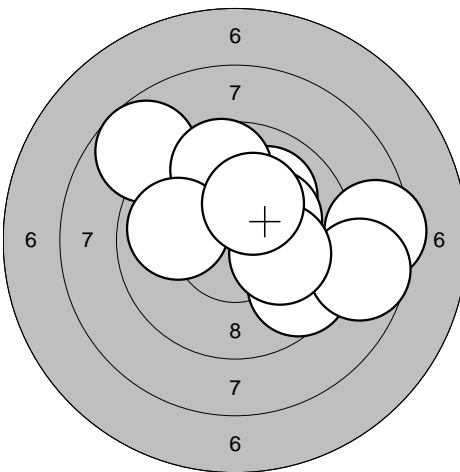
<p>Series 1</p> 	<p>1: 10,2* ↘ 2: 9,8 ↑ 3: 8,3 ↘ 4: 10,1 → 5: 9,5 → 6: 10,1 ← 7: 10,2* ↓ 8: 9,0 ← 9: 9,1 → 10: 9,5 ↑</p> <table border="1" style="width:100%; border-collapse: collapse;"> <tr><td style="text-align: right;">Serie</td><td style="text-align: right;">93,0</td></tr> <tr><td style="text-align: right;">Sum</td><td style="text-align: right;">93,0</td></tr> </table>	Serie	93,0	Sum	93,0	<p>Series 2</p> 	<p>1: 10,0 ↗ 2: 8,5 → 3: 9,6 ↘ 4: 8,7 ↗ 5: 8,7 → 6: 10,2* ↗ 7: 10,1 → 8: 9,7 ↑ 9: 9,9 ← 10: 10,3* ↗</p> <table border="1" style="width:100%; border-collapse: collapse;"> <tr><td style="text-align: right;">Serie</td><td style="text-align: right;">91,0</td></tr> <tr><td style="text-align: right;">Sum</td><td style="text-align: right;">184,0</td></tr> </table>	Serie	91,0	Sum	184,0
Serie	93,0										
Sum	93,0										
Serie	91,0										
Sum	184,0										

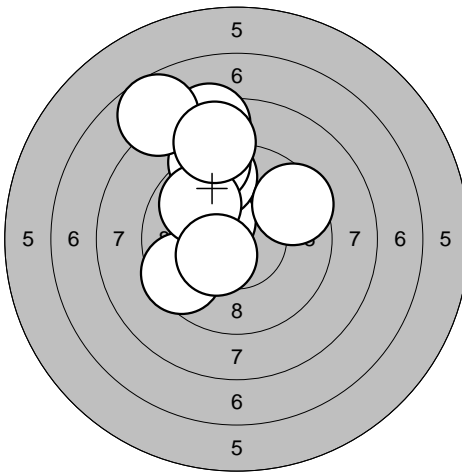
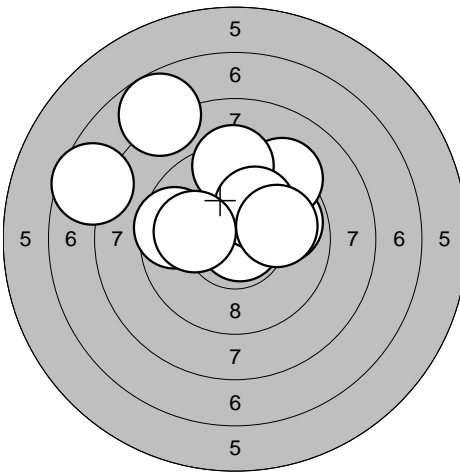
<p>Series 3</p> 	<p>1: 10,3* ↖ 2: 9,5 ↑ 3: 9,2 ↑ 4: 9,5 ← 5: 9,5 → 6: 8,4 ↑ 7: 9,8 ↗ 8: 7,7 ↑ 9: 8,8 ↑ 10: 10,4* ↖</p> <table border="1" style="width:100%; border-collapse: collapse;"> <tr><td style="text-align: right;">Serie</td><td style="text-align: right;">88,0</td></tr> <tr><td style="text-align: right;">Sum</td><td style="text-align: right;">272,0</td></tr> </table>	Serie	88,0	Sum	272,0	<p>Series 4</p> 	<p>1: 9,6 ← 2: 10,8* → 3: 9,8 → 4: 7,8 ↗ 5: 9,3 ↗ 6: 9,4 ↑ 7: 10,1 ↗ 8: 7,6 ← 9: 10,0 ← 10: 10,0 →</p> <table border="1" style="width:100%; border-collapse: collapse;"> <tr><td style="text-align: right;">Serie</td><td style="text-align: right;">90,0</td></tr> <tr><td style="text-align: right;">Sum</td><td style="text-align: right;">362,0</td></tr> </table>	Serie	90,0	Sum	362,0
Serie	88,0										
Sum	272,0										
Serie	90,0										
Sum	362,0										

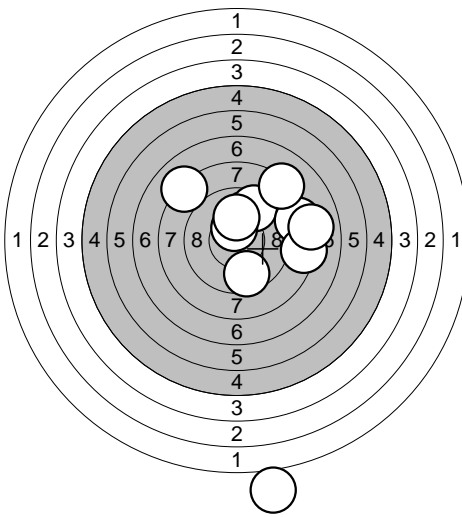
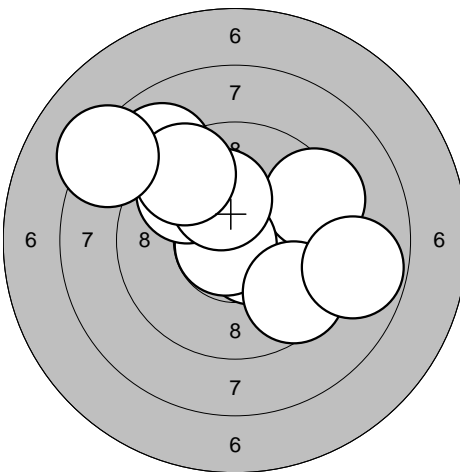
<p>Series 5</p> 	<p>1: 1,1 ↓ 2: 9,6 ↓ 3: 9,5 ↗ 4: 8,1 ↗ 5: 8,4 → 6: 8,2 ↗ 7: 10,5* ↑ 8: 10,1 ↑ 9: 8,3 → 10: 8,0 →</p> <table border="1" style="width:100%; border-collapse: collapse;"> <tr><td style="text-align: right;">Serie</td><td style="text-align: right;">79,0</td></tr> <tr><td style="text-align: right;">Sum</td><td style="text-align: right;">441,0</td></tr> </table>	Serie	79,0	Sum	441,0	<p>Series 6</p> 	<p>1: 10,5* ↘ 2: 9,4 → 3: 9,0 ↗ 4: 10,8* ↖ 5: 9,8 ↗ 6: 10,2* ↑ 7: 9,6 ↘ 8: 9,5 ↗ 9: 8,8 → 10: 8,3 ↖</p> <table border="1" style="width:100%; border-collapse: collapse;"> <tr><td style="text-align: right;">Serie</td><td style="text-align: right;">91,0</td></tr> <tr><td style="text-align: right;">Sum</td><td style="text-align: right;">532,0</td></tr> </table>	Serie	91,0	Sum	532,0
Serie	79,0										
Sum	441,0										
Serie	91,0										
Sum	532,0										

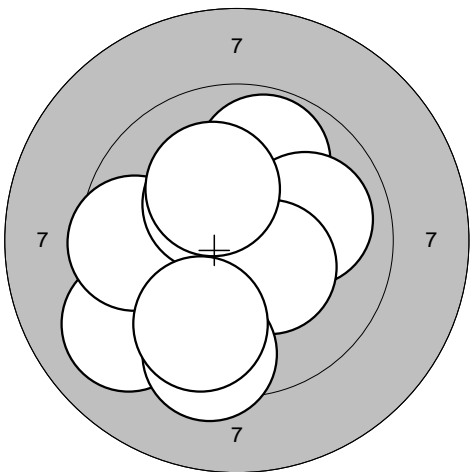
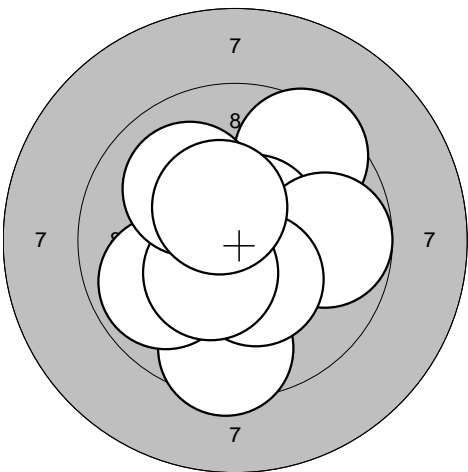
<p>Series 1</p> 	<p>Series 2</p> 	
1: 10,4* ↖ 2: 9,1 ↙ 3: 9,9 ↑ 4: 9,6 ← 5: 10,4* ↗ 6: 10,0 → 7: 10,4* ↘ 8: 9,4 ↓ 9: 10,2* ↗ 10: 9,7 ↓	1: 9,5 ↗ 2: 10,7* ↓ 3: 10,6* ↗ 4: 9,8 → 5: 9,5 ↓ 6: 9,9 ↙ 7: 10,4* ↓ 8: 10,4* ↙ 9: 10,0 ↗ 10: 10,5* ↗	
Serie 95,0	Serie 96,0	
Sum 95,0	Sum 191,0	

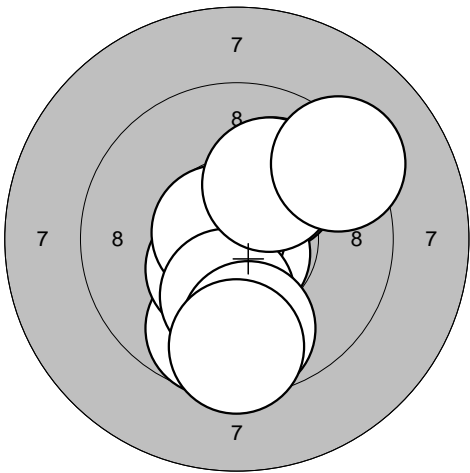
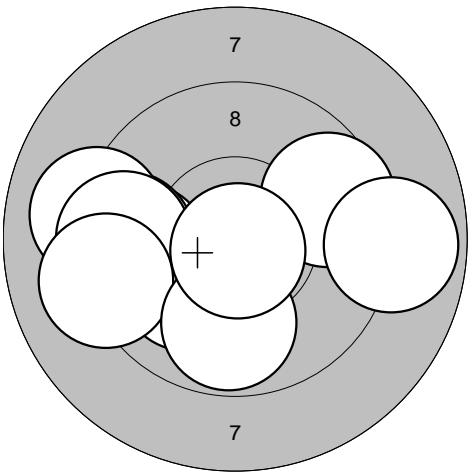
<p>Series 3</p> 	<p>Series 4</p> 	
1: 10,1 ↗ 2: 9,7 ↓ 3: 10,4* ↙ 4: 10,7* ↘ 5: 10,7* ← 6: 10,2* ↓ 7: 9,7 ↓ 8: 9,5 ↓ 9: 10,1 ↗ 10: 9,3 ↗	1: 10,1 ↙ 2: 9,7 ← 3: 9,5 ← 4: 9,1 ← 5: 9,5 ← 6: 9,6 → 7: 9,2 ← 8: 9,8 ↓ 9: 8,9 → 10: 10,8* ↓	
Serie 96,0	Serie 91,0	
Sum 287,0	Sum 378,0	

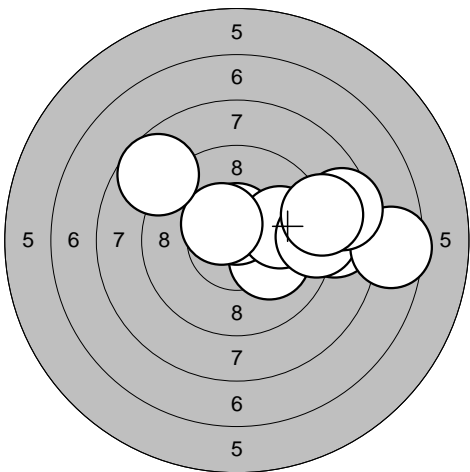
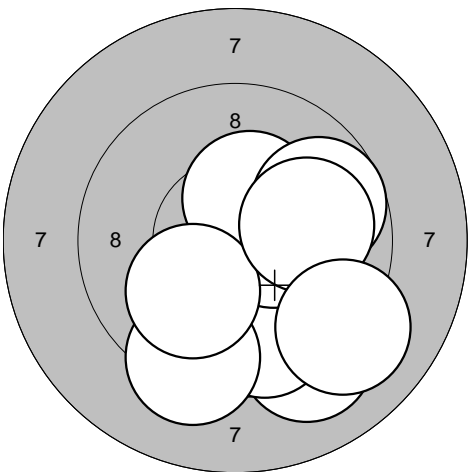
<p>Series 5</p> 	<p>Series 6</p> 	
1: 10,1 ↘ 2: 10,6* ↑ 3: 8,8 → 4: 9,9 → 5: 9,2 → 6: 10,5* ↗ 7: 7,6 → 8: 8,5 → 9: 8,7 ↗ 10: 9,0 →	1: 9,6 ↓ 2: 9,1 ↓ 3: 9,7 ↓ 4: 10,4* → 5: 9,3 ↓ 6: 10,3* ↗ 7: 9,7 → 8: 10,1 ↙ 9: 10,0 → 10: 9,1 ↓	
Serie 88,0	Serie 94,0	
Sum 466,0	Sum 560,0	

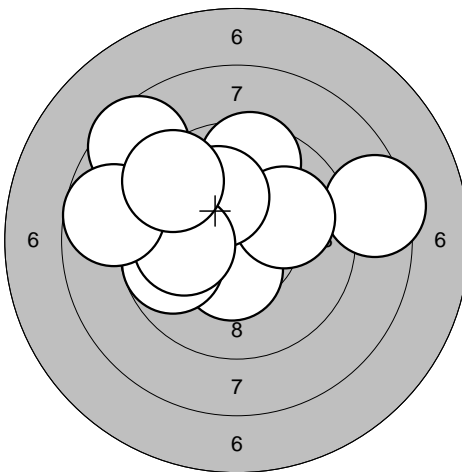
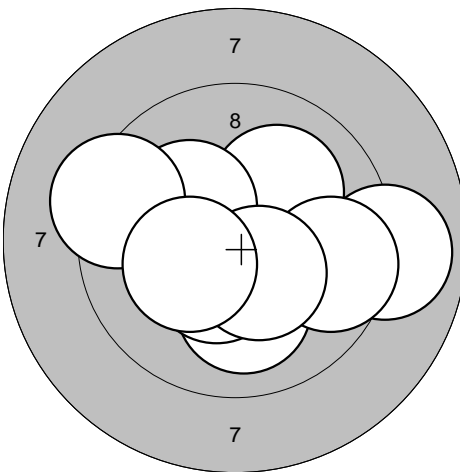
<p>Series 1</p> 	<p>1: 9,6 ↗</p> <p>2: 8,4 →</p> <p>3: 10,4* ↓</p> <p>4: 10,0 →</p> <p>5: 9,8 ←</p> <p>6: 8,6 ↗</p> <p>7: 10,1 ↗</p> <p>8: 10,0 ←</p> <p>9: 8,8 ←</p> <p>10: 9,4 ↗</p>	<p>Series 2</p> 	<p>1: 10,5* ↖</p> <p>2: 10,1 ↓</p> <p>3: 10,4* ↓</p> <p>4: 10,1 ↗</p> <p>5: 8,9 →</p> <p>6: 10,2* ↗</p> <p>7: 9,6 →</p> <p>8: 9,3 ←</p> <p>9: 10,4* ↓</p> <p>10: 10,3* ↖</p>
Serie 91,0	Serie 96,0	Serie 96,0	Serie 96,0
Sum 91,0	Sum 91,0	Sum 187,0	Sum 187,0

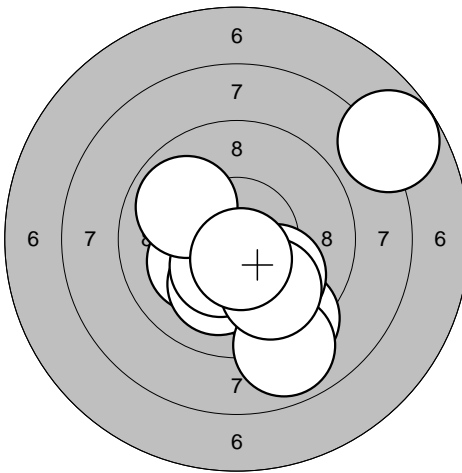
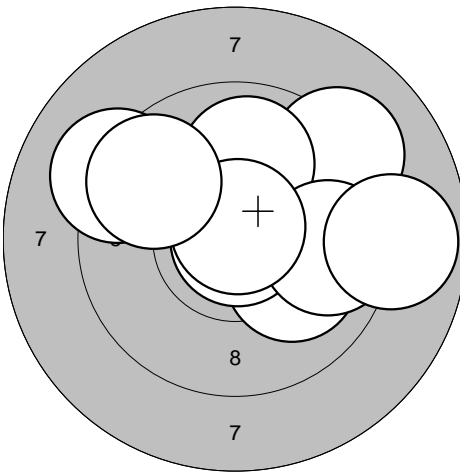
<p>Series 3</p> 	<p>1: 9,3 ↓</p> <p>2: 10,2* ↖</p> <p>3: 10,0 ↓</p> <p>4: 10,1 ↓</p> <p>5: 8,9 ↓</p> <p>6: 10,4* ↖</p> <p>7: 9,9 ↗</p> <p>8: 9,9 ↓</p> <p>9: 10,6* ↓</p> <p>10: 7,8 ↗</p>	<p>Series 4</p> 	<p>1: 10,0 ↘</p> <p>2: 9,2 ↗</p> <p>3: 10,9* →</p> <p>4: 10,4* ↑</p> <p>5: 9,9 ↑</p> <p>6: 9,7 →</p> <p>7: 9,2 ↖</p> <p>8: 10,8* ↑</p> <p>9: 8,9 →</p> <p>10: 9,6 ↖</p>
Serie 92,0	Serie 92,0	Serie 93,0	Serie 93,0
Sum 279,0	Sum 279,0	Sum 372,0	Sum 372,0

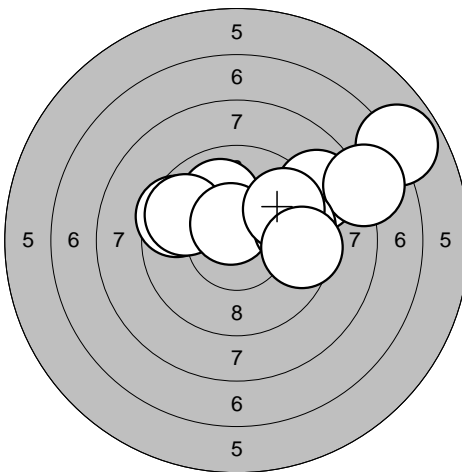
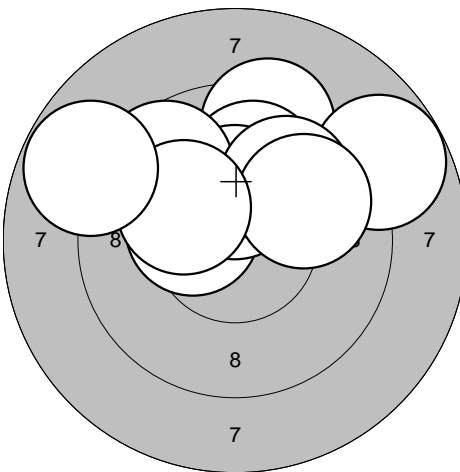
<p>Series 5</p> 	<p>1: 6,9 ↗</p> <p>2: 9,5 ←</p> <p>3: 10,0 ↗</p> <p>4: 9,7 ↖</p> <p>5: 8,9 ↗</p> <p>6: 10,6* ↗</p> <p>7: 7,9 →</p> <p>8: 9,6 →</p> <p>9: 9,7 ↗</p> <p>10: 9,5 →</p>	<p>Series 6</p> 	<p>1: 9,4 ↗</p> <p>2: 10,4* ↖</p> <p>3: 8,8 ↗</p> <p>4: 9,9 ↑</p> <p>5: 10,3* ↑</p> <p>6: 9,6 ↖</p> <p>7: 9,9 ↗</p> <p>8: 9,9 ↗</p> <p>9: 10,1 ↖</p> <p>10: 8,8 ↖</p>
Serie 86,0	Serie 86,0	Serie 91,0	Serie 91,0
Sum 458,0	Sum 458,0	Sum 549,0	Sum 549,0

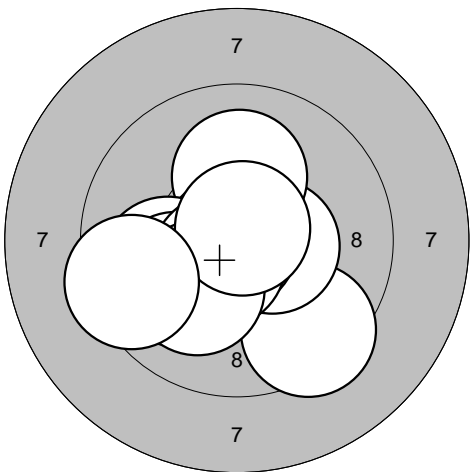
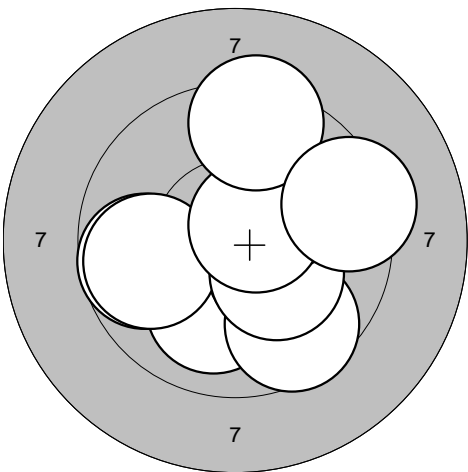
<p>Series 1</p> 	<p>1: 9,4 ↘ 2: 10,5* → 3: 10,1 ↑ 4: 10,9* ↙ 5: 10,0 ← 6: 10,0 ← 7: 10,6* ↘ 8: 10,1 ↘ 9: 10,8* ↗ 10: 9,4 ←</p> <p>Serie 98,0 Sum 98,0</p>	<p>Series 2</p>  <p>1: 10,0 ↓ 2: 9,6 ↘ 3: 9,7 ← 4: 10,3* ↘ 5: 9,8 ← 6: 10,2* ↘ 7: 10,2* ↗ 8: 10,6* ↗ 9: 9,4 ↑ 10: 9,4 →</p> <p>Serie 95,0 Sum 193,0</p>
--	--	---

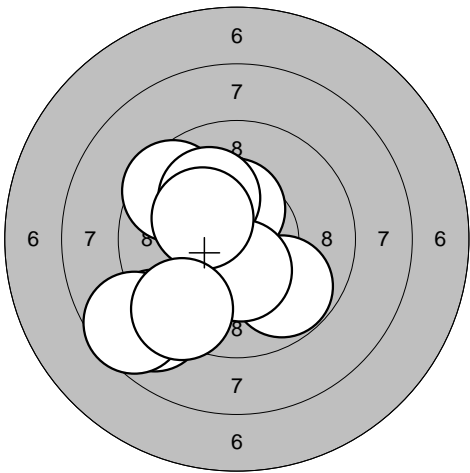
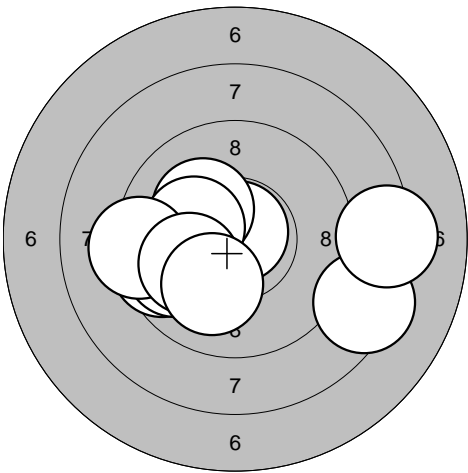
<p>Series 3</p> 	<p>1: 9,6 ↖ 2: 9,8 ↘ 3: 8,9 ↙ 4: 10,3* ↗ 5: 10,4* ↑ 6: 10,1 ↗ 7: 8,6 ↙ 8: 10,4* ↓ 9: 10,2* ↗ 10: 9,4 ↘</p> <p>Serie 93,0 Sum 286,0</p>	<p>Series 4</p>  <p>1: 10,8* ↗ 2: 10,2* ↖ 3: 10,2* ← 4: 9,6 ← 5: 9,8 ← 6: 9,3 ← 7: 8,4 ↘ 8: 8,3 → 9: 10,1 ← 10: 10,1 ↓</p> <p>Serie 93,0 Sum 379,0</p>
---	--	---

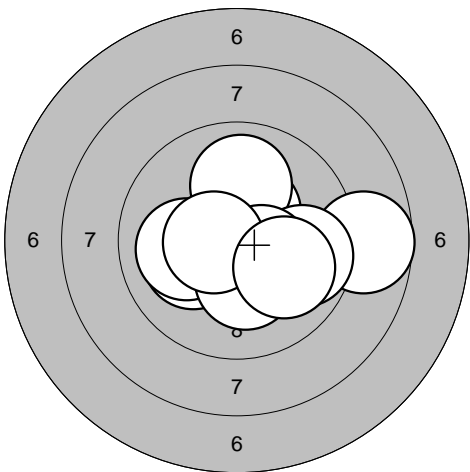
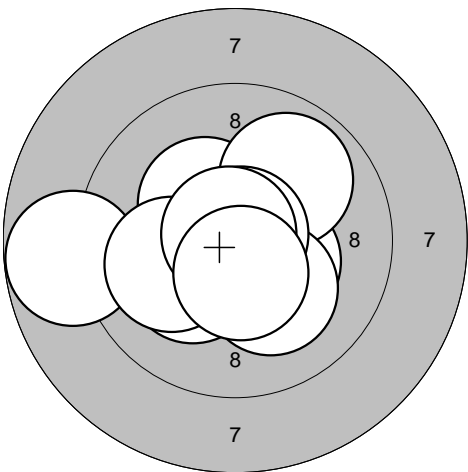
<p>Series 5</p> 	<p>1: 10,4* ↗ 2: 10,1 ← 3: 10,0 ↑ 4: 10,1 ← 5: 8,7 → 6: 9,8 → 7: 10,4* ↘ 8: 10,2* ↓ 9: 10,6* ← 10: 10,0 ↘</p> <p>Serie 97,0 Sum 476,0</p>	<p>Series 6</p>  <p>1: 10,2* ↙ 2: 10,3* ↖ 3: 10,4* ↘ 4: 9,9 ↗ 5: 10,2* ↘ 6: 10,8* ↗ 7: 8,8 ← 8: 10,0 ← 9: 10,8* ↗ 10: 10,5* ↓</p> <p>Serie 97,0 Sum 573,0</p>
--	---	---

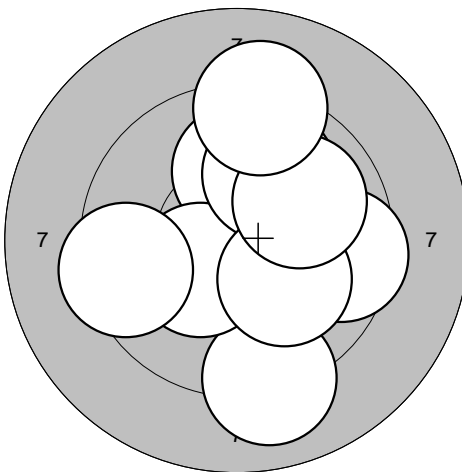
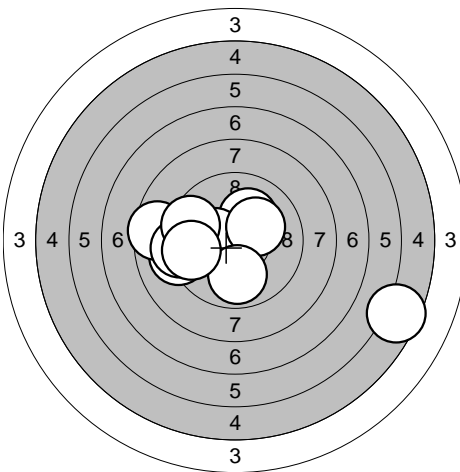
<p>Series 1</p> 	<p>1: 10,0 ↑</p> <p>2: 10,1 ➤</p> <p>3: 9,1 ↓</p> <p>4: 10,3* ↙</p> <p>5: 10,0 ↗</p> <p>6: 9,5 ➤</p> <p>7: 9,4 ←</p> <p>8: 10,1 ➤</p> <p>9: 10,0 ↗</p> <p>10: 9,2 ↑</p>	<p>Series 2</p> 	<p>1: 10,2* ↗</p> <p>2: 9,2 ←</p> <p>3: 10,3* ←</p> <p>4: 5,5 ➤</p> <p>5: 8,6 ←</p> <p>6: 9,2 ←</p> <p>7: 9,5 ←</p> <p>8: 10,2* ↗</p> <p>9: 9,9 ↓</p> <p>10: 9,6 ←</p>
	Serie 96,0		Serie 88,0
	Sum 96,0		Sum 184,0

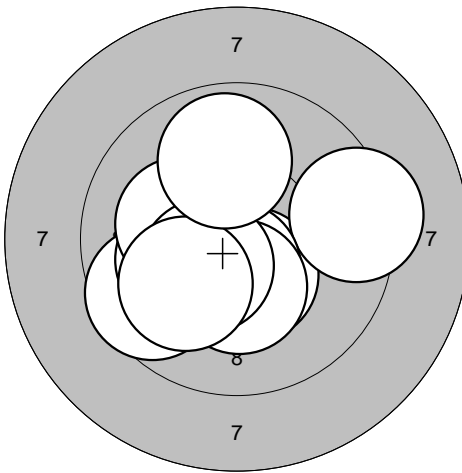
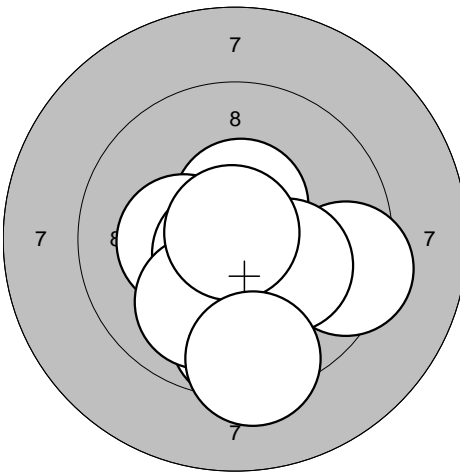
<p>Series 3</p> 	<p>1: 9,6 ←</p> <p>2: 10,4* ↓</p> <p>3: 10,2* ←</p> <p>4: 9,3 ➤</p> <p>5: 10,5* ↓</p> <p>6: 10,3* ↓</p> <p>7: 10,2* ←</p> <p>8: 10,4* ↙</p> <p>9: 10,0 ↙</p> <p>10: 9,9 ↑</p>	<p>Series 4</p> 	<p>1: 10,5* ↑</p> <p>2: 10,3* ←</p> <p>3: 9,4 ➤</p> <p>4: 9,7 ↓</p> <p>5: 10,2* ↓</p> <p>6: 10,7* ↙</p> <p>7: 10,0 ↓</p> <p>8: 10,2* ➤</p> <p>9: 10,8* ↗</p> <p>10: 9,3 ↓</p>
	Serie 97,0		Serie 97,0
	Sum 281,0		Sum 378,0

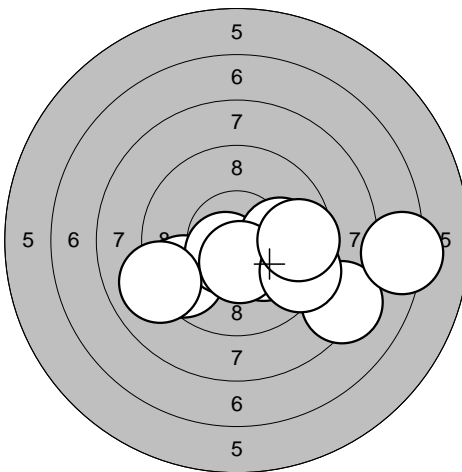
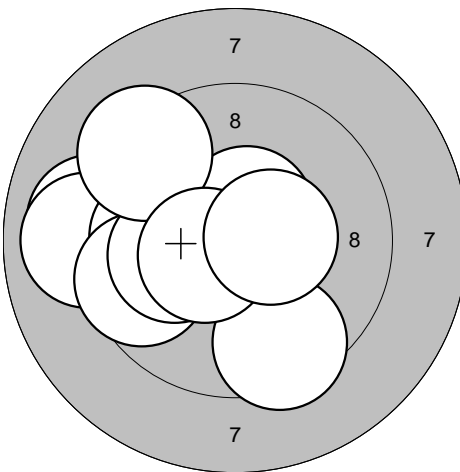
<p>Series 5</p> 	<p>1: 10,2* ➤</p> <p>2: 9,5 ↙</p> <p>3: 8,2 ➤</p> <p>4: 10,6* ↙</p> <p>5: 10,0 ➤</p> <p>6: 7,3 ➤</p> <p>7: 10,4* ↓</p> <p>8: 9,0 ↙</p> <p>9: 9,4 ➤</p> <p>10: 9,6 ➤</p>	<p>Series 6</p> 	<p>1: 9,0 ←</p> <p>2: 10,5* ↗</p> <p>3: 9,0 ←</p> <p>4: 9,5 ↓</p> <p>5: 9,9 ←</p> <p>6: 9,6 ←</p> <p>7: 10,1 ←</p> <p>8: 9,3 ↗</p> <p>9: 10,5* ←</p> <p>10: 10,5* ➤</p>
	Serie 91,0		Serie 94,0
	Sum 469,0		Sum 563,0

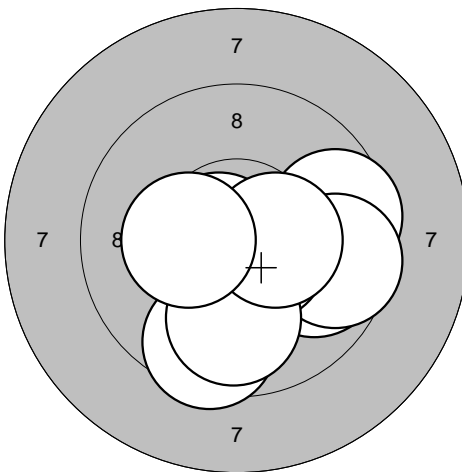
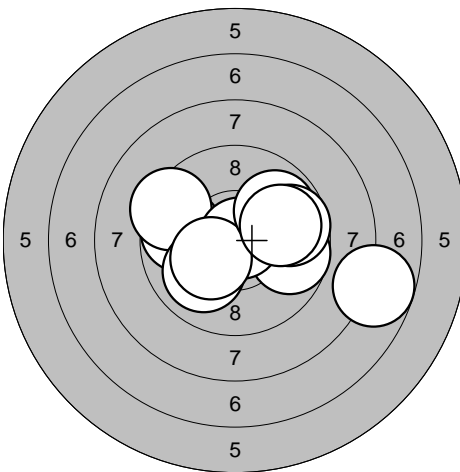
<p>Series 1</p> 	<p>1: 9,5 ↓</p> <p>2: 10,7* ←</p> <p>3: 9,8 →</p> <p>4: 9,6 →</p> <p>5: 10,2* ↓</p> <p>6: 9,6 →</p> <p>7: 10,6* →</p> <p>8: 9,9 ↓</p> <p>9: 10,4* →</p> <p>10: 10,3* ←</p>	<p>Series 2</p> 	<p>1: 9,8 ←</p> <p>2: 9,4 ←</p> <p>3: 10,0 ↓</p> <p>4: 9,7 →</p> <p>5: 10,8* →</p> <p>6: 7,8 →</p> <p>7: 10,3* ←</p> <p>8: 9,9 ↗</p> <p>9: 9,7 →</p> <p>10: 9,9 →</p>
Serie 95,0	Serie 91,0	Serie 91,0	Serie 91,0
Sum 95,0	Sum 95,0	Sum 186,0	Sum 186,0

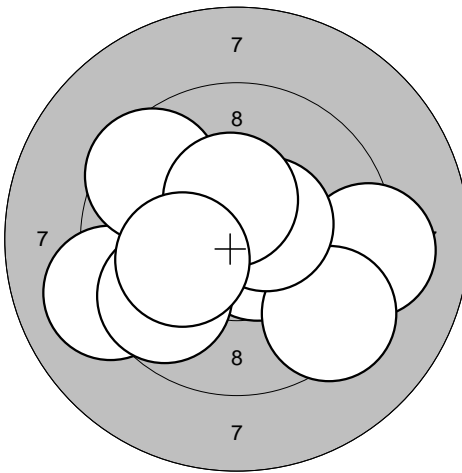
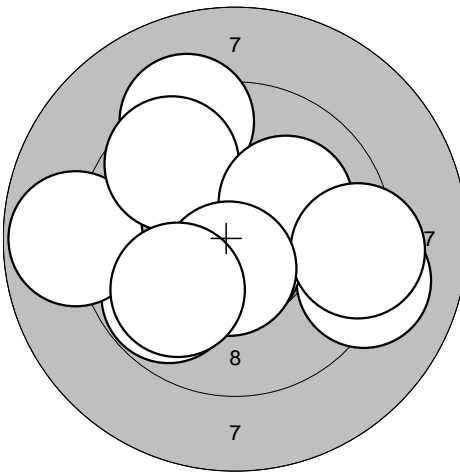
<p>Series 3</p> 	<p>1: 9,1 ←</p> <p>2: 9,2 →</p> <p>3: 9,6 ↗</p> <p>4: 10,6* ↓</p> <p>5: 9,3 ↓</p> <p>6: 9,7 ←</p> <p>7: 10,7* ↑</p> <p>8: 10,5* ↗</p> <p>9: 10,4* ↑</p> <p>10: 10,2* ←</p>	<p>Series 4</p> 	<p>1: 9,1 →</p> <p>2: 10,7* ↓</p> <p>3: 9,3 ↑</p> <p>4: 9,8 ↓</p> <p>5: 8,8 ←</p> <p>6: 9,6 ↗</p> <p>7: 10,1 ↗</p> <p>8: 9,3 →</p> <p>9: 10,5* ↓</p> <p>10: 9,9 ←</p>
Serie 95,0	Serie 95,0	Serie 92,0	Serie 92,0
Sum 281,0	Sum 281,0	Sum 373,0	Sum 373,0

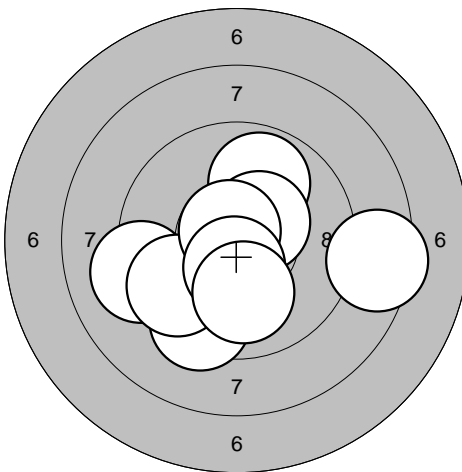
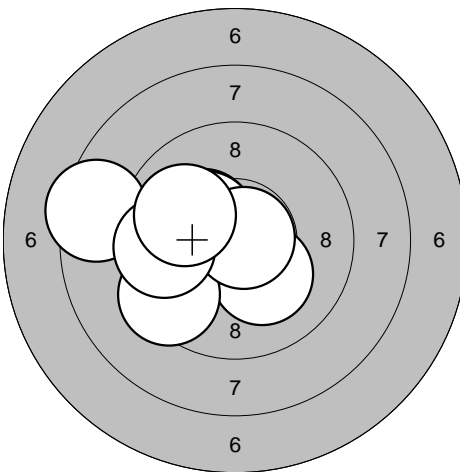
<p>Series 5</p> 	<p>1: 9,9 ↗</p> <p>2: 9,2 ←</p> <p>3: 8,5 →</p> <p>4: 10,9* ←</p> <p>5: 9,4 ↓</p> <p>6: 10,4* ↗</p> <p>7: 9,6 ←</p> <p>8: 10,7* ↗</p> <p>9: 10,5* ↓</p> <p>10: 10,0 ↓</p>	<p>Series 6</p> 	<p>1: 10,2* ↓</p> <p>2: 10,1 ←</p> <p>3: 10,2* ←</p> <p>4: 8,5 ←</p> <p>5: 10,3* ↗</p> <p>6: 10,3* ↗</p> <p>7: 9,5 ↓</p> <p>8: 10,8* →</p> <p>9: 9,7 ←</p> <p>10: 10,0 ←</p>
Serie 94,0	Serie 94,0	Serie 96,0	Serie 96,0
Sum 467,0	Sum 467,0	Sum 563,0	Sum 563,0

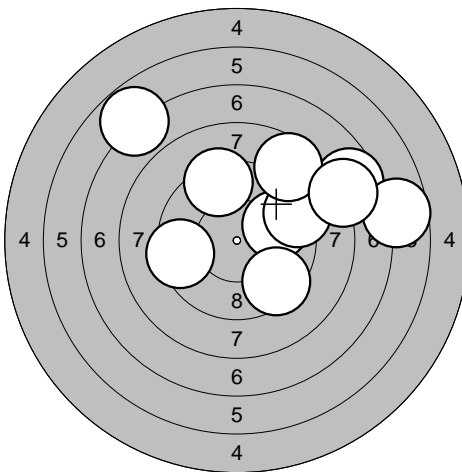
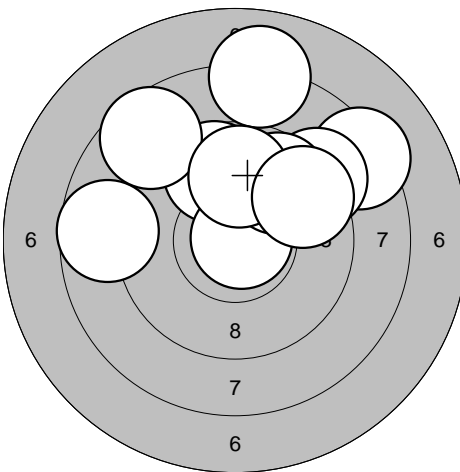
<p>Series 1</p> 	<p>1: 9,3 ↗</p> <p>2: 9,8 →</p> <p>3: 7,6 →</p> <p>4: 6,8 ↖</p> <p>5: 9,2 →</p> <p>6: 8,6 ↗</p> <p>7: 6,7 →</p> <p>8: 9,4 ←</p> <p>9: 7,9 →</p> <p>10: 9,5 ↘</p>	<p>Series 2</p> 	<p>1: 9,7 ↖</p> <p>2: 8,3 ↗</p> <p>3: 8,7 ←</p> <p>4: 10,8* →</p> <p>5: 8,0 ↑</p> <p>6: 9,2 ↗</p> <p>7: 8,6 ↖</p> <p>8: 9,7 ↗</p> <p>9: 9,8 ↑</p> <p>10: 9,5 ↗</p>
Serie 79,0		Serie 87,0	
Sum 79,0		Sum 166,0	

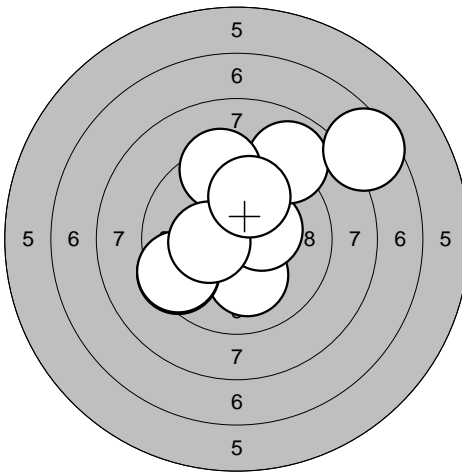
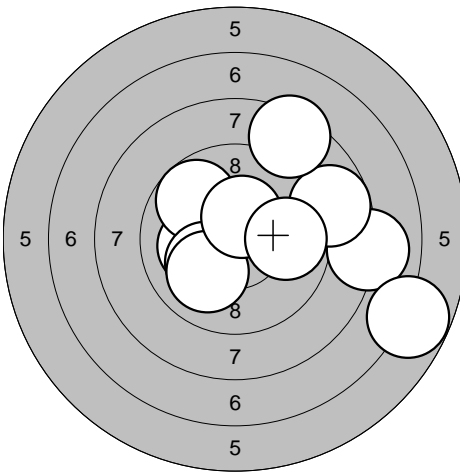
<p>Series 3</p> 	<p>1: 10,1 ↘</p> <p>2: 10,4* →</p> <p>3: 9,8 ↑</p> <p>4: 9,5 ←</p> <p>5: 8,9 ↗</p> <p>6: 7,5 →</p> <p>7: 9,4 ↑</p> <p>8: 9,5 ←</p> <p>9: 10,4* ←</p> <p>10: 10,0 ↑</p>	<p>Series 4</p> 	<p>1: 10,1 ←</p> <p>2: 8,0 →</p> <p>3: 8,8 →</p> <p>4: 9,8 ↖</p> <p>5: 10,1 ←</p> <p>6: 6,8 →</p> <p>7: 10,0 ↘</p> <p>8: 10,4* ↑</p> <p>9: 9,8 →</p> <p>10: 8,4 ↑</p>
Serie 91,0		Serie 88,0	
Sum 257,0		Sum 345,0	

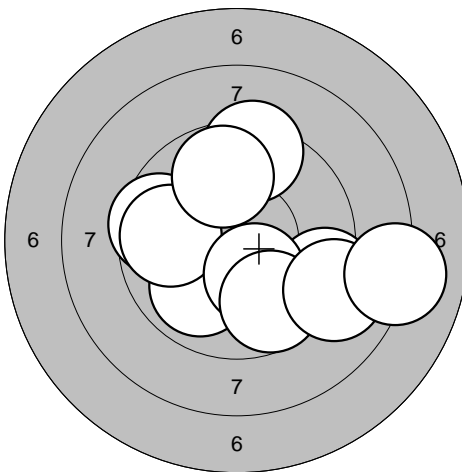
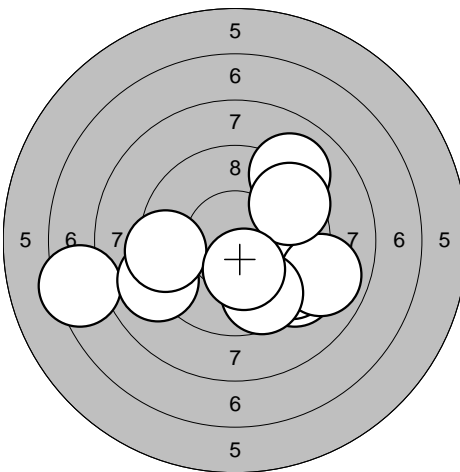
<p>Series 5</p> 	<p>1: 9,4 ↑</p> <p>2: 9,9 ↘</p> <p>3: 9,6 ←</p> <p>4: 9,3 →</p> <p>5: 9,8 ←</p> <p>6: 10,3* ↘</p> <p>7: 9,8 ↑</p> <p>8: 9,7 ↘</p> <p>9: 9,0 ↘</p> <p>10: 8,1 →</p>	<p>Series 6</p> 	<p>1: 9,3 ↘</p> <p>2: 9,1 ↗</p> <p>3: 9,5 ↘</p> <p>4: 7,4 ←</p> <p>5: 8,9 →</p> <p>6: 9,0 ←</p> <p>7: 9,4 ←</p> <p>8: 9,5 ↗</p> <p>9: 9,6 ↘</p> <p>10: 10,3* ↘</p>
Serie 90,0		Serie 88,0	
Sum 435,0		Sum 523,0	

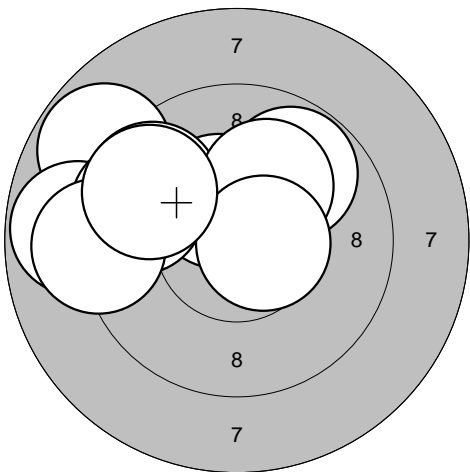
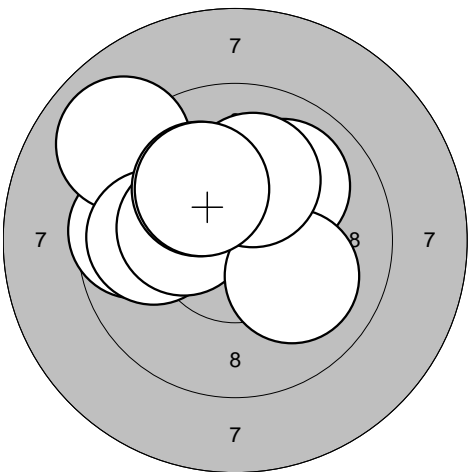
<p>Series 1</p> 	<p>1: 10,4* ↗</p> <p>2: 8,8 ↗</p> <p>3: 8,8 ←</p> <p>4: 9,5 ↗</p> <p>5: 9,1 ←</p> <p>6: 9,6 ↗</p> <p>7: 9,8 ↗</p> <p>8: 10,1 ↗</p> <p>9: 10,6* →</p> <p>10: 9,6 ↗</p>	<p>Series 2</p> 	<p>1: 9,6 ←</p> <p>2: 10,4* ↑</p> <p>3: 9,0 ↗</p> <p>4: 9,9 ←</p> <p>5: 10,3* ←</p> <p>6: 10,0 ↗</p> <p>7: 10,1 ↘</p> <p>8: 10,1 ↑</p> <p>9: 10,1 ↗</p> <p>10: 10,1 ↗</p>
Serie 91,0	Serie 97,0	Serie 97,0	Serie 97,0
Sum 91,0	Sum 188,0	Sum 188,0	Sum 188,0

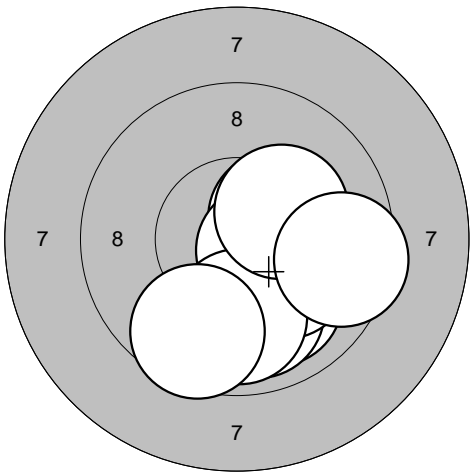
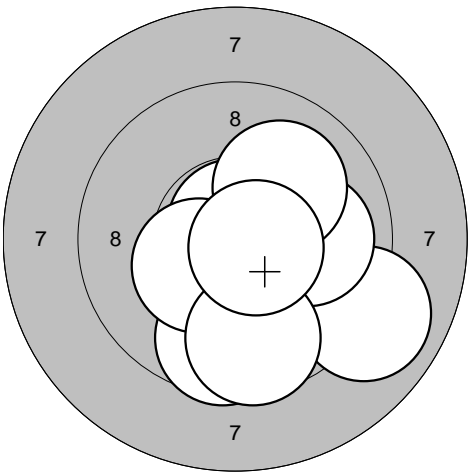
<p>Series 3</p> 	<p>1: 10,4* ↗</p> <p>2: 10,0 ↘</p> <p>3: 10,5* →</p> <p>4: 10,0 ↘</p> <p>5: 10,2* ↘</p> <p>6: 10,5* →</p> <p>7: 9,9 ↘</p> <p>8: 9,6 ↘</p> <p>9: 10,3* ↗</p> <p>10: 9,5 →</p>	<p>Series 4</p> 	<p>1: 10,8* ↑</p> <p>2: 10,0 ↘</p> <p>3: 9,6 ↘</p> <p>4: 10,5* ↘</p> <p>5: 9,0 ↘</p> <p>6: 10,3* ↙</p> <p>7: 10,0 →</p> <p>8: 9,6 ↘</p> <p>9: 10,0 ↗</p> <p>10: 10,6* ↘</p>
Serie 97,0	Serie 97,0	Serie 97,0	Serie 97,0
Sum 285,0	Sum 382,0	Sum 382,0	Sum 382,0

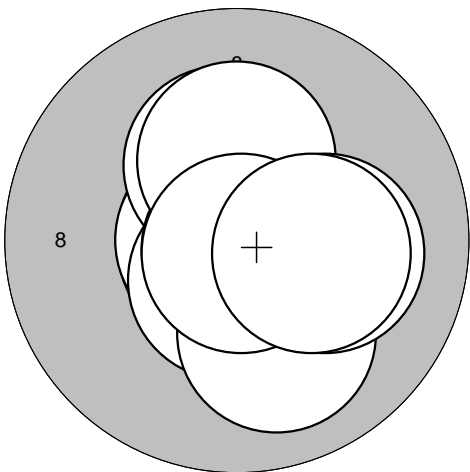
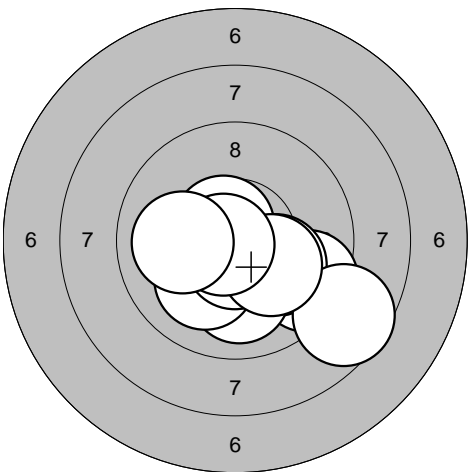
<p>Series 5</p> 	<p>1: 10,7* ←</p> <p>2: 10,2* ↑</p> <p>3: 10,6* ↘</p> <p>4: 10,4* ↘</p> <p>5: 10,8* ↘</p> <p>6: 10,0 ↘</p> <p>7: 10,2* ↑</p> <p>8: 10,1 →</p> <p>9: 10,8* ↘</p> <p>10: 10,3* →</p>	<p>Series 6</p> 	<p>1: 9,5 ↘</p> <p>2: 10,1 ↘</p> <p>3: 10,6* ↗</p> <p>4: 10,0 ↘</p> <p>5: 10,1 ↘</p> <p>6: 8,6 ↘</p> <p>7: 10,6* ↓</p> <p>8: 10,2* ↘</p> <p>9: 10,7* ←</p> <p>10: 10,0 ←</p>
Serie 100,0	Serie 97,0	Serie 97,0	Serie 97,0
Sum 482,0	Sum 579,0	Sum 579,0	Sum 579,0

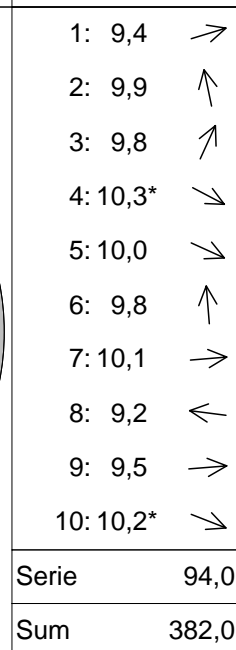
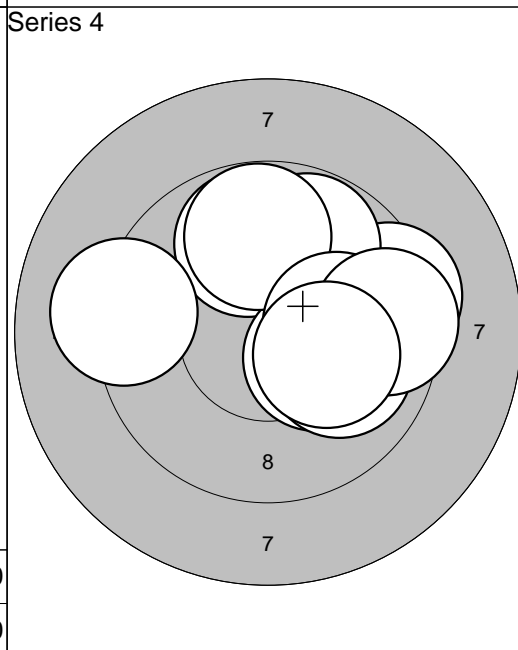
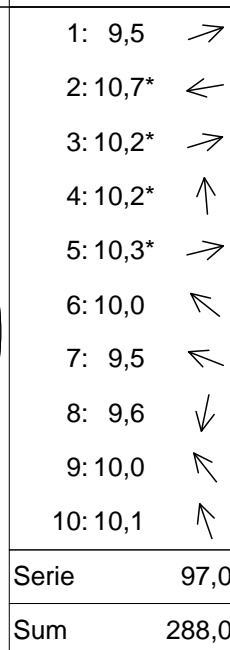
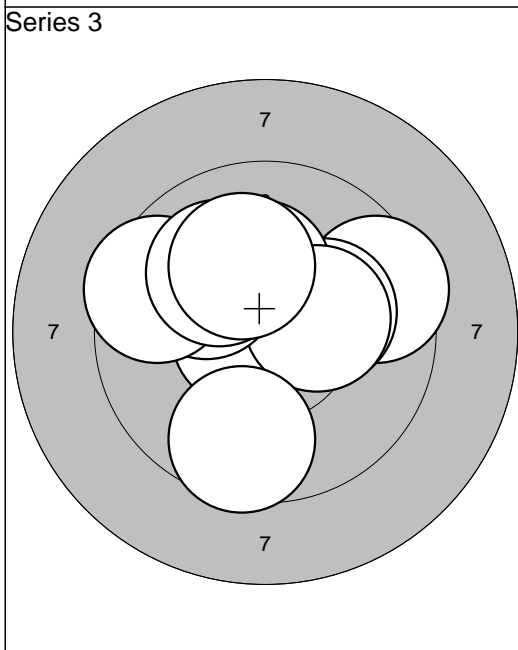
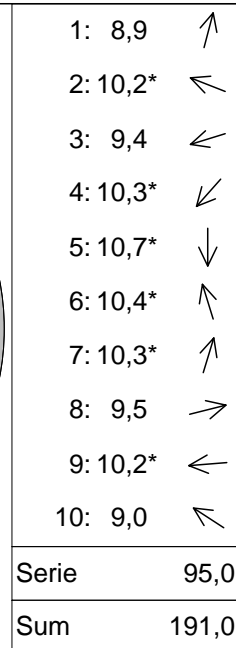
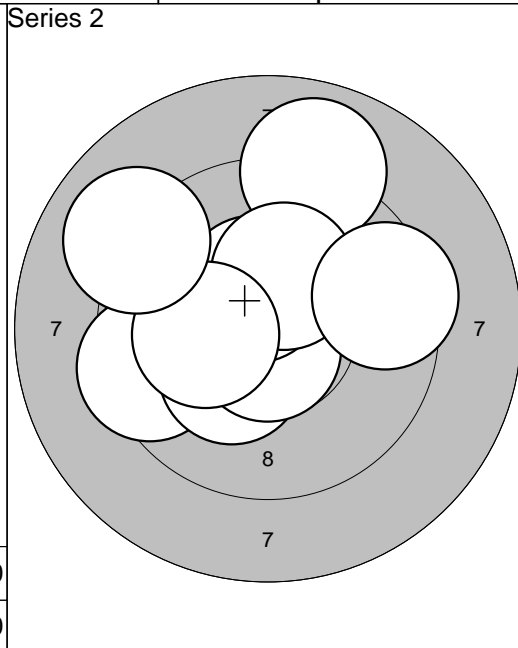
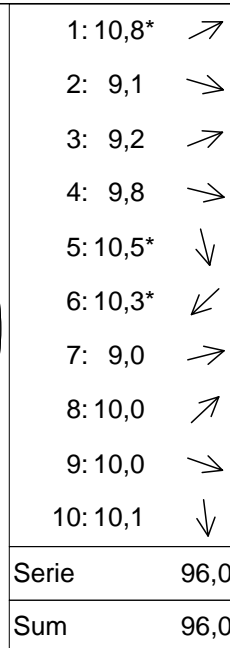
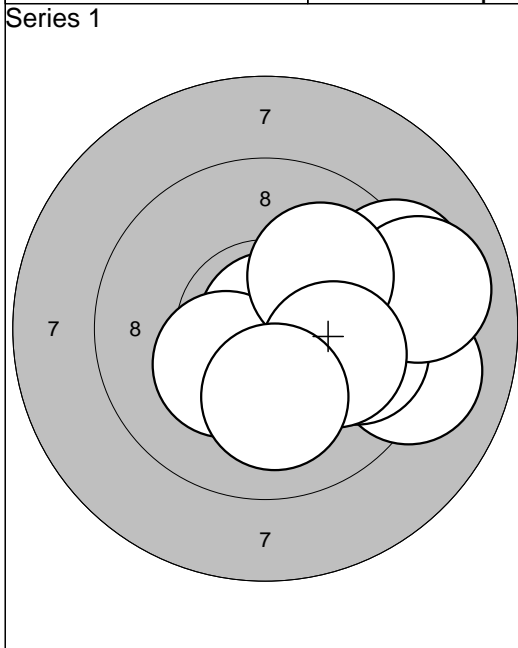

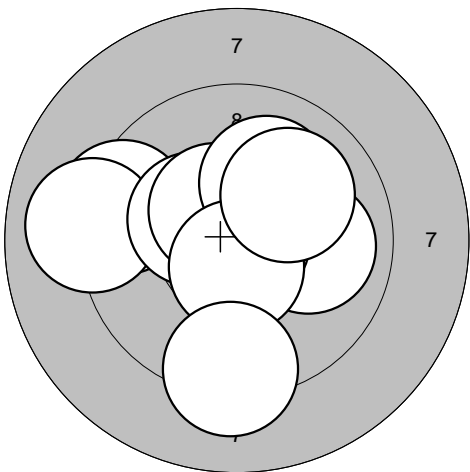
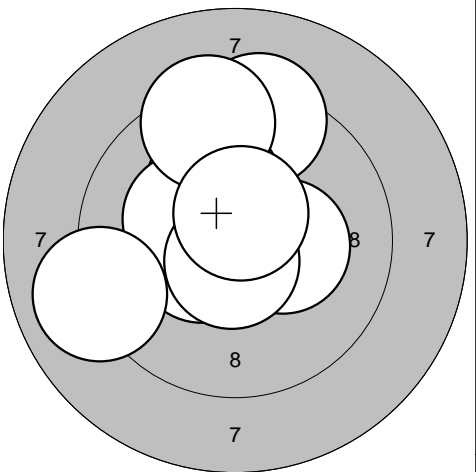
<p>Series 1</p> 	<p>1: 9,4 ←</p> <p>2: 10,0 →</p> <p>3: 9,0 ←</p> <p>4: 10,9* →</p> <p>5: 10,3* ↗</p> <p>6: 10,5* ↗</p> <p>7: 10,1 ↗</p> <p>8: 10,6* ↓</p> <p>9: 10,0 ↗</p> <p>10: 9,2 ↓</p>	<p>Series 2</p> 	<p>1: 9,3 ↑</p> <p>2: 10,5* ↑</p> <p>3: 10,5* ←</p> <p>4: 10,2* ↗</p> <p>5: 10,3* →</p> <p>6: 10,3* ↖</p> <p>7: 10,6* ↓</p> <p>8: 9,0 ←</p> <p>9: 9,4 ↑</p> <p>10: 10,6* ↑</p>
Serie 97,0	Serie 97,0	Serie 97,0	Serie 97,0
Sum 97,0	Sum 97,0	Sum 194,0	Sum 194,0

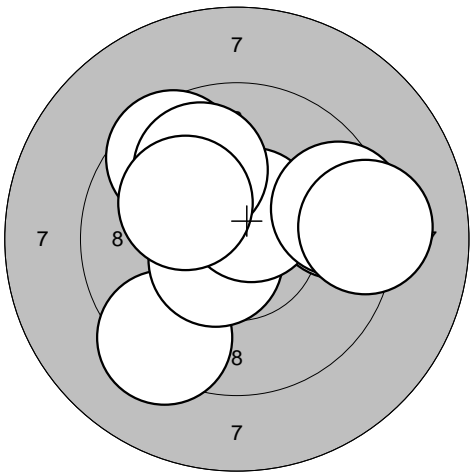
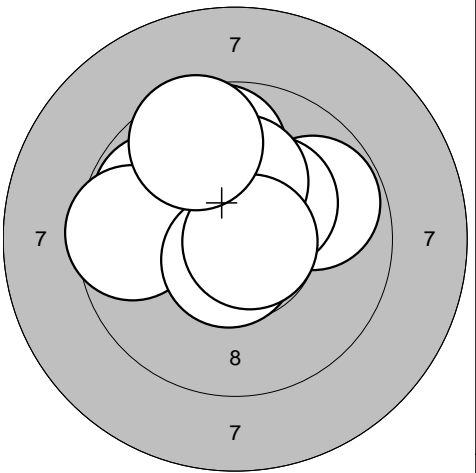
<p>Series 3</p> 	<p>1: 9,6 ↖</p> <p>2: 9,3 ↘</p> <p>3: 9,5 →</p> <p>4: 10,6* ↑</p> <p>5: 10,6* ↘</p> <p>6: 10,6* ↗</p> <p>7: 9,6 →</p> <p>8: 9,2 →</p> <p>9: 9,9 ↑</p> <p>10: 10,1 ↖</p>	<p>Series 4</p> 	<p>1: 9,8 ↗</p> <p>2: 9,8 ↑</p> <p>3: 10,3* ↗</p> <p>4: 10,2* ↑</p> <p>5: 9,8 ↖</p> <p>6: 10,3* ↖</p> <p>7: 9,6 ←</p> <p>8: 10,7* ↓</p> <p>9: 10,7* →</p> <p>10: 9,6 ↑</p>
Serie 94,0	Serie 94,0	Serie 95,0	Serie 95,0
Sum 288,0	Sum 288,0	Sum 383,0	Sum 383,0

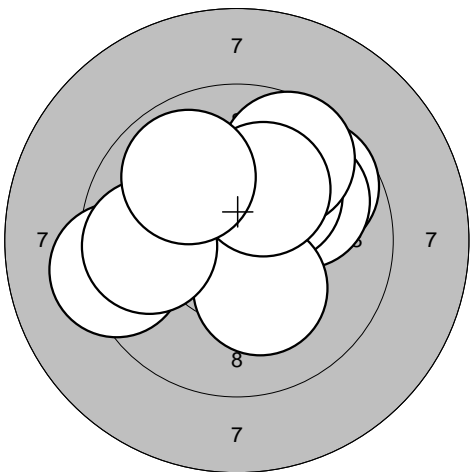
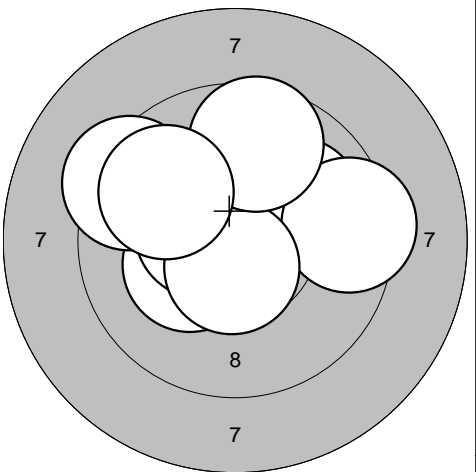
<p>Series 5</p> 	<p>1: 9,3 ←</p> <p>2: 9,7 ↗</p> <p>3: 9,9 ↗</p> <p>4: 10,3* ↑</p> <p>5: 10,2* ↗</p> <p>6: 10,2* ↘</p> <p>7: 9,7 ↗</p> <p>8: 9,8 ←</p> <p>9: 10,2* ↗</p> <p>10: 9,9 ↖</p>	<p>Series 6</p> 	<p>1: 10,3* ↖</p> <p>2: 10,5* ↖</p> <p>3: 10,0 ↗</p> <p>4: 10,1 ↑</p> <p>5: 10,5* ←</p> <p>6: 9,4 →</p> <p>7: 10,6* ↓</p> <p>8: 9,4 ↖</p> <p>9: 9,6 ↑</p> <p>10: 9,8 ↖</p>
Serie 94,0	Serie 94,0	Serie 96,0	Serie 96,0
Sum 477,0	Sum 477,0	Sum 573,0	Sum 573,0

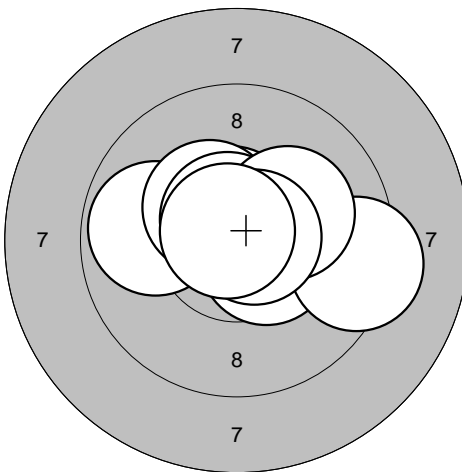
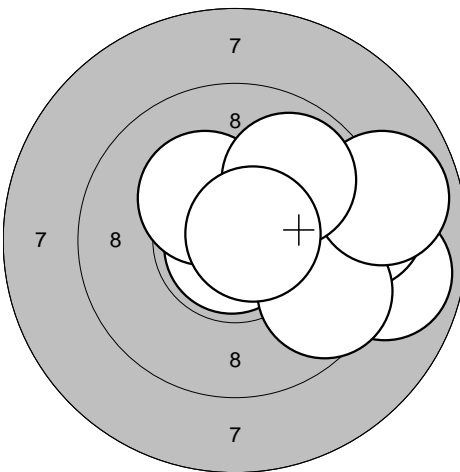
<p>Series 1</p> 	<p>1: 10,6* ↗</p> <p>2: 10,8* ↗</p> <p>3: 9,8 ←</p> <p>4: 10,5* ↘</p> <p>5: 10,4* ↗</p> <p>6: 10,7* ↗</p> <p>7: 9,3 →</p> <p>8: 10,2* ↗</p> <p>9: 10,7* →</p> <p>10: 10,8* ↗</p>	<p>Series 2</p> 	<p>1: 8,9 →</p> <p>2: 10,1 →</p> <p>3: 10,5* →</p> <p>4: 9,3 →</p> <p>5: 10,9* ↓</p> <p>6: 9,6 ↘</p> <p>7: 10,3* ↗</p> <p>8: 8,9 →</p> <p>9: 9,9 ↗</p> <p>10: 10,7* →</p>
Serie 98,0	Serie 93,0		
Sum 98,0	Sum 191,0		

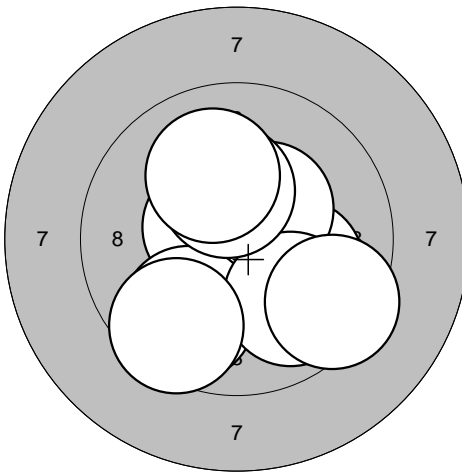
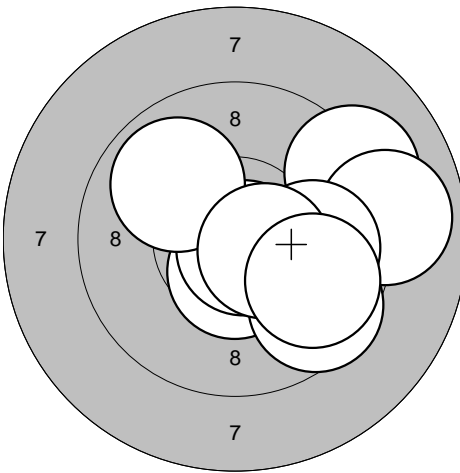
<p>Series 3</p> 	<p>1: 10,1 ↘</p> <p>2: 10,1 →</p> <p>3: 10,5* ↗</p> <p>4: 10,4* ↗</p> <p>5: 9,8 ↘</p> <p>6: 9,9 ↘</p> <p>7: 9,5 ↘</p> <p>8: 10,3* ↗</p> <p>9: 10,0 ↗</p> <p>10: 9,4 ↘</p>	<p>Series 4</p> 	<p>1: 9,8 →</p> <p>2: 10,5* ↓</p> <p>3: 9,2 ↗</p> <p>4: 10,8* ↘</p> <p>5: 9,5 ↘</p> <p>6: 8,9 →</p> <p>7: 9,9 ↗</p> <p>8: 9,9 →</p> <p>9: 10,5* ↘</p> <p>10: 9,8 ↘</p>
Serie 96,0	Serie 92,0		
Sum 287,0	Sum 379,0		

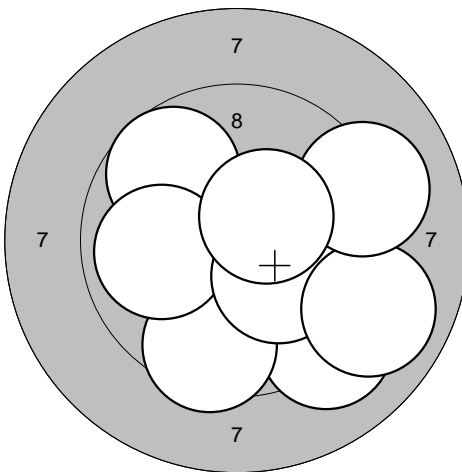
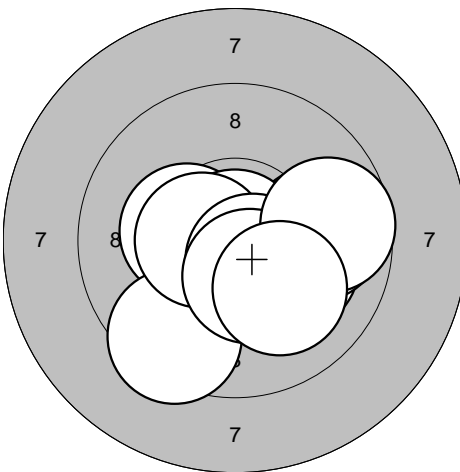
<p>Series 5</p> 	<p>1: 9,4 ↘</p> <p>2: 9,8 ↗</p> <p>3: 9,1 ↘</p> <p>4: 9,5 ↘</p> <p>5: 10,4* →</p> <p>6: 9,9 ←</p> <p>7: 10,2* ↘</p> <p>8: 8,9 ↘</p> <p>9: 9,1 →</p> <p>10: 10,5* ↗</p>	<p>Series 6</p> 	<p>1: 10,3* ←</p> <p>2: 10,1 →</p> <p>3: 9,9 →</p> <p>4: 10,9* ↑</p> <p>5: 9,4 ↘</p> <p>6: 10,5* ←</p> <p>7: 10,6* ↘</p> <p>8: 10,4* ↘</p> <p>9: 9,7 →</p> <p>10: 10,1 ↘</p>
Serie 92,0	Serie 97,0		
Sum 471,0	Sum 568,0		

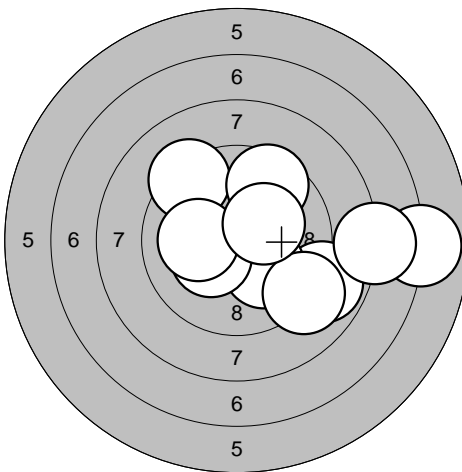
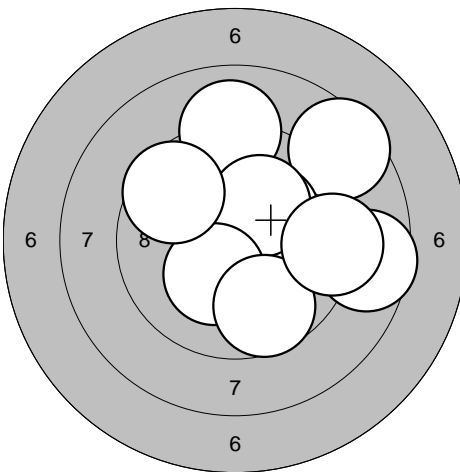
<p>Series 1</p> 	<p>1: 8,9 ↘ 2: 10,1 ↘ 3: 6,9 → 4: 7,9 → 5: 10,3* ↙ 6: 9,3 ↗ 7: 10,1 ← 8: 9,6 ↗ 9: 9,1 ↘ 10: 10,3* ↗</p> <table border="1" style="width:100%; border-collapse: collapse;"> <tr><td>Serie</td><td style="text-align: right;">88,0</td></tr> <tr><td>Sum</td><td style="text-align: right;">88,0</td></tr> </table>	Serie	88,0	Sum	88,0	<p>Series 2</p> 	<p>1: 9,0 ↑ 2: 10,3* ↗ 3: 8,5 ↗ 4: 10,2* ↗ 5: 10,2* ↗ 6: 10,2* ↘ 7: 8,6 → 8: 9,6 ↖ 9: 9,7 ↘ 10: 9,2 →</p> <table border="1" style="width:100%; border-collapse: collapse;"> <tr><td>Serie</td><td style="text-align: right;">92,0</td></tr> <tr><td>Sum</td><td style="text-align: right;">180,0</td></tr> </table>	Serie	92,0	Sum	180,0
Serie	88,0										
Sum	88,0										
Serie	92,0										
Sum	180,0										

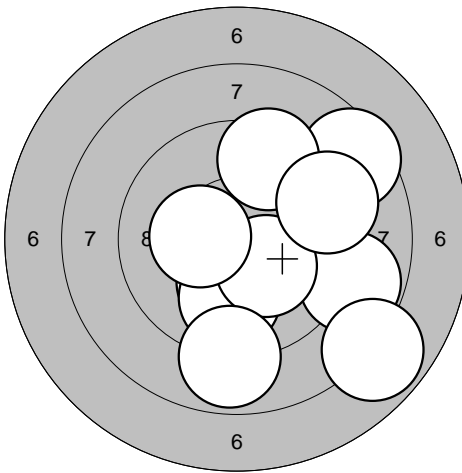
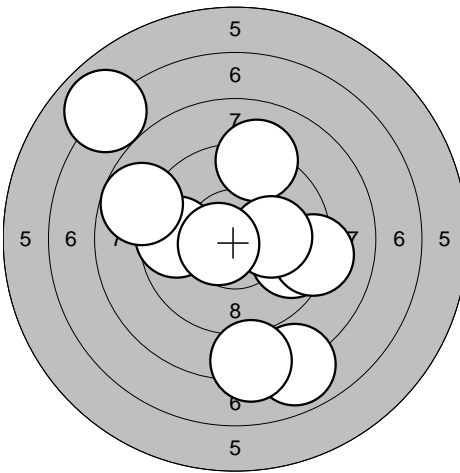
<p>Series 3</p> 	<p>1: 8,5 ↗ 2: 9,4 ↗ 3: 10,2* ↘ 4: 8,8 → 5: 9,9 ↘ 6: 10,2* ↘ 7: 10,3* ← 8: 8,9 ↘ 9: 7,8 ↘ 10: 9,2 →</p> <table border="1" style="width:100%; border-collapse: collapse;"> <tr><td>Serie</td><td style="text-align: right;">88,0</td></tr> <tr><td>Sum</td><td style="text-align: right;">268,0</td></tr> </table>	Serie	88,0	Sum	268,0	<p>Series 4</p> 	<p>1: 7,9 ↘ 2: 8,2 ↘ 3: 9,1 ↑ 4: 9,7 ← 5: 9,7 → 6: 8,8 ← 7: 9,2 → 8: 10,2* → 9: 10,6* ← 10: 7,0 ↖</p> <table border="1" style="width:100%; border-collapse: collapse;"> <tr><td>Serie</td><td style="text-align: right;">86,0</td></tr> <tr><td>Sum</td><td style="text-align: right;">354,0</td></tr> </table>	Serie	86,0	Sum	354,0
Serie	88,0										
Sum	268,0										
Serie	86,0										
Sum	354,0										

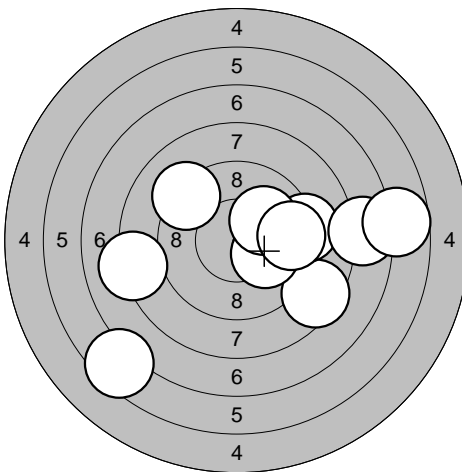
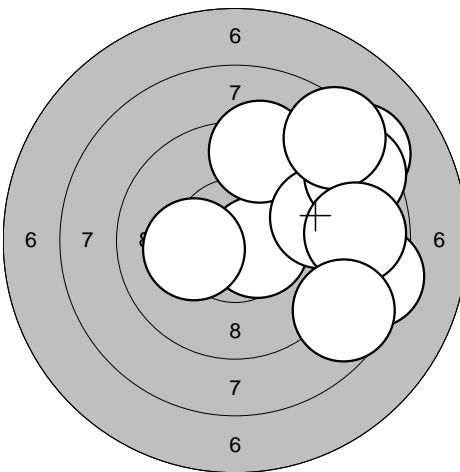
<p>Series 5</p> 	<p>1: 8,5 ↘ 2: 9,1 → 3: 7,6 → 4: 6,7 → 5: 8,2 ← 6: 9,2 ↗ 7: 10,1 → 8: 6,5 ↘ 9: 10,0 ↗ 10: 9,5 →</p> <table border="1" style="width:100%; border-collapse: collapse;"> <tr><td>Serie</td><td style="text-align: right;">82,0</td></tr> <tr><td>Sum</td><td style="text-align: right;">436,0</td></tr> </table>	Serie	82,0	Sum	436,0	<p>Series 6</p> 	<p>1: 10,5* → 2: 9,3 ↑ 3: 9,4 → 4: 8,3 ↗ 5: 8,5 ↗ 6: 10,2* ← 7: 8,4 ↗ 8: 8,4 → 9: 8,8 → 10: 8,7 ↘</p> <table border="1" style="width:100%; border-collapse: collapse;"> <tr><td>Serie</td><td style="text-align: right;">86,0</td></tr> <tr><td>Sum</td><td style="text-align: right;">522,0</td></tr> </table>	Serie	86,0	Sum	522,0
Serie	82,0										
Sum	436,0										
Serie	86,0										
Sum	522,0										

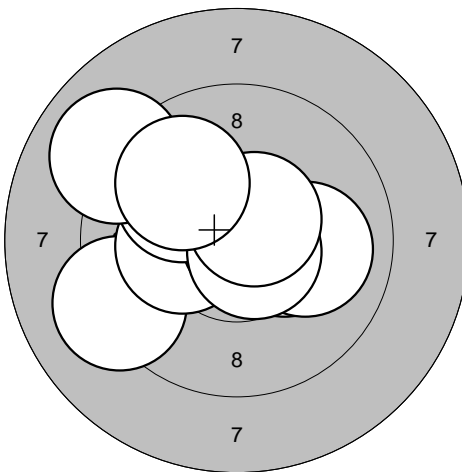
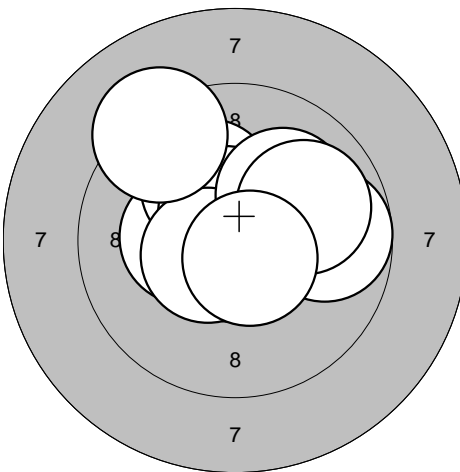
<p>Series 1</p> 	<p>1: 10,3* →</p> <p>2: 9,2 ←</p> <p>3: 10,2* ←</p> <p>4: 10,8* →</p> <p>5: 10,0 ↗</p> <p>6: 10,0 →</p> <p>7: 9,0 ↗</p> <p>8: 10,7* ↘</p> <p>9: 10,6* ↗</p> <p>10: 9,9 ↗</p>	<p>Series 2</p> 	<p>1: 9,8 →</p> <p>2: 10,3* ←</p> <p>3: 10,1 ↗</p> <p>4: 10,9* ↗</p> <p>5: 10,6* ↗</p> <p>6: 10,6* ←</p> <p>7: 9,2 ↗</p> <p>8: 10,1 ↗</p> <p>9: 9,9 →</p> <p>10: 10,6* ↘</p>
Serie 97,0		Serie 97,0	
Sum 97,0		Sum 194,0	

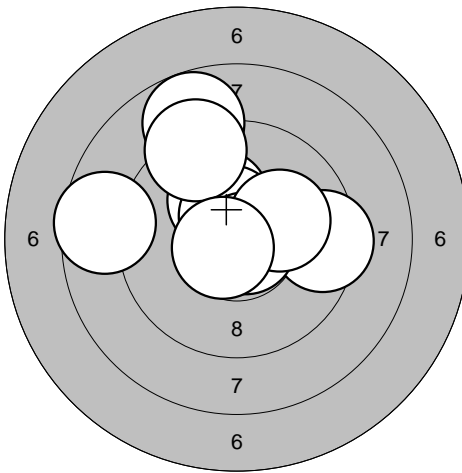
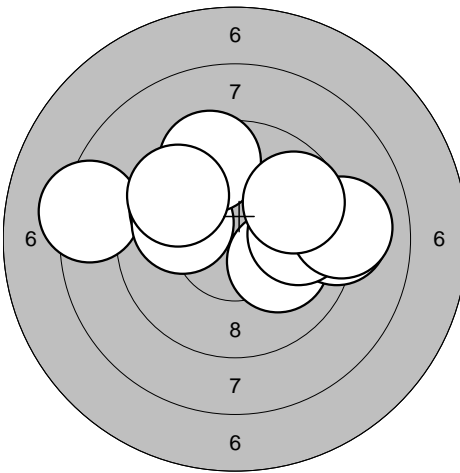
<p>Series 3</p> 	<p>1: 9,4 →</p> <p>2: 10,2* ↗</p> <p>3: 8,8 ↗</p> <p>4: 8,6 ←</p> <p>5: 10,7* ↗</p> <p>6: 10,5* ↗</p> <p>7: 9,2 ↗</p> <p>8: 10,8* ↘</p> <p>9: 10,1 →</p> <p>10: 10,7* ←</p>	<p>Series 4</p> 	<p>1: 10,1 ↘</p> <p>2: 8,3 ←</p> <p>3: 9,9 ↗</p> <p>4: 9,1 →</p> <p>5: 10,0 ←</p> <p>6: 9,8 →</p> <p>7: 9,5 ↗</p> <p>8: 9,1 →</p> <p>9: 9,7 ↗</p> <p>10: 9,7 ↗</p>
Serie 94,0		Serie 91,0	
Sum 288,0		Sum 379,0	

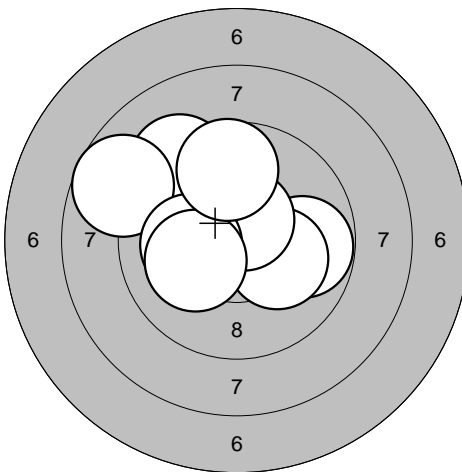
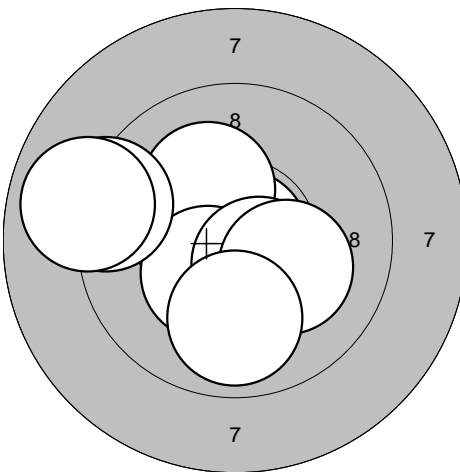
<p>Series 5</p> 	<p>1: 10,2* ←</p> <p>2: 10,4* ↗</p> <p>3: 9,8 →</p> <p>4: 10,2* ↘</p> <p>5: 9,3 ↗</p> <p>6: 8,7 ↗</p> <p>7: 10,6* ↗</p> <p>8: 10,2* ←</p> <p>9: 10,1 ←</p> <p>10: 9,7 ↗</p>	<p>Series 6</p> 	<p>1: 10,9* ↗</p> <p>2: 10,8* ←</p> <p>3: 10,5* ←</p> <p>4: 10,2* ↗</p> <p>5: 10,4* ↘</p> <p>6: 9,2 ←</p> <p>7: 10,5* ↘</p> <p>8: 10,2* ↘</p> <p>9: 9,9 ↓</p> <p>10: 8,9 ←</p>
Serie 95,0		Serie 96,0	
Sum 474,0		Sum 570,0	

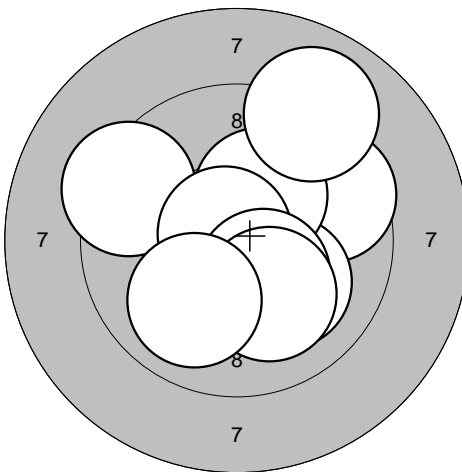
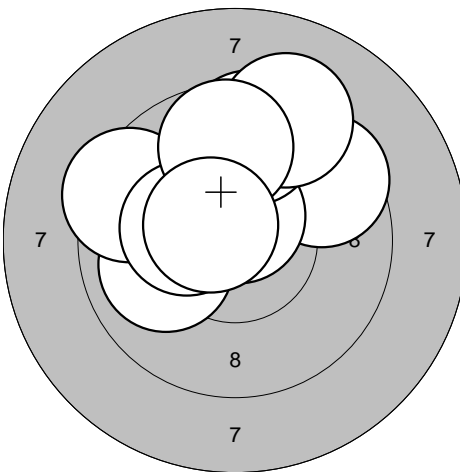
<p>Series 1</p> 	<p>1: 9,6 →</p> <p>2: 9,4 ←</p> <p>3: 10,1 ↓</p> <p>4: 10,2* ↑</p> <p>5: 10,5* ↓</p> <p>6: 10,8* ↗</p> <p>7: 9,0 ↗</p> <p>8: 10,3* ↓</p> <p>9: 10,1 ↓</p> <p>10: 10,0 ↓</p> <table border="1" style="width:100%; border-collapse: collapse;"> <tr> <td style="text-align: right;">Serie</td> <td style="text-align: right;">97,0</td> </tr> <tr> <td style="text-align: right;">Sum</td> <td style="text-align: right;">97,0</td> </tr> </table>	Serie	97,0	Sum	97,0	<p>Series 2</p> 	<p>1: 10,1 ↖</p> <p>2: 9,5 ↗</p> <p>3: 10,6* ↑</p> <p>4: 10,0 ←</p> <p>5: 9,4 ←</p> <p>6: 9,6 ↑</p> <p>7: 9,2 ↗</p> <p>8: 10,3* ←</p> <p>9: 9,7 ↑</p> <p>10: 10,6* ↖</p> <table border="1" style="width:100%; border-collapse: collapse;"> <tr> <td style="text-align: right;">Serie</td> <td style="text-align: right;">95,0</td> </tr> <tr> <td style="text-align: right;">Sum</td> <td style="text-align: right;">192,0</td> </tr> </table>	Serie	95,0	Sum	192,0
Serie	97,0										
Sum	97,0										
Serie	95,0										
Sum	192,0										

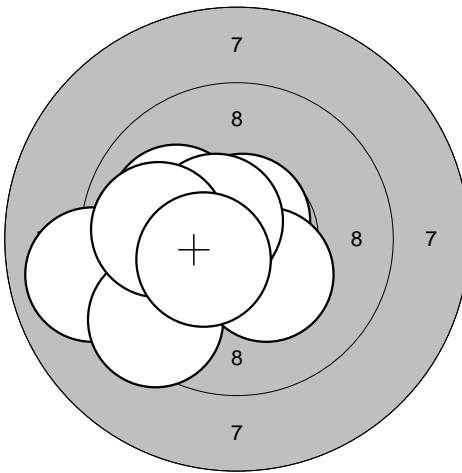
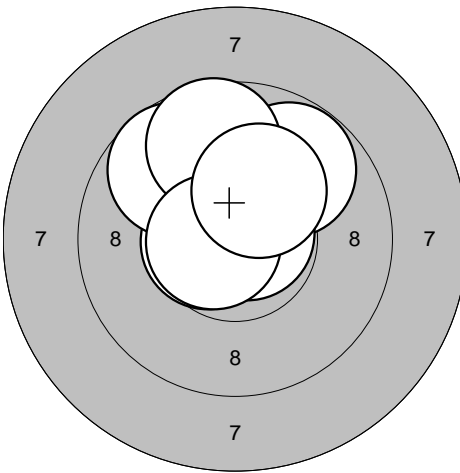
<p>Series 3</p> 	<p>1: 10,6* ←</p> <p>2: 9,0 ←</p> <p>3: 9,4 ↖</p> <p>4: 10,7* ↑</p> <p>5: 10,3* ↓</p> <p>6: 10,6* ←</p> <p>7: 10,1 ↗</p> <p>8: 10,6* ↗</p> <p>9: 9,9 ←</p> <p>10: 10,4* ↖</p> <table border="1" style="width:100%; border-collapse: collapse;"> <tr> <td style="text-align: right;">Serie</td> <td style="text-align: right;">97,0</td> </tr> <tr> <td style="text-align: right;">Sum</td> <td style="text-align: right;">289,0</td> </tr> </table>	Serie	97,0	Sum	289,0	<p>Series 4</p> 	<p>1: 10,1 ↑</p> <p>2: 10,6* ←</p> <p>3: 9,8 ↗</p> <p>4: 10,8* ↗</p> <p>5: 10,6* ↖</p> <p>6: 9,7 ↗</p> <p>7: 9,7 ↑</p> <p>8: 10,8* ↗</p> <p>9: 10,7* ←</p> <p>10: 10,2* ↗</p> <table border="1" style="width:100%; border-collapse: collapse;"> <tr> <td style="text-align: right;">Serie</td> <td style="text-align: right;">97,0</td> </tr> <tr> <td style="text-align: right;">Sum</td> <td style="text-align: right;">386,0</td> </tr> </table>	Serie	97,0	Sum	386,0
Serie	97,0										
Sum	289,0										
Serie	97,0										
Sum	386,0										

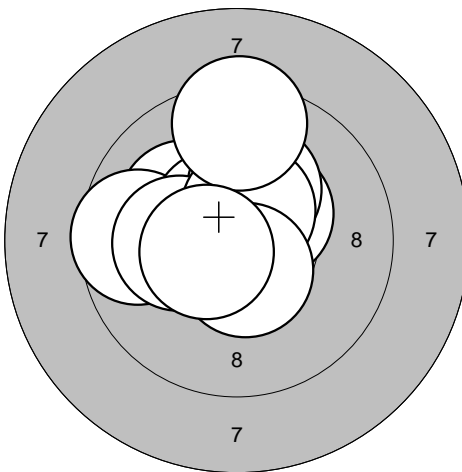
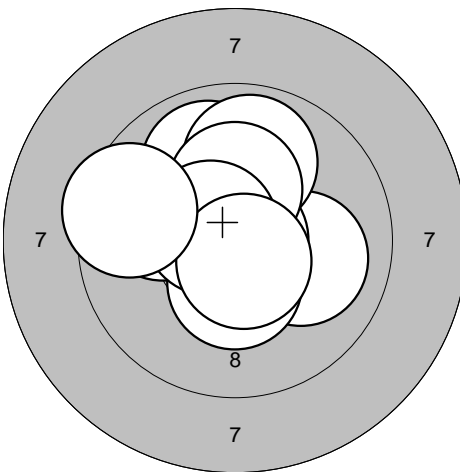
<p>Series 5</p> 	<p>1: 10,1 ↖</p> <p>2: 10,4* ↗</p> <p>3: 9,6 ←</p> <p>4: 10,6* ↗</p> <p>5: 10,2* ↑</p> <p>6: 10,2* ←</p> <p>7: 10,5* ↗</p> <p>8: 9,4 ↑</p> <p>9: 10,5* ↓</p> <p>10: 10,5* ←</p> <table border="1" style="width:100%; border-collapse: collapse;"> <tr> <td style="text-align: right;">Serie</td> <td style="text-align: right;">98,0</td> </tr> <tr> <td style="text-align: right;">Sum</td> <td style="text-align: right;">484,0</td> </tr> </table>	Serie	98,0	Sum	484,0	<p>Series 6</p> 	<p>1: 10,0 →</p> <p>2: 9,9 ←</p> <p>3: 9,9 ↑</p> <p>4: 10,4* ↓</p> <p>5: 9,9 ↑</p> <p>6: 10,9* →</p> <p>7: 10,3* ↑</p> <p>8: 10,6* ←</p> <p>9: 10,7* ↓</p> <p>10: 9,5 ←</p> <table border="1" style="width:100%; border-collapse: collapse;"> <tr> <td style="text-align: right;">Serie</td> <td style="text-align: right;">96,0</td> </tr> <tr> <td style="text-align: right;">Sum</td> <td style="text-align: right;">580,0</td> </tr> </table>	Serie	96,0	Sum	580,0
Serie	98,0										
Sum	484,0										
Serie	96,0										
Sum	580,0										

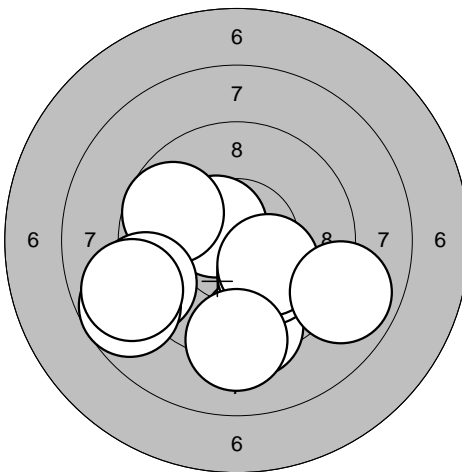
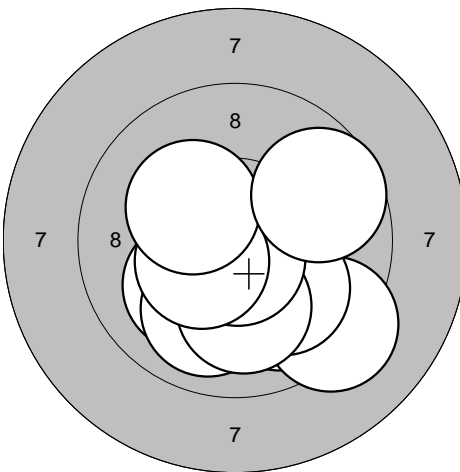
<p>Series 1</p> 	<table style="width:100%; border-collapse: collapse;"> <tr><td>1: 10,5*</td><td style="text-align: right;">↖</td></tr> <tr><td>2: 9,7</td><td style="text-align: right;">↖</td></tr> <tr><td>3: 9,4</td><td style="text-align: right;">↓</td></tr> <tr><td>4: 10,1</td><td style="text-align: right;">↓</td></tr> <tr><td>5: 9,2</td><td style="text-align: right;">←</td></tr> <tr><td>6: 10,2*</td><td style="text-align: right;">↓</td></tr> <tr><td>7: 8,9</td><td style="text-align: right;">→</td></tr> <tr><td>8: 8,8</td><td style="text-align: right;">←</td></tr> <tr><td>9: 8,9</td><td style="text-align: right;">←</td></tr> <tr><td>10: 9,2</td><td style="text-align: right;">↓</td></tr> <tr style="border-top: 1px solid black;"><td style="text-align: right;">Serie</td><td style="text-align: right;">90,0</td></tr> <tr><td style="text-align: right;">Sum</td><td style="text-align: right;">90,0</td></tr> </table>	1: 10,5*	↖	2: 9,7	↖	3: 9,4	↓	4: 10,1	↓	5: 9,2	←	6: 10,2*	↓	7: 8,9	→	8: 8,8	←	9: 8,9	←	10: 9,2	↓	Serie	90,0	Sum	90,0	<p>Series 2</p> 	<table style="width:100%; border-collapse: collapse;"> <tr><td>1: 9,9</td><td style="text-align: right;">↓</td></tr> <tr><td>2: 9,2</td><td style="text-align: right;">↓</td></tr> <tr><td>3: 10,1</td><td style="text-align: right;">↙</td></tr> <tr><td>4: 10,1</td><td style="text-align: right;">↓</td></tr> <tr><td>5: 9,9</td><td style="text-align: right;">↓</td></tr> <tr><td>6: 10,1</td><td style="text-align: right;">↓</td></tr> <tr><td>7: 10,7*</td><td style="text-align: right;">↓</td></tr> <tr><td>8: 10,4*</td><td style="text-align: right;">←</td></tr> <tr><td>9: 10,2*</td><td style="text-align: right;">↖</td></tr> <tr><td>10: 9,7</td><td style="text-align: right;">↗</td></tr> <tr style="border-top: 1px solid black;"><td style="text-align: right;">Serie</td><td style="text-align: right;">96,0</td></tr> <tr><td style="text-align: right;">Sum</td><td style="text-align: right;">186,0</td></tr> </table>	1: 9,9	↓	2: 9,2	↓	3: 10,1	↙	4: 10,1	↓	5: 9,9	↓	6: 10,1	↓	7: 10,7*	↓	8: 10,4*	←	9: 10,2*	↖	10: 9,7	↗	Serie	96,0	Sum	186,0
1: 10,5*	↖																																																		
2: 9,7	↖																																																		
3: 9,4	↓																																																		
4: 10,1	↓																																																		
5: 9,2	←																																																		
6: 10,2*	↓																																																		
7: 8,9	→																																																		
8: 8,8	←																																																		
9: 8,9	←																																																		
10: 9,2	↓																																																		
Serie	90,0																																																		
Sum	90,0																																																		
1: 9,9	↓																																																		
2: 9,2	↓																																																		
3: 10,1	↙																																																		
4: 10,1	↓																																																		
5: 9,9	↓																																																		
6: 10,1	↓																																																		
7: 10,7*	↓																																																		
8: 10,4*	←																																																		
9: 10,2*	↖																																																		
10: 9,7	↗																																																		
Serie	96,0																																																		
Sum	186,0																																																		

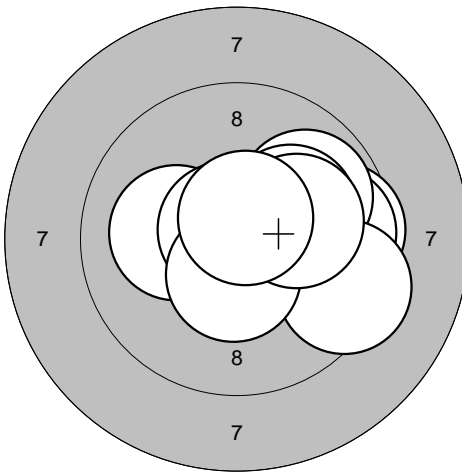
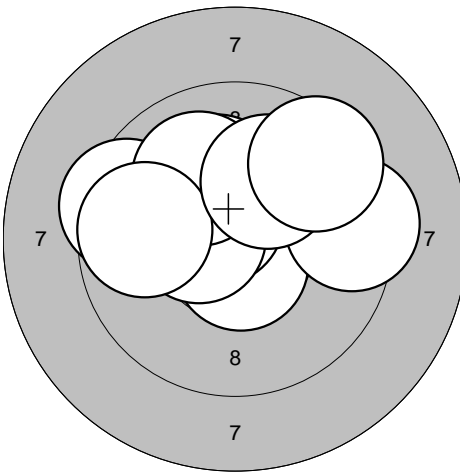
<p>Series 3</p> 	<table style="width:100%; border-collapse: collapse;"> <tr><td>1: 10,2*</td><td style="text-align: right;">←</td></tr> <tr><td>2: 9,6</td><td style="text-align: right;">→</td></tr> <tr><td>3: 9,7</td><td style="text-align: right;">→</td></tr> <tr><td>4: 10,7*</td><td style="text-align: right;">↖</td></tr> <tr><td>5: 9,9</td><td style="text-align: right;">↗</td></tr> <tr><td>6: 10,2*</td><td style="text-align: right;">↗</td></tr> <tr><td>7: 9,4</td><td style="text-align: right;">→</td></tr> <tr><td>8: 10,5*</td><td style="text-align: right;">↓</td></tr> <tr><td>9: 10,1</td><td style="text-align: right;">→</td></tr> <tr><td>10: 10,7*</td><td style="text-align: right;">↗</td></tr> <tr style="border-top: 1px solid black;"><td style="text-align: right;">Serie</td><td style="text-align: right;">96,0</td></tr> <tr><td style="text-align: right;">Sum</td><td style="text-align: right;">282,0</td></tr> </table>	1: 10,2*	←	2: 9,6	→	3: 9,7	→	4: 10,7*	↖	5: 9,9	↗	6: 10,2*	↗	7: 9,4	→	8: 10,5*	↓	9: 10,1	→	10: 10,7*	↗	Serie	96,0	Sum	282,0	<p>Series 4</p> 	<table style="width:100%; border-collapse: collapse;"> <tr><td>1: 10,6*</td><td style="text-align: right;">↓</td></tr> <tr><td>2: 10,2*</td><td style="text-align: right;">↗</td></tr> <tr><td>3: 10,6*</td><td style="text-align: right;">↗</td></tr> <tr><td>4: 9,4</td><td style="text-align: right;">←</td></tr> <tr><td>5: 10,5*</td><td style="text-align: right;">←</td></tr> <tr><td>6: 10,0</td><td style="text-align: right;">↗</td></tr> <tr><td>7: 9,7</td><td style="text-align: right;">←</td></tr> <tr><td>8: 9,4</td><td style="text-align: right;">→</td></tr> <tr><td>9: 10,1</td><td style="text-align: right;">↗</td></tr> <tr><td>10: 9,5</td><td style="text-align: right;">↗</td></tr> <tr style="border-top: 1px solid black;"><td style="text-align: right;">Serie</td><td style="text-align: right;">96,0</td></tr> <tr><td style="text-align: right;">Sum</td><td style="text-align: right;">378,0</td></tr> </table>	1: 10,6*	↓	2: 10,2*	↗	3: 10,6*	↗	4: 9,4	←	5: 10,5*	←	6: 10,0	↗	7: 9,7	←	8: 9,4	→	9: 10,1	↗	10: 9,5	↗	Serie	96,0	Sum	378,0
1: 10,2*	←																																																		
2: 9,6	→																																																		
3: 9,7	→																																																		
4: 10,7*	↖																																																		
5: 9,9	↗																																																		
6: 10,2*	↗																																																		
7: 9,4	→																																																		
8: 10,5*	↓																																																		
9: 10,1	→																																																		
10: 10,7*	↗																																																		
Serie	96,0																																																		
Sum	282,0																																																		
1: 10,6*	↓																																																		
2: 10,2*	↗																																																		
3: 10,6*	↗																																																		
4: 9,4	←																																																		
5: 10,5*	←																																																		
6: 10,0	↗																																																		
7: 9,7	←																																																		
8: 9,4	→																																																		
9: 10,1	↗																																																		
10: 9,5	↗																																																		
Serie	96,0																																																		
Sum	378,0																																																		

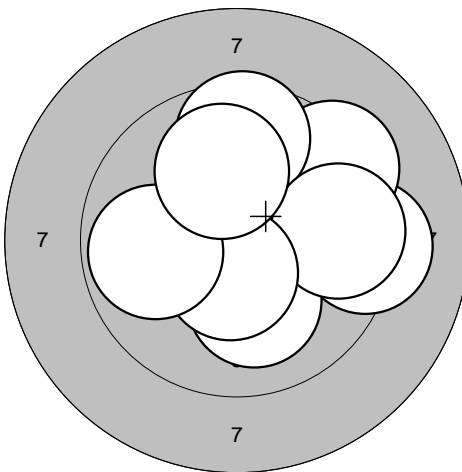
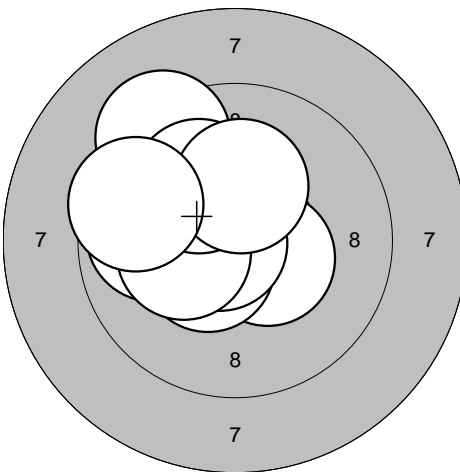
<p>Series 5</p> 	<table style="width:100%; border-collapse: collapse;"> <tr><td>1: 10,0</td><td style="text-align: right;">↗</td></tr> <tr><td>2: 10,4*</td><td style="text-align: right;">↗</td></tr> <tr><td>3: 9,2</td><td style="text-align: right;">→</td></tr> <tr><td>4: 10,1</td><td style="text-align: right;">↓</td></tr> <tr><td>5: 9,3</td><td style="text-align: right;">↗</td></tr> <tr><td>6: 9,6</td><td style="text-align: right;">↑</td></tr> <tr><td>7: 9,6</td><td style="text-align: right;">→</td></tr> <tr><td>8: 10,5*</td><td style="text-align: right;">↓</td></tr> <tr><td>9: 9,9</td><td style="text-align: right;">←</td></tr> <tr><td>10: 10,0</td><td style="text-align: right;">↗</td></tr> <tr style="border-top: 1px solid black;"><td style="text-align: right;">Serie</td><td style="text-align: right;">95,0</td></tr> <tr><td style="text-align: right;">Sum</td><td style="text-align: right;">473,0</td></tr> </table>	1: 10,0	↗	2: 10,4*	↗	3: 9,2	→	4: 10,1	↓	5: 9,3	↗	6: 9,6	↑	7: 9,6	→	8: 10,5*	↓	9: 9,9	←	10: 10,0	↗	Serie	95,0	Sum	473,0	<p>Series 6</p> 	<table style="width:100%; border-collapse: collapse;"> <tr><td>1: 10,1</td><td style="text-align: right;">↖</td></tr> <tr><td>2: 10,5*</td><td style="text-align: right;">↘</td></tr> <tr><td>3: 10,5*</td><td style="text-align: right;">↙</td></tr> <tr><td>4: 9,3</td><td style="text-align: right;">↗</td></tr> <tr><td>5: 9,9</td><td style="text-align: right;">←</td></tr> <tr><td>6: 10,7*</td><td style="text-align: right;">←</td></tr> <tr><td>7: 10,3*</td><td style="text-align: right;">←</td></tr> <tr><td>8: 10,1</td><td style="text-align: right;">↗</td></tr> <tr><td>9: 10,2*</td><td style="text-align: right;">↑</td></tr> <tr><td>10: 9,6</td><td style="text-align: right;">←</td></tr> <tr style="border-top: 1px solid black;"><td style="text-align: right;">Serie</td><td style="text-align: right;">97,0</td></tr> <tr><td style="text-align: right;">Sum</td><td style="text-align: right;">570,0</td></tr> </table>	1: 10,1	↖	2: 10,5*	↘	3: 10,5*	↙	4: 9,3	↗	5: 9,9	←	6: 10,7*	←	7: 10,3*	←	8: 10,1	↗	9: 10,2*	↑	10: 9,6	←	Serie	97,0	Sum	570,0
1: 10,0	↗																																																		
2: 10,4*	↗																																																		
3: 9,2	→																																																		
4: 10,1	↓																																																		
5: 9,3	↗																																																		
6: 9,6	↑																																																		
7: 9,6	→																																																		
8: 10,5*	↓																																																		
9: 9,9	←																																																		
10: 10,0	↗																																																		
Serie	95,0																																																		
Sum	473,0																																																		
1: 10,1	↖																																																		
2: 10,5*	↘																																																		
3: 10,5*	↙																																																		
4: 9,3	↗																																																		
5: 9,9	←																																																		
6: 10,7*	←																																																		
7: 10,3*	←																																																		
8: 10,1	↗																																																		
9: 10,2*	↑																																																		
10: 9,6	←																																																		
Serie	97,0																																																		
Sum	570,0																																																		

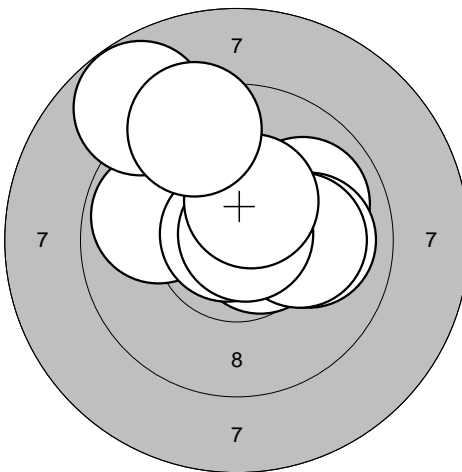
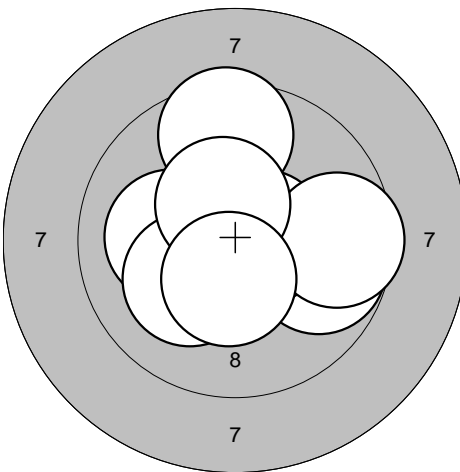
<p>Series 1</p> 	<p>1: 9,9 →</p> <p>2: 9,8 ←</p> <p>3: 10,0 →</p> <p>4: 10,6* →</p> <p>5: 10,1 →</p> <p>6: 10,8* ↗</p> <p>7: 10,8* ↗</p> <p>8: 10,4* ↗</p> <p>9: 8,8 ↗</p> <p>10: 9,4 ↗</p>	<p>Series 2</p> 	<p>1: 9,6 ↑</p> <p>2: 10,5* ←</p> <p>3: 9,8 →</p> <p>4: 10,6* →</p> <p>5: 9,6 →</p> <p>6: 10,4* ←</p> <p>7: 10,1 ←</p> <p>8: 10,2* ↙</p> <p>9: 10,5* ↑</p> <p>10: 10,4* ↓</p>
Serie 95,0	Serie 97,0	Serie 97,0	Serie 97,0
Sum 95,0	Sum 192,0	Sum 192,0	Sum 192,0

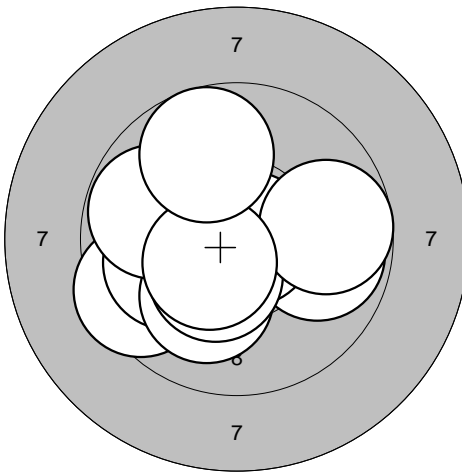
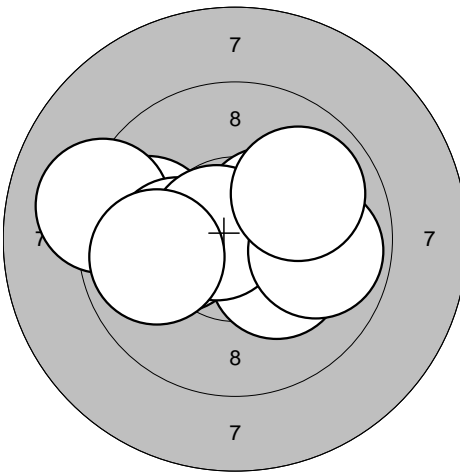
<p>Series 3</p> 	<p>1: 9,5 ←</p> <p>2: 10,0 ←</p> <p>3: 9,9 →</p> <p>4: 10,8* →</p> <p>5: 10,1 ↘</p> <p>6: 10,4* ↘</p> <p>7: 9,7 →</p> <p>8: 9,8 ←</p> <p>9: 10,5* ↙</p> <p>10: 9,8 ↗</p>	<p>Series 4</p> 	<p>1: 10,4* ↗</p> <p>2: 10,5* →</p> <p>3: 9,8 ←</p> <p>4: 9,1 ←</p> <p>5: 10,2* ←</p> <p>6: 10,3* ↘</p> <p>7: 10,7* ←</p> <p>8: 9,9 ←</p> <p>9: 9,9 →</p> <p>10: 9,9 ↗</p>
Serie 95,0	Serie 95,0	Serie 95,0	Serie 95,0
Sum 287,0	Sum 382,0	Sum 382,0	Sum 382,0

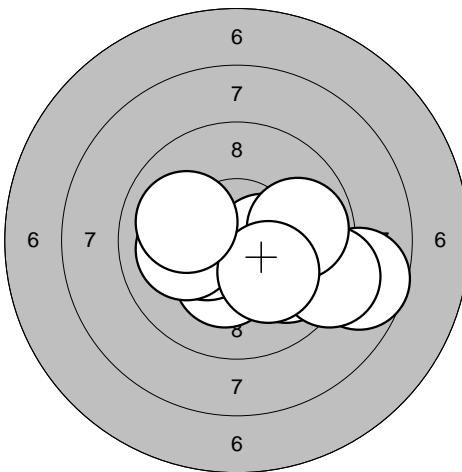
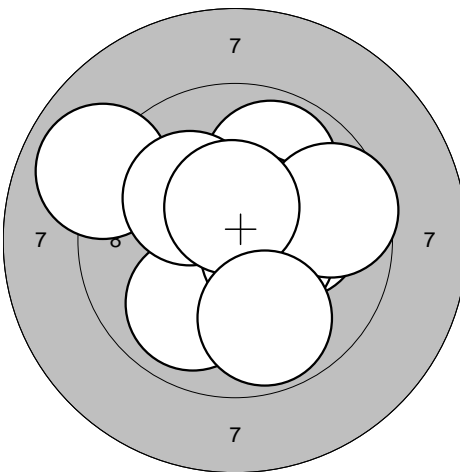
<p>Series 5</p> 	<p>1: 8,7 →</p> <p>2: 10,3* ↓</p> <p>3: 10,4* ←</p> <p>4: 10,5* →</p> <p>5: 9,9 ↘</p> <p>6: 9,2 →</p> <p>7: 9,9 →</p> <p>8: 10,1 ←</p> <p>9: 10,2* ↘</p> <p>10: 10,0 ←</p>	<p>Series 6</p> 	<p>1: 9,9 ↗</p> <p>2: 8,9 ←</p> <p>3: 10,6* ↗</p> <p>4: 10,0 ↘</p> <p>5: 10,2* →</p> <p>6: 10,1 ↗</p> <p>7: 10,5* →</p> <p>8: 9,6 →</p> <p>9: 10,5* ↑</p> <p>10: 9,8 ↓</p>
Serie 95,0	Serie 95,0	Serie 95,0	Serie 95,0
Sum 477,0	Sum 572,0	Sum 572,0	Sum 572,0

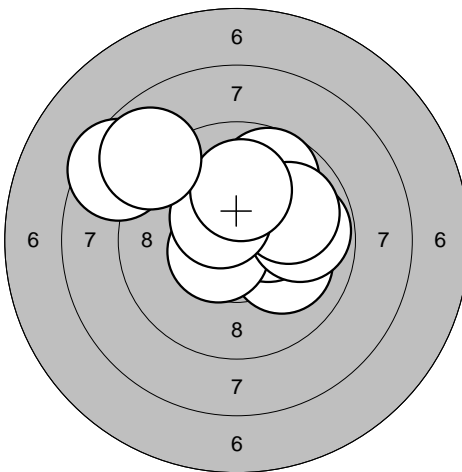
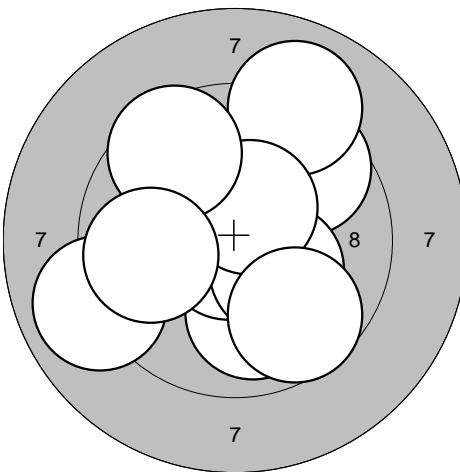
<p>Series 1</p> 	<p>1: 10,1 →</p> <p>2: 9,7 ↗</p> <p>3: 10,3* →</p> <p>4: 10,6* ↖</p> <p>5: 9,8 →</p> <p>6: 8,5 ↗</p> <p>7: 9,9 →</p> <p>8: 10,5* ↗</p> <p>9: 10,1 ↑</p> <p>10: 8,9 ↖</p>	<p>Series 2</p> 	<p>1: 10,0 ↓</p> <p>2: 8,9 ↖</p> <p>3: 9,6 ↗</p> <p>4: 10,8* ↘</p> <p>5: 9,0 ↗</p> <p>6: 10,3* ↘</p> <p>7: 10,5* ↗</p> <p>8: 9,7 ↘</p> <p>9: 9,5 ↗</p> <p>10: 9,8 ↖</p>
Serie 93,0		Serie 93,0	
Sum 93,0		Sum 186,0	

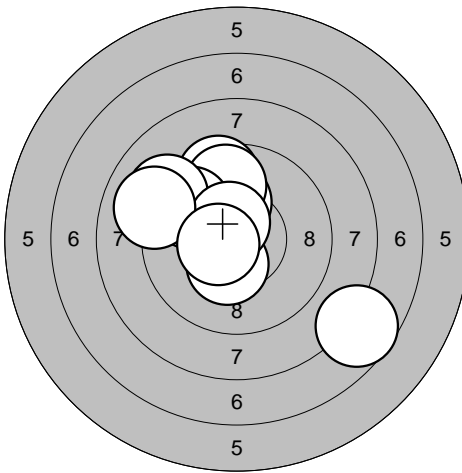
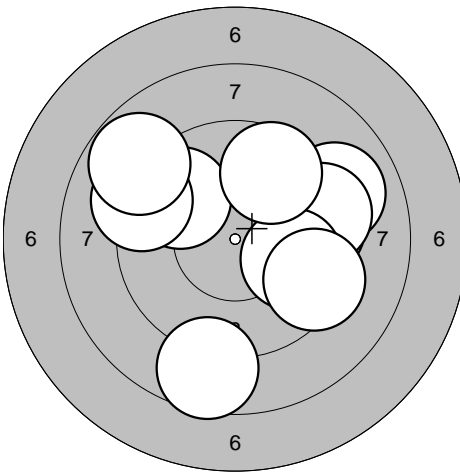
<p>Series 3</p> 	<p>1: 10,4* ↓</p> <p>2: 10,1 ↑</p> <p>3: 9,5 ↑</p> <p>4: 9,8 ↑</p> <p>5: 9,7 ↗</p> <p>6: 9,1 ↗</p> <p>7: 10,6* ↗</p> <p>8: 9,0 ↖</p> <p>9: 7,7 ↘</p> <p>10: 10,5* ↖</p>	<p>Series 4</p> 	<p>1: 8,6 ↓</p> <p>2: 9,0 →</p> <p>3: 9,5 →</p> <p>4: 9,8 ↖</p> <p>5: 9,4 →</p> <p>6: 9,2 ↖</p> <p>7: 9,9 →</p> <p>8: 8,8 ↖</p> <p>9: 9,6 ↗</p> <p>10: 9,4 ↘</p>
Serie 92,0		Serie 88,0	
Sum 278,0		Sum 366,0	

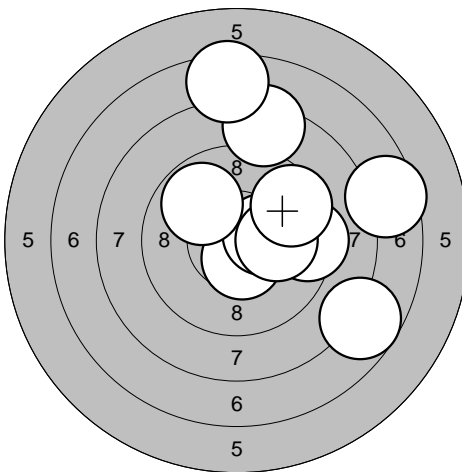
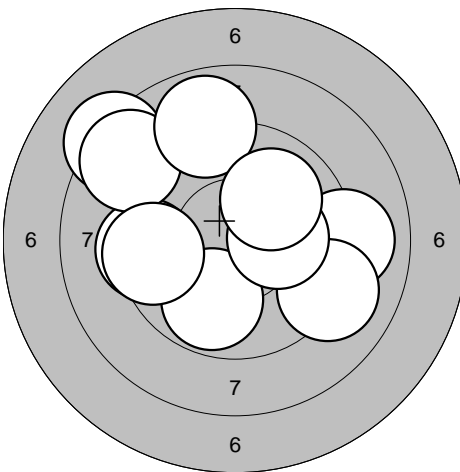
<p>Series 5</p> 	<p>1: 9,4 →</p> <p>2: 8,4 ↑</p> <p>3: 10,5* ↓</p> <p>4: 10,4* →</p> <p>5: 7,7 ↘</p> <p>6: 7,5 →</p> <p>7: 10,1 →</p> <p>8: 9,9 ↗</p> <p>9: 7,5 ↑</p> <p>10: 9,5 ↗</p>	<p>Series 6</p> 	<p>1: 9,0 →</p> <p>2: 9,8 ↓</p> <p>3: 8,2 ↗</p> <p>4: 9,1 ↘</p> <p>5: 10,2* →</p> <p>6: 9,4 ↖</p> <p>7: 8,6 ↖</p> <p>8: 8,9 ↑</p> <p>9: 10,0 ↗</p> <p>10: 9,5 ↖</p>
Serie 86,0		Serie 89,0	
Sum 452,0		Sum 541,0	

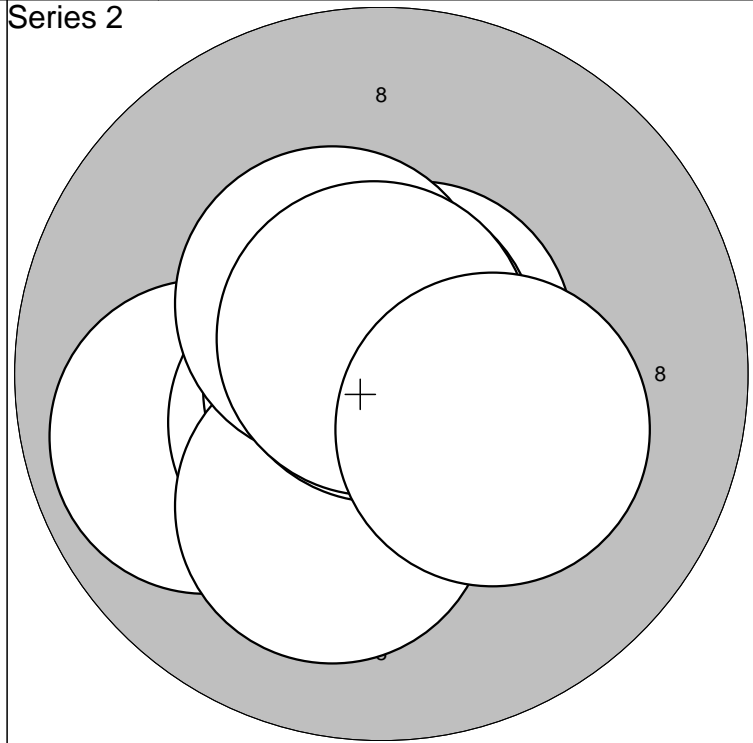
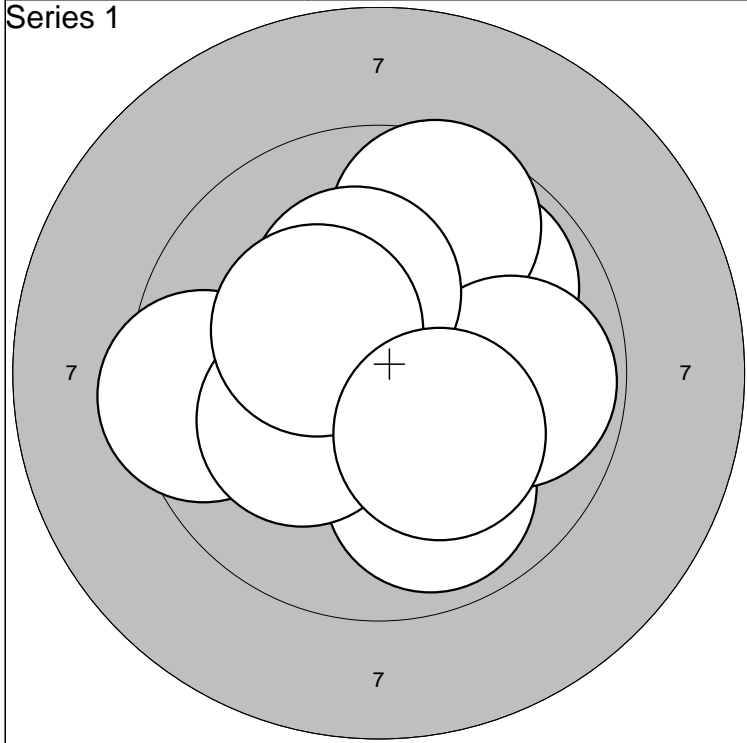

1: 9,9 ↗	6: 9,6 ↑	Serie	95,0
2: 9,9 ↓	7: 9,8 →		
3: 9,5 ←	8:10,2* ↑	Sum	95,0
4:10,2* ↙	9:10,3* ↗		
5:10,5* →	10:10,2* ↓		

1:10,7* ↗	6:10,1 ↓	Serie	99,0
2:10,6* ↓	7:10,5* ↘		
3: 9,9 ←	8:10,8* ↑	Sum	194,0
4:10,5* ↙	9:10,8* ↑		
5:10,8* ↖	10:10,3* ➤		

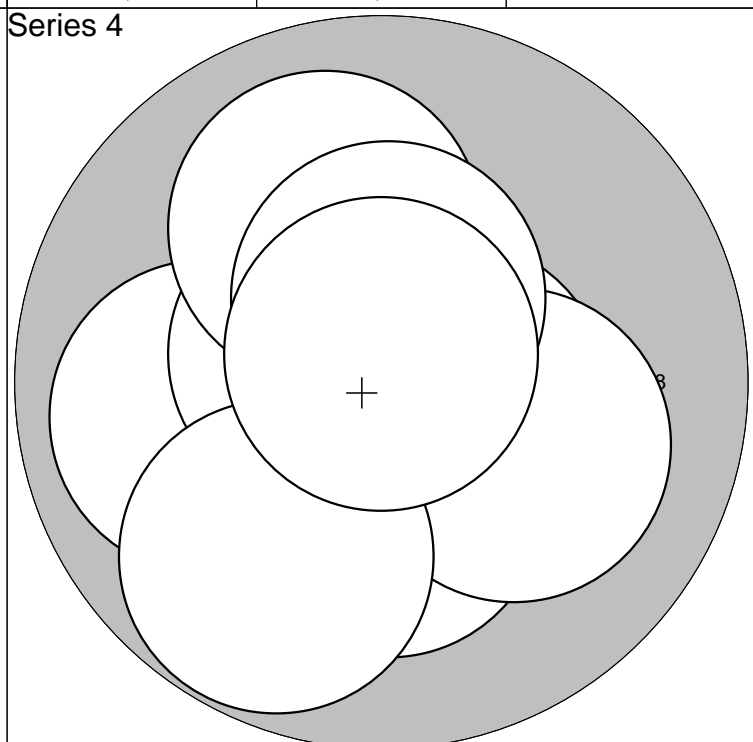
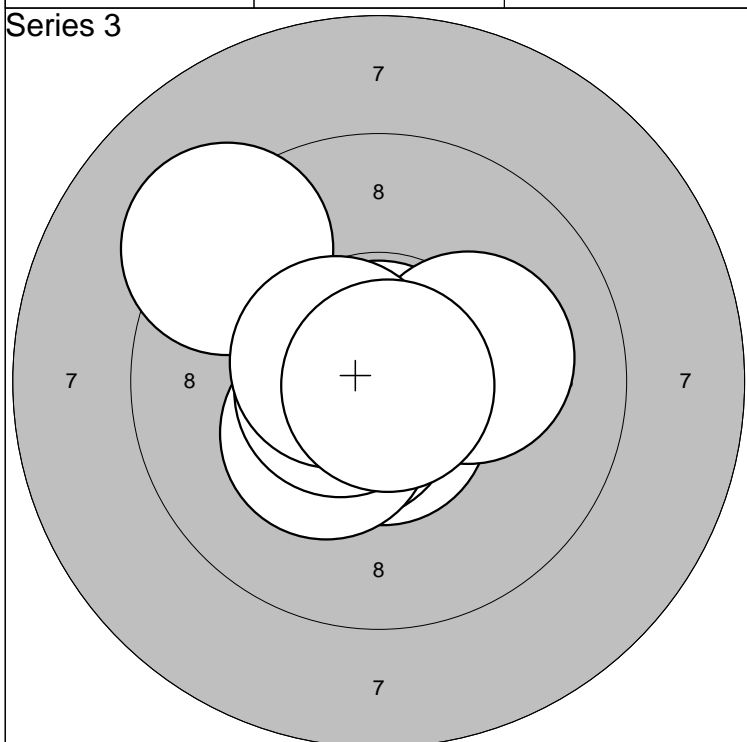

1:10,8* ↑	6:10,6* ←	Serie	99,0
2:10,6* ↓	7: 9,3 ↗		
3:10,6* ↙	8:10,2* ➤	Sum	293,0
4:10,6* ←	9:10,5* ↖		
5:10,3* ↙	10:10,9* ➤		

1: 9,9 ←	6:10,0 ↑	Serie	98,0
2:10,3* ↓	7:10,1 ➤		
3:10,8* ←	8: 9,8 ↓	Sum	391,0
4:10,5* ➤	9:10,5* ↑		
5:10,6* ↖	10:10,8* ↑		

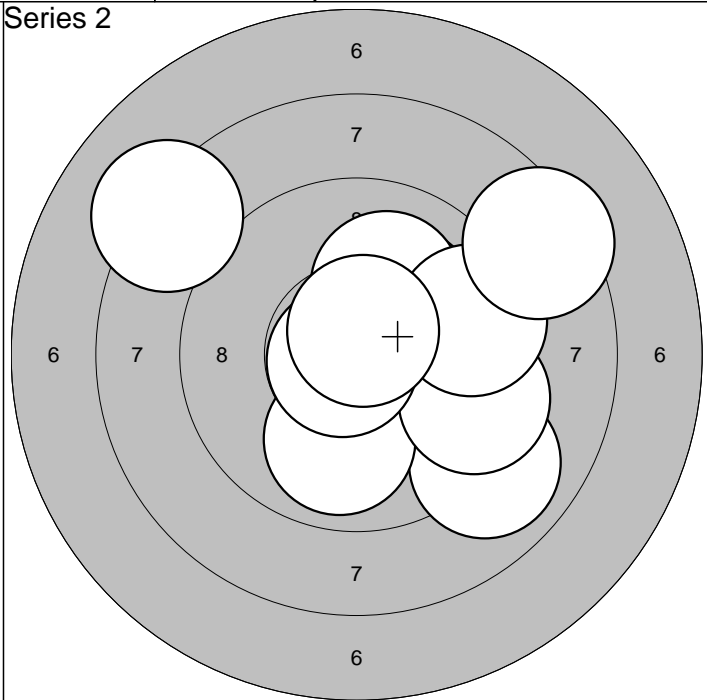
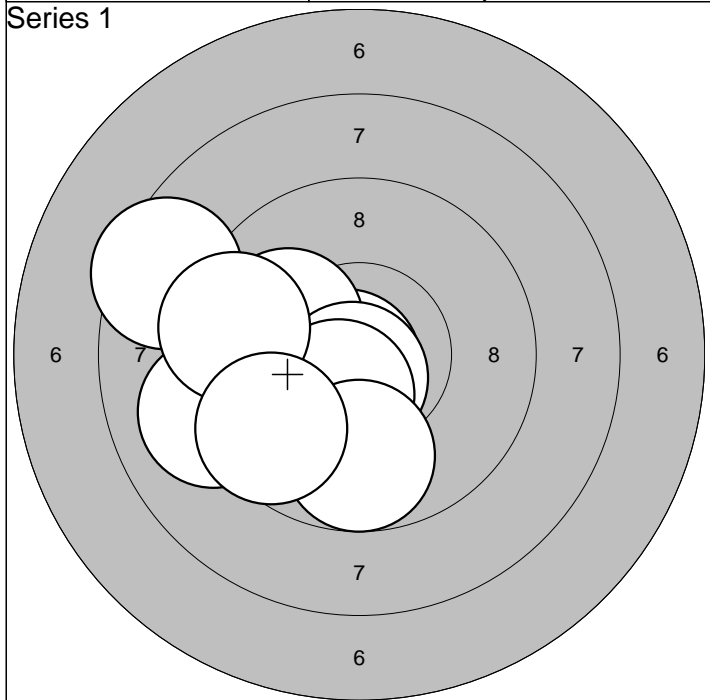

1:10,7* ↙	6:10,4* ↓	Serie	94,0
2:10,2* ↙	7: 8,5 ↙		
3:10,0 ↖	8: 9,7 ↓	Sum	94,0
4:10,6* ↓	9: 9,4 ↖		
5: 9,1 ↖	10: 9,6 ↙		

1: 8,9 ↘	6:10,1 ↗	Serie	91,0
2: 9,9 ↓	7:10,8* ↖		
3: 9,5 ↗	8: 9,5 →	Sum	185,0
4: 8,2 ↖	9: 8,4 ↗		
5:10,1 ↗	10:10,7* ↗		

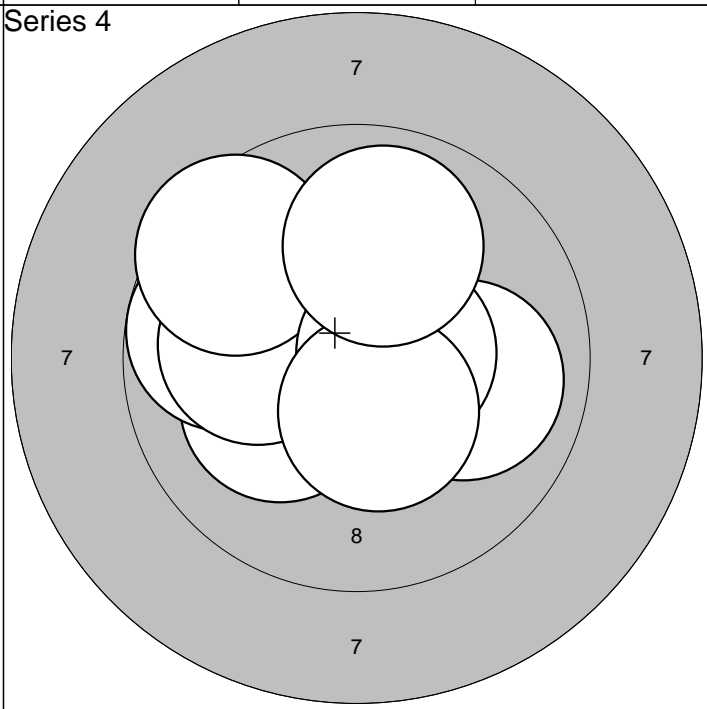
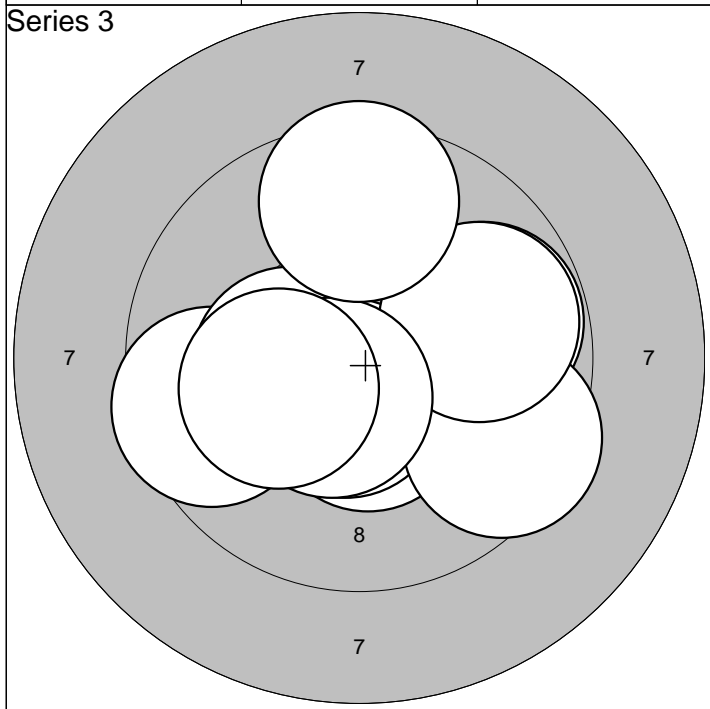

1:10,5* ↓	6: 9,5 ↗	Serie	95,0
2: 9,6 ↖	7: 9,8 →		
3:10,4* ↖	8:10,5* ↙	Sum	280,0
4: 9,8 →	9: 9,6 ↗		
5:10,6* ↓	10:10,2* ↖		

1:10,3* ↗	6: 9,9 →	Serie	96,0
2:10,2* ↖	7: 9,5 ↖		
3:10,5* ↗	8:10,6* →	Sum	376,0
4: 9,8 ↖	9:10,4* ↓		
5:10,0 ↖	10: 9,9 ↗		

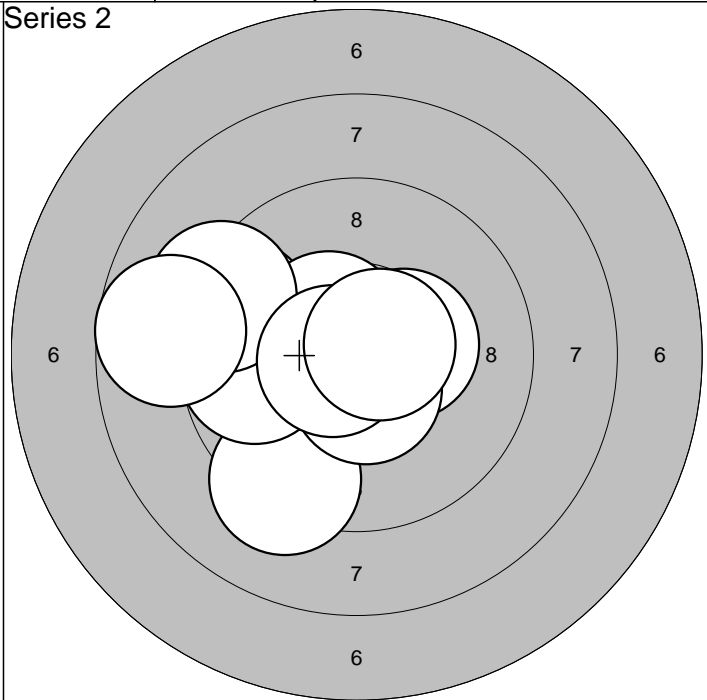
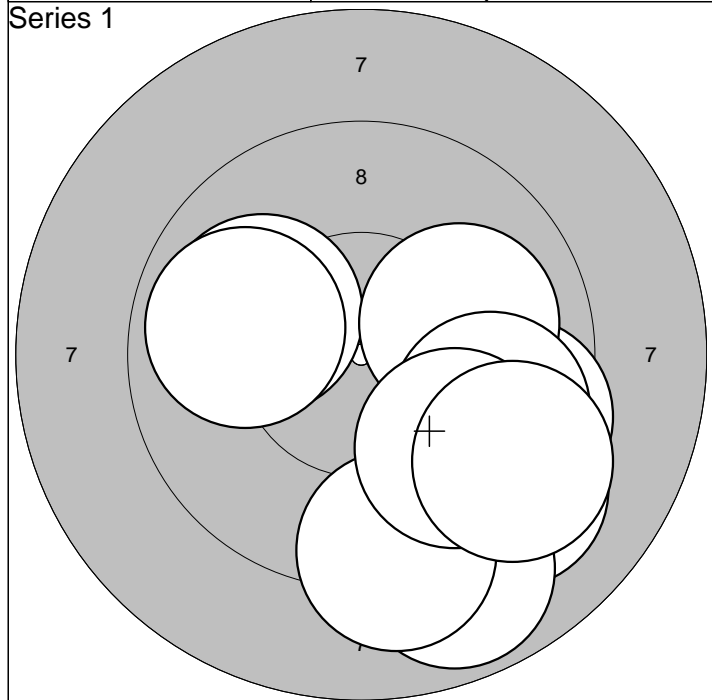

1:10,0 ↖	6: 9,7 →			Serie	91,0
2: 9,5 →	7: 9,2 ↓				
3:10,0 →	8: 9,8 ↓	Sum	91,0		
4: 9,2 ↓	9: 9,3 ↓				
5: 8,8 ↓	10: 9,9 ←				

1: 9,5 ↖	6:10,5* ↖			Serie	94,0
2: 9,2 ↓	7: 9,2 ↖				
3:10,4* →	8:10,7* ↖	Sum	185,0		
4:10,5* ↓	9: 8,7 ↖				
5: 9,8 ←	10:10,6* →				

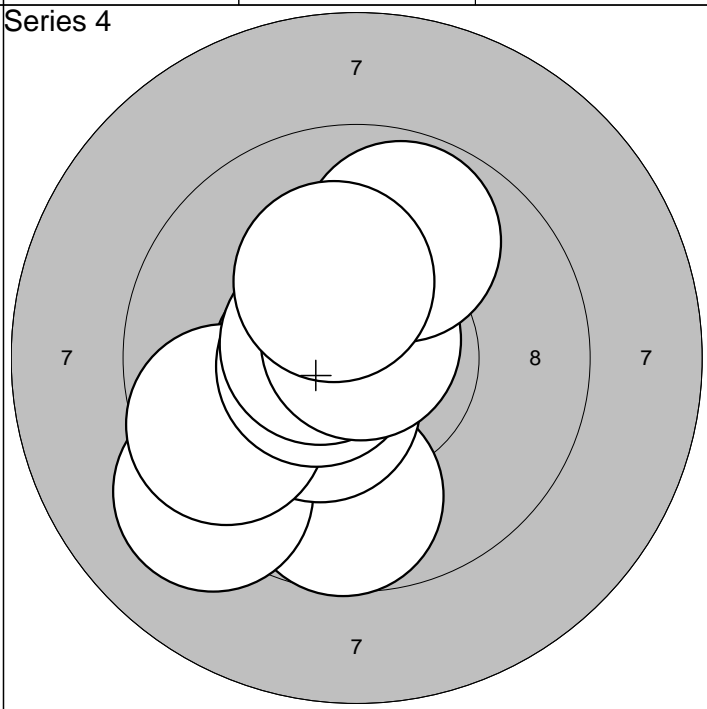
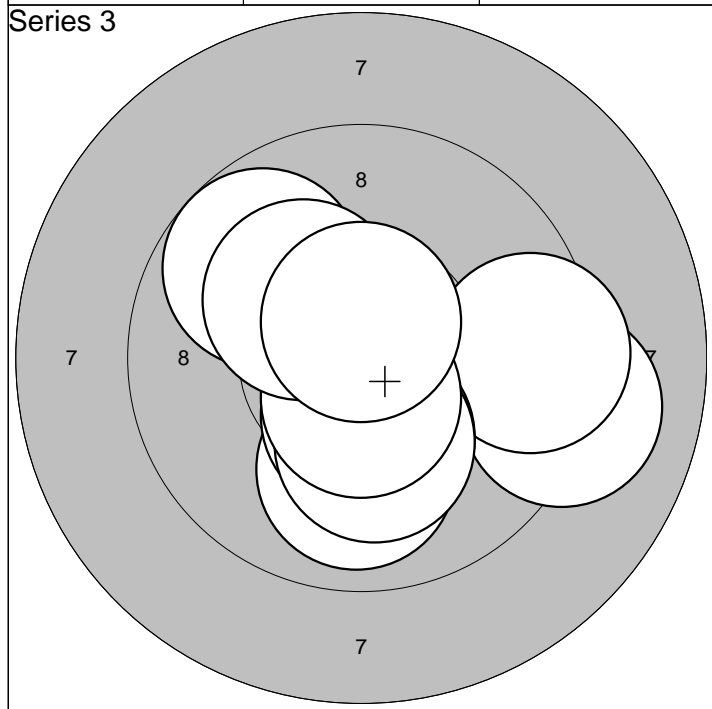

1:10,0 ↓	6:10,4* ↓			Serie	97,0
2: 9,1 →	7:10,2* ↓				
3: 9,4 →	8:10,6* ↓	Sum	282,0		
4:10,2* ↓	9:10,2* ↖				
5: 9,8 ↖	10:10,6* ↑				

1:10,6* ↖	6:10,6* ↖			Serie	96,0
2: 9,7 ↓	7:10,6* ↖				
3: 9,2 ↖	8:10,8* ↑	Sum	378,0		
4:10,4* ↖	9: 9,8 ↑				
5: 9,6 ↖	10:10,2* ↑				

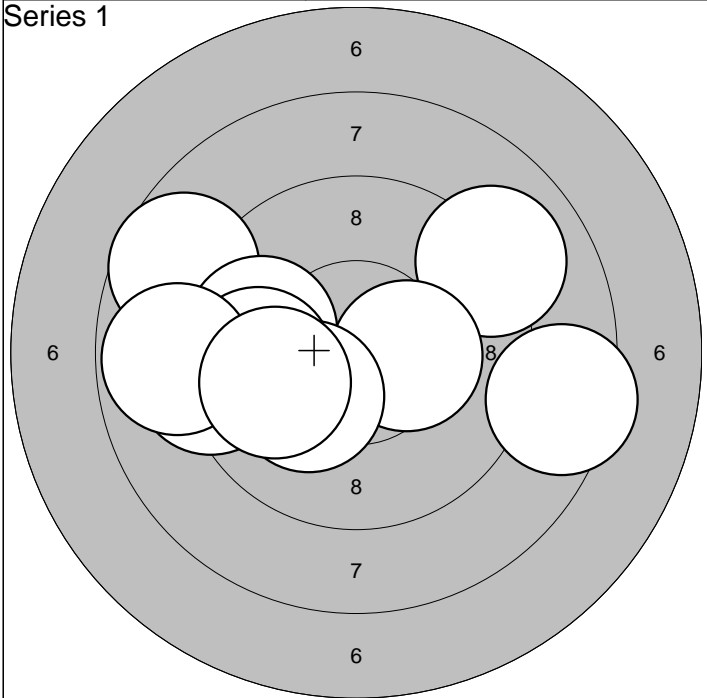

1: 8,7 ↖	6: 9,8 ←	Serie	89,0
2: 9,0 ↗	7:10,3* →		
3: 9,8 ←	8: 8,8 ←	Sum	89,0
4: 9,2 ←	9:10,2* ↙		
5: 8,4 →	10: 9,9 ←		

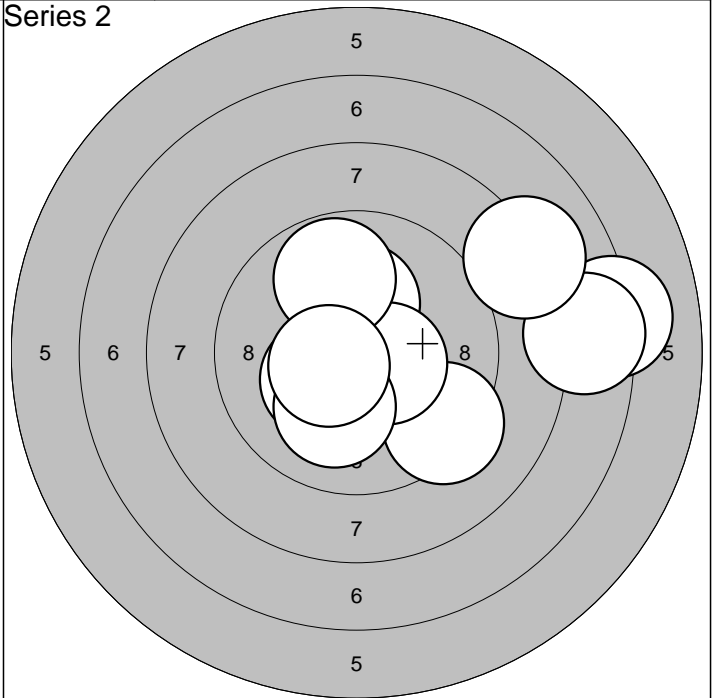

1: 9,3 ↘	6: 9,8 ↗	Serie	90,0
2: 7,2 →	7:10,1 ↘		
3:10,2* ↑	8:10,5* ↙	Sum	179,0
4:10,3* ↙	9: 7,6 →		
5:10,5* ↘	10: 8,1 ↗		

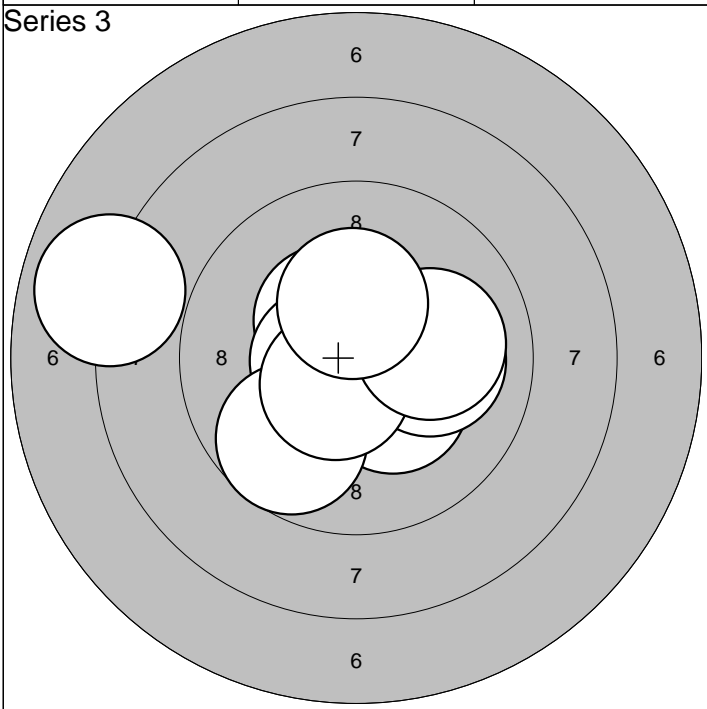

1:10,4* ↗	6: 9,7 ↙	Serie	96,0
2: 7,9 ←	7:10,1 →		
3:10,6* ↘	8:10,5* ↙	Sum	275,0
4:10,3* ↘	9:10,1 →		
5:10,6* ←	10:10,3* ↑		

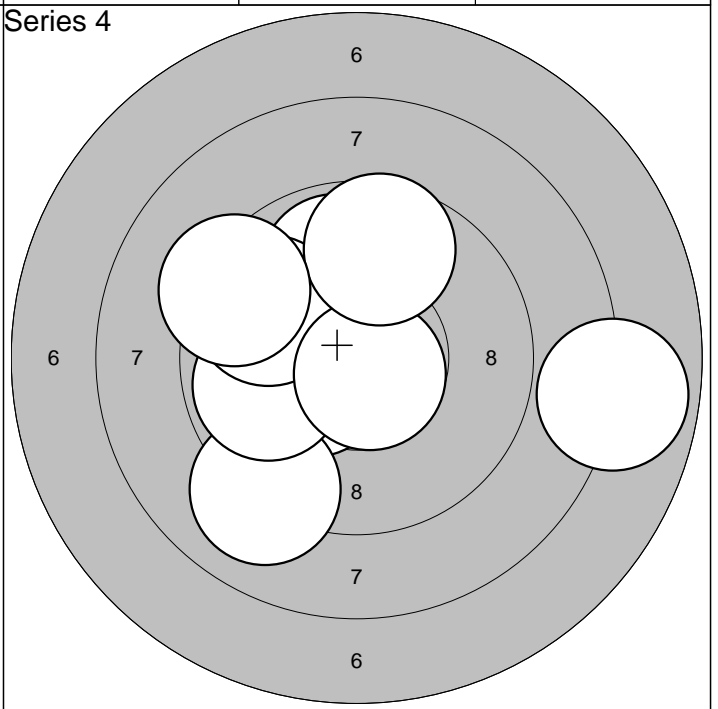

1:10,1 ↖	6: 9,8 ↙	Serie	91,0
2:10,3* ↙	7:10,7* ↘		
3: 9,9 ↑	8: 9,6 ↑	Sum	366,0
4: 9,0 ↙	9: 7,9 →		
5: 9,9 ←	10: 9,3 ↙		

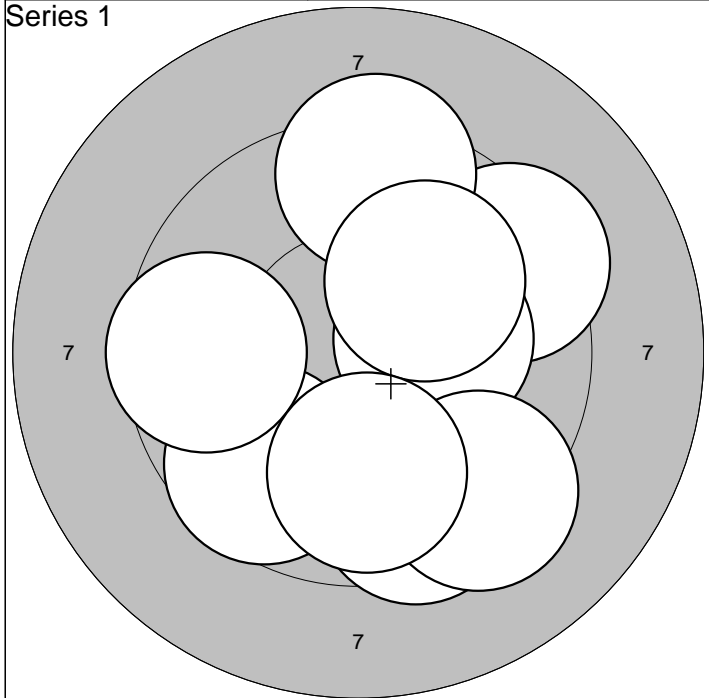

1: 9,7 ↙	6: 9,3 ↑			Serie	92,0
2: 9,5 ↘	7: 9,6 ←				
3: 9,4 ↗	8:10,1 ↗	Sum	92,0		
4:10,3* →	9: 9,3 ↘				
5: 9,5 ↘	10: 9,9 ↓				

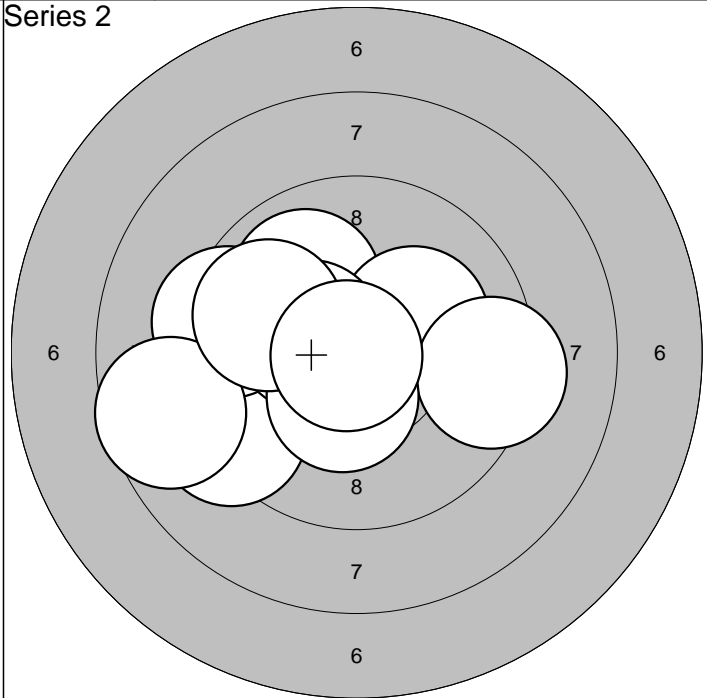

1: 9,2 ↙	6: 9,3 →			Serie	94,0
2: 9,4 ←	7:10,4* ←				
3:10,0 ↖	8:10,4* ↓	Sum	186,0		
4: 8,6 ←	9: 9,8 ↖				
5:10,2* ↗	10:10,8* ←				

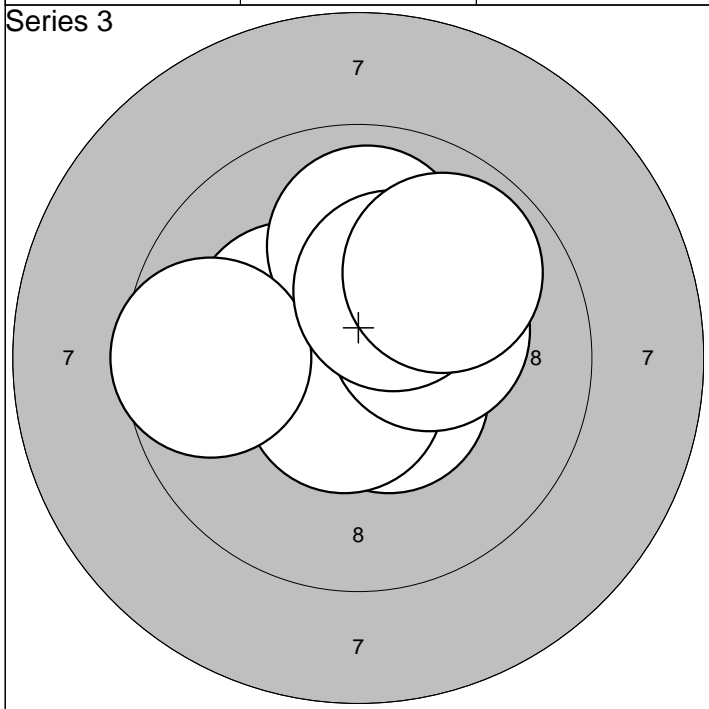

1:10,6* →	6:10,6* ↓			Serie	98,0
2:10,4* ↗	7: 9,6 ←				
3:10,5* ↘	8:10,3* →	Sum	284,0		
4:10,3* ↖	9:10,3* ↗				
5:10,0 ↑	10: 9,9 ↗				

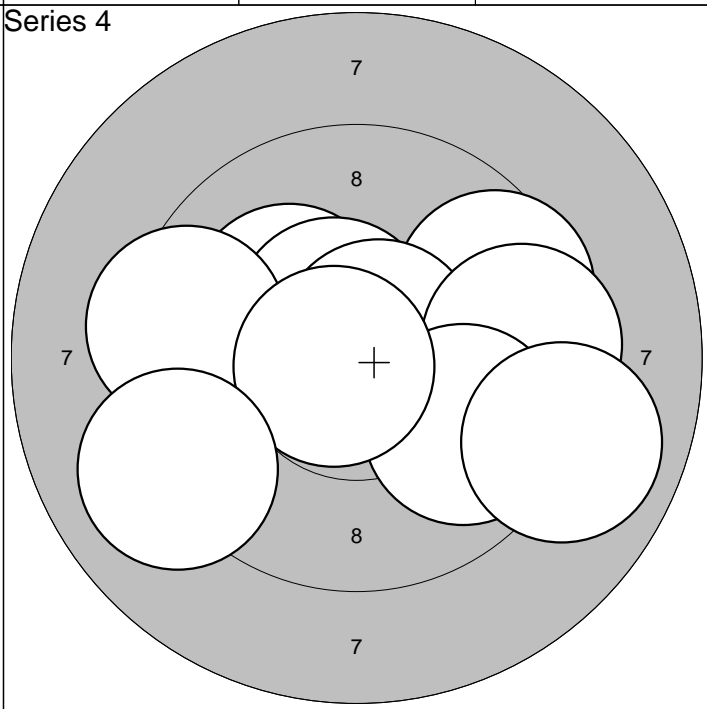

1:10,2* ↖	6: 9,4 ←			Serie	94,0
2:10,5* ↗	7: 9,8 ↘				
3: 9,6 ↗	8:10,7* ←	Sum	378,0		
4:10,7* ↗	9: 9,1 ←				
5: 9,5 →	10: 9,0 →				

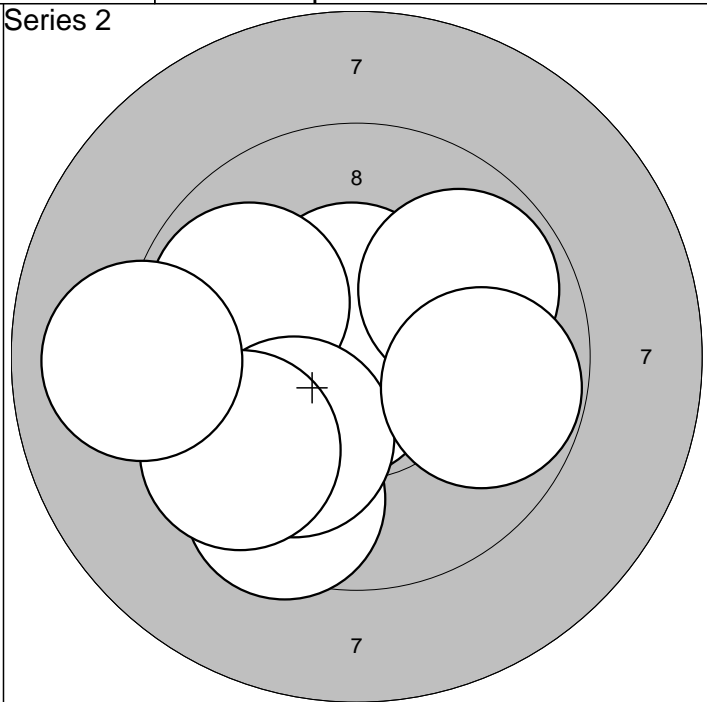
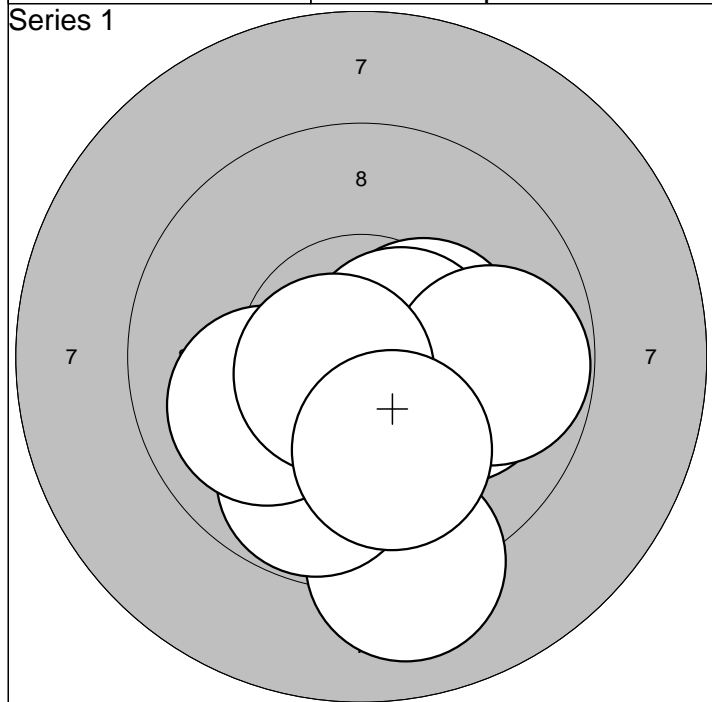

1:10,4* →	6:10,6* →	Serie	97,0
2: 9,1 ↓	7:10,0 ←		
3: 9,8 ↓	8: 9,8 →	Sum	97,0
4:10,2* →	9:10,7* ←		
5:10,1 →	10:10,1 ↓		

1:10,7* ↙	6:10,1 ↙	Serie	93,0
2: 9,6 ↙	7: 9,6 ↙		
3:10,5* ↑	8: 9,9 ↗	Sum	190,0
4: 9,9 ↖	9: 9,0 ←		
5: 9,5 ↓	10: 9,8 →		

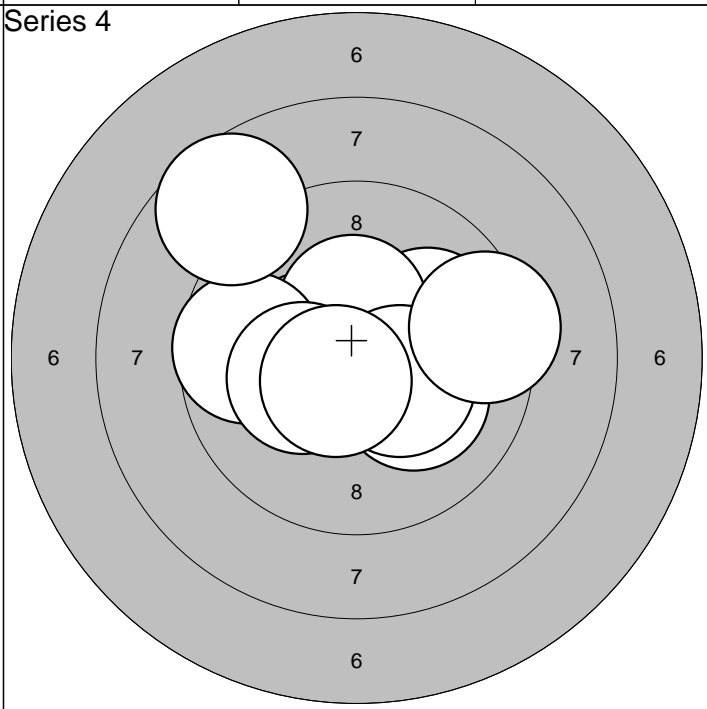
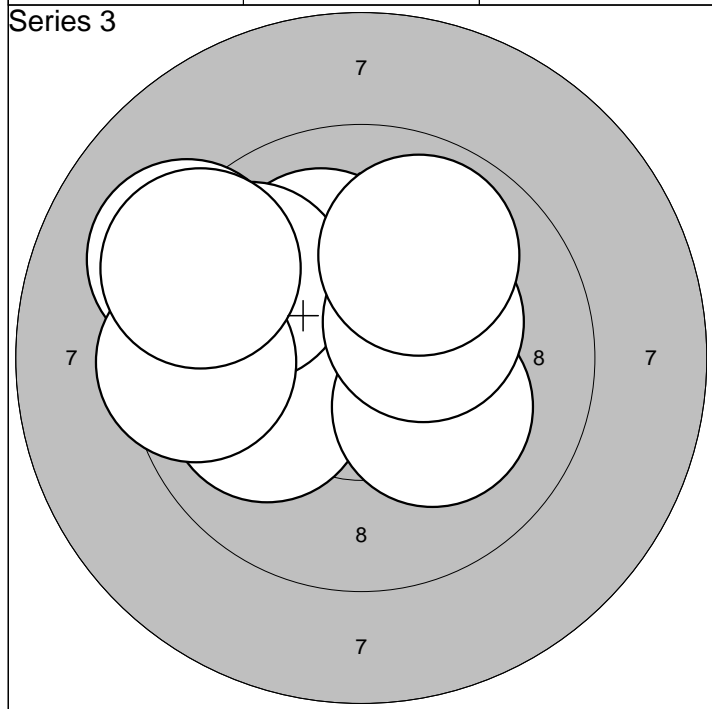

1:10,5* ↗	6: 9,7 ↖	Serie	95,0
2: 9,2 ↖	7:10,3* →		
3:10,1 ↗	8: 9,9 ↗	Sum	285,0
4:10,0 ←	9: 9,5 ←		
5:10,2* ↘	10: 9,3 ↖		

1:10,1 →	6:10,4* →	Serie	96,0
2:10,0 →	7:10,3* ←		
3:10,4* ←	8:10,6* ↙	Sum	381,0
4:10,4* ↑	9: 8,6 ↖		
5: 9,7 ←	10: 9,4 →		

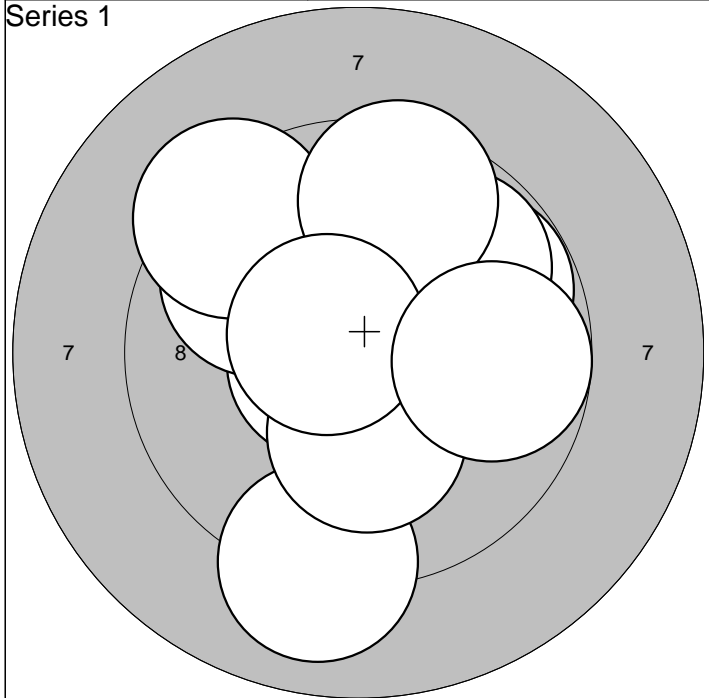

1:10,7* ←	6: 9,5 ↑	Serie	93,0
2: 9,8 ↗	7: 9,0 ↓		
3: 9,9 ↖	8:10,2* ↓	Sum	93,0
4: 9,3 ↗	9:10,6* ↖		
5: 9,8 ↗	10: 9,7 →		

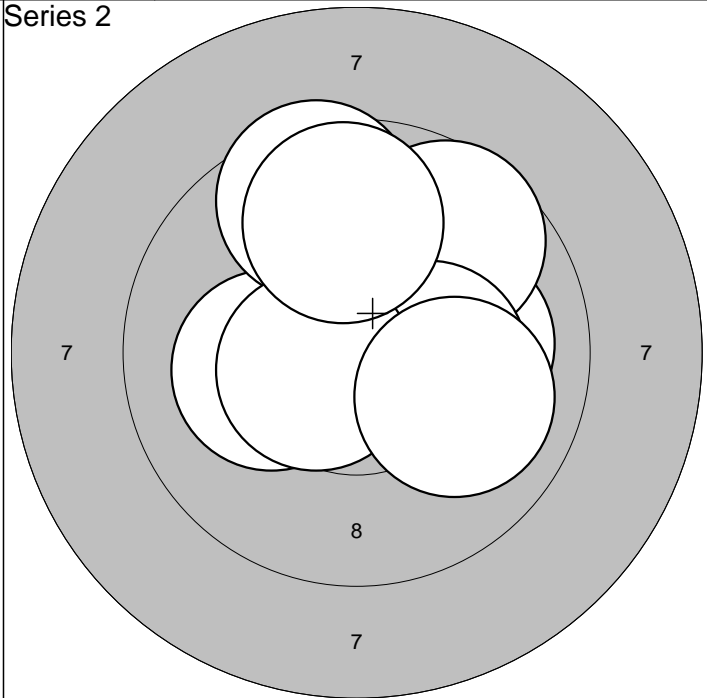

1:10,5* ↑	6:10,3* →	Serie	97,0
2:10,7* ↑	7: 9,5 ↑		
3:10,0 →	8:10,6* ←	Sum	190,0
4: 9,7 ↗	9: 9,8 ↑		
5:10,2* ←	10:10,0 →		

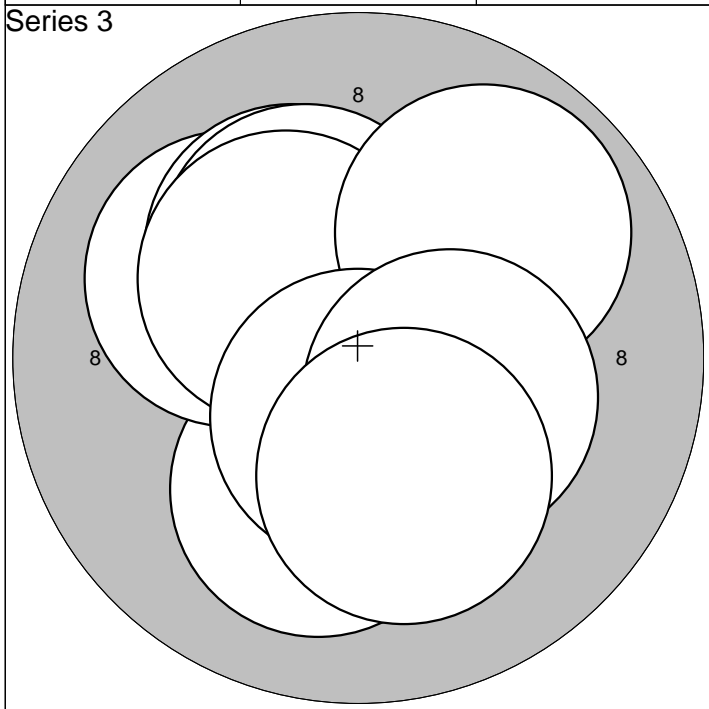

1:10,5* →	6:10,3* ↖	Serie	99,0
2:10,1 ↓	7: 9,9 ↗		
3:10,1 ↖	8:10,6* ↓	Sum	289,0
4:10,2* ↗	9:10,3* →		
5:10,2* ↗	10:10,2* ↓		

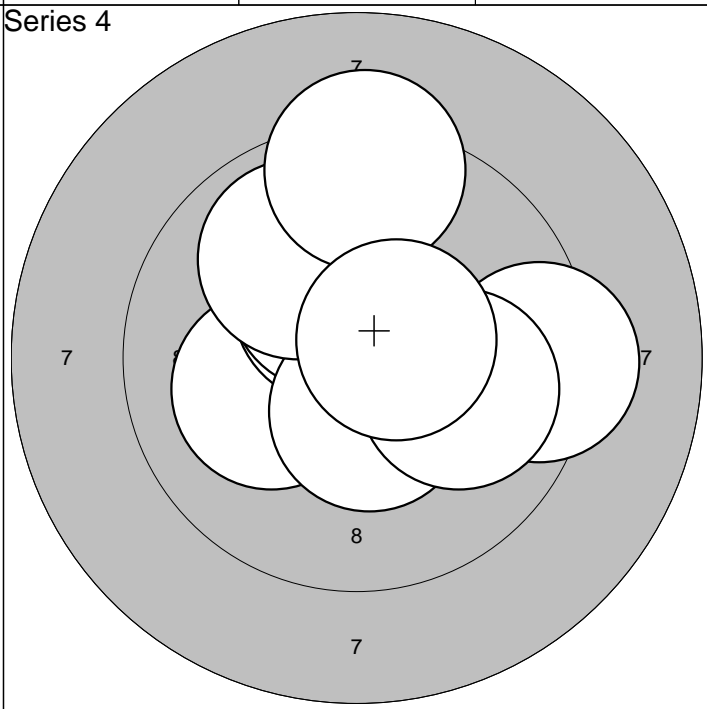

1:10,1 ←	6:10,4* ↓	Serie	97,0
2:10,4* ↑	7: 9,9 ↗		
3: 9,3 →	8: 9,3 ↑	Sum	386,0
4:10,6* ↘	9:10,0 →		
5:10,3* ↑	10:10,6* →		

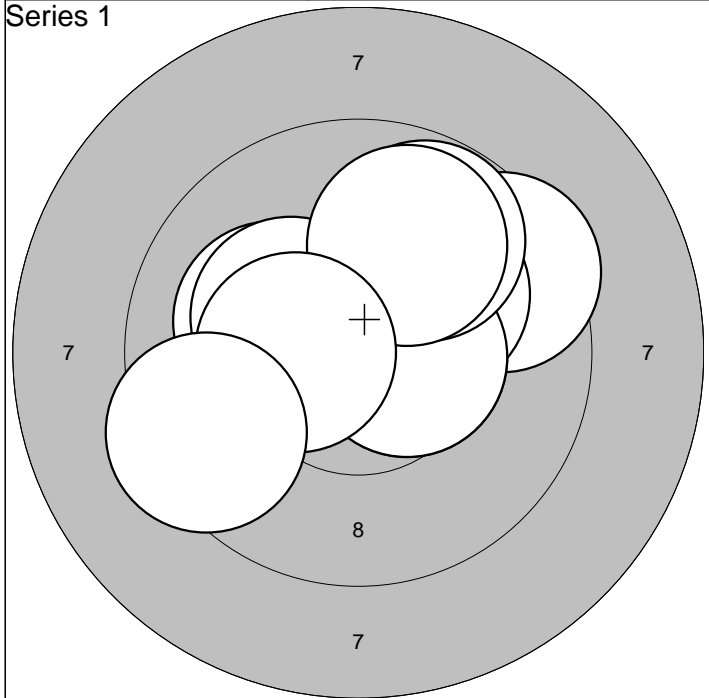

1: 9,5 ↗	6:10,5* →	Serie	96,0
2:10,5* →	7: 9,8 ↗		
3:10,1 ↖	8: 9,9 ↗	Sum	96,0
4:10,1 ↗	9:10,4* ←		
5:10,3* ↖	10: 9,4 ↖		

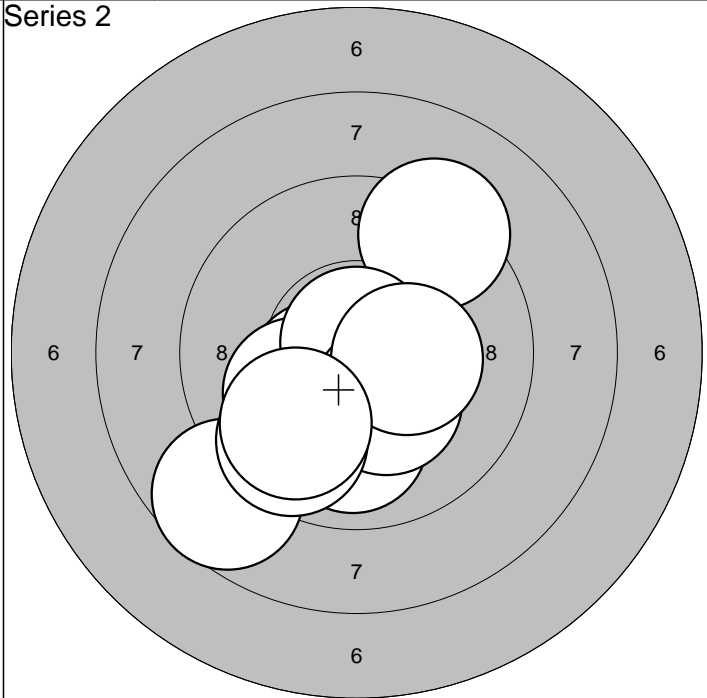

1:10,0 ↓	6:10,3* ↓	Serie	95,0
2:10,5* ↖	7: 8,7 ↖		
3: 9,3 ↗	8: 9,7 ↖	Sum	191,0
4:10,1 ↖	9:10,4* →		
5:10,8* ↑	10: 9,8 ↖		

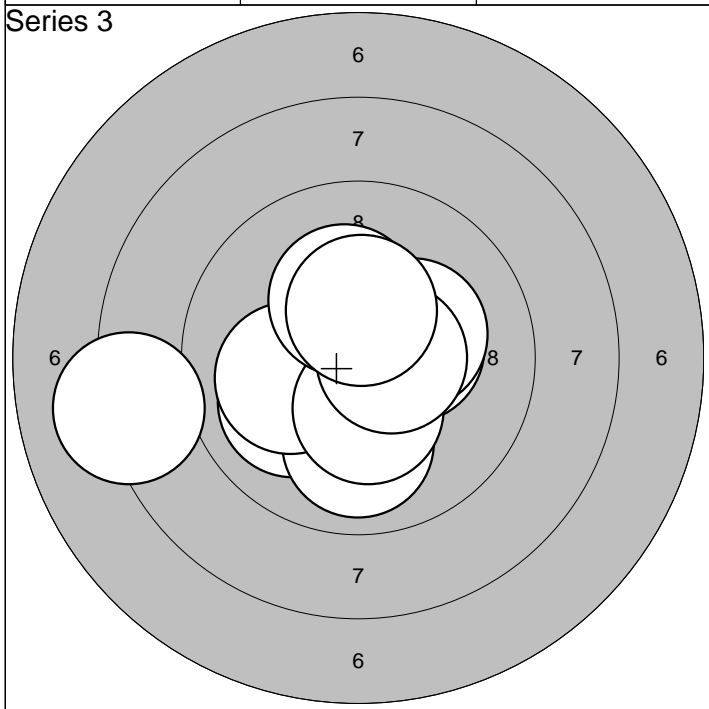

1:10,3* →	6:10,3* →	Serie	98,0
2:10,0 ↖	7:10,5* →		
3:10,0 ↓	8:10,3* ↑	Sum	289,0
4:10,1 ←	9: 8,2 ←		
5:10,3* ↓	10:10,4* ↑		

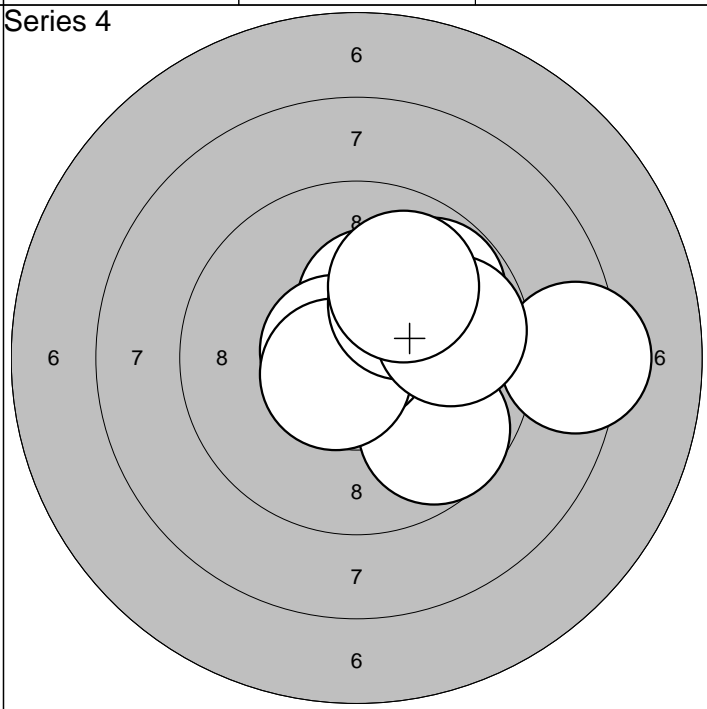

1: 9,8 ↗	6:10,7* ↖	Serie	94,0
2:10,3* ↑	7:10,7* ↖		
3: 9,7 ↘	8:10,1 ↗	Sum	383,0
4:10,8* ↑	9: 9,8 →		
5: 8,4 →	10: 9,9 ↗		

Lag
4

Skive
11

Ashild Solbrekken Flatla

Day 2, Rifle

NTG Lillehammer

ARJW

3-6.1.2010

Swedish Cup 2010

Swedishcup 10

Series 1

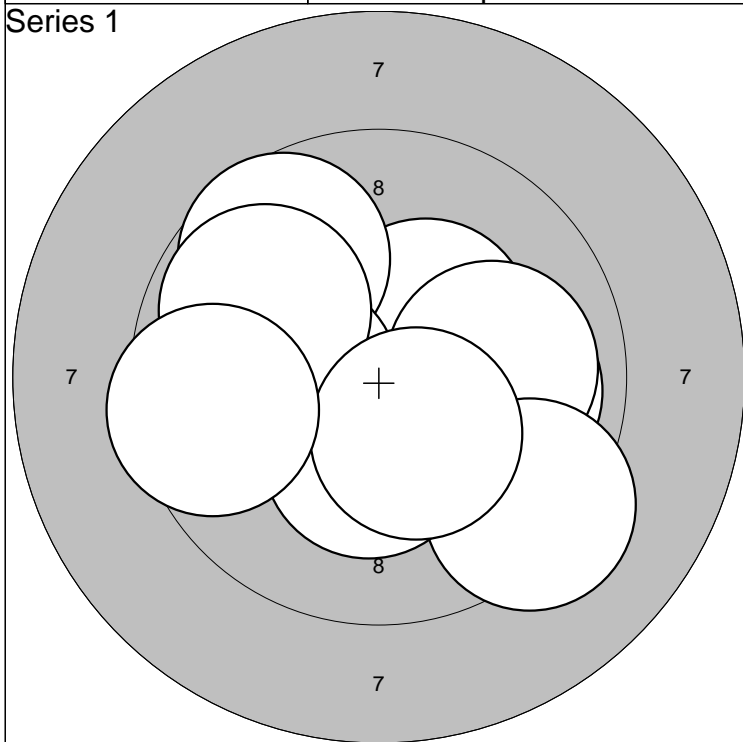

1:10,0	→	6: 9,3	↘	Serie	96,0
2:10,4*	↗	7:10,3*	↘		
3:10,0	→	8: 9,8	↖	Sum	96,0
4: 9,7	↗	9:10,4*	↘		
5:10,2*	←	10: 9,5	←		

Series 2

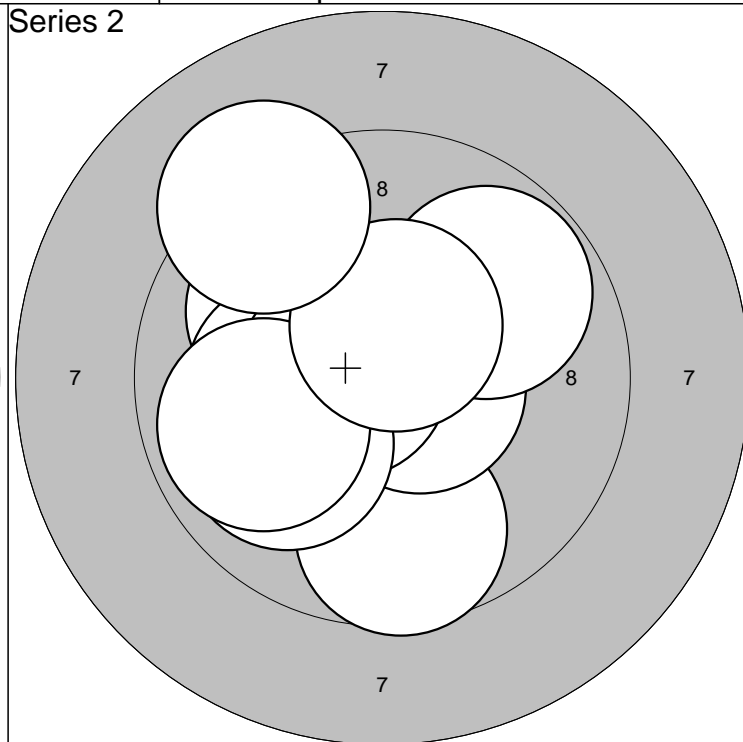

1: 9,6	↓	6:10,6*	←	Serie	96,0
2:10,0	↖	7:10,0	↙		
3:10,2*	←	8: 9,9	←	Sum	192,0
4:10,6*	→	9:10,5*	↑		
5: 9,8	↗	10: 9,2	↖		

Series 3

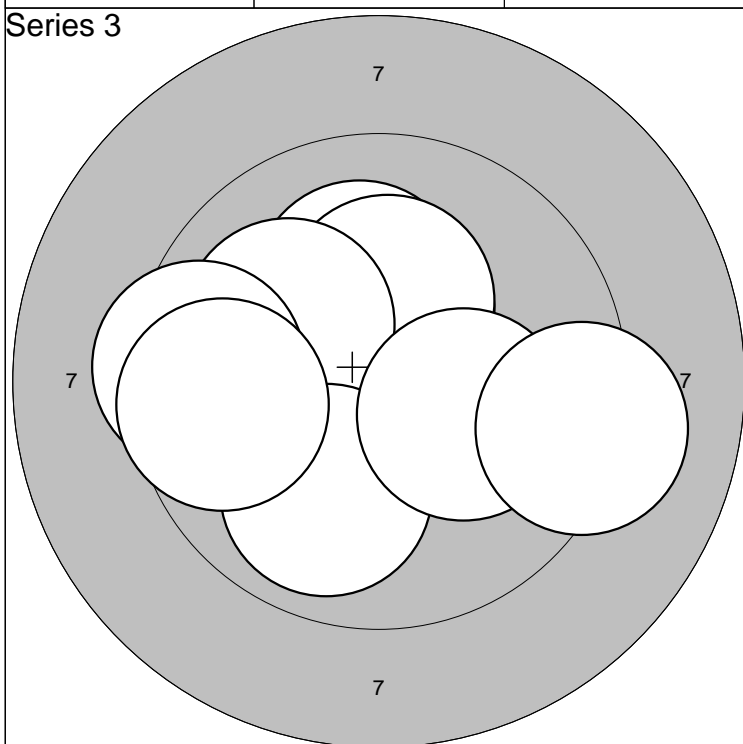

1:10,1	↑	6: 9,9	↘	Serie	96,0
2:10,4*	↑	7: 9,4	←		
3:10,2*	↖	8: 9,6	←	Sum	288,0
4:10,3*	↑	9:10,2*	→		
5:10,0	↖	10: 9,2	→		

Series 4

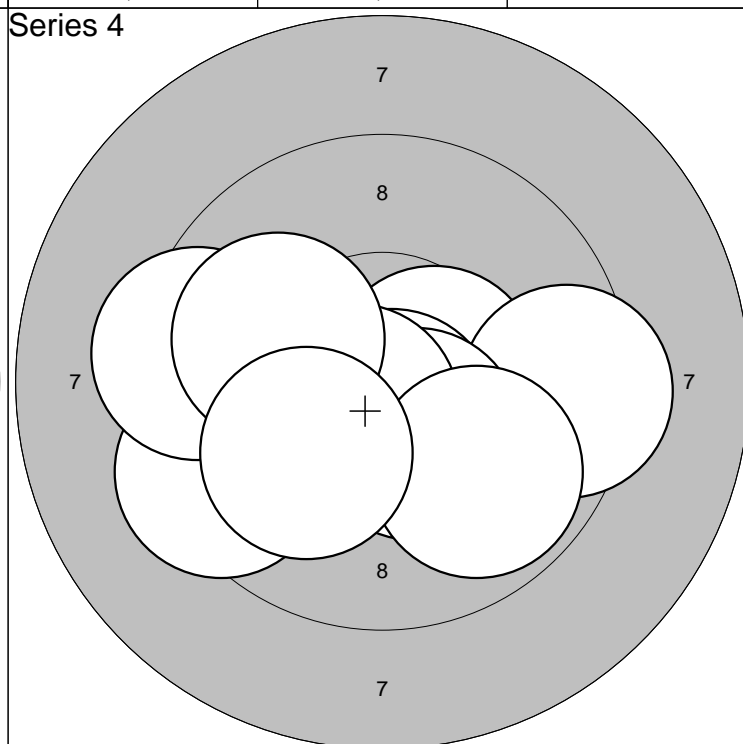

1:10,5*	→	6: 9,4	←	Serie	96,0
2: 9,4	↙	7:10,6*	↘		
3: 9,4	→	8: 9,9	↘	Sum	384,0
4:10,6*	↓	9:10,0	↖		
5:10,4*	↘	10:10,1	↙		

Edman Precision, Morini, Interprodukter

Sävsjö kommun, Sävsjö Skytte Center

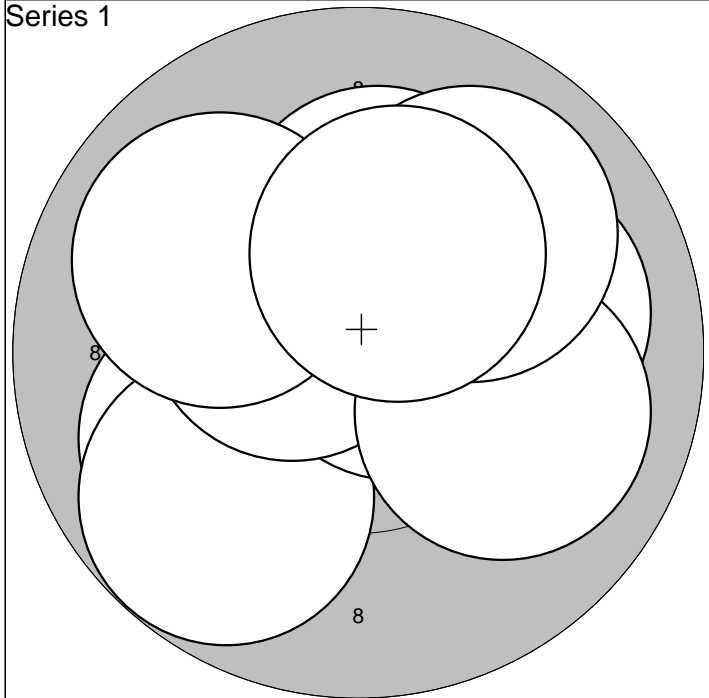

1:10,0 ↙	6:10,5* ↖	Serie 98,0
2:10,0 →	7: 9,9 ↖	
3: 9,7 ↙	8:10,0 →	Sum 98,0
4:10,7* →	9:10,0 ↗	
5:10,2* ↑	10:10,3* ↑	

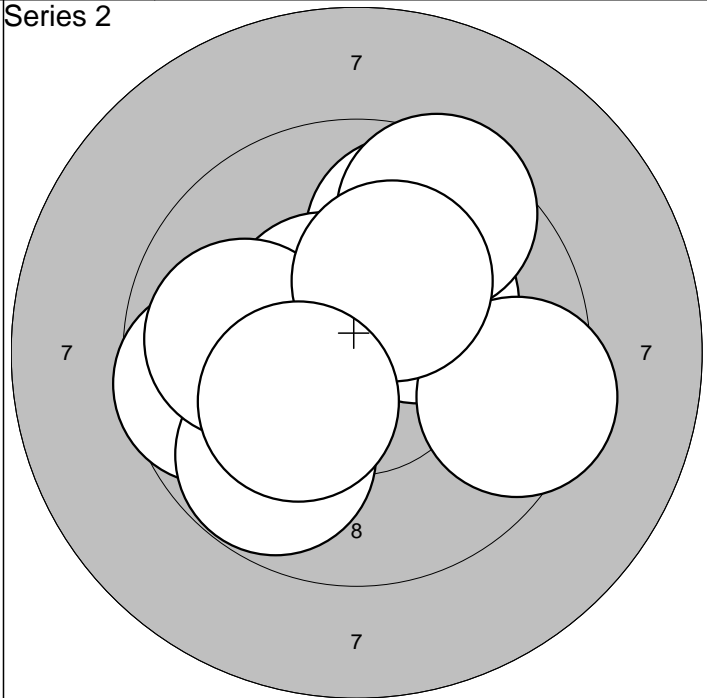

1: 9,7 ←	6: 9,5 ↗	Serie 94,0
2: 9,8 ↙	7: 9,9 ←	
3: 9,8 ↗	8: 9,4 →	Sum 192,0
4:10,3* ↗	9:10,2* ↗	
5:10,5* ↖	10:10,3* ↙	

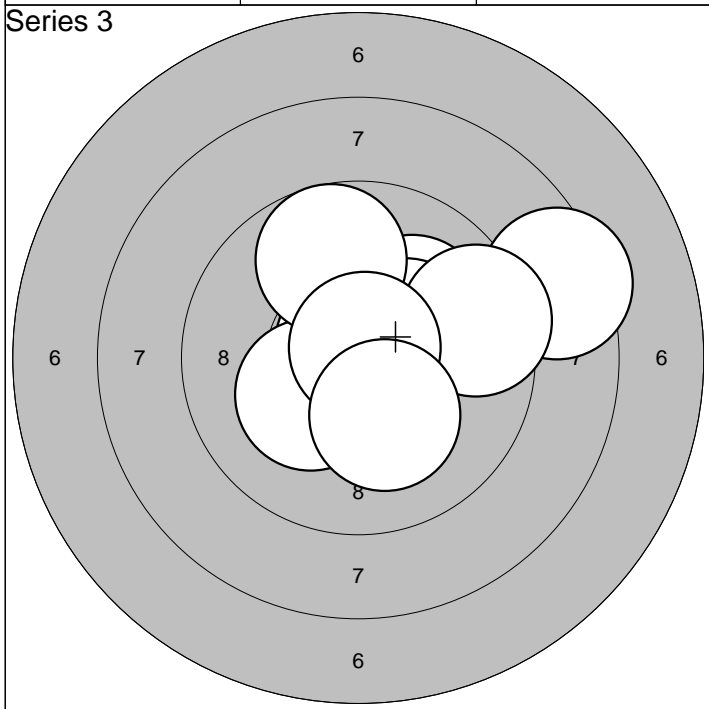

1:10,1 ↗	6:10,9* ↗	Serie 96,0
2: 8,4 →	7:10,3* ↖	
3:10,3* →	8: 9,8 ↑	Sum 288,0
4:10,8* ↖	9:10,8* ↗	
5: 9,5 →	10:10,2* ↘	

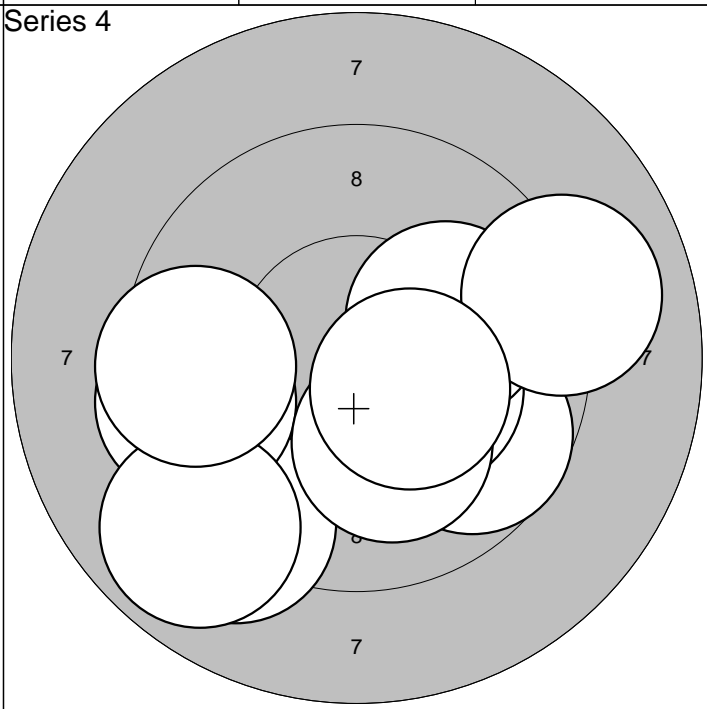

1: 9,7 →	6: 8,9 ↙	Serie 93,0
2: 9,1 ↙	7: 9,5 ←	
3:10,3* →	8:10,1 ↘	Sum 381,0
4:10,1 →	9: 9,0 →	
5: 9,4 ←	10:10,4* →	

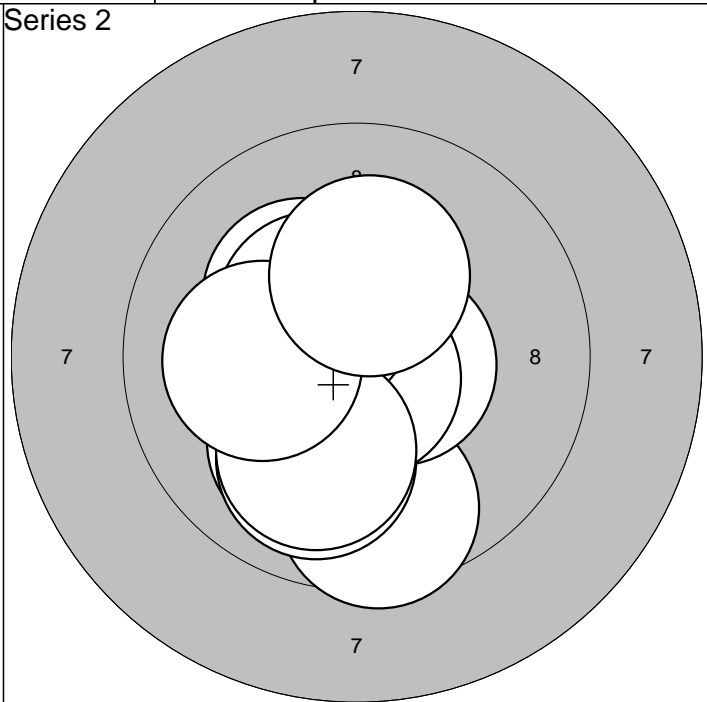
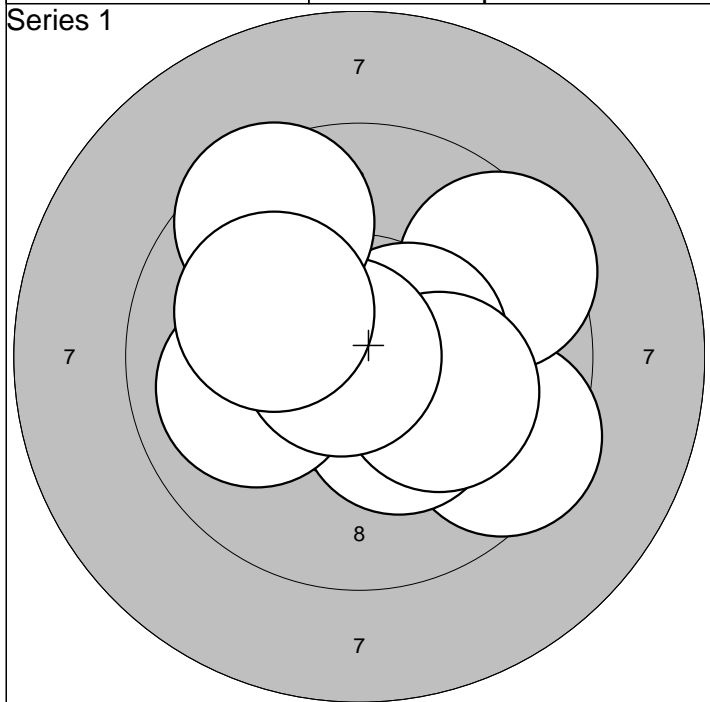

1: 9,5 ↘	6:10,5* →	Serie	97,0
2:10,3* ↘	7:10,1 →		
3: 9,5 ↗	8:10,8* ←	Sum	97,0
4:10,0 ←	9: 9,5 ↗		
5:10,2* ↖	10:10,1 ↖		

1: 9,6 ↓	6:10,7* ↓	Serie	99,0
2:10,1 ↓	7:10,4* ↗		
3:10,0 ↓	8:10,0 ↓	Sum	196,0
4:10,3* ↗	9:10,1 ←		
5:10,6* →	10:10,2* ↑		

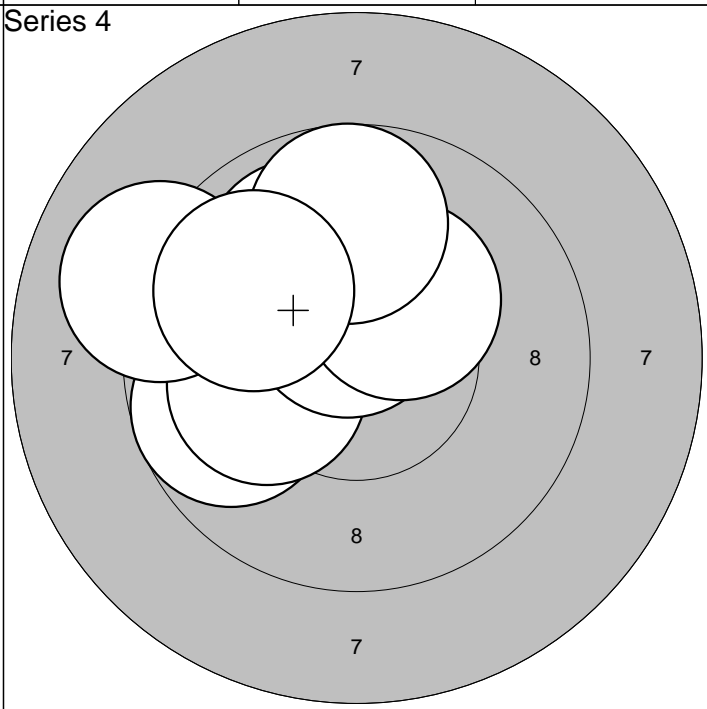
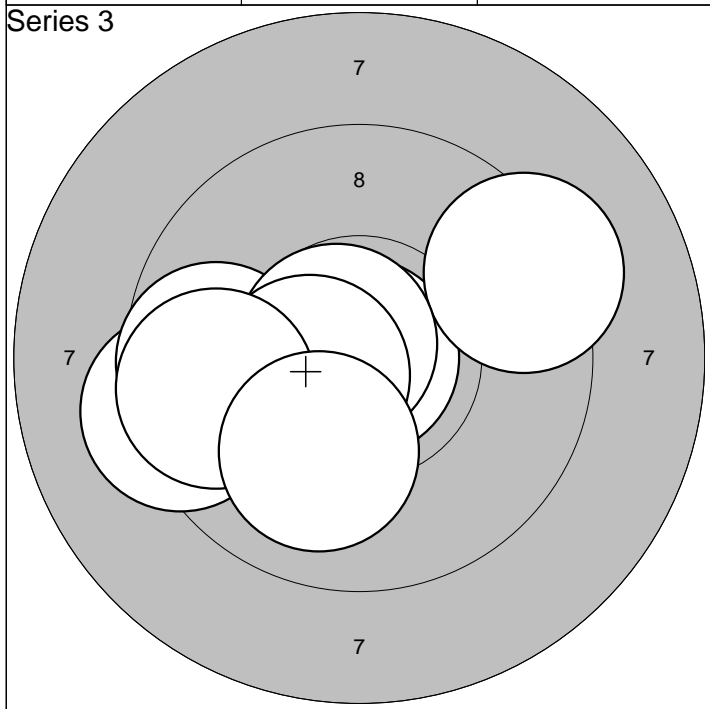

1:10,7* ↖	6: 9,3 ↗	Serie	96,0
2:10,0 ←	7:10,7* ↖		
3: 9,3 ←	8:10,5* ←	Sum	292,0
4:10,9*	9: 9,6 ←		
5: 9,7 ←	10:10,0 ↓		

1: 9,8 ←	6: 9,9 ↖	Serie	95,0
2:10,3* ↗	7:10,3* ↗		
3:10,4* ←	8: 9,8 ↑	Sum	387,0
4:10,1 ←	9: 9,1 ↖		
5:10,6* ↑	10: 9,9 ↖		

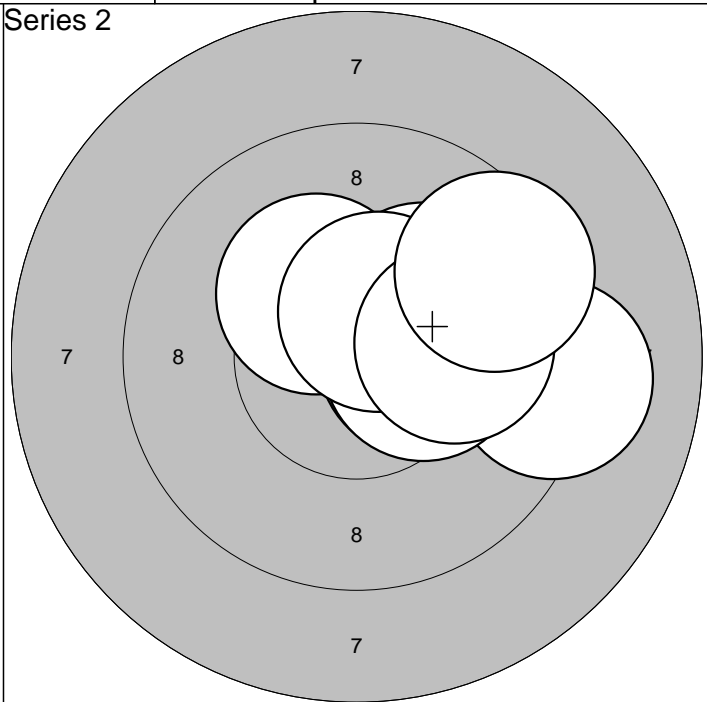
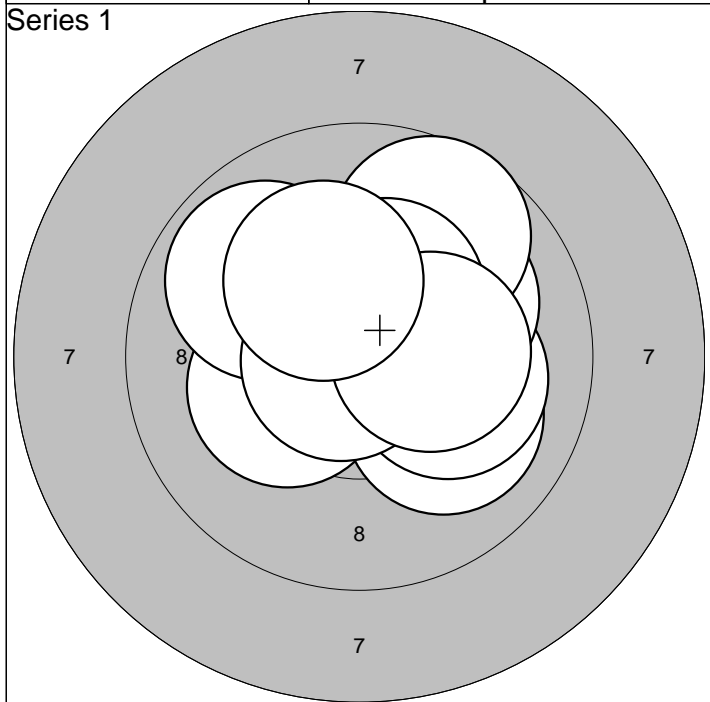

1:10,3* ↙	6: 9,7 ↗	Serie 98,0
2:10,0 ↘	7:10,4* ↗	
3:10,1 →	8:10,8* ←	Sum 98,0
4:10,1 ↗	9:10,3* →	
5: 9,9 ↖	10:10,2* ↗	

1:10,1 →	6: 9,2 →	Serie 98,0
2:10,3* ↖	7:10,4* →	
3:10,3* ↗	8:10,5* ↗	Sum 196,0
4:10,4* →	9:10,1 →	
5:10,2* ↗	10: 9,5 ↗	

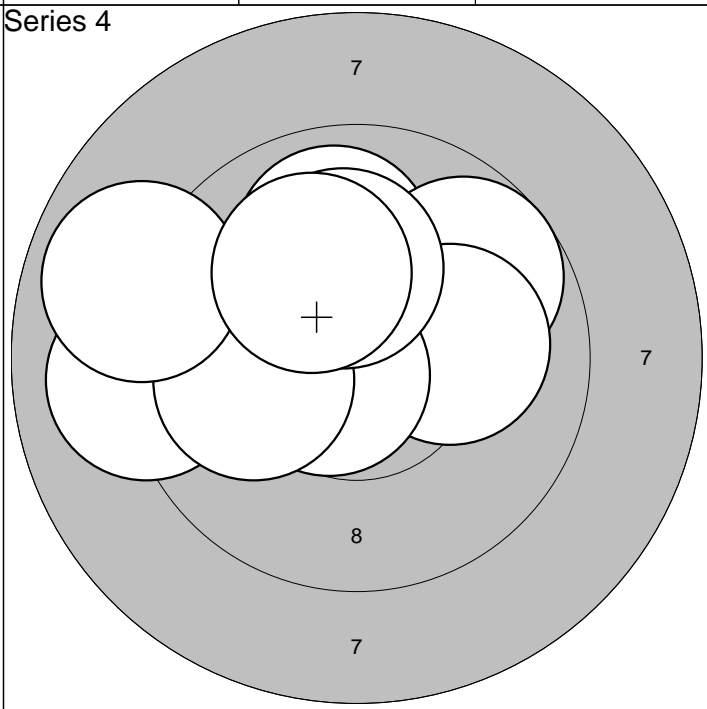
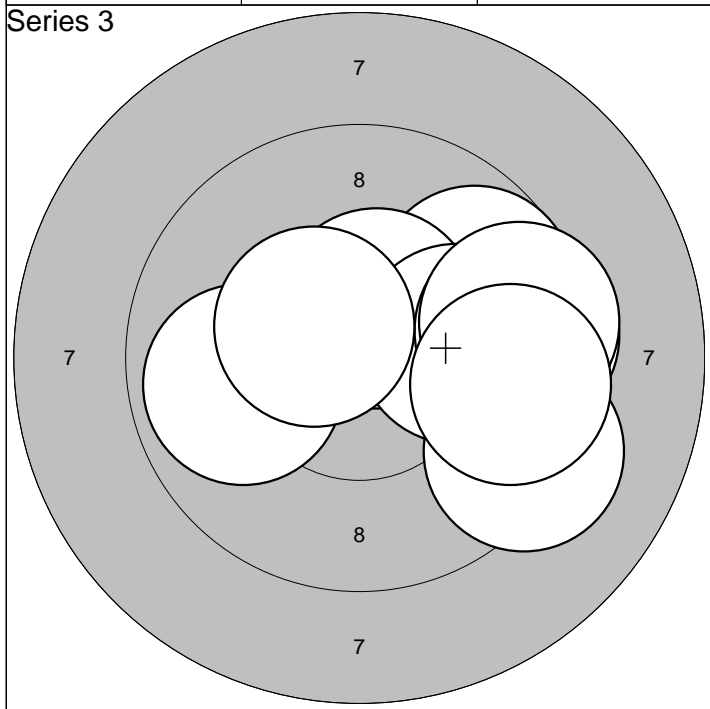

1: 9,7 ↗	6:10,0 →	Serie 93,0
2: 9,3 ↘	7: 9,5 →	
3: 9,5 →	8: 9,5 →	Sum 289,0
4: 9,9 ←	9:10,5* ↖	
5:10,5* ↗	10: 9,6 →	

1: 9,9 ↗	6: 9,1 ←	Serie 95,0
2:10,7* ↗	7:10,0 ←	
3: 9,7 ↗	8: 8,9 ←	Sum 384,0
4:10,1 →	9:10,1 ↗	
5:10,7* ↖	10:10,1 ↖	

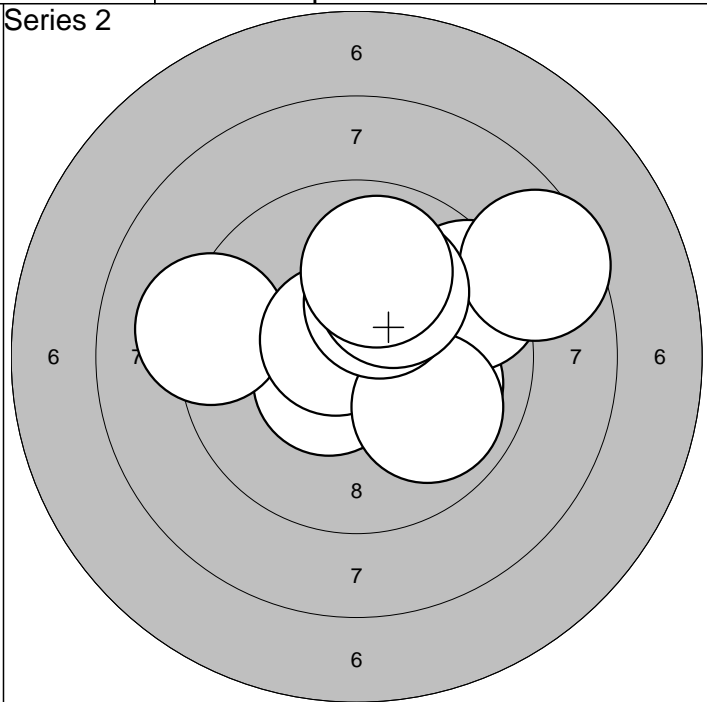
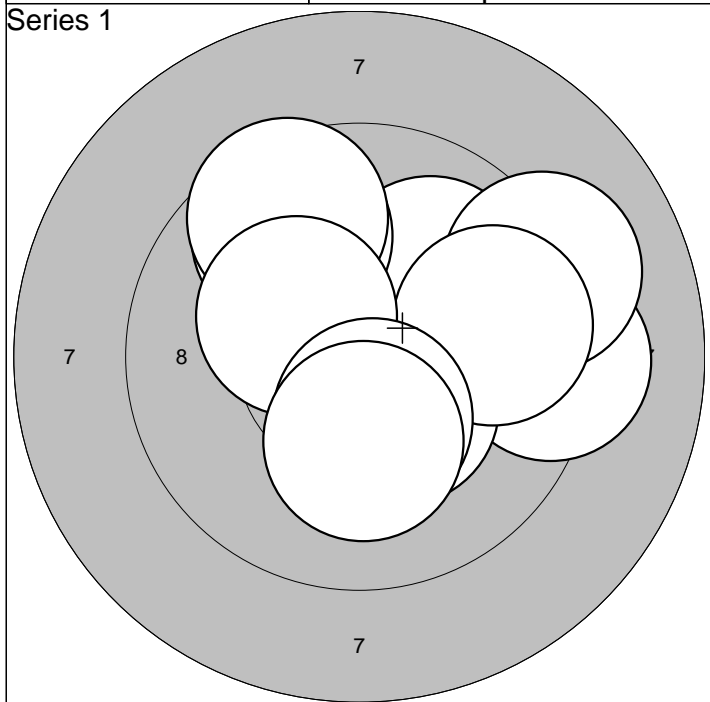

1:10,0 ↗	6: 9,1 ↗				
2: 9,7 ↖	7: 9,7 →				
3: 9,2 →	8:10,3* ↖	Serie	95,0		
4: 9,6 ↖	9:10,4* ↓	Sum	95,0		
5:10,4* ↘	10:10,2* ↓				

1:10,1 →	6: 9,9 ↘				
2:10,5* ↙	7:10,3* ↗				
3: 9,5 ↗	8: 8,6 →	Serie	94,0		
4: 9,2 ←	9:10,1 ↗	Sum	189,0		
5:10,6* ↖	10: 9,9 ↗				

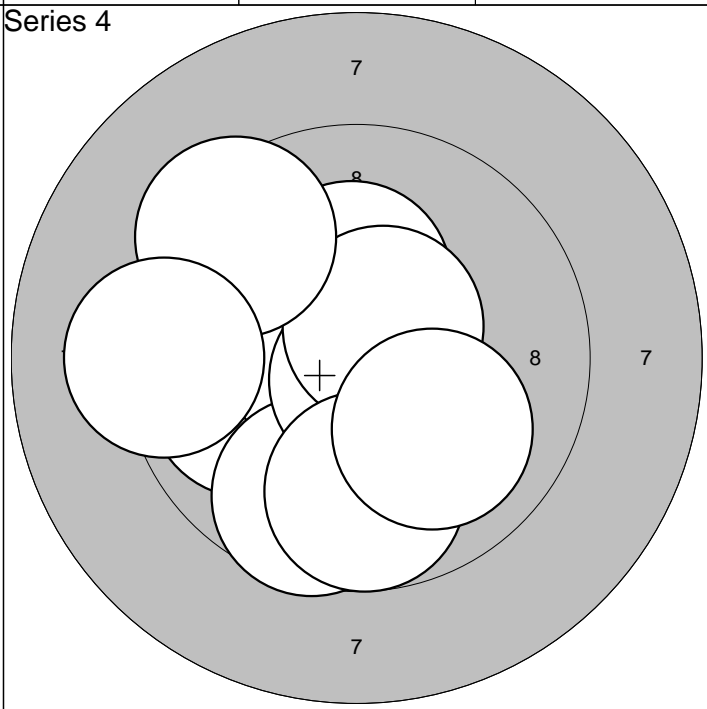
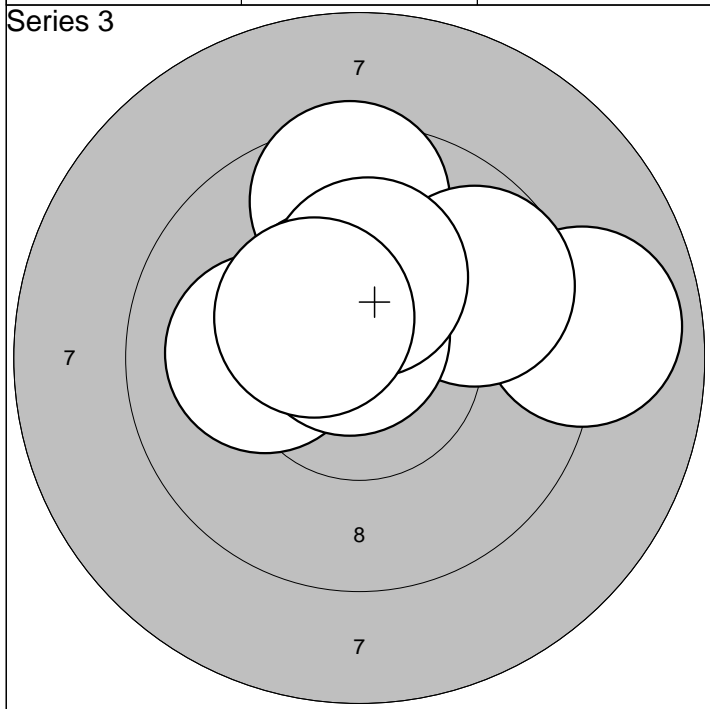

1:10,5* ↑	6:10,1 ←				
2: 9,6 ↑	7:10,4* ↑				
3:10,4* ↖	8:10,7* ↖	Serie	96,0		
4: 8,9 →	9:10,2* ↑	Sum	285,0		
5: 9,7 ↗	10:10,4* ↖				

1:10,3* ↑	6:10,6* ↗				
2: 9,9 ←	7: 9,7 ↓				
3:10,7* ←	8: 9,4 ↖	Serie	95,0		
4: 9,6 ↓	9:10,0 ↘	Sum	380,0		
5:10,7* ↘	10: 9,2 ←				

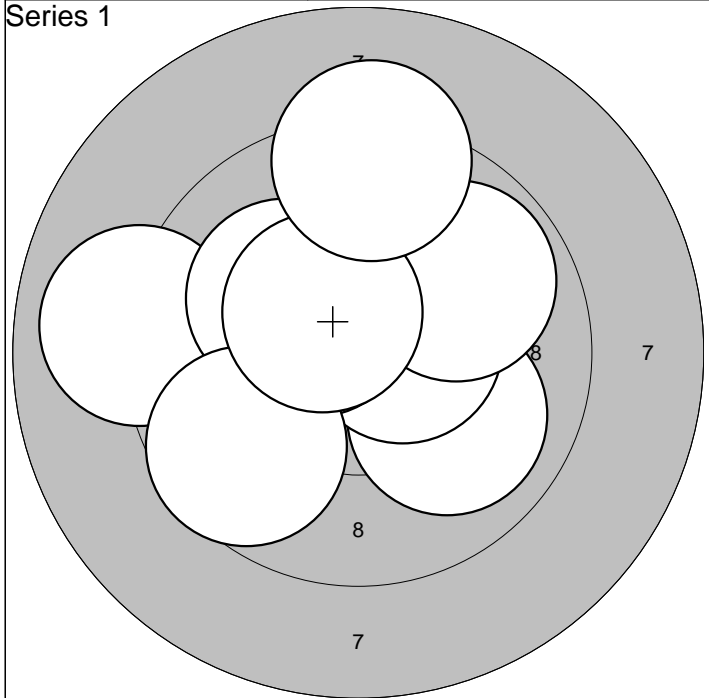

1: 9,0 ←	6:10,4* ↖			Serie	96,0
2:10,5* ↗	7:10,2* ↖				
3:10,0 ↘	8: 9,6 ↙			Sum	96,0
4:10,5* →	9:10,5* ↗				
5: 9,9 ↗	10: 9,2 ↑				

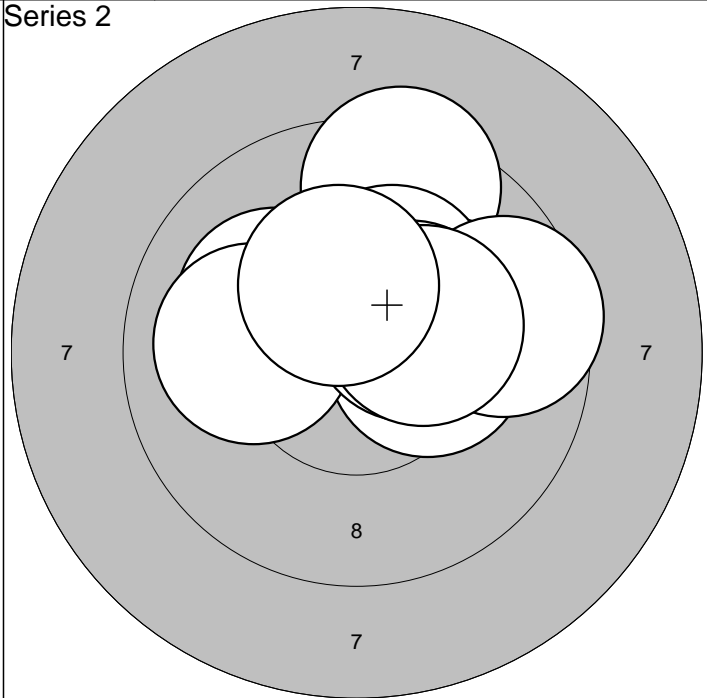

1: 9,4 ↑	6: 9,6 →			Serie	98,0
2:10,1 ←	7:10,0 ←				
3:10,1 →	8:10,4* →			Sum	194,0
4:10,3* →	9:10,3* →				
5:10,3* ↑	10:10,3* ↑				

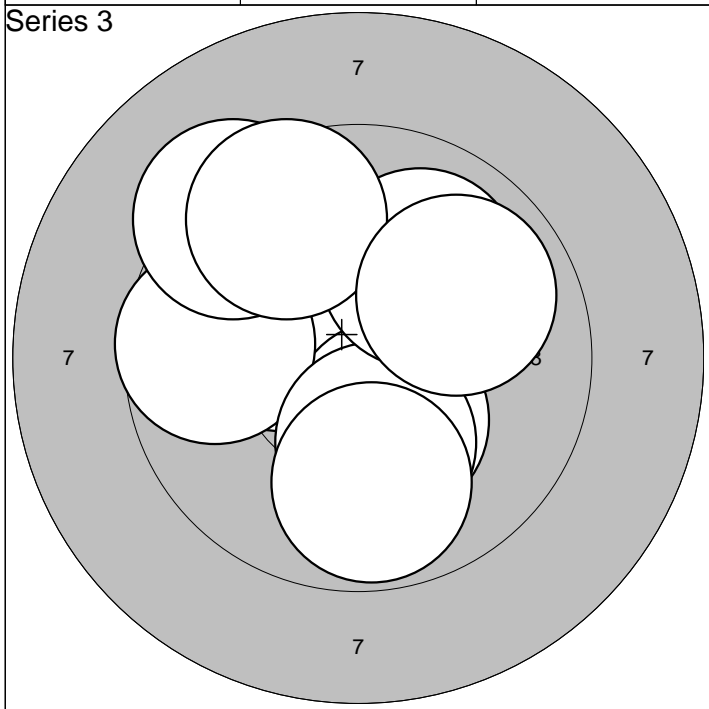

1:10,2* ←	6:10,2* ↓			Serie	95,0
2:10,5* ↗	7:10,0 ↗				
3:10,3* ↘	8: 9,8 ↓			Sum	289,0
4: 9,7 ←	9: 9,6 ↗				
5: 9,3 ↗	10: 9,9 ↗				

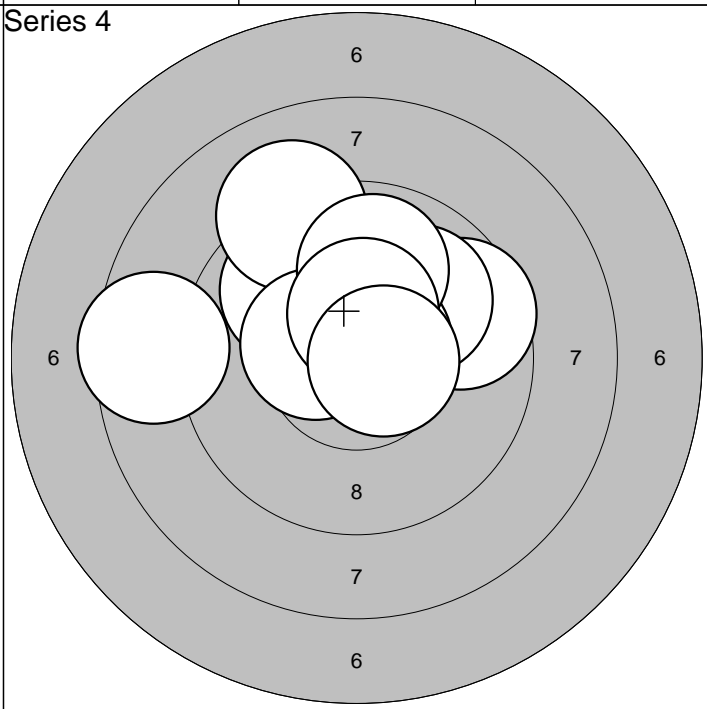

1: 9,6 →	6:10,4* ←			Serie	93,0
2: 9,9 ↖	7: 9,9 ↑				
3: 9,9 ↗	8: 8,5 ←			Sum	382,0
4: 9,1 ↖	9:10,4* ↑				
5:10,7* ↗	10:10,6* →				

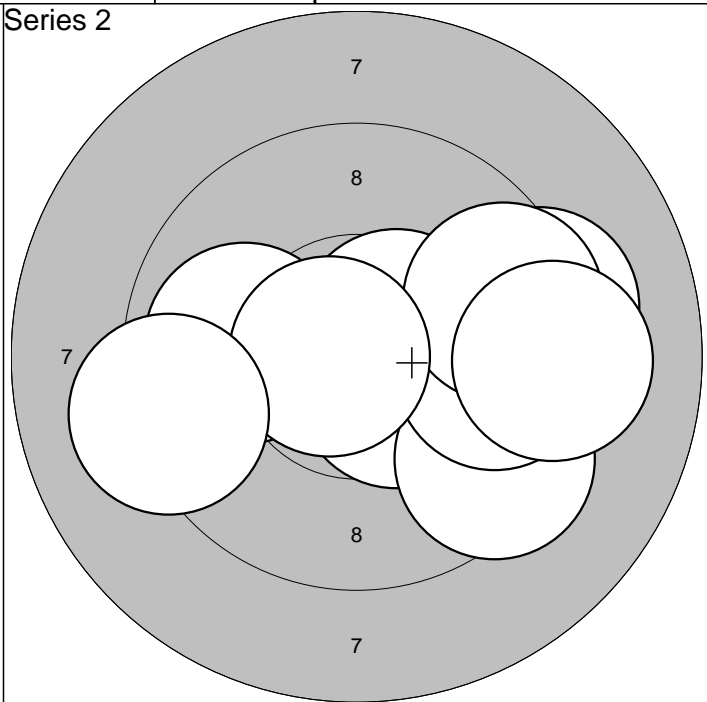
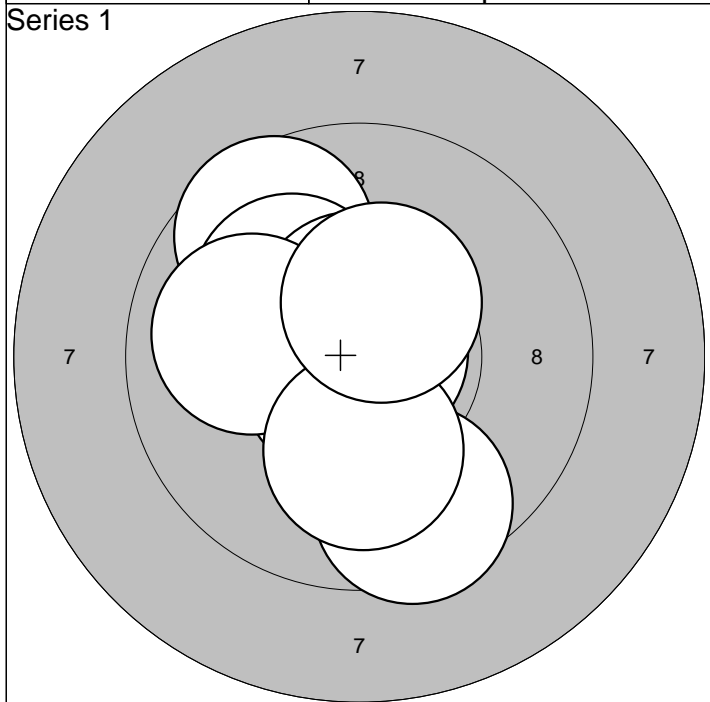

1:10,8* ↓	6:10,6* ↑				
2:10,7* ↙	7:10,0 ←				
3:10,9* →	8: 9,6 ↓	Serie	98,0		
4: 9,6 ↗	9:10,1 ↓	Sum	98,0		
5:10,1 ↖	10:10,4* ↑				

1:10,5* ↘	6: 9,6 →				
2:10,5* ↗	7: 9,9 ←				
3: 9,4 ↘	8:10,7* ←	Serie	93,0		
4: 9,7 →	9: 9,2 →	Sum	191,0		
5: 9,2 →	10: 9,2 ←				

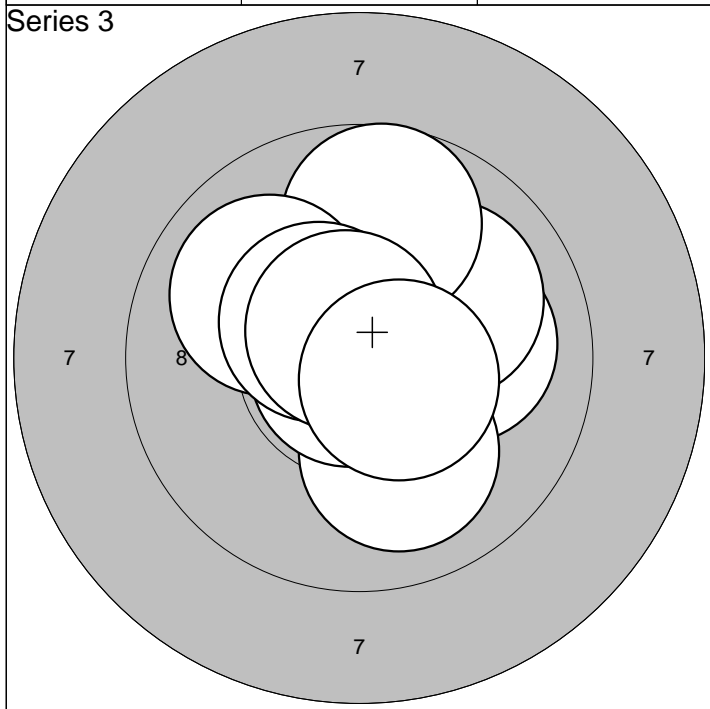

1:10,1 →	6:10,8* ↙				
2:10,5* ↑	7:10,0 ↖				
3:10,0 ↗	8:10,5* ↗	Serie	99,0		
4:10,0 ↓	9:10,7* ↗	Sum	290,0		
5: 9,7 ↑	10:10,5* ↘				

1: 9,8 ←	6:10,6* ↓				
2: 9,5 ←	7:10,5* ←				
3: 9,7 ←	8:10,5* ↖	Serie	96,0		
4:10,0 ↓	9:10,0 →	Sum	386,0		
5: 9,7 ↓	10:10,1 ↗				

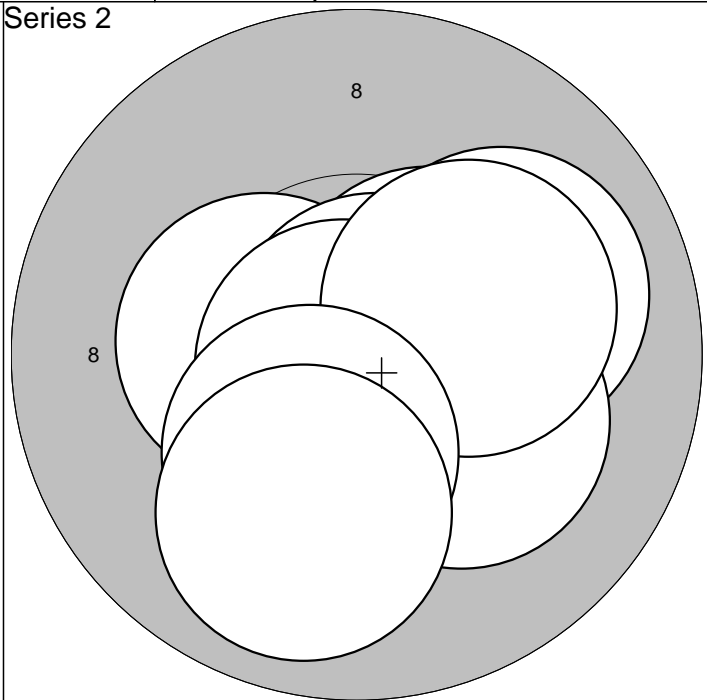
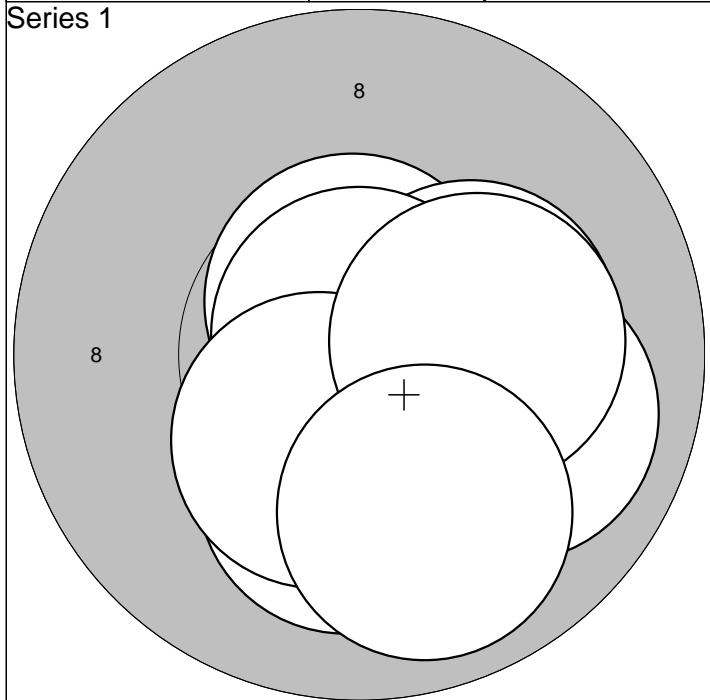

1:10,6* ↑	6:10,2* →	Serie	99,0
2:10,1 ↓	7:10,8* ↑		
3:10,0 →	8:10,4* ↓	Sum	99,0
4:10,5* ↘	9:10,2* →		
5:10,8* ↓	10: 9,9 ↓		

1:10,4* ↗	6:10,8* ↙	Serie	99,0
2:10,4* ←	7:10,2* ↘		
3:10,0 →	8:10,2* →	Sum	198,0
4:10,8* ↗	9:10,3* ↓		
5:10,8* ↓	10: 9,9 ↓		

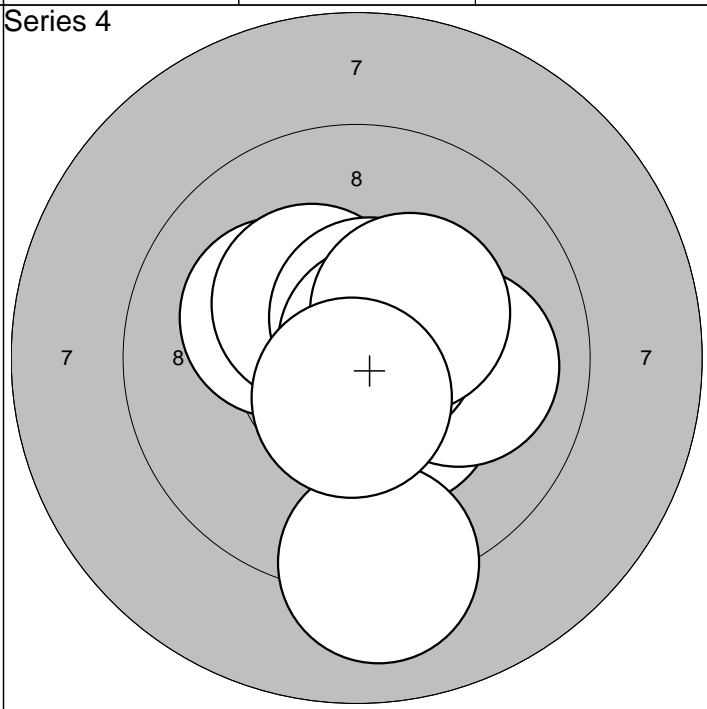
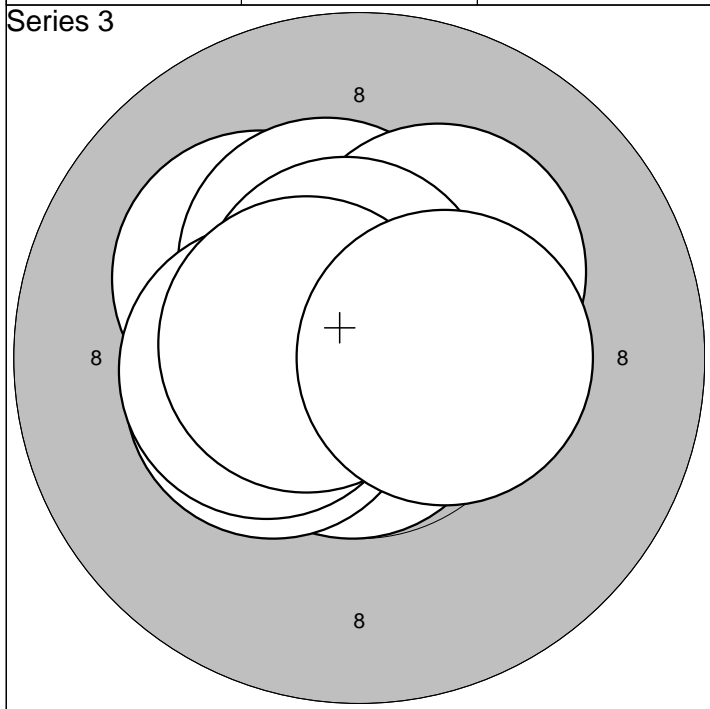

1:10,6* ↑	6:10,4* ←	Serie	100,0
2:10,2* ↖	7:10,2* ↗		
3:10,8* ↓	8:10,6* ↑	Sum	298,0
4:10,4* ←	9:10,6* ←		
5:10,3* ↑	10:10,4* →		

1:10,4* ↓	6:10,6* ↑	Serie	99,0
2:10,8* ↓	7:10,7* ↗		
3:10,2* ↖	8: 9,1 ↓	Sum	397,0
4:10,0 →	9:10,3* ↗		
5:10,3* ↖	10:10,6* ↓		

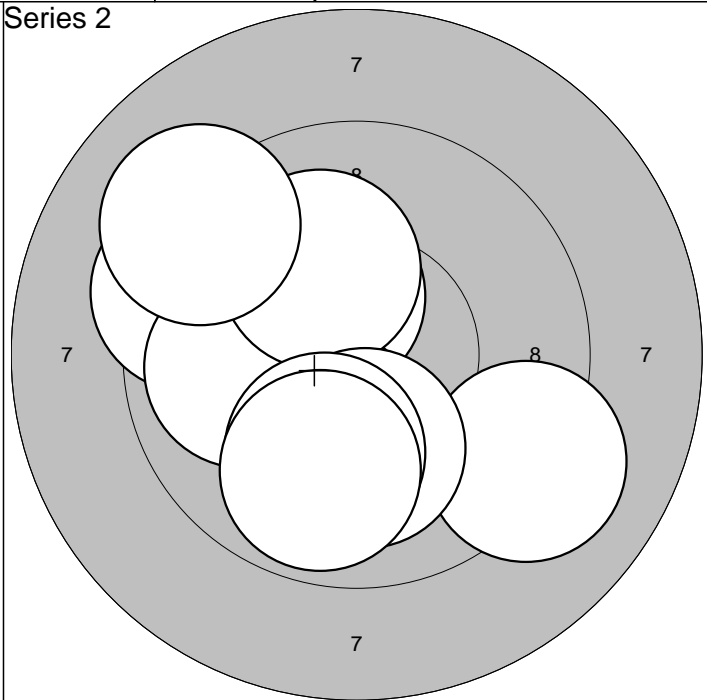
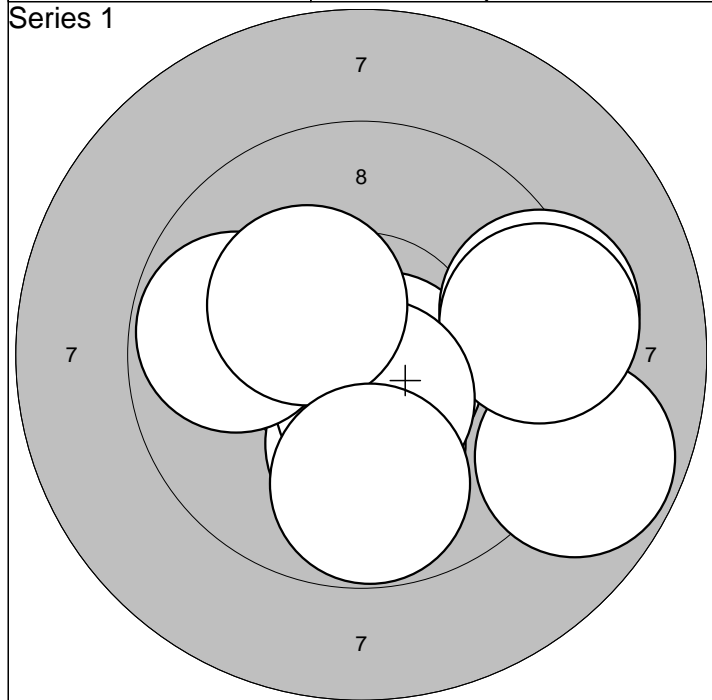

1:10,7* ↓	6:10,1 ↓	Serie	94,0
2:10,7* ↘	7:10,5* ↓		
3: 8,8 ↘	8: 9,8 ←	Sum	94,0
4: 9,3 →	9:10,3* ↗		
5: 9,3 →	10: 9,8 ↓		

1: 9,4 ←	6: 9,2 ↘	Serie	96,0
2:10,4* ↗	7:10,1 ↓		
3:10,2* ↓	8:10,0 ↓	Sum	190,0
4:10,0 ←	9: 9,9 ↓		
5:10,1 ↗	10: 9,1 ↗		

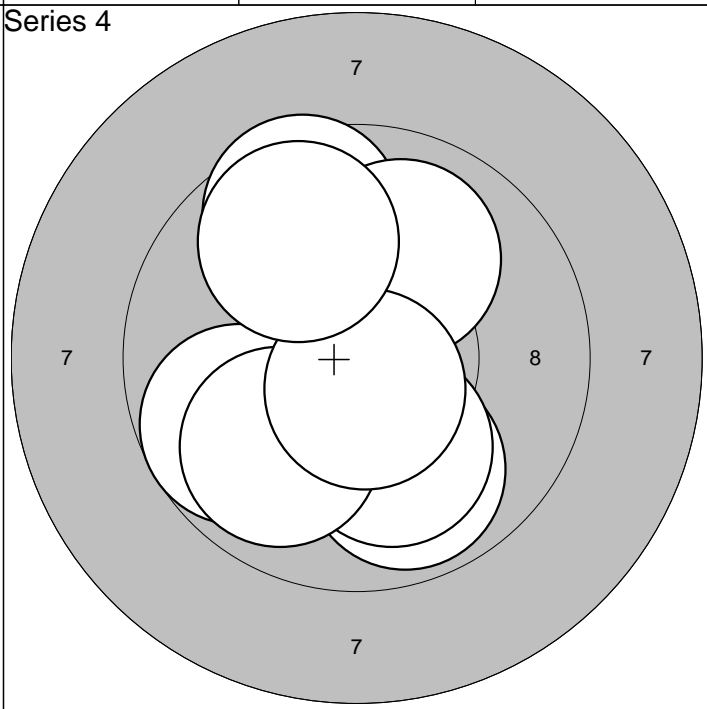
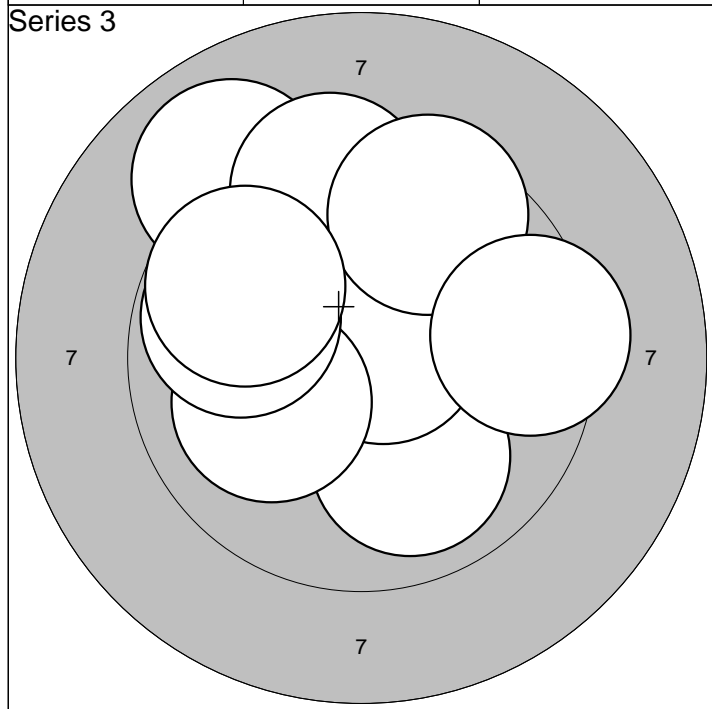

1: 9,0 ↗	6:10,1 ←	Serie	94,0
2: 9,5 ↑	7: 9,5 ↑		
3:10,0 ↓	8: 9,8 ←	Sum	284,0
4:10,4* ↗	9: 9,7 ↗		
5:10,7* ↗	10: 9,4 →		

1:10,1 ↑	6: 9,9 ↓	Serie	94,0
2: 9,6 ↗	7:10,1 ↓		
3: 9,9 ↘	8: 9,9 ↘	Sum	378,0
4: 9,7 ←	9:10,7* ↓		
5:10,0 ↑	10: 9,8 ↗		

Lag
4

Skive
21

Cecilia Runarsson

Day 2, Rifle

Norrskedike-Forsmark

ARJW

3-6.1.2010

Swedish Cup 2010

Swedishcup 10

Series 1

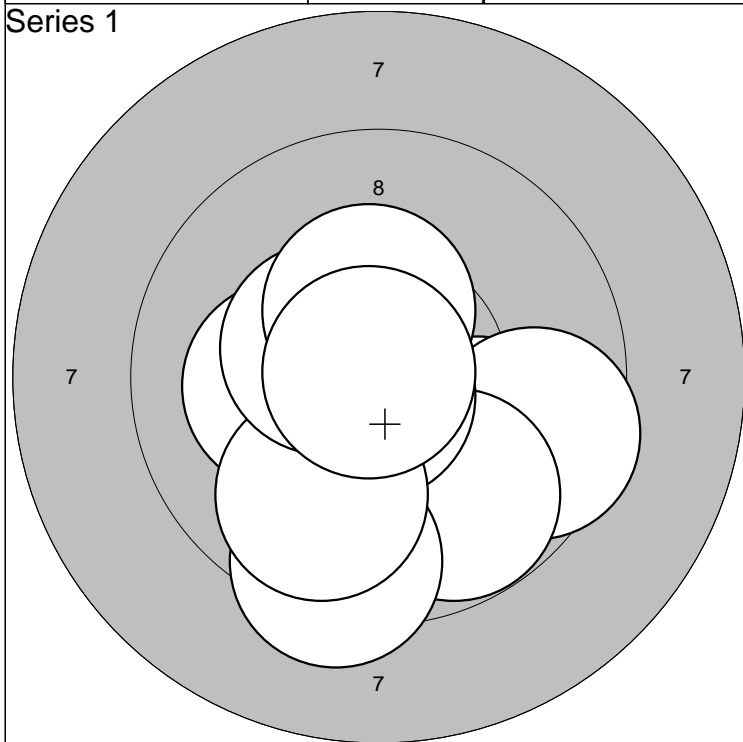

1: 9,9 ↘	6: 10,8* ↘	Serie	95,0
2: 9,6 ↘	7: 9,8 ↘		
3: 10,2* ←	8: 10,5* ↖	Sum	95,0
4: 9,7 ↘	9: 10,4* ↑		
5: 9,3 ↓	10: 10,9* ↖		

Series 2

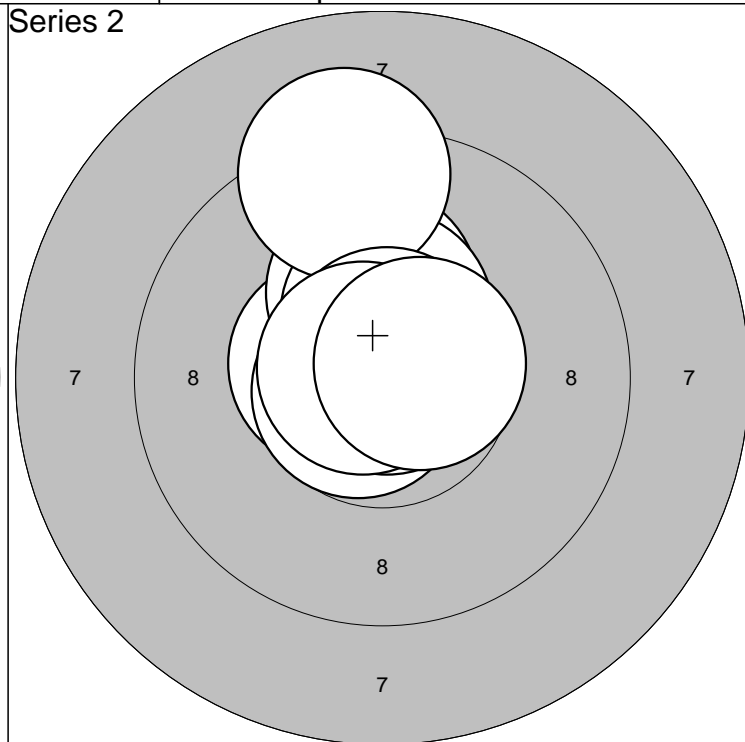

1: 10,7* ↗	6: 9,2 ↑	Serie	99,0
2: 10,5* ←	7: 10,8* ↗		
3: 10,7* ↖	8: 10,8* ↑	Sum	194,0
4: 10,2* ↑	9: 10,8* ↖		
5: 10,4* ↑	10: 10,6* →		

Series 3

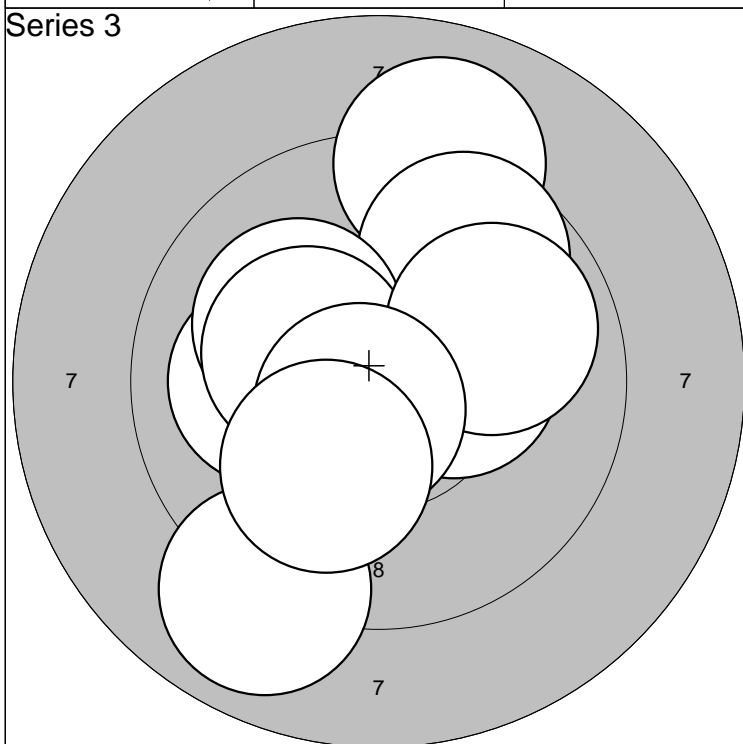

1: 10,3* →	6: 10,3* ←	Serie	96,0
2: 9,0 ↑	7: 9,9 →		
3: 9,7 ↗	8: 10,7* ↘	Sum	290,0
4: 10,1 ←	9: 9,0 ↘		
5: 10,1 ↖	10: 10,1 ↘		

Series 4

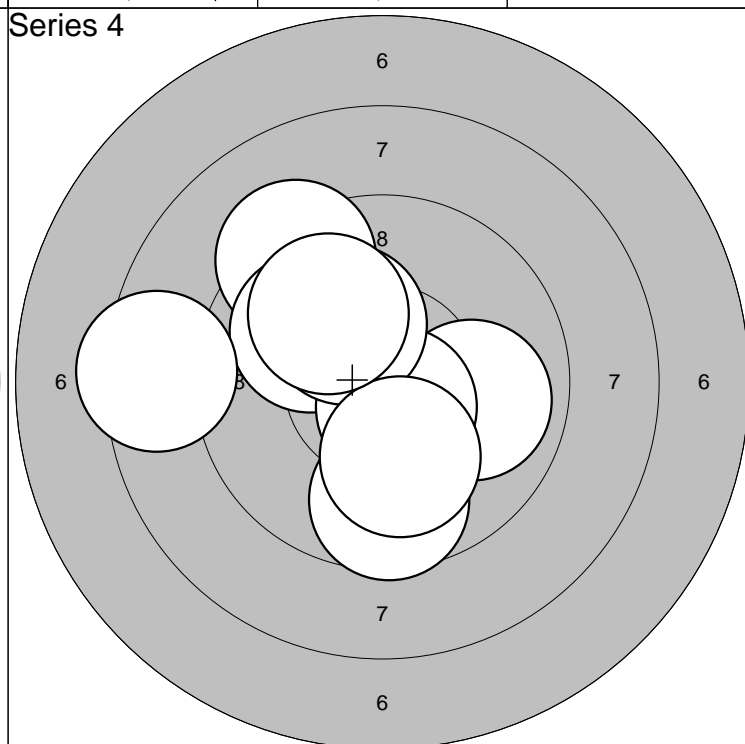

1: 9,6 ↓	6: 9,9 →	Serie	95,0
2: 9,3 ↗	7: 10,6* ↘		
3: 10,0 ↗	8: 10,2* ↗	Sum	385,0
4: 8,4 ←	9: 10,1 ↘		
5: 10,3* ↘	10: 10,0 ↗		

Edman Precision, Morini, Interprodukter

Sävsjö kommun, Sävsjö Skytte Center

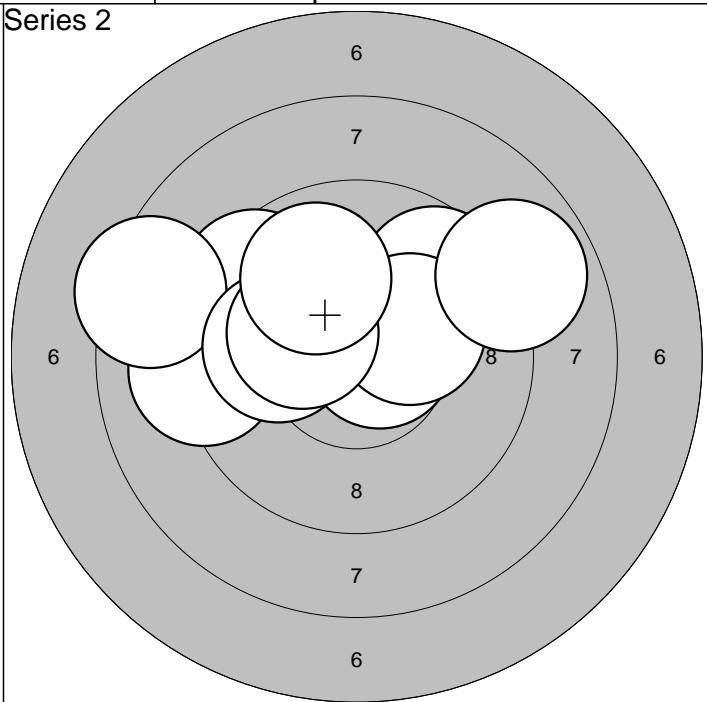
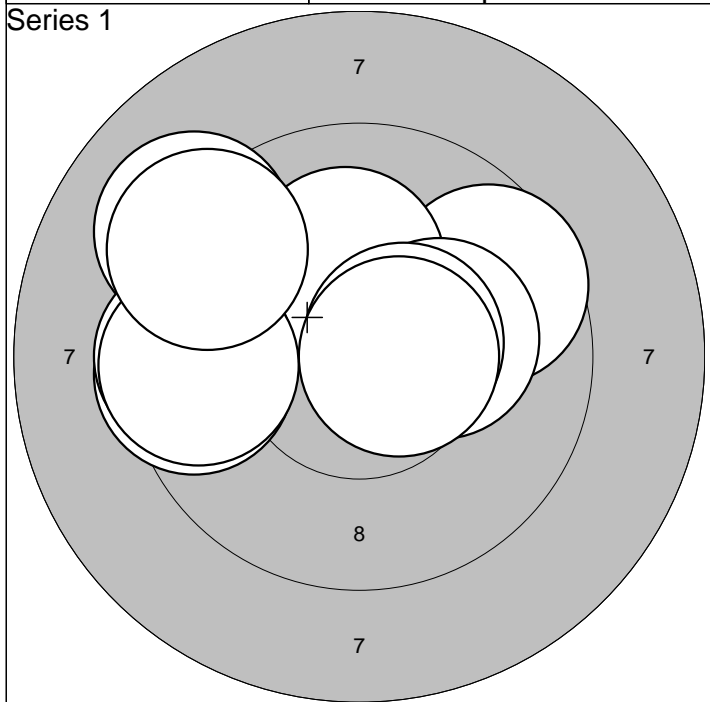

1: 9,6 ↗	6: 9,5 ←		Serie	94,0
2:10,1 ↑	7:10,5* →			
3:10,2* →	8: 9,5 ←	Sum	94,0	
4: 9,5 ←	9: 9,3 ↗			
5: 9,1 ↖	10:10,6* →			

1: 9,7 ↗	6:10,2* ↗		Serie	92,0
2: 9,1 ←	7: 8,9 ↗			
3:10,7* →	8:10,0 ←	Sum	186,0	
4: 9,5 ↗	9:10,3* ↖			
5: 8,4 ←	10: 9,9 ↗			

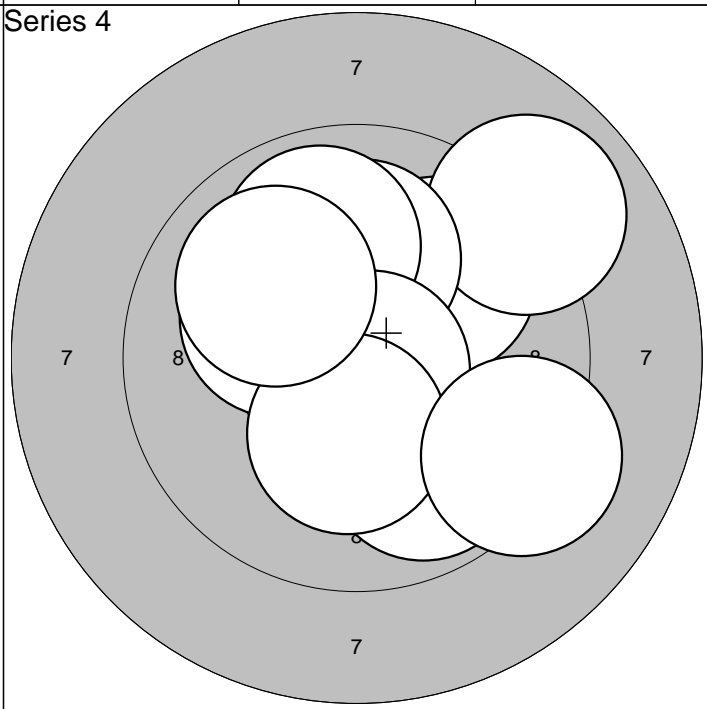
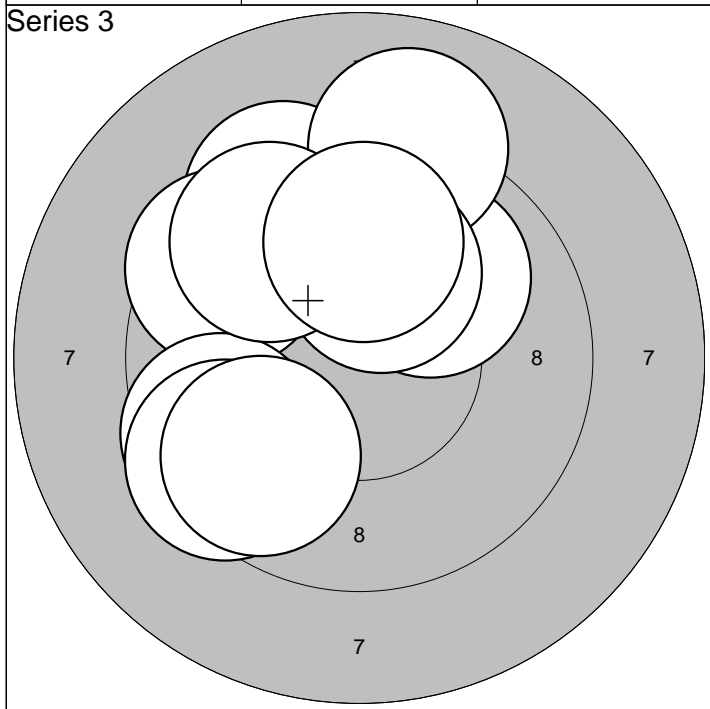

1: 9,4 ↖	6:10,1 ↑		Serie	92,0
2: 9,5 ↖	7: 9,4 ←			
3:10,0 ↗	8: 9,6 ↖	Sum	278,0	
4: 9,0 ↑	9: 9,9 ↑			
5: 9,5 ←	10: 9,7 ↖			

1: 9,9 ↗	6: 9,9 ↑		Serie	95,0
2:10,2* ↖	7:10,8* ↘			
3: 9,0 ↗	8:10,3* ↓	Sum	373,0	
4: 9,9 ↘	9: 9,2 ↘			
5:10,1 ↑	10:10,0 ↗			

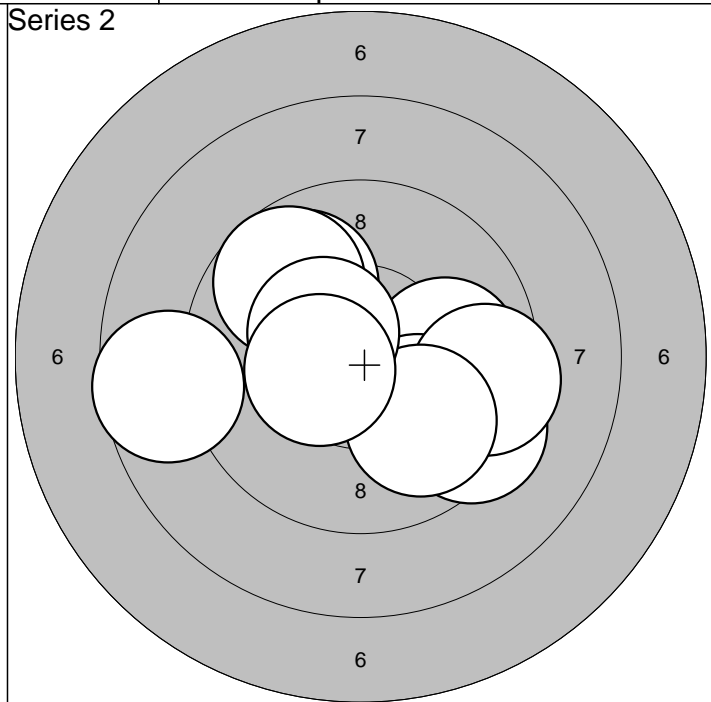
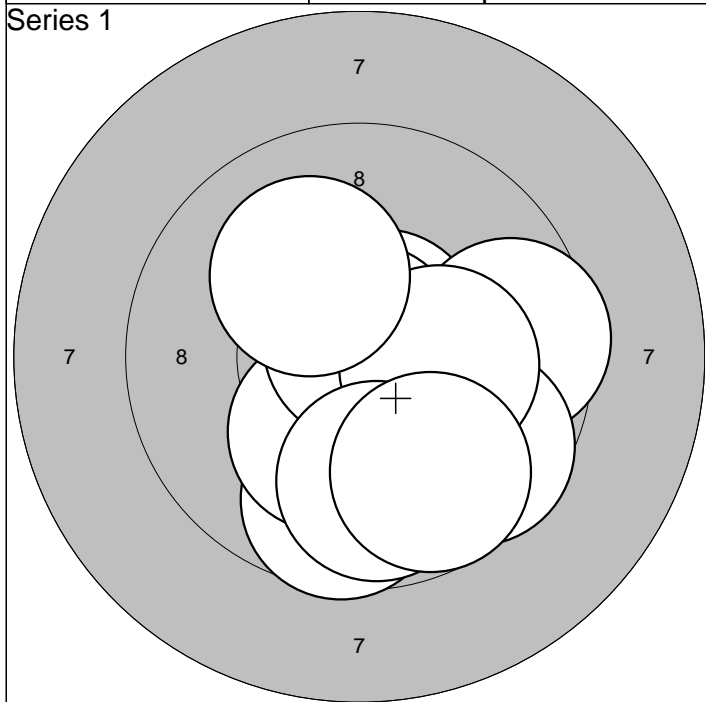

1:10,6* ↗	6:10,8* ↑			Serie	95,0
2: 9,7 ↓	7:10,2* →				
3: 9,6 →	8:10,1 ↗			Sum	95,0
4:10,2* ↓	9: 9,8 ↓				
5: 9,6 ↘	10: 9,7 ↓				

1: 9,9 ↗	6: 9,9 ↘			Serie	93,0
2:10,0 →	7: 9,7 ↗				
3: 9,4 ↘	8:10,4* ↗			Sum	188,0
4:10,0 ↓	9: 8,6 ←				
5: 9,5 →	10:10,4* ←				

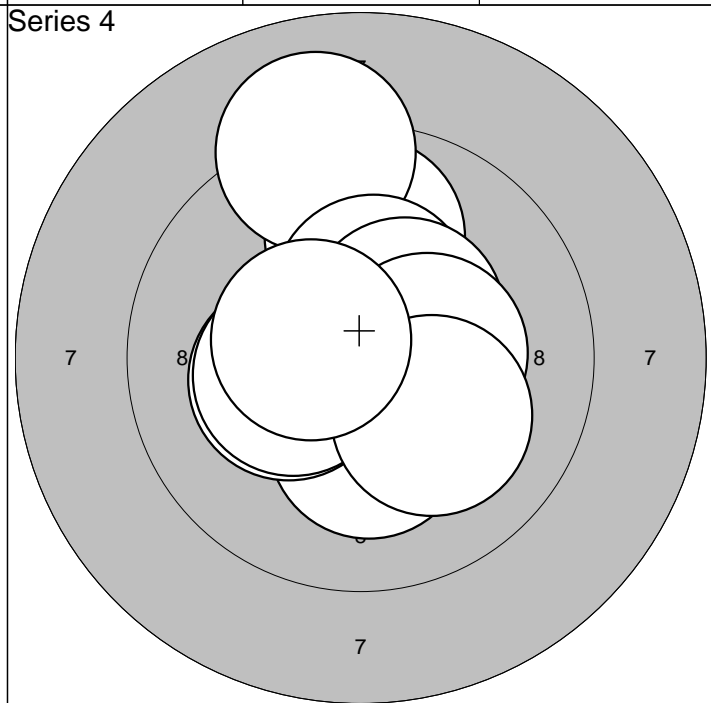
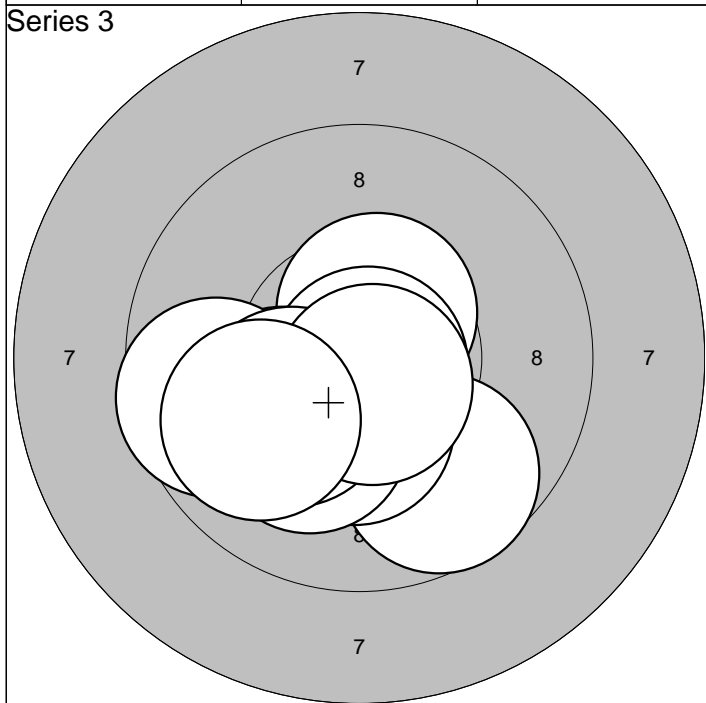

1: 9,7 ↘	6:10,1 ←			Serie	97,0
2:10,5* ↗	7: 9,6 ←				
3:10,4* ↓	8:10,2* ←			Sum	285,0
4:10,9* ↘	9:10,7* ↓				
5:10,1 ↘	10: 9,9 ←				

1:10,2* ↓	6:10,4* ↗			Serie	98,0
2: 9,9 ↑	7:10,3* ←				
3: 9,0 ↑	8:10,3* →			Sum	383,0
4:10,4* ↑	9:10,1 ↘				
5:10,3* ←	10:10,5* ←				

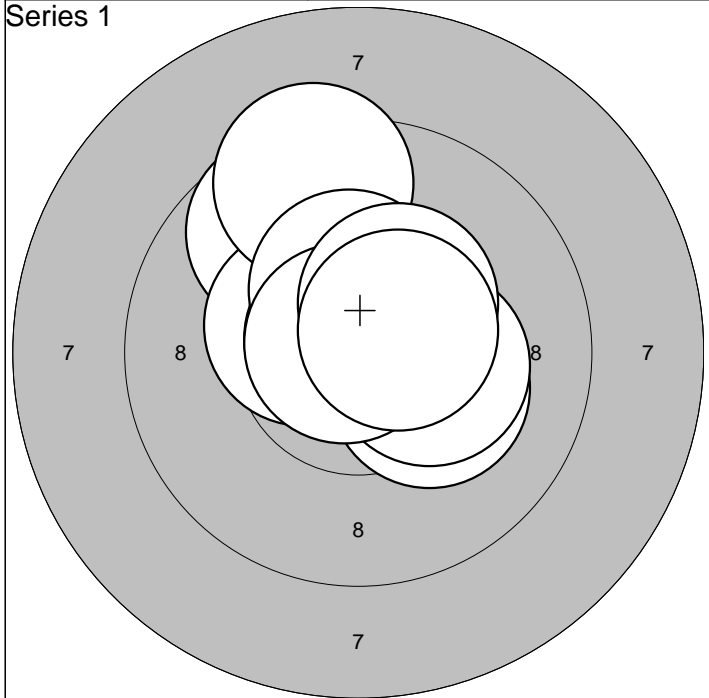

1:10,2* ↘	6:10,8* ↖	Serie 98,0
2: 9,7 ↗	7:10,4* ↑	
3:10,3* →	8:10,8* ↖	Sum 98,0
4:10,4* ↖	9:10,4* ↗	
5: 9,4 ↑	10:10,5* ↗	

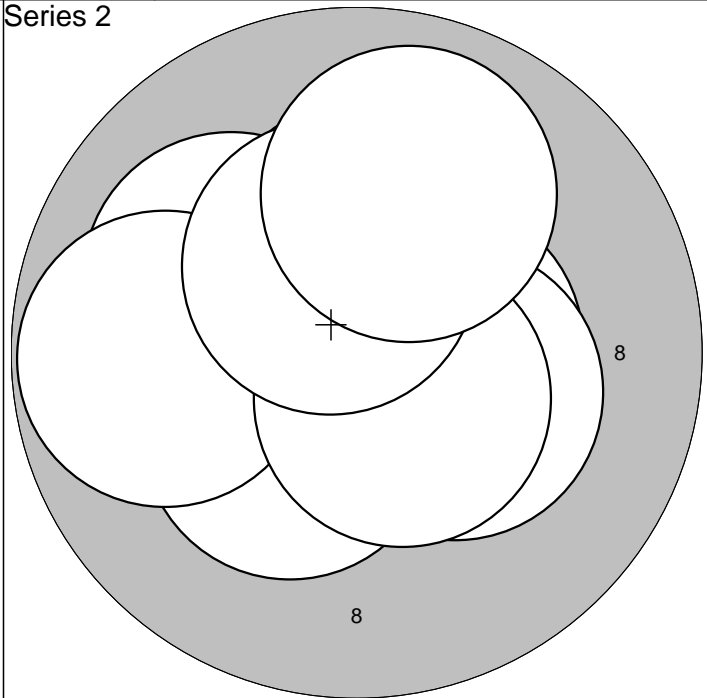

1:10,1 ←	6:10,1 ↖	Serie 99,0
2:10,3* ↙	7: 9,8 ←	
3:10,5* →	8:10,5* ↘	Sum 197,0
4:10,3* →	9:10,4* ↑	
5:10,3* ↑	10:10,0 ↑	

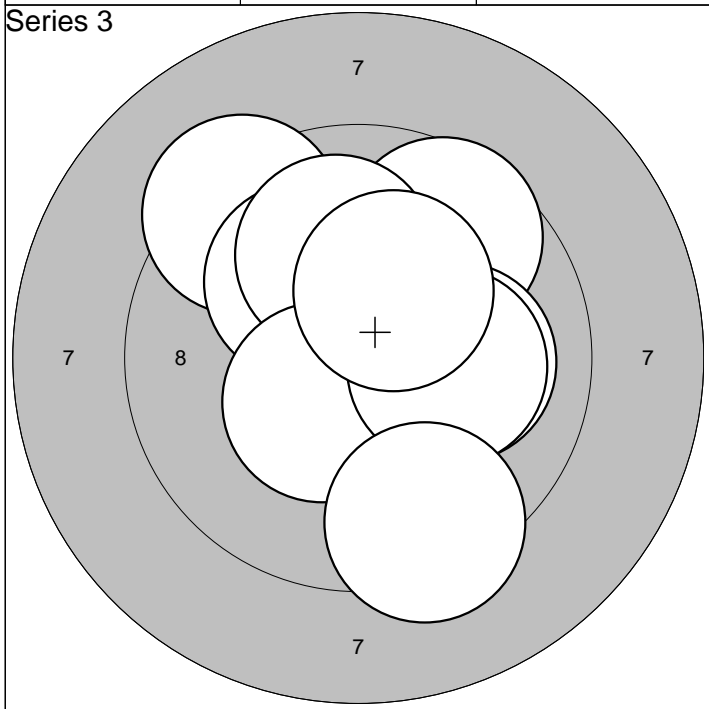

1: 9,6 ↗	6:10,7* ↘	Serie 97,0
2: 9,3 ↗	7:10,4* ↙	
3:10,1 ↗	8:10,1 →	Sum 294,0
4:10,1 →	9:10,3* ↗	
5:10,0 ↑	10: 9,4 ↘	

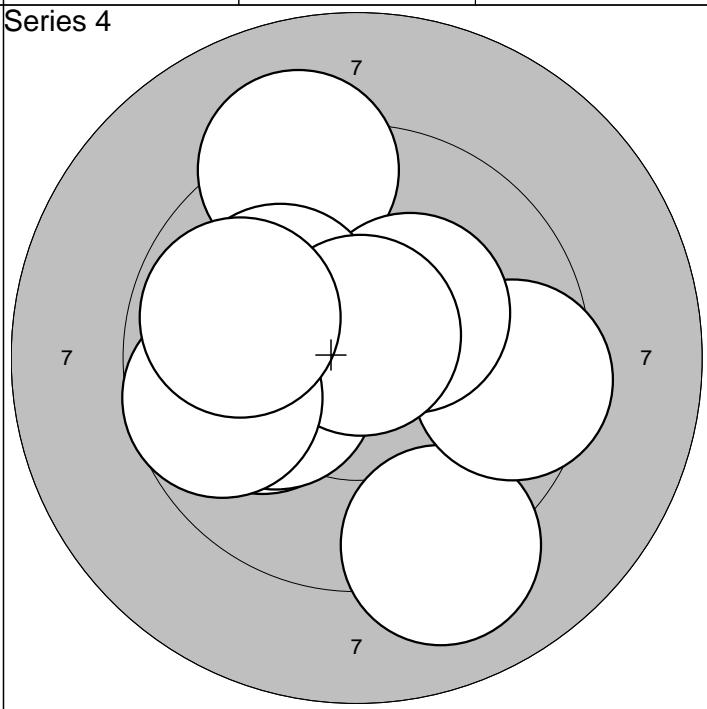

1: 9,1 ↘	6:10,1 ↖	Serie 95,0
2: 9,5 →	7:10,2* ←	
3: 9,2 ↑	8:10,7* ↑	Sum 389,0
4:10,1 ←	9: 9,7 ←	
5:10,3* ↗	10: 9,9 ←	

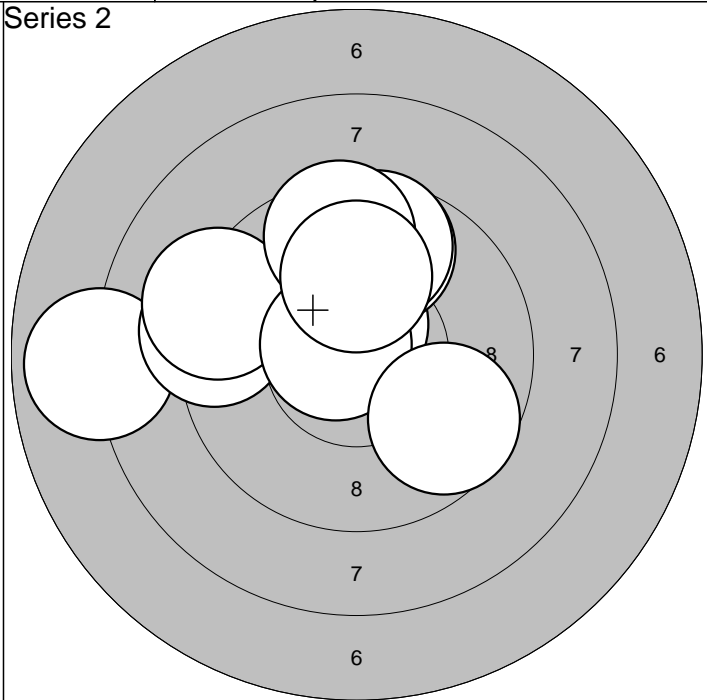
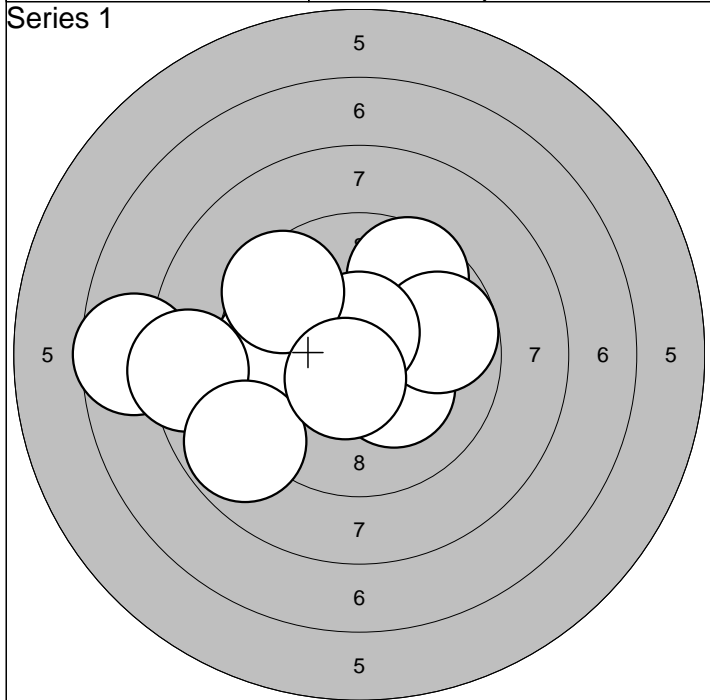

1: 9,7 ←	6: 9,7 →						
2:10,2* ↘	7:10,6* ↑					Serie	89,0
3: 7,6 ←	8: 9,5 ↖					Sum	89,0
4: 8,4 ←	9: 8,8 ↙						
5: 9,6 ↗	10:10,5* ↘						

1:10,6* ↑	6: 9,7 ↑						
2: 7,9 ←	7:10,7* ↖					Serie	91,0
3: 9,3 ←	8: 9,5 ↑					Sum	180,0
4: 9,7 ↑	9: 9,7 ↘						
5: 9,2 ←	10:10,0 ↑						

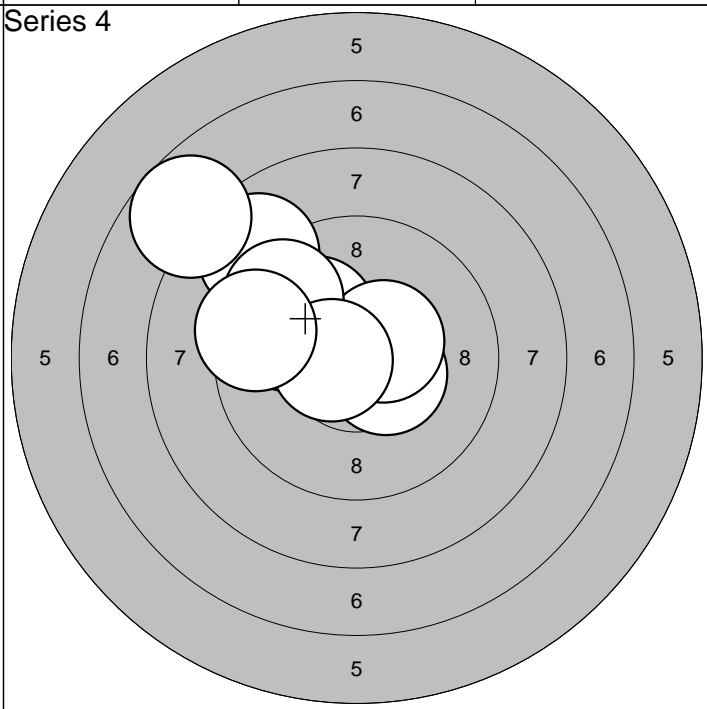
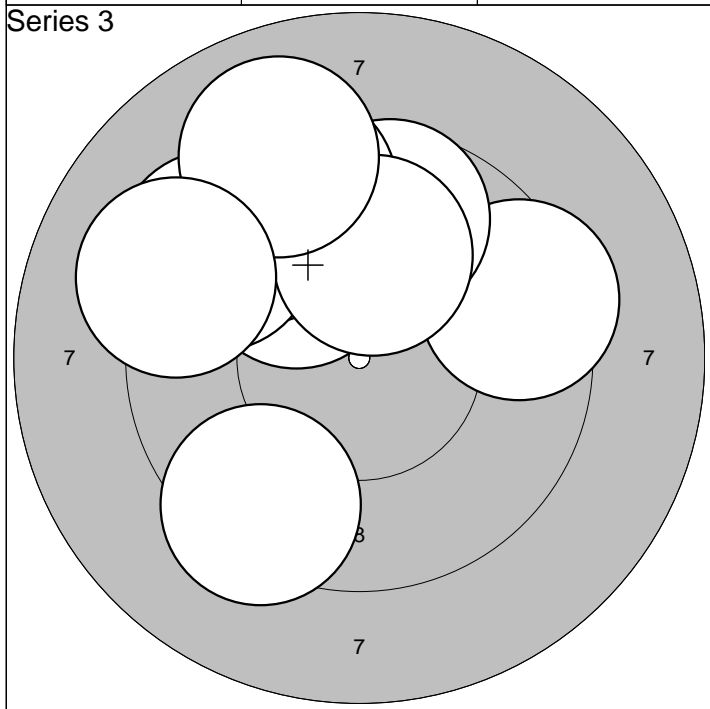

1:10,0 ↗	6: 9,7 ↑						
2: 9,5 ↗	7: 9,3 ↑					Serie	92,0
3: 9,3 ↖	8:10,0 ↑					Sum	272,0
4: 9,4 →	9: 9,0 ↑						
5: 9,4 ↘	10: 9,2 ↖						

1: 9,9 ←	6:10,4* ↘						
2:10,1 ↗	7:10,5* →					Serie	92,0
3:10,9* ↖	8: 9,6 ↖					Sum	364,0
4: 8,8 ↗	9:10,6* ←						
5: 7,7 ↗	10: 9,4 ↖						

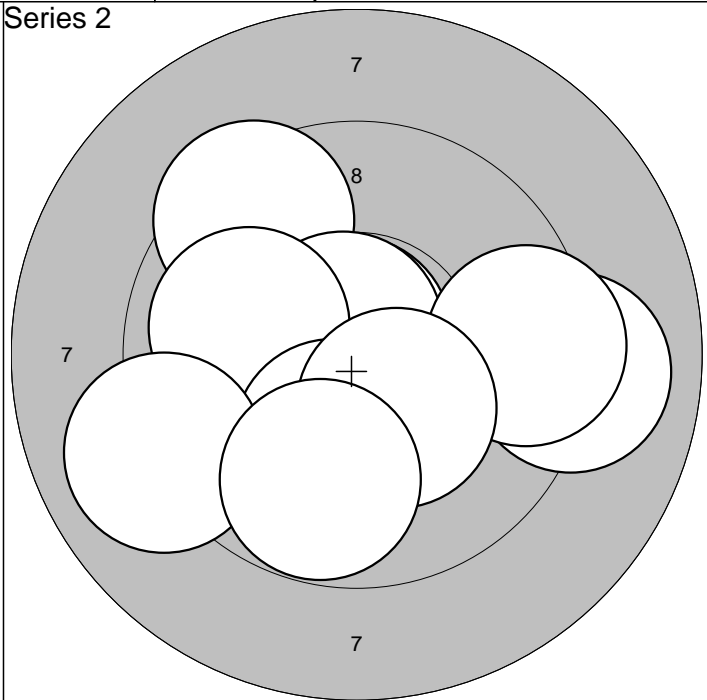
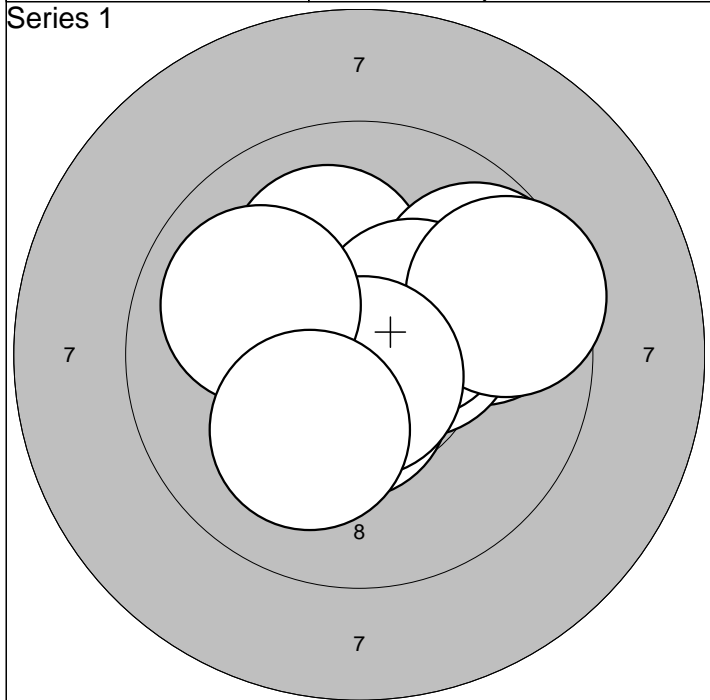

1:10,5* ↓	6:10,4* ↗				
2:10,1 ↑	7: 9,5 →				
3: 9,8 →	8:10,8* ↓	Serie	97,0		
4:10,4* →	9:10,0 ←	Sum	97,0		
5: 9,7 ↗	10:10,1 ↘				

1: 9,4 ↖	6: 9,0 →				
2:10,8* ↑	7: 9,0 ←				
3:10,7* ↖	8: 9,4 →	Serie	95,0		
4:10,0 ←	9:10,4* ↓	Sum	192,0		
5:10,2* ↓	10: 9,8 ↓				

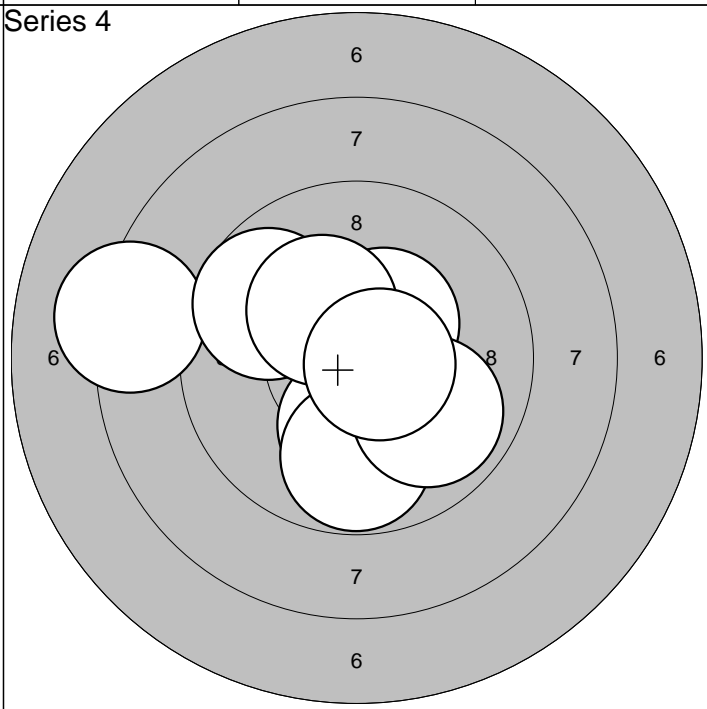
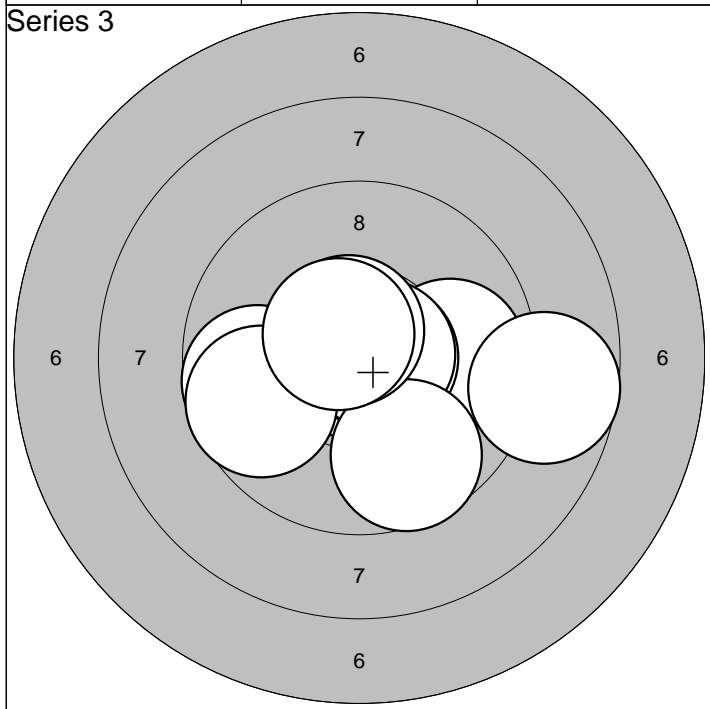

1:10,9* ↓	6: 9,7 ←				
2: 9,9 →	7: 8,7 →				
3:10,7* →	8: 9,6 ↓	Serie	94,0		
4:10,7* →	9:10,6* ↑	Sum	286,0		
5: 9,7 ←	10:10,6* ↖				

1:10,4* ↗	6:10,1 ↓				
2:10,6* ↘	7: 9,8 ↓				
3:10,3* ↓	8: 9,9 ↘	Serie	95,0		
4: 8,2 ←	9:10,3* ↖	Sum	381,0		
5: 9,7 ↖	10:10,7* →				

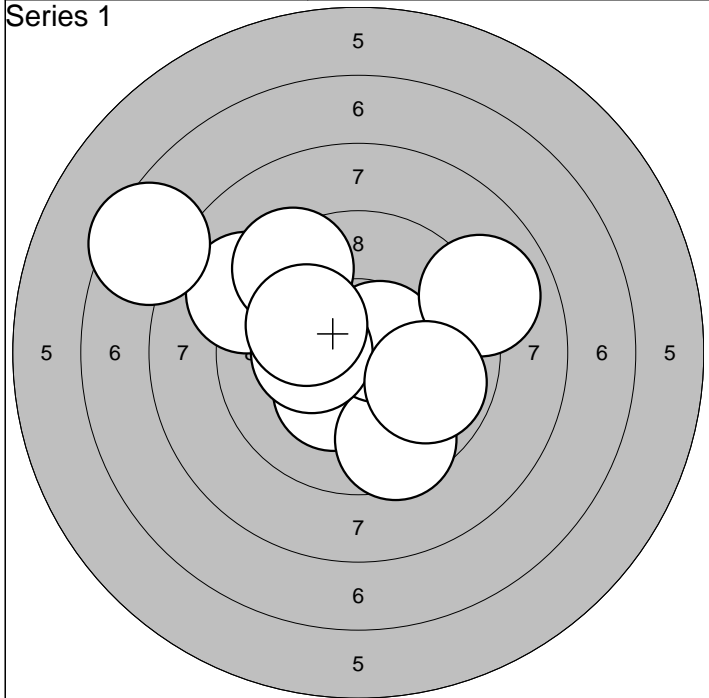

1:10,3* ↘	6:10,3* ←		Serie	91,0
2: 9,6 ↘	7: 7,5 ↙			
3: 9,1 ↗	8:10,1 ↙	Sum	91,0	
4:10,6* ↗	9: 8,9 ↗			
5: 9,4 ↗	10: 9,8 ↘			

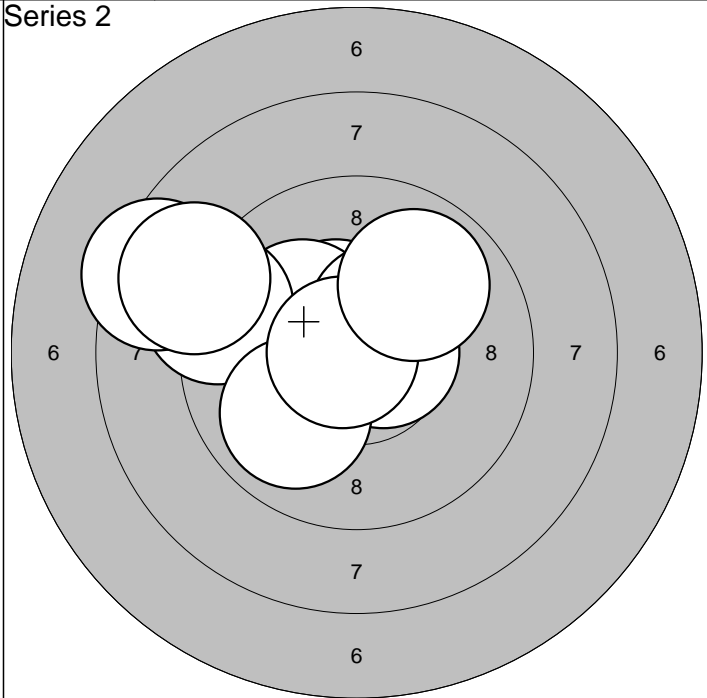

1:10,4* ↗	6: 8,4 ↙		Serie	93,0
2:10,2* ↙	7: 9,9 ↘			
3:10,4* ↗	8:10,8* ←	Sum	184,0	
4: 9,2 ←	9: 8,8 ↙			
5:10,6* →	10: 9,9 ↗			

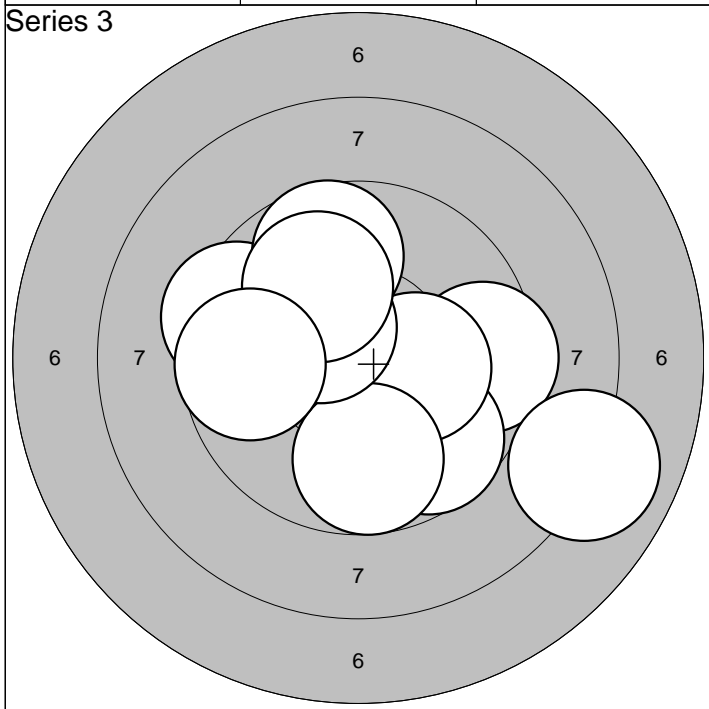

1: 9,5 →	6: 9,7 ↓		Serie	92,0
2: 9,7 ↘	7:10,4* ↙			
3: 9,4 ↙	8: 8,0 ↘	Sum	276,0	
4:10,3* →	9:10,0 ↗			
5: 9,7 ↗	10: 9,7 ←			

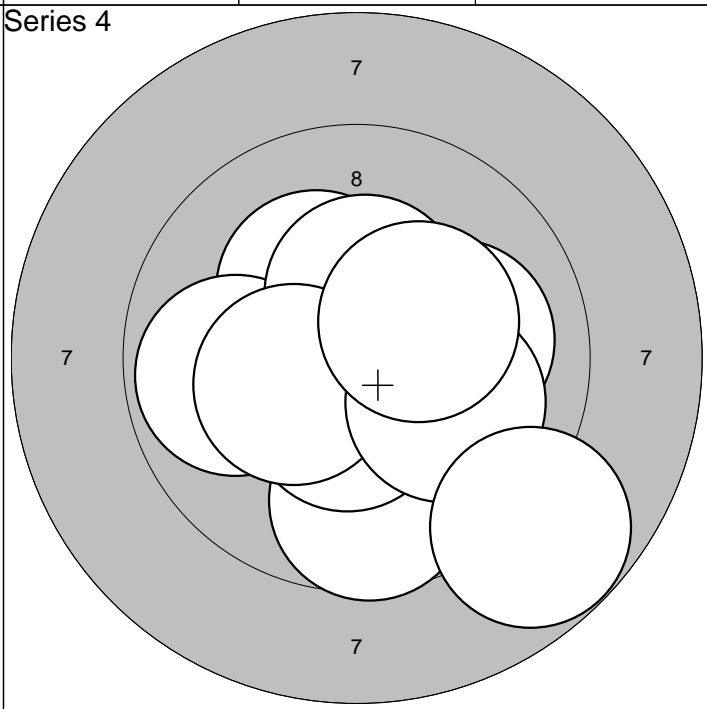

1:10,2* ↗	6:10,4* ↗		Serie	96,0
2: 9,7 ↘	7:10,4* ↙			
3:10,5* ↓	8:10,0 →	Sum	372,0	
4:10,1 →	9:10,3* ↗			
5: 9,9 ←	10: 8,8 ↘			

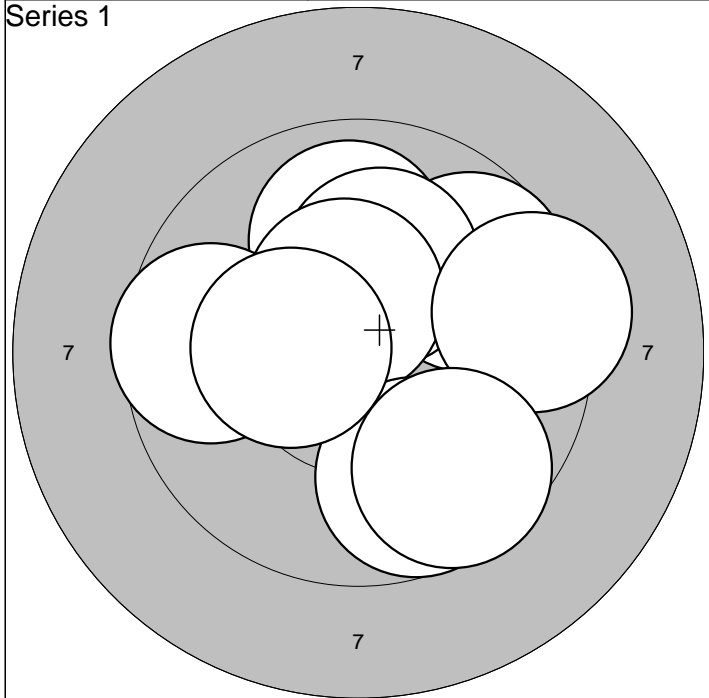

1:10,1	↑	6: 9,7	↓	Serie	94,0
2: 9,7	↗	7: 9,3	→		
3: 9,9	↑	8: 9,6	←	Sum	94,0
4:10,2*	↑	9:10,4*	←		
5:10,5*	↑	10: 9,6	↓		



1:10,1	→	6:10,6*	↓	Serie	92,0
2: 9,2	↘	7: 9,9	↗		
3: 8,9	→	8: 9,8	↘	Sum	186,0
4: 7,9	→	9:10,3*	↗		
5:10,4*	↘	10:10,2*	↑		

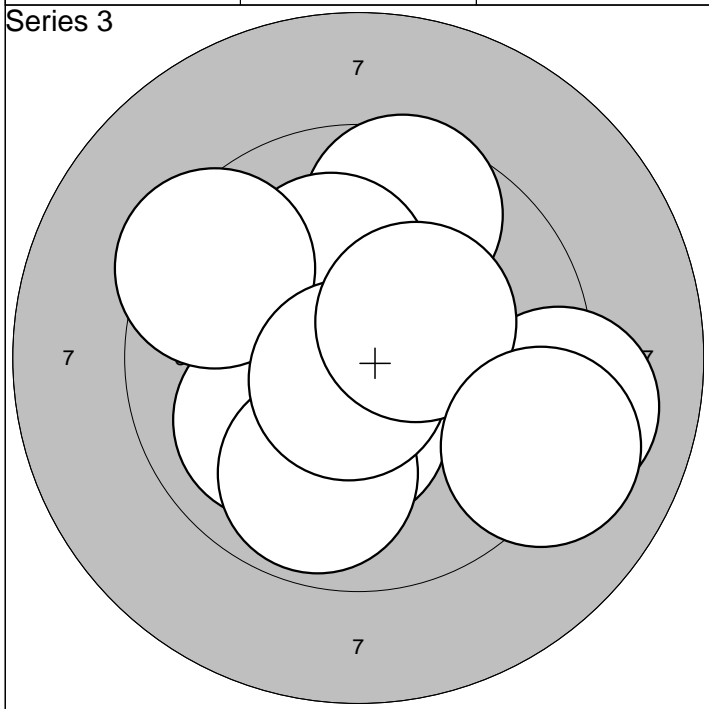

1: 9,1	→	6: 9,9	↓	Serie	95,0
2: 9,6	↑	7: 9,4	↖		
3:10,0	↖	8:10,8*	↓	Sum	281,0
4:10,4*	↓	9:10,3*	↗		
5:10,2*	↑	10: 9,1	→		

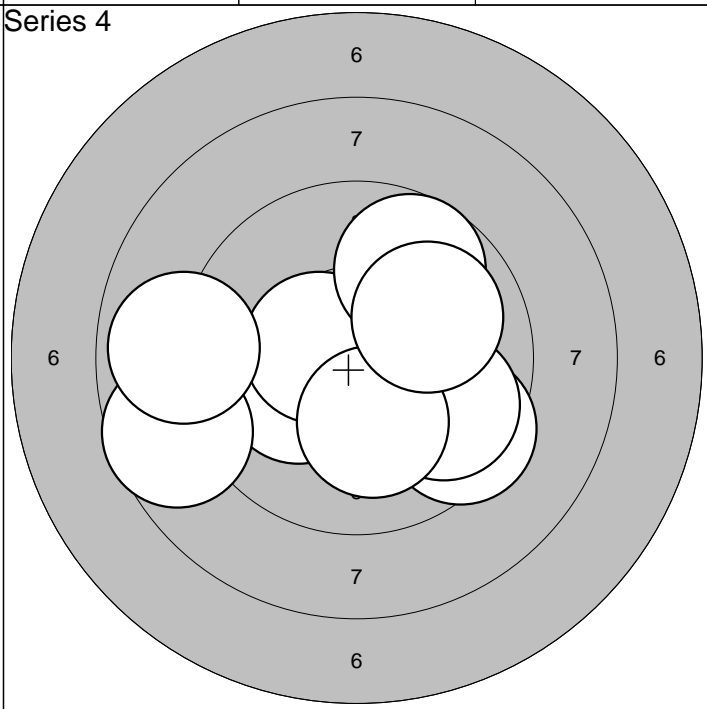

1: 9,5	↘	6: 9,7	↘	Serie	93,0
2:10,6*	↗	7: 8,9	←		
3:10,2*	↖	8: 9,7	↗	Sum	374,0
4:10,5*	↖	9:10,2*	↓		
5: 8,6	←	10:10,0	↗		

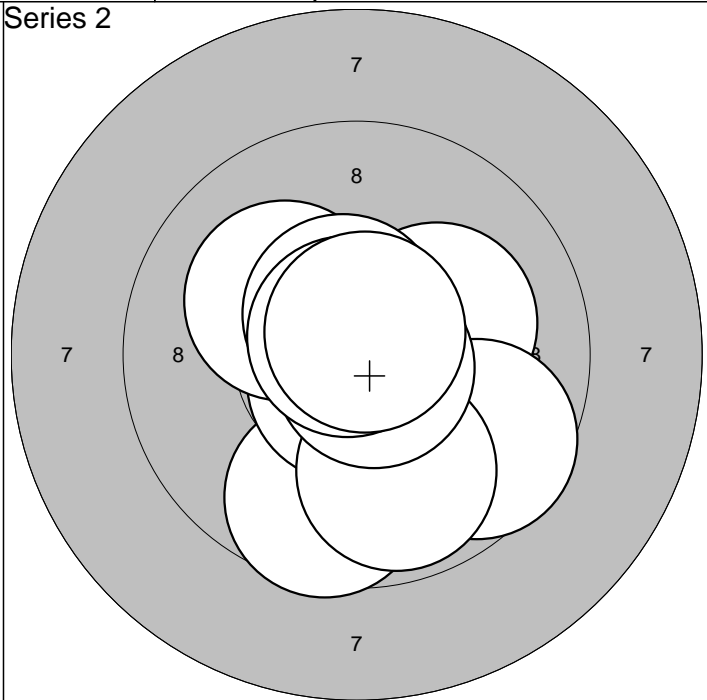
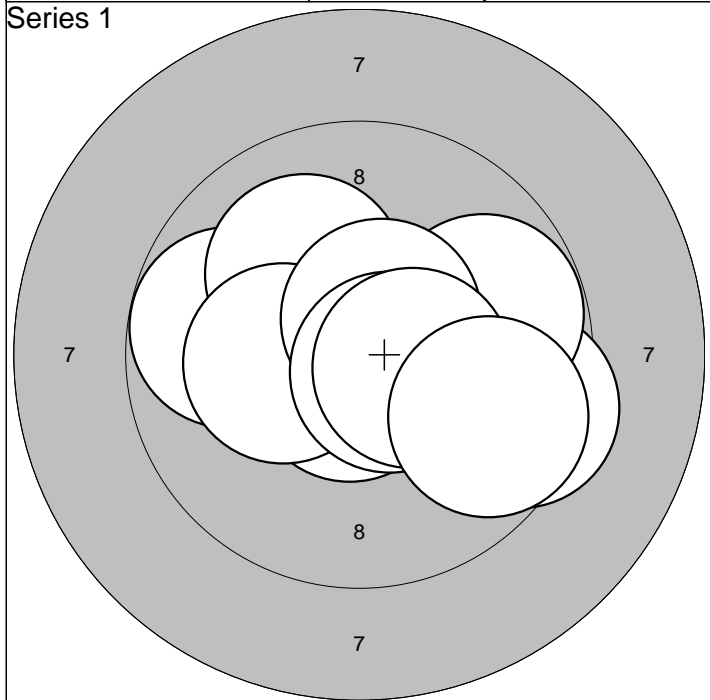

1:10,7* ↓	6:10,2* ←	Serie	96,0
2: 9,8 ←	7:10,6* ↗		
3: 9,4 →	8:10,6* ↘	Sum	96,0
4: 9,8 →	9:10,5* →		
5:10,1 ↗	10: 9,7 ↘		

1:10,2* →	6: 9,8 ↓	Serie	97,0
2: 9,7 ↓	7:10,8* ↘		
3: 9,6 ↘	8:10,6* ↗	Sum	193,0
4:10,7* ↓	9:10,8* ↗		
5:10,1 ↗	10:10,7* ↗		

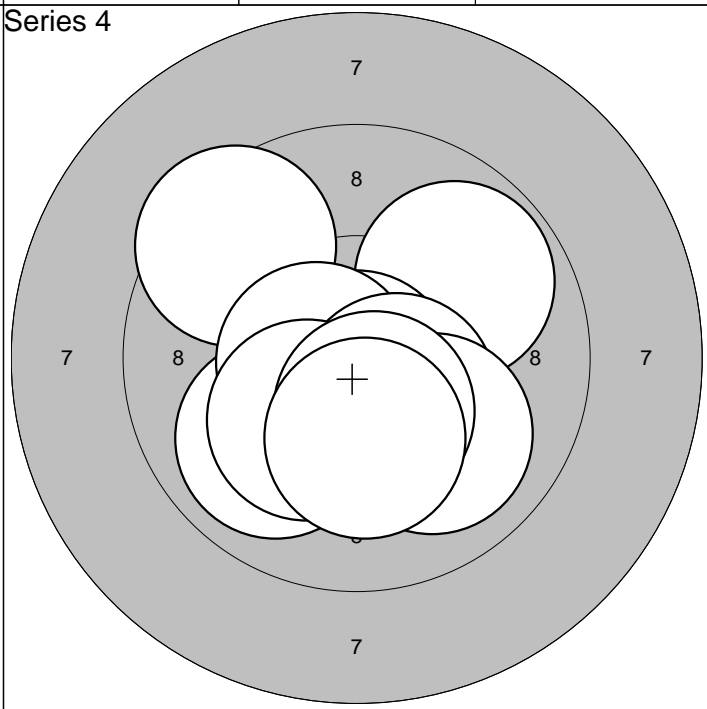
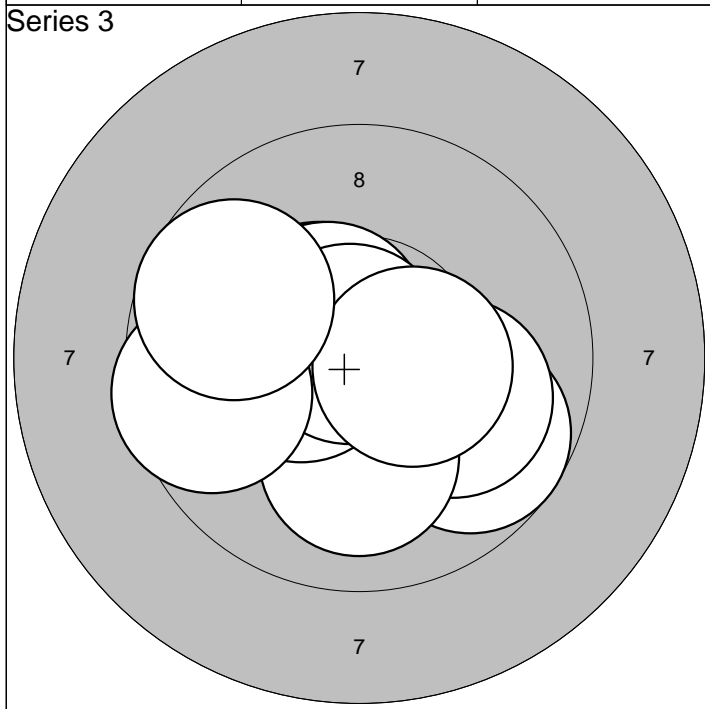

1: 9,7 ↘	6:10,4* ←	Serie	97,0
2:10,5* ↗	7:10,8* ↗		
3:10,1 →	8: 9,6 ←	Sum	290,0
4:10,1 ↓	9:10,5* →		
5:10,5* ↗	10: 9,7 ↖		

1: 9,9 ↖	6:10,5* ↘	Serie	97,0
2: 9,9 ↗	7:10,0 ↘		
3: 9,5 ↖	8:10,3* ↖	Sum	387,0
4:10,8* ↓	9:10,4* ↓		
5:10,6* ←	10:10,2* ↓		

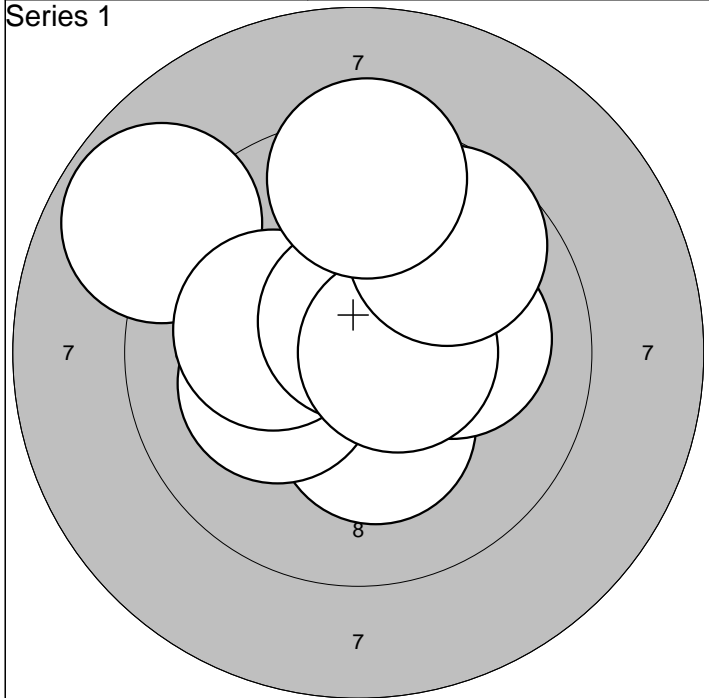

1:10,3* ↓	6:10,2* ←	Serie	96,0
2:10,5* →	7:10,7* ↑		
3:10,1 →	8:10,6* →	Sum	96,0
4:10,2* ←	9: 9,7 ↗		
5: 8,8 ↖	10: 9,4 ↑		

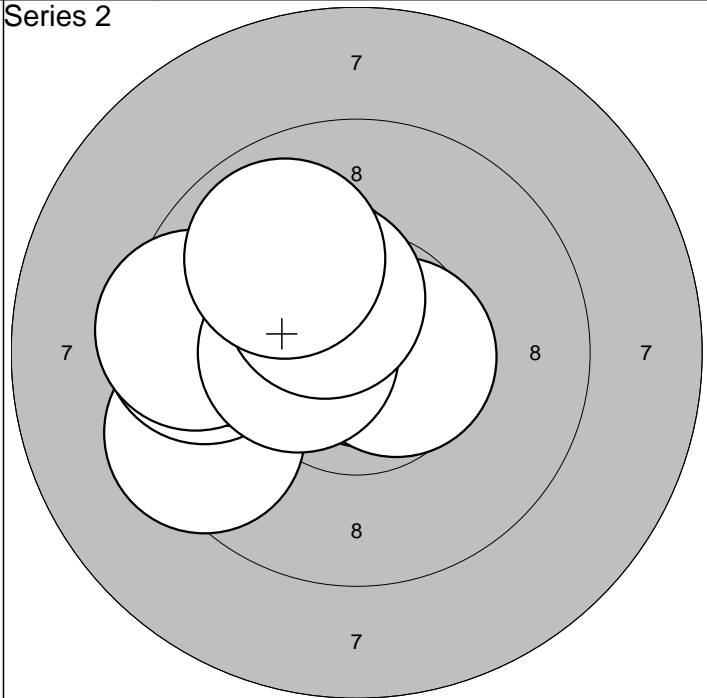

1: 9,4 ↙	6: 9,5 ←	Serie	95,0
2: 9,6 ←	7:10,6* →		
3:10,2* ↖	8:10,4* ←	Sum	191,0
4: 9,7 ←	9:10,4* ↗		
5:10,8* →	10: 9,9 ↗		

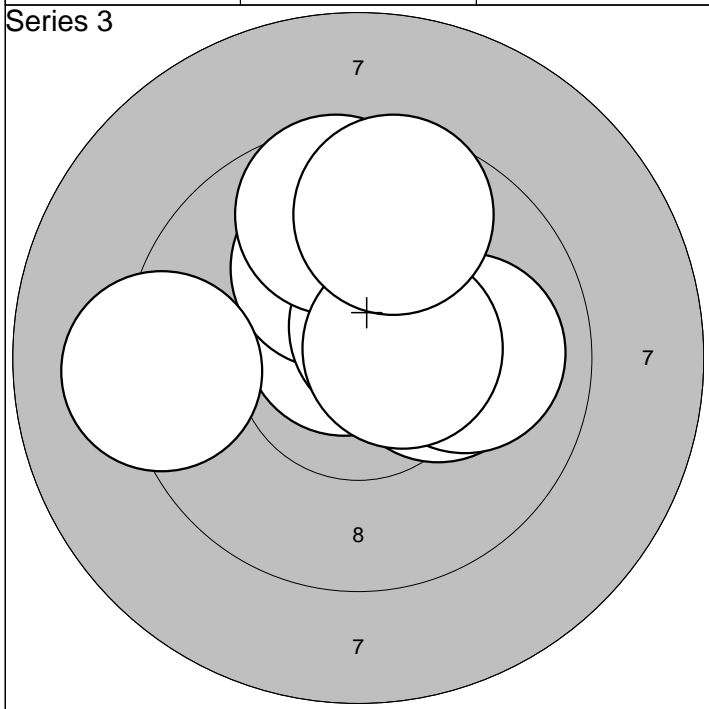

1:10,7* ↖	6:10,0 →	Serie	97,0
2:10,4* ↗	7: 9,7 ↑		
3:10,2* →	8:10,5* →	Sum	288,0
4:10,1 ↑	9: 9,6 ↑		
5:10,6* ↗	10: 9,2 ←		

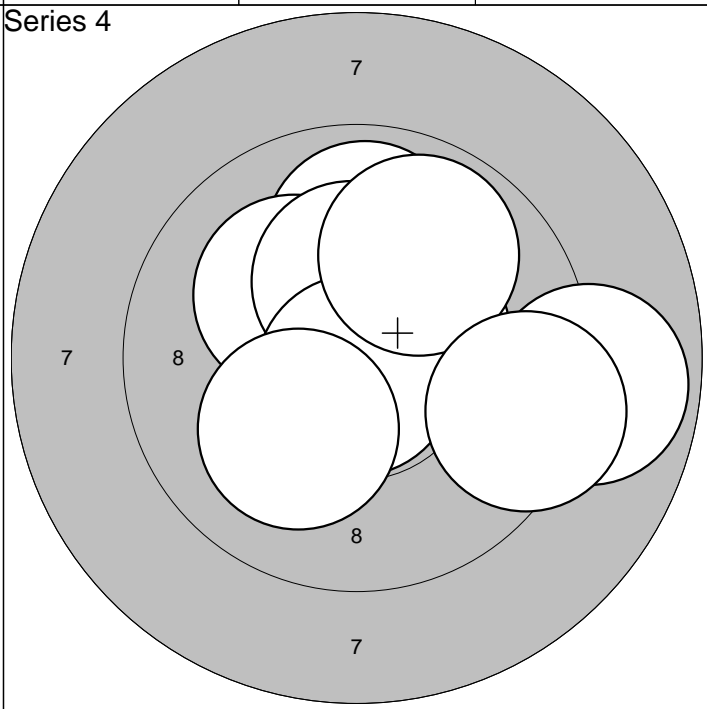

1:10,5* ↑	6:10,8* ↓	Serie	95,0
2: 9,9 ↑	7: 9,9 ↗		
3:10,2* ↖	8:10,1 ↙	Sum	383,0
4:10,3* ↑	9: 8,9 →		
5:10,4* ↗	10: 9,4 →		

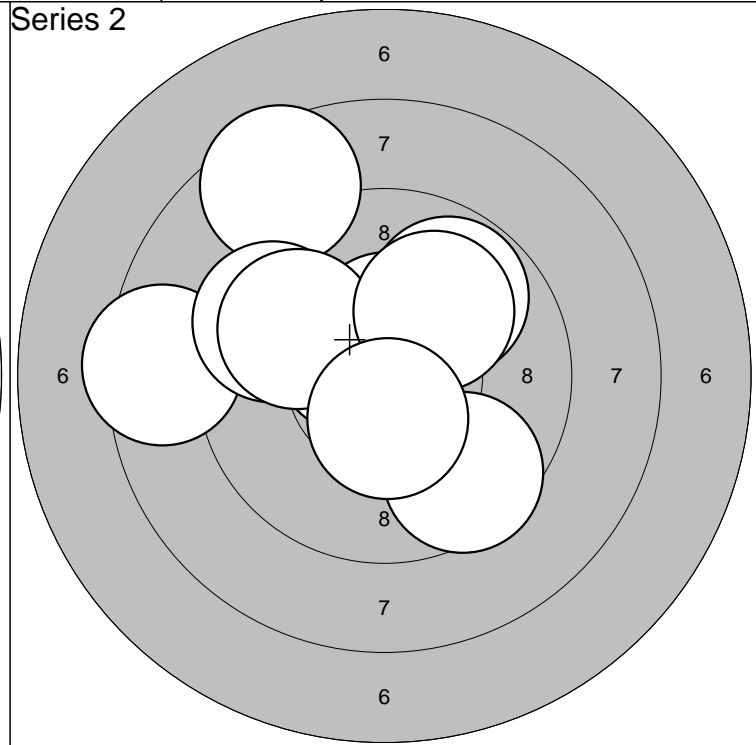
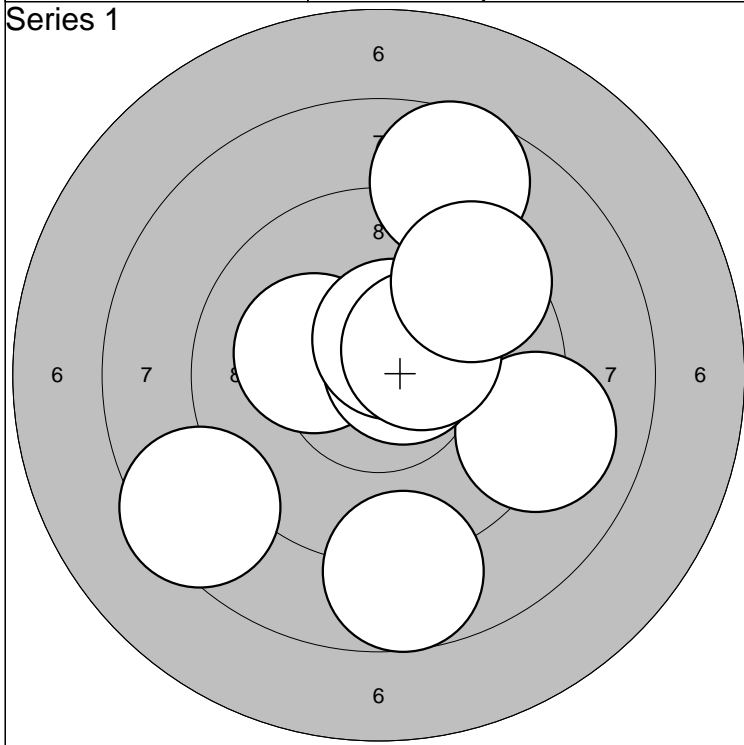

1:10,2*	←	6:10,7*	→	Serie	92,0
2: 8,7	↑	7:10,5*	↑		
3: 8,7	↓	8: 8,4	←	Sum	92,0
4: 9,1	→	9:10,4*	→		
5:10,5*	↗	10: 9,5	↗		

1: 9,5	↘	6: 8,5	↗	Serie	92,0
2:10,6*	↖	7: 9,6	←		
3: 8,5	←	8: 9,9	↖	Sum	184,0
4:10,5*	↑	9:10,0	↗		
5: 9,8	↗	10:10,5*	↓		

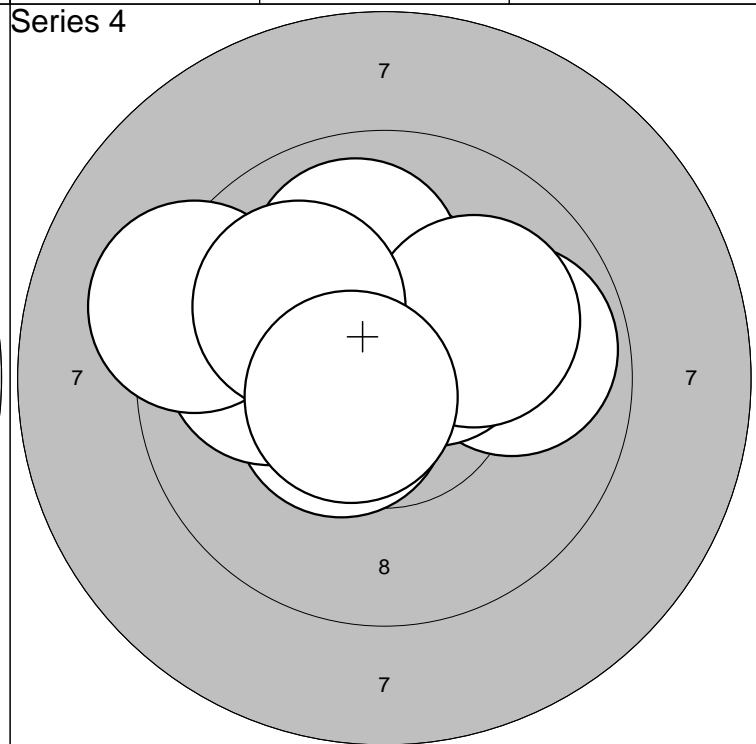
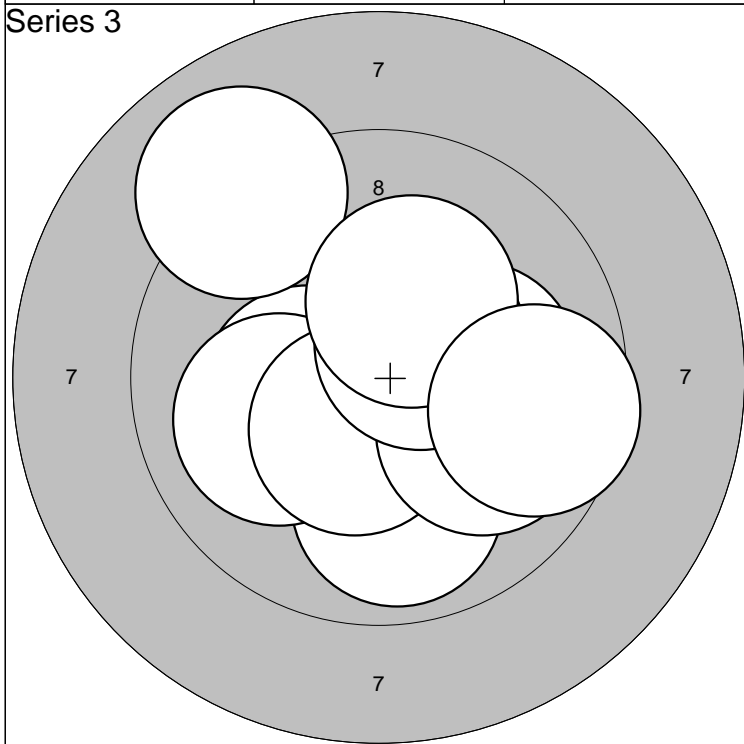

1:10,3*	←	6:10,5*	↘	Serie	96,0
2: 9,9	↓	7: 9,9	→		
3: 9,0	↗	8:10,5*	↗	Sum	280,0
4:10,2*	→	9:10,3*	↑		
5:10,0	←	10: 9,6	→		

1: 9,8	→	6:10,0	↑	Serie	98,0
2:10,3*	↑	7: 9,2	←		
3:10,5*	↗	8:10,1	↗	Sum	378,0
4:10,5*	↖	9:10,0	↖		
5:10,0	←	10:10,6*	↖		

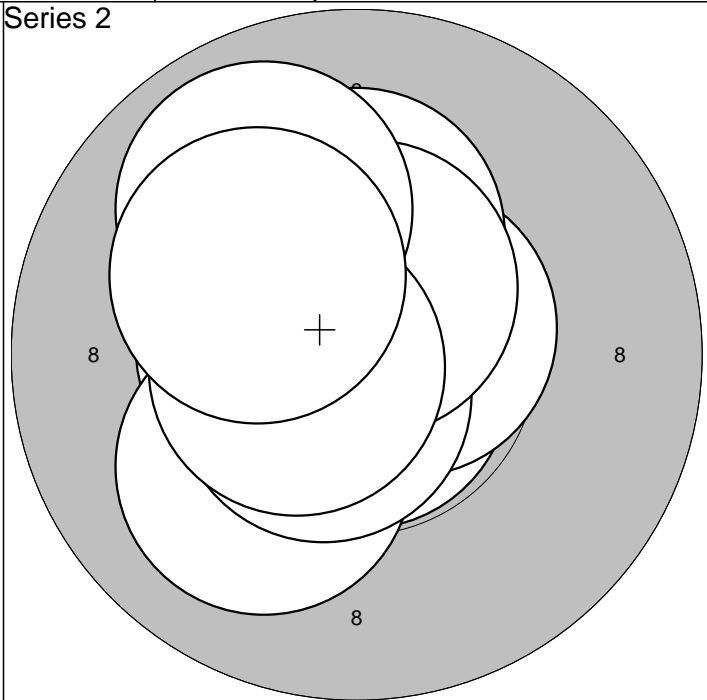
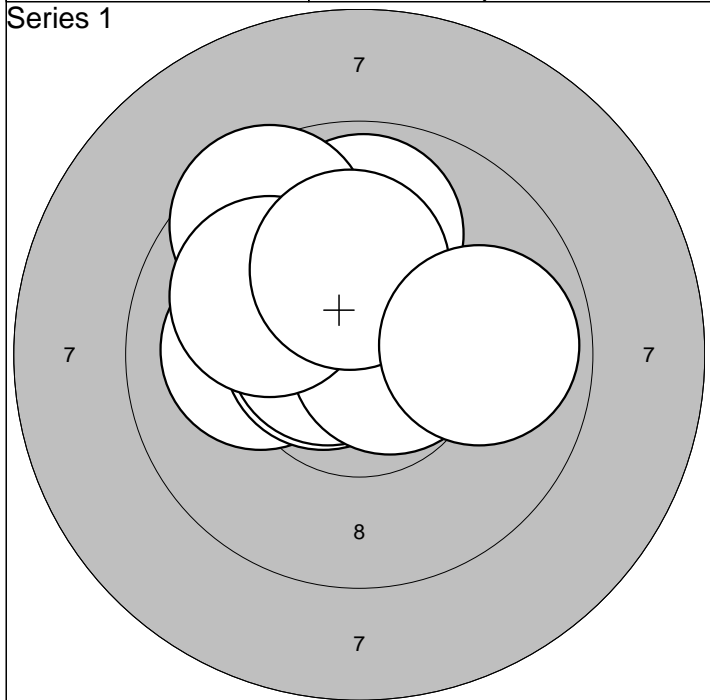

1: 9,9 ↑	6:10,7* ←	Serie 97,0
2:10,1 ←	7:10,7* →	
3:10,6* ←	8:10,0 ↗	Sum 97,0
4:10,6* ↗	9:10,2* ↑	
5: 9,6 ↗	10: 9,9 →	

1:10,5* ←	6:10,6* ↘	Serie 99,0
2:10,8* ↓	7:10,5* ↑	
3:10,1 ↘	8: 9,9 ↗	Sum 196,0
4:10,6* ↗	9:10,6* ←	
5:10,2* ↑	10:10,2* ↖	

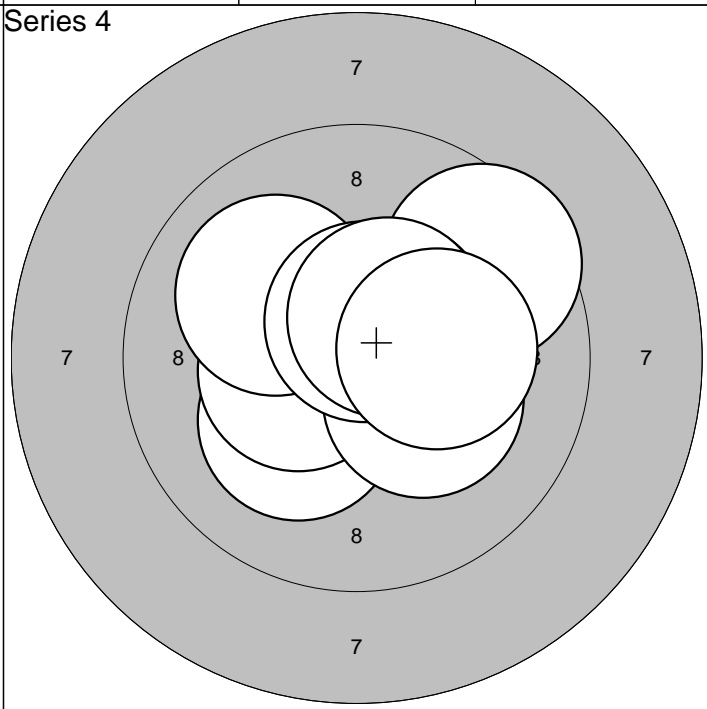
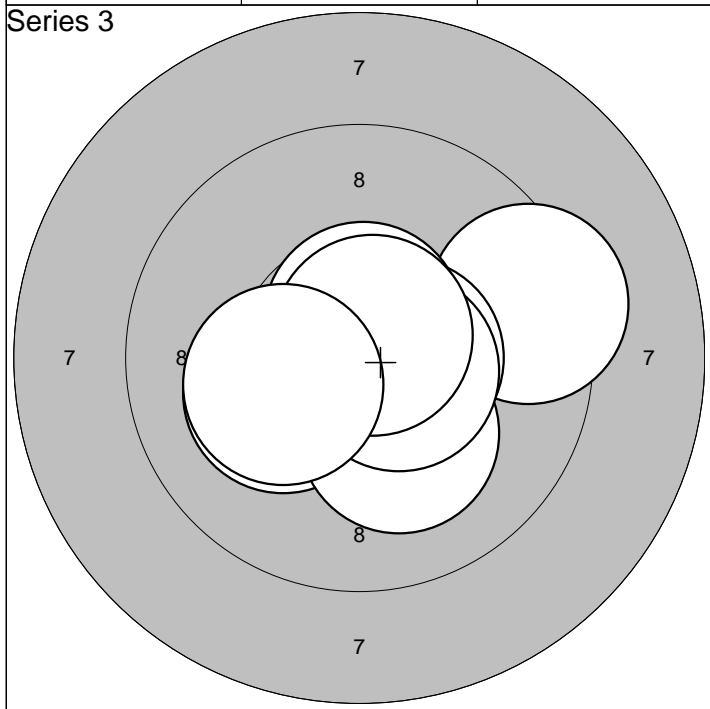

1:10,7* →	6:10,6* ↑	Serie 99,0
2:10,6* ➤	7:10,2* ↓	
3:10,2* ←	8:10,6* ➤	Sum 295,0
4: 9,3 ➤	9:10,7* ↗	
5:10,6* ➤	10:10,2* ←	

1:10,2* ↘	6:10,0 ↖	Serie 99,0
2:10,5* ➤	7:10,2* ➤	
3: 9,6 ↗	8:10,6* ↑	Sum 394,0
4:10,4* ←	9:10,5* ↗	
5:10,5* ↗	10:10,2* ➤	

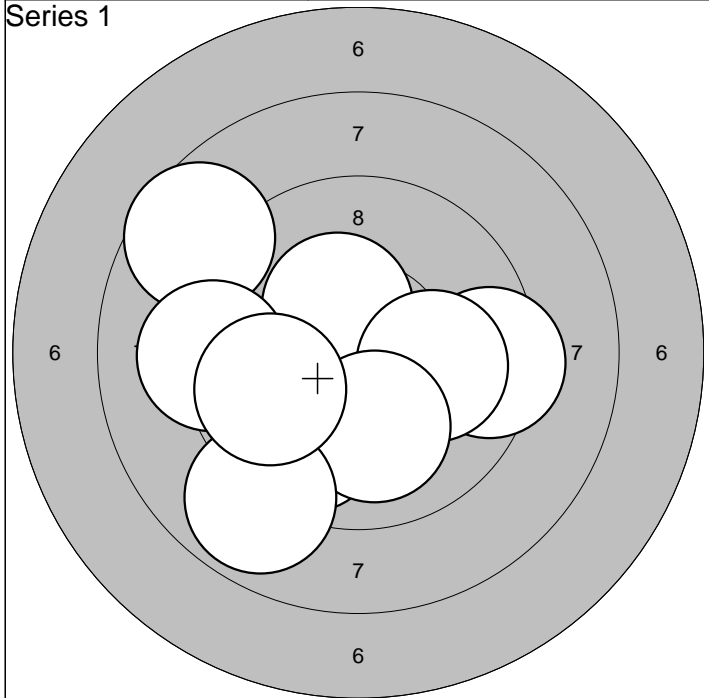

1: 9,8 ↙	6: 8,6 ↖	Serie	91,0
2:10,4* ↗	7:10,0 ↓		
3: 9,4 →	8: 8,9 ↘	Sum	91,0
4: 9,8 ↘	9: 9,2 ←		
5:10,1 →	10: 9,8 ←		

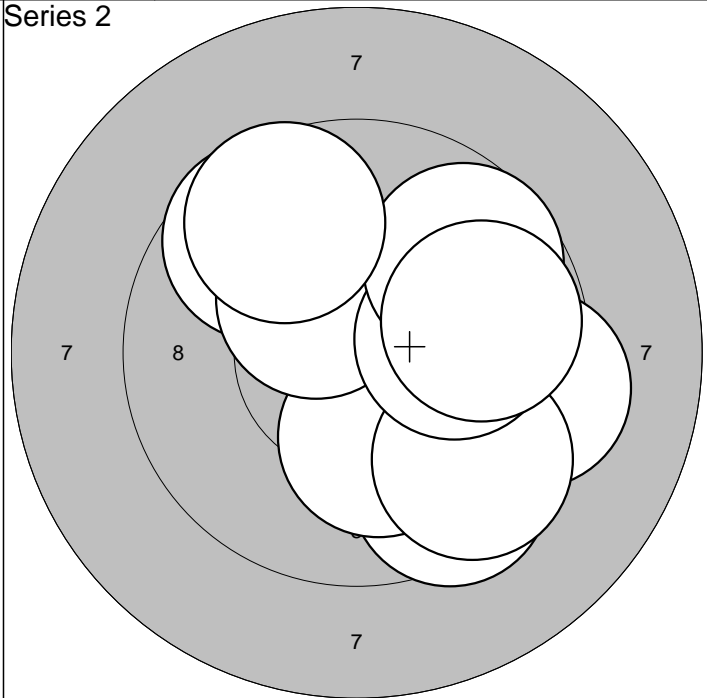

1: 9,7 ↗	6:10,3* ↖	Serie	93,0
2: 9,5 ↘	7:10,1 →		
3:10,2* ↘	8: 9,7 ↗	Sum	184,0
4: 9,3 →	9: 9,6 ↖		
5: 9,5 ↘	10: 9,8 →		

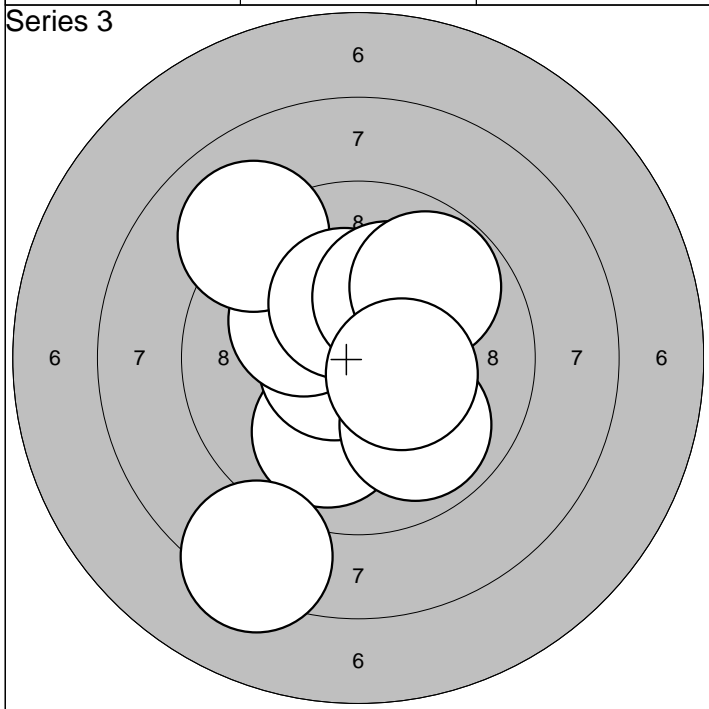

1:10,0 ↓	6:10,1 ↗	Serie	95,0
2:10,6* ←	7: 9,9 ↘		
3:10,2* ↖	8: 8,3 ↘	Sum	279,0
4: 9,0 ↗	9: 9,8 ↗		
5:10,3* ↗	10:10,4* →		

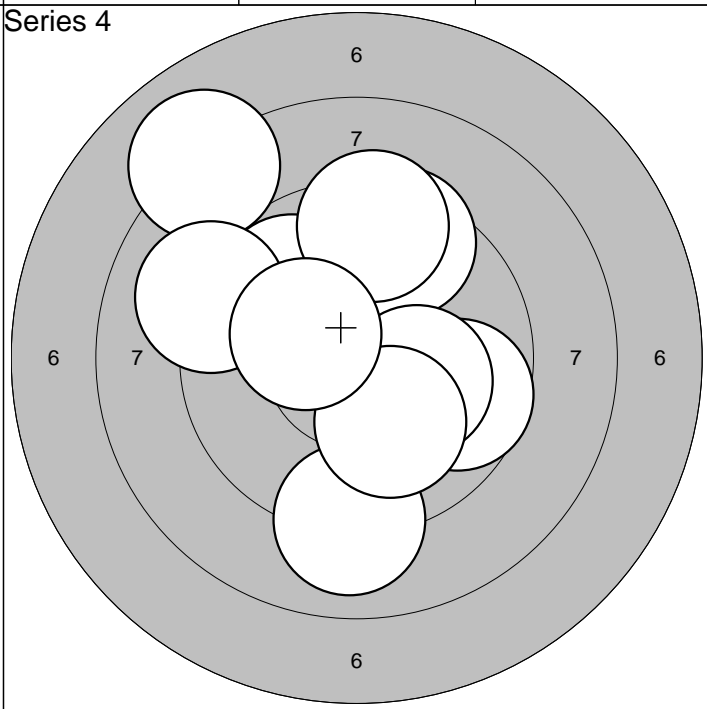

1: 8,0 ↖	6: 9,4 ↗	Serie	92,0
2: 9,7 →	7: 9,1 ←		
3: 9,0 ↓	8:10,2* →	Sum	371,0
4: 9,8 ↗	9:10,1 ↓		
5: 9,5 ↗	10:10,3* ↖		

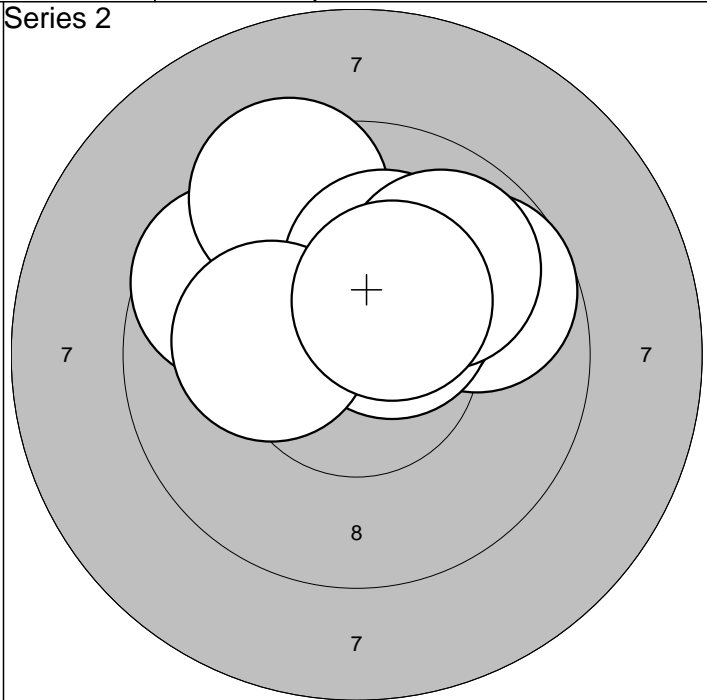
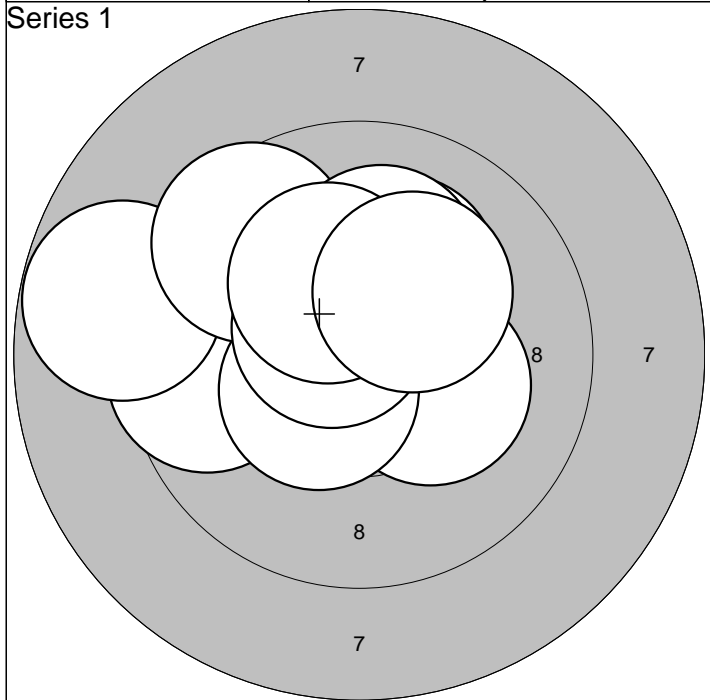

1:10,2* →	6:10,6* ↖				
2: 9,6 ←	7:10,1 ↗				
3: 8,8 ←	8:10,1 ↗	Serie	96,0		
4:10,5* ↙	9:10,2* ↗	Sum	96,0		
5: 9,6 ↖	10:10,2* ↗				

1: 9,6 ↖	6:10,5* ↗				
2: 9,7 ↗	7:10,1 ↗				
3:10,3* ↗	8:10,2* ←	Serie	96,0		
4: 9,4 ↖	9: 9,9 ↗	Sum	192,0		
5:10,5* ↗	10:10,4* ↗				

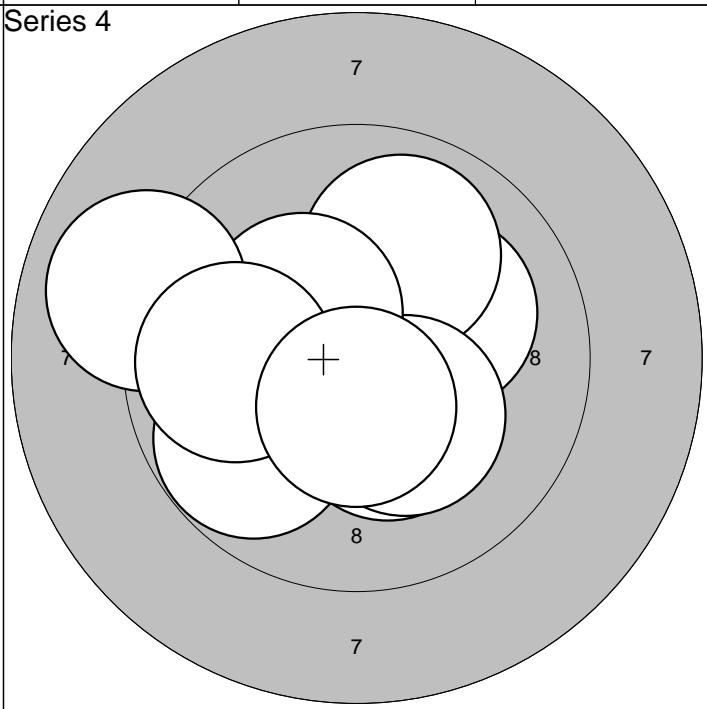
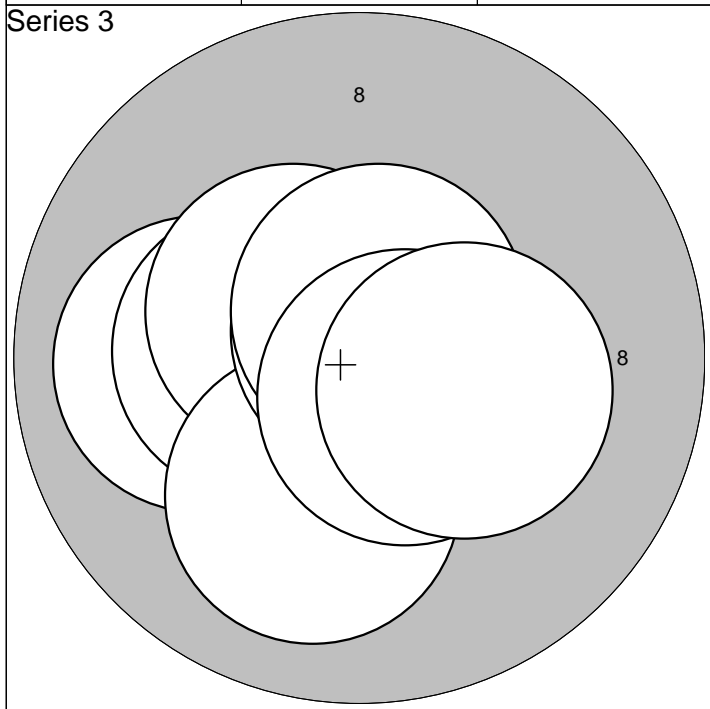

1:10,0 ←	6:10,1 ↓				
2:10,9* →	7:10,8* ↗				
3:10,4* ←	8:10,6* ↗	Serie	100,0		
4:10,8* ↗	9:10,6* ↓	Sum	292,0		
5:10,5* ↖	10:10,3* →				

1:10,4* ←	6:10,3* ↖				
2:10,1 ↗	7: 9,0 ←				
3:10,3* ↓	8: 9,8 ↙	Serie	96,0		
4: 9,9 ↗	9: 9,9 ←	Sum	388,0		
5:10,3* ↓	10:10,5* ↓				

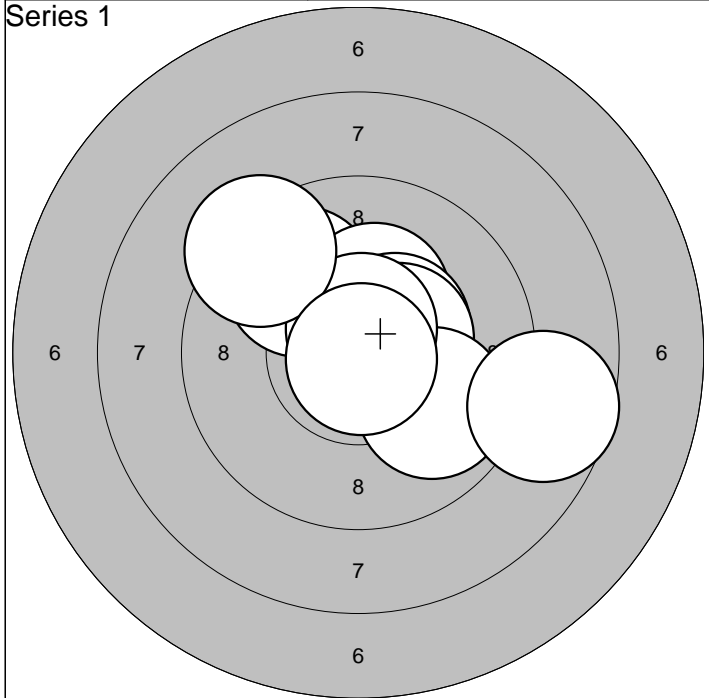

1: 9,9 ↖	6: 9,9 ↘	Serie	95,0
2:10,3* ↑	7:10,7* ↑		
3:10,6* ↗	8: 9,3 ↗	Sum	95,0
4:10,4* ↘	9:10,9* ↘		
5:10,4* →	10: 8,7 →		

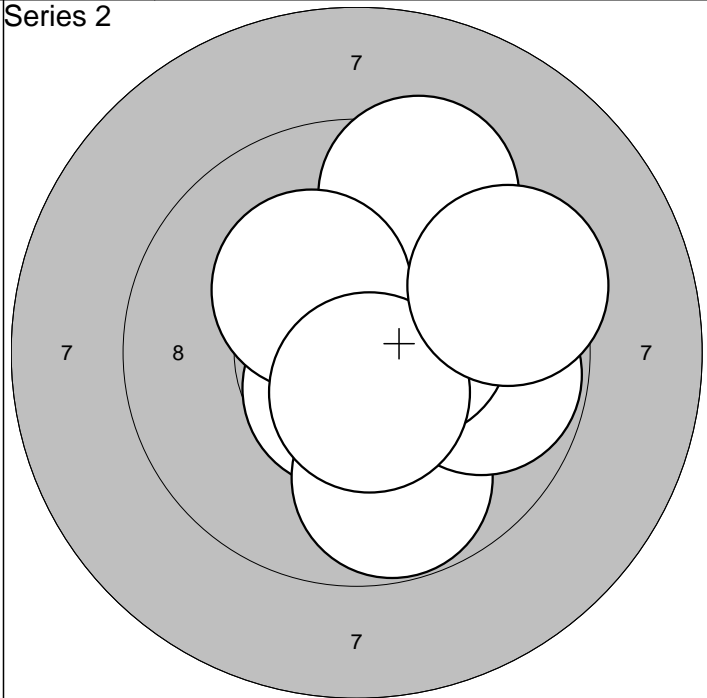

1:10,6* ↓	6:10,4* →	Serie	96,0
2: 9,8 ↓	7: 9,4 ↑		
3:10,6* ↗	8:10,3* ↖	Sum	191,0
4:10,7* ↘	9:10,6* ↘		
5: 9,8 →	10: 9,5 ↗		

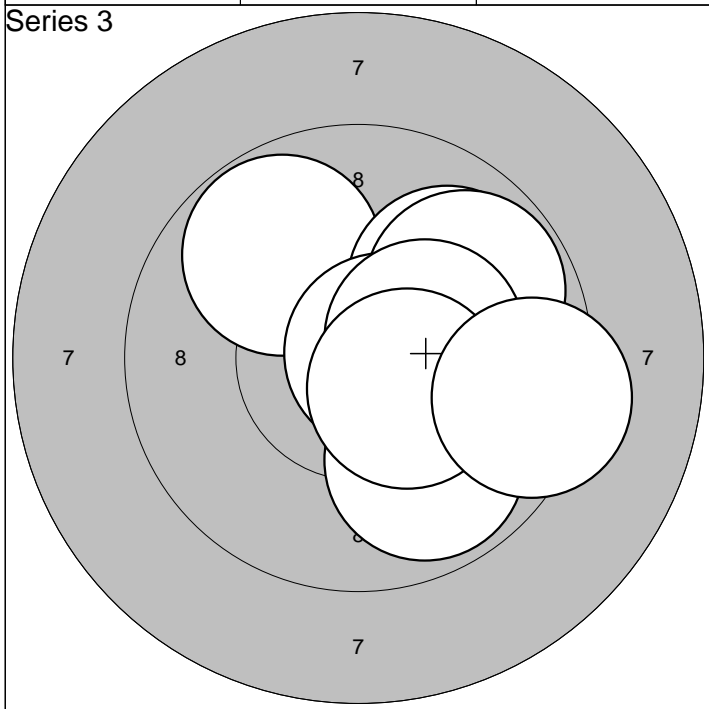

1: 9,8 ↖	6: 9,8 ↗	Serie	95,0
2:10,0 →	7:10,3* →		
3: 9,9 ↗	8: 9,8 ↘	Sum	286,0
4:10,7* →	9:10,4* ↘		
5:10,4* →	10: 9,3 →		

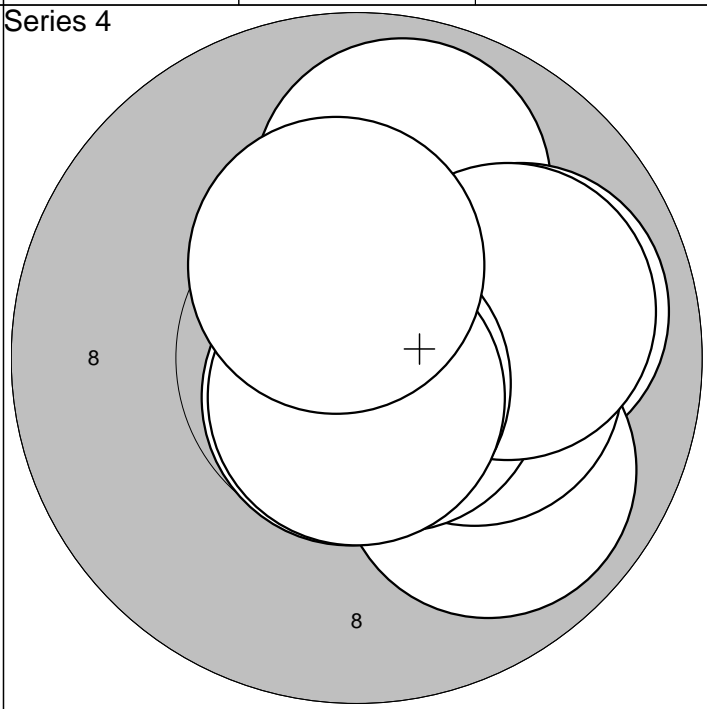

1: 9,9 ↑	6:10,7* ↘	Serie	97,0
2: 9,9 →	7:10,0 →		
3:10,7* ↓	8:10,8* ↘	Sum	383,0
4: 9,9 ↘	9:10,7* ↘		
5:10,2* →	10:10,4* ↑		

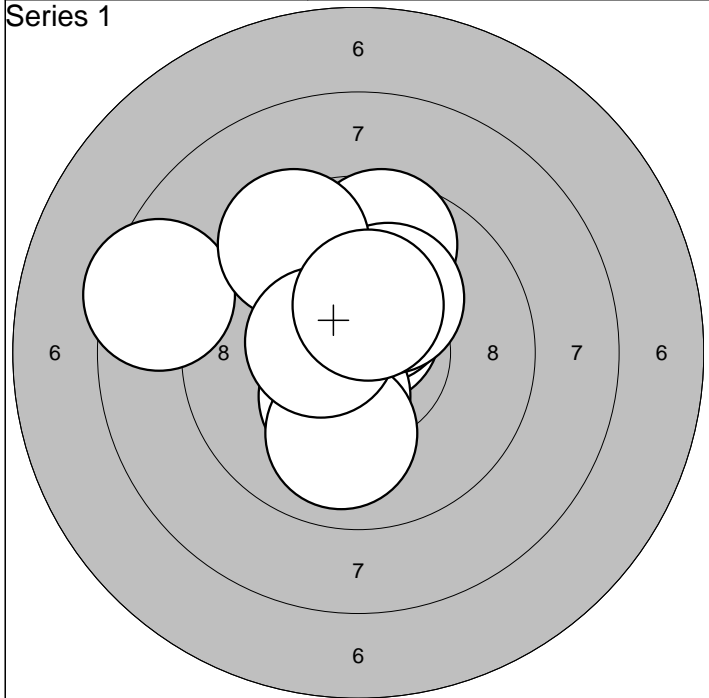

1: 9,7	↑	6:10,2*	↗			Serie	96,0
2:10,7*	↑	7: 9,5	↖				
3:10,4*	↗	8:10,0	↓			Sum	96,0
4: 8,5	←	9:10,5*	↖				
5:10,4*	↘	10:10,4*	↑				

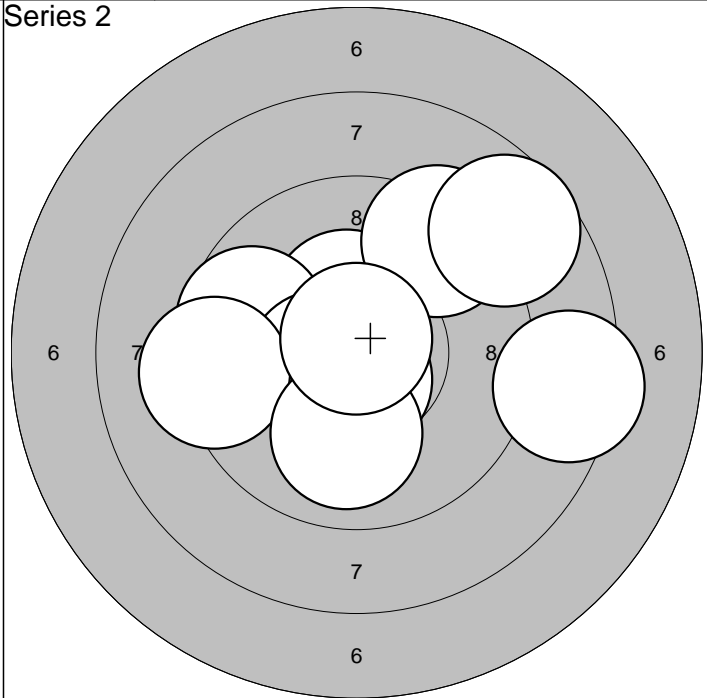

1:10,4*	↑	6: 8,7	↗			Serie	93,0
2: 9,6	←	7: 9,2	←				
3:10,5*	↖	8:10,0	↓			Sum	189,0
4: 9,3	↗	9:10,8*	↑				
5:10,6*	↓	10: 8,4	→				

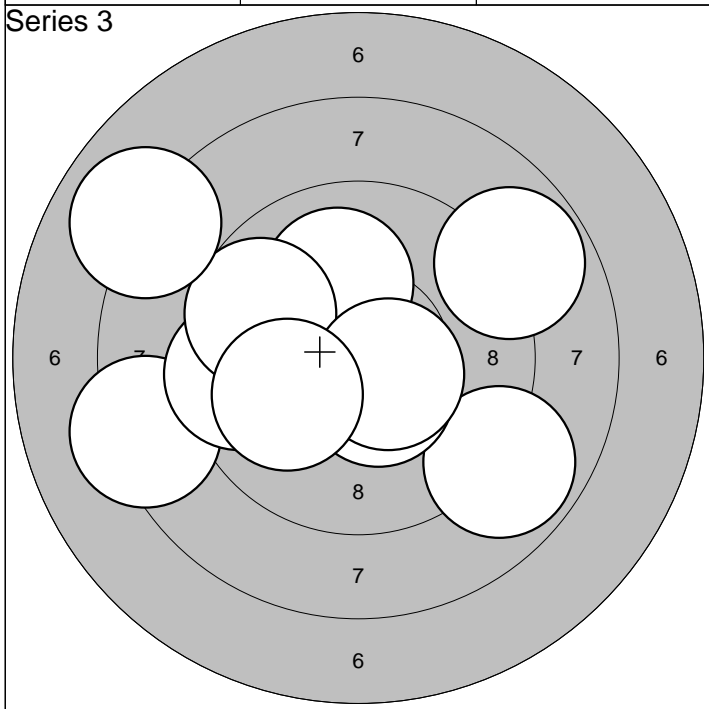

1: 8,3	←	6:10,5*	↘			Serie	90,0
2:10,0	↑	7: 9,7	↖				
3: 9,6	←	8: 8,0	↖			Sum	279,0
4: 8,9	↗	9:10,5*	↘				
5: 8,9	↘	10:10,0	←				

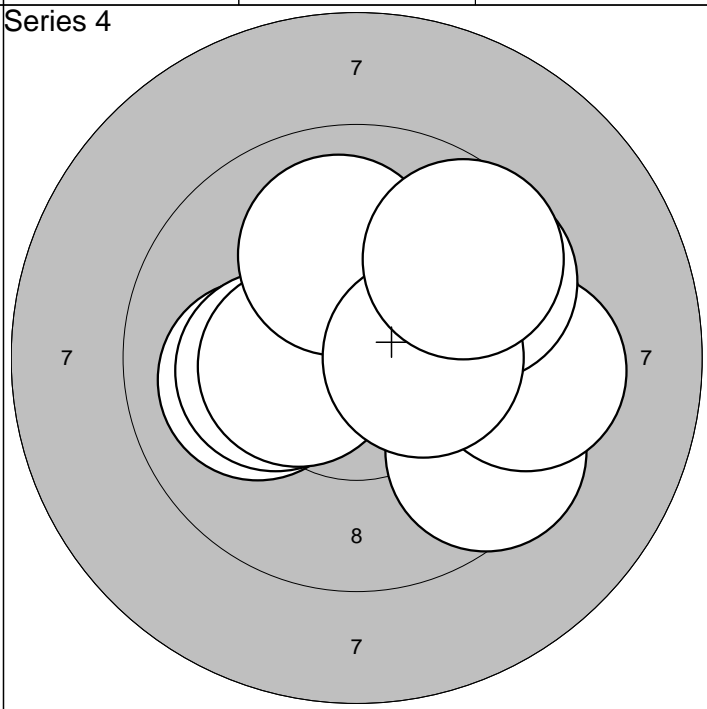

1:10,0	←	6: 9,4	→			Serie	96,0
2:10,2*	←	7:10,0	↑				
3:10,6*	↑	8: 9,7	↗			Sum	375,0
4: 9,5	↘	9:10,4*	→				
5:10,4*	←	10: 9,7	↗				

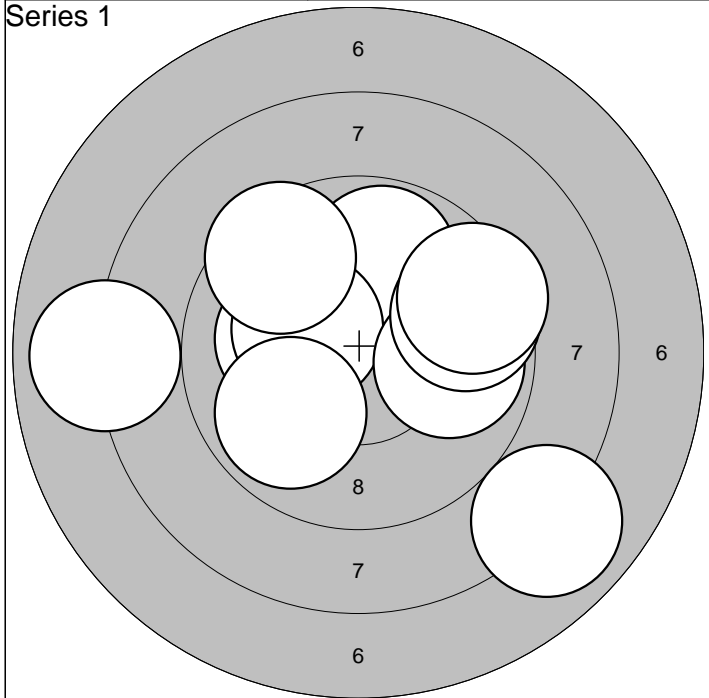

1:10,2* ←	6: 9,5 ↗	Serie	89,0
2: 9,8 ↑	7: 7,9 ↘		
3:10,3* ←	8: 9,4 →	Sum	89,0
4: 9,9 →	9: 9,9 ↙		
5: 9,6 →	10: 8,0 ←		

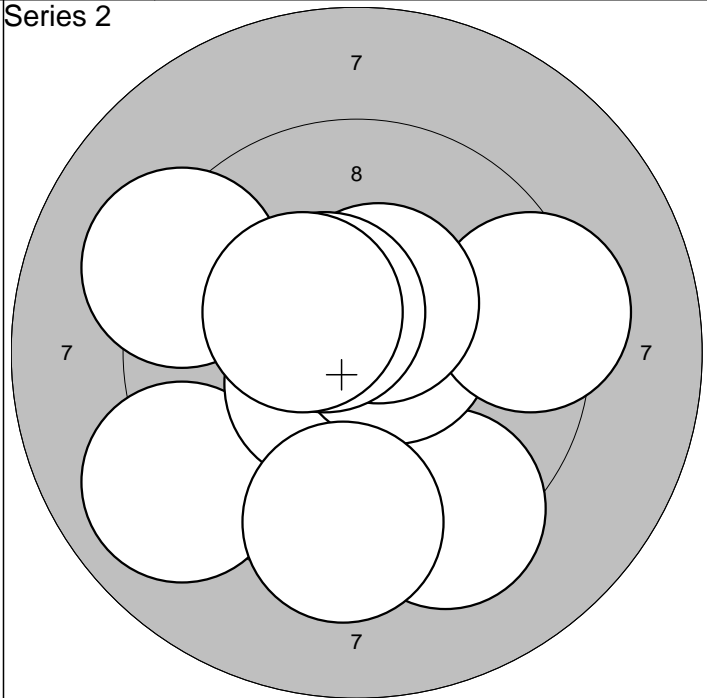

1: 9,0 ↙	6: 9,3 →	Serie	95,0
2: 9,3 ↘	7: 9,4 ↓		
3:10,5* ↙	8:10,5* ↑	Sum	184,0
4:10,6* →	9:10,5* ↗		
5: 9,2 ↖	10:10,3* ↖		

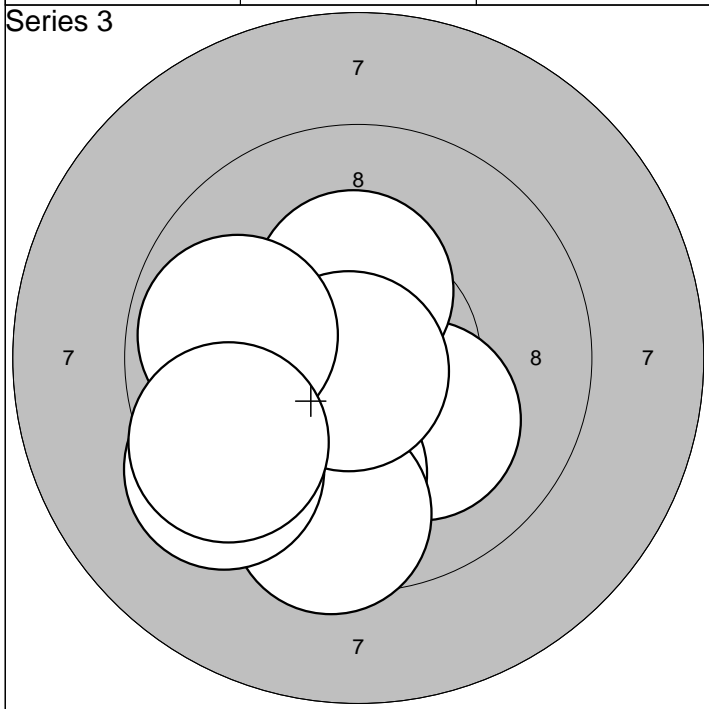

1:10,2* ↘	6: 9,4 ↙	Serie	95,0
2: 9,9 ↓	7:10,4* ↑		
3:10,6* ↗	8:10,8* ↘	Sum	279,0
4:10,4* ←	9: 9,9 ←		
5: 9,5 ↓	10: 9,5 ↙		

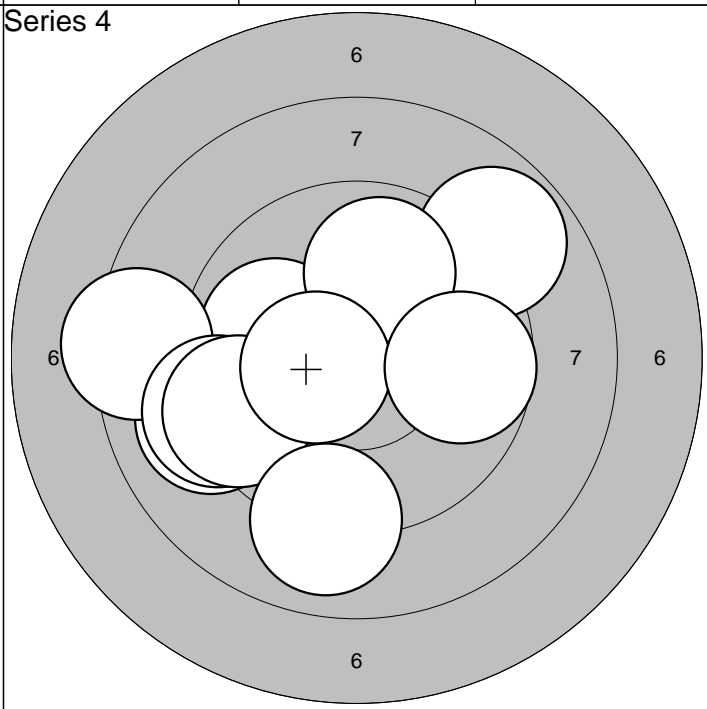

1: 9,1 ↖	6: 8,9 ↗	Serie	89,0
2: 9,9 ↖	7: 9,9 ↑		
3: 8,4 ↖	8: 9,0 ↓	Sum	368,0
4: 9,2 ↖	9:10,5* ←		
5: 9,4 ↖	10: 9,7 →		

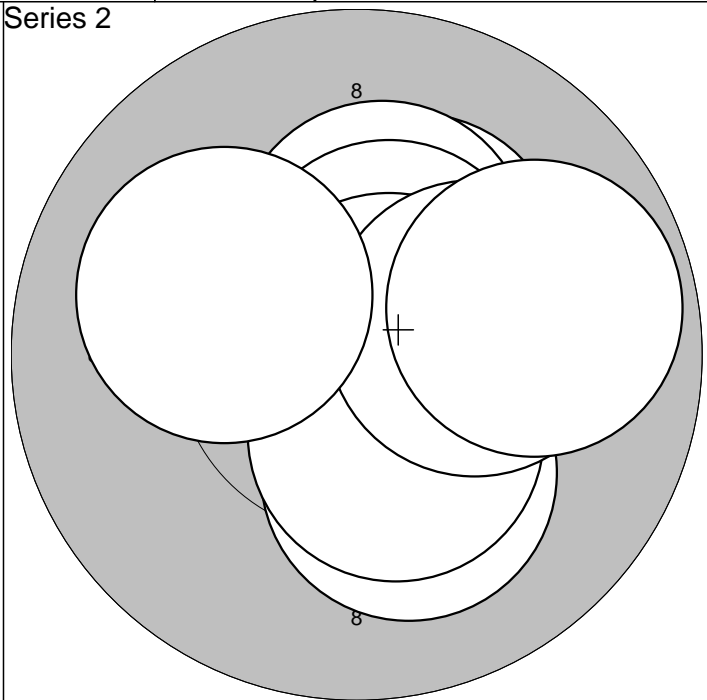
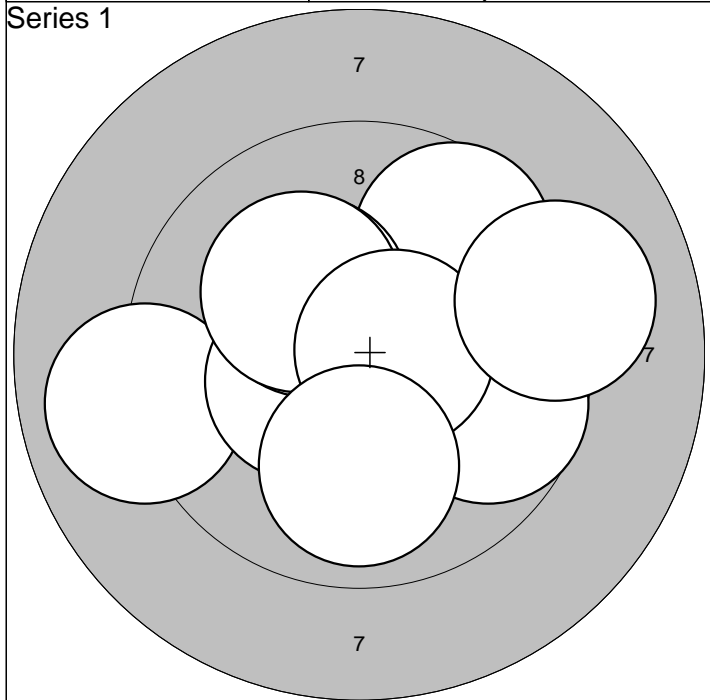

1: 9,0 ↙	6: 9,7 →	Serie	95,0
2:10,4* ↙	7:10,2* ↗		
3:10,6* ↘	8:10,6* →	Sum	95,0
4: 9,6 ↗	9: 9,9 ↓		
5:10,3* ↖	10: 9,1 →		

1:10,7* ↑	6:10,7* →	Serie	99,0
2:10,3* ↗	7:10,4* ↘		
3:10,3* ↑	8:10,2* →	Sum	194,0
4:10,5* ↗	9:10,1 ↙		
5:10,2* ↘	10: 9,8 →		

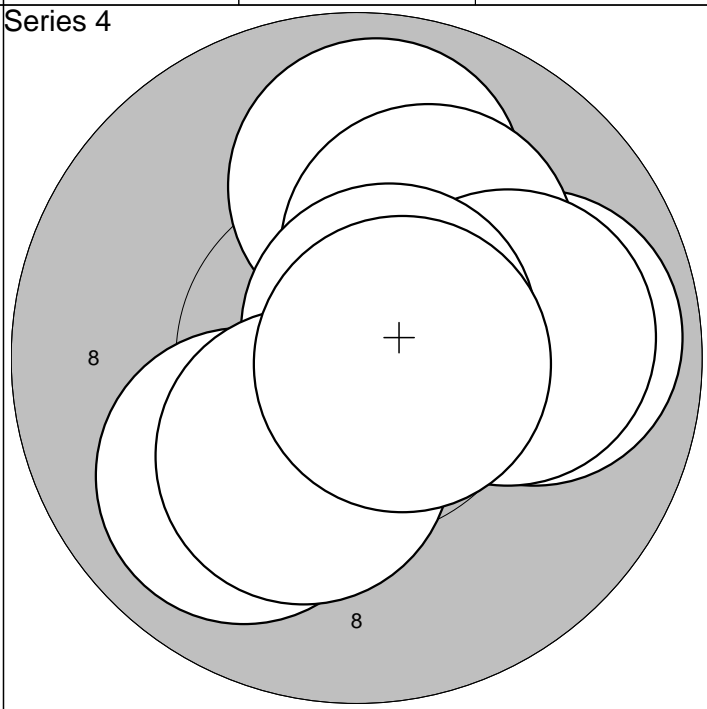
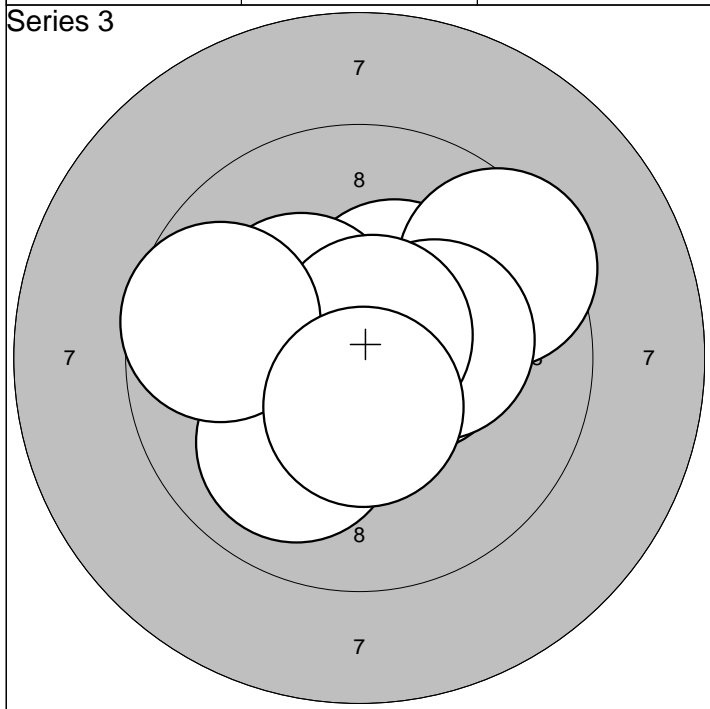

1:10,3* ↗	6:10,0 ↘	Serie	98,0
2:10,3* ↖	7:10,9* →		
3:10,5* →	8:10,7* ↗	Sum	292,0
4: 9,5 ↗	9: 9,7 ↖		
5:10,3* →	10:10,5* ↓		

1:10,5* ↗	6:10,2* ↗	Serie	98,0
2:10,0 ↘	7:10,0 →		
3:10,6* ↗	8:10,7* ↗	Sum	390,0
4: 9,9 ↑	9:10,3* ↘		
5: 9,8 →	10:10,6* →		

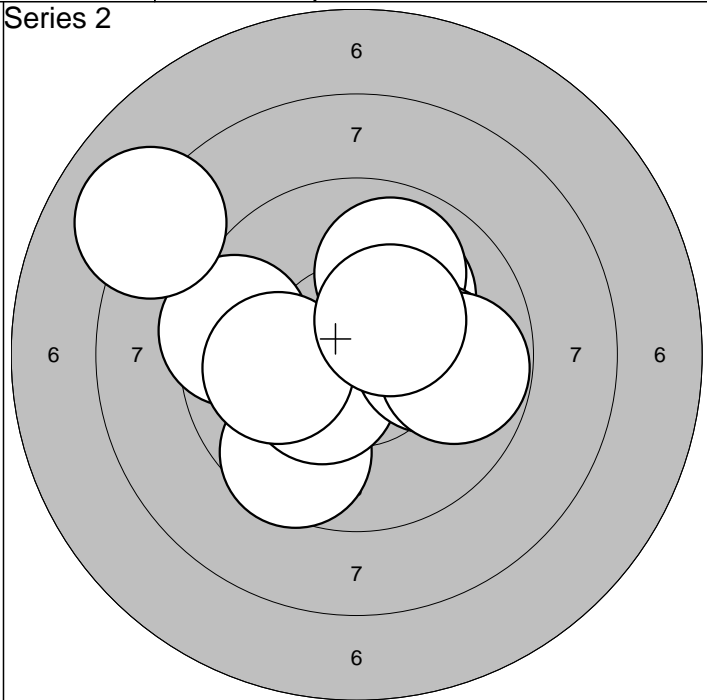
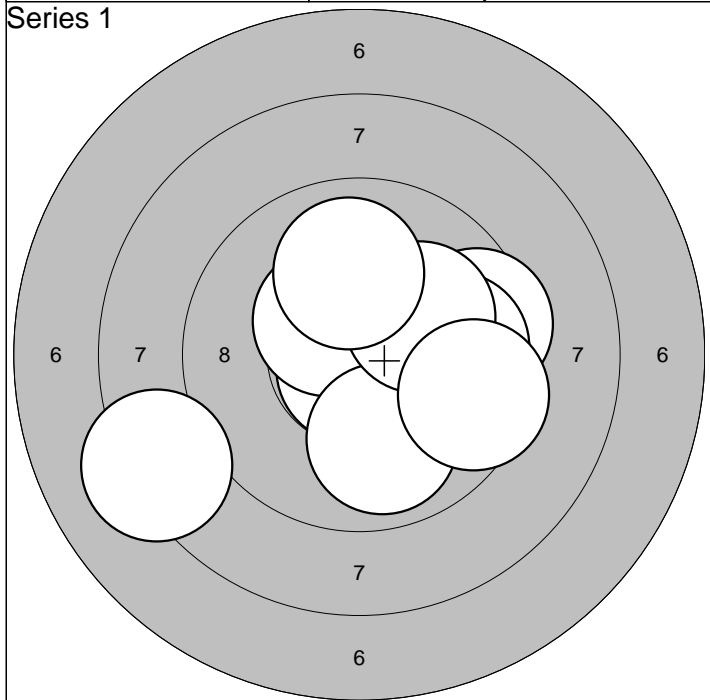

1: 9,5 →	6: 9,8 →		Serie	93,0
2: 10,8* ↓	7: 9,9 ↓			
3: 8,2 ←	8: 10,1 →		Sum	93,0
4: 10,4* ↗	9: 10,0 ↑			
5: 9,9 →	10: 9,5 →			

1: 10,1 ↗	6: 10,4* ↙		Serie	94,0
2: 9,5 ←	7: 10,1 →			
3: 8,0 ↖	8: 9,8 →		Sum	187,0
4: 9,6 ↓	9: 10,0 ←			
5: 9,9 ↗	10: 10,4* ↗			

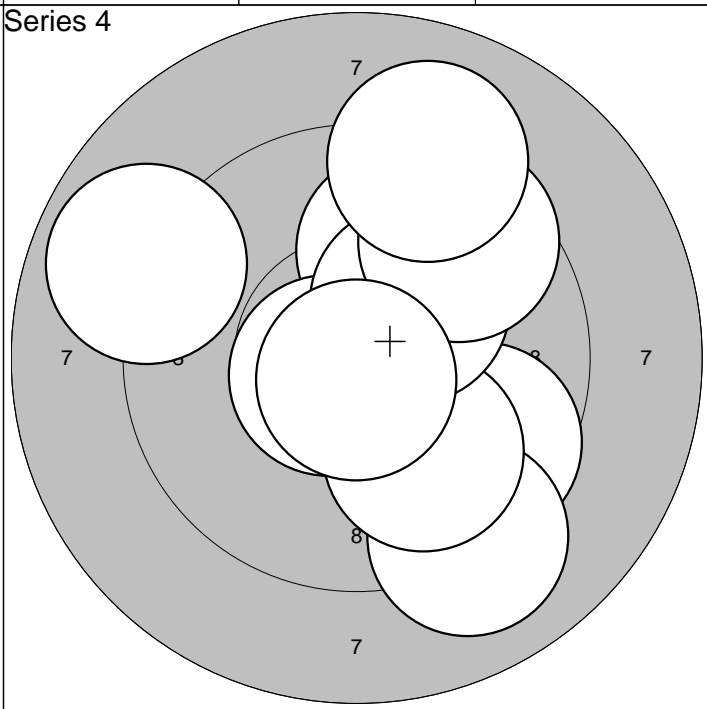
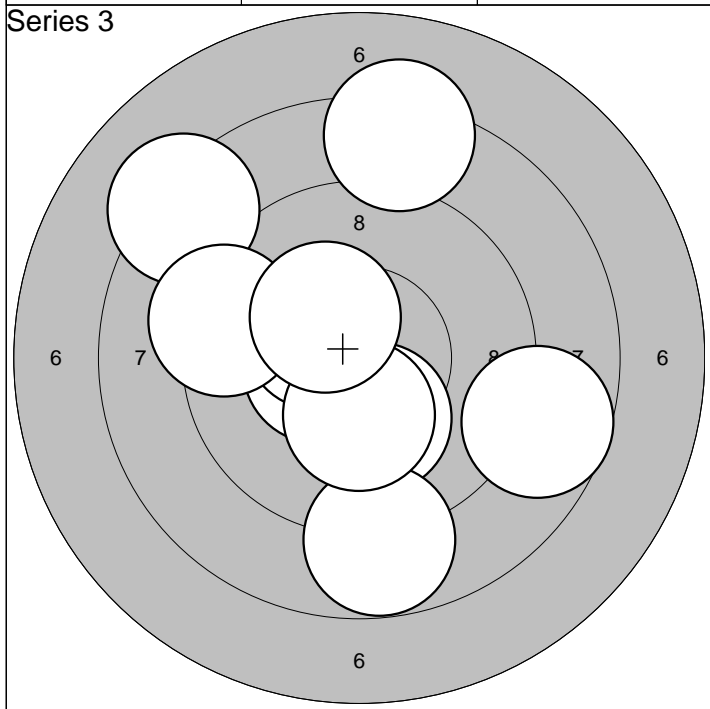

1: 10,5* ←	6: 10,4* ↖		Serie	91,0
2: 10,2* ↓	7: 9,3 ←			
3: 8,7 →	8: 8,8 ↓		Sum	278,0
4: 8,3 ↑	9: 10,3* ↓			
5: 8,2 ↖	10: 10,3* ↗			

1: 9,9 ↗	6: 10,3* ↗		Serie	92,0
2: 9,6 ↘	7: 9,5 ↗			
3: 10,7* ↖	8: 10,8* ↓		Sum	370,0
4: 9,0 ↓	9: 9,1 ↗			
5: 9,9 ↓	10: 8,9 ↖			

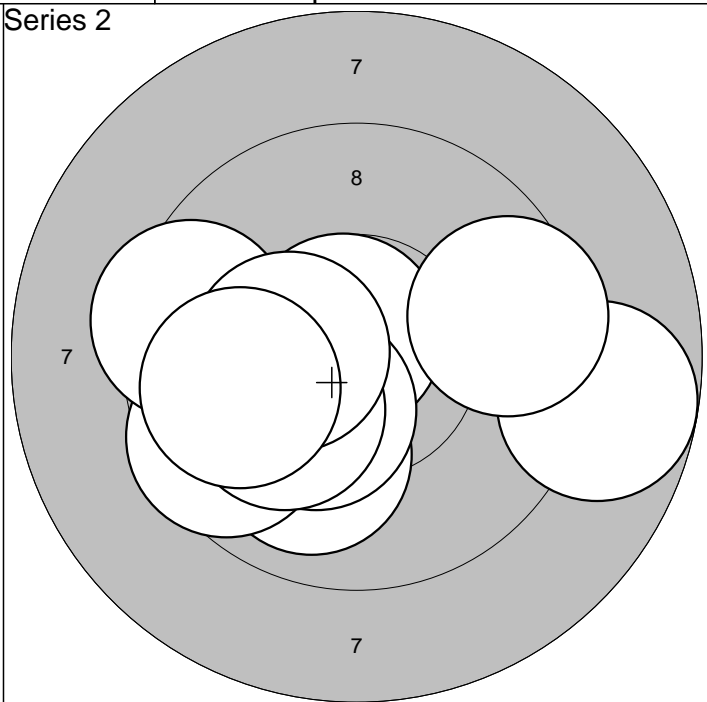
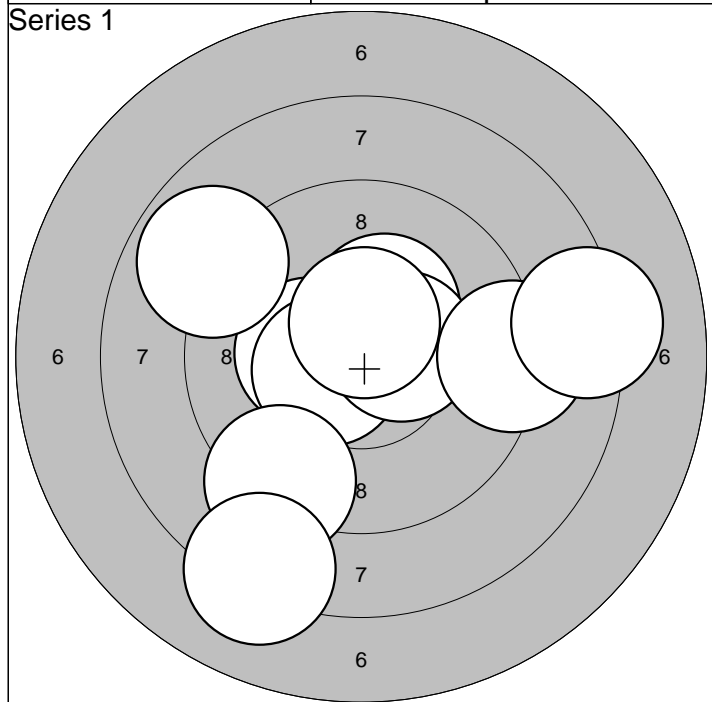

1:10,3* ↗	6: 9,2 ↘	Serie	92,0
2:10,3* ←	7: 9,1 →		
3:10,5* ←	8: 8,2 →	Sum	92,0
4:10,5* →	9: 8,2 ↘		
5:10,5* ↑	10: 8,9 ↖		

1:10,7* ↗	6:10,4* ↘	Serie	94,0
2:10,0 ↘	7:10,1 ↙		
3: 8,8 →	8:10,3* ←	Sum	186,0
4: 9,6 ↙	9: 9,5 →		
5: 9,4 ←	10: 9,9 ←		

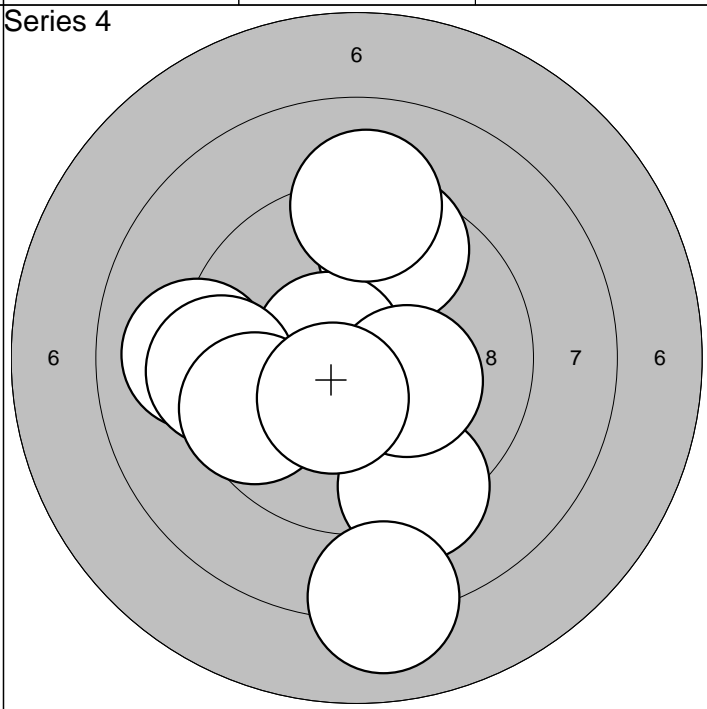
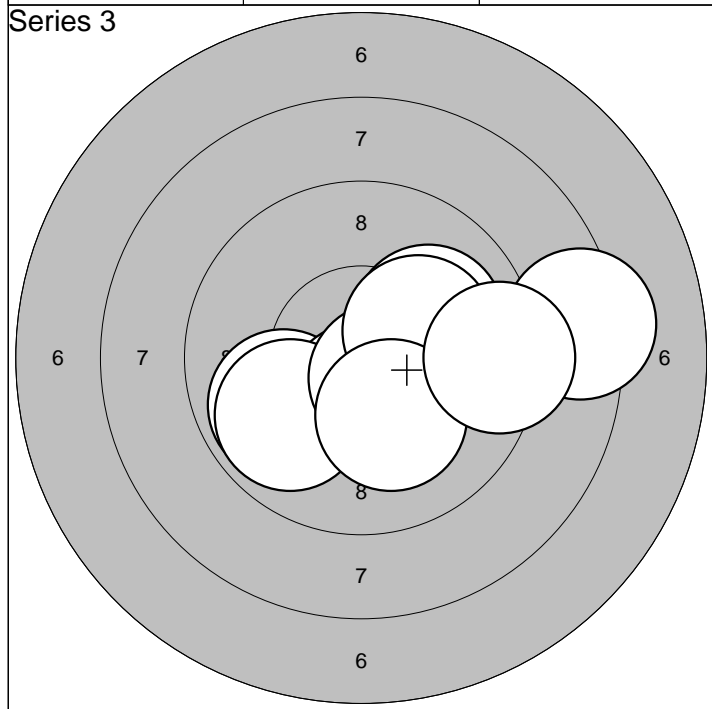

1: 9,9 ↙	6:10,6* ↘	Serie	95,0
2:10,2* →	7:10,0 →		
3:10,5* ↓	8:10,2* →	Sum	281,0
4: 9,9 ↙	9:10,2* ↘		
5: 8,3 →	10: 9,3 →		

1: 9,6 ↑	6: 9,3 ←	Serie	92,0
2: 9,1 ←	7:10,3* →		
3:10,6* ↙	8: 9,6 ↙	Sum	373,0
4: 9,1 ↑	9:10,4* ↘		
5: 9,3 ↘	10: 8,1 ↓		

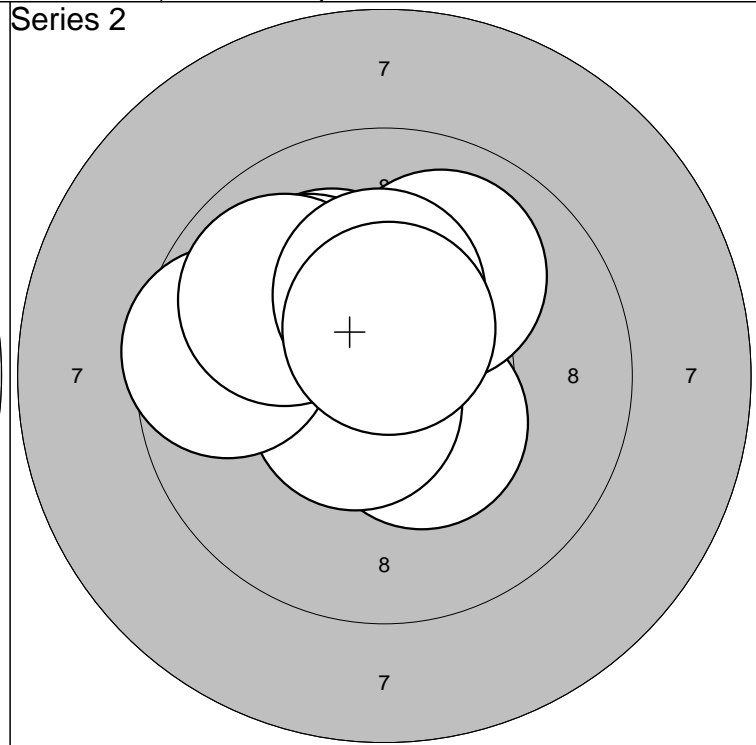
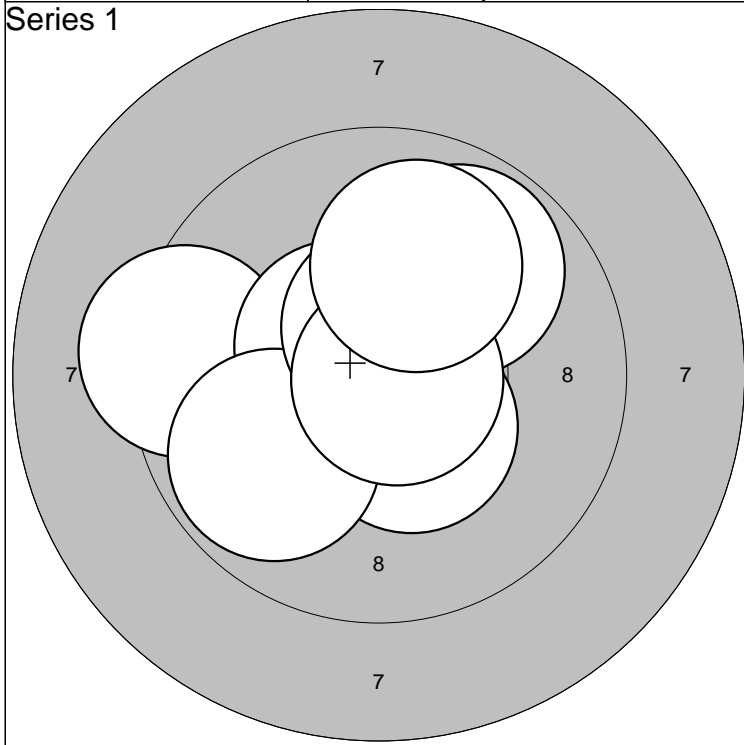

1:10,4* ←	6:10,5* ↖	Serie	97,0
2: 9,8 ↗	7: 9,8 ↙		
3:10,3* ←	8:10,5* ↑	Sum	97,0
4: 9,3 ←	9:10,8* →		
5:10,4* ↘	10:10,0 ↑		

1:10,1 ↗	6:10,6* ↙	Serie	98,0
2:10,5* ↗	7: 9,6 ←		
3:10,4* ↘	8: 9,9 ↖	Sum	195,0
4:10,0 ↗	9:10,3* ↑		
5:10,0 ↗	10:10,6* ↑		

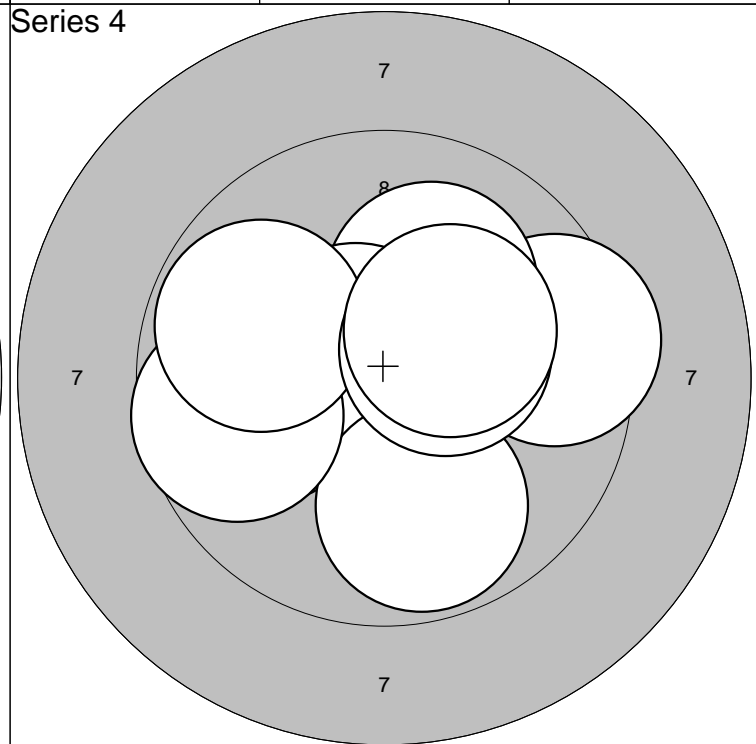
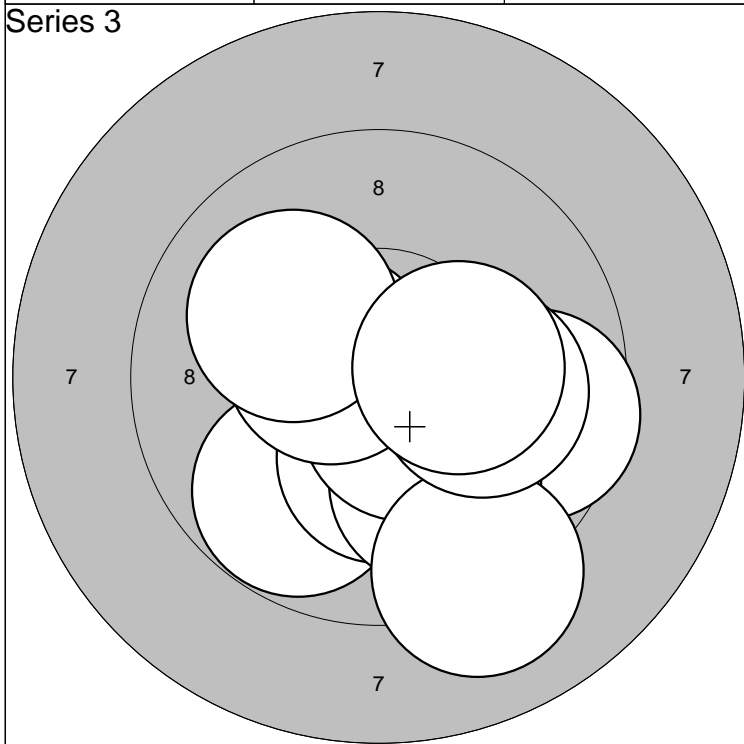

1: 9,6 →	6:10,5* ↖	Serie	97,0
2: 9,7 ↘	7:10,1 ↗		
3:10,3* ↘	8: 9,1 ↘	Sum	292,0
4:10,0 ↘	9:10,1 →		
5:10,6* ↘	10:10,3* →		

1:10,7* ↗	6: 9,8 ↘	Serie	95,0
2: 9,5 →	7: 9,7 ←		
3:10,1 ↗	8: 9,8 ←	Sum	387,0
4: 9,9 ←	9:10,4* →		
5:10,6* ↖	10:10,3* ↗		

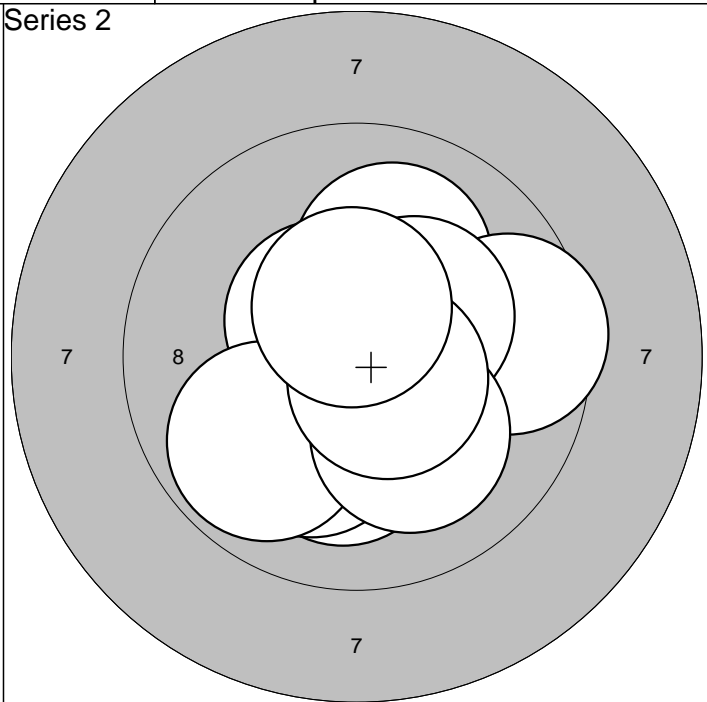
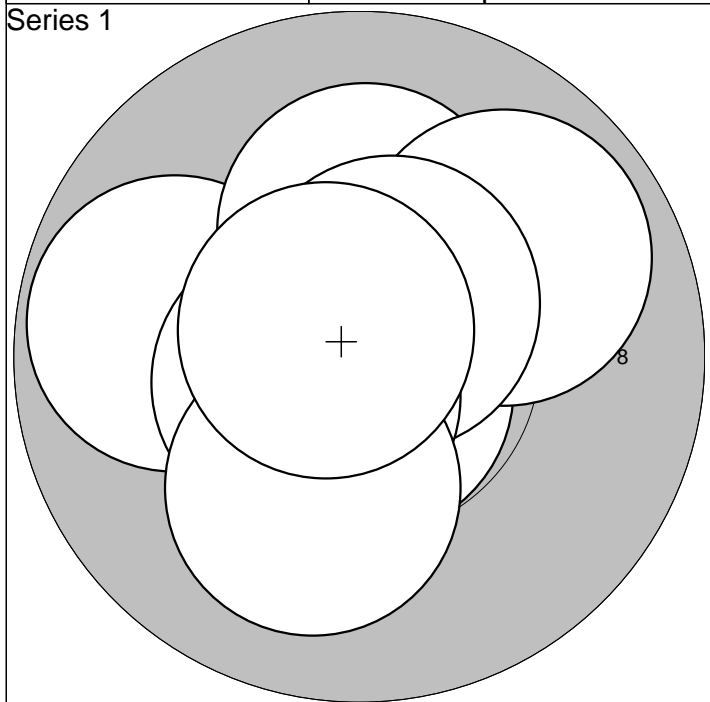

1:10,7* ↓	6:10,6* ↗	Serie	98,0
2:10,6* ↑	7:10,6* ↙		
3: 9,8 ←	8:10,5* ←	Sum	98,0
4:10,2* ↑	9:10,1 ↓		
5: 9,9 ↗	10:10,7* ↖		

1:10,1 ↗	6: 9,8 ↙	Serie	98,0
2: 9,6 →	7:10,3* ↗		
3:10,1 ↓	8:10,1 ↓	Sum	196,0
4:10,5* ↖	9:10,6* ↘		
5:10,1 ↓	10:10,5* ↑		

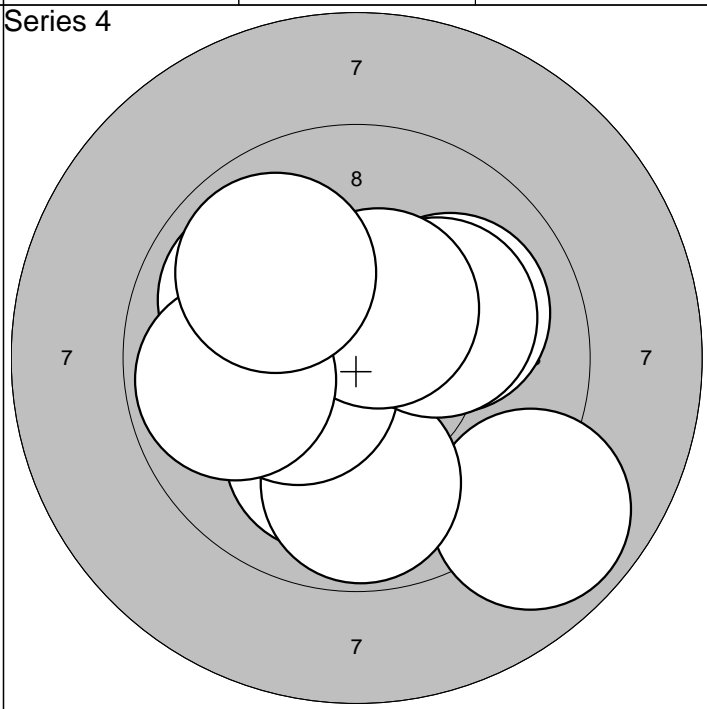
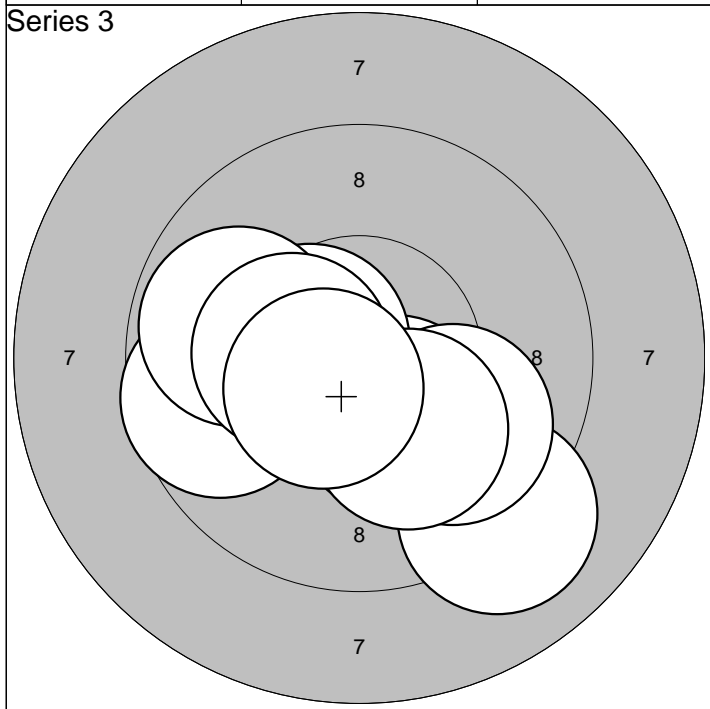

1:10,3* ↓	6: 9,9 ↓	Serie	96,0
2: 9,1 ↓	7:10,2* ↓		
3:10,5* ←	8: 9,8 ←	Sum	292,0
4:10,2* ←	9:10,3* ←		
5: 9,7 ←	10:10,5* ↙		

1:10,0 ↗	6:10,4* ↙	Serie	94,0
2: 9,9 ↖	7:10,2* ↗		
3: 8,9 ↘	8:10,5* ↑	Sum	386,0
4:10,1 ↓	9: 9,8 ←		
5: 9,8 ↓	10: 9,9 ↖		

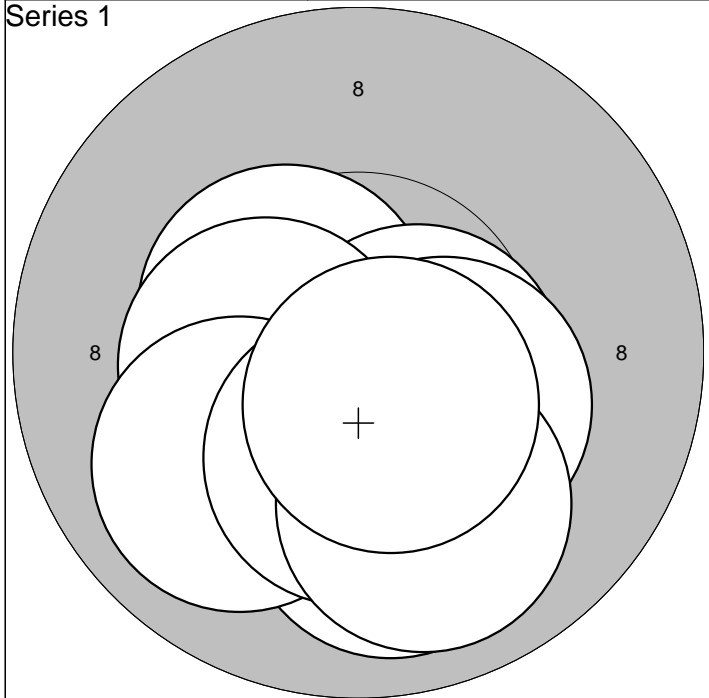

1:10,5* ↖	6:10,3* ↘	Serie	100,0
2:10,6* →	7:10,0 ↙		
3:10,0 ↓	8:10,3* ↓	Sum	100,0
4:10,4* ←	9:10,0 ↓		
5:10,5* ↓	10:10,6* ↘		

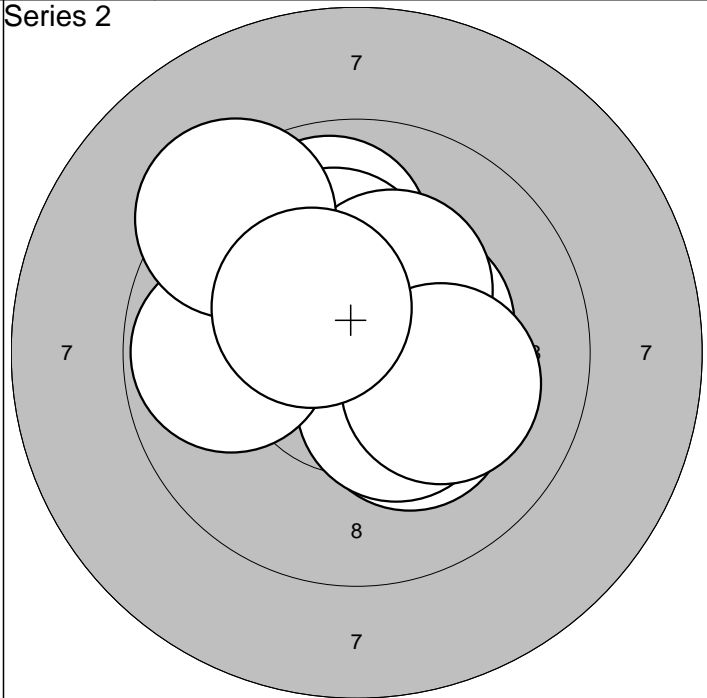

1: 9,9 ↑	6:10,4* ↘	Serie	97,0
2:10,4* →	7:10,1 →		
3:10,2* ↘	8: 9,8 ←	Sum	197,0
4:10,2* ↑	9: 9,3 ↗		
5:10,3* ↗	10:10,4* ↗		

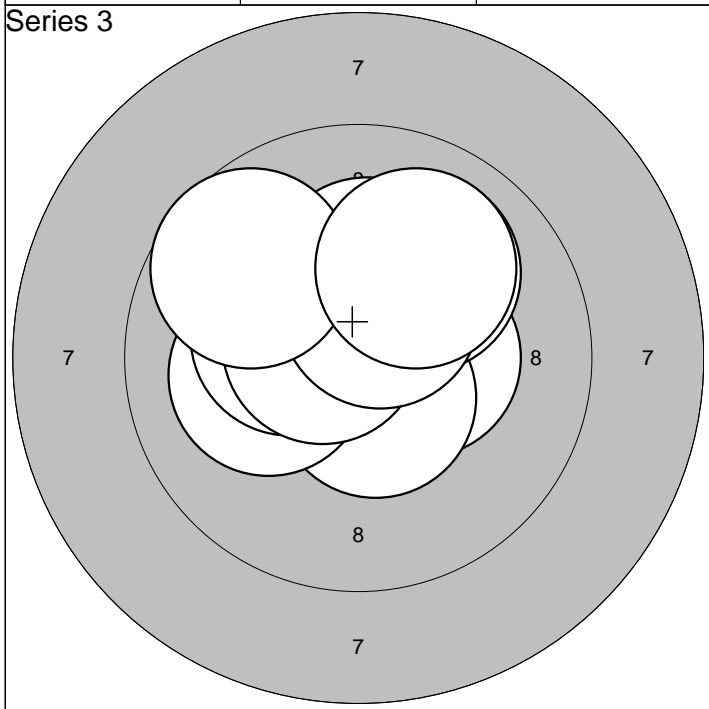

1:10,2* ↑	6:10,3* ←	Serie	99,0
2:10,4* →	7:10,6* ←		
3:10,6* ↘	8:10,5* ↗	Sum	296,0
4:10,1 ←	9: 9,7 ↖		
5:10,0 ↗	10:10,0 ↗		

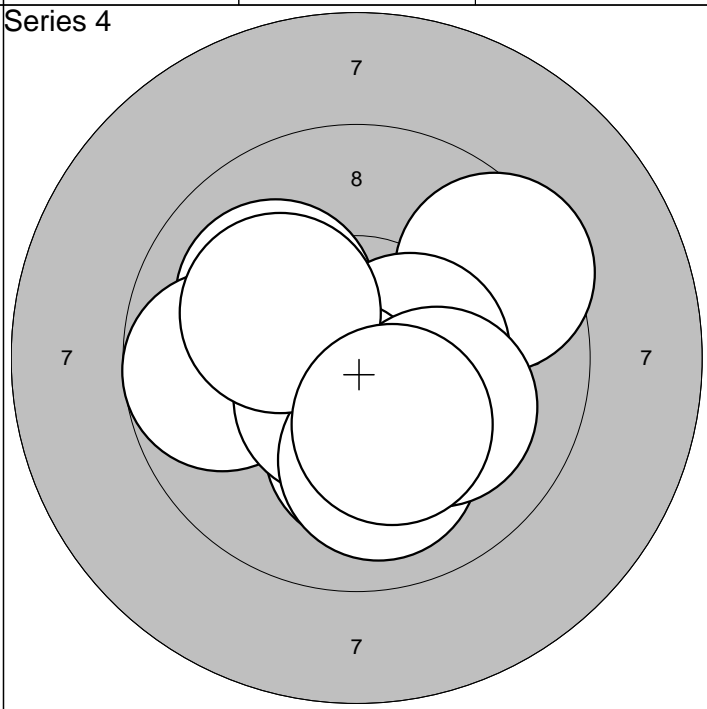

1: 9,5 ↗	6:10,6* ↘	Serie	98,0
2:10,1 ↓	7:10,0 ↓		
3:10,1 ↖	8:10,1 →	Sum	394,0
4: 9,7 ←	9:10,1 ↗		
5:10,5* →	10:10,2* ↓		

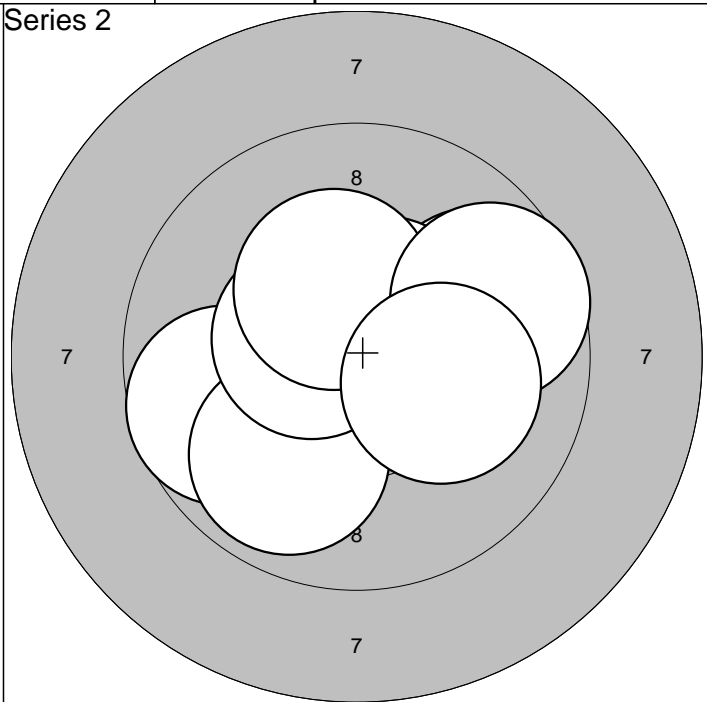
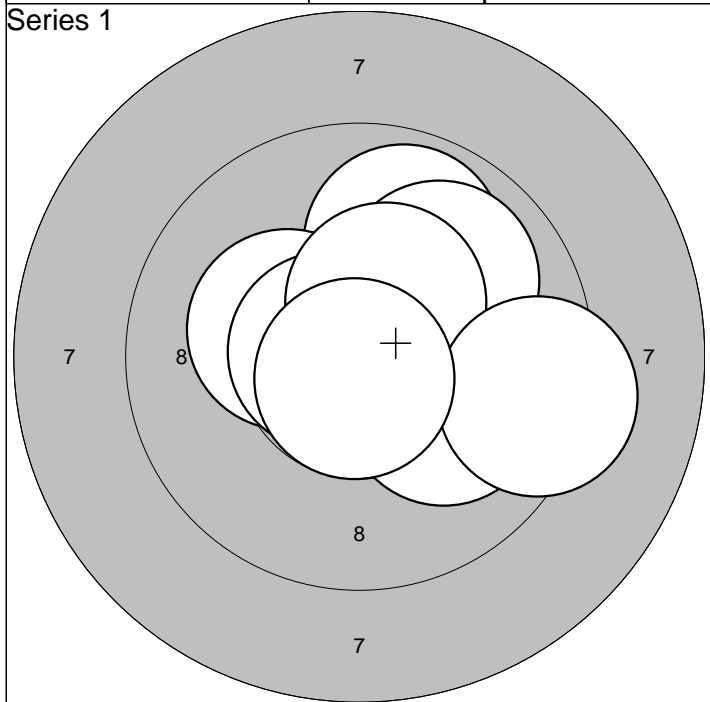

1: 9,9 ↗	6:10,0 ↗	Serie	98,0
2:10,7* →	7:10,7* ←		
3:10,6* ↘	8:10,4* ↗	Sum	98,0
4:10,3* ↖	9: 9,3 →		
5:10,1 ↘	10:10,8* ↓		

1:10,6* ←	6:10,5* ↗	Serie	96,0
2: 9,7 ←	7:10,5* ←		
3: 9,8 →	8:10,3* ↗	Sum	194,0
4:10,9* ↓	9: 9,7 →		
5: 9,9 ↙	10:10,1 →		

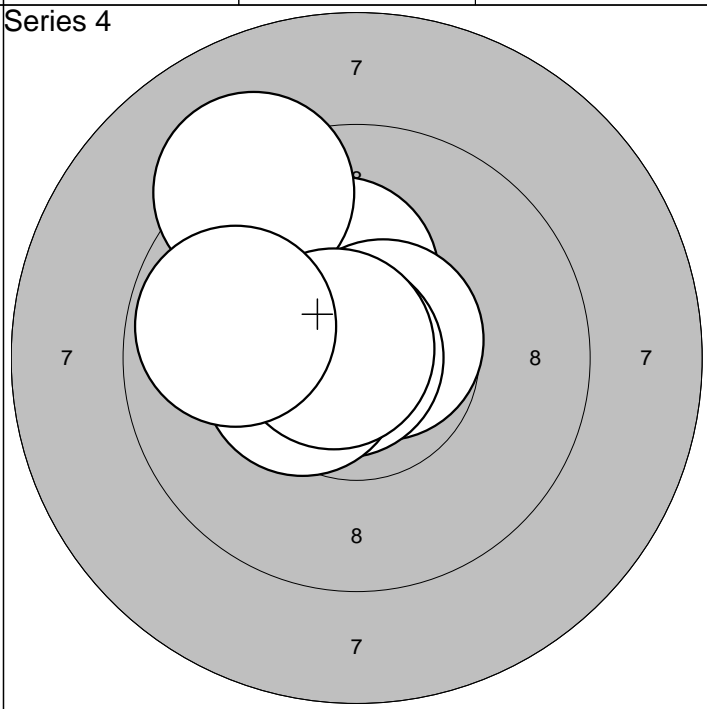
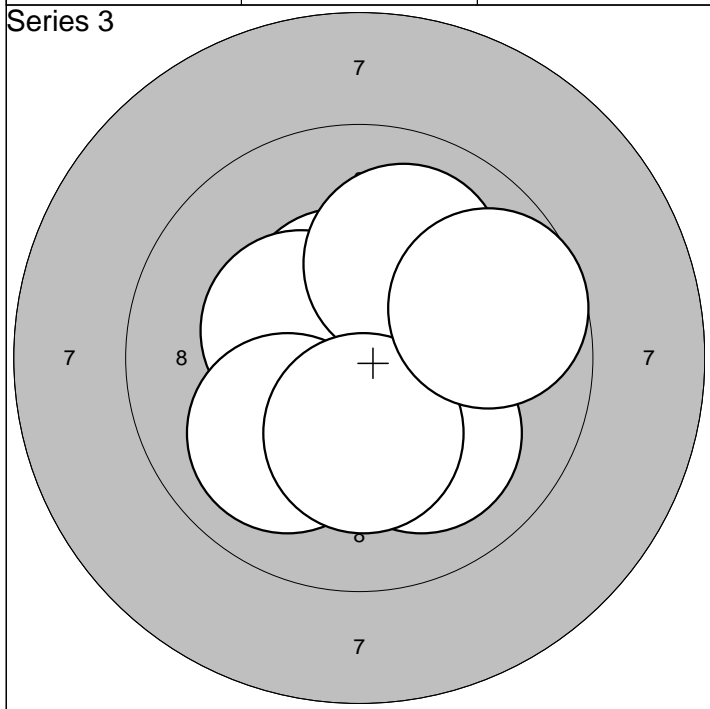

1:10,7* ↗	6:10,4* ←	Serie	99,0
2:10,5* ↗	7:10,0 ↙		
3:10,4* →	8:10,0 ↗	Sum	293,0
4:10,4* ↙	9:10,3* ↓		
5:10,1 ↘	10: 9,7 →		

1: 9,9 ↖	6:10,8* ←	Serie	97,0
2:10,7* ↗	7: 9,2 ↗		
3:10,6* ↗	8:10,4* ←	Sum	390,0
4:10,2* ↗	9:10,8* ←		
5:10,7* ↗	10: 9,8 ←		

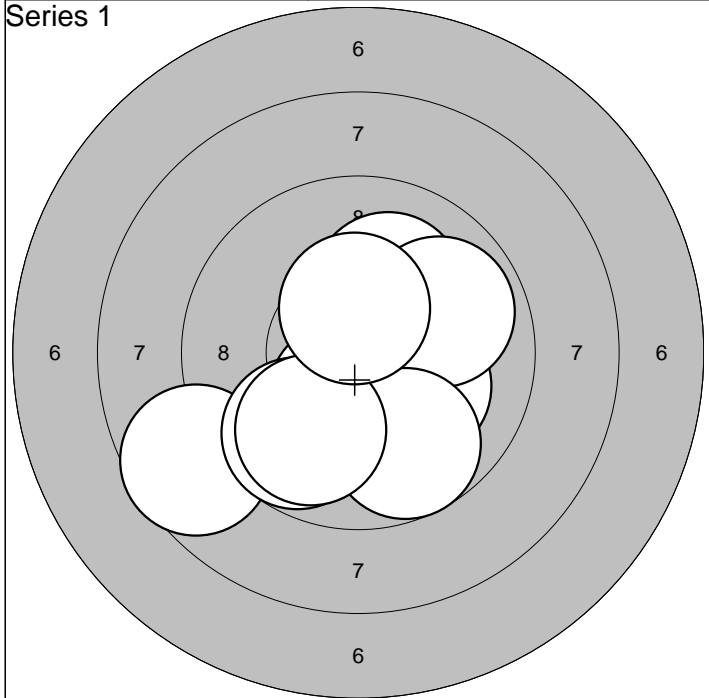

1:10,2* ↘	6: 9,7 ↙	Serie	94,0
2:10,6* →	7: 9,9 →		
3:10,4* ↓	8: 9,7 ↓	Sum	94,0
4:10,1 ↗	9: 9,9 ↙		
5: 8,7 ↙	10:10,4* ↑		

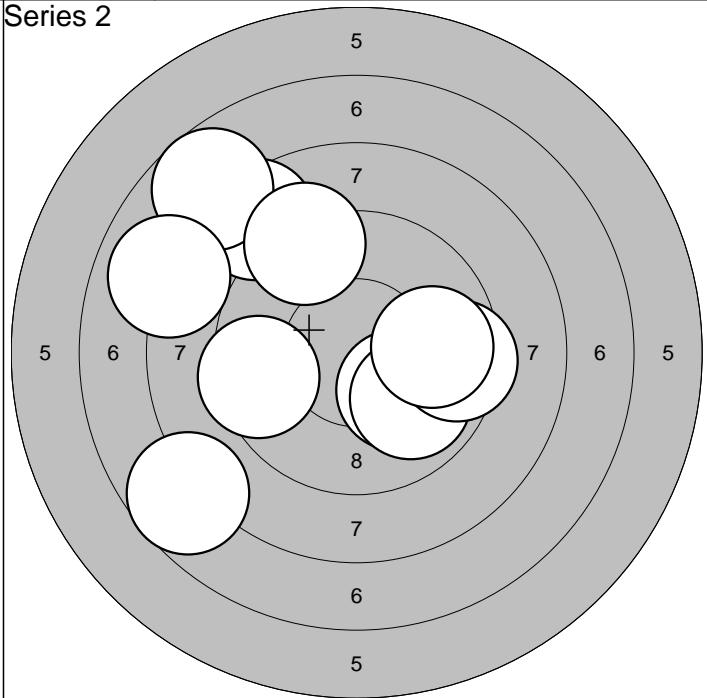

1: 9,4 ←	6: 9,9 ↘	Serie	85,0
2: 8,5 ↗	7: 9,5 →		
3: 7,7 ↗	8: 8,0 ↙	Sum	179,0
4: 9,2 ↗	9: 9,8 →		
5:10,1 ↘	10: 7,7 ↙		

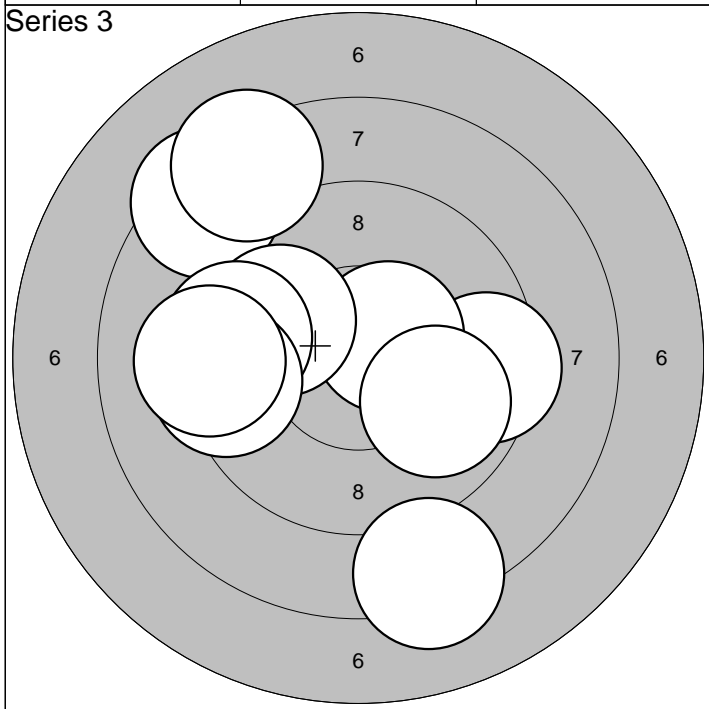

1: 8,4 ↗	6: 8,3 ↓	Serie	88,0
2: 9,4 →	7: 9,9 ↘		
3:10,5* ↗	8: 8,3 ↗	Sum	267,0
4: 9,9 ↙	9: 9,4 ←		
5: 9,5 ←	10: 9,2 ←		

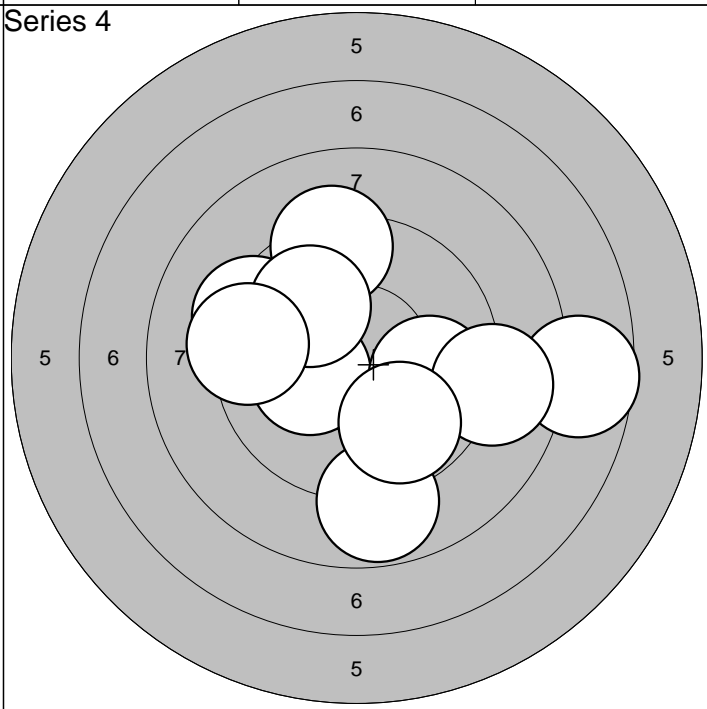

1:10,2* ←	6: 9,8 →	Serie	87,0
2: 8,8 ↓	7: 7,7 →		
3: 9,3 ↗	8: 8,9 →	Sum	354,0
4: 9,3 ↙	9: 9,8 ↘		
5: 9,9 ↗	10: 9,3 ←		

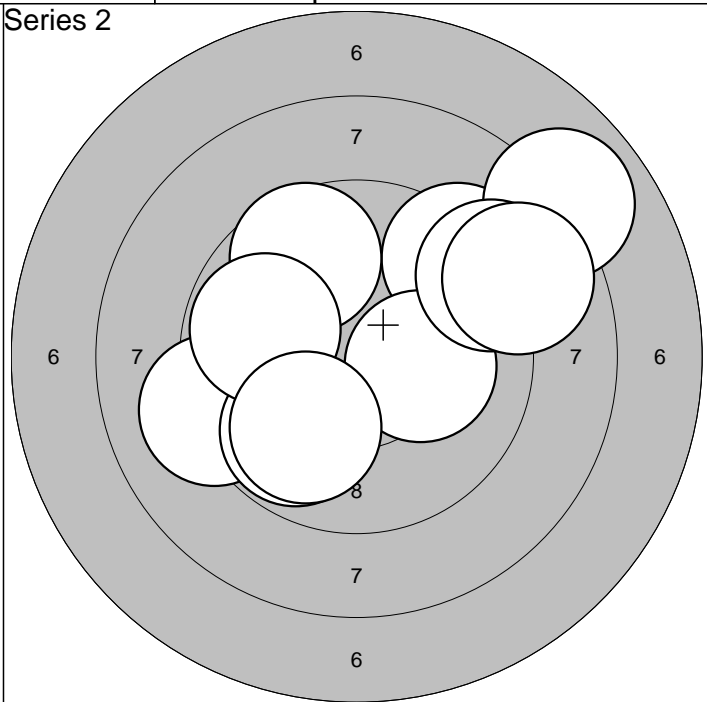
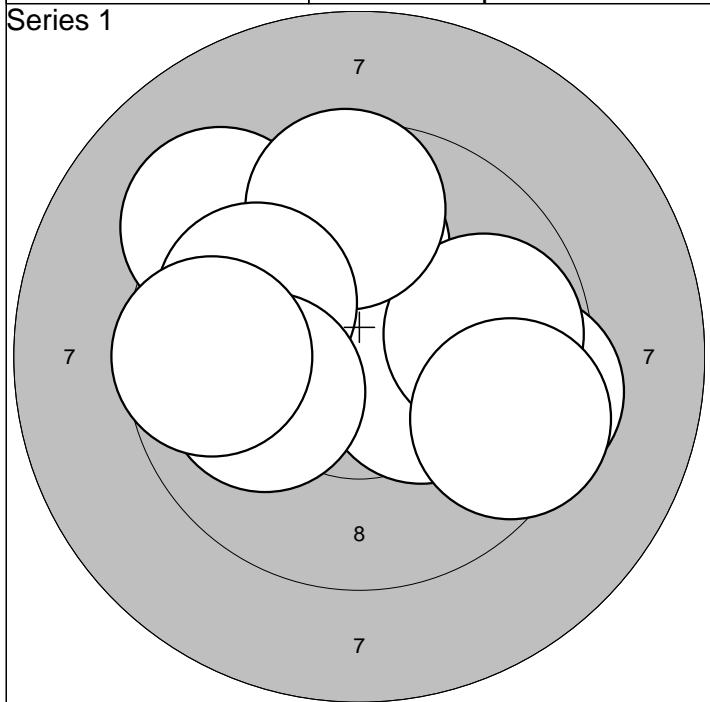

1:10,0	↑	6: 9,5	→	Serie	93,0
2:10,3*	→	7: 9,6	↑		
3: 9,2	↗	8: 9,9	↖	Sum	93,0
4: 9,4	→	9:10,0	←		
5: 9,8	→	10: 9,6	←		

1: 9,3	↗	6: 9,8	↘	Serie	89,0
2:10,2*	→	7: 9,1	↗		
3: 9,1	↖	8: 9,8	↖	Sum	182,0
4: 8,0	↗	9: 8,8	↗		
5: 9,7	↖	10: 9,9	↘		

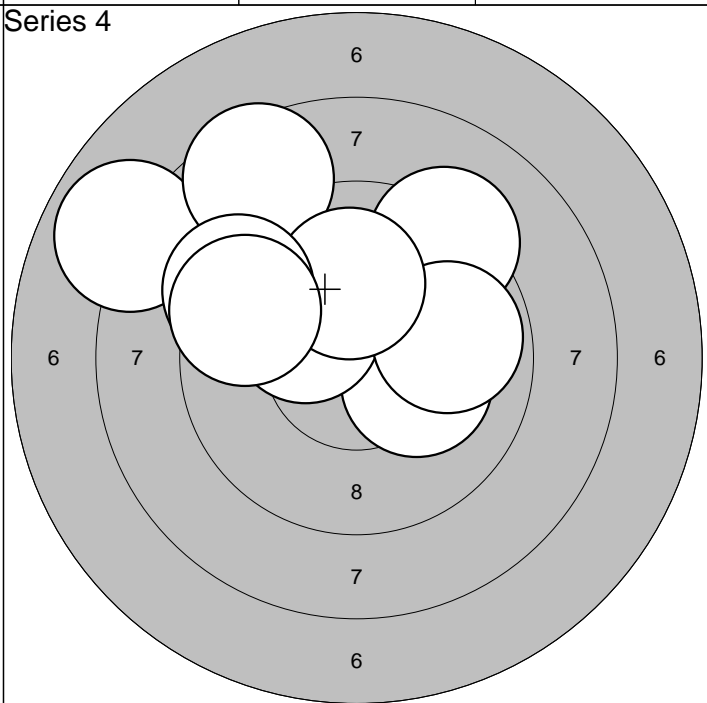
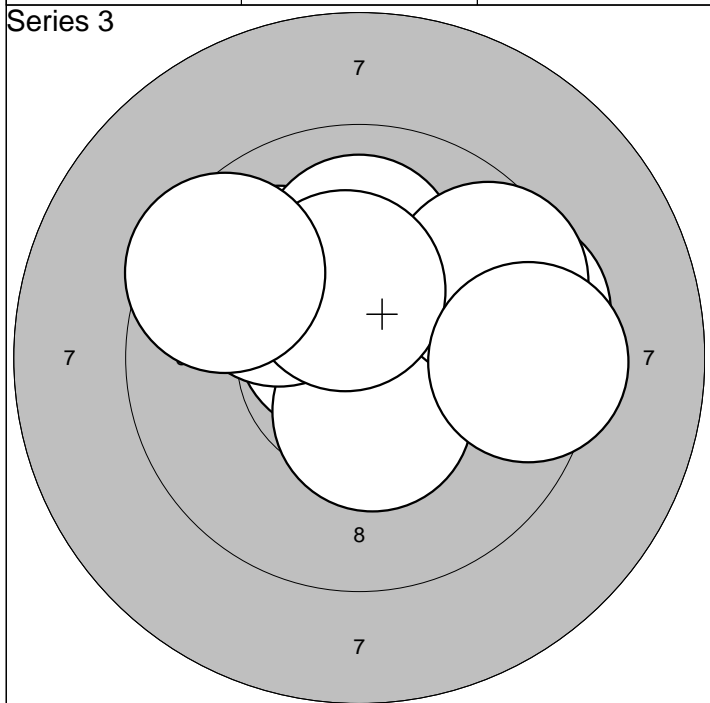

1: 9,5	→	6:10,0	↑	Serie	96,0
2:10,6*	↗	7: 9,6	↗		
3:10,7*	↖	8:10,3*	↑	Sum	278,0
4:10,5*	↓	9: 9,5	↖		
5:10,0	↖	10: 9,4	→		

1:10,1	↗	6: 8,5	↖	Serie	91,0
2:10,2*	→	7: 9,9	→		
3: 7,9	↖	8:10,1	↑	Sum	369,0
4:10,2*	↖	9: 9,3	↖		
5: 9,2	↗	10: 9,5	↖		

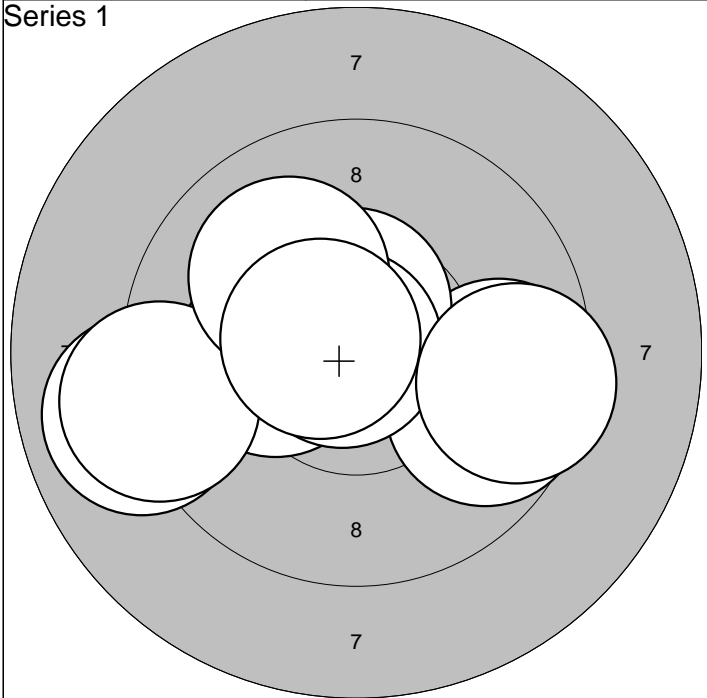

1:10,2* ←	6:10,8* ←	Serie	95,0
2: 9,6 →	7: 9,1 ←		
3: 9,7 →	8:10,0 ↗	Sum	95,0
4: 9,0 ←	9:10,6* ←		
5:10,5* ↑	10: 9,5 →		

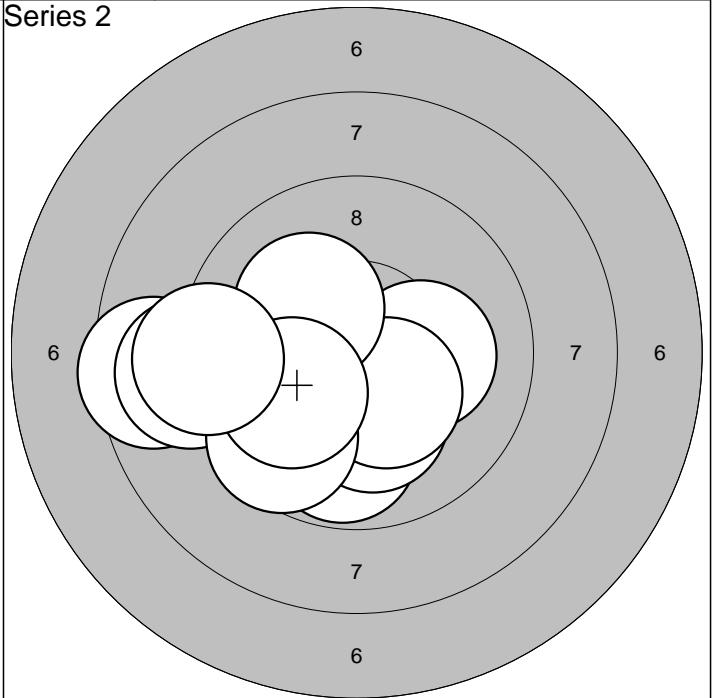

1: 9,8 ↓	6:10,3* ↓	Serie	94,0
2:10,2* ↓	7:10,2* ↖		
3: 8,5 ←	8: 9,6 ↘	Sum	189,0
4:10,2* →	9:10,0 ←		
5: 9,0 ←	10: 9,2 ←		

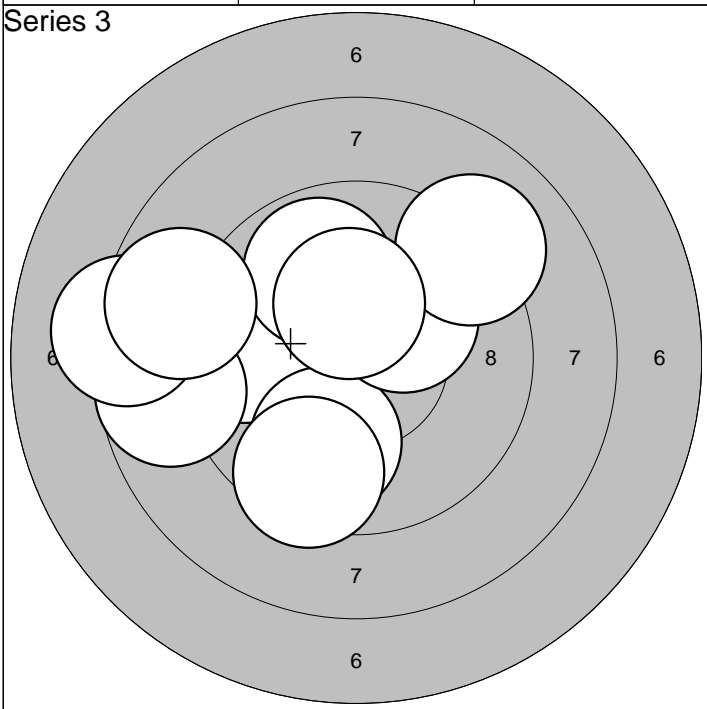

1: 9,6 ←	6: 9,9 ↗	Serie	89,0
2: 9,9 ↓	7: 8,2 ←		
3: 9,5 ↓	8: 9,1 ↗	Sum	278,0
4: 8,7 ←	9:10,3* ↑		
5:10,2* ↗	10: 8,8 ←		

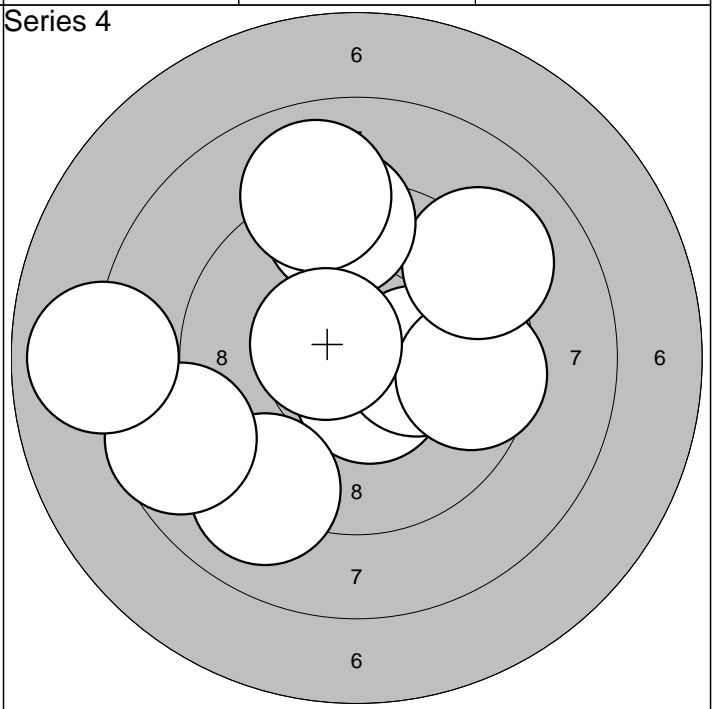

1:10,6* ↓	6: 9,1 ↗	Serie	89,0
2: 9,1 ↓	7: 9,4 ↑		
3:10,2* →	8: 7,9 ←	Sum	367,0
4: 8,6 ←	9: 8,9 ↑		
5: 9,6 →	10:10,6* ↖		

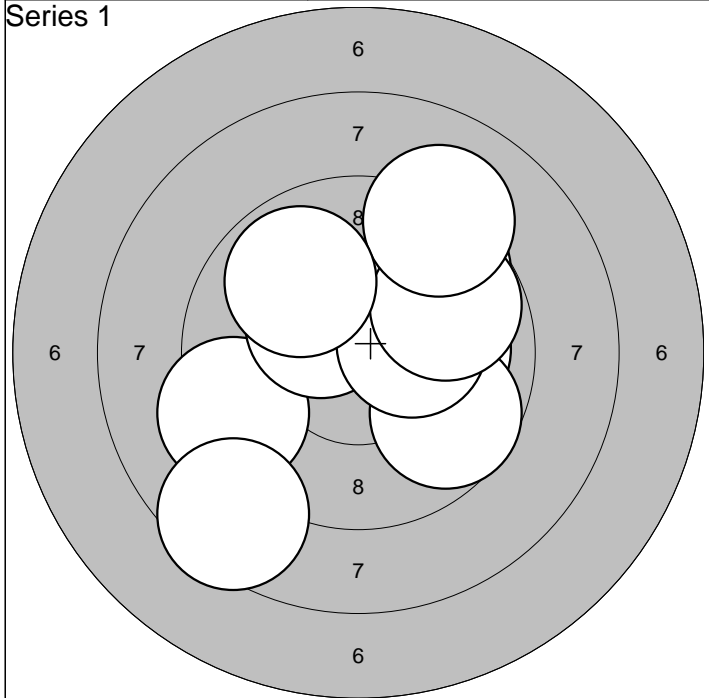

1: 9,3 ↙	6: 10,3* →		Serie	92,0
2: 8,5 ↘	7: 9,6 ↗			
3: 10,0 →	8: 9,8 ↗	Sum	92,0	
4: 10,4* ↖	9: 9,1 ↗			
5: 9,7 ↘	10: 9,9 ↖			

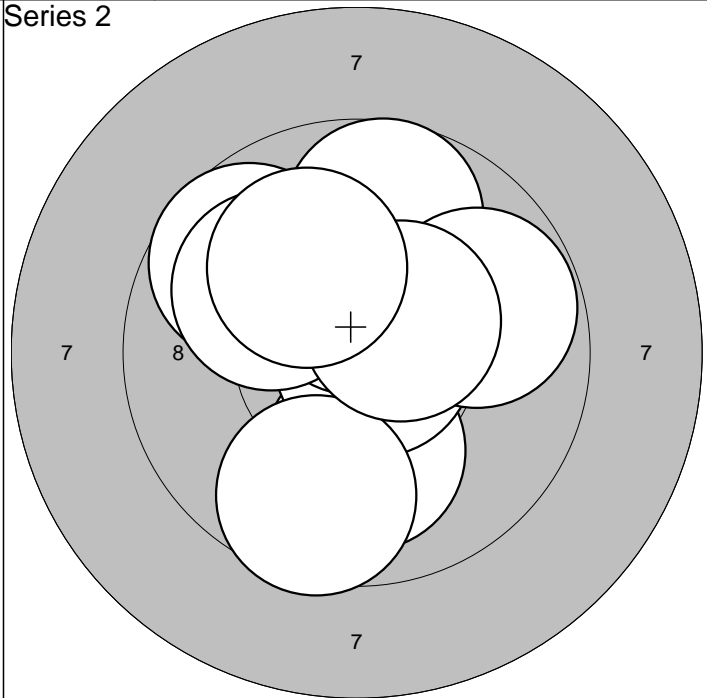

1: 10,1 ↓	6: 9,7 ↖		Serie	96,0
2: 10,8* →	7: 10,0 ↖			
3: 10,4* ↑	8: 9,8 →	Sum	188,0	
4: 9,7 ↑	9: 10,5* ↗			
5: 9,6 ↓	10: 10,1 ↖			

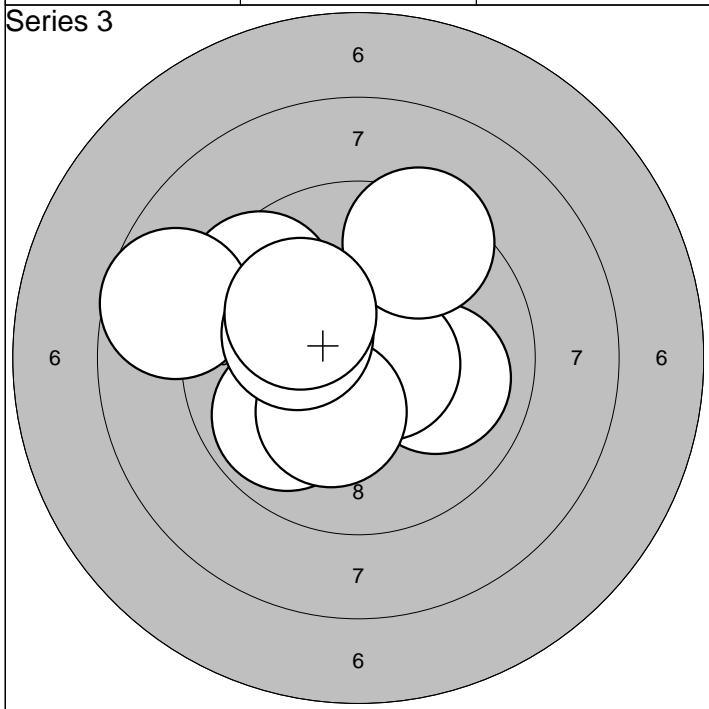

1: 9,5 ↖	6: 8,7 ←		Serie	95,0
2: 10,3* ↘	7: 9,8 ←			
3: 10,0 →	8: 10,2* ↘	Sum	283,0	
4: 10,6* →	9: 10,2* ←			
5: 9,4 ↗	10: 10,1 ↖			

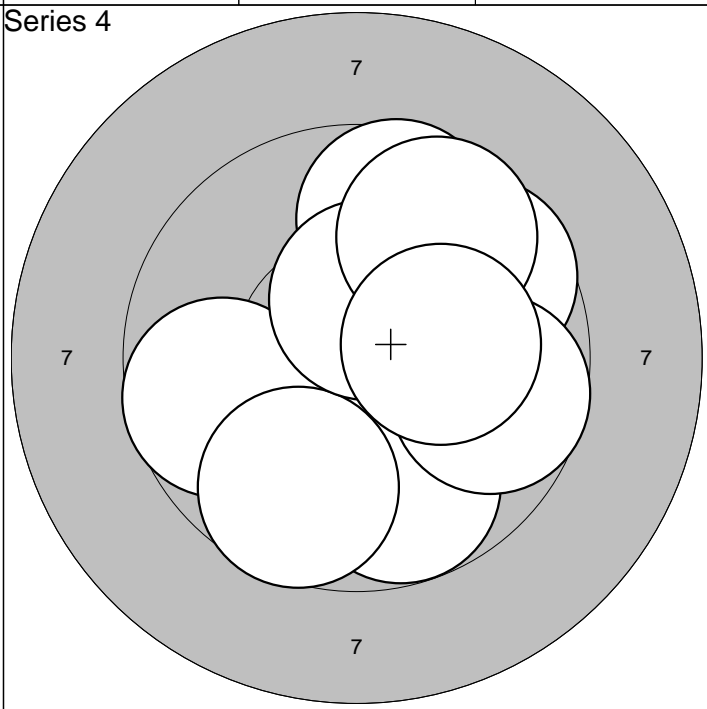

1: 9,6 ↑	6: 9,7 ↓		Serie	93,0
2: 9,8 ↓	7: 10,4* ↑			
3: 9,7 ↗	8: 10,4* ↑	Sum	376,0	
4: 9,7 ←	9: 9,6 ↗			
5: 9,7 →	10: 10,2* →			

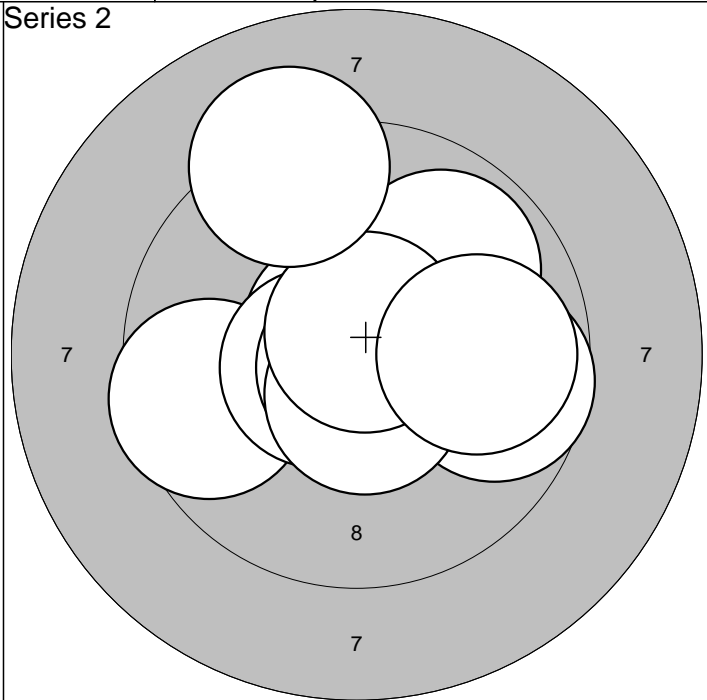
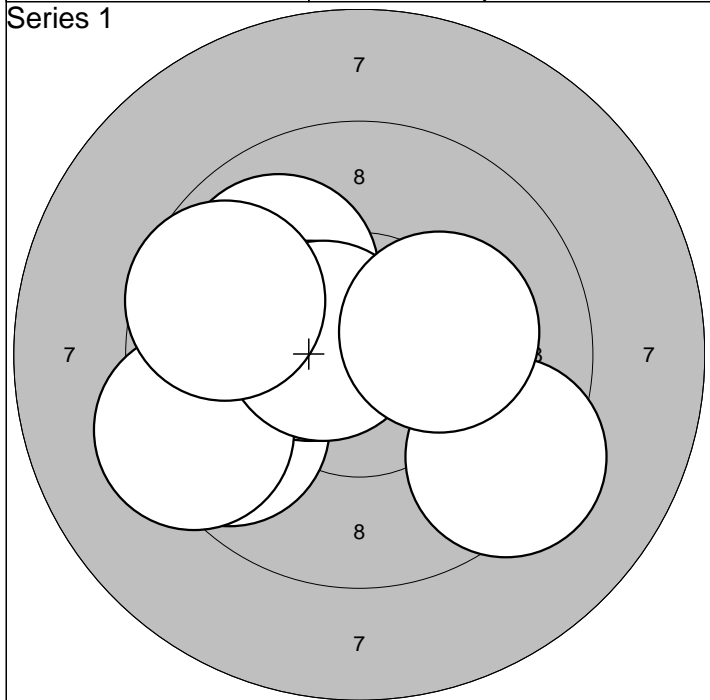

1:10,0 ↖	6:10,5* ←	Serie 95,0
2: 9,3 ↘	7: 9,3 ←	
3: 9,6 ←	8:10,6* ←	Sum 95,0
4:10,4* ↖	9: 9,6 ←	
5: 9,9 ↗	10:10,2* →	

1:10,7* ↗	6:10,8* ↓	Serie 95,0
2: 9,6 ←	7:10,6* ↓	
3: 9,7 →	8:10,7* ↗	Sum 190,0
4:10,6* ←	9: 9,2 ↗	
5: 9,9 ↗	10: 9,9 →	

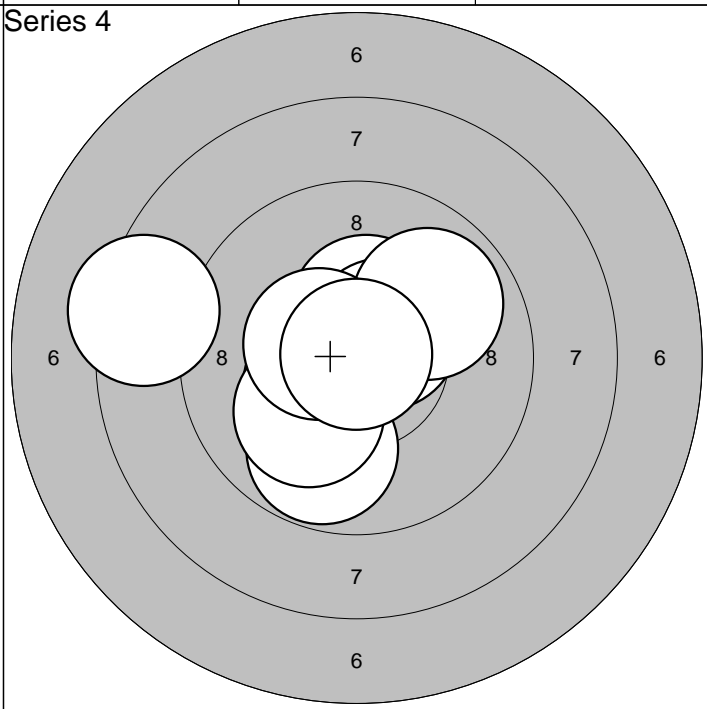
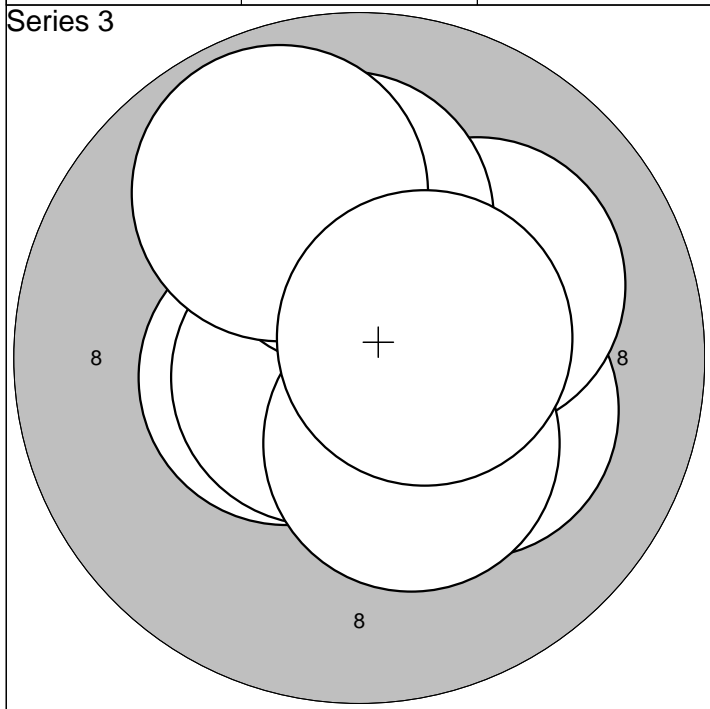

1:10,8* ↓	6:10,1 ↗	Serie 99,0
2:10,2* ↘	7:10,4* ↓	
3:10,6* ↘	8:10,1 ↑	Sum 289,0
4:10,5* ←	9: 9,8 ↗	
5:10,7* ←	10:10,5* →	

1:10,4* ↑	6:10,5* ↗	Serie 96,0
2:10,4* ←	7: 9,9 ↗	
3:10,9* ←	8:10,5* ←	Sum 385,0
4: 9,8 ↓	9:10,9* ↑	
5:10,1 ↘	10: 8,4 ←	

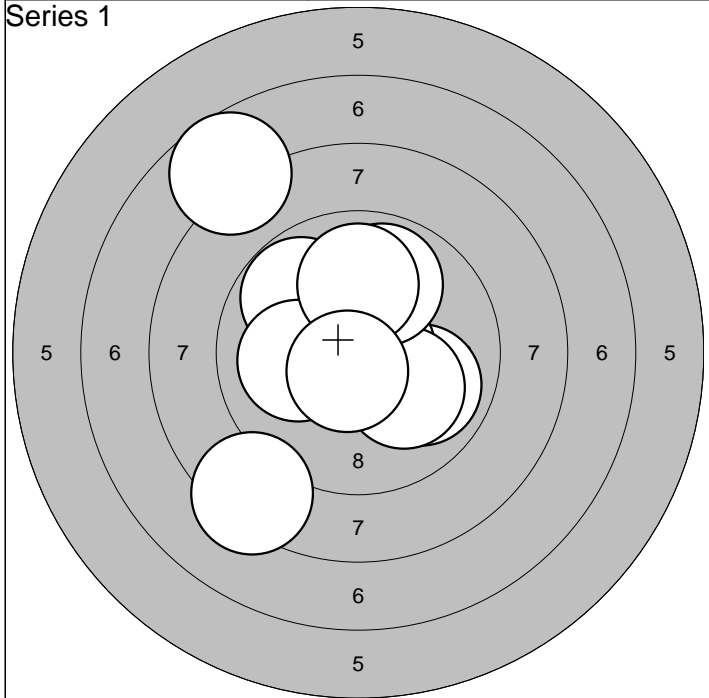

1: 8,3 ↙	6: 9,9 ↗		Serie	91,0
2: 9,8 ↖	7: 7,7 ↖			
3: 9,9 ↘	8:10,1 ←	Sum	91,0	
4:10,7* →	9: 9,9 ↑			
5:10,1 ↘	10:10,6* ↘			

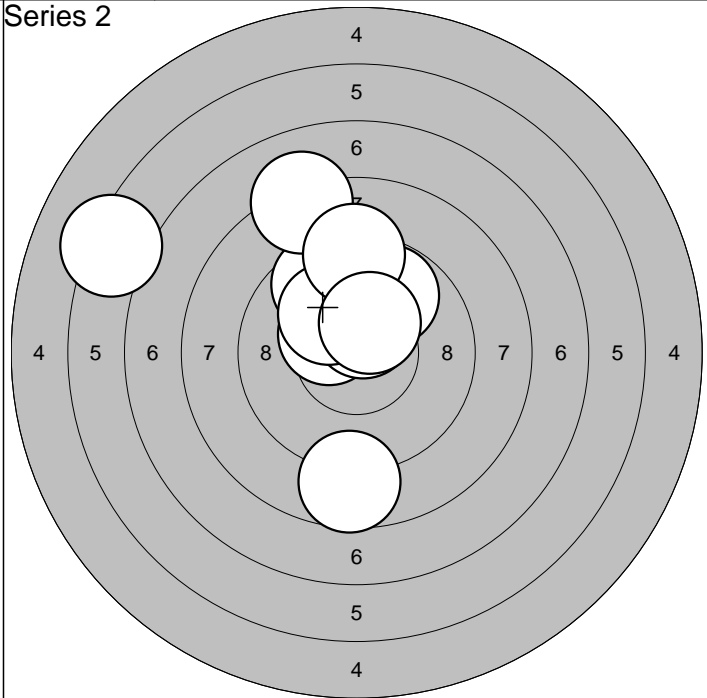

1:10,4* ↖	6: 8,7 ↓		Serie	89,0
2: 6,3 ↖	7: 8,1 ↗			
3:10,5* ↑	8:10,1 ↖	Sum	180,0	
4: 9,6 ↗	9: 9,2 ↑			
5: 9,8 ↗	10:10,4* ↗			

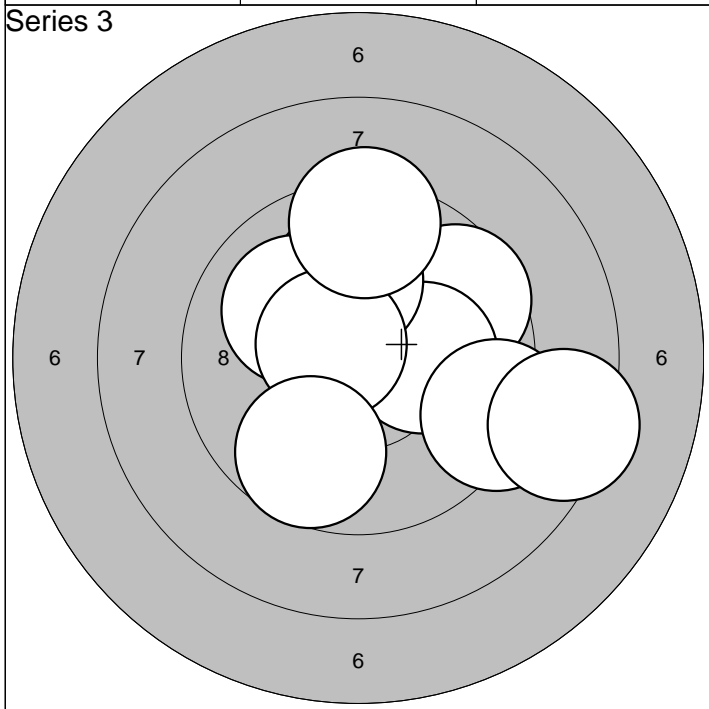

1:10,1 ↗	6:10,0 ↖		Serie	94,0
2: 9,6 ↗	7:10,6* ↖			
3:10,2* →	8: 8,4 →	Sum	274,0	
4:10,0 ↑	9: 9,7 ↘			
5: 9,2 ↘	10: 9,3 ↑			

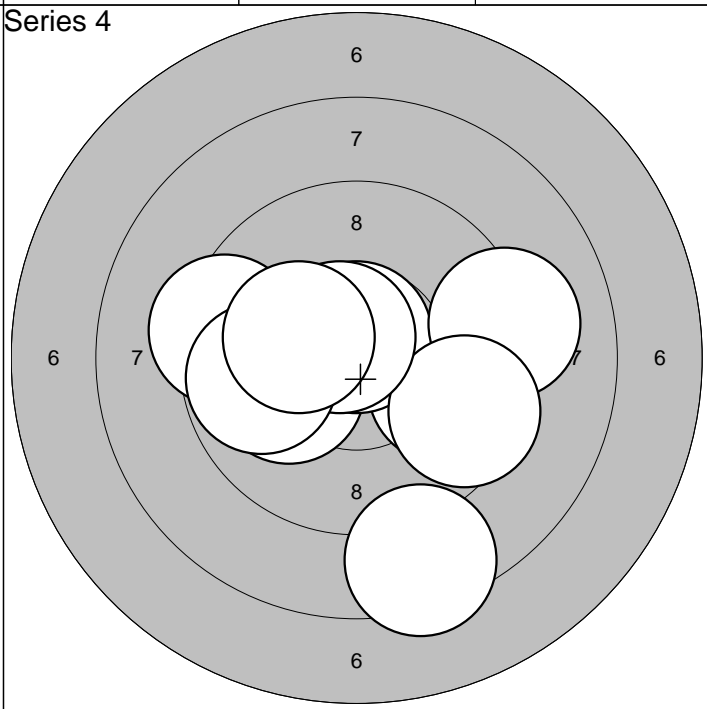

1: 9,8 →	6: 8,4 ↓		Serie	93,0
2:10,1 ↖	7: 9,5 ↘			
3: 9,3 ←	8:10,7* ↗	Sum	367,0	
4:10,7* ↑	9: 9,8 ←			
5: 9,1 →	10:10,2* ↖			

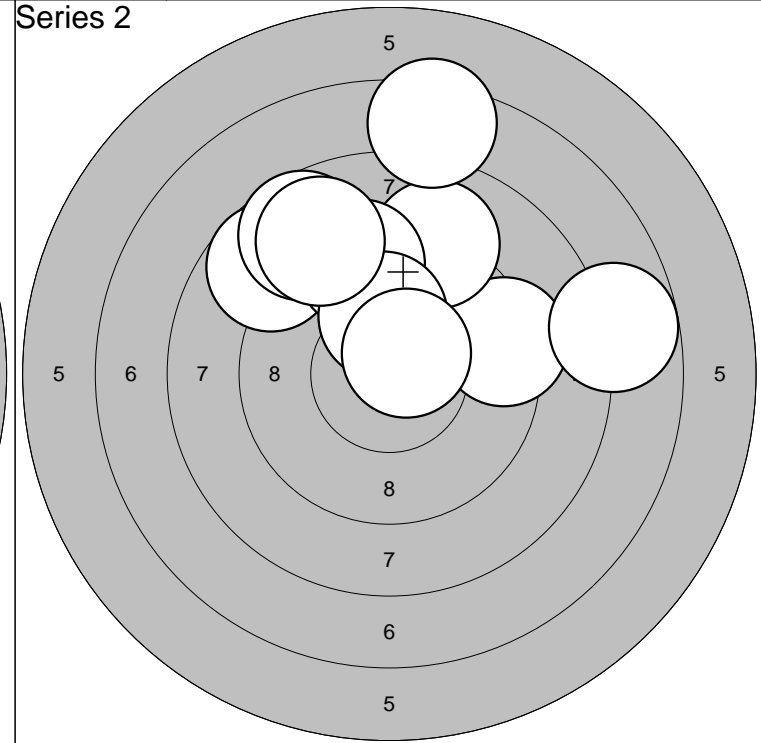
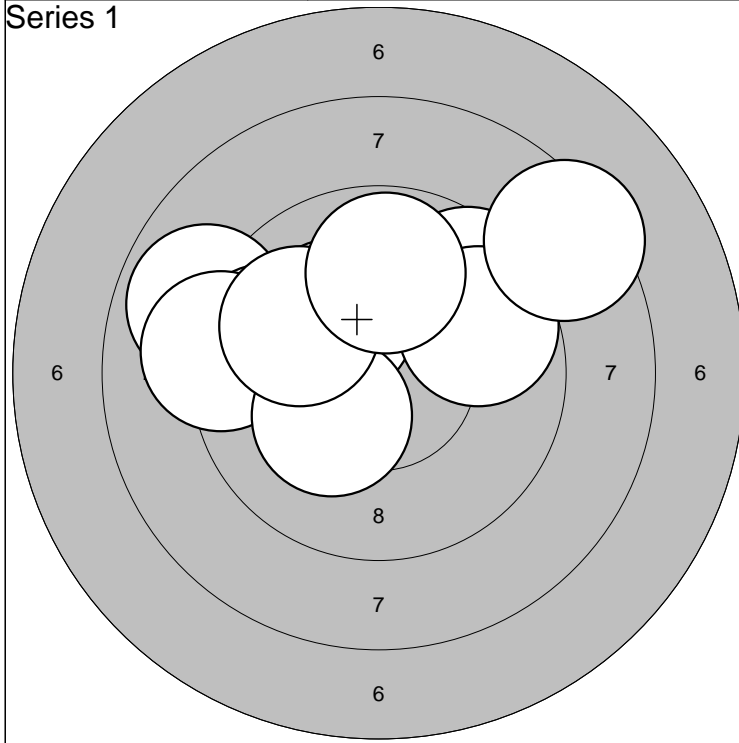

1: 8,9	←	6: 9,7	→	Serie	90,0
2: 9,7	←	7:10,2*	↙		
3:10,2*	↗	8: 8,4	↗	Sum	90,0
4: 9,6	↗	9: 9,9	↖		
5: 9,2	←	10: 9,8	↑		

1: 9,3	→	6: 7,4	↑	Serie	85,0
2: 9,0	↑	7: 9,4	↑		
3: 8,7	↖	8:10,1	↑	Sum	175,0
4: 7,8	→	9: 8,9	↖		
5: 8,7	↖	10:10,6*	↗		

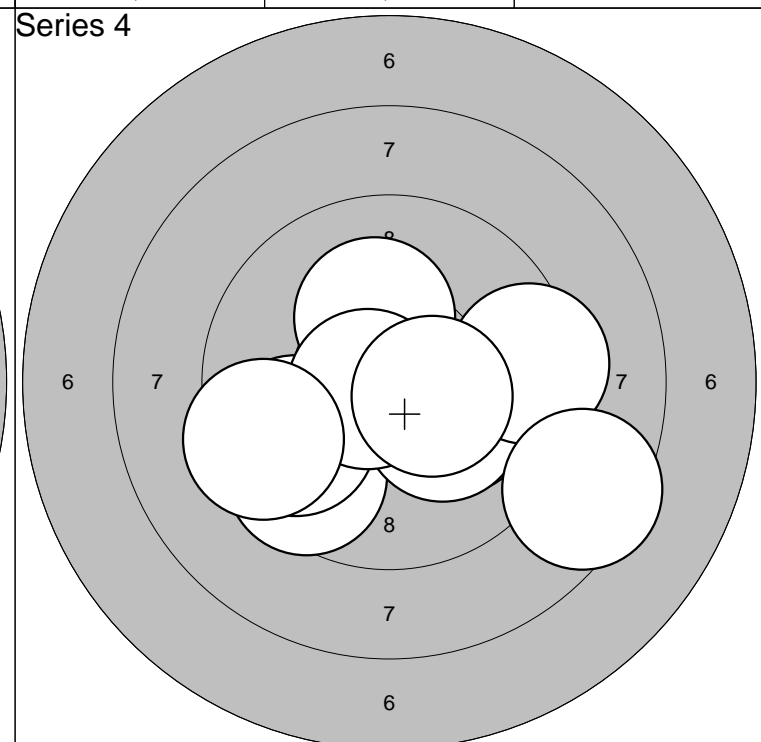
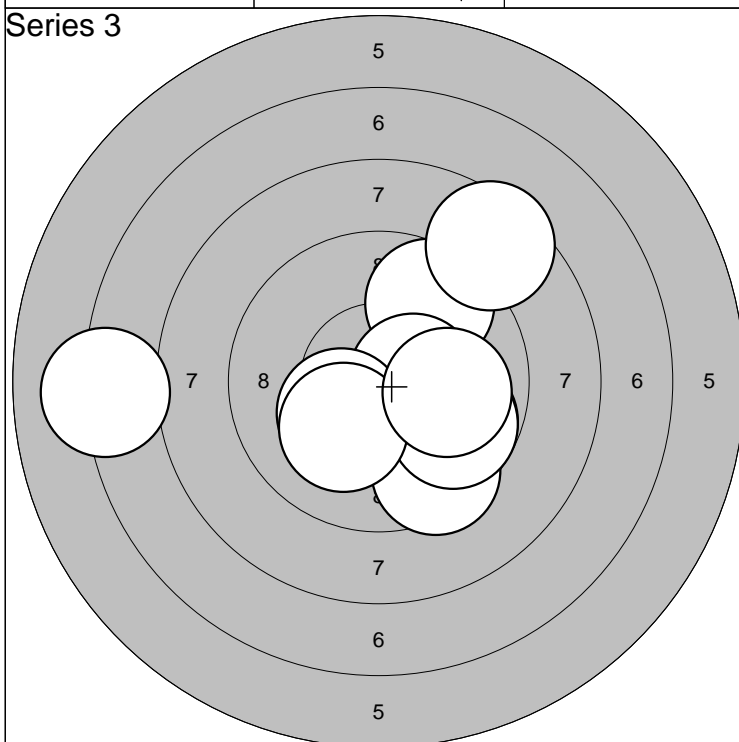

1: 9,5	↘	6: 9,8	↘	Serie	91,0
2: 9,6	↗	7:10,3*	↙		
3: 8,5	↗	8:10,2*	↙	Sum	266,0
4: 9,8	↘	9:10,0	→		
5:10,5*	→	10: 7,2	←		

1: 9,6	↙	6:10,7*	←	Serie	94,0
2:10,1	↘	7: 9,4	→		
3: 9,7	↙	8: 8,5	↘	Sum	360,0
4:10,2*	↘	9:10,5*	↘		
5:10,2*	↑	10: 9,4	←		

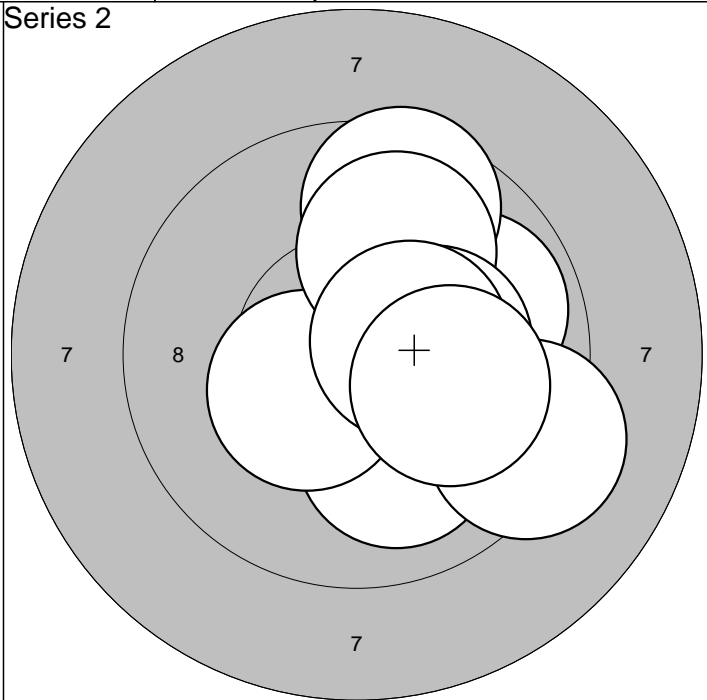
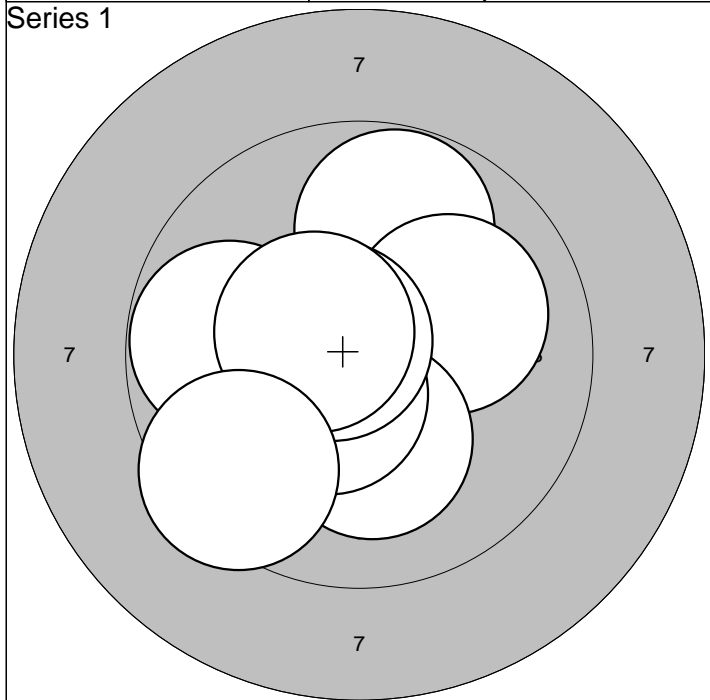

1:10,2* ↗	6:10,2* ↓	Serie	97,0
2:10,8* ↘	7:10,5* ↘		
3: 9,8 ↗	8:10,7* ↖	Sum	97,0
4: 9,8 ←	9:10,5* ↖		
5:10,1 →	10: 9,4 ↘		

1:10,7* ↓	6:10,0 ↗	Serie	97,0
2: 9,9 →	7:10,3* →		
3:10,1 ↓	8: 9,3 ↘	Sum	194,0
4: 9,6 ↗	9:10,5* →		
5:10,4* ↖	10:10,1 →		

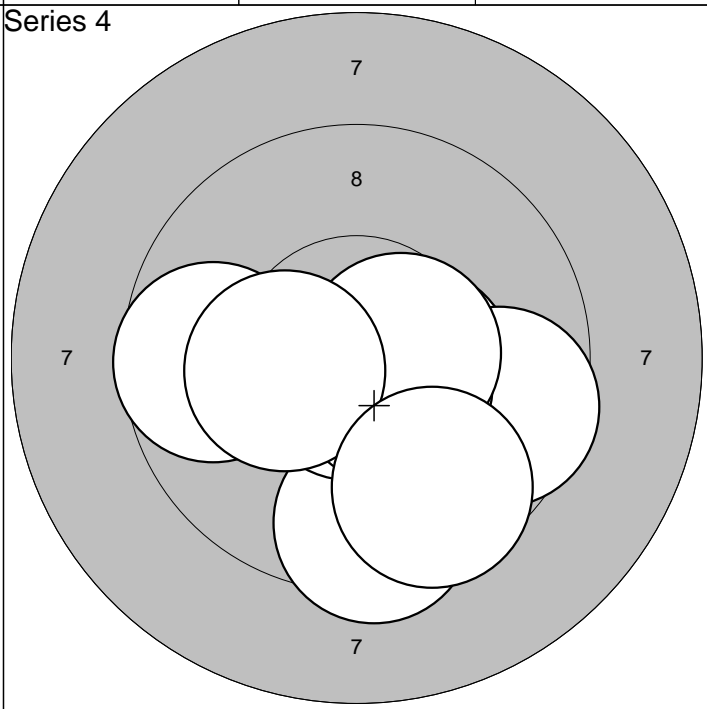
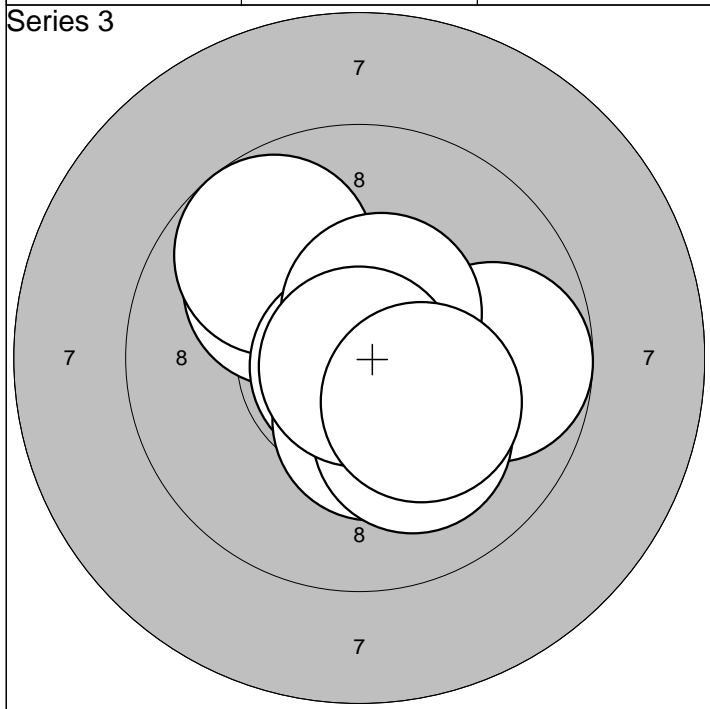

1:10,0 ↗	6:10,4* ↓	Serie	98,0
2: 9,8 ↗	7:10,1 ↘		
3:10,6* ↘	8:10,5* ↗	Sum	292,0
4: 9,8 →	9:10,9* ↓		
5:10,8* ↘	10:10,3* ↘		

1:10,4* →	6:10,8* ↓	Serie	96,0
2:10,3* ↓	7:10,6* ↘		
3: 9,7 ←	8:10,6* →	Sum	388,0
4: 9,5 ↓	9:10,3* ←		
5: 9,6 →	10: 9,6 ↓		

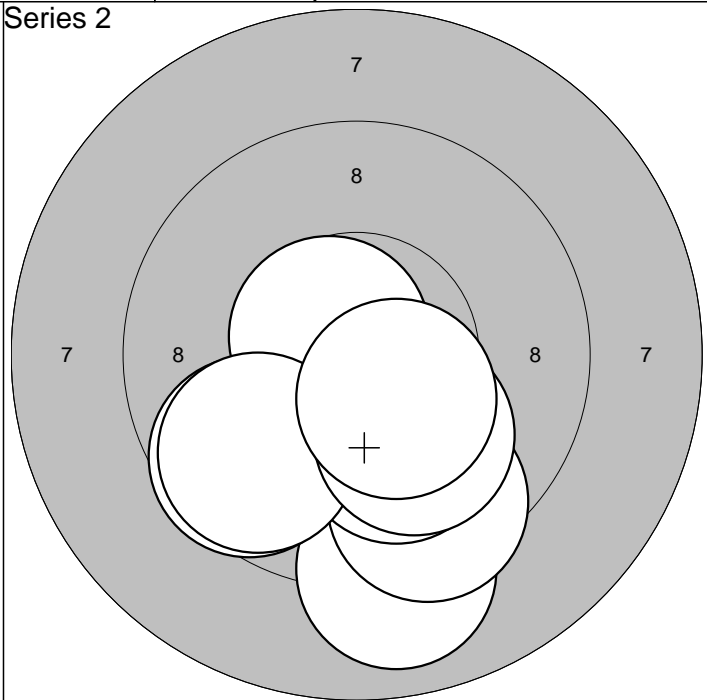
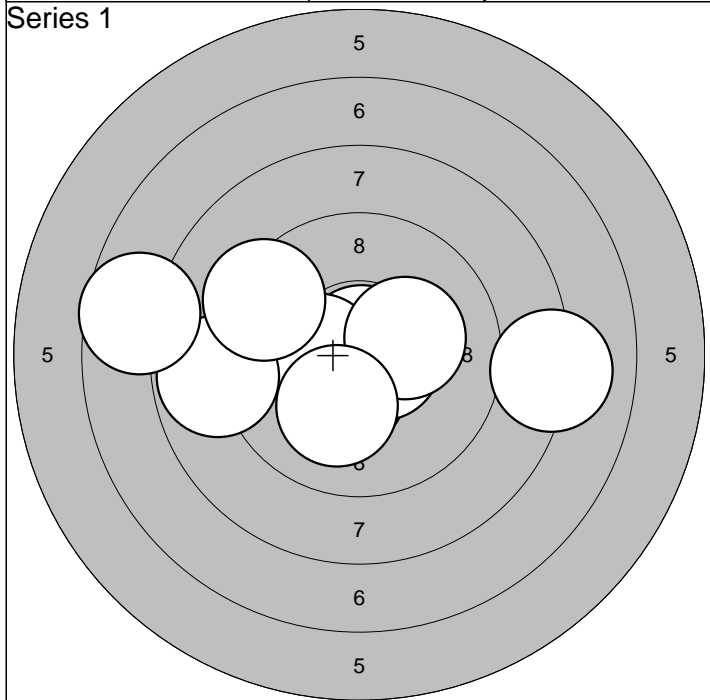

1:10,4* ↓	6: 8,8 ←	Serie	92,0
2:10,8* ↑	7: 7,6 ←		
3:10,6* →	8:10,2* →	Sum	92,0
4:10,4* ←	9: 9,3 ↖		
5: 8,1 →	10:10,1 ↓		

1:10,3* ↓	6:10,1 ↓	Serie	95,0
2: 9,9 ↓	7: 9,6 ↙		
3: 9,0 ↓	8: 9,7 ↙	Sum	187,0
4:10,6* ↗	9:10,1 ↓		
5: 9,5 ↓	10:10,4* ↓		

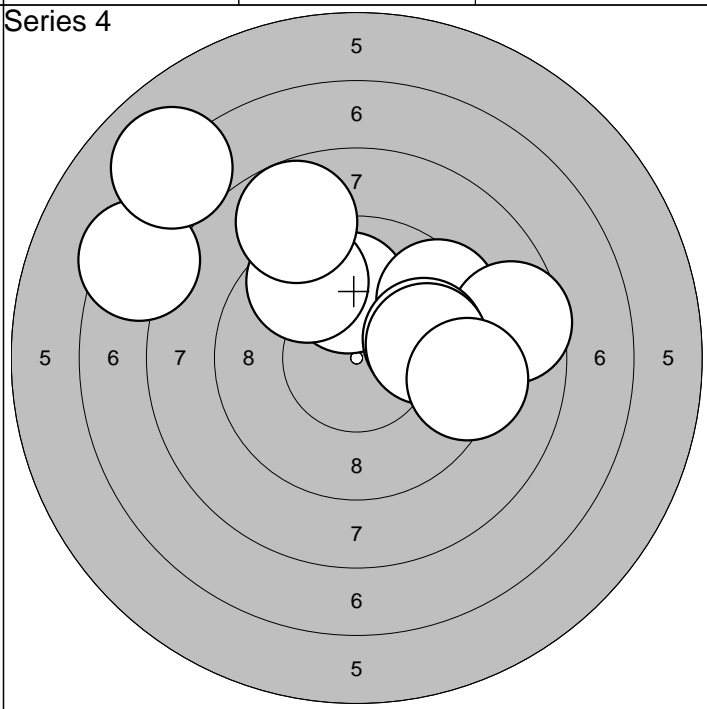
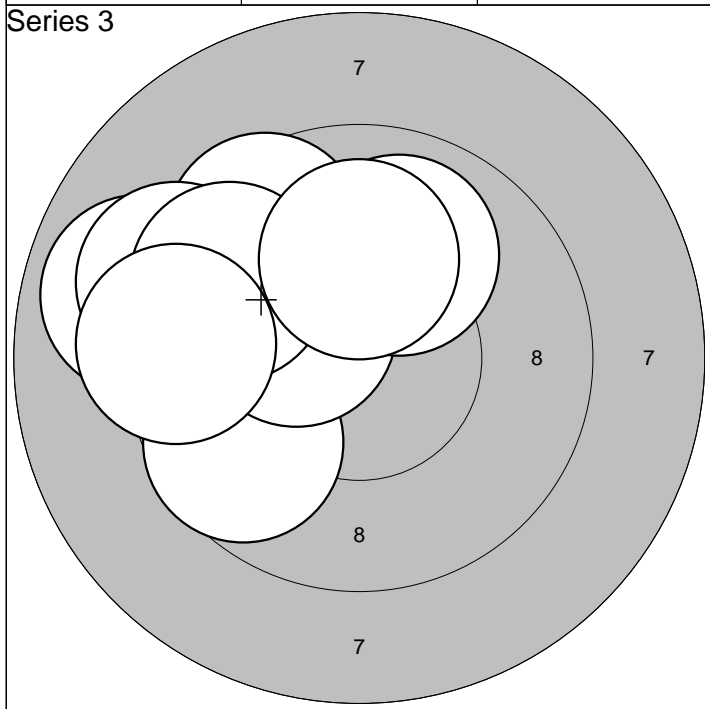

1: 9,7 ↙	6: 8,9 ←	Serie	93,0
2:10,1 ↗	7: 9,2 ←		
3:10,3* ↖	8: 9,6 ↖	Sum	280,0
4:10,0 ↗	9: 9,3 ←		
5: 9,5 ↖	10:10,1 ↑		

1:10,0 ↑	6: 9,9 →	Serie	85,0
2: 7,4 ↖	7: 9,9 →		
3: 9,5 ↗	8: 8,8 ↗	Sum	365,0
4: 9,6 ↗	9: 9,3 →		
5: 8,6 →	10: 7,0 ↖		

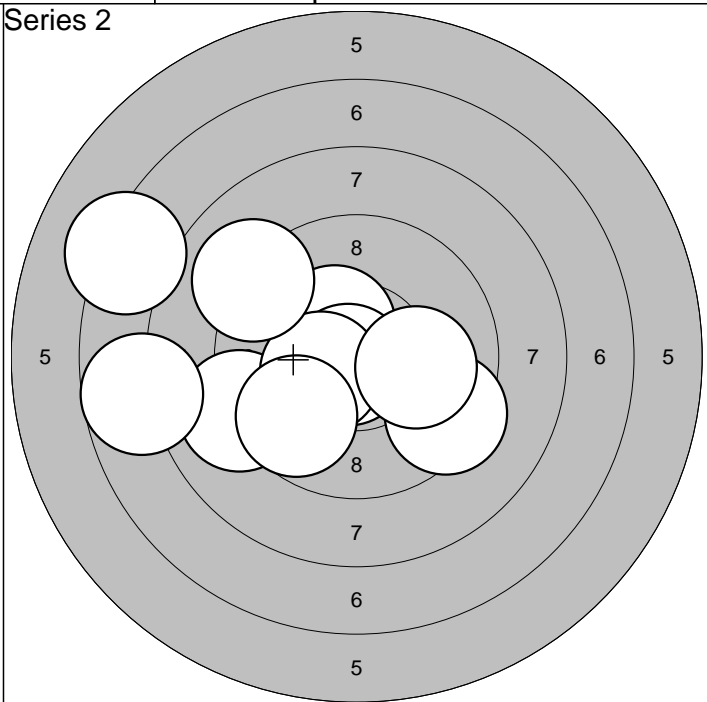
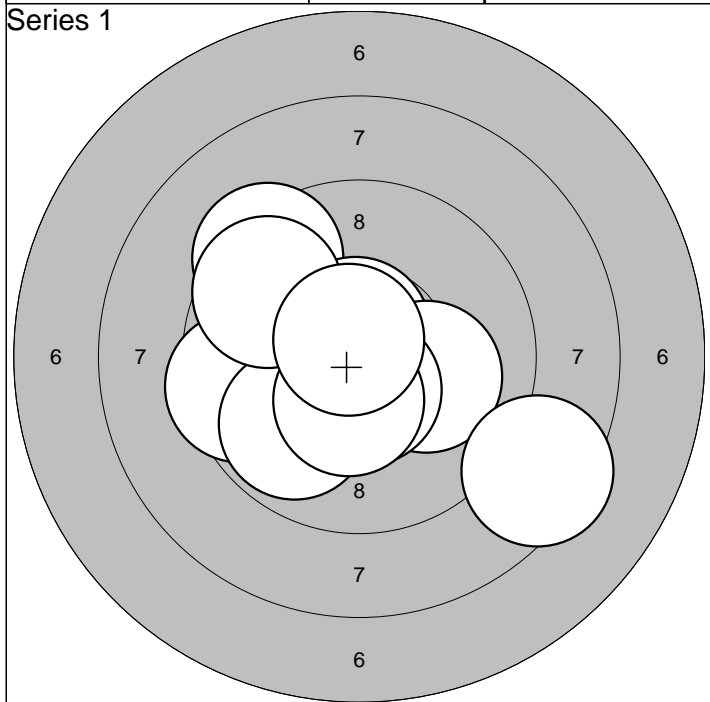

1: 9,4 ↖	6: 9,8 ↘			Serie	94,0
2: 10,7* ↑	7: 8,4 →				
3: 9,5 ←	8: 10,4* ↓			Sum	94,0
4: 10,1 →	9: 9,6 ↖				
5: 10,5* ↓	10: 10,7* ↗				

1: 10,4* ↖	6: 10,4* ↙			Serie	90,0
2: 7,2 ↖	7: 9,1 ↖				
3: 9,0 ↙	8: 9,7 ↘			Sum	184,0
4: 10,8* ↘	9: 7,8 ←				
5: 9,4 ↘	10: 10,0 →				

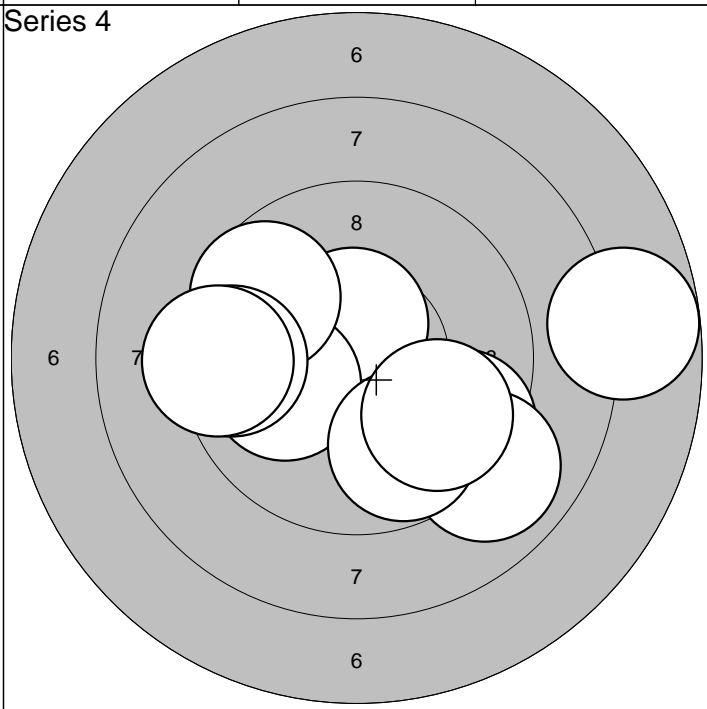
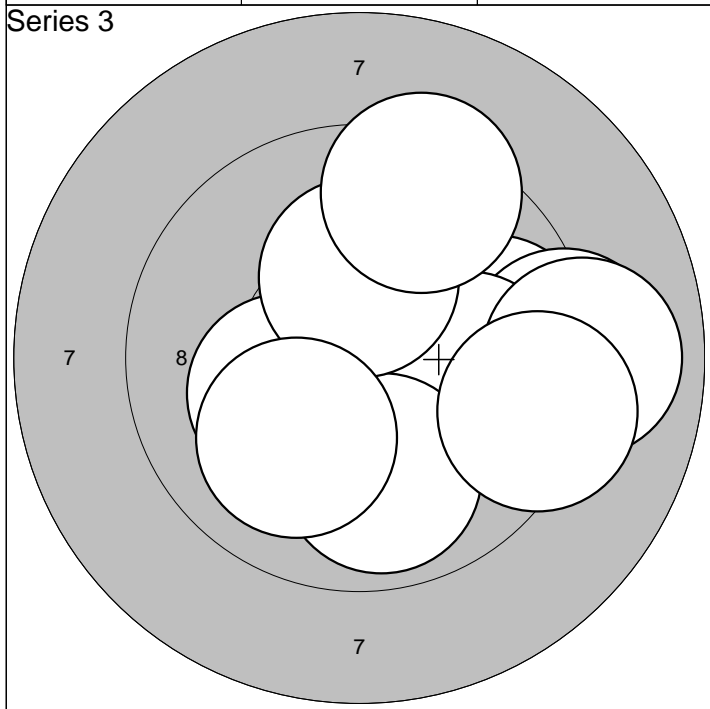

1: 10,2* ↙	6: 10,2* ↑			Serie	94,0
2: 9,7 →	7: 9,0 →				
3: 9,1 →	8: 9,4 ↑			Sum	278,0
4: 10,0 →	9: 9,3 →				
5: 9,9 ↓	10: 10,0 ↘				

1: 10,5* ↑	6: 7,7 →			Serie	89,0
2: 9,5 ↘	7: 9,8 ↘				
3: 8,9 ↘	8: 9,5 ←			Sum	367,0
4: 10,0 ↙	9: 9,3 ←				
5: 9,6 ↖	10: 9,8 ↘				

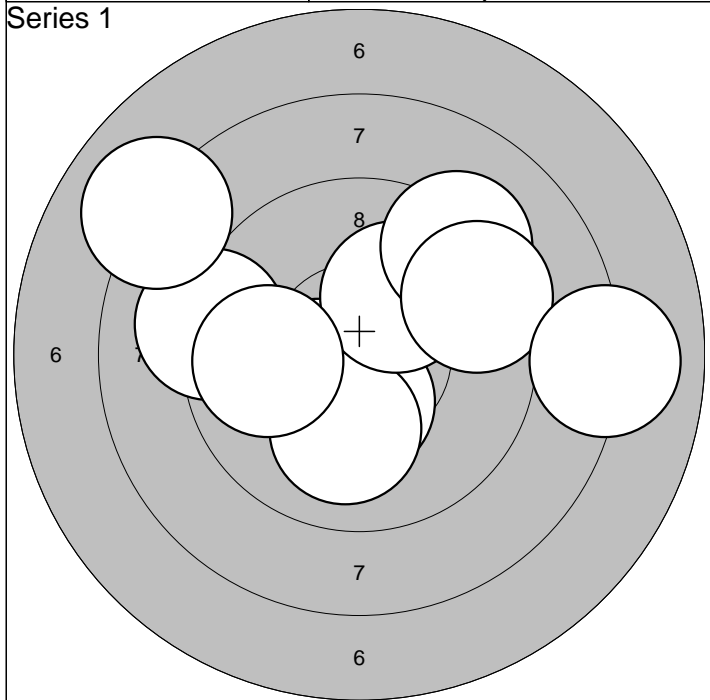

1:10,4* ↓	6:10,1 ↗	Serie	92,0
2: 9,2 ←	7: 9,2 ↗		
3:10,4* ↙	8: 9,4 →	Sum	92,0
4:10,0 ↓	9: 8,0 →		
5: 8,0 ↖	10: 9,9 ←		

1: 9,8 →	6: 8,5 ↙	Serie	94,0
2: 9,4 →	7:10,3* ↗		
3:10,4* ↑	8:10,0 ↖	Sum	186,0
4: 9,4 ↗	9:10,2* ↗		
5: 9,9 ↙	10:10,2* →		

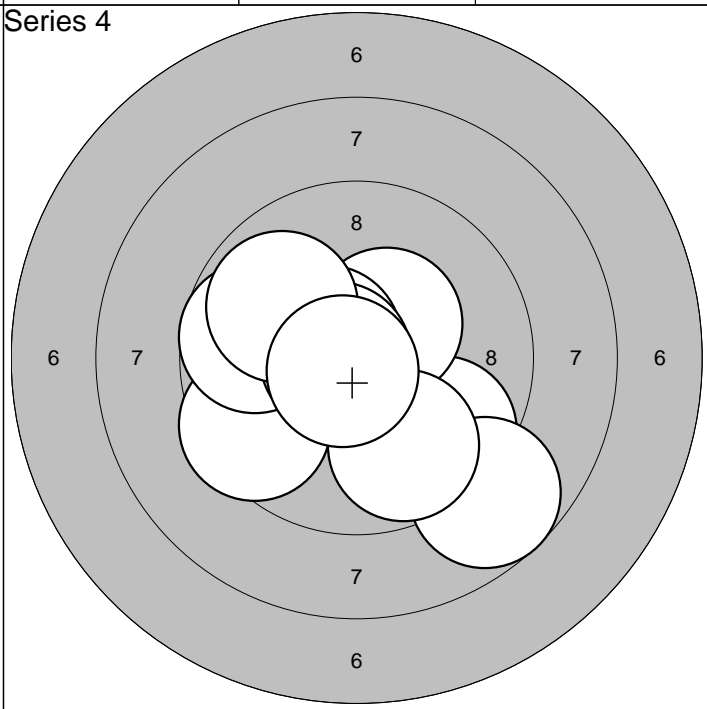
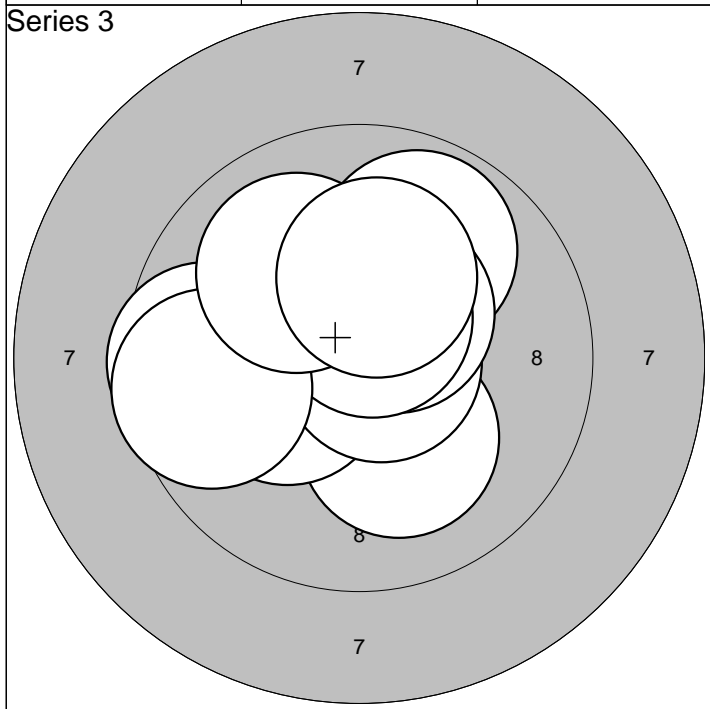

1:10,2* ↓	6:10,4* ↗	Serie	97,0
2: 9,6 ←	7:10,6* ↗		
3:10,3* ↙	8: 9,6 ←	Sum	283,0
4: 9,9 ↗	9:10,0 ↖		
5:10,8* →	10:10,2* ↗		

1: 9,6 ↓	6: 9,7 ↓	Serie	93,0
2:10,4* ↗	7: 9,7 ←		
3: 8,7 ↓	8:10,7* ←	Sum	376,0
4: 9,5 ↙	9: 9,9 ↖		
5:10,5* ↖	10:10,7* ↙		

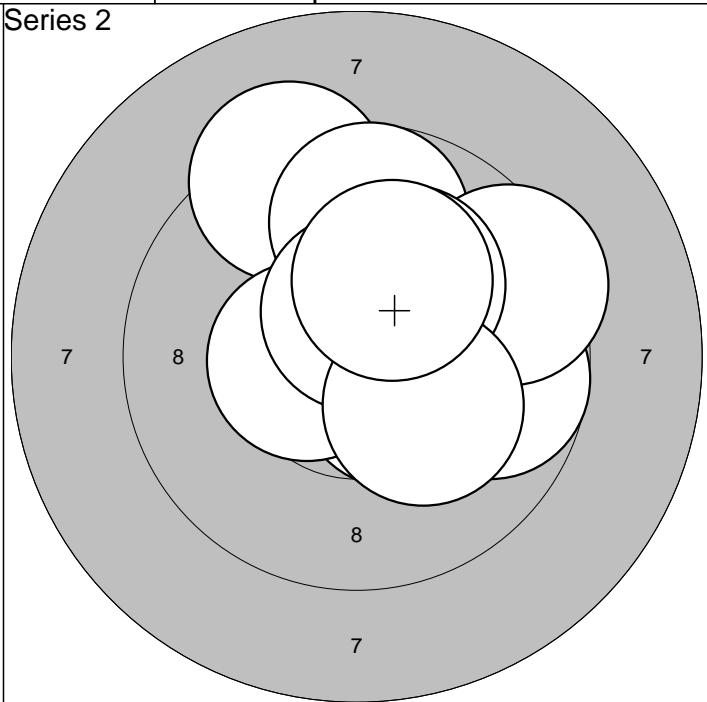
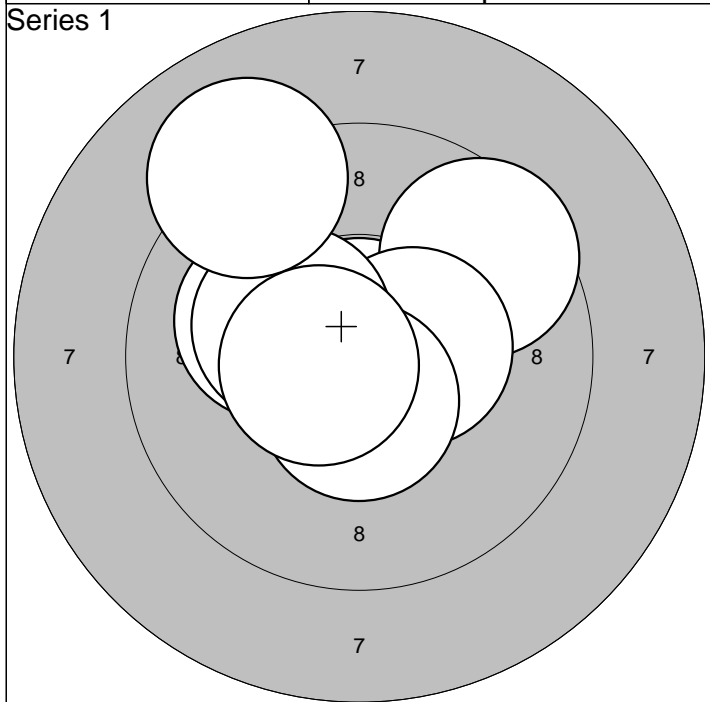

1:10,1 ↙	6:10,5* →			Serie	98,0
2:10,8* ↑	7:10,3* ↙				
3: 9,5 ↗	8:10,6* ↓			Sum	98,0
4:10,8* ←	9: 9,0 ↗				
5:10,6* ←	10:10,6* ←				

1:10,5* ↘	6:10,5* ←			Serie	96,0
2: 9,3 ↗	7:10,2* ↗				
3: 9,7 ↑	8:10,6* ↑			Sum	194,0
4: 9,7 →	9:10,2* ↘				
5: 9,5 ↗	10:10,2* ↗				

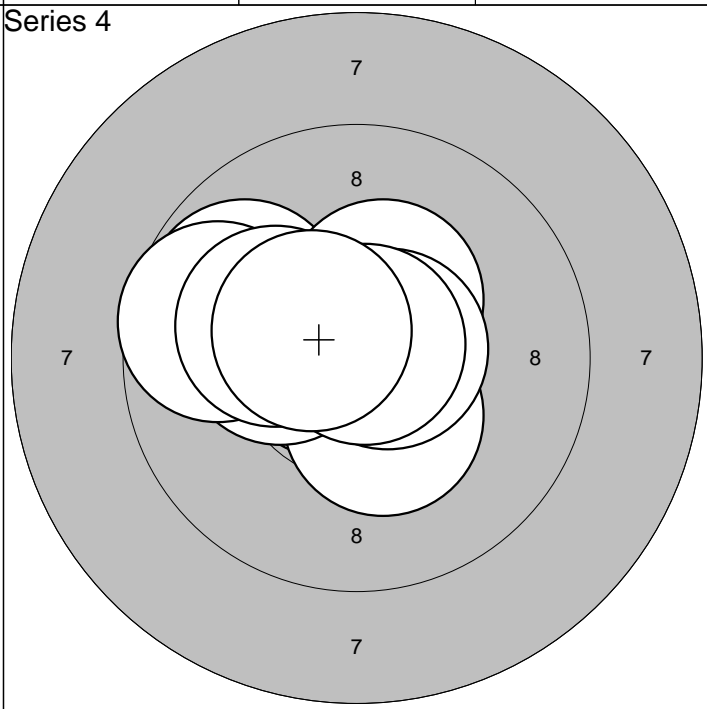
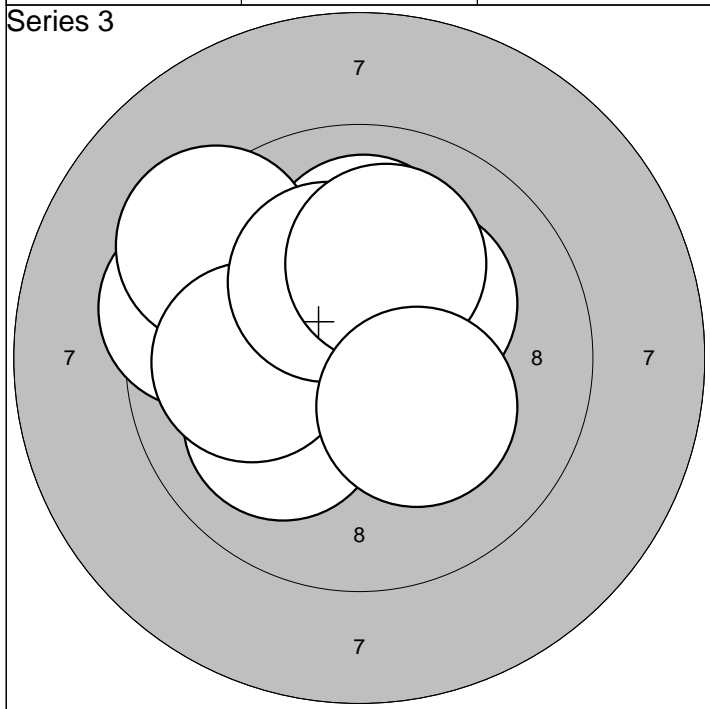

1: 9,4 ↙	6: 9,3 ↖			Serie	98,0
2:10,6* ←	7:10,0 ←				
3:10,1 ↙	8:10,2* ↗			Sum	292,0
4:10,0 ↑	9:10,1 ↗				
5:10,2* ↗	10:10,3* ↘				

1:10,7* ←	6:10,7* →			Serie	98,0
2: 9,8 ↙	7:10,8* ↗				
3:10,4* ↗	8: 9,7 ←			Sum	390,0
4:10,4* ↓	9:10,2* ←				
5:10,3* ←	10:10,5* ↖				

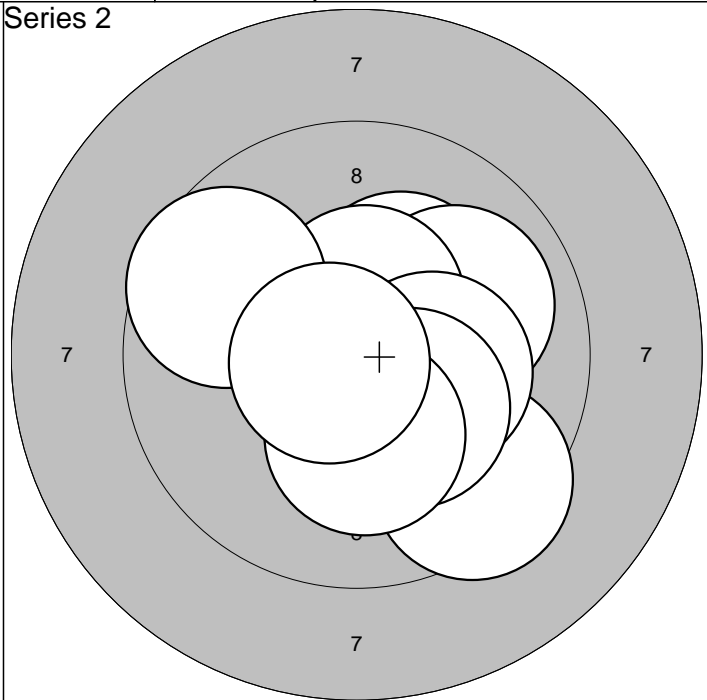
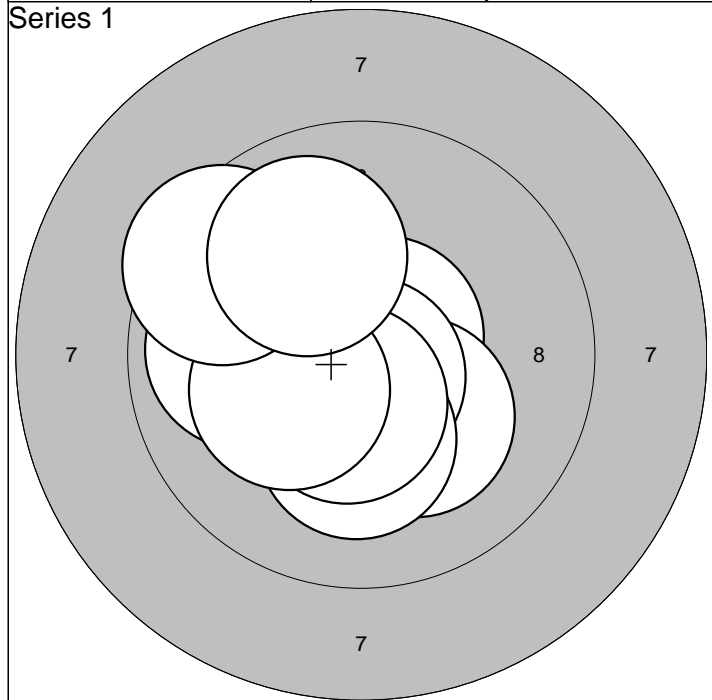

1:10,7* ↗	6:10,5* ↓	Serie	97,0
2:10,4* ↓	7: 9,9 ←		
3:10,2* ↘	8:10,2* ←	Sum	97,0
4:10,7* ↓	9: 9,5 ↗		
5:10,2* ↓	10: 9,9 ↗		

1: 9,4 ↓	6:10,3* →	Serie	98,0
2:10,6* ↗	7: 9,6 ←		
3:10,3* ↗	8:10,3* ↓	Sum	195,0
4:10,0 →	9:10,2* ↓		
5:10,5* ↑	10:10,7* ←		

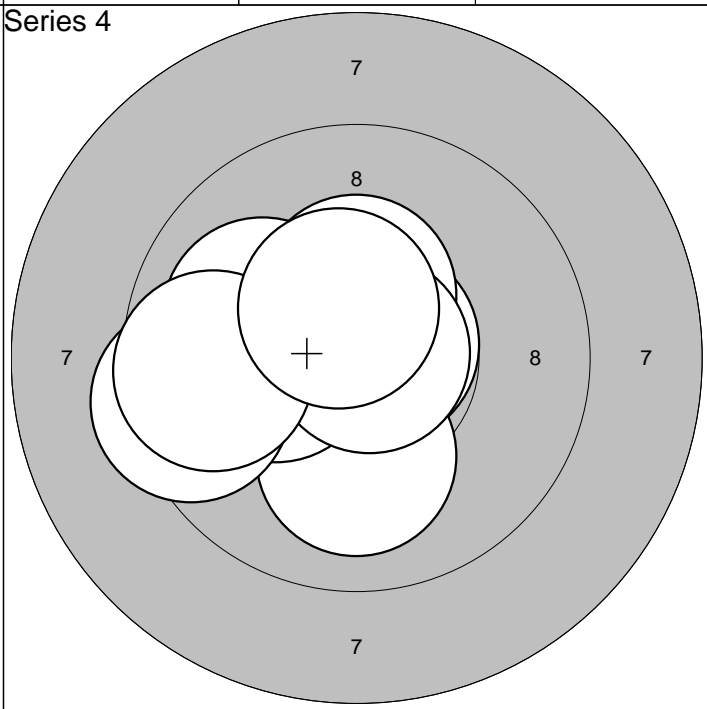
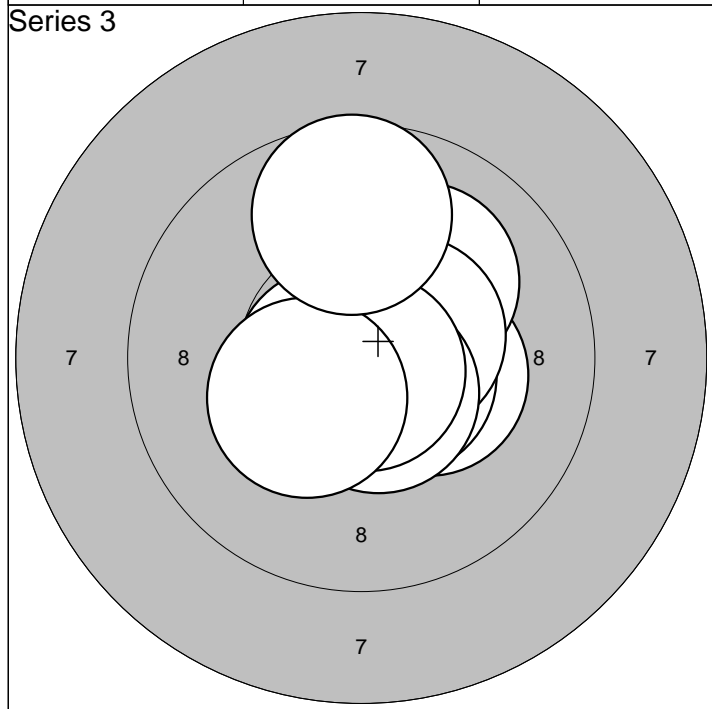

1:10,3* →	6:10,5* →	Serie	99,0
2:10,6* →	7:10,6* ↓		
3:10,3* ↗	8:10,8* ↓	Sum	294,0
4:10,1 ↗	9:10,4* ←		
5:10,7* ←	10: 9,7 ↑		

1:10,7* ↗	6:10,0 ←	Serie	98,0
2:10,1 ↓	7:10,4* ↑		
3:10,4* ↗	8:10,8* →	Sum	392,0
4:10,2* ←	9: 9,7 ←		
5: 9,4 ←	10:10,5* ↑		

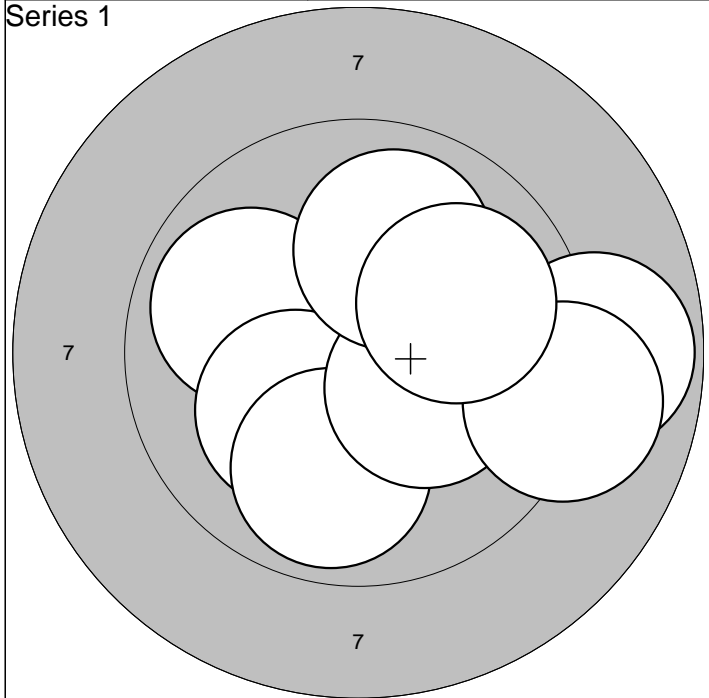

1: 8,8 →	6: 9,9 ↓				
2:10,6* →	7:10,3* →				
3:10,6* →	8:10,0 ↑	Serie	95,0		
4: 9,9 ←	9: 9,0 →	Sum	95,0		
5:10,2* ↙	10:10,0 →				

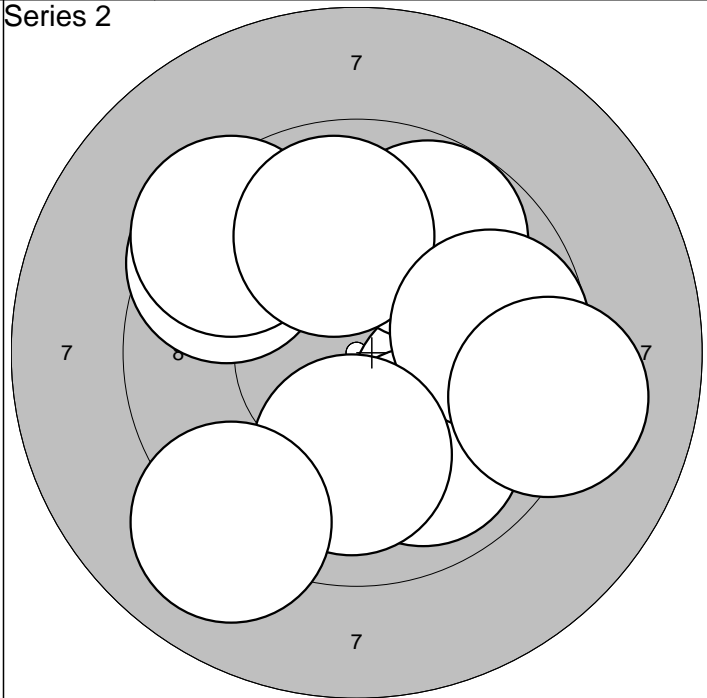

1: 9,5 ↖	6: 9,9 ↓				
2: 9,4 ↖	7: 9,7 →				
3:10,0 →	8:10,0 ↓	Serie	92,0		
4: 9,8 ↗	9: 9,1 ↙	Sum	187,0		
5: 9,9 ↑	10: 9,2 →				

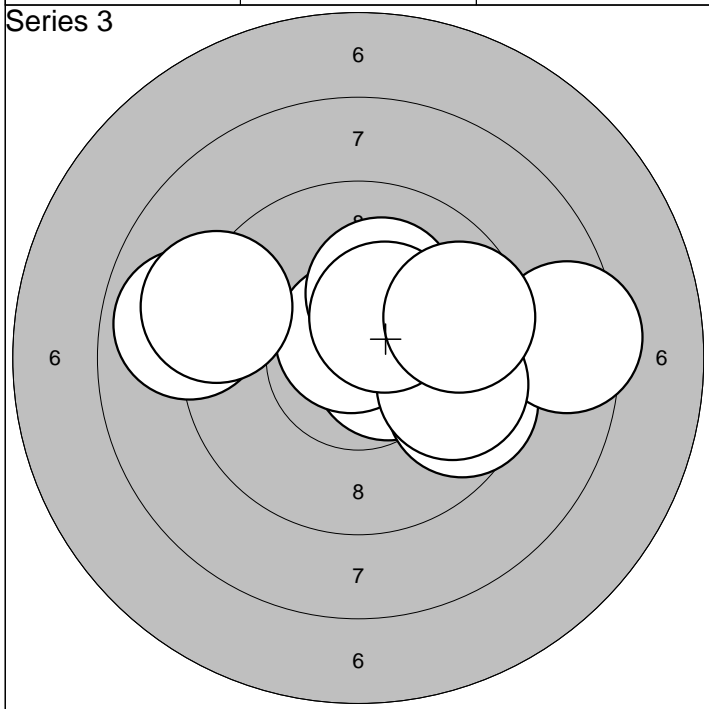

1:10,6* →	6: 9,2 ←				
2: 9,6 →	7: 9,8 →				
3: 8,5 →	8:10,2* ↑	Serie	92,0		
4: 8,9 ←	9:10,4* ↗	Sum	279,0		
5:10,7* ↑	10: 9,6 →				

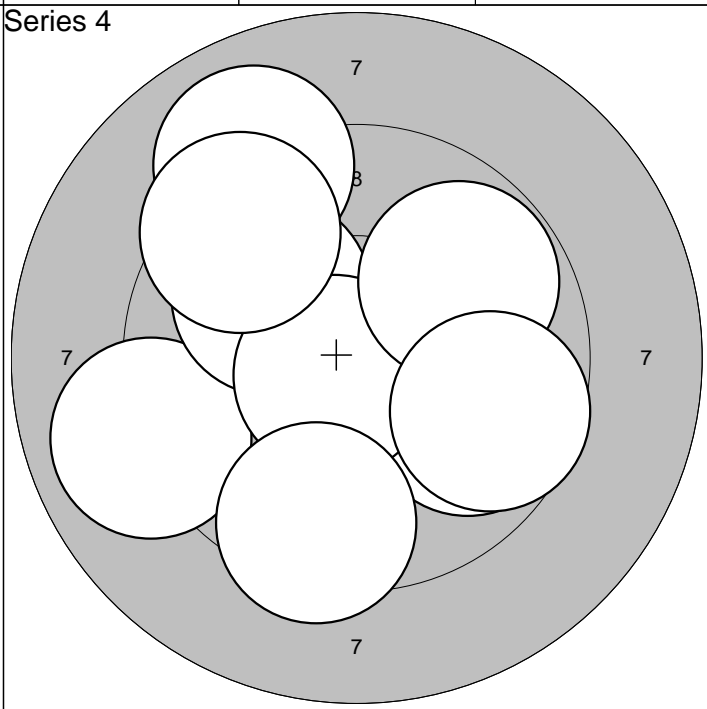

1: 9,0 ↖	6:10,7* ↙				
2: 9,0 ←	7: 9,8 ↗				
3:10,0 ↖	8: 9,4 ↗	Serie	93,0		
4:10,5* ↓	9: 9,7 →	Sum	372,0		
5: 9,8 →	10: 9,4 ↓				

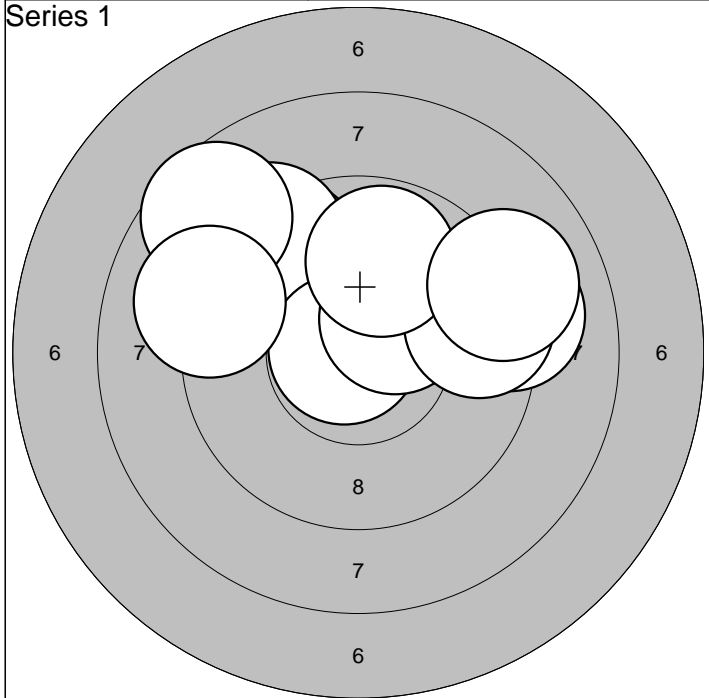

1: 9,5 ↗	6: 8,6 ↖		Serie	91,0
2: 9,3 ↗	7: 9,1 ←			
3: 10,8* ←	8: 9,5 →	Sum	91,0	
4: 10,3* ↗	9: 9,8 ↑			
5: 9,1 →	10: 9,1 ↗			

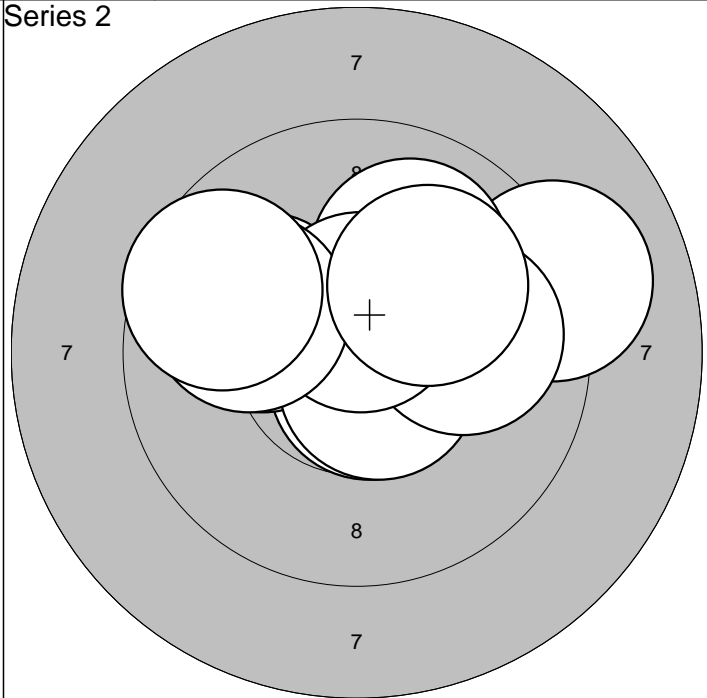

1: 10,7* ↓	6: 10,0 →		Serie	97,0
2: 10,0 ←	7: 10,6* ↑			
3: 9,1 →	8: 9,9 ←	Sum	188,0	
4: 10,0 ↑	9: 9,6 ↖			
5: 10,6* ↓	10: 10,1 ↗			

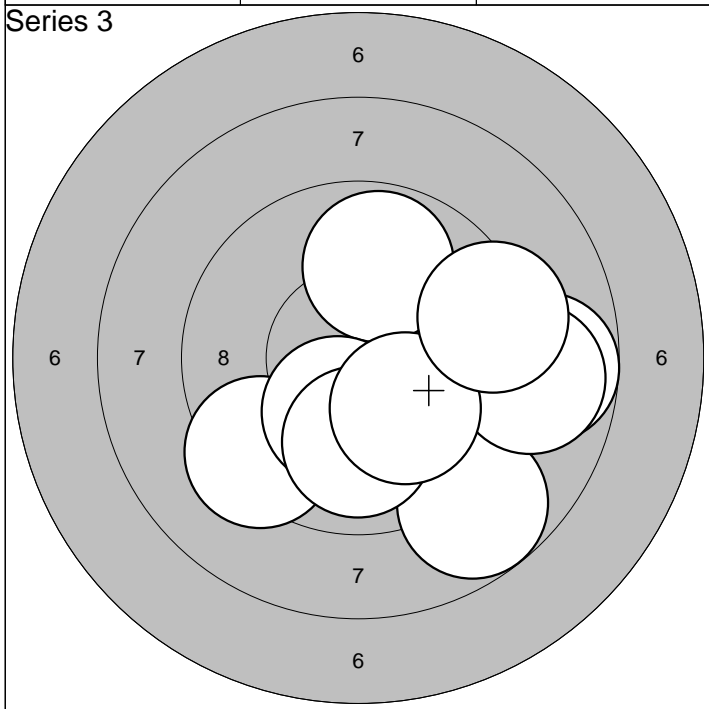

1: 9,3 ↙	6: 8,8 →		Serie	90,0
2: 9,9 ↑	7: 10,0 ↓			
3: 8,8 ↘	8: 8,9 →	Sum	278,0	
4: 10,2* ↓	9: 10,1 ↘			
5: 9,2 →	10: 9,3 →			

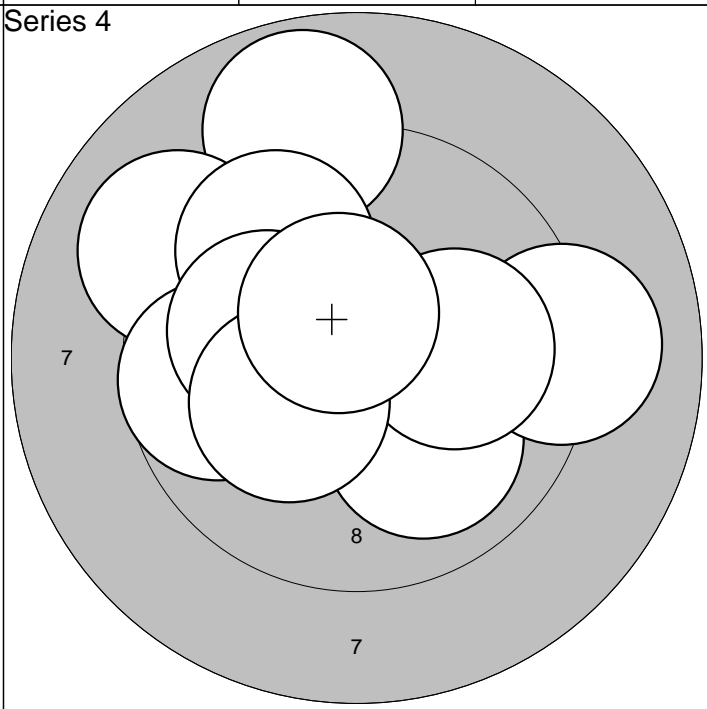

1: 8,9 ↑	6: 9,7 ←		Serie	94,0
2: 9,1 ↖	7: 9,7 ↗			
3: 10,0 ↓	8: 10,1 ←	Sum	372,0	
4: 9,1 →	9: 10,2* ↙			
5: 10,1 →	10: 10,5* ↑			

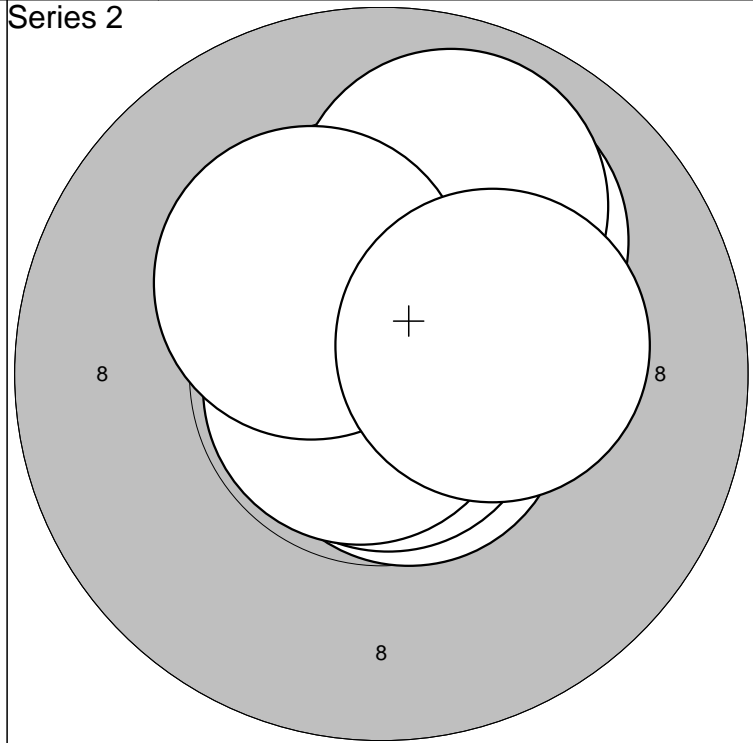
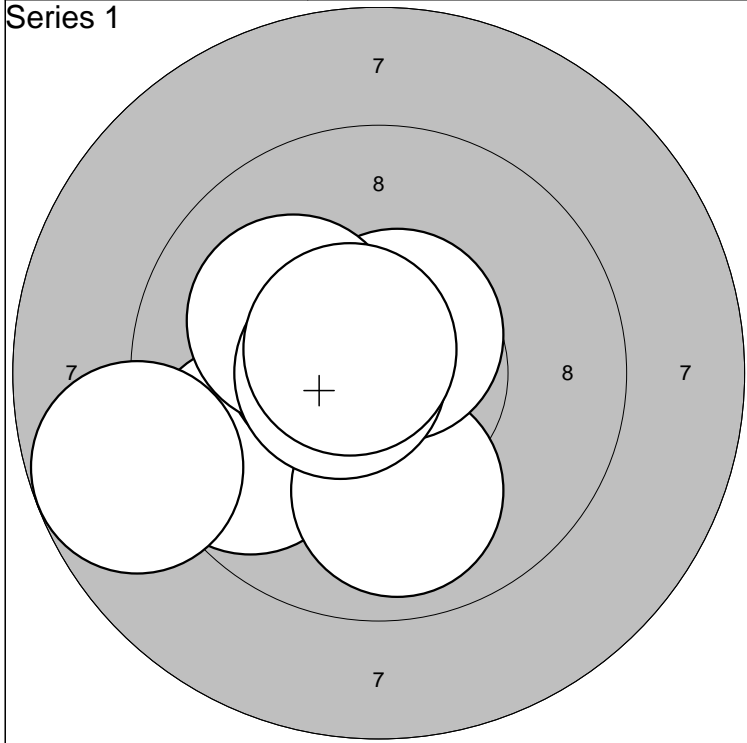

1:10,5* ↓	6:10,4* ↖	Serie	96,0
2: 9,7 ↙	7:10,6* ↗		
3:10,5* ↖	8:10,1 ↖	Sum	96,0
4: 8,8 ↖	9:10,6* ↖		
5: 9,9 ↓	10:10,6* ↗		

1:10,0 ↗	6:10,7* ↗	Serie	99,0
2:10,7* ↘	7:10,8* ↓		
3:10,4* ↑	8:10,8* ↖	Sum	195,0
4:10,5* ↗	9:10,3* ↗		
5: 9,9 ↗	10:10,3* →		

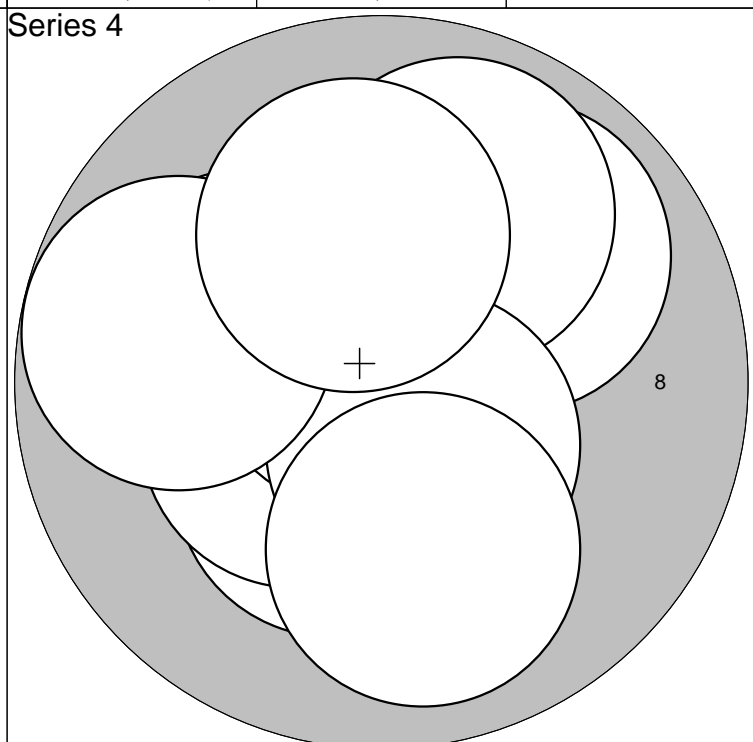
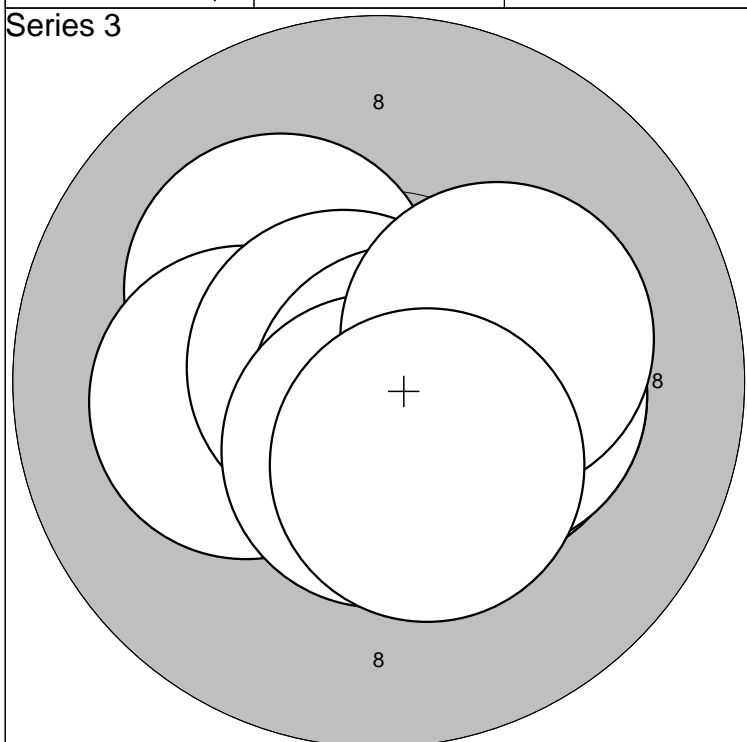

1:10,2* ↗	6:10,7* ↖	Serie	100,0
2:10,3* →	7:10,8* ↘		
3:10,4* →	8:10,6* ↓	Sum	295,0
4:10,3* →	9:10,2* →		
5:10,2* ↖	10:10,4* ↓		

1:10,3* ↓	6: 9,9 ↗	Serie	97,0
2:10,1 ↖	7:10,5* ↓		
3:10,4* ↖	8: 9,7 ↖	Sum	392,0
4: 9,9 ↗	9:10,1 ↑		
5:10,8* ↗	10:10,0 ↓		

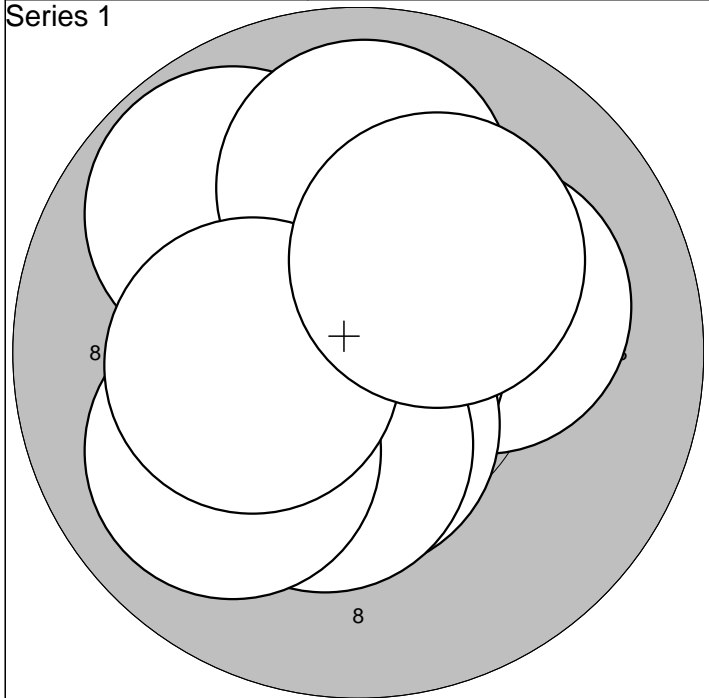

1: 9,8 ↖	6:10,5* ↓				
2:10,7* →	7:10,3* ↓				
3:10,1 →	8:10,0 ↙	Serie	99,0		
4:10,0 ↑	9:10,3* ←	Sum	99,0		
5:10,9* ↓	10:10,2* ↗				

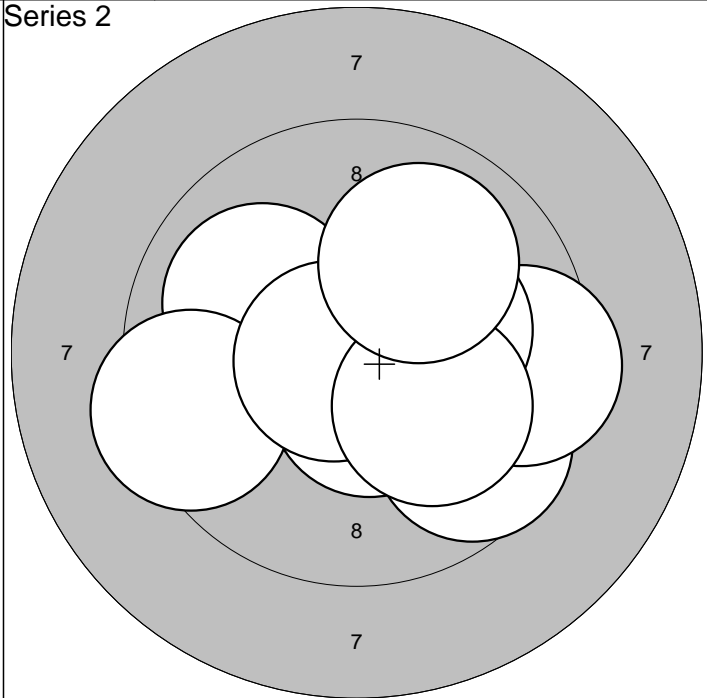

1:10,0 ↖	6: 9,5 →				
2: 9,6 ↘	7:10,2* →				
3:10,8* ↓	8:10,7* ←	Serie	97,0		
4:10,5* ↓	9:10,1 ↘	Sum	196,0		
5: 9,4 ←	10:10,0 ↗				

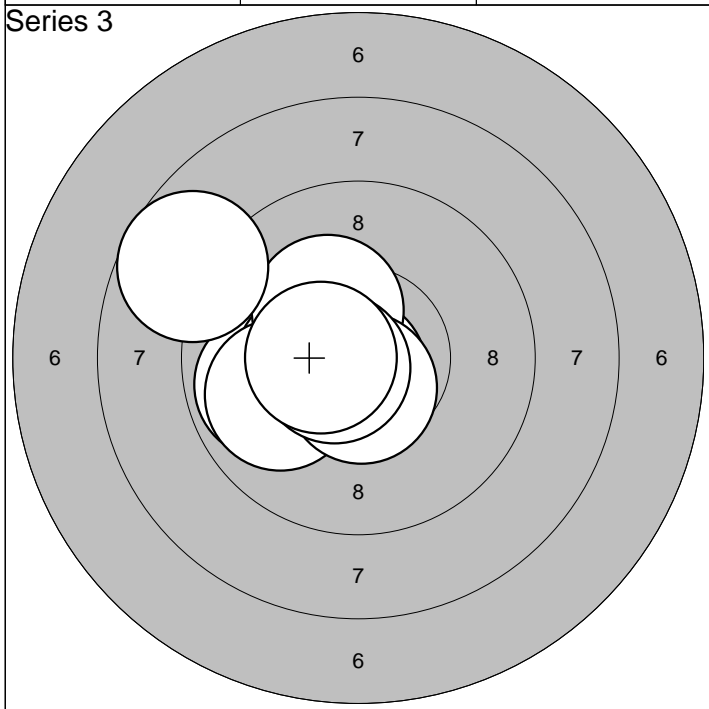

1: 9,9 ←	6:10,3* ↗				
2:10,7* ←	7:10,6* ↓				
3:10,8* ↓	8: 8,7 ↖	Serie	96,0		
4:10,4* ←	9:10,6* ←	Sum	292,0		
5: 9,9 ←	10:10,5* ←				

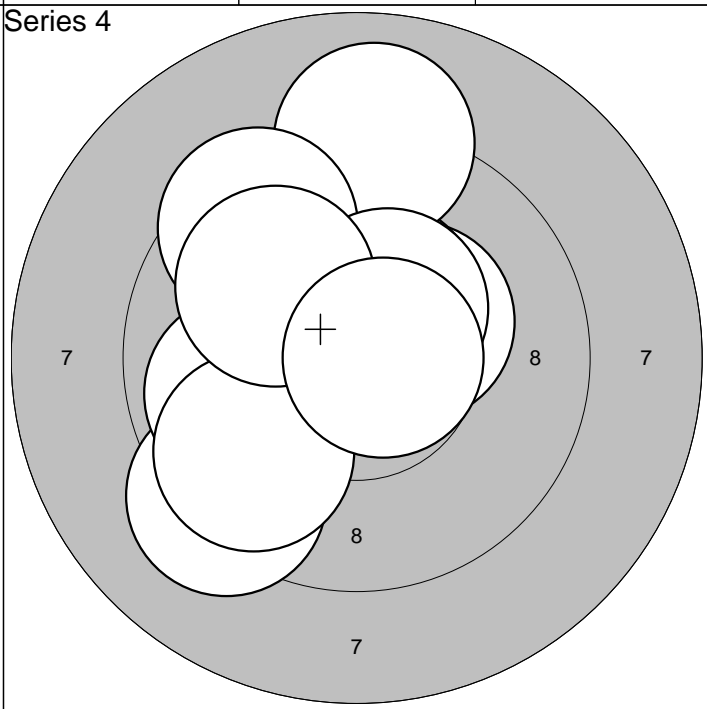

1: 9,2 ↙	6: 9,0 ↑				
2: 9,9 ←	7: 9,5 ↖				
3: 9,7 ↙	8:10,4* ↗	Serie	95,0		
4:10,3* ↗	9:10,0 ↖	Sum	387,0		
5:10,4* ↗	10:10,7* →				

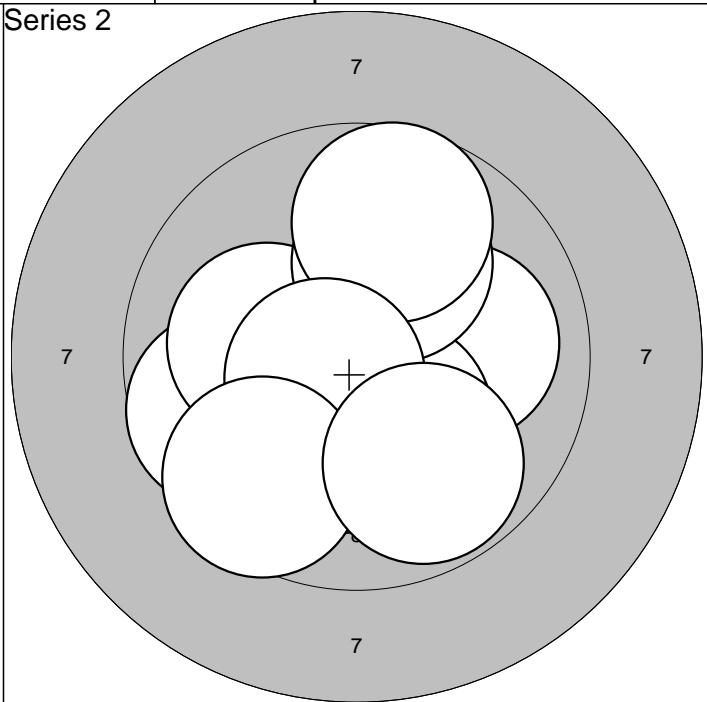
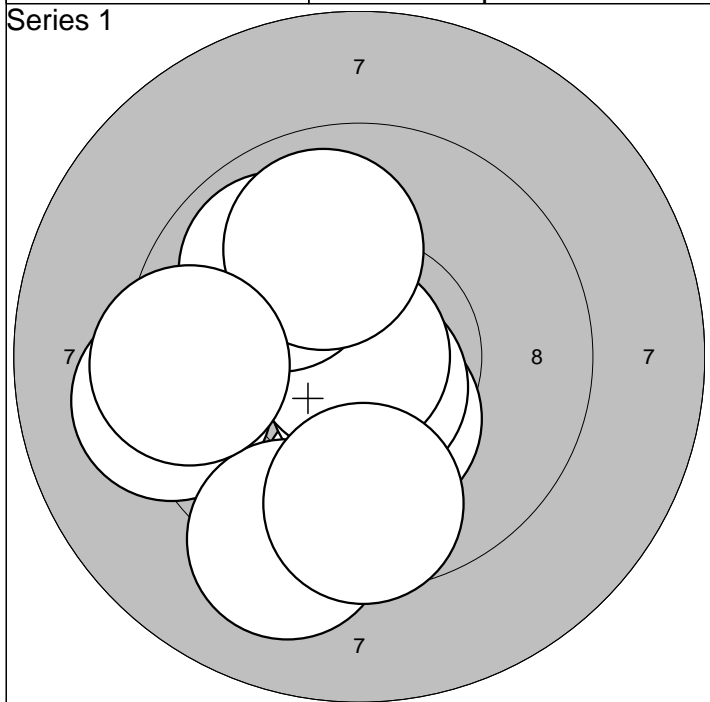

1: 9,2 ←	6: 9,2 ↓	Serie	93,0
2: 9,7 ↓	7: 9,6 ↓		
3: 10,4* ↓	8: 9,9 ↗	Sum	93,0
4: 10,7* ↓	9: 9,9 ↗		
5: 10,9* ←	10: 9,4 ←		

1: 9,7 ←	6: 10,0 ↗	Serie	96,0
2: 10,0 →	7: 9,7 ↗		
3: 10,3* ↓	8: 10,6* ←	Sum	189,0
4: 10,3* ↓	9: 9,6 ↘		
5: 10,1 ←	10: 9,8 ↓		

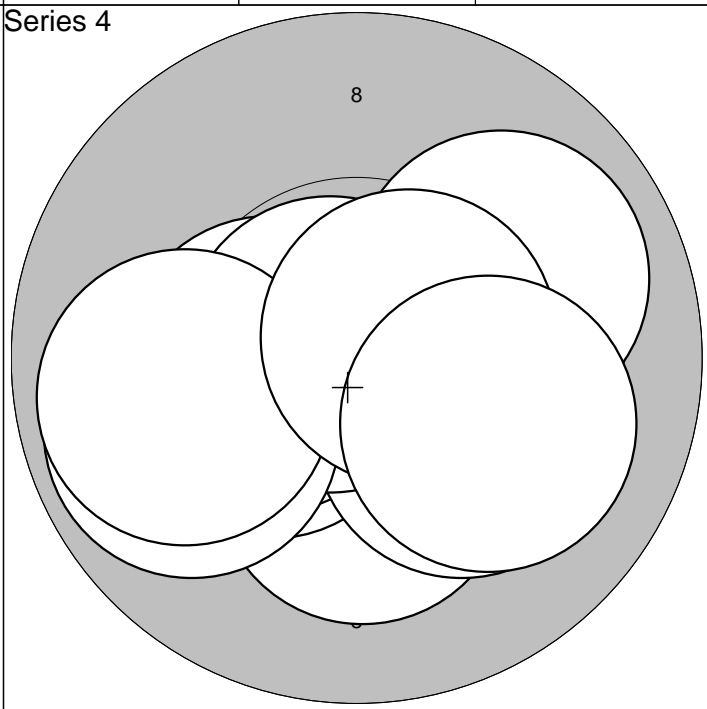
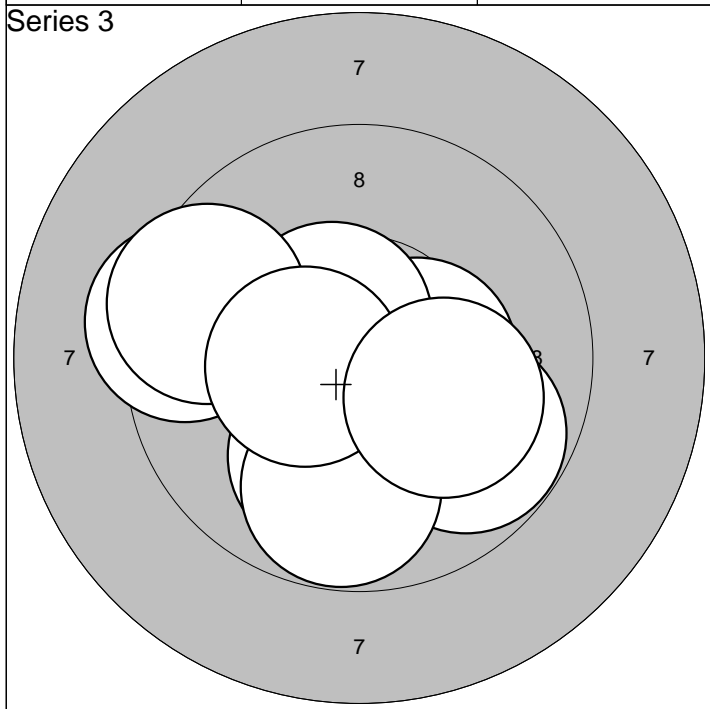

1: 10,5* ↘	6: 9,4 ←	Serie	96,0
2: 10,0 ↓	7: 10,5* ↗		
3: 9,8 ↘	8: 9,5 ←	Sum	285,0
4: 10,4* →	9: 10,5* ←		
5: 9,8 ↓	10: 10,1 ↘		

1: 10,2* ↓	6: 10,8* ↗	Serie	97,0
2: 10,4* ←	7: 9,9 ←		
3: 10,4* ←	8: 9,9 ←	Sum	382,0
4: 9,9 ↗	9: 10,6* ↗		
5: 10,2* ↘	10: 10,1 ↘		

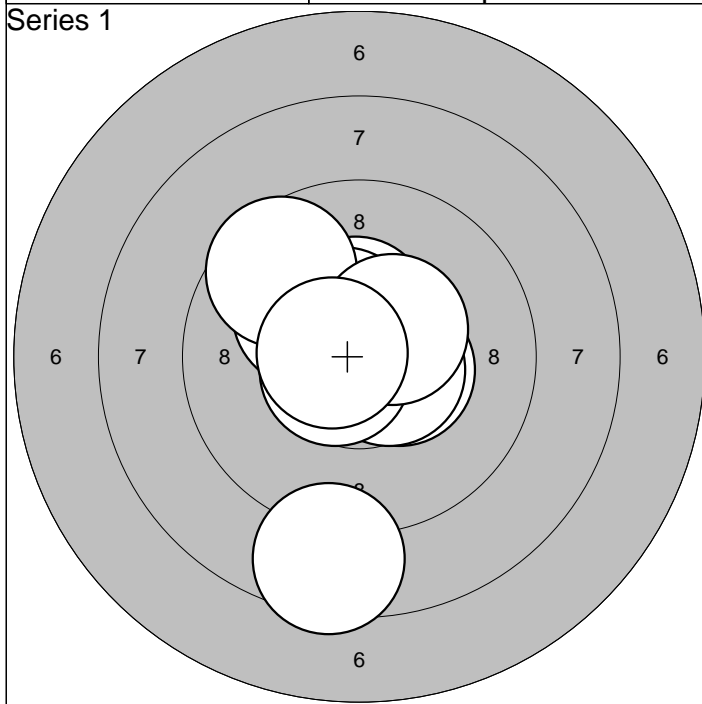

1:10,4* ↑	6:10,6* ←	Serie 97,0
2:10,5* →	7: 9,6 ↖	
3:10,6* →	8: 8,5 ↓	Sum 97,0
4:10,1 ↗	9:10,4* ↗	
5:10,5* ↗	10:10,6* ←	

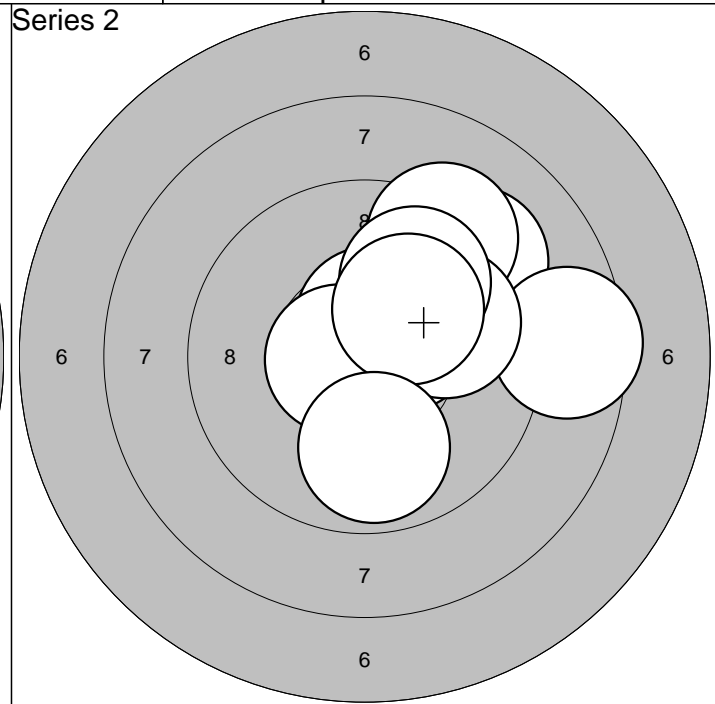

1: 9,2 ↗	6: 9,9 →	Serie 93,0
2: 9,3 ↗	7:10,7* ←	
3: 8,5 →	8: 9,9 ↗	Sum 190,0
4:10,5* →	9:10,2* ↗	
5:10,6* ↑	10: 9,8 ↓	

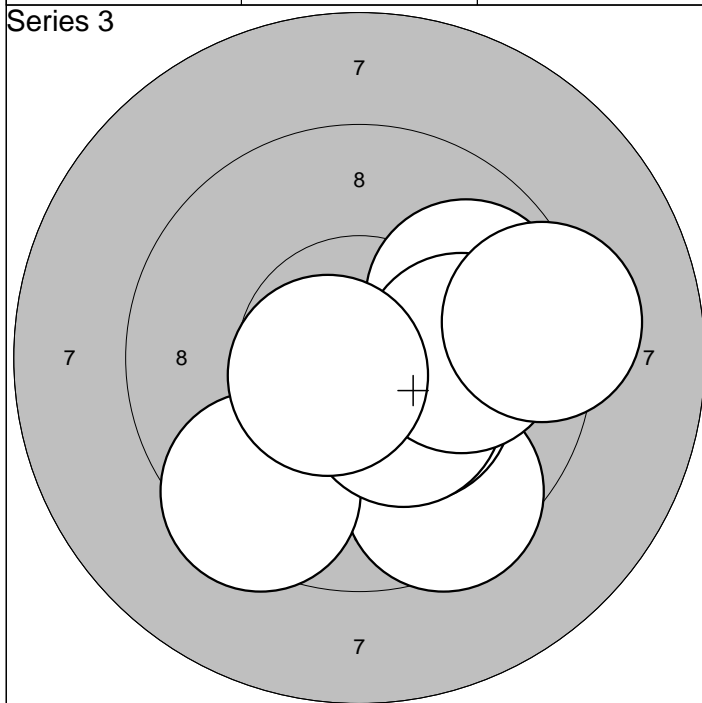

1: 9,9 →	6: 9,8 →	Serie 95,0
2:10,3* ↓	7:10,3* ↓	
3: 9,5 ↓	8:10,0 →	Sum 285,0
4: 9,5 ↓	9: 9,3 →	
5:10,3* ↓	10:10,6* ←	

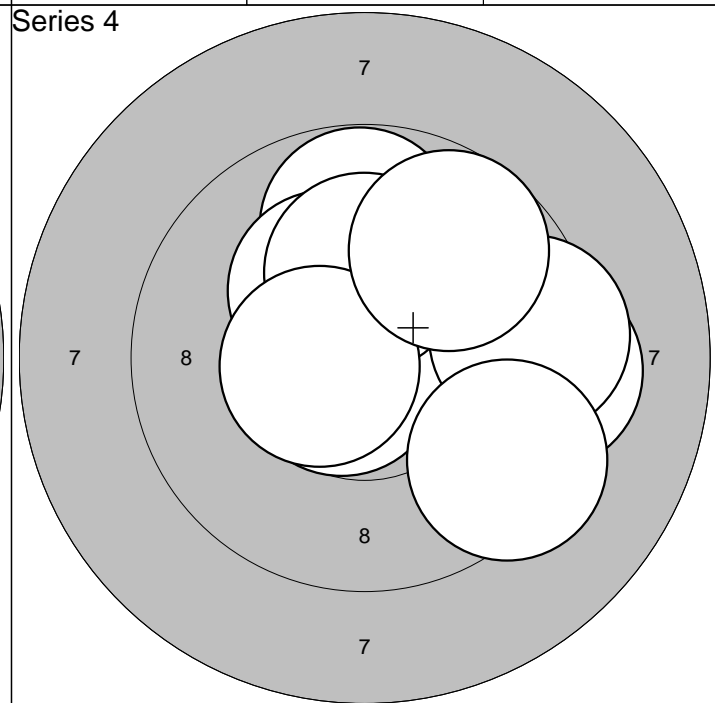

1: 9,3 →	6: 9,5 →	Serie 95,0
2: 9,8 ↑	7:10,2* ↑	
3:10,6* ↗	8:10,6* ←	Sum 380,0
4:10,3* ↖	9: 9,7 ↗	
5:10,7* ↖	10: 9,4 ↓	

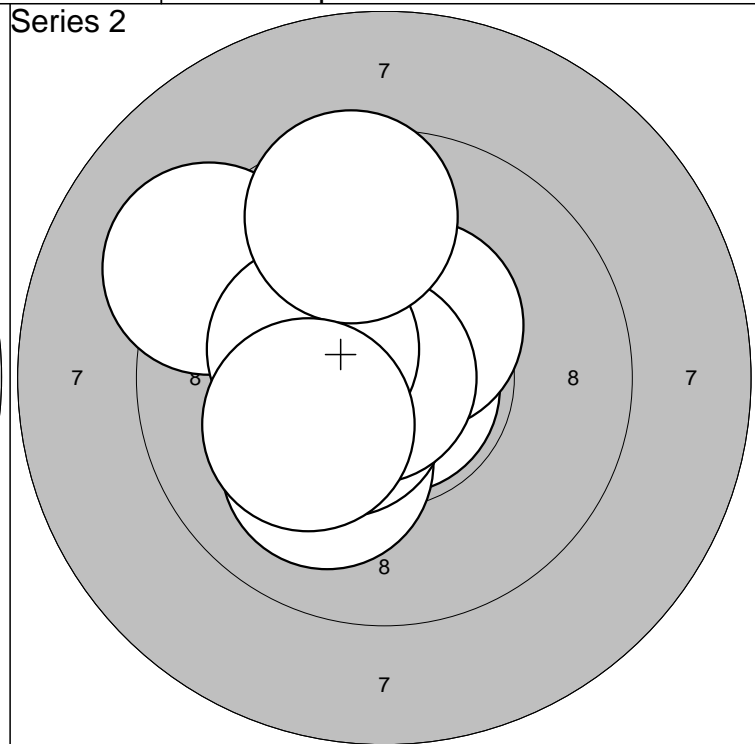
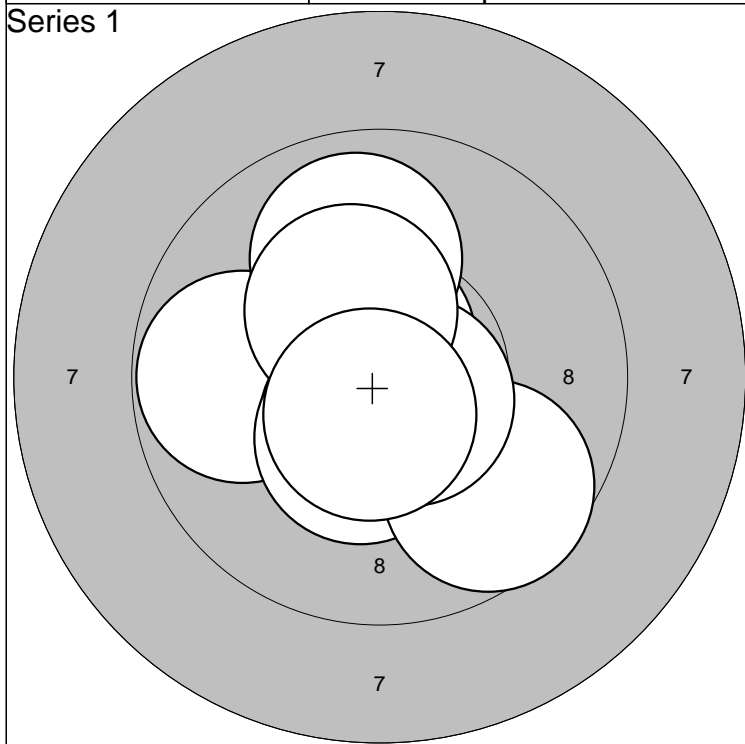

1: 9,8	←	6: 9,6	↘	Serie	97,0
2: 10,5*	↘	7: 9,9	↑		
3: 10,5*	↘	8: 10,6*	↘	Sum	97,0
4: 10,4*	↘	9: 10,3*	↑		
5: 10,7*	↑	10: 10,6*	↘		

1: 10,8*	↘	6: 10,8*	←	Serie	98,0
2: 10,4*	↑	7: 9,2	↖		
3: 10,4*	↗	8: 10,3*	←	Sum	195,0
4: 10,1	↘	9: 9,5	↑		
5: 10,5*	↖	10: 10,2*	↖		

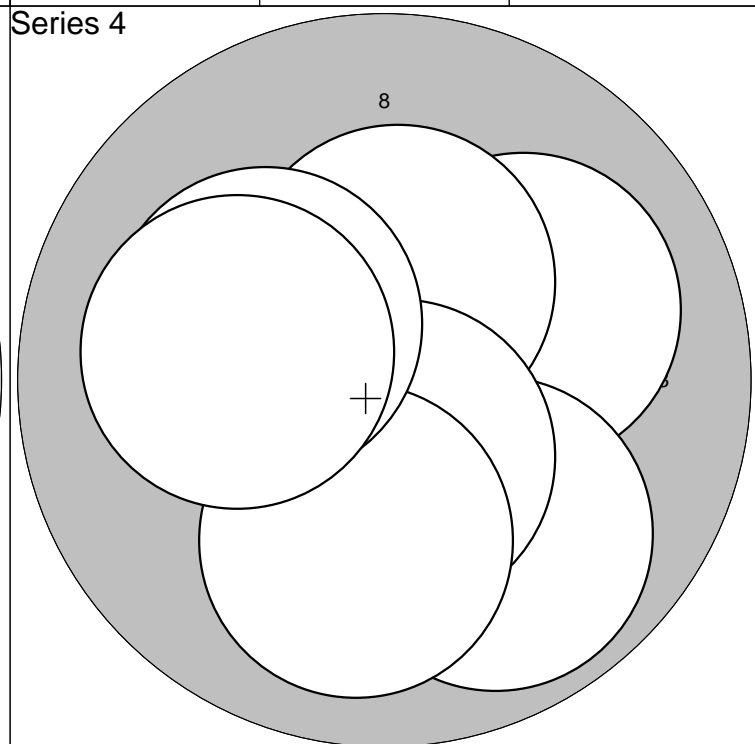
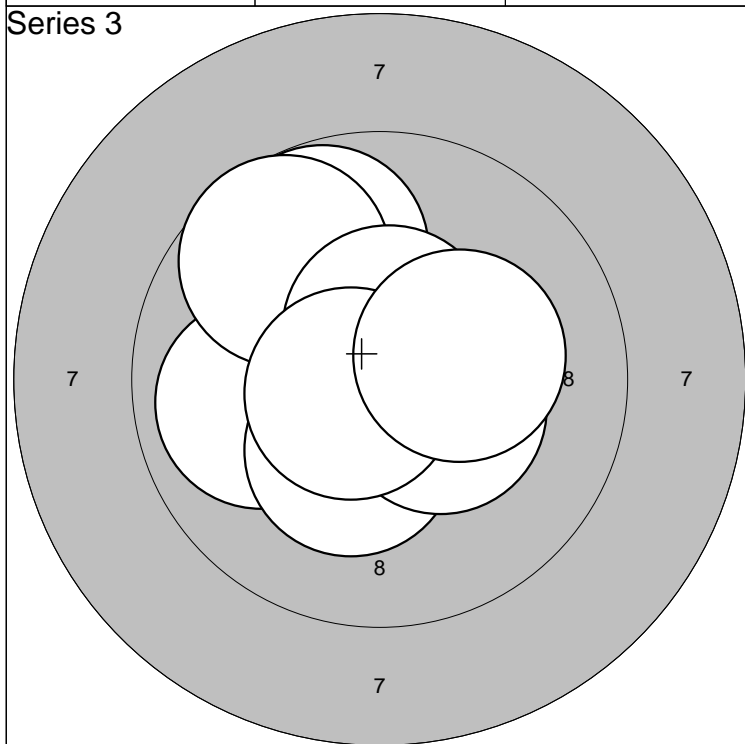

1: 10,6*	↗	6: 9,7	↖	Serie	97,0
2: 10,3*	↖	7: 10,4*	→		
3: 9,9	←	8: 10,5*	↑	Sum	292,0
4: 9,8	↑	9: 10,7*	←		
5: 10,3*	↘	10: 10,2*	→		

1: 10,5*	←	6: 10,4*	↑	Serie	99,0
2: 10,1	↗	7: 10,5*	↘		
3: 9,9	↘	8: 10,0	↘	Sum	391,0
4: 10,3*	←	9: 10,2*	↖		
5: 10,6*	↘	10: 10,1	←		

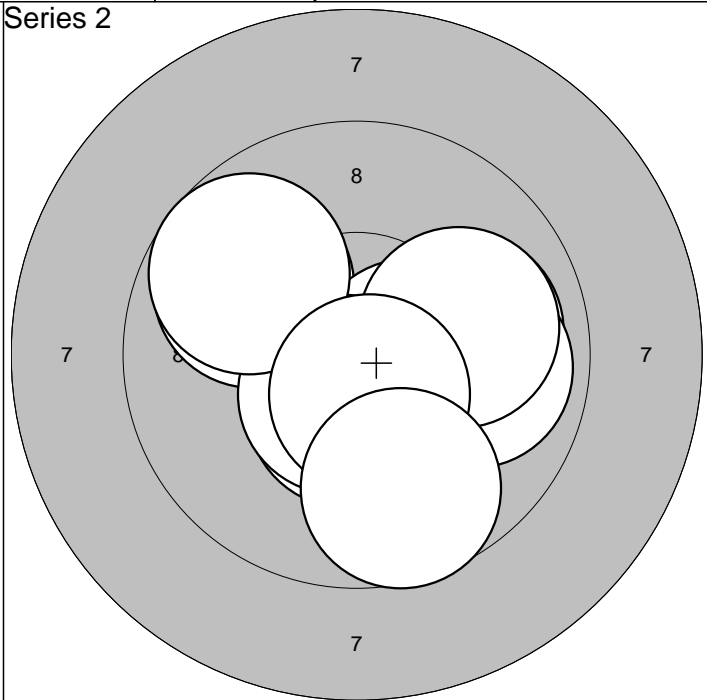
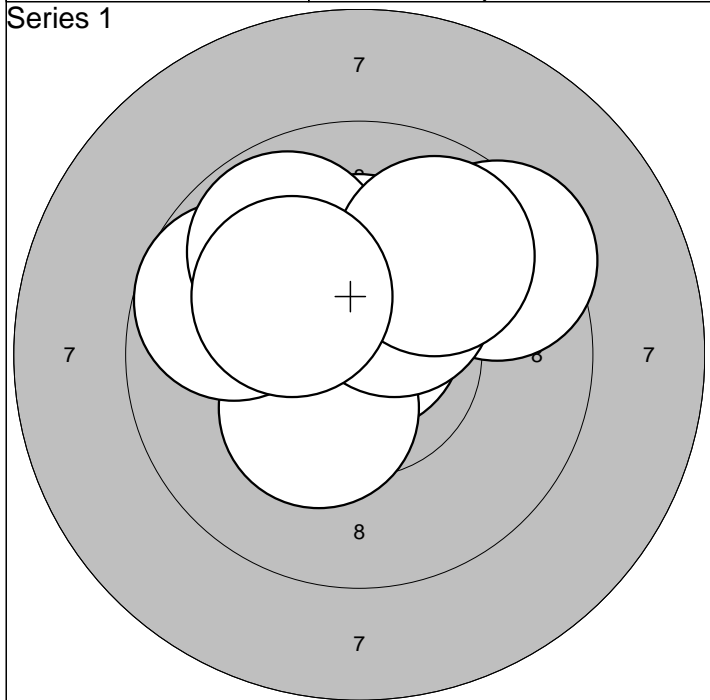

1:10,2* ↖	6:10,2* ↑	Serie	96,0
2:10,7* ↑	7:10,3* ↗		
3:10,4* ↘	8: 9,8 ↖	Sum	96,0
4: 9,4 ↗	9: 9,8 ↗		
5: 9,7 ↖	10:10,1 ↖		

1: 9,9 ↖	6:10,0 →	Serie	96,0
2:10,0 →	7:10,6* ↓		
3:10,4* →	8: 9,8 ↖	Sum	192,0
4:10,5* ↓	9:10,6* ↓		
5: 9,9 →	10: 9,7 ↓		

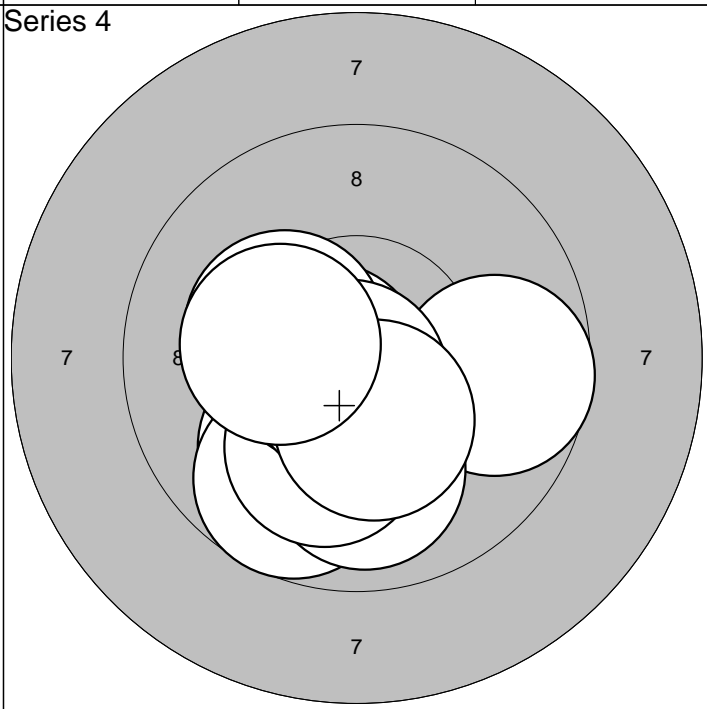
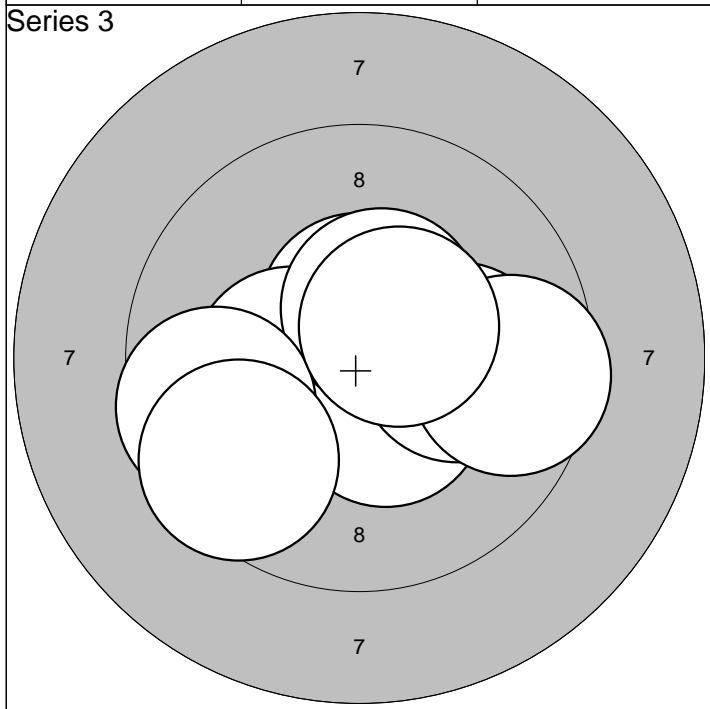

1:10,6* ↑	6:10,1 →	Serie	97,0
2:10,5* ↖	7: 9,6 ↖		
3:10,4* ↖	8: 9,6 →	Sum	289,0
4:10,4* ↘	9:10,5* ↗		
5:10,5* ↗	10: 9,5 ↘		

1:10,0 ↘	6:10,7* ↖	Serie	97,0
2: 9,7 ↘	7:10,3* ↖		
3: 9,7 →	8:10,7* ↓	Sum	386,0
4: 9,9 ↓	9:10,4* ↓		
5:10,1 ↓	10:10,3* ↖		

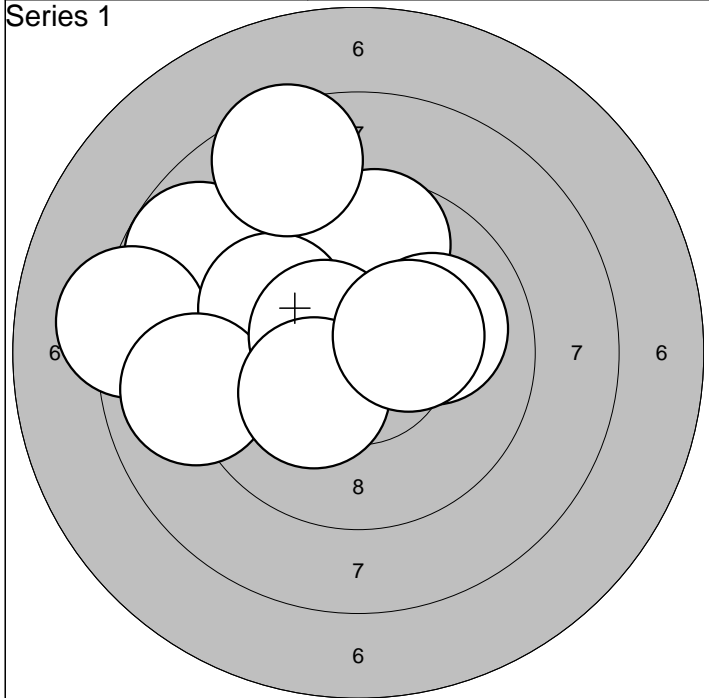

1: 8,8 ↖	6: 8,5 ↗	Serie	91,0
2: 8,2 ←	7: 9,0 ←		
3: 9,7 ↑	8:10,5* ↖	Sum	91,0
4:10,0 →	9:10,2* ↙		
5: 9,8 ↖	10:10,3* →		

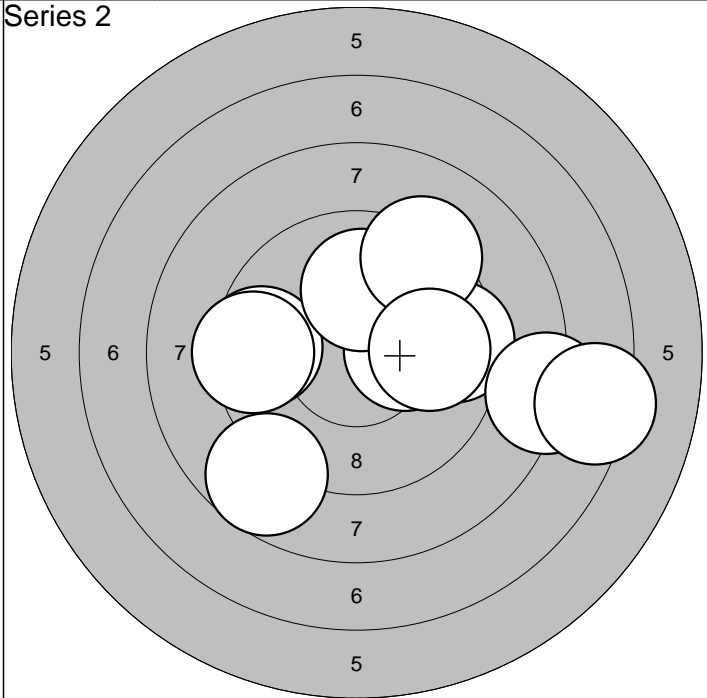

1:10,2* →	6:10,0 ↑	Serie	88,0
2: 9,5 ←	7: 9,3 ↗		
3: 9,4 ←	8: 7,4 →	Sum	179,0
4: 9,5 →	9: 9,9 →		
5: 8,1 →	10: 8,7 ↙		

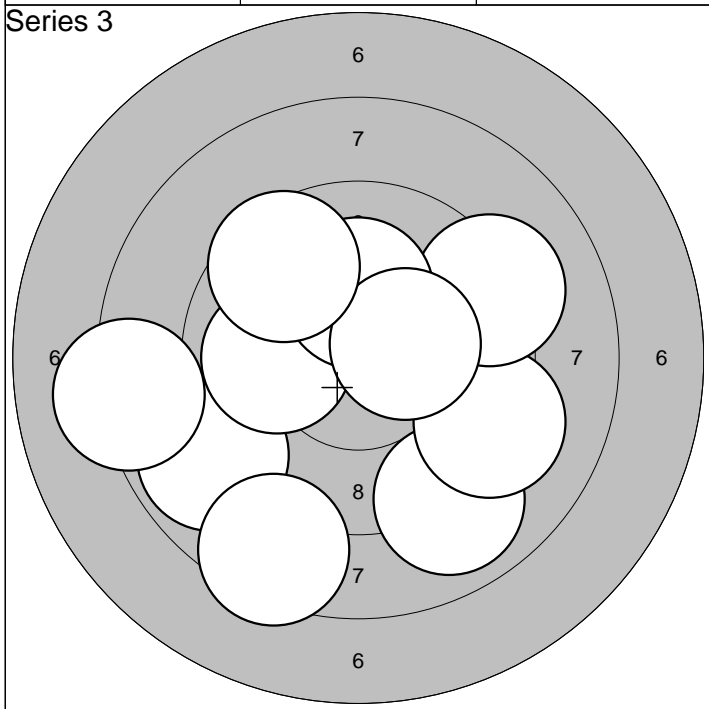

1: 8,9 ↙	6:10,2* ↑	Serie	90,0
2: 9,0 ↘	7:10,3* →		
3: 9,2 ↘	8: 8,2 ←	Sum	269,0
4: 9,2 ↗	9: 9,6 ↗		
5:10,0 ←	10: 8,5 ↘		

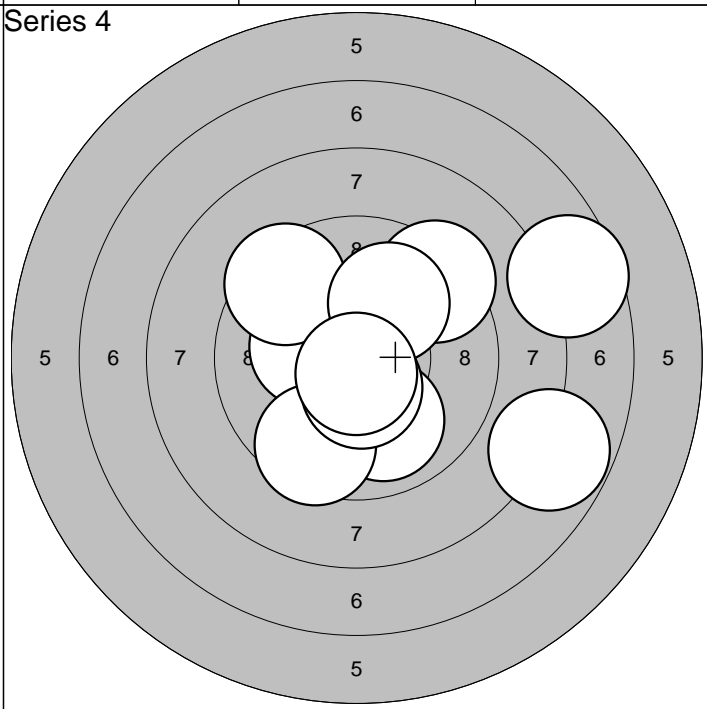

1: 9,9 ↘	6:10,5* ↘	Serie	90,0
2: 9,3 ↗	7:10,0 ↗		
3:10,3* ←	8:10,7* ↘	Sum	359,0
4: 9,5 ↘	9: 7,8 ↘		
5: 9,5 ↗	10: 7,6 →		

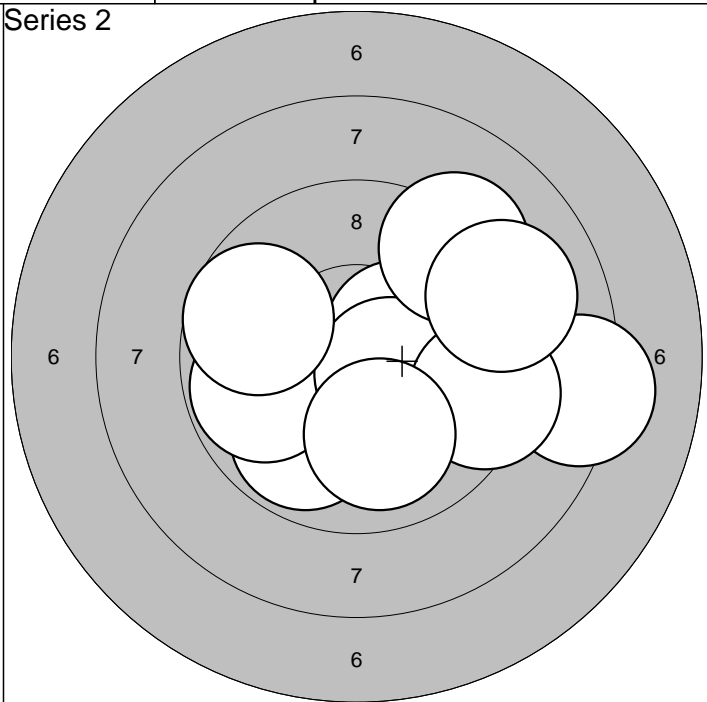
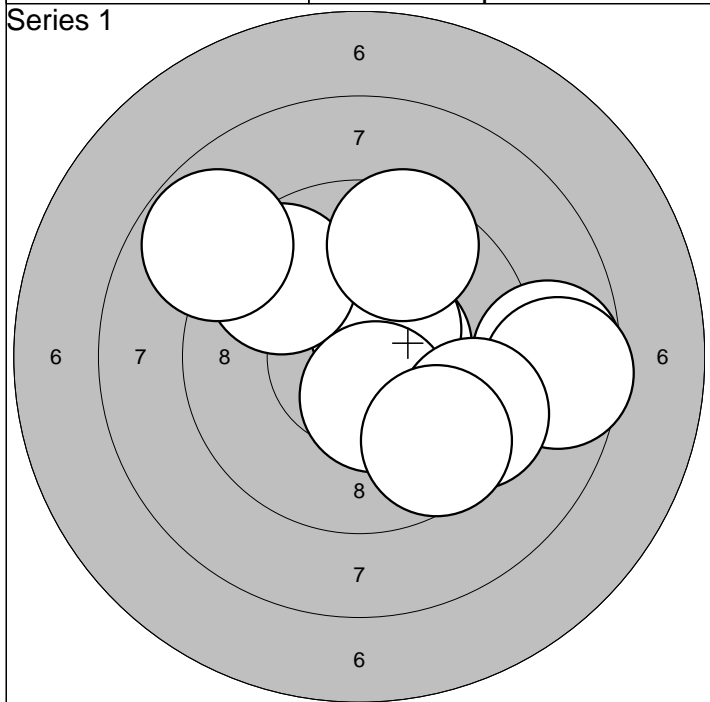

1: 8,7 →	6: 8,8 ↖	Serie	90,0
2: 10,5* →	7: 8,6 →		
3: 10,5* ↗	8: 9,5 ↗	Sum	90,0
4: 9,6 ↖	9: 9,4 →		
5: 10,4* ↓	10: 9,6 ↓		

1: 10,4* ↗	6: 9,4 →	Serie	92,0
2: 9,8 ↓	7: 10,0 ↓		
3: 8,3 →	8: 9,7 ↖	Sum	182,0
4: 9,8 ←	9: 9,2 ↗		
5: 10,5* →	10: 9,1 ↗		

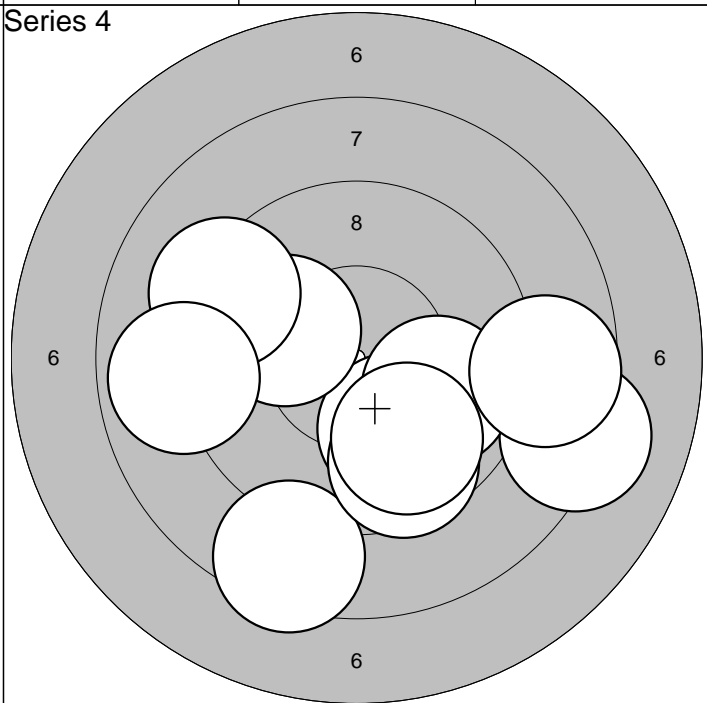
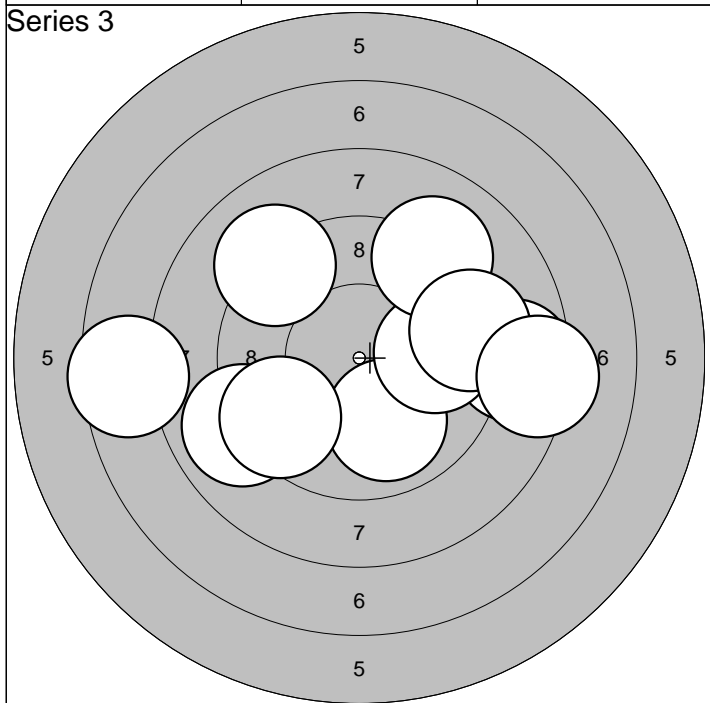

1: 8,7 →	6: 9,1 ↗	Serie	86,0
2: 9,9 ↓	7: 9,2 →		
3: 9,0 ←	8: 9,1 ↗	Sum	268,0
4: 9,5 ←	9: 8,3 →		
5: 9,8 →	10: 7,5 ←		

1: 10,0 ↓	6: 9,9 →	Serie	88,0
2: 10,1 ↖	7: 8,9 ←		
3: 9,2 ↖	8: 8,7 →	Sum	356,0
4: 8,2 →	9: 9,6 ↓		
5: 8,5 ↓	10: 9,8 ↓		

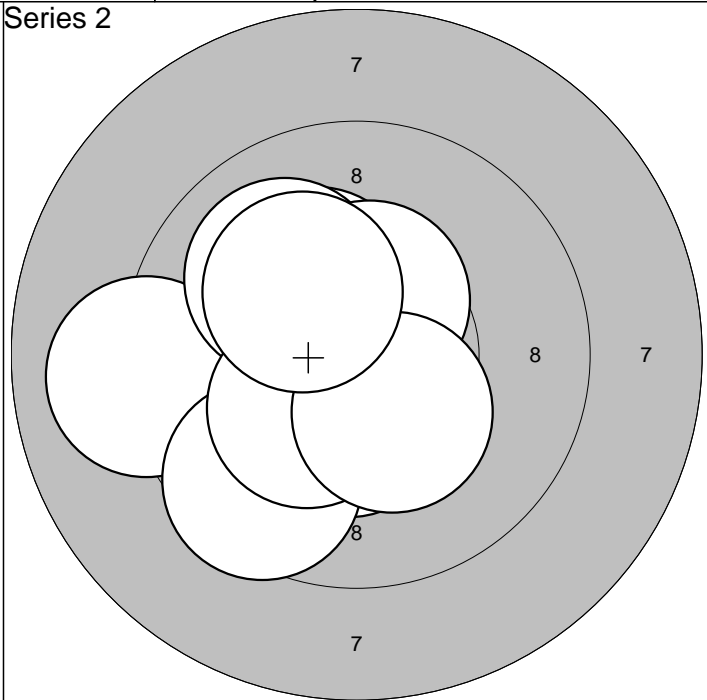
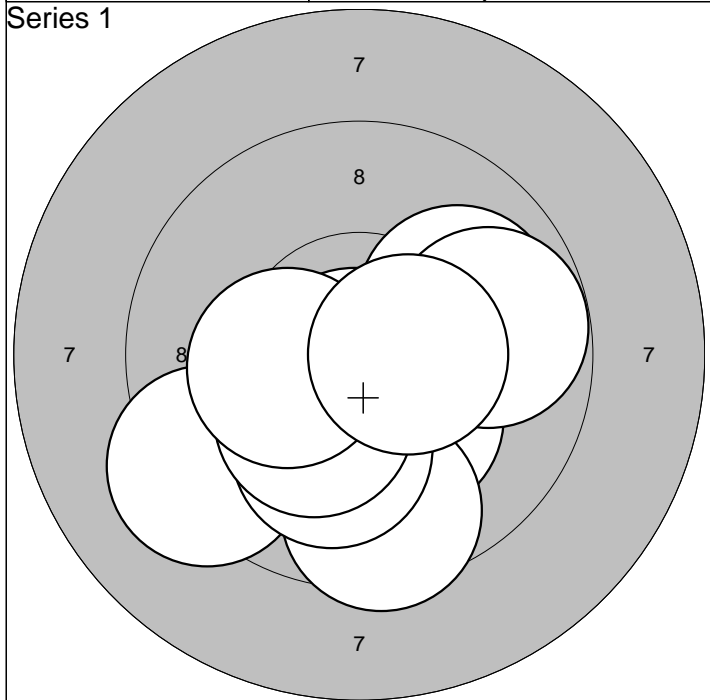

1:10,8* ↓	6:10,0 →	Serie 97,0
2: 9,2 ↙	7: 9,8 →	
3:10,2* ↓	8:10,3* ↘	Sum 97,0
4: 9,5 ↓	9:10,3* ←	
5:10,1 ↓	10:10,5* →	

1:10,4* ↓	6:10,0 ↖	Serie 98,0
2: 9,1 ←	7:10,3* ↘	
3:10,7* ↗	8:10,4* ↗	Sum 195,0
4:10,3* ↖	9:10,3* ↘	
5: 9,5 ↘	10:10,2* ↖	

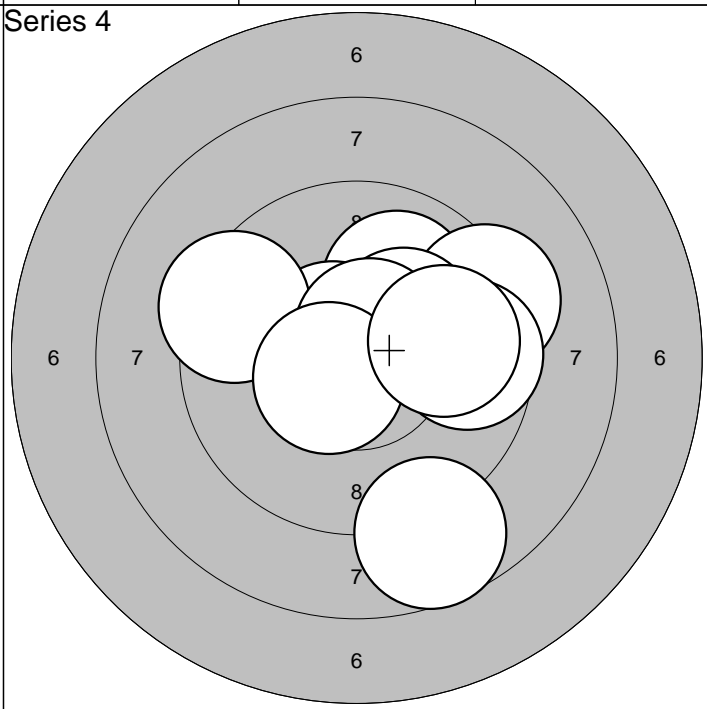
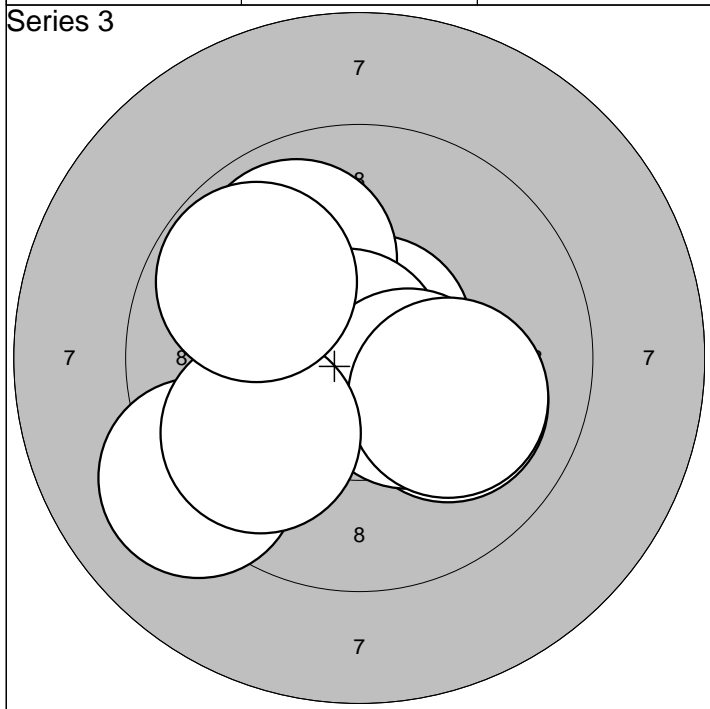

1:10,4* ↖	6: 9,2 ↙	Serie 96,0
2:10,1 ↘	7:10,4* ↘	
3:10,7* ↗	8:10,1 →	Sum 291,0
4: 9,9 ↗	9: 9,8 ↙	
5:10,8* ↖	10: 9,8 ↖	

1:10,0 ↗	6: 8,7 ↓	Serie 94,0
2: 9,3 →	7: 9,6 →	
3:10,6* ↖	8:10,6* ↗	Sum 385,0
4:10,2* ↗	9:10,5* ↙	
5: 9,4 ↖	10: 9,9 →	

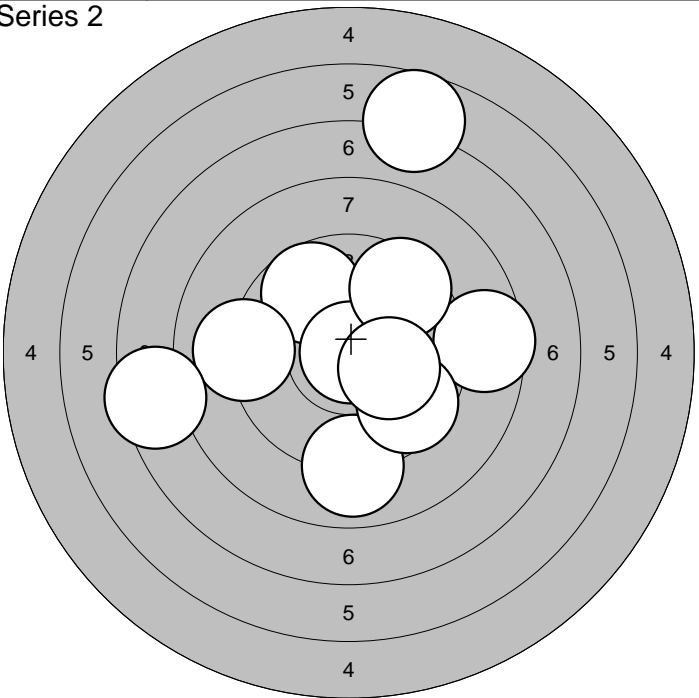
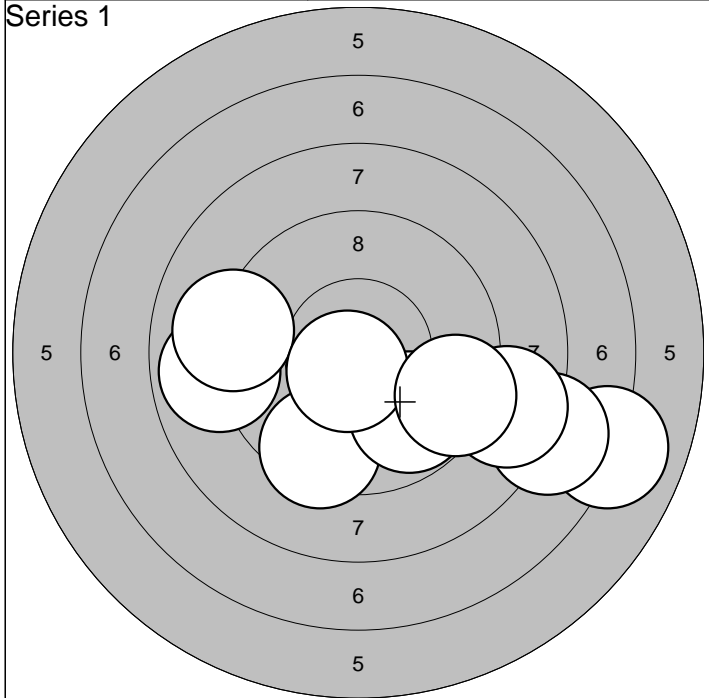

1:10,2* ↓	6: 9,1 ←	Serie 86,0
2: 8,9 ←	7: 9,8 ↓	
3: 7,0 →	8: 8,6 →	Sum 86,0
4: 9,4 ↓	9:10,6* ↓	
5: 7,9 →	10: 9,4 →	

1: 8,9 ↓	6: 9,5 ↗	Serie 85,0
2: 8,5 →	7: 9,6 ↓	
3: 9,7 ↖	8:10,2* →	Sum 171,0
4:10,9* →	9: 9,1 ←	
5: 6,7 ↑	10: 7,5 ←	

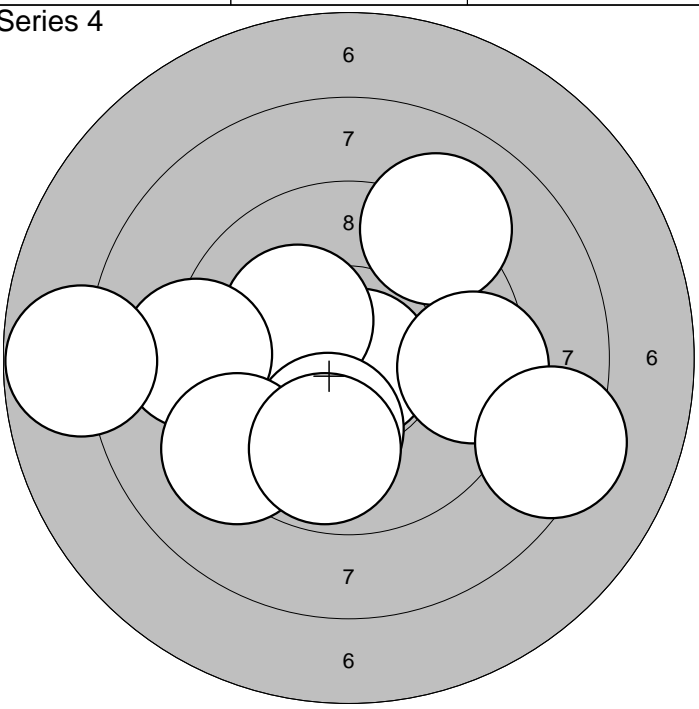
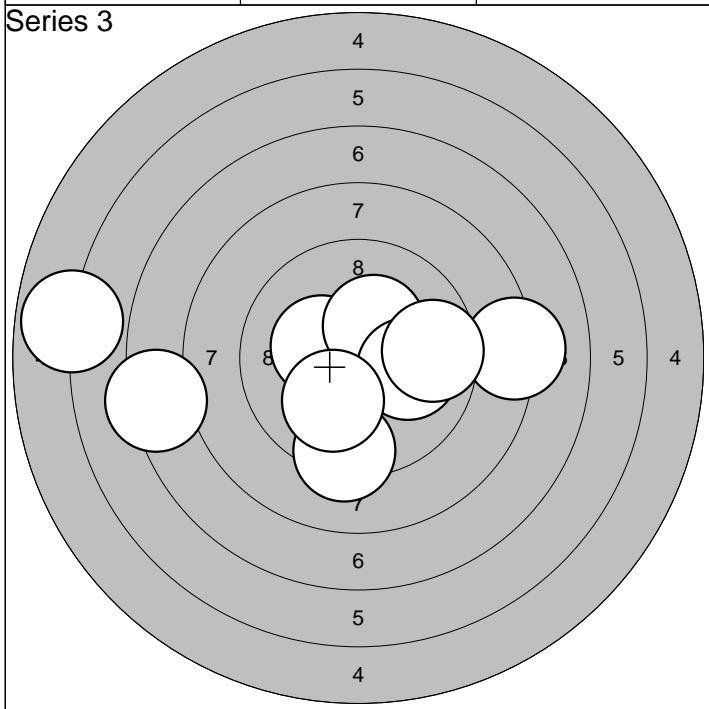

1:10,4* ←	6: 5,9 ←	Serie 88,0
2:10,3* ←	7:10,3* ↗	
3: 9,3 ↓	8:10,0 →	Sum 259,0
4: 7,3 ←	9: 9,6 →	
5: 8,2 →	10:10,1 ↓	

1:10,8* →	6: 9,2 ↙	Serie 90,0
2: 9,1 ↗	7: 7,8 ←	
3:10,2* ↖	8: 9,8 ↓	Sum 349,0
4:10,1 ↓	9: 9,5 →	
5: 9,1 ←	10: 8,3 →	

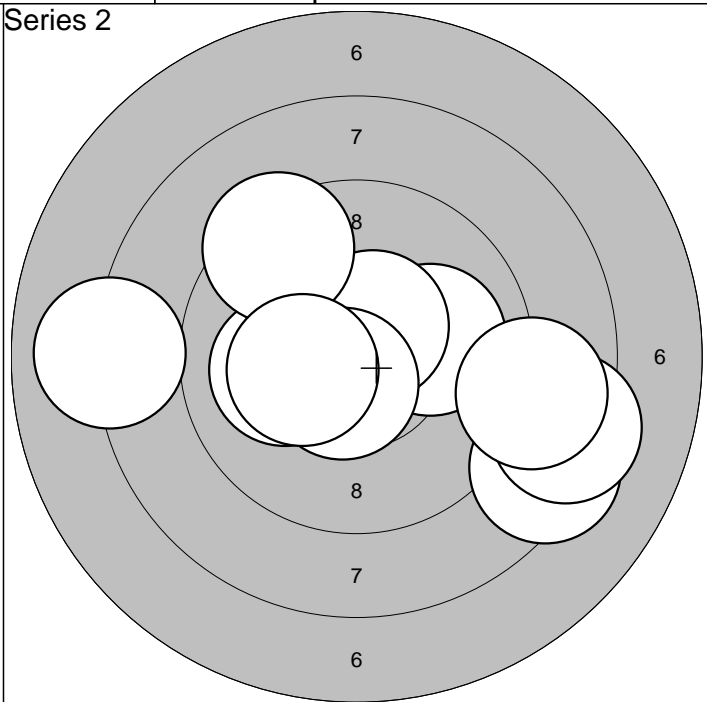
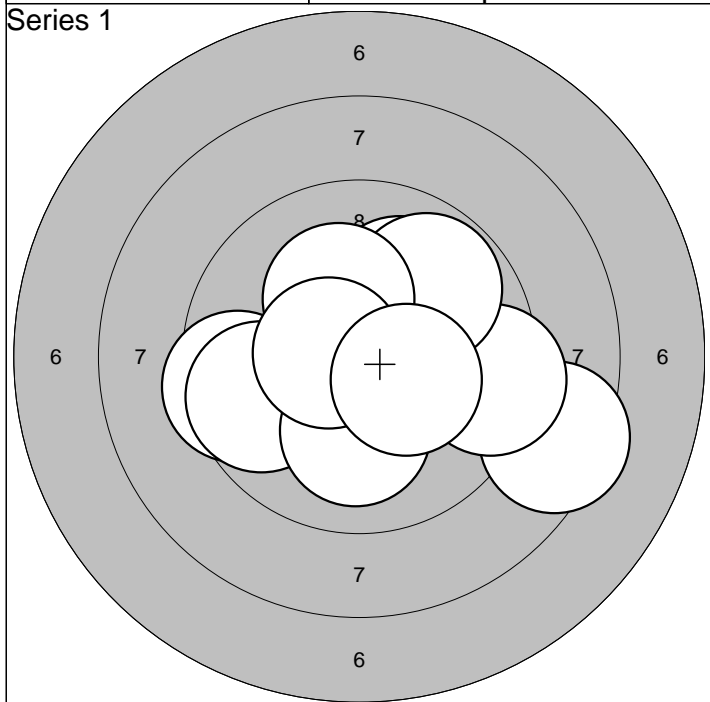

1: 8,4 →	6: 9,8 ↗		Serie	94,0
2: 9,5 ←	7: 10,1 ↓			
3: 10,1 ↗	8: 10,2* ↑	Sum	94,0	
4: 9,4 →	9: 10,6* ←			
5: 9,7 ←	10: 10,3* →			

1: 8,4 →	6: 8,3 →		Serie	91,0
2: 10,0 →	7: 9,4 ↗			
3: 10,5* ↗	8: 8,8 →	Sum	185,0	
4: 10,6* ↓	9: 8,0 ←			
5: 10,1 ←	10: 10,3* ←			

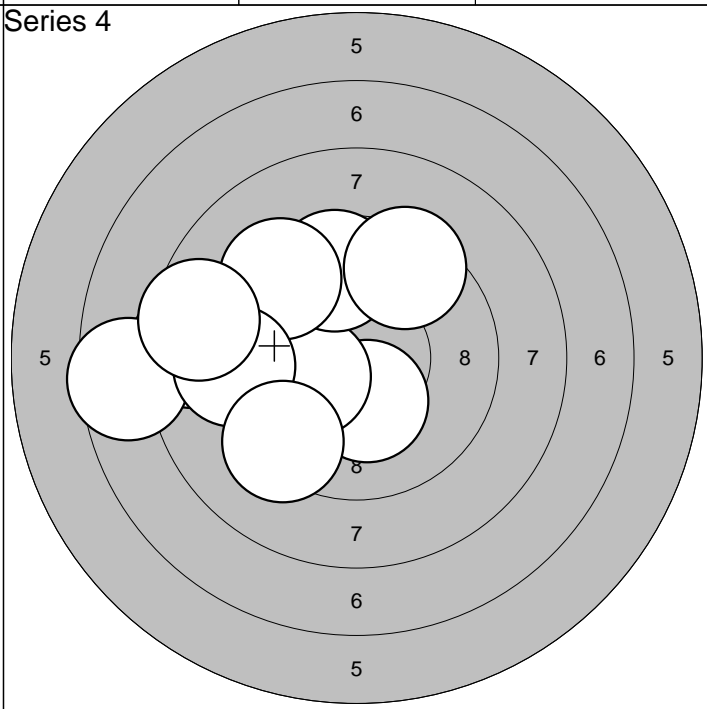
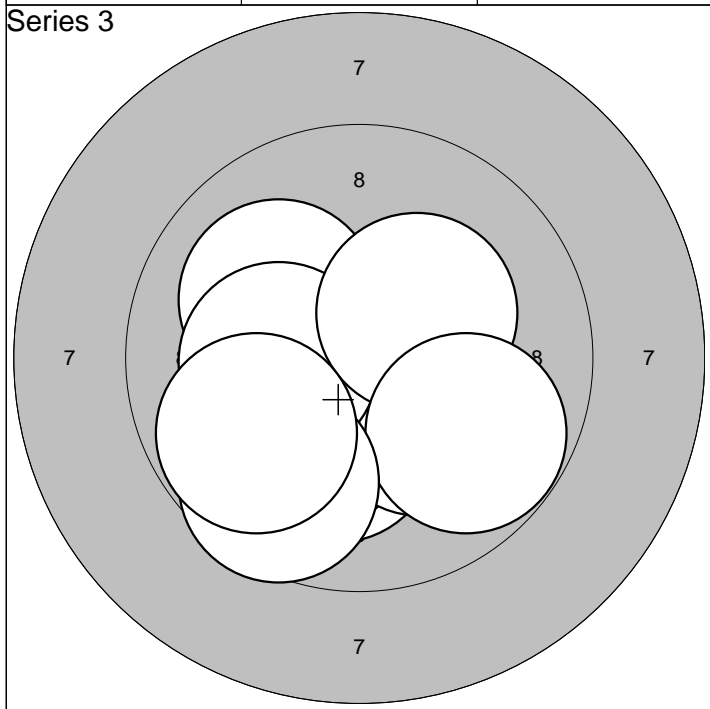

1: 10,2* ↓	6: 10,2* ←		Serie	97,0
2: 10,1 ↓	7: 10,3* ↗			
3: 10,2* →	8: 9,8 →	Sum	282,0	
4: 10,6* ←	9: 9,6 ↓			
5: 10,1 ↖	10: 9,8 ↙			

1: 10,3* ↓	6: 9,3 ↖		Serie	88,0
2: 10,2* ←	7: 9,2 ←			
3: 8,5 ←	8: 9,3 ↓	Sum	370,0	
4: 7,6 ←	9: 9,5 ↗			
5: 9,6 ↑	10: 8,6 ←			

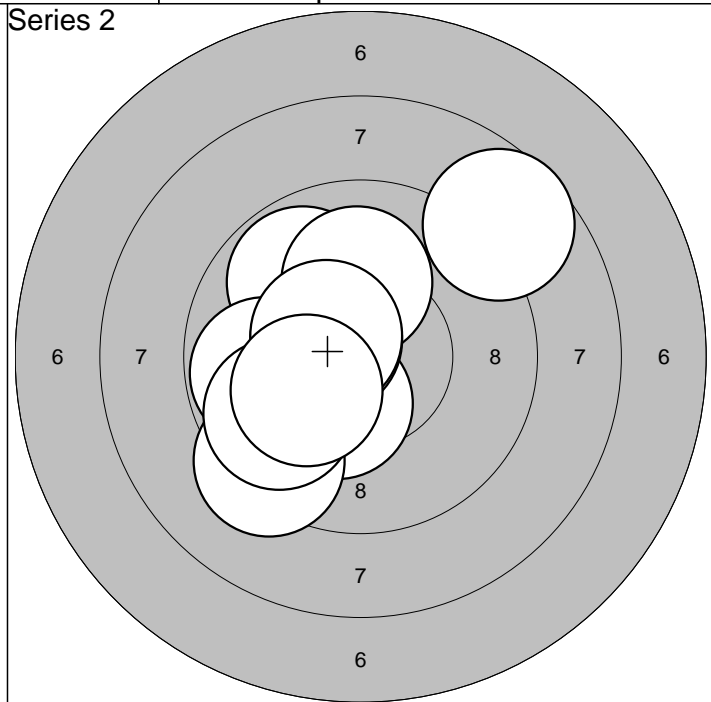
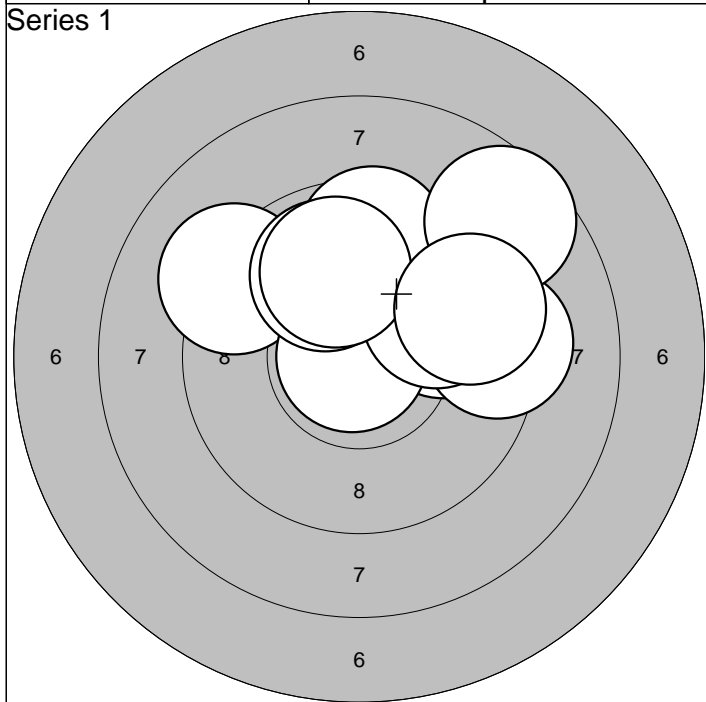

1: 9,9 →	6: 9,6 ↑	Serie 90,0
2: 9,2 ↖	7: 8,6 ↗	
3: 9,3 →	8: 9,9 ↑	Sum 90,0
4: 10,9* ←	9: 9,9 ↑	
5: 9,9 ↗	10: 9,5 ↗	

1: 10,3* ↓	6: 10,5* ↖	Serie 94,0
2: 9,8 ↖	7: 9,8 ↙	
3: 10,1 ↑	8: 8,7 ↗	Sum 184,0
4: 9,8 ←	9: 10,5* ↖	
5: 9,3 ↓	10: 10,2* ↙	

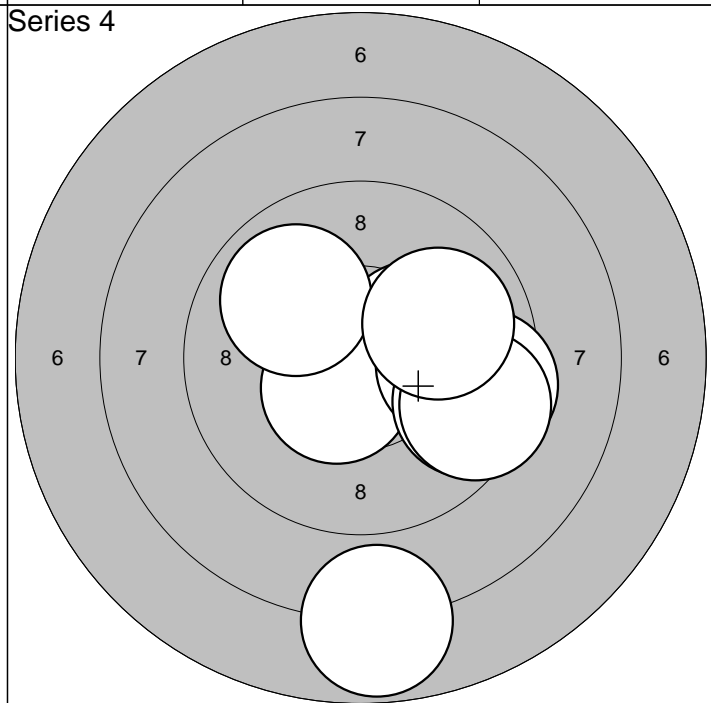
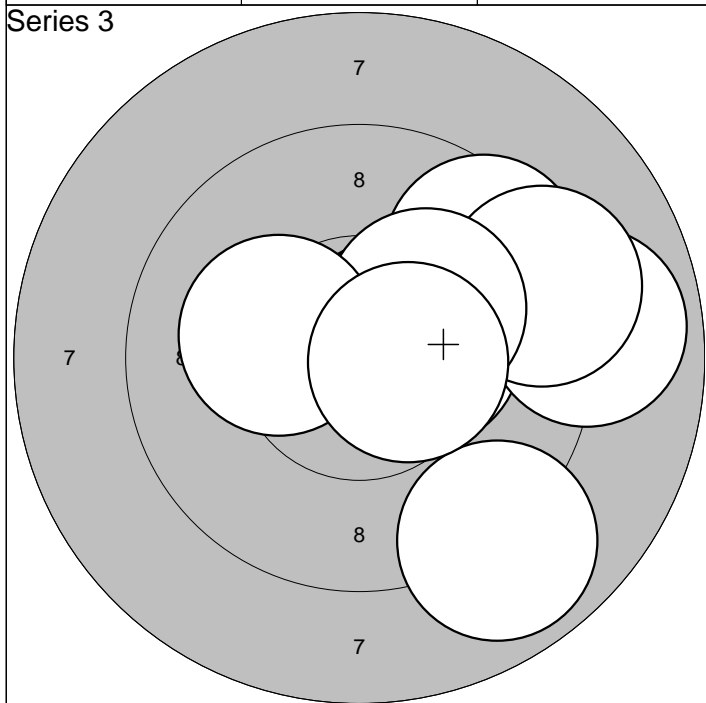

1: 8,9 ↓	6: 10,6* ↗	Serie 94,0
2: 9,5 ↗	7: 10,6* ↗	
3: 10,4* →	8: 10,2* ↗	Sum 278,0
4: 8,9 →	9: 10,2* ←	
5: 9,2 ↗	10: 10,5* →	

1: 7,8 ↓	6: 9,6 →	Serie 91,0
2: 10,3* →	7: 9,9 ↖	
3: 10,0 →	8: 9,5 →	Sum 369,0
4: 10,5* ↓	9: 9,5 →	
5: 9,9 →	10: 9,9 →	

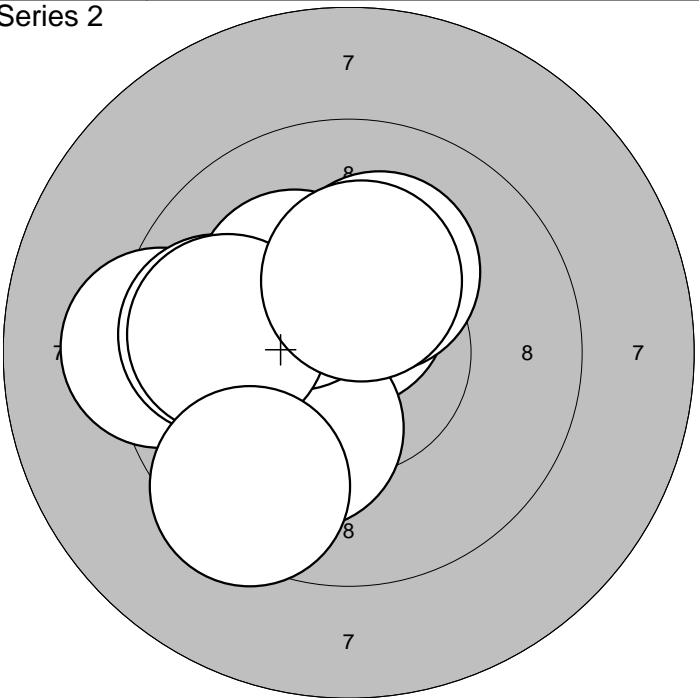
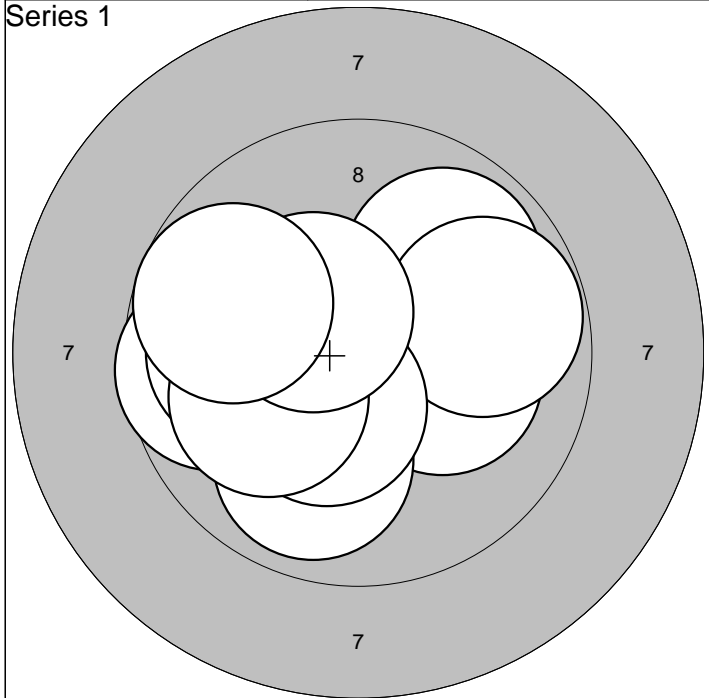

1: 9,9 ↗	6:10,4* ↓		Serie	94,0
2:10,2* →	7: 9,9 ←			
3: 9,9 ↓	8:10,0 ←	Sum	94,0	
4: 9,8 →	9:10,4* ↗			
5: 9,7 ←	10: 9,7 ←			

1:10,0 ↙	6:10,1 ↓		Serie	96,0
2:10,5* ↑	7:10,2* ↖			
3: 9,3 ←	8: 9,8 ←	Sum	190,0	
4: 9,8 ←	9:10,3* ↑			
5:10,2* ↑	10: 9,5 ↓			

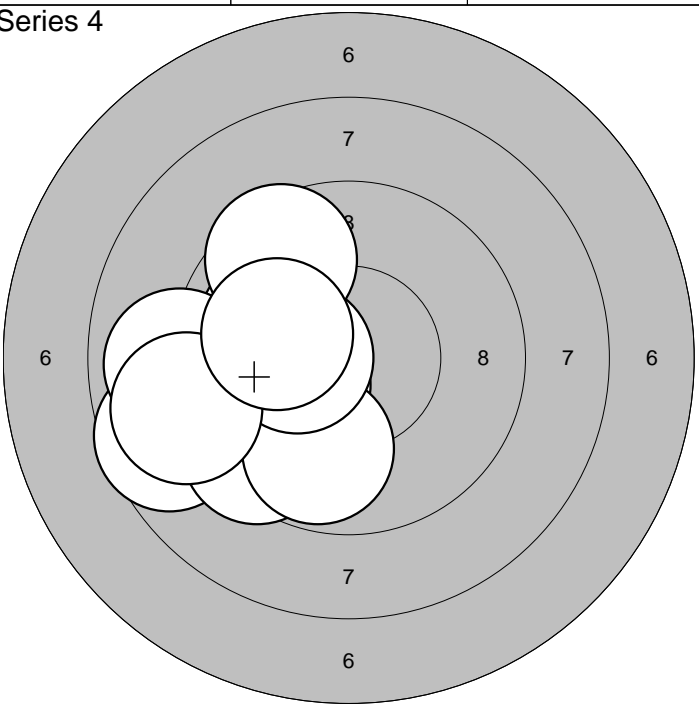
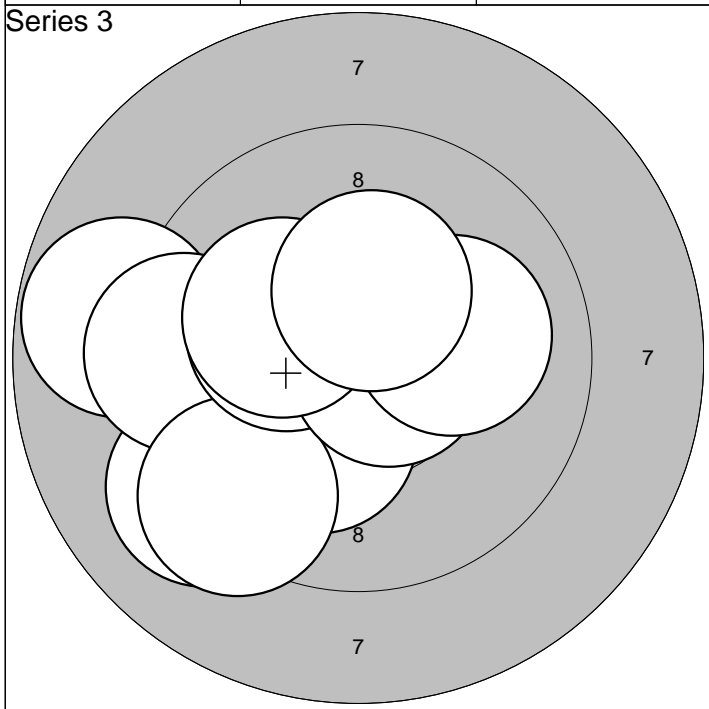

1:10,2* ↓	6:10,3* ←		Serie	95,0
2: 8,8 ←	7:10,7* →			
3: 9,2 ↙	8:10,2* ←	Sum	285,0	
4: 9,4 ←	9:10,1 →			
5: 9,3 ↙	10:10,3* ↑			

1: 8,6 ←	6:10,4* ←		Serie	92,0
2:10,0 ←	7: 8,9 ←			
3:10,2* ←	8: 9,0 ←	Sum	377,0	
4: 9,4 ↙	9: 9,5 ↗			
5: 9,8 ↓	10:10,1 ←			

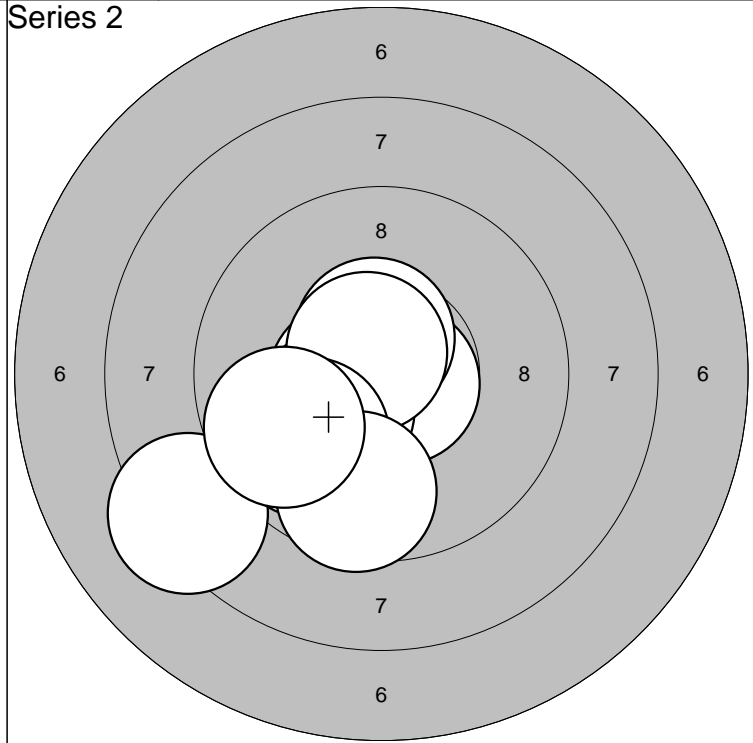
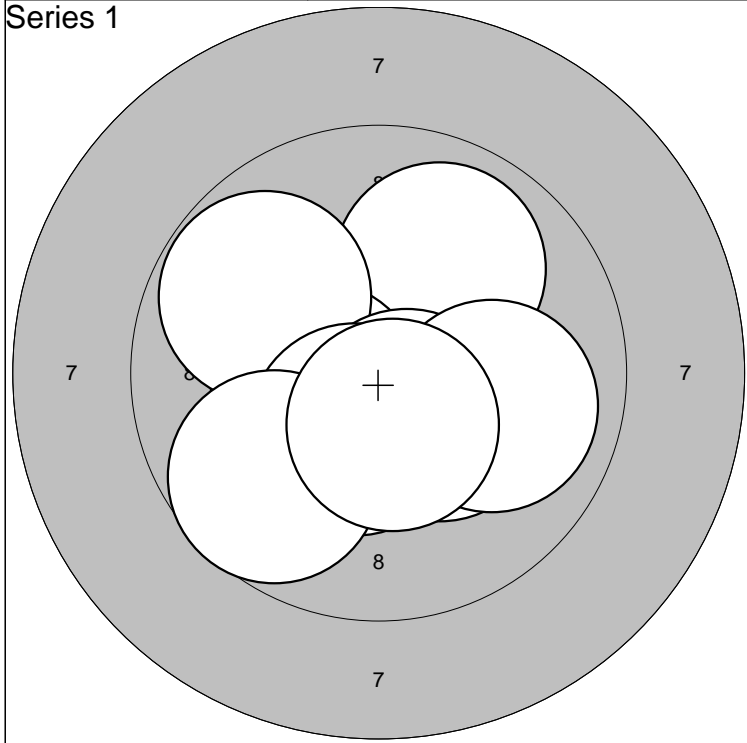

1:10,3*	↘	6:10,5*	↘	Serie	96,0
2:10,6*	↑	7: 9,9	→		
3: 9,9	↗	8:10,4*	↘	Sum	96,0
4:10,4*	←	9: 9,7	↙		
5: 9,8	↖	10:10,5*	↘		

1:10,6*	←	6:10,3*	↙	Serie	94,0
2:10,7*	↘	7:10,7*	↖		
3: 9,9	↙	8: 9,9	↙	Sum	190,0
4:10,5*	↑	9: 9,6	↘		
5: 8,3	↙	10: 9,7	↙		

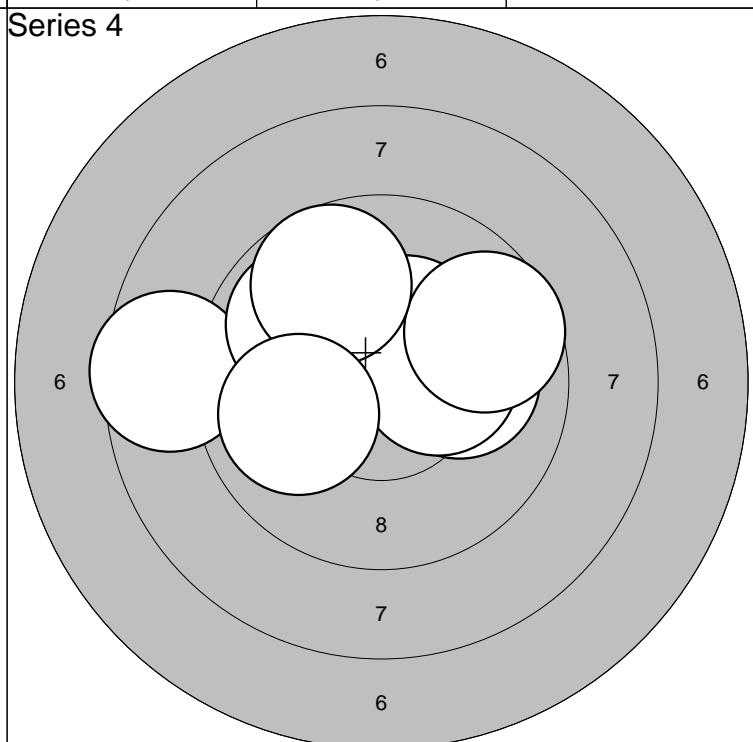
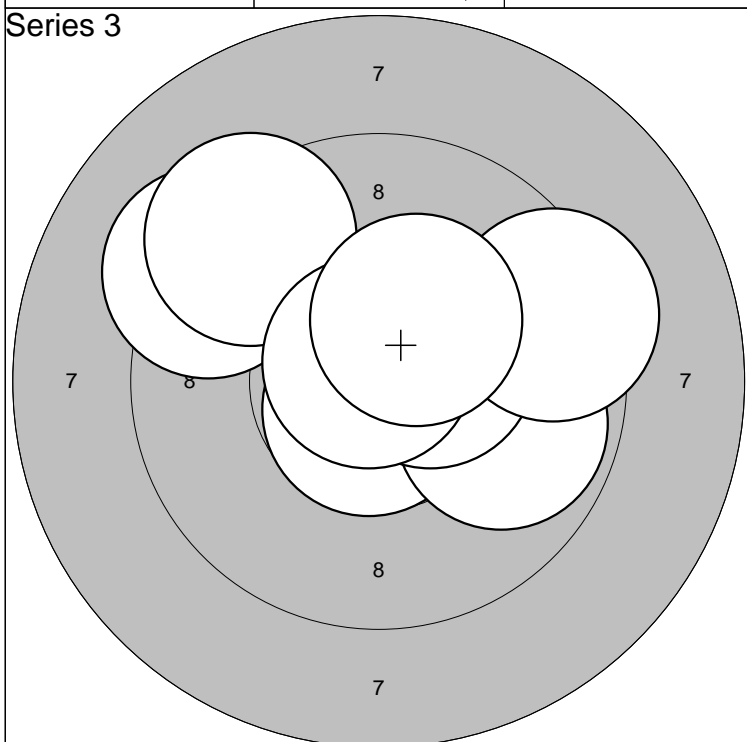

1:10,7*	↘	6: 9,8	→	Serie	96,0
2: 9,2	↖	7:10,5*	→		
3:10,4*	→	8:10,8*	↗	Sum	286,0
4: 9,3	↖	9: 9,4	→		
5:10,2*	→	10:10,4*	↗		

1:10,1	→	6: 9,9	↖	Serie	94,0
2:10,4*	↗	7:10,3*	→		
3:10,1	→	8: 9,7	↗	Sum	380,0
4:10,0	↖	9: 9,7	↗		
5: 8,6	←	10: 9,9	↙		

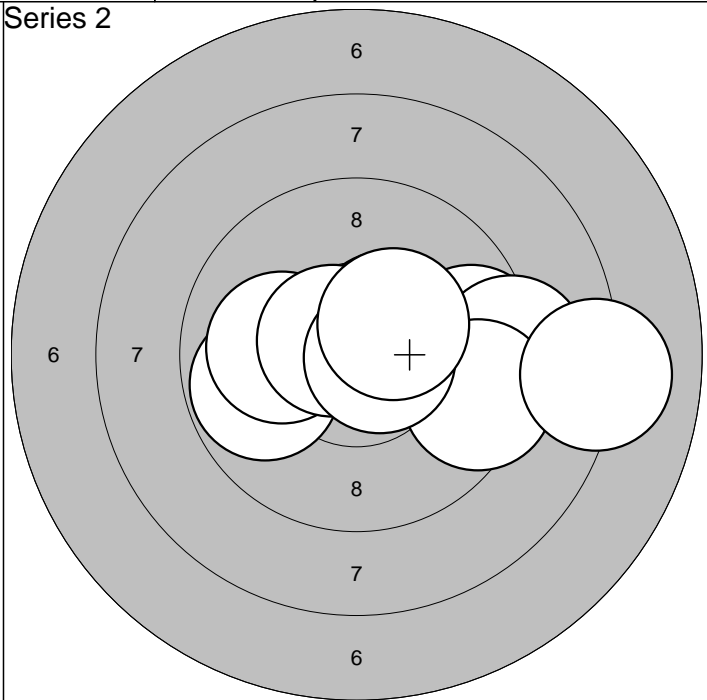
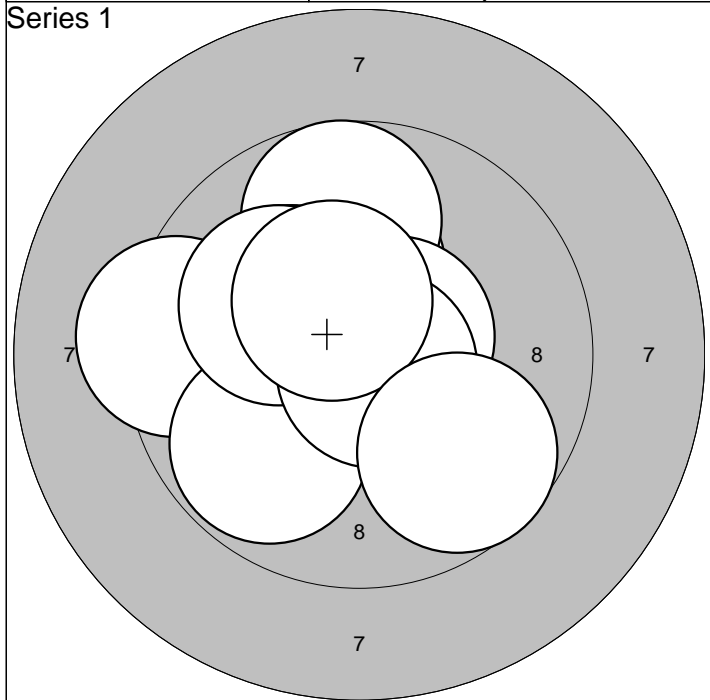

1: 9,3	←	6:10,6*	→								
2:10,2*	↑	7:10,1	↖							Serie	96,0
3: 9,7	↑	8:10,8*	↘							Sum	96,0
4:10,2*	↖	9:10,4*	↗								
5: 9,8	↙	10: 9,7	↘								

1: 9,6	→	6:10,1	←								
2: 9,8	←	7: 8,1	→							Serie	94,0
3:10,5*	↗	8:10,6*	↖							Sum	190,0
4: 9,1	→	9:10,7*	→								
5: 9,4	→	10:10,4*	↗								

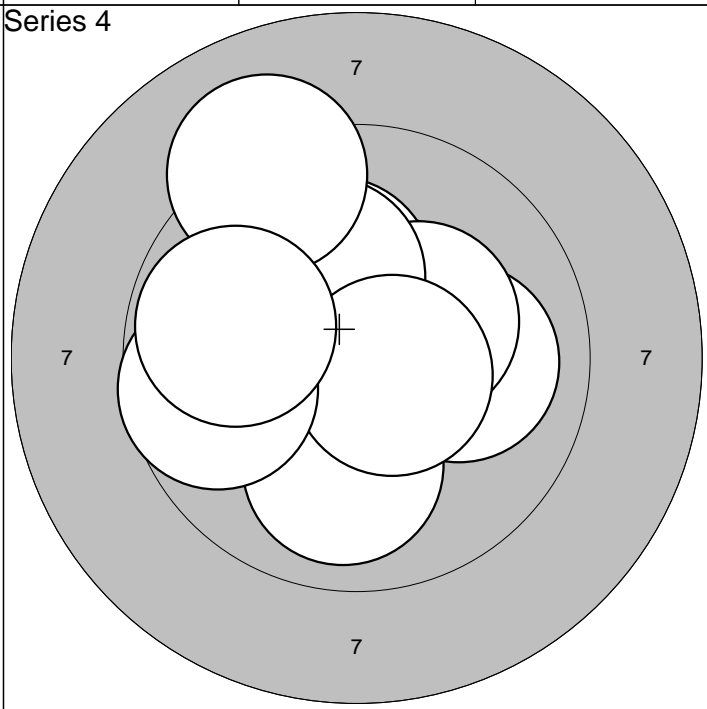
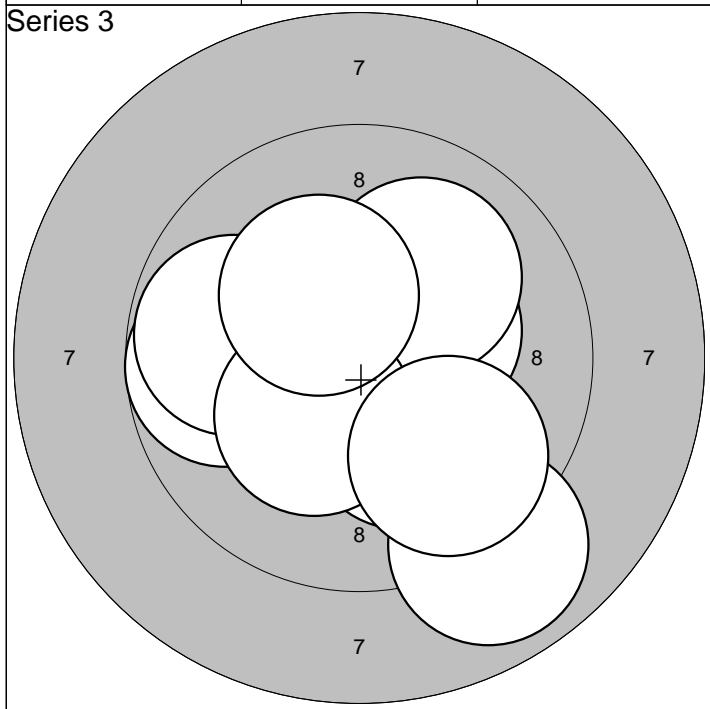

1:10,7*	←	6: 9,8	←								
2:10,2*	↘	7:10,0	↗							Serie	95,0
3: 8,9	↘	8:10,3*	↘							Sum	285,0
4: 9,8	←	9: 9,8	↘								
5:10,4*	↗	10:10,3*	↗								

1:10,5*	↗	6:10,2*	↗								
2:10,0	→	7:10,6*	↘							Serie	97,0
3:10,2*	↗	8: 9,1	↗							Sum	382,0
4:10,3*	↗	9: 9,7	←								
5:10,0	↓	10: 9,8	←								

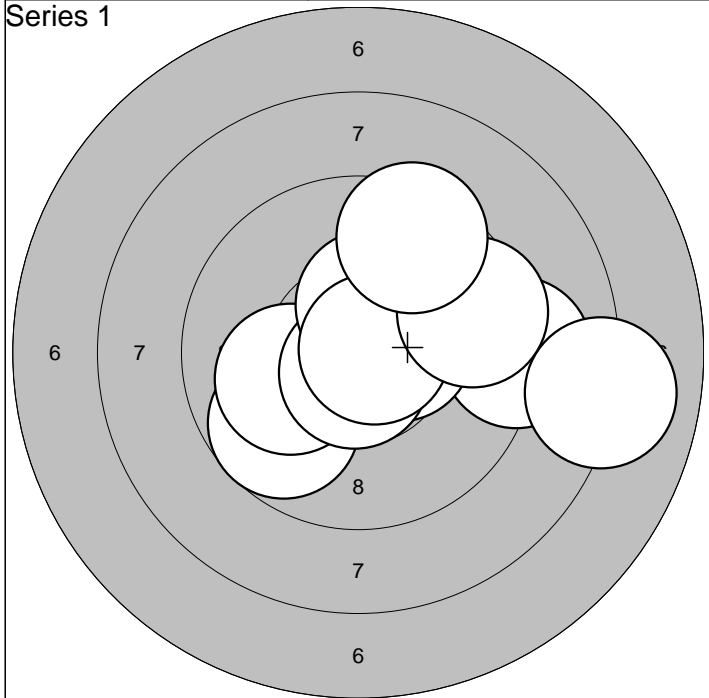

1: 9,1 →	6:10,7* ↓	Serie	94,0
2: 9,7 ↙	7:10,4* ↑		
3:10,5* →	8:10,7* →	Sum	94,0
4: 8,0 →	9: 9,5 →		
5:10,1 ←	10: 9,5 ↑		

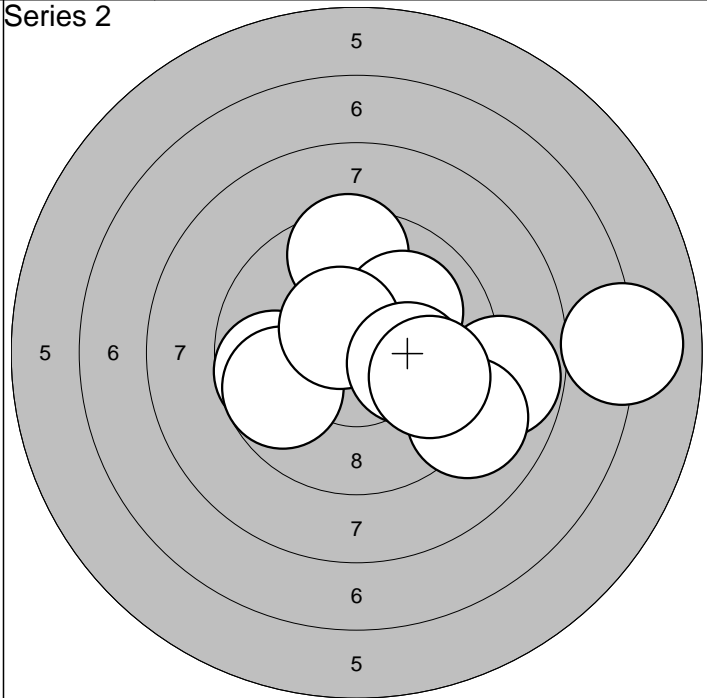

1: 9,5 ↑	6:10,5* ↗	Serie	90,0
2: 9,7 ←	7: 9,1 ↘		
3: 9,8 ↙	8:10,2* →	Sum	184,0
4:10,0 ↗	9: 9,8 ↘		
5: 8,8 →	10: 7,0 →		

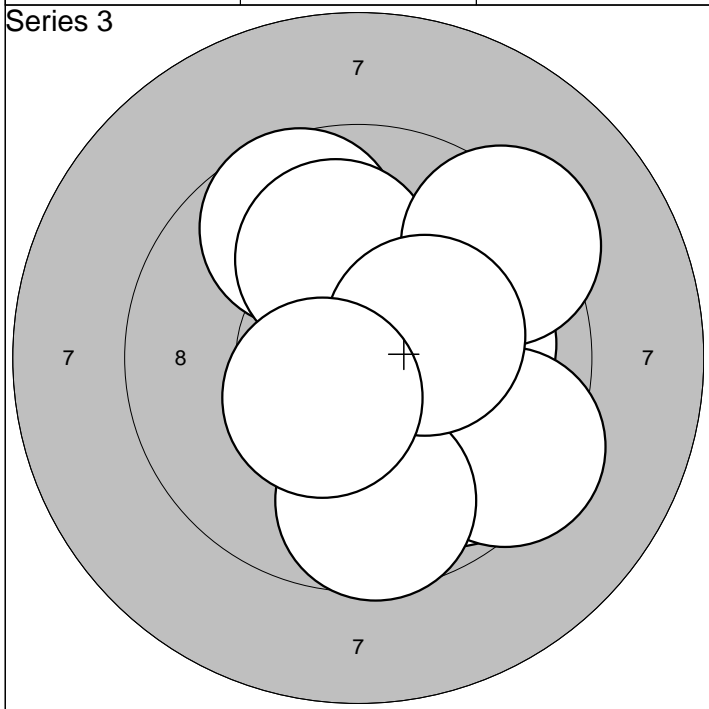

1:10,1 →	6: 9,6 ↓	Serie	95,0
2: 9,7 ↗	7:10,0 ↑		
3:10,7* ↑	8: 9,3 ↗	Sum	279,0
4: 9,8 ↘	9:10,3* →		
5: 9,4 ↘	10:10,5* ↙		

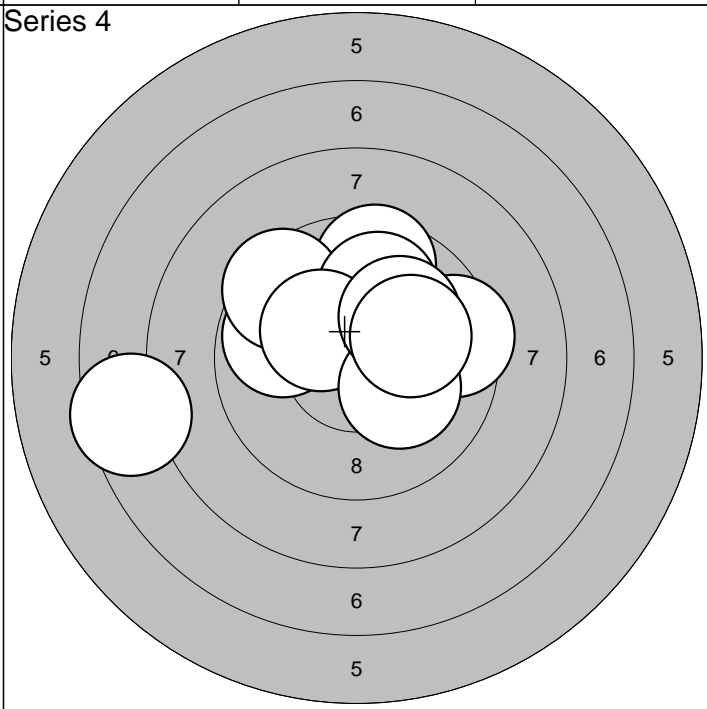

1: 9,5 →	6: 9,9 ↑	Serie	92,0
2: 9,8 ←	7:10,3* ↖		
3: 9,6 ↑	8:10,2* ↘	Sum	371,0
4: 7,5 ←	9:10,1 ↗		
5: 9,5 ↖	10:10,1 →		

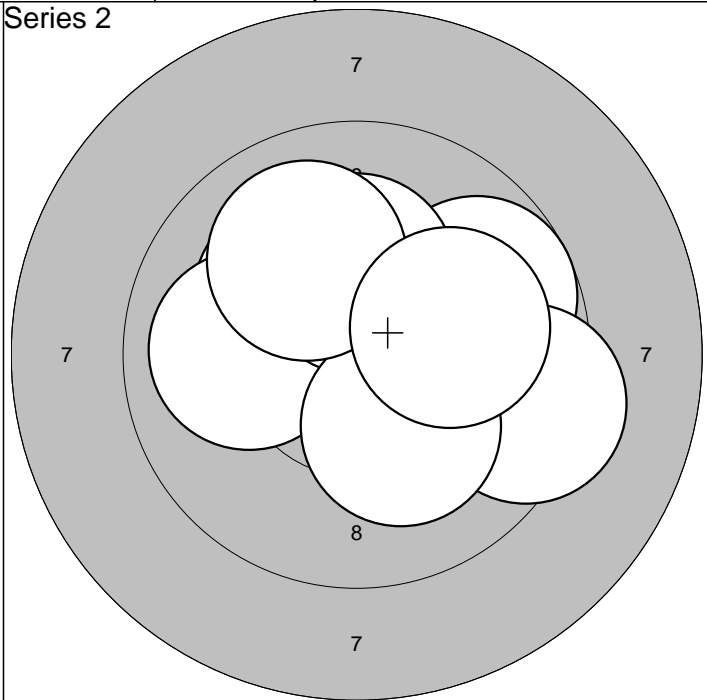
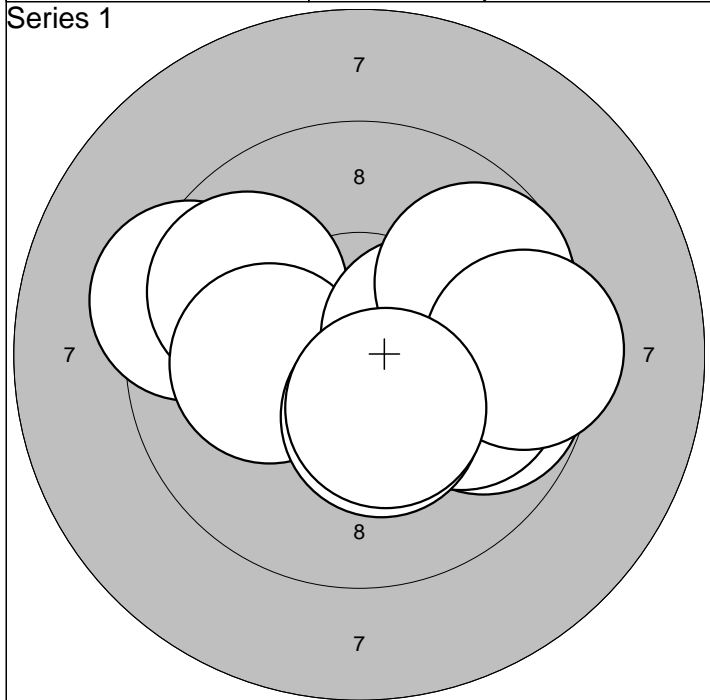

1: 9,3 ↖	6:10,4* ↓			Serie	95,0
2: 9,8 →	7:10,4* →				
3: 9,8 ↗	8: 9,7 ↗	Sum	95,0		
4:10,2* ←	9: 9,5 →				
5:10,0 →	10:10,4* ↓				

1:10,2* ↖	6:10,0 ←			Serie	98,0
2:10,0 →	7:10,2* ↑				
3: 9,7 ↗	8:10,2* ↓	Sum	193,0		
4: 9,4 →	9:10,0 ↗				
5:10,7* ↑	10:10,1 →				

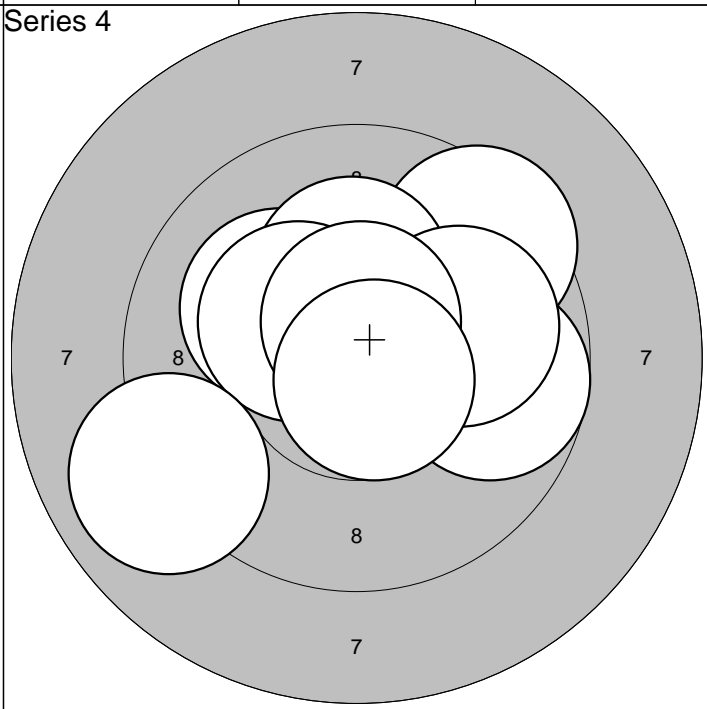
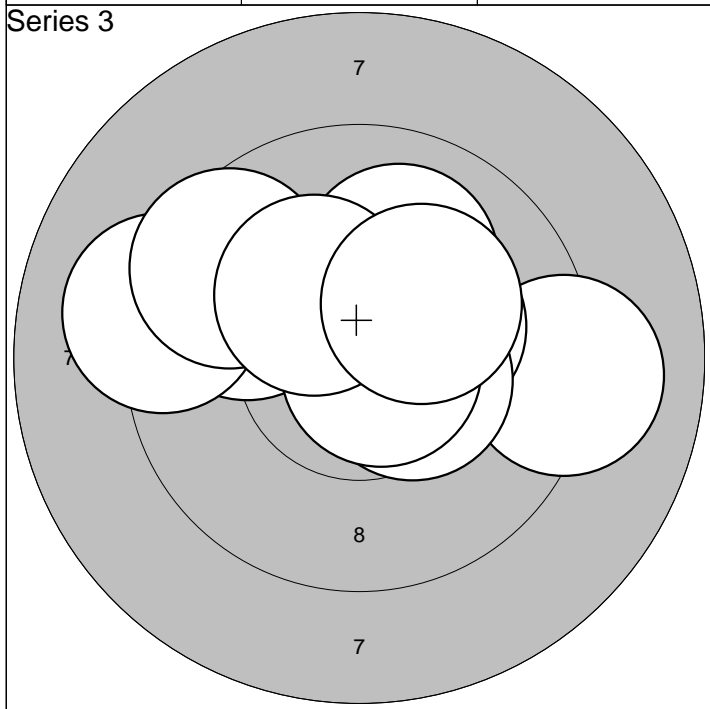

1: 9,1 →	6: 9,1 ←			Serie	96,0
2:10,0 ↗	7:10,7* →				
3:10,3* ↗	8: 9,5 ↖	Sum	289,0		
4: 9,8 ↖	9:10,3* ↗				
5:10,4* →	10:10,2* ↗				

1:10,3* →	6:10,3* ↖			Serie	97,0
2:10,1 ↖	7:10,0 →				
3: 9,5 ↗	8:10,6* ↑	Sum	386,0		
4: 9,7 →	9: 9,0 ←				
5:10,2* ↑	10:10,7* ↓				

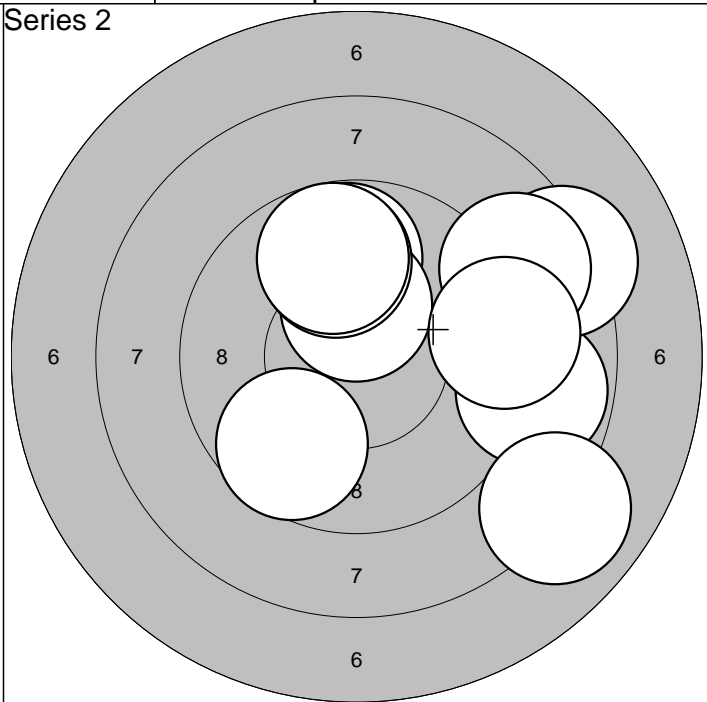
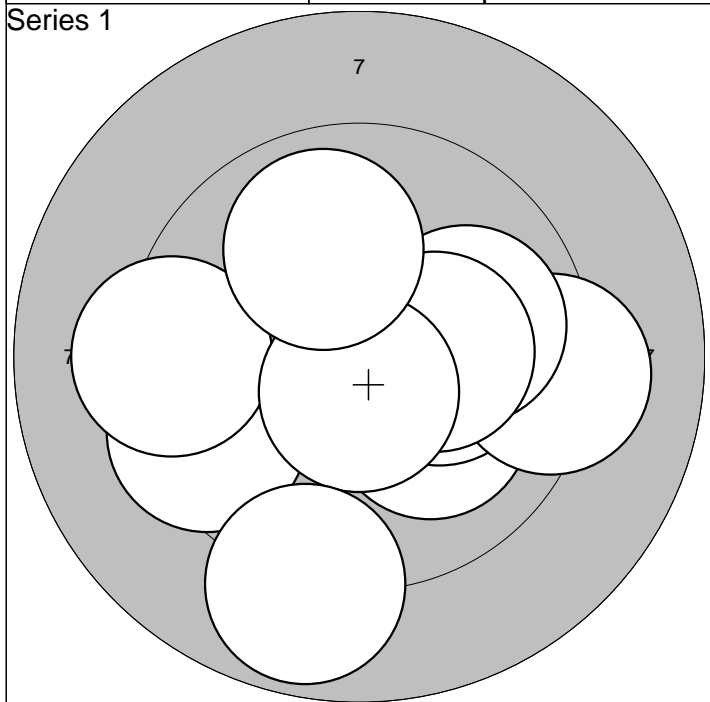

1:10,1 ↘	6: 9,3 ←				
2:10,2* →	7:10,3* →				
3: 9,2 →	8:10,6* ↓				
4: 9,4 ←	9:10,0 ↑	Sum	95,0		
5:10,0 →	10: 8,8 ↓				

1: 9,8 ↑	6:10,4* ↑				
2: 8,9 →	7: 9,2 →				
3: 8,3 →	8: 9,8 ↑				
4: 8,8 →	9: 8,0 ↘	Sum	182,0		
5: 9,7 ↙	10: 9,8 ↑				

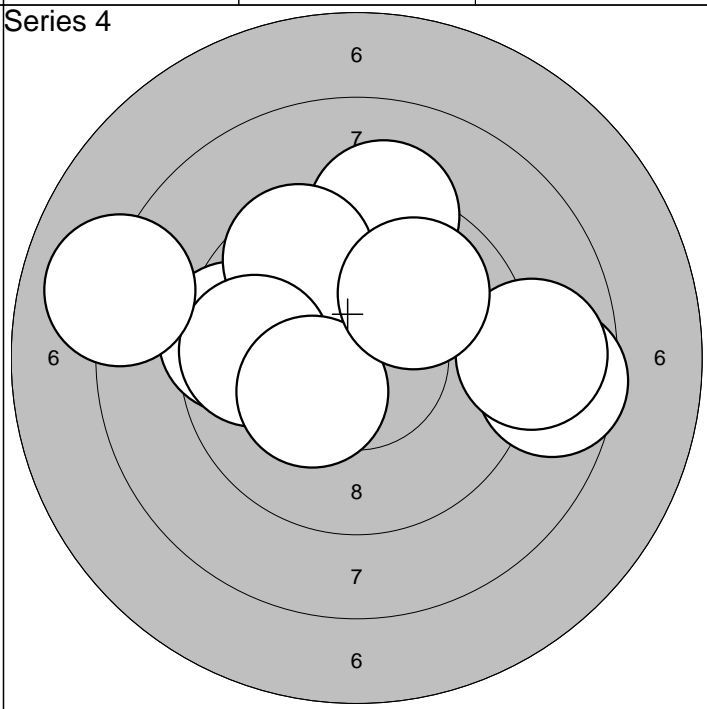
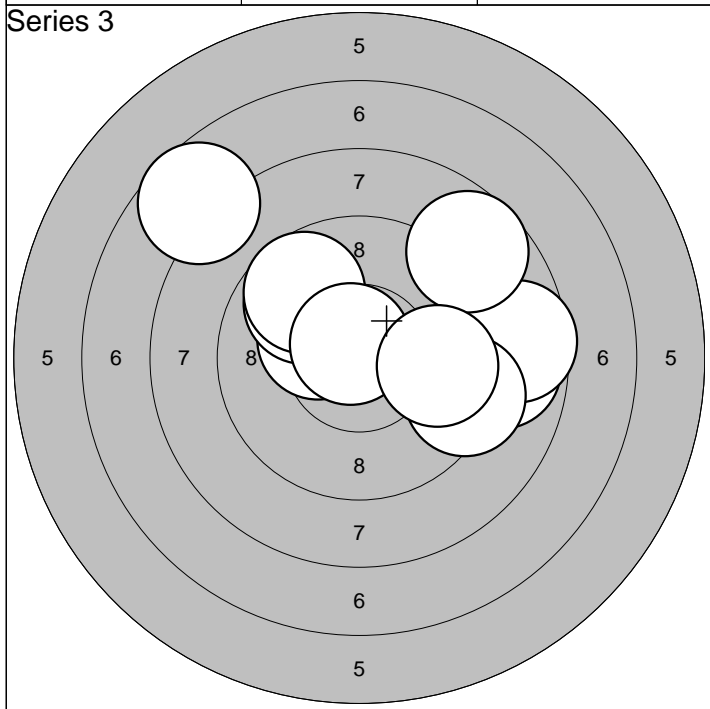

1:10,3* ←	6: 8,6 →				
2: 9,8 ↗	7:10,7* ↗				
3: 9,7 ↗	8: 8,7 ↗				
4: 8,9 →	9: 9,3 →	Sum	269,0		
5: 7,7 ↗	10: 9,8 →				

1: 8,6 →	6: 9,6 ↖				
2: 9,8 ↑	7: 9,8 ←				
3: 9,5 ←	8:10,3* ↙				
4: 9,2 ↑	9: 8,0 ←	Sum	357,0		
5: 8,9 →	10: 9,9 ↗				

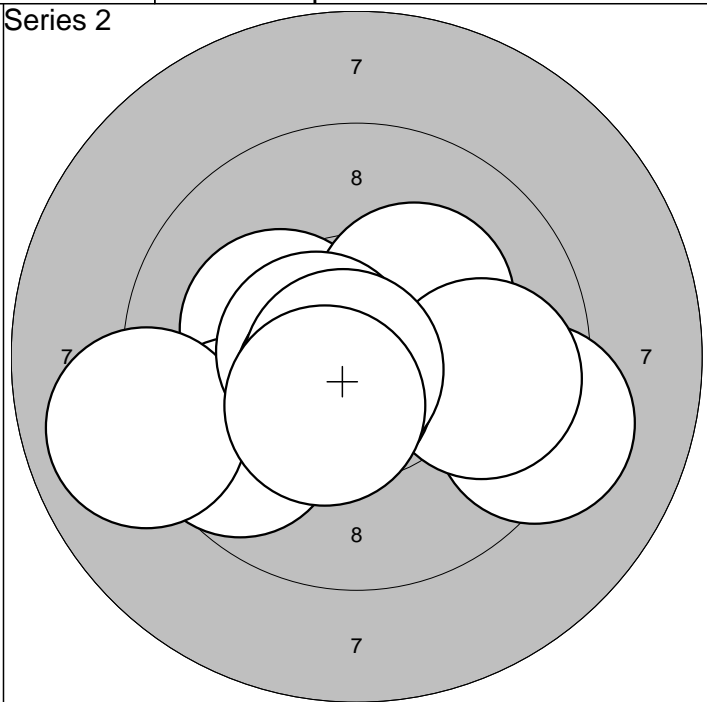
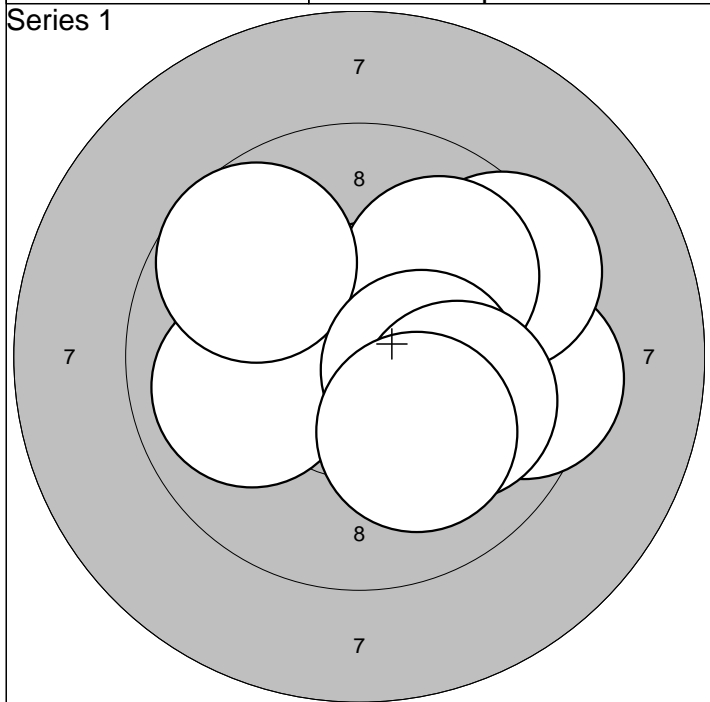

1: 9,5 →	6:10,0 ←				
2:10,6* ↗	7: 9,7 ↗				
3:10,2* ←	8:10,4* →			Serie	96,0
4: 9,4 ↗	9:10,0 →			Sum	96,0
5: 9,9 ↗	10:10,1 ↓				

1:10,2* ←	6:10,6* ←				
2: 9,7 ↙	7: 9,8 →				
3: 9,2 →	8:10,6* ↘			Serie	96,0
4:10,2* ↗	9:10,8* ↘			Sum	192,0
5: 9,0 ←	10:10,4* ↘				

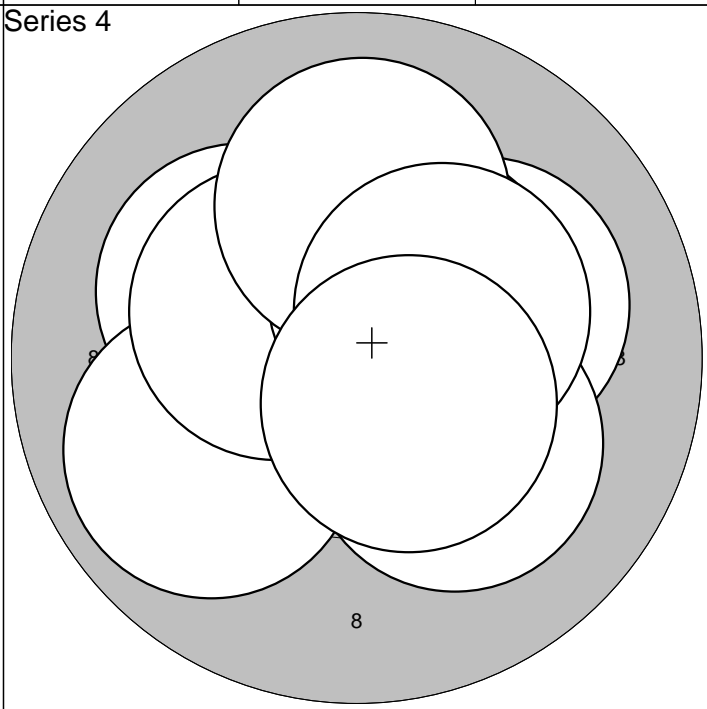
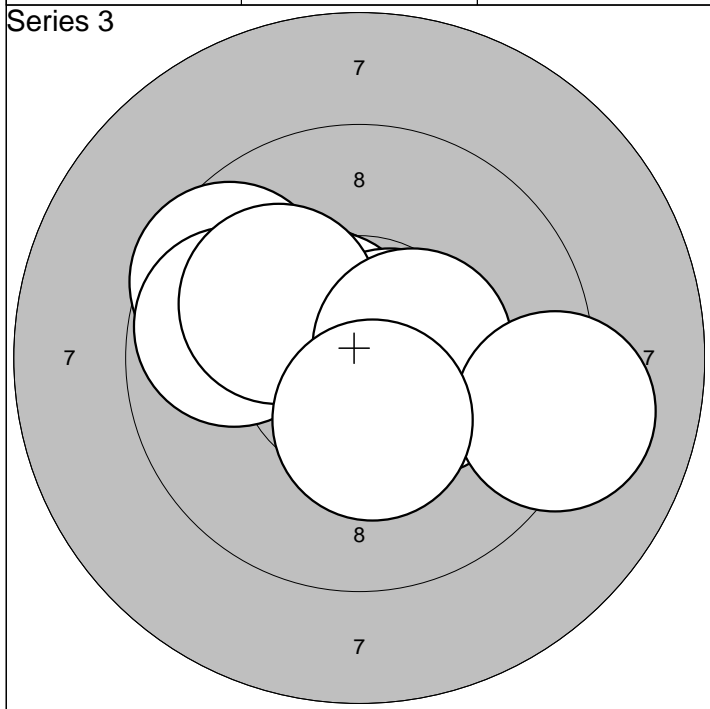

1:10,5* ↙	6:10,7* →				
2:10,5* ↙	7:10,1 ↙				
3:10,4* →	8:10,5* →			Serie	97,0
4: 9,6 ↙	9: 9,1 →			Sum	289,0
5: 9,8 ←	10:10,4* ↓				

1:10,2* ↙	6:10,2* ↘				
2:10,1 →	7:10,4* ↗				
3:10,5* ↘	8:10,0 ↑			Serie	99,0
4: 9,9 ↙	9:10,4* ↗			Sum	388,0
5:10,4* ↙	10:10,5* ↘				

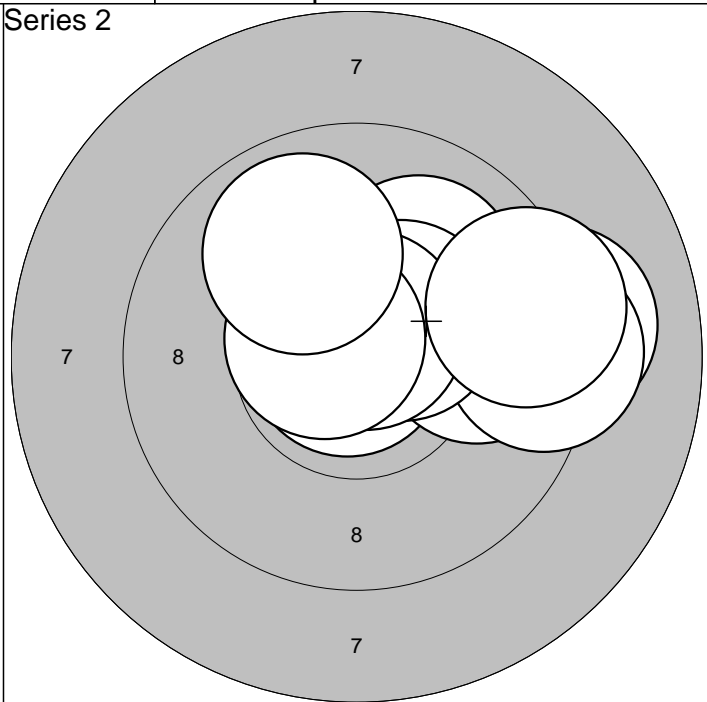
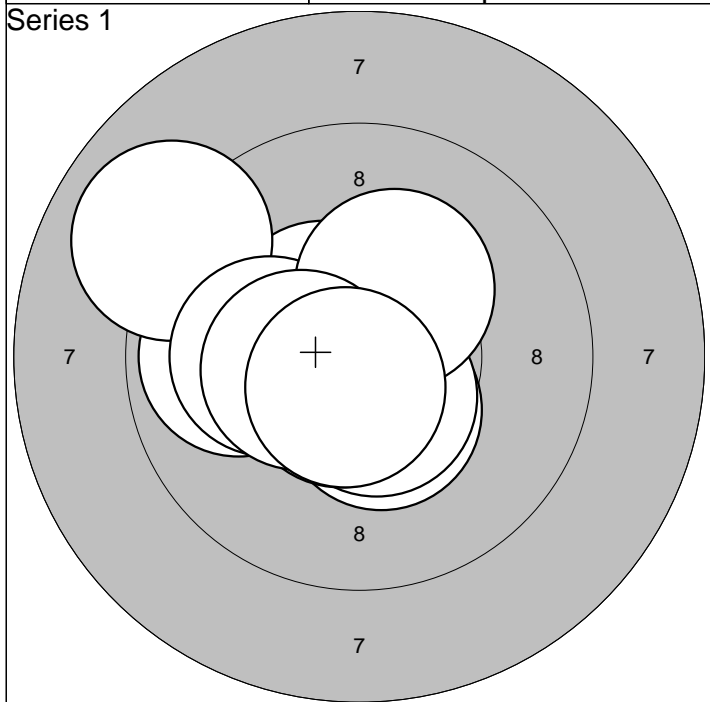

1:10,4* ↓	6: 9,0 ↖	Serie	98,0
2: 9,9 ←	7:10,2* ←		
3:10,6* ↓	8:10,3* ↗	Sum	98,0
4:10,6* ↓	9:10,4* ←		
5:10,5* ↗	10:10,7* ↓		

1:10,9* ←	6:10,4* ↗	Serie	95,0
2: 9,9 →	7:10,7* ↑		
3: 9,1 →	8:10,6* ↖	Sum	193,0
4:10,0 ↗	9: 9,4 →		
5: 9,3 →	10: 9,9 ↗		

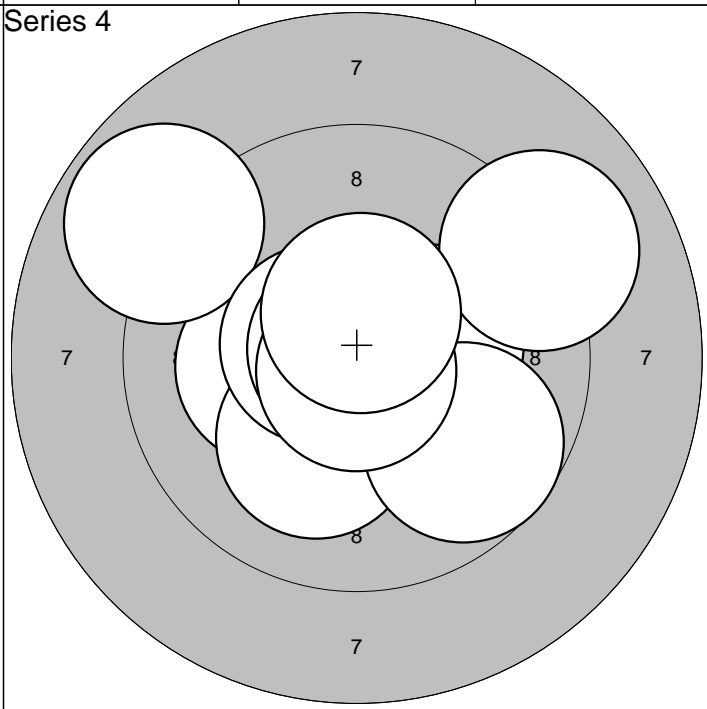
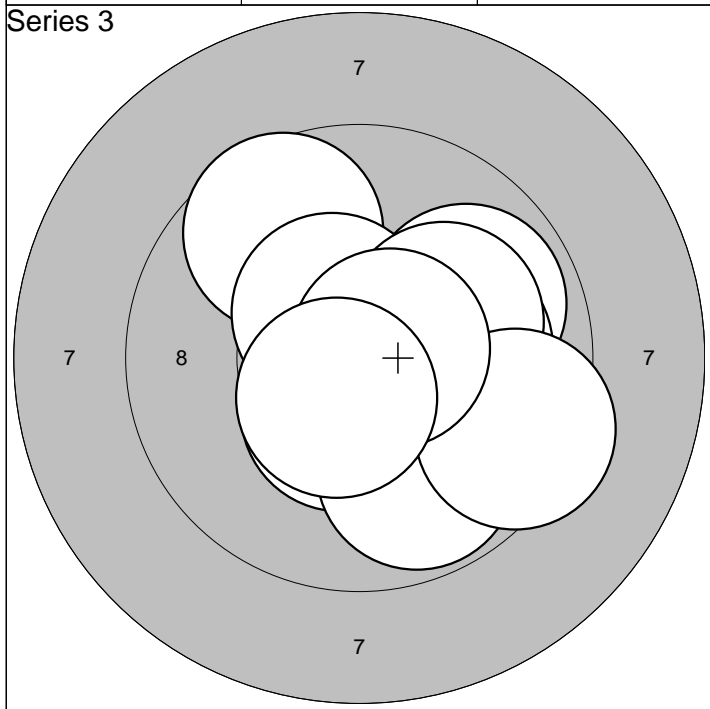

1: 9,9 ↗	6:10,5* ↗	Serie	96,0
2: 9,7 ↗	7:10,1 →		
3:10,4* ↓	8: 9,4 →	Sum	289,0
4: 9,8 ↓	9:10,7* →		
5:10,1 →	10:10,5* ↓		

1:10,2* ←	6: 9,7 ↓	Serie	96,0
2:10,3* →	7:10,6* ↖		
3:10,1 ↓	8:10,8* ↖	Sum	385,0
4: 8,8 ↖	9:10,8* ↓		
5: 9,1 ↗	10:10,5* ↑		

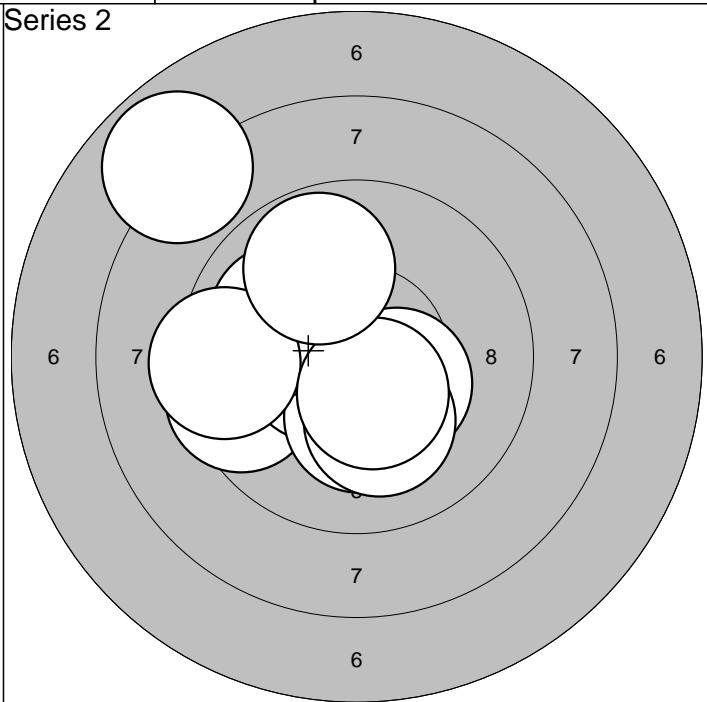
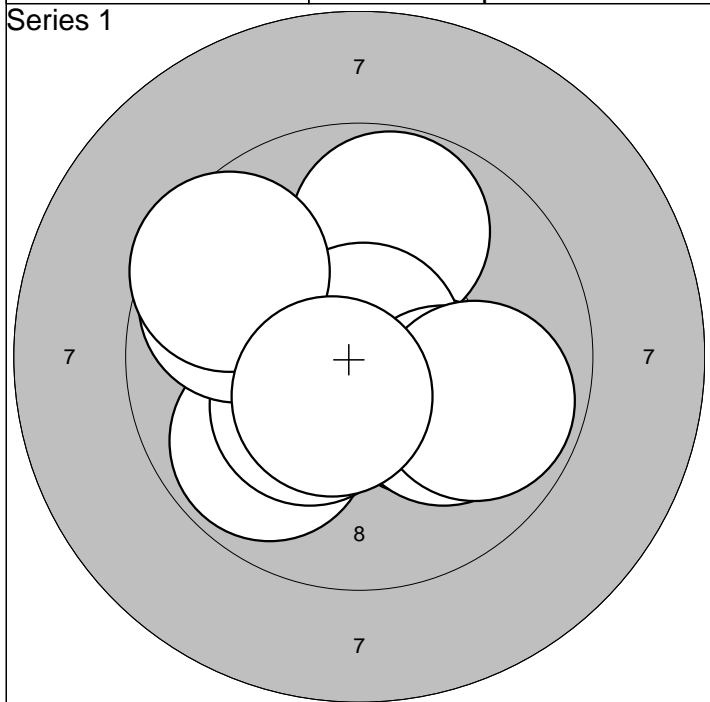

1: 9,8 ↗	6:10,8* ↗	Serie 95,0
2: 9,9 ↘	7: 9,6 ↖	
3:10,3* ↘	8:10,1 ↘	Sum 95,0
4: 9,8 ↖	9: 9,8 ↗	
5:10,2* ↘	10:10,5* ↘	

1:10,4* ↘	6: 9,4 ←	Serie 94,0
2: 9,5 ←	7:10,1 ↘	
3:10,5* ←	8:10,5* ↘	Sum 189,0
4:10,2* ↓	9: 7,9 ↗	
5:10,0 ↖	10: 9,8 ↗	

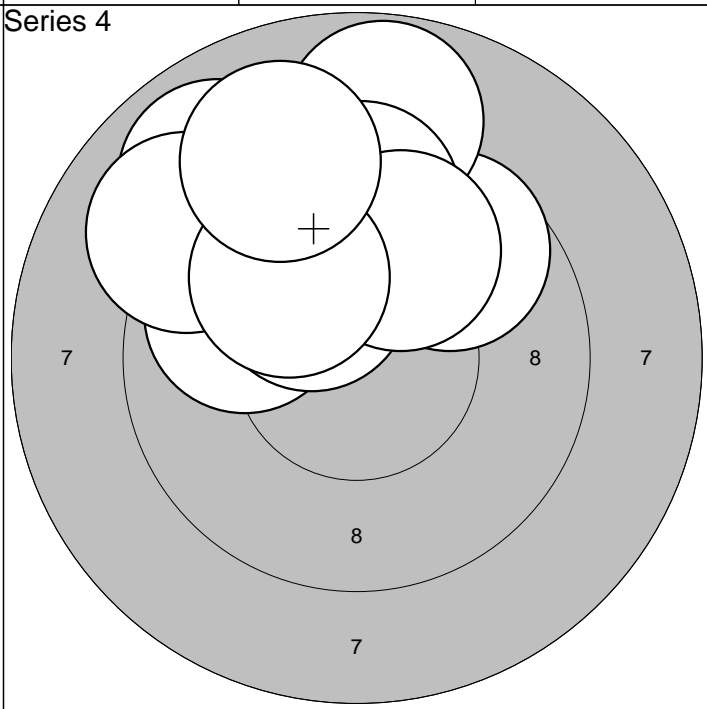
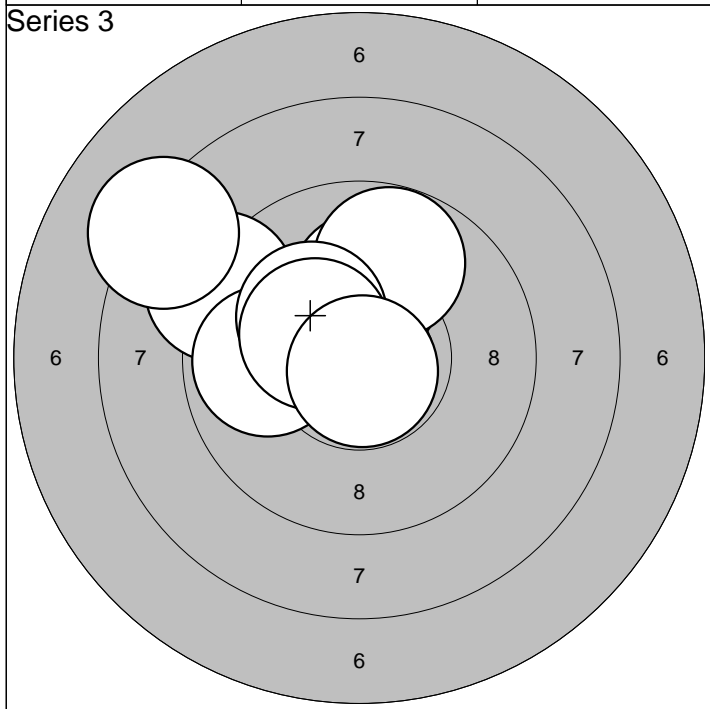

1: 9,1 ↖	6:10,9* ↓	Serie 95,0
2:10,1 ↑	7: 9,8 ↗	
3:10,6* ↖	8:10,2* ↖	Sum 284,0
4: 8,2 ↖	9:10,4* ↖	
5: 9,9 ←	10:10,8* ↓	

1: 9,7 ↗	6: 9,0 ↖	Serie 90,0
2: 9,9 ↖	7: 9,5 ↑	
3:10,2* ↖	8: 9,9 ↗	Sum 374,0
4: 8,8 ↑	9:10,0 ↖	
5: 8,9 ↖	10: 9,1 ↗	

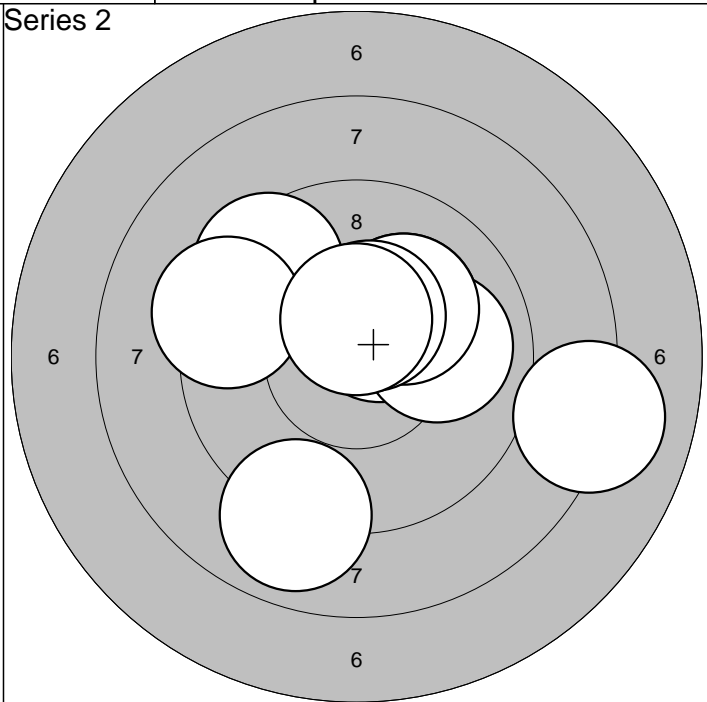
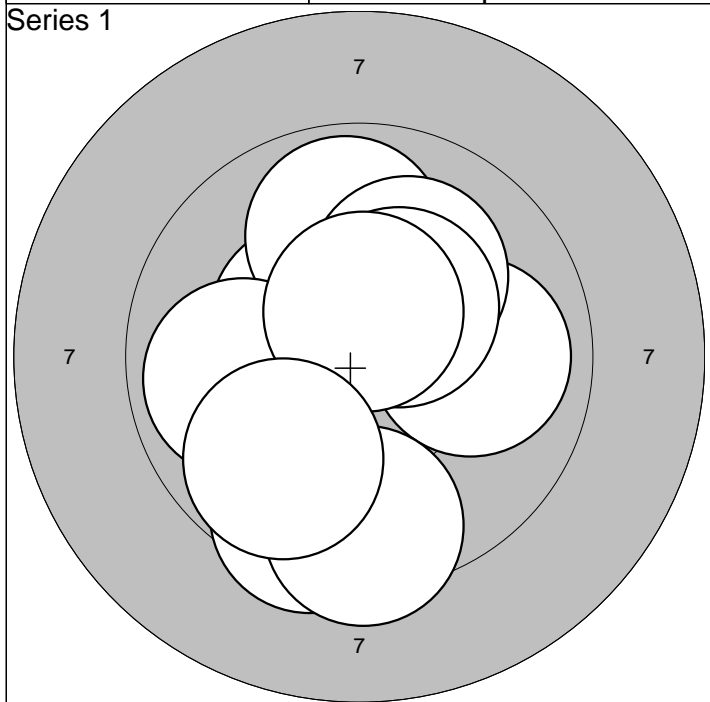

1:10,4* ↖	6:10,4* ↗		Serie	94,0
2: 9,9 ↑	7: 9,9 ←			
3: 9,5 ↓	8: 9,4 ↓	Sum	94,0	
4: 9,9 →	9:10,5* ↑			
5:10,1 ↗	10: 9,8 ↘			

1:10,5* ↗	6: 9,0 ↓		Serie	95,0
2:10,2* ↗	7:10,2* ↗			
3: 8,1 →	8: 9,4 ←	Sum	189,0	
4: 9,5 ↗	9:10,5* ↑			
5:10,0 →	10:10,5* ↑			

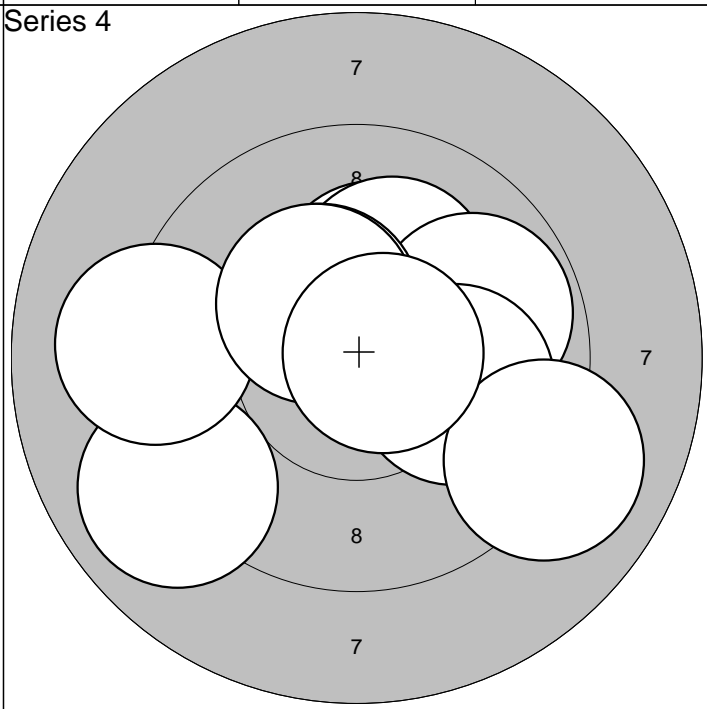
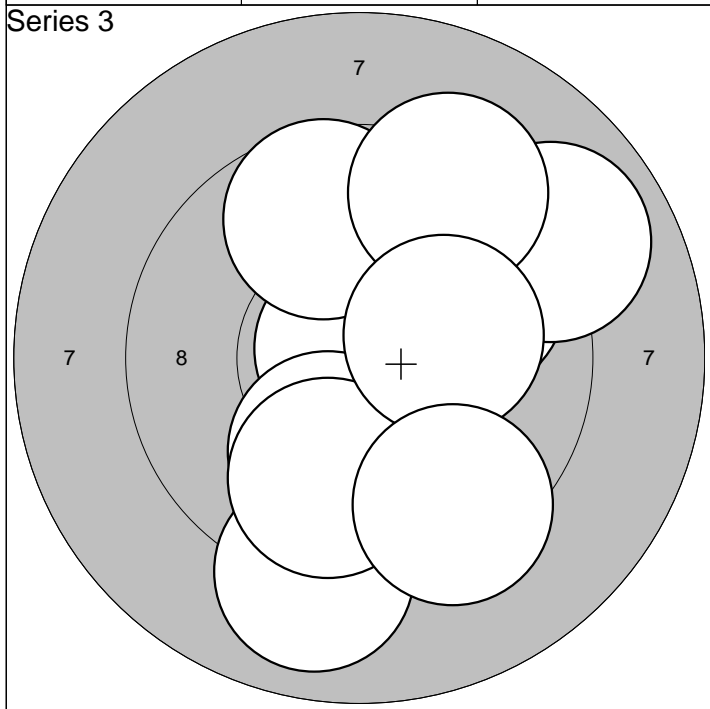

1: 9,8 ↗	6: 9,3 ↗		Serie	92,0
2:10,9* ↖	7: 9,0 ↓			
3: 9,7 ↑	8: 9,8 ↓	Sum	281,0	
4:10,1 ↓	9:10,2* →			
5: 8,9 ↗	10: 9,4 ↓			

1:10,2* ↑	6:10,0 →		Serie	96,0
2:10,2* ↑	7: 9,1 ←			
3: 9,8 →	8: 9,0 →	Sum	377,0	
4: 9,0 ←	9:10,4* ↗			
5:10,4* ↖	10:10,7* →			

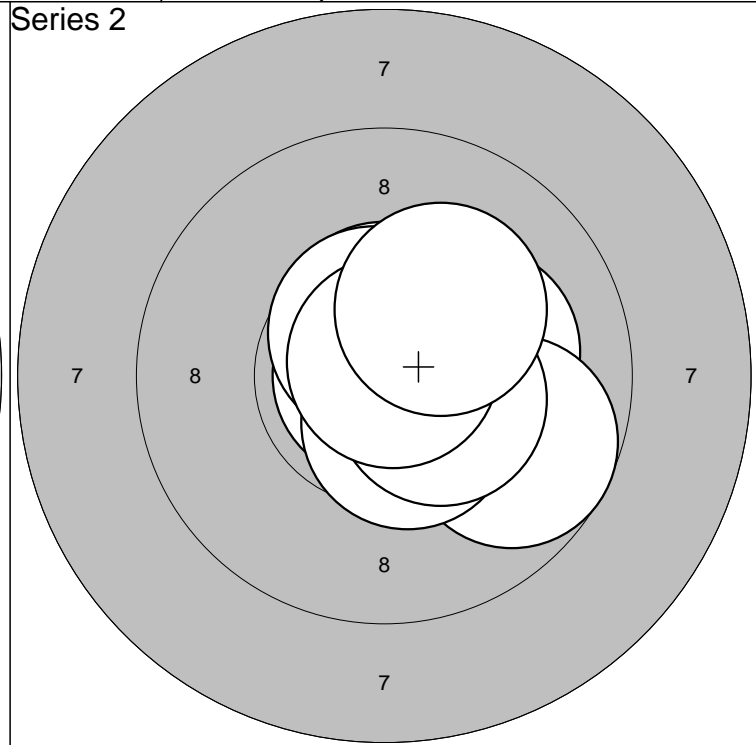
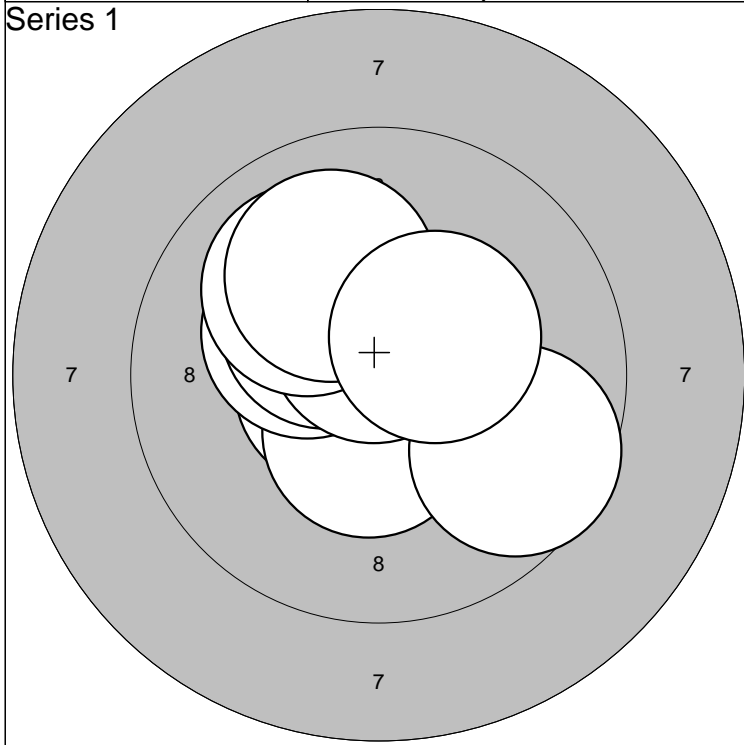

1:10,5* →	6:10,3* ↖	Serie	99,0
2:10,6* ←	7:10,6* ↑		
3:10,5* ↓	8:10,0 ↖	Sum	99,0
4: 9,6 ↘	9:10,0 ↑		
5:10,3* ↖	10:10,4* ↗		

1:10,5* ↑	6:10,5* ↓	Serie	99,0
2:10,2* →	7:10,6* ↑		
3:10,9* ←	8:10,4* →	Sum	198,0
4:10,6* ↑	9:10,8* ↗		
5: 9,7 ↘	10:10,2* ↗		

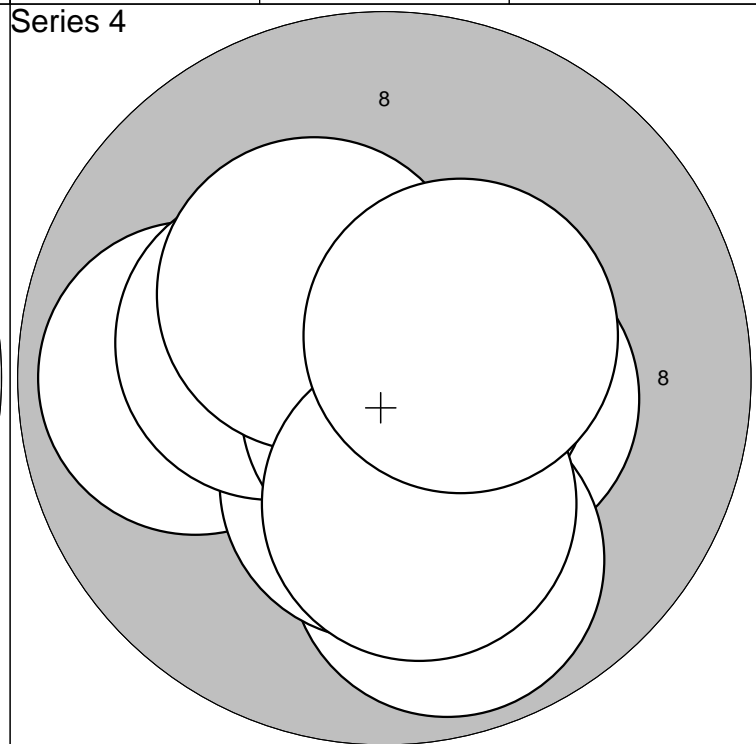
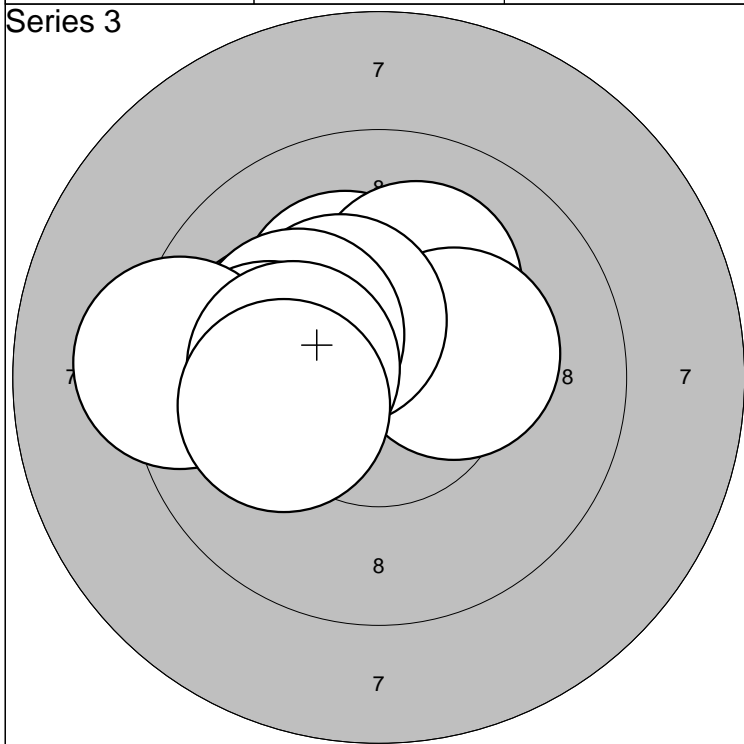

1:10,2* ↖	6:10,2* ↖	Serie	99,0
2:10,1 ↑	7:10,0 ←		
3:10,1 ←	8: 9,3 ←	Sum	297,0
4:10,3* →	9:10,2* ←		
5:10,4* ↖	10:10,1 ←		

1:10,4* →	6:10,3* ↖	Serie	98,0
2:10,7* →	7:10,8* ↓		
3: 9,9 ↓	8:10,3* ↗	Sum	395,0
4: 9,9 ←	9:10,2* ↓		
5:10,3* ↓	10:10,5* ↗		

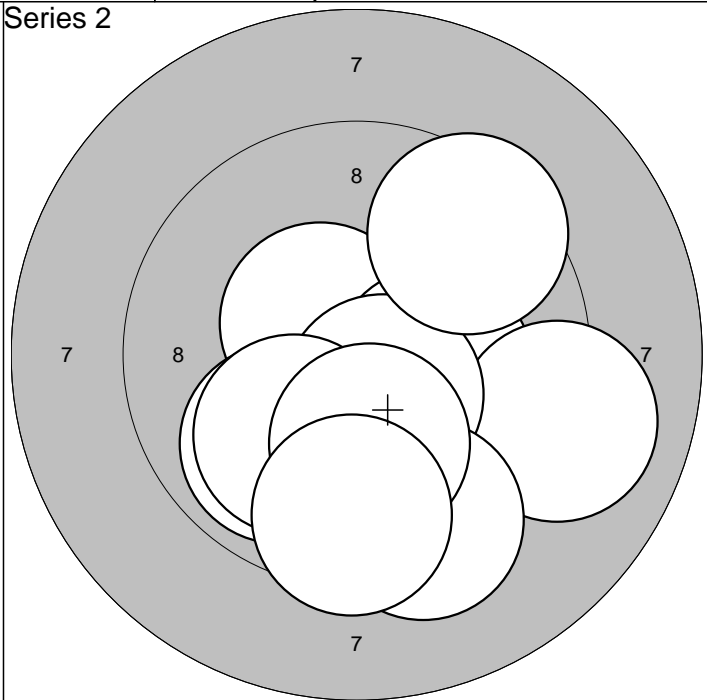
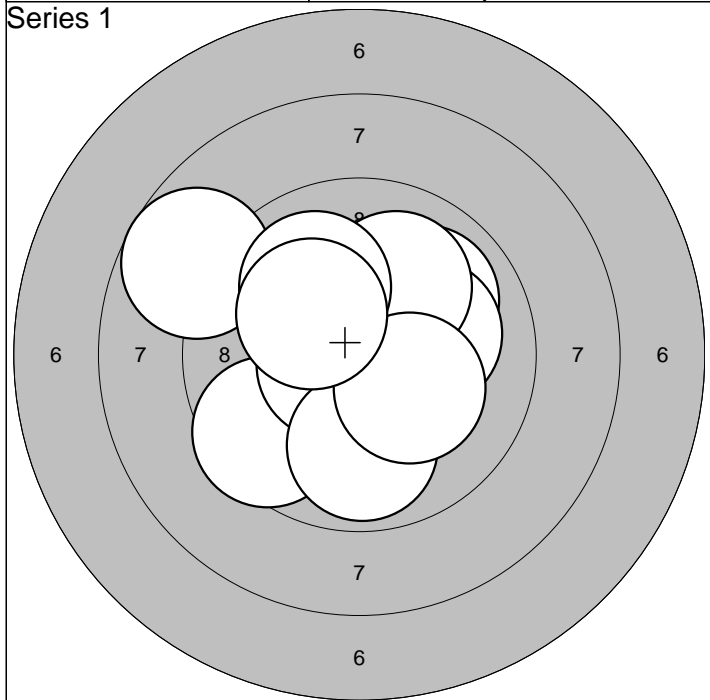

1: 9,5 ↙	6: 9,9 ↓	Serie	96,0
2:10,0 ↗	7: 8,8 ↖		
3:10,1 →	8:10,2* ↘	Sum	96,0
4:10,6* ←	9:10,0 ↗		
5:10,0 ↗	10:10,2* ↗		

1:10,5* ↗	6:10,0 ↙	Serie	95,0
2:10,3* →	7: 9,4 ↓		
3: 9,1 →	8:10,1 ↓	Sum	191,0
4: 9,9 ↙	9: 9,5 ↓		
5:10,5* ↘	10: 9,5 ↗		

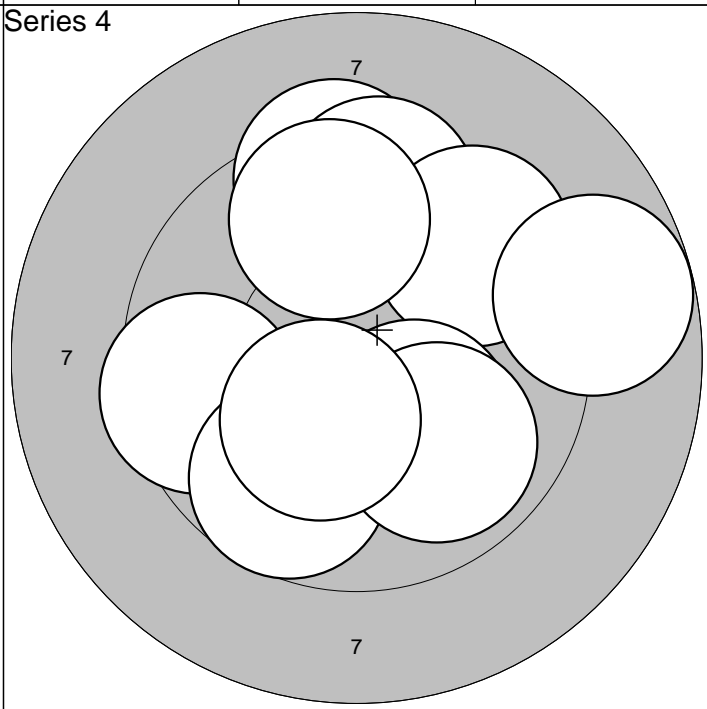
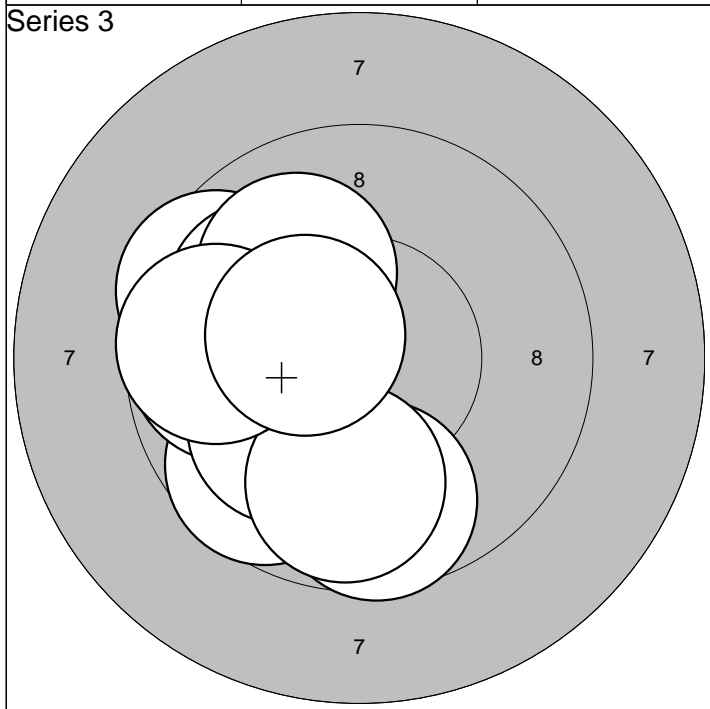

1: 9,5 ↖	6:10,0 ↗	Serie	94,0
2: 9,7 ↙	7:10,1 ↙		
3:10,0 ↖	8: 9,8 ↓	Sum	285,0
4: 9,8 ←	9: 9,7 ←		
5: 9,7 ↓	10:10,4* ↖		

1: 9,3 ↑	6: 8,8 →	Serie	91,0
2: 9,5 ↑	7:10,2* ↘		
3: 9,5 ←	8: 9,7 ↑	Sum	376,0
4: 9,7 ↙	9: 9,9 ↘		
5: 9,5 ↗	10:10,3* ↙		

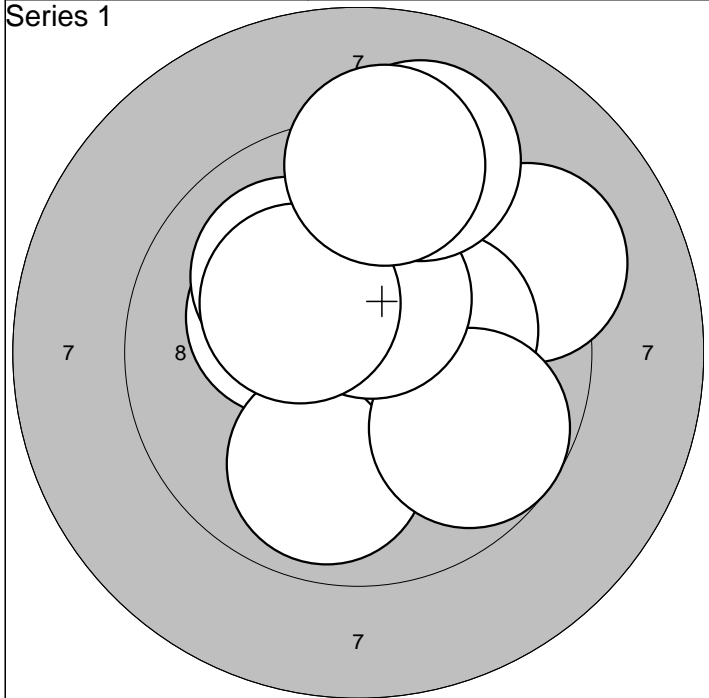

1:10,2* ↙	6: 9,7 ↘	Serie	95,0
2:10,1 ↗	7:10,4* ↑		
3: 9,9 ↓	8:10,3* ↖	Sum	95,0
4: 9,3 ↘	9: 9,1 ↑		
5:10,2* →	10: 9,3 ↑		

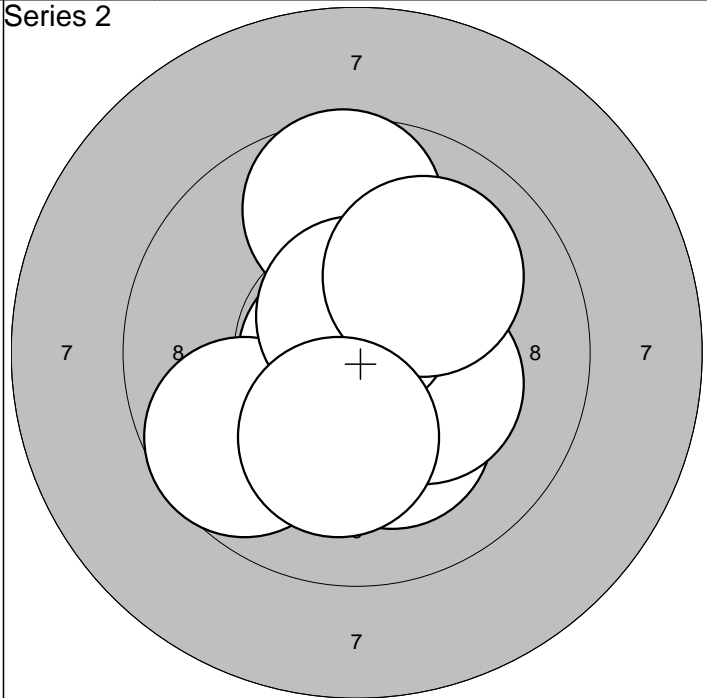

1:10,4* ↓	6:10,3* ↗	Serie	98,0
2:10,2* ↓	7: 9,7 ↙		
3: 9,7 ↑	8:10,6* ↑	Sum	193,0
4:10,4* ↘	9:10,0 ↗		
5:10,8* ←	10:10,2* ↓		

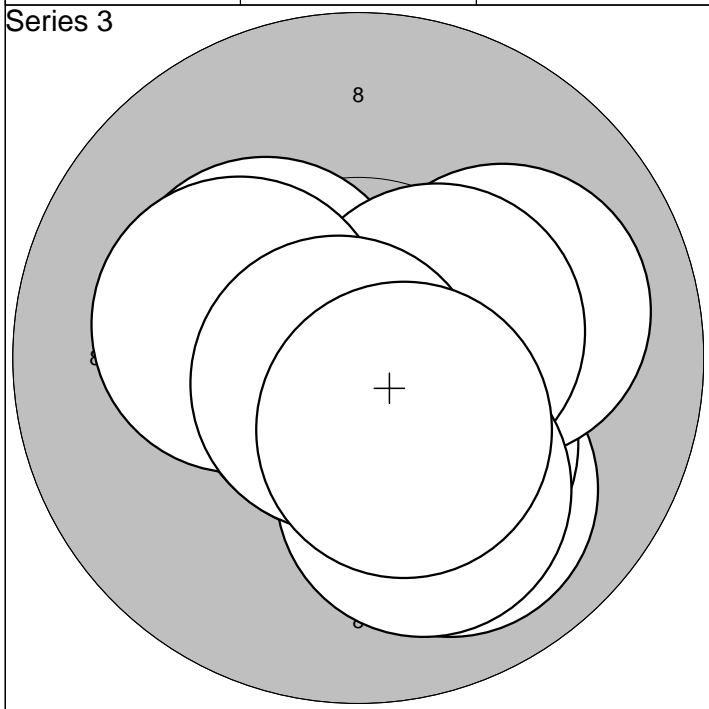

1:10,3* ↙	6:10,4* →	Serie	100,0
2:10,0 ↓	7:10,1 ↓		
3:10,3* ↓	8:10,2* ←	Sum	293,0
4:10,6* ↘	9:10,8* ↘		
5:10,0 →	10:10,4* ↓		

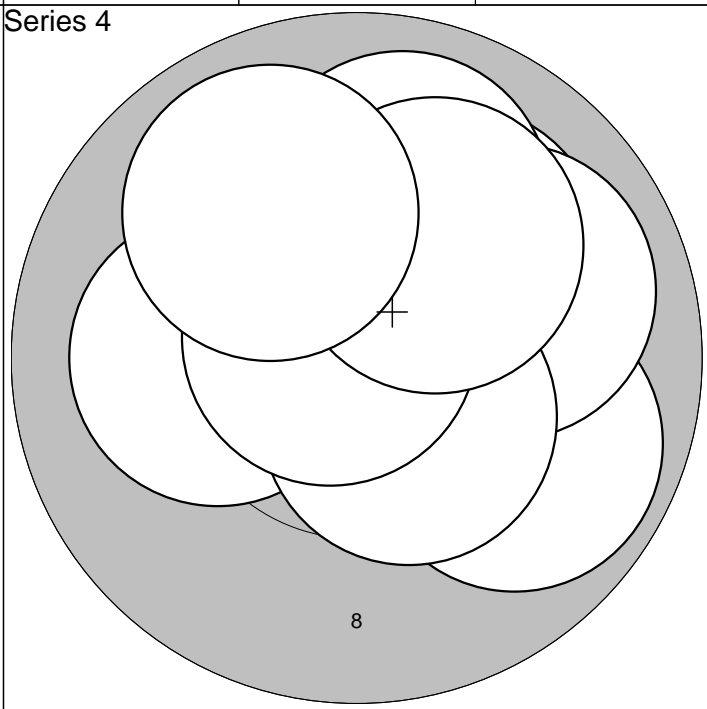

1:10,1 ←	6:10,0 →	Serie	97,0
2:10,1 ↗	7:10,5* ↓		
3: 9,9 ↘	8:10,8* ↖	Sum	390,0
4:10,8* →	9:10,1 ↗		
5: 9,9 ↑	10: 9,9 ↖		

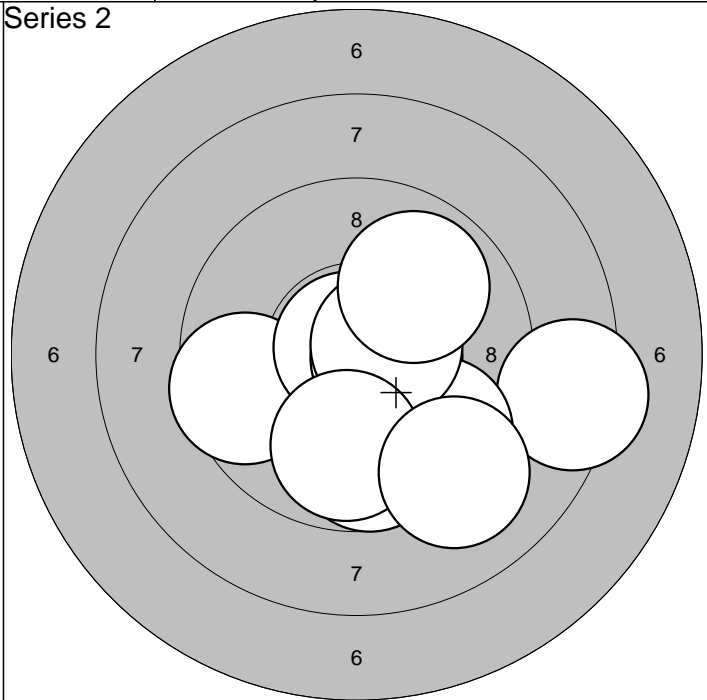
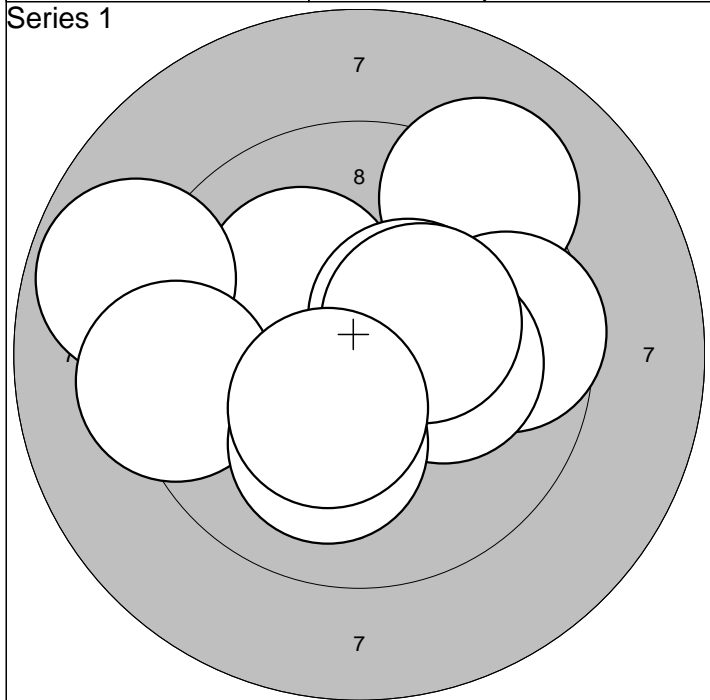

1: 9,2 ↗	6:10,2* →			Serie	95,0
2:10,2* ↖	7:10,3* →				
3: 8,8 ←	8: 9,3 ←			Sum	95,0
4:10,4* ↗	9:10,1 ↓				
5: 9,6 →	10:10,4* ↘				

1: 9,7 ↓	6: 9,6 ↘			Serie	92,0
2: 9,6 ←	7:10,6* →				
3:10,8* ↗	8: 9,9 ↓			Sum	187,0
4:10,6* →	9: 9,1 ↘				
5: 8,3 →	10: 9,9 ↗				

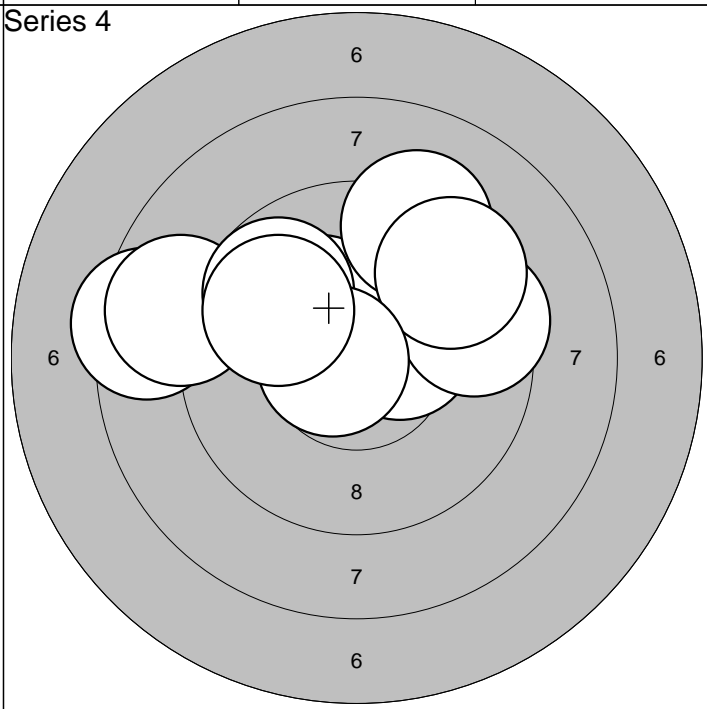
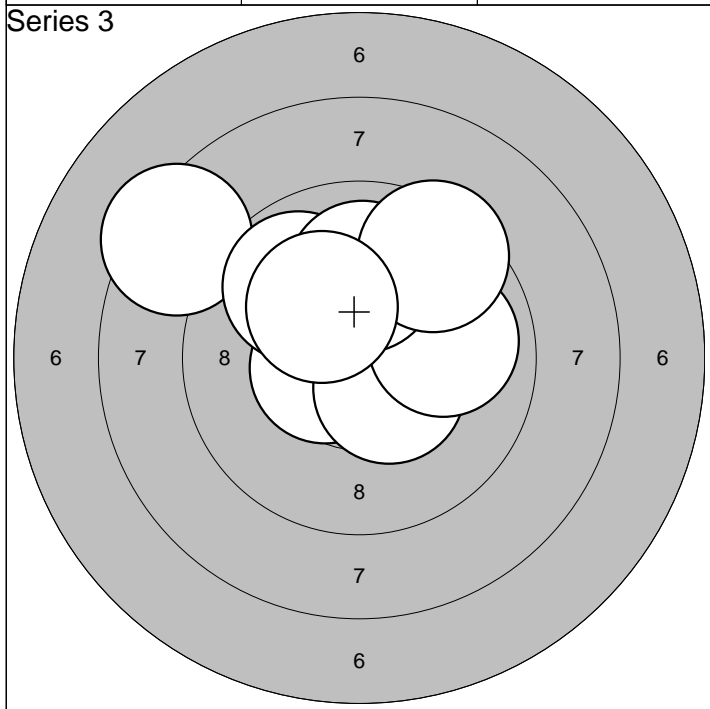

1:10,3* →	6: 9,8 ↖			Serie	95,0
2: 8,4 ↖	7: 9,9 →				
3:10,6* ←	8:10,0 ↑			Sum	282,0
4:10,2* ↑	9: 9,5 ↗				
5:10,4* ↘	10:10,2* ↖				

1:10,4* →	6: 8,4 ←			Serie	91,0
2: 9,5 →	7: 8,8 ←				
3:10,2* ↖	8: 9,8 ↖			Sum	373,0
4: 9,2 ↑	9:10,7* ←				
5: 9,5 ↗	10: 9,9 ↖				

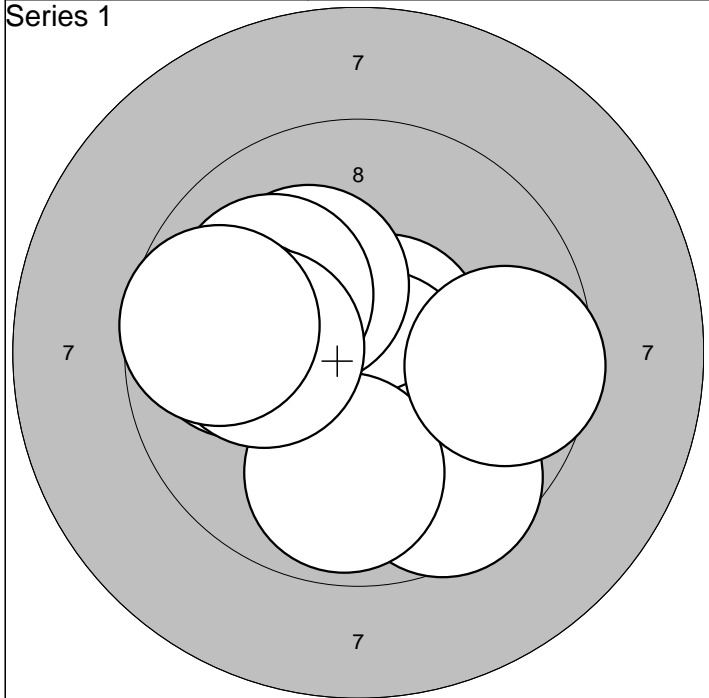

1:10,6* ↗	6: 9,9 ↓	Serie 95,0
2:10,7* ↘	7: 9,6 →	
3: 9,6 ↘	8: 9,9 ←	Sum 95,0
4:10,2* ↗	9:10,1 ←	
5:10,0 ↖	10: 9,7 ←	

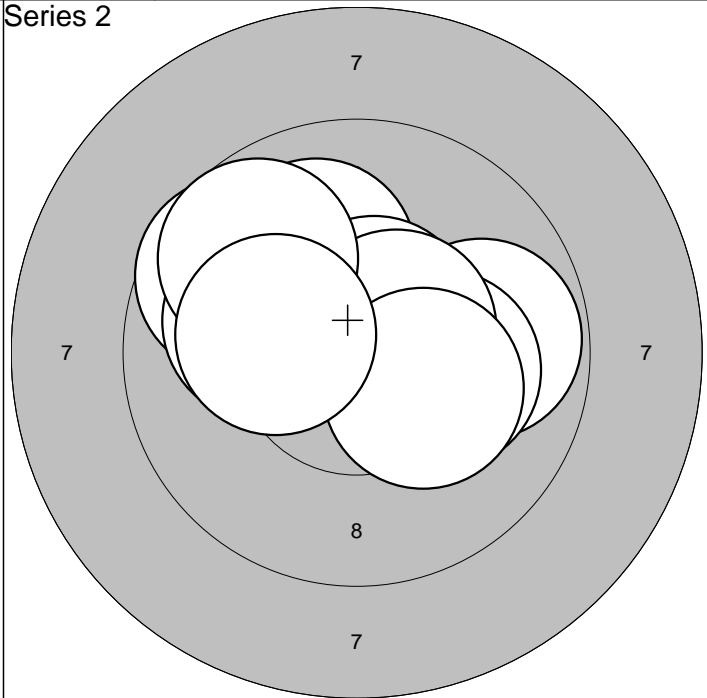

1:10,1 ↖	6:10,1 ↙	Serie 97,0
2: 9,7 ↖	7:10,5* ↗	
3: 9,8 →	8:10,3* ↘	Sum 192,0
4:10,2* →	9: 9,7 ↗	
5:10,6* ↗	10:10,2* ↙	

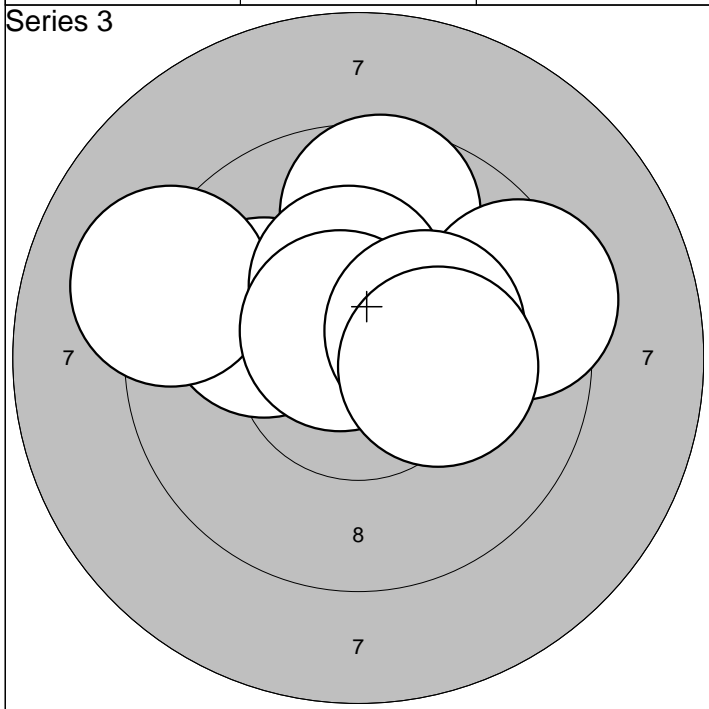

1:10,1 ↗	6:10,3* ↑	Serie 97,0
2: 9,6 ↑	7: 9,4 →	
3:10,4* ↖	8:10,7* ↖	Sum 289,0
4:10,0 ↙	9:10,3* →	
5: 9,2 ↙	10:10,2* →	

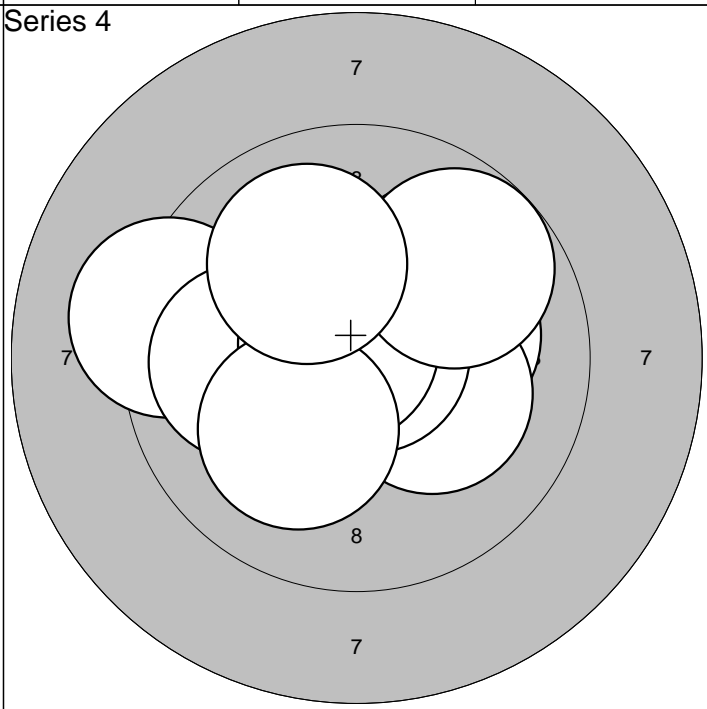

1: 9,2 ↙	6:10,8* ↗	Serie 98,0
2:10,1 →	7:10,7* ↖	
3:10,0 ↗	8:10,1 ↘	Sum 387,0
4:10,0 ↙	9: 9,7 ↗	
5:10,2* ↘	10:10,0 ↖	

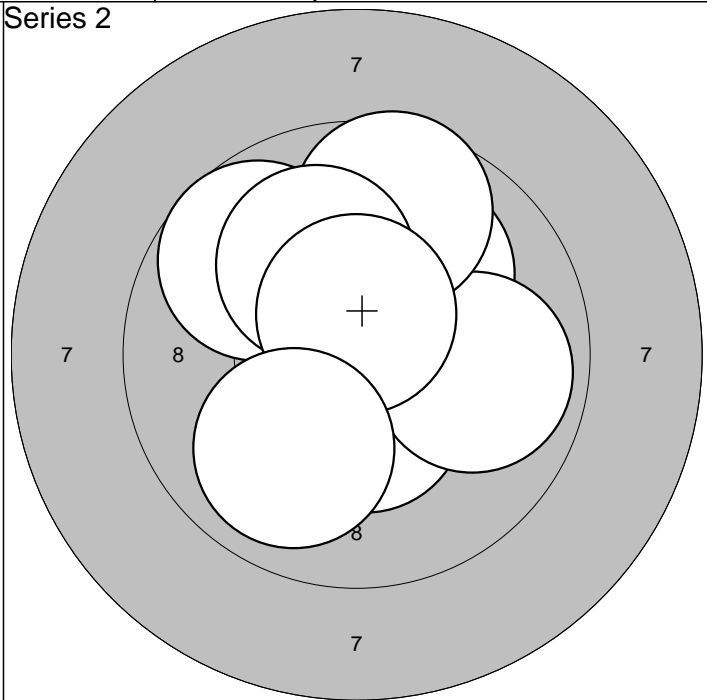
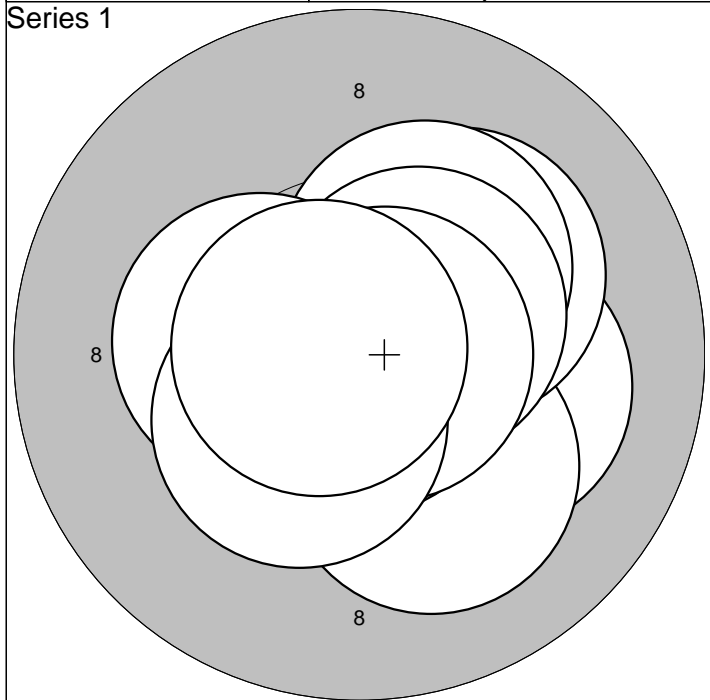

1:10,2* →	6:10,5* ↗			Serie	100,0
2:10,1 ↓	7:10,4* ←				
3:10,9* ↓	8:10,8* →			Sum	100,0
4:10,2* ↗	9:10,4* ↘				
5:10,3* ↗	10:10,7* ←				

1:10,2* ↗	6:10,1 ↑			Serie	96,0
2:10,4* ↓	7: 9,6 ↑				
3: 9,7 ↖	8:10,1 ↖			Sum	196,0
4:10,1 ↗	9:10,6* ↑				
5: 9,9 →	10: 9,9 ↘				

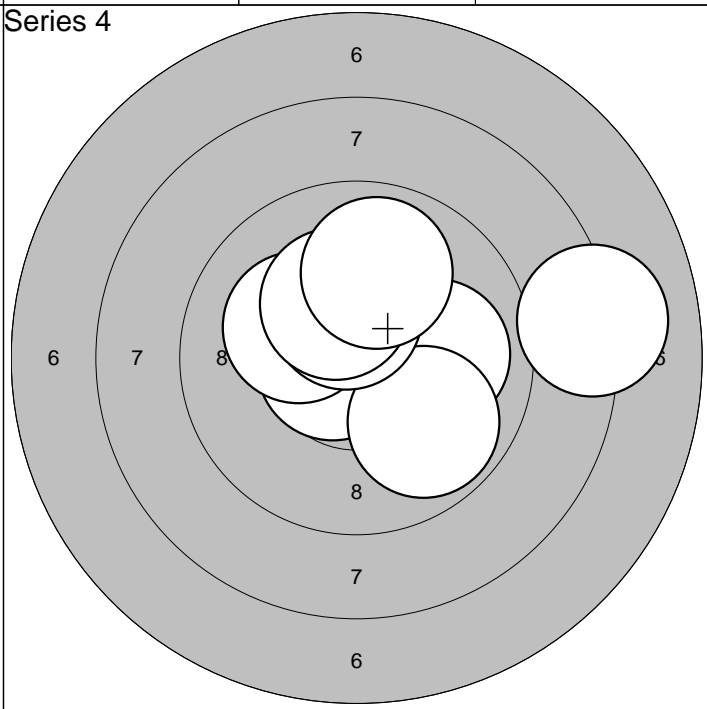
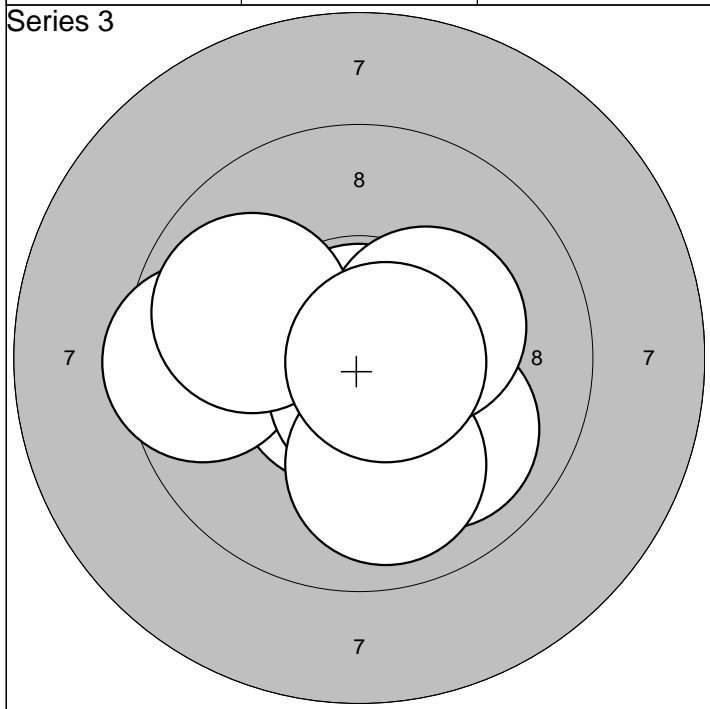

1:10,6* ↘	6:10,7* ↓			Serie	97,0
2: 9,5 ←	7: 9,9 ↓				
3:10,6* →	8:10,3* →			Sum	293,0
4:10,8* ↑	9: 9,9 ←				
5:10,0 ↓	10:10,7* →				

1:10,2* ↑	6: 9,9 ↓			Serie	96,0
2: 8,1 →	7:10,2* ↖				
3:10,2* ↗	8:10,4* ↑			Sum	389,0
4:10,0 →	9:10,2* ↖				
5:10,7* ←	10: 9,9 ↑				

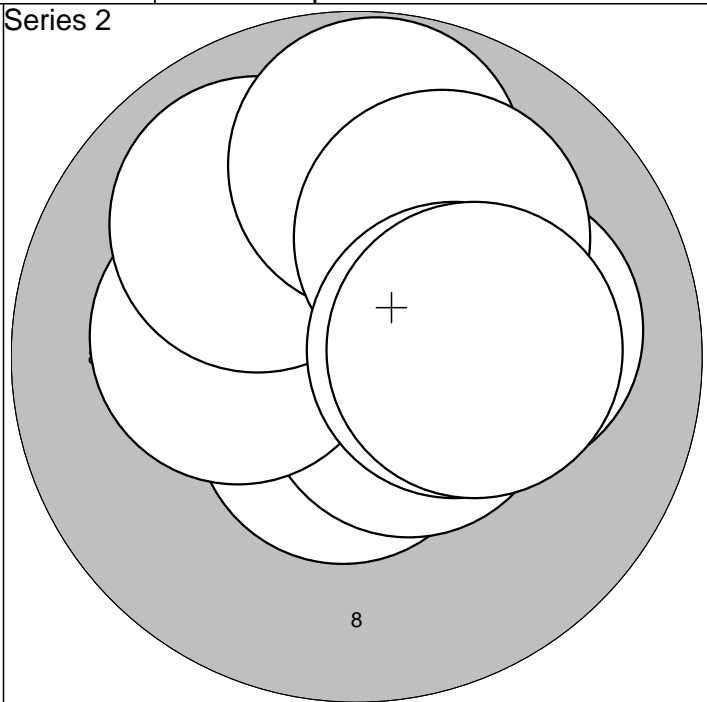
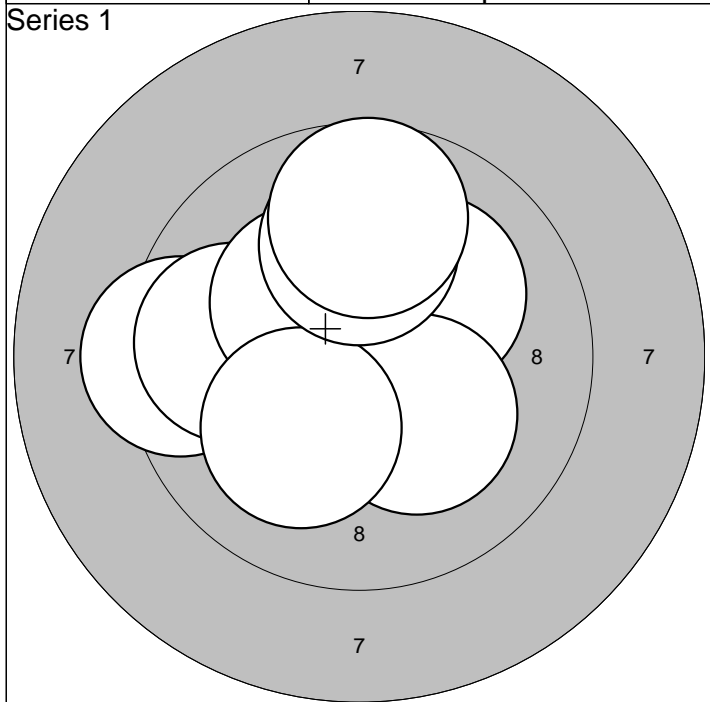

1: 9,3 ←	6: 10,3* ↗	Serie	96,0
2: 10,6* ↗	7: 10,2* ↘		
3: 10,5* ←	8: 10,1 ↙	Sum	96,0
4: 9,8 ←	9: 9,9 ↑		
5: 10,1 ↗	10: 9,7 ↑		

1: 10,3* ↗	6: 9,8 ↑	Serie	98,0
2: 10,6* ↓	7: 10,1 →		
3: 10,6* ↘	8: 10,1 ↗	Sum	194,0
4: 10,2* ←	9: 10,3* →		
5: 9,9 ↗	10: 10,2* →		

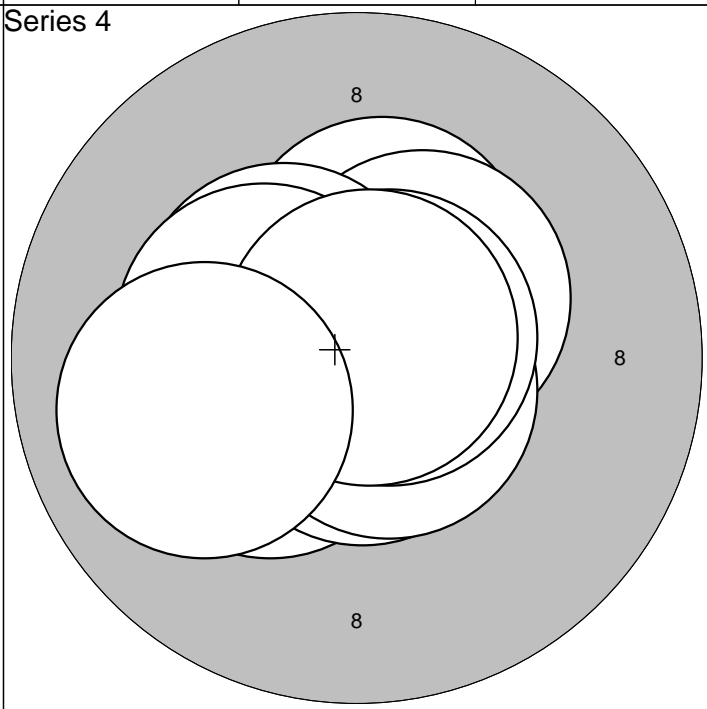
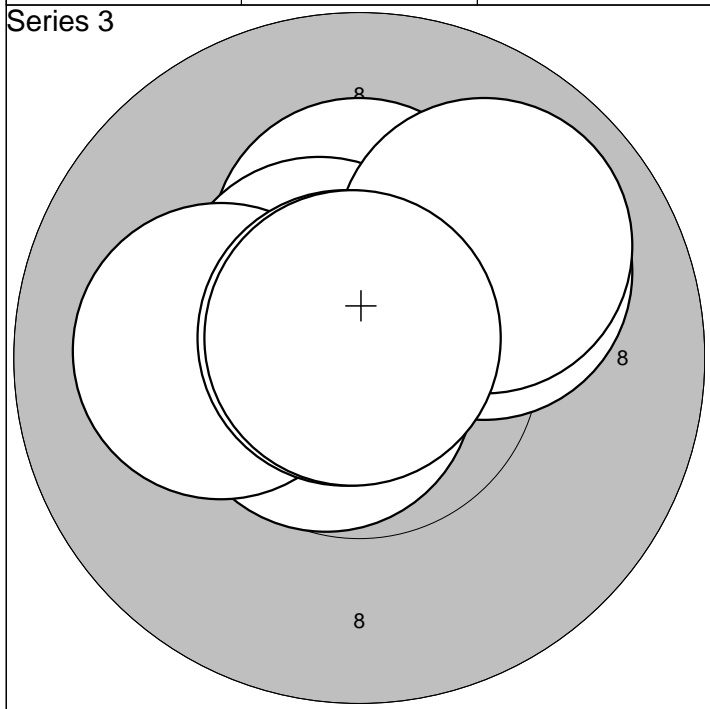

1: 10,4* ↑	6: 10,5* ↗	Serie	99,0
2: 10,7* ↙	7: 9,9 ↗		
3: 10,0 ↗	8: 10,1 ←	Sum	293,0
4: 10,3* ↑	9: 10,8* ↗		
5: 10,7* ↑	10: 10,8* ↑		

1: 10,4* ↑	6: 10,7* ↓	Serie	100,0
2: 10,3* ↙	7: 10,7* ↘		
3: 10,4* ↗	8: 10,7* ↗	Sum	393,0
4: 10,4* ↙	9: 10,8* ↗		
5: 10,4* ←	10: 10,0 ←		

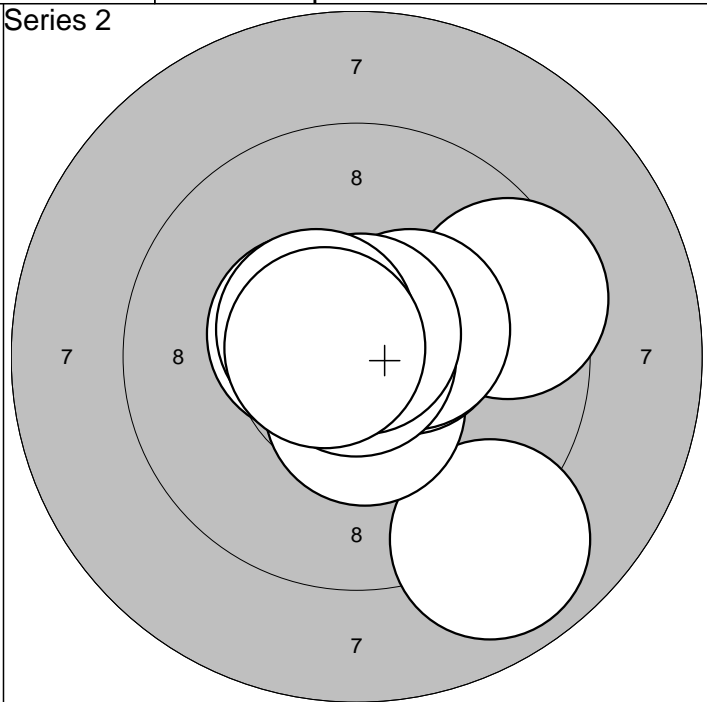
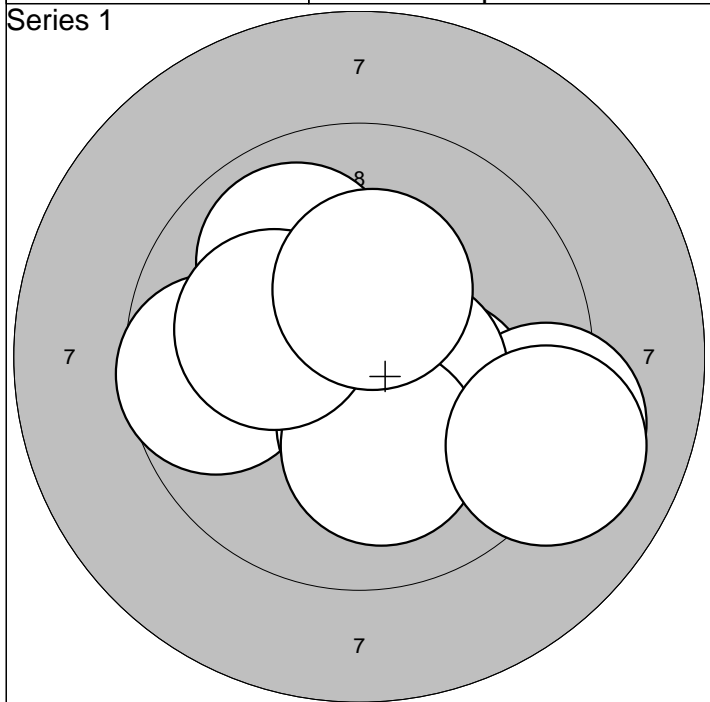

1: 9,7 ←	6:10,5* →			Serie	96,0
2:10,2* ↘	7:10,1 ↓				
3:10,3* ↓	8:10,2* ←	Sum	96,0		
4: 9,2 ↘	9:10,4* ↑				
5: 9,9 ↗	10: 9,1 ↘				

1:10,5* ←	6:10,4* →			Serie	97,0
2: 8,9 ↓	7:10,9*				
3:10,5* ↓	8:10,7* ↑	Sum	193,0		
4: 9,5 →	9:10,5* ←				
5:10,5* →	10:10,7* ←				

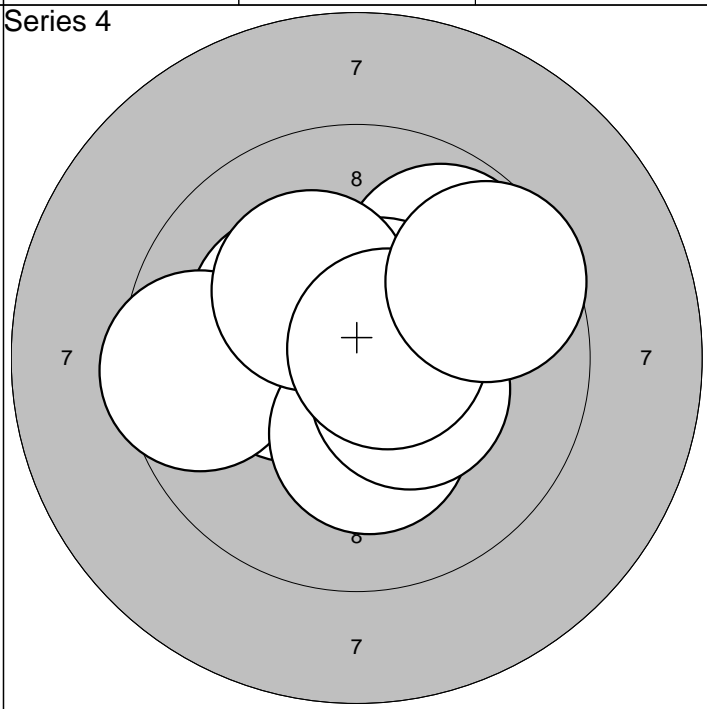
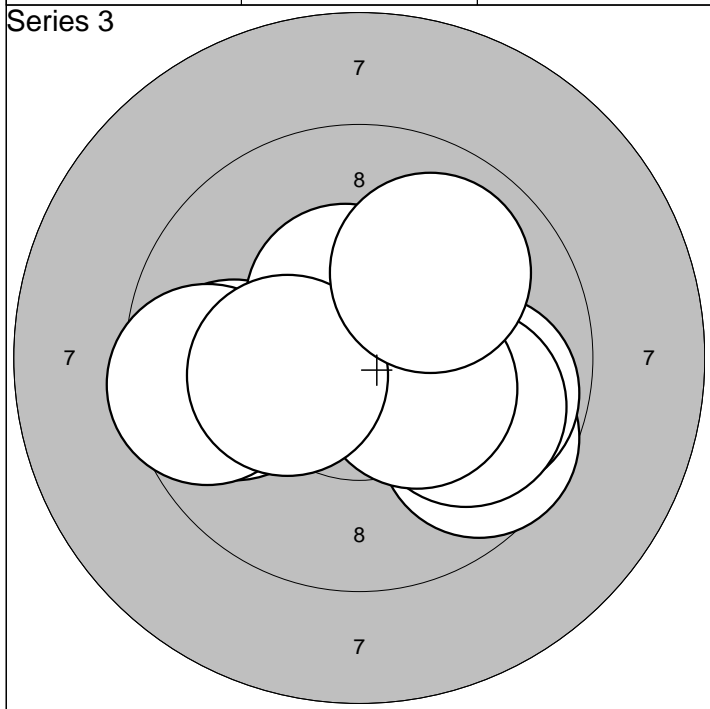

1: 9,6 ↘	6:10,5* ↑			Serie	95,0
2: 9,8 →	7: 9,5 ←				
3:10,4* →	8:10,3* ↘	Sum	288,0		
4: 9,9 ↘	9:10,3* ←				
5: 9,8 ←	10:10,0 ↗				

1:10,4* ←	6:10,5* ↗			Serie	97,0
2:10,2* ←	7:10,4* ↘				
3: 9,5 ←	8:10,2* ↗	Sum	385,0		
4:10,3* ↓	9:10,6* →				
5: 9,8 ↗	10: 9,6 →				

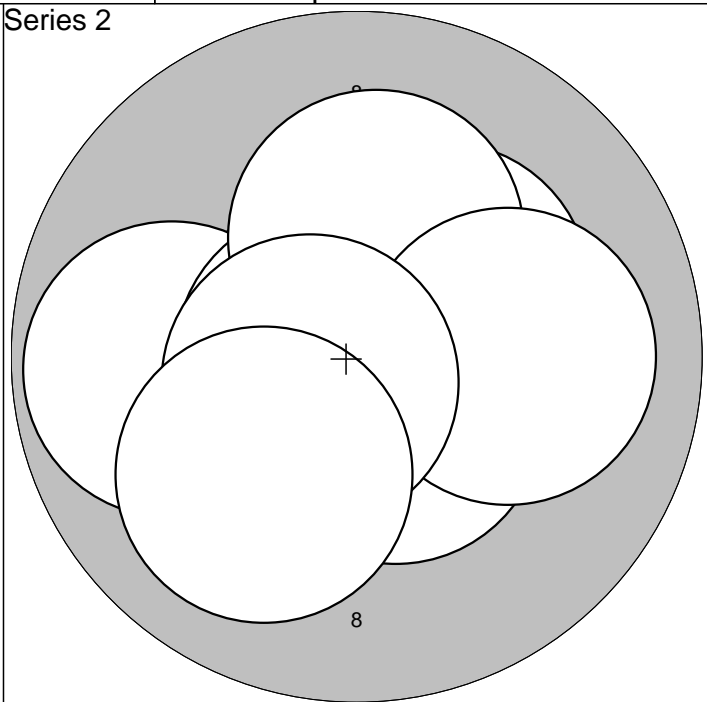
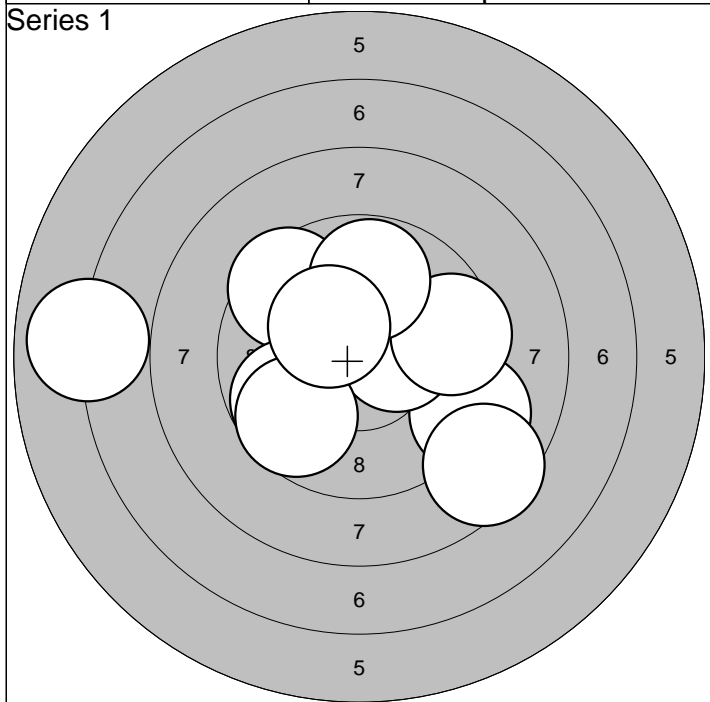

1: 6,9	←	6:10,4*	→	Serie	88,0
2: 9,5	↖	7: 9,7	↘		
3: 9,8	↙	8: 9,5	→		
4: 9,1	↘	9: 9,8	↑		
5: 8,5	↘	10:10,3*	↖		
Sum				88,0	

1:10,4*	↙	6:10,7*	←	Serie	99,0
2:10,5*	↘	7:10,2*	↑		
3: 9,8	←	8:10,0	→		
4:10,6*	↗	9:10,6*	↙		
5:10,3*	↗	10:10,0	↘		
Sum				187,0	

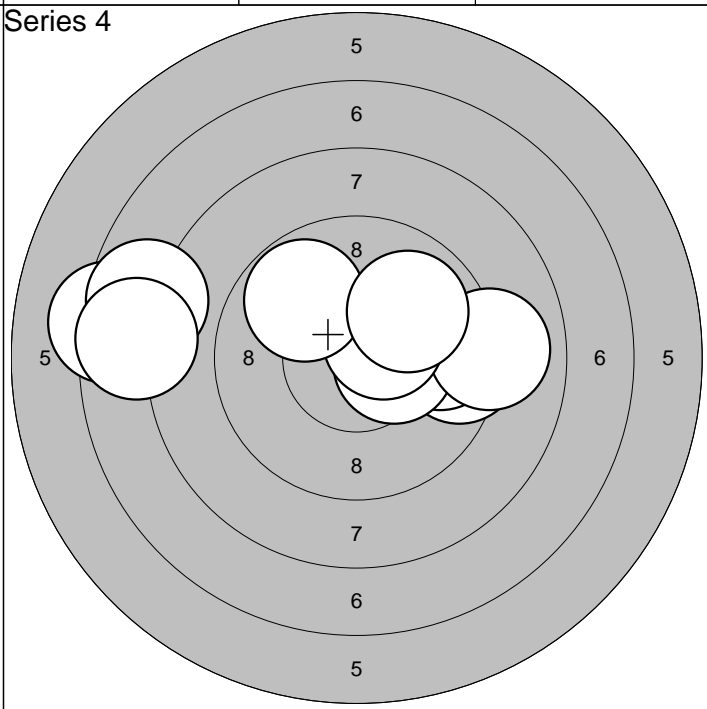
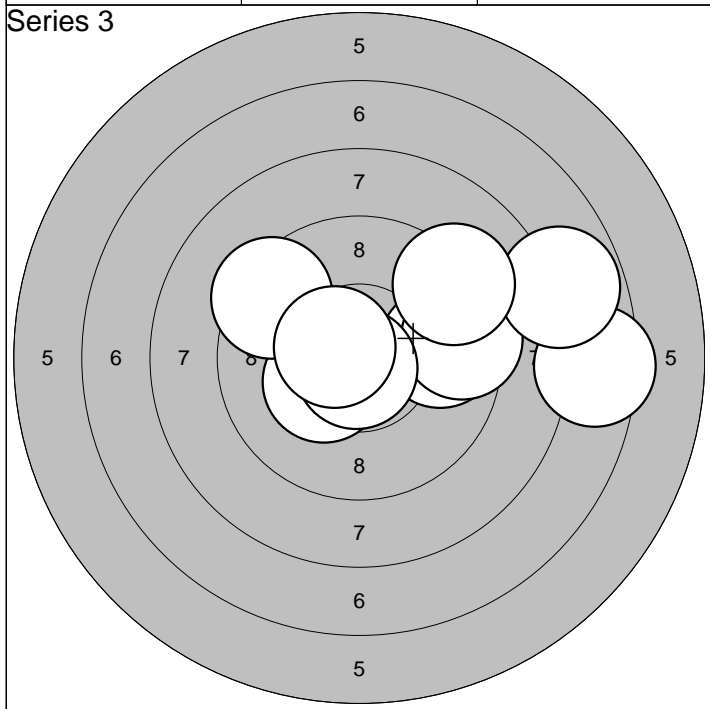

1:10,5*	←	6: 9,4	↖	Serie	90,0
2: 7,5	→	7: 7,8	→		
3: 9,7	→	8:10,8*	↘		
4:10,3*	↙	9: 9,2	↗		
5: 9,4	→	10:10,6*	↖		
Sum				277,0	

1: 9,4	→	6:10,5*	↗	Serie	86,0
2: 9,7	→	7: 9,8	↖		
3:10,4*	→	8: 9,9	↗		
4: 7,3	←	9: 7,8	←		
5: 9,0	→	10: 7,7	←		
Sum				363,0	

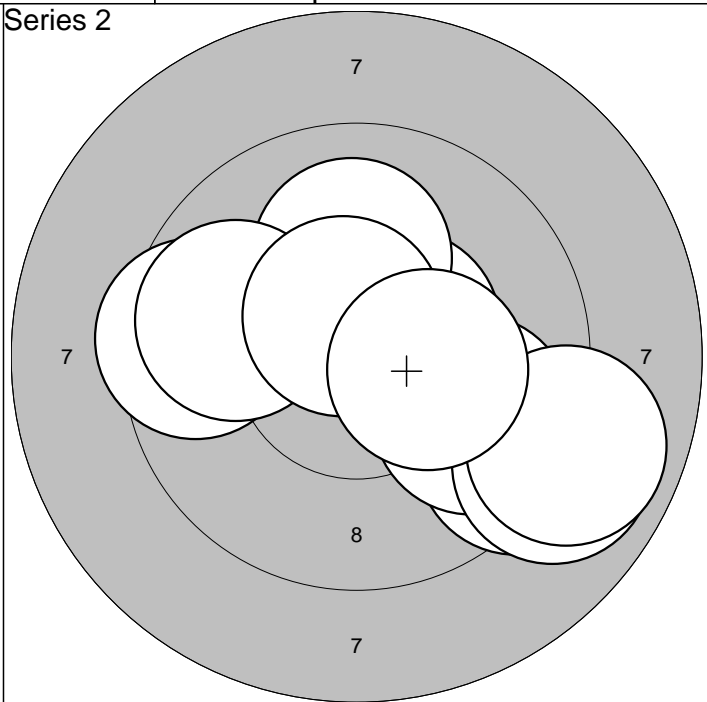
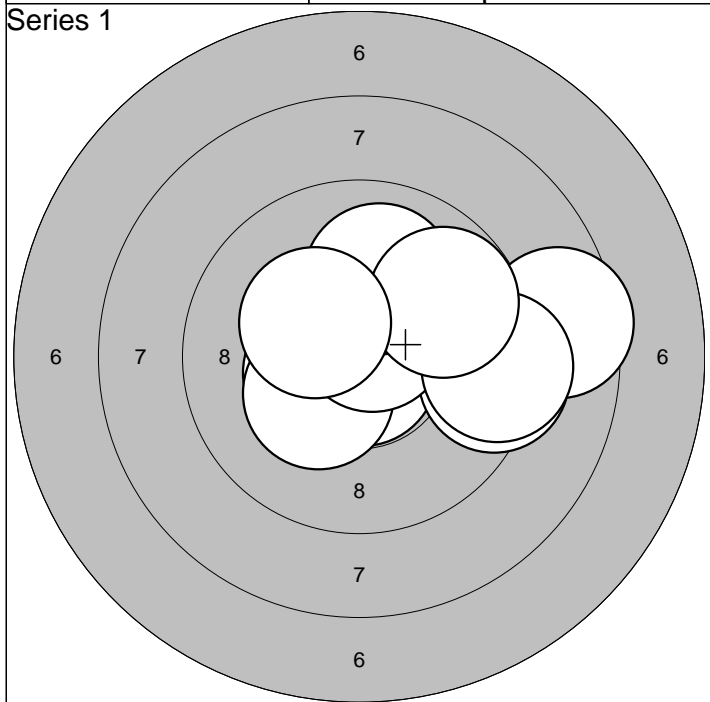

1:10,8* ↓	6: 8,6 →				
2: 9,3 →	7: 9,3 →				
3:10,4* ←	8:10,0 ↑	Sum	95,0		
4:10,3* ↙	9: 9,7 ↗				
5:10,7* ↗	10:10,3* ↖				

1:10,5* ↗	6:10,1 ↑				
2: 9,3 ↘	7: 9,8 ←				
3: 9,8 ↘	8: 8,9 ↘	Sum	188,0		
4: 9,0 ↘	9:10,6* ↑				
5: 9,5 ←	10:10,3* →				

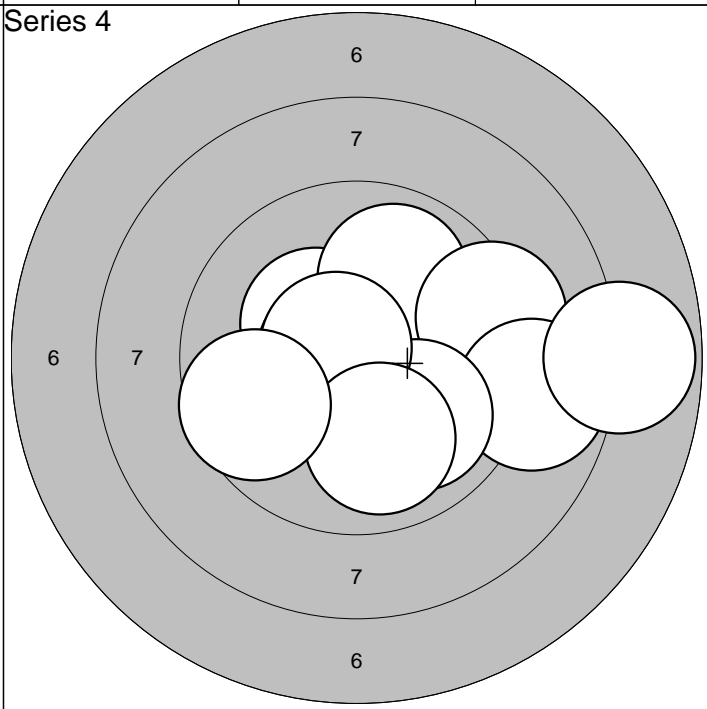
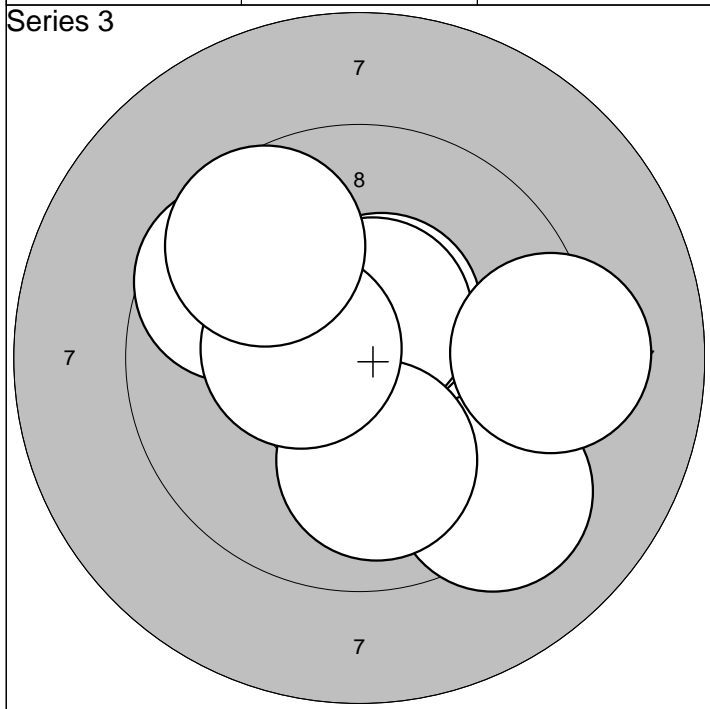

1:10,8* ↓	6:10,6* ↑				
2: 9,6 ↖	7: 9,2 →				
3:10,2* ↓	8:10,0 ↓	Sum	284,0		
4:10,5* ↗	9:10,4* ←				
5: 9,3 ↘	10: 9,7 ↗				

1:10,3* ↖	6: 9,9 ↘				
2: 9,9 ↑	7:10,7* ↖				
3: 9,3 →	8: 7,8 →	Sum	375,0		
4:10,7* ←	9:10,0 ↓				
5: 8,8 →	10: 9,6 ↖				

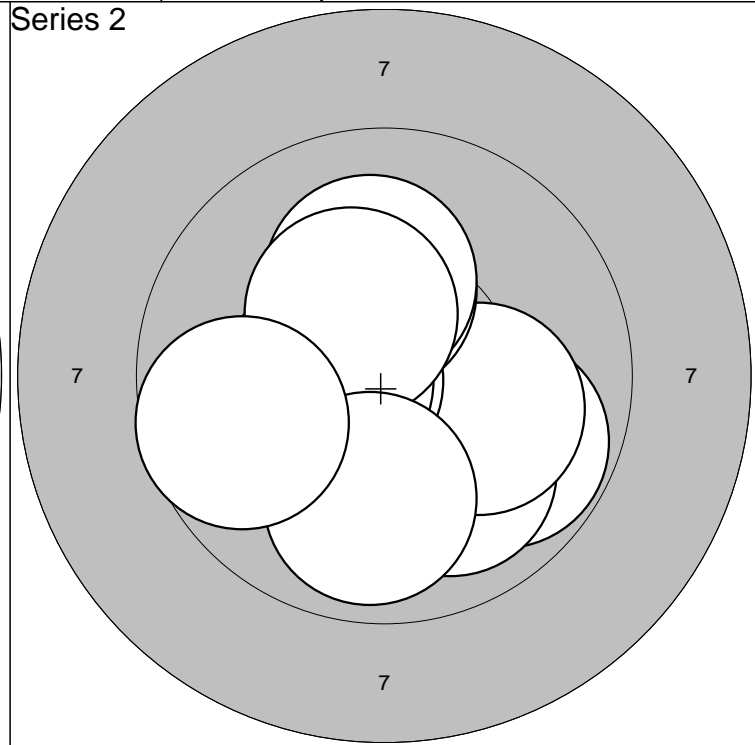
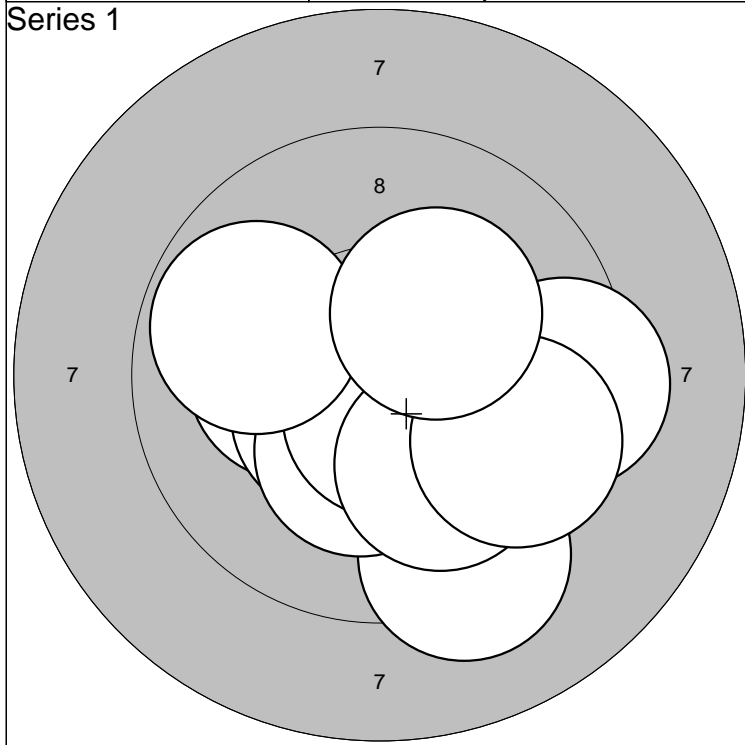

1: 9,3	↓	6:10,6*	↓	Serie	96,0
2: 9,4	→	7:10,0	↓		
3:10,2*	←	8: 9,6	→	Sum	96,0
4:10,5*	↙	9: 9,8	↖		
5:10,3*	↓	10:10,2*	↗		

1: 9,8	↘	6:10,1	↑	Serie	97,0
2:10,0	↓	7:10,5*	←		
3:10,1	↘	8:10,4*	↗	Sum	193,0
4:10,2*	↑	9: 9,9	↓		
5:10,5*	←	10: 9,7	←		

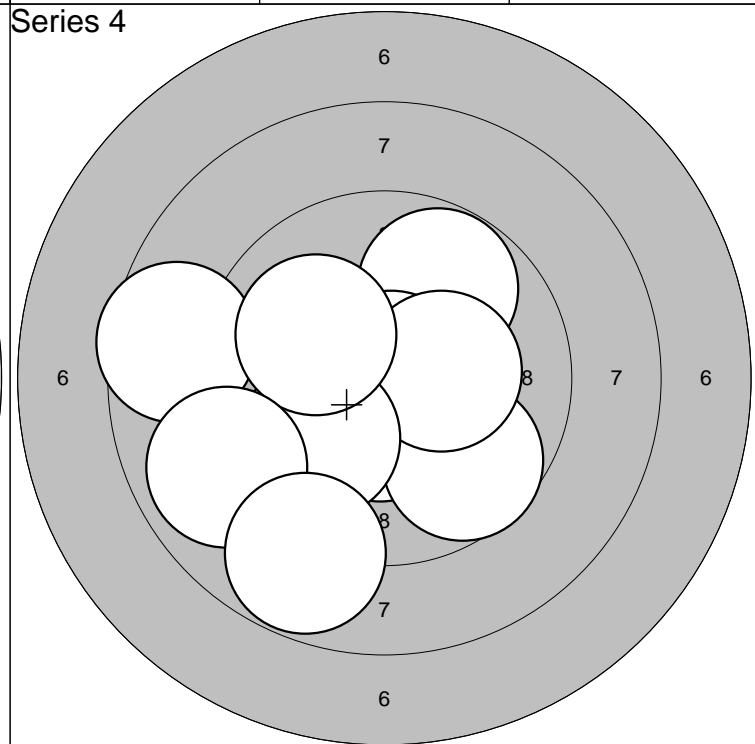
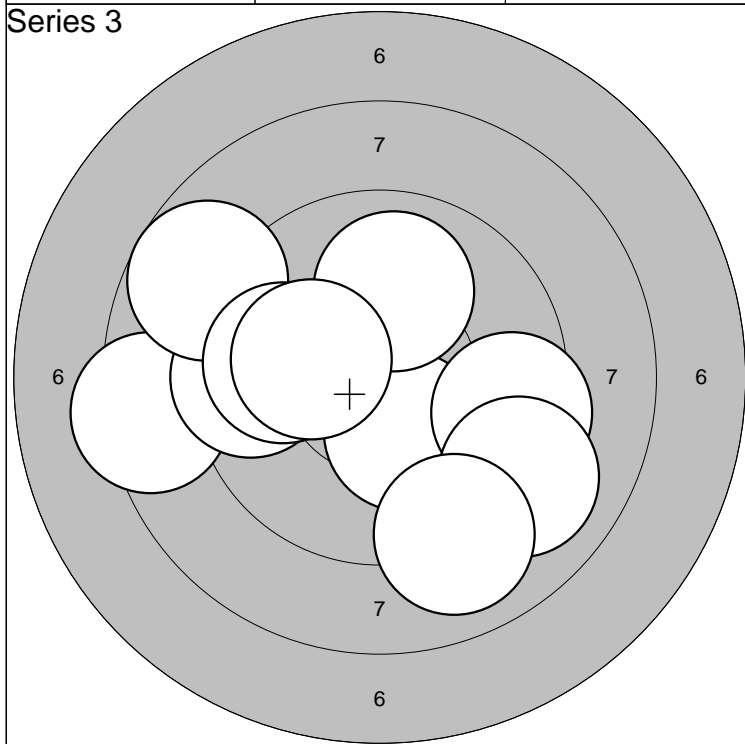

1: 8,3	←	6:10,0	↑	Serie	91,0
2:10,3*	↓	7: 8,8	↖		
3: 9,5	←	8: 9,9	←	Sum	284,0
4: 9,4	→	9:10,2*	←		
5: 9,0	↘	10: 9,0	↓		

1: 9,8	↗	6:10,3*	→	Serie	92,0
2:10,5*	↓	7:10,0	↙		
3:10,8*	↗	8:10,1	↖	Sum	376,0
4: 9,7	↘	9: 8,9	←		
5: 8,6	←	10: 8,8	↓		

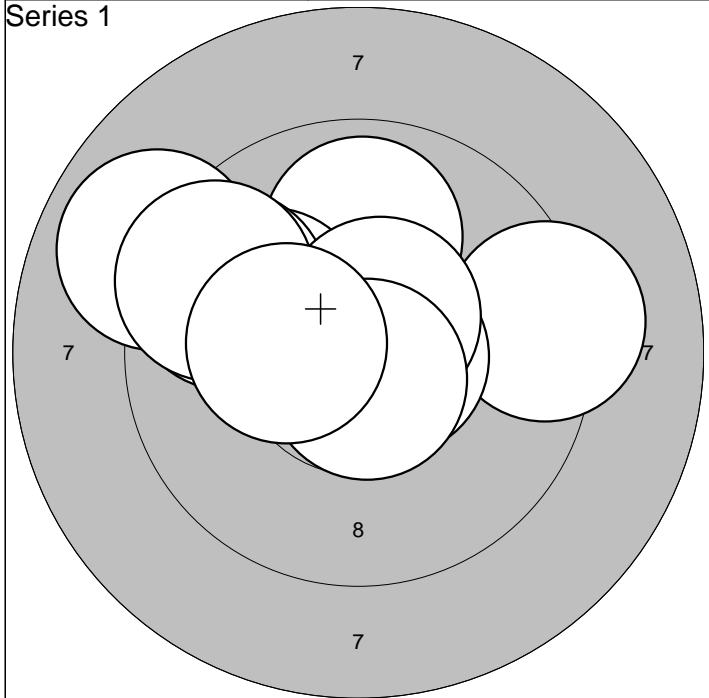

1: 9,9	↑	6: 9,6	↖	Serie	94,0
2: 9,2	→	7: 9,5	↖		
3:10,0	↖	8:10,6*	↗	Sum	94,0
4: 8,9	↖	9:10,7*	↓		
5:10,7*	→	10:10,3*	↖		

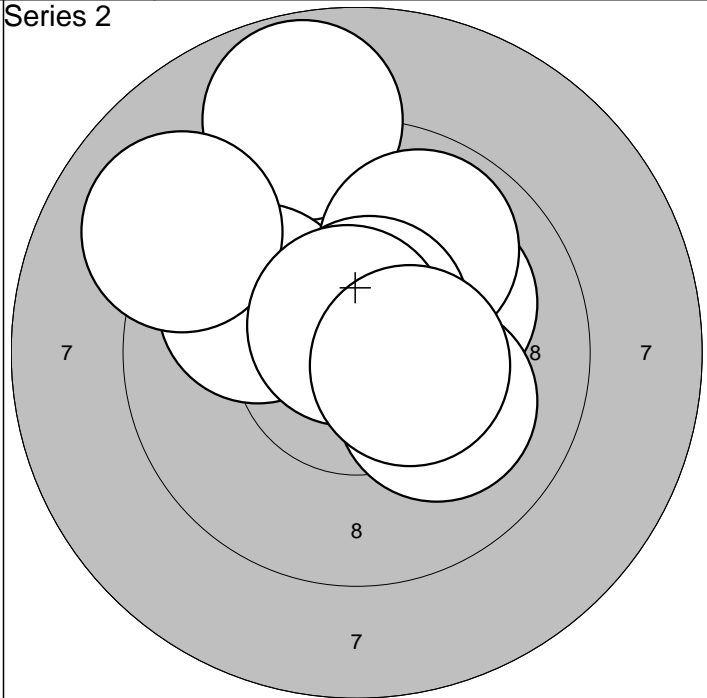

1:10,1	↗	6: 9,0	↖	Serie	96,0
2:10,1	↘	7: 9,9	↗		
3:10,0	↑	8:10,6*	↗	Sum	190,0
4: 8,8	↑	9:10,7*	↗		
5:10,0	↖	10:10,4*	→		

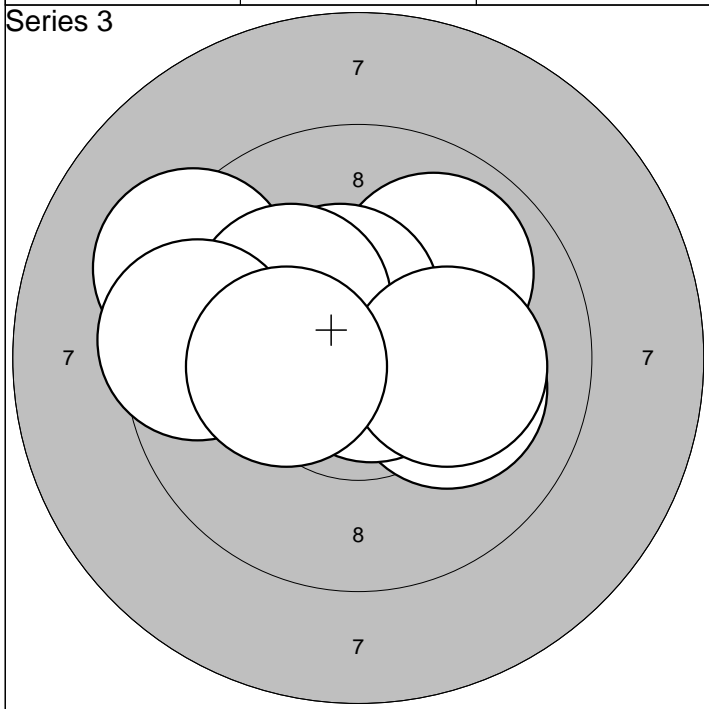

1: 9,9	↗	6:10,4*	↗	Serie	97,0
2:10,1	↘	7:10,2*	↖		
3:10,3*	↖	8:10,1	→	Sum	287,0
4:10,8*	↘	9: 9,5	↖		
5: 9,3	↖	10:10,3*	↖		

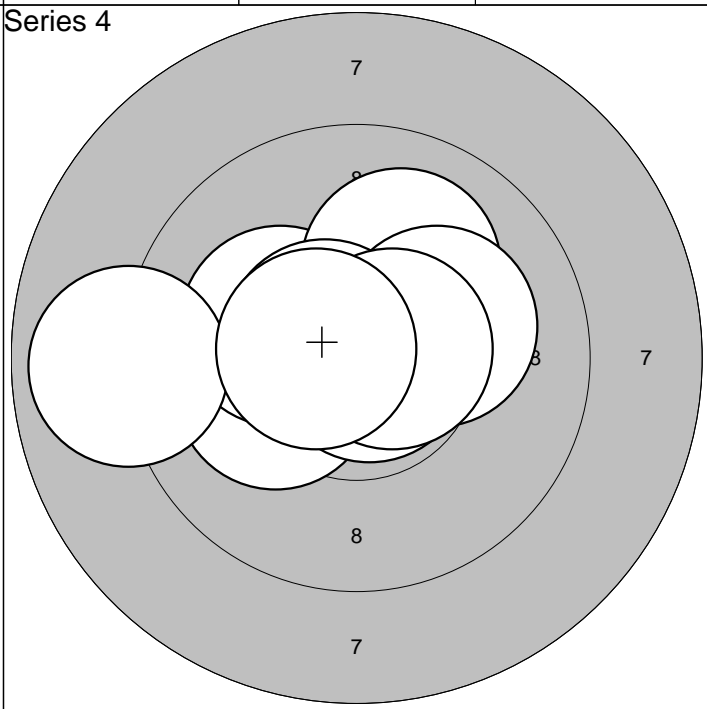

1:10,3*	↖	6:10,6*	↖	Serie	98,0
2:10,2*	↖	7:10,2*	↗		
3:10,8*	↘	8: 8,9	↖	Sum	385,0
4:10,2*	↖	9:10,6*	↗		
5:10,1	↗	10:10,6*	↖		

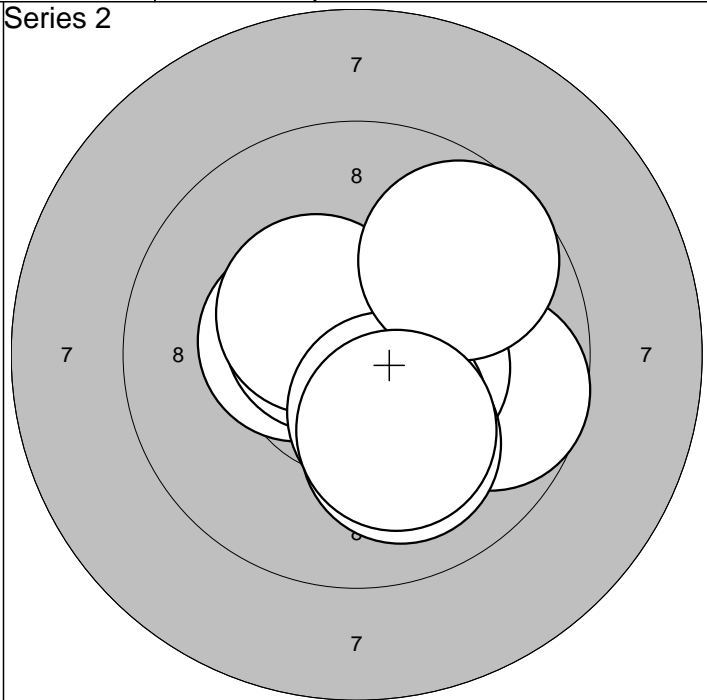
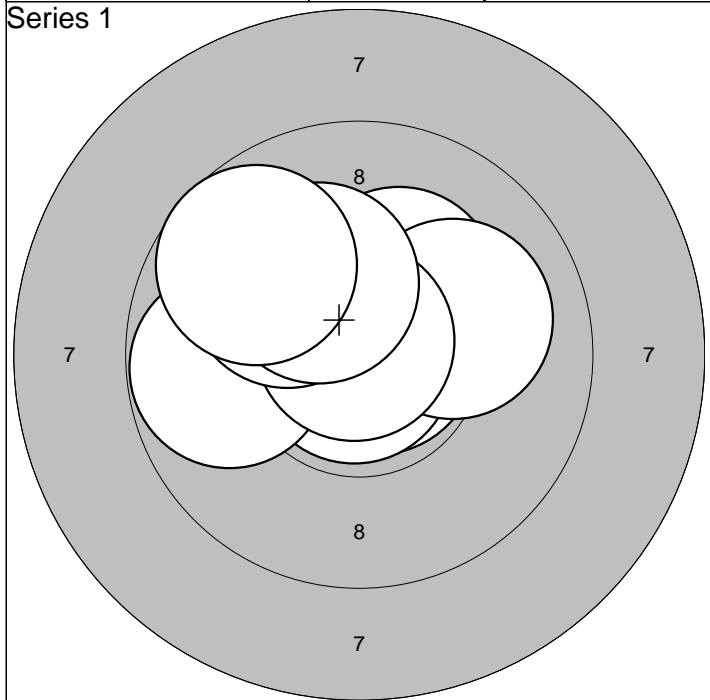

1:10,3* ↗	6: 9,8 ←	Serie	98,0
2:10,7* ↑	7:10,8* ↑		
3:10,8* →	8:10,1 ↗	Sum	98,0
4:10,8* ↓	9:10,2* ↑		
5:10,1 →	10: 9,7 ↗		

1:10,4* ←	6:10,4* ↗	Serie	98,0
2: 9,7 →	7:10,1 ↓		
3:10,6* ↗	8:10,4* ↓	Sum	196,0
4:10,5* →	9: 9,7 ↗		
5:10,4* →	10:10,2* ↓		

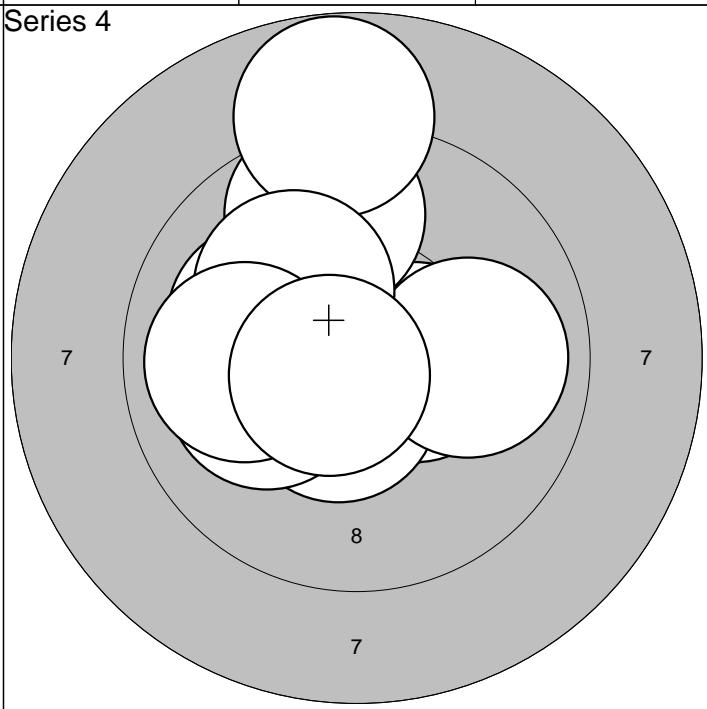
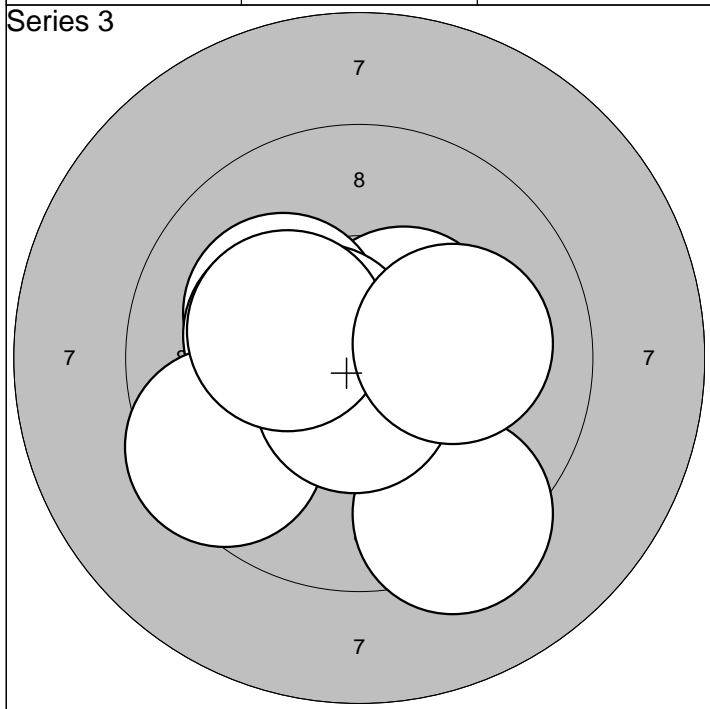

1:10,5* ↗	6:10,6* ←	Serie	98,0
2:10,1 ←	7: 9,3 ↓		
3:10,2* ←	8:10,6* ↓	Sum	294,0
4: 9,5 ←	9:10,3* ←		
5:10,5* ↘	10:10,1 →		

1:10,4* →	6:10,1 ←	Serie	96,0
2:10,5* ↓	7: 8,8 ↑		
3:10,1 ←	8:10,1 ↗	Sum	390,0
4: 9,6 ↑	9:10,0 ←		
5: 9,9 →	10:10,7* ↙		

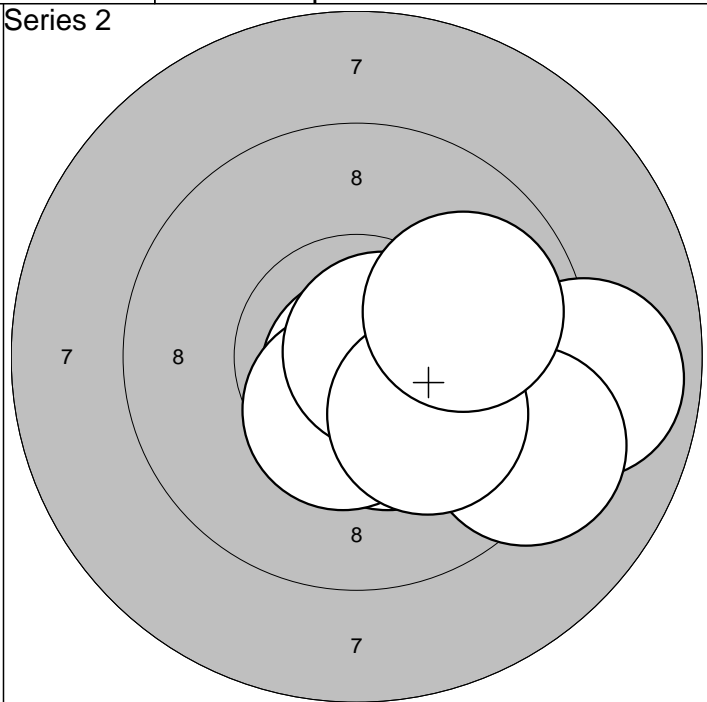
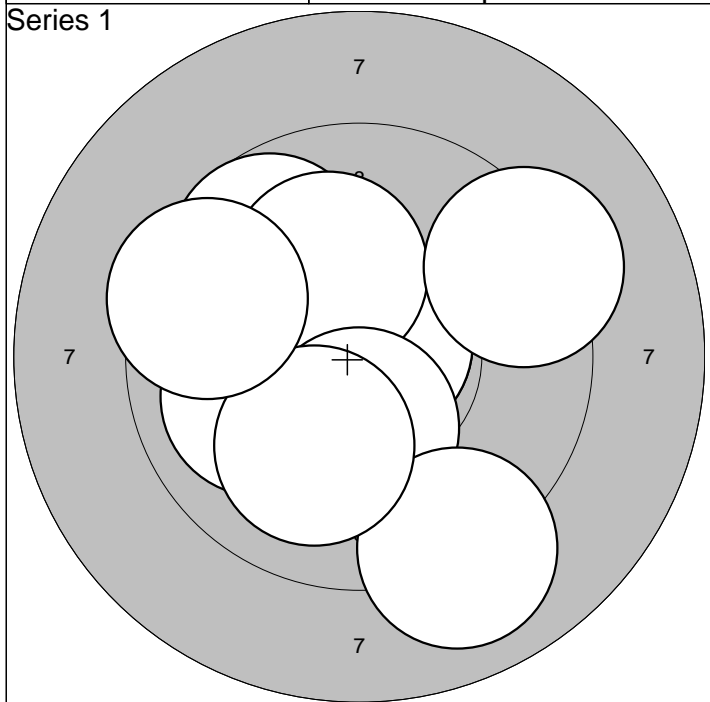

1: 9,7 ↖	6: 9,3 →			Serie	96,0
2:10,8* ↗	7:10,3* ↓				
3:10,0 ←	8: 9,0 ↓	Sum	96,0		
4:10,8* ↗	9:10,0 ↓				
5:10,1 ↑	10: 9,5 ←				

1:10,5* →	6:10,5* ↓			Serie	96,0
2:10,8* ↓	7:10,7* →				
3:10,6* →	8: 9,3 ↘	Sum	192,0		
4: 8,9 →	9:10,1 ↘				
5:10,4* ↓	10: 9,9 →				

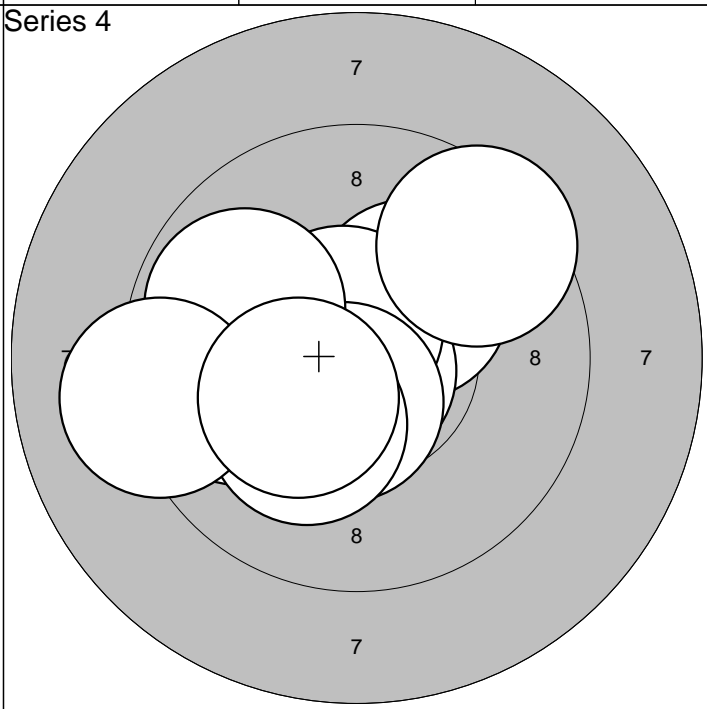
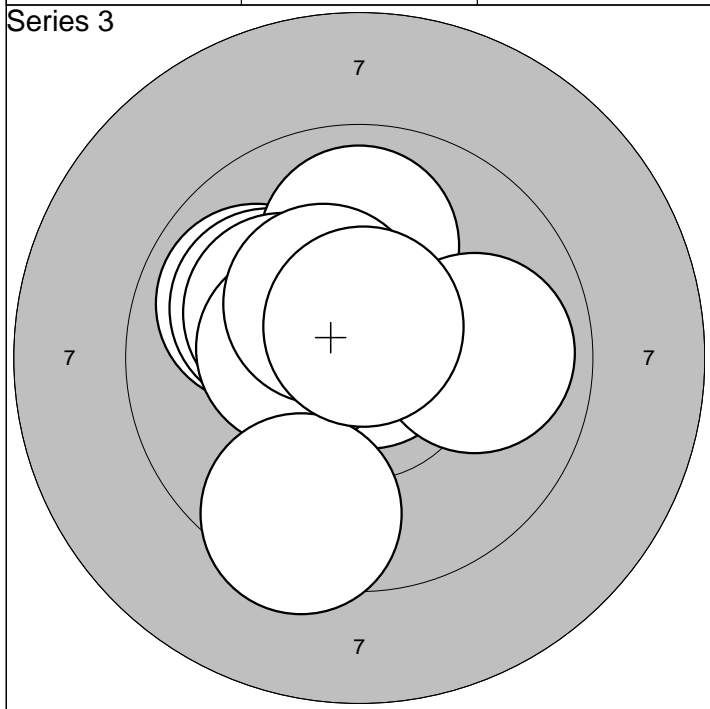

1: 9,9 ↖	6: 9,9 →			Serie	96,0
2:10,0 ↖	7:10,4* ←				
3:10,8* ↗	8:10,4* ↖	Sum	288,0		
4: 9,9 ↑	9: 9,4 ↓				
5:10,2* ↖	10:10,7* ↑				

1:10,2* ↗	6: 9,5 ↗			Serie	96,0
2:10,8* ↓	7: 9,8 ↖				
3: 9,9 ←	8:10,2* ↓	Sum	384,0		
4:10,6* ↖	9: 9,2 ←				
5:10,5* ↓	10:10,3* ↖				

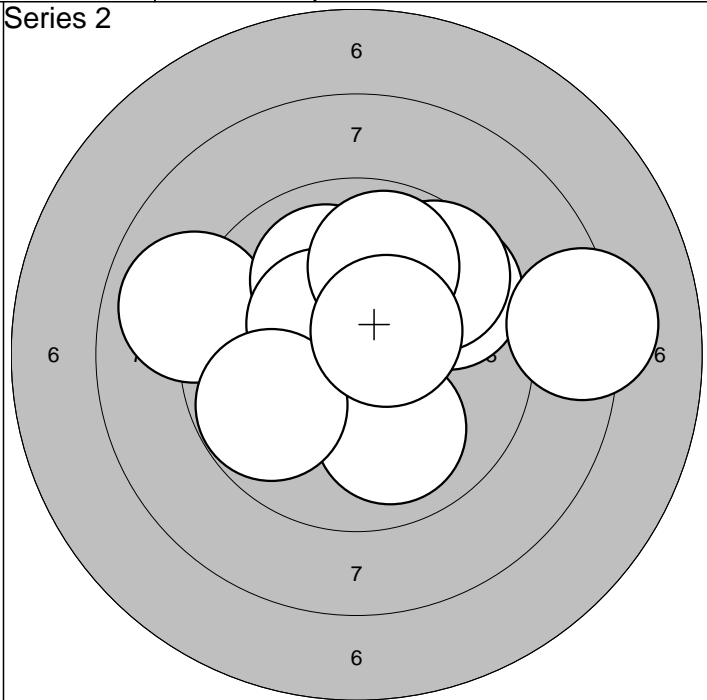
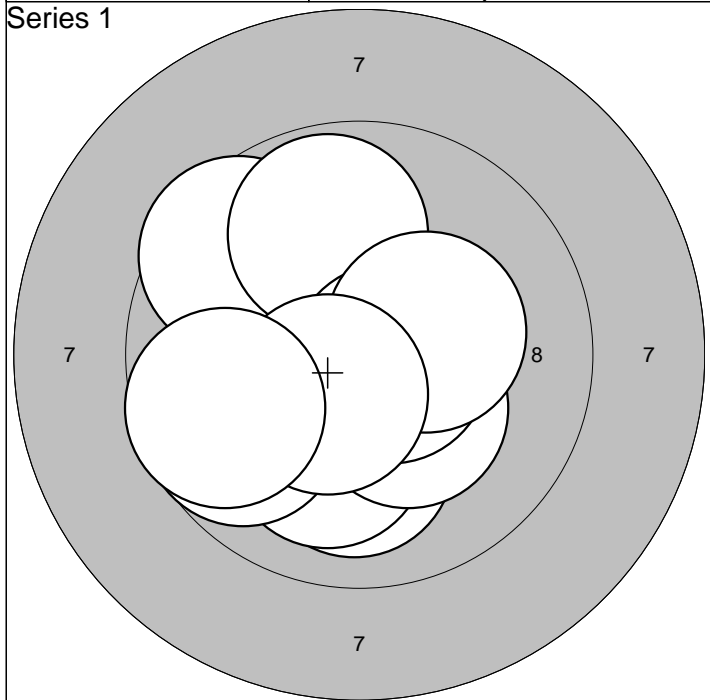

1:10,0 ↓	6: 9,8 ↑	Serie 96,0
2:10,1 ↓	7:10,7* →	
3: 9,7 ←	8:10,3* →	Sum 96,0
4:10,3* ↓	9:10,5* ↓	
5: 9,6 ↗	10: 9,7 ←	

1: 9,7 ↗	6:10,4* ↖	Serie 92,0
2: 8,9 ←	7: 9,8 ↙	
3:10,0 ↑	8: 9,9 ↑	Sum 188,0
4: 9,7 ↗	9:10,5* ↗	
5:10,0 ↓	10: 8,3 →	

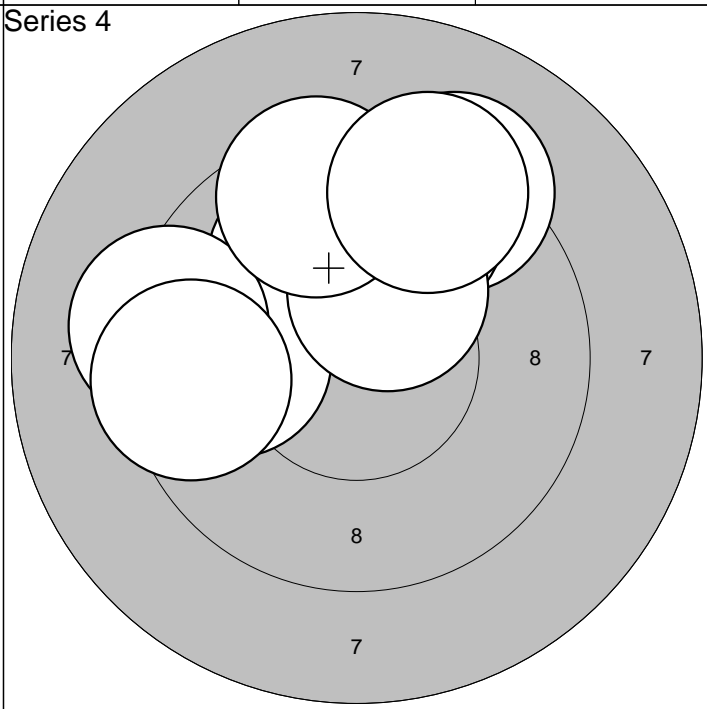
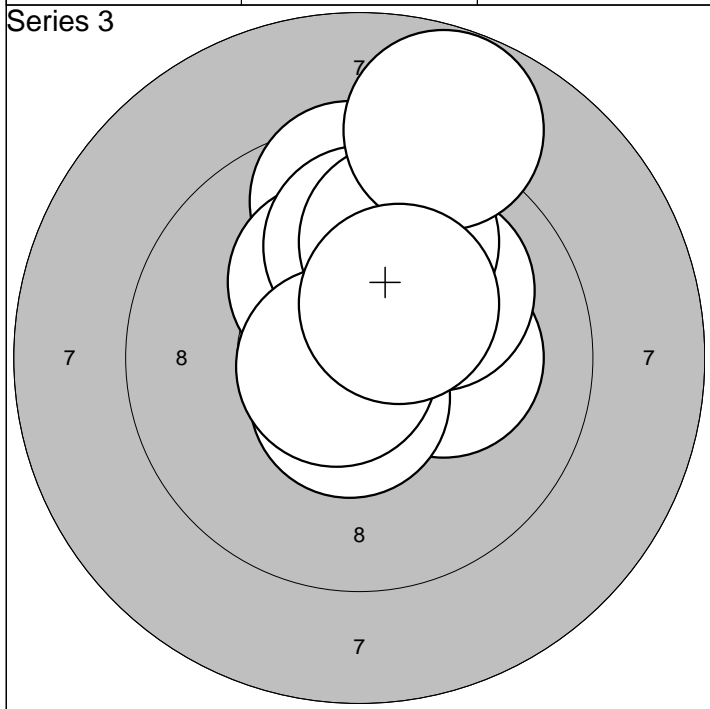

1: 9,6 ↑	6: 9,9 ↑	Serie 95,0
2:10,2* →	7:10,6* ↓	
3:10,2* ↗	8:10,8* ←	Sum 283,0
4: 9,9 ↑	9: 8,8 ↑	
5:10,0 ↗	10:10,4* ↗	

1: 9,9 ↑	6:10,3* ↑	Serie 92,0
2:10,0 ↖	7: 9,2 ←	
3: 9,2 ↗	8: 9,4 ↑	Sum 375,0
4: 9,8 ←	9: 9,5 ←	
5: 9,7 ↑	10: 9,3 ↑	

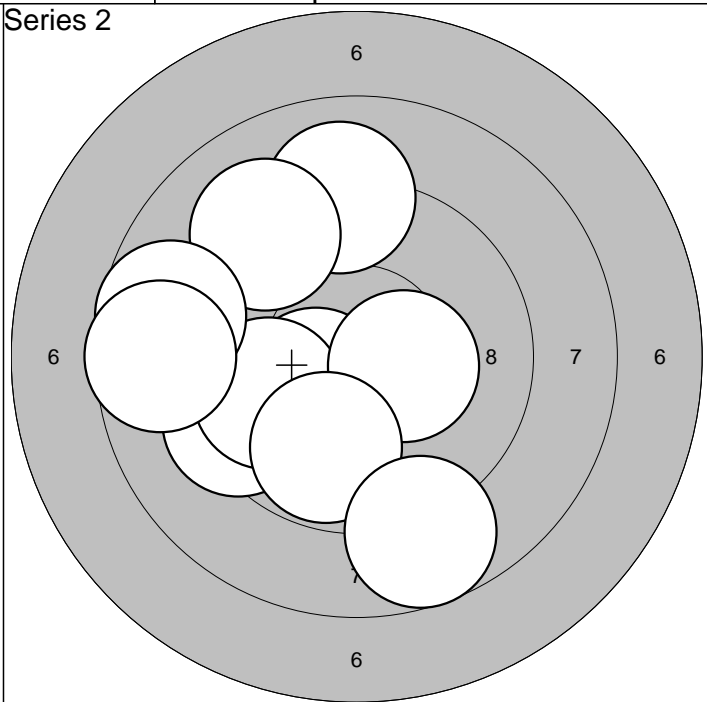
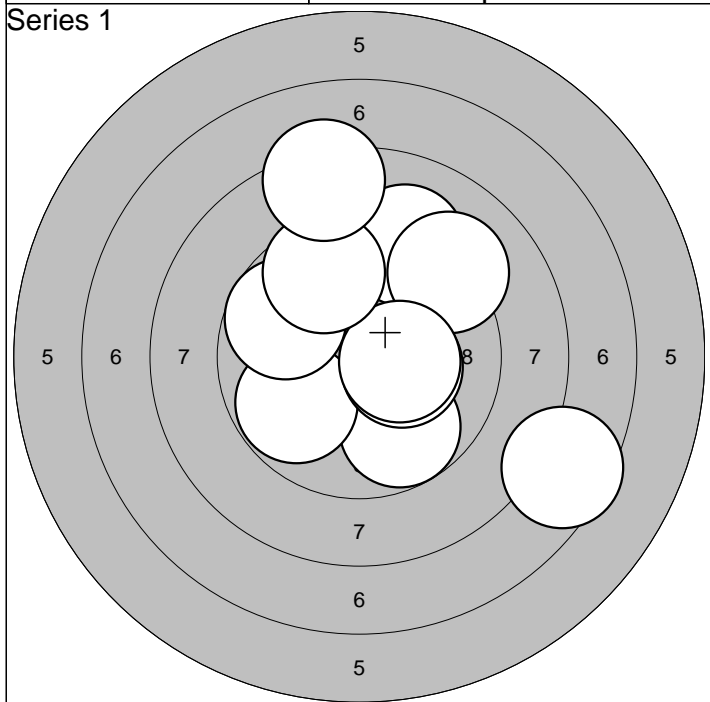

1: 9,2 ↗	6:10,3* →	Serie 89,0
2: 9,1 ↗	7: 9,7 ←	
3: 7,5 ↘	8:10,4* →	Sum 89,0
4: 9,8 ↓	9: 9,6 ↗	
5: 9,8 ↙	10: 8,3 ↗	

1: 9,1 ↗	6:10,4* →	Serie 89,0
2: 9,2 ↘	7: 8,7 ←	
3: 9,4 ↙	8: 8,6 ←	Sum 178,0
4:10,4* ↙	9: 9,8 ↓	
5: 9,8 ↙	10: 8,7 ↓	

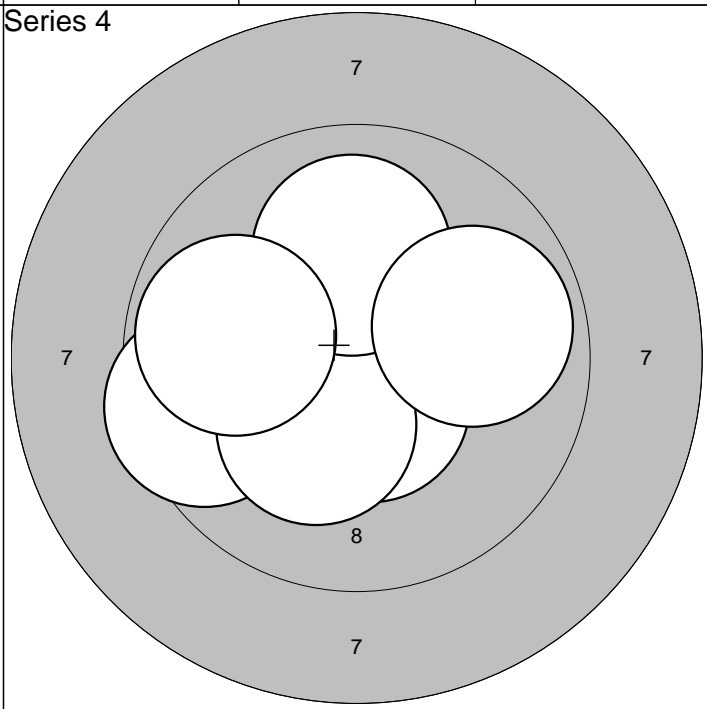
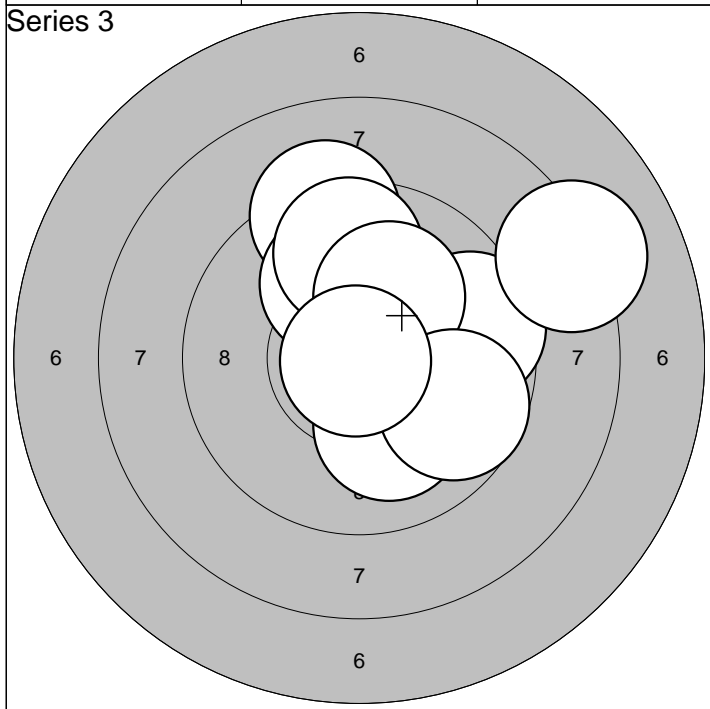

1: 9,6 →	6:10,1 ↗	Serie 94,0
2: 9,2 ↗	7: 8,1 →	
3:10,0 ↗	8:10,1 ↓	Sum 272,0
4:10,5* ↗	9: 9,7 →	
5: 9,7 ↗	10:10,9* ↙	

1:10,5* ←	6:10,5* ↗	Serie 97,0
2:10,5* ↗	7:10,3* ↓	
3: 9,5 ←	8:10,0 ↗	Sum 369,0
4:10,5* ↓	9: 9,8 ←	
5:10,6* ↗	10: 9,9 →	

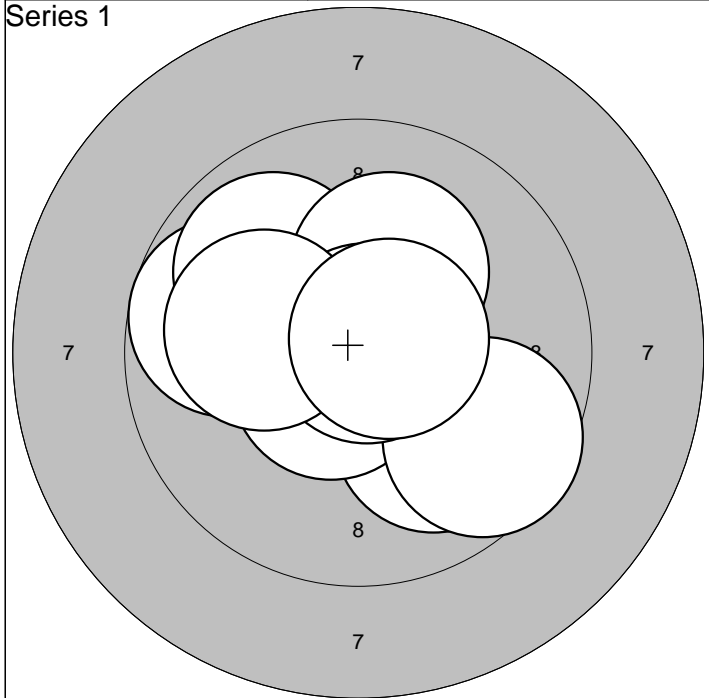

1:10,0 ↘	6: 9,6 ↘	Serie	97,0
2: 9,7 ←	7:10,2* ↑		
3:10,4* ↗	8:10,8* ↗	Sum	97,0
4: 9,9 ↗	9:10,1 ←		
5:10,6* ↙	10:10,6* →		

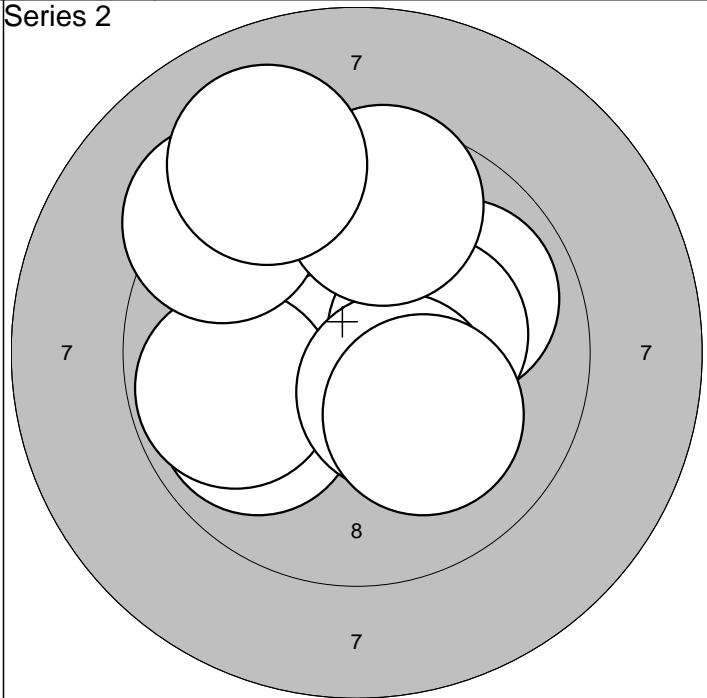

1:10,8* ↙	6:10,3* →	Serie	94,0
2: 9,9 ←	7:10,4* ↘		
3: 9,9 →	8: 9,6 ↑	Sum	191,0
4: 9,8 ←	9:10,1 ↘		
5: 9,3 ↖	10: 9,1 ↑		

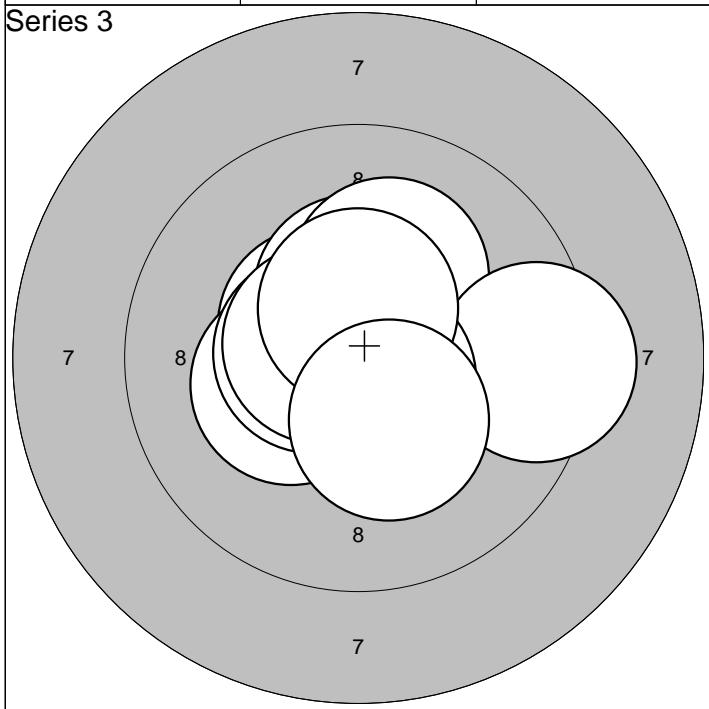

1:10,5* ↖	6:10,7* ↘	Serie	99,0
2:10,4* ↑	7:10,5* ←		
3:10,2* ↗	8:10,6* ←	Sum	290,0
4:10,3* ←	9:10,5* ↑		
5: 9,4 →	10:10,3* ↘		

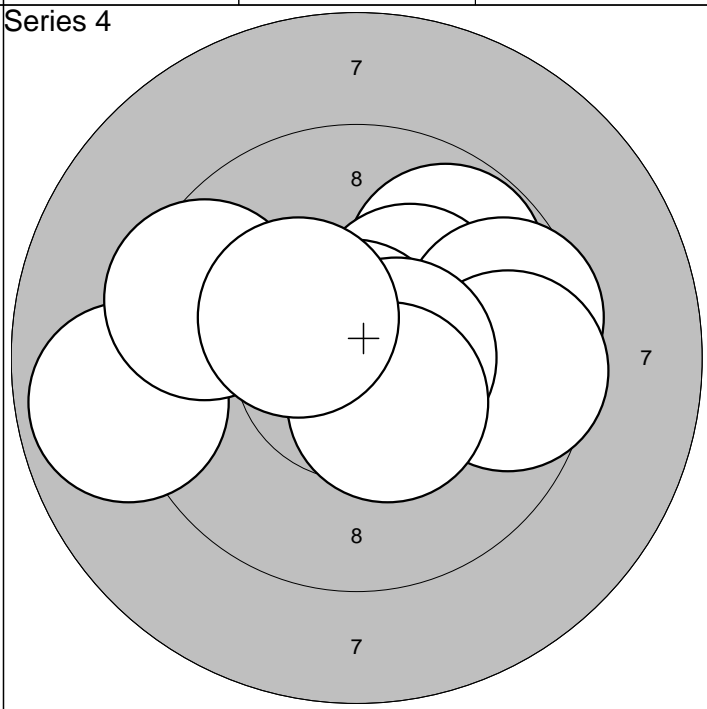

1: 9,8 ↗	6: 8,9 ←	Serie	94,0
2:10,3* ↗	7: 9,5 ←		
3: 9,6 →	8:10,6* →	Sum	384,0
4: 9,6 →	9:10,5* ↘		
5:10,8* ↑	10:10,3* ↖		

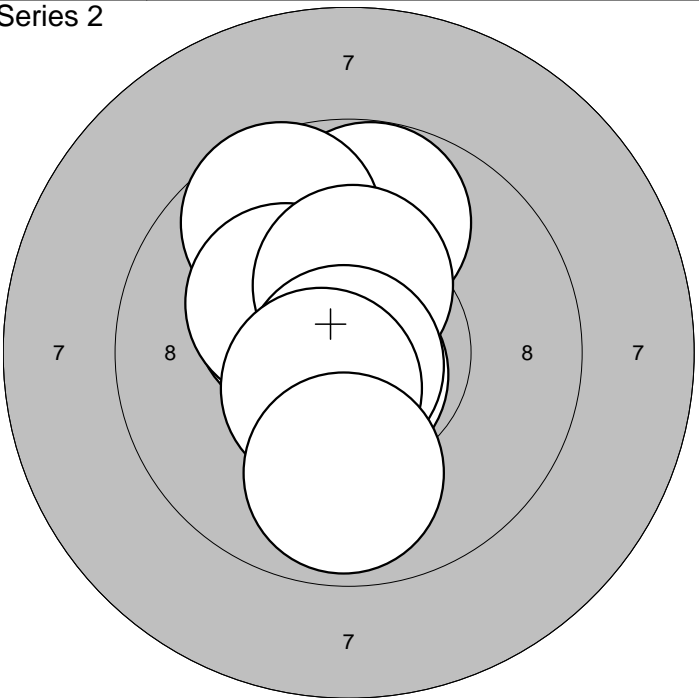
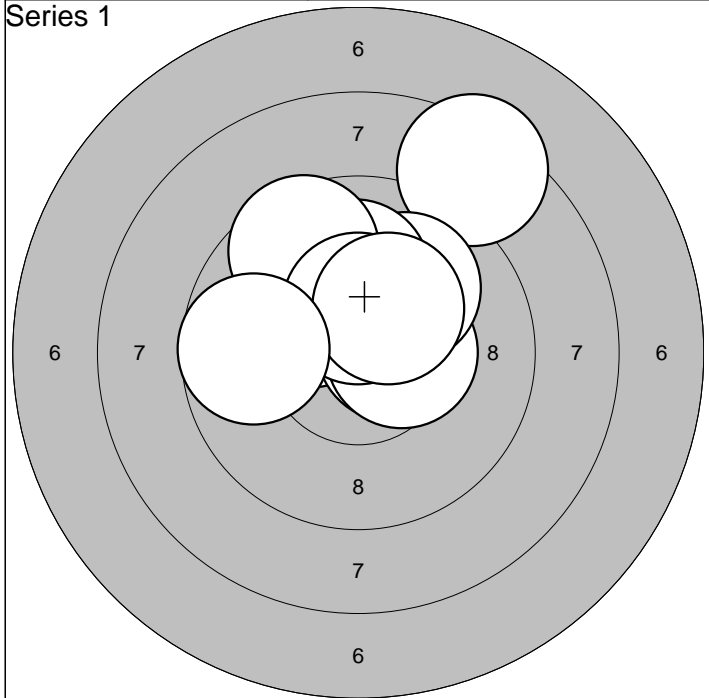

1:10,2* ↖	6:10,0 ↑	Serie 96,0
2:10,5* →	7: 9,6 ↖	
3: 8,4 ↗	8:10,4* ↑	Sum 96,0
4:10,4* →	9:10,3* ↗	
5:10,0 ↗	10: 9,7 ←	

1:10,4* ↖	6:10,2* ↖	Serie 97,0
2:10,3* ↑	7:10,4* ↑	
3:10,7* ↓	8:10,8* ↓	Sum 193,0
4: 9,8 ↑	9:10,6* ↙	
5: 9,6 ↖	10: 9,9 ↓	

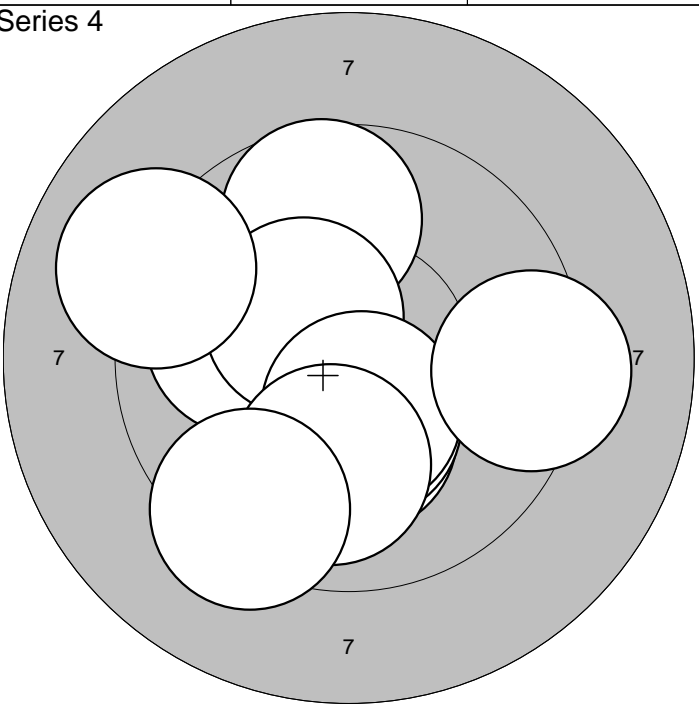
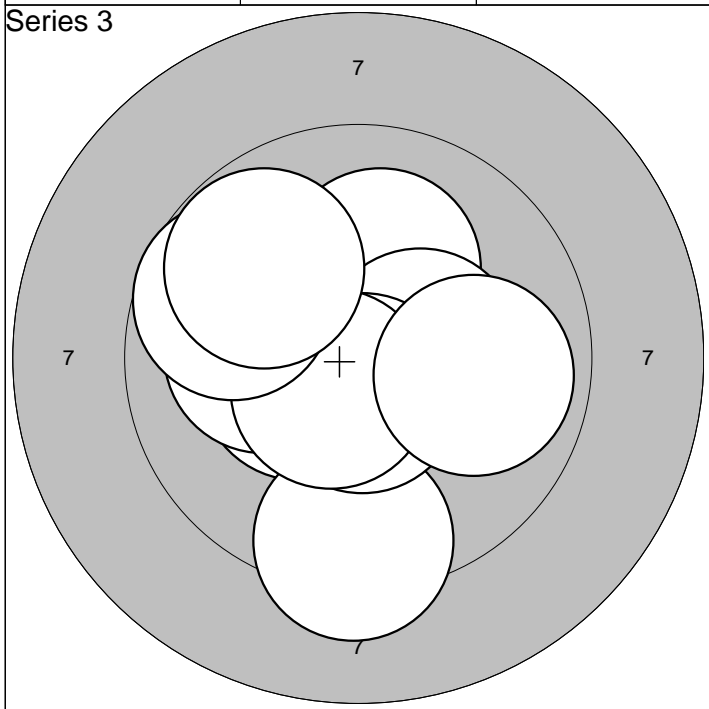

1:10,1 ↑	6:10,6* ↓	Serie 96,0
2:10,4* ←	7:10,6* ↙	
3:10,4* →	8: 9,7 ←	Sum 289,0
4:10,1 ←	9: 9,8 ↗	
5: 9,3 ↓	10: 9,9 →	

1: 9,7 ↑	6: 9,0 ↖	Serie 96,0
2:10,3* ↓	7:10,4* ↓	
3:10,0 ←	8:10,0 ↓	Sum 385,0
4:10,4* ↓	9: 9,3 ↙	
5:10,4* ↖	10: 9,3 →	

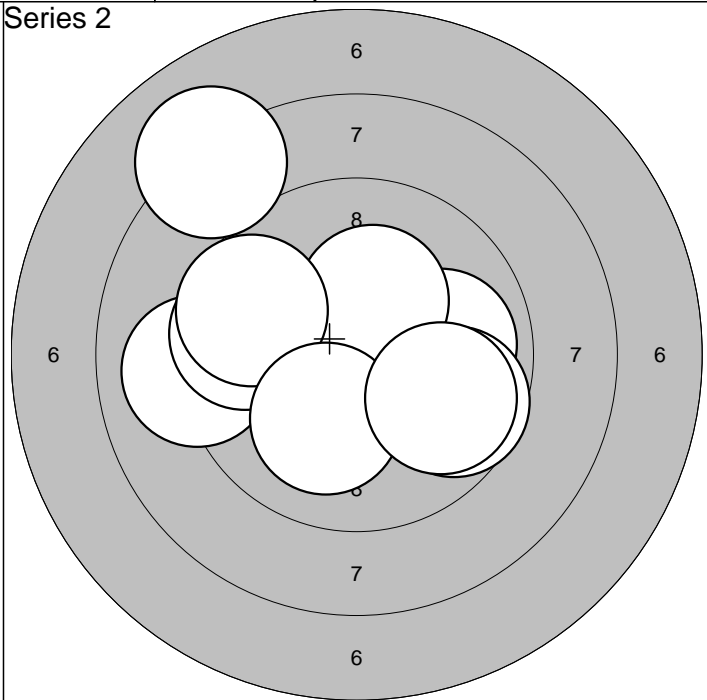
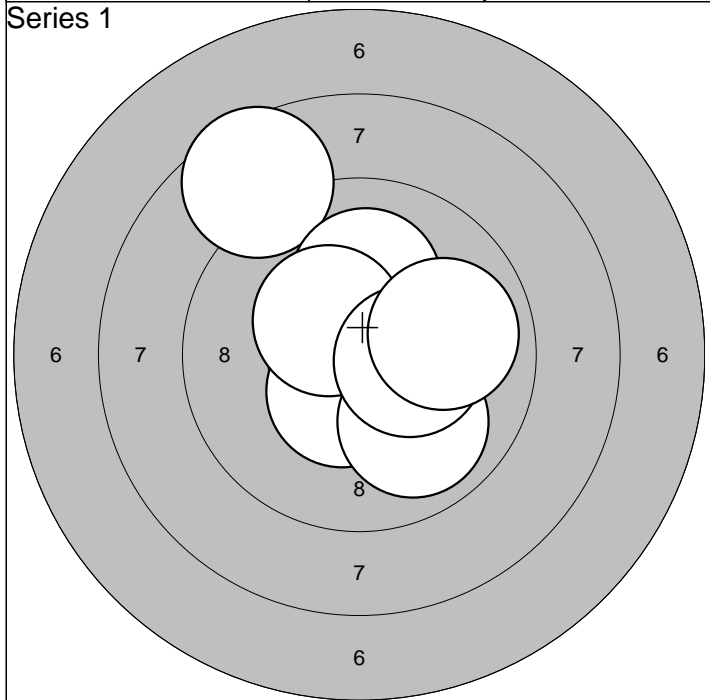

1: 8,6 ↗	6:10,5* ↓	Serie	96,0
2:10,5* ↑	7:10,4* ↗		
3:10,5* ↗	8: 9,9 ↓	Sum	96,0
4:10,8* ↑	9:10,3* →		
5:10,1 ↑	10: 9,9 →		

1: 9,1 ←	6: 8,1 ↗	Serie	93,0
2:10,0 →	7: 9,6 ↖		
3:10,7* ↗	8:10,1 ↓	Sum	189,0
4: 9,6 ←	9: 9,6 ↘		
5:10,3* ↑	10: 9,8 ↘		

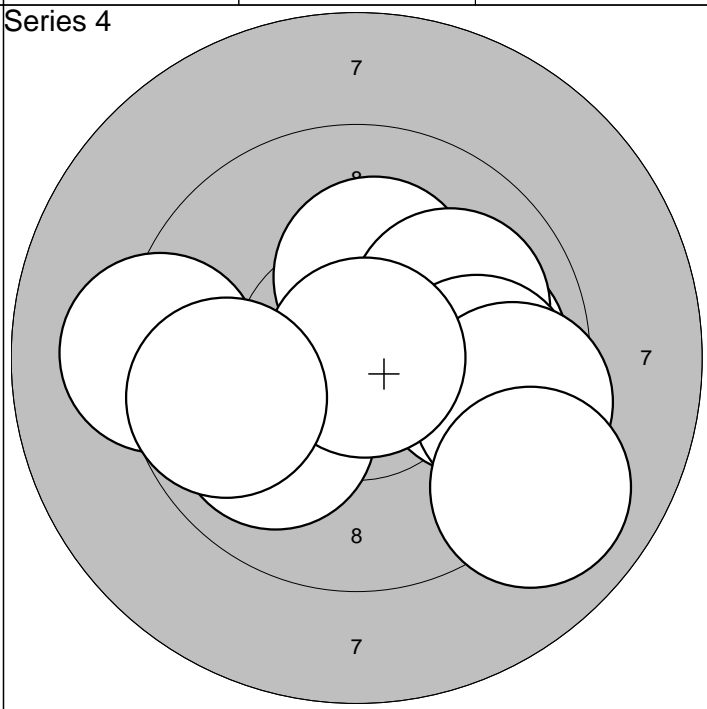
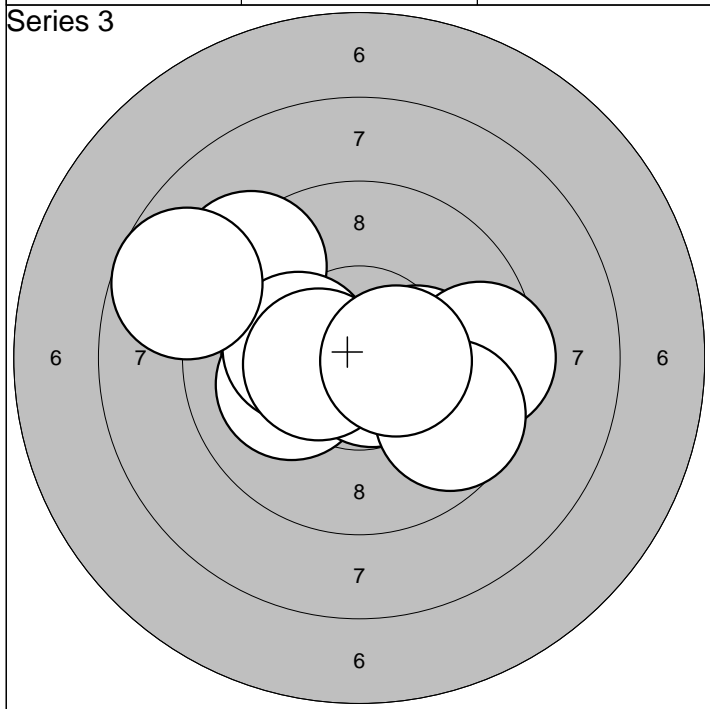

1:10,1 ←	6:10,5* ←	Serie	95,0
2: 9,3 ↗	7:10,3* →		
3:10,2* ←	8: 9,5 →	Sum	284,0
4: 8,7 ↖	9: 9,7 ↘		
5:10,7* ↓	10:10,5* →		

1:10,2* ↑	6: 9,8 →	Serie	94,0
2:10,0 ↙	7: 9,5 →		
3: 9,9 →	8:10,9* →	Sum	378,0
4:10,0 ↗	9: 9,8 ←		
5: 9,2 ←	10: 9,0 ↘		

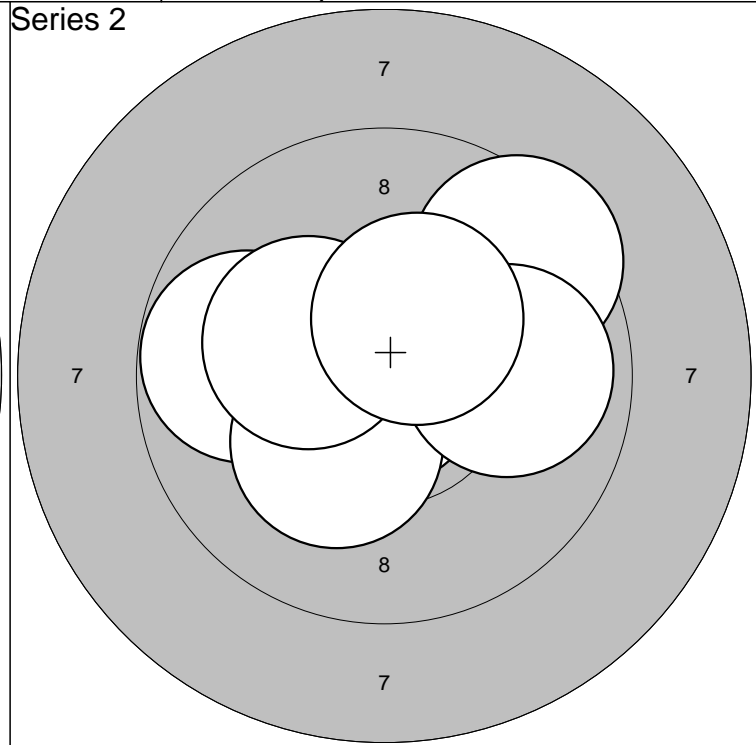
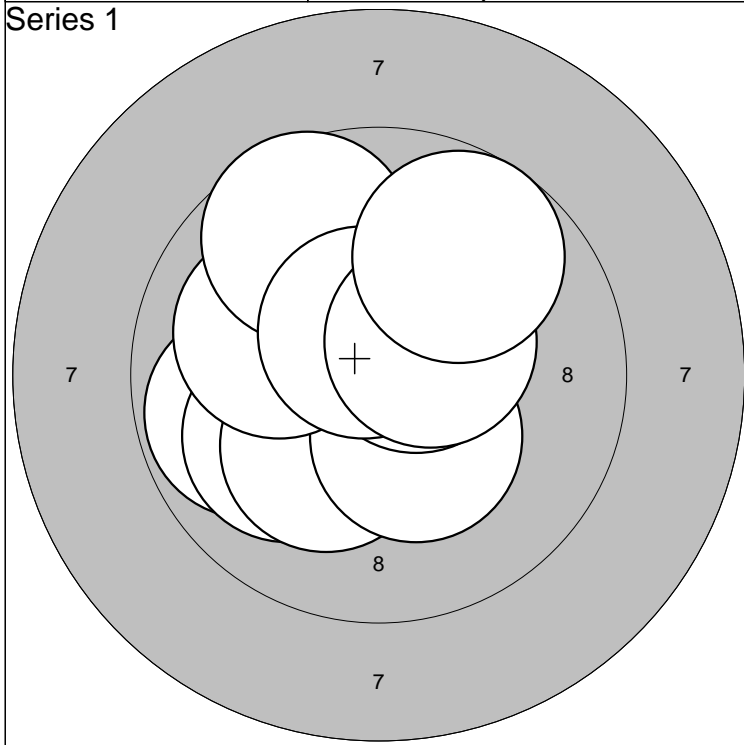

1: 9,8 ←	6:10,0 ←	Serie	97,0
2:10,0 ←	7: 9,7 ↗		
3:10,2* ↘	8:10,6* ↗	Sum	97,0
4:10,3* ↘	9:10,4* ↗		
5:10,6* ↗	10: 9,7 ↗		

1:10,5* ←	6:10,9* ↘	Serie	97,0
2: 9,8 ←	7:10,3* ↘		
3:10,1 ↗	8:10,3* ←	Sum	194,0
4: 9,5 ↗	9: 9,9 →		
5:10,7* ↗	10:10,4* ↗		

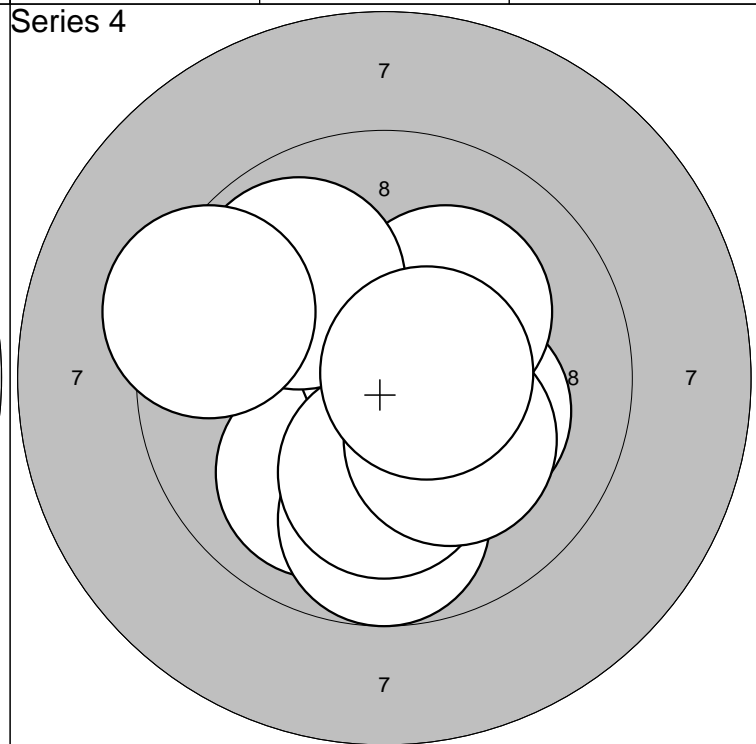
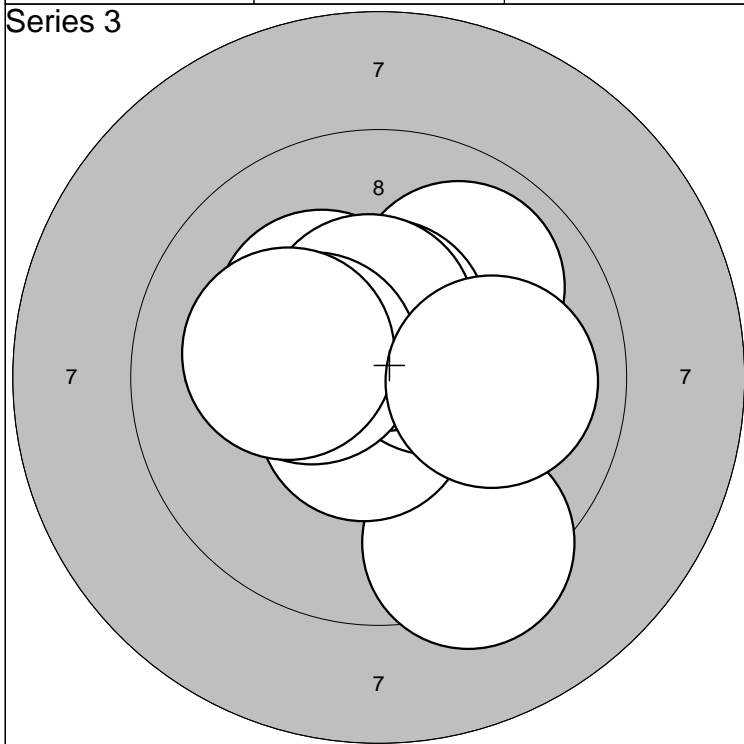

1: 9,3 ↘	6:10,5* ↗	Serie	98,0
2:10,6* ↘	7:10,4* ↗		
3:10,2* ↖	8:10,4* ←	Sum	292,0
4:10,4* ↗	9:10,1 ←		
5: 9,9 ↗	10:10,0 →		

1:10,0 ↘	6:10,1 ↓	Serie	97,0
2:10,7* ↗	7: 9,9 ↖		
3:10,2* ➡	8: 9,4 ←	Sum	389,0
4: 9,7 ↓	9:10,2* ↘		
5:10,2* ↗	10:10,6* ➡		

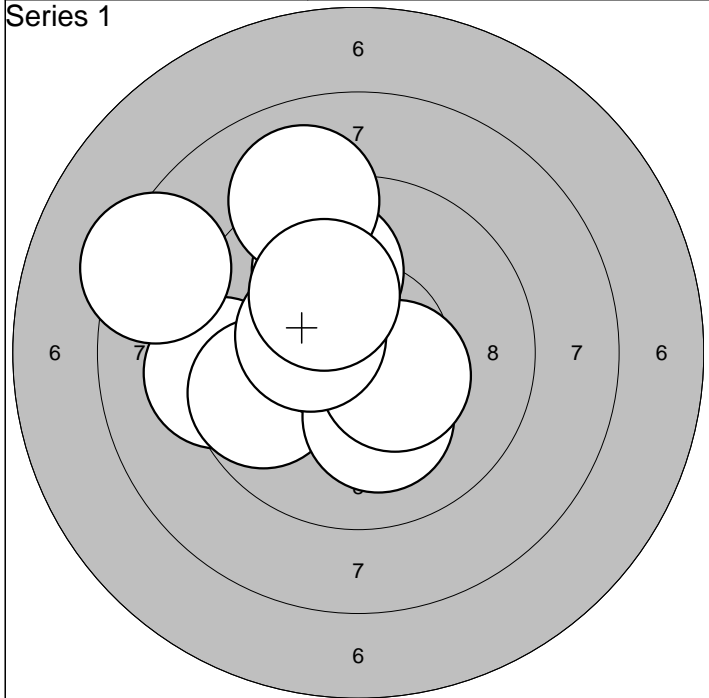

1: 9,3 ←	6: 8,4 ↖		Serie	94,0
2: 9,7 ←	7: 9,0 ↗			
3: 10,6* ↖	8: 10,5* ↘	Sum	94,0	
4: 10,2* ↘	9: 10,4* ↖			
5: 9,9 ↗	10: 10,1 ↗			

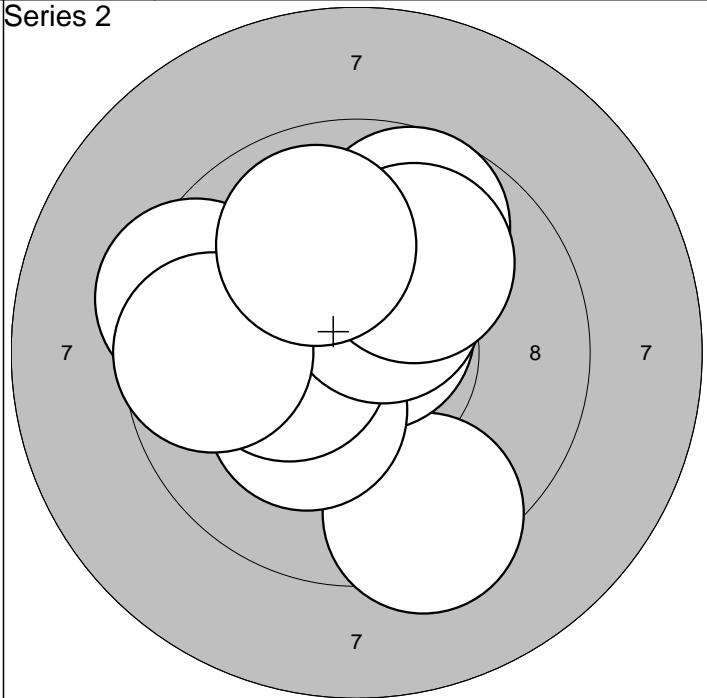

1: 9,4 ↓	6: 10,3* ←		Serie	95,0
2: 10,7* ↗	7: 10,5* ↗			
3: 9,7 ↗	8: 9,7 ←	Sum	189,0	
4: 9,4 ←	9: 10,0 ↗			
5: 10,3* ↘	10: 9,9 ↗			

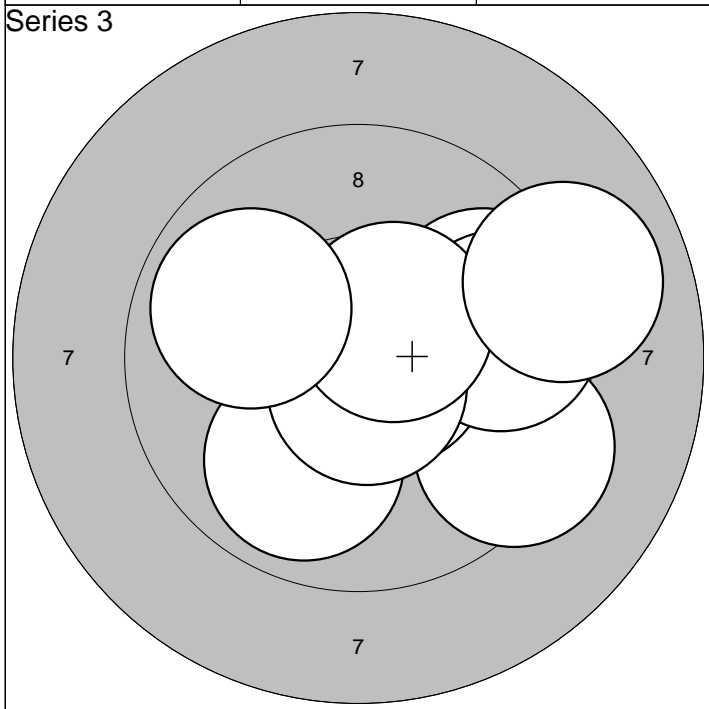

1: 9,3 ↘	6: 9,7 →		Serie	94,0
2: 10,6* →	7: 10,7* ↓			
3: 9,9 ↓	8: 10,5* ↗	Sum	283,0	
4: 9,7 →	9: 9,0 →			
5: 10,9* ↑	10: 9,9 ←			

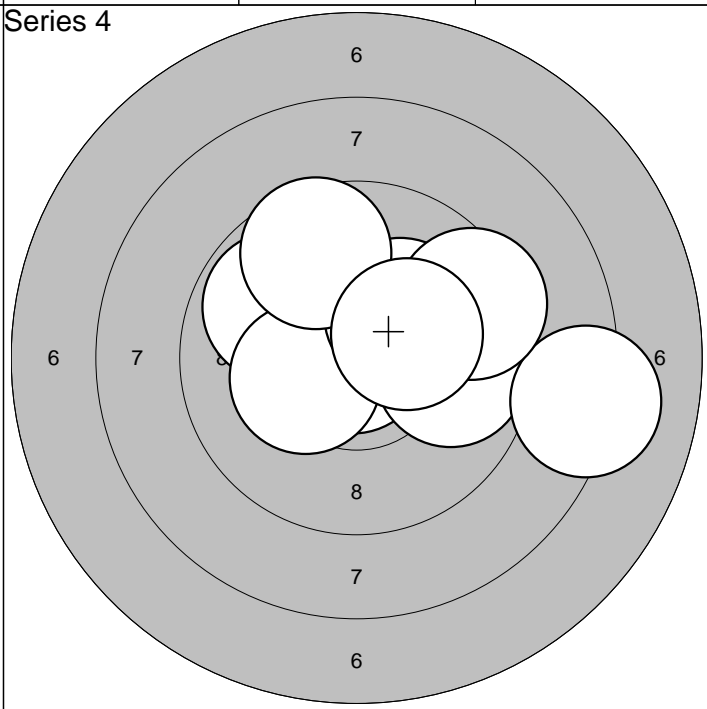

1: 10,0 ↗	6: 10,3* ←		Serie	94,0
2: 10,9* ←	7: 10,2* ↗			
3: 9,8 →	8: 9,4 →	Sum	377,0	
4: 8,2 →	9: 9,6 ↗			
5: 9,8 ↖	10: 10,3* →			

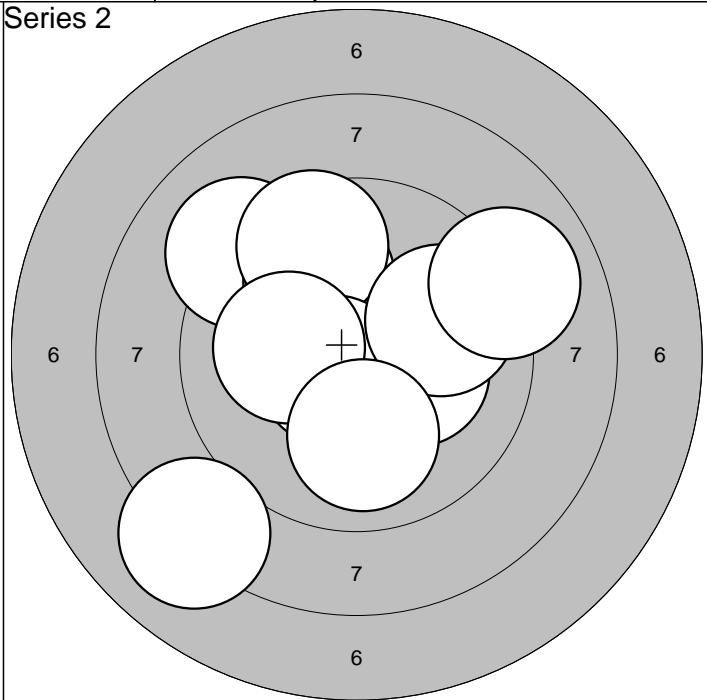
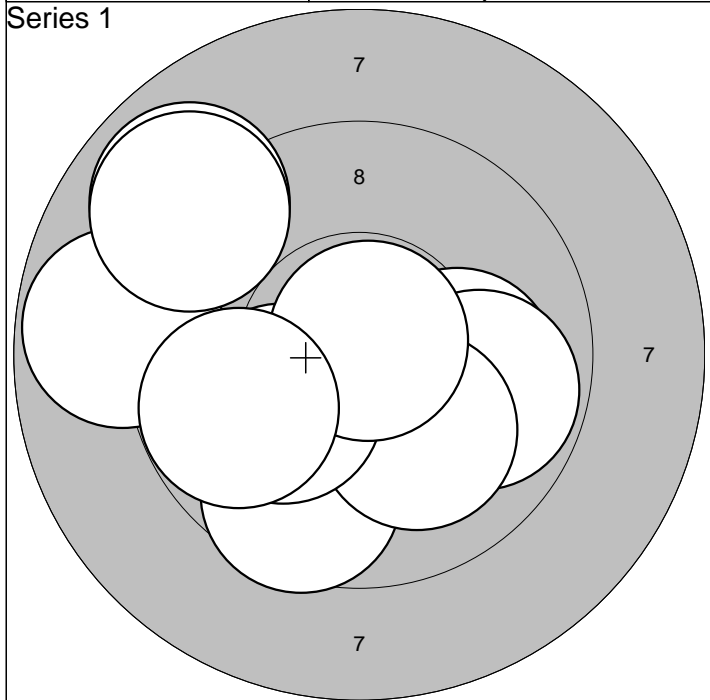

1:10,1 →	6:10,1 ↓			Serie	92,0
2: 9,8 →	7:10,1 ←				
3: 8,9 ↗	8:10,8* ↗			Sum	92,0
4: 8,8 ←	9: 9,8 ←				
5: 9,6 ↓	10: 9,0 ↖				

1: 8,1 ↙	6:10,6* ↙			Serie	94,0
2: 9,2 ↖	7:10,1 ←				
3:10,3* →	8: 9,9 →			Sum	186,0
4:10,0 ↗	9: 9,0 →				
5: 9,6 ↗	10:10,0 ↓				

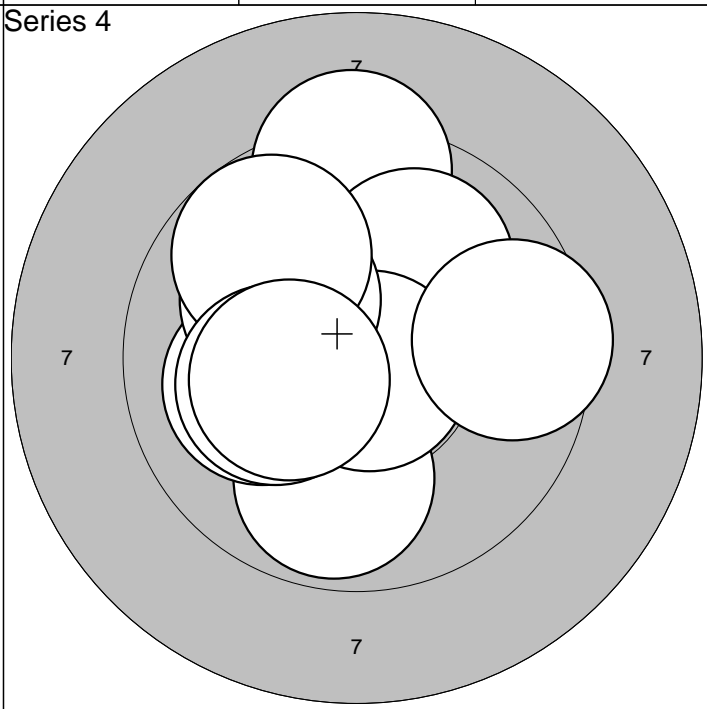
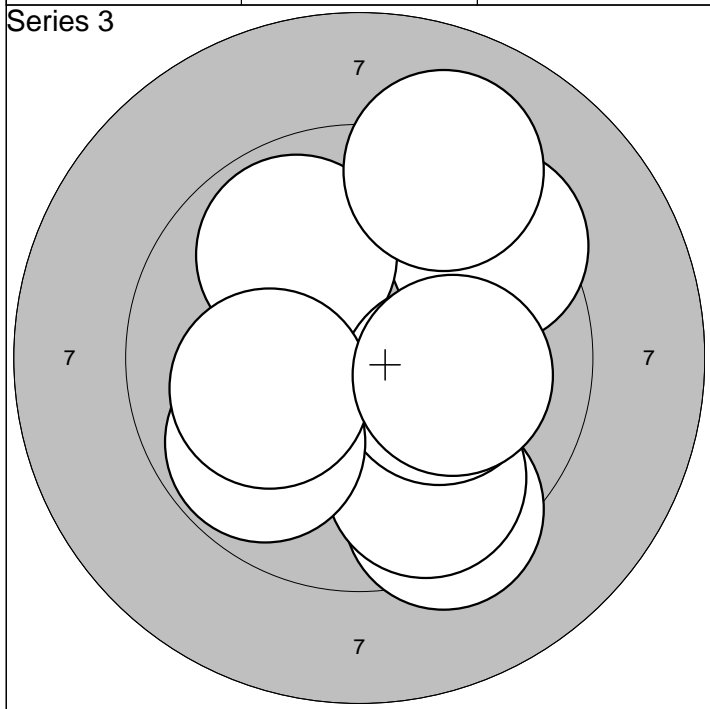

1: 9,4 ↗	6:10,2* →			Serie	94,0
2:10,5* ↙	7: 9,8 ←				
3: 9,9 ↗	8: 9,1 ↗			Sum	280,0
4: 9,4 ↓	9:10,1 ←				
5: 9,7 ↓	10:10,1 →				

1: 9,8 ↓	6:10,1 ↖			Serie	96,0
2: 9,3 ↑	7: 9,7 ↖				
3:10,1 ←	8:10,2* ←			Sum	376,0
4:10,0 ↗	9:10,3* ←				
5:10,8* ↓	10: 9,5 →				

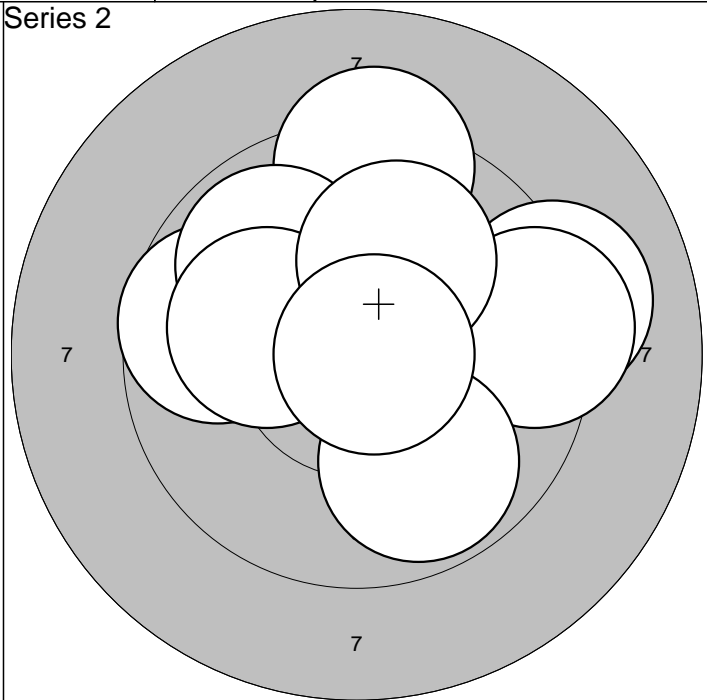
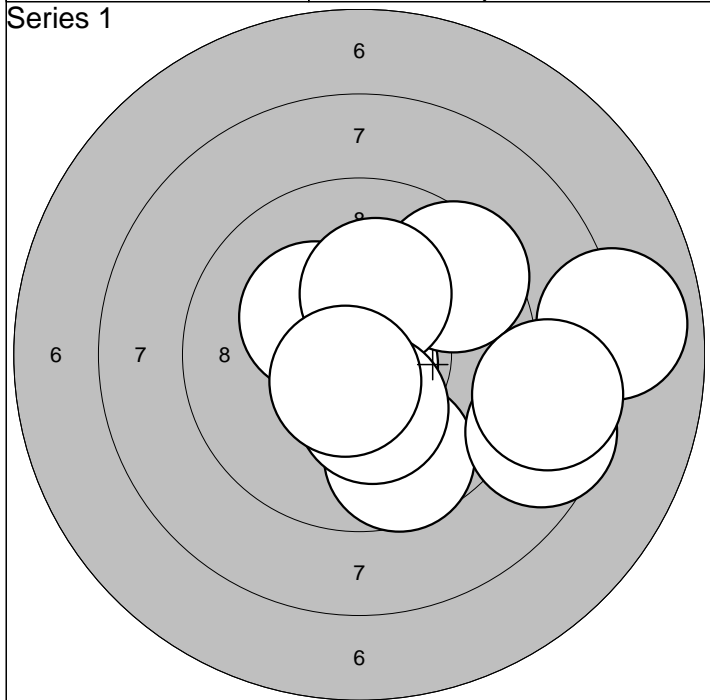

1:10,8* ↓	6:10,3* ↖	Serie	91,0
2: 9,6 ↓	7:10,2* ↑		
3: 7,9 →	8: 8,7 →	Sum	91,0
4: 9,5 ↗	9:10,3* ↓		
5: 8,6 ↘	10:10,6* ↘		

1: 9,7 ←	6: 9,9 ↖	Serie	94,0
2:10,0 ↑	7:10,1 ←		
3: 9,3 ↑	8: 9,8 ↓	Sum	185,0
4: 9,1 →	9:10,0 ↑		
5: 9,3 →	10:10,8* →		

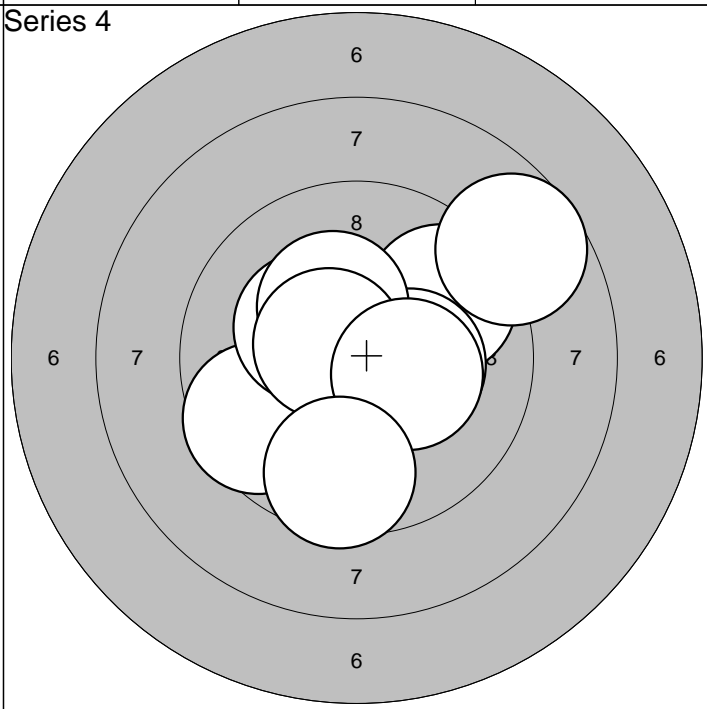
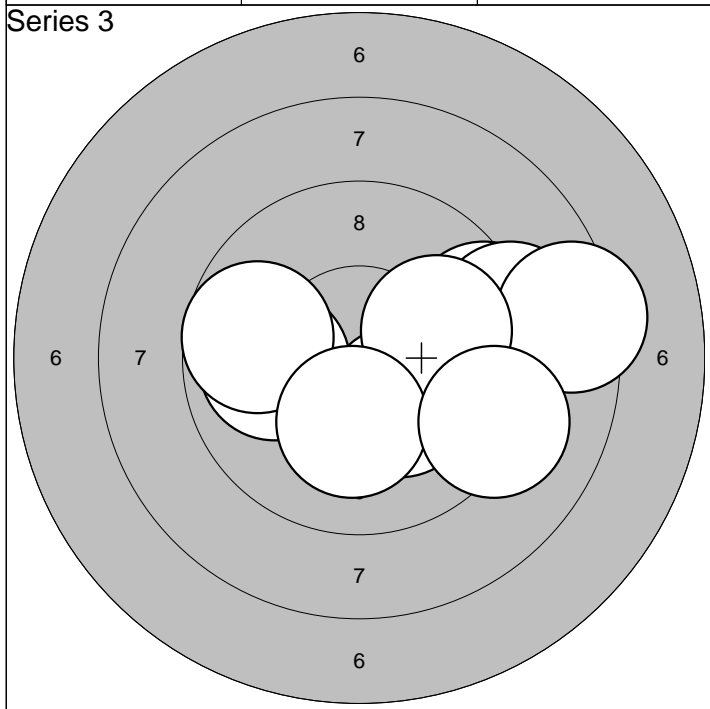

1: 9,4 →	6: 8,4 →	Serie	94,0
2:10,0 →	7: 9,7 ←		
3:10,2* ↓	8:10,0 →	Sum	279,0
4: 9,1 →	9:10,2* ↓		
5:10,0 ←	10: 9,2 ↘		

1:10,4* ↓	6:10,3* ↖	Serie	95,0
2: 9,6 ←	7:10,6* ←		
3: 9,8 ↗	8:10,3* →	Sum	374,0
4:10,3* ↖	9: 9,6 ↓		
5:10,3* →	10: 8,7 ↗		

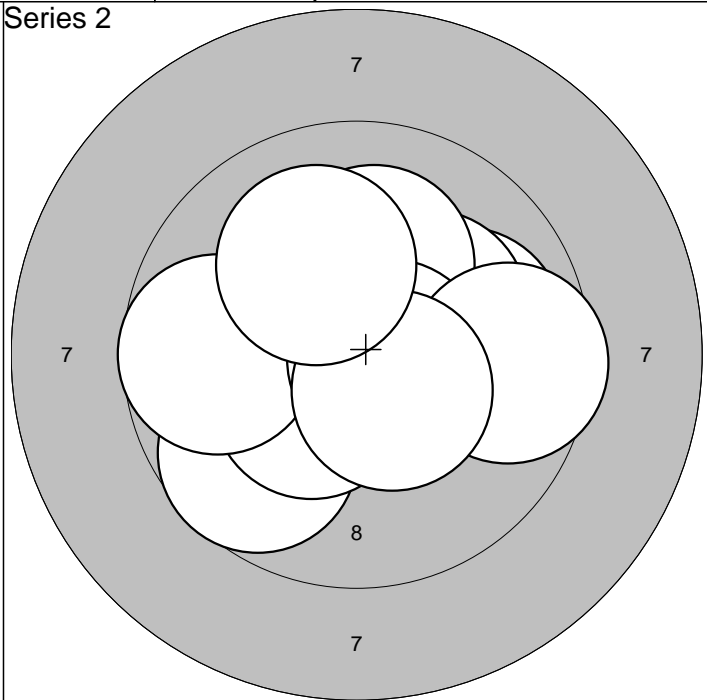
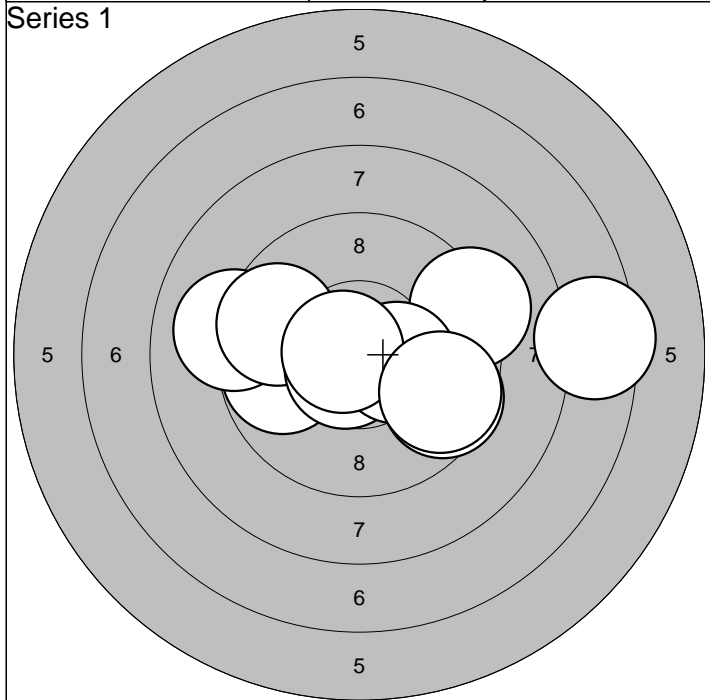

1: 9,8 ←	6: 9,2 →				
2: 9,1 ←	7: 9,5 →				
3: 9,7 ←	8:10,4* →	Sum	91,0		
4:10,7* ↙	9:10,7* ←				
5: 7,5 →	10: 9,6 →				

1:10,0 →	6: 9,7 ←				
2:10,2* ↗	7:10,7* →				
3: 9,7 ↘	8: 9,6 →	Sum	188,0		
4:10,1 ↑	9:10,5* ↘				
5:10,4* ↙	10:10,1 ↗				

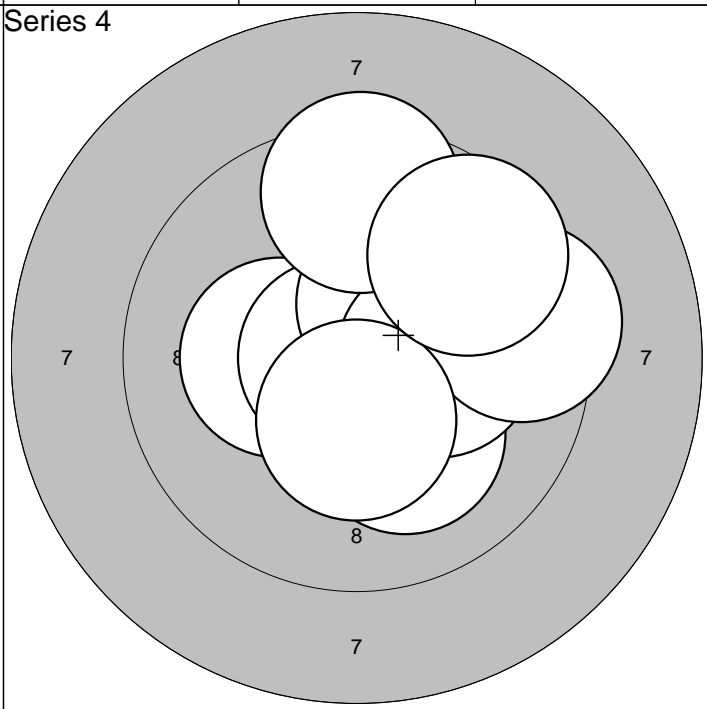
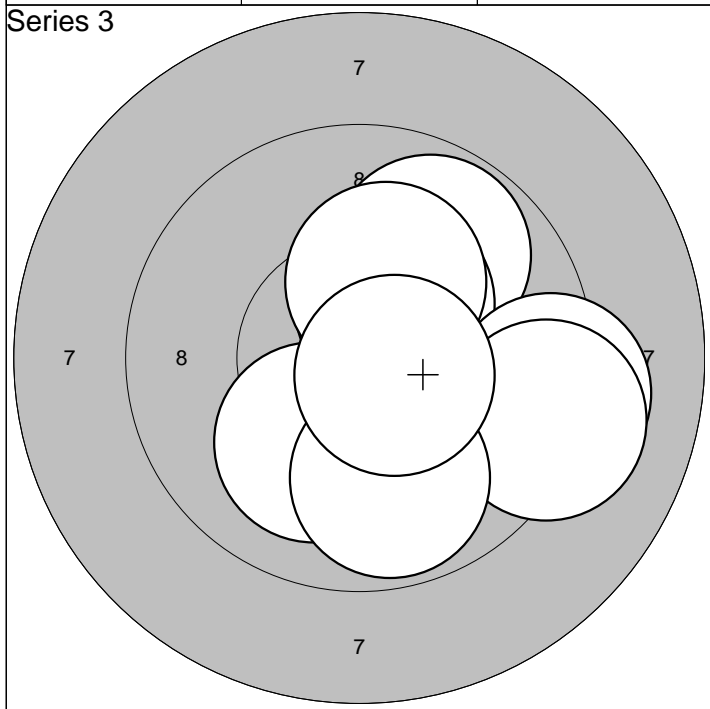

1:10,2* ↘	6: 9,2 →				
2:10,1 ↘	7: 9,2 →				
3: 9,8 ↗	8: 9,8 ↓	Sum	284,0		
4:10,5* →	9:10,2* ↑				
5:10,4* ↗	10:10,6* →				

1:10,3* ←	6:10,2* →				
2:10,2* ↘	7: 9,5 ↑				
3:10,8* ←	8: 9,4 →	Sum	381,0		
4:10,4* →	9:10,4* ↓				
5:10,4* ↗	10: 9,6 ↗				

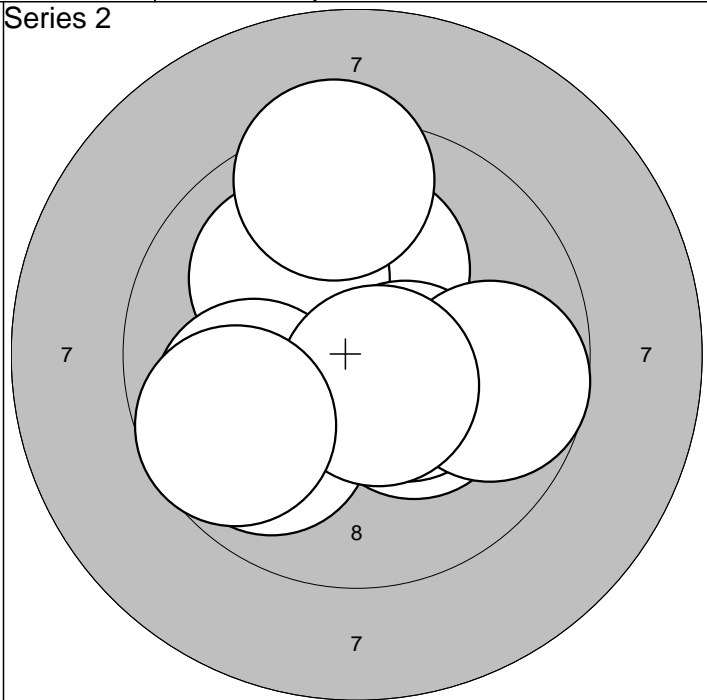
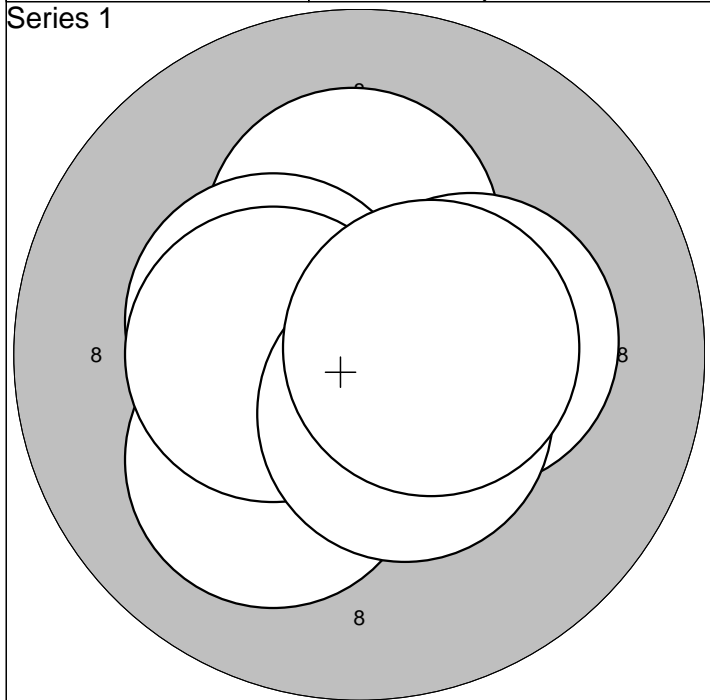

1:10,2* ↑	6:10,3* →		Serie	100,0
2:10,3* ↘	7:10,1 ↘			
3:10,5* ↙	8:10,4* ←			
4:10,4* ↖	9:10,5* ↘		Sum	100,0
5:10,5* ↙	10:10,5* →			

1:10,3* ↘	6: 9,9 ↙		Serie	96,0
2:10,2* ↑	7:10,0 ←			
3:10,1 ↗	8: 9,7 →			
4: 9,4 ↑	9:10,6* ↘		Sum	196,0
5:10,5* ↘	10: 9,7 ↙			

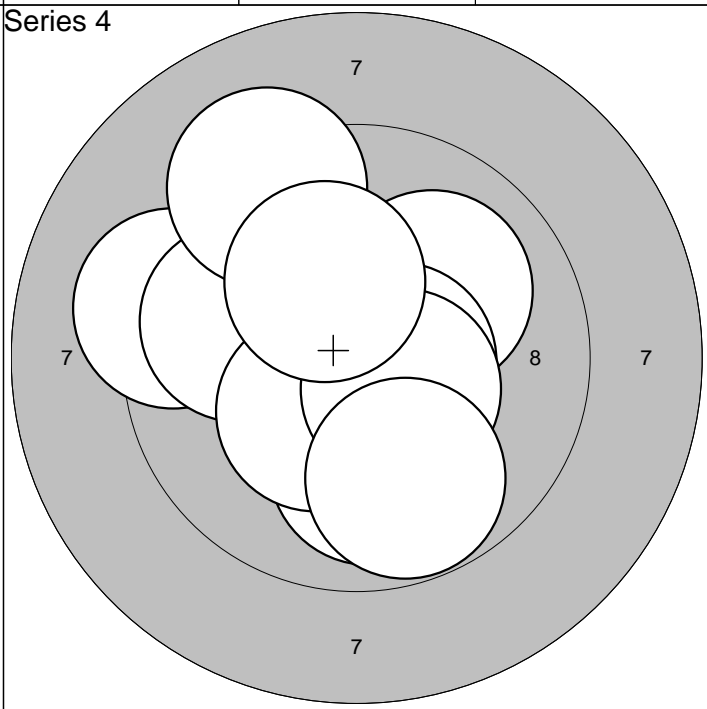
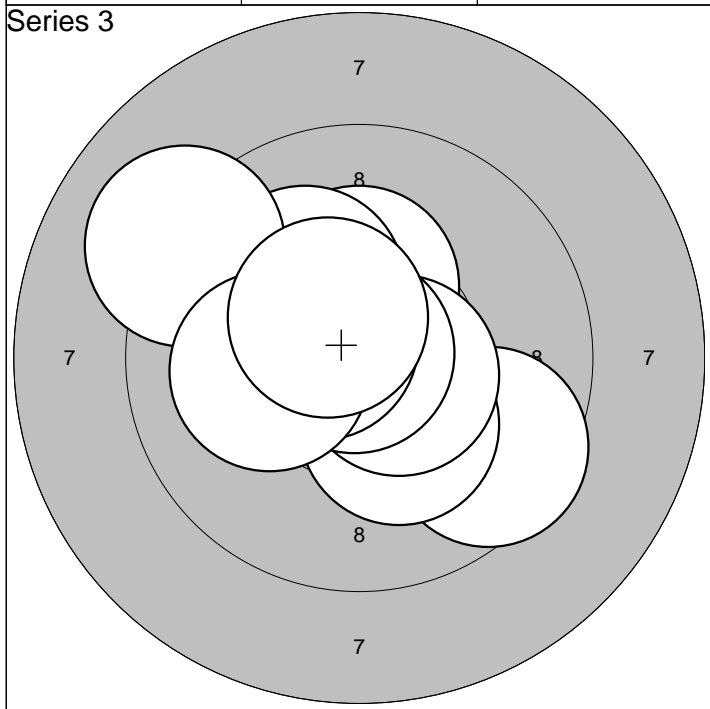

1: 9,5 ↘	6:10,9* ↗		Serie	98,0
2:10,2* ↘	7: 9,1 ↗			
3:10,3* ↑	8:10,5* ↖			
4:10,6* ↘	9:10,1 ←		Sum	294,0
5:10,2* ↗	10:10,5* ↗			

1: 9,3 ←	6:10,6* →		Serie	96,0
2: 9,9 ←	7:10,3* ↘			
3:10,0 ↗	8:10,5* ↘			
4: 9,2 ↗	9:10,2* ↑		Sum	390,0
5:10,0 ↓	10: 9,8 ↘			

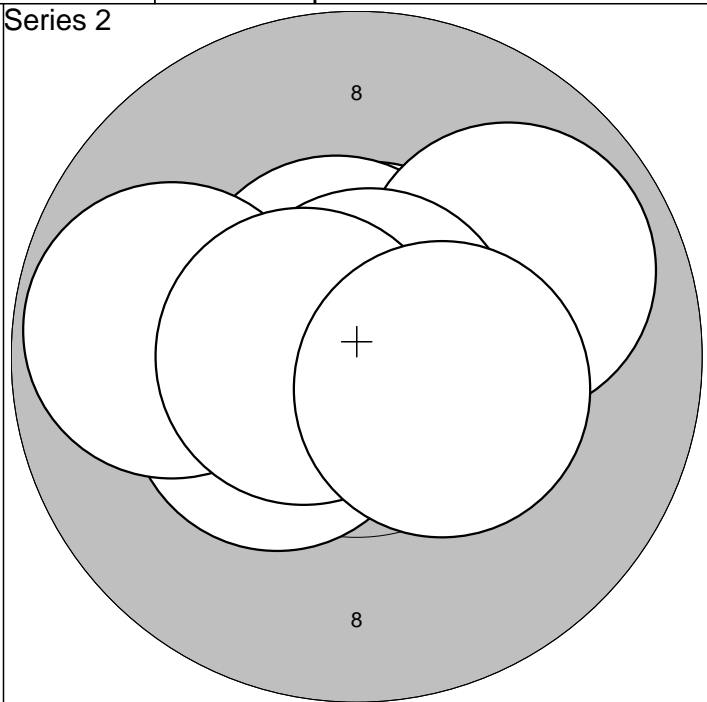
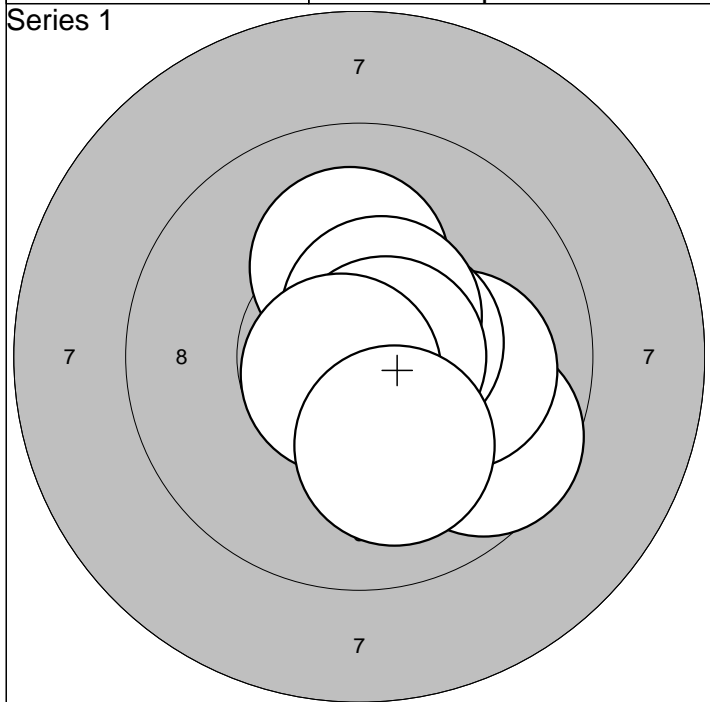

1:10,4* ↘	6:10,1 ↑			Serie	99,0
2: 9,6 ↘	7:10,5* ↗				
3:10,6* ↘	8:10,7* →	Sum	99,0		
4:10,1 →	9:10,7* ↙				
5:10,5* →	10:10,1 ↓				

1:10,8* ↗	6: 9,8 ←			Serie	98,0
2:10,7* ↑	7: 9,9 ↗				
3:10,6* ↖	8:10,8* ↗	Sum	197,0		
4:10,4* ←	9:10,6* ←				
5:10,6* →	10:10,4* →				

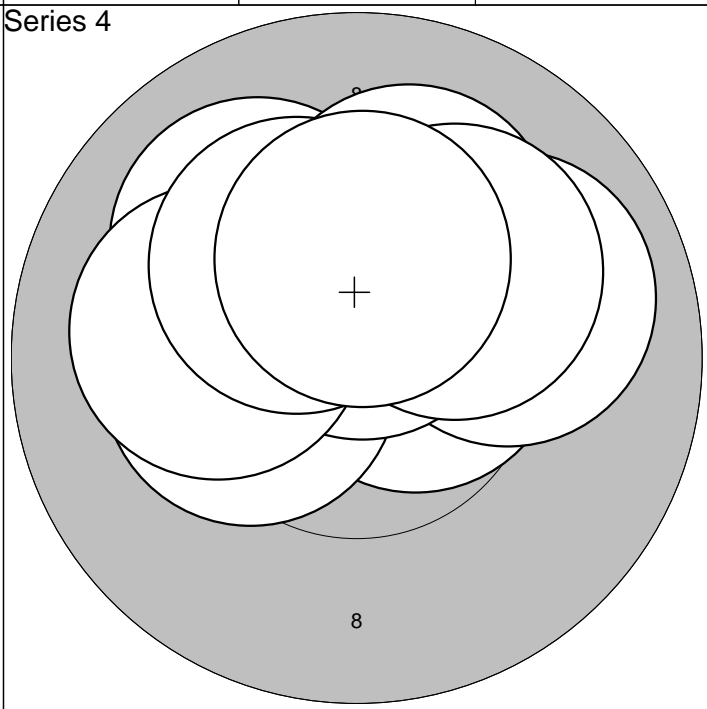
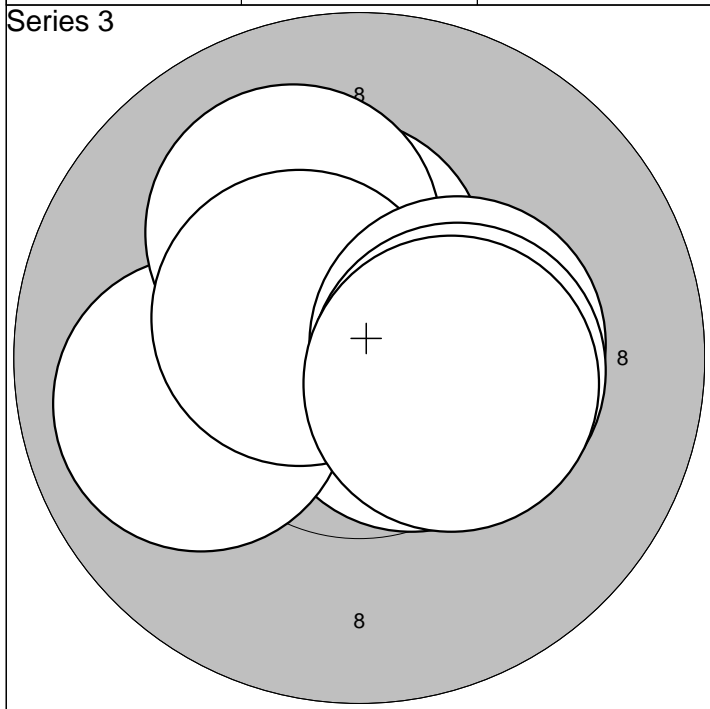

1:10,6* ↖	6:10,1 ↖			Serie	100,0
2:10,6* →	7:10,5* ↖				
3:10,4* ↑	8:10,4* →	Sum	297,0		
4:10,6* ↘	9:10,3* →				
5:10,0 ←	10:10,4* →				

1:10,6* →	6:10,6* ↑			Serie	100,0
2:10,1 ↖	7:10,1 ←				
3:10,0 →	8:10,3* ↖	Sum	397,0		
4:10,1 ↑	9:10,2* ↗				
5:10,3* ←	10:10,3* ↑				

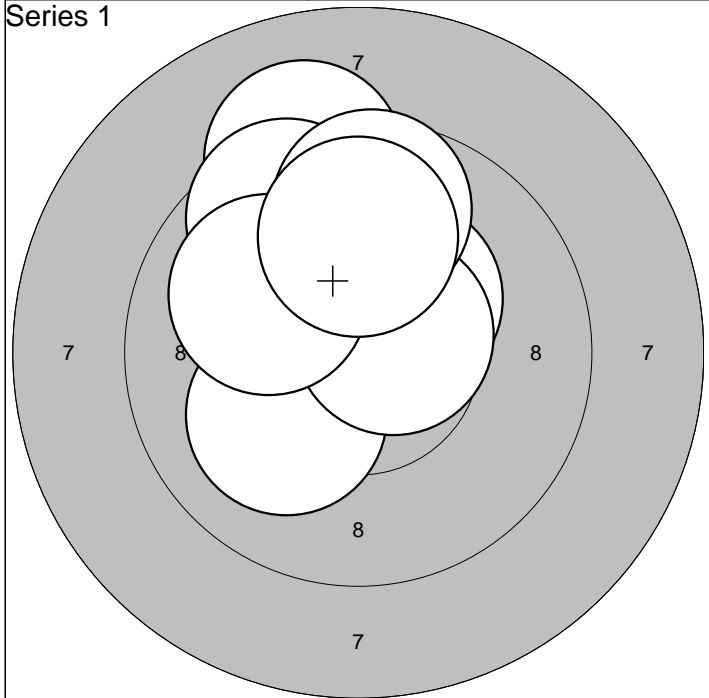

1:10,3* ↖	6:10,1 ↙	Serie 96,0
2: 9,1 ↗	7:10,6* →	
3:10,3* ↗	8:10,0 ↖	Sum 96,0
4: 9,6 ↗	9: 9,7 ↗	
5:10,7* ↗	10: 9,9 ↗	

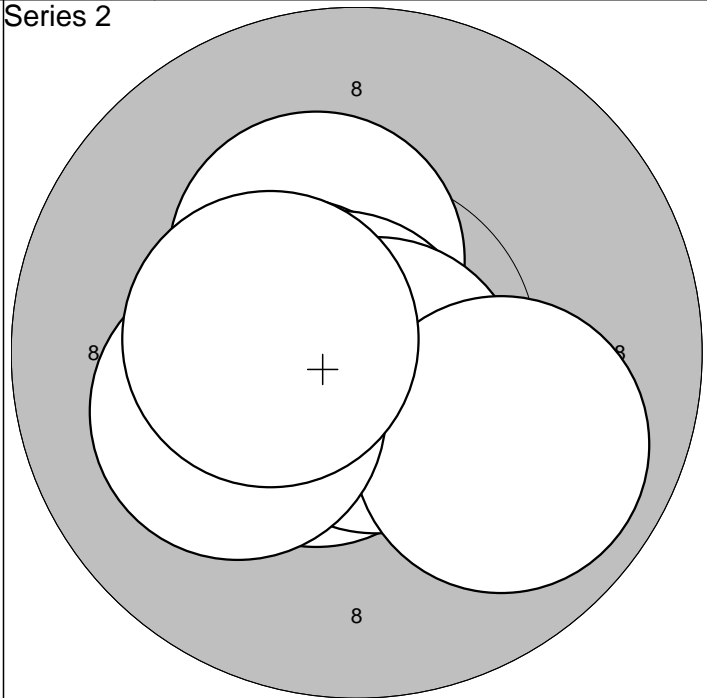

1:10,3* ↖	6:10,6* ↙	Serie 99,0
2:10,6* ←	7:10,7* ↘	
3:10,6* ↘	8: 9,9 ↘	Sum 195,0
4:10,8* ←	9:10,2* ←	
5:10,4* ←	10:10,4* ←	

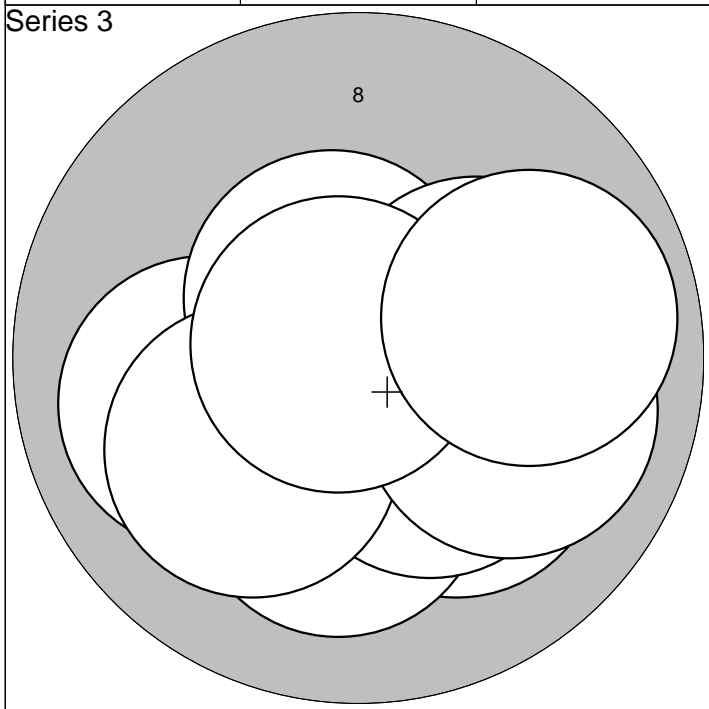

1:10,0 ←	6:10,3* ↘	Serie 99,0
2:10,1 ↘	7:10,1 ↙	
3:10,6* ↗	8:10,0 →	Sum 294,0
4:10,1 ↓	9:10,8* ↗	
5:10,2* →	10: 9,9 →	

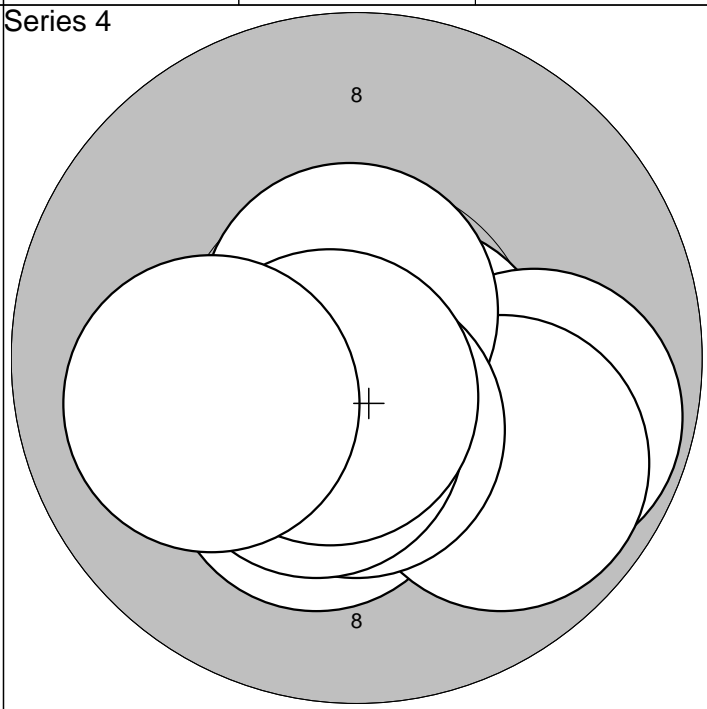

1:10,3* ↘	6:10,7* ↗	Serie 98,0
2:10,6* →	7:10,5* ↘	
3:10,9* ↗	8:10,5* ↘	Sum 392,0
4: 9,8 →	9:10,7* ↘	
5: 9,9 ↘	10:10,0 ←	

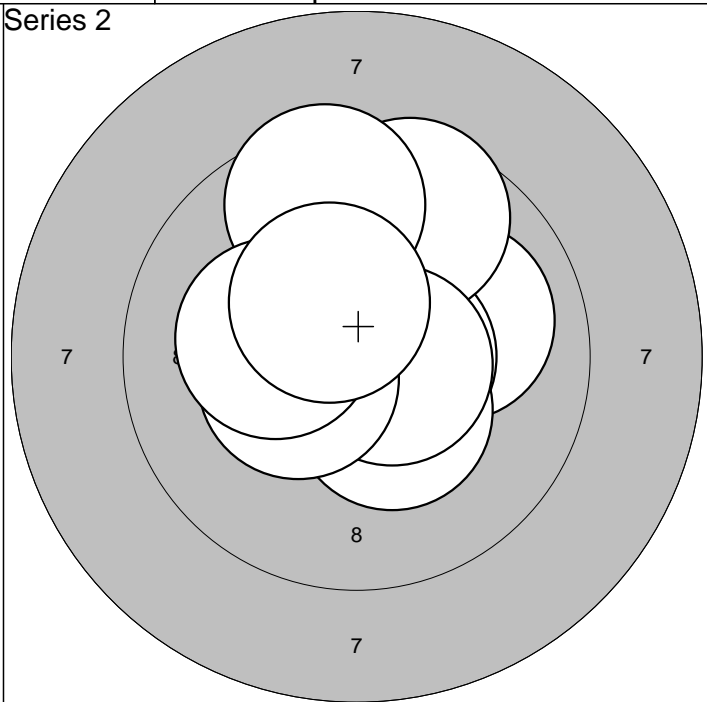
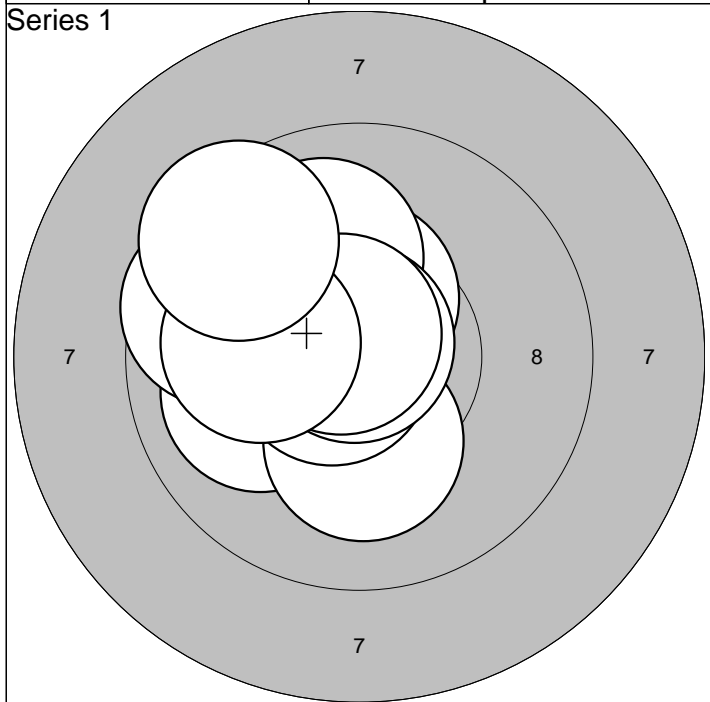

1:10,4* ↑	6:10,8* ↗	Serie 98,0
2:10,0 ←	7:10,7* ↗	
3:10,2* ↓	8: 9,6 ←	Sum 98,0
4:10,0 ↗	9:10,1 ←	
5:10,7* ←	10: 9,5 ↗	

1:10,0 →	6:10,4* ↓	Serie 98,0
2:10,5* ←	7:10,6* →	
3:10,6* →	8:10,4* ←	Sum 196,0
4: 9,6 ↗	9:10,2* ←	
5: 9,6 ↗	10:10,4* ↗	

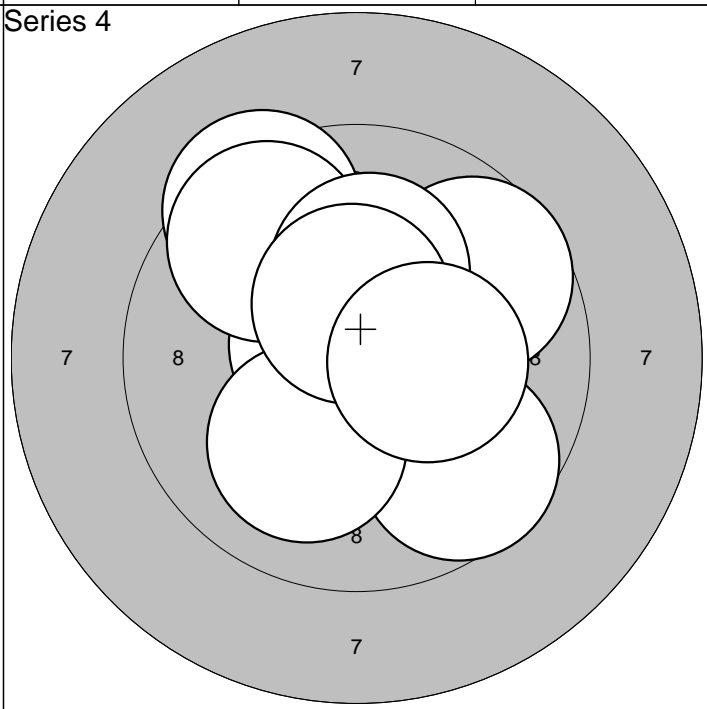
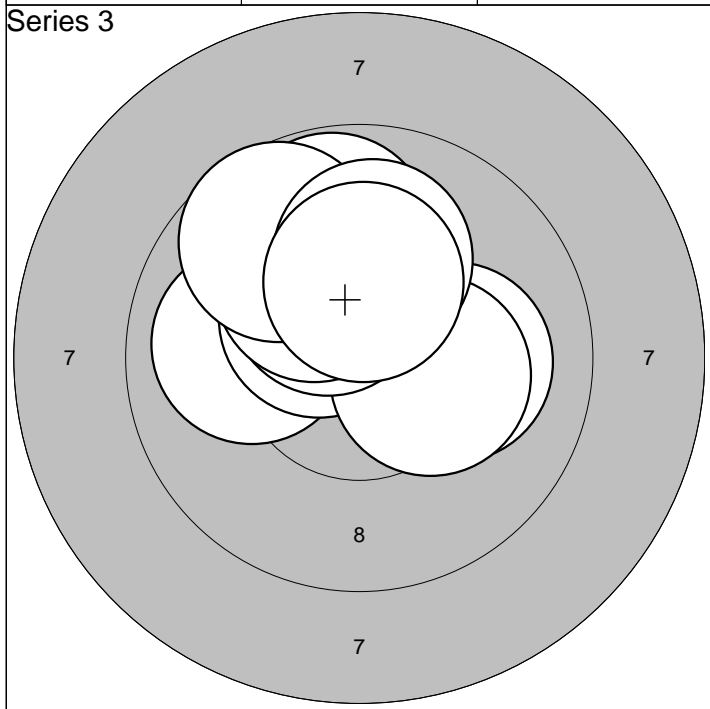

1:10,1 →	6:10,3* ↗	Serie 98,0
2: 9,8 ↗	7:10,2* ↗	
3:10,0 ←	8: 9,7 ↗	Sum 294,0
4:10,4* ↗	9:10,1 ↗	
5:10,3* →	10:10,3* ↗	

1: 9,4 ↗	6: 9,6 ↗	Serie 96,0
2: 9,7 ↗	7:10,1 ↓	
3:10,9* ↓	8:10,2* ↗	Sum 390,0
4: 9,6 ↓	9:10,5* ↗	
5:10,7* ↗	10:10,3* →	

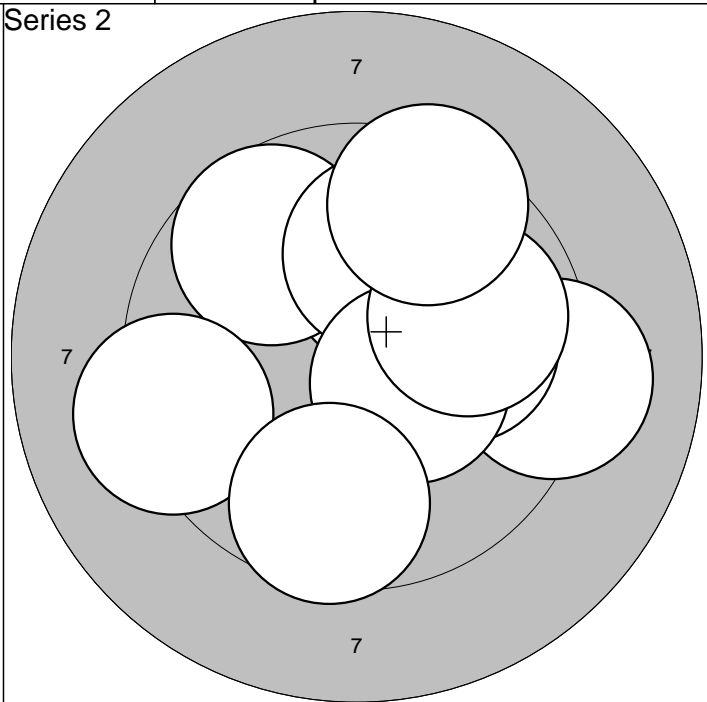
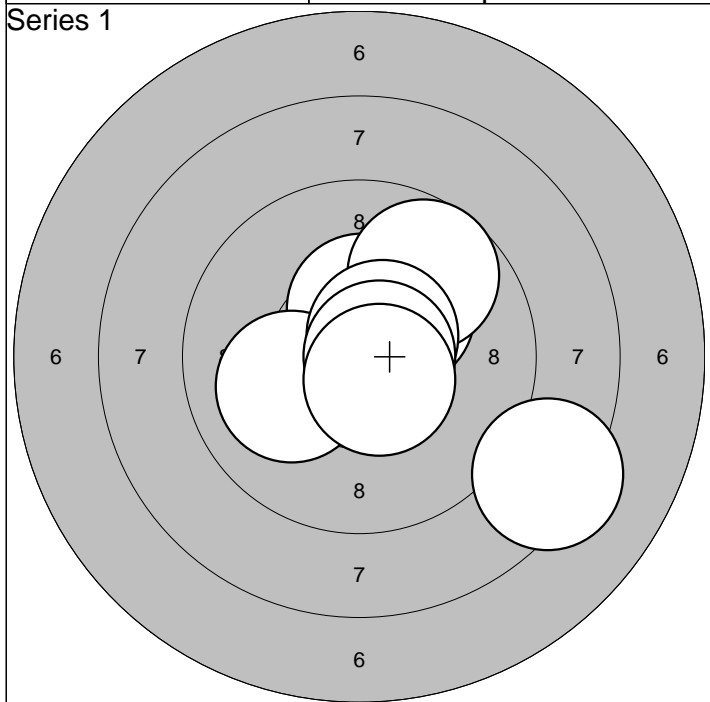

1:10,2* ↗	6: 8,3 ↘	Serie	97,0
2:10,8* ↓	7: 9,7 ↗		
3:10,4* ↑	8:10,6* ↗	Sum	97,0
4:10,8* →	9:10,7* →		
5:10,1 ←	10:10,6* ↘		

1:10,1 ↗	6:10,0 →	Serie	94,0
2: 9,2 →	7:10,4* ↘		
3: 9,7 ↖	8: 9,9 →	Sum	191,0
4:10,0 ↑	9: 9,6 ↓		
5: 9,2 ←	10: 9,5 ↗		

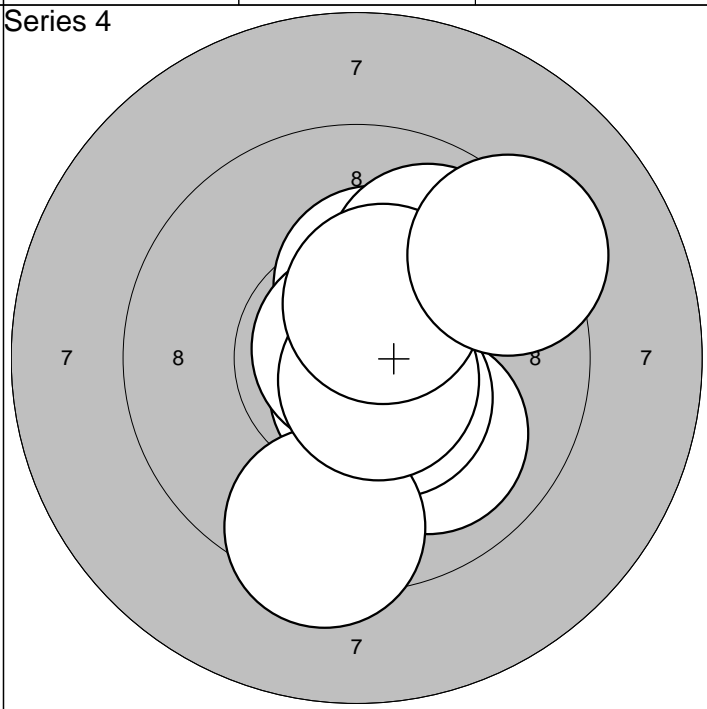
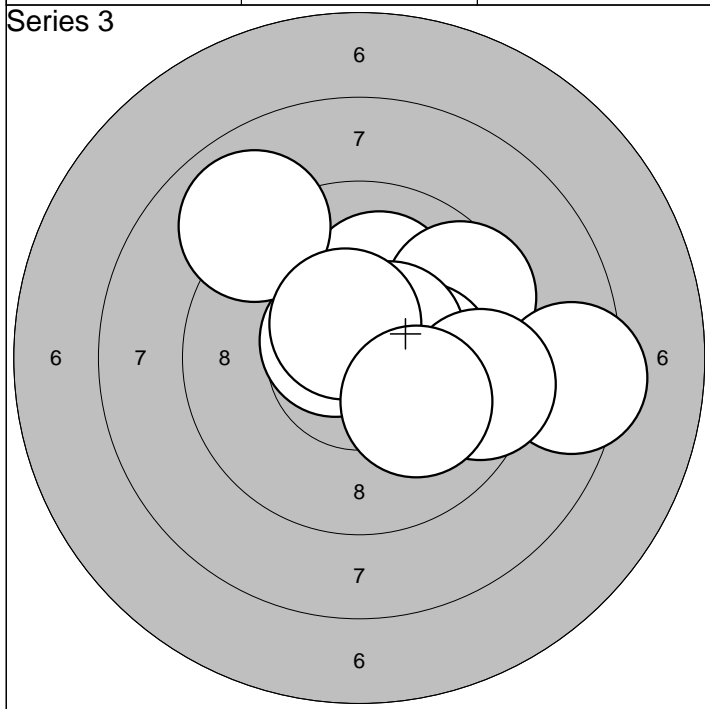

1:10,1 ↑	6: 9,0 ↖	Serie	95,0
2: 9,6 ↗	7:10,5* ↗		
3: 8,4 →	8:10,5* ↗	Sum	286,0
4:10,6* ↖	9: 9,5 →		
5:10,2* →	10:10,1 ↘		

1:10,0 ↘	6: 9,4 ↓	Serie	97,0
2:10,3* ↑	7:10,9* ↖		
3:10,6* ↘	8:10,7* ↘	Sum	383,0
4: 9,9 ↗	9:10,4* ↗		
5:10,5* ↘	10: 9,3 ↗		

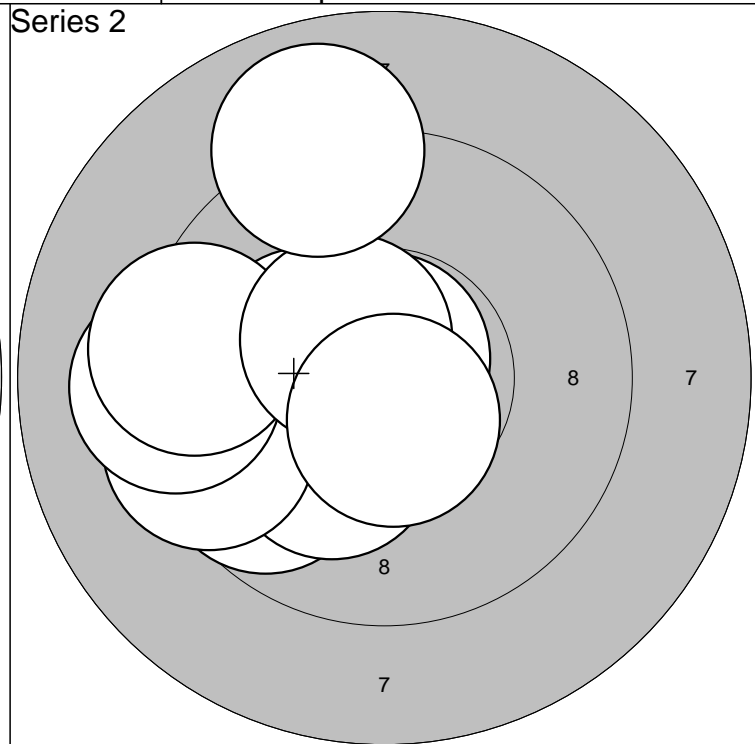
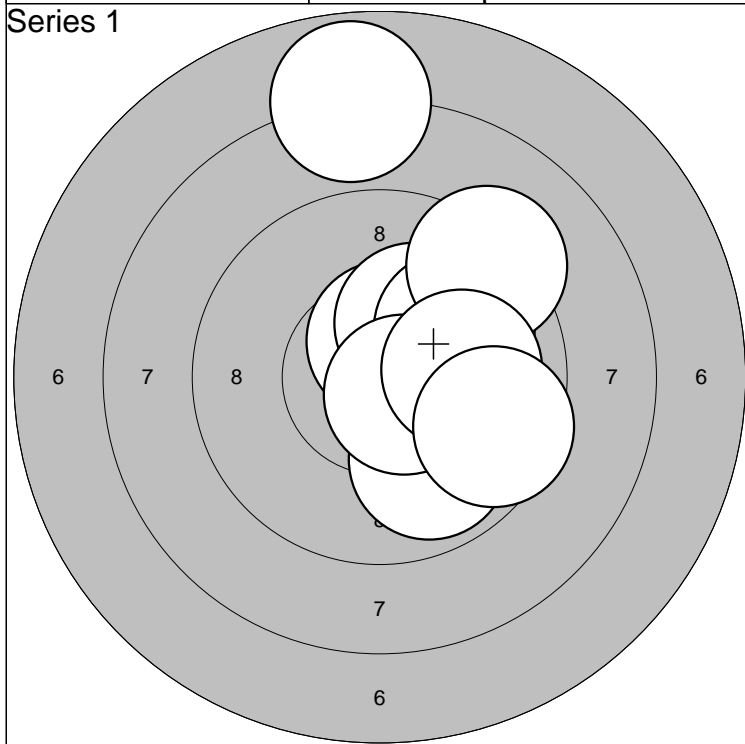

1:10,5* ↑	6: 9,9 ↓	Serie	94,0
2:10,2* ↗	7:10,6* ↘		
3:10,0 ↘	8:10,0 →	Sum	94,0
4:10,0 ↗	9: 9,5 ↘		
5: 9,2 ↗	10: 7,8 ↑		

1:10,3* ←	6: 9,4 ←	Serie	95,0
2: 9,7 ↘	7:10,8* ↑		
3:10,2* ↘	8:10,5* ↖	Sum	189,0
4: 9,4 ←	9: 9,0 ↑		
5: 9,2 ←	10:10,6* ↓		

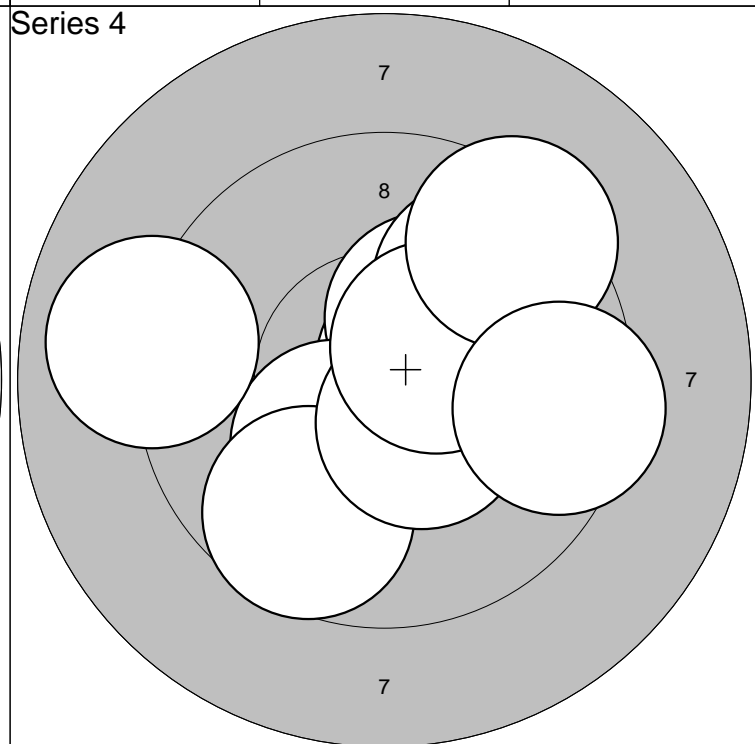
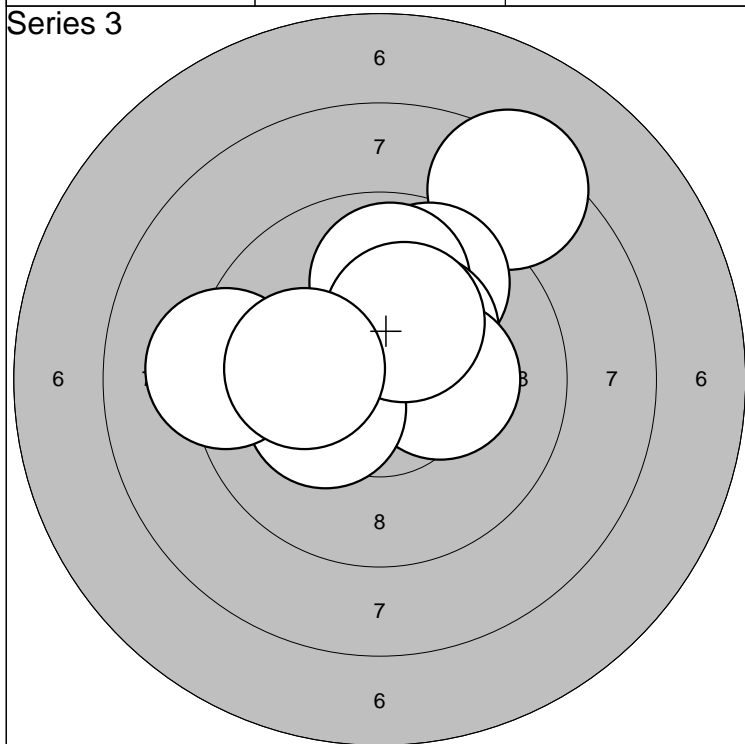

1: 8,4 ↗	6:10,3* →	Serie	95,0
2: 9,7 ↗	7:10,3* ←		
3: 9,9 ↑	8:10,2* ↑	Sum	284,0
4:10,5* →	9: 9,2 ←		
5:10,3* ↗	10:10,1 ←		

1:10,6* →	6:10,5* ↘	Serie	95,0
2:10,3* ↗	7:10,4* ↗		
3: 9,8 ↗	8: 9,0 ←	Sum	379,0
4:10,3* ↘	9: 9,4 ↗		
5: 9,7 ↘	10: 9,4 →		

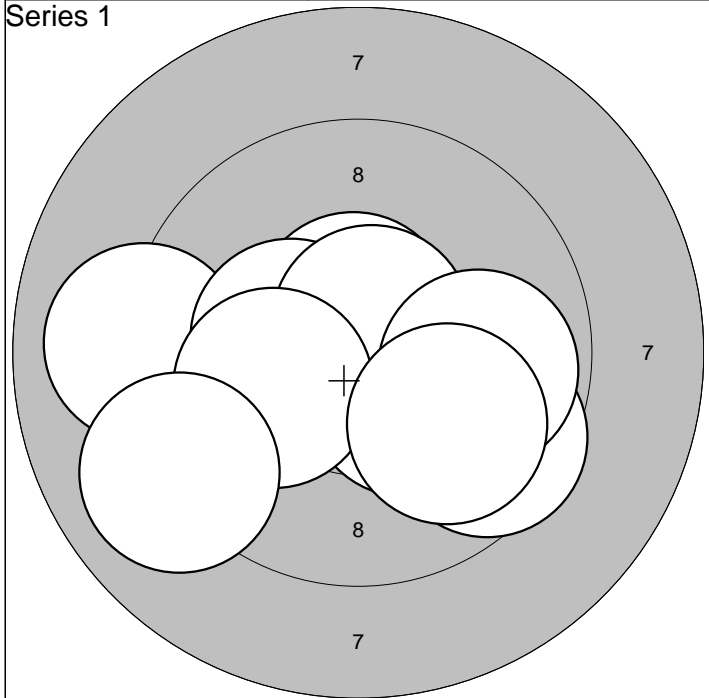

1: 9,0 ←	6:10,1 ←	Serie	95,0
2:10,6* ↑	7: 9,5 ↘		
3:10,3* ↘	8: 9,9 →	Sum	95,0
4:10,3* ←	9: 9,0 ←		
5:10,7* ↗	10: 9,9 ↘		

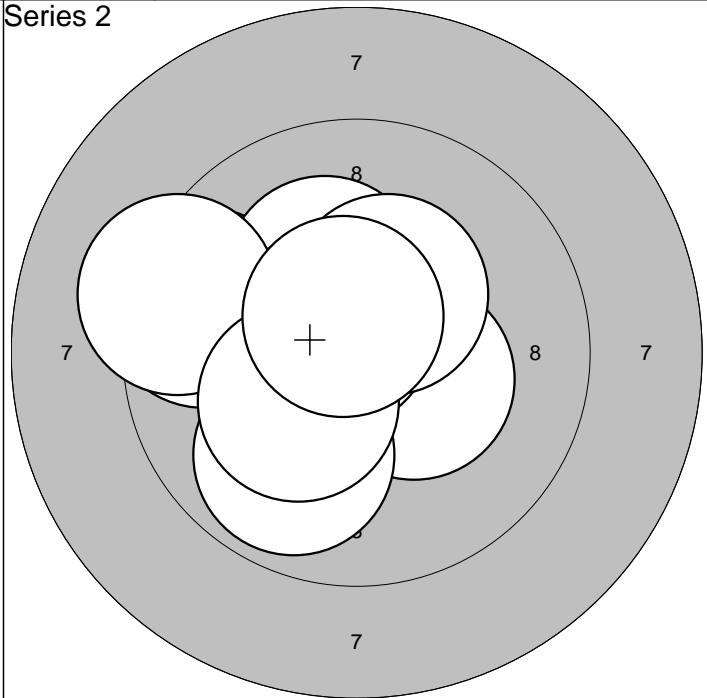

1: 9,5 ←	6:10,7* ↖	Serie	97,0
2:10,4* →	7: 9,3 ←		
3:10,2* ↗	8:10,3* ↘	Sum	192,0
4:10,5* ←	9:10,4* ↗		
5: 9,9 ↘	10:10,6* ↗		

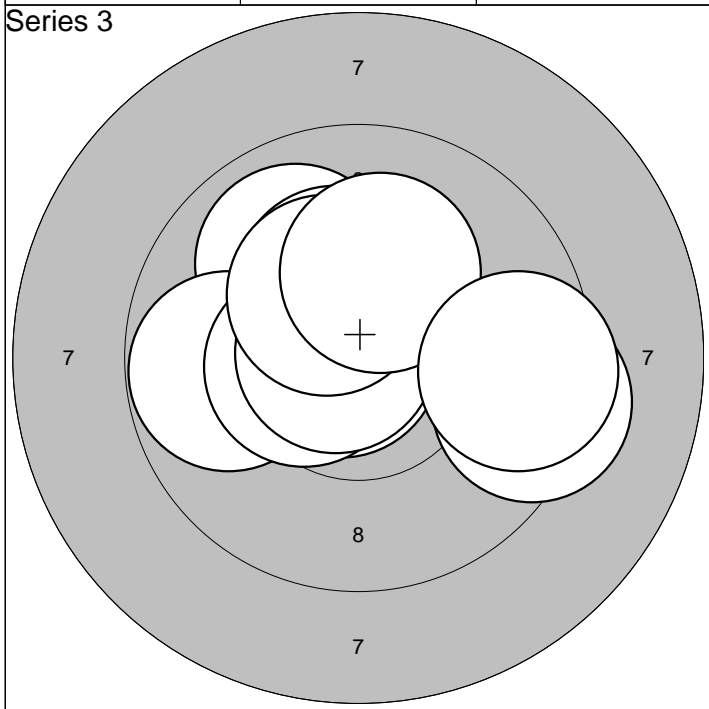

1:10,0 ↗	6: 9,4 →	Serie	97,0
2:10,8* ←	7:10,3* ↗		
3: 9,8 ←	8:10,3* ↗	Sum	289,0
4:10,4* ←	9:10,2* ↗		
5:10,7* ←	10: 9,5 →		

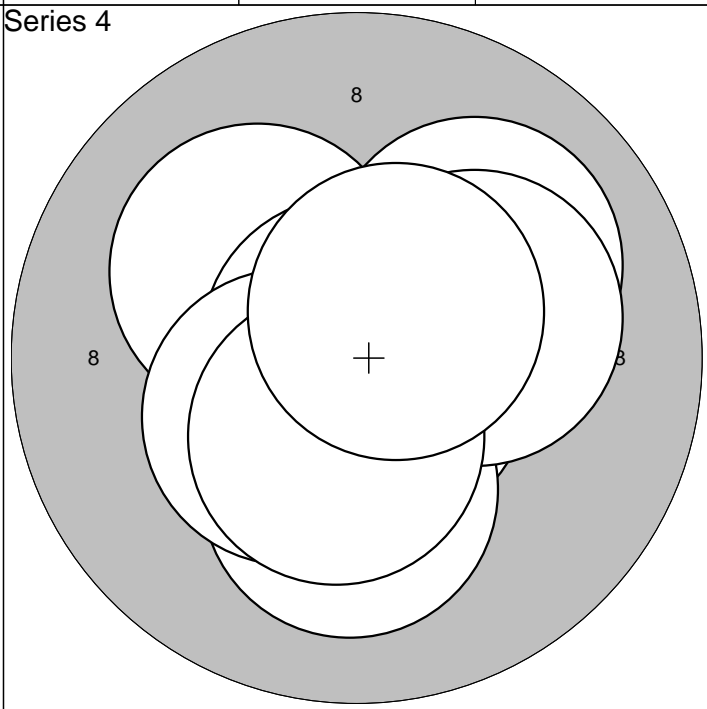

1:10,8* ↗	6:10,2* →	Serie	100,0
2:10,2* ↖	7:10,9* ↖		
3:10,0 ↗	8:10,4* ↘	Sum	389,0
4:10,7* ↘	9:10,5* ↘		
5:10,2* ↘	10:10,6* ↗		

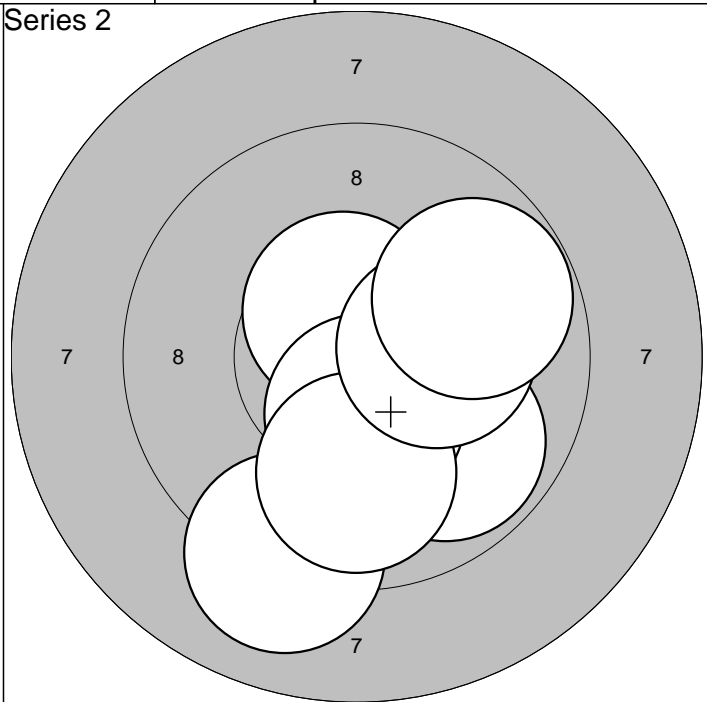
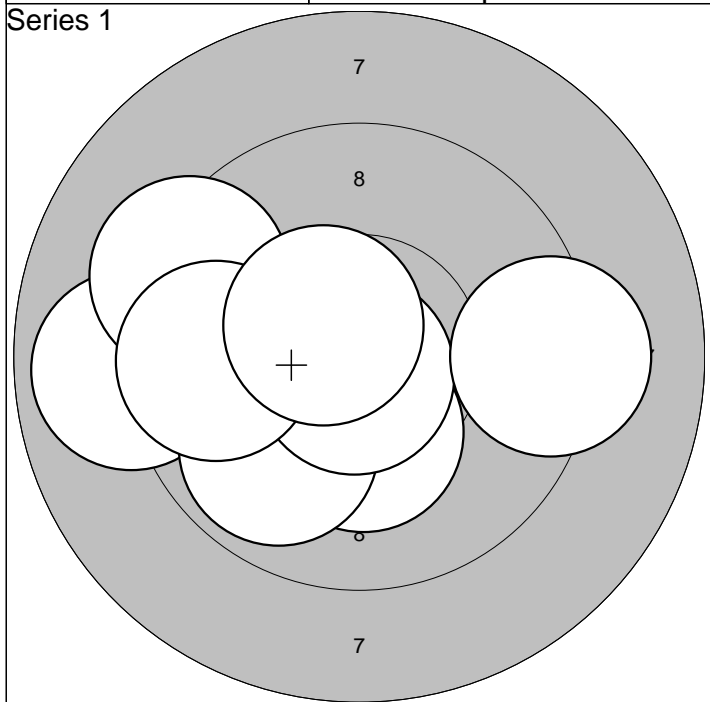

1:10,2* ←	6:10,8* ↓	Serie	93,0
2: 9,7 ←	7: 9,3 ↖		
3: 8,9 ←	8: 9,7 ←	Sum	93,0
4:10,3* ↓	9: 9,2 →		
5: 9,9 ↙	10:10,5* ↗		

1:10,1 ↓	6: 9,8 ↓	Serie	96,0
2: 9,1 ↓	7:10,4* ↓		
3:10,6* ↗	8: 9,9 ↓	Sum	189,0
4:10,3* ↓	9:10,2* →		
5:10,2* ↓	10: 9,8 ↗		

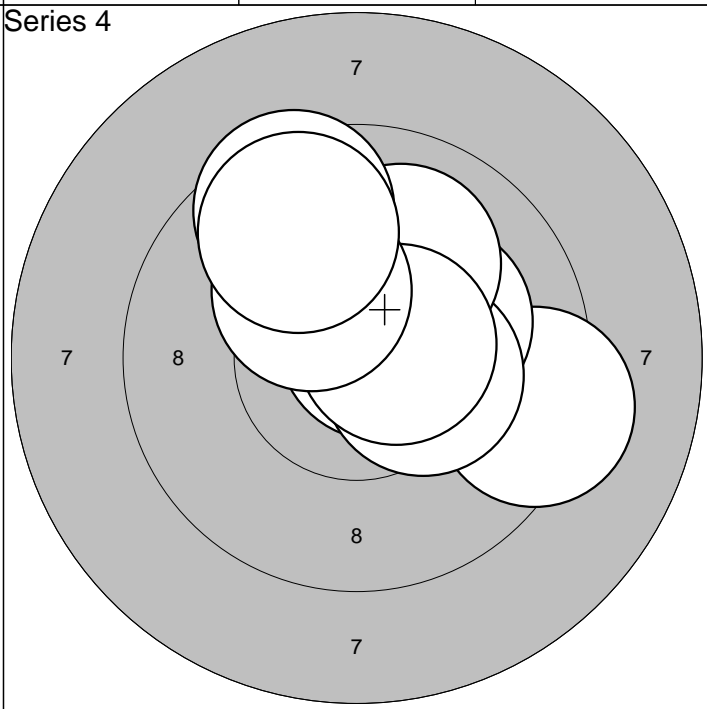
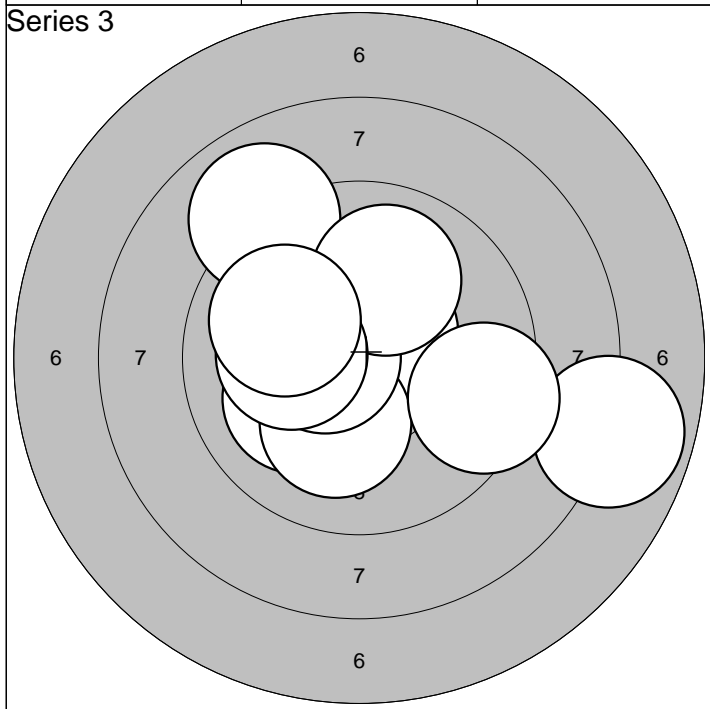

1:10,1 ↖	6: 7,9 →	Serie	95,0
2:10,5* ↗	7:10,0 ↑		
3: 9,0 ↖	8: 9,4 →	Sum	284,0
4:10,2* ↓	9:10,1 ←		
5:10,5* ←	10:10,0 ↖		

1:10,4* ↑	6:10,0 ↑	Serie	97,0
2: 9,3 →	7:10,6* →		
3:10,7* ↗	8: 9,5 ↑	Sum	381,0
4:10,2* →	9:10,2* ↗		
5:10,3* →	10: 9,7 ↑		

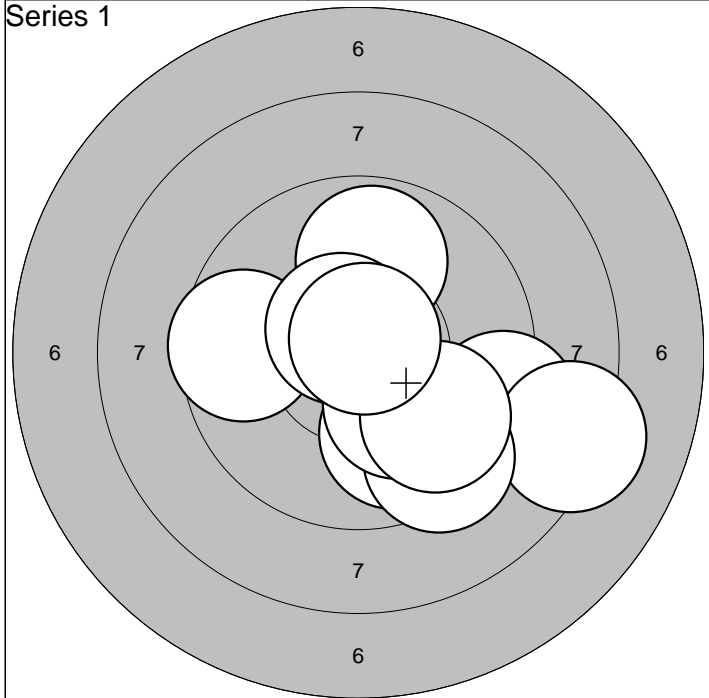

1: 9,8	↑	6: 9,4	↓	Serie	92,0
2: 9,9	↓	7:10,2*	↓		
3: 9,6	←	8: 9,8	↓	Sum	92,0
4: 9,1	↘	9:10,6*	↗		
5: 8,2	↘	10:10,8*	↗		

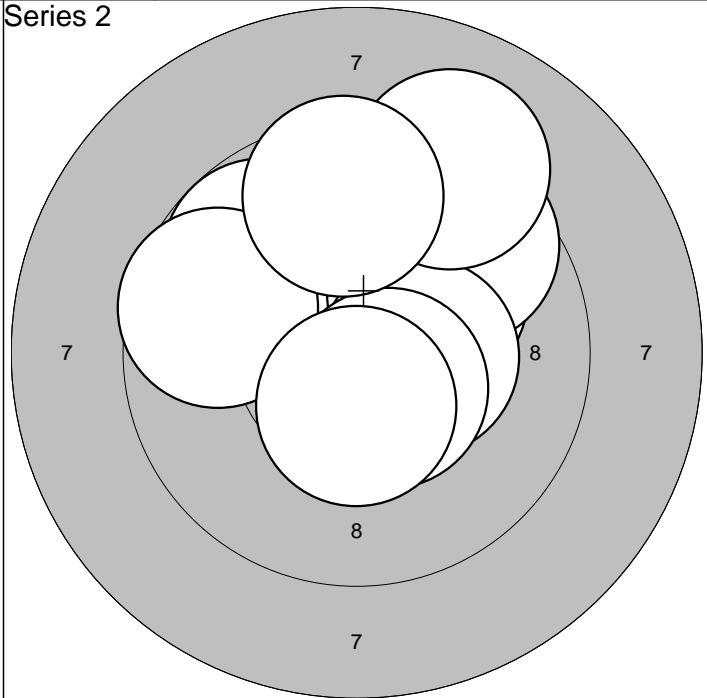

1:10,2*	↗	6:10,4*	→	Serie	95,0
2: 9,8	↖	7: 9,1	↗		
3: 9,7	←	8:10,5*	↓	Sum	187,0
4:10,1	↗	9: 9,5	↑		
5: 9,6	↗	10:10,5*	↓		

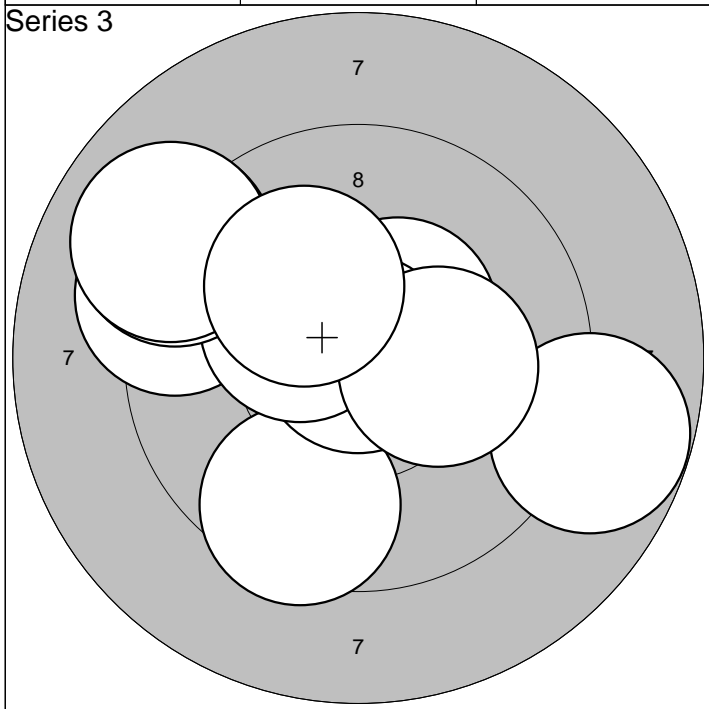

1:10,4*	↗	6:10,3*	↖	Serie	94,0
2: 9,2	←	7: 9,0	↖		
3: 9,5	↓	8: 9,0	↗	Sum	281,0
4: 8,8	↘	9:10,2*	→		
5:10,9*	↑	10:10,2*	↗		

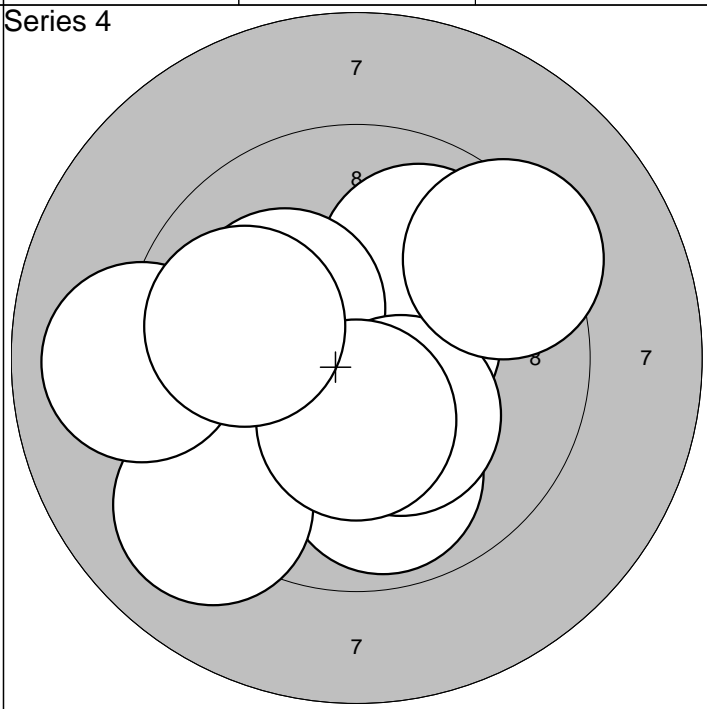

1:10,5*	→	6:10,2*	↖	Serie	94,0
2: 9,9	↓	7:10,3*	↓		
3: 9,1	↙	8:10,4*	↓	Sum	375,0
4: 9,0	←	9: 9,9	←		
5: 9,9	↗	10: 9,4	↗		

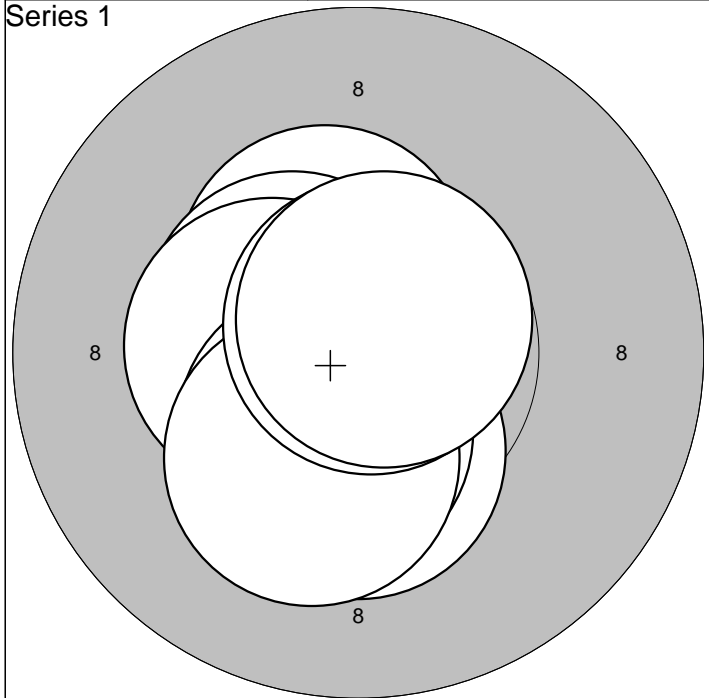

1:10,6* ↗	6:10,4* ←	Serie 100,0
2:10,4* ↗	7:10,4* ↓	
3:10,5* ↓	8:10,2* ↓	Sum 100,0
4:10,4* ↓	9:10,8* ↗	
5:10,5* ↖	10:10,7* ↗	

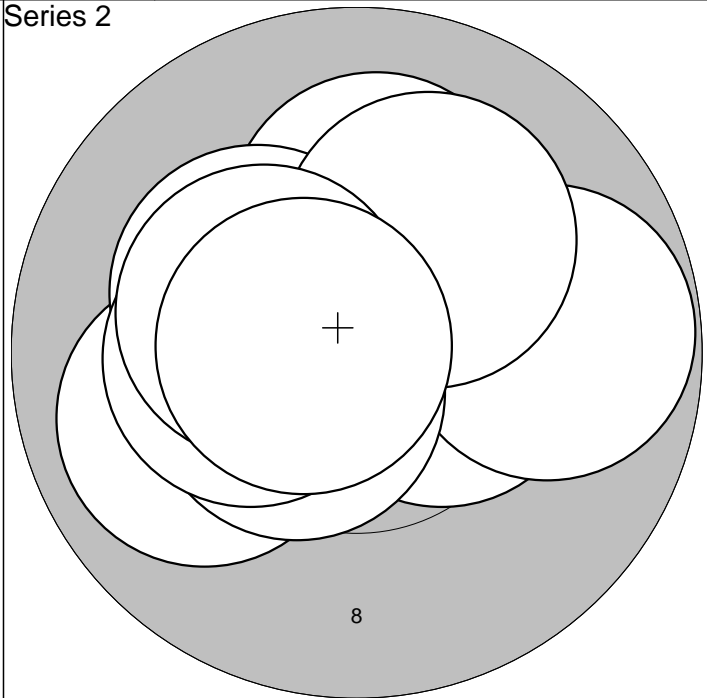

1: 9,9 ←	6:10,3* ↖	Serie 98,0
2:10,1 ↑	7:10,3* ←	
3:10,4* →	8:10,1 ↗	Sum 198,0
4: 9,8 →	9:10,3* ↖	
5:10,5* ↖	10:10,6* ←	

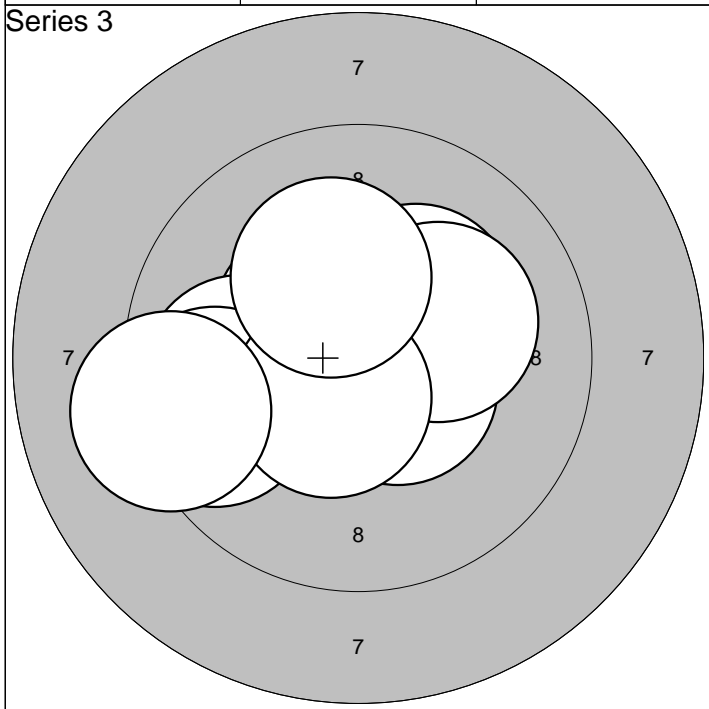

1:10,7* ↓	6:10,2* →	Serie 97,0
2:10,4* ↖	7: 9,6 ←	
3:10,5* ↘	8:10,5* ↓	Sum 295,0
4: 9,9 ←	9: 9,2 ←	
5:10,2* ↗	10:10,2* ↗	

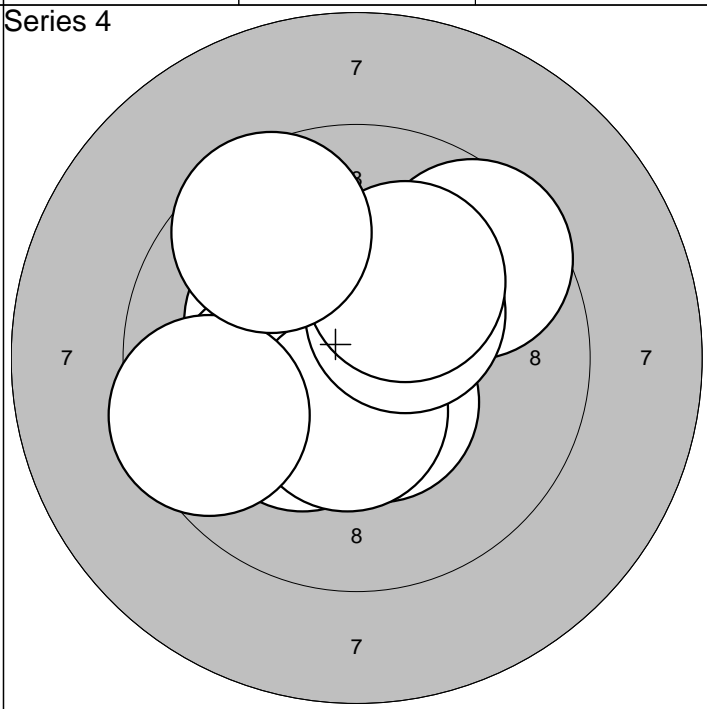

1:10,3* ↖	6:10,5* ↓	Serie 97,0
2:10,2* ↖	7:10,3* ↗	
3:10,5* ↓	8: 9,5 ←	Sum 392,0
4:10,2* ←	9:10,1 ↗	
5: 9,6 ↗	10: 9,6 ↖	

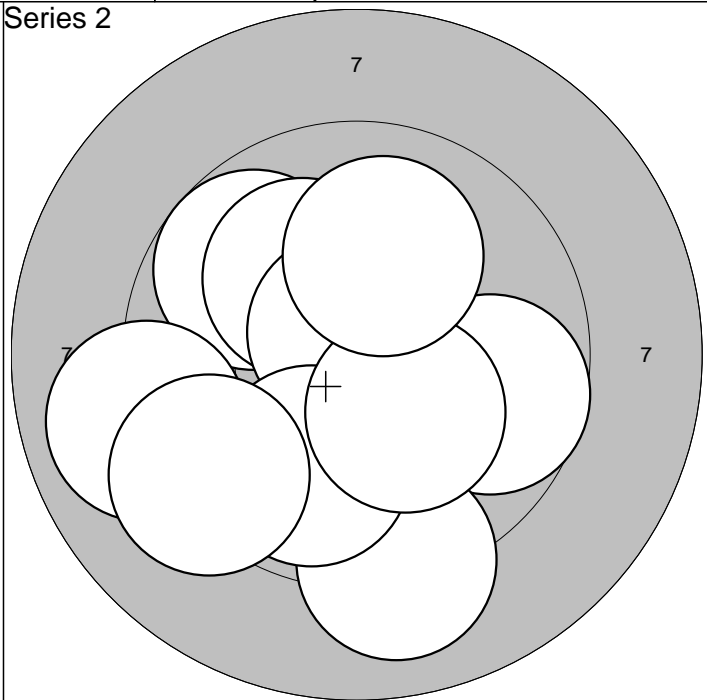
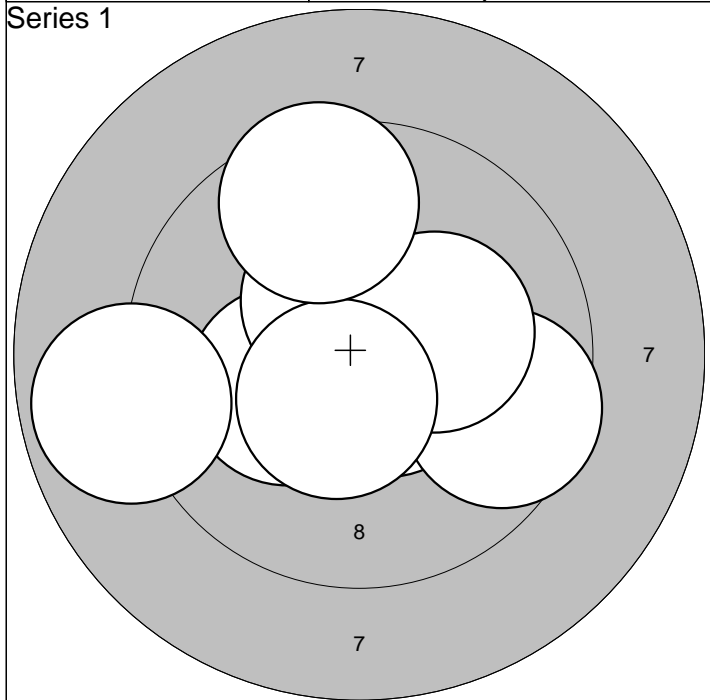

1:10,5* →	6: 9,6 →		Serie	96,0
2:10,3* ←	7:10,2* →			
3:10,6* ↘	8:10,5* ↘	Sum	96,0	
4:10,7* ↑	9: 8,9 ←			
5:10,4* ↑	10: 9,6 ↑			

1: 9,7 ↖	6: 9,1 ↓		Serie	94,0
2: 9,7 →	7: 9,9 ↓			
3:10,1 ↗	8: 9,3 ↙	Sum	190,0	
4: 9,0 ←	9:10,3* ↘			
5:10,7* ↑	10:10,0 ↑			

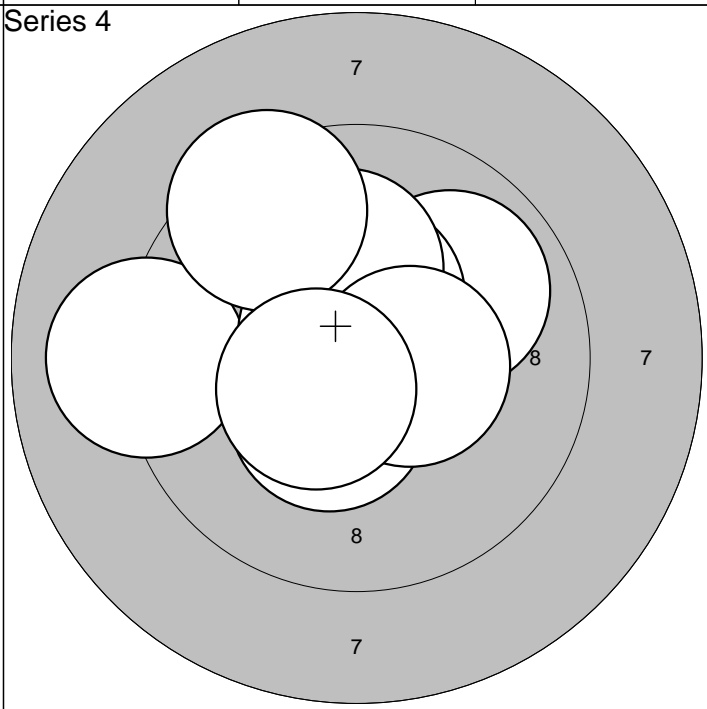

1: 9,9 ↖	6: 9,7 ↗		Serie	95,0
2: 9,9 ↗	7:10,1 ←			
3: 9,3 ↓	8:10,4* ↘	Sum	285,0	
4:10,1 ↗	9:10,5* ↓			
5:10,6* ↘	10: 9,9 ↑			

1: 9,1 ←	6:10,4* ↘		Serie	97,0
2:10,6* ↗	7:10,2* ↑			
3:10,7* ↖	8:10,5* →	Sum	382,0	
4: 9,9 ↗	9: 9,4 ↖			
5:10,4* ↑	10:10,5* ↙			

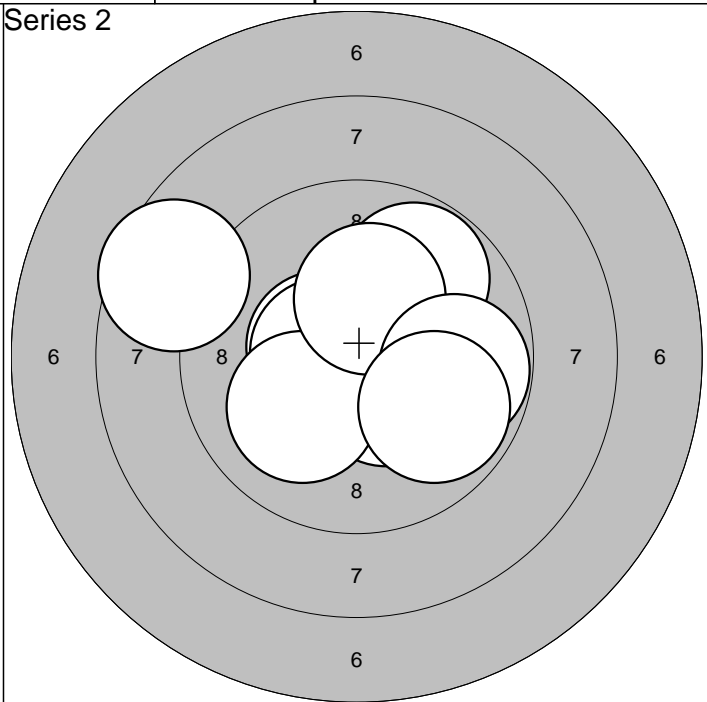
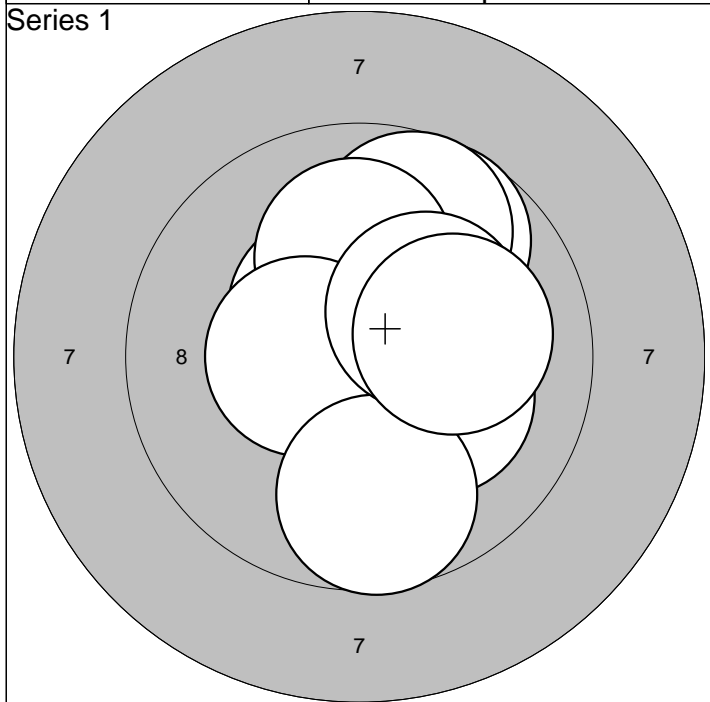

1:10,5* ↖	6:10,2* →	Serie	97,0
2: 9,7 ↗	7:10,5* ←		
3:10,7* ←	8: 9,7 ↓	Sum	97,0
4: 9,7 ↗	9:10,2* ↗		
5:10,1 ↑	10:10,1 →		

1:10,5* ←	6:10,1 ↙	Serie	95,0
2:10,0 ↗	7:10,2* ↑		
3:10,4* ↘	8: 9,8 →	Sum	192,0
4: 9,8 ↗	9: 9,8 ↘		
5:10,6* ←	10: 8,6 ↖		

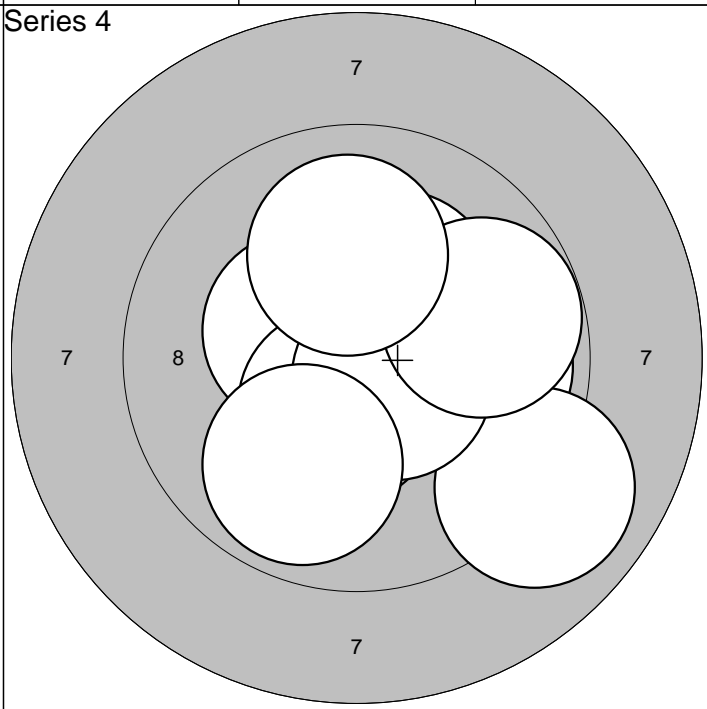
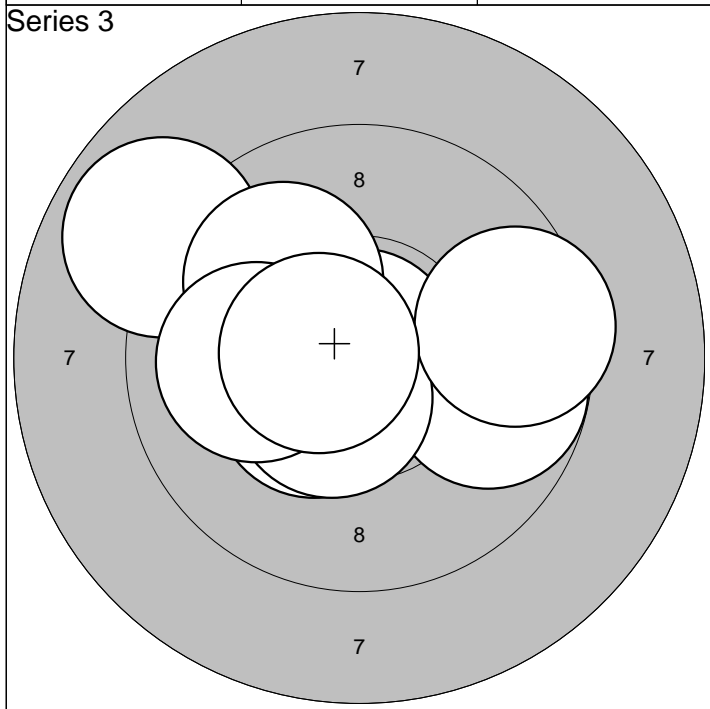

1: 8,9 ↖	6: 9,8 →	Serie	96,0
2:10,4* ←	7:10,5* ↘		
3:10,4* ↙	8: 9,5 →	Sum	288,0
4:10,9* ↑	9:10,0 ←		
5:10,0 ↖	10:10,6* ←		

1:10,4* ↖	6: 9,0 ↘	Serie	96,0
2:10,3* ↗	7:10,6* ↘		
3:10,3* ↗	8: 9,9 ↘	Sum	384,0
4: 9,9 →	9: 9,8 →		
5:10,5* ↘	10:10,0 ↑		

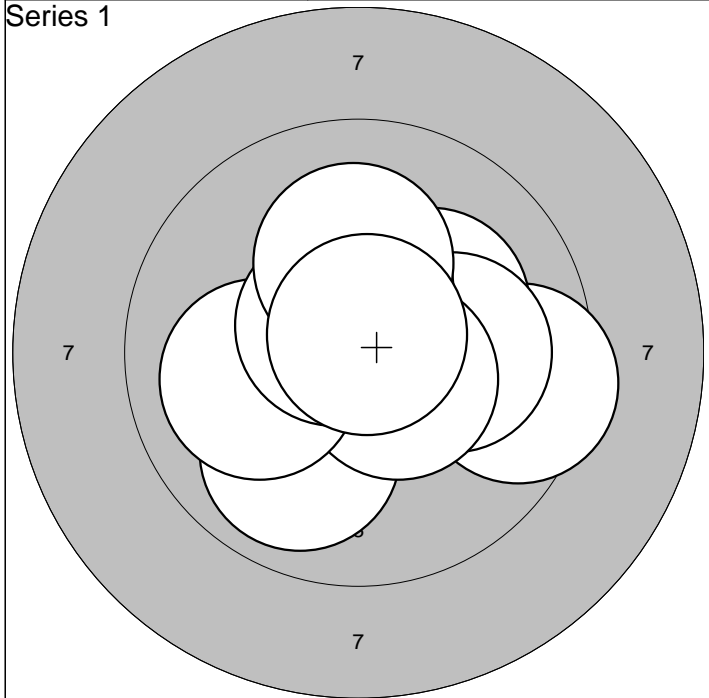

1: 9,5 →	6:10,4* ↑	Serie	98,0
2:10,2* ↗	7:10,0 ←		
3:10,1 →	8:10,6* ↘	Sum	98,0
4: 9,9 ↓	9:10,1 ↑		
5:10,5* ↘	10:10,8* ↗		

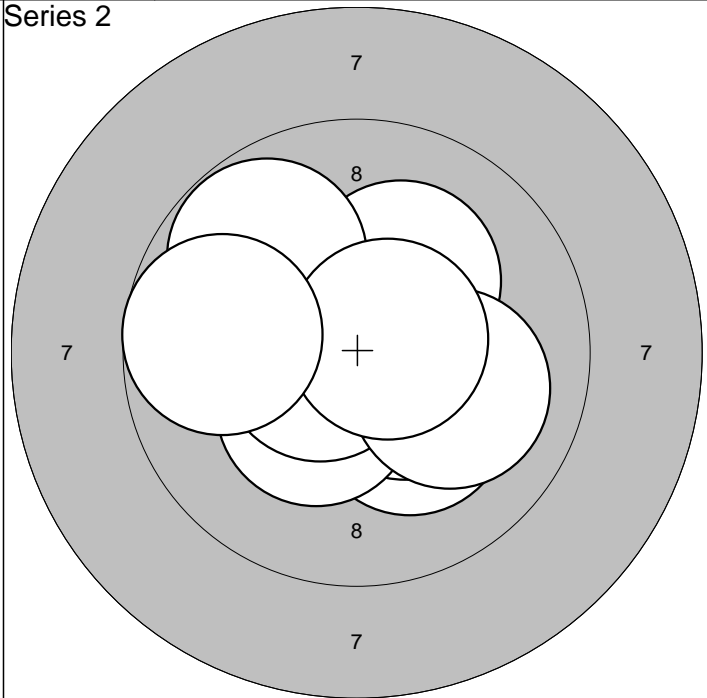

1:10,2* ↘	6:10,2* ↗	Serie	98,0
2:10,5* ↘	7: 9,8 ↖		
3:10,4* ↙	8:10,0 →	Sum	196,0
4:10,6* ↗	9:10,6* →		
5:10,6* ←	10: 9,7 ←		

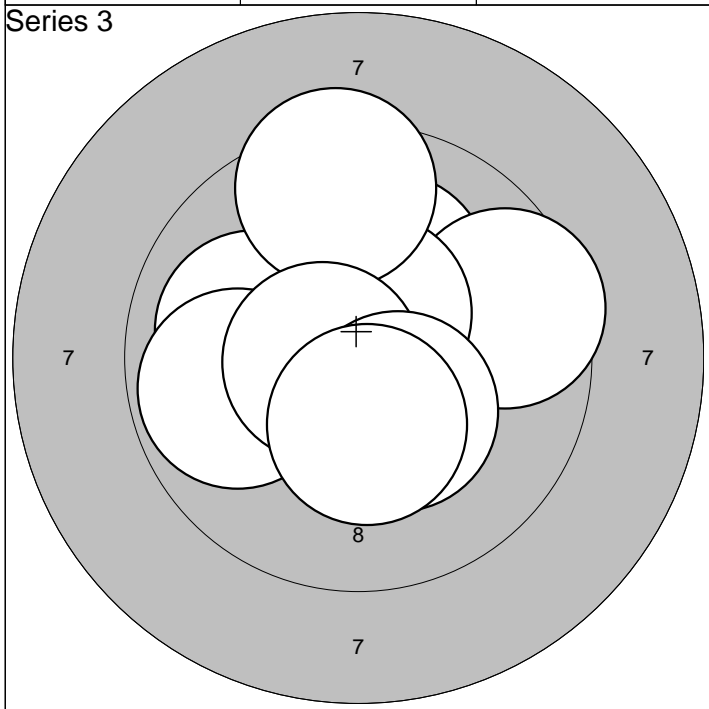

1:10,5* ↑	6:10,5* ↑	Serie	97,0
2:10,0 ←	7: 9,4 ↑		
3:10,1 ↑	8:10,6* ←	Sum	293,0
4: 9,8 ←	9:10,4* ↓		
5: 9,6 →	10:10,3* ↓		

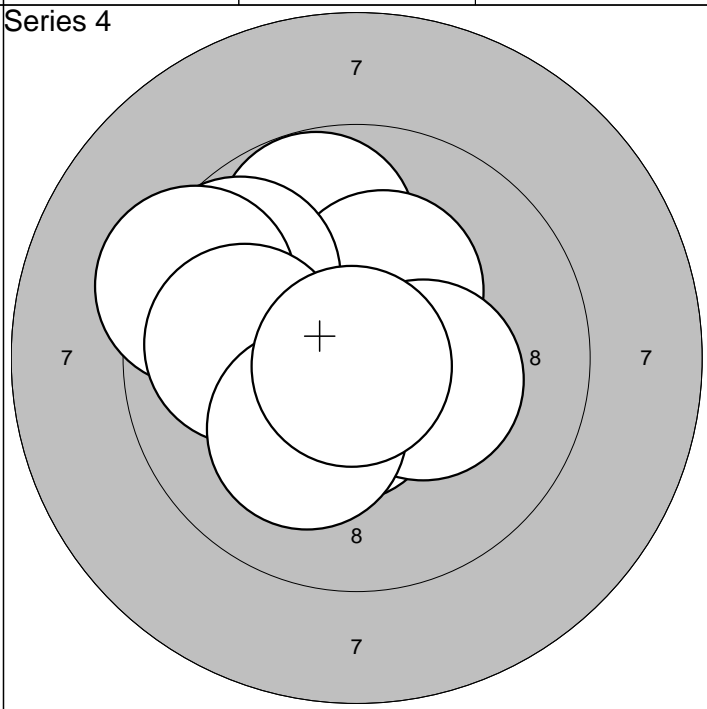

1:10,5* ↓	6: 9,4 ↖	Serie	96,0
2:10,7* ↗	7:10,3* →		
3: 9,8 ↑	8: 9,9 ←	Sum	389,0
4:10,3* ↑	9:10,2* ↙		
5: 9,7 ↖	10:10,9* ↙		

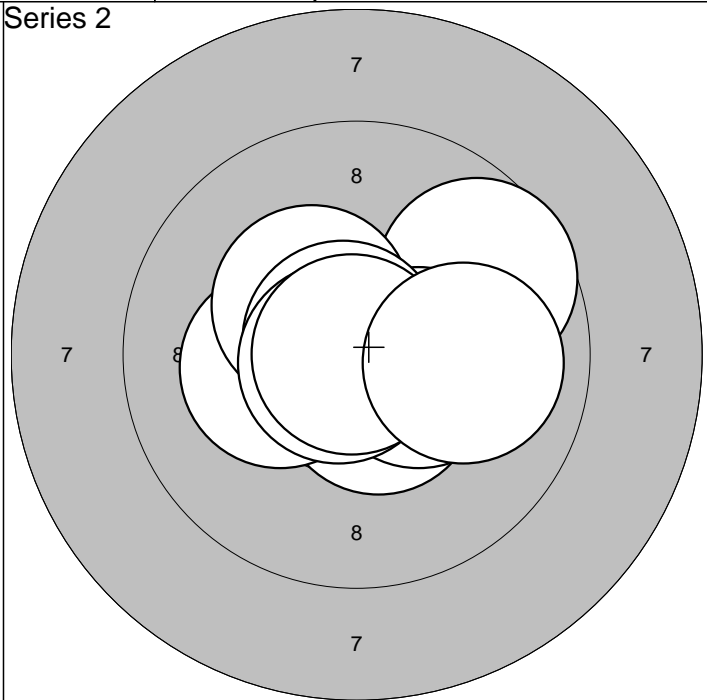
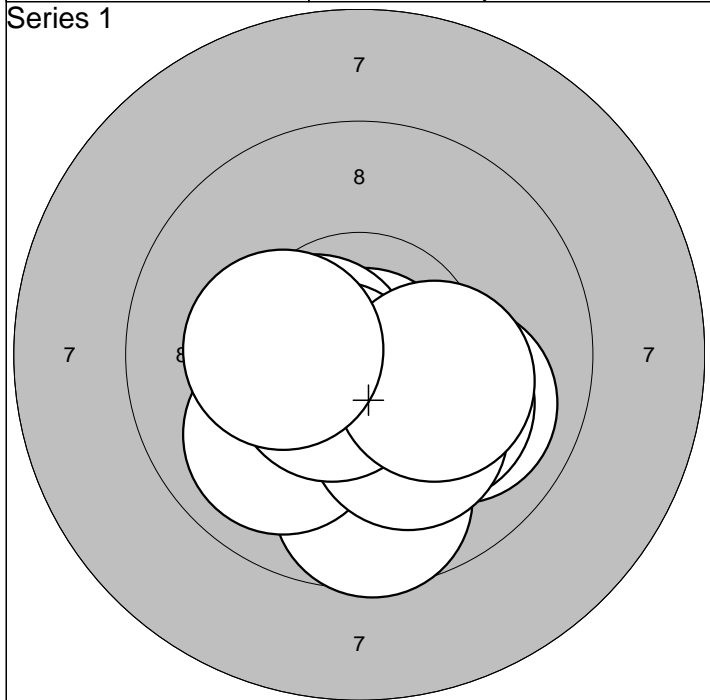

1:10,0	➤	6:10,8*	↓								
2: 9,7	↓	7:10,5*	←							Serie	99,0
3:10,0	↙	8:10,6*	↘							Sum	99,0
4:10,1	➤	9:10,2*	➤								
5:10,1	↘	10:10,3*	←								

1:10,6*	↓	6:10,4*	↗								
2: 9,7	↗	7:10,8*	↗							Serie	99,0
3:10,6*	↖	8:10,8*	←							Sum	198,0
4:10,4*	➤	9:10,9*	←								
5:10,3*	←	10:10,0	➤								

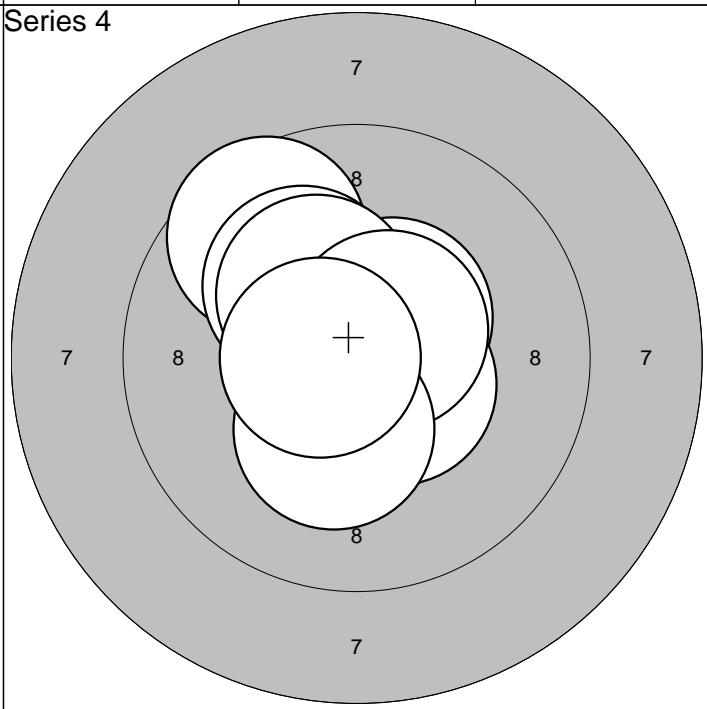
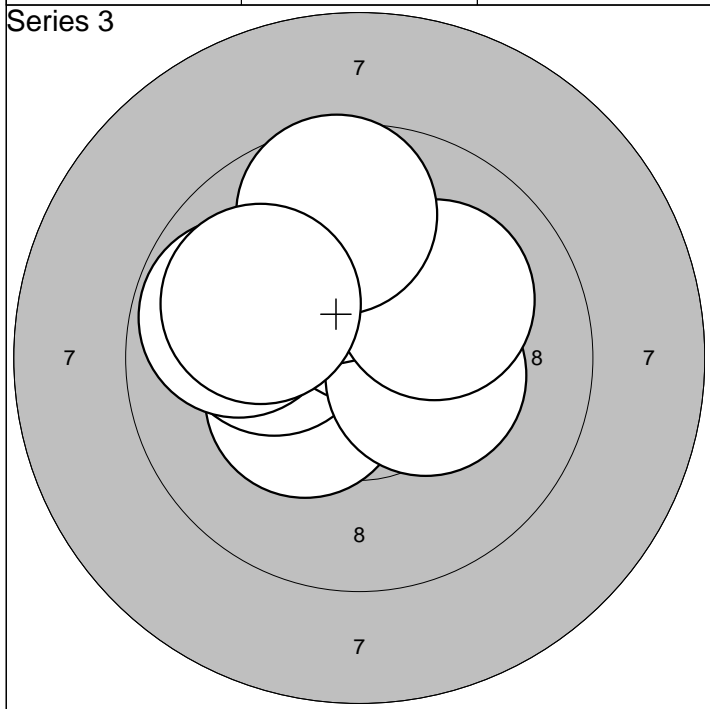

1:10,3*	↙	6:10,1	↑								
2:10,6*	↗	7: 9,8	←							Serie	98,0
3:10,2*	←	8:10,1	↗							Sum	296,0
4:10,5*	↑	9: 9,6	↑								
5:10,3*	➤	10:10,0	↙								

1: 9,6	↖	6:10,5*	↘								
2:10,7*	↗	7:10,3*	↖							Serie	99,0
3:10,4*	↗	8:10,6*	↗							Sum	395,0
4:10,2*	↖	9:10,3*	↓								
5:10,6*	↘	10:10,6*	←								

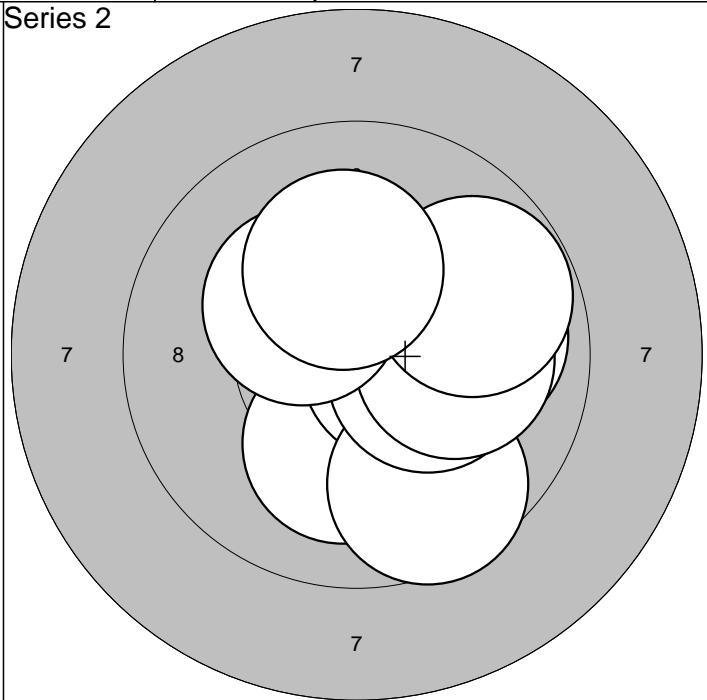
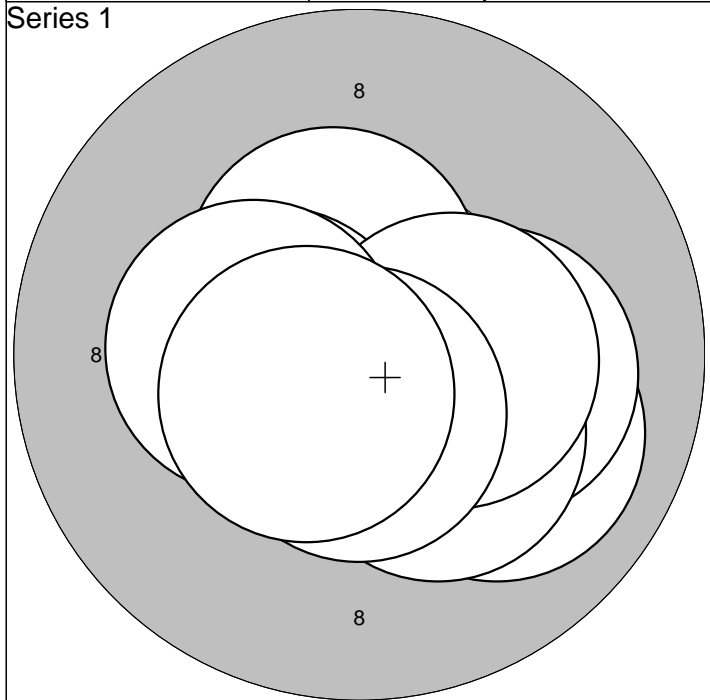

1:10,0 ↘	6:10,3* ↘	Serie	100,0
2:10,4* →	7:10,4* →		
3:10,1 →	8:10,6* ↓	Sum	100,0
4:10,5* ↗	9:10,3* ←		
5:10,4* ←	10:10,6* ↙		

1:10,1 ↓	6:10,3* →	Serie	97,0
2:10,5* →	7:10,1 →		
3:10,5* →	8:10,3* ↖	Sum	197,0
4: 9,6 ↓	9: 9,8 →		
5: 9,9 →	10:10,2* ↗		

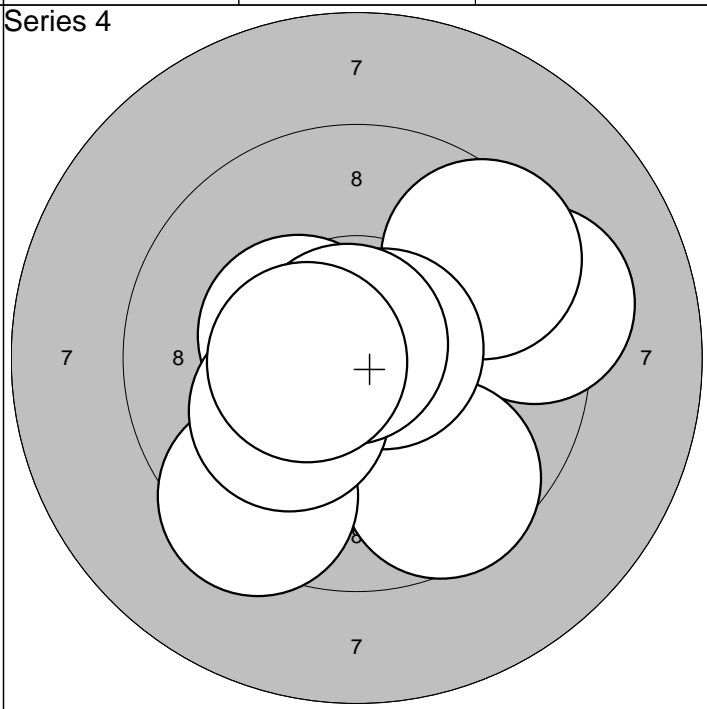
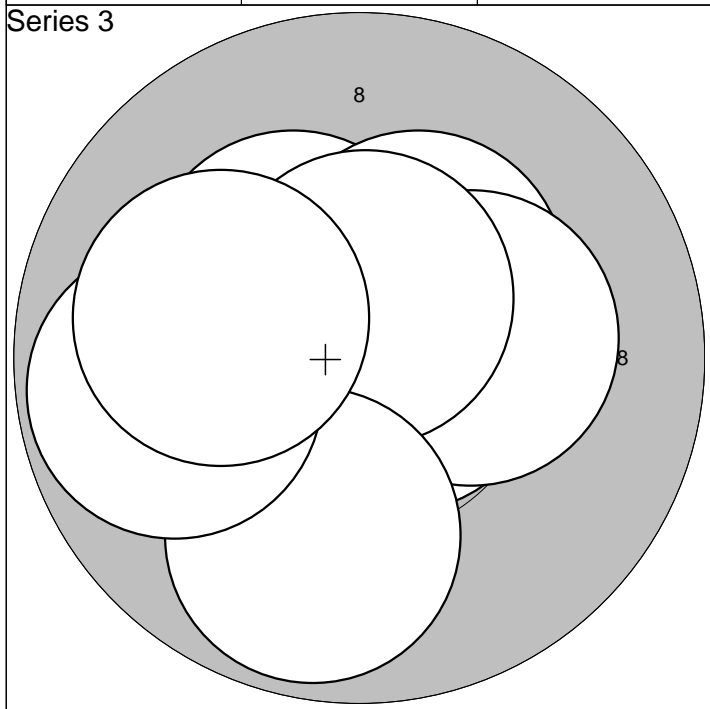

1:10,3* ↖	6:10,3* →	Serie	98,0
2:10,7* →	7:10,6* ↗		
3:10,3* ↙	8: 9,9 ↓	Sum	295,0
4:10,6* ↙	9: 9,8 ←		
5:10,3* ↗	10:10,1 ←		

1: 9,3 →	6: 9,4 ↘	Serie	96,0
2: 9,5 ↗	7:10,7* →		
3:10,9*	8:10,2* ↙	Sum	391,0
4: 9,6 ↓	9:10,8* ↖		
5:10,4* ↙	10:10,5* ←		

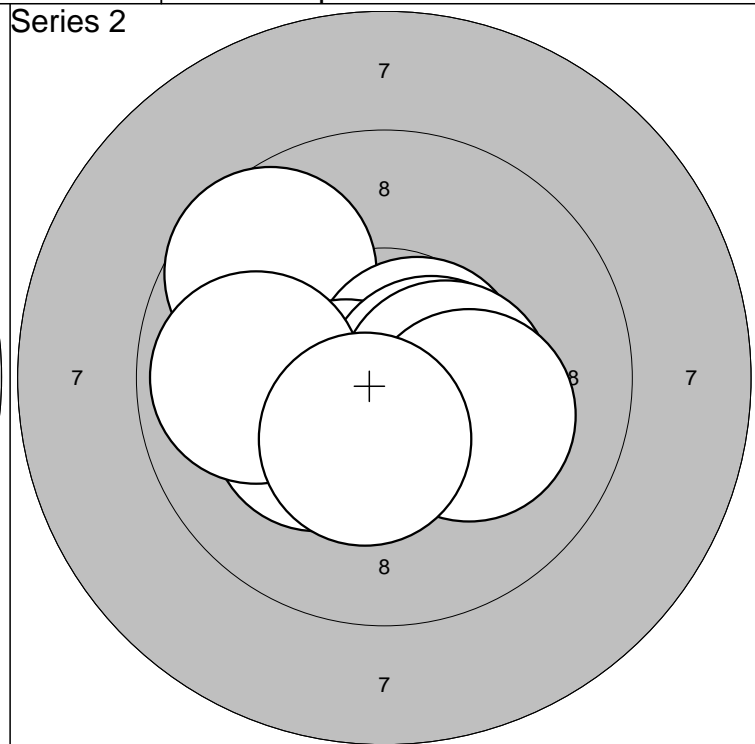
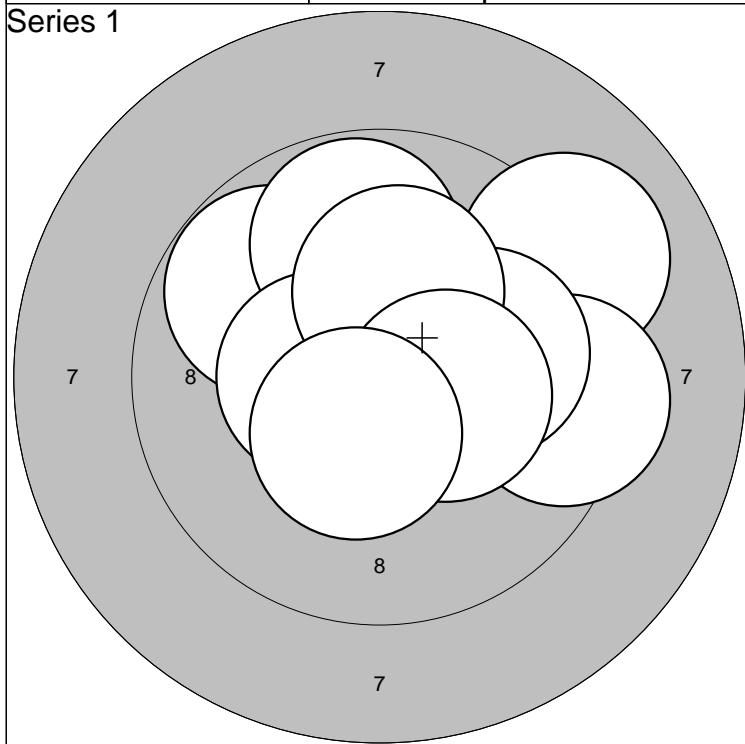

1: 9,8 ↖	6:10,0 →	Serie	96,0
2: 9,8 ↑	7:10,5* ←		
3:10,1 ↗	8:10,2* ↑	Sum	96,0
4: 9,1 ↗	9:10,4* →		
5: 9,4 →	10:10,4* ↓		

1:10,8* ↙	6:10,6* →	Serie	98,0
2:10,3* ↙	7:10,4* →		
3: 9,7 ↖	8: 9,9 ←	Sum	194,0
4:10,6* ↗	9:10,1 →		
5:10,6* ↙	10:10,4* ↓		

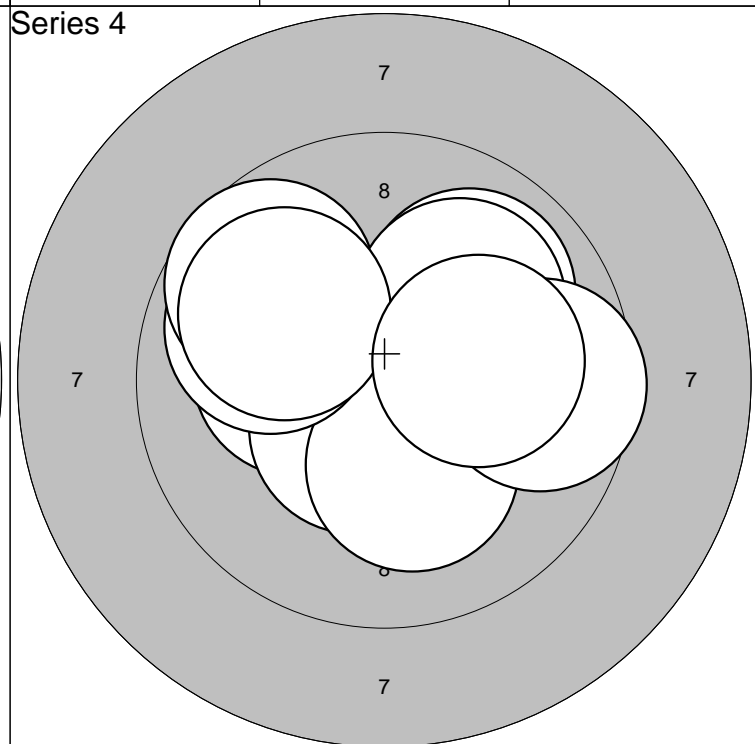
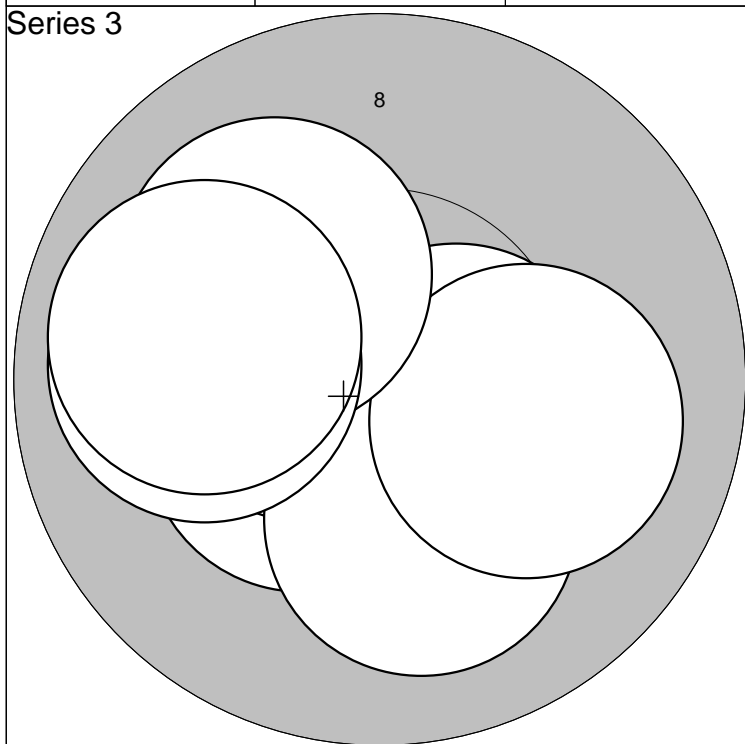

1:10,8* ↓	6:10,1 ↓	Serie	99,0
2:10,6* ↓	7:10,1 →		
3:10,4* ↙	8:10,1 ↗	Sum	293,0
4:10,6* ←	9:10,0 ←		
5:10,5* →	10: 9,9 ←		

1:10,2* ←	6: 9,7 ↖	Serie	95,0
2:10,5* ↓	7:10,0 ↗		
3:10,2* ↓	8: 9,9 ↖	Sum	388,0
4: 9,9 ↖	9: 9,6 →		
5: 9,9 ↗	10:10,2* →		

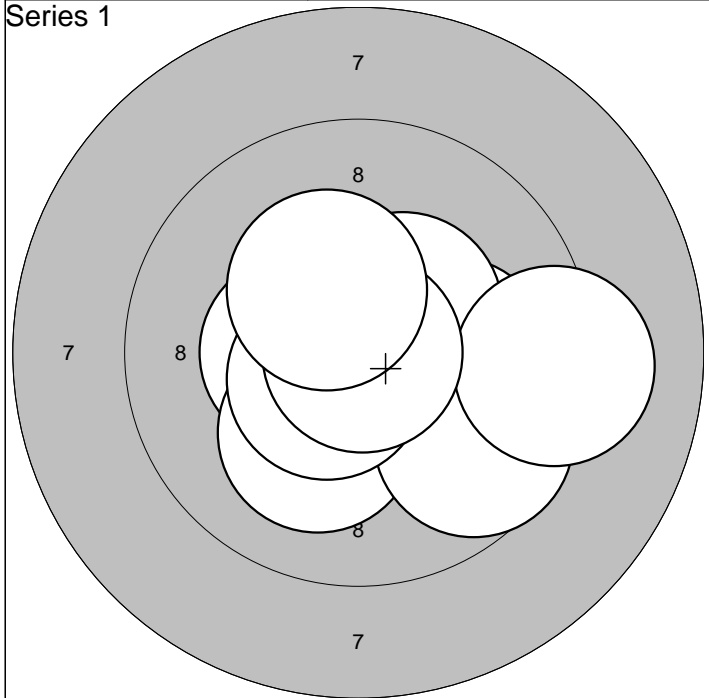

1:10,1 →	6: 9,7 ↘	Serie	98,0
2:10,4* ←	7:10,6* ↙		
3:10,4* ↓	8: 9,2 →	Sum	98,0
4:10,1 ↓	9:10,9* →		
5:10,4* ↗	10:10,3* ↗		

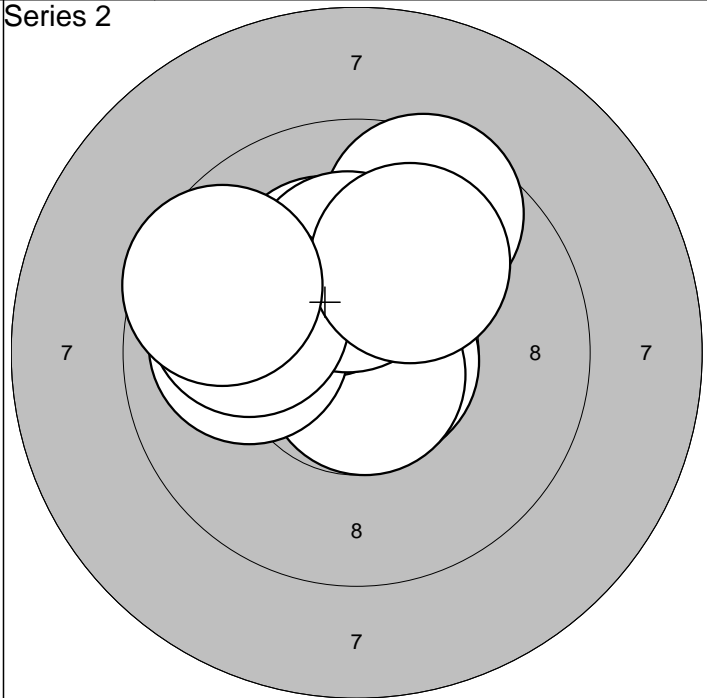

1:10,1 ↖	6: 9,6 ↗	Serie	97,0
2:10,7* →	7:10,2* ↑		
3:10,7* ↓	8: 9,9 ←	Sum	195,0
4:10,2* ↑	9:10,0 ↗		
5:10,0 ←	10: 9,6 ↖		

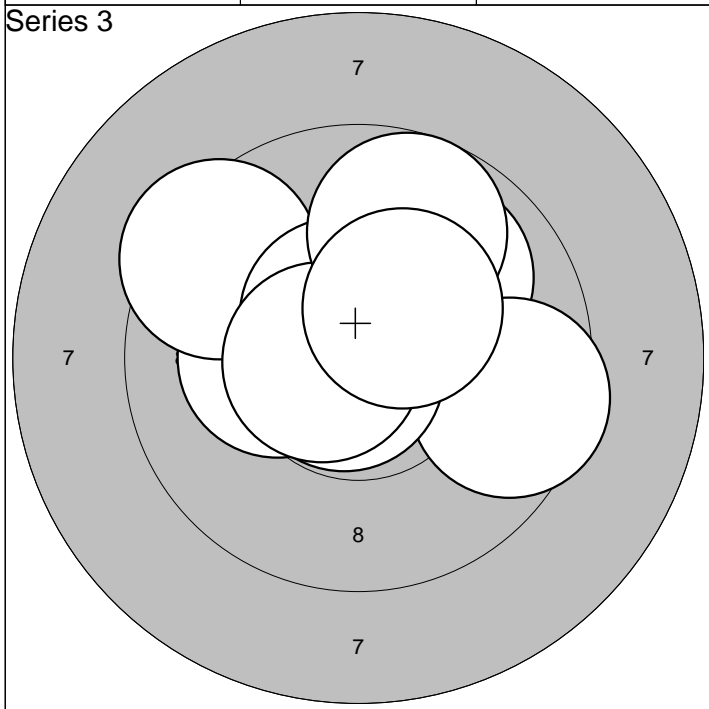

1: 9,9 ↗	6:10,6* ↗	Serie	96,0
2:10,3* ←	7:10,8* ↙		
3:10,2* ←	8:10,6* ←	Sum	291,0
4: 9,5 →	9: 9,7 ↑		
5: 9,4 ↖	10:10,4* ↗		

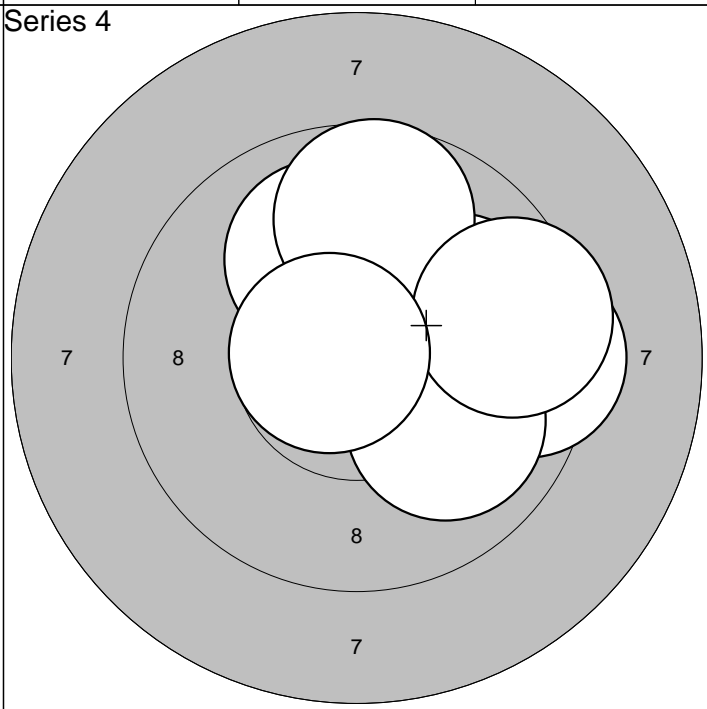

1: 9,9 →	6:10,0 ↗	Serie	95,0
2:10,0 ↗	7: 9,7 ↑		
3: 9,9 →	8:10,0 ↘	Sum	386,0
4: 9,4 →	9: 9,5 →		
5:10,9* ↑	10:10,7* ←		

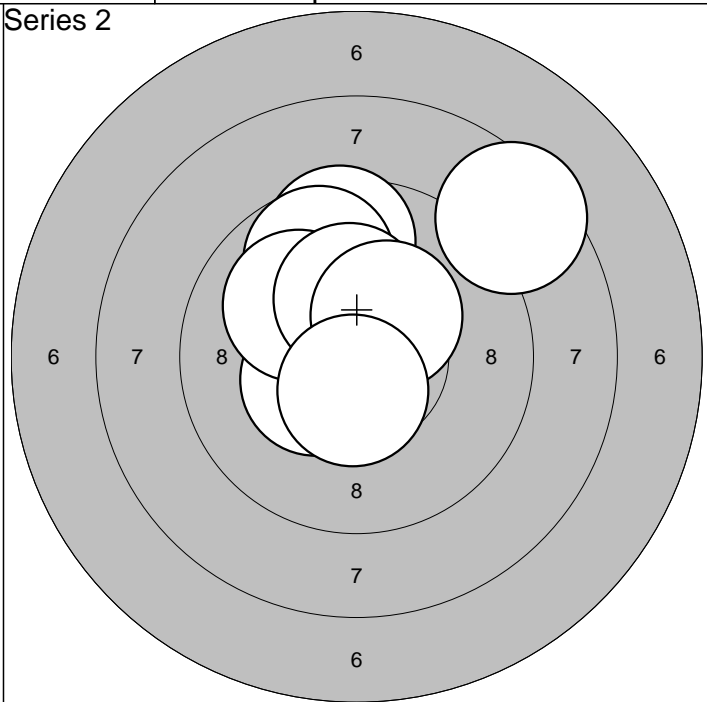
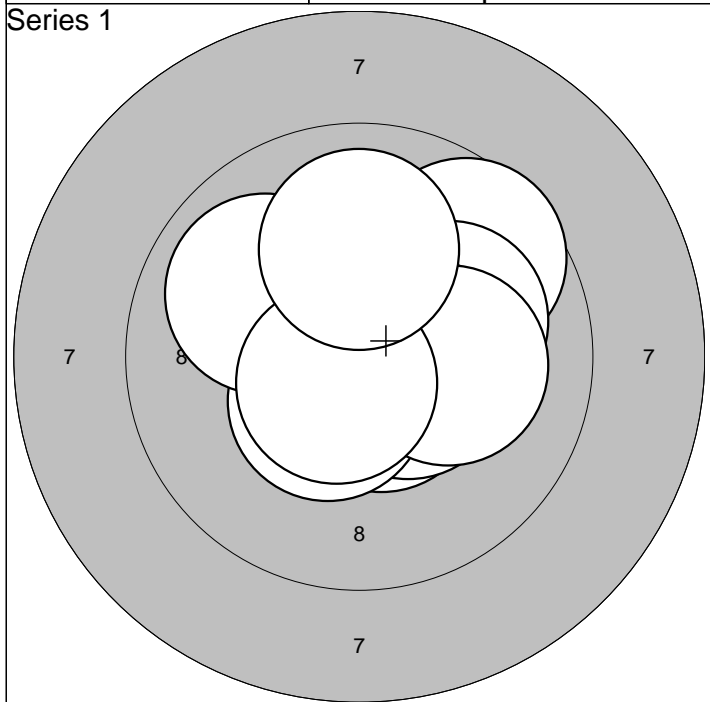

1:10,6* ↘	6:10,4* →		Serie	98,0
2: 9,6 ↗	7: 9,9 ↖			
3:10,5* ↘	8:10,1 →	Sum	98,0	
4:10,5* ↘	9:10,6* ↙			
5:10,1 →	10:10,0 ↑			

1: 9,6 ↑	6:10,0 ↖		Serie	96,0
2:10,5* ↑	7:10,3* ↑			
3:10,8* ←	8:10,4* ↗	Sum	194,0	
4: 9,7 ↑	9:10,6* ↓			
5:10,4* ↙	10: 8,5 ↗			

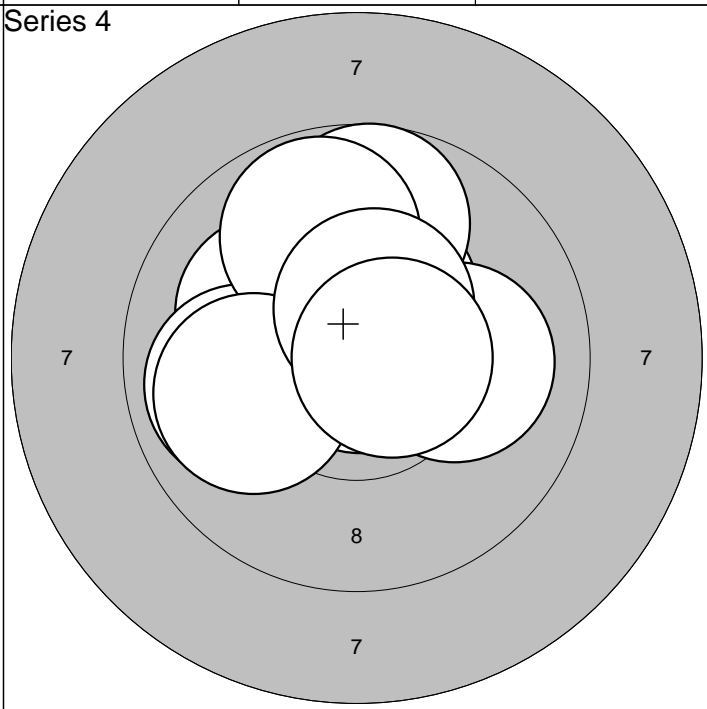
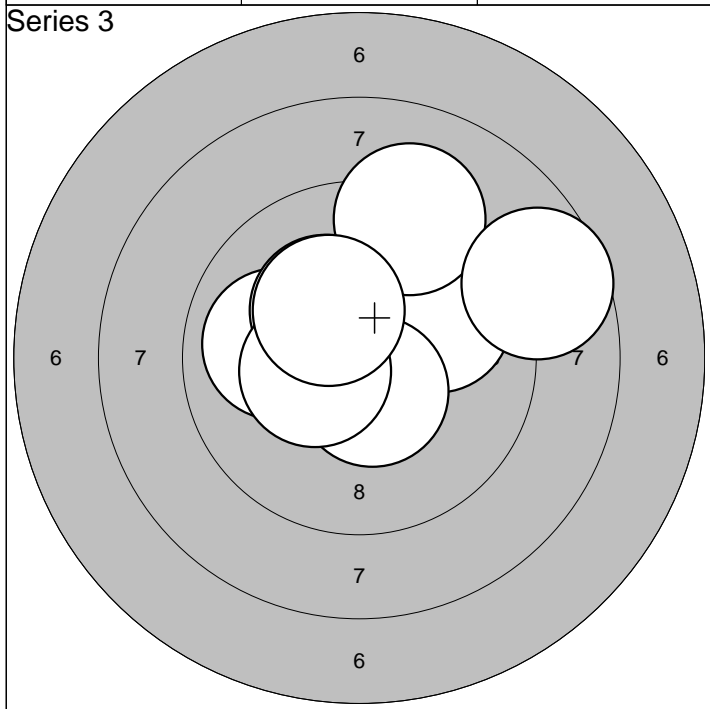

1:10,0 ↗	6: 9,2 ↑		Serie	96,0
2:10,5* ↖	7:10,5* ↓			
3: 9,9 ↗	8:10,4* ←	Sum	290,0	
4:10,0 ←	9:10,3* ↖			
5:10,3* ↖	10: 8,7 →			

1:10,1 ↖	6: 9,8 ↑		Serie	97,0
2:10,4* ↑	7:10,9* ↗			
3:10,1 →	8:10,0 ←	Sum	387,0	
4: 9,8 ↑	9:10,5* ↑			
5: 9,9 ←	10:10,6* →			

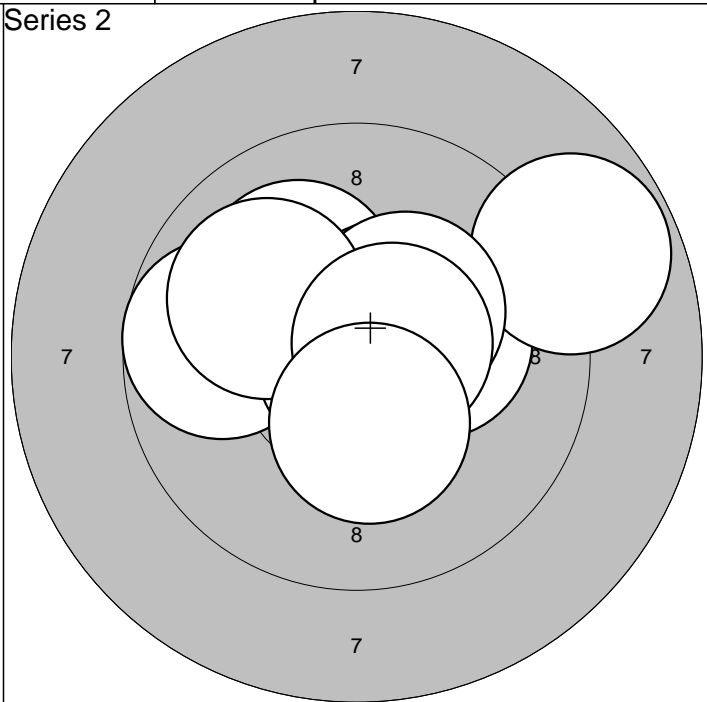
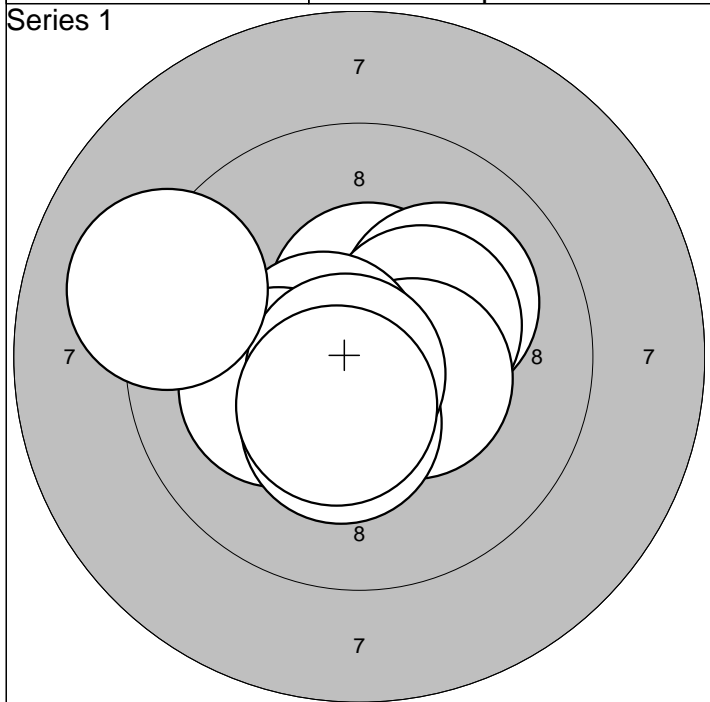

1:10,5* ↑	6:10,2* ←			Serie	99,0
2:10,1 ↗	7:10,3* ↓				
3:10,3* ↗	8:10,7* ↓			Sum	99,0
4:10,4* ➤	9: 9,1 ←				
5:10,6* ←	10:10,5* ↓				

1:10,1 ↖	6: 8,8 ↗			Serie	97,0
2:10,5* ↗	7:10,3* ↗				
3: 9,7 ←	8:10,0 ↖			Sum	196,0
4:10,9* ↓	9:10,6* ➤				
5:10,3* ➤	10:10,3* ↓				

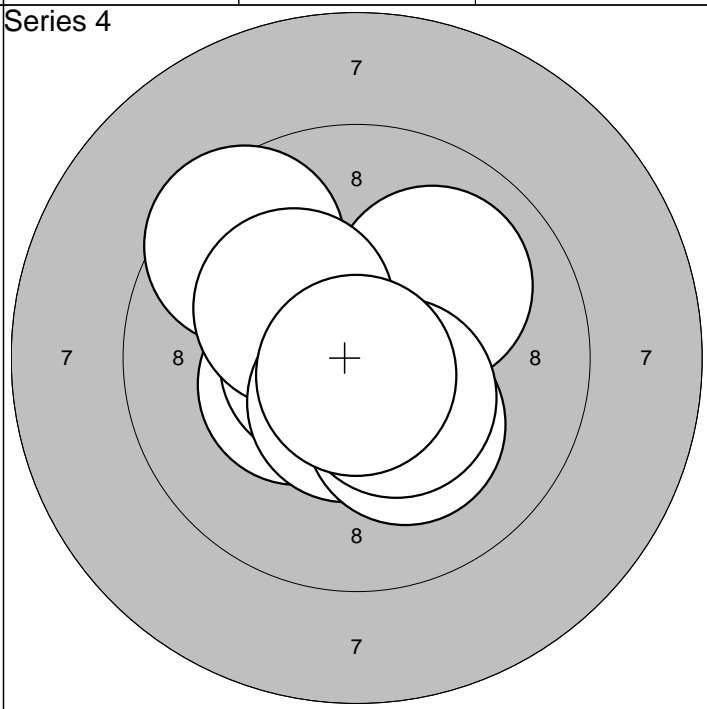
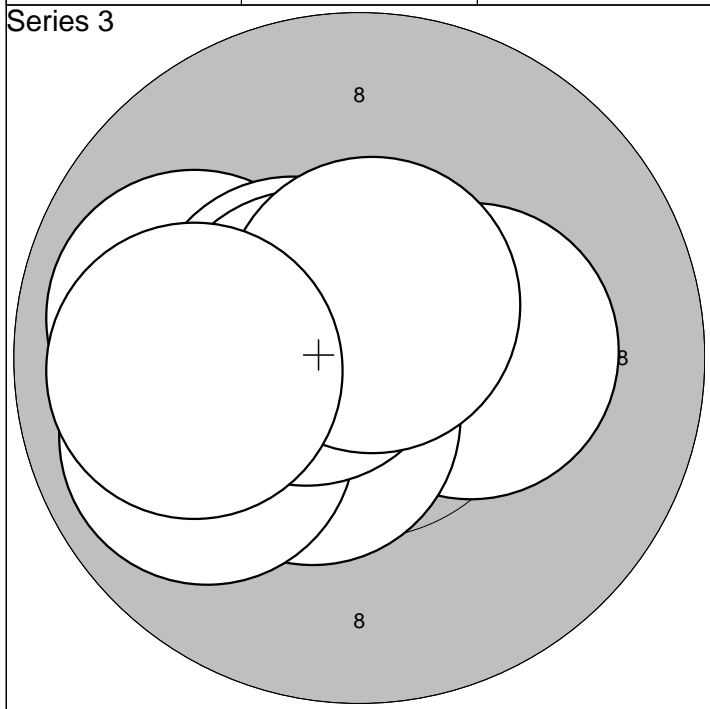

1:10,5* ➤	6:10,5* ←			Serie	97,0
2:10,7* ↗	7: 9,9 ←				
3:10,3* ➤	8:10,6* ←			Sum	293,0
4: 9,9 ←	9:10,6* ↑				
5:10,5* ↓	10: 9,9 ←				

1:10,4* ←	6:10,2* ↖			Serie	99,0
2:10,7* ↓	7:10,5* ↓				
3: 9,5 ↖	8:10,2* ↓			Sum	392,0
4:10,0 ↗	9:10,4* ➤				
5:10,6* ←	10:10,8* ↓				

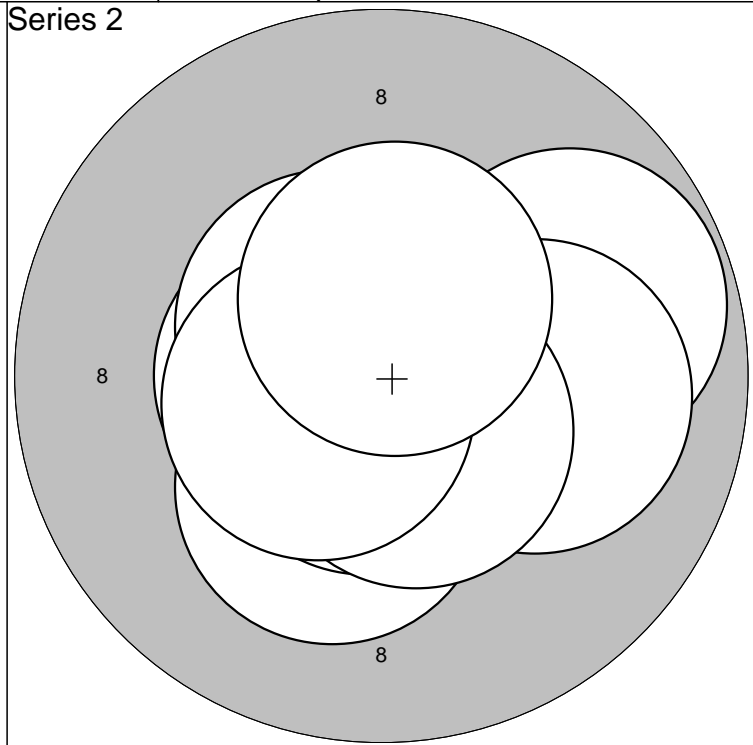
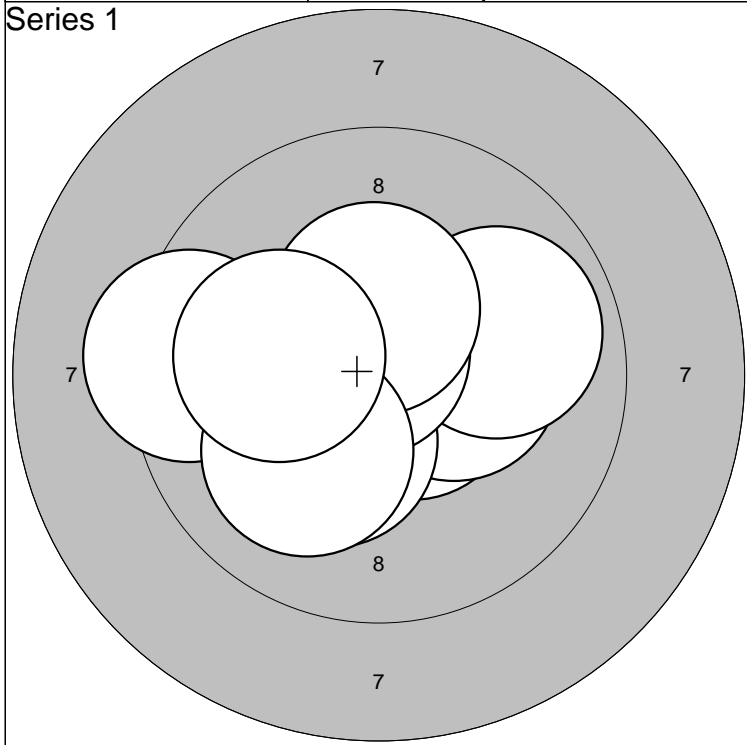

1:10,6* ↘	6:10,7* ↗	Serie	98,0
2:10,3* →	7:10,4* ↑		
3: 9,9 →	8: 9,3 ←	Sum	98,0
4:10,2* ↙	9:10,1 ↘		
5:10,6* ↗	10:10,1 ←		

1:10,7* ↖	6:10,7* ↙	Serie	99,0
2: 9,8 →	7:10,6* ↗		
3:10,3* ↙	8:10,6* ↘	Sum	197,0
4:10,1 →	9:10,5* ←		
5:10,6* ←	10:10,5* ↑		

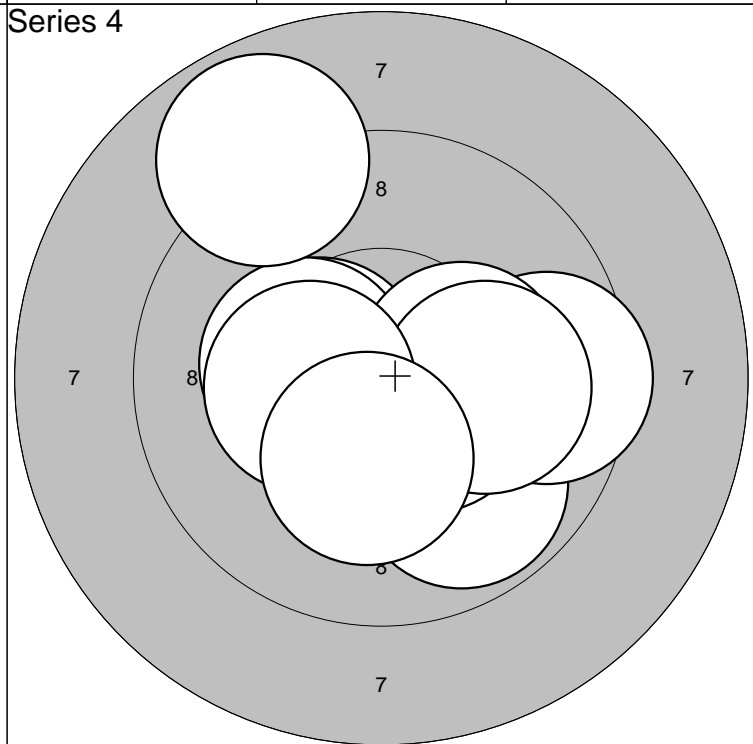
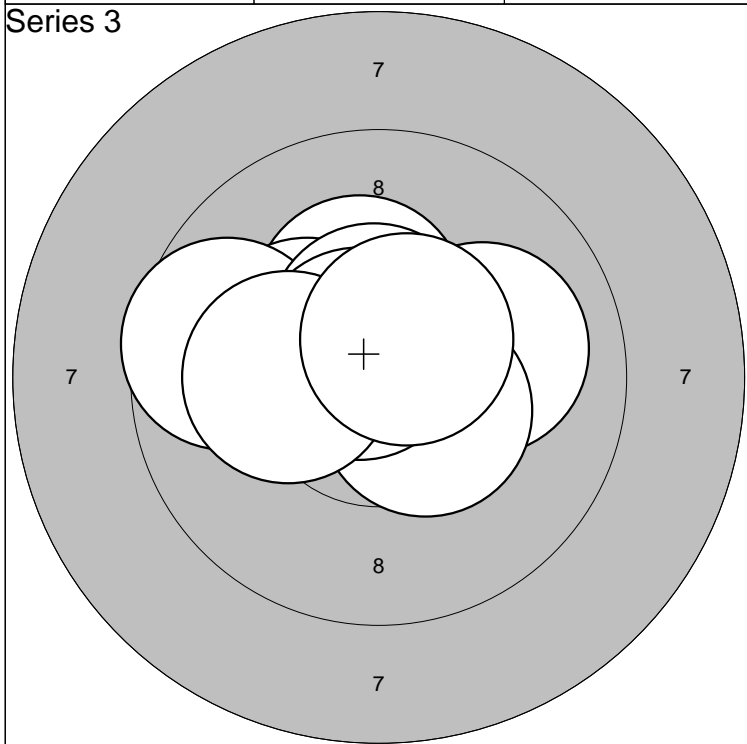

1:10,3* ↑	6:10,5* ↑	Serie	99,0
2:10,8* →	7:10,5* ↘		
3:10,3* ↖	8:10,7* ↗	Sum	296,0
4:10,1 →	9:10,2* ←		
5: 9,7 ←	10:10,6* ↗		

1:10,4* ←	6:10,3* →	Serie	96,0
2: 9,8 ↙	7:10,0 →		
3:10,5* ↘	8:10,3* ←	Sum	392,0
4: 9,6 →	9:10,2* ↙		
5:10,3* ←	10: 8,8 ↗		

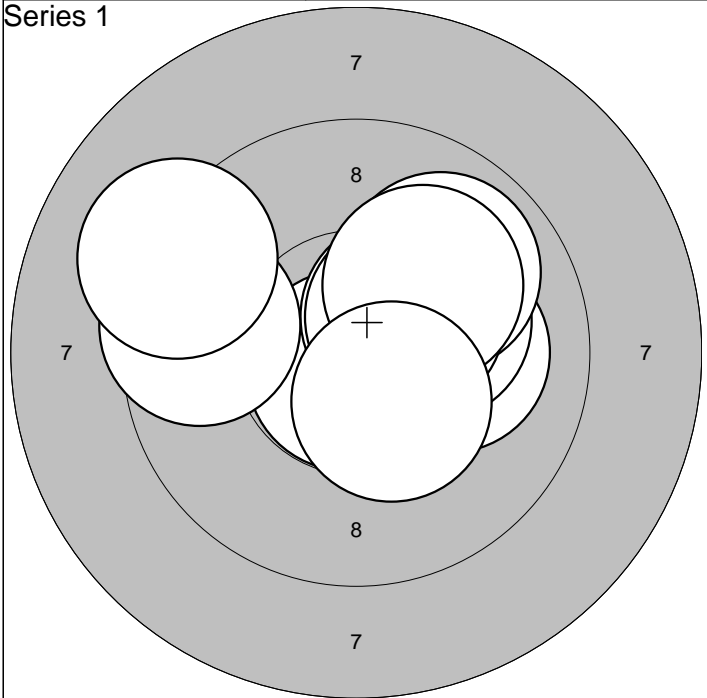

1:10,1 →	6: 9,5 ←				
2:10,2* →	7:10,4* ↗				
3:10,8* ↓	8:10,1 ↗	Serie	97,0		
4:10,4* ↗	9: 9,1 ←	Sum	97,0		
5: 9,9 ↗	10:10,4* ↓				

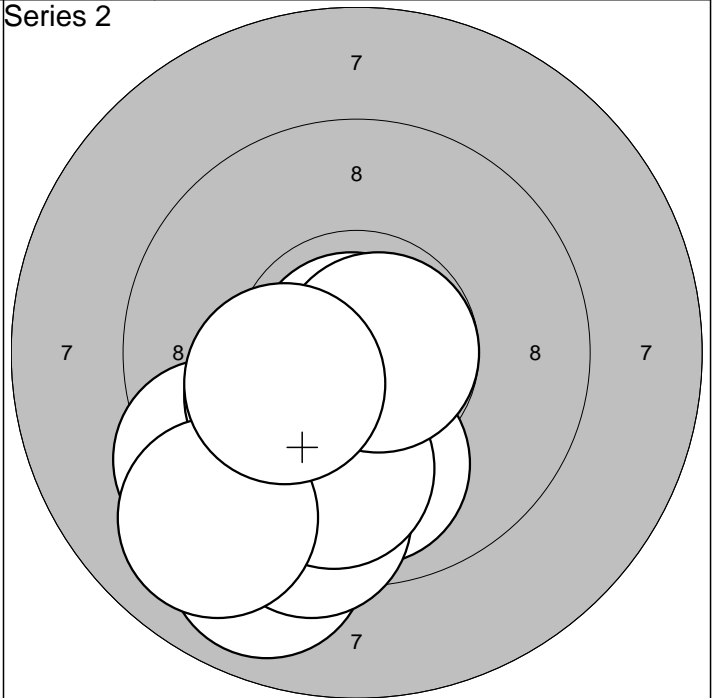

1: 9,0 ↓	6: 9,4 ↓				
2: 9,4 ←	7: 9,9 ↓				
3:10,2* ←	8:10,7* →	Serie	94,0		
4: 9,9 ↓	9: 9,0 ↓	Sum	191,0		
5:10,9* ←	10:10,2* ←				

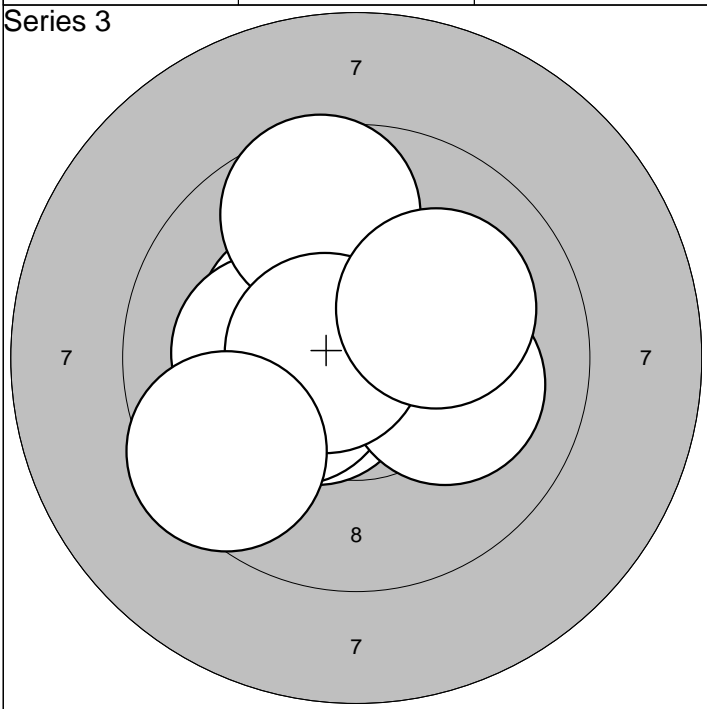

1:10,5* ←	6:10,2* ←				
2:10,3* ←	7: 9,6 ↑				
3:10,1 →	8:10,7* ←	Serie	98,0		
4:10,3* ↖	9:10,1 ↗	Sum	289,0		
5:10,6* ↖	10: 9,5 ↖				

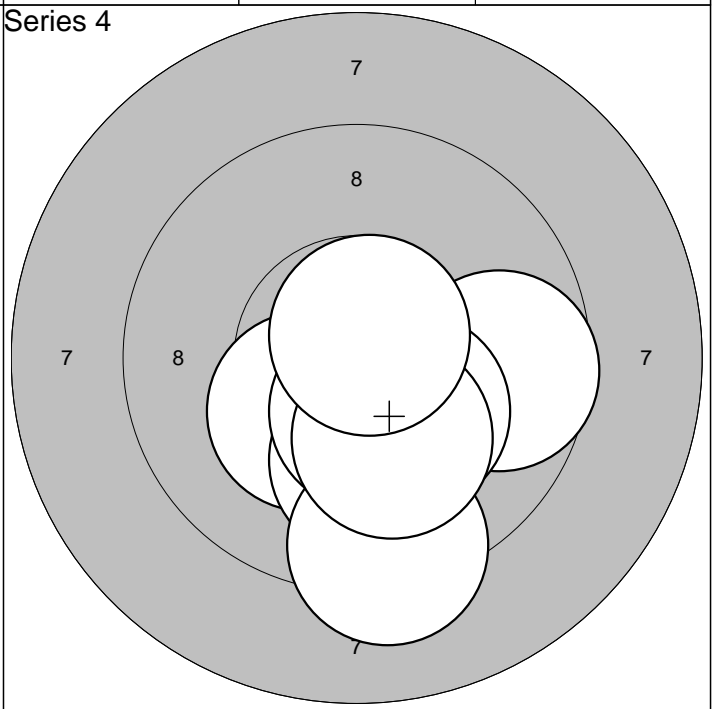

1:10,4* ↘	6:10,5* ↓				
2:10,3* ↖	7: 9,7 →				
3:10,0 ↓	8:10,3* ↘	Serie	98,0		
4: 9,3 ↓	9:10,2* ↓	Sum	387,0		
5:10,6* ↘	10:10,7* ↗				

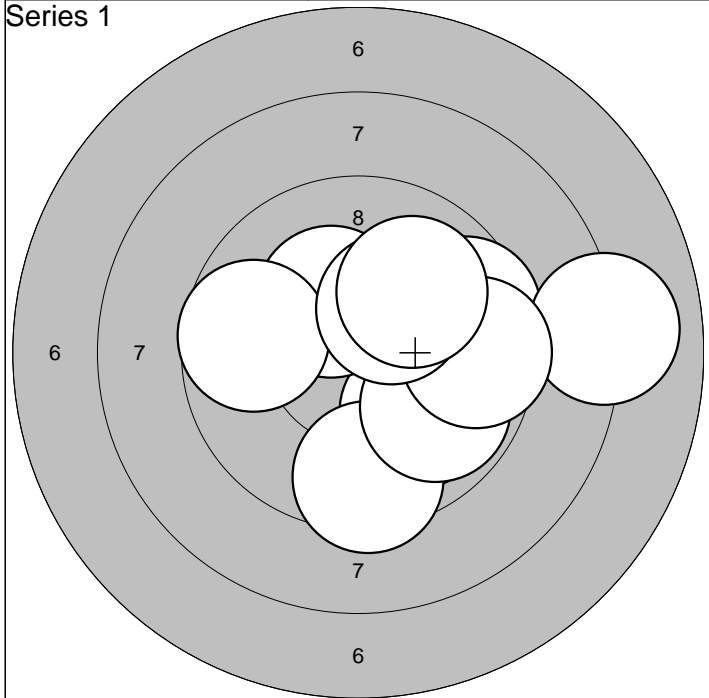

1: 9,9 ↘	6: 9,6 →		Serie	92,0
2: 10,3* ↗	7: 8,0 →			
3: 9,5 ↓	8: 9,6 →	Sum	92,0	
4: 9,7 ←	9: 10,3* ↗			
5: 9,8 ↘	10: 10,0 ↗			

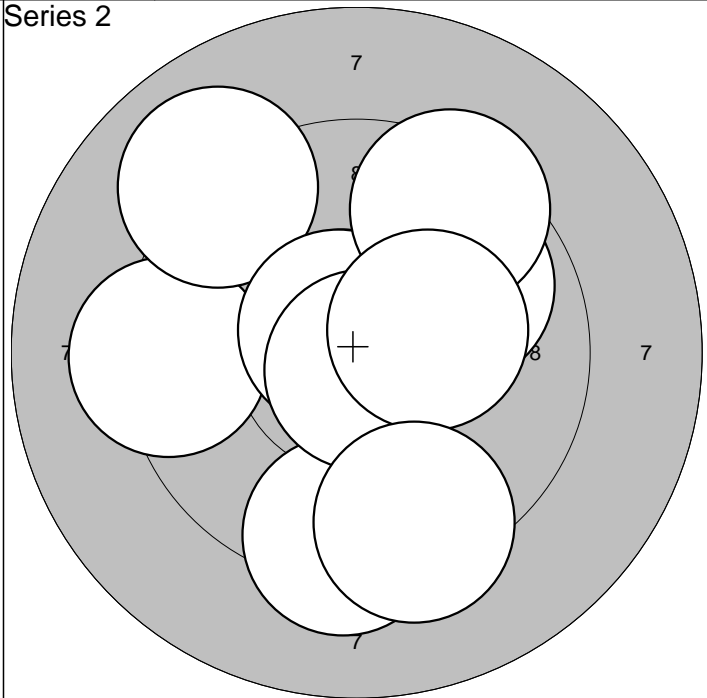

1: 9,3 ←	6: 10,7* ↖		Serie	94,0
2: 9,3 ↓	7: 10,8* ↓			
3: 10,7* ↖	8: 9,4 ↗	Sum	186,0	
4: 9,9 ↗	9: 10,3* →			
5: 9,0 ↖	10: 9,4 ↓			

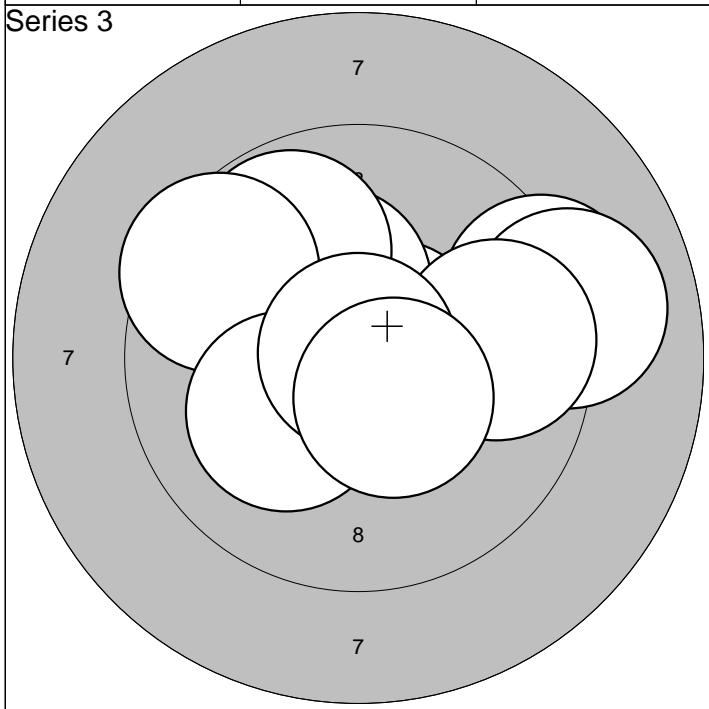

1: 10,6* ↗	6: 9,2 →		Serie	95,0
2: 10,3* ↗	7: 9,0 →			
3: 9,8 ↗	8: 9,7 →	Sum	281,0	
4: 9,5 ↖	9: 10,9* ↑			
5: 10,2* ↙	10: 10,5* ↘			

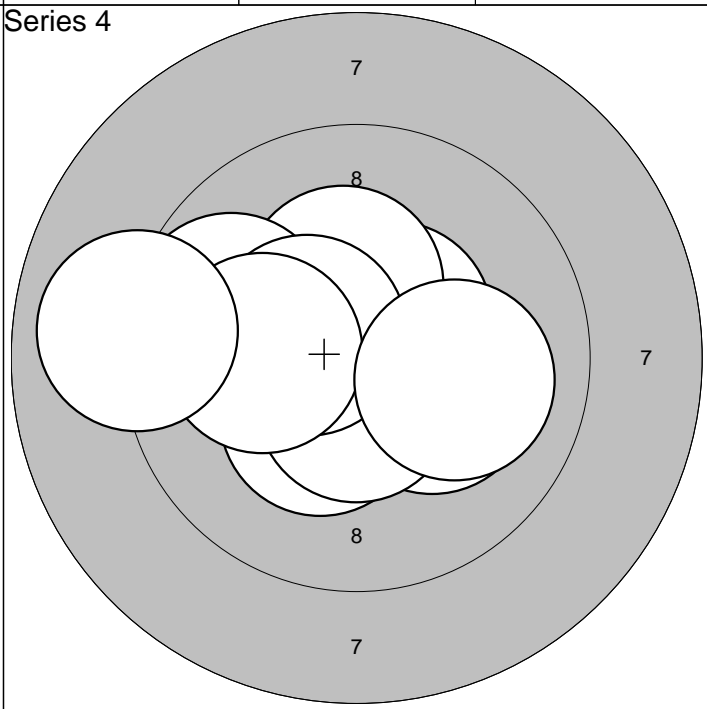

1: 10,5* ↗	6: 10,6* ↓		Serie	98,0
2: 10,3* ↗	7: 10,5* ↖			
3: 10,2* →	8: 10,1 ←	Sum	379,0	
4: 10,3* ↙	9: 9,0 ←			
5: 9,8 ←	10: 10,0 →			

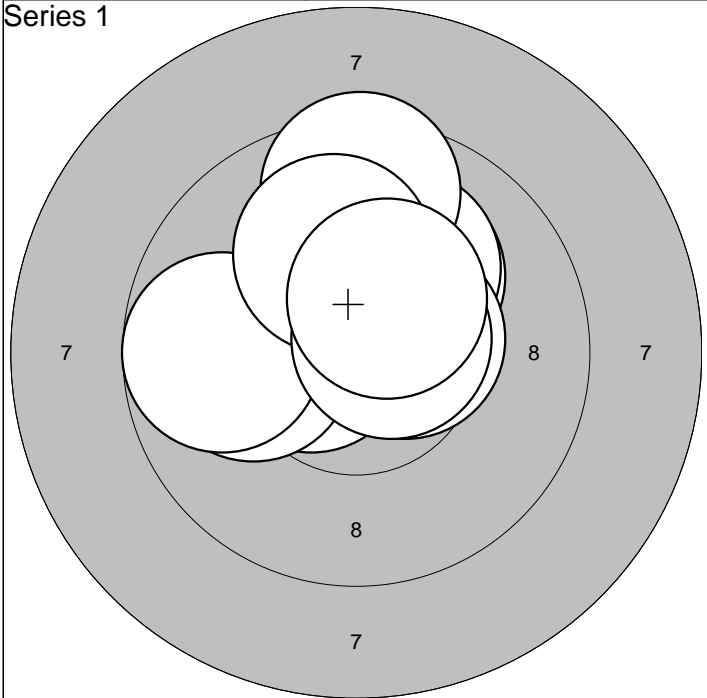

1:10,6* ←	6: 9,5 ↑	Serie	98,0
2:10,0 ←	7:10,0 ↑		
3: 9,7 ←	8:10,5* →	Sum	98,0
4:10,1 ↗	9:10,6* →		
5:10,1 ↗	10:10,4* ↗		

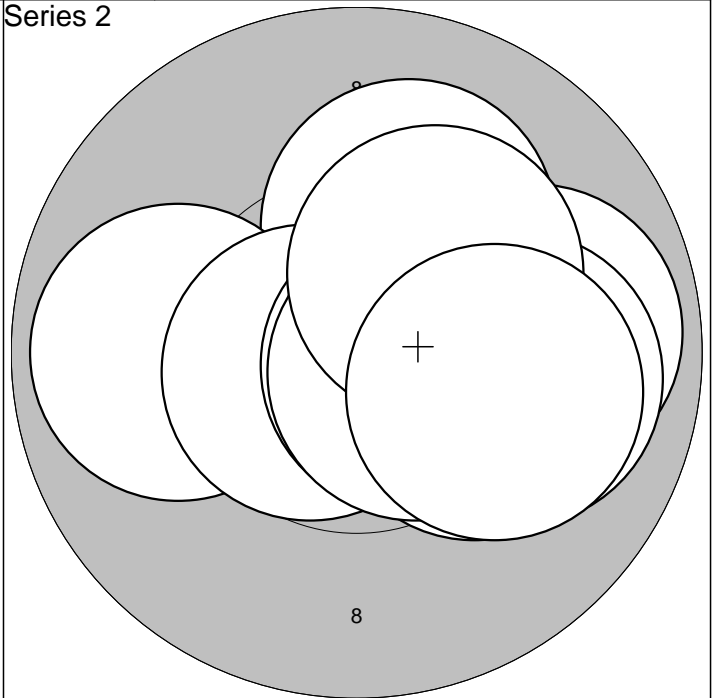

1:10,1 ↗	6:10,0 →	Serie	98,0
2:10,2* →	7:10,6* →		
3: 9,9 ←	8:10,6* →	Sum	196,0
4:10,6* ←	9:10,3* ↗		
5: 9,9 →	10:10,1 →		

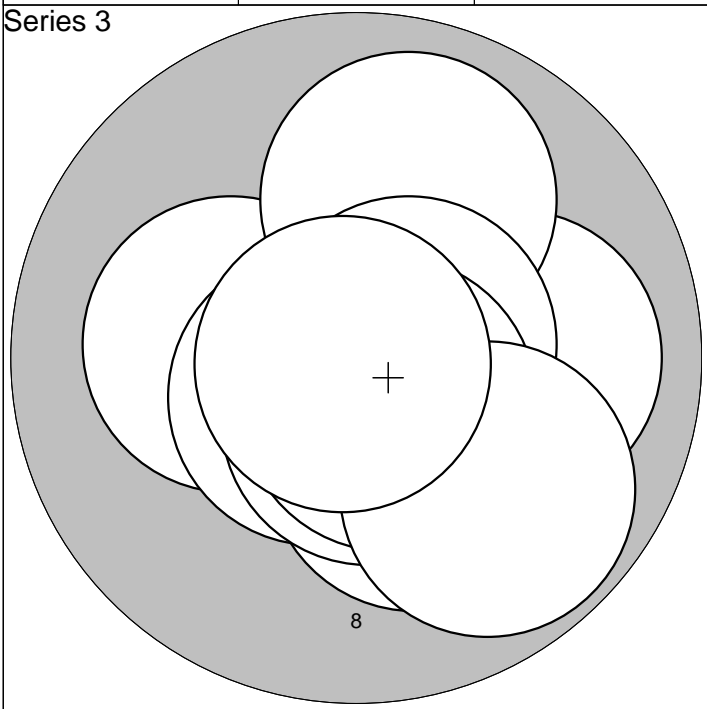

1:10,0 →	6:10,6* →	Serie	98,0
2:10,2* ↘	7:10,6* ↘		
3:10,2* ←	8:10,6* ↘	Sum	294,0
4: 9,9 ↗	9: 9,8 ↘		
5:10,6* ↙	10:10,9* ←		

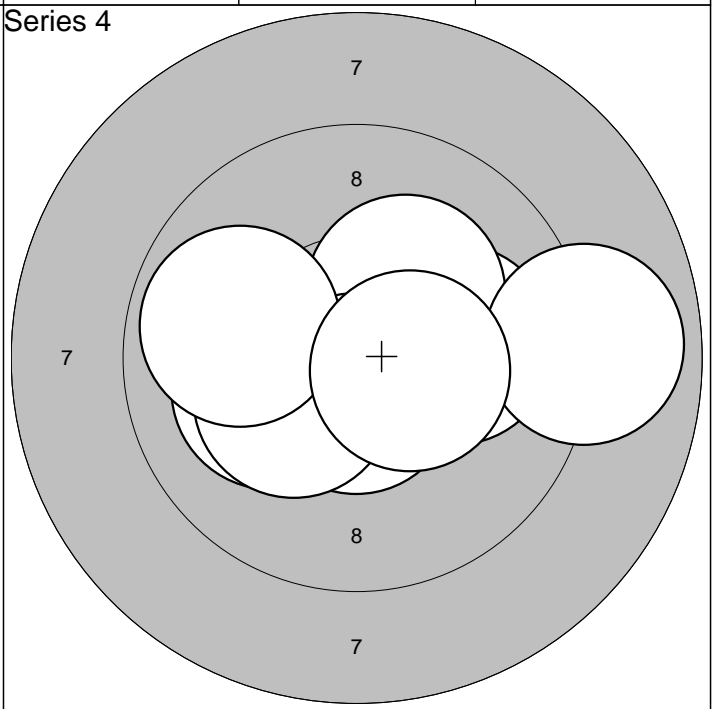

1:10,4* →	6: 8,9 →	Serie	97,0
2:10,1 →	7:10,6* ↓		
3:10,6* →	8:10,3* ←	Sum	391,0
4:10,1 ←	9: 9,9 ←		
5:10,2* ↗	10:10,4* →		

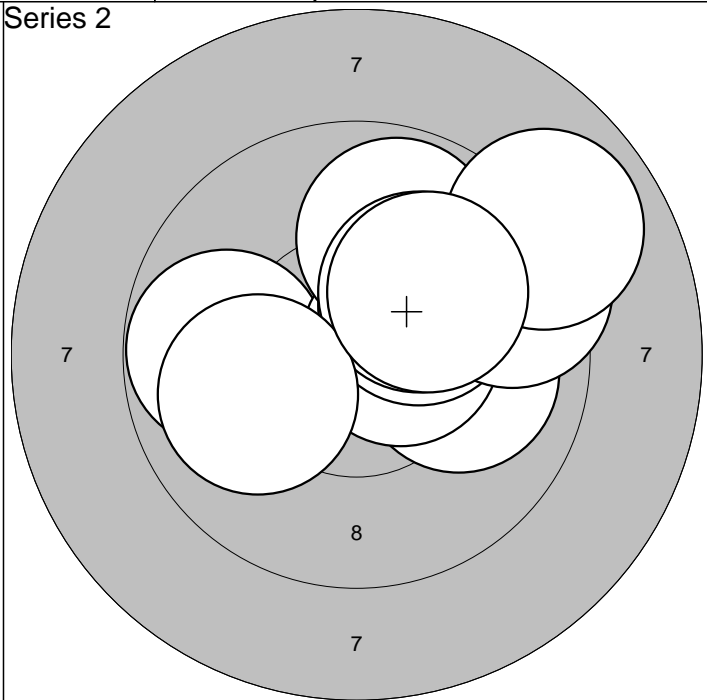
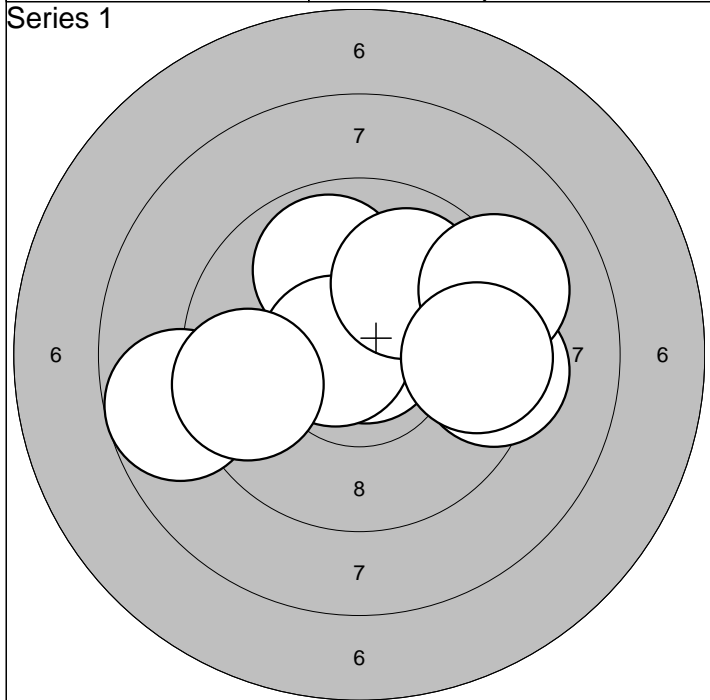

1: 8,7 ←	6: 9,9 ↗	Serie 92,0
2: 9,9 ↗	7: 9,6 ←	
3: 10,0 ↗	8: 9,4 →	Sum 92,0
4: 10,8* ↗	9: 9,2 ↗	
5: 10,7* ←	10: 9,6 →	

1: 10,0 →	6: 9,4 ↗	Serie 95,0
2: 9,8 ←	7: 10,2* ↗	
3: 10,5* →	8: 10,0 ←	Sum 187,0
4: 9,9 ↗	9: 8,9 ↗	
5: 10,2* ↗	10: 10,1 ↗	

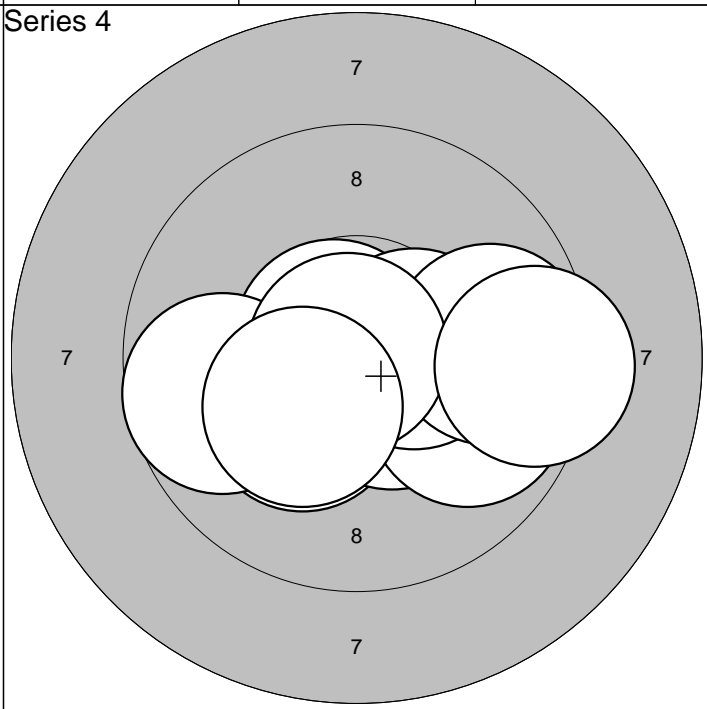
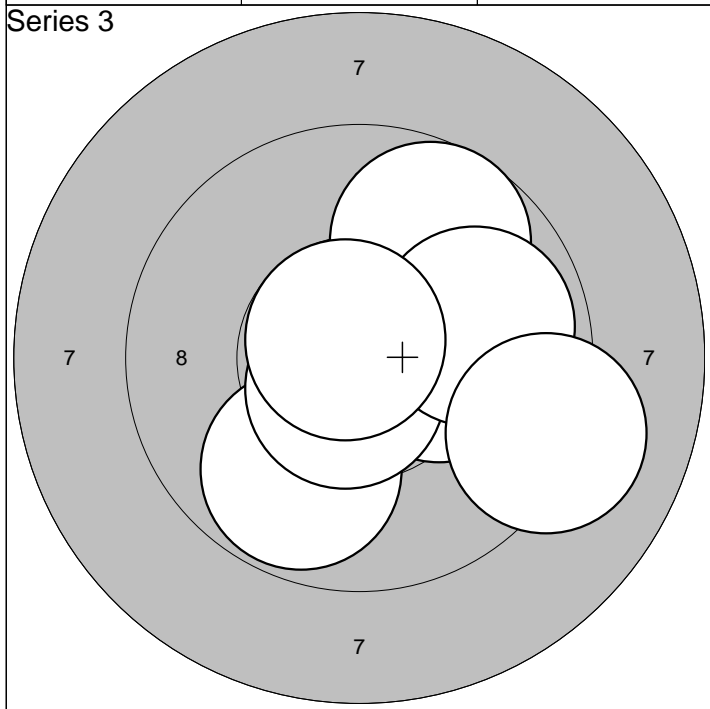

1: 9,8 ↓	6: 9,7 ↗	Serie 96,0
2: 10,2* →	7: 10,7* ↓	
3: 10,5* ↗	8: 9,9 →	Sum 283,0
4: 10,8* ↗	9: 10,8* ↗	
5: 10,8* ↗	10: 9,1 →	

1: 10,3* ↓	6: 9,7 ←	Serie 96,0
2: 10,5* ↓	7: 9,7 →	
3: 10,7* ↗	8: 10,9* ←	Sum 379,0
4: 9,9 →	9: 9,4 →	
5: 10,4* →	10: 10,3* ↓	

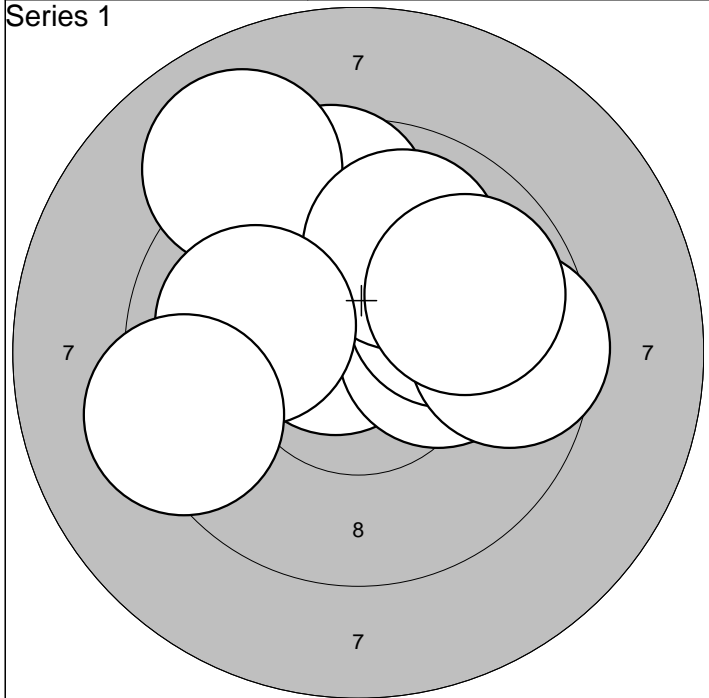

1:10,7* ↖	6: 9,9 ↗	Serie	94,0
2:10,2* →	7: 9,6 →		
3: 9,6 ↑	8:10,0 ←	Sum	94,0
4: 9,0 ↗	9: 9,8 ↗		
5:10,1 ↗	10: 9,3 ←		



1: 9,9 ↖	6: 9,5 ↗	Serie	93,0
2: 9,6 →	7: 9,8 ↗		
3: 9,4 ←	8:10,4* ↗	Sum	187,0
4: 9,1 →	9: 9,8 ↗		
5:10,0 ↗	10:10,3* ↑		

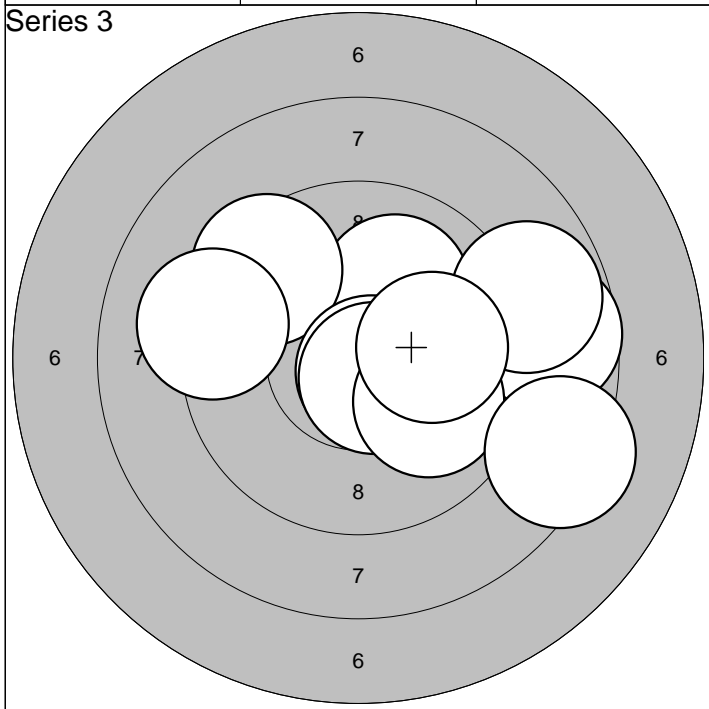

1:10,0 ↗	6: 9,9 ↘	Serie	91,0
2: 9,4 ↗	7: 8,8 →		
3:10,7* ↘	8: 9,2 ←	Sum	278,0
4:10,6* ↘	9:10,1 →		
5: 8,7 →	10: 8,3 ↘		

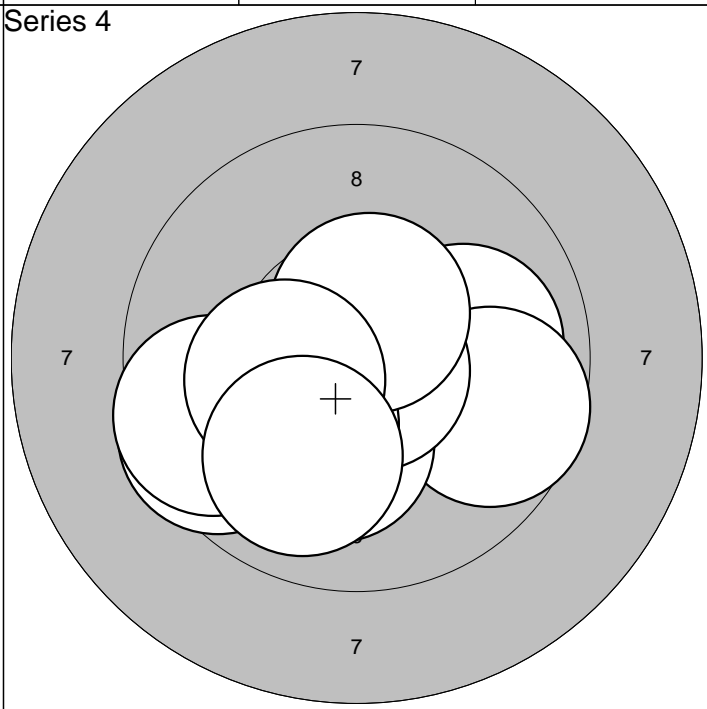

1:10,0 →	6:10,2* ↘	Serie	96,0
2: 9,7 →	7:10,5* ↑		
3:10,2* ↓	8: 9,6 ←	Sum	374,0
4:10,8* ↘	9:10,3* ←		
5: 9,5 ←	10: 9,9 ↘		

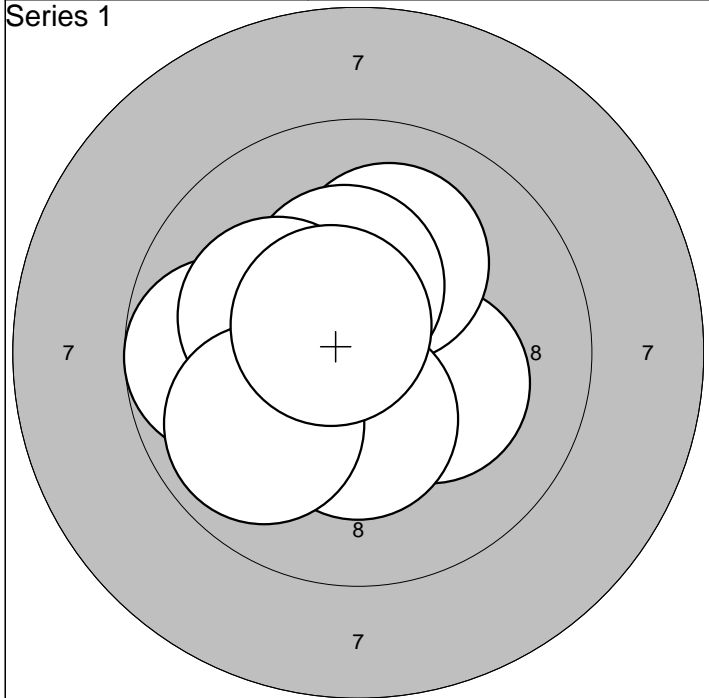

1: 9,8 ←	6: 10,3* ↑	Serie	98,0
2: 10,4* →	7: 10,4* ↓		
3: 10,2* →	8: 10,2* ←	Sum	98,0
4: 10,1 ↑	9: 9,9 ←		
5: 10,4* ↗	10: 10,6* ↗		

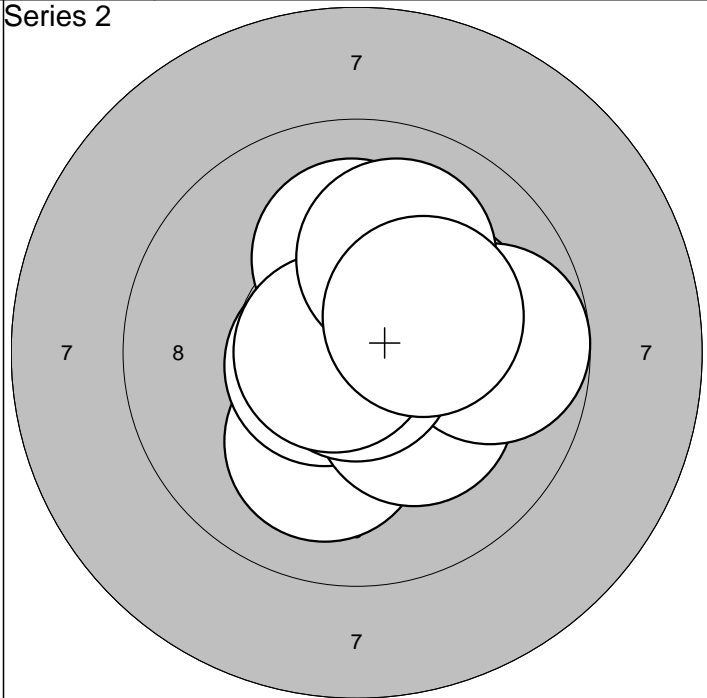

1: 10,2* →	6: 9,7 →	Serie	99,0
2: 10,1 ↓	7: 10,9* ↓		
3: 10,6* ←	8: 10,7* ←	Sum	197,0
4: 10,1 ↑	9: 10,0 ↑		
5: 10,2* ↘	10: 10,3* →		

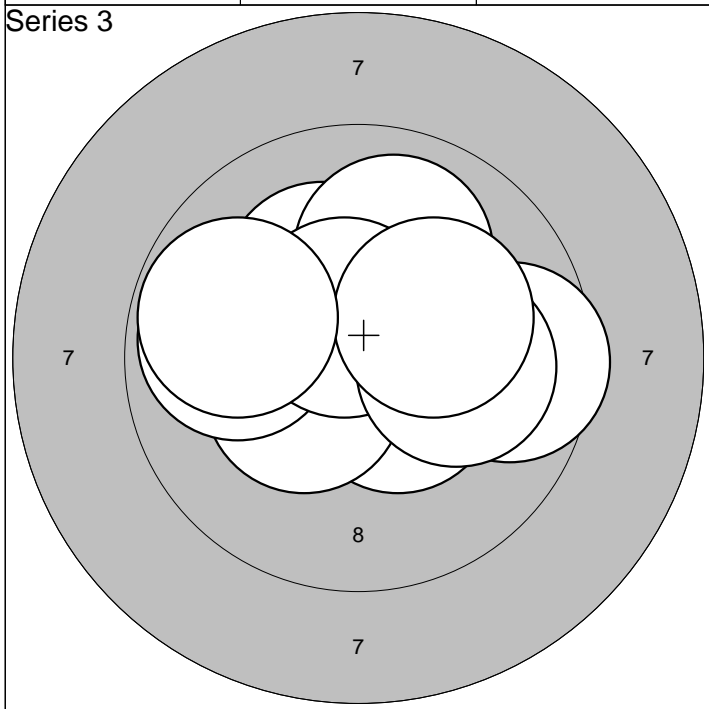

1: 9,6 →	6: 9,8 ←	Serie	97,0
2: 10,2* ↑	7: 10,6* ↑		
3: 10,4* ↓	8: 10,1 →	Sum	294,0
4: 10,4* ←	9: 10,2* →		
5: 10,0 ↑	10: 9,8 ←		

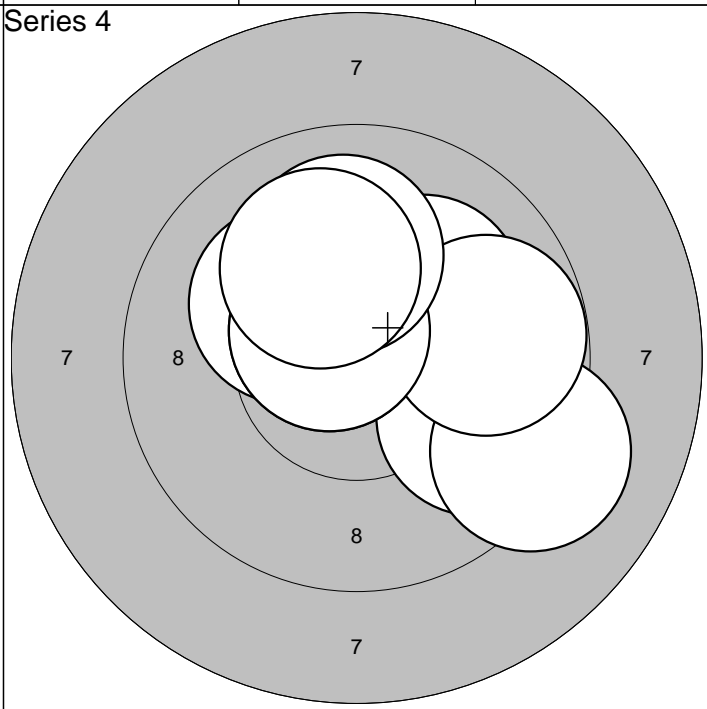

1: 9,7 ↘	6: 10,1 ↗	Serie	97,0
2: 9,2 ↘	7: 9,8 →		
3: 10,3* ↑	8: 10,6* ←	Sum	391,0
4: 10,2* ←	9: 10,0 ↑		
5: 10,6* ↗	10: 10,1 ↑		

Lag
6

Skive
11

Linn Larsen Glemmestad

Day 2, Rifle

Nordstrand SS

ARW

3-6.1.2010

Swedish Cup 2010

Swedishcup 10

Series 1

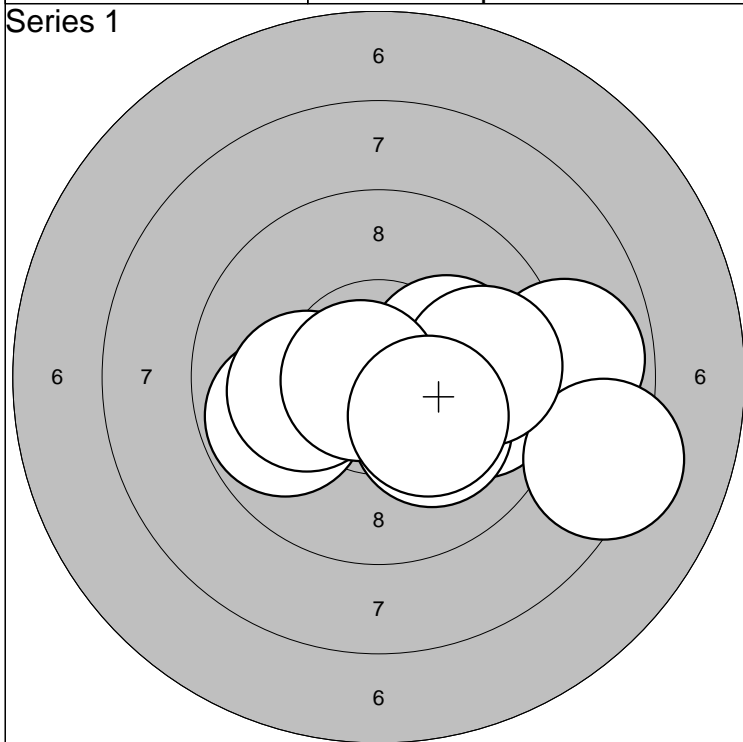

Series 2

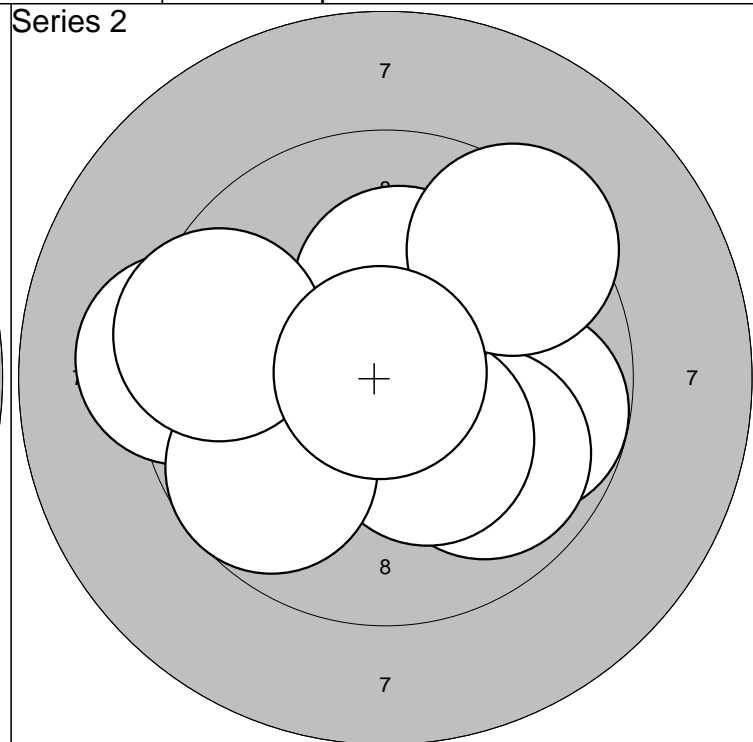

1: 9,8	→	6: 8,9	→	Serie	93,0
2: 10,2*	→	7: 8,3	→		
3: 9,8	←	8: 9,8	→	Sum	93,0
4: 10,1	↓	9: 10,7*	←		
5: 10,1	←	10: 10,2*	↓		

1: 10,5*	←	6: 10,2*	↑	Serie	94,0
2: 9,2	←	7: 9,7	←		
3: 9,8	→	8: 9,4	↗	Sum	187,0
4: 9,9	↓	9: 9,5	←		
5: 10,3*	↓	10: 10,9*	↗		

Series 3



Series 4

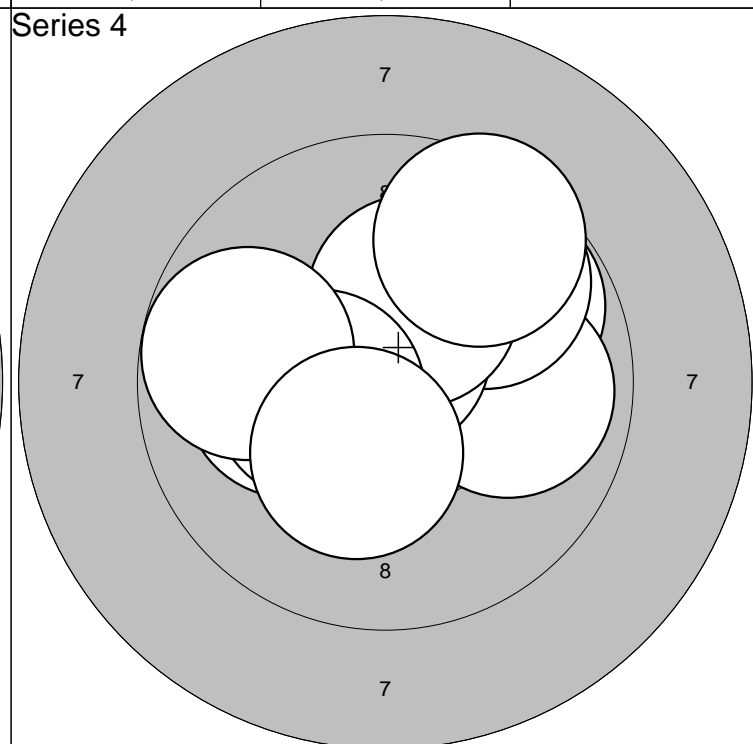

1: 9,8	↗	6: 8,5	←	Serie	94,0
2: 10,6*	→	7: 10,5*	←		
3: 10,6*	↗	8: 10,8*	→	Sum	281,0
4: 9,8	←	9: 9,8	←		
5: 10,1	↓	10: 9,8	↗		

1: 9,8	↗	6: 10,2*	↑	Serie	95,0
2: 9,9	→	7: 9,5	↗		
3: 9,8	↗	8: 10,4*	←	Sum	376,0
4: 10,2*	←	9: 9,7	←		
5: 10,7*	↑	10: 10,3*	↓		

Edman Precision, Morini, Interprodukter

Sävsjö kommun, Sävsjö Skytte Center

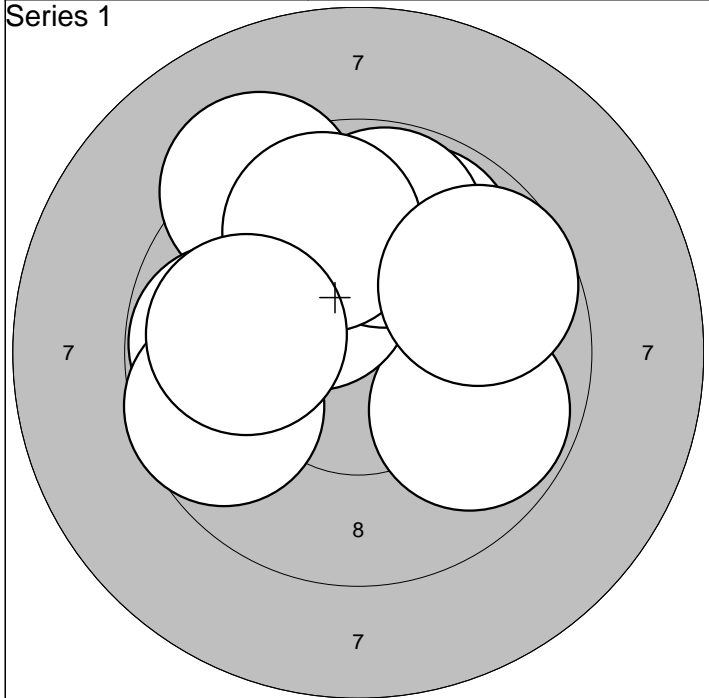

1: 9,3 ↗	6: 9,8 ↑	Serie	91,0
2: 9,8 ←	7: 9,8 ↑		
3: 9,9 ↗	8: 9,7 ←	Sum	91,0
4: 9,8 ↘	9: 9,9 ←		
5: 10,3* ↗	10: 9,7 ↗		

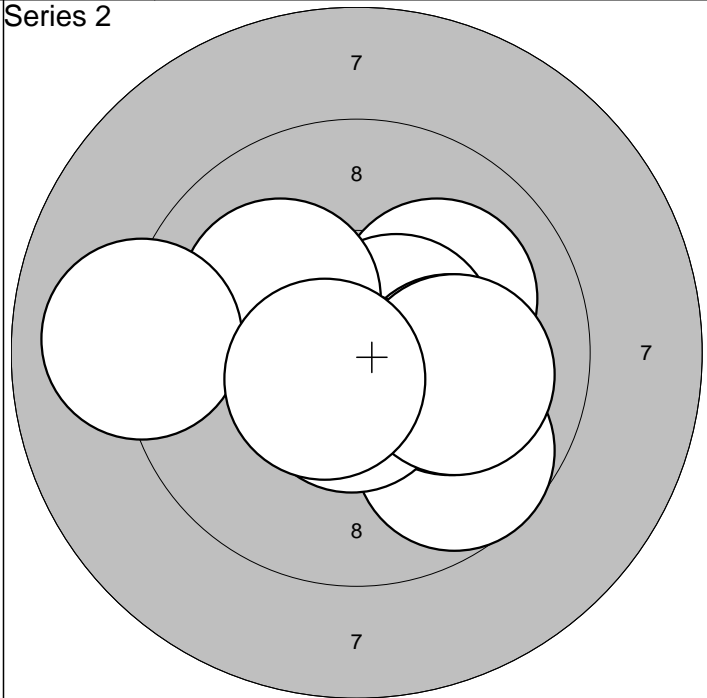

1: 10,3* →	6: 9,7 ↘	Serie	98,0
2: 10,1 ↗	7: 10,1 →		
3: 10,5* →	8: 10,6* ↓	Sum	189,0
4: 10,1 ↗	9: 10,0 →		
5: 9,0 ←	10: 10,6* ↙		

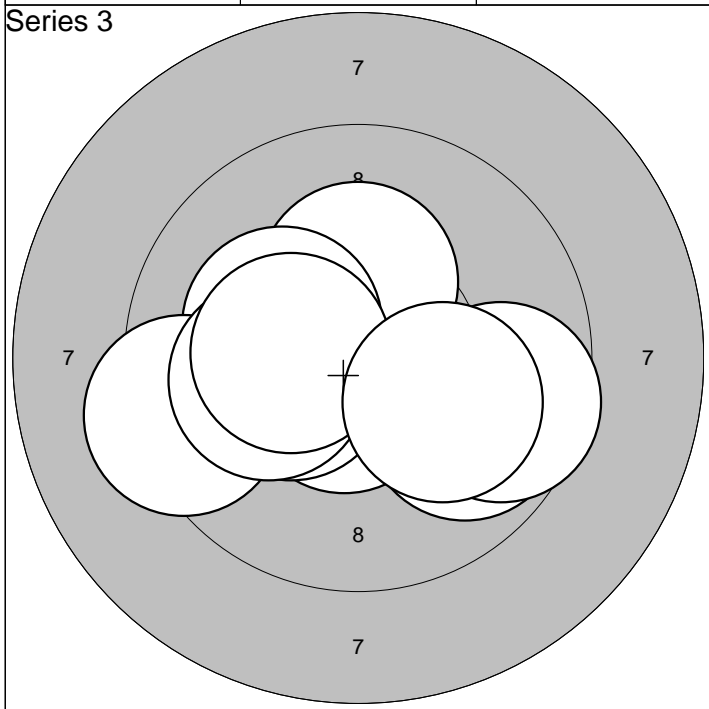

1: 10,6* ↓	6: 9,9 ↘	Serie	97,0
2: 10,3* ←	7: 10,1 ←		
3: 10,3* ↑	8: 10,4* ←	Sum	286,0
4: 10,2* ←	9: 9,6 →		
5: 9,3 ←	10: 10,1 ↘		

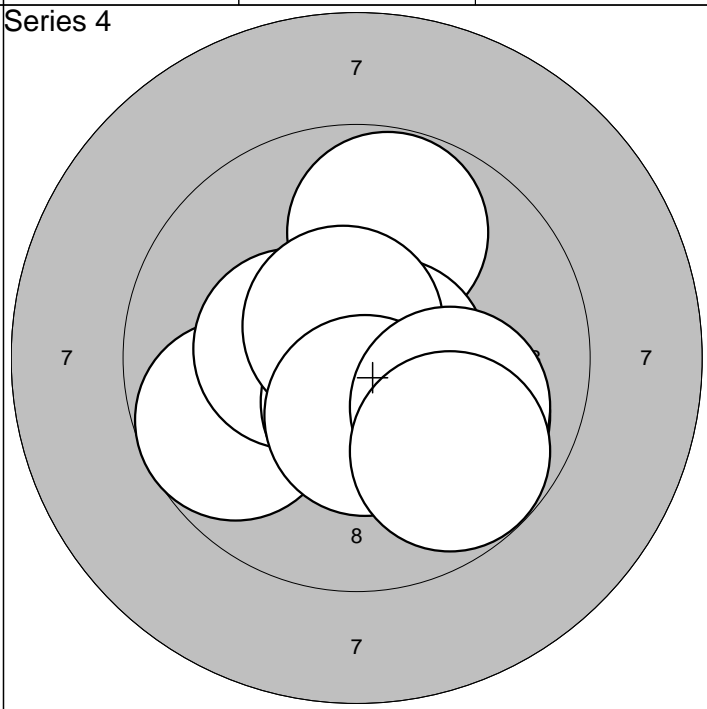

1: 9,7 ←	6: 10,6* ↗	Serie	96,0
2: 9,8 ↑	7: 9,9 ↘		
3: 10,4* ←	8: 10,4* ↓	Sum	382,0
4: 10,7* →	9: 10,0 →		
5: 10,6* ↓	10: 9,7 ↘		

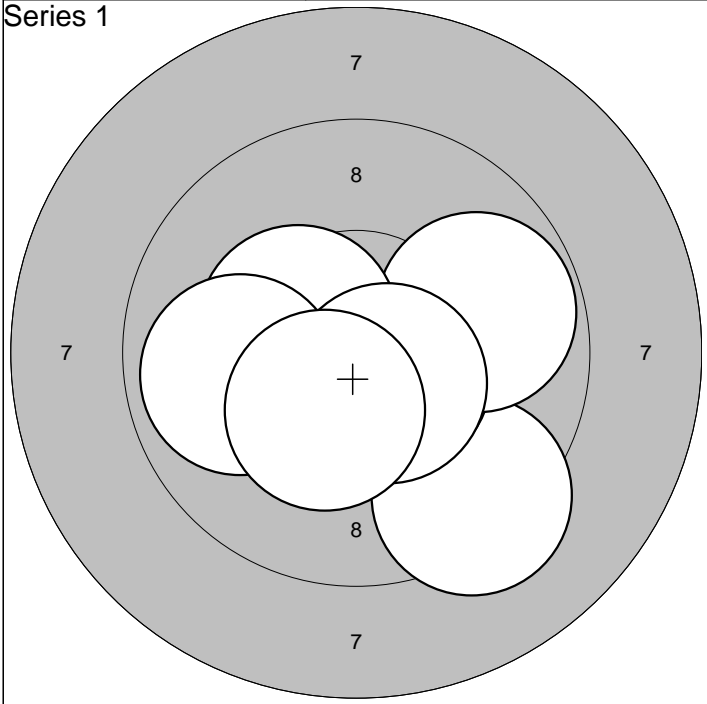

1:10,6* ←	6:10,2* ←		Serie	97,0
2: 9,3 ↘	7:10,4* ↖			
3:10,6* ↘	8:10,6* ↘	Sum	97,0	
4:10,5* ↘	9: 9,9 ←			
5: 9,8 →	10:10,3* ↘			

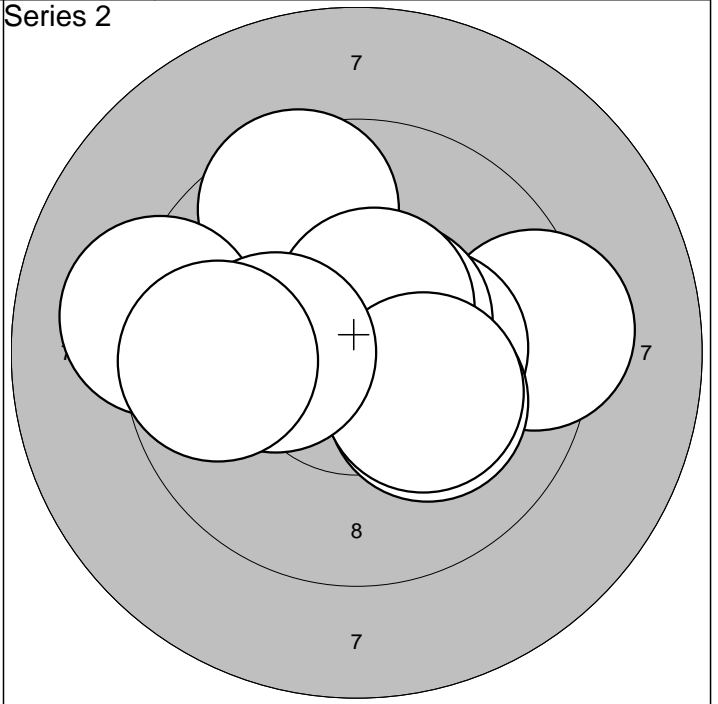

1: 9,3 →	6:10,5* ↗		Serie	96,0
2: 9,6 ↗	7:10,2* ↘			
3:10,3* →	8:10,3* ↘	Sum	193,0	
4:10,5* ↗	9:10,2* ←			
5: 9,2 ←	10: 9,7 ←			

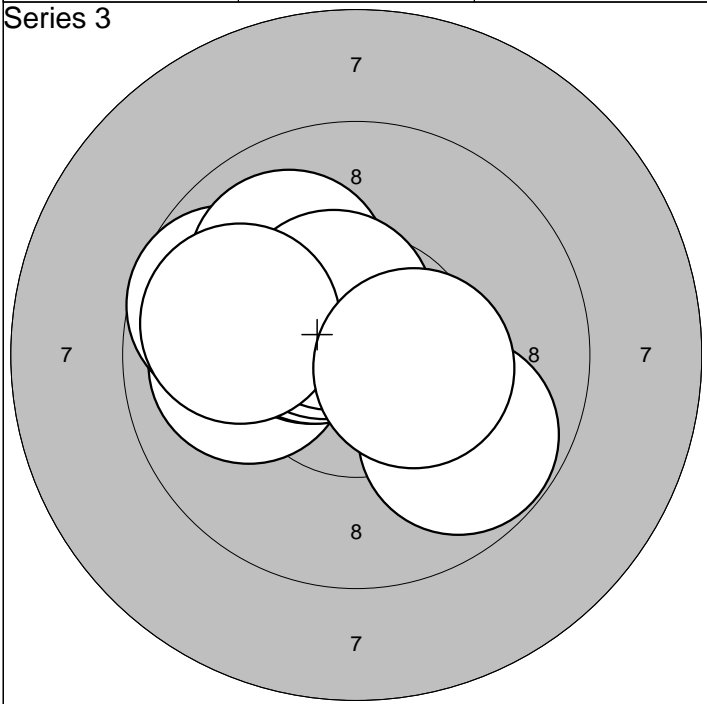

1:10,0 ←	6:10,5* ↗		Serie	97,0
2: 9,7 ↖	7: 9,8 ↘			
3:10,5* ↗	8:10,5* ↗	Sum	290,0	
4:10,0 ↗	9: 9,9 ←			
5:10,5* ↗	10:10,4* →			

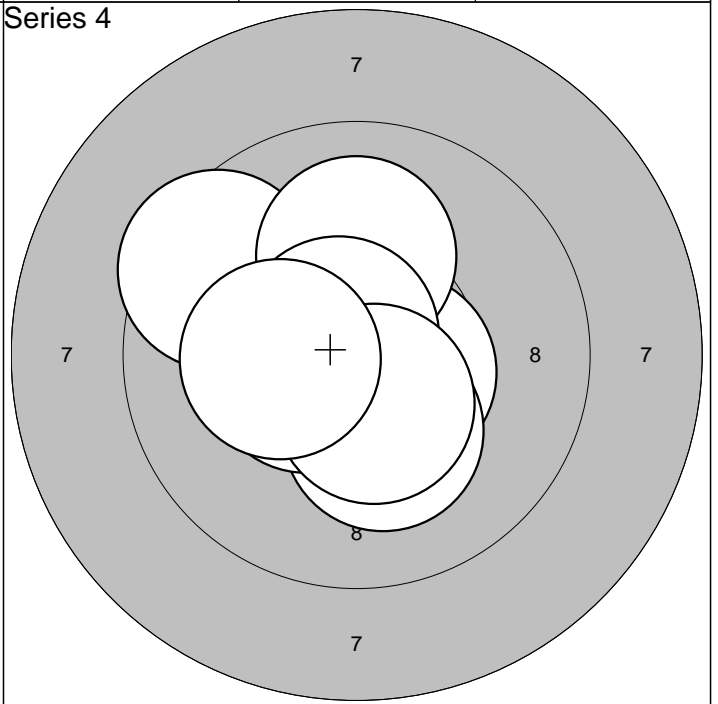

1: 9,5 ↖	6:10,5* ←		Serie	99,0
2:10,6* ↗	7:10,1 ↗			
3:10,5* ↘	8:10,7* ↖	Sum	389,0	
4:10,4* ←	9:10,5* ↘			
5:10,2* ↘	10:10,3* ←			

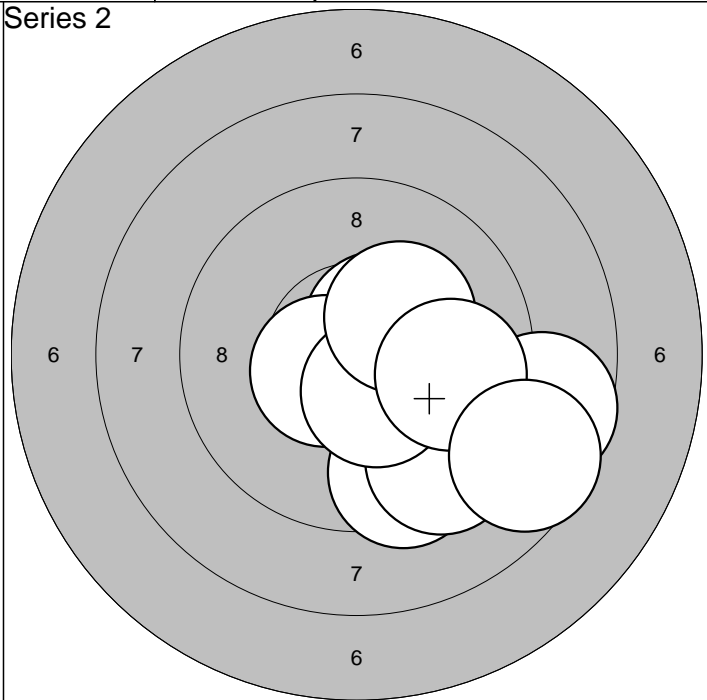
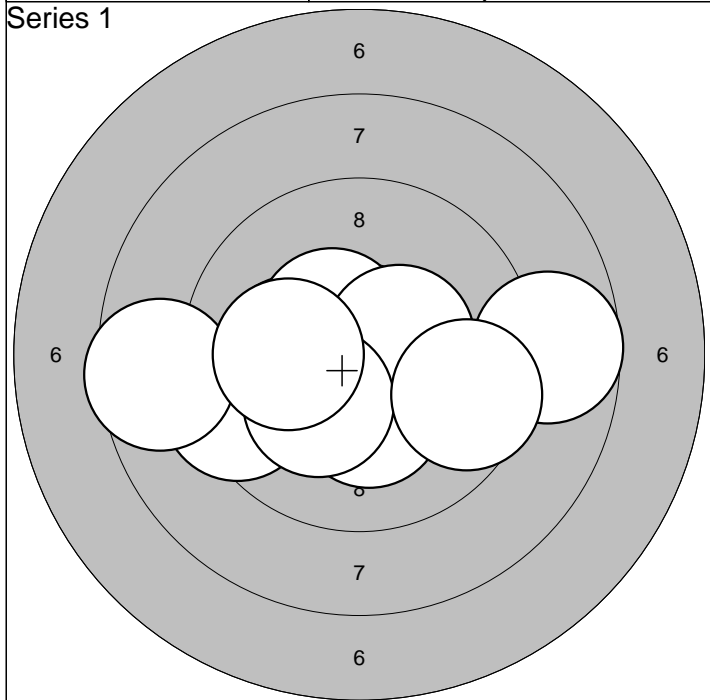

1:10,2* ←	6:10,5* →		Serie	94,0
2:10,5* ↘	7: 8,7 →			
3: 9,4 ←	8:10,2* ↙	Sum	94,0	
4: 8,6 ←	9:10,1 ←			
5:10,3* ↓	10: 9,6 →			

1: 8,6 →	6:10,5* ←		Serie	92,0
2: 9,4 ↓	7:10,5* ↓			
3:10,5* ↗	8:10,3* ↗	Sum	186,0	
4: 9,7 ↘	9: 9,8 →			
5: 9,4 ↓	10: 8,6 ↘			

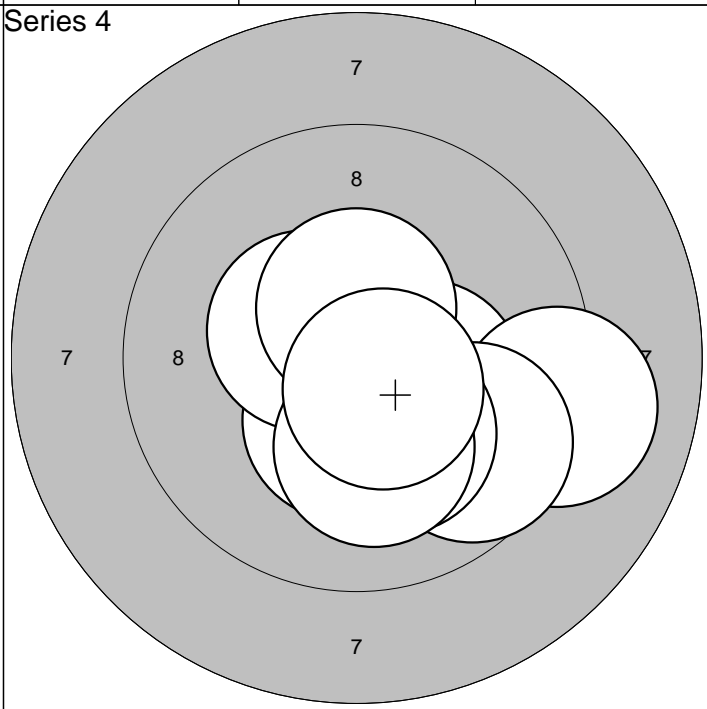
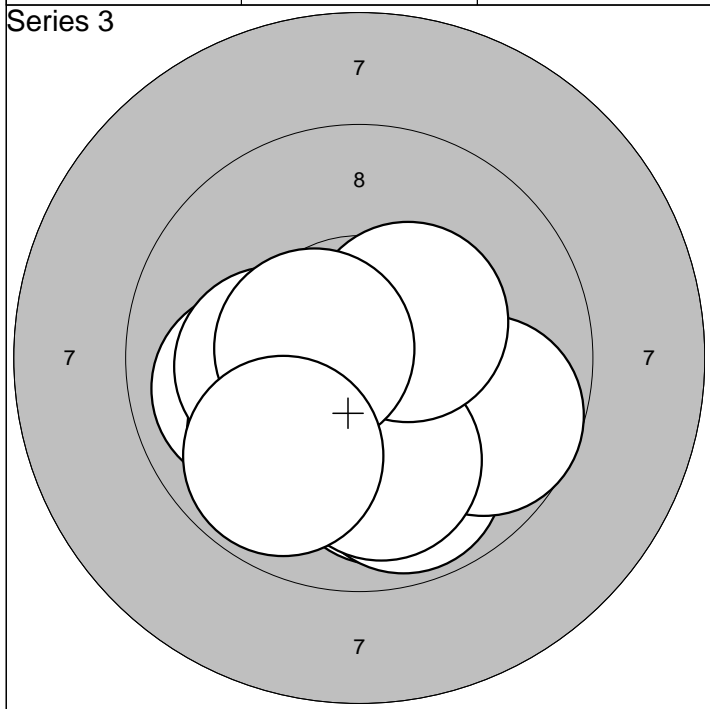

1:10,0 ←	6: 9,7 →		Serie	97,0
2:10,0 ↙	7:10,0 ↓			
3:10,2* ←	8:10,4* ↗	Sum	283,0	
4:10,0 ↓	9:10,5* ←			
5: 9,8 ↓	10: 9,9 ↙			

1:10,6* ↓	6: 9,6 ↓		Serie	98,0
2:10,4* ↓	7:10,2* ↓			
3:10,3* →	8:10,1 ↓	Sum	381,0	
4: 9,1 →	9:10,5* ↑			
5:10,4* ↗	10:10,6* ↓			

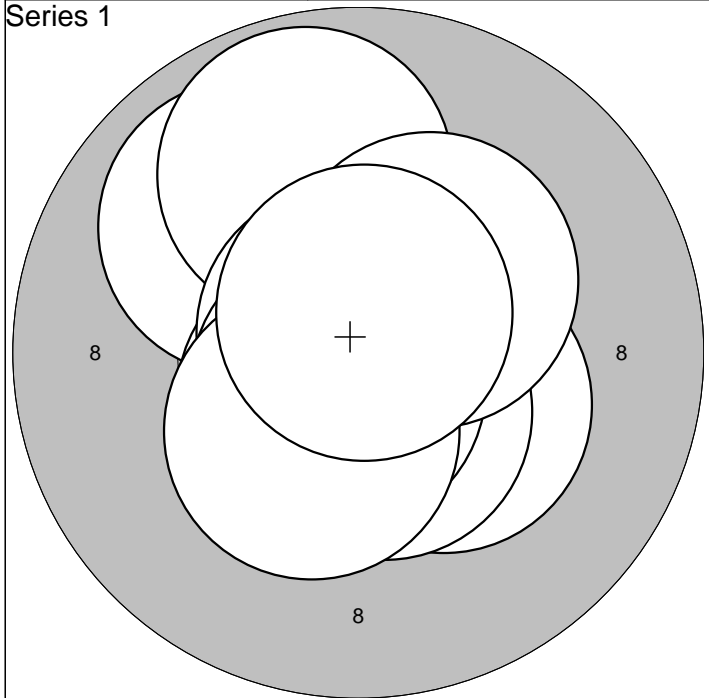

1:10,3* ↘	6:10,6* ↓		Serie	98,0
2: 9,9 ↗	7:10,7* ↓			
3:10,6* ↘	8:10,3* ↗	Sum	98,0	
4: 9,8 ↑	9:10,4* ↓			
5:10,8* ↗	10:10,7* ↑			

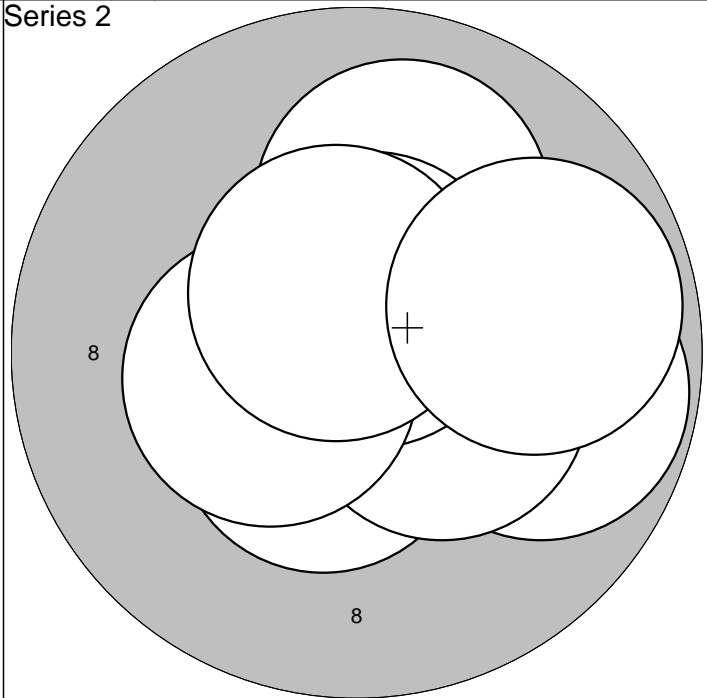

1: 9,8 →	6:10,0 ↑		Serie	98,0
2:10,5* ↑	7:10,6* ↑			
3:10,5* ↓	8:10,4* ←	Sum	196,0	
4:10,1 →	9:10,6* ↑			
5:10,4* →	10: 9,8 →			

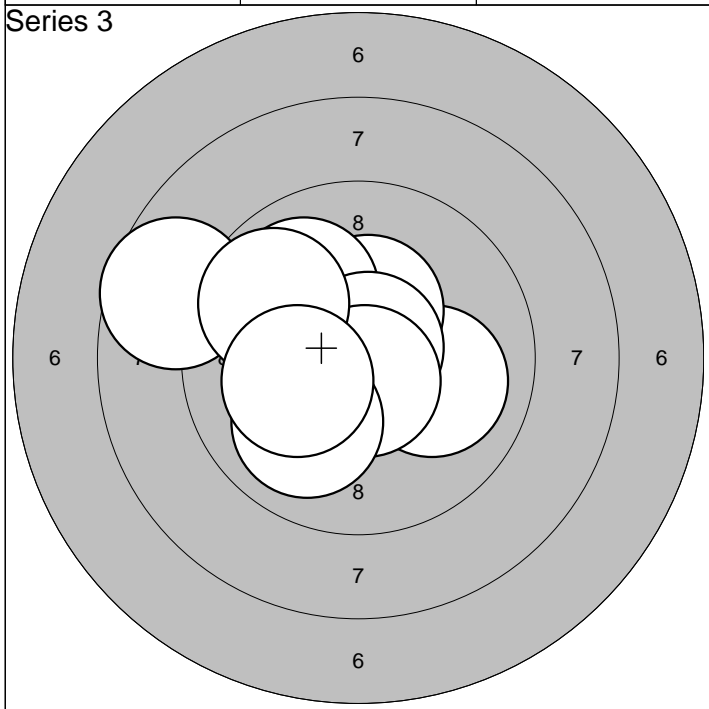

1:10,4* ←	6:10,6* ↓		Serie	96,0
2:10,0 →	7: 8,7 ←			
3:10,4* ↑	8: 9,8 ↖	Sum	292,0	
4: 9,9 ↗	9:10,0 ↓			
5:10,8* ↗	10:10,2* ←			

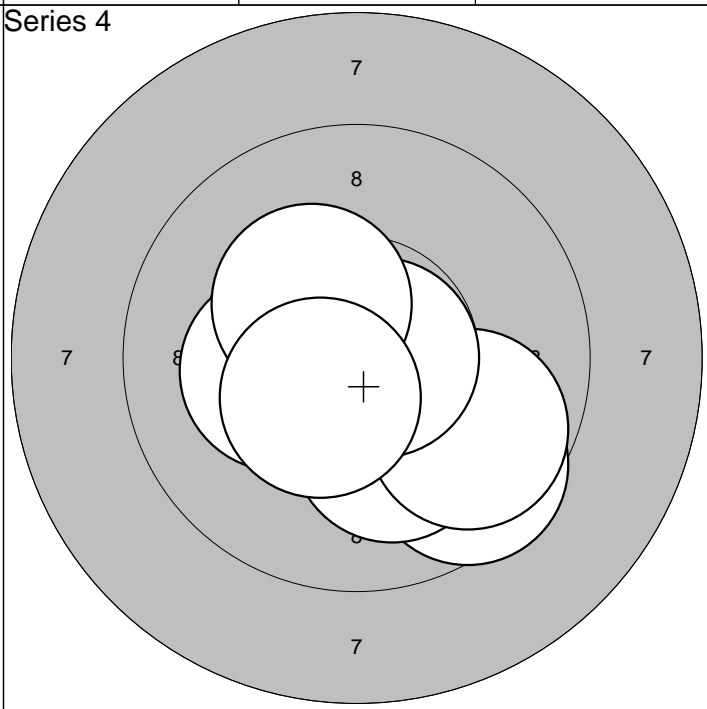

1: 9,6 ↓	6:10,4* ↖		Serie	98,0
2:10,3* ↓	7:10,3* ←			
3:10,5* ←	8:10,7* →	Sum	390,0	
4:10,1 ↓	9:10,3* ↗			
5: 9,8 →	10:10,5* ↓			

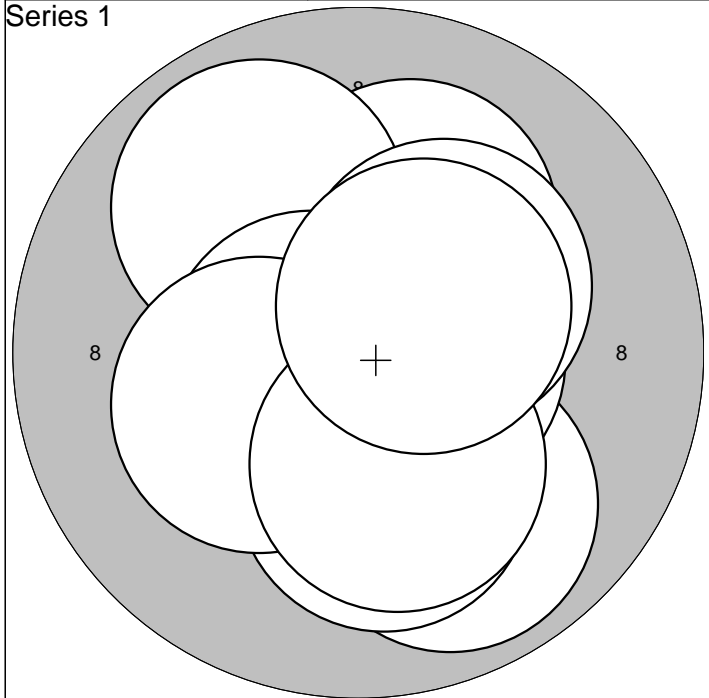

1: 9,9 ↓	6:10,7* ←	Serie	98,0
2:10,1 ↑	7:10,2* ↓		
3:10,6* →	8:10,3* ←	Sum	98,0
4: 9,9 ↗	9:10,2* ↓		
5:10,3* ↘	10:10,5* ↗		

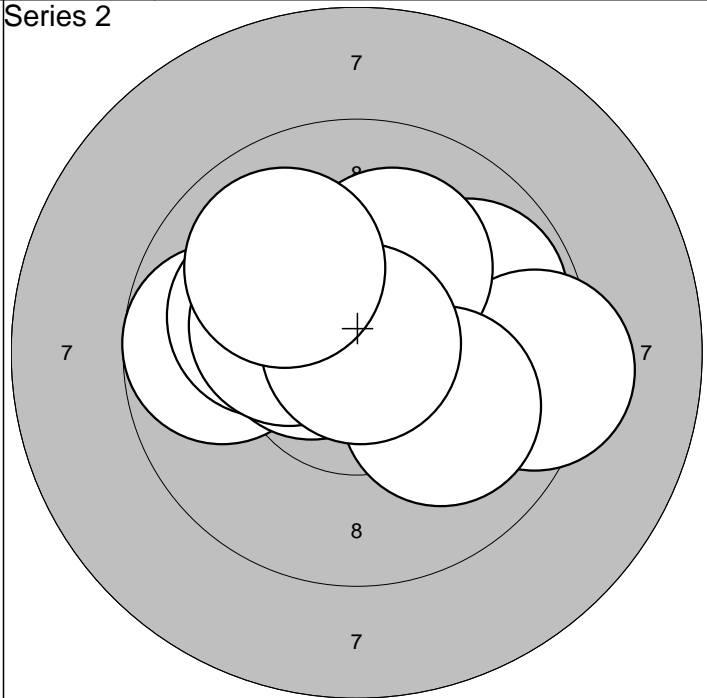

1: 9,8 ←	6:10,5* ←	Serie	97,0
2: 9,8 ↗	7:10,1 ←		
3: 9,3 →	8:10,3* ←	Sum	195,0
4:10,1 ↑	9:10,9* ↑		
5:10,1 ↓	10:10,0 ↖		

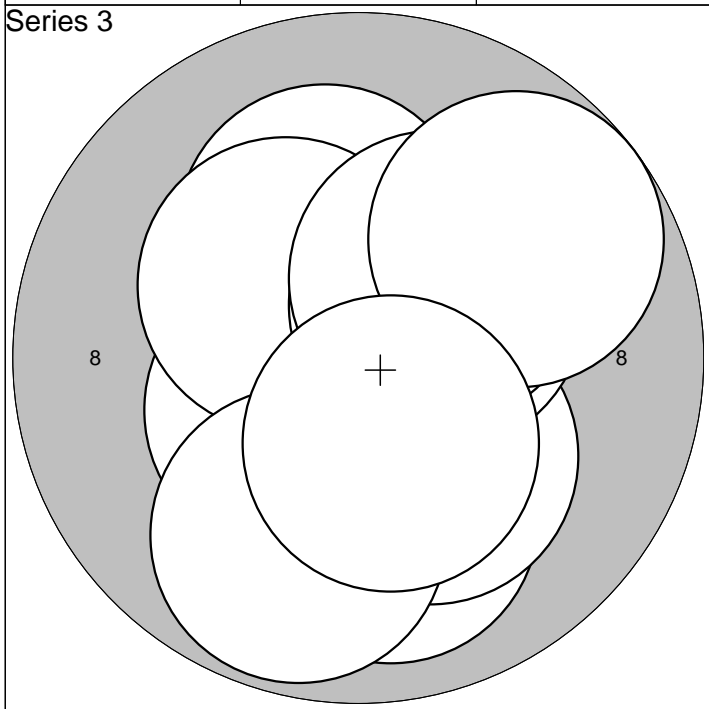

1:10,0 ↓	6:10,4* ↗	Serie	98,0
2:10,2* ↑	7: 9,8 ↓		
3:10,4* ↖	8:10,3* ↗	Sum	293,0
4:10,2* ↓	9: 9,7 ↗		
5:10,3* ↖	10:10,4* ↓		

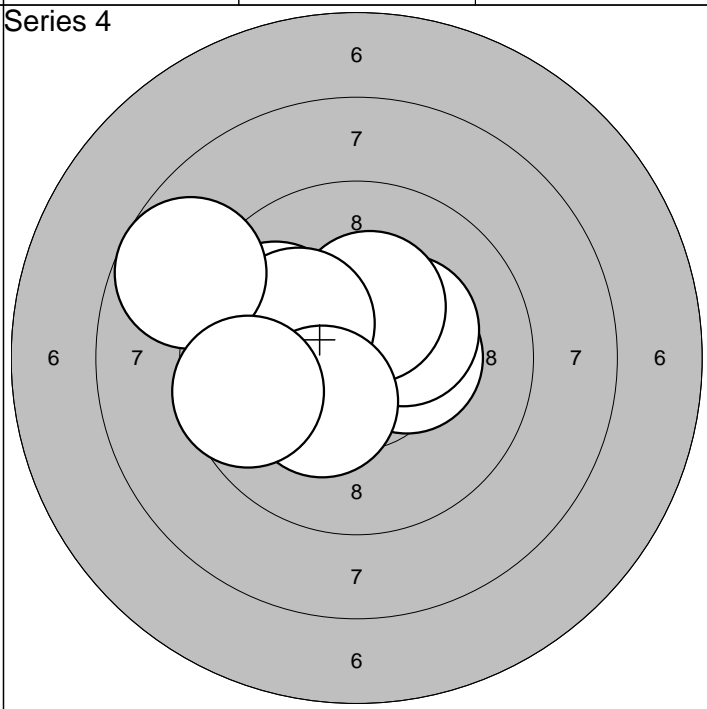

1:10,6* →	6:10,1 ←	Serie	96,0
2:10,3* →	7:10,2* ←		
3:10,3* ↗	8: 8,8 ←	Sum	389,0
4: 9,9 ↖	9:10,3* ↖		
5:10,3* ↑	10: 9,6 ←		

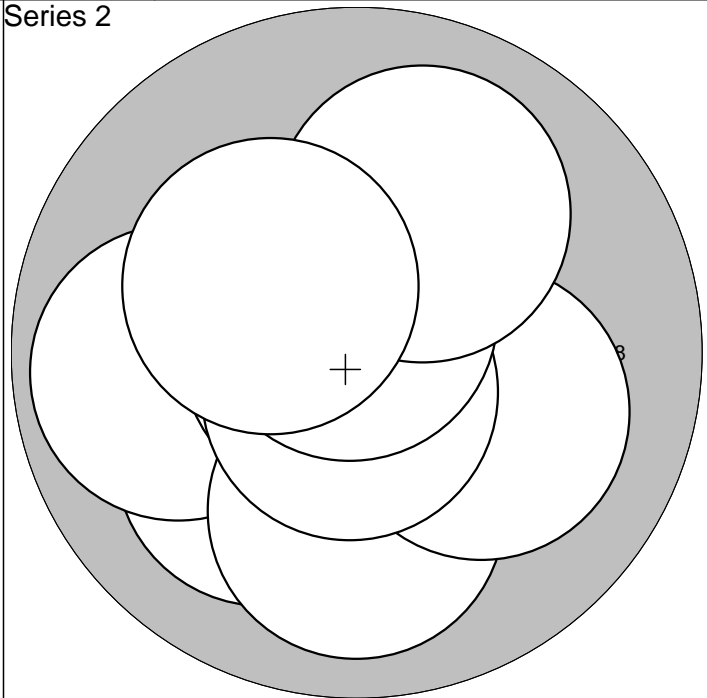
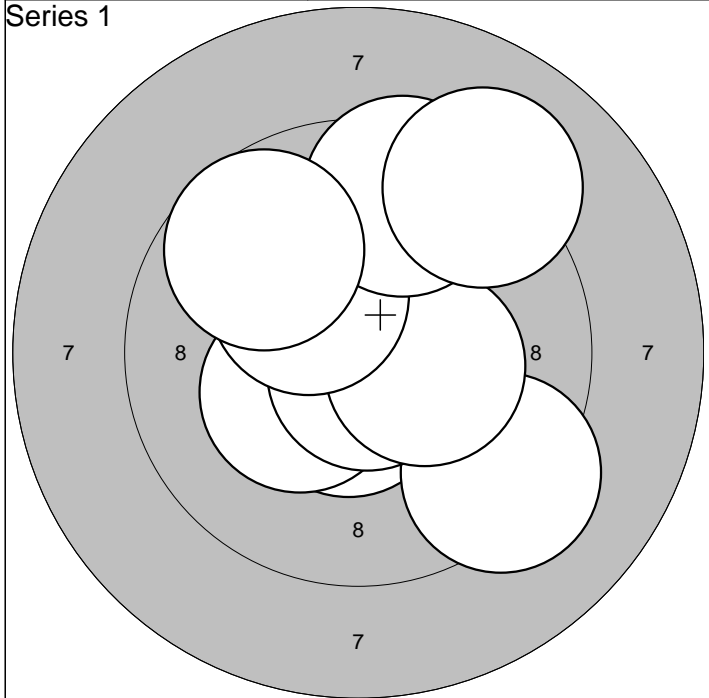

1:10,6* ↓	6:10,4* →		Serie	95,0
2:10,3* ↙	7:10,3* ↗			
3: 9,3 ↘	8: 9,5 ↑	Sum	95,0	
4:10,8* ↓	9: 9,7 ↗			
5: 9,7 ↑	10: 9,1 ↗			

1:10,1 ↙	6:10,8* ←		Serie	99,0
2:10,4* →	7:10,7* ↓			
3: 9,9 ←	8:10,7* ↑	Sum	194,0	
4:10,0 ↓	9:10,0 ↗			
5:10,1 →	10:10,3* ↖			

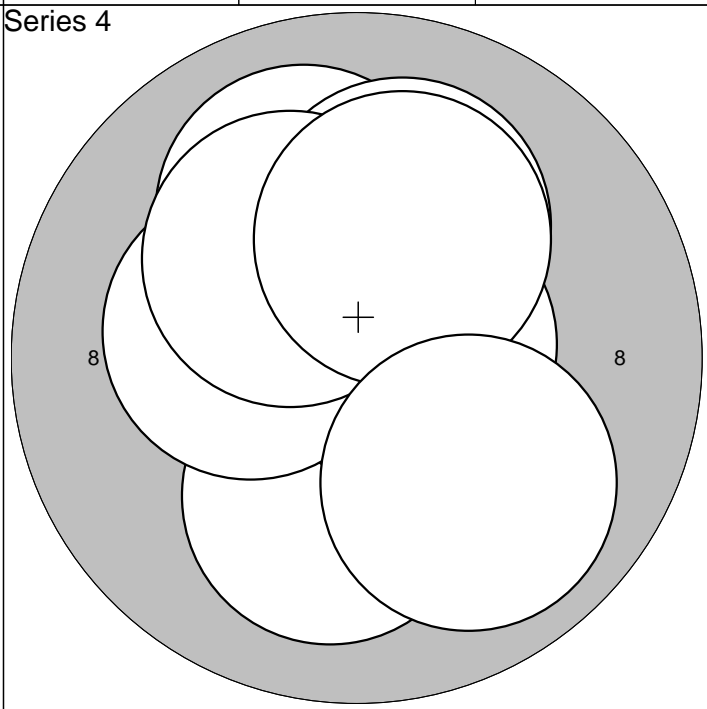
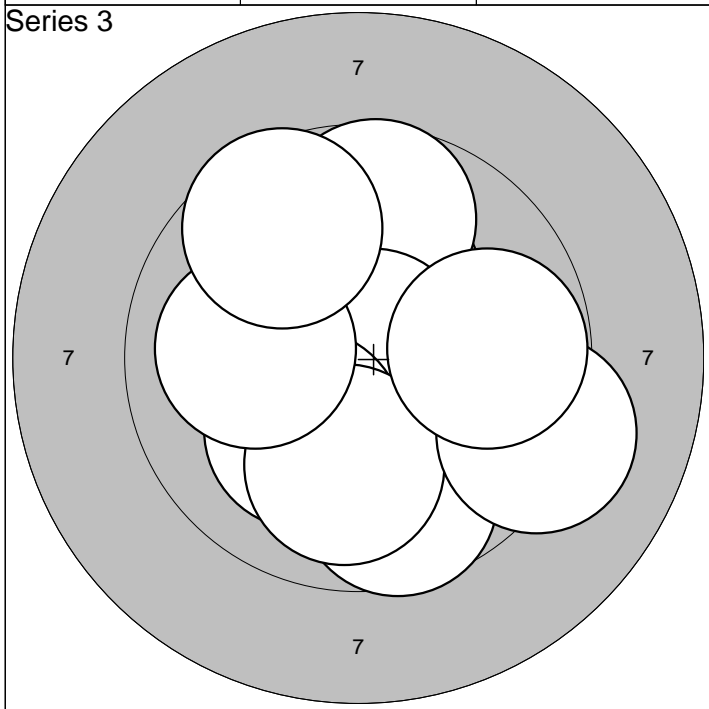

1:10,3* ↑	6:10,0 ↓		Serie	95,0
2: 9,6 ↓	7:10,0 ←			
3: 9,7 ↑	8: 9,2 →	Sum	289,0	
4:10,8* ↗	9: 9,8 →			
5:10,2* ↘	10: 9,6 ↗			

1:10,2* ↑	6:10,6* →		Serie	99,0
2:10,0 ↗	7:10,3* ←			
3:10,7* ↗	8:10,2* ↗	Sum	388,0	
4:10,1 ↑	9:10,2* ↑			
5:10,1 ↓	10: 9,9 ↘			

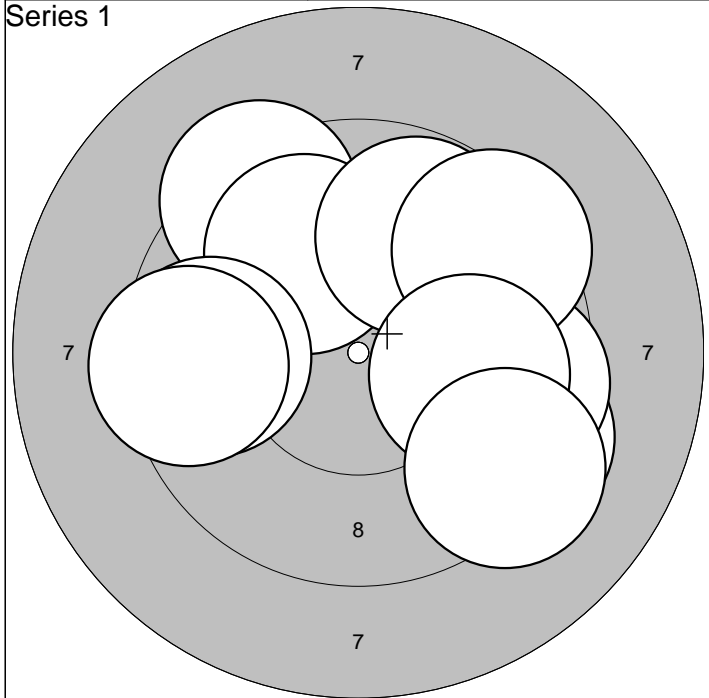

1: 9,3 ↗	6: 9,5 →	Serie	90,0
2: 9,9 ↗	7: 9,8 ↗		
3: 9,6 ←	8: 9,5 ↗	Sum	90,0
4: 9,4 ↘	9: 9,9 →		
5: 9,4 ←	10: 9,3 ↘		

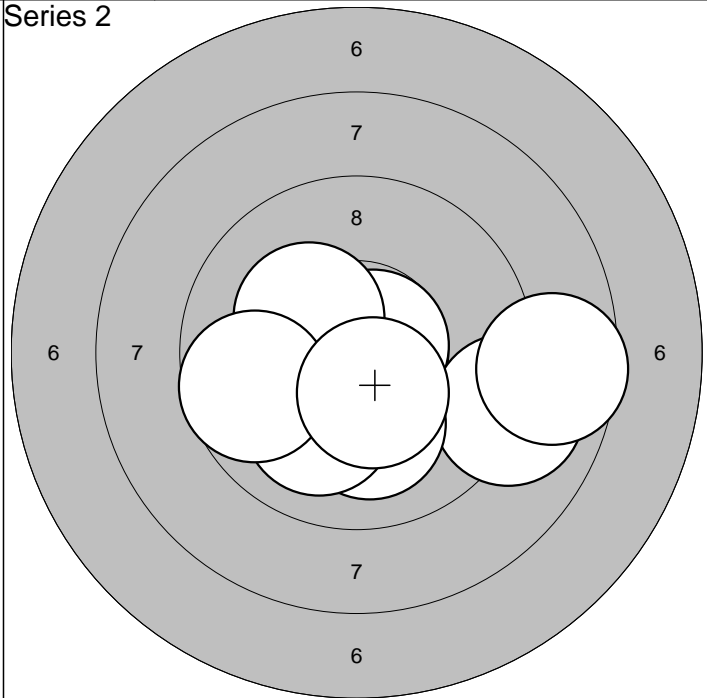

1:10,6* ↘	6:10,3* ↖	Serie	96,0
2:10,7* →	7:10,0 ↘		
3: 9,0 →	8: 9,7 ←	Sum	186,0
4:10,1 ↘	9: 8,6 →		
5:10,1 ↘	10:10,4* ↘		

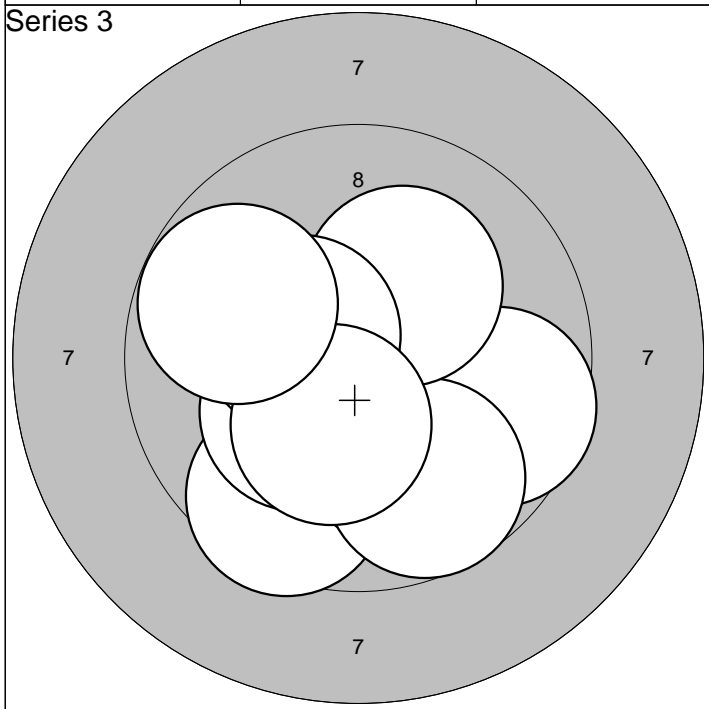

1: 9,6 ↘	6: 9,7 ↘	Serie	96,0
2:10,0 ↘	7:10,2* ↗		
3:10,5* ↘	8:10,4* ←	Sum	282,0
4:10,2* ↖	9:10,3* ↘		
5: 9,6 →	10: 9,8 ←		

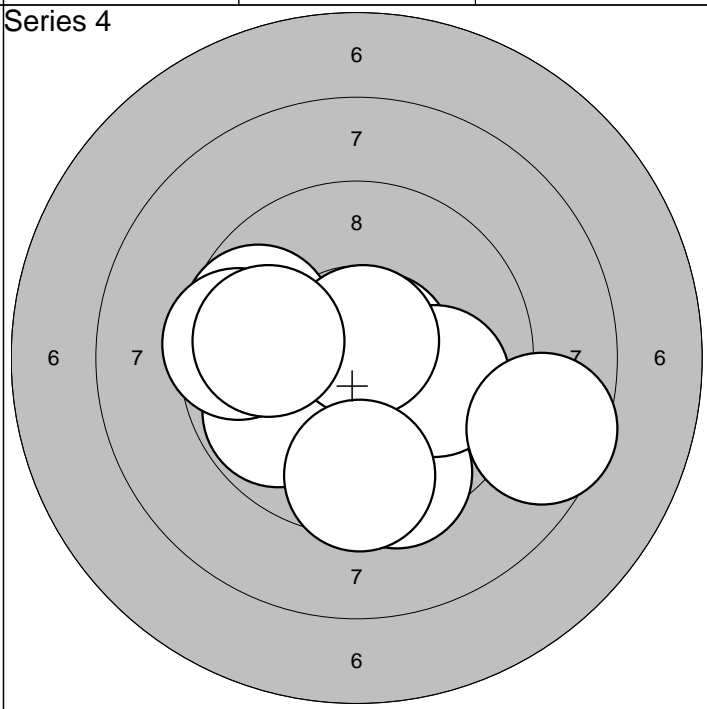

1: 9,7 ←	6:10,7* ↗	Serie	92,0
2: 9,5 ↘	7: 9,5 ←		
3: 9,8 ↖	8: 9,9 ←	Sum	374,0
4:10,7* →	9: 8,6 →		
5:10,0 →	10: 9,5 ↘		

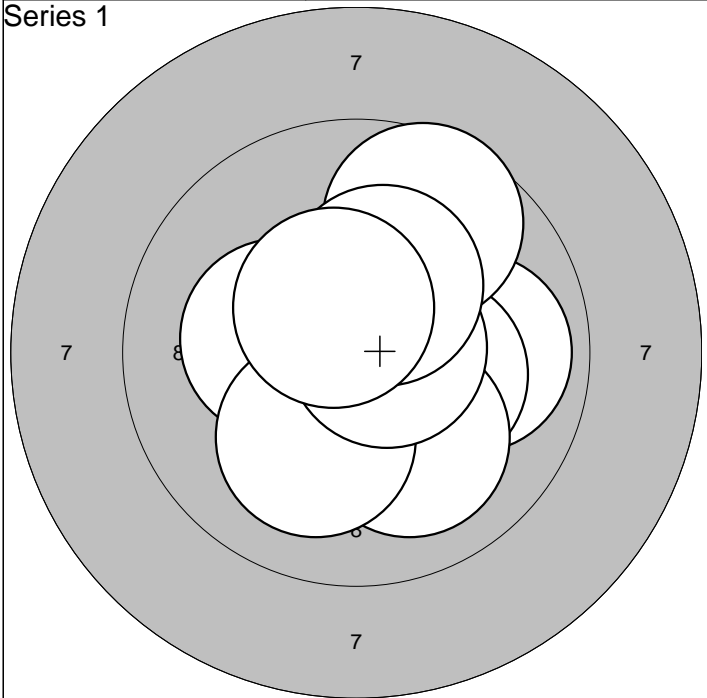

1:10,5* ↓	6:10,1 ↓	Serie	98,0
2: 9,9 →	7:10,6* →		
3:10,3* ↘	8: 9,7 ↗	Sum	98,0
4:10,2* ←	9:10,3* ↗		
5:10,0 ↓	10:10,5* ↗		

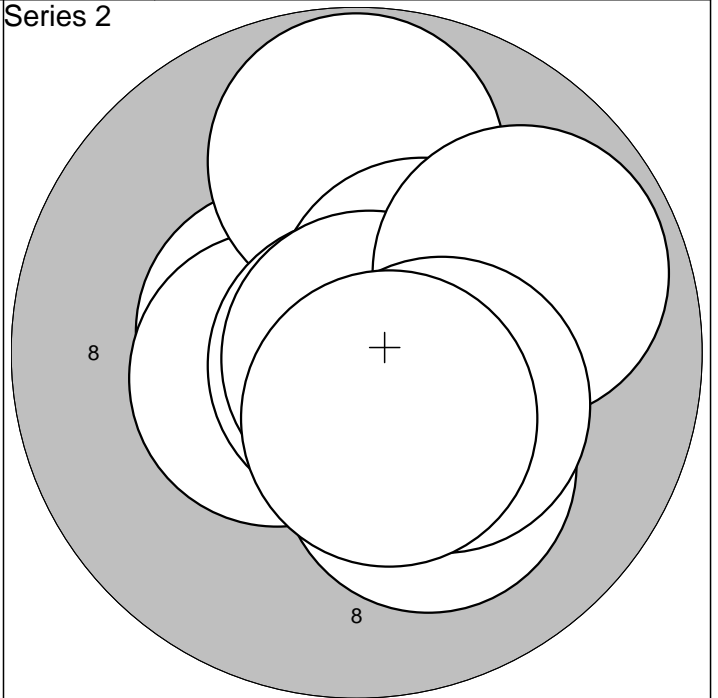

1:10,5* ←	6:10,8* ↘	Serie	98,0
2:10,5* ←	7:10,2* ↓		
3: 9,8 ↑	8: 9,8 ↗	Sum	196,0
4:10,5* ↗	9:10,3* ↘		
5:10,9* ↓	10:10,5* ↓		

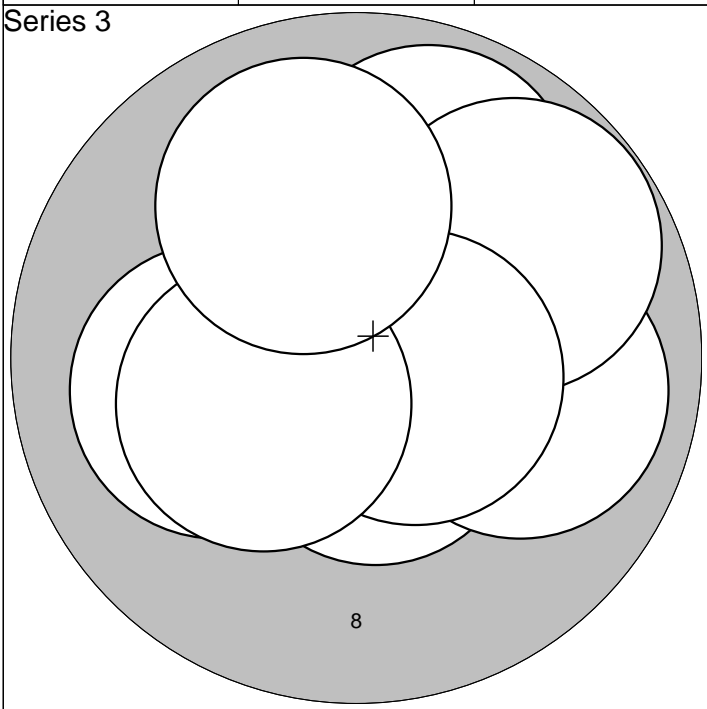

1:10,1 ←	6: 9,9 →	Serie	97,0
2:10,6* ↓	7: 9,8 ↗		
3:10,7* ←	8:10,6* →	Sum	293,0
4: 9,8 ↗	9:10,3* ←		
5:10,8* ↘	10:10,0 ↗		

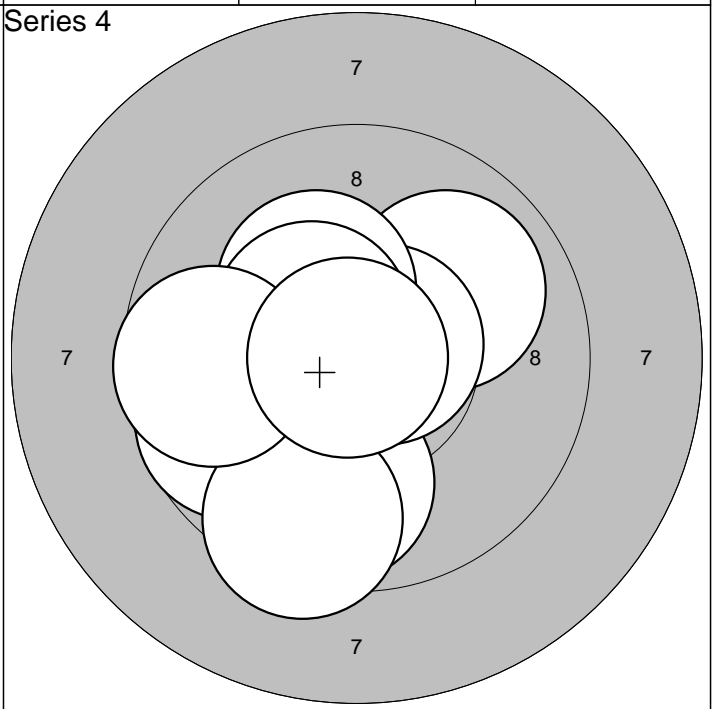

1: 9,7 ←	6:10,2* ↗	Serie	95,0
2:10,4* ←	7:10,5* ←		
3: 9,9 ↗	8: 9,4 ↓	Sum	388,0
4: 9,8 ↓	9: 9,6 ←		
5:10,7* ↗	10:10,9* ←		

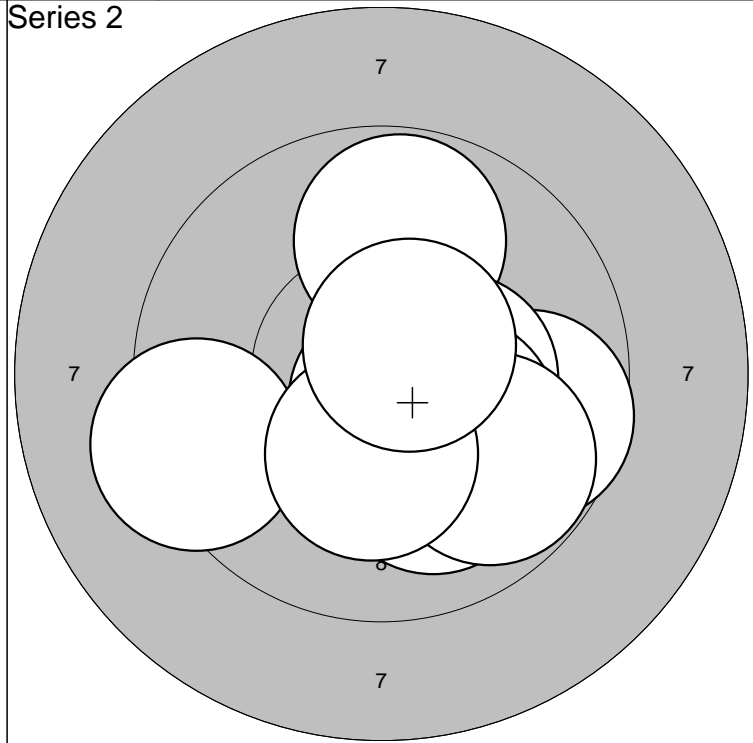
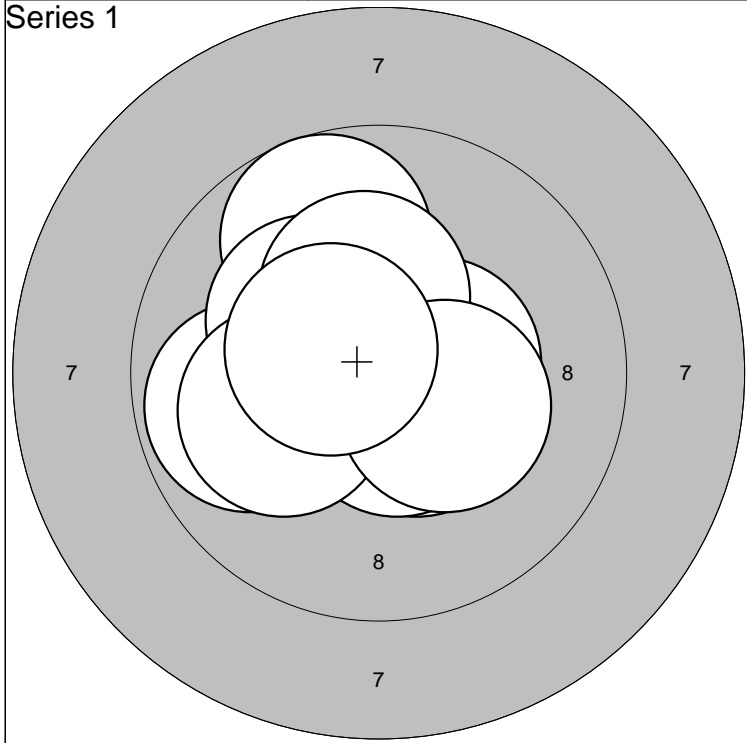

1: 9,8 ←	6:10,6* ↓	Serie	98,0
2:10,5* ↓	7:10,3* ↑		
3: 9,7 ↑	8:10,1 ←	Sum	98,0
4:10,5* →	9:10,3* →		
5:10,3* ↗	10:10,5* ↖		

1:10,7* ↓	6:10,3* →	Serie	96,0
2: 9,8 ↑	7:10,2* ↓		
3: 9,7 →	8: 9,8 ↓	Sum	194,0
4: 9,3 ←	9:10,3* ↓		
5:10,0 ↓	10:10,6* ↗		

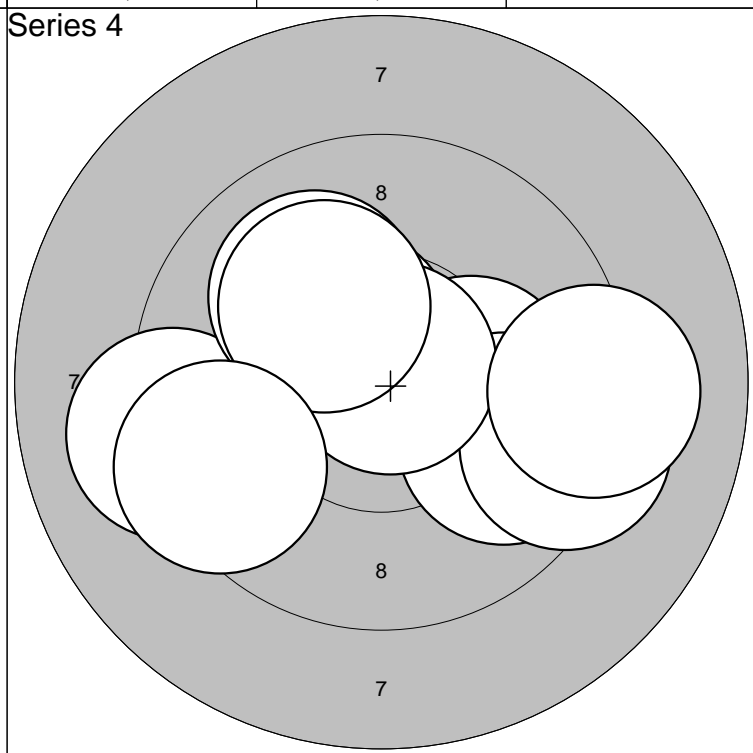
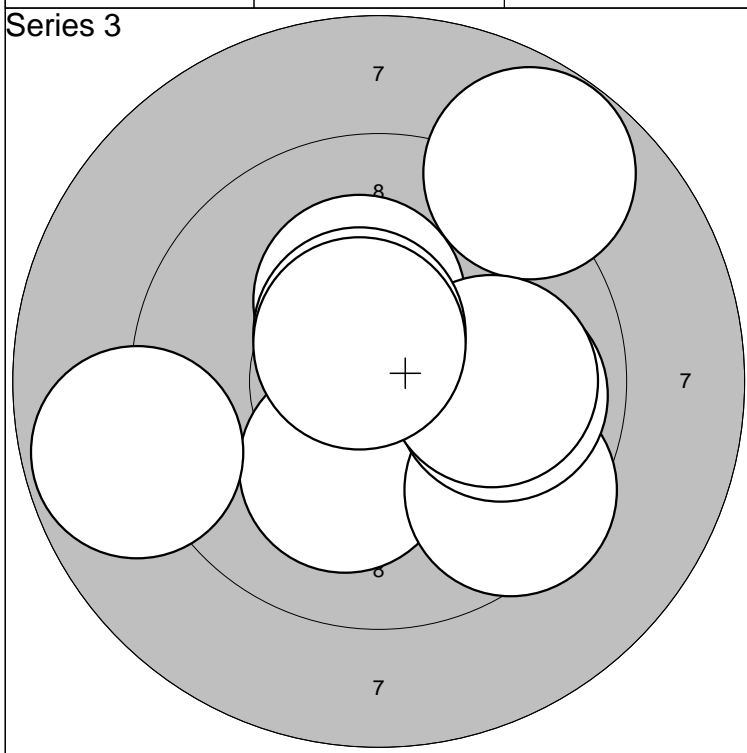

1:10,3* →	6:10,3* ↑	Serie	94,0
2:10,2* ↓	7: 9,9 →		
3: 8,8 ↗	8:10,0 →	Sum	288,0
4: 8,8 ←	9:10,5* ↑		
5: 9,5 ↓	10:10,6* ↗		

1:10,2* →	6:10,8* ↗	Serie	95,0
2: 9,1 ←	7: 9,2 →		
3:10,5* ↗	8:10,0 ↗	Sum	383,0
4: 9,8 →	9:10,2* ↗		
5: 9,3 →	10: 9,4 ←		

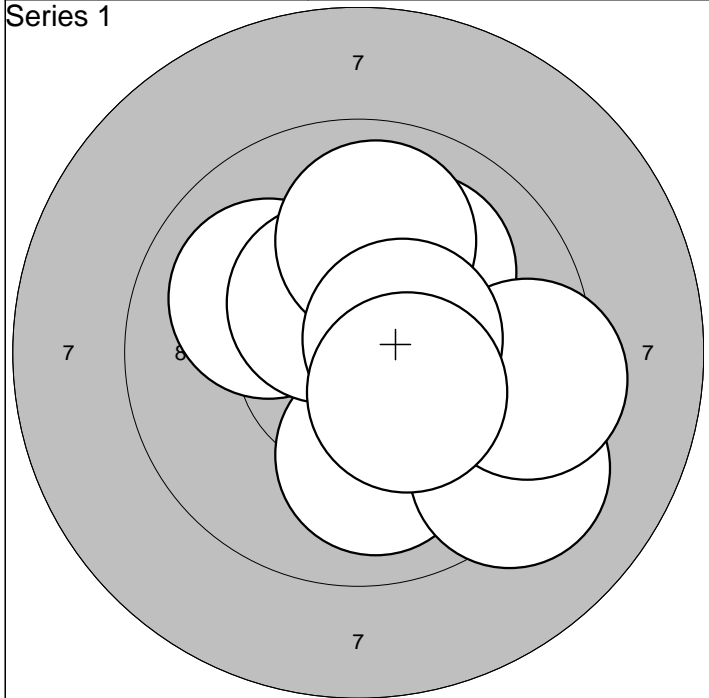

1:10,0 ↓	6: 9,3 ↘	Serie	97,0
2:10,1 ↗	7: 9,4 →		
3:10,4* ↑	8: 9,9 ↑	Sum	97,0
4:10,0 ↖	9:10,5* →		
5:10,4* ↗	10:10,4* ↘		

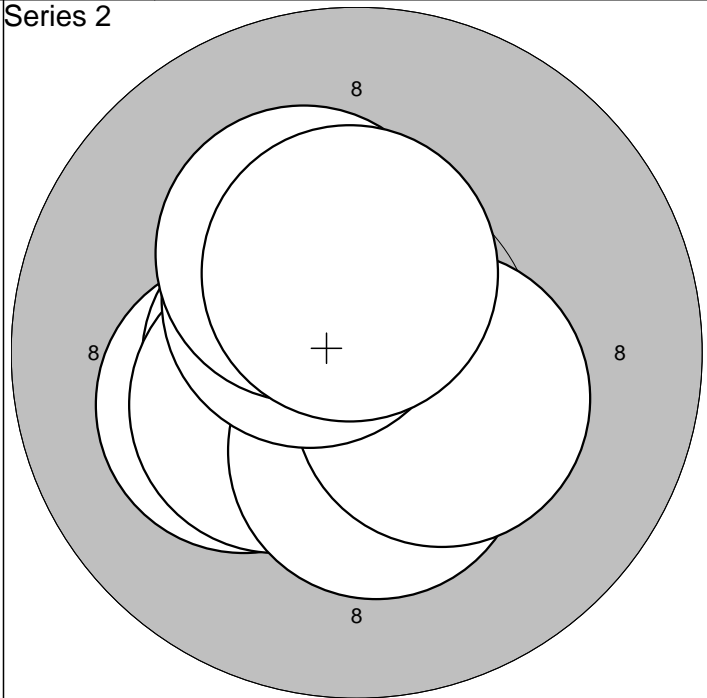

1:10,2* ←	6:10,3* ↓	Serie	100,0
2:10,9* ←	7:10,3* ↘		
3:10,5* ←	8:10,5* ↗	Sum	197,0
4:10,4* ←	9:10,3* ↗		
5:10,4* ↗	10:10,5* ↑		

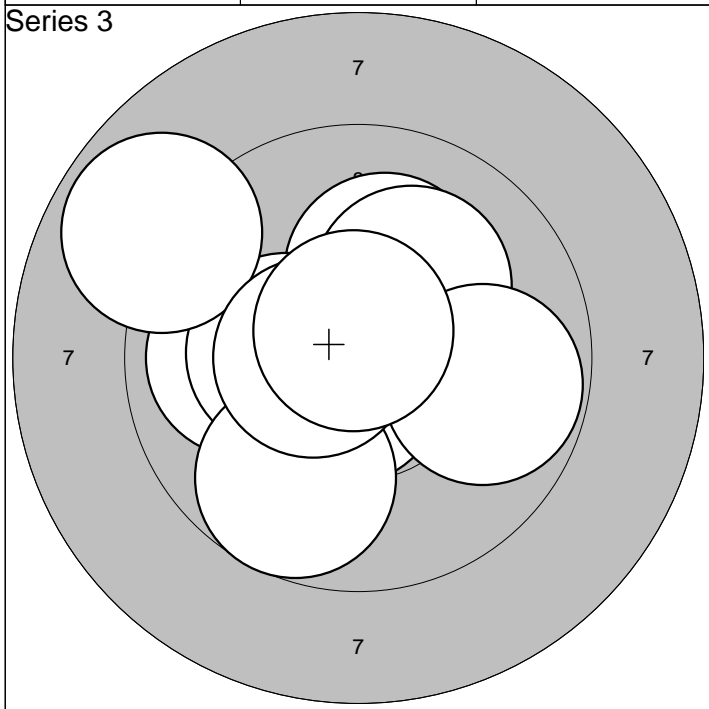

1: 9,9 ←	6: 9,7 ↘	Serie	95,0
2:10,2* ↑	7: 8,9 ↖		
3:10,1 ↗	8:10,5* ←	Sum	292,0
4:10,3* ←	9: 9,8 →		
5:10,7* ↘	10:10,7* ↑		

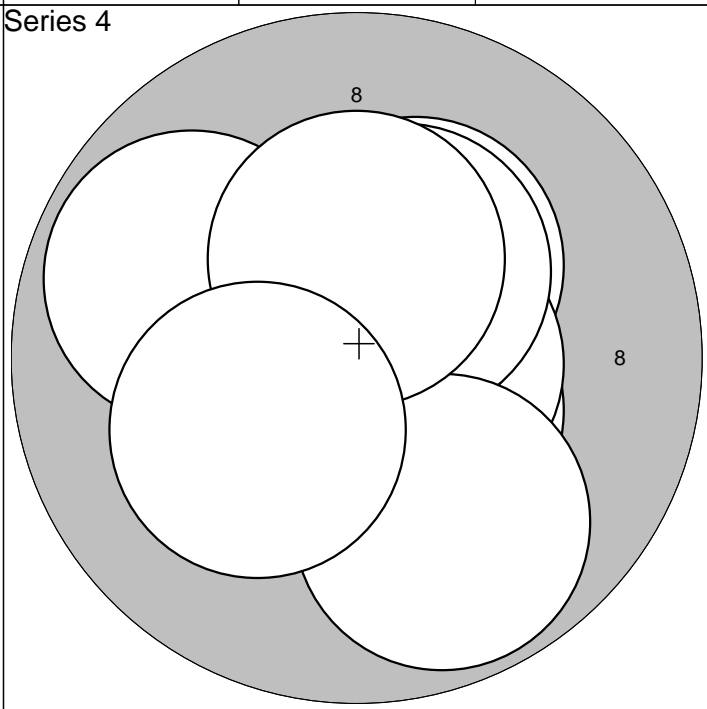

1:10,6* ←	6:10,5* ↗	Serie	98,0
2:10,3* ↗	7:10,4* ↗		
3: 9,9 ↖	8: 9,8 ↓	Sum	390,0
4:10,5* ↘	9:10,4* ↑		
5:10,6* →	10:10,2* ↙		

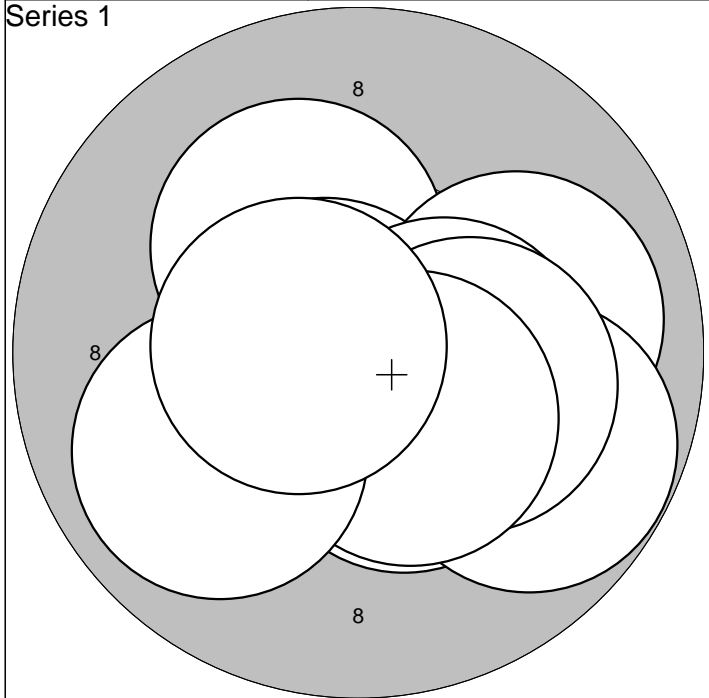

1:10,4* ↘	6:10,4* →		Serie	98,0
2:10,2* ↗	7:10,2* →			
3:10,0 →	8:10,4* ↘	Sum	98,0	
4:10,8* ←	9: 9,9 ←			
5: 9,8 ↘	10:10,6* ←			

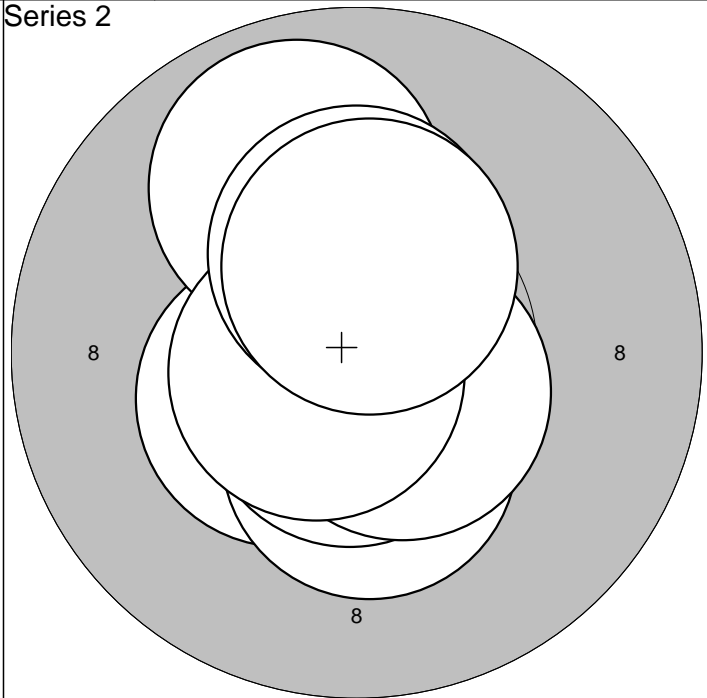

1:10,5* ↙	6:10,6* ↘		Serie	99,0
2:10,4* ↙	7: 9,9 ↗			
3:10,9* ↑	8:10,7* ↙	Sum	197,0	
4:10,3* ↓	9:10,4* ↑			
5:10,7* ↓	10:10,4* ↑			

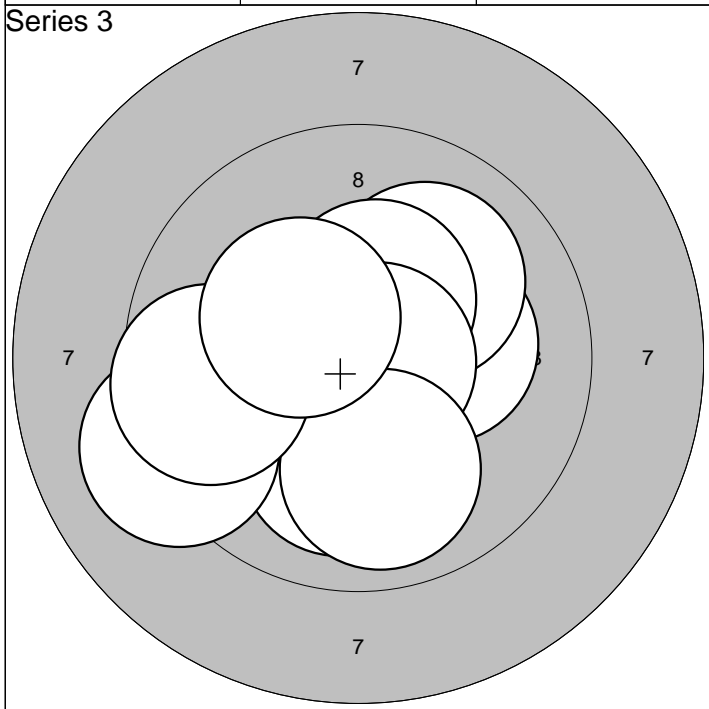

1:10,2* →	6: 9,2 ←		Serie	97,0
2:10,1 ↗	7:10,8* →			
3:10,4* ↑	8: 9,9 ↓	Sum	294,0	
4:10,1 ↓	9: 9,6 ←			
5:10,8* ↘	10:10,3* ↖			

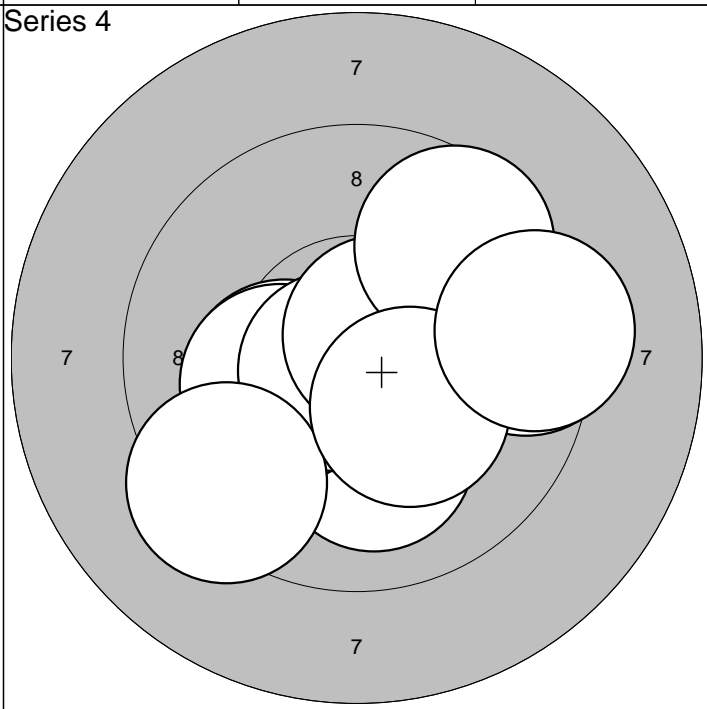

1:10,1 ↓	6:10,6* ↗		Serie	96,0
2:10,3* ←	7: 9,6 ↗			
3:10,2* ←	8: 9,3 ↙	Sum	390,0	
4: 9,4 →	9:10,3* ↘			
5:10,8* ↙	10: 9,3 →			

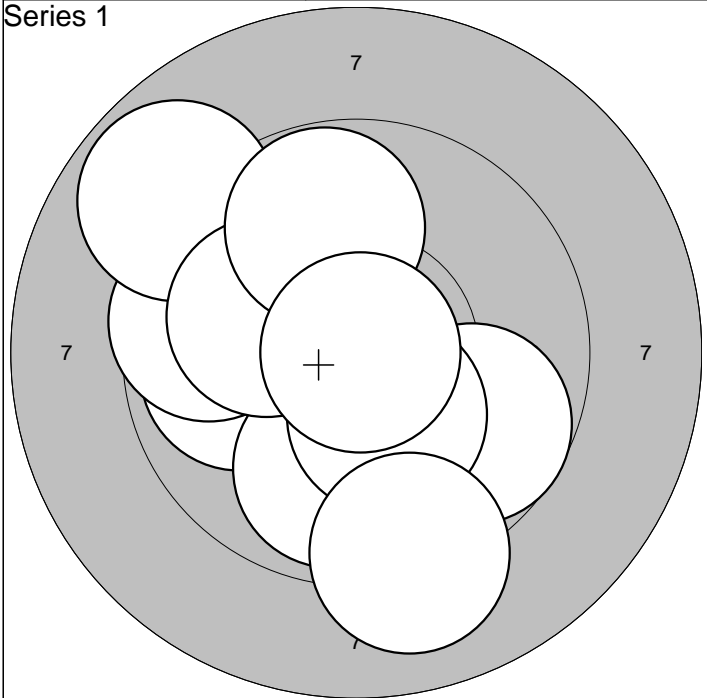

1: 9,7 ↘	6: 8,8 ↗	Serie	92,0
2: 9,9 ←	7: 9,1 ↓		
3: 9,9 ↓	8:10,1 ←	Sum	92,0
4: 9,6 ←	9: 9,8 ↑		
5:10,3* ↓	10:10,9* →		

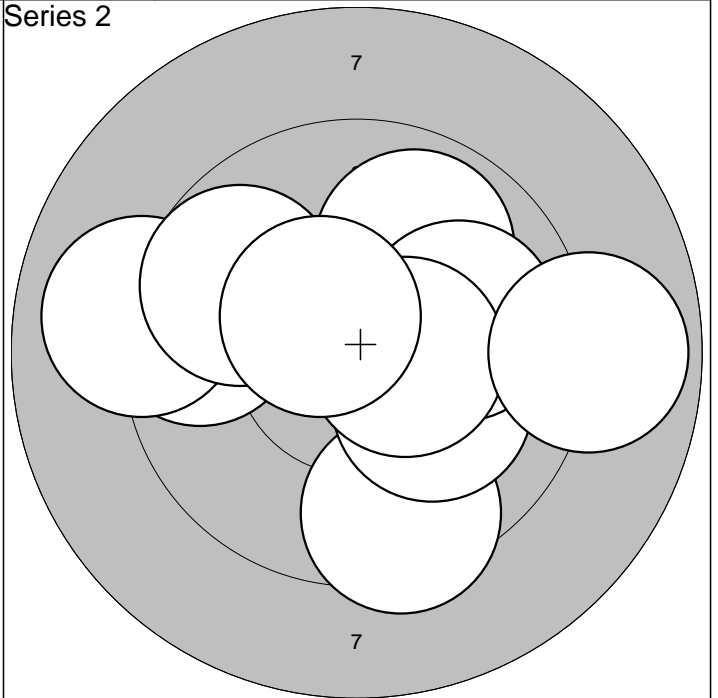

1: 9,5 ↓	6:10,0 →	Serie	93,0
2: 9,5 ←	7: 9,7 ←		
3: 9,9 ↗	8:10,5* →	Sum	185,0
4: 9,0 ←	9: 8,9 →		
5:10,1 ↓	10:10,5* ↗		

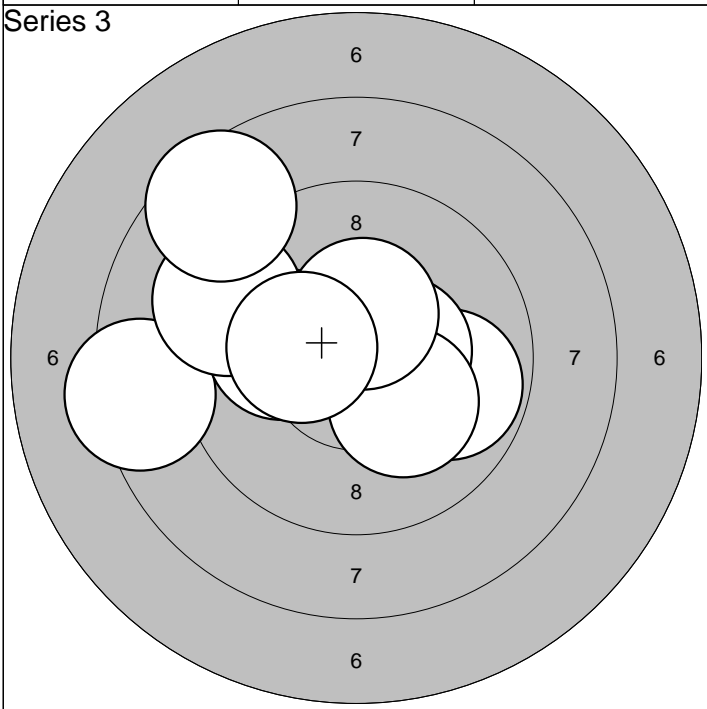

1: 8,4 ←	6:10,1 ←	Serie	94,0
2:10,1 →	7: 9,3 ←		
3: 9,8 →	8:10,4* ↑	Sum	279,0
4:10,4* →	9:10,3* ←		
5:10,2* ↓	10: 8,6 ↗		

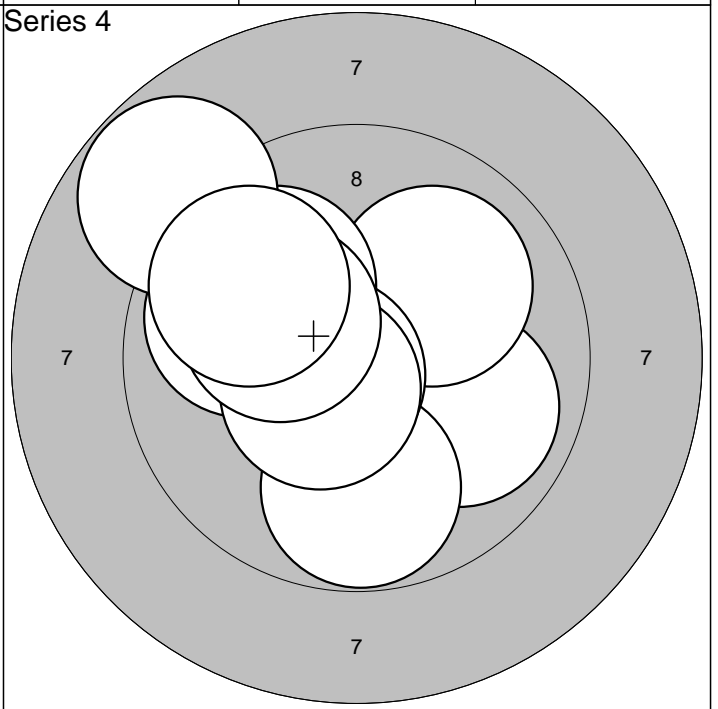

1: 9,9 →	6:10,0 ↗	Serie	94,0
2: 9,9 ←	7: 8,8 ↗		
3:10,0 ↗	8:10,5* ↘	Sum	373,0
4: 9,8 ↓	9:10,2* ←		
5:10,6* ←	10: 9,8 ↗		

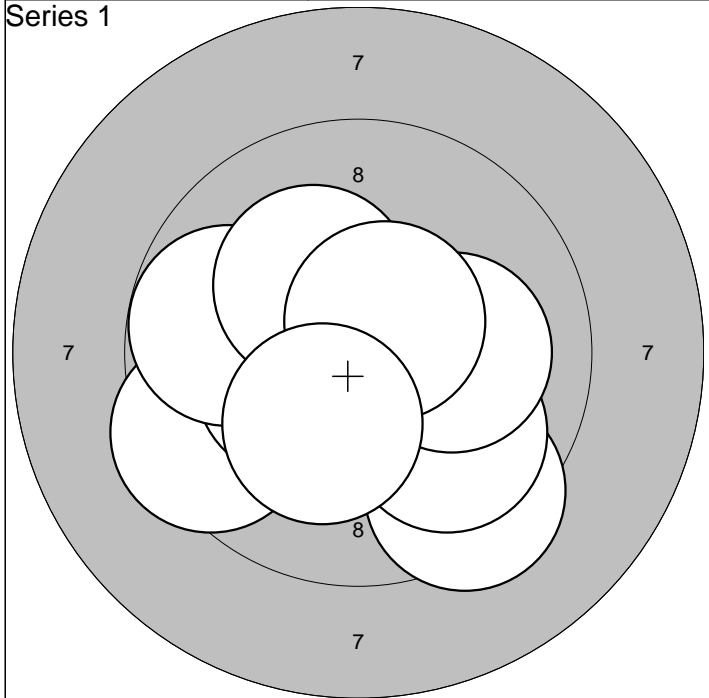

1: 9,4 ↙	6:10,6* ↑		Serie	96,0
2: 9,4 ↘	7: 9,8 ←			
3: 9,9 ↘	8:10,2* ↗	Sum	96,0	
4:10,4* ←	9:10,6* ↗			
5:10,1 →	10:10,2* ↘			

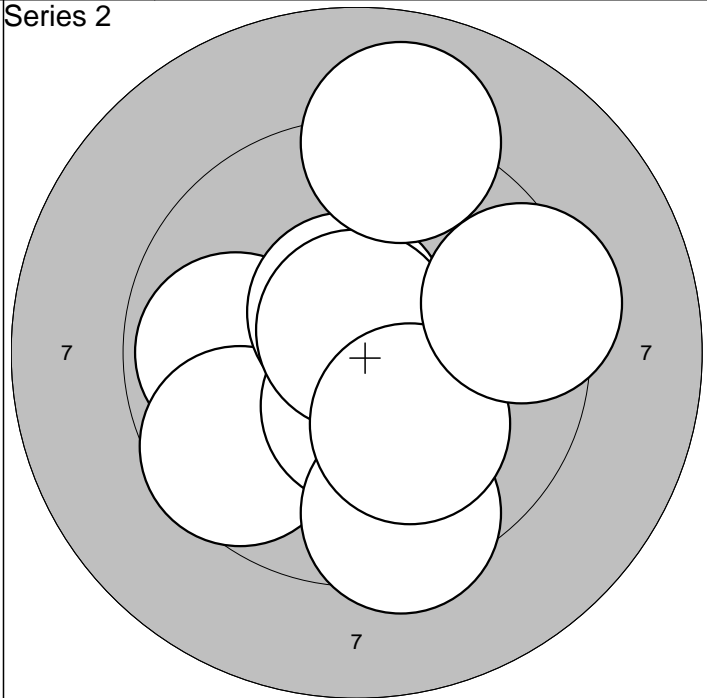

1: 9,9 ←	6:10,7* ↑		Serie	95,0
2:10,7* →	7: 9,5 ↓			
3: 9,6 ↙	8: 9,0 ↑	Sum	191,0	
4:10,5* ↓	9:10,2* ↘			
5:10,6* ↑	10: 9,4 →			

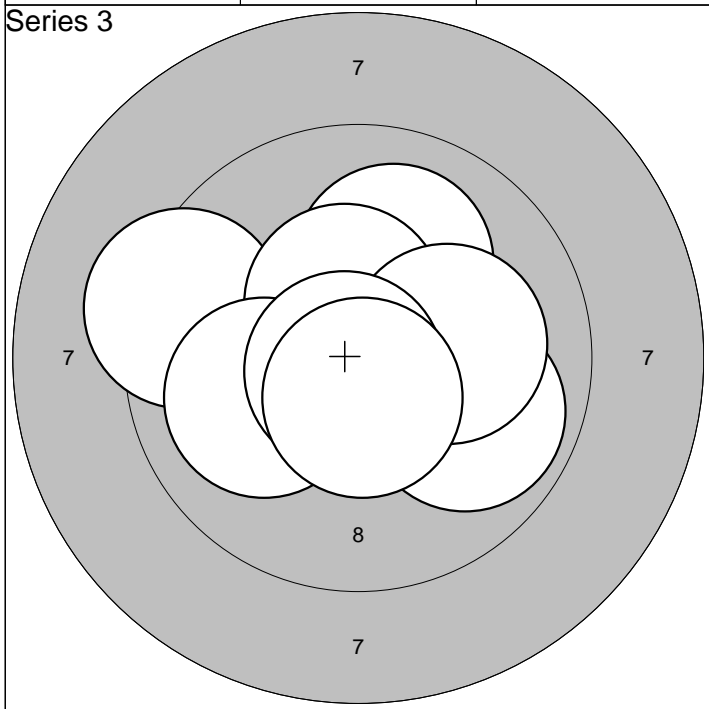

1:10,3* ←	6:10,5* ↑		Serie	98,0
2: 9,3 ←	7:10,0 ←			
3:10,7* ↘	8:10,1 →	Sum	289,0	
4: 9,9 ↘	9:10,8* ↙			
5:10,1 ↑	10:10,6* ↓			

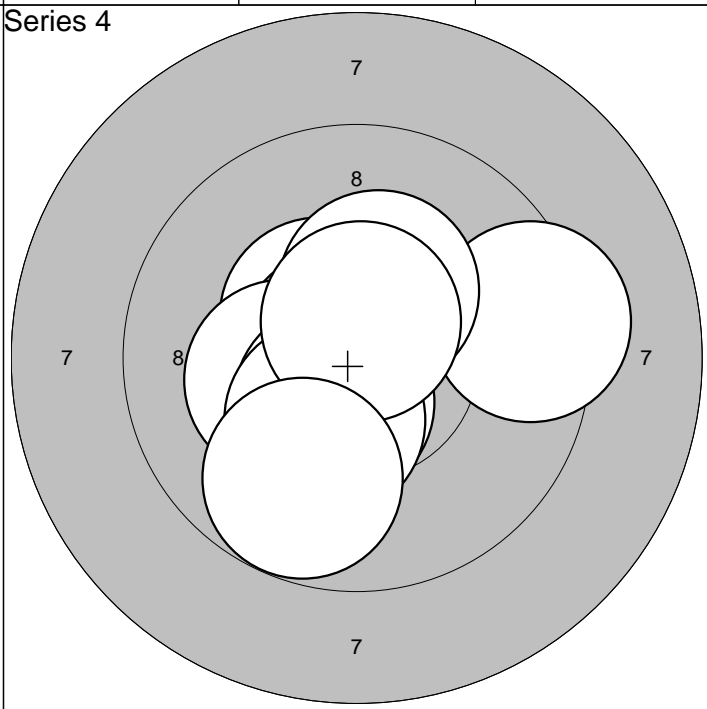

1:10,5* ↗	6:10,5* ↘		Serie	98,0
2: 9,4 →	7:10,3* ↑			
3:10,4* ←	8:10,3* ↘	Sum	387,0	
4:10,8* ↙	9:10,6* ↑			
5:10,3* ←	10: 9,8 ↘			

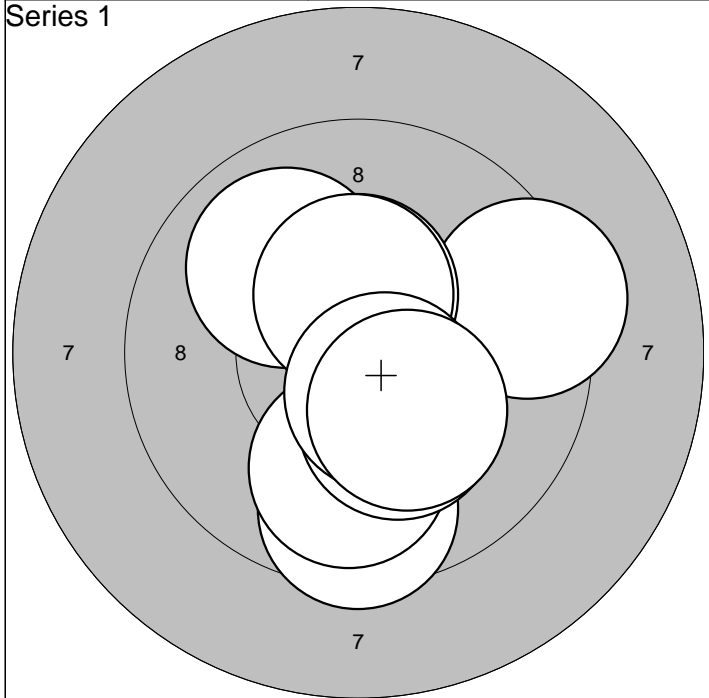

1: 9,3 →	6: 9,9 ↗	Serie	96,0
2: 10,5* ↓	7: 10,4* ↑		
3: 9,6 ↓	8: 10,4* ↑	Sum	96,0
4: 9,9 ↓	9: 10,5* ↓		
5: 10,3* ↓	10: 10,3* ↓		

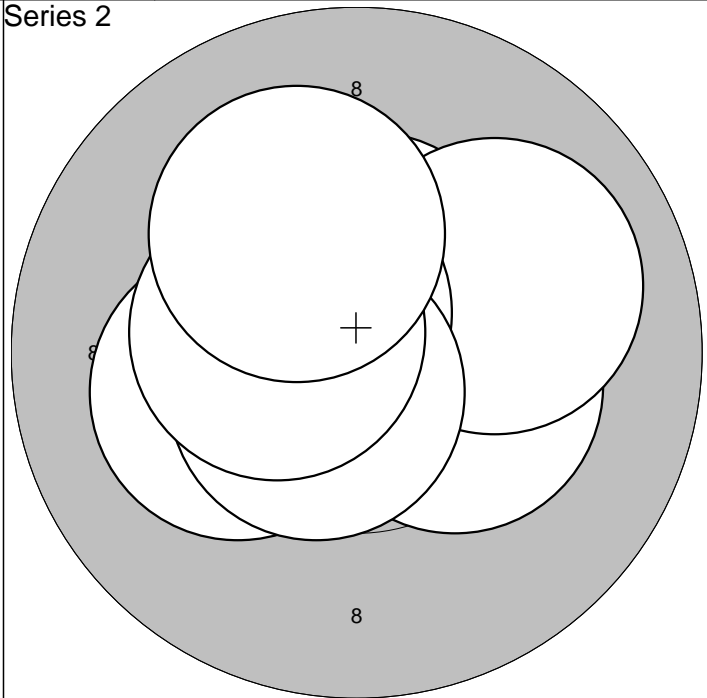

1: 10,3* →	6: 10,0 →	Serie	100,0
2: 10,7* ↗	7: 10,5* ↖		
3: 10,3* →	8: 10,6* ↘	Sum	196,0
4: 10,2* ←	9: 10,4* ←		
5: 10,5* ↑	10: 10,1 ↗		

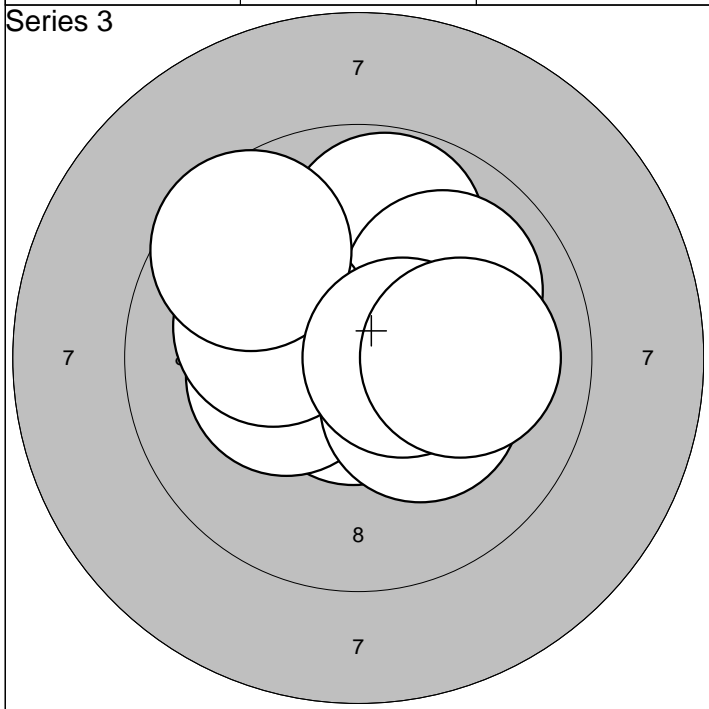

1: 10,2* →	6: 10,3* ↓	Serie	98,0
2: 10,7* ↓	7: 10,1 ←		
3: 9,8 ↑	8: 9,6 ↗	Sum	294,0
4: 10,0 ↗	9: 10,5* →		
5: 10,3* ←	10: 10,0 →		

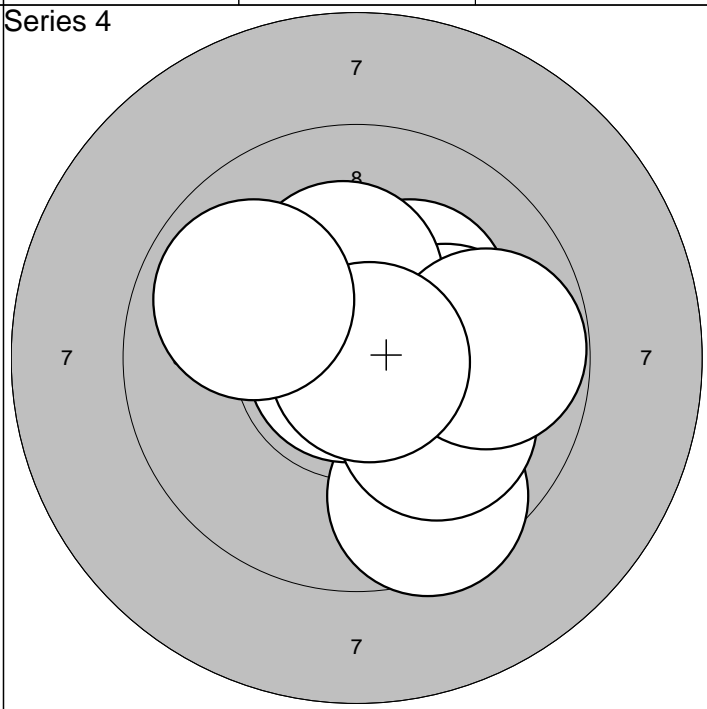

1: 9,6 ↓	6: 10,0 ↓	Serie	97,0
2: 10,6* ↗	7: 10,2* ↑		
3: 10,2* ↗	8: 9,8 →	Sum	391,0
4: 10,1 →	9: 10,8* →		
5: 10,9* ←	10: 9,9 ↖		

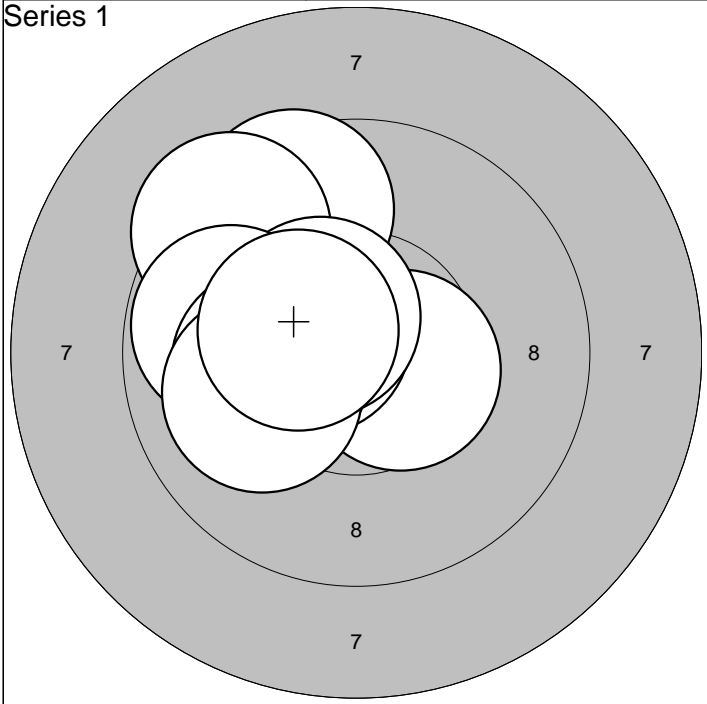

1:10,5* ↖	6:10,5* ↗	Serie	97,0
2: 9,5 ↗	7: 9,8 ↖		
3:10,5* ↘	8:10,2* ↖	Sum	97,0
4: 9,4 ↗	9:10,0 ↖		
5:10,5* ↖	10:10,4* ↖		

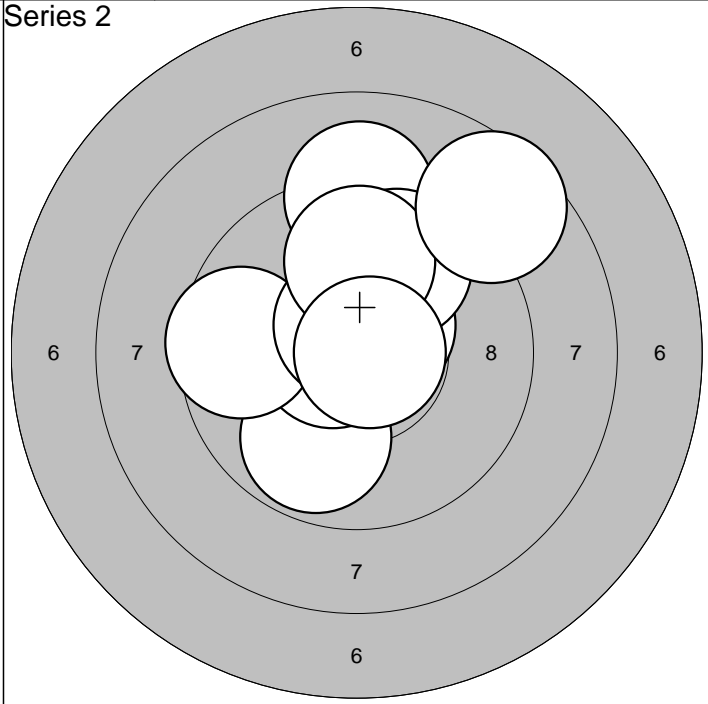

1: 9,9 ↘	6: 9,8 ↗	Serie	93,0
2:10,7* ↖	7:10,6* ↗		
3:10,5* ↗	8: 9,9 ↗	Sum	190,0
4: 9,1 ↗	9: 8,6 ↗		
5: 9,6 ↖	10:10,8* →		

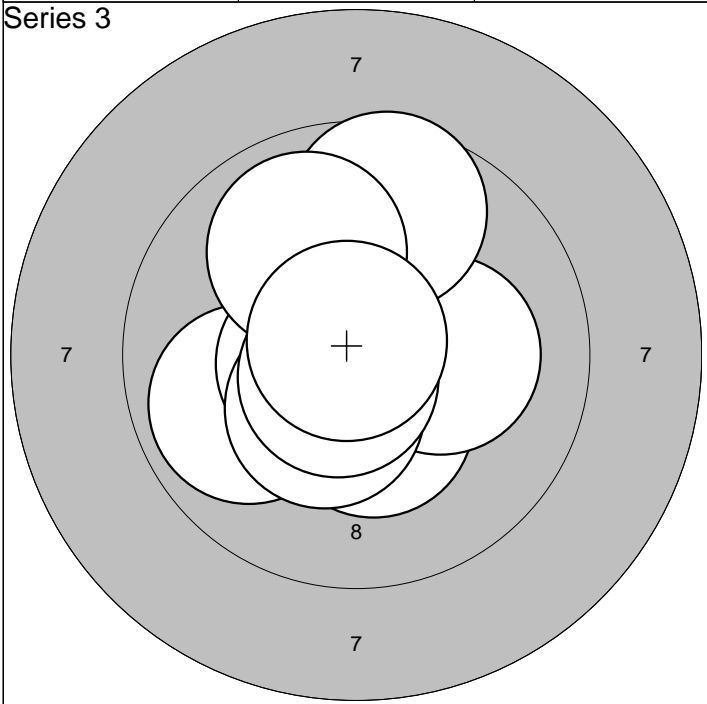

1:10,4* ↘	6: 9,6 ↗	Serie	97,0
2:10,7* ↗	7: 9,9 ↗		
3: 9,9 ↖	8:10,4* ↘	Sum	287,0
4:10,2* →	9:10,7* ↘		
5:10,6* ↖	10:10,8* ↗		

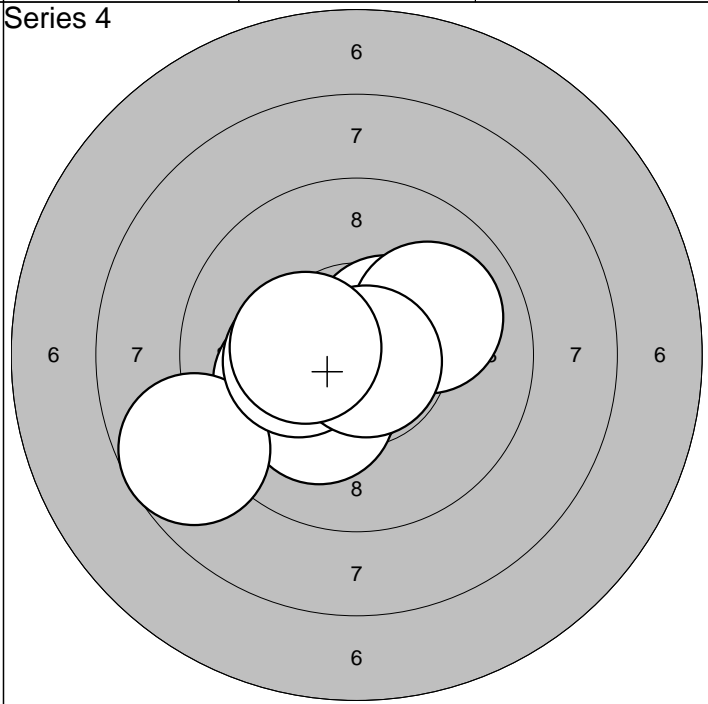

1:10,5* ↘	6: 8,7 ↖	Serie	98,0
2:10,5* ↗	7:10,3* ↖		
3:10,6* ↘	8:10,0 ↗	Sum	385,0
4:10,1 ↖	9:10,8* ↘		
5:10,2* ↘	10:10,3* ↖		

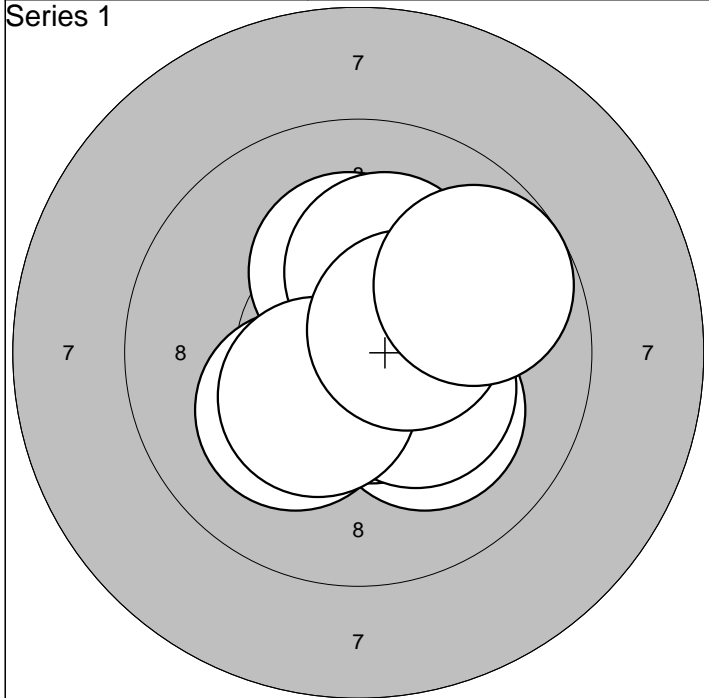

1:10,2* ↑	6:10,2* ↑		Serie	99,0
2:10,1 ↘	7:10,3* ↘			
3:10,4* →	8:10,4* ↙	Sum	99,0	
4:10,2* ↙	9:10,5* →			
5:10,6* ↘	10: 9,7 ↗			

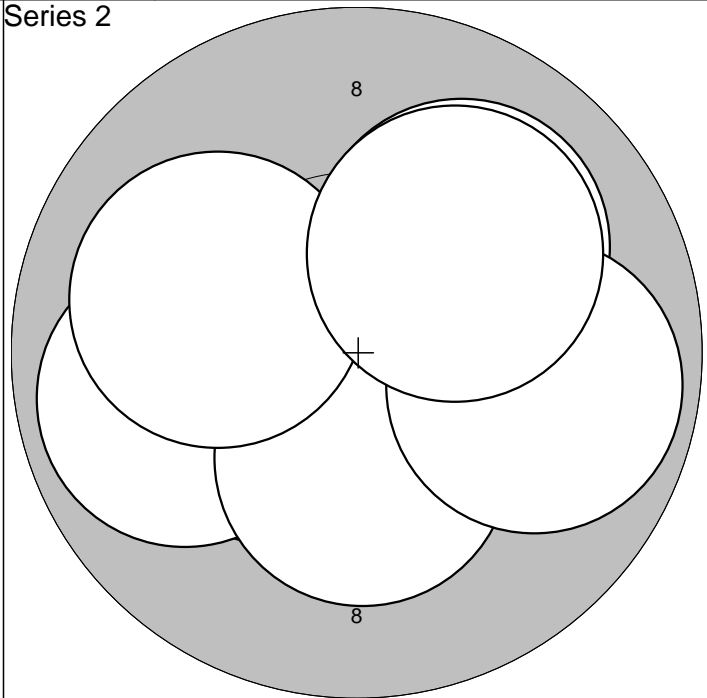

1:10,1 ↗	6:10,9* ↖		Serie	98,0
2:10,8* ↘	7:10,3* ↓			
3:10,4* ↙	8:10,0 ↖	Sum	197,0	
4: 9,9 ←	9: 9,9 →			
5:10,9* ↘	10:10,1 ↗			

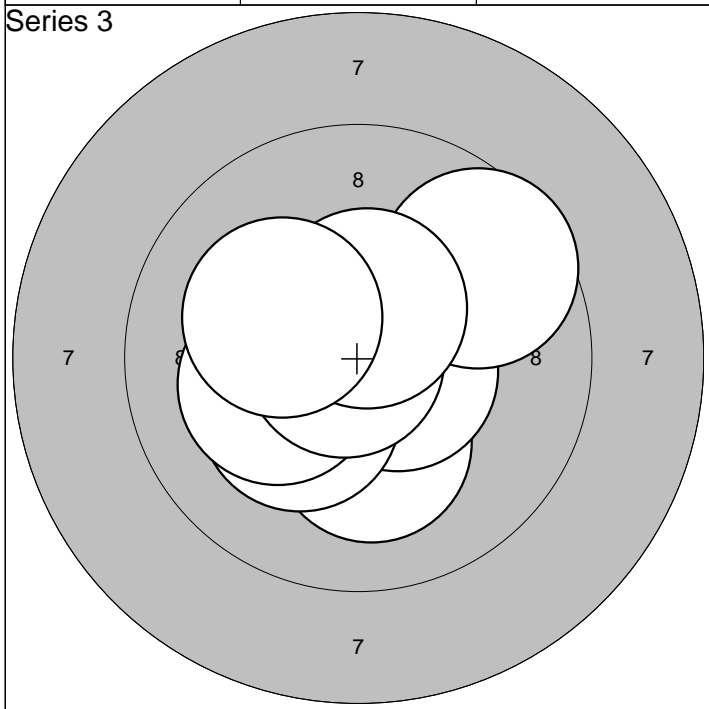

1:10,8* ↓	6:10,3* ↙		Serie	99,0
2:10,2* ↓	7:10,2* ←			
3:10,7* →	8:10,8* ←	Sum	296,0	
4:10,6* →	9:10,5* ↑			
5: 9,6 ↗	10:10,2* ↖			

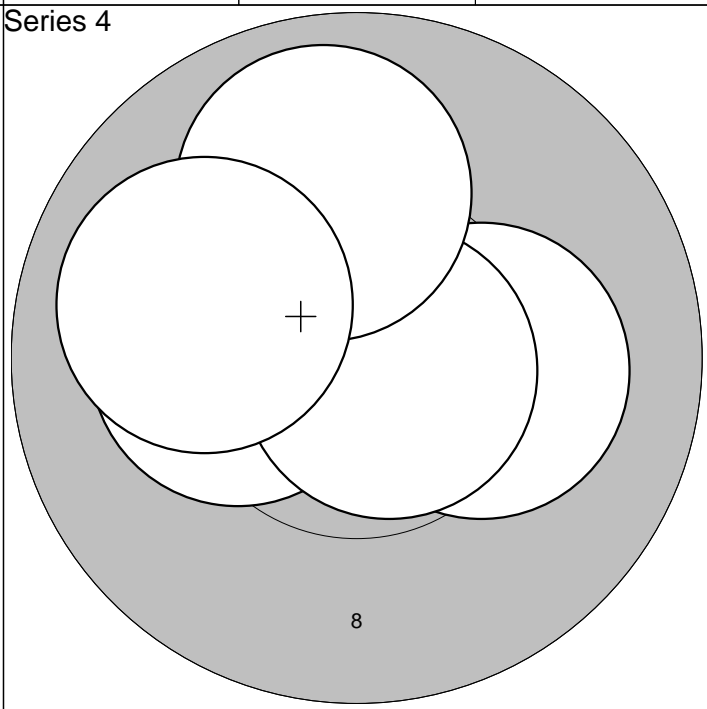

1:10,1 ↑	6:10,2* ←		Serie	99,0
2:10,5* ←	7:10,2* →			
3:10,5* ↖	8:10,7* →	Sum	395,0	
4:10,2* ↖	9: 9,9 ↑			
5:10,2* ←	10:10,0 ↖			

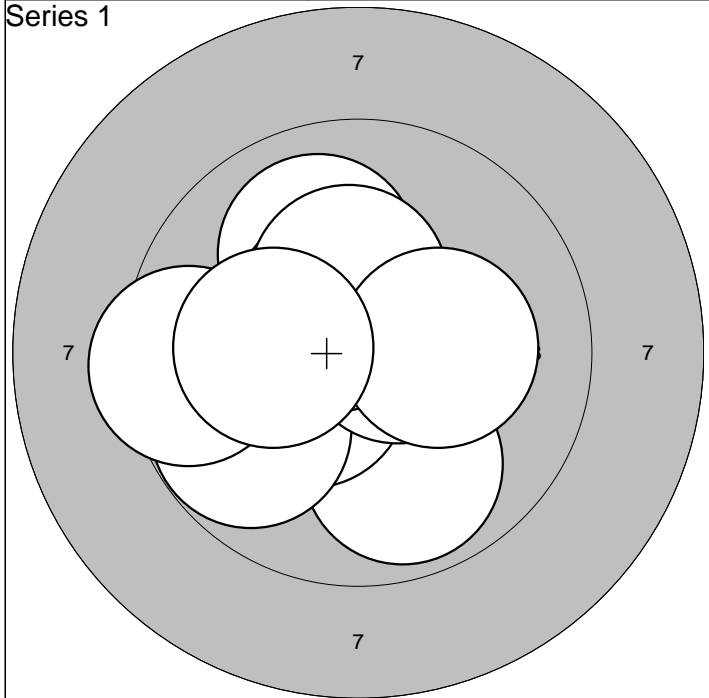

1: 9,9 ↓	6:10,0 ↑	Serie	97,0
2:10,4* ↙	7:10,5* ↗		
3: 9,8 ↙	8:10,4* ↑	Sum	97,0
4: 9,4 ←	9:10,2* →		
5:10,6* →	10:10,2* ←		

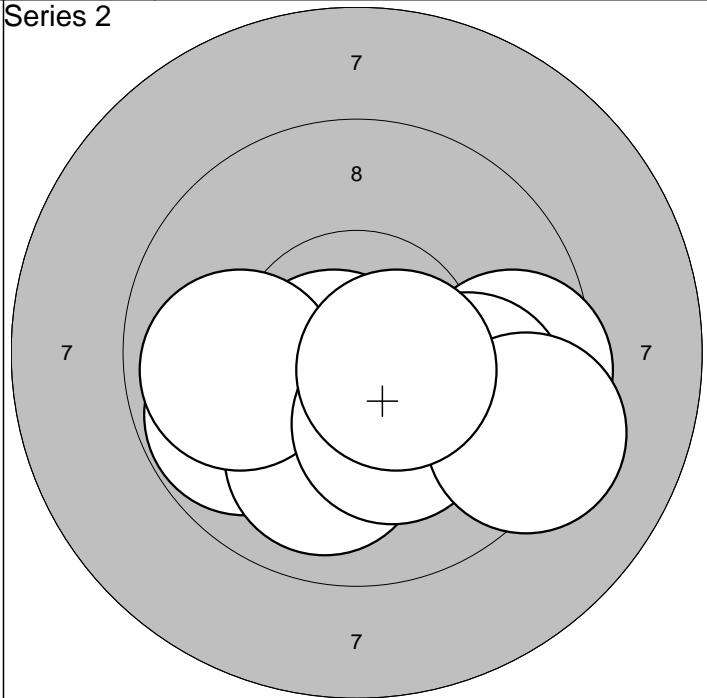

1: 9,5 →	6: 9,9 →	Serie	95,0
2:10,7* ↙	7: 9,9 ←		
3: 9,8 ↙	8:10,2* ↓	Sum	192,0
4:10,4* ↓	9: 9,3 →		
5:10,0 ↓	10:10,5* →		

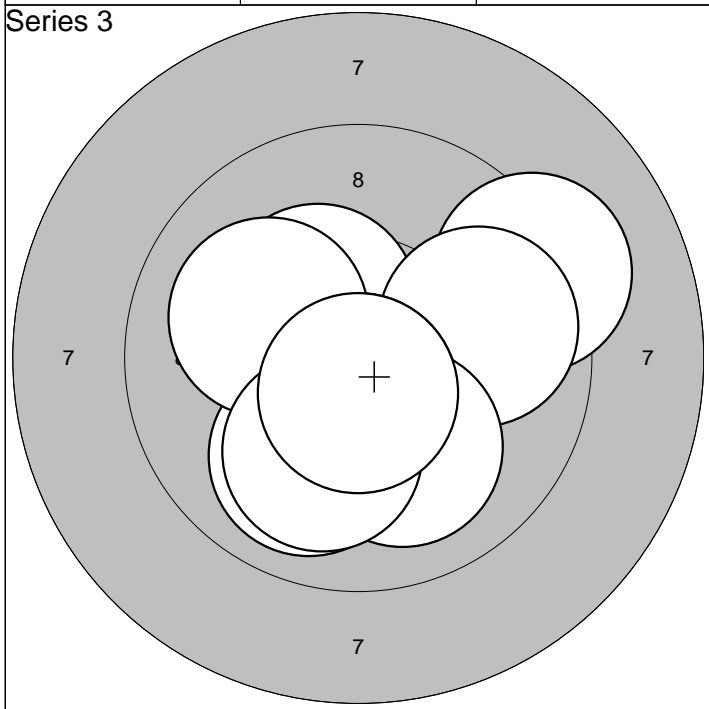

1:10,4* ↓	6:10,6* ↓	Serie	98,0
2:10,4* ↗	7:10,0 ↓		
3: 9,2 →	8:10,1 ←	Sum	290,0
4: 9,8 →	9:10,0 ↓		
5:10,0 ↓	10:10,6* ↓		

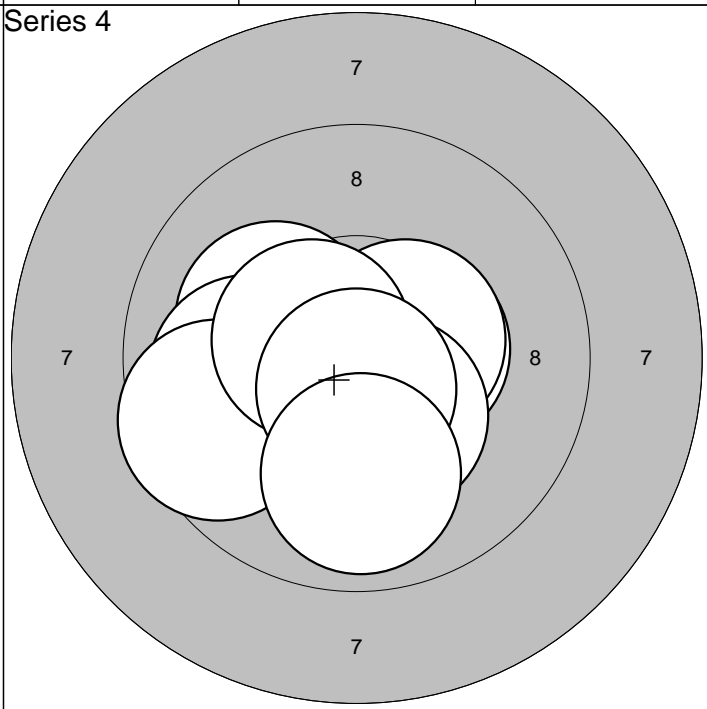

1:10,2* ↙	6:10,5* →	Serie	98,0
2:10,5* →	7:10,4* ↓		
3:10,8* ↓	8:10,5* ←	Sum	388,0
4:10,0 ←	9:10,7* ↓		
5: 9,6 ↙	10: 9,9 ↓		

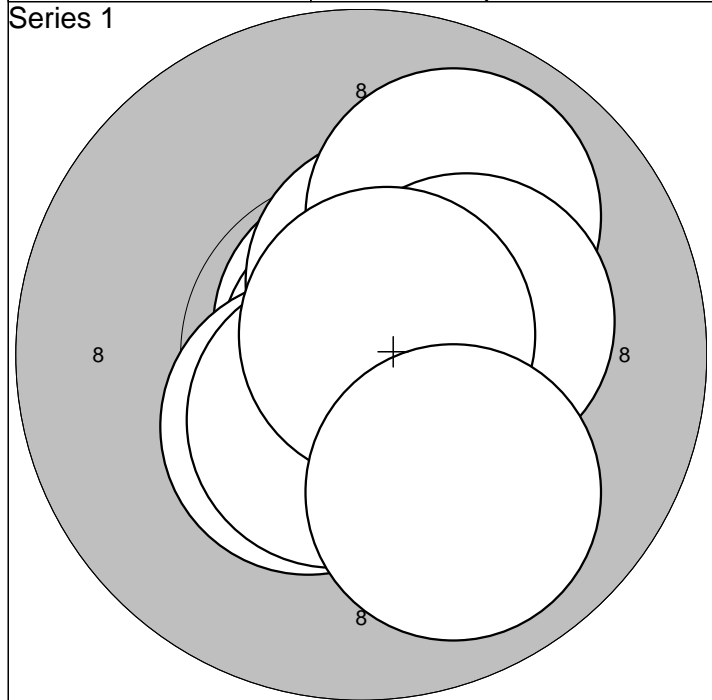

1:10,8* ↑	6:10,6* →				
2:10,9* →	7: 9,9 ↗				
3:10,5* ↗	8:10,3* →	Serie	98,0		
4:10,4* ↘	9:10,7* ↗	Sum	98,0		
5:10,5* ↘	10: 9,9 ↘				

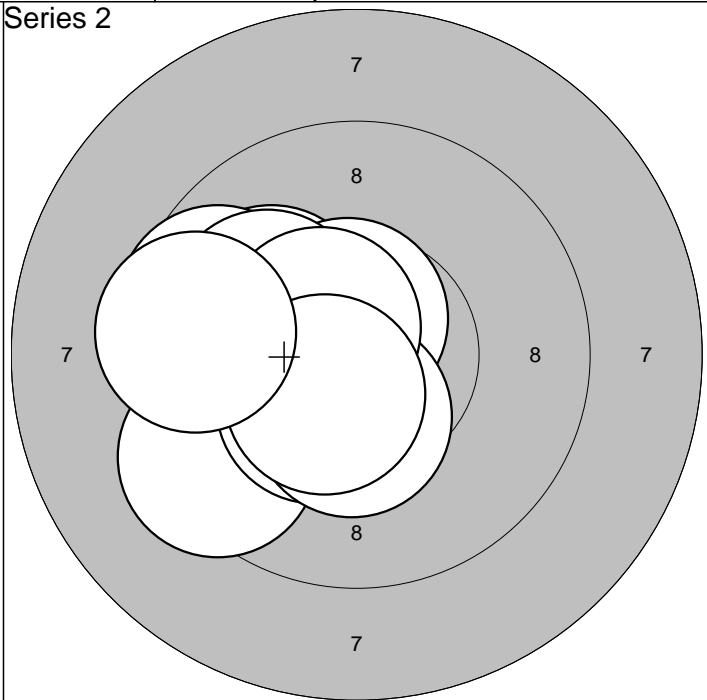

1:10,1 ↖	6: 9,6 ↖				
2:10,6* ↑	7:10,1 ↖				
3: 9,4 ↙	8:10,5* ↖	Serie	97,0		
4:10,4* ↘	9:10,5* ↘	Sum	195,0		
5:10,4* ↓	10: 9,5 ←				

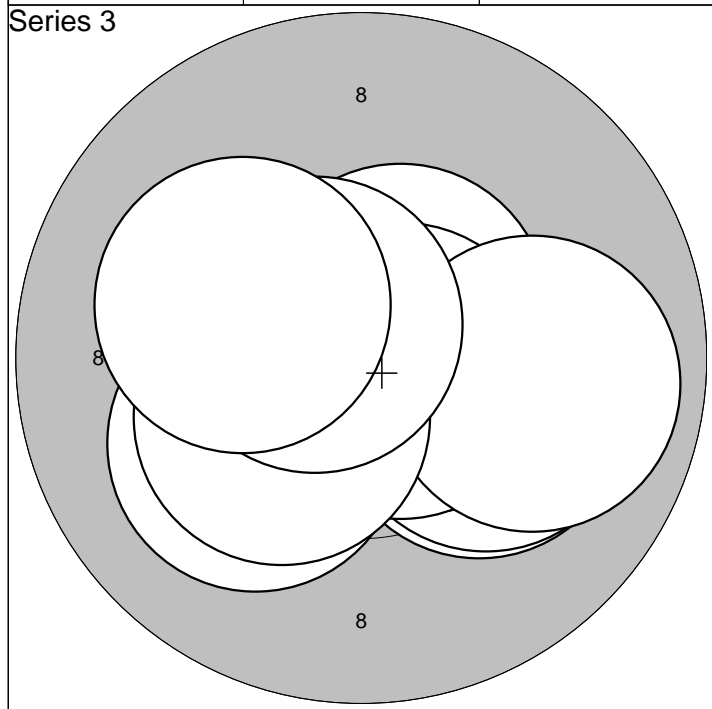

1:10,2* →	6:10,7* →				
2:10,2* →	7: 9,9 →				
3:10,6* →	8:10,3* ↙	Serie	99,0		
4:10,6* ↗	9:10,6* ↖	Sum	294,0		
5:10,1 ↙	10:10,2* ↖				

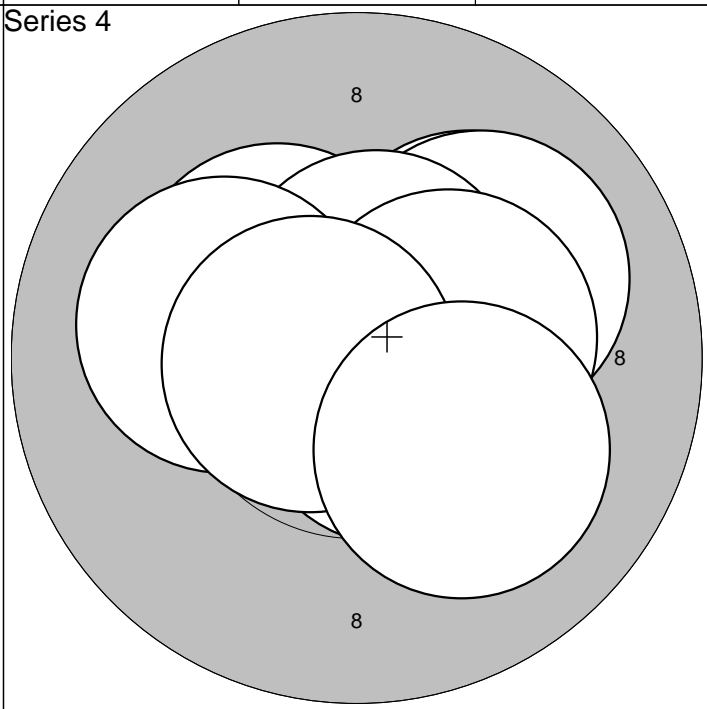

1:10,1 ↗	6:10,6* ↑				
2:10,3* ↖	7:10,4* →				
3:10,0 ↗	8:10,1 ←	Serie	100,0		
4:10,6* ↘	9:10,7* ←	Sum	394,0		
5:10,5* →	10:10,1 ↘				

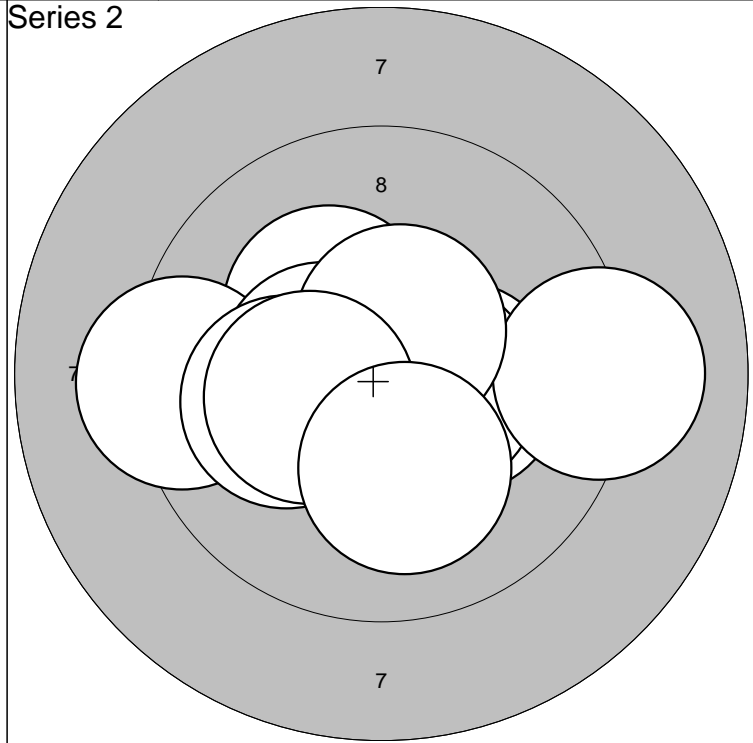
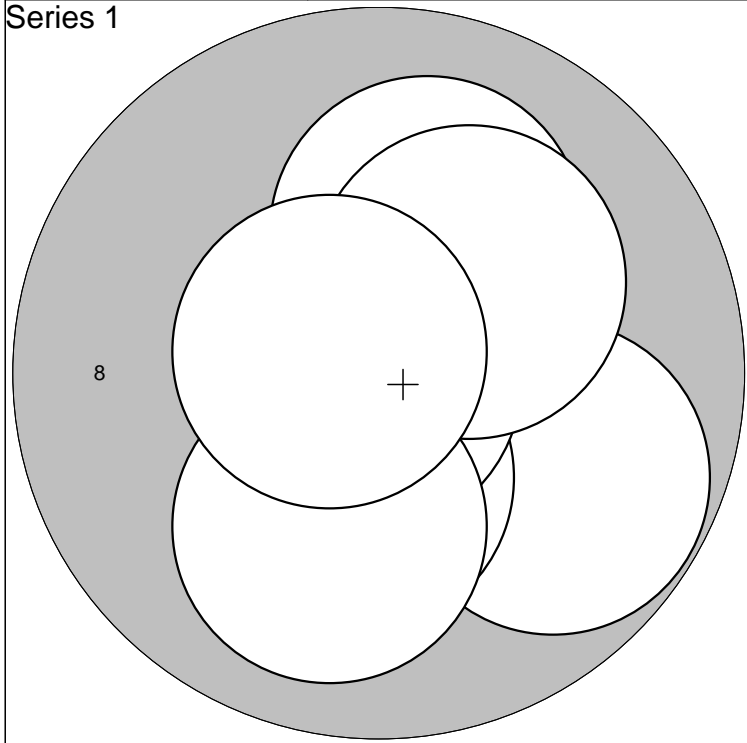

1:10,6* ↓	6:10,9* ←	Serie	99,0
2:10,8* ↘	7:10,0 ↓		
3:10,4* ↗	8:10,1 ↑	Sum	99,0
4: 9,8 ↘	9:10,2* ↗		
5:10,4* ↓	10:10,6* ←		

1:10,3* ↗	6: 9,1 →	Serie	98,0
2:10,3* →	7:10,5* ↗		
3:10,5* →	8:10,1 ←	Sum	197,0
4: 9,2 ←	9:10,3* ←		
5:10,5* ←	10:10,1 ↓		

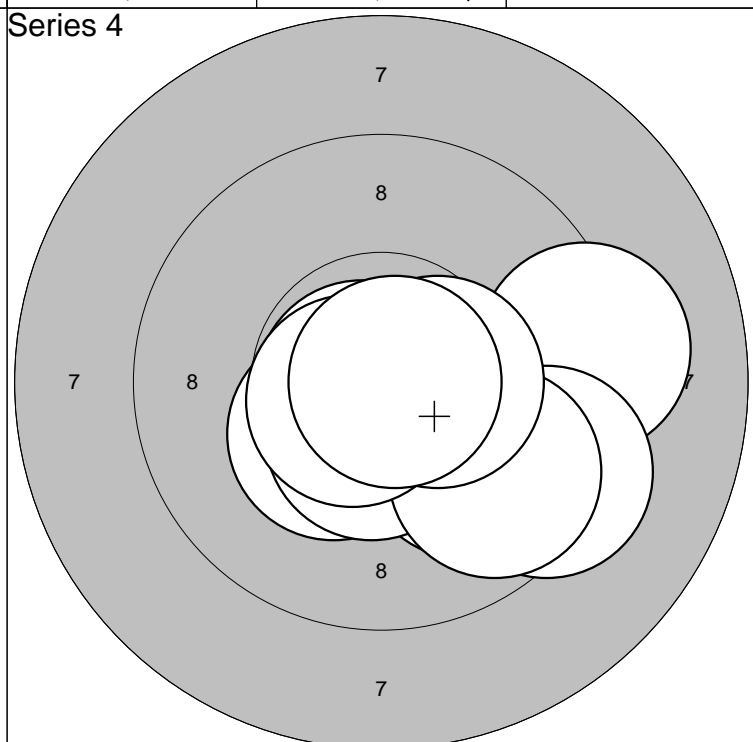
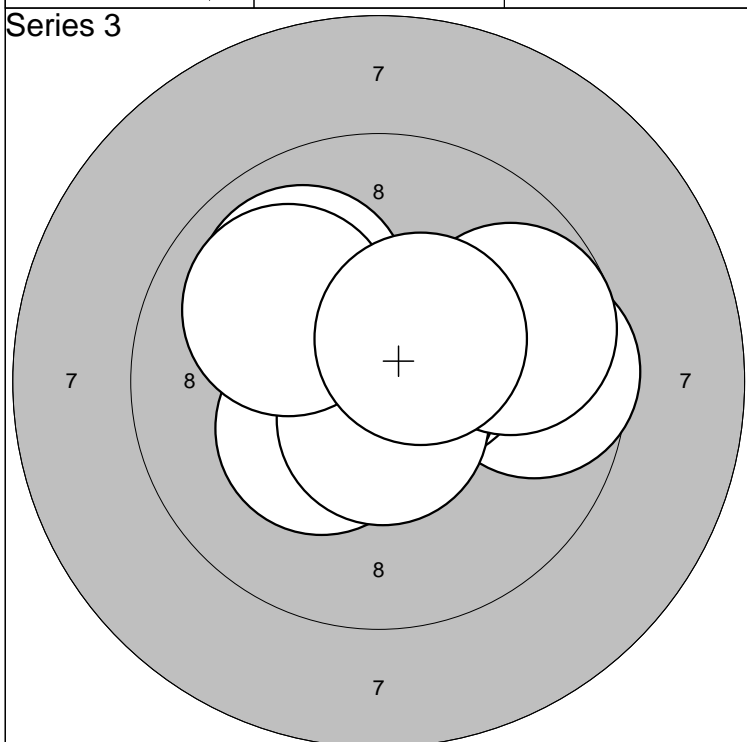

1:10,7* ↗	6:10,8* ↘	Serie	98,0
2:10,0 ↗	7:10,6* ↓		
3:10,3* ↙	8:10,0 ↖	Sum	295,0
4: 9,6 →	9: 9,8 →		
5:10,5* ↗	10:10,4* ↗		

1:10,8* ←	6: 9,3 ↘	Serie	97,0
2:10,0 ↘	7: 9,7 ↘		
3:10,3* ↙	8:10,7* ↙	Sum	392,0
4: 9,2 →	9:10,5* →		
5:10,5* ↓	10:10,8* →		

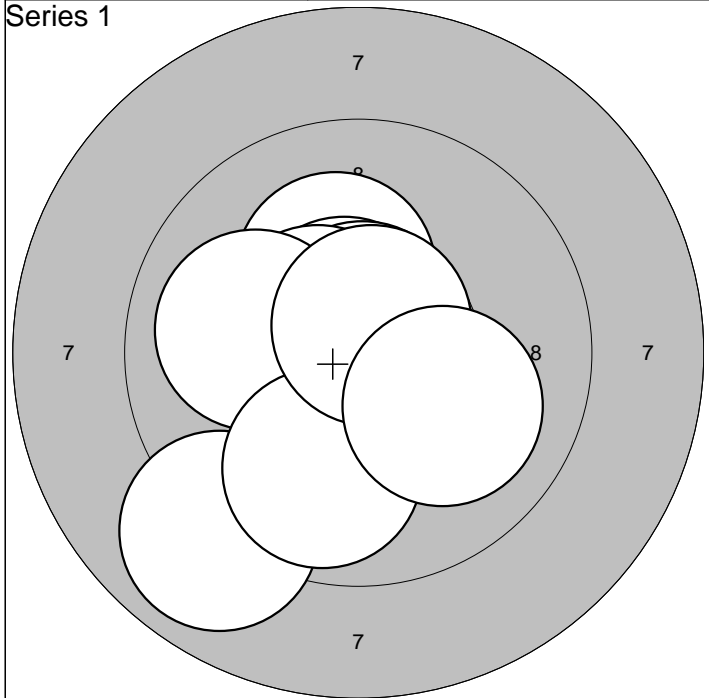

1:10,2* ↑	6: 8,9 ↘			Serie	97,0
2:10,6* ↑	7:10,0 ←				
3:10,9* ↘	8: 9,9 ↓	Sum	97,0		
4:10,6* ↑	9:10,7* ↗				
5:10,5* ↖	10:10,1 ↘				

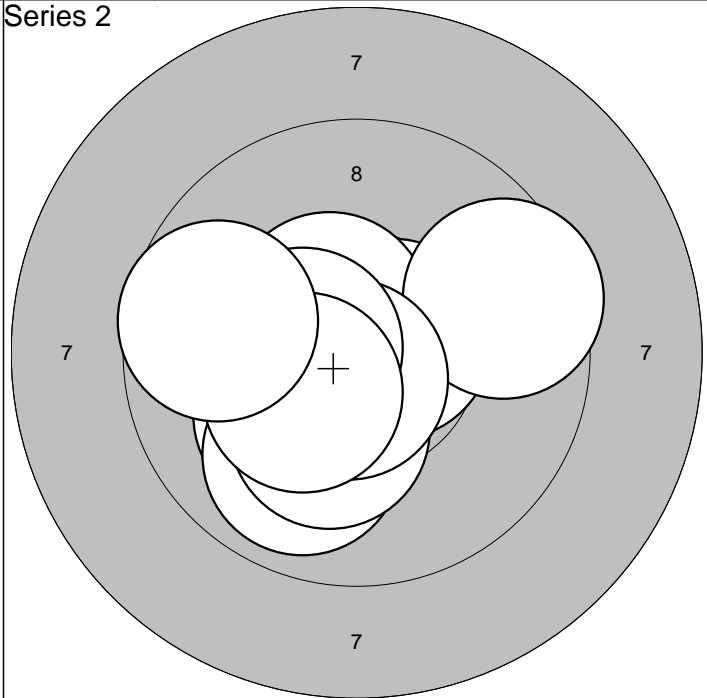

1:10,6* →	6:10,3* ↓			Serie	97,0
2:10,2* ↘	7:10,7* ↓				
3: 9,9 ↓	8:10,5* ←	Sum	194,0		
4:10,5* ↗	9:10,4* ↘				
5: 9,5 →	10: 9,7 ←				

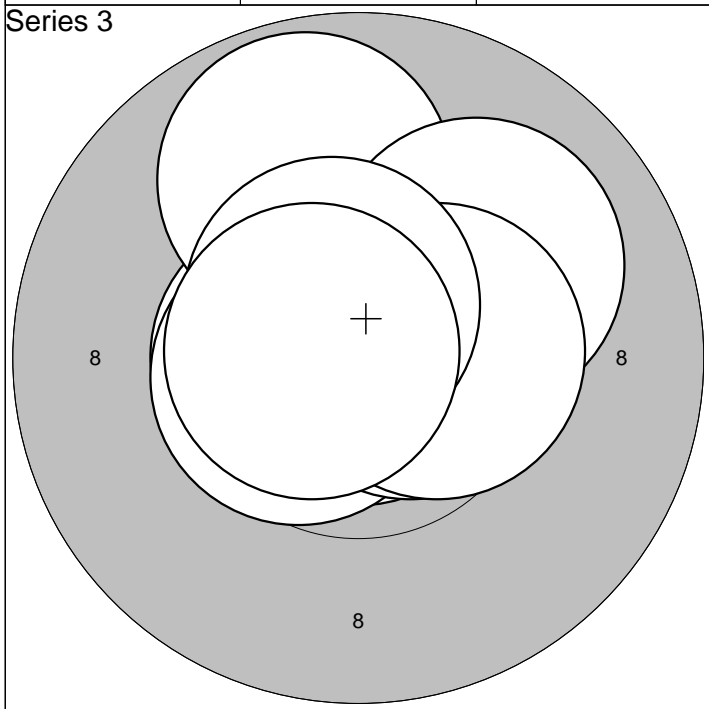

1:10,9*	6:10,0 ↗			Serie	99,0
2:10,6* ←	7:10,6* →				
3:10,6* ←	8:10,5* →	Sum	293,0		
4:10,3* ↗	9:10,6* ↗				
5: 9,8 ↑	10:10,7* ←				

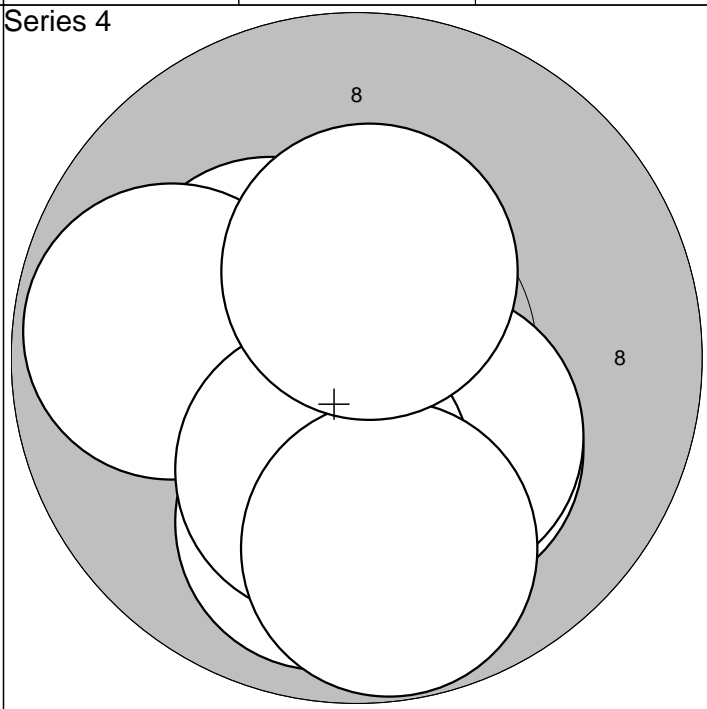

1:10,7* ←	6:10,3* ↓			Serie	97,0
2:10,3* ↖	7: 9,9 ↓				
3:10,2* ↓	8:10,3* ↓	Sum	390,0		
4:10,6* ←	9: 9,8 ↓				
5: 9,8 ←	10:10,4* ↑				

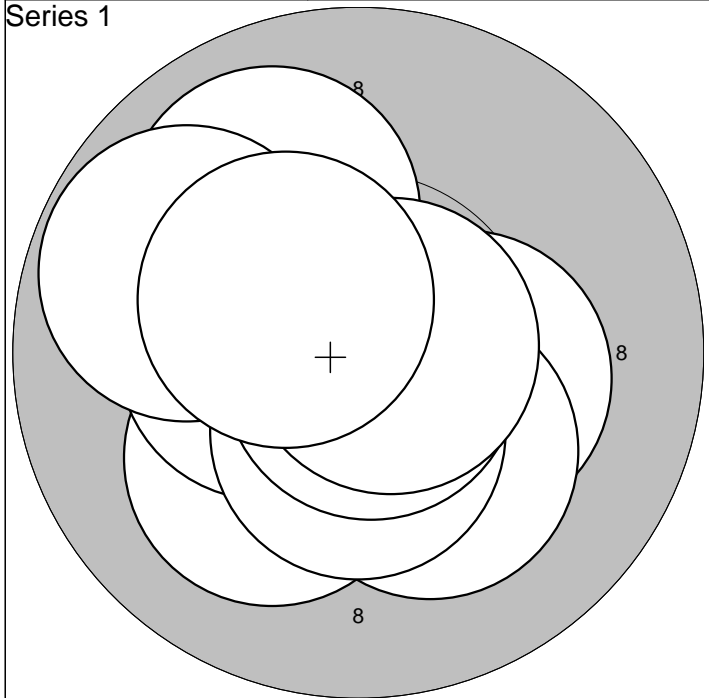

1:10,0 ↗	6:10,5* ↓	Serie	99,0
2:10,1 ↘	7:10,8* ↓		
3:10,3* →	8:10,8* →	Sum	99,0
4:10,4* ←	9: 9,8 ↖		
5:10,2* ↙	10:10,4* ↗		

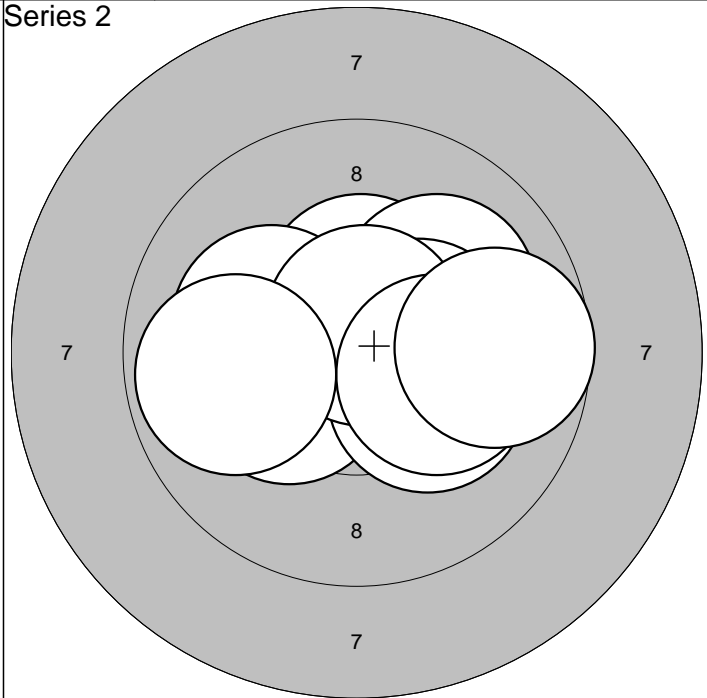

1:10,4* ↑	6:10,2* ↘	Serie	98,0
2:10,1 ↗	7:10,7* ↑		
3:10,4* →	8:10,2* →	Sum	197,0
4:10,3* ←	9: 9,9 ←		
5:10,1 ←	10: 9,7 →		

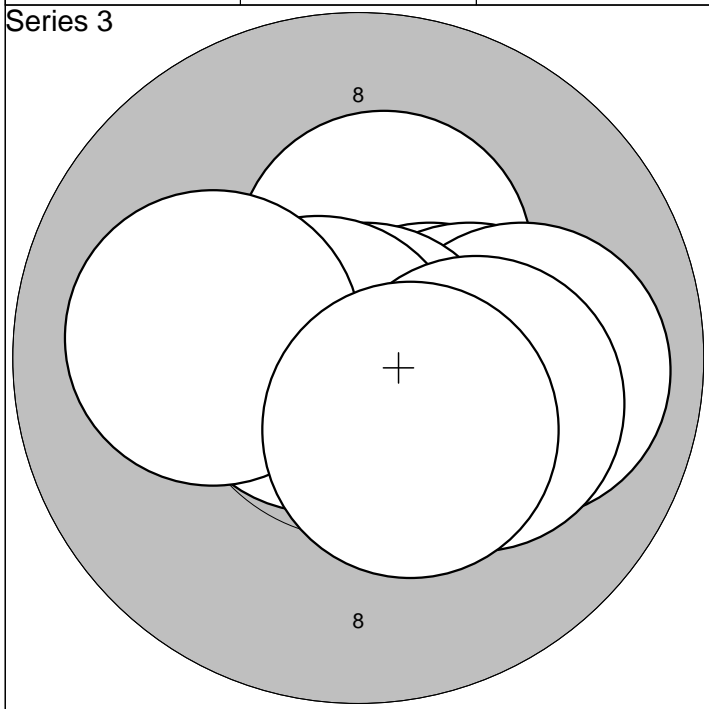

1:10,3* ↑	6:10,9* ↓	Serie	99,0
2:10,5* →	7:10,7* ←		
3:10,3* →	8:10,1 ←	Sum	296,0
4:10,6* ↘	9:10,2* ↘		
5: 9,9 →	10:10,4* ↘		

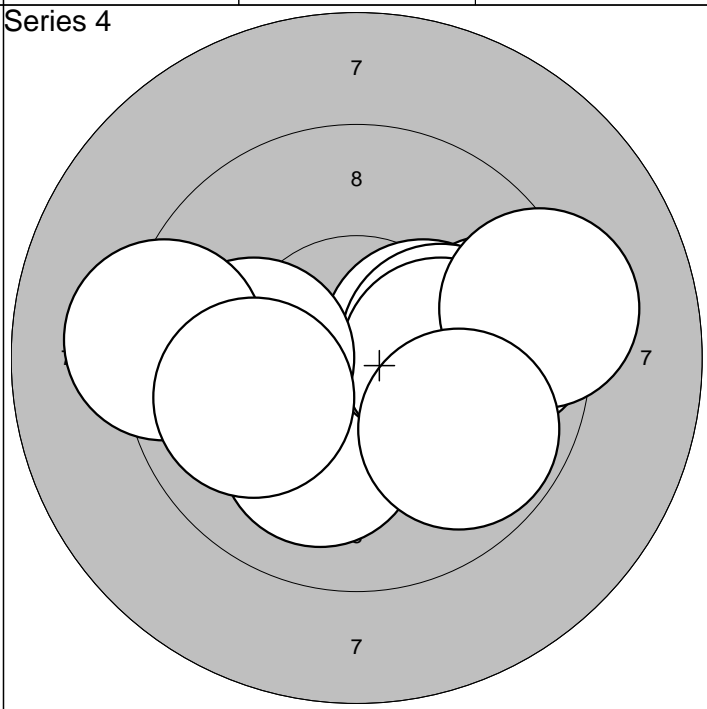

1: 9,7 →	6: 9,3 →	Serie	96,0
2:10,1 ↘	7: 9,8 ↘		
3:10,3* →	8:10,0 ←	Sum	392,0
4:10,2* →	9: 9,2 ←		
5:10,2* →	10:10,0 ←		

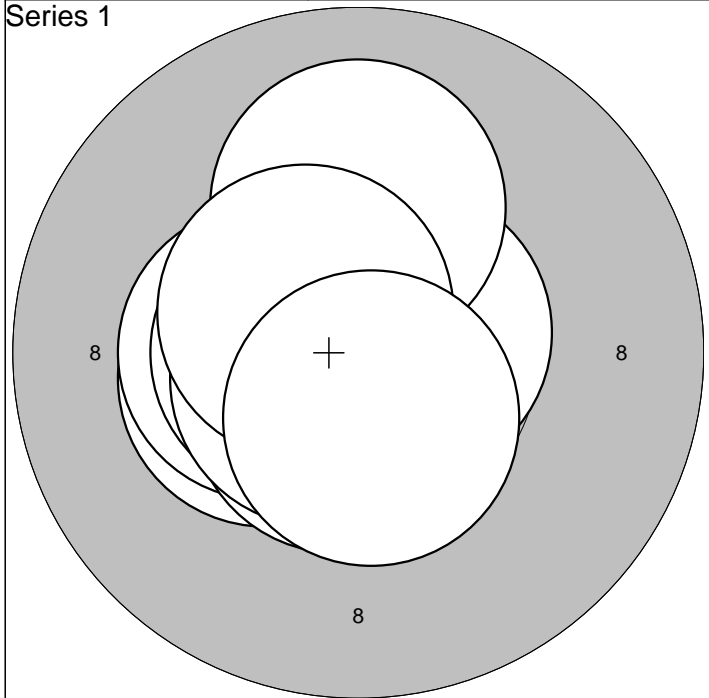

1:10,4* ←	6:10,1 ↑	Serie	100,0
2:10,7* ↓	7:10,6* ↓		
3:10,6* →	8:10,7* ←	Sum	100,0
4:10,4* ←	9:10,5* ↖		
5:10,6* ←	10:10,5* ↓		

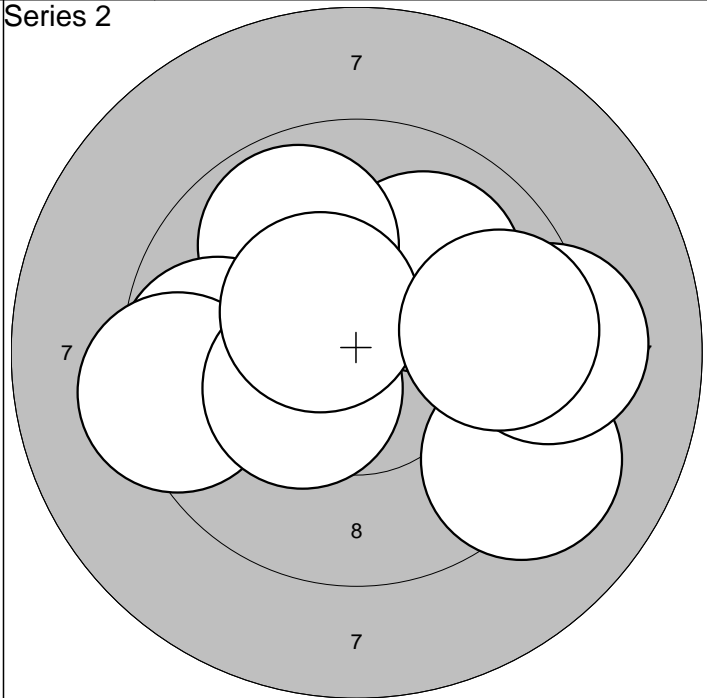

1: 9,9 ←	6: 9,2 ↘	Serie	93,0
2:10,0 ↗	7:10,4* ←		
3: 9,9 ↖	8: 9,2 →	Sum	193,0
4: 9,7 ←	9:10,5* ↗		
5: 9,3 ←	10: 9,7 →		

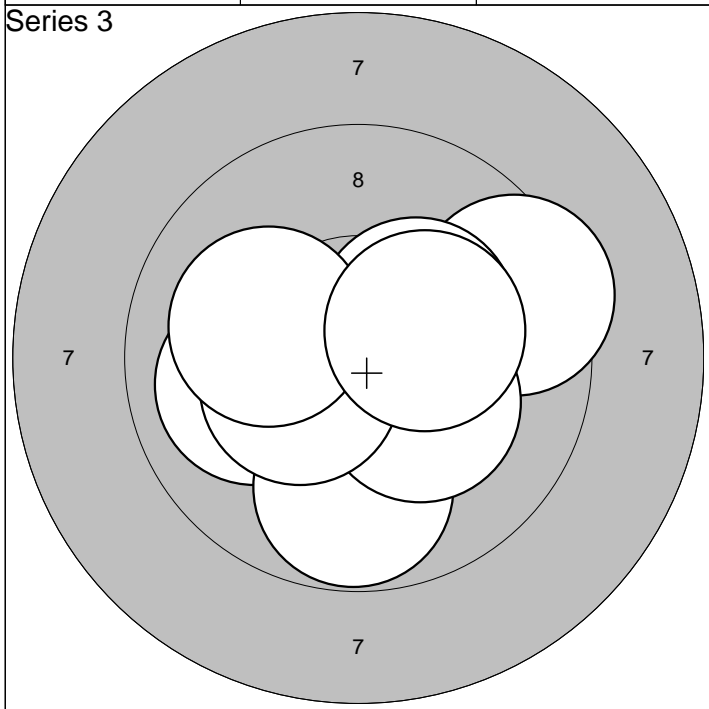

1: 9,4 →	6: 9,8 ↓	Serie	98,0
2:10,6* ↘	7:10,3* ↘		
3:10,3* ↗	8:10,4* ←	Sum	291,0
4:10,0 ←	9:10,1 ←		
5:10,4* ↓	10:10,3* →		

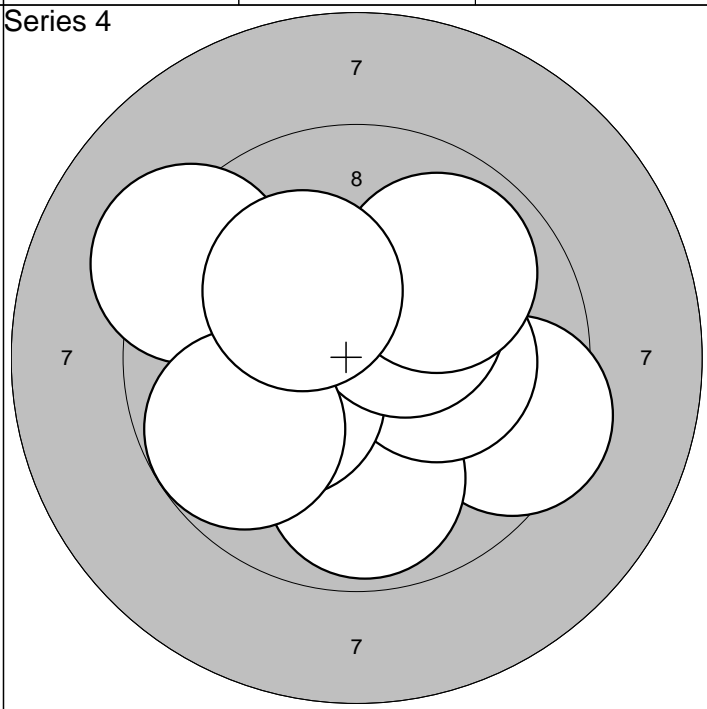

1:10,2* ←	6:10,4* ↗	Serie	95,0
2: 9,5 →	7: 9,2 ↖		
3: 9,9 ↓	8: 9,9 ↗	Sum	386,0
4:10,2* →	9: 9,8 ←		
5:10,2* ←	10:10,2* ↖		

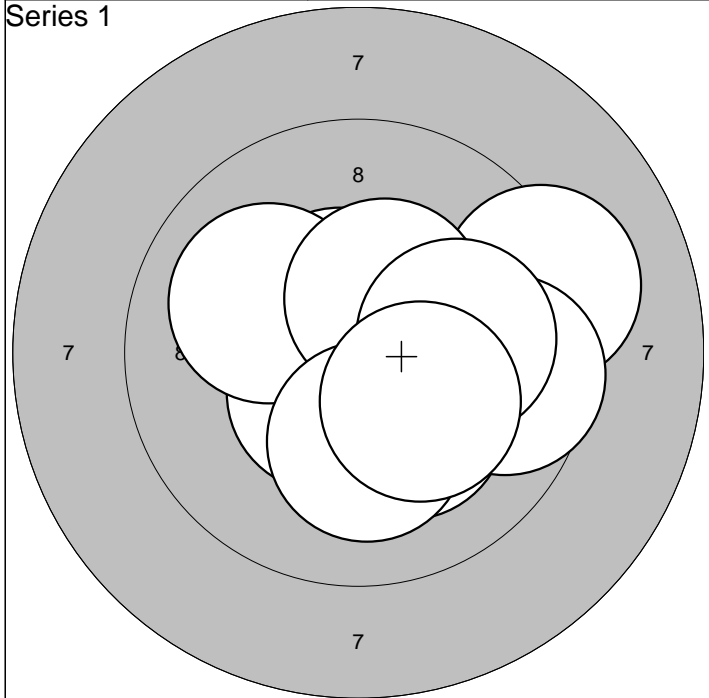

1:10,2* ↘	6:10,0 ↙	Serie	98,0
2:10,5* ↙	7:10,4* ↗		
3:10,5* ↗	8:10,1 →	Sum	98,0
4: 9,2 →	9:10,2* ↓		
5: 9,6 →	10:10,2* ↘		

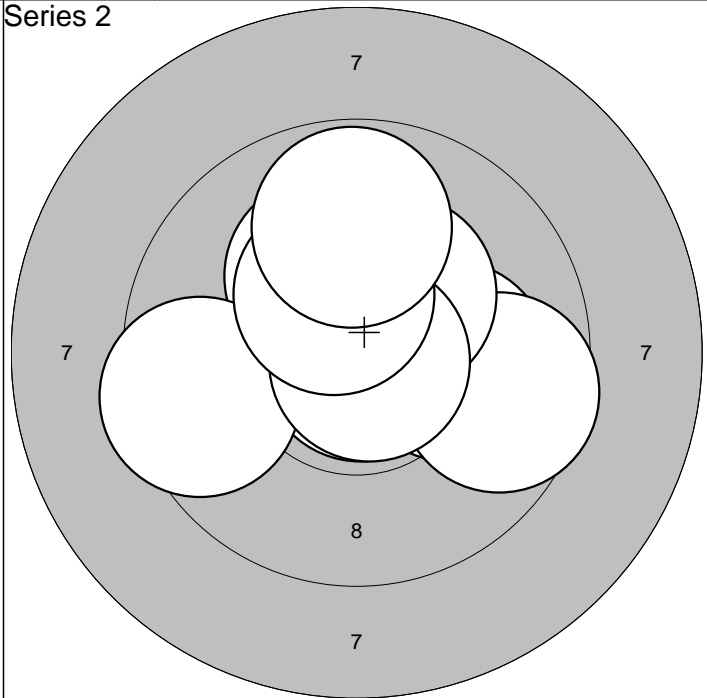

1:10,9* ↑	6:10,3* ↗	Serie	97,0
2:10,1 →	7: 9,5 ←		
3: 9,6 →	8:10,8* ↘	Sum	195,0
4:10,9* ↓	9:10,4* ↗		
5:10,2* ↗	10: 9,8 ↑		

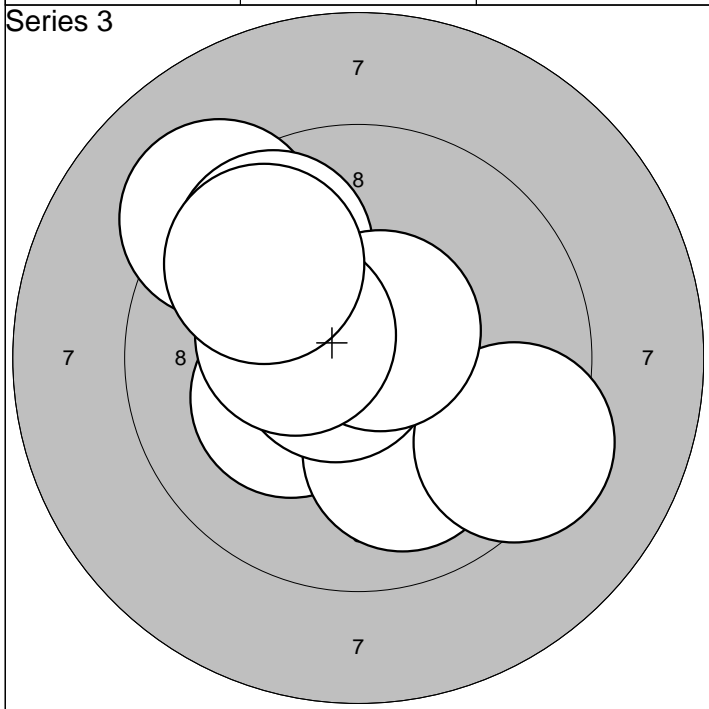

1:10,7* ↙	6: 9,2 ↗	Serie	96,0
2:10,2* ↙	7: 9,7 ↗		
3:10,0 ↓	8:10,6* ↗	Sum	291,0
4:10,8* ←	9:10,4* ←		
5: 9,4 ↘	10: 9,8 ↗		

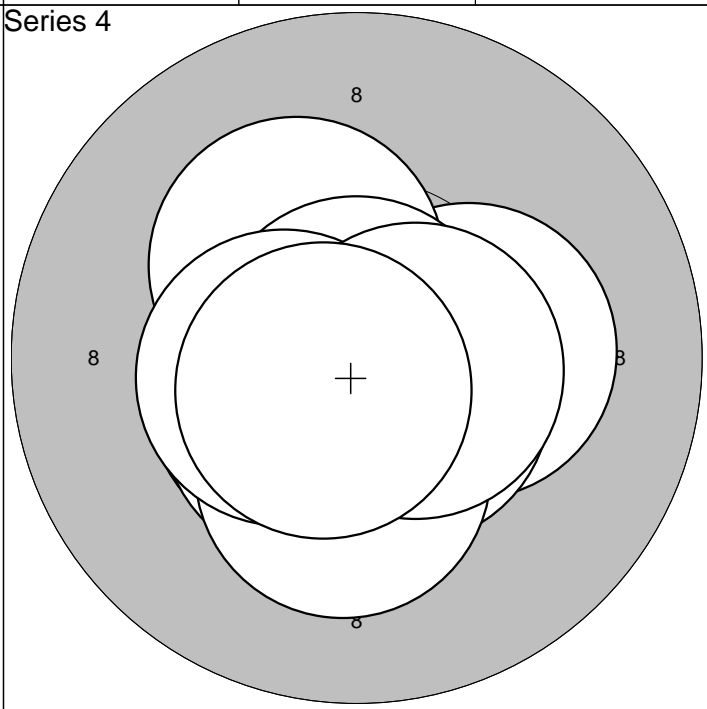

1:10,3* →	6:10,5* ↘	Serie	100,0
2:10,3* ↗	7:10,3* ↓		
3:10,6* ↘	8:10,5* ←	Sum	391,0
4:10,5* ↙	9:10,6* →		
5:10,9* ↑	10:10,7* ↘		

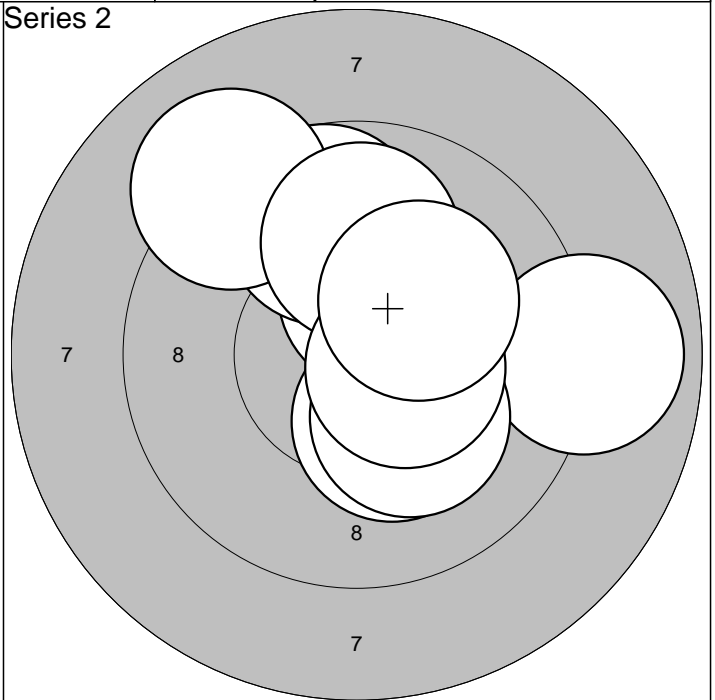
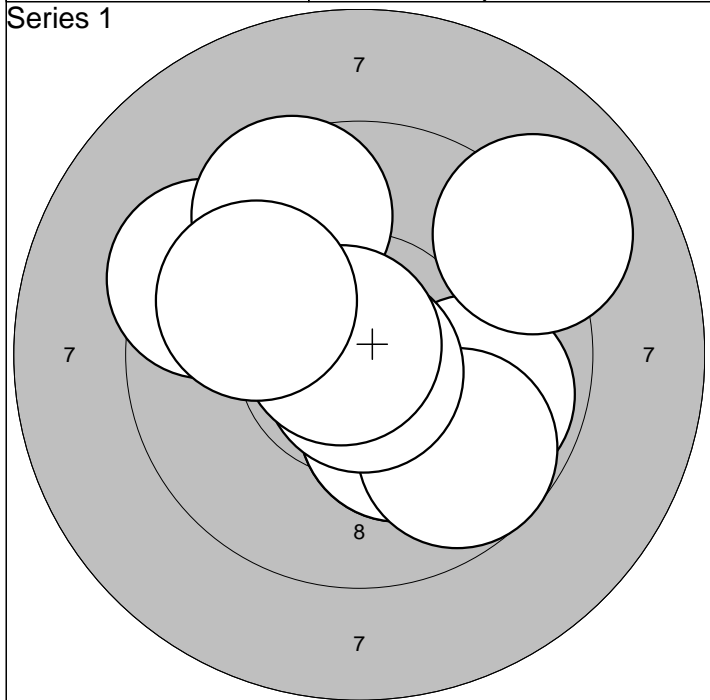

1:10,2* ↘	6:10,8* ↓			Serie	94,0
2:10,2* ↘	7: 9,6 ↗				
3: 9,4 ↗	8: 9,0 ↗	Sum	94,0		
4: 9,9 ↘	9:10,8* ↖				
5: 9,7 ↘	10: 9,9 ↖				

1:10,1 ↑	6:10,2* ↘			Serie	95,0
2:10,4* ↑	7: 9,1 ↗				
3: 8,9 →	8: 9,9 ↑	Sum	189,0		
4:10,3* ↘	9:10,5* →				
5: 9,8 ↑	10:10,2* ↗				

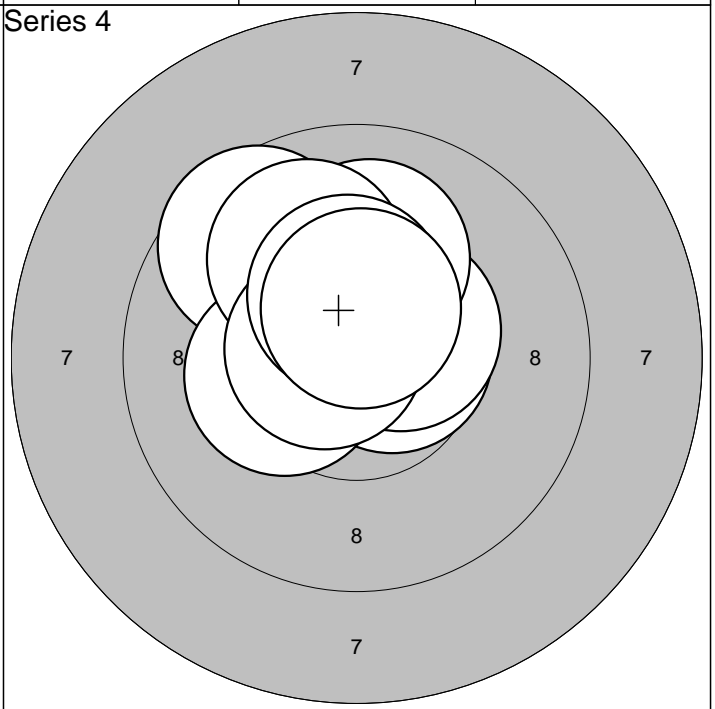
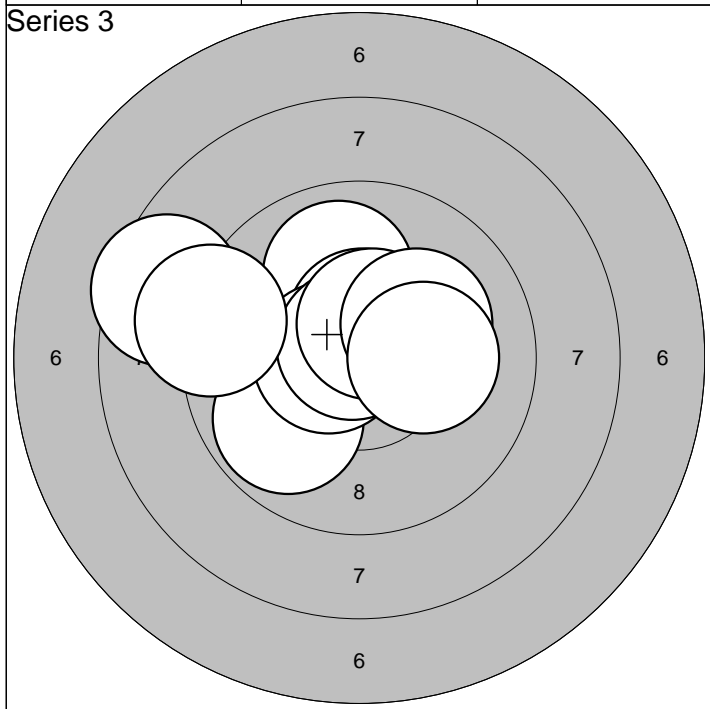

1:10,0 ↑	6:10,5* ↑			Serie	96,0
2: 9,9 ↙	7: 8,5 ←				
3:10,6* ↑	8: 9,1 ←	Sum	285,0		
4:10,6* ←	9:10,2* ↗				
5:10,8* ↗	10:10,2* →				

1:10,6* →	6:10,5* ↗			Serie	99,0
2: 9,6 ↖	7:10,0 ↗				
3:10,5* ↗	8:10,7* ←	Sum	384,0		
4:10,1 ↑	9:10,4* ↑				
5:10,3* ←	10:10,5* ↑				

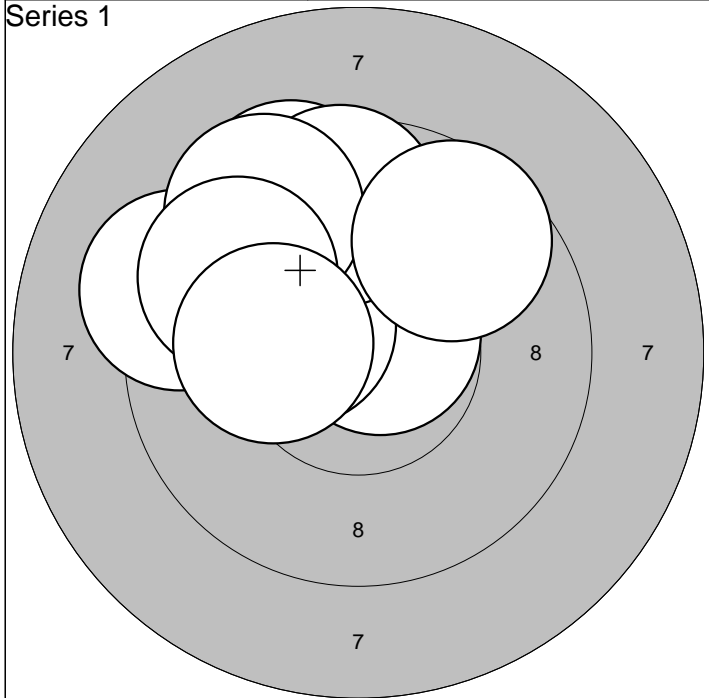

1: 9,9 ↖	6: 9,3 ←			Serie	93,0
2: 9,4 ↗	7: 9,5 ↗				
3: 10,7* ↗	8: 9,7 ↖	Sum	93,0		
4: 10,3* ←	9: 10,2* ←				
5: 9,6 ↑	10: 9,7 ↗				

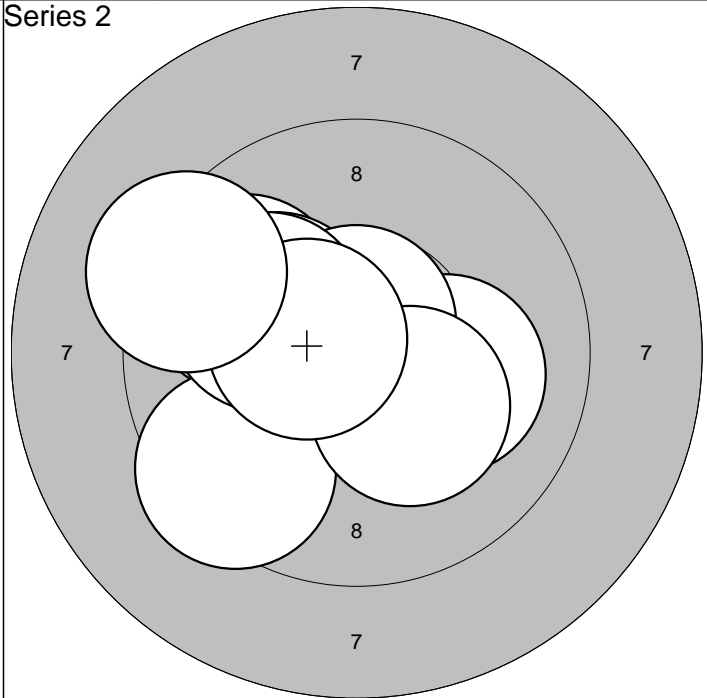

1: 10,7* ←	6: 10,7* ↑			Serie	97,0
2: 9,8 ↖	7: 10,3* ↘				
3: 10,1 ↖	8: 10,1 ←	Sum	190,0		
4: 10,1 →	9: 10,5* ←				
5: 9,5 ↘	10: 9,3 ↖				

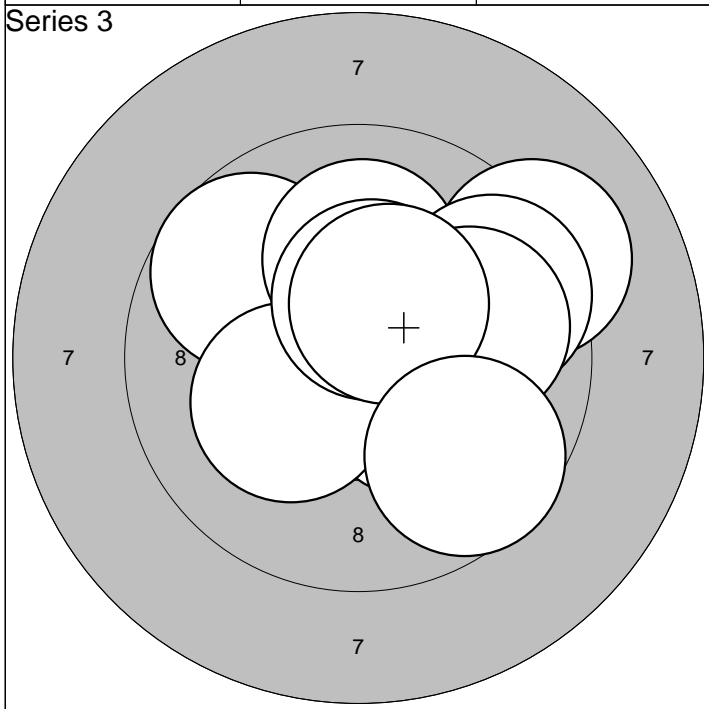

1: 9,2 ↗	6: 9,6 →			Serie	95,0
2: 10,3* ↘	7: 9,9 →				
3: 9,7 ↖	8: 10,4* ↑	Sum	285,0		
4: 10,1 ↑	9: 10,4* ↗				
5: 10,2* ↙	10: 9,6 ↘				

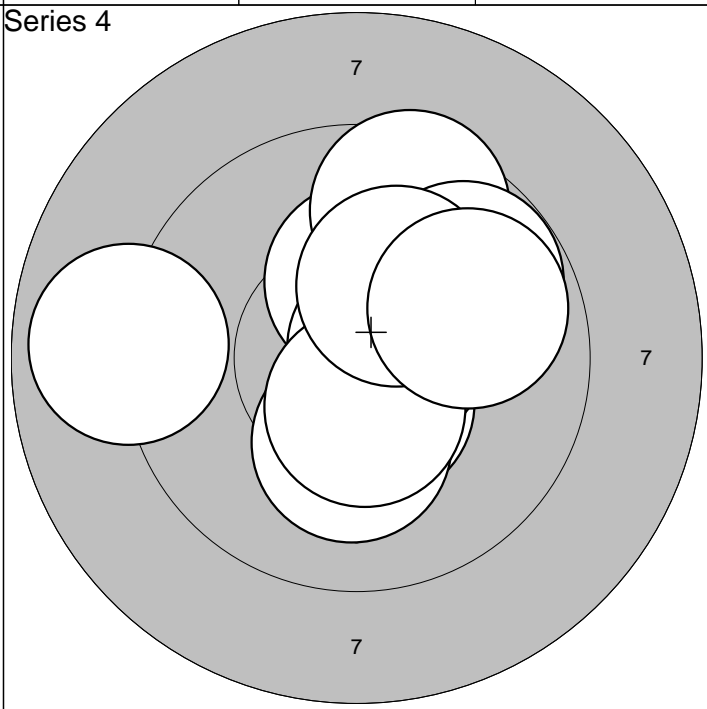

1: 10,3* ↑	6: 10,2* ↓			Serie	95,0
2: 9,6 ↗	7: 9,8 ↗				
3: 8,9 ←	8: 10,5* ↓	Sum	380,0		
4: 10,5* ↓	9: 10,2* ↗				
5: 10,7* →	10: 9,9 →				

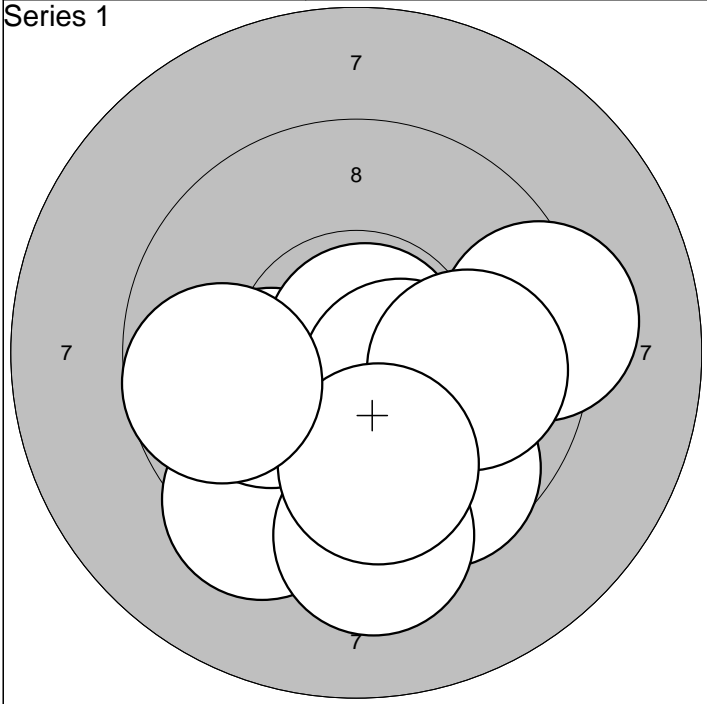

1: 9,4 ↘	6: 9,7 ↘	Serie	93,0
2:10,1 ←	7: 9,9 →		
3: 9,3 →	8: 9,3 ↓	Sum	93,0
4:10,9* ↗	9: 9,9 ↓		
5:10,5* ↘	10: 9,7 ←		

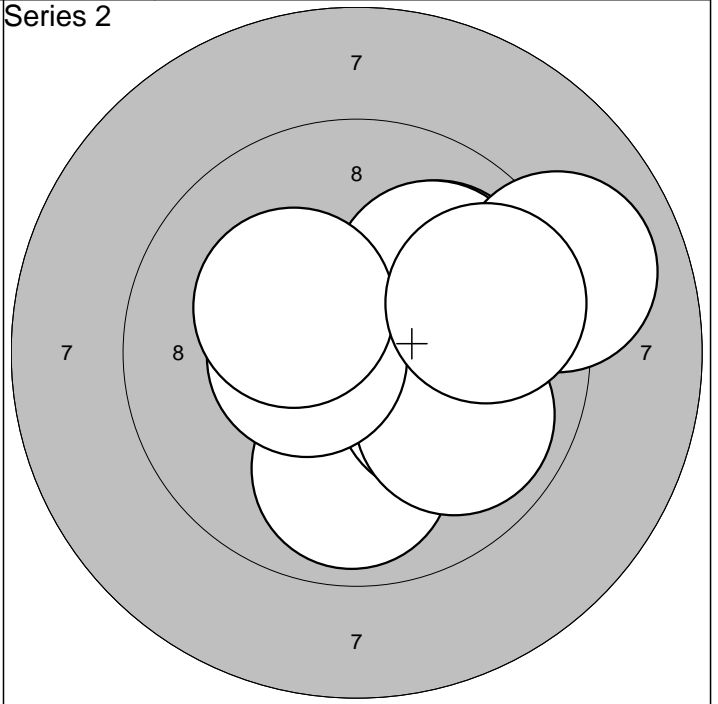

1:10,9* ↗	6: 9,9 ↘	Serie	96,0
2: 9,9 ↓	7: 9,0 →		
3:10,1 ↘	8:10,5* ←	Sum	189,0
4:10,0 ↗	9:10,3* ↖		
5:10,0 ↗	10: 9,7 →		

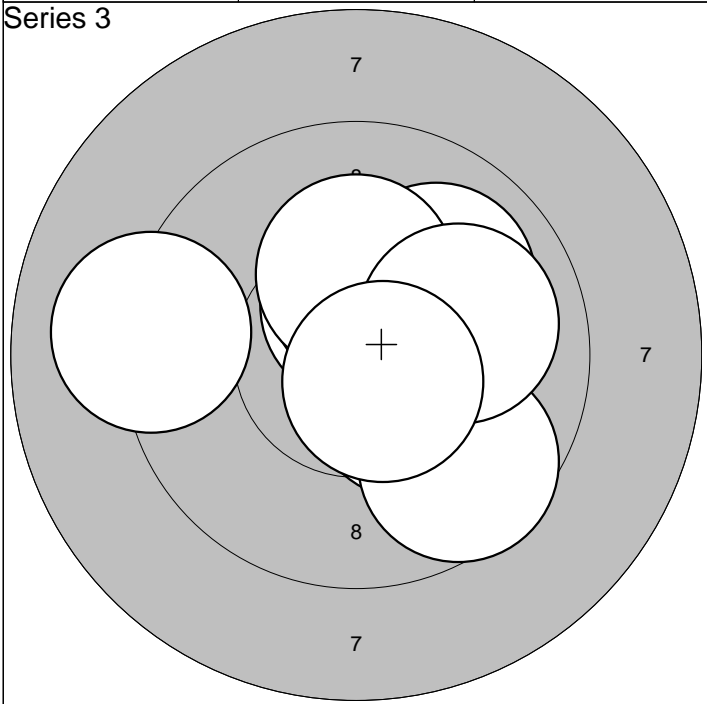

1:10,5* ↑	6: 9,6 ↘	Serie	98,0
2:10,4* ↑	7: 9,1 ←		
3:10,3* ↘	8:10,2* ↑	Sum	287,0
4:10,3* ↘	9:10,0 →		
5:10,0 ↗	10:10,6* ↘		

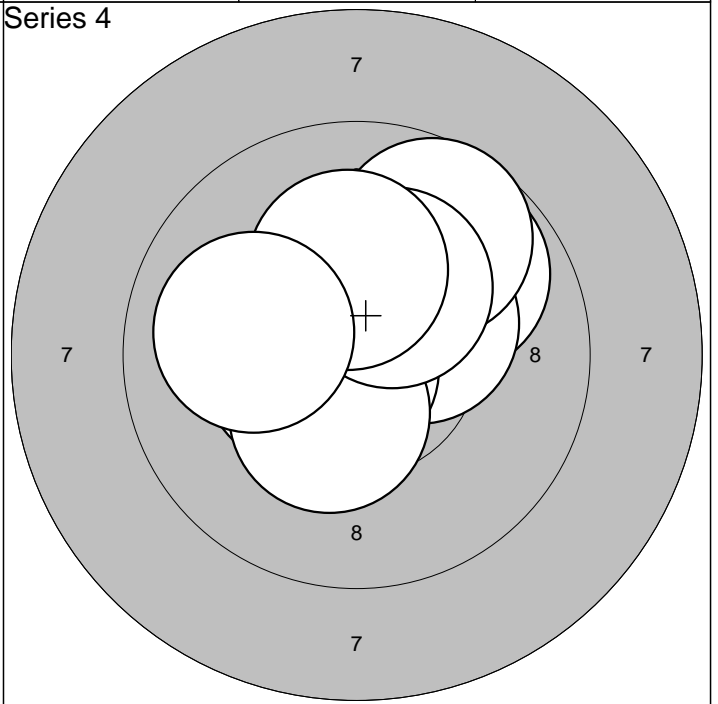

1: 9,8 ↗	6: 9,7 ↗	Serie	98,0
2:10,3* ↗	7:10,4* ↓		
3:10,5* ←	8:10,3* ↗	Sum	385,0
4:10,1 ↗	9:10,2* ↑		
5:10,7* ↖	10:10,0 ←		

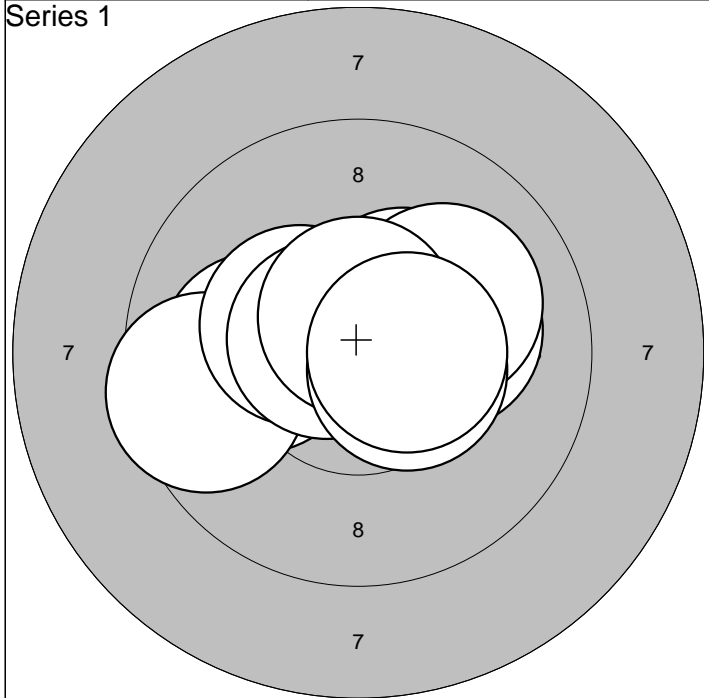

1:10,1 ←	6:10,1 →		Serie	99,0
2:10,4* ↗	7:10,6* ←			
3: 9,5 ←	8:10,6* ↑	Sum	99,0	
4:10,4* ↖	9:10,5* →			
5:10,2* →	10:10,5* →			

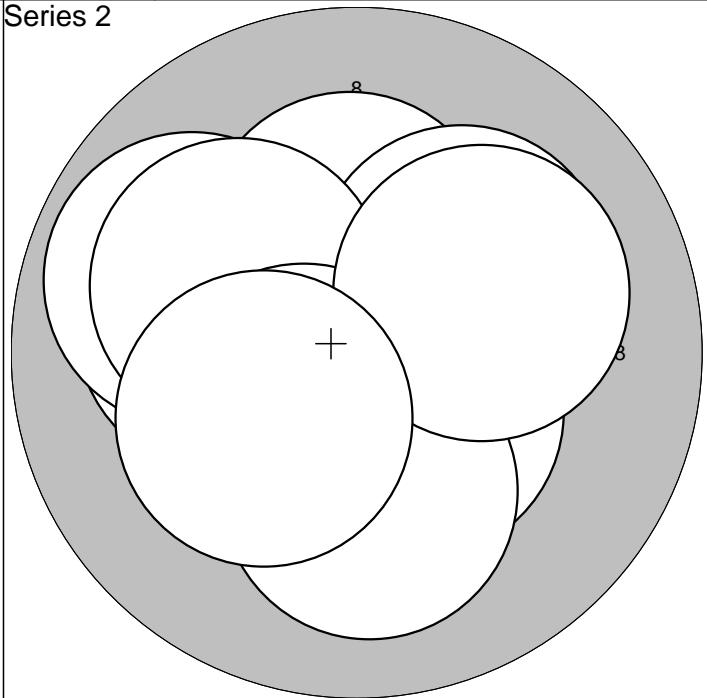

1:10,1 ←	6:10,4* ↘		Serie	99,0
2: 9,8 ←	7:10,5* ↙			
3:10,3* ↑	8:10,1 ↓	Sum	198,0	
4:10,2* ↗	9:10,1 →			
5:10,1 ←	10:10,3* ↙			

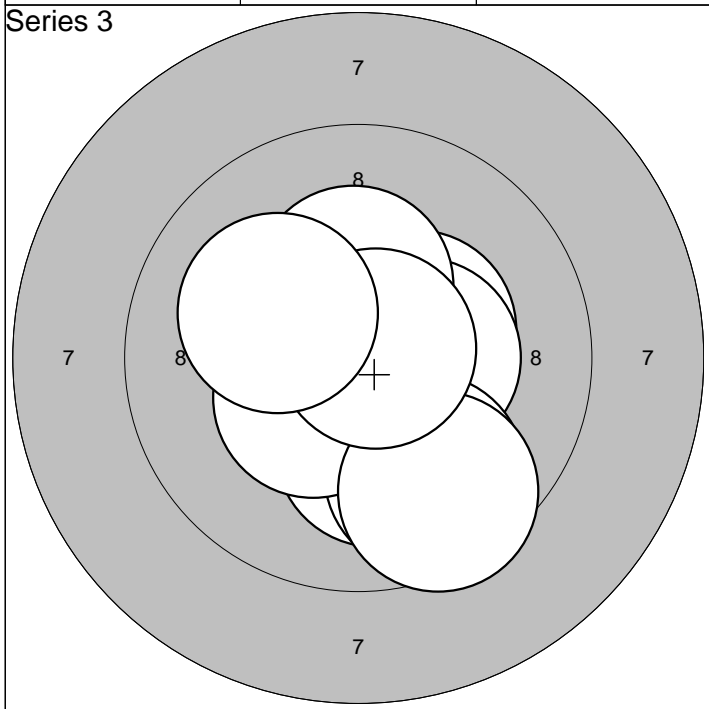

1:10,1 ↓	6:10,4* ↙		Serie	98,0
2:10,5* ↑	7:10,3* ↑			
3:10,4* ↗	8: 9,5 ↓	Sum	296,0	
4:10,4* →	9:10,8* →			
5: 9,7 ↓	10:10,1 ←			

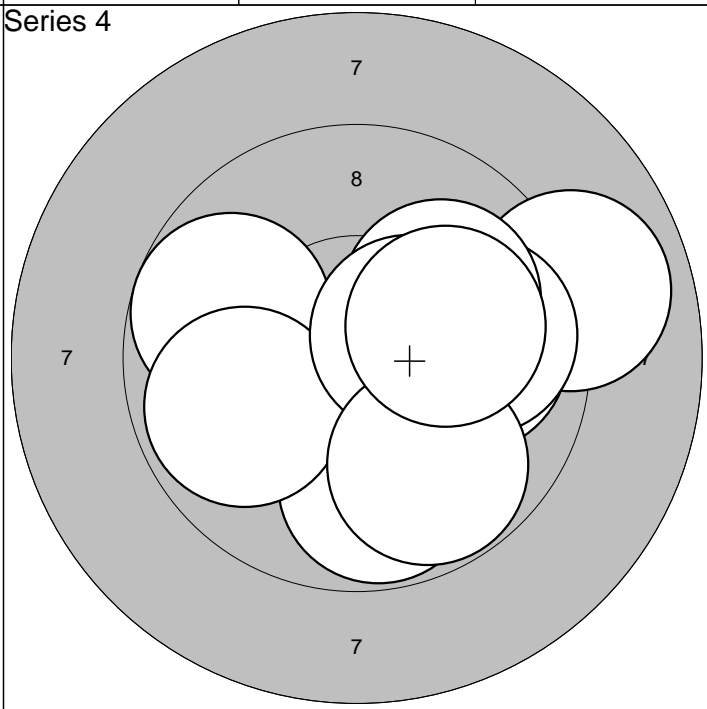

1: 8,9 →	6: 9,9 ←		Serie	92,0
2: 9,7 ←	7:10,0 →			
3: 9,9 →	8:10,4* →	Sum	388,0	
4: 9,8 →	9: 9,8 ↓			
5: 9,8 ↓	10:10,1 →			

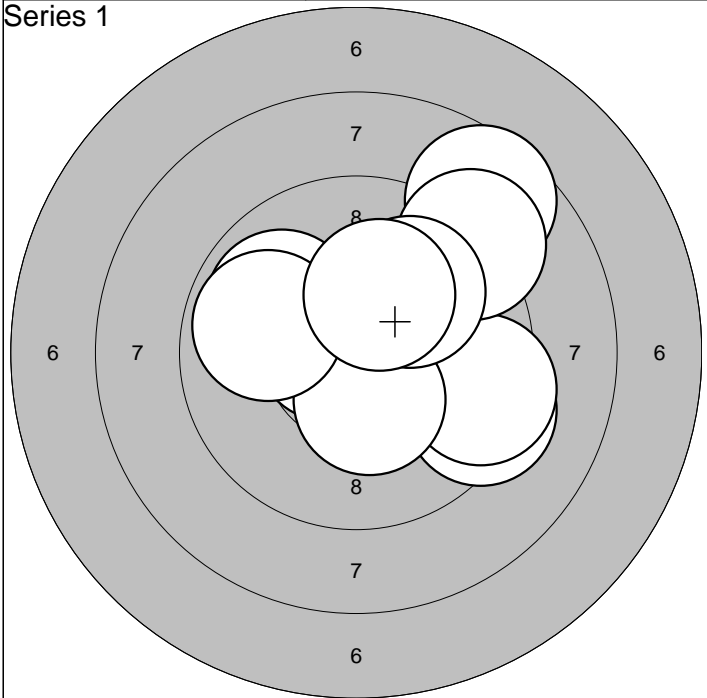

1: 9,9 ↖	6:10,4* ↓	Serie	93,0
2: 9,3 →	7: 9,1 ↗		
3: 8,6 ↗	8: 9,9 ←	Sum	93,0
4:10,6* ←	9:10,0 ↗		
5: 9,4 →	10:10,2* ↗		

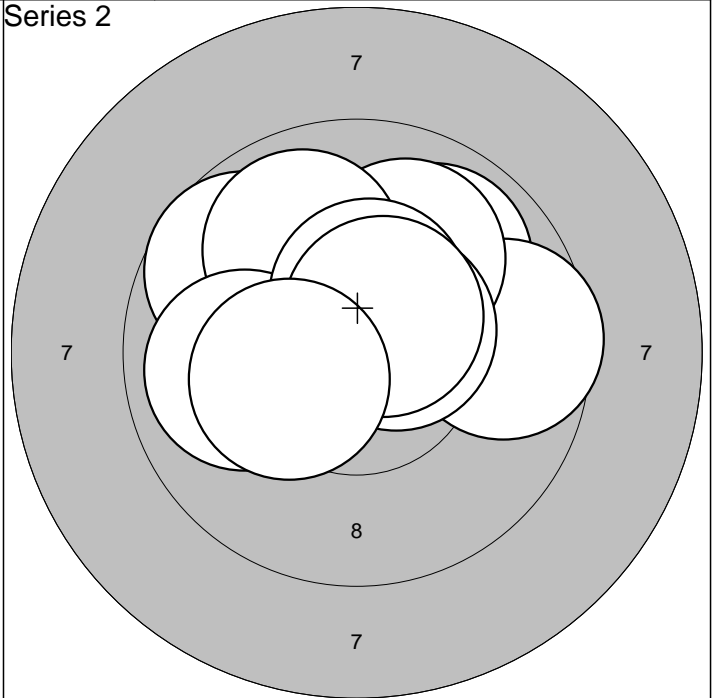

1: 9,9 ↗	6: 9,9 ↖	Serie	95,0
2: 9,6 →	7: 9,9 ←		
3:10,0 ↗	8:10,4* ↗	Sum	188,0
4: 9,7 ↖	9:10,6* ↗		
5:10,5* ↗	10:10,3* ←		

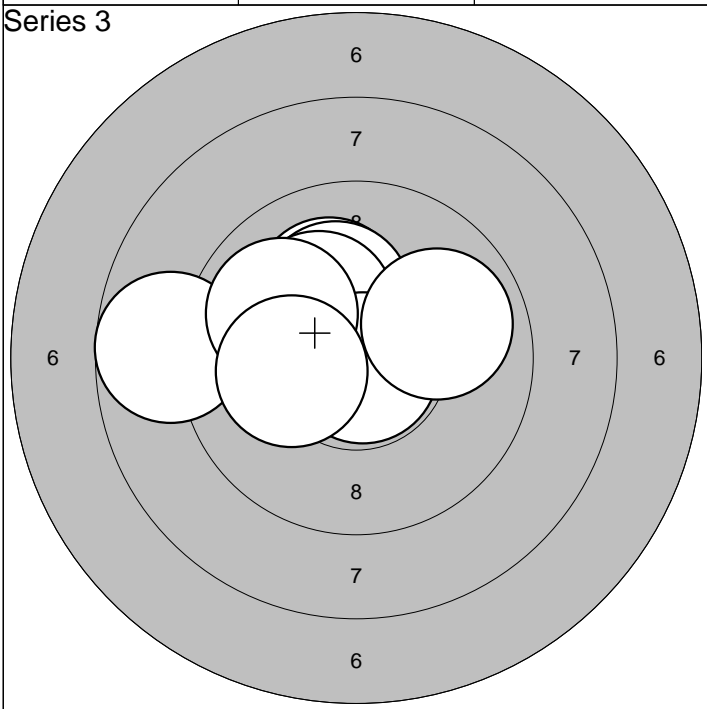

1:10,2* ←	6:10,2* ↗	Serie	96,0
2: 8,8 ←	7:10,8* ↓		
3:10,1 ↗	8: 9,9 →	Sum	284,0
4:10,2* ↗	9: 9,9 ↖		
5:10,5* ←	10:10,2* ←		

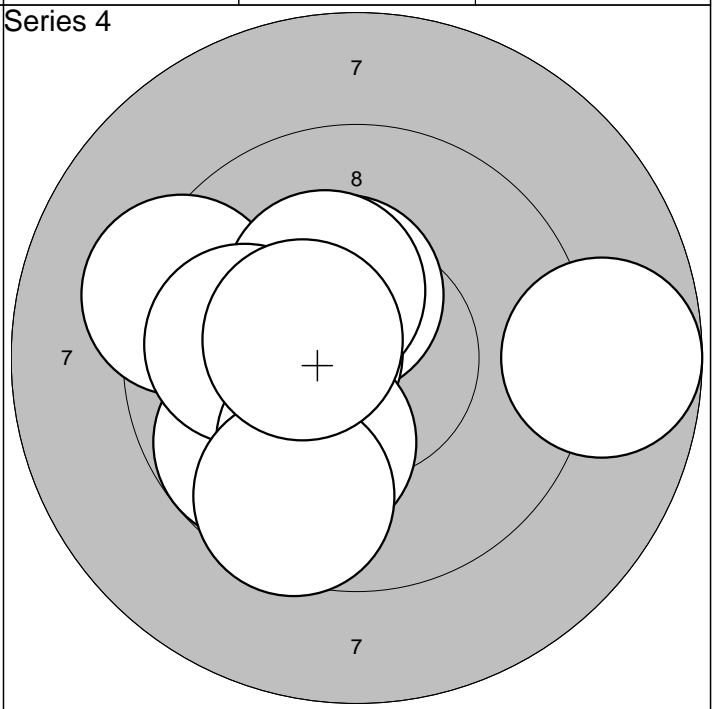

1: 9,7 ↖	6:10,0 ←	Serie	95,0
2: 9,3 ←	7:10,1 ↓		
3:10,4* ↗	8: 9,6 ↓	Sum	379,0
4:10,5* ←	9:10,5* ←		
5:10,3* ↗	10: 8,7 →		

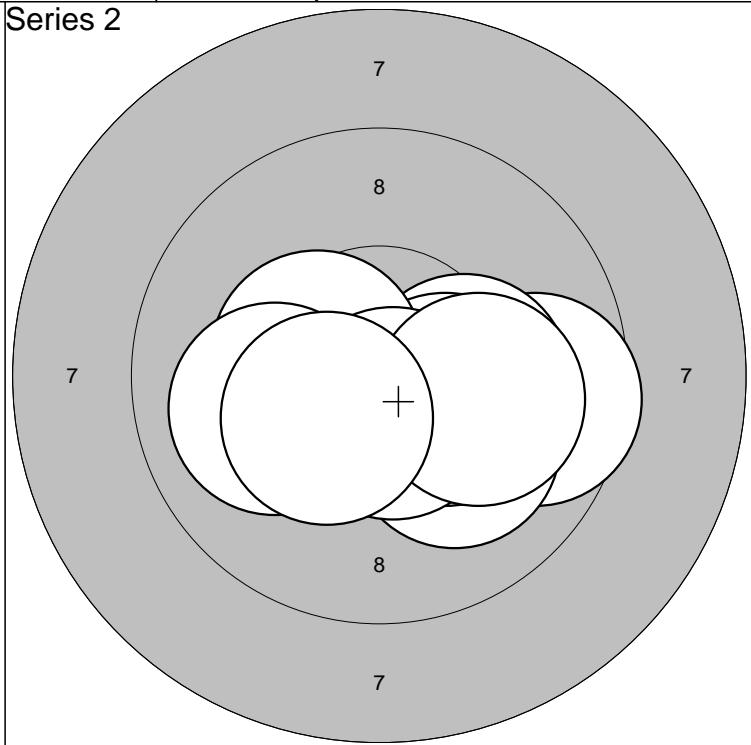
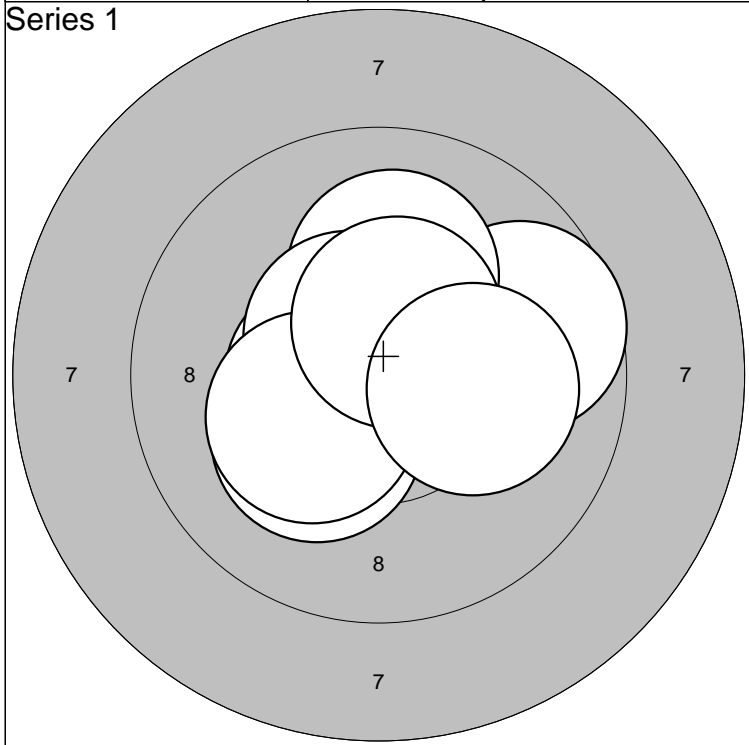

1:10,2* ↙	6:10,8* ↗	Serie	99,0
2:10,5* ↑	7:10,6* ↗		
3: 9,7 →	8:10,3* ↙	Sum	99,0
4:10,1 ↑	9:10,5* ↑		
5:10,5* ←	10:10,1 →		

1: 9,6 →	6:10,4* ←	Serie	99,0
2:10,1 ↘	7:10,0 ←		
3:10,2* ←	8:10,6* ↓	Sum	198,0
4:10,2* →	9:10,1 →		
5:10,3* →	10:10,4* ↙		

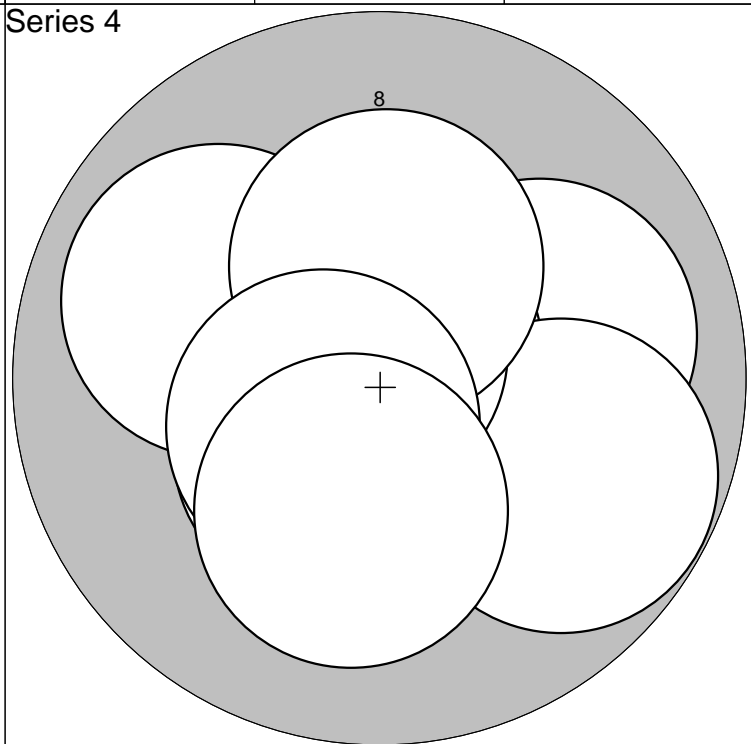
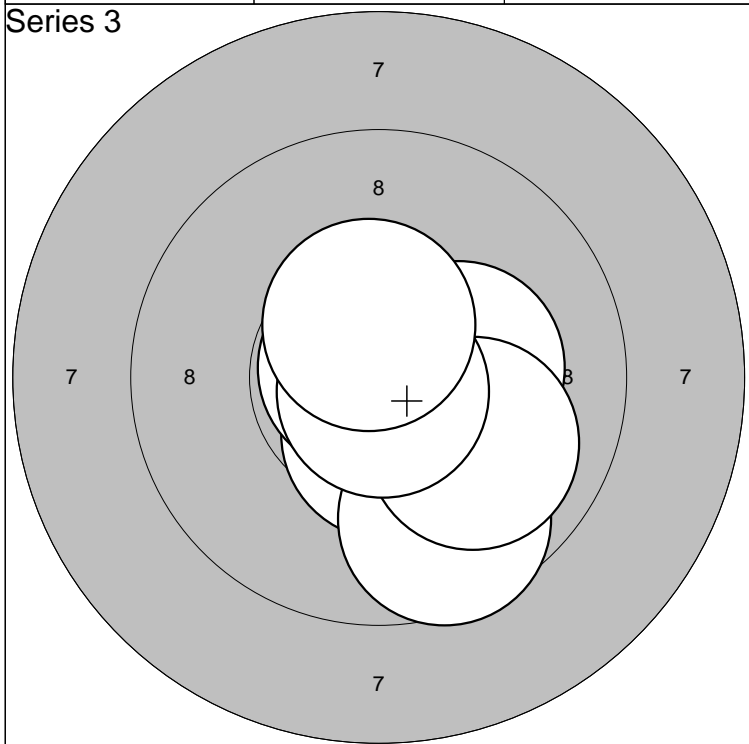

1:10,5* ↘	6:10,8* ↗	Serie	99,0
2:10,7* ↑	7:10,3* →		
3:10,7* ↘	8:10,0 ↓	Sum	297,0
4:10,5* ↓	9:10,8* ↓		
5: 9,6 ↓	10:10,5* ↑		

1:10,8* ↙	6:10,7* ↗	Serie	98,0
2:10,0 →	7: 9,9 ←		
3:10,8* ↑	8:10,3* ↑	Sum	395,0
4:10,5* ↙	9:10,5* ↙		
5: 9,8 →	10:10,2* ↓		

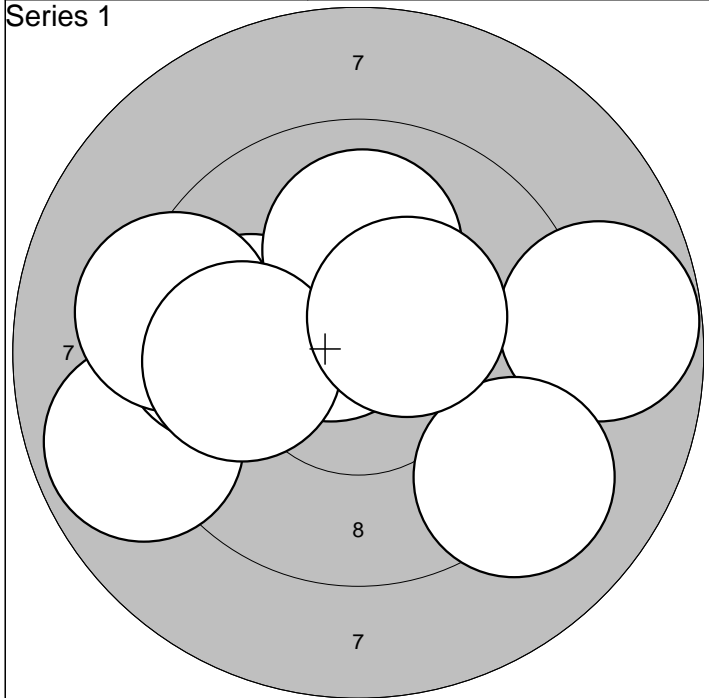

1: 8,8 →	6:10,0 ↑		Serie	92,0
2:10,6* ↗	7: 9,1 ↘			
3: 8,9 ←	8: 9,3 ←	Sum	92,0	
4: 9,7 ←	9: 9,9 ←			
5:10,0 ←	10:10,4* ↗			

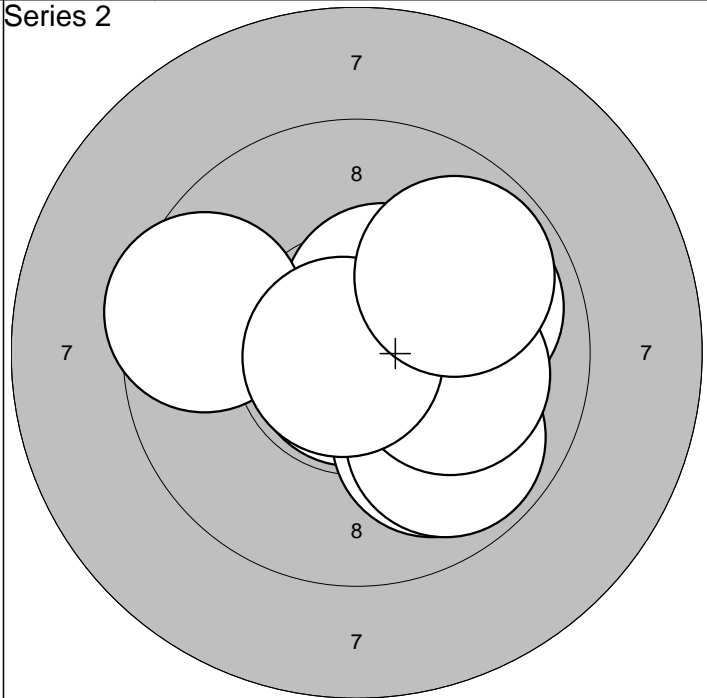

1: 9,9 ↗	6: 9,6 ←		Serie	95,0
2:10,3* →	7: 9,8 ↘			
3:10,8* ↓	8:10,1 →	Sum	187,0	
4:10,5* ↗	9:10,8* ←			
5: 9,9 ↘	10: 9,8 ↗			

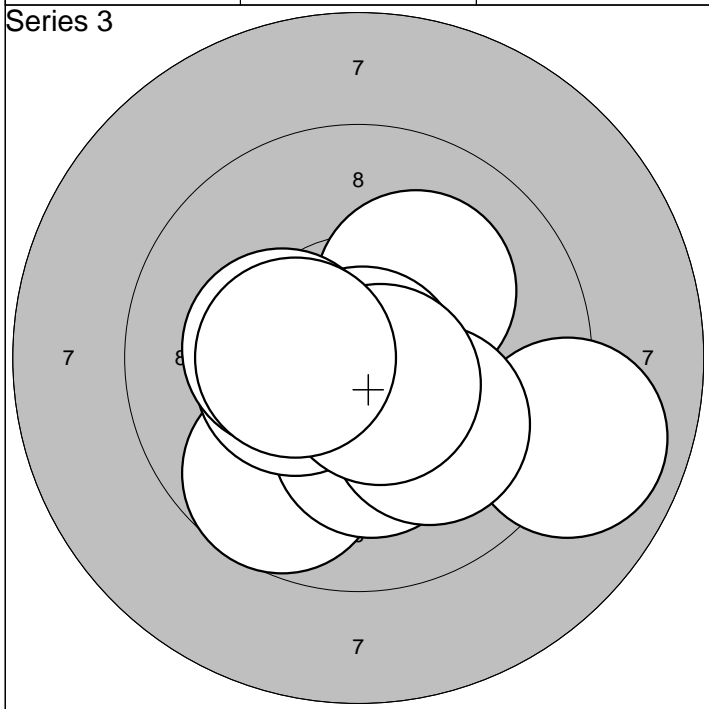

1:10,1 ↗	6:10,4* ←		Serie	97,0
2:10,9* ↓	7:10,3* ←			
3: 8,9 →	8:10,1 ↘	Sum	284,0	
4: 9,7 ↓	9:10,7* ↓			
5:10,2* ↓	10:10,4* ←			

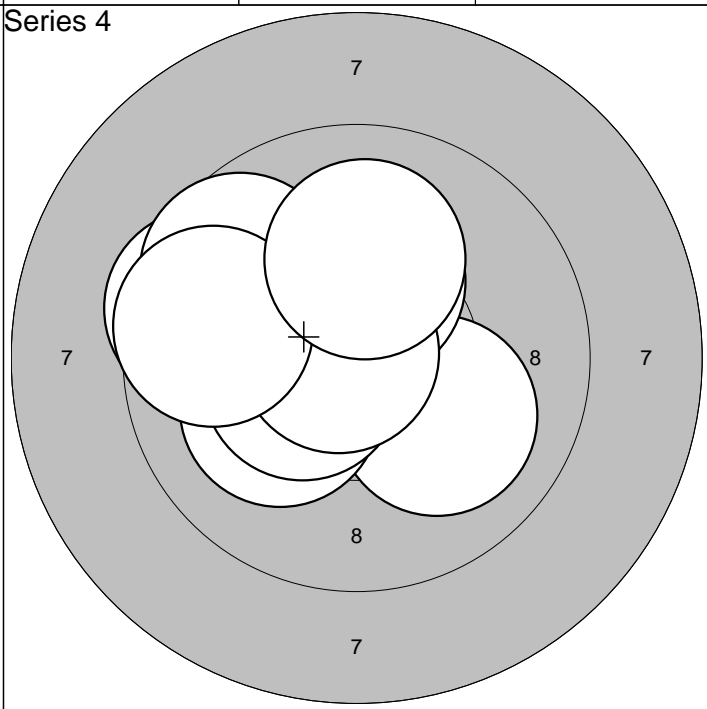

1:10,1 ↘	6:10,3* ↑		Serie	97,0
2:10,3* ←	7:10,4* ←			
3: 9,5 ←	8:10,8* ←	Sum	381,0	
4:10,1 ←	9: 9,6 ←			
5: 9,7 ↗	10:10,1 ↑			

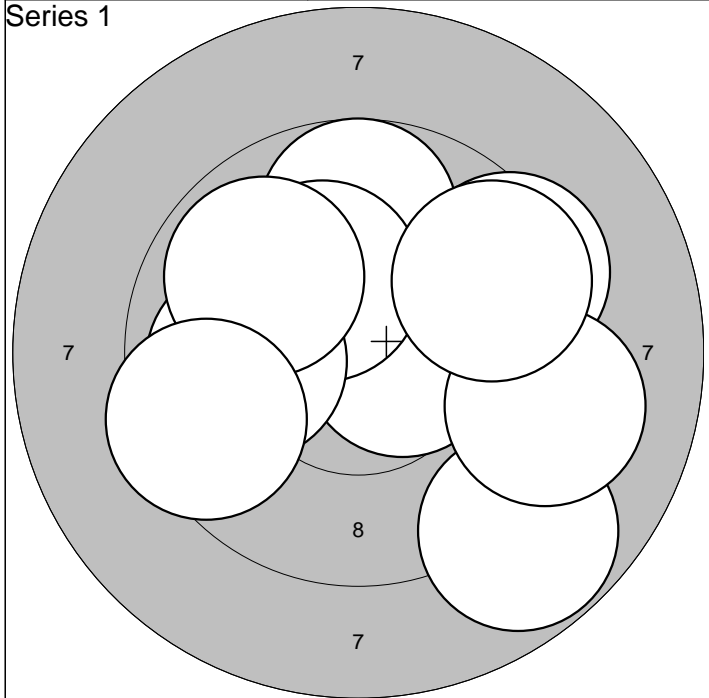

1: 8,8 ↘	6: 9,9 ↖		Serie	92,0
2: 9,8 ↑	7: 9,4 →			
3: 10,6* →	8: 9,5 ←		Sum	92,0
4: 10,2* ↗	9: 9,2 →			
5: 10,0 ←	10: 9,6 ↗			

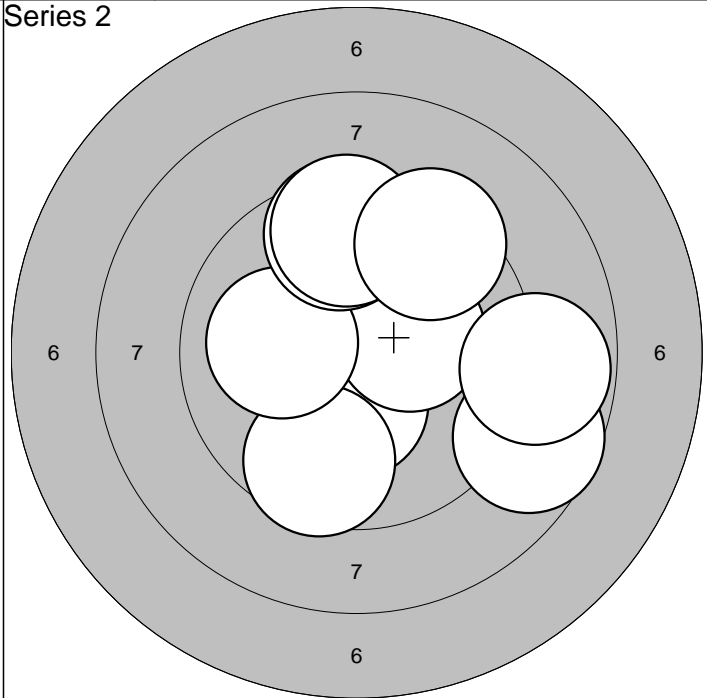

1: 10,2* ↗	6: 10,0 ←		Serie	92,0
2: 10,3* ↓	7: 9,6 ↑			
3: 10,3* →	8: 9,5 ↑		Sum	184,0
4: 9,6 ↓	9: 9,4 ↗			
5: 8,7 →	10: 8,8 →			

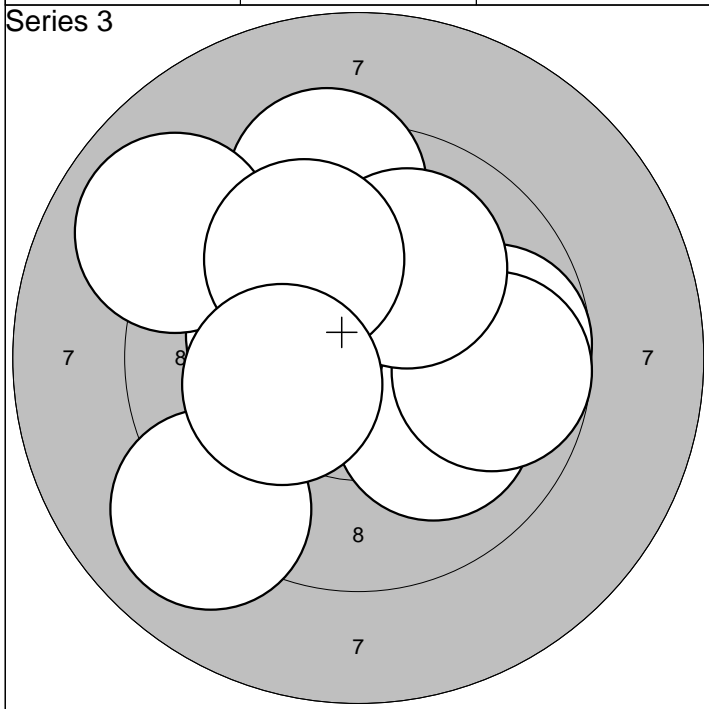

1: 9,8 →	6: 9,8 →		Serie	94,0
2: 10,1 ↘	7: 9,0 ↖			
3: 9,4 ↑	8: 10,0 ↗		Sum	278,0
4: 9,0 ↙	9: 9,9 ↗			
5: 10,3* ←	10: 10,2* ←			

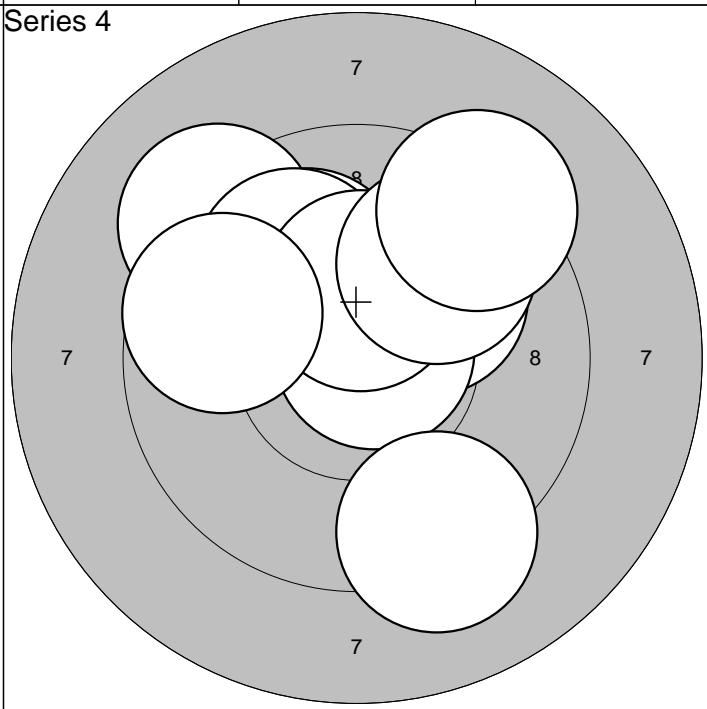

1: 10,1 ↗	6: 9,2 ↓		Serie	95,0
2: 9,2 ↖	7: 10,4* ↑			
3: 10,0 ↖	8: 9,7 ←		Sum	373,0
4: 10,1 ↗	9: 9,8 ↗			
5: 10,8* ↗	10: 9,3 ↗			

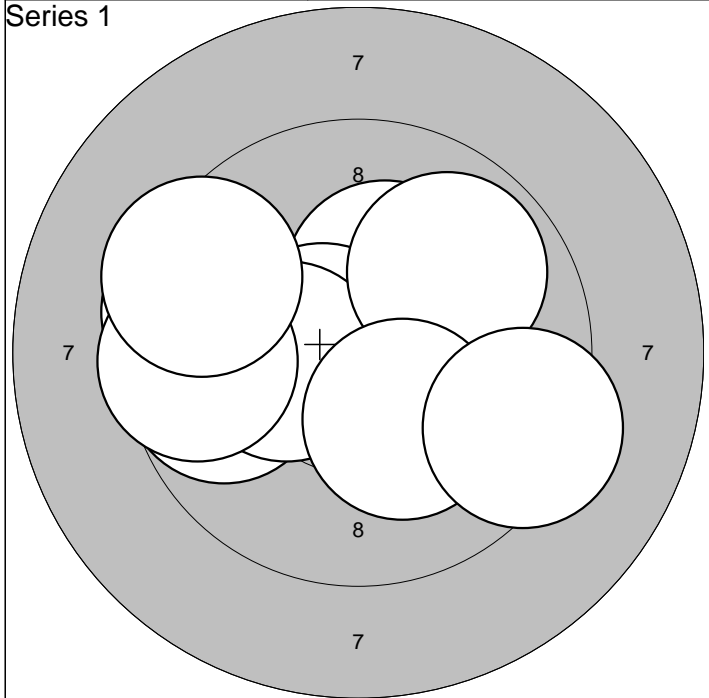

1: 9,7 ←	6: 9,9 ↗	Serie	94,0
2: 10,3* ↗	7: 10,2* ↘		
3: 9,5 ←	8: 9,5 ←	Sum	94,0
4: 10,6* ←	9: 9,4 ↗		
5: 10,3* ←	10: 9,3 ↘		

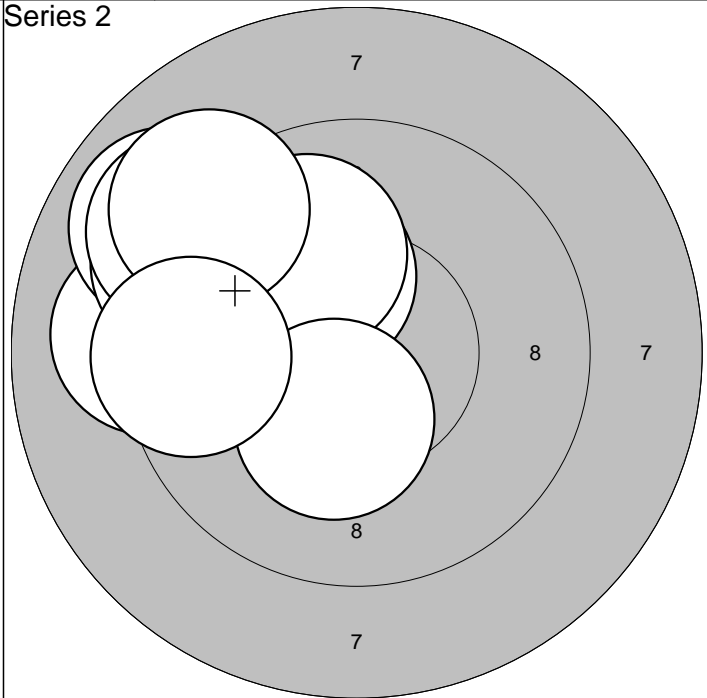

1: 9,1 ←	6: 10,0 ↗	Serie	93,0
2: 10,3* ←	7: 9,1 ↗		
3: 8,9 ↗	8: 10,3* ↘	Sum	187,0
4: 9,3 ↗	9: 9,1 ↗		
5: 10,2* ↗	10: 9,5 ←		

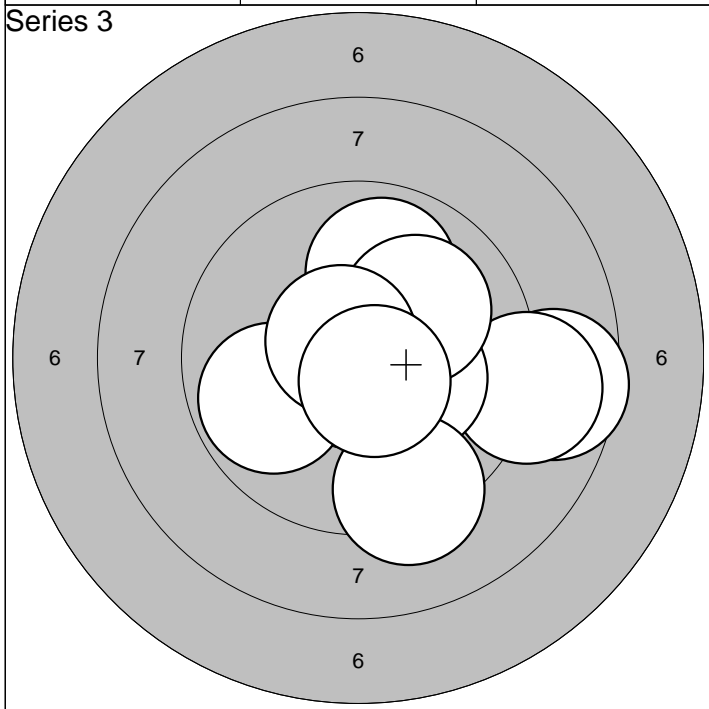

1: 10,3* ↗	6: 10,1 ↗	Serie	93,0
2: 9,9 ↗	7: 9,3 ↘		
3: 8,6 →	8: 9,8 ←	Sum	280,0
4: 8,9 →	9: 10,7* ↗		
5: 10,3* →	10: 10,6* ↘		

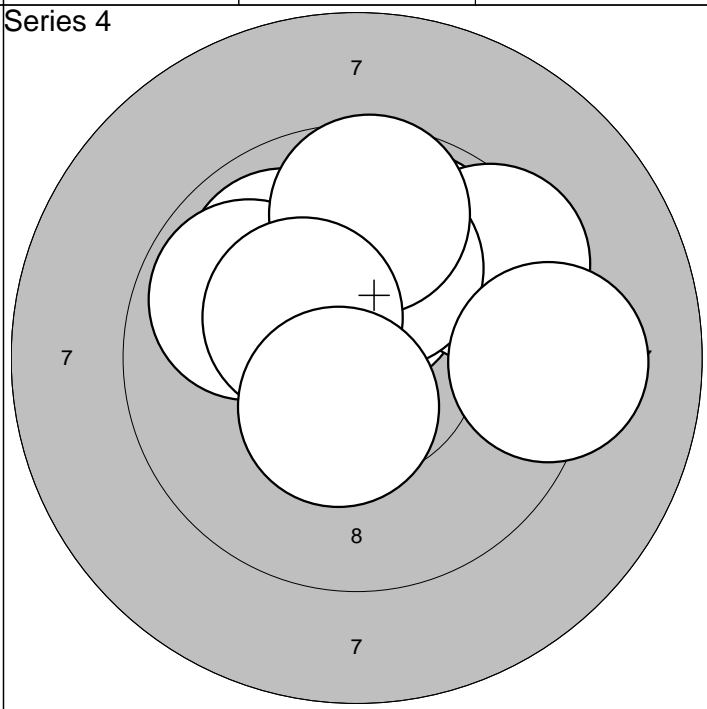

1: 9,9 ↗	6: 10,1 ↗	Serie	94,0
2: 9,9 ↗	7: 9,7 ↗		
3: 10,4* ↗	8: 9,2 →	Sum	374,0
4: 9,9 ↗	9: 10,4* ↗		
5: 9,5 ↗	10: 10,5* ↘		

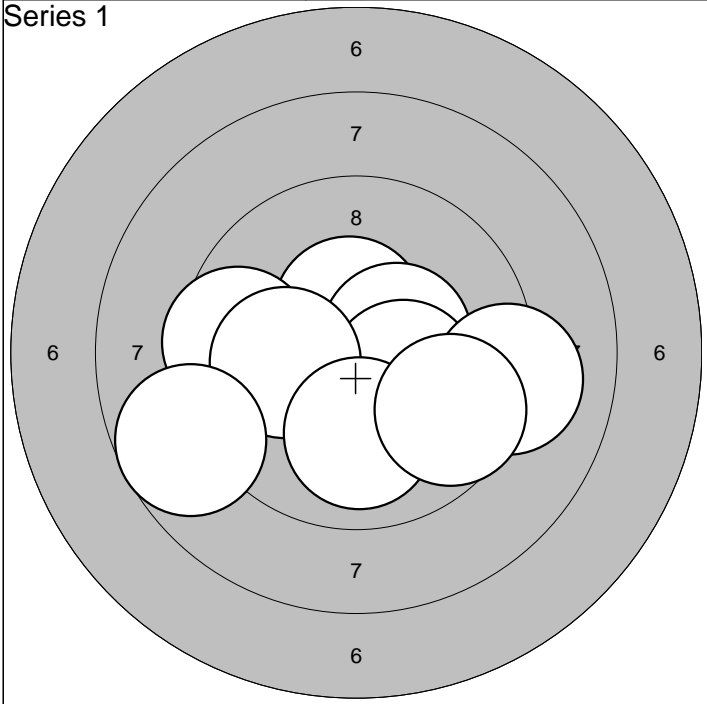

1:10,5* ↑	6:10,1 ←	Serie	95,0
2:10,5* ↓	7:10,0 ↓		
3:10,4* →	8: 8,7 ←	Sum	95,0
4:10,3* ↘	9: 9,1 →		
5: 9,6 ←	10: 9,6 ↘		

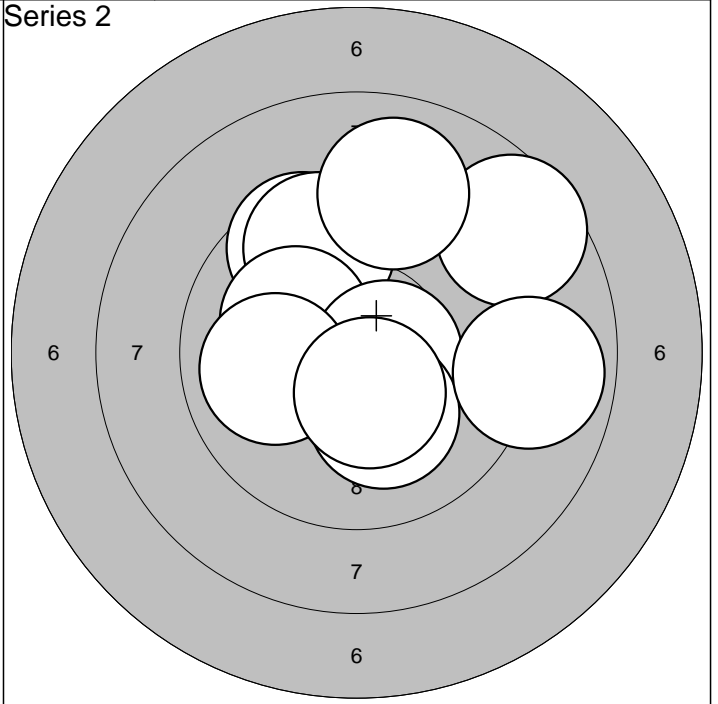

1: 9,6 ↗	6: 8,6 ↗	Serie	93,0
2: 9,6 ↗	7:10,0 ←		
3:10,2* ↖	8: 9,0 ↑	Sum	188,0
4:10,6* →	9: 8,9 →		
5:10,2* ↓	10:10,4* ↓		

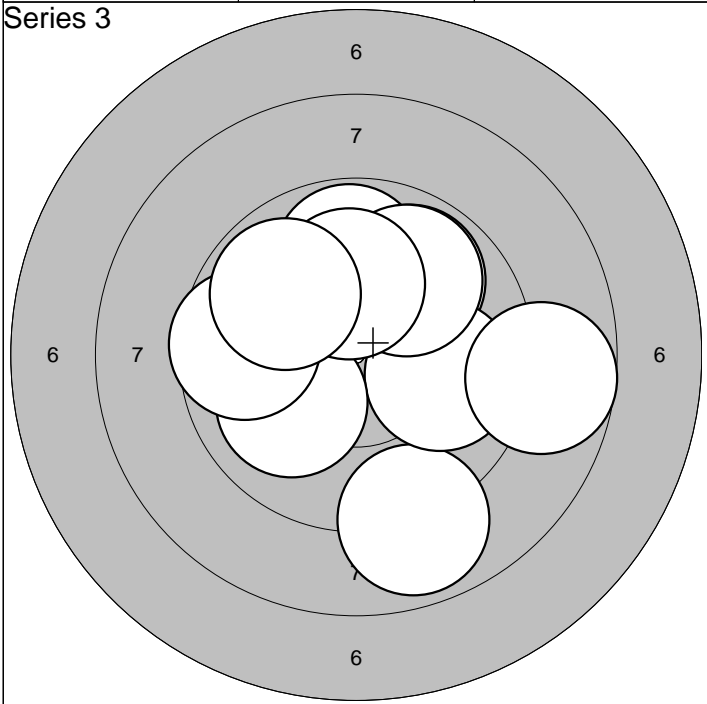

1: 9,8 ↑	6:10,0 ↖	Serie	90,0
2: 9,9 ↗	7: 9,9 ↗		
3: 8,9 ↓	8:10,1 ↑	Sum	278,0
4: 9,9 →	9: 9,6 ←		
5: 8,7 →	10: 9,9 ↖		

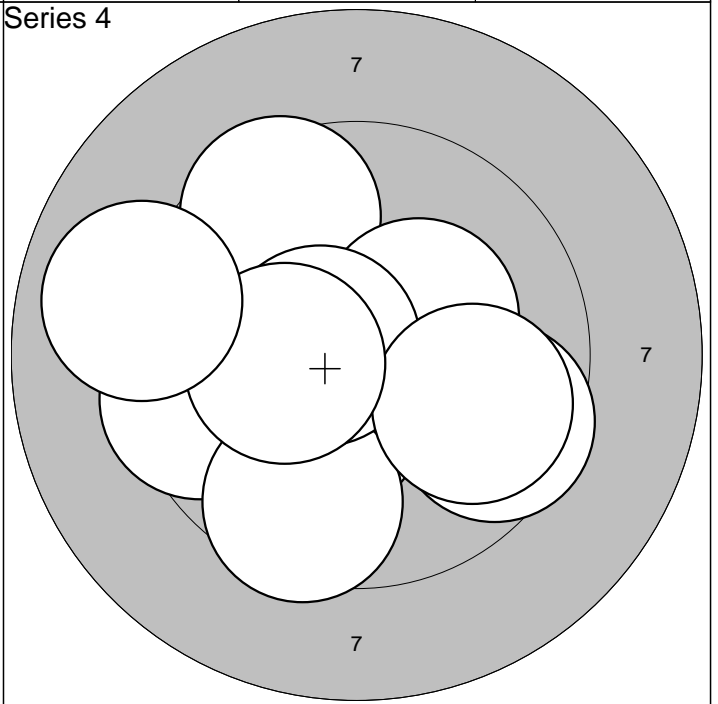

1:10,3* ↓	6:10,6* ←	Serie	94,0
2: 9,5 ↗	7: 9,6 ↘		
3: 9,5 ←	8: 9,8 →	Sum	372,0
4: 9,5 ↓	9:10,3* ←		
5:10,3* ↗	10: 9,0 ←		

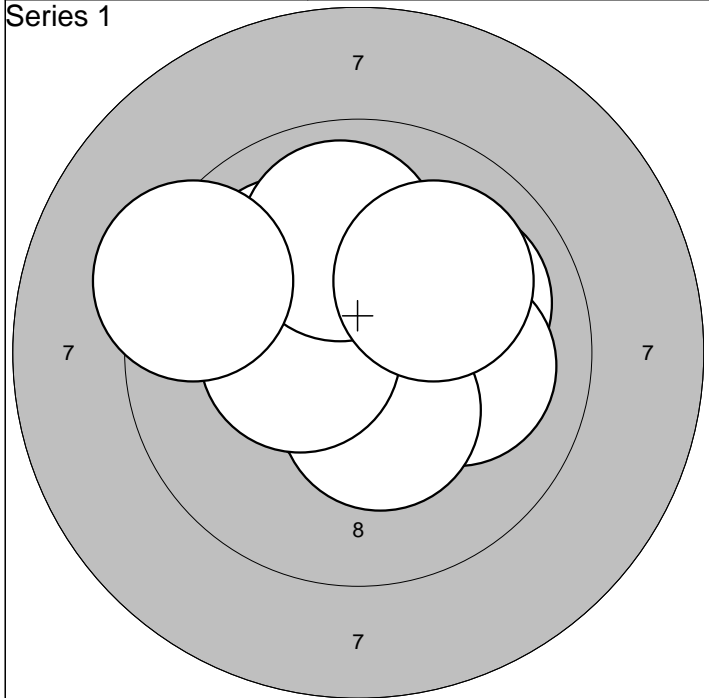

1:10,4* ↗	6:10,1 ↖	Serie	98,0
2:10,5* →	7:10,4* ←		
3:10,0 →	8: 9,9 ↑	Sum	98,0
4:10,1 →	9: 9,3 ←		
5:10,4* ↓	10:10,0 ↗		

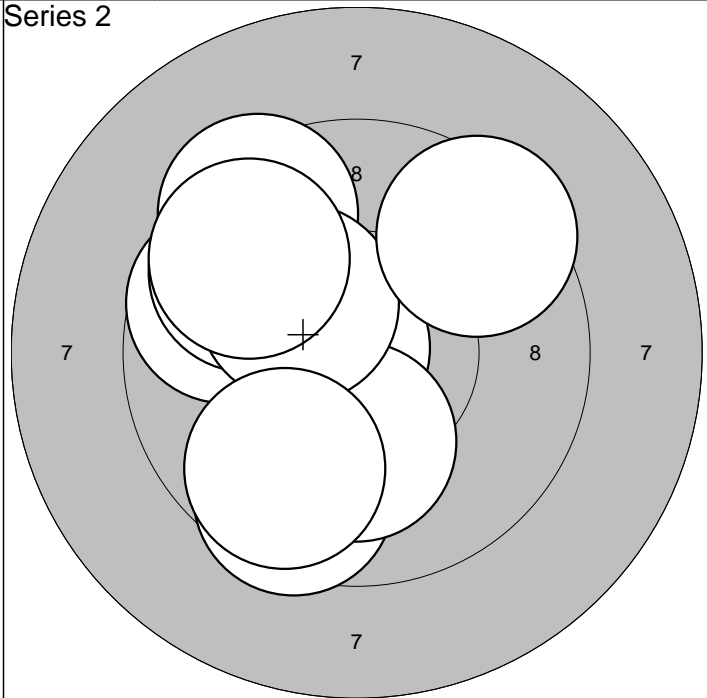

1: 9,4 ↗	6: 9,8 ↖	Serie	93,0
2:10,7* ←	7:10,3* ↗		
3: 9,7 ↖	8: 9,7 ↗	Sum	191,0
4: 9,5 ↓	9: 9,7 ↓		
5:10,1 ↓	10: 9,5 ↗		

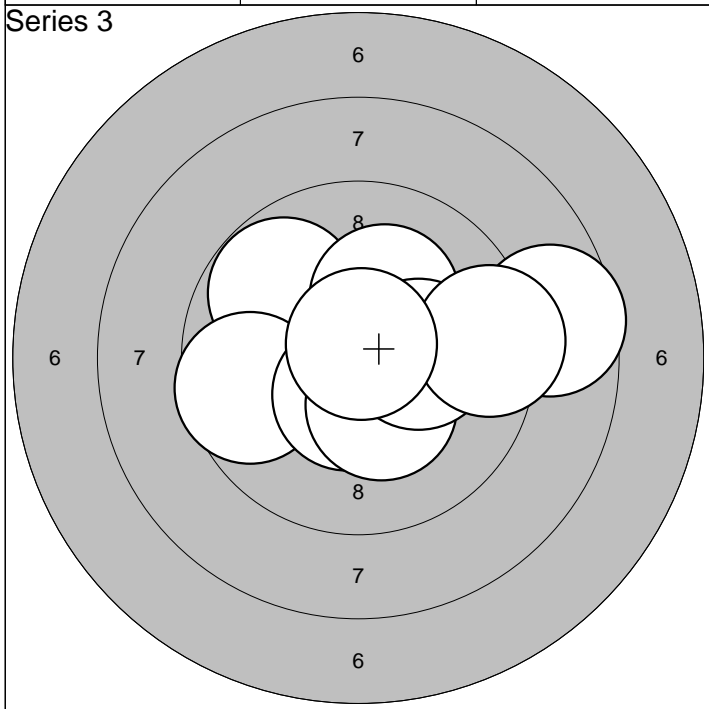

1:10,5* ↖	6: 8,6 →	Serie	95,0
2: 9,8 ↖	7:10,3* ↓		
3: 9,6 ←	8:10,2* →	Sum	286,0
4:10,5* ↓	9: 9,4 →		
5:10,2* ↗	10:10,8* ↑		

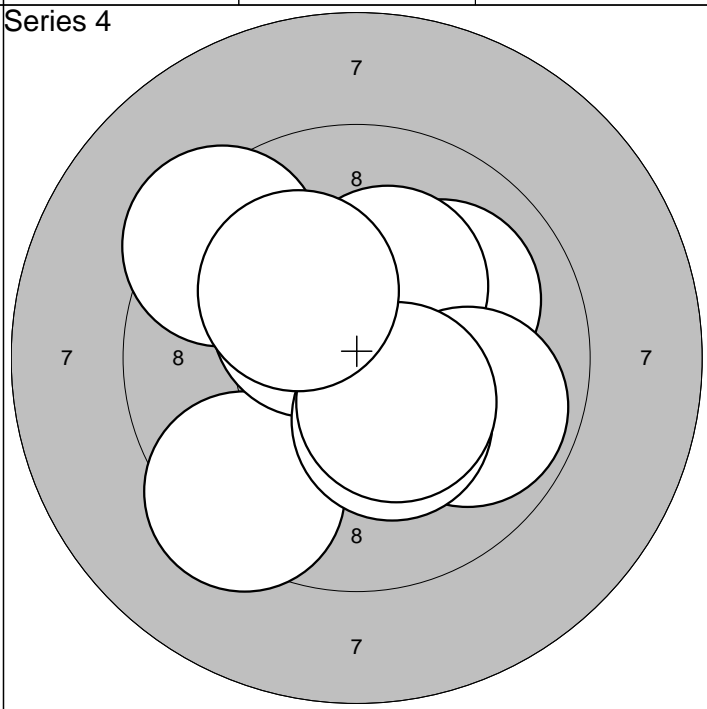

1: 9,4 ↓	6:10,3* ↗	Serie	97,0
2:10,5* →	7: 9,9 →		
3:10,0 ↗	8:10,3* ↓	Sum	383,0
4:10,4* ↗	9:10,4* ↓		
5: 9,4 ↗	10:10,2* ↗		

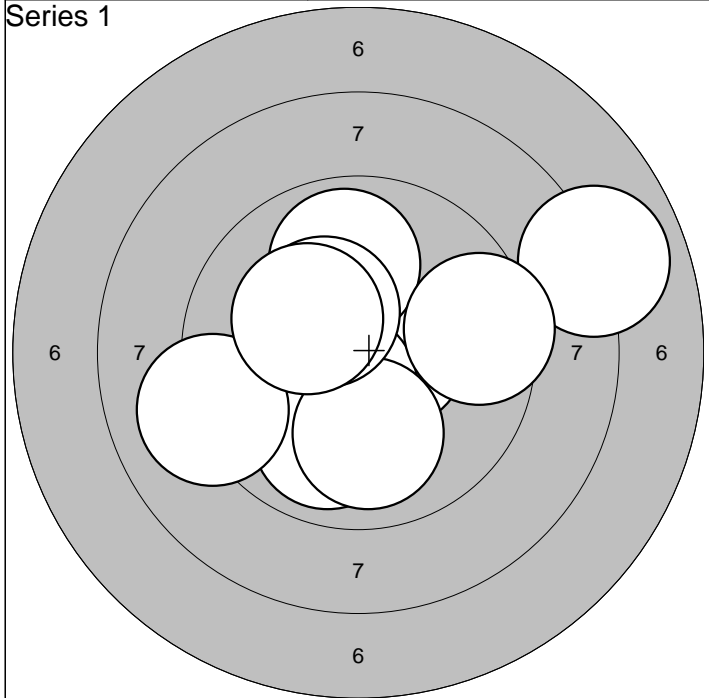

1:10,5* →	6:10,3* ↖	Serie	93,0
2: 9,9 ↑	7: 7,9 →		
3:10,5* ↘	8: 9,5 →	Sum	93,0
4: 9,9 ↘	9: 9,1 ←		
5:10,0 ↓	10:10,2* ↖		

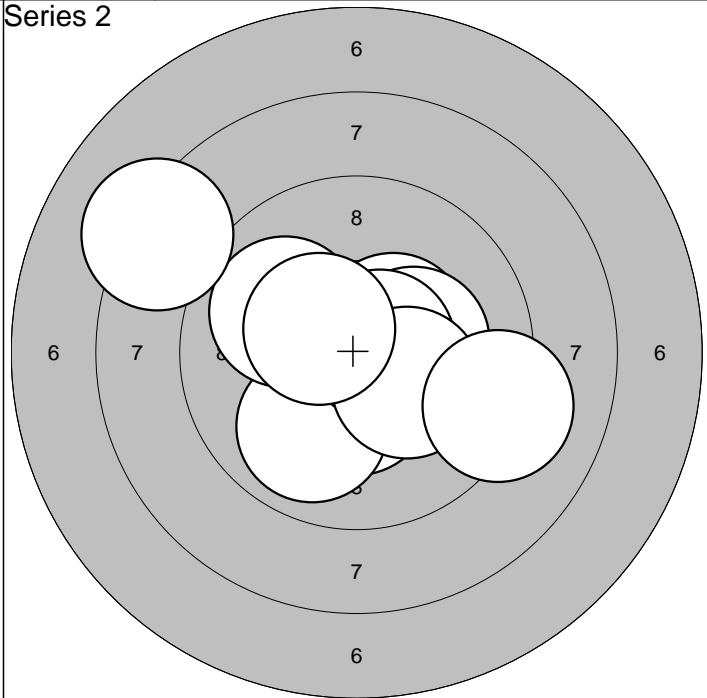

1:10,4* ↗	6:10,0 ↖	Serie	96,0
2:10,4* ↓	7:10,3* ↘		
3: 9,9 ↘	8:10,4* ↗	Sum	189,0
4:10,3* →	9: 9,2 ↗		
5:10,7* →	10: 8,2 ↗		

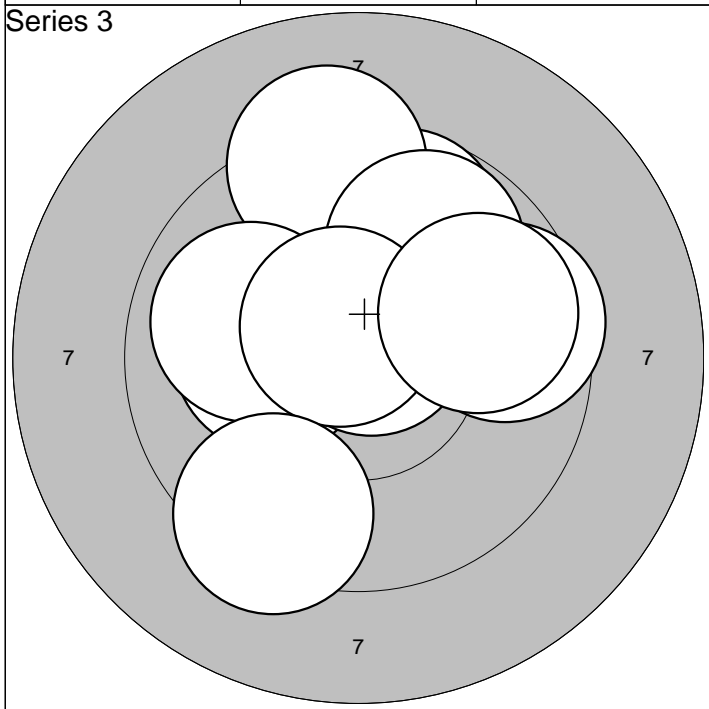

1:10,2* ←	6: 9,9 ←	Serie	93,0
2: 9,7 ↑	7:10,6* ↗		
3:10,7* ↗	8: 9,6 →	Sum	282,0
4: 9,2 ↑	9: 9,4 ↘		
5: 9,8 ↗	10: 9,8 →		

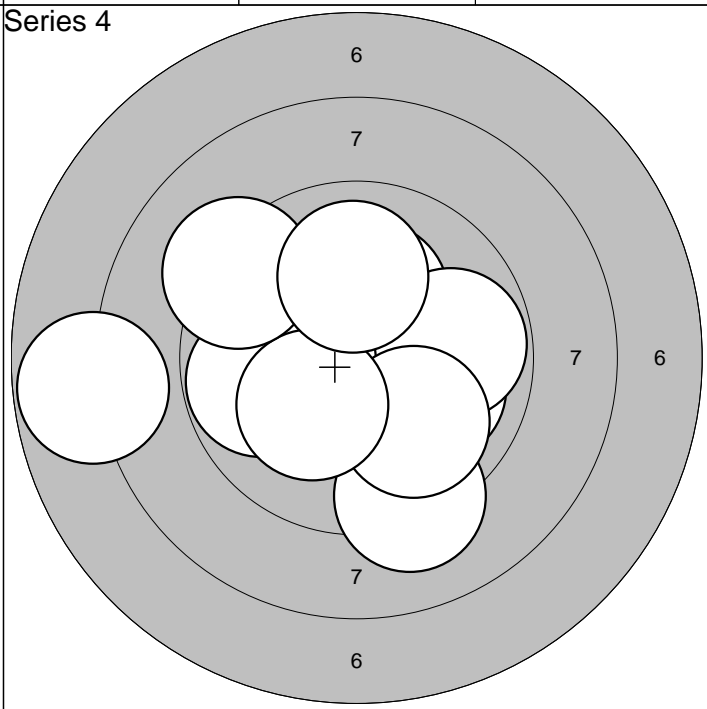

1:10,0 →	6: 7,8 ←	Serie	92,0
2:10,2* ↑	7: 9,9 ↘		
3: 9,2 ↘	8:10,2* ↘	Sum	374,0
4: 9,8 →	9: 9,2 ↖		
5: 9,8 ←	10:10,0 ↑		

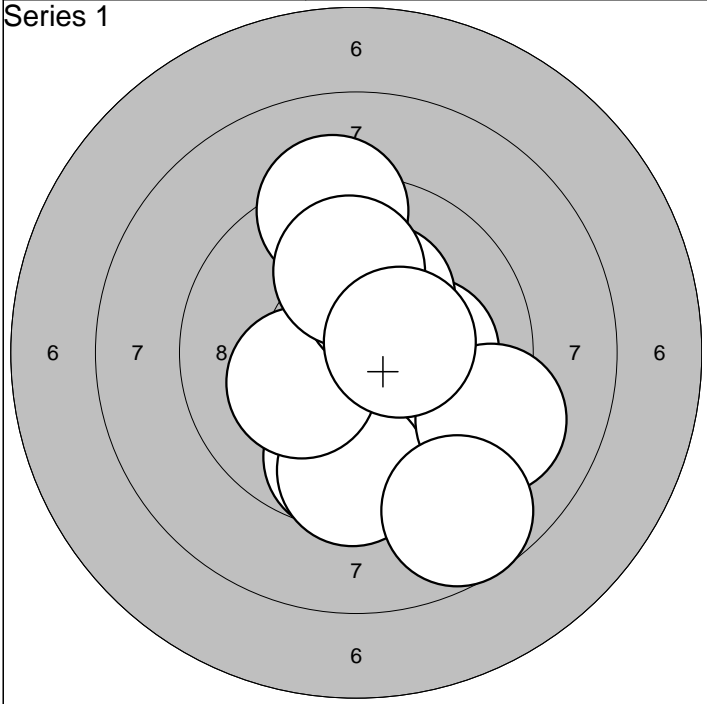

1:10,1 →	6: 9,2 →	Serie	94,0
2: 9,3 ↑	7:10,3* ↗		
3: 9,7 ↓	8:10,0 ↑	Sum	94,0
4: 9,6 ↓	9:10,4* →		
5:10,2* ↙	10: 8,7 ↘		

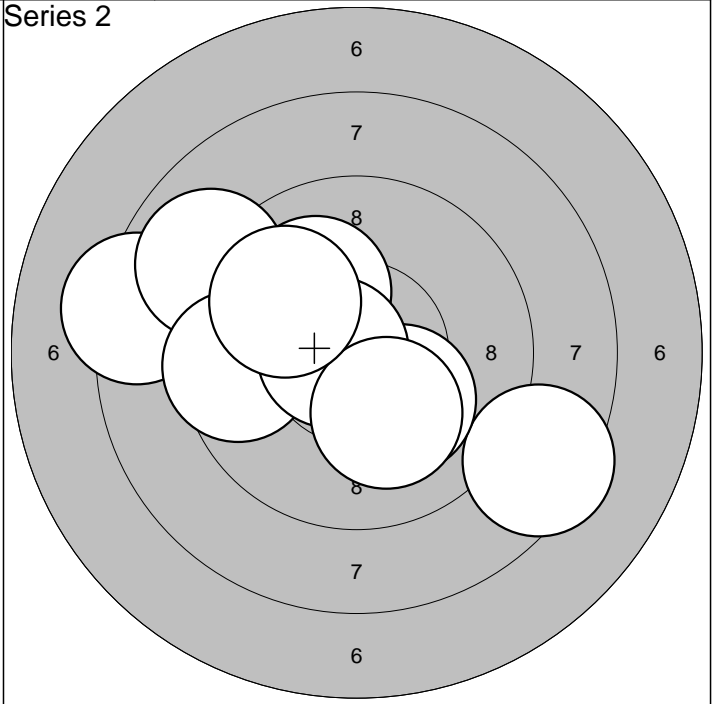

1:10,0 ↖	6:10,1 ↗	Serie	92,0
2: 8,4 ↘	7: 9,5 ←		
3: 8,3 ←	8:10,7* ←	Sum	186,0
4:10,2* ↘	9:10,1 ↓		
5: 8,9 ↗	10: 9,9 ↗		

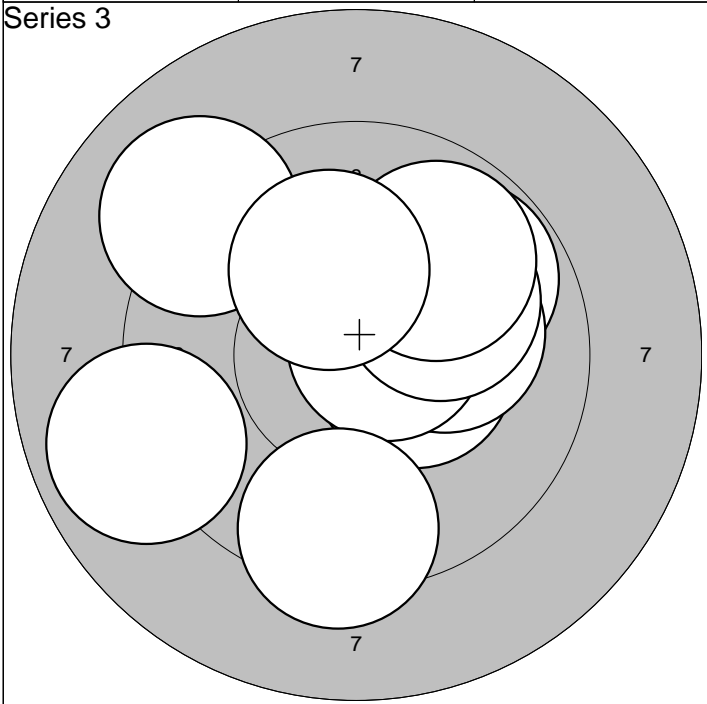

1:10,4* →	6:10,7* →	Serie	94,0
2: 9,8 ↗	7:10,1 ↗		
3: 8,9 ←	8: 9,4 ↓	Sum	280,0
4: 9,1 ↖	9: 9,9 ↗		
5:10,1 →	10:10,2* ↗		

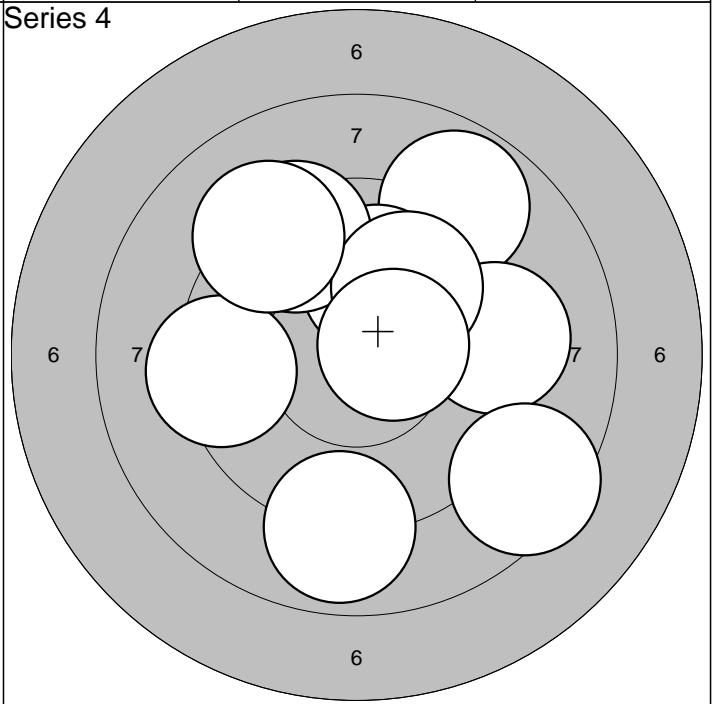

1: 8,9 ↓	6: 9,9 ↗	Serie	89,0
2: 8,8 ↗	7: 8,5 ↘		
3: 9,3 →	8:10,5* →	Sum	369,0
4:10,0 ↑	9: 9,4 ←		
5: 9,4 ↖	10: 9,2 ↖		

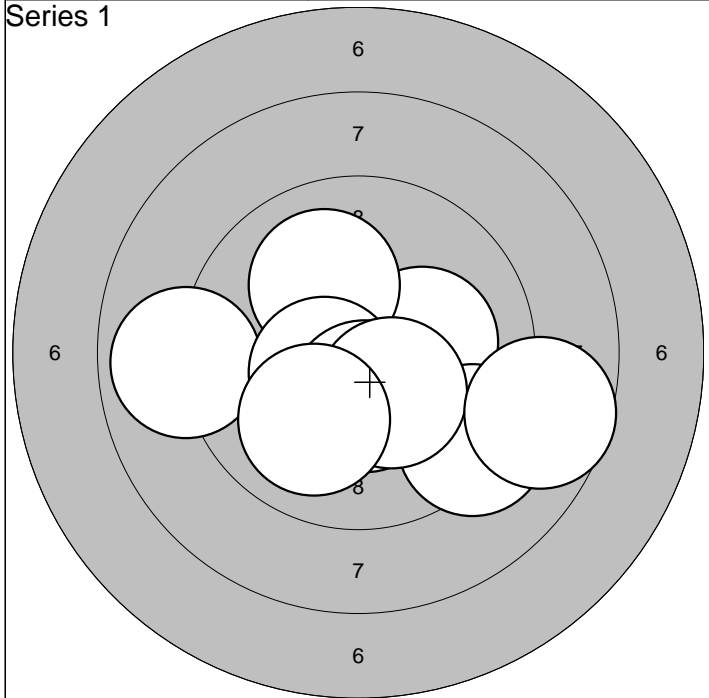

1: 8,9	←	6: 9,2	↘	Serie	95,0
2:10,2*	→	7:10,4*	↓		
3:10,4*	↓	8:10,3*	↘	Sum	95,0
4:10,0	↗	9: 8,7	→		
5:10,5*	↙	10:10,0	↘		

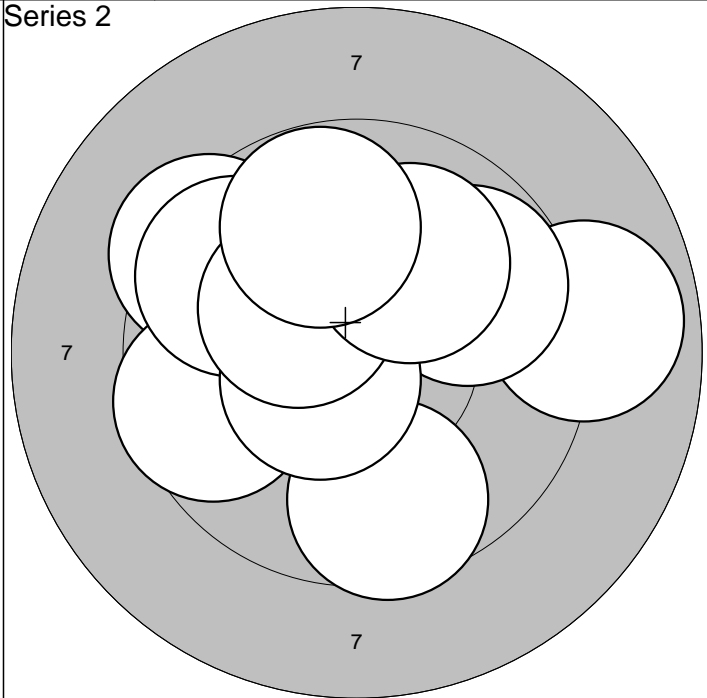

1: 9,6	↓	6: 9,7	↖	Serie	92,0
2: 8,9	→	7:10,6*	↙		
3: 9,4	↖	8:10,3*	↖	Sum	187,0
4: 9,6	←	9:10,0	↗		
5: 9,8	↗	10: 9,8	↗		

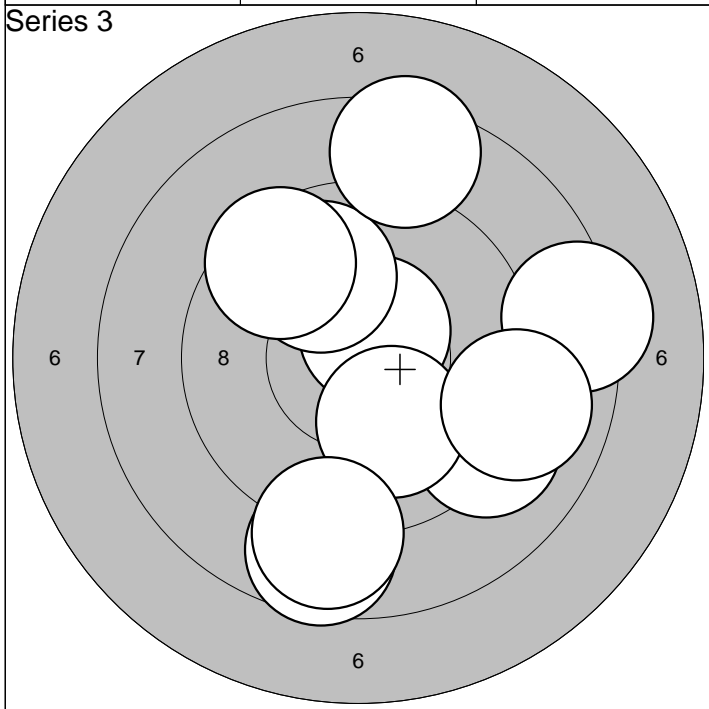

1: 8,6	↓	6: 9,9	↗	Serie	88,0
2: 9,1	↘	7: 9,5	↗		
3: 8,3	→	8: 9,0	→	Sum	275,0
4:10,5*	↗	9: 8,5	↗		
5:10,1	↘	10: 8,8	↓		

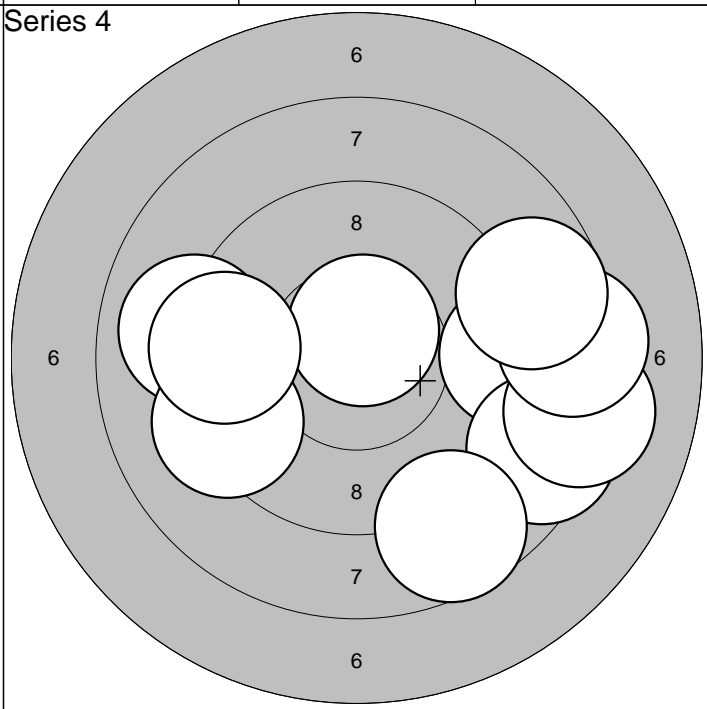

1: 9,0	←	6: 8,2	→	Serie	86,0
2: 9,3	↙	7: 8,4	→		
3: 9,1	→	8:10,6*	↑	Sum	361,0
4: 8,5	↘	9: 8,7	↗		
5: 8,7	↓	10: 9,4	←		

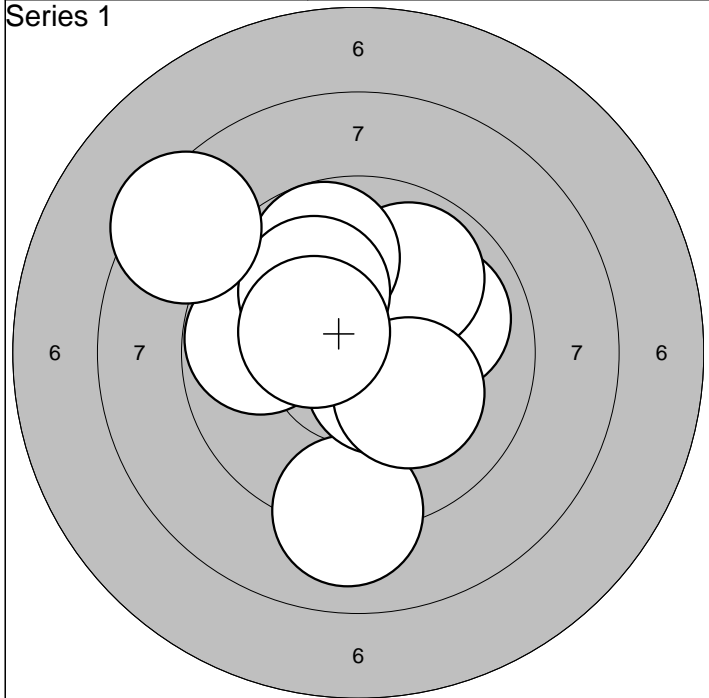

1: 9,1 ↓	6: 9,8 ←		Serie	93,0
2: 9,9 →	7: 9,8 ↑			
3: 10,5* ↘	8: 10,1 ↗	Sum	93,0	
4: 9,9 ↗	9: 8,4 ↗			
5: 10,2* ↘	10: 10,4* ←			

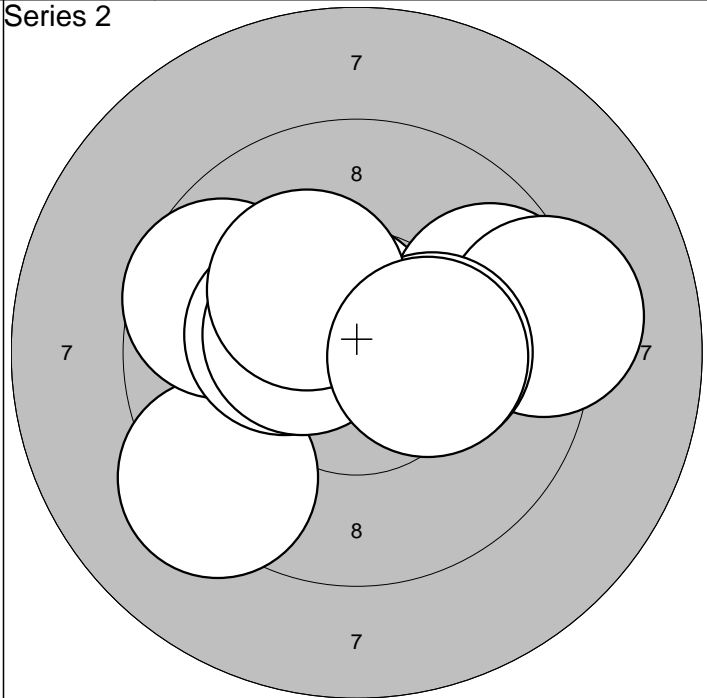

1: 9,3 ↙	6: 9,7 →		Serie	96,0
2: 10,6* ↗	7: 9,2 →			
3: 9,6 ←	8: 10,3* →	Sum	189,0	
4: 10,3* ←	9: 10,2* ↗			
5: 10,4* ←	10: 10,3* →			

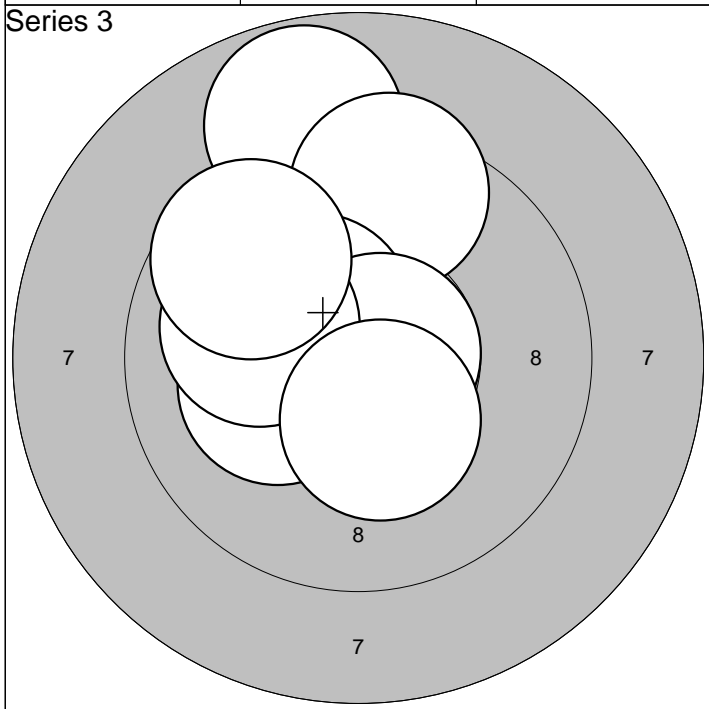

1: 10,7* ↙	6: 10,7* →		Serie	96,0
2: 8,8 ↑	7: 10,2* ←			
3: 9,4 ↑	8: 10,0 ←	Sum	285,0	
4: 10,4* ↗	9: 9,7 ↗			
5: 10,6* ←	10: 10,4* ↘			

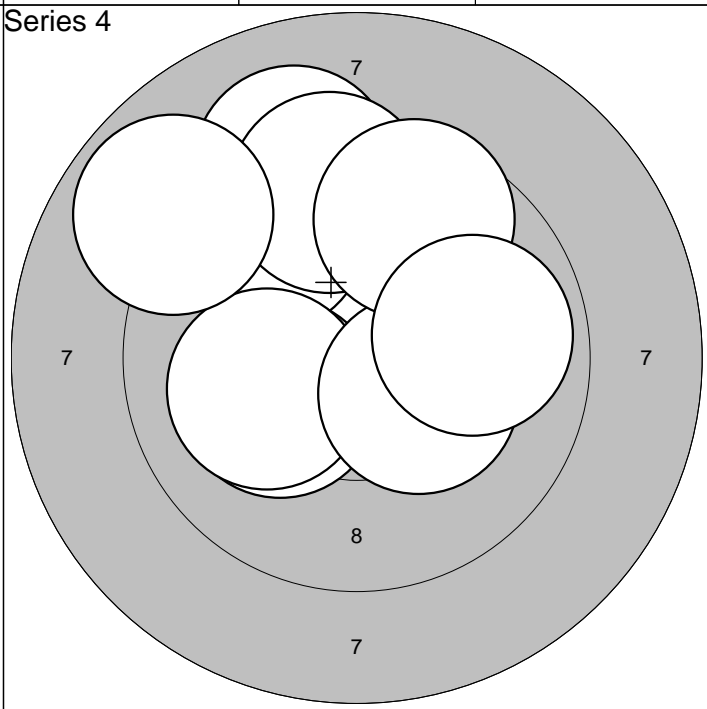

1: 10,2* ↑	6: 10,1 ←		Serie	93,0
2: 9,6 ↗	7: 10,3* ↘			
3: 10,2* ←	8: 8,9 ↗	Sum	378,0	
4: 9,1 ↑	9: 9,6 ↗			
5: 9,4 ↑	10: 9,9 →			

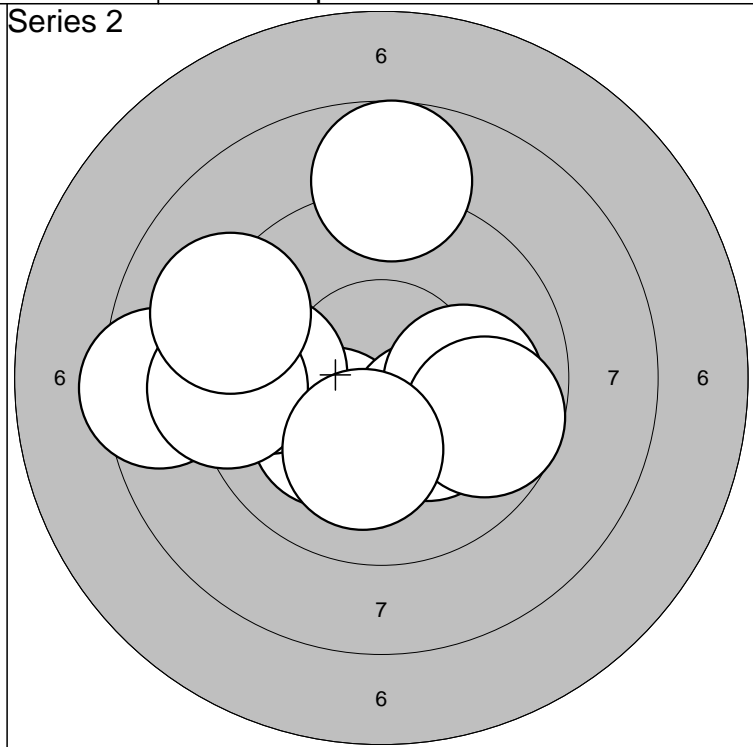
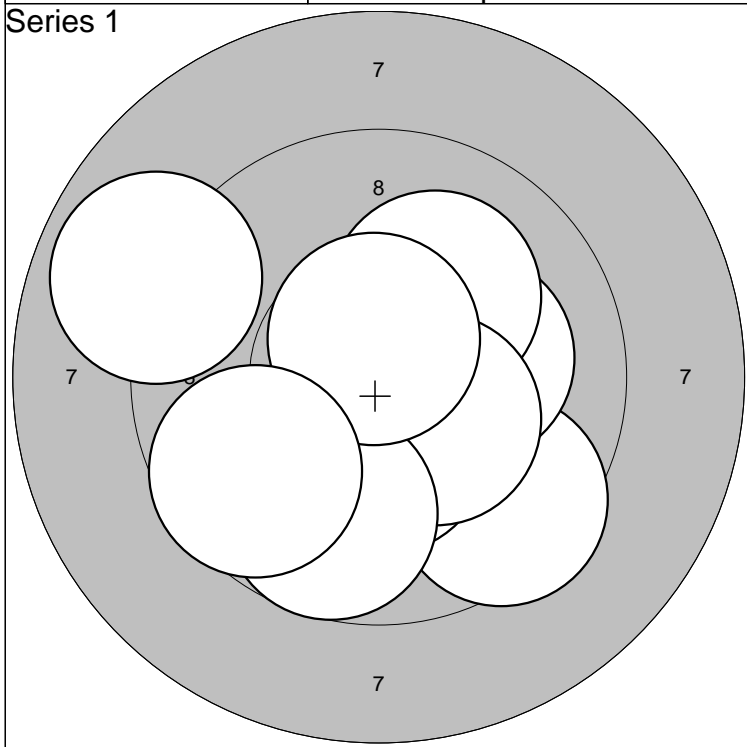

1: 9,5 ↘	6:10,1 ↗	Serie	95,0
2:10,4* ↓	7:10,4* ↘		
3:10,5* ↗	8: 9,7 ↓	Sum	95,0
4:10,2* →	9:10,6* ↑		
5: 8,9 ↖	10: 9,6 ↙		

1:10,2* ↙	6: 9,7 →	Serie	92,0
2: 9,7 ←	7: 9,2 ←		
3:10,3* ↘	8: 9,1 ↖	Sum	187,0
4:10,0 →	9:10,1 ↓		
5: 8,5 ←	10: 8,8 ↑		

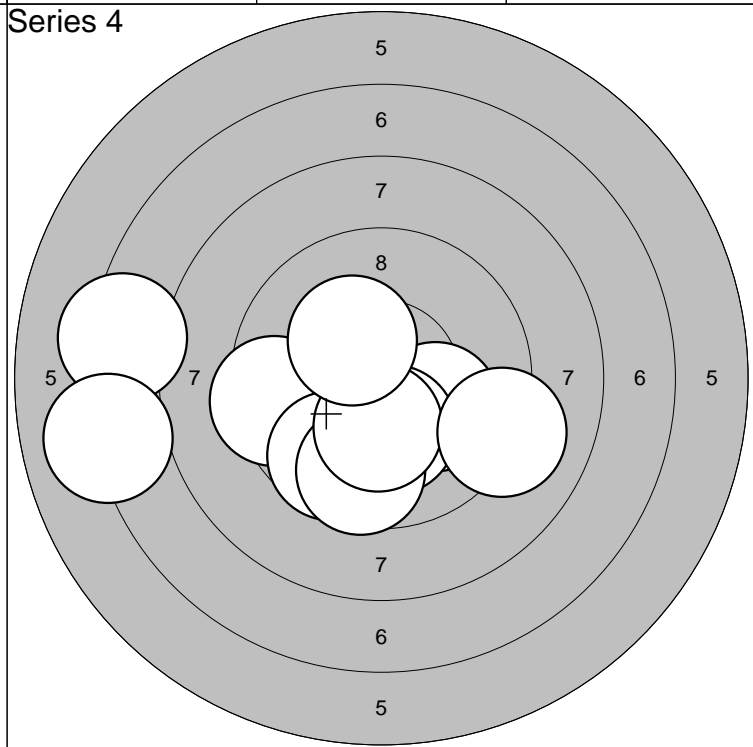
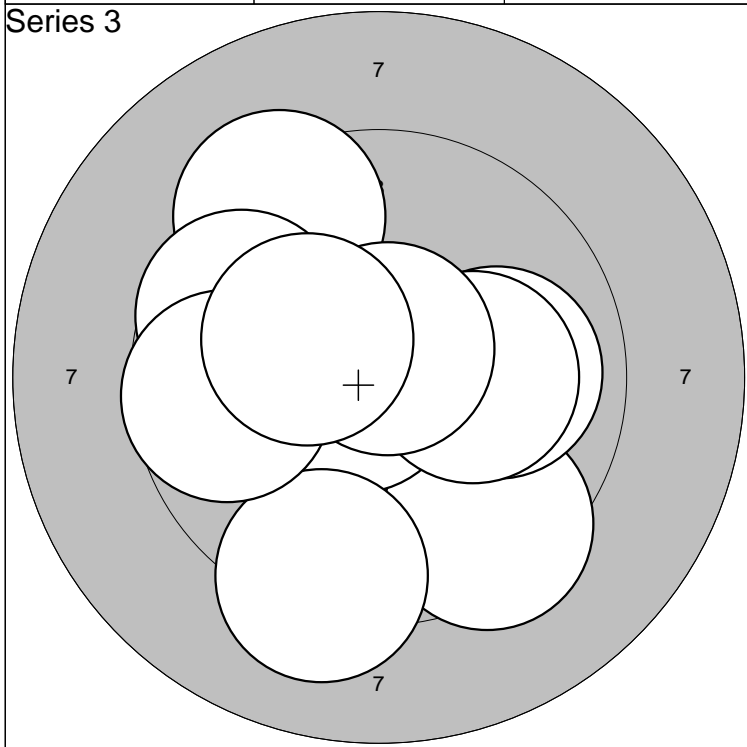

1: 9,4 ↗	6:10,0 →	Serie	95,0
2: 9,4 ↘	7:10,2* →		
3: 9,7 ↖	8: 9,7 ←	Sum	282,0
4:10,7* ←	9:10,7* ↑		
5: 9,2 ↓	10:10,3* ↖		

1:10,1 →	6: 9,7 ↙	Serie	90,0
2:10,2* ↓	7: 9,6 ↓		
3: 9,4 ←	8:10,3* ↓	Sum	372,0
4: 7,3 ←	9:10,3* ↗		
5: 7,1 ←	10: 9,1 →		

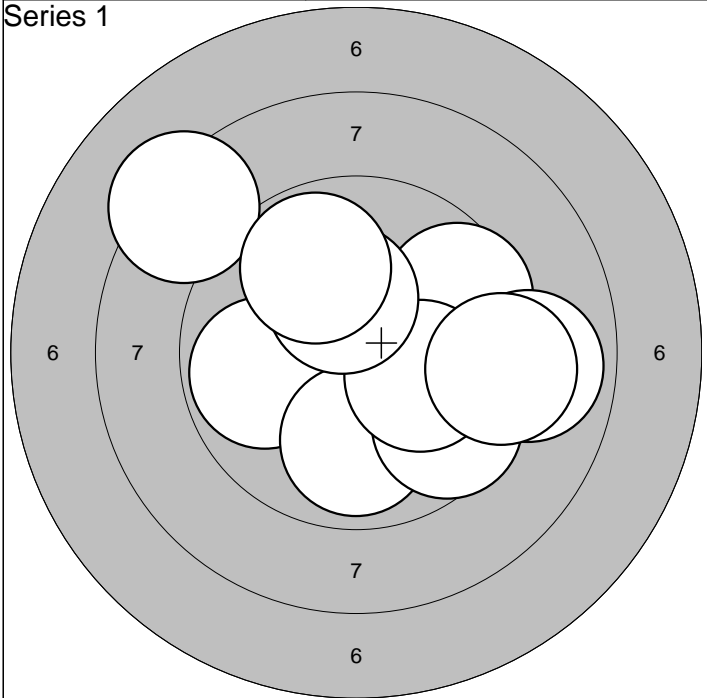

1: 9,8	←	6:10,1	→			Serie	90,0
2: 9,6	↗	7: 8,3	↗				
3: 9,9	↓	8: 9,2	→	Sum	90,0		
4: 9,6	↘	9:10,3*	↑				
5: 8,9	→	10: 9,8	↗				

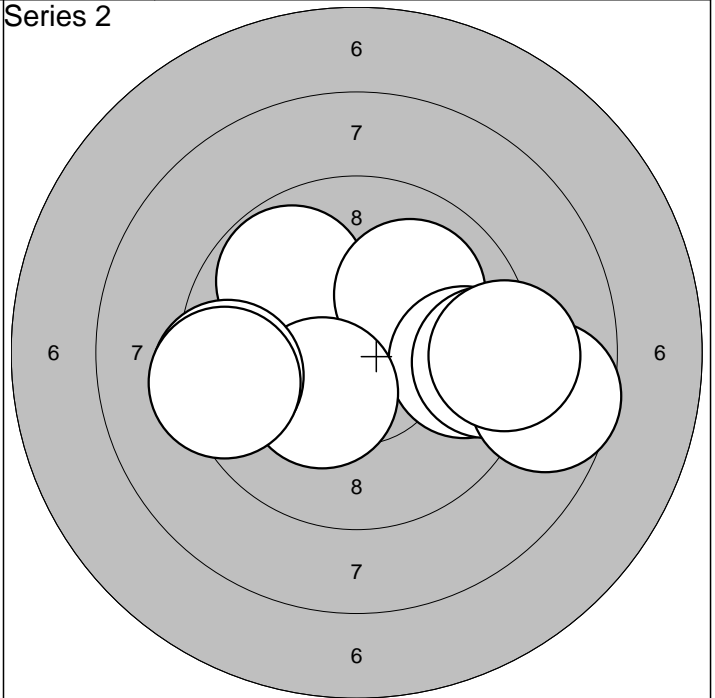

1:10,1	←	6:10,3*	↘			Serie	92,0
2: 9,8	↖	7: 9,4	←				
3:10,0	↗	8: 9,4	←	Sum	182,0		
4: 9,7	→	9: 8,7	→				
5: 9,4	→	10: 9,2	→				

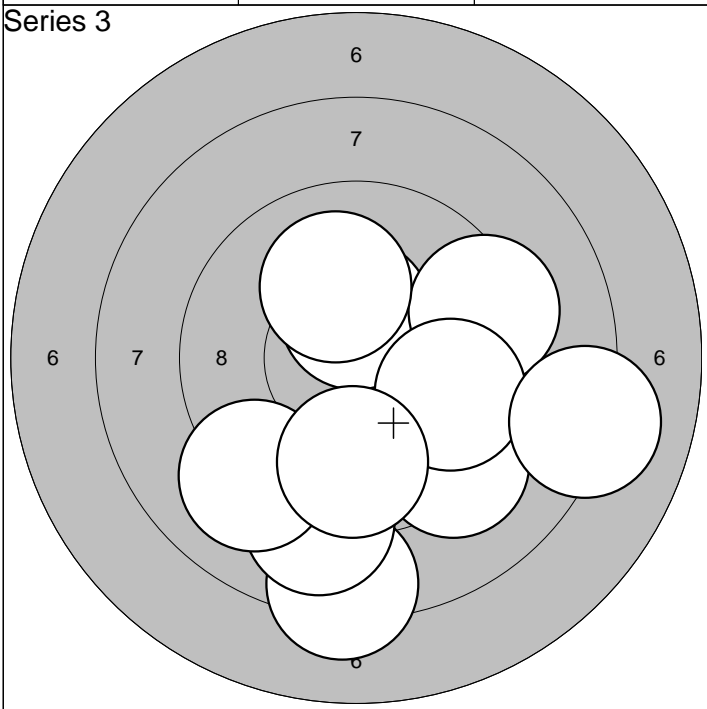

1:10,4*	↑	6: 9,1	↘			Serie	90,0
2: 8,3	↓	7: 9,8	→				
3: 9,3	↘	8:10,1	↑	Sum	272,0		
4: 9,0	↓	9: 8,1	→				
5: 9,3	↗	10: 9,7	↓				

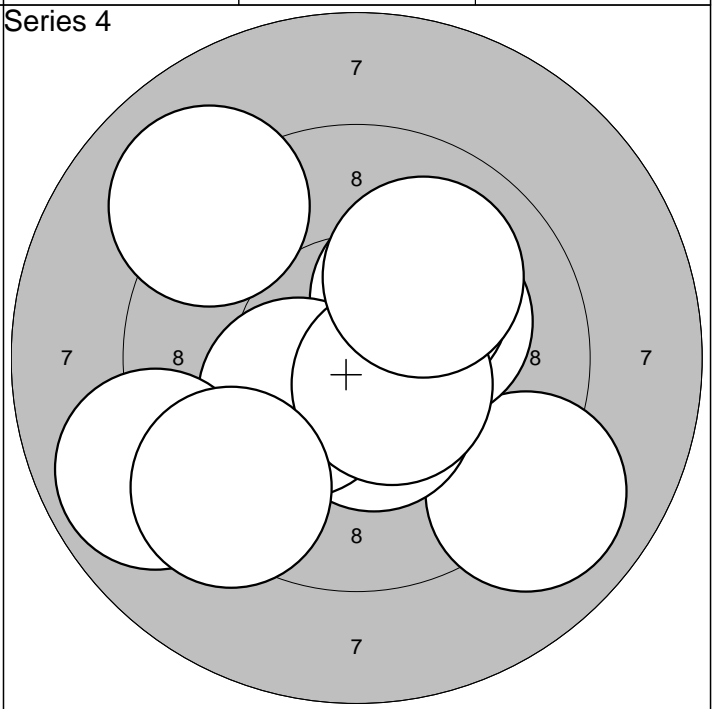

1: 9,0	↘	6:10,6*	↘			Serie	95,0
2:10,2*	↗	7: 8,9	←				
3:10,2*	↗	8:10,0	↗	Sum	367,0		
4:10,4*	↓	9: 9,1	↖				
5:10,3*	↖	10: 9,3	↘				

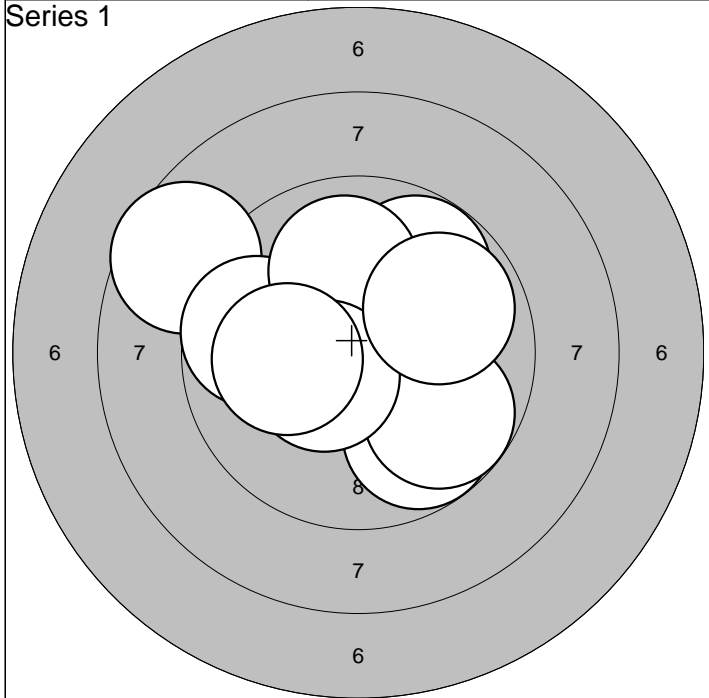

1: 8,6 ↖	6:10,0 ↑				
2: 9,7 ←	7: 9,7 ↘				
3:10,4* ↘	8:10,5* ↙	Serie	93,0		
4: 9,8 ↗	9: 9,8 ↗	Sum	93,0		
5: 9,8 ↘	10:10,1 ←				

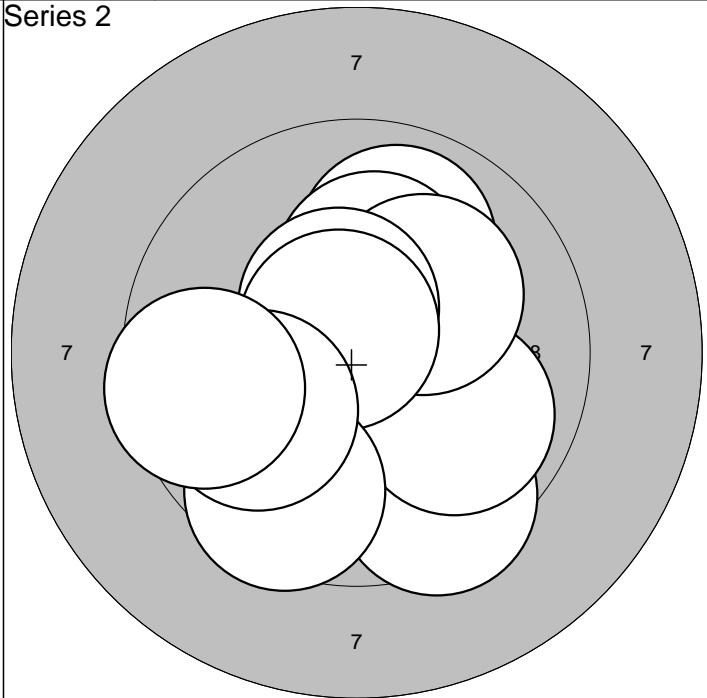

1: 9,5 ↘	6:10,5* ↑				
2: 9,9 ↑	7:10,7* ↖				
3: 9,9 ↘	8: 9,5 ↘	Serie	94,0		
4:10,2* ↑	9: 9,9 ←	Sum	187,0		
5:10,2* ↗	10: 9,6 ←				

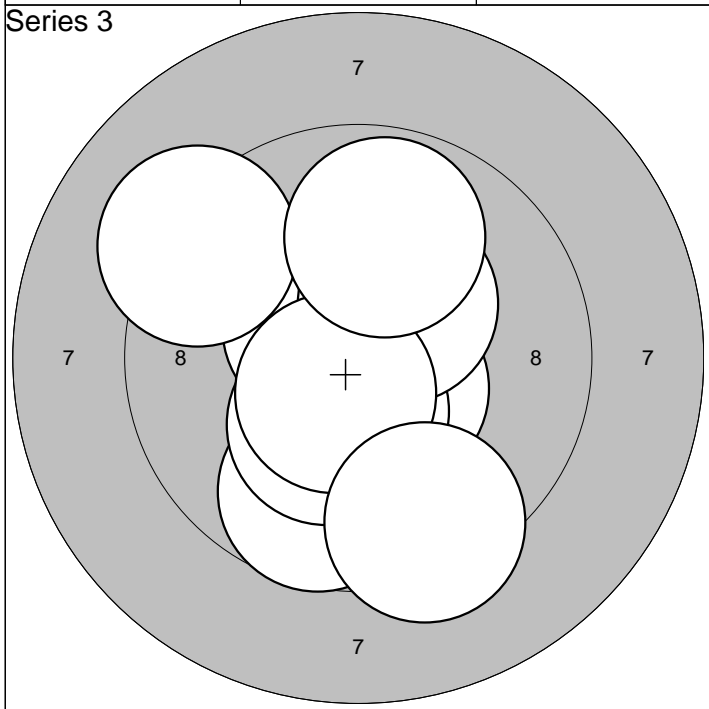

1:10,6* ↘	6:10,3* ↘				
2:10,5* ↘	7: 9,2 ↖				
3:10,5* ↖	8:10,6* ↘	Serie	96,0		
4:10,3* ↗	9: 9,9 ↑	Sum	283,0		
5: 9,7 ↘	10: 9,4 ↘				

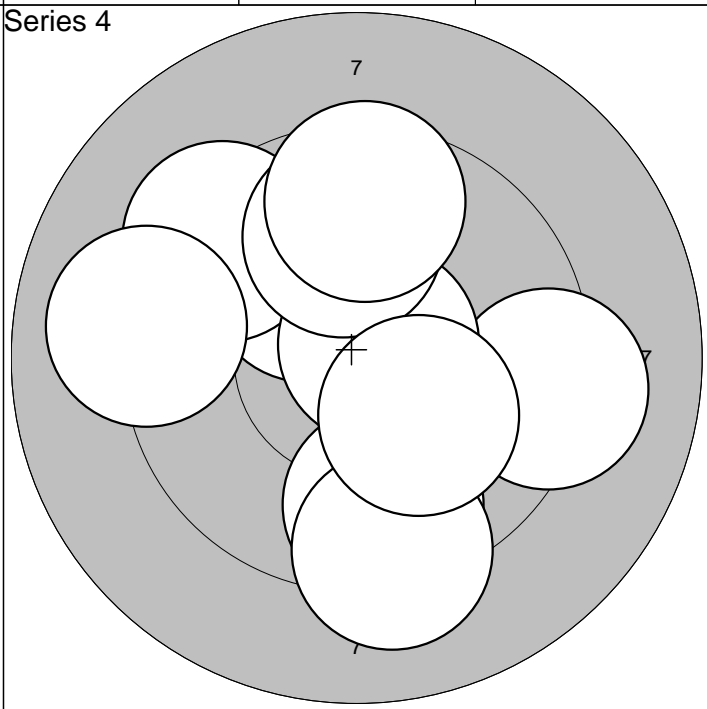

1:10,1 ↑	6:10,7* ↗				
2: 9,4 ↗	7: 9,2 ↘				
3: 9,0 ←	8: 9,8 ↑	Serie	93,0		
4: 9,2 →	9: 9,5 ↑	Sum	376,0		
5: 9,6 ↘	10:10,2* ↘				

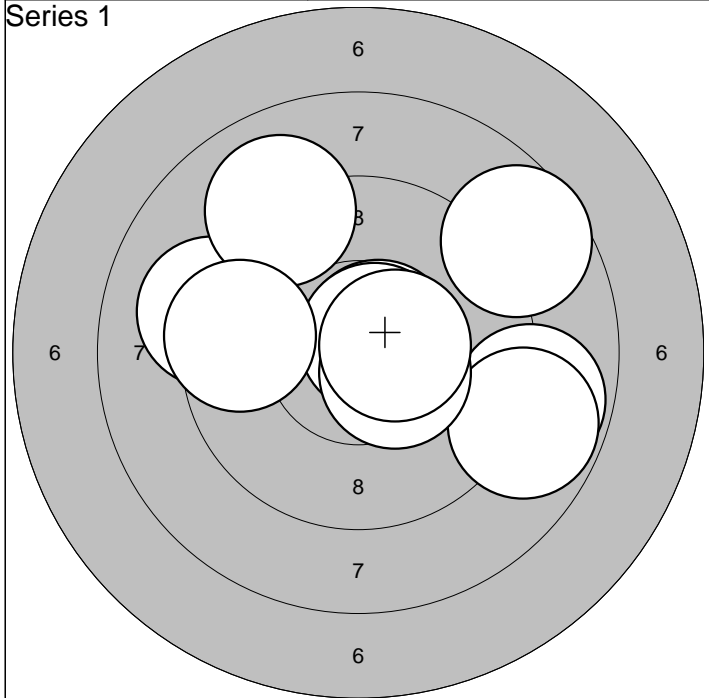

1:10,6* ↗	6:10,5* ↘			Serie	91,0
2: 8,7 ↗	7: 9,1 ←				
3:10,7* ↗	8:10,5* →	Sum	91,0		
4: 8,8 ↘	9: 9,0 ↗				
5: 8,8 ↘	10: 9,5 ←				

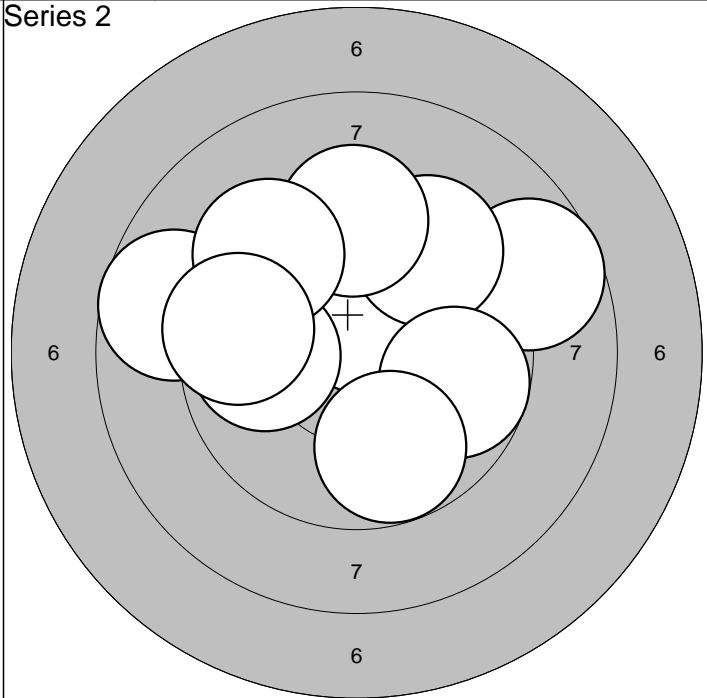

1:10,5* ↑	6: 9,9 ←			Serie	89,0
2: 8,7 ←	7: 9,4 ↗				
3: 8,7 ↗	8: 9,7 →	Sum	180,0		
4: 9,5 ↗	9: 9,8 ↓				
5: 9,4 ↑	10: 9,5 ←				

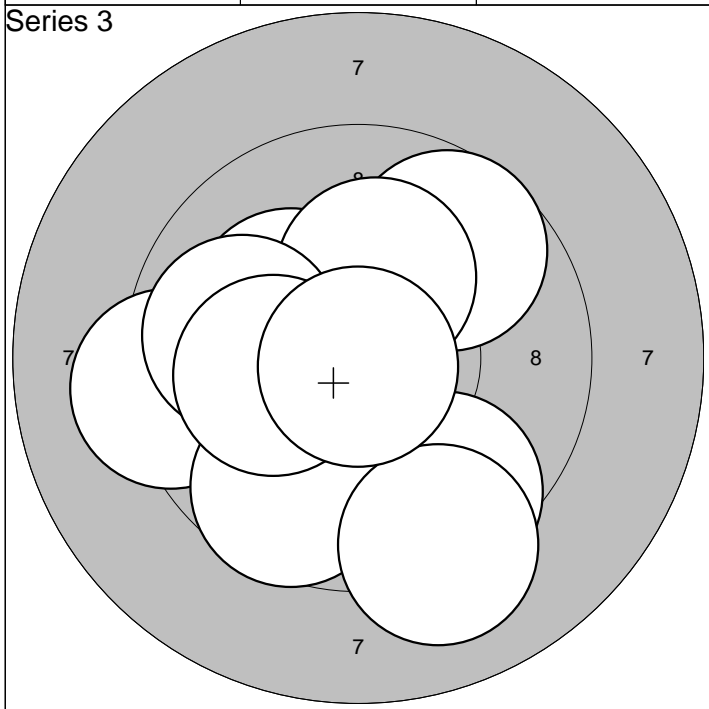

1: 9,3 ←	6:10,2* ↑			Serie	94,0
2: 9,5 ↓	7: 9,1 ↓				
3:10,2* ↖	8: 9,9 ←	Sum	274,0		
4: 9,7 ↗	9:10,2* ←				
5: 9,6 ↓	10:10,9* ↓				

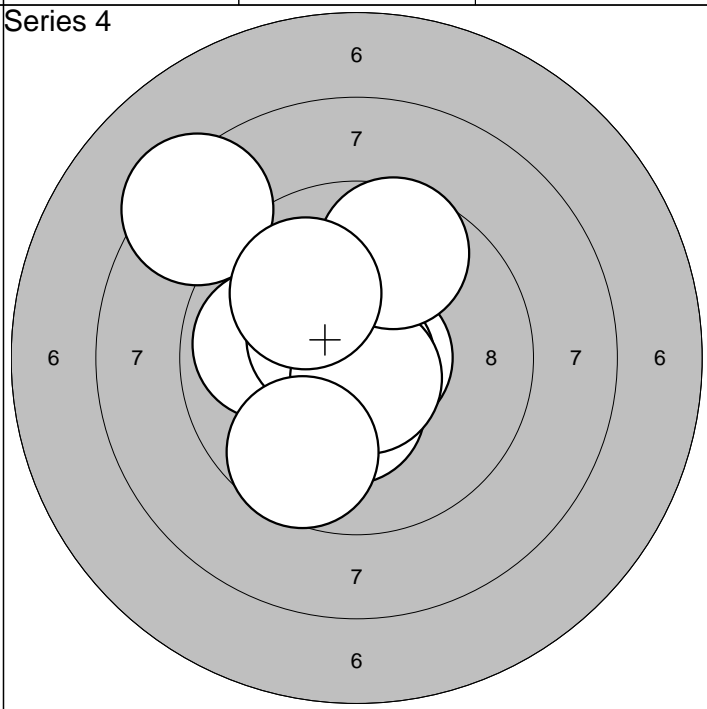

1:10,4* ↓	6:10,7* ↓			Serie	95,0
2:10,7* →	7: 9,6 ↑				
3: 9,9 ←	8: 8,4 ↗	Sum	369,0		
4:10,9* ↓	9:10,0 ↗				
5:10,5* ↗	10: 9,7 ↓				

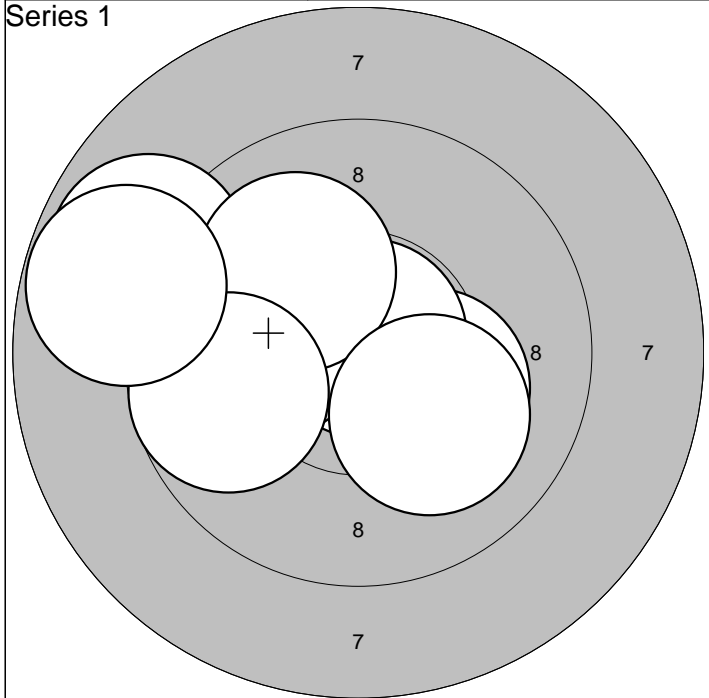

1: 9,8	←	6: 8,9	↖	Serie	93,0
2:10,2*	↘	7:10,1	↗		
3: 9,0	←	8:10,1	↘		
4:10,8*	↗	9: 9,8	←		
5:10,1	←	10: 8,8	←		
Sum				93,0	

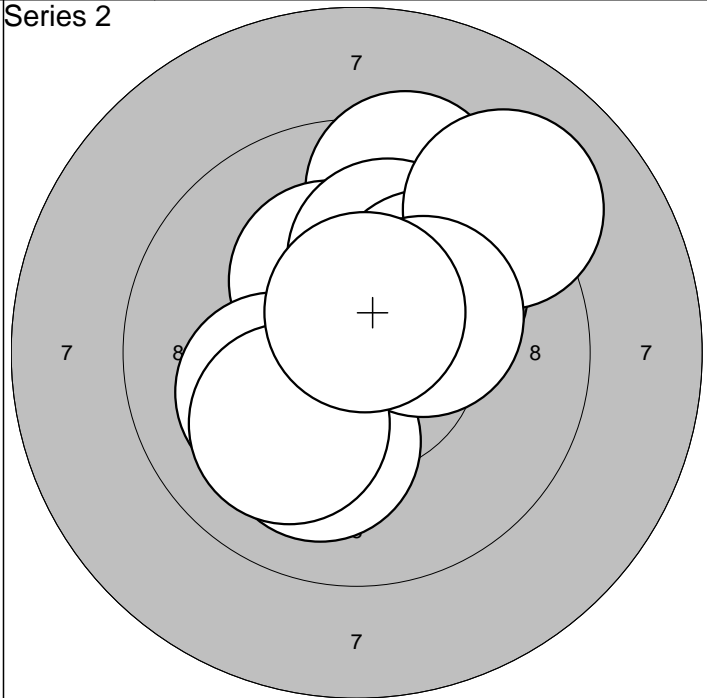

1: 9,5	↑	6: 9,1	↗	Serie	98,0
2:10,3*	↖	7:10,3*	↗		
3:10,1	↑	8:10,1	←		
4:10,1	↗	9:10,1	↘		
5:10,1	↘	10:10,6*	↑		
Sum				191,0	

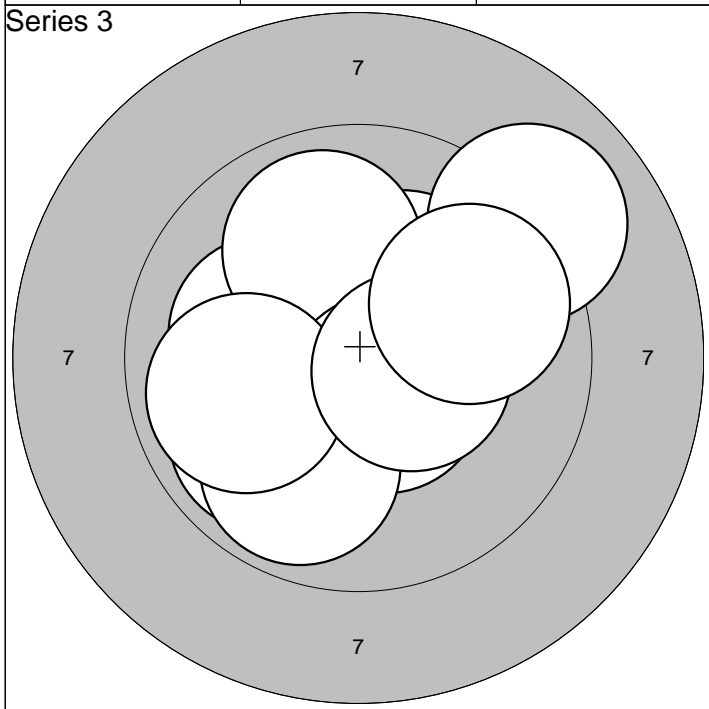

1:10,2*	↗	6: 9,8	↘	Serie	94,0
2:10,1	←	7: 9,9	←		
3: 9,9	↑	8: 9,0	↗		
4:10,6*	↘	9:10,5*	→		
5: 9,9	↙	10: 9,8	↗		
Sum				285,0	

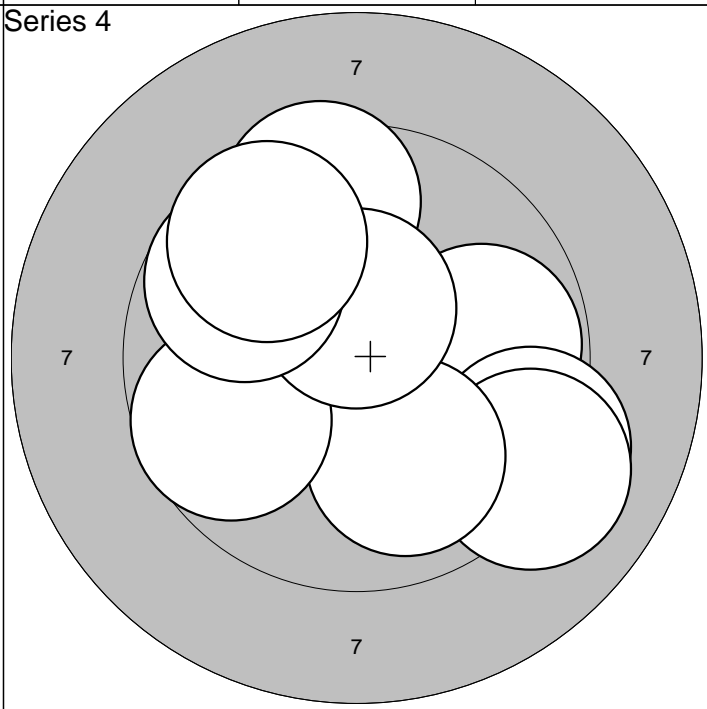

1: 9,8	→	6: 9,7	↙	Serie	93,0
2: 9,2	↘	7: 9,5	↑		
3: 9,1	↘	8:10,5*	↑		
4:10,7*	↘	9: 9,7	↖		
5:10,0	↘	10: 9,6	↖		
Sum				378,0	

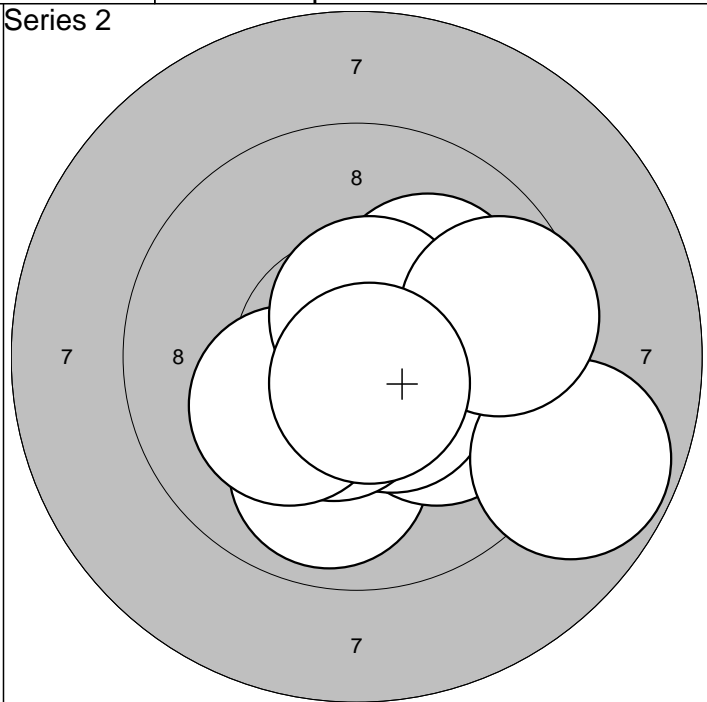
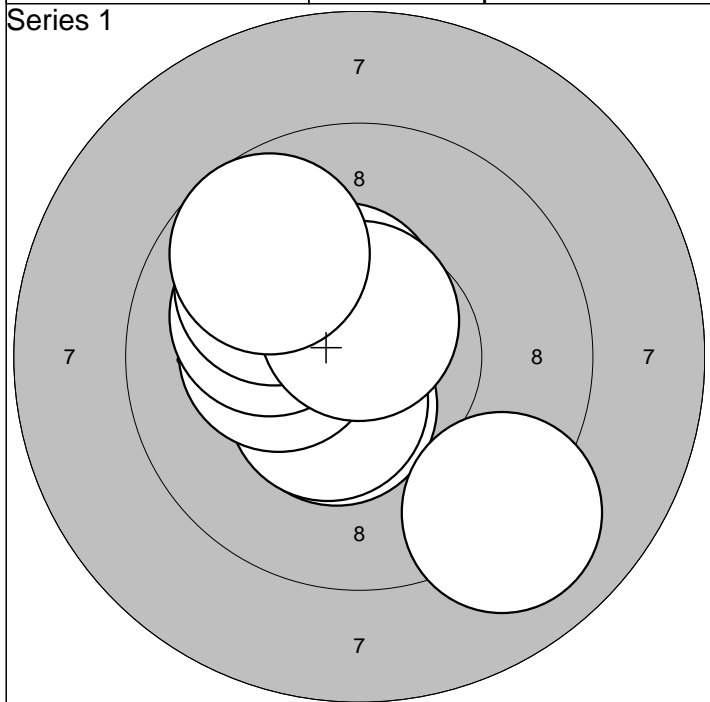

1:10,5* ↓	6:10,5* ↑	Serie	97,0
2:10,3* ↖	7:10,1 ↖		
3:10,5* ↓	8: 9,9 ↗	Sum	97,0
4:10,2* ←	9:10,6* ↑		
5: 9,0 ↓	10: 9,7 ↗		

1: 9,9 ↓	6:10,2* ↙	Serie	96,0
2:10,1 ↘	7: 8,8 ↘		
3:10,1 ↗	8:10,6* ↑	Sum	193,0
4:10,5* ↓	9: 9,6 →		
5:10,5* ↓	10:10,7* ↓		

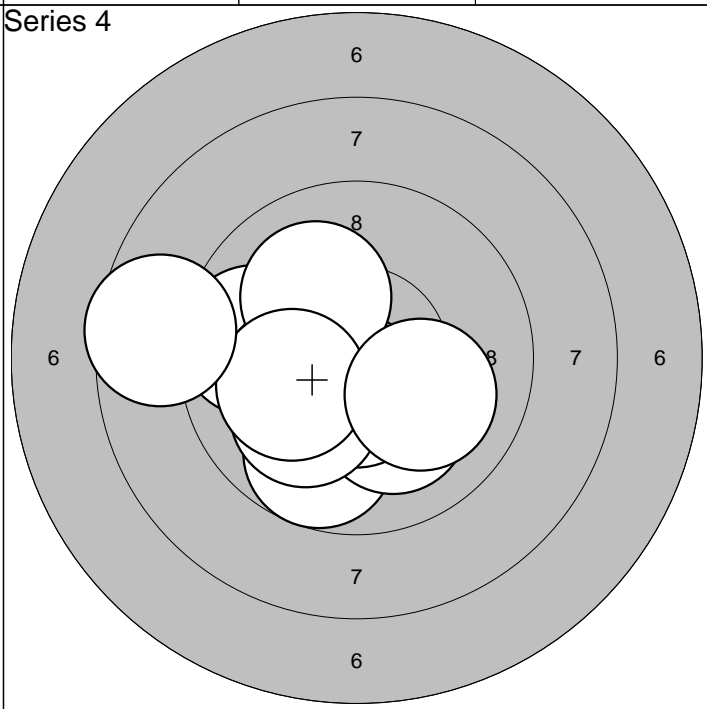
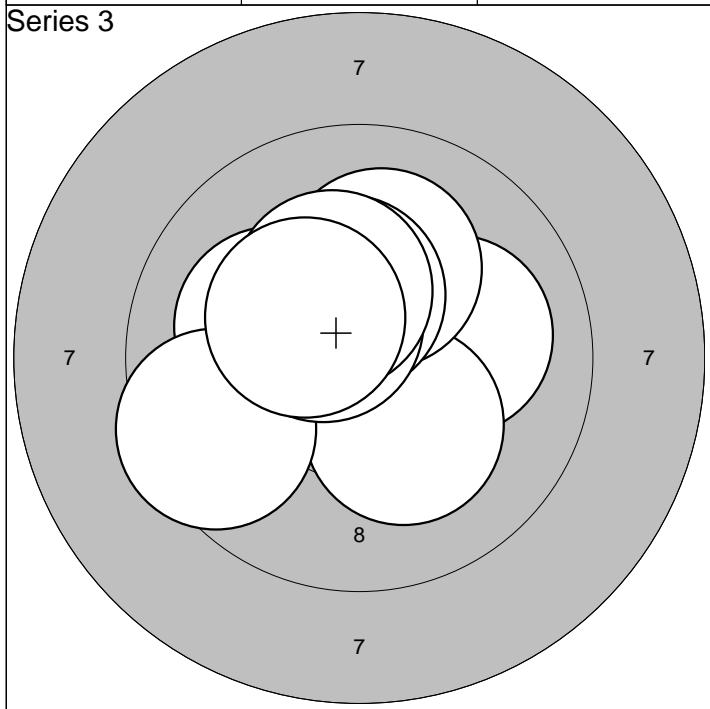

1:10,1 →	6:10,1 ↖	Serie	99,0
2:10,2* ↓	7: 9,5 ↖		
3:10,1 ↑	8:10,5* ↗	Sum	292,0
4:10,4* ↑	9:10,3* ↑		
5:10,4* ↖	10:10,4* ↖		

1: 9,8 ↓	6:10,1 ↙	Serie	96,0
2:10,1 ↓	7:10,1 ↗		
3:10,5* ↓	8:10,1 ↖	Sum	388,0
4: 9,7 ←	9: 8,6 ←		
5:10,2* ←	10:10,1 ↘		

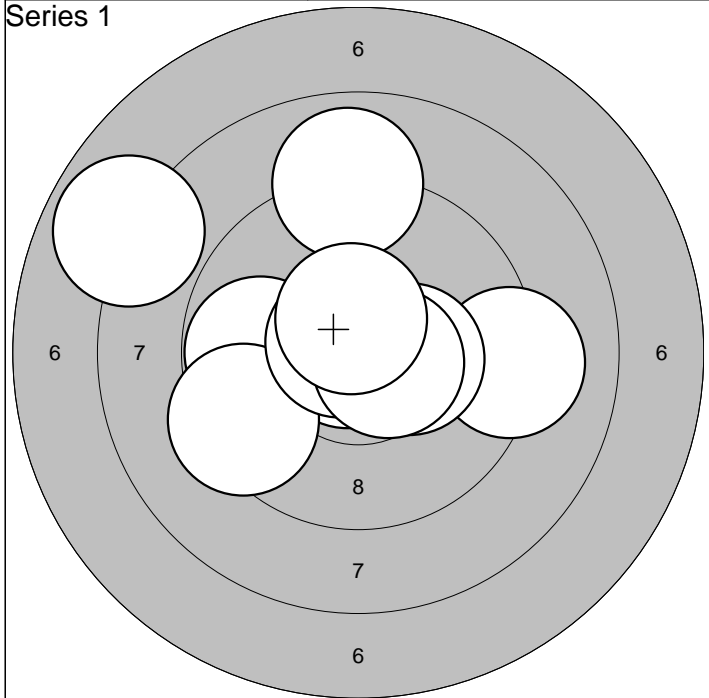

1: 9,2 →	6: 9,4 ←	Serie	92,0
2: 7,9 ←	7: 10,7* ←		
3: 8,9 ↑	8: 10,3* →	Sum	92,0
4: 10,8* ←	9: 10,6* →		
5: 9,8 ←	10: 10,5* ↑		

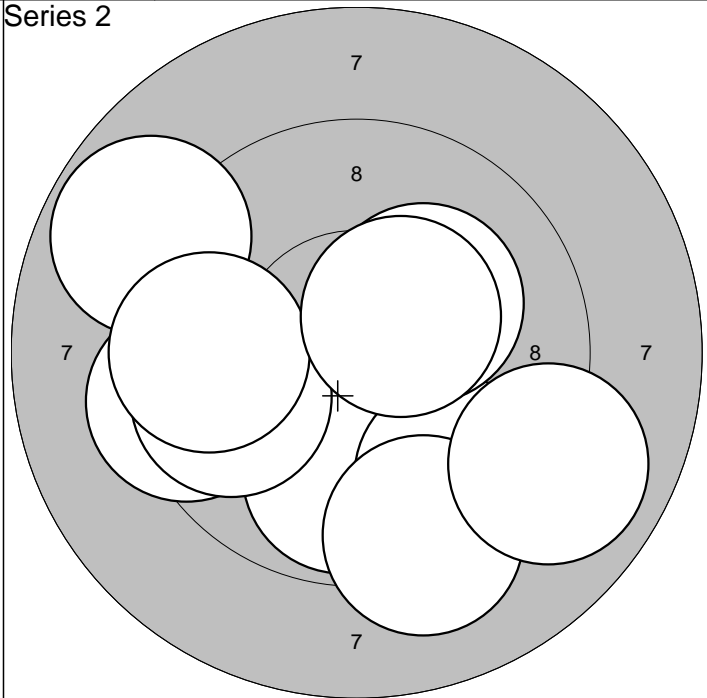

1: 9,9 ↓	6: 10,2* ↗	Serie	91,0
2: 8,8 ←	7: 9,2 ↓		
3: 9,4 ←	8: 9,0 →	Sum	183,0
4: 9,8 ←	9: 9,6 ←		
5: 9,5 ↓	10: 10,4* ↗		

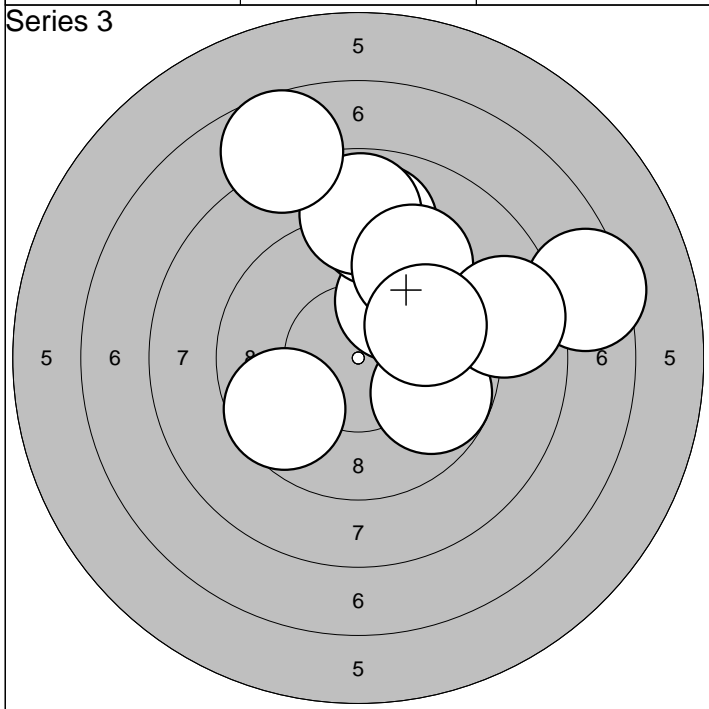

1: 9,9 ↗	6: 8,8 ↑	Serie	84,0
2: 9,8 →	7: 9,4 ↗		
3: 9,0 ↑	8: 8,7 →	Sum	267,0
4: 7,4 →	9: 7,7 ↑		
5: 9,6 ←	10: 9,8 ↗		

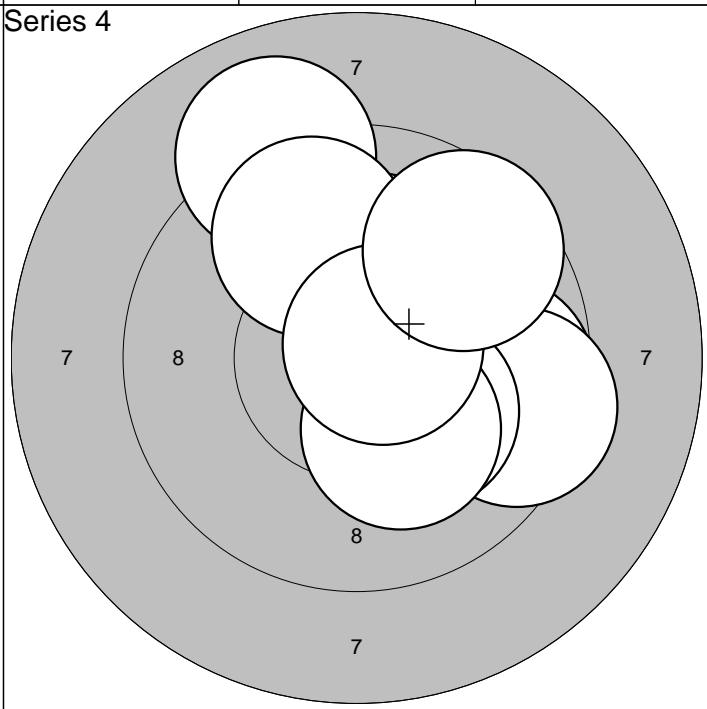

1: 10,2* ↑	6: 10,2* ↓	Serie	95,0
2: 10,1 →	7: 9,0 ↗		
3: 9,7 →	8: 9,8 ↗	Sum	362,0
4: 9,4 →	9: 10,7* ↗		
5: 10,2* ↓	10: 9,6 ↗		

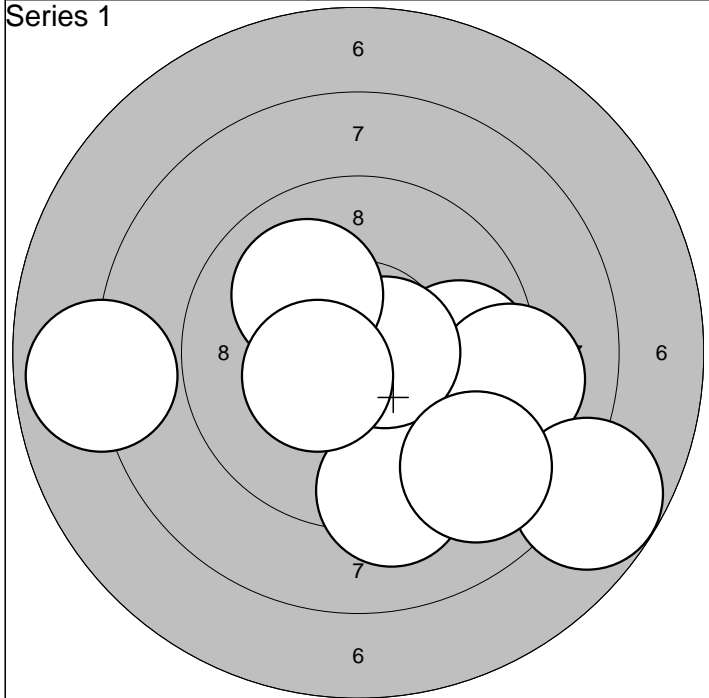

1: 7,9 ←	6:10,6* →			Serie	90,0
2: 9,8 →	7:10,0 ↗				
3:10,3* ↘	8: 7,8 ↘	Sum	90,0		
4: 9,1 →	9:10,4* ←				
5: 9,3 ↘	10: 9,0 ↘				

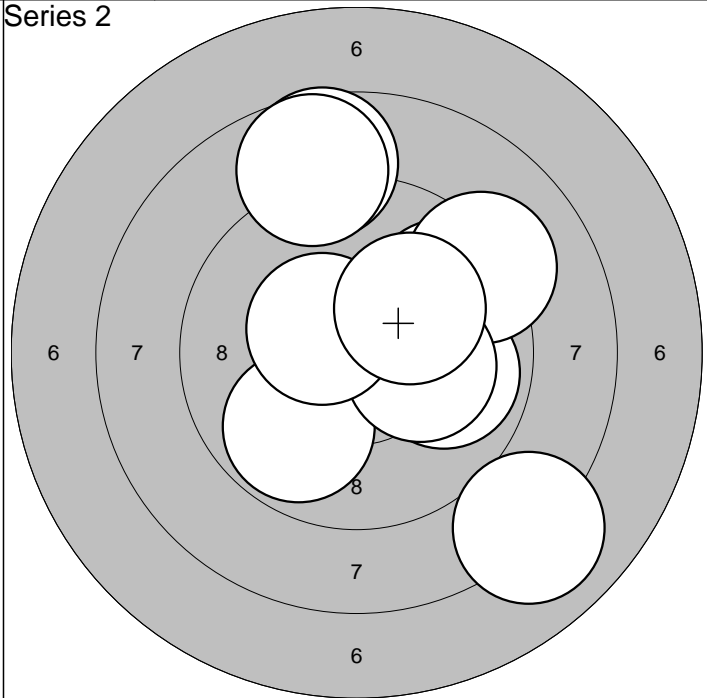

1: 9,7 ↗	6:10,5* ↖			Serie	90,0
2: 9,9 →	7: 8,0 ↘				
3: 9,2 ↗	8:10,1 ↗	Sum	180,0		
4: 9,8 ↘	9: 8,7 ↑				
5:10,2* →	10: 8,7 ↑				

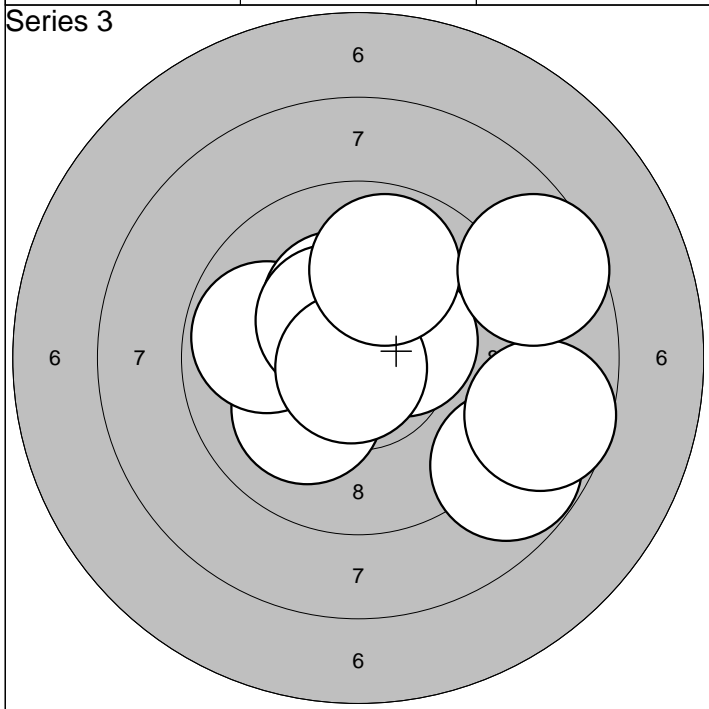

1:10,1 ↘	6:10,4* ↗			Serie	92,0
2: 9,8 ←	7:10,8* ↘				
3:10,3* ↗	8: 8,7 →	Sum	272,0		
4:10,4* →	9: 9,8 ↑				
5: 8,8 ↘	10: 8,6 →				

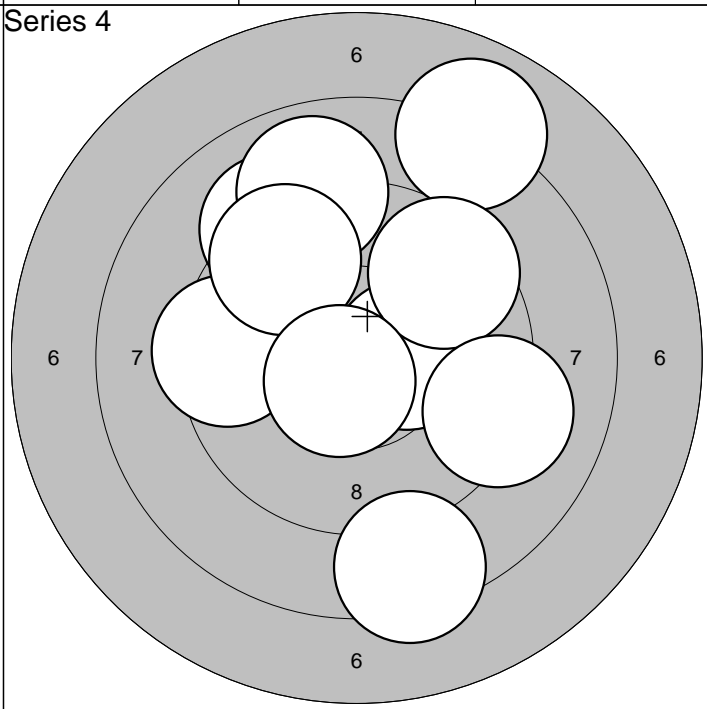

1: 9,1 ↗	6: 8,0 ↗			Serie	89,0
2: 8,9 ↑	7: 9,5 ↗				
3: 8,4 ↘	8: 9,5 ↗	Sum	361,0		
4:10,3* →	9: 9,2 →				
5: 9,4 ←	10:10,6* ↘				

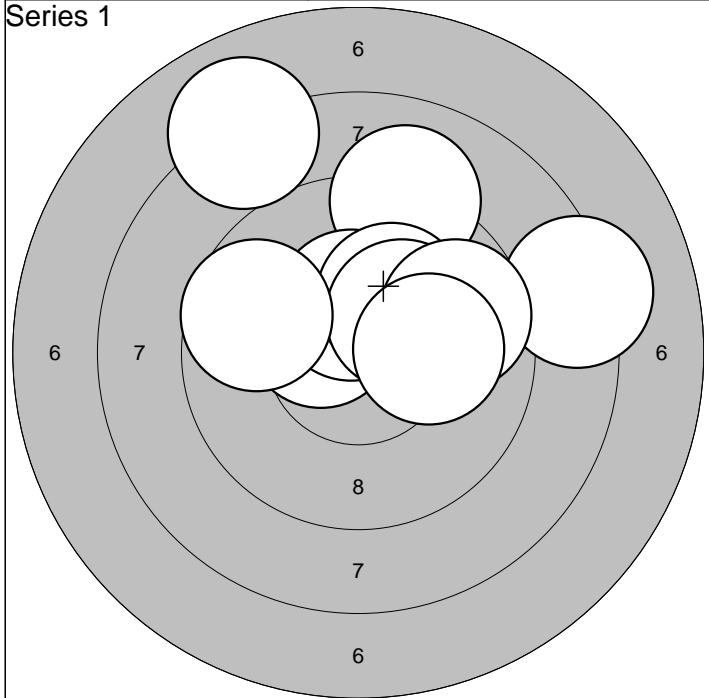

1: 8,3 →	6:10,2* ↗	Serie	93,0
2: 8,0 ↖	7:10,3* ↗		
3:10,5* ↖	8: 9,7 →	Sum	93,0
4: 9,1 ↑	9: 9,7 ←		
5:10,4* ↑	10:10,1 →		

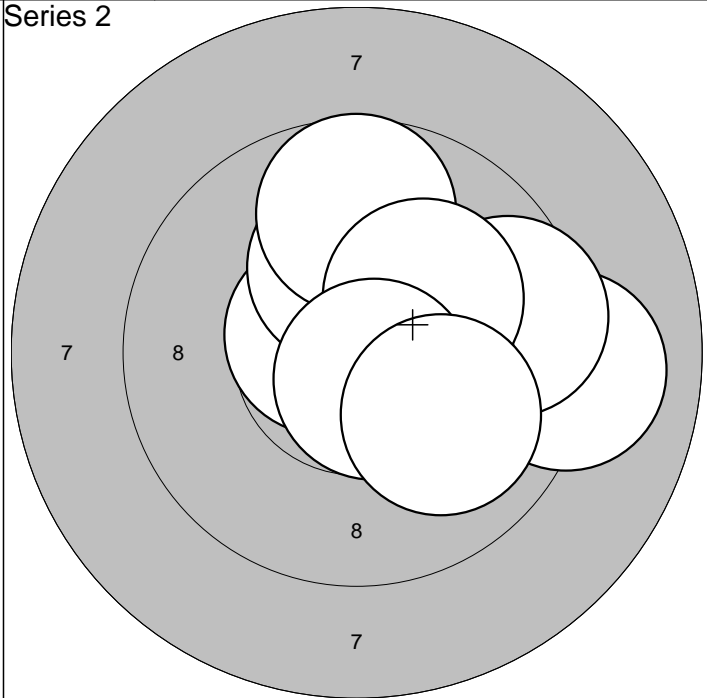

1:10,6* ↖	6: 9,6 →	Serie	97,0
2:10,3* ↑	7:10,4* →		
3: 9,1 →	8:10,2* ↗	Sum	190,0
4:10,2* ↑	9:10,6* ↘		
5: 9,7 ↑	10:10,0 ↘		

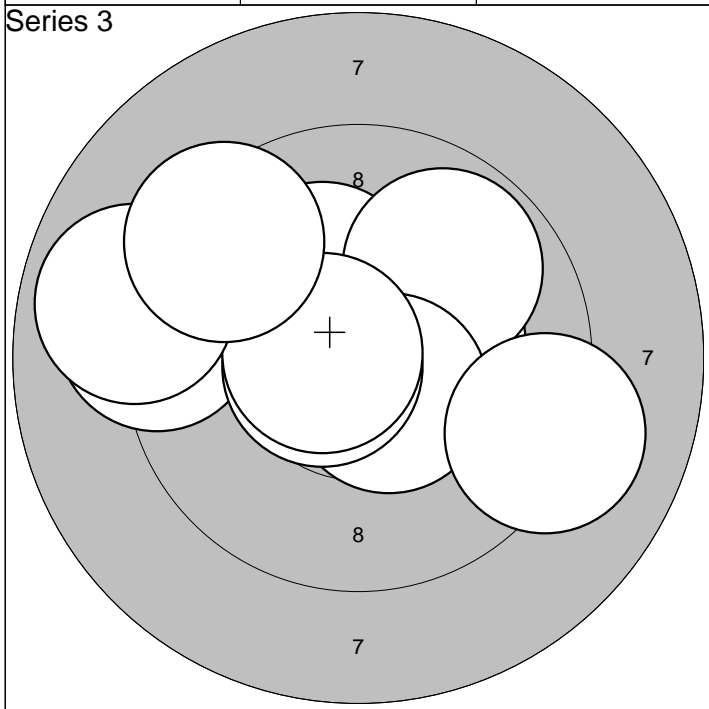

1:10,2* ↖	6:10,6* ←	Serie	94,0
2:10,3* →	7: 9,1 →		
3: 9,1 ←	8:10,6* ←	Sum	284,0
4: 9,8 ↗	9: 8,9 ←		
5:10,5* ↘	10: 9,3 ↗		

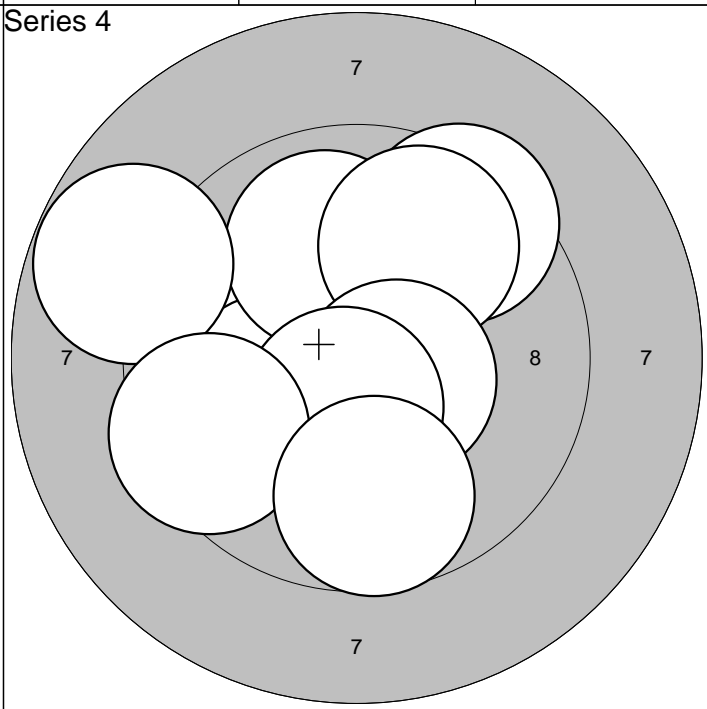

1: 9,4 ↗	6: 8,8 ↖	Serie	94,0
2:10,0 ←	7:10,5* ↘		
3:10,2* ←	8:10,5* ↘	Sum	378,0
4:10,0 ↑	9: 9,5 ←		
5: 9,8 ↗	10: 9,7 ↘		

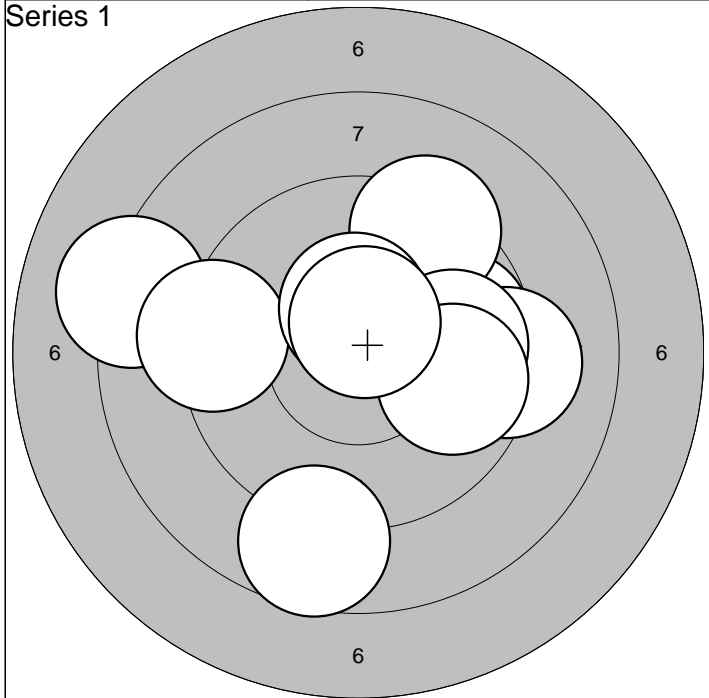

1: 8,6	↓	6: 9,2	←	Serie	90,0
2: 9,8	→	7: 10,4*	↑		
3: 9,3	↗	8: 9,8	→		
4: 9,2	→	9: 9,8	→		
5: 8,2	←	10: 10,6*	↑		
Sum				90,0	

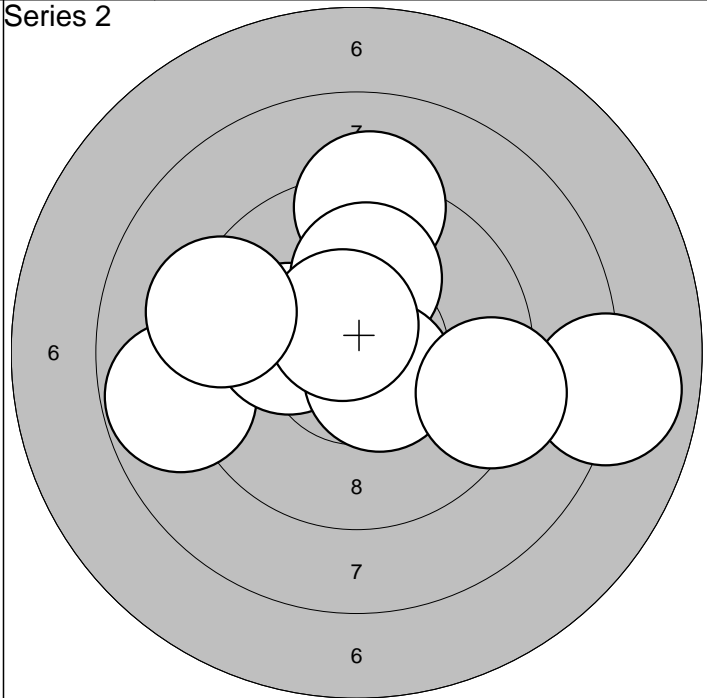

1: 8,8	←	6: 10,1	↑	Serie	92,0
2: 9,2	↑	7: 10,6*	↘		
3: 10,7*	↖	8: 9,3	→		
4: 10,1	←	9: 10,6*	↗		
5: 7,9	→	10: 9,3	←		
Sum				182,0	

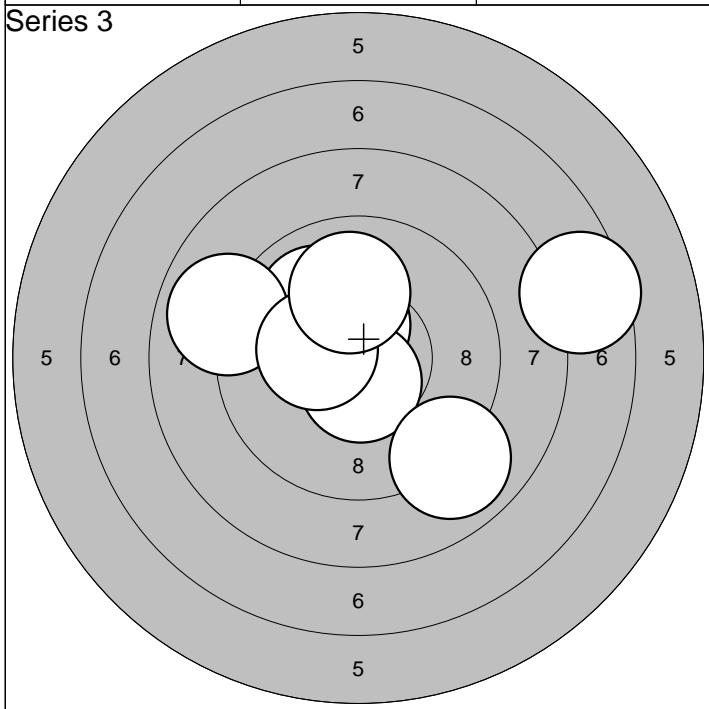

1: 10,4*	↗	6: 8,9	←	Serie	93,0
2: 10,7*	↖	7: 10,3*	←		
3: 10,4*	↑	8: 7,5	→		
4: 10,6*	↓	9: 10,0	↑		
5: 10,0	↖	10: 8,9	↘		
Sum				275,0	

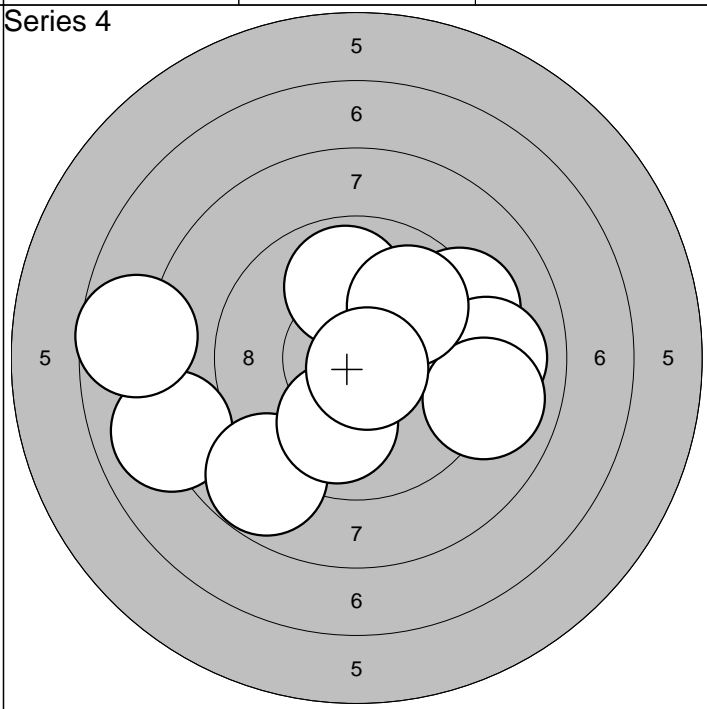

1: 9,9	↑	6: 9,0	→	Serie	88,0
2: 8,0	←	7: 10,0	↓		
3: 8,8	↘	8: 9,0	→		
4: 9,3	↗	9: 9,9	↗		
5: 7,7	←	10: 10,7*	↘		
Sum				363,0	

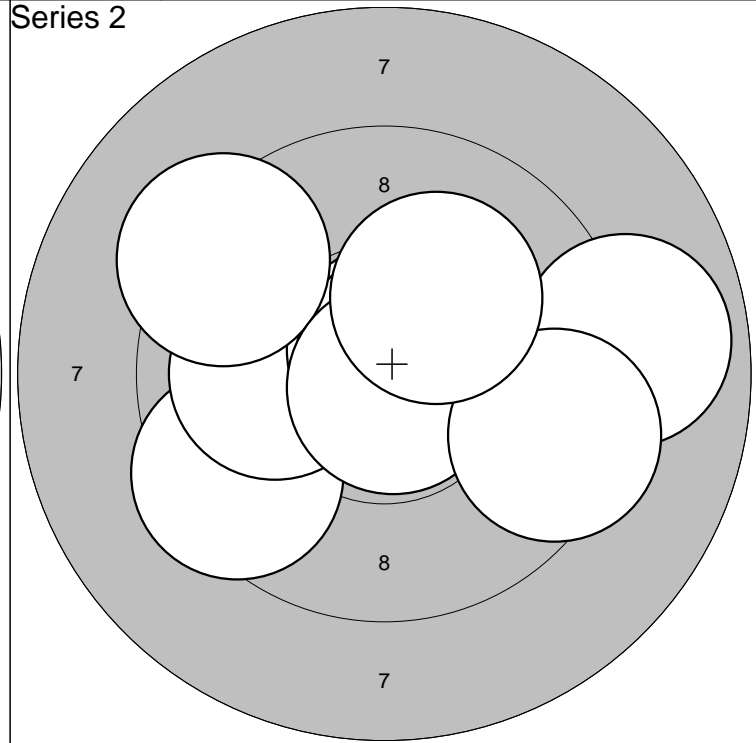
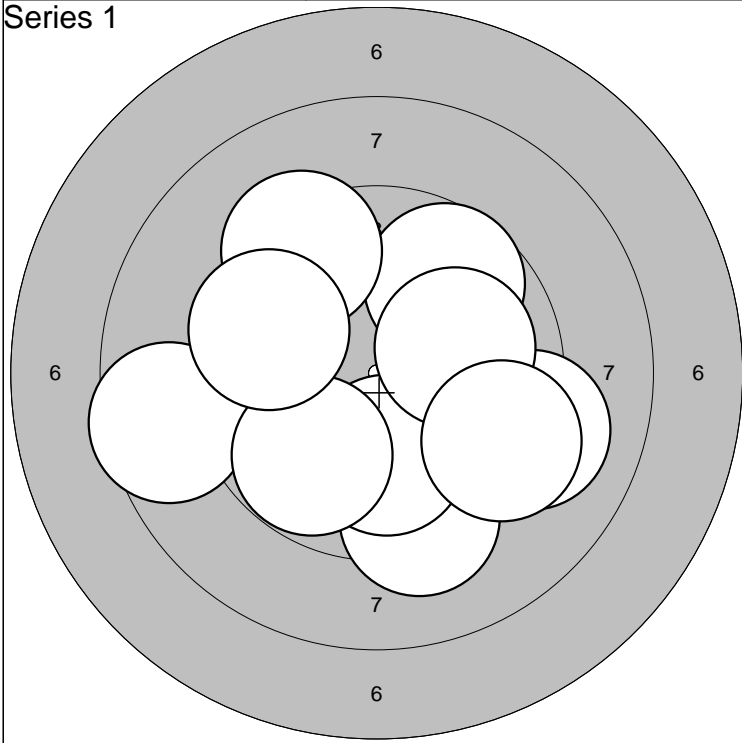

1: 9,7 ↗	6:10,0 ↓	Serie	91,0
2: 9,3 ↗	7: 9,8 ↓		
3: 9,1 ➔	8:10,0 ➔	Sum	91,0
4: 9,3 ↓	9: 9,4 ➔		
5: 8,6 ←	10: 9,7 ←		

1:10,8* ↖	6:10,7* ↗	Serie	95,0
2: 8,9 ➔	7: 9,3 ↖		
3: 9,5 ↙	8:10,8* ↓	Sum	186,0
4:10,0 ←	9: 9,4 ➔		
5:10,7* ↑	10:10,2* ↗		

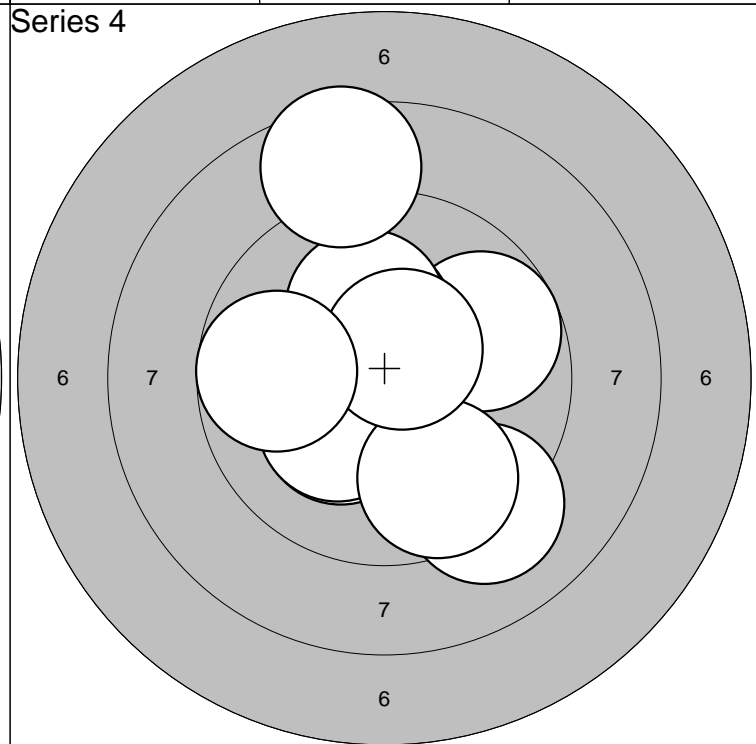
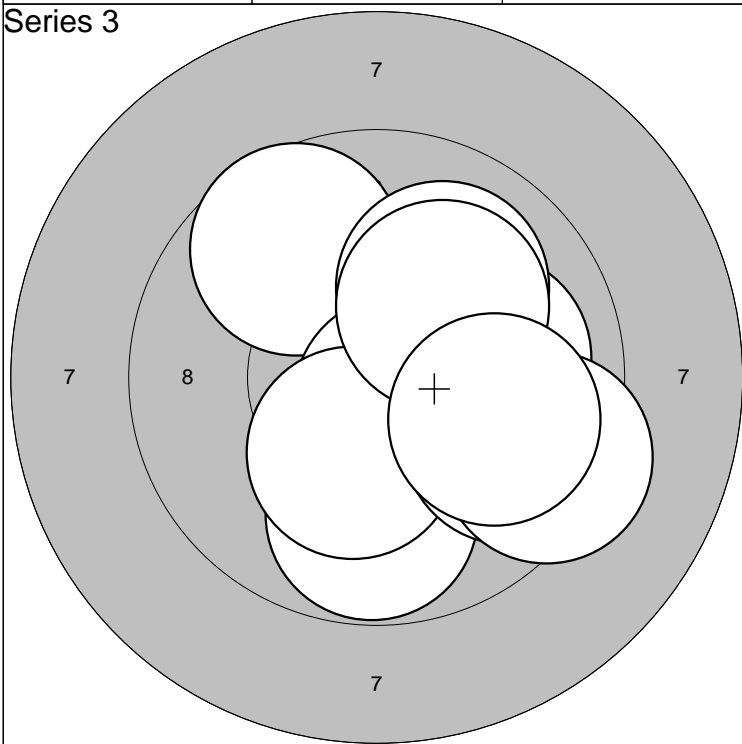

1: 9,8 ↓	6:10,0 ↗	Serie	95,0
2:10,0 ➔	7: 9,7 ➔		
3: 9,7 ↗	8: 9,4 ➔	Sum	281,0
4:10,7* ↓	9:10,1 ↗		
5:10,3* ↓	10: 9,9 ➔		

1:10,3* ↙	6:10,3* ↙	Serie	94,0
2: 9,8 ➔	7: 9,7 ↓		
3: 9,1 ↙	8:10,6* ↗	Sum	375,0
4:10,3* ↑	9: 8,5 ↑		
5:10,2* ↑	10: 9,8 ←		