

Kalix

2010-07-23

Tavelträffen 2010

Ramselefors SKF

Provskott

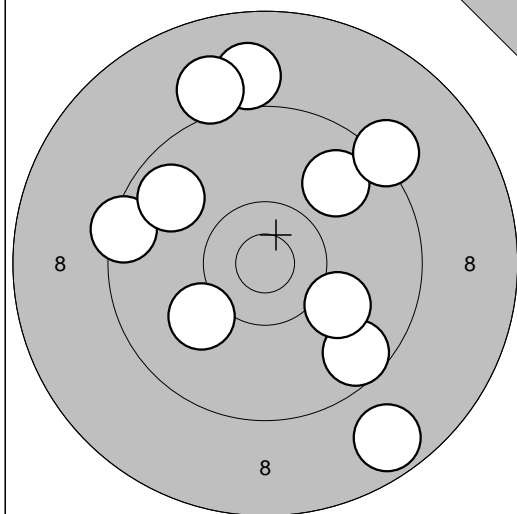

1: 9,6 ↘
 2: 9,0 ↑
 3: 9,4 ←
 4: 9,0 ↑
 5: 8,7 ↘
 6: 9,8 ↗
 7: 9,8 ↗
 8: 10,1 ↘
 9: 10,1 ↙
 10: 9,2 ↗

Serie 91,0

Totalt 0,0

Provskott

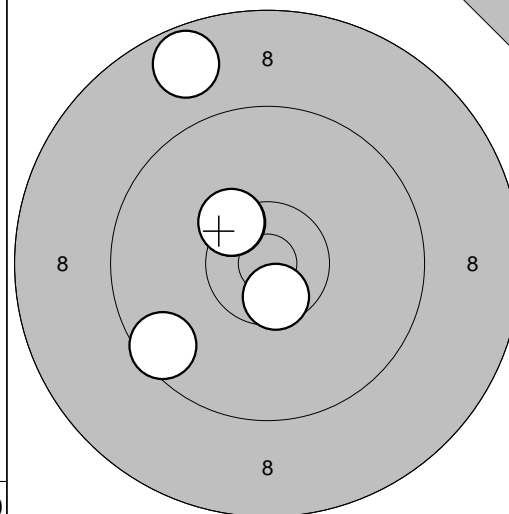

11: 10,4* ↗
 12: 8,7 ↑
 13: 9,6 ↙
 14: 10,6* ↘
 15: 10,4* ↗

Serie 47,0

Totalt 0,0

Tävlingsskott

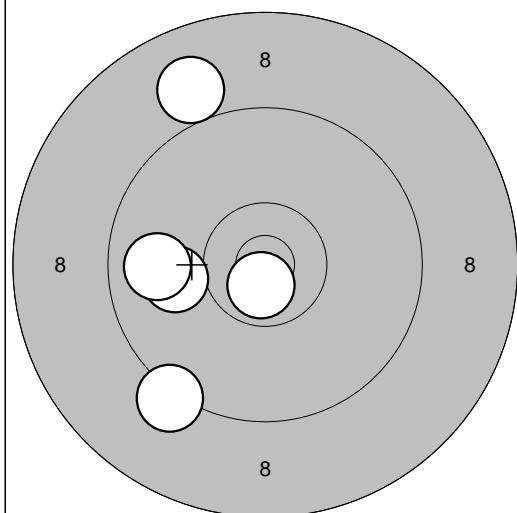

1: 9,2 ↙
 2: 10,7* ↘
 3: 10,0 ←
 4: 9,0 ↑
 5: 9,8 ←

Serie 47,0

Totalt 47,0

Tävlingsskott

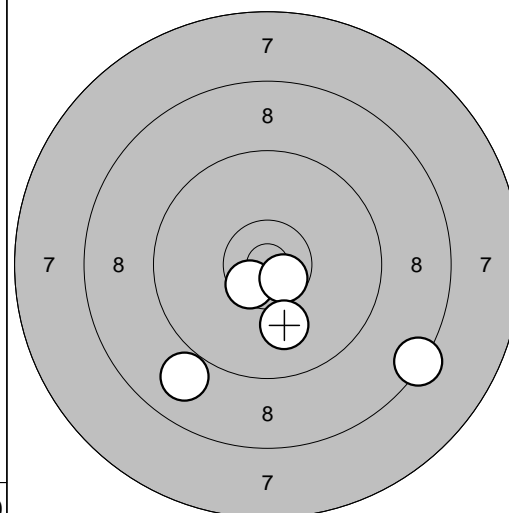

6: 10,6* ↙
 7: 10,6* ↘
 8: 10,0 ↘
 9: 8,9 ↙
 10: 8,4 ↘

Serie 46,0

Totalt 93,0

Tävlingsskott

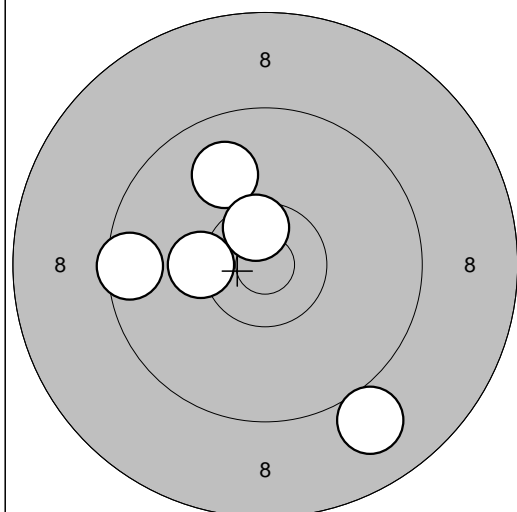

11: 9,9 ↗
 12: 10,6* ↑
 13: 10,3 ←
 14: 9,5 ←
 15: 9,0 ↘

Serie 47,0

Totalt 140,0

Tävlingsskott

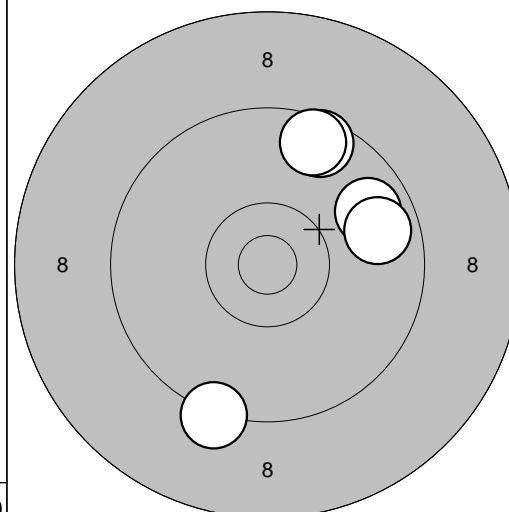

16: 9,8 ↗
 17: 9,3 ↘
 18: 9,7 ↗
 19: 9,6 ↑
 20: 9,6 ↑

Serie 45,0

Totalt 185,0

Ramselefors

2010-07-23

Tavelträffen 2010

Ramselefors SKF

Provskott

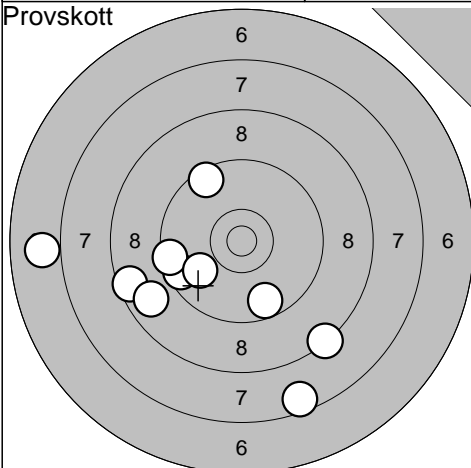

1: 6,9 ←
 2: 9,6 ←
 3: 9,5 ↗
 4: 9,7 ↓
 5: 8,3 ↓
 6: 9,5 ←
 7: 8,6 ←
 8: 7,6 ↓
 9: 8,8 ←
 10: 9,9 ↙

Serie 82,0

Totalt 0,0

Provskott

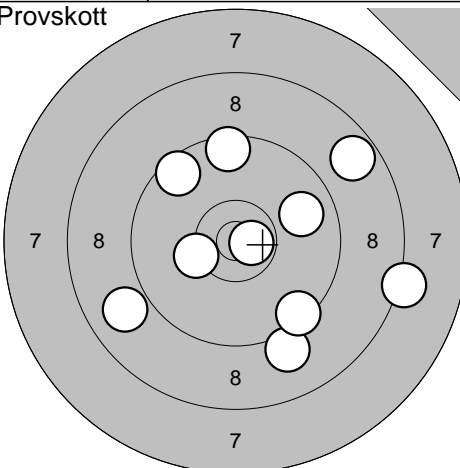

11: 8,2 →
 12: 8,9 ↙
 13: 10,3 ←
 14: 9,1 ↓
 15: 10,7* →
 16: 9,4 ↓
 17: 9,8 →
 18: 8,7 ↗
 19: 9,5 ↑
 20: 9,6 ↖

Serie 89,0

Totalt 0,0

Provskott

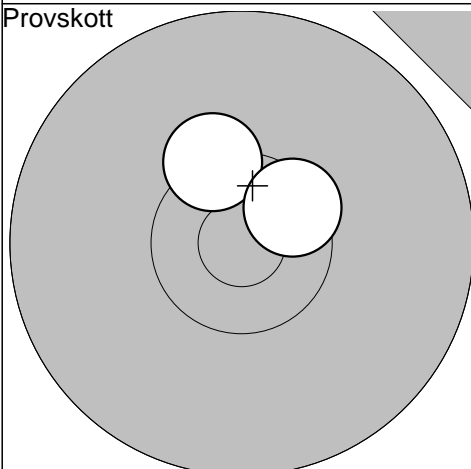

21: 10,3* ↑
 22: 10,5* ↗

Serie 20,0

Totalt 0,0

Tävlingsskott

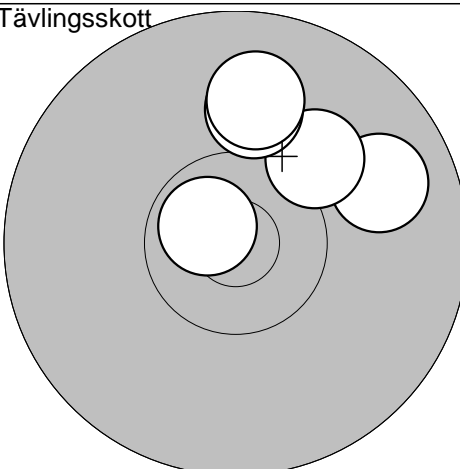

1: 10,7* ↖
 2: 9,8 →
 3: 10,1 ↗
 4: 10,0 ↑
 5: 9,9 ↑

Serie 48,0

Totalt 48,0

Tävlingsskott

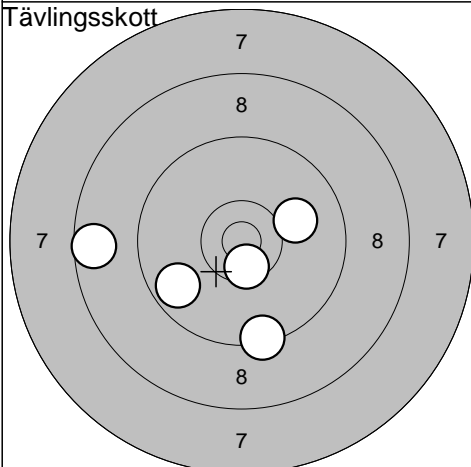

6: 10,0 →
 7: 8,6 ←
 8: 9,7 ↙
 9: 9,4 ↓
 10: 10,5* ↓

Serie 46,0

Totalt 94,0

Tävlingsskott

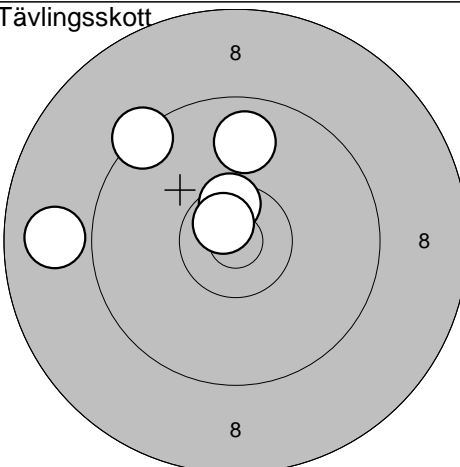

11: 10,5* ↑
 12: 9,8 ↑
 13: 10,7* ↖
 14: 9,4 ↖
 15: 8,9 ←

Serie 46,0

Totalt 140,0

Tävlingsskott

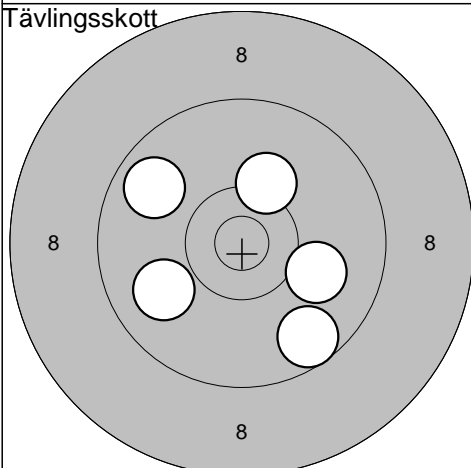

16: 10,2 ↑
 17: 9,8 ↖
 18: 9,6 ↓
 19: 9,9 ↙
 20: 10,0 →

Serie 47,0

Totalt 187,0

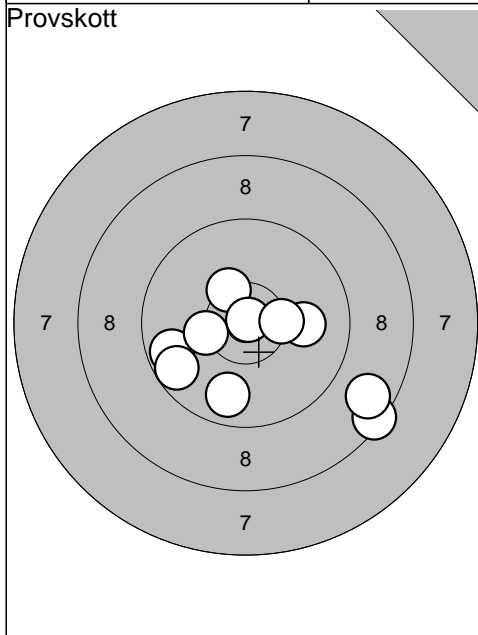

1: 8,4	↘
2: 9,7	←
3: 10,4*	↗
4: 10,3*	←
5: 9,7	←
6: 10,9*	↗
7: 10,0	→
8: 10,4*	→
9: 8,7	↘
10: 9,8	↓
Serie	93,0
Totalt	0,0

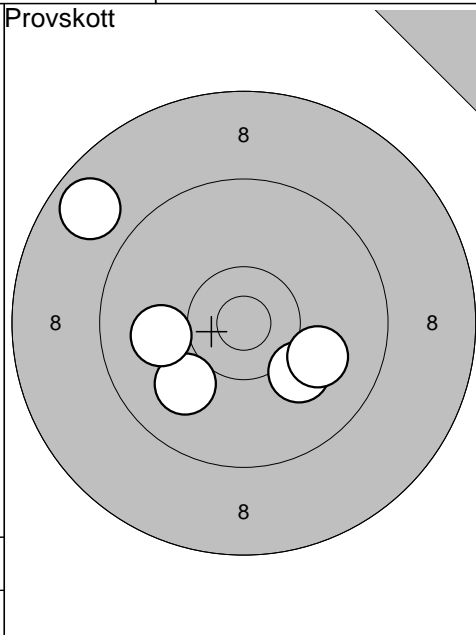

11: 10,1	↘
12: 8,8	↗
13: 10,0	↘
14: 10,0	←
15: 10,0	↘
Serie	48,0
Totalt	0,0

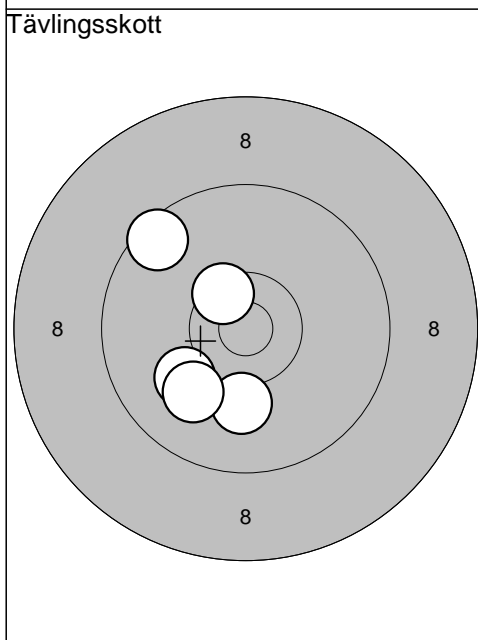

1: 9,5	↗
2: 10,5*	↗
3: 10,1	↘
4: 10,1	↓
5: 10,0	↘
Serie	49,0
Totalt	49,0

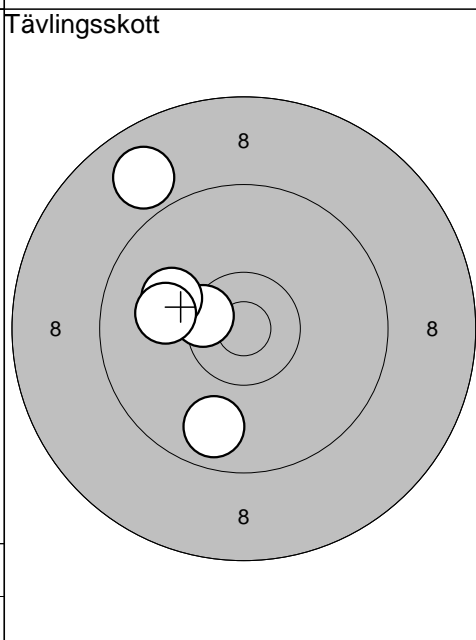

6: 10,5*	←
7: 10,1	←
8: 8,9	↗
9: 10,0	←
10: 9,8	↓
Serie	47,0
Totalt	96,0

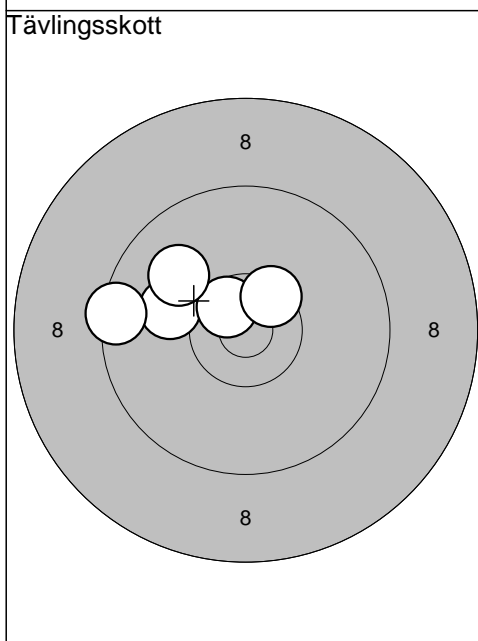

11: 10,1	←
12: 10,6*	↗
13: 10,5*	↗
14: 10,0	↗
15: 9,5	←
Serie	49,0
Totalt	145,0

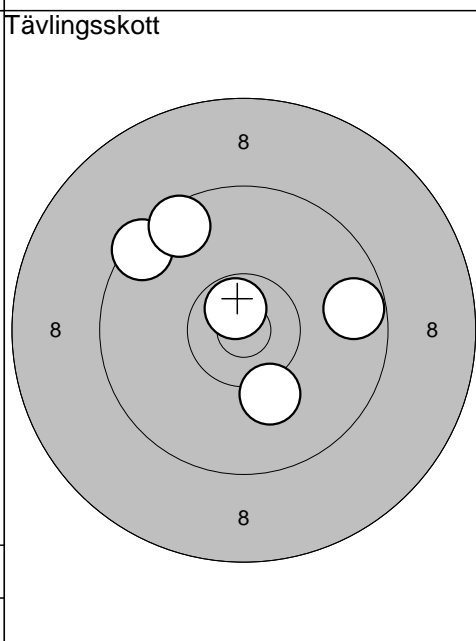

16: 9,5	↗
17: 9,6	↗
18: 9,7	→
19: 10,7*	↗
20: 10,2	↓
Serie	47,0
Totalt	192,0

Ramselefors

2010-07-23

Tavelträffen 2010

Ramselefors SKF

Provskott

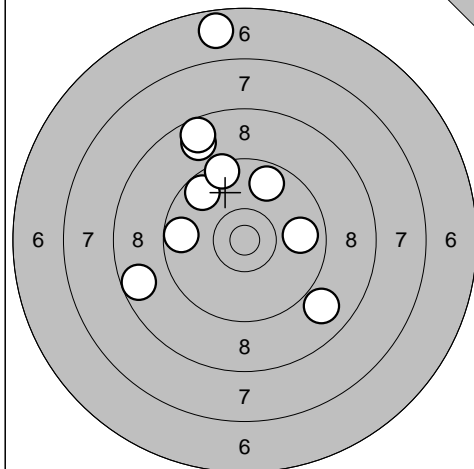

1: 6,7 ↗
 2: 9,7 ↗
 3: 8,8 ↗
 4: 8,9 ↘
 5: 8,7 ←
 6: 9,7 ↗
 7: 9,5 ↗
 8: 8,7 ↗
 9: 9,7 ←
 10: 9,8 →

Serie 83,0

Totalt 0,0

Provskott

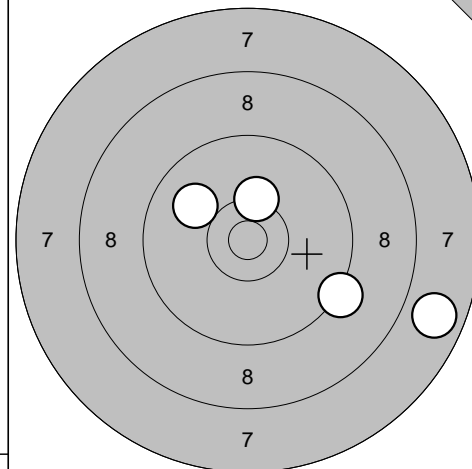

11: 9,3 ↘
 12: 10,0 ↗
 13: 7,8 →
 14: 10,3* ↑

Serie 36,0

Totalt 0,0

Tävlingsskott

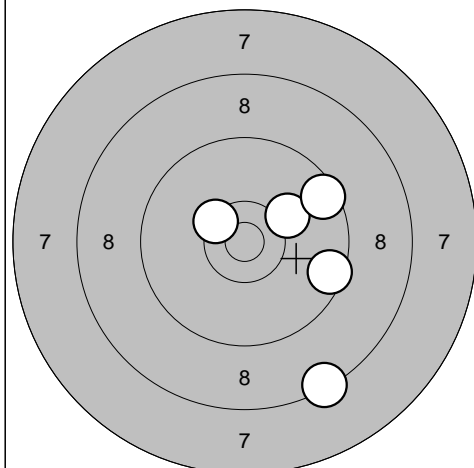

1: 9,5 →
 2: 10,2 ↗
 3: 9,5 ↗
 4: 10,4* ↗
 5: 8,4 ↘

Serie 46,0

Totalt 46,0

Tävlingsskott

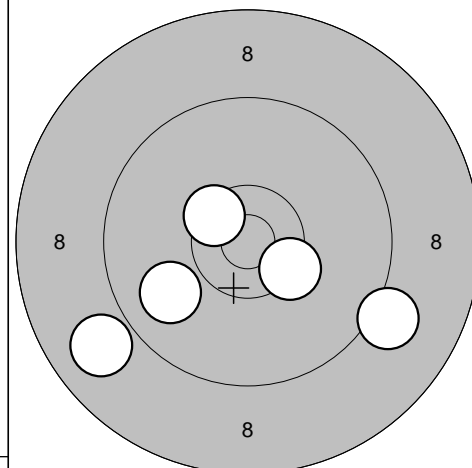

6: 8,9 ←
 7: 10,5* ↗
 8: 9,1 →
 9: 10,4* ↘
 10: 9,9 ←

Serie 46,0

Totalt 92,0

Tävlingsskott

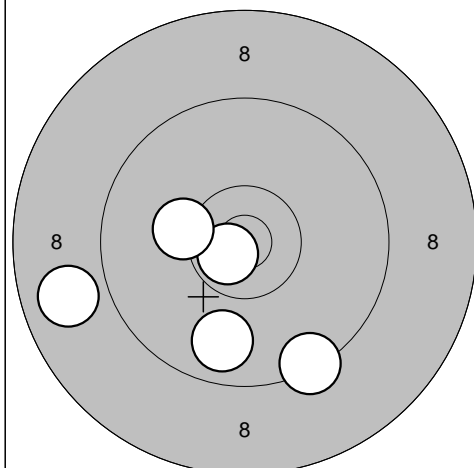

11: 9,4 ↘
 12: 10,7* ↘
 13: 9,8 ↘
 14: 10,2 ←
 15: 8,8 ←

Serie 46,0

Totalt 138,0

Tävlingsskott

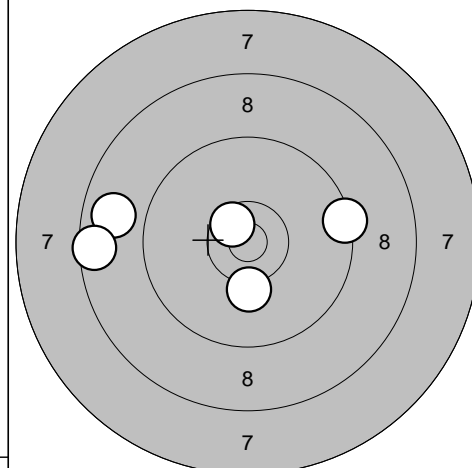

16: 10,2 ↓
 17: 10,6* ↗
 18: 8,8 ←
 19: 8,5 ←
 20: 9,4 →

Serie 45,0

Totalt 183,0

Ramselefors

2010-07-23

Tavelträffen 2010

Ramselefors SKF

Provsjött

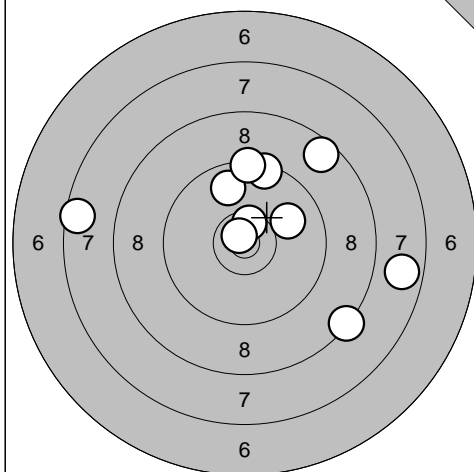

1: 8,3 ↘
 2: 7,7 →
 3: 10,5* ↑
 4: 9,5 ↑
 5: 8,6 ↗
 6: 10,0 →
 7: 9,8 ↑
 8: 10,8* ↗
 9: 7,6 ←
 10: 9,4 ↑

Serie 87,0

Totalt 0,0

Tävlingssjött

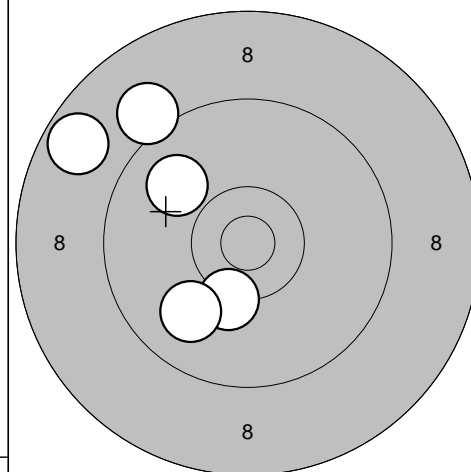

1: 10,3 ↓
 2: 9,9 ↘
 3: 8,7 ↖
 4: 9,1 ↗
 5: 9,9 ↗

Serie 45,0

Totalt 45,0

Tävlingssjött

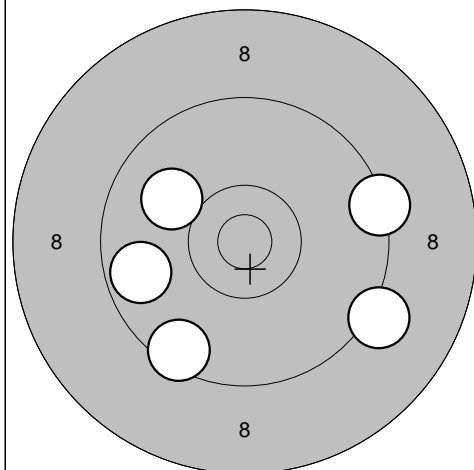

6: 9,5 ↓
 7: 9,3 →
 8: 10,0 ↗
 9: 9,2 ↘
 10: 9,7 ←

Serie 46,0

Totalt 91,0

Tävlingssjött

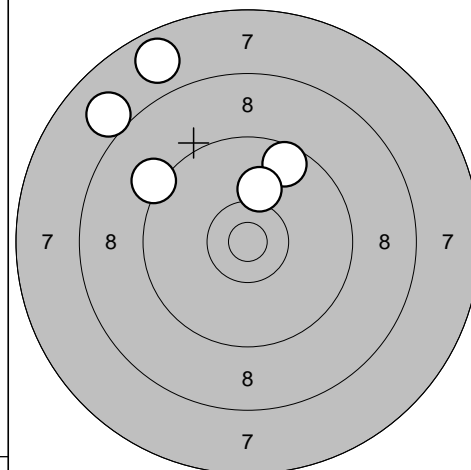

11: 9,6 ↑
 12: 7,8 ↖
 13: 10,1 ↑
 14: 8,0 ↖
 15: 9,2 ↖

Serie 43,0

Totalt 134,0

Tävlingssjött

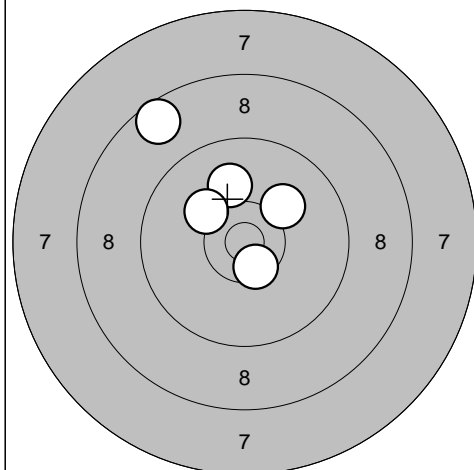

16: 10,0 ↑
 17: 10,5* ↓
 18: 8,6 ↗
 19: 10,1 ↗
 20: 10,2 ↖

Serie 48,0

Totalt 182,0

Kalix

2010-07-23

Tavelträffen 2010

Ramselefors SKF

Provs-kott

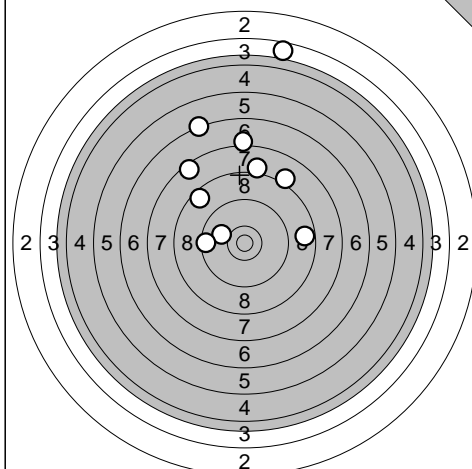

1: 3,6 ↑
 2: 8,1 ↗
 3: 6,3 ↑
 4: 7,2 ↑
 5: 7,5 ↗
 6: 8,1 ↑
 7: 8,7 →
 8: 10,0 ↖
 9: 9,5 ←
 10: 8,6 ↗

Serie 74,0

Totalt 0,0

Provs-kott

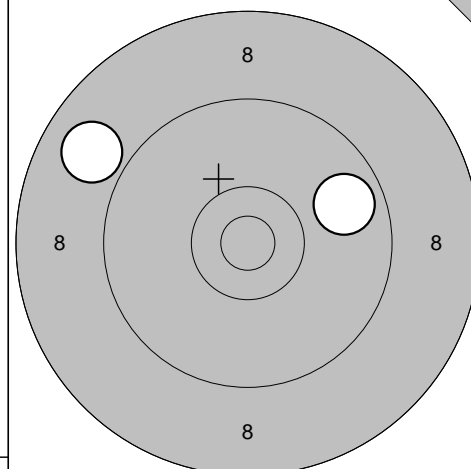

11: 9,8 ↗
 12: 8,9 ↖

Serie 17,0

Totalt 0,0

Tävlingsskott

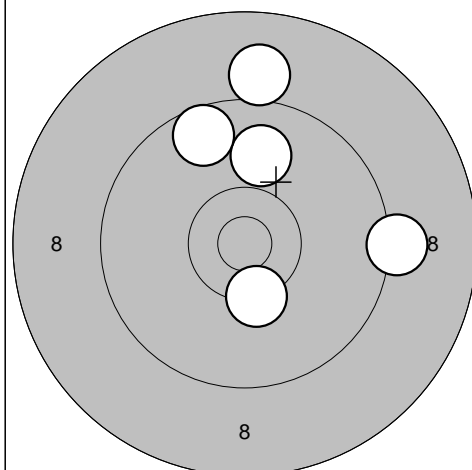

1: 9,9 ↑
 2: 9,6 ↗
 3: 10,3* ↓
 4: 9,0 ↑
 5: 9,2 →

Serie 46,0

Totalt 46,0

Tävlingsskott

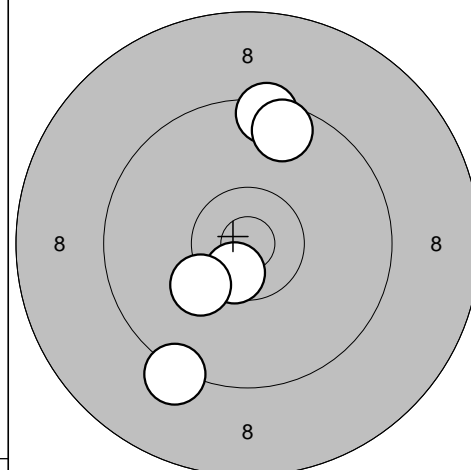

6: 10,6* ↓
 7: 9,5 ↑
 8: 10,2 ↖
 9: 9,2 ↓
 10: 9,6 ↑

Serie 47,0

Totalt 93,0

Tävlingsskott

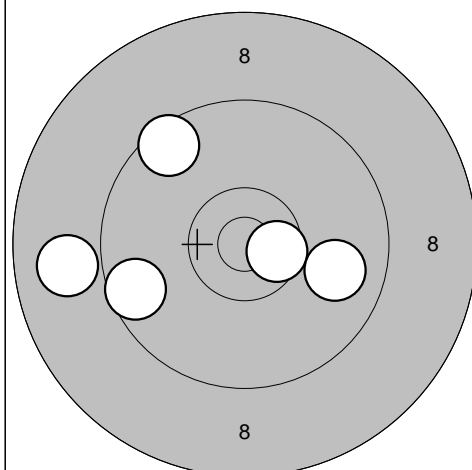

11: 8,9 ←
 12: 10,6* →
 13: 9,5 ↗
 14: 9,6 ←
 15: 9,9 →

Serie 45,0

Totalt 138,0

Tävlingsskott

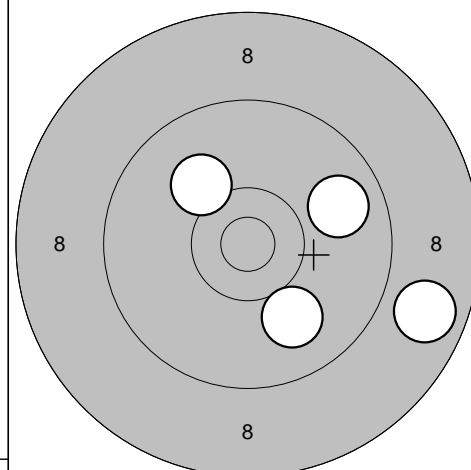

16: 10,1 ↗
 17: 10,0 ↓
 18: 8,8 →
 19: 9,8 →

Serie 37,0

Totalt 175,0

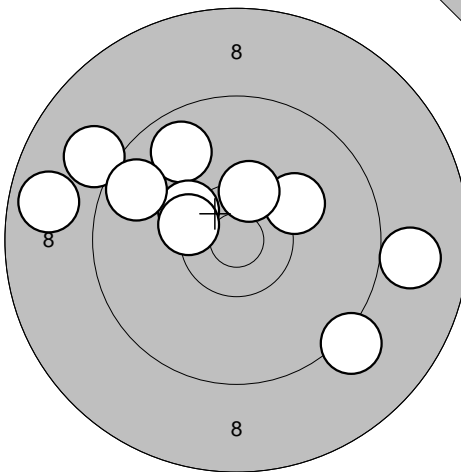
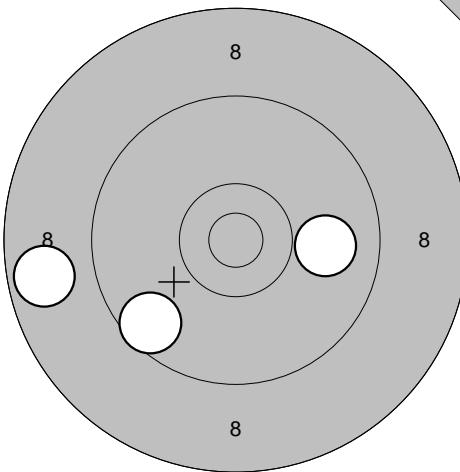
<p>Provskott</p> 	<p>1: 9,8 ↗ 2: 10,3* ↗ 3: 9,1 ↗ 4: 8,8 ← 5: 10,2 ↗ 6: 10,4* ← 7: 9,7 ↗ 8: 9,2 ↘ 9: 9,0 → 10: 10,4* ↗</p>	<p>Provskott</p> 	<p>11: 8,7 ← 12: 9,6 ↘ 13: 9,9 →</p>
Serie	93,0	Serie	26,0
Totalt	0,0	Totalt	0,0

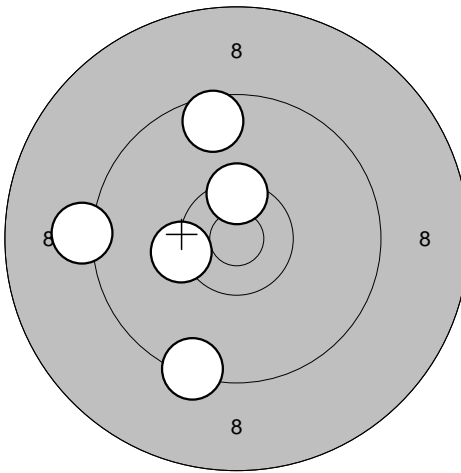
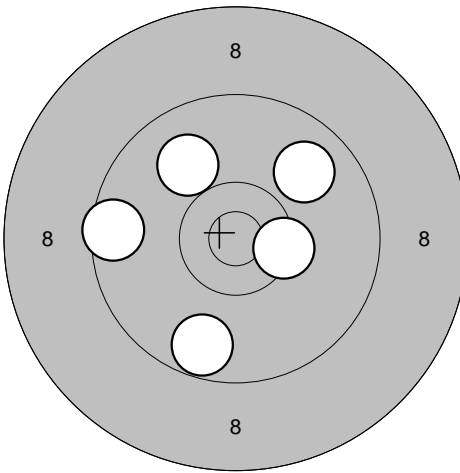
<p>Tävlingsskott</p> 	<p>1: 9,4 ↘ 2: 10,4* ↑ 3: 9,2 ← 4: 10,3* ← 5: 9,6 ↑</p>	<p>Tävlingsskott</p> 	<p>6: 9,7 ↘ 7: 10,0 ↗ 8: 10,4* → 9: 9,9 ↗ 10: 9,6 ←</p>
Serie	47,0	Serie	47,0
Totalt	47,0	Totalt	94,0

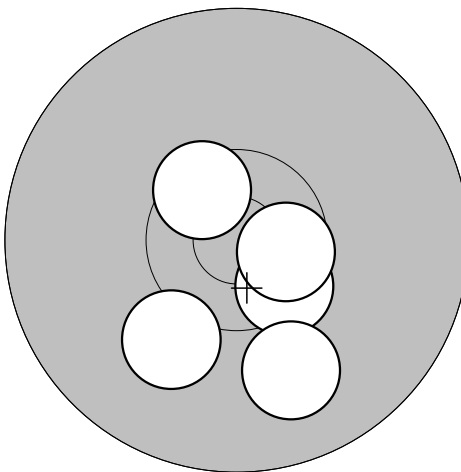
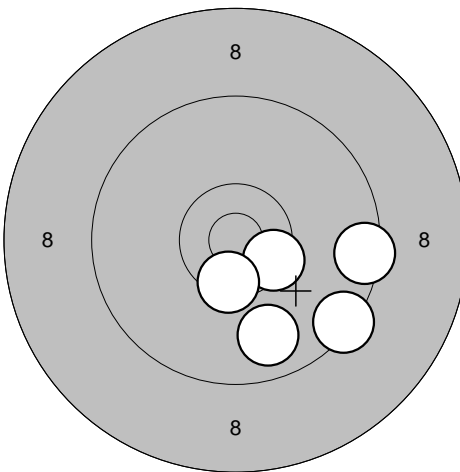
<p>Tävlingsskott</p> 	<p>11: 10,1 ↘ 12: 10,5* ↘ 13: 10,6* → 14: 10,5* ↗ 15: 9,9 ↘</p>	<p>Tävlingsskott</p> 	<p>16: 10,5* ↗ 17: 10,5* ↘ 18: 9,5 → 19: 9,4 ↘ 20: 9,8 ↘</p>
Serie	49,0	Serie	47,0
Totalt	143,0	Totalt	190,0

Umeå

2010-07-23

Tavelträffen 2010

Ramselefors SKF

Provskott

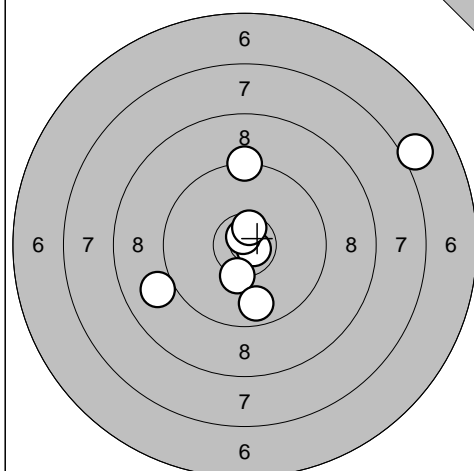

1: 9,3 ↑
 2: 10,7* →
 3: 7,1 ↗
 4: 9,0 ↙
 5: 10,3* ↓
 6: 10,8* ↑
 7: 9,8 ↓
 8: 10,6* ↑

Serie 74,0

Totalt 0,0

Tävlingsskott

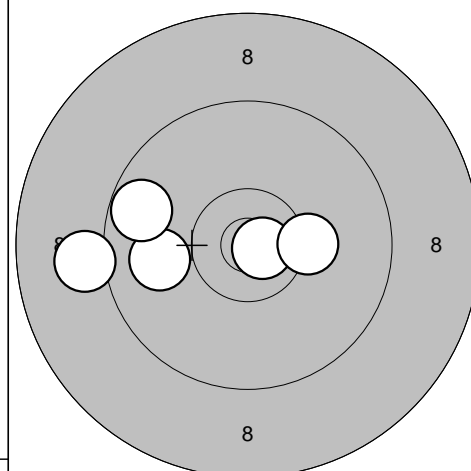

1: 10,8* →
 2: 9,1 ←
 3: 9,9 ←
 4: 10,3 →
 5: 9,7 ←

Serie 47,0

Totalt 47,0

Tävlingsskott

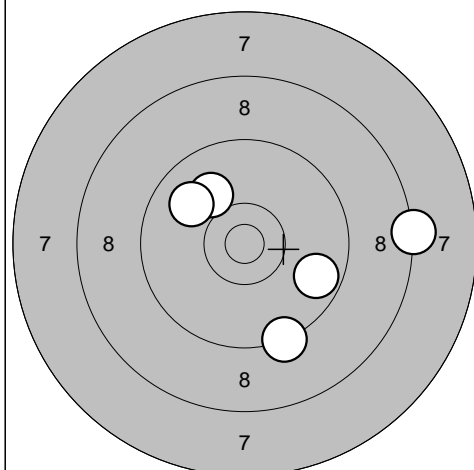

6: 10,0 ↗
 7: 9,9 ↗
 8: 9,7 →
 9: 9,3 ↓
 10: 8,3 →

Serie 45,0

Totalt 92,0

Tävlingsskott

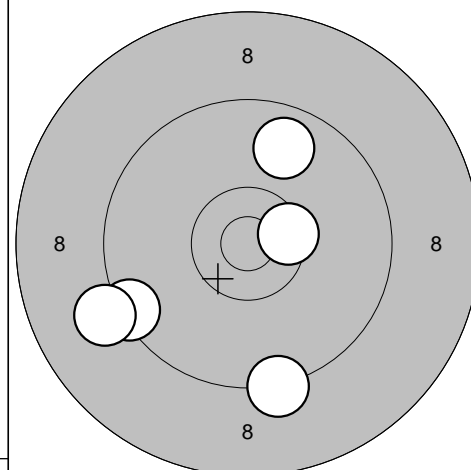

11: 10,5* →
 12: 9,4 ↙
 13: 9,1 ↙
 14: 9,3 ↓
 15: 9,8 ↑

Serie 46,0

Totalt 138,0

Tävlingsskott

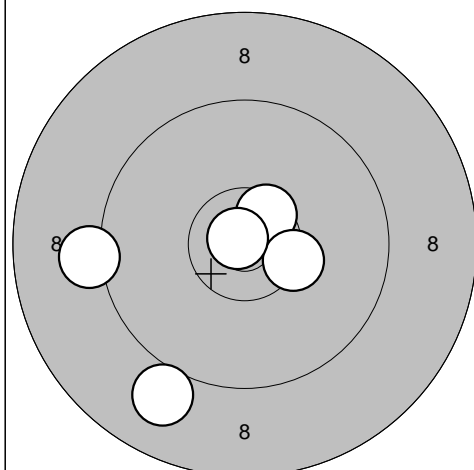

16: 10,5* ↗
 17: 9,2 ←
 18: 10,4* →
 19: 9,0 ↓
 20: 10,8* ↗

Serie 48,0

Totalt 186,0

2010-07-23

Tavelträffen 2010

Ramselefors SKF

Provskott

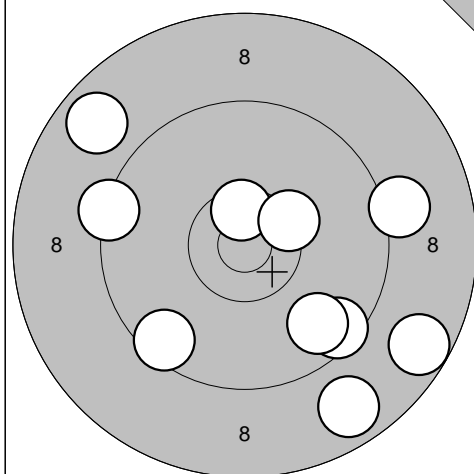

1: 8,7 ↘
 2: 9,5 ↘
 3: 8,8 ↘
 4: 9,5 ↘
 5: 8,8 ↗
 6: 9,4 ←
 7: 10,5* ↑
 8: 9,1 →
 9: 9,7 ↘
 10: 10,4* ↗

Serie 89,0

Totalt 0,0

Tävlingsskott

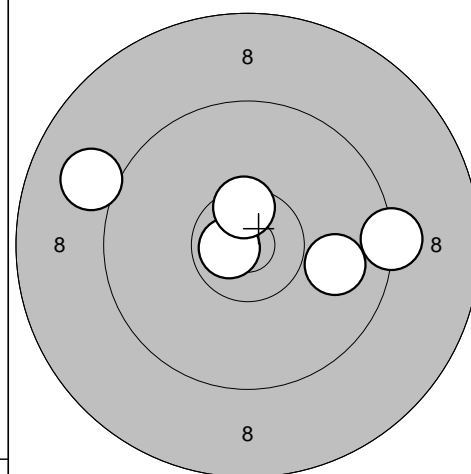

1: 10,7* ←
 2: 10,5* ↑
 3: 9,3 →
 4: 9,9 →
 5: 9,0 ↖

Serie 47,0

Totalt 47,0

Tävlingsskott

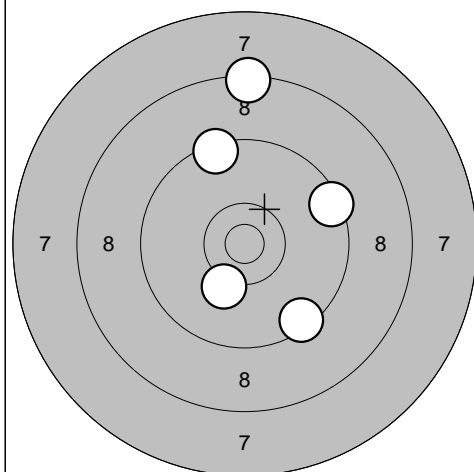

6: 10,2 ↘
 7: 8,4 ↑
 8: 9,4 ↑
 9: 9,4 ↘
 10: 9,5 ↗

Serie 45,0

Totalt 92,0

Tävlingsskott

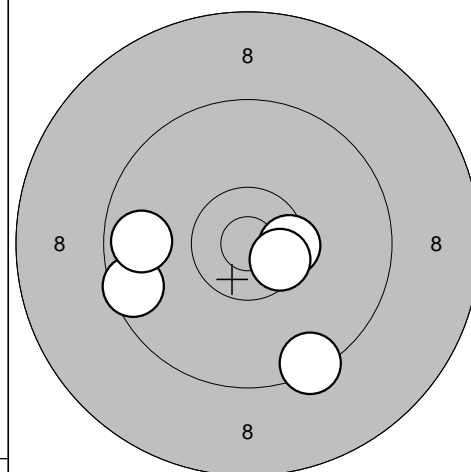

11: 9,6 ←
 12: 10,5* →
 13: 10,5* ↘
 14: 9,4 ↘
 15: 9,7 ←

Serie 47,0

Totalt 139,0

Tävlingsskott

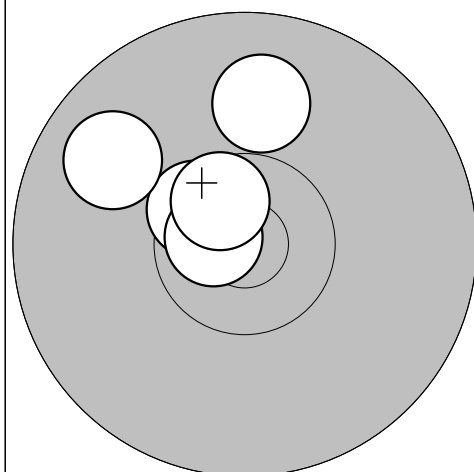

16: 10,5* ↖
 17: 10,7* ←
 18: 10,6* ↗
 19: 9,9 ↑
 20: 9,8 ↖

Serie 48,0

Totalt 187,0

Ramselefors

2010-07-23

Tavelträffen 2010

Ramselefors SKF

Provskott

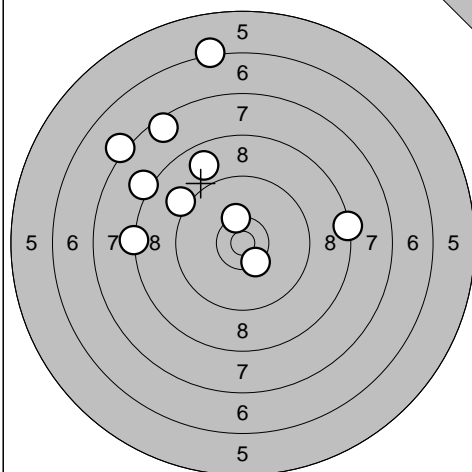

1: 6,3 ↗
 2: 7,5 ↗
 3: 7,2 ↗
 4: 8,3 ←
 5: 9,2 ↗
 6: 8,2 ↗
 7: 8,4 →
 8: 8,8 ↗
 9: 10,3* ↗
 10: 10,4* ↘

Serie 81,0

Totalt 0,0

Provskott

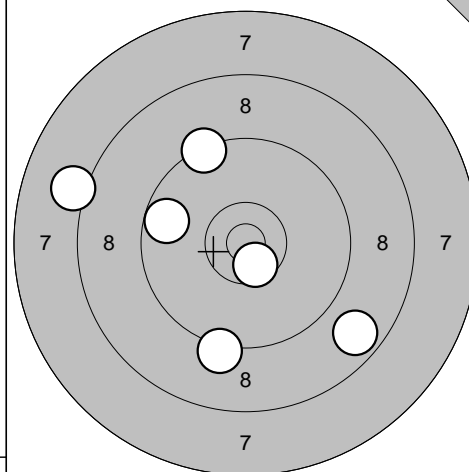

11: 10,6* ↘
 12: 9,4 ↗
 13: 8,1 ↖
 14: 9,7 ↖
 15: 9,2 ↘
 16: 8,7 ↘

Serie 53,0

Totalt 0,0

Tävlingsskott

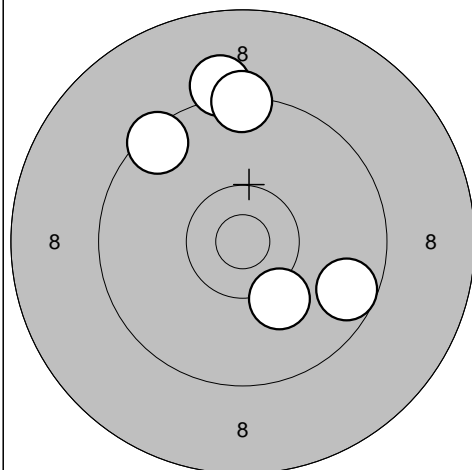

1: 9,5 ↗
 2: 10,2 ↘
 3: 9,2 ↗
 4: 9,6 ↘
 5: 9,4 ↗

Serie 46,0

Totalt 46,0

Tävlingsskott

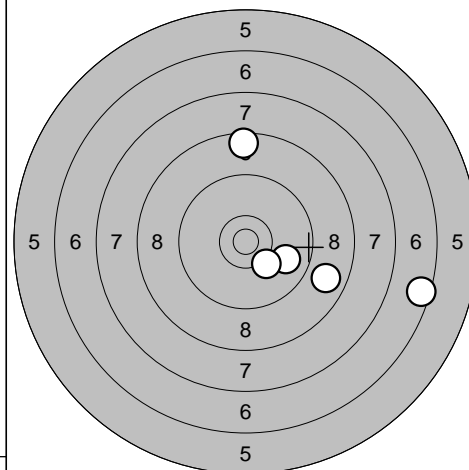

6: 9,9 ↘
 7: 6,5 ↘
 8: 10,2 ↘
 9: 8,6 ↗
 10: 8,8 ↘

Serie 41,0

Totalt 87,0

Tävlingsskott

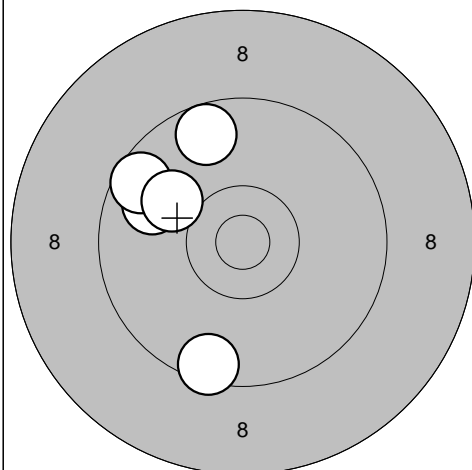

11: 9,8 ↖
 12: 9,5 ↘
 13: 9,7 ↗
 14: 9,6 ↗
 15: 10,0 ↗

Serie 46,0

Totalt 133,0

Tävlingsskott

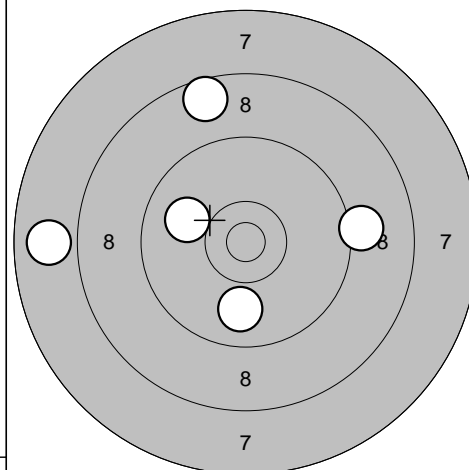

16: 7,9 ←
 17: 8,6 ↗
 18: 10,0 ↖
 19: 9,9 ↘
 20: 9,1 →

Serie 43,0

Totalt 176,0

Rundvik

2010-07-23

Tavelträffen 2010

Ramselefors SKF

Provskott

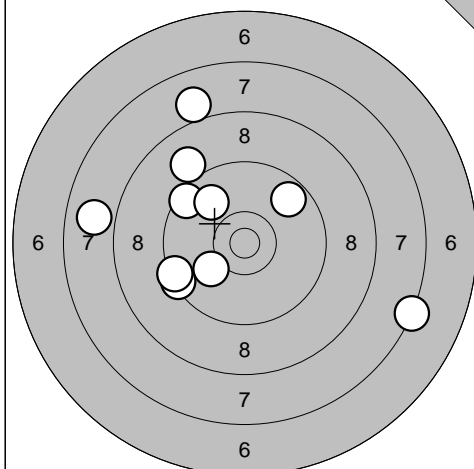

1: 8,0 ↗
 2: 7,9 ←
 3: 9,5 ↗
 4: 10,1 ↙
 5: 9,9 ↗
 6: 9,0 ↗
 7: 9,4 ↙
 8: 7,3 →
 9: 9,7 ↗
 10: 9,4 ↙

Serie 86,0

Totalt 0,0

Provskott

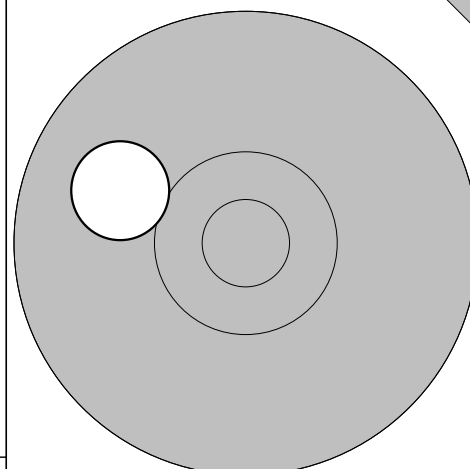

11: 10,0 ↙

Serie 10,0

Totalt 0,0

Tävlingsskott

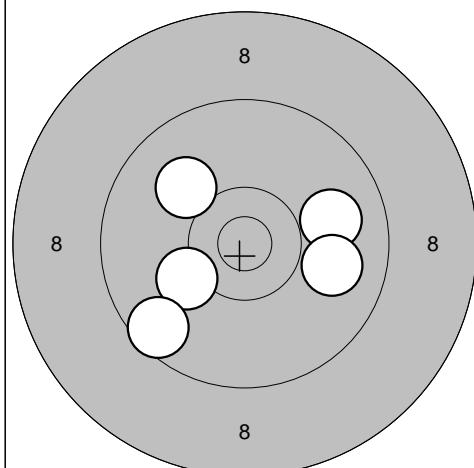

1: 9,9 →
 2: 9,9 →
 3: 10,0 ↗
 4: 10,2 ↙
 5: 9,6 ↙

Serie 47,0

Totalt 47,0

Tävlingsskott

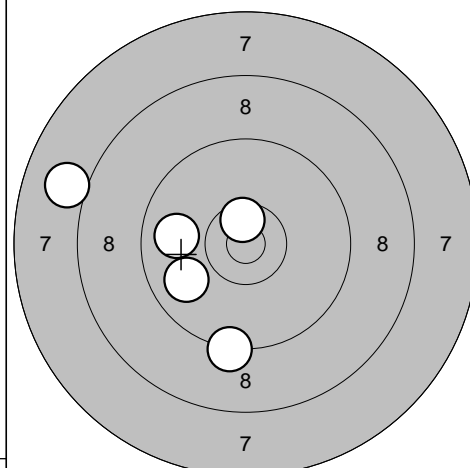

6: 8,0 ↙
 7: 9,3 ↓
 8: 10,6* ↑
 9: 9,9 ←
 10: 9,9 ↙

Serie 45,0

Totalt 92,0

Tävlingsskott

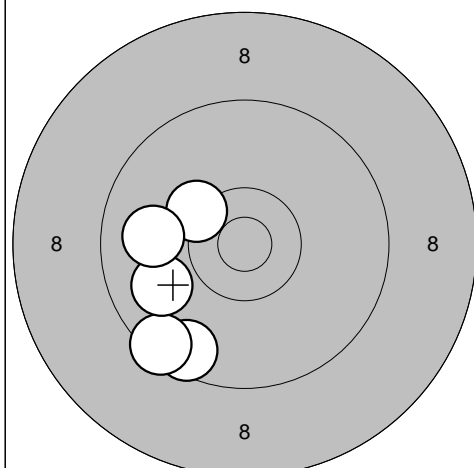

11: 9,6 ↙
 12: 9,5 ↙
 13: 9,9 ←
 14: 10,3* ↗
 15: 9,9 ←

Serie 46,0

Totalt 138,0

Tävlingsskott

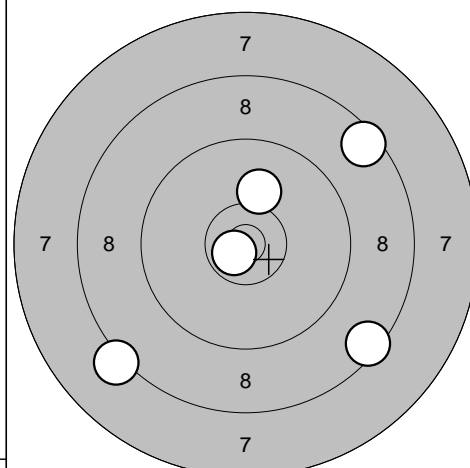

16: 10,1 ↑
 17: 8,2 ↙
 18: 8,5 ↘
 19: 10,7* ↙
 20: 8,5 ↗

Serie 44,0

Totalt 182,0

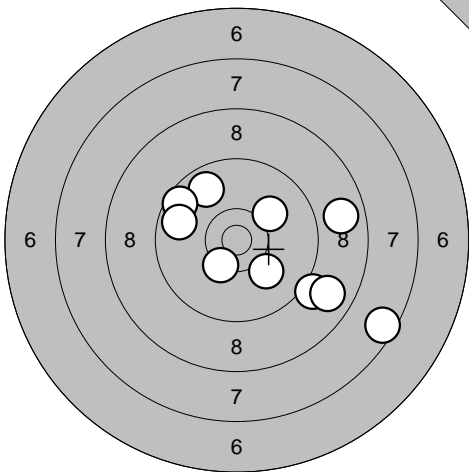
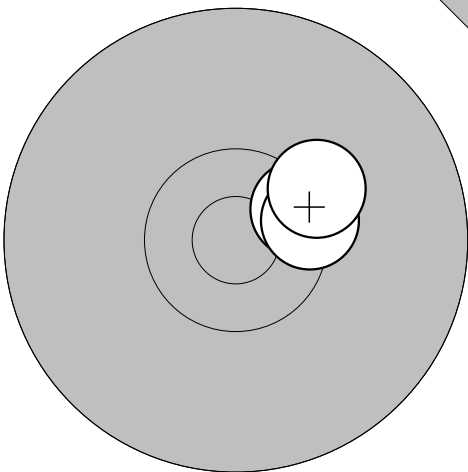
<p>Provskott</p> 	<p>1: 10,1 ↘ 2: 7,6 ↘ 3: 9,1 ↘ 4: 8,8 ↘ 5: 8,8 → 6: 9,8 ↗ 7: 9,6 ↗ 8: 10,4* ↘ 9: 10,1 ↗ 10: 9,8 ←</p> <table border="1" style="width:100%; border-collapse: collapse;"> <tr><td>Serie</td><td style="text-align: right;">89,0</td></tr> <tr><td>Totalt</td><td style="text-align: right;">0,0</td></tr> </table>	Serie	89,0	Totalt	0,0	<p>Provskott</p>  <p>11: 10,4* → 12: 10,4* → 13: 10,3 →</p> <table border="1" style="width:100%; border-collapse: collapse;"> <tr><td>Serie</td><td style="text-align: right;">30,0</td></tr> <tr><td>Totalt</td><td style="text-align: right;">0,0</td></tr> </table>	Serie	30,0	Totalt	0,0
Serie	89,0									
Totalt	0,0									
Serie	30,0									
Totalt	0,0									

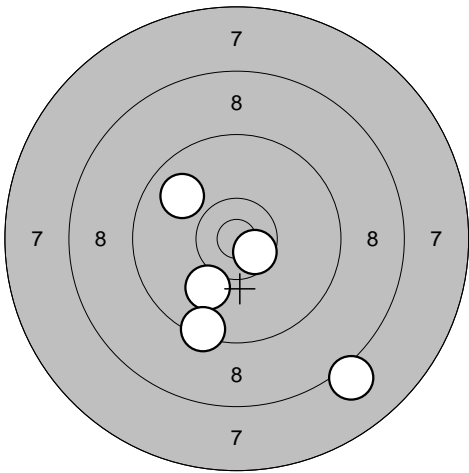
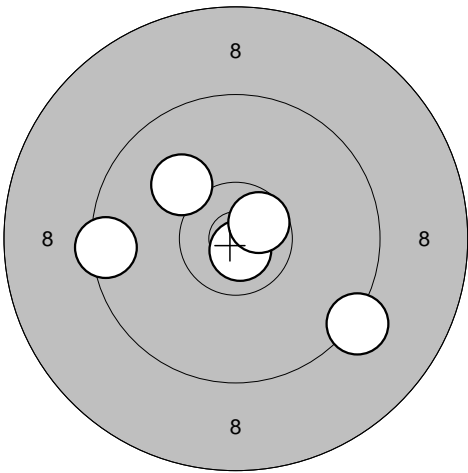
<p>Tävlingsskott</p> 	<p>1: 10,1 ↘ 2: 8,1 ↘ 3: 9,4 ↘ 4: 10,6* ↘ 5: 9,9 ↗</p> <table border="1" style="width:100%; border-collapse: collapse;"> <tr><td>Serie</td><td style="text-align: right;">46,0</td></tr> <tr><td>Totalt</td><td style="text-align: right;">46,0</td></tr> </table>	Serie	46,0	Totalt	46,0	<p>Tävlingsskott</p>  <p>6: 9,5 ← 7: 10,1 ↗ 8: 10,8* ↘ 9: 9,3 ↘ 10: 10,6* ↗</p> <table border="1" style="width:100%; border-collapse: collapse;"> <tr><td>Serie</td><td style="text-align: right;">48,0</td></tr> <tr><td>Totalt</td><td style="text-align: right;">94,0</td></tr> </table>	Serie	48,0	Totalt	94,0
Serie	46,0									
Totalt	46,0									
Serie	48,0									
Totalt	94,0									

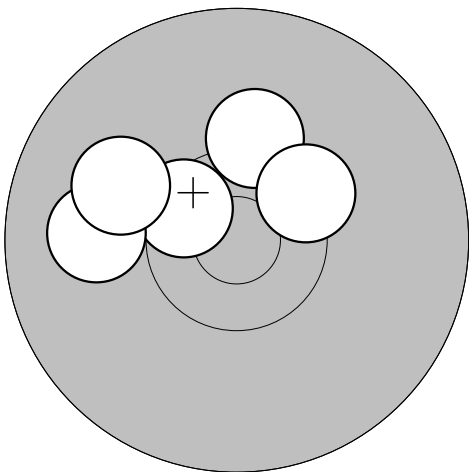
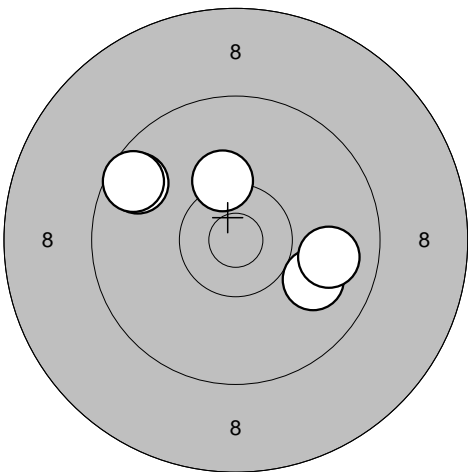
<p>Tävlingsskott</p> 	<p>11: 10,2 ↑ 12: 10,5* ↗ 13: 10,0 ← 14: 10,4* ↗ 15: 10,0 ←</p> <table border="1" style="width:100%; border-collapse: collapse;"> <tr><td>Serie</td><td style="text-align: right;">50,0</td></tr> <tr><td>Totalt</td><td style="text-align: right;">144,0</td></tr> </table>	Serie	50,0	Totalt	144,0	<p>Tävlingsskott</p>  <p>16: 9,7 ↗ 17: 10,3 ↑ 18: 10,0 ↘ 19: 9,9 → 20: 9,6 ↗</p> <table border="1" style="width:100%; border-collapse: collapse;"> <tr><td>Serie</td><td style="text-align: right;">47,0</td></tr> <tr><td>Totalt</td><td style="text-align: right;">191,0</td></tr> </table>	Serie	47,0	Totalt	191,0
Serie	50,0									
Totalt	144,0									
Serie	47,0									
Totalt	191,0									

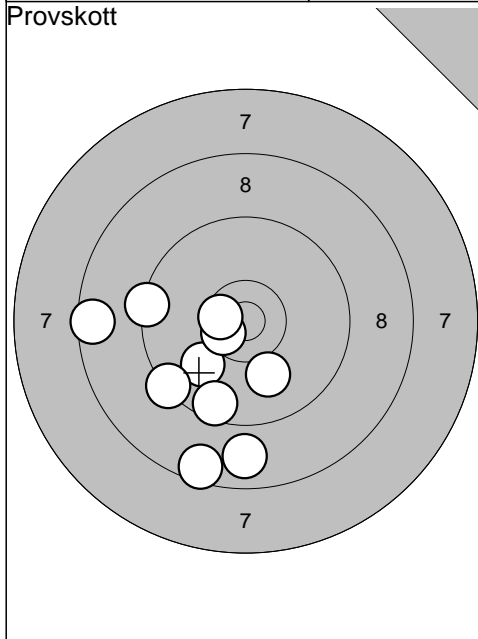

1: 9,4	←
2: 8,5	↓
3: 10,0	↙
4: 9,4	↙
5: 10,6*	←
6: 10,5*	←
7: 9,6	↓
8: 10,0	↓
9: 8,8	↓
10: 8,5	←
Serie	91,0
Totalt	0,0

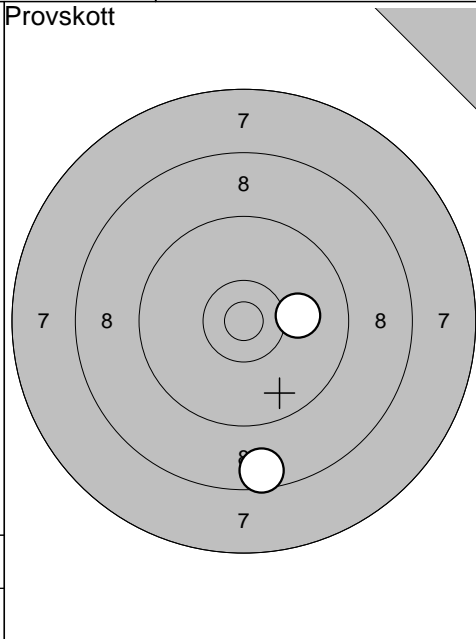

11: 10,1	→
12: 8,6	↓
Serie	18,0
Totalt	0,0

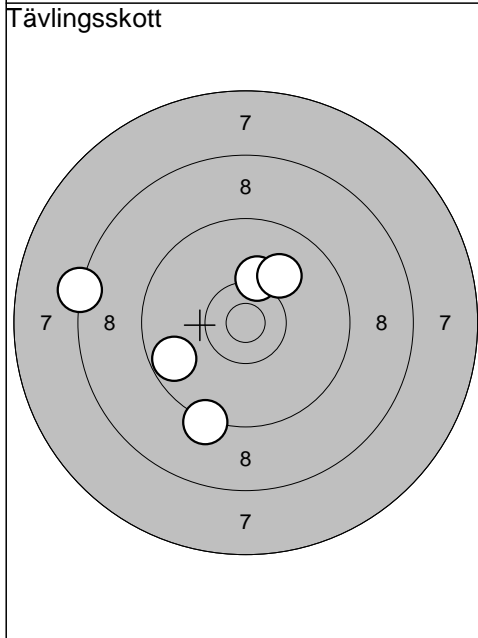

1: 9,3	↓
2: 10,2	↑
3: 10,0	↗
4: 8,3	←
5: 9,7	↙
Serie	46,0
Totalt	46,0

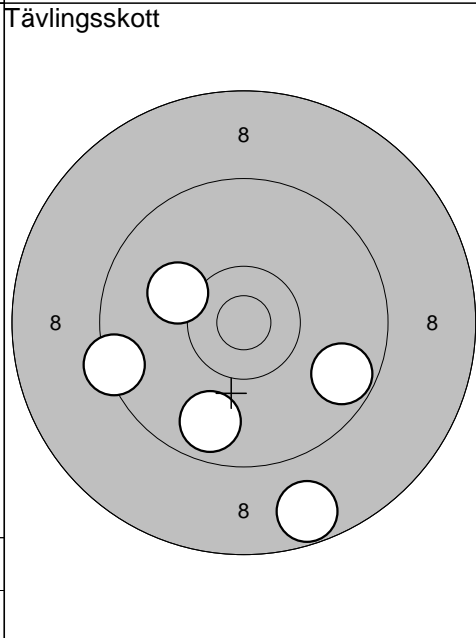

6: 8,7	↓
7: 9,4	←
8: 10,1	↙
9: 9,7	↘
10: 9,8	↓
Serie	45,0
Totalt	91,0

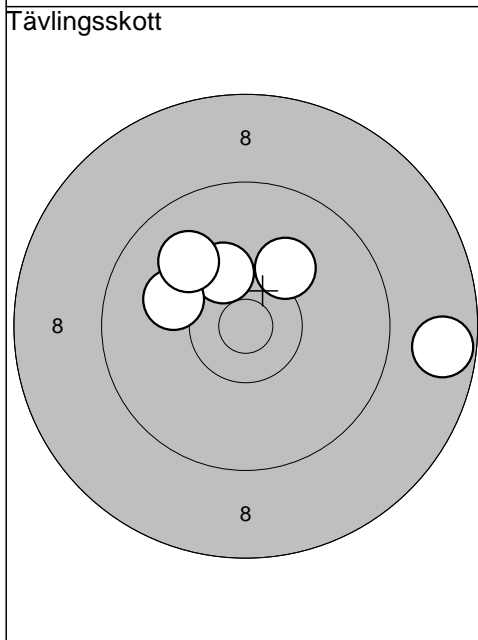

11: 10,3*	↗
12: 10,1	←
13: 8,7	→
14: 10,0	↗
15: 10,2	↗
Serie	48,0
Totalt	139,0

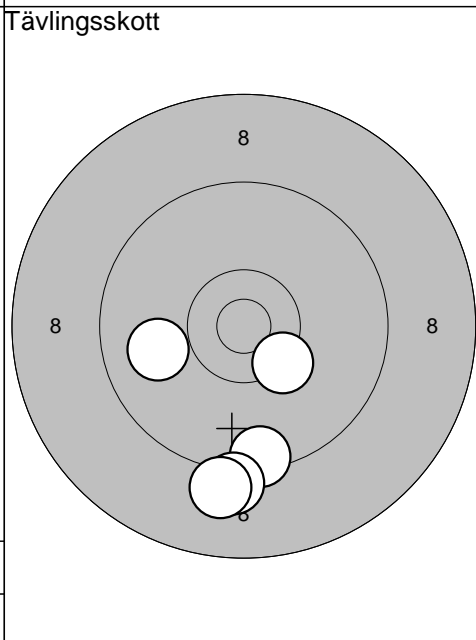

16: 10,3*	↘
17: 9,4	↓
18: 9,1	↓
19: 9,9	←
20: 9,1	↓
Serie	46,0
Totalt	185,0

Ununge

2010-07-23

Tavelträffen 2010

Ramselefors SKF

Provskott

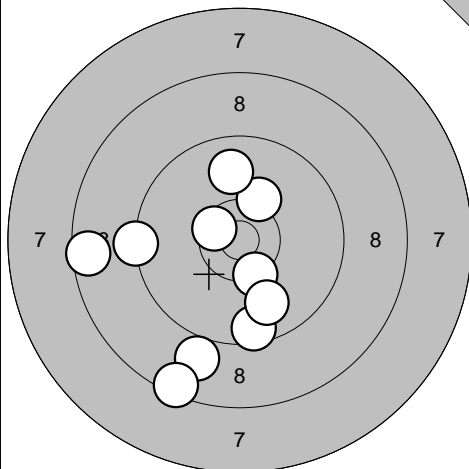

- 1: 9,0 ↓
- 2: 8,5 ↓
- 3: 8,6 ←
- 4: 10,2 ↗
- 5: 9,9 ↑
- 6: 9,5 ↓
- 7: 10,3* ↓
- 8: 9,3 ←
- 9: 10,5* ↗
- 10: 9,9 ↓

Serie 91,0
Totalt 0,0

Provskott

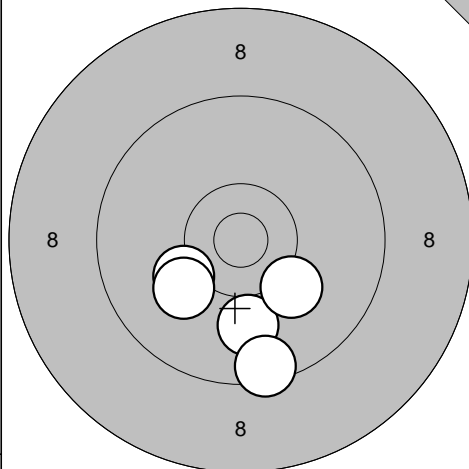

- 11: 10,0 ↓
- 12: 9,5 ↓
- 13: 10,2 ↗
- 14: 10,1 ↗
- 15: 10,2 ↘

Serie 49,0
Totalt 0,0

Tävlingsskott

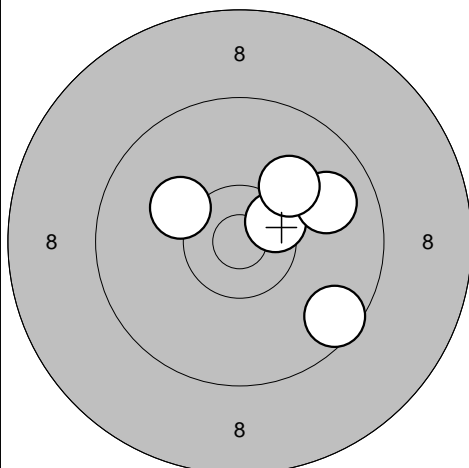

- 1: 9,6 ↘
- 2: 10,5* ↗
- 3: 9,9 ↗
- 4: 10,1 ↗
- 5: 10,2 ↖

Serie 48,0
Totalt 48,0

Tävlingsskott

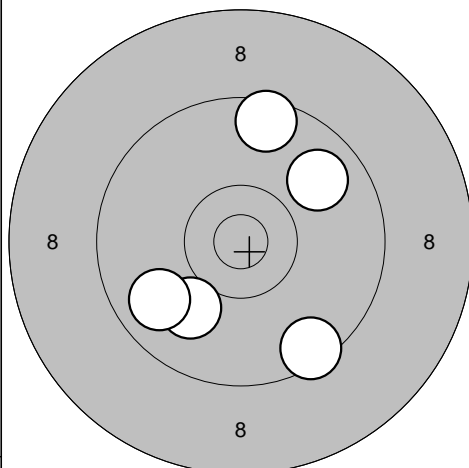

- 6: 9,8 ↗
- 7: 9,5 ↑
- 8: 10,0 ↘
- 9: 9,8 ↖
- 10: 9,5 ↘

Serie 46,0
Totalt 94,0

Tävlingsskott

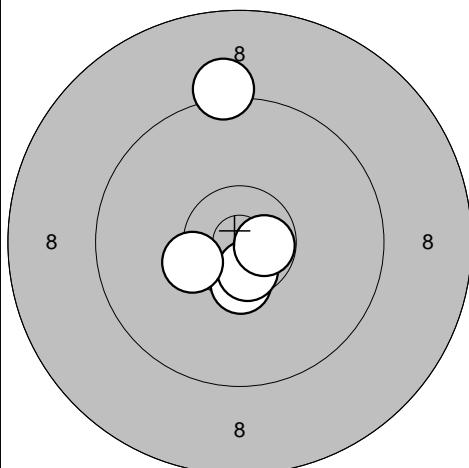

- 11: 10,5* ↓
- 12: 10,6* ↓
- 13: 10,4* ←
- 14: 9,2 ↑
- 15: 10,7* →

Serie 49,0
Totalt 143,0

Tävlingsskott

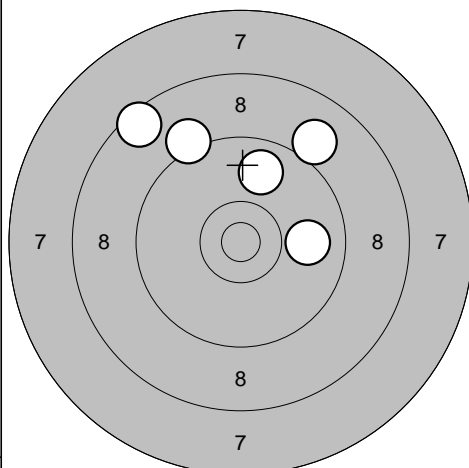

- 16: 9,2 ↖
- 17: 9,8 ↑
- 18: 9,0 ↗
- 19: 9,9 →
- 20: 8,5 ↖

Serie 44,0
Totalt 187,0

I 19 / A 9

2010-07-23

Tavelträffen 2010

Ramselefors SKF

Provs-kott

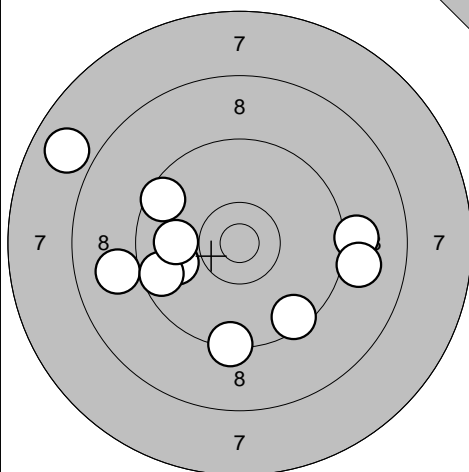

- 1: 9,6 ↖
- 2: 9,3 ↓
- 3: 9,9 ←
- 4: 9,0 ←
- 5: 9,6 ←
- 6: 9,1 →
- 7: 9,0 →
- 8: 9,5 ↓
- 9: 10,0 ←
- 10: 7,9 ↗

Serie 89,0
Totalt 0,0

Provs-kott

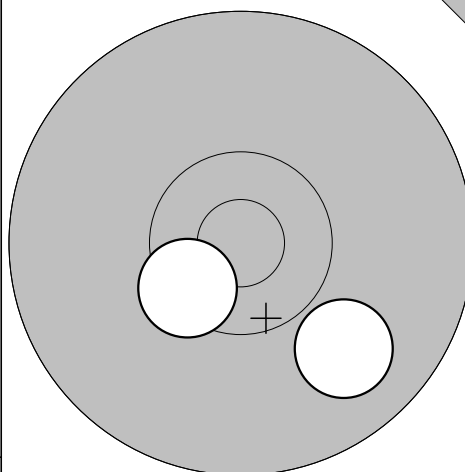

- 11: 10,5* ↖
- 12: 9,9 ↘

Serie 19,0
Totalt 0,0

Tävlingsskott

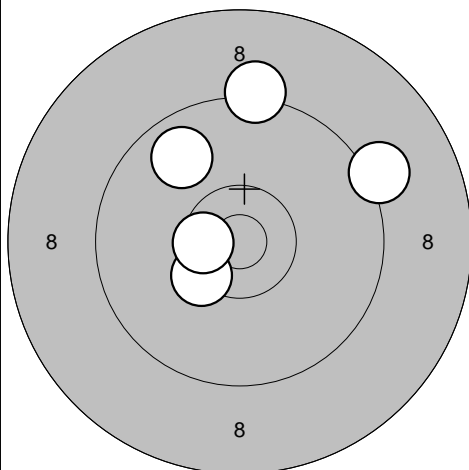

- 1: 10,4* ↖
- 2: 9,2 ↗
- 3: 10,5* ←
- 4: 9,8 ↗
- 5: 9,2 ↑

Serie 47,0
Totalt 47,0

Tävlingsskott

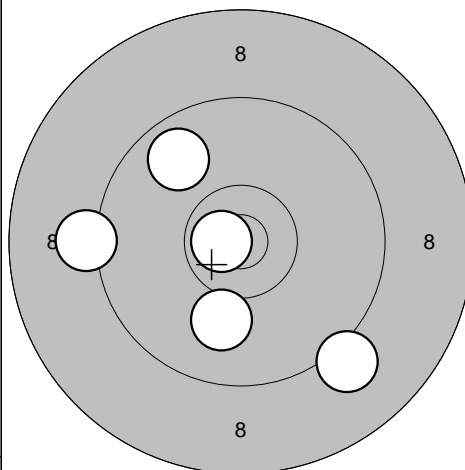

- 6: 9,2 ←
- 7: 9,8 ↗
- 8: 9,1 ↓
- 9: 10,7* ←
- 10: 10,0 ↓

Serie 47,0
Totalt 94,0

Tävlingsskott

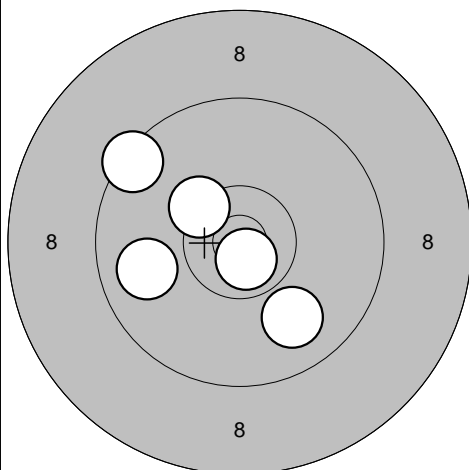

- 11: 10,3* ↗
- 12: 9,4 ↗
- 13: 9,9 ↓
- 14: 9,9 ←
- 15: 10,7* ↓

Serie 47,0
Totalt 141,0

Tävlingsskott

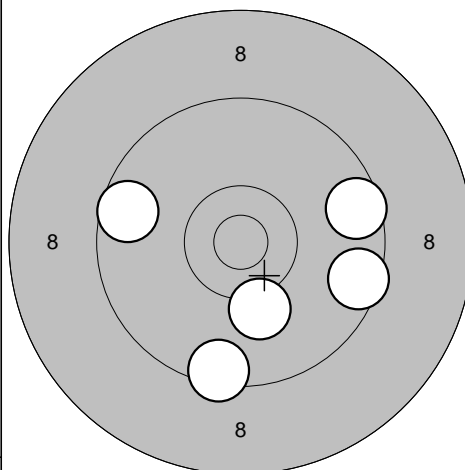

- 16: 9,5 ↓
- 17: 9,5 →
- 18: 9,6 →
- 19: 9,6 ←
- 20: 10,2 ↓

Serie 46,0
Totalt 187,0

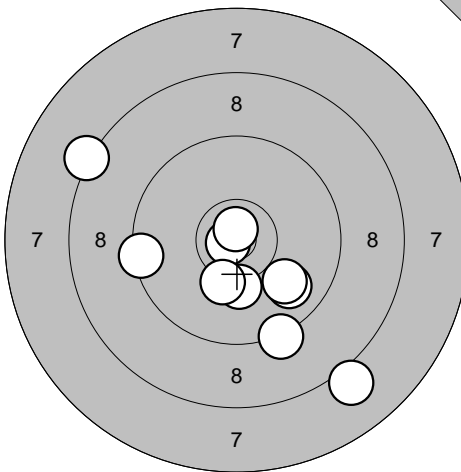
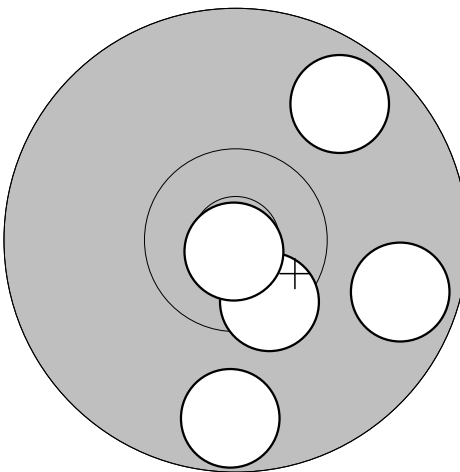
<p>Provsjött</p> 	<p>1: 9,3 ↓ 2: 9,4 ← 3: 10,8* ← 4: 10,2 ↓ 5: 9,8 ↓ 6: 8,1 ↓ 7: 8,3 ↗ 8: 9,9 ↓ 9: 10,2 ↓ 10: 10,8* ↑</p> <table border="1" style="width:100%; border-collapse: collapse;"> <tr><td>Serie</td><td style="text-align: right;">92,0</td></tr> <tr><td>Totalt</td><td style="text-align: right;">0,0</td></tr> </table>	Serie	92,0	Totalt	0,0	<p>Tävlingssjött</p> 	<p>1: 10,4* ↓ 2: 9,7 → 3: 9,7 ↓ 4: 9,7 ↗ 5: 10,9* ↓</p> <table border="1" style="width:100%; border-collapse: collapse;"> <tr><td>Serie</td><td style="text-align: right;">47,0</td></tr> <tr><td>Totalt</td><td style="text-align: right;">47,0</td></tr> </table>	Serie	47,0	Totalt	47,0
Serie	92,0										
Totalt	0,0										
Serie	47,0										
Totalt	47,0										

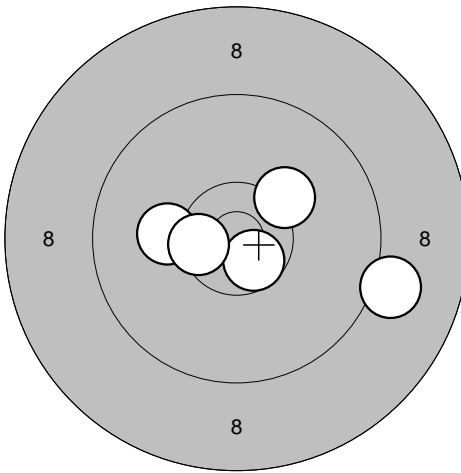
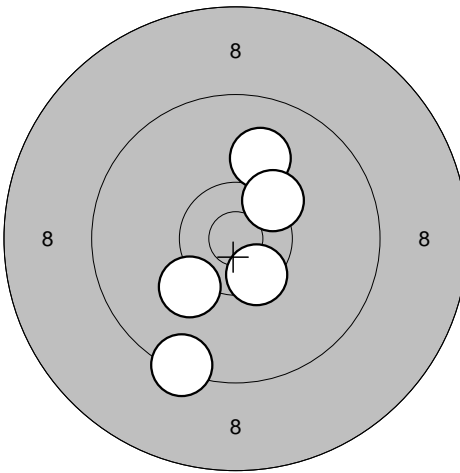
<p>Tävlingssjött</p> 	<p>6: 10,2 ↗ 7: 10,2 ← 8: 10,6* ↓ 9: 9,1 → 10: 10,5* ←</p> <table border="1" style="width:100%; border-collapse: collapse;"> <tr><td>Serie</td><td style="text-align: right;">49,0</td></tr> <tr><td>Totalt</td><td style="text-align: right;">96,0</td></tr> </table>	Serie	49,0	Totalt	96,0	<p>Tävlingssjött</p> 	<p>11: 10,0 ↑ 12: 10,5* ↓ 13: 9,4 ↓ 14: 10,2 ↙ 15: 10,3* ↗</p> <table border="1" style="width:100%; border-collapse: collapse;"> <tr><td>Serie</td><td style="text-align: right;">49,0</td></tr> <tr><td>Totalt</td><td style="text-align: right;">145,0</td></tr> </table>	Serie	49,0	Totalt	145,0
Serie	49,0										
Totalt	96,0										
Serie	49,0										
Totalt	145,0										

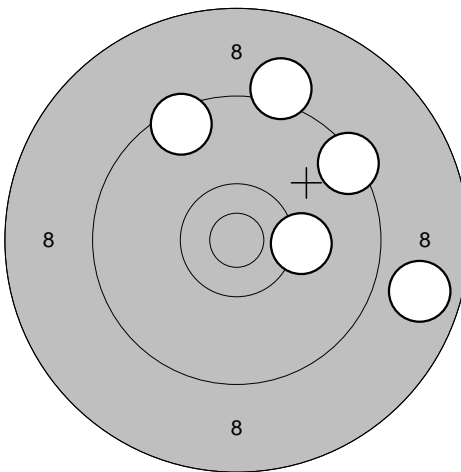
<p>Tävlingssjött</p> 	<p>16: 9,1 ↑ 17: 9,5 ↗ 18: 8,8 → 19: 10,2 → 20: 9,4 ↗</p> <table border="1" style="width:100%; border-collapse: collapse;"> <tr><td>Serie</td><td style="text-align: right;">45,0</td></tr> <tr><td>Totalt</td><td style="text-align: right;">190,0</td></tr> </table>	Serie	45,0	Totalt	190,0		
Serie	45,0						
Totalt	190,0						

Bälinge-Jumkil

2010-07-23

Tavelträffen 2010

Ramselefors SKF

Provskott

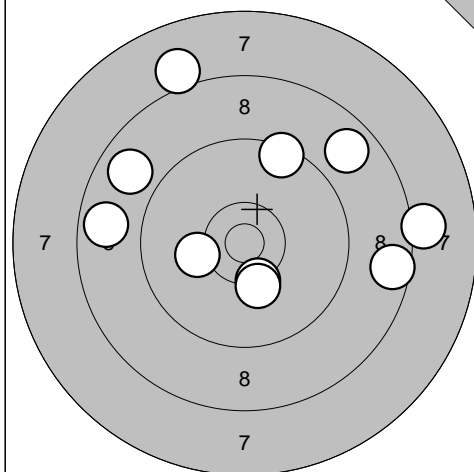

1: 8,1 ↖
 2: 8,8 ↗
 3: 10,2 ←
 4: 10,3* ↓
 5: 8,1 →
 6: 8,8 ↗
 7: 10,2 ↓
 8: 9,5 ↗
 9: 8,8 ←
 10: 8,6 →

Serie 87,0

Totalt 0,0

Provskott

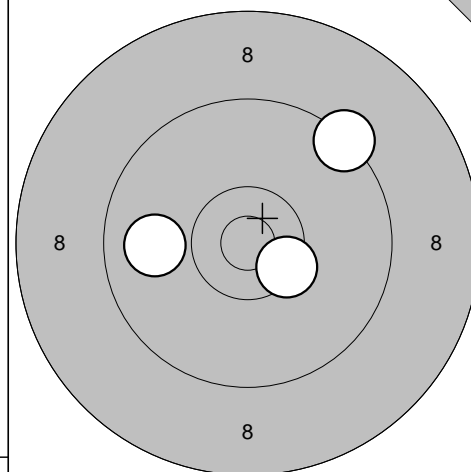

11: 9,9 ←
 12: 10,4* ↘
 13: 9,3 ↗

Serie 28,0

Totalt 0,0

Tävlingsskott

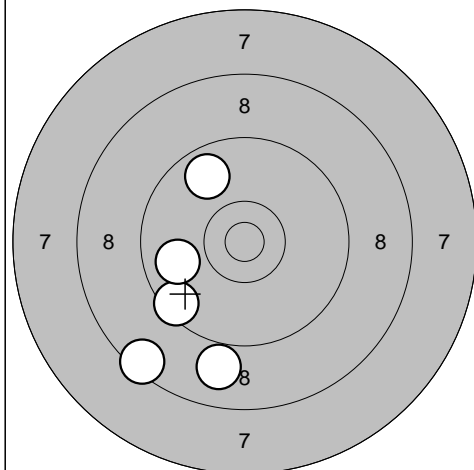

1: 9,5 ↙
 2: 9,8 ↗
 3: 8,9 ↓
 4: 8,5 ↙
 5: 9,9 ←

Serie 43,0

Totalt 43,0

Tävlingsskott

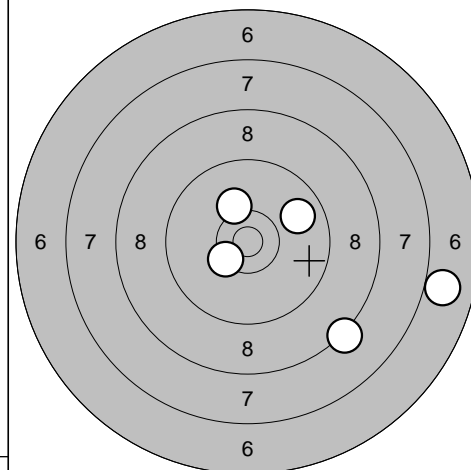

6: 10,2 ↖
 7: 6,9 →
 8: 10,4* ↙
 9: 9,8 ↗
 10: 8,2 ↘

Serie 43,0

Totalt 86,0

Tävlingsskott

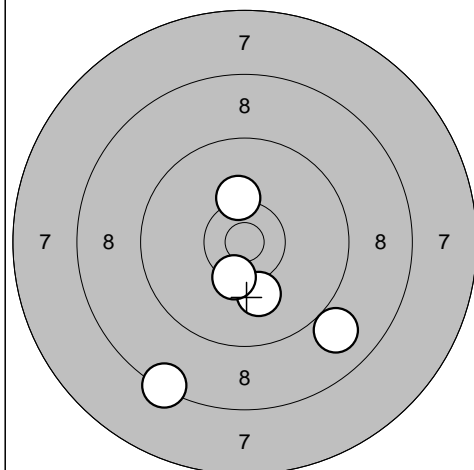

11: 10,3 ↖
 12: 8,9 ↘
 13: 10,1 ↓
 14: 8,4 ↙
 15: 10,4* ↓

Serie 46,0

Totalt 132,0

Tävlingsskott

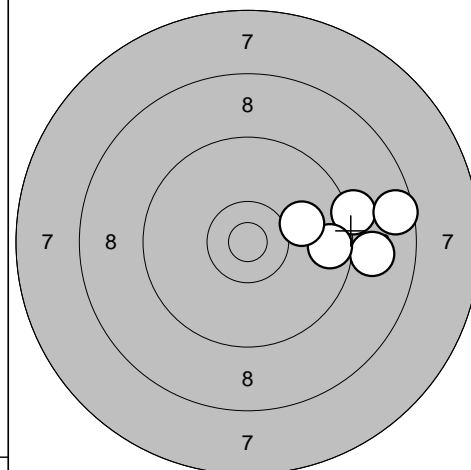

16: 9,0 →
 17: 9,2 →
 18: 8,6 →
 19: 9,7 →
 20: 10,1 →

Serie 45,0

Totalt 177,0

Bälinge-Jumkil

2010-07-23

Tavelträffen 2010

Ramselefors SKF

Provs-kott

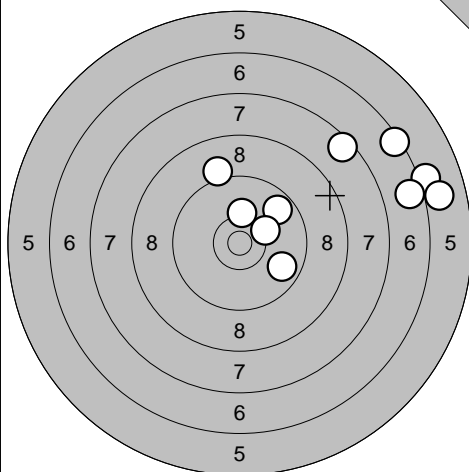

- 1: 6,2 →
- 2: 5,9 →
- 3: 6,6 →
- 4: 7,5 ↗
- 5: 6,4 ↗
- 6: 9,1 ↑
- 7: 9,7 ↗
- 8: 10,2 ↑
- 9: 9,8 ↘
- 10: 10,2 ↗

Serie 77,0
Totalt 0,0

Provs-kott

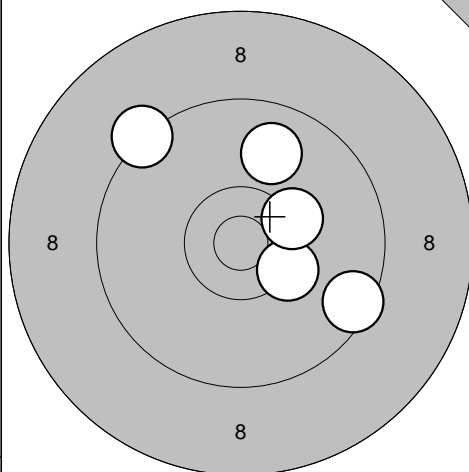

- 11: 9,9 ↑
- 12: 10,3* ↘
- 13: 9,3 ↗
- 14: 9,5 ↘
- 15: 10,3* ↗

Serie 47,0
Totalt 0,0

Tävlingsskott

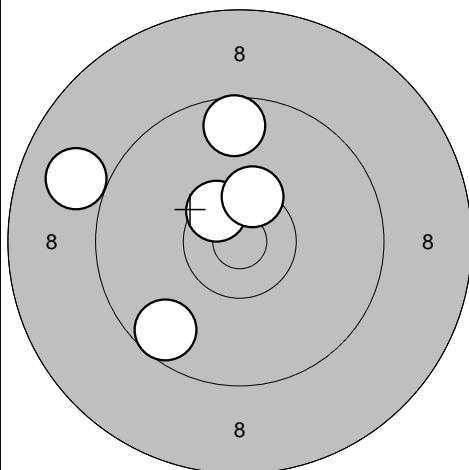

- 1: 10,5* ↖
- 2: 10,4* ↑
- 3: 9,6 ↑
- 4: 9,0 ↖
- 5: 9,6 ↘

Serie 47,0
Totalt 47,0

Tävlingsskott

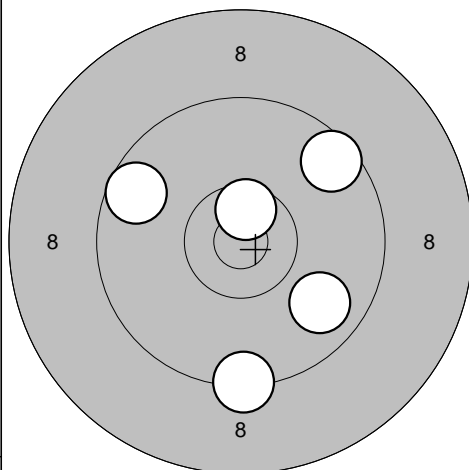

- 6: 9,3 ↓
- 7: 10,6* ↑
- 8: 9,8 ↘
- 9: 9,6 ↗
- 10: 9,6 ↖

Serie 46,0
Totalt 93,0

Tävlingsskott

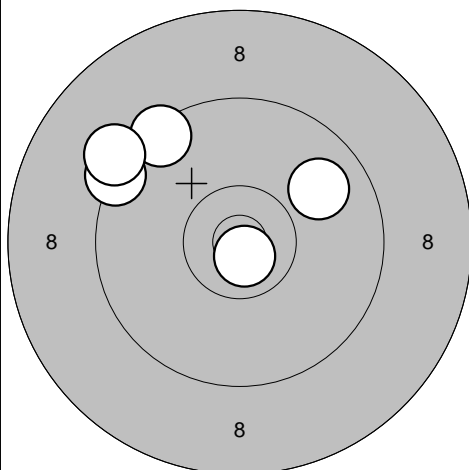

- 11: 9,9 ↗
- 12: 10,8* ↘
- 13: 9,4 ↗
- 14: 9,3 ↗
- 15: 9,2 ↗

Serie 46,0
Totalt 139,0

Tävlingsskott

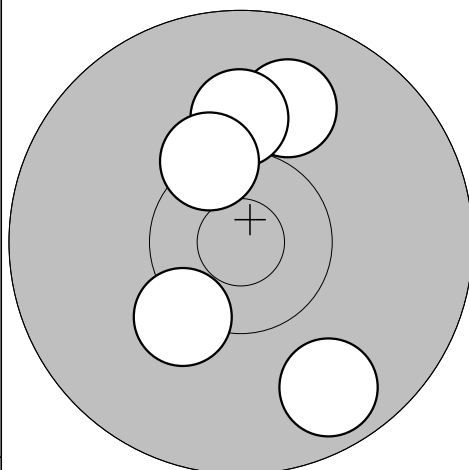

- 16: 9,9 ↑
- 17: 10,3 ↘
- 18: 10,1 ↑
- 19: 9,7 ↘
- 20: 10,3* ↑

Serie 48,0
Totalt 187,0

Bälinge-Jumkil

2010-07-23

Tavelträffen 2010

Ramselefors SKF

Provskott

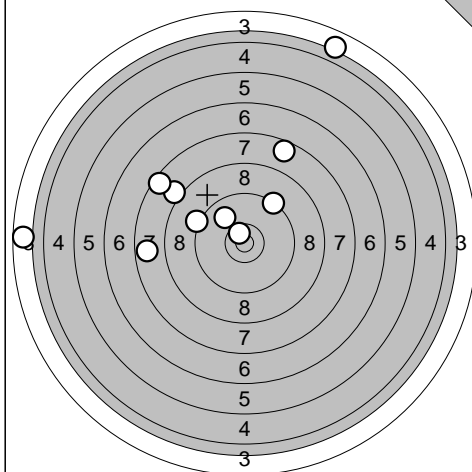

1: 3,8 ↗
 2: 3,7 ←
 3: 7,7 ←
 4: 8,1 ↗
 5: 7,5 ↗
 6: 9,2 ↗
 7: 9,9 ↗
 8: 7,6 ↗
 9: 10,6* ↗
 10: 9,3 ↗

Serie 72,0

Totalt 0,0

Tävlingsskott

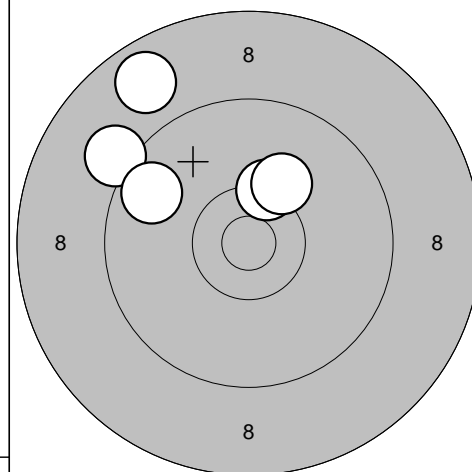

1: 8,8 ↖
 2: 10,3* ↗
 3: 9,1 ↖
 4: 10,2 ↗
 5: 9,7 ↖

Serie 46,0

Totalt 46,0

Tävlingsskott

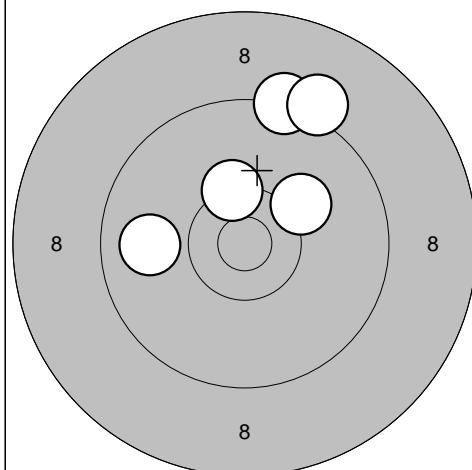

6: 9,9 ←
 7: 10,3* ↗
 8: 9,3 ↗
 9: 10,2 ↗
 10: 9,2 ↗

Serie 47,0

Totalt 93,0

Tävlingsskott

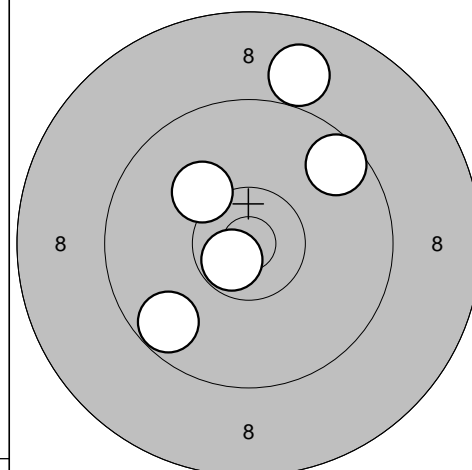

11: 10,7* ↖
 12: 9,6 ↗
 13: 9,7 ↖
 14: 10,2 ↖
 15: 8,9 ↗

Serie 46,0

Totalt 139,0

Tävlingsskott

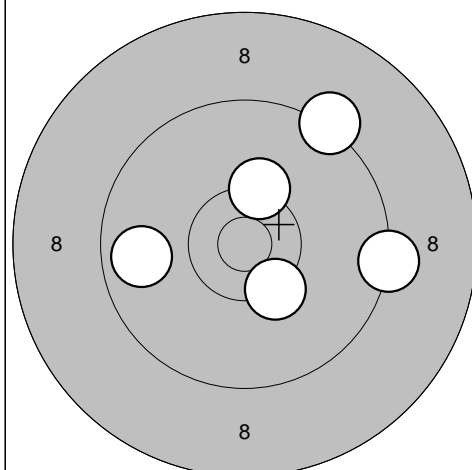

16: 9,8 ←
 17: 10,3* ↗
 18: 10,3* ↘
 19: 9,3 →
 20: 9,3 ↗

Serie 47,0

Totalt 186,0

Niemisel

2010-07-23

Tavelträffen 2010

Ramselefors SKF

Provskott

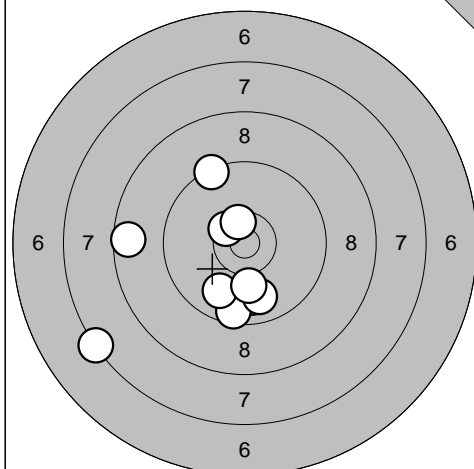

1: 9,4 ↗
 2: 9,8 ↓
 3: 7,3 ↙
 4: 9,6 ↓
 5: 9,8 ↓
 6: 10,5* ↗
 7: 10,5* ↗
 8: 9,9 ↓
 9: 8,6 ←
 10: 10,1 ↓

Serie 90,0

Totalt 0,0

Provskott

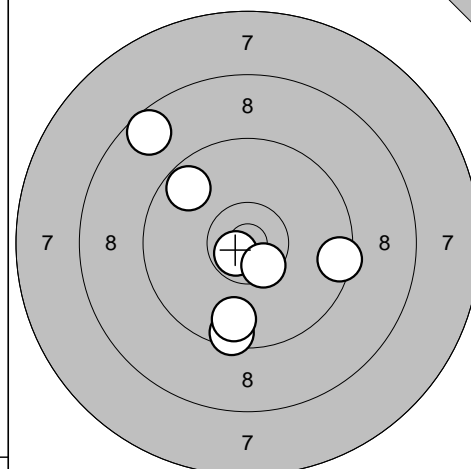

11: 9,7 ↖
 12: 9,5 ↓
 13: 10,7* ↙
 14: 8,6 ↗
 15: 9,7 ↓
 16: 10,5* ↓
 17: 9,5 →

Serie 64,0

Totalt 0,0

Tävlingsskott

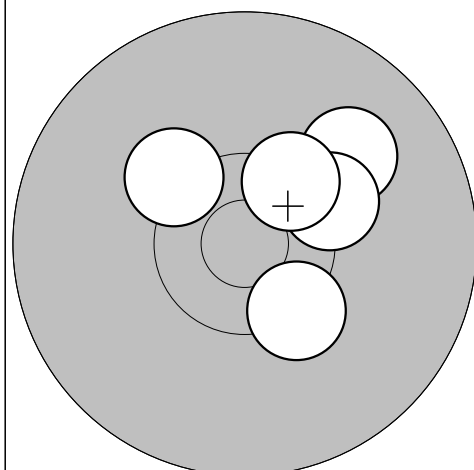

1: 10,3 ↖
 2: 10,0 ↗
 3: 10,3 →
 4: 10,3* ↓
 5: 10,4* ↗

Serie 50,0

Totalt 50,0

Tävlingsskott

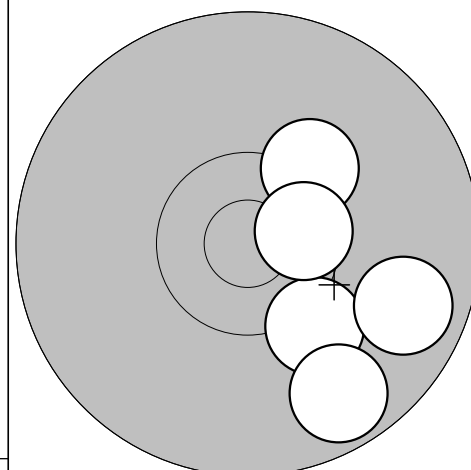

6: 10,2 ↓
 7: 10,3 ↗
 8: 9,7 ↓
 9: 10,5* →
 10: 9,8 ↘

Serie 48,0

Totalt 98,0

Tävlingsskott

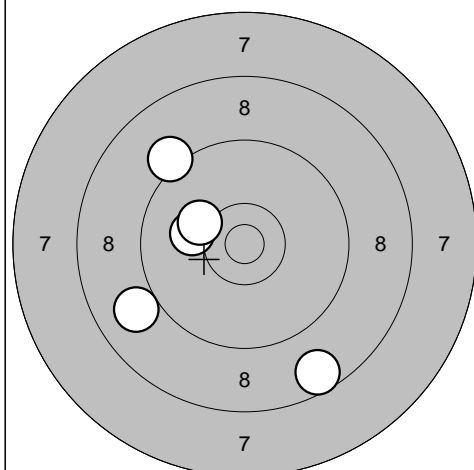

11: 9,0 ↙
 12: 8,6 ↓
 13: 10,1 ↙
 14: 10,2 ↗
 15: 9,2 ↗

Serie 46,0

Totalt 144,0

Tävlingsskott

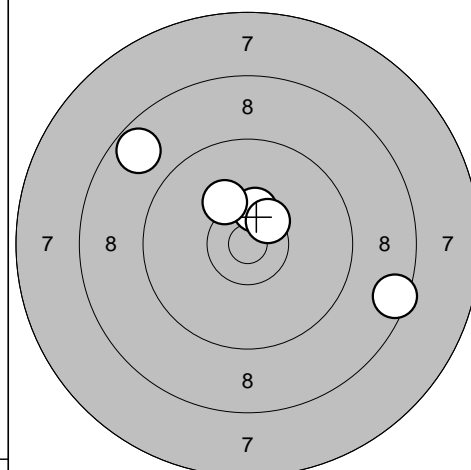

16: 10,4* ↑
 17: 8,7 ↖
 18: 10,2 ↗
 19: 10,5* ↗
 20: 8,5 →

Serie 46,0

Totalt 190,0

Ramselefors

2010-07-23

Tavelträffen 2010

Ramselefors SKF

Provskott

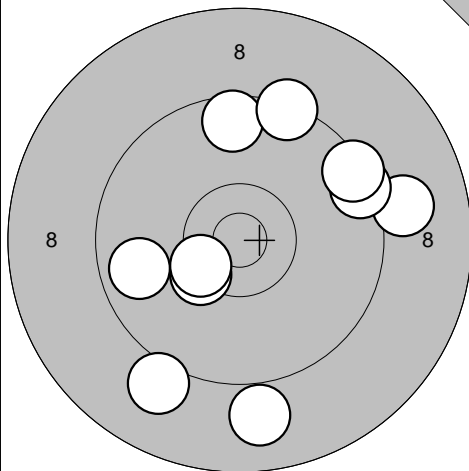

- 1: 9,0 →
- 2: 9,6 ↑
- 3: 10,4* ↙
- 4: 9,4 ↑
- 5: 9,4 →
- 6: 9,4 →
- 7: 9,8 ←
- 8: 10,4* ↙
- 9: 8,9 ↓
- 10: 9,1 ↙

Serie	91,0
Totalt	0,0

Provskott

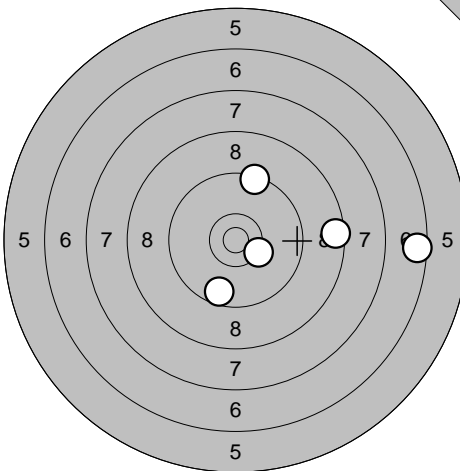

- 11: 10,3* →
- 12: 9,6 ↓
- 13: 9,4 ↑
- 14: 8,5 →
- 15: 6,5 →

Serie	42,0
Totalt	0,0

Tävlingsskott

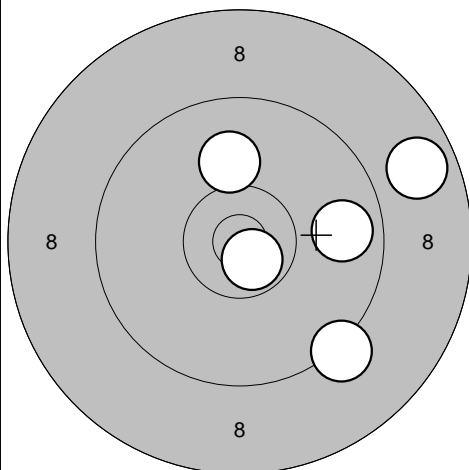

- 1: 9,8 →
- 2: 9,2 ↘
- 3: 10,7* ↘
- 4: 10,0 ↑
- 5: 8,8 →

Serie	46,0
Totalt	46,0

Tävlingsskott

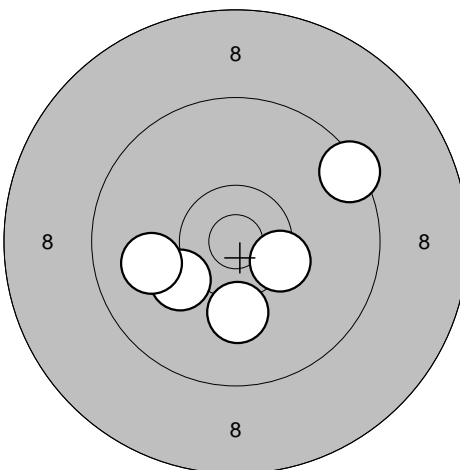

- 6: 10,4* →
- 7: 9,4 ↗
- 8: 10,1 ↓
- 9: 10,2 ↙
- 10: 10,0 ←

Serie	49,0
Totalt	95,0

Tävlingsskott

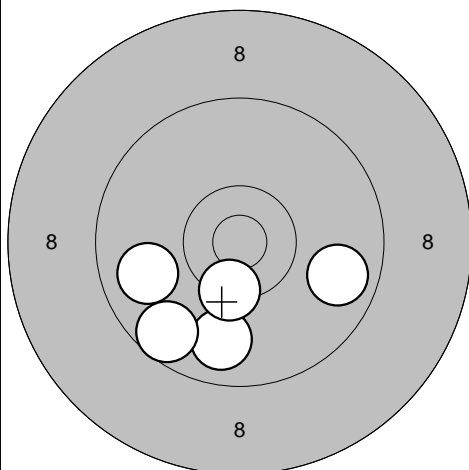

- 11: 9,8 ↓
- 12: 9,8 →
- 13: 9,8 ←
- 14: 10,4* ↓
- 15: 9,6 ↙

Serie	46,0
Totalt	141,0

Tävlingsskott

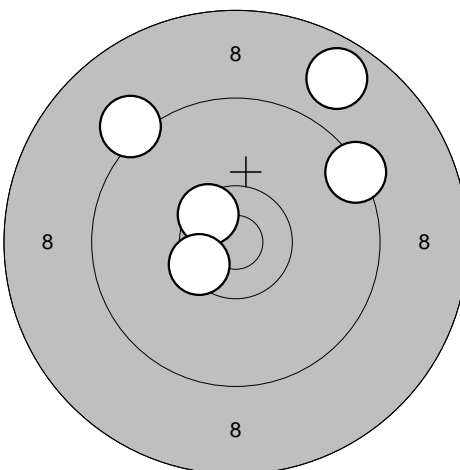

- 16: 8,8 ↗
- 17: 10,5* ↖
- 18: 9,4 ↗
- 19: 10,5* ↙
- 20: 9,2 ↖

Serie	46,0
Totalt	187,0

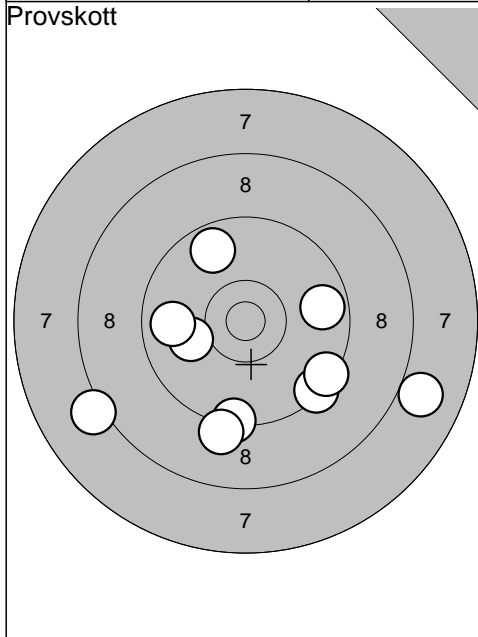

1: 10,0	←
2: 9,4	↓
3: 8,0	→
4: 9,4	↓
5: 9,7	→
6: 9,4	↓
7: 9,7	↗
8: 9,2	↓
9: 9,8	←
10: 8,2	↙
Serie 89,0	
Totalt 0,0	

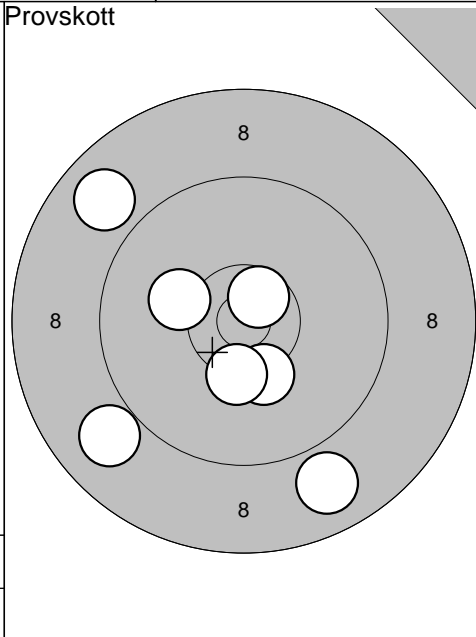

11: 8,9	↓
12: 10,6*	↗
13: 10,3*	↓
14: 8,8	↖
15: 8,9	↙
16: 10,2	←
17: 10,3*	↓
Serie 64,0	
Totalt 0,0	

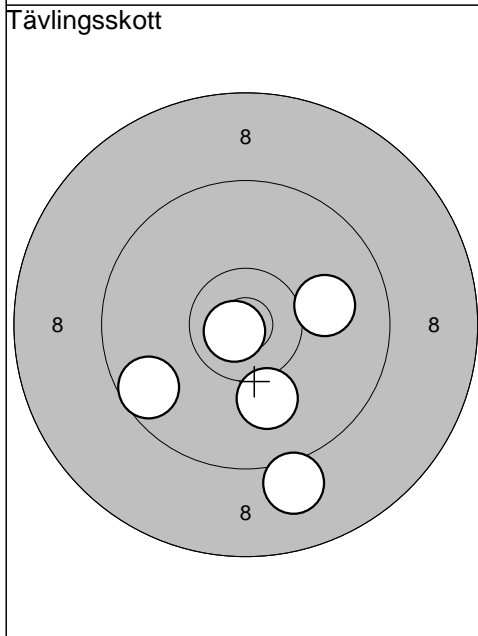

1: 9,6	↙
2: 10,0	→
3: 9,1	↓
4: 10,1	↓
5: 10,8*	↙
Serie 48,0	
Totalt 48,0	

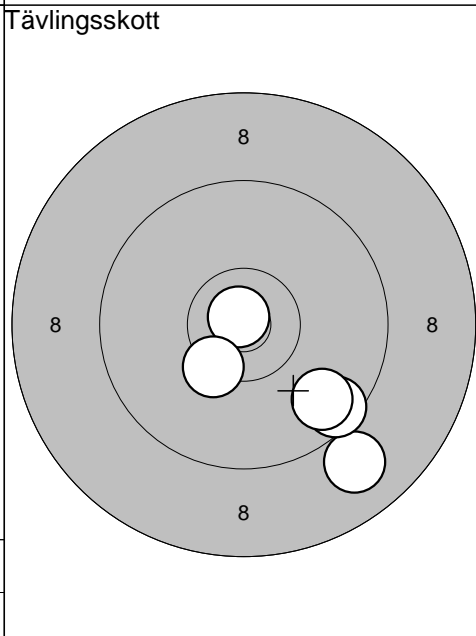

6: 8,9	↓
7: 10,8*	↗
8: 10,4*	↙
9: 9,5	↓
10: 9,7	↘
Serie 46,0	
Totalt 94,0	

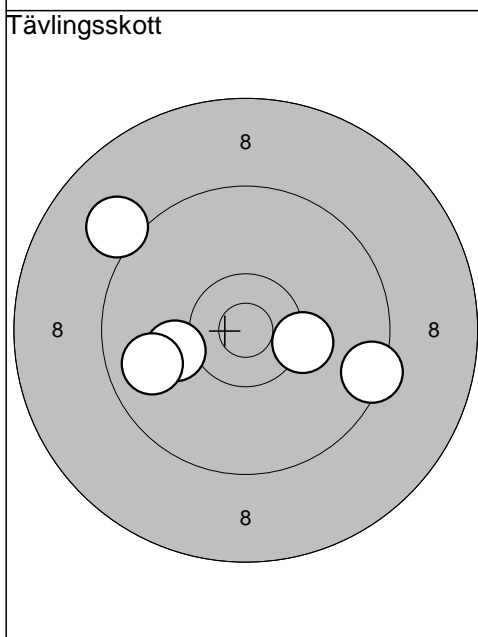

11: 10,3	→
12: 10,1	←
13: 9,8	←
14: 9,4	→
15: 9,1	↗
Serie 47,0	
Totalt 141,0	

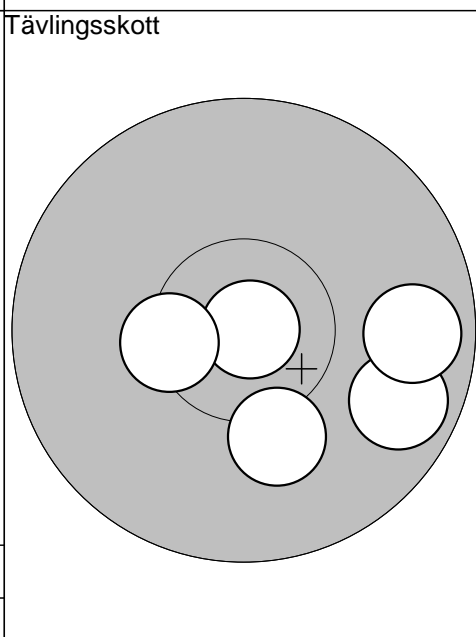

16: 9,7	↘
17: 10,9*	→
18: 10,2	↓
19: 10,4*	←
20: 9,8	→
Serie 48,0	
Totalt 189,0	

Piteå

2010-07-23

Tavelträffen 2010

Ramselefors SKF

Provskott

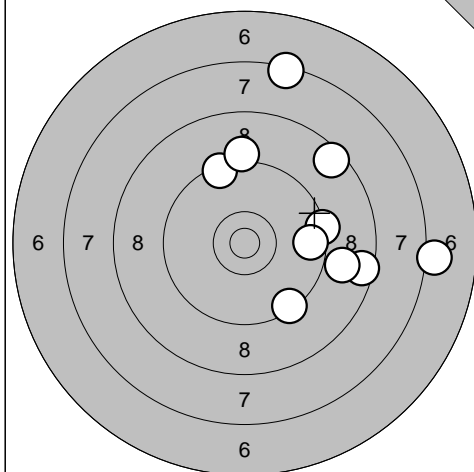

1: 7,4 ↗
 2: 8,5 ↗
 3: 9,3 →
 4: 9,4 ↗
 5: 9,2 ↗
 6: 9,4 ↘
 7: 7,1 →
 8: 8,5 →
 9: 8,9 →
 10: 9,6 →

Serie 83,0

Totalt 0,0

Provskott

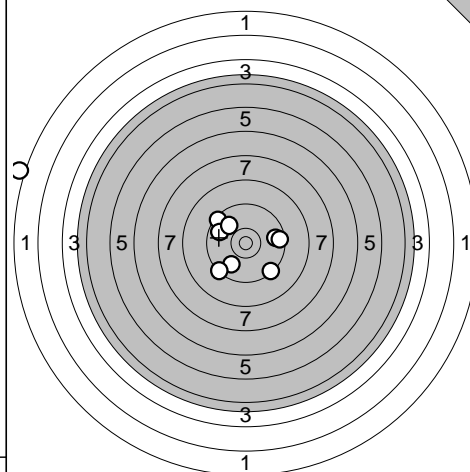

11: 9,4 ↖
 12: 9,9 ↘
 13: 9,4 ↘
 14: 9,8 ↖
 15: 10,0 ↗
 16: 9,7 →
 17: 9,4 ↘
 18: 9,5 →
 19: 1,1 ←

Serie 74,0

Totalt 0,0

Tävlingsskott

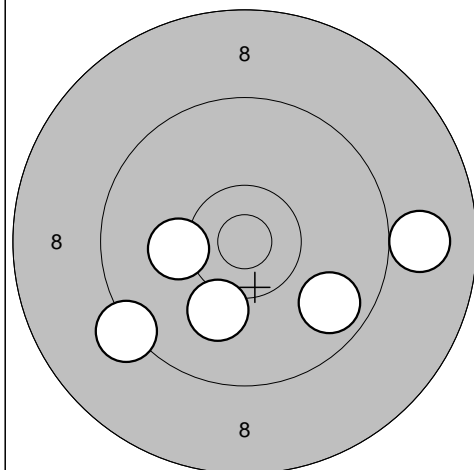

1: 9,3 ↖
 2: 8,9 →
 3: 9,8 ↘
 4: 10,2 ←
 5: 10,1 ↘

Serie 46,0

Totalt 46,0

Tävlingsskott

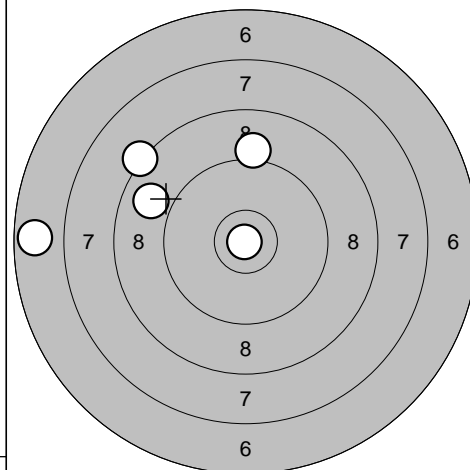

6: 10,9* ↖
 7: 6,7 ←
 8: 8,3 ↗
 9: 9,1 ↗
 10: 8,9 ↖

Serie 41,0

Totalt 87,0

Tävlingsskott

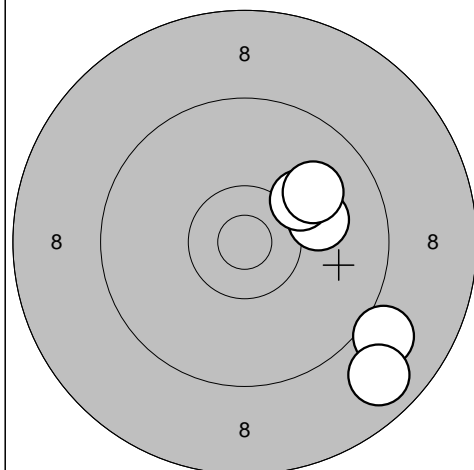

11: 9,0 ↘
 12: 10,1 →
 13: 10,2 ↗
 14: 8,8 ↘
 15: 10,0 ↗

Serie 47,0

Totalt 134,0

Tävlingsskott

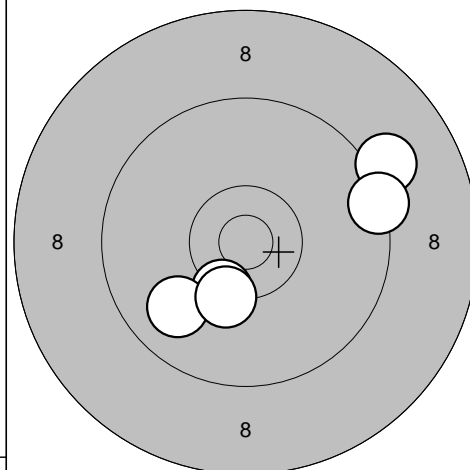

16: 10,3* ↘
 17: 9,9 ↖
 18: 9,1 ↗
 19: 9,4 →
 20: 10,3 ↘

Serie 47,0

Totalt 181,0

2010-07-23

Tavelträffen 2010

Ramselefors SKF

Provskott

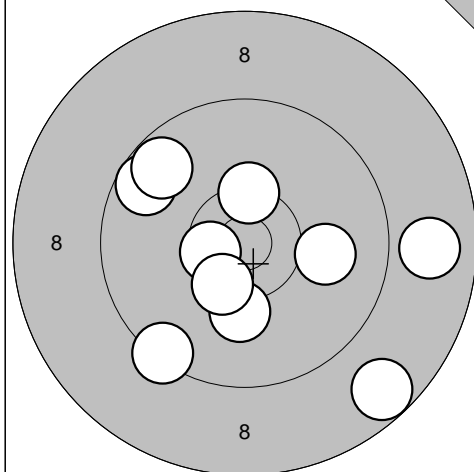

1: 10,2 ↓
 2: 10,4* ↑
 3: 10,6* ←
 4: 10,0 →
 5: 9,4 ↘
 6: 10,4* ↘
 7: 9,6 ↗
 8: 8,7 ↘
 9: 8,8 →
 10: 9,7 ↗

Serie 93,0

Totalt 0,0

Provskott

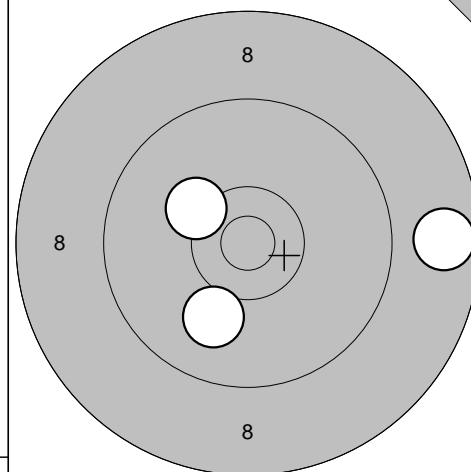

11: 10,2 ↖
 12: 10,0 ↘
 13: 8,7 →

Serie 28,0

Totalt 0,0

Tävlingsskott

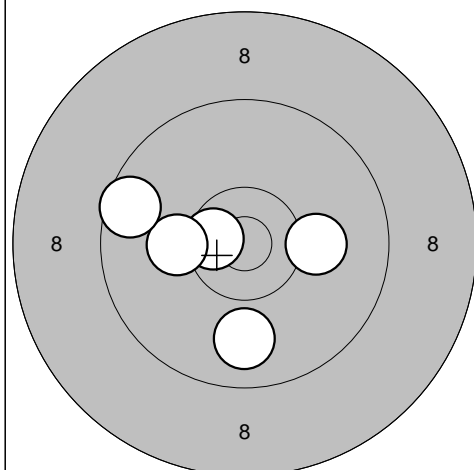

1: 9,9 ↓
 2: 10,6* ←
 3: 10,2 ←
 4: 9,6 ↖
 5: 10,1 →

Serie 48,0

Totalt 48,0

Tävlingsskott

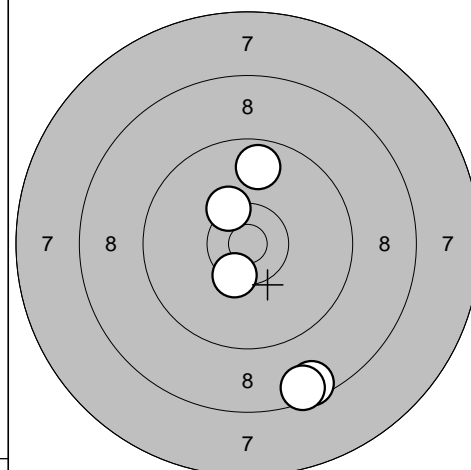

6: 8,5 ↘
 7: 10,3* ↗
 8: 10,4* ↘
 9: 8,5 ↘
 10: 9,7 ↑

Serie 45,0

Totalt 93,0

Tävlingsskott

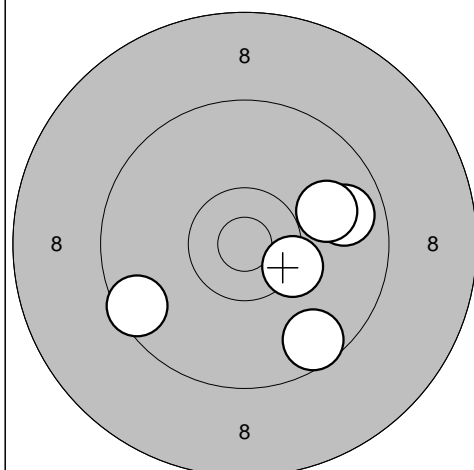

11: 9,8 →
 12: 9,5 ↖
 13: 9,9 →
 14: 10,3* →
 15: 9,6 ↘

Serie 46,0

Totalt 139,0

Tävlingsskott

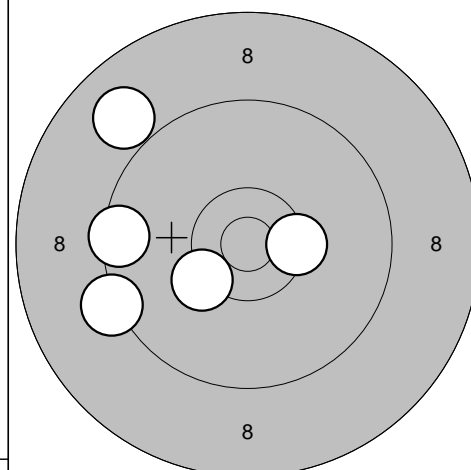

16: 9,5 ←
 17: 10,4* →
 18: 8,9 ↖
 19: 10,3* ↖
 20: 9,3 ←

Serie 46,0

Totalt 185,0

2010-07-23

Tavelträffen 2010

Ramselefors SKF

Provs-kott

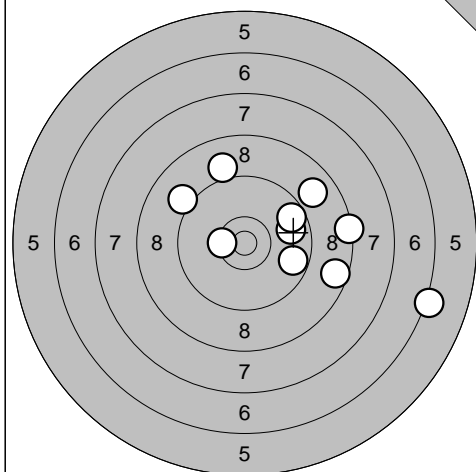

1: 9,8 →
 2: 8,4 →
 3: 9,6 →
 4: 8,9 ↗
 5: 10,4* ←
 6: 9,1 ↗
 7: 9,0 ↗
 8: 6,2 →
 9: 8,6 →
 10: 9,7 →

Serie 85,0

Totalt 0,0

Tävlingsskott

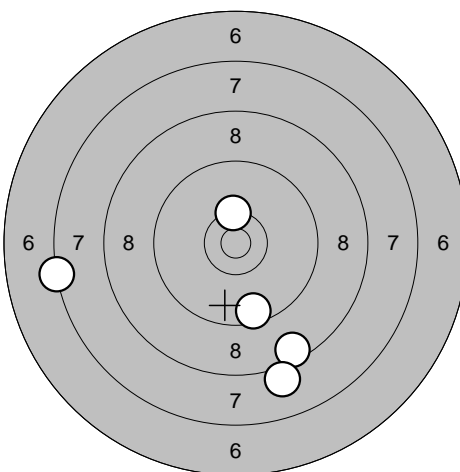

1: 7,3 ←
 2: 9,5 ↓
 3: 8,5 ↓
 4: 8,1 ↓
 5: 10,4* ↑

Serie 42,0

Totalt 42,0

Tävlingsskott

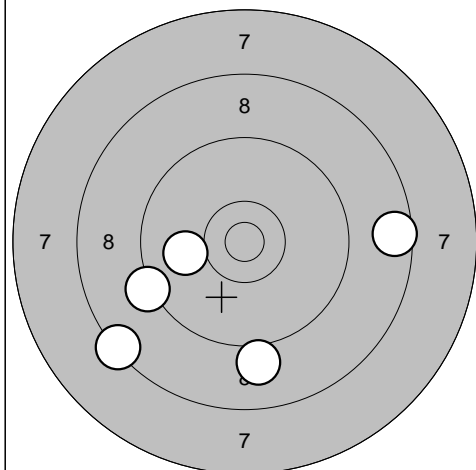

6: 9,0 ↓
 7: 8,4 ↙
 8: 10,0 ←
 9: 9,3 ↙
 10: 8,6 →

Serie 44,0

Totalt 86,0

Tävlingsskott

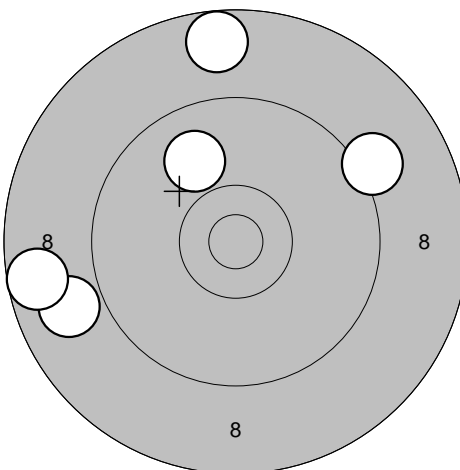

11: 9,2 ↗
 12: 9,9 ↖
 13: 8,9 ←
 14: 8,7 ↑
 15: 8,7 ←

Serie 42,0

Totalt 128,0

Tävlingsskott

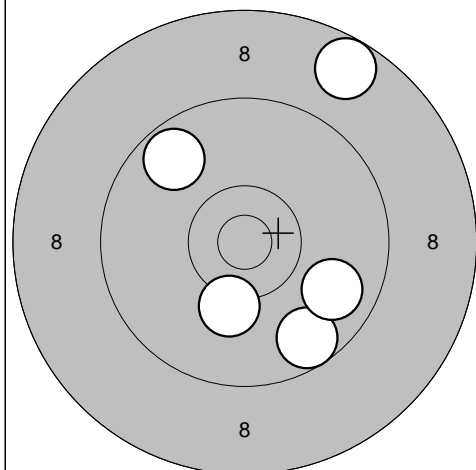

16: 10,2 ↓
 17: 9,6 ↓
 18: 9,8 →
 19: 9,7 ↗
 20: 8,7 ↗

Serie 45,0

Totalt 173,0

Ramselefors

2010-07-23

Tavelträffen 2010

Ramselefors SKF

Provskott

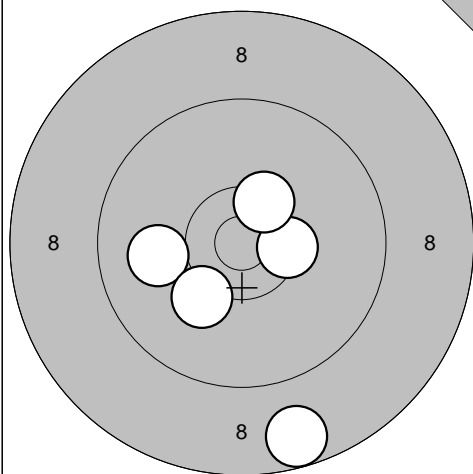

1: 10,0 ←

2: 10,2 ↙

3: 10,4* →

4: 8,7 ↘

5: 10,4* ↗

Serie 48,0

Totalt 0,0

Tävlingsskott

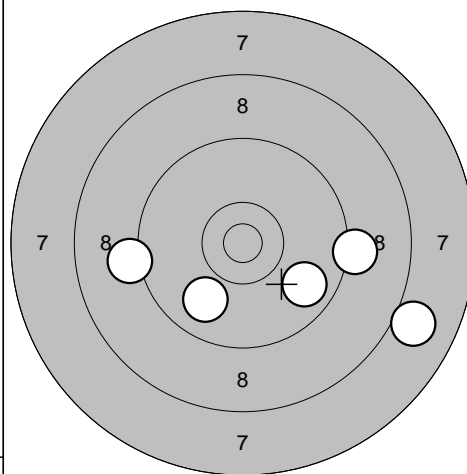

1: 9,8 ↘

2: 8,0 ↘

3: 9,9 ↘

4: 9,2 ←

5: 9,2 →

Serie 44,0

Totalt 44,0

Tävlingsskott

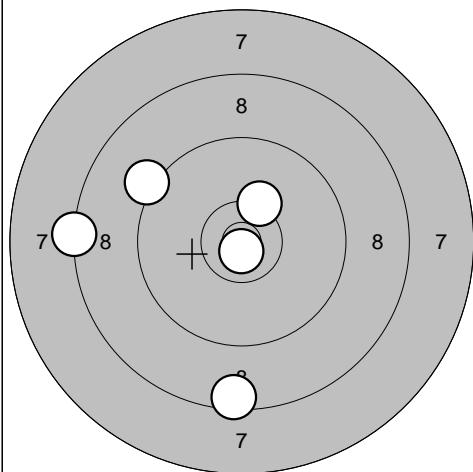

6: 10,8* ↓

7: 10,3 ↗

8: 9,2 ↗

9: 8,3 ←

10: 8,5 ↓

Serie 45,0

Totalt 89,0

Tävlingsskott

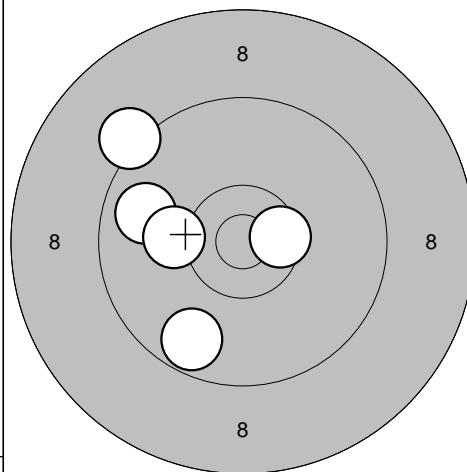

11: 10,5* →

12: 9,8 ←

13: 9,7 ↘

14: 9,2 ↗

15: 10,2 ←

Serie 47,0

Totalt 136,0

Tävlingsskott

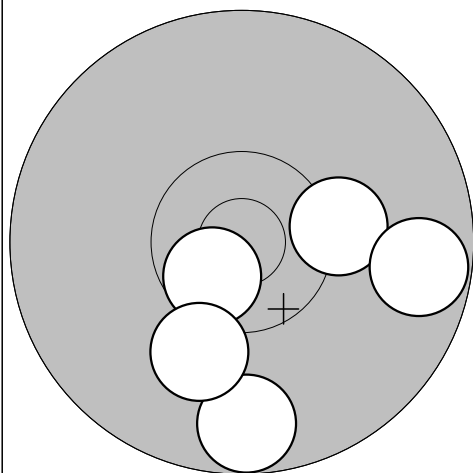

16: 9,7 ↓

17: 10,6* ↙

18: 10,3 →

19: 9,7 →

20: 10,1 ↘

Serie 48,0

Totalt 184,0

2010-07-23

Tavelträffen 2010

Ramselefors SKF

Provskott

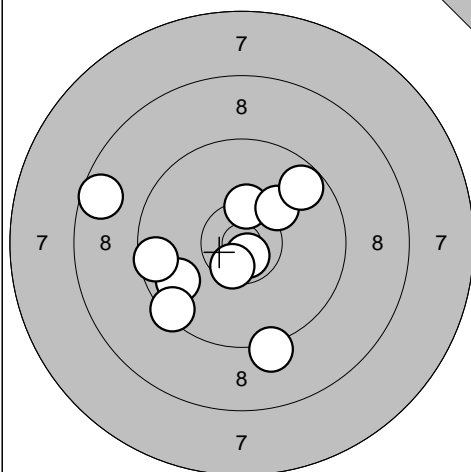

1: 10,4* ↑
 2: 9,2 ↓
 3: 10,2 ↗
 4: 9,8 ↖
 5: 8,6 ←
 6: 10,7* ↓
 7: 9,4 ↖
 8: 9,6 ←
 9: 9,7 ↗
 10: 10,6* ↓

Serie 93,0

Totalt 0,0

Provskott

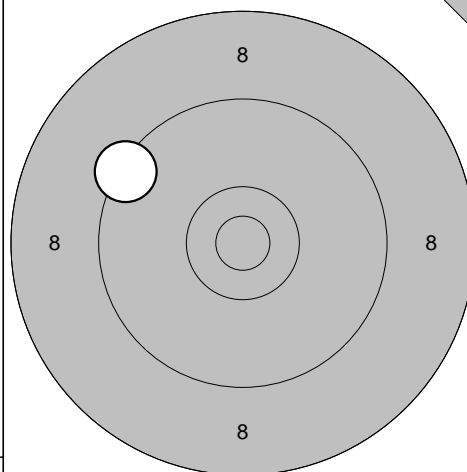

11: 9,4 ↖

Serie 9,0

Totalt 0,0

Tävlingsskott

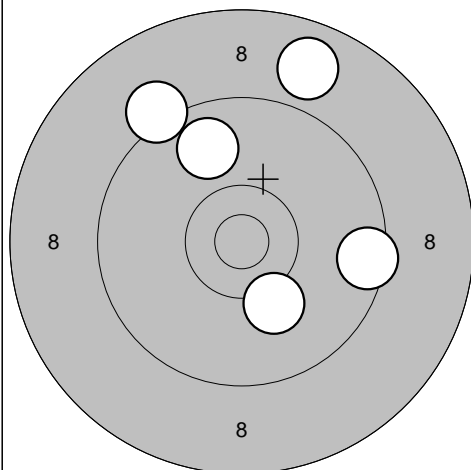

1: 10,1 ↓
 2: 8,8 ↑
 3: 9,8 ↑
 4: 9,5 →
 5: 9,2 ↗

Serie 45,0

Totalt 45,0

Tävlingsskott

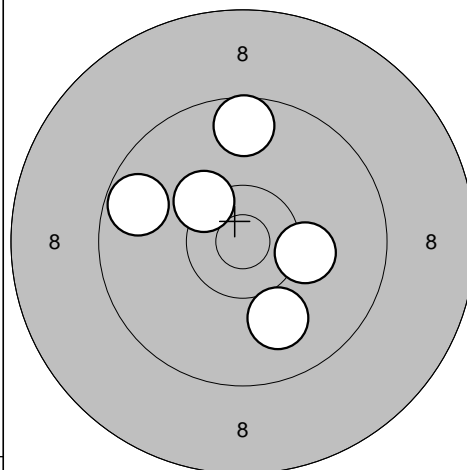

6: 9,7 ↖
 7: 10,3* ↗
 8: 9,6 ↑
 9: 10,2 →
 10: 10,0 ↓

Serie 48,0

Totalt 93,0

Tävlingsskott

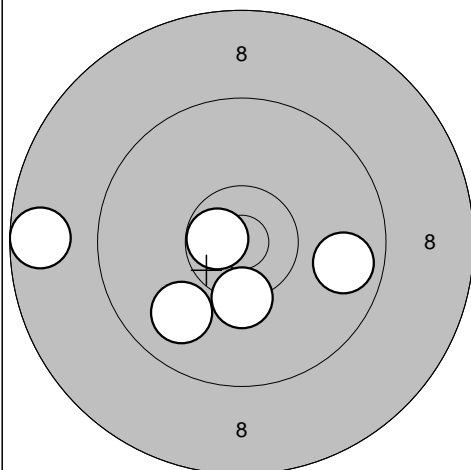

11: 9,8 →
 12: 10,3* ↓
 13: 10,7* ←
 14: 8,7 ←
 15: 9,9 ↖

Serie 46,0

Totalt 139,0

Tävlingsskott

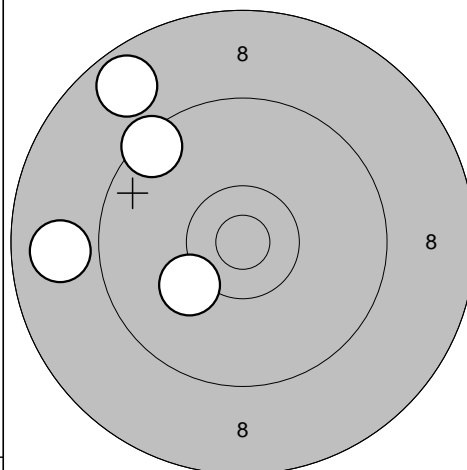

16: 8,7 ↖
 17: 10,2 ↖
 18: 9,4 ↗
 19: 8,9 ←
 0,0 ↖

Serie 35,0

Totalt 174,0

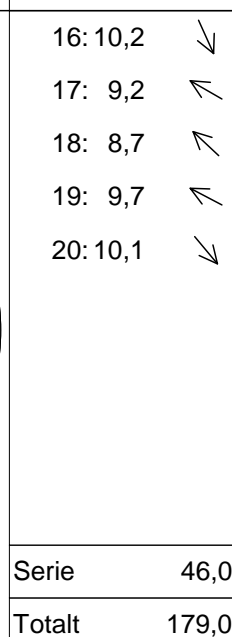
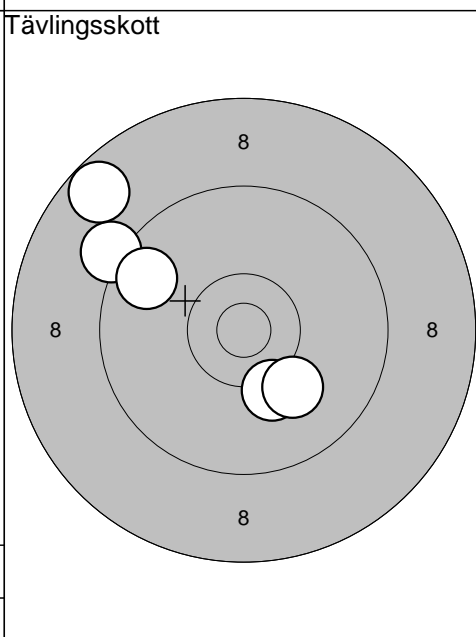
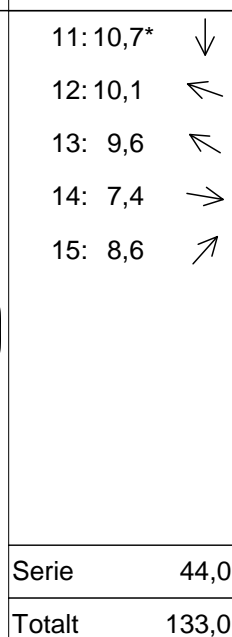
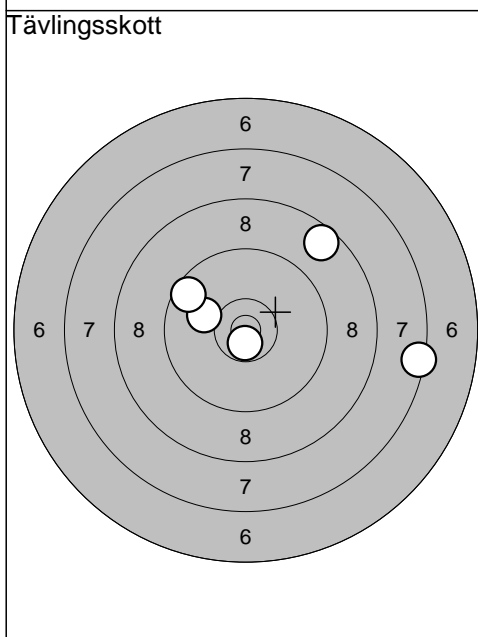
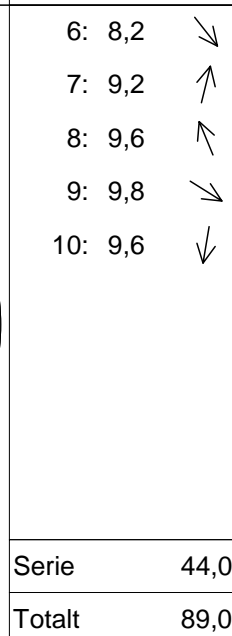
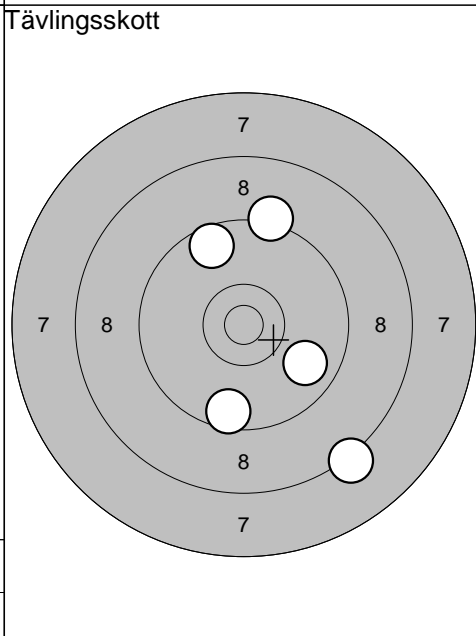
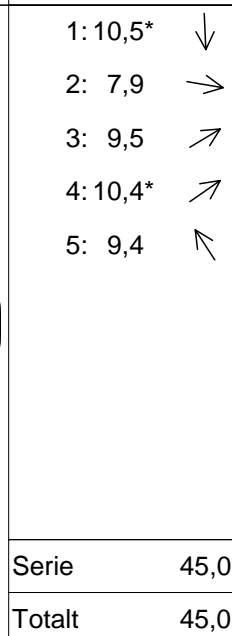
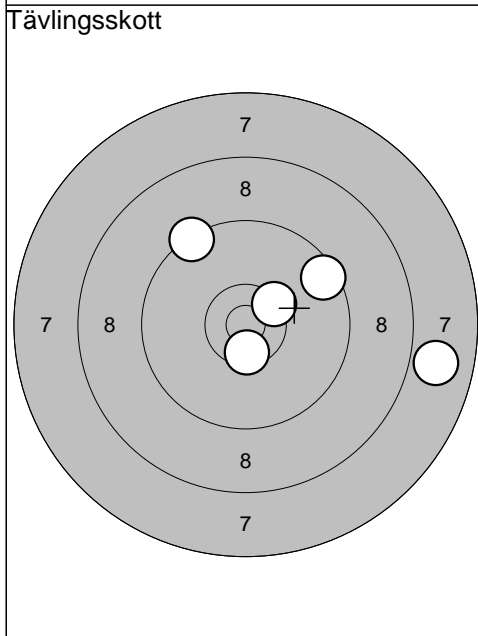
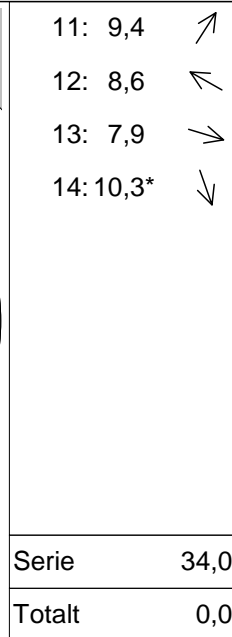
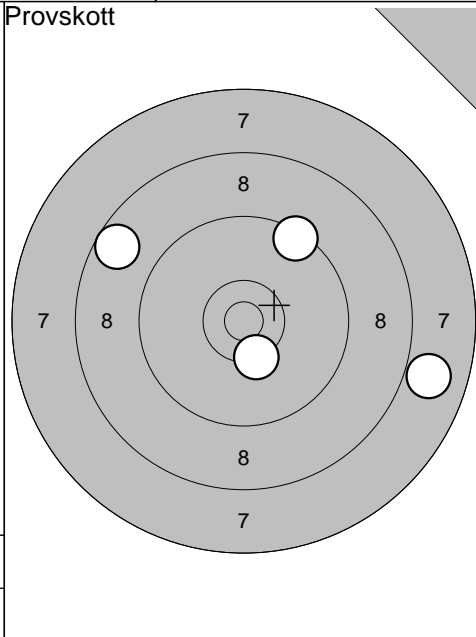
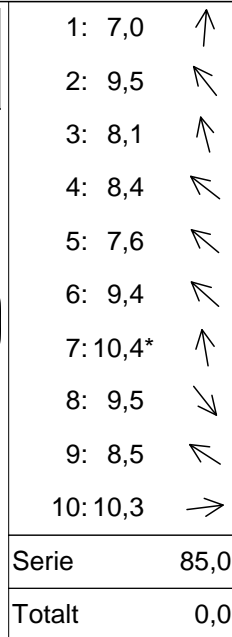
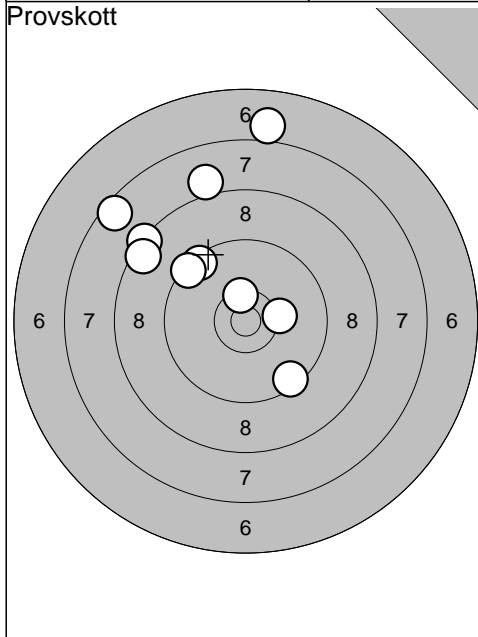

Umeå

2010-07-23

Tavelträffen 2010

Ramselefors SKF

Provskott

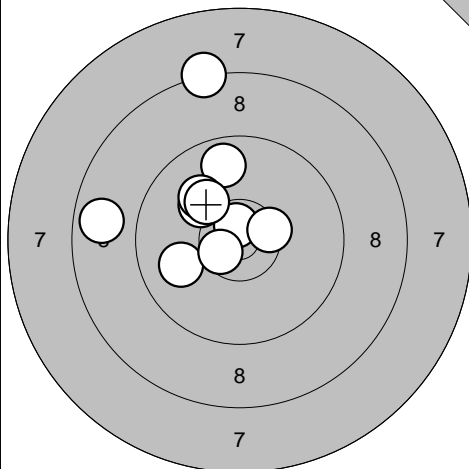

- 1: 8,3 ↗
- 2: 10,1 ↗
- 3: 9,8 ↗
- 4: 10,7* ↗
- 5: 10,0 ↗
- 6: 8,8 ←
- 7: 10,0 ←
- 8: 10,6* ↙
- 9: 10,5* →
- 10: 10,2 ↗

Serie 95,0
Totalt 0,0

Provskott

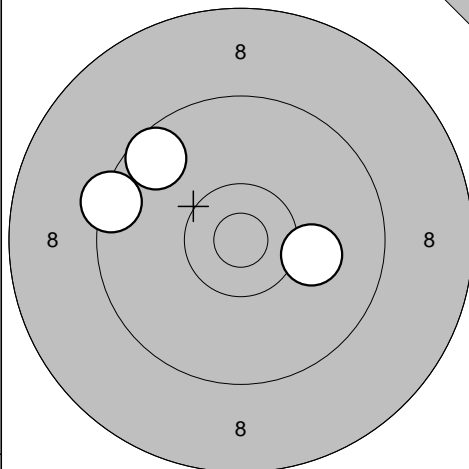

- 11: 9,4 ↙
- 12: 10,1 →
- 13: 9,6 ↗

Serie 28,0
Totalt 0,0

Tävlingsskott

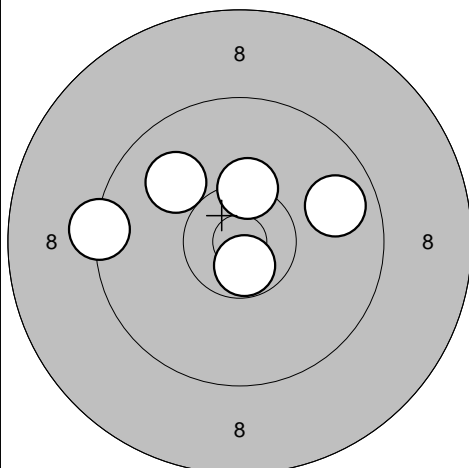

- 1: 10,3* ↗
- 2: 9,8 →
- 3: 10,0 ↗
- 4: 10,7* ↘
- 5: 9,3 ←

Serie 48,0
Totalt 48,0

Tävlingsskott

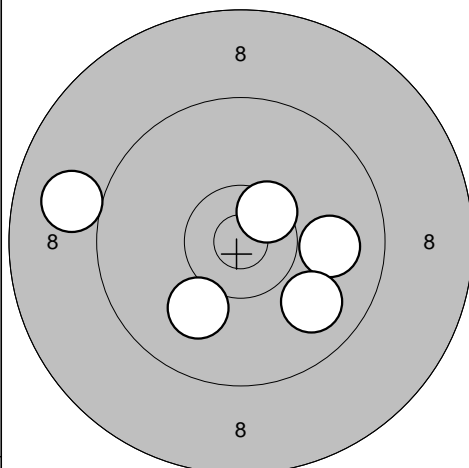

- 6: 9,9 →
- 7: 10,5* ↗
- 8: 10,1 ↘
- 9: 9,0 ←
- 10: 9,9 ↘

Serie 47,0
Totalt 95,0

Tävlingsskott

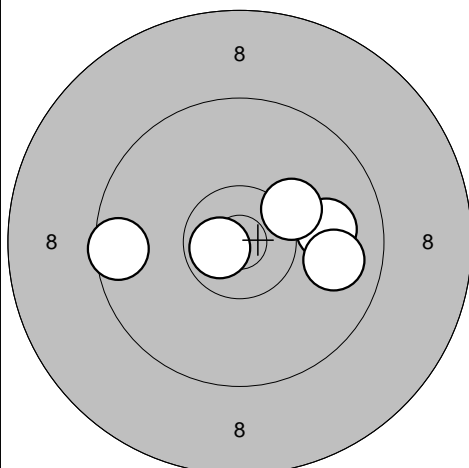

- 11: 9,9 →
- 12: 10,7* ↙
- 13: 9,6 ←
- 14: 10,2 ↗
- 15: 9,8 →

Serie 47,0
Totalt 142,0

Tävlingsskott

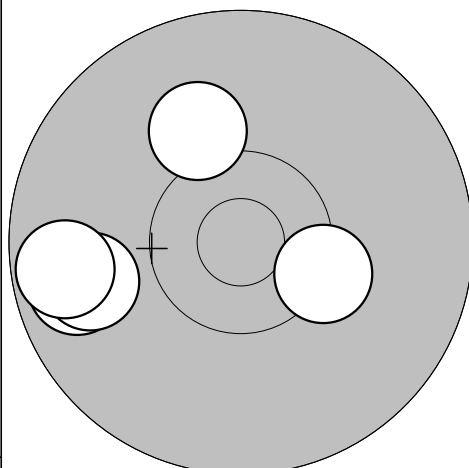

- 16: 9,7 ↙
- 17: 10,1 ↗
- 18: 9,8 ←
- 19: 10,3* →
- 20: 9,7 ←

Serie 47,0
Totalt 189,0

Umeå

2010-07-23

Tavelträffen 2010

Ramselefors SKF

Provskott

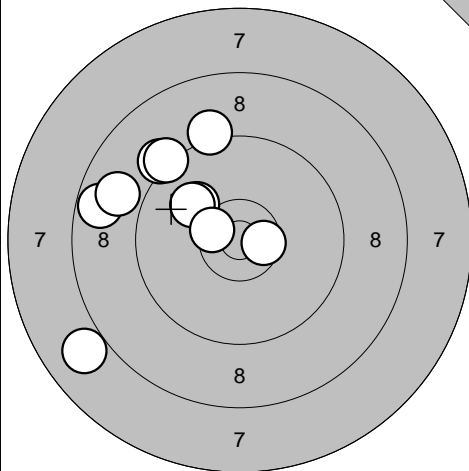

1: 10,1 ↗
 2: 8,0 ↙
 3: 8,7 ←
 4: 9,2 ↗
 5: 10,6* →
 6: 10,0 ↗
 7: 10,5* ↗
 8: 9,2 ↗
 9: 8,9 ↗
 10: 9,2 ↗

Serie 91,0

Totalt 0,0

Provskott

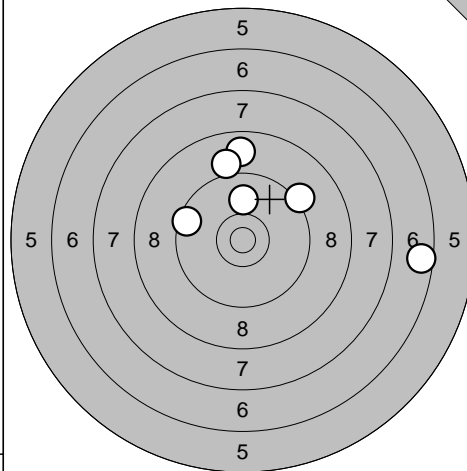

11: 10,0 ↑
 12: 9,5 ←
 13: 9,2 ↗
 14: 8,8 ↑
 15: 6,6 →
 16: 9,1 ↑

Serie 51,0

Totalt 0,0

Tävlingsskott

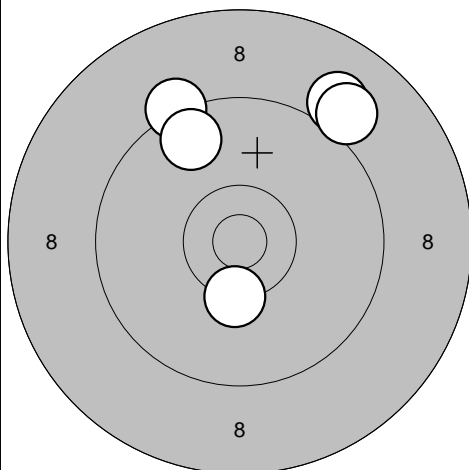

1: 9,0 ↗
 2: 9,0 ↗
 3: 9,3 ↗
 4: 9,7 ↗
 5: 10,3* ↓

Serie 46,0

Totalt 46,0

Tävlingsskott

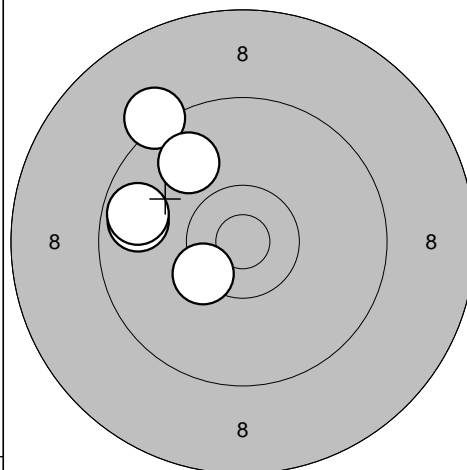

6: 9,2 ↗
 7: 9,7 ←
 8: 9,7 ←
 9: 10,4* ↙
 10: 9,9 ↗

Serie 46,0

Totalt 92,0

Tävlingsskott

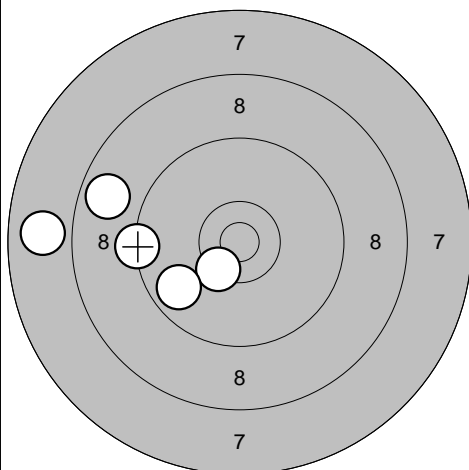

11: 9,3 ←
 12: 7,9 ←
 13: 10,4* ↙
 14: 9,8 ←
 15: 8,8 ←

Serie 43,0

Totalt 135,0

Tävlingsskott

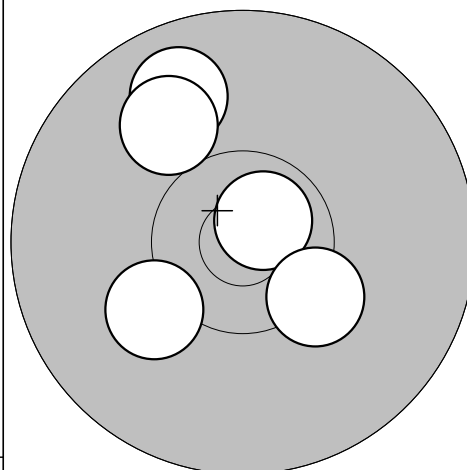

16: 9,8 ↗
 17: 10,2 ↙
 18: 10,7* ↗
 19: 10,3* ↘
 20: 10,0 ↗

Serie 49,0

Totalt 184,0

Umeå

2010-07-23

Tavelträffen 2010

Ramselefors SKF

Provskott

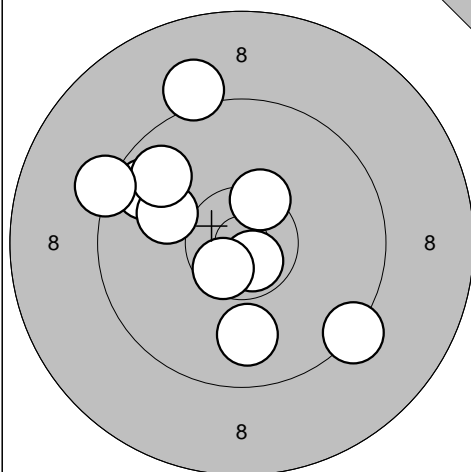

1: 9,3 ↘
 2: 9,7 ↗
 3: 9,1 ↗
 4: 10,0 ↗
 5: 10,7* ↘
 6: 10,6* ↘
 7: 9,8 ↗
 8: 9,3 ↗
 9: 10,4* ↗
 10: 9,9 ↘

Serie 94,0

Totalt 0,0

Provskott

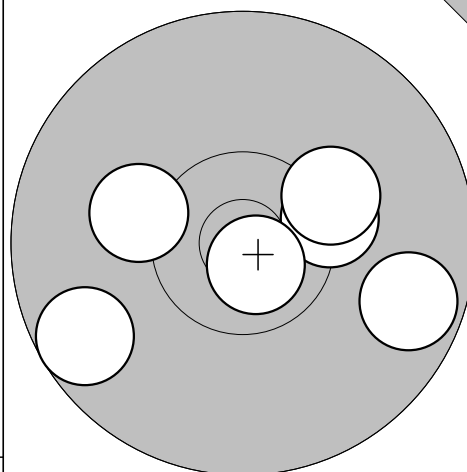

11: 10,3* →
 12: 9,7 →
 13: 10,2 ↗
 14: 9,7 ↖
 15: 10,2 ←
 16: 10,8* ↘

Serie 58,0

Totalt 0,0

Tävlingsskott

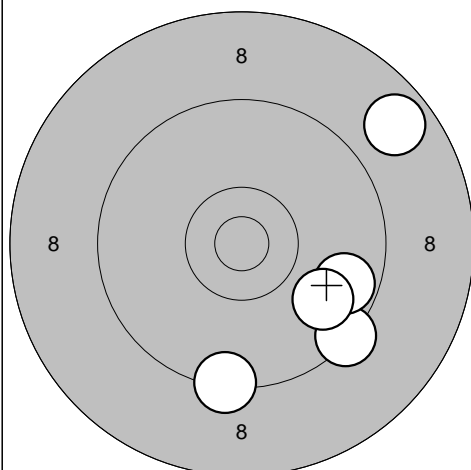

1: 9,4 ↘
 2: 8,7 ↗
 3: 9,7 →
 4: 9,4 ↘
 5: 9,8 ↘

Serie 44,0

Totalt 44,0

Tävlingsskott

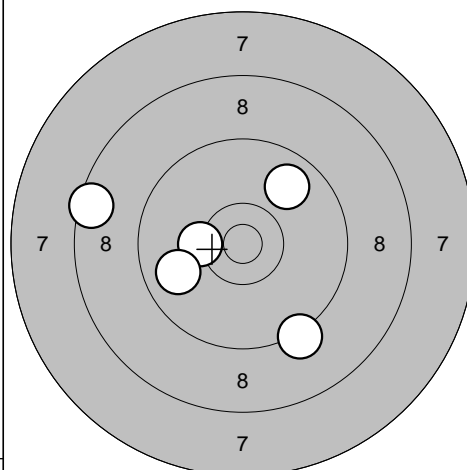

6: 8,5 ←
 7: 10,3 ←
 8: 9,8 ←
 9: 9,8 ↗
 10: 9,2 ↘

Serie 45,0

Totalt 89,0

Tävlingsskott

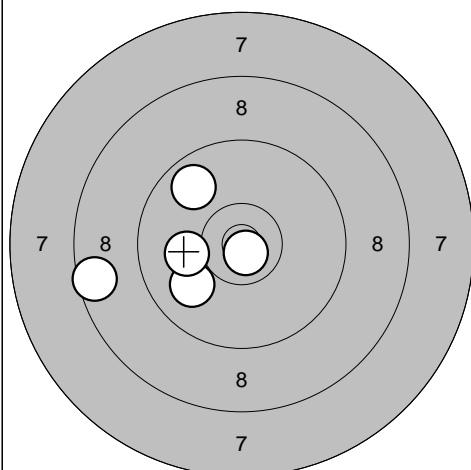

11: 8,6 ←
 12: 9,9 ↖
 13: 9,8 ↗
 14: 10,8* ↘
 15: 10,1 ←

Serie 46,0

Totalt 135,0

Tävlingsskott

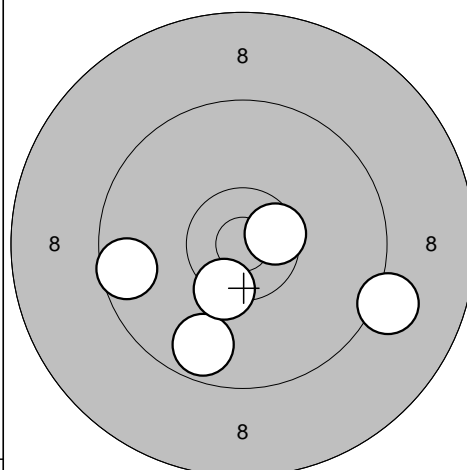

16: 9,2 →
 17: 10,6* →
 18: 9,6 ←
 19: 9,7 ↘
 20: 10,4* ↘

Serie 47,0

Totalt 182,0

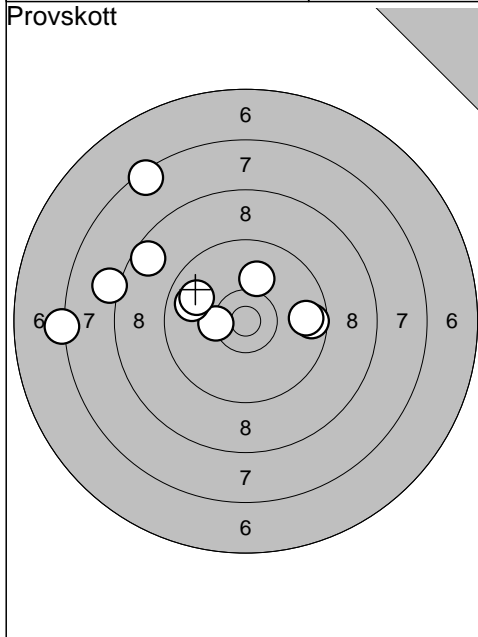

1: 7,4	↗
2: 7,3	←
3: 8,6	↗
4: 8,1	←
5: 10,4*	←
6: 9,8	↖
7: 9,6	→
8: 9,7	→
9: 9,9	↖
10: 10,1	↗
Serie	86,0
Totalt	0,0

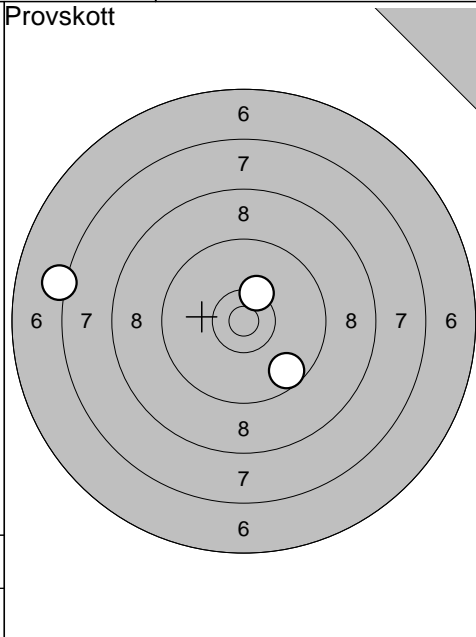

11: 10,3*	↗
12: 9,6	↘
13: 7,2	←
Serie	26,0
Totalt	0,0

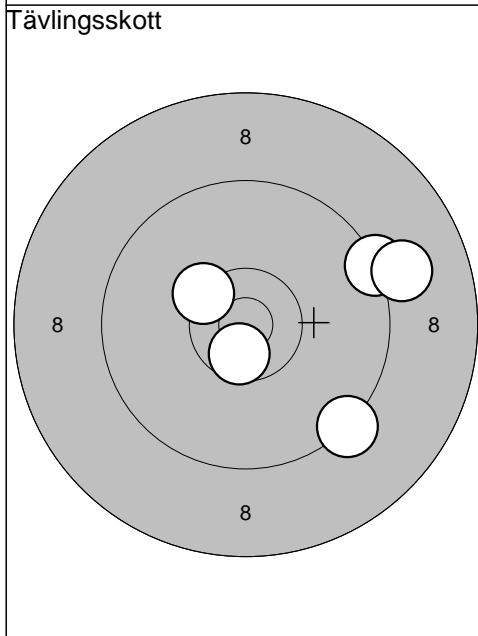

1: 10,4*	↖
2: 9,3	↗
3: 9,1	→
4: 9,3	↘
5: 10,6*	↘
Serie	47,0
Totalt	47,0

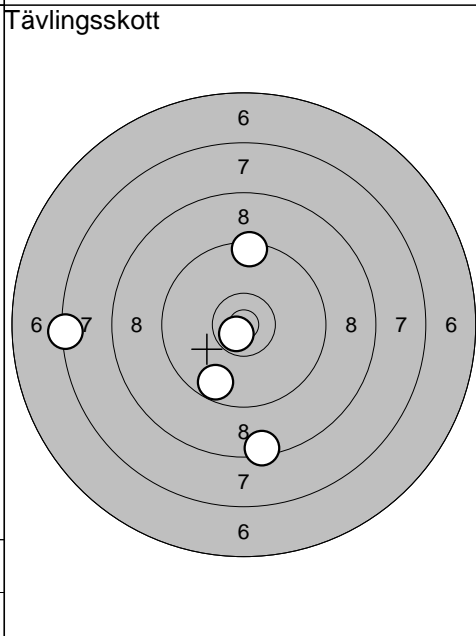

6: 7,4	←
7: 8,4	↓
8: 9,4	↑
9: 10,7*	↘
10: 9,7	↘
Serie	43,0
Totalt	90,0

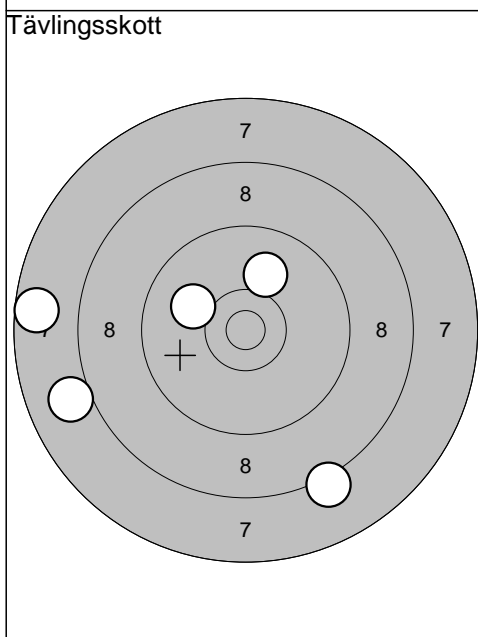

11: 7,7	←
12: 10,0	↗
13: 8,0	←
14: 10,0	↖
15: 8,2	↘
Serie	43,0
Totalt	133,0

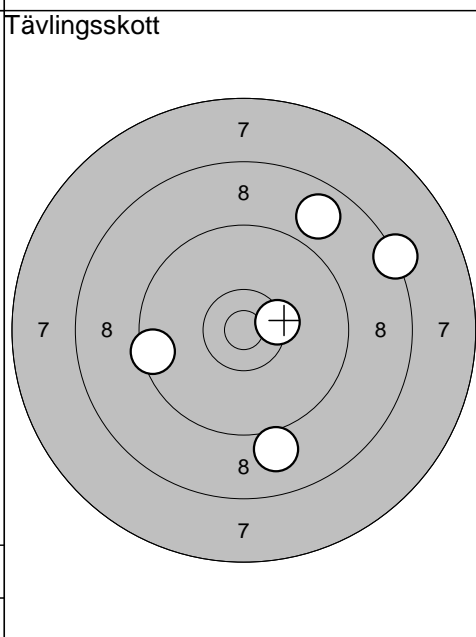

16: 10,4*	→
17: 8,8	↗
18: 9,0	↓
19: 8,3	↗
20: 9,5	←
Serie	44,0
Totalt	177,0

Ununge

2010-07-23

Tavelträffen 2010

Ramselefors SKF

Provskott

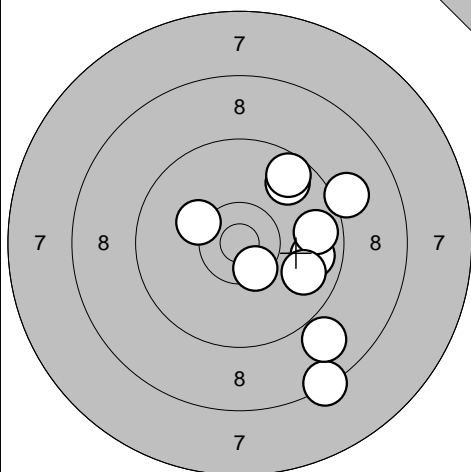

- 1: 8,4 ↘
- 2: 9,8 →
- 3: 9,7 →
- 4: 9,1 →
- 5: 8,9 ↘
- 6: 10,2 ↗
- 7: 10,5* ↘
- 8: 9,7 ↗
- 9: 9,8 →
- 10: 9,6 ↗

Serie 90,0
Totalt 0,0

Provskott

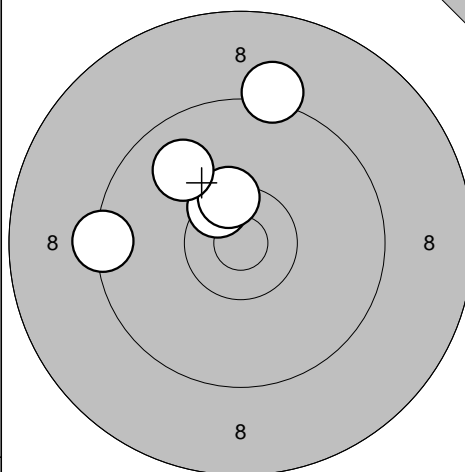

- 11: 10,5* ↗
- 12: 9,4 ←
- 13: 10,4* ↑
- 14: 9,2 ↑
- 15: 9,9 ↗

Serie 47,0
Totalt 0,0

Tävlingsskott

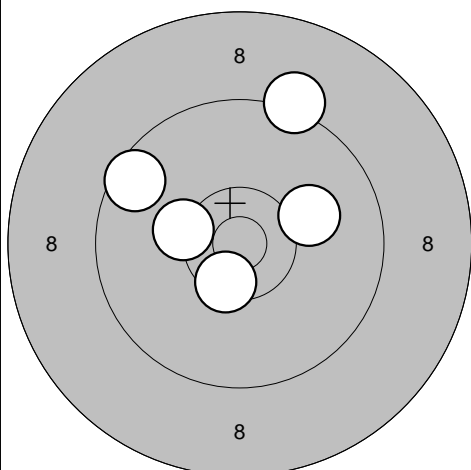

- 1: 10,1 →
- 2: 9,2 ↗
- 3: 10,5* ↘
- 4: 10,3* ←
- 5: 9,6 ↗

Serie 48,0
Totalt 48,0

Tävlingsskott

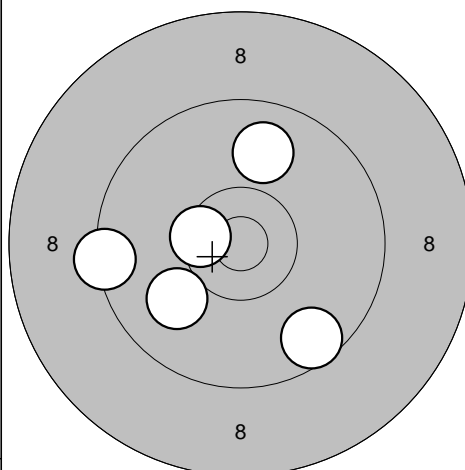

- 6: 9,6 ↘
- 7: 9,4 ←
- 8: 10,5* ←
- 9: 10,0 ↙
- 10: 9,9 ↑

Serie 47,0
Totalt 95,0

Tävlingsskott

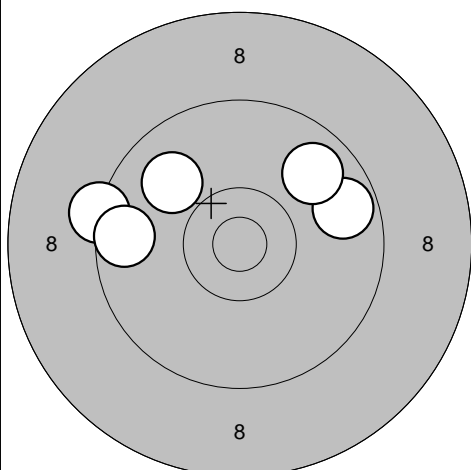

- 11: 9,9 ↗
- 12: 9,3 ←
- 13: 9,7 →
- 14: 9,8 ↗
- 15: 9,6 ←

Serie 45,0
Totalt 140,0

Tävlingsskott

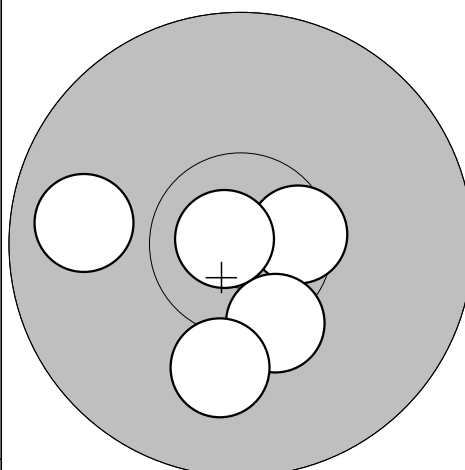

- 16: 9,8 ←
- 17: 10,5* →
- 18: 10,3* ↘
- 19: 10,1 ↘
- 20: 10,8* ←

Serie 49,0
Totalt 189,0

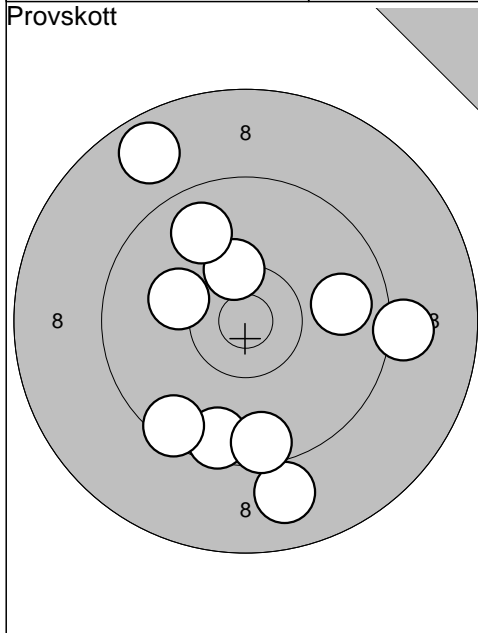

1: 10,3*	↗
2: 9,6	↘
3: 8,7	↗
4: 8,9	↘
5: 10,1	↖
6: 9,8	→
7: 9,1	→
8: 9,8	↗
9: 9,5	↘
10: 9,5	↘
<hr/>	
Serie	90,0
<hr/>	
Totalt	0,0

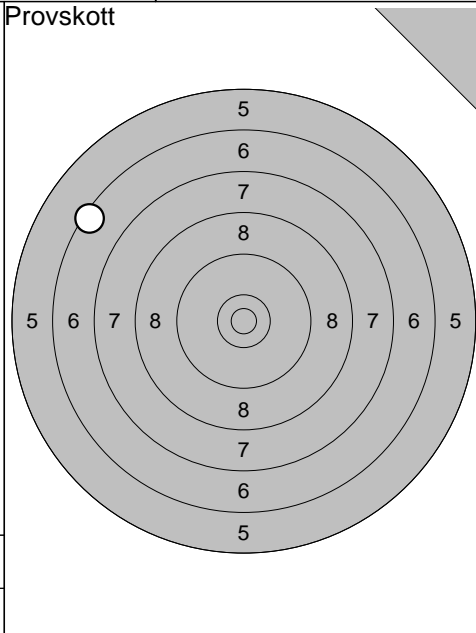

11: 6,5	↖
<hr/>	
Serie	6,0
<hr/>	
Totalt	0,0

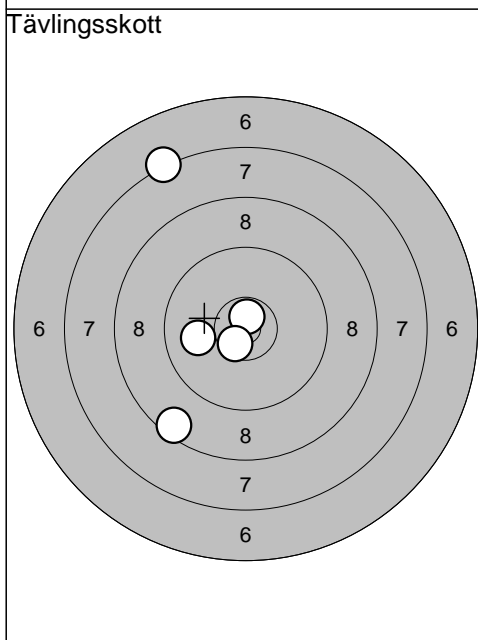

1: 10,0	↖
2: 10,7*	↗
3: 7,3	↗
4: 8,5	↘
5: 10,6*	↘
<hr/>	
Serie	45,0
<hr/>	
Totalt	45,0

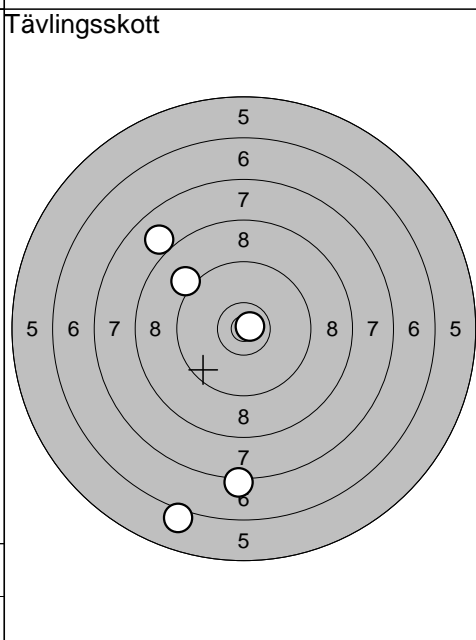

6: 10,8*	↗
7: 9,1	↖
8: 8,0	↗
9: 7,2	↘
10: 6,1	↘
<hr/>	
Serie	40,0
<hr/>	
Totalt	85,0

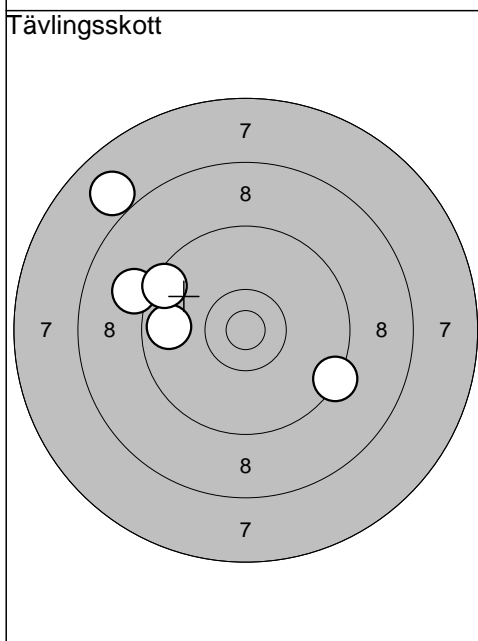

11: 9,1	↖
12: 8,0	↗
13: 9,3	↘
14: 9,7	↖
15: 9,5	↗
<hr/>	
Serie	44,0
<hr/>	
Totalt	129,0

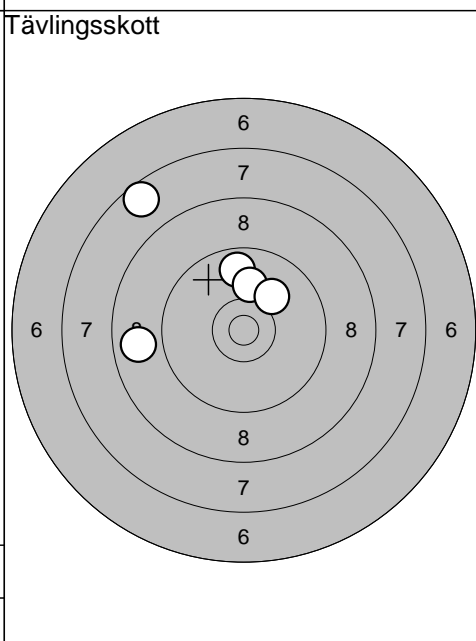

16: 9,7	↗
17: 8,8	↖
18: 10,0	↗
19: 10,1	↗
20: 7,6	↖
<hr/>	
Serie	44,0
<hr/>	
Totalt	173,0

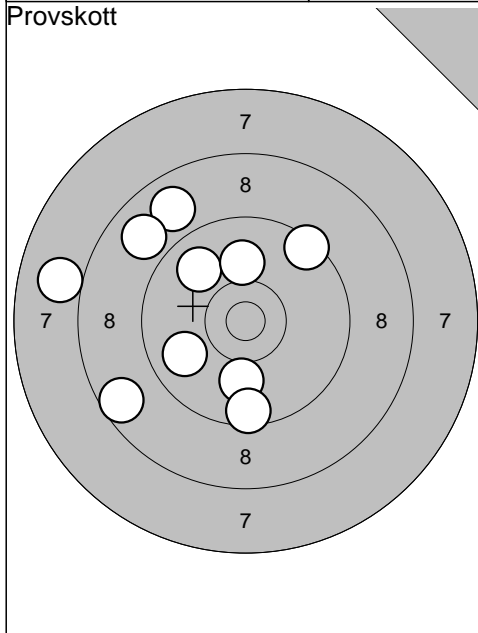

1: 8,6	↙
2: 8,9	↗
3: 9,4	↗
4: 9,9	↙
5: 10,0	↓
6: 8,0	←
7: 9,9	↗
8: 10,0	↑
9: 9,5	↓
10: 8,9	↖
Serie 88,0	
Totalt 0,0	

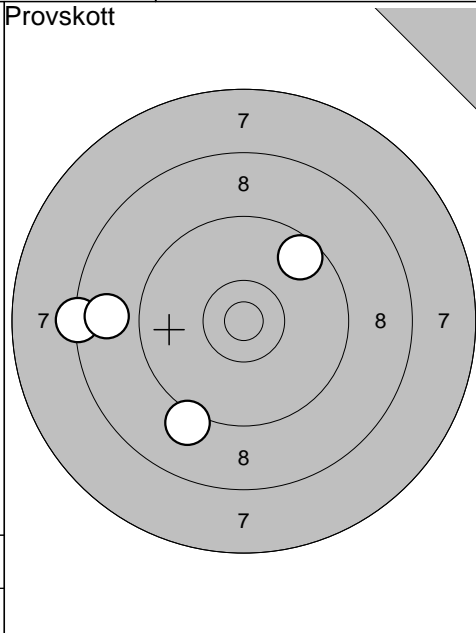

11: 9,6	↗
12: 8,4	←
13: 8,8	←
14: 9,1	↘
Serie 34,0	
Totalt 0,0	

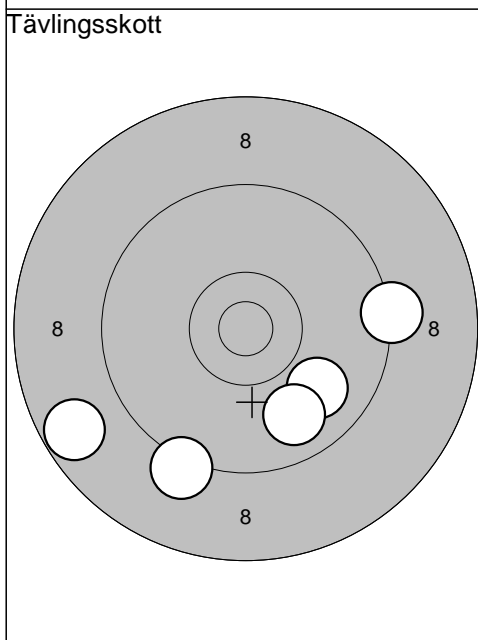

1: 9,9	↘
2: 9,3	→
3: 9,2	↘
4: 8,7	↙
5: 9,8	↘
Serie 44,0	
Totalt 44,0	

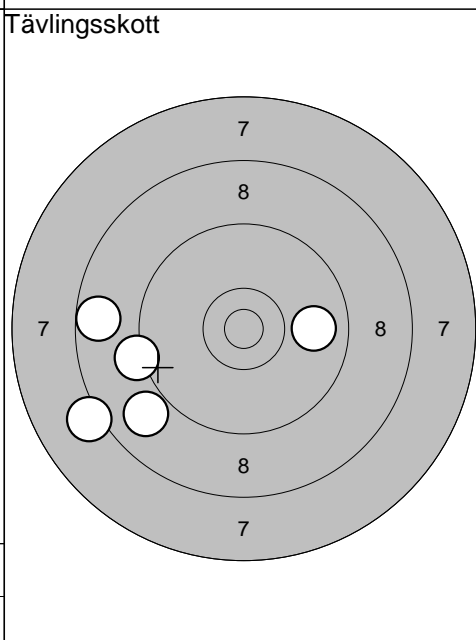

6: 9,2	←
7: 8,1	↙
8: 8,7	←
9: 9,8	→
10: 8,9	↙
Serie 42,0	
Totalt 86,0	

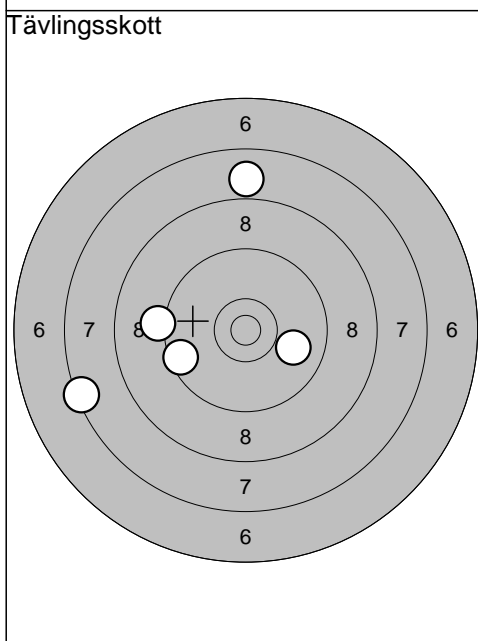

11: 9,5	←
12: 9,2	←
13: 7,9	↑
14: 9,9	→
15: 7,4	↙
Serie 41,0	
Totalt 127,0	

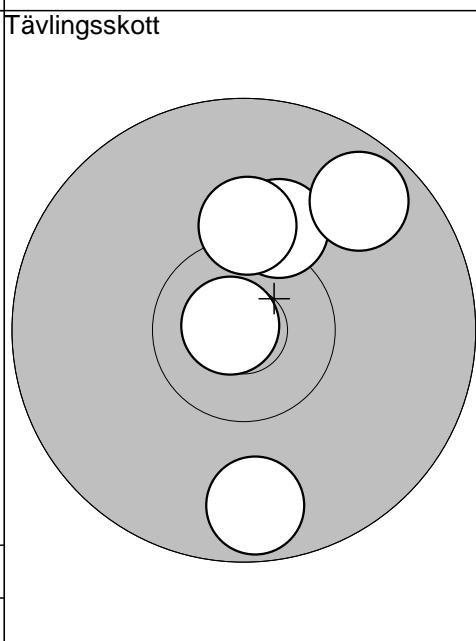

16: 9,7	↓
17: 10,2	↗
18: 10,2	↑
19: 9,7	↗
20: 10,9*	↙
Serie 48,0	
Totalt 175,0	

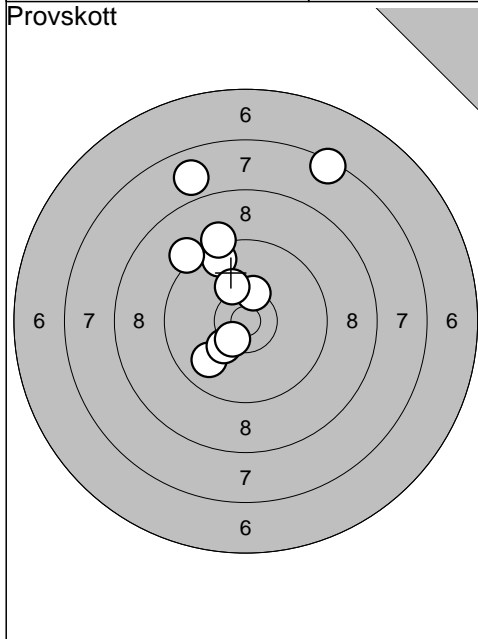

1: 7,4	↗
2: 9,6	↗
3: 7,9	↗
4: 9,2	↗
5: 10,4*	↗
6: 10,2	↗
7: 9,9	↘
8: 10,3	↘
9: 9,2	↗
10: 10,5*	↘
Serie	90,0
Totalt	0,0

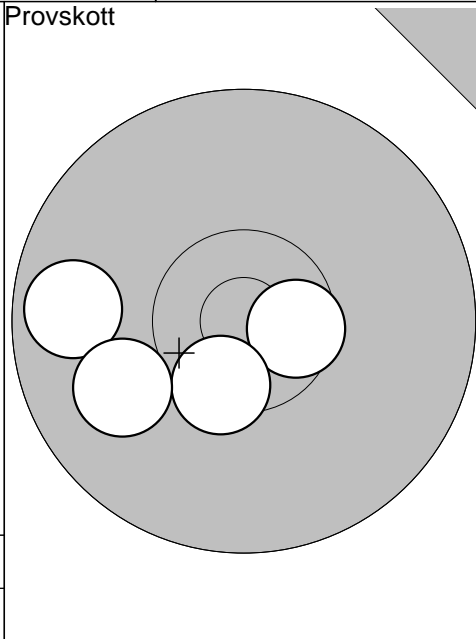

11: 10,6*	→
12: 10,5*	↘
13: 9,7	←
14: 10,0	↙
Serie	39,0
Totalt	0,0

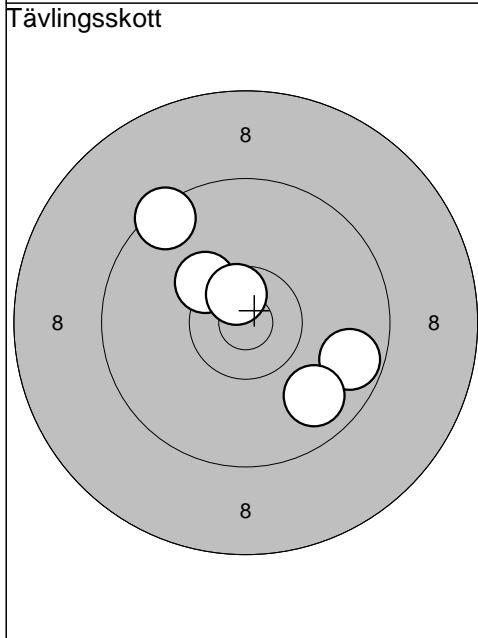

1: 10,3*	↗
2: 10,6*	↗
3: 9,4	↗
4: 9,7	→
5: 9,8	↘
Serie	47,0
Totalt	47,0

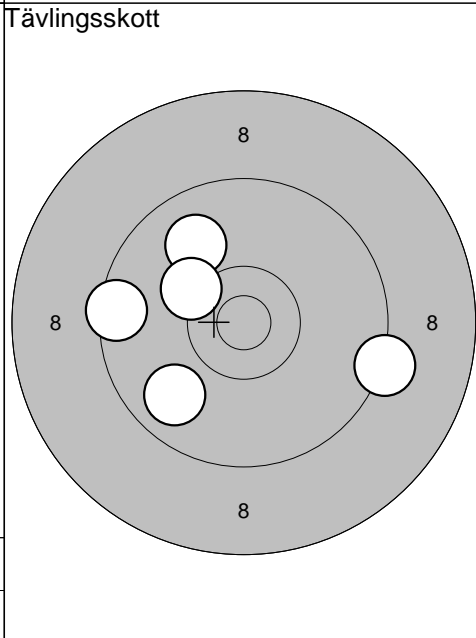

6: 9,9	↗
7: 10,2	↖
8: 9,8	↘
9: 9,5	←
10: 9,3	→
Serie	46,0
Totalt	93,0

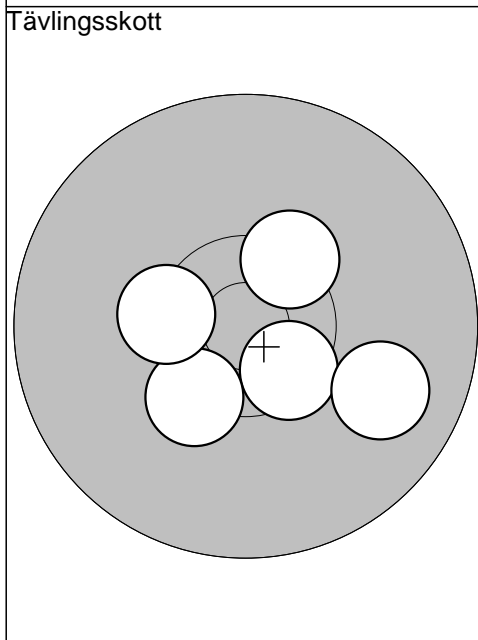

11: 10,5*	↘
12: 9,9	→
13: 10,4*	↗
14: 10,3*	↘
15: 10,4*	←
Serie	49,0
Totalt	142,0

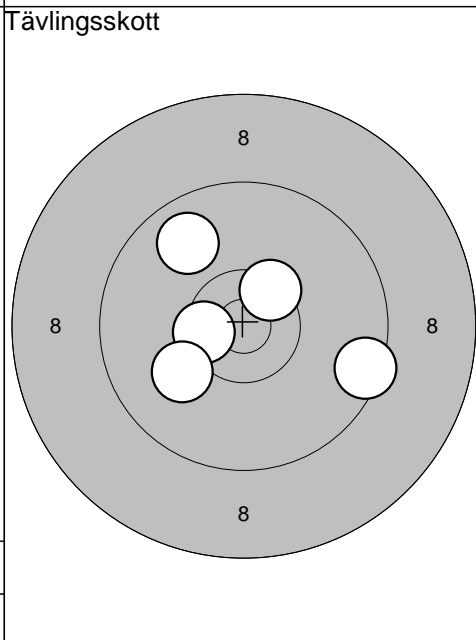

16: 9,5	→
17: 10,5*	←
18: 10,4*	↗
19: 9,8	↖
20: 10,1	↙
Serie	48,0
Totalt	190,0

Ununge

2010-07-23

Tavelträffen 2010

Ramselefors SKF

Provskott

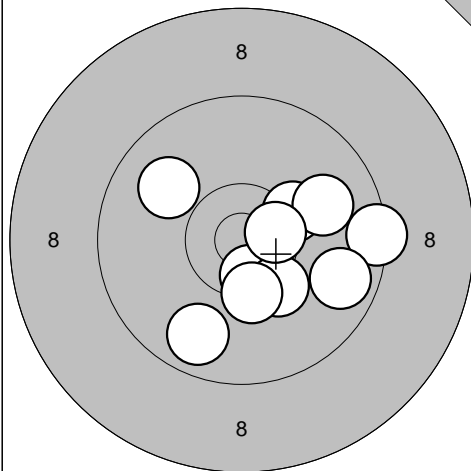

- 1: 10,3 →
- 2: 10,5* ↓
- 3: 9,4 →
- 4: 9,7 →
- 5: 9,9 →
- 6: 10,3 ↓
- 7: 9,8 ↓
- 8: 9,9 ↗
- 9: 10,3* ↓
- 10: 10,6* →

Serie	95,0
Totalt	0,0

Provskott

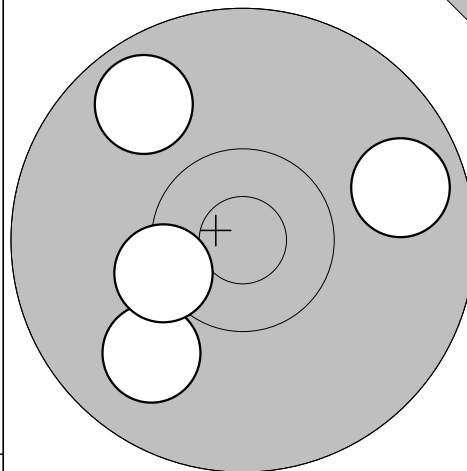

- 11: 9,8 →
- 12: 9,9 ↘
- 13: 9,8 ↖
- 14: 10,3* ←

Serie	37,0
Totalt	0,0

Tävlingsskott

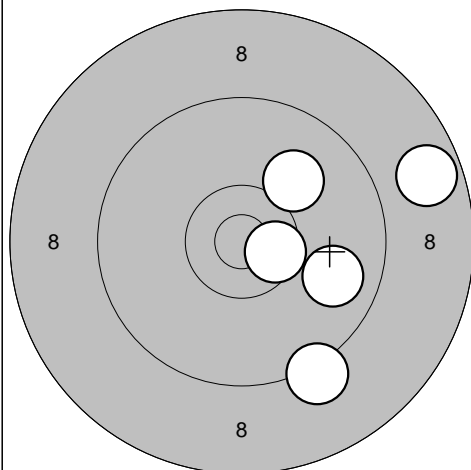

- 1: 9,2 ↓
- 2: 8,7 →
- 3: 10,5* →
- 4: 9,8 →
- 5: 10,0 ↗

Serie	46,0
Totalt	46,0

Tävlingsskott

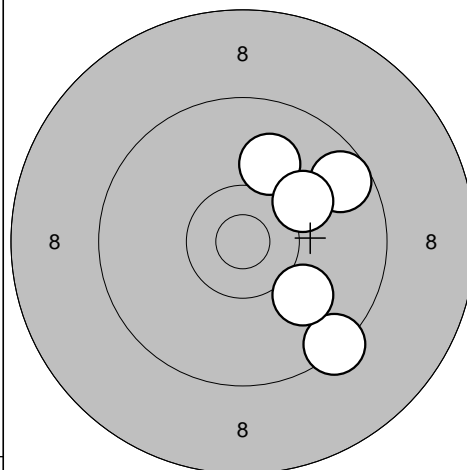

- 6: 9,4 ↓
- 7: 9,6 ↗
- 8: 10,0 ↓
- 9: 10,0 ↑
- 10: 10,1 ↗

Serie	48,0
Totalt	94,0

Tävlingsskott

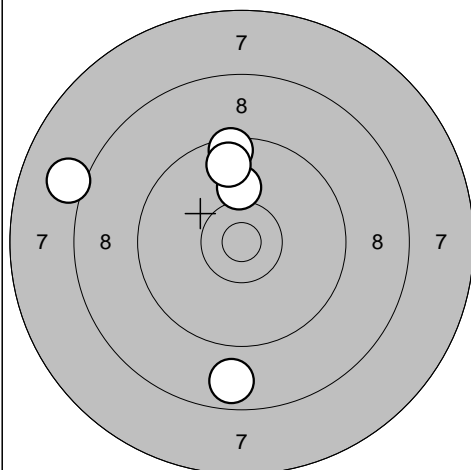

- 11: 8,1 ←
- 12: 8,8 ↓
- 13: 9,5 ↑
- 14: 10,1 ↑
- 15: 9,7 ↑

Serie	44,0
Totalt	138,0

Tävlingsskott

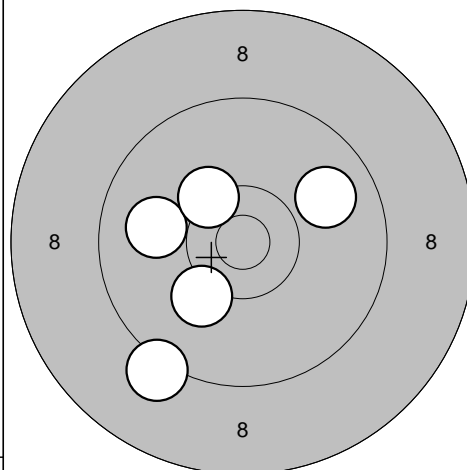

- 16: 9,2 ↓
- 17: 9,9 ↗
- 18: 10,2 ↓
- 19: 10,0 ←
- 20: 10,3* ↖

Serie	48,0
Totalt	186,0

Provs-kott

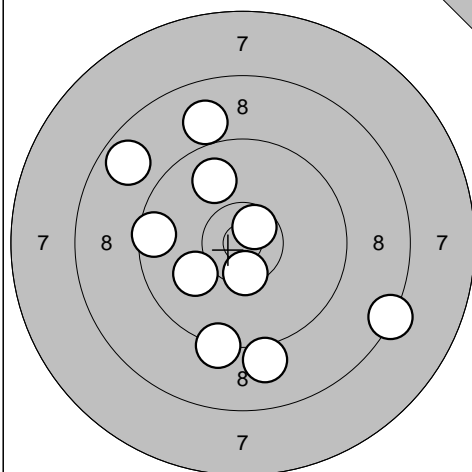

- 1: 9,5 ←
- 2: 10,5* ↓
- 3: 10,1 ↙
- 4: 9,1 ↓
- 5: 10,6* ↗
- 6: 8,8 ↗
- 7: 9,3 ↓
- 8: 9,0 ↑
- 9: 9,9 ↑
- 10: 8,3 ↘

Serie 91,0
Totalt 0,0

Tävlingsskott

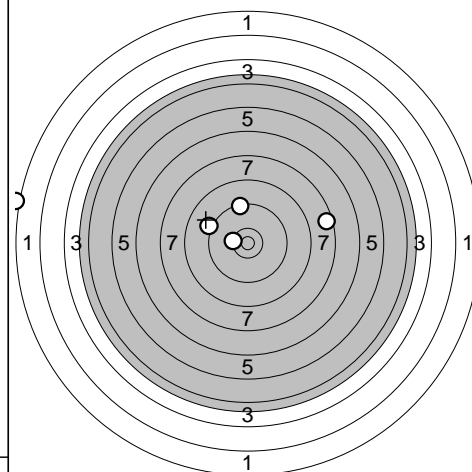

- 1: 9,2 ↙
- 2: 9,4 ↑
- 3: 1,2 ↙
- 4: 10,3* ↙
- 5: 7,6 →

Serie 36,0
Totalt 36,0

Tävlingsskott

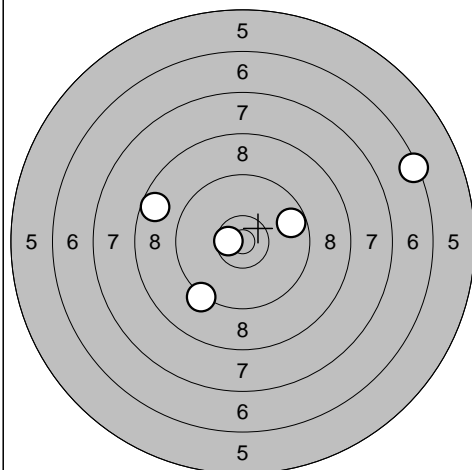

- 6: 9,3 ↙
- 7: 6,4 →
- 8: 10,6* ←
- 9: 9,7 →
- 10: 8,7 ←

Serie 42,0
Totalt 78,0

Tävlingsskott

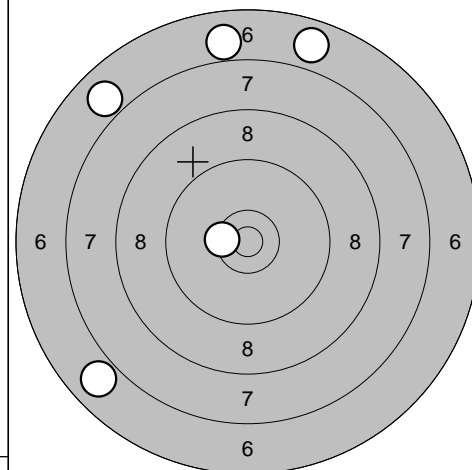

- 11: 6,9 ↑
- 12: 6,8 ↑
- 13: 10,4* ←
- 14: 6,9 ↙
- 15: 6,9 ↙

Serie 34,0
Totalt 112,0

Tävlingsskott

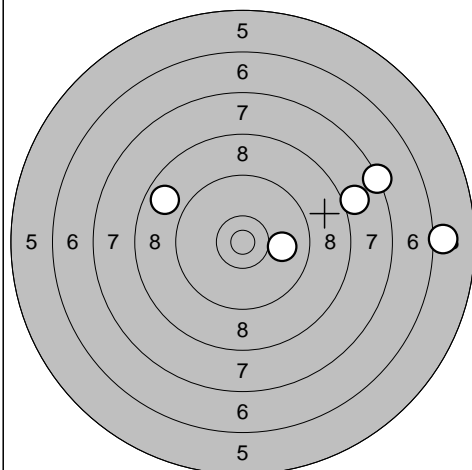

- 16: 8,8 ↙
- 17: 10,0 →
- 18: 7,3 →
- 19: 6,1 →
- 20: 8,0 →

Serie 39,0
Totalt 151,0

Ramselefors

2010-07-23

Tavelträffen 2010

Ramselefors SKF

Provskott

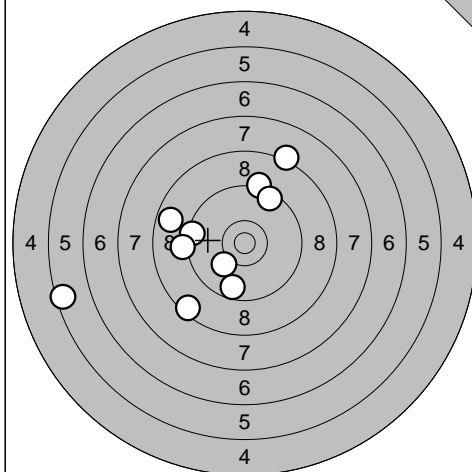

1: 5,5 ←
 2: 8,7 ←
 3: 8,2 ↑
 4: 9,2 ↑
 5: 9,5 ↑
 6: 10,1 ↓
 7: 9,4 ←
 8: 8,5 ↓
 9: 9,2 ←
 10: 9,6 ↓

Serie 84,0

Totalt 0,0

Provskott

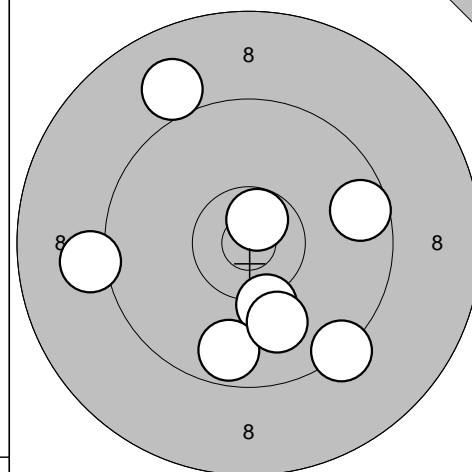

11: 10,2 ↓
 12: 9,6 →
 13: 10,7* ↑
 14: 9,7 ↓
 15: 9,0 ↑
 16: 10,0 ↓
 17: 9,1 ←
 18: 9,3 ↓

Serie 75,0

Totalt 0,0

Tävlingsskott

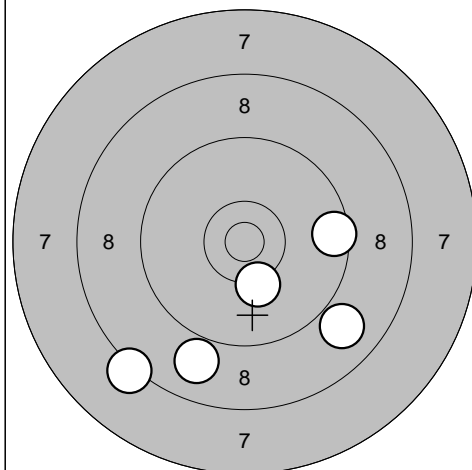

1: 8,9 ↓
 2: 8,2 ↓
 3: 9,5 →
 4: 10,2 ↓
 5: 8,9 ↓

Serie 43,0

Totalt 43,0

Tävlingsskott

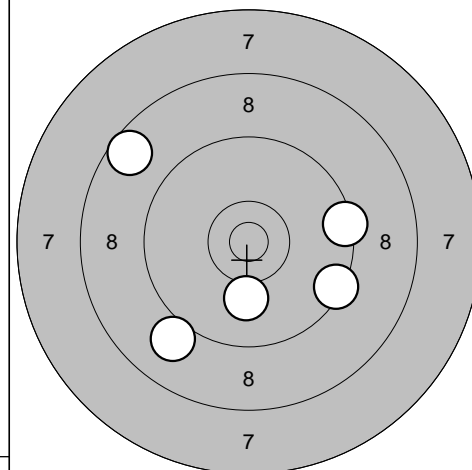

6: 9,4 ↘
 7: 10,1 ↓
 8: 8,6 ↗
 9: 9,4 →
 10: 9,0 ↓

Serie 45,0

Totalt 88,0

Tävlingsskott

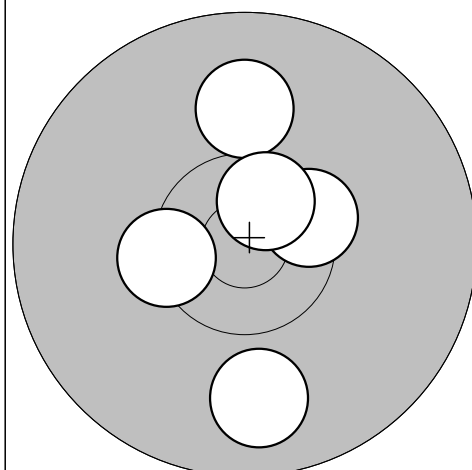

11: 10,4* ←
 12: 10,5* →
 13: 9,8 ↓
 14: 10,0 ↑
 15: 10,6* ↗

Serie 49,0

Totalt 137,0

Tävlingsskott

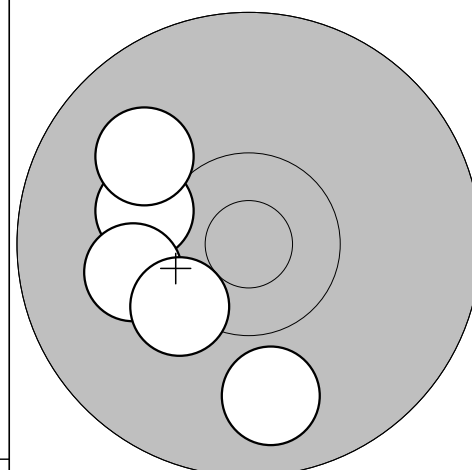

16: 9,9 ↓
 17: 10,2 ←
 18: 10,0 ↗
 19: 10,1 ←
 20: 10,3* ↘

Serie 49,0

Totalt 186,0

Ramselefors

2010-07-23

Tavelträffen 2010

Ramselefors SKF

Provskott

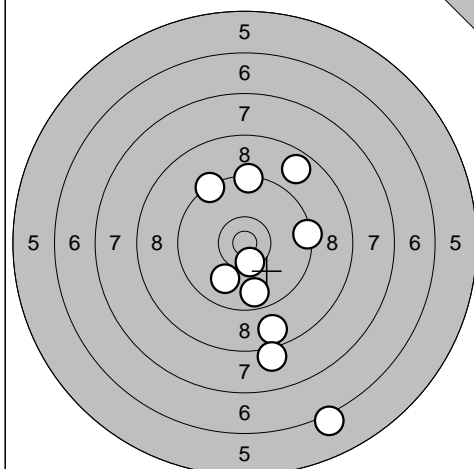

1: 10,5* ↓
 2: 9,4 →
 3: 10,0 ↓
 4: 9,4 ↖
 5: 9,4 ↑
 6: 8,8 ↗
 7: 8,7 ↓
 8: 8,1 ↓
 9: 9,7 ↓
 10: 6,1 ↓

Serie 86,0

Totalt 0,0

Provskott

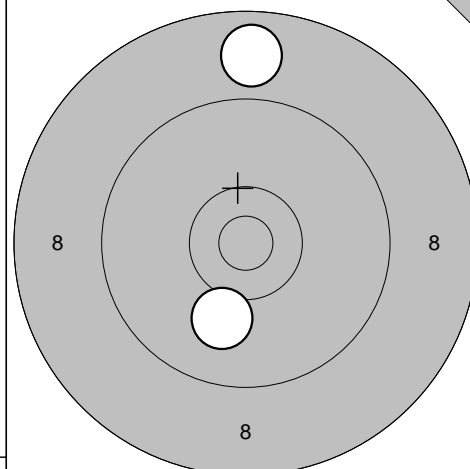

11: 10,1 ↓
 12: 8,8 ↑

Serie 18,0

Totalt 0,0

Tävlingsskott

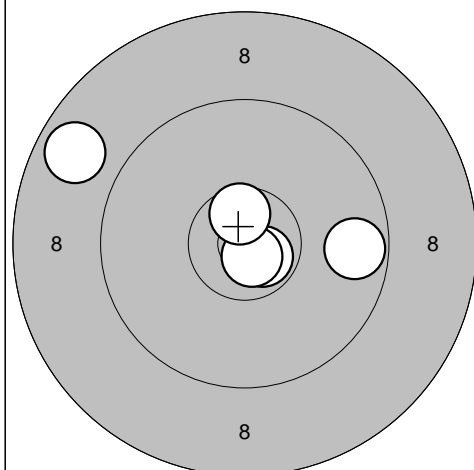

1: 10,7* ↓
 2: 10,8* ↓
 3: 10,6* ↑
 4: 9,7 →
 5: 8,8 ↖

Serie 47,0

Totalt 47,0

Tävlingsskott

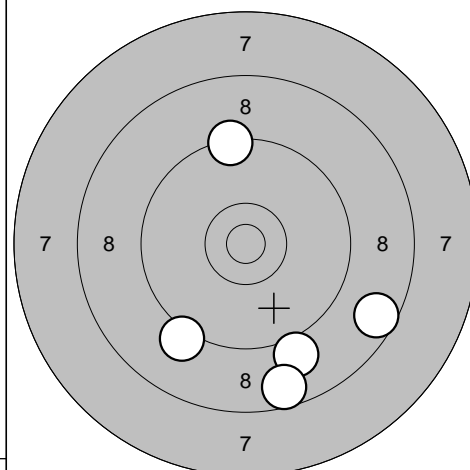

6: 9,2 ↓
 7: 8,6 ↘
 8: 9,0 ↓
 9: 8,6 ↓
 10: 9,4 ↑

Serie 43,0

Totalt 90,0

Tävlingsskott

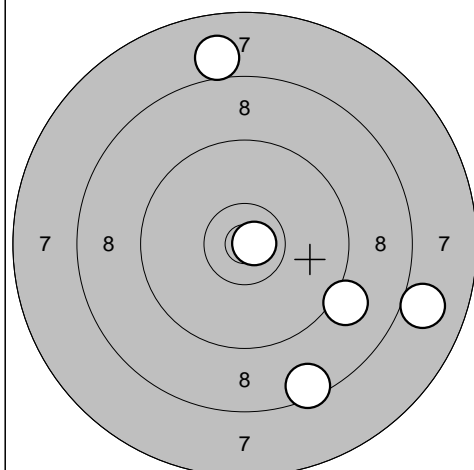

11: 8,0 ↑
 12: 8,0 →
 13: 10,8* →
 14: 8,5 ↓
 15: 9,1 ↓

Serie 43,0

Totalt 133,0

Tävlingsskott

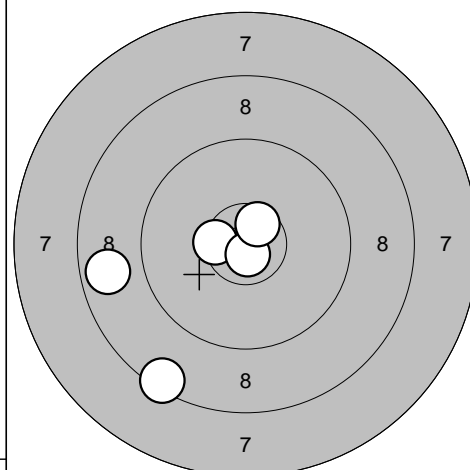

16: 10,5* ←
 17: 8,7 ←
 18: 10,8* ↓
 19: 8,4 ↓
 20: 10,6* ↗

Serie 46,0

Totalt 179,0

Kalix

2010-07-23

Tavelträffen 2010

Ramselefors SKF

Provskott

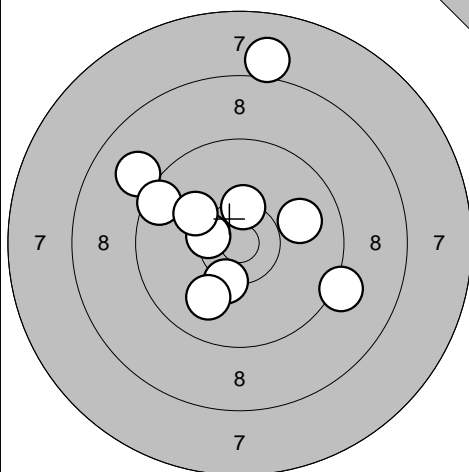

1: 8,0 ↗
 2: 9,0 ↗
 3: 10,5* ←
 4: 9,5 ↗
 5: 9,2 ↘
 6: 10,3* ↓
 7: 10,1 ↗
 8: 9,9 →
 9: 10,4* ↑
 10: 10,0 ↓

Serie 94,0

Totalt 0,0

Provskott

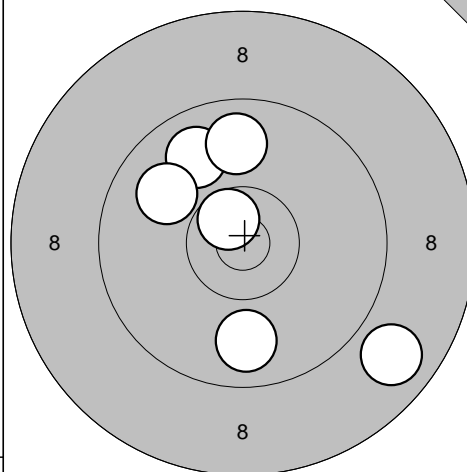

11: 9,8 ↓
 12: 9,8 ↗
 13: 9,8 ↑
 14: 10,6* ↗
 15: 9,9 ↗
 16: 8,8 ↓

Serie 54,0

Totalt 0,0

Tävlingsskott

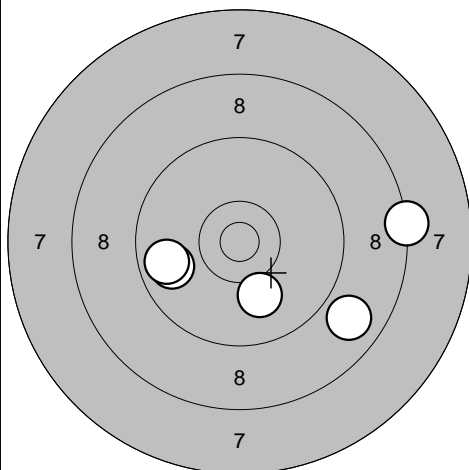

1: 8,8 ↘
 2: 9,8 ←
 3: 10,0 ↓
 4: 9,8 ←
 5: 8,3 →

Serie 44,0

Totalt 44,0

Tävlingsskott

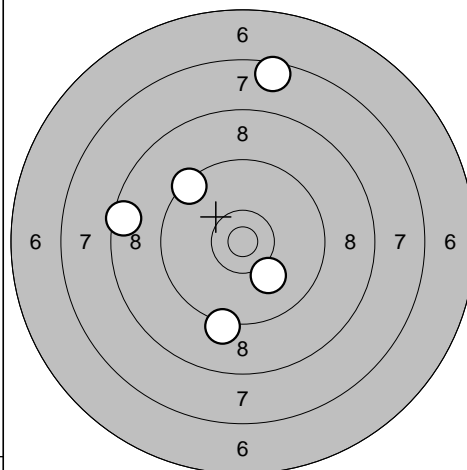

6: 9,2 ↓
 7: 7,5 ↑
 8: 10,1 ↓
 9: 9,4 ↗
 10: 8,5 ←

Serie 43,0

Totalt 87,0

Tävlingsskott

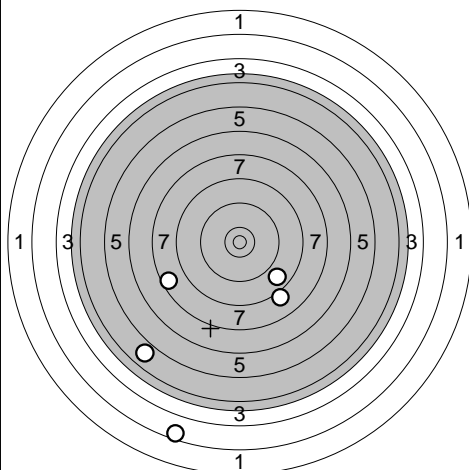

11: 8,1 ↓
 12: 4,9 ↓
 13: 8,8 ↓
 14: 7,6 ←
 15: 2,5 ↓

Serie 29,0

Totalt 116,0

Tävlingsskott

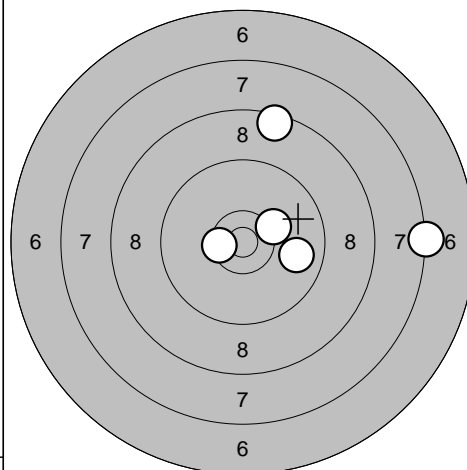

16: 10,5* ←
 17: 10,3 ↗
 18: 7,3 →
 19: 9,8 →
 20: 8,5 ↑

Serie 44,0

Totalt 160,0

Ramselefors

2010-07-23

Tavelträffen 2010

Ramselefors SKF

Provskott

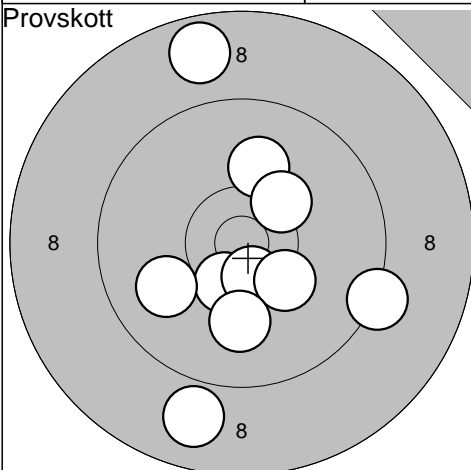

1: 10,1 ↗
 2: 8,9 ↘
 3: 10,5* ↘
 4: 10,5* ↘
 5: 9,3 →
 6: 10,3* ↗
 7: 10,3* ↘
 8: 10,0 ↖
 9: 10,1 ↘
 10: 8,7 ↗

Serie 95,0

Totalt 0,0

Provskott

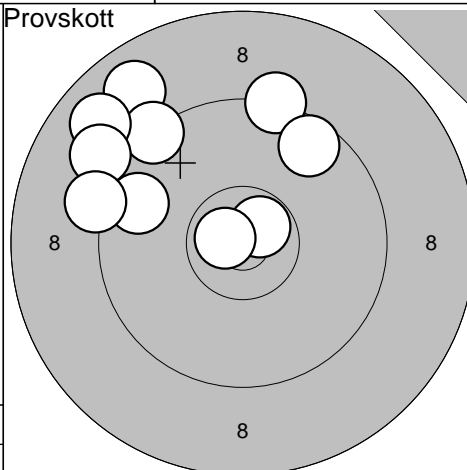

11: 8,8 ↖
 12: 9,3 ↗
 13: 9,3 ↗
 14: 9,6 ↗
 15: 10,7* ↗
 16: 9,7 ↖
 17: 8,8 ↗
 18: 9,0 ↗
 19: 10,7* ↖
 20: 9,2 ↖

Serie 90,0

Totalt 0,0

Provskott

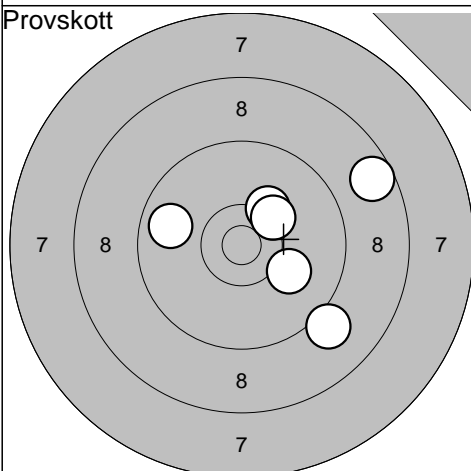

21: 9,1 ↘
 22: 10,2 ↗
 23: 9,8 ↖
 24: 10,1 ↘
 25: 8,6 ↗
 26: 10,3 ↗

Serie 56,0

Totalt 0,0

Tävlingsskott

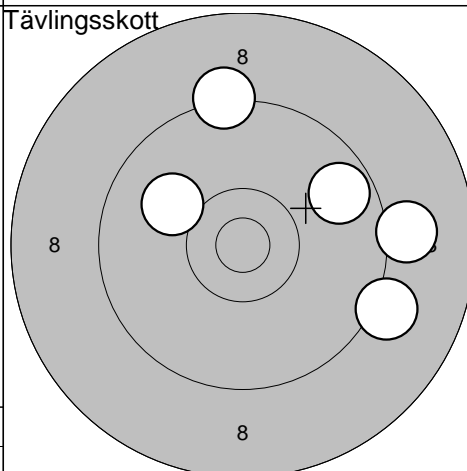

1: 9,3 ↗
 2: 10,0 ↖
 3: 9,2 ↘
 4: 9,1 →
 5: 9,7 ↗

Serie 46,0

Totalt 46,0

Tävlingsskott

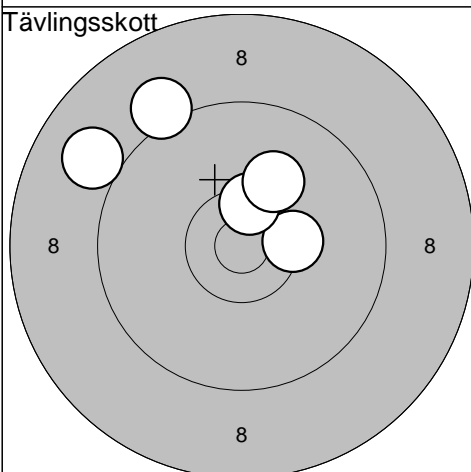

6: 10,4* →
 7: 10,5* ↗
 8: 9,0 ↖
 9: 10,1 ↗
 10: 9,1 ↖

Serie 48,0

Totalt 94,0

Tävlingsskott

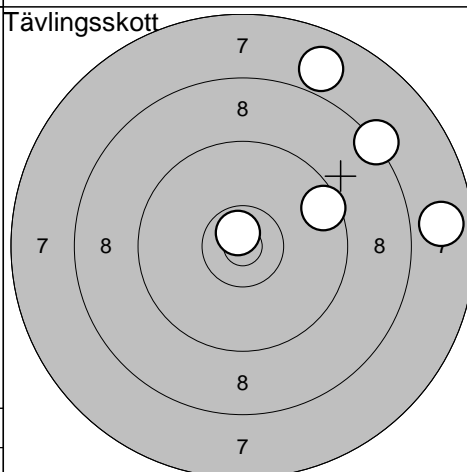

11: 10,7* ↖
 12: 7,8 →
 13: 7,9 ↗
 14: 8,3 ↗
 15: 9,5 ↗

Serie 41,0

Totalt 135,0

Tävlingsskott

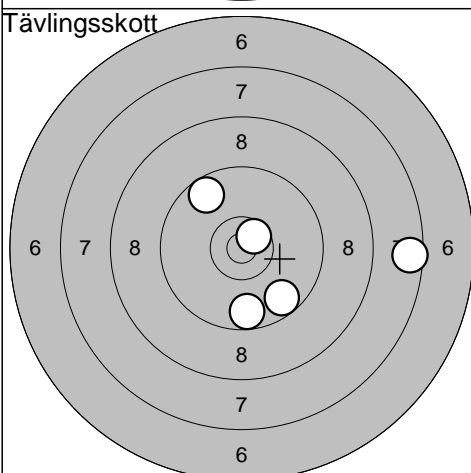

16: 7,6 →
 17: 9,7 ↘
 18: 9,7 ↗
 19: 9,7 ↘
 20: 10,6* ↗

Serie 44,0

Totalt 179,0

2010-07-23

Tavelträffen 2010

Ramselefors SKF

Provskott

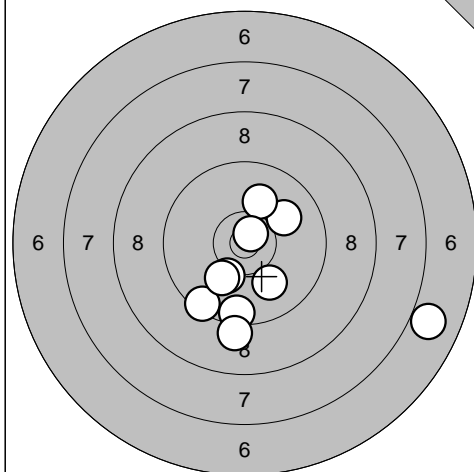

1: 9,5 ↙
 2: 6,9 →
 3: 9,5 ↓
 4: 10,0 ↗
 5: 10,1 ↗
 6: 10,2 ↓
 7: 10,1 ↓
 8: 10,7* ↗
 9: 9,1 ↓
 10: 10,0 ↓

Serie 93,0

Totalt 0,0

Provskott

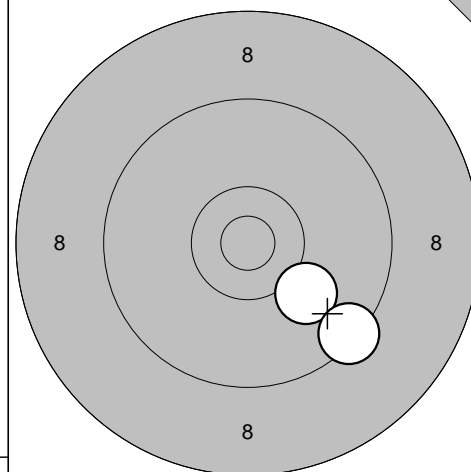

11: 10,1 ↘
 12: 9,4 ↘

Serie 19,0

Totalt 0,0

Tävlingsskott

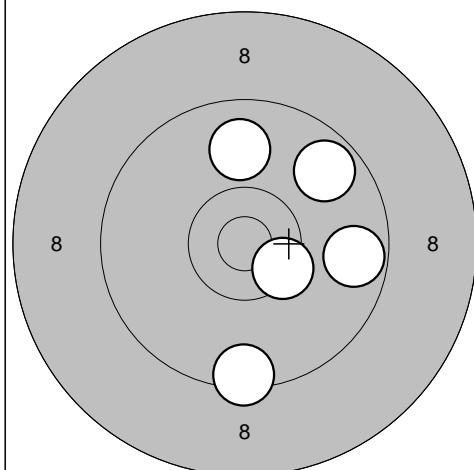

1: 9,7 ↗
 2: 10,4* ↘
 3: 9,9 ↑
 4: 9,7 →
 5: 9,5 ↓

Serie 46,0

Totalt 46,0

Tävlingsskott

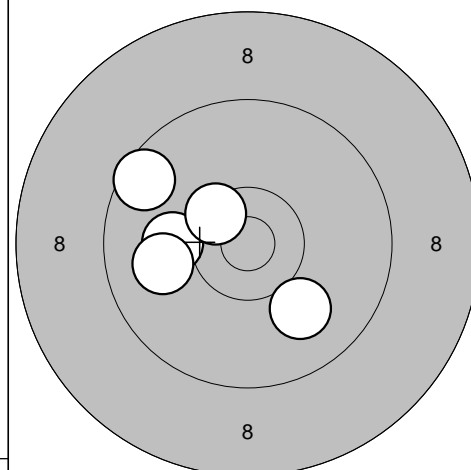

6: 10,0 ↘
 7: 9,6 ↗
 8: 10,1 ←
 9: 10,5* ↗
 10: 10,0 ←

Serie 49,0

Totalt 95,0

Tävlingsskott

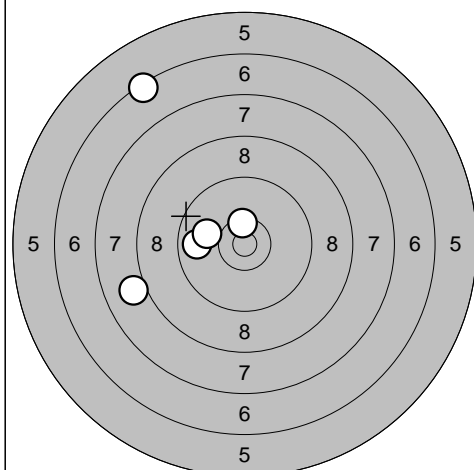

11: 10,4* ↑
 12: 9,8 ←
 13: 10,0 ←
 14: 6,4 ↗
 15: 8,0 ←

Serie 43,0

Totalt 138,0

Tävlingsskott

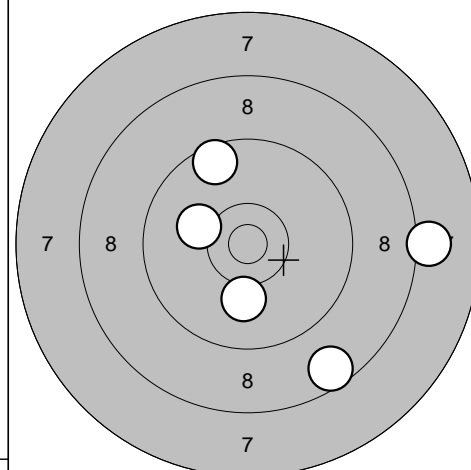

16: 10,1 ←
 17: 9,6 ↗
 18: 8,6 ↓
 19: 8,1 →
 20: 10,1 ↓

Serie 45,0

Totalt 183,0

Ramselefors

2010-07-23

Tavelträffen 2010

Ramselefors SKF

Provskott

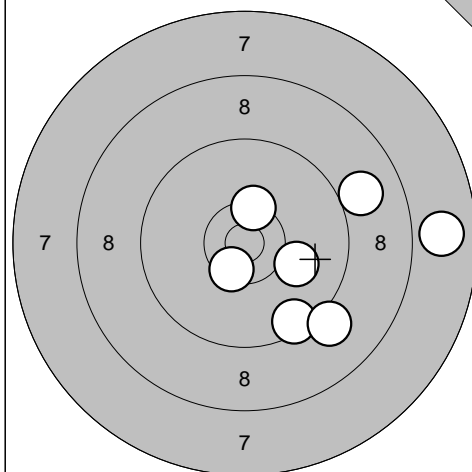

1: 9,0 →
 2: 9,5 ↘
 3: 10,4* ↑
 4: 7,8 →
 5: 10,5* ↘
 6: 9,1 ↘
 7: 10,1 ↘

Serie 64,0

Totalt 0,0

Tävlingsskott

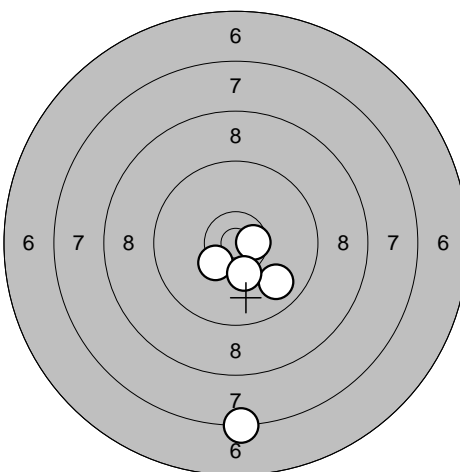

1: 7,3 ↓
 2: 10,4* ↙
 3: 10,6* →
 4: 9,8 ↘
 5: 10,3* ↘

Serie 46,0

Totalt 46,0

Tävlingsskott

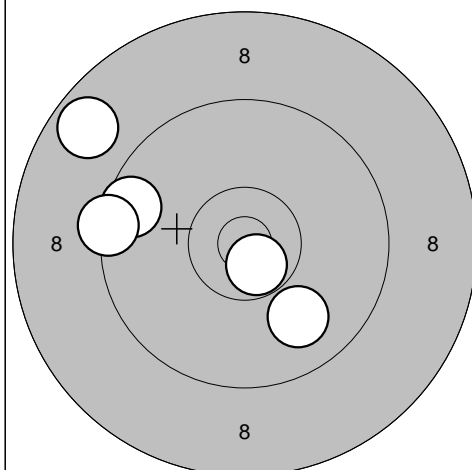

6: 10,7* ↘
 7: 9,9 ↘
 8: 9,6 ↗
 9: 8,7 ↗
 10: 9,4 ←

Serie 45,0

Totalt 91,0

Tävlingsskott

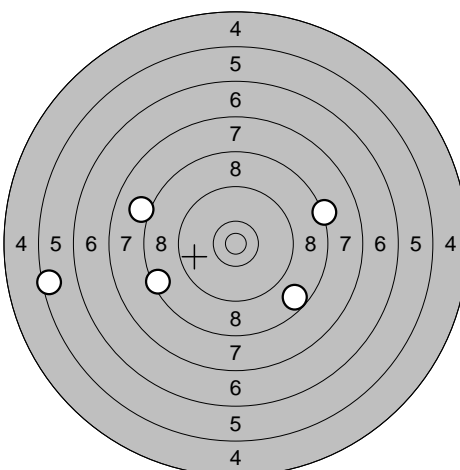

11: 8,1 ↙
 12: 8,7 ↘
 13: 8,3 →
 14: 8,5 ↙
 15: 5,5 ←

Serie 37,0

Totalt 128,0

Tävlingsskott

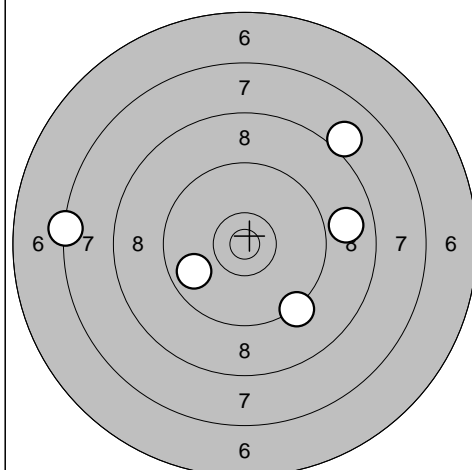

16: 9,3 ↘
 17: 7,4 ←
 18: 8,0 ↗
 19: 8,9 →
 20: 9,8 ↙

Serie 41,0

Totalt 169,0

Ramselefors

2010-07-23

Tavelträffen 2010

Ramselefors SKF

Provsnitt

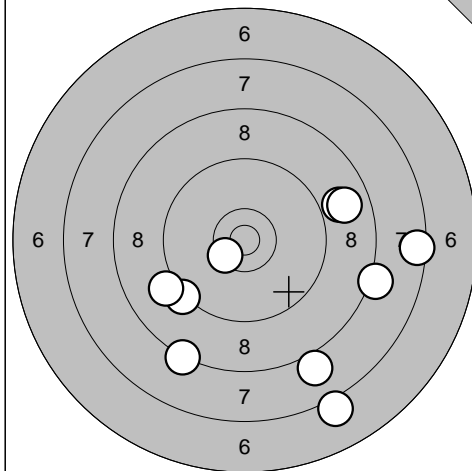

1: 8,9 →
 2: 7,5 →
 3: 7,1 ↓
 4: 8,3 ↓
 5: 9,3 ↙
 6: 10,5* ↙
 7: 8,2 →
 8: 9,1 ↙
 9: 8,0 ↓
 10: 8,8 →

Serie 82,0

Totalt 0,0

Provsnitt

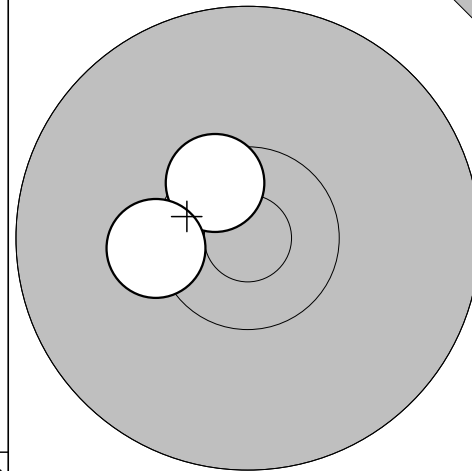

11: 10,5* ↖
 12: 10,3* ←

Serie 20,0

Totalt 0,0

Tävlingssnitt

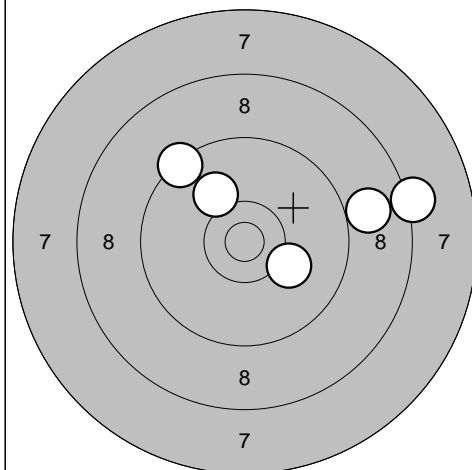

1: 9,4 ↖
 2: 10,2 ↗
 3: 8,9 →
 4: 8,2 →
 5: 10,1 ↖

Serie 45,0

Totalt 45,0

Tävlingssnitt

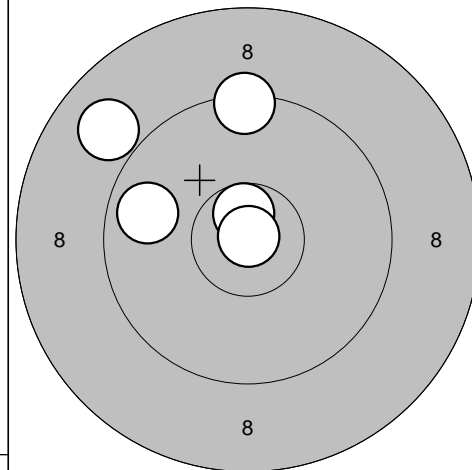

6: 10,7* ↑
 7: 9,4 ↑
 8: 8,9 ↖
 9: 9,8 ←
 10: 10,9* ↗

Serie 46,0

Totalt 91,0

Tävlingssnitt

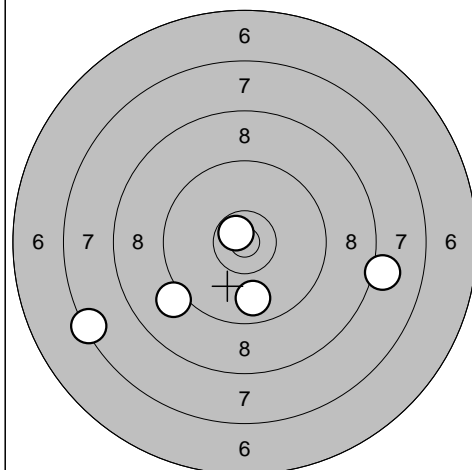

11: 10,7* ↖
 12: 7,4 ↙
 13: 8,1 →
 14: 9,1 ↙
 15: 9,8 ↓

Serie 43,0

Totalt 134,0

Tävlingssnitt

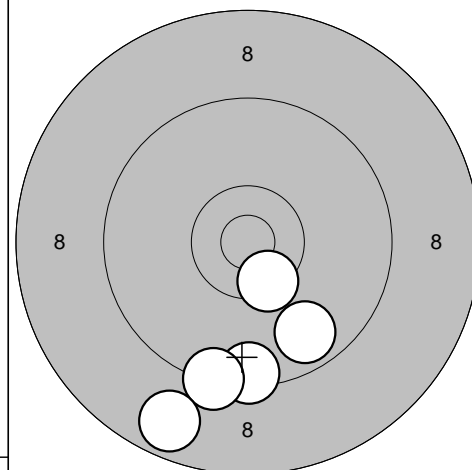

16: 9,7 ↓
 17: 9,5 ↓
 18: 9,3 ↓
 19: 10,4* ↓
 20: 8,7 ↓

Serie 45,0

Totalt 179,0

Kalix

2010-07-23

Tavelträffen 2010

Ramselefors SKF

Provskott

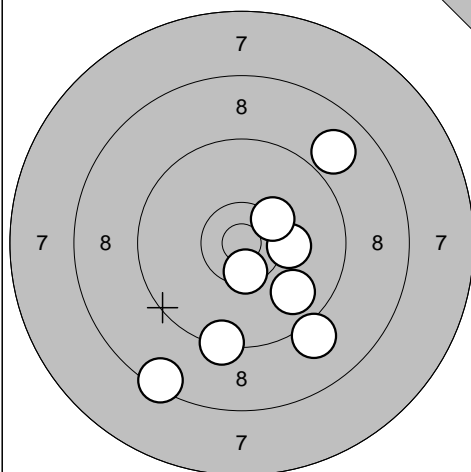

1: 9,1 ↘
 2: 10,5* ↓
 3: 9,3 ↓
 4: 10,2 →
 5: 8,9 ↗
 6: 9,8 ↘
 7: 10,3* ↗
 8: 8,4 ↓
 9: 0,0 ←

Serie 73,0

Totalt 0,0

Tävlingsskott

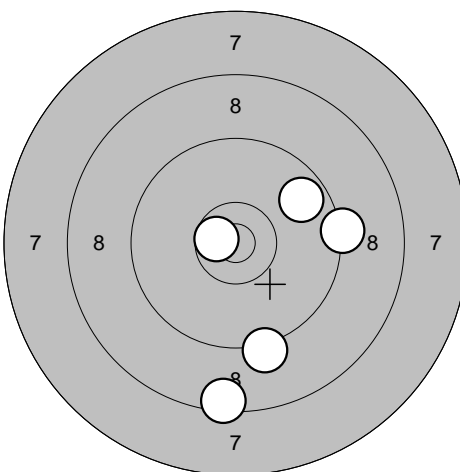

1: 9,7 ↗
 2: 10,6* ←
 3: 8,5 ↓
 4: 9,2 ↓
 5: 9,3 →

Serie 45,0

Totalt 45,0

Tävlingsskott

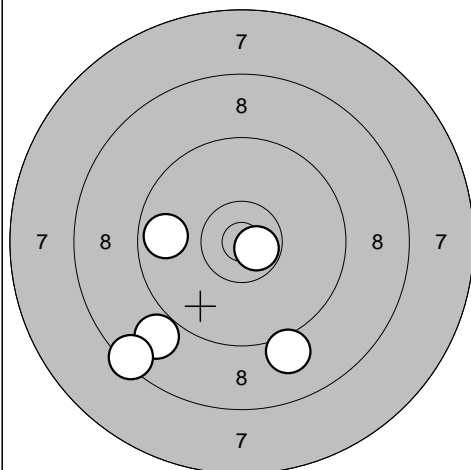

6: 9,1 ↓
 7: 10,7* →
 8: 9,8 ←
 9: 8,9 ↘
 10: 8,4 ↘

Serie 44,0

Totalt 89,0

Tävlingsskott

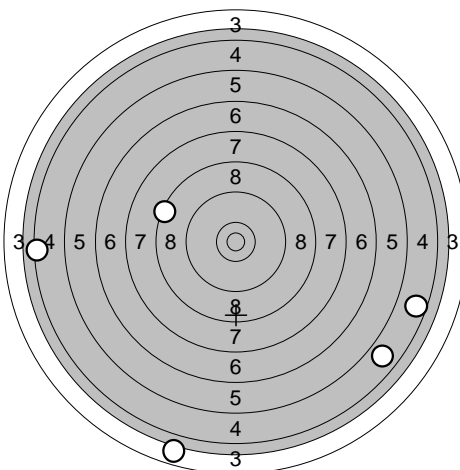

11: 4,4 ←
 12: 4,6 →
 13: 4,8 ↘
 14: 8,4 ←
 15: 3,8 ↓

Serie 23,0

Totalt 112,0

Tävlingsskott

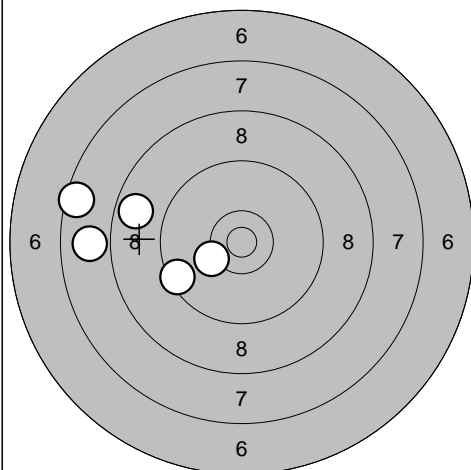

16: 8,8 ←
 17: 7,9 ←
 18: 9,5 ←
 19: 10,3 ←
 20: 7,5 ←

Serie 41,0

Totalt 153,0

Göteborg

2010-07-23

Tavelträffen 2010

Ramselefors SKF

Provskott

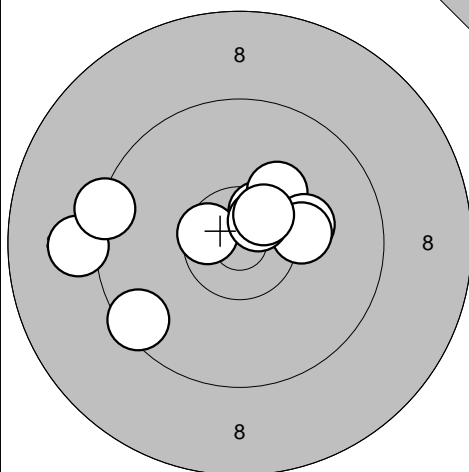

1: 9,5 ↙
 2: 9,1 ←
 3: 10,5* ↗
 4: 10,2 ↗
 5: 10,2 →
 6: 9,4 ←
 7: 10,2 →
 8: 10,6* ←
 9: 10,6* ↗
 10: 10,5* ↗

Serie 97,0

Totalt 0,0

Provskott

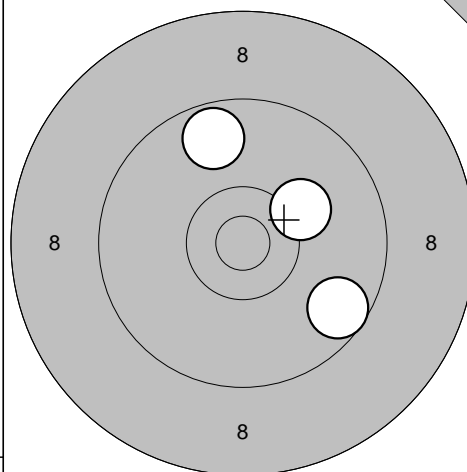

11: 9,6 ↘
 12: 9,7 ↑
 13: 10,2 ↗

Serie 28,0

Totalt 0,0

Tävlingsskott

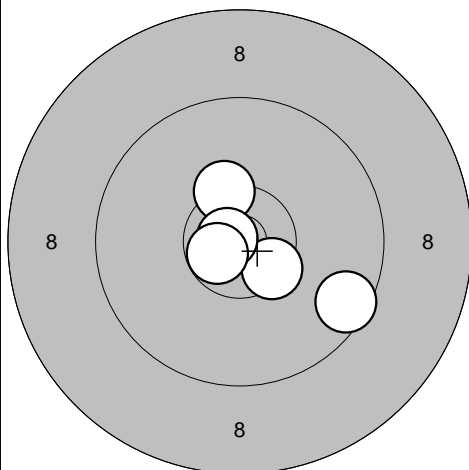

1: 10,4* ↑
 2: 10,5* ↘
 3: 9,6 ↘
 4: 10,8* ←
 5: 10,7* ←

Serie 49,0

Totalt 49,0

Tävlingsskott

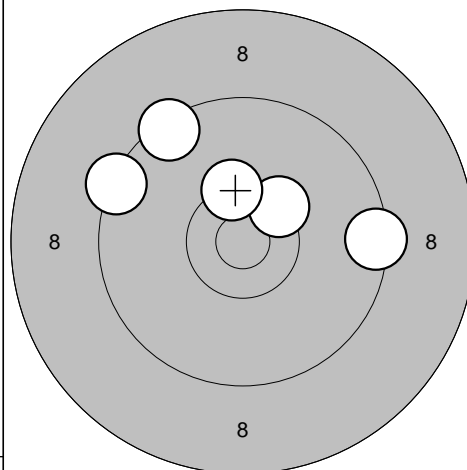

6: 9,4 →
 7: 10,4* ↗
 8: 9,4 ←
 9: 10,3* ↑
 10: 9,4 ↗

Serie 47,0

Totalt 96,0

Tävlingsskott

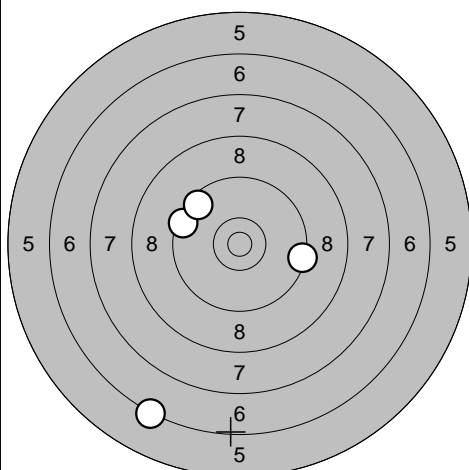

11: 9,5 ←
 12: 0,0 ↓
 13: 6,3 ↙
 14: 9,6 ↗
 15: 9,4 →

Serie 33,0

Totalt 129,0

Tävlingsskott

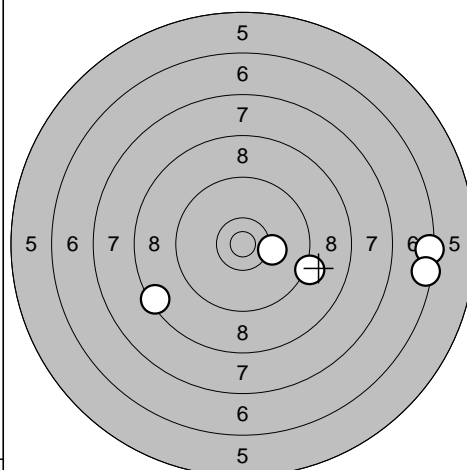

16: 9,2 ↘
 17: 10,2 →
 18: 6,4 →
 19: 8,4 ↙
 20: 6,4 →

Serie 39,0

Totalt 168,0

Umeå

2010-07-23

Tavelträffen 2010

Ramselefors SKF

Provskott

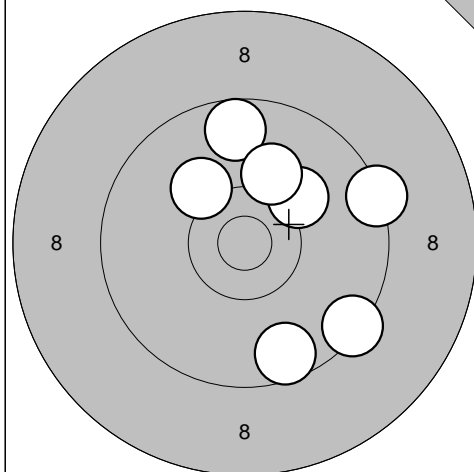

1: 10,1 ↗
 2: 9,6 ↓
 3: 9,7 ↑
 4: 10,2 ↗
 5: 10,1 ↑
 6: 9,4 ↓
 7: 9,3 ↗

Serie 66,0
 Totalt 0,0

Tävlingsskott

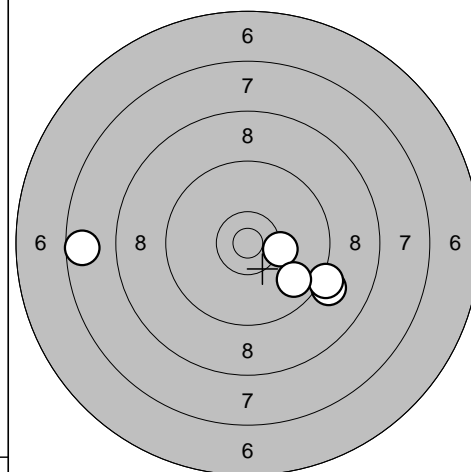

1: 10,3 →
 2: 9,1 ↘
 3: 9,2 ↘
 4: 9,8 ↘
 5: 7,6 ←

Serie 44,0
 Totalt 44,0

Tävlingsskott

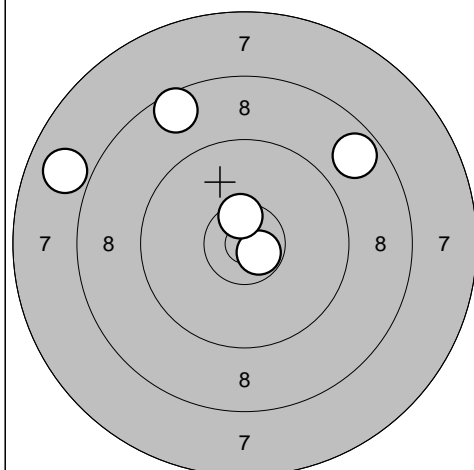

6: 7,9 ←
 7: 8,7 ↗
 8: 8,6 ↑
 9: 10,7* ↘
 10: 10,5* ↑

Serie 43,0
 Totalt 87,0

Tävlingsskott

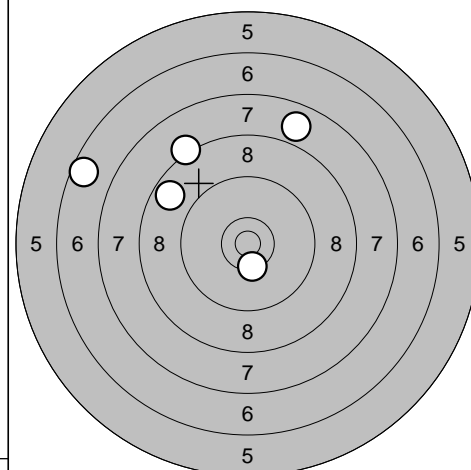

11: 7,9 ↑
 12: 10,4* ↓
 13: 6,6 ←
 14: 8,7 ↗
 15: 8,2 ↗

Serie 39,0
 Totalt 126,0

Tävlingsskott

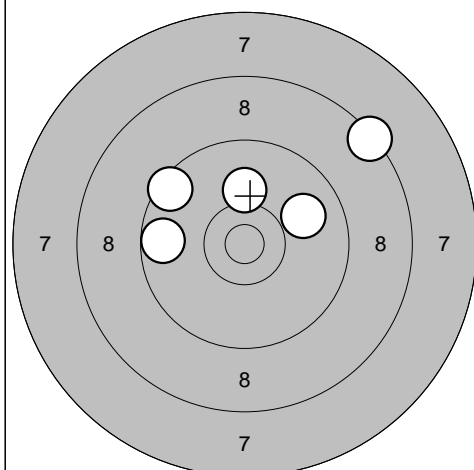

16: 9,7 ←
 17: 8,4 ↗
 18: 9,9 ↗
 19: 10,1 ↑
 20: 9,5 ↗

Serie 45,0
 Totalt 171,0

2010-07-23

Tavelträffen 2010

Ramselefors SKF

Provskott

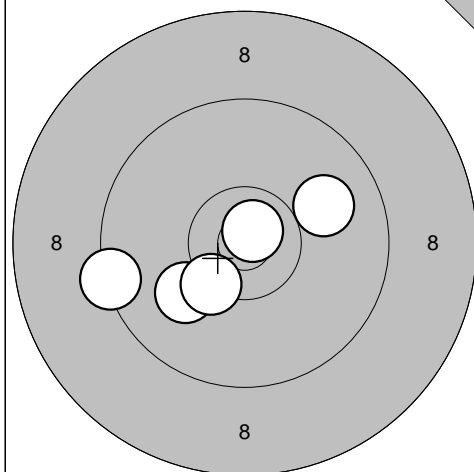

1: 10,1 ↙
 2: 10,3* ↙
 3: 9,4 ←
 4: 10,8* ↗
 5: 9,9 →

Serie 48,0
 Totalt 0,0

Tävlingsskott

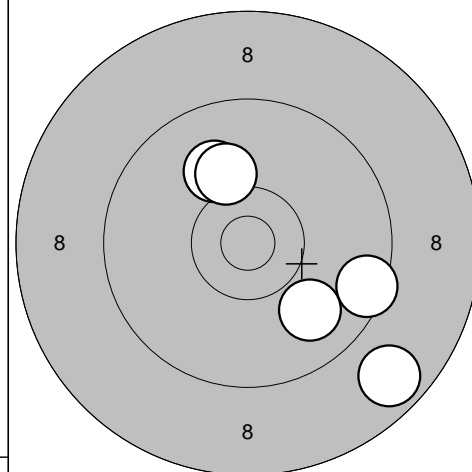

1: 10,1 ↗
 2: 10,1 ↗
 3: 8,7 ↘
 4: 9,5 ↘
 5: 9,9 ↘

Serie 46,0
 Totalt 46,0

Tävlingsskott

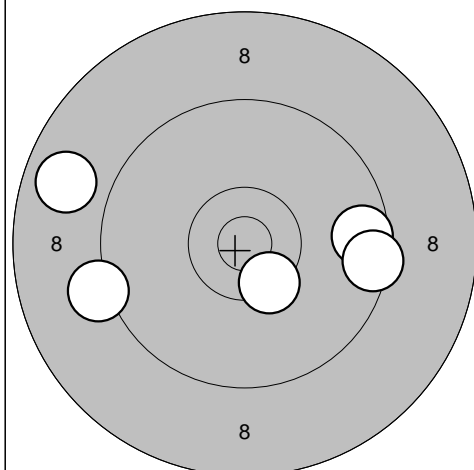

6: 10,4* ↘
 7: 8,8 ←
 8: 9,2 ←
 9: 9,6 →
 10: 9,5 →

Serie 45,0
 Totalt 91,0

Tävlingsskott

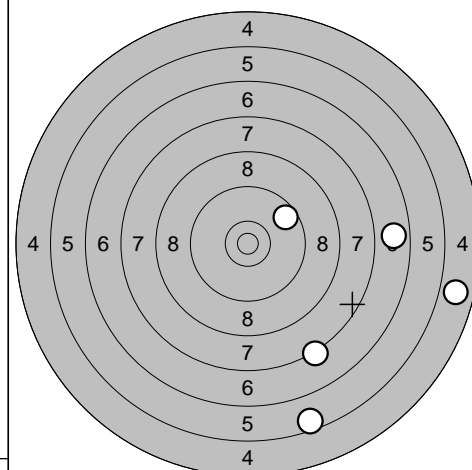

11: 6,8 →
 12: 7,2 ↘
 13: 9,6 ↗
 14: 5,6 ↘
 15: 4,8 →

Serie 31,0
 Totalt 122,0

Tävlingsskott

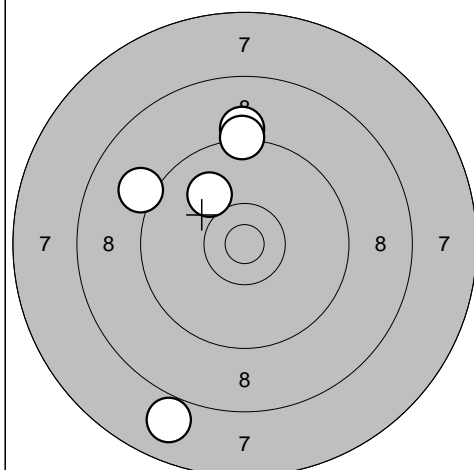

16: 9,1 ↑
 17: 10,0 ↗
 18: 9,1 ↗
 19: 7,9 ↘
 20: 9,3 ↑

Serie 44,0
 Totalt 166,0

Rundvik

2010-07-23

Tavelträffen 2010

Ramselefors SKF

Provskott

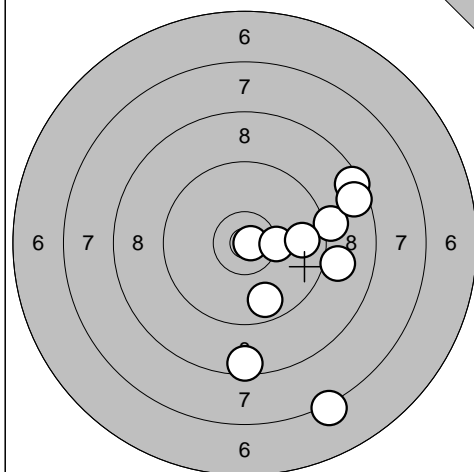

1: 8,5 →
 2: 7,2 ↓
 3: 8,5 ↓
 4: 9,2 →
 5: 10,8* →
 6: 10,3* →
 7: 9,0 →
 8: 9,7 ↓
 9: 8,6 →
 10: 9,8 →

Serie 87,0

Totalt 0,0

Provskott

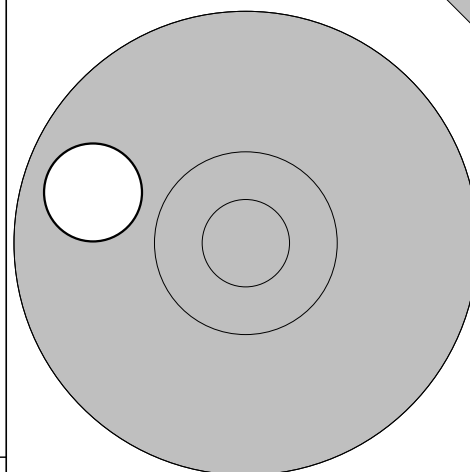

11: 9,8 ←

Serie 9,0

Totalt 0,0

Tävlingsskott

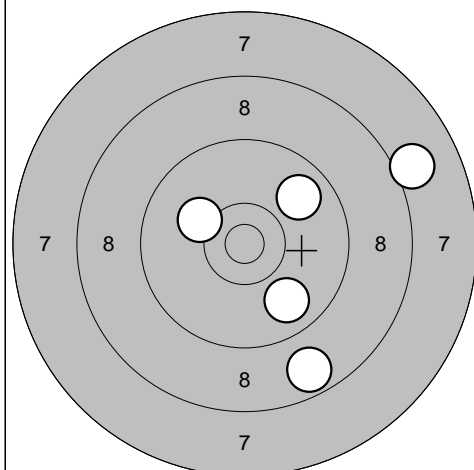

1: 8,7 ↓
 2: 9,8 ↓
 3: 8,0 →
 4: 10,2 ↖
 5: 9,8 ↗

Serie 44,0

Totalt 44,0

Tävlingsskott

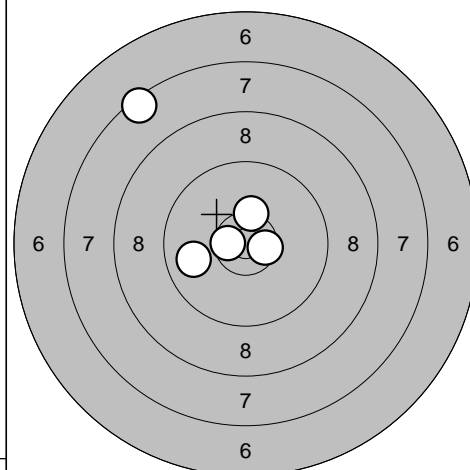

6: 10,6* ←
 7: 10,3* ↑
 8: 7,5 ↖
 9: 10,5* →
 10: 9,9 ←

Serie 46,0

Totalt 90,0

Tävlingsskott

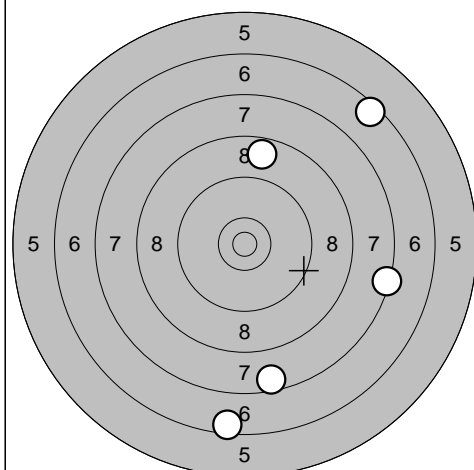

11: 6,5 ↓
 12: 8,7 ↑
 13: 7,6 ↓
 14: 7,4 →
 15: 6,5 ↗

Serie 34,0

Totalt 124,0

Tävlingsskott

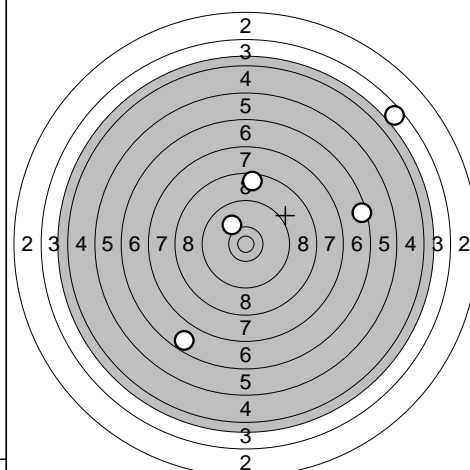

16: 6,7 ↓
 17: 6,5 →
 18: 10,1 ↖
 19: 8,6 ↑
 20: 3,6 ↗

Serie 33,0

Totalt 157,0

Drängsmark

2010-07-23

Tavelträffen 2010

Ramselefors SKF

Provskott

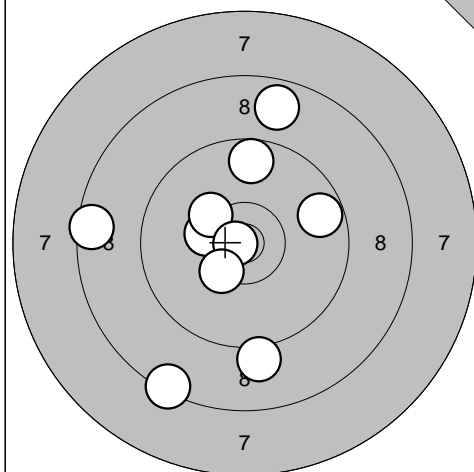

1: 8,8 ↗
 2: 8,4 ↘
 3: 9,7 →
 4: 8,5 ←
 5: 10,3* ←
 6: 10,3 ↗
 7: 9,7 ↑
 8: 10,8* ←
 9: 9,1 ↓
 10: 10,4* ↘

Serie 91,0

Totalt 0,0

Tävlingsskott

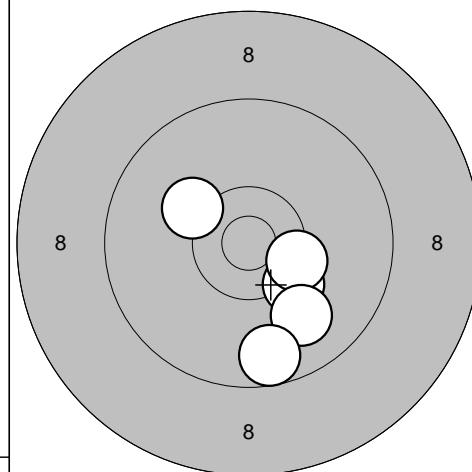

1: 10,3 ↘
 2: 10,4* ↘
 3: 9,9 ↘
 4: 9,6 ↘
 5: 10,2 ↗

Serie 48,0

Totalt 48,0

Tävlingsskott

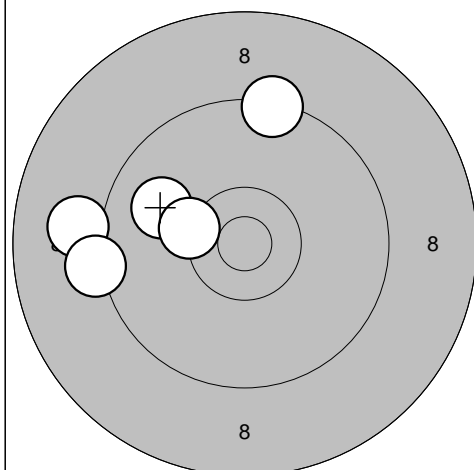

6: 9,0 ←
 7: 9,2 ←
 8: 9,4 ↑
 9: 9,9 ←
 10: 10,3* ←

Serie 46,0

Totalt 94,0

Tävlingsskott

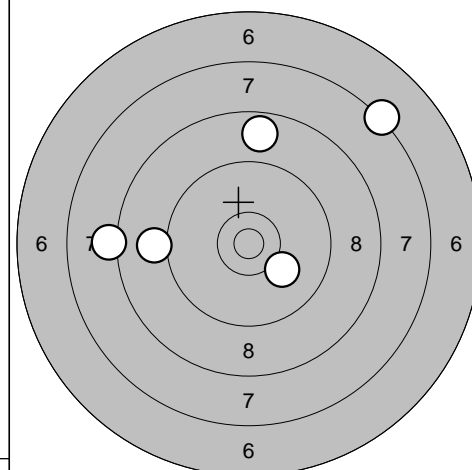

11: 9,1 ←
 12: 8,2 ←
 13: 8,7 ↑
 14: 7,3 ↗
 15: 10,1 ↘

Serie 42,0

Totalt 136,0

Tävlingsskott

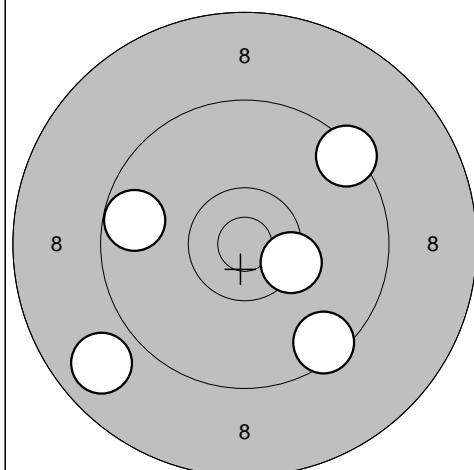

16: 10,4* →
 17: 9,4 ↗
 18: 9,7 ←
 19: 9,5 ↘
 20: 8,8 ↘

Serie 45,0

Totalt 181,0

Djurö

2010-07-23

Tavelträffen 2010

Ramselefors SKF

Provskott

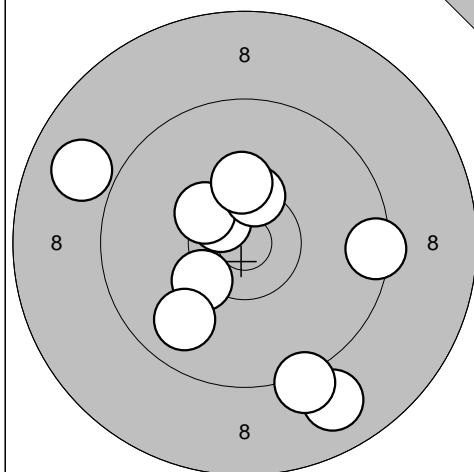

1: 10,6* ↗
 2: 8,9 ↘
 3: 10,3* ↙
 4: 8,9 ↗
 5: 10,4* ↗
 6: 9,4 →
 7: 9,8 ↙
 8: 9,2 ↘
 9: 10,4* ↑
 10: 10,3 ↑

Serie 93,0

Totalt 0,0

Tävlingsskott

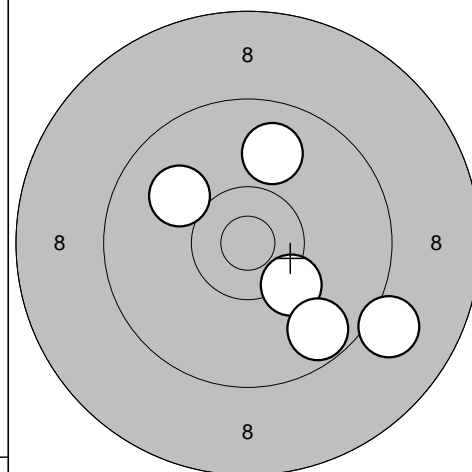

1: 10,3 ↘
 2: 9,1 ↘
 3: 9,7 ↘
 4: 10,0 ↗
 5: 9,9 ↑

Serie 47,0

Totalt 47,0

Tävlingsskott

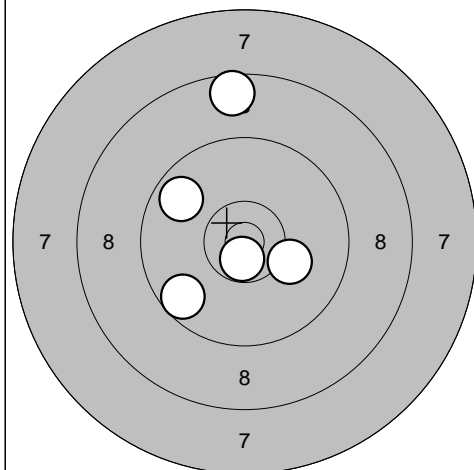

6: 8,6 ↑
 7: 10,2 →
 8: 9,7 ↙
 9: 10,7* ↘
 10: 9,8 ↗

Serie 46,0

Totalt 93,0

Tävlingsskott

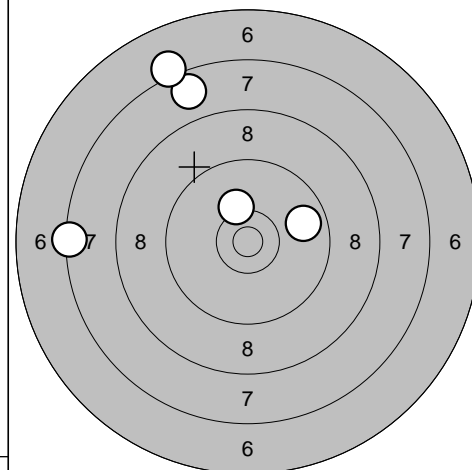

11: 7,4 ←
 12: 10,2 ↑
 13: 7,7 ↑
 14: 9,8 →
 15: 7,2 ↑

Serie 40,0

Totalt 133,0

Tävlingsskott

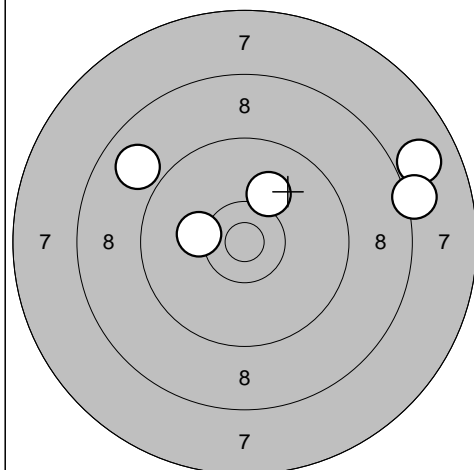

16: 7,9 →
 17: 8,9 ↗
 18: 10,2 ←
 19: 10,1 ↗
 20: 8,2 →

Serie 43,0

Totalt 176,0

Ununge

2010-07-23

Tavelträffen 2010

Ramselefors SKF

Provs-kott

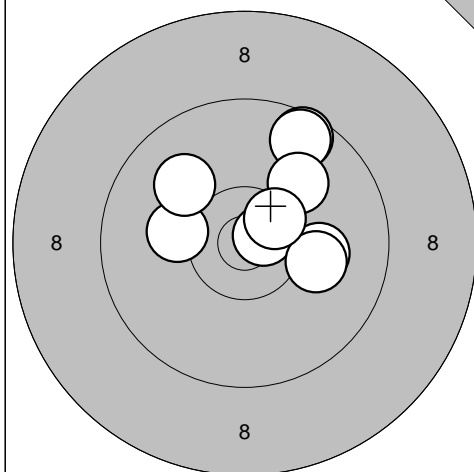

1: 10,2 ←
 2: 9,6 ↗
 3: 10,1 →
 4: 9,6 ↗
 5: 10,0 ↗
 6: 10,7* →
 7: 10,0 ↗
 8: 10,1 →
 9: 10,5* ↗

Serie 88,0

Totalt 0,0

Tävlingsskott

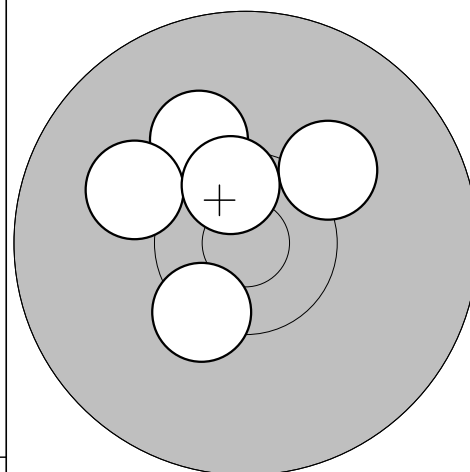

1: 10,2 ↗
 2: 10,4* ↘
 3: 10,1 ↗
 4: 10,1 ↘
 5: 10,5* ↗

Serie 50,0

Totalt 50,0

Tävlingsskott

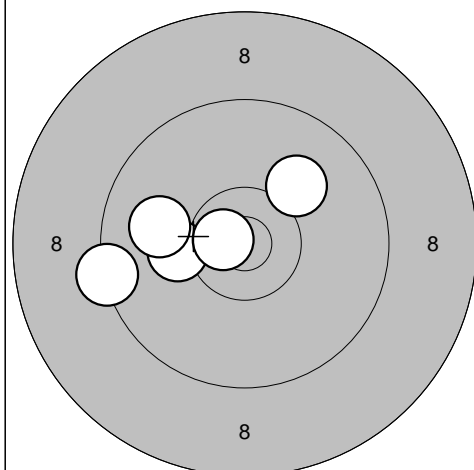

6: 9,3 ←
 7: 10,2 ←
 8: 10,1 ↗
 9: 10,0 ←
 10: 10,7* ←

Serie 49,0

Totalt 99,0

Tävlingsskott

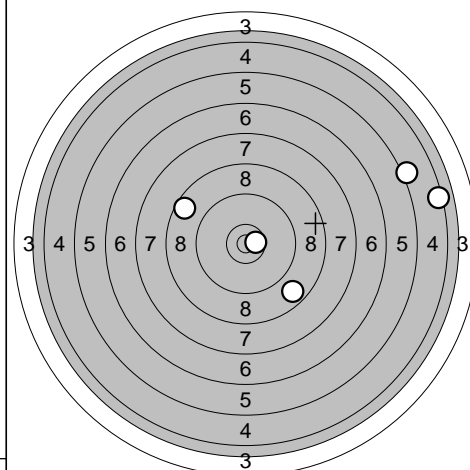

11: 8,6 ↘
 12: 8,7 ↘
 13: 10,6* →
 14: 5,2 →
 15: 4,4 →

Serie 35,0

Totalt 134,0

Tävlingsskott

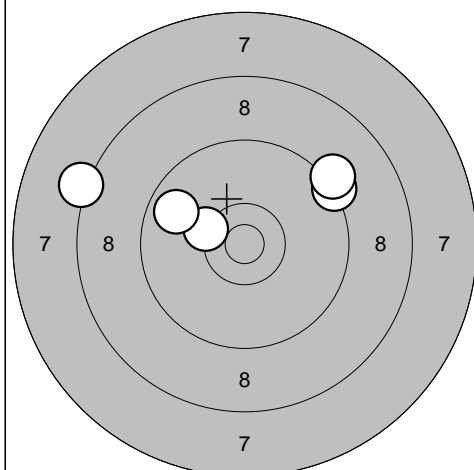

16: 8,2 ←
 17: 10,3* ←
 18: 9,8 ↘
 19: 9,3 ↗
 20: 9,2 ↗

Serie 45,0

Totalt 179,0

2010-07-23

Tavelträffen 2010

Ramselefors SKF

Provskott

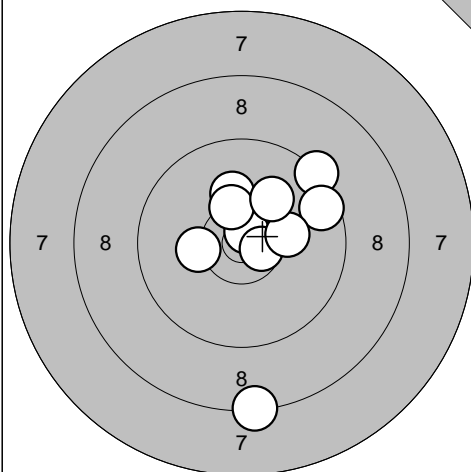

1: 8,3 ↓
 2: 10,8* ↗
 3: 10,2 ↑
 4: 9,3 ↗
 5: 9,6 →
 6: 10,3 ←
 7: 10,6* →
 8: 10,4* ↑
 9: 10,2 →
 10: 10,1 ↗

Serie 96,0

Totalt 0,0

Tävlingsskott

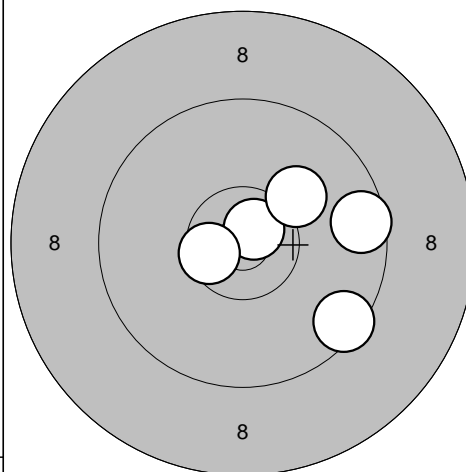

1: 9,5 ↘
 2: 10,7* ↗
 3: 10,1 ↗
 4: 9,6 →
 5: 10,6* ←

Serie 48,0

Totalt 48,0

Tävlingsskott

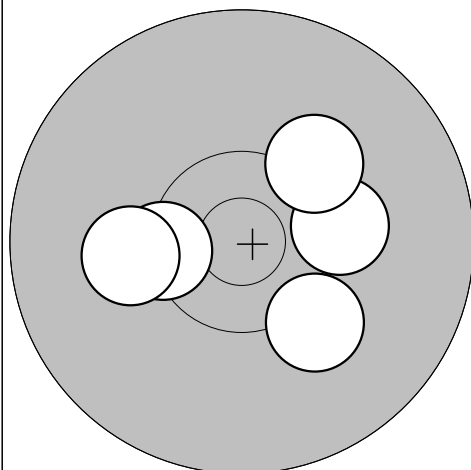

6: 10,2 →
 7: 10,2 ↗
 8: 10,2 ↓
 9: 10,4* ←
 10: 10,2 ←

Serie 50,0

Totalt 98,0

Tävlingsskott

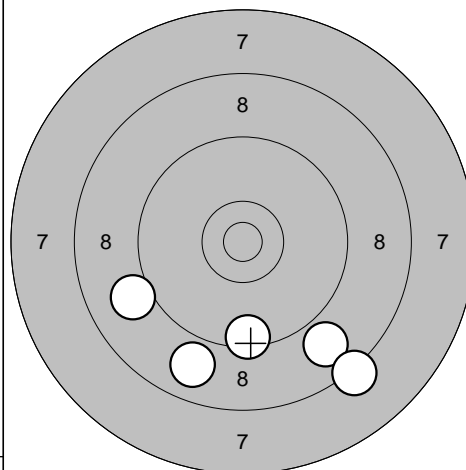

11: 9,4 ↓
 12: 8,9 ↓
 13: 8,9 ↓
 14: 8,2 ↓
 15: 9,0 ↙

Serie 42,0

Totalt 140,0

Tävlingsskott

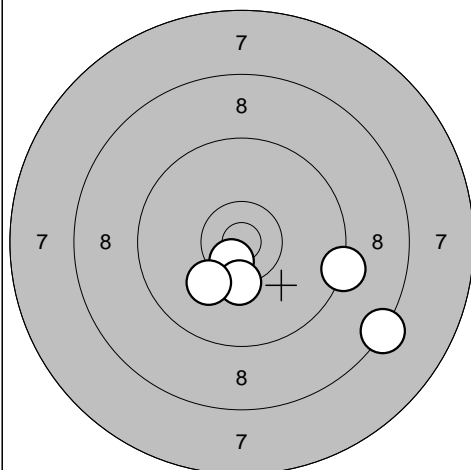

16: 10,6* ↘
 17: 10,3* ↓
 18: 8,3 ↘
 19: 10,1 ↘
 20: 9,3 →

Serie 47,0

Totalt 187,0

Skellefteå

2010-07-23

Tavelträffen 2010

Ramselefors SKF

Provskott

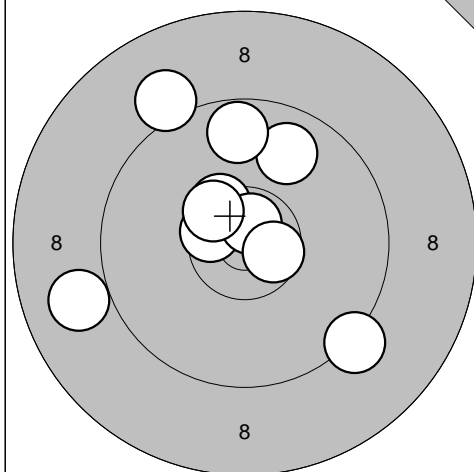

1: 10,4* ↗
 2: 9,8 ↗
 3: 9,1 ↗
 4: 9,2 ↘
 5: 9,7 ↗
 6: 10,5* ↖
 7: 10,7* ↗
 8: 10,6* ↘
 9: 9,0 ↖
 10: 10,4* ↗

Serie 95,0

Totalt 0,0

Provskott

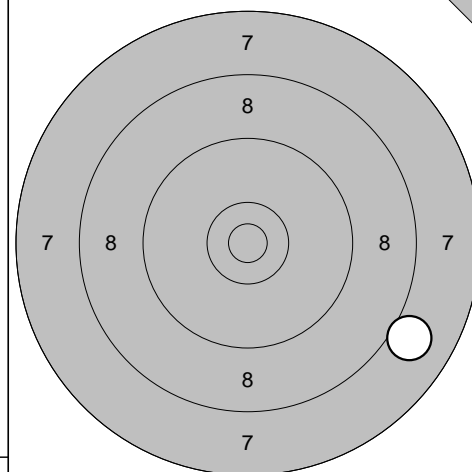

11: 8,0 ↘

Serie 8,0

Totalt 0,0

Tävlingsskott

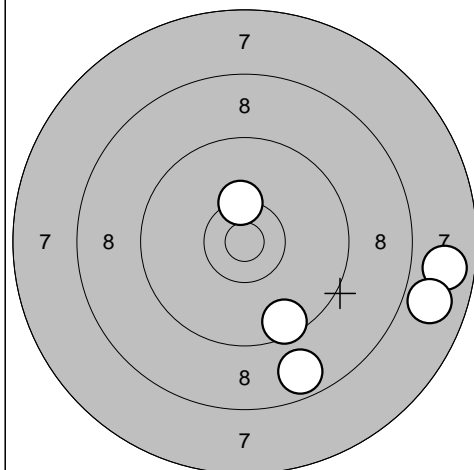

1: 7,8 →
 2: 7,9 →
 3: 9,5 ↘
 4: 10,3* ↗
 5: 8,7 ↘

Serie 41,0

Totalt 41,0

Tävlingsskott

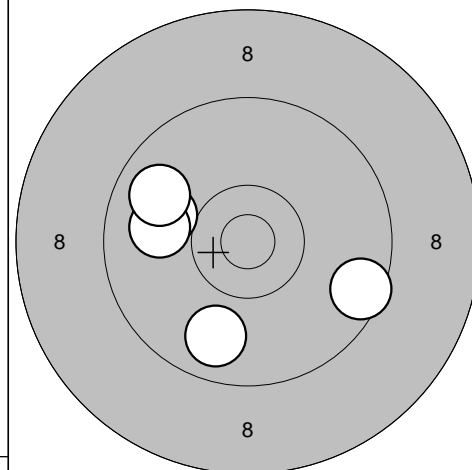

6: 10,0 ↖
 7: 9,5 →
 8: 9,8 ↘
 9: 9,9 ↖
 10: 9,8 ↖

Serie 46,0

Totalt 87,0

Tävlingsskott

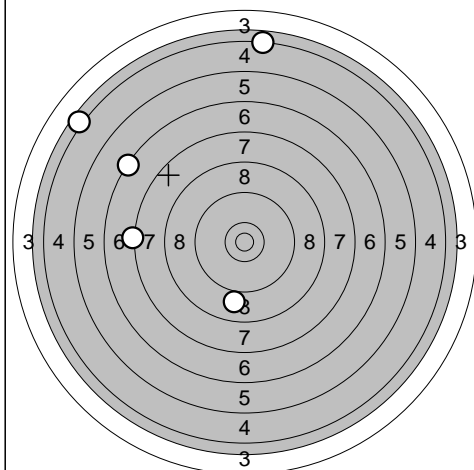

11: 4,2 ↖
 12: 4,4 ↗
 13: 6,4 ↗
 14: 7,3 ↖
 15: 8,9 ↘

Serie 29,0

Totalt 116,0

Tävlingsskott

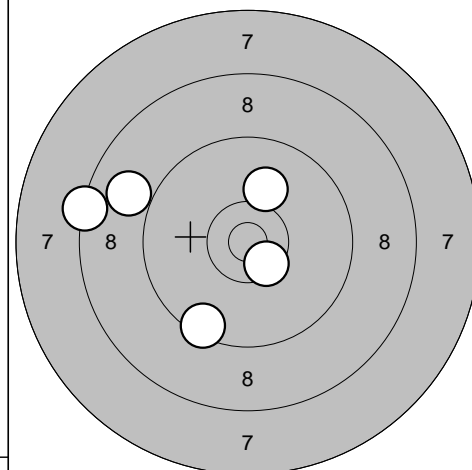

16: 10,1 ↗
 17: 8,3 ↖
 18: 10,5* ↘
 19: 8,9 ↖
 20: 9,5 ↘

Serie 45,0

Totalt 161,0

Bälinge-Jumkil

2010-07-23

Tavelträffen 2010

Ramselefors SKF

Provskott

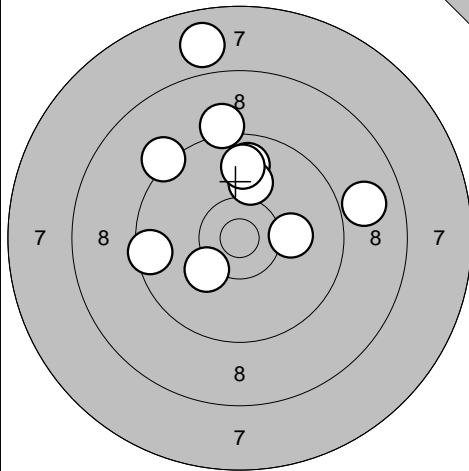

1: 10,2 ↙
 2: 9,5 ←
 3: 8,9 →
 4: 9,2 ↖
 5: 9,8 ↑
 6: 7,9 ↑
 7: 9,2 ↑
 8: 10,1 ↑
 9: 9,8 ↑
 10: 10,1 →

Serie 90,0

Totalt 0,0

Provskott

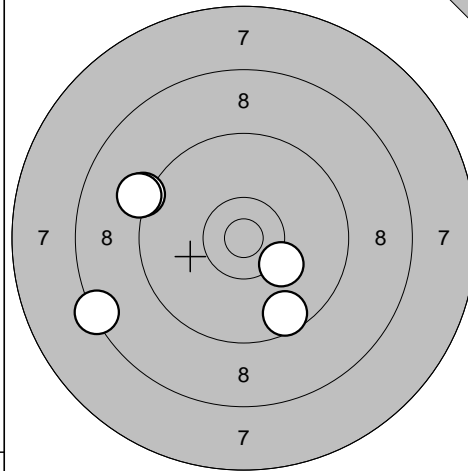

11: 9,2 ↖
 12: 9,2 ↖
 13: 8,4 ↖
 14: 10,2 ↘
 15: 9,6 ↘

Serie 45,0

Totalt 0,0

Tävlingsskott

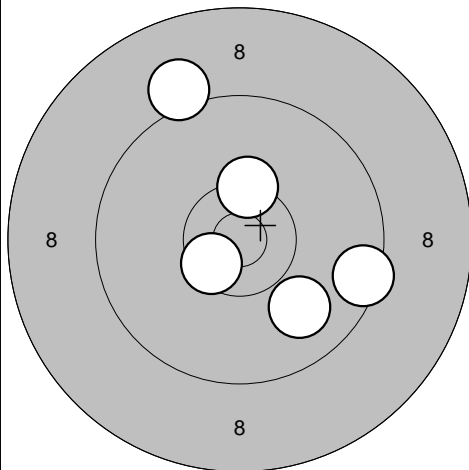

1: 9,1 ↖
 2: 10,5* ↘
 3: 9,9 ↘
 4: 9,5 →
 5: 10,3* ↑

Serie 47,0

Totalt 47,0

Tävlingsskott

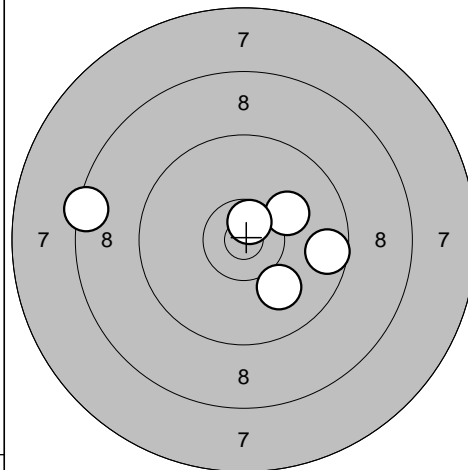

6: 9,6 →
 7: 10,0 ↘
 8: 10,1 ↗
 9: 10,7* ↑
 10: 8,4 ←

Serie 47,0

Totalt 94,0

Tävlingsskott

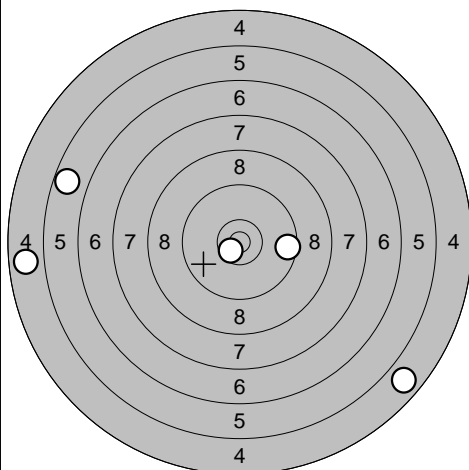

11: 9,6 →
 12: 4,8 ↘
 13: 5,7 ↖
 14: 10,6* ↘
 15: 4,8 ←

Serie 32,0

Totalt 126,0

Tävlingsskott

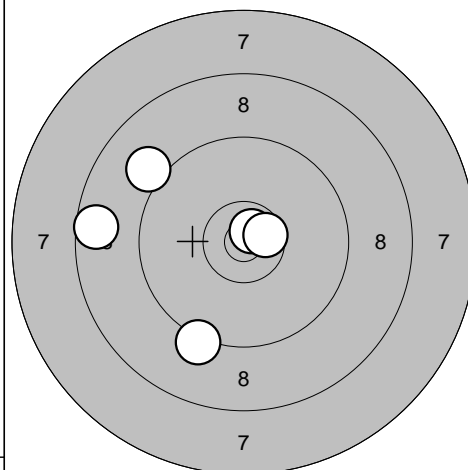

16: 10,7* ↗
 17: 8,6 ←
 18: 10,6* →
 19: 9,1 ↖
 20: 9,2 ↘

Serie 46,0

Totalt 172,0

Bälinge-Jumkil

2010-07-23

Tavelträffen 2010

Ramselefors SKF

Provskott

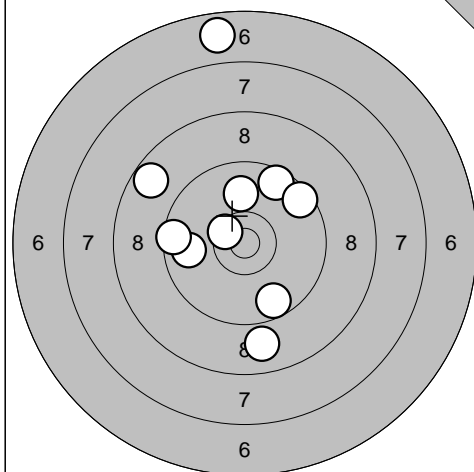

1: 9,6 ↗
 2: 6,8 ↑
 3: 10,0 ↑
 4: 10,5* ↖
 5: 8,9 ↓
 6: 9,8 ←
 7: 9,5 ↗
 8: 8,7 ↖
 9: 9,7 ↓
 10: 9,5 ←

Serie 87,0

Totalt 0,0

Tävlingsskott

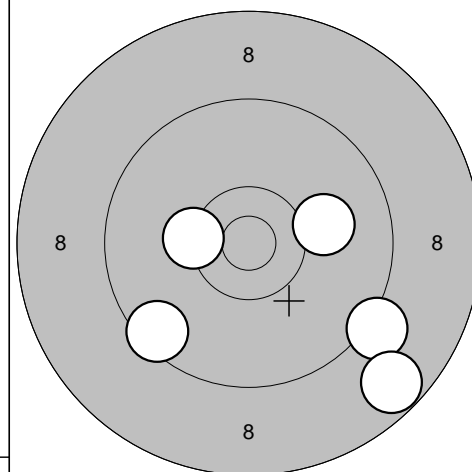

1: 10,1 →
 2: 9,2 ↘
 3: 10,3* ←
 4: 8,7 ↘
 5: 9,5 ↘

Serie 46,0

Totalt 46,0

Tävlingsskott

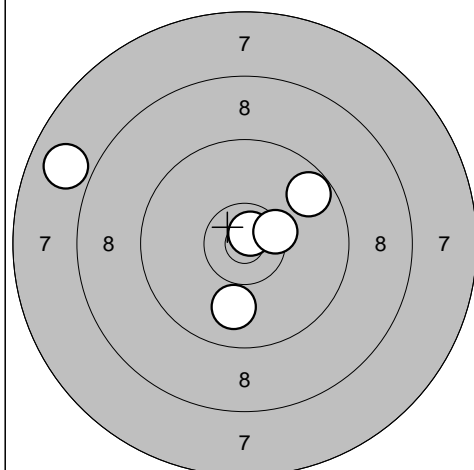

6: 7,9 ←
 7: 10,8* ↗
 8: 9,9 ↓
 9: 9,7 ↗
 10: 10,4* →

Serie 45,0

Totalt 91,0

Tävlingsskott

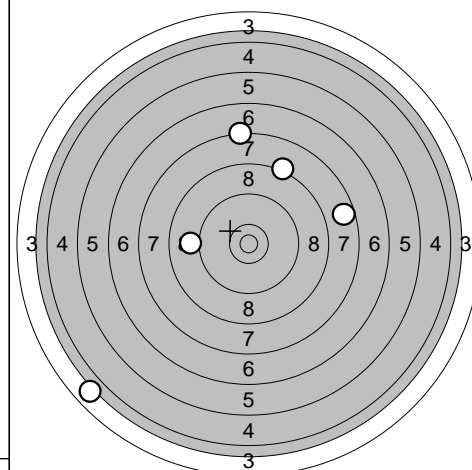

11: 3,8 ↙
 12: 9,0 ←
 13: 7,7 →
 14: 7,3 ↑
 15: 8,3 ↗

Serie 34,0

Totalt 125,0

Tävlingsskott

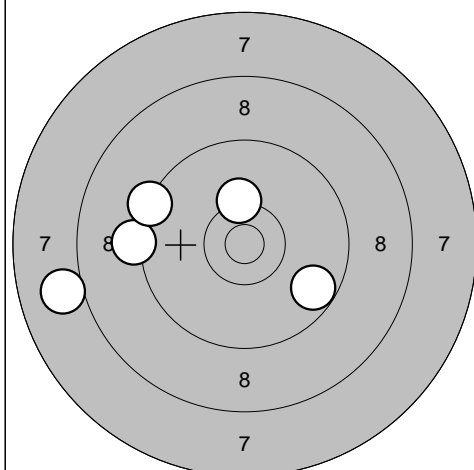

16: 9,2 ←
 17: 8,0 ←
 18: 9,3 ↖
 19: 10,3 ↑
 20: 9,7 ↘

Serie 45,0

Totalt 170,0

Bälinge-Jumkil

2010-07-23

Tavelträffen 2010

Ramselefors SKF

Provskott

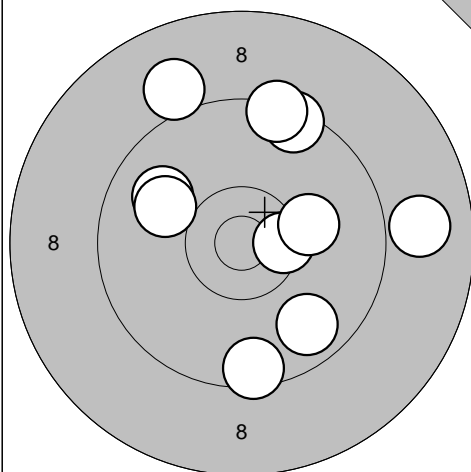

1: 8,9 →
 2: 9,4 ↗
 3: 9,4 ↗
 4: 10,5* →
 5: 9,9 ↗
 6: 10,0 ↗
 7: 9,0 ↗
 8: 10,2 →
 9: 9,8 ↘
 10: 9,5 ↘

Serie 92,0

Totalt 0,0

Provskott

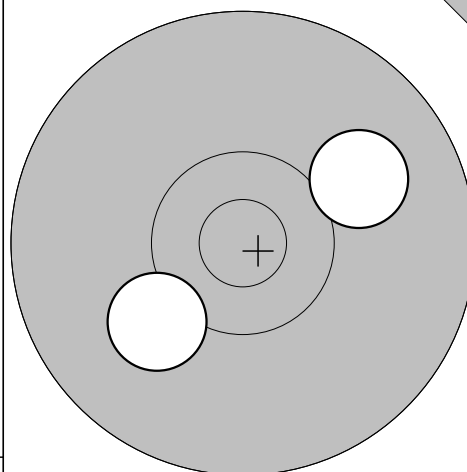

11: 10,1 ↙
 12: 10,0 →

Serie 20,0

Totalt 0,0

Tävlingsskott

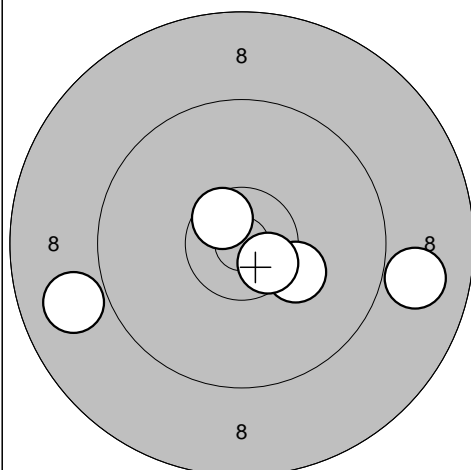

1: 8,9 →
 2: 10,2 ↘
 3: 10,6* ↘
 4: 10,6* ↗
 5: 8,9 ←

Serie 46,0

Totalt 46,0

Tävlingsskott

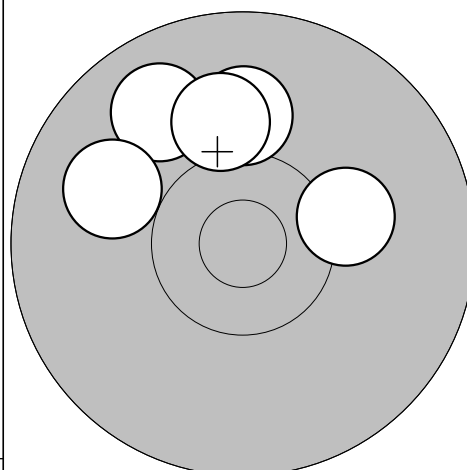

6: 9,9 ↖
 7: 10,2 →
 8: 10,0 ↑
 9: 9,9 ↖
 10: 10,1 ↑

Serie 48,0

Totalt 94,0

Tävlingsskott

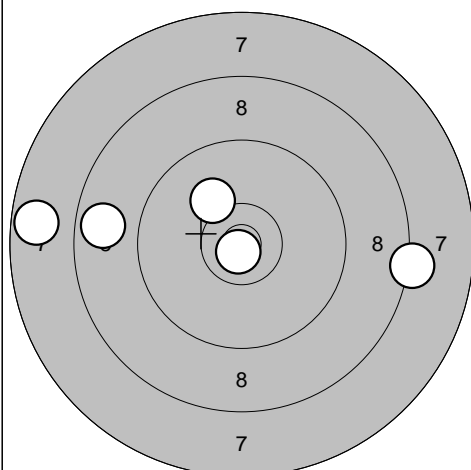

11: 7,7 ←
 12: 8,2 →
 13: 8,8 ←
 14: 10,1 ↗
 15: 10,8* ↘

Serie 43,0

Totalt 137,0

Tävlingsskott

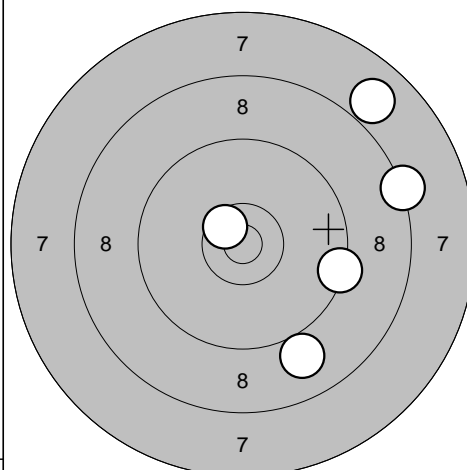

16: 7,9 ↗
 17: 9,4 →
 18: 9,0 ↘
 19: 10,6* ↗
 20: 8,3 →

Serie 43,0

Totalt 180,0

Niemisel

2010-07-23

Tavelträffen 2010

Ramselefors SKF

Provsnitt

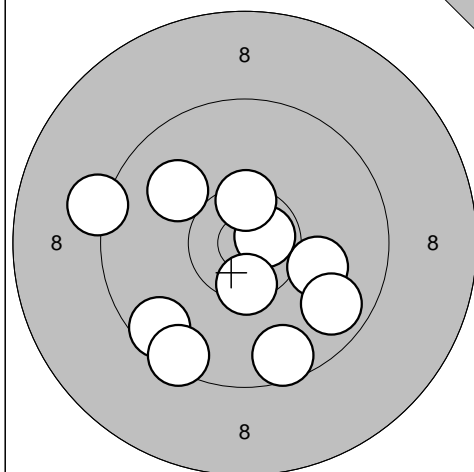

1: 10,1 →
 2: 9,7 ↘
 3: 10,0 ↗
 4: 10,7* →
 5: 10,5* ↓
 6: 9,2 ←
 7: 9,6 ↙
 8: 9,6 ↓
 9: 10,5* ↑
 10: 9,5 ↘

Serie 95,0

Totalt 0,0

Provsnitt

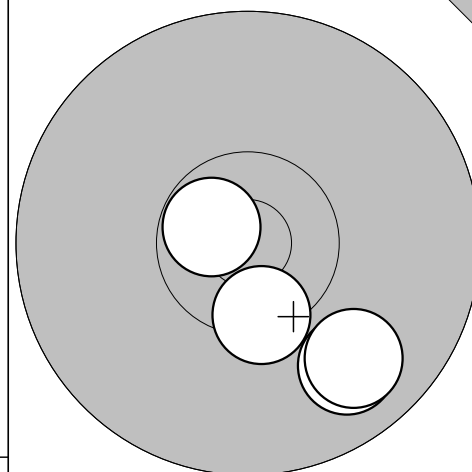

11: 9,8 ↘
 12: 10,7* ↗
 13: 10,4* ↓
 14: 9,8 ↘

Serie 38,0

Totalt 0,0

Tävlingssnitt

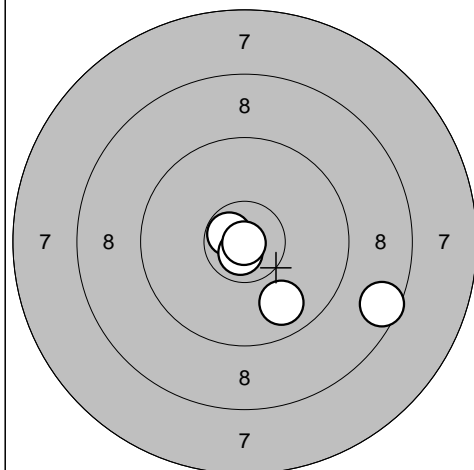

1: 10,7* ↖
 2: 9,8 ↘
 3: 10,8* ↘
 4: 8,6 →
 5: 10,9* ↓

Serie 47,0

Totalt 47,0

Tävlingssnitt

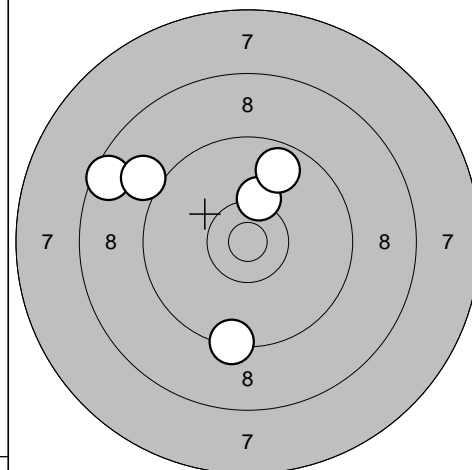

6: 8,5 ↖
 7: 9,0 ↖
 8: 9,3 ↓
 9: 10,3 ↑
 10: 9,7 ↑

Serie 45,0

Totalt 92,0

Tävlingssnitt

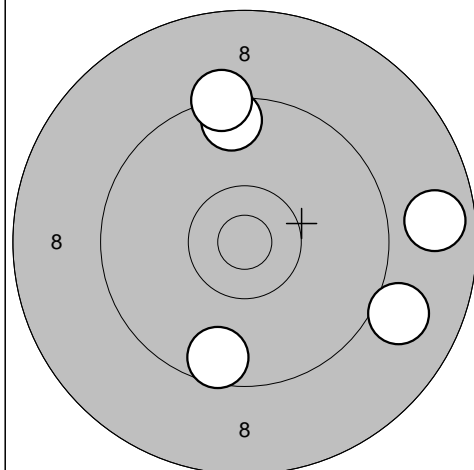

11: 9,6 ↑
 12: 9,6 ↓
 13: 9,0 →
 14: 8,8 →
 15: 9,3 ↑

Serie 44,0

Totalt 136,0

Tävlingssnitt

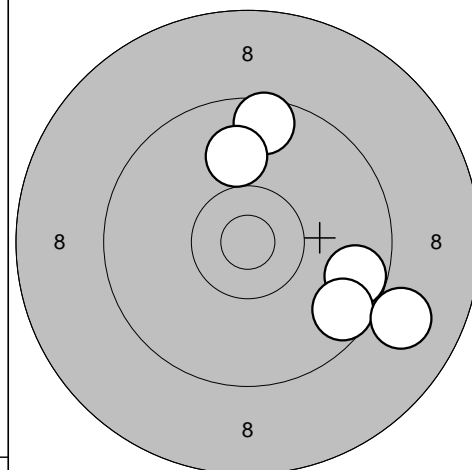

16: 9,7 →
 17: 9,6 ↘
 18: 9,0 ↘
 19: 9,6 ↑
 20: 10,0 ↑

Serie 46,0

Totalt 182,0

Ramselefors

2010-07-23

Tavelträffen 2010

Ramselefors SKF

Provskott

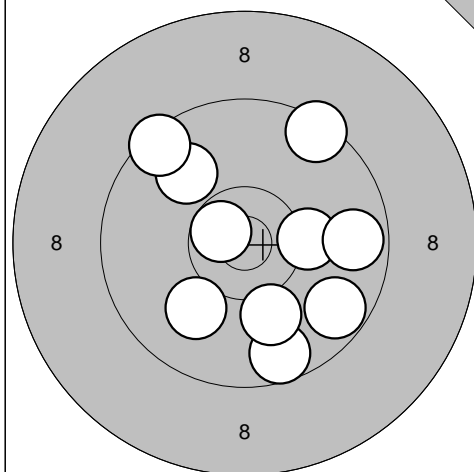

1: 9,9 ↗
 2: 9,4 ↗
 3: 10,2 →
 4: 9,5 ↗
 5: 10,7* ↗
 6: 9,7 →
 7: 9,6 ↓
 8: 10,1 ↓
 9: 9,7 ↓
 10: 10,0 ↓

Serie 94,0

Totalt 0,0

Provskott

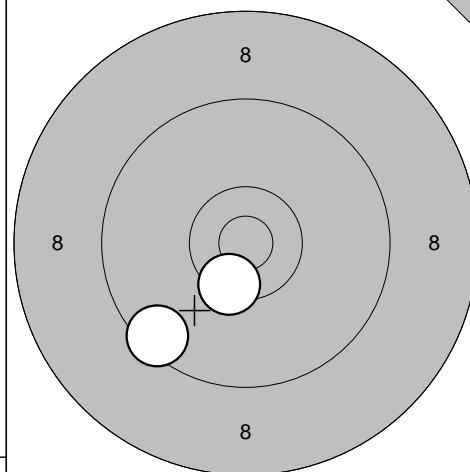

11: 9,5 ↘
 12: 10,4* ↘

Serie 19,0

Totalt 0,0

Tävlingsskott

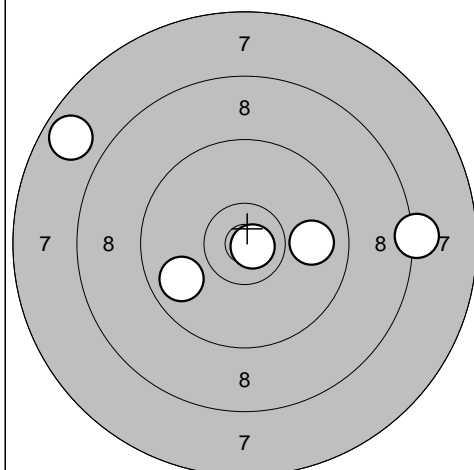

1: 8,2 →
 2: 10,8* →
 3: 9,9 →
 4: 7,8 ↗
 5: 9,8 ↙

Serie 43,0

Totalt 43,0

Tävlingsskott

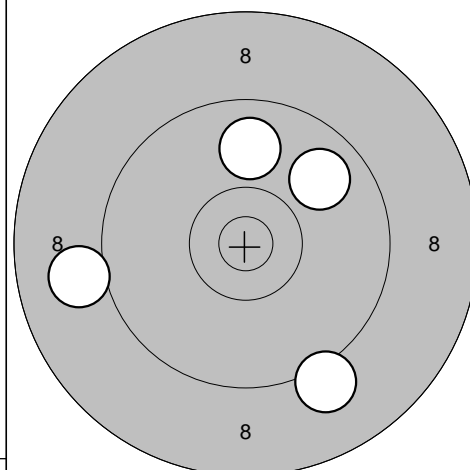

6: 9,9 ↑
 7: 9,8 ↗
 8: 9,0 ←
 9: 9,1 ↓
 0,0 ↘

Serie 36,0

Totalt 79,0

Tävlingsskott

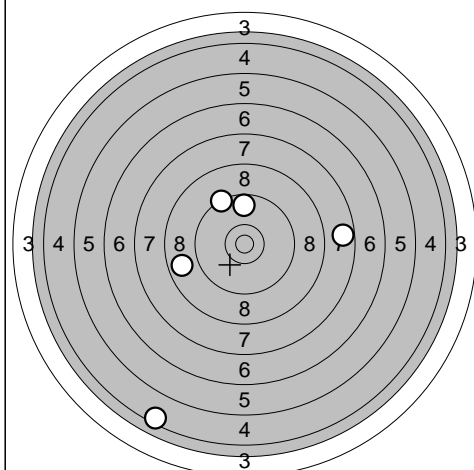

11: 8,8 ←
 12: 7,7 →
 13: 9,7 ↑
 14: 9,3 ↗
 15: 4,5 ↓

Serie 37,0

Totalt 116,0

Tävlingsskott

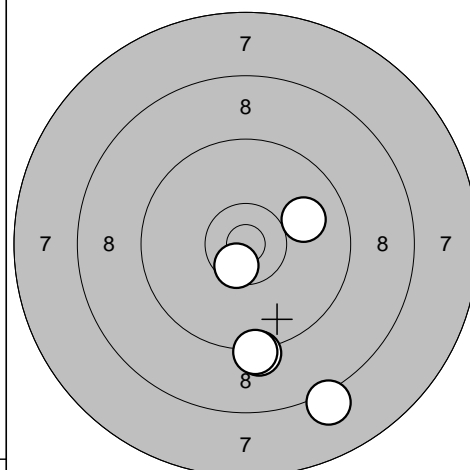

16: 8,1 ↓
 17: 10,6* ↓
 18: 9,2 ↓
 19: 9,2 ↓
 20: 10,0 →

Serie 46,0

Totalt 162,0

Hajom

2010-07-23

Tavelträffen 2010

Ramselefors SKF

Provskott

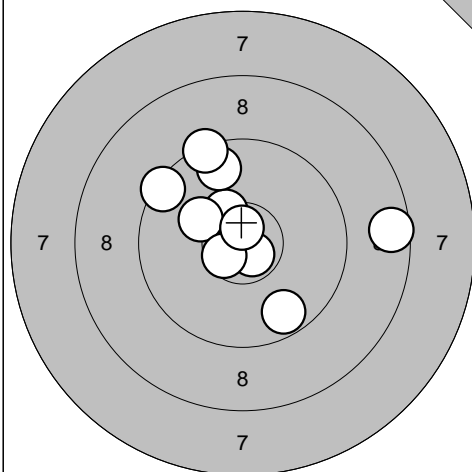

1: 10,4* ↗
 2: 8,6 →
 3: 9,4 ↗
 4: 9,7 ↗
 5: 10,2 ↗
 6: 9,7 ↘
 7: 10,7* ↘
 8: 10,6* ↙
 9: 9,4 ↗
 10: 10,7* ↑

Serie 94,0

Totalt 0,0

Provskott

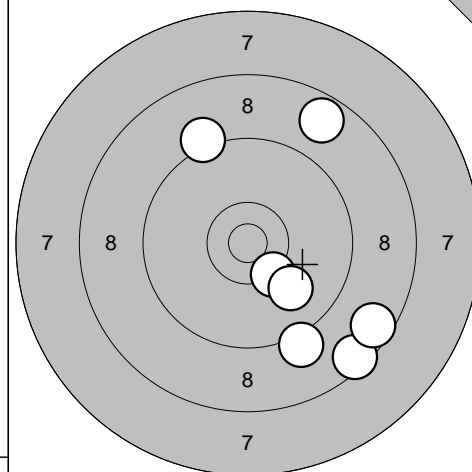

11: 8,5 ↘
 12: 9,1 ↘
 13: 8,6 ↘
 14: 8,7 ↗
 15: 10,3* ↘
 16: 10,0 ↘
 17: 9,2 ↗

Serie 62,0

Totalt 0,0

Tävlingsskott

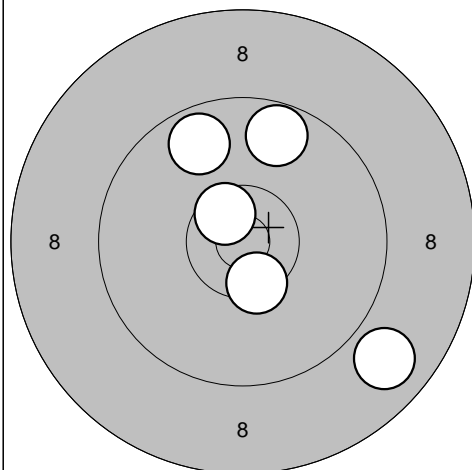

1: 10,6* ↗
 2: 9,7 ↗
 3: 8,8 ↘
 4: 10,4* ↘
 5: 9,7 ↗

Serie 46,0

Totalt 46,0

Tävlingsskott

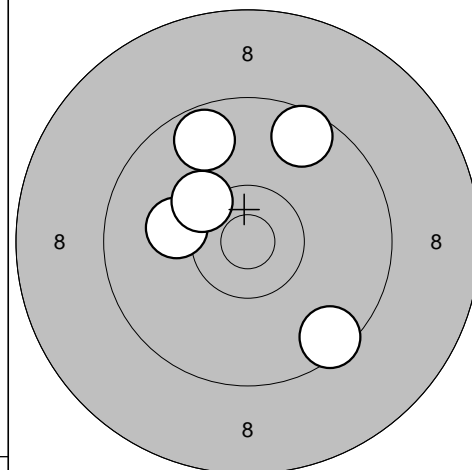

6: 9,6 ↗
 7: 10,1 ←
 8: 9,5 ↘
 9: 10,3 ↗
 10: 9,7 ↗

Serie 47,0

Totalt 93,0

Tävlingsskott

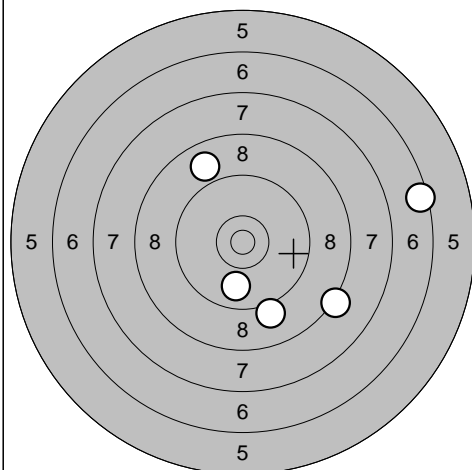

11: 9,1 ↘
 12: 6,5 →
 13: 9,9 ↘
 14: 8,2 ↘
 15: 8,9 ↗

Serie 40,0

Totalt 133,0

Tävlingsskott

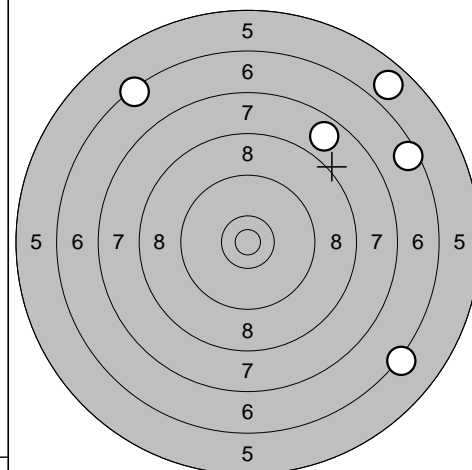

16: 6,2 ↘
 17: 6,5 ↗
 18: 6,4 ↗
 19: 5,8 ↗
 20: 7,8 ↗

Serie 30,0

Totalt 163,0

Piteå

2010-07-23

Tavelträffen 2010

Ramselefors SKF

Provskott

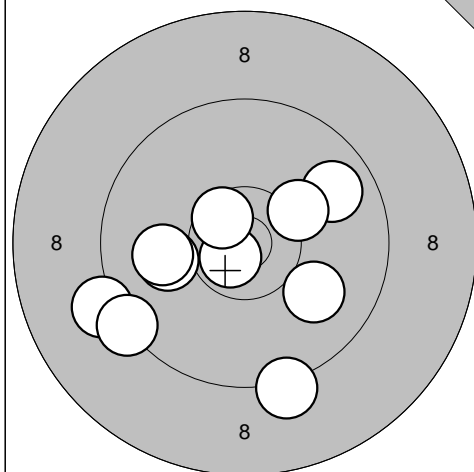

1: 10,7* ↙
 2: 9,8 ↗
 3: 10,6* ↗
 4: 9,2 ↓
 5: 9,2 ←
 6: 9,3 ←
 7: 10,1 ←
 8: 10,0 ←
 9: 10,2 ↗
 10: 10,0 ↘

Serie 96,0

Totalt 0,0

Provskott

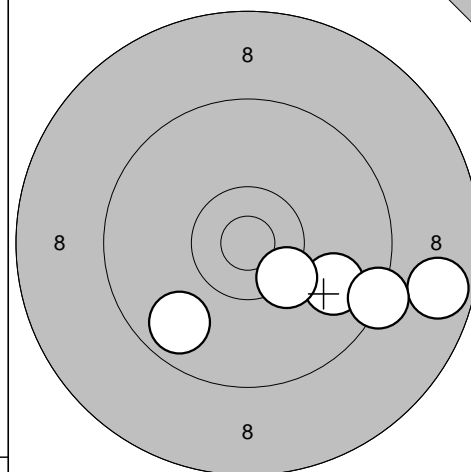

11: 8,7 →
 12: 9,8 ↙
 13: 9,9 →
 14: 10,4* ↘
 15: 9,3 →

Serie 45,0

Totalt 0,0

Tävlingsskott

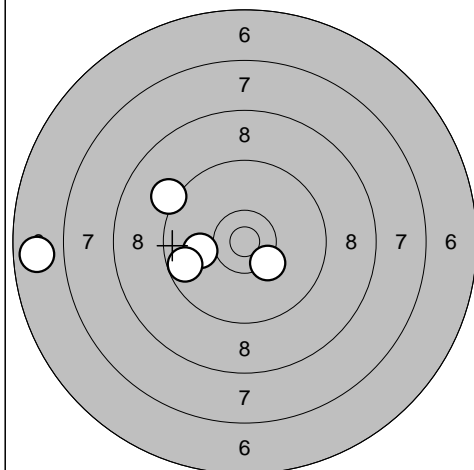

1: 9,2 ↗
 2: 10,0 ←
 3: 6,8 ←
 4: 9,7 ←
 5: 10,3* ↘

Serie 44,0

Totalt 44,0

Tävlingsskott

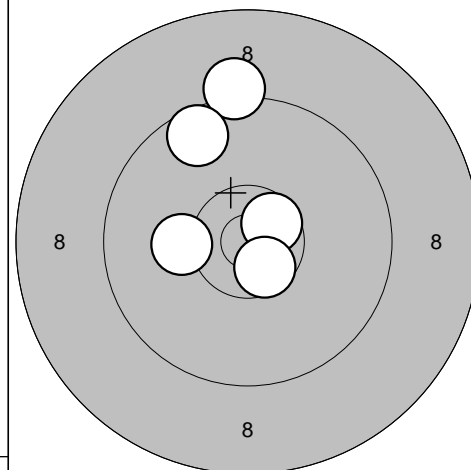

6: 10,2 ←
 7: 10,6* ↗
 8: 10,6* ↘
 9: 9,2 ↑
 10: 9,6 ↗

Serie 48,0

Totalt 92,0

Tävlingsskott

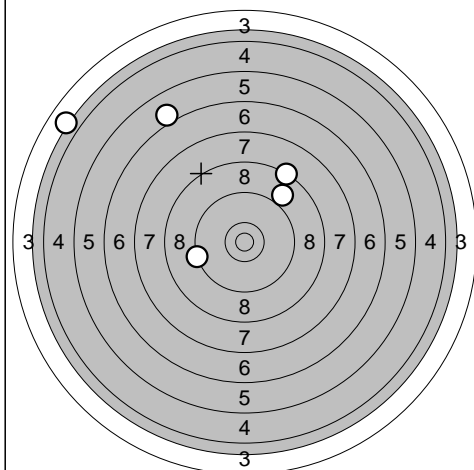

11: 9,3 ←
 12: 3,9 ↗
 13: 8,3 ↗
 14: 9,0 ↗
 15: 6,1 ↗

Serie 35,0

Totalt 127,0

Tävlingsskott

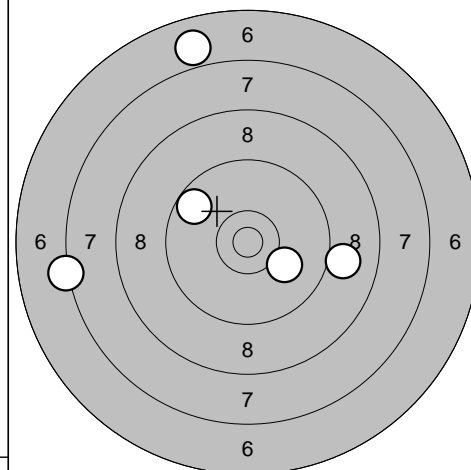

16: 6,9 ↑
 17: 9,7 ↗
 18: 7,3 ←
 19: 10,1 ↘
 20: 9,0 →

Serie 41,0

Totalt 168,0

S 3

2010-07-23

Tavelträffen 2010

Ramselefors SKF

Provskott

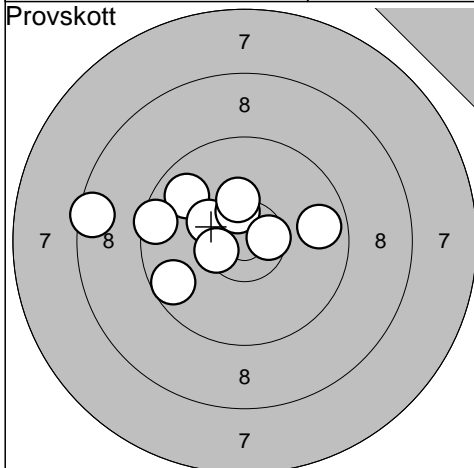

1: 8,5 ←
 2: 9,8 ↗
 3: 10,3* ↖
 4: 10,5* ↑
 5: 9,8 →
 6: 9,7 ←
 7: 10,3* ↑
 8: 10,6* →
 9: 9,5 ←
 10: 10,5* ←

Serie 94,0

Totalt 0,0

Provskott

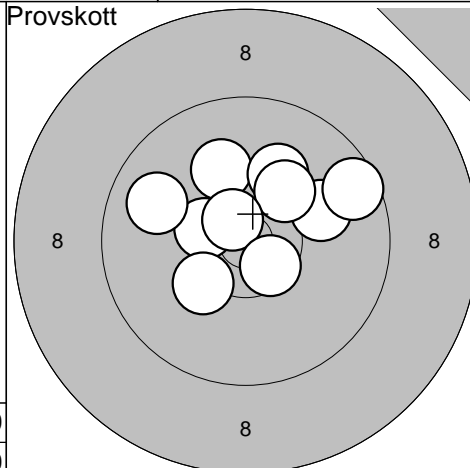

11: 10,1 ↑
 12: 10,5* ←
 13: 10,1 ↑
 14: 10,0 →
 15: 10,2 ↗
 16: 10,7* ↗
 17: 10,5* ↘
 18: 9,6 →
 19: 10,3 ←
 20: 9,9 ←

Serie 98,0

Totalt 0,0

Provskott

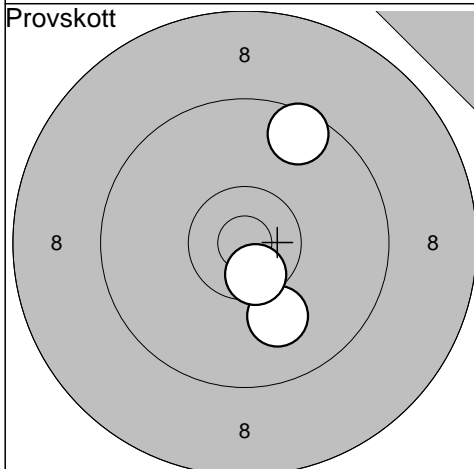

21: 9,6 ↗
 22: 10,0 ↘
 23: 10,6* ↘

Serie 29,0

Totalt 0,0

Tävlingsskott

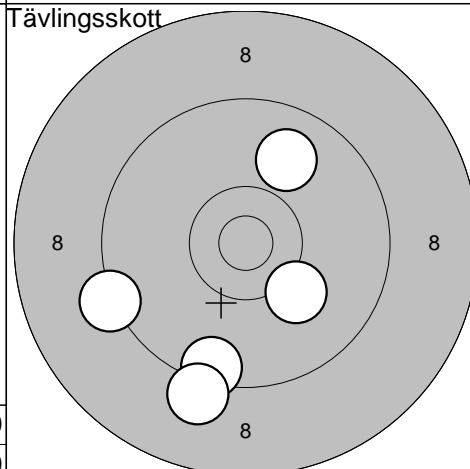

1: 9,9 ↗
 2: 9,5 ↓
 3: 9,1 ↓
 4: 10,1 ↘
 5: 9,3 ←

Serie 46,0

Totalt 46,0

Tävlingsskott

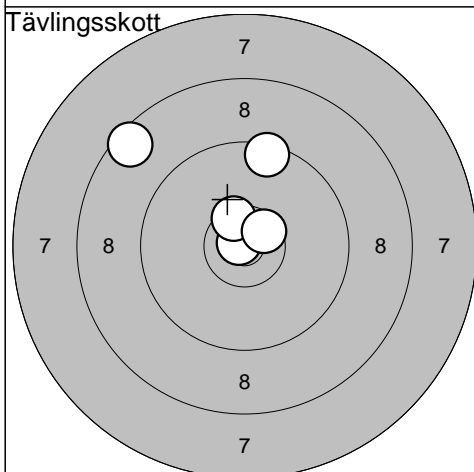

6: 10,9* ←
 7: 9,5 ↑
 8: 10,5* ↑
 9: 8,5 ↗
 10: 10,6* ↗

Serie 47,0

Totalt 93,0

Tävlingsskott

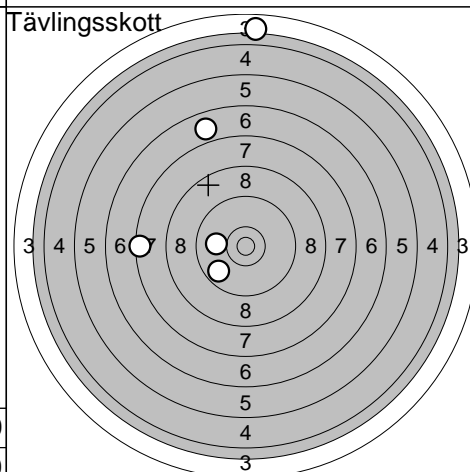

11: 3,8 ↑
 12: 6,9 ↑
 13: 7,5 ←
 14: 9,7 ↘
 15: 10,0 ←

Serie 35,0

Totalt 128,0

Tävlingsskott

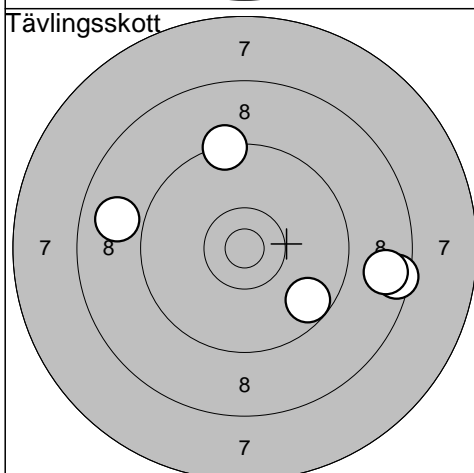

16: 8,5 →
 17: 9,3 ↑
 18: 8,9 ←
 19: 9,7 ↘
 20: 8,7 →

Serie 42,0

Totalt 170,0

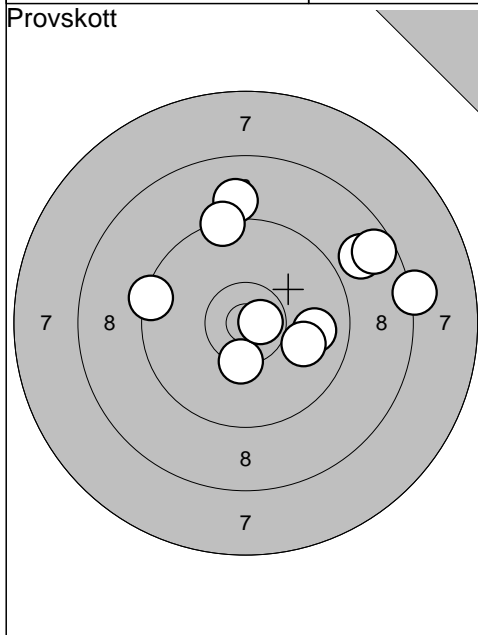

1: 9,0	↑
2: 8,9	↗
3: 8,2	→
4: 8,6	↗
5: 10,3*	↓
6: 9,4	↑
7: 9,4	←
8: 9,9	→
9: 10,0	↘
10: 10,7*	→
Serie	90,0
Totalt	0,0

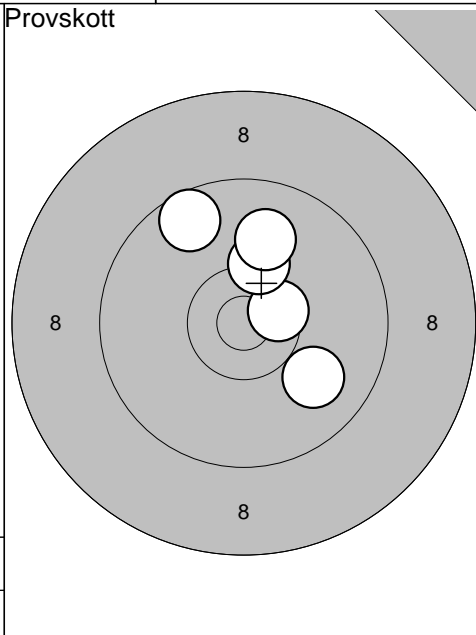

11: 10,5*	↘
12: 10,3	↑
13: 9,9	↘
14: 9,6	↖
15: 10,0	↑
Serie	48,0
Totalt	0,0

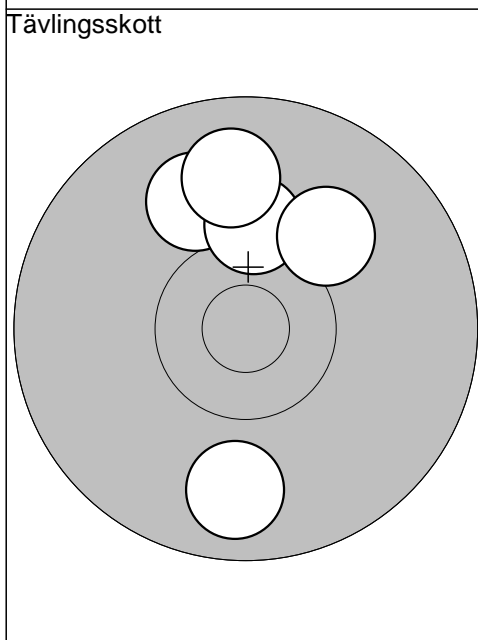

1: 10,0	↖
2: 10,2	↑
3: 9,9	↑
4: 10,1	↗
5: 9,8	↓
Serie	48,0
Totalt	48,0

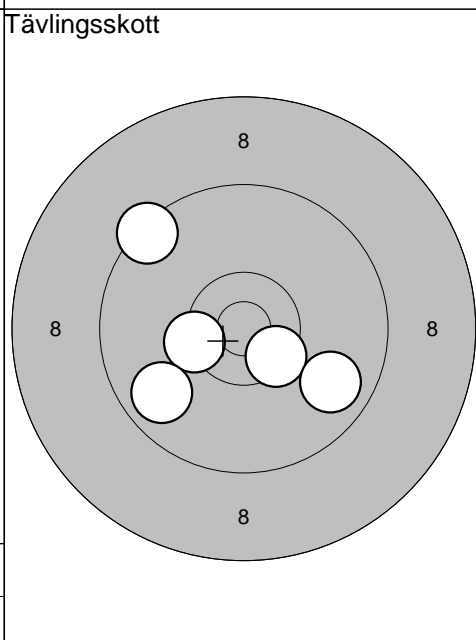

6: 10,4*	←
7: 9,8	↙
8: 10,5*	↘
9: 9,4	↗
10: 9,8	↘
Serie	47,0
Totalt	95,0

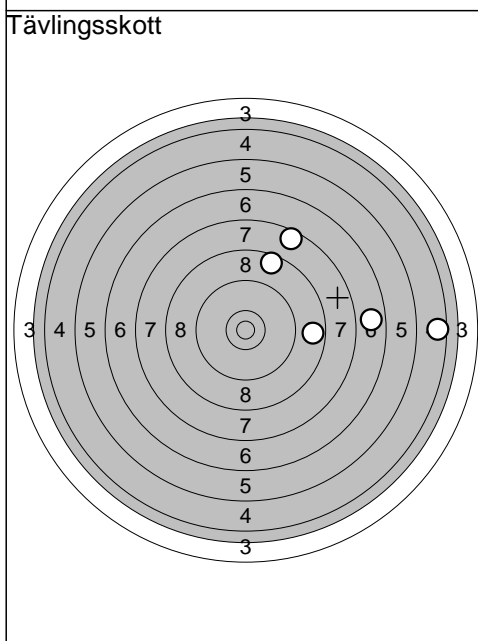

11: 4,6	→
12: 6,8	→
13: 7,6	↗
14: 8,7	→
15: 8,6	↗
Serie	33,0
Totalt	128,0

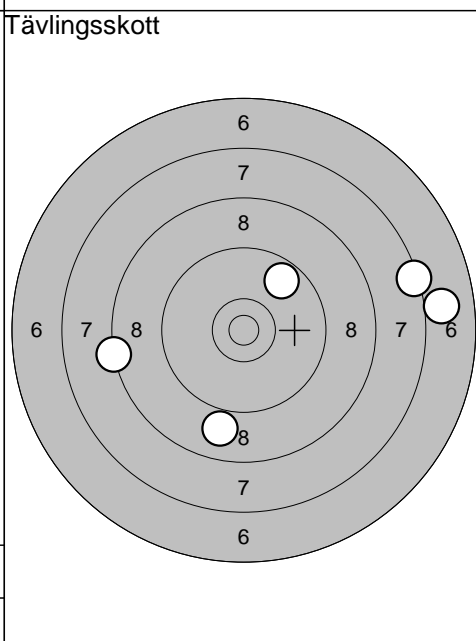

16: 8,3	←
17: 7,0	→
18: 9,7	↗
19: 8,9	↓
20: 7,4	→
Serie	39,0
Totalt	167,0

Ale

2010-07-23

Tavelträffen 2010

Ramselefors SKF

Provskott

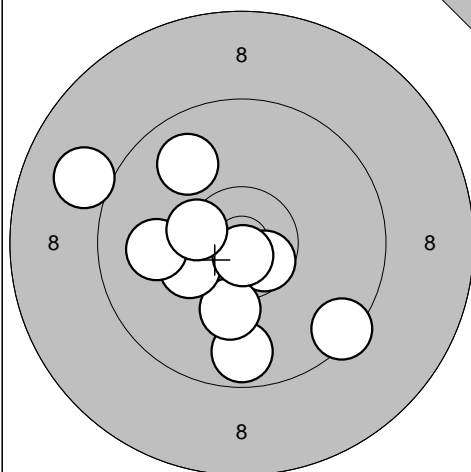

1: 9,7 ↓
 2: 9,4 ↘
 3: 10,6* ↘
 4: 10,2 ↓
 5: 9,0 ↗
 6: 10,3* ←
 7: 10,8* ↓
 8: 10,0 ←
 9: 9,9 ↗
 10: 10,4* ←

Serie 96,0

Totalt 0,0

Provskott

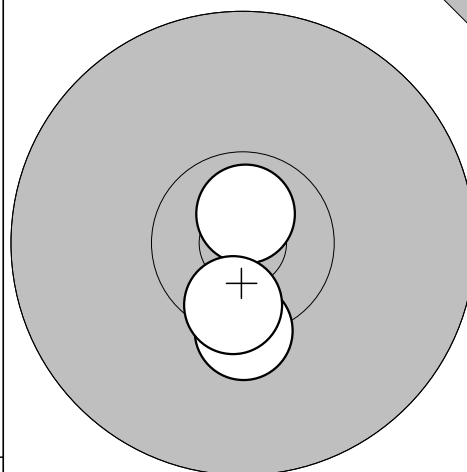

11: 10,7* ↑
 12: 10,3* ↓
 13: 10,5* ↓

Serie 30,0

Totalt 0,0

Tävlingsskott

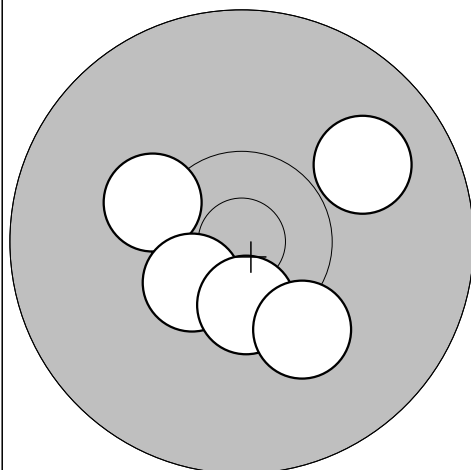

1: 10,3 ←
 2: 10,5* ↘
 3: 10,5* ↓
 4: 10,2 ↓
 5: 9,9 ↗

Serie 49,0

Totalt 49,0

Tävlingsskott

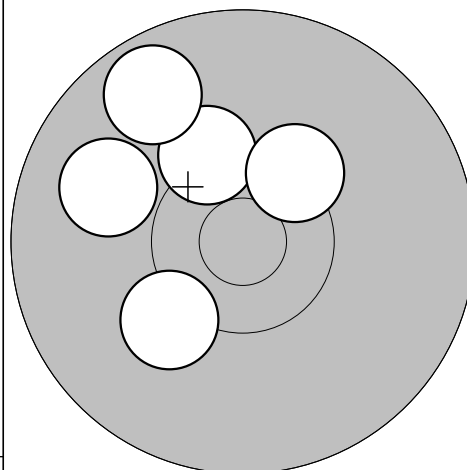

6: 10,3* ↗
 7: 9,7 ↗
 8: 10,2 ↘
 9: 10,3* ↗
 10: 9,9 ←

Serie 48,0

Totalt 97,0

Tävlingsskott

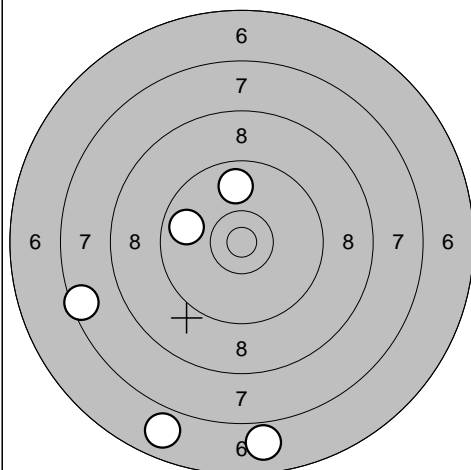

11: 9,8 ↑
 12: 9,8 ←
 13: 7,5 ←
 14: 6,9 ↓
 15: 6,9 ↓

Serie 37,0

Totalt 134,0

Tävlingsskott

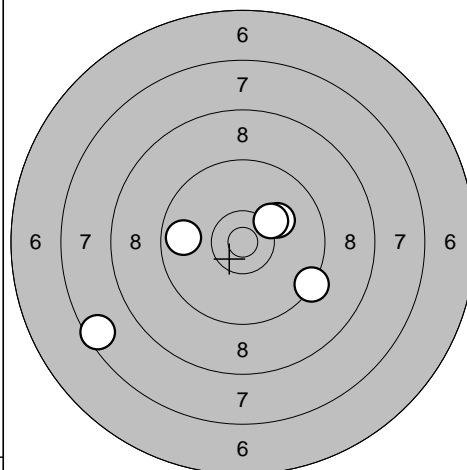

16: 9,3 ↘
 17: 9,8 ←
 18: 10,1 ↗
 19: 10,2 ↗
 20: 7,5 ←

Serie 45,0

Totalt 179,0

Ramselefors

2010-07-23

Tavelträffen 2010

Ramselefors SKF

Provskott

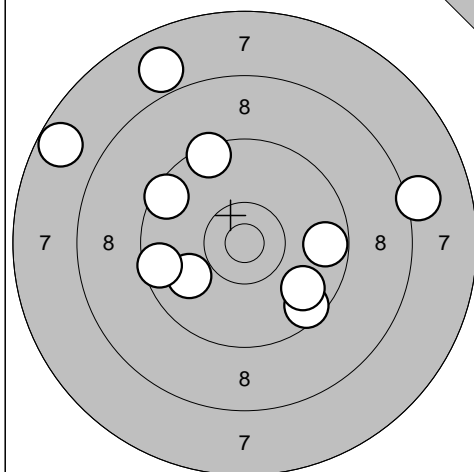

1: 7,7 ↖
 2: 9,5 ↗
 3: 9,9 ↙
 4: 7,9 ↗
 5: 9,6 ↙
 6: 9,6 ↘
 7: 9,5 ↗
 8: 8,1 →
 9: 9,8 ↘
 10: 9,7 →

Serie 85,0

Totalt 0,0

Provskott

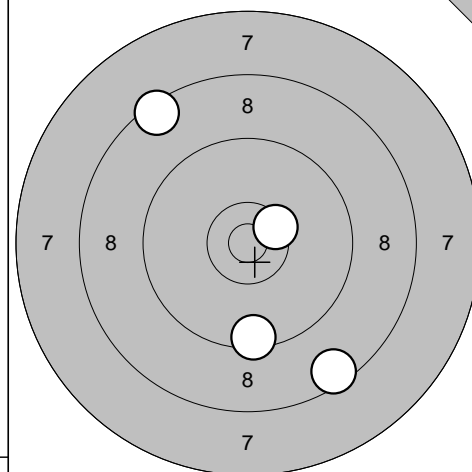

11: 8,5 ↗
 12: 9,5 ↓
 13: 8,5 ↘
 14: 10,4* ↗

Serie 35,0

Totalt 0,0

Tävlingsskott

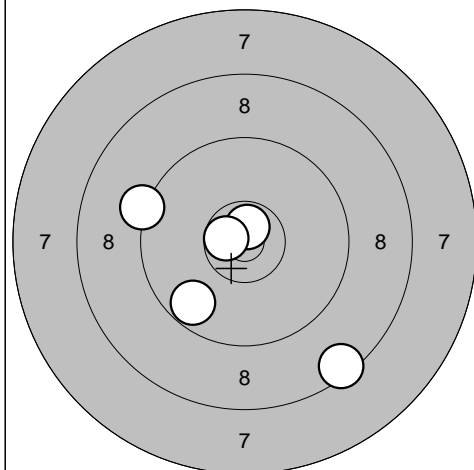

1: 10,7* ↑
 2: 10,7* ↙
 3: 9,3 ↖
 4: 8,5 ↘
 5: 9,7 ↙

Serie 46,0

Totalt 46,0

Tävlingsskott

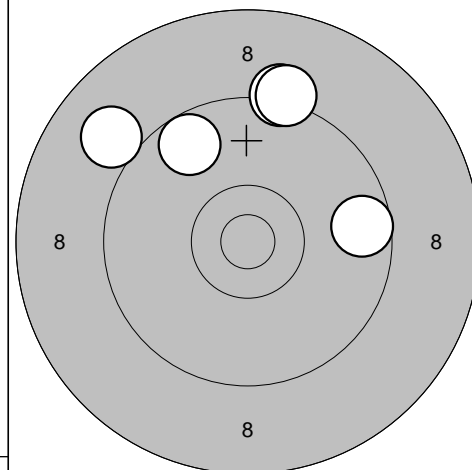

6: 9,6 →
 7: 9,7 ↖
 8: 9,2 ↑
 9: 9,0 ↖
 10: 9,2 ↑

Serie 45,0

Totalt 91,0

Tävlingsskott

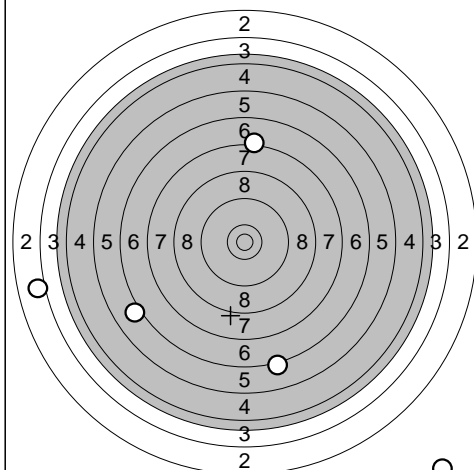

11: 0,0 ↘
 12: 6,1 ↙
 13: 3,1 ↙
 14: 6,2 ↘
 15: 7,2 ↑

Serie 22,0

Totalt 113,0

Tävlingsskott

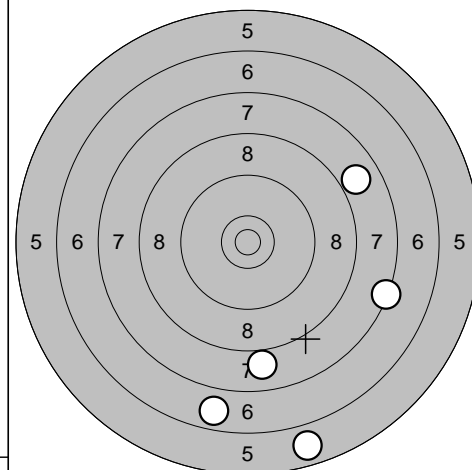

16: 6,8 ↓
 17: 7,9 ↓
 18: 5,8 ↓
 19: 7,9 ↗
 20: 7,3 →

Serie 32,0

Totalt 145,0