

Drängsmark

2010-08-15

Förbundsmästerskap 2010

Ramselefors SKF

Provskott

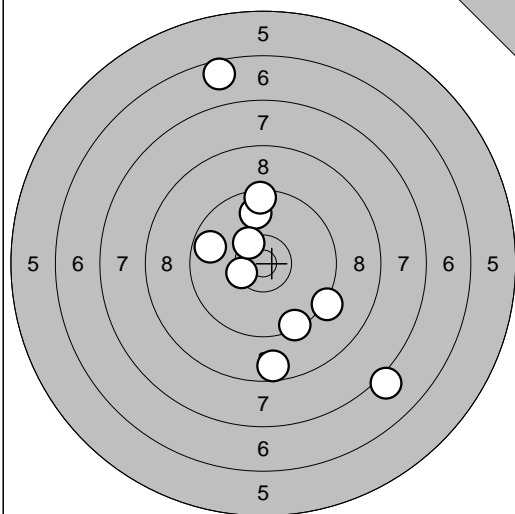

1: 6,6 ↗
 2: 9,8 ↗
 3: 7,1 ↘
 4: 10,4* ↙
 5: 9,4 ↘
 6: 8,6 ↘
 7: 10,4* ↗
 8: 9,7 ↙
 9: 9,5 ↗
 10: 9,2 ↘

Serie 86,0

Totalt 0,0

Provskott

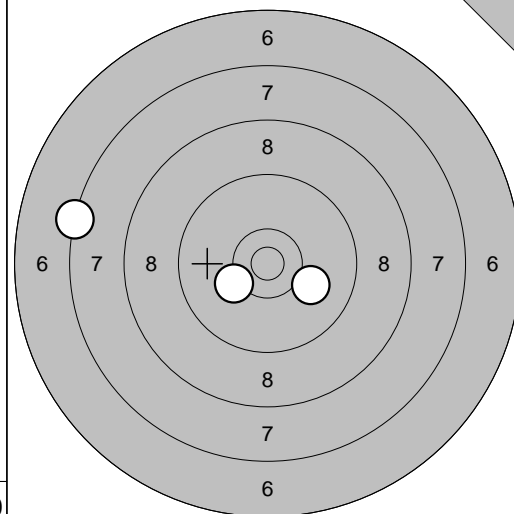

11: 10,2 ↙
 12: 7,3 ↙
 13: 10,1 ↘

Serie 27,0

Totalt 0,0

Tävlingsskott

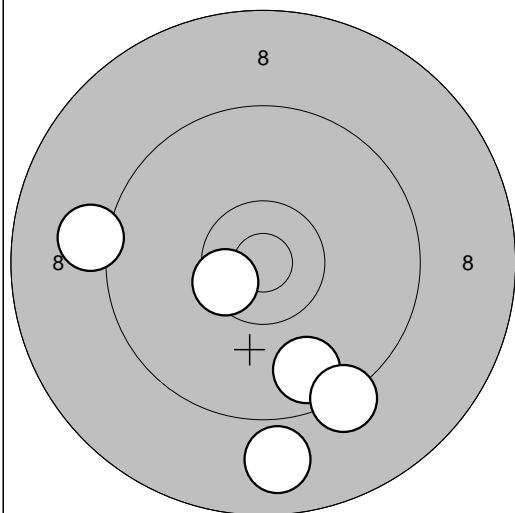

1: 9,7 ↘
 2: 10,5* ↙
 3: 9,1 ↙
 4: 9,3 ↘
 5: 8,9 ↘

Serie 45,0

Totalt 45,0

Tävlingsskott

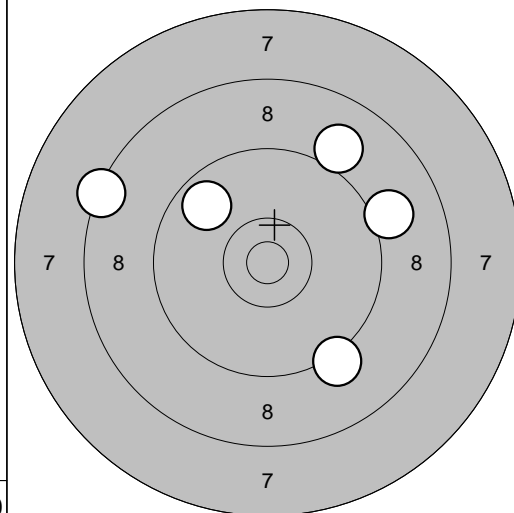

6: 9,0 ↗
 7: 9,1 ↗
 8: 9,8 ↗
 9: 9,2 ↘
 10: 8,4 ↙

Serie 44,0

Totalt 89,0

Tävlingsskott

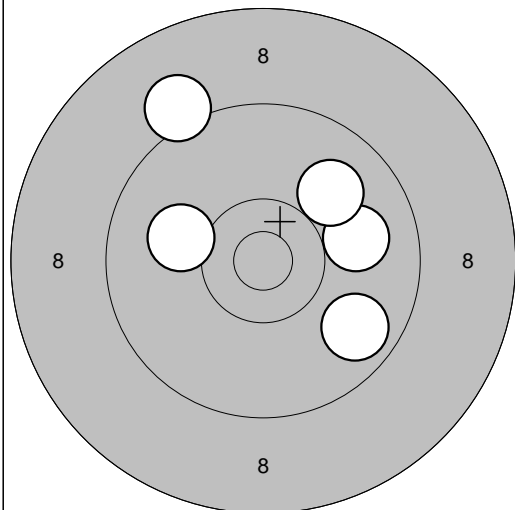

11: 9,8 ↘
 12: 10,1 ↙
 13: 9,9 ↗
 14: 9,1 ↗
 15: 9,9 ↗

Serie 46,0

Totalt 135,0

Tävlingsskott

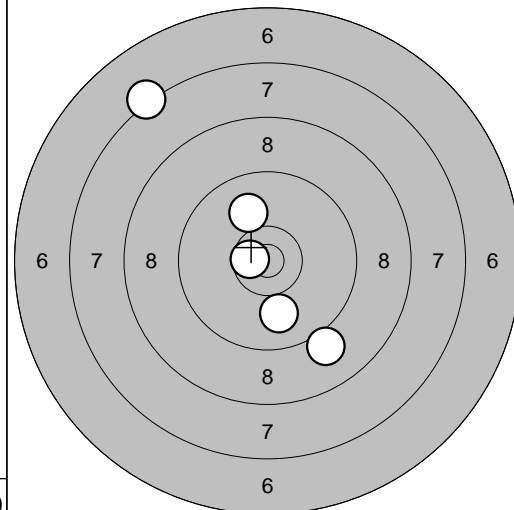

16: 7,3 ↗
 17: 10,6* ↙
 18: 10,0 ↗
 19: 10,0 ↘
 20: 9,0 ↘

Serie 46,0

Totalt 181,0

Drängsmark

2010-08-15

Förbundsmästerskap 2010

Ramselefors SKF

Provskott

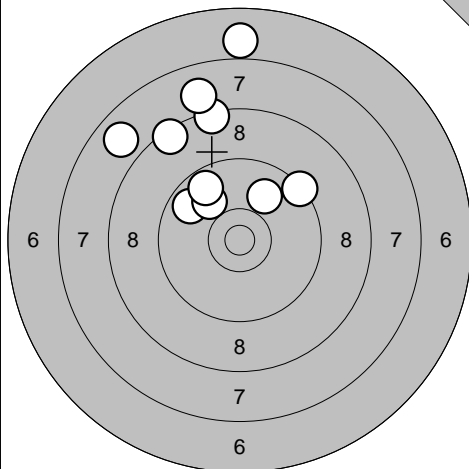

- 1: 8,4 ↗
- 2: 7,0 ↑
- 3: 9,8 ↗
- 4: 8,5 ↗
- 5: 8,0 ↑
- 6: 10,0 ↗
- 7: 7,8 ↗
- 8: 9,7 ↗
- 9: 9,4 ↗
- 10: 9,9 ↗

Serie 84,0
Totalt 0,0

Provskott

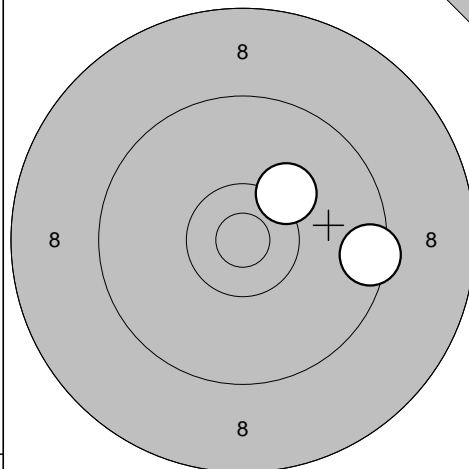

- 11: 9,5 →
- 12: 10,2 ↗

Serie 19,0
Totalt 0,0

Tävlingsskott

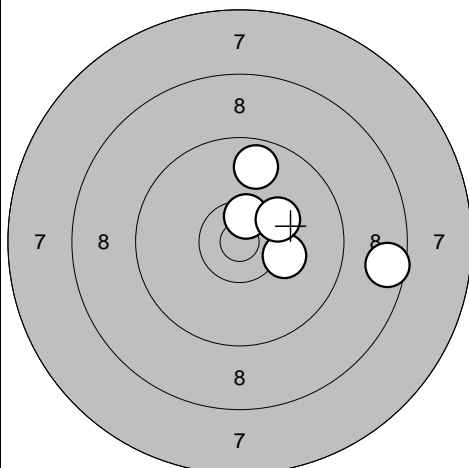

- 1: 8,6 →
- 2: 10,5* ↑
- 3: 10,2 →
- 4: 9,7 ↑
- 5: 10,3 ↗

Serie 47,0
Totalt 47,0

Tävlingsskott

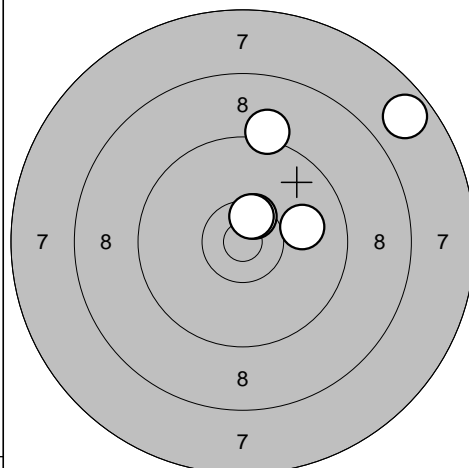

- 6: 10,0 →
- 7: 9,2 ↑
- 8: 7,7 ↗
- 9: 10,5* ↗
- 10: 10,5* ↑

Serie 46,0
Totalt 93,0

Tävlingsskott

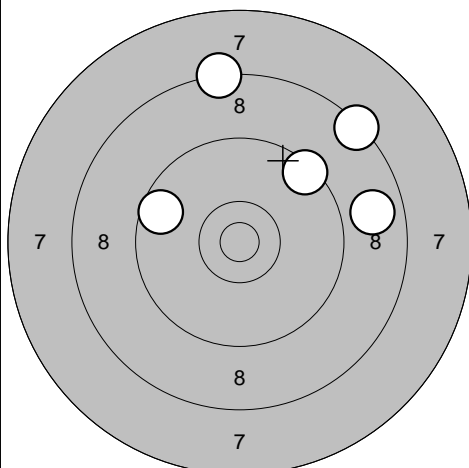

- 11: 8,8 →
- 12: 8,3 ↑
- 13: 9,4 ↗
- 14: 9,6 ↖
- 15: 8,4 ↗

Serie 42,0
Totalt 135,0

Tävlingsskott

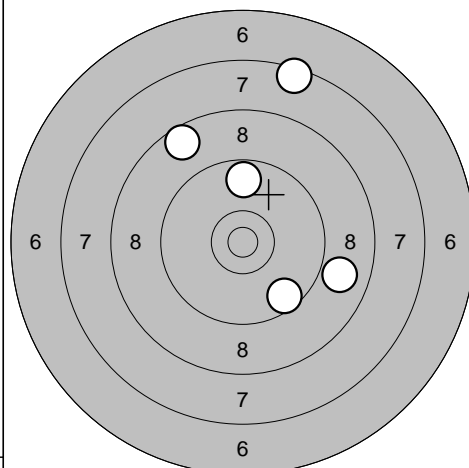

- 16: 7,5 ↑
- 17: 8,9 →
- 18: 9,7 ↑
- 19: 9,6 ↘
- 20: 8,6 ↗

Serie 41,0
Totalt 176,0

2010-08-15

Förbundsmästerskap 2010

Ramselefors SKF

Provskott

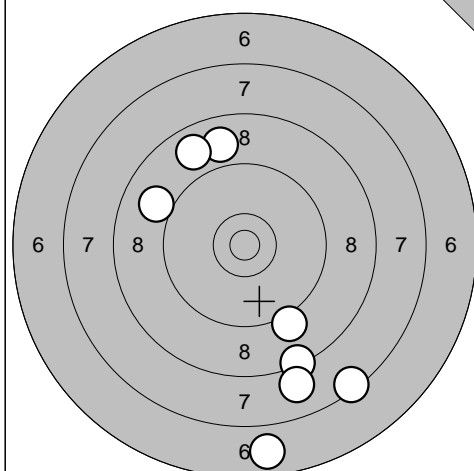

1: 9,0 ↖
 2: 8,9 ↑
 3: 8,8 ↗
 4: 9,1 ↘
 5: 7,4 ↘
 6: 8,4 ↘
 7: 6,8 ↘
 8: 8,0 ↘

Serie 63,0

Totalt 0,0

Tävlingsskott

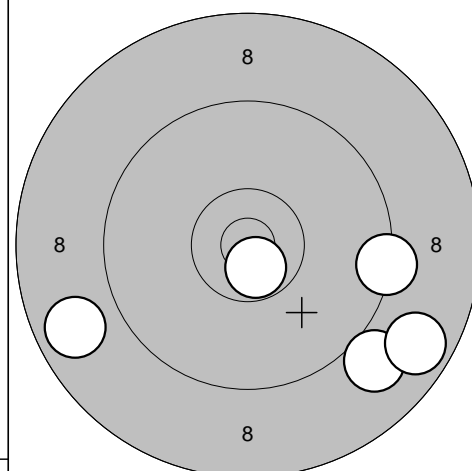

1: 9,0 ↘
 2: 8,7 ↘
 3: 10,7* ↘
 4: 9,3 →
 5: 8,8 ←

Serie 44,0

Totalt 44,0

Tävlingsskott

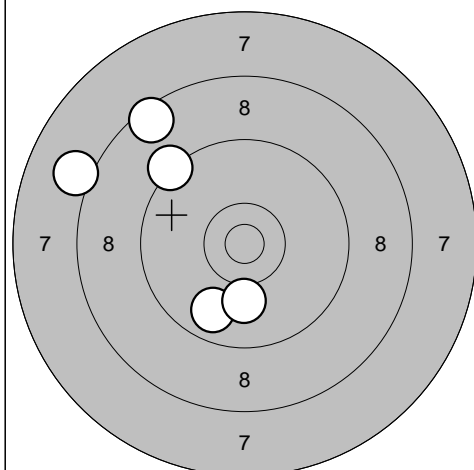

6: 9,8 ↘
 7: 10,0 ↘
 8: 8,1 ↗
 9: 8,5 ↗
 10: 9,3 ↗

Serie 44,0

Totalt 88,0

Tävlingsskott

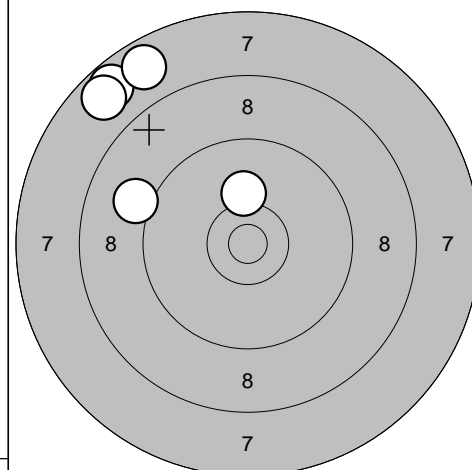

11: 7,7 ↗
 12: 7,7 ↗
 13: 9,1 ←
 14: 10,2 ↑
 15: 7,7 ↗

Serie 40,0

Totalt 128,0

Tävlingsskott

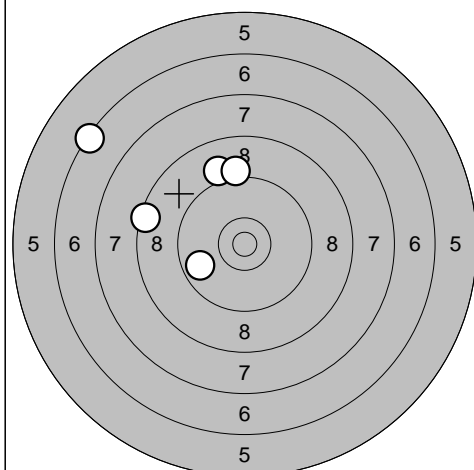

16: 9,8 ←
 17: 9,1 ↑
 18: 6,4 ↗
 19: 8,5 ←
 20: 9,2 ↑

Serie 41,0

Totalt 169,0

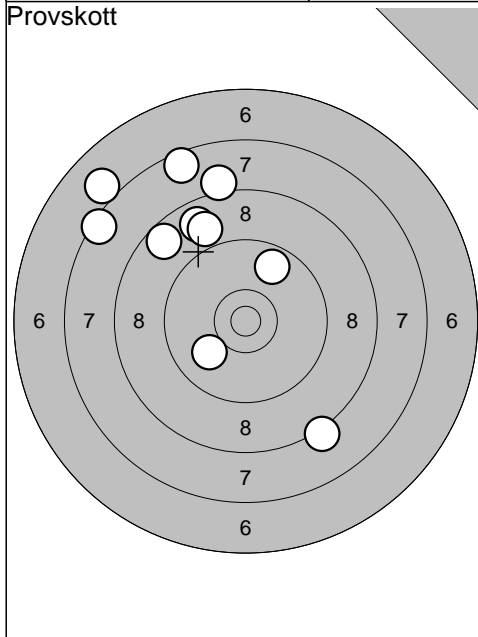

1: 8,2	↘
2: 8,7	↗
3: 7,0	↗
4: 7,6	↗
5: 7,5	↗
6: 8,1	↗
7: 8,8	↗
8: 8,9	↗
9: 9,7	↗
10: 10,0	↙
Serie	80,0
Totalt	0,0

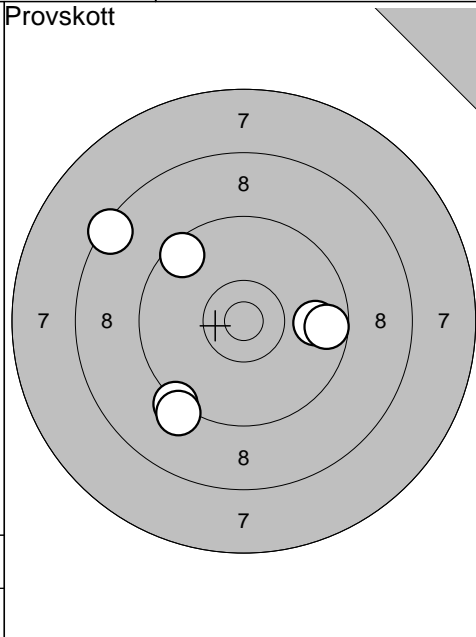

11: 9,3	↙
12: 8,4	↖
13: 9,8	→
14: 9,5	↖
15: 9,2	↙
16: 9,6	→
Serie	53,0
Totalt	0,0

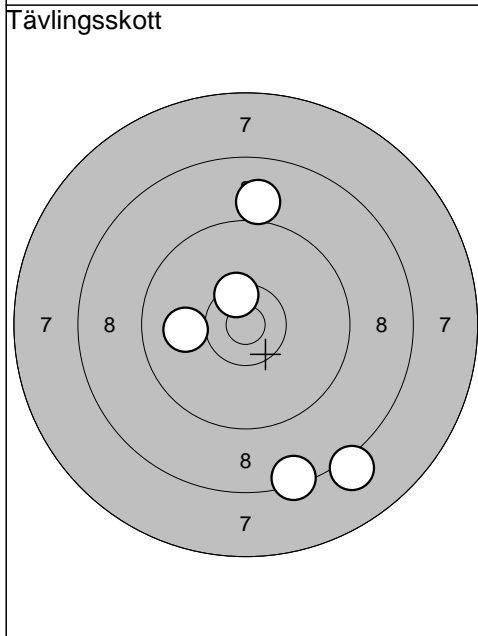

1: 8,1	↘
2: 8,4	↘
3: 10,5*	↗
4: 10,0	←
5: 9,0	↗
Serie	45,0
Totalt	45,0

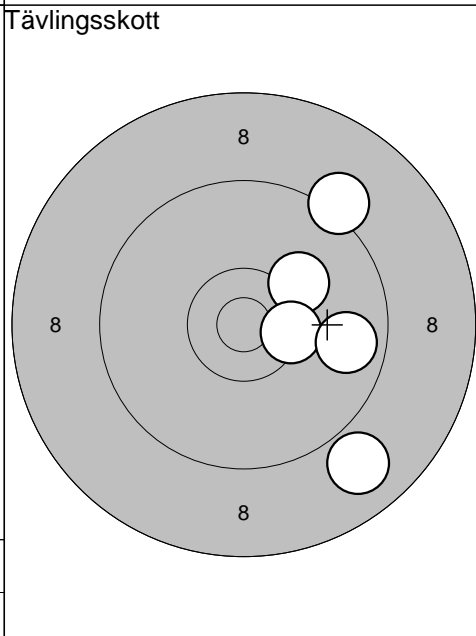

6: 10,2	↗
7: 8,9	↘
8: 9,2	↗
9: 10,4*	→
10: 9,8	→
Serie	46,0
Totalt	91,0

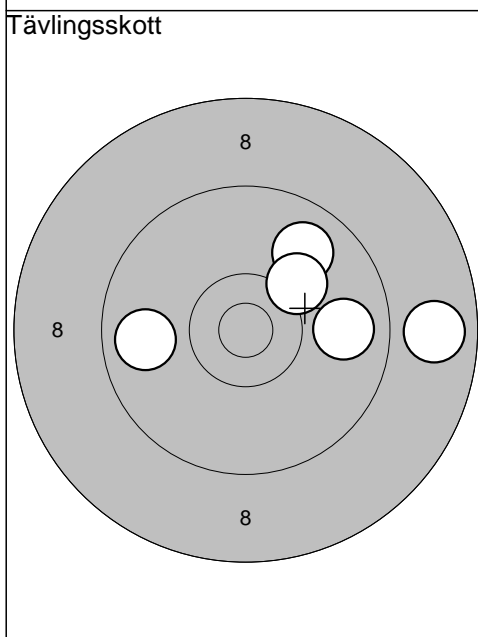

11: 8,8	→
12: 9,8	↗
13: 9,8	←
14: 9,8	→
15: 10,2	↗
Serie	45,0
Totalt	136,0

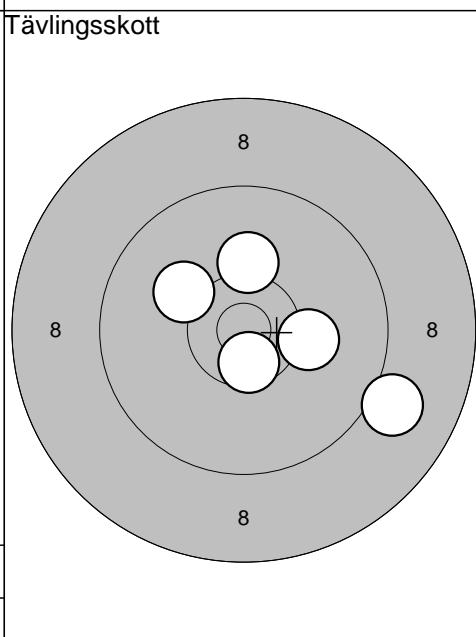

16: 10,2	↗
17: 10,1	↖
18: 9,0	↘
19: 10,2	→
20: 10,6*	↘
Serie	49,0
Totalt	185,0

Skellefteå

2010-08-15	Förbundsmästerskap 2010	Ramselefors SKF
------------	-------------------------	-----------------

Provskott

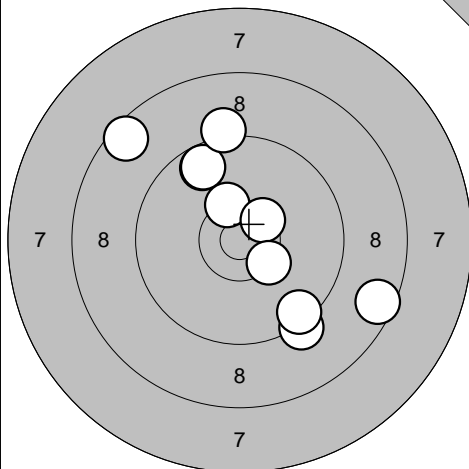

- 1: 9,7 ↗
- 2: 9,7 ↗
- 3: 8,6 →
- 4: 9,2 ↗
- 5: 8,6 ↗
- 6: 10,4* ↗
- 7: 10,5* ↗
- 8: 9,3 ↓
- 9: 9,5 ↓
- 10: 10,4* ↓

Serie	91,0
Totalt	0,0

Provskott

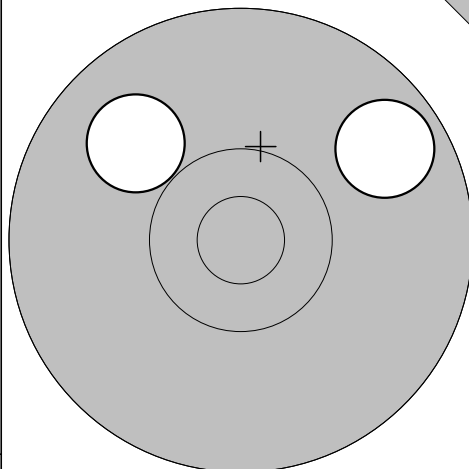

- 11: 9,9 ↖
- 12: 9,7 ↗

Serie	18,0
Totalt	0,0

Tävlingsskott

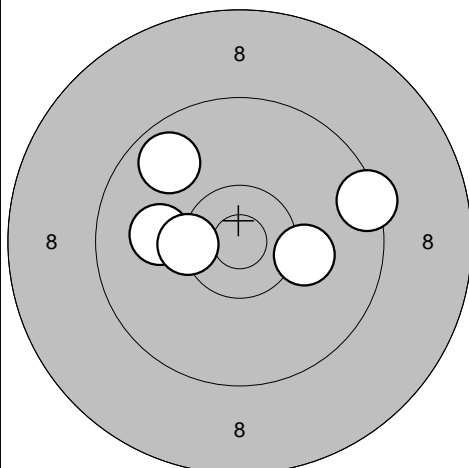

- 1: 9,4 →
- 2: 9,7 ↗
- 3: 10,0 ←
- 4: 10,2 →
- 5: 10,4* ←

Serie	48,0
Totalt	48,0

Tävlingsskott

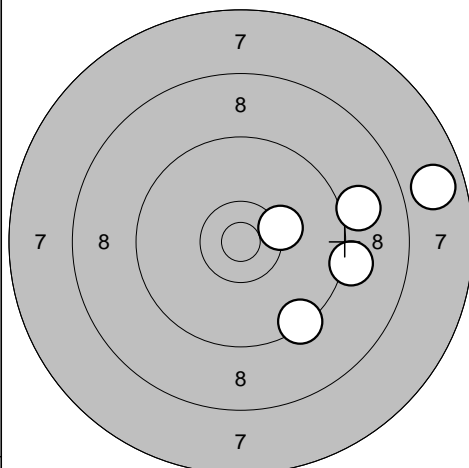

- 6: 9,4 ↓
- 7: 9,2 →
- 8: 7,8 →
- 9: 9,0 →
- 10: 10,3 →

Serie	44,0
Totalt	92,0

Tävlingsskott

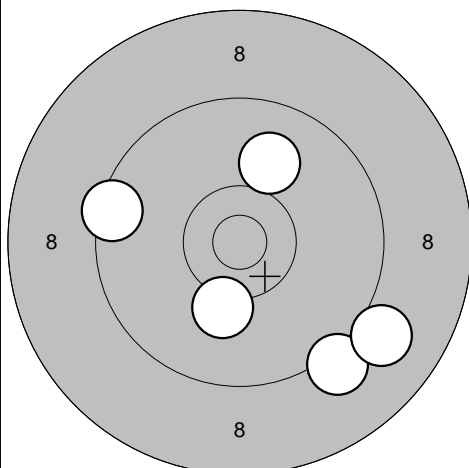

- 11: 9,5 ←
- 12: 10,2 ↓
- 13: 10,0 ↗
- 14: 9,2 ↓
- 15: 9,0 ↓

Serie	47,0
Totalt	139,0

Tävlingsskott

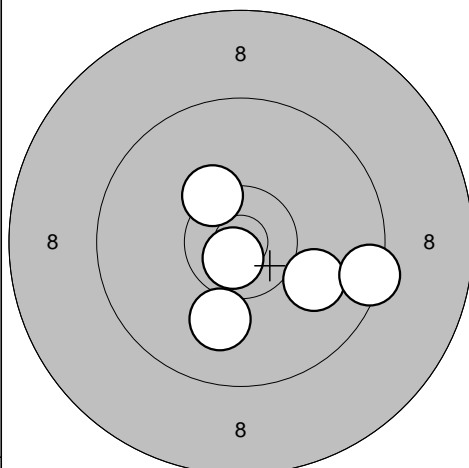

- 16: 10,0 →
- 17: 10,7* ↓
- 18: 10,3* ↗
- 19: 10,0 ↓
- 20: 9,4 →

Serie	49,0
Totalt	188,0

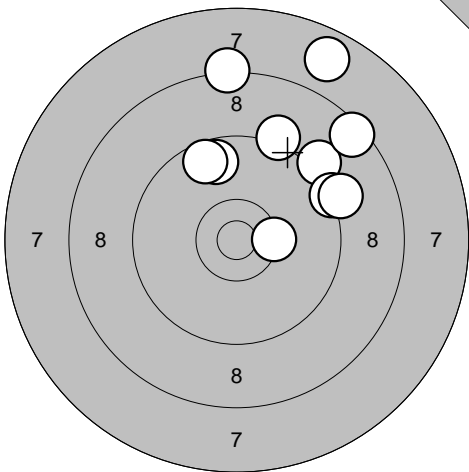
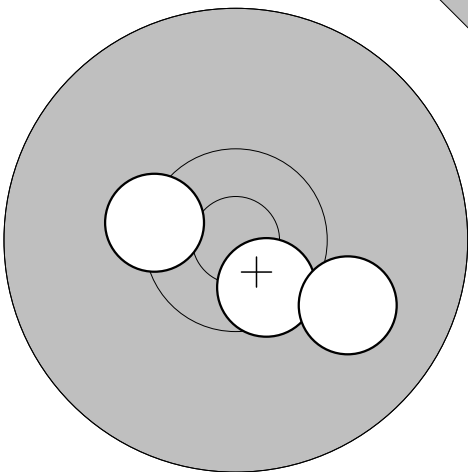
<p>Provskott</p> 	<p>1: 7,8 ↗ 2: 8,3 ↑ 3: 9,2 ↗ 4: 9,7 ↑ 5: 8,5 ↗ 6: 9,2 ↑ 7: 9,3 ↗ 8: 9,6 ↑ 9: 9,2 ↗ 10: 10,4* →</p>	<p>Provskott</p> 
Serie 87,0		Serie 30,0
Totalt 0,0		Totalt 0,0

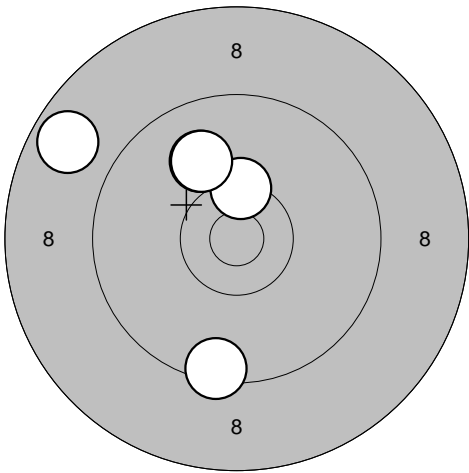
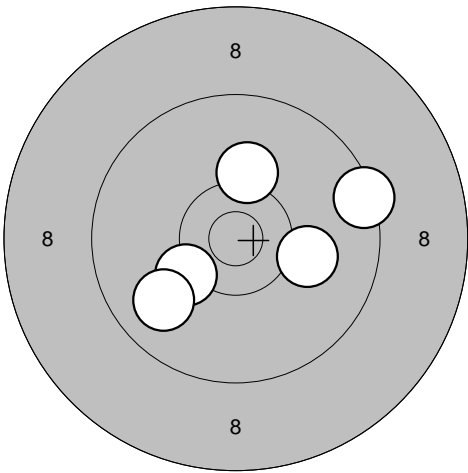
<p>Tävlingsskott</p> 	<p>1: 10,4* ↑ 2: 10,0 ↗ 3: 8,7 ↗ 4: 10,0 ↑ 5: 9,4 ↓</p>	<p>Tävlingsskott</p> 
Serie 47,0		Serie 48,0
Totalt 47,0		Totalt 95,0

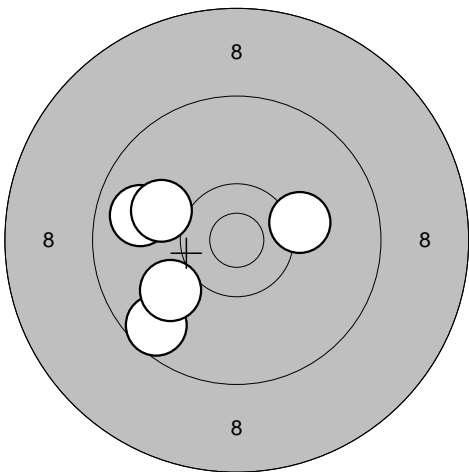
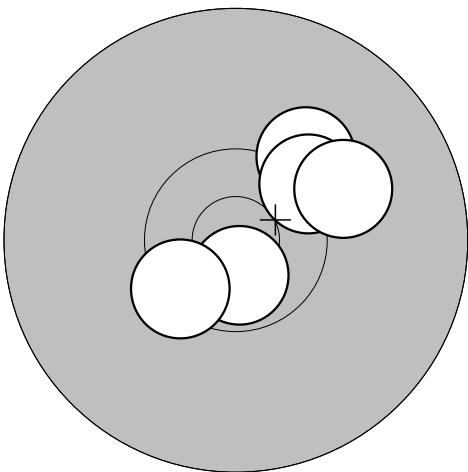
<p>Tävlingsskott</p> 	<p>11: 9,6 ↙ 12: 9,8 ← 13: 10,0 ↙ 14: 10,0 ← 15: 10,2 →</p>	<p>Tävlingsskott</p> 
Serie 48,0		Serie 50,0
Totalt 143,0		Totalt 193,0

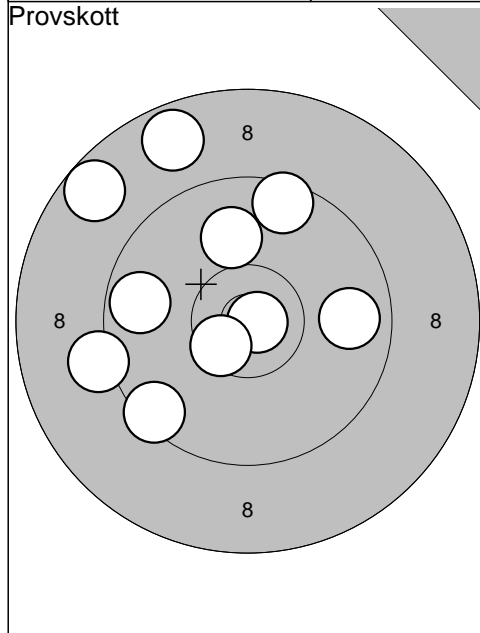

1: 8,7	↖
2: 9,5	↙
3: 10,8*	→
4: 8,7	↖
5: 9,5	↑
6: 10,5*	↙
7: 9,2	←
8: 10,0	↑
9: 9,7	←
10: 9,8	→
<hr/>	
Serie	91,0
<hr/>	
Totalt	0,0

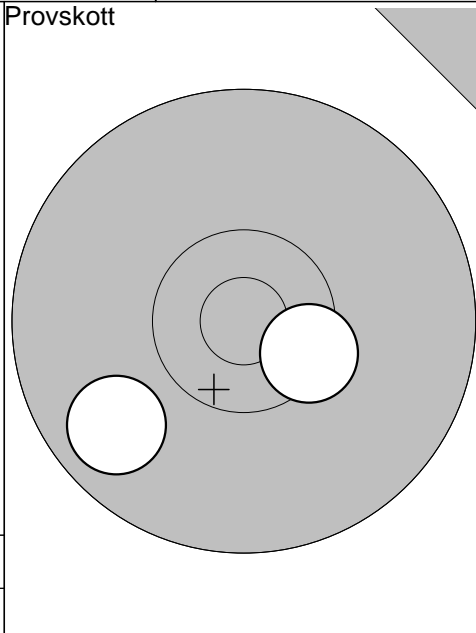

11: 10,4*	↘
12: 9,8	↙
<hr/>	
Serie	19,0
<hr/>	
Totalt	0,0

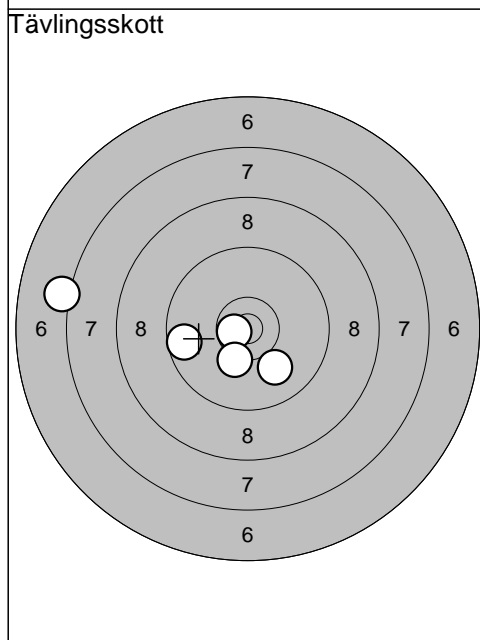

1: 10,0	↘
2: 10,7*	←
3: 10,3	↙
4: 9,7	←
5: 7,2	←
<hr/>	
Serie	46,0
<hr/>	
Totalt	46,0

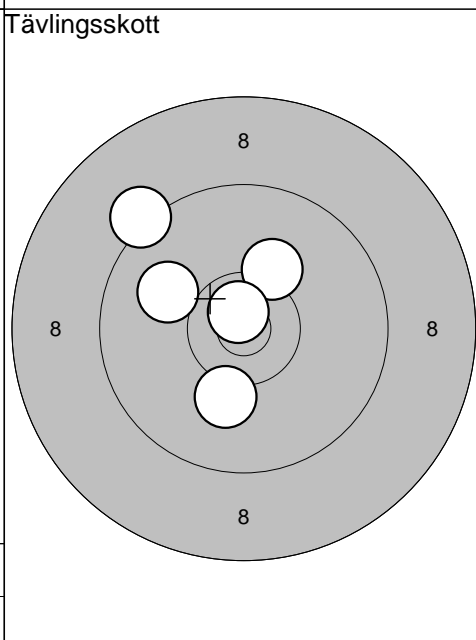

6: 10,2	↗
7: 10,0	↖
8: 9,2	↗
9: 10,1	↘
10: 10,8*	↗
<hr/>	
Serie	49,0
<hr/>	
Totalt	95,0

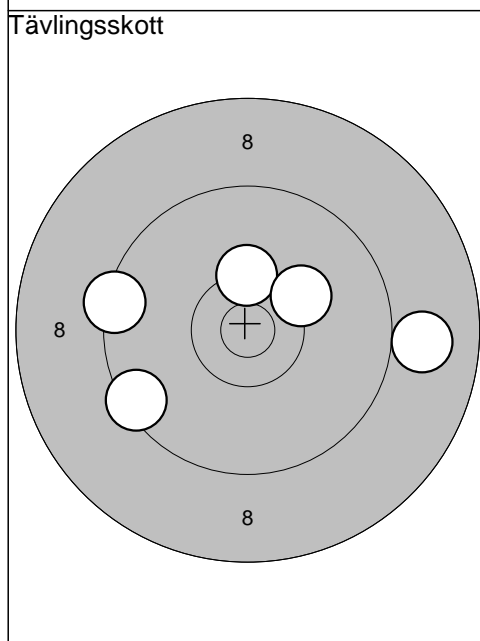

11: 9,4	↙
12: 10,3*	↑
13: 10,2	↗
14: 9,0	→
15: 9,4	←
<hr/>	
Serie	47,0
<hr/>	
Totalt	142,0

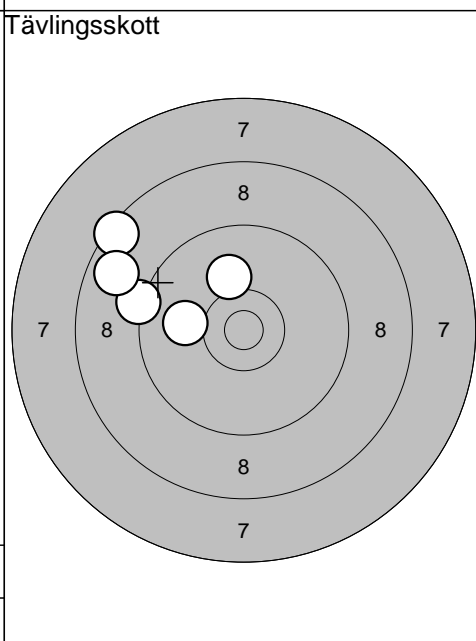

16: 9,2	←
17: 8,5	↖
18: 8,8	←
19: 10,1	↗
20: 10,0	←
<hr/>	
Serie	45,0
<hr/>	
Totalt	187,0

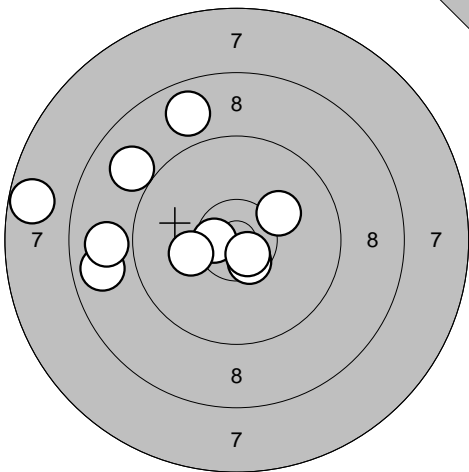
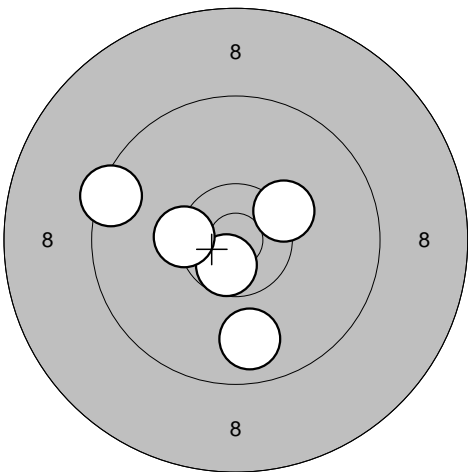
Provsnitt 	1: 9,0 ↖ 2: 8,8 ← 3: 8,9 ← 4: 10,6* ← 5: 10,2 ← 6: 10,6* ↘ 7: 10,7* ↘ 8: 10,2 ↗ 9: 7,7 ← 10: 8,8 ↗ <hr/> Serie 90,0 Totalt 0,0	Tävlingssnitt 	1: 9,8 ↓ 2: 10,3* ↗ 3: 9,4 ← 4: 10,6* ↘ 5: 10,4* ← <hr/> Serie 48,0 Totalt 48,0
------------------------------------------------------------------------------------------------------	-----------------------------------------------------------------------------------------------------------------------------------------------------------------	------------------------------------------------------------------------------------------------------------	---------------------------------------------------------------------------------------------------

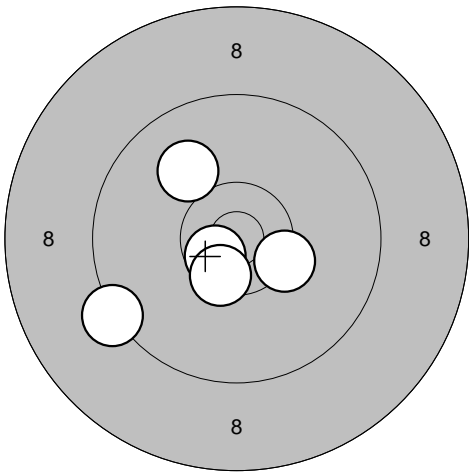
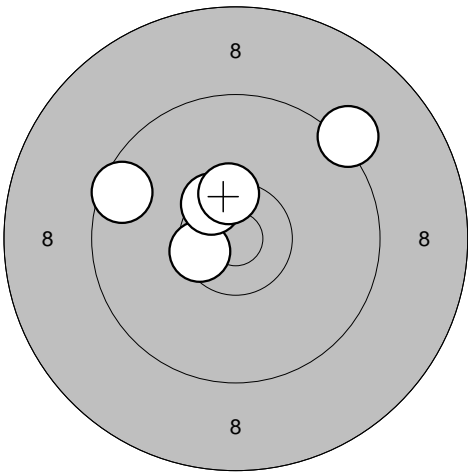
Tävlingssnitt 	6: 10,0 ↗ 7: 10,3* ↘ 8: 10,6* ↘ 9: 10,5* ↘ 10: 9,3 ← <hr/> Serie 49,0 Totalt 97,0	Tävlingssnitt 	11: 9,6 ← 12: 10,5* ← 13: 9,2 ↗ 14: 10,5* ↖ 15: 10,4* ↑ <hr/> Serie 48,0 Totalt 145,0
-----------------------------------------------------------------------------------------------------------	-----------------------------------------------------------------------------------------------------	-------------------------------------------------------------------------------------------------------------	---------------------------------------------------------------------------------------------------------

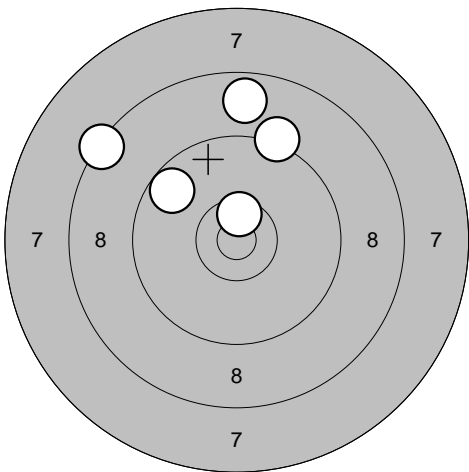
Tävlingssnitt 	16: 8,4 ↖ 17: 8,8 ↑ 18: 10,5* ↑ 19: 9,7 ↖ 20: 9,2 ↗ <hr/> Serie 44,0 Totalt 189,0		
------------------------------------------------------------------------------------------------------------	-----------------------------------------------------------------------------------------------------	--	--

Ramselefors

2010-08-15

Förbundsmästerskap 2010

Ramselefors SKF

Provskott

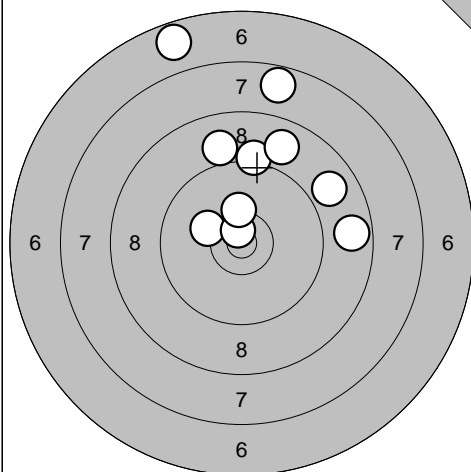

- 1: 8,7 →
- 2: 9,2 ↑
- 3: 10,2 ↖
- 4: 8,9 →
- 5: 10,7* ↑
- 6: 6,7 ↑
- 7: 9,0 ↑
- 8: 8,9 ↗
- 9: 7,7 ↑
- 10: 10,3* ↑

Serie 85,0
Totalt 0,0

Provskott

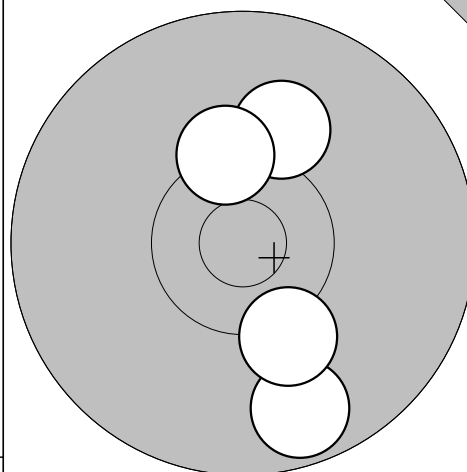

- 11: 9,7 ↓
- 12: 10,1 ↗
- 13: 10,2 ↓
- 14: 10,3* ↑

Serie 39,0
Totalt 0,0

Tävlingsskott

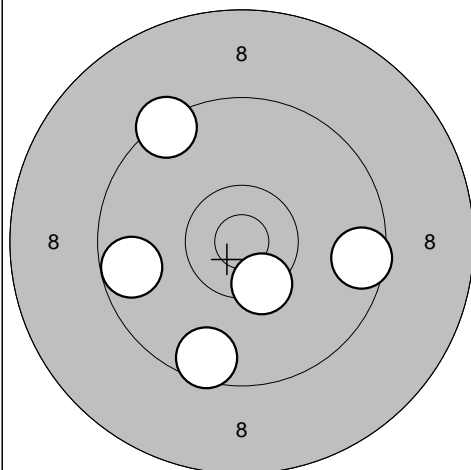

- 1: 9,7 ←
- 2: 9,4 ↗
- 3: 9,6 →
- 4: 10,4* ↓
- 5: 9,6 ↓

Serie 46,0
Totalt 46,0

Tävlingsskott

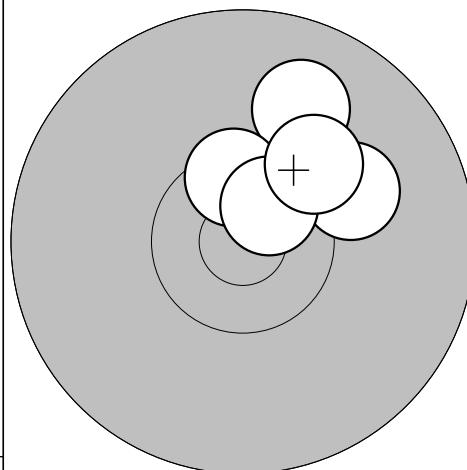

- 6: 9,9 ↗
- 7: 10,1 →
- 8: 10,5* ↑
- 9: 10,6* ↗
- 10: 10,2 ↗

Serie 49,0
Totalt 95,0

Tävlingsskott

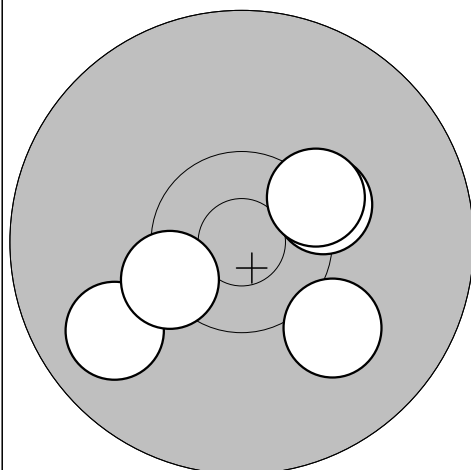

- 11: 10,1 ↓
- 12: 9,9 ↖
- 13: 10,4* ↖
- 14: 10,3* →
- 15: 10,3* →

Serie 49,0
Totalt 144,0

Tävlingsskott

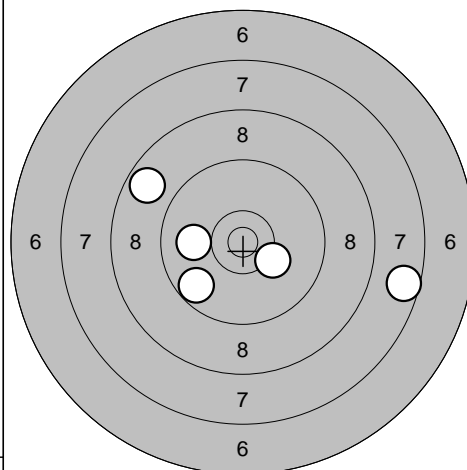

- 16: 10,2 ↘
- 17: 10,0 ←
- 18: 8,7 ↖
- 19: 9,7 ↖
- 20: 7,6 →

Serie 44,0
Totalt 188,0

Umeå

2010-08-15

Förbundsmästerskap 2010

Ramselefors SKF

Provs-kott

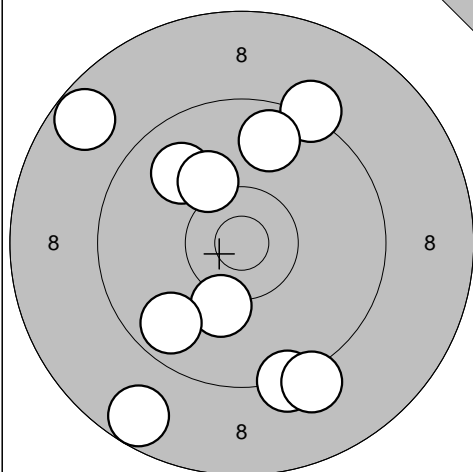

- 1: 10,2 ↘
- 2: 9,3 ↘
- 3: 9,3 ↗
- 4: 9,7 ↗
- 5: 8,7 ↘
- 6: 9,7 ↘
- 7: 9,2 ↘
- 8: 9,9 ↗
- 9: 8,7 ↗
- 10: 10,2 ↗

Serie 90,0
Totalt 0,0

Tävlingsskott

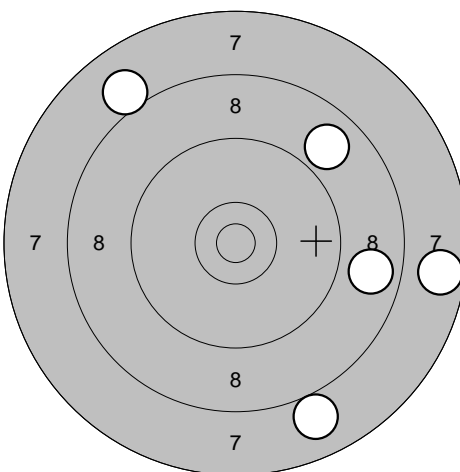

- 1: 7,7 →
- 2: 7,9 ↘
- 3: 8,0 ↗
- 4: 8,8 →
- 5: 8,9 ↗

Serie 38,0
Totalt 38,0

Tävlingsskott

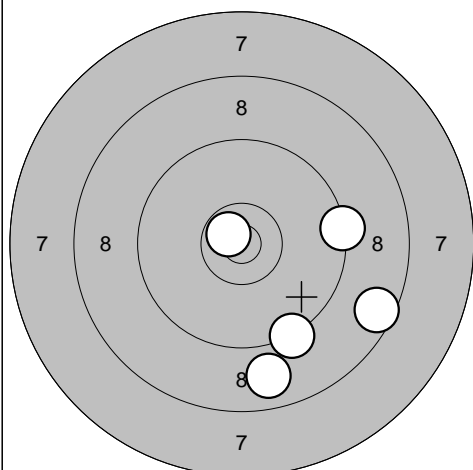

- 6: 8,8 ↘
- 7: 8,6 →
- 8: 10,7* ↗
- 9: 9,3 ↘
- 10: 9,3 →

Serie 44,0
Totalt 82,0

Tävlingsskott

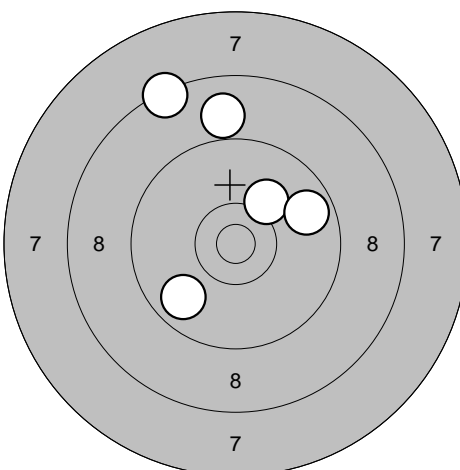

- 11: 9,8 ↙
- 12: 10,1 ↗
- 13: 9,7 →
- 14: 8,9 ↑
- 15: 8,4 ↗

Serie 44,0
Totalt 126,0

Tävlingsskott

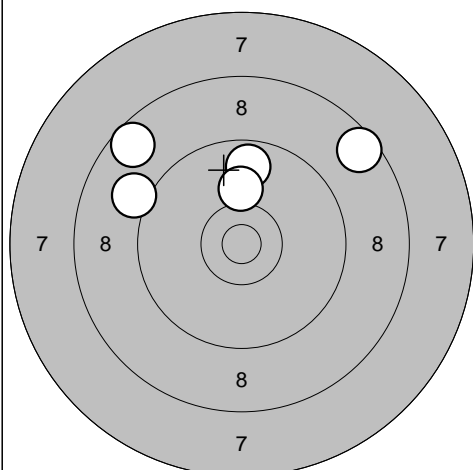

- 16: 9,1 ↙
- 17: 9,7 ↑
- 18: 10,1 ↑
- 19: 8,6 ↗
- 20: 8,6 ↙

Serie 44,0
Totalt 170,0

Ramselefors

2010-08-15

Förbundsmästerskap 2010

Ramselefors SKF

Provskott

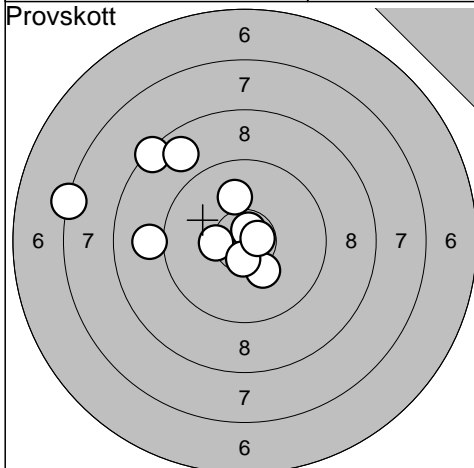

1: 9,0 ←
 2: 7,3 ←
 3: 10,1 ↑
 4: 8,4 ↗
 5: 10,2 ↓
 6: 10,4* ←
 7: 10,7* ↑
 8: 10,6* ↓
 9: 8,8 ↗
 10: 10,7* →

Serie 92,0

Totalt 0,0

Provskott

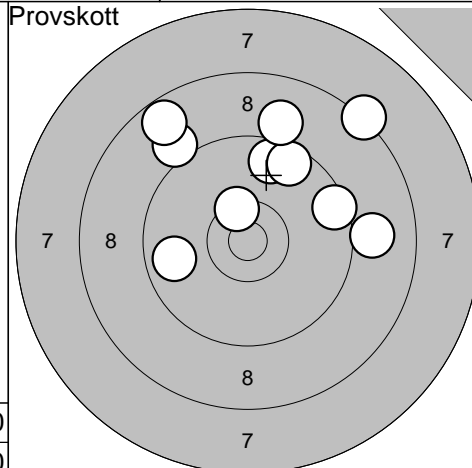

11: 9,6 ↑
 12: 9,6 ↑
 13: 9,5 →
 14: 9,1 ↖
 15: 8,3 ↗
 16: 9,0 ↑
 17: 9,0 →
 18: 10,4* ↑
 19: 9,8 ←
 20: 8,7 ↖

Serie 89,0

Totalt 0,0

Provskott

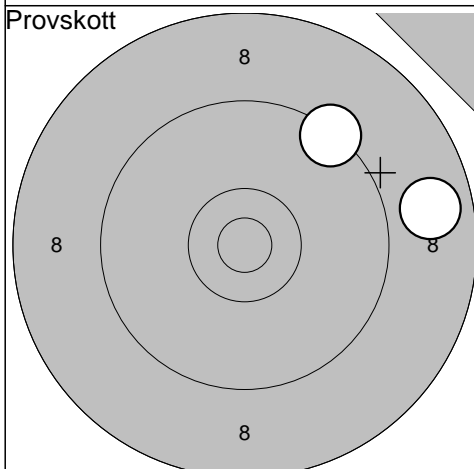

21: 8,8 →
 22: 9,4 ↗

Serie 17,0

Totalt 0,0

Tävlingsskott

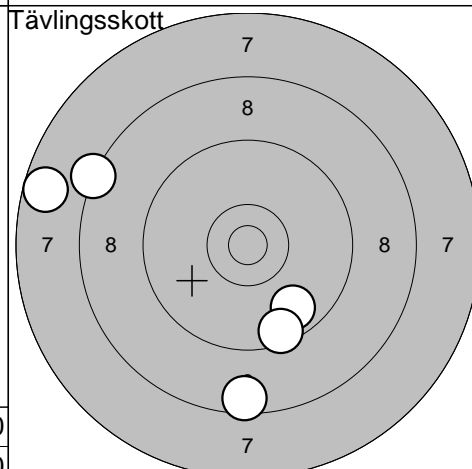

1: 8,3 ↖
 2: 7,7 ←
 3: 9,7 ↓
 4: 9,5 ↓
 5: 8,5 ↓

Serie 41,0

Totalt 41,0

Tävlingsskott

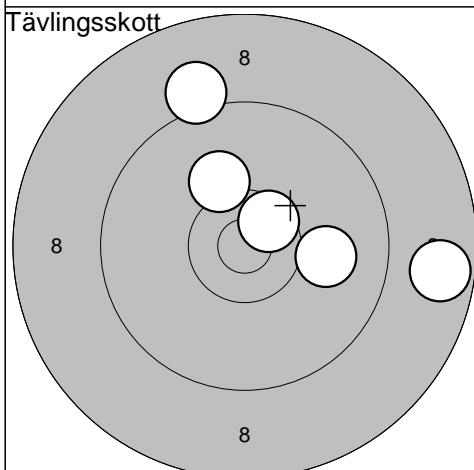

6: 10,6* ↗
 7: 10,0 →
 8: 8,7 →
 9: 10,2 ↗
 10: 9,1 ↑

Serie 47,0

Totalt 88,0

Tävlingsskott

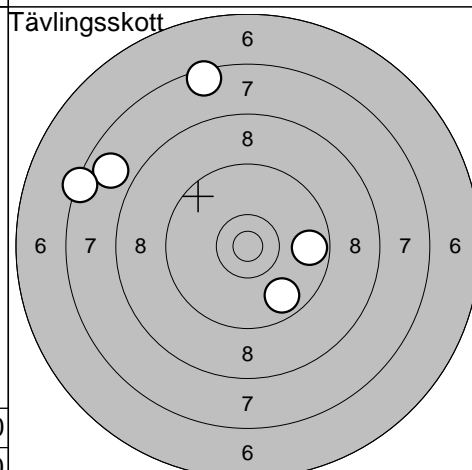

11: 9,7 →
 12: 7,8 ↖
 13: 9,7 ↓
 14: 7,4 ↖
 15: 7,5 ↑

Serie 39,0

Totalt 127,0

Tävlingsskott

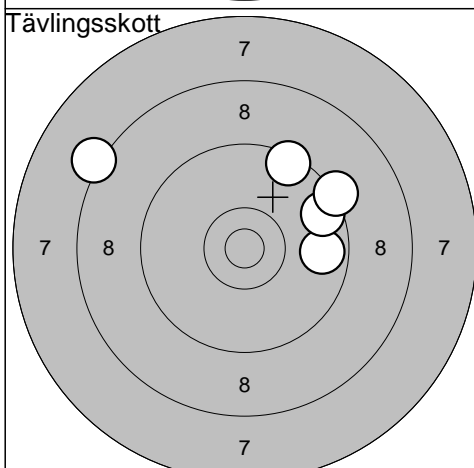

16: 9,7 →
 17: 8,2 ↖
 18: 9,4 ↑
 19: 9,6 →
 20: 9,3 ↗

Serie 44,0

Totalt 171,0

Ramselefors

2010-08-15

Förbundsmästerskap 2010

Ramselefors SKF

Provskott

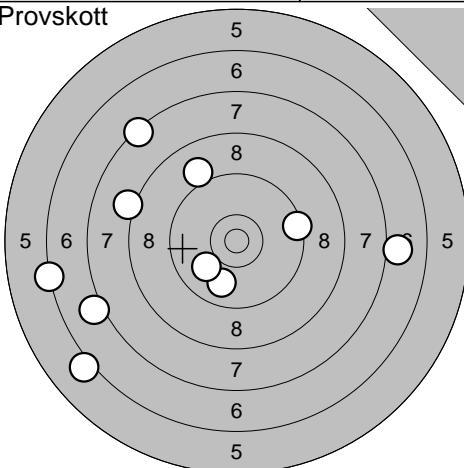

1: 6,3 ←
 2: 6,1 ↙
 3: 9,9 ↓
 4: 10,0 ↙
 5: 9,0 ↗
 6: 8,2 ↙
 7: 7,4 ↗
 8: 9,4 →
 9: 7,0 →
 10: 7,1 ↙

Serie 78,0
 Totalt 0,0

Provskott

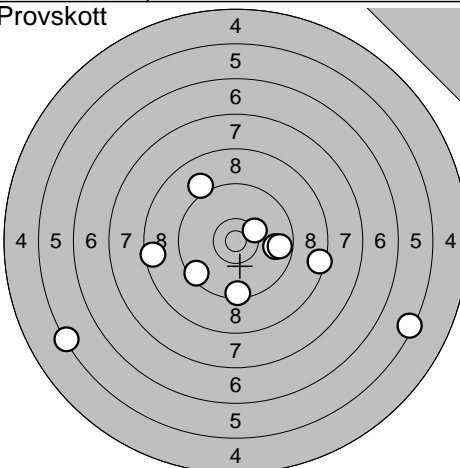

11: 9,8 →
 12: 9,1 ↗
 13: 8,6 ←
 14: 10,3* ↗
 15: 9,5 ↙
 16: 9,7 →
 17: 9,5 ↓
 18: 5,4 ↘
 19: 8,5 →
 20: 5,3 ↙

Serie 81,0
 Totalt 0,0

Provskott

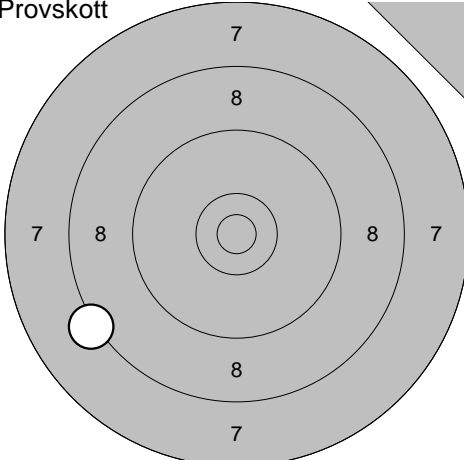

21: 8,2 ↙

Serie 8,0
 Totalt 0,0

Tävlingsskott

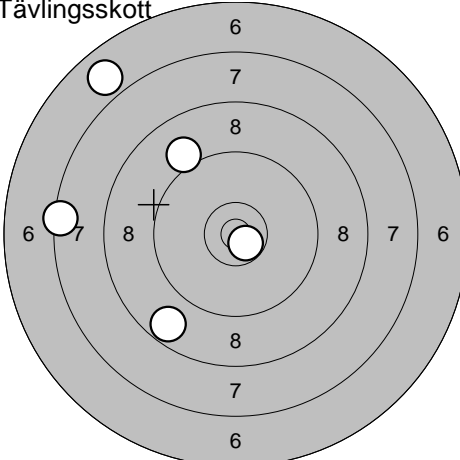

1: 10,7* ↘
 2: 7,4 ←
 3: 6,9 ↗
 4: 8,7 ↙
 5: 9,1 ↗

Serie 40,0
 Totalt 40,0

Tävlingsskott

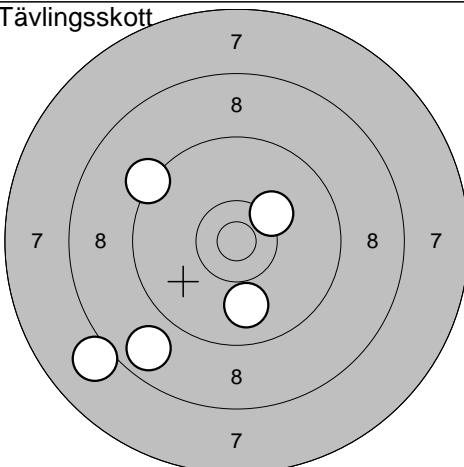

6: 8,1 ↙
 7: 10,3 ↗
 8: 8,8 ↙
 9: 9,9 ↓
 10: 9,3 ↙

Serie 44,0
 Totalt 84,0

Tävlingsskott

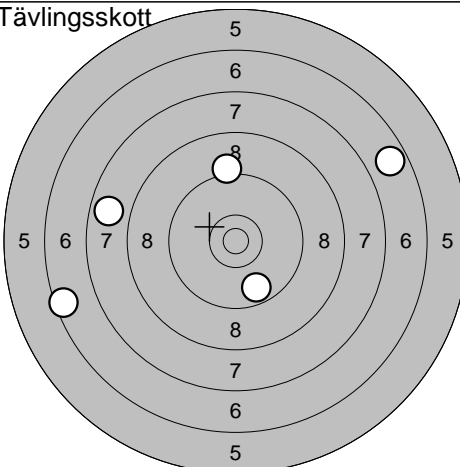

11: 6,5 ←
 12: 9,7 ↓
 13: 7,8 ←
 14: 6,7 ↗
 15: 9,2 ↑

Serie 37,0
 Totalt 121,0

Tävlingsskott

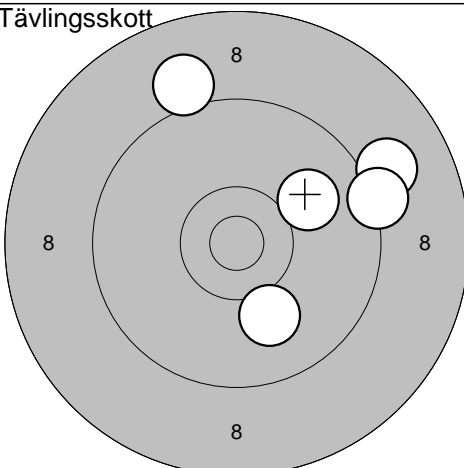

16: 9,0 ↗
 17: 10,0 ↗
 18: 9,3 →
 19: 9,0 ↑
 20: 10,0 ↓

Serie 47,0
 Totalt 168,0

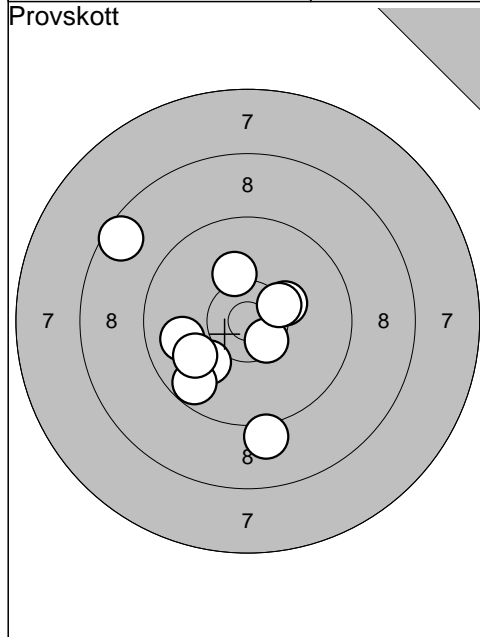

1: 8,6	↖
2: 10,1	↙
3: 9,9	←
4: 9,7	↙
5: 9,1	↓
6: 10,3*	→
7: 10,5*	↘
8: 10,0	↖
9: 10,4*	→
10: 10,2	↑
<hr/>	
Serie	95,0
<hr/>	
Totalt	0,0

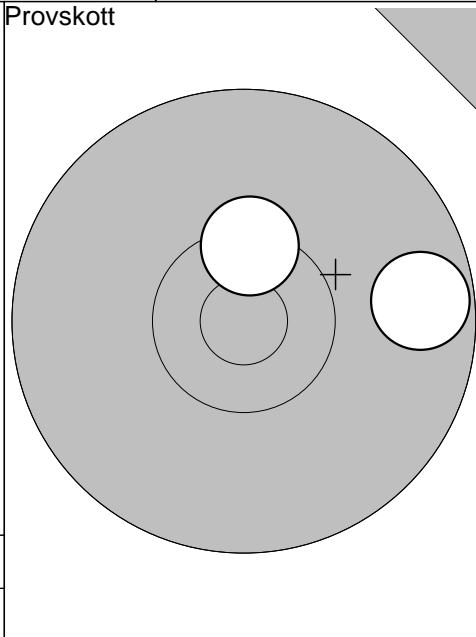

11: 9,7	→
12: 10,4*	↑
<hr/>	
Serie	19,0
<hr/>	
Totalt	0,0

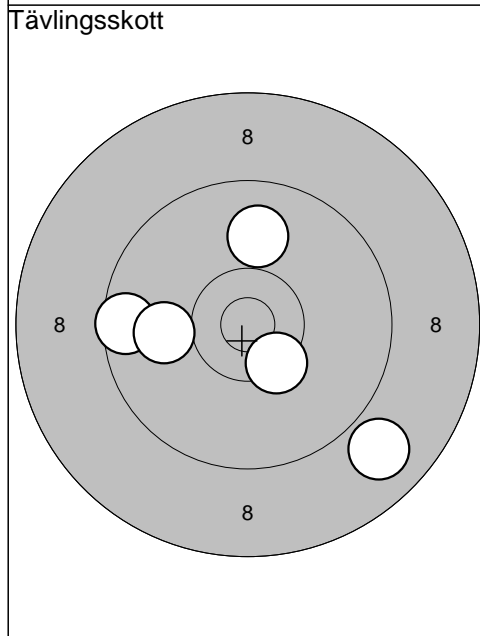

1: 9,6	←
2: 10,0	←
3: 10,4*	↘
4: 8,9	↘
5: 9,9	↑
<hr/>	
Serie	46,0
<hr/>	
Totalt	46,0

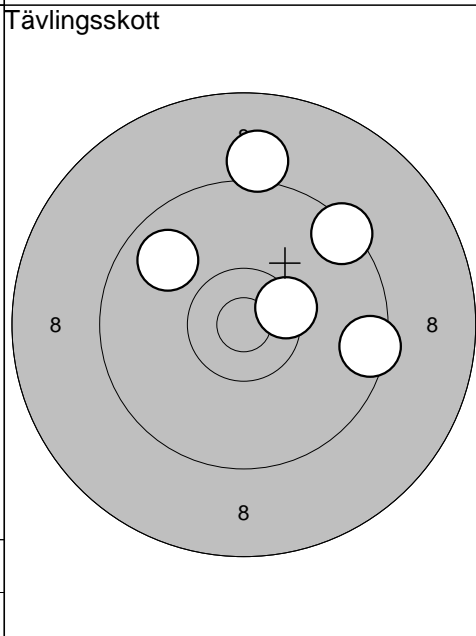

6: 10,4*	→
7: 9,1	↑
8: 9,8	↖
9: 9,5	→
10: 9,4	↗
<hr/>	
Serie	46,0
<hr/>	
Totalt	92,0

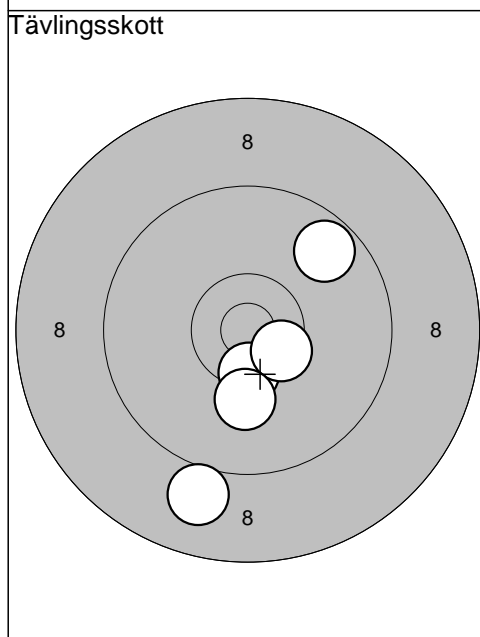

11: 10,5*	↓
12: 10,5*	↘
13: 10,2	↓
14: 9,7	↗
15: 9,0	↓
<hr/>	
Serie	48,0
<hr/>	
Totalt	140,0

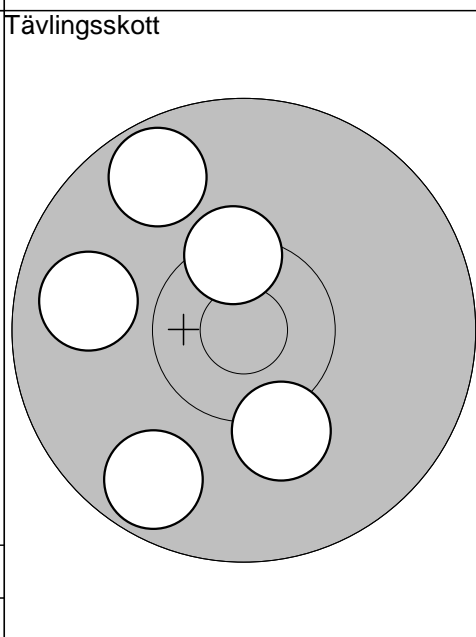

16: 10,4*	↑
17: 10,2	↓
18: 9,7	↙
19: 9,8	←
20: 9,7	↖
<hr/>	
Serie	47,0
<hr/>	
Totalt	187,0

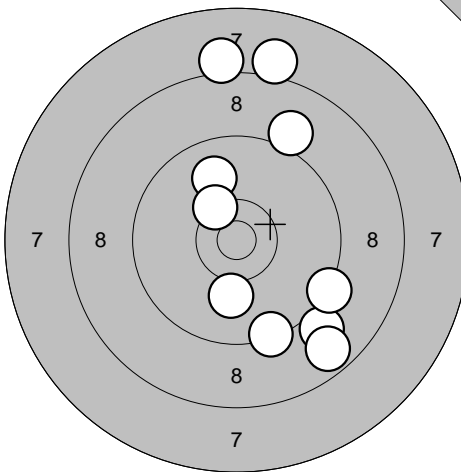
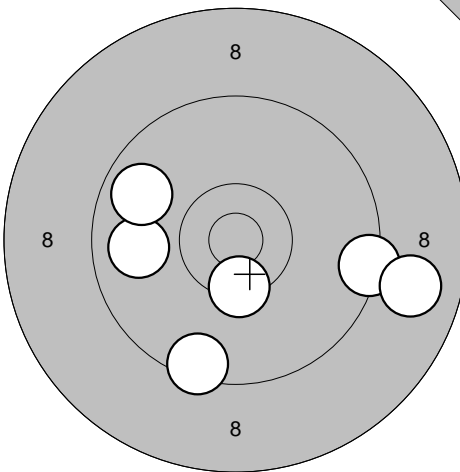
<p>Provskott</p> 	<p>1: 8,1 ↑</p> <p>2: 9,0 ↘</p> <p>3: 9,9 ↑</p> <p>4: 10,1 ↓</p> <p>5: 8,1 ↑</p> <p>6: 9,1 ↑</p> <p>7: 10,3* ↑</p> <p>8: 9,4 ↓</p> <p>9: 8,7 ↓</p> <p>10: 9,3 ↘</p>	<p>Provskott</p> 	<p>11: 10,4* ↓</p> <p>12: 9,4 →</p> <p>13: 9,8 ←</p> <p>14: 9,5 ↓</p> <p>15: 9,8 ↖</p> <p>16: 8,9 →</p>
Serie 89,0		Serie 54,0	
Totalt 0,0		Totalt 0,0	

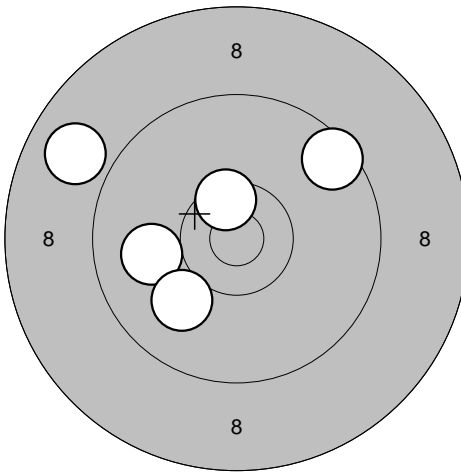
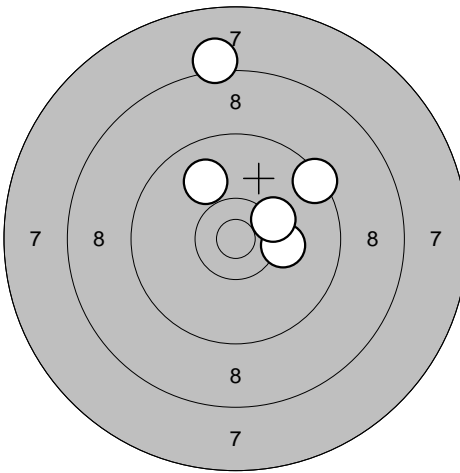
<p>Tävlingsskott</p> 	<p>1: 9,5 ↗</p> <p>2: 8,9 ↖</p> <p>3: 10,0 ←</p> <p>4: 10,0 ↙</p> <p>5: 10,5* ↑</p>	<p>Tävlingsskott</p> 	<p>6: 10,2 →</p> <p>7: 9,9 ↖</p> <p>8: 10,3 ↗</p> <p>9: 9,4 ↗</p> <p>10: 8,1 ↑</p>
Serie 47,0		Serie 46,0	
Totalt 47,0		Totalt 93,0	

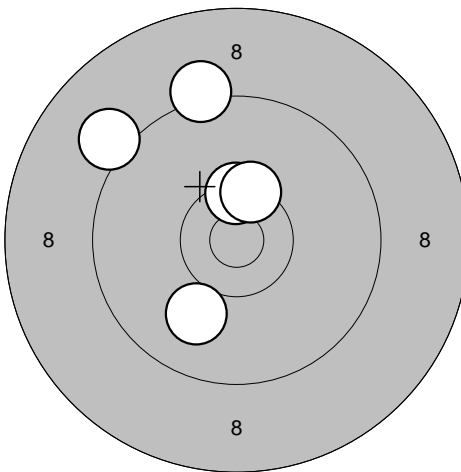
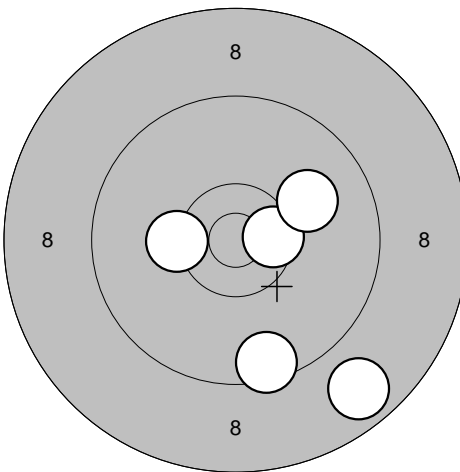
<p>Tävlingsskott</p> 	<p>11: 10,4* ↑</p> <p>12: 9,2 ↑</p> <p>13: 9,1 ↖</p> <p>14: 10,0 ↓</p> <p>15: 10,4* ↑</p>	<p>Tävlingsskott</p> 	<p>16: 10,5* →</p> <p>17: 10,3 ←</p> <p>18: 10,0 ↗</p> <p>19: 8,7 ↓</p> <p>20: 9,5 ↓</p>
Serie 48,0		Serie 47,0	
Totalt 141,0		Totalt 188,0	

Umeå

2010-08-15

Förbundsmästerskap 2010

Ramselefors SKF

Provskott

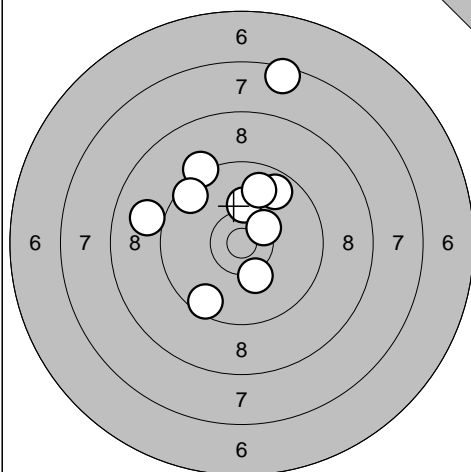

1: 7,5 ↗
 2: 9,6 ↘
 3: 9,3 ↗
 4: 9,7 ↗
 5: 10,2 ↑
 6: 10,4* ↗
 7: 9,0 ←
 8: 10,2 ↘
 9: 9,6 ↗
 10: 9,8 ↑

Serie 91,0

Totalt 0,0

Provskott

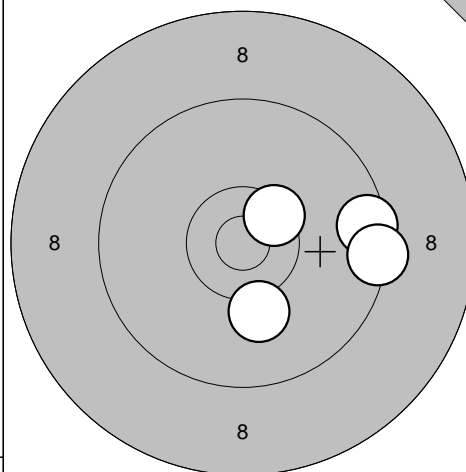

11: 9,5 →
 12: 10,1 ↘
 13: 10,5* ↗
 14: 9,4 →

Serie 38,0

Totalt 0,0

Tävlingsskott

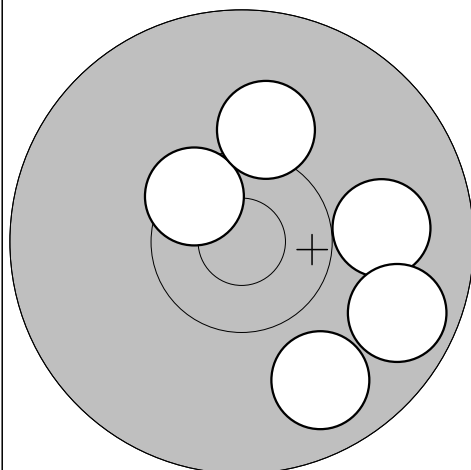

1: 10,5* ↗
 2: 10,1 ↑
 3: 10,0 →
 4: 9,8 ↘
 5: 9,7 ↘

Serie 48,0

Totalt 48,0

Tävlingsskott

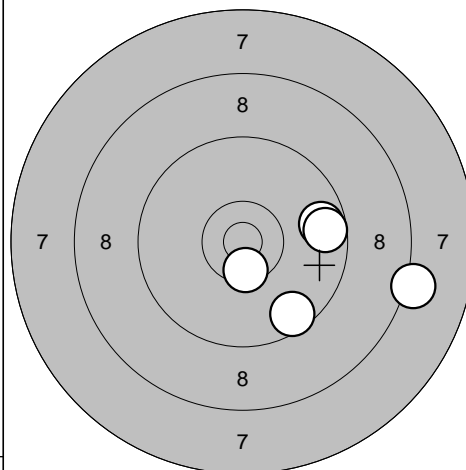

6: 8,2 →
 7: 9,7 →
 8: 10,5* ↘
 9: 9,6 →
 10: 9,6 ↘

Serie 45,0

Totalt 93,0

Tävlingsskott

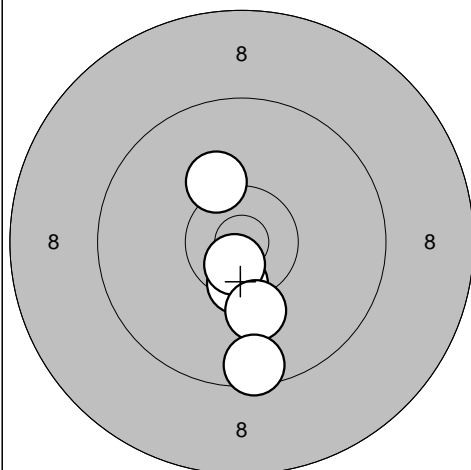

11: 10,5* ↘
 12: 10,7* ↘
 13: 10,2 ↗
 14: 10,1 ↘
 15: 9,5 ↘

Serie 49,0

Totalt 142,0

Tävlingsskott

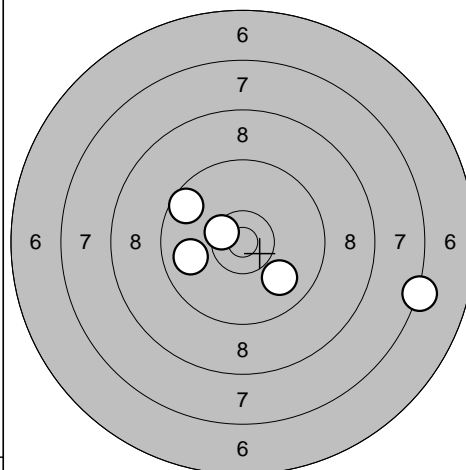

16: 10,5* ↗
 17: 9,6 ↗
 18: 9,9 ←
 19: 9,9 ↘
 20: 7,3 →

Serie 44,0

Totalt 186,0

Drängsmark

2010-08-15

Förbundsmästerskap 2010

Ramselefors SKF

Provskott

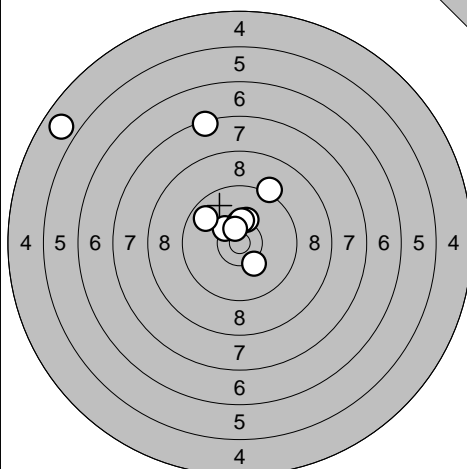

1: 4,9 ↙
 2: 10,3 ↑
 3: 9,2 ↗
 4: 10,4* ↙
 5: 7,4 ↑
 6: 10,4* ↑
 7: 10,3* ↑
 8: 10,5* ↑
 9: 9,8 ↗
 10: 10,2 ↓

Serie 89,0

Totalt 0,0

Tävlingskott

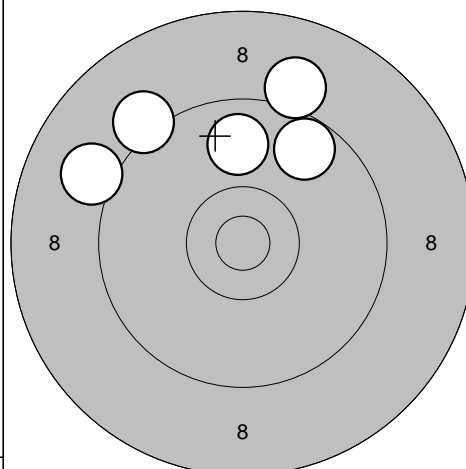

1: 9,1 ↑
 2: 9,7 ↗
 3: 9,2 ↙
 4: 9,1 ↙
 5: 9,8 ↑

Serie 45,0

Totalt 45,0

Tävlingskott

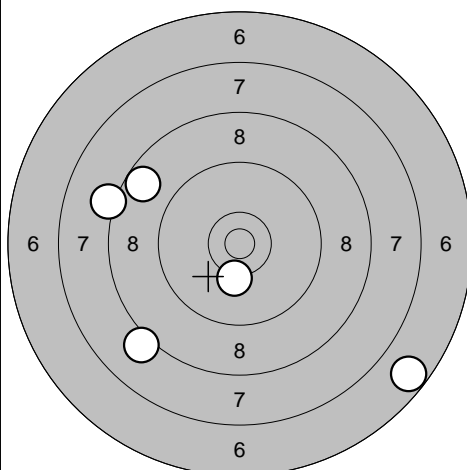

6: 8,1 ↙
 7: 6,7 ↓
 8: 10,2 ↓
 9: 8,2 ↙
 10: 8,7 ↙

Serie 40,0

Totalt 85,0

Tävlingskott

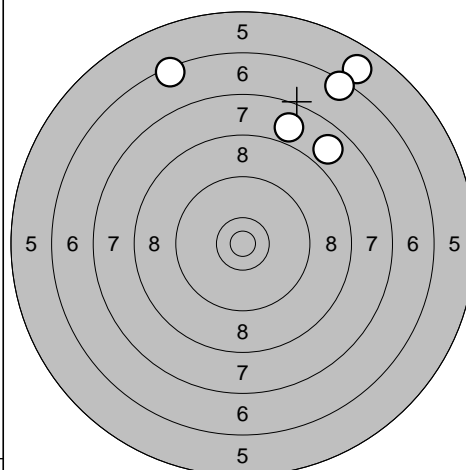

11: 7,9 ↗
 12: 7,9 ↑
 13: 5,9 ↗
 14: 6,4 ↙
 15: 6,5 ↗

Serie 31,0

Totalt 116,0

Tävlingskott

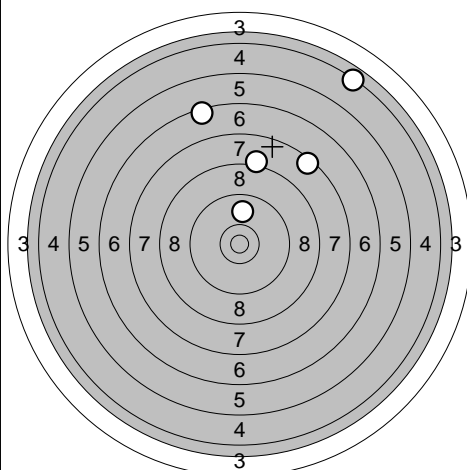

16: 9,9 ↑
 17: 8,2 ↑
 18: 4,4 ↗
 19: 7,5 ↗
 20: 6,5 ↑

Serie 34,0

Totalt 150,0

2010-08-15

Förbundsmästerskap 2010

Ramselefors SKF

Provskott

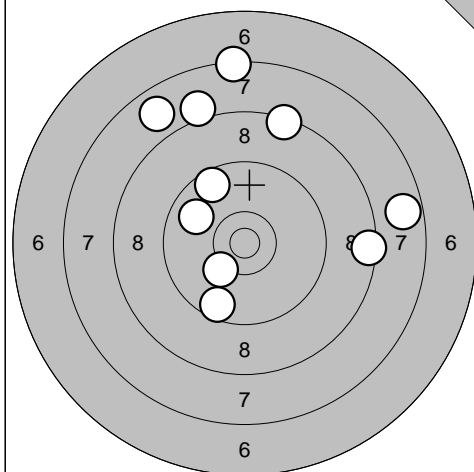

1: 10,2 ↙
 2: 7,4 ↑
 3: 8,1 ↑
 4: 9,6 ↓
 5: 9,8 ↖
 6: 8,4 ↑
 7: 9,6 ↑
 8: 7,8 ↑
 9: 7,7 →
 10: 8,5 →

Serie 82,0

Totalt 0,0

Provskott

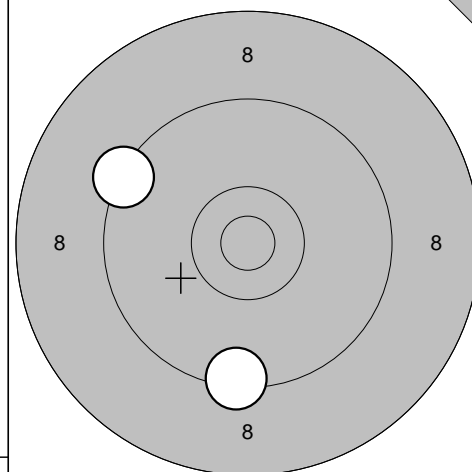

11: 9,4 ↓
 12: 9,3 ↖

Serie 18,0

Totalt 0,0

Tävlingsskott

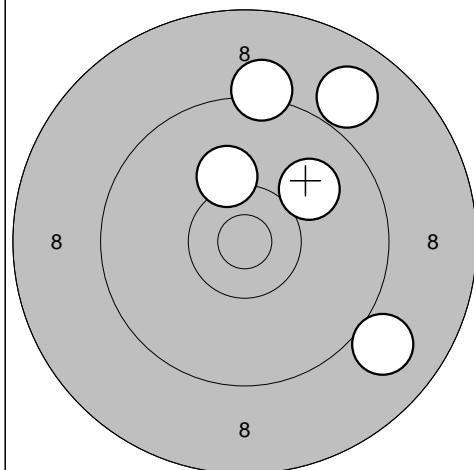

1: 8,9 ↗
 2: 9,0 ↘
 3: 9,2 ↑
 4: 10,2 ↑
 5: 10,0 ↗

Serie 46,0

Totalt 46,0

Tävlingsskott

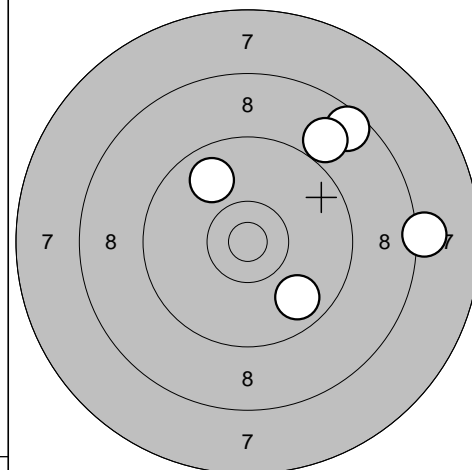

6: 8,2 →
 7: 8,6 ↗
 8: 8,9 ↗
 9: 9,8 ↖
 10: 9,8 ↘

Serie 42,0

Totalt 88,0

Tävlingsskott

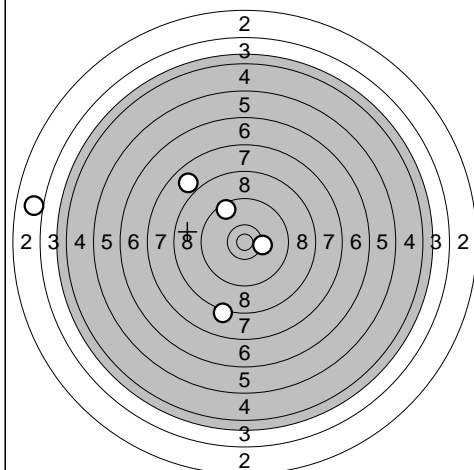

11: 7,9 ↖
 12: 8,2 ↓
 13: 3,0 ←
 14: 9,6 ↗
 15: 10,3 →

Serie 37,0

Totalt 125,0

Tävlingsskott

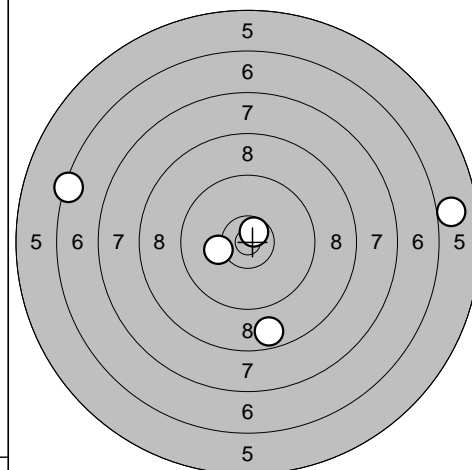

16: 8,7 ↓
 17: 10,7* ↗
 18: 5,9 →
 19: 10,2 ←
 20: 6,4 ↖

Serie 39,0

Totalt 164,0

2010-08-15

Förbundsmästerskap 2010

Ramselefors SKF

Provskott

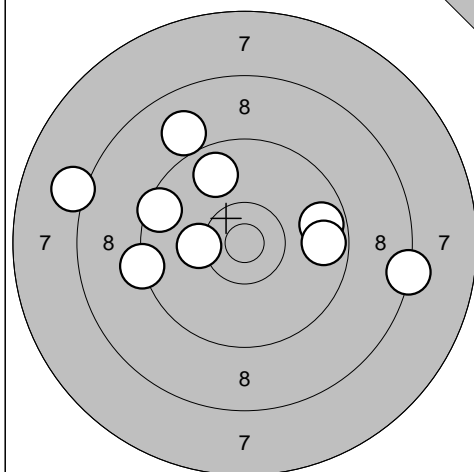

1: 8,1 ↖
 2: 8,3 →
 3: 9,5 ↖
 4: 9,3 ←
 5: 10,2 ←
 6: 9,7 →
 7: 9,8 ↗
 8: 9,0 ↗
 9: 9,7 →

Serie 80,0

Totalt 0,0

Tävlingsskott

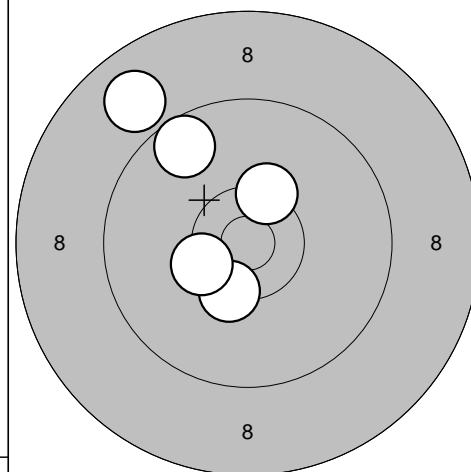

1: 10,4* ↓
 2: 10,4* ↖
 3: 8,9 ↗
 4: 10,3* ↗
 5: 9,6 ↗

Serie 47,0

Totalt 47,0

Tävlingsskott

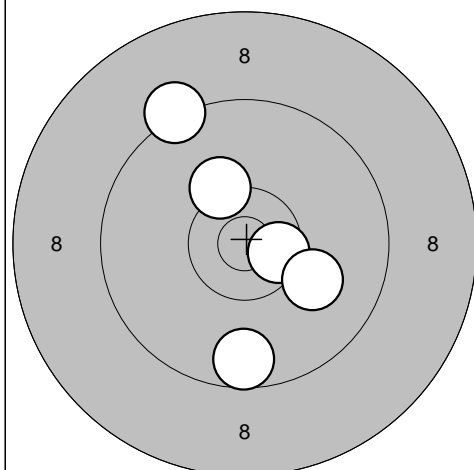

6: 10,3 ↗
 7: 10,5* →
 8: 9,6 ↓
 9: 9,3 ↗
 10: 10,1 ↓

Serie 48,0

Totalt 95,0

Tävlingsskott

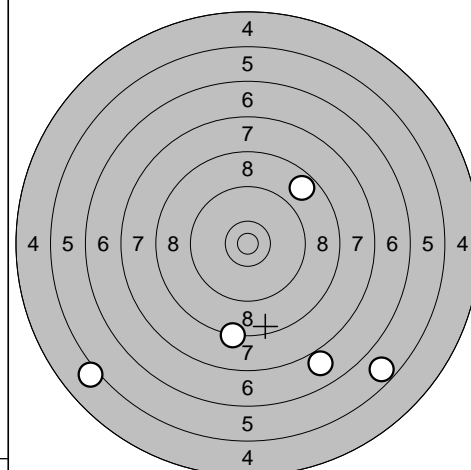

11: 8,3 ↓
 12: 5,7 ↘
 13: 8,7 ↗
 14: 5,1 ↖
 15: 6,9 ↓

Serie 32,0

Totalt 127,0

Tävlingsskott

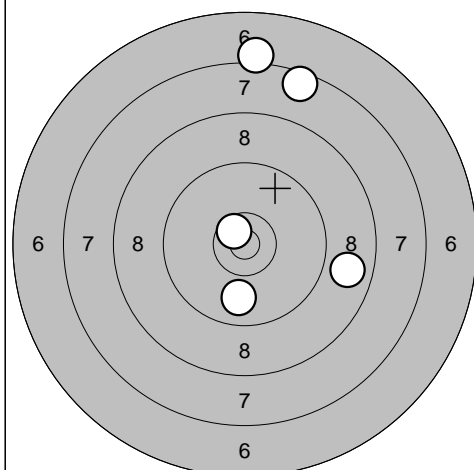

16: 10,6* ↖
 17: 7,2 ↑
 18: 7,6 ↗
 19: 8,8 →
 20: 9,9 ↓

Serie 41,0

Totalt 168,0

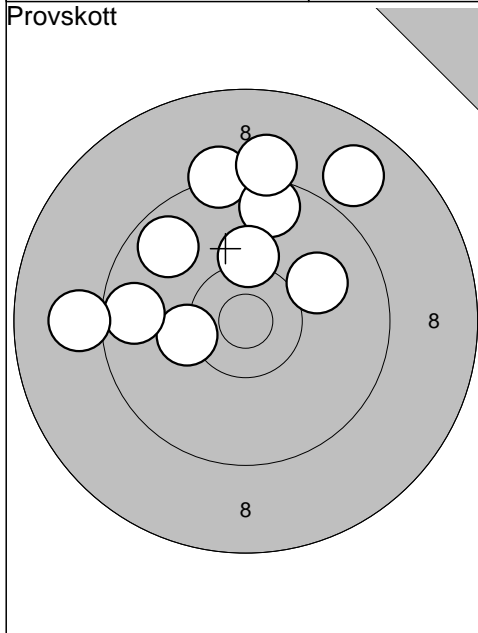

1: 10,3	←
2: 8,9	↗
3: 9,7	←
4: 9,7	↖
5: 9,1	←
6: 9,3	↑
7: 10,0	↗
8: 9,6	↑
9: 9,2	↑
10: 10,2	↑
<hr/>	
Serie	92,0
<hr/>	
Totalt	0,0

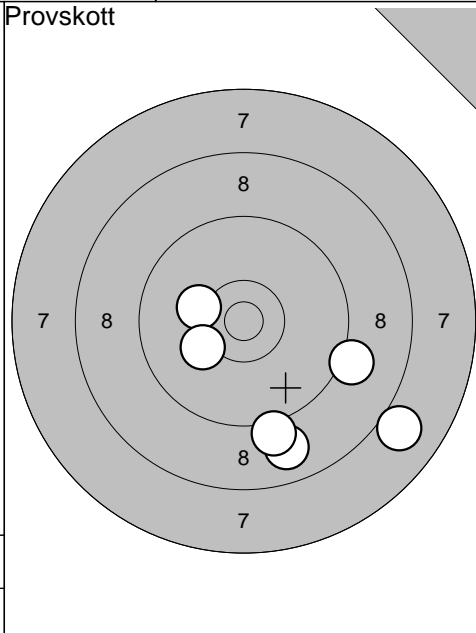

11: 9,1	↘
12: 10,2	↖
13: 8,9	↓
14: 10,2	↖
15: 9,1	↓
16: 8,0	↘
<hr/>	
Serie	54,0
<hr/>	
Totalt	0,0

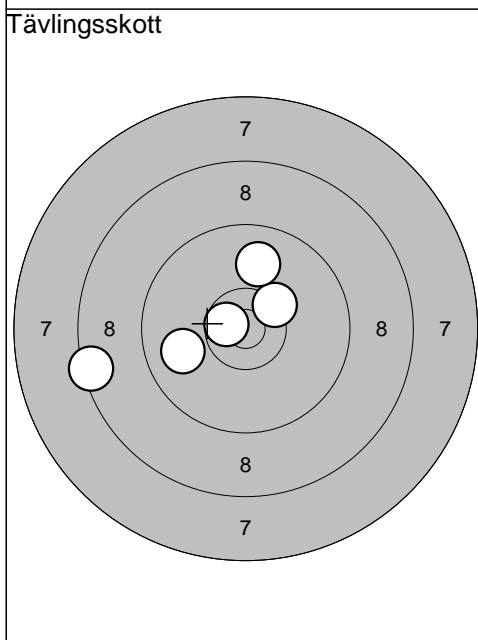

1: 10,4*	↗
2: 9,9	←
3: 10,6*	←
4: 9,9	↑
5: 8,4	←
<hr/>	
Serie	46,0
<hr/>	
Totalt	46,0

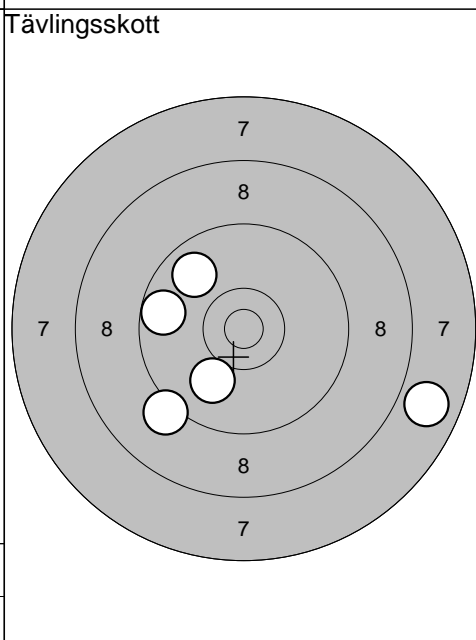

6: 9,8	↖
7: 7,8	↘
8: 10,0	↓
9: 9,2	↘
10: 9,7	←
<hr/>	
Serie	44,0
<hr/>	
Totalt	90,0

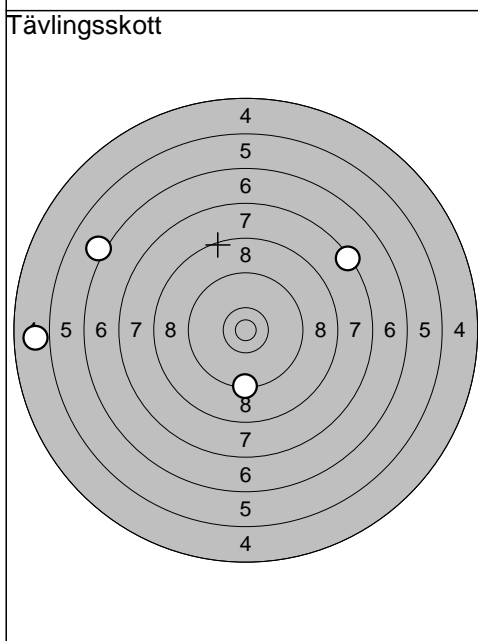

11: 9,3	↓
12: 6,1	↖
13: 7,4	↗
14: 4,9	←
15: 0,0	↑
<hr/>	
Serie	26,0
<hr/>	
Totalt	116,0

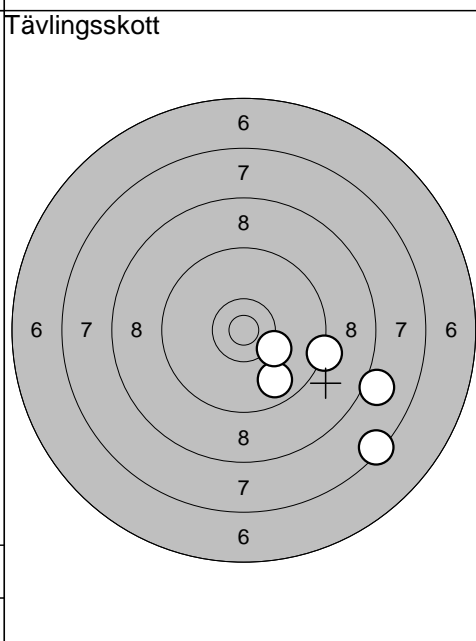

16: 8,0	↘
17: 9,8	↓
18: 10,2	↓
19: 9,3	↘
20: 7,4	↘
<hr/>	
Serie	43,0
<hr/>	
Totalt	159,0

Skellefteå

2010-08-15	Förbundsmästerskap 2010	Ramselefors SKF
------------	-------------------------	-----------------

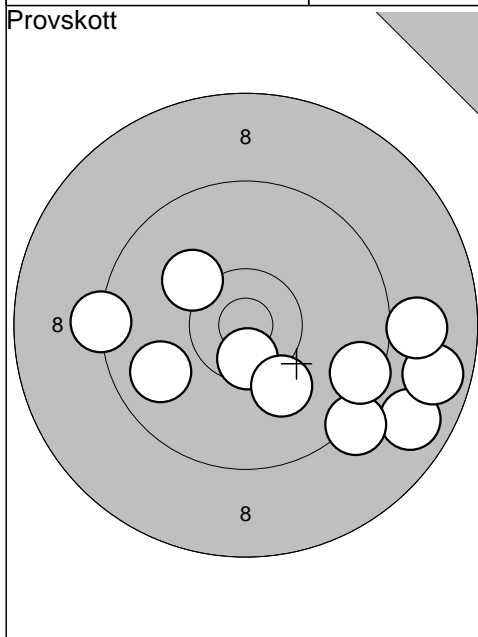

1: 10,2	↗
2: 9,3	←
3: 9,8	↙
4: 8,8	↘
5: 10,6*	↓
6: 9,2	↘
7: 8,7	→
8: 9,0	→
9: 9,5	→
10: 10,1	↘
Serie	91,0
Totalt	0,0

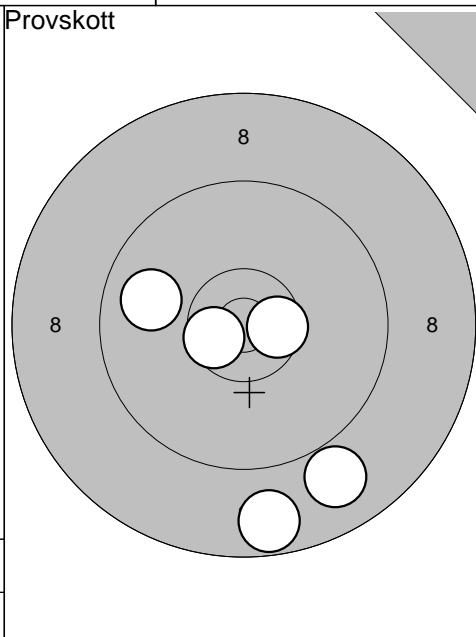

11: 10,6*	→
12: 9,9	←
13: 8,7	↓
14: 10,6*	↙
15: 8,9	↘
Serie	45,0
Totalt	0,0

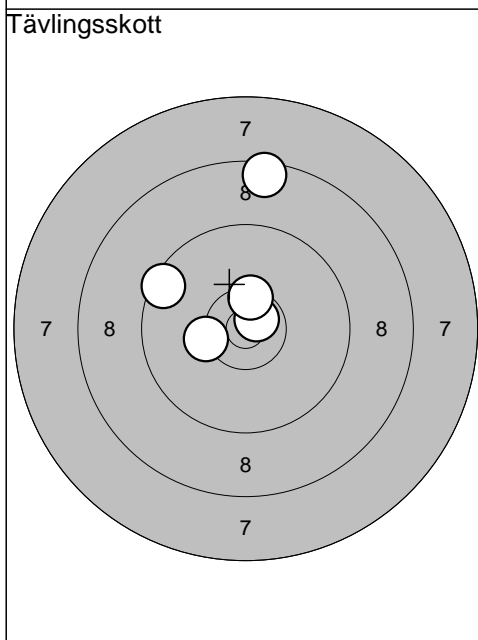

1: 10,7*	↗
2: 10,3*	←
3: 9,5	↙
4: 10,5*	↑
5: 8,5	↑
Serie	47,0
Totalt	47,0

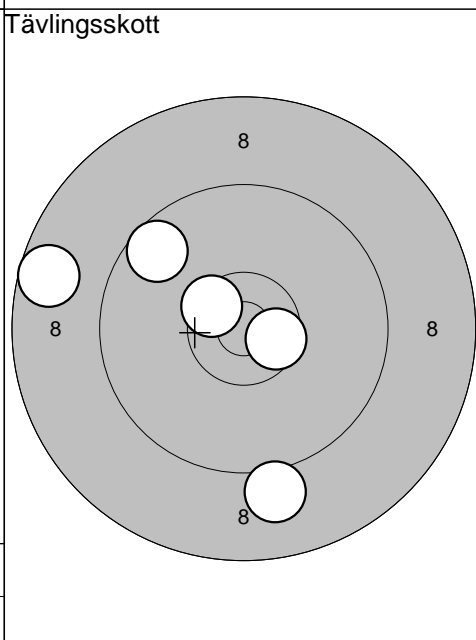

6: 10,5*	↙
7: 9,6	↗
8: 8,7	←
9: 10,6*	→
10: 9,1	↓
Serie	46,0
Totalt	93,0

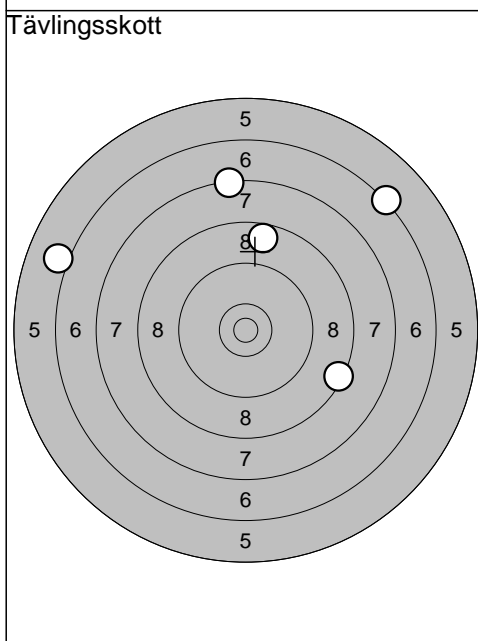

11: 6,3	↗
12: 7,3	↑
13: 6,1	←
14: 8,4	↘
15: 8,7	↑
Serie	35,0
Totalt	128,0

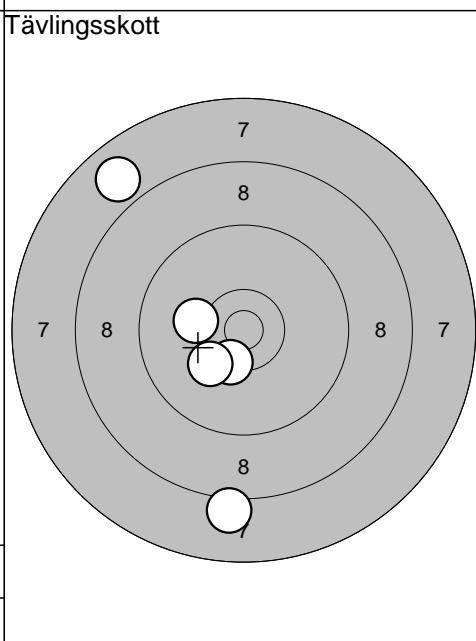

16: 10,4*	↘
17: 10,2	←
18: 8,1	↓
19: 7,9	↗
20: 10,2	↙
Serie	45,0
Totalt	173,0

Ramselefors

2010-08-15

Förbundsmästerskap 2010

Ramselefors SKF

Provskott

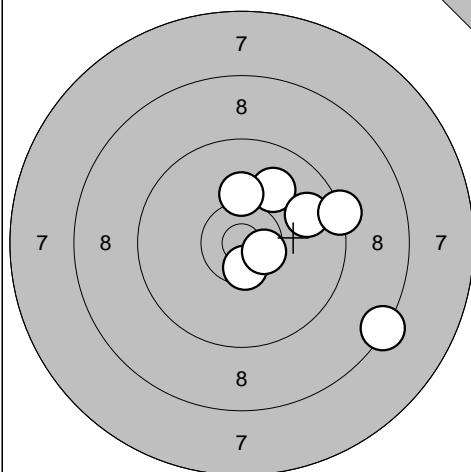

1: 10,6* ↓
 2: 10,0 ↗
 3: 8,4 →
 4: 10,6* →
 5: 10,2 ↑
 6: 9,8 →
 7: 9,3 →

Serie 66,0
 Totalt 0,0

Tävlingsskott

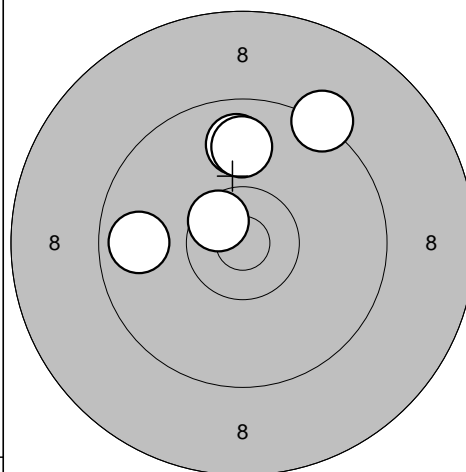

1: 9,3 ↗
 2: 9,8 ←
 3: 9,8 ↑
 4: 9,9 ↑
 5: 10,6* ↖

Serie 46,0
 Totalt 46,0

Tävlingsskott

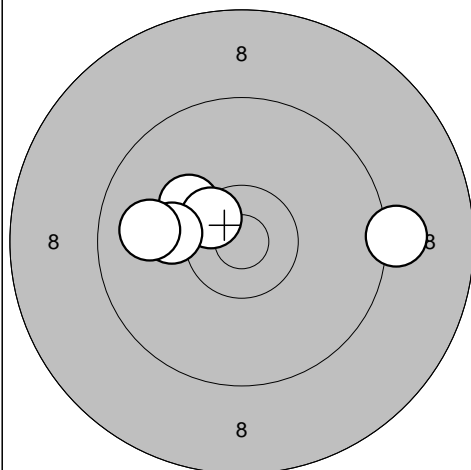

6: 10,2 ↖
 7: 10,5* ↗
 8: 10,2 ←
 9: 9,2 →
 10: 9,9 ←

Serie 48,0
 Totalt 94,0

Tävlingsskott

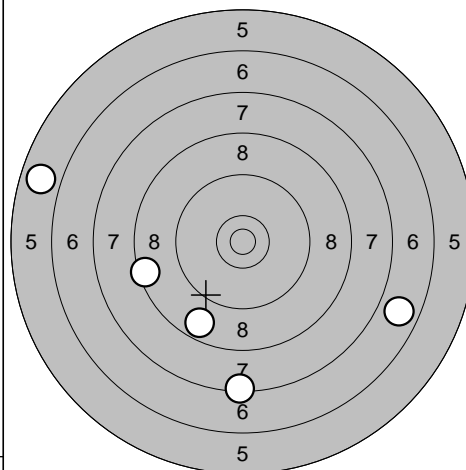

11: 8,7 ↘
 12: 7,4 ↓
 13: 5,8 ←
 14: 6,8 →
 15: 8,5 ←

Serie 34,0
 Totalt 128,0

Tävlingsskott

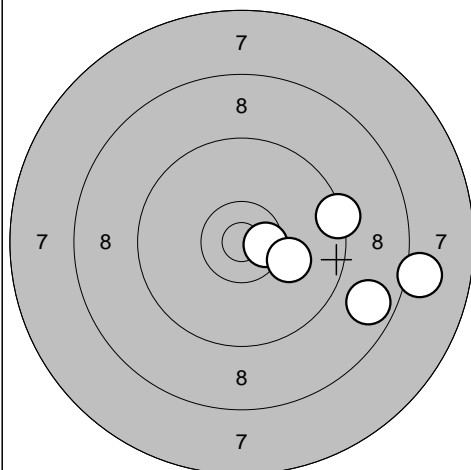

16: 9,4 →
 17: 8,7 →
 18: 10,6* →
 19: 8,1 →
 20: 10,2 →

Serie 45,0
 Totalt 173,0

Umeå

2010-08-15

Förbundsmästerskap 2010

Ramselefors SKF

Provskott

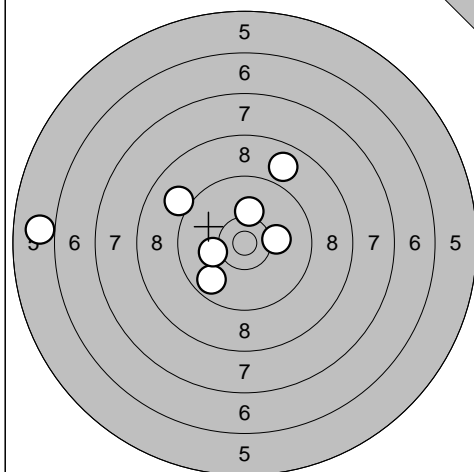

1: 6,0 ←
 2: 8,9 ↗
 3: 10,2 →
 4: 9,7 ↘
 5: 10,2 ↑
 6: 9,1 ↖
 7: 10,2 ←

Serie 62,0

Totalt 0,0

Tävlingsskott

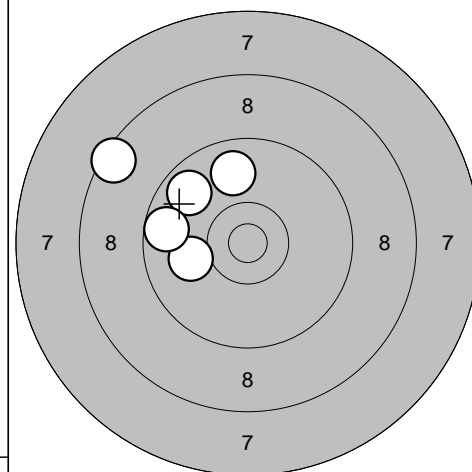

1: 10,0 ←
 2: 9,8 ↑
 3: 8,5 ↖
 4: 9,7 ↗
 5: 9,7 ←

Serie 45,0

Totalt 45,0

Tävlingsskott

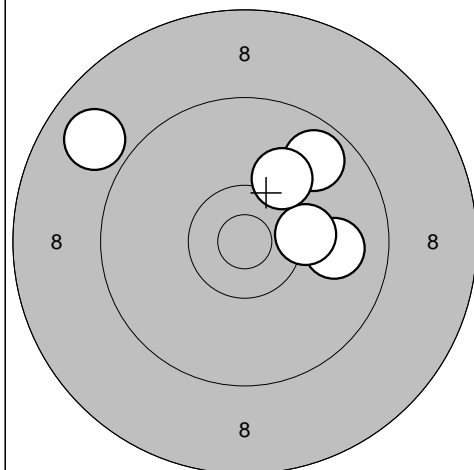

6: 8,9 ↖
 7: 9,7 ↗
 8: 9,9 →
 9: 10,2 →
 10: 10,1 ↗

Serie 46,0

Totalt 91,0

Tävlingsskott

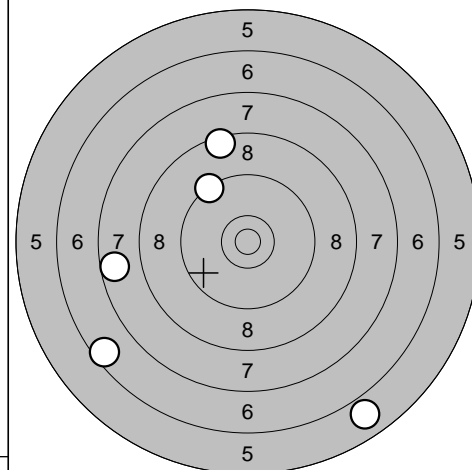

11: 9,3 ↖
 12: 7,7 ←
 13: 6,6 ↘
 14: 5,9 ↘
 15: 8,5 ↑

Serie 35,0

Totalt 126,0

Tävlingsskott

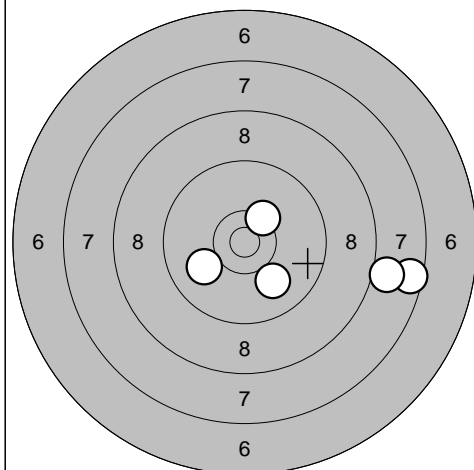

16: 10,0 ↖
 17: 7,5 →
 18: 8,0 →
 19: 10,3* ↗
 20: 10,0 ↘

Serie 45,0

Totalt 171,0

Ramselefors

2010-08-15	Förbundsmästerskap 2010	Ramselefors SKF
------------	-------------------------	-----------------

Provs skott

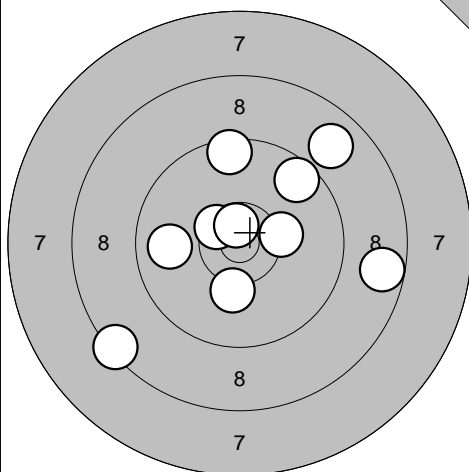

- 1: 8,4 ↙
- 2: 10,5* ↖
- 3: 9,6 ↗
- 4: 9,5 ↑
- 5: 8,7 →
- 6: 10,3 →
- 7: 8,9 ↗
- 8: 10,2 ↓
- 9: 9,9 ←
- 10: 10,7* ↑

Serie	91,0
Totalt	0,0

Tävlingsskott

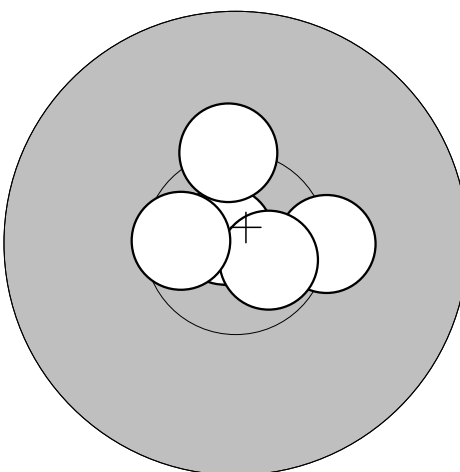

- 1: 10,3* →
- 2: 10,9* ↖
- 3: 10,3* ↑
- 4: 10,7* ↘
- 5: 10,6* ←

Serie	50,0
Totalt	50,0

Tävlingsskott

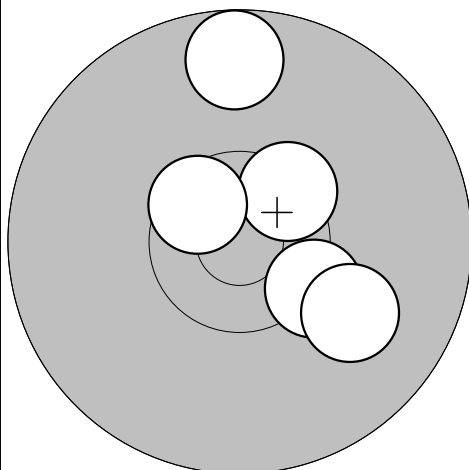

- 6: 10,5* ↗
- 7: 10,6* ↖
- 8: 10,3* ↘
- 9: 9,7 ↑
- 10: 10,0 ↘

Serie	49,0
Totalt	99,0

Tävlingsskott

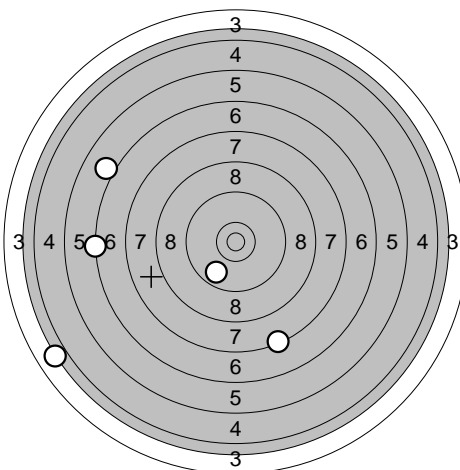

- 11: 6,3 ←
- 12: 7,4 ↓
- 13: 6,1 ↖
- 14: 9,8 ↘
- 15: 3,9 ↙

Serie	31,0
Totalt	130,0

Tävlingsskott

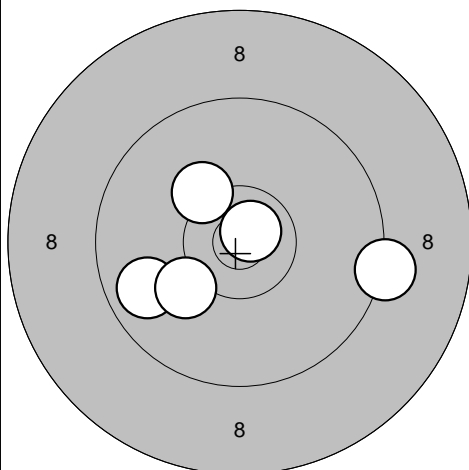

- 16: 10,8* ↗
- 17: 10,2 ↖
- 18: 9,3 →
- 19: 9,8 ↖
- 20: 10,1 ↖

Serie	48,0
Totalt	178,0

Ramselefors

2010-08-15

Förbundsmästerskap 2010

Ramselefors SKF

Provskott

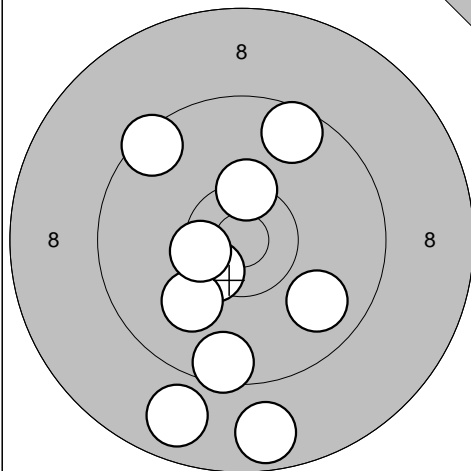

1: 10,5* ↙
 2: 8,7 ↓
 3: 10,1 ↙
 4: 10,4* ↑
 5: 10,5* ←
 6: 8,8 ↓
 7: 9,5 ↓
 8: 9,5 ↗
 9: 9,8 ↘
 10: 9,6 ↗

Serie 92,0

Totalt 0,0

Provskott

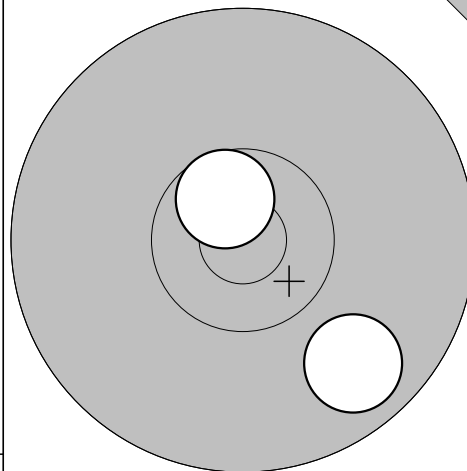

11: 10,6* ↗
 12: 9,8 ↘

Serie 19,0

Totalt 0,0

Tävlingsskott

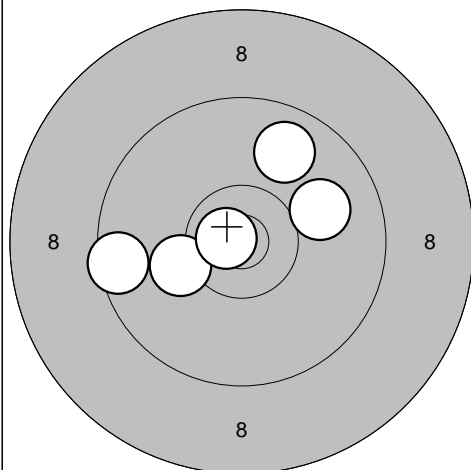

1: 10,0 →
 2: 9,8 ↗
 3: 9,5 ←
 4: 10,2 ←
 5: 10,8* ←

Serie 48,0

Totalt 48,0

Tävlingsskott

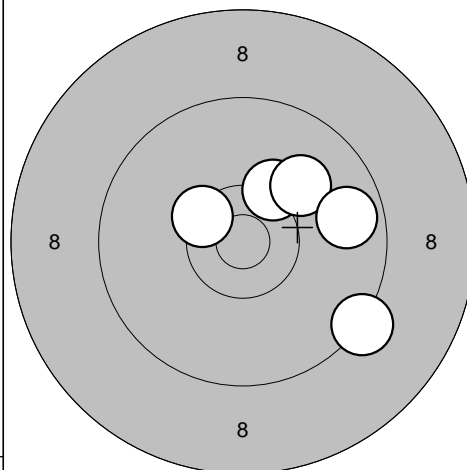

6: 10,3 ↗
 7: 10,4* ↙
 8: 10,0 ↗
 9: 9,3 ↘
 10: 9,7 →

Serie 48,0

Totalt 96,0

Tävlingsskott

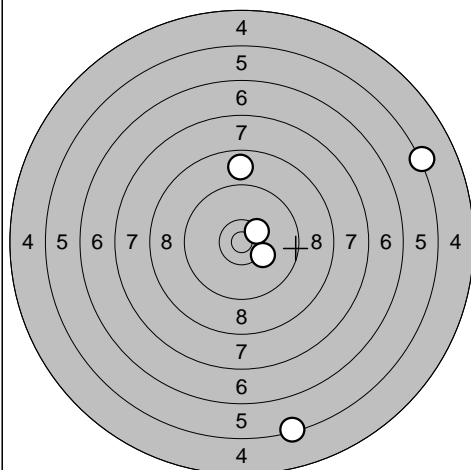

11: 10,4* ↗
 12: 8,8 ↑
 13: 5,3 →
 14: 10,2 ↘
 15: 5,4 ↓

Serie 38,0

Totalt 134,0

Tävlingsskott

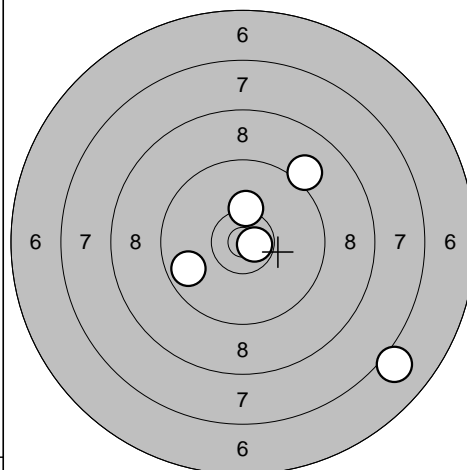

16: 10,7* →
 17: 10,3 ↑
 18: 9,1 ↗
 19: 9,7 ↙
 20: 7,0 ↘

Serie 45,0

Totalt 179,0