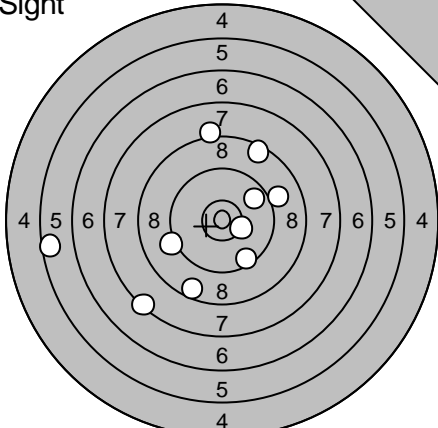
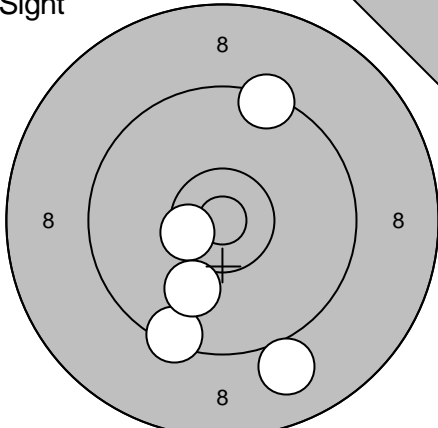
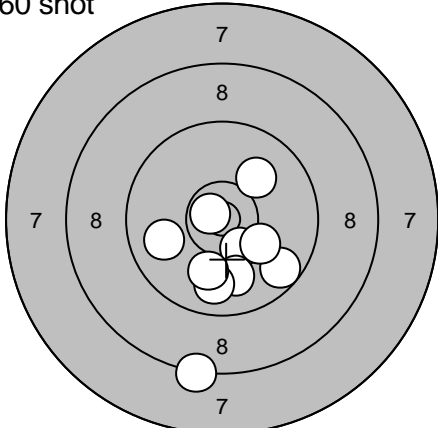
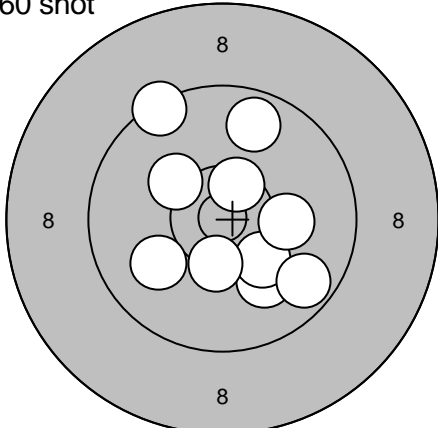
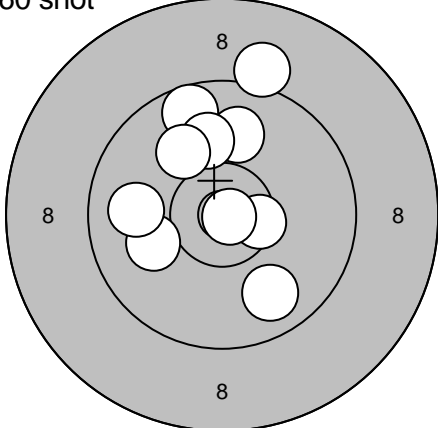
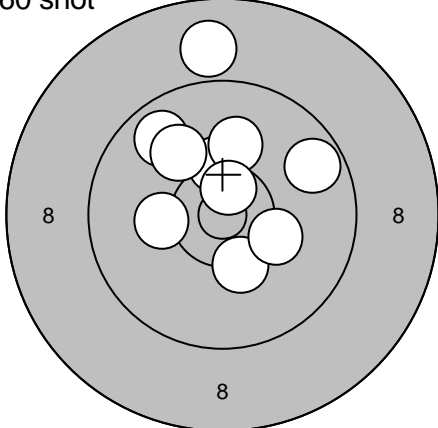
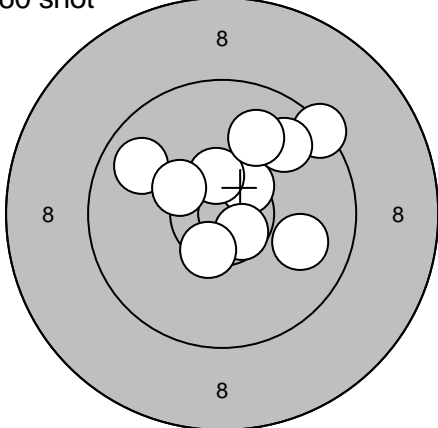
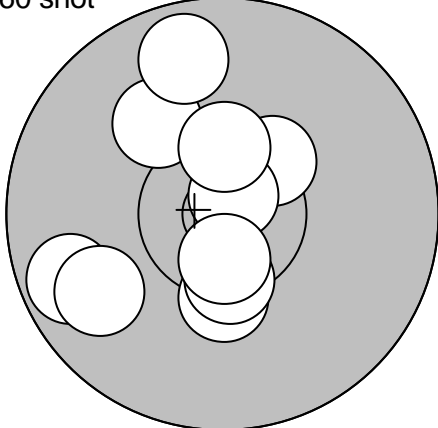

2010-08-19	Föreningsmästerskap 2010	Umeå skytteallians
------------	--------------------------	--------------------

Sight 	1: 5,6 ← 2: 7,4 ↙ 3: 9,2 ← 4: 9,1 → 5: 8,3 ↑ 6: 8,6 ↗ 7: 8,6 ↓ 8: 9,6 ↓ 9: 10,3* → 10: 9,7 ↗ <hr/> Serie: 82,0 Summa: 0,0	Sight 	11: 9,0 ↓ 12: 10,5* ← 13: 9,4 ↓ 14: 9,4 ↑ 15: 10,0 ↓ <hr/> Serie: 47,0 Summa: 0,0
---	--	--	---

60 shot 	1: 9,9 ← 2: 10,4* ↓ 3: 9,7 ↓ 4: 10,7* ← 5: 10,1 ↗ 6: 10,0 ↓ 7: 9,8 ↓ 8: 10,2 ↓ 9: 10,0 ↓ 10: 8,3 ↓ <hr/> Serie: 95,0 Summa: 95,0	60 shot 	11: 10,0 ↓ 12: 10,2 ↓ 13: 9,7 ↓ 14: 10,5* ↑ 15: 9,4 ↗ 16: 10,0 ← 17: 10,2 → 18: 9,7 ↑ 19: 10,2 ↖ 20: 10,4* ↓ <hr/> Serie: 97,0 Summa: 192,0
--	---	---	--

60 shot 	21: 9,8 ↓ 22: 10,0 ← 23: 9,6 ↗ 24: 10,0 ↑ 25: 9,9 ← 26: 10,5* → 27: 10,9* → 28: 9,1 ↑ 29: 10,0 ↑ 30: 10,0 ↗ <hr/> Serie: 96,0 Summa: 288,0	60 shot 	31: 8,9 ↑ 32: 10,3* ↑ 33: 10,3* ↓ 34: 10,2 ← 35: 10,2 → 36: 10,1 ↑ 37: 9,8 ↖ 38: 10,6* ↑ 39: 10,0 ↗ 40: 9,7 ↗ <hr/> Serie: 96,0 Summa: 384,0
---	---	--	---

60 shot 	41: 9,4 ↗ 42: 10,5* ↗ 43: 9,8 ↗ 44: 9,8 ↖ 45: 9,9 → 46: 10,6* ↓ 47: 10,5* ↗ 48: 9,9 ↑ 49: 10,5* ↓ 50: 10,3* ↖ <hr/> Serie: 95,0 Summa: 479,0	60 shot 	51: 9,7 ← 52: 10,4* ↗ 53: 10,8* ↗ 54: 10,1 ↖ 55: 10,3* ↓ 56: 9,7 ↑ 57: 10,4* ↓ 58: 9,8 ← 59: 10,4* ↑ 60: 10,6* ↓ <hr/> Serie: 97,0 Summa: 576,0
---	---	--	--

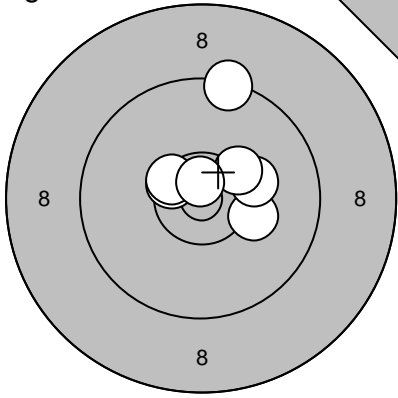
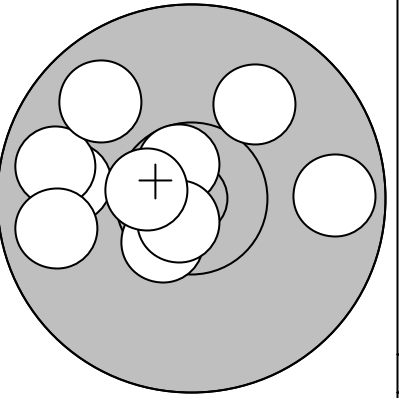
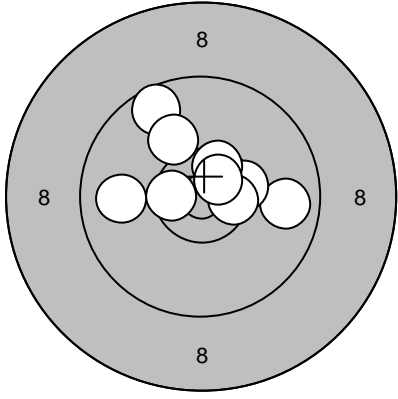
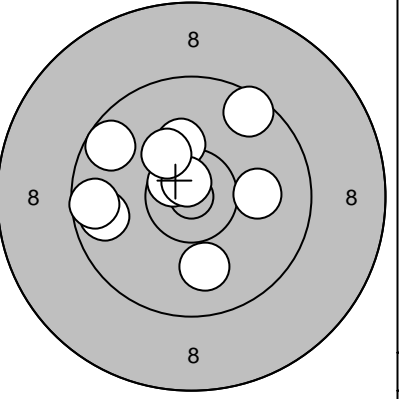
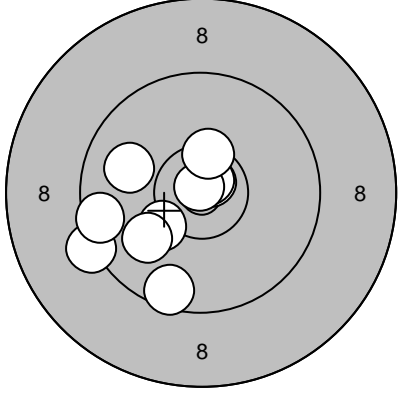
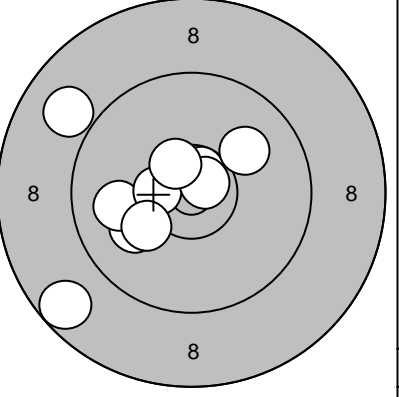
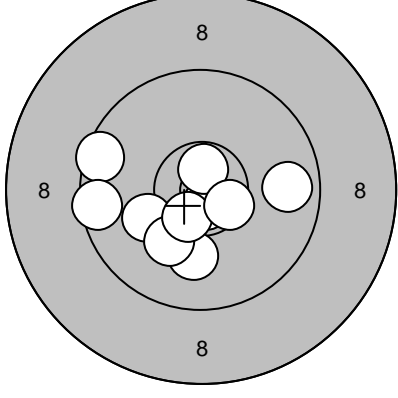
Lag	Tavla	Stefan Thorin		
1	11			
2010-08-19	Föreningsmästerskap 2010	Umeå skytteallians		
Sight		1: 10,5* ← 2: 10,5* ↖ 3: 10,2 → 4: 10,2 → 5: 10,3* ↗ 6: 9,4 ↑ 7: 10,7* ↑ Serie: 69,0 Summa: 0,0	60 shot 	1: 9,9 ← 2: 10,0 ↗ 3: 9,8 ← 4: 10,5* ↘ 5: 10,6* ↗ 6: 9,8 ← 7: 9,7 → 8: 9,8 ↗ 9: 10,7* ↘ 10: 10,6* ← Serie: 95,0 Summa: 95,0
60 shot		11: 9,6 ↖ 12: 10,5* ↗ 13: 9,8 → 14: 10,3* → 15: 10,5* → 16: 10,5* ↗ 17: 10,6* ← 18: 10,6* ↗ 19: 10,1 ↖ 20: 9,9 ← Serie: 97,0 Summa: 192,0	60 shot 	21: 9,6 ↗ 22: 9,7 ← 23: 10,6* ↗ 24: 9,7 ↗ 25: 10,2 ↑ 26: 10,8* ↗ 27: 9,6 ← 28: 10,0 ↘ 29: 10,3 ↗ 30: 10,1 → Serie: 96,0 Summa: 288,0
60 shot		31: 10,8* ↗ 32: 10,7* ↗ 33: 10,3 ↘ 34: 9,9 ← 35: 9,3 ← 36: 10,0 ← 37: 10,9* ↖ 38: 9,5 ← 39: 9,6 ↘ 40: 10,4* ↑ Serie: 96,0 Summa: 384,0	60 shot 	41: 10,0 ← 42: 10,7* ↗ 43: 10,0 ← 44: 10,5* ← 45: 8,7 ↘ 46: 10,0 ↗ 47: 10,7* ↗ 48: 10,2 ↘ 49: 9,0 ↗ 50: 10,5* ↗ Serie: 97,0 Summa: 481,0
60 shot		51: 10,0 ↘ 52: 9,5 ← 53: 10,1 ← 54: 10,7* ↘ 55: 9,5 ← 56: 10,1 ↘ 57: 9,8 → 58: 10,5* ↘ 59: 10,7* ↑ 60: 10,5* ↘ Serie: 97,0 Summa: 578,0		

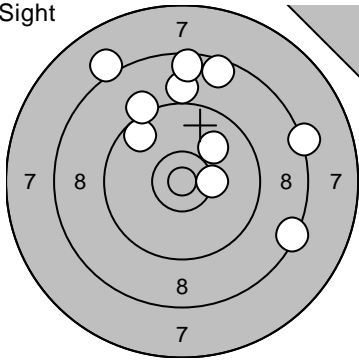
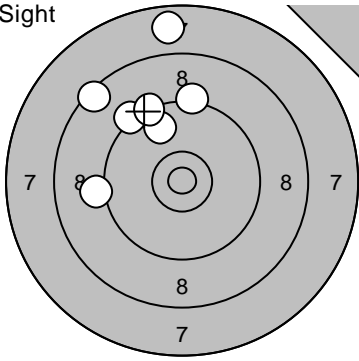
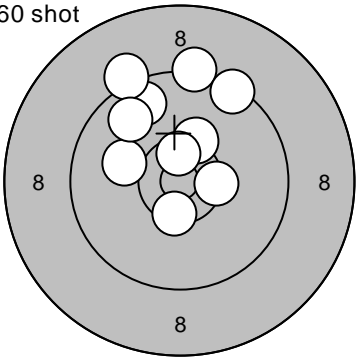
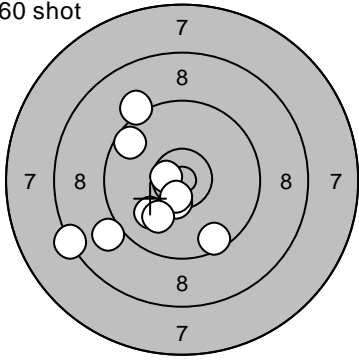
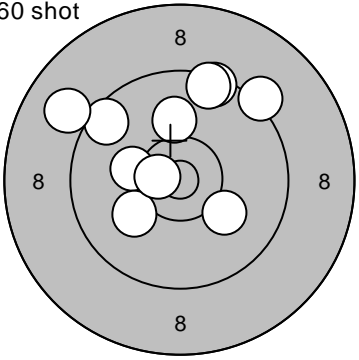
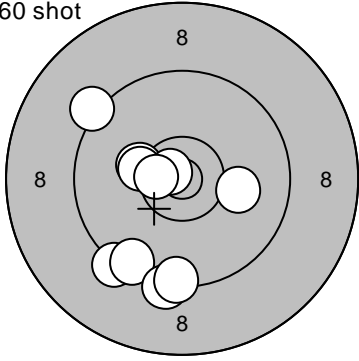
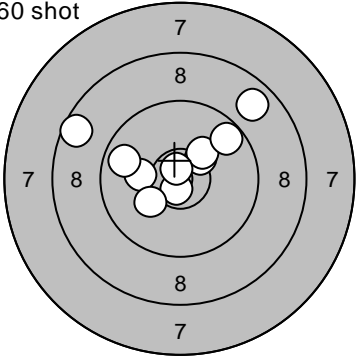
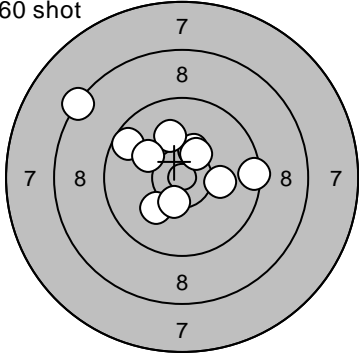
Lag	Tavla	John Lindgren	
1	12		
2010-08-19	Föreningsmästerskap 2010	Umeå skytteallians	
Sight		1: 8,4 → 2: 8,3 → 3: 9,7 ↗ 4: 10,0 ↗ 5: 8,6 ↗ 6: 9,0 ↗ 7: 9,2 ↗ 8: 8,1 ↗ 9: 10,3* → 10: 8,6 ↑ Serie: 87,0 Summa: 0,0	Sight
			11: 9,0 → 12: 9,7 → 13: 10,6* ↙ 14: 10,4* ↘ 15: 9,0 ↘ 16: 10,0 → 17: 8,9 ↓ 18: 9,6 ↓ 19: 9,2 ↓ 20: 9,7 ← Serie: 92,0 Summa: 0,0
Sight		21: 9,2 ← 22: 8,4 ↗ 23: 9,3 ↗ 24: 9,8 ↗ 25: 9,3 ↗ 26: 7,8 ↗ 27: 9,3 ↗ Serie: 60,0 Summa: 0,0	60 shot
			
			1: 10,4* → 2: 10,1 ← 3: 10,4* ↓ 4: 10,3* ↑ 5: 10,5* ↑ 6: 9,3 ↑ 7: 9,4 ↑ 8: 9,7 ↑ 9: 9,2 ↑ 10: 9,8 ↑ Serie: 95,0 Summa: 95,0
60 shot		11: 10,4* ↓ 12: 9,2 ↗ 13: 10,6* ↗ 14: 9,7 ↗ 15: 9,0 ↗ 16: 10,0 ↗ 17: 10,6* ↗ 18: 10,0 ↗ 19: 9,5 ↗ 20: 8,3 ↗ Serie: 94,0 Summa: 189,0	60 shot
			
			21: 10,1 ↘ 22: 9,2 ↗ 23: 9,6 ↗ 24: 9,5 ↑ 25: 10,2 ← 26: 9,5 ↑ 27: 10,1 ↙ 28: 10,6* ← 29: 10,1 ↑ 30: 9,0 ↗ Serie: 95,0 Summa: 284,0
60 shot		31: 10,1 → 32: 9,3 ↘ 33: 9,5 ↘ 34: 10,3 ↗ 35: 10,7* ↗ 36: 9,2 ↗ 37: 10,3* ↗ 38: 9,3 ↓ 39: 9,4 ↓ 40: 10,6* ← Serie: 95,0 Summa: 379,0	60 shot
			
			41: 10,4* ↗ 42: 8,6 ↙ 43: 10,2 ↗ 44: 10,7* ↓ 45: 10,1 ← 46: 9,8 ← 47: 9,7 ↗ 48: 8,8 ↗ 49: 10,2 ↙ 50: 10,7* ↑ Serie: 94,0 Summa: 473,0
60 shot		51: 10,3* ↑ 52: 9,7 ↗ 53: 10,1 ↗ 54: 10,1 → 55: 10,1 ↘ 56: 9,4 → 57: 10,1 ↗ 58: 10,4* ↓ 59: 10,4* ↗ 60: 8,3 ↗ Serie: 96,0 Summa: 569,0	

Lag	Tavla	Stig Jussén		
1	14			
2010-08-19	Föreningsmästerskap 2010	Umeå skytteallians		
Sight		1: 5,2 ↑ 2: 8,7 ↑ 3: 7,2 ← 4: 9,1 ← 5: 8,6 ← 6: 8,4 ↑ 7: 9,7 ↑ 8: 8,9 ↓ 9: 10,3* ↑ 10: 10,0 → Serie: 82,0 Summa: 0,0	Sight 	11: 9,4 ← 12: 10,9* ↓ Serie: 19,0 Summa: 0,0
60 shot		1: 10,1 ↑ 2: 8,8 ↓ 3: 10,0 ↓ 4: 10,6* → 5: 9,8 ↓ 6: 10,4* ← 7: 7,6 ↑ 8: 9,8 ↑ 9: 10,6* ↓ 10: 8,4 ↖ Serie: 91,0 Summa: 91,0	60 shot 	11: 9,4 ↗ 12: 9,4 ↗ 13: 9,9 ↑ 14: 10,4* ↗ 15: 7,3 ↗ 16: 9,9 ↗ 17: 10,6* ↗ 18: 9,4 ↗ 19: 6,9 ↗ 20: 9,2 ↑ Serie: 87,0 Summa: 178,0
60 shot		21: 7,1 ↖ 22: 10,0 ← 23: 9,1 ↗ 24: 10,1 ← 25: 9,5 ↗ 26: 7,8 ↗ 27: 9,1 ↑ 28: 9,0 ↗ 29: 9,7 ← 30: 10,2 ← Serie: 89,0 Summa: 267,0	60 shot 	31: 9,0 ↗ 32: 9,2 ↑ 33: 8,3 ↗ 34: 9,5 ↑ 35: 8,9 ↗ 36: 7,8 ← 37: 9,8 ↓ 38: 9,6 ← 39: 9,3 ↙ 40: 9,4 ↑ Serie: 86,0 Summa: 353,0
60 shot		41: 9,5 ← 42: 10,4* ↙ 43: 9,4 ← 44: 8,9 ↓ 45: 8,6 ↑ 46: 8,7 ↓ 47: 10,4* ↘ 48: 9,4 ↓ 49: 10,2 ↓ 50: 9,8 ↑ Serie: 90,0 Summa: 443,0	60 shot 	51: 9,2 ← 52: 9,3 ↓ 53: 9,9 ↑ 54: 9,7 ↗ 55: 8,2 ← 56: 7,7 ← 57: 9,1 ← 58: 9,7 ← 59: 9,4 ↗ 60: 9,6 ↑ Serie: 87,0 Summa: 530,0

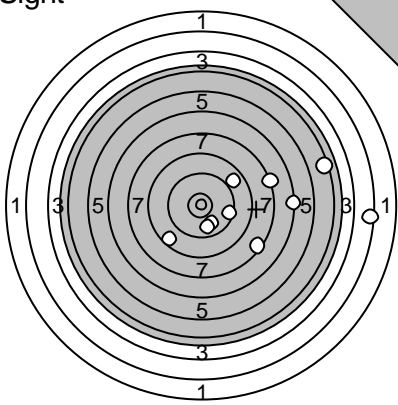
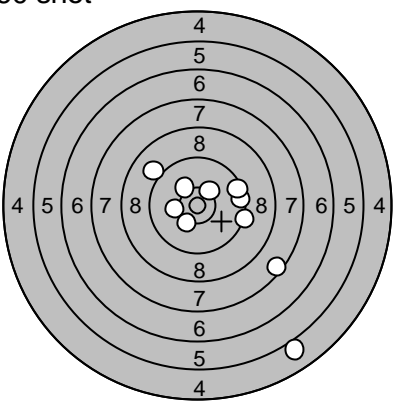
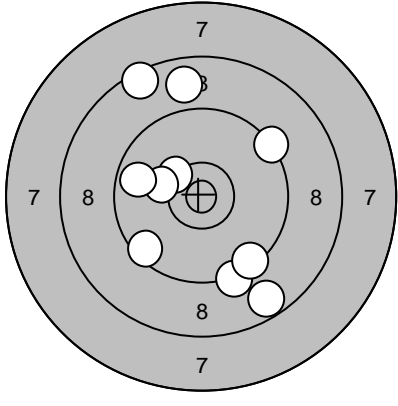
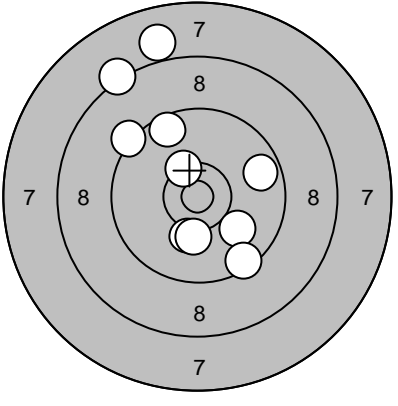
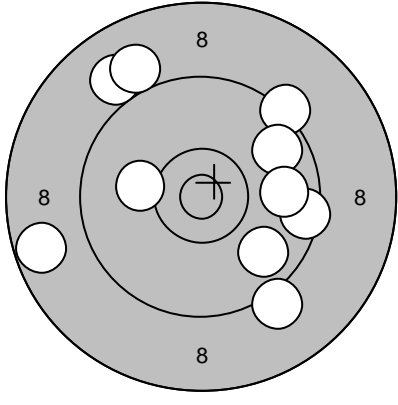
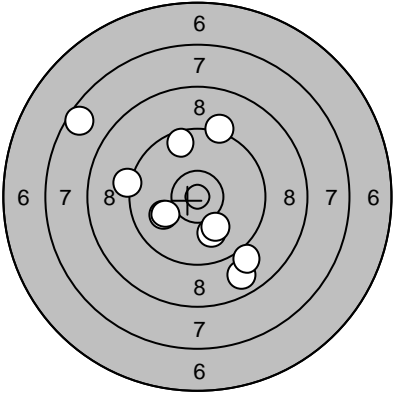
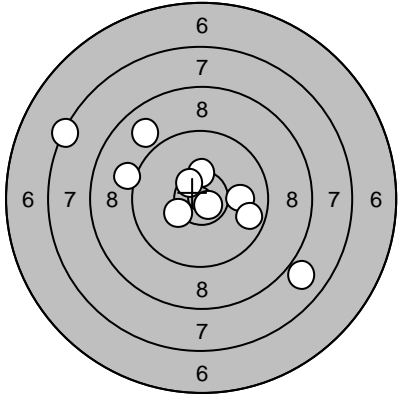
Lag	Tavla		
1	15	Allan Nordgren	
2010-08-19		Föreningsmästerskap 2010	Umeå skytteallians
Sight		1: 4,6 → 2: 7,4 → 3: 6,5 → 4: 2,6 → 5: 7,6 ↘ 6: 9,5 → 7: 10,0 ↘ 8: 9,0 ↗ 9: 9,9 ↘ 10: 8,8 ↙ Serie: 71,0 Summa: 0,0	60 shot  1: 10,1 ← 2: 7,6 ↘ 3: 9,0 ↗ 4: 9,5 → 5: 10,2 ↘ 6: 9,5 → 7: 10,3* ↗ 8: 9,3 ↘ 9: 5,0 ↘ 10: 10,2 ↗ Serie: 88,0 Summa: 88,0
60 shot		11: 8,7 ↘ 12: 8,9 ↑ 13: 9,3 ↘ 14: 9,3 ↗ 15: 10,3* ↗ 16: 10,2 ← 17: 8,5 ↗ 18: 9,5 ↘ 19: 9,7 ← 20: 9,4 ↘ Serie: 89,0 Summa: 177,0	60 shot  21: 9,3 ↗ 22: 10,2 ↘ 23: 10,2 ↘ 24: 10,4* ↗ 25: 10,0 ↘ 26: 9,5 ↘ 27: 9,6 ↗ 28: 8,3 ↗ 29: 8,0 ↑ 30: 9,7 → Serie: 92,0 Summa: 269,0
60 shot		31: 9,1 ↘ 32: 10,1 ← 33: 9,3 ↗ 34: 9,0 ↗ 35: 9,0 ↗ 36: 9,5 → 37: 9,8 ↘ 38: 9,7 ↗ 39: 9,8 → 40: 8,7 ← Serie: 90,0 Summa: 359,0	60 shot  41: 9,3 ↑ 42: 10,0 ← 43: 8,8 ↘ 44: 10,1 ← 45: 9,6 ↑ 46: 7,6 ↗ 47: 10,0 ↘ 48: 10,1 ↘ 49: 9,0 ↘ 50: 9,3 ← Serie: 91,0 Summa: 450,0
60 shot		51: 10,0 → 52: 9,1 ← 53: 7,9 ↘ 54: 7,4 ↗ 55: 9,7 → 56: 8,9 ↗ 57: 10,4* ↑ 58: 10,3* ↘ 59: 10,5* ↗ 60: 10,7* ↘ Serie: 90,0 Summa: 540,0	