

Skjutlag

1

Tavla

1

Edward Yu

Umeå

2010-09-04

Höstträffen 2010

Ramselefors SKF

Provskott

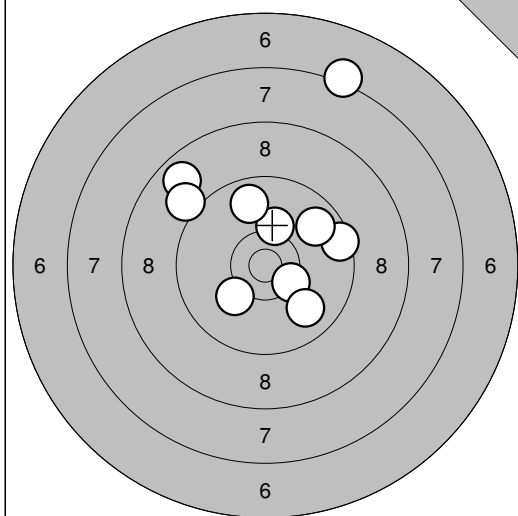

1: 7,2 ↗  
 2: 10,2 ↑  
 3: 9,5 →  
 4: 10,4\* ↘  
 5: 8,8 ↗  
 6: 9,8 ↑  
 7: 9,9 ↘  
 8: 10,2 ↘  
 9: 9,8 ↗  
 10: 9,1 ↙

Serie 90,0

Totalt 0,0

Provskott

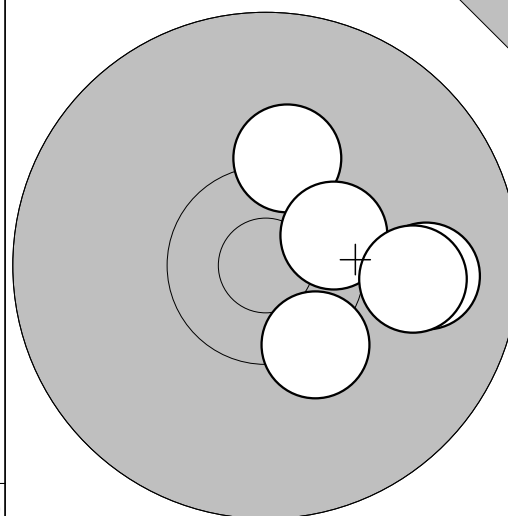

11: 9,9 →  
 12: 10,2 ↑  
 13: 10,5\* →  
 14: 10,3\* ↘  
 15: 10,0 →

Serie 49,0

Totalt 0,0

Tävlingsskott

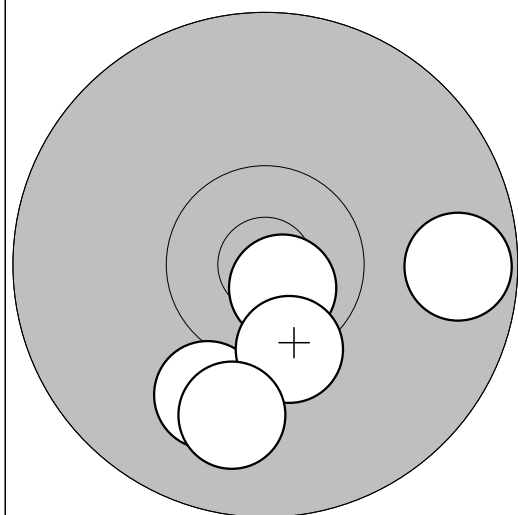

1: 10,0 ↘  
 2: 10,8\* ↘  
 3: 9,7 →  
 4: 10,4\* ↘  
 5: 9,9 ↘

Serie 48,0

Totalt 48,0

Tävlingsskott

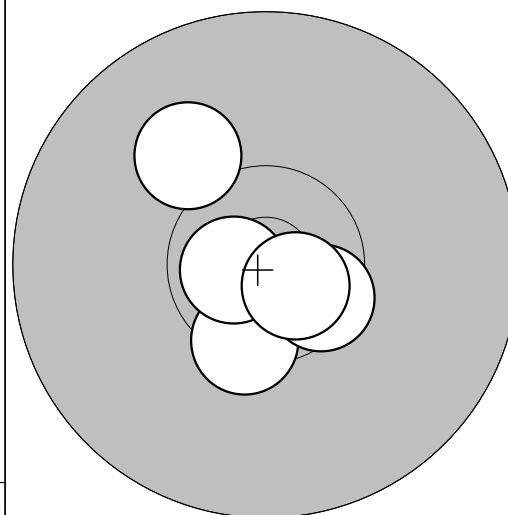

6: 10,4\* ↘  
 7: 10,5\* ↘  
 8: 10,1 ↗  
 9: 10,7\* ←  
 10: 10,7\* ↘

Serie 50,0

Totalt 98,0

Tävlingsskott

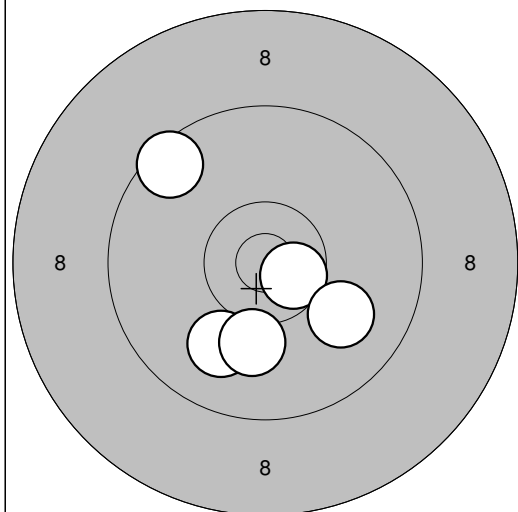

11: 10,6\* →  
 12: 10,0 ↘  
 13: 10,0 ↘  
 14: 9,5 ↗  
 15: 10,1 ↘

Serie 49,0

Totalt 147,0

Tävlingsskott

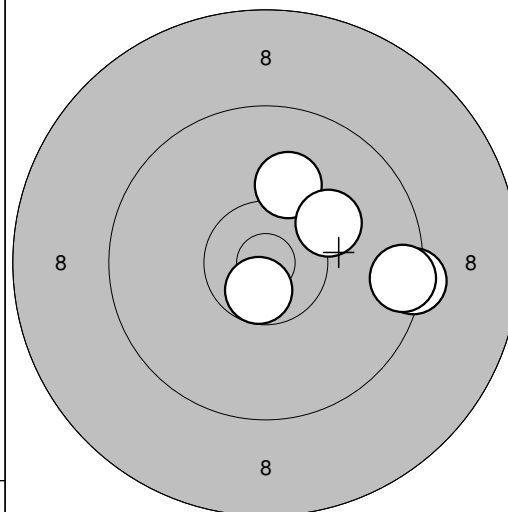

16: 10,6\* ↘  
 17: 10,1 ↑  
 18: 10,2 ↗  
 19: 9,4 →  
 20: 9,5 →

Serie 48,0

Totalt 195,0

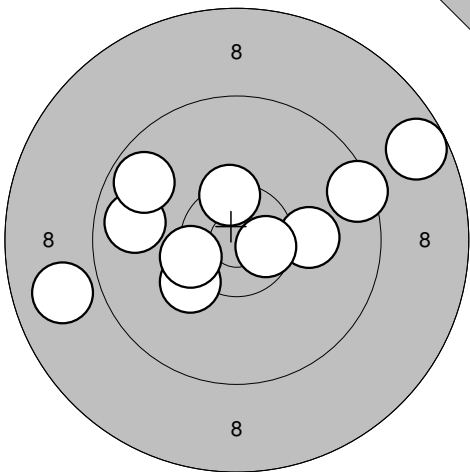
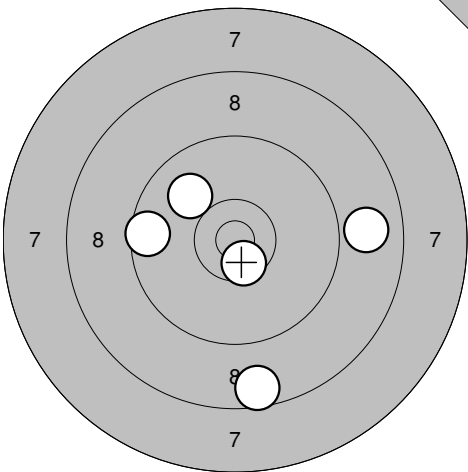
<p>Provskott</p> 	<p>1: 8,7 →</p> <p>2: 10,2 ↙</p> <p>3: 10,1 →</p> <p>4: 10,4* ↙</p> <p>5: 9,8 ↙</p> <p>6: 8,9 ↙</p> <p>7: 9,5 →</p> <p>8: 10,6* →</p> <p>9: 10,4* ↑</p> <p>10: 9,7 ↙</p>	<p>Provskott</p> 	<p>11: 10,6* ↓</p> <p>12: 8,6 ↓</p> <p>13: 9,6 ←</p> <p>14: 10,0 ↗</p> <p>15: 8,9 →</p>
Serie 93,0		Serie 45,0	
Totalt 0,0		Totalt 0,0	

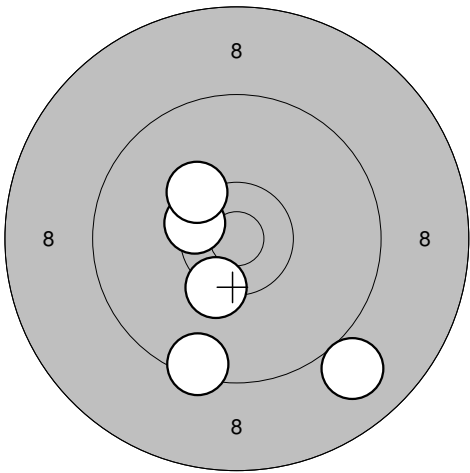
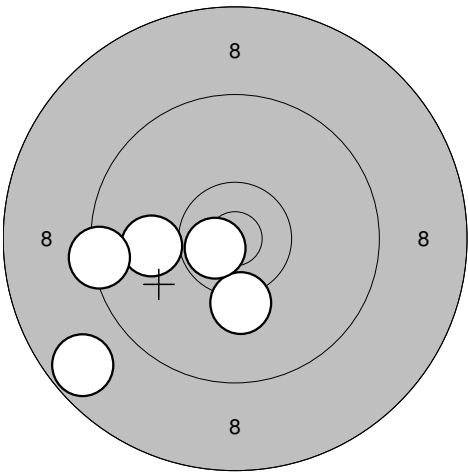
<p>Tävlingsskott</p> 	<p>1: 10,4* ↙</p> <p>2: 10,3 ↗</p> <p>3: 9,0 ↓</p> <p>4: 10,3* ↓</p> <p>5: 9,4 ↓</p>	<p>Tävlingsskott</p> 	<p>6: 10,0 ←</p> <p>7: 10,2 ↓</p> <p>8: 9,4 ←</p> <p>9: 10,7* ↙</p> <p>10: 8,7 ↙</p>
Serie 48,0		Serie 47,0	
Totalt 48,0		Totalt 95,0	

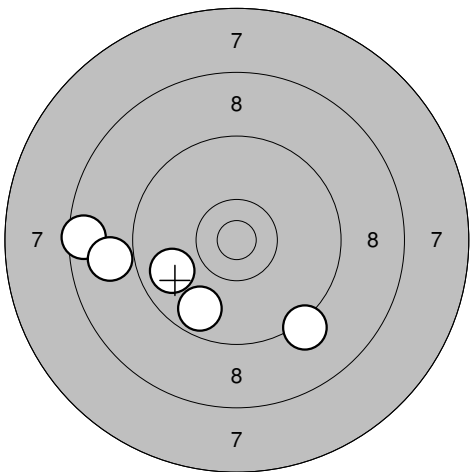
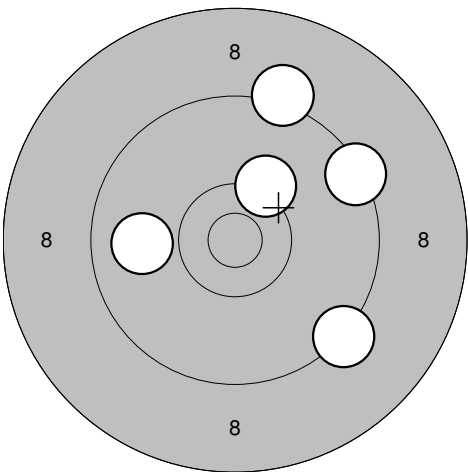
<p>Tävlingsskott</p> 	<p>11: 8,5 ←</p> <p>12: 8,9 ←</p> <p>13: 9,8 ↙</p> <p>14: 9,2 ↓</p> <p>15: 9,7 ↓</p>	<p>Tävlingsskott</p> 	<p>16: 9,3 ↘</p> <p>17: 10,2 ↗</p> <p>18: 9,9 ←</p> <p>19: 9,4 ↗</p> <p>20: 9,2 ↑</p>
Serie 43,0		Serie 46,0	
Totalt 138,0		Totalt 184,0	

Umeå

2010-09-04

Höstträffen 2010

Ramselefors SKF

Provskott

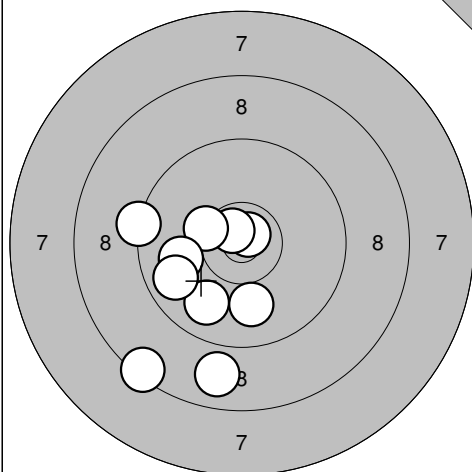

1: 8,4 ↙  
 2: 9,3 ←  
 3: 10,8\* ↗  
 4: 9,9 ↓  
 5: 8,8 ↓  
 6: 10,7\* ↗  
 7: 10,3\* ↗  
 8: 10,0 ←  
 9: 9,8 ←  
 10: 10,0 ↓

Serie 93,0

Totalt 0,0

Provskott

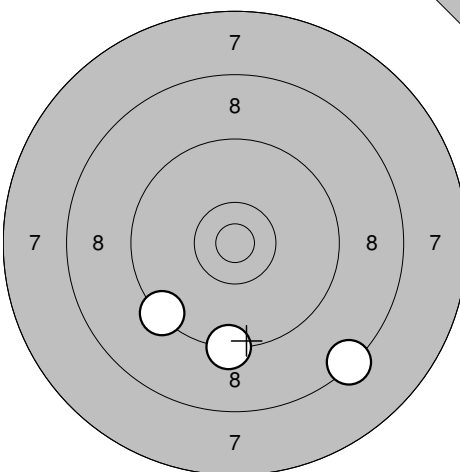

11: 9,4 ↙  
 12: 9,3 ↓  
 13: 8,4 ↘

Serie 26,0

Totalt 0,0

Tävlingsskott

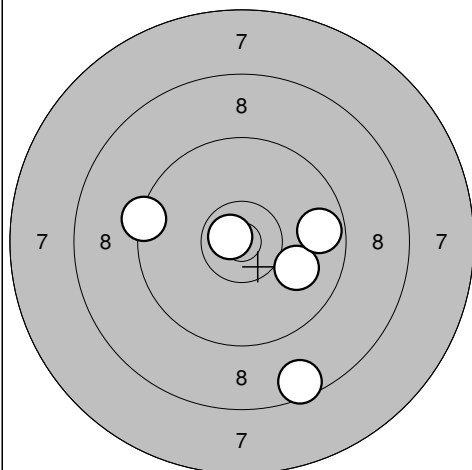

1: 10,0 ↘  
 2: 9,4 ←  
 3: 8,6 ↓  
 4: 9,7 →  
 5: 10,8\* ↗

Serie 46,0

Totalt 46,0

Tävlingsskott

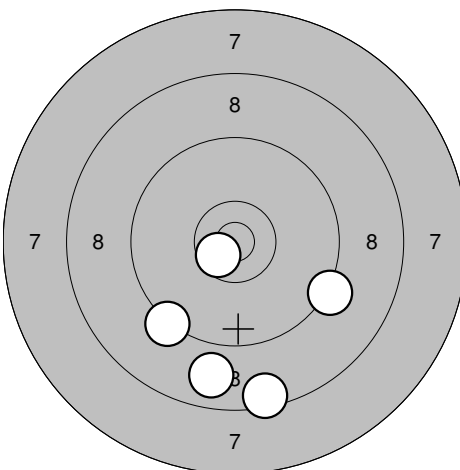

6: 10,6\* ↙  
 7: 8,5 ↓  
 8: 9,3 ↙  
 9: 9,3 ↘  
 10: 8,8 ↓

Serie 44,0

Totalt 90,0

Tävlingsskott

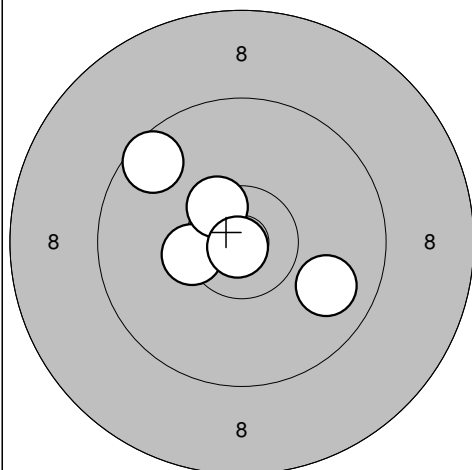

11: 10,4\* ←  
 12: 9,6 ↗  
 13: 9,9 ↘  
 14: 10,5\* ↗  
 15: 10,9\* ↓

Serie 48,0

Totalt 138,0

Tävlingsskott

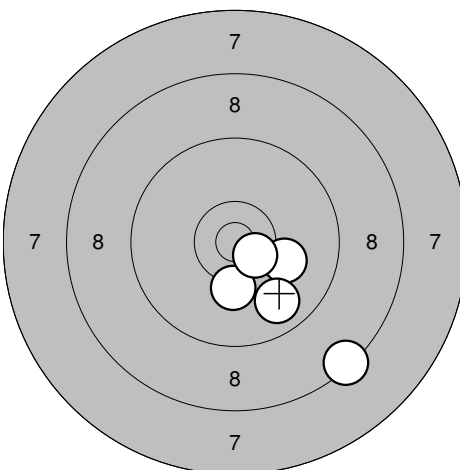

16: 10,2 ↓  
 17: 10,1 ↘  
 18: 10,6\* ↘  
 19: 9,8 ↓  
 20: 8,4 ↘

Serie 47,0

Totalt 185,0

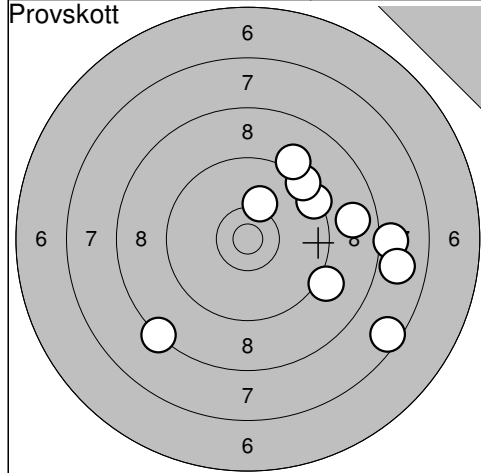

1: 8,8	→
2: 9,4	↗
3: 8,1	→
4: 7,9	→
5: 7,6	↘
6: 10,2	↑
7: 8,3	↙
8: 9,4	↗
9: 9,1	↘
10: 9,2	↗
<b>Serie 84,0</b>	
<b>Totalt 0,0</b>	

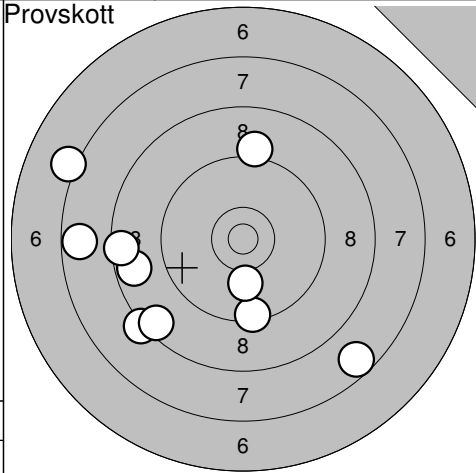

11: 9,1	↑
12: 8,7	←
13: 7,7	←
14: 7,2	↖
15: 7,6	↘
16: 8,5	←
17: 9,4	↓
18: 10,1	↓
19: 8,3	↙
20: 8,5	↙
<b>Serie 81,0</b>	
<b>Totalt 0,0</b>	

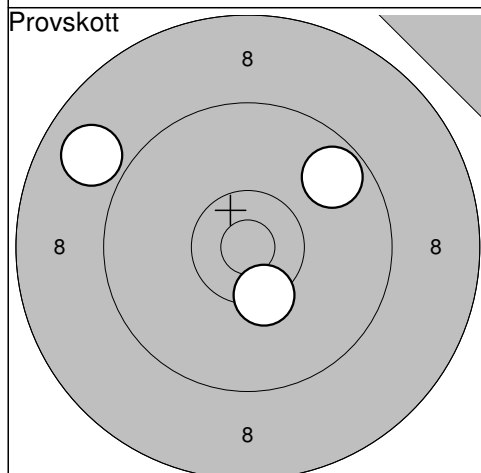

21: 8,9	↖
22: 9,7	↗
23: 10,4*	↓
<b>Serie 27,0</b>	
<b>Totalt 0,0</b>	

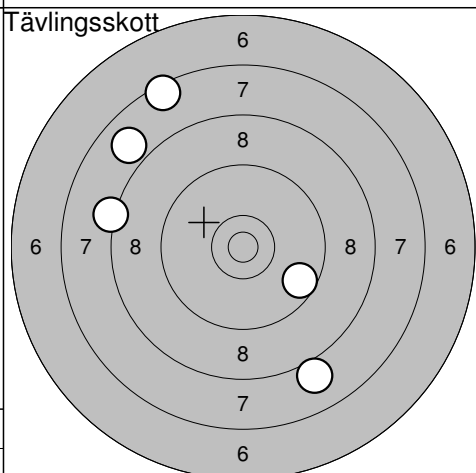

1: 7,9	↗
2: 7,5	↗
3: 8,2	←
4: 9,6	↘
5: 8,0	↘
<b>Serie 39,0</b>	
<b>Totalt 39,0</b>	

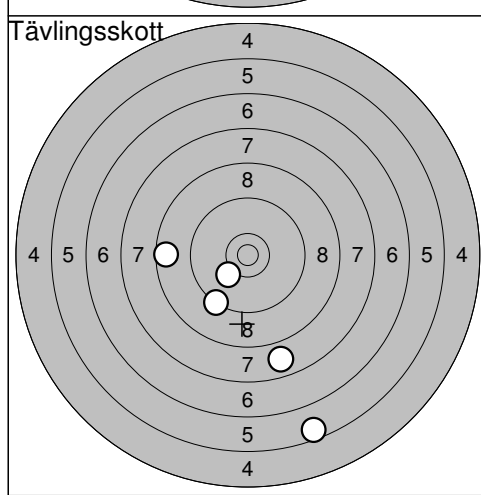

6: 5,6	↓
7: 8,6	←
8: 7,8	↓
9: 10,2	↙
10: 9,3	↙
<b>Serie 39,0</b>	
<b>Totalt 78,0</b>	

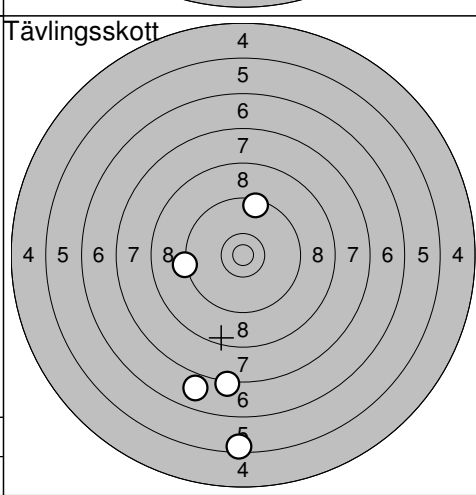

11: 7,2	↓
12: 6,9	↓
13: 9,3	←
14: 5,5	↓
15: 9,5	↑
<b>Serie 36,0</b>	
<b>Totalt 114,0</b>	

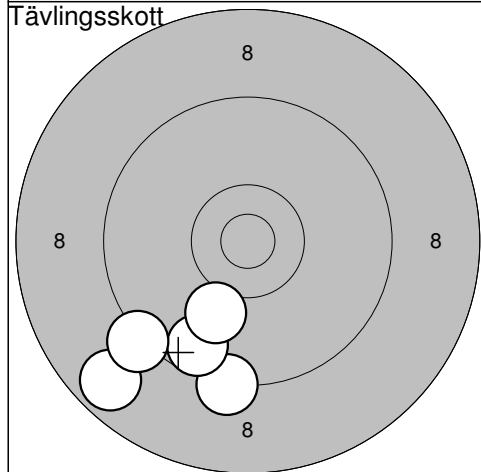

16: 9,3	↓
17: 9,6	↓
18: 8,7	↙
19: 9,3	↙
20: 10,1	↓
<b>Serie 45,0</b>	
<b>Totalt 159,0</b>	

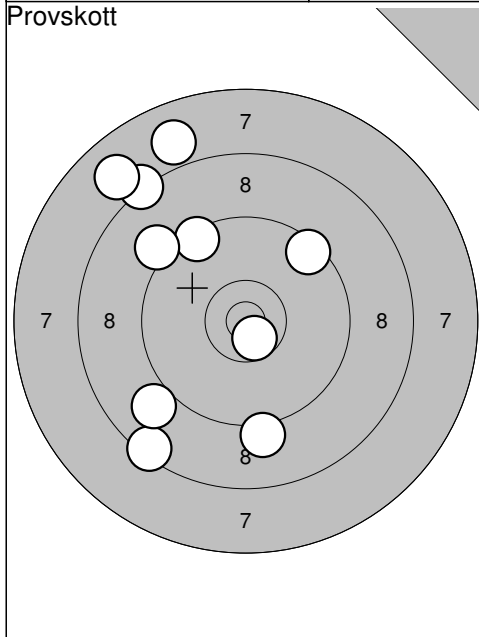

1: 8,3	↗
2: 9,5	↗
3: 7,9	↗
4: 9,1	↘
5: 9,5	↗
6: 9,1	↗
7: 7,9	↗
8: 10,6*	↘
9: 8,4	↘
10: 9,0	↘
Serie	85,0
Totalt	0,0

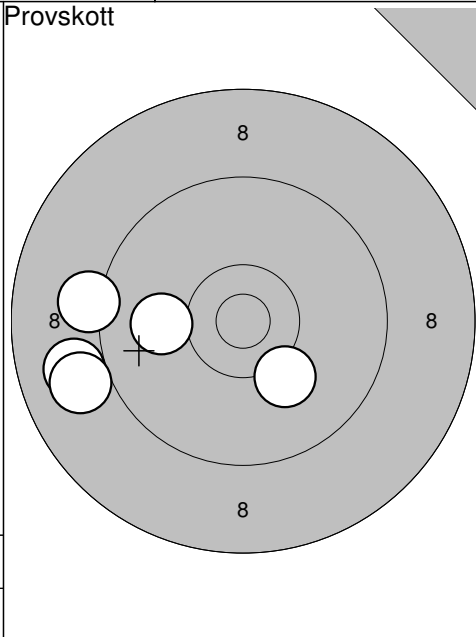

11: 9,0	←
12: 10,0	←
13: 9,2	←
14: 9,0	←
15: 10,1	↘
Serie	47,0
Totalt	0,0

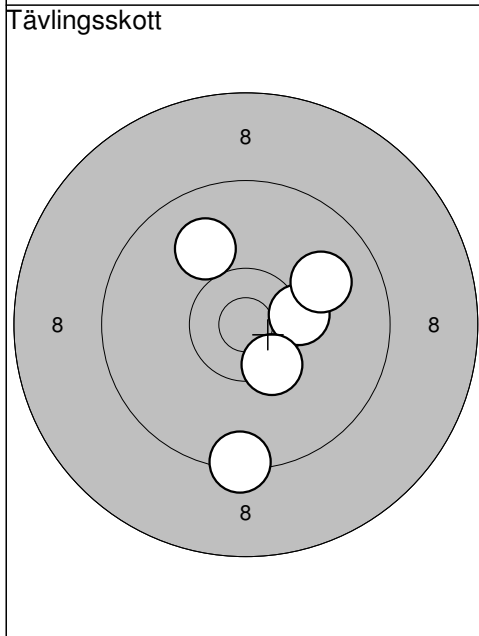

1: 9,4	↘
2: 10,3*	→
3: 10,4*	↘
4: 10,0	↗
5: 10,0	↗
Serie	49,0
Totalt	49,0

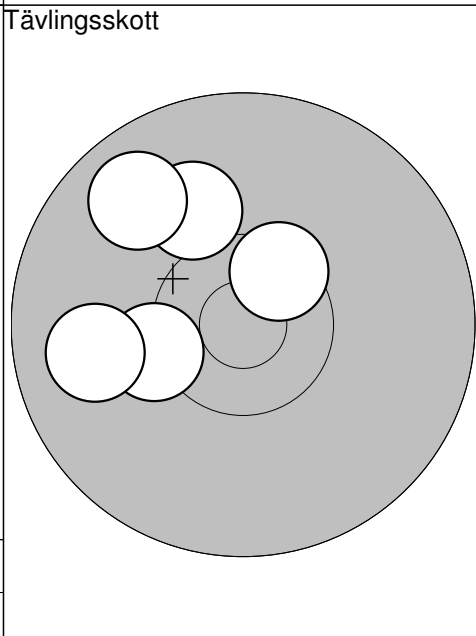

6: 10,1	↗
7: 10,3*	←
8: 9,8	↗
9: 10,5*	↗
10: 9,9	←
Serie	48,0
Totalt	97,0

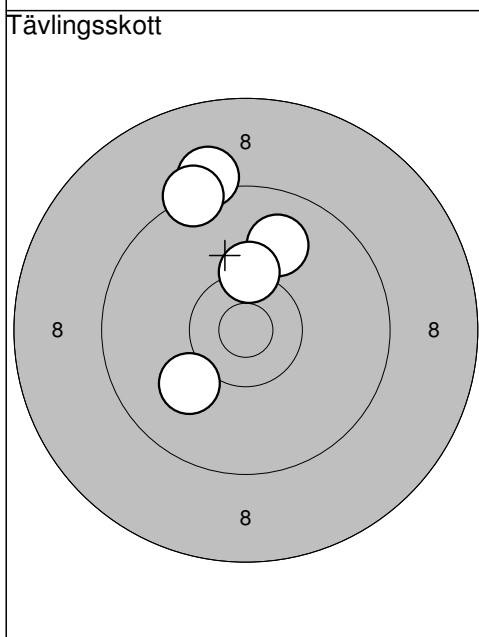

11: 9,9	↗
12: 10,3*	↑
13: 10,1	↘
14: 9,2	↗
15: 9,3	↗
Serie	47,0
Totalt	144,0

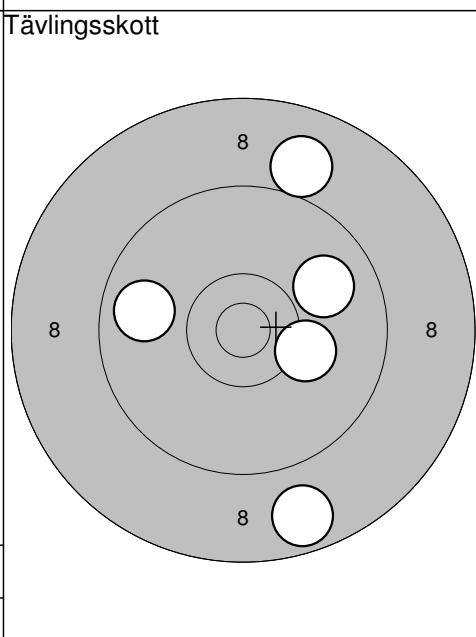

16: 9,8	←
17: 9,9	↗
18: 8,7	↘
19: 9,0	↗
20: 10,2	→
Serie	45,0
Totalt	189,0

Skellefteå

2010-09-04

Höstträffen 2010

Ramselefors SKF

Provskott

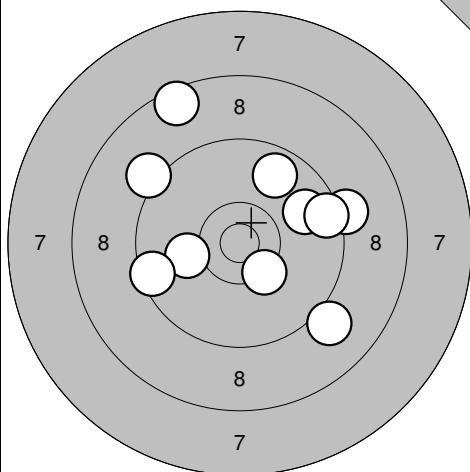

- 1: 9,1 ↘
- 2: 9,8 →
- 3: 9,2 →
- 4: 9,5 →
- 5: 9,2 ↗
- 6: 8,5 ↗
- 7: 9,8 ↗
- 8: 10,1 ←
- 9: 9,5 ←
- 10: 10,3\* ↘

Serie	91,0
Totalt	0,0

Provskott

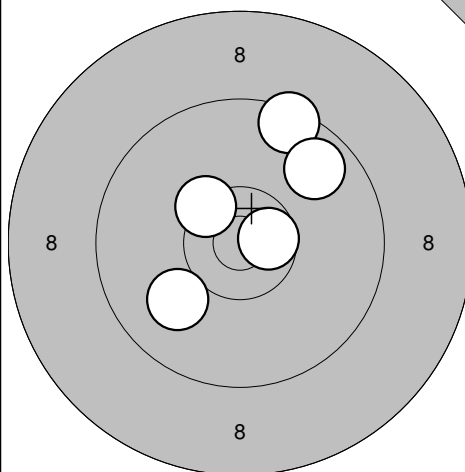

- 11: 10,0 ↙
- 12: 9,5 ↗
- 13: 9,7 ↗
- 14: 10,6\* →
- 15: 10,4\* ↙

Serie	48,0
Totalt	0,0

Tävlingsskott

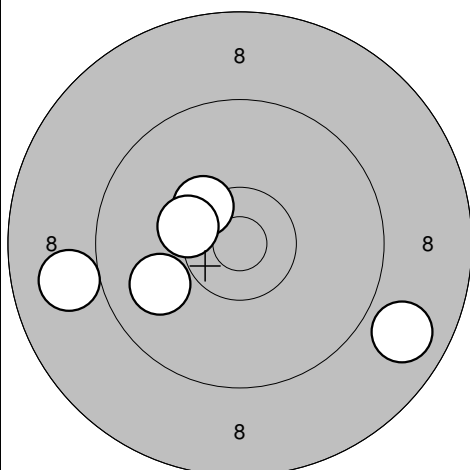

- 1: 10,4\* ↗
- 2: 8,8 ↘
- 3: 10,3\* ↖
- 4: 9,0 ←
- 5: 9,9 ↖

Serie	46,0
Totalt	46,0

Tävlingsskott

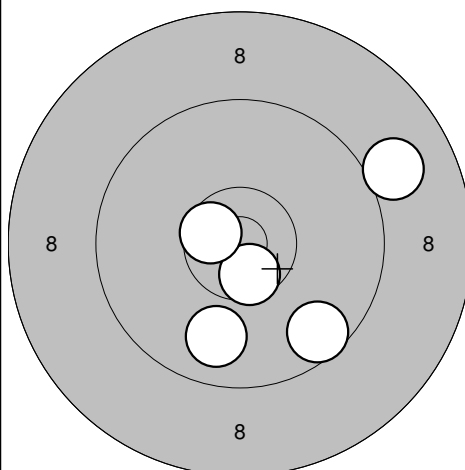

- 6: 10,6\* ↘
- 7: 9,9 ↘
- 8: 10,6\* ↖
- 9: 9,0 →
- 10: 9,6 ↘

Serie	47,0
Totalt	93,0

Tävlingsskott

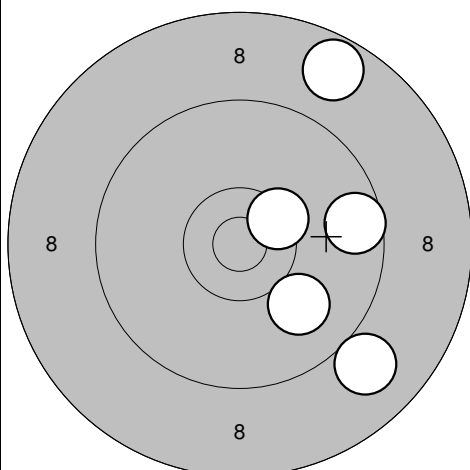

- 11: 10,0 ↘
- 12: 9,0 ↘
- 13: 10,4\* ↗
- 14: 8,7 ↗
- 15: 9,6 →

Serie	46,0
Totalt	139,0

Tävlingsskott

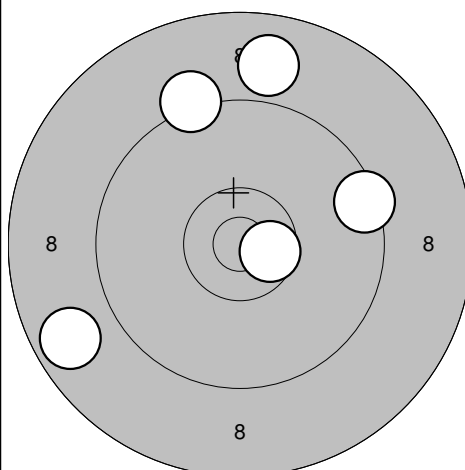

- 16: 9,2 ↗
- 17: 8,9 ↗
- 18: 9,4 →
- 19: 8,7 ↖
- 20: 10,6\* →

Serie	44,0
Totalt	183,0

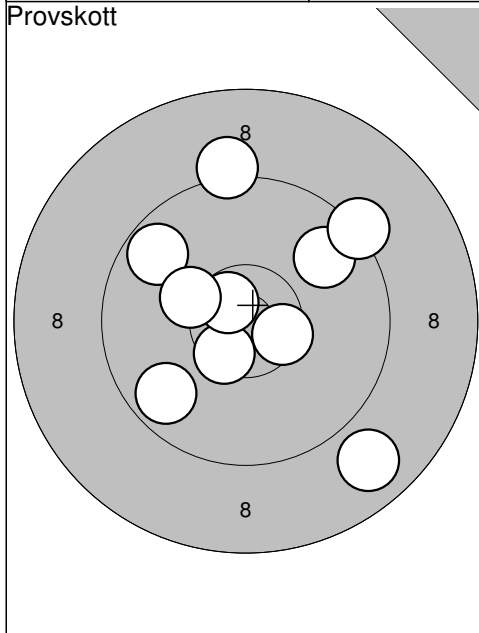

1: 8,8	↘
2: 9,7	↙
3: 10,5*	→
4: 10,5*	↙
5: 9,8	↗
6: 10,7*	↖
7: 9,3	↗
8: 9,2	↑
9: 9,7	↖
10: 10,3	↖
Serie	93,0
Totalt	0,0

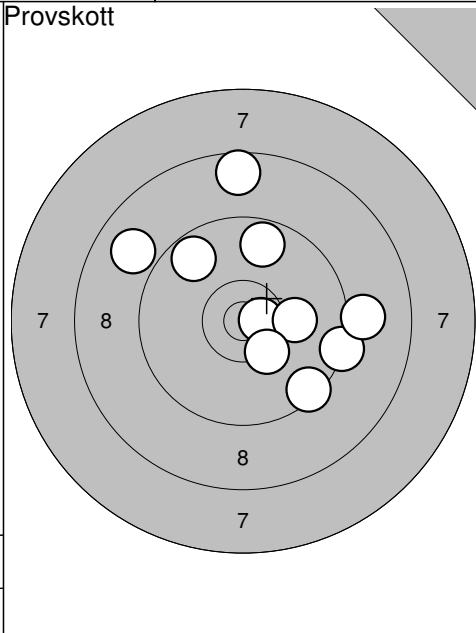

11: 10,7*	→
12: 9,7	↑
13: 8,6	↑
14: 9,7	↖
15: 8,9	↖
16: 9,5	↘
17: 10,1	→
18: 10,3*	↘
19: 9,3	→
20: 9,1	→
Serie	91,0
Totalt	0,0

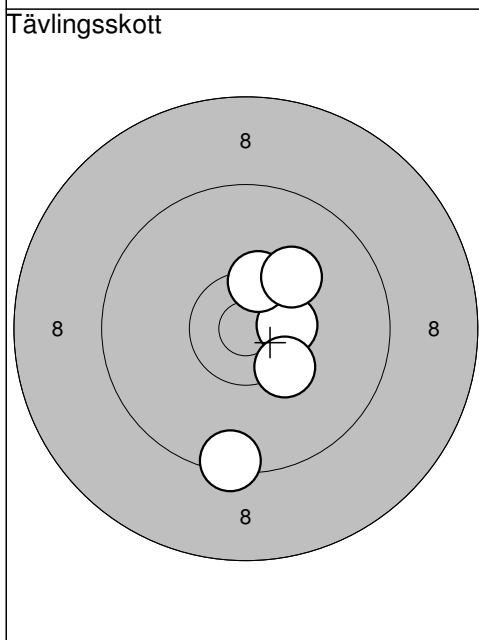

1: 10,5*	→
2: 10,3*	↘
3: 10,4*	↑
4: 10,2	↗
5: 9,4	↘
Serie	49,0
Totalt	49,0

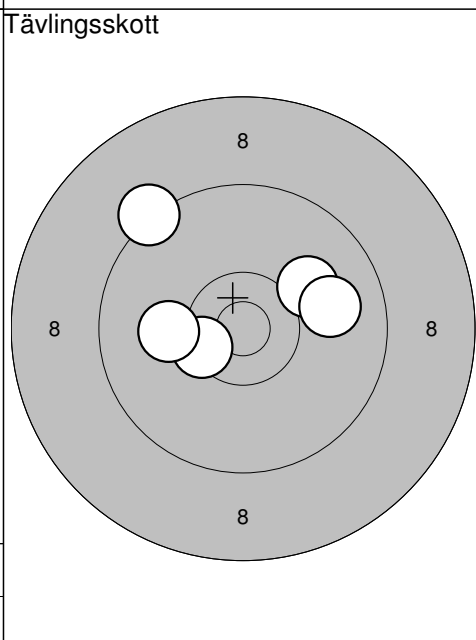

6: 10,1	↗
7: 9,3	↖
8: 9,9	→
9: 10,4*	↙
10: 10,1	←
Serie	48,0
Totalt	97,0

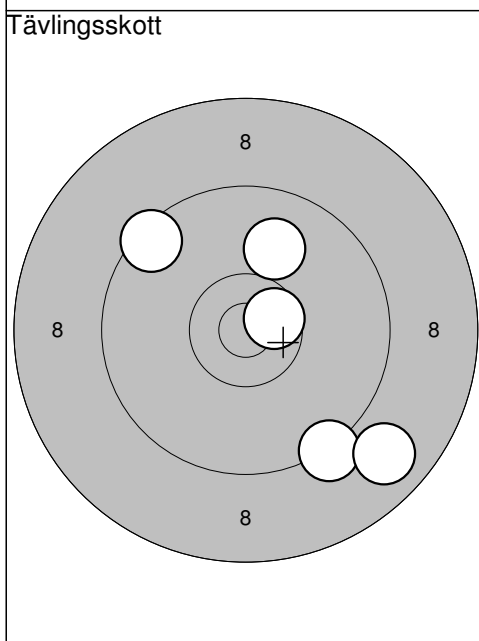

11: 9,5	↖
12: 9,3	↘
13: 8,8	↘
14: 10,0	↑
15: 10,6*	↗
Serie	46,0
Totalt	143,0

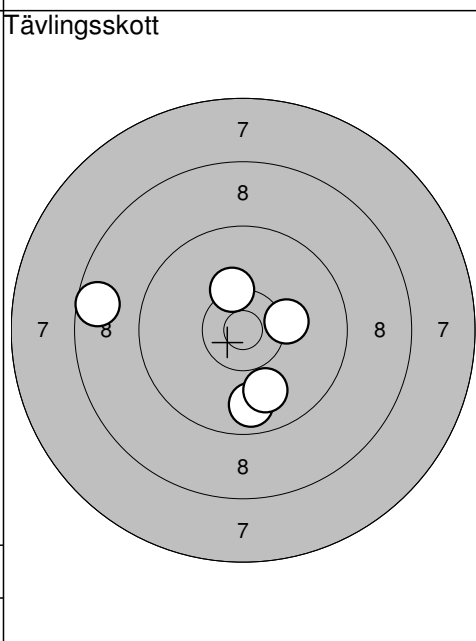

16: 9,8	↘
17: 9,9	↘
18: 10,3*	↑
19: 8,6	←
20: 10,2	→
Serie	46,0
Totalt	189,0

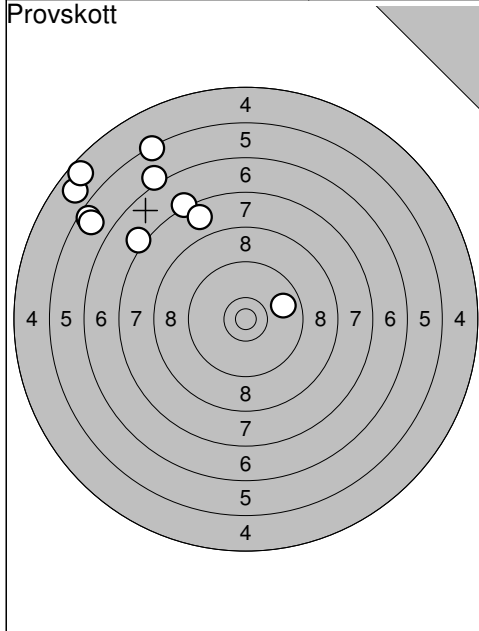

1: 5,6	↗
2: 4,8	↗
3: 7,2	↗
4: 5,7	↗
5: 7,8	↗
6: 4,7	↗
7: 7,2	↗
8: 5,4	↗
9: 6,1	↗
10: 9,8	→
Serie	59,0
Totalt	0,0

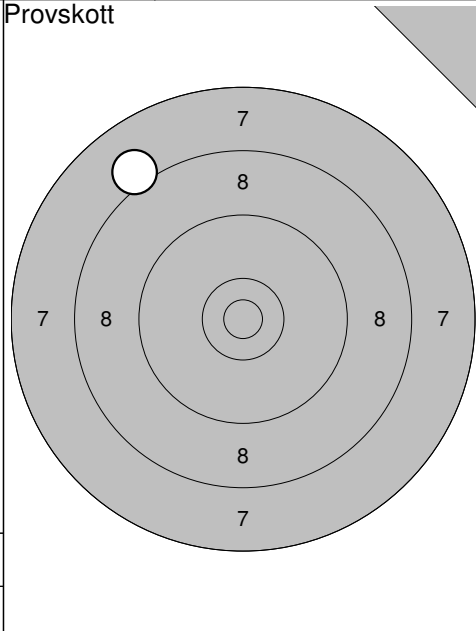

11: 0,0	↑
12: 8,1	↖
Serie	8,0
Totalt	0,0

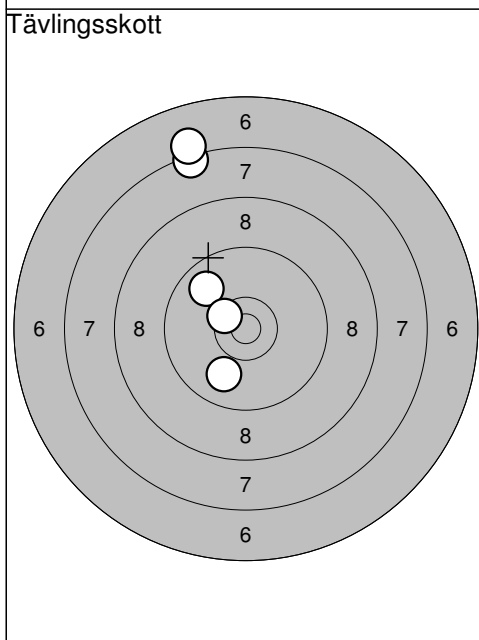

1: 7,4	↗
2: 7,1	↗
3: 9,8	↗
4: 9,9	↘
5: 10,5*	↖
Serie	42,0
Totalt	42,0

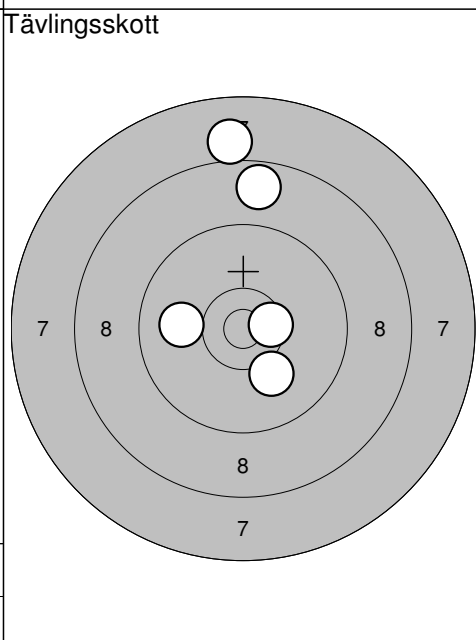

6: 10,0	←
7: 10,5*	→
8: 8,0	↑
9: 10,1	↘
10: 8,7	↑
Serie	46,0
Totalt	88,0

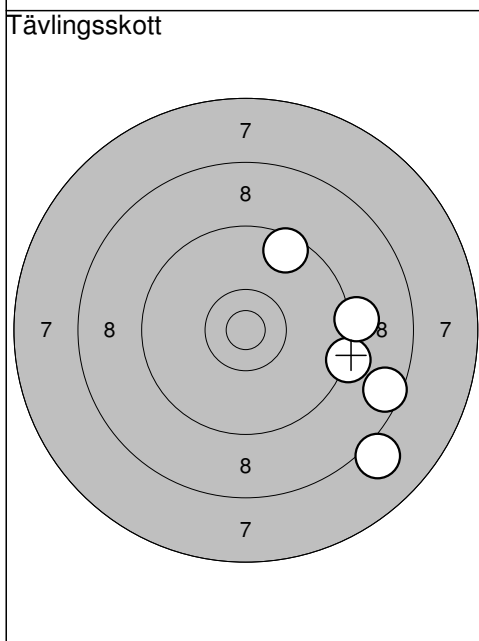

11: 8,1	↘
12: 9,5	↗
13: 8,6	→
14: 9,3	→
15: 9,2	→
Serie	43,0
Totalt	131,0

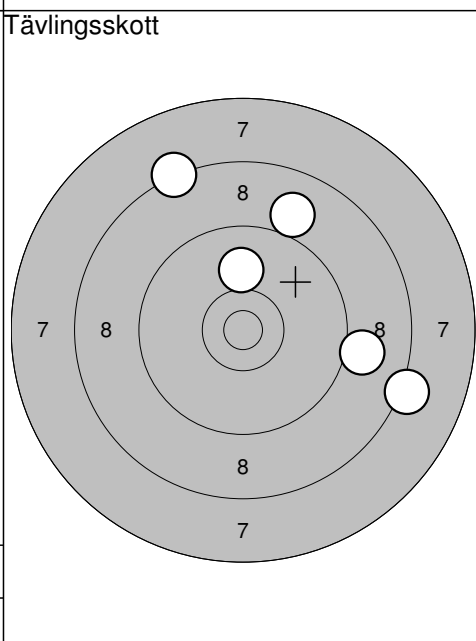

16: 9,0	→
17: 9,0	↗
18: 8,3	↖
19: 10,0	↑
20: 8,2	→
Serie	44,0
Totalt	175,0



Rundvik

2010-09-04

Höstträffen 2010

Ramselefors SKF

Provskott

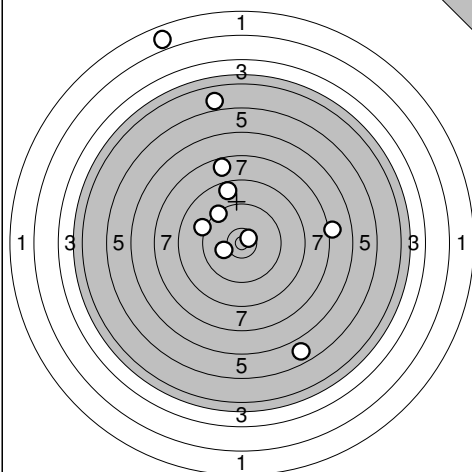

1: 5,8 ↘  
 2: 5,0 ↗  
 3: 1,9 ↗  
 4: 8,7 ↗  
 5: 7,7 ↗  
 6: 9,2 ↖  
 7: 7,1 →  
 8: 10,2 ←  
 9: 10,6\* ↗  
 10: 9,4 ↖

Serie 71,0

Totalt 0,0

Tävlingsskott

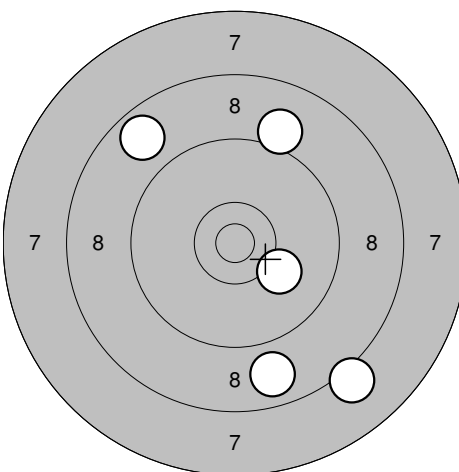

1: 10,1 ↘  
 2: 9,1 ↗  
 3: 8,8 ↘  
 4: 8,8 ↗  
 5: 8,1 ↘

Serie 43,0

Totalt 43,0

Tävlingsskott

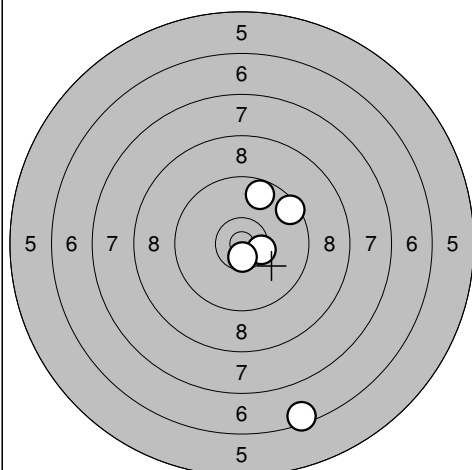

6: 10,4\* →  
 7: 10,6\* ↓  
 8: 9,5 ↗  
 9: 6,5 ↓  
 10: 9,7 ↗

Serie 44,0

Totalt 87,0

Tävlingsskott

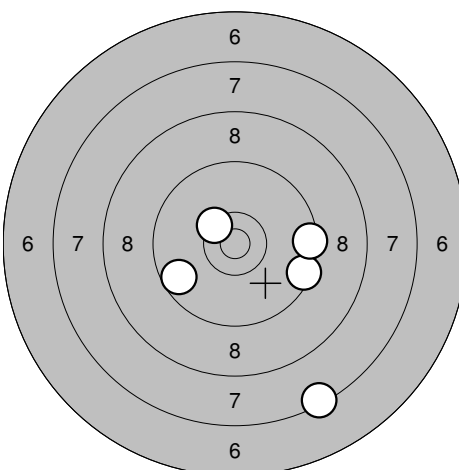

11: 7,4 ↘  
 12: 9,4 →  
 13: 9,6 ←  
 14: 9,4 →  
 15: 10,4\* ↖

Serie 44,0

Totalt 131,0

Tävlingsskott

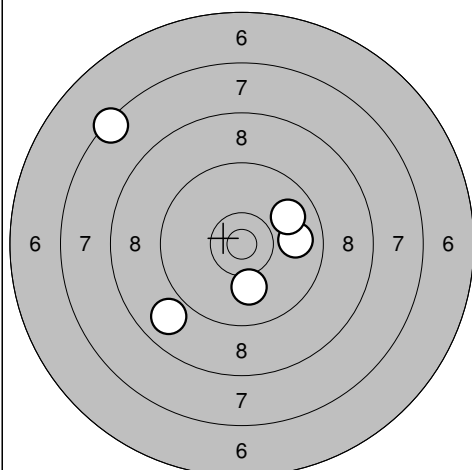

16: 9,9 →  
 17: 9,9 ↗  
 18: 7,4 ↖  
 19: 10,1 ↓  
 20: 8,9 ↖

Serie 43,0

Totalt 174,0

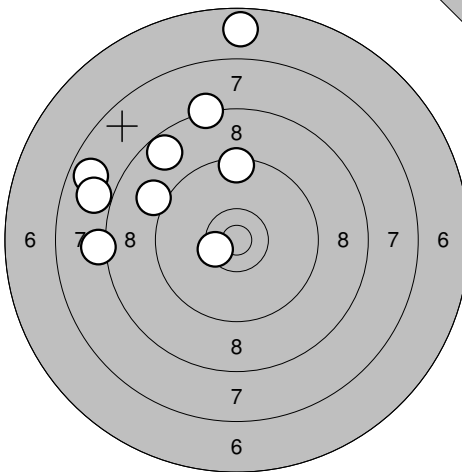
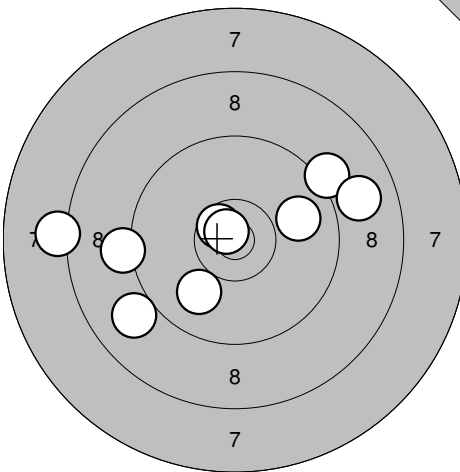
<p>Provskott</p> 	<p>1: 0,0 ↖</p> <p>2: 6,7 ↑</p> <p>3: 7,8 ↖</p> <p>4: 9,5 ↑</p> <p>5: 9,1 ↖</p> <p>6: 8,3 ↑</p> <p>7: 8,7 ↖</p> <p>8: 8,0 ↖</p> <p>9: 10,5* ↖</p> <p>10: 8,2 ←</p>	<p>Provskott</p> 	<p>11: 8,2 ←</p> <p>12: 9,2 ←</p> <p>13: 9,0 ↖</p> <p>14: 10,0 ↘</p> <p>15: 10,6* ↖</p> <p>16: 9,2 ↗</p> <p>17: 9,9 →</p> <p>18: 8,9 →</p> <p>19: 10,8* ↖</p>
Serie 73,0	Totalt 0,0	Serie 82,0	Totalt 0,0

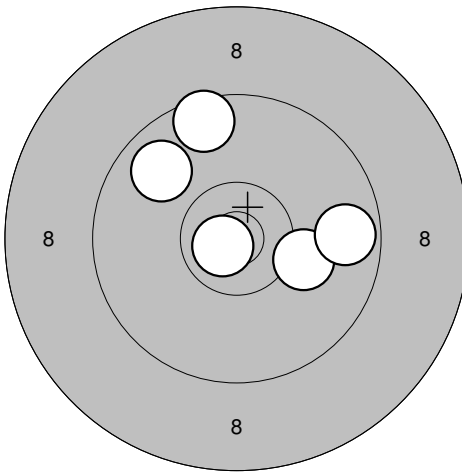
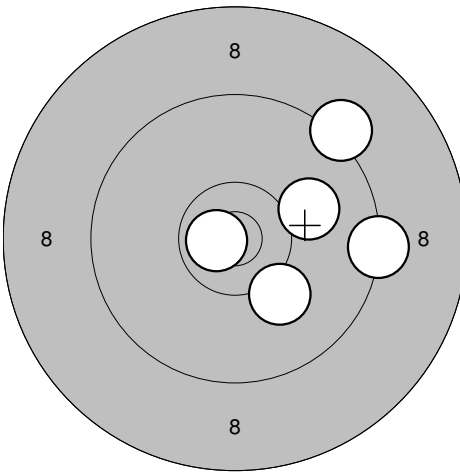
<p>Tävlingsskott</p> 	<p>1: 10,1 →</p> <p>2: 9,6 ↑</p> <p>3: 9,7 →</p> <p>4: 10,8* ↖</p> <p>5: 9,8 ↖</p>	<p>Tävlingsskott</p> 	<p>6: 10,0 →</p> <p>7: 10,7* ←</p> <p>8: 9,3 →</p> <p>9: 10,1 ↘</p> <p>10: 9,2 ↗</p>
Serie 47,0	Totalt 47,0	Serie 48,0	Totalt 95,0

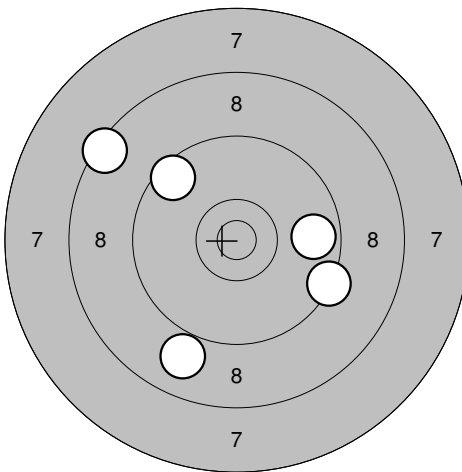
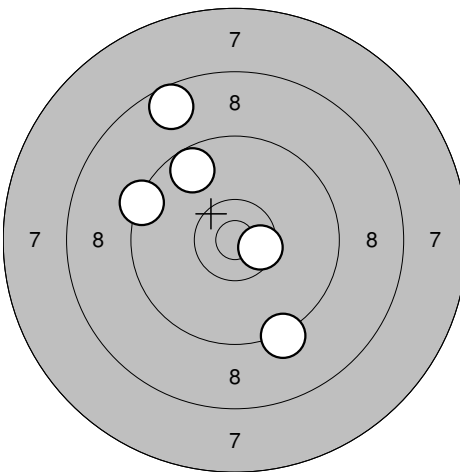
<p>Tävlingsskott</p> 	<p>11: 9,3 →</p> <p>12: 8,9 ↘</p> <p>13: 9,7 →</p> <p>14: 8,5 ↗</p> <p>15: 9,6 ↗</p>	<p>Tävlingsskott</p> 	<p>16: 10,5* →</p> <p>17: 9,3 ↘</p> <p>18: 9,7 ↗</p> <p>19: 9,4 ↖</p> <p>20: 8,6 ↗</p>
Serie 43,0	Totalt 138,0	Serie 45,0	Totalt 183,0

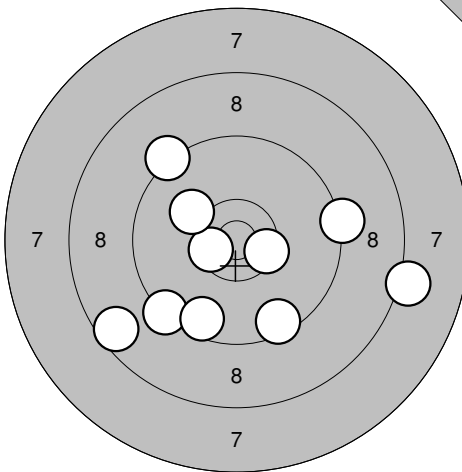
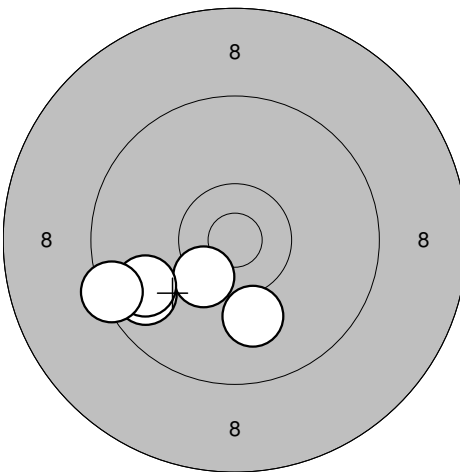
<p>Provskott</p> 	<p>Tävlingsskott</p> 	<p>1: 8,2 →</p> <p>2: 9,5 ↘</p> <p>3: 10,4* →</p> <p>4: 9,3 →</p> <p>5: 10,5* ←</p> <p>6: 10,1 ↗</p> <p>7: 9,4 ↘</p> <p>8: 9,6 ↘</p> <p>9: 8,6 ↘</p> <p>10: 9,3 ↗</p> <hr/> <p>Serie 91,0</p> <p>Totalt 0,0</p>
		<p>1: 10,4* ↘</p> <p>2: 9,8 ↘</p> <p>3: 10,1 ↘</p> <p>4: 9,8 ↘</p> <p>5: 9,4 ←</p> <hr/> <p>Serie 47,0</p> <p>Totalt 47,0</p>

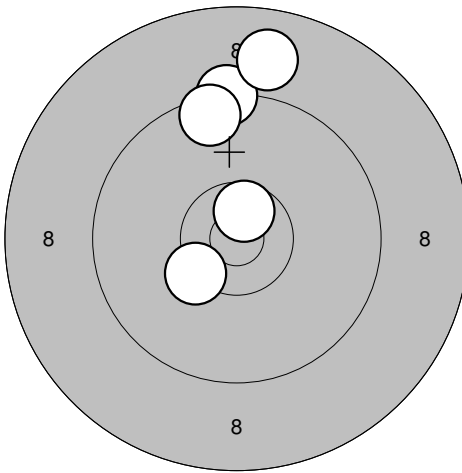
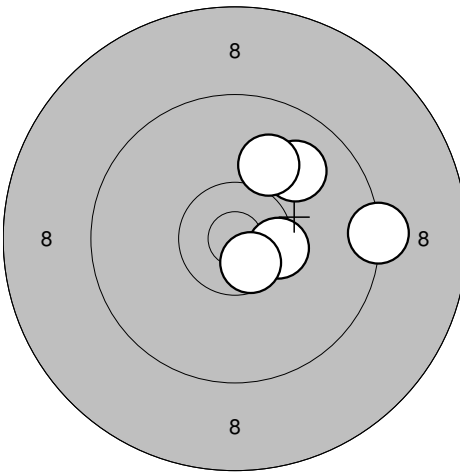
<p>Tävlingsskott</p> 	<p>Tävlingsskott</p> 	<p>6: 10,3* ↘</p> <p>7: 9,3 ↑</p> <p>8: 10,6* ↑</p> <p>9: 9,5 ↑</p> <p>10: 8,9 ↑</p> <hr/> <p>Serie 46,0</p> <p>Totalt 93,0</p>
		<p>11: 9,3 →</p> <p>12: 10,4* →</p> <p>13: 10,6* ↘</p> <p>14: 9,9 ↗</p> <p>15: 10,0 ↑</p> <hr/> <p>Serie 48,0</p> <p>Totalt 141,0</p>

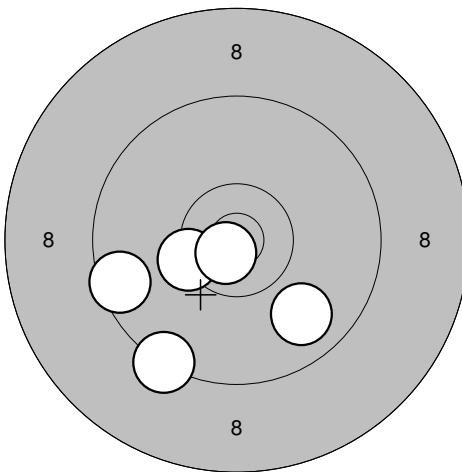
<p>Tävlingsskott</p> 	<p>16: 10,4* ←</p> <p>17: 9,3 ↘</p> <p>18: 9,5 ←</p> <p>19: 10,8* ↘</p> <p>20: 9,8 ↘</p> <hr/> <p>Serie 47,0</p> <p>Totalt 188,0</p>	
---	--	--

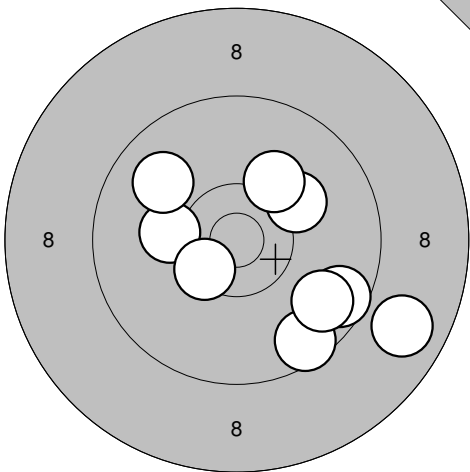
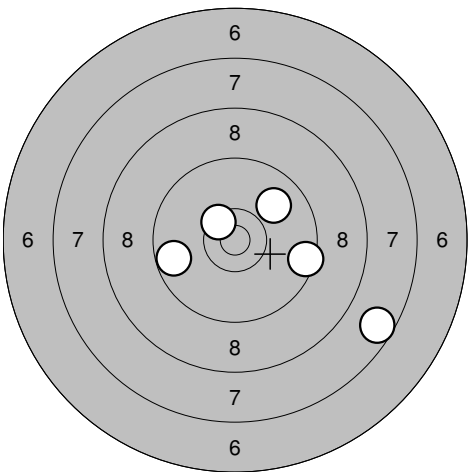
<b>Provs-kott</b> 	1: 10,1 ↗ 2: 9,6 ↘ 3: 9,6 → 4: 9,7 ↘ 5: 10,2 ↗ 6: 10,2 ← 7: 9,9 ↗ 8: 10,5* ↘ 9: 8,8 → <hr/> Serie 84,0 Totalt 0,0	<b>Tävlingsskott</b> 	1: 10,5* ↗ 2: 7,6 ↘ 3: 9,5 → 4: 9,9 ↗ 5: 9,7 ← <hr/> Serie 44,0 Totalt 44,0
---	---	--	---

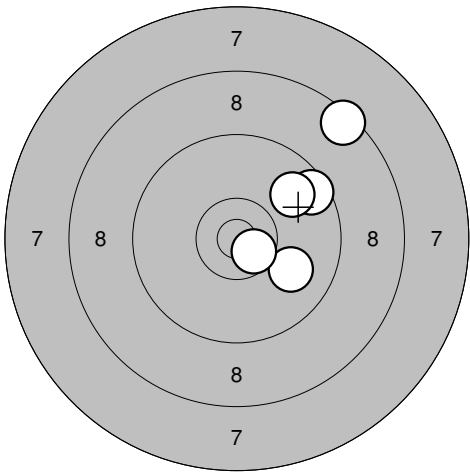
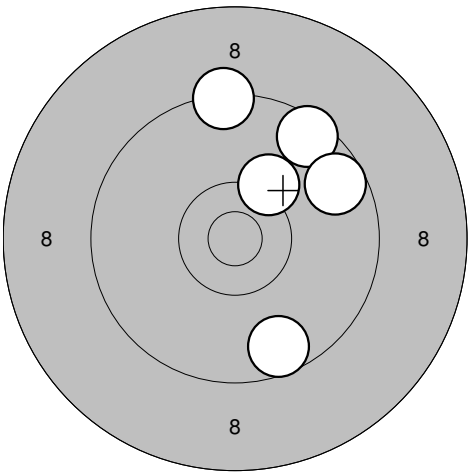
<b>Tävlingsskott</b> 	6: 8,5 ↗ 7: 9,6 ↗ 8: 9,8 ↗ 9: 10,0 → 10: 10,6* ↘ <hr/> Serie 46,0 Totalt 90,0	<b>Tävlingsskott</b> 	11: 10,2 ↗ 12: 9,5 ↗ 13: 9,3 ↑ 14: 9,6 ↘ 15: 9,6 → <hr/> Serie 46,0 Totalt 136,0
---	---	---	--

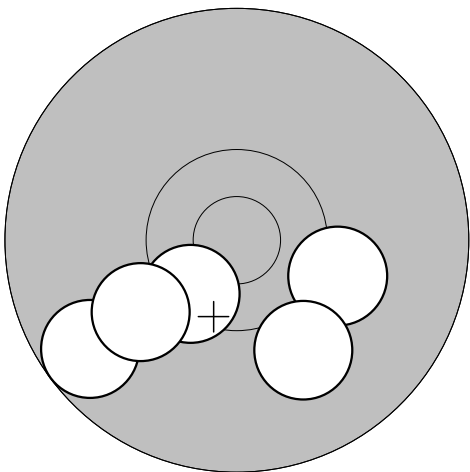
<b>Tävlingsskott</b> 	16: 9,7 ↘ 17: 10,2 → 18: 10,0 ↘ 19: 10,4* ↘ 20: 10,1 ↘ <hr/> Serie 49,0 Totalt 185,0		
--	--	--	--

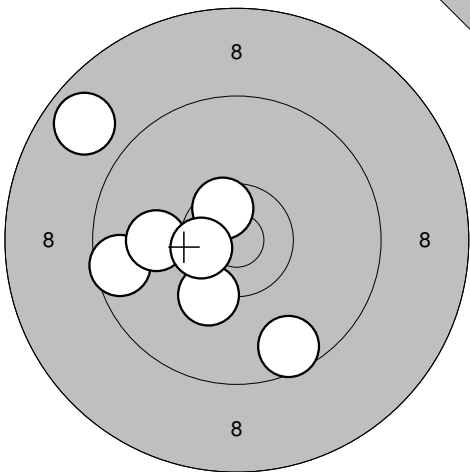
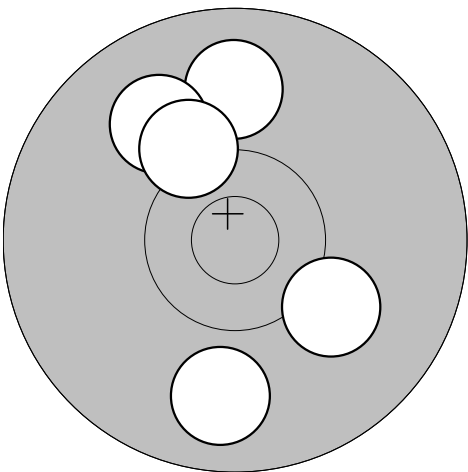
<p>Provskott</p> 	<p>Tävlingsskott</p> 	
<p>1: 8,8 ↖ 2: 9,6 ← 3: 10,0 ← 4: 10,2 ↓ 5: 10,6* ↑ 6: 10,5* ← 7: 9,6 ↓</p>	<p>1: 9,9 ↑ 2: 9,8 ↓ 3: 10,0 ↗ 4: 10,1 ↘ 5: 10,2 ↗</p>	
Serie 66,0	Serie 48,0	
Totalt 0,0	Totalt 48,0	

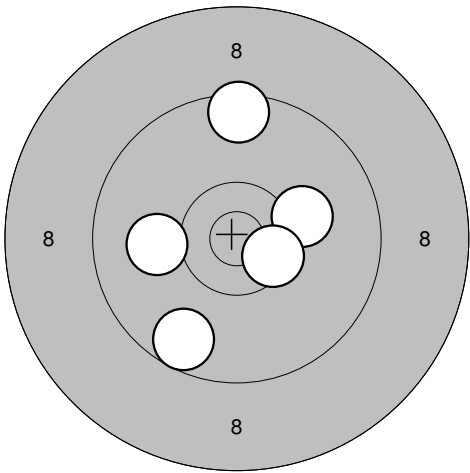
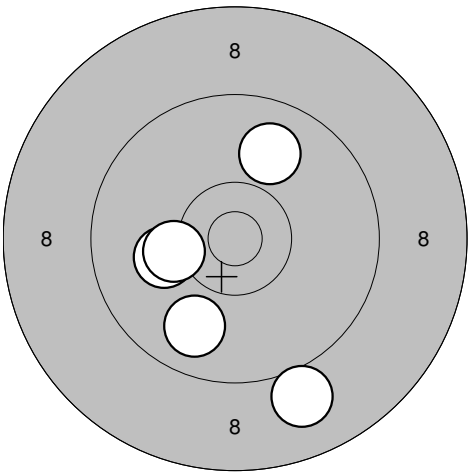
<p>Tävlingsskott</p> 	<p>Tävlingsskott</p> 	
<p>6: 10,2 → 7: 10,0 ← 8: 10,5* → 9: 9,5 ↑ 10: 9,6 ↓</p>	<p>11: 9,9 ↓ 12: 10,1 ← 13: 9,0 ↓ 14: 9,9 ↑ 15: 10,2 ←</p>	
Serie 48,0	Serie 47,0	
Totalt 96,0	Totalt 143,0	

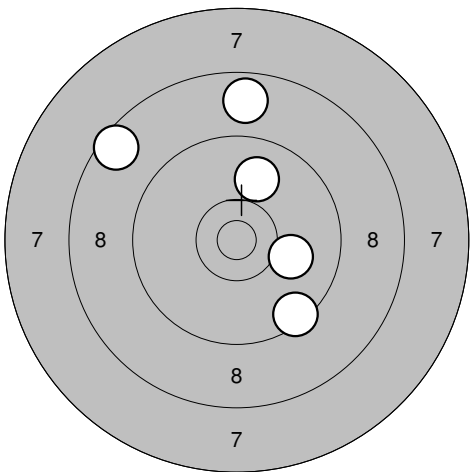
<p>Tävlingsskott</p> 	<p>16: 8,8 ↑ 17: 8,6 ↖ 18: 9,5 ↓ 19: 10,0 → 20: 9,9 ↑</p>	
Serie 44,0		
Totalt 187,0		

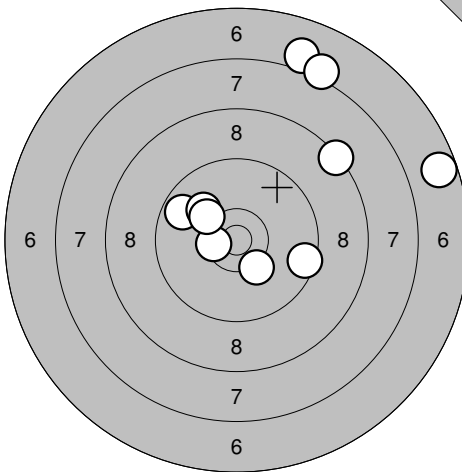
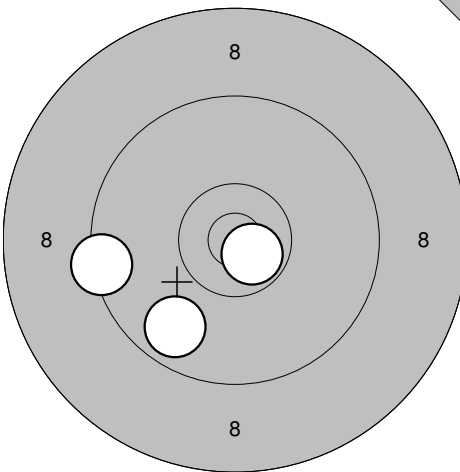
<p>Provskott</p> 	<p>1: 7,0 ↗ 2: 6,7 → 3: 7,2 ↗ 4: 8,4 ↗ 5: 9,5 → 6: 10,5* ← 7: 9,7 ↗ 8: 10,1 ↗ 9: 10,2 ↗ 10: 10,3 ↘</p> <table border="1" style="width:100%; border-collapse: collapse;"> <tr><td style="text-align: right;">Serie</td><td style="text-align: right;">86,0</td></tr> <tr><td style="text-align: right;">Totalt</td><td style="text-align: right;">0,0</td></tr> </table>	Serie	86,0	Totalt	0,0	<p>Provskott</p> 	<p>11: 9,4 ← 12: 9,7 ↘ 13: 10,7* ↘</p> <table border="1" style="width:100%; border-collapse: collapse;"> <tr><td style="text-align: right;">Serie</td><td style="text-align: right;">28,0</td></tr> <tr><td style="text-align: right;">Totalt</td><td style="text-align: right;">0,0</td></tr> </table>	Serie	28,0	Totalt	0,0
Serie	86,0										
Totalt	0,0										
Serie	28,0										
Totalt	0,0										

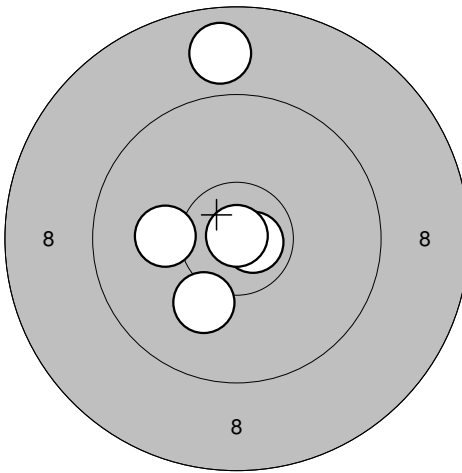
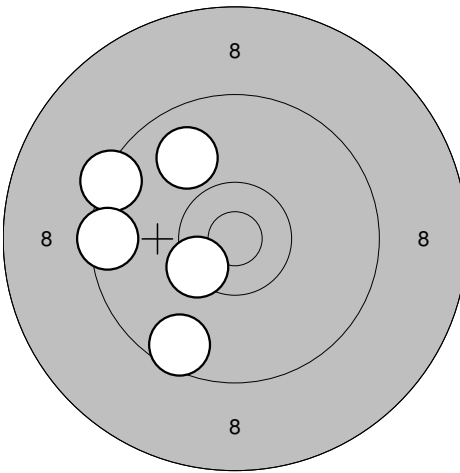
<p>Tävlingsskott</p> 	<p>1: 10,8* → 2: 8,8 ↑ 3: 10,1 ← 4: 10,1 ↘ 5: 10,9* ↑</p> <table border="1" style="width:100%; border-collapse: collapse;"> <tr><td style="text-align: right;">Serie</td><td style="text-align: right;">48,0</td></tr> <tr><td style="text-align: right;">Totalt</td><td style="text-align: right;">48,0</td></tr> </table>	Serie	48,0	Totalt	48,0	<p>Tävlingsskott</p> 	<p>6: 10,4* ← 7: 9,4 ← 8: 9,6 ↘ 9: 9,5 ← 10: 9,9 ↗</p> <table border="1" style="width:100%; border-collapse: collapse;"> <tr><td style="text-align: right;">Serie</td><td style="text-align: right;">46,0</td></tr> <tr><td style="text-align: right;">Totalt</td><td style="text-align: right;">94,0</td></tr> </table>	Serie	46,0	Totalt	94,0
Serie	48,0										
Totalt	48,0										
Serie	46,0										
Totalt	94,0										

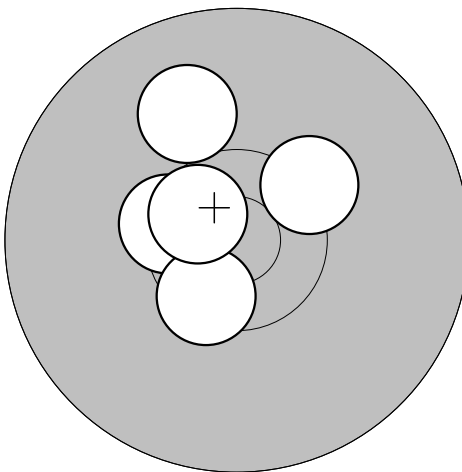
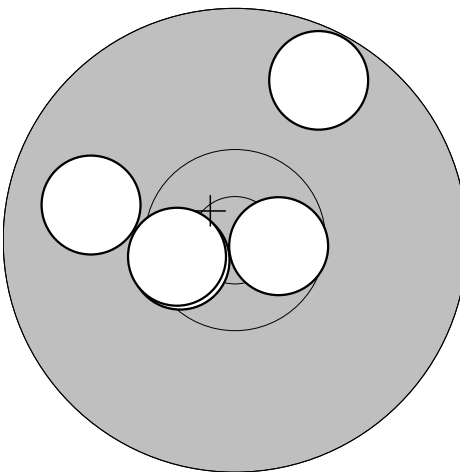
<p>Tävlingsskott</p> 	<p>11: 10,3* ↗ 12: 10,0 ↑ 13: 10,5* ← 14: 10,5* ↘ 15: 10,6* ↗</p> <table border="1" style="width:100%; border-collapse: collapse;"> <tr><td style="text-align: right;">Serie</td><td style="text-align: right;">50,0</td></tr> <tr><td style="text-align: right;">Totalt</td><td style="text-align: right;">144,0</td></tr> </table>	Serie	50,0	Totalt	144,0	<p>Tävlingsskott</p> 	<p>16: 10,5* ← 17: 9,9 ← 18: 10,5* ← 19: 9,7 ↗ 20: 10,6* →</p> <table border="1" style="width:100%; border-collapse: collapse;"> <tr><td style="text-align: right;">Serie</td><td style="text-align: right;">48,0</td></tr> <tr><td style="text-align: right;">Totalt</td><td style="text-align: right;">192,0</td></tr> </table>	Serie	48,0	Totalt	192,0
Serie	50,0										
Totalt	144,0										
Serie	48,0										
Totalt	192,0										

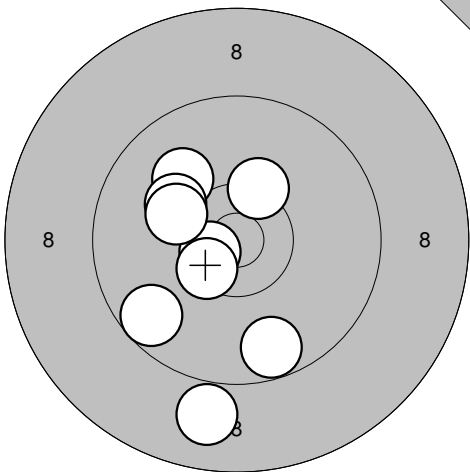
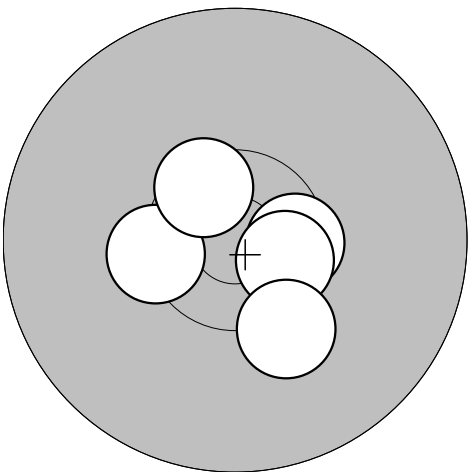
<b>Provs-kott</b> 	1: 9,7 ↓ 2: 8,9 ↓ 3: 9,7 ↙ 4: 10,0 ↗ 5: 10,6* ↙ 6: 10,1 ↗ 7: 10,5* ↙ 8: 10,2 ↙ 9: 10,3* ↗	<b>Tävlingsskott</b> 	1: 10,5* → 2: 10,6* → 3: 10,4* ← 4: 10,5* ↗ 5: 10,2 ↓
Serie 86,0		Serie 50,0	
Totalt 0,0		Totalt 50,0	

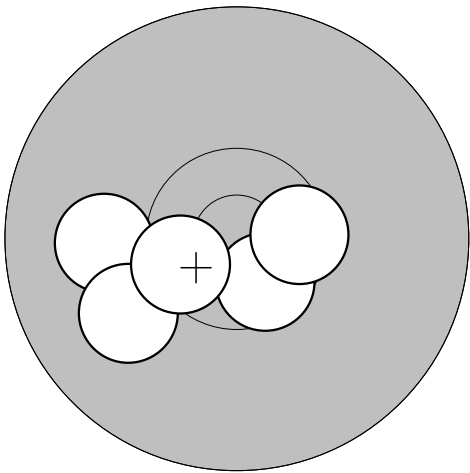
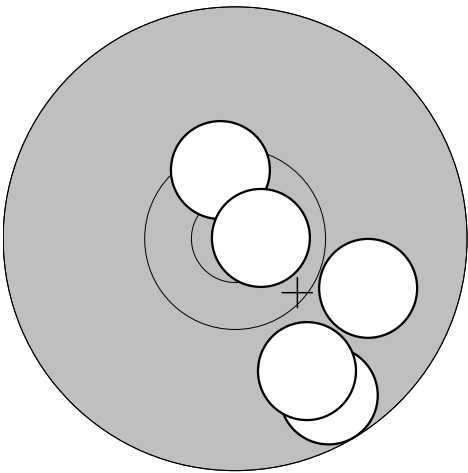
<b>Tävlingsskott</b> 	6: 10,0 ← 7: 10,0 ↙ 8: 10,6* ↓ 9: 10,5* → 10: 10,5* ←	<b>Tävlingsskott</b> 	11: 9,7 ↓ 12: 9,9 ↓ 13: 10,5* ↗ 14: 10,8* → 15: 9,9 ↘
Serie 50,0		Serie 47,0	
Totalt 100,0		Totalt 147,0	

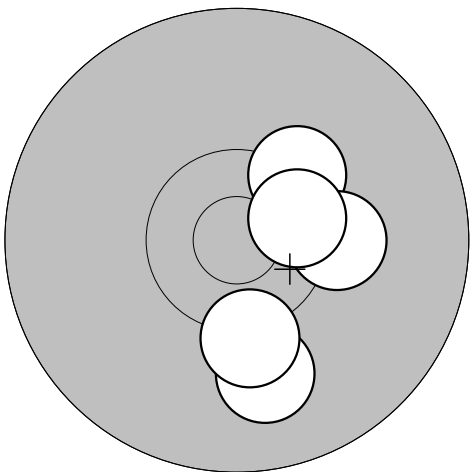
<b>Tävlingsskott</b> 	16: 10,3* ↗ 17: 10,2 → 18: 10,0 ↓ 19: 10,5* → 20: 10,2 ↓		
Serie 50,0			
Totalt 197,0			

Drängsmark

2010-09-04

Höstträffen 2010

Ramselefors SKF

Provsjött

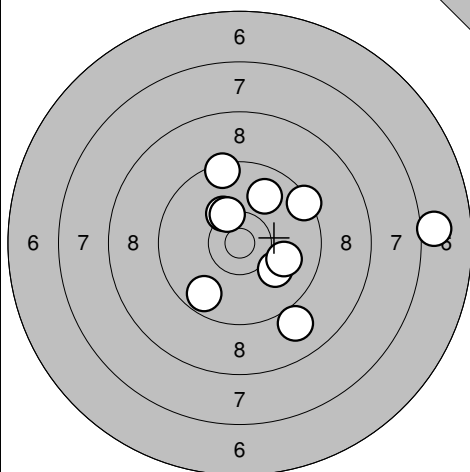

- 1: 9,0 ↘
- 2: 7,0 →
- 3: 9,5 ↗
- 4: 10,3 ↗
- 5: 10,1 ↘
- 6: 9,4 ↗
- 7: 10,0 →
- 8: 9,7 ↘
- 9: 9,9 ↗
- 10: 10,3\* ↗

Serie	92,0
Totalt	0,0

Provsjött

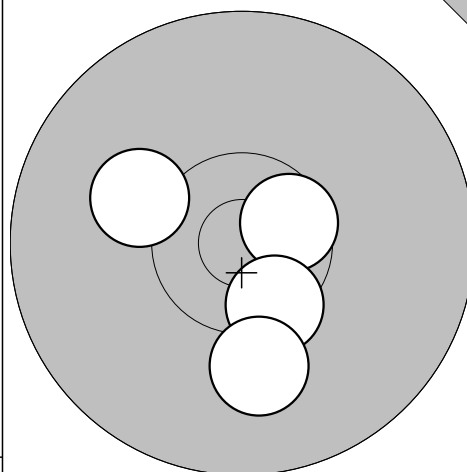

- 11: 10,6\* ↗
- 12: 10,5\* ↘
- 13: 10,2 ↖
- 14: 10,1 ↘

Serie	40,0
Totalt	0,0

Tävlingssjött

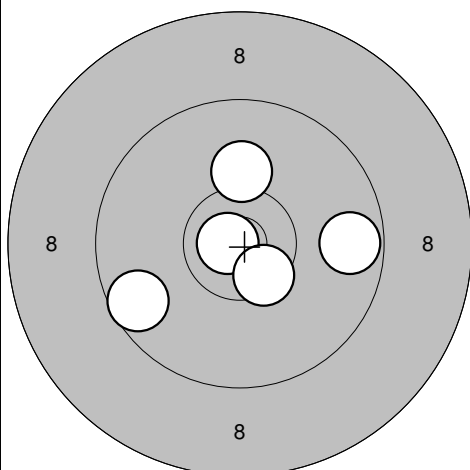

- 1: 10,8\* ←
- 2: 10,5\* ↘
- 3: 9,7 →
- 4: 9,6 ↖
- 5: 10,1 ↑

Serie	48,0
Totalt	48,0

Tävlingssjött

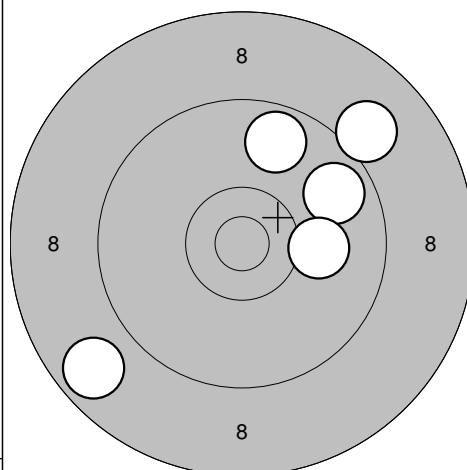

- 6: 9,8 ↗
- 7: 8,7 ↖
- 8: 10,1 →
- 9: 9,0 ↗
- 10: 9,7 ↑

Serie	45,0
Totalt	93,0

Tävlingssjött

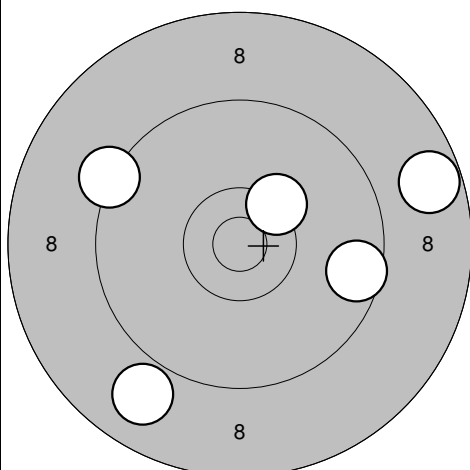

- 11: 8,7 →
- 12: 9,6 →
- 13: 8,9 ↘
- 14: 10,3\* ↗
- 15: 9,3 ↖

Serie	44,0
Totalt	137,0

Tävlingssjött

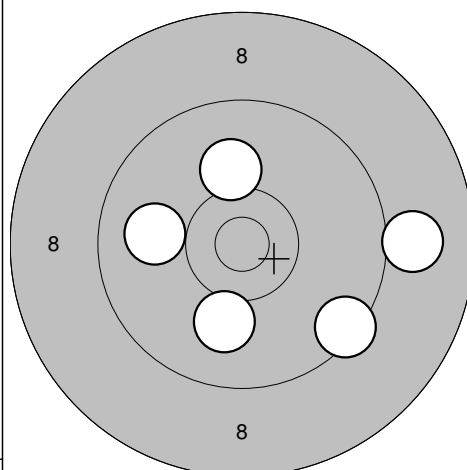

- 16: 10,0 ←
- 17: 10,1 ↑
- 18: 10,0 ↘
- 19: 9,0 →
- 20: 9,4 ↘

Serie	48,0
Totalt	185,0



Drängsmark

2010-09-04

Höstträffen 2010

Ramselefors SKF

Provskott

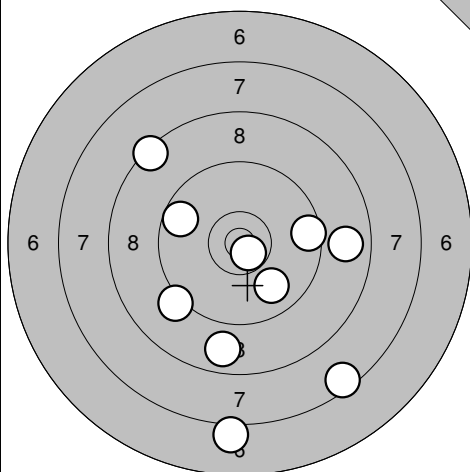

- 1: 8,4 ↗
- 2: 8,8 →
- 3: 10,7\* ↘
- 4: 7,5 ↘
- 5: 8,8 ↓
- 6: 9,6 →
- 7: 9,9 ↘
- 8: 9,2 ↙
- 9: 9,7 ↖
- 10: 7,1 ↓

Serie	84,0
Totalt	0,0

Provskott

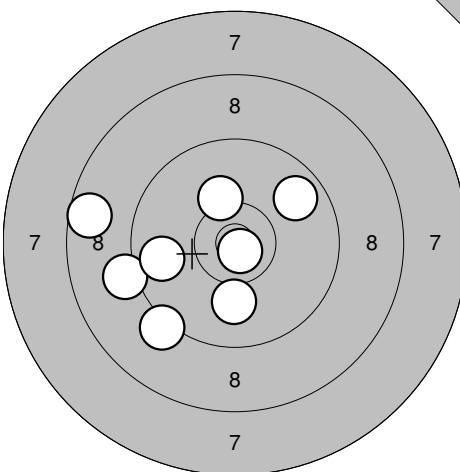

- 11: 10,8\* ↘
- 12: 8,6 ←
- 13: 10,0 ↓
- 14: 9,2 ←
- 15: 10,2 ↑
- 16: 9,2 ↙
- 17: 9,8 ←
- 18: 9,8 ↗

Serie	74,0
Totalt	0,0

Tävlingsskott

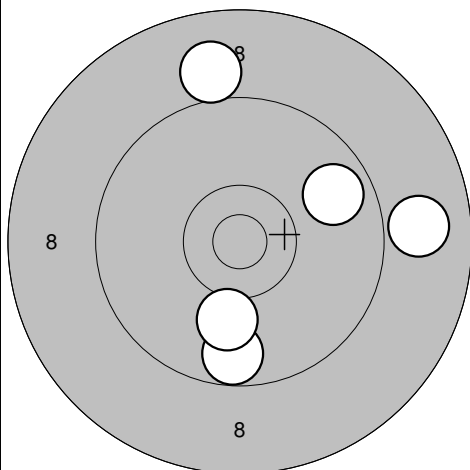

- 1: 9,7 ↓
- 2: 9,8 ↗
- 3: 8,9 →
- 4: 10,0 ↓
- 5: 9,0 ↑

Serie	45,0
Totalt	45,0

Tävlingsskott

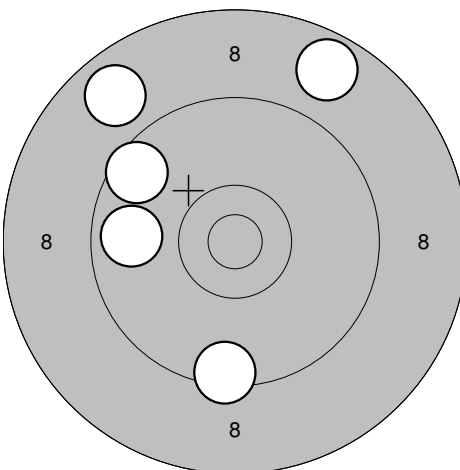

- 6: 9,6 ↖
- 7: 9,8 ←
- 8: 8,7 ↗
- 9: 8,8 ↖
- 10: 9,5 ↓

Serie	43,0
Totalt	88,0

Tävlingsskott

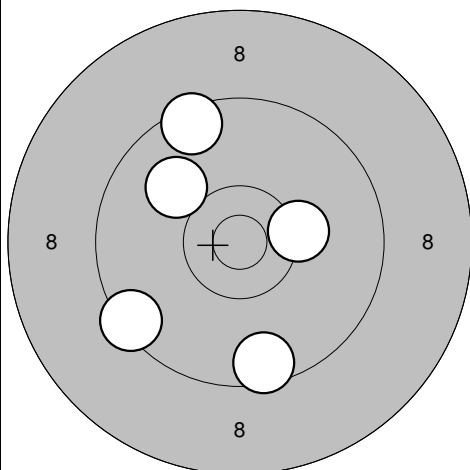

- 11: 9,4 ↖
- 12: 9,5 ↓
- 13: 9,5 ↑
- 14: 10,3 →
- 15: 10,0 ↖

Serie	47,0
Totalt	135,0

Tävlingsskott

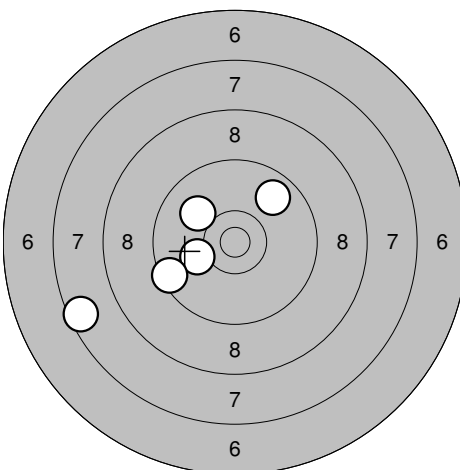

- 16: 7,6 ←
- 17: 10,0 ↖
- 18: 10,1 ←
- 19: 9,5 ←
- 20: 9,8 ↗

Serie	45,0
Totalt	180,0

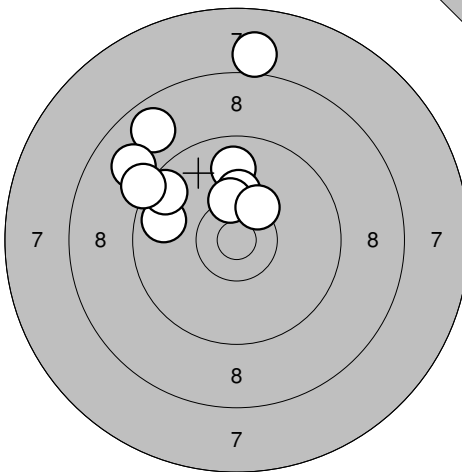
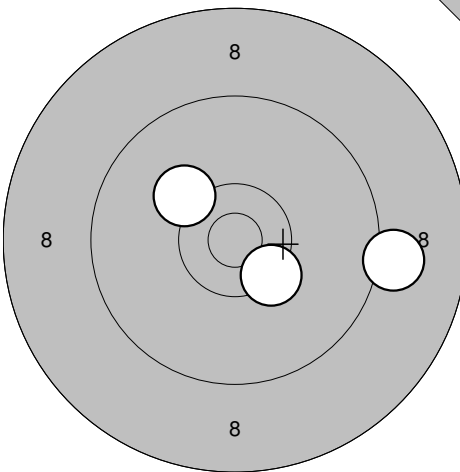
<p>Provskott</p> 	<p>1: 8,8 ↗                  2: 9,8 ←                  3: 9,8 ↑                  4: 9,6 ↗                  5: 8,0 ↑                  6: 9,0 ↗                  7: 10,2 ↑                  8: 9,3 ↗                  9: 10,3* ↑                  10: 10,3* ↗</p> <table border="1" style="width:100%; border-collapse: collapse;"> <tr><td>Serie</td><td style="text-align: right;">91,0</td></tr> <tr><td>Totalt</td><td style="text-align: right;">0,0</td></tr> </table>	Serie	91,0	Totalt	0,0	<p>Provskott</p>  <p>11: 10,2 ↗                  12: 10,4* ↘                  13: 9,1 →</p> <table border="1" style="width:100%; border-collapse: collapse;"> <tr><td>Serie</td><td style="text-align: right;">29,0</td></tr> <tr><td>Totalt</td><td style="text-align: right;">0,0</td></tr> </table>	Serie	29,0	Totalt	0,0
Serie	91,0									
Totalt	0,0									
Serie	29,0									
Totalt	0,0									

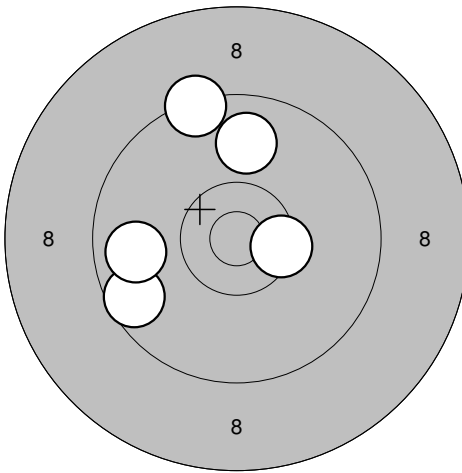
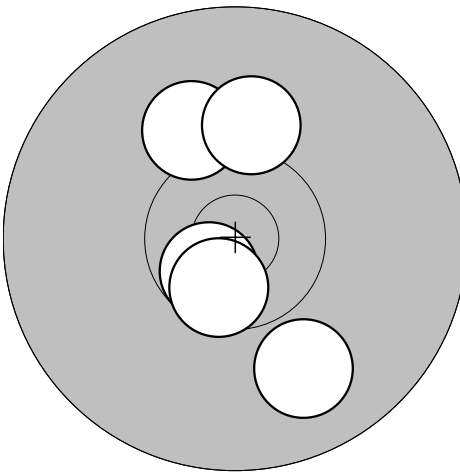
<p>Tävlingsskott</p> 	<p>1: 9,4 ↗                  2: 10,4* →                  3: 9,9 ↑                  4: 9,6 ←                  5: 9,8 ←</p> <table border="1" style="width:100%; border-collapse: collapse;"> <tr><td>Serie</td><td style="text-align: right;">46,0</td></tr> <tr><td>Totalt</td><td style="text-align: right;">46,0</td></tr> </table>	Serie	46,0	Totalt	46,0	<p>Tävlingsskott</p>  <p>6: 10,1 ↗                  7: 10,7* ↘                  8: 10,6* ↘                  9: 9,9 ↘                  10: 10,1 ↑</p> <table border="1" style="width:100%; border-collapse: collapse;"> <tr><td>Serie</td><td style="text-align: right;">49,0</td></tr> <tr><td>Totalt</td><td style="text-align: right;">95,0</td></tr> </table>	Serie	49,0	Totalt	95,0
Serie	46,0									
Totalt	46,0									
Serie	49,0									
Totalt	95,0									

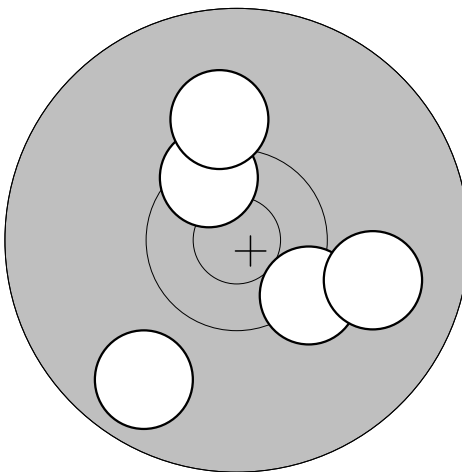
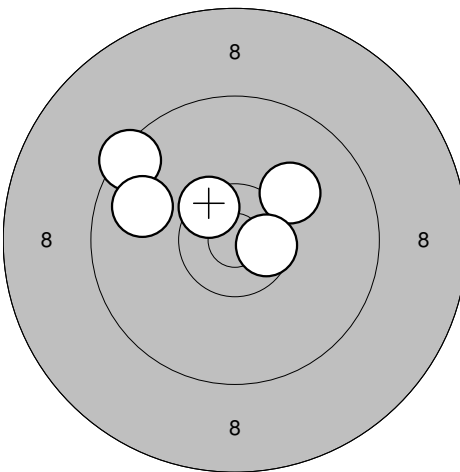
<p>Tävlingsskott</p> 	<p>11: 9,8 ↘                  12: 10,3* ↘                  13: 10,5* ↗                  14: 10,1 ↑                  15: 9,9 →</p> <table border="1" style="width:100%; border-collapse: collapse;"> <tr><td>Serie</td><td style="text-align: right;">48,0</td></tr> <tr><td>Totalt</td><td style="text-align: right;">143,0</td></tr> </table>	Serie	48,0	Totalt	143,0	<p>Tävlingsskott</p>  <p>16: 9,5 ↗                  17: 9,8 ←                  18: 10,1 ↗                  19: 10,6* →                  20: 10,5* ↗</p> <table border="1" style="width:100%; border-collapse: collapse;"> <tr><td>Serie</td><td style="text-align: right;">48,0</td></tr> <tr><td>Totalt</td><td style="text-align: right;">191,0</td></tr> </table>	Serie	48,0	Totalt	191,0
Serie	48,0									
Totalt	143,0									
Serie	48,0									
Totalt	191,0									

Skellefteå

2010-09-04

Höstträffen 2010

Ramselefors SKF

Provs-kott

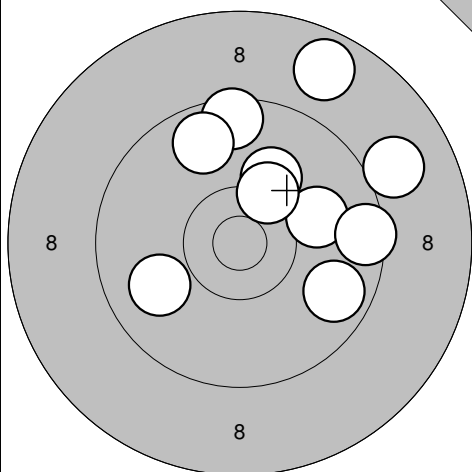

- 1: 10,0 →
- 2: 9,7 ↘
- 3: 10,1 ↗
- 4: 9,5 →
- 5: 9,5 ↑
- 6: 9,9 ←
- 7: 8,8 ↗
- 8: 10,3\* ↗
- 9: 9,0 →
- 10: 9,7 ↗

Serie 92,0  
Totalt 0,0

Provs-kott

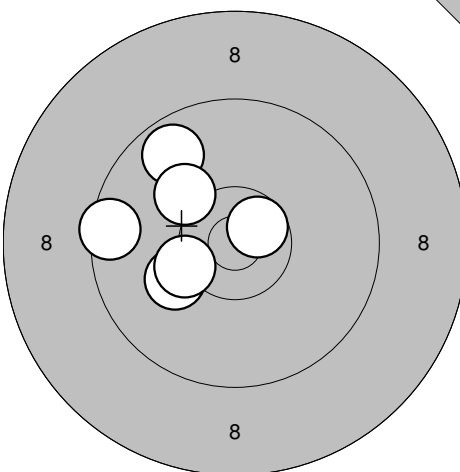

- 11: 9,5 ←
- 12: 10,2 ←
- 13: 9,7 ↗
- 14: 10,6\* ↗
- 15: 10,3\* ←
- 16: 10,2 ↗

Serie 58,0  
Totalt 0,0

Tävlingsskott

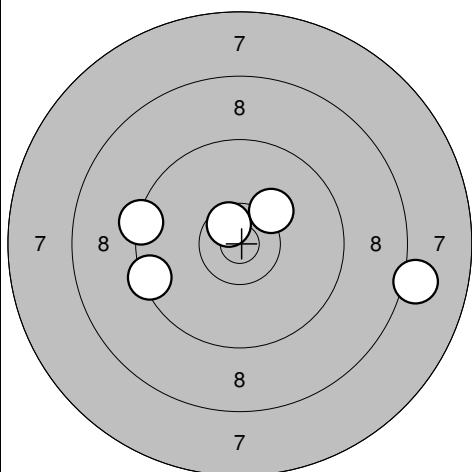

- 1: 8,1 →
- 2: 9,4 ←
- 3: 9,4 ←
- 4: 10,6\* ↗
- 5: 10,2 ↗

Serie 46,0  
Totalt 46,0

Tävlingsskott

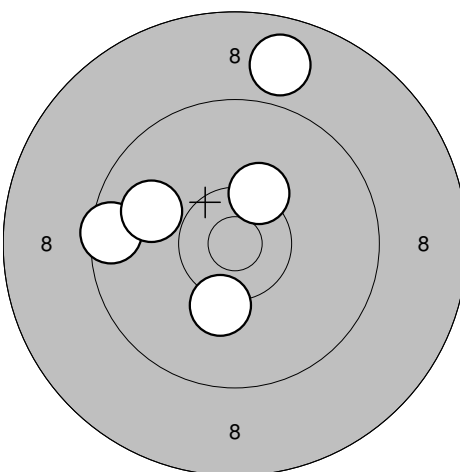

- 6: 10,2 ↓
- 7: 8,9 ↑
- 8: 9,5 ←
- 9: 10,3\* ↗
- 10: 9,9 ←

Serie 46,0  
Totalt 92,0

Tävlingsskott

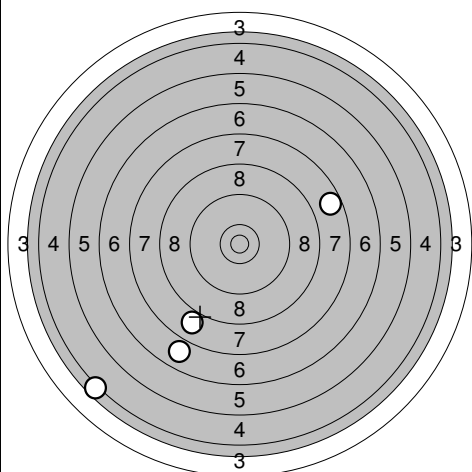

- 11: 6,9 ↓
- 12: 7,9 ↓
- 13: 7,7 →
- 14: 4,2 ←
- 0,0 ↓

Serie 24,0  
Totalt 116,0

Tävlingsskott

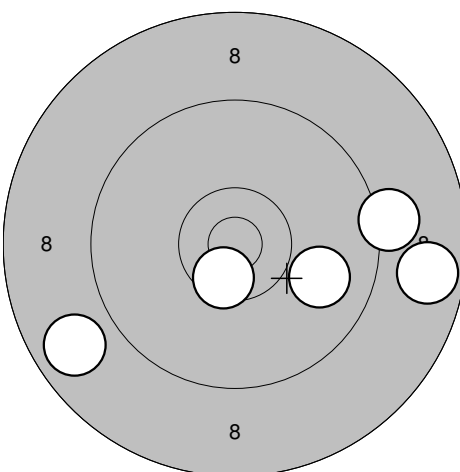

- 16: 8,8 ←
- 17: 8,7 →
- 18: 10,5\* ↓
- 19: 9,9 →
- 20: 9,2 →

Serie 44,0  
Totalt 160,0

Umeå

2010-09-04

Höstträffen 2010

Ramselefors SKF

Provskott

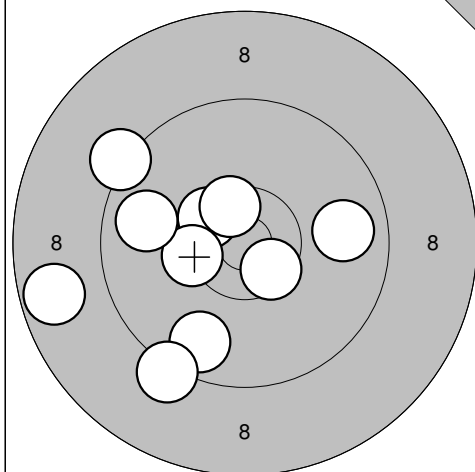

1: 10,5\*



2: 10,4\*



3: 9,8



4: 8,7



5: 10,3\*



6: 9,7



7: 9,2



8: 9,8



9: 9,2



10: 10,5\*



Serie 93,0

Totalt 0,0

Provskott

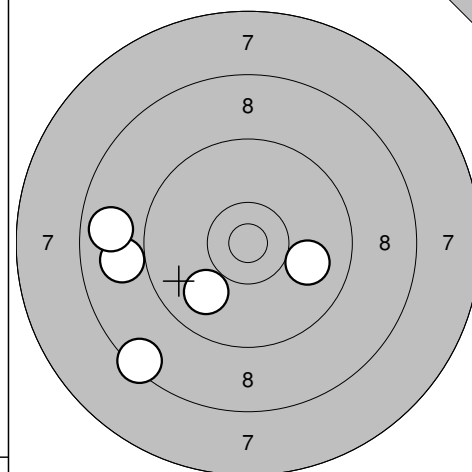

11: 8,4



12: 9,0



13: 10,0



14: 8,8



15: 9,9



Serie 44,0

Totalt 0,0

Tävlingsskott

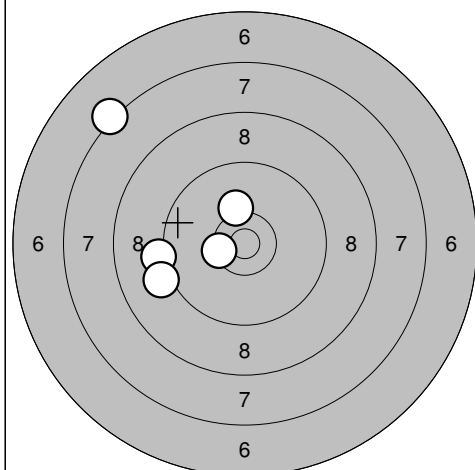

1: 10,2



2: 10,4\*



3: 9,2



4: 7,2



5: 9,1



Serie 45,0

Totalt 45,0

Tävlingsskott

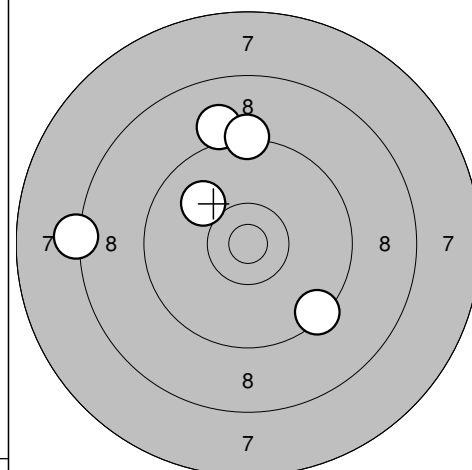

6: 9,1



7: 8,3



8: 9,4



9: 9,3



10: 10,0



Serie 45,0

Totalt 90,0

Tävlingsskott

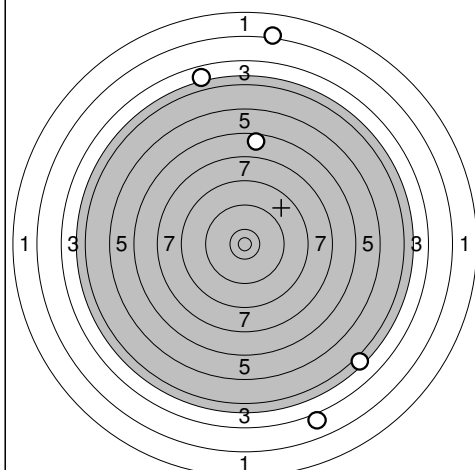

11: 6,7



12: 2,2



13: 3,8



14: 3,0



15: 4,1



Serie 18,0

Totalt 108,0

Tävlingsskott

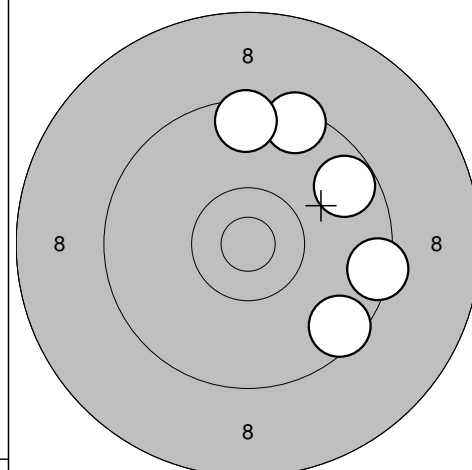

16: 9,5



17: 9,7



18: 9,5



19: 9,4



20: 9,6



Serie 45,0

Totalt 153,0

Rundvik

2010-09-04

Höstträffen 2010

Ramselefors SKF

Provskott

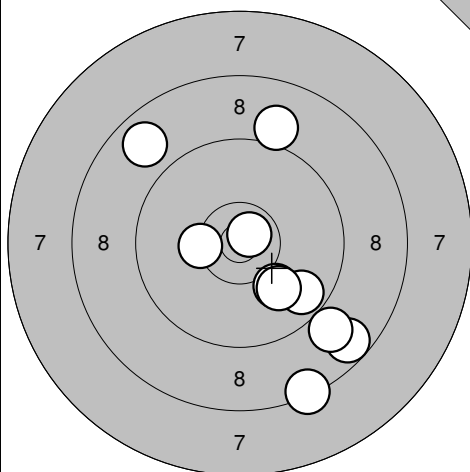

- 1: 8,4 ↘
- 2: 10,3\* ←
- 3: 10,1 ↘
- 4: 8,8 ↗
- 5: 9,7 ↘
- 6: 10,7\* ↗
- 7: 8,7 ↘
- 8: 9,0 ↘
- 9: 9,1 ↗
- 10: 10,0 ↘

Serie	91,0
Totalt	0,0

Provskott

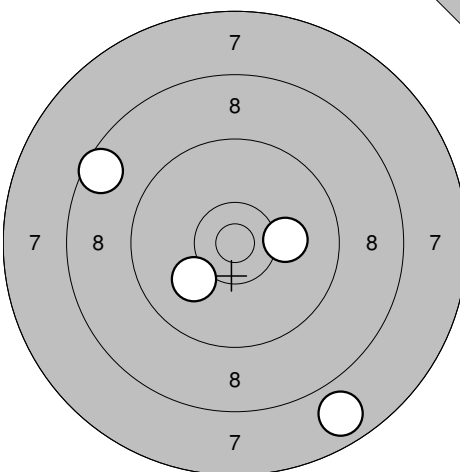

- 11: 10,1 →
- 12: 7,8 ↘
- 13: 10,1 ↘
- 14: 8,6 ↖

Serie	35,0
Totalt	0,0

Tävlingsskott

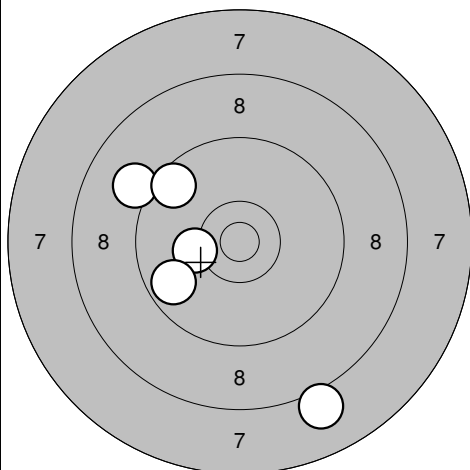

- 1: 10,2 ←
- 2: 8,1 ↘
- 3: 9,1 ↗
- 4: 9,7 ↖
- 5: 9,6 ↗

Serie	45,0
Totalt	45,0

Tävlingsskott

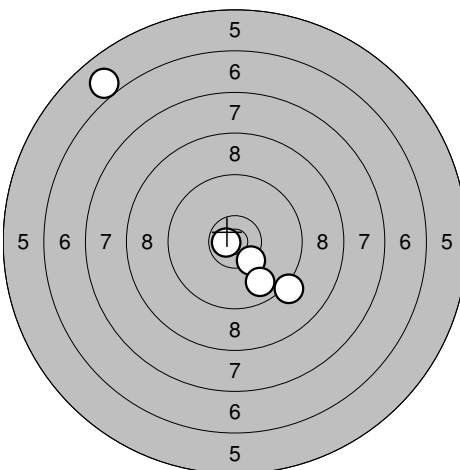

- 6: 10,3\* ↘
- 7: 9,8 ↘
- 8: 10,7\* ←
- 9: 6,0 ↗
- 10: 9,2 ↘

Serie	44,0
Totalt	89,0

Tävlingsskott

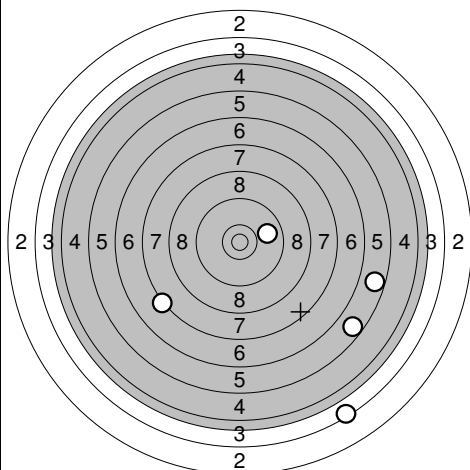

- 11: 5,7 →
- 12: 5,7 ↘
- 13: 7,3 ↖
- 14: 9,9 →
- 15: 3,4 ↘

Serie	29,0
Totalt	118,0

Tävlingsskott

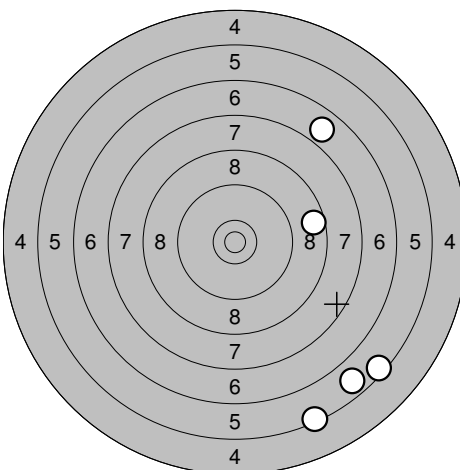

- 16: 5,5 ↘
- 17: 5,7 ↘
- 18: 5,4 ↘
- 19: 6,9 ↗
- 20: 8,6 →

Serie	29,0
Totalt	147,0

Rundvik

2010-09-04

Höstträffen 2010

Ramselefors SKF

Provskott

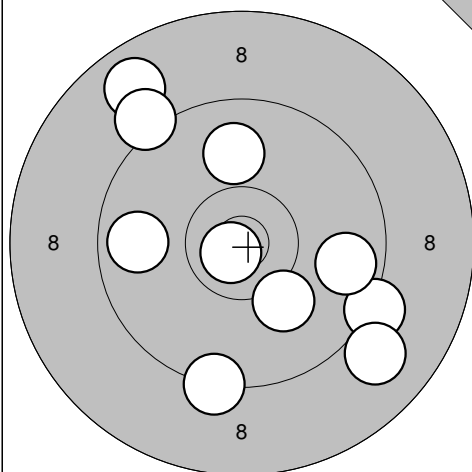

1: 8,8 ↗  
 2: 9,2 ↘  
 3: 9,8 ←  
 4: 9,0 ↘  
 5: 10,1 ↘  
 6: 9,9 ↑  
 7: 9,2 ↗  
 8: 9,3 ↘  
 9: 10,8\* ↙  
 10: 9,7 →

Serie 91,0

Totalt 0,0

Provskott

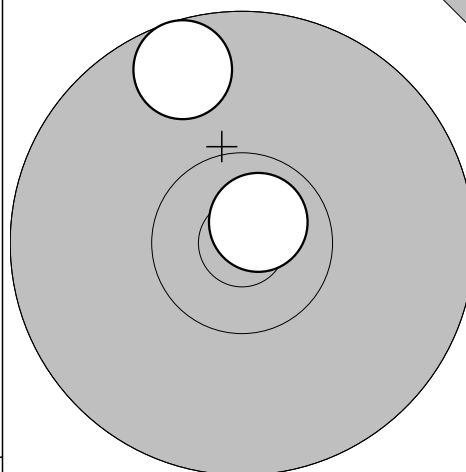

11: 9,7 ↗  
 12: 10,8\* ↗

Serie 19,0

Totalt 0,0

Tävlingsskott

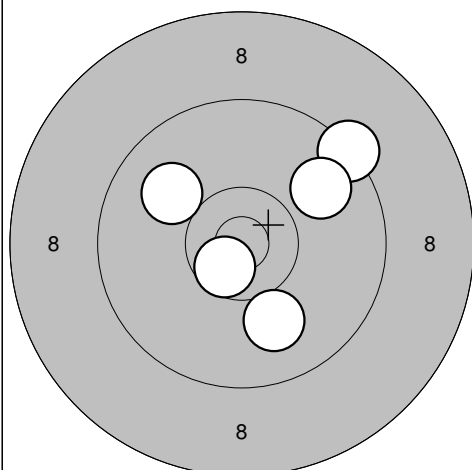

1: 10,0 ↖  
 2: 10,0 ↘  
 3: 9,3 ↗  
 4: 10,6\* ↙  
 5: 9,8 ↗

Serie 48,0

Totalt 48,0

Tävlingsskott

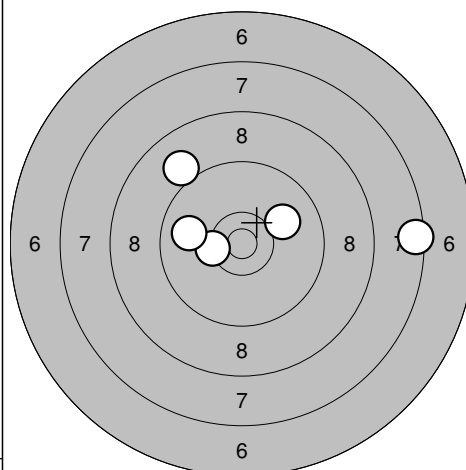

6: 7,5 →  
 7: 10,0 ↗  
 8: 10,4\* ←  
 9: 9,9 ←  
 10: 9,0 ↗

Serie 45,0

Totalt 93,0

Tävlingsskott

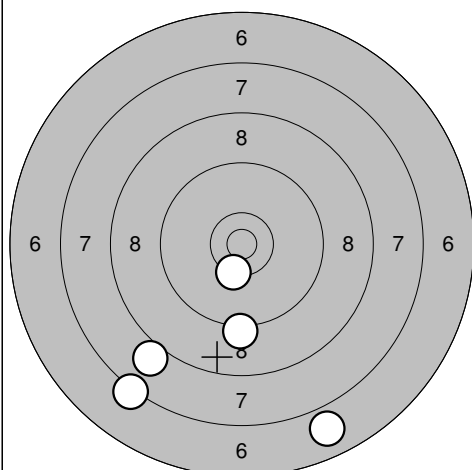

11: 7,2 ↙  
 12: 10,4\* ↘  
 13: 6,9 ↘  
 14: 8,0 ↙  
 15: 9,2 ↘

Serie 40,0

Totalt 133,0

Tävlingsskott

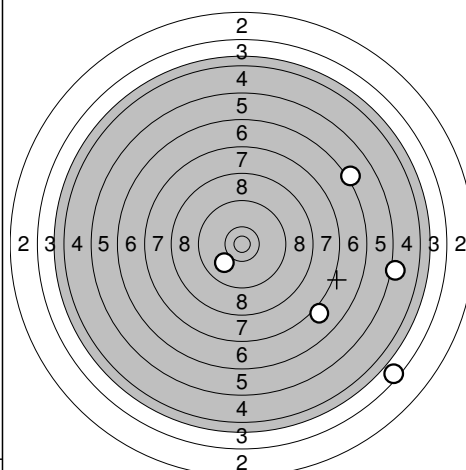

16: 6,2 ↗  
 17: 3,5 ↘  
 18: 7,1 ↘  
 19: 10,0 ↙  
 20: 5,2 →

Serie 31,0

Totalt 164,0

Umeå

2010-09-04

Höstträffen 2010

Ramselefors SKF

Provskott

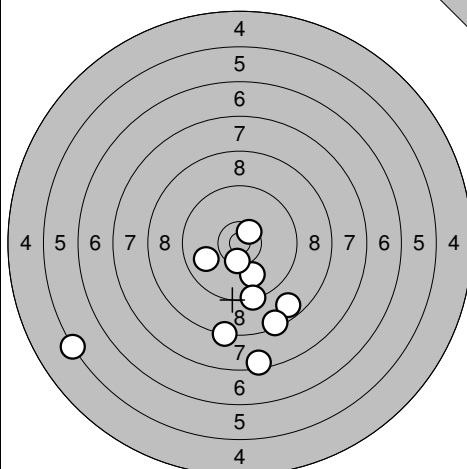

1: 9,9 ↙  
 2: 8,7 ↘  
 3: 5,3 ↙  
 4: 8,3 ↘  
 5: 8,4 ↘  
 6: 7,5 ↘  
 7: 10,0 ↘  
 8: 10,5\* ↗  
 9: 10,4\* ↘  
 10: 9,3 ↘

Serie 84,0

Totalt 0,0

Provskott

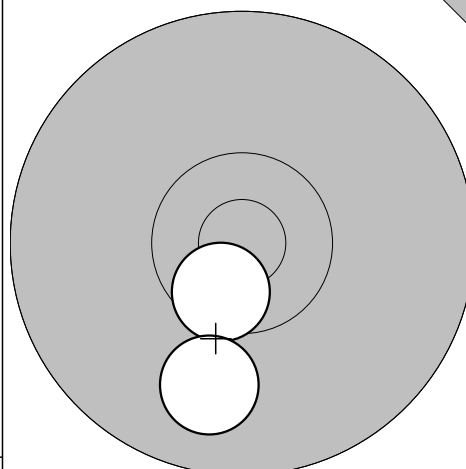

11: 10,6\* ↘  
 12: 9,9 ↘

Serie 19,0

Totalt 0,0

Tävlingsskott

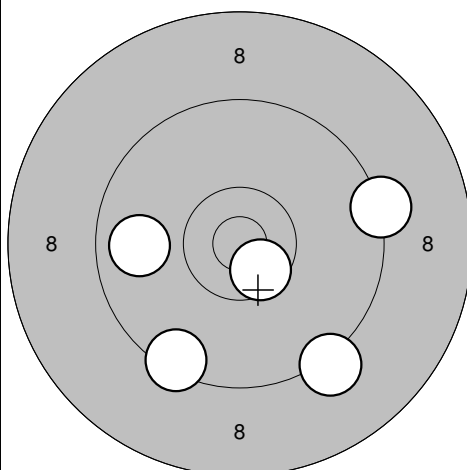

1: 10,6\* ↘  
 2: 9,2 ↘  
 3: 9,8 ↙  
 4: 9,4 ↘  
 5: 9,3 →

Serie 46,0

Totalt 46,0

Tävlingsskott

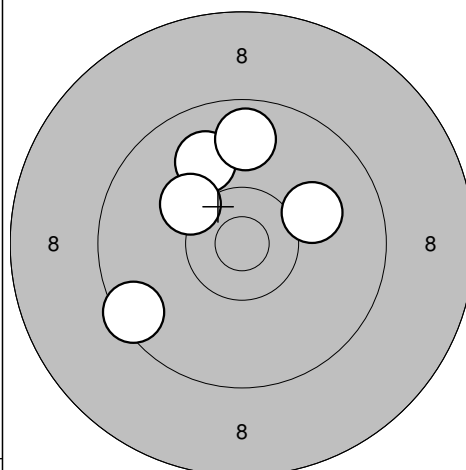

6: 9,9 ↗  
 7: 9,8 ↑  
 8: 10,1 →  
 9: 9,5 ↙  
 10: 10,2 ↖

Serie 47,0

Totalt 93,0

Tävlingsskott

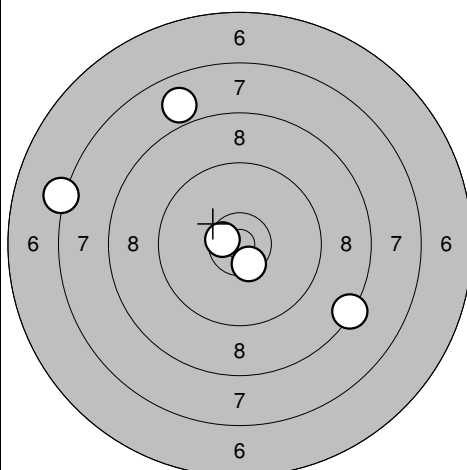

11: 7,2 ↙  
 12: 8,4 ↘  
 13: 10,5\* ↘  
 14: 7,9 ↗  
 15: 10,6\* ↙

Serie 42,0

Totalt 135,0

Tävlingsskott

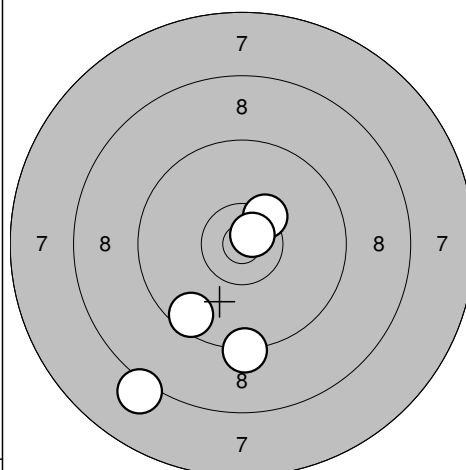

16: 10,4\* ↗  
 17: 9,3 ↘  
 18: 9,6 ↘  
 19: 10,7\* ↗  
 20: 8,1 ↘

Serie 46,0

Totalt 181,0

Ramselefors

2010-09-04

Höstträffen 2010

Ramselefors SKF

Provskott

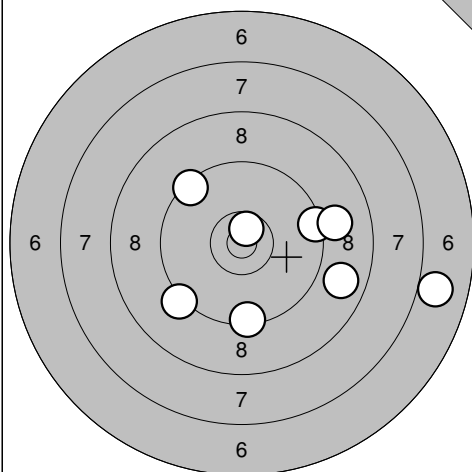

1: 7,0 →  
 2: 9,2 ↙  
 3: 10,7\* ↗  
 4: 9,4 →  
 5: 9,0 →  
 6: 9,4 ↓  
 7: 8,8 →  
 8: 9,4 ↗

Serie 70,0  
 Totalt 0,0

Tävlingsskott

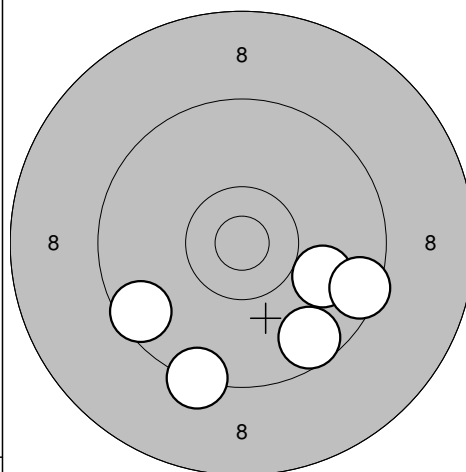

1: 9,3 ↓  
 2: 10,0 →  
 3: 9,5 →  
 4: 9,6 ↓  
 5: 9,6 ↙

Serie 46,0  
 Totalt 46,0

Tävlingsskott

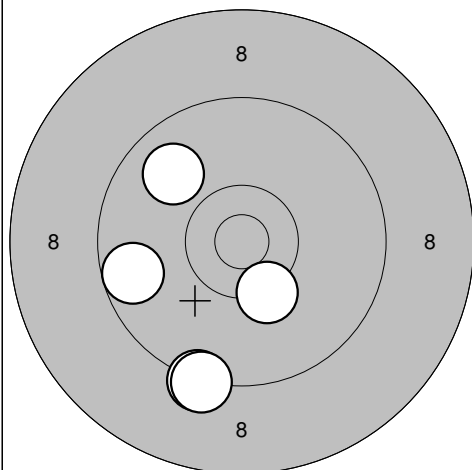

6: 9,3 ↓  
 7: 9,7 ←  
 8: 10,3\* ↓  
 9: 9,3 ↓  
 10: 9,9 ↗

Serie 46,0  
 Totalt 92,0

Tävlingsskott

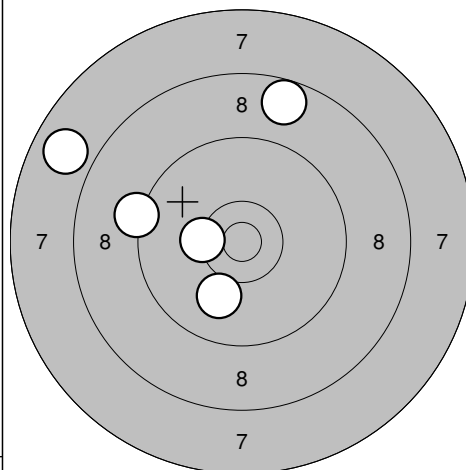

11: 10,0 ↓  
 12: 8,7 ↗  
 13: 9,2 ←  
 14: 10,3\* ←  
 15: 7,8 ↙

Serie 44,0  
 Totalt 136,0

Tävlingsskott

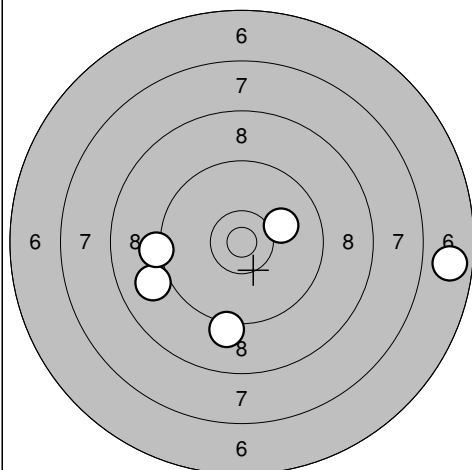

16: 10,1 →  
 17: 9,0 ←  
 18: 9,2 ←  
 19: 6,8 →  
 20: 9,2 ↓

Serie 43,0  
 Totalt 179,0



Ramselefors

2010-09-04

Höstträffen 2010

Ramselefors SKF

Provskott

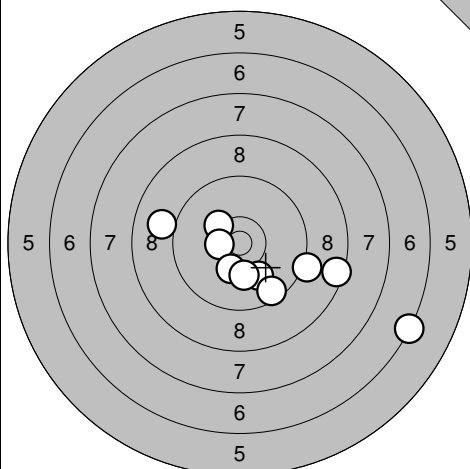

1: 6,3 ↘  
 2: 9,0 ←  
 3: 8,5 →  
 4: 10,0 ↘  
 5: 9,2 ↘  
 6: 9,5 ↘  
 7: 10,3 ↗  
 8: 10,5\* ←  
 9: 10,3 ↘  
 10: 10,2 ↘

Serie 91,0

Totalt 0,0

Provskott

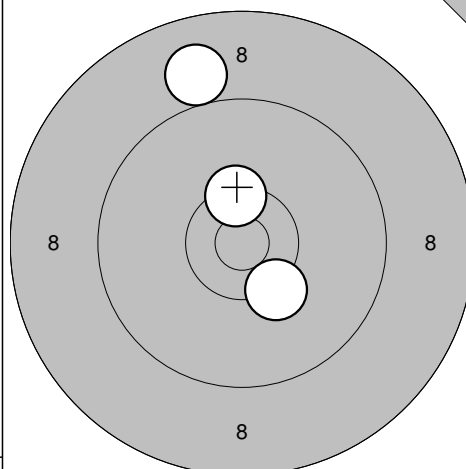

11: 10,3\* ↘  
 12: 9,0 ↑  
 13: 10,4\* ↑

Serie 29,0

Totalt 0,0

Tävlingsskott

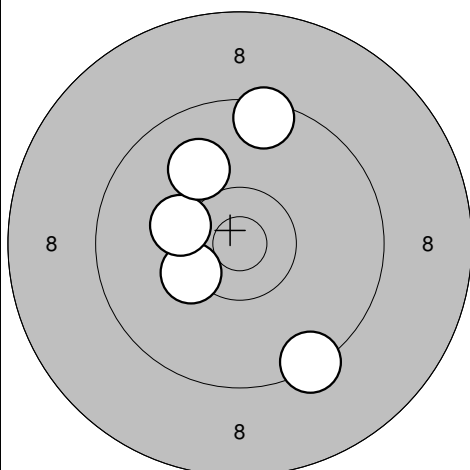

1: 9,4 ↘  
 2: 10,3\* ↙  
 3: 9,5 ↑  
 4: 10,2 ↙  
 5: 10,0 ↗

Serie 48,0

Totalt 48,0

Tävlingsskott

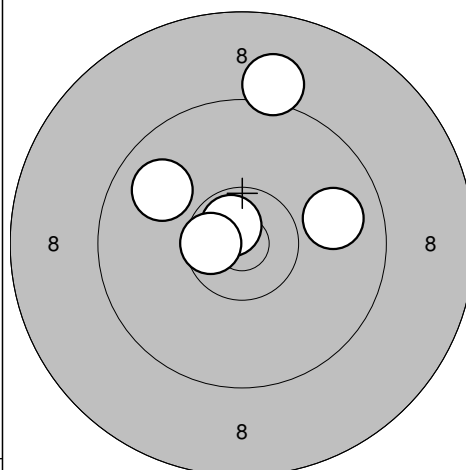

6: 10,7\* ↖  
 7: 9,9 →  
 8: 10,6\* ←  
 9: 9,1 ↑  
 10: 9,9 ↖

Serie 47,0

Totalt 95,0

Tävlingsskott

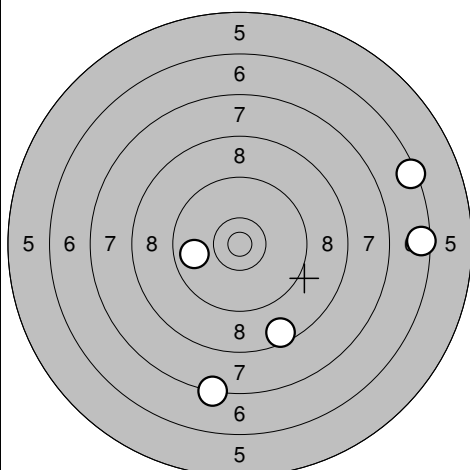

11: 9,8 ←  
 12: 7,3 ↘  
 13: 8,6 ↘  
 14: 6,5 →  
 15: 6,5 →

Serie 36,0

Totalt 131,0

Tävlingsskott

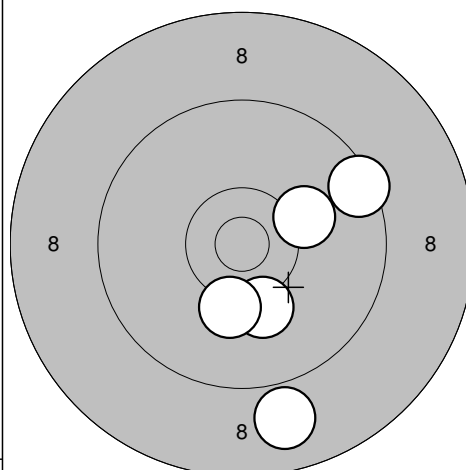

16: 8,9 ↘  
 17: 9,5 ↗  
 18: 10,2 ↘  
 19: 10,2 ↗  
 20: 10,2 ↘

Serie 47,0

Totalt 178,0

Umeå

2010-09-04

Höstträffen 2010

Ramselefors SKF

Provskott

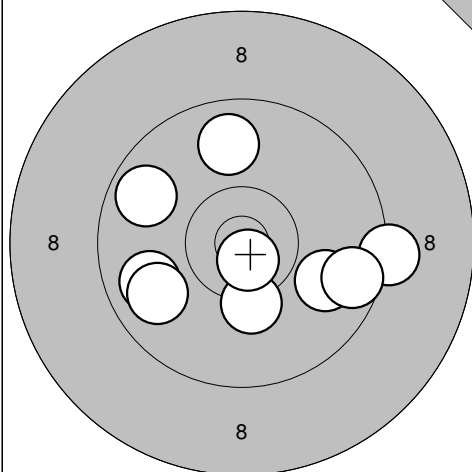

1: 9,3 →  
 2: 9,9 ↘  
 3: 10,2 ↓  
 4: 10,7\* ↓  
 5: 9,6 →  
 6: 9,8 ↑  
 7: 9,8 ←  
 8: 9,8 ←  
 9: 9,7 ↖

Serie 83,0

Totalt 0,0

Tävlingsskott

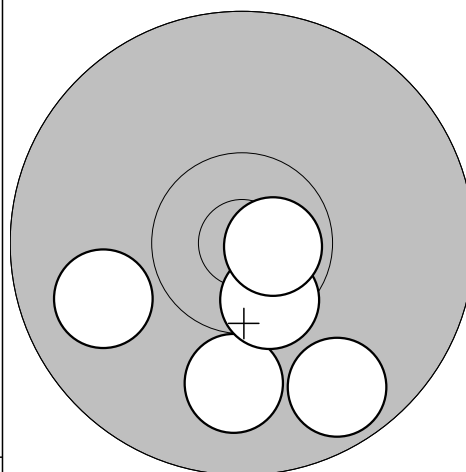

1: 9,7 ↓  
 2: 10,0 ↓  
 3: 10,5\* ↓  
 4: 9,9 ←  
 5: 10,7\* →

Serie 48,0

Totalt 48,0

Tävlingsskott

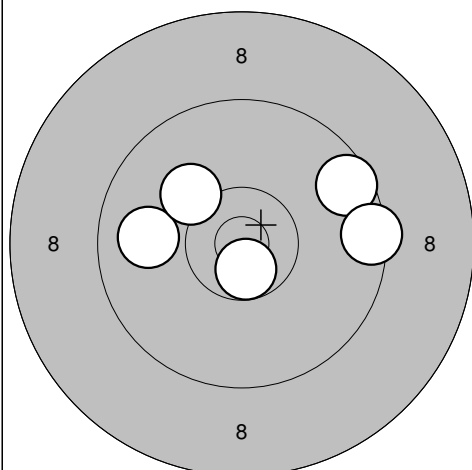

6: 9,6 ↗  
 7: 9,9 ←  
 8: 10,7\* ↓  
 9: 10,1 ↗  
 10: 9,5 →

Serie 47,0

Totalt 95,0

Tävlingsskott

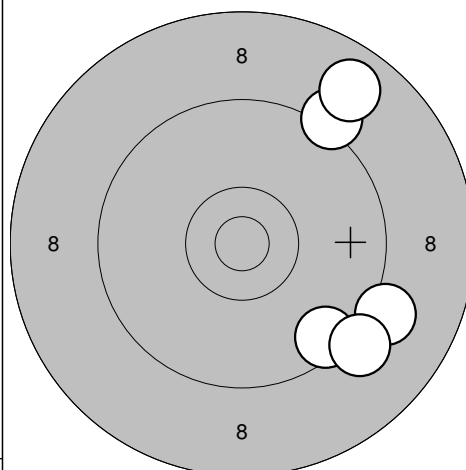

11: 9,2 ↗  
 12: 9,5 ↓  
 13: 8,8 ↗  
 14: 9,1 ↘  
 15: 9,2 ↓

Serie 44,0

Totalt 139,0

Tävlingsskott

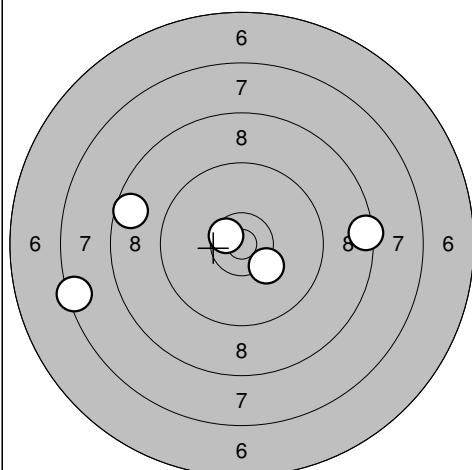

16: 8,6 ←  
 17: 10,3 ↓  
 18: 8,4 →  
 19: 10,6\* ↗  
 20: 7,5 ←

Serie 43,0

Totalt 182,0

Umeå

2010-09-04

Höstträffen 2010

Ramselefors SKF

Provs-kott

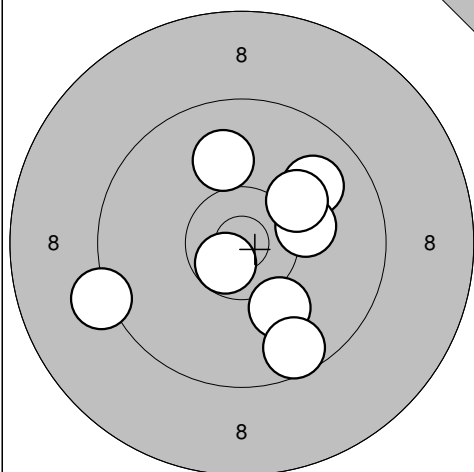

- 1: 9,9 ↗
- 2: 10,2 →
- 3: 10,1 ↓
- 4: 10,7\* ↙
- 5: 9,6 ↓
- 6: 10,0 ↑
- 7: 10,2 ↗
- 8: 9,2 ←

Serie 77,0  
Totalt 0,0

Tävlingsskott

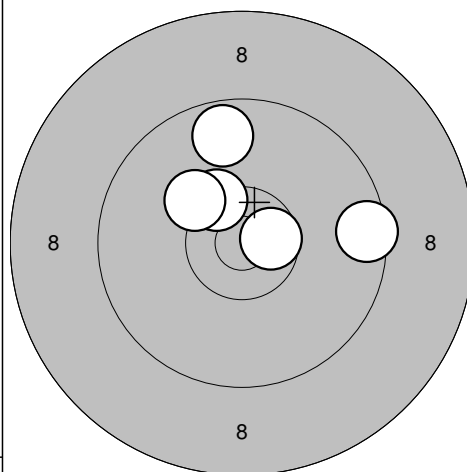

- 1: 9,5 →
- 2: 10,4\* ↗
- 3: 10,6\* →
- 4: 10,2 ↗
- 5: 9,7 ↑

Serie 48,0  
Totalt 48,0

Tävlingsskott

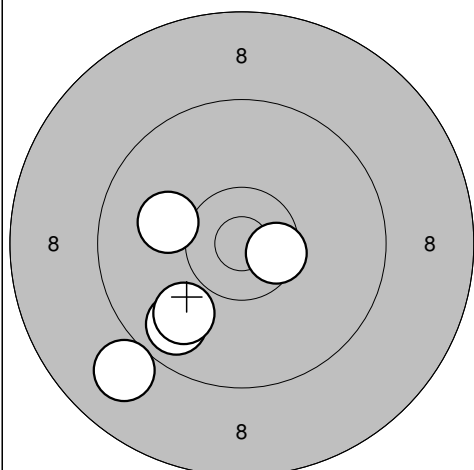

- 6: 9,0 ↙
- 7: 10,5\* →
- 8: 9,8 ↙
- 9: 10,1 ←
- 10: 9,9 ↙

Serie 47,0  
Totalt 95,0

Tävlingsskott

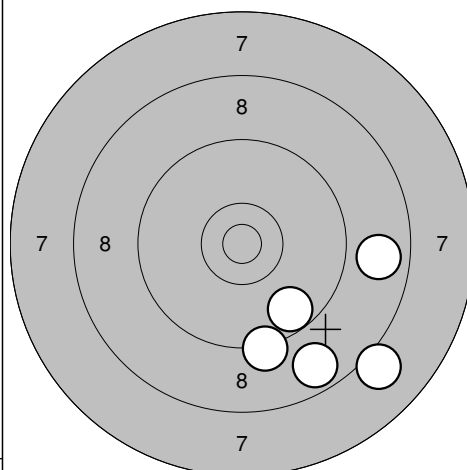

- 11: 9,7 ↓
- 12: 9,3 ↓
- 13: 8,7 ↓
- 14: 8,8 →
- 15: 8,1 ↘

Serie 42,0  
Totalt 137,0

Tävlingsskott

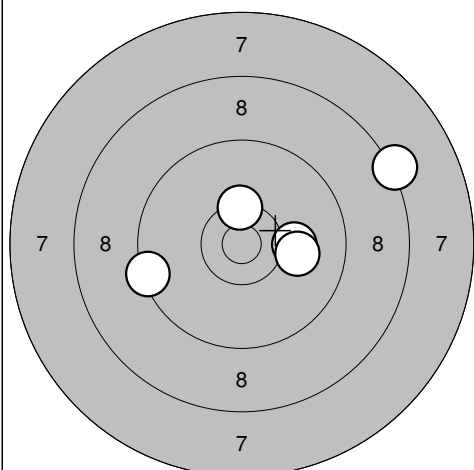

- 16: 10,1 →
- 17: 9,4 ←
- 18: 10,4\* ↑
- 19: 8,3 ↗
- 20: 10,1 →

Serie 47,0  
Totalt 184,0

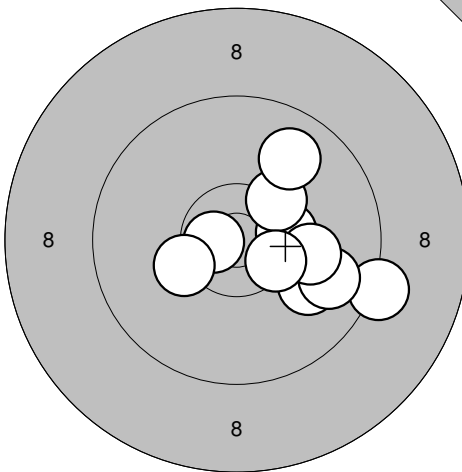
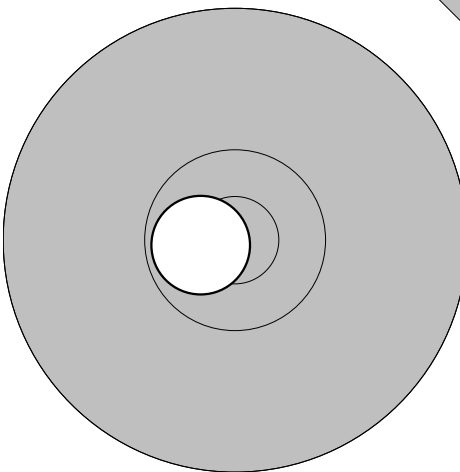
<p>Provskott</p> 	<p>1: 10,4* →</p> <p>2: 9,2 →</p> <p>3: 10,3* ↗</p> <p>4: 10,0 →</p> <p>5: 9,8 →</p> <p>6: 9,8 ↗</p> <p>7: 10,1 →</p> <p>8: 10,7* ←</p> <p>9: 10,4* →</p> <p>10: 10,3 ↙</p>	<p>Provskott</p> 
Serie 97,0		Serie 10,0
Totalt 0,0		Totalt 0,0

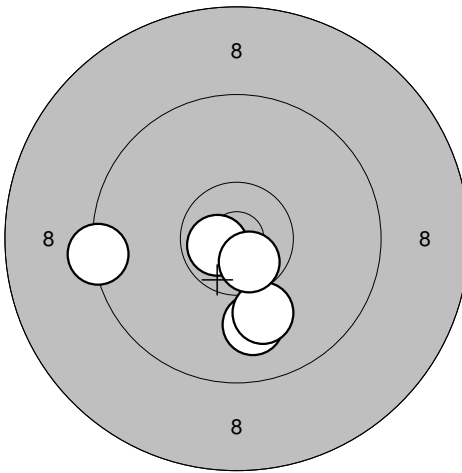
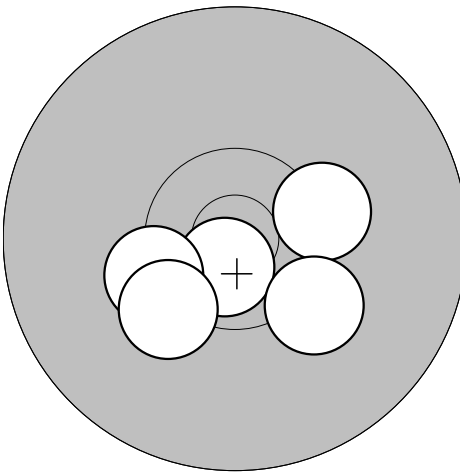
<p>Tävlingsskott</p> 	<p>1: 9,4 ←</p> <p>2: 10,7* ←</p> <p>3: 9,9 ↓</p> <p>4: 10,0 ↓</p> <p>5: 10,6* ↓</p>	<p>Tävlingsskott</p> 
Serie 48,0		Serie 50,0
Totalt 48,0		Totalt 98,0

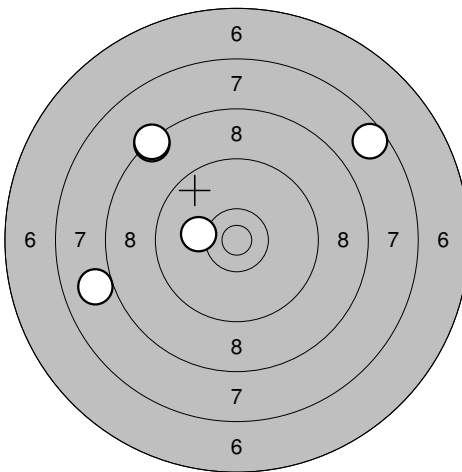
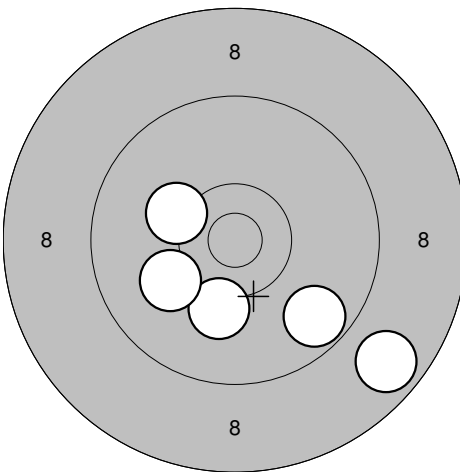
<p>Tävlingsskott</p> 	<p>11: 8,4 ↗</p> <p>12: 8,4 ↗</p> <p>13: 10,2 ←</p> <p>14: 8,0 ←</p> <p>15: 7,6 ↗</p>	<p>Tävlingsskott</p> 
Serie 41,0		Serie 47,0
Totalt 139,0		Totalt 186,0

Drängsmark

2010-09-04

Höstträffen 2010

Ramselefors SKF

Provskott

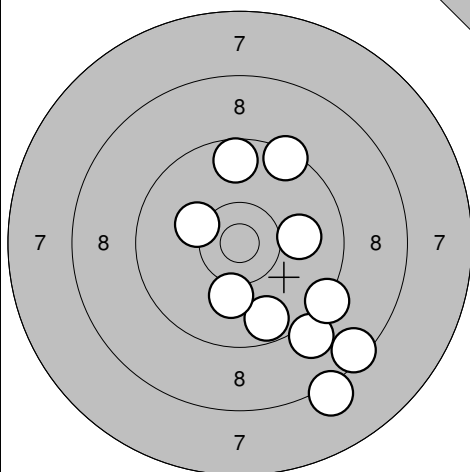

- 1: 9,1 ↘
- 2: 9,7 ↘
- 3: 9,7 ↑
- 4: 10,0 →
- 5: 9,4 ↗
- 6: 10,2 ↖
- 7: 8,2 ↘
- 8: 9,3 ↘
- 9: 8,5 ↘
- 10: 10,1 ↘

Serie	91,0
Totalt	0,0

Provskott

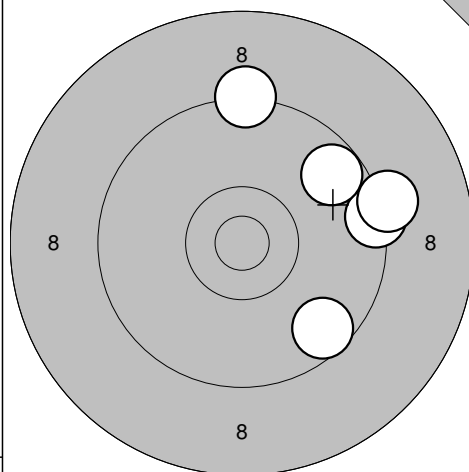

- 11: 9,4 →
- 12: 9,3 ↑
- 13: 9,2 →
- 14: 9,7 ↗
- 15: 9,6 ↘

Serie	45,0
Totalt	0,0

Tävlingsskott

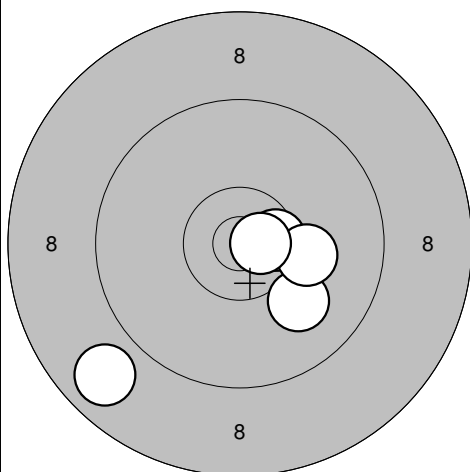

- 1: 10,5\* →
- 2: 10,0 ↘
- 3: 8,8 ↙
- 4: 10,2 →
- 5: 10,7\* →

Serie	48,0
Totalt	48,0

Tävlingsskott

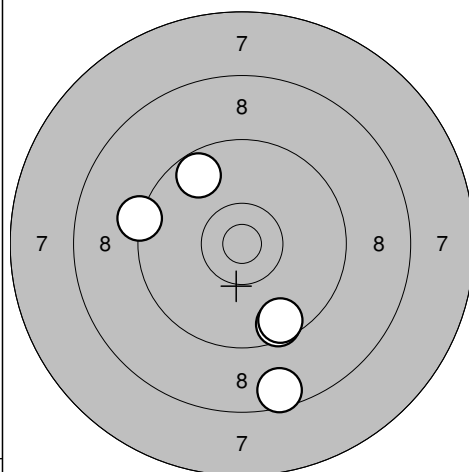

- 6: 8,6 ↘
- 7: 9,6 ↘
- 8: 9,7 ↗
- 9: 9,6 ↘
- 10: 9,3 ←

Serie	44,0
Totalt	92,0

Tävlingsskott

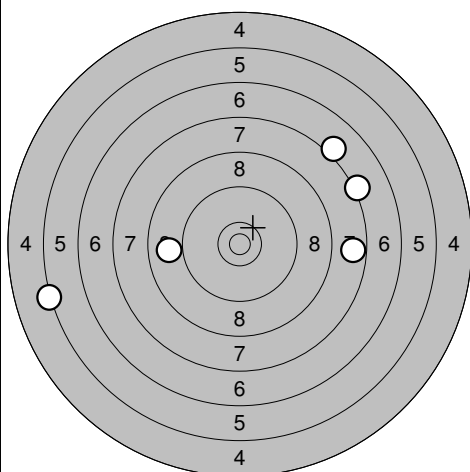

- 11: 8,9 ←
- 12: 7,2 ↗
- 13: 5,3 ←
- 14: 7,1 ↗
- 15: 7,7 →

Serie	34,0
Totalt	126,0

Tävlingsskott

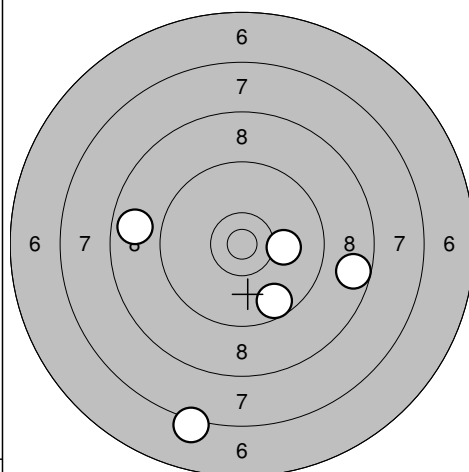

- 16: 7,2 ↘
- 17: 9,6 ↘
- 18: 10,1 →
- 19: 8,6 →
- 20: 8,8 ←

Serie	42,0
Totalt	168,0

Drängsmark

2010-09-04

Höstträffen 2010

Ramselefors SKF

Provskott

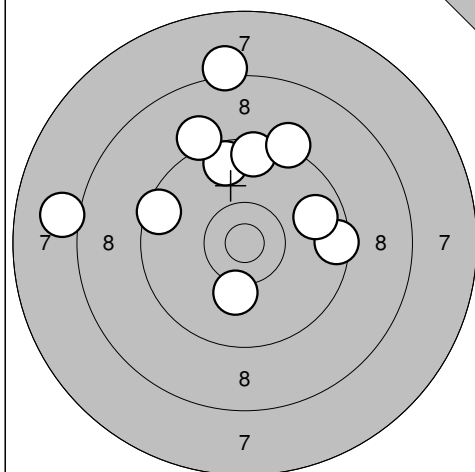

1: 9,7 ↗  
 2: 8,2 ↑  
 3: 9,5 →  
 4: 9,2 ↗  
 5: 9,8 →  
 6: 9,5 ↖  
 7: 9,6 ↑  
 8: 10,2 ↓  
 9: 9,3 ↗  
 10: 8,1 ←

Serie 89,0

Totalt 0,0

Provskott

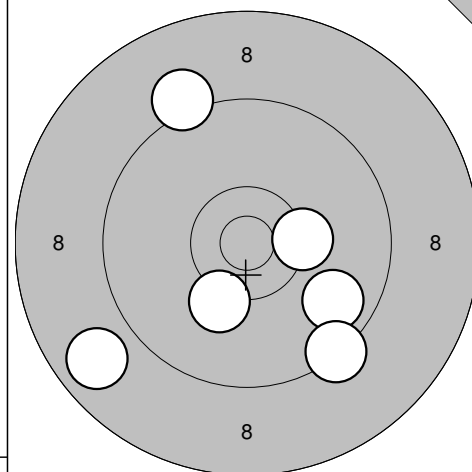

11: 9,2 ↗  
 12: 8,8 ↖  
 13: 10,2 ↓  
 14: 10,3\* →  
 15: 9,8 ↘  
 16: 9,3 ↘

Serie 55,0

Totalt 0,0

Tävlingsskott

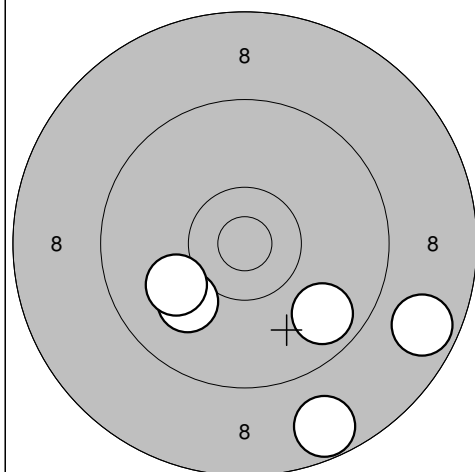

1: 10,0 ↖  
 2: 10,0 ↖  
 3: 8,7 ↓  
 4: 8,7 →  
 5: 9,8 ↘

Serie 45,0

Totalt 45,0

Tävlingsskott

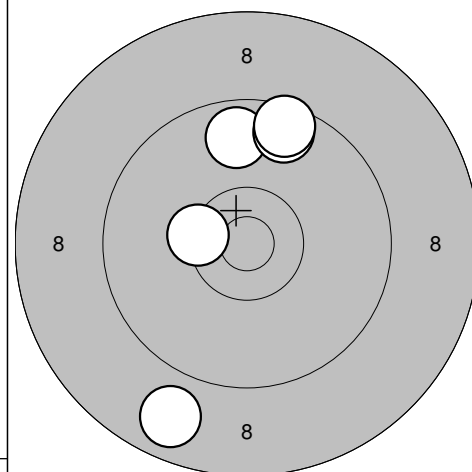

6: 9,7 ↑  
 7: 8,8 ↘  
 8: 9,6 ↑  
 9: 9,5 ↑  
 10: 10,4\* ←

Serie 45,0

Totalt 90,0

Tävlingsskott

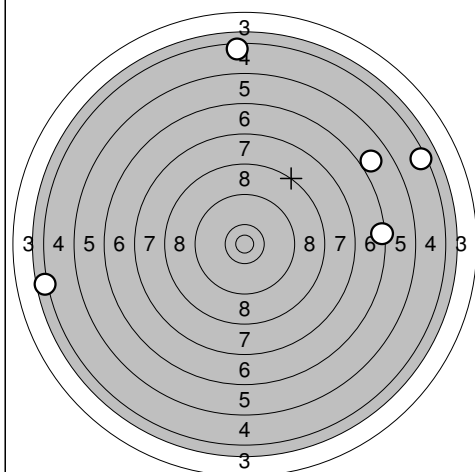

11: 6,0 ↗  
 12: 4,3 ←  
 13: 4,5 →  
 14: 4,5 ↑  
 15: 6,4 →

Serie 24,0

Totalt 114,0

Tävlingsskott

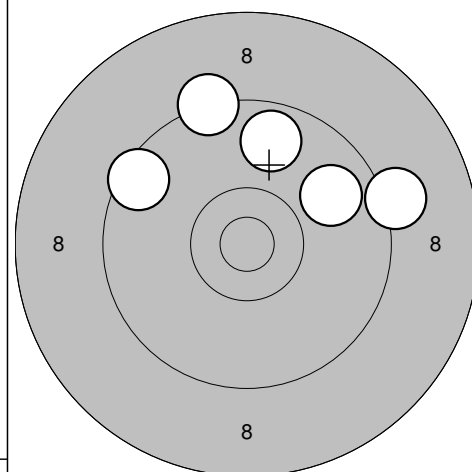

16: 9,2 →  
 17: 9,3 ↑  
 18: 9,8 →  
 19: 9,5 ↖  
 20: 9,7 ↑

Serie 45,0

Totalt 159,0

Umeå

2010-09-04

Höstträffen 2010

Ramselefors SKF

Provskott

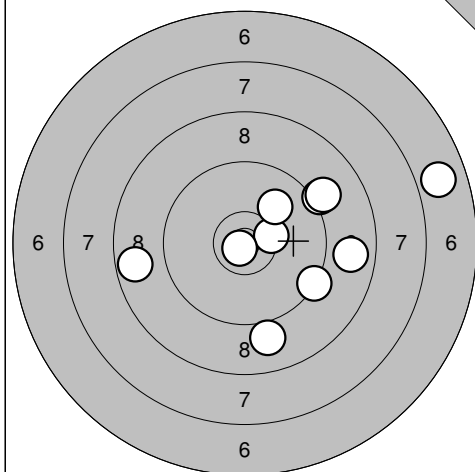

1: 6,9 →  
 2: 8,8 →  
 3: 8,7 ←  
 4: 9,2 →  
 5: 9,0 ↓  
 6: 10,4\* →  
 7: 9,1 →  
 8: 9,3 →  
 9: 10,0 ↗  
 10: 10,8\* ↙

Serie 88,0  
 Totalt 0,0

Tävlingsskott

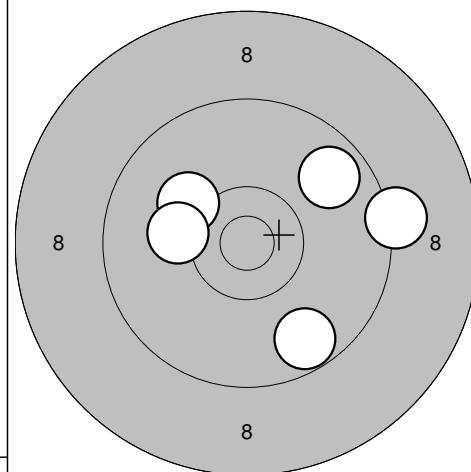

1: 10,1 ↖  
 2: 9,7 ↓  
 3: 9,8 ↗  
 4: 10,2 ←  
 5: 9,2 →

Serie 47,0  
 Totalt 47,0

Tävlingsskott

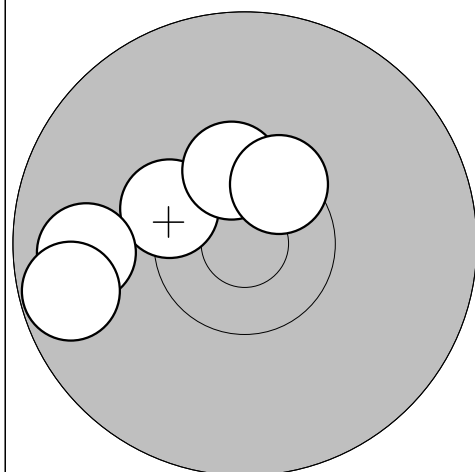

6: 10,4\* ↖  
 7: 9,8 ←  
 8: 9,7 ←  
 9: 10,4\* ↑  
 10: 10,5\* ↗

Serie 48,0  
 Totalt 95,0

Tävlingsskott

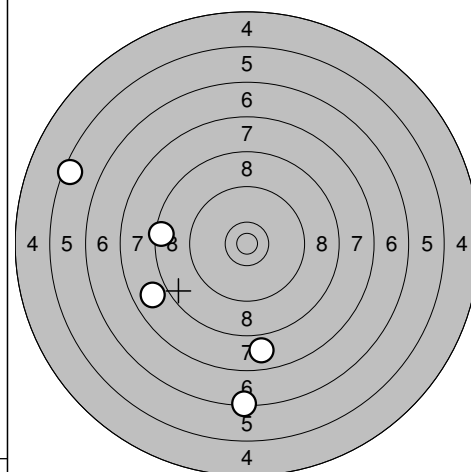

11: 8,5 ←  
 12: 6,4 ↓  
 13: 7,9 ↖  
 14: 5,5 ↖  
 15: 7,9 ↓

Serie 33,0  
 Totalt 128,0

Tävlingsskott

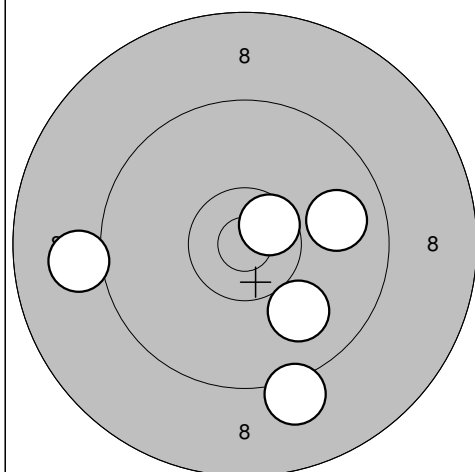

16: 9,9 →  
 17: 9,0 ←  
 18: 10,0 ↓  
 19: 10,6\* ↗  
 20: 9,1 ↓

Serie 47,0  
 Totalt 175,0