

1:	9,1	↗
2:	9,3	↖
3:	9,7	↘
4:	9,6	↙
5:	10,5*	↘
6:	10,2*	↗
7:	9,4	↗
8:	9,6	↗
9:	10,3*	↗
10:	9,7	↗

Serie: 97,4

Summa: 390,0

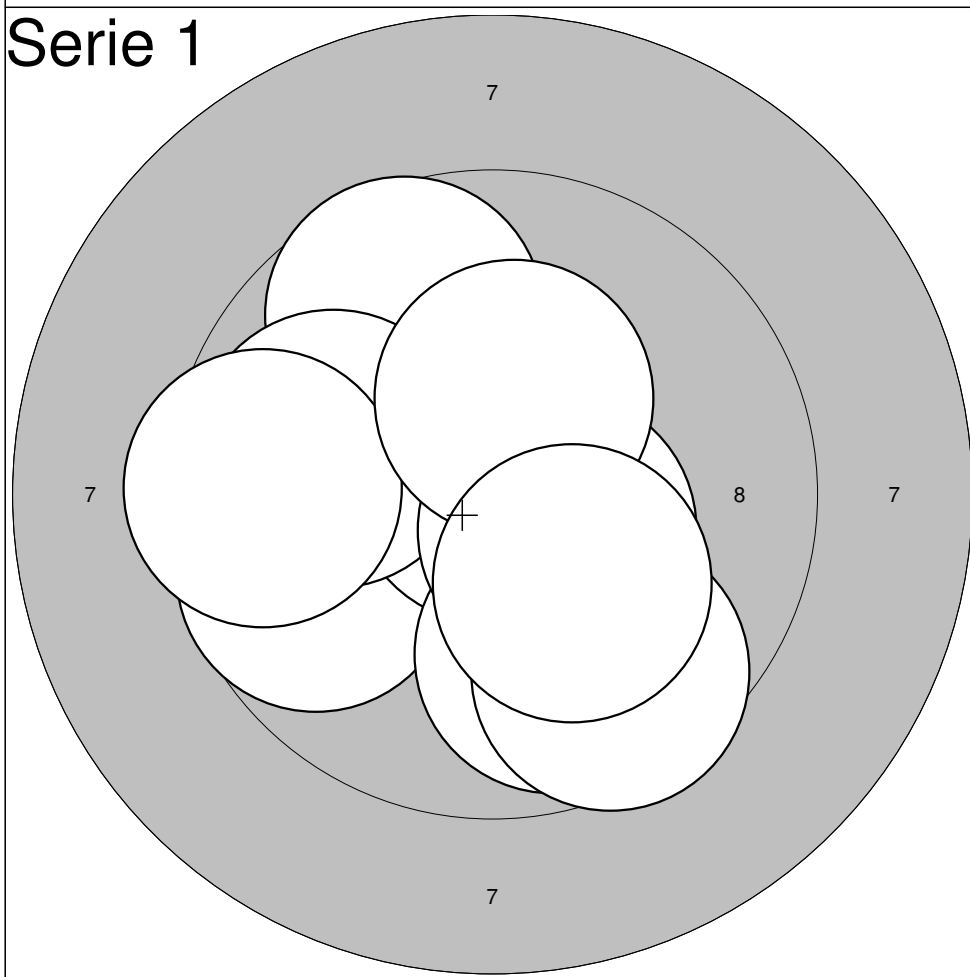

1:	9,7	↗
2:	9,7	↖
3:	10,9*	↗
4:	9,9	↖
5:	9,5	↖
6:	9,8	↘
7:	9,6	↘
8:	10,5*	↘
9:	10,3*	↗
10:	10,2*	↘

Serie: 100,1

Summa: 490,1

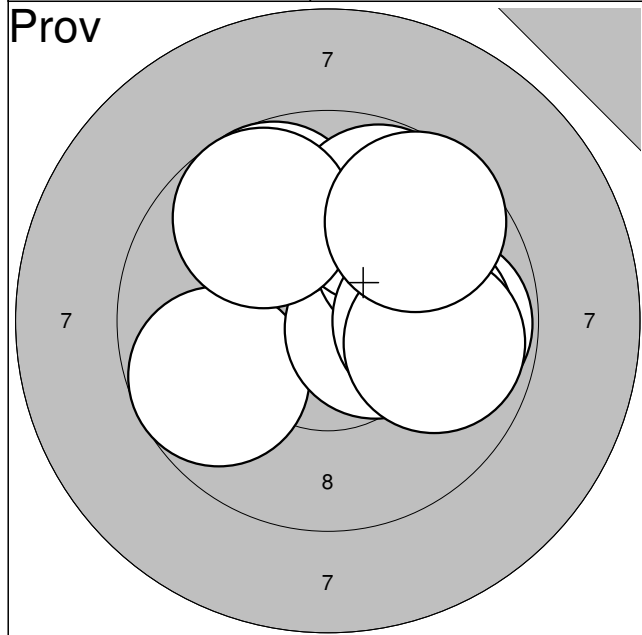

1:	9,7	←
2:	9,8	→
3:	10,5*	→
4:	9,7	↖
5:	9,9	↗
6:	9,8	↖
7:	10,0	→
8:	9,9	→
9:	9,7	↖
10:	9,6	↗

Serie: 98,6

Summa: 390,0

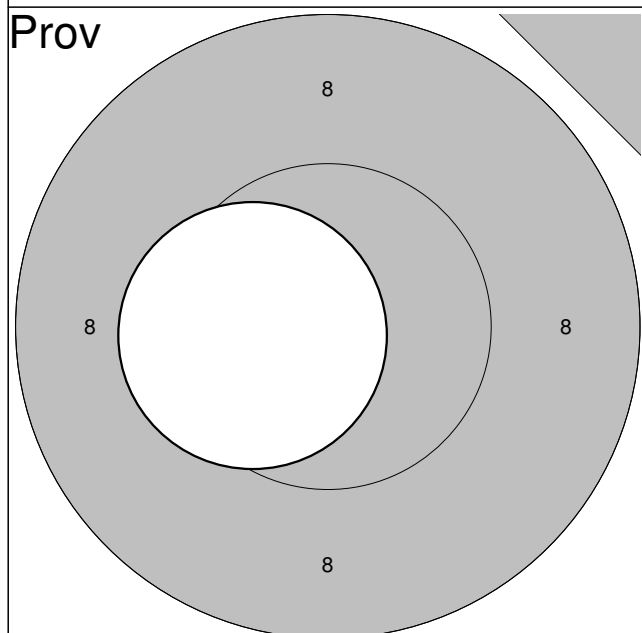

11:	10,4*	←
-----	-------	---

Serie: 10,4

Summa: 390,0

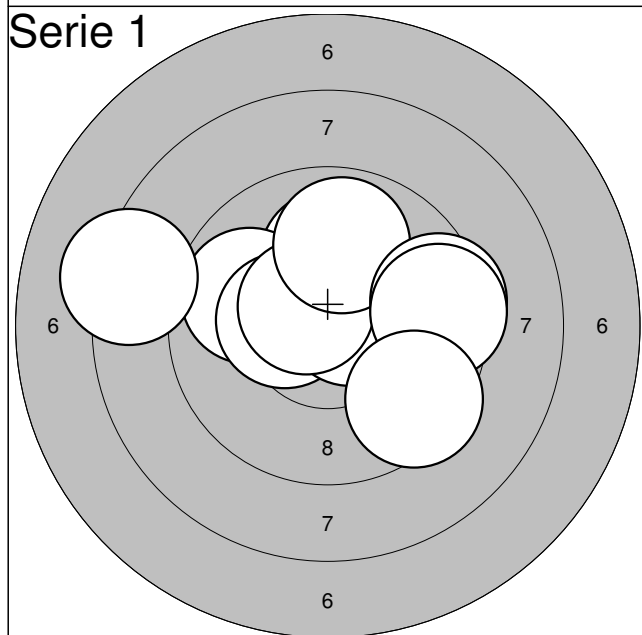

1:	10,1	↑
2:	9,9	←
3:	10,4*	←
4:	10,6*	→
5:	10,6*	↗
6:	9,9	↑
7:	9,5	→
8:	9,5	→
9:	9,5	↘
10:	8,3	←

Serie: 98,3

Summa: 488,3

Prov

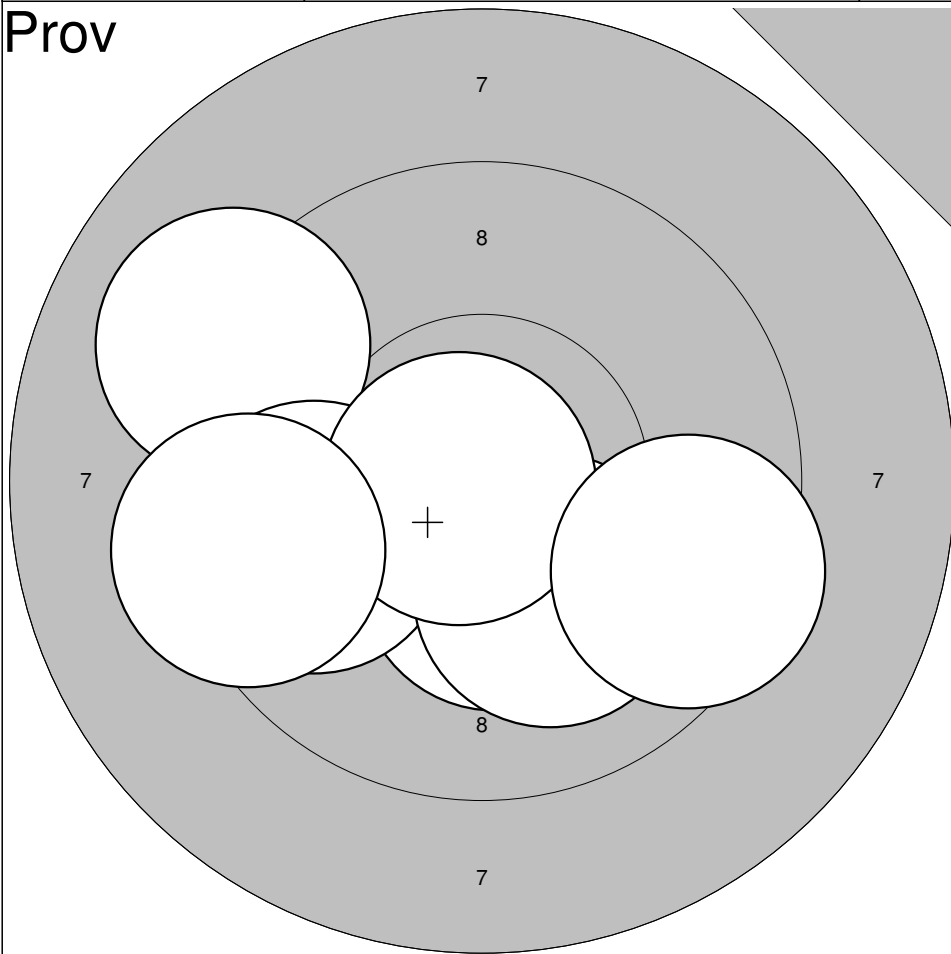

- 1: 9,1 ↖
- 2: 10,3* ↓
- 3: 9,8 ↙
- 4: 10,1 ↓
- 5: 10,8* ↙
- 6: 9,3 ↙
- 7: 9,5 →

Serie: 68,9

Summa: 389,0

Serie 1

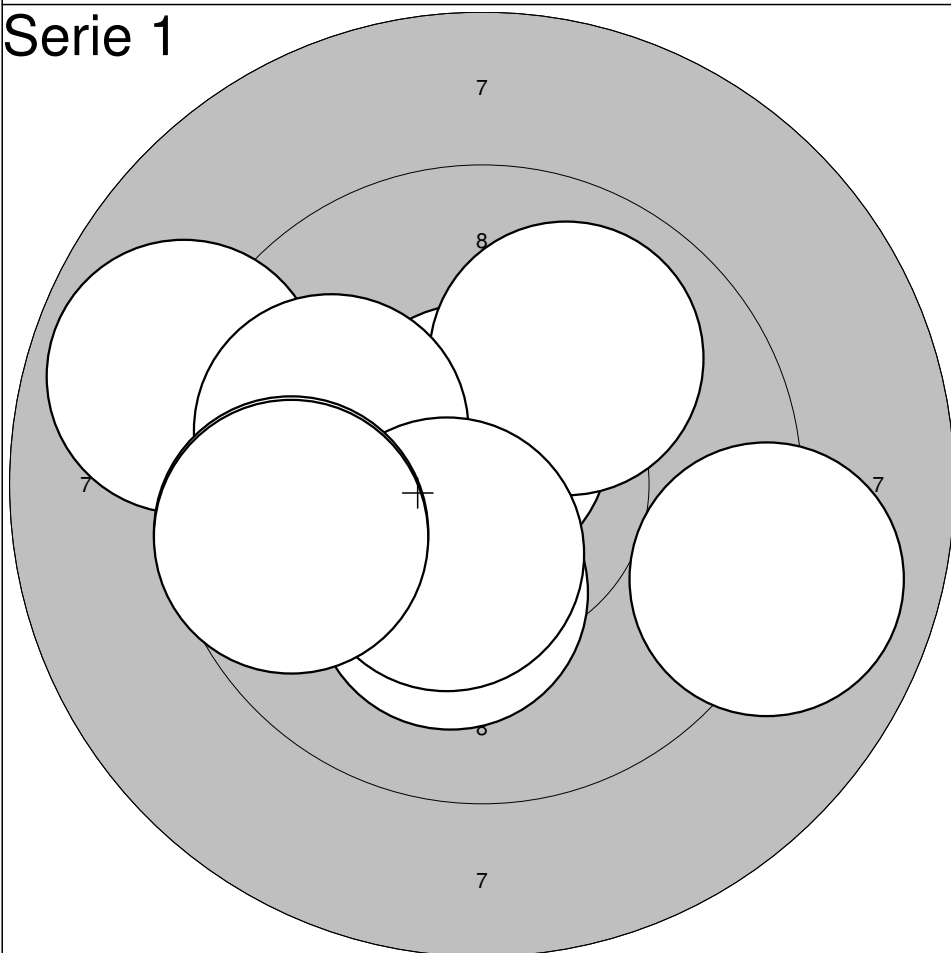

- 1: 10,2* ↙
- 2: 10,2* ↓
- 3: 9,0 →
- 4: 10,7* ↑
- 5: 8,9 ↙
- 6: 10,0 ↗
- 7: 9,9 ↙
- 8: 10,4* ↓
- 9: 9,7 ↙
- 10: 9,7 ↙

Serie: 98,7

Summa: 487,7

Prov

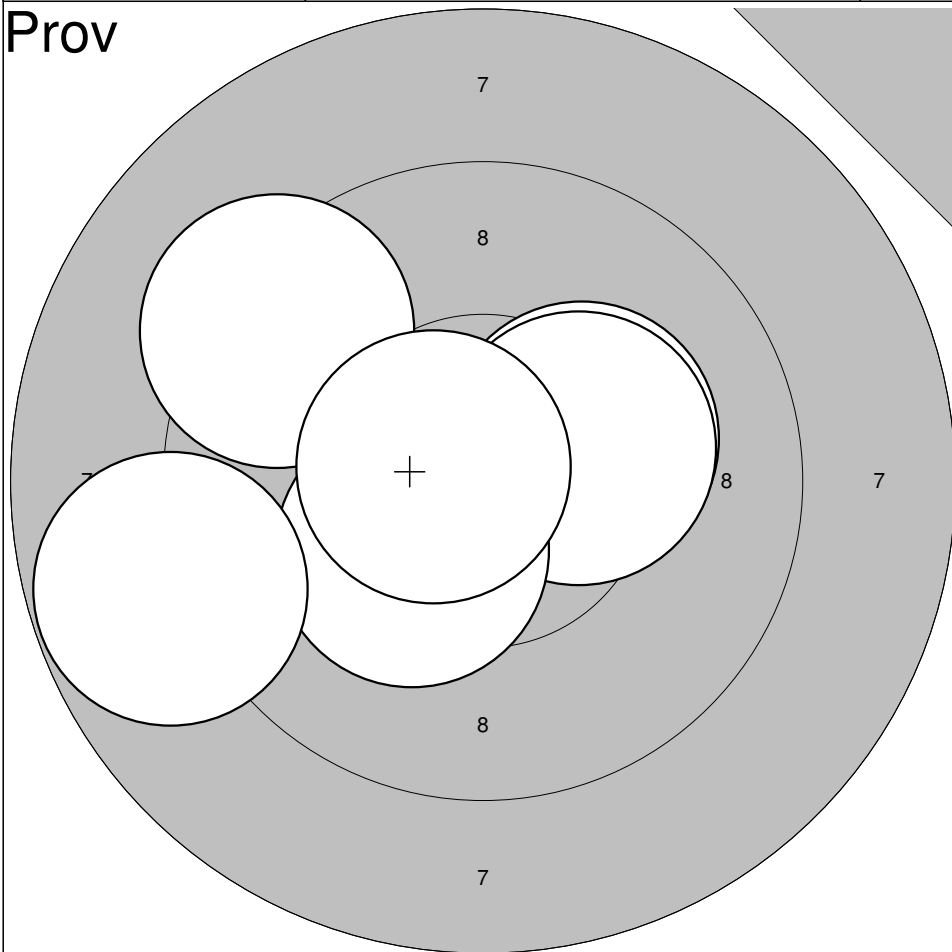

- 1: 10,2* →
- 2: 10,3* →
- 3: 10,3* ↙
- 4: 9,3 ↗
- 5: 10,6* ↖
- 6: 8,8 ↙

Serie: 59,5

Summa: 389,0

Serie 1

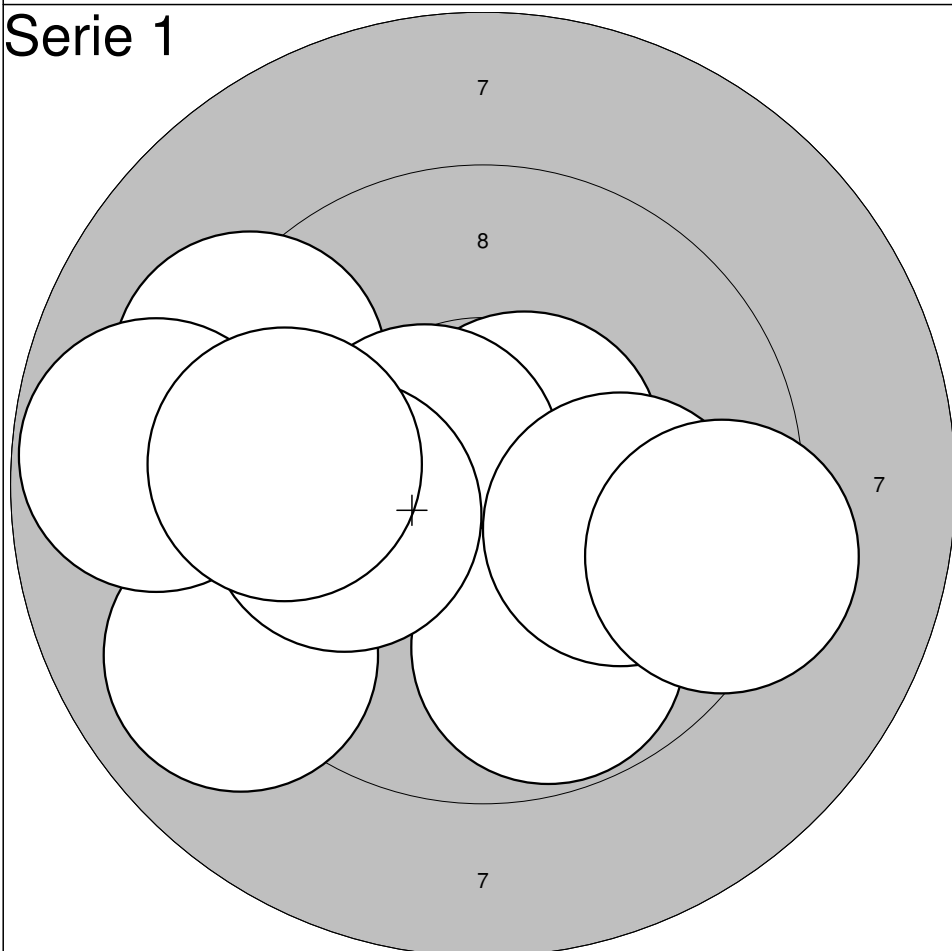

- 1: 10,6* ↗
- 2: 9,0 ↙
- 3: 9,2 ↖
- 4: 10,5* ↖
- 5: 9,8 ↘
- 6: 8,8 ↖
- 7: 10,0 ↖
- 8: 9,6 ↖
- 9: 10,0 →
- 10: 9,3 →

Serie: 96,8

Summa: 485,8

Prov

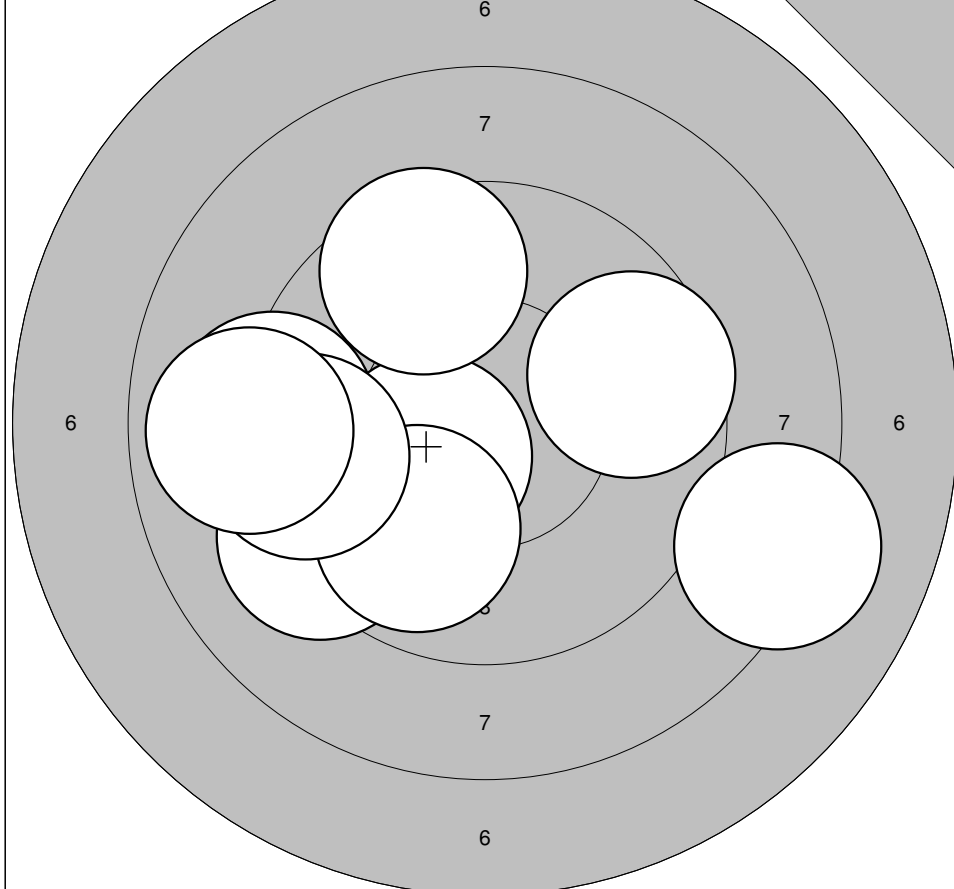

1:	9,2	↙
2:	10,4*	↙
3:	8,2	→
4:	9,9	↘
5:	9,1	←
6:	9,4	←
7:	8,9	←
8:	9,6	→
9:	9,5	↗

Serie: 84,2

Summa: 389,0

Serie 1

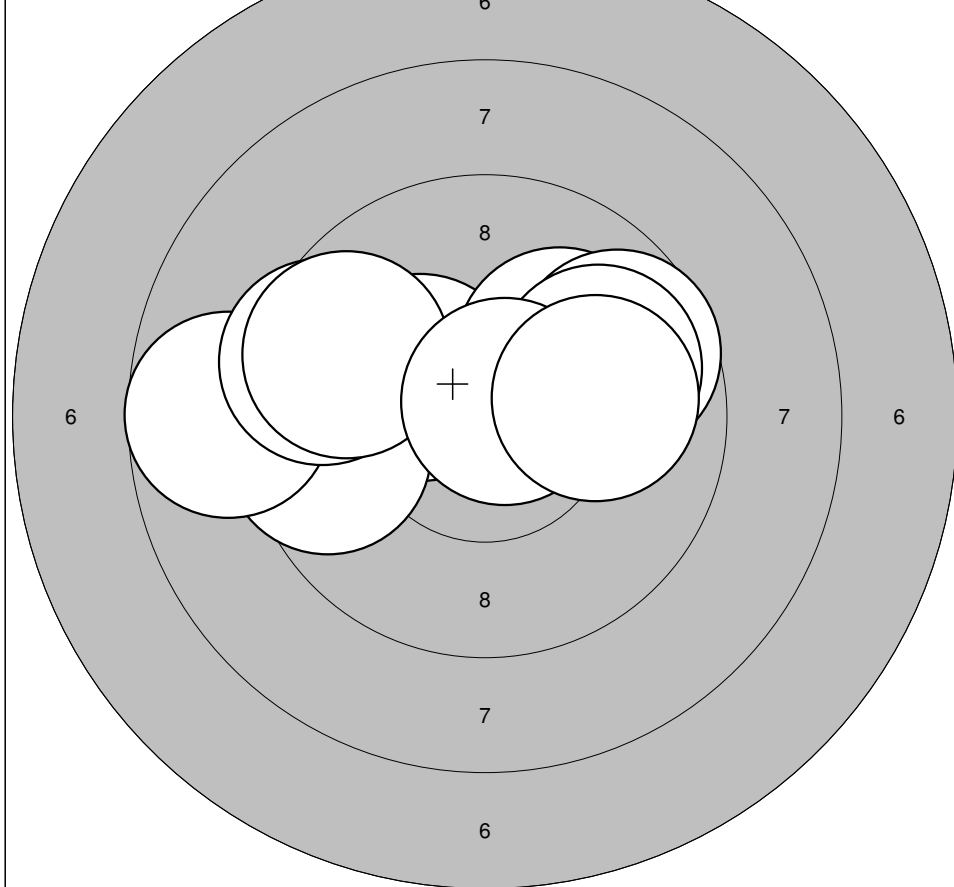

1:	10,3*	↙
2:	9,6	←
3:	8,7	←
4:	9,5	↙
5:	10,1	↗
6:	9,7	→
7:	9,9	→
8:	9,6	↙
9:	10,7*	↗
10:	10,0	→

Serie: 98,1

Summa: 487,1

Prov

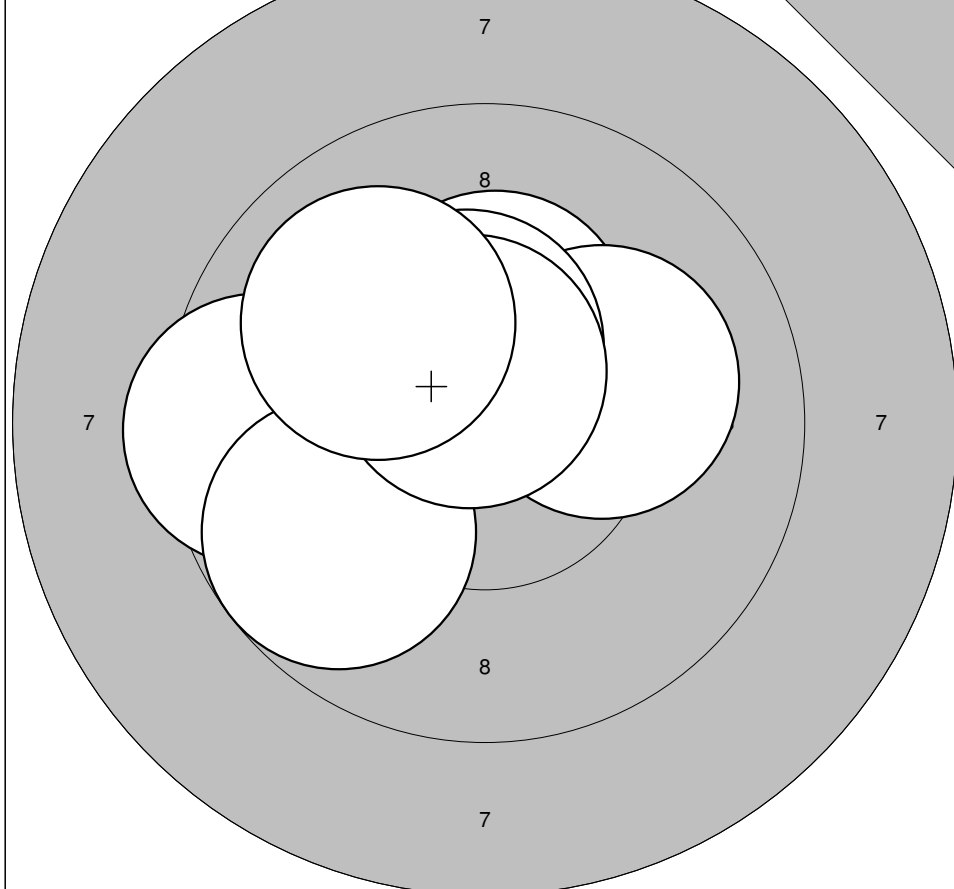

1: 10,3*	↑
2: 10,1	→
3: 9,5	←
4: 10,5*	↖
5: 9,8	↙
6: 10,4*	↑
7: 10,6*	↑
8: 10,0	↖

Serie:	81,2
Summa:	389,0

Serie 1

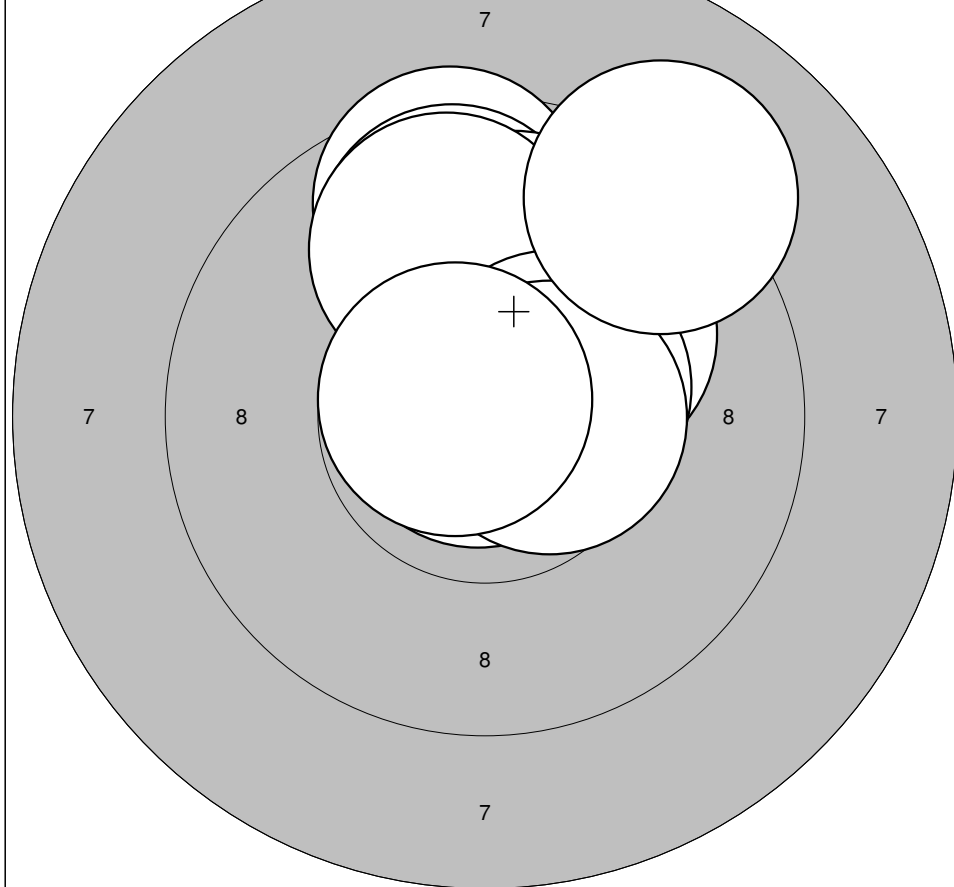

1: 9,5	↑
2: 9,8	↑
3: 10,0	↑
4: 10,1	↗
5: 9,8	↑
6: 10,5*	↗
7: 10,9*	↖
8: 10,5*	→
9: 10,7*	↖
10: 9,1	↗

Serie:	100,9
Summa:	489,9

Prov

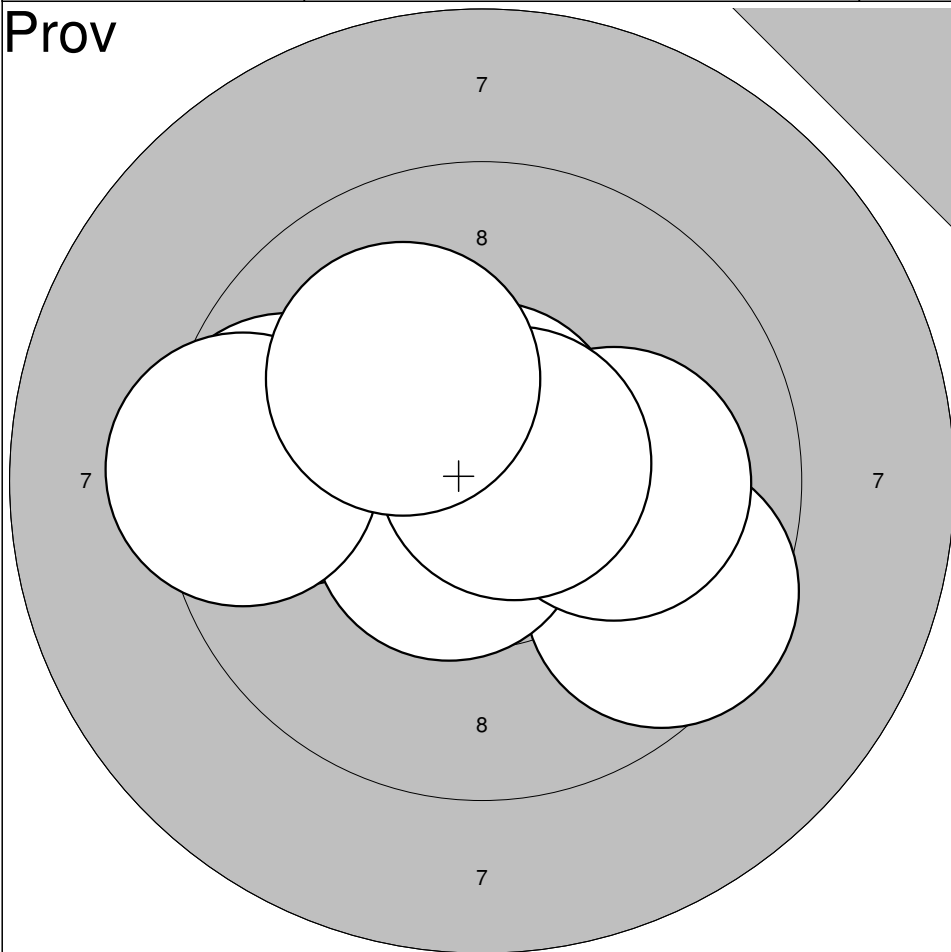

- 1: 9,6 ↘
- 2: 9,7 ←
- 3: 10,7* ↑
- 4: 10,6* ↙
- 5: 9,4 ←
- 6: 10,1 →
- 7: 10,7* ↗
- 8: 10,1 ↖

Serie: 80,9

Summa: 389,0

Serie 1

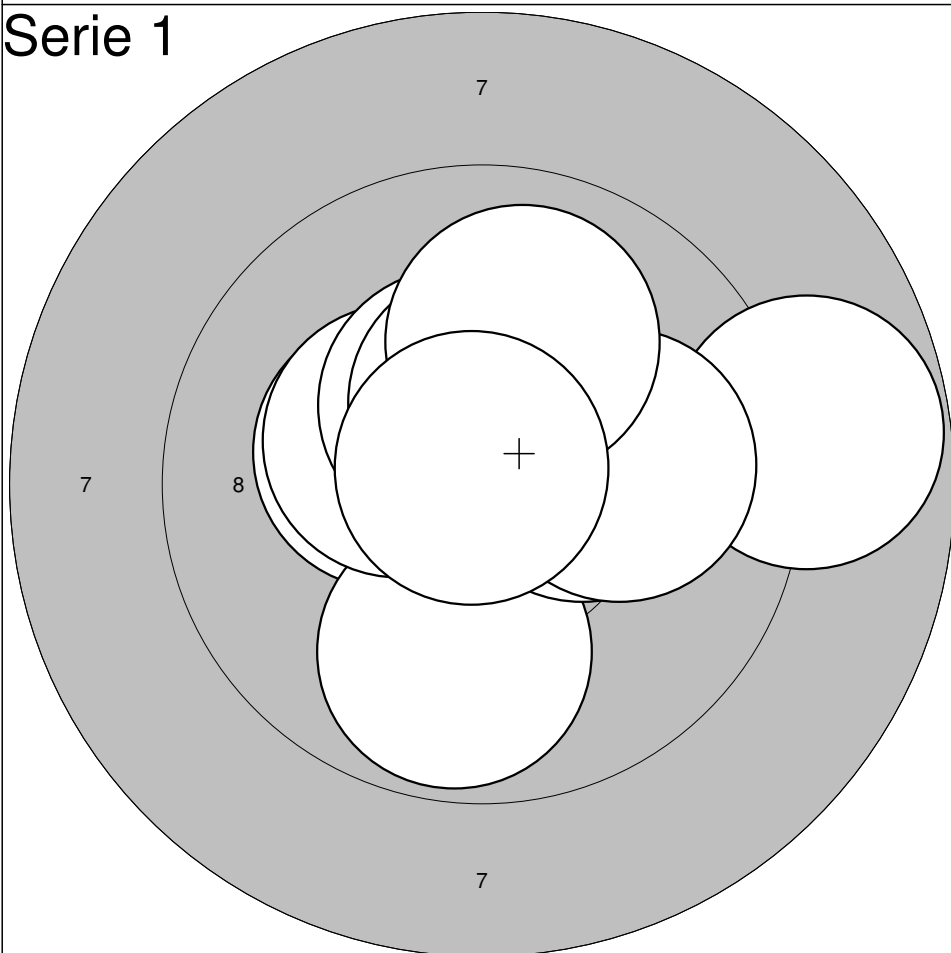

- 1: 10,3* ↖
- 2: 9,8 ↓
- 3: 10,3* ↖
- 4: 10,4* ↑
- 5: 8,8 →
- 6: 10,4* ↑
- 7: 10,3* →
- 8: 10,0 →
- 9: 10,0 ↑
- 10: 10,8* ↖

Serie: 101,1

Summa: 490,1

Prov

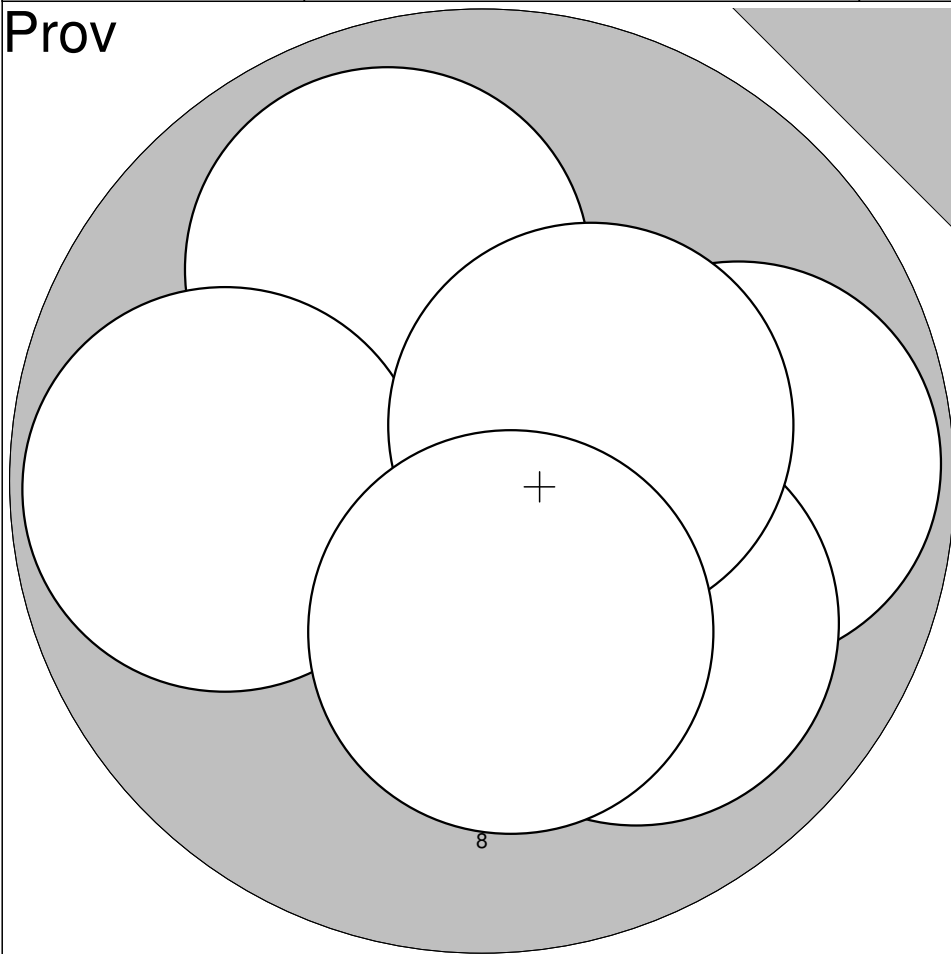

- 1: 10,5* →
- 2: 9,9 ↗
- 3: 9,8 ←
- 4: 10,2* →
- 5: 9,8 →
- 6: 10,0 ↘
- 7: 10,4* ↗
- 8: 10,3* ↓

Serie: 80,9

Summa: 389,0

Serie 1

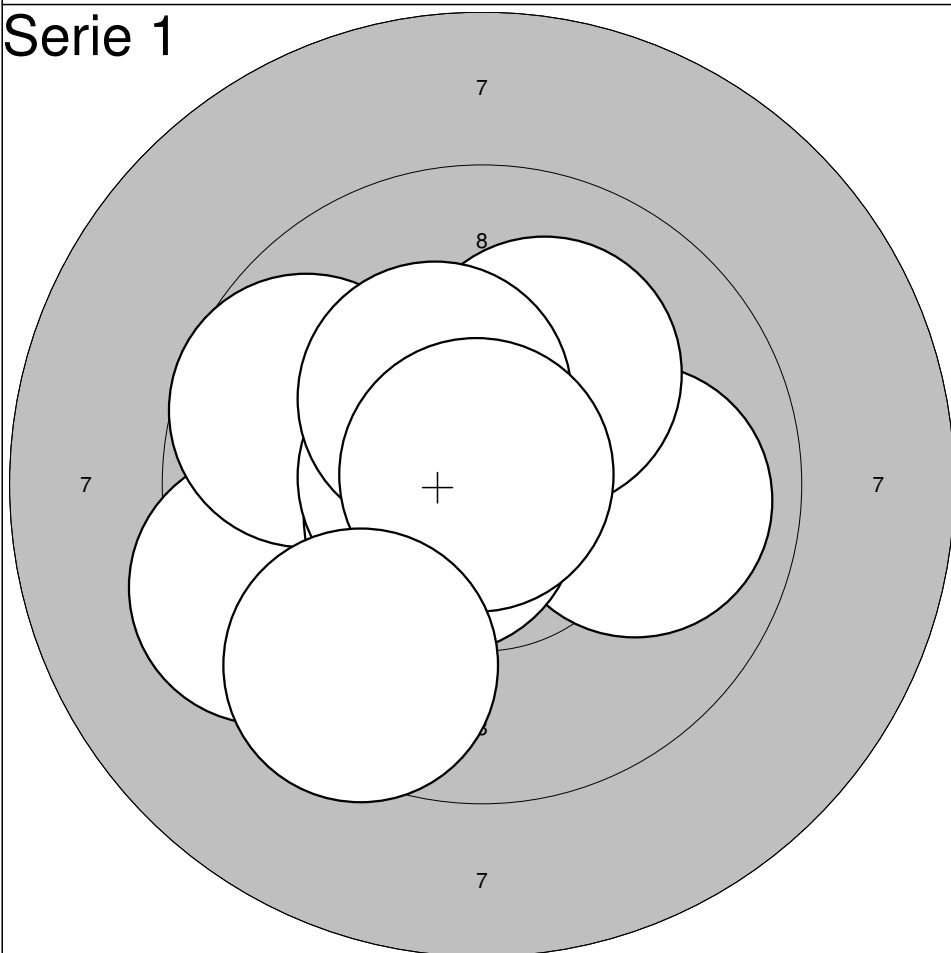

- 1: 10,8* ↗
- 2: 9,4 ←
- 3: 9,9 →
- 4: 10,1 ↗
- 5: 9,7 ←
- 6: 10,6* ←
- 7: 10,6* ←
- 8: 10,3* ↗
- 9: 10,9* ↗
- 10: 9,5 ↓

Serie: 101,8

Summa: 490,8

Prov

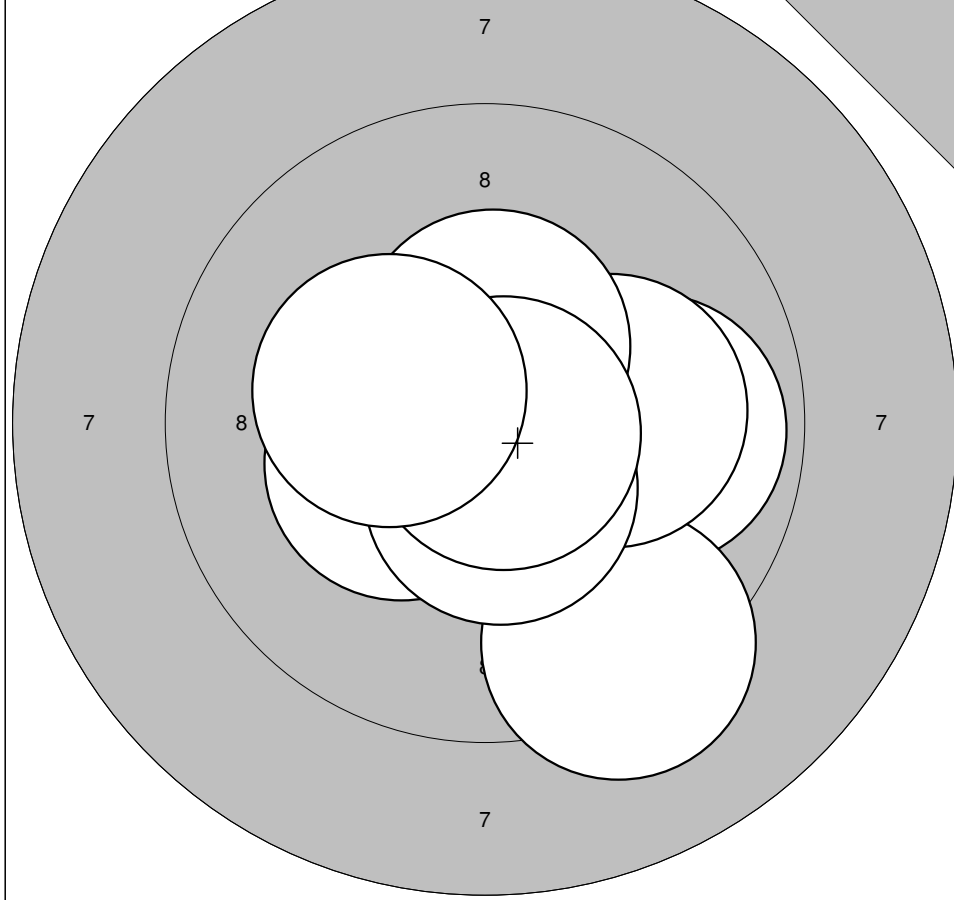

1:	9,9	→
2:	10,7*	↑
3:	9,3	↓
4:	10,3*	↙
5:	10,1	→
6:	10,5*	↓
7:	10,4*	↑
8:	10,8*	↘
9:	10,3*	↙

Serie:	92,3
Summa:	389,0

Serie 1

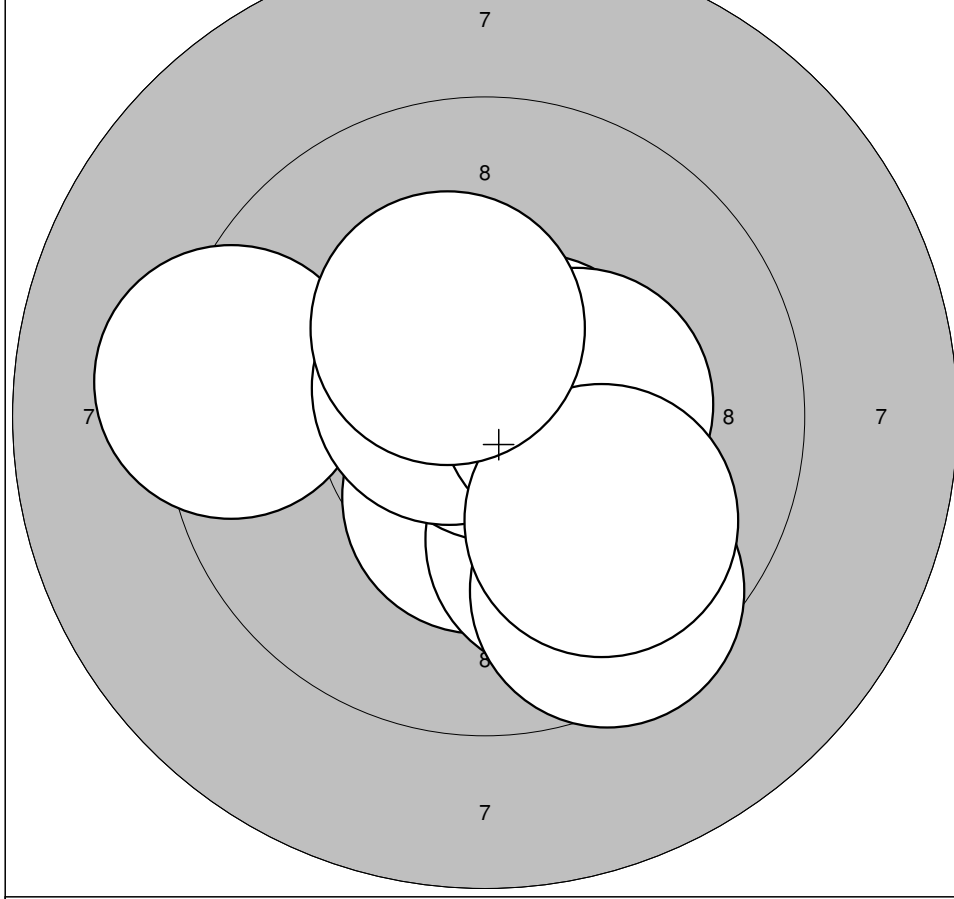

1:	10,6*	↗
2:	10,4*	↓
3:	9,3	↙
4:	10,0	↘
5:	10,8*	↗
6:	10,7*	↗
7:	9,6	↘
8:	10,3*	→
9:	9,9	↘
10:	10,3*	↑

Serie:	101,9
Summa:	490,9

Prov

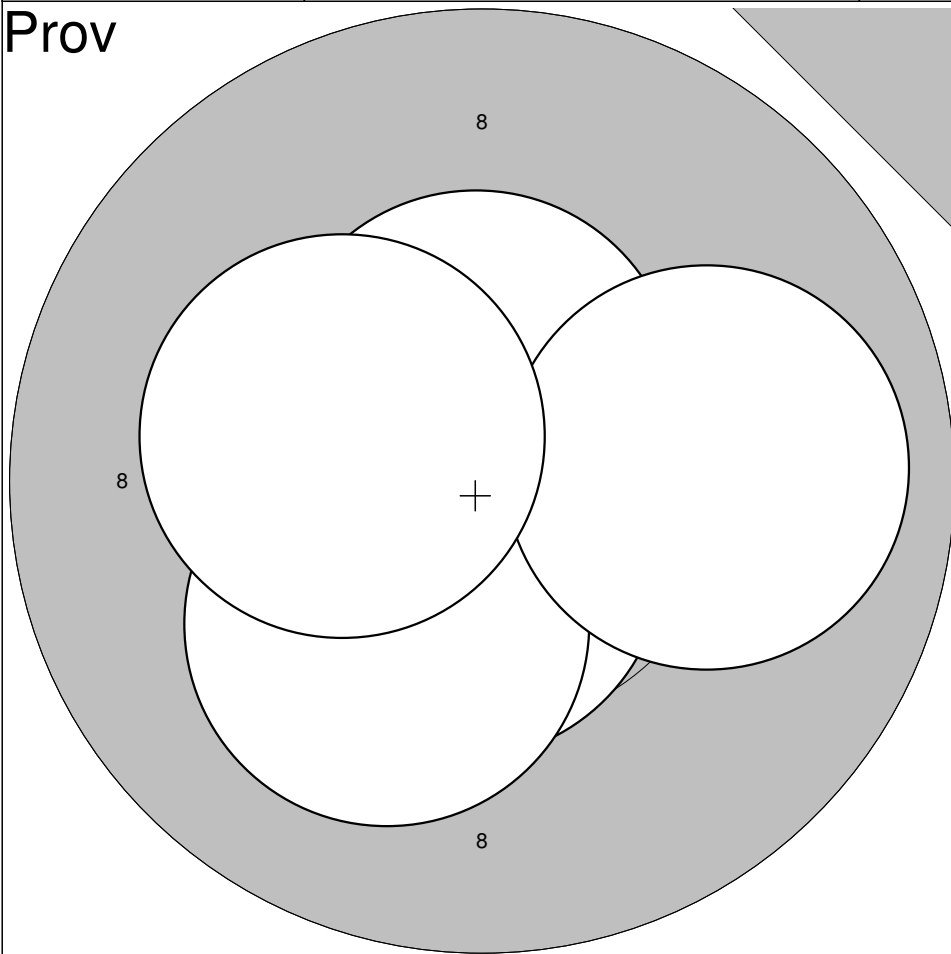

- 1: 10,6* ↓
- 2: 10,6* ↑
- 3: 10,2* ↙
- 4: 9,9 →
- 5: 10,3* ↖

Serie: 51,6

Summa: 388,0

Serie 1

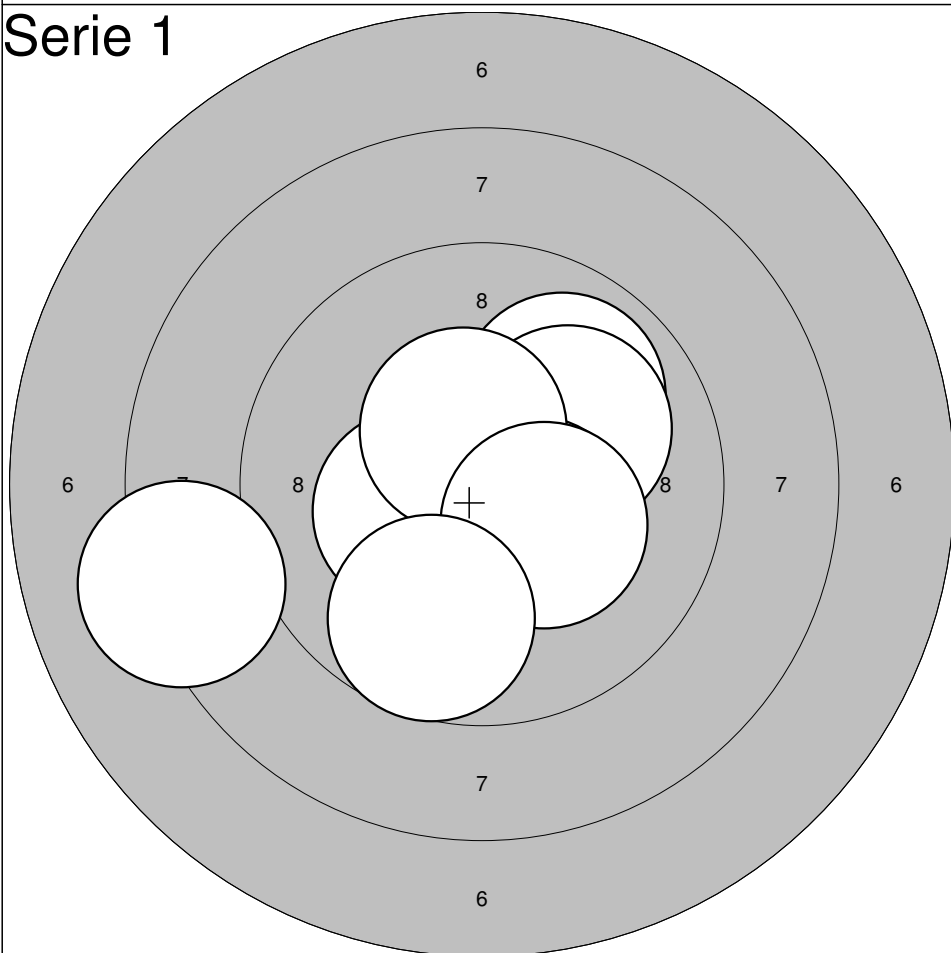

- 1: 10,7* ↗
- 2: 8,2 ↖
- 3: 10,5* ↓
- 4: 9,9 ↗
- 5: 10,1 ↗
- 6: 10,4* ↘
- 7: 10,3* ↖
- 8: 10,5* ↑
- 9: 10,3* ↘
- 10: 9,7 ↓

Serie: 100,6

Summa: 488,6

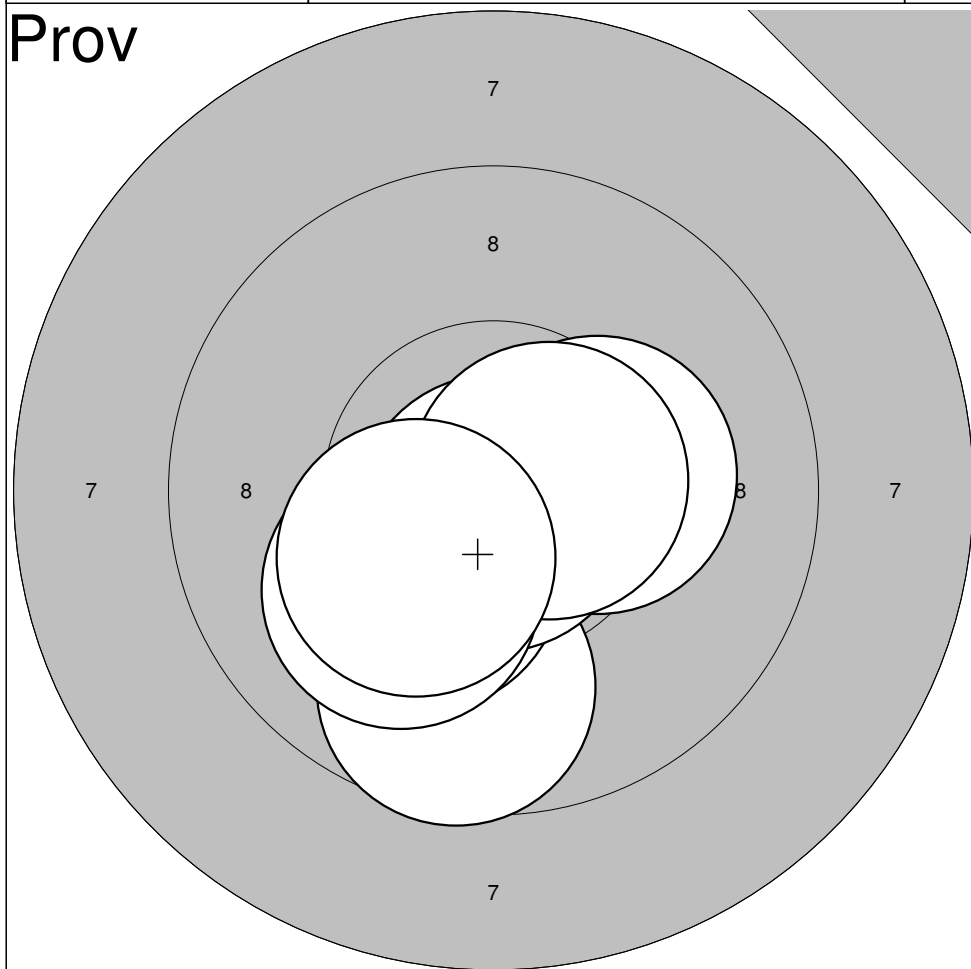

1: 9,7	↘
2: 10,3*	↙
3: 10,8*	↘
4: 10,3*	→
5: 10,6*	→
6: 10,1	↙
7: 10,3*	↙

Serie: 72,1

Summa: 394,0

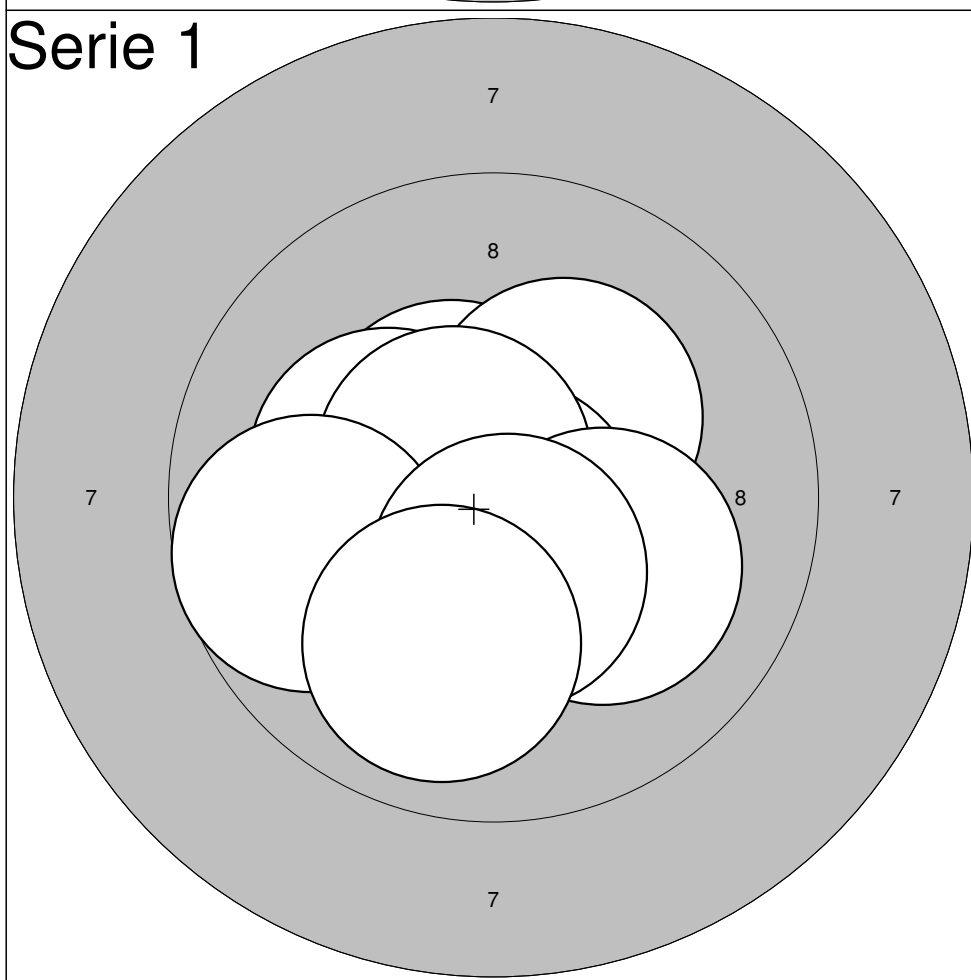

1: 10,6*	↑
2: 10,5*	↖
3: 10,3*	↗
4: 10,2*	↖
5: 10,8*	↘
6: 10,6*	↗
7: 10,1	↘
8: 9,7	↖
9: 10,5*	↘
10: 9,9	↘

Serie: 103,2

Summa: 497,2

Prov

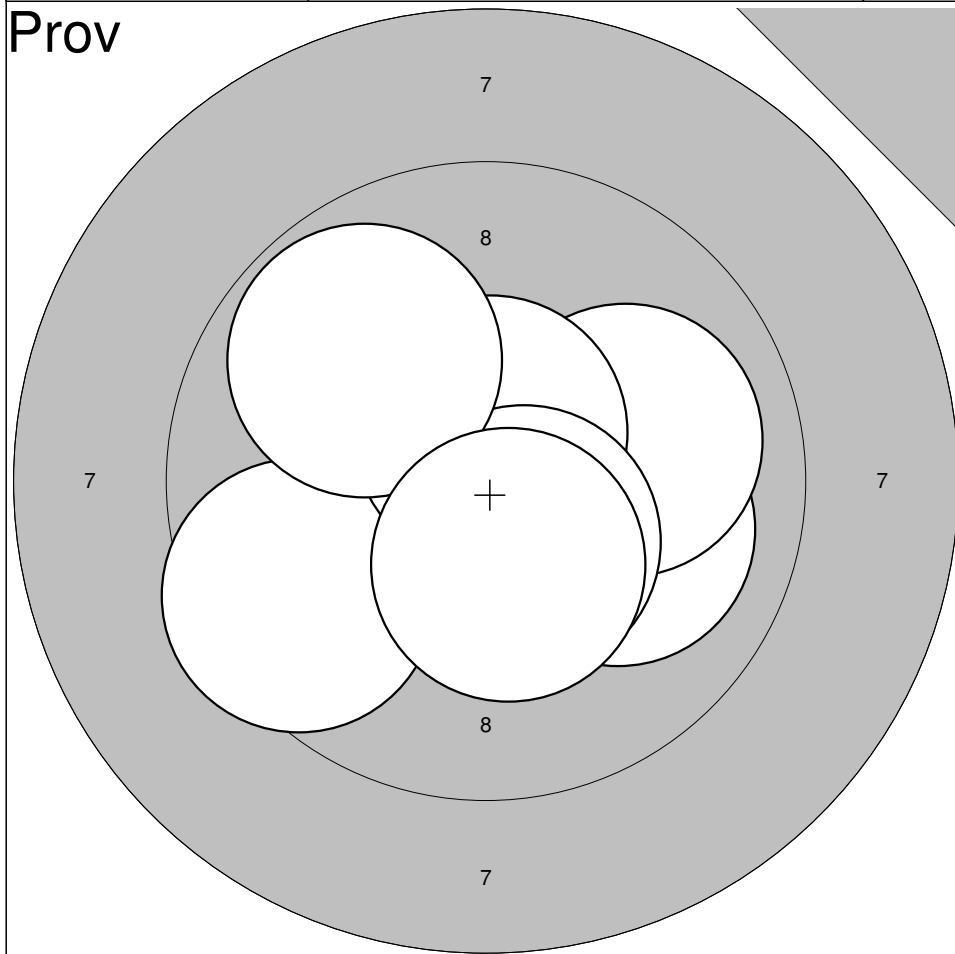

1: 9,5	↙
2: 10,0	→
3: 10,0	→
4: 10,6*	↑
5: 10,5*	↘
6: 9,8	↗
7: 10,4*	↘

Serie: 70,8

Summa: 394,0

Serie 1

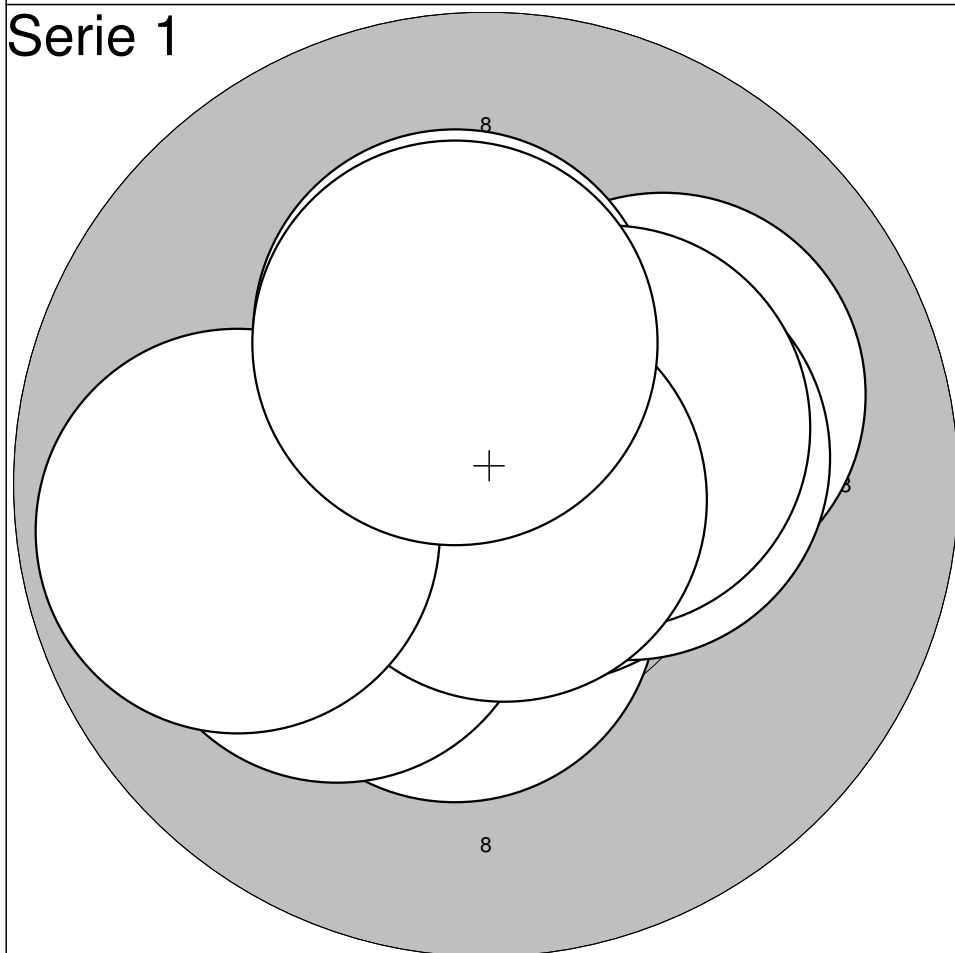

1: 10,1	↗
2: 10,4*	↘
3: 10,3*	↑
4: 10,7*	→
5: 10,3*	→
6: 10,2*	↙
7: 10,4*	↗
8: 10,8*	↘
9: 9,8	↙
10: 10,3*	↑

Serie: 103,3

Summa: 497,3

Prov

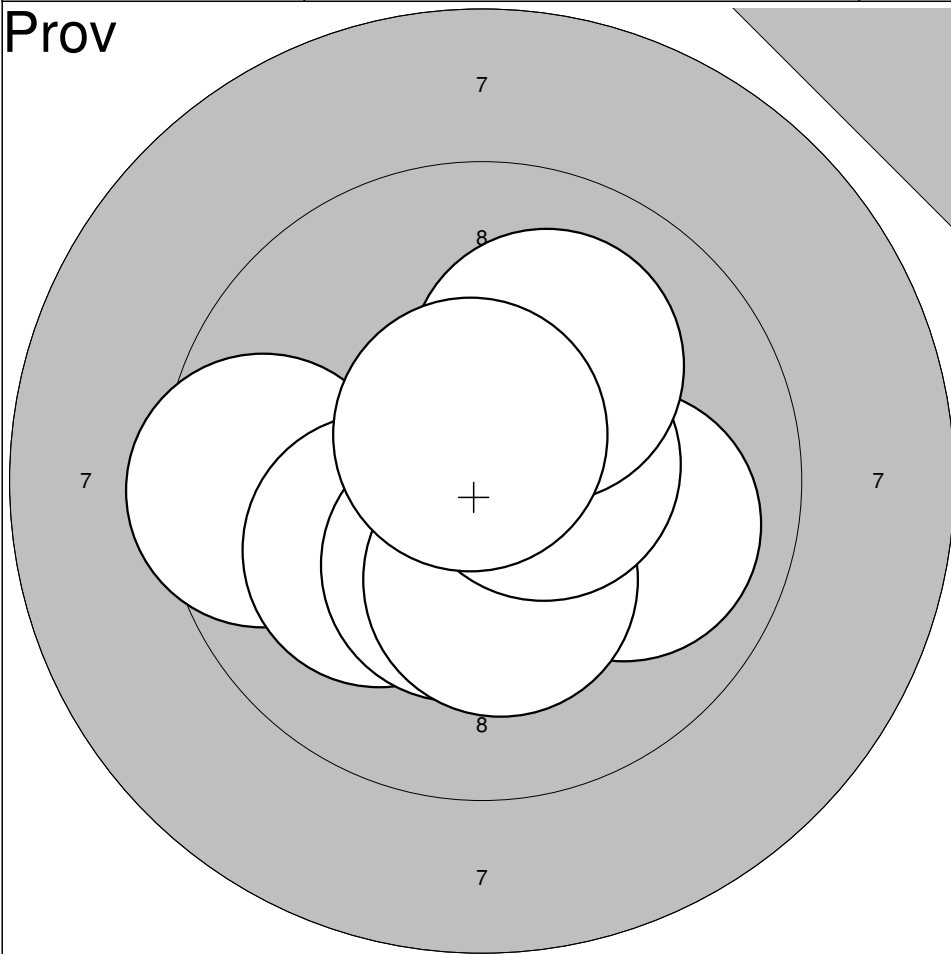

- 1: 9,5 ←
- 2: 10,1 ↙
- 3: 10,4* ↓
- 4: 10,0 →
- 5: 10,3* ↓
- 6: 10,5* →
- 7: 10,1 ↗
- 8: 10,6* ↑

Serie: 81,5

Summa: 393,0

Serie 1

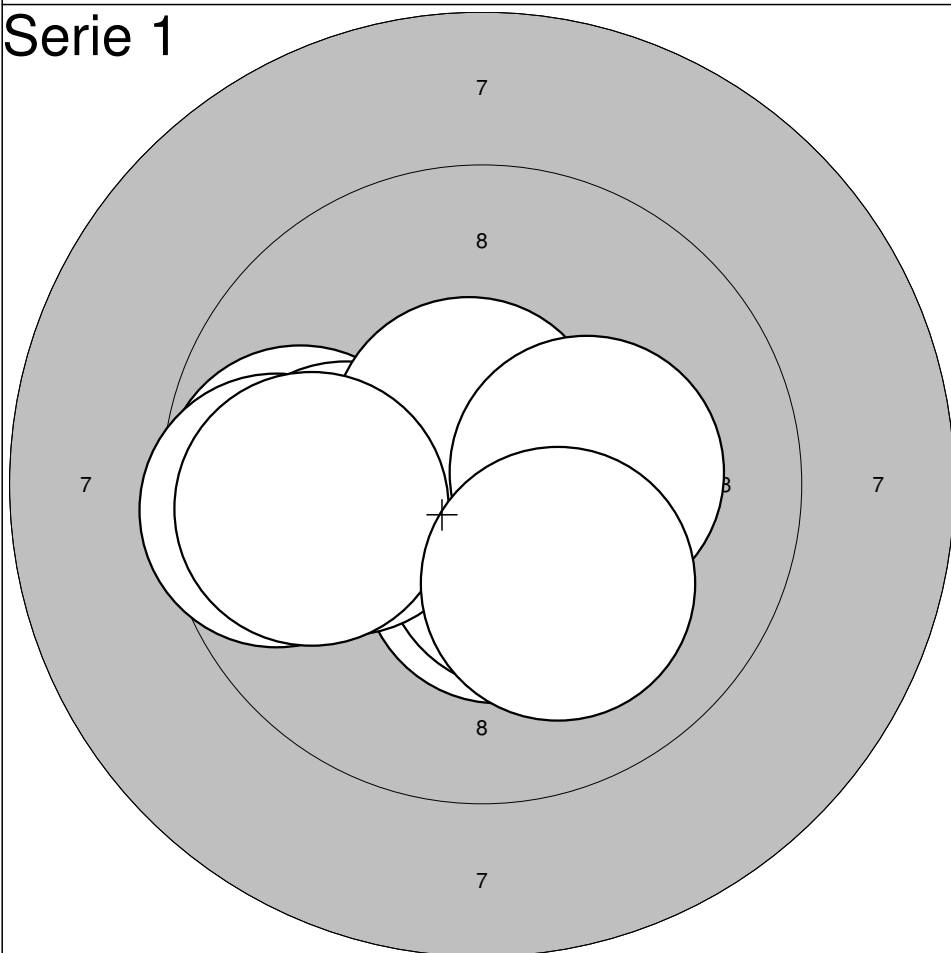

- 1: 10,4* ↘
- 2: 9,8 ←
- 3: 10,4* ↓
- 4: 10,4* ↘
- 5: 10,1 ←
- 6: 9,6 ←
- 7: 10,6* ↑
- 8: 10,3* →
- 9: 9,8 ←
- 10: 10,1 ↘

Serie: 101,5

Summa: 494,5

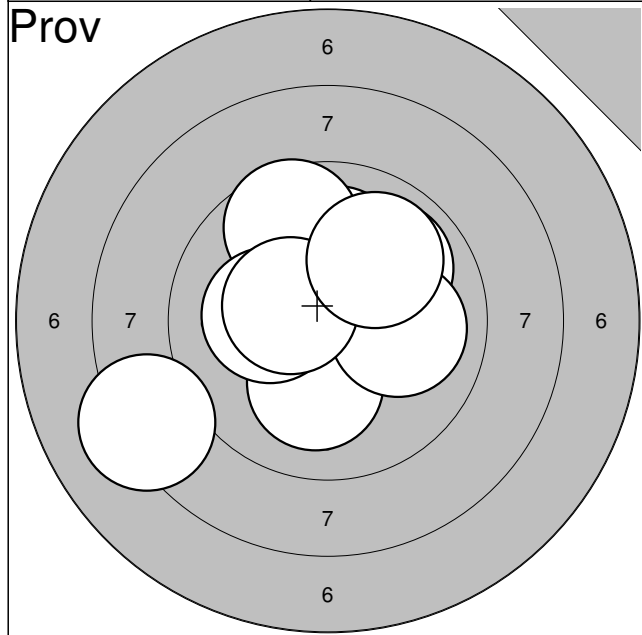

1:	10,1	↑
2:	9,9	↗
3:	10,4*	↗
4:	9,6	↑
5:	10,1	↓
6:	10,0	→
7:	10,2*	←
8:	10,4*	↖
9:	8,2	↙
10:	9,9	↗
Serie:		98,8
Summa:		392,0

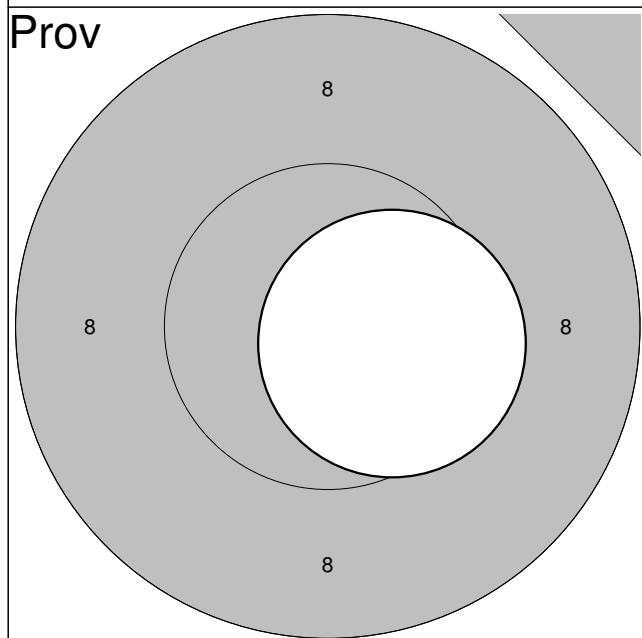

11:	10,5*	→
Serie:		10,5
Summa:		392,0

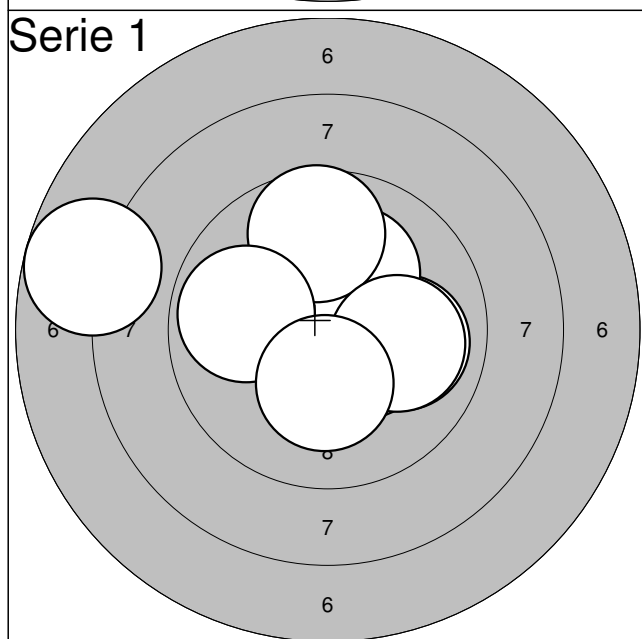

1:	10,0	→
2:	10,8*	↓
3:	10,4*	↘
4:	10,7*	↘
5:	10,2*	↗
6:	9,7	↑
7:	10,0	→
8:	9,9	←
9:	10,2*	↓
10:	7,8	←
Serie:		99,7
Summa:		491,7

Prov

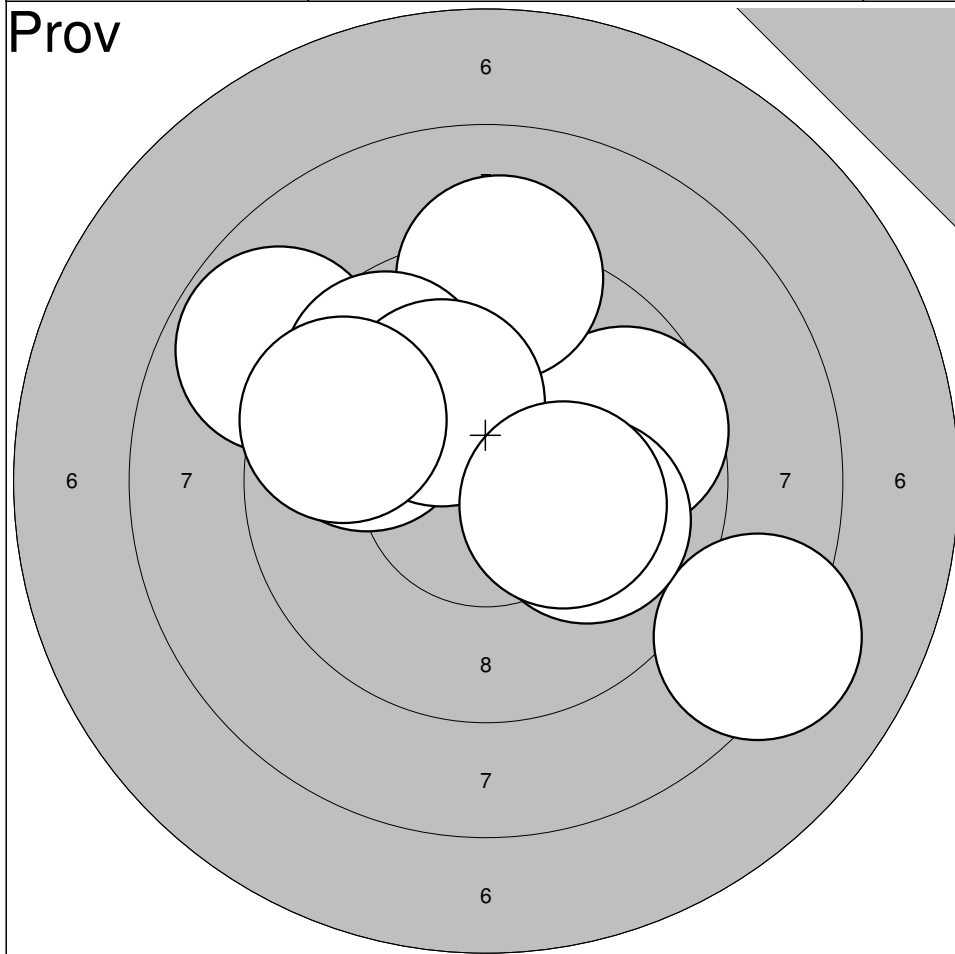

1:	9,7	→
2:	9,2	↑
3:	8,8	↖
4:	9,8	↖
5:	9,7	↖
6:	10,2*	↖
7:	8,2	↘
8:	9,6	↖
9:	10,0	↘
10:	10,2*	→

Serie: 95,4

Summa: 392,0

Serie 1

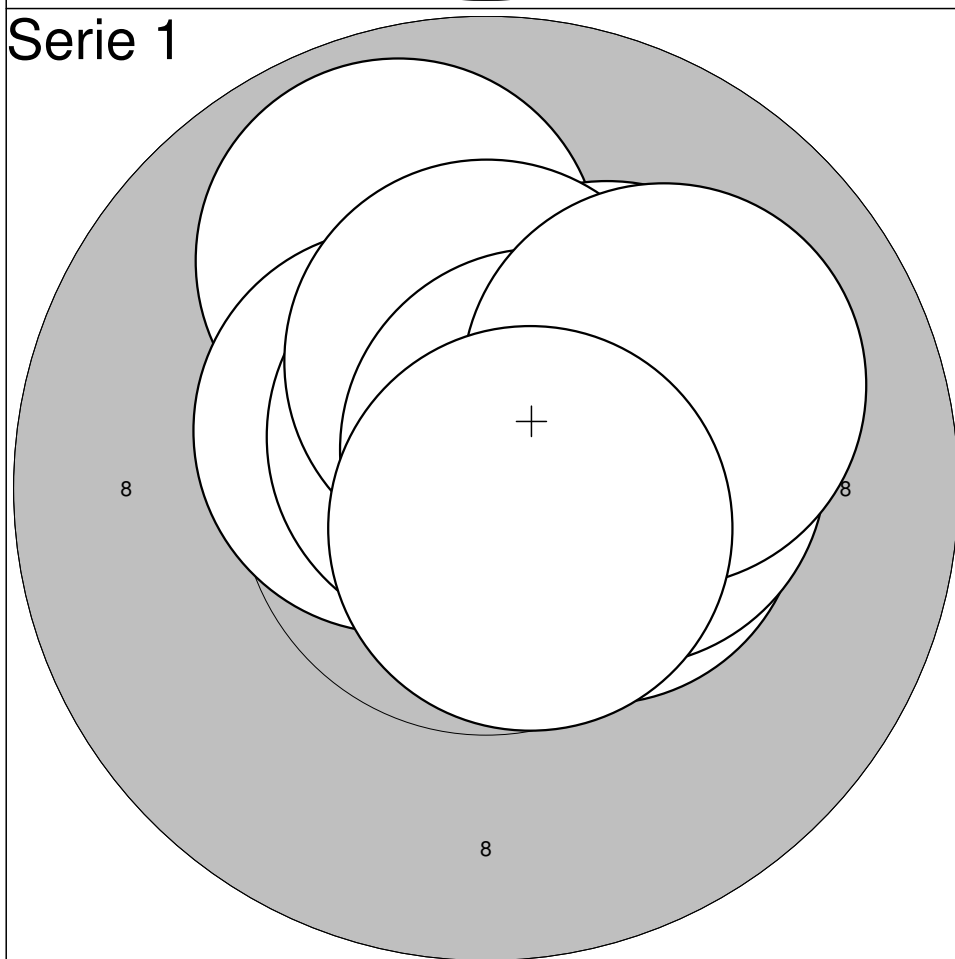

1:	10,4*	→
2:	9,9	↑
3:	10,3*	→
4:	10,5*	↖
5:	10,7*	↑
6:	10,2*	↖
7:	10,4*	↑
8:	10,6*	↖
9:	10,0	↖
10:	10,7*	↘

Serie: 103,7

Summa: 495,7

Prov

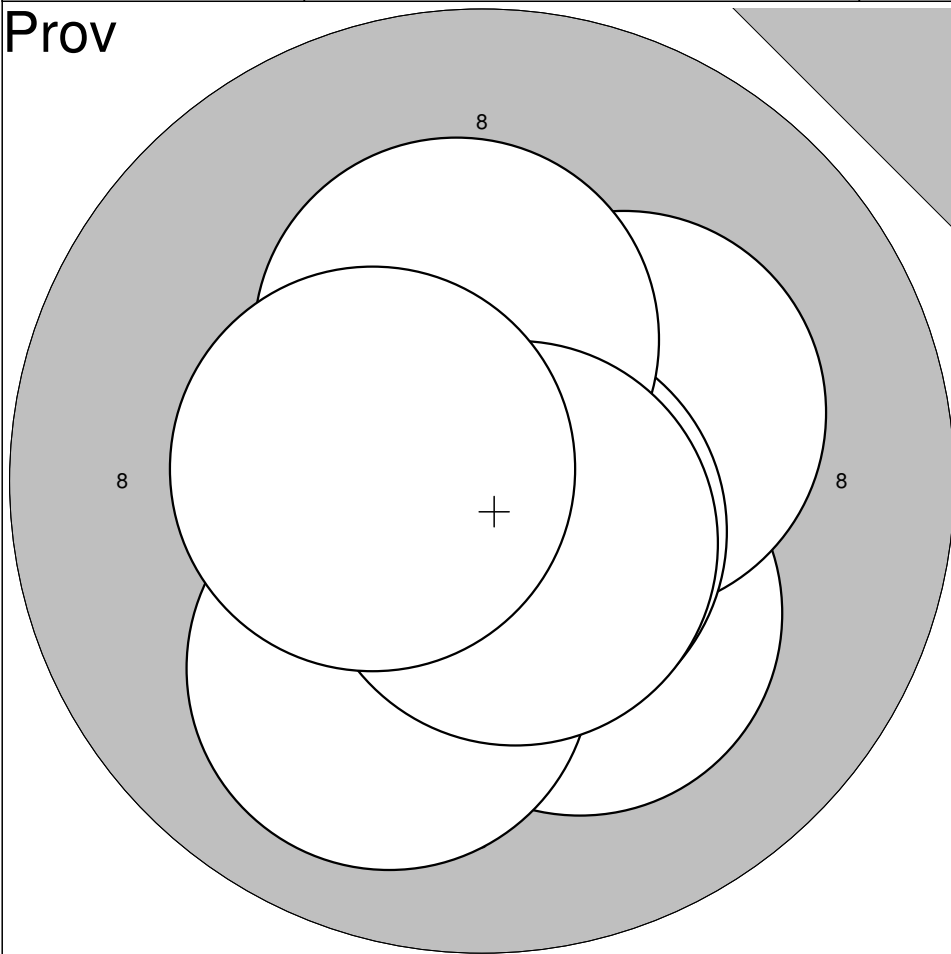

1: 10,2* ↘

2: 10,2* ↗

3: 10,0 ↘

4: 10,7* ↘

5: 10,3* ↗

6: 10,6* ↘

7: 10,5* ←

Serie: 72,5

Summa: 391,0

Serie 1

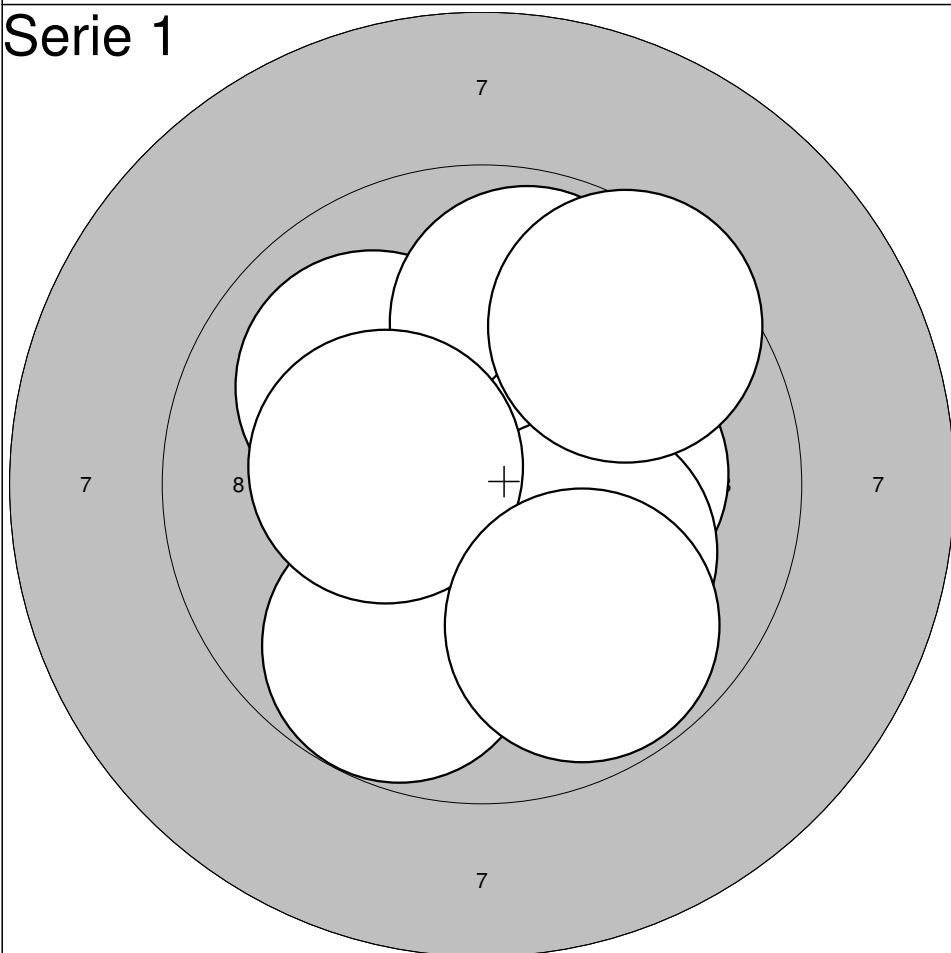

1: 10,2* ↓

2: 10,0 ↗

3: 10,4* ↗

4: 9,8 ↘

5: 9,9 ↗

6: 10,2* →

7: 10,2* ↘

8: 10,3* ←

9: 9,8 ↘

10: 9,6 ↗

Serie: 100,4

Summa: 491,4

Prov

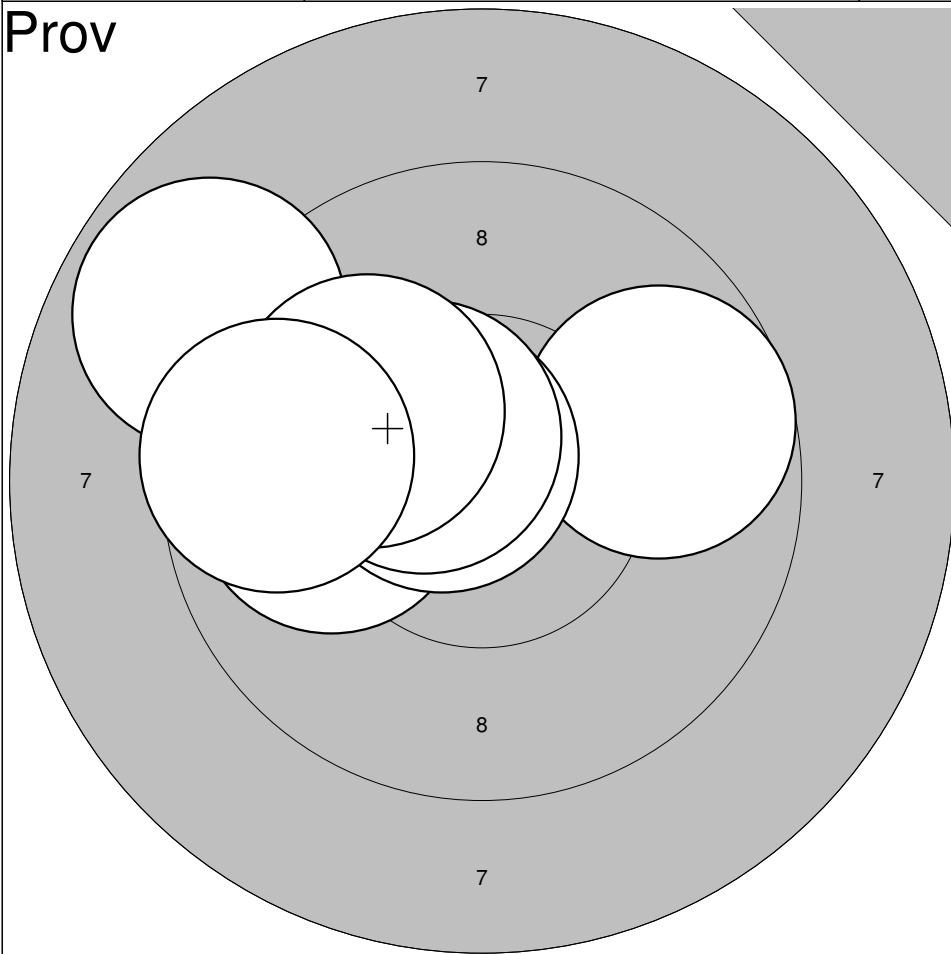

- 1: 9,7 →
- 2: 10,0 ←
- 3: 10,6* ↗
- 4: 10,5* ↗
- 5: 8,9 ↗
- 6: 10,1 ↗
- 7: 9,6 ←

Serie: 69,4

Summa: 391,0

Serie 1

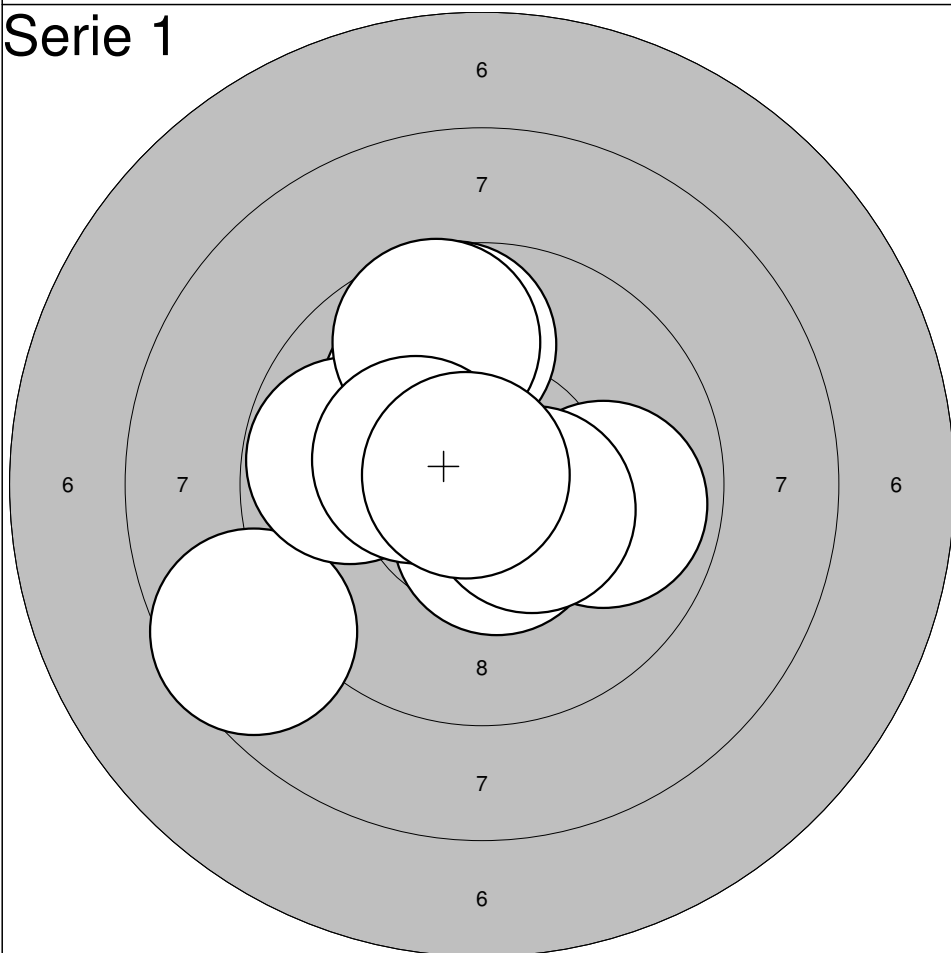

- 1: 10,0 ↗
- 2: 9,9 →
- 3: 9,7 ↗
- 4: 10,5* ↘
- 5: 8,6 ←
- 6: 9,8 ←
- 7: 9,7 ↗
- 8: 10,3* ↗
- 9: 10,5* ↘
- 10: 10,8* ↗

Serie: 99,8

Summa: 490,8

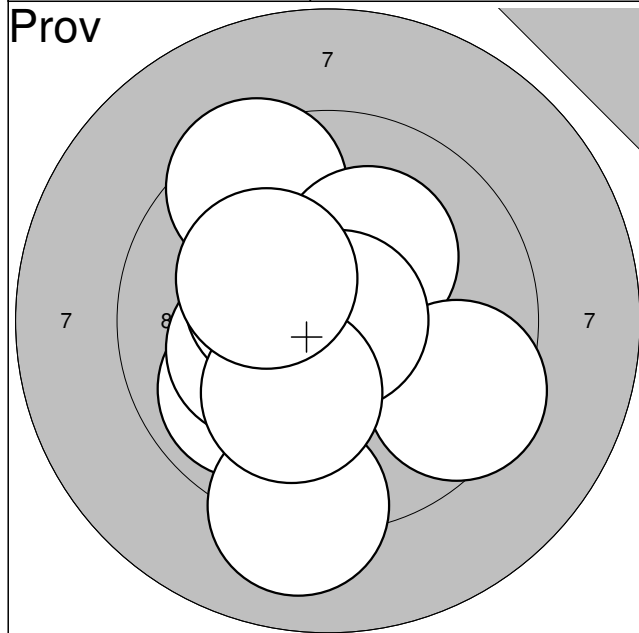

1:	9,5	↗
2:	10,2*	↗
3:	9,5	↘
4:	9,9	↘
5:	10,2*	←
6:	10,4*	←
7:	10,8*	→
8:	9,1	↓
9:	10,2*	↓
10:	10,2*	↙
Serie:		100,0
Summa:		390,0

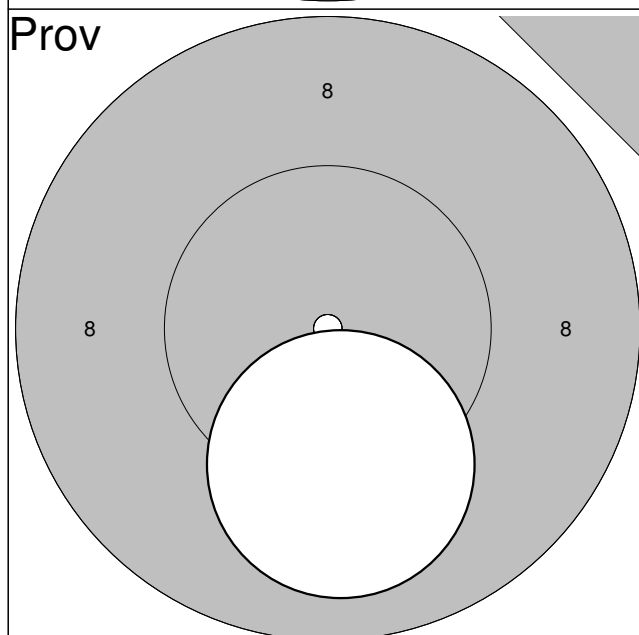

11:	10,0	↓
Serie:		10,0
Summa:		390,0

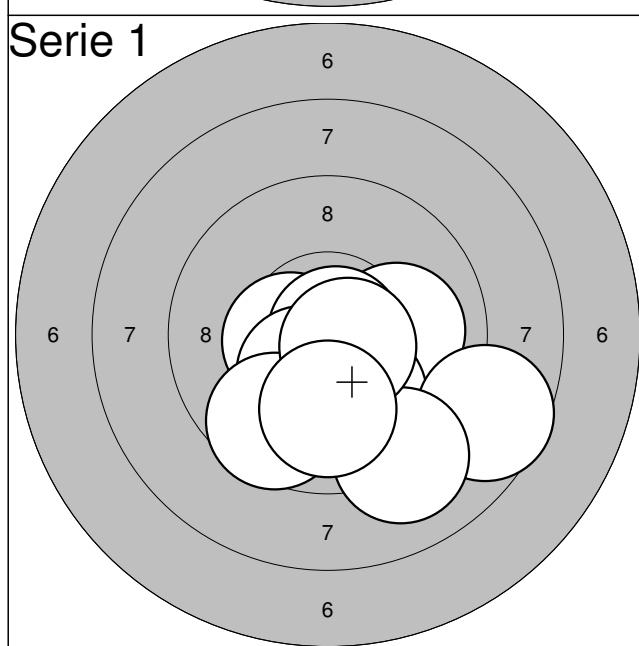

1:	10,5*	←
2:	10,0	→
3:	10,1	↘
4:	10,8*	→
5:	8,6	↘
6:	9,1	↘
7:	10,4*	↘
8:	9,6	↘
9:	10,6*	↘
10:	10,0	↓
Serie:		99,7
Summa:		489,7

Prov

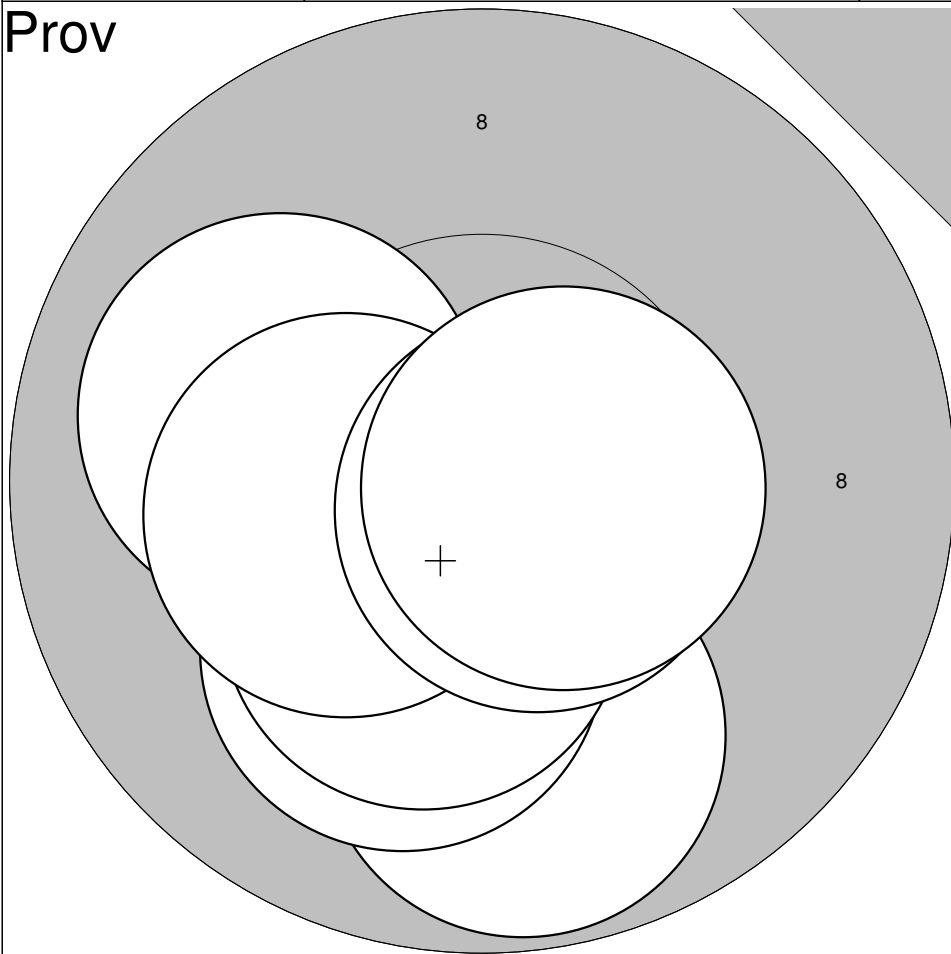

- 1: 9,8 ↓
- 2: 10,1 ↘
- 3: 10,3* ↘
- 4: 10,0 ←
- 5: 10,3* ←
- 6: 10,7* ↗
- 7: 10,6* →

Serie: 71,8

Summa: 390,0

Serie 1

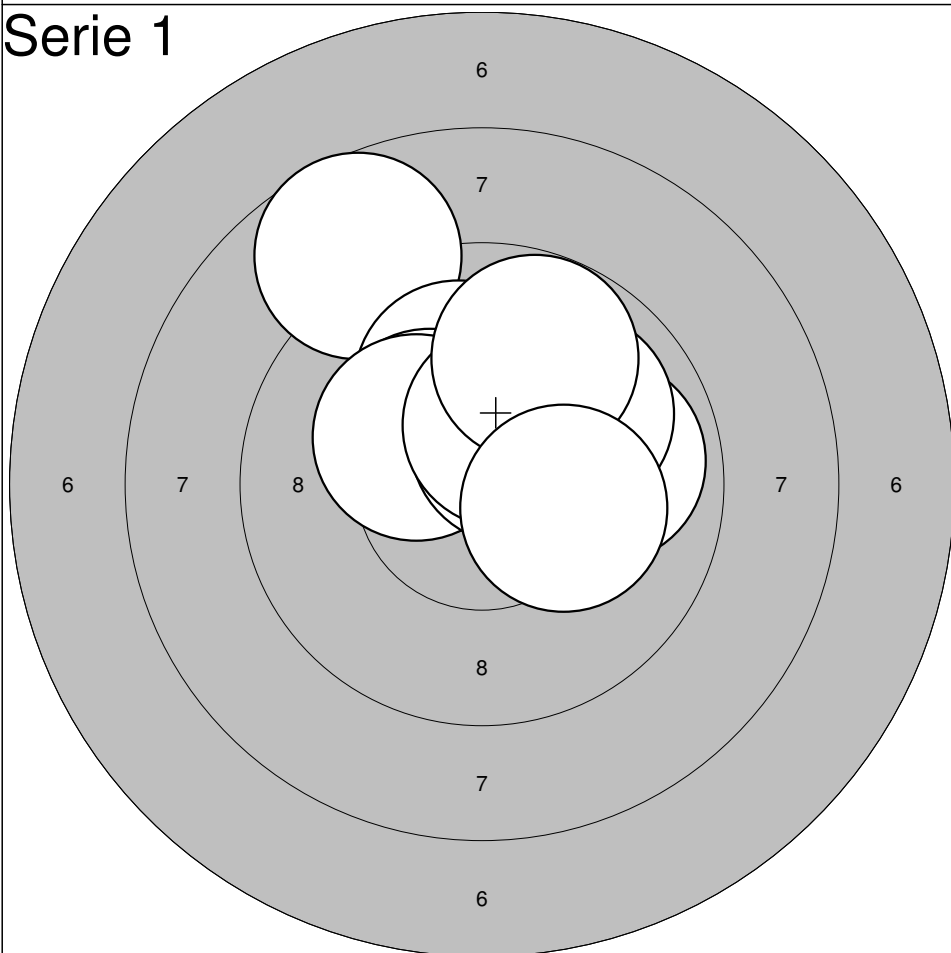

- 1: 8,7 ↖
- 2: 10,1 ↑
- 3: 10,3* ↖
- 4: 10,3* ↖
- 5: 9,9 →
- 6: 10,0 ↗
- 7: 10,5* ↗
- 8: 10,4* ↗
- 9: 9,8 ↗
- 10: 10,2* →

Serie: 100,2

Summa: 490,2

Prov

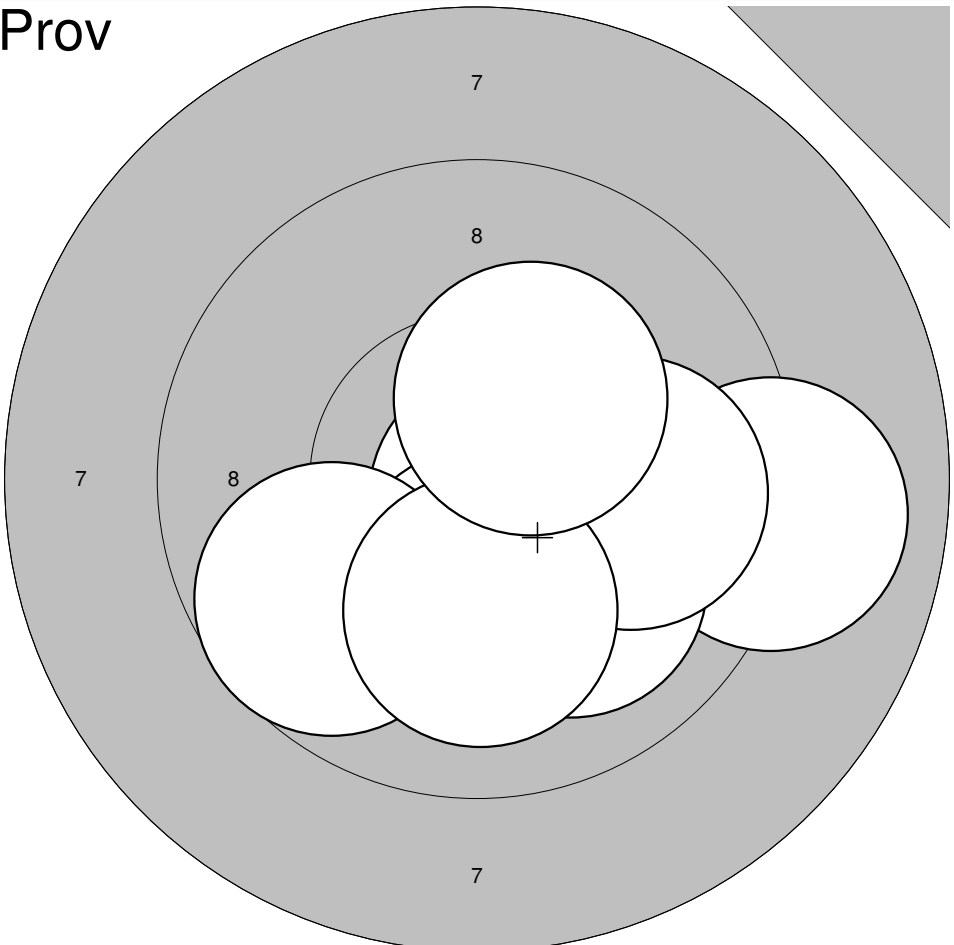

1:	10,1	↘
2:	9,0	→
3:	10,6*	↘
4:	10,7*	↘
5:	10,3*	↓
6:	10,0	↘
7:	9,7	↙
8:	9,9	→
9:	10,1	↓
10:	10,3*	↗

Serie: 100,7

Summa: 390,0

Serie 1

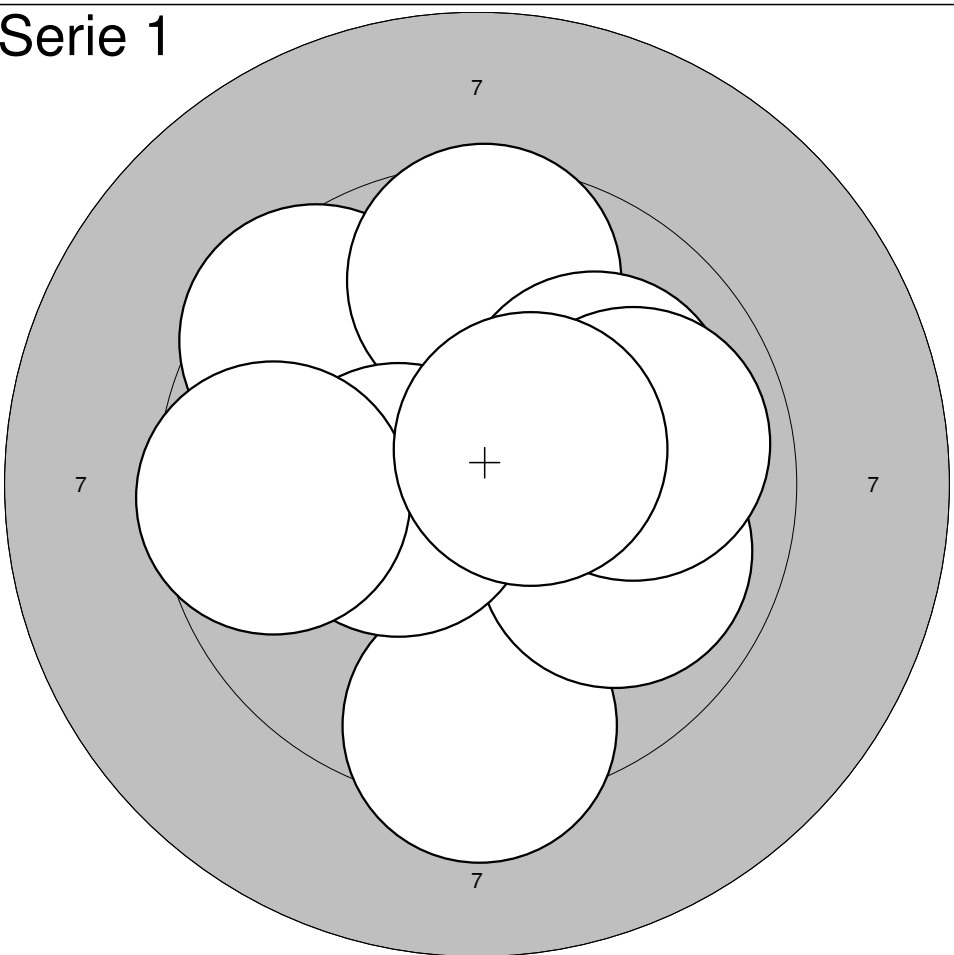

1:	10,4*	↗
2:	9,5	↖
3:	9,6	↑
4:	10,0	↗
5:	9,4	↓
6:	9,9	↘
7:	10,4*	←
8:	9,6	←
9:	9,9	→
10:	10,5*	↗

Serie: 99,2

Summa: 489,2

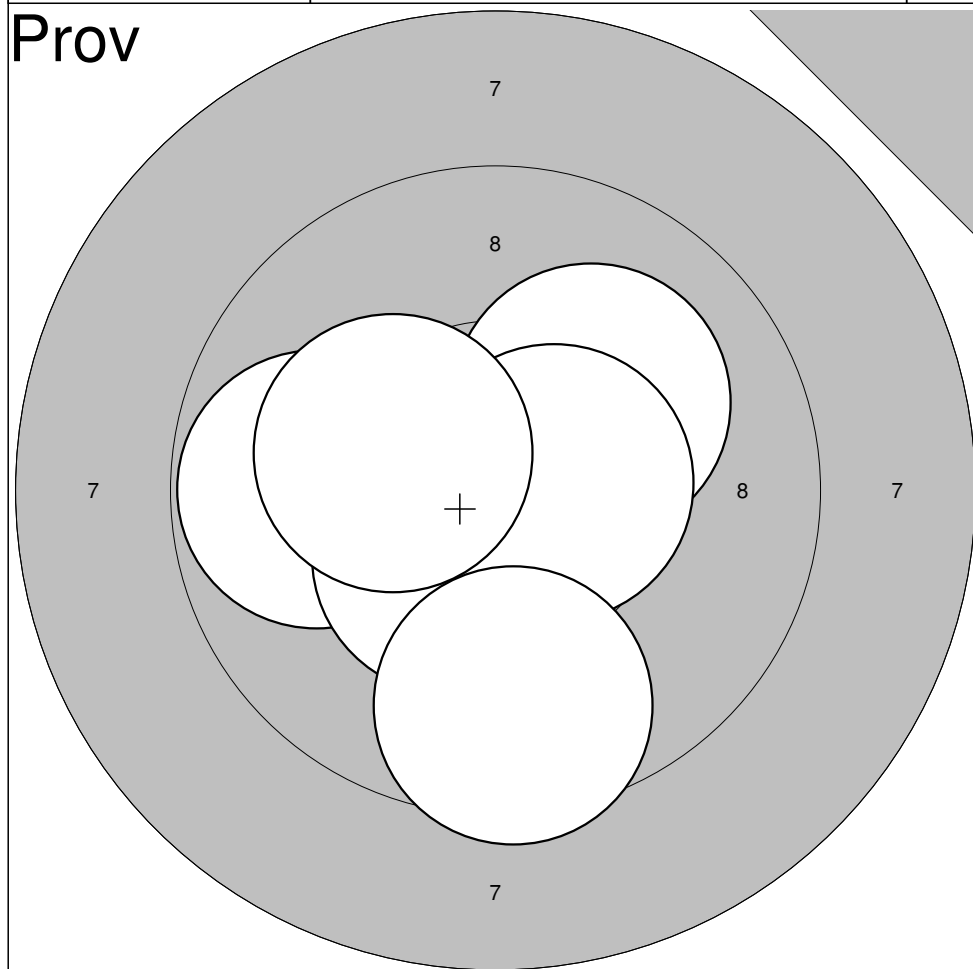

1: 10,3*	←
2: 10,1	↗
3: 9,8	←
4: 10,4*	↘
5: 10,6*	→
6: 10,2*	←
7: 9,6	↓

Serie: 71,0

Summa: 385,0

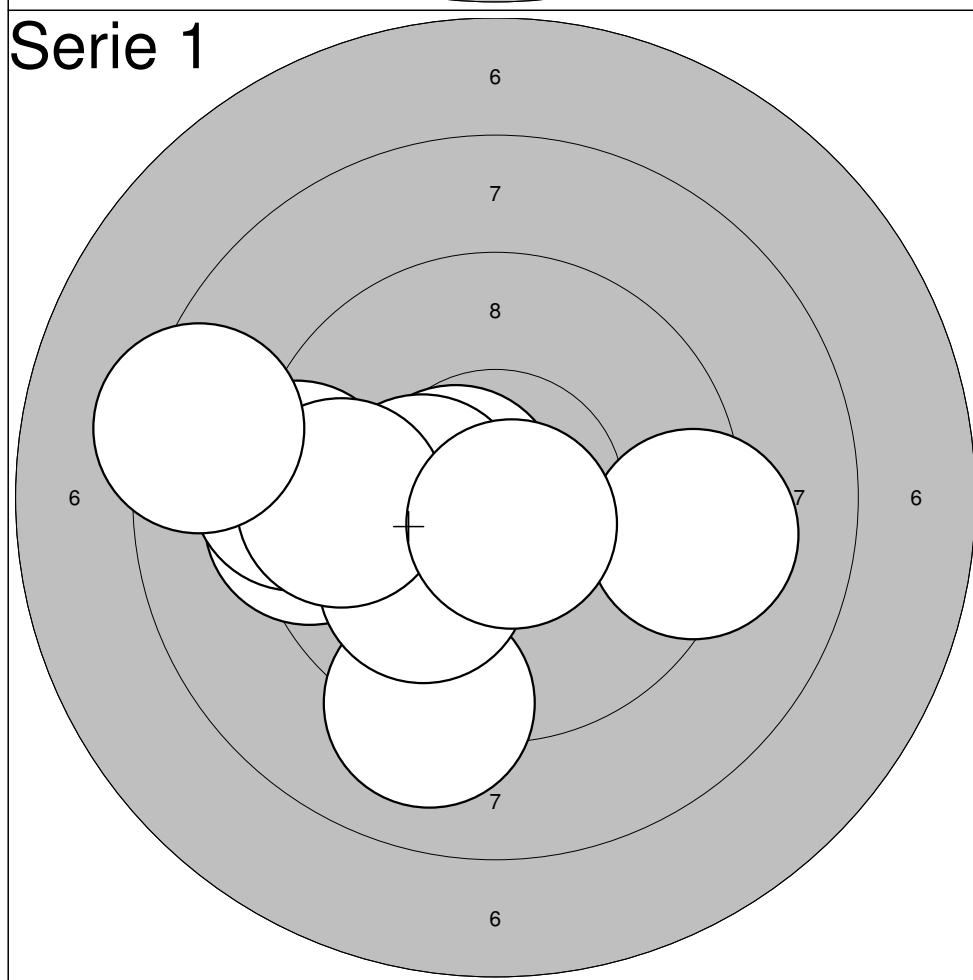

1: 10,6*	←
2: 9,4	←
3: 9,1	↘
4: 9,2	→
5: 9,2	←
6: 10,3*	←
7: 10,0	↘
8: 9,6	←
9: 10,7*	↘
10: 8,3	←

Serie: 96,4

Summa: 481,4

Prov

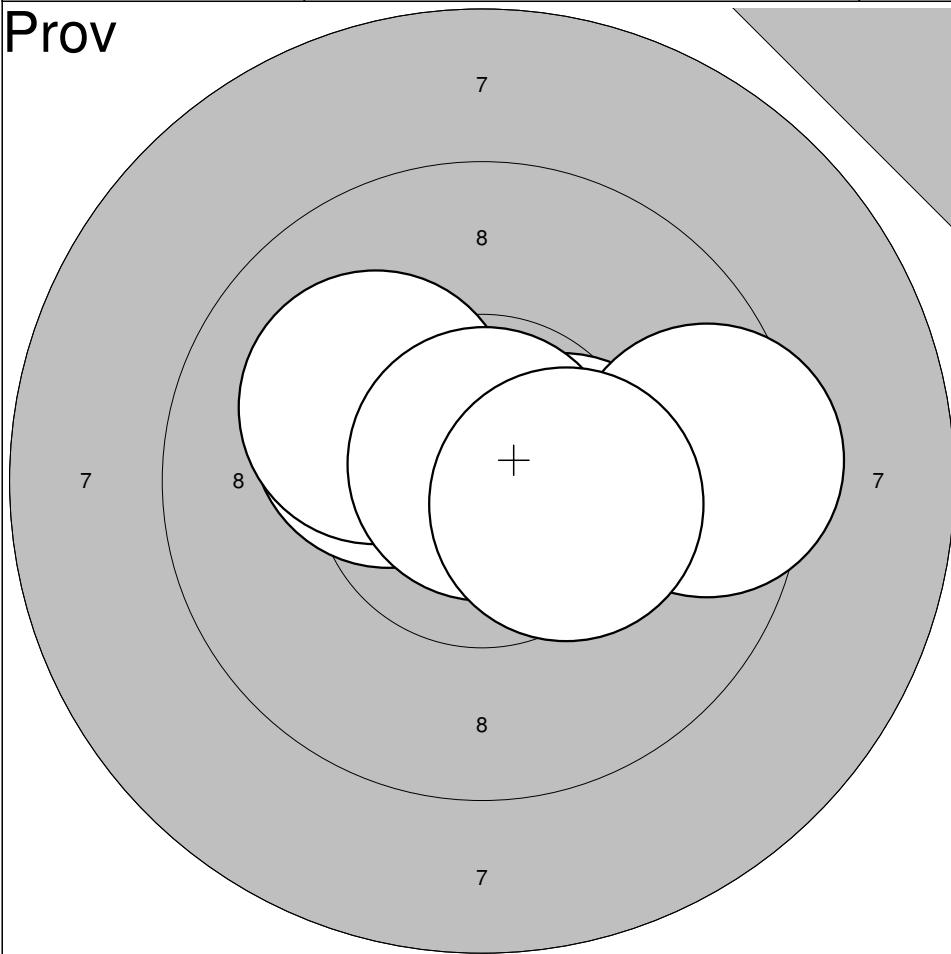

1: 10,3* ↖

2: 10,4* →

3: 10,1 ↗

4: 10,8* ↑

5: 9,5 →

6: 10,4* →

Serie: 61,5

Summa: 381,0

Serie 1

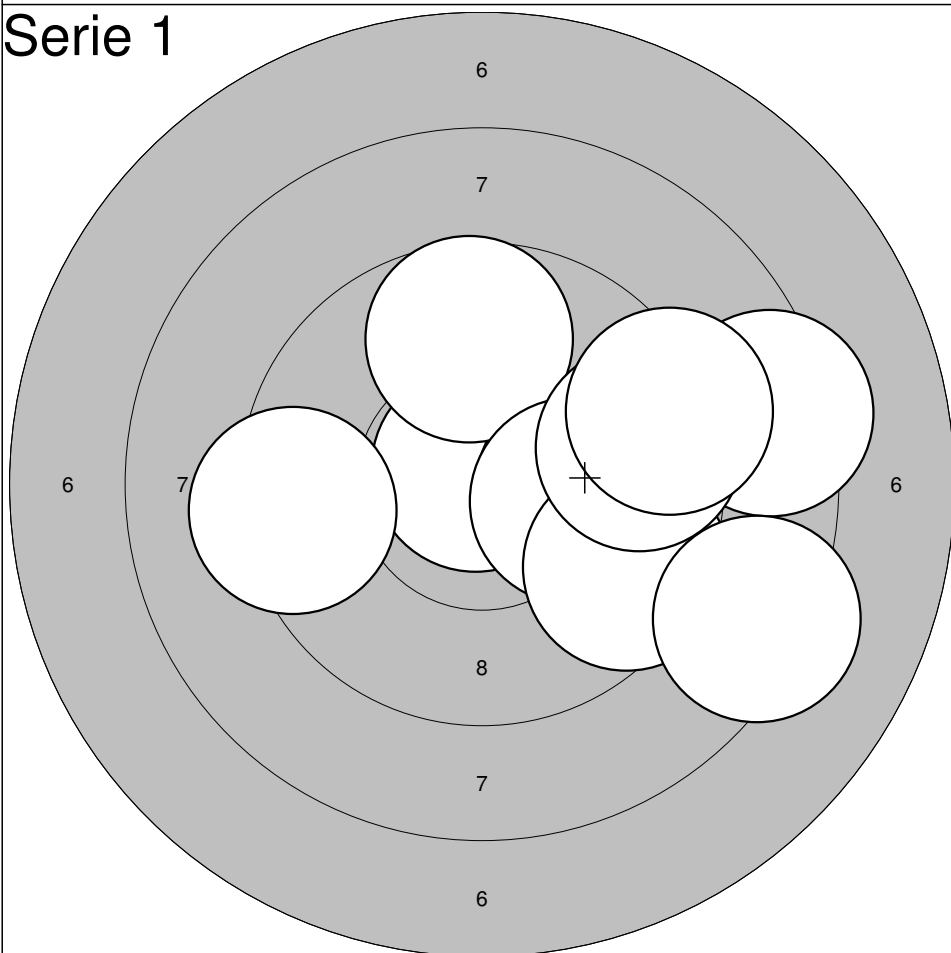

1: 10,8* ↑

2: 10,1 →

3: 8,4 →

4: 9,7 ↑

5: 10,1 →

6: 9,5 ↘

7: 9,5 →

8: 8,3 ↘

9: 9,3 ←

10: 9,2 →

Serie: 94,9

Summa: 475,9

Prov

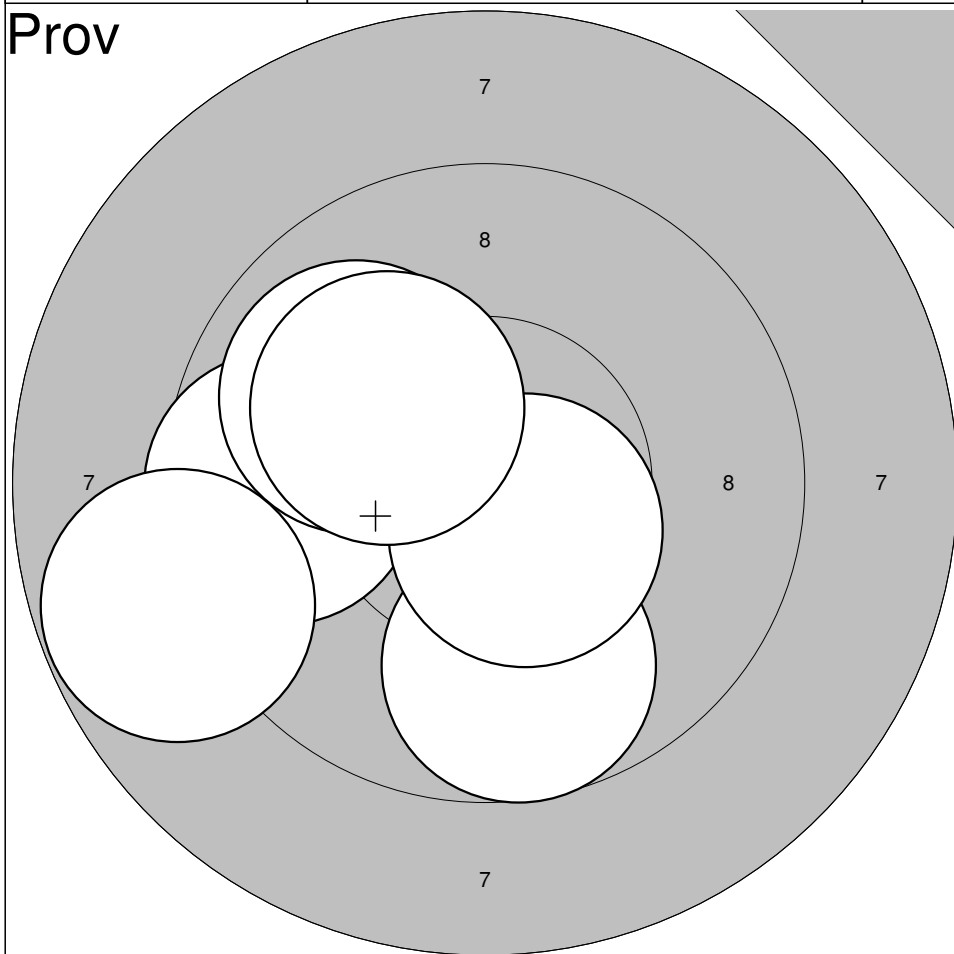

- 1: 9,6 ←
- 2: 9,9 ↗
- 3: 9,7 ↓
- 4: 8,8 ←
- 5: 10,5* ↘
- 6: 10,1 ↗

Serie: 58,6

Summa: 379,0

Serie 1

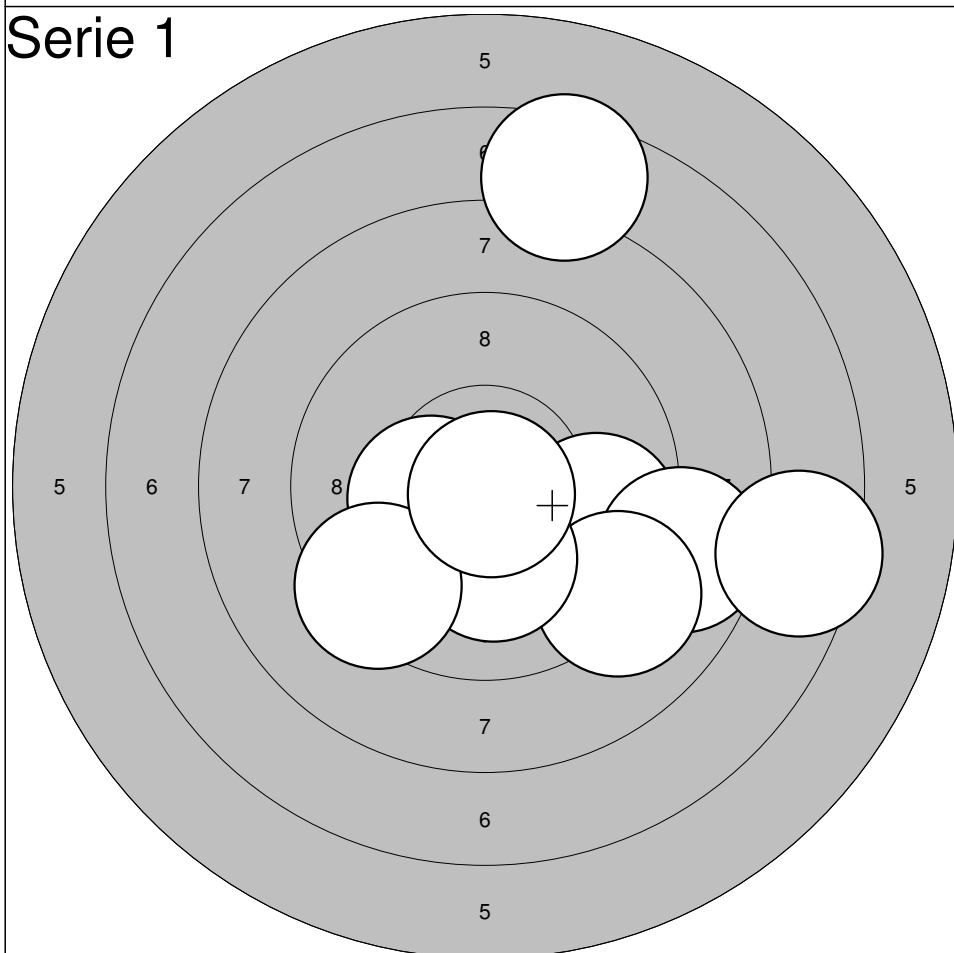

- 1: 10,5* ↓
- 2: 7,5 ↑
- 3: 9,7 →
- 4: 10,4* ←
- 5: 8,7 →
- 6: 9,1 ↘
- 7: 10,2* ↓
- 8: 7,5 →
- 9: 9,4 ↙
- 10: 10,8* ↓

Serie: 93,8

Summa: 472,8

Prov

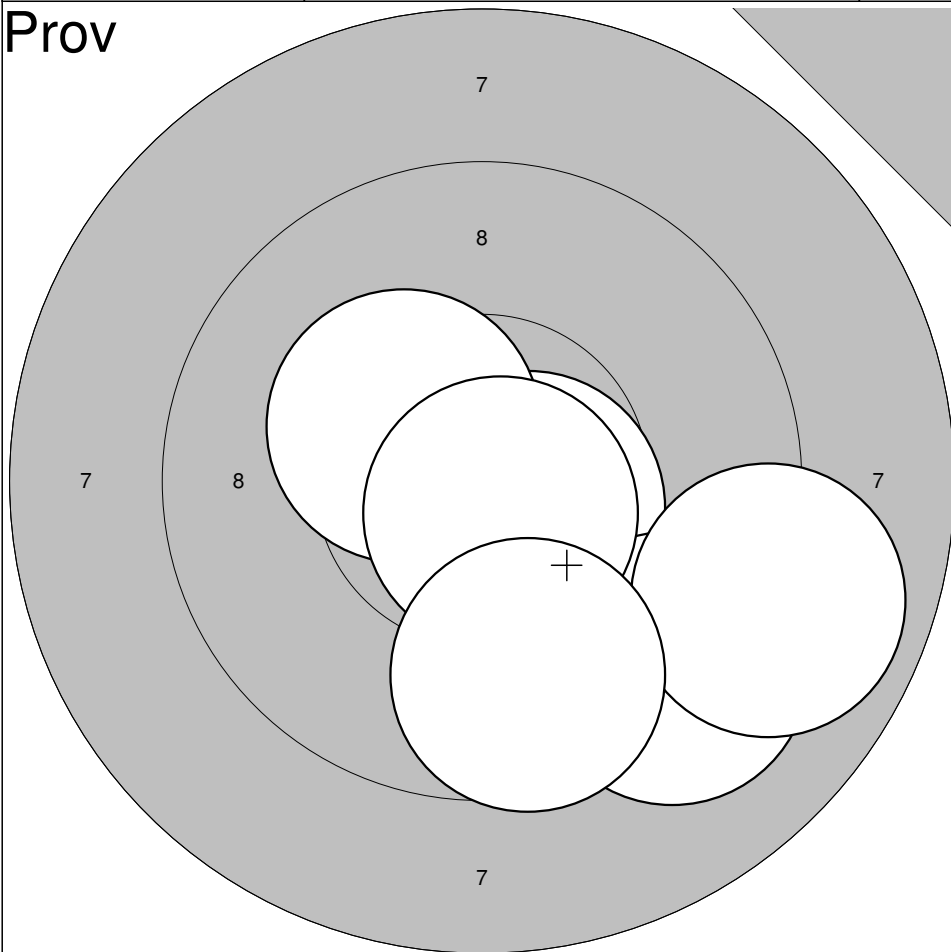

- 1: 10,6* ↘
- 2: 9,2 ↘
- 3: 10,3* ↗
- 4: 8,9 ↘
- 5: 10,7* ↘
- 6: 9,6 ↘

Serie: 59,3

Summa: 378,0

Serie 1

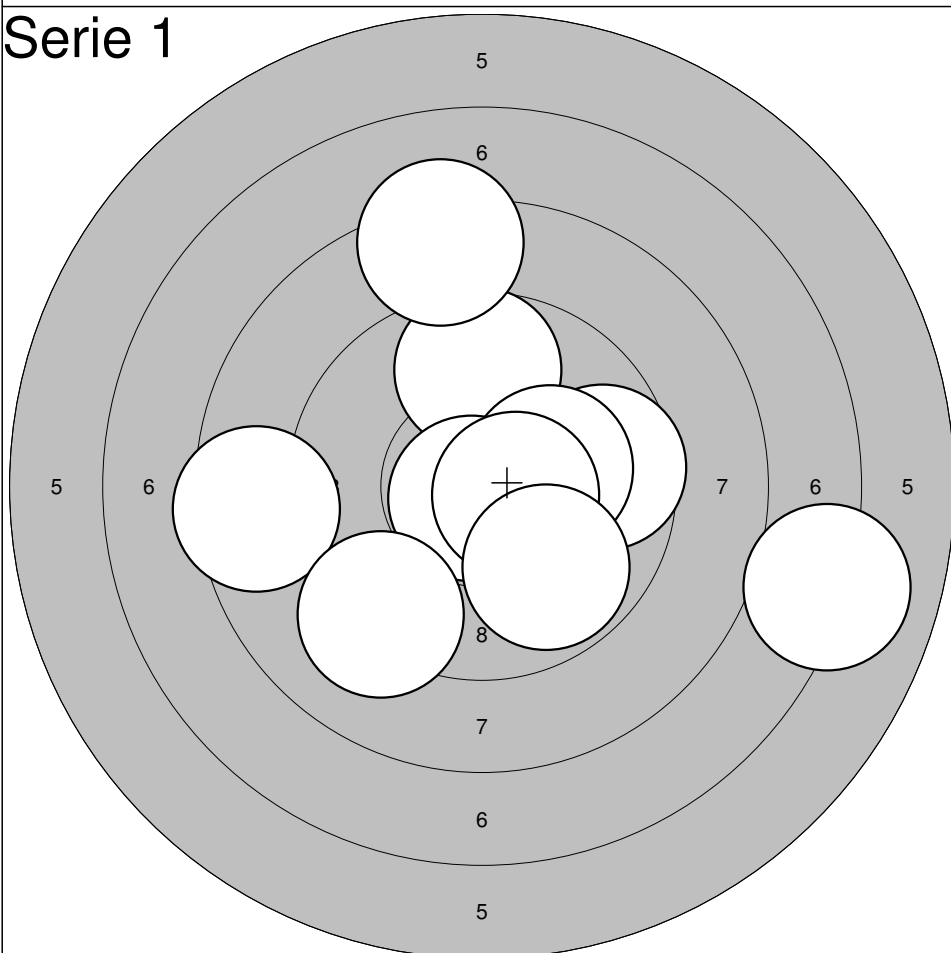

- 1: 9,6 →
- 2: 7,1 →
- 3: 8,5 ←
- 4: 9,7 ↑
- 5: 10,2* →
- 6: 10,8* ↘
- 7: 10,6* →
- 8: 9,2 ↘
- 9: 8,3 ↑
- 10: 9,8 ↘

Serie: 93,8

Summa: 471,8

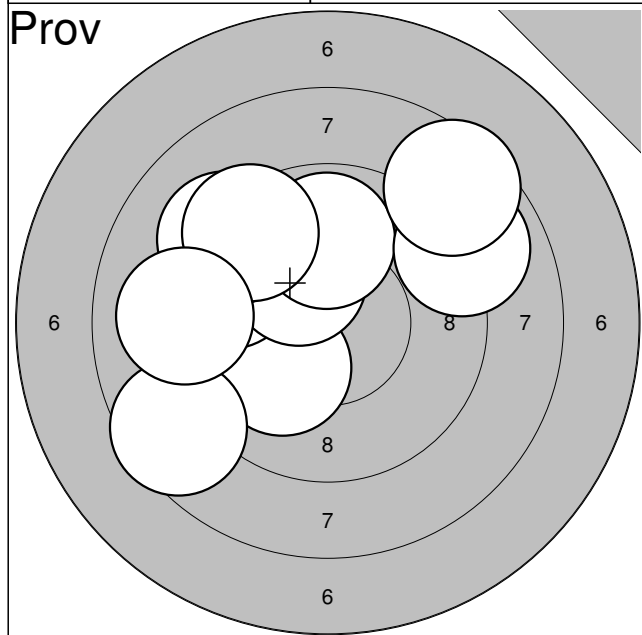

1:	10,1	↙
2:	9,5	↖
3:	10,3*	↗
4:	9,9	↑
5:	9,2	↗
6:	8,9	→
7:	8,6	↙
8:	9,4	↗
9:	9,1	←
10:	8,5	↗
Serie:		93,5
Summa:		378,0

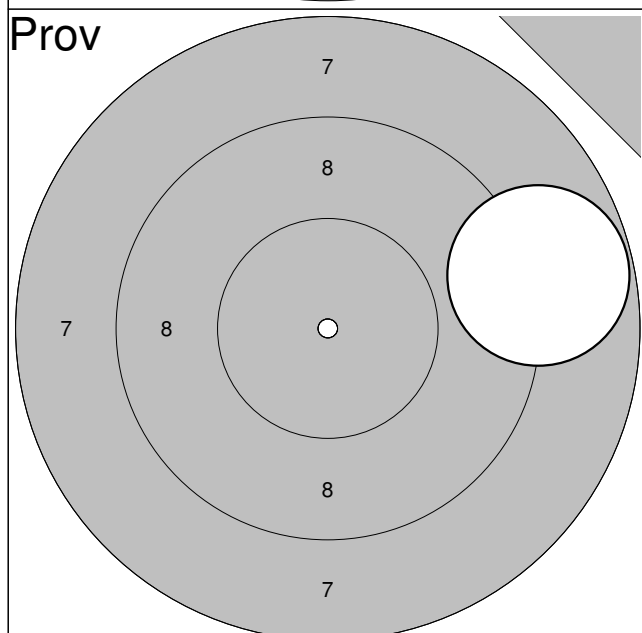

11:	8,8	→
Serie:		8,8
Summa:		378,0

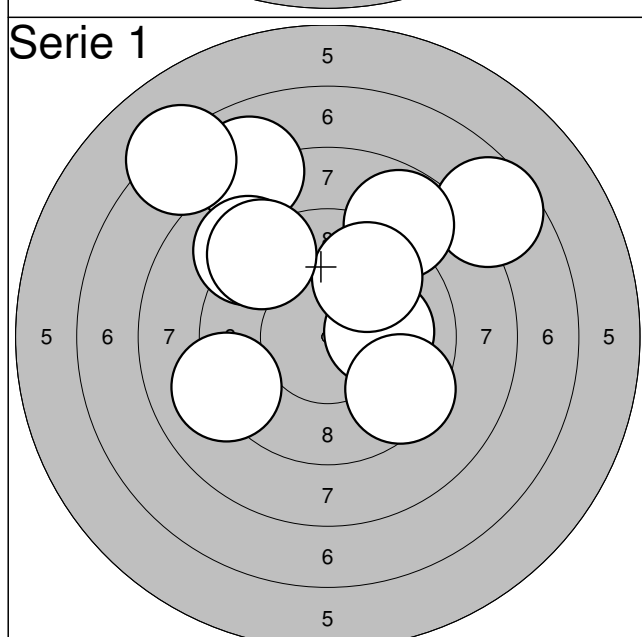

1:	8,0	↖
2:	7,6	↗
3:	8,8	↗
4:	10,1	→
5:	9,8	↗
6:	9,0	↗
7:	9,5	↘
8:	9,2	↗
9:	7,2	↗
10:	9,1	←
Serie:		88,3
Summa:		466,3

Lag 1	Tavla 25	Dan Eriksson
-----------------	--------------------	---------------------

	Figeholm	Vet Stå
--	----------	---------

06.11.2010	Final SM 2010	Gullabo SKF
------------	---------------	-------------

Prov

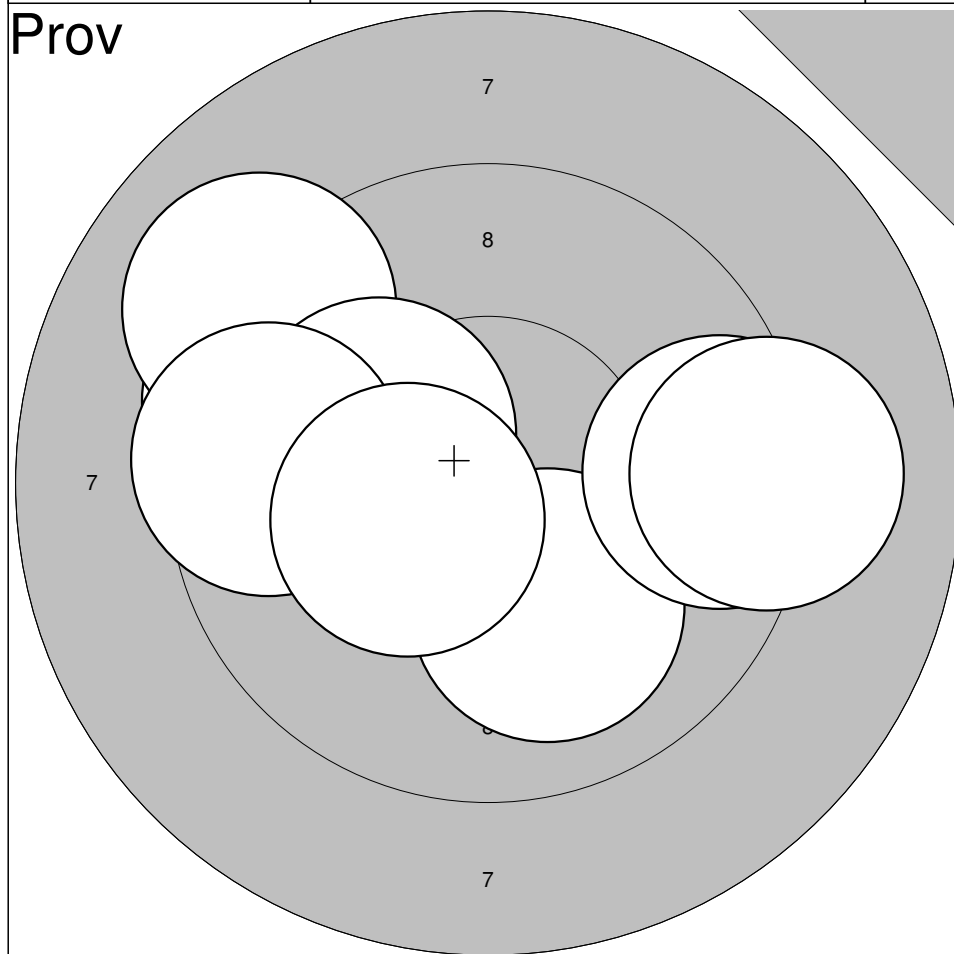

- 1: 9,5 ↖
- 2: 9,1 ↗
- 3: 10,2* ↗
- 4: 10,1 ↘
- 5: 9,4 →
- 6: 9,5 ←
- 7: 9,1 →
- 8: 10,4* ↙

Serie: 77,3

Summa: 377,0

Serie 1

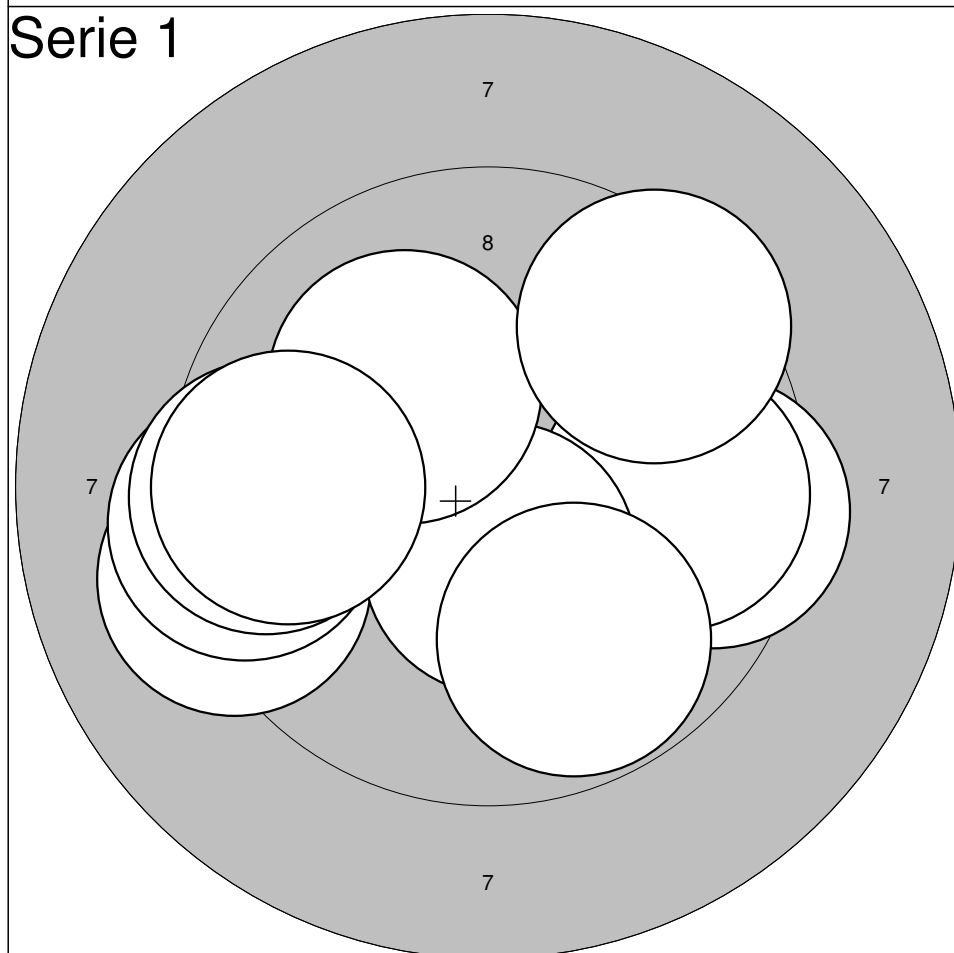

- 1: 9,2 ↙
- 2: 9,5 →
- 3: 9,7 →
- 4: 9,3 ←
- 5: 10,5* ↘
- 6: 10,1 ↗
- 7: 9,5 ←
- 8: 9,8 ↘
- 9: 9,4 ↗
- 10: 9,6 ←

Serie: 96,6

Summa: 473,6

SM 2010

Prov

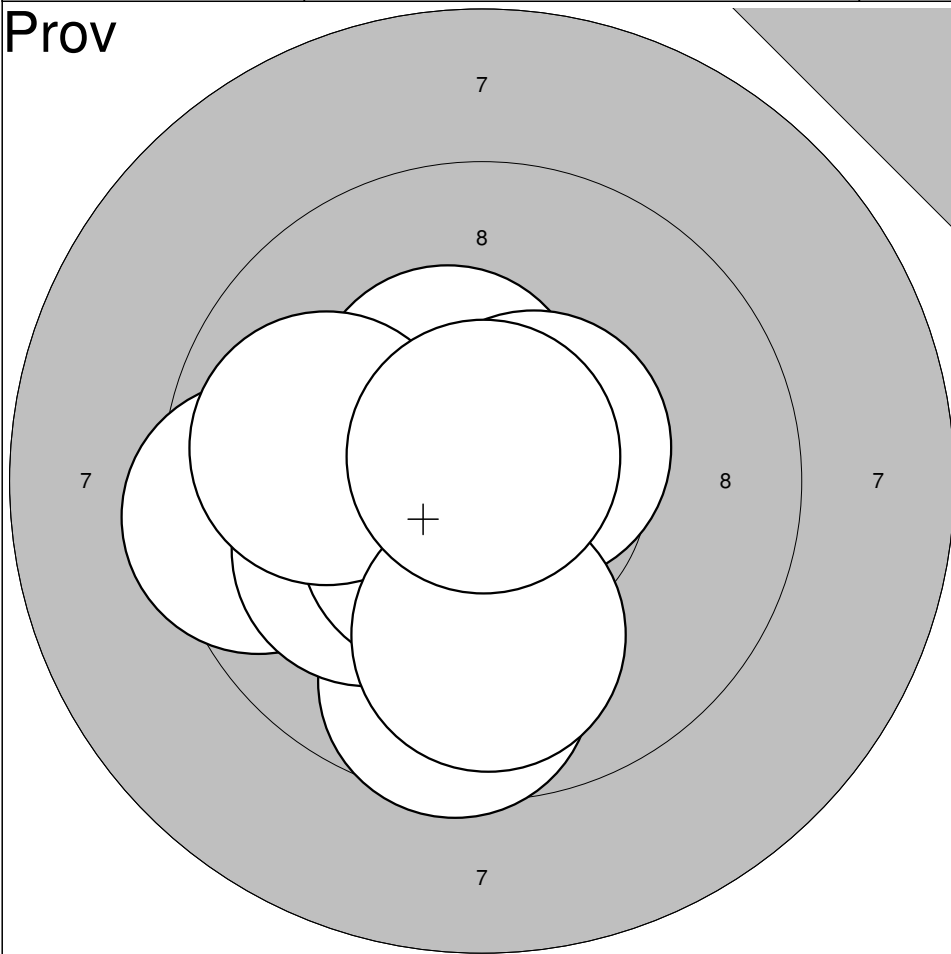

- 1: 9,6 ↓
- 2: 10,4* ↗
- 3: 9,5 ←
- 4: 10,1 ↙
- 5: 10,5* ↘
- 6: 9,9 ←
- 7: 10,5* ↗
- 8: 9,9 ↓
- 9: 10,8* ↑

Serie: 91,2

Summa: 374,0

Serie 1

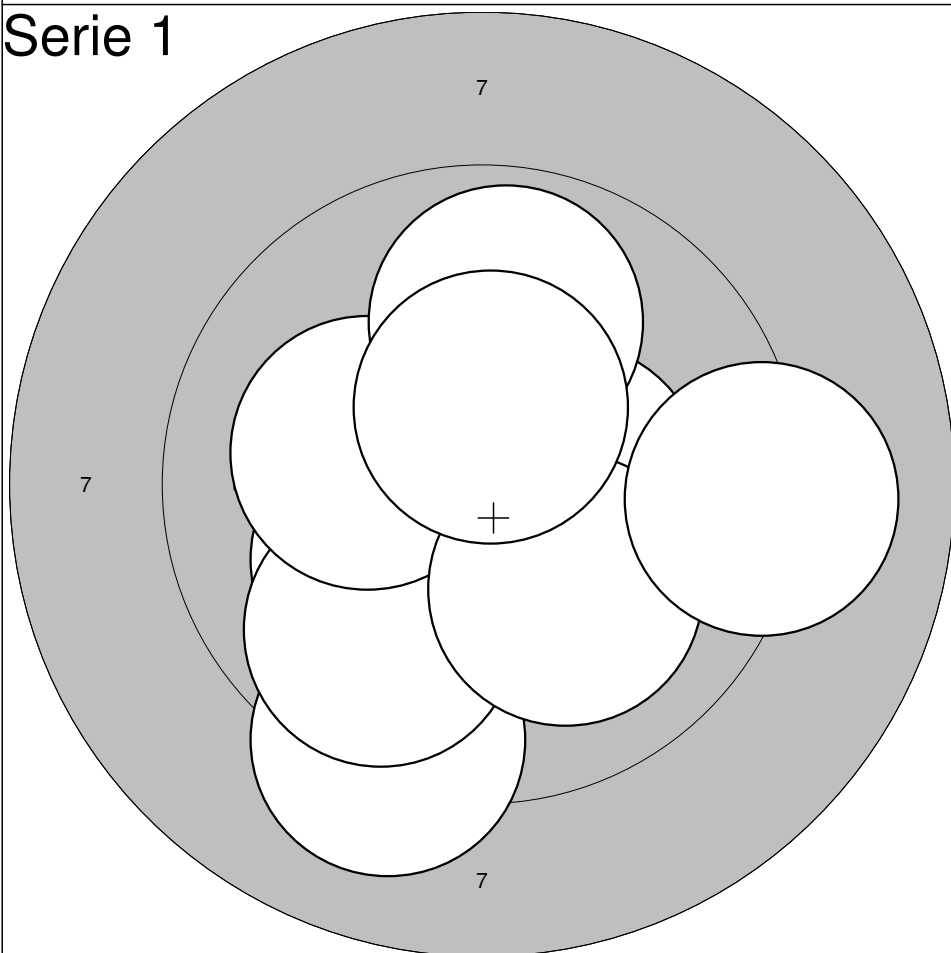

- 1: 9,2 ↓
- 2: 10,2* ↙
- 3: 10,7* →
- 4: 10,4* →
- 5: 9,8 ↘
- 6: 10,2* ←
- 7: 10,1 ↘
- 8: 9,9 ↑
- 9: 10,4* ↑
- 10: 9,1 →

Serie: 100,0

Summa: 474,0

Prov

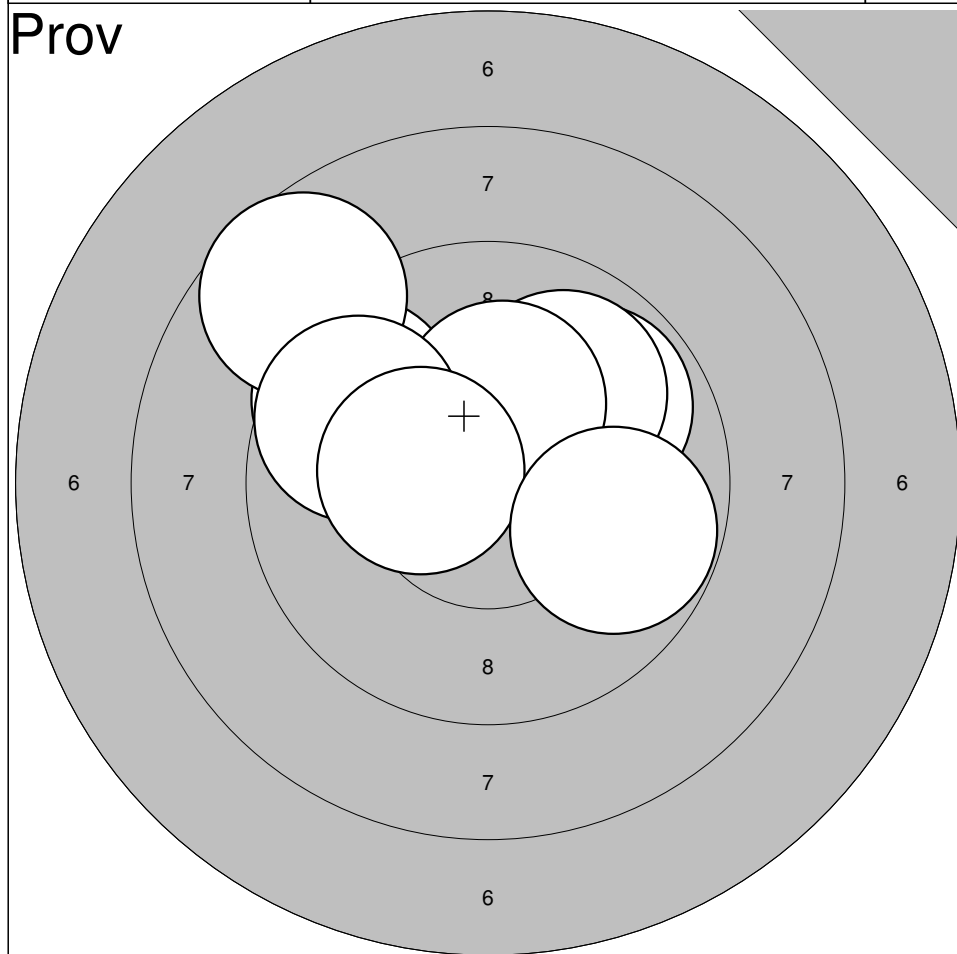

- 1: 9,6 ↗
- 2: 8,7 ↗
- 3: 9,9 ↗
- 4: 9,9 ↗
- 5: 10,3* ↑
- 6: 9,7 ↗
- 7: 10,4* ←
- 8: 9,8 →

Serie: 78,3

Summa: 373,0

Serie 1

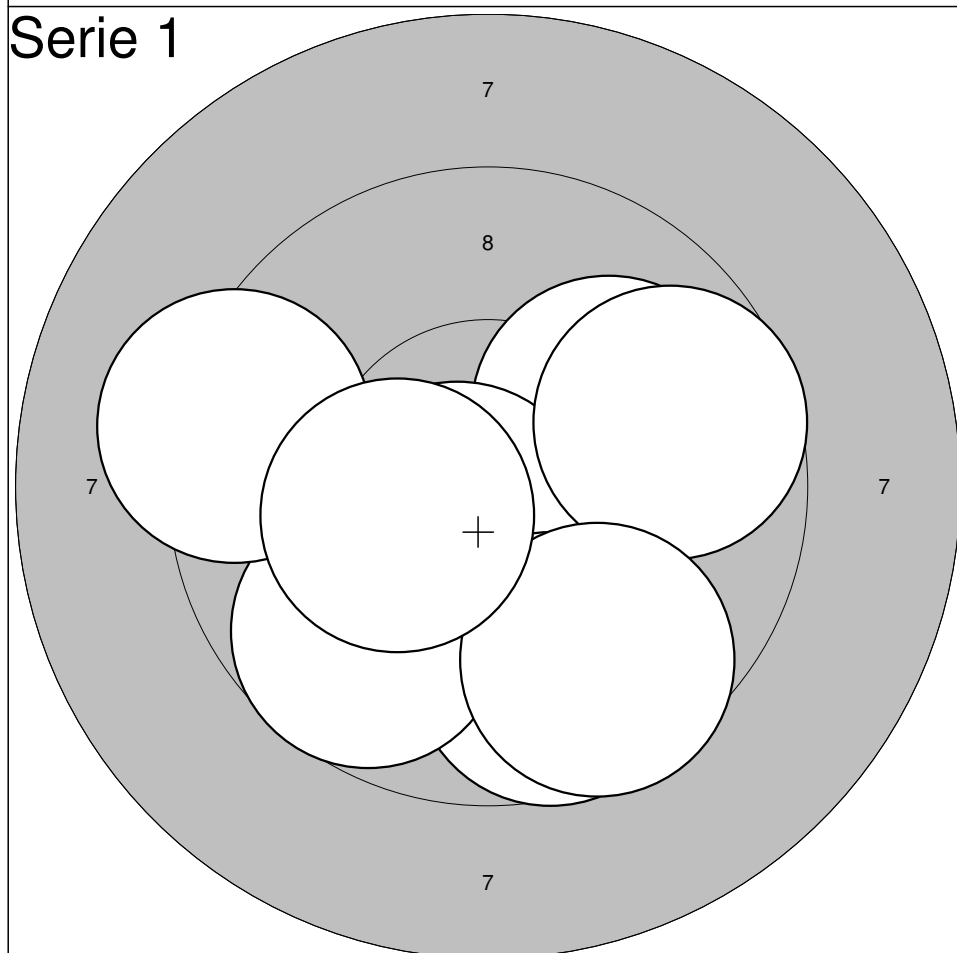

- 1: 10,3* ←
- 2: 10,0 ↗
- 3: 10,6* ↓
- 4: 10,7* ↙
- 5: 9,7 ↓
- 6: 9,7 →
- 7: 9,7 ↙
- 8: 9,2 ←
- 9: 9,6 ↓
- 10: 10,3* ←

Serie: 99,8

Summa: 472,8

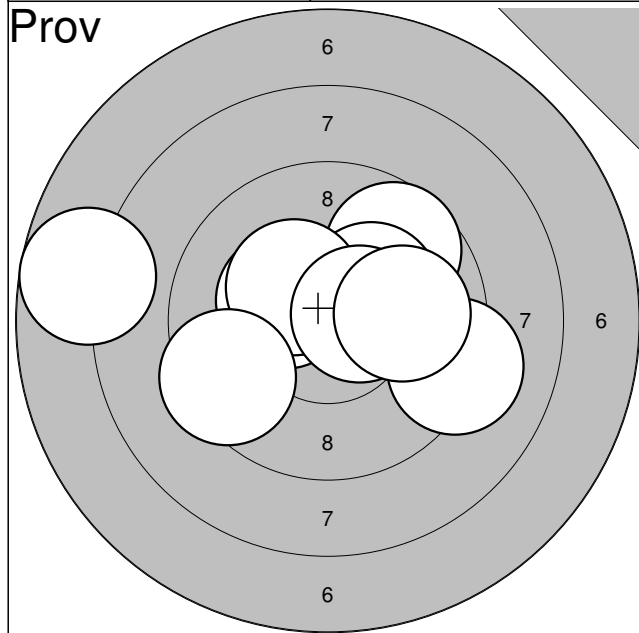

1:	9,2	→
2:	10,4*	↗
3:	10,3*	↖
4:	9,7	↗
5:	10,3*	↗
6:	7,8	←
7:	10,3*	↗
8:	9,4	←
9:	10,5*	→
10:	10,0	→
Serie:		97,9
Summa:		373,0

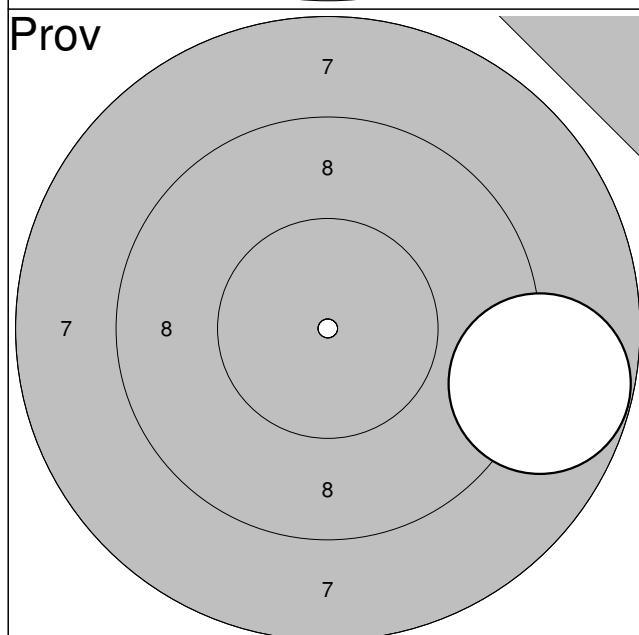

11:	8,8	→
Serie:		8,8
Summa:		373,0

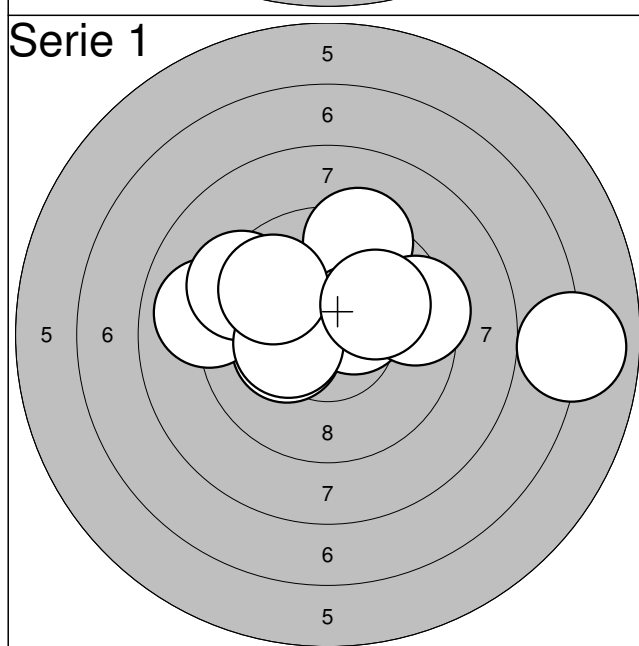

1:	9,4	↑
2:	10,3*	←
3:	9,0	←
4:	10,5*	↗
5:	9,3	↖
6:	9,5	→
7:	10,3*	←
8:	7,0	→
9:	9,8	↗
10:	10,0	↗
Serie:		95,1
Summa:		468,1

Prov

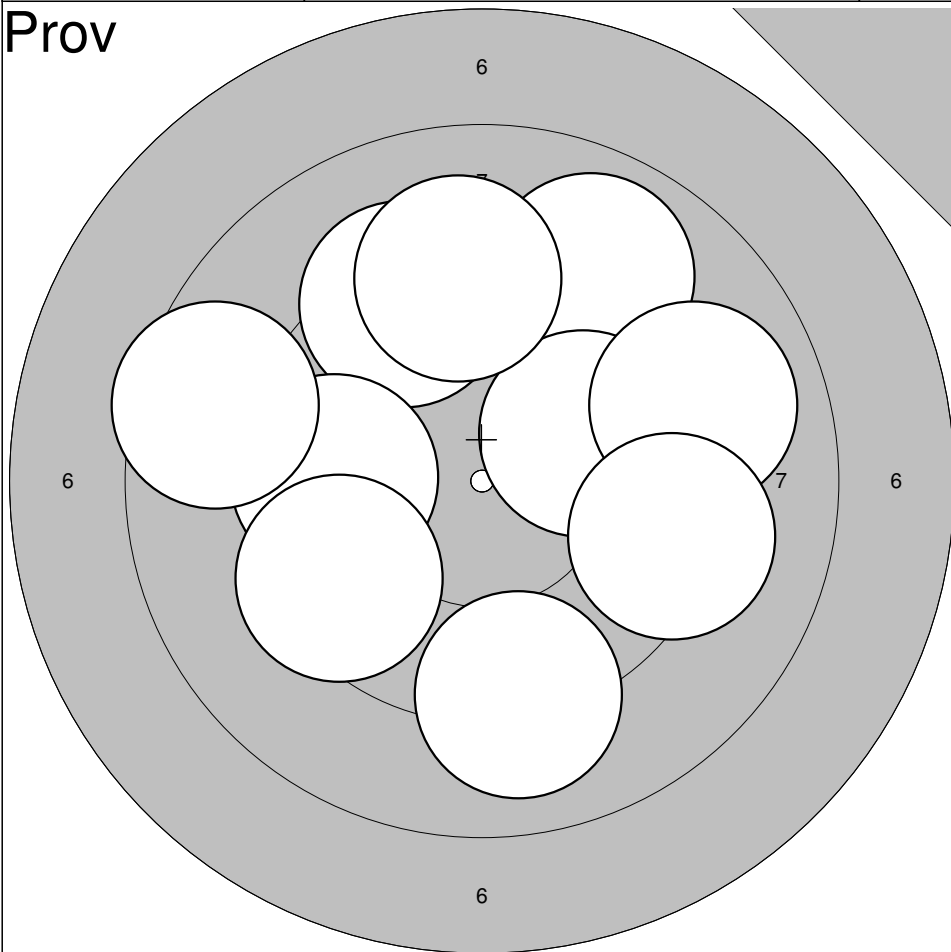

1: 8,9	↗
2: 9,3	↖
3: 9,7	←
4: 10,0	↗
5: 9,0	↗
6: 9,2	↑
7: 9,2	→
8: 8,5	↖
9: 9,1	↓
10: 9,5	↙

Serie: 92,4

Summa: 371,0

Serie 1

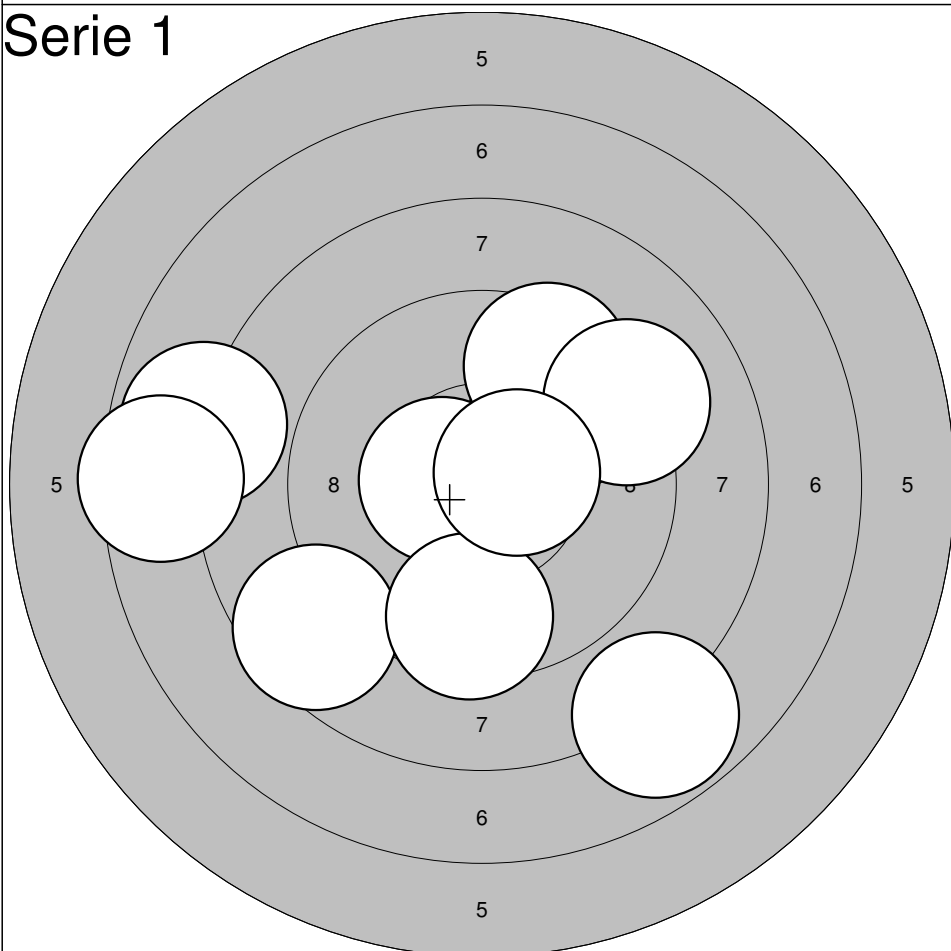

1: 9,9	↗
2: 8,6	↖
3: 10,5*	←
4: 9,5	↗
5: 9,5	↓
6: 7,9	↖
7: 9,2	↗
8: 10,6*	→
9: 7,5	↖
10: 7,8	↘

Serie: 91,0

Summa: 462,0

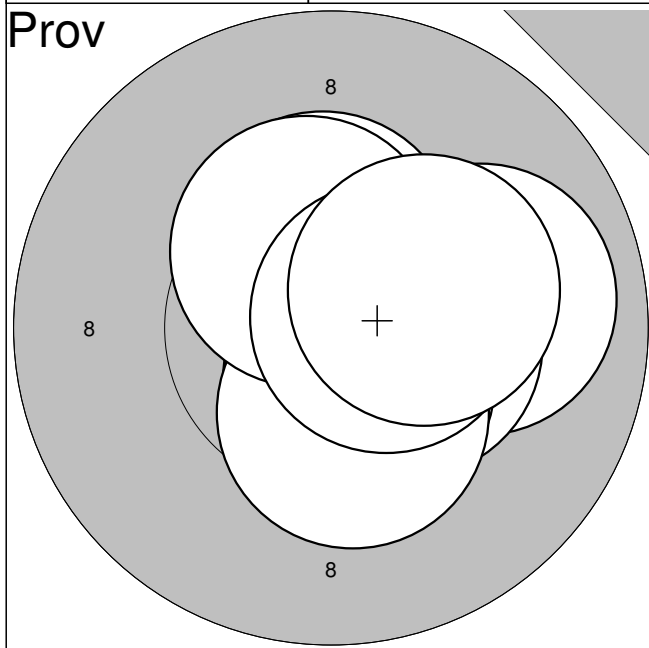

1:	9,9	→
2:	10,5*	↘
3:	10,4*	→
4:	10,6*	↘
5:	10,7*	↗
6:	10,4*	↑
7:	10,4*	↘
8:	10,4*	↑
9:	10,6*	→
10:	10,3*	→

Serie:	104,2
---------------	--------------

Summa:	421,9
---------------	--------------

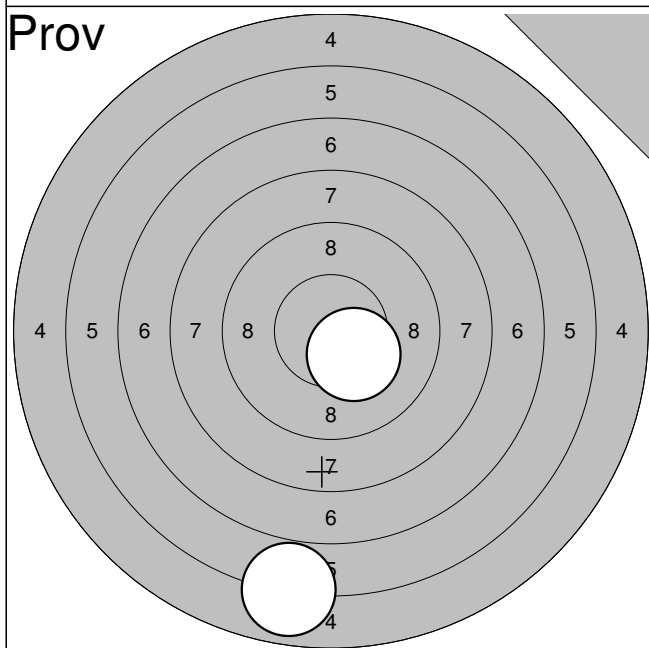

11:	10,3*	↘
12:	5,9	↘

Serie:	16,2
---------------	-------------

Summa:	421,9
---------------	--------------

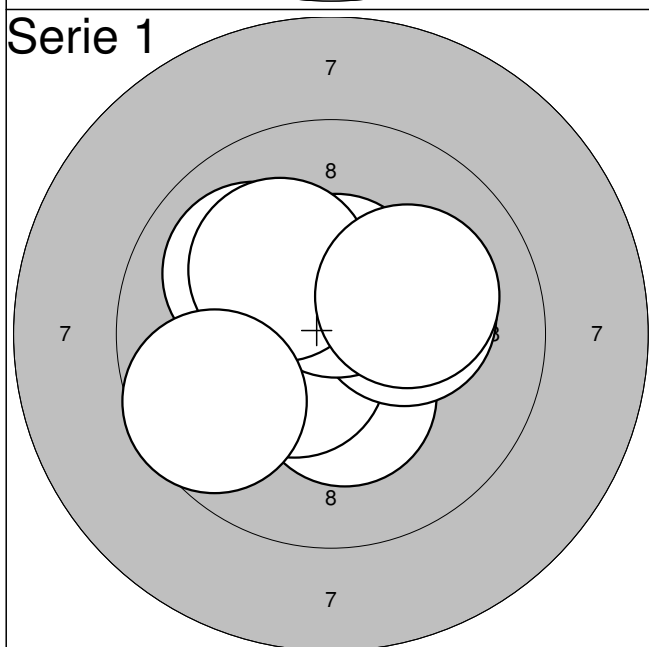

1:	10,7*	↖
2:	10,0	↗
3:	10,6*	↘
4:	10,3*	↘
5:	10,5*	↘
6:	10,2*	→
7:	10,5*	↑
8:	10,2*	↗
9:	10,1	→
10:	9,6	↖

Serie:	102,7
---------------	--------------

Summa:	524,6
---------------	--------------

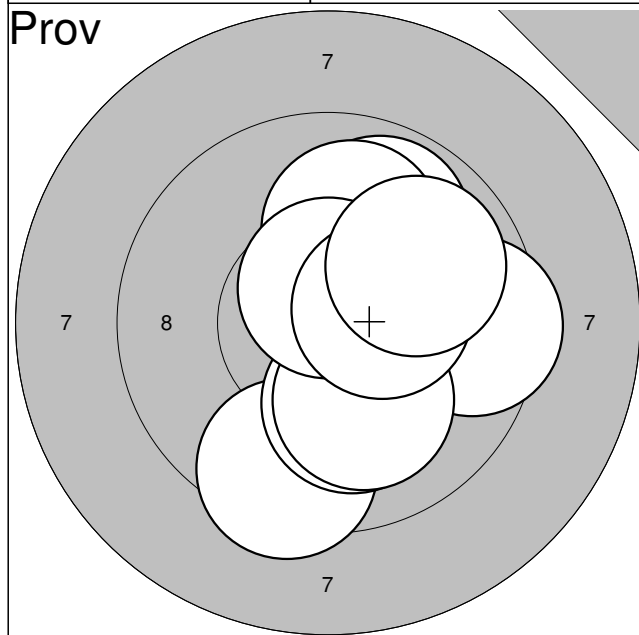

1:	9,4		↓
2:	10,1		↓
3:	9,9		↑
4:	9,5		→
5:	10,1		↓
6:	10,4*		↗
7:	10,0		↑
8:	10,6*		↑
9:	10,4*		→
10:	9,9		↗
Serie:			100,3
Summa:			421,1

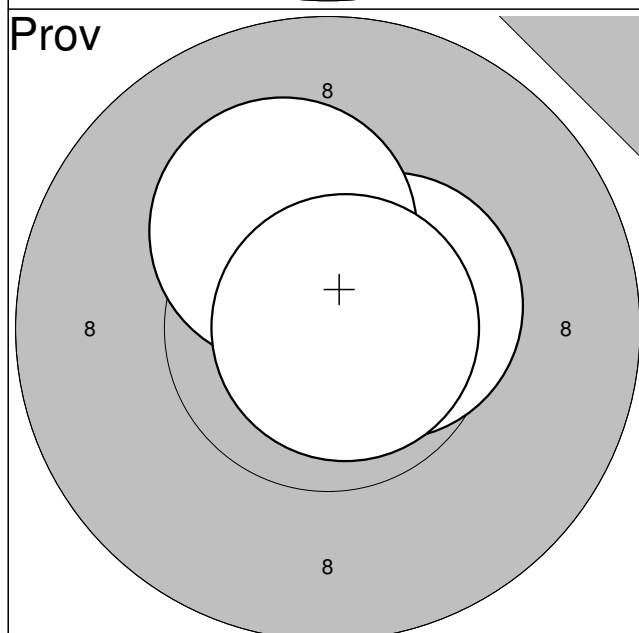

11:	10,5*		↗
12:	10,2*		↑
13:	10,8*		→
Serie:			31,5
Summa:			421,1

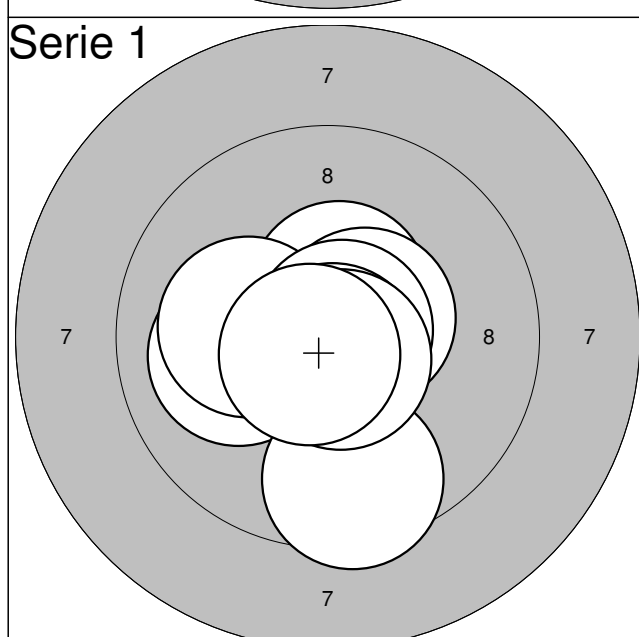

1:	10,5*		↑
2:	10,5*		↗
3:	10,7*		↘
4:	10,1		←
5:	10,2*		←
6:	10,8*		↗
7:	10,8*		↓
8:	9,5		↓
9:	10,7*		↓
10:	10,7*		↘
Serie:			104,5
Summa:			525,6

Prov

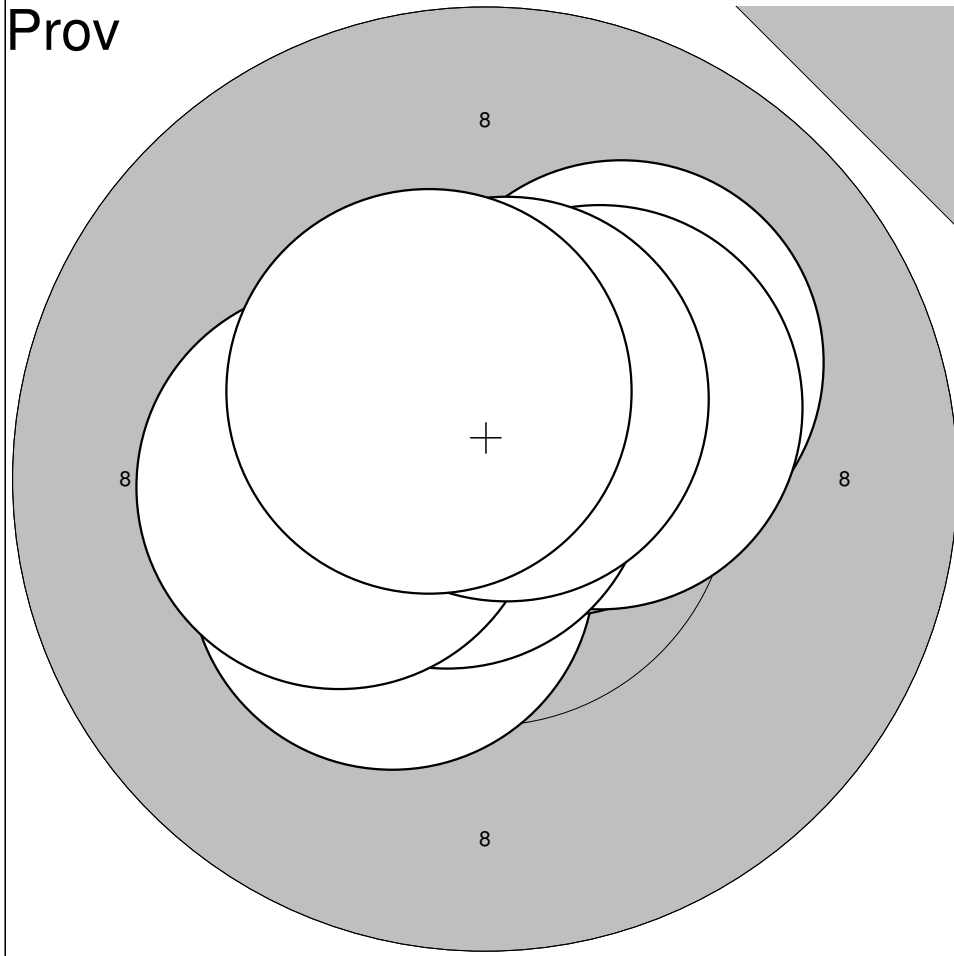

- 1: 10,2* ↗
- 2: 10,4* ↘
- 3: 10,5* ↗
- 4: 10,3* ↗
- 5: 10,8* ↙
- 6: 10,3* ←
- 7: 10,6* ↑
- 8: 10,5* ↖

Serie:	83,6
Summa:	420,8

Serie 1

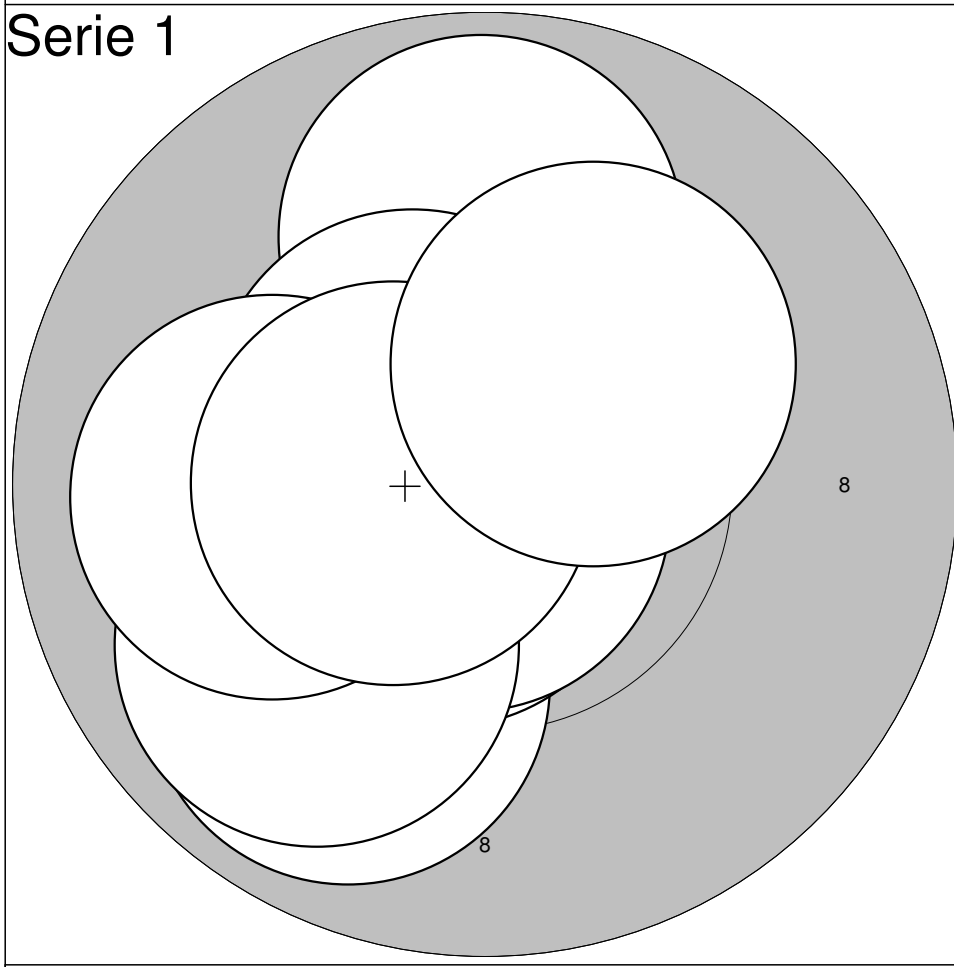

- 1: 9,9 ↑
- 2: 9,9 ↘
- 3: 10,7* ↘
- 4: 10,2* ←
- 5: 10,8* ↘
- 6: 9,9 ↘
- 7: 10,5* ↖
- 8: 10,0 ←
- 9: 10,5* ←
- 10: 10,2* ↗

Serie:	102,6
Summa:	523,4

Prov

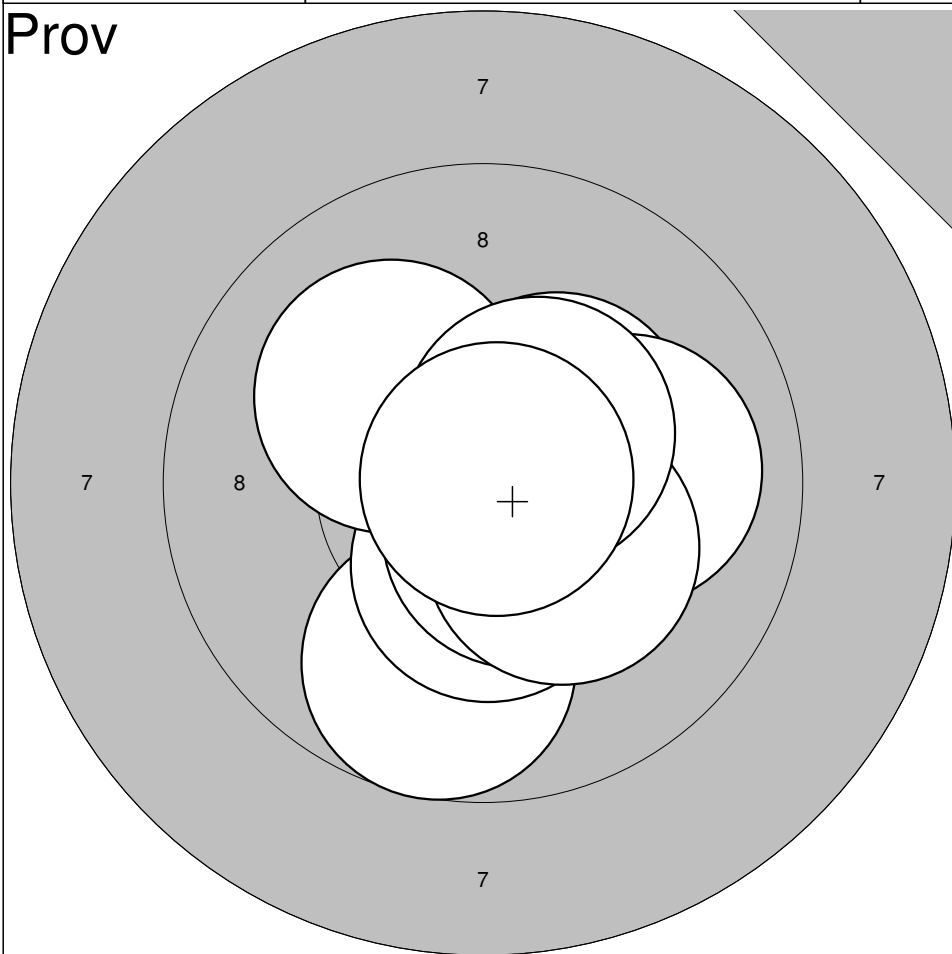

- 1: 9,7 ↓
- 2: 10,4* ↓
- 3: 10,5* ↓
- 4: 10,1 ↗
- 5: 10,4* ↗
- 6: 10,0 →
- 7: 10,3* ↘
- 8: 10,5* ↗
- 9: 10,9* →

Serie: 92,8

Summa: 419,0

Serie 1

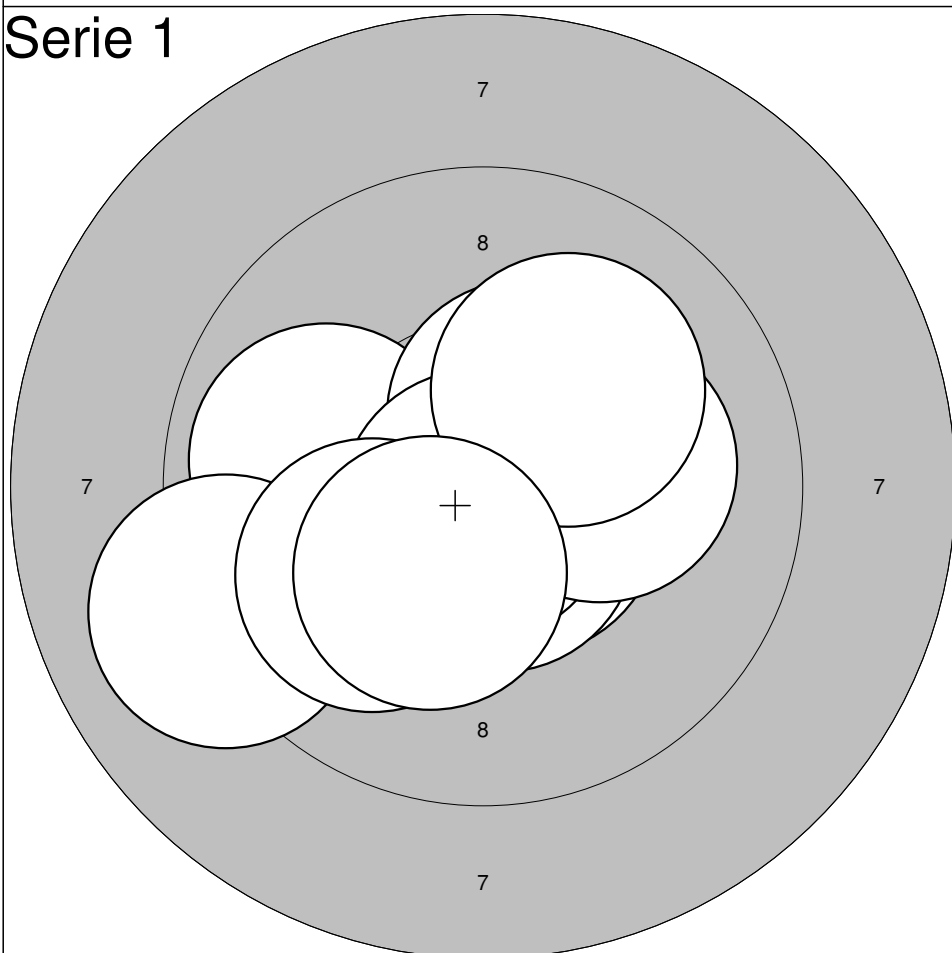

- 1: 9,9 ←
- 2: 10,6* ↘
- 3: 10,4* ↗
- 4: 10,6* ↓
- 5: 10,8* ↓
- 6: 9,1 ←
- 7: 10,2* →
- 8: 10,0 ←
- 9: 10,1 ↗
- 10: 10,3* ↓

Serie: 102,0

Summa: 521,0

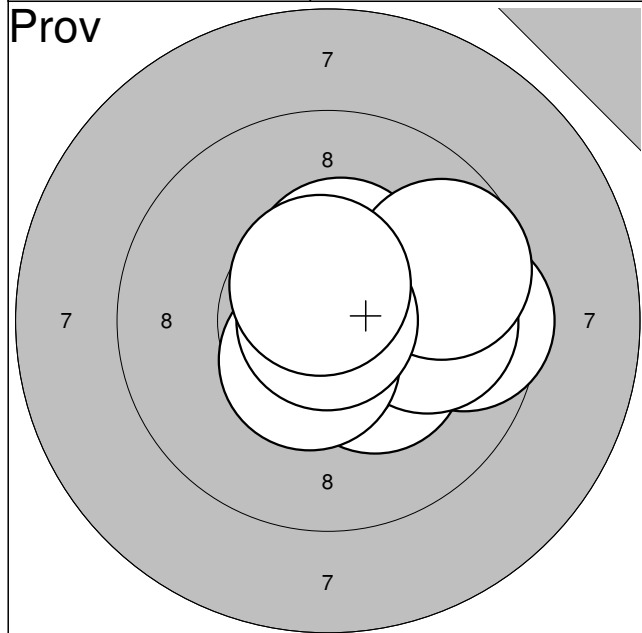

1:	9,6	→
2:	10,6*	↑
3:	10,3*	↘
4:	10,6*	↙
5:	10,4*	↑
6:	10,0	→
7:	9,7	↗
8:	10,5*	↙
9:	10,9*	←
10:	10,6*	↑

Serie:	103,2
---------------	--------------

Summa:	417,8
---------------	--------------

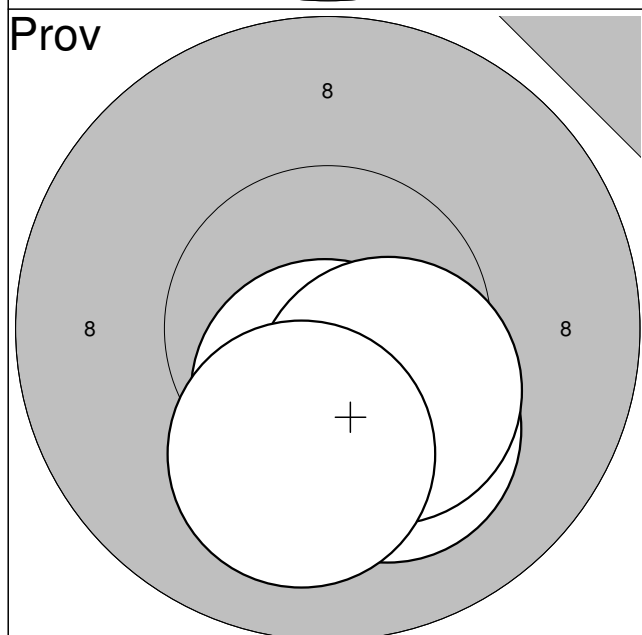

11:	10,2*	↙
12:	10,5*	↙
13:	10,4*	↘
14:	10,1	↙

Serie:	41,2
---------------	-------------

Summa:	417,8
---------------	--------------

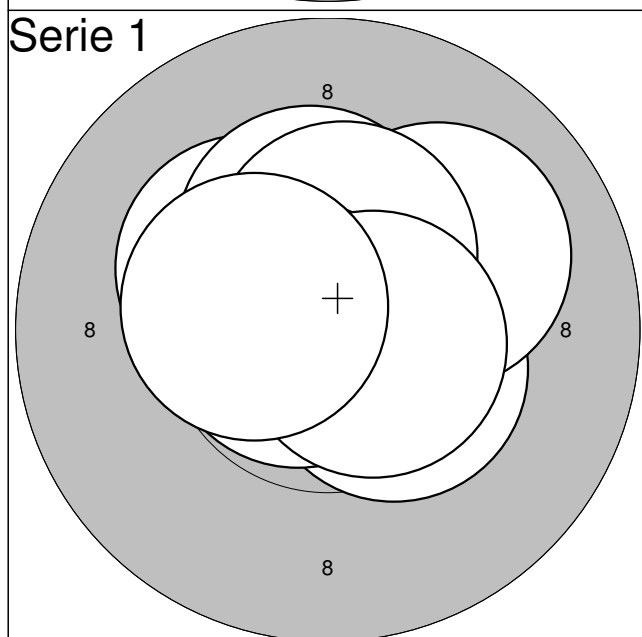

1:	10,4*	↘
2:	10,3*	↗
3:	10,6*	→
4:	10,3*	↑
5:	10,6*	↑
6:	10,1	↗
7:	10,4*	↑
8:	10,7*	←
9:	10,6*	→
10:	10,4*	←

Serie:	104,4
---------------	--------------

Summa:	522,2
---------------	--------------

Prov

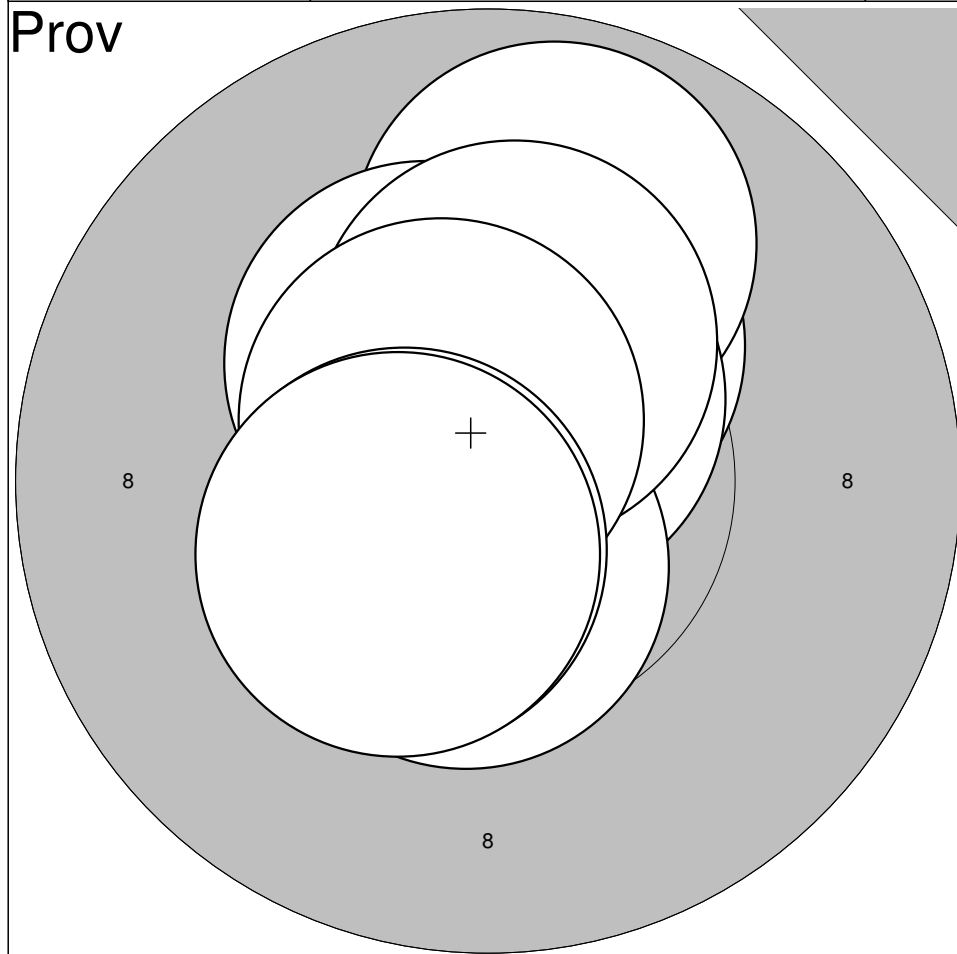

1: 10,6*	↙
2: 10,3*	↗
3: 9,9	↗
4: 10,6*	↗
5: 10,4*	↖
6: 10,6*	↘
7: 10,3*	↗
8: 10,6*	↖
9: 10,5*	↙
10: 10,4*	↙

Serie: 104,2

Summa: 416,4

Serie 1

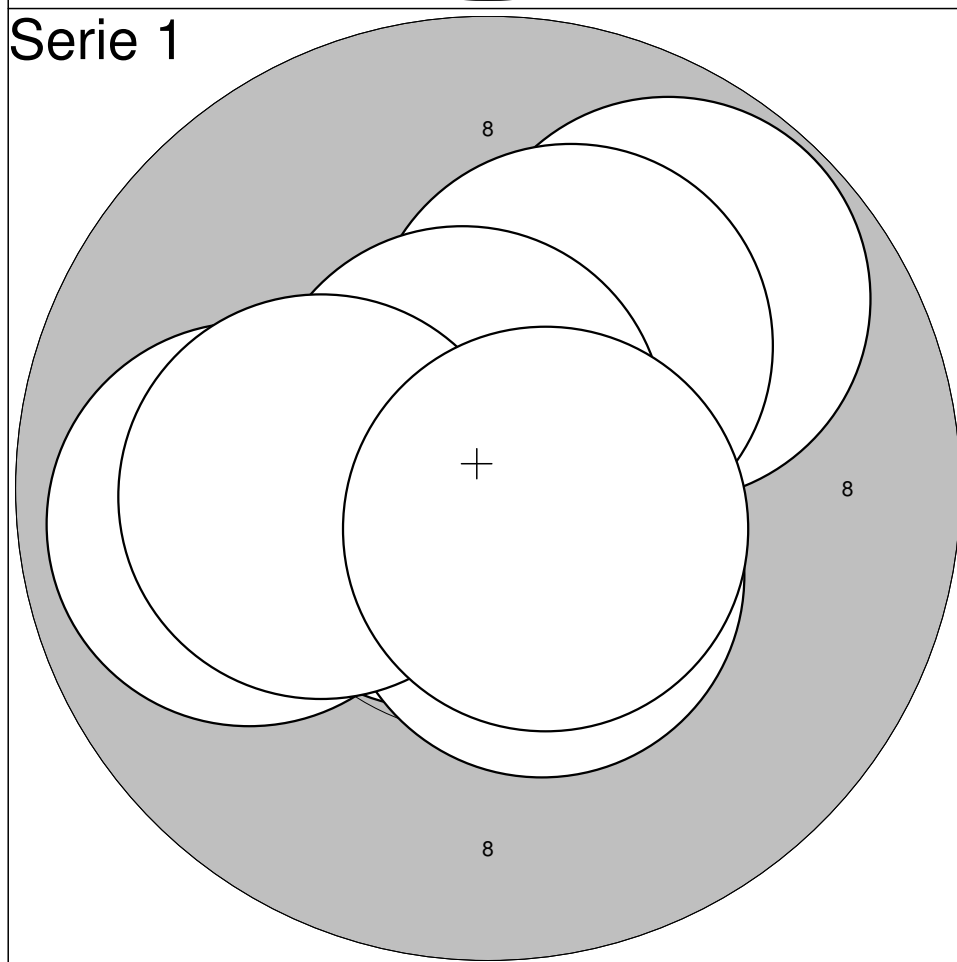

1: 10,7*	↗
2: 9,9	←
3: 9,8	↗
4: 10,9*	→
5: 10,2*	↗
6: 10,7*	←
7: 10,7*	↗
8: 10,5*	↘
9: 10,2*	←
10: 10,6*	↘

Serie: 104,2

Summa: 520,6

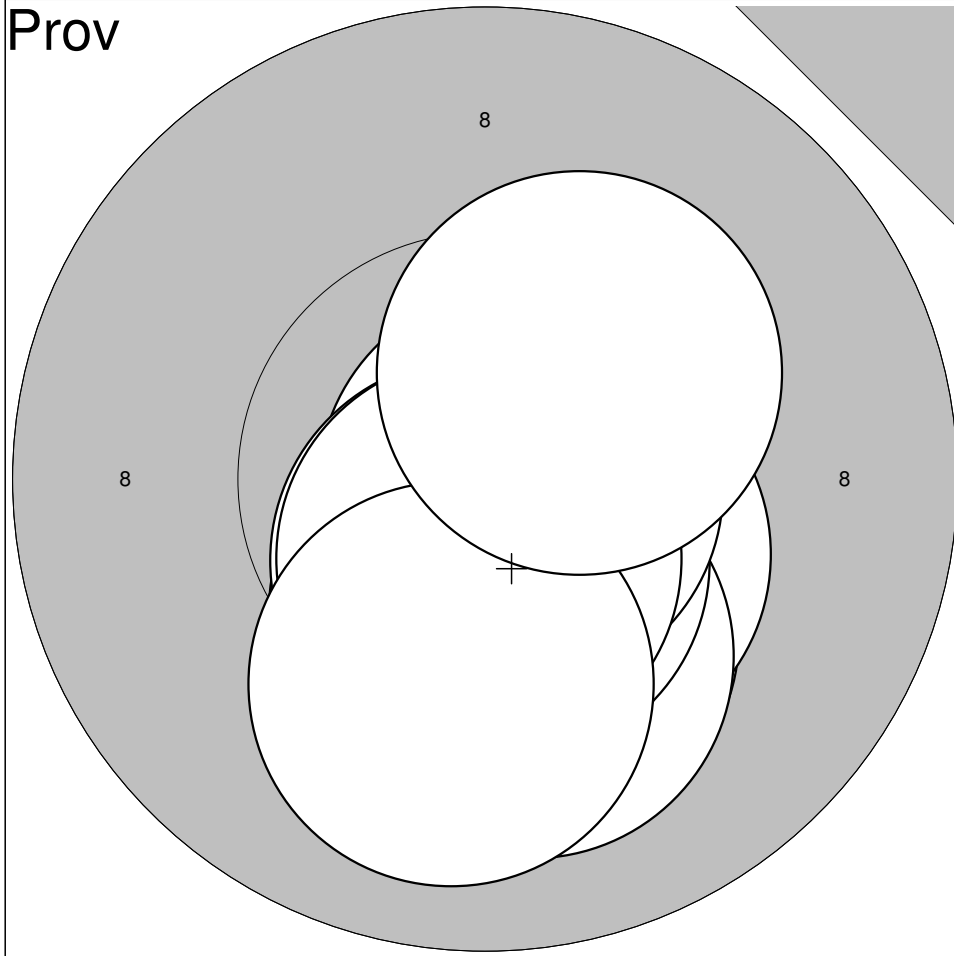

1:	10,2*	↘
2:	10,4*	↘
3:	10,1	↘
4:	10,4*	↘
5:	10,6*	↘
6:	10,8*	→
7:	10,6*	↘
8:	10,6*	↘
9:	10,0	↘
10:	10,3*	↗

Serie: 104,0

Summa: 416,4

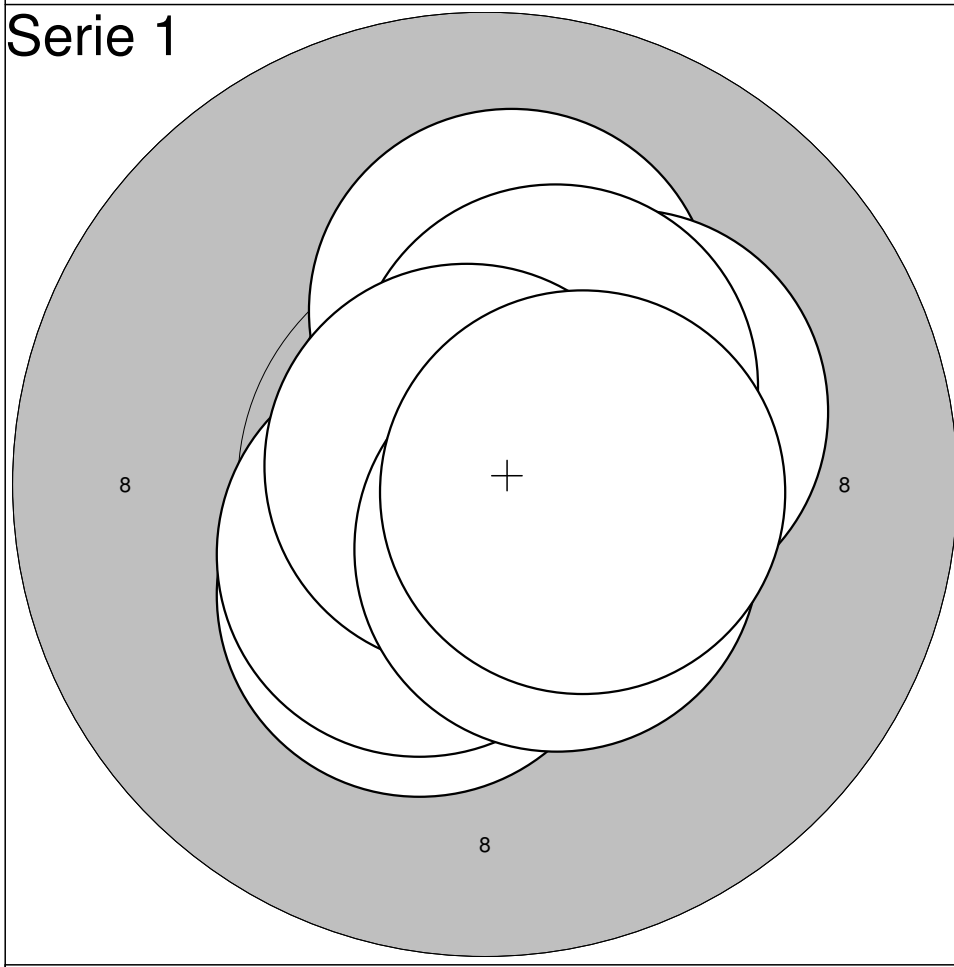

1:	10,6*	↙
2:	10,4*	↙
3:	10,7*	↑
4:	10,2*	↑
5:	10,5*	↙
6:	10,2*	→
7:	10,4*	↗
8:	10,8*	↗
9:	10,5*	↘
10:	10,5*	→

Serie: 104,8

Summa: 521,2

Prov

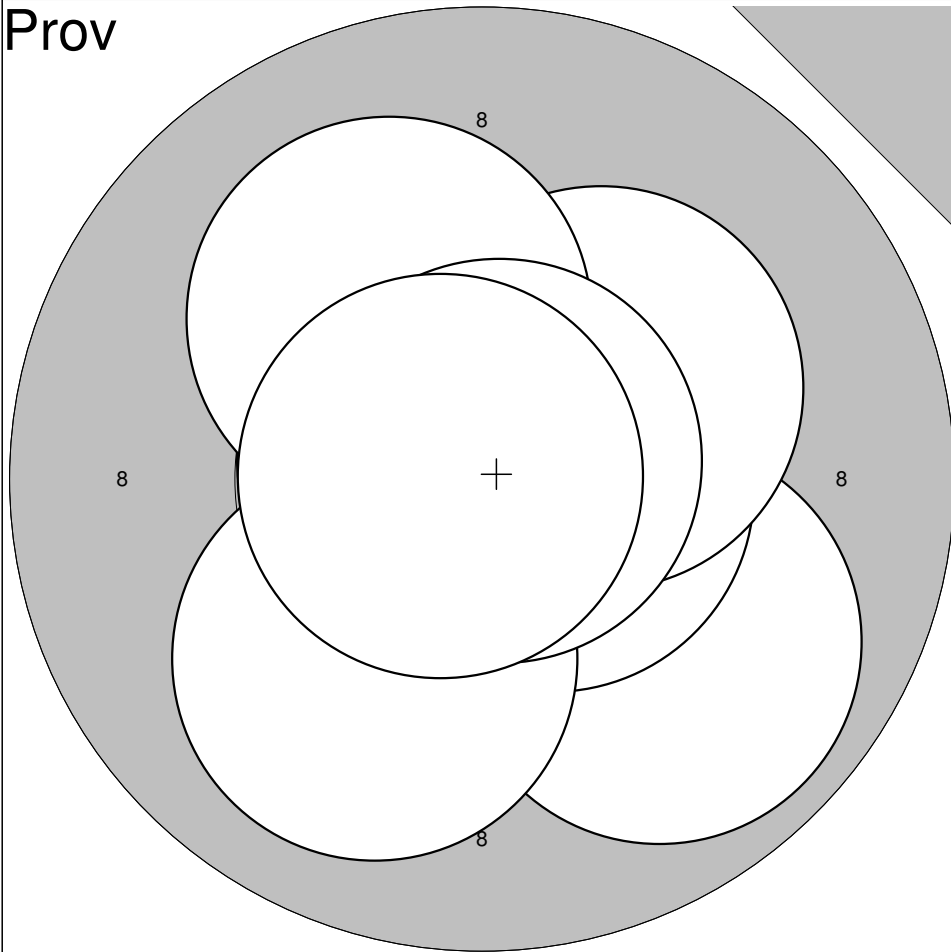

1: 10,5*	↑
2: 10,8*	↗
3: 9,9	↘
4: 10,6*	→
5: 10,7*	↖
6: 10,3*	↗
7: 10,1	↑
8: 10,0	↘
9: 10,8*	↗
10: 10,8*	←

Serie: 104,5

Summa: 414,3

Serie 1

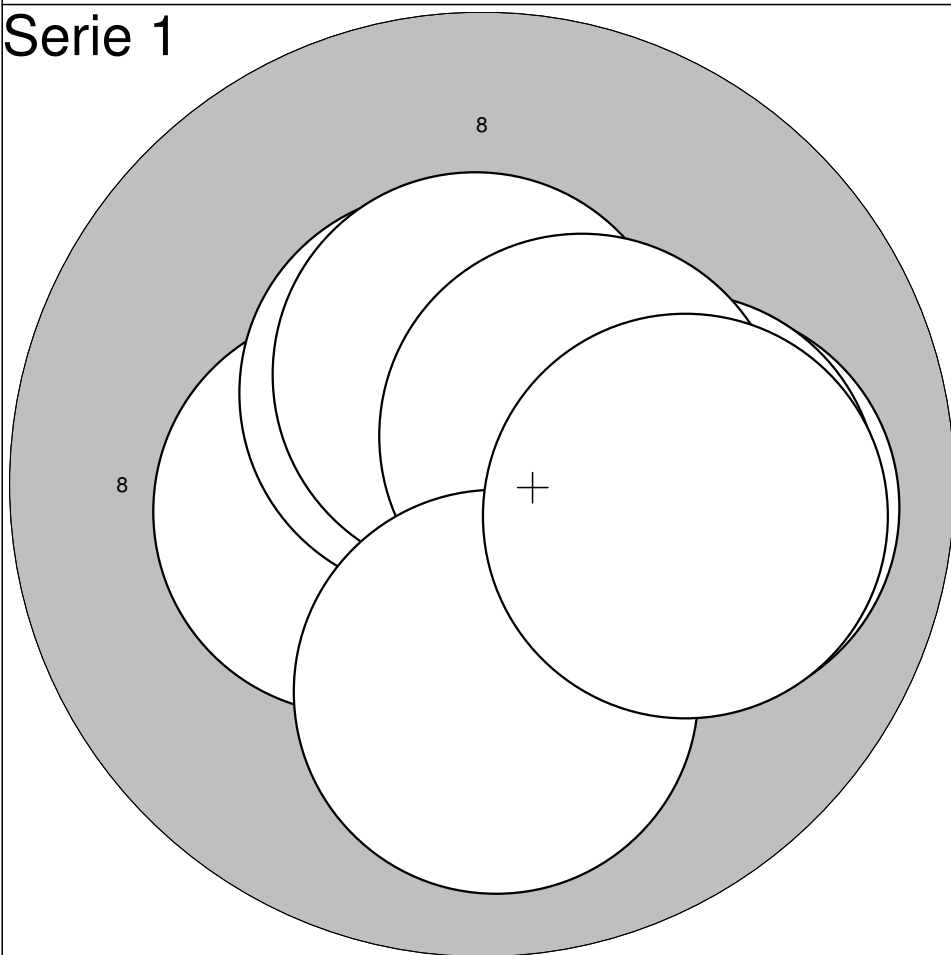

1: 10,6*	↖
2: 10,0	→
3: 10,1	→
4: 10,9*	↘
5: 10,4*	←
6: 10,5*	↑
7: 10,5*	↑
8: 10,5*	↗
9: 10,0	↓
10: 10,0	→

Serie: 103,5

Summa: 517,8

Prov

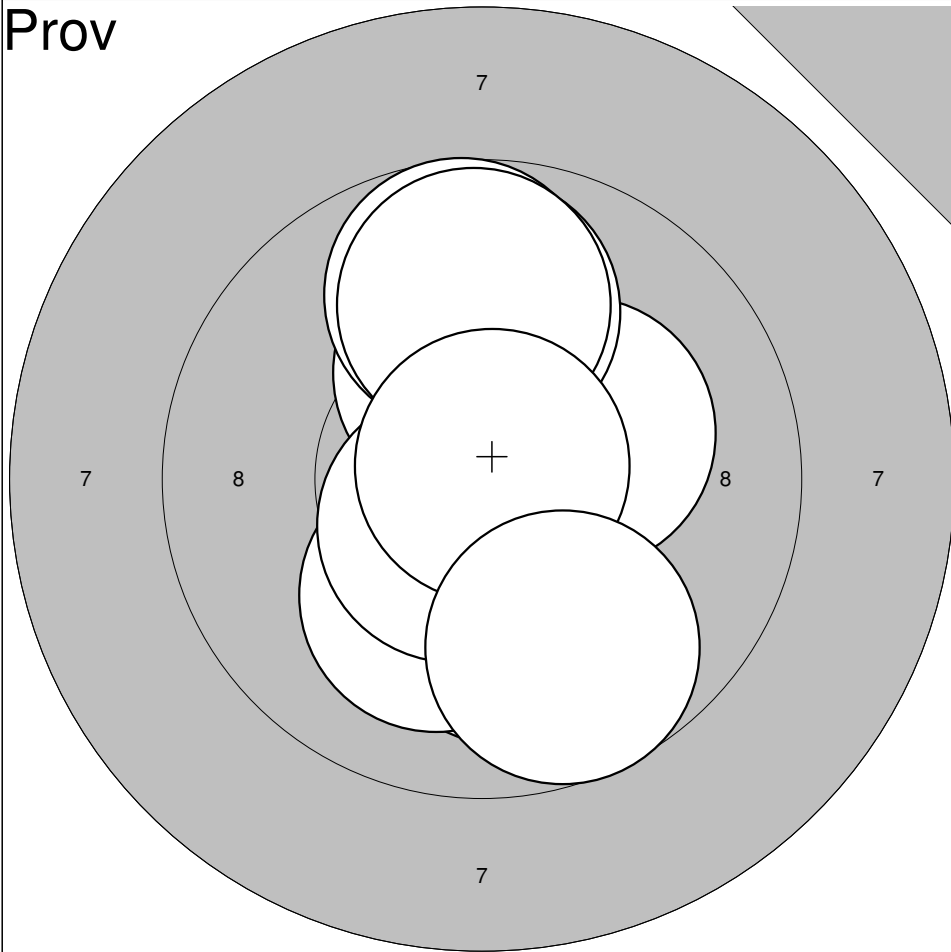

1: 10,3*	↑
2: 9,7	↑
3: 10,2*	↗
4: 9,9	↑
5: 10,1	↓
6: 9,8	↑
7: 10,1	↓
8: 10,6*	↙
9: 10,8*	↗
10: 9,7	↓

Serie: 101,2

Summa: 414,0

Serie 1

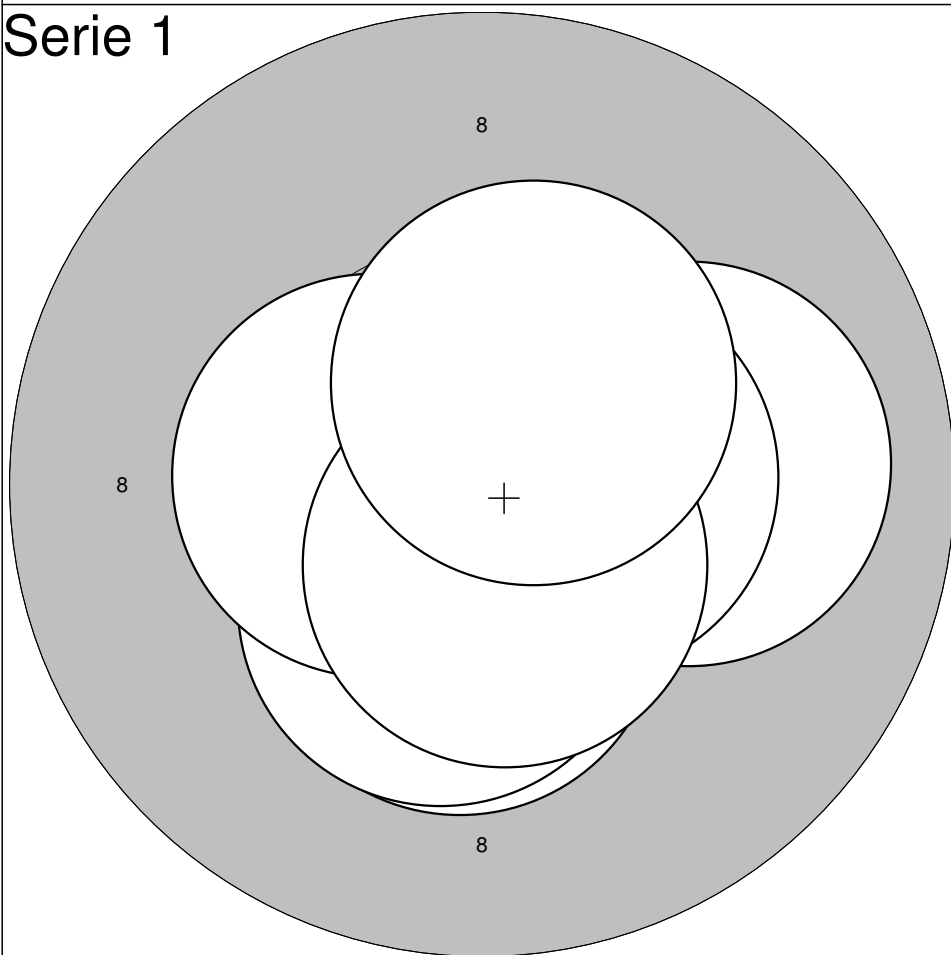

1: 10,4*	↓
2: 10,7*	↗
3: 10,6*	↗
4: 10,0	→
5: 10,5*	→
6: 10,6*	↙
7: 10,4*	↓
8: 10,5*	←
9: 10,6*	↓
10: 10,4*	↗

Serie: 104,7

Summa: 518,7

Lag 1	Tavla 5	Jan Gustafsson	
-----------------	-------------------	-----------------------	--

Västerviks		Veteran
------------	--	---------

06.11.2010	Final SM 2010	Gullabo SKF
------------	---------------	-------------

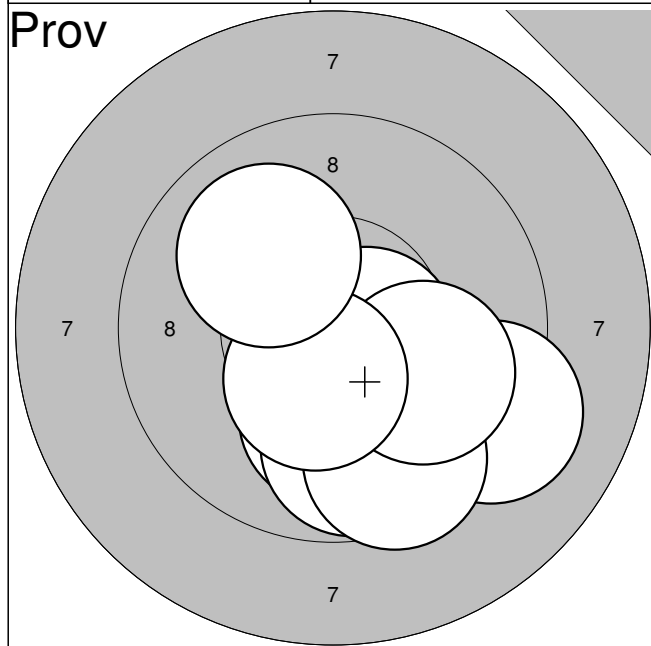

1:	9,2	↘
2:	10,1	↓
3:	9,8	↘
4:	10,3*	↘
5:	9,5	↘
6:	10,6*	↘
7:	10,6*	→
8:	10,0	↘
9:	10,4*	↘
10:	10,0	↗

Serie:	100,5
---------------	--------------

Summa:	419,6
---------------	--------------

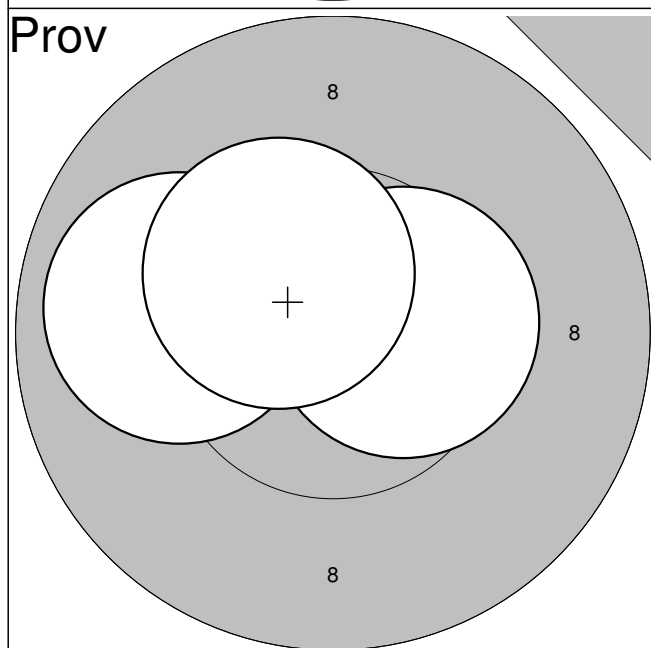

11:	10,5*	→
12:	9,9	←
13:	10,4*	↗

Serie:	30,8
---------------	-------------

Summa:	419,6
---------------	--------------

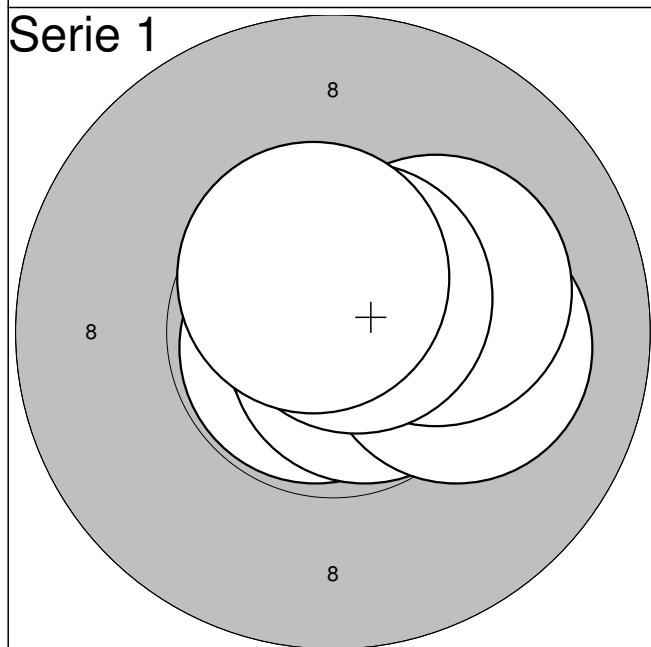

1:	10,4*	→
2:	10,7*	↑
3:	10,8*	↘
4:	10,8*	→
5:	10,7*	→
6:	10,7*	↘
7:	10,1	→
8:	10,2*	→
9:	10,7*	↗
10:	10,6*	↑

Serie:	105,7
---------------	--------------

Summa:	525,3
---------------	--------------

Lag 1	Tavla 6	Gustaf Floderus
-----------------	-------------------	------------------------

	Södra Trögds	Veteran
--	--------------	---------

06.11.2010	Final SM 2010	Gullabo SKF
------------	---------------	-------------

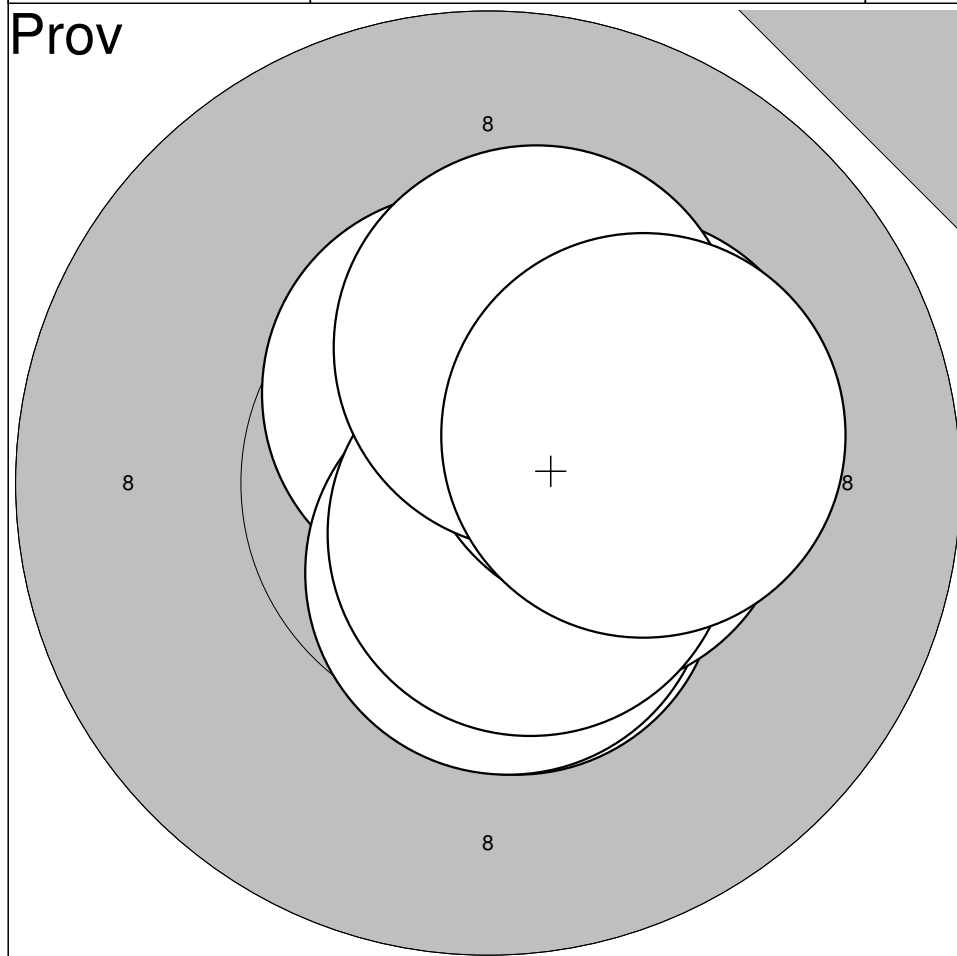

1:10,5*	↓
2:10,5*	↑
3:10,5*	↓
4:10,5*	→
5:10,7*	↘
6:10,3*	↗
7:10,3*	↑
8:10,2*	→

Serie:	83,5
---------------	-------------

Summa:	419,0
---------------	--------------

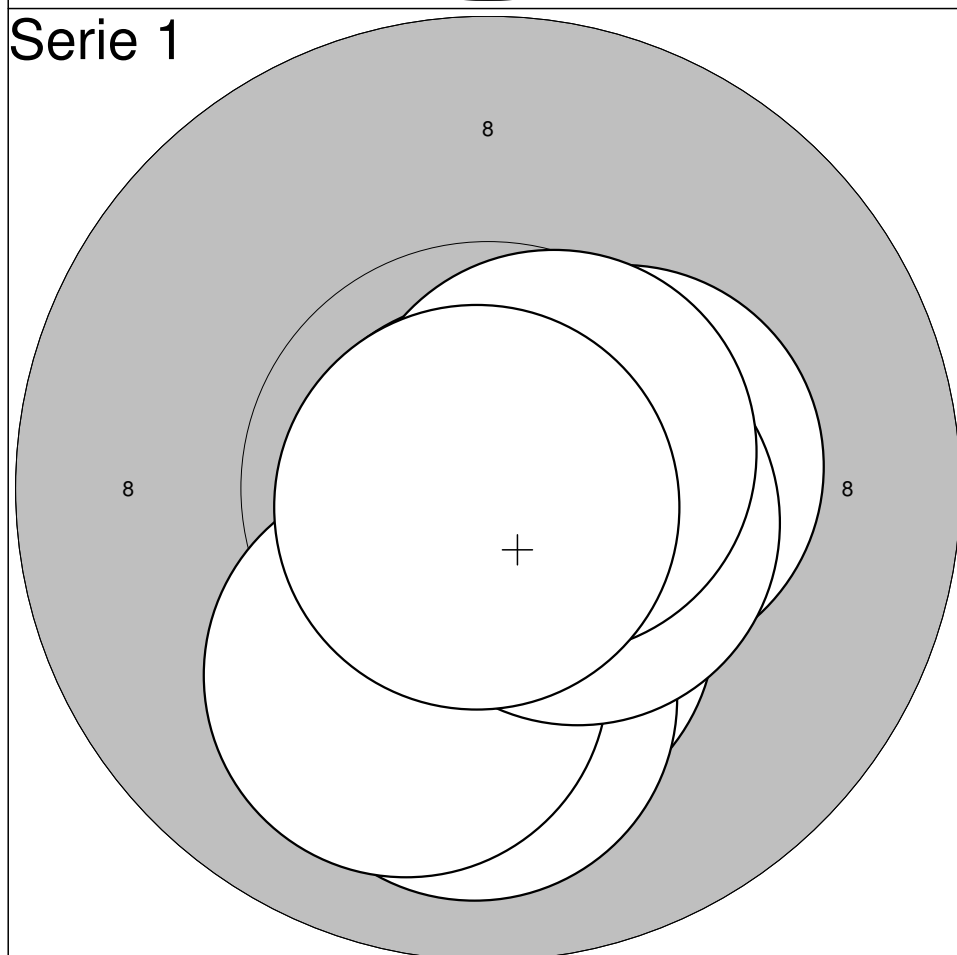

1:10,7*	↓
2:10,3*	↓
3:10,9*	↓
4:10,6*	→
5:10,3*	→
6:10,0	↓
7:10,0	↓
8:10,5*	→
9:10,6*	↗
10:10,9*	↘

Serie:	104,8
---------------	--------------

Summa:	523,8
---------------	--------------

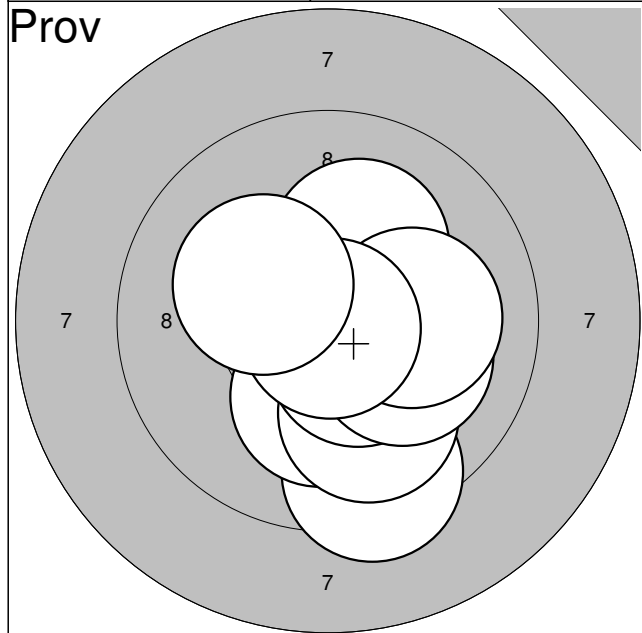

1:	9,4	↓
2:	10,2*	↓
3:	9,9	↓
4:	10,5*	↓
5:	10,4*	↑
6:	10,2*	↑
7:	10,1	→
8:	10,1	→
9:	10,9*	↓
10:	10,2*	↖

Serie:	101,9
Summa:	418,3

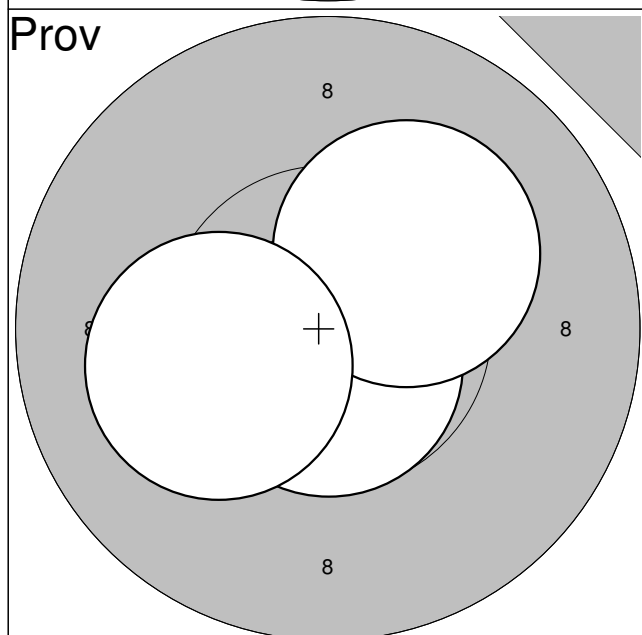

11:	10,7*	↓
12:	10,2*	↗
13:	10,2*	↖

Serie:	31,1
Summa:	418,3

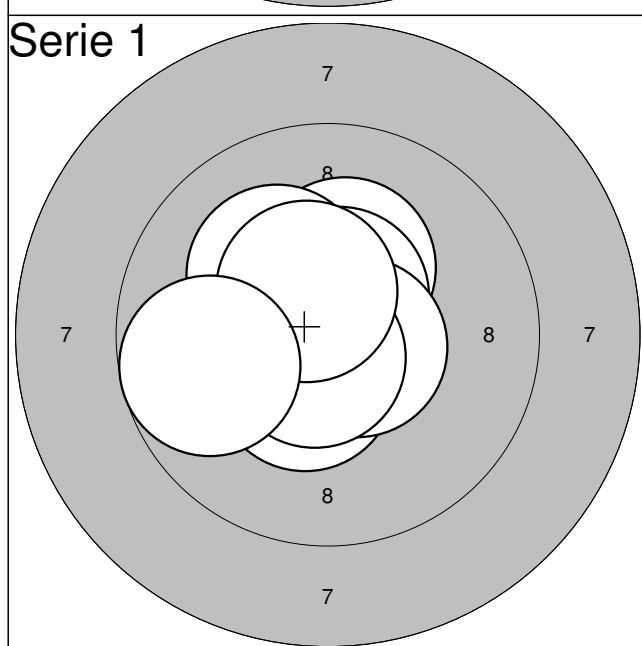

1:	10,3*	↑
2:	10,7*	↓
3:	10,6*	↑
4:	10,4*	↓
5:	10,3*	←
6:	10,6*	→
7:	10,2*	↗
8:	10,7*	↓
9:	10,5*	↑
10:	9,7	←

Serie:	104,0
Summa:	522,3

Lag 1	Tavla 8	Karl-Erik Hansson
-----------------	-------------------	--------------------------

Sörby Odensberg		Veteran
-----------------	--	---------

06.11.2010	Final SM 2010	Gullabo SKF
------------	---------------	-------------

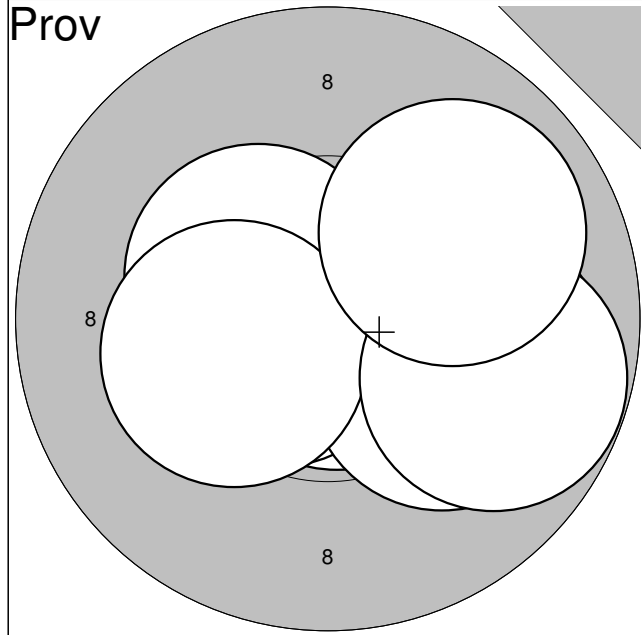

1:	9,8	→
2:	10,8*	↗
3:	10,8*	↓
4:	9,9	→
5:	10,6*	←
6:	10,1	↓
7:	10,4*	↗
8:	10,3*	←
9:	9,8	→
10:	9,9	↗

Serie:	102,4
--------	-------

Summa:	416,9
--------	-------

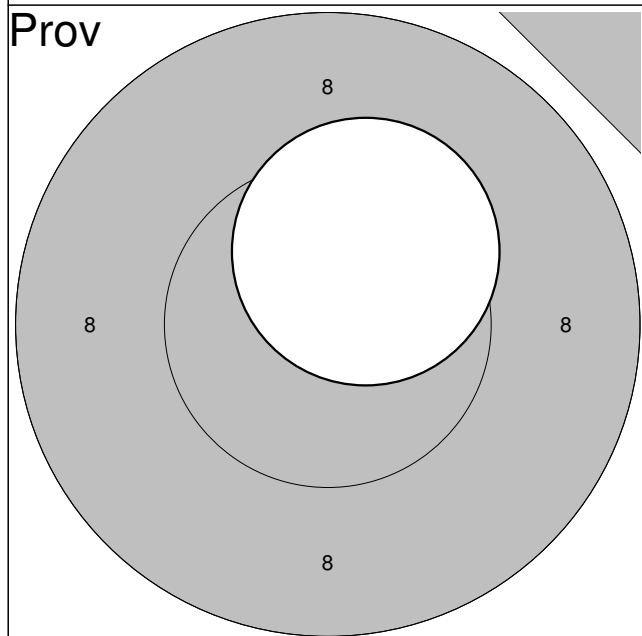

11:	10,4*	↗
-----	-------	---

Serie:	10,4
--------	------

Summa:	416,9
--------	-------

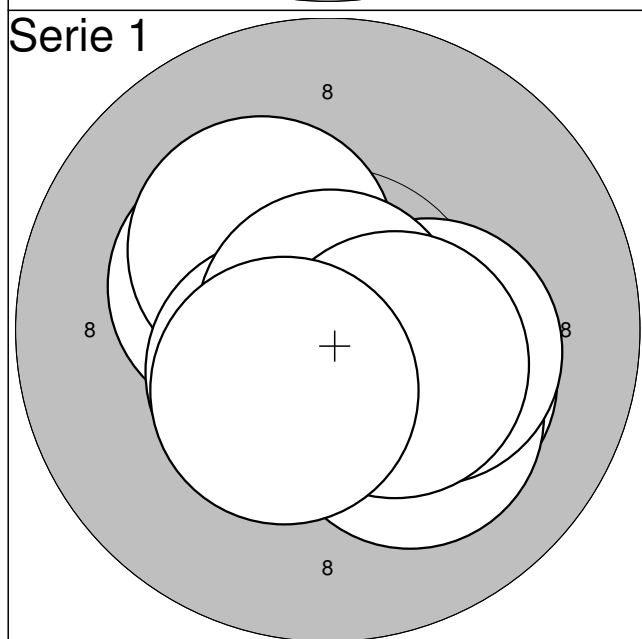

1:	10,3*	↖
2:	10,2*	↓
3:	10,7*	←
4:	10,2*	↓
5:	10,3*	→
6:	10,3*	↗
7:	10,5*	←
8:	10,9*	↗
9:	10,4*	↓
10:	10,4*	↓

Serie:	104,2
--------	-------

Summa:	521,1
--------	-------

SM 2010

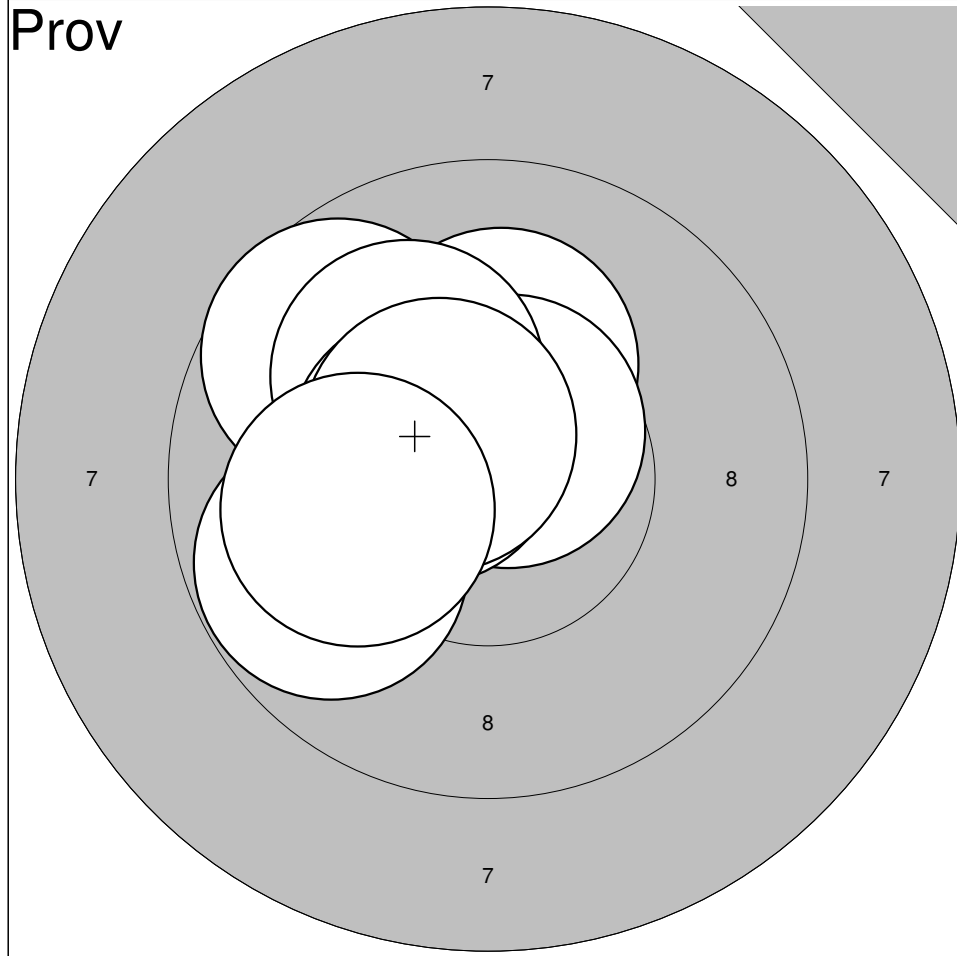

1: 10,2*	↑
2: 9,7	↖
3: 10,6*	↗
4: 10,1	↖
5: 9,8	↙
6: 10,5*	↖
7: 10,5*	↗
8: 10,1	↙

Serie:	81,5
Summa:	416,1

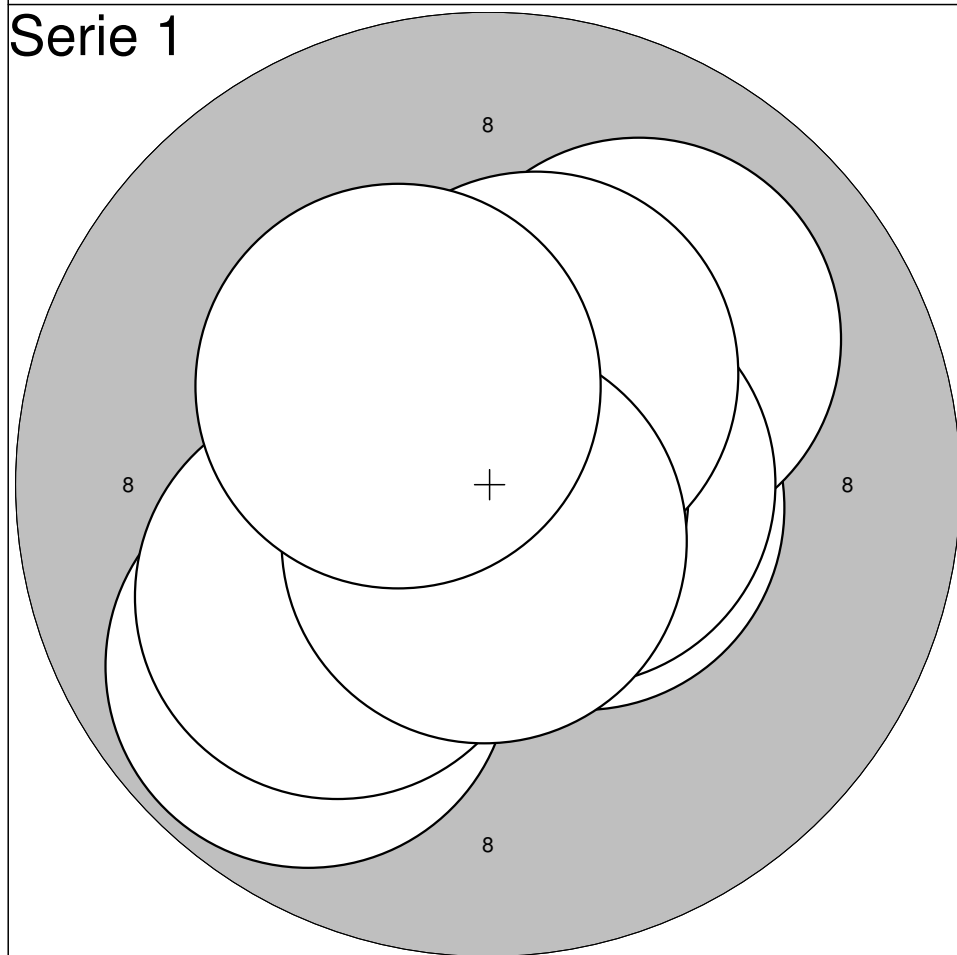

1: 9,8	↙
2: 10,1	↙
3: 10,5*	→
4: 10,0	↗
5: 10,6*	↗
6: 10,6*	→
7: 10,9*	↓
8: 10,4*	↗
9: 10,7*	↓
10: 10,4*	↖

Serie:	104,0
Summa:	520,1

Prov

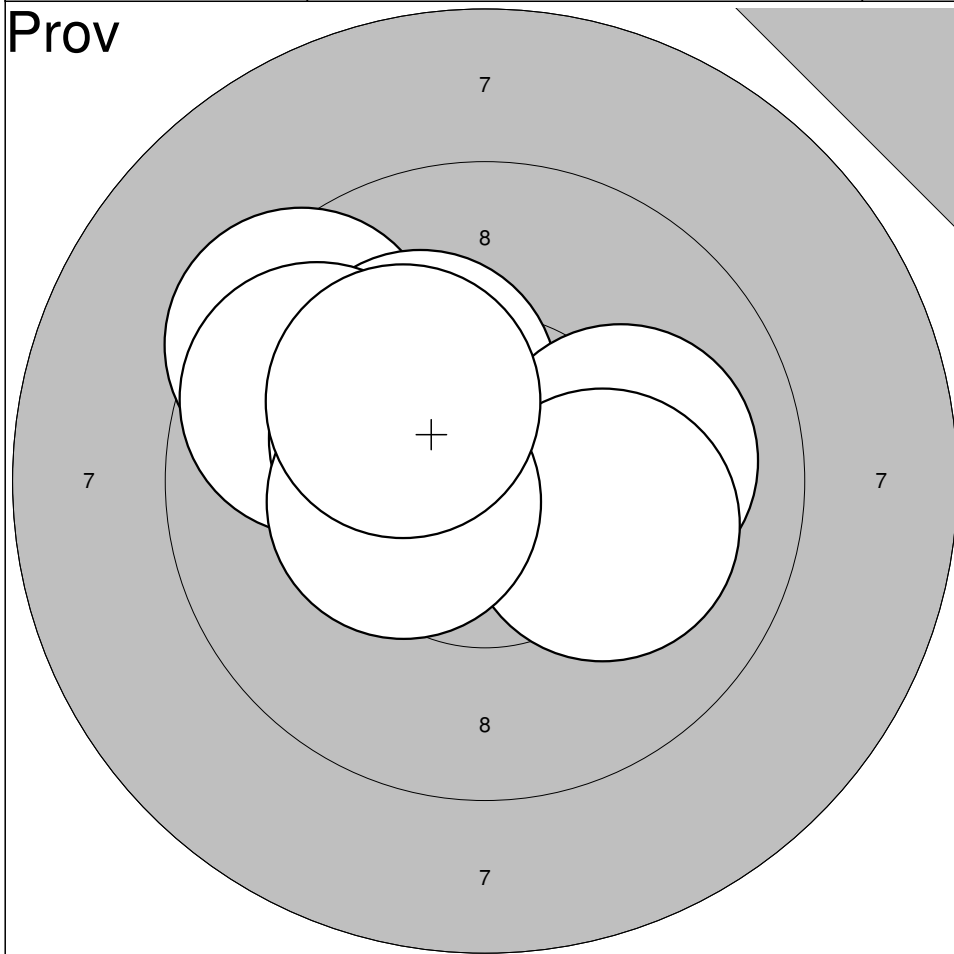

- 1: 9,5 ↗
- 2: 10,2* ↗
- 3: 10,3* ↗
- 4: 9,7 ↗
- 5: 10,4* ↗
- 6: 10,0 →
- 7: 10,1 →
- 8: 10,4* ←
- 9: 10,2* ↗

Serie: 90,8

Summa: 415,7

Serie 1

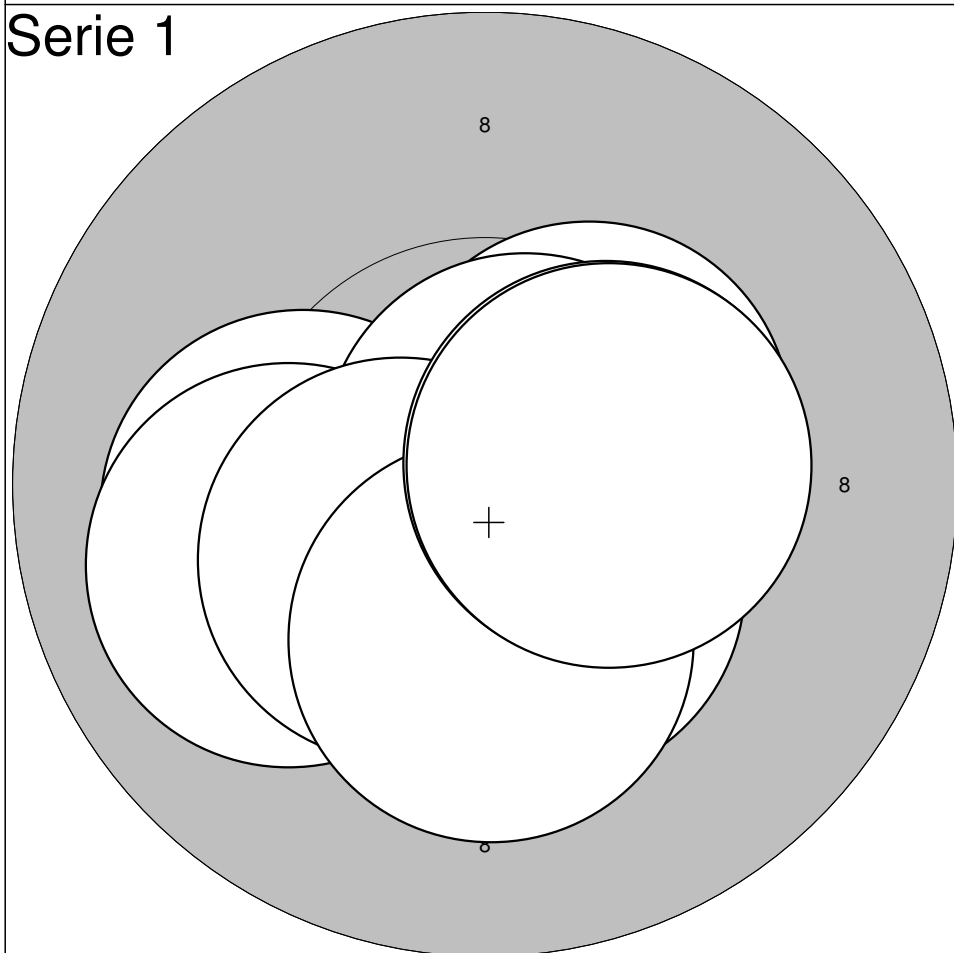

- 1: 10,1 ←
- 2: 10,6* ↓
- 3: 10,4* ↓
- 4: 10,4* ↗
- 5: 10,0 ←
- 6: 10,7* ↗
- 7: 10,4* ←
- 8: 10,3* ↓
- 9: 10,4* →
- 10: 10,4* →

Serie: 103,7

Summa: 519,4

Prov

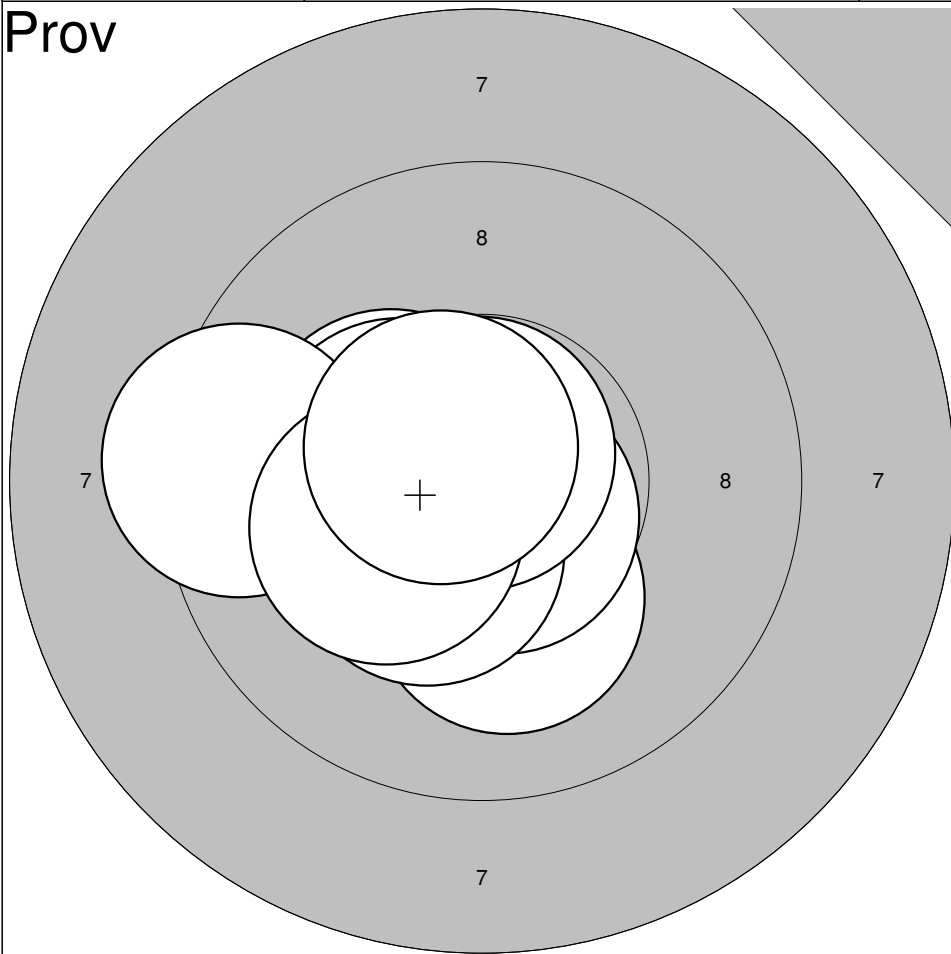

- 1: 10,2* ↓
- 2: 10,7* ↓
- 3: 10,4* ↙
- 4: 10,3* ↖
- 5: 10,8* ↑
- 6: 10,4* ↖
- 7: 9,3 ←
- 8: 10,3* ↙
- 9: 10,6* ↖

Serie: 93,0

Summa: 415,3

Serie 1

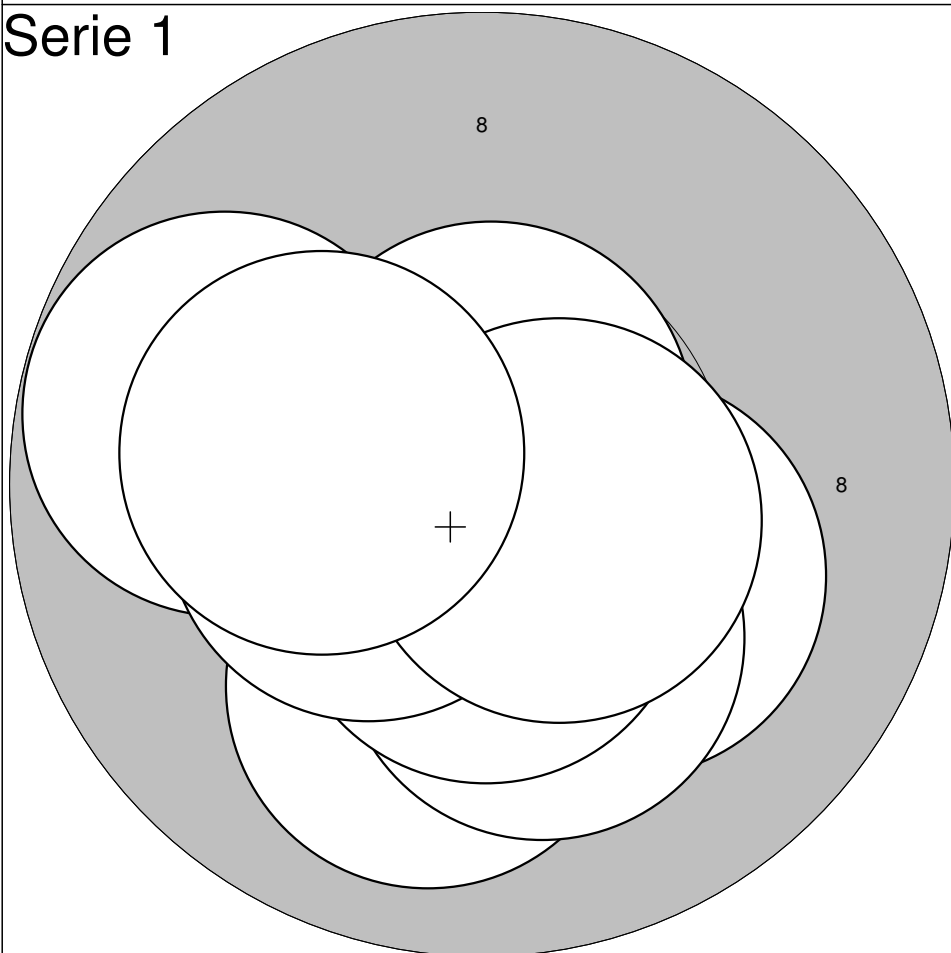

- 1: 10,0 ↓
- 2: 10,2* ↘
- 3: 10,8* ↗
- 4: 10,2* ↓
- 5: 10,5* ↓
- 6: 9,8 ↖
- 7: 10,4* ←
- 8: 10,7* ↑
- 9: 10,6* ↘
- 10: 10,2* ←

Serie: 103,4

Summa: 518,7

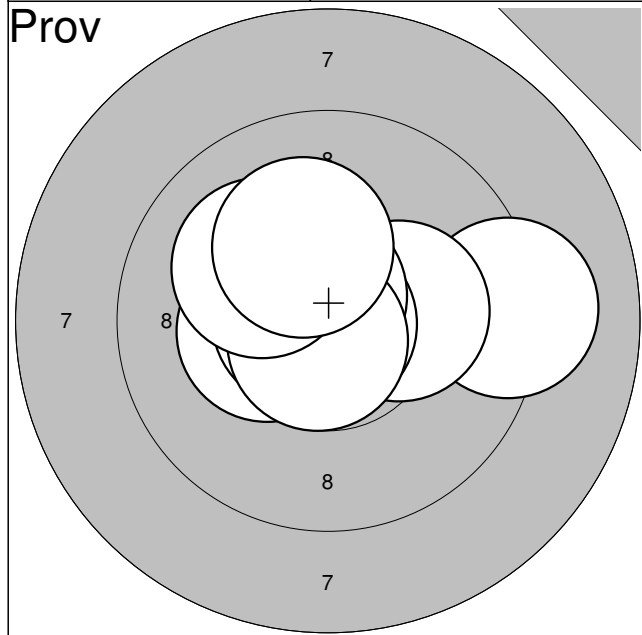

1:	10,3*	↗
2:	9,2	→
3:	10,2*	→
4:	10,3*	←
5:	10,7*	←
6:	10,9*	↓
7:	10,7*	↑
8:	10,7*	↓
9:	10,1	↗
10:	10,2*	↑
Serie:		103,3
Summa:		415,2

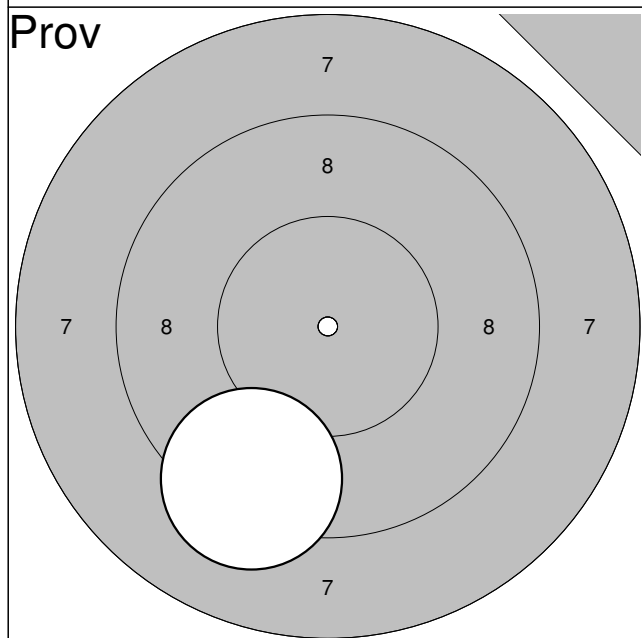

11:	9,3	↓
Serie:		9,3
Summa:		415,2

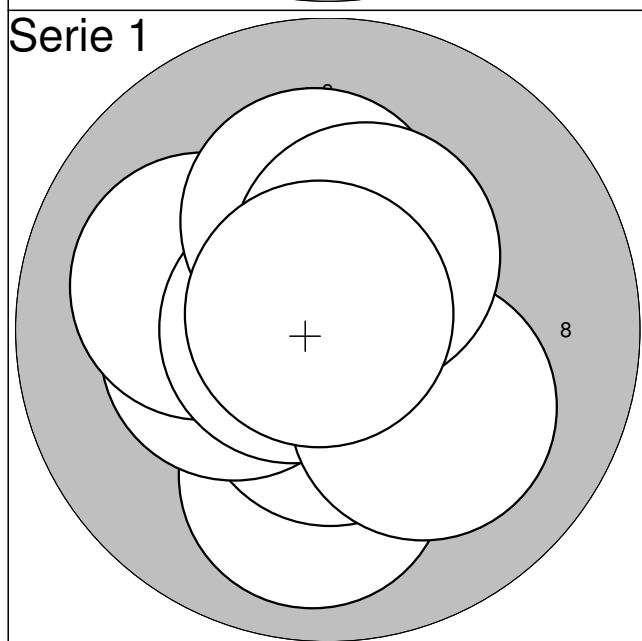

1:	10,4*	←
2:	10,0	↓
3:	10,5*	↓
4:	10,3*	←
5:	10,1	←
6:	10,7*	←
7:	10,1	↘
8:	10,2*	↑
9:	10,4*	↗
10:	10,8*	↗
Serie:		103,5
Summa:		518,7

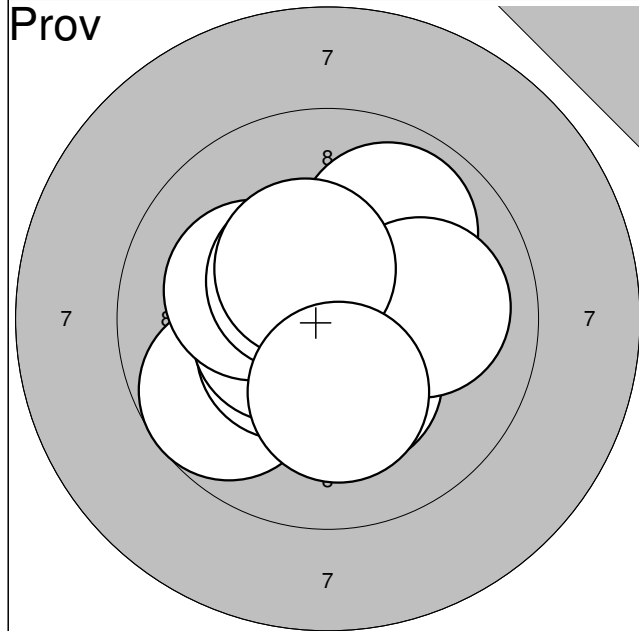

1:	10,3*	↓
2:	9,7	↙
3:	10,4*	↙
4:	10,5*	↙
5:	10,2*	↙
6:	10,5*	↗
7:	9,9	↗
8:	10,0	→
9:	10,4*	↗
10:	10,2*	↓

Serie:	102,1
---------------	--------------

Summa:	415,1
---------------	--------------

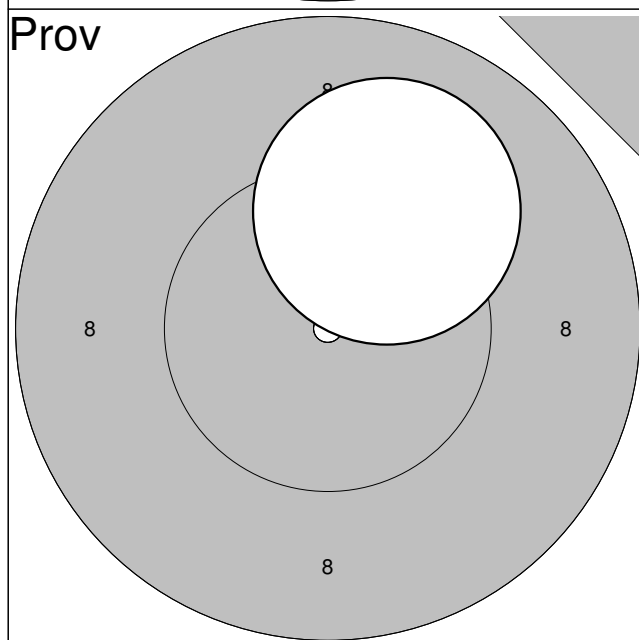

11:	10,1	↗
-----	------	---

Serie:	10,1
---------------	-------------

Summa:	415,1
---------------	--------------

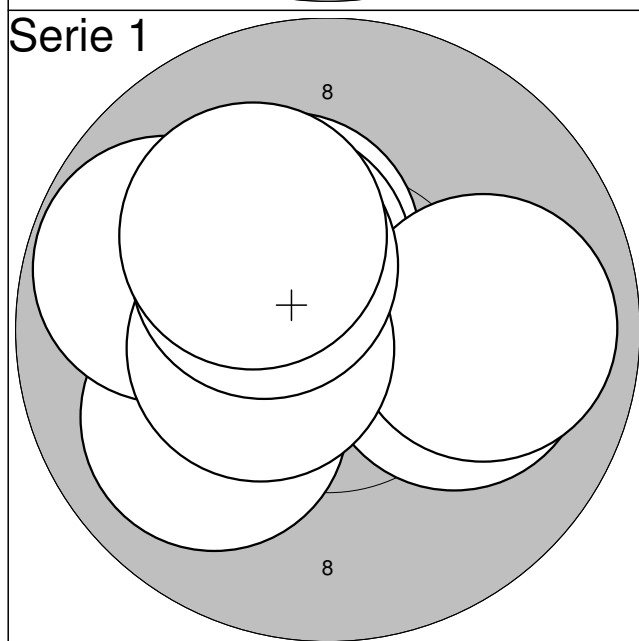

1:	10,1	→
2:	10,3*	↗
3:	10,4*	↗
4:	10,4*	↙
5:	9,9	→
6:	10,0	↙
7:	9,8	↙
8:	10,5*	↙
9:	10,3*	↗
10:	10,1	↗

Serie:	101,8
---------------	--------------

Summa:	516,9
---------------	--------------

Prov

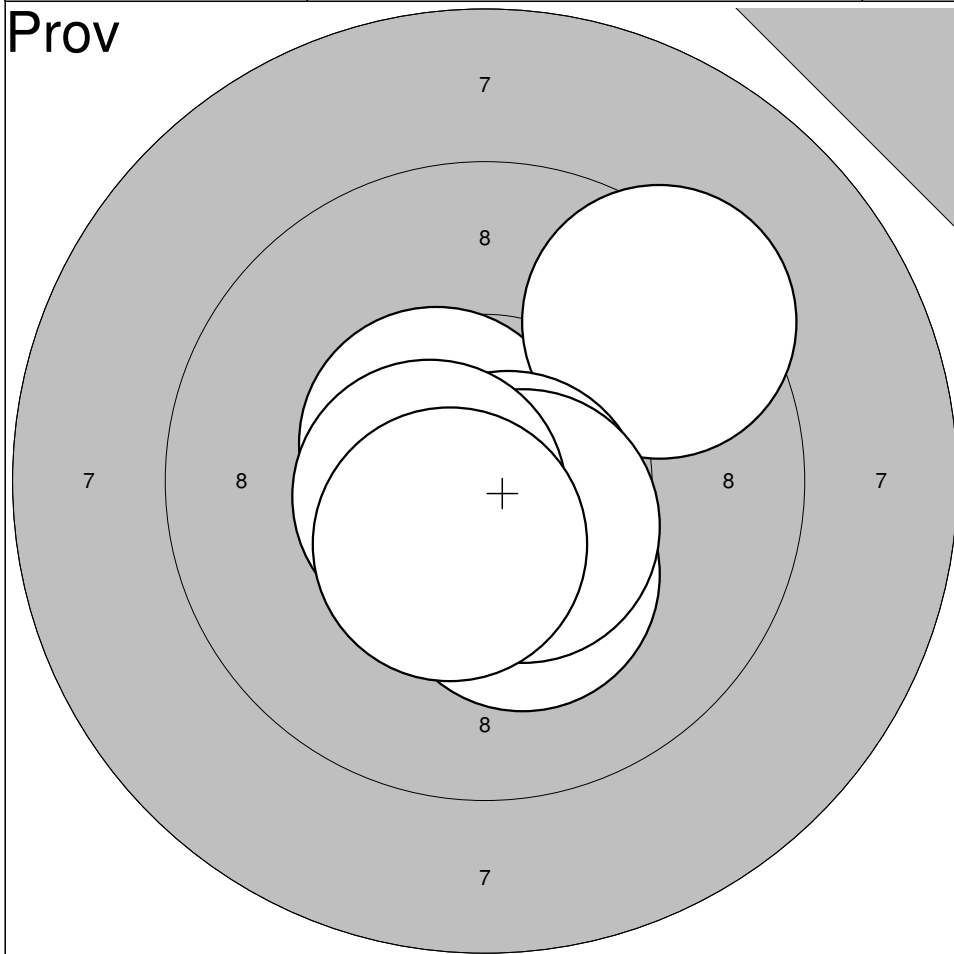

- 1: 10,5* ↗
- 2: 9,4 ↗
- 3: 10,6* ↓
- 4: 10,7* ↘
- 5: 10,3* ↘
- 6: 10,6* ↘
- 7: 10,6* ←
- 8: 10,5* ↘

Serie: 83,2

Summa: 414,7

Serie 1

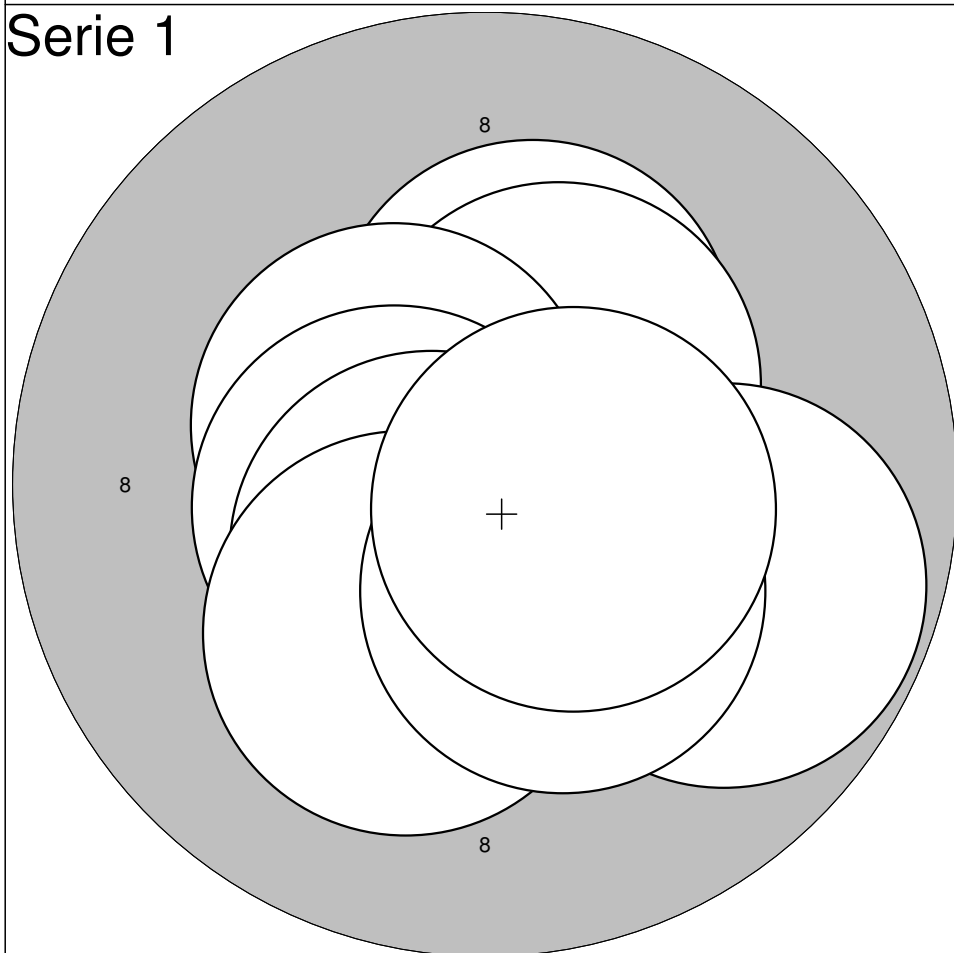

- 1: 10,3* ↑
- 2: 10,4* ↗
- 3: 10,4* ↓
- 4: 10,5* ↗
- 5: 9,8 →
- 6: 10,5* ←
- 7: 10,6* ↘
- 8: 10,2* ↘
- 9: 10,4* ↘
- 10: 10,5* →

Serie: 103,6

Summa: 518,3