

Umeå

2011-08-14

Förbundsmästerskap 2011

Ramselefors SKF

Provskott

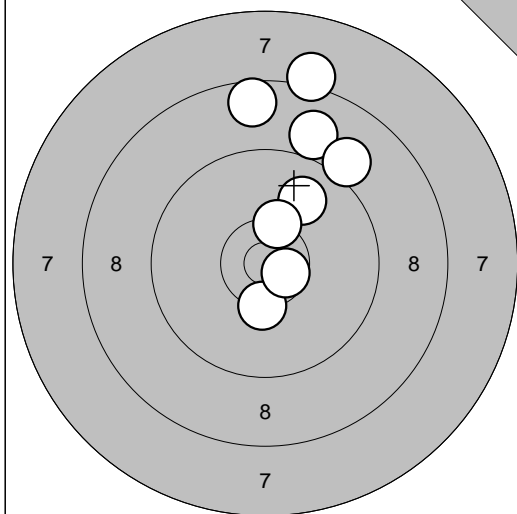

1: 9,0 ↗
 2: 8,2 ↗
 3: 8,6 ↗
 4: 9,1 ↗
 5: 9,9 ↗
 6: 10,4* ↗
 7: 10,3* ↓
 8: 10,6* →

Serie 73,0

Totalt 0,0

Tävlingsskott

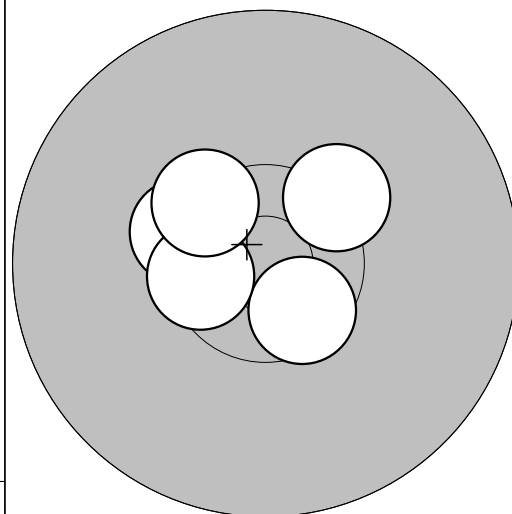

1: 10,4* ←
 2: 10,3* ↗
 3: 10,6* ↘
 4: 10,5* ←
 5: 10,4* ↗

Serie 50,0

Totalt 50,0

Tävlingsskott

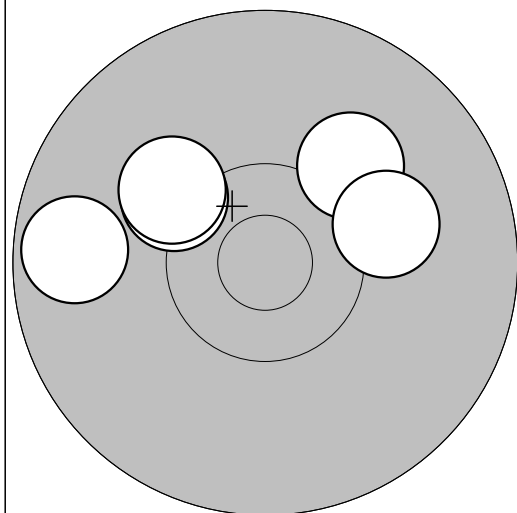

6: 9,7 ←
 7: 10,1 ↗
 8: 10,2 ↗
 9: 10,2 ↗
 10: 10,1 →

Serie 49,0

Totalt 99,0

Tävlingsskott

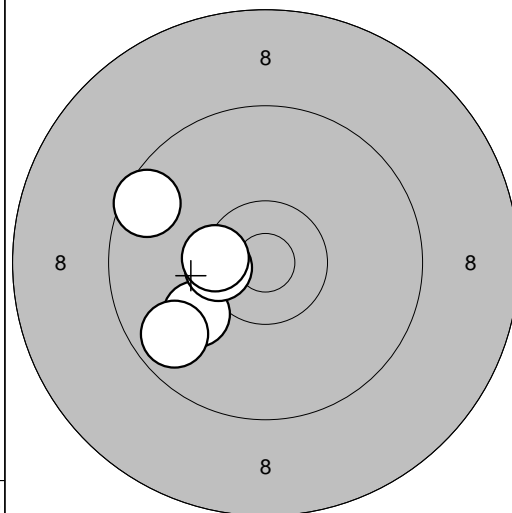

11: 10,0 ↘
 12: 9,7 ↘
 13: 10,5* ←
 14: 9,6 ↗
 15: 10,4* ←

Serie 48,0

Totalt 147,0

Tävlingsskott

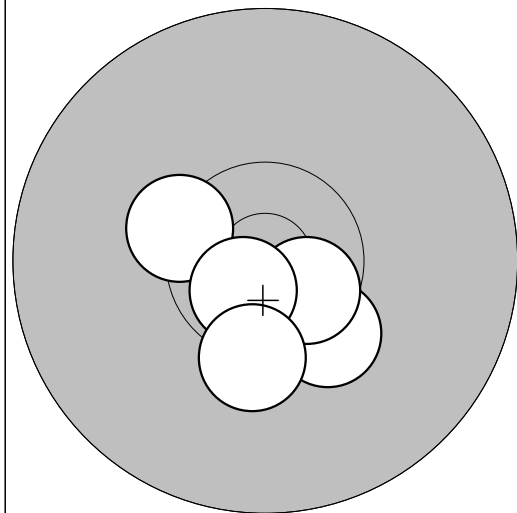

16: 10,4* ←
 17: 10,3* ↘
 18: 10,6* ↘
 19: 10,7* ↘
 20: 10,3* ↓

Serie 50,0

Totalt 197,0

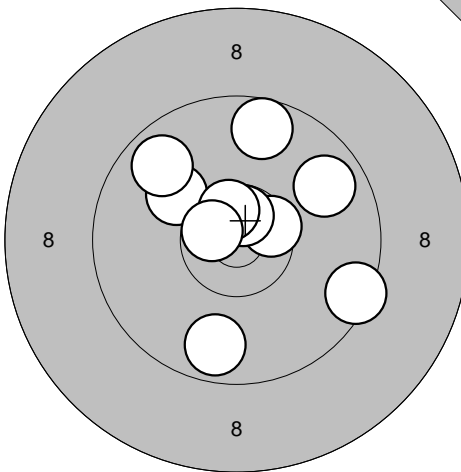
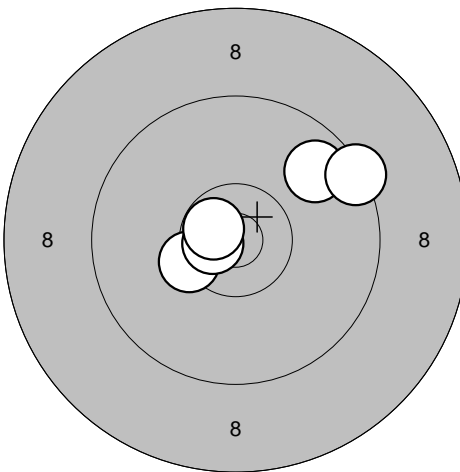
<p>Provskott</p> 	<p>1: 9,8 ↗ 2: 10,5* → 3: 9,6 ↑ 4: 10,1 ↖ 5: 10,7* ↑ 6: 10,6* ↑ 7: 9,7 ↓ 8: 9,5 → 9: 9,8 ↗ 10: 10,7* ↖</p> <table border="1" style="width:100%; border-collapse: collapse;"> <tr><td style="text-align: right;">Serie</td><td style="text-align: right;">95,0</td></tr> <tr><td style="text-align: right;">Totalt</td><td style="text-align: right;">0,0</td></tr> </table>	Serie	95,0	Totalt	0,0	<p>Tävlingsskott</p> 	<p>1: 9,8 ↗ 2: 10,4* ↖ 3: 10,7* ↖ 4: 9,4 → 5: 10,7* ↖</p> <table border="1" style="width:100%; border-collapse: collapse;"> <tr><td style="text-align: right;">Serie</td><td style="text-align: right;">48,0</td></tr> <tr><td style="text-align: right;">Totalt</td><td style="text-align: right;">48,0</td></tr> </table>	Serie	48,0	Totalt	48,0
Serie	95,0										
Totalt	0,0										
Serie	48,0										
Totalt	48,0										

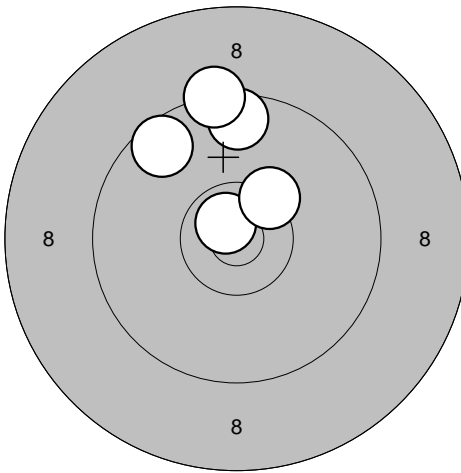
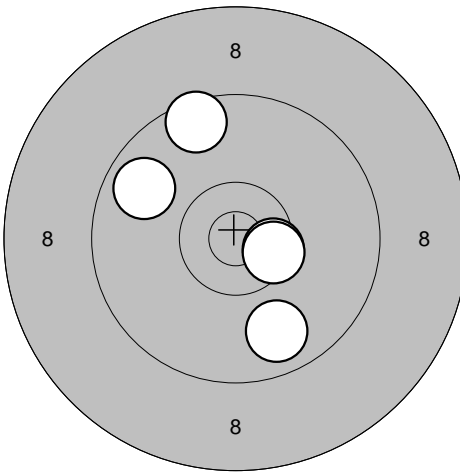
<p>Tävlingsskott</p> 	<p>6: 9,6 ↑ 7: 10,7* ↖ 8: 10,4* ↗ 9: 9,6 ↖ 10: 9,3 ↑</p> <table border="1" style="width:100%; border-collapse: collapse;"> <tr><td style="text-align: right;">Serie</td><td style="text-align: right;">47,0</td></tr> <tr><td style="text-align: right;">Totalt</td><td style="text-align: right;">95,0</td></tr> </table>	Serie	47,0	Totalt	95,0	<p>Tävlingsskott</p> 	<p>11: 9,5 ↑ 12: 10,5* → 13: 9,8 ↗ 14: 10,5* → 15: 9,8 ↓</p> <table border="1" style="width:100%; border-collapse: collapse;"> <tr><td style="text-align: right;">Serie</td><td style="text-align: right;">47,0</td></tr> <tr><td style="text-align: right;">Totalt</td><td style="text-align: right;">142,0</td></tr> </table>	Serie	47,0	Totalt	142,0
Serie	47,0										
Totalt	95,0										
Serie	47,0										
Totalt	142,0										

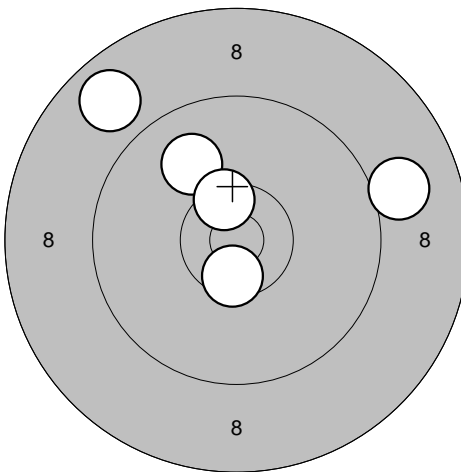
<p>Tävlingsskott</p> 	<p>16: 9,9 ↖ 17: 9,0 → 18: 10,5* ↓ 19: 10,5* ↑ 20: 8,8 ↖</p> <table border="1" style="width:100%; border-collapse: collapse;"> <tr><td style="text-align: right;">Serie</td><td style="text-align: right;">46,0</td></tr> <tr><td style="text-align: right;">Totalt</td><td style="text-align: right;">188,0</td></tr> </table>	Serie	46,0	Totalt	188,0		
Serie	46,0						
Totalt	188,0						

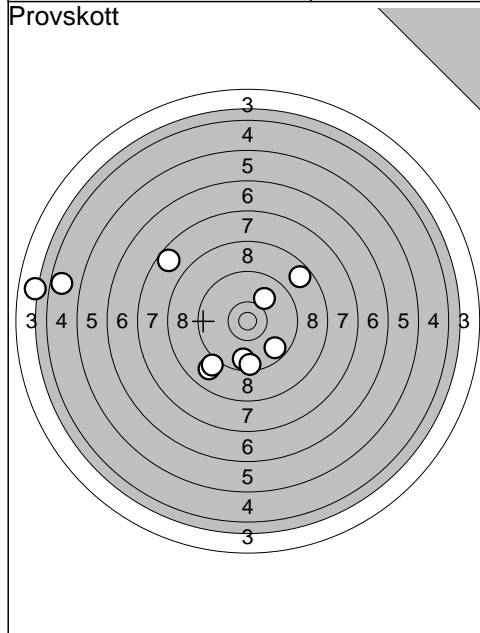

1: 3,9	←
2: 4,7	←
3: 7,7	↗
4: 10,0	↗
5: 8,7	↗
6: 9,7	↘
7: 9,7	↓
8: 8,9	↘
9: 9,1	↘
10: 9,5	↓
Serie	76,0
Totalt	0,0

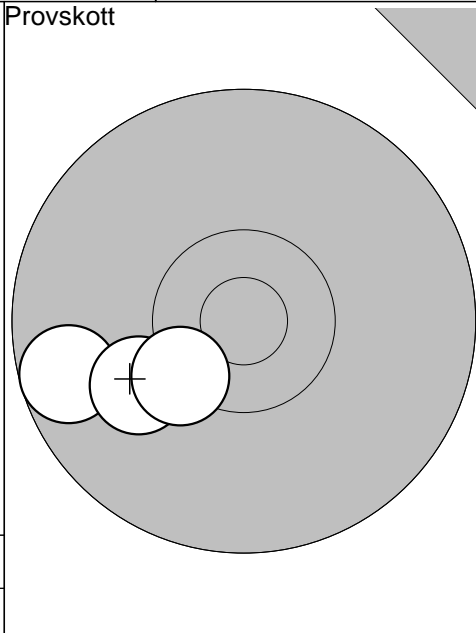

11: 9,7	←
12: 10,1	↘
13: 10,4*	↘
Serie	29,0
Totalt	0,0

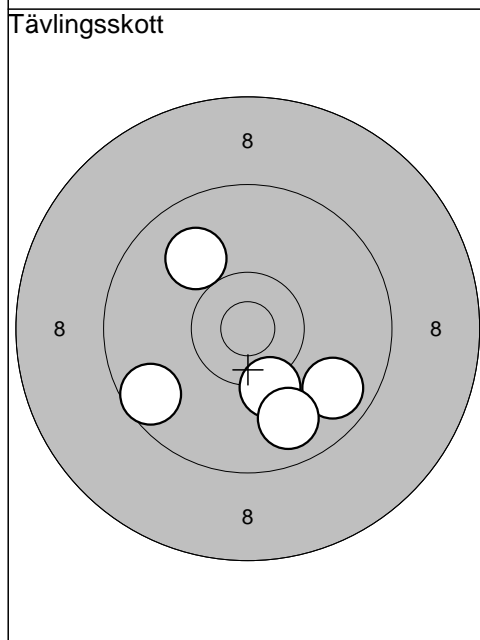

1: 9,6	←
2: 10,0	↗
3: 9,8	↘
4: 10,2	↓
5: 9,8	↘
Serie	47,0
Totalt	47,0

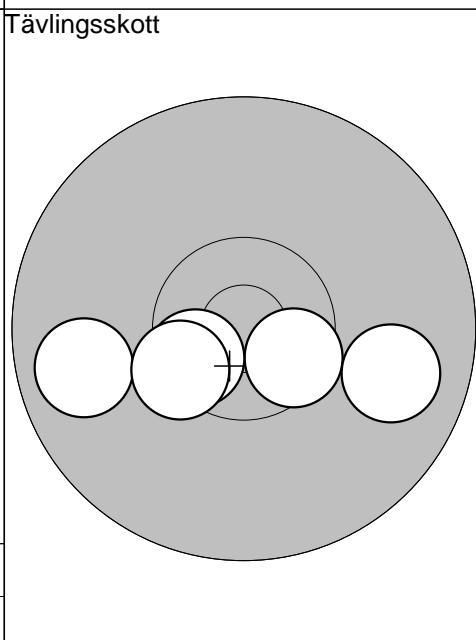

6: 9,8	←
7: 10,5*	↘
8: 9,9	→
9: 10,5*	↘
10: 10,4*	↘
Serie	48,0
Totalt	95,0

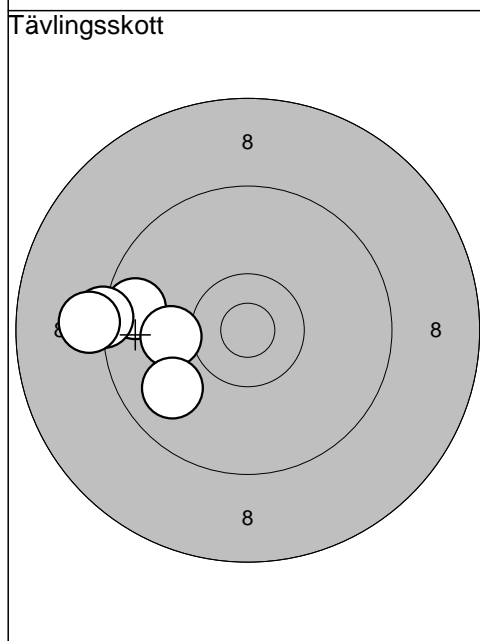

11: 9,6	←
12: 9,3	←
13: 10,1	←
14: 9,9	↘
15: 9,1	←
Serie	46,0
Totalt	141,0

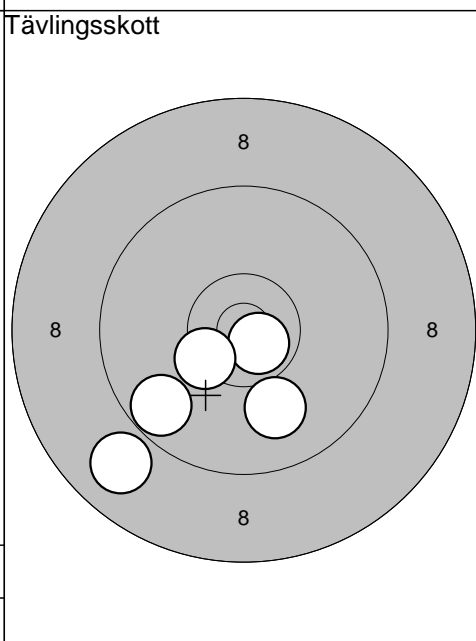

16: 10,7*	↘
17: 9,7	↘
18: 10,4*	↘
19: 8,9	↘
20: 10,0	↓
Serie	47,0
Totalt	188,0

2011-08-14

Förbundsmästerskap 2011

Ramselefors SKF

Provskott

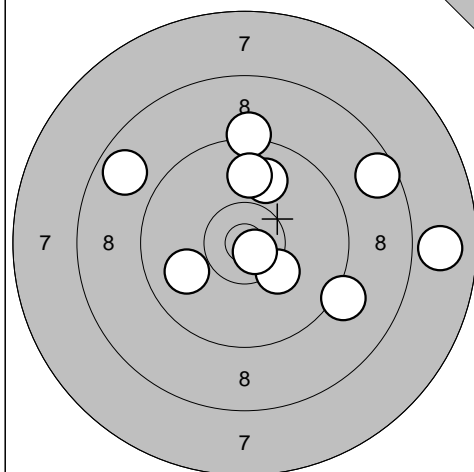

1: 9,2 ↘
 2: 10,3 ↘
 3: 9,9 ↗
 4: 8,6 ↗
 5: 7,9 →
 6: 10,7* ↘
 7: 9,3 ↗
 8: 8,8 ↖
 9: 9,9 ↗
 10: 9,9 ↖

Serie 88,0

Totalt 0,0

Provskott

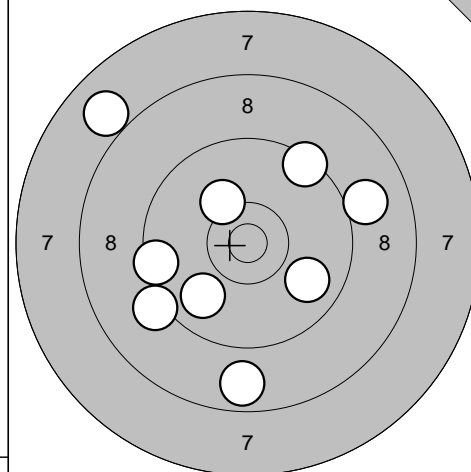

11: 8,7 ↓
 12: 9,4 ↗
 13: 9,9 ↘
 14: 7,9 ↖
 15: 10,2 ↗
 16: 9,2 ↖
 17: 9,5 ←
 18: 9,0 →
 19: 9,8 ↘

Serie 79,0

Totalt 0,0

Tävlingsskott

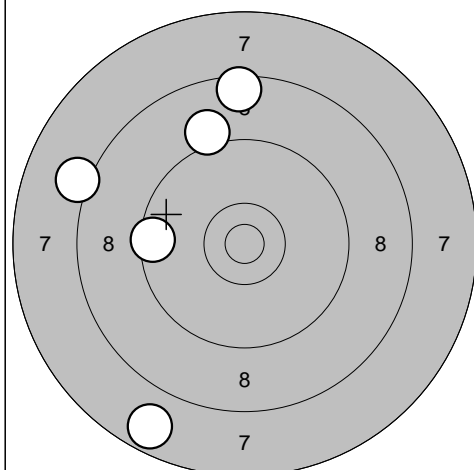

1: 9,1 ↗
 2: 9,5 ←
 3: 7,7 ↘
 4: 8,1 ↖
 5: 8,5 ↗

Serie 41,0

Totalt 41,0

Tävlingsskott

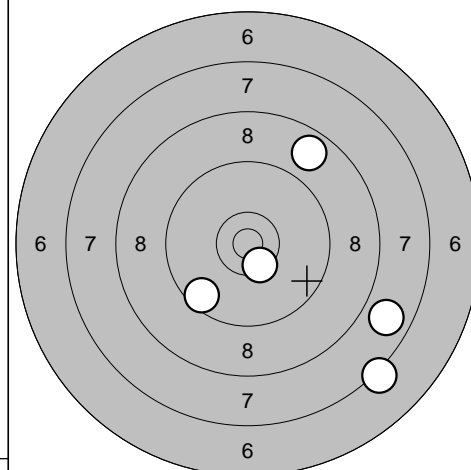

6: 10,5* ↓
 7: 7,2 ↘
 8: 7,8 ↗
 9: 8,8 ↗
 10: 9,6 ↘

Serie 41,0

Totalt 82,0

Tävlingsskott

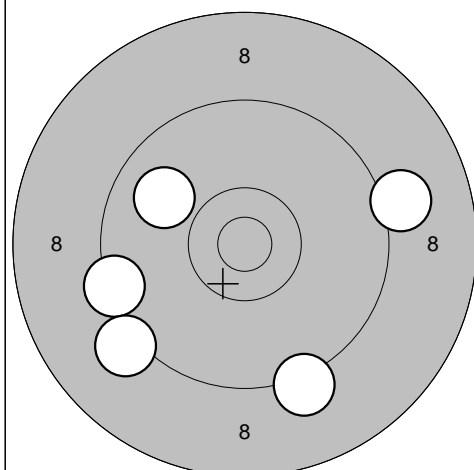

11: 9,2 ↓
 12: 9,4 ←
 13: 9,2 ↘
 14: 9,9 ↖
 15: 9,1 →

Serie 45,0

Totalt 127,0

Tävlingsskott

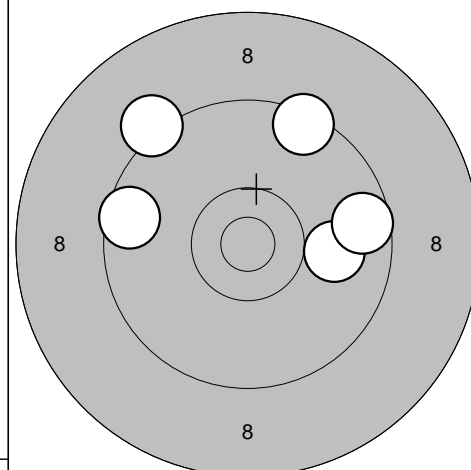

16: 10,0 →
 17: 9,6 →
 18: 9,4 ↗
 19: 9,6 ←
 20: 9,2 ↗

Serie 46,0

Totalt 173,0

Umeå

2011-08-14

Förbundsmästerskap 2011

Ramselefors SKF

Provskott

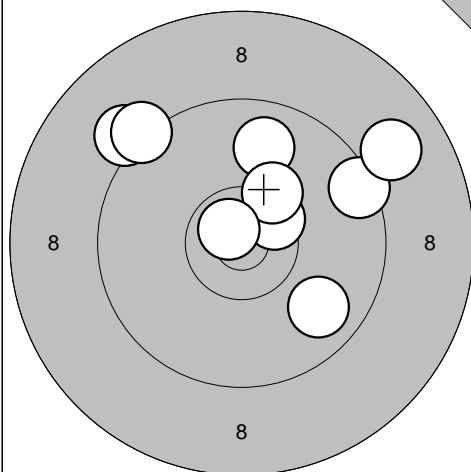

1: 9,5 →
 2: 9,1 ↗
 3: 9,8 ↘
 4: 9,3 ↗
 5: 8,9 ↗
 6: 10,5* ↗
 7: 9,8 ↑
 8: 10,3 ↗
 9: 10,7* ↖

Serie 83,0

Totalt 0,0

Tävlingsskott

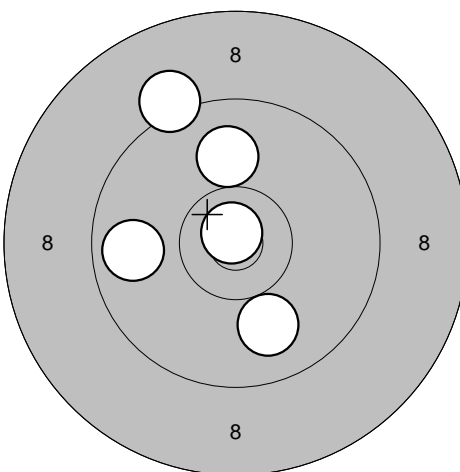

1: 9,2 ↖
 2: 9,8 ←
 3: 10,0 ↑
 4: 9,9 ↘
 5: 10,8* ↗

Serie 47,0

Totalt 47,0

Tävlingsskott

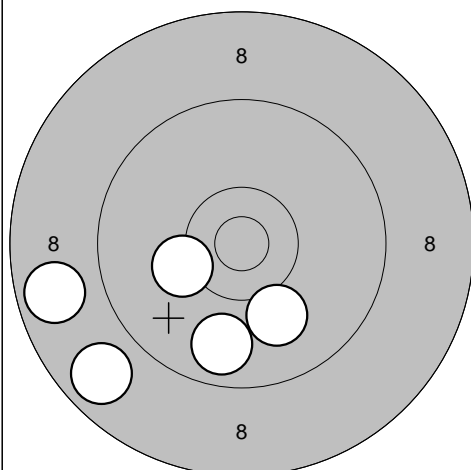

6: 10,2 ←
 7: 9,8 ↓
 8: 10,0 ↓
 9: 8,8 ↖
 10: 8,7 ←

Serie 45,0

Totalt 92,0

Tävlingsskott

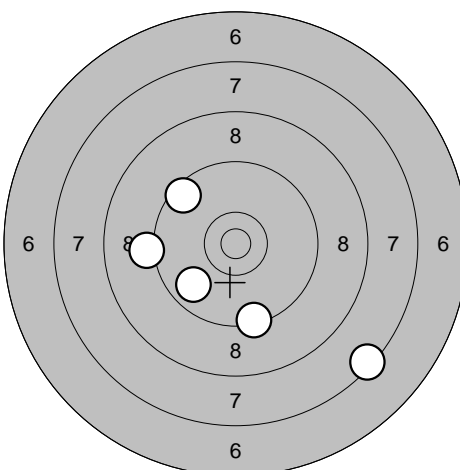

11: 9,5 ↖
 12: 9,2 ←
 13: 9,4 ↓
 14: 9,8 ↖
 15: 7,4 ↘

Serie 43,0

Totalt 135,0

Tävlingsskott

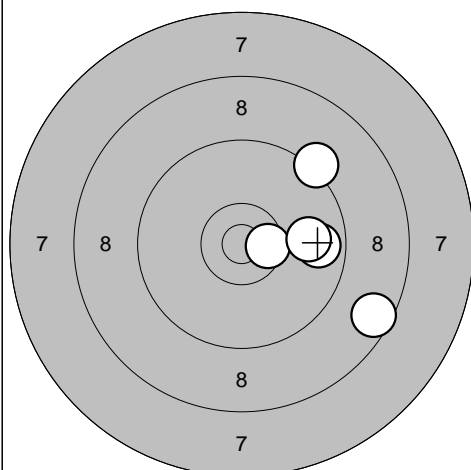

16: 10,5* →
 17: 8,6 ↘
 18: 9,7 →
 19: 9,2 ↗
 20: 9,9 →

Serie 45,0

Totalt 180,0

Drängsmark

2011-08-14

Förbundsmästerskap 2011

Ramselefors SKF

Provskott

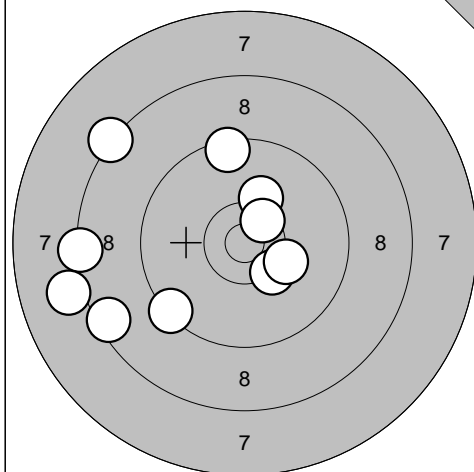

1: 8,4 ←
 2: 8,3 ↗
 3: 8,1 ←
 4: 8,5 ↙
 5: 9,4 ↙
 6: 10,3* ↘
 7: 10,2 →
 8: 9,5 ↑
 9: 10,2 ↑
 10: 10,5* ↗

Serie 90,0

Totalt 0,0

Provskott

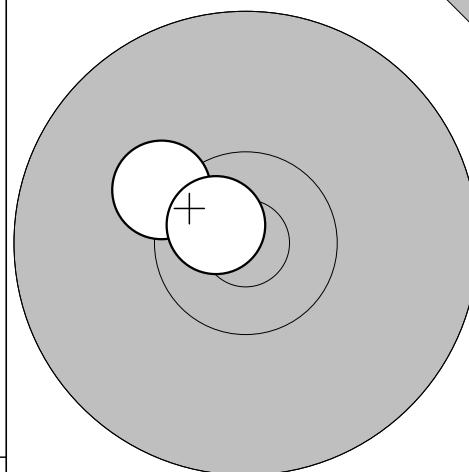

11: 10,2 ↖
 12: 10,7* ↖

Serie 20,0

Totalt 0,0

Tävlingsskott

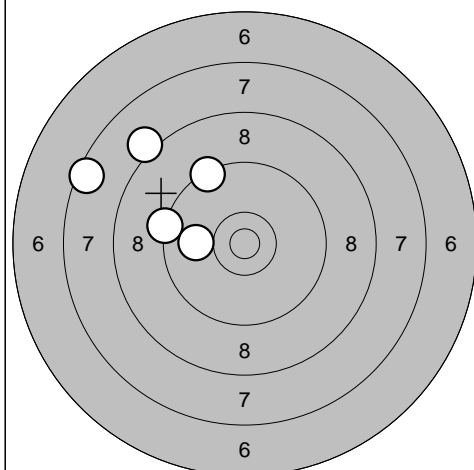

1: 9,4 ↗
 2: 8,2 ↗
 3: 9,3 ←
 4: 7,5 ↗
 5: 10,0 ←

Serie 43,0

Totalt 43,0

Tävlingsskott

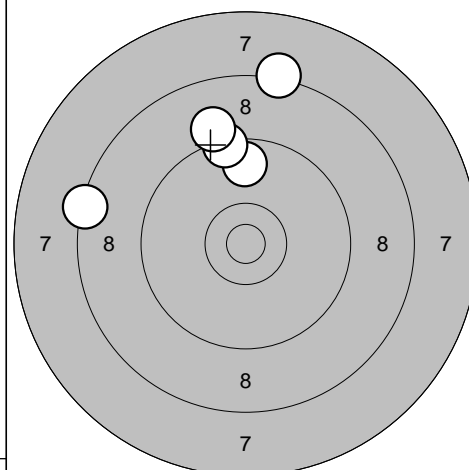

6: 9,7 ↑
 7: 8,3 ↑
 8: 9,4 ↑
 9: 9,1 ↑
 10: 8,4 ←

Serie 43,0

Totalt 86,0

Tävlingsskott

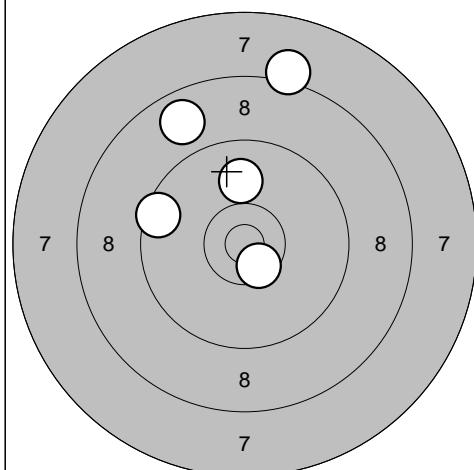

11: 9,5 ←
 12: 10,0 ↑
 13: 10,5* ↘
 14: 8,2 ↑
 15: 8,8 ↗

Serie 45,0

Totalt 131,0

Tävlingsskott

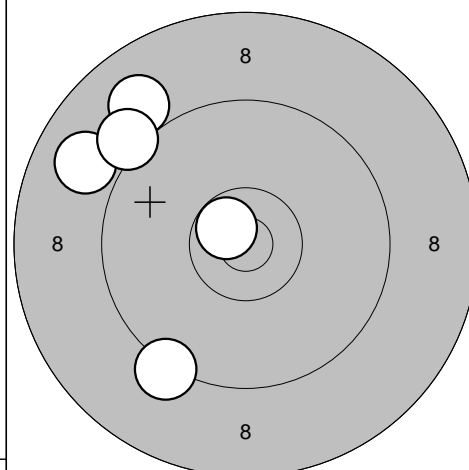

16: 8,9 ↖
 17: 10,7* ↖
 18: 9,3 ↘
 19: 9,0 ↗
 20: 9,2 ↖

Serie 45,0

Totalt 176,0

Umeå

2011-08-14

Förbundsmästerskap 2011

Ramselefors SKF

Provskott

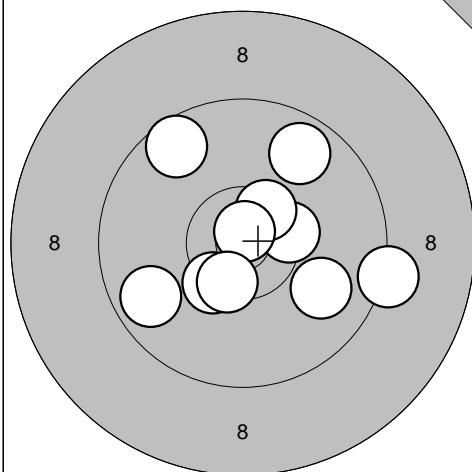

1: 9,7 ↗
 2: 10,4* →
 3: 10,5* ↗
 4: 10,8* ↑
 5: 9,2 →
 6: 9,9 →
 7: 10,4* ↘
 8: 10,5* ↘
 9: 9,7 ↙
 10: 9,6 ↗

Serie 95,0

Totalt 0,0

Tävlingsskott

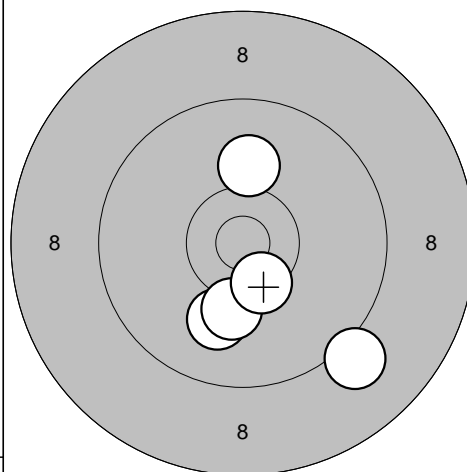

1: 10,0 ↓
 2: 9,1 ↘
 3: 10,2 ↓
 4: 10,1 ↑
 5: 10,4* ↓

Serie 49,0

Totalt 49,0

Tävlingsskott

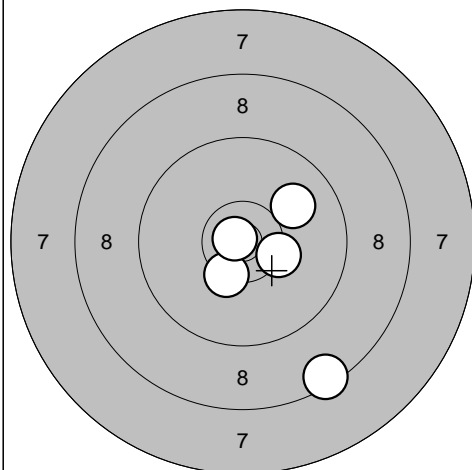

6: 10,0 ↗
 7: 10,3* →
 8: 8,5 ↓
 9: 10,4* ↘
 10: 10,8* ↙

Serie 48,0

Totalt 97,0

Tävlingsskott

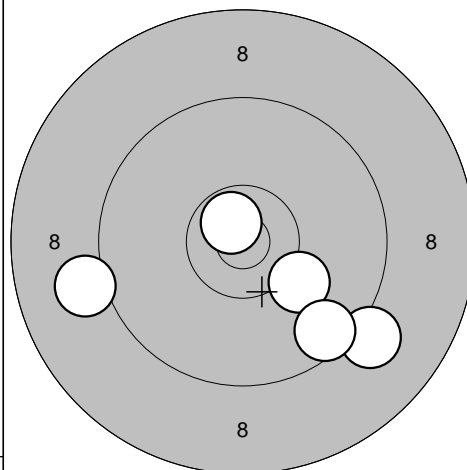

11: 10,2 ↘
 12: 10,7* ↗
 13: 9,1 ↙
 14: 9,1 ↘
 15: 9,6 ↘

Serie 47,0

Totalt 144,0

Tävlingsskott

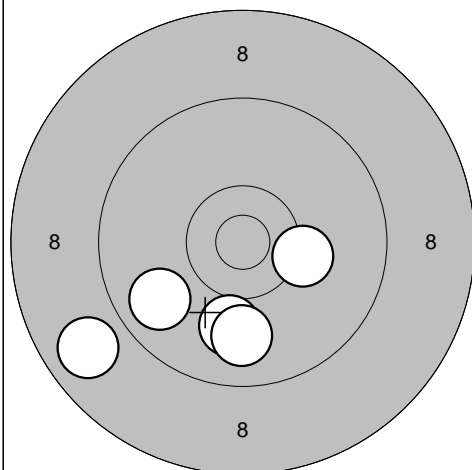

16: 10,0 ↓
 17: 9,8 ↙
 18: 8,8 ↙
 19: 10,2 →
 20: 9,9 ↓

Serie 46,0

Totalt 190,0

Drängsmark

2011-08-14

Förbundsmästerskap 2011

Ramselefors SKF

Provskott

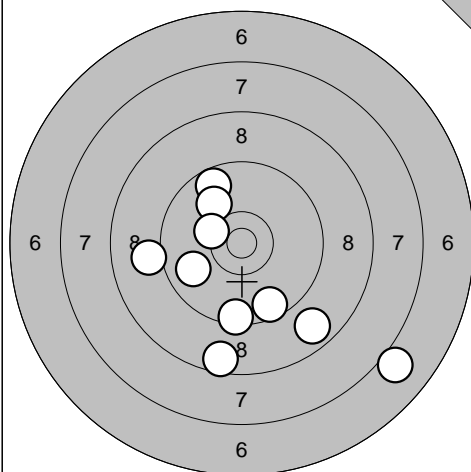

1: 9,7 ↗
 2: 7,0 ↘
 3: 8,8 ↘
 4: 9,6 ↘
 5: 8,6 ↘
 6: 9,5 ↘
 7: 9,9 ←
 8: 9,1 ←
 9: 10,0 ↗
 10: 10,3* ↗

Serie 88,0

Totalt 0,0

Provskott

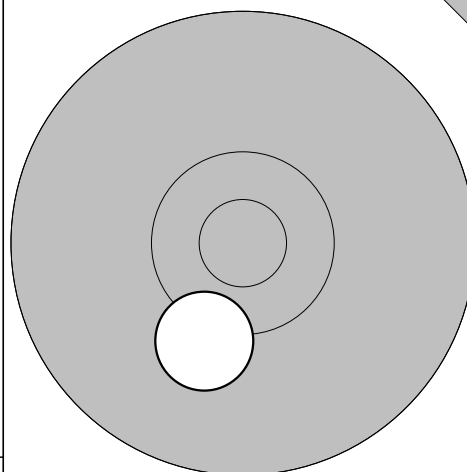

11: 10,2 ↘

Serie 10,0

Totalt 0,0

Tävlingsskott

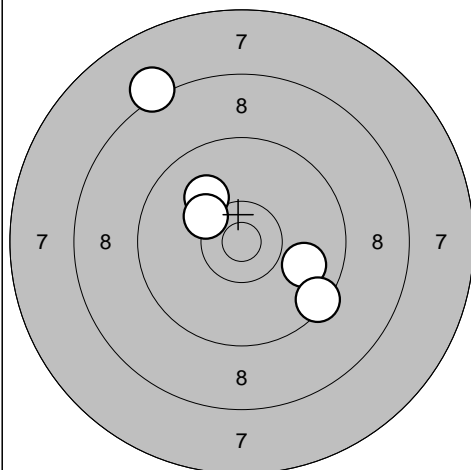

1: 10,1 ↗
 2: 8,2 ↗
 3: 9,9 ↘
 4: 10,3 ↗
 5: 9,4 ↘

Serie 46,0

Totalt 46,0

Tävlingsskott

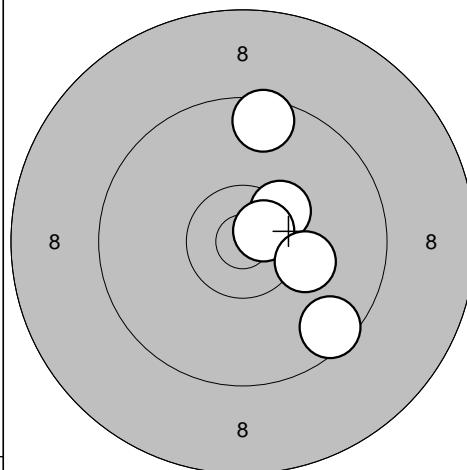

6: 10,4* ↗
 7: 9,6 ↑
 8: 10,7* ↗
 9: 9,5 ↘
 10: 10,2 →

Serie 48,0

Totalt 94,0

Tävlingsskott

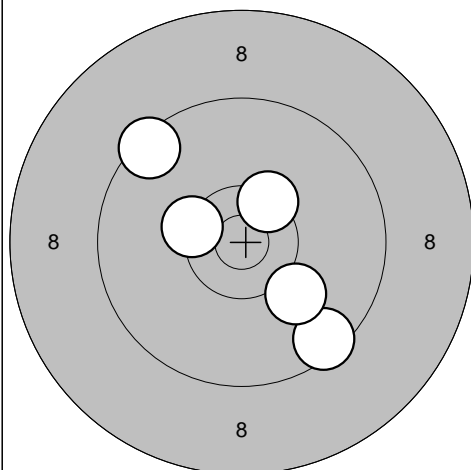

11: 10,4* ↗
 12: 9,5 ↘
 13: 9,5 ↗
 14: 10,4* ↗
 15: 10,1 ↘

Serie 48,0

Totalt 142,0

Tävlingsskott

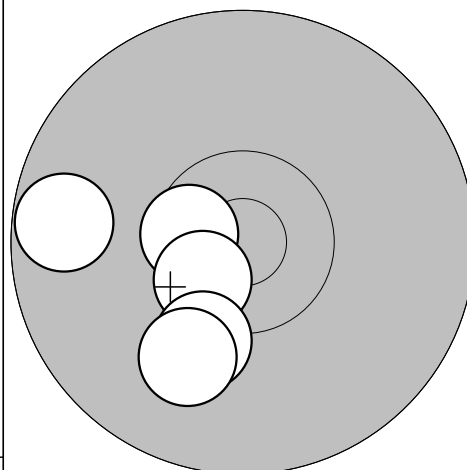

16: 10,6* ←
 17: 10,6* ↘
 18: 9,7 ←
 19: 10,2 ↘
 20: 10,0 ↘

Serie 49,0

Totalt 191,0

Umeå

2011-08-14

Förbundsmästerskap 2011

Ramselefors SKF

Provsnitt

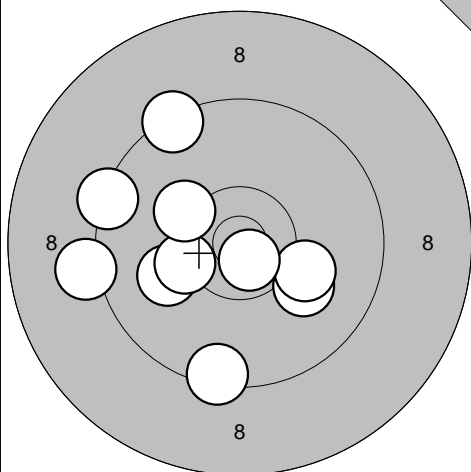

- 1: 9,4 ↘
- 2: 9,2 ←
- 3: 10,1 ↘
- 4: 10,1 →
- 5: 10,7* ↘
- 6: 9,4 ↗
- 7: 10,1 ←
- 8: 10,3 ←
- 9: 10,2 ↗
- 10: 9,4 ↗

Serie	96,0
Totalt	0,0

Provsnitt

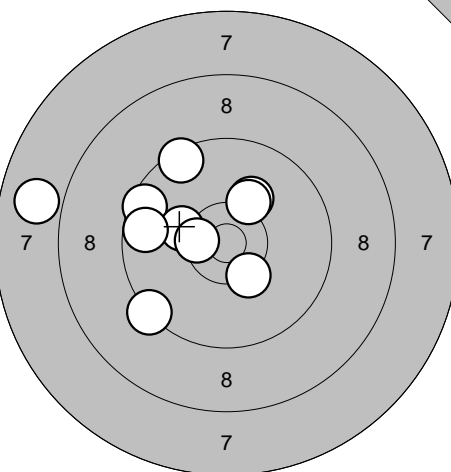

- 11: 10,2 ↗
- 12: 9,5 ←
- 13: 10,3* ↘
- 14: 10,2 ←
- 15: 7,9 ←
- 16: 9,5 ↗
- 17: 9,3 ↘
- 18: 10,2 ↗
- 19: 10,5* ←
- 20: 9,7 ←

Serie	93,0
Totalt	0,0

Tävlingssnitt

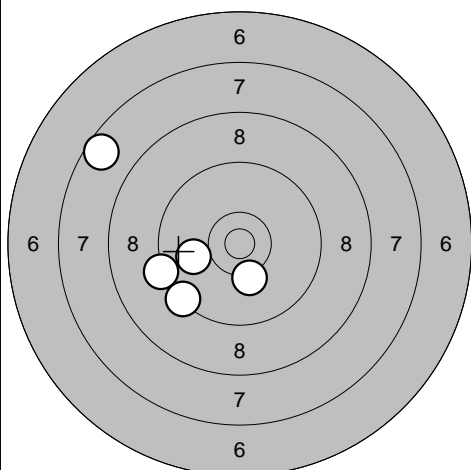

- 1: 9,3 ←
- 2: 7,6 ↗
- 3: 9,4 ↘
- 4: 10,0 ←
- 5: 10,2 ↘

Serie	45,0
Totalt	45,0

Tävlingssnitt

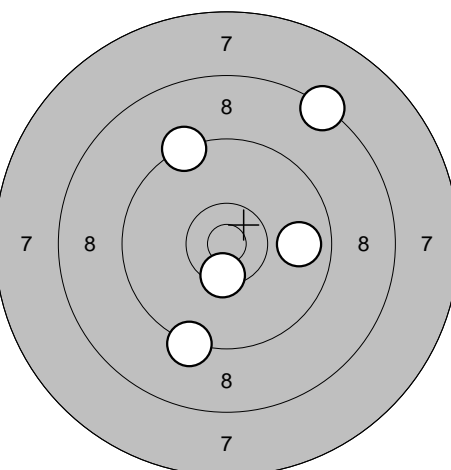

- 6: 10,5* ↘
- 7: 9,3 ↘
- 8: 9,3 ↗
- 9: 8,3 ↗
- 10: 9,8 →

Serie	45,0
Totalt	90,0

Tävlingssnitt

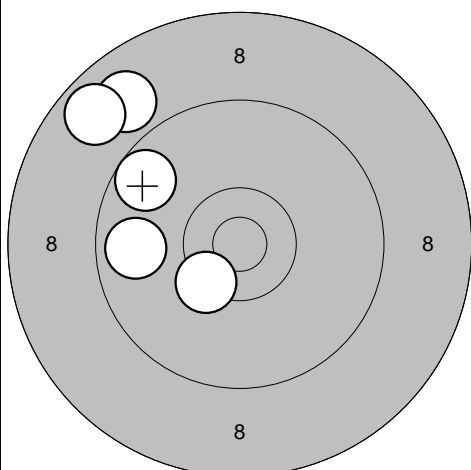

- 11: 10,4* ↘
- 12: 8,9 ↗
- 13: 9,7 ↗
- 14: 9,8 ←
- 15: 8,7 ↗

Serie	44,0
Totalt	134,0

Tävlingssnitt

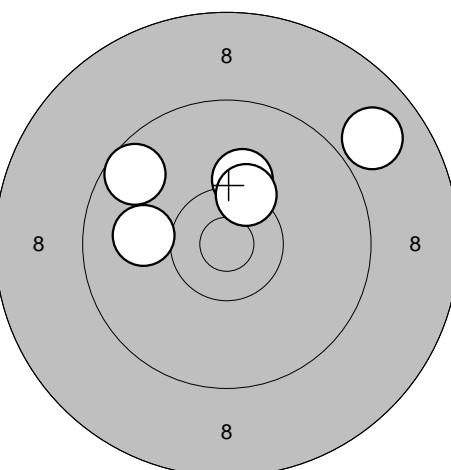

- 16: 10,2 ↗
- 17: 9,6 ↘
- 18: 8,9 ↗
- 19: 10,0 ←
- 20: 10,3* ↗

Serie	47,0
Totalt	181,0

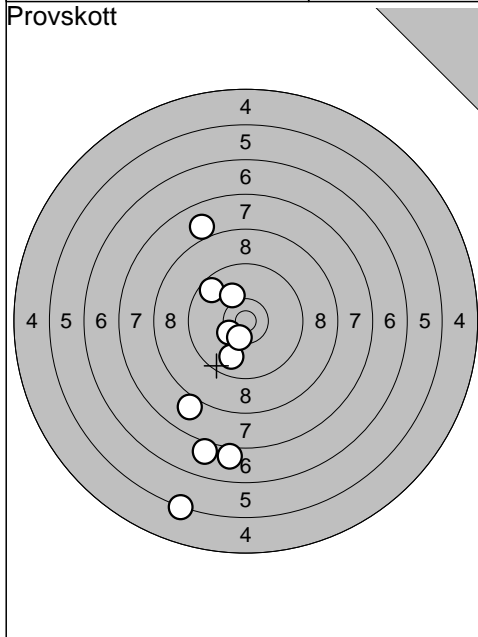

1: 8,0	↗
2: 7,0	↓
3: 5,3	↓
4: 9,6	↖
5: 10,4*	↙
6: 8,0	↓
7: 7,0	↓
8: 9,8	↓
9: 10,1	↗
10: 10,4*	↓
<hr/>	
Serie	83,0
Totalt	0,0

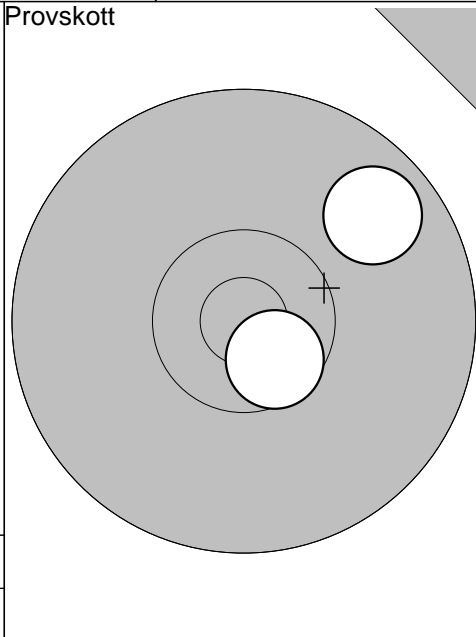

11: 9,8	↗
12: 10,6*	↘
<hr/>	
Serie	19,0
Totalt	0,0

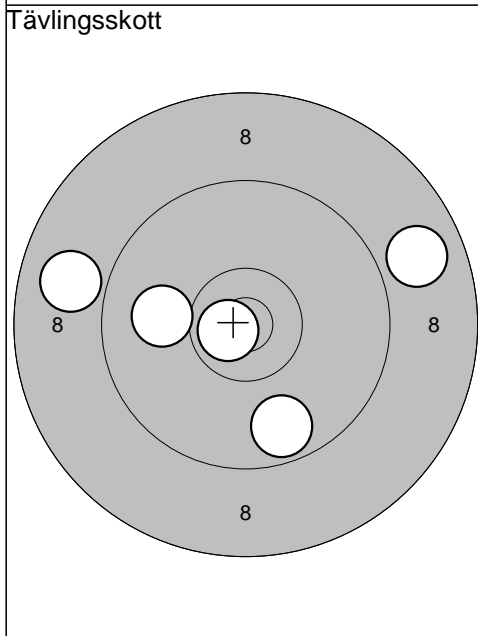

1: 8,8	→
2: 8,9	←
3: 9,7	↓
4: 10,0	←
5: 10,7*	←
<hr/>	
Serie	45,0
Totalt	45,0

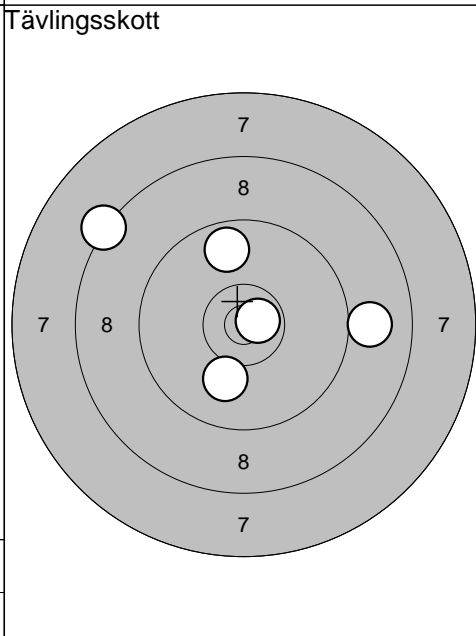

6: 9,0	→
7: 10,0	↓
8: 8,3	↖
9: 9,8	↑
10: 10,7*	→
<hr/>	
Serie	46,0
Totalt	91,0

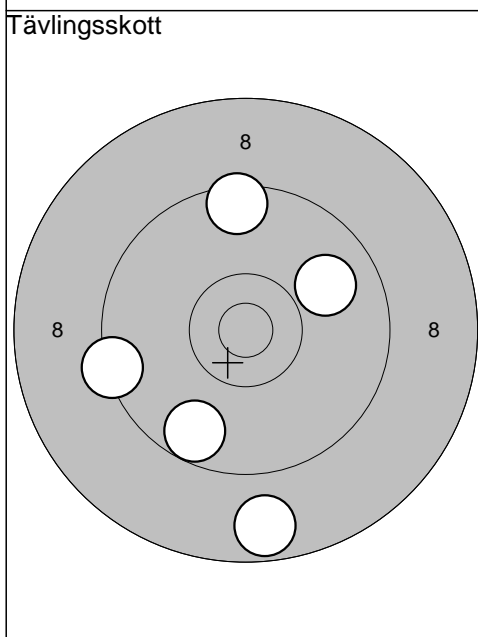

11: 9,4	←
12: 9,9	↗
13: 8,7	↓
14: 9,5	↑
15: 9,7	↓
<hr/>	
Serie	44,0
Totalt	135,0

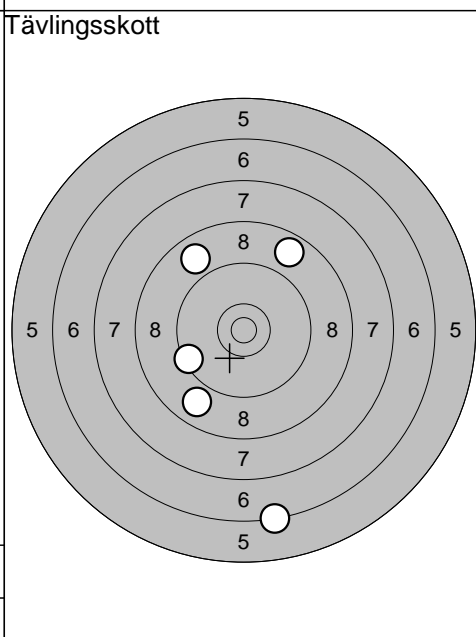

16: 8,9	↙
17: 8,9	↖
18: 9,4	←
19: 6,3	↓
20: 8,8	↗
<hr/>	
Serie	39,0
Totalt	174,0

Skellefteå

2011-08-14	Förbundsmästerskap 2011	Ramselefors SKF
------------	-------------------------	-----------------

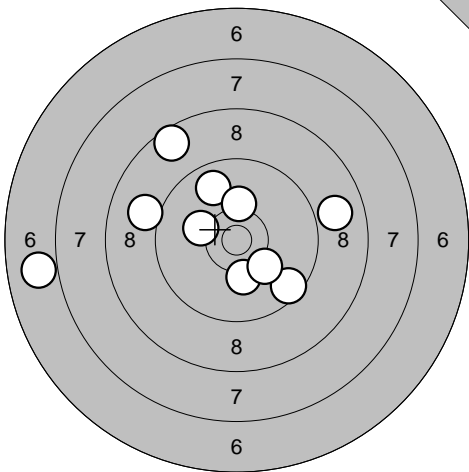
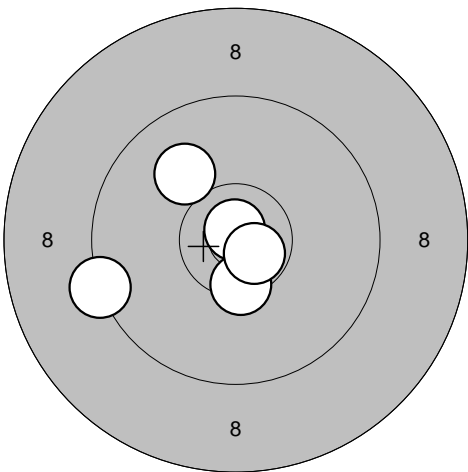
<p>Provskott</p> 	<p>1: 6,9 ←</p> <p>2: 10,2 ↓</p> <p>3: 8,9 →</p> <p>4: 10,2 ←</p> <p>5: 9,6 ↘</p> <p>6: 9,8 ↗</p> <p>7: 10,2 ↘</p> <p>8: 10,2 ↑</p> <p>9: 9,0 ←</p> <p>10: 8,6 ↗</p> <table border="1" style="width:100%; border-collapse: collapse; margin-top: 10px;"> <tr> <td style="text-align: right;">Serie</td> <td style="text-align: right;">89,0</td> </tr> <tr> <td style="text-align: right;">Totalt</td> <td style="text-align: right;">0,0</td> </tr> </table>	Serie	89,0	Totalt	0,0	<p>Tävlingsskott</p>  <table border="1" style="width:100%; border-collapse: collapse; margin-top: 10px;"> <tr> <td style="text-align: right;">Serie</td> <td style="text-align: right;">49,0</td> </tr> <tr> <td style="text-align: right;">Totalt</td> <td style="text-align: right;">49,0</td> </tr> </table>	Serie	49,0	Totalt	49,0
Serie	89,0									
Totalt	0,0									
Serie	49,0									
Totalt	49,0									

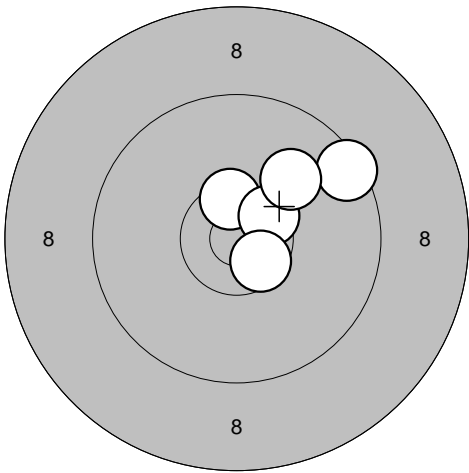
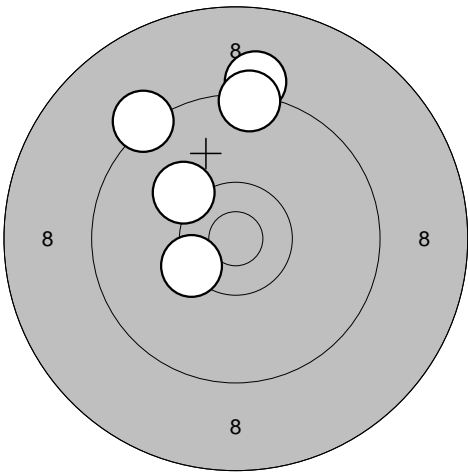
<p>Tävlingsskott</p>  <table border="1" style="width:100%; border-collapse: collapse; margin-top: 10px;"> <tr> <td style="text-align: right;">Serie</td> <td style="text-align: right;">49,0</td> </tr> <tr> <td style="text-align: right;">Totalt</td> <td style="text-align: right;">98,0</td> </tr> </table>	Serie	49,0	Totalt	98,0	<p>Tävlingsskott</p>  <table border="1" style="width:100%; border-collapse: collapse; margin-top: 10px;"> <tr> <td style="text-align: right;">Serie</td> <td style="text-align: right;">47,0</td> </tr> <tr> <td style="text-align: right;">Totalt</td> <td style="text-align: right;">145,0</td> </tr> </table>	Serie	47,0	Totalt	145,0
Serie	49,0								
Totalt	98,0								
Serie	47,0								
Totalt	145,0								

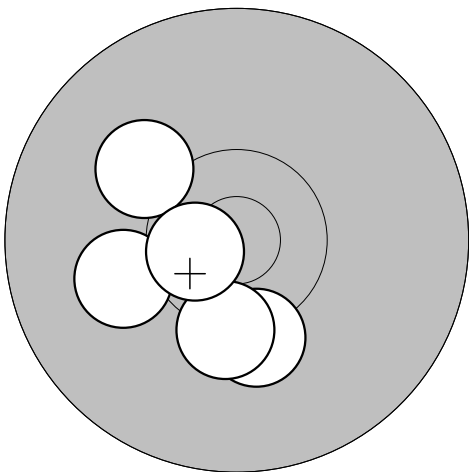
<p>Tävlingsskott</p>  <table border="1" style="width:100%; border-collapse: collapse; margin-top: 10px;"> <tr> <td style="text-align: right;">Serie</td> <td style="text-align: right;">50,0</td> </tr> <tr> <td style="text-align: right;">Totalt</td> <td style="text-align: right;">195,0</td> </tr> </table>	Serie	50,0	Totalt	195,0	<p>16: 10,1 ←</p> <p>17: 10,2 ↓</p> <p>18: 10,3* ↓</p> <p>19: 10,1 ↗</p> <p>20: 10,6* ←</p>	
Serie	50,0					
Totalt	195,0					

Runvik

2011-08-14

Föbunds mästerskap 2011

Ramselefors SKF

Provskott

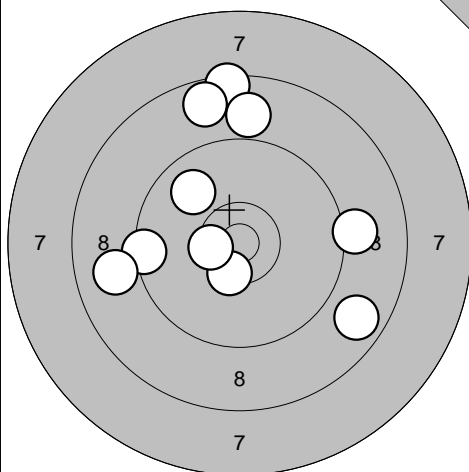

- 1: 10,4* ↘
- 2: 9,4 ←
- 3: 9,1 →
- 4: 8,5 ↑
- 5: 8,9 ↑
- 6: 10,5* ←
- 7: 8,7 ↑
- 8: 8,9 ←
- 9: 8,8 ↘
- 10: 9,9 ↗

Serie 87,0
Totalt 0,0

Provskott

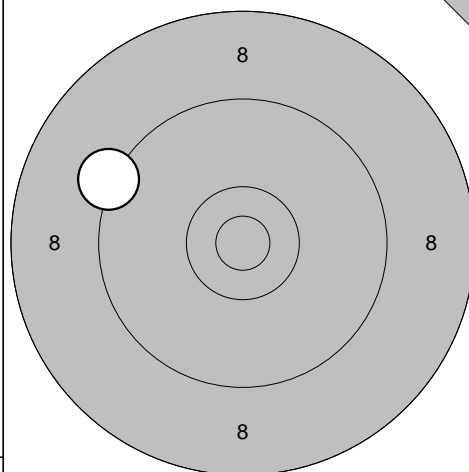

11: 9,3 ↖

Serie 9,0
Totalt 0,0

Tävlingsskott

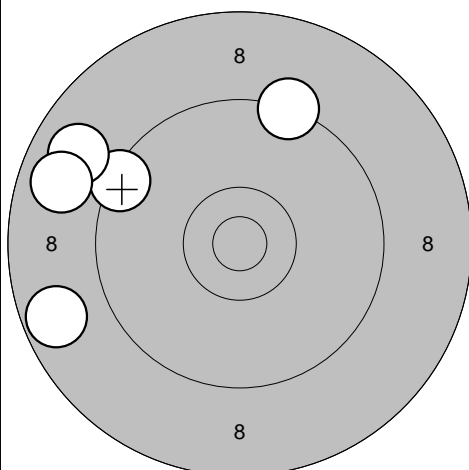

- 1: 9,4 ↖
- 2: 8,9 ↖
- 3: 8,7 ←
- 4: 8,8 ↖
- 5: 9,3 ↑

Serie 42,0
Totalt 42,0

Tävlingsskott

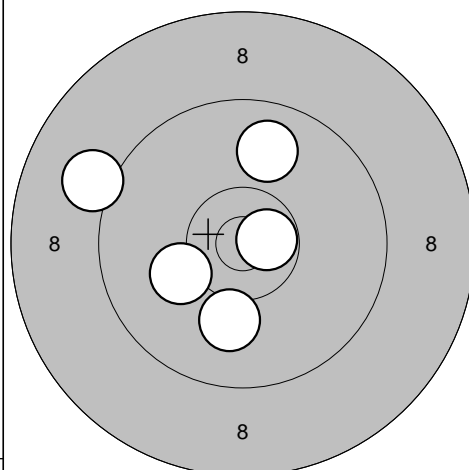

- 6: 9,1 ↖
- 7: 10,2 ↖
- 8: 9,9 ↑
- 9: 10,1 ↓
- 10: 10,7* →

Serie 48,0
Totalt 90,0

Tävlingsskott

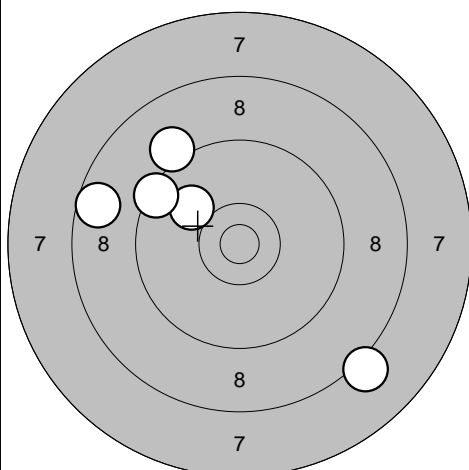

- 11: 9,1 ↗
- 12: 10,0 ↗
- 13: 9,4 ↗
- 14: 8,6 ↖
- 15: 8,1 ↘

Serie 44,0
Totalt 134,0

Tävlingsskott

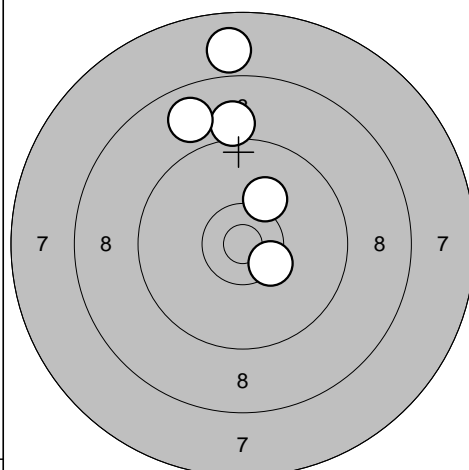

- 16: 10,2 ↗
- 17: 10,4* ↘
- 18: 9,1 ↑
- 19: 8,8 ↖
- 20: 7,9 ↑

Serie 44,0
Totalt 178,0

Ramselefors

2011-08-14

Förbundsmästerskap 2011

Ramselefors SKF

Provskott

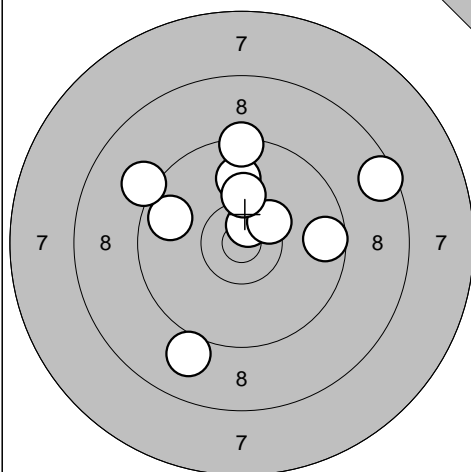

- 1: 9,9 ↑
- 2: 9,8 ↖
- 3: 9,0 ↓
- 4: 9,2 ↖
- 5: 9,4 ↑
- 6: 10,7* ↑
- 7: 10,4* ↗
- 8: 8,5 ↗
- 9: 9,6 →
- 10: 10,2 ↑

Serie 92,0
Totalt 0,0

Provskott

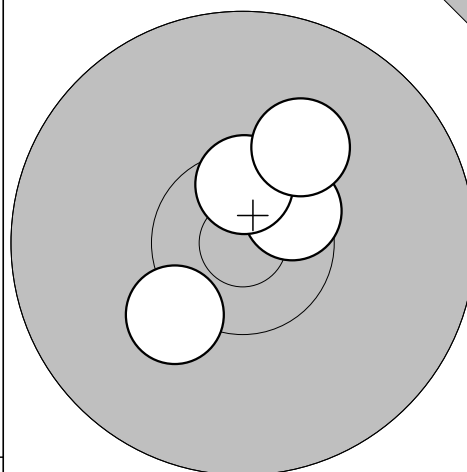

- 11: 10,5* ↗
- 12: 10,5* ↑
- 13: 10,3 ↘
- 14: 10,2 ↗

Serie 40,0
Totalt 0,0

Tävlingsskott

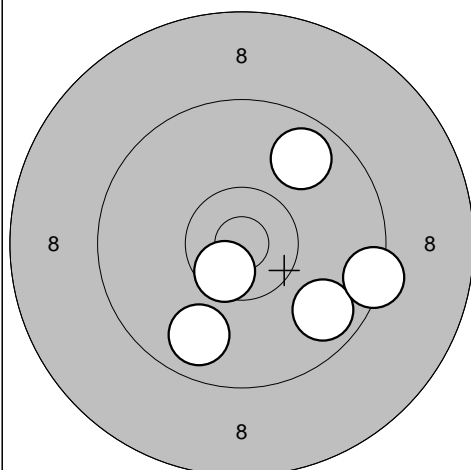

- 1: 9,8 ↓
- 2: 9,8 ↘
- 3: 9,4 →
- 4: 9,8 ↗
- 5: 10,6* ↓

Serie 46,0
Totalt 46,0

Tävlingsskott

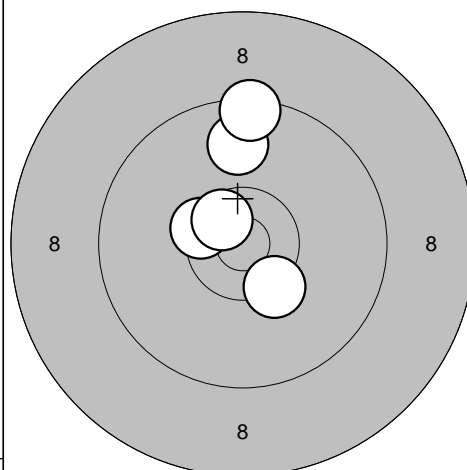

- 6: 10,4* ↖
- 7: 9,8 ↑
- 8: 9,4 ↑
- 9: 10,3* ↓
- 10: 10,6* ↗

Serie 48,0
Totalt 94,0

Tävlingsskott

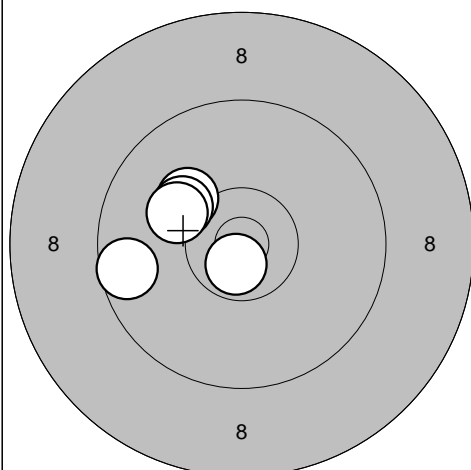

- 11: 10,7* ↓
- 12: 10,2 ↗
- 13: 10,2 ↗
- 14: 9,6 ↖
- 15: 10,1 ↖

Serie 49,0
Totalt 143,0

Tävlingsskott

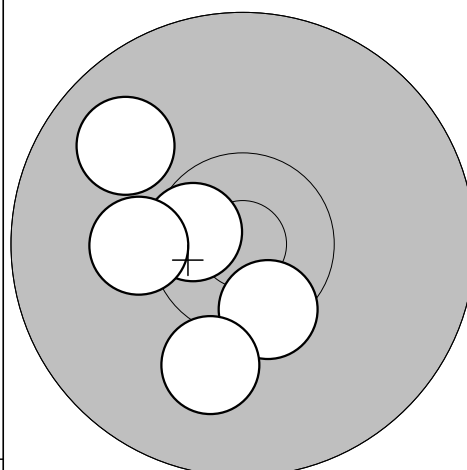

- 16: 10,6* ↖
- 17: 9,9 ↖
- 18: 10,2 ↖
- 19: 10,5* ↓
- 20: 10,1 ↓

Serie 49,0
Totalt 192,0

Vännäs

2011-08-14

Förbundsmästerskap 2011

Ramselefors SKF

Provskott

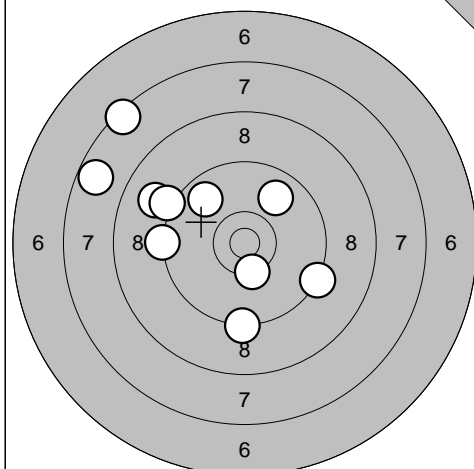

1: 9,3 ↓
 2: 9,3 ←
 3: 9,0 ↗
 4: 9,9 ↖
 5: 7,7 ↖
 6: 9,2 ↖
 7: 9,3 ↘
 8: 7,5 ↖
 9: 9,8 ↖
 10: 10,4* ↓

Serie 87,0

Totalt 0,0

Provskott

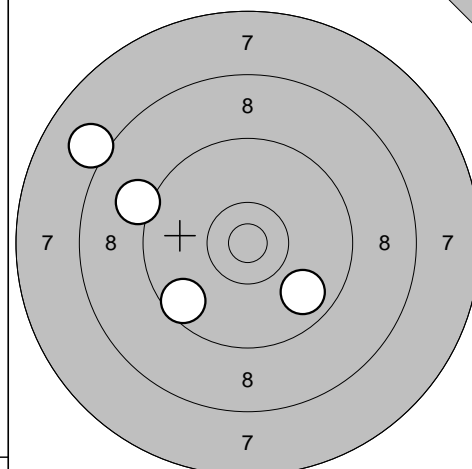

11: 9,6 ↙
 12: 8,1 ↗
 13: 9,1 ↙
 14: 9,8 ↘

Serie 35,0

Totalt 0,0

Tävlingsskott

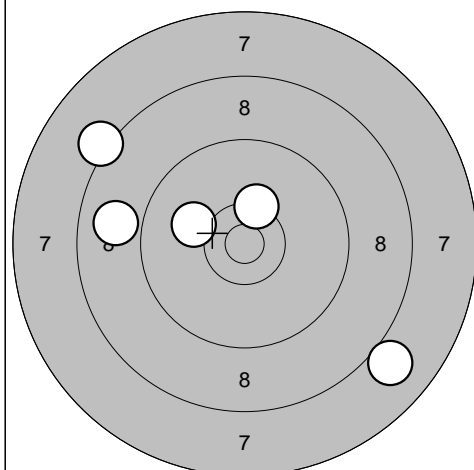

1: 8,9 ←
 2: 10,1 ↖
 3: 10,3* ↖
 4: 8,2 ↖
 5: 8,0 ↘

Serie 44,0

Totalt 44,0

Tävlingsskott

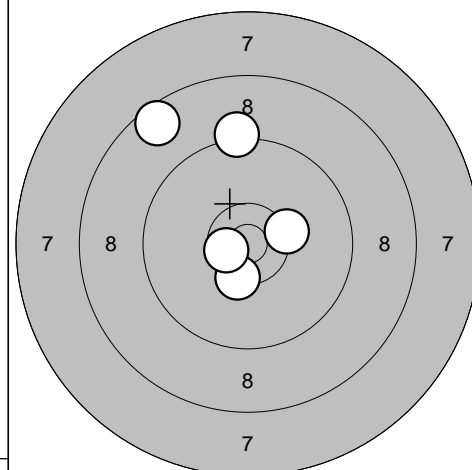

6: 10,4* ↓
 7: 10,3* →
 8: 8,6 ↖
 9: 9,2 ↑
 10: 10,6* ←

Serie 47,0

Totalt 91,0

Tävlingsskott

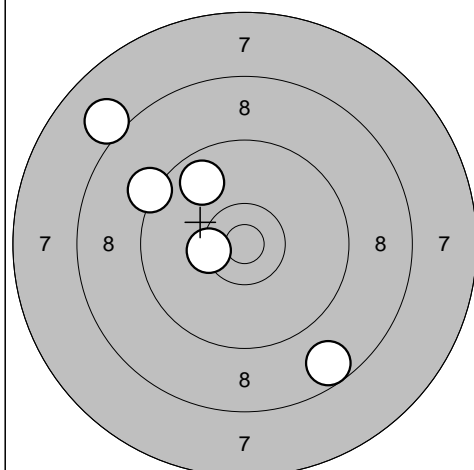

11: 9,8 ↖
 12: 8,7 ↘
 13: 10,4* ←
 14: 8,1 ↖
 15: 9,2 ↖

Serie 44,0

Totalt 135,0

Tävlingsskott

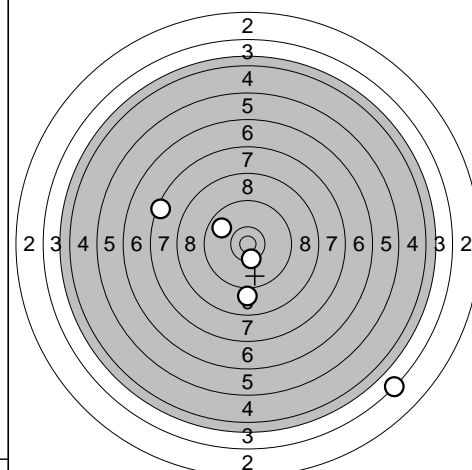

16: 10,4* ↓
 17: 9,8 ↖
 18: 7,5 ↖
 19: 9,0 ↓
 20: 3,3 ↘

Serie 38,0

Totalt 173,0

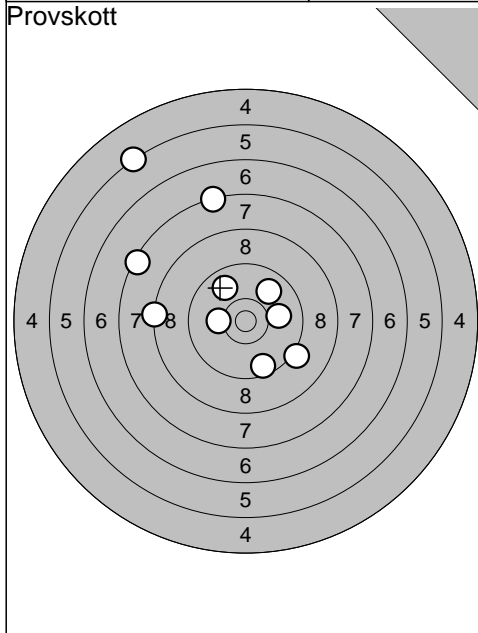

1: 5,3	↖
2: 7,4	↖
3: 7,3	↖
4: 10,2	←
5: 9,8	↖
6: 8,3	←
7: 9,6	↘
8: 9,9	↖
9: 9,2	↘
10: 10,0	→
<hr/>	
Serie	83,0
Totalt	0,0

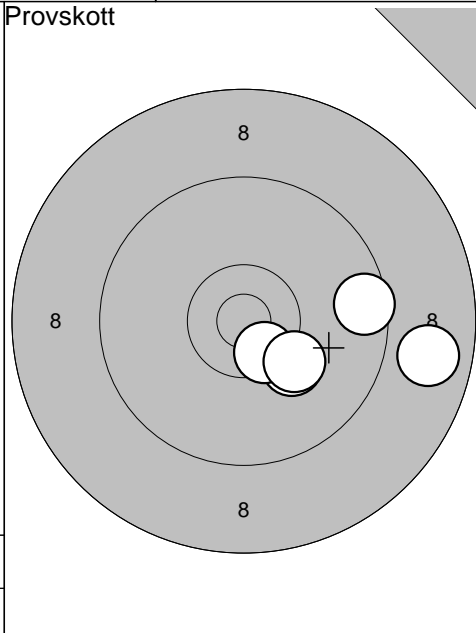

11: 10,2	↘
12: 9,6	→
13: 10,5*	↘
14: 10,2	↘
15: 8,8	→
<hr/>	
Serie	47,0
Totalt	0,0

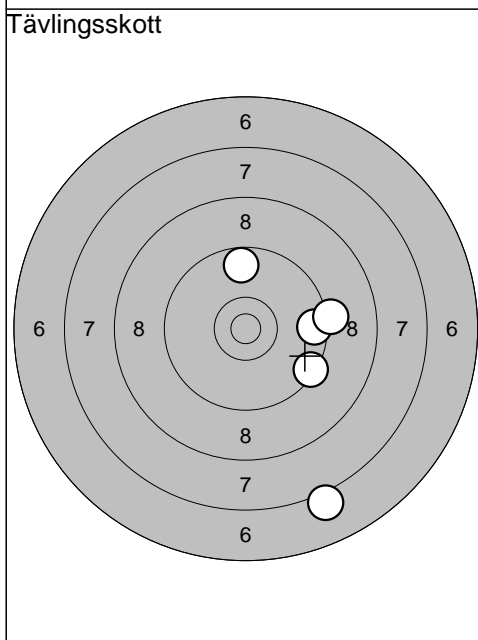

1: 9,6	→
2: 9,7	↑
3: 9,4	↘
4: 9,2	→
5: 7,1	↘
<hr/>	
Serie	43,0
Totalt	43,0

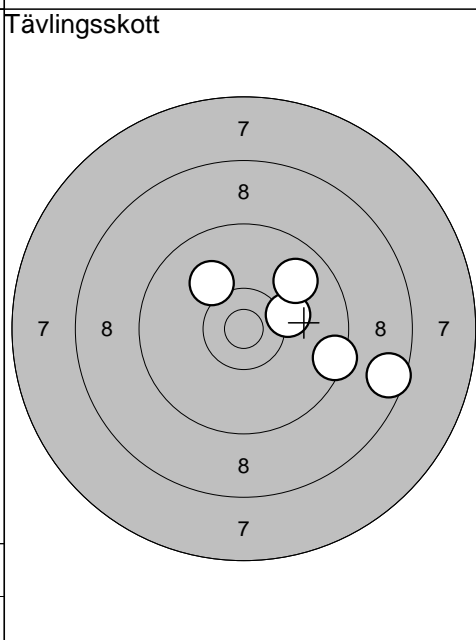

6: 9,4	→
7: 8,6	→
8: 10,1	↖
9: 10,2	→
10: 9,8	↗
<hr/>	
Serie	46,0
Totalt	89,0

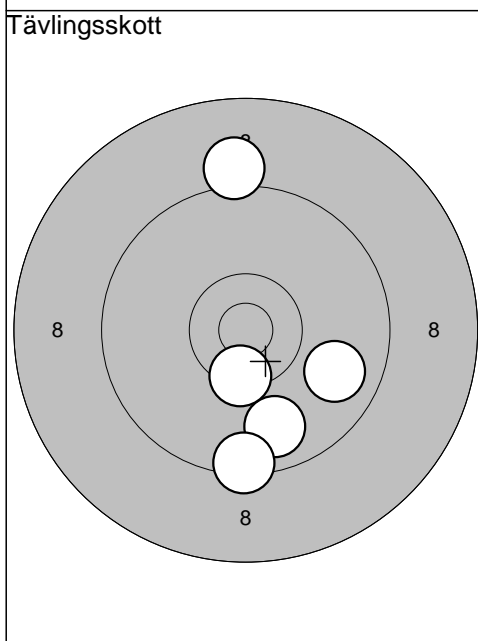

11: 9,1	↑
12: 9,8	↘
13: 9,8	↘
14: 10,4*	↘
15: 9,4	↘
<hr/>	
Serie	46,0
Totalt	135,0

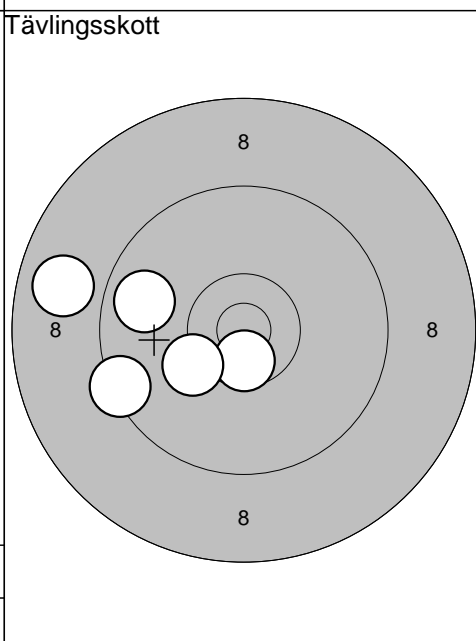

16: 8,8	←
17: 10,6*	↓
18: 10,2	↙
19: 9,4	↙
20: 9,8	↙
<hr/>	
Serie	46,0
Totalt	181,0

Ramselefors

2011-08-14

Förbundsmästerskap 2011

Ramselefors SKF

Provskott

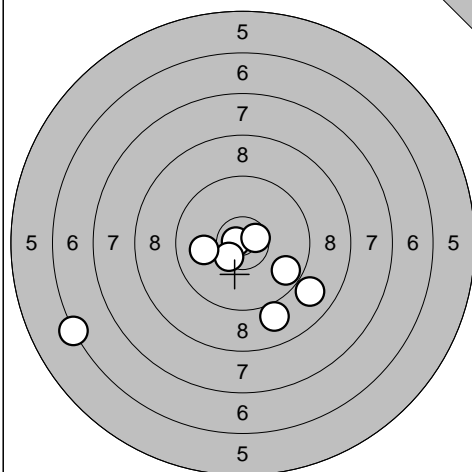

1: 6,3 ↙
 2: 9,7 ↘
 3: 10,8* ←
 4: 10,6* →
 5: 9,0 ↘
 6: 10,5* ↙
 7: 8,9 ↘
 8: 10,0 ←

Serie 72,0

Totalt 0,0

Tävlingsskott

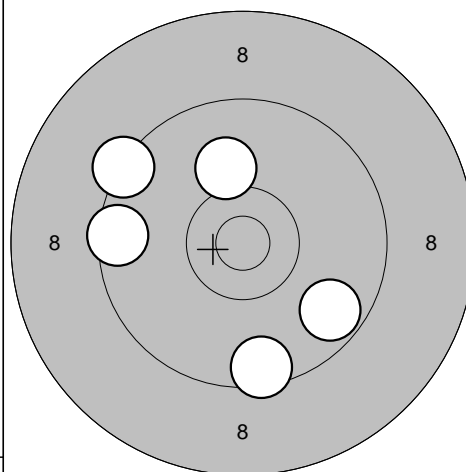

1: 9,7 ↘
 2: 9,5 ←
 3: 10,1 ↑
 4: 9,5 ↘
 5: 9,3 ↙

Serie 46,0

Totalt 46,0

Tävlingsskott

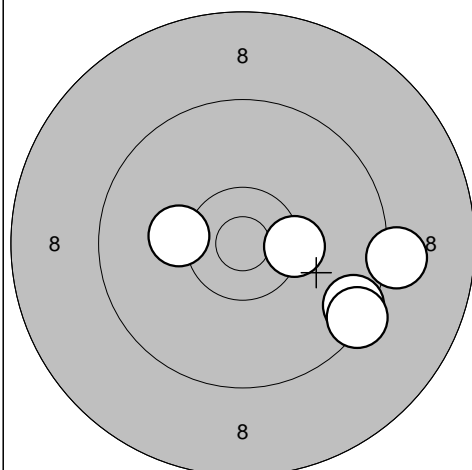

6: 9,2 →
 7: 9,5 ↘
 8: 10,4* →
 9: 9,4 ↘
 10: 10,2 ←

Serie 47,0

Totalt 93,0

Tävlingsskott

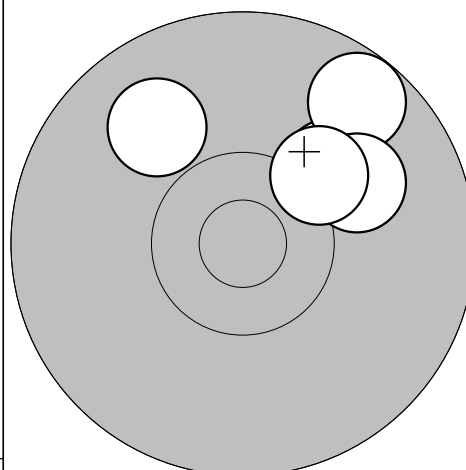

11: 10,1 ↗
 12: 9,7 ↗
 13: 10,0 →
 14: 9,9 ↙
 15: 10,2 ↗

Serie 48,0

Totalt 141,0

Tävlingsskott

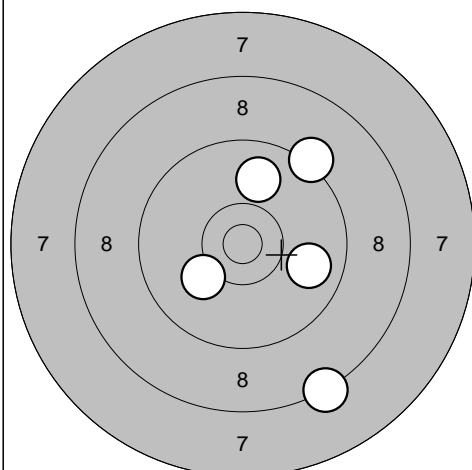

16: 9,9 →
 17: 8,3 ↘
 18: 9,9 ↑
 19: 9,2 ↗
 20: 10,1 ↙

Serie 45,0

Totalt 186,0

Umeå

2011-08-14

Förbundsmästerskap 2011

Ramselefors SKF

Provskott

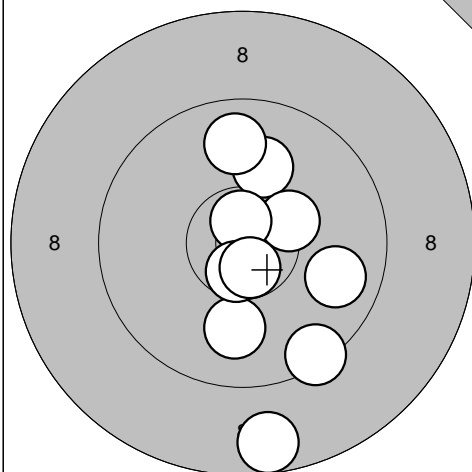

1: 10,1 ↑
 2: 10,4* →
 3: 9,8 →
 4: 9,8 ↑
 5: 10,0 ↓
 6: 8,7 ↓
 7: 10,7* ↑
 8: 9,4 ↓
 9: 10,6* ↓
 10: 10,7* ↓

Serie 95,0

Totalt 0,0

Tävlingsskott

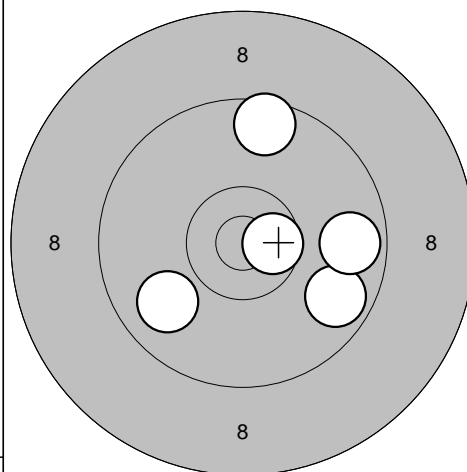

1: 9,7 ↘
 2: 9,6 ↑
 3: 9,9 ↙
 4: 10,6* →
 5: 9,7 →

Serie 46,0

Totalt 46,0

Tävlingsskott

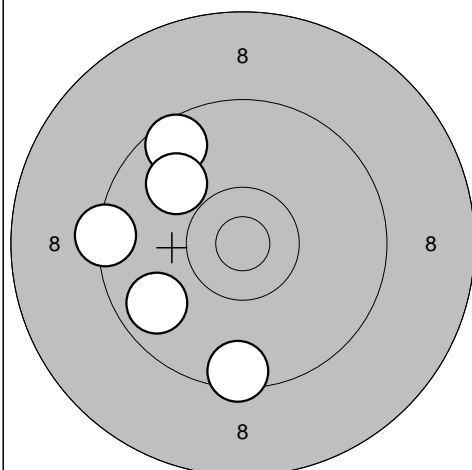

6: 9,6 ↑
 7: 9,9 ↗
 8: 9,8 ↙
 9: 9,4 ←
 10: 9,5 ↓

Serie 45,0

Totalt 91,0

Tävlingsskott

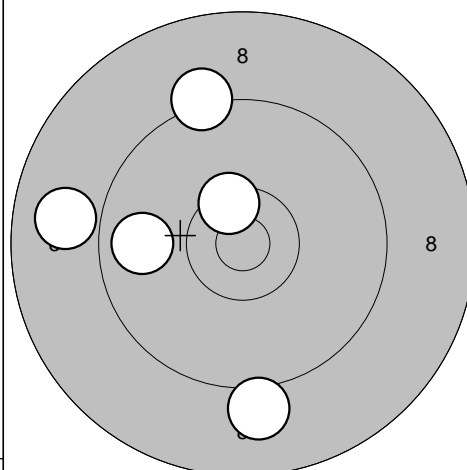

11: 10,5* ↑
 12: 9,8 ←
 13: 8,9 ←
 14: 9,1 ↓
 15: 9,2 ↑

Serie 45,0

Totalt 136,0

Tävlingsskott

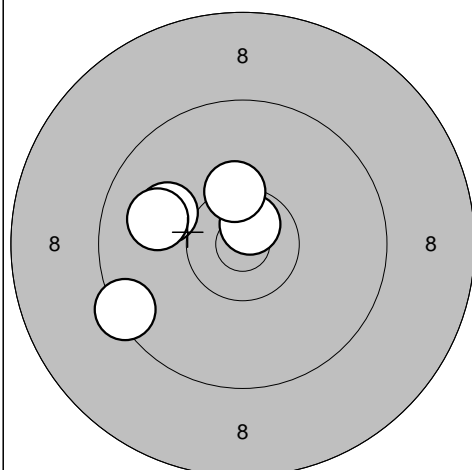

16: 9,4 ↙
 17: 10,7* ↑
 18: 10,3* ↑
 19: 10,0 ↙
 20: 9,9 ↙

Serie 48,0

Totalt 184,0

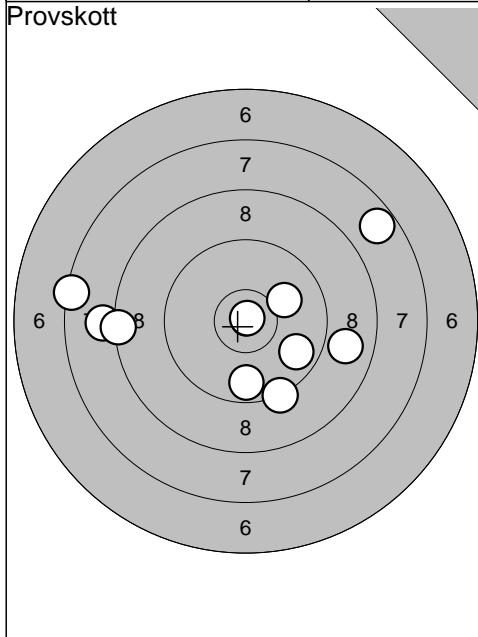

1: 7,7	↗
2: 9,3	↘
3: 10,1	↗
4: 8,9	→
5: 9,7	↘
6: 8,1	←
7: 7,4	←
8: 9,8	↗
9: 10,9*	↗
10: 8,4	←
<hr/>	
Serie	85,0
Totalt	0,0

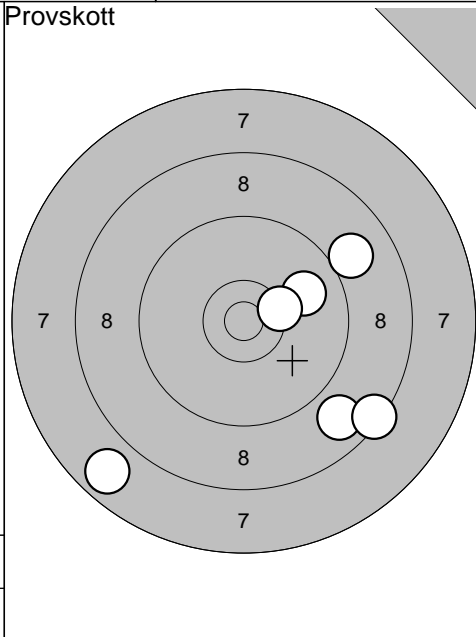

11: 9,0	↗
12: 7,8	↘
13: 8,8	↘
14: 8,4	↘
15: 9,9	↗
16: 10,4*	↗
<hr/>	
Serie	51,0
Totalt	0,0

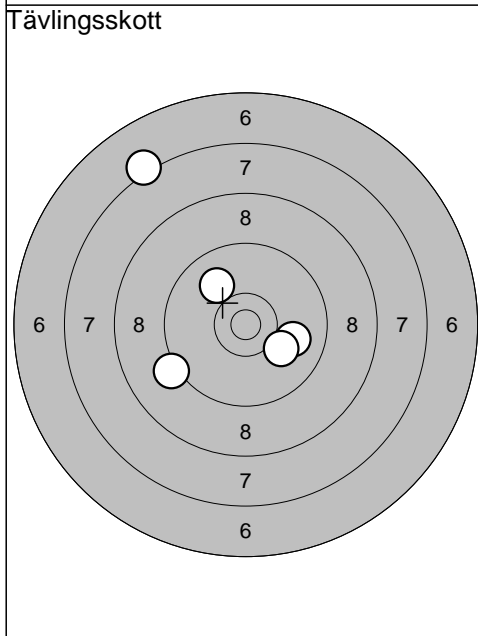

1: 9,2	↖
2: 10,0	↗
3: 10,1	↘
4: 10,0	↗
5: 7,2	↗
<hr/>	
Serie	46,0
Totalt	46,0

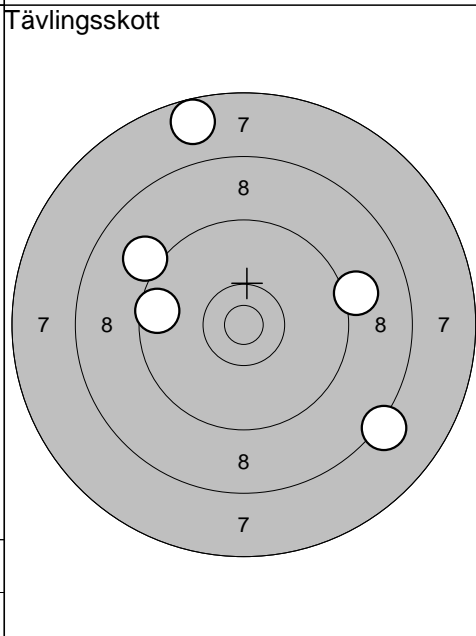

6: 7,7	↑
7: 9,1	↖
8: 9,6	←
9: 9,1	↗
10: 8,2	↘
<hr/>	
Serie	42,0
Totalt	88,0

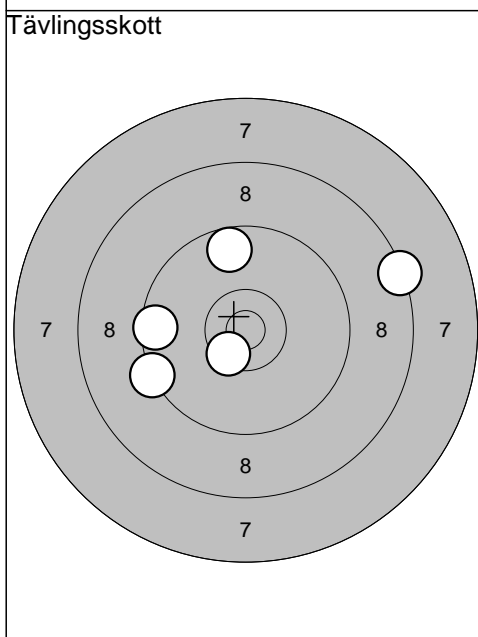

11: 8,4	↗
12: 9,3	↖
13: 9,5	←
14: 10,5*	↘
15: 9,7	↑
<hr/>	
Serie	45,0
Totalt	133,0

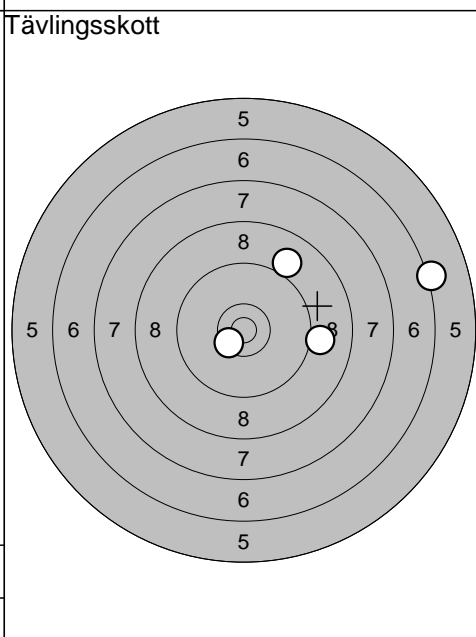

16: 10,5*	↖
17: 9,1	→
18: 6,2	→
19: 9,0	↗
0,0	↖
<hr/>	
Serie	34,0
Totalt	167,0

Umeå

2011-08-14

Förbundsmästerskap 2011

Ramselefors SKF

Provsjött

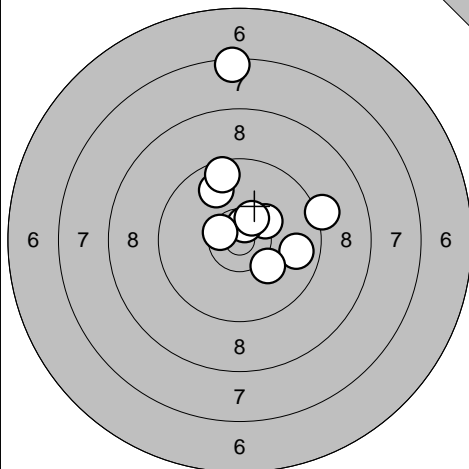

- 1: 7,4 ↑
- 2: 9,8 →
- 3: 9,2 →
- 4: 9,8 ↑
- 5: 9,6 ↑
- 6: 10,3* →
- 7: 10,6* ↑
- 8: 10,5* ←
- 9: 10,2 ↓
- 10: 10,5* ↑

Serie 93,0
Totalt 0,0

Tävlingssjött

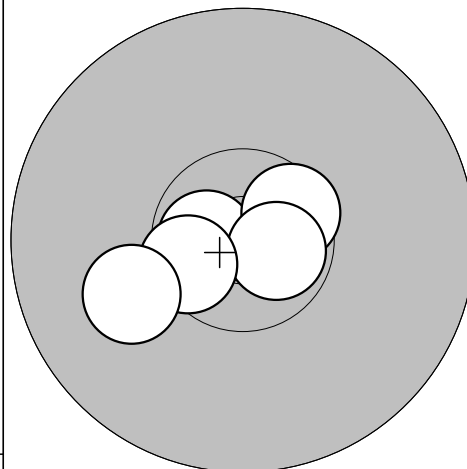

- 1: 10,7* ←
- 2: 10,6* ↗
- 3: 10,7* →
- 4: 10,5* ←
- 5: 10,1 ←

Serie 50,0
Totalt 50,0

Tävlingssjött

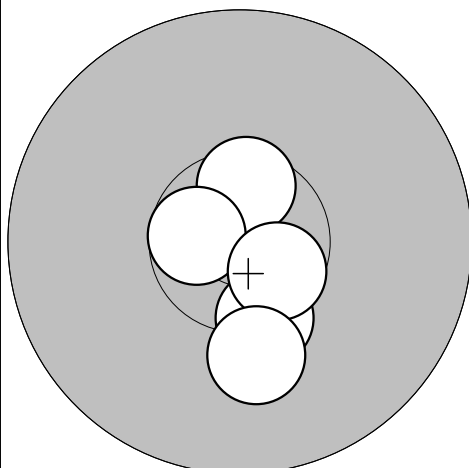

- 6: 10,6* ↑
- 7: 10,6* ←
- 8: 10,4* ↓
- 9: 10,6* ↓
- 10: 10,1 ↓

Serie 50,0
Totalt 100,0

Tävlingssjött

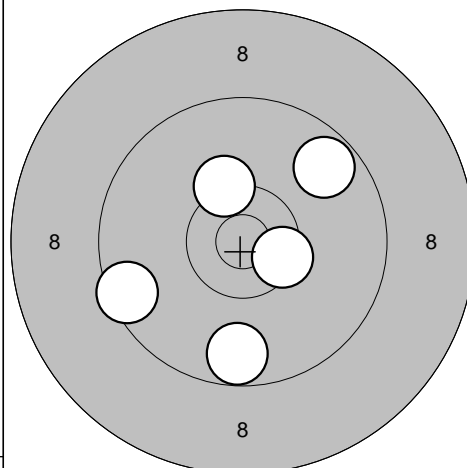

- 11: 9,7 ↗
- 12: 9,7 ↓
- 13: 9,5 ←
- 14: 10,5* →
- 15: 10,3* ↑

Serie 47,0
Totalt 147,0

Tävlingssjött

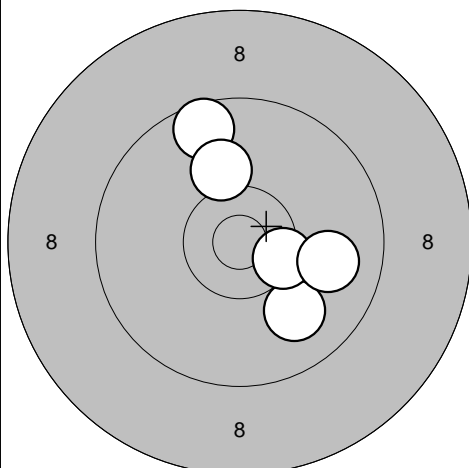

- 16: 9,9 ↓
- 17: 10,4* →
- 18: 9,9 →
- 19: 9,6 ↑
- 20: 10,1 ↑

Serie 47,0
Totalt 194,0

Umeå

2011-08-14

Förbundsmästerskap 2011

Ramselefors SKF

Provskott

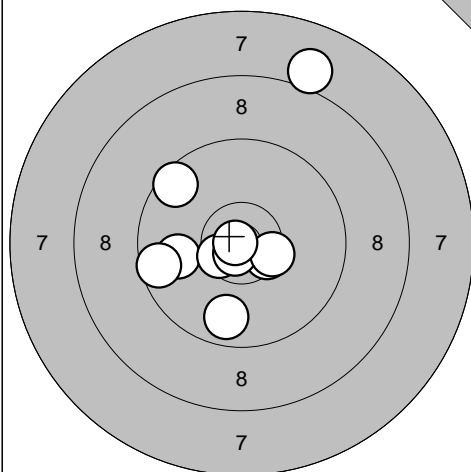

1: 8,0 ↗
 2: 9,8 ↓
 3: 9,9 ←
 4: 10,5* →
 5: 9,6 ↗
 6: 10,6* ←
 7: 9,6 ←
 8: 10,8* ↓
 9: 10,4* →
 10: 10,9* ←

Serie 94,0

Totalt 0,0

Provskott

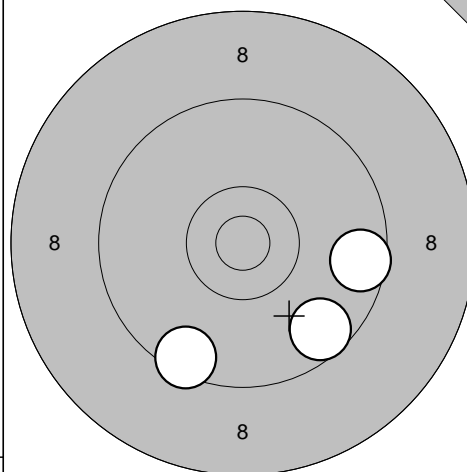

11: 9,6 →
 12: 9,6 ↓
 13: 9,5 ↓

Serie 27,0

Totalt 0,0

Tävlingsskott

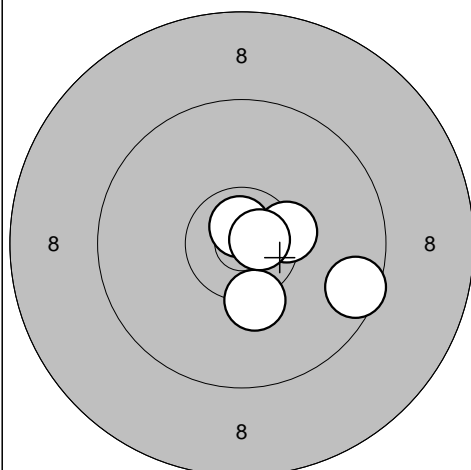

1: 10,4* →
 2: 10,3 ↓
 3: 10,8* ↑
 4: 9,6 →
 5: 10,7* →

Serie 49,0

Totalt 49,0

Tävlingsskott

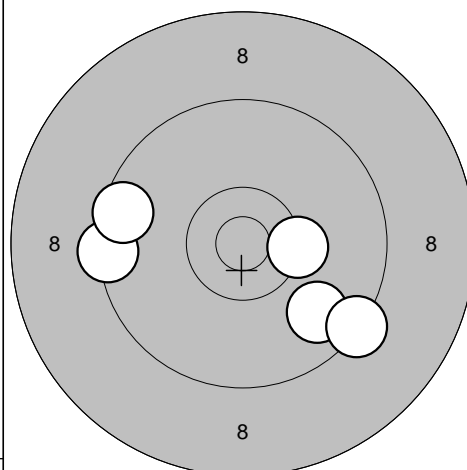

6: 9,8 ↓
 7: 9,3 ↓
 8: 10,3* →
 9: 9,4 ←
 10: 9,5 ←

Serie 46,0

Totalt 95,0

Tävlingsskott

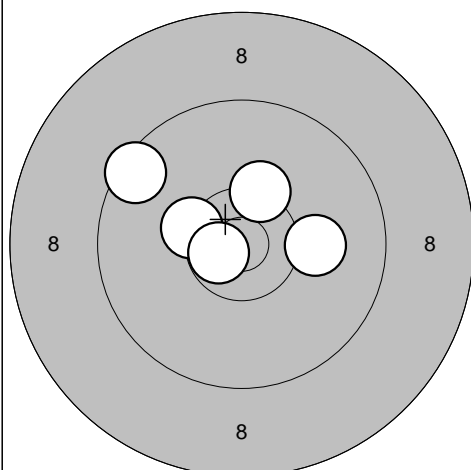

11: 10,3* ↗
 12: 10,1 →
 13: 10,4* ←
 14: 10,7* ←
 15: 9,5 ↗

Serie 49,0

Totalt 144,0

Tävlingsskott

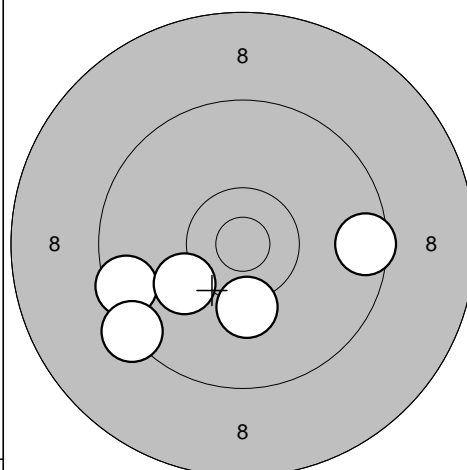

16: 9,5 ←
 17: 9,5 →
 18: 10,1 ←
 19: 9,3 ←
 20: 10,2 ↓

Serie 47,0

Totalt 191,0

Umeå

2011-08-14

Förbundsmästerskap 2011

Ramselefors SKF

Provsjött

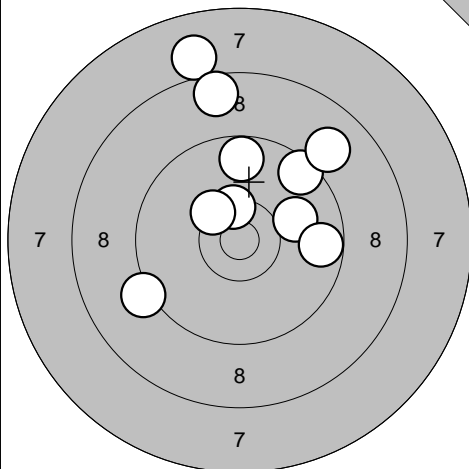

- 1: 8,0 ↗
- 2: 10,0 →
- 3: 9,7 →
- 4: 9,5 ↗
- 5: 9,0 ↗
- 6: 9,7 ↑
- 7: 8,6 ↑
- 8: 10,4* ↑
- 9: 10,3* ↗
- 10: 9,2 ↙

Serie 91,0
Totalt 0,0

Provsjött

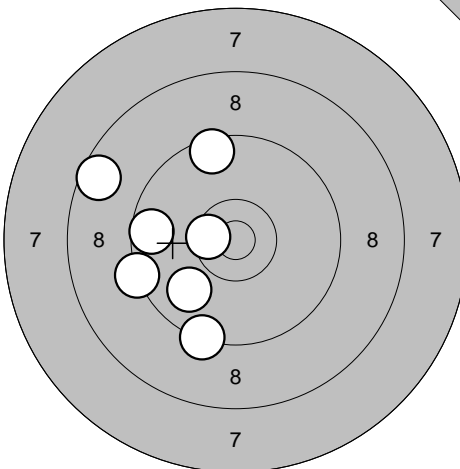

- 11: 9,9 ↘
- 12: 9,3 ↓
- 13: 9,3 ←
- 14: 8,6 ↙
- 15: 10,5* ←
- 16: 9,5 ↑
- 17: 9,6 ←

Serie 63,0
Totalt 0,0

Tävlingssjött

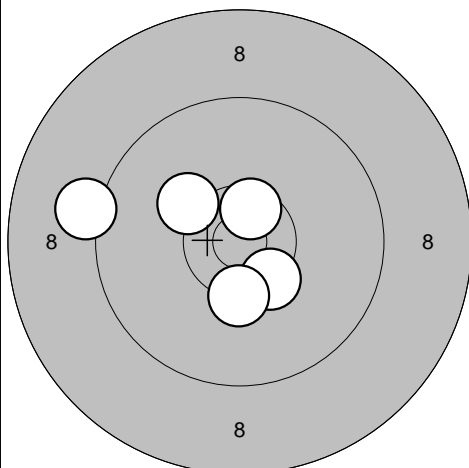

- 1: 10,4* ↘
- 2: 10,3* ↓
- 3: 9,2 ←
- 4: 10,2 ↗
- 5: 10,6* ↑

Serie 49,0
Totalt 49,0

Tävlingssjött

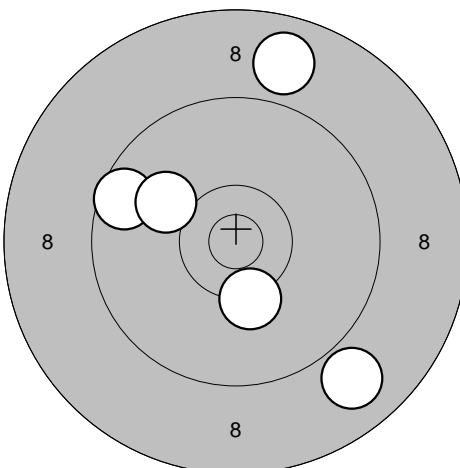

- 6: 9,6 ↙
- 7: 8,9 ↘
- 8: 10,3 ↓
- 9: 10,0 ↙
- 10: 8,8 ↑

Serie 45,0
Totalt 94,0

Tävlingssjött

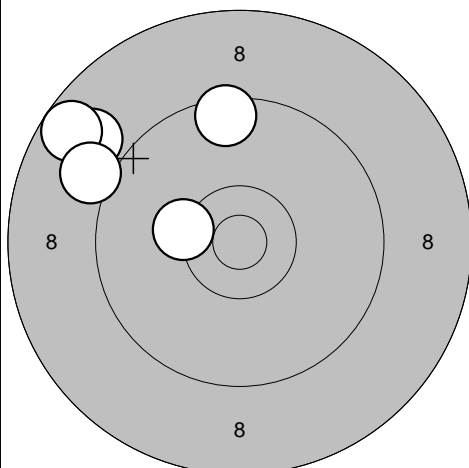

- 11: 9,5 ↑
- 12: 10,3* ←
- 13: 8,9 ↗
- 14: 8,7 ↗
- 15: 9,1 ↗

Serie 44,0
Totalt 138,0

Tävlingssjött

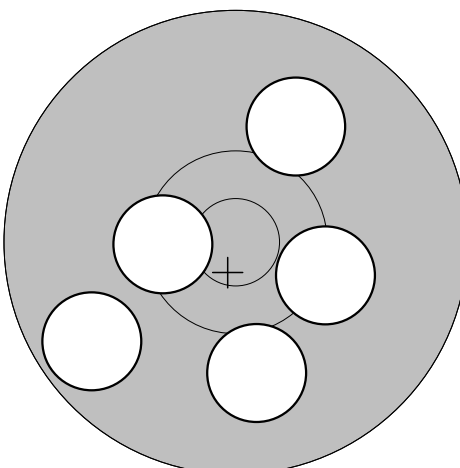

- 16: 10,0 ↓
- 17: 10,0 ↗
- 18: 10,3 →
- 19: 10,4* ←
- 20: 9,7 ↙

Serie 49,0
Totalt 187,0

2011-08-14

Förbundsmästerskap 2011

Ramselefors SKF

Provskott

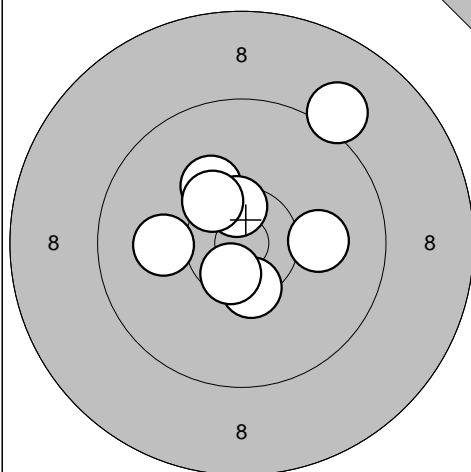

1: 9,1 ↗
 2: 10,2 ↗
 3: 10,4* ↓
 4: 10,5* ↑
 5: 10,4* ↗
 6: 10,1 ←
 7: 10,6* ↓
 8: 10,1 →

Serie 79,0

Totalt 0,0

Tävlingsskott

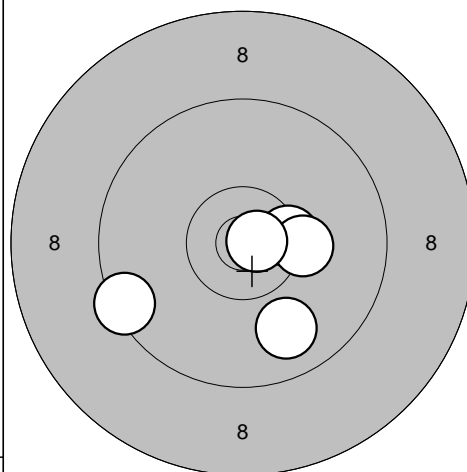

1: 10,4* →
 2: 9,9 ↓
 3: 10,3 →
 4: 10,8* →
 5: 9,4 ↙

Serie 48,0

Totalt 48,0

Tävlingsskott

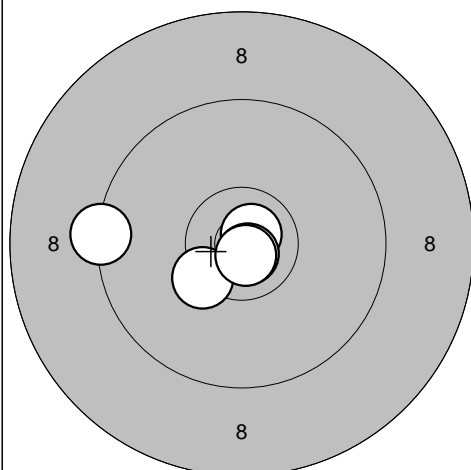

6: 9,3 ←
 7: 10,8* ↗
 8: 10,8* ↓
 9: 10,4* ↙
 10: 10,8* ↓

Serie 49,0

Totalt 97,0

Tävlingsskott

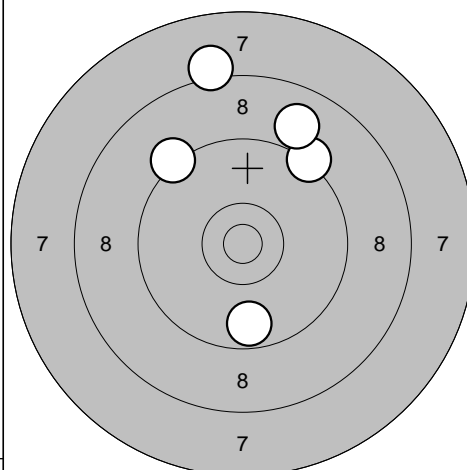

11: 9,3 ↗
 12: 8,2 ↑
 13: 9,3 ↗
 14: 8,9 ↗
 15: 9,7 ↓

Serie 43,0

Totalt 140,0

Tävlingsskott

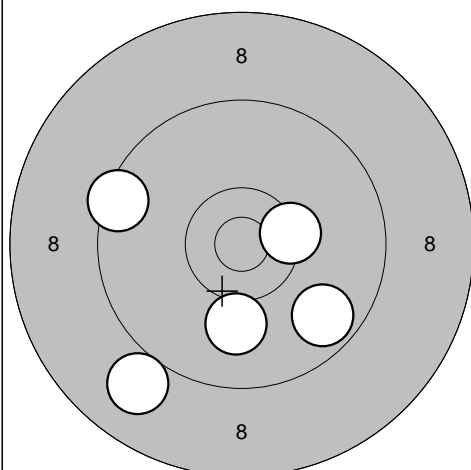

16: 9,0 ↙
 17: 9,7 ↙
 18: 9,5 ←
 19: 10,0 ↓
 20: 10,4* →

Serie 47,0

Totalt 187,0

Ramselefors

2011-08-14

Förbundsmästerskap 2011

Ramselefors SKF

Provskott

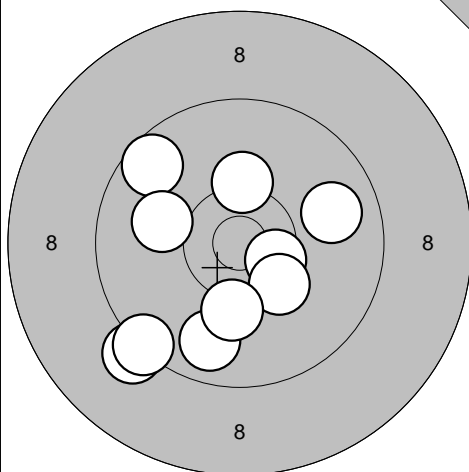

1: 9,2 ↙
 2: 10,5* →
 3: 9,8 →
 4: 10,3 ↑
 5: 10,3* ↘
 6: 9,4 ↙
 7: 9,6 ↗
 8: 9,8 ↘
 9: 10,2 ↘
 10: 10,0 ←

Serie 95,0

Totalt 0,0

Provskott

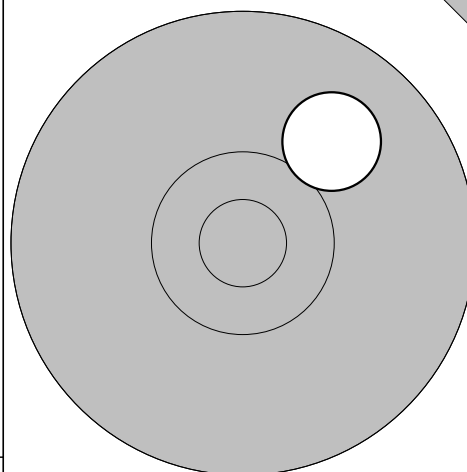

11: 10,0 ↗

Serie 10,0

Totalt 0,0

Tävlingsskott

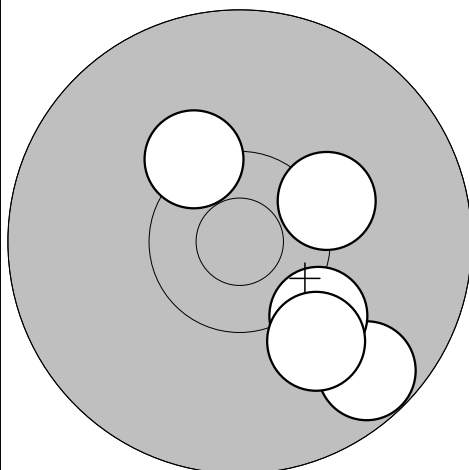

1: 9,7 ↘
 2: 10,2 ↘
 3: 10,1 ↘
 4: 10,3 ↗
 5: 10,3 →

Serie 49,0

Totalt 49,0

Tävlingsskott

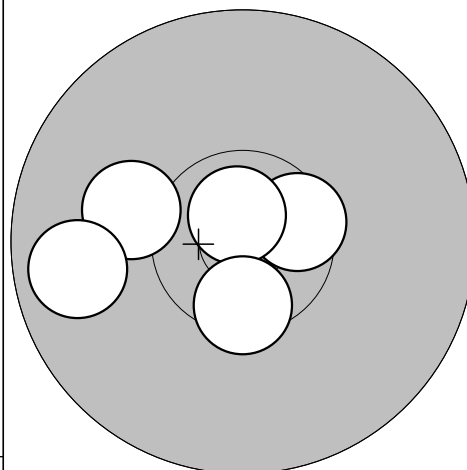

6: 10,1 ←
 7: 9,8 ←
 8: 10,5* →
 9: 10,8* ↑
 10: 10,5* ↓

Serie 49,0

Totalt 98,0

Tävlingsskott

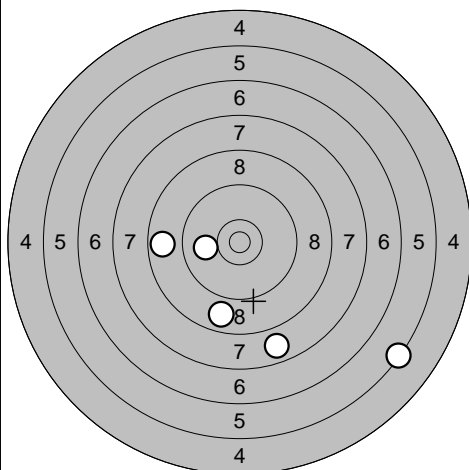

11: 8,8 ↘
 12: 7,8 ↘
 13: 10,0 ←
 14: 5,3 ↘
 15: 8,8 ←

Serie 38,0

Totalt 136,0

Tävlingsskott

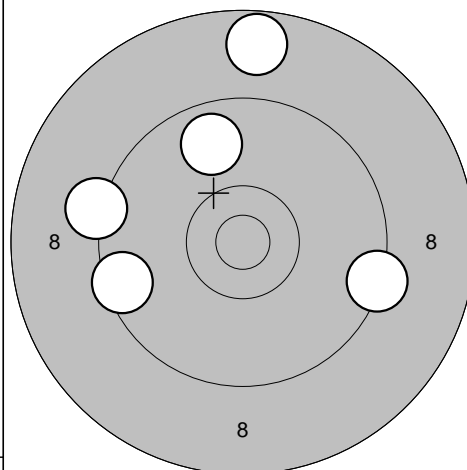

16: 9,5 ←
 17: 9,2 ←
 18: 9,8 ↑
 19: 9,4 →
 20: 8,7 ↑

Serie 44,0

Totalt 180,0

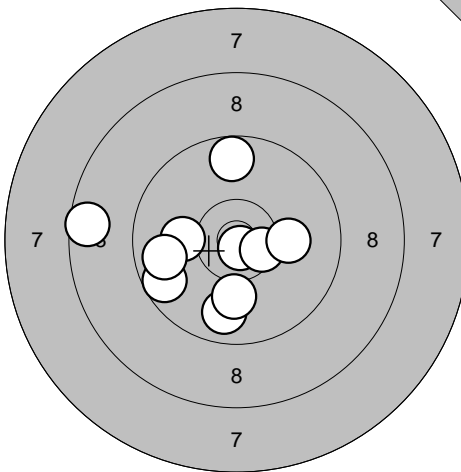
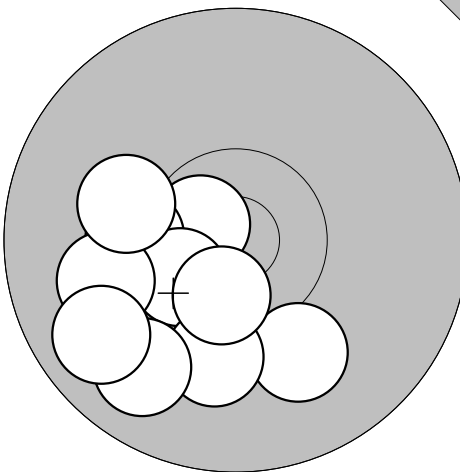
<p>Provskott</p> 	<p>1: 8,6 ←</p> <p>2: 9,7 ↑</p> <p>3: 10,1 ←</p> <p>4: 9,8 ↓</p> <p>5: 10,1 ↓</p> <p>6: 10,8* ↓</p> <p>7: 9,7 ←</p> <p>8: 9,8 ←</p> <p>9: 10,5* →</p> <p>10: 10,1 →</p>	<p>Provskott</p> 	<p>11: 10,7* ←</p> <p>12: 10,2 ←</p> <p>13: 10,5* ↙</p> <p>14: 10,0 ↓</p> <p>15: 10,1 ↓</p> <p>16: 9,8 ↙</p> <p>17: 10,0 ←</p> <p>18: 10,5* ↓</p> <p>19: 10,1 ←</p> <p>20: 9,8 ↙</p>
Serie 94,0	Totalt 0,0	Serie 98,0	Totalt 0,0

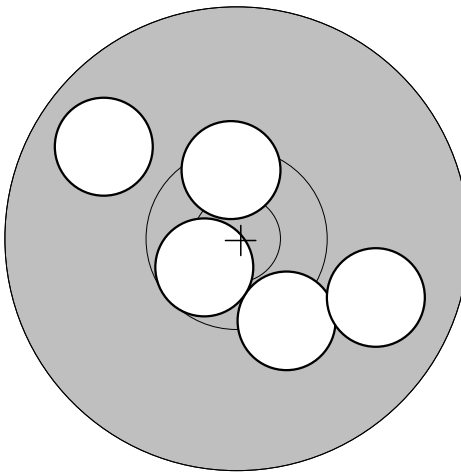
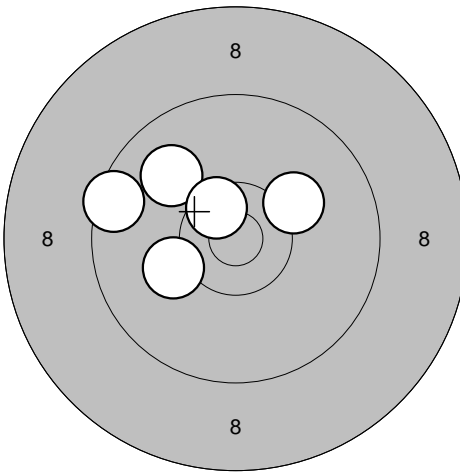
<p>Tävlingsskott</p> 	<p>1: 10,3 ↓</p> <p>2: 9,9 →</p> <p>3: 10,5* ↑</p> <p>4: 10,6* ↙</p> <p>5: 9,8 ↗</p>	<p>Tävlingsskott</p> 	<p>6: 10,2 ↗</p> <p>7: 9,9 ↖</p> <p>8: 10,5* ↗</p> <p>9: 9,5 ←</p> <p>10: 10,2 ←</p>
Serie 48,0	Totalt 48,0	Serie 48,0	Totalt 96,0

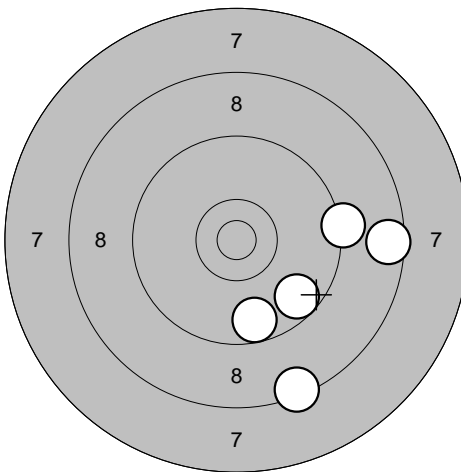
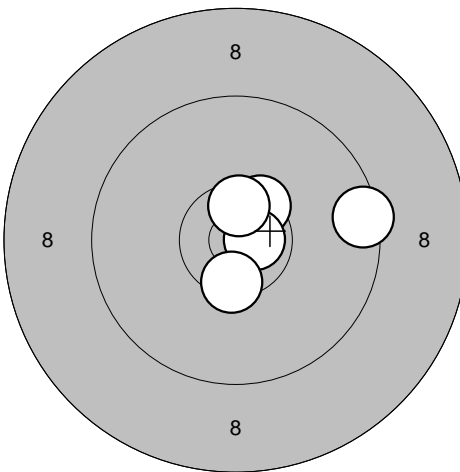
<p>Tävlingsskott</p> 	<p>11: 8,6 →</p> <p>12: 9,3 →</p> <p>13: 8,4 ↓</p> <p>14: 9,6 ↓</p> <p>15: 9,7 ↓</p>	<p>Tävlingsskott</p> 	<p>16: 10,5* ↗</p> <p>17: 10,7* →</p> <p>18: 10,5* ↓</p> <p>19: 9,5 →</p> <p>20: 10,6* ↑</p>
Serie 43,0	Totalt 139,0	Serie 49,0	Totalt 188,0

Ramselefors

2011-08-14

Förbundsmästerskap 2011

Ramselefors SKF

Provsnitt

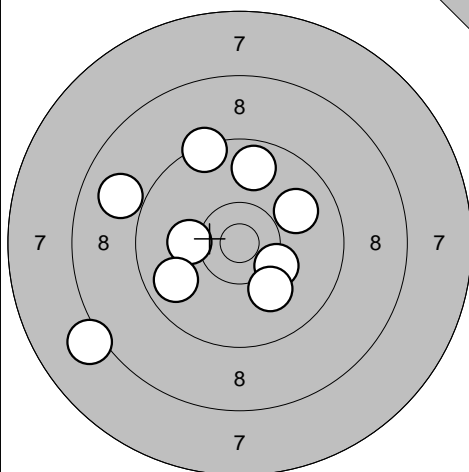

- 1: 8,9 ↙
- 2: 10,2 ←
- 3: 8,1 ↙
- 4: 9,8 ↙
- 5: 9,4 ↑
- 6: 10,3 →
- 7: 9,8 ↑
- 8: 9,9 →
- 9: 10,1 ↓

Serie 82,0
Totalt 0,0

Tävlingsnitt

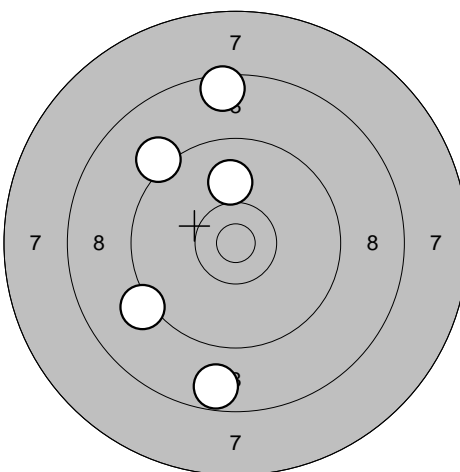

- 1: 8,7 ↓
- 2: 9,2 ↙
- 3: 8,5 ↑
- 4: 10,0 ↑
- 5: 9,2 ↙

Serie 44,0
Totalt 44,0

Tävlingsnitt

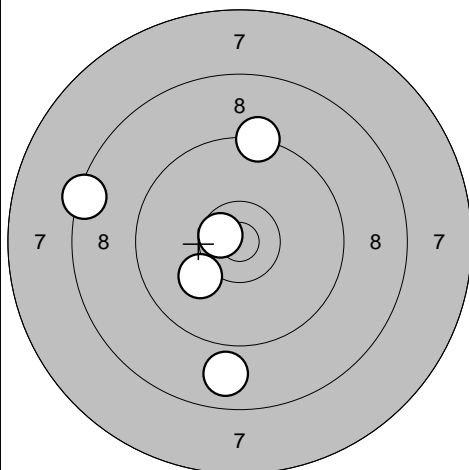

- 6: 8,9 ↓
- 7: 9,3 ↑
- 8: 8,4 ←
- 9: 10,6* ↙
- 10: 10,1 ↙

Serie 45,0
Totalt 89,0

Tävlingsnitt

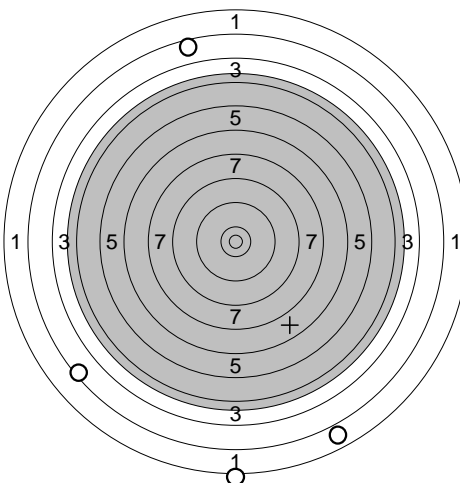

- 11: 0,0 →
- 12: 2,5 ↙
- 13: 1,9 ↓
- 14: 2,6 ↑
- 15: 1,2 ↓

Serie 6,0
Totalt 95,0

Tävlingsnitt

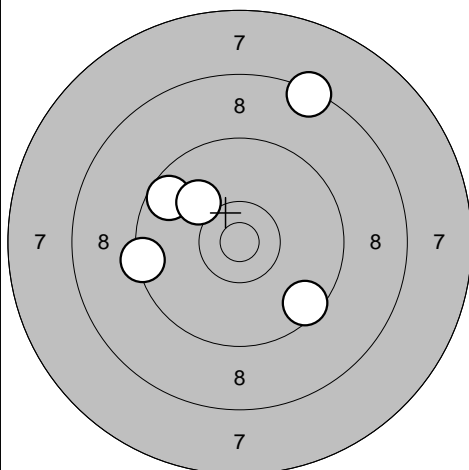

- 16: 9,5 ↓
- 17: 9,6 ↙
- 18: 9,4 ←
- 19: 8,4 ↑
- 20: 10,1 ↙

Serie 45,0
Totalt 140,0

Umeå

2011-08-14

Förbundsmästerskap 2011

Ramselefors SKF

Provskott

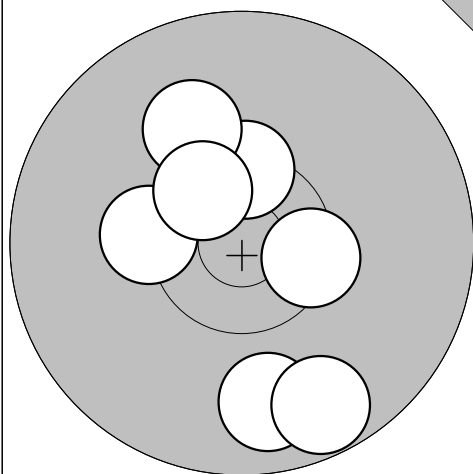

1: 10,3* ←
 2: 9,8 ↓
 3: 9,7 ↓
 4: 10,4* ↑
 5: 10,1 ↑
 6: 10,4* →
 7: 10,5* ↗

Serie 68,0
 Totalt 0,0

Tävlingskott

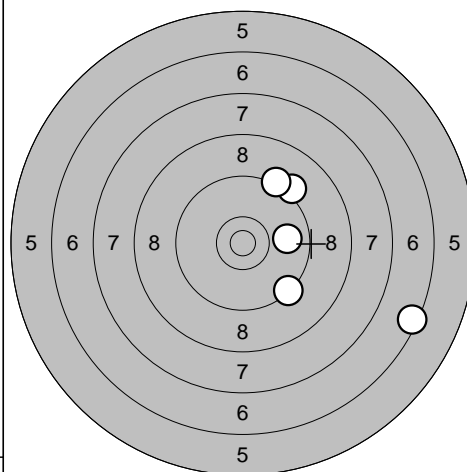

1: 6,4 →
 2: 9,2 ↗
 3: 9,3 ↗
 4: 9,3 ↓
 5: 9,9 →

Serie 42,0
 Totalt 42,0

Tävlingskott

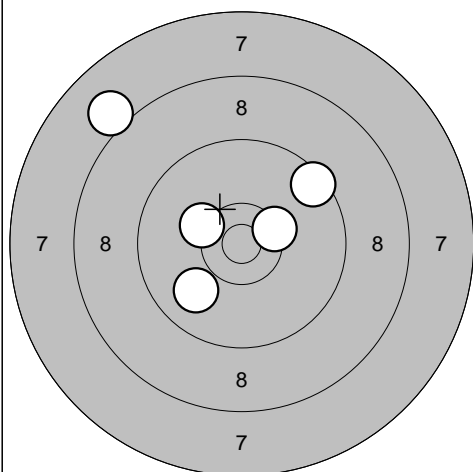

6: 10,3 ↗
 7: 9,9 ↘
 8: 8,0 ↗
 9: 9,5 ↗
 10: 10,4* →

Serie 46,0
 Totalt 88,0

Tävlingskott

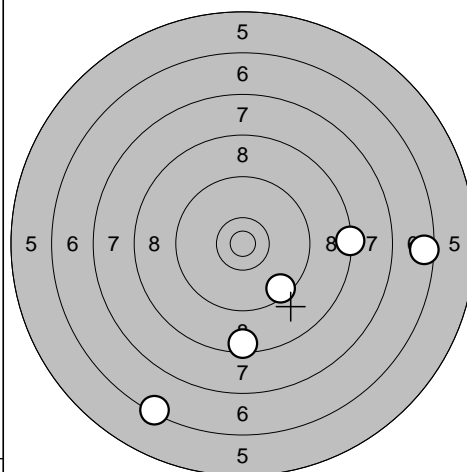

11: 6,4 ↘
 12: 9,5 ↘
 13: 6,5 →
 14: 8,5 ↓
 15: 8,3 →

Serie 37,0
 Totalt 125,0

Tävlingskott

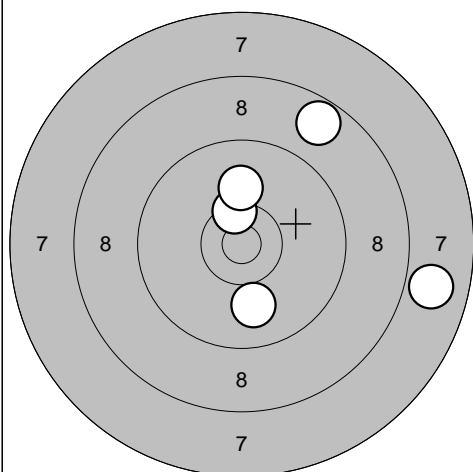

16: 7,9 →
 17: 10,0 ↓
 18: 8,7 ↗
 19: 10,4* ↑
 20: 10,1 ↑

Serie 45,0
 Totalt 170,0

Drängsmark

2011-08-14

Förbundsmästerskap 2011

Ramselefors SKF

Provsjött

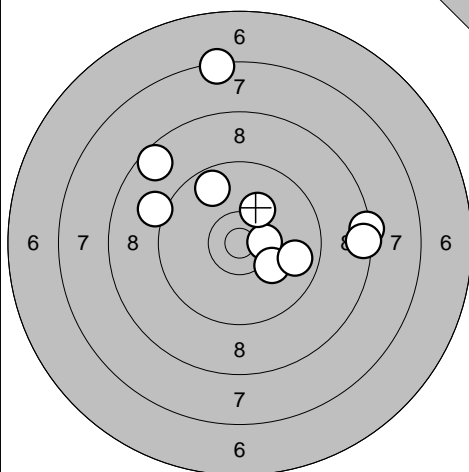

- 1: 10,4* →
- 2: 9,1 ←
- 3: 10,2 ↗
- 4: 8,4 →
- 5: 8,5 →
- 6: 7,4 ↑
- 7: 10,2 ↘
- 8: 8,6 ↗
- 9: 9,8 →
- 10: 9,7 ↑

Serie 88,0
Totalt 0,0

Provsjött

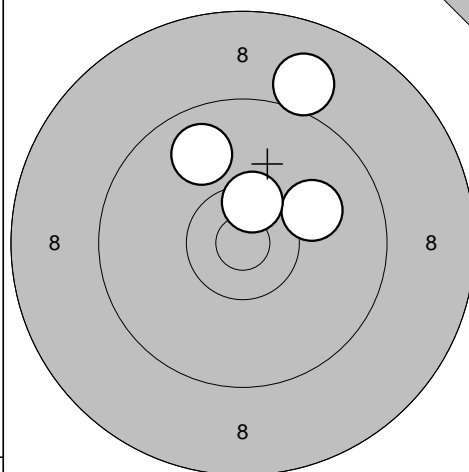

- 11: 9,8 ↖
- 12: 10,1 →
- 13: 10,5* ↑
- 14: 9,0 ↑

Serie 38,0
Totalt 0,0

Tävlingssjött

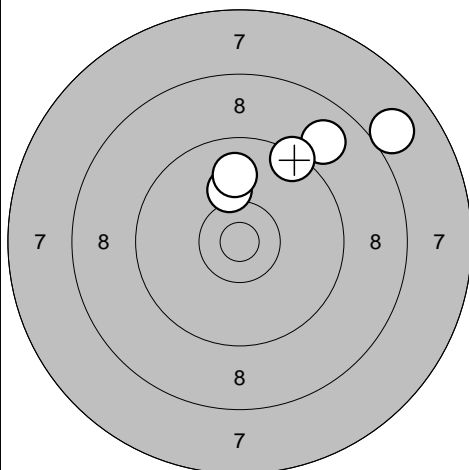

- 1: 8,9 ↗
- 2: 10,1 ↑
- 3: 9,4 ↗
- 4: 8,0 →
- 5: 9,9 ↑

Serie 44,0
Totalt 44,0

Tävlingssjött

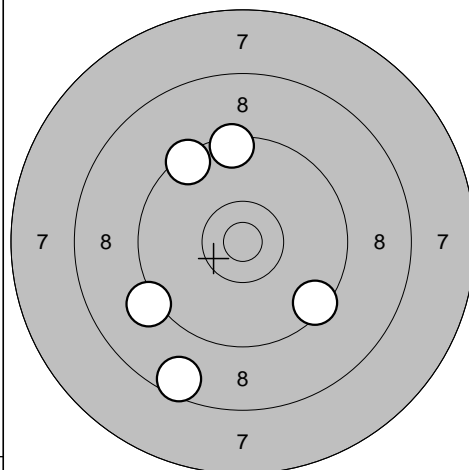

- 6: 9,4 ↑
- 7: 8,6 ↘
- 8: 9,4 ↖
- 9: 9,2 ↙
- 10: 9,5 ↘

Serie 44,0
Totalt 88,0

Tävlingssjött

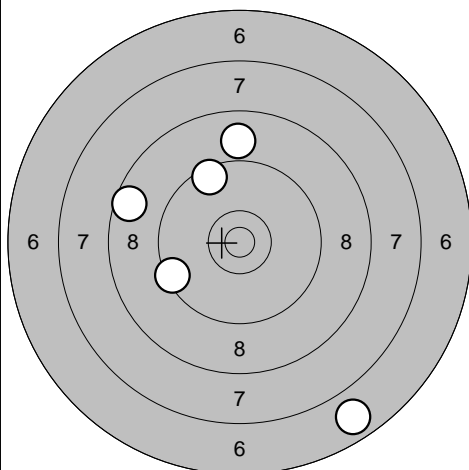

- 11: 6,8 ↘
- 12: 9,5 ↖
- 13: 8,9 ↑
- 14: 9,4 ↙
- 15: 8,6 ←

Serie 40,0
Totalt 128,0

Tävlingssjött

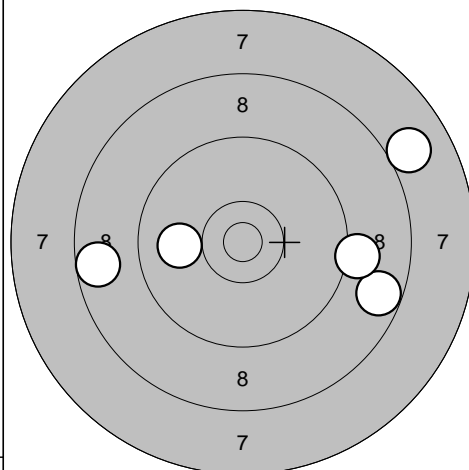

- 16: 10,0 ←
- 17: 8,7 ←
- 18: 8,0 →
- 19: 8,7 →
- 20: 9,1 →

Serie 43,0
Totalt 171,0

Umeå

2011-08-14

Förbundsmästerskap 2011

Ramselefors SKF

Provskott

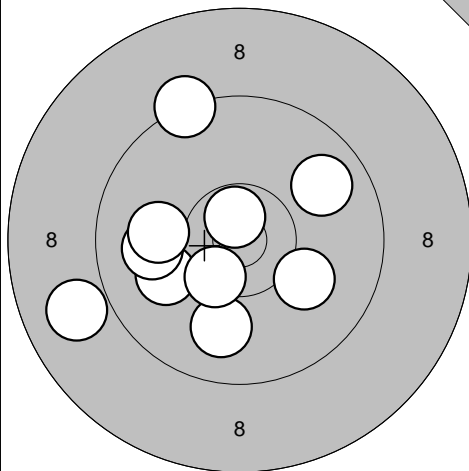

1: 10,7* ↗
 2: 8,9 ←
 3: 10,0 ←
 4: 9,3 ↗
 5: 10,0 ←
 6: 10,0 ←
 7: 9,9 ↓
 8: 9,8 ↗
 9: 10,1 ↘
 10: 10,4* ↙

Serie 95,0

Totalt 0,0

Tävlingsskott

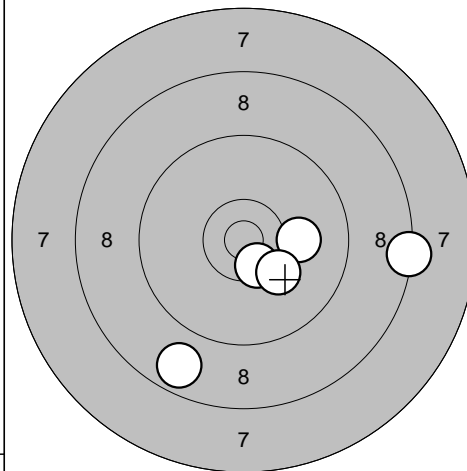

1: 8,3 →
 2: 8,7 ↙
 3: 10,5* ↓
 4: 10,1 →
 5: 10,2 ↙

Serie 46,0

Totalt 46,0

Tävlingsskott

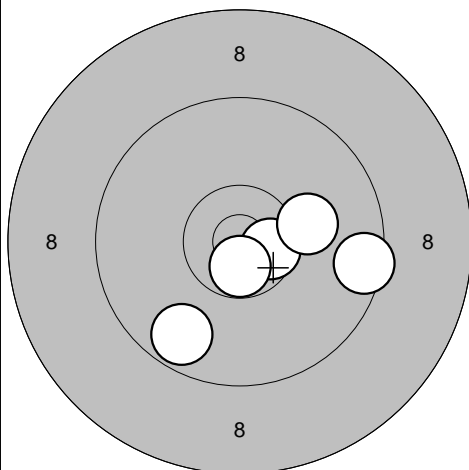

6: 10,6* →
 7: 9,5 →
 8: 9,7 ↙
 9: 10,7* ↓
 10: 10,1 →

Serie 48,0

Totalt 94,0

Tävlingsskott

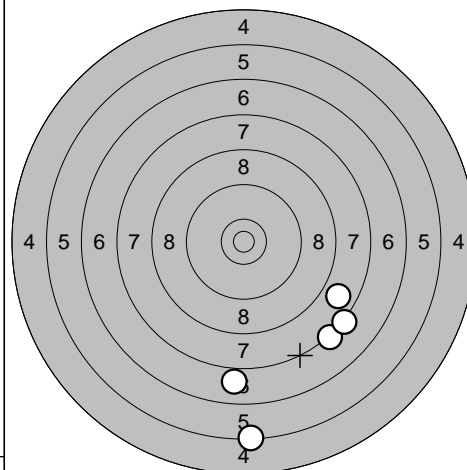

11: 7,3 ↙
 12: 6,9 ↓
 13: 7,8 ↘
 14: 5,3 ↓
 15: 7,3 ↙

Serie 32,0

Totalt 126,0

Tävlingsskott

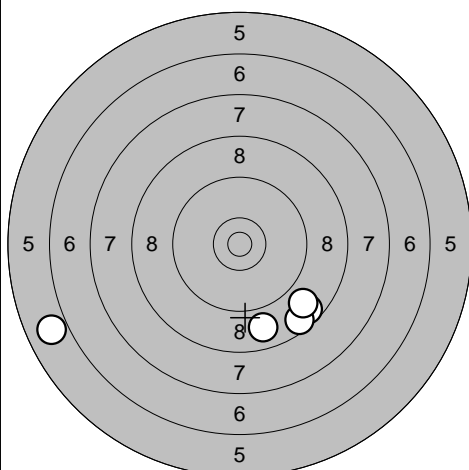

16: 8,7 ↙
 17: 8,6 ↙
 18: 8,8 ↙
 19: 8,8 ↙
 20: 5,9 ←

Serie 37,0

Totalt 163,0

Drängsmark

2011-08-14

Förbundsmästerskap 2011

Ramselefors SKF

Provskott

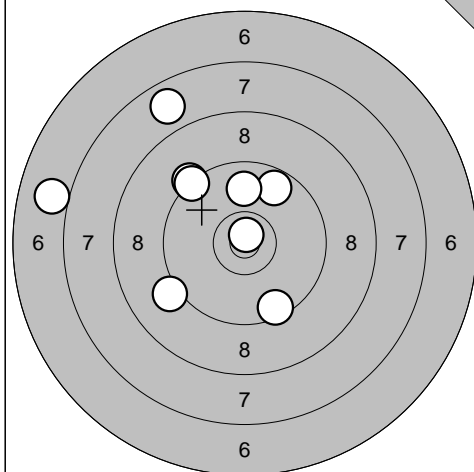

1: 7,0 ←
 2: 9,1 ↙
 3: 9,3 ↗
 4: 9,7 ↗
 5: 9,4 ↗
 6: 7,8 ↗
 7: 9,9 ↑
 8: 10,8* ↑
 9: 9,5 ↓

Serie 78,0

Totalt 0,0

Tävlingskott

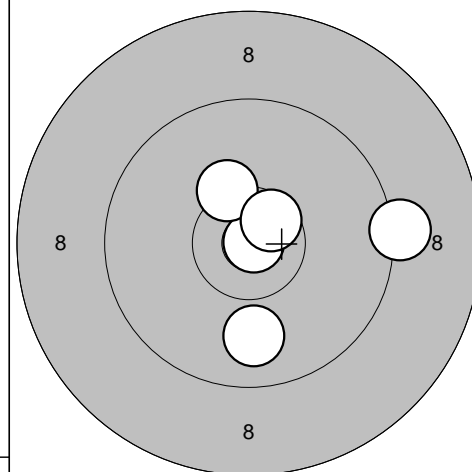

1: 10,9* →
 2: 10,3* ↗
 3: 9,2 →
 4: 10,6* ↗
 5: 9,9 ↓

Serie 48,0

Totalt 48,0

Tävlingskott

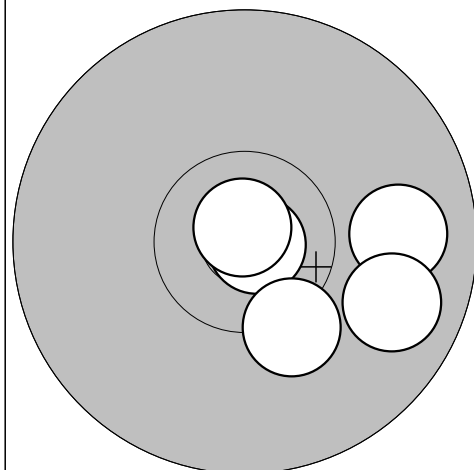

6: 9,9 →
 7: 10,9* →
 8: 10,8* ↑
 9: 9,8 →
 10: 10,3 ↓

Serie 48,0

Totalt 96,0

Tävlingskott

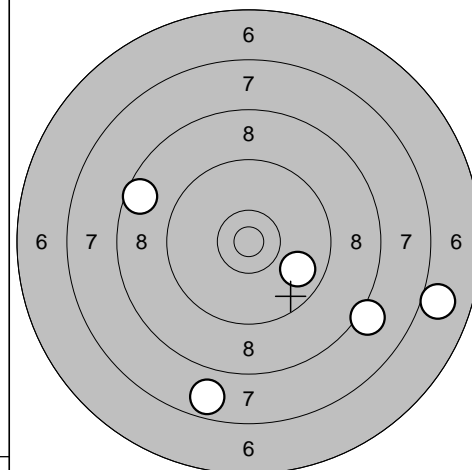

11: 7,0 →
 12: 7,7 ↓
 13: 8,1 ↘
 14: 8,6 ↖
 15: 9,8 ↘

Serie 39,0

Totalt 135,0

Tävlingskott

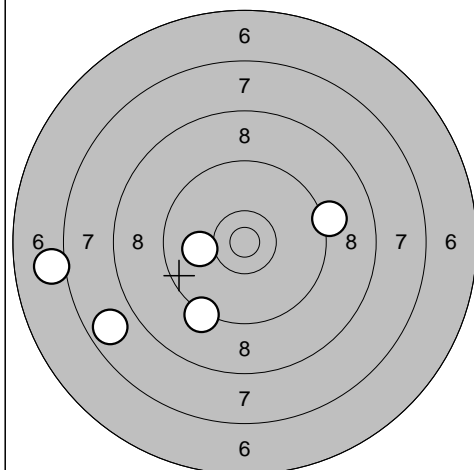

16: 9,2 →
 17: 7,8 ↙
 18: 9,2 ↓
 19: 10,0 ←
 20: 7,1 ←

Serie 42,0

Totalt 177,0

2011-08-14

Förbundsmästerskap 2011

Ramselefors SKF

Provskott

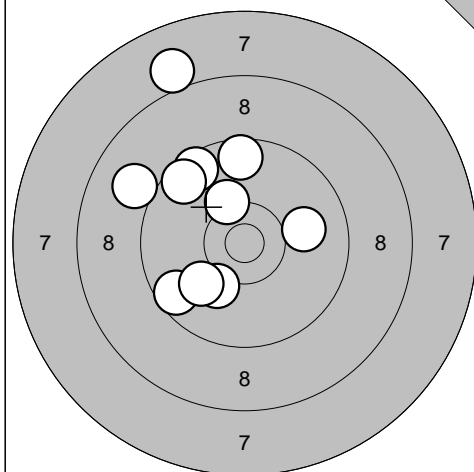

1: 8,0 ↗
 2: 9,6 ↗
 3: 9,6 ↑
 4: 9,6 ↗
 5: 10,3 ↑
 6: 10,0 →
 7: 9,6 ↙
 8: 10,2 ↙
 9: 9,0 ↗
 10: 10,0 ↙

Serie 93,0

Totalt 0,0

Provskott

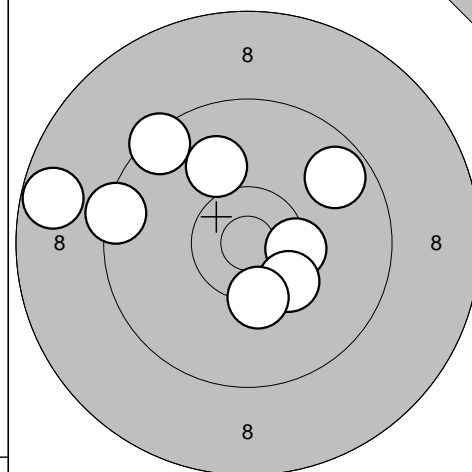

11: 10,4* →
 12: 10,3* ↘
 13: 10,3* ↘
 14: 9,7 ↗
 15: 9,4 ↗
 16: 8,7 ←
 17: 10,0 ↗
 18: 9,4 ←

Serie 75,0

Totalt 0,0

Tävlingsskott

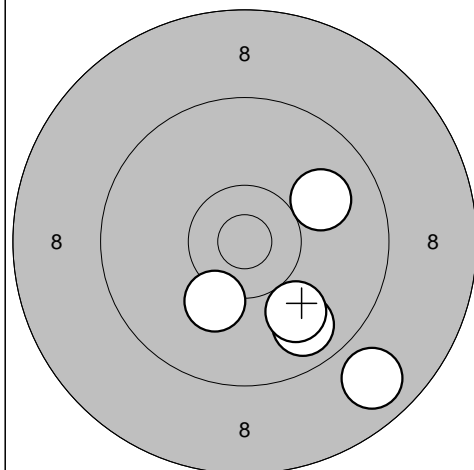

1: 9,8 ↘
 2: 10,2 ↘
 3: 10,0 ↘
 4: 8,8 ↘
 5: 10,0 ↗

Serie 47,0

Totalt 47,0

Tävlingsskott

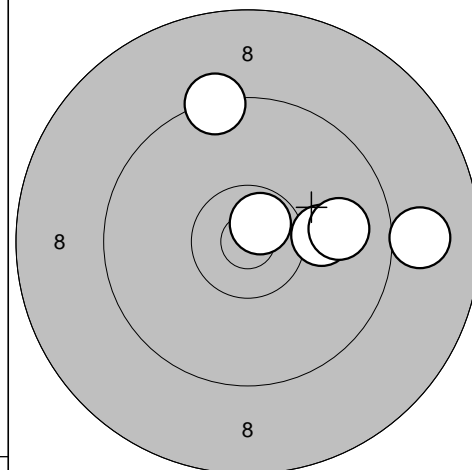

6: 10,1 →
 7: 9,0 →
 8: 9,9 →
 9: 10,7* ↗
 10: 9,3 ↑

Serie 47,0

Totalt 94,0

Tävlingsskott

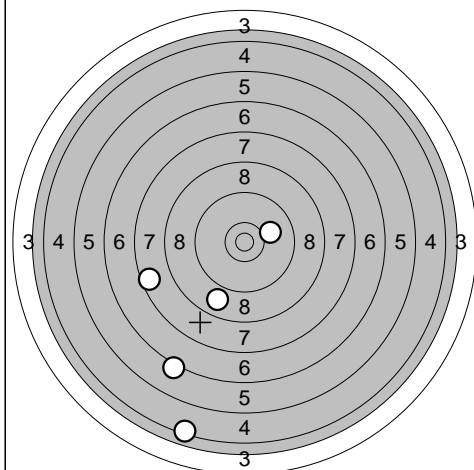

11: 6,2 ↘
 12: 4,4 ↘
 13: 8,8 ↘
 14: 10,0 →
 15: 7,6 ←

Serie 35,0

Totalt 129,0

Tävlingsskott

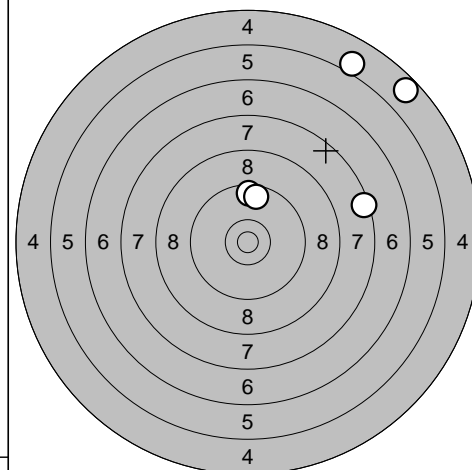

16: 9,6 ↑
 17: 4,7 ↗
 18: 5,0 ↗
 19: 7,5 →
 20: 9,6 ↑

Serie 34,0

Totalt 163,0

Drängsmark

2011-08-14

Förbundsmästerskap 2011

Ramselefors SKF

Provskott

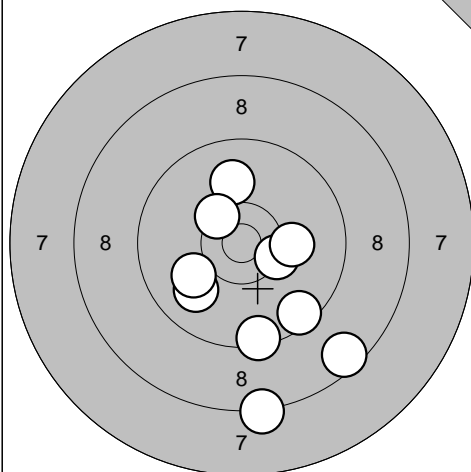

1: 10,4* →
 2: 9,9 ↙
 3: 10,0 ↑
 4: 10,1 →
 5: 8,6 ↘
 6: 9,4 ↘
 7: 9,5 ↘
 8: 10,4* ↗
 9: 10,0 ↙
 10: 8,3 ↓

Serie 93,0
 Totalt 0,0

Provskott

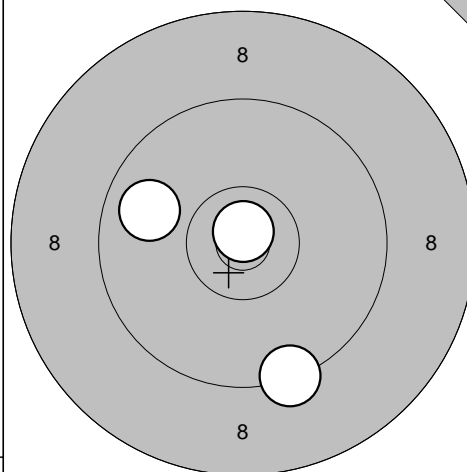

11: 10,8* ↑
 12: 9,3 ↓
 13: 9,8 ↙

Serie 28,0
 Totalt 0,0

Tävlingsskott

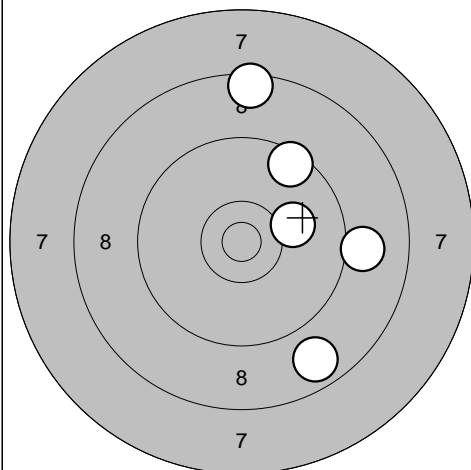

1: 9,0 →
 2: 9,5 ↗
 3: 8,5 ↑
 4: 10,1 →
 5: 8,8 ↘

Serie 44,0
 Totalt 44,0

Tävlingsskott

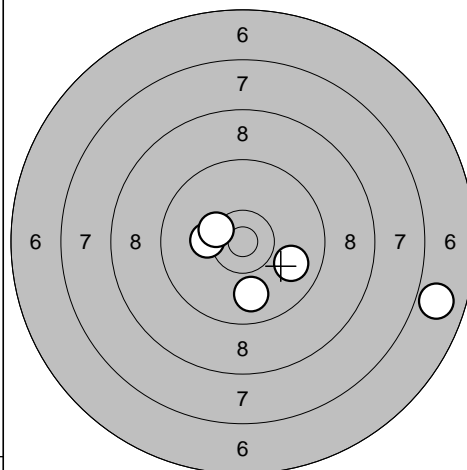

6: 10,2 ←
 7: 10,4* ↙
 8: 9,9 ↘
 9: 6,9 →
 10: 9,9 ↓

Serie 44,0
 Totalt 88,0

Tävlingsskott

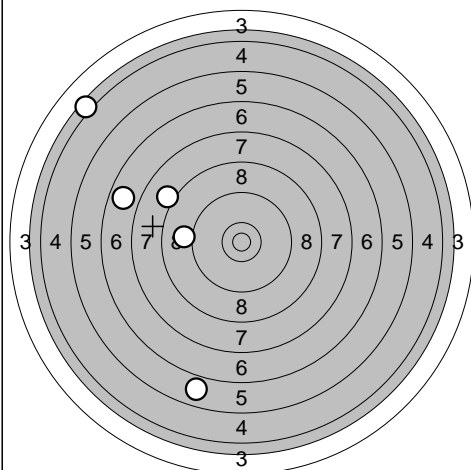

11: 4,2 ↗
 12: 5,9 ↓
 13: 9,1 ←
 14: 6,8 ↙
 15: 8,1 ↗

Serie 32,0
 Totalt 120,0

Tävlingsskott

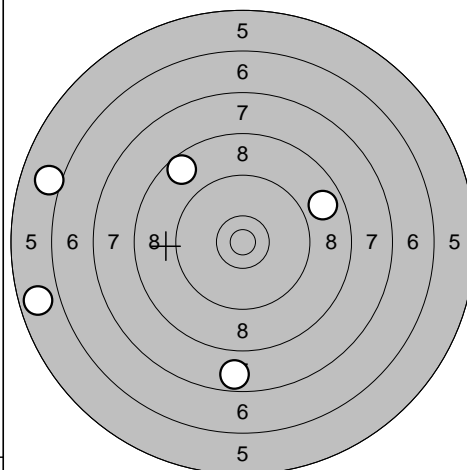

16: 6,0 ←
 17: 8,6 ↗
 18: 7,7 ↓
 19: 5,8 ←
 20: 8,8 →

Serie 34,0
 Totalt 154,0

Skellefteå

2011-08-14	Förbundsmästerskap 2011	Ramselefors SKF
------------	-------------------------	-----------------

Provskott

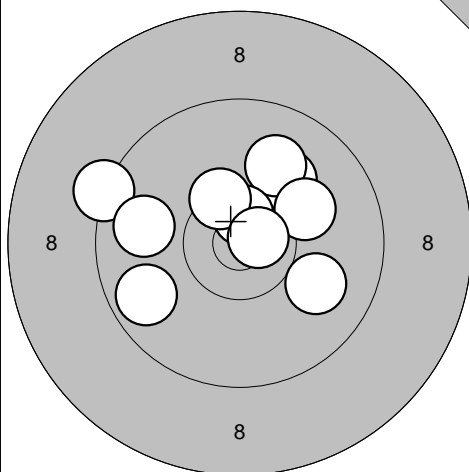

- 1: 10,1 ↗
- 2: 10,0 ↗
- 3: 10,0 →
- 4: 9,3 ↖
- 5: 9,7 ↖
- 6: 9,8 ←
- 7: 10,1 ↗
- 8: 10,6* ↑
- 9: 10,4* ↑
- 10: 10,7* →

Serie	97,0
Totalt	0,0

Tävlingskott

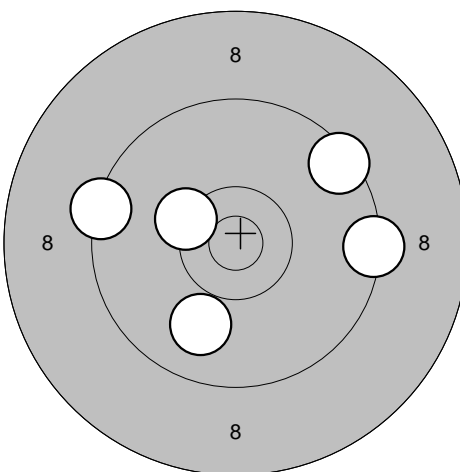

- 1: 9,4 →
- 2: 9,5 ↗
- 3: 10,3* ↖
- 4: 9,9 ↓
- 5: 9,4 ←

Serie	46,0
Totalt	46,0

Tävlingskott

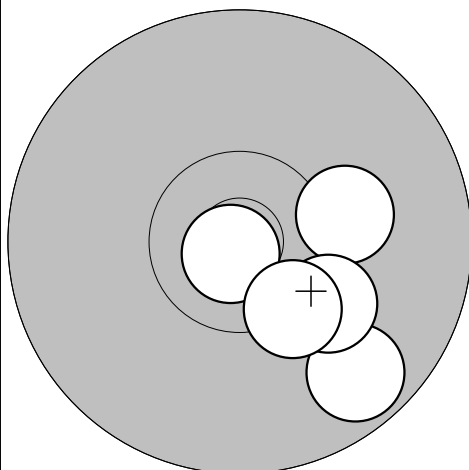

- 6: 9,7 ↓
- 7: 10,2 →
- 8: 10,8* ↖
- 9: 10,2 ↓
- 10: 10,3* ↓

Serie	49,0
Totalt	95,0

Tävlingskott

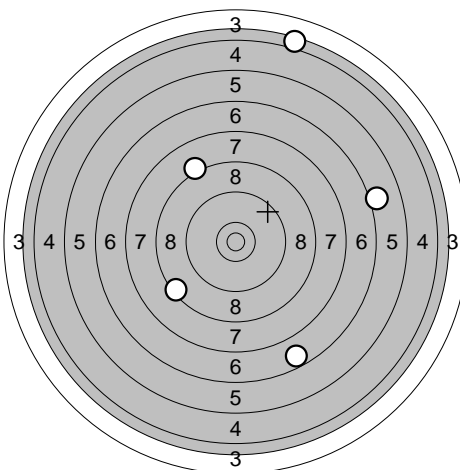

- 11: 4,1 ↑
- 12: 6,1 →
- 13: 8,4 ↖
- 14: 8,2 ↗
- 15: 6,7 ↓

Serie	32,0
Totalt	127,0

Tävlingskott

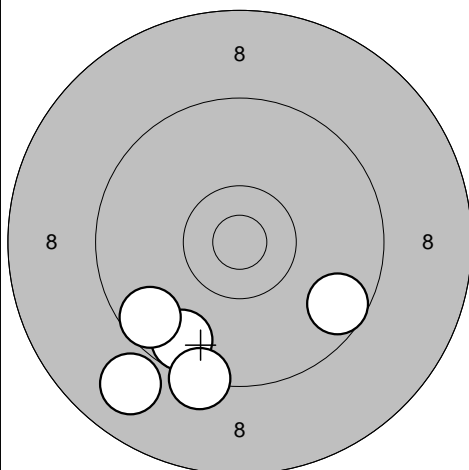

- 16: 9,6 →
- 17: 9,6 ↖
- 18: 8,9 ↖
- 19: 9,6 ↖
- 20: 9,3 ↓

Serie	44,0
Totalt	171,0

Runvik

2011-08-14

Förbundsmästerskap 2011

Ramselefors SKF

Provskott

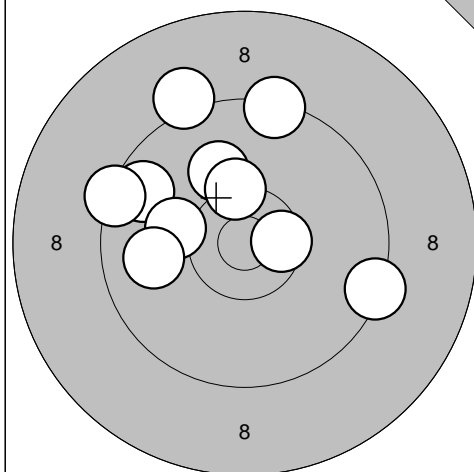

1: 9,7 ↖
 2: 10,5* →
 3: 9,4 ↖
 4: 9,4 ↑
 5: 10,1 ↑
 6: 10,1 ↖
 7: 9,4 →
 8: 9,9 ↖
 9: 9,2 ↑
 10: 10,3* ↑

Serie 94,0

Totalt 0,0

Provskott

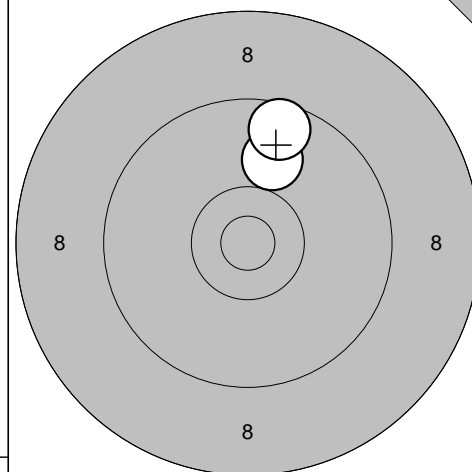

11: 10,0 ↑
 12: 9,6 ↑

Serie 19,0

Totalt 0,0

Tävlingsskott

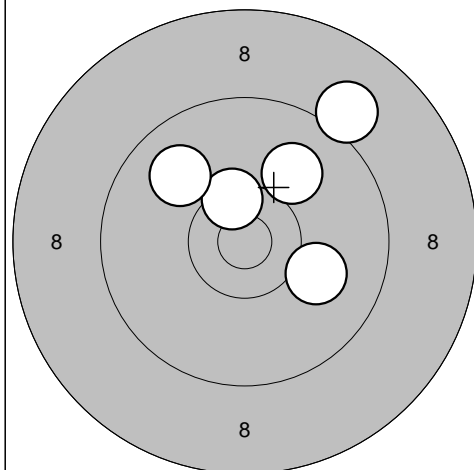

1: 9,1 ↗
 2: 10,4* ↑
 3: 10,0 ↗
 4: 9,9 ↗
 5: 10,1 ↘

Serie 48,0

Totalt 48,0

Tävlingsskott

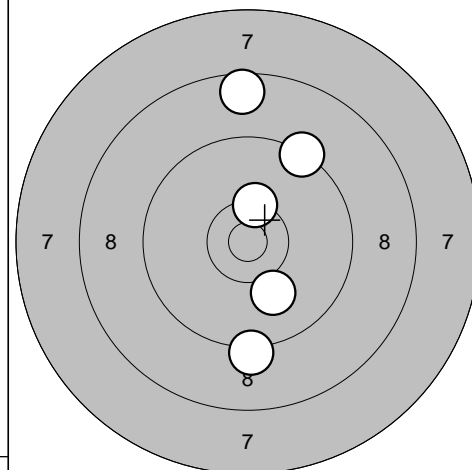

6: 10,0 ↓
 7: 9,3 ↗
 8: 10,4* ↑
 9: 8,6 ↑
 10: 9,2 ↓

Serie 46,0

Totalt 94,0

Tävlingsskott

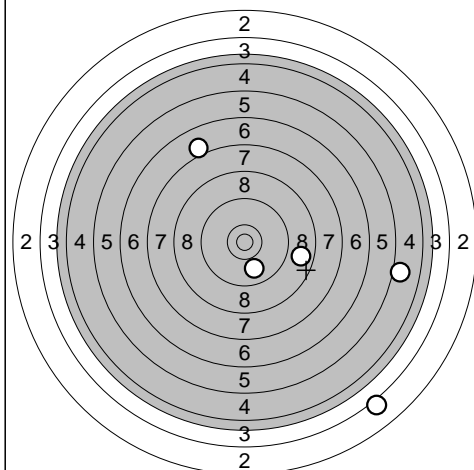

11: 8,8 →
 12: 9,9 ↓
 13: 7,1 ↑
 14: 5,0 →
 15: 3,1 ↓

Serie 32,0

Totalt 126,0

Tävlingsskott

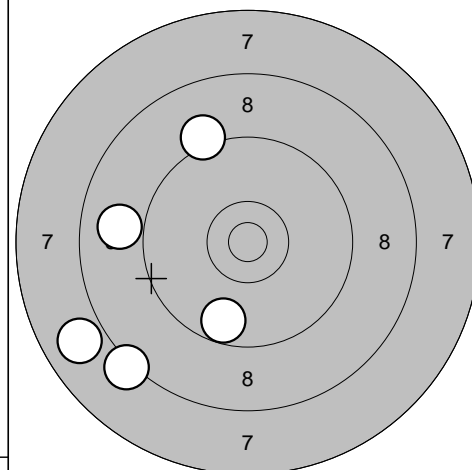

16: 9,7 ↓
 17: 9,2 ↑
 18: 7,9 ↖
 19: 8,9 ↖
 20: 8,2 ↖

Serie 41,0

Totalt 167,0

Ramselefors

2011-08-14

Förbundsmästerskap 2011

Ramselefors SKF

Provskott

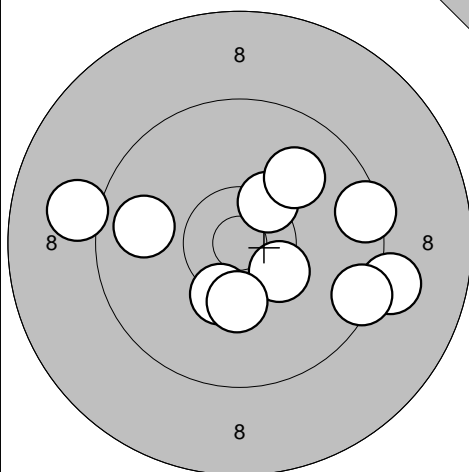

1: 9,1 ←
 2: 10,3* ↓
 3: 9,2 →
 4: 10,4* ↗
 5: 10,4* ↘
 6: 9,5 →
 7: 10,3 ↓
 8: 9,8 ←
 9: 10,0 ↗
 10: 9,4 →

Serie 95,0

Totalt 0,0

Provskott

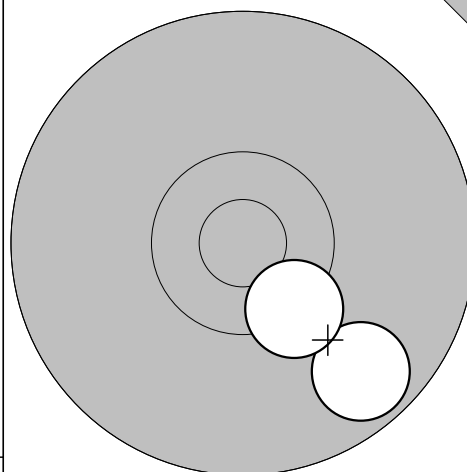

11: 9,7 ↘
 12: 10,4* ↘

Serie 19,0

Totalt 0,0

Tävlingsskott

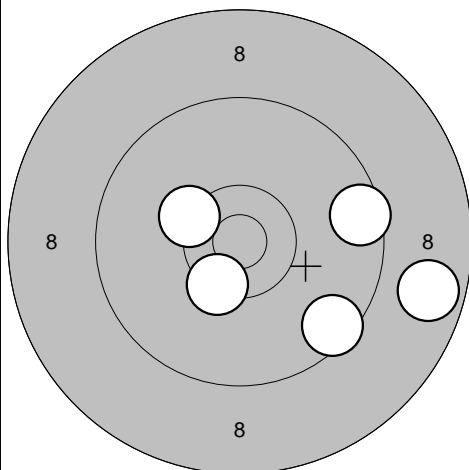

1: 9,5 →
 2: 10,4* ↓
 3: 9,5 ↘
 4: 8,7 →
 5: 10,3* ↗

Serie 46,0

Totalt 46,0

Tävlingsskott

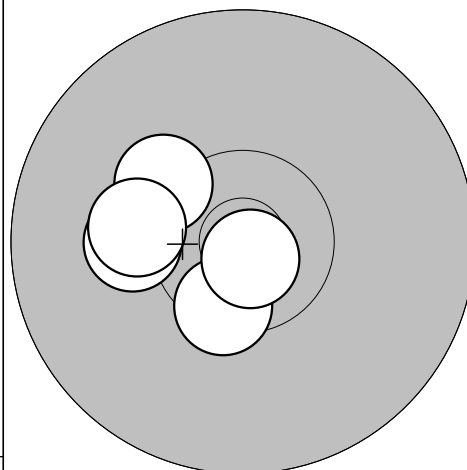

6: 10,2 ←
 7: 10,3 ↗
 8: 10,5* ↓
 9: 10,8* ↘
 10: 10,2 ←

Serie 50,0

Totalt 96,0

Tävlingsskott

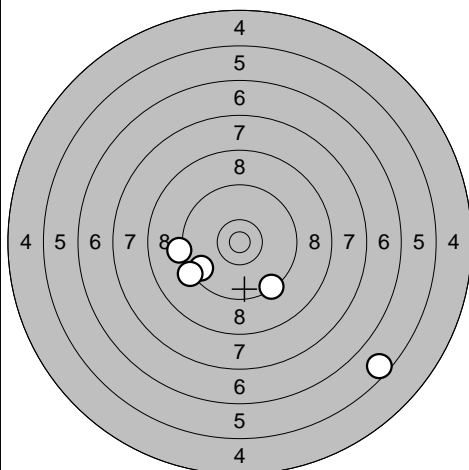

11: 5,6 ↘
 12: 9,2 ←
 13: 9,6 ↙
 14: 9,3 ↙
 15: 9,4 ↘

Serie 41,0

Totalt 137,0

Tävlingsskott

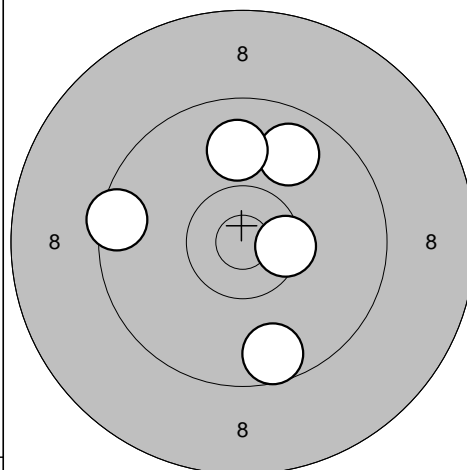

16: 10,5* →
 17: 9,8 ↗
 18: 9,5 ←
 19: 9,9 ↑
 20: 9,6 ↓

Serie 46,0

Totalt 183,0