

2011-09-03

Höstträffen 2011

Ramselefors SKF

Provskott

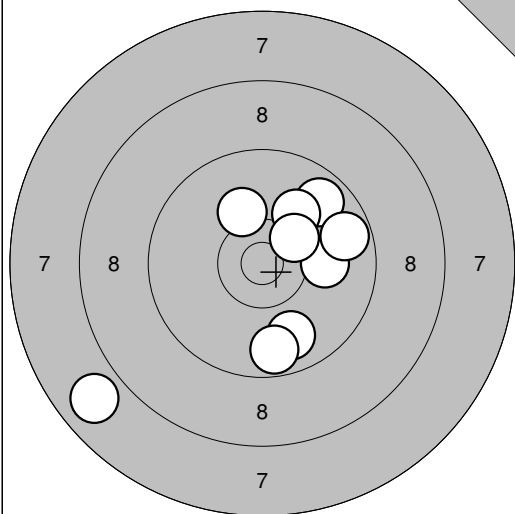

1: 7,8 ↙
 2: 9,8 ↓
 3: 10,0 →
 4: 9,7 ↓
 5: 9,7 ↗
 6: 9,7 →
 7: 10,1 ↗
 8: 10,2 ↗
 9: 10,4* ↗

Serie 83,0

Totalt 0,0

Tävlingsskott

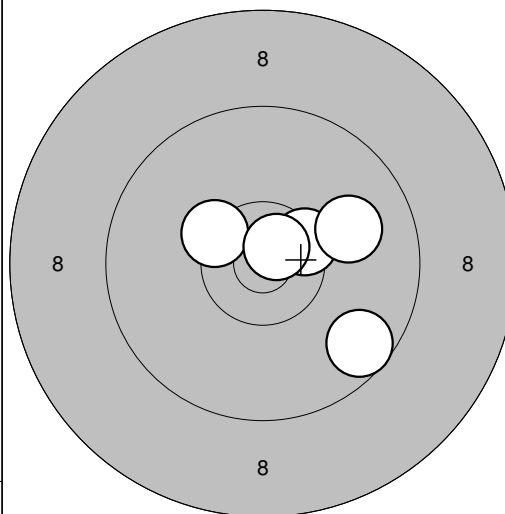

1: 10,5* ↗
 2: 10,4* ↖
 3: 9,6 ↓
 4: 10,7* ↗
 5: 10,0 ↗

Serie 49,0

Totalt 49,0

Tävlingsskott

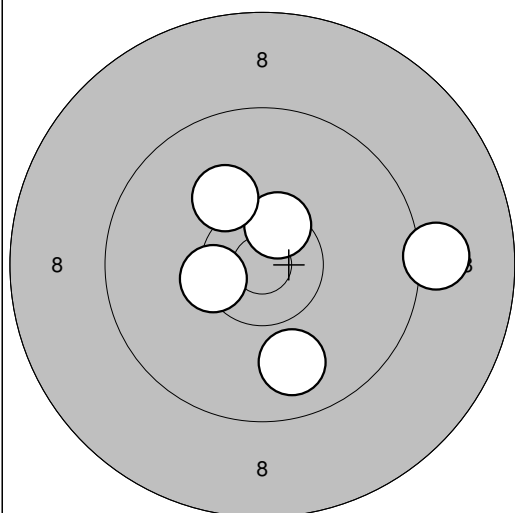

6: 10,5* ↗
 7: 9,9 ↓
 8: 10,2 ↗
 9: 10,4* ↖
 10: 9,1 →

Serie 48,0

Totalt 97,0

Tävlingsskott

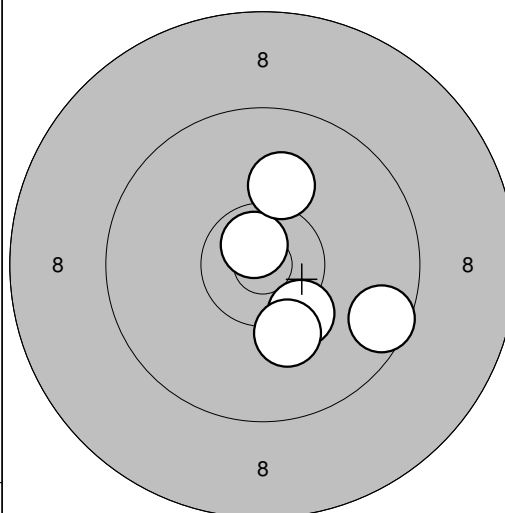

11: 9,6 ↘
 12: 10,7* ↗
 13: 10,3* ↓
 14: 10,1 ↗
 15: 10,2 ↓

Serie 49,0

Totalt 146,0

Tävlingsskott

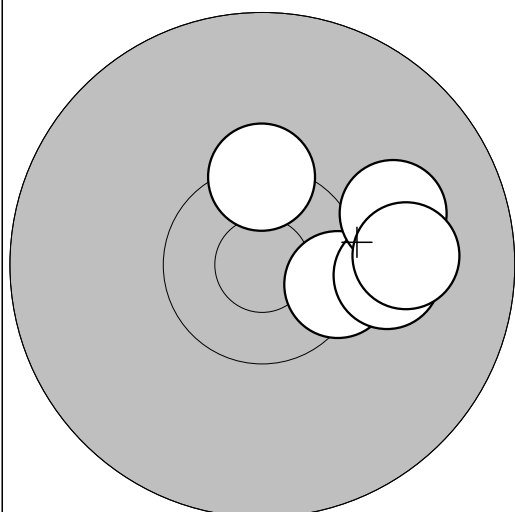

16: 10,4* →
 17: 10,4* ↑
 18: 10,1 →
 19: 10,0 →
 20: 10,0 →

Serie 50,0

Totalt 196,0

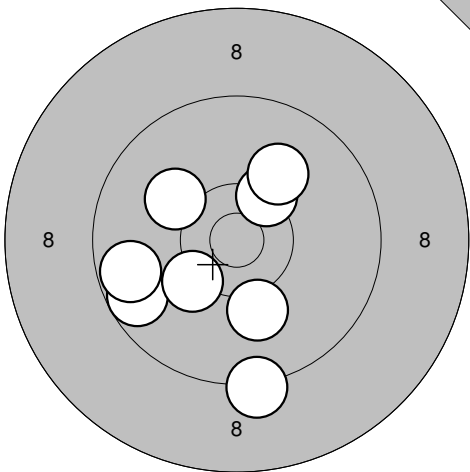
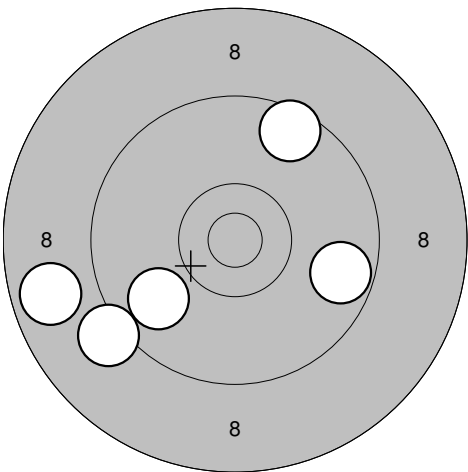
<p>Provskott</p> 	<p>1: 9,3 ↓</p> <p>2: 9,7 ↙</p> <p>3: 10,3 ↙</p> <p>4: 9,7 ↙</p> <p>5: 10,1 ↓</p> <p>6: 10,3* ↗</p> <p>7: 10,1 ↗</p> <p>8: 10,1 ↙</p>	<p>Tävlingsskott</p> 
Serie 77,0		Serie 44,0
Totalt 0,0		Totalt 44,0

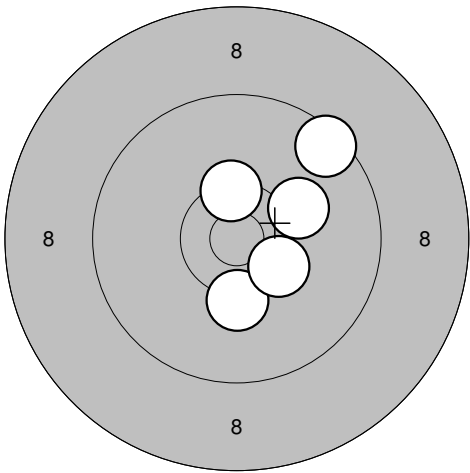
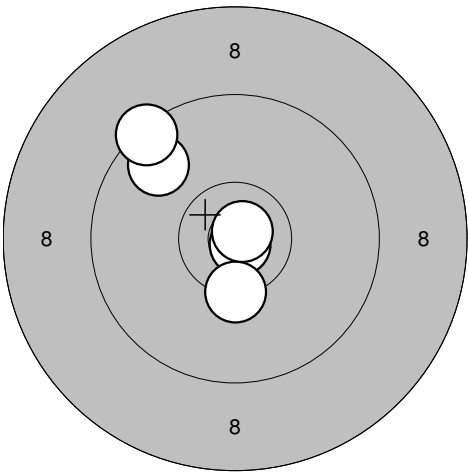
<p>Tävlingsskott</p> 	<p>6: 10,2 ↓</p> <p>7: 10,4* ↘</p> <p>8: 9,5 ↗</p> <p>9: 10,4* ↑</p> <p>10: 10,2 ↗</p>	<p>Tävlingsskott</p> 
Serie 49,0		Serie 48,0
Totalt 93,0		Totalt 141,0

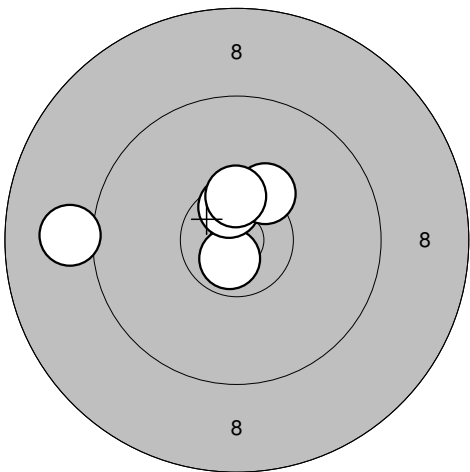
<p>Tävlingsskott</p> 	<p>16: 10,7* ↓</p> <p>17: 10,6* ↑</p> <p>18: 10,3* ↗</p> <p>19: 9,1 ↙</p> <p>20: 10,5* ↑</p>	
Serie 49,0		
Totalt 190,0		

Ramselefors

2011-09-03

Höstträffen 2011

Ramselefors SKF

Provskott

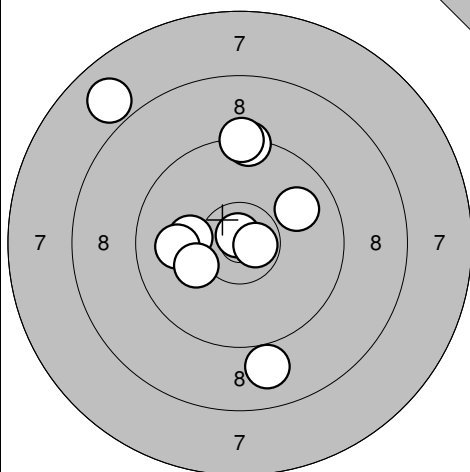

- 1: 7,9 ↖
- 2: 9,4 ↑
- 3: 10,2 ←
- 4: 9,9 ↗
- 5: 9,3 ↑
- 6: 10,8* ↑
- 7: 10,0 ←
- 8: 10,2 ↙
- 9: 9,0 ↓
- 10: 10,7* →

Serie 93,0
Totalt 0,0

Provskott

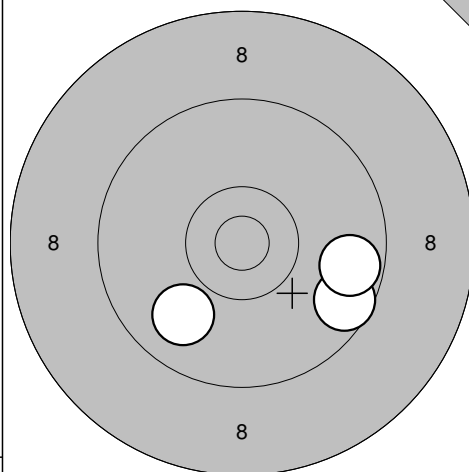

- 11: 9,6 ↘
- 12: 9,9 ↙
- 13: 9,7 →

Serie 27,0
Totalt 0,0

Tävlingsskott

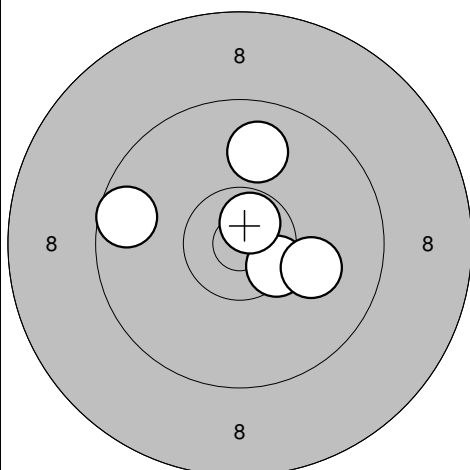

- 1: 9,6 ←
- 2: 9,9 ↑
- 3: 10,5* ↘
- 4: 10,1 →
- 5: 10,7* ↗

Serie 48,0
Totalt 48,0

Tävlingsskott

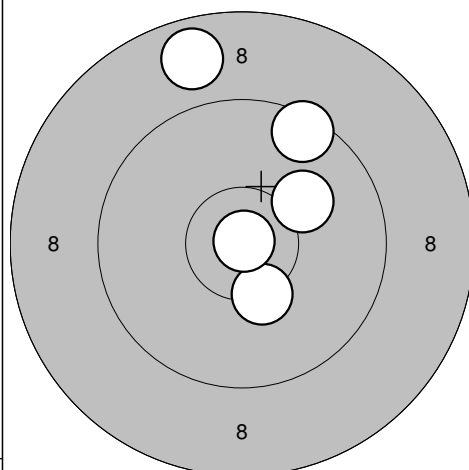

- 6: 10,3* ↘
- 7: 9,5 ↗
- 8: 10,9* ↗
- 9: 10,1 ↗
- 10: 8,8 ↑

Serie 47,0
Totalt 95,0

Tävlingsskott

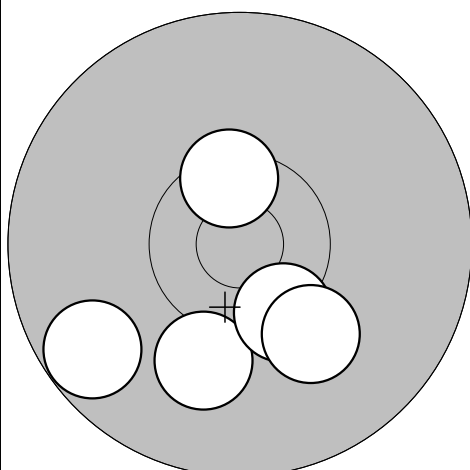

- 11: 10,1 ↘
- 12: 10,5* ↑
- 13: 10,4* ↘
- 14: 9,7 ↙
- 15: 10,1 ↘

Serie 49,0
Totalt 144,0

Tävlingsskott

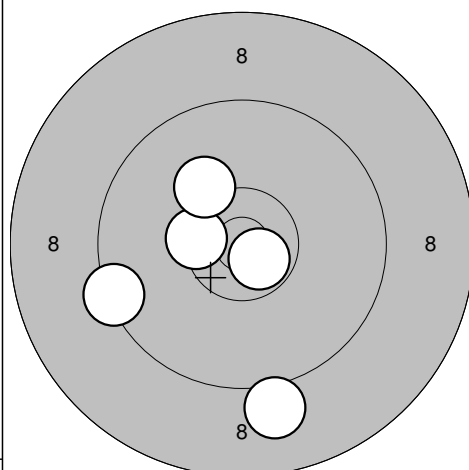

- 16: 10,7* ↘
- 17: 9,4 ←
- 18: 9,0 ↓
- 19: 10,4* ←
- 20: 10,2 ↗

Serie 48,0
Totalt 192,0

Ramselefors

2011-09-03

Höstträffen 2011

Ramselefors SKF

Provskott

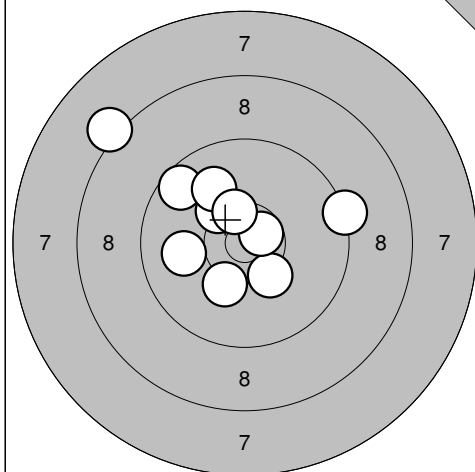

1: 10,3* ↗
 2: 8,2 ↗
 3: 10,0 ←
 4: 9,6 ↗
 5: 10,3* ↘
 6: 10,7* →
 7: 10,0 ↗
 8: 10,4* ↗
 9: 10,2 ↘
 10: 9,3 →

Serie 96,0

Totalt 0,0

Provskott

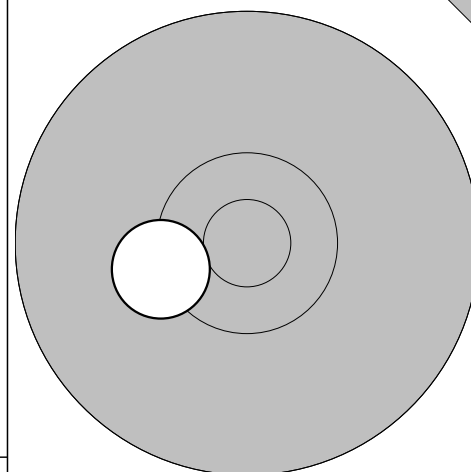

11: 10,3* ←

Serie 10,0

Totalt 0,0

Tävlingsskott

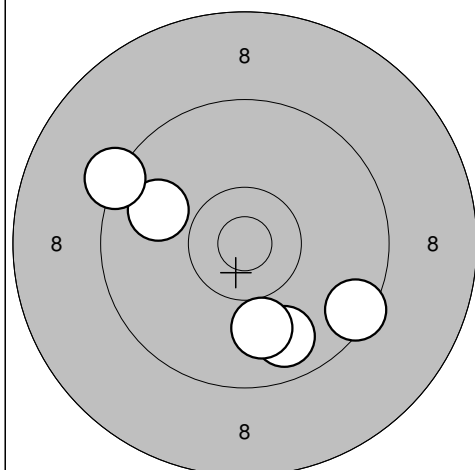

1: 9,9 ←
 2: 9,3 ↗
 3: 9,8 ↘
 4: 9,5 ↘
 5: 10,0 ↘

Serie 46,0

Totalt 46,0

Tävlingsskott

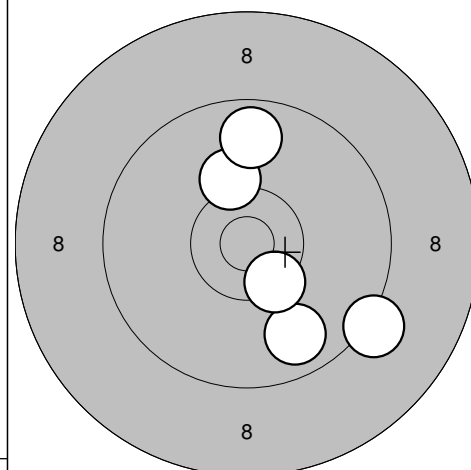

6: 9,8 ↘
 7: 10,4* ↘
 8: 9,2 ↘
 9: 10,2 ↗
 10: 9,7 ↗

Serie 47,0

Totalt 93,0

Tävlingsskott

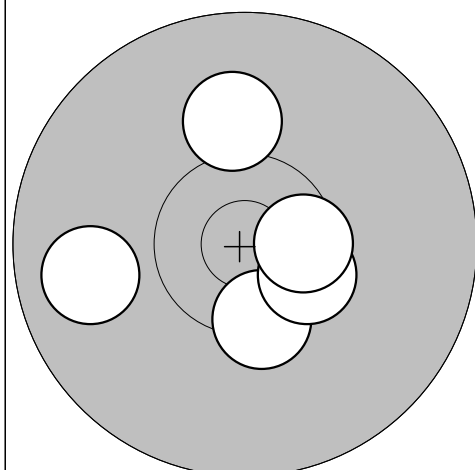

11: 10,4* ↘
 12: 10,1 ↗
 13: 9,8 ←
 14: 10,5* ↘
 15: 10,5* →

Serie 49,0

Totalt 142,0

Tävlingsskott

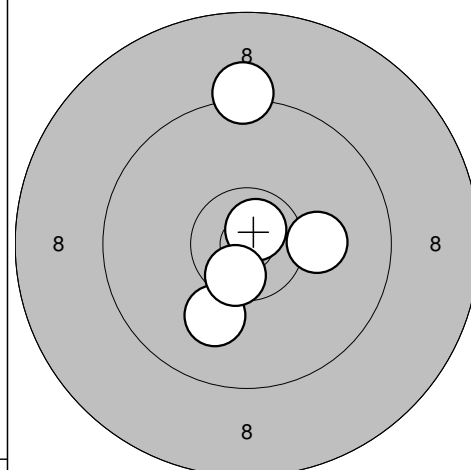

16: 10,1 ↘
 17: 10,1 →
 18: 10,8* ↗
 19: 9,2 ↗
 20: 10,6* ↘

Serie 49,0

Totalt 191,0

Vännäs

2011-09-03

Höstträffen 2011

Ramselefors SKF

Provs-kott

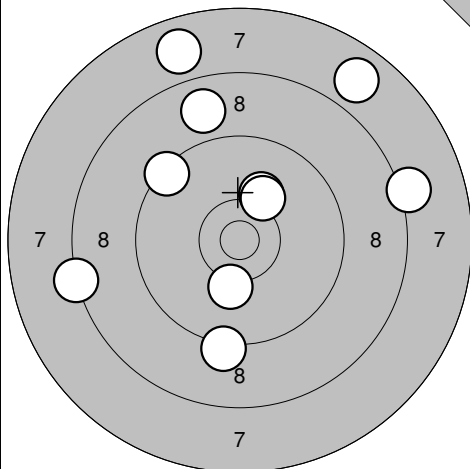

- 1: 7,8 ↗
- 2: 8,2 →
- 3: 7,8 ↗
- 4: 8,8 ↗
- 5: 9,4 ↗
- 6: 10,2 ↗
- 7: 10,2 ↗
- 8: 8,3 ←
- 9: 10,2 ↓
- 10: 9,2 ↓

Serie 86,0
Totalt 0,0

Provs-kott

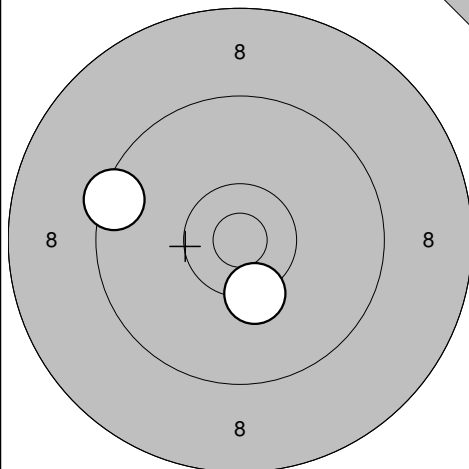

- 11: 9,4 ←
- 12: 10,3* ↓

Serie 19,0
Totalt 0,0

Tävlingsskott

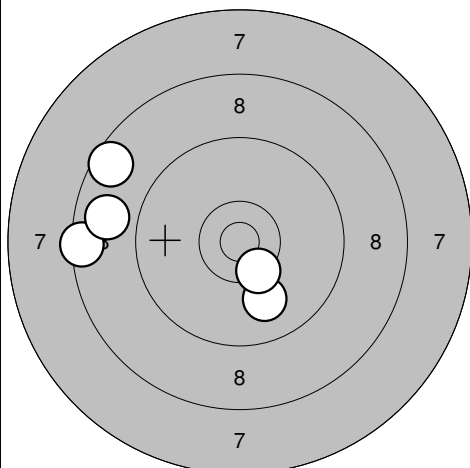

- 1: 8,5 ←
- 2: 8,8 ←
- 3: 10,0 ↓
- 4: 10,4* ↓
- 5: 8,6 ↗

Serie 44,0
Totalt 44,0

Tävlingsskott

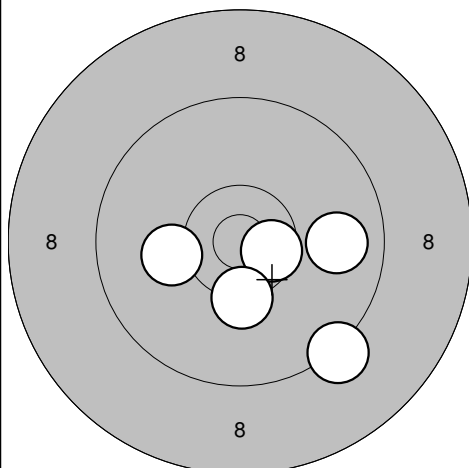

- 6: 9,3 ↓
- 7: 9,8 →
- 8: 10,2 ←
- 9: 10,6* →
- 10: 10,3* ↓

Serie 48,0
Totalt 92,0

Tävlingsskott

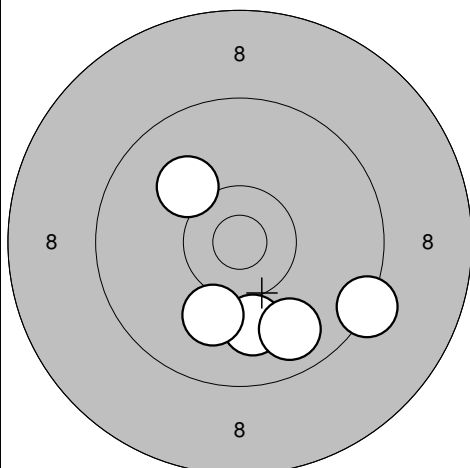

- 11: 10,1 ↗
- 12: 9,3 ↓
- 13: 10,0 ↓
- 14: 9,8 ↓
- 15: 10,1 ↓

Serie 48,0
Totalt 140,0

Tävlingsskott

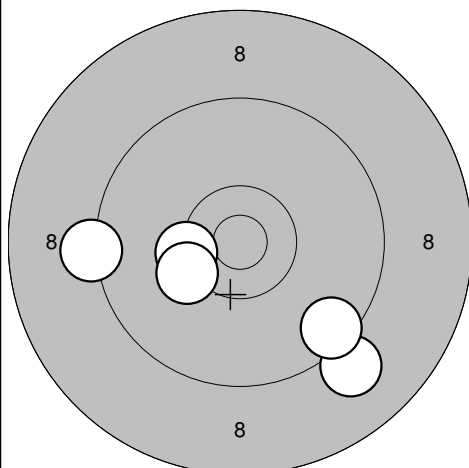

- 16: 10,3* ←
- 17: 10,3 ←
- 18: 9,1 ↓
- 19: 9,3 ←
- 20: 9,5 ↓

Serie 47,0
Totalt 187,0

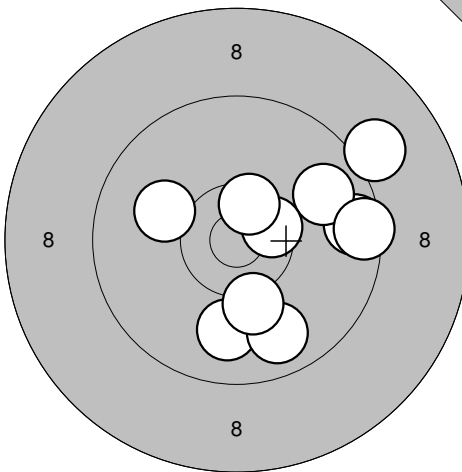
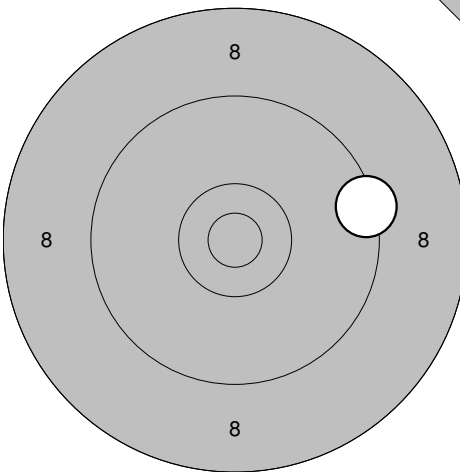
<p>Provskott</p> 	<p>1: 9,1 →</p> <p>2: 9,9 ↓</p> <p>3: 9,6 →</p> <p>4: 9,8 →</p> <p>5: 9,8 ↓</p> <p>6: 10,1 ↖</p> <p>7: 10,2 ↓</p> <p>8: 10,5* →</p> <p>9: 10,5* ↗</p> <p>10: 9,5 →</p>	<p>Provskott</p> 
Serie 94,0		11: 9,4 →
Totalt 0,0		Serie 9,0
		Totalt 0,0

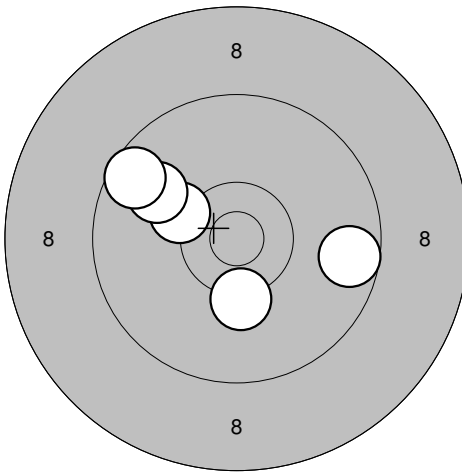
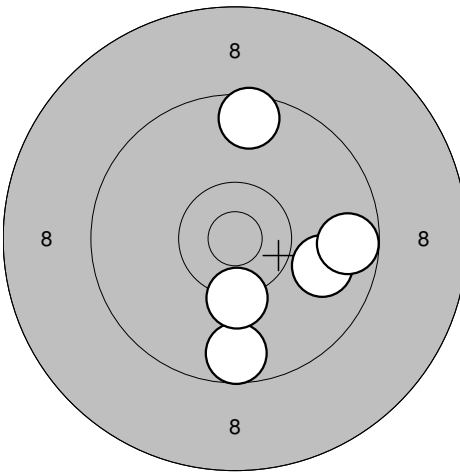
<p>Tävlingsskott</p> 	<p>1: 10,2 ↖</p> <p>2: 9,6 →</p> <p>3: 9,9 ↗</p> <p>4: 10,3 ↓</p> <p>5: 9,6 ↖</p>	<p>Tävlingsskott</p> 
Serie 47,0		6: 9,9 →
Totalt 47,0		7: 9,6 ↓
		8: 9,7 →
		9: 10,3 ↓
		10: 9,6 ↗
		Serie 46,0
		Totalt 93,0

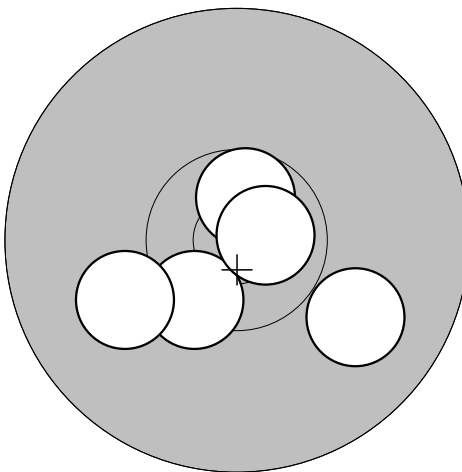
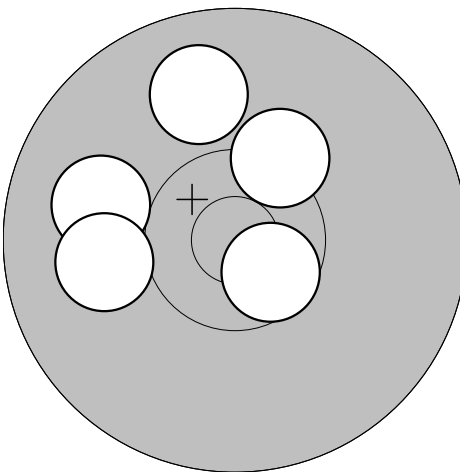
<p>Tävlingsskott</p> 	<p>11: 10,6* ↗</p> <p>12: 9,9 →</p> <p>13: 10,4* ↘</p> <p>14: 10,7* →</p> <p>15: 10,0 ↖</p>	<p>Tävlingsskott</p> 
Serie 49,0		16: 10,0 ↖
Totalt 142,0		17: 10,0 ↖
		18: 10,6* ↘
		19: 9,9 ↗
		20: 10,3* ↗
		Serie 49,0
		Totalt 191,0

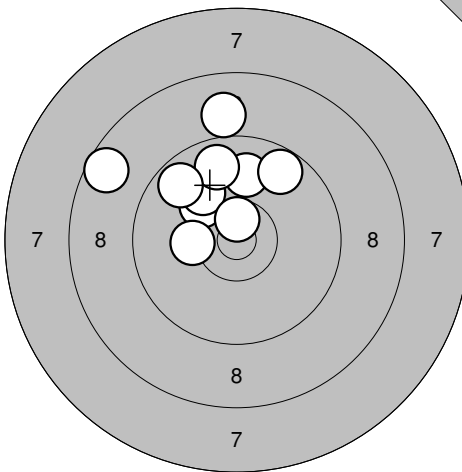
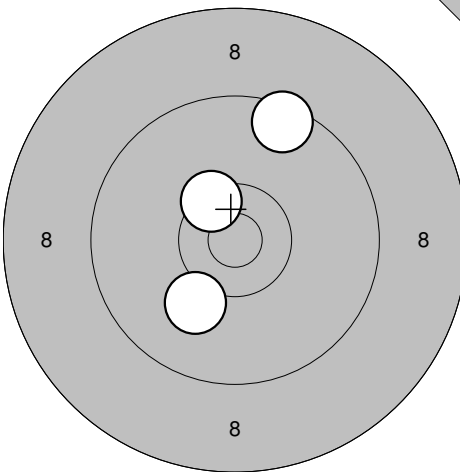
<p>Provskott</p> 	<p>1: 9,0 ↑</p> <p>2: 10,2 ↗</p> <p>3: 10,0 ↗</p> <p>4: 9,9 ↑</p> <p>5: 9,8 ↑</p> <p>6: 10,6* ↑</p> <p>7: 9,7 ↗</p> <p>8: 8,6 ↗</p> <p>9: 10,3 ←</p> <p>10: 9,7 ↗</p>	<p>Provskott</p> 
Serie 93,0		Serie 29,0
Totalt 0,0		Totalt 0,0

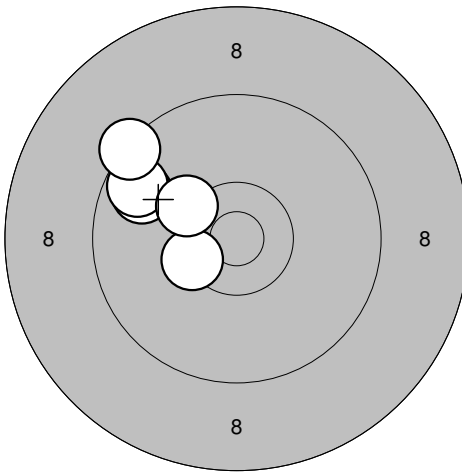
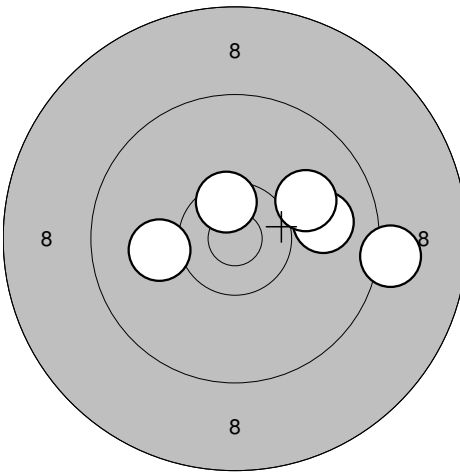
<p>Tävlingsskott</p> 	<p>1: 10,4* ←</p> <p>2: 9,8 ↗</p> <p>3: 9,7 ↗</p> <p>4: 10,3 ↗</p> <p>5: 9,4 ↗</p>	<p>Tävlingsskott</p> 
Serie 47,0		Serie 48,0
Totalt 47,0		Totalt 95,0

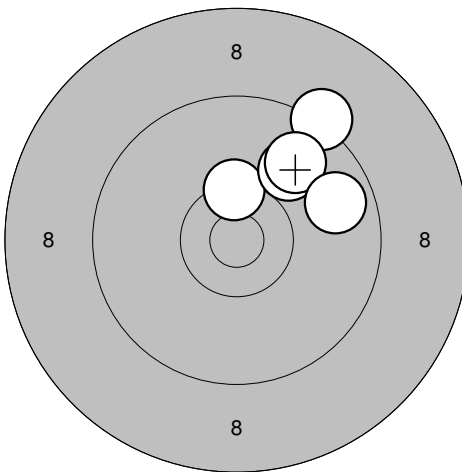
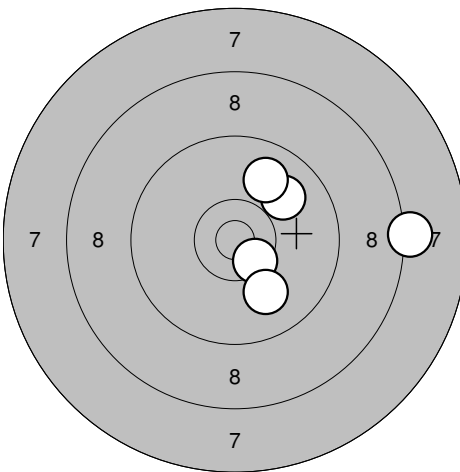
<p>Tävlingsskott</p> 	<p>11: 10,4* ↑</p> <p>12: 9,3 ↗</p> <p>13: 10,0 ↗</p> <p>14: 9,8 ↗</p> <p>15: 9,7 →</p>	<p>Tävlingsskott</p> 
Serie 47,0		Serie 46,0
Totalt 142,0		Totalt 188,0

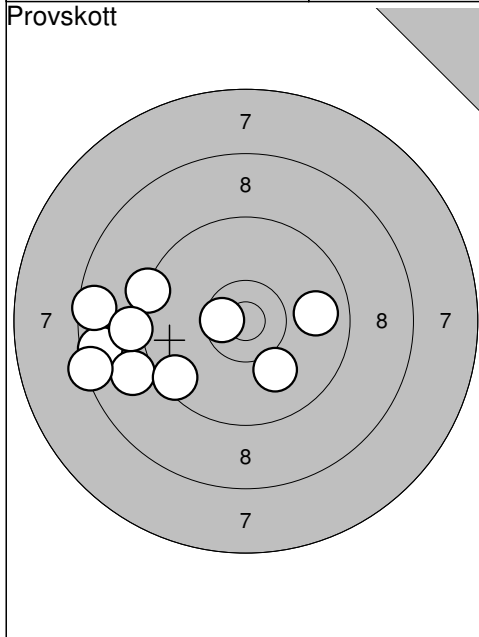

1: 9,8	→
2: 10,6*	←
3: 8,6	←
4: 9,0	←
5: 10,1	↘
6: 8,4	←
7: 8,6	←
8: 9,3	↖
9: 9,5	↘
10: 9,1	←
Serie	89,0
Totalt	0,0

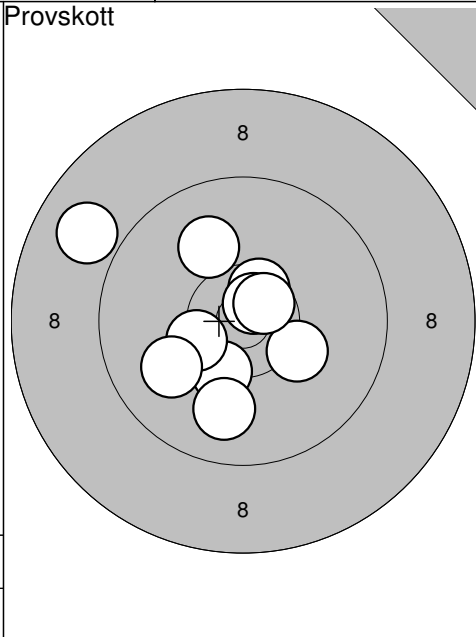

11: 10,3*	↘
12: 8,9	↖
13: 10,0	↗
14: 9,9	↘
15: 10,5*	↗
16: 10,7*	↗
17: 10,2	↘
18: 10,6*	↗
19: 10,4*	←
20: 10,0	←
Serie	97,0
Totalt	0,0

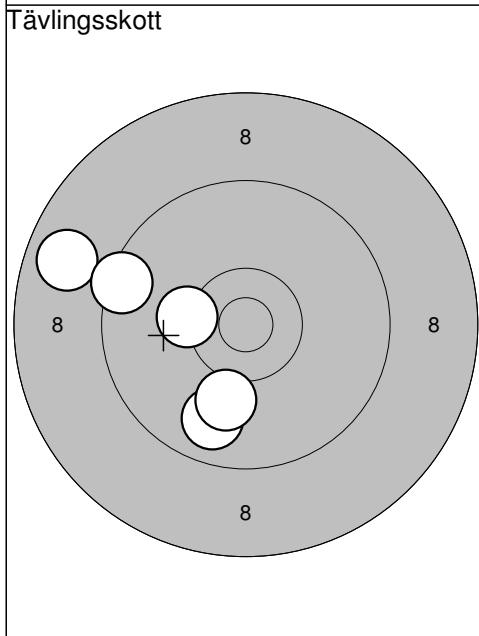

1: 9,8	↘
2: 8,8	↖
3: 9,5	↖
4: 10,1	↘
5: 10,3	←
Serie	46,0
Totalt	46,0

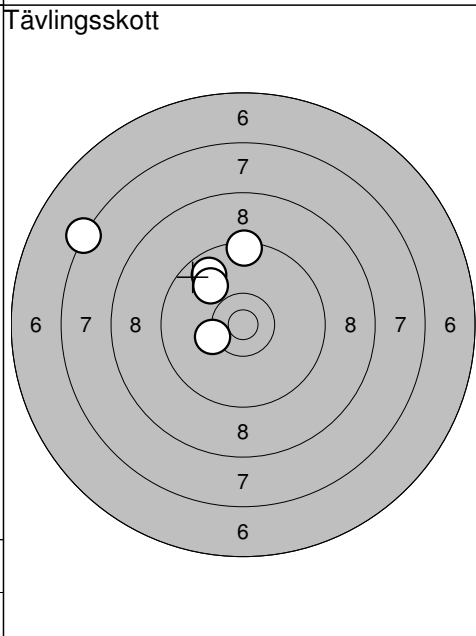

6: 9,8	↖
7: 10,3*	←
8: 7,3	↖
9: 9,4	↑
10: 9,9	↖
Serie	44,0
Totalt	90,0

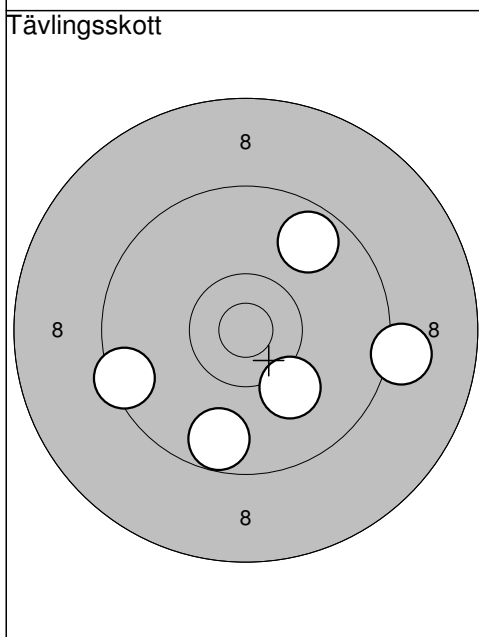

11: 10,1	↘
12: 9,2	→
13: 9,7	↘
14: 9,5	←
15: 9,7	↗
Serie	46,0
Totalt	136,0

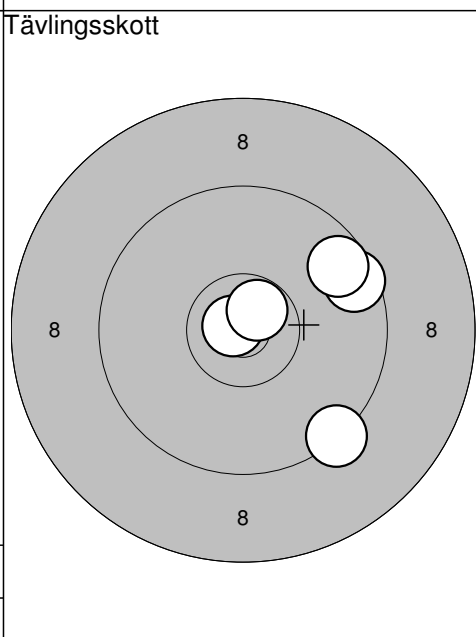

16: 9,3	↘
17: 10,8*	↖
18: 10,7*	↗
19: 9,6	↗
20: 9,6	↗
Serie	47,0
Totalt	183,0

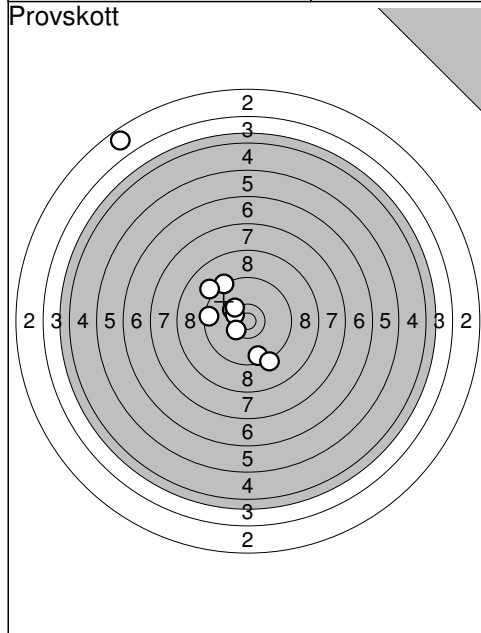

1: 2,7	↗
2: 10,2	↗
3: 9,6	↘
4: 10,4*	↗
5: 9,3	↗
6: 9,1	↗
7: 9,5	↖
8: 9,2	↘
9: 10,4*	↘
10: 10,3	↗
<hr/>	
Serie	87,0
Totalt	0,0

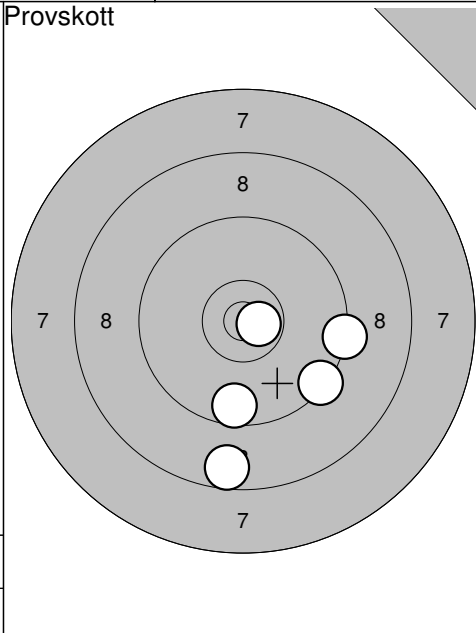

11: 9,3	→
12: 10,7*	→
13: 9,4	↘
14: 9,6	↘
15: 8,6	↘
<hr/>	
Serie	45,0
Totalt	0,0

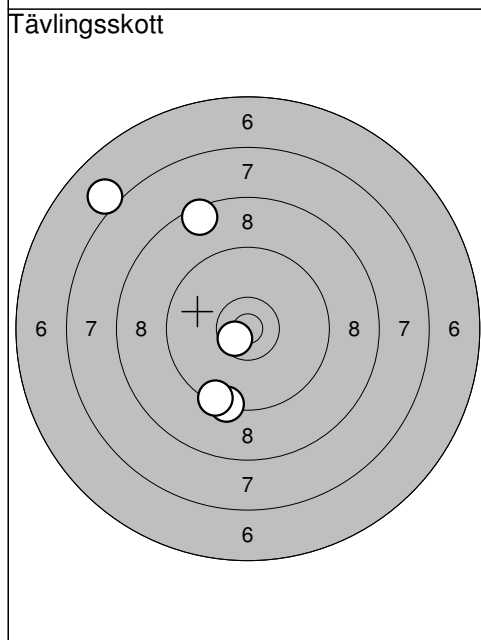

1: 9,4	↘
2: 9,4	↘
3: 8,5	↗
4: 10,6*	↖
5: 7,1	↗
<hr/>	
Serie	43,0
Totalt	43,0

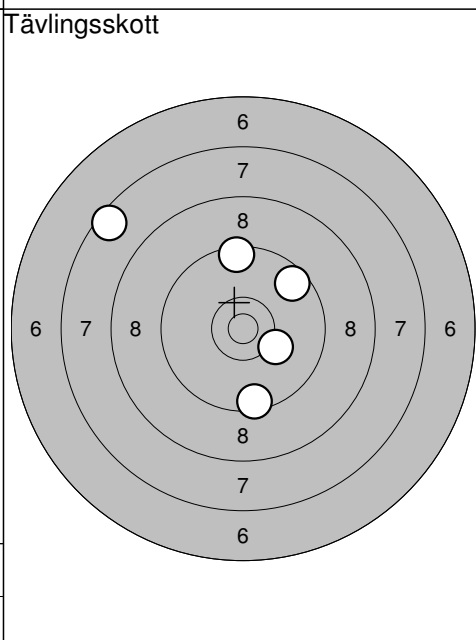

6: 9,5	↑
7: 9,5	↘
8: 7,6	↖
9: 10,2	↘
10: 9,6	↗
<hr/>	
Serie	44,0
Totalt	87,0

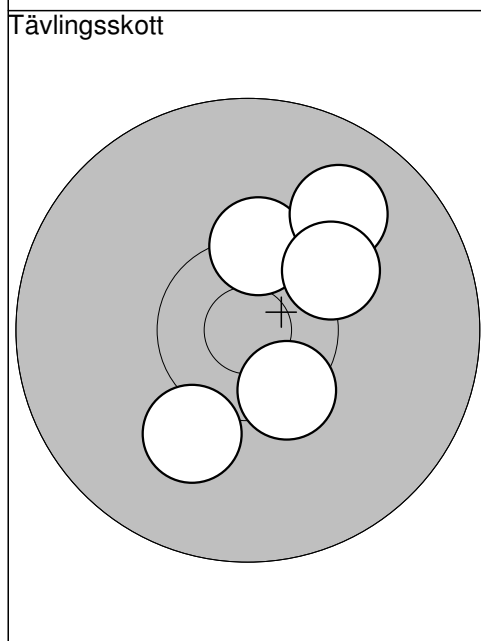

11: 10,4*	↘
12: 10,4*	↑
13: 10,1	↘
14: 9,9	↗
15: 10,2	↗
<hr/>	
Serie	49,0
Totalt	136,0

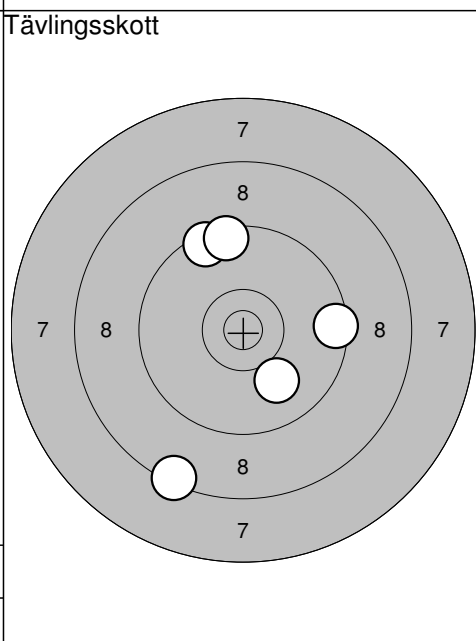

16: 9,5	↖
17: 9,5	↑
18: 8,4	↘
19: 9,5	→
20: 10,0	↘
<hr/>	
Serie	45,0
Totalt	181,0

Umeå

2011-09-03

Höstträffen 2011

Ramselefors SKF

Provs-kott

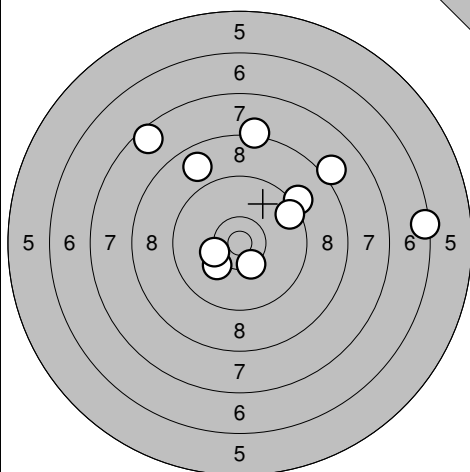

- 1: 6,4 →
- 2: 8,1 ↗
- 3: 9,2 ↗
- 4: 8,3 ↑
- 5: 7,6 ↖
- 6: 10,3* ↓
- 7: 10,2 ↙
- 8: 10,3* ←
- 9: 8,8 ↑
- 10: 9,5 ↗

Serie 85,0
Totalt 0,0

Provs-kott

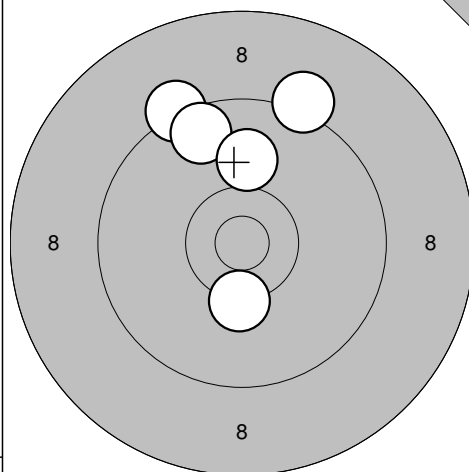

- 11: 9,3 ↖
- 12: 9,2 ↗
- 13: 9,6 ↖
- 14: 10,0 ↑
- 15: 10,3 ↓

Serie 47,0
Totalt 0,0

Tävlingsskott

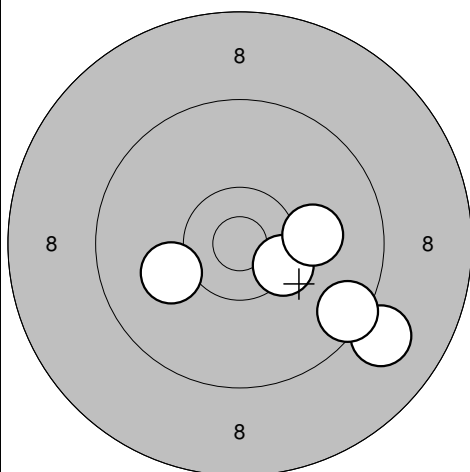

- 1: 9,0 ↘
- 2: 9,5 ↘
- 3: 10,4* ↘
- 4: 10,1 ←
- 5: 10,1 →

Serie 48,0
Totalt 48,0

Tävlingsskott

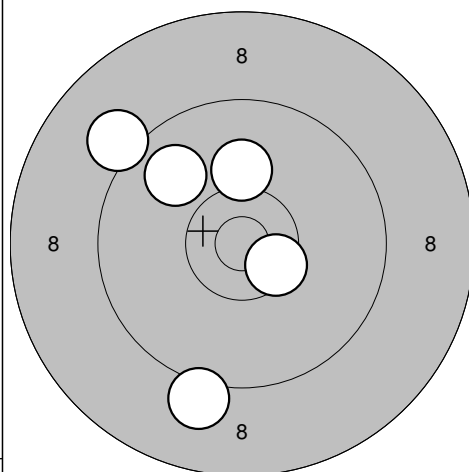

- 6: 10,5* ↘
- 7: 9,9 ↖
- 8: 10,1 ↑
- 9: 9,1 ↓
- 10: 9,1 ↖

Serie 47,0
Totalt 95,0

Tävlingsskott

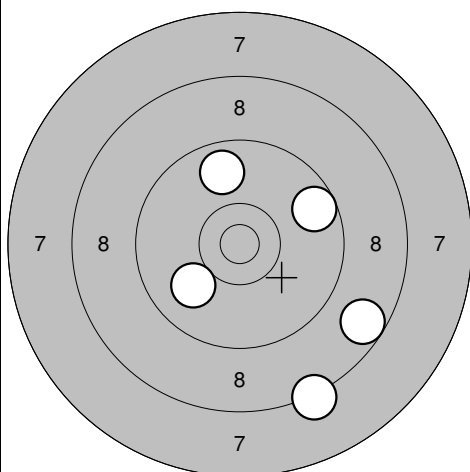

- 11: 9,8 ↑
- 12: 8,7 ↘
- 13: 9,7 ↗
- 14: 8,3 ↓
- 15: 10,0 ↙

Serie 44,0
Totalt 139,0

Tävlingsskott

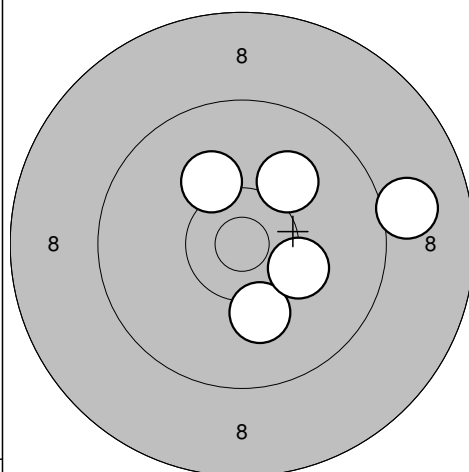

- 16: 9,0 →
- 17: 10,1 ↗
- 18: 10,1 ↓
- 19: 10,2 ↘
- 20: 10,2 ↖

Serie 49,0
Totalt 188,0

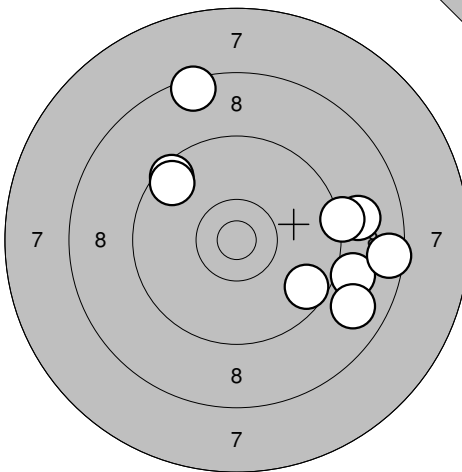
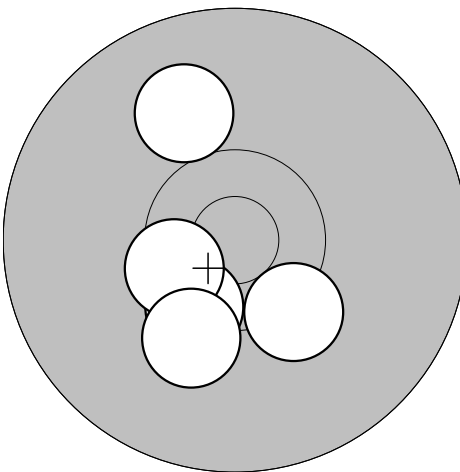
Provsnitt 	1: 8,5 ↗ 2: 9,0 → 3: 8,8 ↘ 4: 9,0 → 5: 8,5 → 6: 9,3 → 7: 9,6 ↘ 8: 9,5 ↗ 9: 9,6 ↗ <hr/> Serie 78,0 Totalt 0,0	Tävlingssnitt 	1: 10,4* ↘ 2: 10,3* ↘ 3: 10,0 ↗ 4: 10,5* ← 5: 10,2 ↘ <hr/> Serie 50,0 Totalt 50,0
--	--	--	---

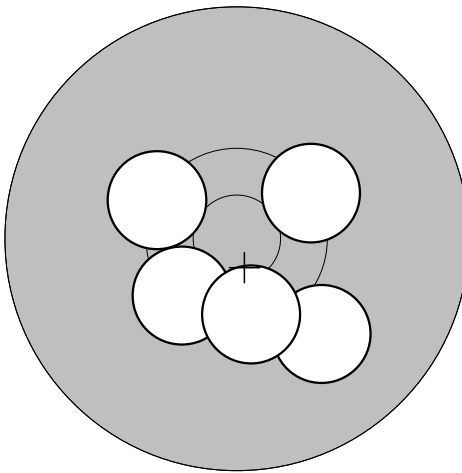
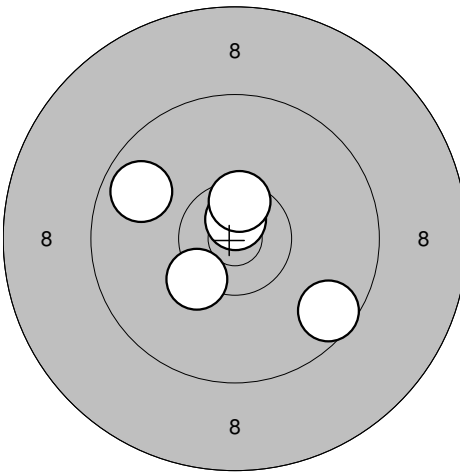
Tävlingssnitt 	6: 10,3* ↖ 7: 10,3* ↗ 8: 10,4* ↖ 9: 10,0 ↘ 10: 10,4* ↘ <hr/> Serie 50,0 Totalt 100,0	Tävlingssnitt 	11: 9,6 ↘ 12: 9,8 ↖ 13: 10,7* ↗ 14: 10,3* ↖ 15: 10,5* ↗ <hr/> Serie 48,0 Totalt 148,0
---	--	---	---

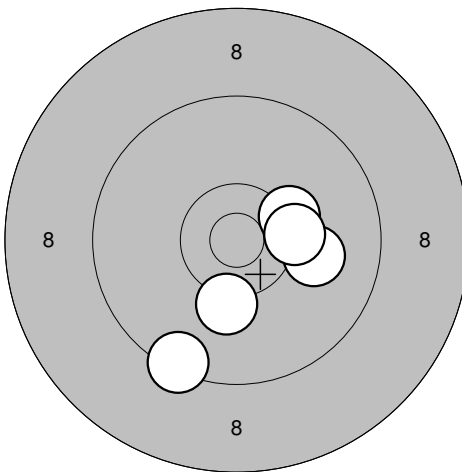
Tävlingssnitt 	16: 10,0 → 17: 10,2 ↘ 18: 10,3* ↗ 19: 10,3 → 20: 9,4 ↘ <hr/> Serie 49,0 Totalt 197,0	
--	--	--

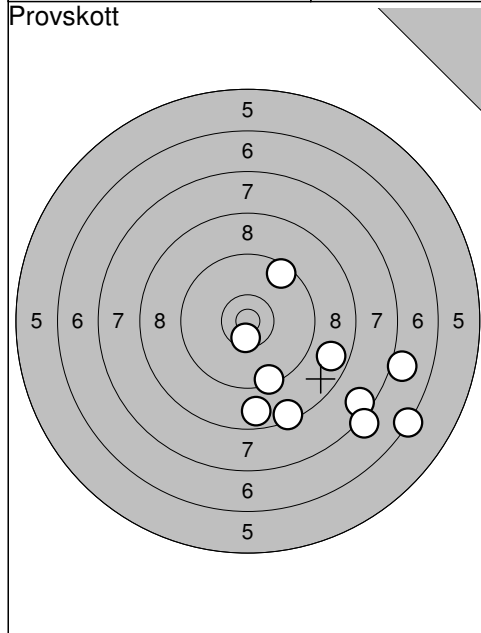

1: 6,3	↘
2: 7,0	→
3: 8,7	→
4: 7,6	↘
5: 7,2	↘
6: 8,5	↘
7: 8,7	↘
8: 9,4	↘
9: 9,5	↗
10: 10,5*	↓
Serie 79,0	
Totalt 0,0	

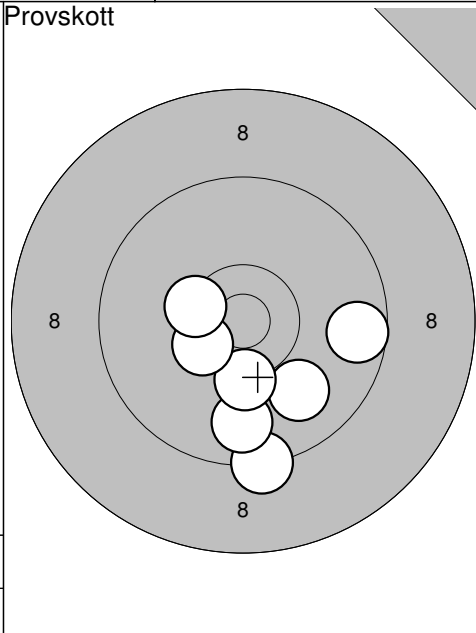

11: 9,3	↓
12: 9,6	→
13: 9,9	↘
14: 9,8	↓
15: 10,3	↓
16: 10,4*	↙
17: 10,4*	↙
Serie 66,0	
Totalt 0,0	

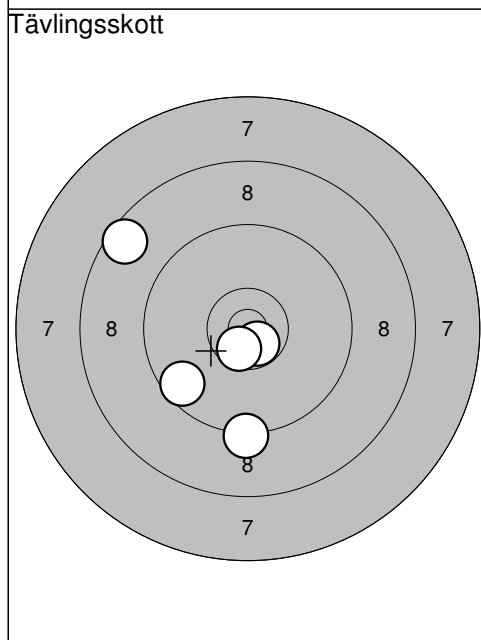

1: 8,6	↖
2: 9,6	↙
3: 9,3	↓
4: 10,7*	↘
5: 10,6*	↘
Serie 46,0	
Totalt 46,0	

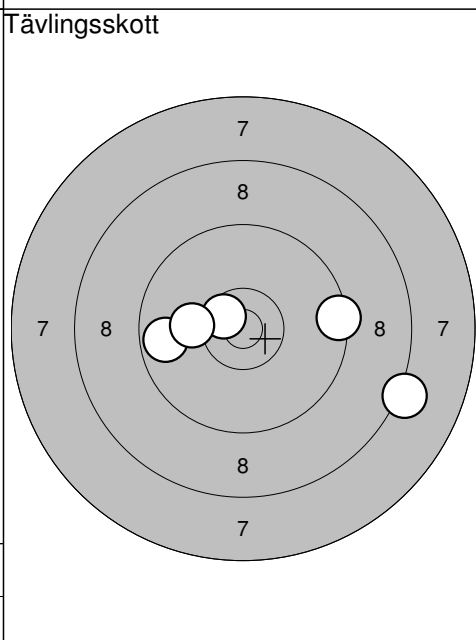

6: 10,6*	↖
7: 9,7	←
8: 9,4	→
9: 10,2	←
10: 8,2	↘
Serie 46,0	
Totalt 92,0	

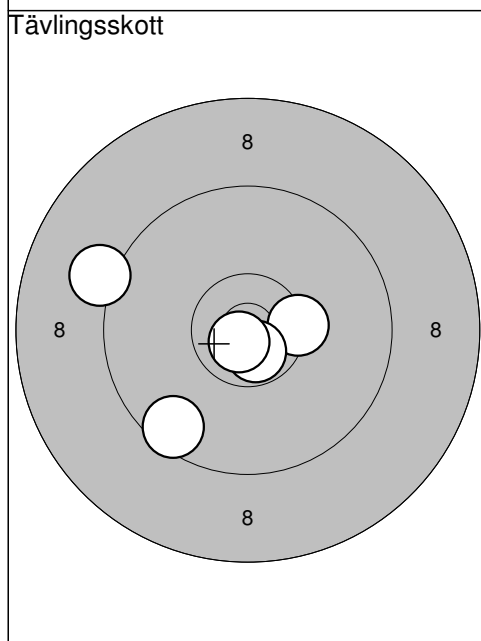

11: 10,4*	→
12: 10,7*	↘
13: 9,6	↙
14: 9,2	↖
15: 10,8*	↘
Serie 48,0	
Totalt 140,0	

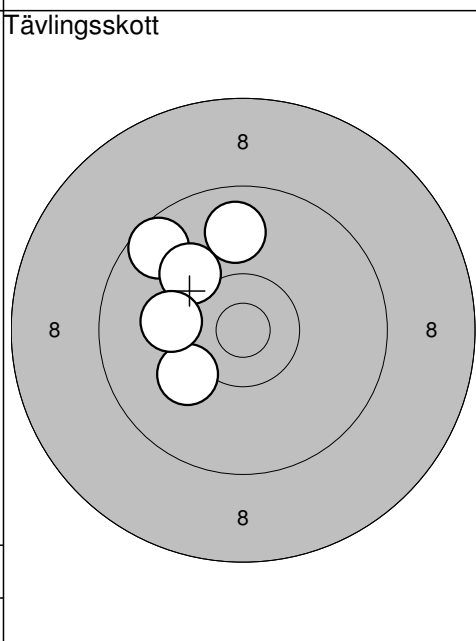

16: 10,1	↙
17: 9,6	↖
18: 10,1	↗
19: 10,1	←
20: 9,8	↑
Serie 48,0	
Totalt 188,0	

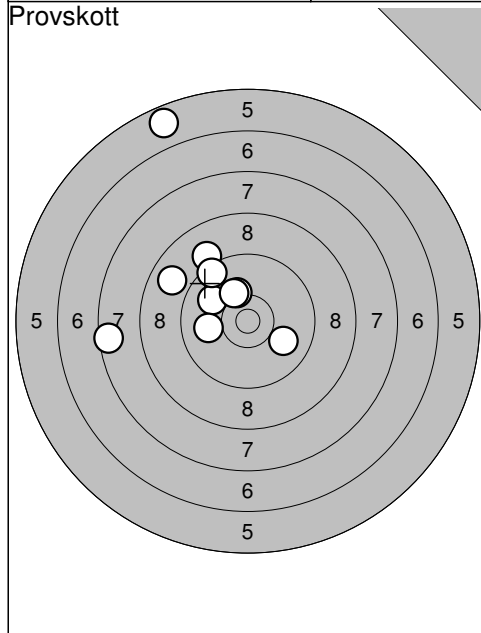

1: 5,7	↗
2: 8,9	↗
3: 9,1	↗
4: 10,2	↗
5: 10,0	↘
6: 10,0	↗
7: 9,5	↗
8: 10,2	↗
9: 7,6	←
10: 10,0	←
Serie	88,0
Totalt	0,0

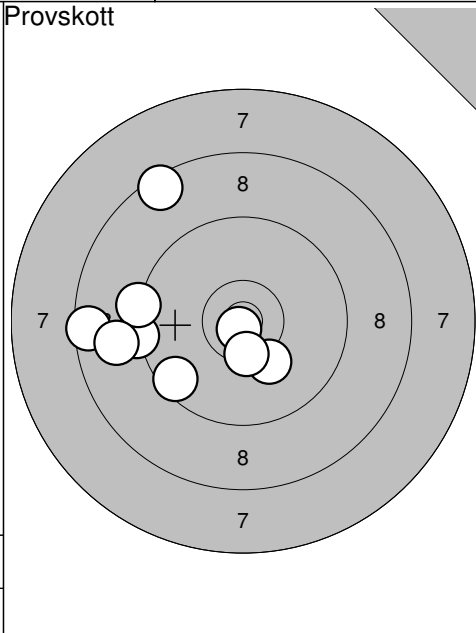

11: 8,5	↖
12: 9,6	↙
13: 10,8*	↘
14: 8,5	←
15: 9,3	←
16: 10,2	↘
17: 9,3	←
18: 8,9	←
19: 10,4*	↓
Serie	81,0
Totalt	0,0

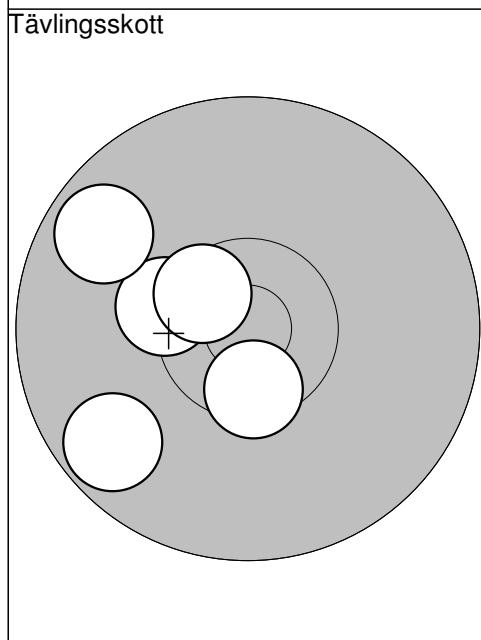

1: 10,3*	←
2: 10,5*	↗
3: 10,5*	↓
4: 9,7	↙
5: 9,7	↗
Serie	48,0
Totalt	48,0

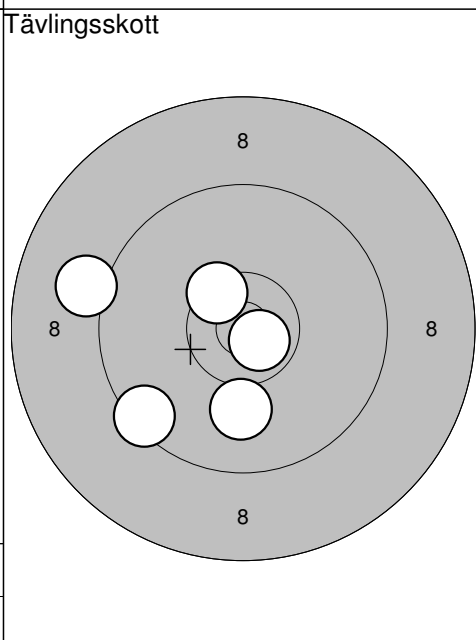

6: 9,1	←
7: 10,4*	↗
8: 10,0	↓
9: 10,7*	↘
10: 9,5	↙
Serie	48,0
Totalt	96,0

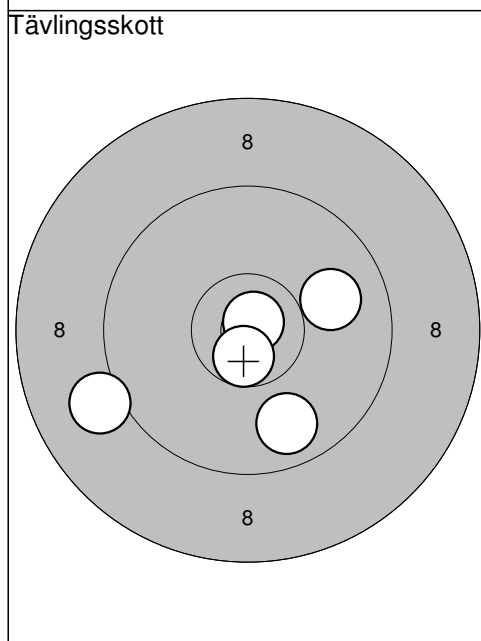

11: 9,1	←
12: 10,8*	↗
13: 10,6*	↓
14: 9,8	↓
15: 9,9	→
Serie	47,0
Totalt	143,0

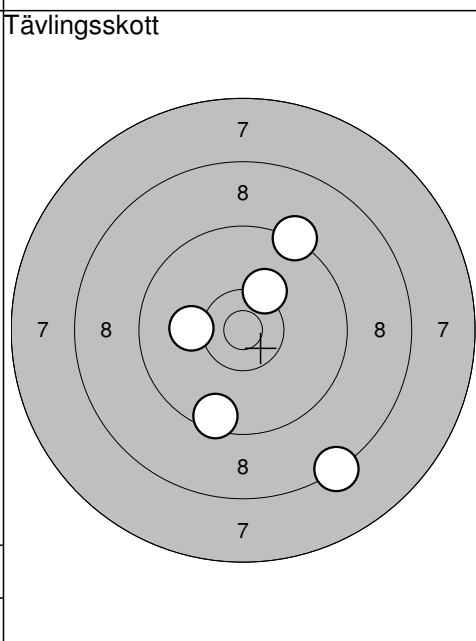

16: 9,5	↘
17: 8,3	↘
18: 10,1	←
19: 9,3	↗
20: 10,3	↗
Serie	46,0
Totalt	189,0

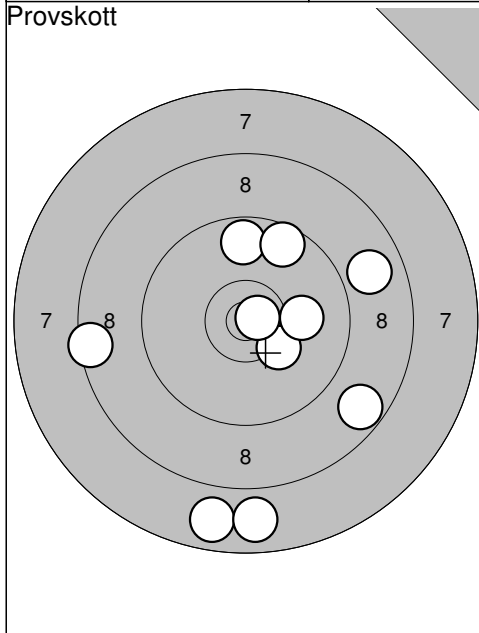

1: 8,5	←
2: 7,8	↓
3: 7,8	↓
4: 9,7	↑
5: 10,3	↘
6: 8,7	↘
7: 9,6	↗
8: 10,1	→
9: 10,8*	→
10: 8,9	↗
<hr/>	
Serie	86,0
Totalt	0,0

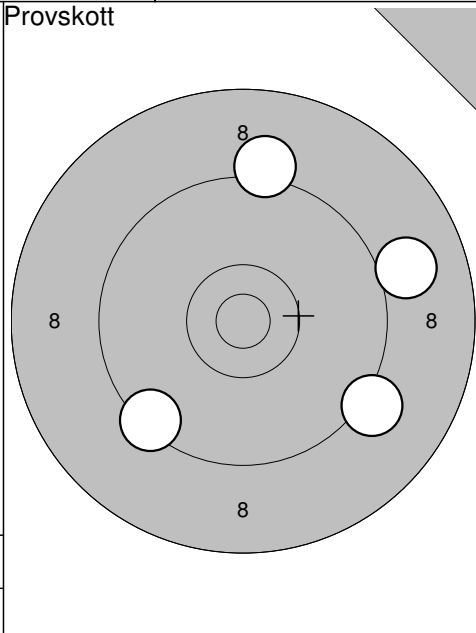

11: 9,2	↘
12: 9,2	↑
13: 9,0	↗
14: 9,4	↘
<hr/>	
Serie	36,0
Totalt	0,0

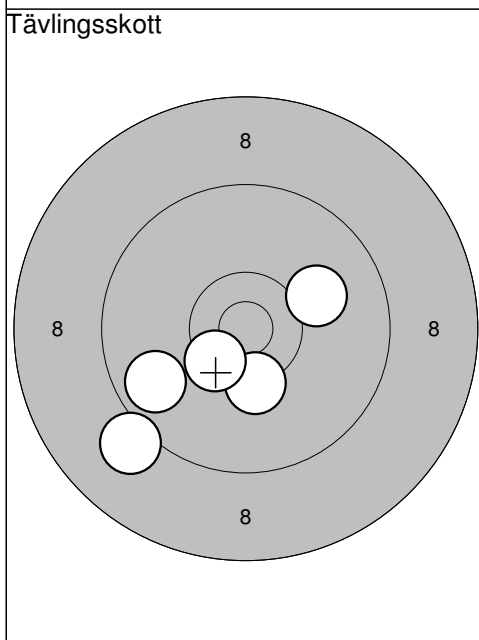

1: 9,8	↙
2: 10,1	↗
3: 9,1	↙
4: 10,3*	↓
5: 10,4*	↙
<hr/>	
Serie	48,0
Totalt	48,0

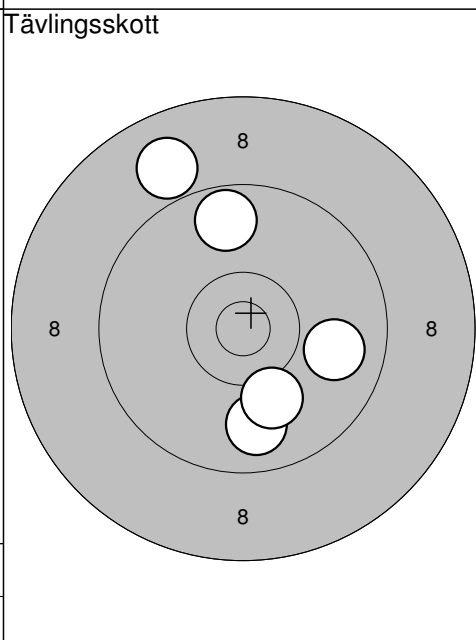

6: 9,8	↓
7: 8,9	↗
8: 9,7	↑
9: 10,1	↓
10: 9,9	↗
<hr/>	
Serie	45,0
Totalt	93,0

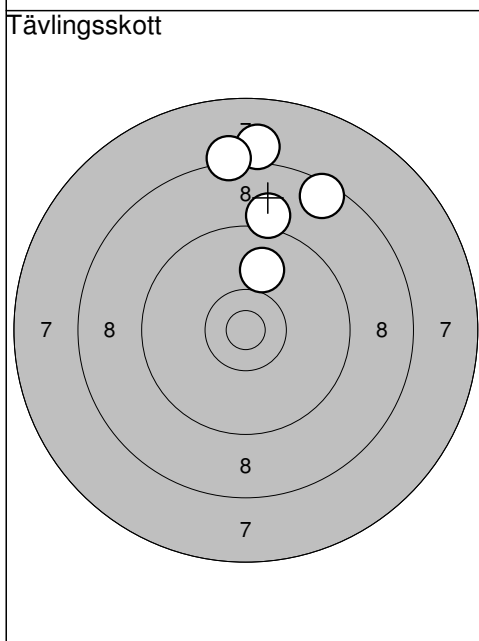

11: 8,5	↗
12: 8,1	↑
13: 10,0	↑
14: 8,2	↑
15: 9,1	↑
<hr/>	
Serie	43,0
Totalt	136,0

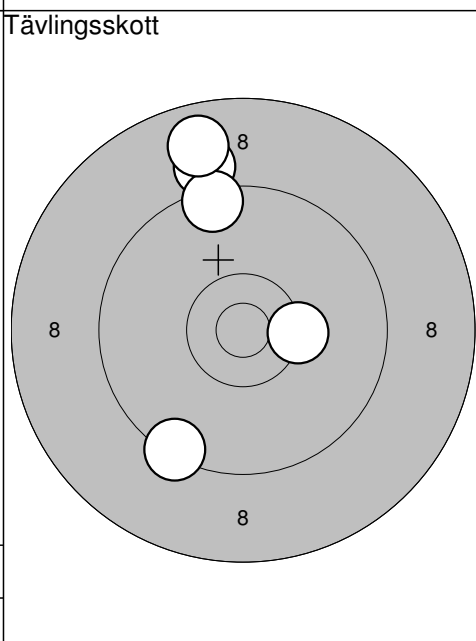

16: 9,0	↑
17: 9,4	↑
18: 9,4	↘
19: 8,8	↑
20: 10,3*	→
<hr/>	
Serie	45,0
Totalt	181,0

Ramselefors

2011-09-03

Höstträffen 2011

Ramselefors SKF

Provskott

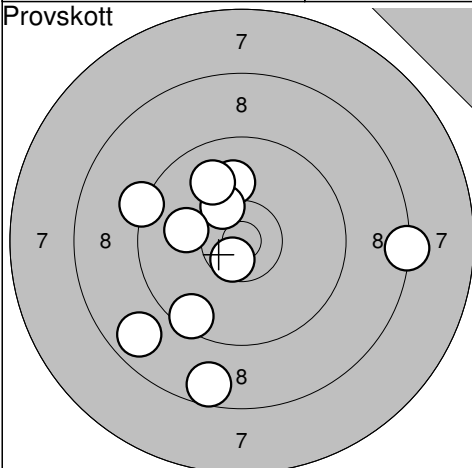

1: 8,8 ↙
 2: 9,3 ↖
 3: 8,6 ↓
 4: 10,0 ↑
 5: 9,5 ↓
 6: 10,6* ↓
 7: 10,3* ↗
 8: 10,1 ↖
 9: 8,3 →
 10: 9,9 ↗

Serie 91,0

Totalt 0,0

Provskott

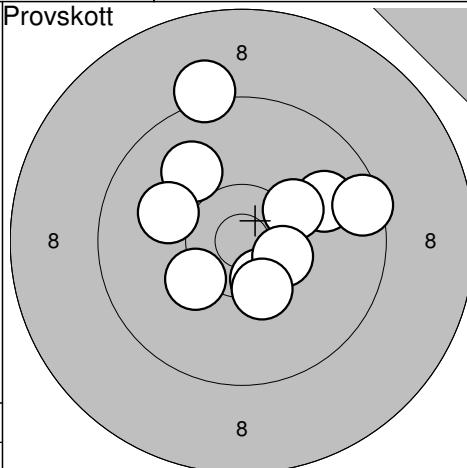

11: 10,0 ↗
 12: 9,9 →
 13: 10,5* ↓
 14: 10,3 ↖
 15: 9,5 →
 16: 10,1 ↖
 17: 10,3 ↗
 18: 10,4* →
 19: 10,4* ↓
 20: 9,2 ↑

Serie 97,0

Totalt 0,0

Provskott

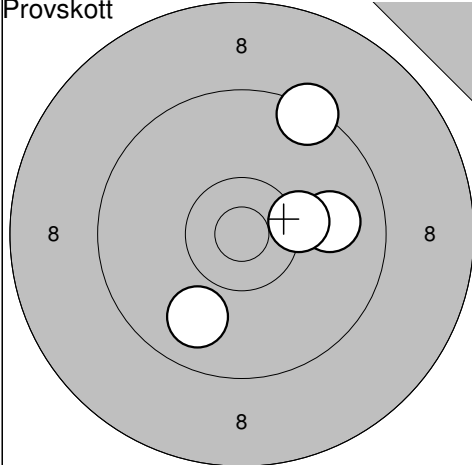

21: 9,4 ↗
 22: 9,9 →
 23: 9,9 ↓
 24: 10,3 →

Serie 37,0

Totalt 0,0

Tävlingsskott

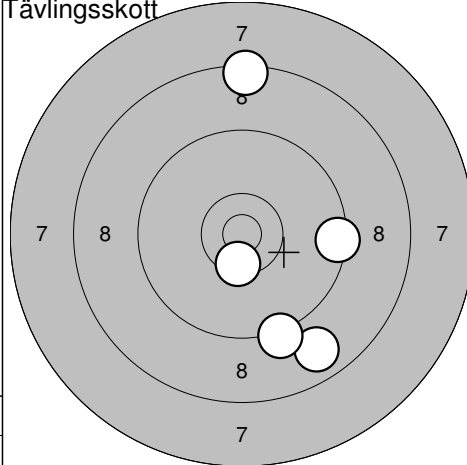

1: 10,5* ↓
 2: 8,8 ↓
 3: 9,4 →
 4: 8,4 ↑
 5: 9,2 ↓

Serie 44,0

Totalt 44,0

Tävlingsskott

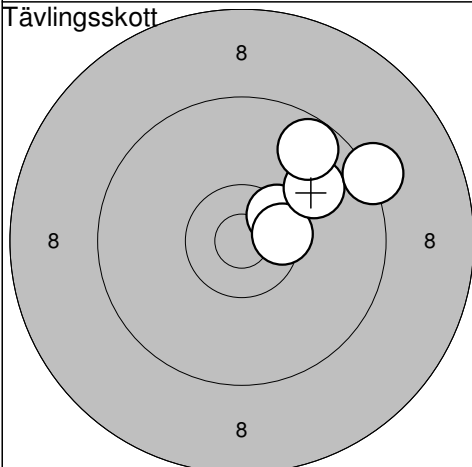

6: 10,4* ↗
 7: 10,5* →
 8: 9,9 ↗
 9: 9,3 ↗
 10: 9,7 ↗

Serie 47,0

Totalt 91,0

Tävlingsskott

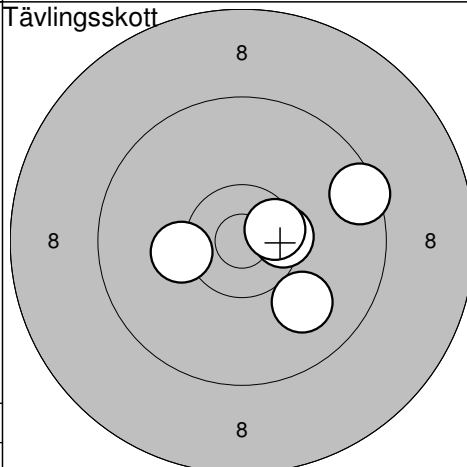

11: 10,5* →
 12: 9,5 →
 13: 10,3 ↖
 14: 10,0 ↓
 15: 10,6* →

Serie 49,0

Totalt 140,0

Tävlingsskott

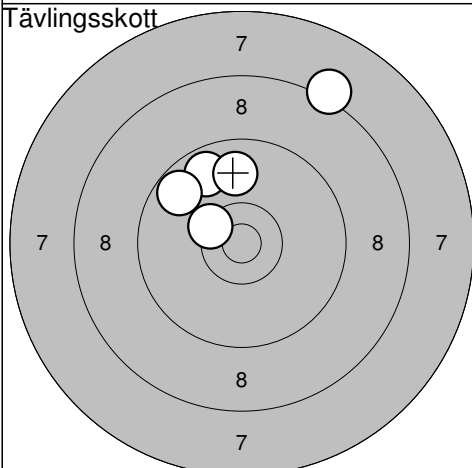

16: 8,2 ↗
 17: 9,7 ↗
 18: 9,9 ↑
 19: 10,4* ↖
 20: 9,7 ↖

Serie 45,0

Totalt 185,0

Ramselefors

2011-09-03

Höstträffen 2011

Ramselefors SKF

Provskott

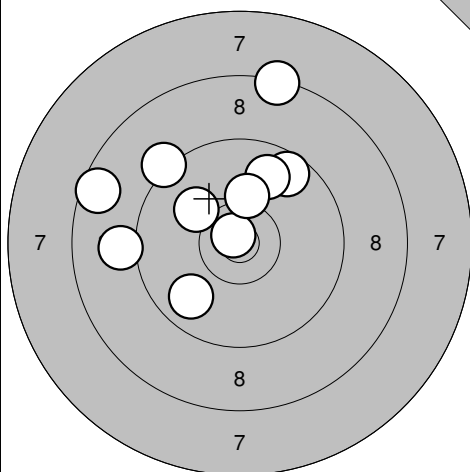

- 1: 8,4 ↗
- 2: 10,1 ↖
- 3: 9,6 ↗
- 4: 9,1 ←
- 5: 8,6 ↖
- 6: 9,8 ↗
- 7: 10,8* ↗
- 8: 9,8 ↘
- 9: 9,2 ↗
- 10: 10,2 ↑

Serie	91,0
Totalt	0,0

Provskott

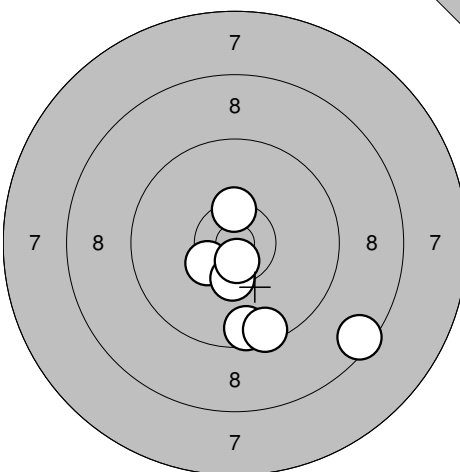

- 11: 10,4* ↖
- 12: 8,5 ↘
- 13: 10,4* ↑
- 14: 9,6 ↓
- 15: 10,4* ↓
- 16: 9,5 ↓
- 17: 10,7* ↓

Serie	66,0
Totalt	0,0

Tävlingsskott

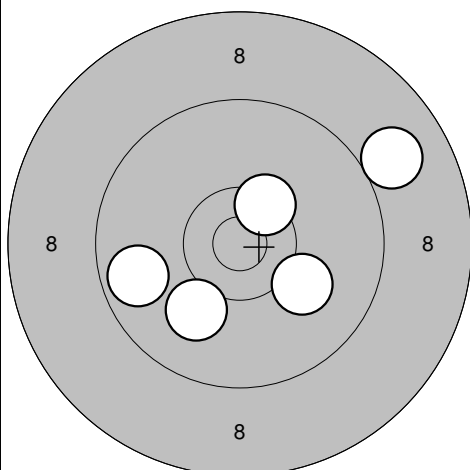

- 1: 9,0 ↗
- 2: 10,4* ↗
- 3: 9,7 ←
- 4: 10,0 ↘
- 5: 10,1 ↘

Serie	48,0
Totalt	48,0

Tävlingsskott

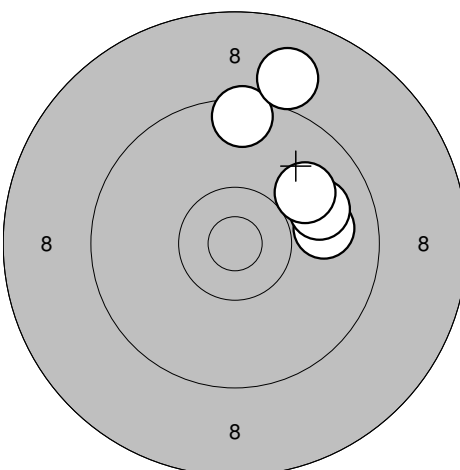

- 6: 9,9 →
- 7: 9,5 ↑
- 8: 9,9 →
- 9: 10,0 ↗
- 10: 9,0 ↑

Serie	46,0
Totalt	94,0

Tävlingsskott

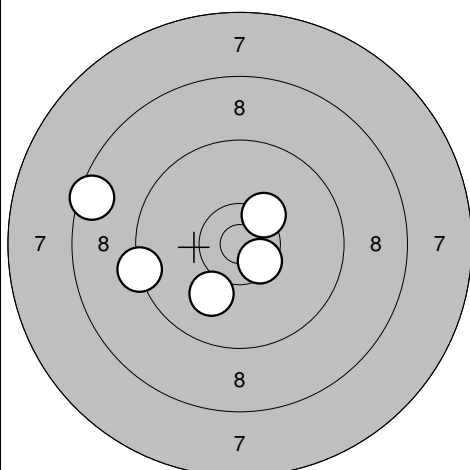

- 11: 10,0 ↘
- 12: 10,5* ↘
- 13: 8,5 ←
- 14: 10,4* ↗
- 15: 9,3 ←

Serie	47,0
Totalt	141,0

Tävlingsskott

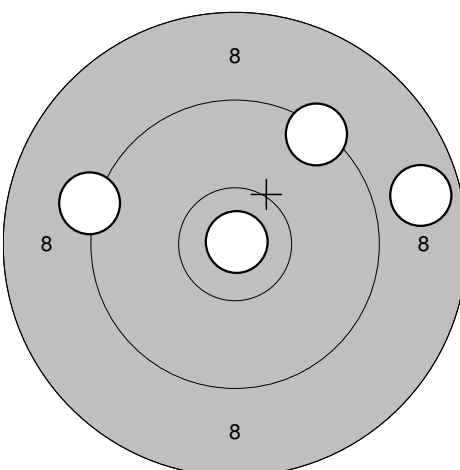

- 16: 9,2 ←
- 17: 10,9* ↗
- 18: 8,8 →
- 19: 9,4 ↗

Serie	36,0
Totalt	177,0

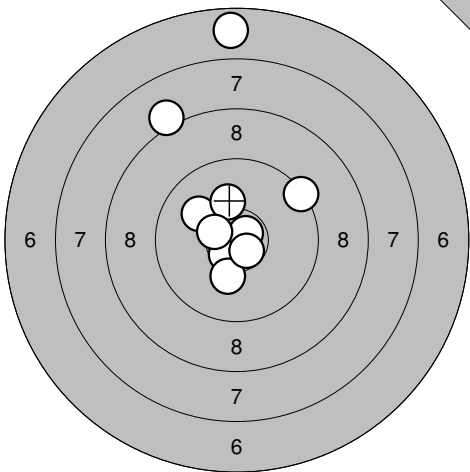
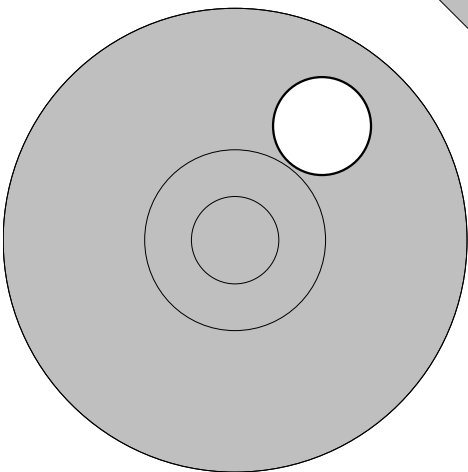
<p>Provskott</p> 	<p>1: 6,8 ↑</p> <p>2: 9,4 ↗</p> <p>3: 10,6* ↘</p> <p>4: 8,1 ↑</p> <p>5: 10,7* ↗</p> <p>6: 10,2 ↘</p> <p>7: 10,7* ↘</p> <p>8: 10,0 ↑</p> <p>9: 10,2 ↑</p> <p>10: 10,5* ↖</p> <table border="1" style="width:100%; border-collapse: collapse;"> <tr> <td>Serie</td> <td style="text-align: right;">93,0</td> </tr> <tr> <td>Totalt</td> <td style="text-align: right;">0,0</td> </tr> </table>	Serie	93,0	Totalt	0,0	<p>Provskott</p>  <p style="text-align: right;">11: 9,9 ↗</p> <table border="1" style="width:100%; border-collapse: collapse;"> <tr> <td>Serie</td> <td style="text-align: right;">9,0</td> </tr> <tr> <td>Totalt</td> <td style="text-align: right;">0,0</td> </tr> </table>	Serie	9,0	Totalt	0,0
Serie	93,0									
Totalt	0,0									
Serie	9,0									
Totalt	0,0									

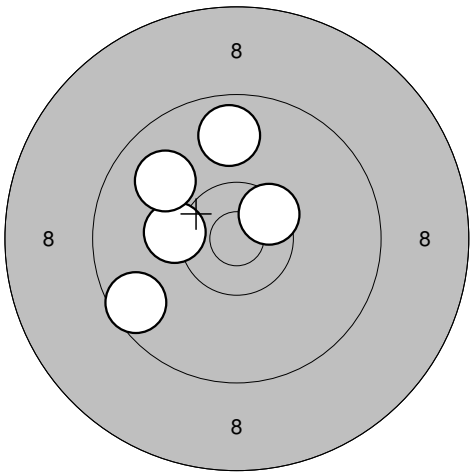
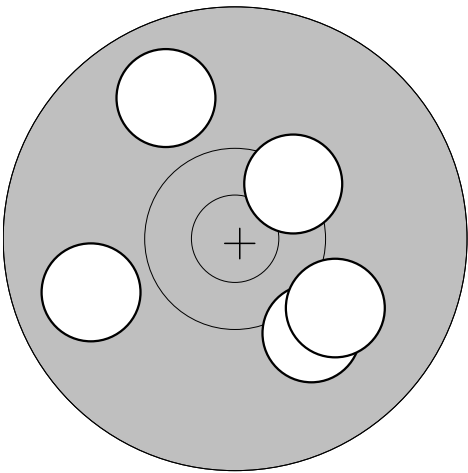
<p>Tävlingsskott</p> 	<p>1: 10,5* ↗</p> <p>2: 9,8 ↑</p> <p>3: 9,6 ↘</p> <p>4: 10,2 ←</p> <p>5: 9,9 ↖</p> <table border="1" style="width:100%; border-collapse: collapse;"> <tr> <td>Serie</td> <td style="text-align: right;">47,0</td> </tr> <tr> <td>Totalt</td> <td style="text-align: right;">47,0</td> </tr> </table>	Serie	47,0	Totalt	47,0	<p>Tävlingsskott</p>  <p>6: 10,1 ↘</p> <p>7: 9,8 ↑</p> <p>8: 10,1 ↘</p> <p>9: 10,4* ↗</p> <p>10: 9,9 ←</p> <table border="1" style="width:100%; border-collapse: collapse;"> <tr> <td>Serie</td> <td style="text-align: right;">48,0</td> </tr> <tr> <td>Totalt</td> <td style="text-align: right;">95,0</td> </tr> </table>	Serie	48,0	Totalt	95,0
Serie	47,0									
Totalt	47,0									
Serie	48,0									
Totalt	95,0									

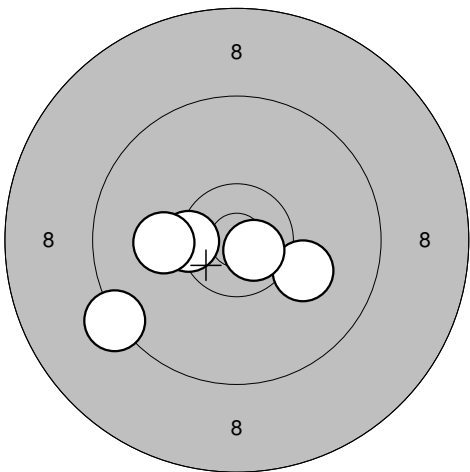
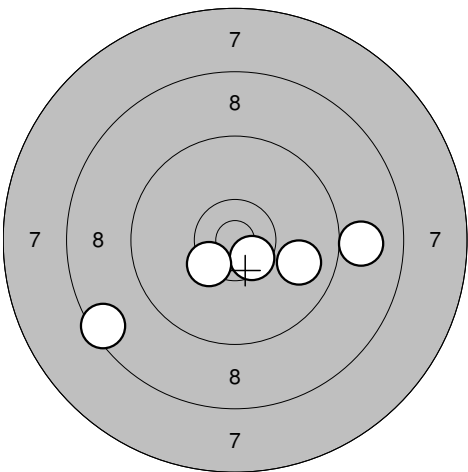
<p>Tävlingsskott</p> 	<p>11: 10,4* ←</p> <p>12: 9,3 ↘</p> <p>13: 10,1 ←</p> <p>14: 10,1 →</p> <p>15: 10,7* ↘</p> <table border="1" style="width:100%; border-collapse: collapse;"> <tr> <td>Serie</td> <td style="text-align: right;">49,0</td> </tr> <tr> <td>Totalt</td> <td style="text-align: right;">144,0</td> </tr> </table>	Serie	49,0	Totalt	144,0	<p>Tävlingsskott</p>  <p>16: 9,0 →</p> <p>17: 10,6* ↘</p> <p>18: 9,9 →</p> <p>19: 10,4* ↘</p> <p>20: 8,5 ↘</p> <table border="1" style="width:100%; border-collapse: collapse;"> <tr> <td>Serie</td> <td style="text-align: right;">46,0</td> </tr> <tr> <td>Totalt</td> <td style="text-align: right;">190,0</td> </tr> </table>	Serie	46,0	Totalt	190,0
Serie	49,0									
Totalt	144,0									
Serie	46,0									
Totalt	190,0									

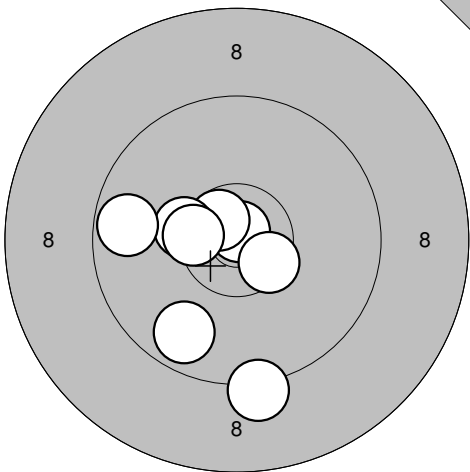
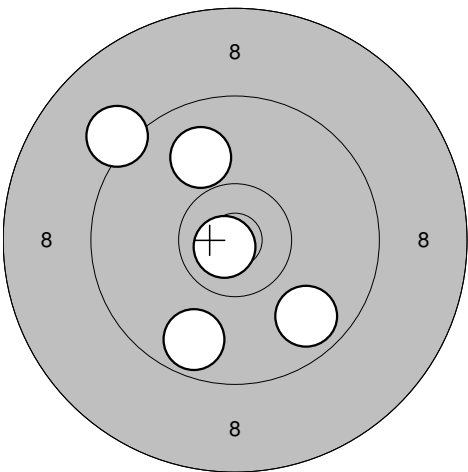
Provskott 	1: 10,9* ↗ 2: 9,2 ↓ 3: 9,7 ↘ 4: 10,7* ↗ 5: 10,5* ↘ 6: 10,3* ← 7: 9,7 ← 8: 10,5* ←	Tävlingskott 	1: 9,8 ↘ 2: 9,9 ↗ 3: 10,8* ↘ 4: 9,2 ↗ 5: 9,7 ↘
Serie 77,0		Serie 46,0	
Totalt 0,0		Totalt 46,0	

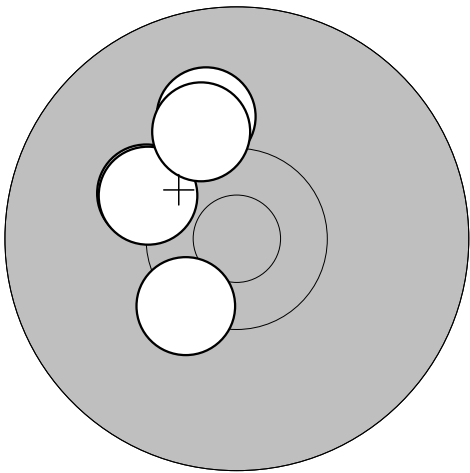
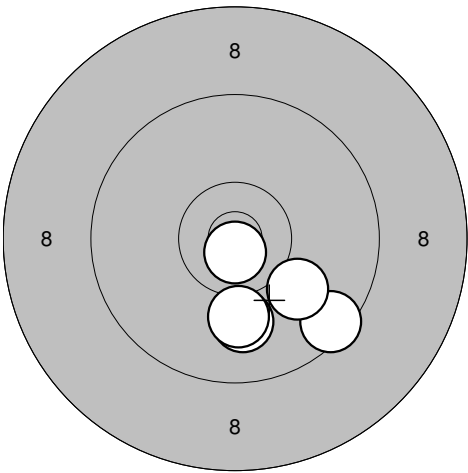
Tävlingskott 	6: 10,2 ↘ 7: 10,1 ↗ 8: 10,3 ↗ 9: 10,2 ↗ 10: 10,3* ↘	Tävlingskott 	11: 9,5 ↘ 12: 10,0 ↓ 13: 10,0 ↘ 14: 10,1 ↓ 15: 10,8* ↓
Serie 50,0		Serie 49,0	
Totalt 96,0		Totalt 145,0	

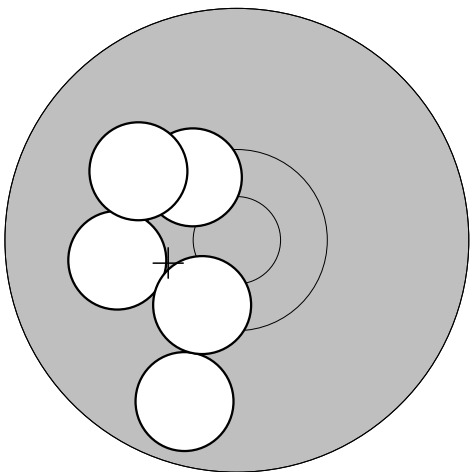
Tävlingskott 	16: 10,1 ← 17: 10,4* ↗ 18: 9,7 ↘ 19: 10,4* ↘ 20: 10,1 ↗	
Serie 49,0		
Totalt 194,0		

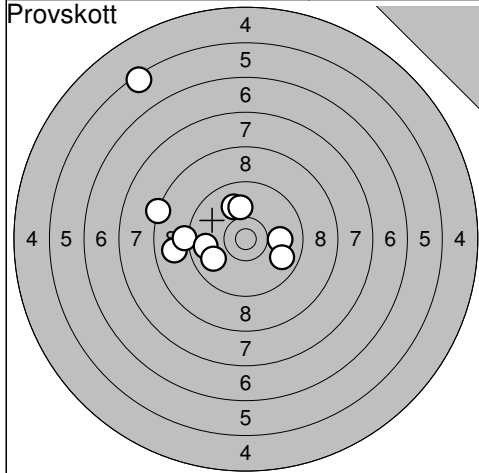

1: 5,5	↗
2: 8,9	←
3: 9,2	←
4: 10,0	→
5: 10,0	↑
6: 10,0	↑
7: 9,8	←
8: 9,8	↘
9: 9,9	←
10: 8,3	←
Serie 87,0	
Totalt 0,0	

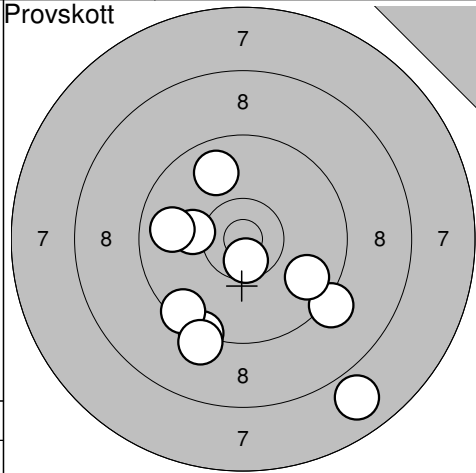

11: 9,3	↘
12: 7,9	↘
13: 9,8	↑
14: 10,6*	↘
15: 9,5	↘
16: 9,2	↘
17: 10,2	←
18: 9,8	←
19: 9,2	↘
20: 9,8	↘
Serie 90,0	
Totalt 0,0	

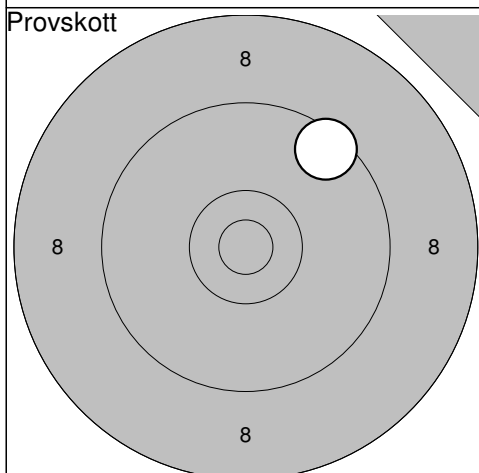

21: 9,5	↗
Serie 9,0	
Totalt 0,0	

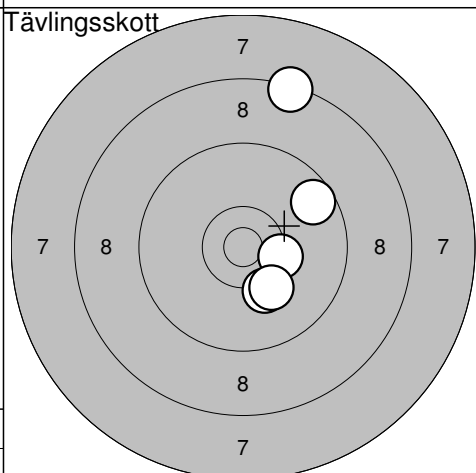

1: 8,4	↑
2: 9,6	↗
3: 10,3*	→
4: 10,2	↘
5: 10,2	↘
Serie 47,0	
Totalt 47,0	

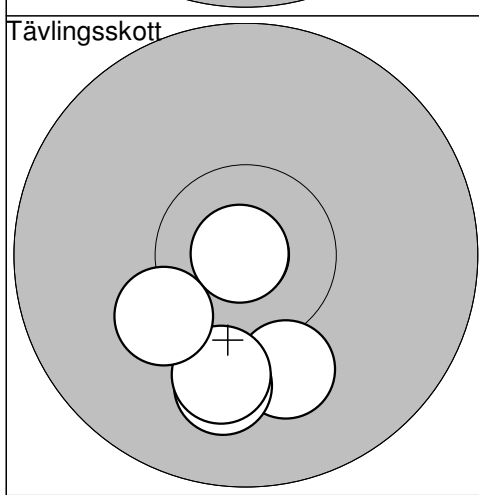

6: 10,1	↘
7: 10,9*	←
8: 10,0	↘
9: 10,1	↘
10: 10,2	↙
Serie 50,0	
Totalt 97,0	

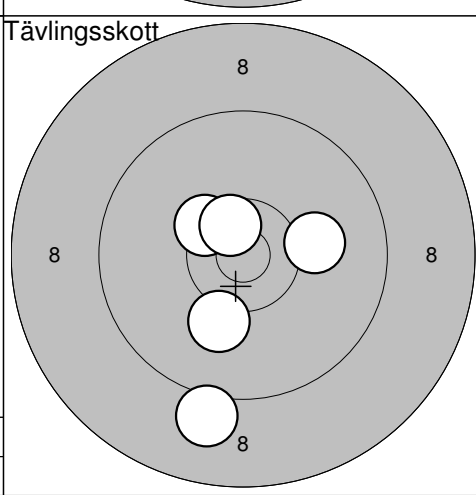

11: 10,4*	↗
12: 10,6*	↗
13: 10,1	↘
14: 10,1	→
15: 9,1	↘
Serie 49,0	
Totalt 146,0	

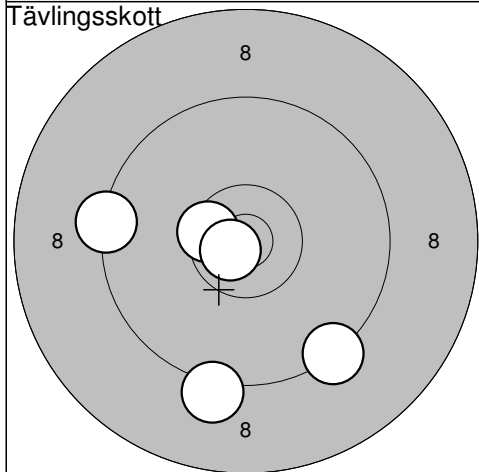

16: 9,3	←
17: 10,5*	←
18: 10,8*	←
19: 9,2	↘
20: 9,3	↘
Serie 47,0	
Totalt 193,0	

Umeå

2011-09-03

Höstträffen 2011

Ramselefors SKF

Provskott

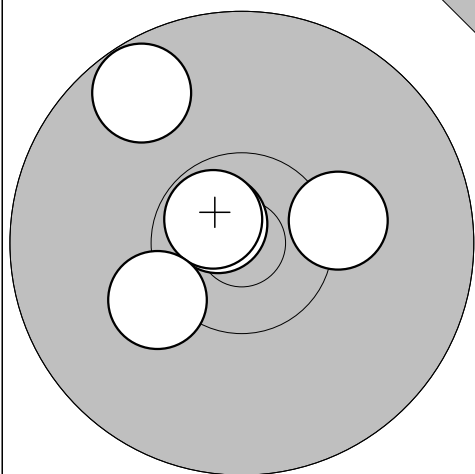

1: 9,7 ↗
 2: 10,2 →
 3: 10,7* ↗
 4: 10,7* ↗
 5: 10,2 ↙

Serie 49,0
 Totalt 0,0

Tävlingsskott

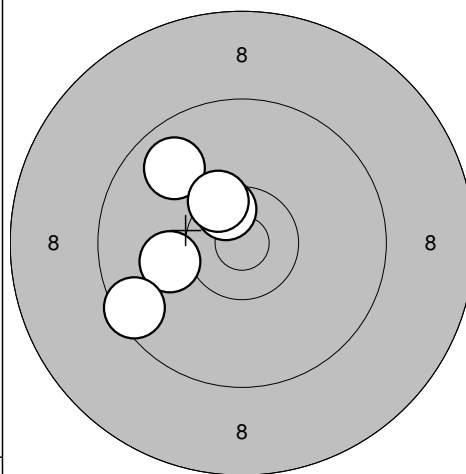

1: 10,5* ↗
 2: 10,1 ↖
 3: 9,5 ↖
 4: 9,8 ↗
 5: 10,4* ↗

Serie 48,0
 Totalt 48,0

Tävlingsskott

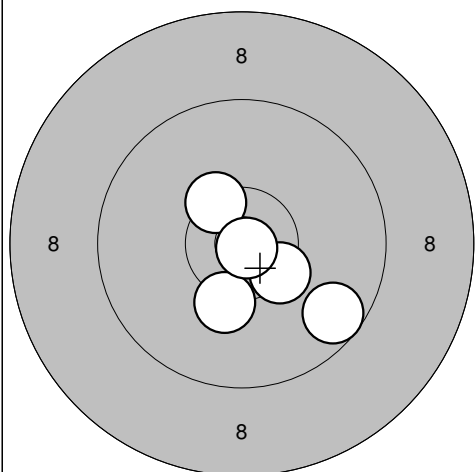

6: 10,4* ↗
 7: 9,6 ↘
 8: 10,4* ↘
 9: 10,3 ↘
 10: 10,9* ↘

Serie 49,0
 Totalt 97,0

Tävlingsskott

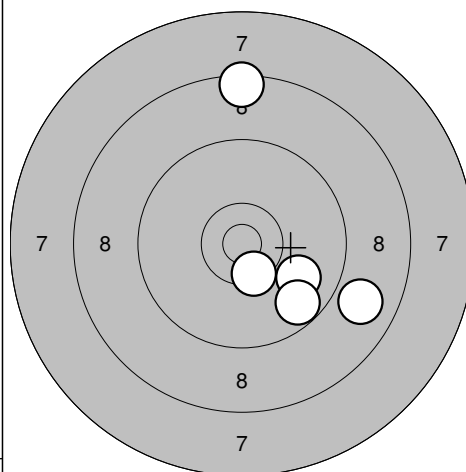

11: 9,9 ↘
 12: 10,4* ↘
 13: 8,5 ↑
 14: 8,9 ↘
 15: 9,7 ↘

Serie 44,0
 Totalt 141,0

Tävlingsskott

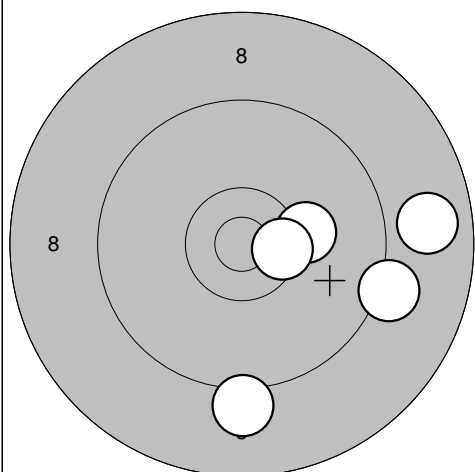

16: 10,2 →
 17: 10,5* →
 18: 9,1 ↓
 19: 8,8 →
 20: 9,2 ↘

Serie 46,0
 Totalt 187,0

Umeå

2011-09-03

Höstträffen 2011

Ramselefors SKF

Provskott

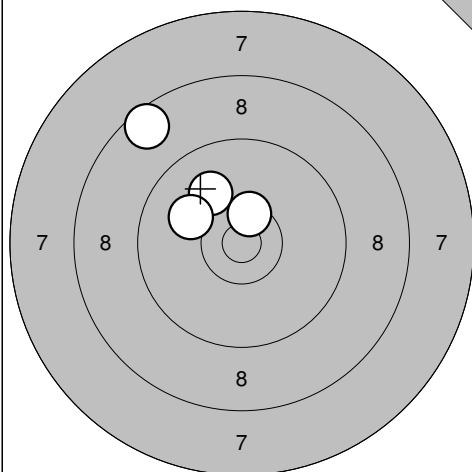

1: 10,0 ↗
 2: 10,5* ↑
 3: 10,1 ↖
 4: 8,6 ↗

Serie 38,0

Totalt 0,0

Tävlingsskott

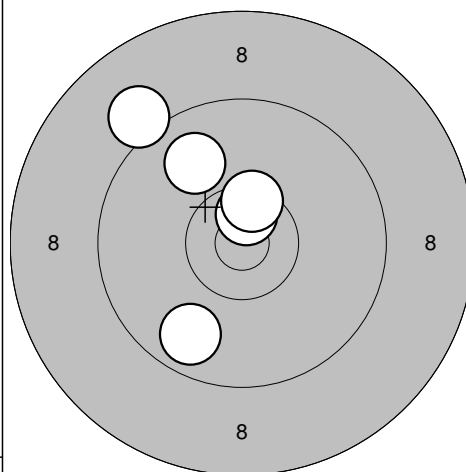

1: 9,8 ↘
 2: 10,6* ↑
 3: 9,9 ↖
 4: 9,1 ↖
 5: 10,5* ↑

Serie 47,0

Totalt 47,0

Tävlingsskott

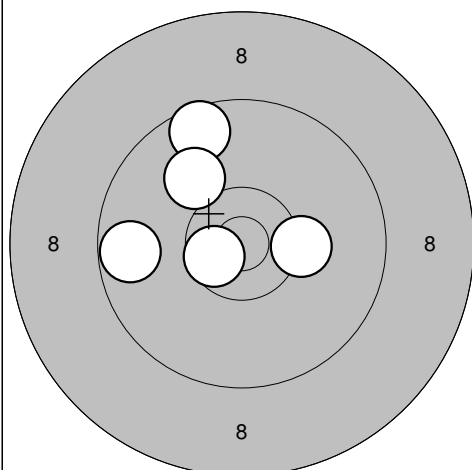

6: 10,6* ↖
 7: 10,3 →
 8: 9,6 ↑
 9: 9,7 ←
 10: 10,0 ↗

Serie 48,0

Totalt 95,0

Tävlingsskott

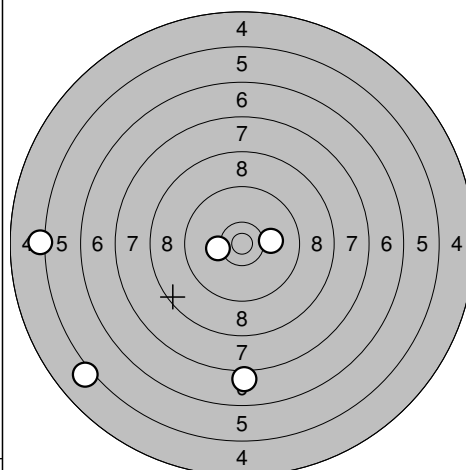

11: 10,1 →
 12: 5,2 ←
 13: 5,1 ↘
 14: 7,1 ↓
 15: 10,3 ←

Serie 37,0

Totalt 132,0

Tävlingsskott

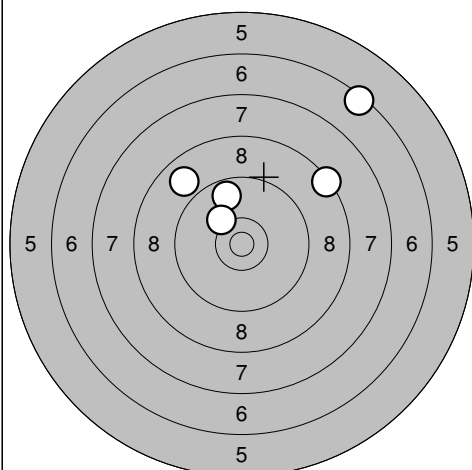

16: 6,4 ↗
 17: 8,4 ↗
 18: 9,7 ↑
 19: 10,2 ↗
 20: 8,9 ↗

Serie 41,0

Totalt 173,0

Ramselefors

2011-09-03

Höstträffen 2011

Ramselefors SKF

Provskott

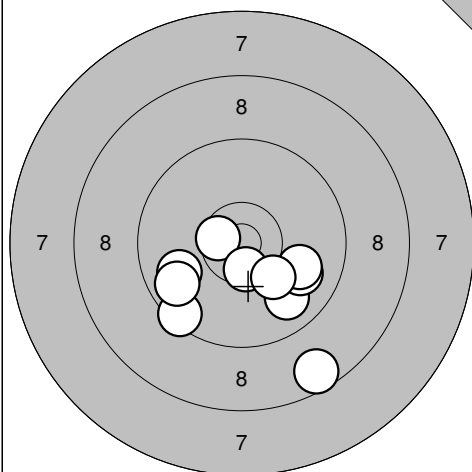

1: 9,9 ↙
 2: 8,6 ↘
 3: 9,8 ↘
 4: 10,6* ↙
 5: 10,5* ↘
 6: 9,9 →
 7: 9,5 ↘
 8: 9,8 ↙
 9: 10,0 →
 10: 10,2 ↘

Serie 93,0

Totalt 0,0

Tävlingsskott

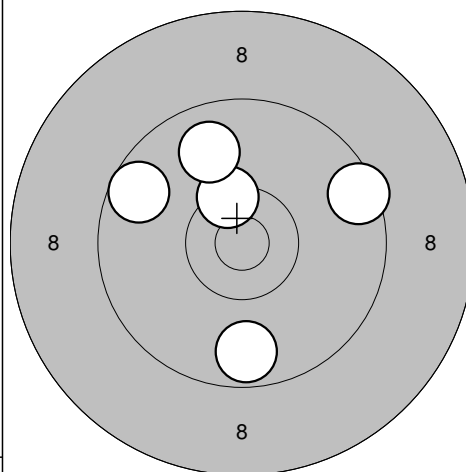

1: 10,4* ↗
 2: 9,6 ↖
 3: 9,7 ↓
 4: 9,8 ↗
 5: 9,5 →

Serie 46,0

Totalt 46,0

Tävlingsskott

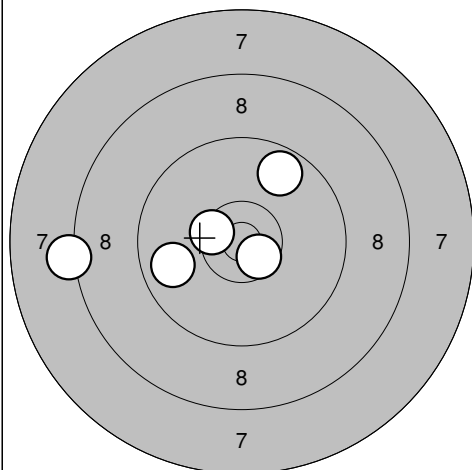

6: 9,8 ↙
 7: 9,7 ↗
 8: 10,5* ↙
 9: 10,6* ↘
 10: 8,2 ↙

Serie 46,0

Totalt 92,0

Tävlingsskott

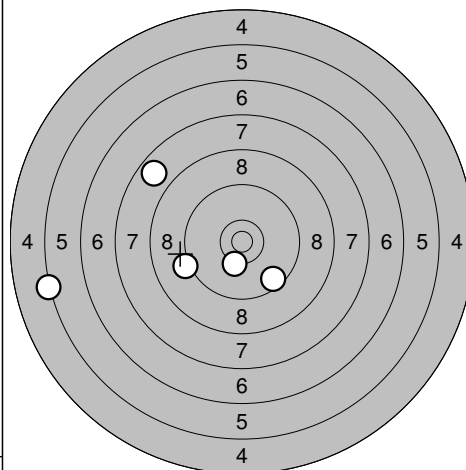

11: 5,3 ↙
 12: 9,6 ↘
 13: 9,2 ↙
 14: 7,8 ↖
 15: 10,3 ↓

Serie 40,0

Totalt 132,0

Tävlingsskott

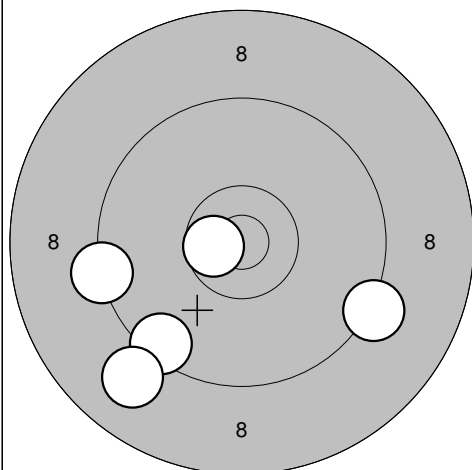

16: 9,5 ↘
 17: 9,0 ↘
 18: 9,3 ↙
 19: 10,6* ↙
 20: 9,2 ↘

Serie 46,0

Totalt 178,0

Ramselefors

2011-09-03

Höstträffen 2011

Ramselefors SKF

Provskott

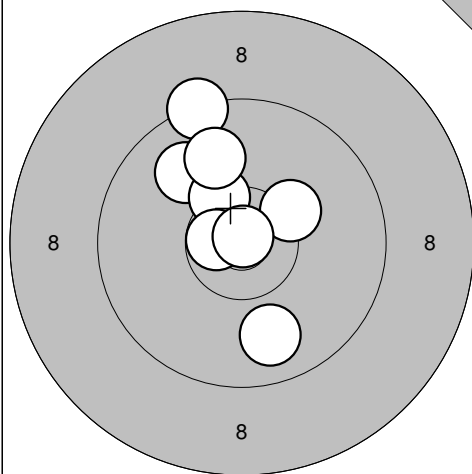

1: 9,9 ↖
 2: 9,3 ↑
 3: 9,8 ↓
 4: 10,4* ↑
 5: 10,3 ↗
 6: 9,9 ↑
 7: 10,7* ←
 8: 10,9* ↑

Serie 76,0
 Totalt 0,0

Tävlingsskott

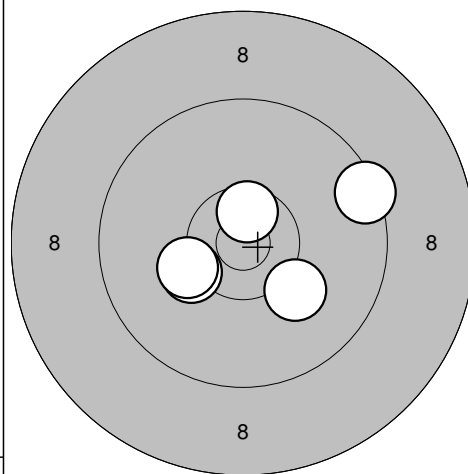

1: 9,4 →
 2: 10,3 ←
 3: 10,6* ↑
 4: 10,3 ←
 5: 10,1 ↘

Serie 49,0
 Totalt 49,0

Tävlingsskott

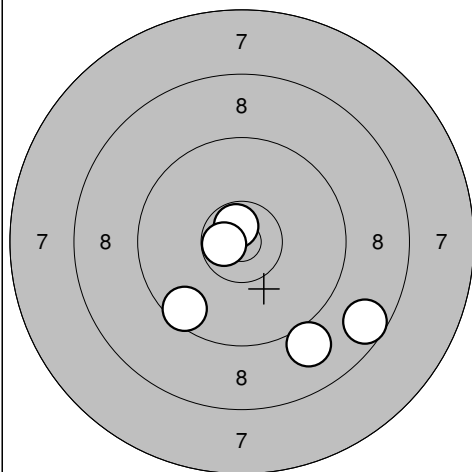

6: 9,0 ↓
 7: 8,6 ↘
 8: 9,6 ↙
 9: 10,7* ↑
 10: 10,7* ←

Serie 46,0
 Totalt 95,0

Tävlingsskott

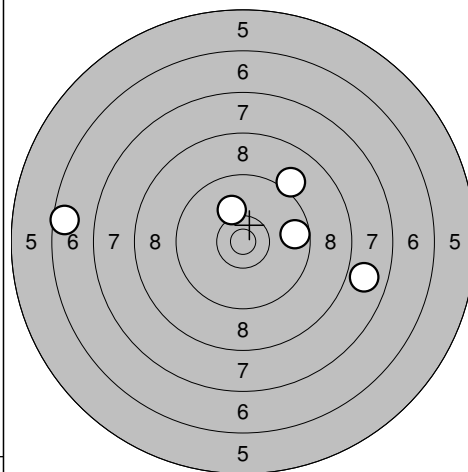

11: 6,6 ←
 12: 9,1 ↗
 13: 10,1 ↑
 14: 7,9 →
 15: 9,7 →

Serie 41,0
 Totalt 136,0

Tävlingsskott

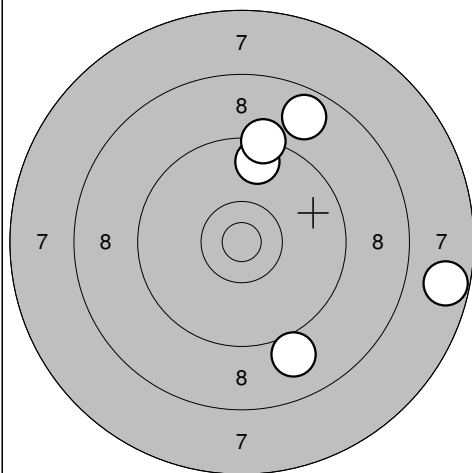

16: 9,7 ↑
 17: 8,8 ↗
 18: 9,3 ↑
 19: 9,0 ↓
 20: 7,7 →

Serie 42,0
 Totalt 178,0

Ramselefors

2011-09-03

Höstträffen 2011

Ramselefors SKF

Provskott

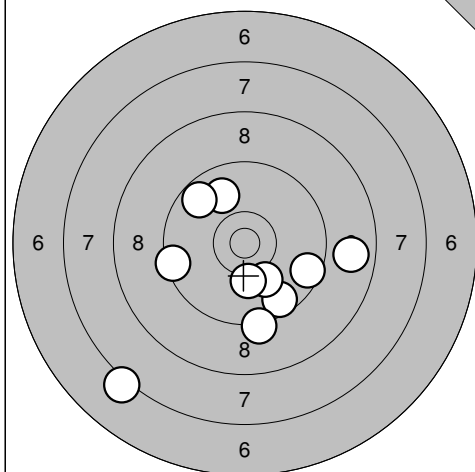

1: 9,9 ↗
 2: 7,2 ↘
 3: 9,7 ↗
 4: 9,6 ↘
 5: 9,5 ←
 6: 9,6 →
 7: 10,1 ↘
 8: 10,2 ↘
 9: 8,8 →
 10: 9,3 ↘

Serie 89,0

Totalt 0,0

Tävlingsskott

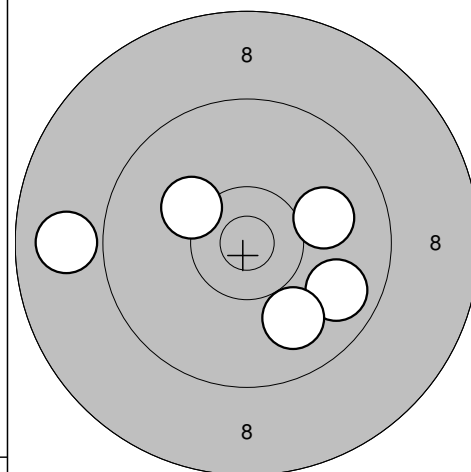

1: 10,2 ↖
 2: 9,8 ↘
 3: 8,9 ←
 4: 9,9 ↘
 5: 10,0 →

Serie 46,0

Totalt 46,0

Tävlingsskott

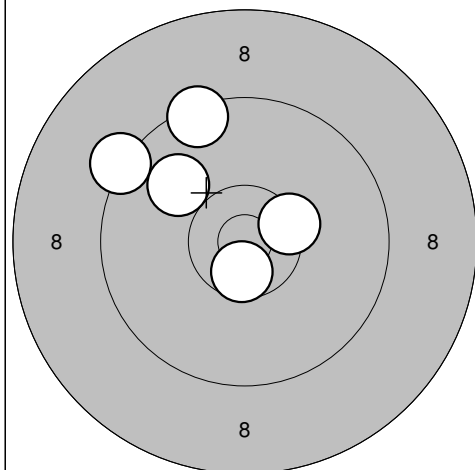

6: 10,6* ↘
 7: 10,4* →
 8: 10,0 ↗
 9: 9,4 ↗
 10: 9,3 ↗

Serie 48,0

Totalt 94,0

Tävlingsskott

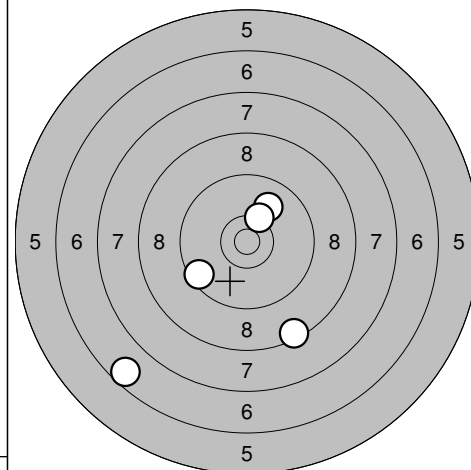

11: 9,5 ↖
 12: 10,0 ↗
 13: 8,4 ↘
 14: 10,3* ↗
 15: 6,6 ↘

Serie 43,0

Totalt 137,0

Tävlingsskott

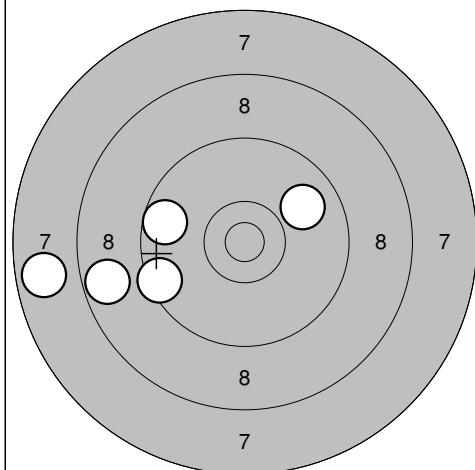

16: 9,7 ←
 17: 8,7 ←
 18: 9,9 →
 19: 7,8 ←
 20: 9,5 ←

Serie 42,0

Totalt 179,0

Skellefteå

2011-09-03

Höstträffen 2011

Ramselefors SKF

Provskott

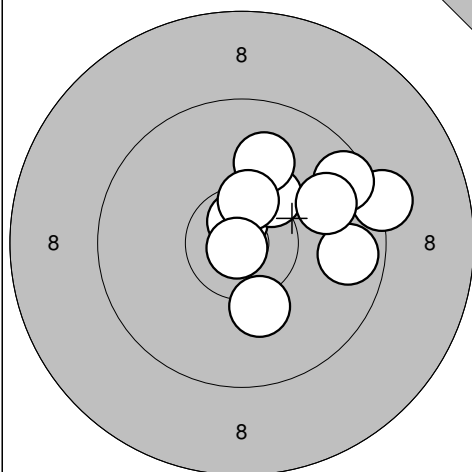

1: 9,3 →
 2: 10,7* ↑
 3: 10,3* ↗
 4: 9,7 →
 5: 9,6 ↗
 6: 10,0 ↑
 7: 10,2 ↓
 8: 10,5* ↑
 9: 9,9 →
 10: 10,9* ↘

Serie 96,0

Totalt 0,0

Provskott

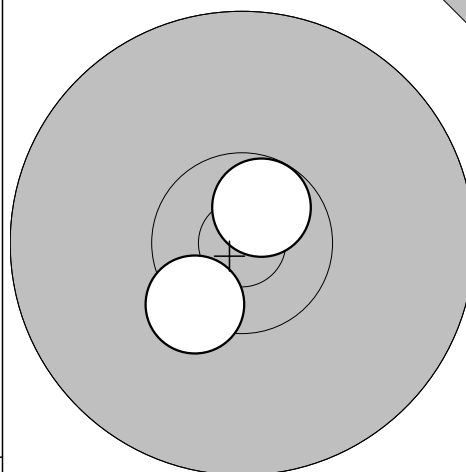

11: 10,7* ↗
 12: 10,4* ↘

Serie 20,0

Totalt 0,0

Tävlingsskott

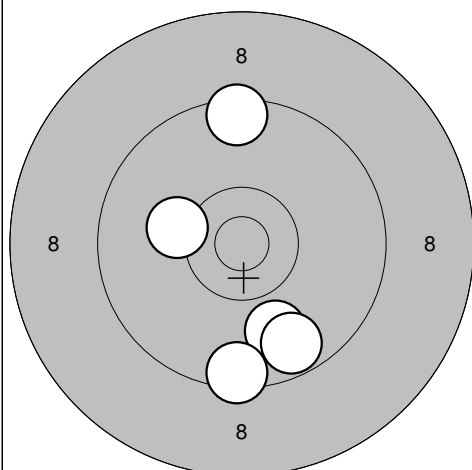

1: 9,5 ↑
 2: 9,9 ↓
 3: 10,2 ←
 4: 9,5 ↓
 5: 9,7 ↓

Serie 46,0

Totalt 46,0

Tävlingsskott

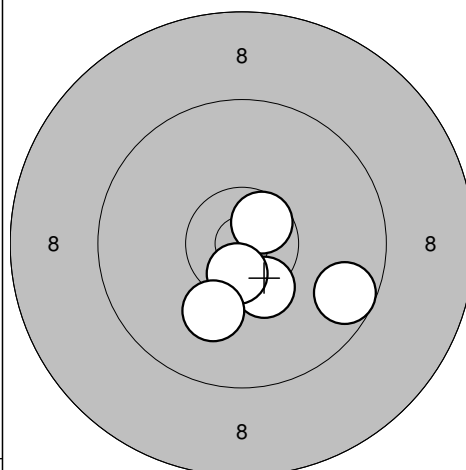

6: 10,6* ↗
 7: 10,4* ↓
 8: 10,6* ↓
 9: 9,6 →
 10: 10,1 ↓

Serie 49,0

Totalt 95,0

Tävlingsskott

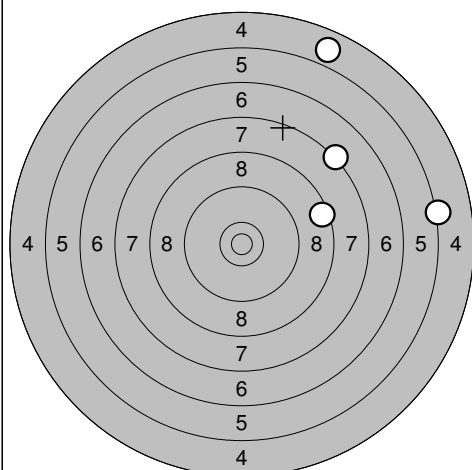

11: 0,0 ↘
 12: 7,3 ↗
 13: 5,3 →
 14: 4,9 ↑
 15: 8,5 →

Serie 24,0

Totalt 119,0

Tävlingsskott

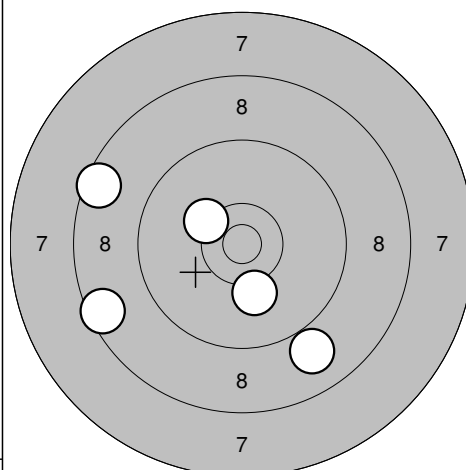

16: 8,9 ↓
 17: 10,2 ↓
 18: 10,3 ↗
 19: 8,5 ←
 20: 8,5 ←

Serie 44,0

Totalt 163,0

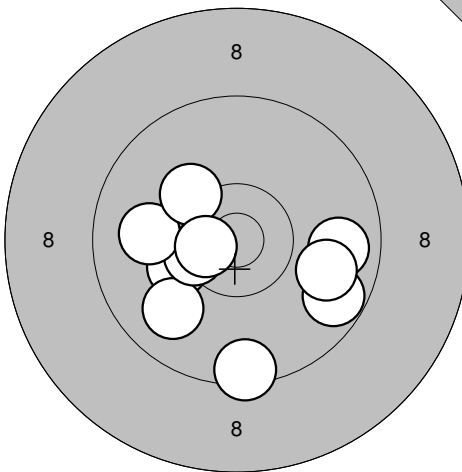
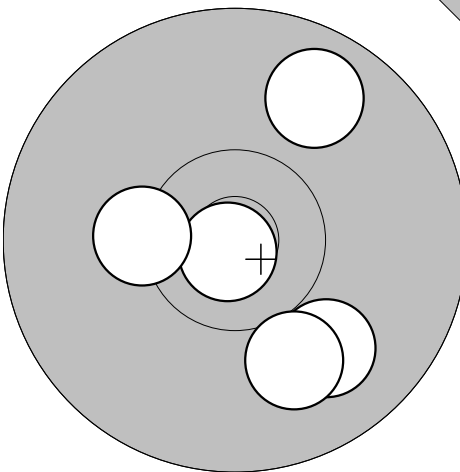
<p>Provskott</p> 	<p>1: 9,7 ↘ 2: 9,8 → 3: 9,9 → 4: 10,2 ← 5: 9,9 ↙ 6: 10,4* ← 7: 10,0 ← 8: 10,2 ↗ 9: 9,5 ↓ 10: 10,6* ←</p> <table border="1" style="width:100%; border-collapse: collapse;"> <tr><td>Serie</td><td style="text-align: right;">95,0</td></tr> <tr><td>Totalt</td><td style="text-align: right;">0,0</td></tr> </table>	Serie	95,0	Totalt	0,0	<p>Provskott</p> 	<p>11: 9,9 ↘ 12: 10,0 ↘ 13: 10,9* ↘ 14: 9,8 ↗ 15: 10,3* ←</p> <table border="1" style="width:100%; border-collapse: collapse;"> <tr><td>Serie</td><td style="text-align: right;">48,0</td></tr> <tr><td>Totalt</td><td style="text-align: right;">0,0</td></tr> </table>	Serie	48,0	Totalt	0,0
Serie	95,0										
Totalt	0,0										
Serie	48,0										
Totalt	0,0										

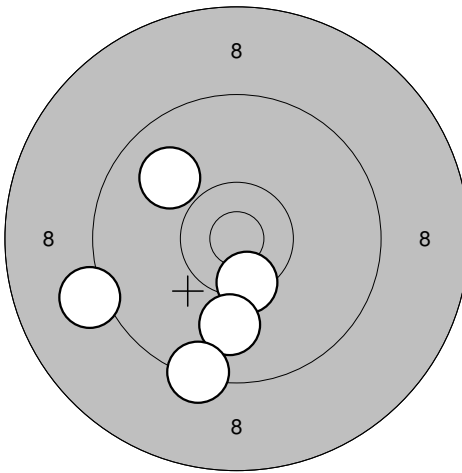
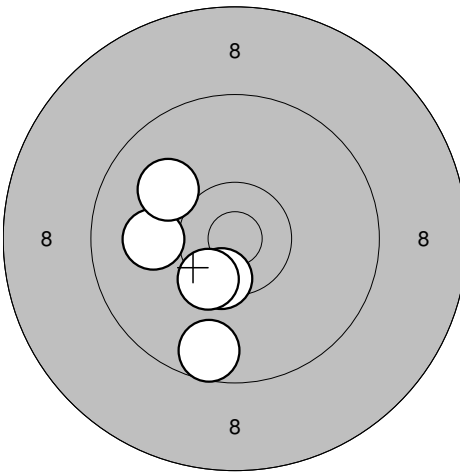
<p>Tävlingsskott</p> 	<p>1: 10,4* ↓ 2: 9,1 ← 3: 10,0 ↓ 4: 9,9 ↗ 5: 9,4 ↓</p> <table border="1" style="width:100%; border-collapse: collapse;"> <tr><td>Serie</td><td style="text-align: right;">47,0</td></tr> <tr><td>Totalt</td><td style="text-align: right;">47,0</td></tr> </table>	Serie	47,0	Totalt	47,0	<p>Tävlingsskott</p> 	<p>6: 10,5* ↓ 7: 10,0 ← 8: 9,6 ↓ 9: 10,4* ↘ 10: 10,0 ↖</p> <table border="1" style="width:100%; border-collapse: collapse;"> <tr><td>Serie</td><td style="text-align: right;">49,0</td></tr> <tr><td>Totalt</td><td style="text-align: right;">96,0</td></tr> </table>	Serie	49,0	Totalt	96,0
Serie	47,0										
Totalt	47,0										
Serie	49,0										
Totalt	96,0										

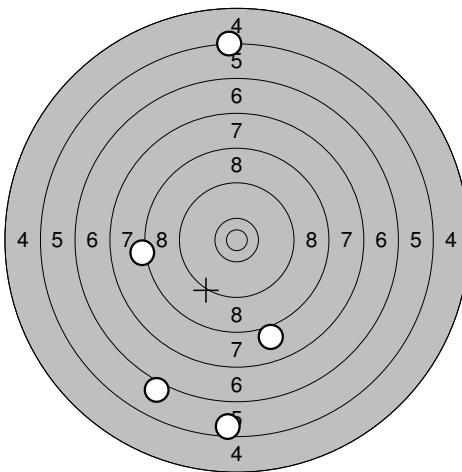
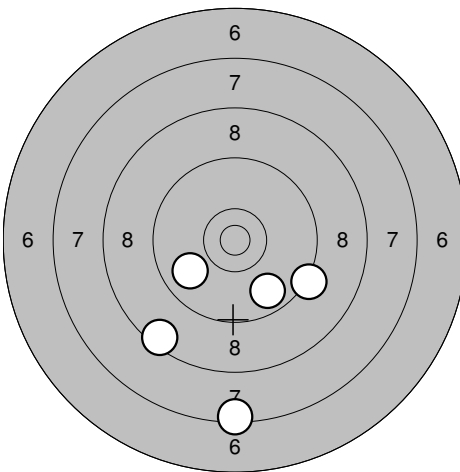
<p>Tävlingsskott</p> 	<p>11: 5,3 ↑ 12: 5,6 ↓ 13: 8,2 ← 14: 6,1 ↘ 15: 8,0 ↓</p> <table border="1" style="width:100%; border-collapse: collapse;"> <tr><td>Serie</td><td style="text-align: right;">32,0</td></tr> <tr><td>Totalt</td><td style="text-align: right;">128,0</td></tr> </table>	Serie	32,0	Totalt	128,0	<p>Tävlingsskott</p> 	<p>16: 9,2 ↘ 17: 8,5 ↘ 18: 9,7 ↘ 19: 9,9 ← 20: 7,4 ↓</p> <table border="1" style="width:100%; border-collapse: collapse;"> <tr><td>Serie</td><td style="text-align: right;">42,0</td></tr> <tr><td>Totalt</td><td style="text-align: right;">170,0</td></tr> </table>	Serie	42,0	Totalt	170,0
Serie	32,0										
Totalt	128,0										
Serie	42,0										
Totalt	170,0										

Drängsmark

2011-09-03

Höstträffen 2011

Ramselefors SKF

Provskott

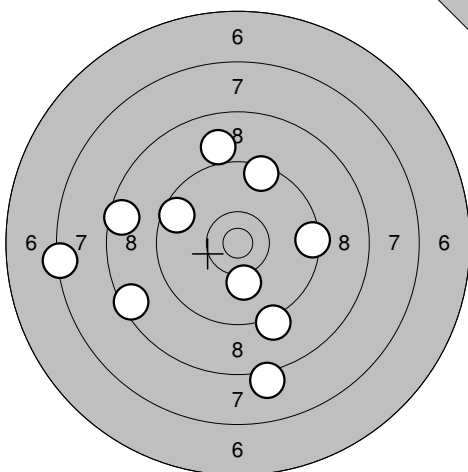

1: 9,2 ↘
 2: 9,4 →
 3: 9,5 ↑
 4: 8,5 ↙
 5: 8,1 ↘
 6: 9,0 ↑
 7: 7,4 ←
 8: 8,6 ←
 9: 9,6 ↙
 10: 10,1 ↘

Serie 86,0

Totalt 0,0

Provskott

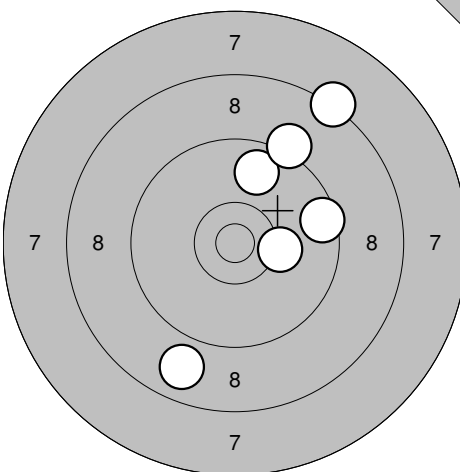

11: 9,8 ↑
 12: 10,2 →
 13: 8,3 ↗
 14: 8,8 ↘
 15: 9,5 →
 16: 9,2 ↗

Serie 53,0

Totalt 0,0

Tävlingsskott

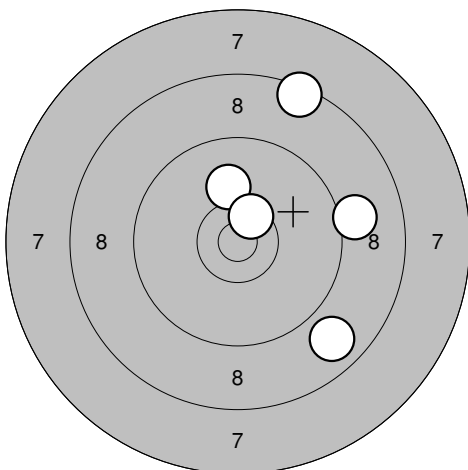

1: 9,1 →
 2: 8,4 ↗
 3: 10,1 ↑
 4: 8,8 ↘
 5: 10,5* ↗

Serie 45,0

Totalt 45,0

Tävlingsskott

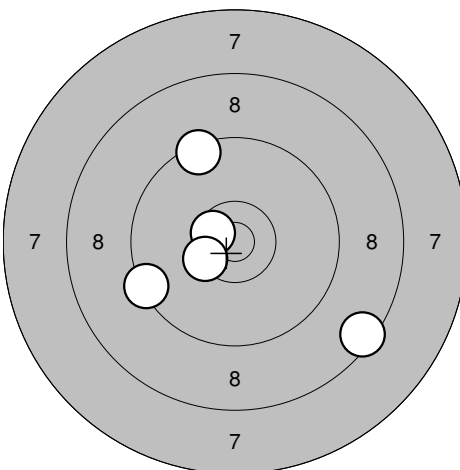

6: 8,5 ↘
 7: 10,6* ↙
 8: 10,4* ↙
 9: 9,4 ↑
 10: 9,4 ↙

Serie 46,0

Totalt 91,0

Tävlingsskott

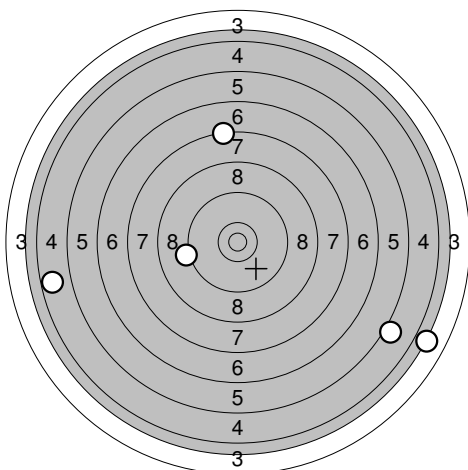

11: 4,7 ←
 12: 5,1 ↘
 13: 7,4 ↑
 14: 9,2 ←
 15: 3,9 ↘

Serie 28,0

Totalt 119,0

Tävlingsskott

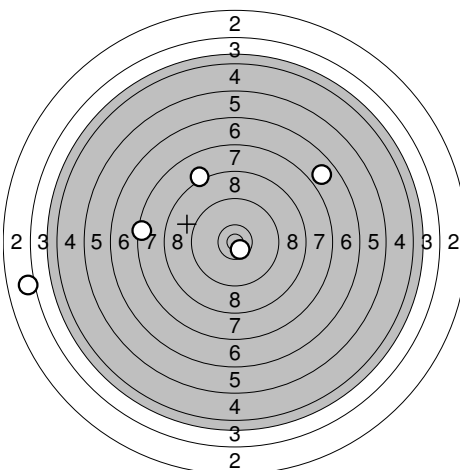

16: 3,1 ←
 17: 8,2 ↗
 18: 7,5 ←
 19: 6,9 ↗
 20: 10,6* ↘

Serie 34,0

Totalt 153,0

Umeå

2011-09-03

Höstträffen 2011

Ramselefors SKF

Provskott

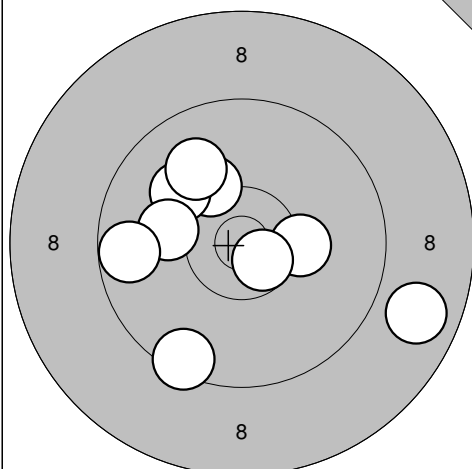

1: 10,3 →
 2: 9,5 ↓
 3: 8,8 →
 4: 10,2 ↗
 5: 10,0 ↗
 6: 10,1 ←
 7: 10,0 ↗
 8: 10,6* ↓
 9: 9,7 ←

Serie 86,0

Totalt 0,0

Tävlingsskott

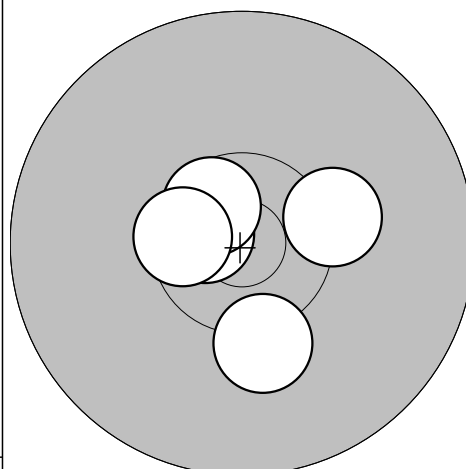

1: 10,3 →
 2: 10,7* ←
 3: 10,2 ↓
 4: 10,6* ↗
 5: 10,5* ←

Serie 50,0

Totalt 50,0

Tävlingsskott

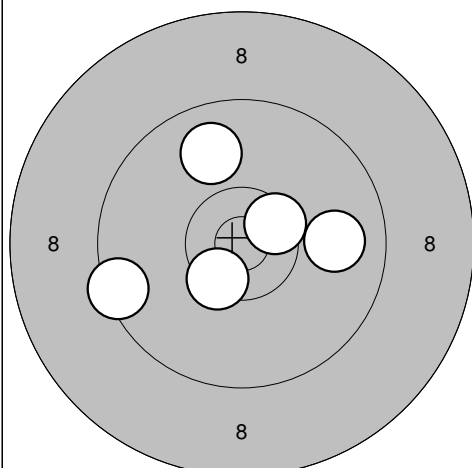

6: 10,5* ↗
 7: 9,9 ↗
 8: 10,5* ↓
 9: 9,5 ←
 10: 9,9 →

Serie 47,0

Totalt 97,0

Tävlingsskott

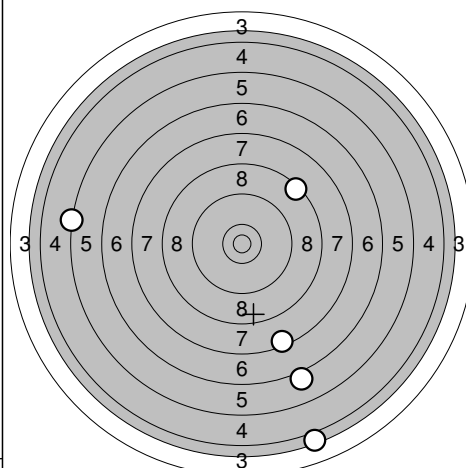

11: 7,5 ↓
 12: 8,4 ↗
 13: 6,1 ↓
 14: 5,3 ←
 15: 4,0 ↓

Serie 30,0

Totalt 127,0

Tävlingsskott

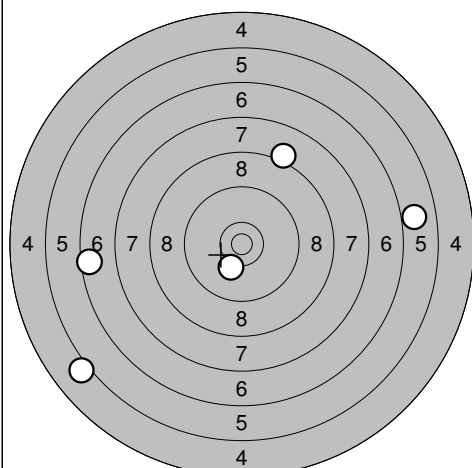

16: 10,2 ↓
 17: 5,9 →
 18: 8,2 ↗
 19: 6,6 ←
 20: 5,1 ↙

Serie 34,0

Totalt 161,0

Ramselefors

2011-09-03

Höstträffen 2011

Ramselefors SKF

Provskott

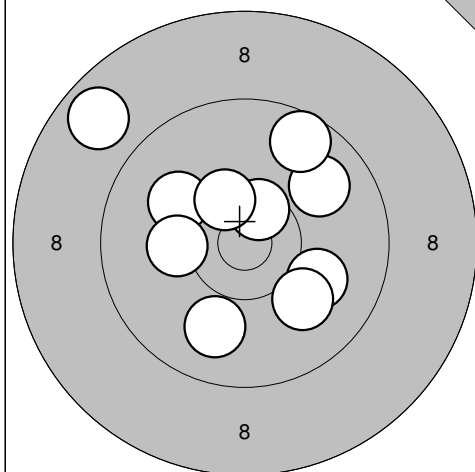

1: 9,9 ↗
 2: 10,5* ↗
 3: 9,6 ↗
 4: 10,0 ↘
 5: 10,1 ↗
 6: 8,8 ↗
 7: 10,4* ↗
 8: 10,2 ←
 9: 9,9 ↓
 10: 10,0 ↓

Serie 95,0

Totalt 0,0

Provskott

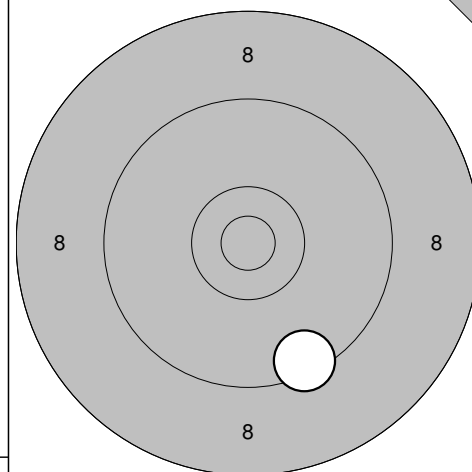

11: 9,5 ↓

Serie 9,0

Totalt 0,0

Tävlingsskott

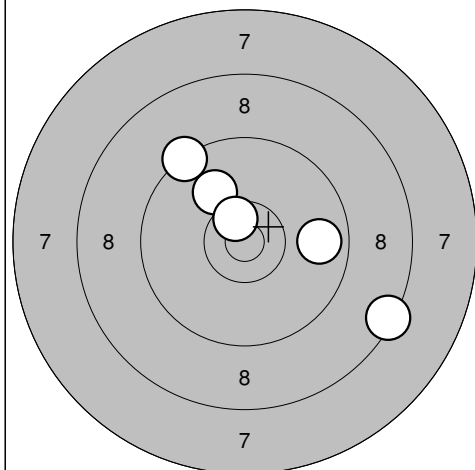

1: 9,8 →
 2: 8,4 ↘
 3: 10,0 ↗
 4: 10,6* ↗
 5: 9,3 ↗

Serie 46,0

Totalt 46,0

Tävlingsskott

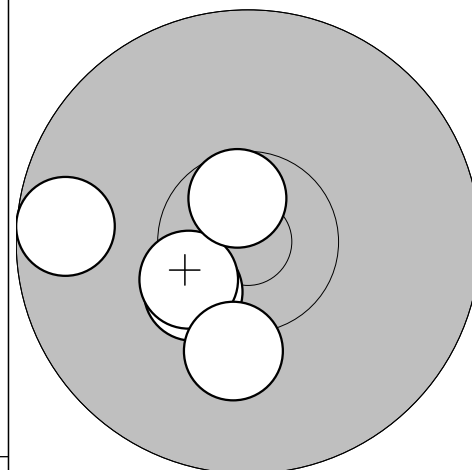

6: 10,4* ↙
 7: 10,5* ↙
 8: 9,7 ←
 9: 10,6* ↑
 10: 10,2 ↓

Serie 49,0

Totalt 95,0

Tävlingsskott

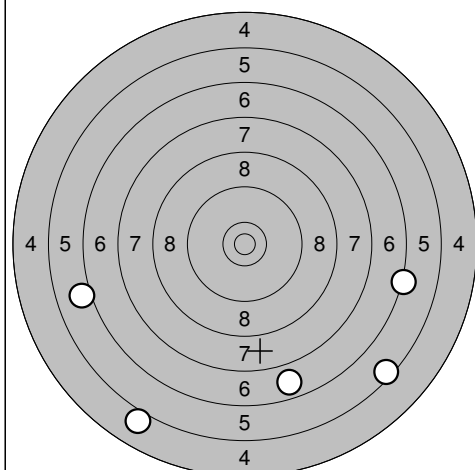

11: 6,8 ↓
 12: 6,3 →
 13: 5,5 ↓
 14: 6,1 ←
 15: 5,0 ↓

Serie 28,0

Totalt 123,0

Tävlingsskott

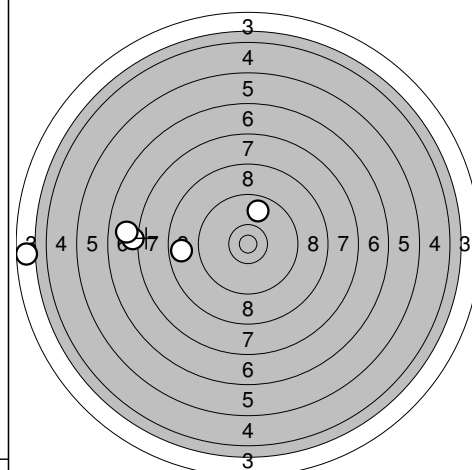

16: 9,8 ↑
 17: 8,8 ←
 18: 3,7 ←
 19: 7,2 ←
 20: 6,9 ←

Serie 33,0

Totalt 156,0