

Ramselefors

2012-05-13

Vindelnskottet

Ramselefors SKF

Provskott

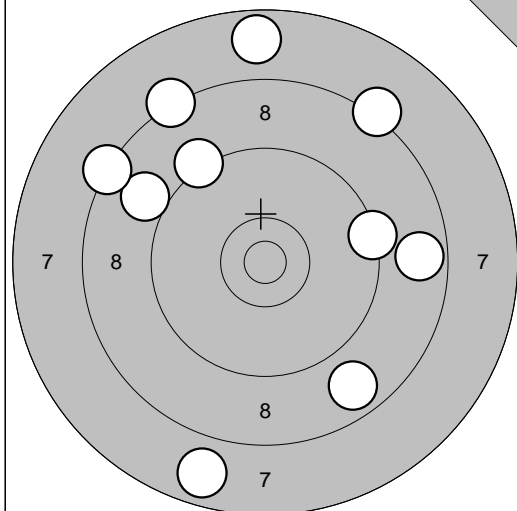

1: 8,3 ↖
 2: 9,0 ↖
 3: 8,3 ↖
 4: 9,4 →
 5: 8,7 →
 6: 7,7 ↑
 7: 8,2 ↗
 8: 7,8 ↓
 9: 9,2 ↗
 10: 8,8 ↓

Serie 81,0

Totalt 0,0

Provskott

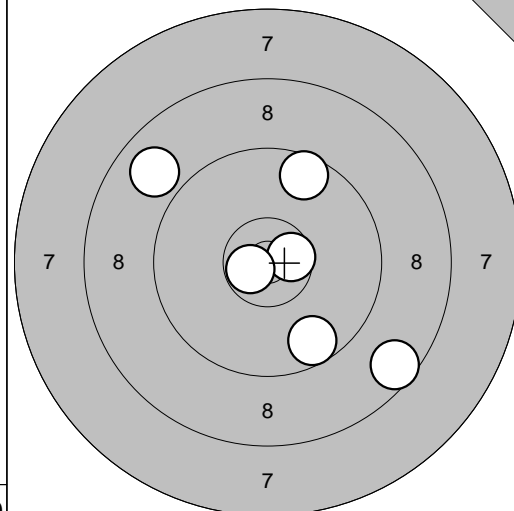

11: 9,6 ↗
 12: 8,9 ↖
 13: 10,6* →
 14: 9,6 ↓
 15: 8,6 ↓
 16: 10,7* ←

Serie 54,0

Totalt 0,0

Tävlingsskott

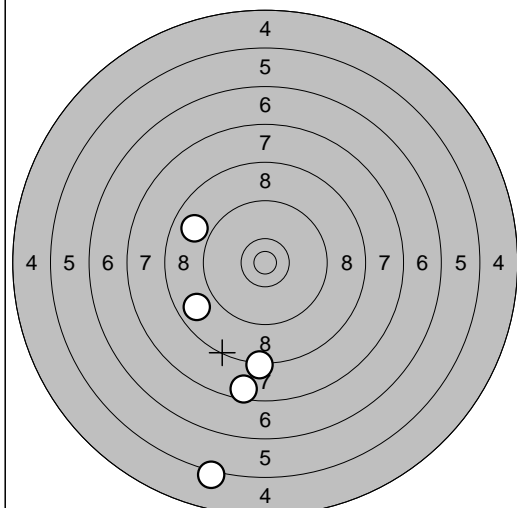

1: 8,8 ↖
 2: 5,2 ↓
 3: 7,6 ↓
 4: 8,3 ↓
 5: 8,9 ↖

Serie 36,0

Totalt 36,0

Tävlingsskott

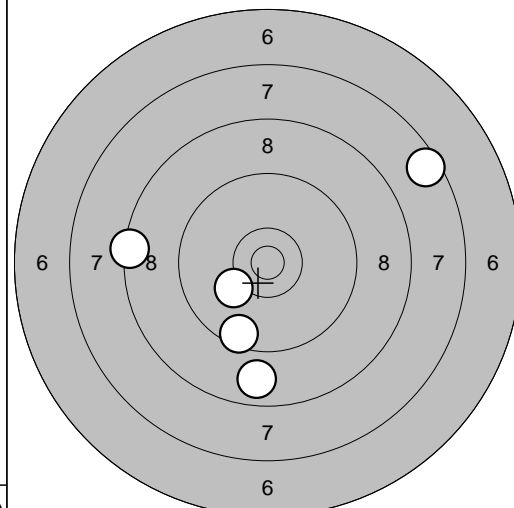

6: 10,2 ↖
 7: 8,4 ←
 8: 9,5 ↓
 9: 8,8 ↓
 10: 7,6 ↗

Serie 42,0

Totalt 78,0

Tävlingsskott

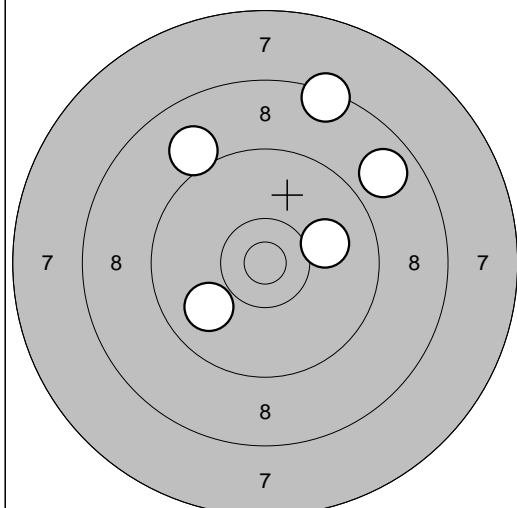

11: 8,8 ↗
 12: 8,4 ↑
 13: 10,0 →
 14: 9,0 ↖
 15: 9,9 ↖

Serie 44,0

Totalt 122,0

Tävlingsskott

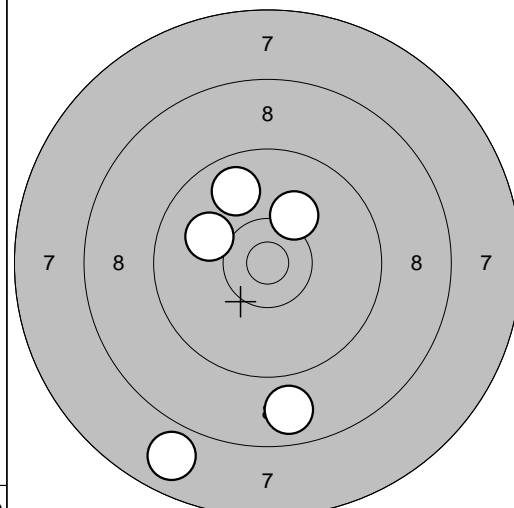

16: 10,2 ↗
 17: 8,8 ↓
 18: 10,0 ↖
 19: 7,8 ↓
 20: 9,8 ↗

Serie 44,0

Totalt 166,0

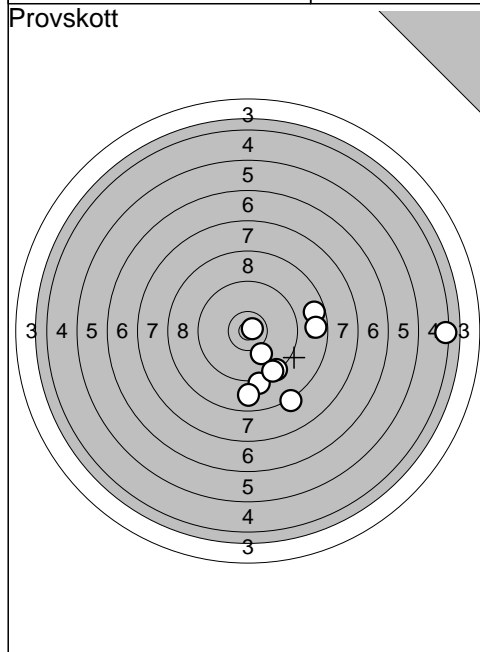

1: 10,1	↘
2: 8,2	↘
3: 9,2	↘
4: 8,7	→
5: 8,8	↘
6: 9,3	↘
7: 8,7	→
8: 10,8*	→
9: 4,4	→
10: 9,4	↘
Serie 83,0	
Totalt 0,0	

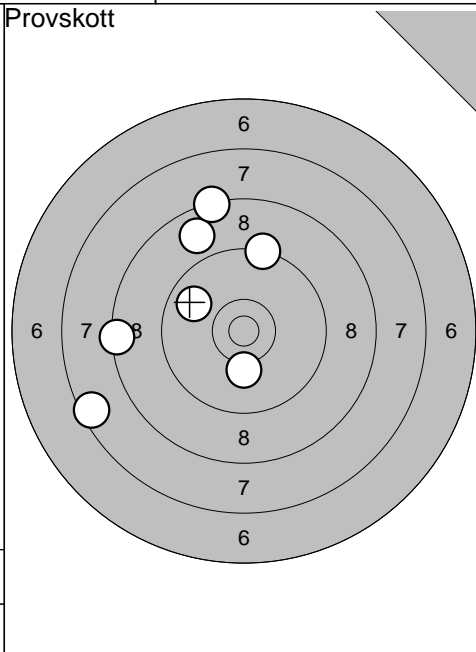

11: 9,3	↑
12: 8,8	↖
13: 8,4	←
14: 9,8	↖
15: 7,5	↙
16: 8,3	↑
17: 10,2	↓
Serie 59,0	
Totalt 0,0	

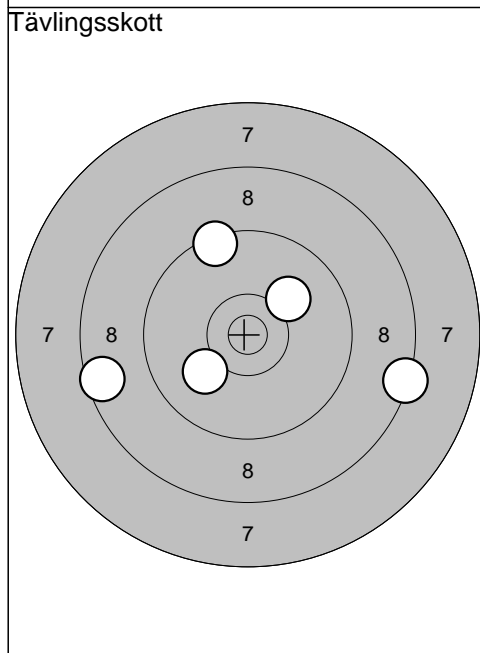

1: 8,4	→
2: 10,1	↗
3: 10,1	↙
4: 9,4	↑
5: 8,6	←
Serie 45,0	
Totalt 45,0	

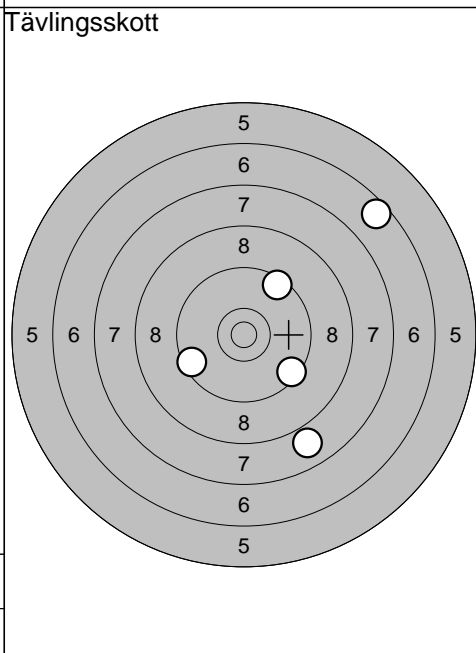

6: 7,9	↘
7: 9,5	↙
8: 6,6	↗
9: 9,5	↗
10: 9,5	↘
Serie 40,0	
Totalt 85,0	

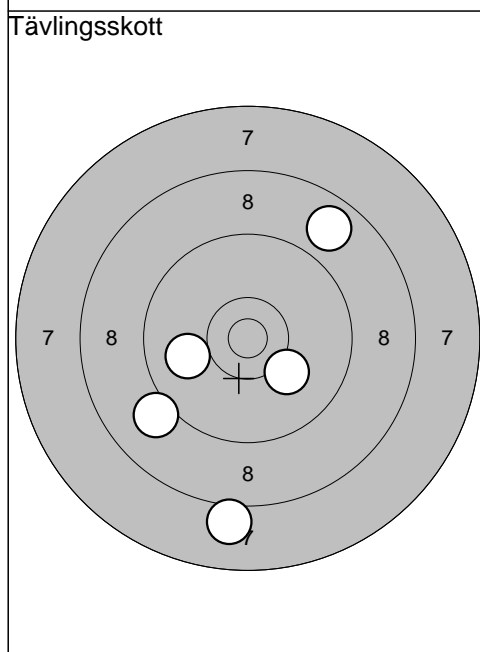

11: 8,8	↗
12: 8,0	↓
13: 9,1	↙
14: 10,0	←
15: 10,1	↘
Serie 45,0	
Totalt 130,0	

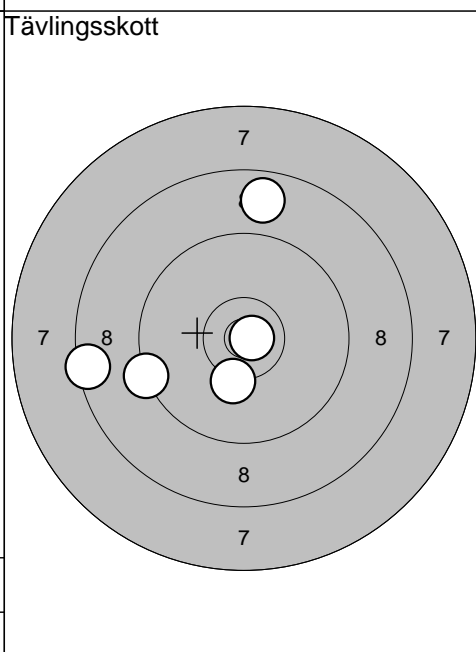

16: 10,3	↓
17: 8,8	↑
18: 8,5	←
19: 10,8*	→
20: 9,3	↙
Serie 45,0	
Totalt 175,0	

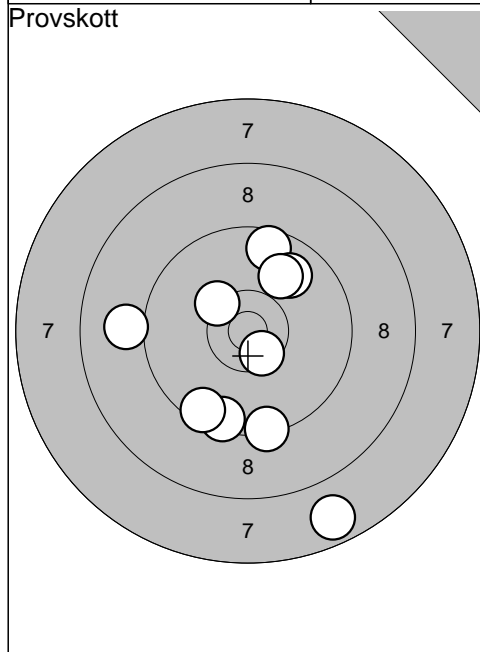

1: 9,0	←
2: 9,6	↑
3: 10,5*	↓
4: 7,7	↓
5: 9,5	↓
6: 9,5	↓
7: 9,9	↗
8: 10,3*	↖
9: 9,9	↗
10: 9,4	↓
Serie 90,0	
Totalt 0,0	

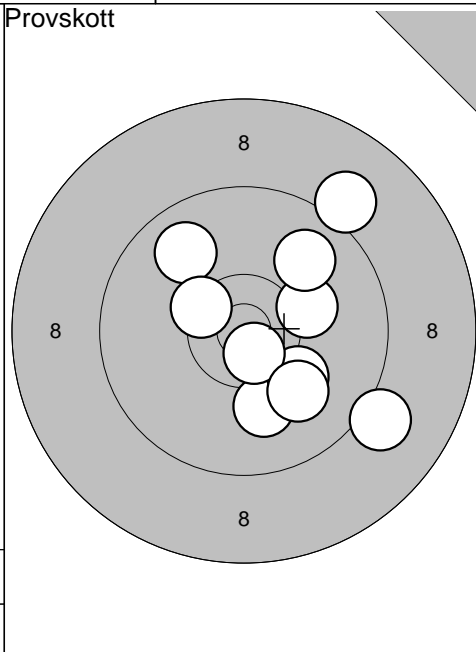

11: 10,1	↓
12: 10,1	↓
13: 10,7*	↓
14: 9,1	↗
15: 10,2	→
16: 9,8	↗
17: 9,9	↗
18: 10,4*	↖
19: 9,1	↓
20: 10,0	↓
Serie 96,0	
Totalt 0,0	

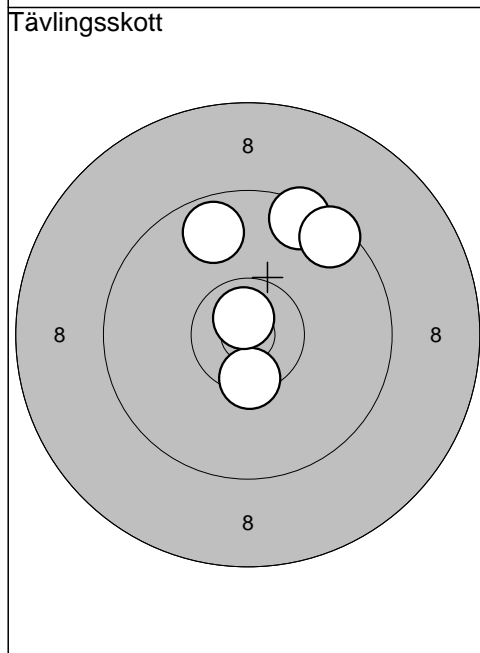

1: 9,7	↖
2: 9,5	↗
3: 10,4*	↓
4: 10,8*	↑
5: 9,5	↗
Serie 47,0	
Totalt 47,0	

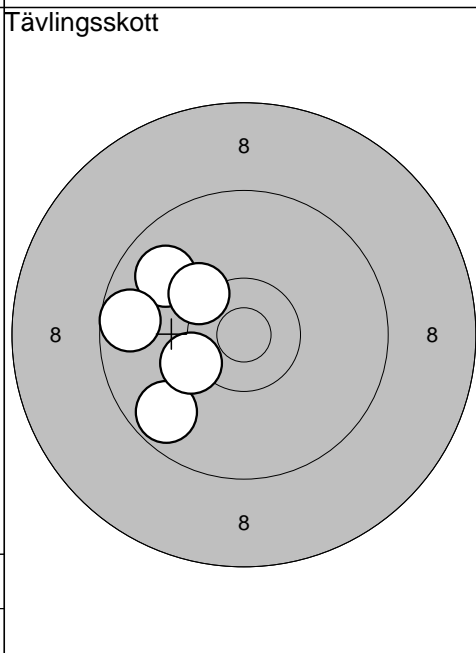

6: 9,8	↖
7: 10,3	↖
8: 9,7	↓
9: 10,3	↖
10: 9,6	←
Serie 47,0	
Totalt 94,0	

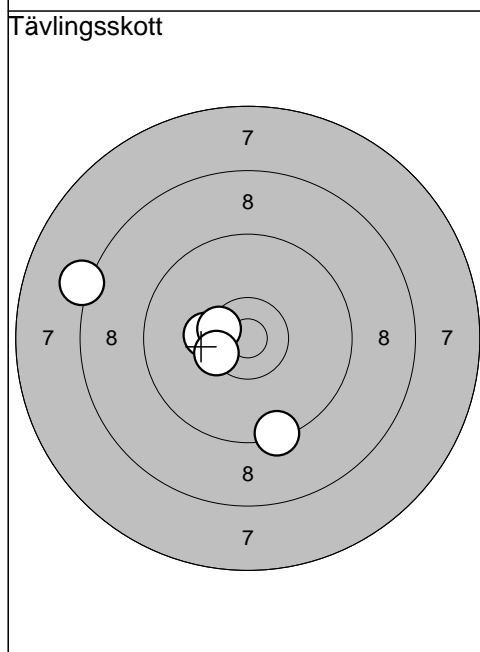

11: 10,3*	←
12: 8,2	↖
13: 10,5*	↖
14: 9,4	↓
15: 10,4*	↖
Serie 47,0	
Totalt 141,0	

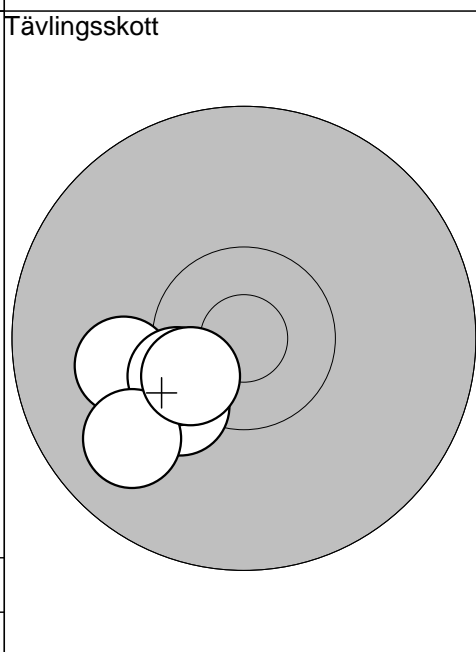

16: 10,1	←
17: 10,3*	↖
18: 10,4*	↖
19: 9,9	↖
20: 10,5*	↖
Serie 49,0	
Totalt 190,0	

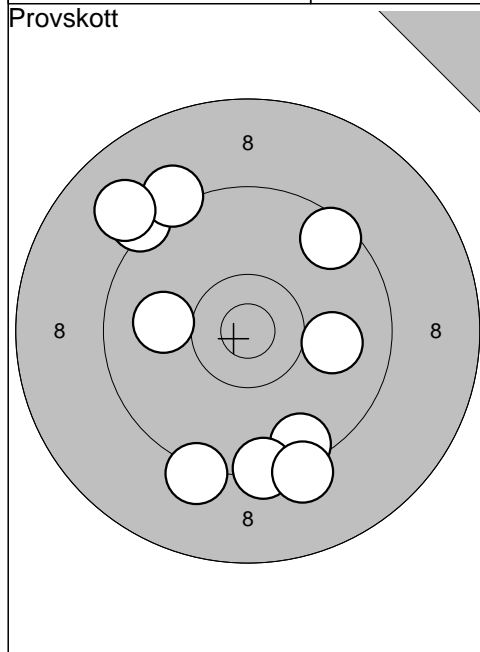

1: 9,2	↖
2: 9,2	↑
3: 9,0	↖
4: 9,5	↗
5: 9,5	↓
6: 9,2	↓
7: 9,4	↓
8: 9,2	↓
9: 10,0	→
10: 10,0	←
<hr/>	
Serie	92,0
Totalt	0,0

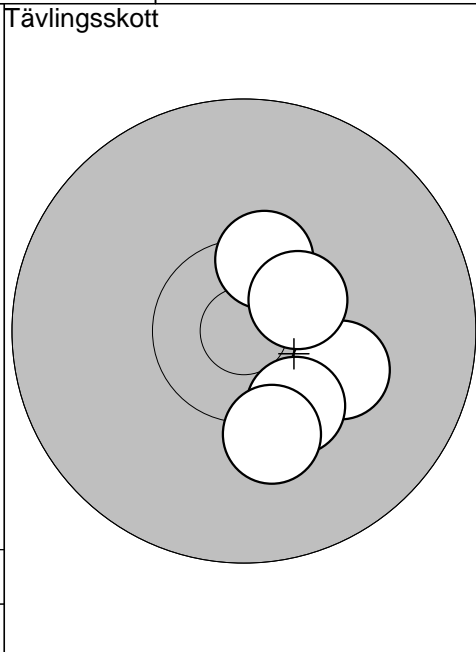

1: 10,2	→
2: 10,4*	↑
3: 10,3*	↓
4: 10,2	↓
5: 10,5*	↗
<hr/>	
Serie	50,0
Totalt	50,0

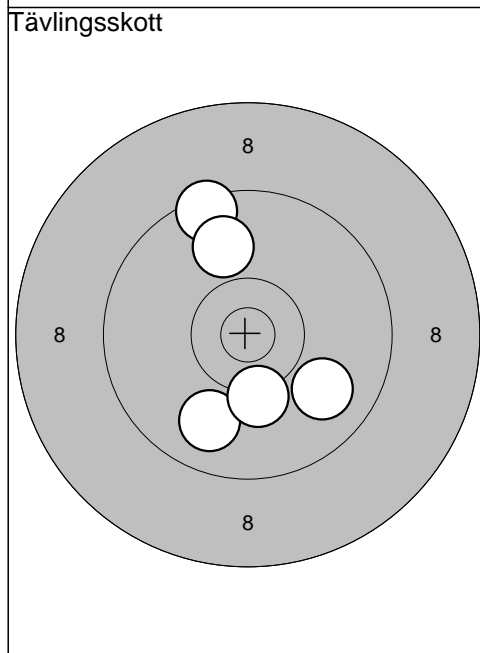

6: 9,9	↘
7: 9,5	↑
8: 9,9	↓
9: 9,9	↑
10: 10,2	↓
<hr/>	
Serie	46,0
Totalt	96,0

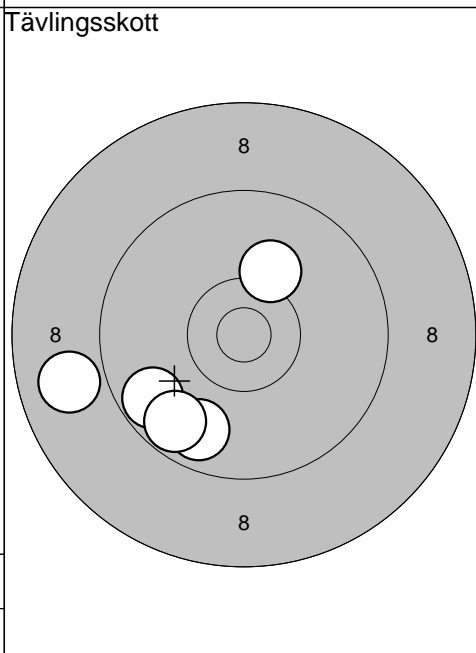

11: 9,7	↙
12: 10,2	↑
13: 9,8	↓
14: 8,9	←
15: 9,7	↘
<hr/>	
Serie	45,0
Totalt	141,0

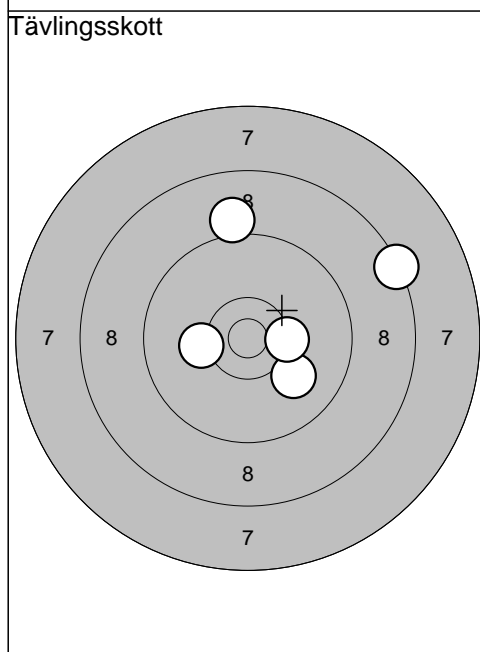

16: 10,2	←
17: 10,0	↘
18: 9,1	↑
19: 8,4	↗
20: 10,3*	→
<hr/>	
Serie	47,0
Totalt	188,0

Drängsmark

2012-05-13	Vindelnskottet	Ramselefors SKF
------------	----------------	-----------------

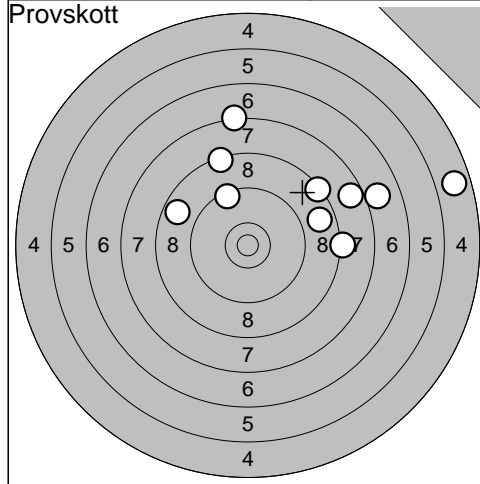

1: 8,2	→
2: 4,8	→
3: 8,7	↖
4: 7,3	↑
5: 7,7	→
6: 7,0	→
7: 9,4	↗
8: 8,8	→
9: 8,4	↗
10: 8,4	↑
Serie	74,0
Totalt	0,0

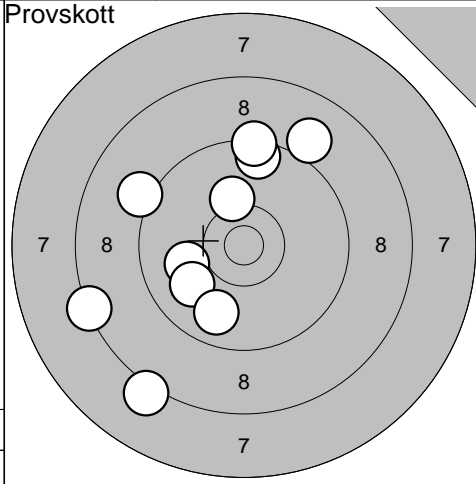

11: 8,3	↖
12: 10,0	↖
13: 9,0	↗
14: 9,9	↖
15: 9,1	↖
16: 8,2	↘
17: 9,8	↘
18: 9,5	↑
19: 9,4	↑
20: 10,2	↑
Serie	90,0
Totalt	0,0

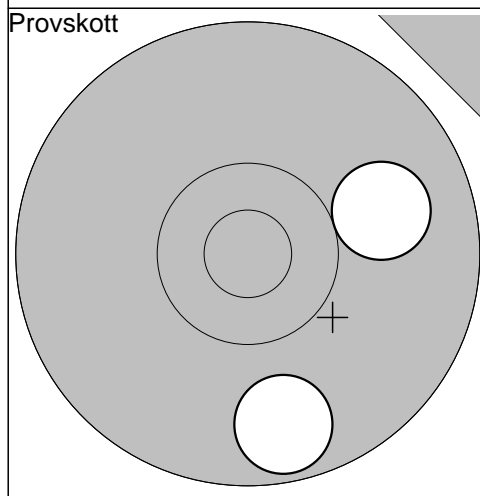

21: 10,0	→
22: 9,7	↓
Serie	19,0
Totalt	0,0

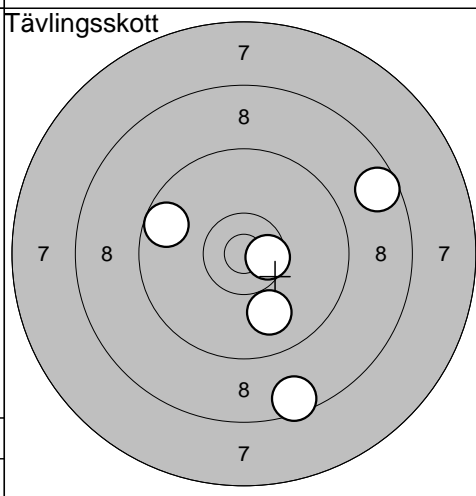

1: 9,7	↖
2: 10,6*	→
3: 9,9	↘
4: 8,5	↘
5: 8,6	→
Serie	44,0
Totalt	44,0

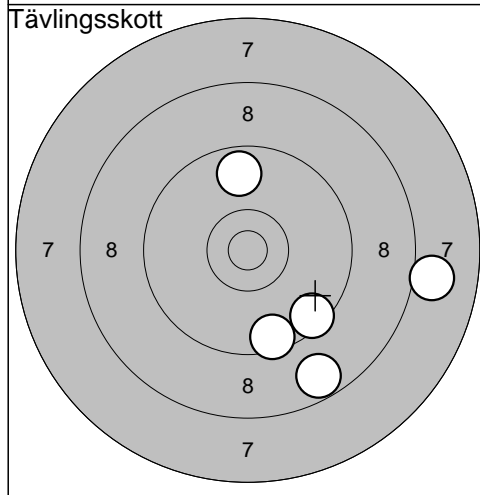

6: 8,7	↘
7: 9,7	↑
8: 9,5	↘
9: 9,5	↘
10: 8,0	→
Serie	43,0
Totalt	87,0

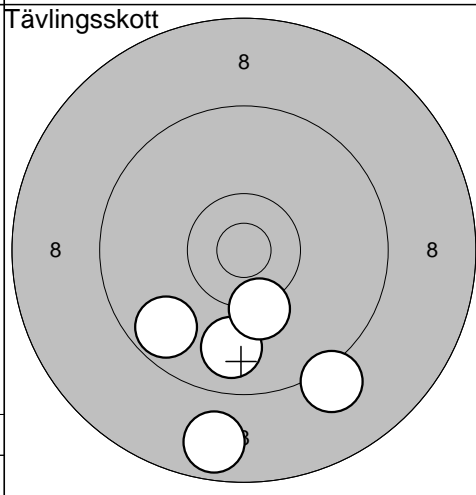

11: 9,1	↘
12: 9,8	↘
13: 8,7	↘
14: 9,7	↖
15: 10,3	↘
Serie	45,0
Totalt	132,0

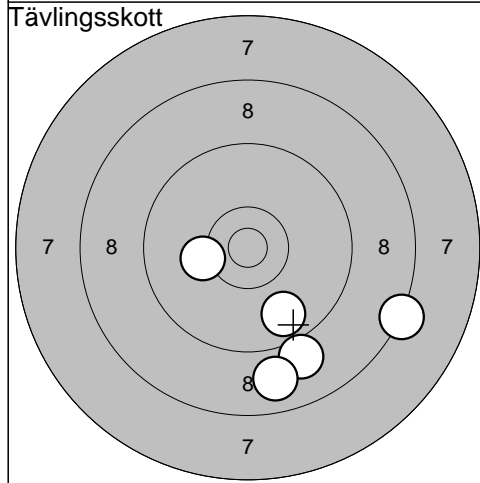

16: 9,0	↘
17: 10,2	↖
18: 8,8	↘
19: 8,3	↘
20: 9,8	↘
Serie	44,0
Totalt	176,0

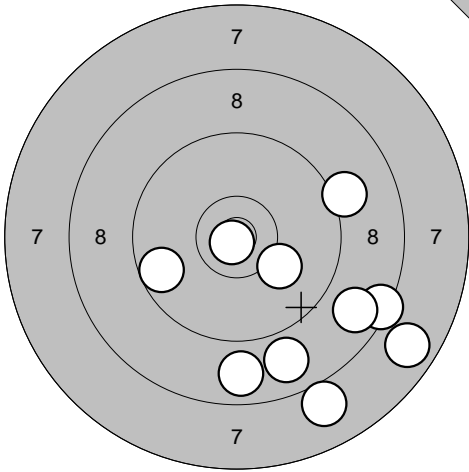
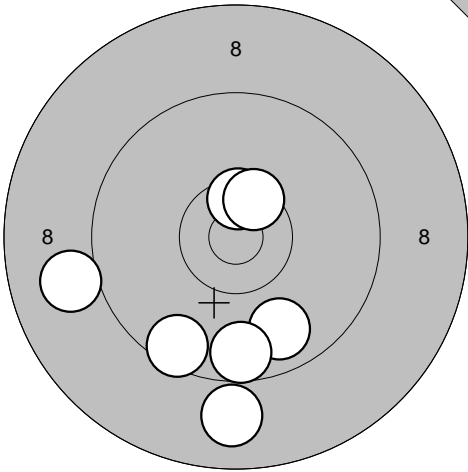
Provs-kott 	1: 7,8 ↘ 2: 8,0 ↘ 3: 8,9 ↘ 4: 8,4 ↘ 5: 10,1 ↘ 6: 8,8 ↓ 7: 8,8 ↘ 8: 9,7 ← 9: 9,1 → 10: 10,8* ↙	Provs-kott 	11: 8,9 ↓ 12: 9,8 ↘ 13: 10,5* ↑ 14: 9,5 ↘ 15: 9,6 ↓ 16: 9,0 ← 17: 10,5* ↗
	Serie 85,0		Serie 64,0
	Totalt 0,0		Totalt 0,0

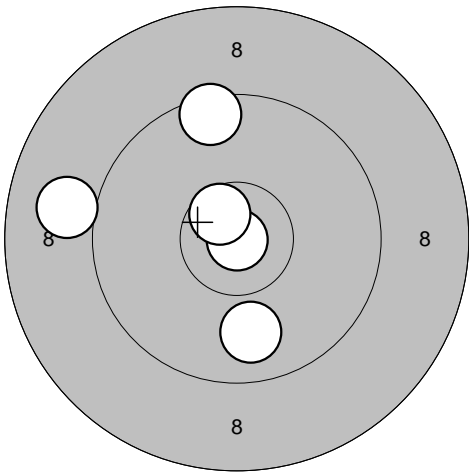
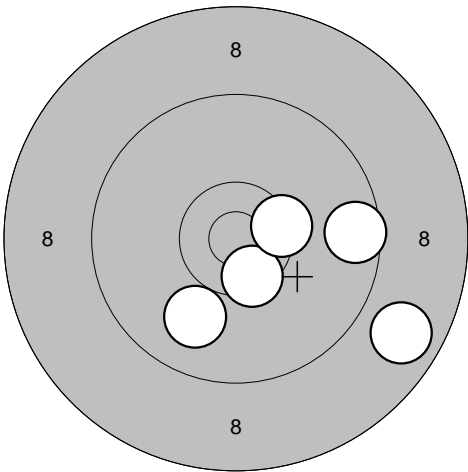
Tävlingskott 	1: 9,5 ↑ 2: 9,0 ← 3: 10,9* ↘ 4: 9,9 ↘ 5: 10,6* ↗	Tävlingskott 	6: 10,5* ↘ 7: 9,6 → 8: 8,8 ↘ 9: 10,4* → 10: 9,9 ↘
	Serie 47,0		Serie 46,0
	Totalt 47,0		Totalt 93,0

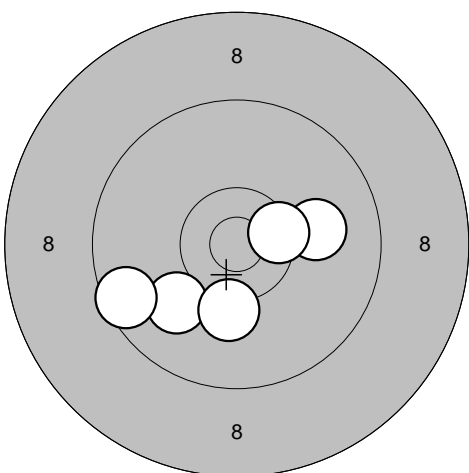
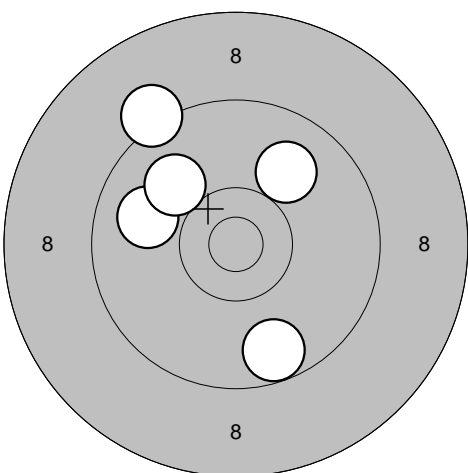
Tävlingskott 	11: 10,0 ↘ 12: 9,5 ← 13: 10,2 ↓ 14: 10,0 → 15: 10,4* →	Tävlingskott 	16: 9,2 ↗ 17: 9,9 ← 18: 9,7 ↓ 19: 10,0 ↗ 20: 9,9 ↗
	Serie 49,0		Serie 46,0
	Totalt 142,0		Totalt 188,0

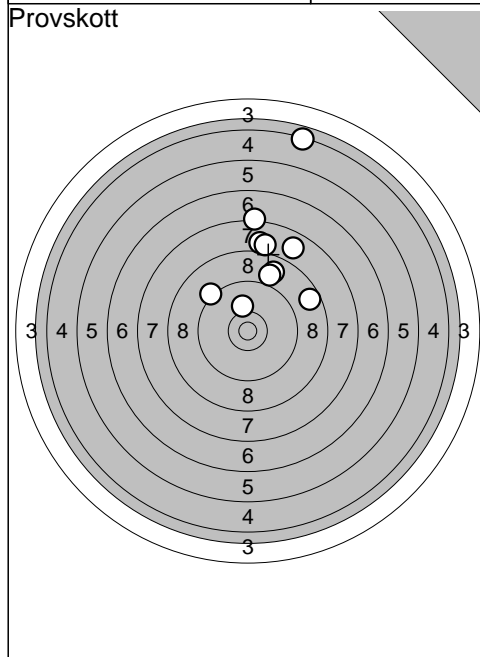

1: 4,4	↗
2: 10,1	↗
3: 8,0	↗
4: 7,8	↗
5: 7,3	↗
6: 8,8	↗
7: 9,0	↗
8: 8,1	↗
9: 8,7	↘
10: 9,2	↖
Serie 78,0	
Totalt 0,0	

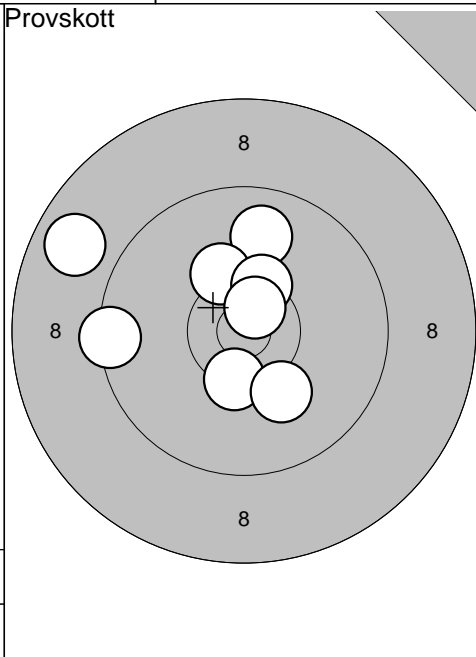

11: 9,9	↗
12: 9,4	↖
13: 8,8	↖
14: 10,4*	↘
15: 10,3	↗
16: 10,4*	↗
17: 10,7*	↗
18: 10,1	↘
Serie 76,0	
Totalt 0,0	

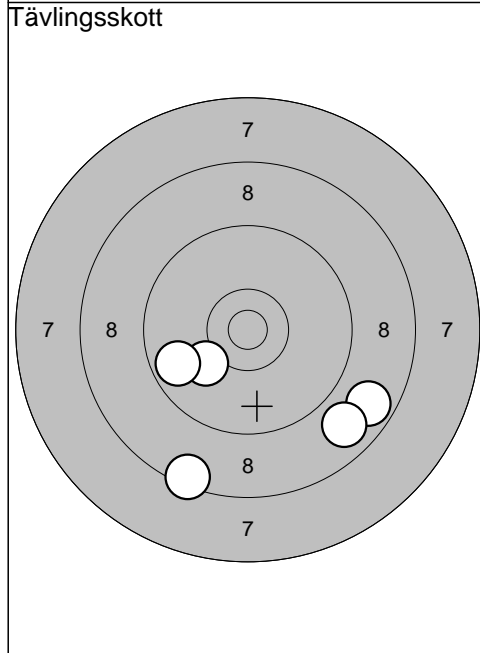

1: 10,1	↖
2: 8,7	↘
3: 8,8	↘
4: 9,7	↖
5: 8,4	↘
Serie 43,0	
Totalt 43,0	

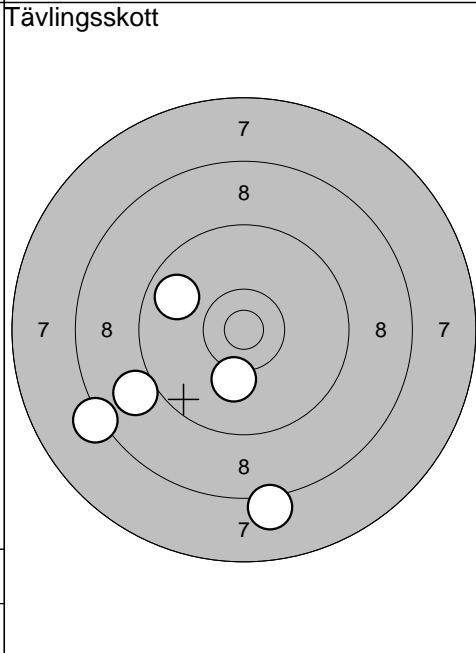

6: 9,0	↖
7: 10,1	↘
8: 9,8	↖
9: 8,1	↘
10: 8,2	↖
Serie 44,0	
Totalt 87,0	

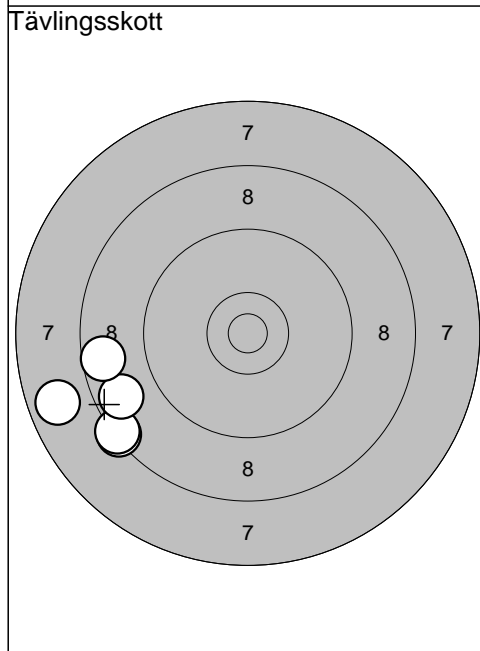

11: 8,4	↖
12: 7,8	↖
13: 8,4	↖
14: 8,7	↖
15: 8,6	↖
Serie 39,0	
Totalt 126,0	

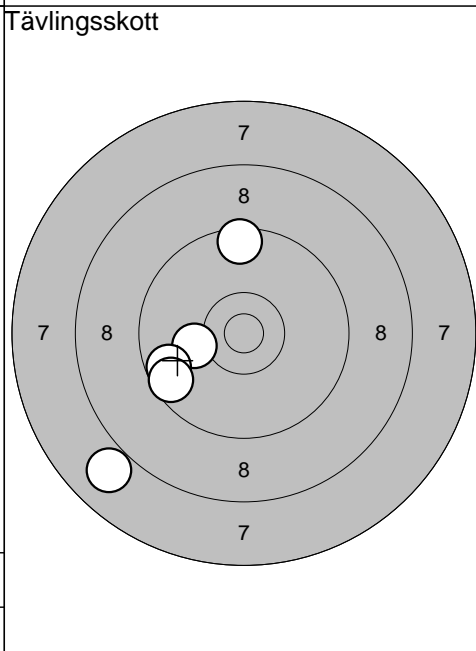

16: 10,1	↖
17: 7,9	↖
18: 9,7	↖
19: 9,6	↖
20: 9,5	↗
Serie 44,0	
Totalt 170,0	

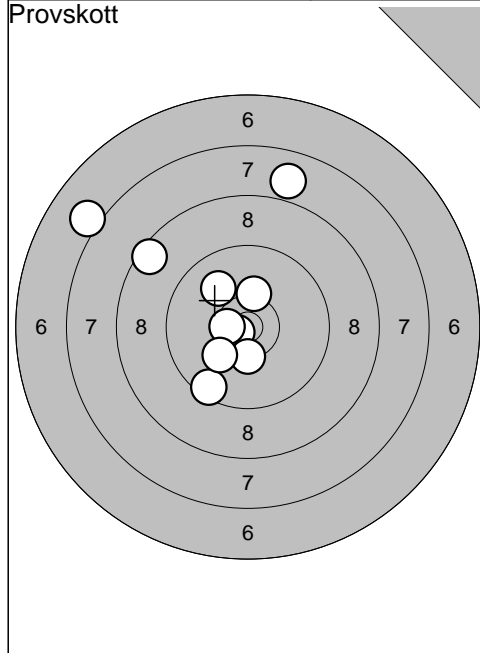

1: 7,1	↖
2: 8,5	↖
3: 10,7*	↙
4: 10,0	↖
5: 7,9	↗
6: 10,3*	↓
7: 9,5	↘
8: 10,5*	←
9: 10,2	↘
10: 10,3	↗
<hr/>	
Serie	91,0
Totalt	0,0

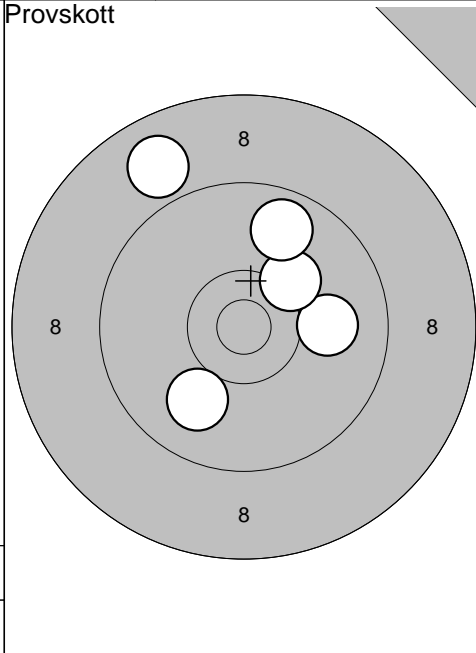

11: 8,9	↖
12: 10,0	→
13: 10,2	↗
14: 9,8	↗
15: 10,0	↘
<hr/>	
Serie	47,0
Totalt	0,0

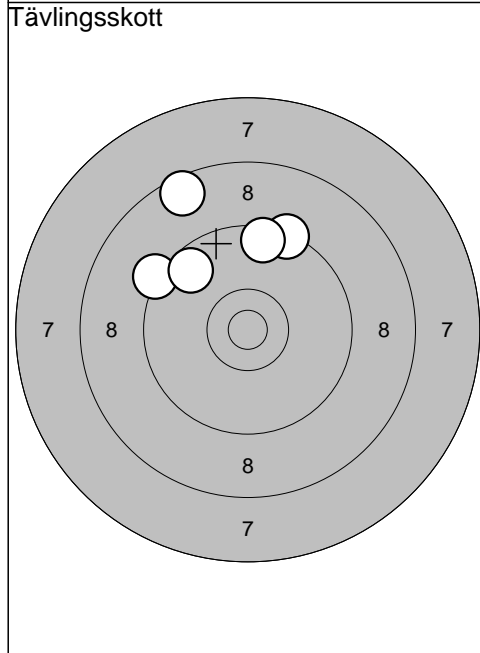

1: 9,4	↗
2: 9,5	↗
3: 9,3	↖
4: 9,7	↖
5: 8,6	↗
<hr/>	
Serie	44,0
Totalt	44,0

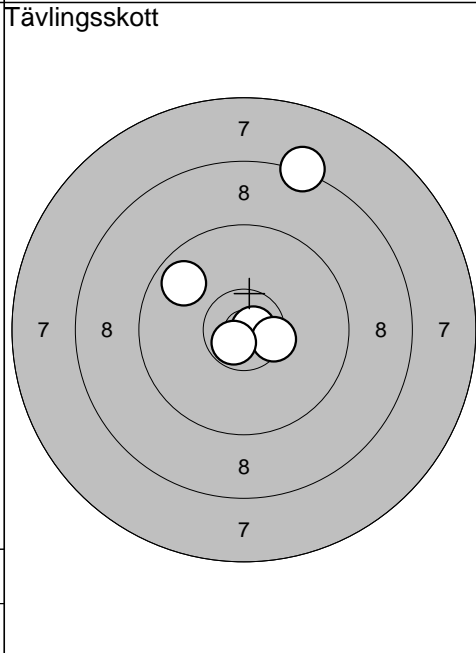

6: 9,8	↖
7: 8,3	↗
8: 10,8*	→
9: 10,5*	→
10: 10,7*	↘
<hr/>	
Serie	47,0
Totalt	91,0

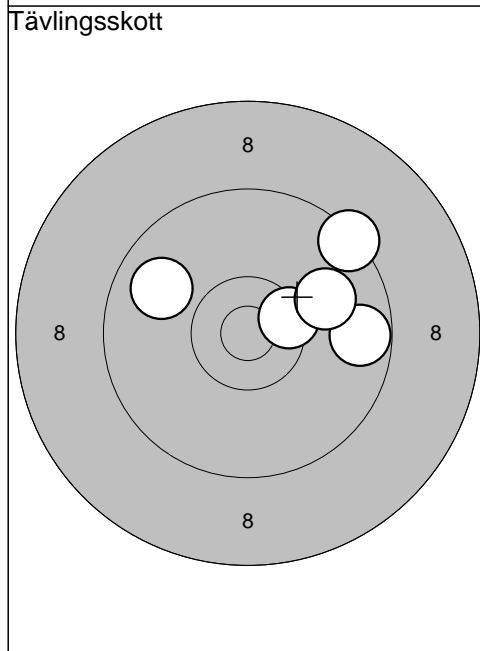

11: 9,4	↗
12: 9,8	↖
13: 10,4*	→
14: 9,7	→
15: 10,0	→
<hr/>	
Serie	47,0
Totalt	138,0

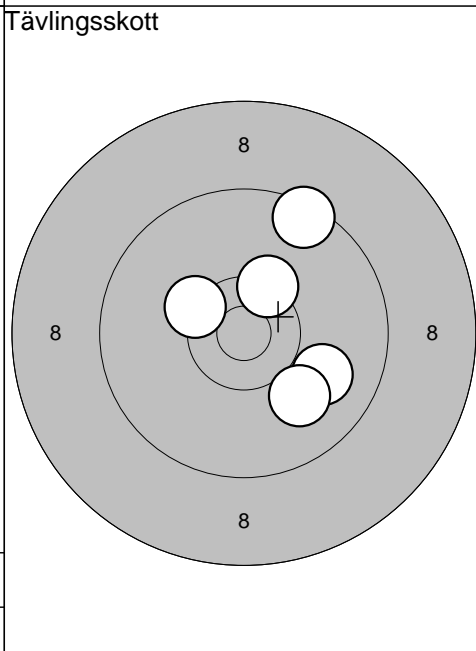

16: 9,9	↘
17: 10,3*	↖
18: 9,5	↗
19: 10,0	↘
20: 10,4*	↗
<hr/>	
Serie	48,0
Totalt	186,0

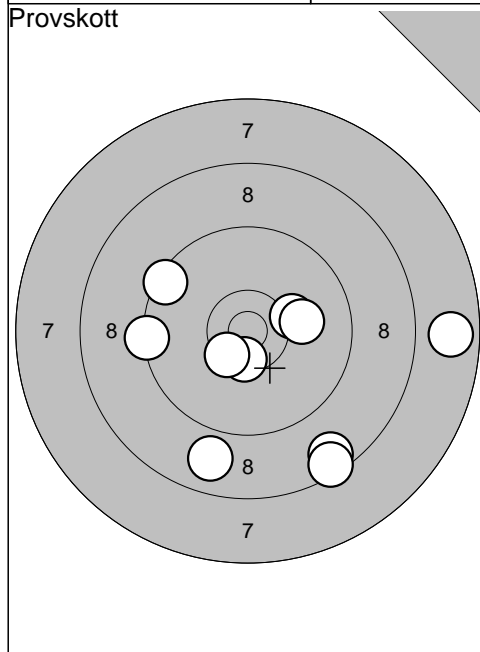

1: 9,5	↖
2: 10,2	→
3: 8,6	↘
4: 10,5*	↓
5: 8,5	↘
6: 7,8	→
7: 8,9	↓
8: 10,4*	↙
9: 9,4	←
10: 10,1	→
<hr/>	
Serie	89,0
Totalt	0,0

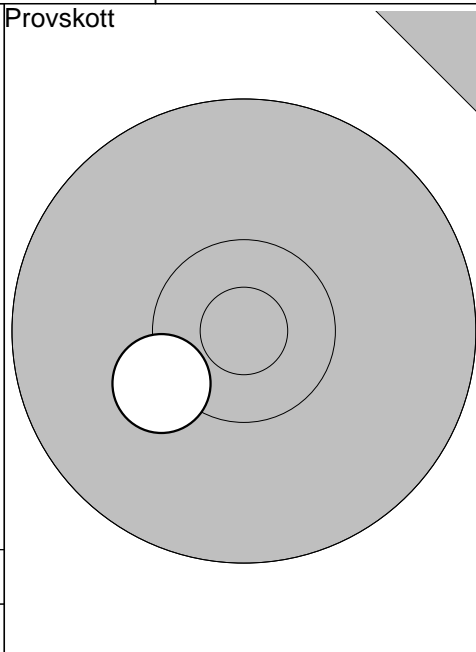

11: 10,3	↙
<hr/>	
Serie	10,0
Totalt	0,0

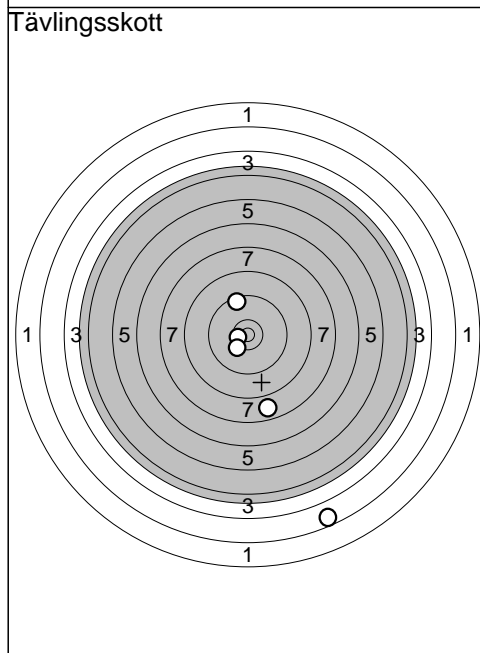

1: 10,5*	←
2: 7,8	↓
3: 10,3	↙
4: 9,5	↑
5: 2,6	↘
<hr/>	
Serie	38,0
Totalt	38,0

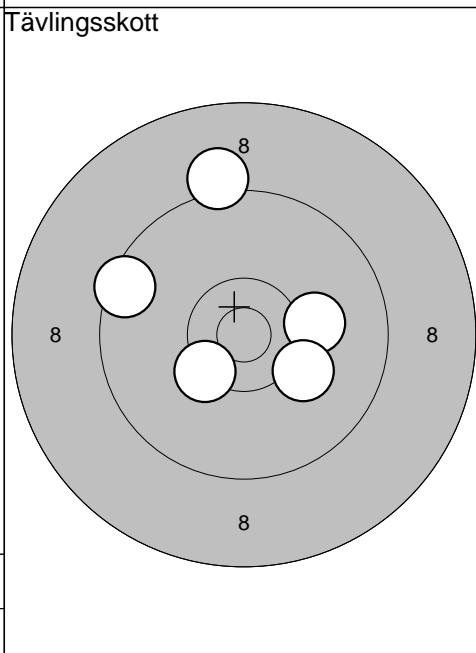

6: 10,1	→
7: 9,1	↑
8: 9,5	↙
9: 10,2	↘
10: 10,3*	↙
<hr/>	
Serie	48,0
Totalt	86,0

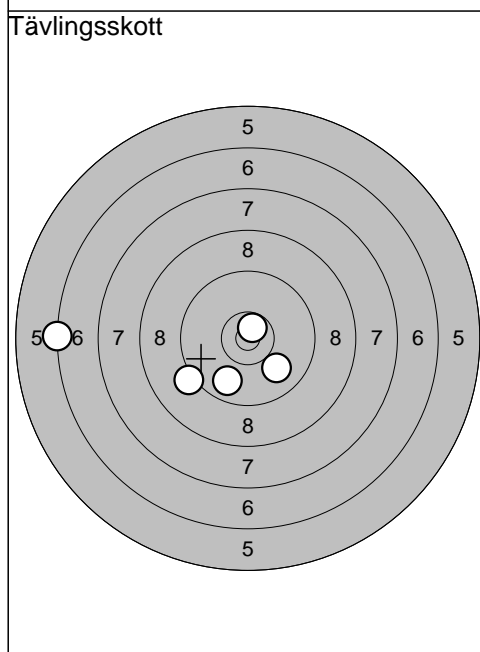

11: 10,7*	↗
12: 9,8	↘
13: 9,9	↘
14: 6,3	←
15: 9,2	↙
<hr/>	
Serie	43,0
Totalt	129,0

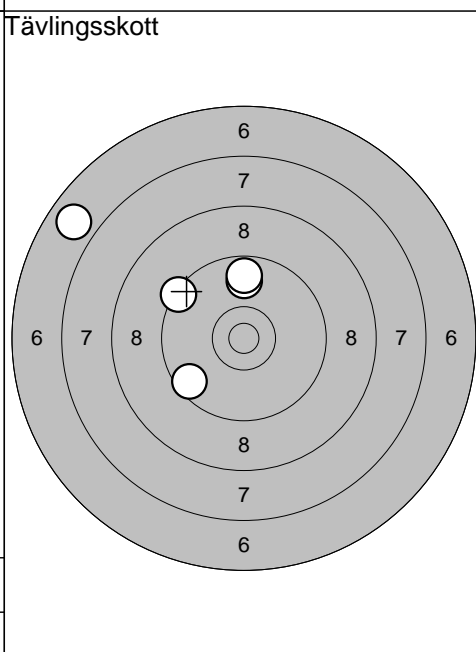

16: 9,8	↑
17: 9,4	↖
18: 9,7	↑
19: 9,6	↙
20: 6,8	↖
<hr/>	
Serie	42,0
Totalt	171,0

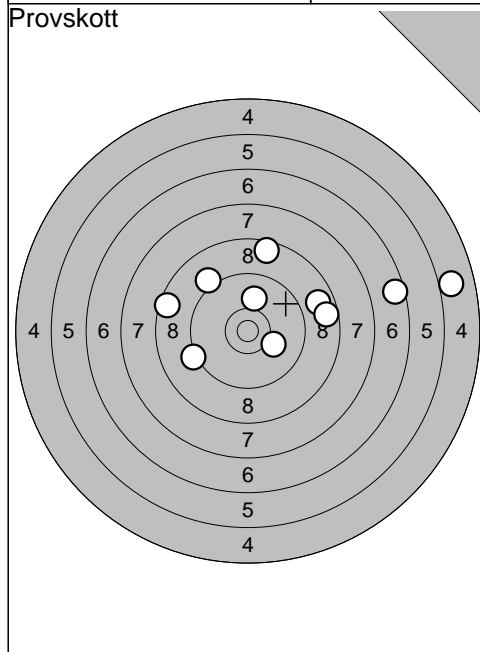

1: 6,6	→
2: 5,0	→
3: 8,8	→
4: 10,1	↘
5: 8,6	↑
6: 8,6	→
7: 10,0	↑
8: 9,2	↙
9: 8,5	↙
10: 9,1	↖
Serie 81,0	
Totalt 0,0	

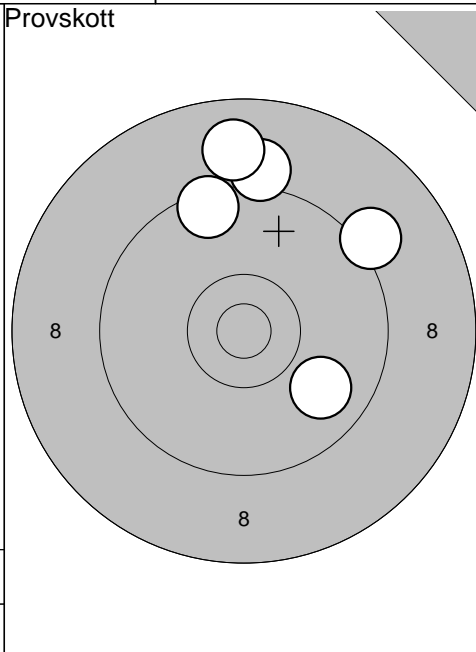

11: 9,1	↑
12: 9,9	↘
13: 8,9	↑
14: 9,2	↗
15: 9,5	↑
Serie 44,0	
Totalt 0,0	

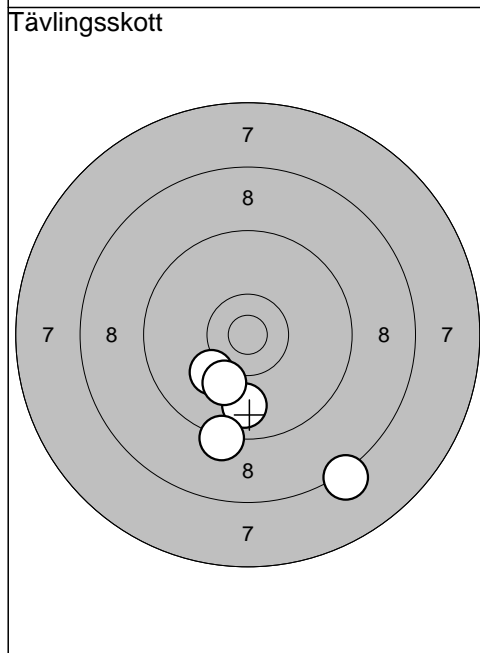

1: 10,1	↙
2: 9,8	↓
3: 10,1	↙
4: 8,2	↘
5: 9,3	↓
Serie 46,0	
Totalt 46,0	

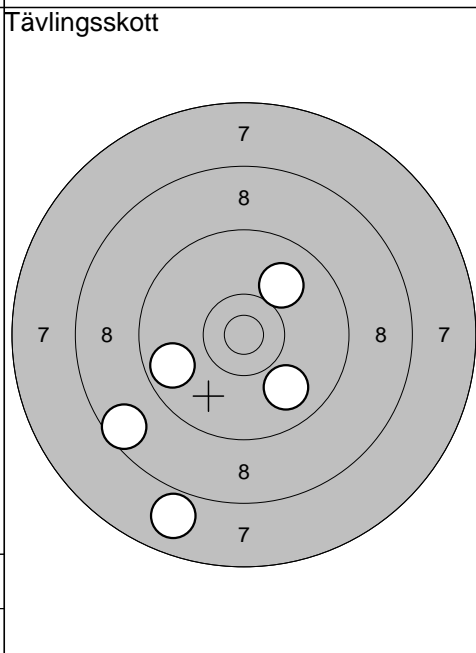

6: 7,9	↘
7: 10,0	↗
8: 9,9	↘
9: 9,7	↙
10: 8,6	↙
Serie 43,0	
Totalt 89,0	

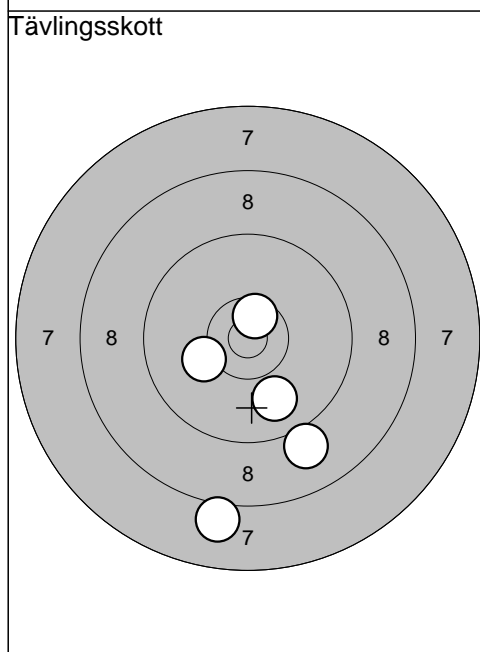

11: 10,2	↙
12: 9,0	↘
13: 10,6*	↑
14: 8,1	↘
15: 9,9	↘
Serie 46,0	
Totalt 135,0	

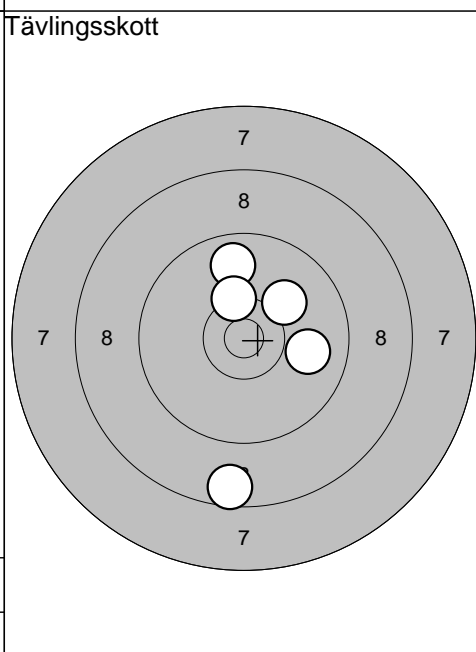

16: 8,6	↓
17: 10,1	↗
18: 9,8	↑
19: 10,3*	↑
20: 9,9	→
Serie 46,0	
Totalt 181,0	

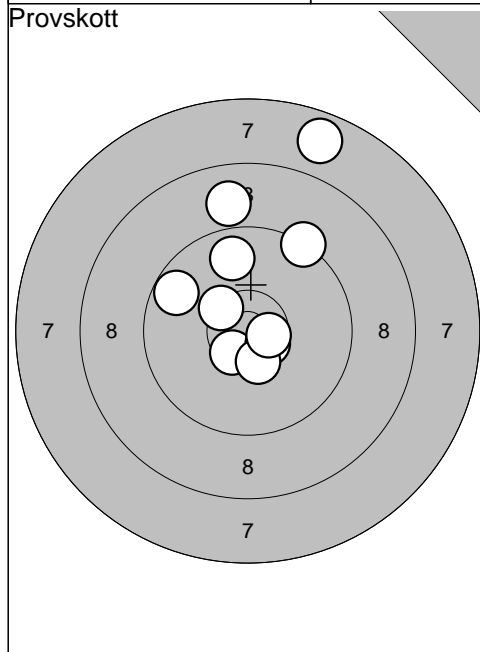

1: 7,8	↗
2: 10,5*	↘
3: 10,6*	↘
4: 10,4*	↘
5: 9,3	↗
6: 10,6*	→
7: 9,8	↗
8: 9,7	↗
9: 10,4*	↗
10: 8,9	↗
<hr/>	
Serie	92,0
Totalt	0,0

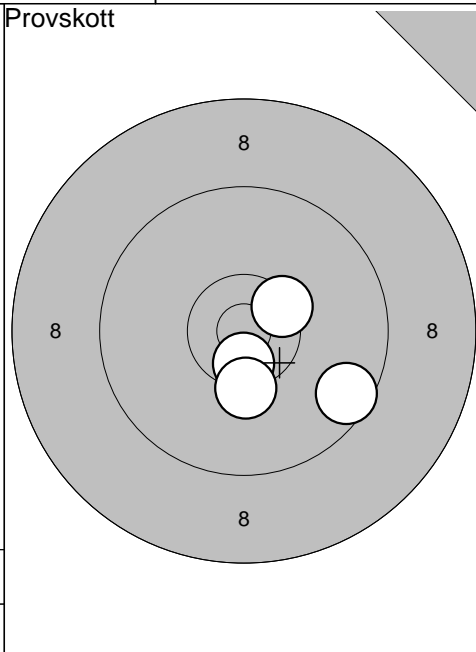

11: 10,6*	↘
12: 10,4*	↗
13: 9,6	↘
14: 10,3*	↘
<hr/>	
Serie	39,0
Totalt	0,0

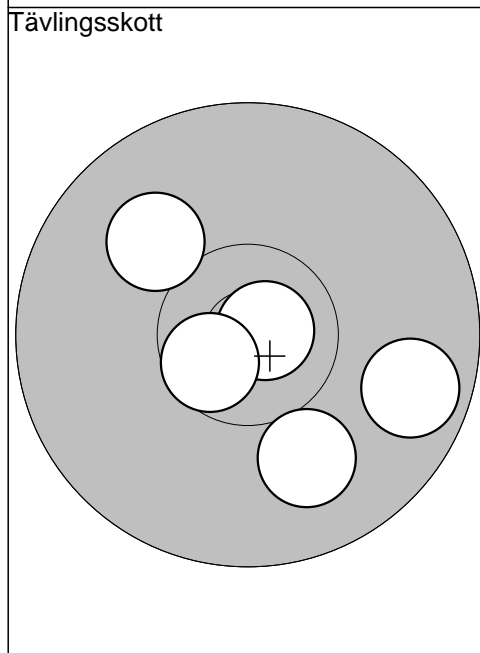

1: 10,8*	→
2: 9,7	→
3: 10,0	↘
4: 10,6*	↘
5: 10,0	↗
<hr/>	
Serie	49,0
Totalt	49,0

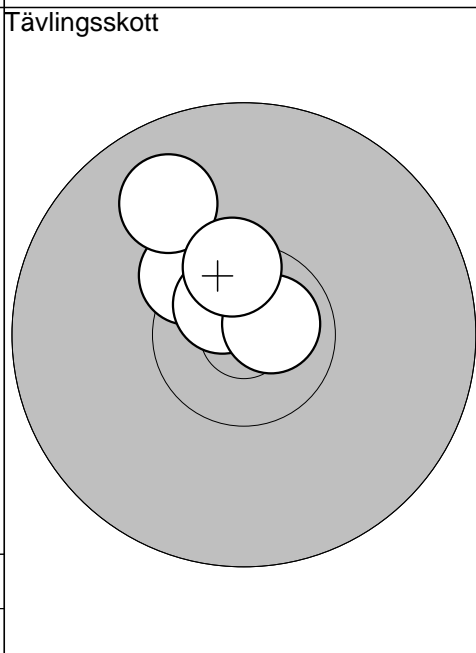

6: 10,4*	↗
7: 10,7*	↗
8: 10,7*	→
9: 9,9	↗
10: 10,5*	↗
<hr/>	
Serie	49,0
Totalt	98,0

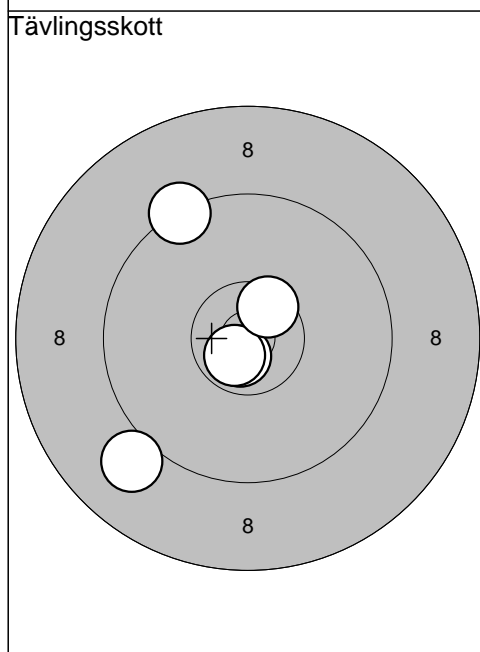

11: 9,3	↗
12: 10,7*	↘
13: 10,7*	↘
14: 10,5*	↗
15: 9,0	↘
<hr/>	
Serie	48,0
Totalt	146,0

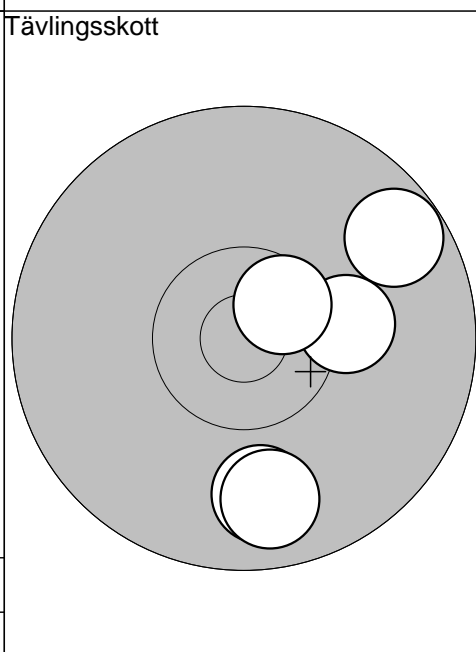

16: 9,8	↘
17: 9,7	↗
18: 10,2	→
19: 9,8	↘
20: 10,6*	↗
<hr/>	
Serie	47,0
Totalt	193,0

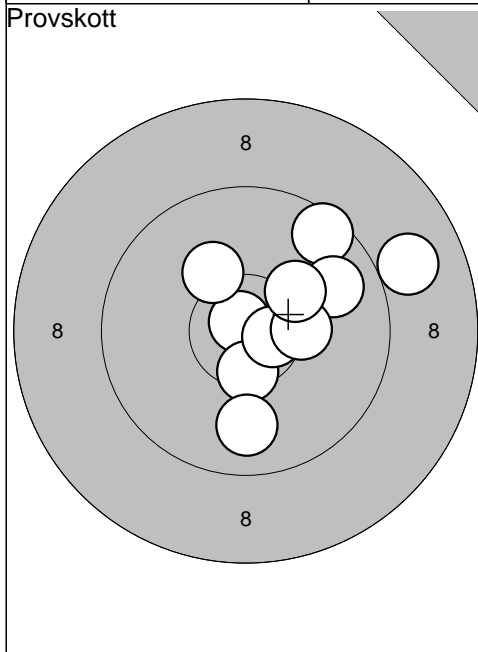

1: 9,5	↗
2: 10,8*	↖
3: 10,5*	↓
4: 9,8	↗
5: 9,9	↓
6: 8,9	↗
7: 10,6*	→
8: 10,3*	→
9: 10,2	↗
10: 10,2	↖
<hr/>	
Serie	95,0
Totalt	0,0

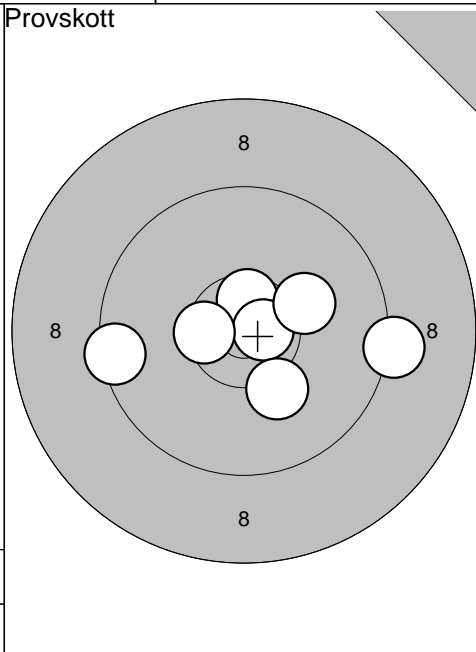

11: 9,2	→
12: 10,6*	↑
13: 9,5	←
14: 10,7*	→
15: 10,2	↗
16: 10,2	↓
17: 10,5*	←
<hr/>	
Serie	68,0
Totalt	0,0

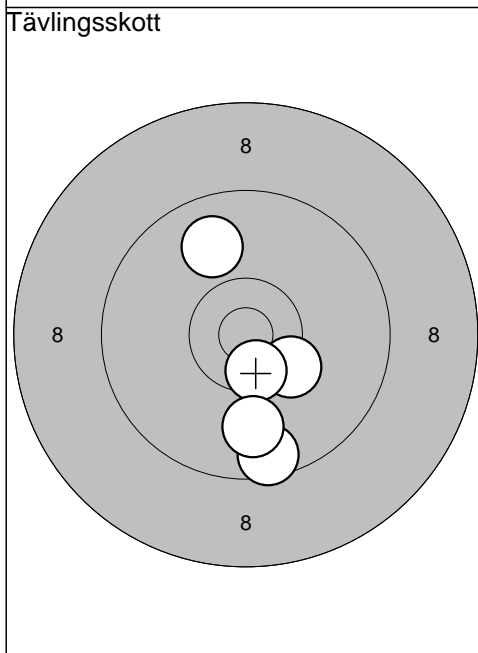

1: 10,3*	↘
2: 9,9	↖
3: 10,5*	↓
4: 9,6	↓
5: 9,9	↓
<hr/>	
Serie	47,0
Totalt	47,0

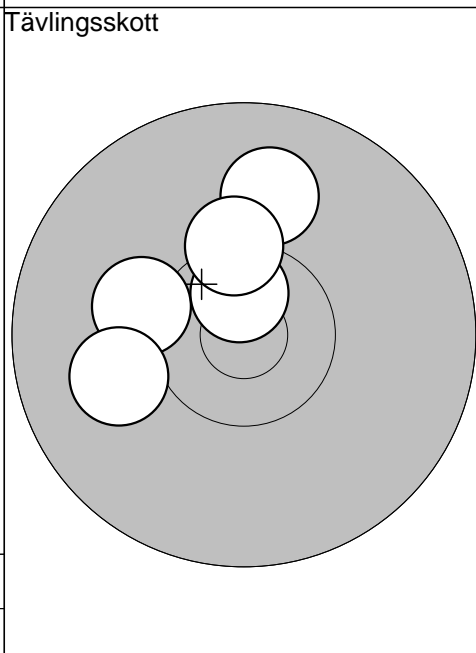

6: 10,2	←
7: 10,0	←
8: 10,0	↑
9: 10,7*	↑
10: 10,3*	↑
<hr/>	
Serie	50,0
Totalt	97,0

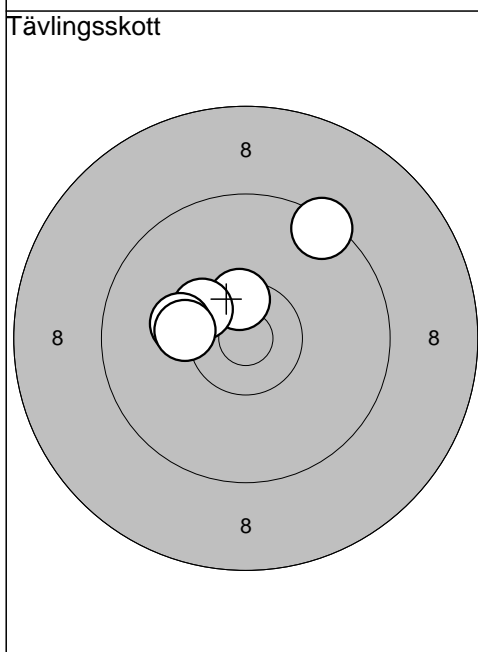

11: 10,5*	↑
12: 10,4*	↖
13: 10,2	←
14: 9,4	↗
15: 10,3	←
<hr/>	
Serie	49,0
Totalt	146,0

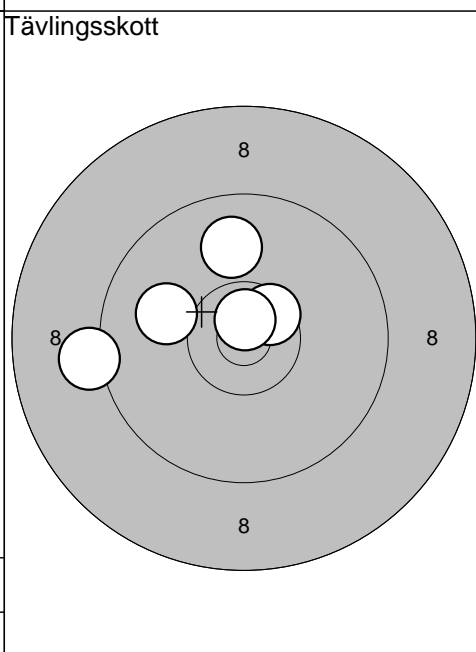

16: 10,5*	↗
17: 10,0	←
18: 9,2	←
19: 9,9	↑
20: 10,7*	↑
<hr/>	
Serie	48,0
Totalt	194,0

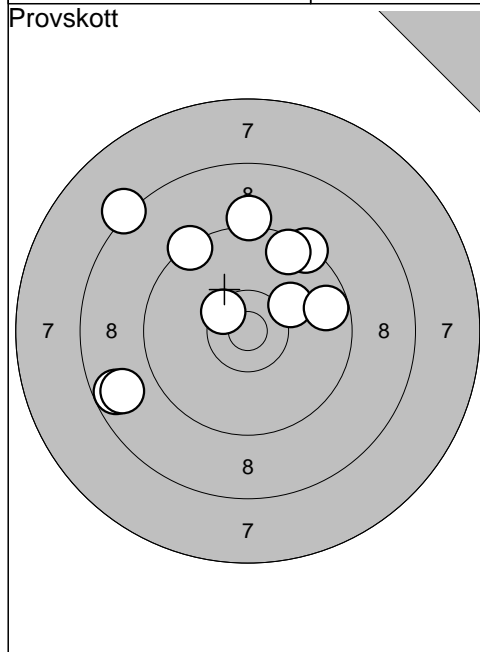

1: 9,4	↖
2: 10,5*	↖
3: 10,2	↗
4: 9,2	↑
5: 9,7	→
6: 9,4	↗
7: 8,7	↖
8: 9,6	↗
9: 8,8	↖
10: 8,2	↖
Serie 89,0	
Totalt 0,0	

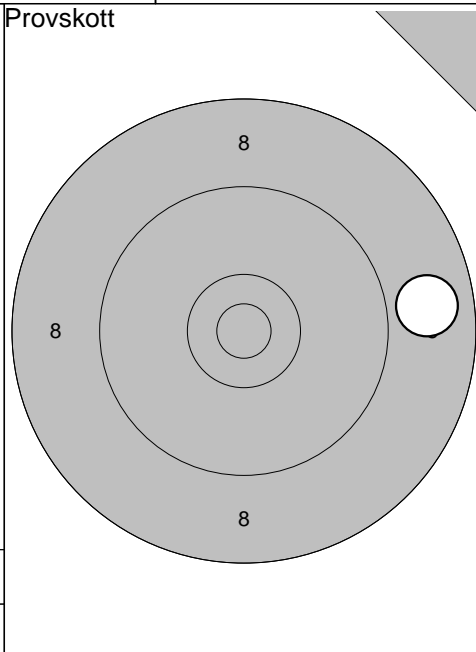

11: 8,8	→
Serie 8,0	
Totalt 0,0	

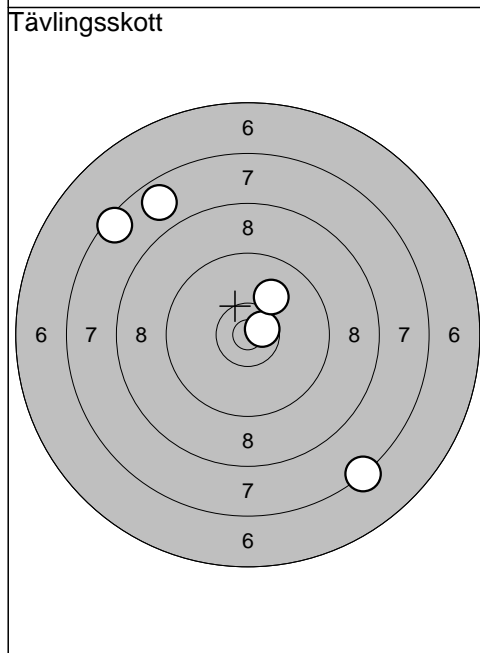

1: 7,8	↖
2: 7,5	↖
3: 7,3	↘
4: 10,6*	→
5: 10,1	↗
Serie 41,0	
Totalt 41,0	

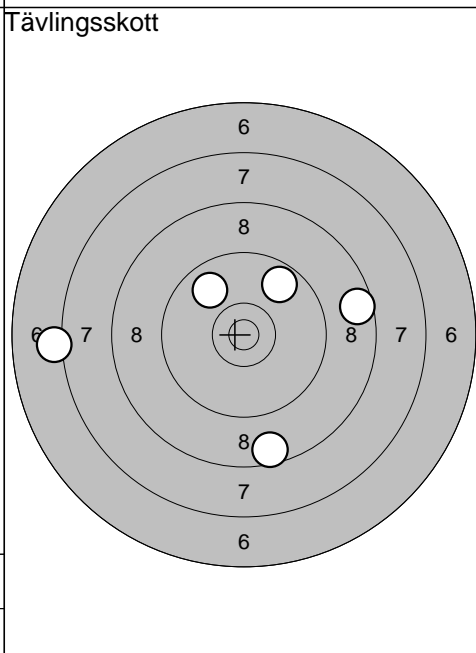

6: 8,6	→
7: 9,8	↖
8: 8,6	↘
9: 7,2	↖
10: 9,7	↗
Serie 41,0	
Totalt 82,0	

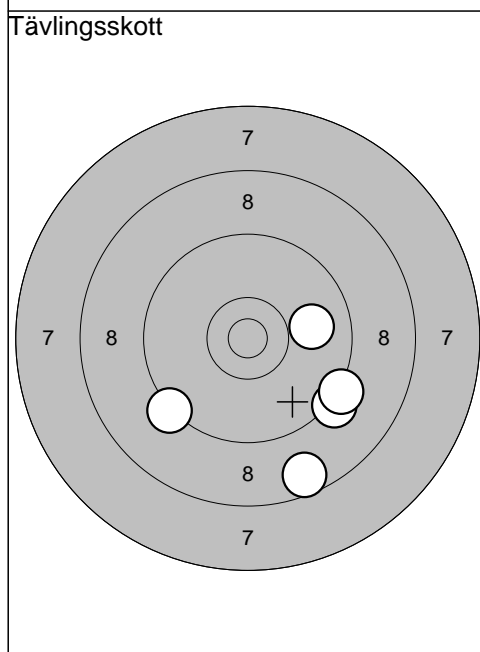

11: 8,6	↘
12: 9,2	↘
13: 9,3	↖
14: 9,9	→
15: 9,2	↘
Serie 44,0	
Totalt 126,0	

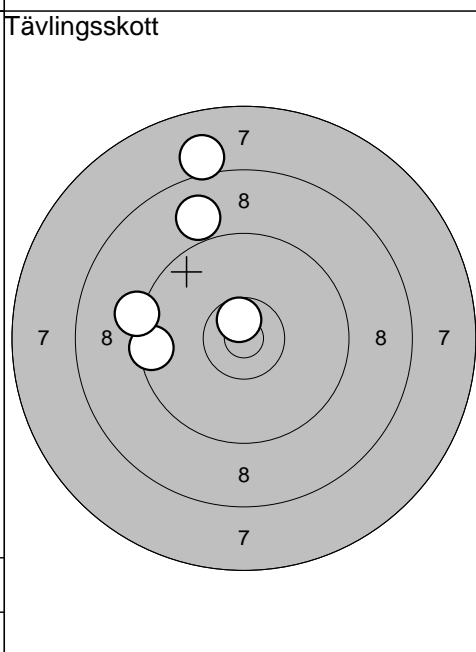

16: 8,9	↖
17: 10,7*	↖
18: 8,0	↖
19: 9,5	↖
20: 9,2	↖
Serie 44,0	
Totalt 170,0	

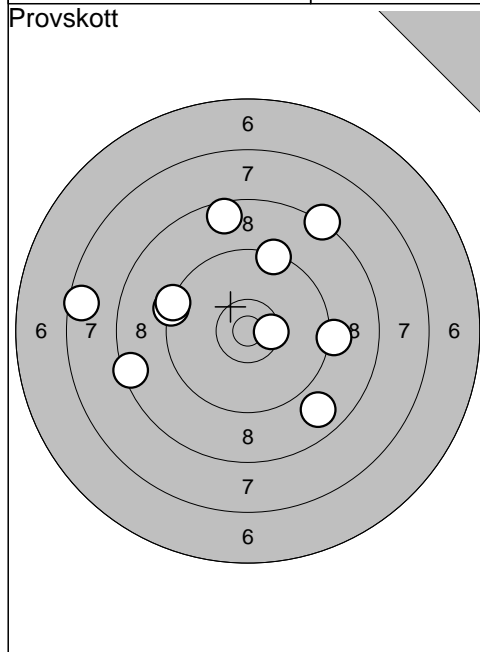

1: 8,6	↗
2: 9,4	↖
3: 8,8	↘
4: 8,5	↖
5: 7,6	↖
6: 9,4	↖
7: 9,4	↗
8: 8,3	↗
9: 9,2	→
10: 10,5*	→
<hr/>	
Serie	85,0
Totalt	0,0

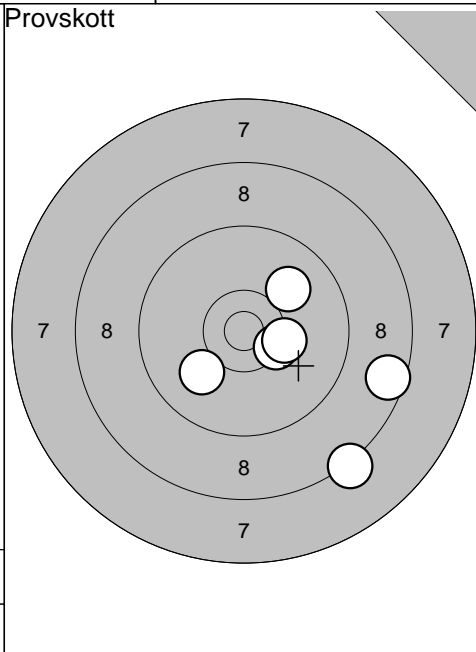

11: 8,6	→
12: 10,0	↗
13: 10,4*	→
14: 10,0	↘
15: 10,3*	→
16: 8,2	↘
<hr/>	
Serie	56,0
Totalt	0,0

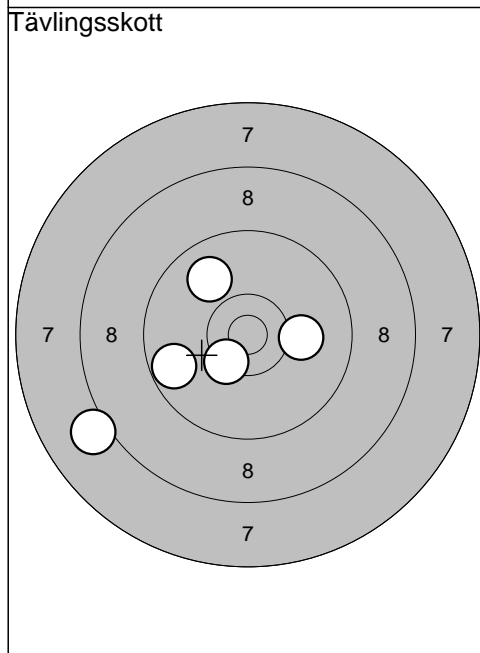

1: 8,1	↖
2: 10,4*	↘
3: 9,9	↗
4: 10,1	→
5: 9,7	↖
<hr/>	
Serie	46,0
Totalt	46,0

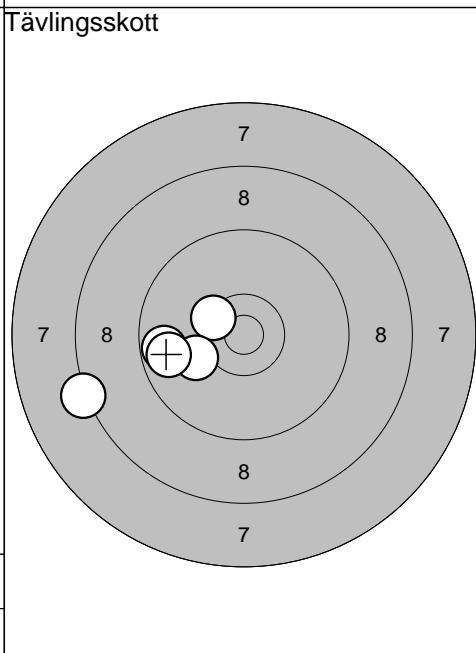

6: 10,4*	↖
7: 9,7	↖
8: 8,3	↖
9: 10,1	↖
10: 9,7	↖
<hr/>	
Serie	46,0
Totalt	92,0

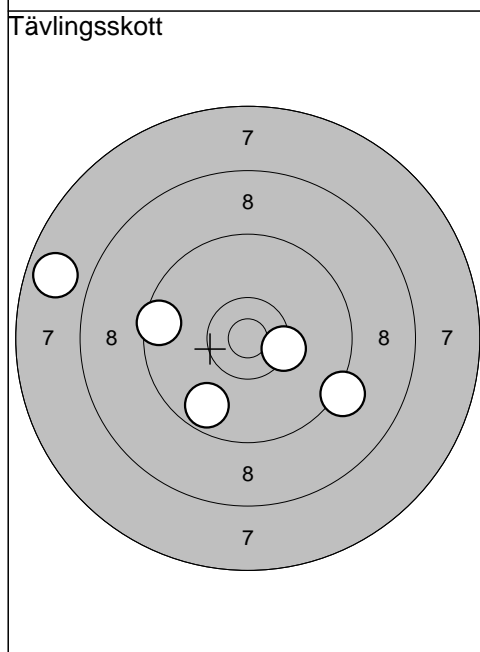

11: 7,8	↖
12: 10,4*	→
13: 9,2	↘
14: 9,7	↘
15: 9,5	↖
<hr/>	
Serie	44,0
Totalt	136,0

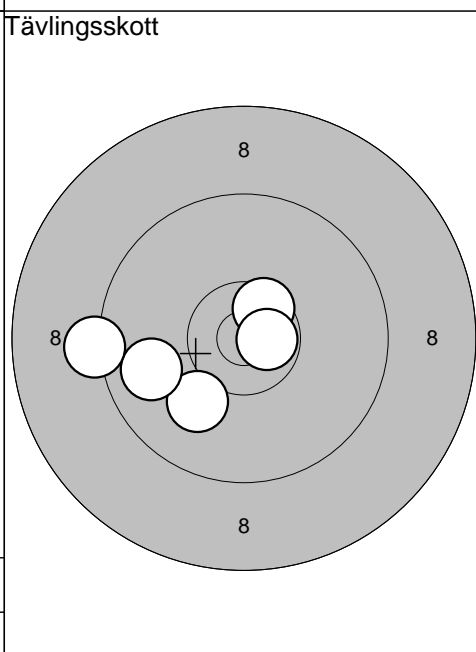

16: 10,1	↘
17: 10,5*	↗
18: 9,8	↖
19: 10,7*	→
20: 9,3	↖
<hr/>	
Serie	48,0
Totalt	184,0

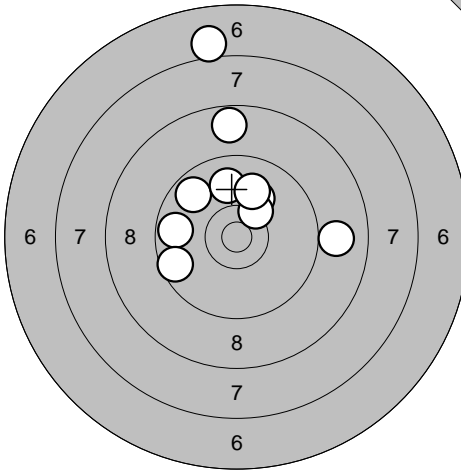
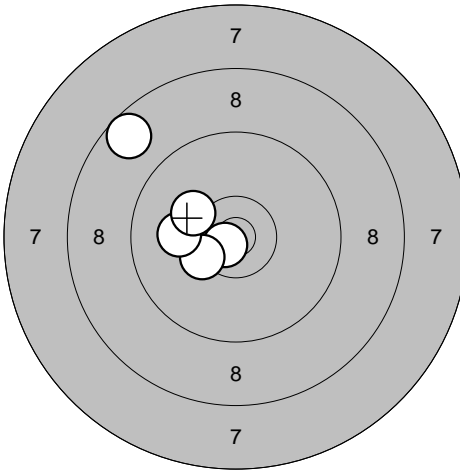
<p>Provs-kott</p> 	<p>1: 7,0 ↑</p> <p>2: 8,7 ↑</p> <p>3: 9,7 ↖</p> <p>4: 8,9 →</p> <p>5: 10,1 ↗</p> <p>6: 9,9 ↑</p> <p>7: 10,3* ↗</p> <p>8: 10,0 ↑</p> <p>9: 9,7 ←</p> <p>10: 9,6 ↙</p> <hr/> <p>Serie 89,0</p> <p>Totalt 0,0</p>	<p>Tävlingsskott</p> 	<p>1: 10,7* ↙</p> <p>2: 10,3* ↙</p> <p>3: 8,6 ↖</p> <p>4: 10,1 ←</p> <p>5: 10,2 ↖</p> <hr/> <p>Serie 48,0</p> <p>Totalt 48,0</p>
--	--	---	--

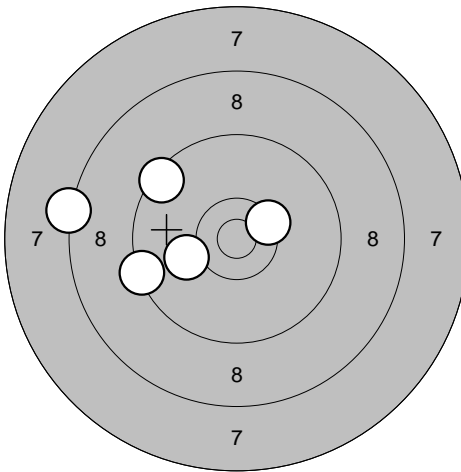
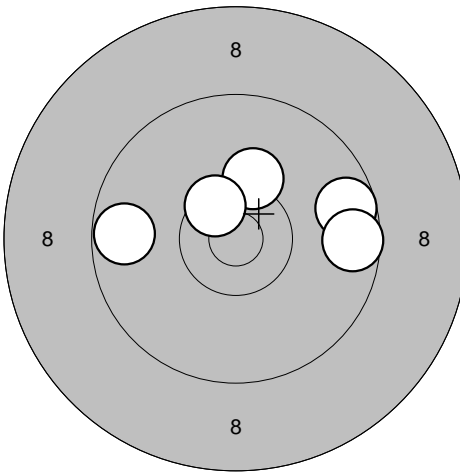
<p>Tävlingsskott</p> 	<p>6: 9,5 ↖</p> <p>7: 10,4* ↗</p> <p>8: 10,1 ←</p> <p>9: 9,4 ←</p> <p>10: 8,3 ←</p> <hr/> <p>Serie 46,0</p> <p>Totalt 94,0</p>	<p>Tävlingsskott</p> 	<p>11: 9,7 ←</p> <p>12: 9,6 →</p> <p>13: 9,6 →</p> <p>14: 10,2 ↑</p> <p>15: 10,5* ↖</p> <hr/> <p>Serie 47,0</p> <p>Totalt 141,0</p>
--	--	--	---

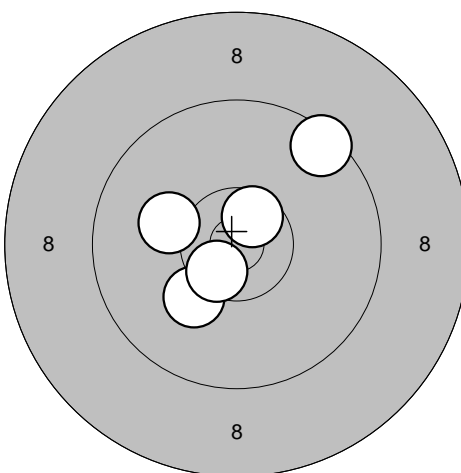
<p>Tävlingsskott</p> 	<p>16: 9,5 ↗</p> <p>17: 10,2 ↙</p> <p>18: 10,1 ←</p> <p>19: 10,6* ↙</p> <p>20: 10,6* ↗</p> <hr/> <p>Serie 49,0</p> <p>Totalt 190,0</p>		
---	--	--	--

Drängsmark

2012-05-13

Vindelnskottet

Ramselefors SKF

Provskott

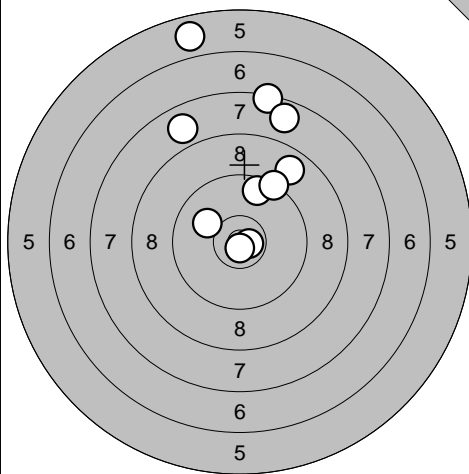

- 1: 7,9 ↖
- 2: 5,8 ↑
- 3: 7,4 ↑
- 4: 7,8 ↑
- 5: 10,0 ↖
- 6: 9,6 ↑
- 7: 10,7* →
- 8: 8,8 ↗
- 9: 9,3 ↗
- 10: 10,8* ↓

Serie 82,0

Totalt 0,0

Provskott

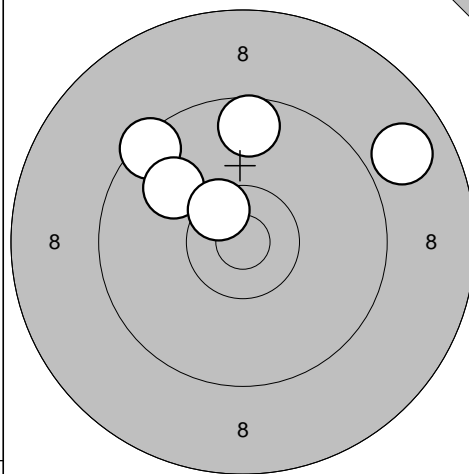

- 11: 9,6 ↑
- 12: 9,5 ↖
- 13: 10,0 ↖
- 14: 10,5* ↖
- 15: 8,9 ↗

Serie 46,0

Totalt 0,0

Tävlingsskott

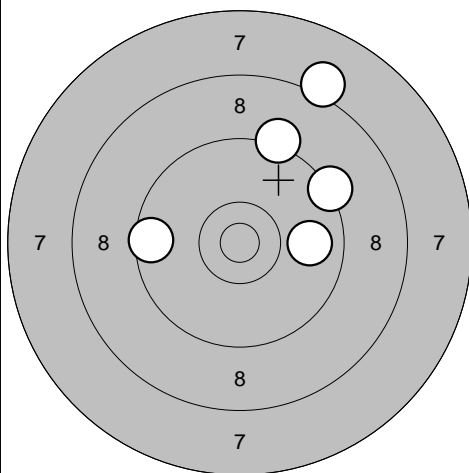

- 1: 8,1 ↗
- 2: 9,2 ↑
- 3: 9,6 ←
- 4: 9,8 →
- 5: 9,3 ↗

Serie 44,0

Totalt 44,0

Tävlingsskott

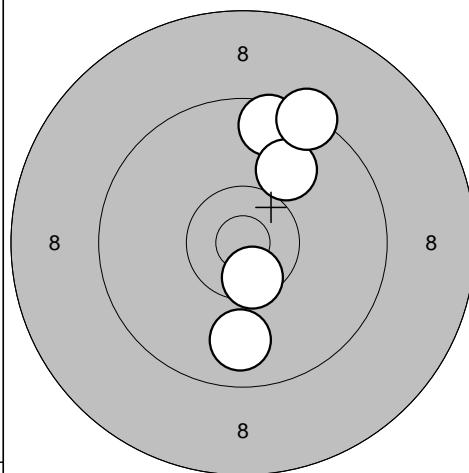

- 6: 9,6 ↑
- 7: 10,0 ↗
- 8: 9,8 ↓
- 9: 9,4 ↗
- 10: 10,5* ↓

Serie 47,0

Totalt 91,0

Tävlingsskott

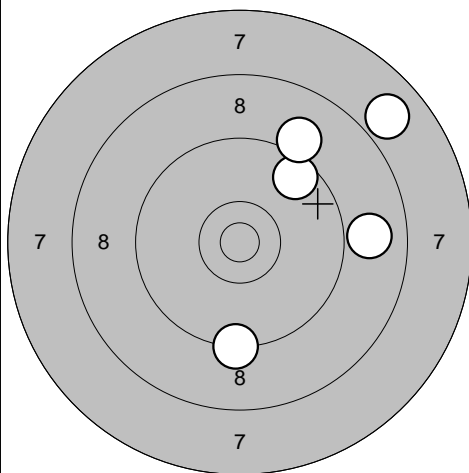

- 11: 8,9 →
- 12: 9,6 ↗
- 13: 9,1 ↗
- 14: 9,3 ↓
- 15: 7,9 ↗

Serie 42,0

Totalt 133,0

Tävlingsskott

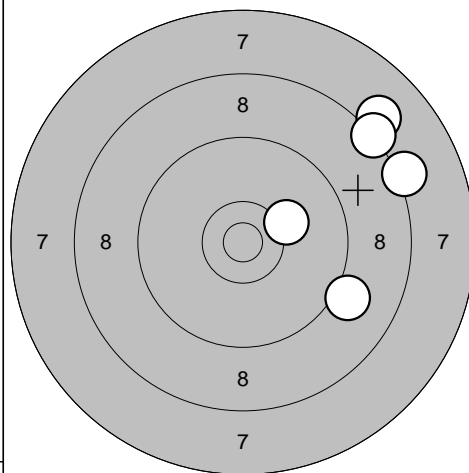

- 16: 8,2 →
- 17: 8,1 ↗
- 18: 10,2 →
- 19: 8,3 ↗
- 20: 9,1 ↘

Serie 43,0

Totalt 176,0

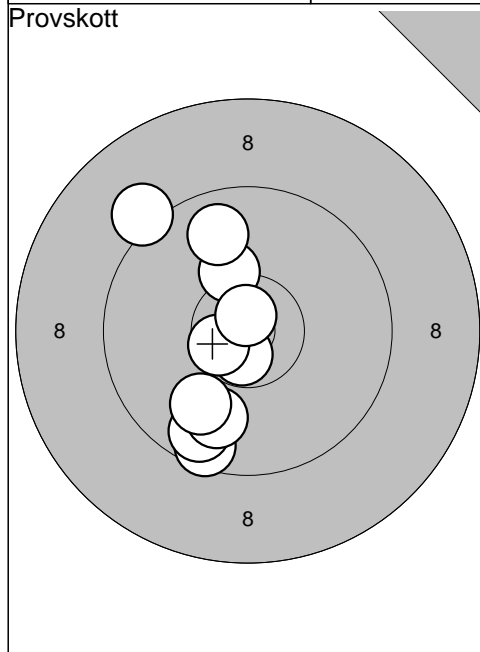

1: 10,7*	↓
2: 9,6	↓
3: 10,6*	↙
4: 9,2	↗
5: 10,2	↑
6: 9,7	↓
7: 10,8*	↑
8: 9,9	↓
9: 9,8	↑
10: 10,0	↘
<hr/>	
Serie	95,0
<hr/>	
Totalt	0,0

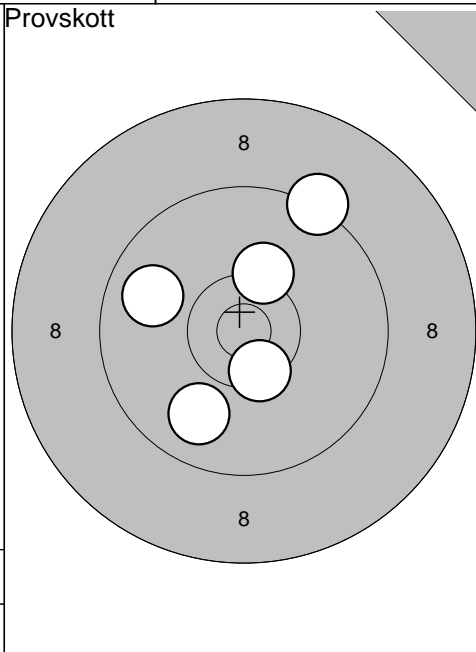

11: 10,5*	↓
12: 9,9	↘
13: 9,3	↗
14: 10,3	↑
15: 9,8	↙
<hr/>	
Serie	47,0
<hr/>	
Totalt	0,0

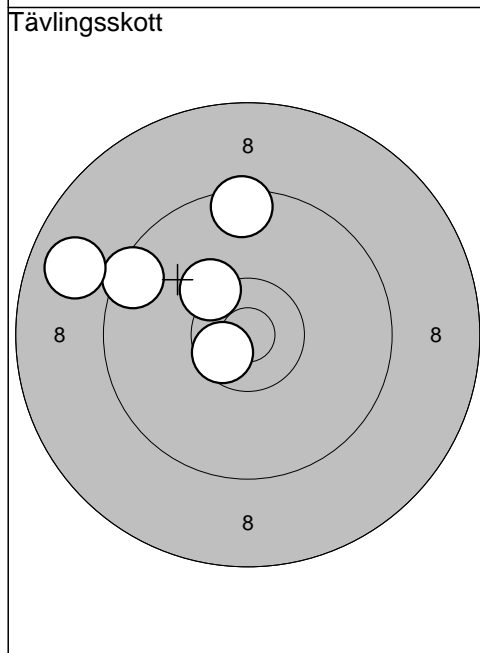

1: 9,5	↙
2: 9,5	↑
3: 10,6*	↙
4: 10,3	↗
5: 8,8	↙
<hr/>	
Serie	46,0
<hr/>	
Totalt	46,0

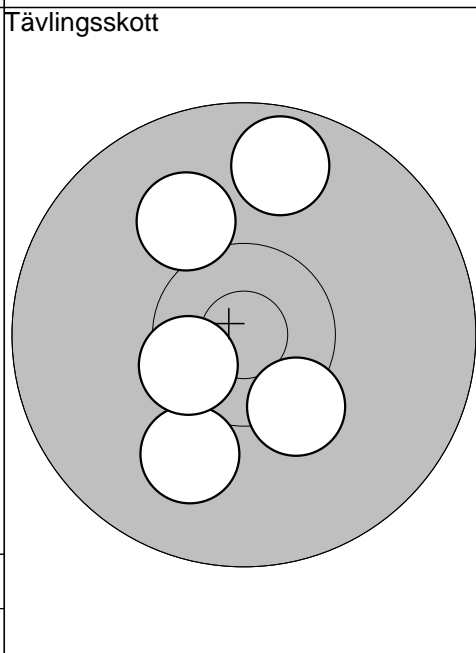

6: 9,7	↑
7: 10,3*	↓
8: 10,1	↗
9: 10,0	↓
10: 10,5*	↙
<hr/>	
Serie	49,0
<hr/>	
Totalt	95,0

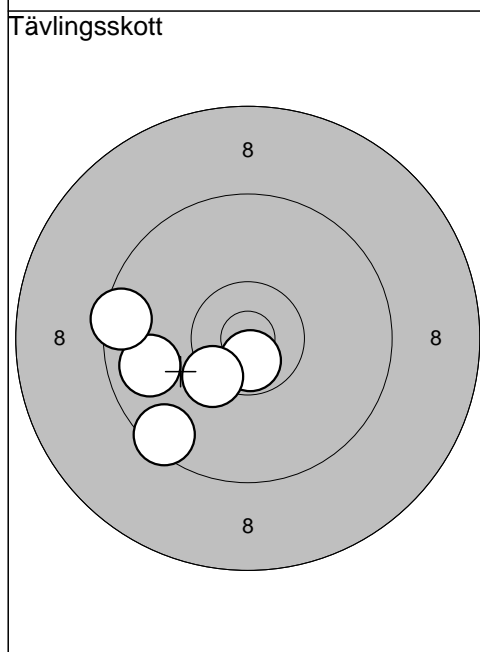

11: 10,7*	↓
12: 9,8	↙
13: 9,5	↘
14: 10,4*	↘
15: 9,5	↙
<hr/>	
Serie	47,0
<hr/>	
Totalt	142,0

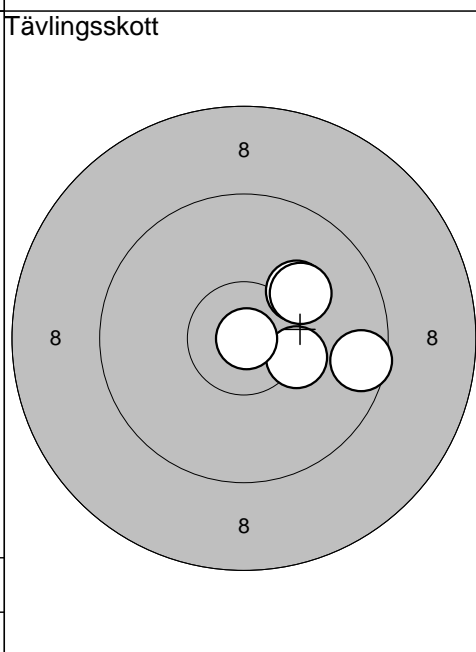

16: 10,1	↗
17: 10,3*	→
18: 9,6	→
19: 10,9*	→
20: 10,1	↗
<hr/>	
Serie	49,0
<hr/>	
Totalt	191,0

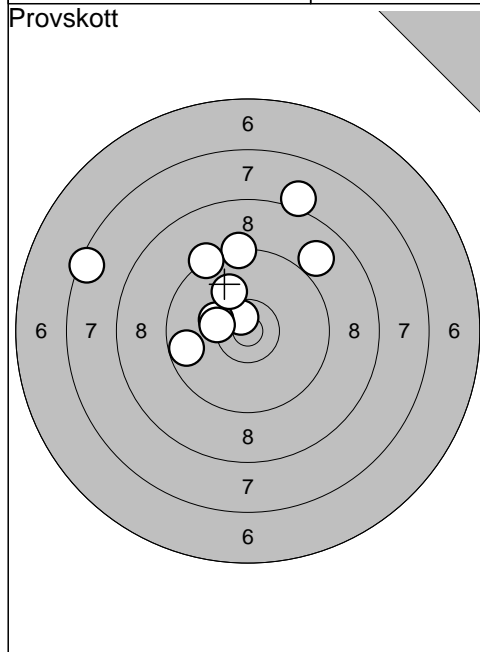

1: 8,1	↗
2: 10,7*	↑
3: 10,3	↖
4: 7,5	↖
5: 9,3	↑
6: 9,3	↑
7: 9,7	↖
8: 10,1	↑
9: 10,3*	↖
10: 9,0	↗
<hr/>	
Serie	91,0
Totalt	0,0

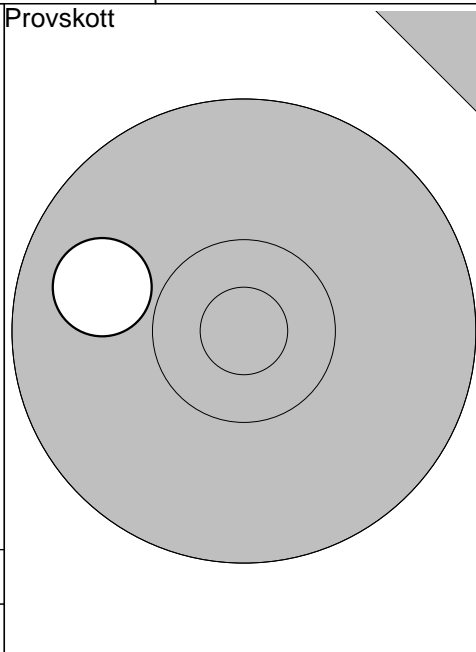

11: 9,9	↖
<hr/>	
Serie	9,0
Totalt	0,0

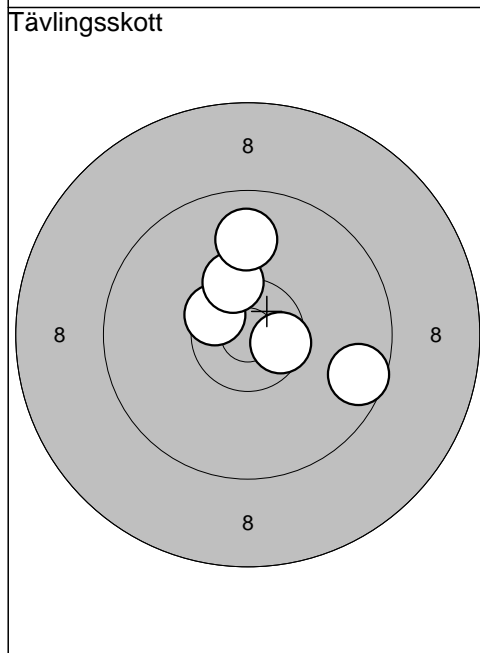

1: 10,5*	↖
2: 10,3*	↑
3: 10,6*	➡
4: 9,6	➡
5: 9,9	↑
<hr/>	
Serie	48,0
Totalt	48,0

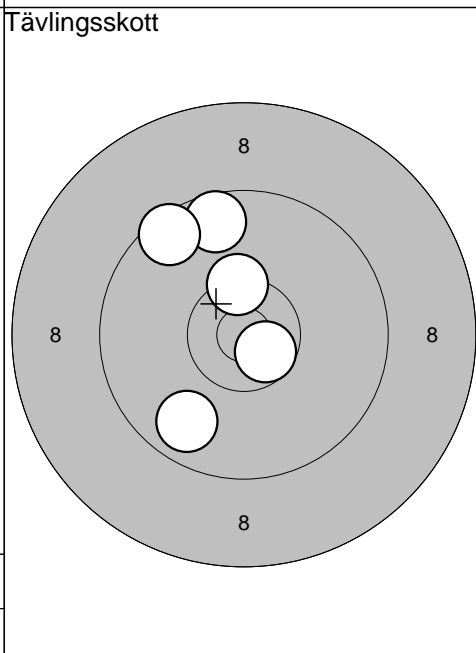

6: 9,6	↑
7: 9,5	↖
8: 10,4*	↑
9: 10,6*	↘
10: 9,8	↘
<hr/>	
Serie	47,0
Totalt	95,0

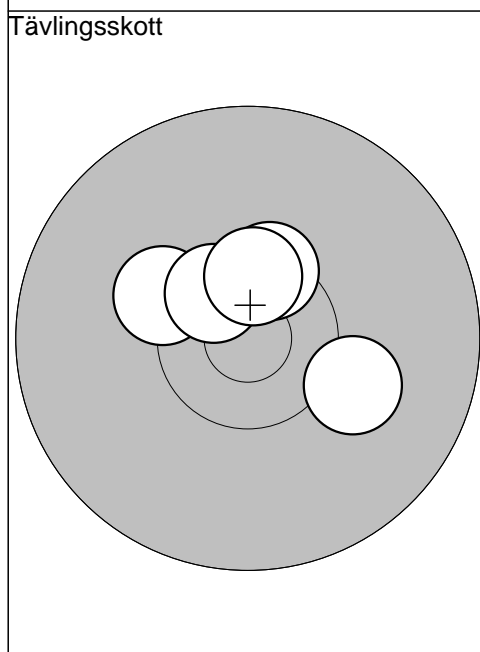

11: 10,1	➡
12: 10,3	↖
13: 10,4*	↑
14: 10,6*	↖
15: 10,5*	↑
<hr/>	
Serie	50,0
Totalt	145,0

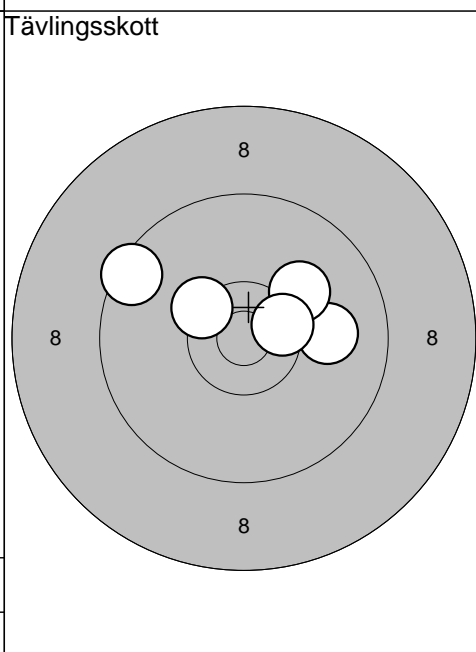

16: 10,4*	↖
17: 10,0	➡
18: 10,1	↗
19: 10,5*	➡
20: 9,5	↖
<hr/>	
Serie	49,0
Totalt	194,0

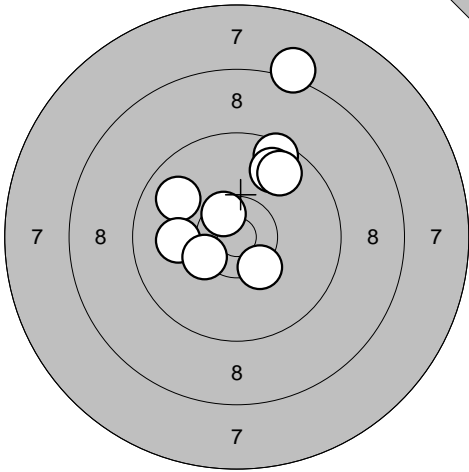
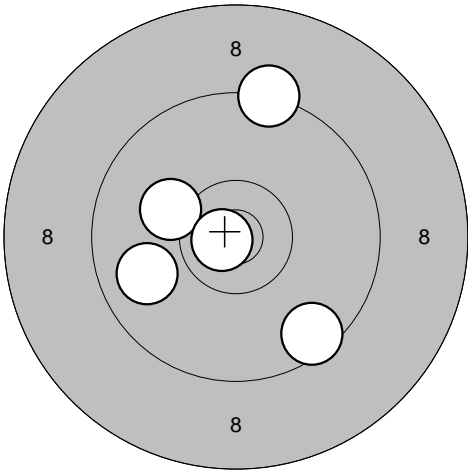
<p>Provs-kott</p> 	<p>Tävlingsskott</p> 	
<p>1: 8,2 ↗ 2: 10,5* ↗ 3: 10,3* ↘ 4: 9,5 ↗ 5: 9,8 ↗ 6: 9,9 ↖ 7: 10,0 ← 8: 10,4* ↙ 9: 9,7 ↗</p>	<p>1: 9,3 ↗ 2: 10,1 ↖ 3: 9,5 ↘ 4: 10,8* ↖ 5: 9,9 ↖</p>	
Serie 84,0	Serie 47,0	
Totalt 0,0	Totalt 47,0	

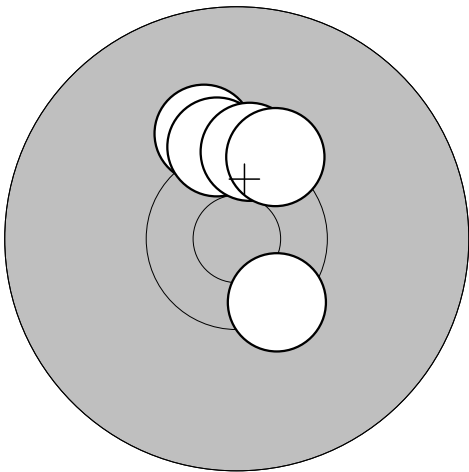
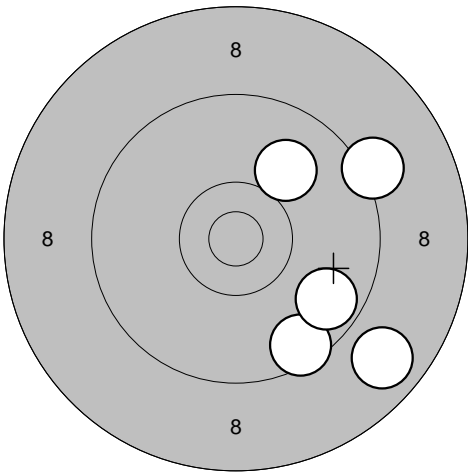
<p>Tävlingsskott</p> 	<p>Tävlingsskott</p> 	
<p>6: 10,2 ↗ 7: 10,3 ↗ 8: 10,4* ↘ 9: 10,3* ↗ 10: 10,3* ↗</p>	<p>11: 10,0 ↗ 12: 9,2 ↗ 13: 8,8 ↘ 14: 9,5 ↘ 15: 9,7 ↘</p>	
Serie 50,0	Serie 45,0	
Totalt 97,0	Totalt 142,0	

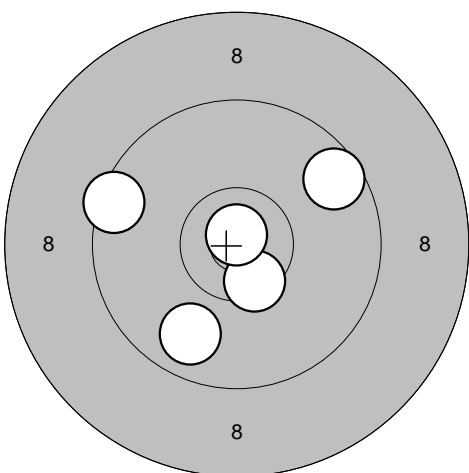
<p>Tävlingsskott</p> 	<p>16: 10,5* ↘ 17: 9,5 ↖ 18: 10,8* ↗ 19: 9,6 ↗ 20: 9,8 ↘</p>	
Serie 47,0		
Totalt 189,0		

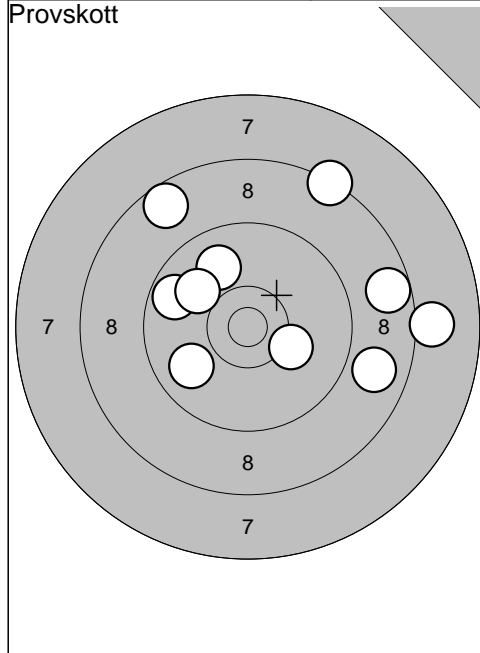

1: 8,1	→
2: 8,3	↗
3: 8,7	→
4: 9,7	↖
5: 9,9	↙
6: 9,9	↗
7: 8,8	→
8: 10,0	↗
9: 8,7	↗
10: 10,2	→
Serie 87,0	
Totalt 0,0	

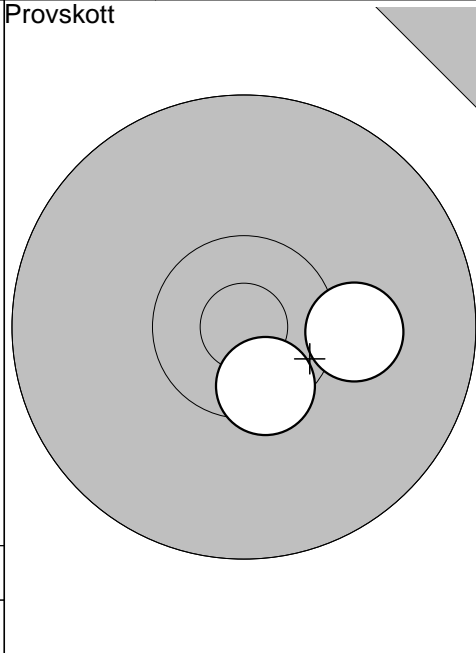

11: 10,2	→
12: 10,5*	↘
Serie 20,0	
Totalt 0,0	

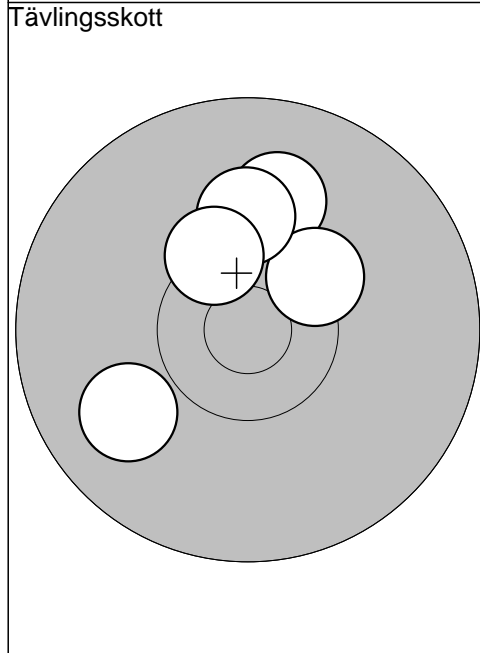

1: 10,0	↗
2: 10,3*	↗
3: 9,9	↙
4: 10,1	↑
5: 10,4*	↗
Serie 49,0	
Totalt 49,0	

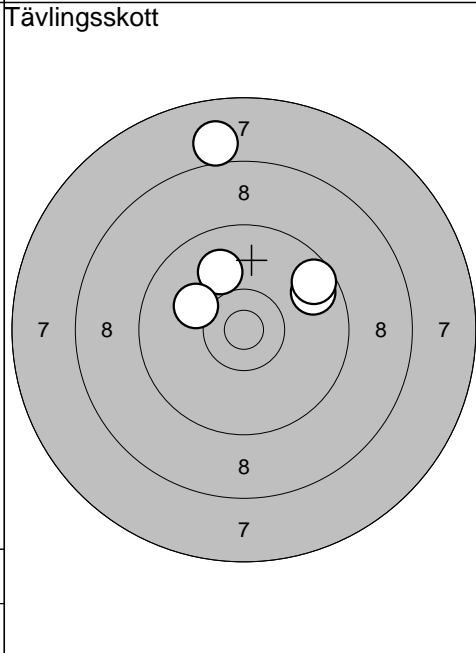

6: 9,7	↗
7: 8,0	↑
8: 9,6	↗
9: 10,0	↑
10: 10,1	↖
Serie 46,0	
Totalt 95,0	

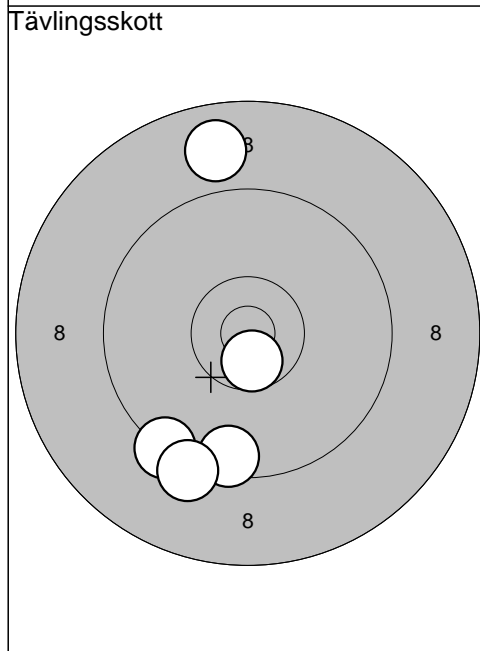

11: 9,3	↙
12: 10,6*	↘
13: 9,5	↘
14: 8,8	↑
15: 9,2	↙
Serie 45,0	
Totalt 140,0	

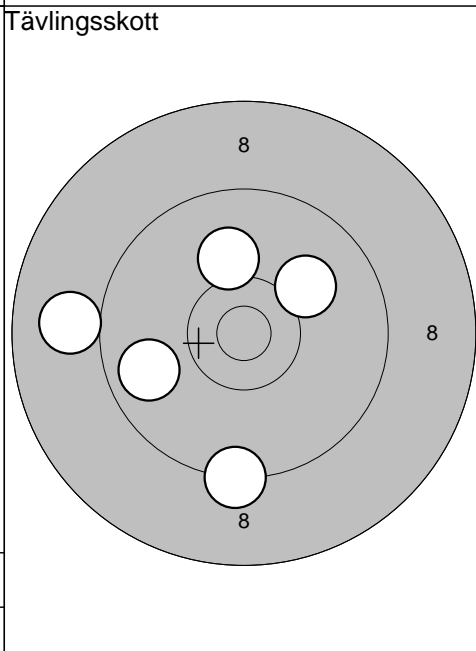

16: 10,1	↑
17: 9,3	↘
18: 9,0	←
19: 10,1	↗
20: 9,8	↖
Serie 47,0	
Totalt 187,0	

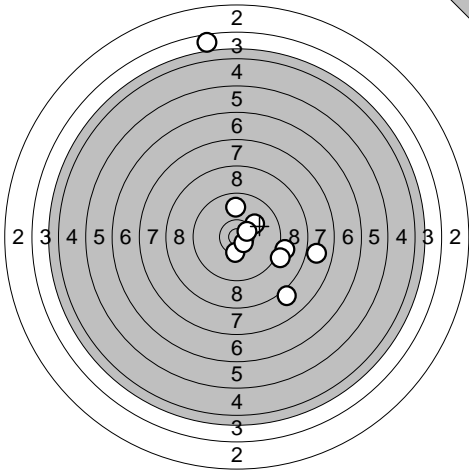
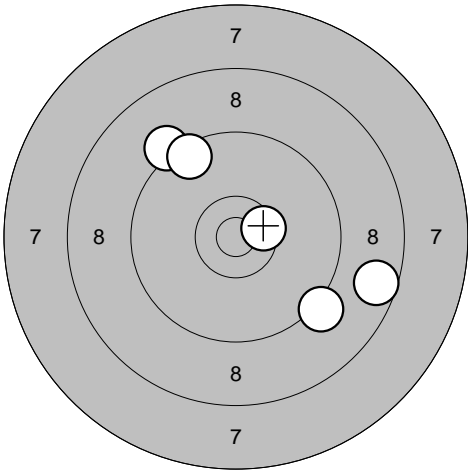
Provs-kott 	1: 3,6 ↑ 2: 9,1 → 3: 9,9 ↑ 4: 7,9 → 5: 8,1 ↓ 6: 10,1 ↗ 7: 10,4* ↓ 8: 10,6* ↓ 9: 10,5* ↗ 10: 9,1 → <hr/> Serie 85,0 Totalt 0,0	Tävlingsskott 	1: 8,6 → 2: 9,2 ↓ 3: 9,2 ↗ 4: 9,5 ↗ 5: 10,5* → <hr/> Serie 45,0 Totalt 45,0
---	--	--	---

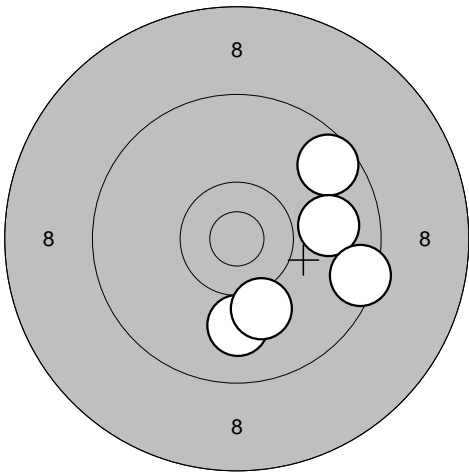
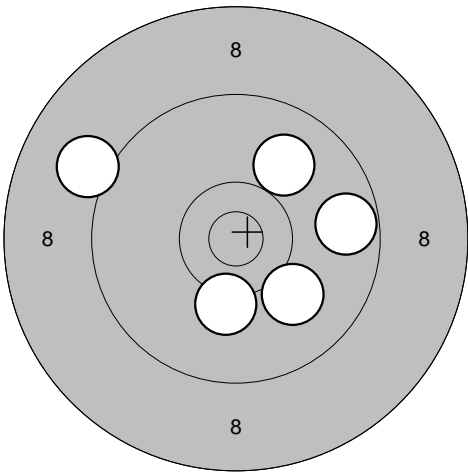
Tävlingsskott 	6: 9,6 ↗ 7: 10,0 ↓ 8: 9,9 → 9: 10,1 ↓ 10: 9,5 → <hr/> Serie 47,0 Totalt 92,0	Tävlingsskott 	11: 9,9 ↗ 12: 9,7 → 13: 9,1 ↖ 14: 10,0 ↓ 15: 10,2 ↓ <hr/> Serie 47,0 Totalt 139,0
---	--	---	---

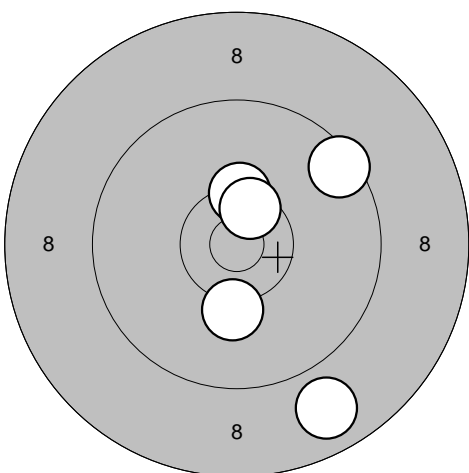
Tävlingsskott 	16: 10,4* ↑ 17: 10,2 ↓ 18: 10,5* ↗ 19: 8,8 ↓ 20: 9,5 ↗ <hr/> Serie 47,0 Totalt 186,0		
--	--	--	--

Ale

2012-05-13	Vindelnskottet	Ramselefors SKF
------------	----------------	-----------------

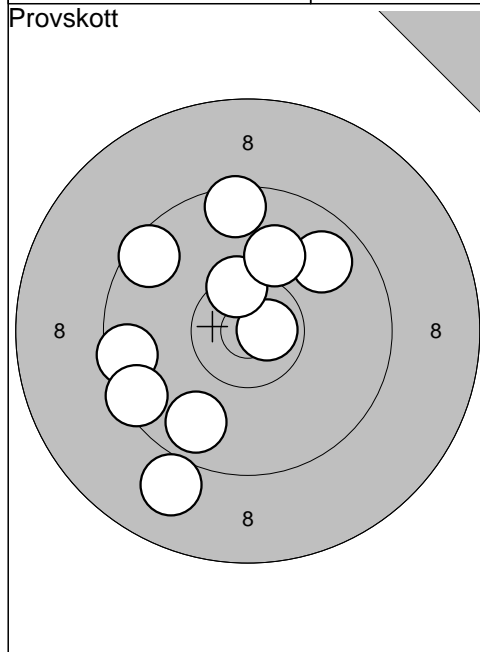

1: 9,5	↑
2: 9,5	↖
3: 9,0	↙
4: 9,8	↘
5: 10,7*	→
6: 9,5	←
7: 9,5	↙
8: 10,4*	↑
9: 9,8	↗
10: 10,0	↑
Serie 93,0	
Totalt 0,0	

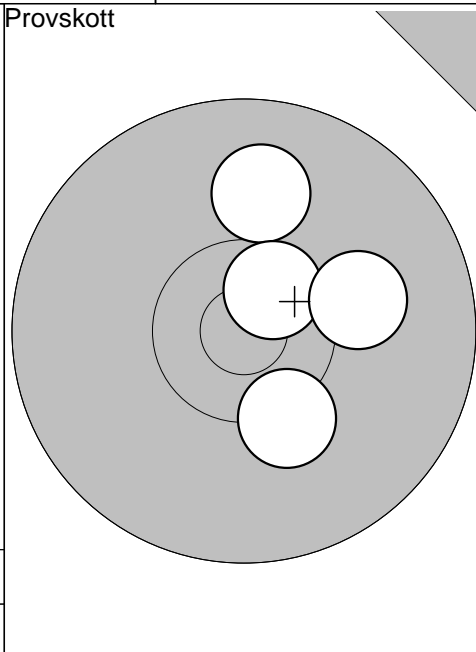

11: 10,0	↑
12: 10,3	↘
13: 10,6*	↗
14: 10,1	→
Serie 40,0	
Totalt 0,0	

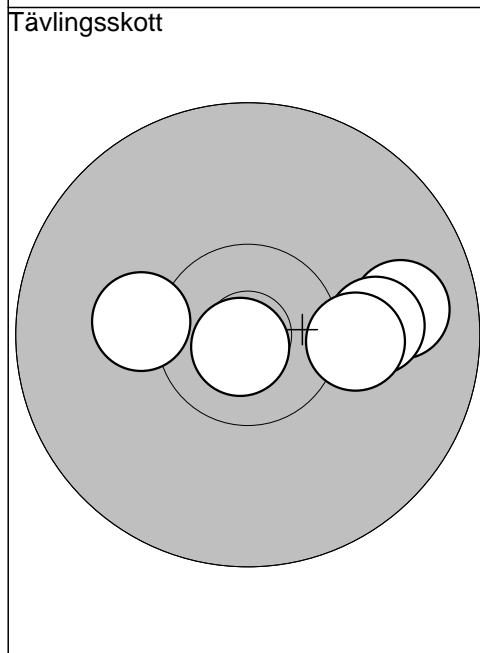

1: 9,8	→
2: 10,0	→
3: 10,8*	↙
4: 10,2	←
5: 10,2	→
Serie 49,0	
Totalt 49,0	

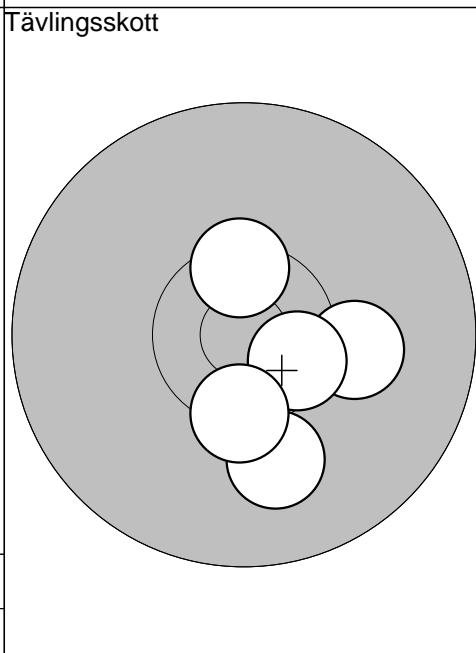

6: 10,2	→
7: 10,0	↘
8: 10,5*	↘
9: 10,5*	↑
10: 10,4*	↘
Serie 50,0	
Totalt 99,0	

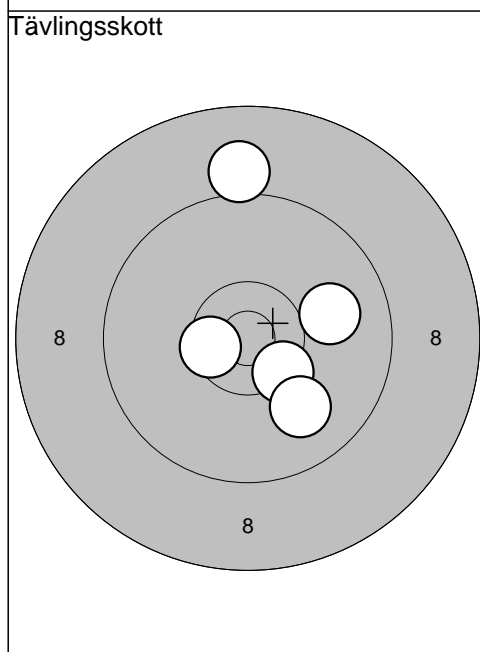

11: 9,0	↑
12: 10,0	→
13: 10,4*	↘
14: 10,5*	←
15: 10,0	↘
Serie 49,0	
Totalt 148,0	

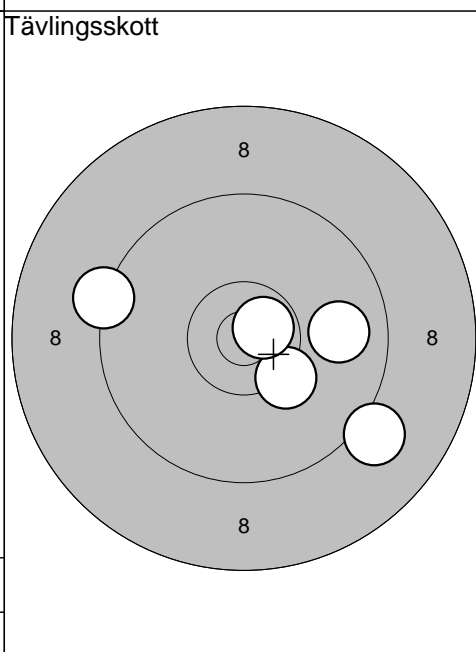

16: 9,3	←
17: 10,3*	↘
18: 10,7*	↗
19: 9,1	↘
20: 9,9	→
Serie 47,0	
Totalt 195,0	

Ale

2012-05-13	Vindelnskottet	Ramselefors SKF
------------	----------------	-----------------

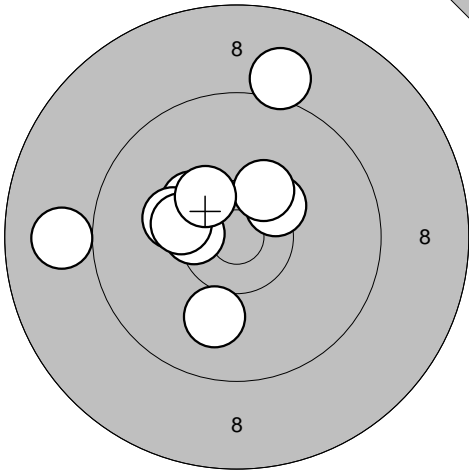
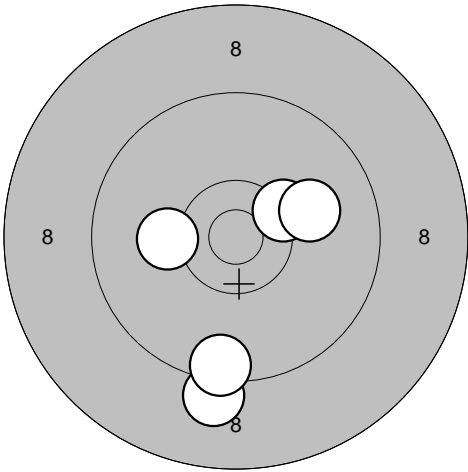
<p>Provskott</p> 	<p>Tävlingsskott</p> 	<table style="width: 100%; border-collapse: collapse;"> <tr> <td style="width: 50%;">1: 10,4* ↗</td> <td style="width: 50%;">1: 10,3* ↗</td> </tr> <tr> <td>2: 10,3* ↗</td> <td>2: 9,1 ↓</td> </tr> <tr> <td>3: 10,2 ←</td> <td>3: 9,5 ↓</td> </tr> <tr> <td>4: 10,5* ←</td> <td>4: 10,1 →</td> </tr> <tr> <td>5: 10,0 ↓</td> <td>5: 10,2 ←</td> </tr> <tr> <td>6: 10,3* ←</td> <td></td> </tr> <tr> <td>7: 9,1 ↑</td> <td></td> </tr> <tr> <td>8: 10,3* ↗</td> <td></td> </tr> <tr> <td>9: 9,0 ←</td> <td></td> </tr> <tr> <td>10: 10,4* ↗</td> <td></td> </tr> <tr> <td style="border-top: 1px solid black;">Serie 98,0</td> <td style="border-top: 1px solid black;">Serie 48,0</td> </tr> <tr> <td style="border-top: 1px solid black;">Totalt 0,0</td> <td style="border-top: 1px solid black;">Totalt 48,0</td> </tr> </table>	1: 10,4* ↗	1: 10,3* ↗	2: 10,3* ↗	2: 9,1 ↓	3: 10,2 ←	3: 9,5 ↓	4: 10,5* ←	4: 10,1 →	5: 10,0 ↓	5: 10,2 ←	6: 10,3* ←		7: 9,1 ↑		8: 10,3* ↗		9: 9,0 ←		10: 10,4* ↗		Serie 98,0	Serie 48,0	Totalt 0,0	Totalt 48,0
1: 10,4* ↗	1: 10,3* ↗																									
2: 10,3* ↗	2: 9,1 ↓																									
3: 10,2 ←	3: 9,5 ↓																									
4: 10,5* ←	4: 10,1 →																									
5: 10,0 ↓	5: 10,2 ←																									
6: 10,3* ←																										
7: 9,1 ↑																										
8: 10,3* ↗																										
9: 9,0 ←																										
10: 10,4* ↗																										
Serie 98,0	Serie 48,0																									
Totalt 0,0	Totalt 48,0																									

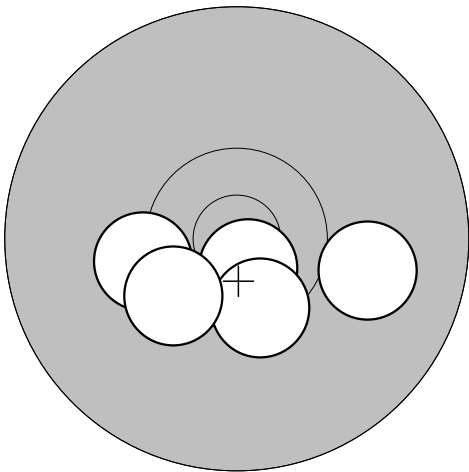
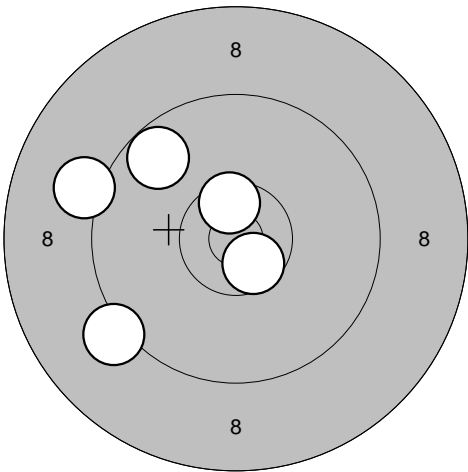
<p>Tävlingsskott</p> 	<p>Tävlingsskott</p> 	<table style="width: 100%; border-collapse: collapse;"> <tr> <td style="width: 50%;">6: 10,3 ←</td> <td style="width: 50%;">11: 9,1 ←</td> </tr> <tr> <td>7: 10,7* ↓</td> <td>12: 9,2 ↙</td> </tr> <tr> <td>8: 10,4* ↓</td> <td>13: 10,5* ↑</td> </tr> <tr> <td>9: 10,3* ↙</td> <td>14: 10,6* ↘</td> </tr> <tr> <td>10: 10,0 →</td> <td>15: 9,7 ↗</td> </tr> <tr> <td style="border-top: 1px solid black;">Serie 50,0</td> <td style="border-top: 1px solid black;">Serie 47,0</td> </tr> <tr> <td style="border-top: 1px solid black;">Totalt 98,0</td> <td style="border-top: 1px solid black;">Totalt 145,0</td> </tr> </table>	6: 10,3 ←	11: 9,1 ←	7: 10,7* ↓	12: 9,2 ↙	8: 10,4* ↓	13: 10,5* ↑	9: 10,3* ↙	14: 10,6* ↘	10: 10,0 →	15: 9,7 ↗	Serie 50,0	Serie 47,0	Totalt 98,0	Totalt 145,0
6: 10,3 ←	11: 9,1 ←															
7: 10,7* ↓	12: 9,2 ↙															
8: 10,4* ↓	13: 10,5* ↑															
9: 10,3* ↙	14: 10,6* ↘															
10: 10,0 →	15: 9,7 ↗															
Serie 50,0	Serie 47,0															
Totalt 98,0	Totalt 145,0															

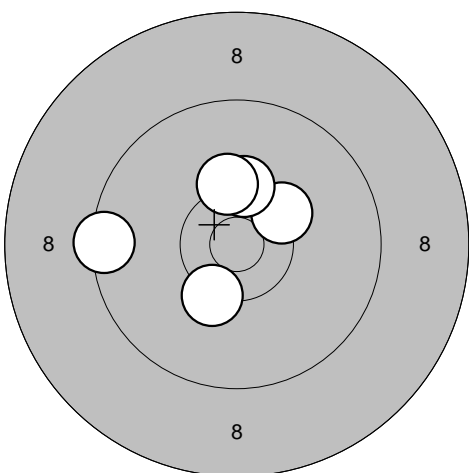
<p>Tävlingsskott</p> 	<table style="width: 100%; border-collapse: collapse;"> <tr> <td style="width: 50%;">16: 9,4 ←</td> <td style="width: 50%;"></td> </tr> <tr> <td>17: 10,3* ↗</td> <td></td> </tr> <tr> <td>18: 10,3* ↘</td> <td></td> </tr> <tr> <td>19: 10,3 ↑</td> <td></td> </tr> <tr> <td>20: 10,3 ↑</td> <td></td> </tr> <tr> <td style="border-top: 1px solid black;">Serie 49,0</td> <td></td> </tr> <tr> <td style="border-top: 1px solid black;">Totalt 194,0</td> <td></td> </tr> </table>	16: 9,4 ←		17: 10,3* ↗		18: 10,3* ↘		19: 10,3 ↑		20: 10,3 ↑		Serie 49,0		Totalt 194,0	
16: 9,4 ←															
17: 10,3* ↗															
18: 10,3* ↘															
19: 10,3 ↑															
20: 10,3 ↑															
Serie 49,0															
Totalt 194,0															

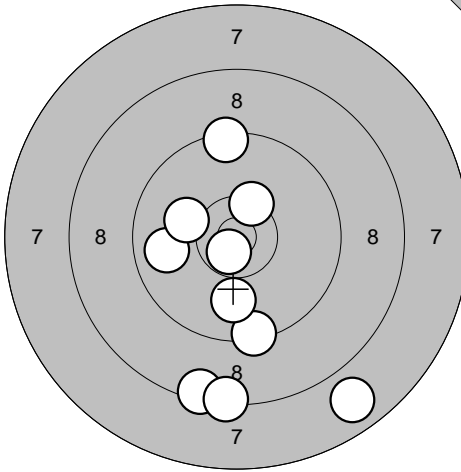
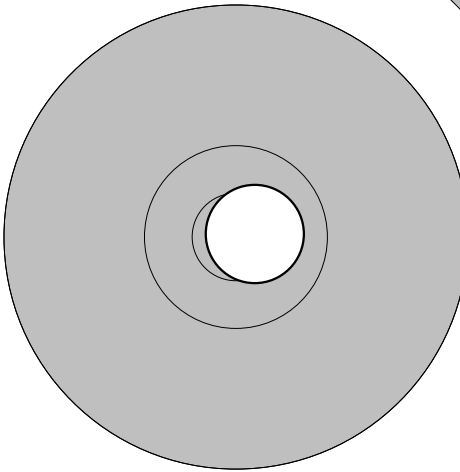
<p>Provskott</p> 	<p>1: 8,4 ↓</p> <p>2: 7,8 ↓</p> <p>3: 8,4 ↓</p> <p>4: 9,4 ↓</p> <p>5: 9,8 ←</p> <p>6: 10,0 ↓</p> <p>7: 9,4 ↑</p> <p>8: 10,7* ↓</p> <p>9: 10,1 ←</p> <p>10: 10,4* ↑</p>	<p>Provskott</p>  <p style="text-align: right;">11: 10,8* →</p>
Serie 90,0		Serie 10,0
Totalt 0,0		Totalt 0,0

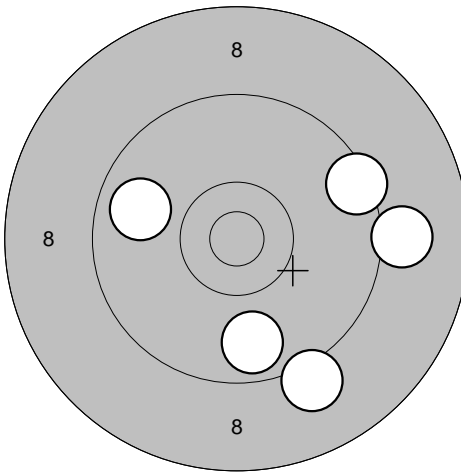
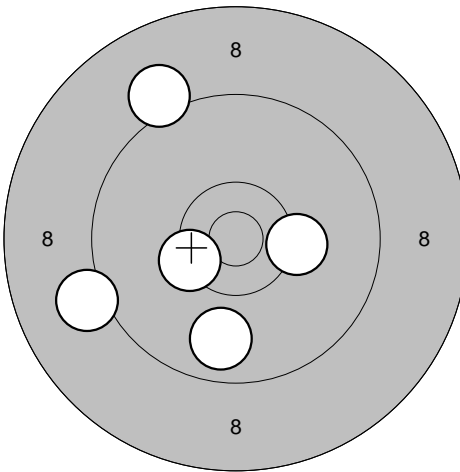
<p>Tävlingsskott</p> 	<p>1: 9,4 →</p> <p>2: 9,1 ↓</p> <p>3: 9,1 →</p> <p>4: 9,7 ↓</p> <p>5: 9,8 ←</p>	<p>Tävlingsskott</p> 
Serie 45,0		Serie 47,0
Totalt 45,0		Totalt 92,0

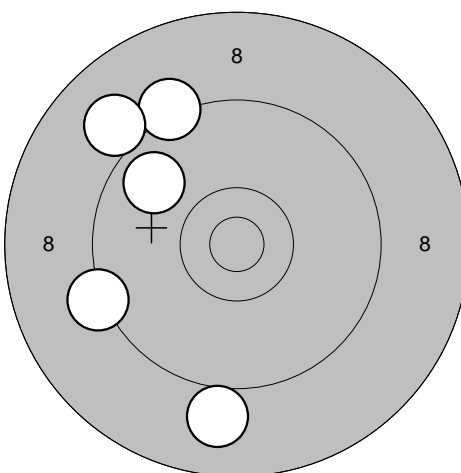
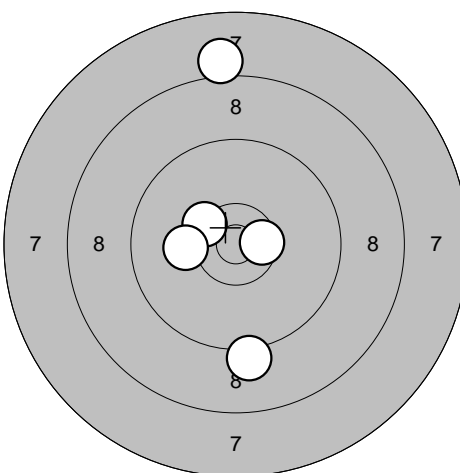
<p>Tävlingsskott</p> 	<p>11: 9,2 ↑</p> <p>12: 9,8 ↑</p> <p>13: 9,2 ←</p> <p>14: 9,0 ↑</p> <p>15: 9,0 ↓</p>	<p>Tävlingsskott</p> 
Serie 45,0		Serie 47,0
Totalt 137,0		Totalt 184,0

I 19 / A 9

2012-05-13

Vindelnskottet

Ramselefors SKF

Provs-kott

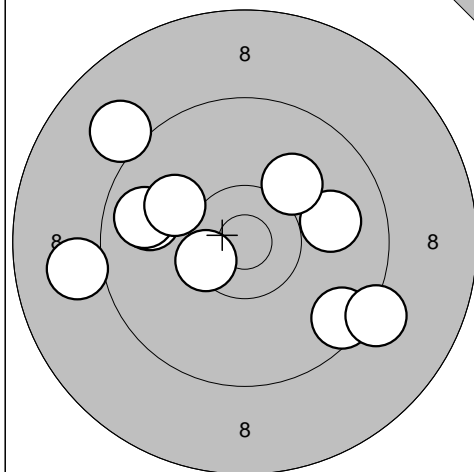

- 1: 9,5 ↘
- 2: 9,8 ←
- 3: 10,5* ↙
- 4: 9,1 ↗
- 5: 9,0 ←
- 6: 9,8 ←
- 7: 9,9 →
- 8: 9,2 ↘
- 9: 10,1 ↗
- 10: 10,1 ←

Serie 93,0

Totalt 0,0

Provs-kott

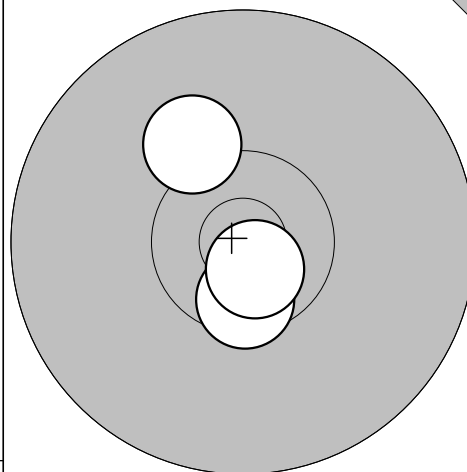

- 11: 10,2 ↗
- 12: 10,5* ↓
- 13: 10,7* ↘

Serie 30,0

Totalt 0,0

Tävlingsskott

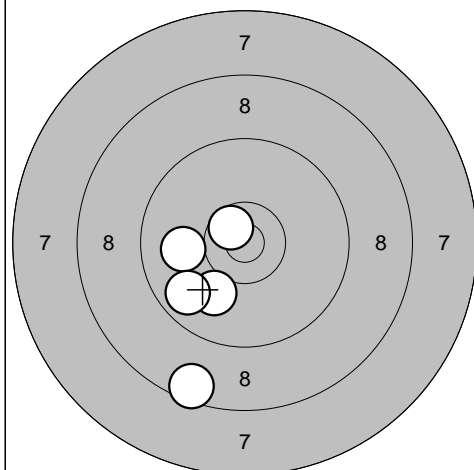

- 1: 10,6* ↗
- 2: 10,0 ←
- 3: 10,0 ↘
- 4: 9,8 ↙
- 5: 8,5 ↘

Serie 47,0

Totalt 47,0

Tävlingsskott

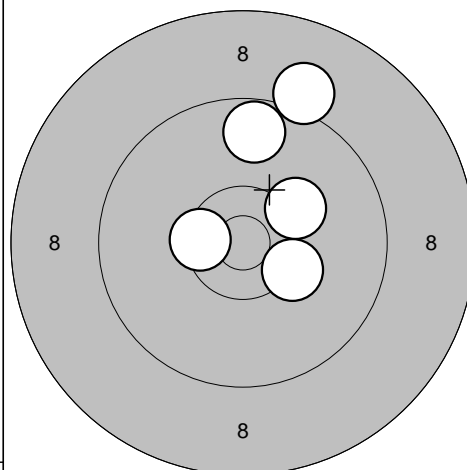

- 6: 10,5* ←
- 7: 10,2 ↗
- 8: 9,1 ↗
- 9: 9,7 ↑
- 10: 10,3* ↘

Serie 48,0

Totalt 95,0

Tävlingsskott

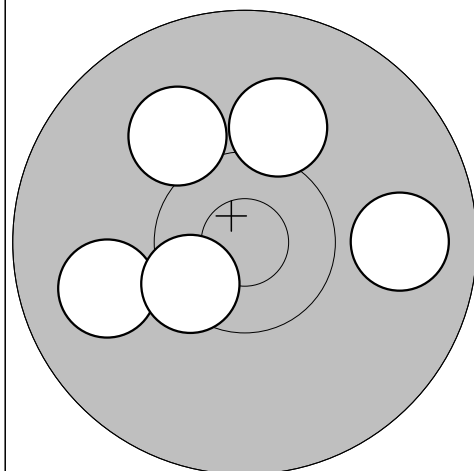

- 11: 9,8 →
- 12: 9,9 ←
- 13: 10,5* ↙
- 14: 10,1 ↗
- 15: 10,1 ↗

Serie 48,0

Totalt 143,0

Tävlingsskott

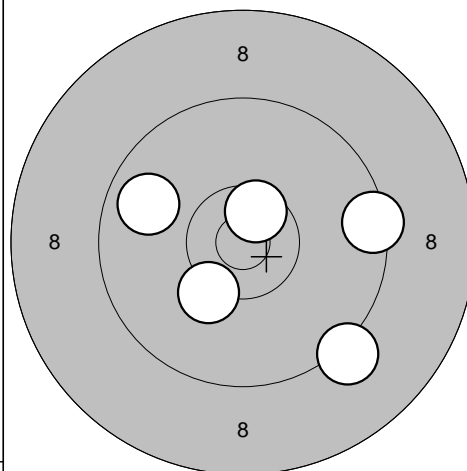

- 16: 10,6* ↗
- 17: 10,3 ↘
- 18: 9,4 →
- 19: 9,8 ←
- 20: 9,2 ↘

Serie 47,0

Totalt 190,0

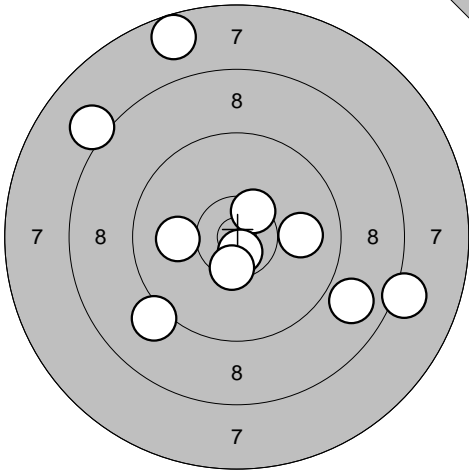
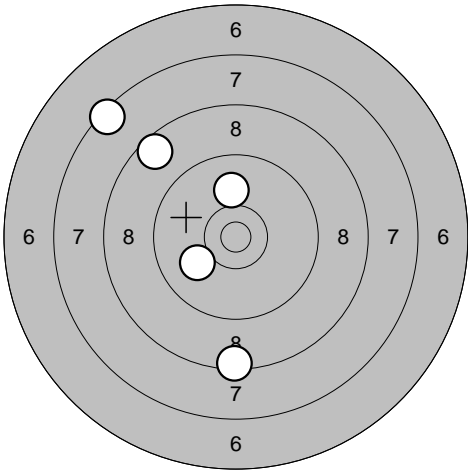
<p>Provs-kott</p> 	<p>1: 9,9 →</p> <p>2: 10,0 ←</p> <p>3: 8,2 →</p> <p>4: 8,9 →</p> <p>5: 9,1 ↙</p> <p>6: 7,7 ↑</p> <p>7: 8,1 ↗</p> <p>8: 10,5* ↗</p> <p>9: 10,7* ↓</p> <p>10: 10,5* ↓</p>	<p>Tävlingsskott</p> 	<p>1: 10,0 ↑</p> <p>2: 8,6 ↗</p> <p>3: 8,4 ↓</p> <p>4: 10,0 ↙</p> <p>5: 7,4 ↗</p>
Serie 89,0	Serie 43,0	Serie 43,0	Serie 43,0
Totalt 0,0	Totalt 43,0	Totalt 43,0	Totalt 43,0

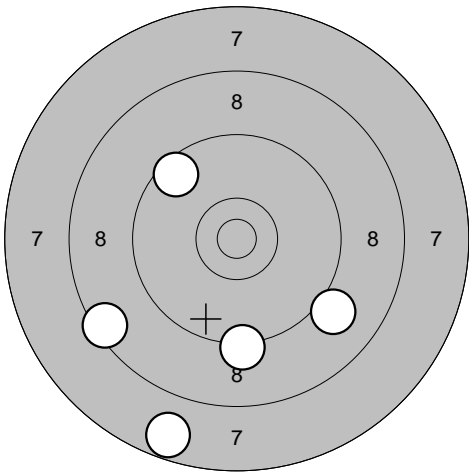
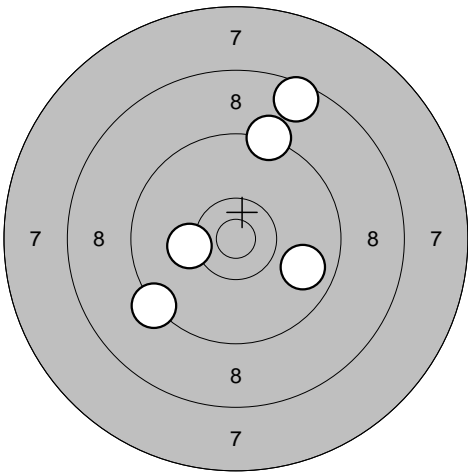
<p>Tävlingsskott</p> 	<p>6: 9,6 ↗</p> <p>7: 9,2 ↓</p> <p>8: 7,7 ↓</p> <p>9: 9,0 →</p> <p>10: 8,5 ↙</p>	<p>Tävlingsskott</p> 	<p>11: 8,6 ↗</p> <p>12: 9,3 ↙</p> <p>13: 10,2 ←</p> <p>14: 9,8 →</p> <p>15: 9,3 ↑</p>
Serie 42,0	Serie 45,0	Serie 45,0	Serie 45,0
Totalt 85,0	Totalt 130,0	Totalt 130,0	Totalt 130,0

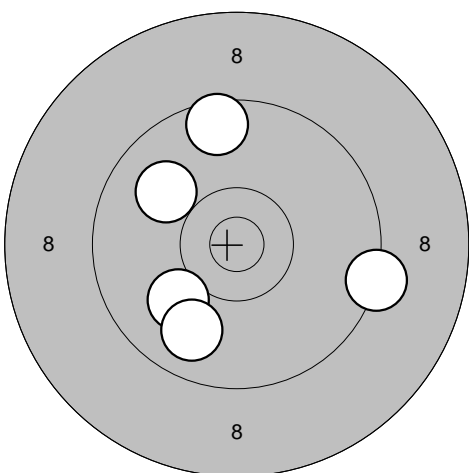
<p>Tävlingsskott</p> 	<p>16: 9,3 →</p> <p>17: 10,0 ↗</p> <p>18: 9,6 ↑</p> <p>19: 10,0 ↙</p> <p>20: 9,8 ↙</p>		
Serie 47,0	Serie 47,0	Serie 47,0	Serie 47,0
Totalt 177,0	Totalt 177,0	Totalt 177,0	Totalt 177,0

S 3

2012-05-13

Vindelnskottet

Ramselefors SKF

Provs-kott

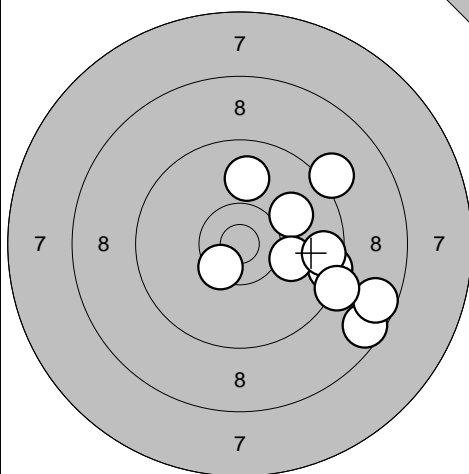

- 1: 10,0 →
- 2: 8,6 ↘
- 3: 9,5 →
- 4: 10,1 →
- 5: 8,6 →
- 6: 9,6 →
- 7: 10,5* ↙
- 8: 9,9 ↑
- 9: 9,3 →
- 10: 9,1 →

Serie	91,0
Totalt	0,0

Tävlingsskott

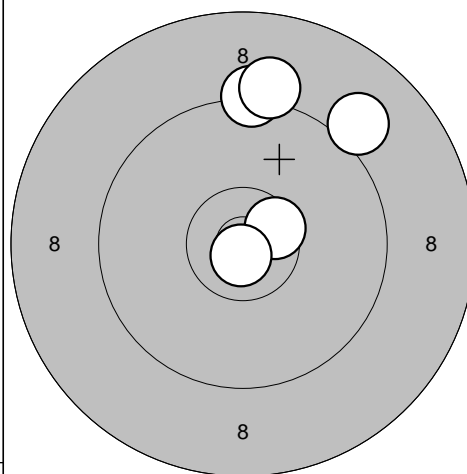

- 1: 10,5* →
- 2: 9,1 ↗
- 3: 10,8* ↓
- 4: 9,3 ↑
- 5: 9,1 ↑

Serie	47,0
Totalt	47,0

Tävlingsskott

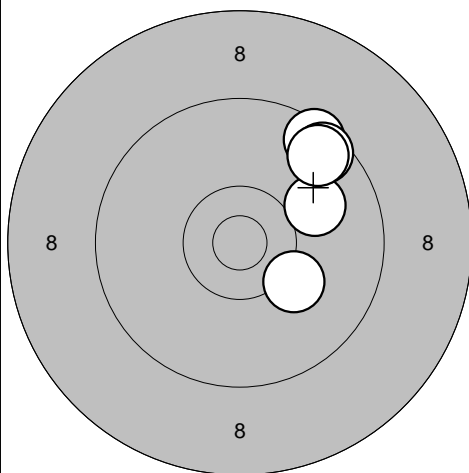

- 6: 10,0 →
- 7: 9,5 ↗
- 8: 9,6 ↗
- 9: 9,6 ↗
- 10: 10,2 ↘

Serie	47,0
Totalt	94,0

Tävlingsskott

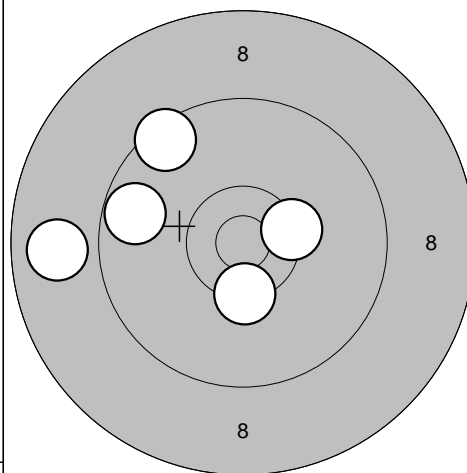

- 11: 9,5 ↖
- 12: 9,7 ←
- 13: 8,8 ←
- 14: 10,4* ↓
- 15: 10,4* →

Serie	46,0
Totalt	140,0

Tävlingsskott

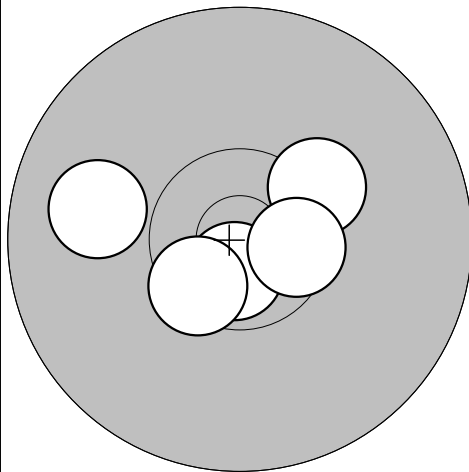

- 16: 9,9 ←
- 17: 10,3 ↗
- 18: 10,7* ↓
- 19: 10,5* ↙
- 20: 10,5* →

Serie	49,0
Totalt	189,0

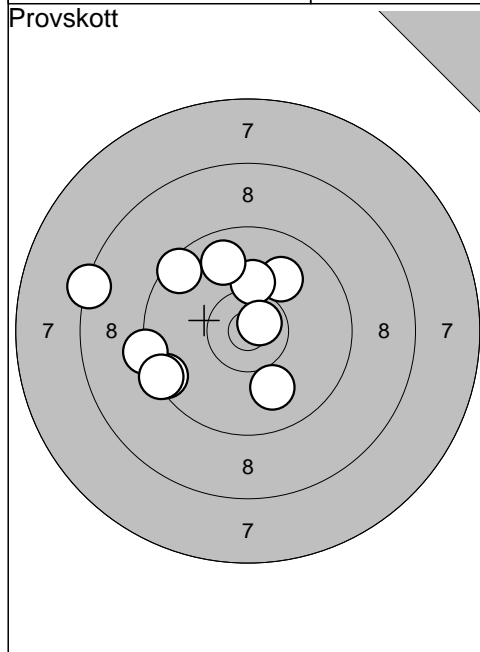

1: 8,4	↖
2: 9,5	↙
3: 10,0	↗
4: 9,3	↖
5: 10,0	↘
6: 9,4	↖
7: 10,2	↗
8: 9,5	↖
9: 10,7*	↗
10: 9,8	↗
<hr/>	
Serie	93,0
Totalt	0,0

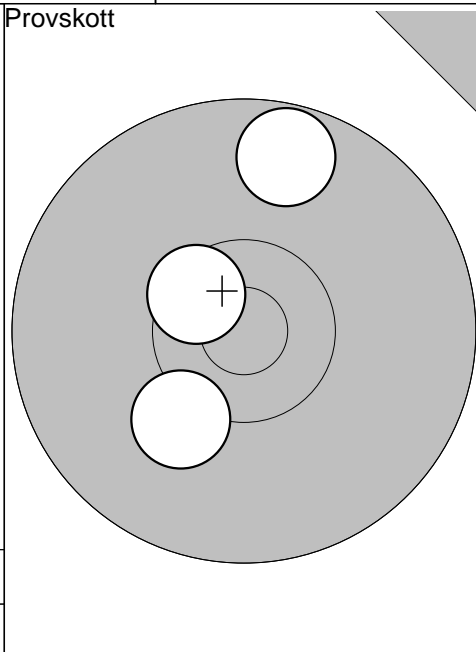

11: 10,2	↘
12: 10,5*	↖
13: 9,7	↗
<hr/>	
Serie	29,0
Totalt	0,0

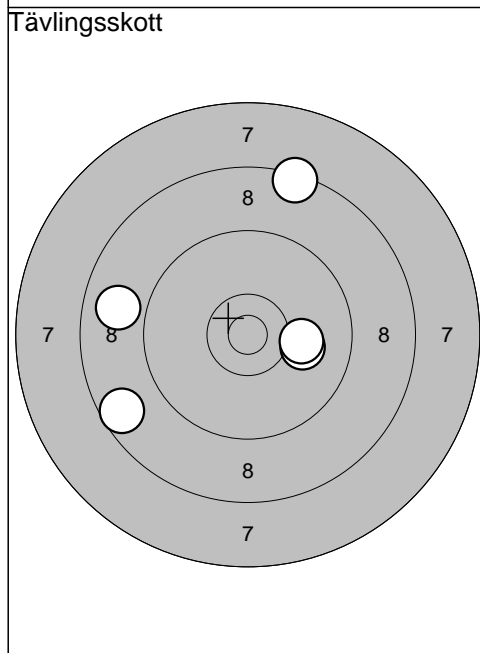

1: 8,4	↗
2: 10,1	→
3: 8,6	↖
4: 8,9	↖
5: 10,1	→
<hr/>	
Serie	44,0
Totalt	44,0

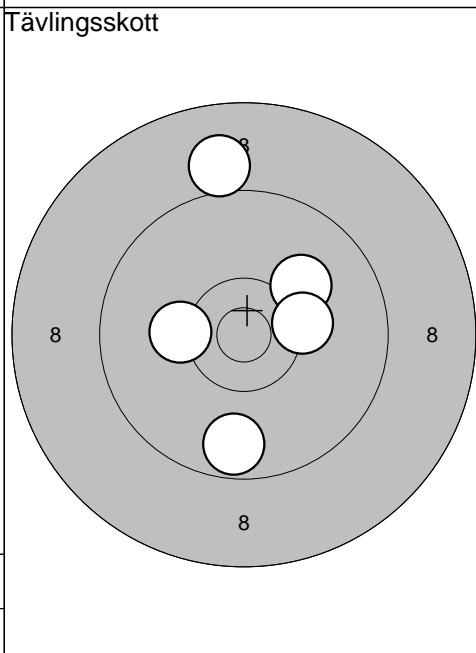

6: 9,7	↘
7: 10,1	↗
8: 10,3	→
9: 9,0	↗
10: 10,2	↖
<hr/>	
Serie	48,0
Totalt	92,0

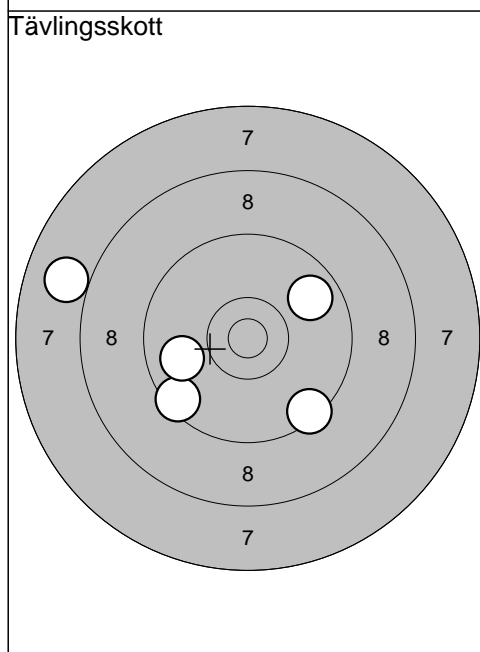

11: 9,8	↗
12: 9,4	↘
13: 8,0	↖
14: 9,5	↖
15: 9,9	↖
<hr/>	
Serie	44,0
Totalt	136,0

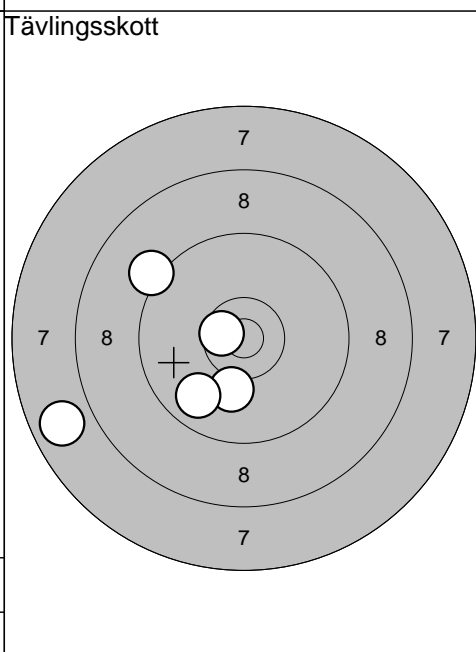

16: 9,2	↖
17: 10,6*	↖
18: 7,8	↖
19: 10,1	↘
20: 9,8	↘
<hr/>	
Serie	45,0
Totalt	181,0

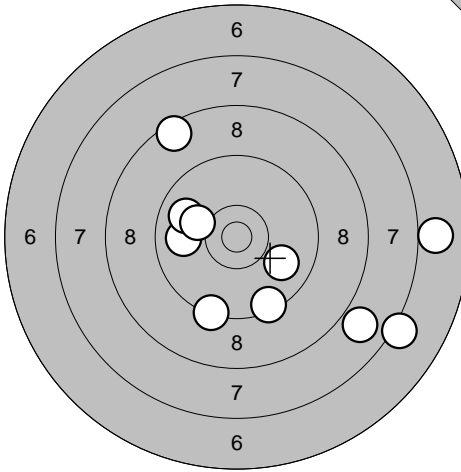
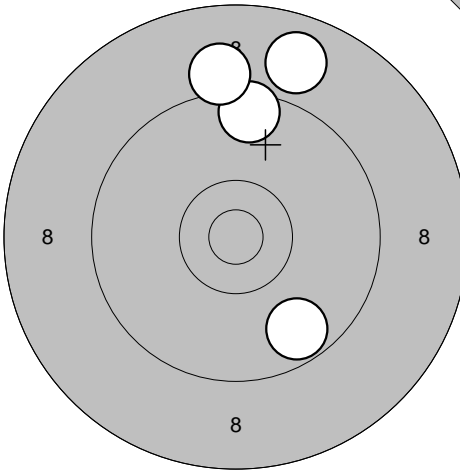
<p>Provskott</p> 	<p>1: 7,0 →</p> <p>2: 7,2 ↘</p> <p>3: 7,9 ↘</p> <p>4: 9,9 ↘</p> <p>5: 9,4 ↘</p> <p>6: 9,9 ←</p> <p>7: 8,5 ↗</p> <p>8: 9,9 ↗</p> <p>9: 9,3 ↘</p> <p>10: 10,1 ←</p>	<p>Provskott</p> 
Serie 84,0		Serie 35,0
Totalt 0,0		Totalt 0,0

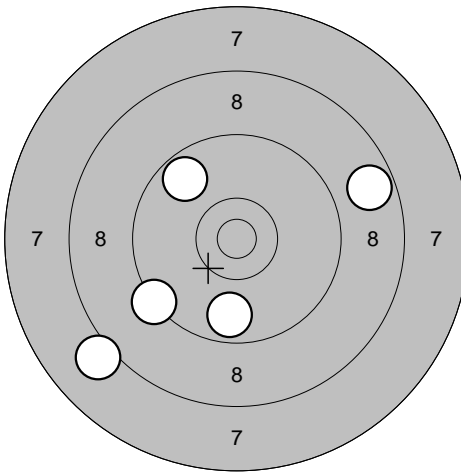
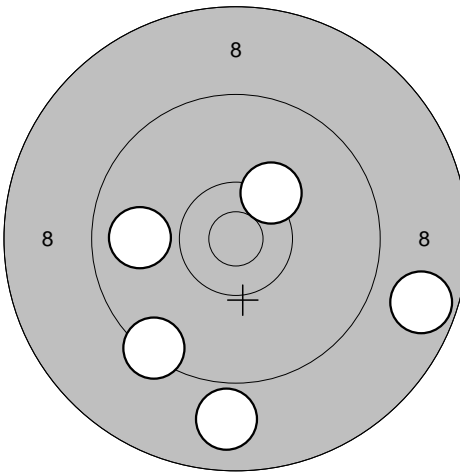
<p>Tävlingsskott</p> 	<p>1: 8,7 →</p> <p>2: 9,7 ↓</p> <p>3: 9,7 ↗</p> <p>4: 9,3 ↘</p> <p>5: 8,1 ↘</p>	<p>Tävlingsskott</p> 
Serie 43,0		Serie 44,0
Totalt 43,0		Totalt 87,0

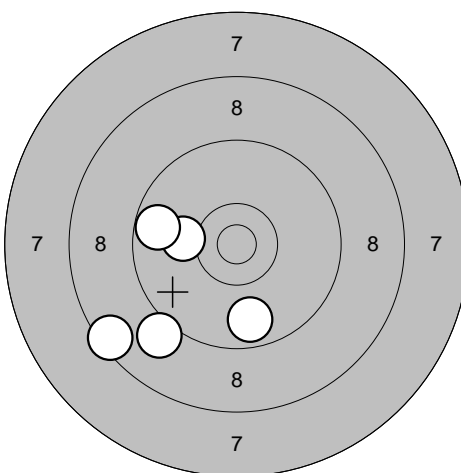
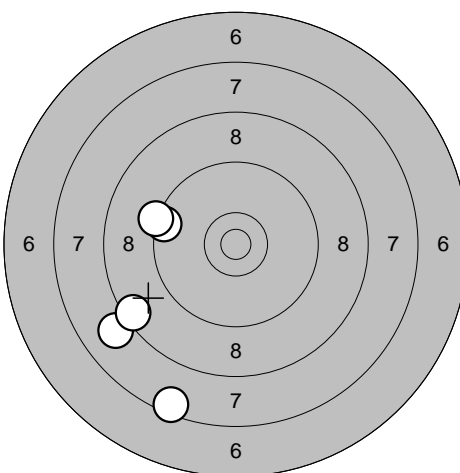
<p>Tävlingsskott</p> 	<p>11: 10,1 ←</p> <p>12: 9,1 ↘</p> <p>13: 8,5 ↘</p> <p>14: 9,7 ←</p> <p>15: 9,7 ↓</p>	<p>Tävlingsskott</p> 
Serie 45,0		Serie 41,0
Totalt 132,0		Totalt 173,0

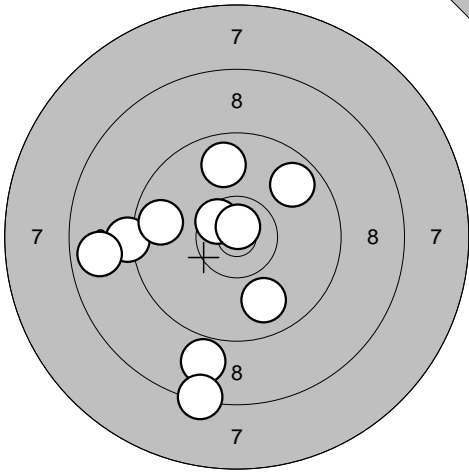
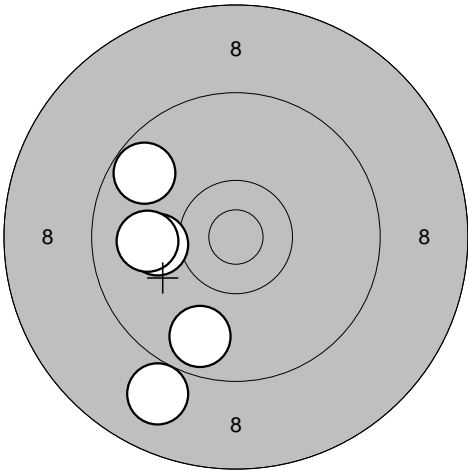
<p>Provs-kott</p> 	<p>1: 8,9 ↓</p> <p>2: 9,2 ←</p> <p>3: 9,7 ↗</p> <p>4: 9,9 ↓</p> <p>5: 9,8 ↑</p> <p>6: 9,7 ←</p> <p>7: 8,4 ↓</p> <p>8: 10,6* ↗</p> <p>9: 8,8 ←</p> <p>10: 10,8* ↑</p>	<p>Tävlingsskott</p> 	<p>1: 9,7 ↖</p> <p>2: 8,9 ↓</p> <p>3: 10,1 ←</p> <p>4: 9,9 ←</p> <p>5: 9,7 ↓</p>
Serie 89,0	Serie 45,0	Serie 45,0	
Totalt 0,0	Totalt 45,0	Totalt 45,0	

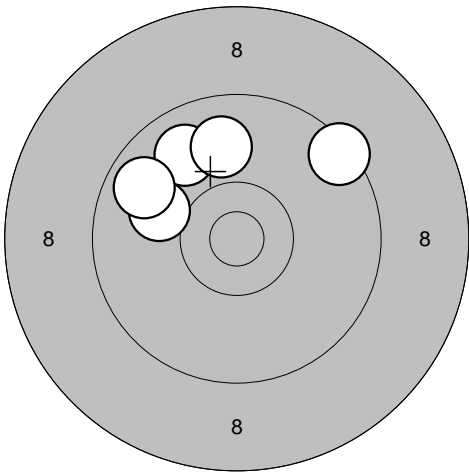
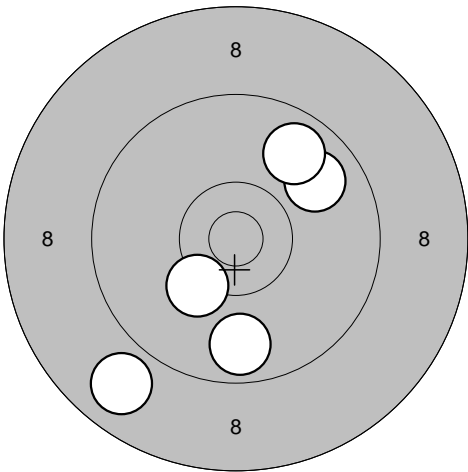
<p>Tävlingsskott</p> 	<p>6: 9,8 ↖</p> <p>7: 9,9 ↑</p> <p>8: 10,0 ←</p> <p>9: 9,4 ↗</p> <p>10: 9,7 ↖</p>	<p>Tävlingsskott</p> 	<p>11: 9,8 ↗</p> <p>12: 9,7 ↓</p> <p>13: 9,8 ↗</p> <p>14: 10,3 ↓</p> <p>15: 8,8 ↓</p>
Serie 46,0	Serie 45,0	Serie 45,0	
Totalt 91,0	Totalt 136,0	Totalt 136,0	

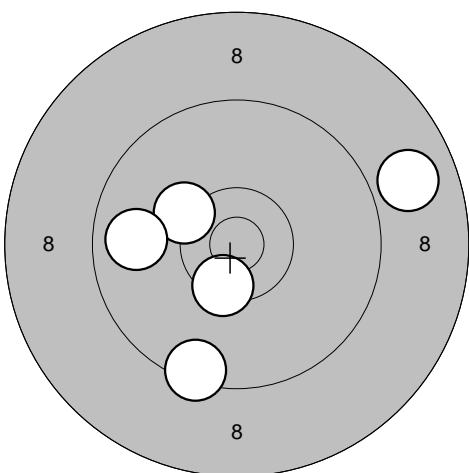
<p>Tävlingsskott</p> 	<p>16: 8,9 →</p> <p>17: 10,3 ↖</p> <p>18: 9,8 ←</p> <p>19: 10,4* ↓</p> <p>20: 9,4 ↓</p>		
Serie 46,0			
Totalt 182,0			

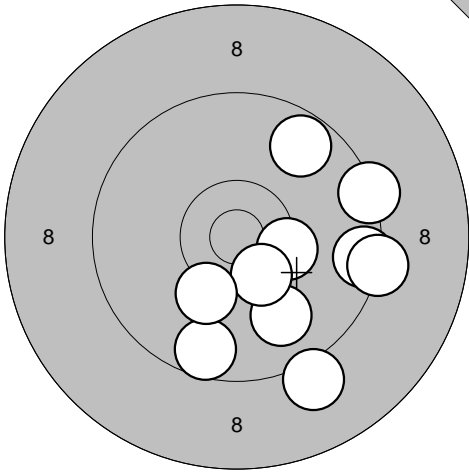
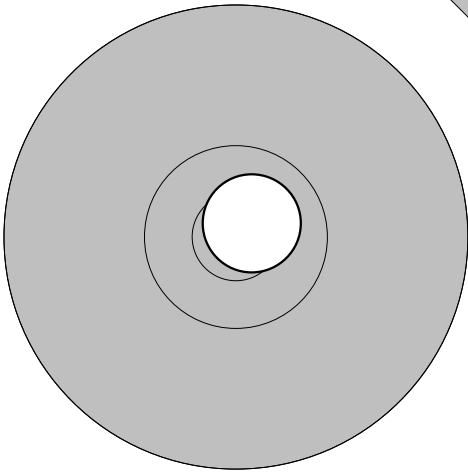
<p>Provskott</p> 	<p>1: 9,4 →</p> <p>2: 9,9 ↓</p> <p>3: 10,4* →</p> <p>4: 9,7 ↗</p> <p>5: 9,5 →</p> <p>6: 9,6 ↓</p> <p>7: 10,4* ↓</p> <p>8: 10,2 ↓</p> <p>9: 9,3 →</p> <p>10: 9,1 ↓</p>	<p>Provskott</p>  <p style="text-align: right;">11: 10,8* ↗</p>
Serie 93,0		Serie 10,0
Totalt 0,0		Totalt 0,0

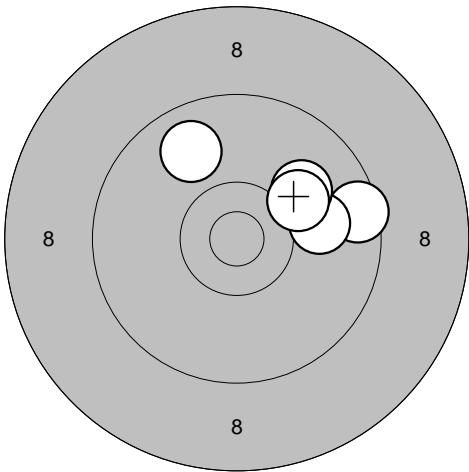
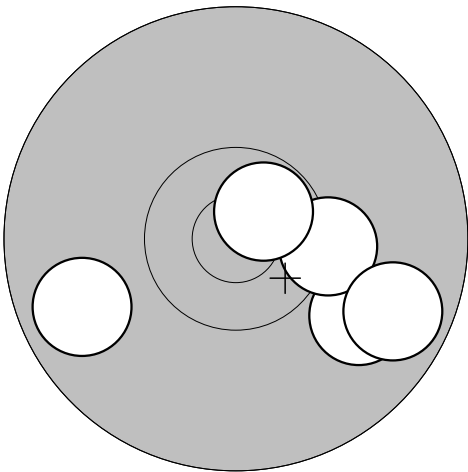
<p>Tävlingsskott</p> 	<p>1: 9,5 →</p> <p>2: 10,0 →</p> <p>3: 10,0 ↗</p> <p>4: 9,8 ↗</p> <p>5: 10,1 ↗</p>	<p>Tävlingsskott</p>  <p style="text-align: right;">6: 9,9 ↓</p> <p style="text-align: right;">7: 10,3* →</p> <p style="text-align: right;">8: 10,7* ↗</p> <p style="text-align: right;">9: 9,7 ↓</p> <p style="text-align: right;">10: 9,8 ←</p>
Serie 48,0		Serie 47,0
Totalt 48,0		Totalt 95,0

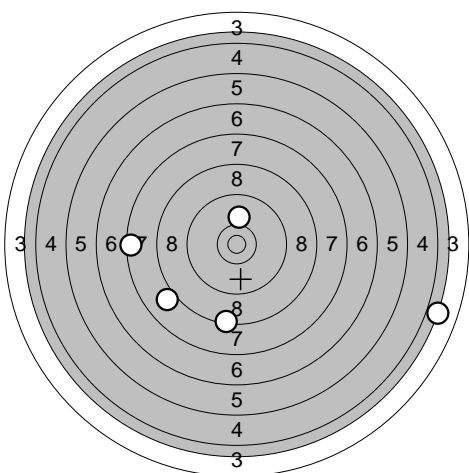
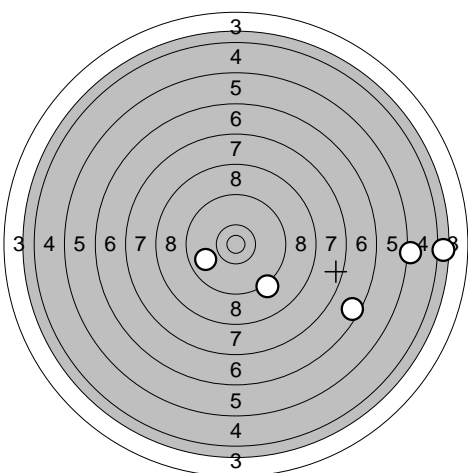
<p>Tävlingsskott</p> 	<p>11: 8,4 ↓</p> <p>12: 7,5 ←</p> <p>13: 3,9 →</p> <p>14: 8,0 ↙</p> <p>15: 10,1 ↑</p>	<p>Tävlingsskott</p>  <p style="text-align: right;">16: 5,2 →</p> <p style="text-align: right;">17: 6,6 ↓</p> <p style="text-align: right;">18: 4,1 →</p> <p style="text-align: right;">19: 9,2 ↓</p> <p style="text-align: right;">20: 9,8 ←</p>
Serie 36,0		Serie 33,0
Totalt 131,0		Totalt 164,0

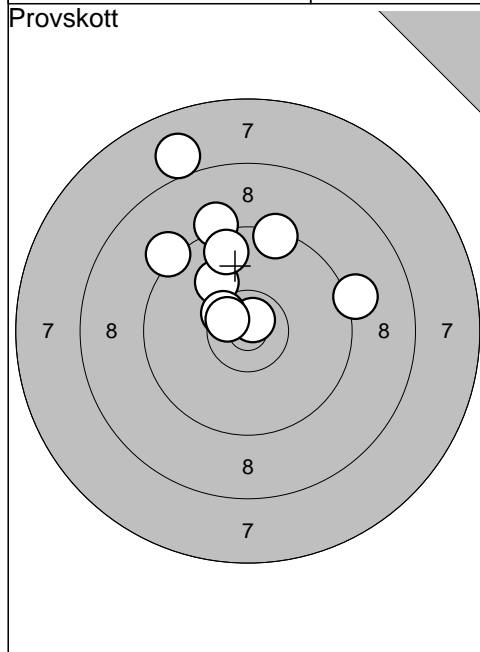

1: 9,2	→
2: 10,8*	↗
3: 10,0	↗
4: 9,2	↗
5: 9,4	↗
6: 10,5*	↗
7: 10,6*	↗
8: 8,0	↗
9: 9,2	↗
10: 9,7	↗
<hr/>	
Serie	93,0
Totalt	0,0

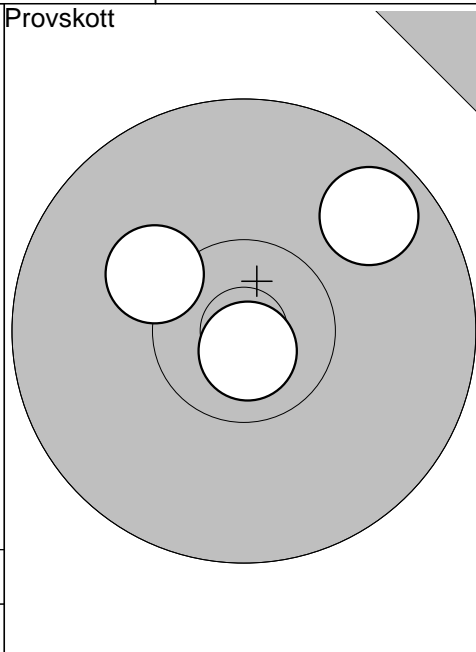

11: 10,8*	↓
12: 9,7	↗
13: 10,2	↖
<hr/>	
Serie	29,0
Totalt	0,0

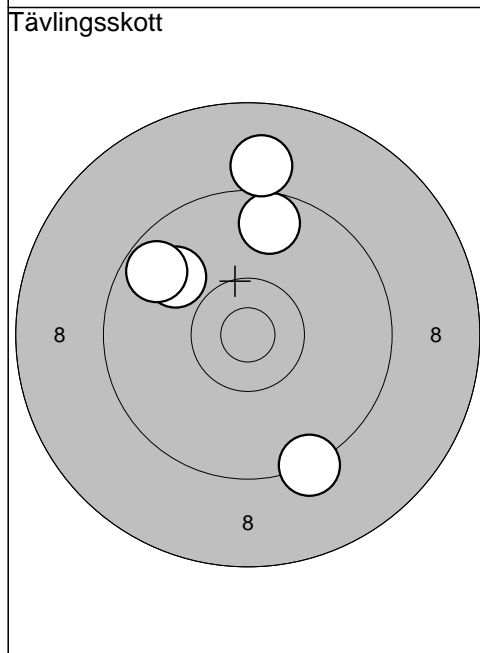

1: 9,9	↖
2: 9,7	↗
3: 9,0	↗
4: 9,3	↘
5: 9,7	↗
<hr/>	
Serie	45,0
Totalt	45,0

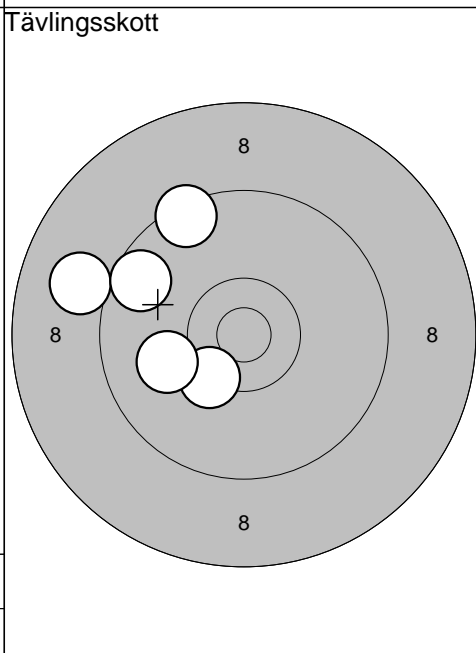

6: 9,4	↗
7: 10,3*	↘
8: 9,0	↖
9: 9,6	↖
10: 10,0	↖
<hr/>	
Serie	47,0
Totalt	92,0

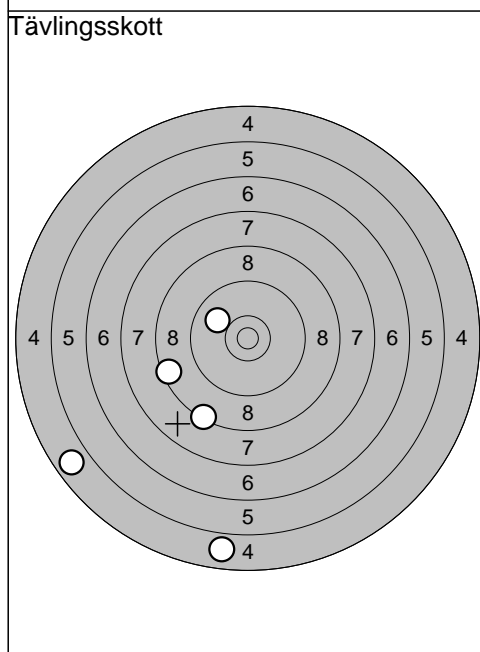

11: 4,9	↓
12: 4,8	↖
13: 8,4	↘
14: 8,5	↖
15: 10,0	↖
<hr/>	
Serie	34,0
Totalt	126,0

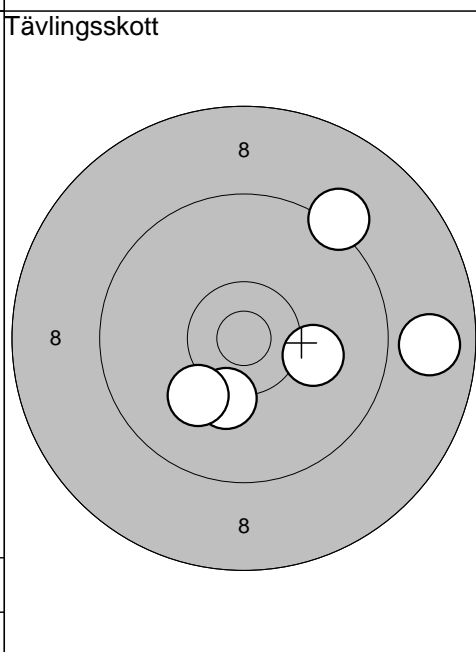

16: 10,1	→
17: 10,2	↓
18: 8,8	→
19: 10,1	↘
20: 9,2	↗
<hr/>	
Serie	47,0
Totalt	173,0

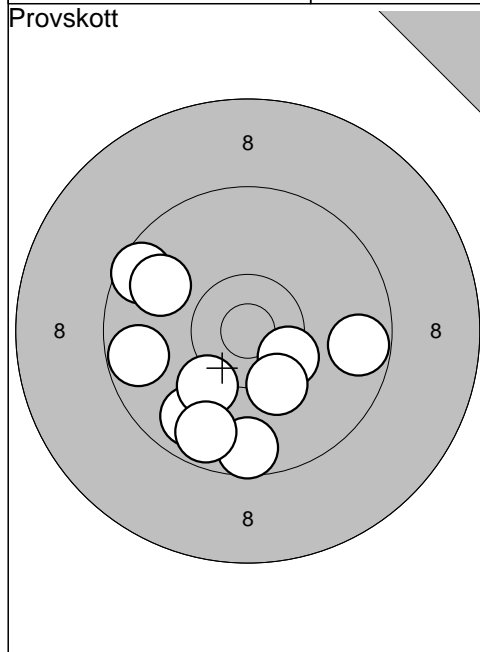

1: 9,6	↓
2: 9,8	↙
3: 9,7	→
4: 10,4*	↘
5: 10,2	↓
6: 10,2	↙
7: 9,7	←
8: 9,6	↗
9: 9,8	↗
10: 9,7	↓
Serie 93,0	
Totalt 0,0	

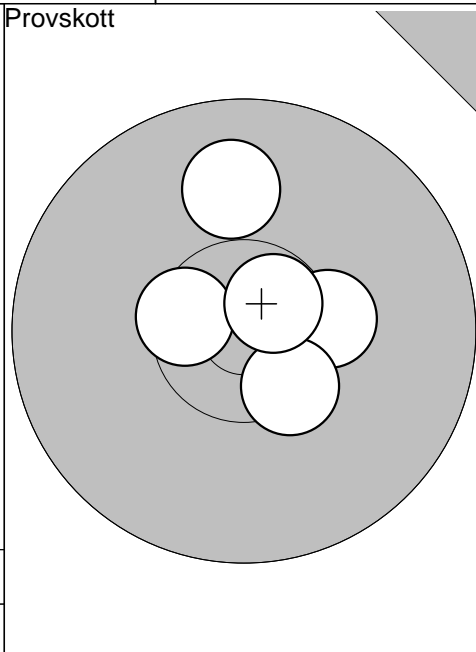

11: 9,9	↑
12: 10,3*	→
13: 10,5*	←
14: 10,4*	↘
15: 10,7*	↗
Serie 49,0	
Totalt 0,0	

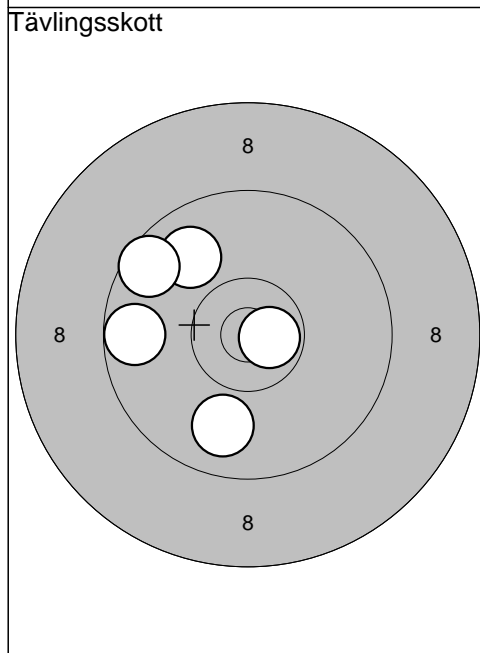

1: 9,9	↗
2: 10,7*	→
3: 9,6	↗
4: 9,9	↓
5: 9,7	←
Serie 46,0	
Totalt 46,0	

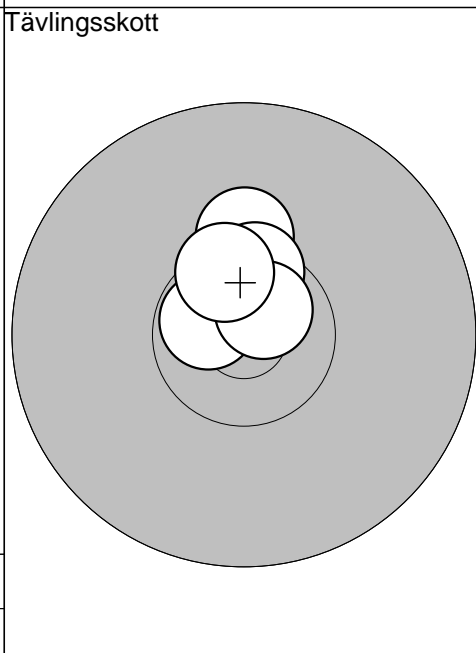

6: 10,3	↑
7: 10,7*	←
8: 10,5*	↑
9: 10,7*	↗
10: 10,5*	↑
Serie 50,0	
Totalt 96,0	

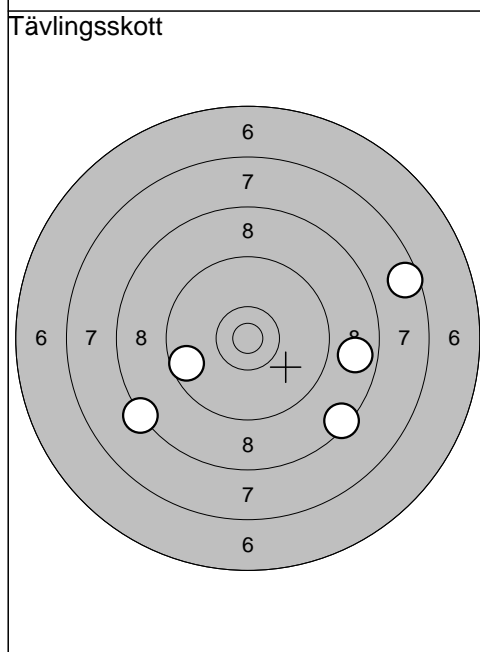

11: 8,4	↘
12: 9,6	←
13: 8,8	→
14: 8,3	↙
15: 7,6	→
Serie 40,0	
Totalt 136,0	

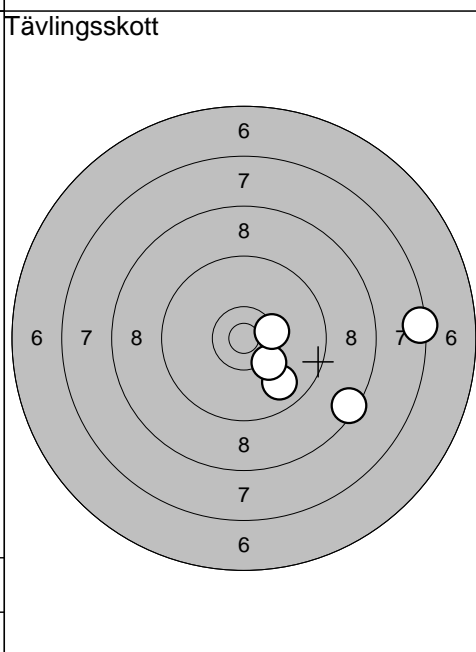

16: 8,4	↘
17: 9,8	↘
18: 7,4	→
19: 10,2	↘
20: 10,4*	→
Serie 44,0	
Totalt 180,0	

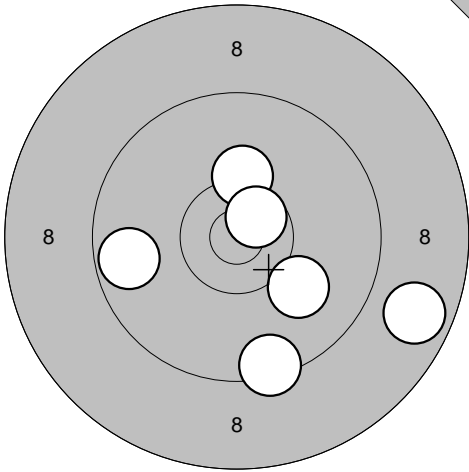
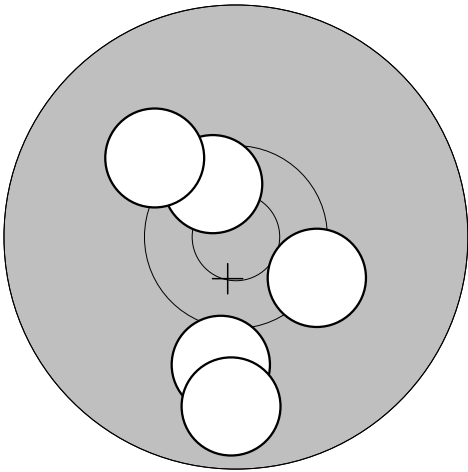
<p>Provs-kott</p> 	<p>Tävlingsskott</p> 	
<p>1: 9,4 ↓</p> <p>2: 8,7 →</p> <p>3: 10,3 ↑</p> <p>4: 10,0 ↓</p> <p>5: 9,7 ←</p> <p>6: 10,6* ↗</p>	<p>1: 10,0 ↓</p> <p>2: 9,7 ↓</p> <p>3: 10,3* →</p> <p>4: 10,5* ↗</p> <p>5: 10,1 ↗</p>	
Serie 56,0	Serie 49,0	
Totalt 0,0	Totalt 49,0	

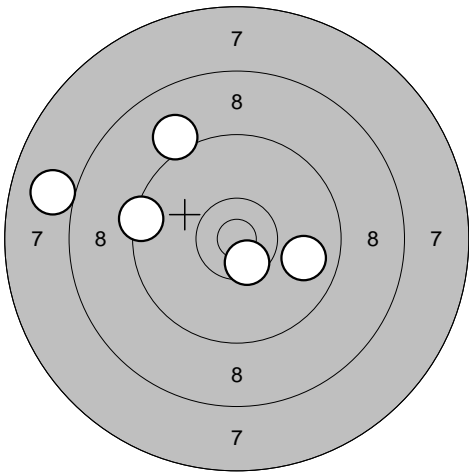
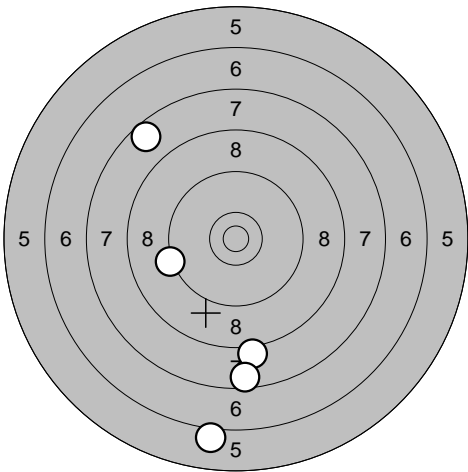
<p>Tävlingsskott</p> 	<p>Tävlingsskott</p> 	
<p>6: 8,0 ←</p> <p>7: 9,8 →</p> <p>8: 9,1 ↗</p> <p>9: 10,5* ↓</p> <p>10: 9,4 ←</p>	<p>11: 9,3 ←</p> <p>12: 8,1 ↓</p> <p>13: 7,7 ↗</p> <p>14: 7,6 ↓</p> <p>15: 6,1 ↓</p>	
Serie 45,0	Serie 37,0	
Totalt 94,0	Totalt 131,0	

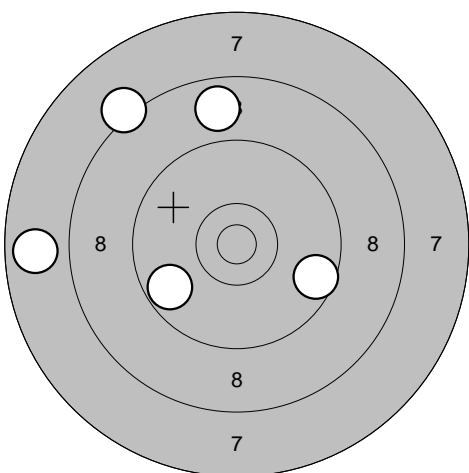
<p>Tävlingsskott</p> 		
<p>16: 8,8 ↑</p> <p>17: 7,8 ←</p> <p>18: 8,2 ↗</p> <p>19: 9,6 →</p> <p>20: 9,7 ←</p>		
Serie 41,0		
Totalt 172,0		

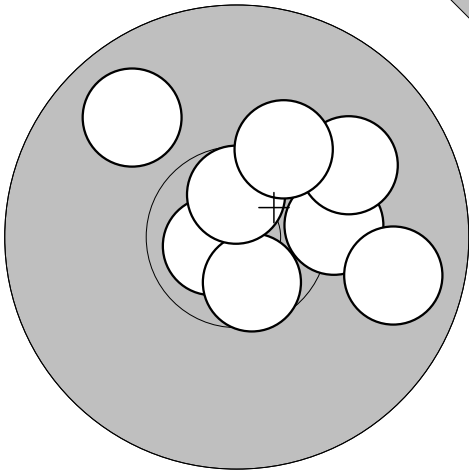
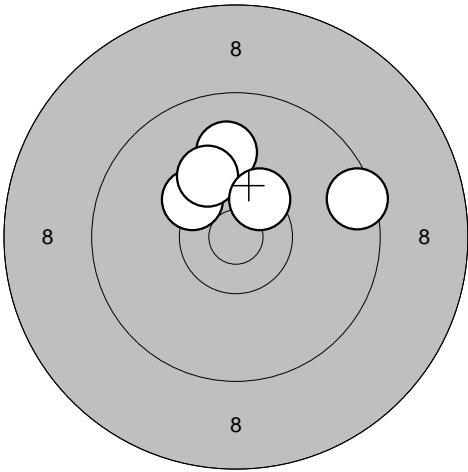
Provs-kott 	1: 10,8* ← 2: 10,3 → 3: 9,8 ↖ 4: 10,6* ↓ 5: 10,7* ↑ 6: 10,0 ↗ 7: 10,2 ↗ 8: 9,8 →	Tävlingsskott 	1: 9,5 → 2: 10,0 ↑ 3: 10,3* ↖ 4: 10,2 ↗ 5: 10,4* ↗
Serie	78,0	Serie	49,0
Totalt	0,0	Totalt	49,0

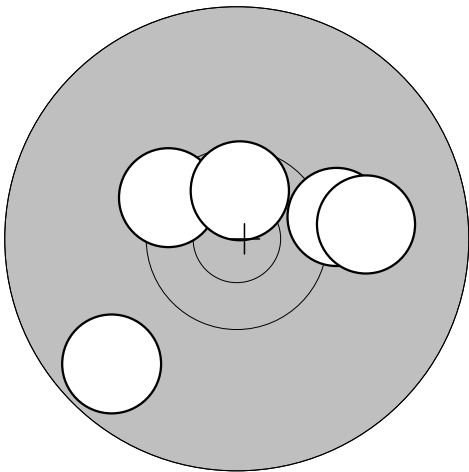
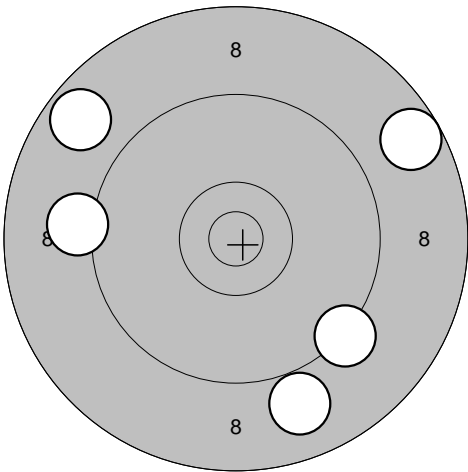
Tävlingsskott 	6: 9,7 ↘ 7: 10,2 → 8: 10,0 → 9: 10,4* ↖ 10: 10,6* ↑	Tävlingsskott 	11: 9,3 ↘ 12: 8,7 ↗ 13: 9,1 ← 14: 8,7 ↖ 15: 8,9 ↓
Serie	49,0	Serie	42,0
Totalt	98,0	Totalt	140,0

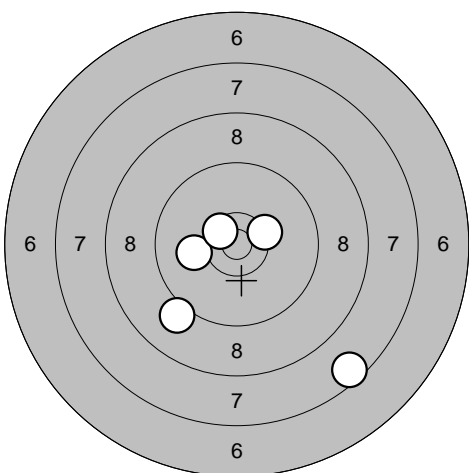
Tävlingsskott 	16: 7,6 ↘ 17: 10,3* ↗ 18: 10,1 ← 19: 10,5* ↖ 20: 9,1 ↘	
Serie	46,0	
Totalt	186,0	

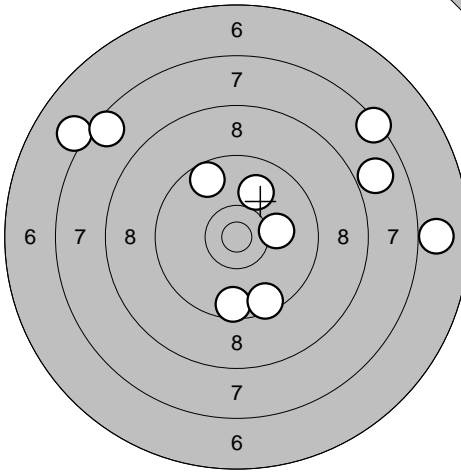
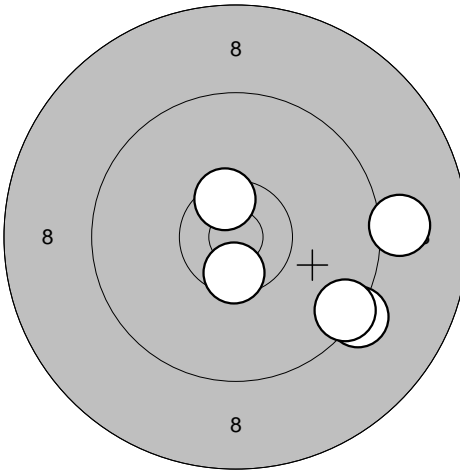
<p>Provs-kott</p> 	<p>1: 7,9 →</p> <p>2: 6,9 →</p> <p>3: 7,4 ↗</p> <p>4: 7,1 ↖</p> <p>5: 7,6 ↗</p> <p>6: 9,7 ↗</p> <p>7: 10,0 ↗</p> <p>8: 10,1 →</p> <p>9: 9,6 ↓</p> <p>10: 9,5 ↓</p> <hr/> <p>Serie 81,0</p> <p>Totalt 0,0</p>	<p>Tävlingsskott</p> 	<p>1: 10,5* ↓</p> <p>2: 9,3 ↘</p> <p>3: 9,4 ↘</p> <p>4: 9,1 →</p> <p>5: 10,5* ↑</p> <hr/> <p>Serie 47,0</p> <p>Totalt 47,0</p>
--	--	---	--

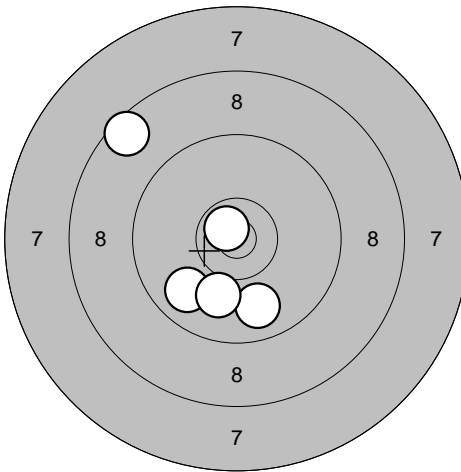
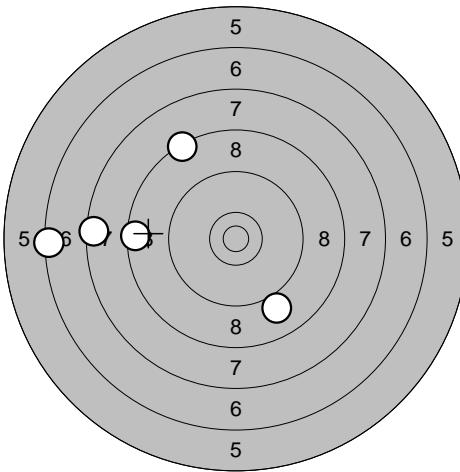
<p>Tävlingsskott</p> 	<p>6: 8,6 ↗</p> <p>7: 10,7* ↗</p> <p>8: 9,8 ↓</p> <p>9: 9,8 ↘</p> <p>10: 10,0 ↓</p> <hr/> <p>Serie 46,0</p> <p>Totalt 93,0</p>	<p>Tävlingsskott</p> 	<p>11: 8,5 ←</p> <p>12: 6,4 ←</p> <p>13: 9,0 ↓</p> <p>14: 7,5 ←</p> <p>15: 8,4 ↗</p> <hr/> <p>Serie 38,0</p> <p>Totalt 131,0</p>
--	--	--	--

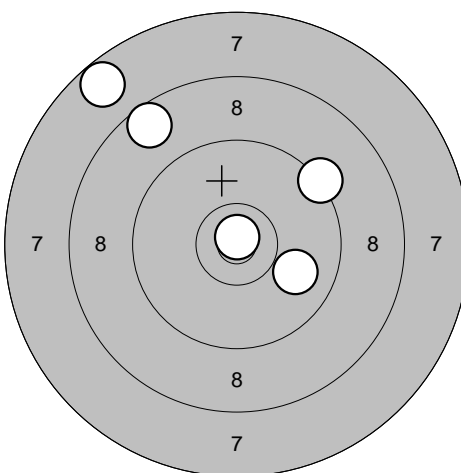
<p>Tävlingsskott</p> 	<p>16: 9,3 ↗</p> <p>17: 9,9 ↘</p> <p>18: 7,7 ↗</p> <p>19: 8,6 ↗</p> <p>20: 10,8* ↑</p> <hr/> <p>Serie 43,0</p> <p>Totalt 174,0</p>		
---	--	--	--

Drängsmark

2012-05-13

Vindelnskottet

Ramselefors SKF

Provskott

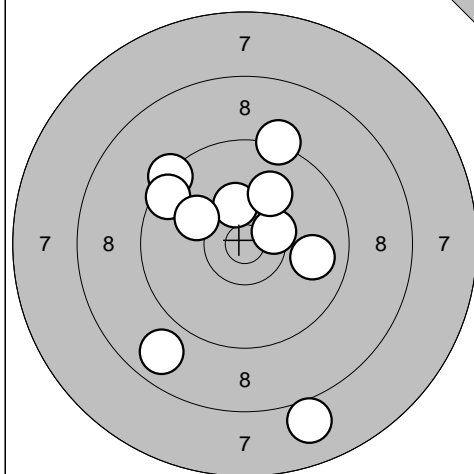

1: 10,3* ↑
 2: 9,4 ↗
 3: 8,8 ↘
 4: 9,5 ↗
 5: 8,0 ↘
 6: 10,4* →
 7: 9,3 ↑
 8: 9,9 →
 9: 10,1 ↗
 10: 10,1 ↗

Serie 92,0

Totalt 0,0

Provskott

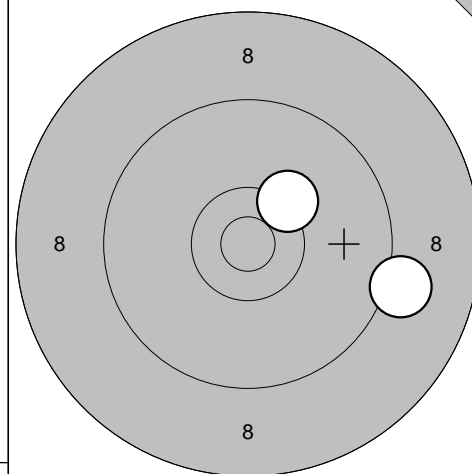

11: 9,1 →
 12: 10,3 ↗

Serie 19,0

Totalt 0,0

Tävlingsskott

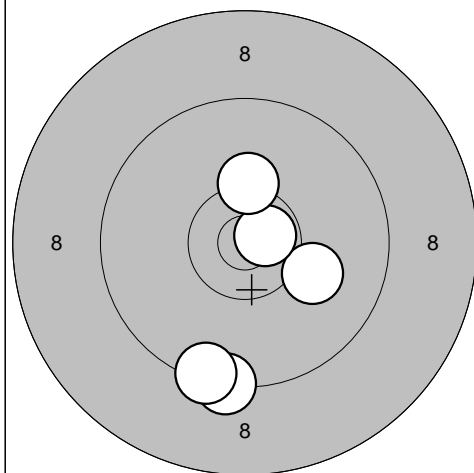

1: 10,1 →
 2: 10,7* →
 3: 9,3 ↘
 4: 10,3 ↑
 5: 9,4 ↘

Serie 48,0

Totalt 48,0

Tävlingsskott

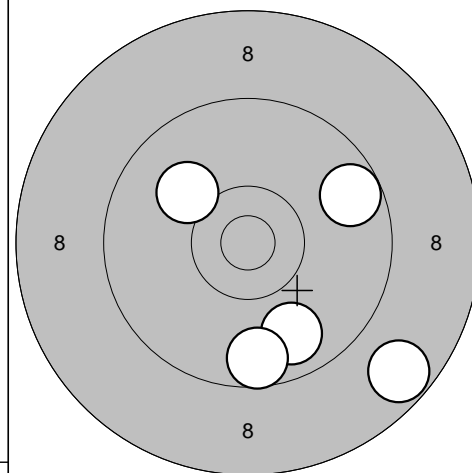

6: 9,7 ↗
 7: 9,8 ↘
 8: 8,7 ↘
 9: 10,1 ↗
 10: 9,6 ↘

Serie 45,0

Totalt 93,0

Tävlingsskott

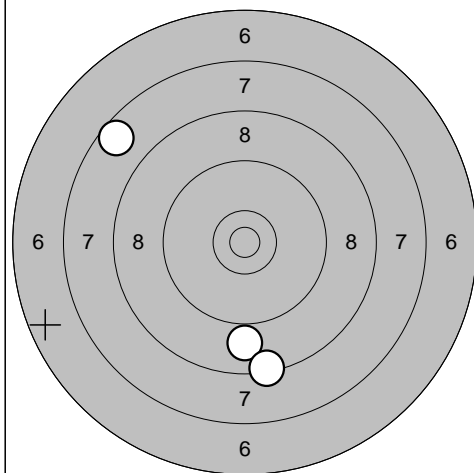

11: 0,0 ↘
 12: 8,9 ↘
 13: 8,4 ↘
 14: 7,6 ↗
 15: 0,0 ←

Serie 23,0

Totalt 116,0

Tävlingsskott

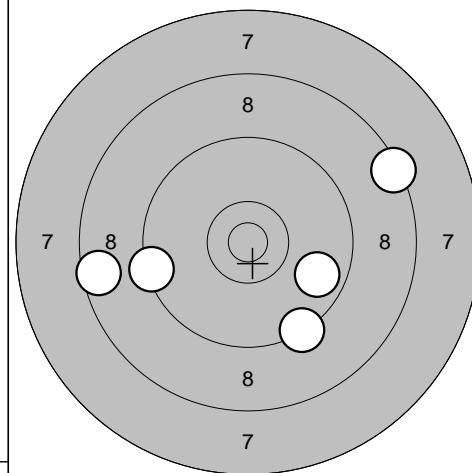

16: 9,4 ←
 17: 9,3 ↘
 18: 8,6 ←
 19: 9,7 →
 20: 8,4 ↗

Serie 43,0

Totalt 159,0

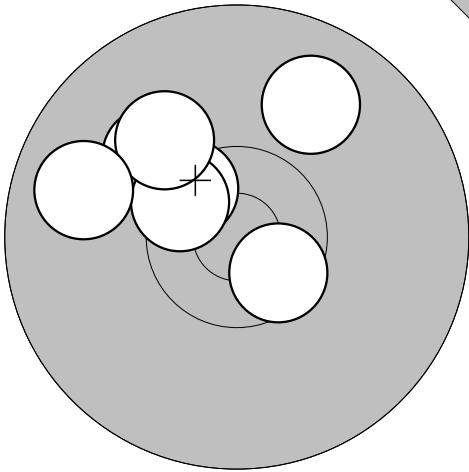
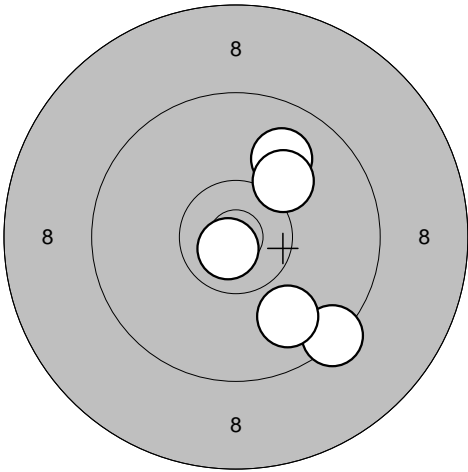
Provs-kott 	1: 10,1 ↖ 2: 9,9 ↗ 3: 10,5* ↗ 4: 10,5* ↗ 5: 10,1 ↗ 6: 9,8 ↖ 7: 10,6* ↘	Tävlingsskott 	1: 10,8* ↘ 2: 9,4 ↘ 3: 9,9 ↘ 4: 9,9 ↗ 5: 10,1 ↗
Serie 68,0	Totalt 0,0	Serie 47,0	Totalt 47,0

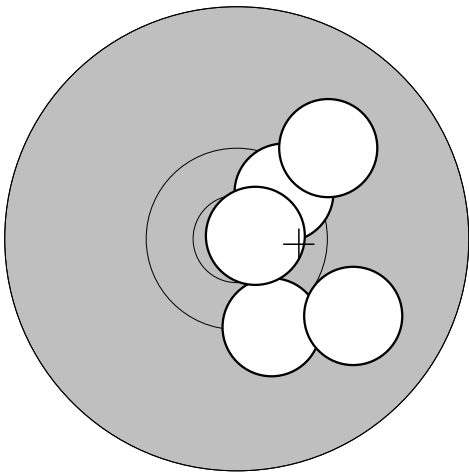
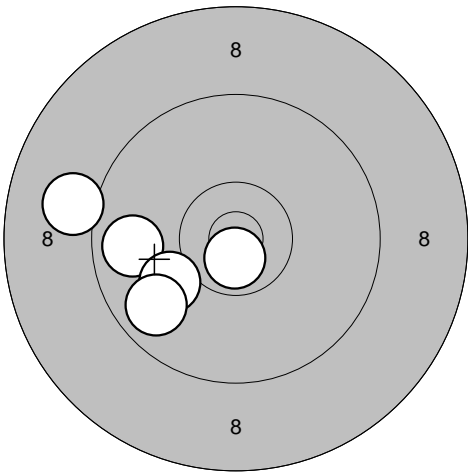
Tävlingsskott 	6: 10,5* ↗ 7: 10,3 ↘ 8: 10,0 ↘ 9: 10,0 ↗ 10: 10,8* →	Tävlingsskott 	11: 9,8 ← 12: 10,0 ↘ 13: 9,8 ↘ 14: 9,1 ← 15: 10,7* ↓
Serie 50,0	Totalt 97,0	Serie 47,0	Totalt 144,0

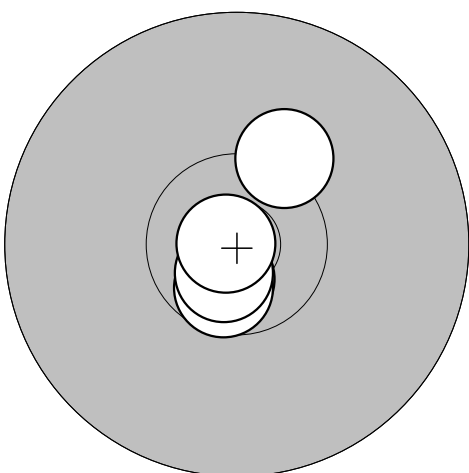
Tävlingsskott 	16: 10,7* ↘ 17: 10,6* ↘ 18: 10,7* ↘ 19: 10,3 ↗ 20: 10,9* ←		
Serie 50,0	Totalt 194,0		

Ale

2012-05-13	Vindelnskottet	Ramselefors SKF
------------	----------------	-----------------

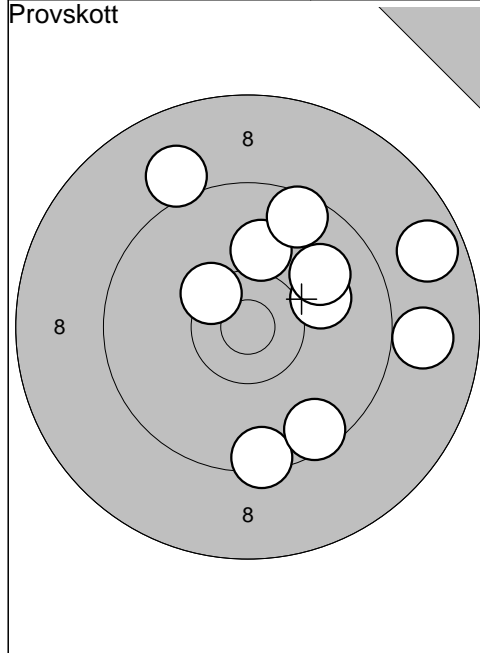

1: 10,1	↗
2: 8,7	→
3: 9,4	↓
4: 10,0	→
5: 9,5	↓
6: 8,9	→
7: 9,1	↗
8: 9,6	↗
9: 9,9	↗
10: 10,4*	↖
Serie 91,0	
Totalt 0,0	

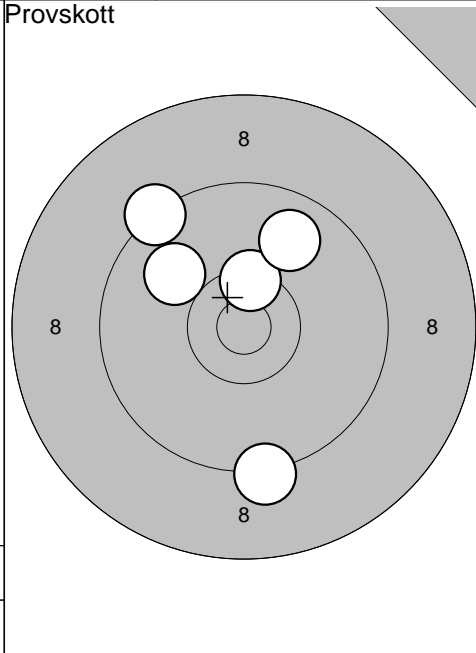

11: 10,0	↖
12: 9,3	↖
13: 9,3	↓
14: 10,4*	↗
15: 9,8	↗
Serie 47,0	
Totalt 0,0	

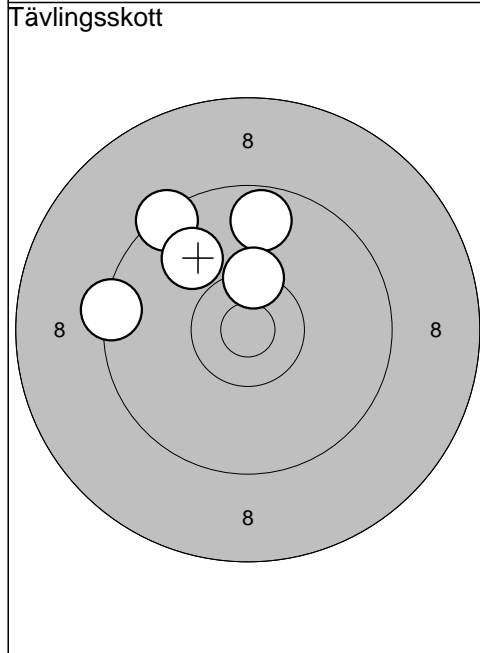

1: 9,4	↖
2: 9,4	←
3: 9,7	↗
4: 9,9	↖
5: 10,4*	↗
Serie 46,0	
Totalt 46,0	

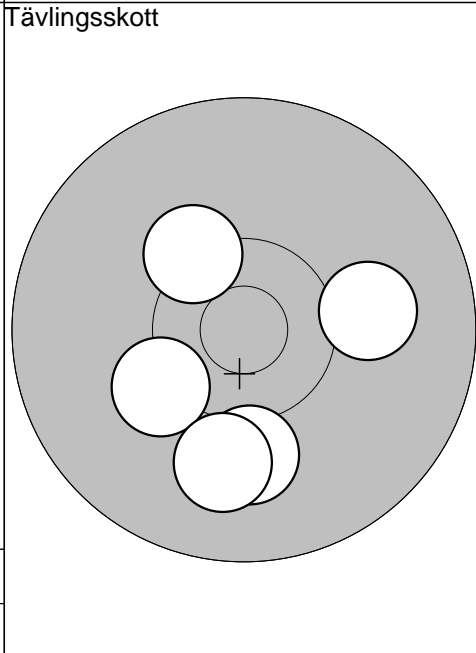

6: 10,1	↓
7: 10,3*	↖
8: 10,2	↖
9: 10,0	↓
10: 10,1	→
Serie 50,0	
Totalt 96,0	

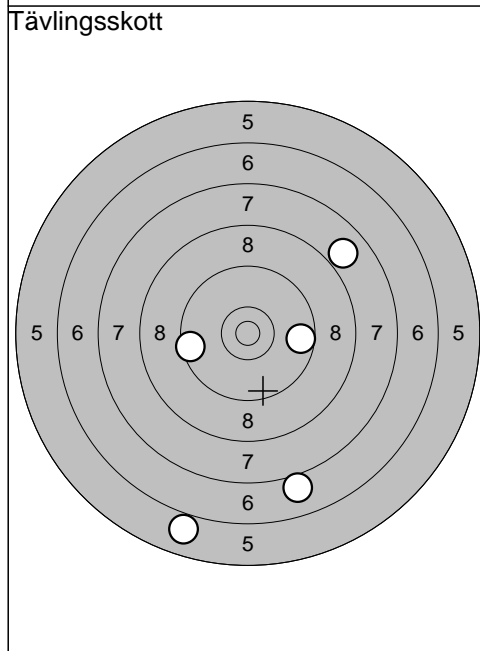

11: 7,0	↓
12: 9,6	→
13: 7,9	↗
14: 5,9	↓
15: 9,5	←
Serie 37,0	
Totalt 133,0	

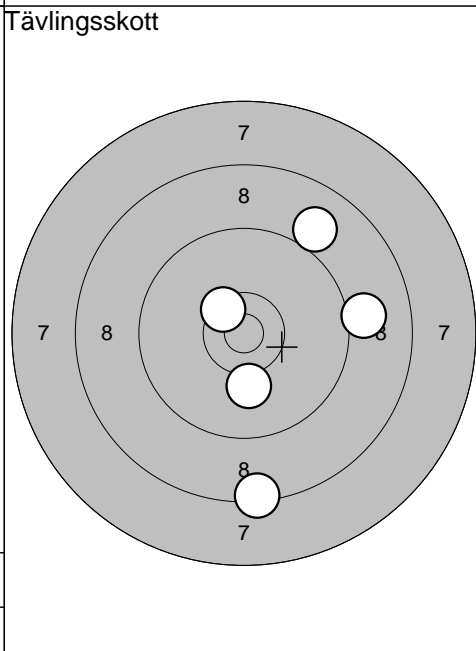

16: 9,0	↗
17: 8,4	↓
18: 9,0	→
19: 10,5*	↖
20: 10,1	↓
Serie 46,0	
Totalt 179,0	

Ramselefors		
-------------	--	--

2012-05-13	Vindelnskottet	Ramselefors SKF
------------	----------------	-----------------

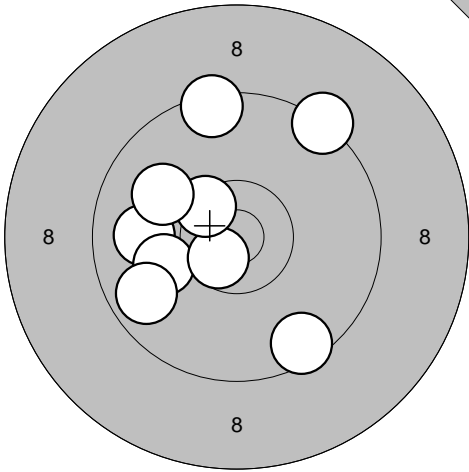
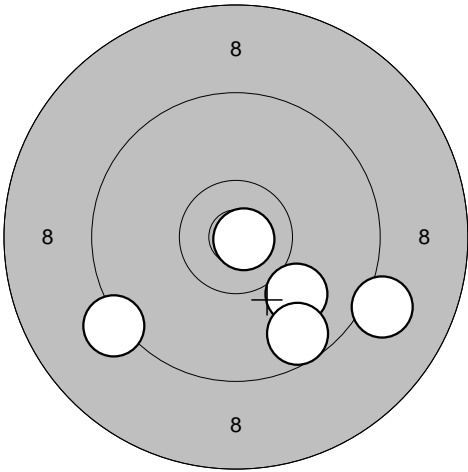
<p>Provs-kott</p> 	<p>1: 9,5 ↘ 2: 9,3 ↗ 3: 9,9 ← 4: 9,4 ↑ 5: 10,1 ← 6: 10,6* ↘ 7: 10,5* ↗ 8: 10,0 ↗ 9: 9,7 ↘</p>	<p>Tävlingsskott</p> 	<p>1: 10,0 ↘ 2: 9,1 ↘ 3: 10,9* → 4: 9,6 ↘ 5: 9,2 ↙</p>
Serie	85,0	Serie	47,0
Totalt	0,0	Totalt	47,0

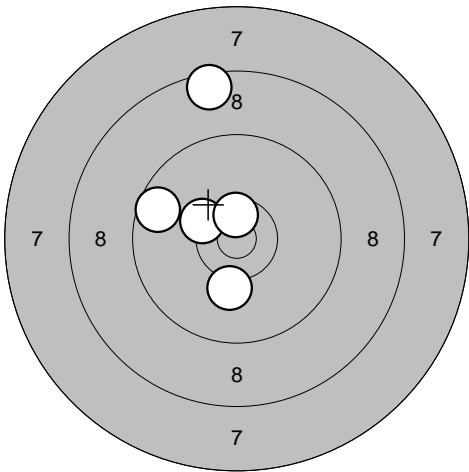
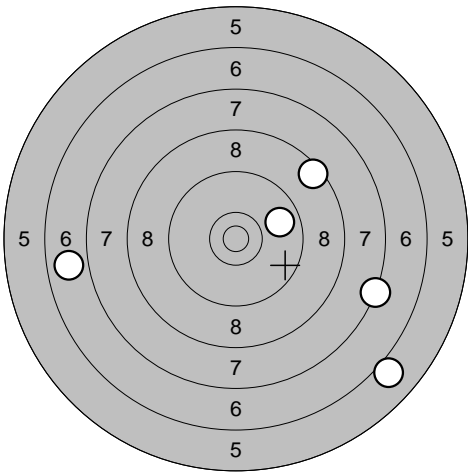
<p>Tävlingsskott</p> 	<p>6: 9,6 ← 7: 10,2 ↓ 8: 10,4* ← 9: 10,6* ↑ 10: 8,5 ↑</p>	<p>Tävlingsskott</p> 	<p>11: 7,3 → 12: 8,5 ↗ 13: 6,8 ← 14: 9,8 → 15: 6,0 ↘</p>
Serie	47,0	Serie	36,0
Totalt	94,0	Totalt	130,0

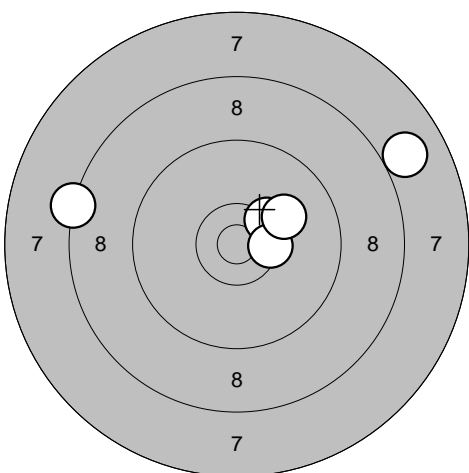
<p>Tävlingsskott</p> 	<p>16: 10,3* ↗ 17: 10,4* → 18: 10,1 ↗ 19: 8,3 ← 20: 7,9 →</p>	
Serie	45,0	
Totalt	175,0	

I 19 / A 9

2012-05-13

Vindelnskottet

Ramselefors SKF

Provskott

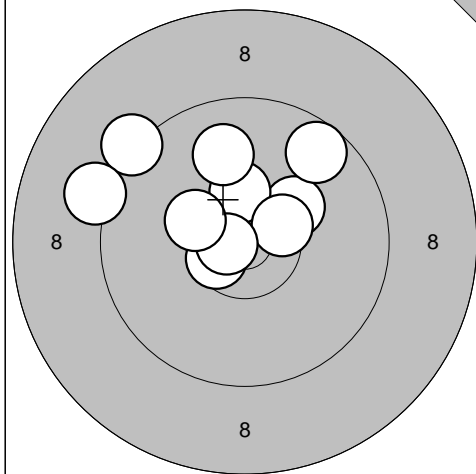

- 1: 9,3 ↖
- 2: 10,3 ↗
- 3: 10,4* ↑
- 4: 10,5* ↗
- 5: 9,6 ↗
- 6: 9,9 ↑
- 7: 10,6* ↖
- 8: 10,7* ←
- 9: 9,2 ↖
- 10: 10,3* ↖

Serie 96,0
Totalt 0,0

Provskott

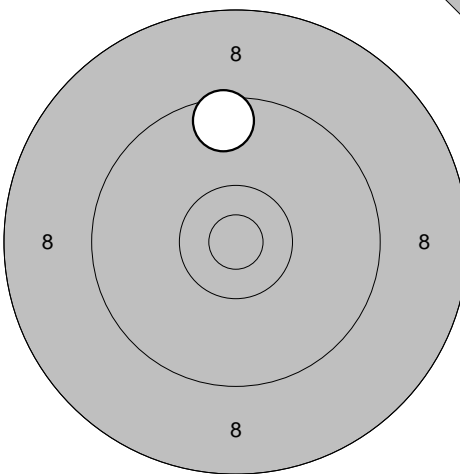

- 11: 9,6 ↑

Serie 9,0
Totalt 0,0

Tävlingsskott

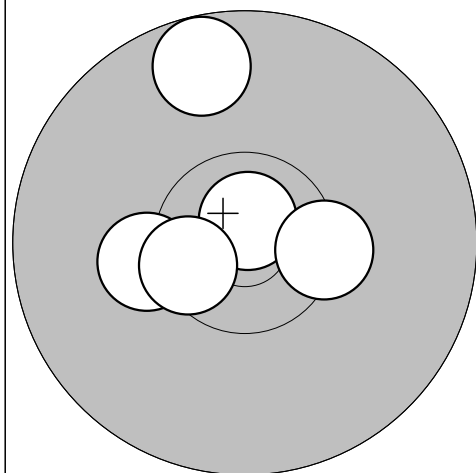

- 1: 10,8* ↑
- 2: 10,2 ←
- 3: 10,5* ←
- 4: 9,7 ↑
- 5: 10,4* →

Serie 49,0
Totalt 49,0

Tävlingsskott

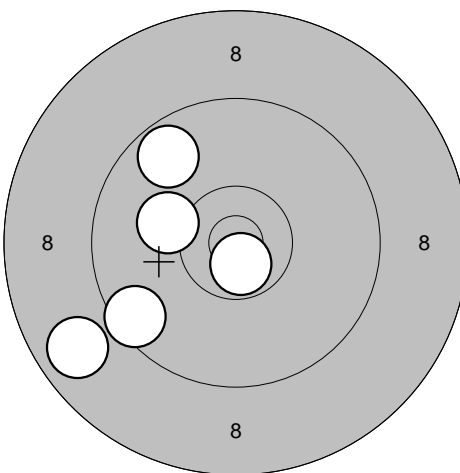

- 6: 9,7 ↖
- 7: 10,1 ←
- 8: 10,7* ↓
- 9: 8,8 ↖
- 10: 9,5 ↖

Serie 46,0
Totalt 95,0

Tävlingsskott

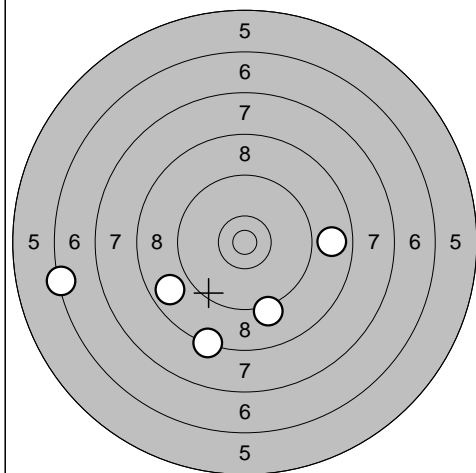

- 11: 8,8 ↖
- 12: 6,4 ←
- 13: 9,2 ↓
- 14: 8,3 ↓
- 15: 8,8 →

Serie 39,0
Totalt 134,0

Tävlingsskott

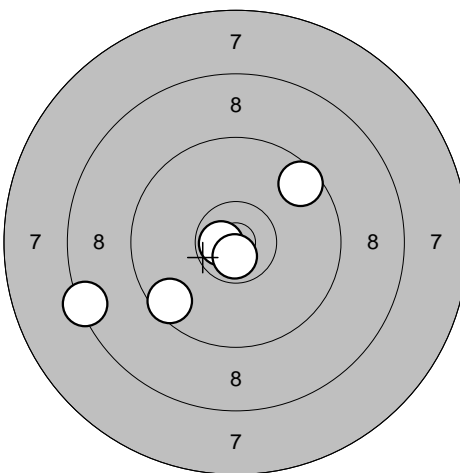

- 16: 8,4 ↖
- 17: 9,6 ↗
- 18: 10,7* ←
- 19: 10,7* ↓
- 20: 9,6 ↖

Serie 46,0
Totalt 180,0

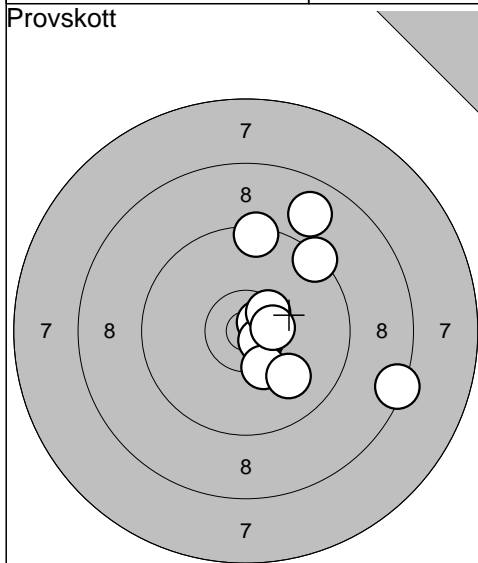

- 1: 8,9 ↗
- 2: 10,7* ↗
- 3: 10,7* ↘
- 4: 8,4 →
- 5: 9,4 ↑
- 6: 10,3* ↘
- 7: 10,5* ↗
- 8: 10,0 ↘
- 9: 10,5* →
- 10: 9,4 ↗

Serie	94,0
Totalt	0,0

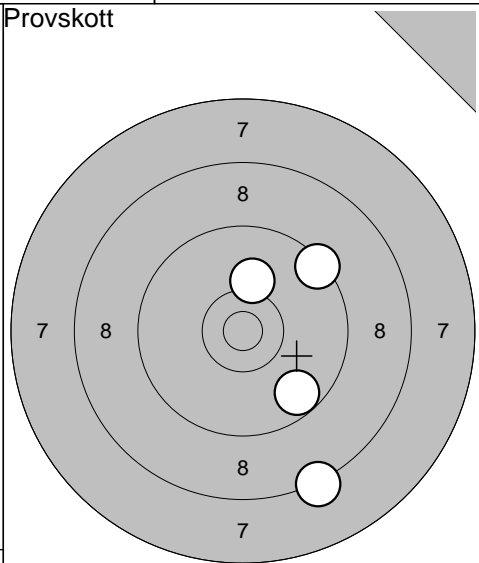

- 11: 9,7 ↘
- 12: 8,3 ↘
- 13: 9,4 ↗
- 14: 10,2 ↑

Serie	36,0
Totalt	0,0

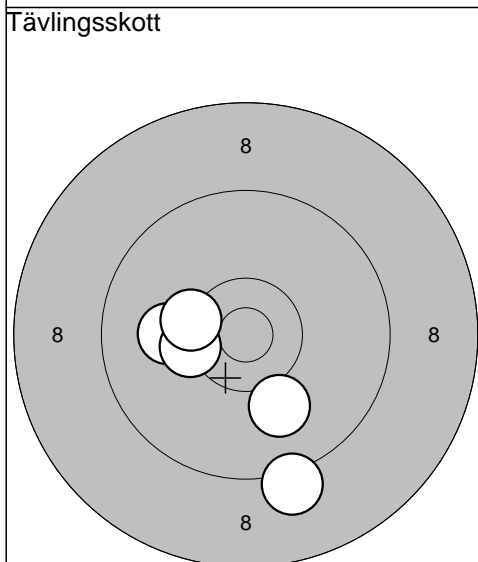

- 1: 10,1 ←
- 2: 10,3* ←
- 3: 10,3* ←
- 4: 10,0 ↘
- 5: 9,2 ↘

Serie	49,0
Totalt	49,0

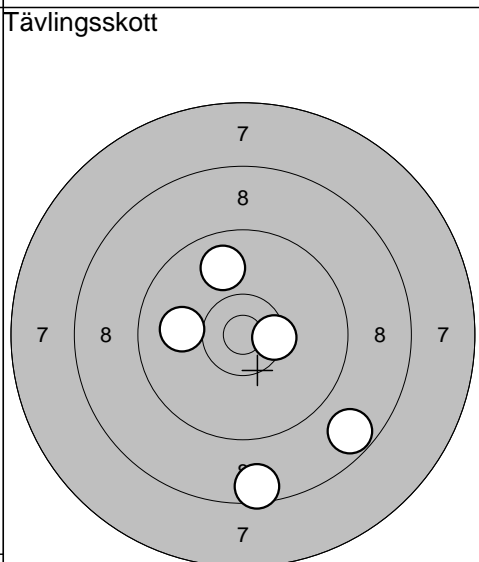

- 6: 10,0 ←
- 7: 8,6 ↓
- 8: 8,7 ↘
- 9: 10,4* →
- 10: 9,9 ↑

Serie	45,0
Totalt	94,0

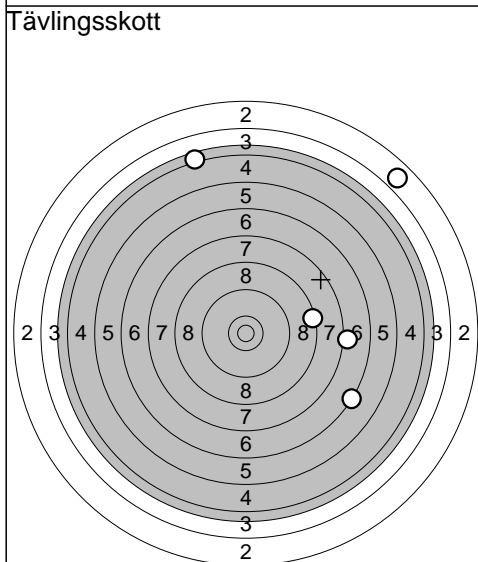

- 11: 2,9 ↗
- 12: 8,4 →
- 13: 7,1 →
- 14: 6,3 ↘
- 15: 4,2 ↑

Serie	27,0
Totalt	121,0

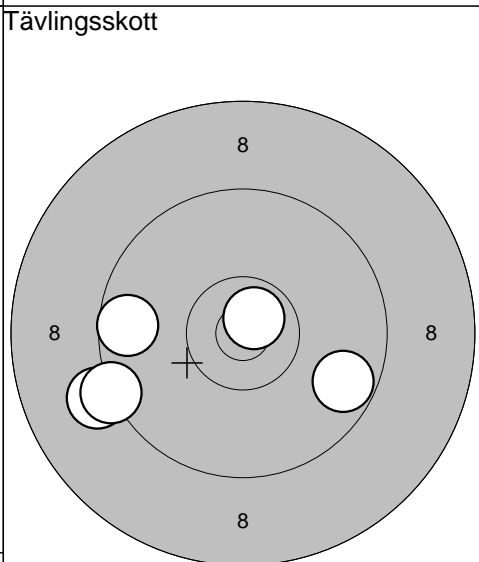

- 16: 9,6 ←
- 17: 9,1 ←
- 18: 9,3 ←
- 19: 9,7 ↘
- 20: 10,7* ↗

Serie	46,0
Totalt	167,0

S 3

2012-05-13

Vindelnskottet

Ramselefors SKF

Provs-kott

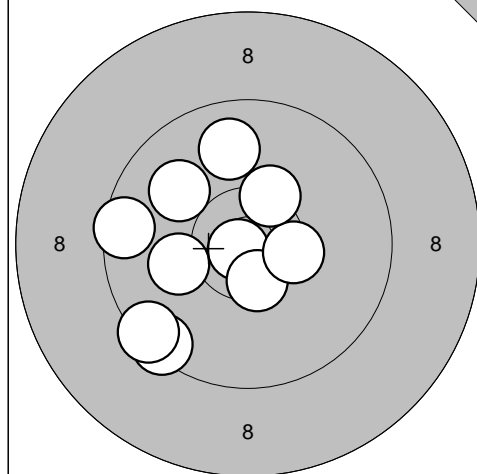

- 1: 10,8* ↙
- 2: 9,4 ↙
- 3: 10,5* ↘
- 4: 9,4 ↙
- 5: 10,4* →
- 6: 9,8 ↑
- 7: 10,1 ←
- 8: 10,3* ↗
- 9: 10,0 ↗
- 10: 9,5 ←

Serie	96,0
Totalt	0,0

Tävlingsskott

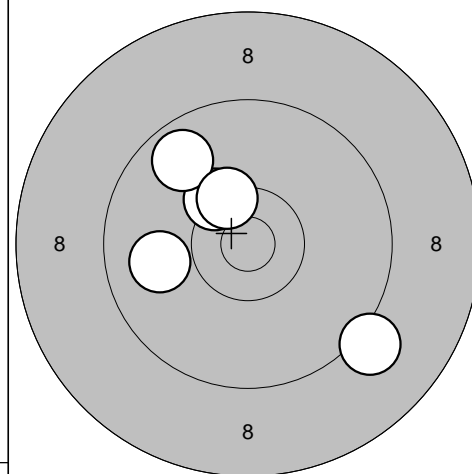

- 1: 10,3* ↗
- 2: 9,7 ↗
- 3: 9,1 ↘
- 4: 9,9 ←
- 5: 10,4* ↗

Serie	47,0
Totalt	47,0

Tävlingsskott

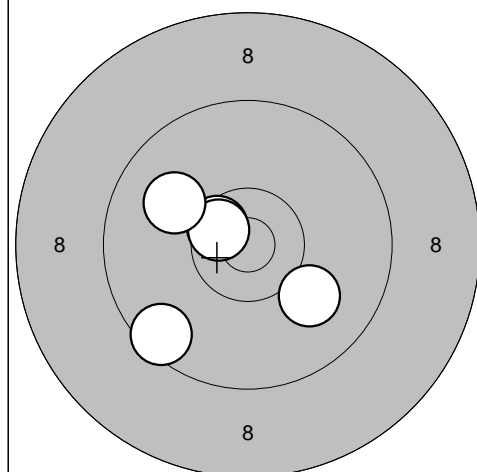

- 6: 10,5* ↗
- 7: 10,0 ↘
- 8: 10,6* ↗
- 9: 10,0 ↗
- 10: 9,5 ↘

Serie	49,0
Totalt	96,0

Tävlingsskott

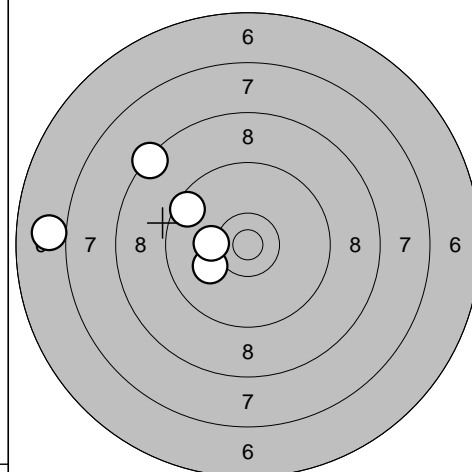

- 11: 8,4 ↗
- 12: 7,0 ←
- 13: 10,1 ↙
- 14: 10,2 ←
- 15: 9,6 ↗

Serie	44,0
Totalt	140,0

Tävlingsskott

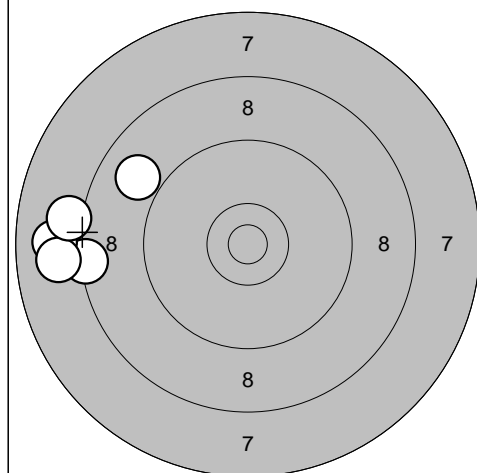

- 16: 8,4 ←
- 17: 7,9 ←
- 18: 8,0 ←
- 19: 8,9 ↗
- 20: 8,1 ←

Serie	39,0
Totalt	179,0

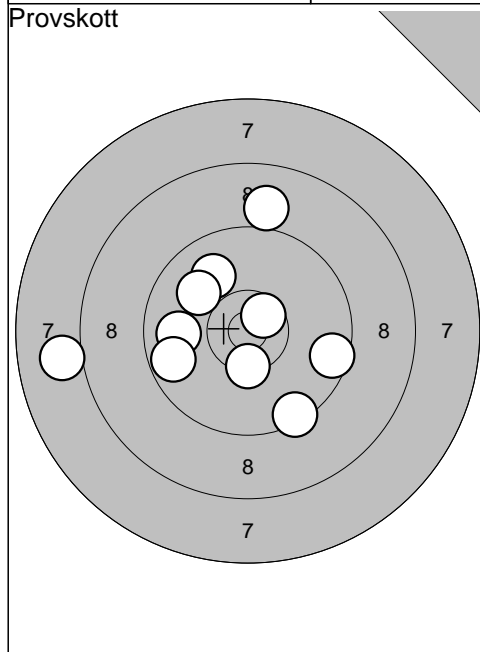

1: 9,9	←
2: 10,6*	↗
3: 9,7	←
4: 9,9	↗
5: 9,4	↘
6: 8,0	←
7: 10,4*	↘
8: 9,6	→
9: 9,0	↑
10: 10,0	↖
Serie 92,0	
Totalt 0,0	

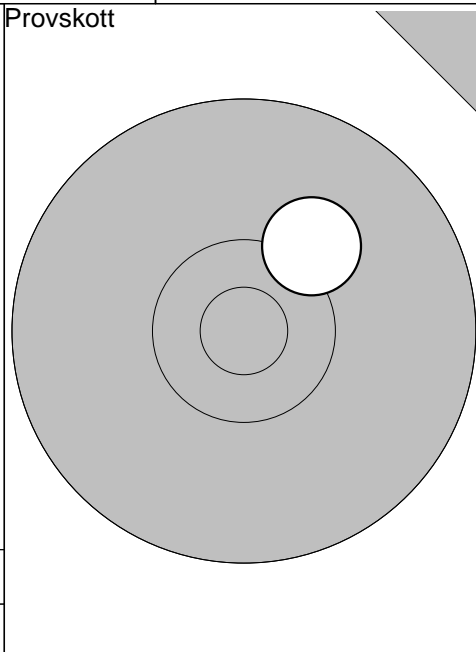

11: 10,2	↗
Serie 10,0	
Totalt 0,0	

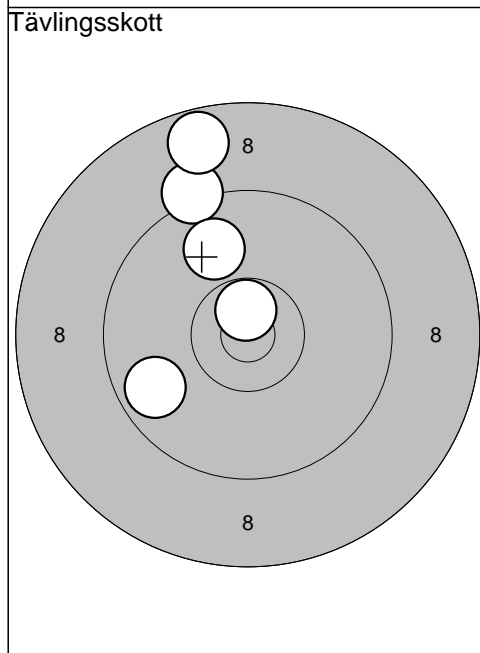

1: 9,2	↖
2: 8,7	↑
3: 10,7*	↑
4: 9,9	↖
5: 9,7	←
Serie 45,0	
Totalt 45,0	

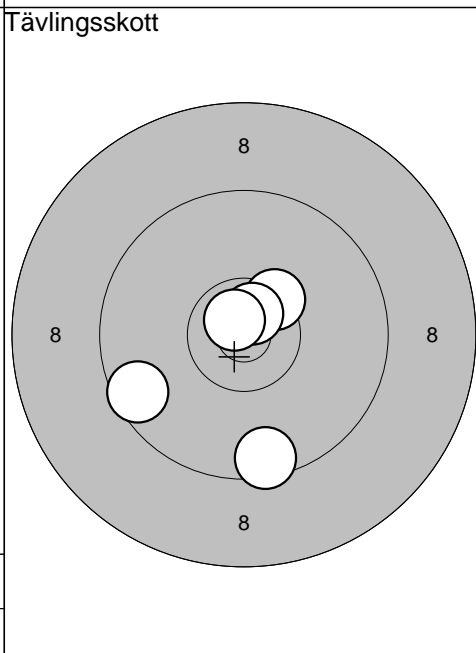

6: 10,4*	↗
7: 9,5	↘
8: 9,6	←
9: 10,7*	↖
10: 10,8*	↖
Serie 48,0	
Totalt 93,0	

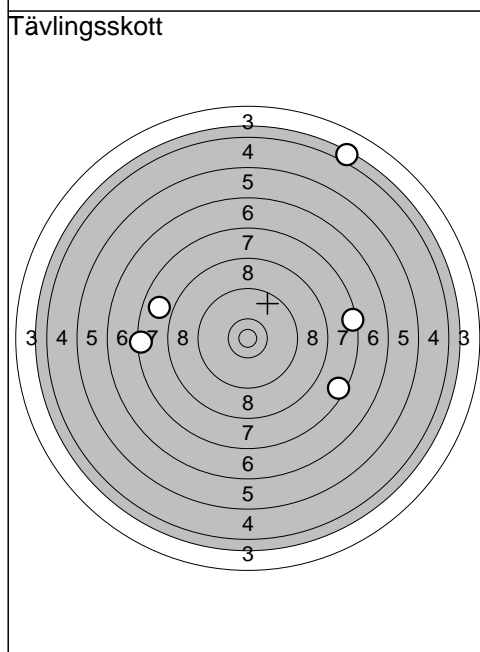

11: 7,9	←
12: 7,4	→
13: 4,1	↗
14: 7,5	↘
15: 7,4	←
Serie 32,0	
Totalt 125,0	

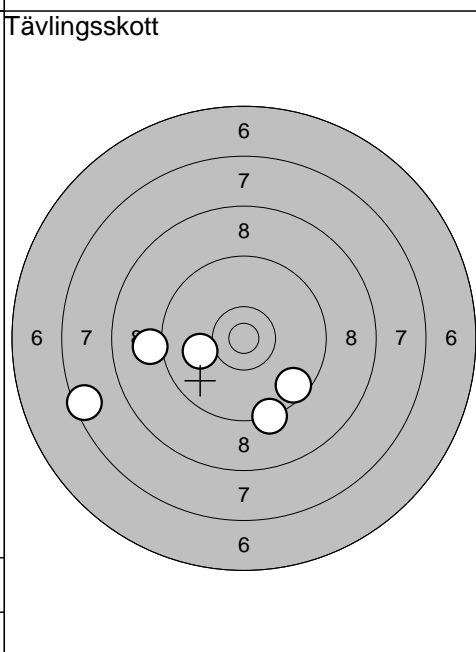

16: 10,0	←
17: 9,1	←
18: 9,6	↘
19: 9,3	↘
20: 7,5	←
Serie 44,0	
Totalt 169,0	

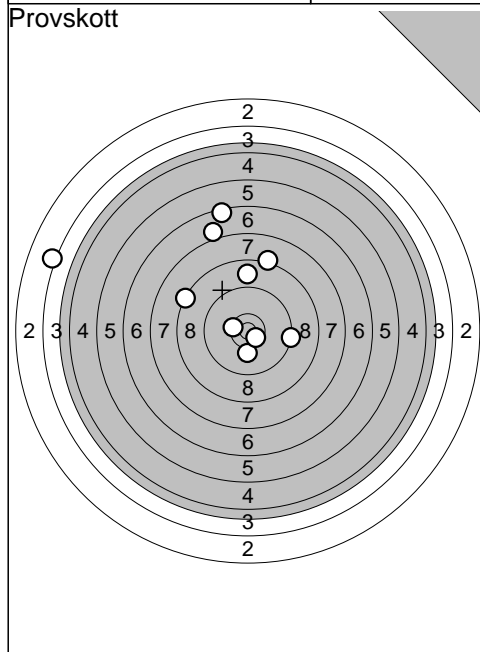

1: 3,2	←
2: 8,2	↑
3: 6,5	↑
4: 7,1	↑
5: 10,1	↓
6: 8,8	↑
7: 8,3	↖
8: 10,5*	↘
9: 10,4*	←
10: 9,3	→
Serie 79,0	
Totalt 0,0	

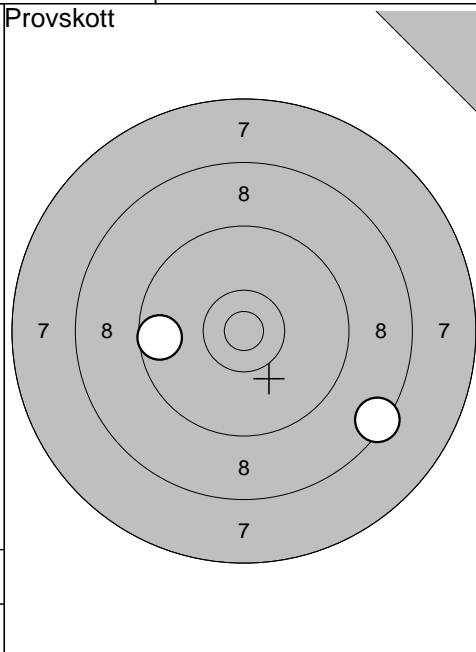

11: 9,6	←
12: 8,4	↘
Serie 17,0	
Totalt 0,0	

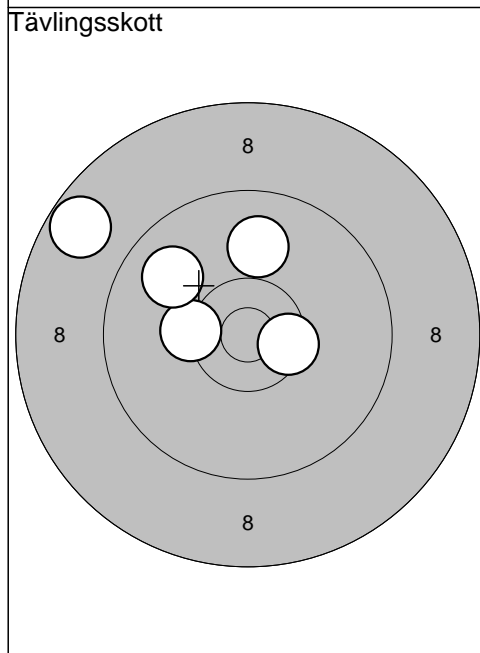

1: 8,7	↖
2: 10,5*	→
3: 10,3*	←
4: 9,9	↑
5: 9,9	↖
Serie 46,0	
Totalt 46,0	

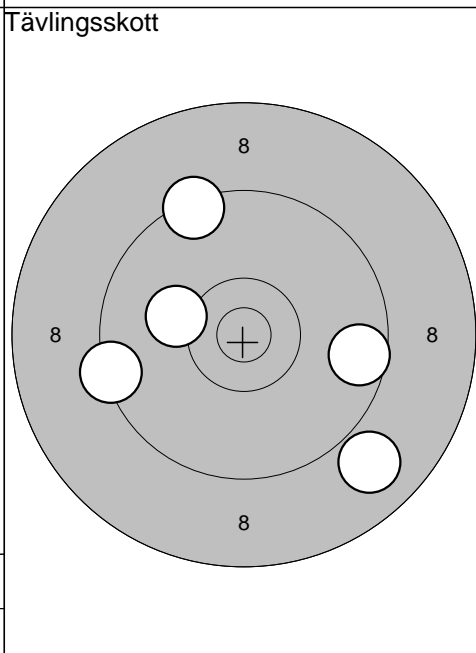

6: 9,4	←
7: 9,4	↑
8: 10,2	←
9: 9,6	→
10: 8,9	↘
Serie 45,0	
Totalt 91,0	

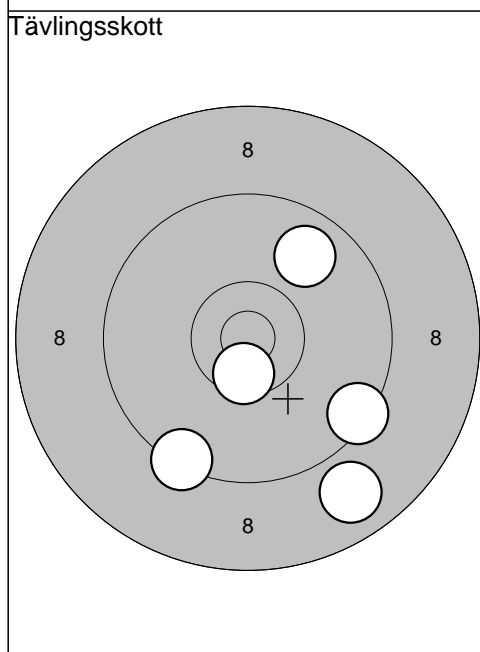

11: 9,4	↘
12: 10,5*	↓
13: 9,8	↖
14: 9,4	↘
15: 8,8	↘
Serie 45,0	
Totalt 136,0	

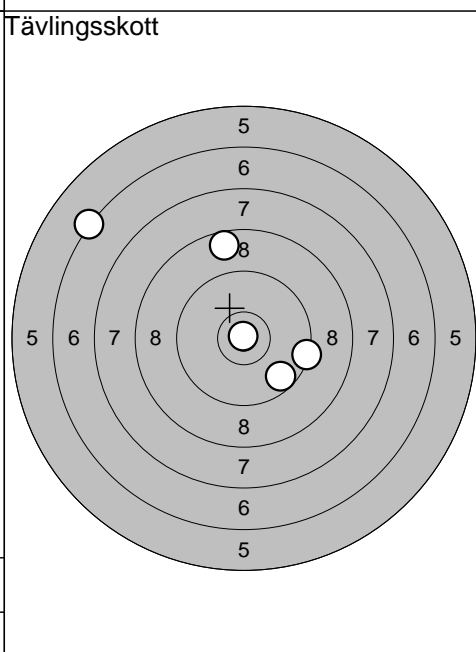

16: 9,4	→
17: 9,7	↘
18: 10,9*	↑
19: 6,3	↖
20: 8,6	↑
Serie 42,0	
Totalt 178,0	

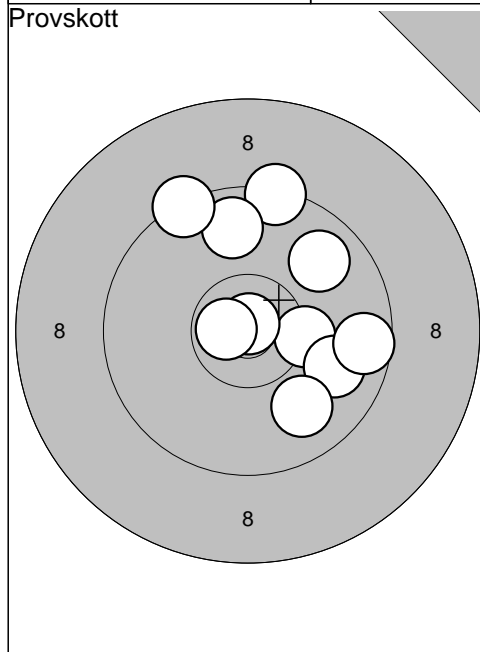

1: 9,4	↗
2: 10,3*	→
3: 9,8	↗
4: 9,9	→
5: 9,8	↑
6: 10,9*	↑
7: 9,9	↘
8: 9,6	→
9: 10,7*	←
10: 9,4	↖
Serie 93,0	
Totalt 0,0	

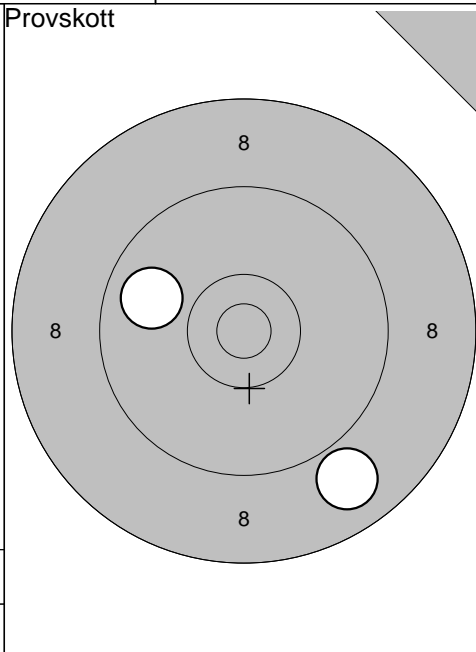

11: 8,9	↘
12: 9,8	↖
Serie 17,0	
Totalt 0,0	

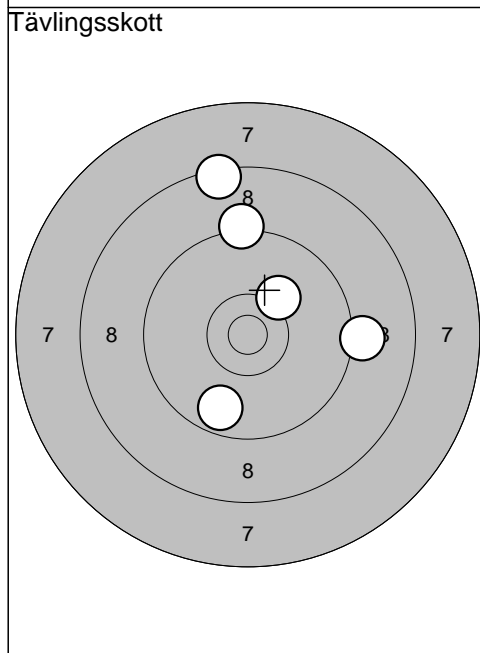

1: 8,4	↖
2: 9,1	→
3: 10,2	↗
4: 9,2	↑
5: 9,7	↘
Serie 45,0	
Totalt 45,0	

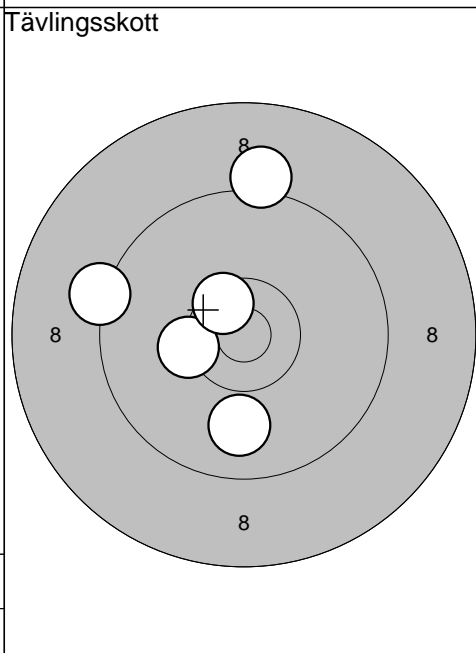

6: 9,9	↘
7: 10,3*	←
8: 9,2	↖
9: 10,5*	↗
10: 9,1	↑
Serie 47,0	
Totalt 92,0	

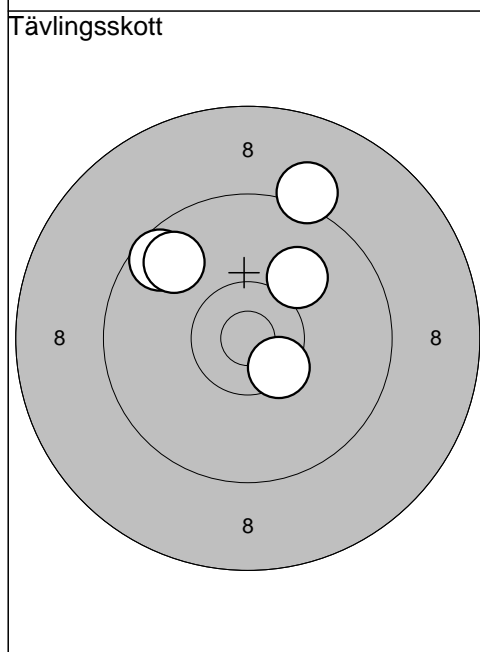

11: 10,5*	↘
12: 9,6	↖
13: 10,1	↗
14: 9,7	↖
15: 9,2	↑
Serie 47,0	
Totalt 139,0	

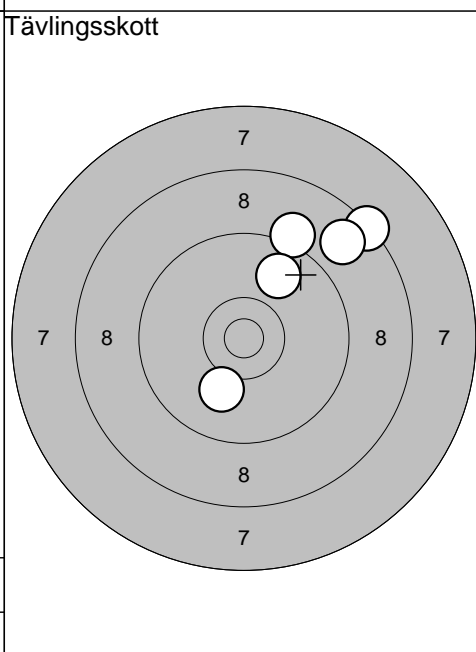

16: 9,2	↖
17: 8,4	↗
18: 8,8	↗
19: 9,8	↖
20: 10,1	↘
Serie 44,0	
Totalt 183,0	

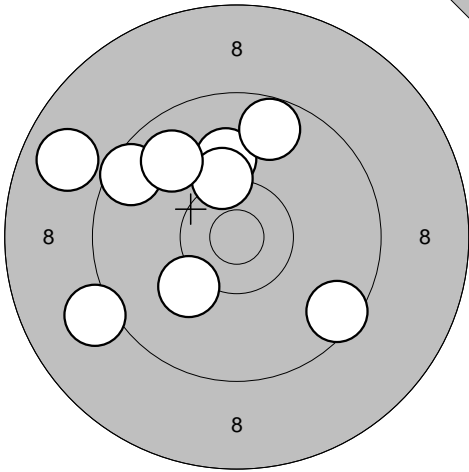
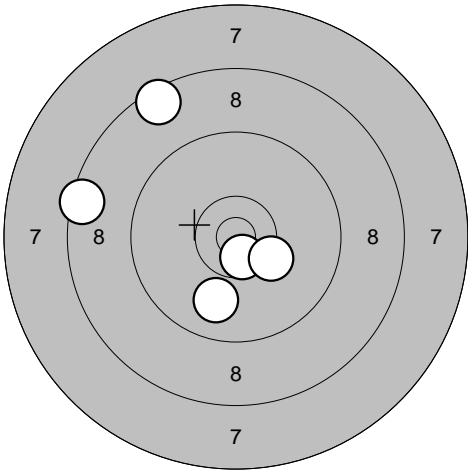
<p>Provs-kott</p> 	<p>Tävlingsskott</p> 	
<p>1: 10,1 ↑</p> <p>2: 8,8 ↖</p> <p>3: 9,6 ↗</p> <p>4: 9,7 ↑</p> <p>5: 10,2 ↙</p> <p>6: 10,3 ↑</p> <p>7: 9,5 ↘</p> <p>8: 9,1 ↖</p> <p>9: 9,8 ↗</p>	<p>1: 8,5 ←</p> <p>2: 8,5 ↗</p> <p>3: 9,9 ↘</p> <p>4: 10,6* ↙</p> <p>5: 10,3* ↘</p>	
Serie 83,0	Serie 45,0	
Totalt 0,0	Totalt 45,0	

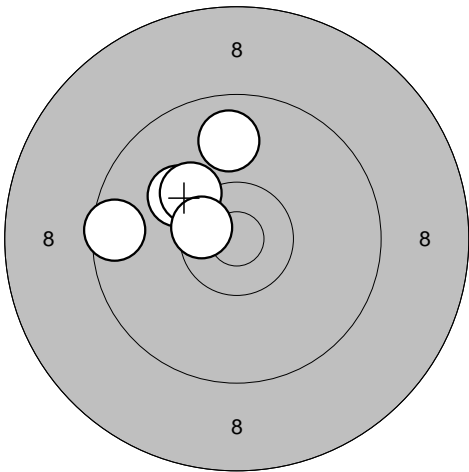
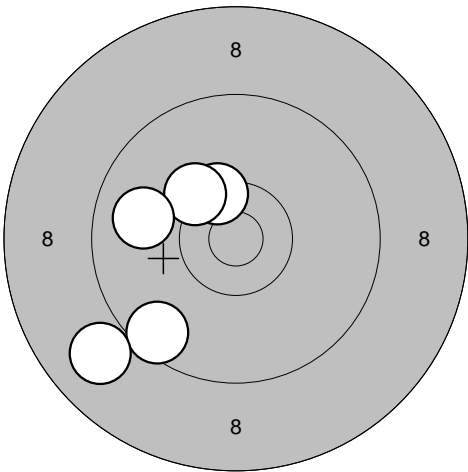
<p>Tävlingsskott</p> 	<p>Tävlingsskott</p> 	
<p>6: 9,8 ↑</p> <p>7: 9,6 ←</p> <p>8: 10,1 ↗</p> <p>9: 10,2 ↗</p> <p>10: 10,5* ←</p>	<p>11: 10,4* ↑</p> <p>12: 10,3 ↗</p> <p>13: 9,9 ←</p> <p>14: 9,6 ↘</p> <p>15: 8,9 ↘</p>	
Serie 48,0	Serie 46,0	
Totalt 93,0	Totalt 139,0	

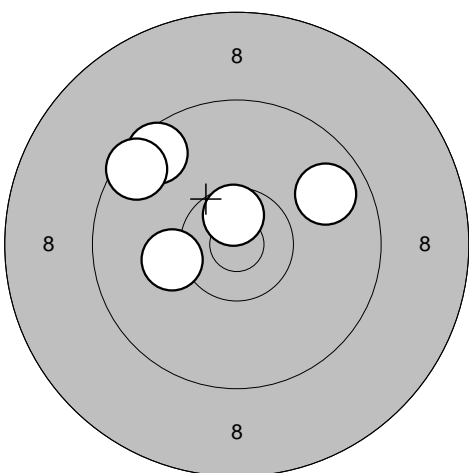
<p>Tävlingsskott</p> 	<p>16: 9,6 ↗</p> <p>17: 10,6* ↑</p> <p>18: 9,8 ↗</p> <p>19: 9,5 ↗</p> <p>20: 10,2 ←</p>	
Serie 47,0		
Totalt 186,0		