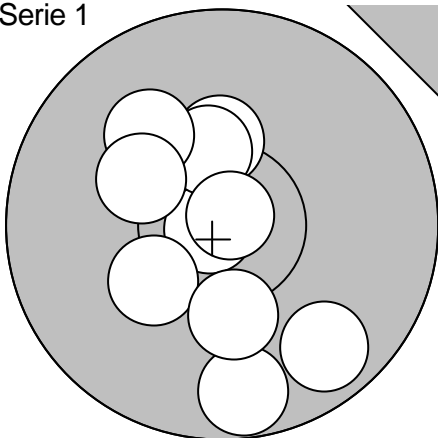
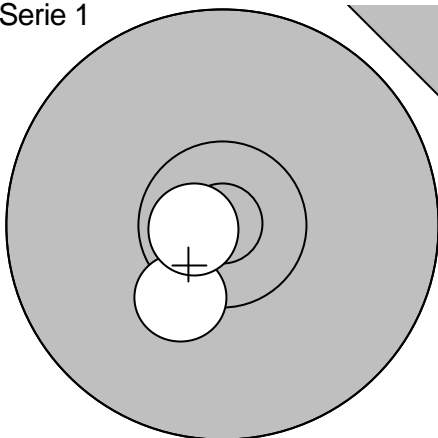
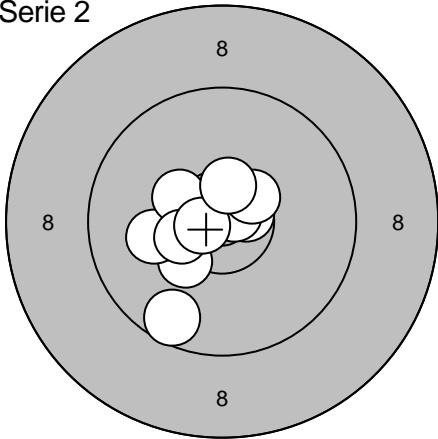
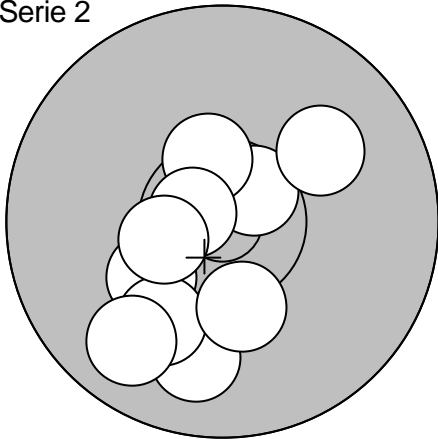
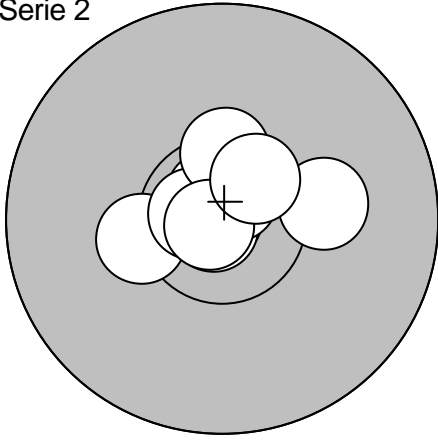
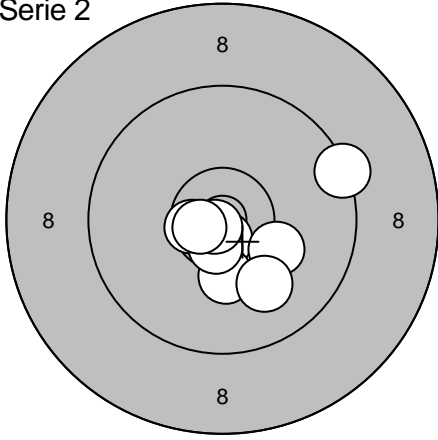
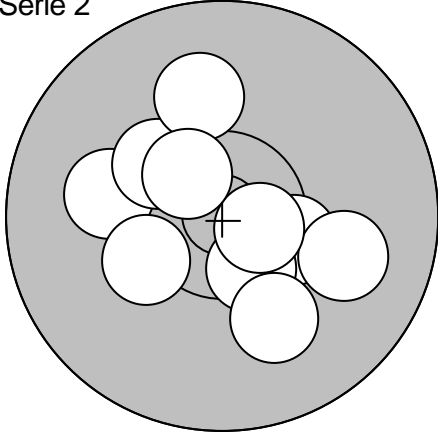
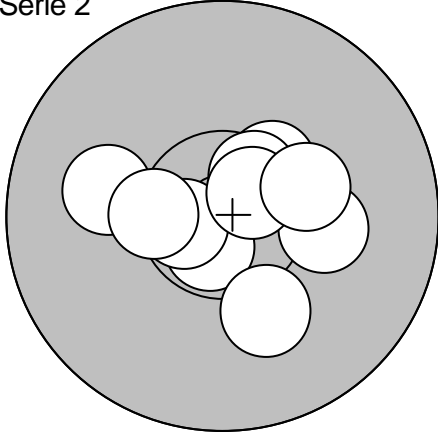
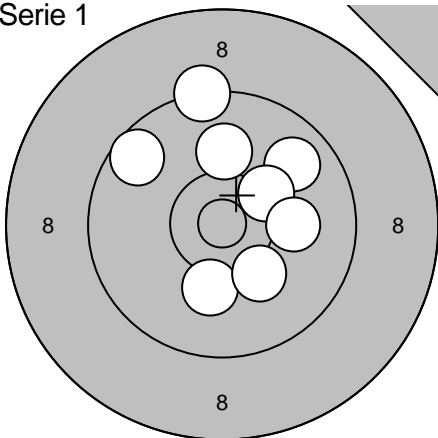
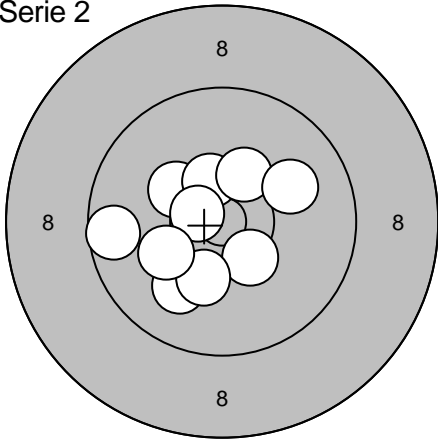
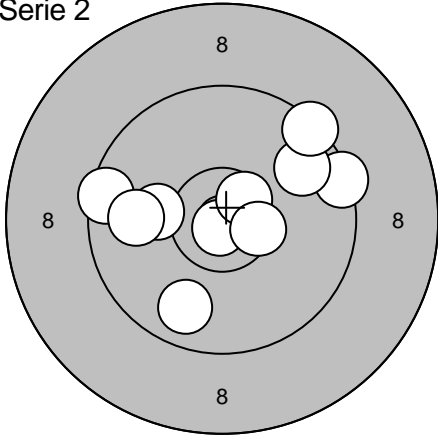
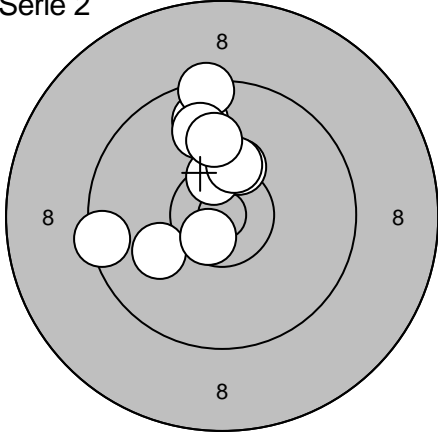
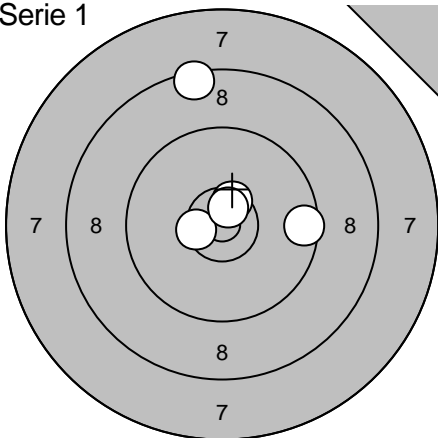
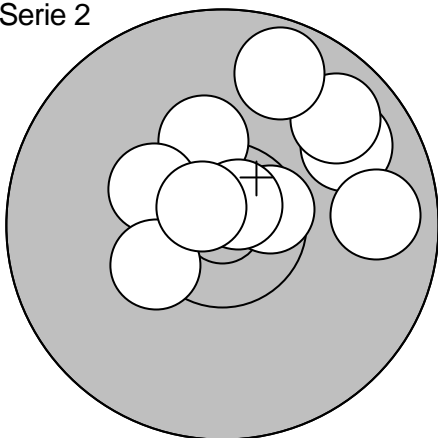
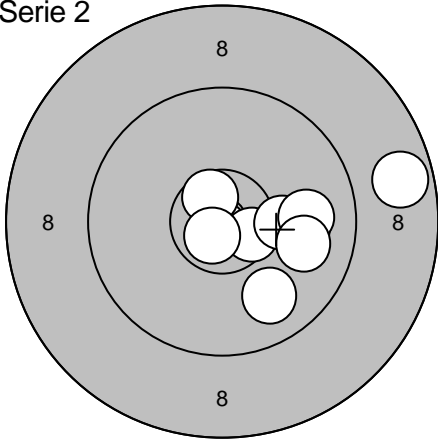
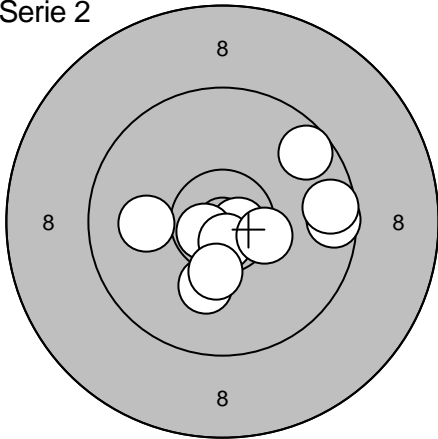
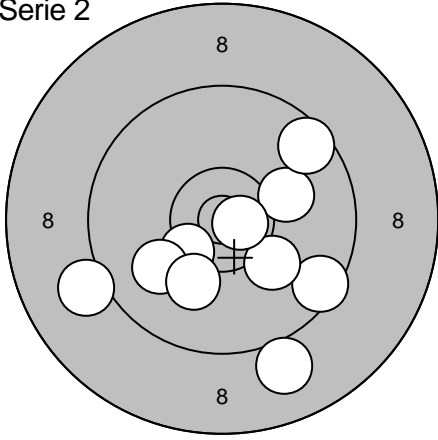
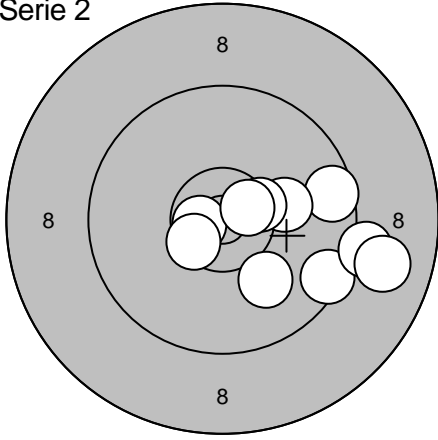
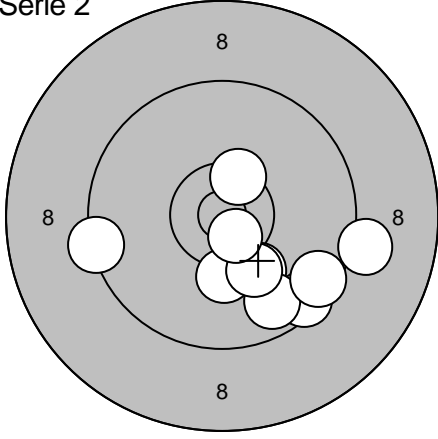
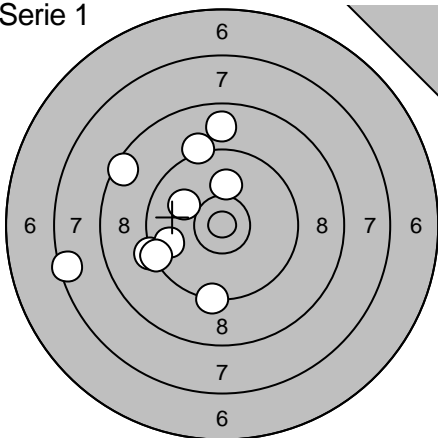
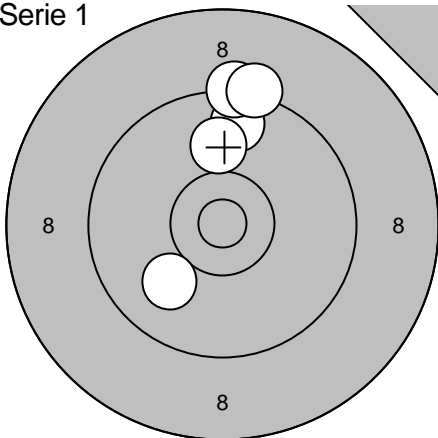
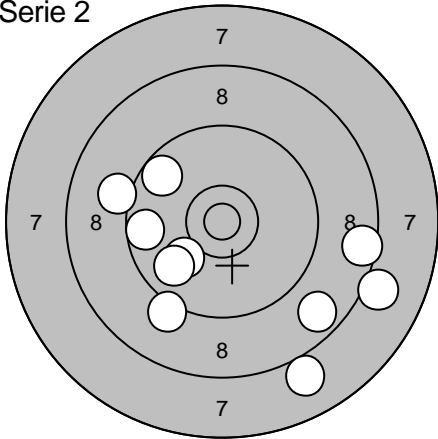
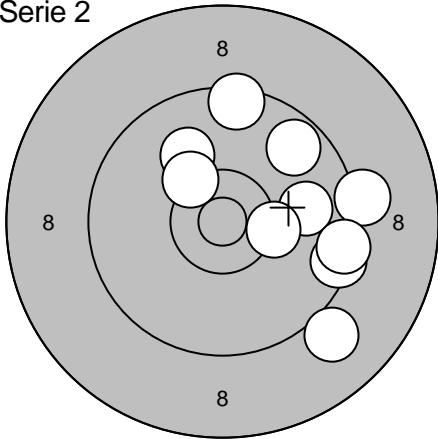
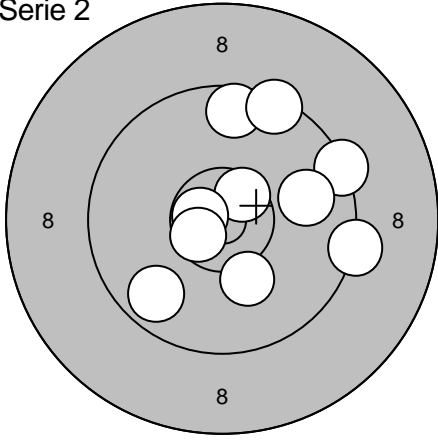
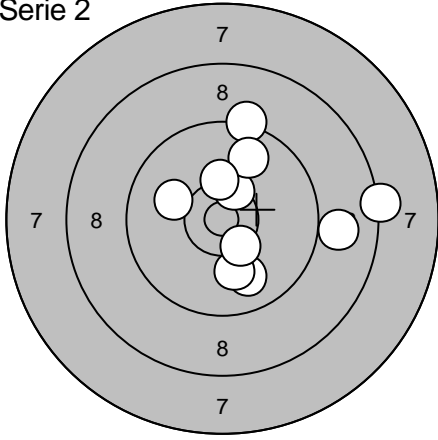
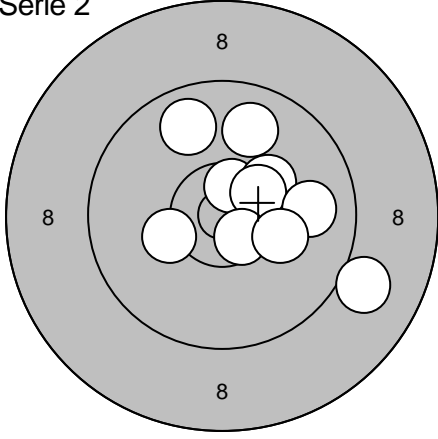
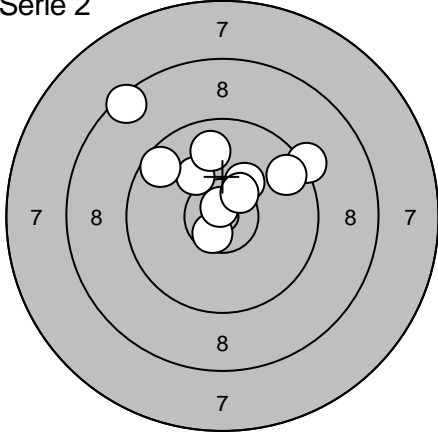
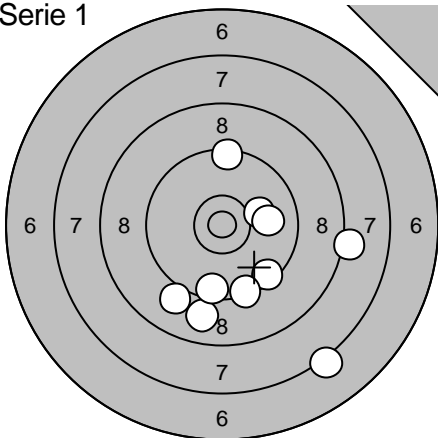
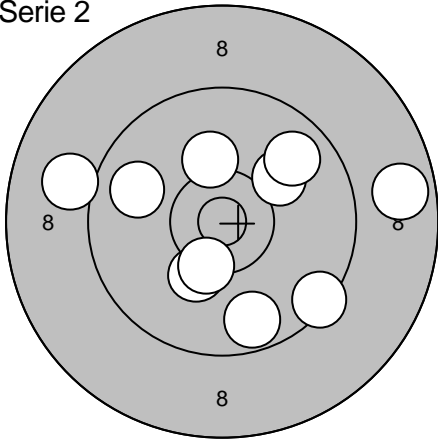
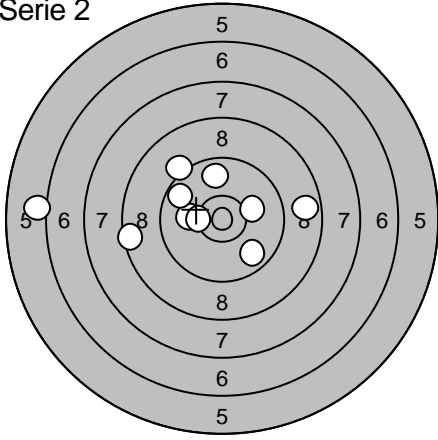
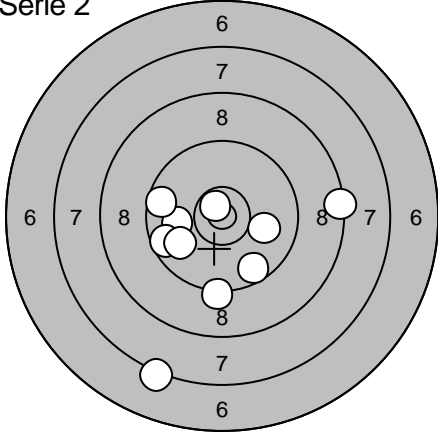

Lag 1	Skive 11	Lars Möllsten			
S					
2012-08-23		Föreningsmästerskap		Umeå Skytteförening	
Serie 1		1: 10,8* ← 2: 10,3* ↑ 3: 10,4* ↑↑ 4: 9,7 ↓↓ 5: 10,1 ↗ 6: 10,2 ↗ 7: 10,3 ↓ 8: 9,7 ↓↓ 9: 10,9* ↗ 10: 10,2 ↓	Serie 1		11: 10,3* ↓ 12: 10,7* ←
		Serie 98,0		Serie 20,0	
		Sum 0,0		Sum 0,0	
Serie 2		1: 10,6* → 2: 9,6 ↓ 3: 10,8* ↗ 4: 10,5* ↗ 5: 10,3* ← 6: 10,1 ← 7: 10,3* ↗ 8: 10,4* ← 9: 10,7* ← 10: 10,5* ↑	Serie 2		11: 9,9 ↓ 12: 10,3 ← 13: 10,6* ↗ 14: 10,1 ↓ 15: 9,8 ↓ 16: 10,0 ↗ 17: 10,3* ↓ 18: 10,5* ↑ 19: 10,7* ← 20: 10,5* ←
		Serie 99,0		Serie 98,0	
		Sum 99,0		Sum 197,0	
Serie 2		21: 10,7* ↑ 22: 10,3* ← 23: 10,2 → 24: 10,6* ↑ 25: 10,9* ↓ 26: 10,8* ↗ 27: 10,7* ← 28: 10,5* ↑ 29: 10,8* ← 30: 10,6* ↗	Serie 2		31: 10,3 ↓ 32: 10,6* ← 33: 10,7* ↓ 34: 10,2 → 35: 10,2 ↓ 36: 10,6* ↓ 37: 10,8* ← 38: 10,0 ↓ 39: 9,4 → 40: 10,7* ←
		Serie 100,0		Serie 99,0	
		Sum 297,0		Sum 396,0	
Serie 2		41: 10,4* → 42: 10,1 ← 43: 10,5* ↓ 44: 10,3* ↗ 45: 10,0 → 46: 10,6* → 47: 10,0 ↗ 48: 10,1 ↓ 49: 10,5* ↗ 50: 10,3 ←	Serie 2		51: 10,2 → 52: 10,1 ← 53: 10,7* ↓ 54: 10,4* ↗ 55: 10,6* ↗ 56: 10,6* ← 57: 10,7* ↗ 58: 10,4* ← 59: 10,1 ↓ 60: 10,3 →
		Serie 100,0		Serie 100,0	
		Sum 496,0		Sum 596,0	

Lag	Skive	Stefan Thorin	
1	10		
S			
2012-08-23	Föreningsmästerskap	Umeå Skytteförening	
Serie 1		1: 9,3 ↑ 2: 9,8 ↗ 3: 10,2 ↓ 4: 10,3* ↗ 5: 10,1 → 6: 9,6 ↖ 7: 10,1 ↑ 8: 10,2 ↓ Serie 77,0 Sum 0,0	Serie 2
			1: 9,3 ↑ 2: 10,4* ↓ 3: 10,1 ↑ 4: 10,2 ↑ 5: 9,8 ← 6: 9,0 ← 7: 10,2 → 8: 10,8* ↓ 9: 10,0 → 10: 9,4 ← Serie 96,0 Sum 96,0
Serie 2		11: 10,4* ↓ 12: 10,3 ↖ 13: 10,0 ↓ 14: 10,4* ↑ 15: 9,6 ← 16: 10,2 ↓ 17: 10,3* ↑ 18: 10,0 → 19: 10,6* ← 20: 10,2 ← Serie 99,0 Sum 195,0	Serie 2
			21: 10,1 → 22: 10,6* ↑ 23: 10,5* → 24: 9,7 ← 25: 10,9* ↓ 26: 9,9 → 27: 9,7 → 28: 10,1 ↑ 29: 10,3* → 30: 10,2 ↗ Serie 97,0 Sum 292,0
Serie 2		31: 10,1 ← 32: 9,5 ← 33: 9,9 ← 34: 10,8* ↓ 35: 9,8 ↓ 36: 10,6* ↗ 37: 9,4 → 38: 9,8 ↗ 39: 9,4 ↗ 40: 10,5* → Serie 94,0 Sum 386,0	Serie 2
			41: 10,3* ← 42: 10,8* → 43: 10,3 ← 44: 10,3* → 45: 9,4 → 46: 10,9* ↓ 47: 9,9 ← 48: 9,9 ← 49: 10,3 ↑ 50: 9,8 → Serie 96,0 Sum 482,0
Serie 2		51: 9,8 ↑ 52: 9,4 ↑ 53: 10,3* ↑ 54: 9,9 ↑ 55: 10,5* ↑ 56: 10,1 ← 57: 9,5 ← 58: 10,3* ↑ 59: 10,6* ↓ 60: 10,0 ↑ Serie 96,0 Sum 578,0	

Lag	Skive	André Olsén			
1	8				
S					
2012-08-23	Föreningsmästerskap	Umeå Skytteförening			
Serie 1		1: 8,5 ↑ 2: 10,5* ← 3: 9,6 → 4: 10,5* ↑ 5: 10,7* ↑	Serie 2		1: 9,8 ↗ 2: 9,8 → 3: 10,3* ↑ 4: 10,4* ↖ 5: 10,4* ← 6: 10,6* → 7: 9,8 ↗ 8: 9,7 ↑ 9: 10,8* ↗ 10: 10,7* ↖
		Serie 47,0		Serie 96,0	
		Sum 0,0		Sum 96,0	
Serie 2		11: 10,8* ↓ 12: 10,6* → 13: 10,0 → 14: 9,9 ↘ 15: 8,7 → 16: 10,6* ↗ 17: 10,2 → 18: 9,9 → 19: 10,7* ↘ 20: 9,9 →	Serie 2		21: 10,1 ↓ 22: 10,7* → 23: 10,0 ← 24: 10,7* ↖ 25: 9,6 → 26: 10,7* ↓ 27: 9,6 ↗ 28: 9,6 → 29: 10,3* ↓ 30: 10,4* →
		Serie 95,0		Serie 97,0	
		Sum 191,0		Sum 288,0	
Serie 2		31: 9,0 ↓ 32: 9,5 ↘ 33: 10,4* ↘ 34: 10,1 ↘ 35: 9,1 ← 36: 10,0 ← 37: 10,1 → 38: 10,1 ↓ 39: 10,7* → 40: 9,6 ↗	Serie 2		41: 9,6 → 42: 10,7* ← 43: 9,5 → 44: 10,2 → 45: 10,5* → 46: 10,5* ↖ 47: 9,2 → 48: 10,6* → 49: 8,9 → 50: 10,0 ↓
		Serie 96,0		Serie 95,0	
		Sum 384,0		Sum 479,0	
Serie 2		51: 9,5 ↘ 52: 9,1 → 53: 9,4 ← 54: 10,2 ↓ 55: 10,4* ↑ 56: 10,1 ↓ 57: 9,7 ↘ 58: 9,5 ↘ 59: 10,2 ↓ 60: 10,6* ↓			
		Serie 95,0			
		Sum 574,0			

Lag	Skive	John Lindgren	
1	13		
S			
2012-08-23		Föreningsmästerskap	Umeå Skytteförening
Serie 1		1: 9,3 ↓ 2: 9,3 ← 3: 7,5 ← 4: 9,7 ← 5: 9,4 ← 6: 8,5 ↗ 7: 8,9 ↑ 8: 10,0 ↖ 9: 10,1 ↑ 10: 9,3 ↑ Serie 88,0 Sum 0,0	Serie 1  11: 9,7 ↑ 12: 10,0 ↑ 13: 9,3 ↑ 14: 9,3 ↑ 15: 10,0 ↙ Serie 47,0 Sum 0,0
Serie 2		1: 8,1 → 2: 8,6 → 3: 8,0 ↓ 4: 8,7 ↓ 5: 9,2 ↓ 6: 10,1 ↖ 7: 9,9 ↖ 8: 9,6 ← 9: 9,1 ← 10: 9,7 ↗ Serie 87,0 Sum 87,0	Serie 2  11: 9,0 ↘ 12: 9,4 → 13: 9,2 → 14: 9,9 → 15: 10,3* → 16: 9,4 → 17: 10,0 ↗ 18: 9,7 ↗ 19: 10,3* ↗ 20: 9,5 ↑ Serie 93,0 Sum 180,0
Serie 2		21: 10,2 ↓ 22: 9,3 → 23: 9,6 ↑ 24: 10,6* ↗ 25: 9,4 → 26: 10,7* ← 27: 10,6* ↖ 28: 9,9 → 29: 9,7 ↖ 30: 9,4 ↑ Serie 94,0 Sum 274,0	Serie 2  31: 10,4* ↑ 32: 9,3 ↑ 33: 9,0 → 34: 9,9 ↓ 35: 8,3 → 36: 10,0 ↓ 37: 10,1 ↖ 38: 9,8 ↑ 39: 10,4* ↓ 40: 10,3* ↑ Serie 94,0 Sum 368,0
Serie 2		41: 10,6* ↑ 42: 9,0 → 43: 10,3 ← 44: 10,2 ↗ 45: 10,4* ↗ 46: 9,8 ↗ 47: 9,9 → 48: 10,6* ↓ 49: 10,2 → 50: 9,9 ↑ Serie 96,0 Sum 464,0	Serie 2  51: 10,6* ↘ 52: 9,3 ↗ 53: 10,2 ↗ 54: 9,6 ↗ 55: 10,8* ↑ 56: 9,7 → 57: 10,3 ↗ 58: 10,5* ↗ 59: 8,5 ↖ 60: 9,8 ↑ Serie 94,0 Sum 558,0

Lag	Skive	Gustav Lindberg	
1	15		
S			
2012-08-23		Föreningsmästerskap	Umeå Skytteförening
Serie 1		1: 9,0 ↙ 2: 8,2 → 3: 8,9 ↓ 4: 9,6 ↓ 5: 10,1 → 6: 10,0 → 7: 7,2 ↓ 8: 9,5 ↑ 9: 9,5 ↓ 10: 9,4 ↓ Serie 88,0 Sum 0,0	Serie 2
			1: 9,5 ← 2: 9,7 ↑ 3: 10,1 ↓ 4: 10,0 ← 5: 9,2 ↗ 6: 8,7 ← 7: 8,4 ↙ 8: 10,1 ← 9: 8,5 ↓ 10: 9,1 ↓ Serie 90,0 Sum 90,0
Serie 2		11: 10,2 ↓ 12: 9,7 ↓ 13: 9,4 ↓ 14: 8,7 → 15: 10,2 ↑ 16: 10,1 → 17: 9,8 → 18: 9,8 ← 19: 10,4* ↓ 20: 9,0 ← Serie 93,0 Sum 183,0	Serie 2
			21: 8,6 → 22: 9,6 → 23: 10,1 ↗ 24: 10,2 ↓ 25: 8,6 ↗ 26: 10,4* ↖ 27: 8,1 ↙ 28: 10,2 ↗ 29: 7,8 ← 30: 10,5* ↓ Serie 90,0 Sum 273,0
Serie 2		31: 10,1 ← 32: 10,3* ← 33: 6,1 ← 34: 8,5 ← 35: 10,1 → 36: 9,7 ↗ 37: 9,8 ↓ 38: 9,2 ↗ 39: 8,8 → 40: 9,8 ↑ Serie 88,0 Sum 361,0	Serie 2
			41: 9,9 ↘ 42: 8,9 ↓ 43: 9,0 ← 44: 10,5* ↓ 45: 8,6 ↓ 46: 10,1 ← 47: 10,4* → 48: 10,1 ↑ 49: 9,0 ↓ 50: 10,5* ↓ Serie 93,0 Sum 454,0
Serie 2		51: 10,0 ← 52: 9,6 ← 53: 9,2 ↓ 54: 10,0 → 55: 9,6 ← 56: 9,9 ← 57: 10,7* ↗ 58: 9,6 ↓ 59: 8,4 → 60: 7,2 ↓ Serie 90,0 Sum 544,0	

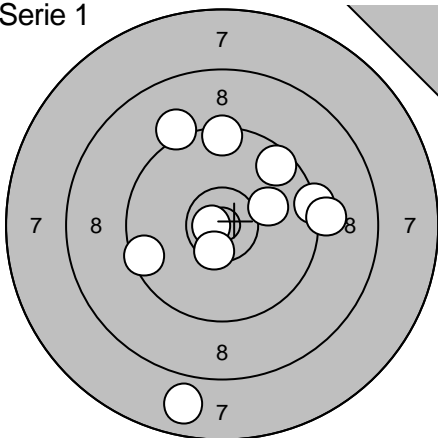
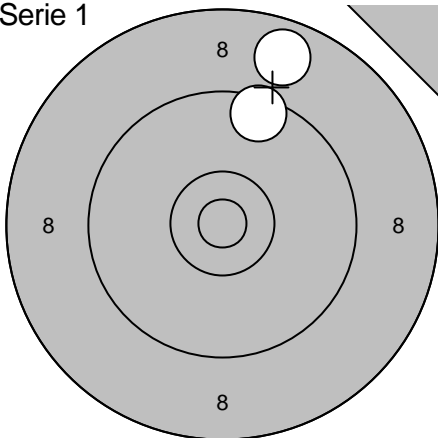
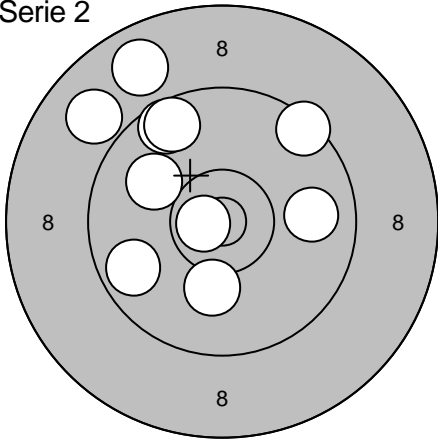
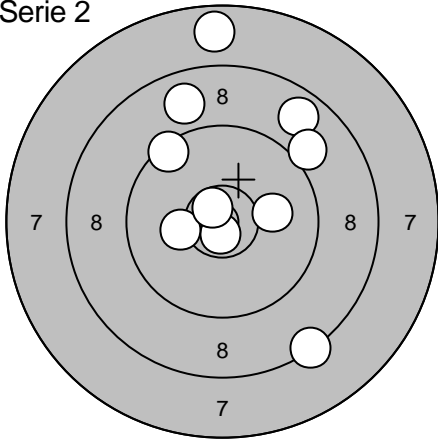
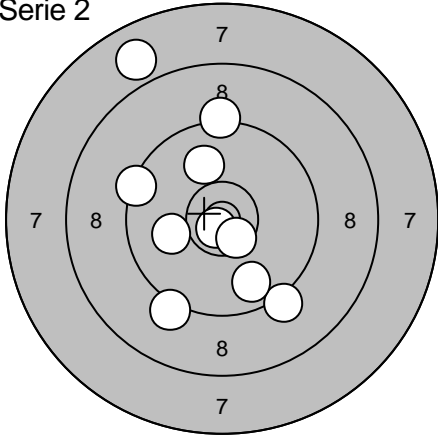
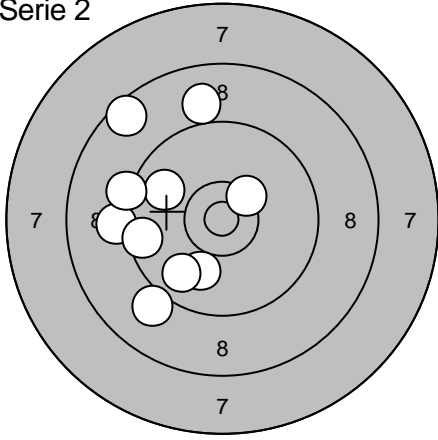
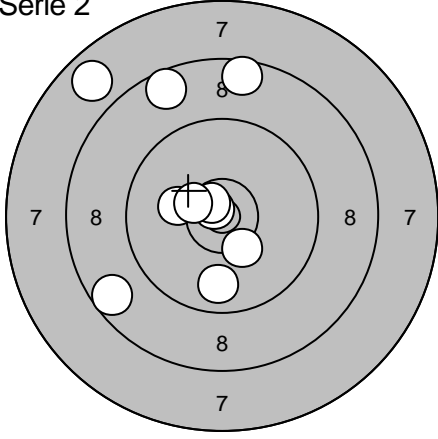
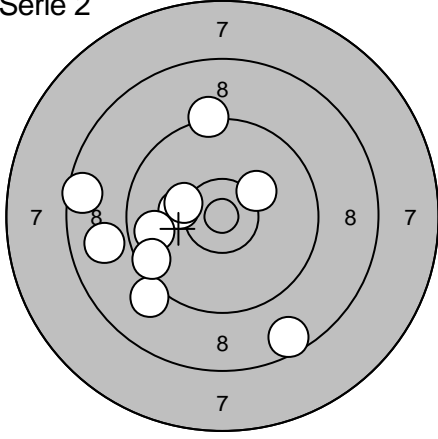
Lag	Skive	Stig Jussén	
1	14		
S			
2012-08-23		Föreningsmästerskap	Umeå Skytteförening
Serie 1		1: 7,8 ↓ 2: 9,5 ← 3: 10,8* ← 4: 9,2 ↗ 5: 10,1 → 6: 9,5 ↑ 7: 9,4 → 8: 9,2 → 9: 9,6 ↗ 10: 10,5* ↓ Serie 91,0 Sum 0,0	Serie 1  11: 9,5 ↑ 12: 8,8 ↑ Serie 17,0 Sum 0,0
Serie 2		1: 9,7 ← 2: 10,0 ↗ 3: 10,1 ↓ 4: 10,7* ← 5: 9,6 ↗ 6: 8,9 ↗ 7: 9,6 ↗ 8: 8,8 ↗ 9: 9,4 ↗ 10: 9,9 → Serie 91,0 Sum 91,0	Serie 2  11: 10,7* ↓ 12: 10,2 ← 13: 8,3 ↘ 14: 8,8 ↗ 15: 10,1 → 16: 7,8 ↑ 17: 9,5 ↗ 18: 8,9 ↑ 19: 9,1 ↗ 20: 10,7* ↗ Serie 89,0 Sum 180,0
Serie 2		21: 9,3 ↑ 22: 9,4 ← 23: 10,8* ↓ 24: 9,2 ↓ 25: 10,1 ← 26: 9,2 ↓ 27: 9,8 ↓ 28: 7,9 ↗ 29: 10,5* ↓ 30: 10,0 ↑ Serie 92,0 Sum 272,0	Serie 2  31: 9,2 ← 32: 9,6 ← 33: 10,0 ↓ 34: 10,4* ↗ 35: 9,9 ↗ 36: 9,1 ↓ 37: 9,0 ↑ 38: 9,3 ← 39: 9,8 ↓ 40: 8,6 ↗ Serie 91,0 Sum 363,0
Serie 2		41: 10,8* ↗ 42: 10,3* ↓ 43: 9,8 ↓ 44: 10,7* ↗ 45: 10,2 ← 46: 8,7 ← 47: 8,6 ↑ 48: 7,8 ↗ 49: 10,4* ↗ 50: 8,6 ↗ Serie 90,0 Sum 453,0	Serie 2  51: 10,2 ← 52: 8,6 ← 53: 9,3 ↑ 54: 10,2 ↗ 55: 9,8 ← 56: 9,1 ↓ 57: 8,9 ← 58: 8,6 ↓ 59: 10,3 ← 60: 9,6 ↘ Serie 90,0 Sum 543,0

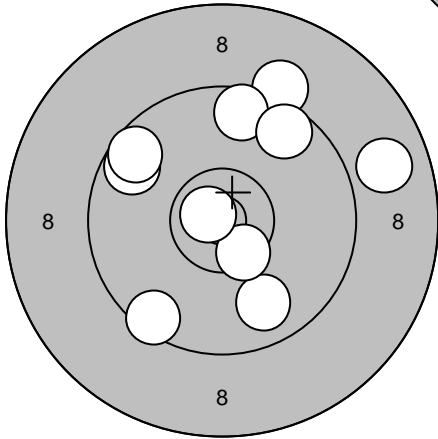
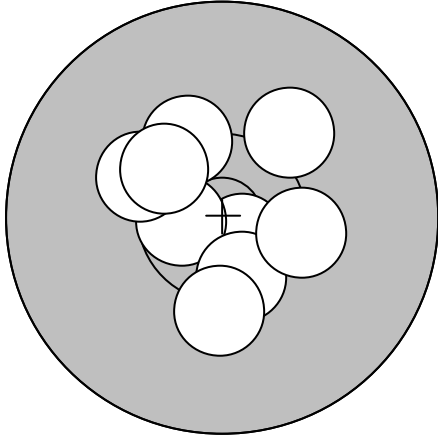
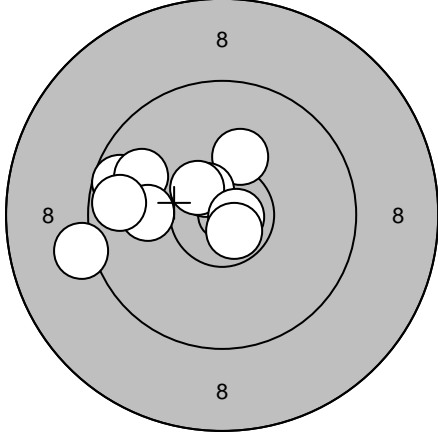
Lag	Skive	William Öster	
1	7		
2012-08-23		Föreningsmästerskap	
Serie 1		1: 9,2 ↗ 2: 9,7 ↘ 3: 8,9 → 4: 9,8 ↓ 5: 10,5* ↓ 6: 10,8* ↖ 7: 9,6 ↗ 8: 9,6 ↗ 9: 9,6 ↖ 10: 9,5 ↓ Serie 91,0 Sum 0,0	Serie 1
			11: 10,5* ↘ 12: 10,8* ↘ 13: 9,5 ↗ 14: 10,8* ↓ 15: 9,9 ↘ 16: 10,1 ↘ 17: 10,3 → 18: 10,3 ↑ Serie 78,0 Sum 0,0
Serie 2		1: 10,6* ↓ 2: 10,7* ↓ 3: 10,6* ← 4: 10,5* ↓ 5: 10,2 ↓ 6: 10,3* → 7: 10,1 ↗ 8: 10,3* ↗ 9: 10,3 ↖ 10: 10,4* ↗ Serie 100,0 Sum 100,0	Serie 2
			11: 9,9 ↖ 12: 9,4 ↑ 13: 10,1 ↖ 14: 9,8 → 15: 10,2 → 16: 10,6* ↓ 17: 9,9 ↘ 18: 10,4* ↖ 19: 10,5* ↓ 20: 10,0 ↘ Serie 96,0 Sum 196,0
Serie 2		21: 10,2 ↑ 22: 9,6 ← 23: 10,6* ↗ 24: 10,5* ↗ 25: 9,8 ↗ 26: 10,8* → 27: 10,0 ← 28: 9,2 ← 29: 10,7* ↓ 30: 9,7 ← Serie 96,0 Sum 292,0	

Lag	Skive	Melker Henriksson
1	6	

Ungdom

2012-08-23 Föreningsmästerskap Umeå Skytteförening

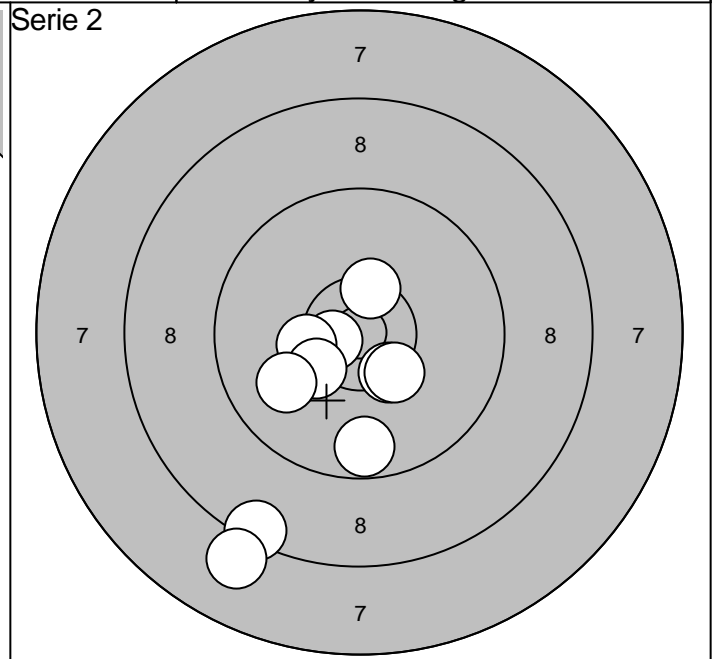
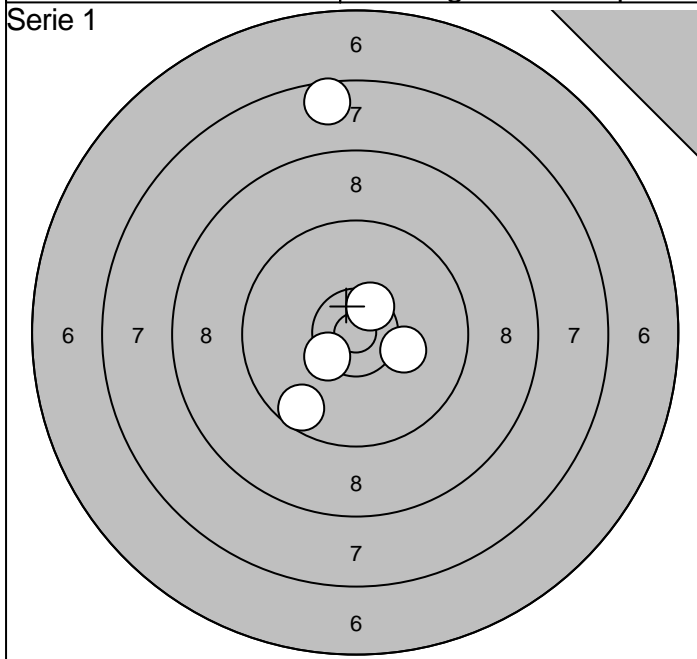

1: 7,6	↑	Serie	46,0
2: 9,6	↙		
3:10,2	→	Sum	0,0
4:10,4*	↙		
5:10,5*	↑		

1:10,6*	←	6: 8,0	↘	Serie	95,0
2: 8,4	↘	7:10,3*	↘		
3:10,4*	↑	8: 9,7	↓	Sum	95,0
4:10,4*	←	9:10,3*	↙		
5:10,4*	↘	10:10,0	↙		

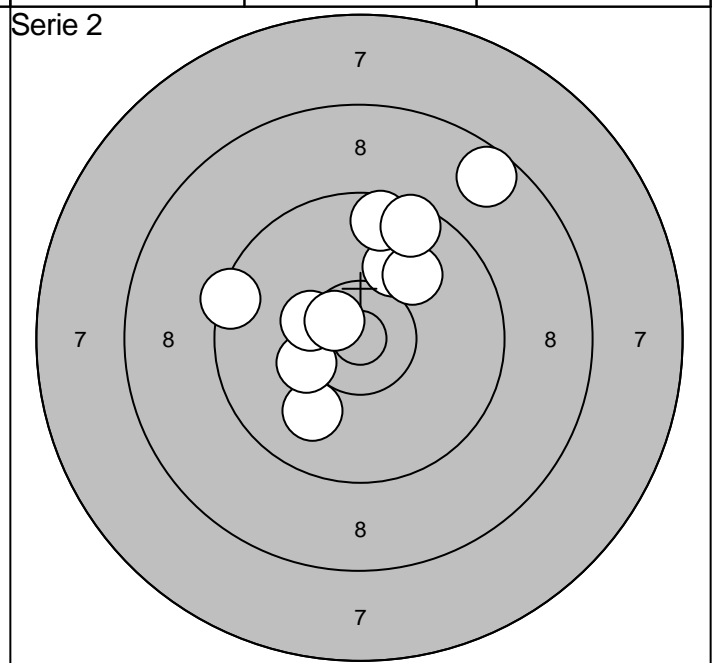
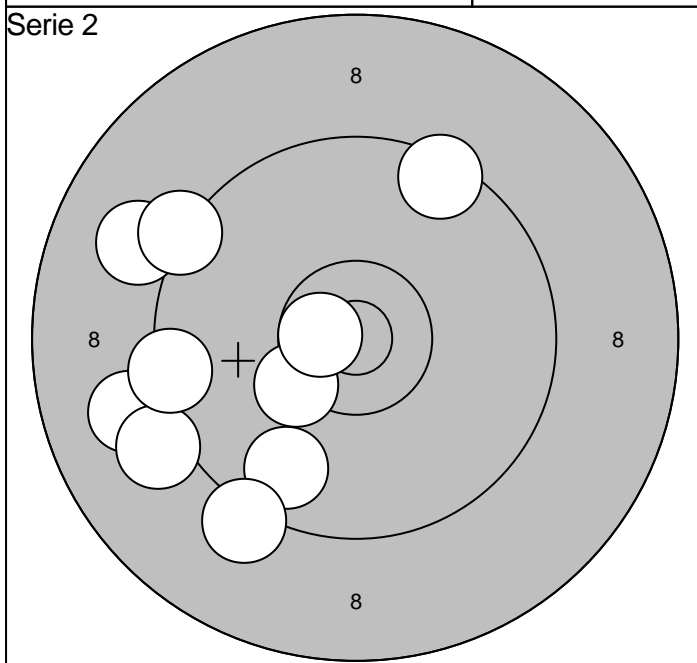

11:10,3*	↙	16: 9,1	←	Serie	92,0
12: 9,7	↘	17: 9,3	↖		
13: 9,5	↑	18: 9,2	↘	Sum	187,0
14: 9,0	←	19:10,7*	←		
15: 9,0	↖	20: 9,4	←		

21:10,0	↘	26: 8,6	↗	Serie	95,0
22:10,3	←	27: 9,6	↑		
23: 9,4	←	28:10,0	↗	Sum	282,0
24:10,4*	←	29: 9,6	↑		
25:10,1	↑	30:10,6*	↖		

2012-08-23	Föreningsmästerskap		
------------	---------------------	--	--

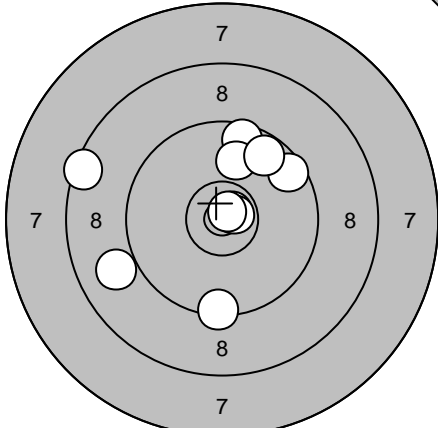
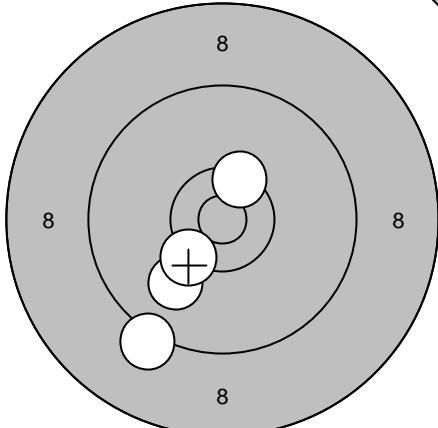
<p>Serie 1</p> 	<p>1: 9,6 ↑</p> <p>2: 9,4 ↓</p> <p>3: 9,6 ↗</p> <p>4: 10,7* ↗</p> <p>5: 9,9 ↑</p> <p>6: 10,7* →</p> <p>7: 9,7 ↗</p> <p>8: 10,8* ↗</p> <p>9: 9,0 ←</p> <p>10: 8,5 ←</p>	<p>Serie 1</p> 	<p>11: 9,2 ↓</p> <p>12: 10,0 ↓</p> <p>13: 10,3* ↓</p> <p>14: 10,4* ↑</p>
--	--	---	--

Serie	92,0	Serie	39,0
Sum	0,0	Sum	0,0

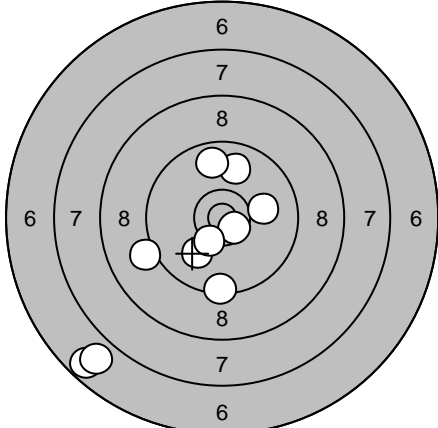
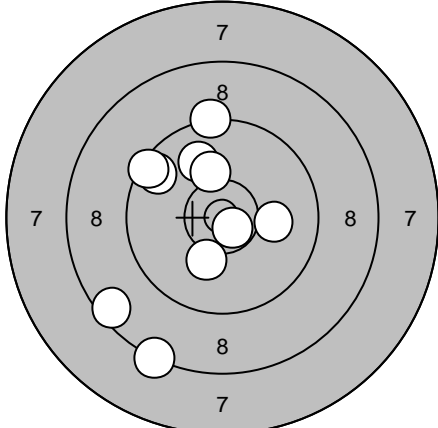
<p>Serie 2</p> 	<p>1: 9,1 ←</p> <p>2: 10,0 →</p> <p>3: 10,0 ↓</p> <p>4: 6,7 ←</p> <p>5: 9,9 ↑</p> <p>6: 10,6* ↘</p> <p>7: 10,4* ↓</p> <p>8: 9,4 ↓</p> <p>9: 6,9 ←</p> <p>10: 9,8 ↑</p>	<p>Serie 2</p> 	<p>11: 9,6 ←</p> <p>12: 10,0 ↑</p> <p>13: 10,7* ↘</p> <p>14: 8,3 ↓</p> <p>15: 9,3 ↑</p> <p>16: 10,2 ↓</p> <p>17: 8,5 ←</p> <p>18: 9,5 ↗</p> <p>19: 10,2 ↑</p> <p>20: 10,1 →</p>
---	--	--	---

Serie	88,0	Serie	93,0
Sum	88,0	Sum	181,0

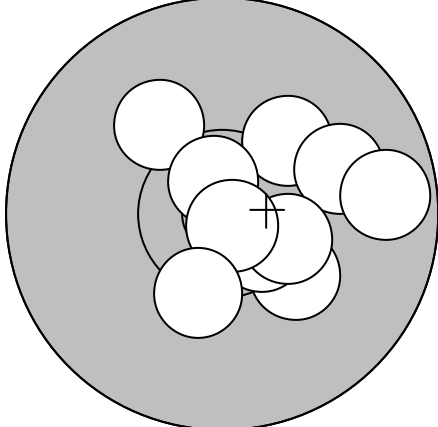
<p>Serie 2</p> 	<p>21: 10,2 ↘</p> <p>22: 10,1 ↗</p> <p>23: 10,2 ↗</p> <p>24: 10,0 →</p> <p>25: 10,7* ↑</p> <p>26: 10,6* ↘</p> <p>27: 10,4* →</p> <p>28: 10,8* ↓</p> <p>29: 9,7 →</p> <p>30: 10,3* ↓</p>		
--	---	--	--

Serie	99,0		
Sum	280,0		