

Umeå

2012-09-01

Höstträffen 2012

Ramselefors SKF

Provskott

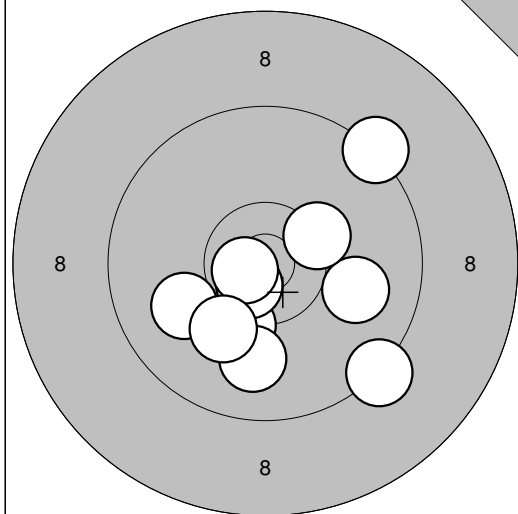

1: 9,3 ↗
 2: 9,3 ↘
 3: 10,3 ↓
 4: 10,0 ←
 5: 10,7* ↓
 6: 9,9 ↓
 7: 10,0 →
 8: 10,7* ←
 9: 10,1 ↓
 10: 10,3* →

Serie 97,0

Totalt 0,0

Tävlingsskott

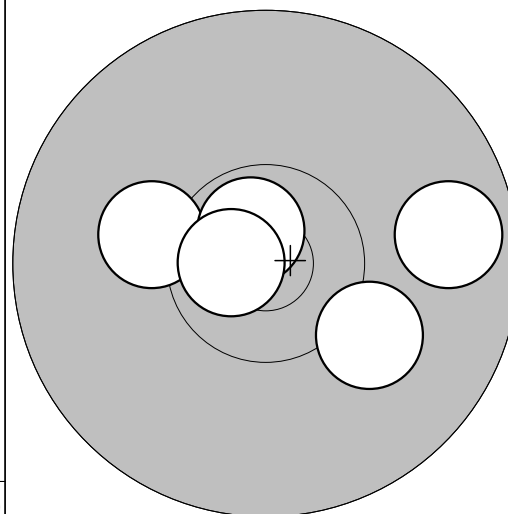

1: 10,2 ←
 2: 9,7 →
 3: 10,7* ↗
 4: 10,7* ←
 5: 10,1 ↓

Serie 49,0

Totalt 49,0

Tävlingsskott

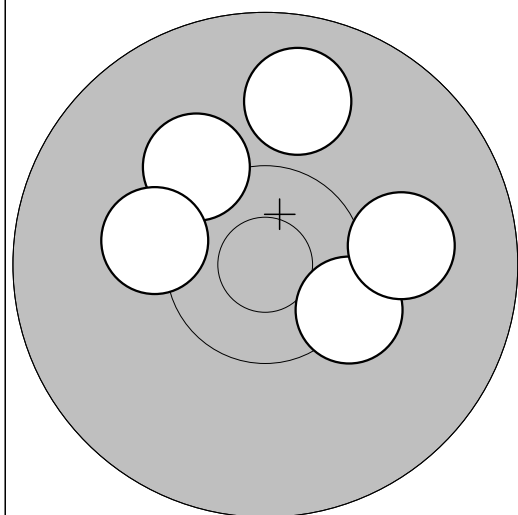

6: 10,2 ↖
 7: 10,3* ↘
 8: 10,1 →
 9: 9,9 ↑
 10: 10,2 ←

Serie 49,0

Totalt 98,0

Tävlingsskott

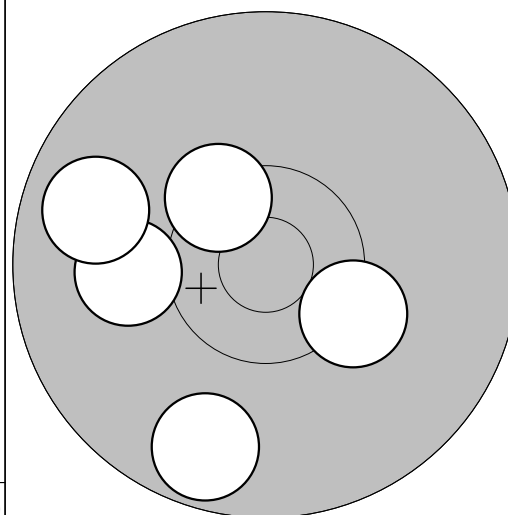

11: 10,1 ←
 12: 9,7 ↓
 13: 10,4* ↗
 14: 10,3* ↘
 15: 9,8 ←

Serie 48,0

Totalt 146,0

Tävlingsskott

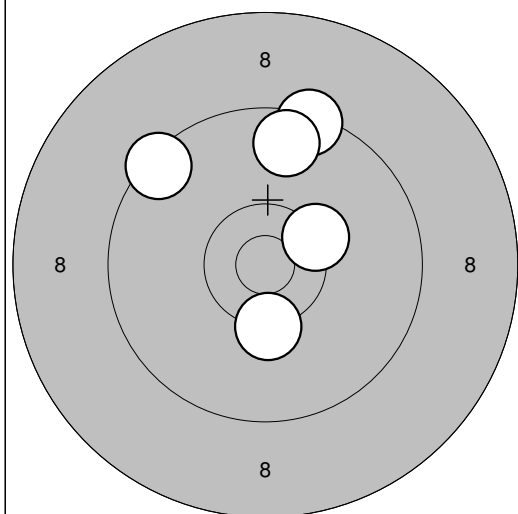

16: 9,4 ↑
 17: 10,3* ↓
 18: 9,4 ↖
 19: 10,3* →
 20: 9,7 ↑

Serie 47,0

Totalt 193,0

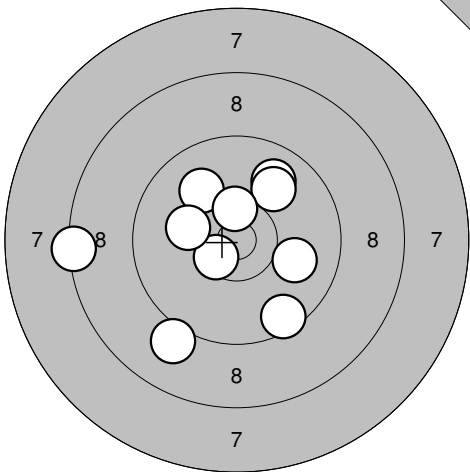
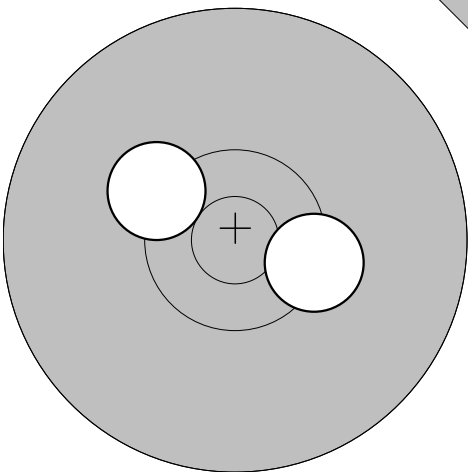
<p>Provskott</p> 	<p>1: 9,1 ↘ 2: 8,4 ← 3: 9,9 ↗ 4: 10,0 ↗ 5: 10,0 ↗ 6: 10,5* ↘ 7: 10,2 ← 8: 10,5* ↑ 9: 9,5 ↘ 10: 10,0 →</p> <table border="1" style="width:100%; border-collapse: collapse;"> <tr><td>Serie</td><td style="text-align: right;">95,0</td></tr> <tr><td>Totalt</td><td style="text-align: right;">0,0</td></tr> </table>	Serie	95,0	Totalt	0,0	<p>Provskott</p>  <p>11: 10,4* → 12: 10,3* ↖</p> <table border="1" style="width:100%; border-collapse: collapse;"> <tr><td>Serie</td><td style="text-align: right;">20,0</td></tr> <tr><td>Totalt</td><td style="text-align: right;">0,0</td></tr> </table>	Serie	20,0	Totalt	0,0
Serie	95,0									
Totalt	0,0									
Serie	20,0									
Totalt	0,0									

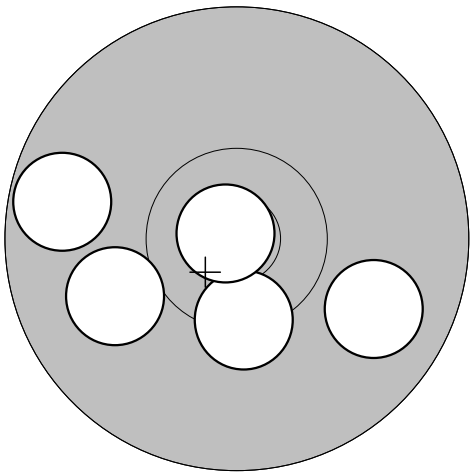
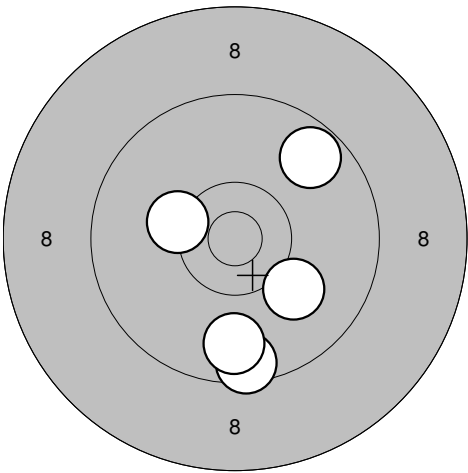
<p>Tävlingsskott</p> 	<p>1: 9,7 ← 2: 9,9 → 3: 10,4* ↓ 4: 10,0 ← 5: 10,9* ↖</p> <table border="1" style="width:100%; border-collapse: collapse;"> <tr><td>Serie</td><td style="text-align: right;">48,0</td></tr> <tr><td>Totalt</td><td style="text-align: right;">48,0</td></tr> </table>	Serie	48,0	Totalt	48,0	<p>Tävlingsskott</p>  <p>6: 10,3 ← 7: 10,1 ↘ 8: 9,7 ↗ 9: 9,5 ↓ 10: 9,8 ↓</p> <table border="1" style="width:100%; border-collapse: collapse;"> <tr><td>Serie</td><td style="text-align: right;">47,0</td></tr> <tr><td>Totalt</td><td style="text-align: right;">95,0</td></tr> </table>	Serie	47,0	Totalt	95,0
Serie	48,0									
Totalt	48,0									
Serie	47,0									
Totalt	95,0									

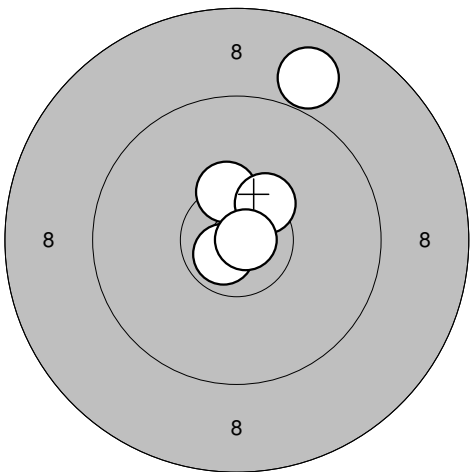
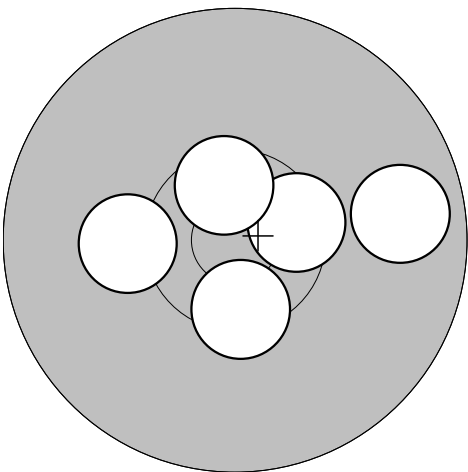
<p>Tävlingsskott</p> 	<p>11: 10,7* ↘ 12: 10,4* ↑ 13: 10,4* ↗ 14: 10,8* → 15: 8,9 ↑</p> <table border="1" style="width:100%; border-collapse: collapse;"> <tr><td>Serie</td><td style="text-align: right;">48,0</td></tr> <tr><td>Totalt</td><td style="text-align: right;">143,0</td></tr> </table>	Serie	48,0	Totalt	143,0	<p>Tävlingsskott</p>  <p>16: 10,5* ↓ 17: 10,2 ← 18: 10,5* → 19: 9,8 → 20: 10,6* ↑</p> <table border="1" style="width:100%; border-collapse: collapse;"> <tr><td>Serie</td><td style="text-align: right;">49,0</td></tr> <tr><td>Totalt</td><td style="text-align: right;">192,0</td></tr> </table>	Serie	49,0	Totalt	192,0
Serie	48,0									
Totalt	143,0									
Serie	49,0									
Totalt	192,0									

Umeå

2012-09-01

Höstträffen 2012

Ramselefors SKF

Provskott

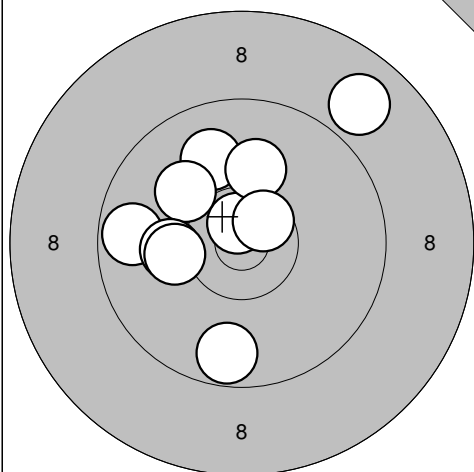

1: 8,9 ↗
 2: 10,7* ↑
 3: 9,9 ↑
 4: 10,1 ↑
 5: 10,1 ↗
 6: 9,7 ←
 7: 9,7 ↓
 8: 10,6* ↗
 9: 10,1 ←
 10: 10,2 ←

Serie 95,0

Totalt 0,0

Tävlingsskott

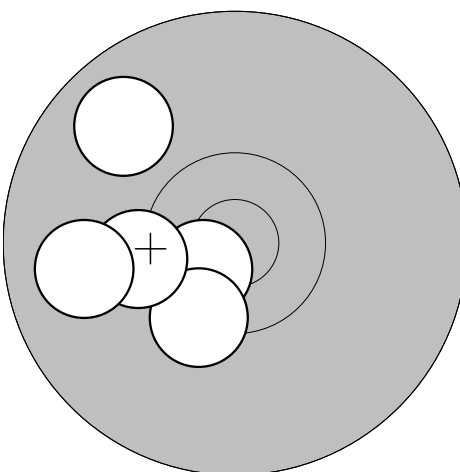

1: 10,7* ↙
 2: 9,8 ↖
 3: 10,4* ↘
 4: 10,3 ←
 5: 9,9 ←

Serie 48,0

Totalt 48,0

Tävlingsskott

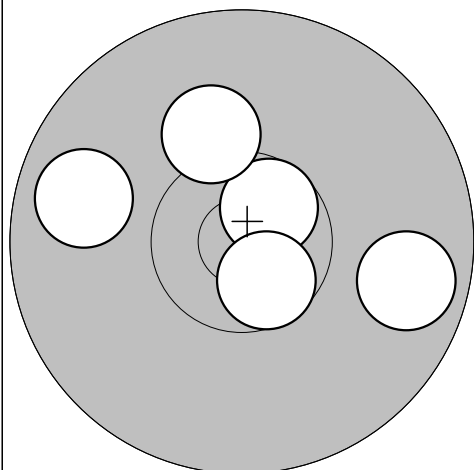

6: 10,6* ↗
 7: 10,2 ↑
 8: 9,8 ←
 9: 10,6* ↘
 10: 9,7 →

Serie 48,0

Totalt 96,0

Tävlingsskott

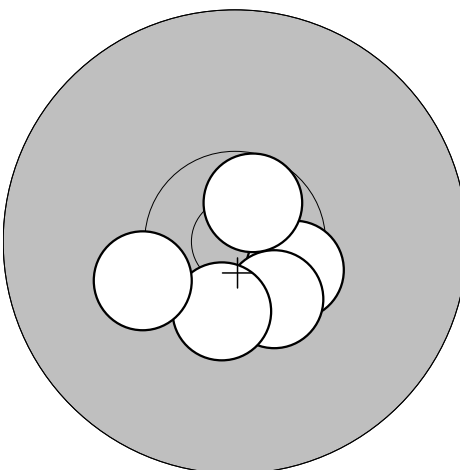

11: 10,5* →
 12: 10,5* ↘
 13: 10,4* ↘
 14: 10,6* ↗
 15: 10,2 ←

Serie 50,0

Totalt 146,0

Tävlingsskott

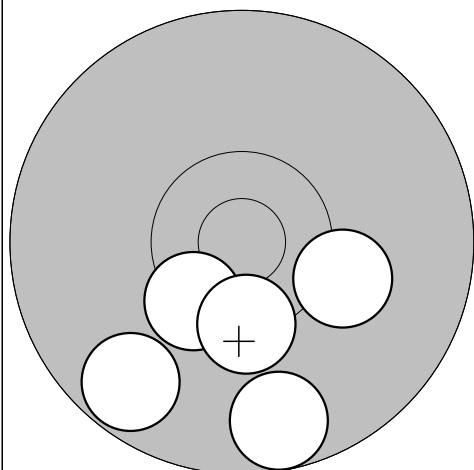

16: 10,4* ↙
 17: 9,7 ↙
 18: 10,2 →
 19: 9,7 ↓
 20: 10,4* ↓

Serie 48,0

Totalt 194,0

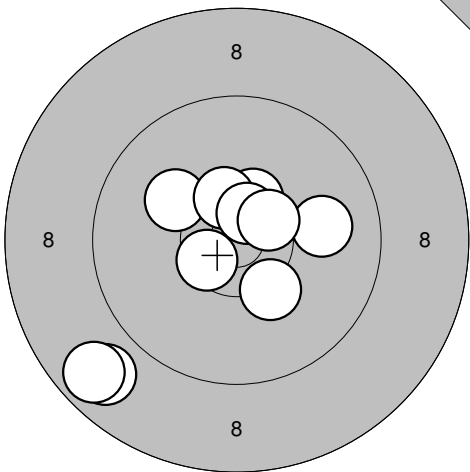
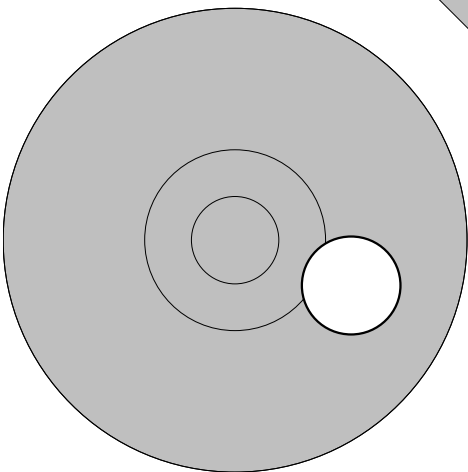
<p>Provskott</p> 	<p>1: 10,4* ↗</p> <p>2: 10,3 ↘</p> <p>3: 10,1 ↗</p> <p>4: 10,5* ↗</p> <p>5: 8,8 ↘</p> <p>6: 8,7 ↘</p> <p>7: 10,0 →</p> <p>8: 10,6* ↗</p> <p>9: 10,5* ↘</p> <p>10: 10,5* ↗</p>	<p>Provskott</p>  <p style="text-align: right;">11: 10,1 →</p>
Serie 96,0		Serie 10,0
Totalt 0,0		Totalt 0,0

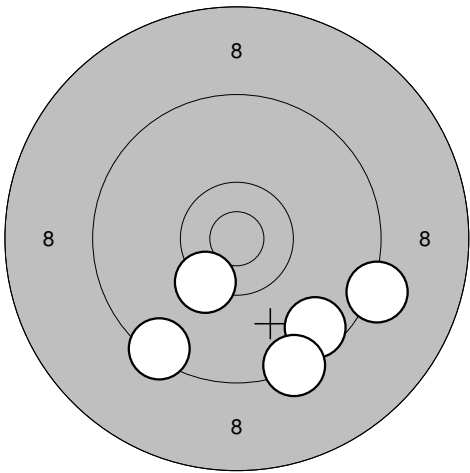
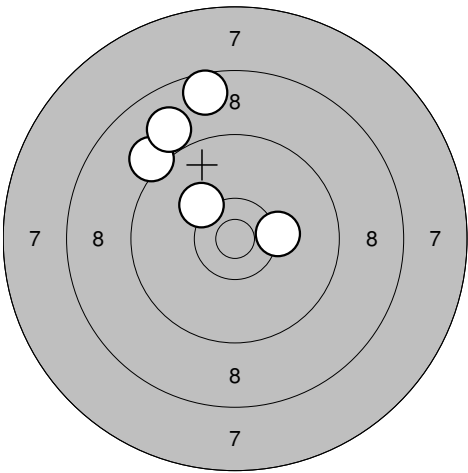
<p>Tävlingsskott</p> 	<p>1: 9,6 ↘</p> <p>2: 9,4 ↘</p> <p>3: 9,2 →</p> <p>4: 10,3* ↘</p> <p>5: 9,4 ↘</p>	<p>Tävlingsskott</p>  <p style="text-align: right;">6: 9,1 ↗</p> <p style="text-align: right;">7: 8,6 ↑</p> <p style="text-align: right;">8: 10,2 ↗</p> <p style="text-align: right;">9: 9,0 ↗</p> <p style="text-align: right;">10: 10,3 →</p>
Serie 46,0		Serie 46,0
Totalt 46,0		Totalt 92,0

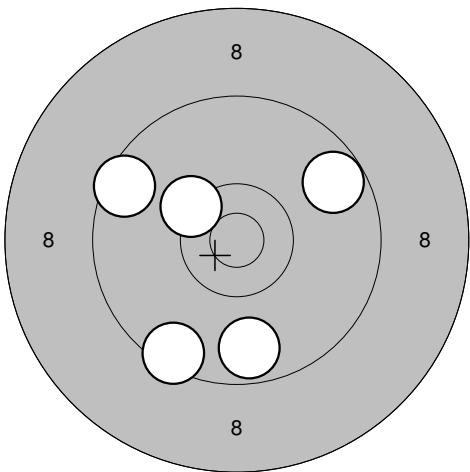
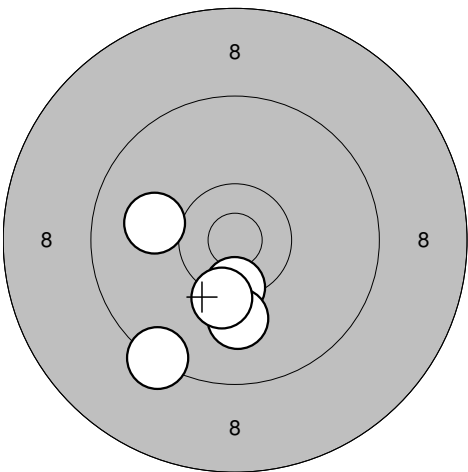
<p>Tävlingsskott</p> 	<p>11: 9,5 ↗</p> <p>12: 10,3* ↗</p> <p>13: 9,7 ↘</p> <p>14: 9,7 ↗</p> <p>15: 9,5 ↘</p>	<p>Tävlingsskott</p>  <p style="text-align: right;">16: 9,3 ↘</p> <p style="text-align: right;">17: 10,4* ↓</p> <p style="text-align: right;">18: 10,1 ↓</p> <p style="text-align: right;">19: 10,0 ←</p> <p style="text-align: right;">20: 10,3 ↓</p>
Serie 46,0		Serie 49,0
Totalt 138,0		Totalt 187,0

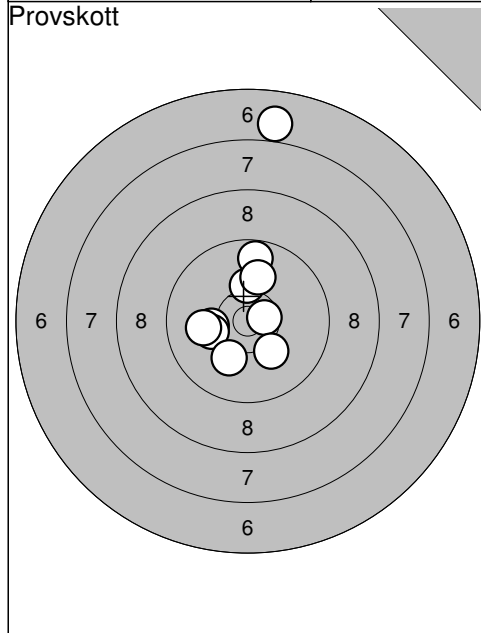

1: 7,0	↑
2: 10,2	↑
3: 10,2	←
4: 10,2	←
5: 10,6*	→
6: 10,2	↘
7: 9,7	↑
8: 10,1	↑
9: 10,1	←
10: 10,1	↘
Serie	96,0
Totalt	0,0

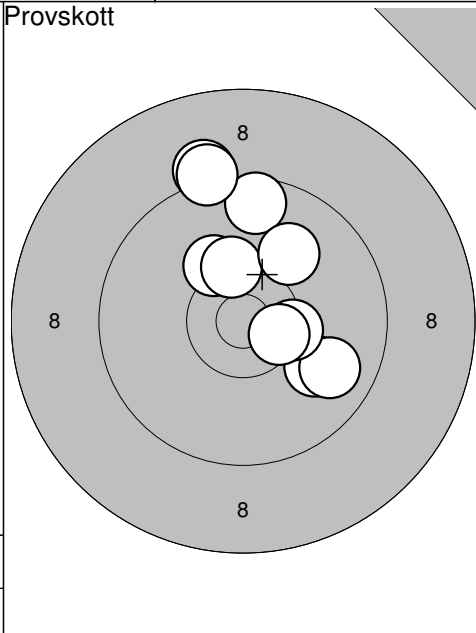

11: 9,6	↑
12: 10,0	↘
13: 9,2	↑
14: 10,2	↗
15: 9,2	↑
16: 10,3*	↑
17: 9,8	↘
18: 10,4*	→
19: 10,0	↗
20: 10,5*	↘
Serie	96,0
Totalt	0,0

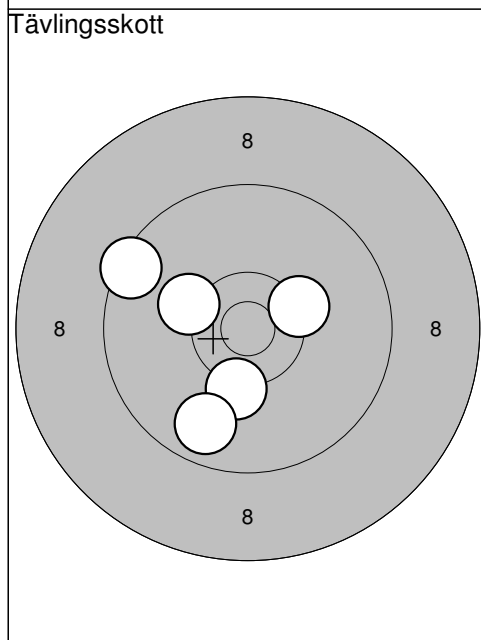

1: 10,2	←
2: 10,2	↘
3: 9,8	↘
4: 9,5	↖
5: 10,3*	→
Serie	48,0
Totalt	48,0

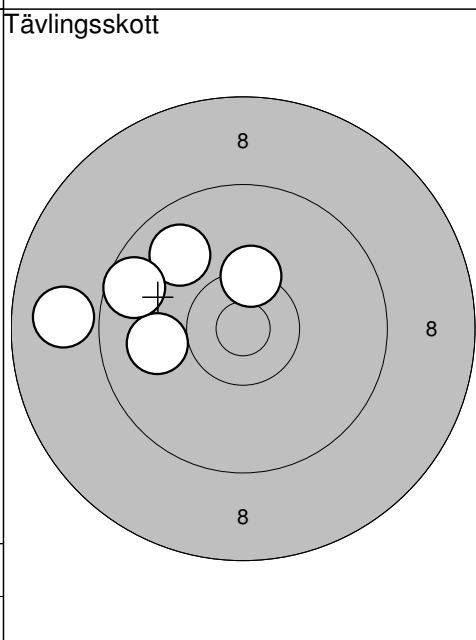

6: 10,0	←
7: 10,3*	↑
8: 8,9	←
9: 9,8	↗
10: 9,6	←
Serie	46,0
Totalt	94,0

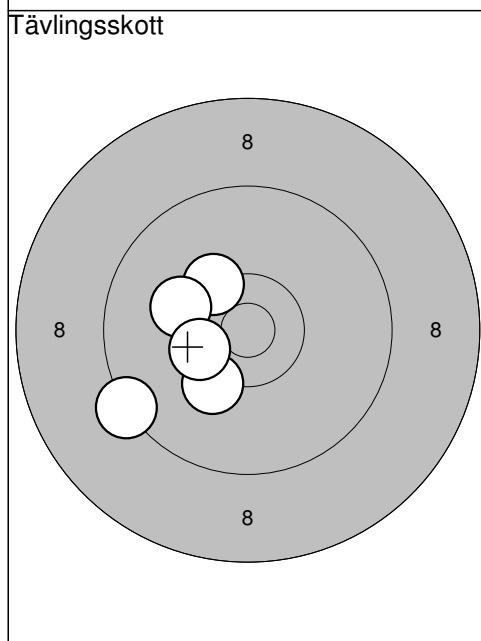

11: 10,2	↘
12: 10,3*	↗
13: 10,1	←
14: 9,3	←
15: 10,4*	←
Serie	49,0
Totalt	143,0

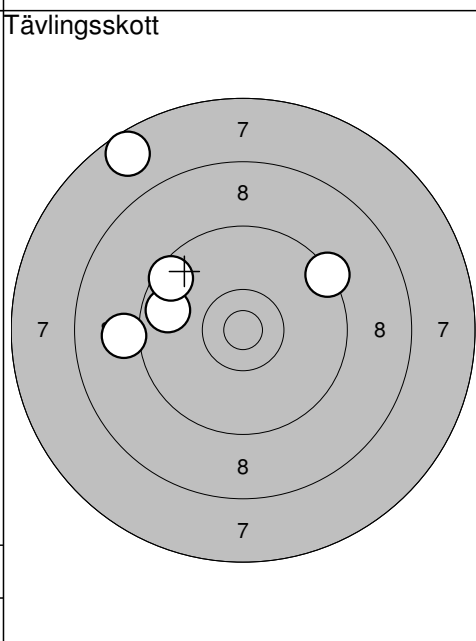

16: 7,7	↗
17: 9,7	←
18: 9,6	↗
19: 9,1	←
20: 9,4	↗
Serie	43,0
Totalt	186,0

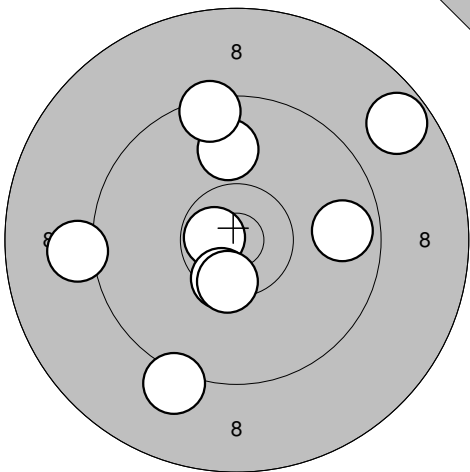
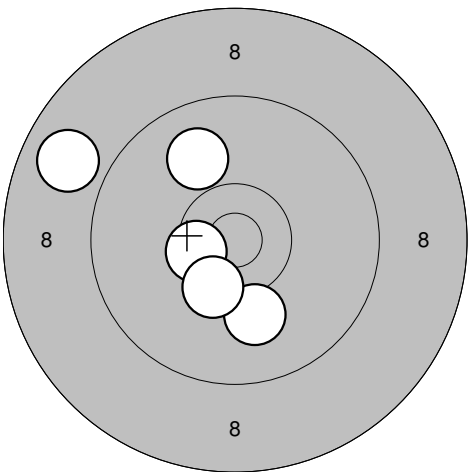
<p>Provskott</p> 	<p>Tävlingsskott</p> 	
<p>1: 8,7 ↗ 2: 9,9 ↑ 3: 9,5 ↑ 4: 9,2 ↓ 5: 10,7* ← 6: 10,5* ↓ 7: 9,1 ← 8: 9,7 → 9: 10,5* ↓</p>	<p>1: 10,1 ↓ 2: 8,8 ↖ 3: 9,9 ↗ 4: 10,5* ← 5: 10,4* ↓</p>	
Serie 83,0	Serie 47,0	
Totalt 0,0	Totalt 47,0	

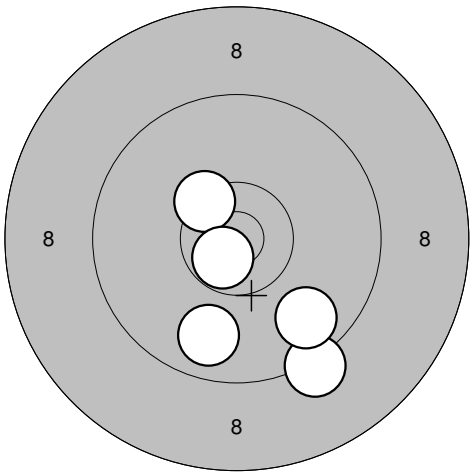
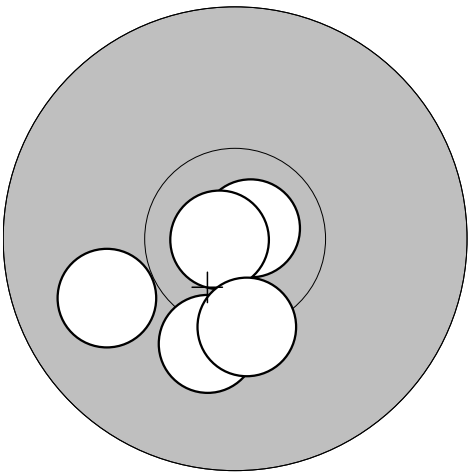
<p>Tävlingsskott</p> 	<p>Tävlingsskott</p> 	
<p>6: 9,8 ↓ 7: 10,4* ↗ 8: 9,2 ↓ 9: 9,7 ↓ 10: 10,7* ↖</p>	<p>11: 10,0 ↖ 12: 10,8* ↗ 13: 10,2 ↓ 14: 10,8* ← 15: 10,3* ↓</p>	
Serie 47,0	Serie 50,0	
Totalt 94,0	Totalt 144,0	

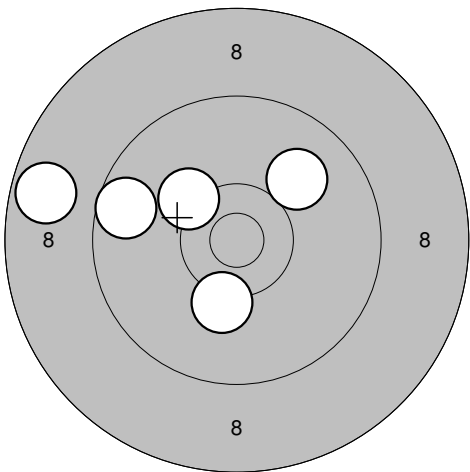
<p>Tävlingsskott</p> 	<p>16: 9,6 ↖ 17: 10,2 ↗ 18: 10,2 ↓ 19: 10,0 ↗ 20: 8,7 ←</p>	
Serie 47,0		
Totalt 191,0		

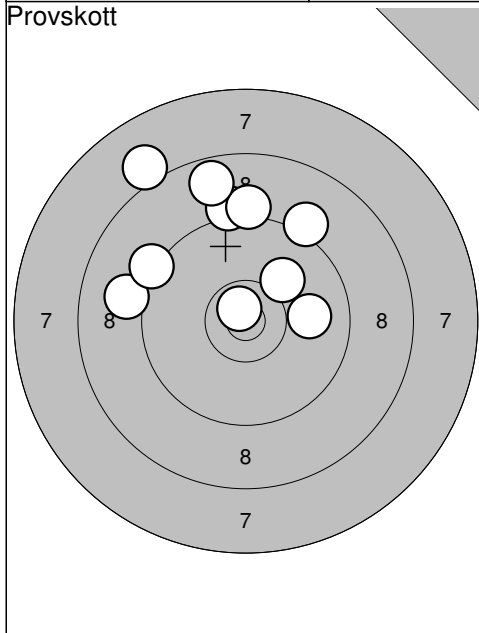

1: 8,1	↗
2: 9,0	←
3: 10,1	↗
4: 9,9	→
5: 9,2	↑
6: 10,7*	↗
7: 9,2	↑
8: 9,2	↖
9: 9,2	↗
10: 8,7	↑
Serie 90,0	
Totalt 0,0	

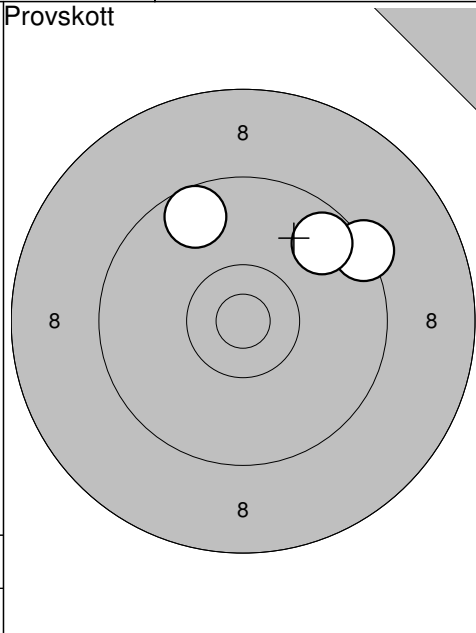

11: 9,4	↗
12: 9,7	↖
13: 9,7	↗
Serie 27,0	
Totalt 0,0	

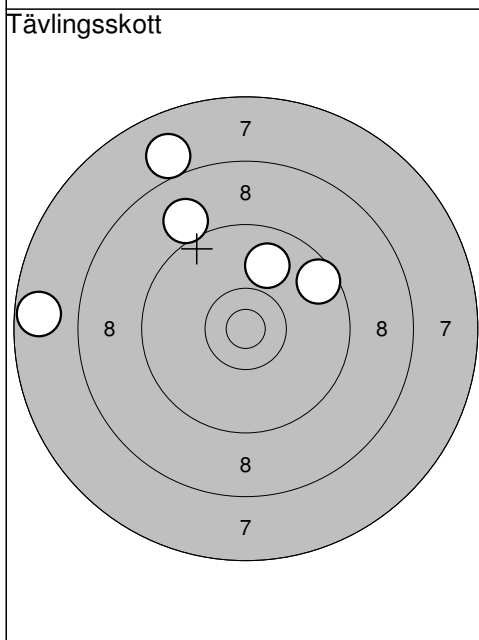

1: 8,0	↖
2: 9,9	↗
3: 9,6	↗
4: 9,0	↖
5: 7,7	←
Serie 42,0	
Totalt 42,0	

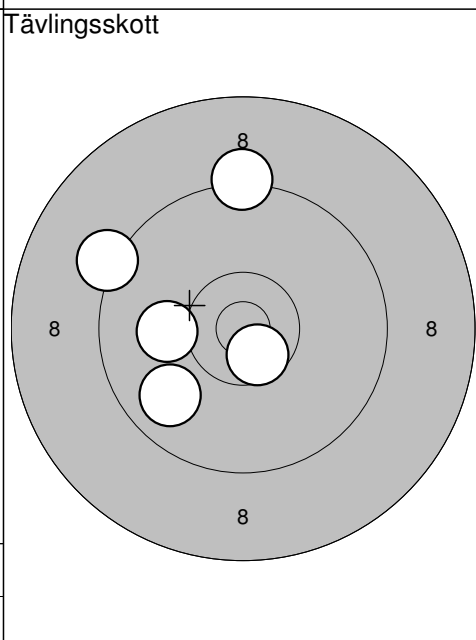

6: 10,1	←
7: 9,3	↑
8: 10,6*	↘
9: 9,8	↖
10: 9,2	↖
Serie 47,0	
Totalt 89,0	

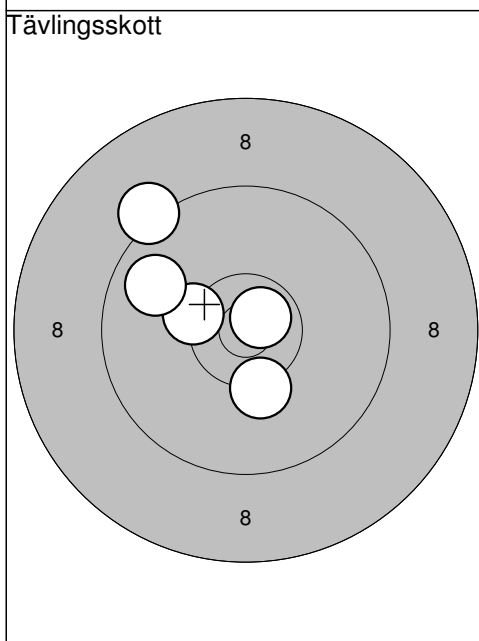

11: 10,7*	↗
12: 10,3*	←
13: 9,2	↗
14: 9,8	↖
15: 10,3	↘
Serie 48,0	
Totalt 137,0	

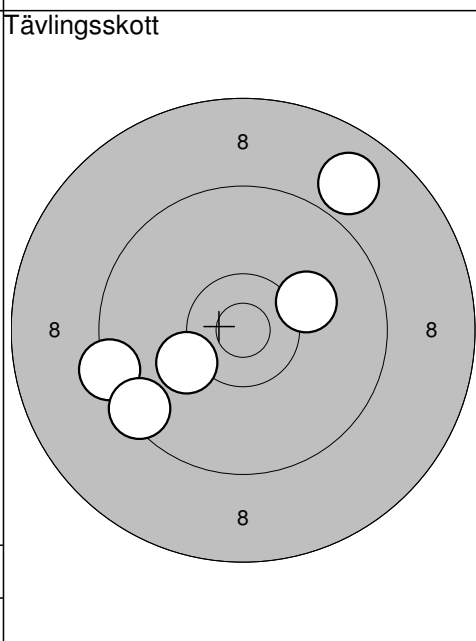

16: 9,4	←
17: 9,5	↖
18: 10,2	↖
19: 10,2	↗
20: 8,9	↗
Serie 46,0	
Totalt 183,0	

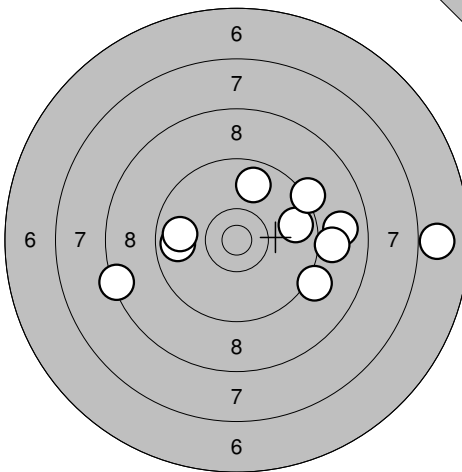
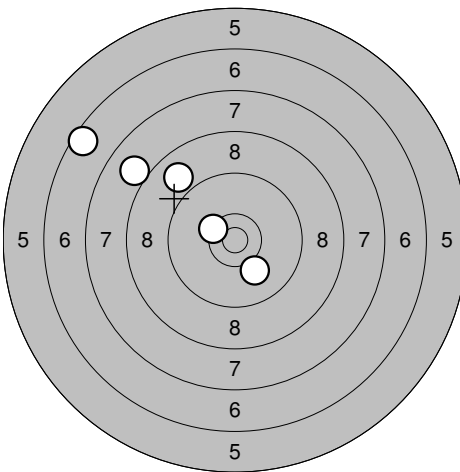
<p>Provskott</p> 	<p>1: 8,9 →</p> <p>2: 6,9 →</p> <p>3: 9,2 ↘</p> <p>4: 9,8 ←</p> <p>5: 9,0 →</p> <p>6: 9,7 →</p> <p>7: 8,4 ←</p> <p>8: 9,8 ←</p> <p>9: 9,8 ↗</p> <p>10: 9,3 ↗</p>	<p>Tävlingsskott</p> 	<p>1: 6,6 ↖</p> <p>2: 8,0 ↖</p> <p>3: 8,9 ↗</p> <p>4: 10,4* ↖</p> <p>5: 10,1 ↘</p>
Serie 85,0	Totalt 0,0	Serie 42,0	Totalt 42,0

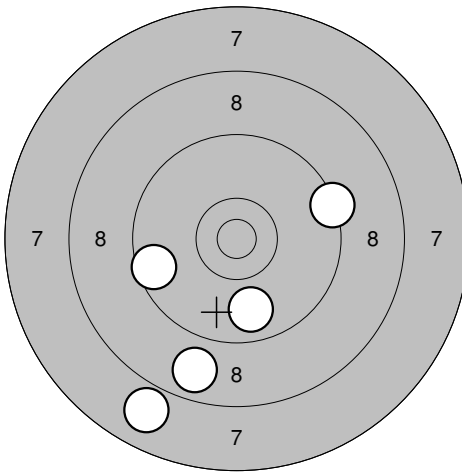
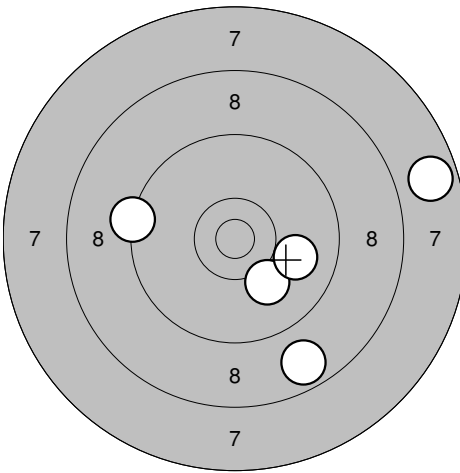
<p>Tävlingsskott</p> 	<p>6: 8,8 ↓</p> <p>7: 9,4 →</p> <p>8: 7,9 ↓</p> <p>9: 9,6 ←</p> <p>10: 9,8 ↓</p>	<p>Tävlingsskott</p> 	<p>11: 9,3 ←</p> <p>12: 10,1 ↓</p> <p>13: 7,7 →</p> <p>14: 9,9 →</p> <p>15: 8,7 ↓</p>
Serie 42,0	Totalt 84,0	Serie 43,0	Totalt 127,0

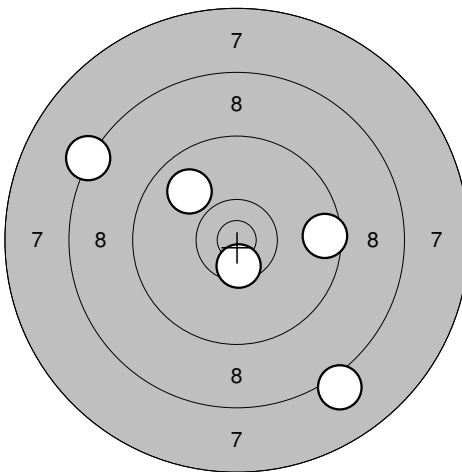
<p>Tävlingsskott</p> 	<p>16: 10,5* ↓</p> <p>17: 9,9 ↗</p> <p>18: 8,1 ↓</p> <p>19: 8,3 ↗</p> <p>20: 9,6 →</p>		
Serie 44,0	Totalt 171,0		

Vännäs

2012-09-01

Höstträffen 2012

Ramselefors SKF

Provskott

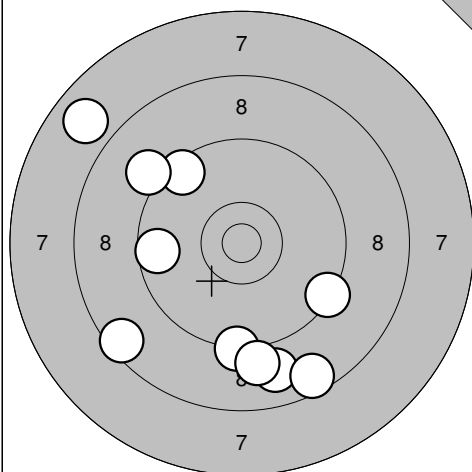

1: 8,9 ↘
 2: 9,3 ↘
 3: 8,6 ↘
 4: 9,6 ←
 5: 8,5 ↙
 6: 9,0 ↘
 7: 9,5 ↗
 8: 9,4 ↘
 9: 9,1 ↗
 10: 7,8 ↗

Serie 85,0

Totalt 0,0

Provskott

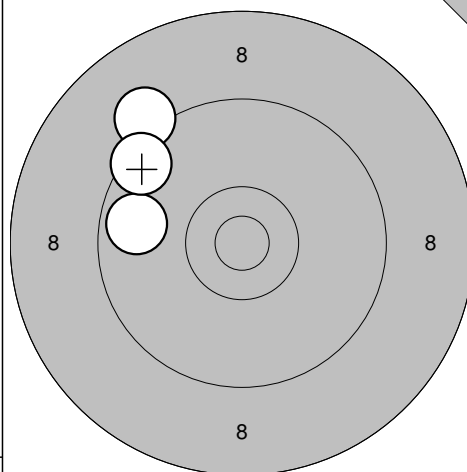

11: 9,7 ←
 12: 9,2 ↗
 13: 9,5 ↗

Serie 27,0

Totalt 0,0

Tävlingsskott

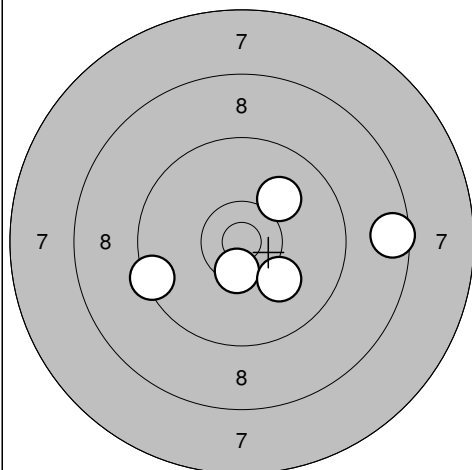

1: 10,5* ↘
 2: 8,6 →
 3: 10,1 ↘
 4: 9,4 ←
 5: 10,1 ↗

Serie 47,0

Totalt 47,0

Tävlingsskott

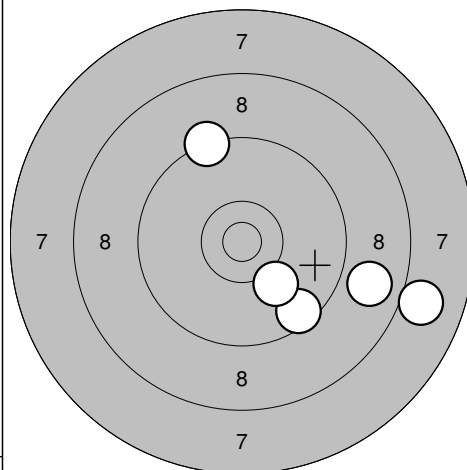

6: 8,0 →
 7: 9,5 ↘
 8: 8,8 →
 9: 9,3 ↗
 10: 10,1 ↘

Serie 44,0

Totalt 91,0

Tävlingsskott

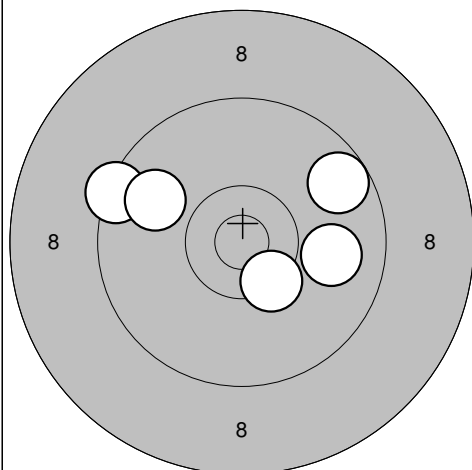

11: 9,4 ←
 12: 9,7 ↗
 13: 10,4* ↘
 14: 9,9 ↗
 15: 9,9 →

Serie 46,0

Totalt 137,0

Tävlingsskott

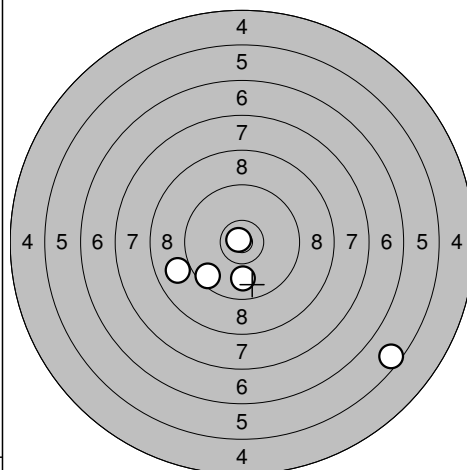

16: 10,8* ↗
 17: 5,6 ↘
 18: 9,9 ↓
 19: 8,9 ←
 20: 9,6 ↘

Serie 41,0

Totalt 178,0

Skellefteå

2012-09-01

Höstträffen 2012

Ramselefors SKF

Provskott

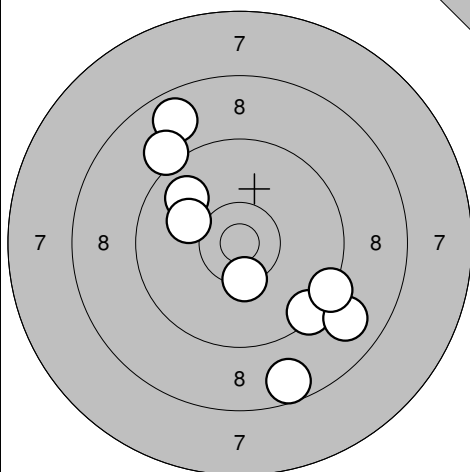

- 1: 0,0 ↗
- 2: 8,6 ↘
- 3: 9,4 ↘
- 4: 8,8 ↗
- 5: 9,1 ↗
- 6: 9,9 ↗
- 7: 10,4* ↘
- 8: 8,9 ↘
- 9: 9,3 ↘
- 10: 10,1 ↗

Serie 80,0
Totalt 0,0

Provskott

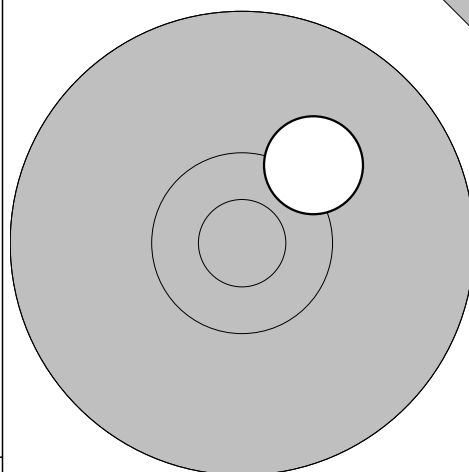

11: 10,2 ↗

Serie 10,0
Totalt 0,0

Tävlingsskott

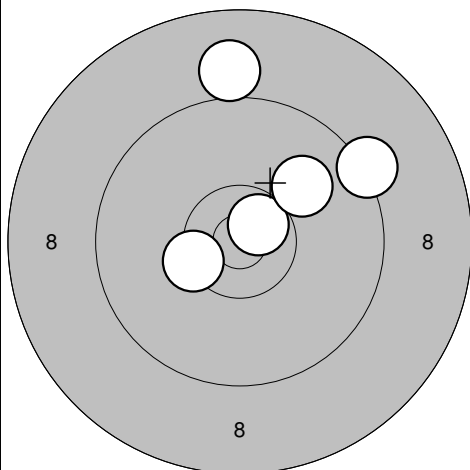

- 1: 9,0 ↗
- 2: 9,3 ↗
- 3: 10,4* ↖
- 4: 10,7* ↗
- 5: 10,0 ↗

Serie 48,0
Totalt 48,0

Tävlingsskott

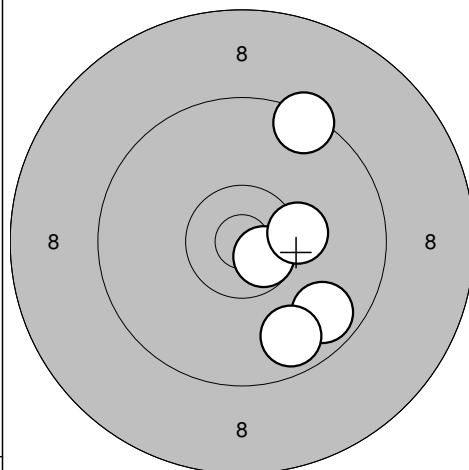

- 6: 10,6* ↘
- 7: 10,3* →
- 8: 9,7 ↘
- 9: 9,7 ↘
- 10: 9,4 ↗

Serie 47,0
Totalt 95,0

Tävlingsskott

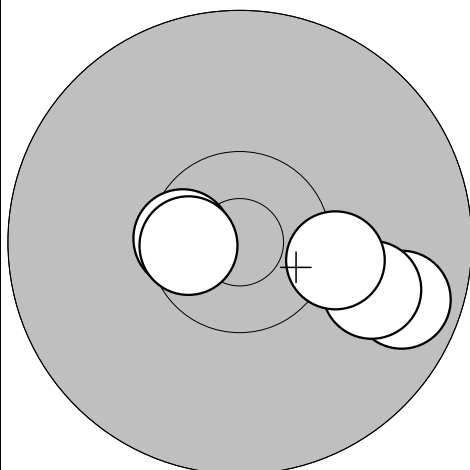

- 11: 10,5* ↖
- 12: 9,7 ↘
- 13: 10,0 ↘
- 14: 10,6* ↖
- 15: 10,3 ↘

Serie 49,0
Totalt 144,0

Tävlingsskott

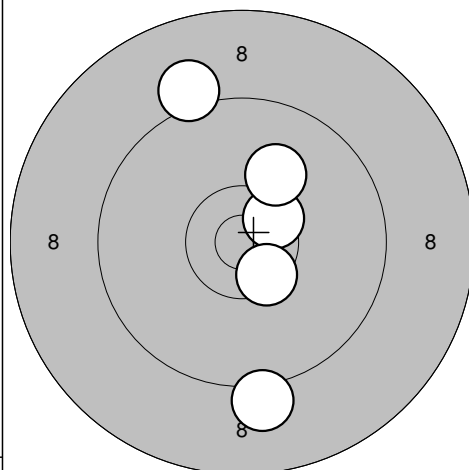

- 16: 9,1 ↗
- 17: 9,1 ↘
- 18: 10,5* ↗
- 19: 10,5* ↘
- 20: 10,1 ↗

Serie 48,0
Totalt 192,0

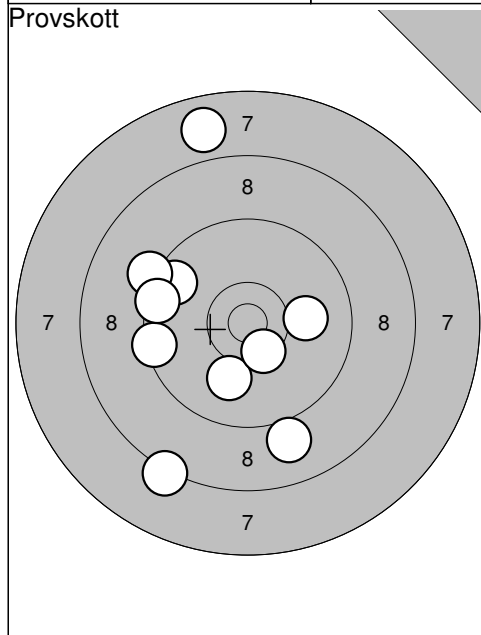

1: 8,3	↙
2: 9,0	↘
3: 10,0	↙
4: 7,8	↗
5: 9,5	←
6: 10,4*	↘
7: 9,6	↗
8: 9,2	↗
9: 10,0	→
10: 9,5	←
Serie	90,0
Totalt	0,0

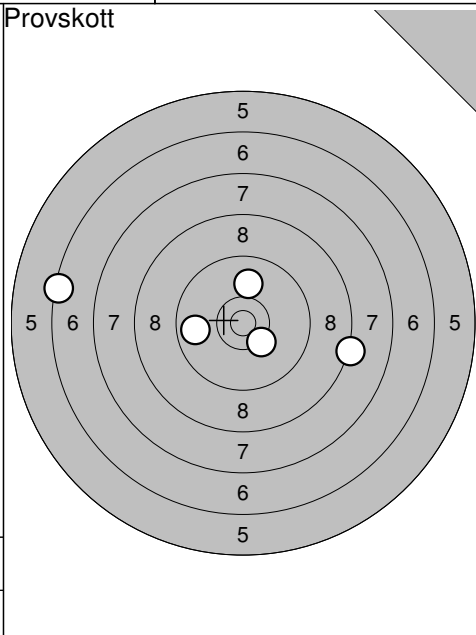

11: 9,8	←
12: 10,0	↑
13: 6,4	←
14: 10,3*	↘
15: 8,2	→
Serie	43,0
Totalt	0,0

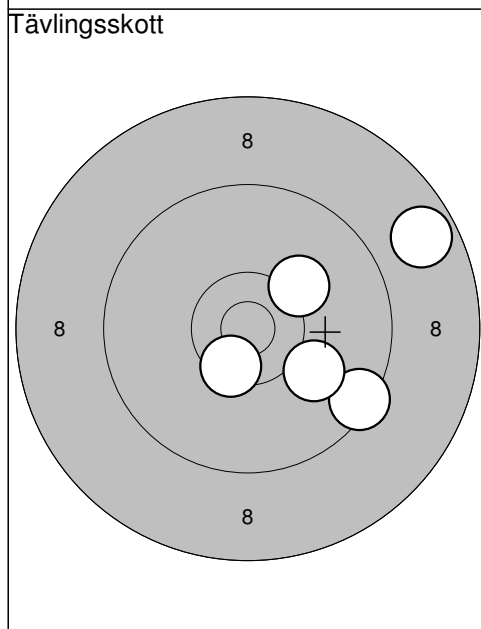

1: 8,7	↗
2: 10,2	↗
3: 9,4	↘
4: 10,1	↘
5: 10,5*	↘
Serie	47,0
Totalt	47,0

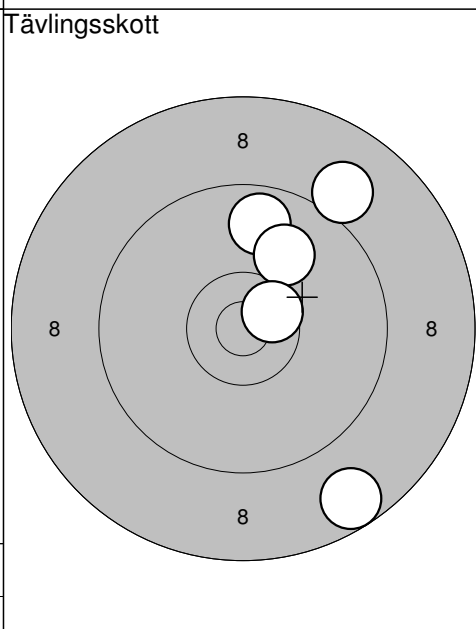

6: 8,7	↘
7: 9,7	↑
8: 9,0	↗
9: 10,0	↗
10: 10,6*	↗
Serie	46,0
Totalt	93,0

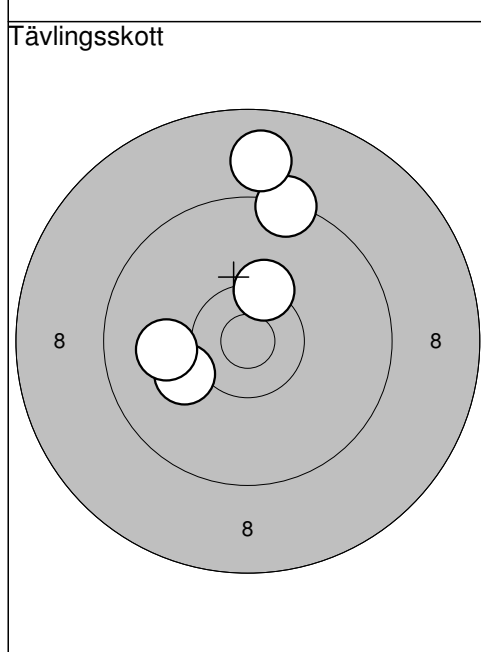

11: 10,3*	↑
12: 10,1	←
13: 9,4	↑
14: 10,0	←
15: 8,9	↑
Serie	47,0
Totalt	140,0

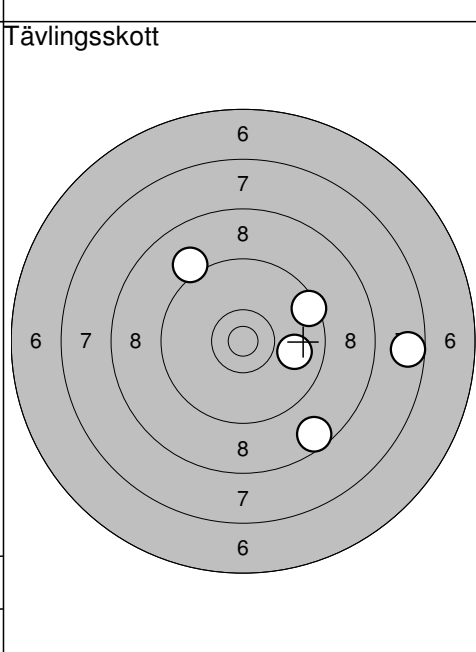

16: 9,5	↗
17: 7,6	→
18: 9,9	→
19: 9,1	↗
20: 8,6	↘
Serie	42,0
Totalt	182,0

Drängsmark

2012-09-01

Höstträffen 2012

Ramselefors SKF

Provskott

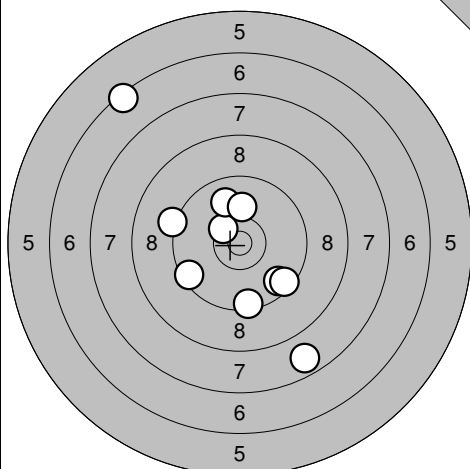

- 1: 6,4 ↗
- 2: 9,6 ↘
- 3: 9,5 ↘
- 4: 7,7 ↘
- 5: 10,4* ↗
- 6: 9,9 ↗
- 7: 10,1 ↗
- 8: 9,5 ↙
- 9: 9,2 ↙
- 10: 9,5 ↘

Serie 87,0
Totalt 0,0

Provskott

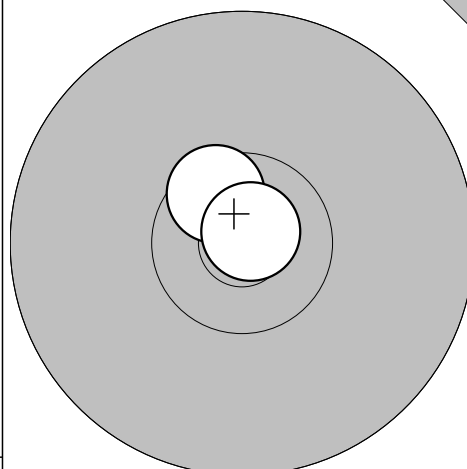

- 11: 10,6* ↖
- 12: 10,8* ↗

Serie 20,0
Totalt 0,0

Tävlingsskott

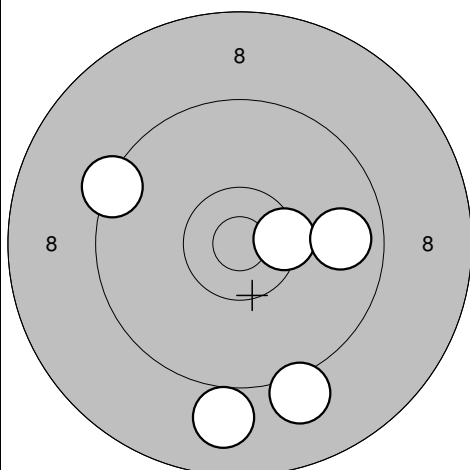

- 1: 10,4* →
- 2: 9,4 ↖
- 3: 9,0 ↘
- 4: 9,1 ↘
- 5: 9,8 →

Serie 46,0
Totalt 46,0

Tävlingsskott

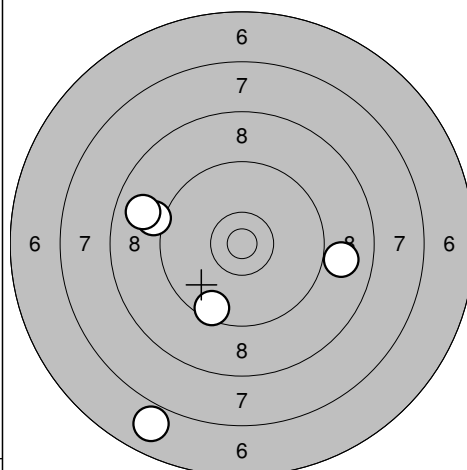

- 6: 9,5 ↘
- 7: 9,1 ↙
- 8: 8,9 ↙
- 9: 6,9 ↘
- 10: 8,9 →

Serie 40,0
Totalt 86,0

Tävlingsskott

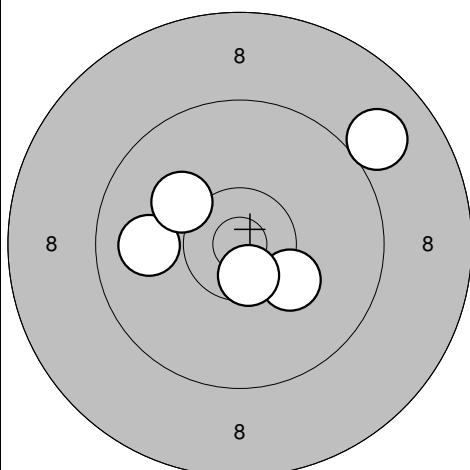

- 11: 9,0 ↗
- 12: 10,2 ↘
- 13: 9,9 ↙
- 14: 10,1 ↗
- 15: 10,6* ↘

Serie 48,0
Totalt 134,0

Tävlingsskott

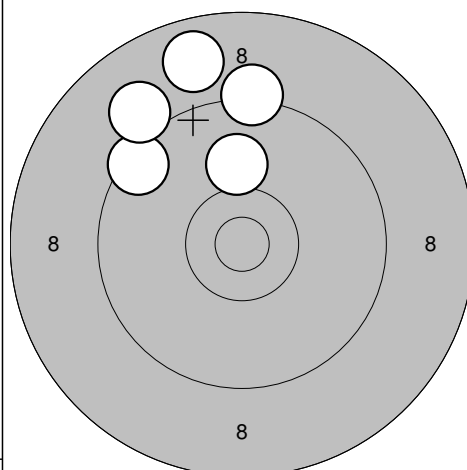

- 16: 9,2 ↗
- 17: 10,0 ↗
- 18: 9,5 ↖
- 19: 8,8 ↗
- 20: 9,1 ↖

Serie 45,0
Totalt 179,0

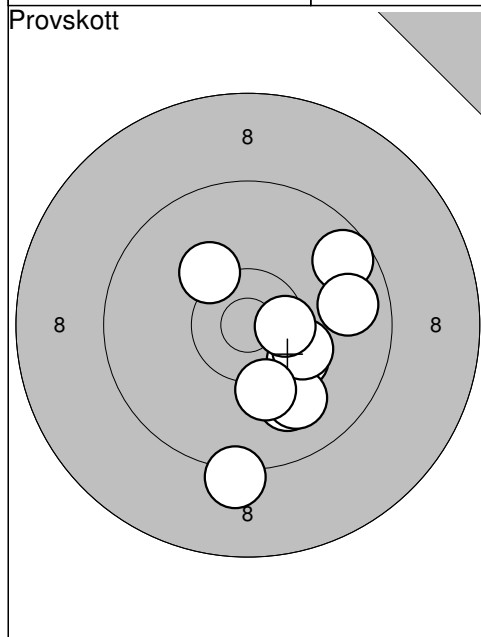

1: 10,2	↗
2: 10,0	↘
3: 9,6	↗
4: 9,2	↘
5: 10,3	↘
6: 9,9	↘
7: 10,3	↗
8: 9,8	→
9: 10,5*	→
10: 10,2	↘
Serie	96,0
Totalt	0,0

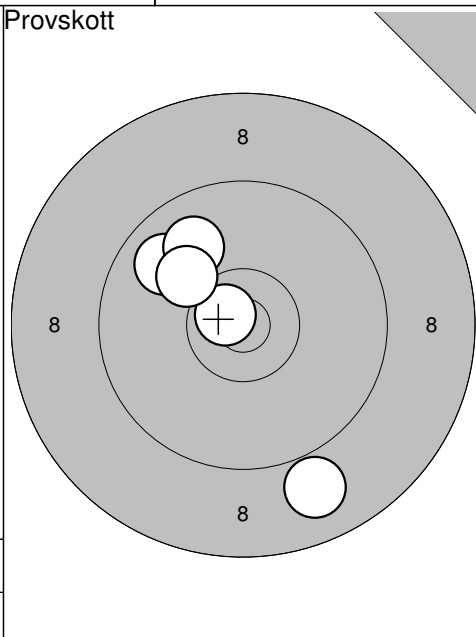

11: 8,9	↘
12: 10,7*	↗
13: 9,8	↗
14: 9,9	↗
15: 10,1	↗
Serie	46,0
Totalt	0,0

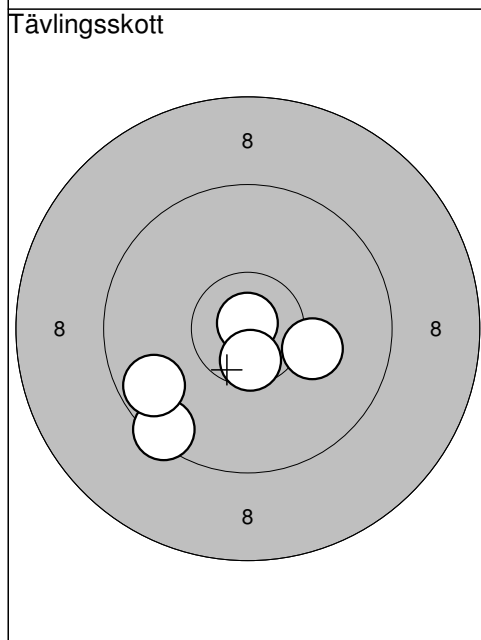

1: 9,5	↘
2: 9,7	↙
3: 10,9*	↑
4: 10,6*	↘
5: 10,2	↗
Serie	48,0
Totalt	48,0

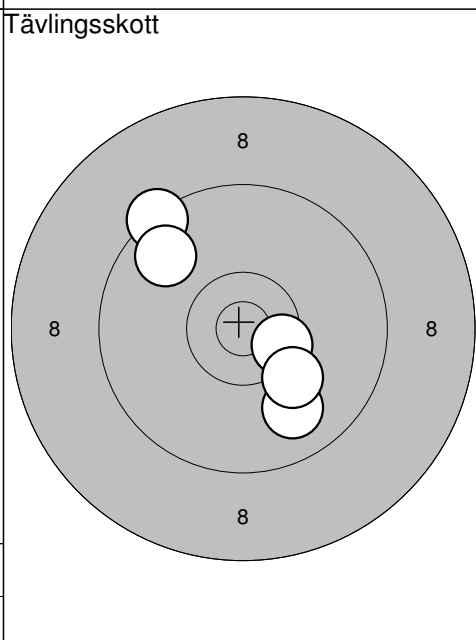

6: 9,4	↗
7: 10,5*	↘
8: 9,9	↘
9: 10,2	↘
10: 9,7	↗
Serie	47,0
Totalt	95,0

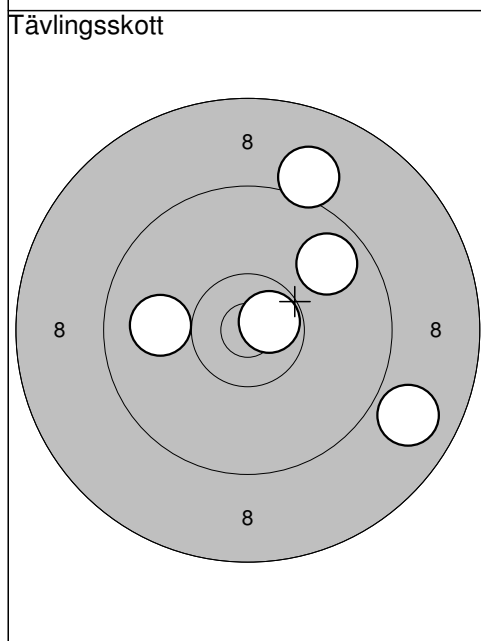

11: 9,8	↗
12: 9,1	↗
13: 8,9	↘
14: 10,7*	↗
15: 10,0	↙
Serie	46,0
Totalt	141,0

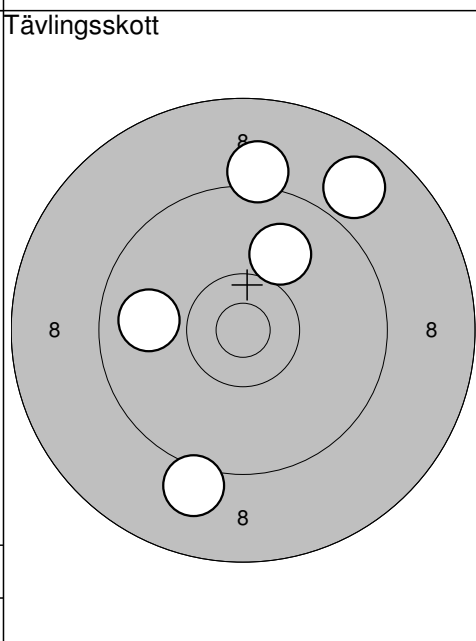

16: 10,0	↗
17: 9,1	↑
18: 9,9	↙
19: 8,9	↗
20: 9,1	↘
Serie	45,0
Totalt	186,0

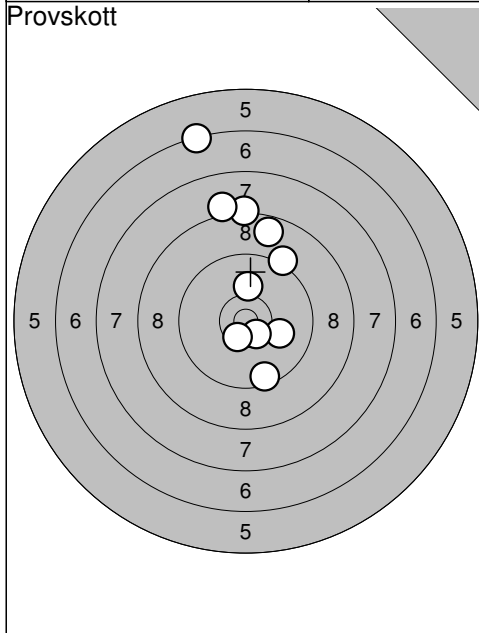

1: 6,4	↑
2: 9,5	↓
3: 10,1	↑
4: 8,7	↑
5: 10,1	→
6: 8,3	↑
7: 8,1	↑
8: 9,2	↗
9: 10,5*	↓
10: 10,5*	↘
Serie	88,0
Totalt	0,0

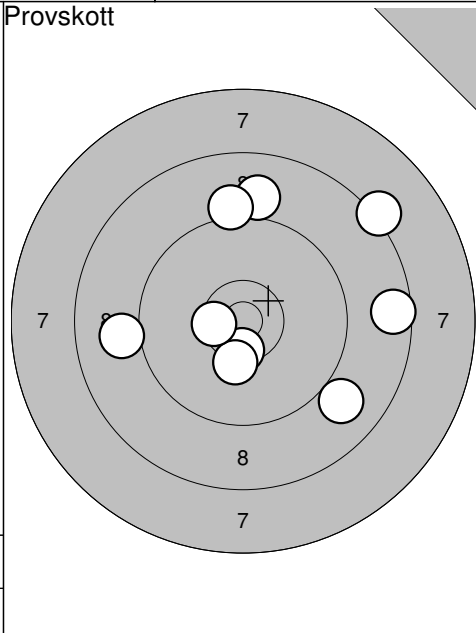

11: 10,5*	↓
12: 9,0	↑
13: 10,3	↓
14: 9,0	↘
15: 8,6	→
16: 8,2	↗
17: 9,2	↑
18: 10,5*	←
19: 9,0	←
Serie	82,0
Totalt	0,0

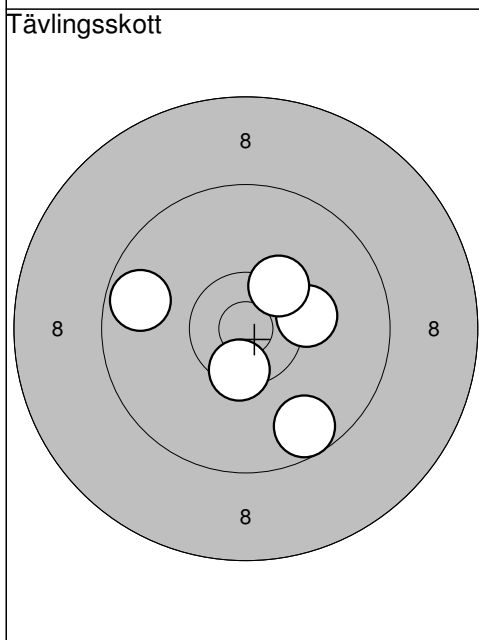

1: 9,6	↓
2: 10,2	→
3: 10,3*	↗
4: 9,7	←
5: 10,5*	↓
Serie	48,0
Totalt	48,0

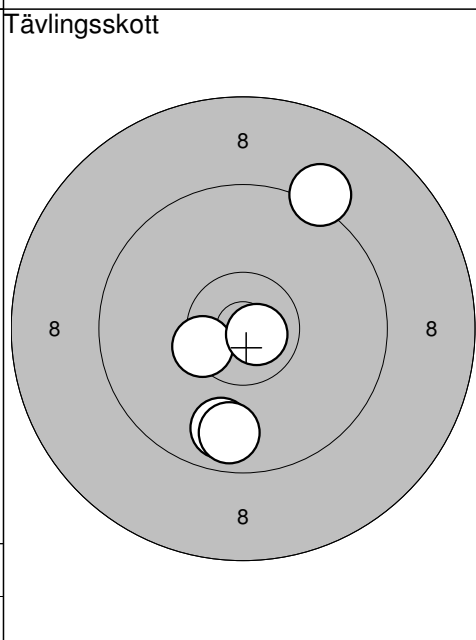

6: 9,8	↓
7: 10,5*	←
8: 9,8	↓
9: 9,2	↗
10: 10,8*	→
Serie	47,0
Totalt	95,0

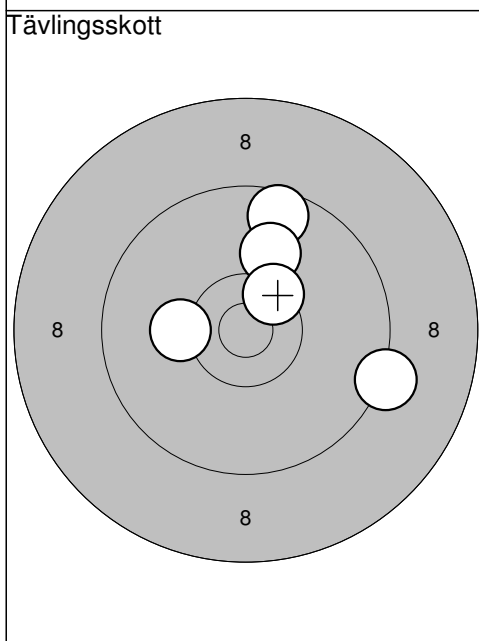

11: 9,6	↑
12: 10,0	↑
13: 10,2	←
14: 9,3	→
15: 10,4*	↗
Serie	48,0
Totalt	143,0

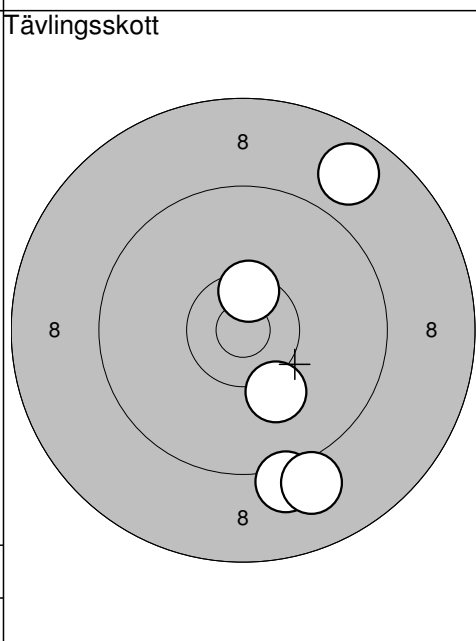

16: 9,2	↓
17: 8,8	↗
18: 10,5*	↑
19: 9,0	↓
20: 10,1	↓
Serie	46,0
Totalt	189,0

Ramselefors

2012-09-01

Höstträffen 2012

Ramselefors SKF

Provskott

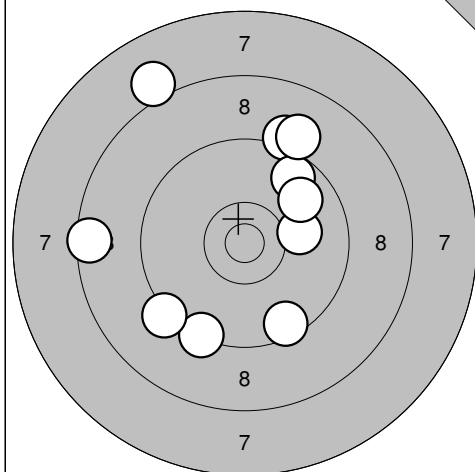

1: 9,3 ↘
 2: 9,2 ↗
 3: 9,7 ↗
 4: 9,1 ↗
 5: 8,1 ↗
 6: 10,1 →
 7: 9,8 ↗
 8: 9,3 ↘
 9: 8,5 ←
 10: 9,5 ↘

Serie 89,0

Totalt 0,0

Provskott

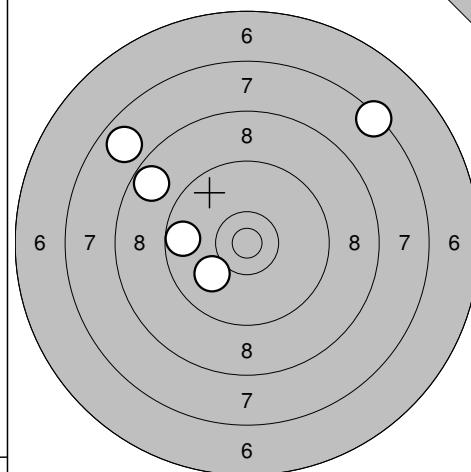

11: 7,4 ↗
 12: 7,8 ↘
 13: 10,0 ↘
 14: 8,7 ↘
 15: 9,7 ←

Serie 41,0

Totalt 0,0

Tävlingsskott

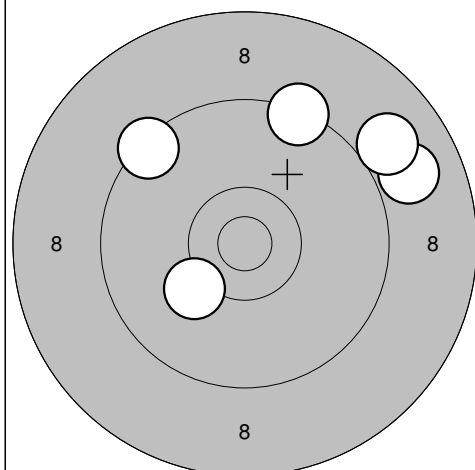

1: 9,4 ↘
 2: 10,2 ↘
 3: 9,4 ↗
 4: 8,9 →
 5: 9,0 ↗

Serie 45,0

Totalt 45,0

Tävlingsskott

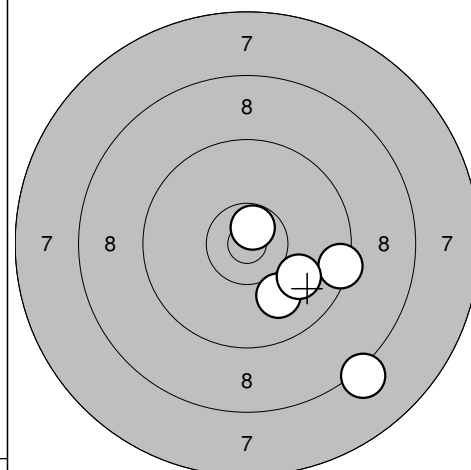

6: 10,0 ↘
 7: 9,4 →
 8: 10,7* ↗
 9: 10,0 ↘
 10: 8,2 ↘

Serie 47,0

Totalt 92,0

Tävlingsskott

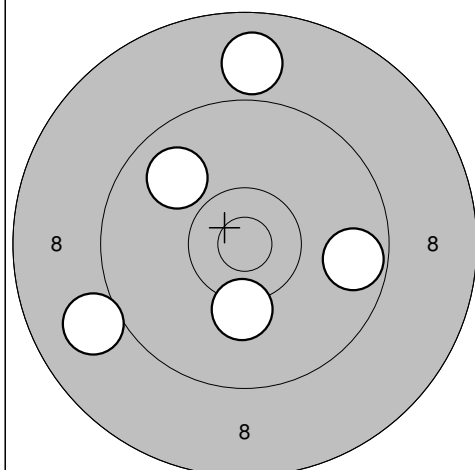

11: 10,2 ↘
 12: 9,7 →
 13: 9,9 ↗
 14: 9,0 ↘
 15: 8,9 ↗

Serie 45,0

Totalt 137,0

Tävlingsskott

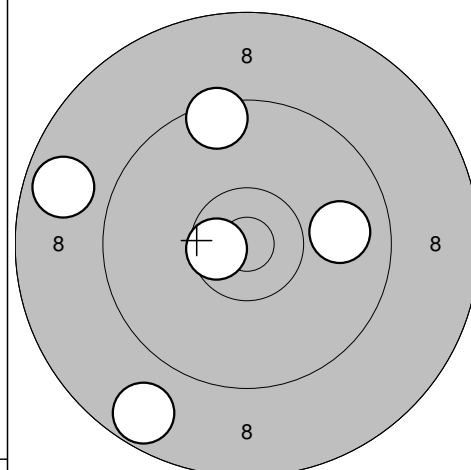

16: 8,7 ↘
 17: 8,8 ←
 18: 9,5 ↗
 19: 9,9 →
 20: 10,6* ←

Serie 44,0

Totalt 181,0

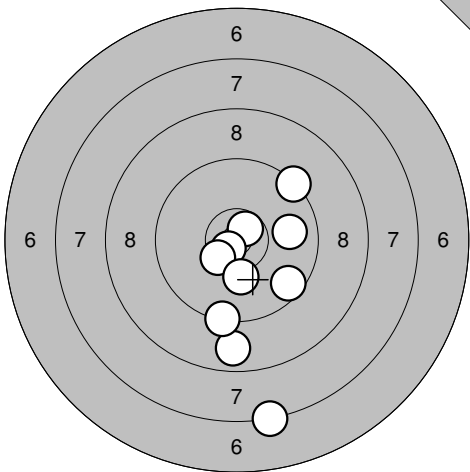
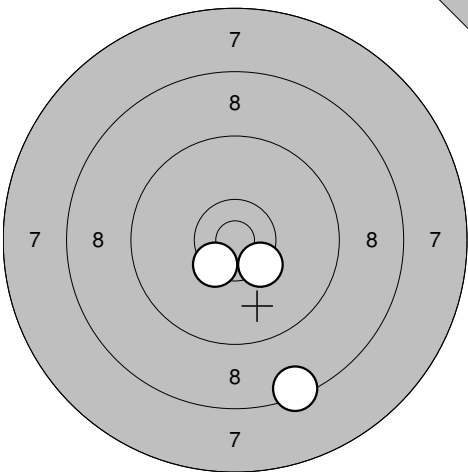
<p>Provskott</p> 	<p>1: 9,3 ↗ 2: 8,8 ↓ 3: 7,3 ↓ 4: 9,6 ↘ 5: 9,9 → 6: 10,7* ↗ 7: 10,7* ↘ 8: 10,4* ↘ 9: 9,3 ↓ 10: 10,2 ↓</p> <table border="1" style="width:100%; border-collapse: collapse;"> <tr><td>Serie</td><td style="text-align: right;">91,0</td></tr> <tr><td>Totalt</td><td style="text-align: right;">0,0</td></tr> </table>	Serie	91,0	Totalt	0,0	<p>Provskott</p>  <p>11: 8,4 ↓ 12: 10,5* ↘ 13: 10,4* ↘</p> <table border="1" style="width:100%; border-collapse: collapse;"> <tr><td>Serie</td><td style="text-align: right;">28,0</td></tr> <tr><td>Totalt</td><td style="text-align: right;">0,0</td></tr> </table>	Serie	28,0	Totalt	0,0
Serie	91,0									
Totalt	0,0									
Serie	28,0									
Totalt	0,0									

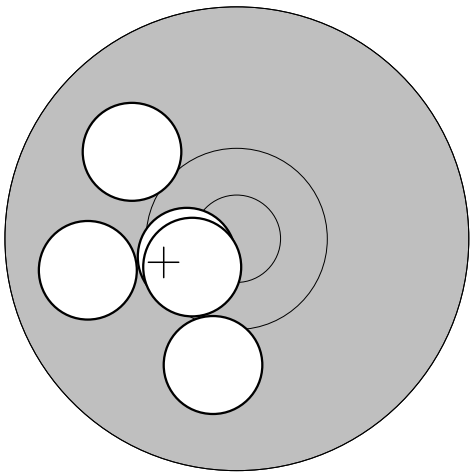
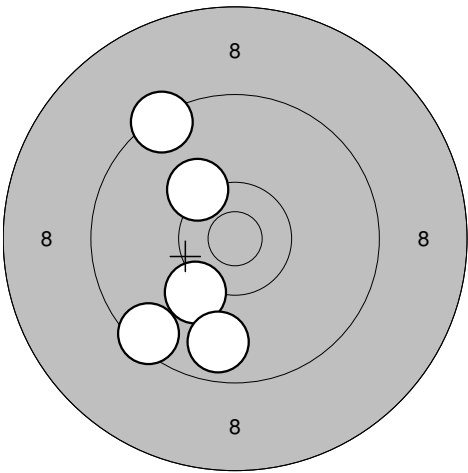
<p>Tävlingsskott</p> 	<p>1: 9,9 ← 2: 10,6* ← 3: 10,0 ↗ 4: 10,6* ↘ 5: 10,0 ↓</p> <table border="1" style="width:100%; border-collapse: collapse;"> <tr><td>Serie</td><td style="text-align: right;">49,0</td></tr> <tr><td>Totalt</td><td style="text-align: right;">49,0</td></tr> </table>	Serie	49,0	Totalt	49,0	<p>Tävlingsskott</p>  <p>6: 10,2 ↘ 7: 9,8 ↓ 8: 9,5 ↘ 9: 10,3 ↗ 10: 9,4 ↗</p> <table border="1" style="width:100%; border-collapse: collapse;"> <tr><td>Serie</td><td style="text-align: right;">47,0</td></tr> <tr><td>Totalt</td><td style="text-align: right;">96,0</td></tr> </table>	Serie	47,0	Totalt	96,0
Serie	49,0									
Totalt	49,0									
Serie	47,0									
Totalt	96,0									

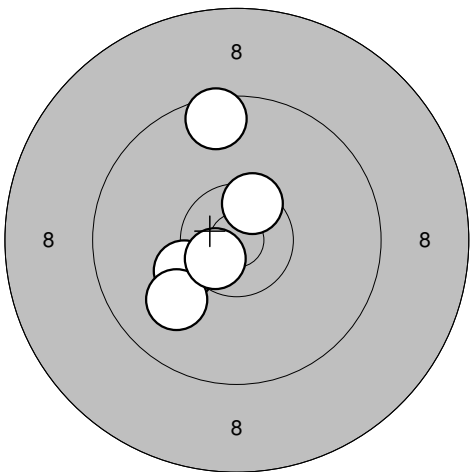
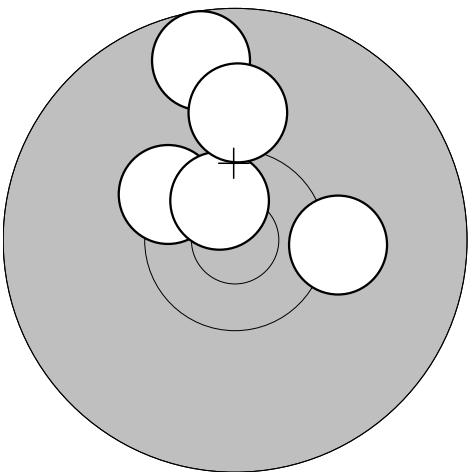
<p>Tävlingsskott</p> 	<p>11: 10,3 ← 12: 10,5* ↗ 13: 10,0 ↘ 14: 9,6 ↑ 15: 10,6* ↘</p> <table border="1" style="width:100%; border-collapse: collapse;"> <tr><td>Serie</td><td style="text-align: right;">49,0</td></tr> <tr><td>Totalt</td><td style="text-align: right;">145,0</td></tr> </table>	Serie	49,0	Totalt	145,0	<p>Tävlingsskott</p>  <p>16: 10,4* ↗ 17: 9,7 ↑ 18: 10,7* ↗ 19: 10,0 ↑ 20: 10,2 →</p> <table border="1" style="width:100%; border-collapse: collapse;"> <tr><td>Serie</td><td style="text-align: right;">49,0</td></tr> <tr><td>Totalt</td><td style="text-align: right;">194,0</td></tr> </table>	Serie	49,0	Totalt	194,0
Serie	49,0									
Totalt	145,0									
Serie	49,0									
Totalt	194,0									

Ramselefors

2012-09-01

Höstträffen 2012

Ramselefors SKF

Provskott

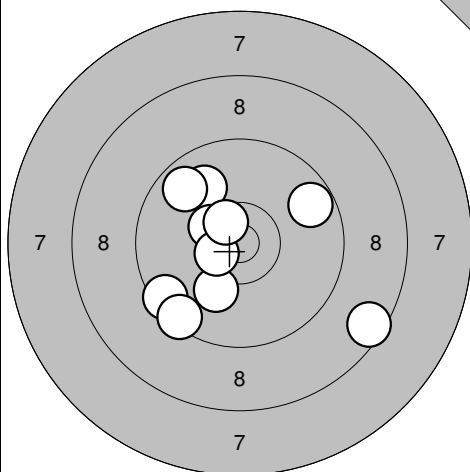

- 1: 9,9 ↗
- 2: 9,7 →
- 3: 8,5 ↘
- 4: 10,4* ↗
- 5: 10,1 ↘
- 6: 10,5* ←
- 7: 9,5 ←
- 8: 9,5 ↘
- 9: 9,7 ↗
- 10: 10,6* ↗

Serie 93,0
Totalt 0,0

Provskott

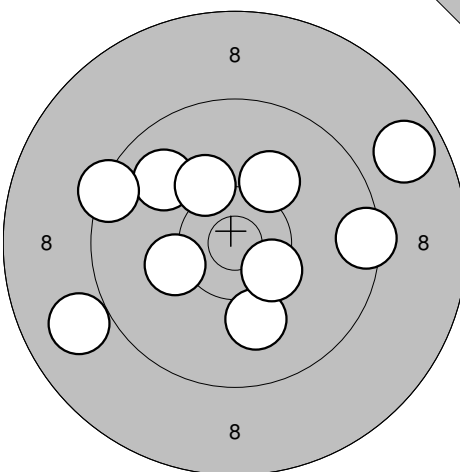

- 11: 9,9 ↖
- 12: 10,2 ←
- 13: 10,2 ↗
- 14: 10,0 ↘
- 15: 9,4 ↖
- 16: 8,8 →
- 17: 9,5 →
- 18: 10,4* ↘
- 19: 10,2 ↗
- 20: 8,9 ←

Serie 93,0
Totalt 0,0

Tävlingsskott

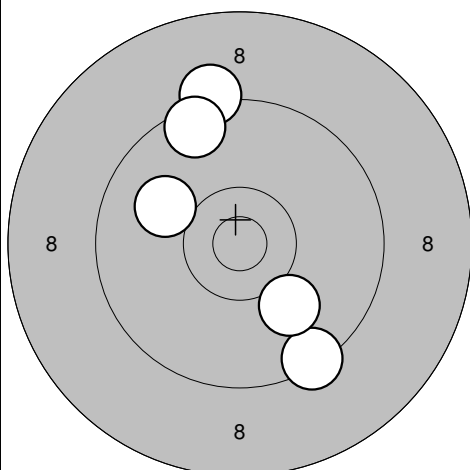

- 1: 9,2 ↗
- 2: 9,5 ↗
- 3: 9,4 ↘
- 4: 10,0 ↗
- 5: 10,0 ↘

Serie 47,0
Totalt 47,0

Tävlingsskott

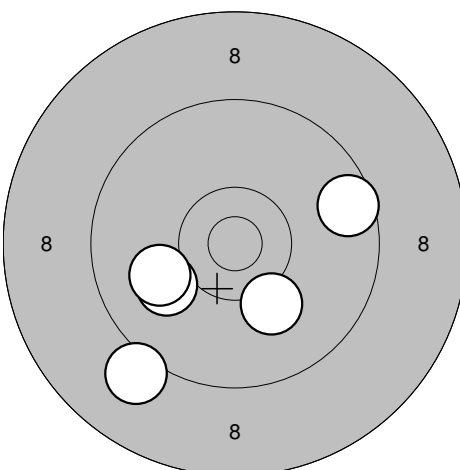

- 6: 9,6 →
- 7: 10,0 ←
- 8: 10,1 ↘
- 9: 10,0 ←
- 10: 9,1 ↘

Serie 48,0
Totalt 95,0

Tävlingsskott

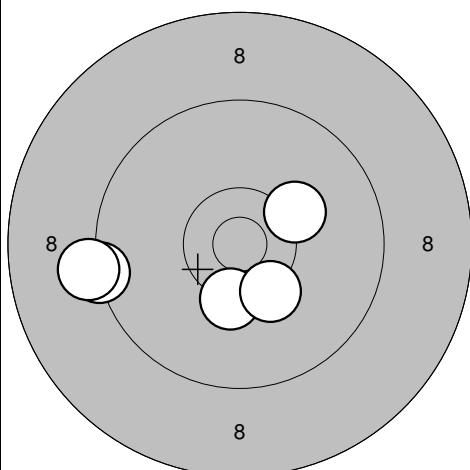

- 11: 10,3* ↘
- 12: 9,3 ←
- 13: 9,2 ←
- 14: 10,3* ↘
- 15: 10,2 →

Serie 48,0
Totalt 143,0

Tävlingsskott

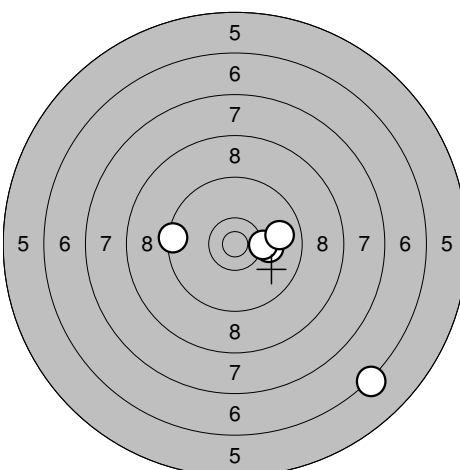

- 16: 10,1 →
- 17: 9,5 ←
- 18: 10,3 →
- 19: 6,2 ↘
- 20: 9,8 →

Serie 44,0
Totalt 187,0

Ramselefors

2012-09-01

Höstträffen 2012

Ramselefors SKF

Provskott

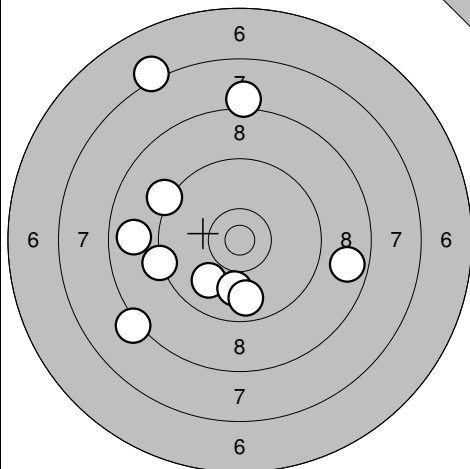

- 1: 9,3 ←
- 2: 8,8 ←
- 3: 8,2 ↙
- 4: 9,9 ↘
- 5: 10,0 ↓
- 6: 9,8 ↓
- 7: 9,2 ↗
- 8: 8,1 ↑
- 9: 8,7 →
- 10: 7,2 ↗

Serie 85,0
Totalt 0,0

Provskott

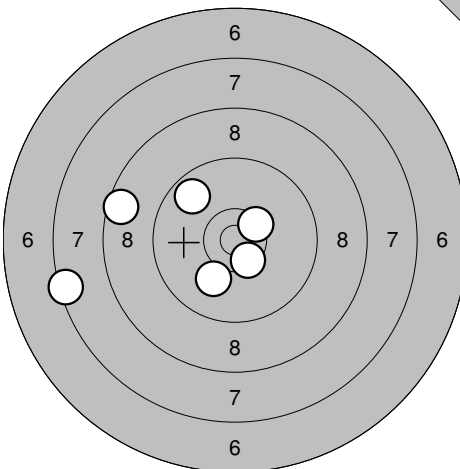

- 11: 10,1 ↓
- 12: 9,7 ↗
- 13: 10,4* ↗
- 14: 7,4 ←
- 15: 10,5* ↓
- 16: 8,6 ←

Serie 54,0
Totalt 0,0

Tävlingsskott

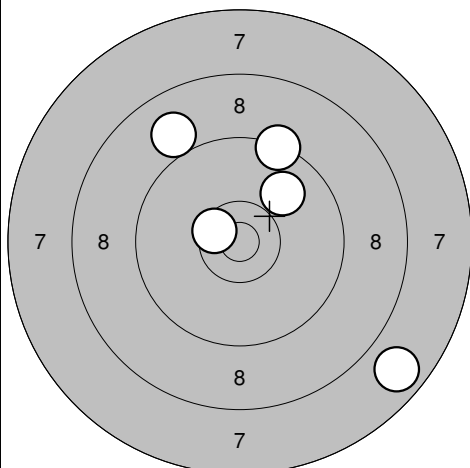

- 1: 9,0 ↗
- 2: 9,9 ↗
- 3: 7,8 ↘
- 4: 10,5* ↙
- 5: 9,4 ↑

Serie 44,0
Totalt 44,0

Tävlingsskott

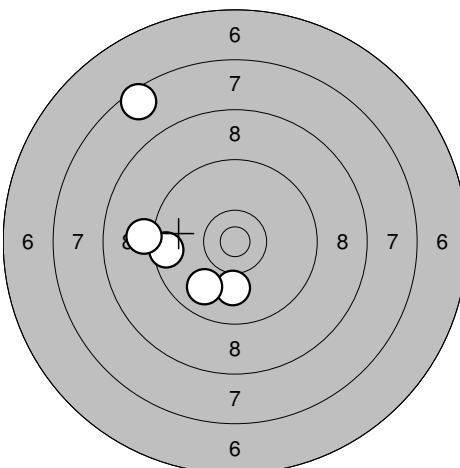

- 6: 7,6 ↗
- 7: 9,6 ←
- 8: 10,0 ↓
- 9: 9,9 ↘
- 10: 9,1 ←

Serie 44,0
Totalt 88,0

Tävlingsskott

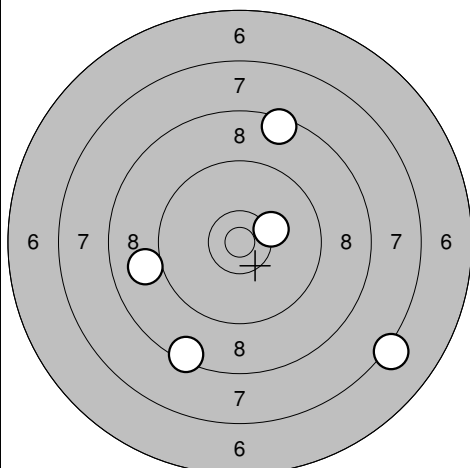

- 11: 7,2 ↘
- 12: 9,0 ←
- 13: 8,5 ↑
- 14: 10,3 →
- 15: 8,5 ↓

Serie 42,0
Totalt 130,0

Tävlingsskott

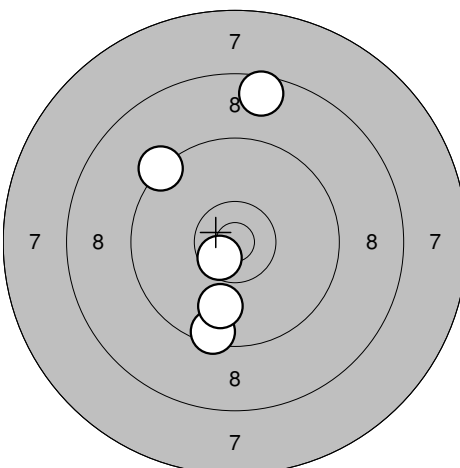

- 16: 9,5 ↓
- 17: 8,6 ↑
- 18: 10,6* ↘
- 19: 9,3 ↗
- 20: 9,9 ↓

Serie 45,0
Totalt 175,0

Ramselefors

2012-09-01

Höstträffen 2012

Ramselefors SKF

Provskott

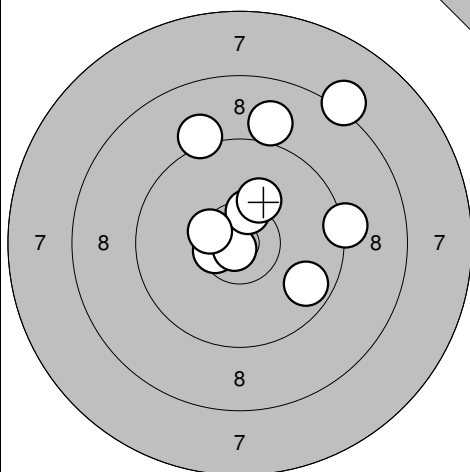

- 1: 10,5* ←
- 2: 8,2 ↗
- 3: 9,0 ↑
- 4: 10,8* ↘
- 5: 9,7 ➔
- 6: 10,4* ↑
- 7: 9,3 ➔
- 8: 10,4* ←
- 9: 9,2 ↑
- 10: 10,2 ↑

Serie	94,0
Totalt	0,0

Provskott

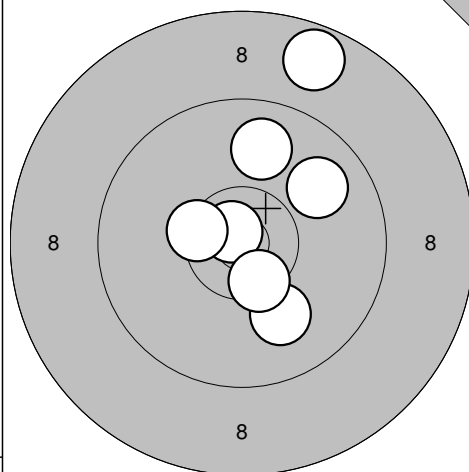

- 11: 10,8* ↖
- 12: 9,9 ↗
- 13: 10,0 ↘
- 14: 8,7 ↗
- 15: 9,9 ↑
- 16: 10,4* ←
- 17: 10,5* ↘

Serie	66,0
Totalt	0,0

Tävlingsskott

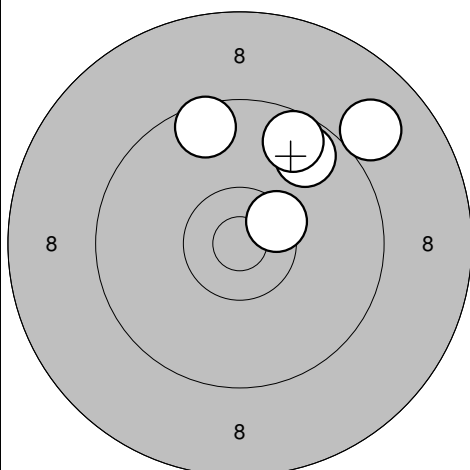

- 1: 9,0 ↗
- 2: 9,7 ↗
- 3: 9,6 ↑
- 4: 10,5* ↗
- 5: 9,6 ↑

Serie	46,0
Totalt	46,0

Tävlingsskott

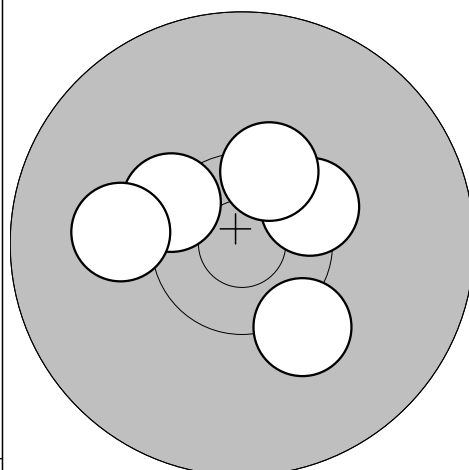

- 6: 10,4* ↗
- 7: 10,2 ↘
- 8: 10,4* ↖
- 9: 10,1 ←
- 10: 10,4* ↑

Serie	50,0
Totalt	96,0

Tävlingsskott

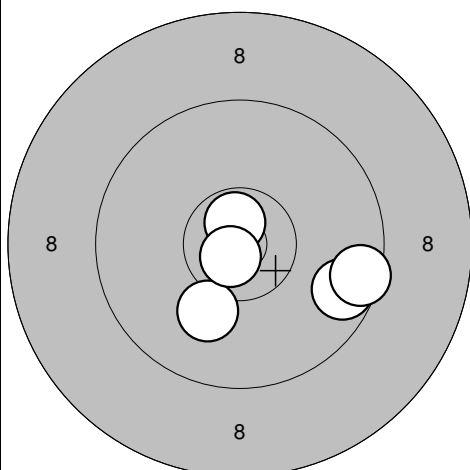

- 11: 10,1 ↘
- 12: 9,7 ➔
- 13: 10,7* ↑
- 14: 10,8* ↘
- 15: 9,5 ➔

Serie	48,0
Totalt	144,0

Tävlingsskott

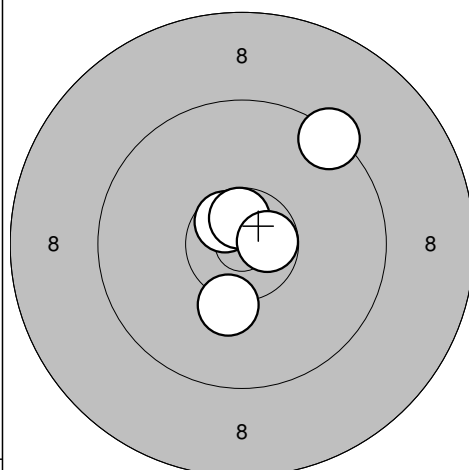

- 16: 10,6* ↖
- 17: 10,7* ↑
- 18: 9,4 ↗
- 19: 10,2 ↘
- 20: 10,7* ➔

Serie	49,0
Totalt	193,0

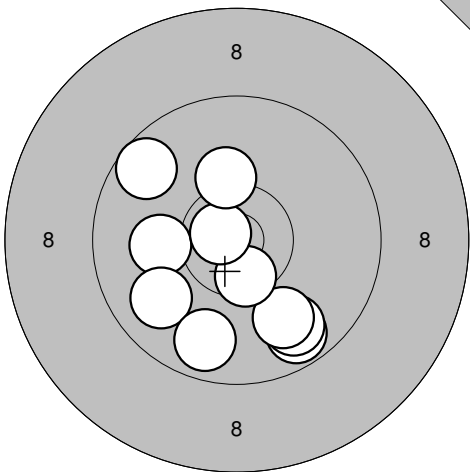
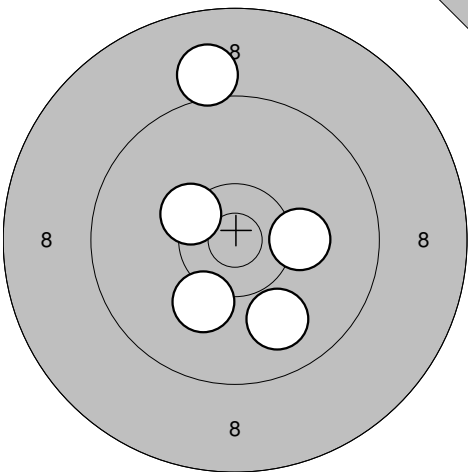
Provs-kott 	1: 10,1 ← 2: 9,7 ↘ 3: 9,8 ↘ 4: 9,9 ↘ 5: 10,5* ↘ 6: 9,9 ← 7: 10,8* ↗ 8: 10,2 ↑ 9: 9,8 ↘ 10: 9,6 ↗	Provs-kott 	11: 10,2 ↘ 12: 10,4* ↗ 13: 9,0 ↑ 14: 9,9 ↘ 15: 10,2 →
Serie 94,0		Serie 48,0	
Totalt 0,0		Totalt 0,0	

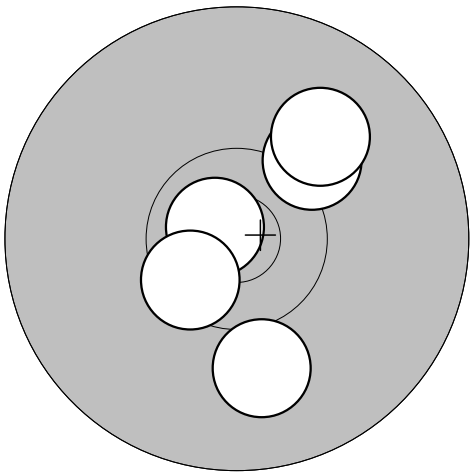
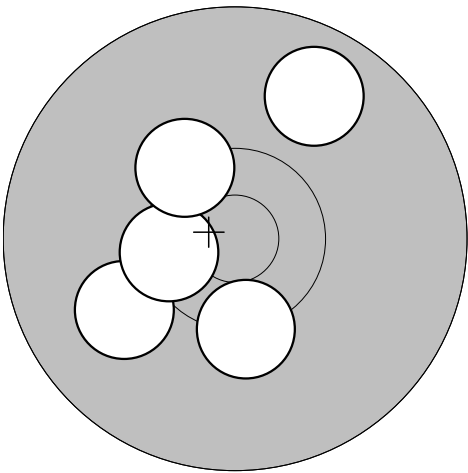
Tävlings-kott 	1: 10,0 ↘ 2: 10,2 ↗ 3: 10,8* ↗ 4: 10,5* ↘ 5: 10,0 ↗	Tävlings-kott 	6: 10,0 ↗ 7: 10,5* ↗ 8: 10,3* ↗ 9: 9,8 ↗ 10: 10,3* ↘
Serie 50,0		Serie 49,0	
Totalt 50,0		Totalt 99,0	

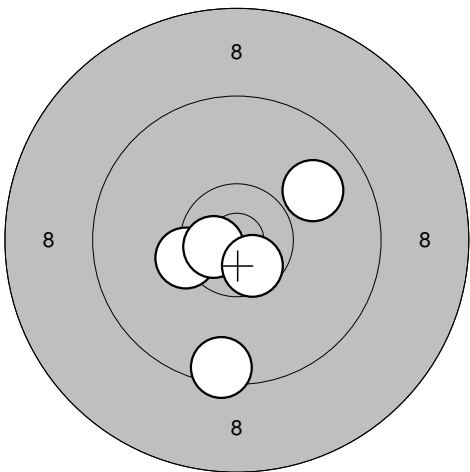
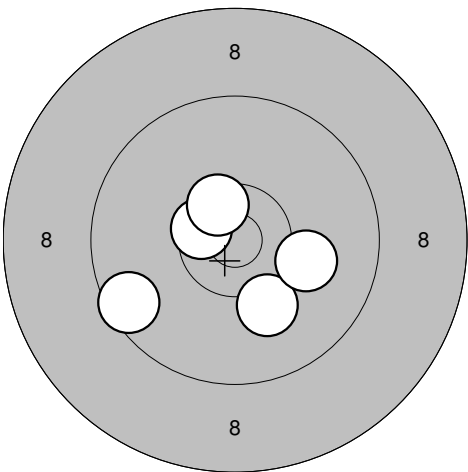
Tävlings-kott 	11: 9,5 ↘ 12: 10,3* ↗ 13: 10,7* ↗ 14: 10,6* ↘ 15: 9,9 ↗	Tävlings-kott 	16: 10,1 ↘ 17: 10,5* ↗ 18: 10,1 → 19: 10,5* ↗ 20: 9,5 ↗
Serie 48,0		Serie 49,0	
Totalt 147,0		Totalt 196,0	

Umeå

2012-09-01

Höstträffen 2012

Ramselefors SKF

Provskott

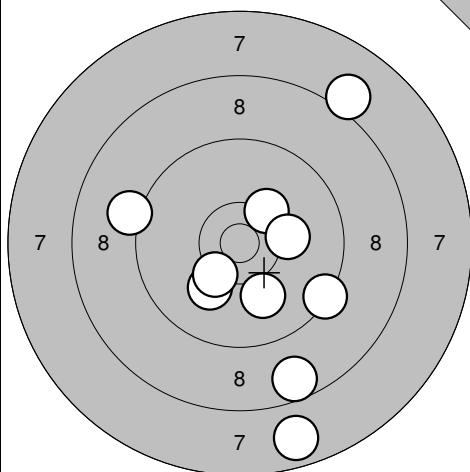

- 1: 8,1 ↗
- 2: 7,8 ↓
- 3: 8,6 ↓
- 4: 9,4 ↘
- 5: 10,3* ↗
- 6: 9,2 ←
- 7: 10,0 ↓
- 8: 10,1 ↓
- 9: 10,3* ↘
- 10: 10,2 →

Serie 91,0
Totalt 0,0

Provskott

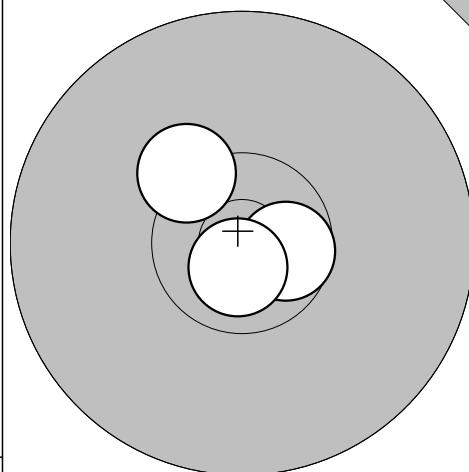

- 11: 10,3* ↗
- 12: 10,6* →
- 13: 10,8* ↓

Serie 30,0
Totalt 0,0

Tävlingsskott

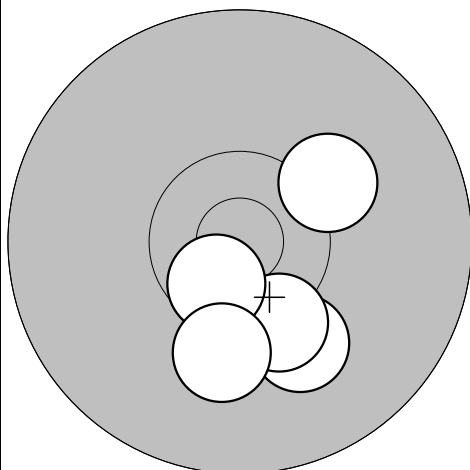

- 1: 10,2 ↗
- 2: 10,1 ↓
- 3: 10,3* ↘
- 4: 10,6* ↘
- 5: 10,2 ↓

Serie 50,0
Totalt 50,0

Tävlingsskott

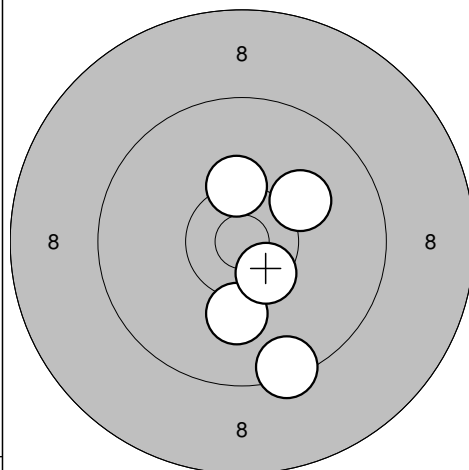

- 6: 10,1 ↓
- 7: 10,1 ↗
- 8: 10,5* ↘
- 9: 10,3* ↑
- 10: 9,4 ↓

Serie 49,0
Totalt 99,0

Tävlingsskott

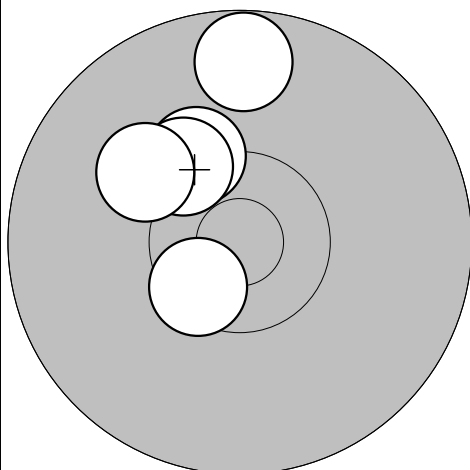

- 11: 9,7 ↑
- 12: 10,5* ↘
- 13: 10,3 ↗
- 14: 10,3 ↗
- 15: 10,1 ↗

Serie 49,0
Totalt 148,0

Tävlingsskott

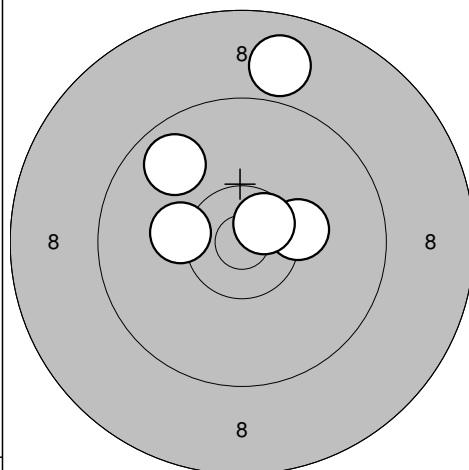

- 16: 10,2 ←
- 17: 10,3* →
- 18: 8,9 ↑
- 19: 10,6* ↗
- 20: 9,8 ↖

Serie 47,0
Totalt 195,0

Umeå

2012-09-01

Höstträffen 2012

Ramselefors SKF

Provskott

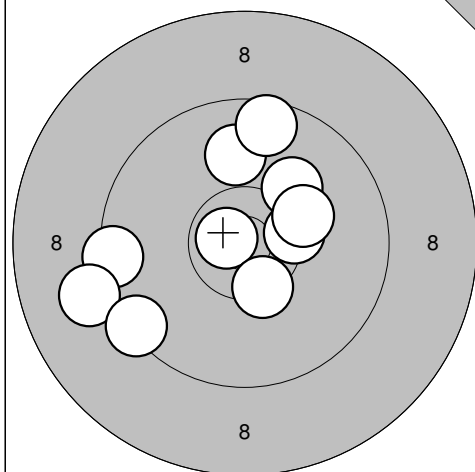

1: 9,4 ←
 2: 10,4* →
 3: 10,1 ↗
 4: 9,9 ↑
 5: 9,1 ←
 6: 10,7* ←
 7: 10,2 →
 8: 9,6 ↑
 9: 9,4 ↙
 10: 10,4* ↓

Serie 95,0

Totalt 0,0

Tävlingsskott

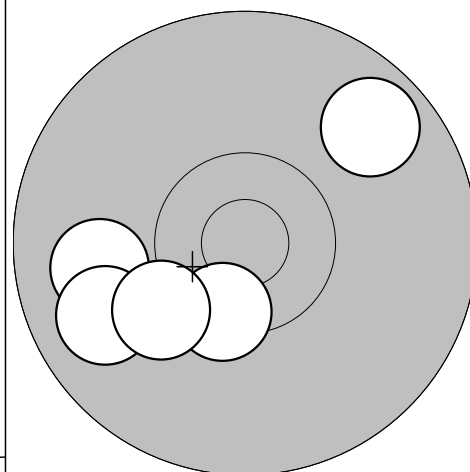

1: 9,9 ←
 2: 9,8 ↙
 3: 10,4* ↓
 4: 10,2 ↙
 5: 9,7 ↗

Serie 47,0

Totalt 47,0

Tävlingsskott

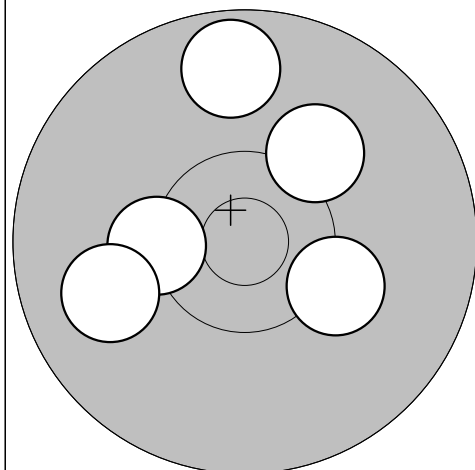

6: 9,7 ↑
 7: 10,2 →
 8: 10,1 ↗
 9: 10,3* ←
 10: 9,9 ←

Serie 48,0

Totalt 95,0

Tävlingsskott

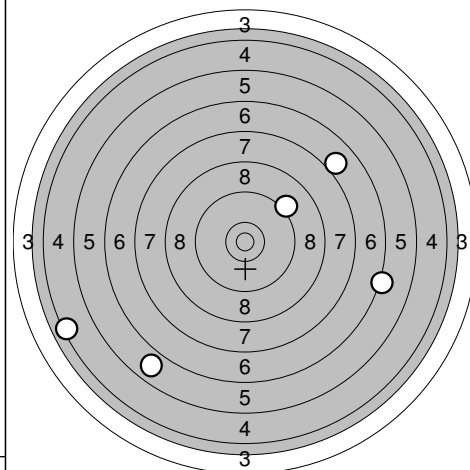

11: 7,0 ↗
 12: 4,4 ←
 13: 6,2 →
 14: 5,8 ↓
 15: 9,2 ↗

Serie 31,0

Totalt 126,0

Tävlingsskott

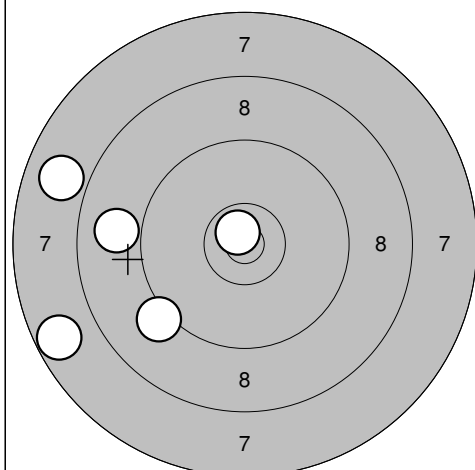

16: 10,7* ↗
 17: 7,9 ↙
 18: 8,9 ←
 19: 7,7 ↙
 20: 9,2 ↙

Serie 41,0

Totalt 167,0

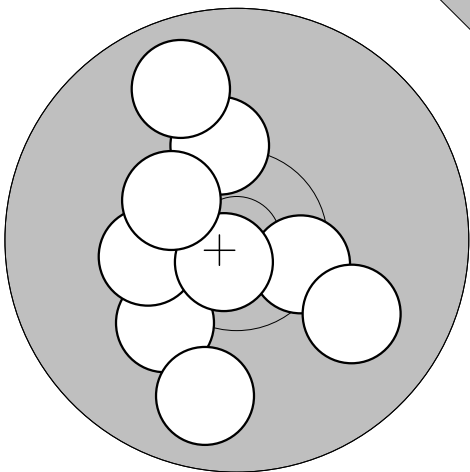
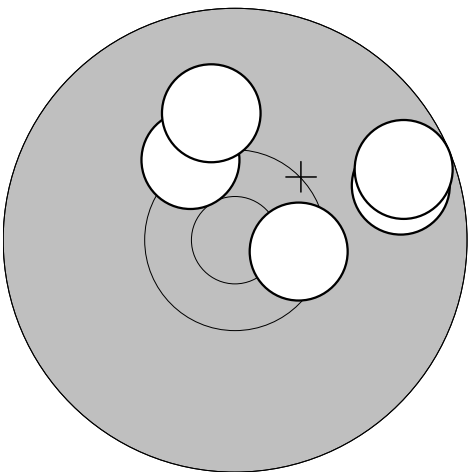
<p>Provskott</p> 	<p>Tävlingsskott</p> 	
<p>1: 10,2 ↙ 2: 10,3 ↑ 3: 10,3* ← 4: 9,8 ↓ 5: 9,8 ↑ 6: 10,5* → 7: 10,8* ↓ 8: 10,0 ↘ 9: 10,4* ↗</p>	<p>1: 10,3* ↖ 2: 9,7 → 3: 10,0 ↑ 4: 10,5* → 5: 9,7 ↗</p>	
Serie 88,0	Serie 48,0	
Totalt 0,0	Totalt 48,0	

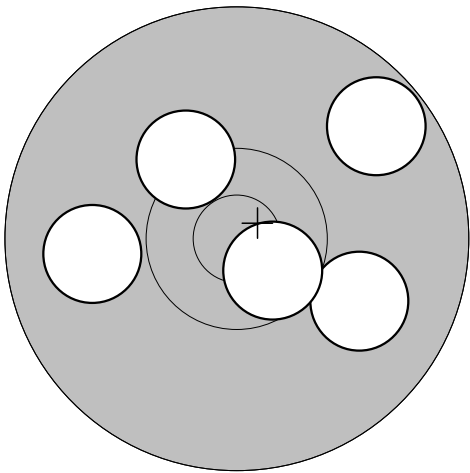
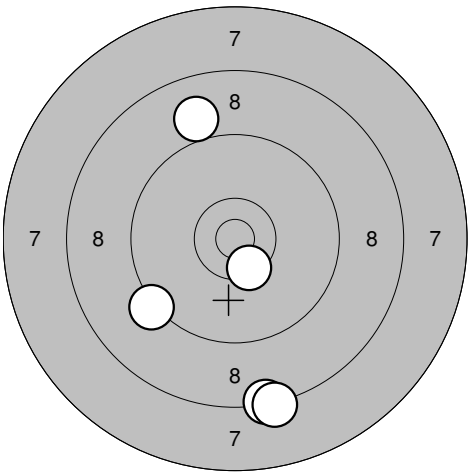
<p>Tävlingsskott</p> 	<p>Tävlingsskott</p> 	
<p>6: 10,3 ↗ 7: 10,0 ↘ 8: 9,9 ← 9: 10,6* ↓ 10: 9,7 ↗</p>	<p>11: 9,0 ↖ 12: 10,4* ↓ 13: 9,3 ↙ 14: 8,3 ↓ 15: 8,3 ↓</p>	
Serie 48,0	Serie 44,0	
Totalt 96,0	Totalt 140,0	

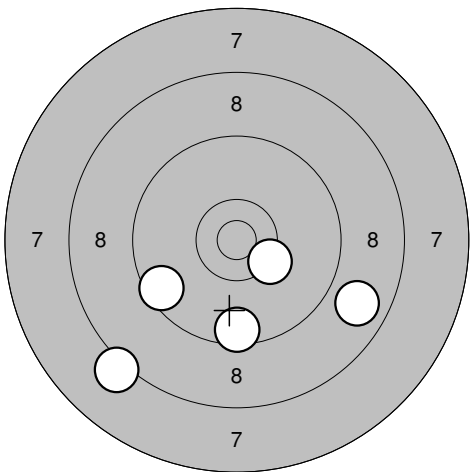
<p>Tävlingsskott</p> 	<p>16: 9,6 ↙ 17: 9,5 ↓ 18: 8,2 ↙ 19: 8,8 → 20: 10,3* ↘</p>	
Serie 44,0		
Totalt 184,0		

Umeå

2012-09-01

Höstträffen 2012

Ramselefors SKF

Provskott

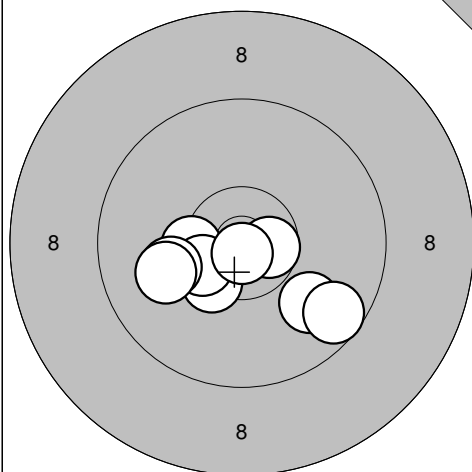

1: 10,4* ←
 2: 10,4* ↘
 3: 10,4* ↙
 4: 10,1 ←
 5: 10,0 ←
 6: 9,9 ↘
 7: 10,6* →
 8: 9,6 ↘
 9: 10,8* ↓

Serie 88,0

Totalt 0,0

Tävlingsskott

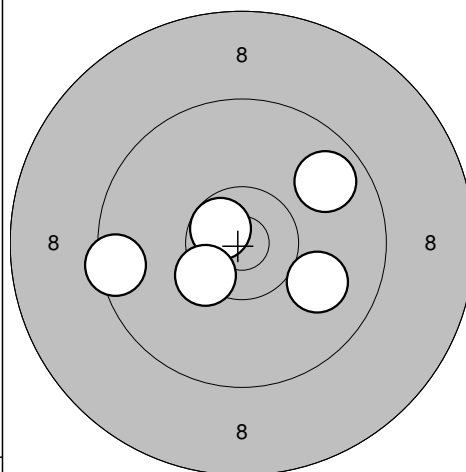

1: 9,8 ↗
 2: 10,0 ↘
 3: 9,5 ←
 4: 10,7* ↙
 5: 10,4* ↘

Serie 48,0

Totalt 48,0

Tävlingsskott

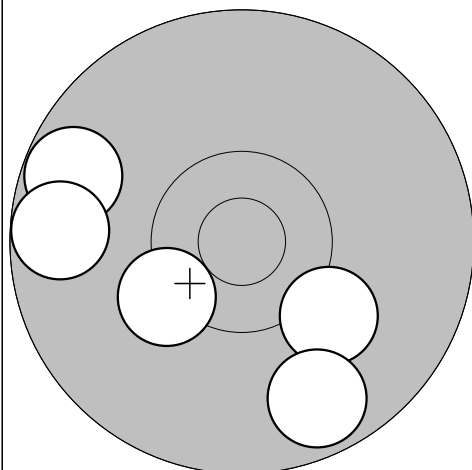

6: 10,1 ↘
 7: 9,7 ↙
 8: 9,7 ←
 9: 10,3* ↙
 10: 9,7 ↘

Serie 47,0

Totalt 95,0

Tävlingsskott

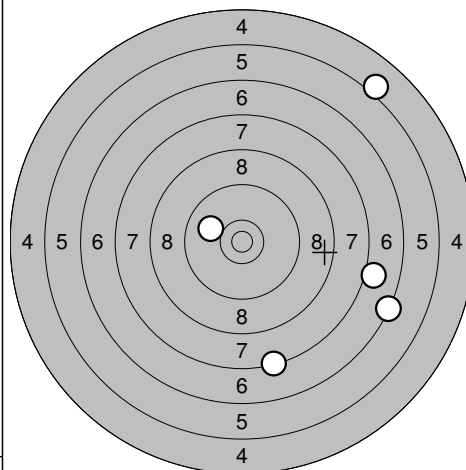

11: 7,3 ↓
 12: 5,1 ↗
 13: 10,0 ←
 14: 7,1 →
 15: 6,3 ↘

Serie 35,0

Totalt 130,0

Tävlingsskott

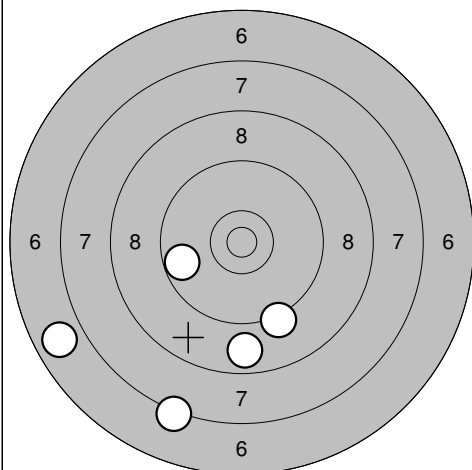

16: 7,2 ↓
 17: 8,8 ↓
 18: 6,8 ↙
 19: 9,2 ↓
 20: 9,7 ←

Serie 39,0

Totalt 169,0

2012-09-01

Höstträffen 2012

Ramselefors SKF

Provskott

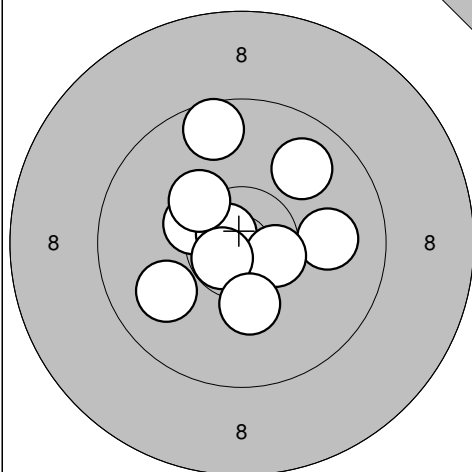

1: 10,4* ←
 2: 9,9 ↙
 3: 10,8* ↗
 4: 10,0 →
 5: 10,3 ↗
 6: 10,5* →
 7: 9,6 ↑
 8: 10,7* ↙
 9: 9,9 ↗
 10: 10,2 ↓

Serie 97,0
 Totalt 0,0

Provskott

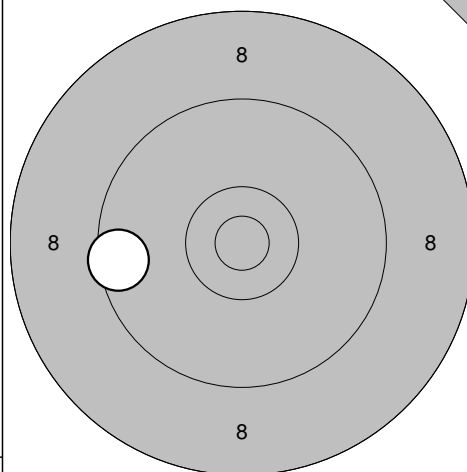

11: 9,5 ←

Serie 9,0
 Totalt 0,0

Tävlingsskott

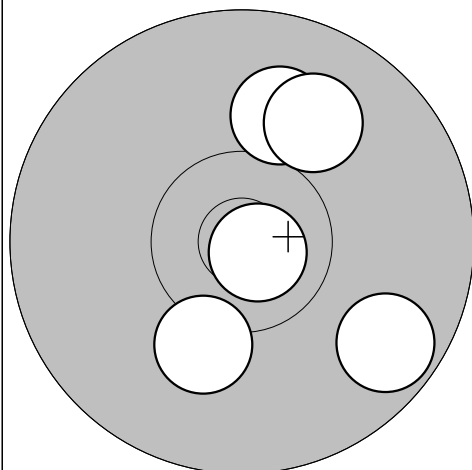

1: 9,7 ↘
 2: 10,0 ↑
 3: 10,8* ↘
 4: 10,0 ↗
 5: 10,2 ↓

Serie 49,0
 Totalt 49,0

Tävlingsskott

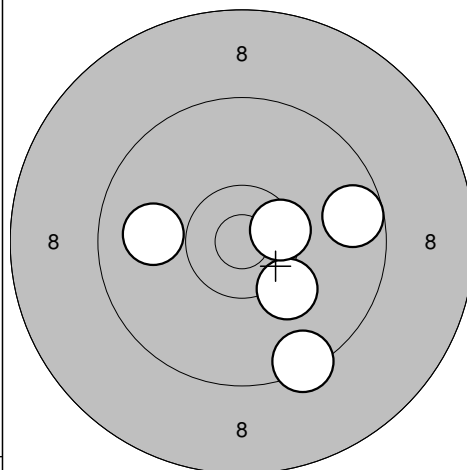

6: 10,2 ↓
 7: 9,4 ↓
 8: 9,9 ←
 9: 9,7 →
 10: 10,5* →

Serie 47,0
 Totalt 96,0

Tävlingsskott

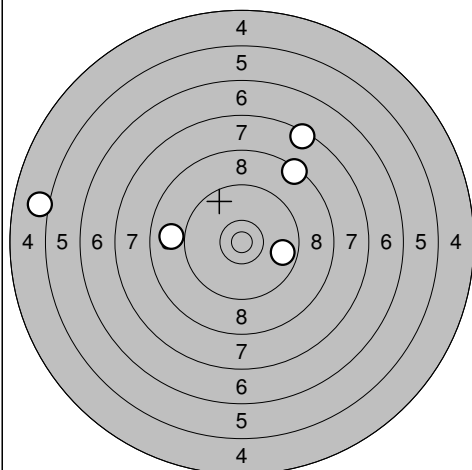

11: 8,9 ←
 12: 7,5 ↑
 13: 9,7 →
 14: 5,1 ←
 15: 8,4 ↗

Serie 37,0
 Totalt 133,0

Tävlingsskott

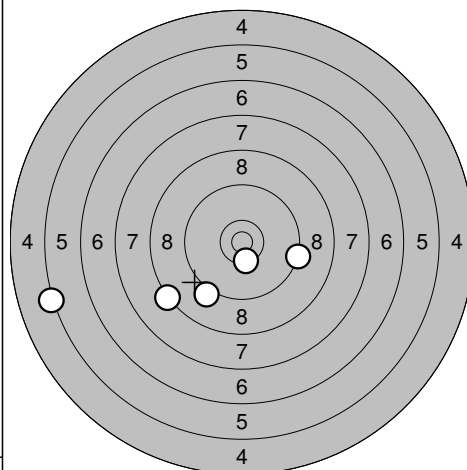

16: 5,2 ←
 17: 8,3 ↙
 18: 9,3 →
 19: 10,4* ↓
 20: 9,1 ↘

Serie 41,0
 Totalt 174,0

Ramselefors

2012-09-01

Höstträffen 2012

Ramselefors SKF

Provskott

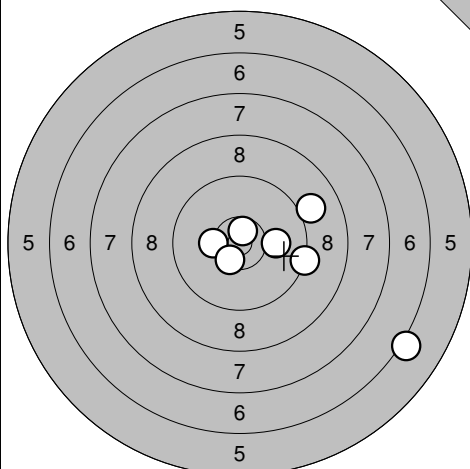

1: 9,0 →
 2: 6,2 ↘
 3: 10,6* ↑
 4: 9,3 →
 5: 10,3* ←
 6: 10,5* ↙
 7: 10,1 →

Serie 64,0
 Totalt 0,0

Tävlingsskott

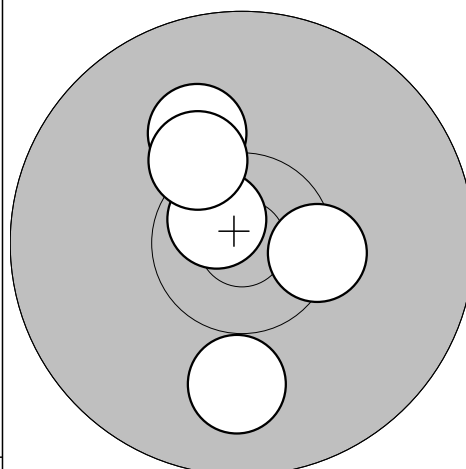

1: 10,7* ↖
 2: 10,1 ↗
 3: 10,4* →
 4: 9,9 ↓
 5: 10,3* ↗

Serie 49,0
 Totalt 49,0

Tävlingsskott

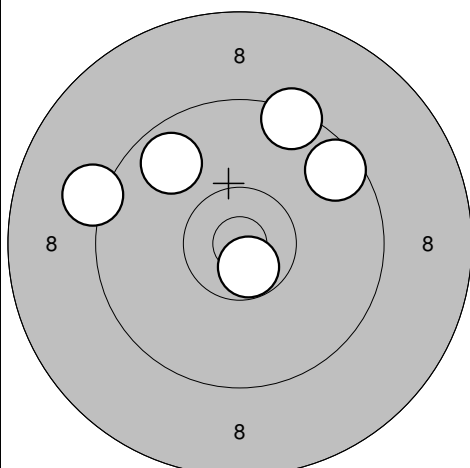

6: 9,4 ↗
 7: 9,2 ←
 8: 9,7 ↗
 9: 9,6 ↗
 10: 10,7* ↘

Serie 46,0
 Totalt 95,0

Tävlingsskott

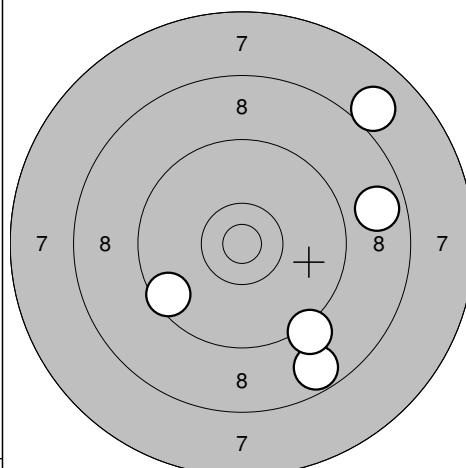

11: 8,7 ↓
 12: 8,8 →
 13: 9,2 ↘
 14: 8,0 ↗
 15: 9,5 ↙

Serie 42,0
 Totalt 137,0

Tävlingsskott

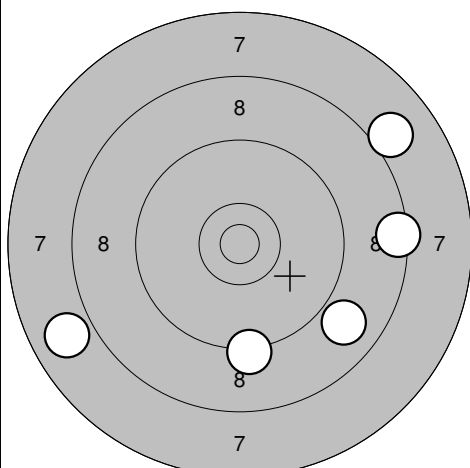

16: 7,9 ↙
 17: 8,0 ↗
 18: 8,9 ↘
 19: 8,5 →
 20: 9,2 ↓

Serie 40,0
 Totalt 177,0

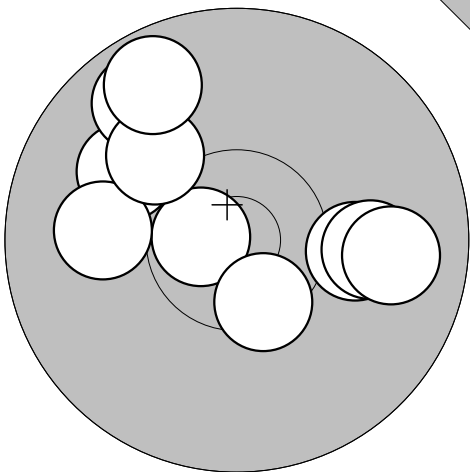
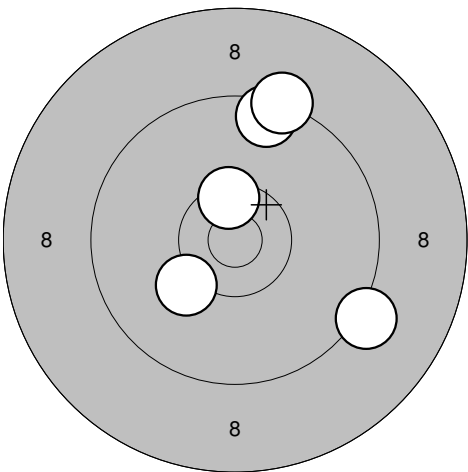
Provskott 	<table style="width:100%; border-collapse: collapse;"> <tr><td>1: 10,1</td><td>→</td></tr> <tr><td>2: 10,0</td><td>↗</td></tr> <tr><td>3: 10,7*</td><td>←</td></tr> <tr><td>4: 10,0</td><td>←</td></tr> <tr><td>5: 9,8</td><td>↗</td></tr> <tr><td>6: 10,1</td><td>↗</td></tr> <tr><td>7: 10,5*</td><td>↘</td></tr> <tr><td>8: 9,7</td><td>↗</td></tr> <tr><td>9: 10,0</td><td>→</td></tr> <tr><td>10: 9,8</td><td>→</td></tr> <tr style="border-top: 1px solid black;"><td style="text-align: right;">Serie</td><td style="text-align: right;">97,0</td></tr> <tr><td style="text-align: right;">Totalt</td><td style="text-align: right;">0,0</td></tr> </table>	1: 10,1	→	2: 10,0	↗	3: 10,7*	←	4: 10,0	←	5: 9,8	↗	6: 10,1	↗	7: 10,5*	↘	8: 9,7	↗	9: 10,0	→	10: 9,8	→	Serie	97,0	Totalt	0,0	Tävlingsskott  <table style="width:100%; border-collapse: collapse;"> <tr><td>1: 9,5</td><td>↑</td></tr> <tr><td>2: 10,5*</td><td>↑</td></tr> <tr><td>3: 10,2</td><td>↙</td></tr> <tr><td>4: 9,3</td><td>↑</td></tr> <tr><td>5: 9,2</td><td>↘</td></tr> <tr style="border-top: 1px solid black;"><td style="text-align: right;">Serie</td><td style="text-align: right;">47,0</td></tr> <tr><td style="text-align: right;">Totalt</td><td style="text-align: right;">47,0</td></tr> </table>	1: 9,5	↑	2: 10,5*	↑	3: 10,2	↙	4: 9,3	↑	5: 9,2	↘	Serie	47,0	Totalt	47,0
1: 10,1	→																																							
2: 10,0	↗																																							
3: 10,7*	←																																							
4: 10,0	←																																							
5: 9,8	↗																																							
6: 10,1	↗																																							
7: 10,5*	↘																																							
8: 9,7	↗																																							
9: 10,0	→																																							
10: 9,8	→																																							
Serie	97,0																																							
Totalt	0,0																																							
1: 9,5	↑																																							
2: 10,5*	↑																																							
3: 10,2	↙																																							
4: 9,3	↑																																							
5: 9,2	↘																																							
Serie	47,0																																							
Totalt	47,0																																							

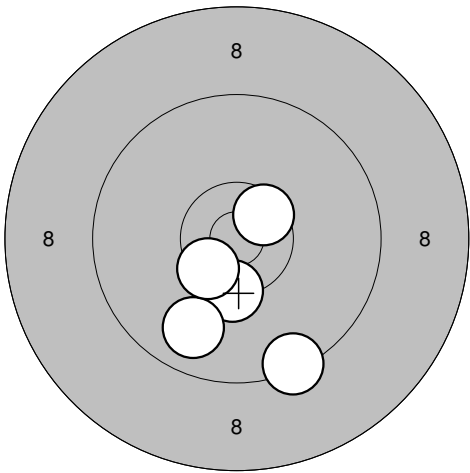
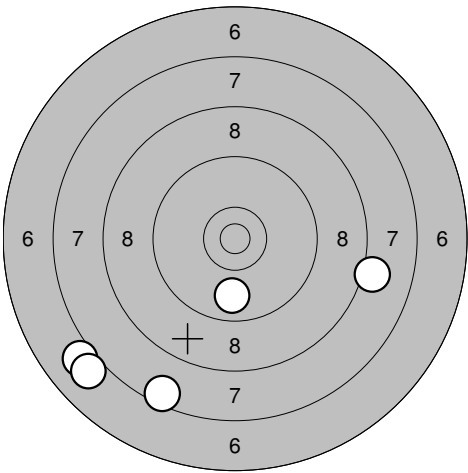
Tävlingsskott  <table style="width:100%; border-collapse: collapse;"> <tr><td>6: 10,5*</td><td>↗</td></tr> <tr><td>7: 10,3*</td><td>↓</td></tr> <tr><td>8: 9,4</td><td>↓</td></tr> <tr><td>9: 9,8</td><td>↓</td></tr> <tr><td>10: 10,5*</td><td>↙</td></tr> <tr style="border-top: 1px solid black;"><td style="text-align: right;">Serie</td><td style="text-align: right;">48,0</td></tr> <tr><td style="text-align: right;">Totalt</td><td style="text-align: right;">95,0</td></tr> </table>	6: 10,5*	↗	7: 10,3*	↓	8: 9,4	↓	9: 9,8	↓	10: 10,5*	↙	Serie	48,0	Totalt	95,0	Tävlingsskott  <table style="width:100%; border-collapse: collapse;"> <tr><td>11: 7,5</td><td>↘</td></tr> <tr><td>12: 8,1</td><td>→</td></tr> <tr><td>13: 9,8</td><td>↓</td></tr> <tr><td>14: 7,0</td><td>↙</td></tr> <tr><td>15: 7,0</td><td>↙</td></tr> <tr style="border-top: 1px solid black;"><td style="text-align: right;">Serie</td><td style="text-align: right;">38,0</td></tr> <tr><td style="text-align: right;">Totalt</td><td style="text-align: right;">133,0</td></tr> </table>	11: 7,5	↘	12: 8,1	→	13: 9,8	↓	14: 7,0	↙	15: 7,0	↙	Serie	38,0	Totalt	133,0
6: 10,5*	↗																												
7: 10,3*	↓																												
8: 9,4	↓																												
9: 9,8	↓																												
10: 10,5*	↙																												
Serie	48,0																												
Totalt	95,0																												
11: 7,5	↘																												
12: 8,1	→																												
13: 9,8	↓																												
14: 7,0	↙																												
15: 7,0	↙																												
Serie	38,0																												
Totalt	133,0																												

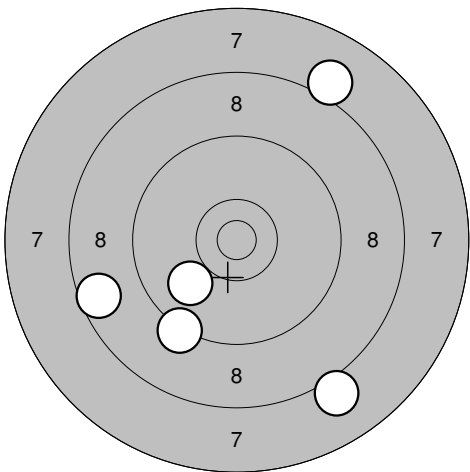
Tävlingsskott  <table style="width:100%; border-collapse: collapse;"> <tr><td>16: 10,0</td><td>↙</td></tr> <tr><td>17: 9,3</td><td>↙</td></tr> <tr><td>18: 8,1</td><td>↗</td></tr> <tr><td>19: 8,6</td><td>←</td></tr> <tr><td>20: 8,1</td><td>↘</td></tr> <tr style="border-top: 1px solid black;"><td style="text-align: right;">Serie</td><td style="text-align: right;">43,0</td></tr> <tr><td style="text-align: right;">Totalt</td><td style="text-align: right;">176,0</td></tr> </table>	16: 10,0	↙	17: 9,3	↙	18: 8,1	↗	19: 8,6	←	20: 8,1	↘	Serie	43,0	Totalt	176,0	
16: 10,0	↙														
17: 9,3	↙														
18: 8,1	↗														
19: 8,6	←														
20: 8,1	↘														
Serie	43,0														
Totalt	176,0														

Drängsmark

2012-09-01

Höstträffen 2012

Ramselefors SKF

Provskott

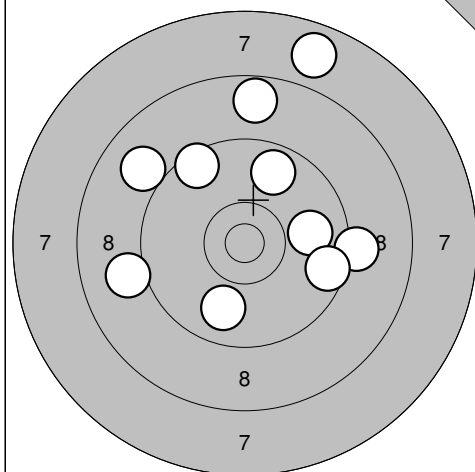

1: 8,7 ↑
 2: 9,9 ↓
 3: 9,9 →
 4: 9,5 ↑
 5: 9,0 ↑
 6: 7,8 ↑
 7: 9,8 ↑
 8: 9,1 ←
 9: 9,2 →
 10: 9,6 →

Serie 87,0

Totalt 0,0

Provskott

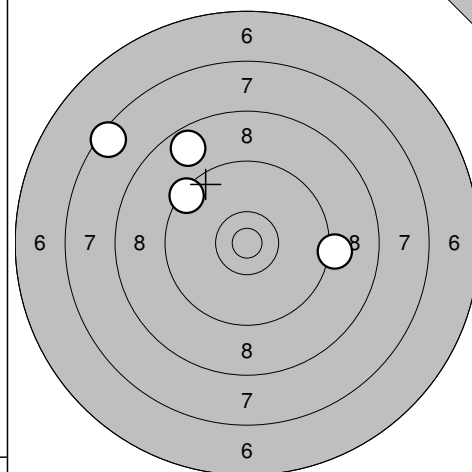

11: 8,7 ↗
 12: 9,4 ↗
 13: 7,5 ↗
 14: 9,2 →

Serie 33,0

Totalt 0,0

Tävlingsskott

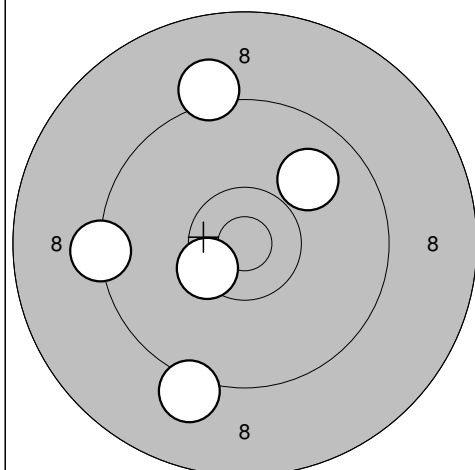

1: 9,9 ↗
 2: 9,2 ↑
 3: 10,4* ↙
 4: 9,1 ↓
 5: 9,3 ←

Serie 46,0

Totalt 46,0

Tävlingsskott

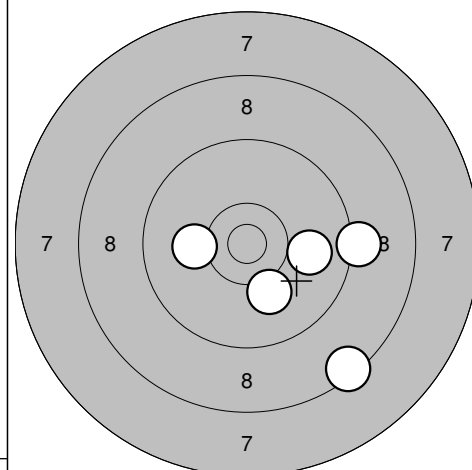

6: 10,0 →
 7: 8,4 ↓
 8: 10,1 ←
 9: 9,2 →
 10: 10,1 ↓

Serie 47,0

Totalt 93,0

Tävlingsskott

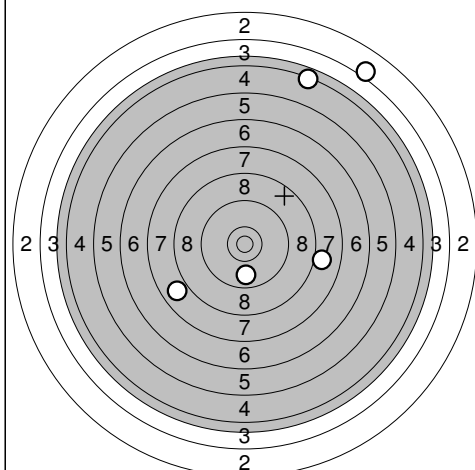

11: 8,0 →
 12: 7,9 ↙
 13: 9,8 ↓
 14: 3,1 ↗
 15: 4,4 ↑

Serie 31,0

Totalt 124,0

Tävlingsskott

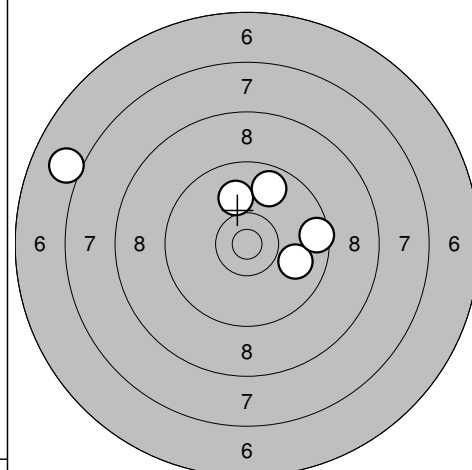

16: 9,9 →
 17: 9,5 →
 18: 10,0 ↑
 19: 9,8 ↗
 20: 7,0 ←

Serie 44,0

Totalt 168,0