

11: 7.2 ↙	12: 8.3 ↙	13: 9.5 ↗	14: 4.0 →	15: 8.0 ↓	16: 6.5 ←	17: 7.6 ↗	18: 8.0 ↗	19: 8.7 ←	

Series	65.0
Total	0.0

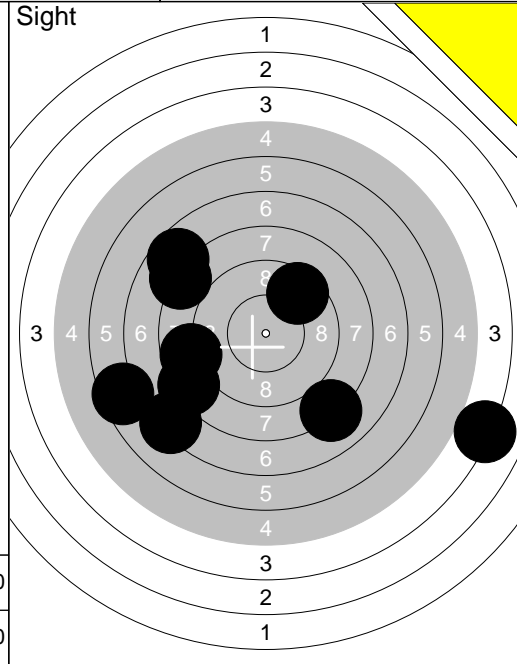

20: 2.0 ↗	21: 7.3 →	22: *10.4 ↓	23: 7.6 ↗	24: 9.7 ↗	25: 10.0 ←	26: 9.0 →	27: 8.3 ←	28: 7.4 ↓	29: 8.9 ↙

Series	71.0
Total	141.0

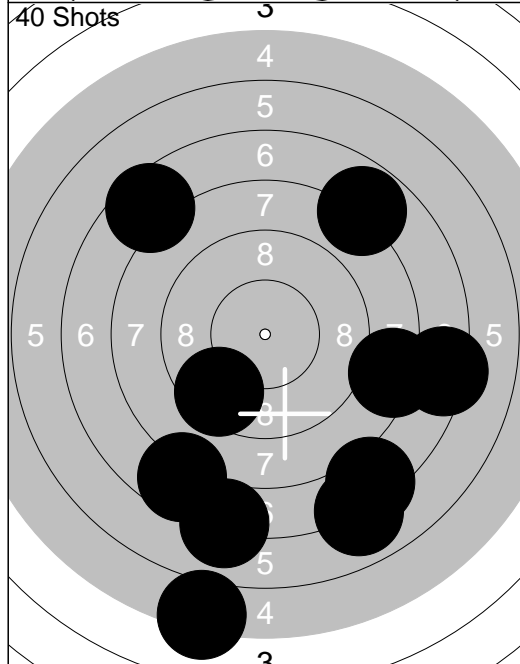

31: 8.2 ↙	32: 9.1 ↓	33: 8.2 ↓	34: 8.5 ←	35: 7.9 →	36: 8.8 ↓	37: 9.4 ↗	38: 9.8 ↓	39: *10.5 ↓	40: 9.4 ←

Series	83.0
Total	224.0

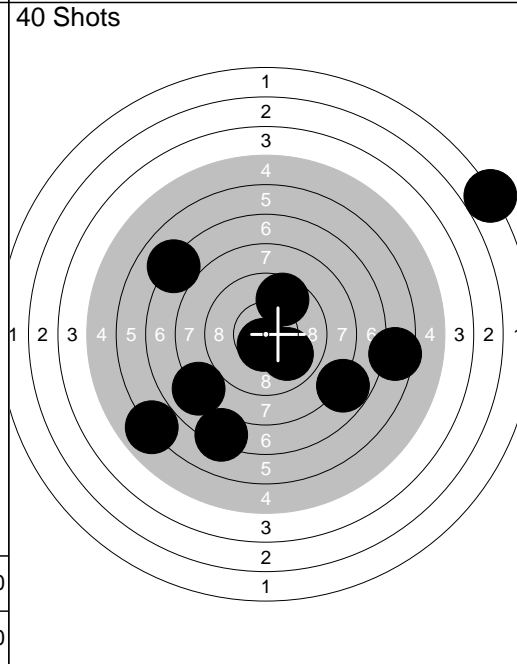

31: 8.2 ↙	32: 9.1 ↓	33: 8.2 ↓	34: 8.5 ←	35: 7.9 →	36: 8.8 ↓	37: 9.4 ↗	38: 9.8 ↓	39: *10.5 ↓	40: 9.4 ←

Series	85.0
Total	309.0

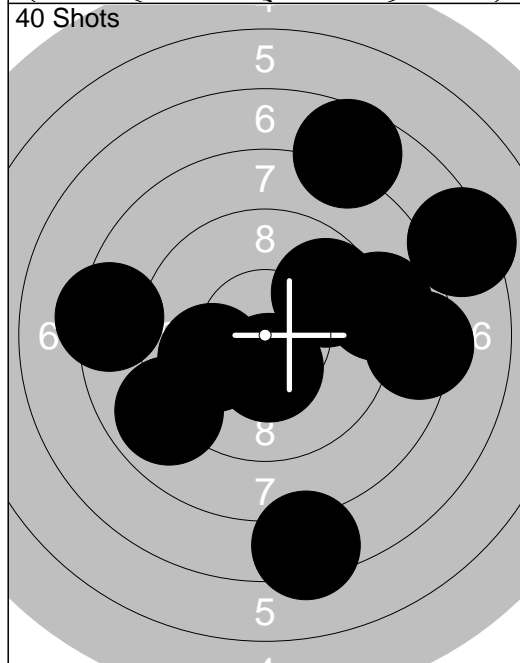

31: 8.2 ↙	32: 9.1 ↓	33: 8.2 ↓	34: 8.5 ←	35: 7.9 →	36: 8.8 ↓	37: 9.4 ↗	38: 9.8 ↓	39: *10.5 ↓	40: 9.4 ←

Series	85.0
Total	309.0

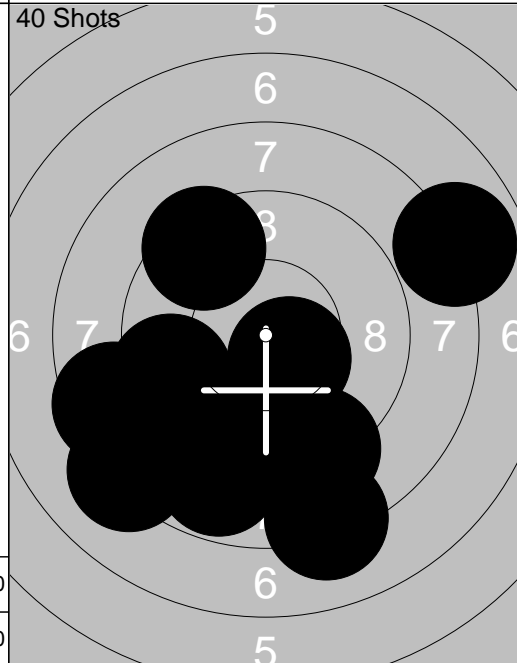

31: 8.2 ↙	32: 9.1 ↓	33: 8.2 ↓	34: 8.5 ←	35: 7.9 →	36: 8.8 ↓	37: 9.4 ↗	38: 9.8 ↓	39: *10.5 ↓	40: 9.4 ←

Series	85.0
Total	309.0

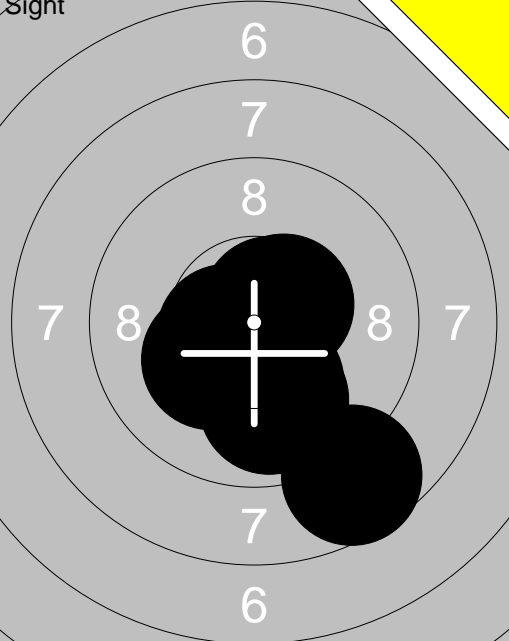
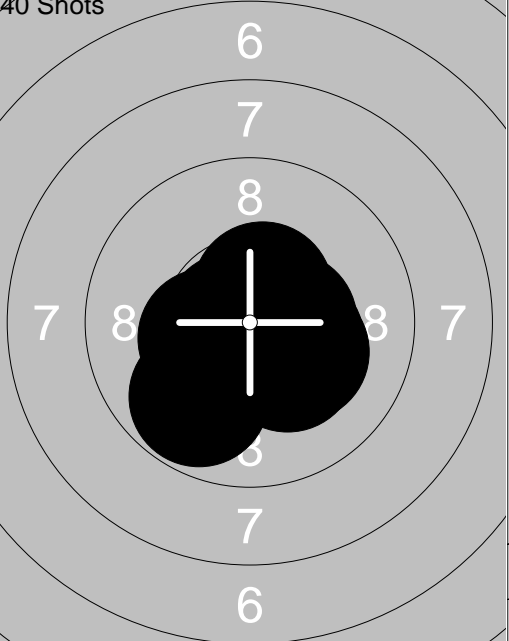
<p>Sight</p> 	<p>40 Shots</p> 	<p>1: 9.9 ↓</p> <p>2: 8.6 ↓</p> <p>3: *10.5 ↗</p> <p>4: 10.1 ↓</p> <p>5: 9.9 ↓</p> <p>6: *10.2 ↙</p> <p>7: *10.7 ↓</p> <p>8: *10.6 ←</p> <p>9: *10.7 ↗</p> <hr/> <p>Series 86.0</p> <p>Total 0.0</p>	<p>1: *10.3 →</p> <p>2: *10.7 ←</p> <p>3: *10.4 ↙</p> <p>4: *10.2 ↓</p> <p>5: *10.5 →</p> <p>6: *10.8 ↑</p> <p>7: *10.2 ↘</p> <p>8: *10.5 ↑</p> <p>9: *10.6 ↓</p> <p>10: 9.8 ↙</p> <hr/> <p>Series 99.0</p> <p>Total 99.0</p>
---	--	--	---

<p>40 Shots</p> 	<p>40 Shots</p> 	<p>11: *10.4 ↓</p> <p>12: *10.2 ↓</p> <p>13: *10.7 ↑</p> <p>14: *10.4 ←</p> <p>15: 9.6 ↑</p> <p>16: 9.6 ↑</p> <p>17: *10.2 ←</p> <p>18: 9.9 ↑</p> <p>19: *10.4 ↗</p> <p>20: *10.6 ↗</p> <hr/> <p>Series 97.0</p> <p>Total 196.0</p>	<p>21: 10.0 ↑</p> <p>22: *10.5 ↗</p> <p>23: 10.0 ←</p> <p>24: *10.6 ↙</p> <p>25: 10.1 ↗</p> <p>26: 10.0 ↑</p> <p>27: 10.1 ↗</p> <p>28: *10.4 →</p> <p>29: *10.5 ↙</p> <p>30: *10.5 ↗</p> <hr/> <p>Series 100.0</p> <p>Total 296.0</p>
---	---	---	---

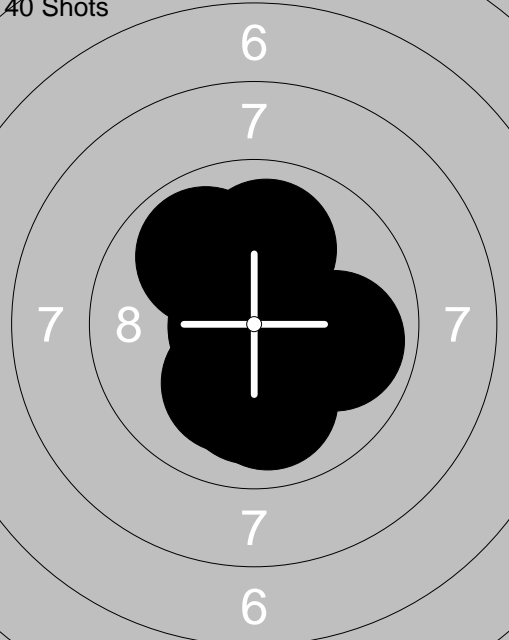
<p>40 Shots</p> 	<p>31: *10.9 ←</p> <p>32: *10.2 ↓</p> <p>33: *10.7 ←</p> <p>34: 10.1 ↓</p> <p>35: 10.0 ↓</p> <p>36: 10.0 ↗</p> <p>37: 9.9 →</p> <p>38: 10.0 ↑</p> <p>39: 9.9 ↗</p> <p>40: 10.1 ↓</p> <hr/> <p>Series 98.0</p> <p>Total 394.0</p>		
--	--	--	--

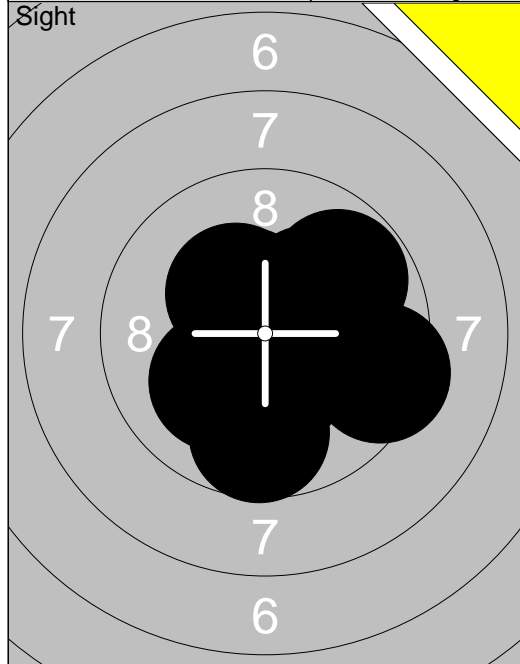

1:	9.8	↗
2:	*10.3	↗
3:	10.1	↘
4:	*10.5	→
5:	*10.4	↓
6:	*10.4	↘
7:	9.7	↓
8:	9.4	→
9:	*10.4	↗
10:	*10.2	↗
Series		97.0
Total		0.0

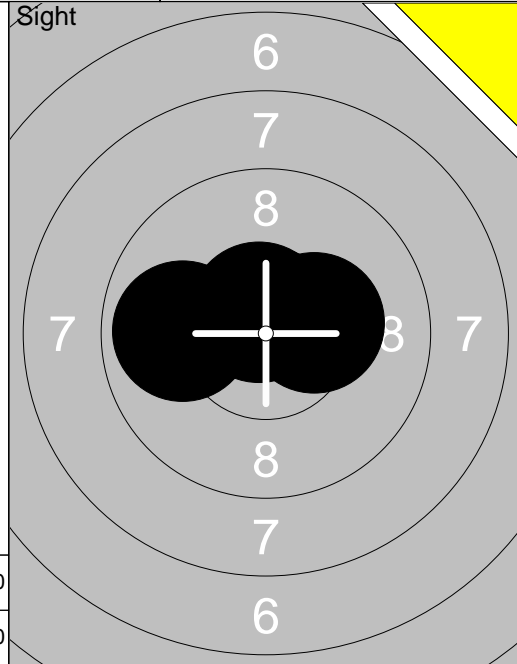

11:	*10.3	→
12:	9.9	←
13:	*10.7	↗
Series		29.0
Total		0.0

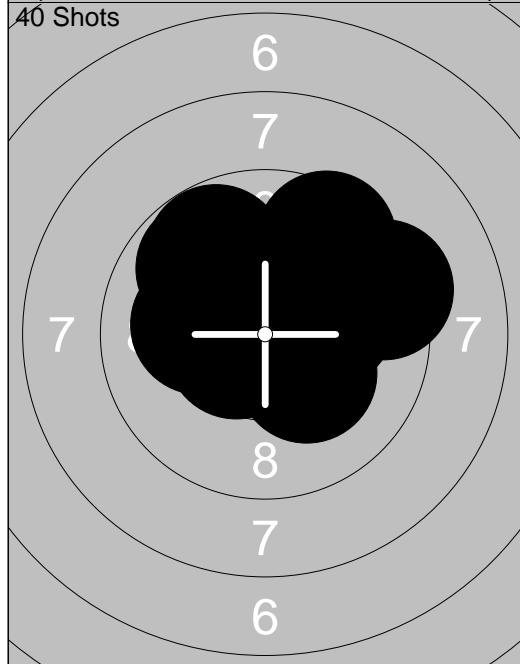

1:	10.1	←
2:	*10.5	→
3:	9.8	↗
4:	*10.2	↘
5:	*10.5	↙
6:	9.3	→
7:	9.5	↗
8:	9.8	↗
9:	*10.2	→
10:	*10.6	↘
Series		96.0
Total		96.0

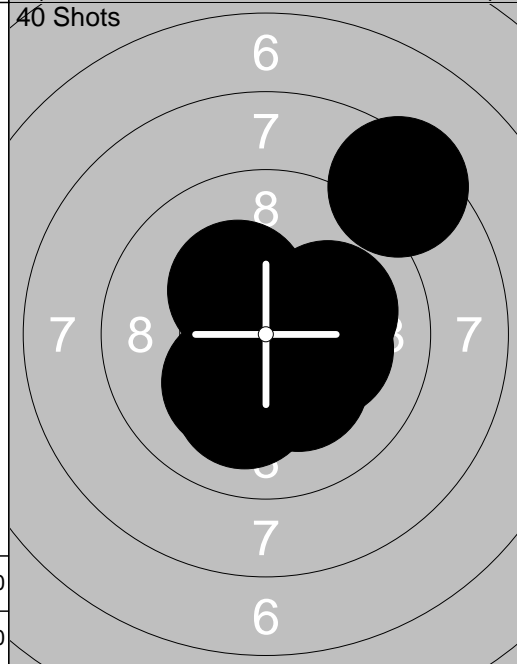

11:	*10.2	↘
12:	*10.7	↓
13:	*10.2	→
14:	*10.3	↗
15:	10.1	→
16:	*10.4	↘
17:	*10.2	→
18:	*10.2	↘
19:	8.4	↗
20:	10.1	↓
Series		98.0
Total		194.0

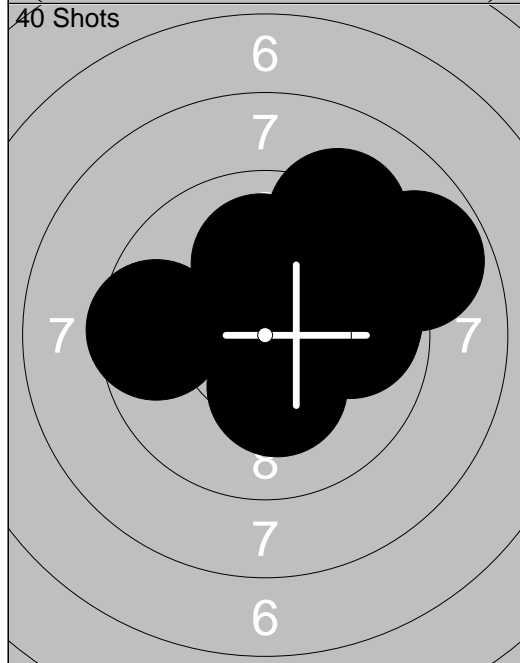

21:	*10.5	→
22:	9.9	→
23:	9.6	←
24:	8.8	↗
25:	*10.3	↓
26:	*10.6	↑
27:	9.8	→
28:	9.2	↗
29:	10.0	↑
30:	*10.4	↗
Series		94.0
Total		288.0

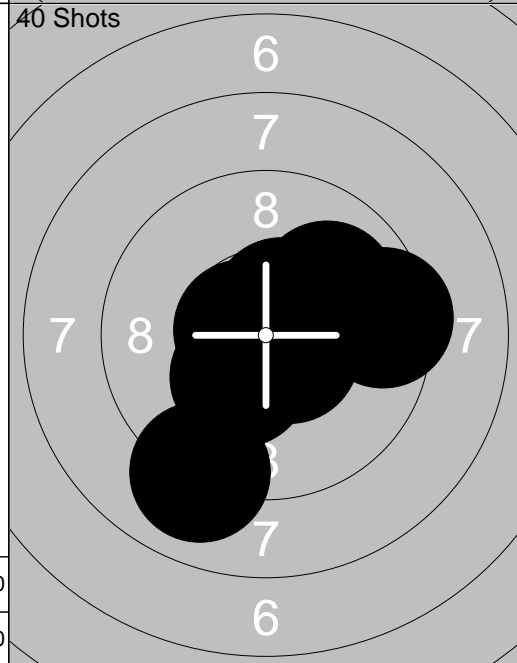

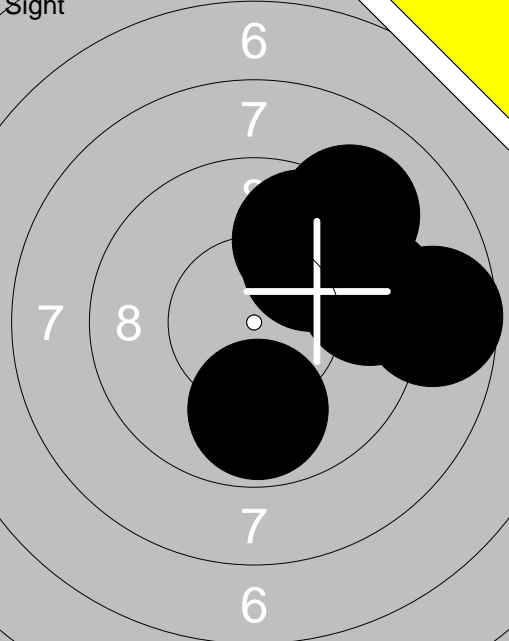
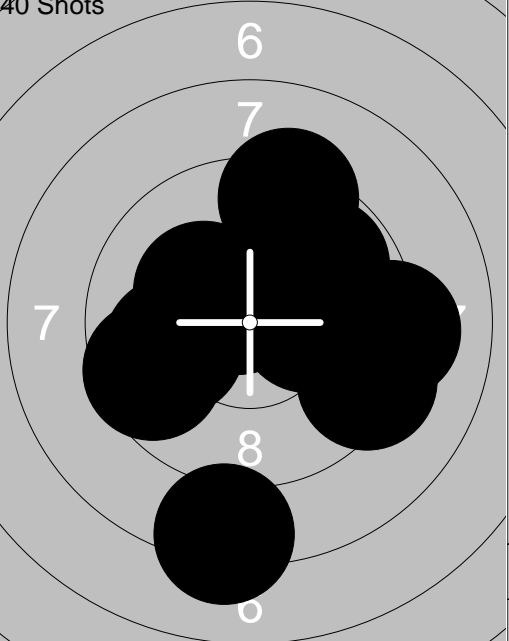

31:	*10.6	↘
32:	9.4	→
33:	9.0	↘
34:	*10.8	↓
35:	10.0	↗
36:	*10.6	↗
37:	*10.3	↘
38:	*10.6	↗
39:	*10.6	→
40:	*10.7	←
Series		98.0
Total		386.0

<p>Sight</p> 	<p>40 Shots</p> 	<p>1: 8.7 →</p> <p>2: 9.7 ↗</p> <p>3: 9.9 ↗</p> <p>4: 9.8 ↓</p> <p>5: 9.4 →</p> <p>6: 9.1 ↗</p> <hr/> <p>Series 53.0</p> <p>Total 0.0</p>	<p>1: 9.8 ↗</p> <p>2: *10.7 ↖</p> <p>3: 9.9 ←</p> <p>4: 9.6 ←</p> <p>5: 9.3 ↘</p> <p>6: *10.2 ↖</p> <p>7: *10.2 →</p> <p>8: 8.2 ↓</p> <p>9: 9.3 ↗</p> <p>10: 9.2 →</p> <hr/> <p>Series 92.0</p> <p>Total 92.0</p>
---	--	---	---

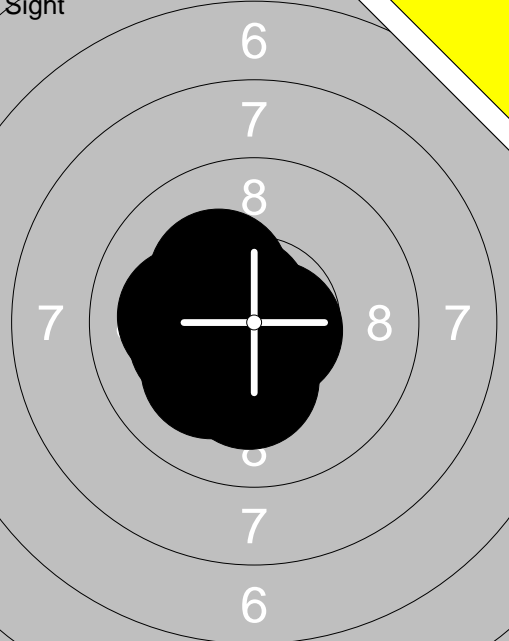
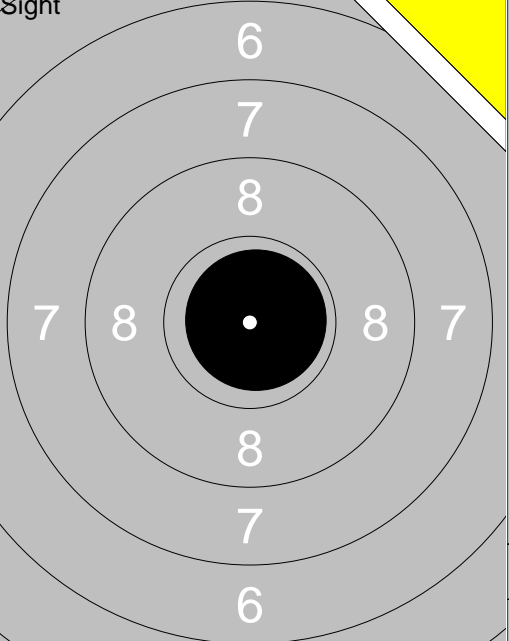

<p>40 Shots</p> 	<p>40 Shots</p> 	<p>11: 9.9 ↗</p> <p>12: 9.7 ←</p> <p>13: *10.2 ↓</p> <p>14: 9.7 →</p> <p>15: 9.2 →</p> <p>16: 9.6 ↑</p> <p>17: 10.1 ←</p> <p>18: 10.1 ↘</p> <p>19: 9.3 ↓</p> <p>20: 10.0 ↗</p> <hr/> <p>Series 94.0</p> <p>Total 186.0</p>	<p>21: 9.9 ↖</p> <p>22: *10.5 ↓</p> <p>23: 9.5 ↗</p> <p>24: *10.4 ←</p> <p>25: 9.6 ↘</p> <p>26: *10.7 ↑</p> <p>27: 8.1 ↖</p> <p>28: 8.8 ↖</p> <p>29: 9.5 ↗</p> <p>30: 9.9 ↗</p> <hr/> <p>Series 91.0</p> <p>Total 277.0</p>
---	---	--	---

<p>40 Shots</p> 	<p>31: 9.9 ←</p> <p>32: *10.3 ↘</p> <p>33: 9.7 ↑</p> <p>34: *10.2 ↗</p> <p>35: *10.6 ↘</p> <p>36: 10.0 ←</p> <p>37: *10.4 ↑</p> <p>38: *10.4 →</p> <p>39: *10.7 ↖</p> <p>40: *10.2 →</p> <hr/> <p>Series 98.0</p> <p>Total 375.0</p>		
--	--	--	--

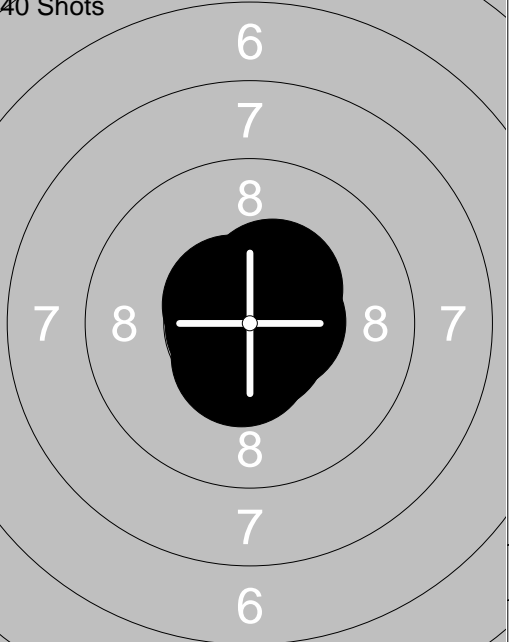

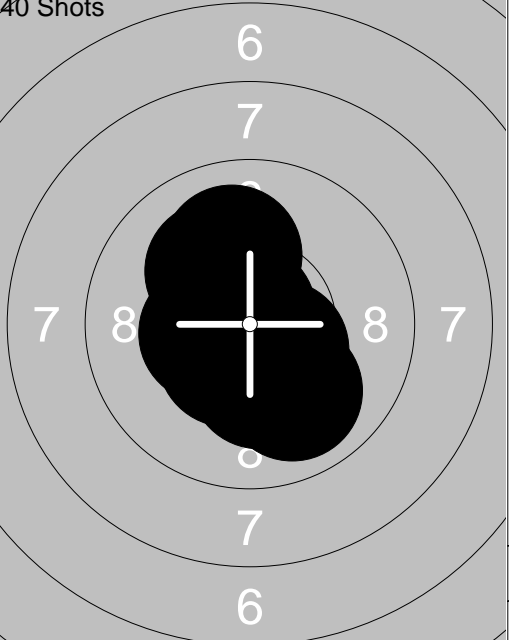
<p>Sight</p> 	<p>Sight</p> 	
<p>1: 10.1 ↙</p> <p>2: *10.2 ↓</p> <p>3: *10.7 →</p> <p>4: *10.7 ↙</p> <p>5: *10.6 ↙</p> <p>6: *10.7 ↗</p> <p>7: *10.2 ↗</p> <p>8: 10.1 ←</p> <p>9: *10.2 ←</p> <p>10: *10.7 ↗</p>	<p>11: *10.9 →</p>	
Series 100.0	Series 10.0	
Total 0.0	Total 0.0	

<p>40 Shots</p> 	<p>40 Shots</p> 	
<p>1: *10.7 ↗</p> <p>2: *10.4 →</p> <p>3: *10.7 ↓</p> <p>4: *10.8 ↓</p> <p>5: *10.8 ↙</p> <p>6: *10.5 ↑</p> <p>7: *10.4 ↗</p> <p>8: *10.5 →</p> <p>9: *10.5 ←</p> <p>10: *10.4 ↓</p>	<p>11: *10.7 ↓</p> <p>12: *10.8 ↓</p> <p>13: *10.8 ←</p> <p>14: *10.4 ↗</p> <p>15: *10.9 ↓</p> <p>16: *10.6 →</p> <p>17: *10.6 ↗</p> <p>18: *10.7 ↗</p> <p>19: *10.5 ↓</p> <p>20: *10.8 ↓</p>	
Series 100.0	Series 100.0	
Total 100.0	Total 200.0	

<p>40 Shots</p> 	<p>40 Shots</p> 	
<p>21: *10.6 →</p> <p>22: *10.3 ←</p> <p>23: *10.6 ↓</p> <p>24: *10.7 ↑</p> <p>25: *10.5 ↗</p> <p>26: *10.6 ↙</p> <p>27: *10.8 →</p> <p>28: *10.6 ←</p> <p>29: *10.2 →</p> <p>30: *10.3 ↓</p>	<p>31: 10.0 ↑</p> <p>32: *10.6 ↙</p> <p>33: *10.4 ↙</p> <p>34: 9.9 ↓</p> <p>35: *10.4 ←</p> <p>36: *10.5 ↙</p> <p>37: *10.8 ↗</p> <p>38: 10.1 ↗</p> <p>39: *10.8 ↗</p> <p>40: *10.2 ↓</p>	
Series 100.0	Series 99.0	
Total 300.0	Total 399.0	

<p>Sight</p> 	<p>Sight</p> 	
<p>1: *10.4 ↘</p> <p>2: 9.5 ↙</p> <p>3: *10.5 ↘</p> <p>4: 9.9 ↓</p> <p>5: *10.3 ↗</p> <p>6: 9.8 ←</p> <p>7: 9.7 ↙</p> <p>8: 9.8 ↓</p> <p>9: *10.3 ↙</p> <p>10: *10.5 →</p>	<p>11: 10.1 ↓</p> <p>12: *10.4 ↗</p> <p>13: *10.5 ↗</p>	
Series 95.0	Series 30.0	
Total 0.0	Total 0.0	

<p>40 Shots</p> 	<p>40 Shots</p> 	
<p>1: *10.6 ↑</p> <p>2: *10.4 ←</p> <p>3: *10.7 ↗</p> <p>4: *10.7 ↑</p> <p>5: 10.0 ↗</p> <p>6: *10.5 ↓</p> <p>7: *10.6 →</p> <p>8: *10.3 ↓</p> <p>9: 9.6 ↗</p> <p>10: 9.6 ↗</p>	<p>11: *10.2 ↑</p> <p>12: *10.4 ↗</p> <p>13: *10.2 ↓</p> <p>14: 10.1 ↗</p> <p>15: *10.7 →</p> <p>16: *10.5 ↗</p> <p>17: 9.7 ←</p> <p>18: *10.6 ↗</p> <p>19: 10.1 ↑</p> <p>20: *10.8 ↙</p>	
Series 98.0	Series 99.0	
Total 98.0	Total 197.0	

<p>40 Shots</p> 	<p>40 Shots</p> 	
<p>21: *10.5 ↙</p> <p>22: 9.9 ↗</p> <p>23: *10.7 ↗</p> <p>24: 10.1 →</p> <p>25: 9.5 ↙</p> <p>26: *10.2 ↓</p> <p>27: 9.9 ↗</p> <p>28: *10.4 ↑</p> <p>29: 9.4 ↗</p> <p>30: 8.7 ↙</p>	<p>31: 10.0 ↗</p> <p>32: *10.4 ↗</p> <p>33: *10.3 ↑</p> <p>34: *10.8 ←</p> <p>35: *10.3 ↑</p> <p>36: *10.2 ↗</p> <p>37: 9.5 →</p> <p>38: 9.0 ↗</p> <p>39: *10.3 →</p> <p>40: 10.1 ↓</p>	
Series 94.0	Series 98.0	
Total 291.0	Total 389.0	

<p>Sight</p>	<p>Sight</p>	
1: *10.2 ↓ 2: *10.2 ↓ 3: *10.7 ↓ 4: *10.4 ↓ 5: 10.1 ↓ 6: 10.0 ↓ 7: *10.6 ↓ 8: 10.1 ↓ 9: *10.3 ↓ 10: 10.0 ↓	11: *10.3 ← 12: *10.2 →	
Series 100.0 Total 0.0	Series 20.0 Total 0.0	

<p>40 Shots</p>	<p>40 Shots</p>	
1: *10.4 ↑ 2: *10.4 ↓ 3: *10.4 → 4: *10.8 ↓ 5: *10.7 ↖ 6: 10.0 ← 7: *10.7 ↗ 8: *10.6 ↖ 9: 10.0 ← 10: *10.5 ↑	11: *10.8 ↑ 12: *10.4 ↓ 13: *10.3 ↙ 14: 9.9 ↙ 15: *10.6 ↓ 16: *10.2 ↙ 17: 9.9 ↗ 18: 10.0 ↑ 19: 10.1 ↑ 20: *10.8 ↘	
Series 100.0 Total 100.0	Series 98.0 Total 198.0	

<p>40 Shots</p>	<p>40 Shots</p>	
21: *10.4 ↘ 22: *10.5 ↑ 23: *10.3 ↖ 24: *10.4 ← 25: *10.2 ↓ 26: *10.7 ↓ 27: *10.4 ↑ 28: *10.8 ↑ 29: *10.4 ↗ 30: *10.8 ↗	31: *10.6 ↘ 32: *10.5 ↓ 33: *10.6 ← 34: *10.4 ↗ 35: *10.3 ↓ 36: *10.5 ↘ 37: *10.5 ↖ 38: *10.7 ↙ 39: *10.6 ↘ 40: *10.2 ↓	
Series 100.0 Total 298.0	Series 100.0 Total 398.0	

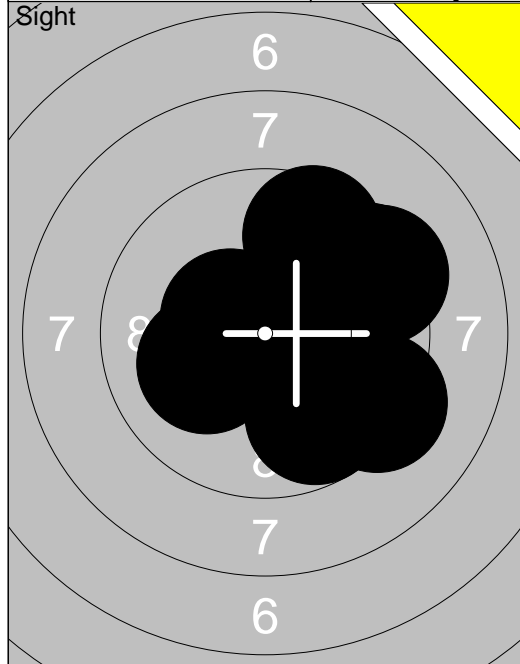

1:	9.7	↘
2:	*10.5	↖
3:	10.1	↖
4:	*10.7	↖
5:	9.5	↗
6:	9.3	↘
7:	9.3	↗
8:	9.6	↗
9:	*10.4	↗
10:	9.9	↗
Series		94.0
Total		0.0

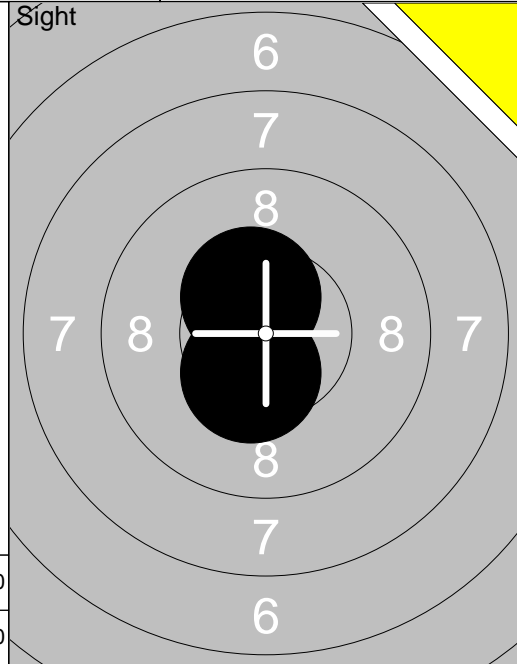

11:	*10.4	↗
12:	*10.4	↘
Series		20.0
Total		0.0

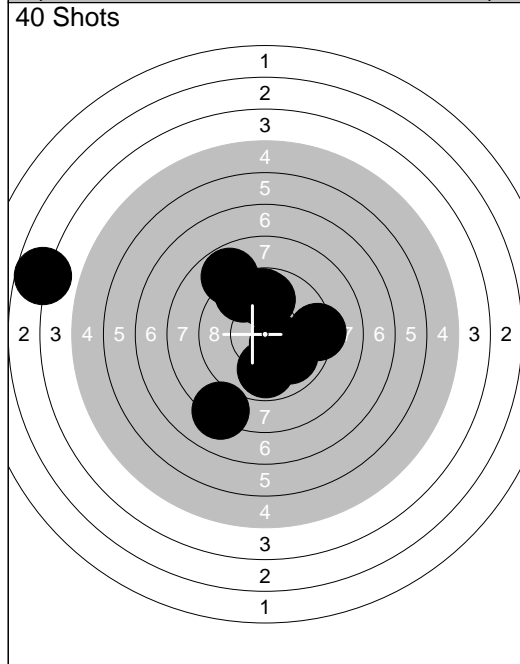

1:	9.9	↘
2:	9.9	↓
3:	8.2	↘
4:	3.7	↖
5:	9.5	↗
6:	8.8	↗
7:	9.3	→
8:	*10.4	↘
9:	9.9	↑
10:	9.8	↑
Series		83.0
Total		83.0

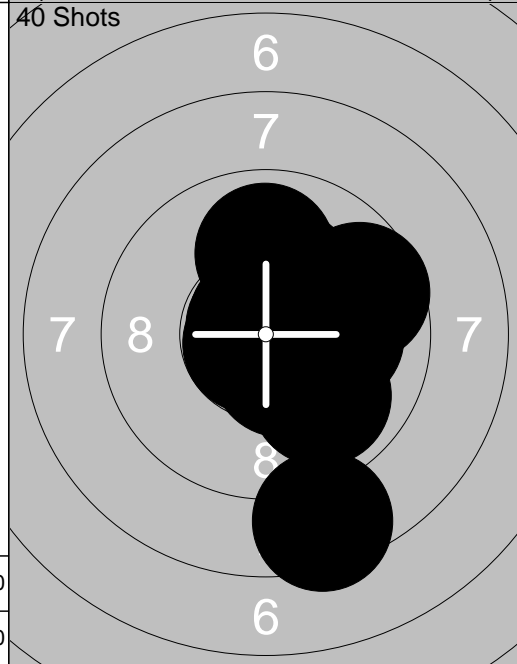

11:	9.6	↗
12:	9.9	↘
13:	*10.5	↘
14:	8.5	↘
15:	*10.8	↗
16:	*10.8	↖
17:	10.1	→
18:	9.9	↑
19:	*10.8	↗
20:	*10.2	↗
Series		95.0
Total		178.0

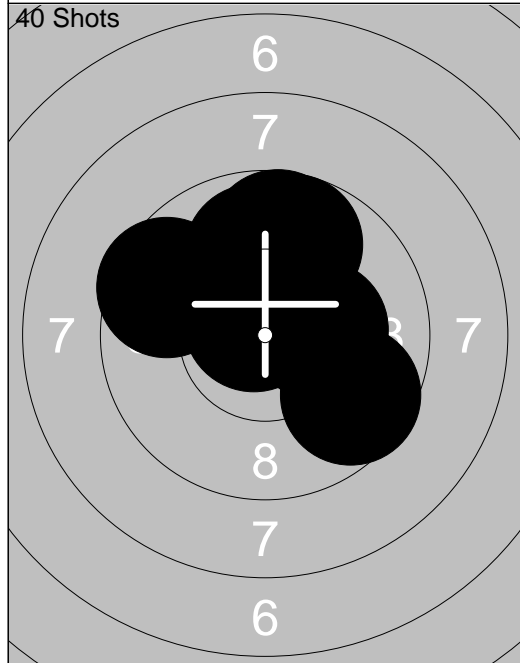

21:	*10.6	↖
22:	9.6	↘
23:	9.6	↖
24:	*10.2	↑
25:	10.0	↑
26:	9.7	↑
27:	9.7	↑
28:	9.9	↑
29:	*10.7	↖
30:	*10.3	→
Series		95.0
Total		273.0

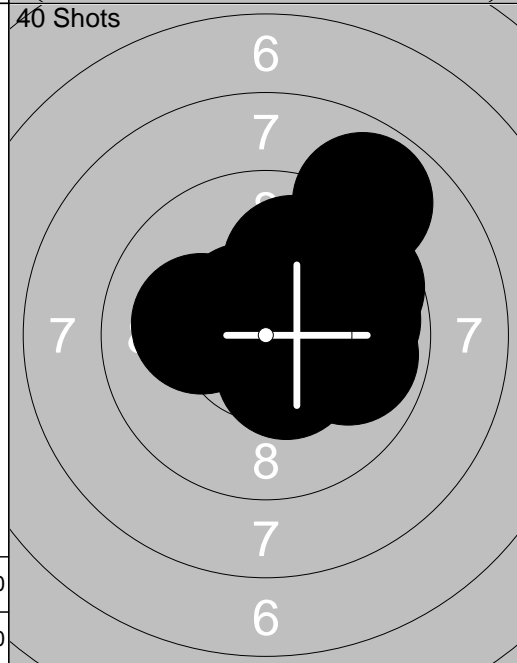

31:	9.9	→
32:	10.0	↗
33:	*10.6	↖
34:	8.9	↗
35:	9.7	↗
36:	10.1	↖
37:	*10.6	→
38:	*10.4	↘
39:	9.8	→
40:	10.0	↗
Series		95.0
Total		368.0

Sight 	Sight
1: 7.5 ↗ 2: 9.0 ↗ 3: 9.6 → 4: 9.4 ↖ 5: 9.7 ↗ 6: *10.5 → 7: 9.5 ↗ 8: *10.2 ↓ 9: *10.3 ↖ 10: *10.7 ↓	11: *10.9 ↖ 12: 9.5 → 13: 10.1 ↓ 14: 10.0 ↖ 15: 10.0 ↓ 16: *10.3 → 17: *10.6 ↖ 18: 9.9 ↖ 19: 10.0 ↗ 20: *10.8 ↖
Series 92.0	Series 98.0
Total 0.0	Total 0.0

40 Shots 	40 Shots
1: *10.3 ↓ 2: *10.7 ↖ 3: *10.4 → 4: *10.3 → 5: 10.1 ↖ 6: *10.3 → 7: 10.1 ↓ 8: *10.5 ↗ 9: *10.5 ↖ 10: 9.2 ↓	11: *10.7 ↓ 12: 9.8 → 13: 10.0 ↖ 14: *10.5 ↗ 15: 9.9 ↓ 16: 9.3 ↓ 17: *10.7 ↓ 18: *10.8 ↖ 19: 9.7 ↖ 20: *10.8 →
Series 99.0	Series 96.0
Total 99.0	Total 195.0

40 Shots 	40 Shots
21: 9.9 → 22: 9.4 ↖ 23: *10.3 ↗ 24: *10.3 → 25: 10.1 ↓ 26: *10.3 ↓ 27: *10.3 → 28: *10.8 ↖ 29: *10.4 → 30: *10.4 ↖	31: *10.5 ↓ 32: *10.7 ↓ 33: *10.6 ↓ 34: *10.6 ↓ 35: *10.2 → 36: *10.4 ↓ 37: *10.5 ↖ 38: *10.5 ↓ 39: *10.5 → 40: 9.6 ↓
Series 98.0	Series 99.0
Total 293.0	Total 392.0

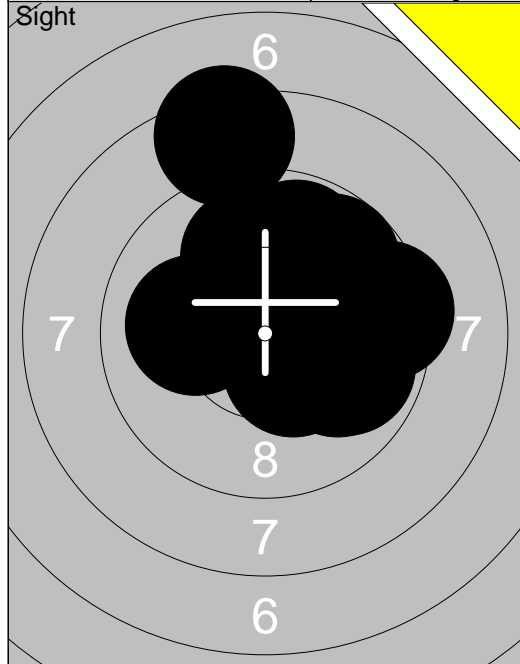

1:	9.9	→
2:	9.7	↗
3:	10.0	↑
4:	*10.5	↗
5:	9.8	↑
6:	9.9	→
7:	*10.4	↘
8:	10.1	←
9:	9.4	→
10:	8.4	↑
Series		93.0
Total		0.0

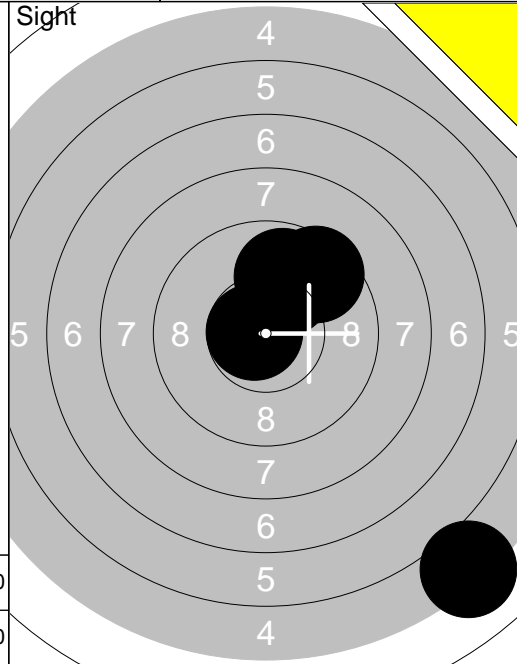

11:	10.0	↗
12:	*10.7	←
13:	9.5	↗
14:	5.1	↘
15:	9.9	↑
Series		43.0
Total		0.0

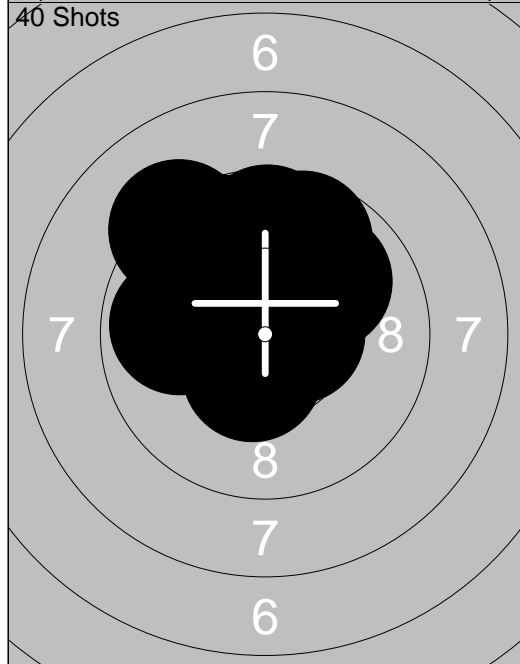

1:	10.0	↖
2:	*10.6	→
3:	*10.3	↑
4:	9.7	↑
5:	9.7	↑
6:	9.9	←
7:	9.6	↖
8:	*10.5	↘
9:	10.0	↗
10:	9.2	↖
Series		95.0
Total		95.0

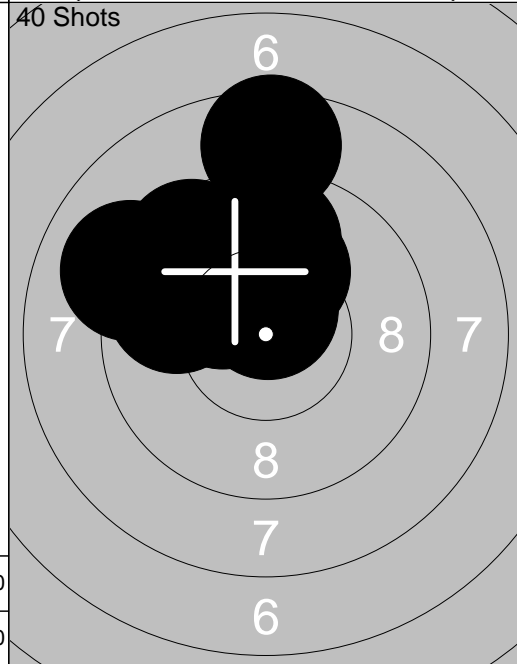

11:	*10.6	↑
12:	10.1	↑
13:	9.5	↖
14:	9.7	←
15:	8.5	↑
16:	9.9	↑
17:	*10.2	↖
18:	9.0	↖
19:	10.1	↑
20:	9.8	↑
Series		93.0
Total		188.0

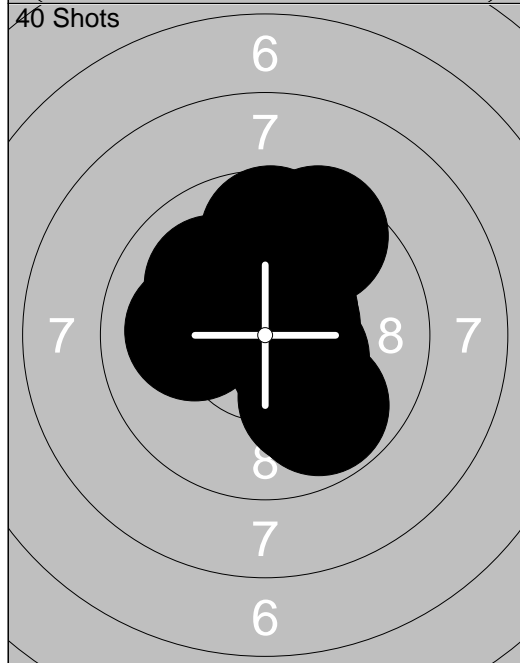

21:	10.1	↑
22:	9.5	↗
23:	10.0	←
24:	9.7	↑
25:	10.0	↖
26:	10.0	↘
27:	*10.5	↗
28:	*10.6	↗
29:	*10.4	↘
30:	9.8	↘
Series		97.0
Total		285.0

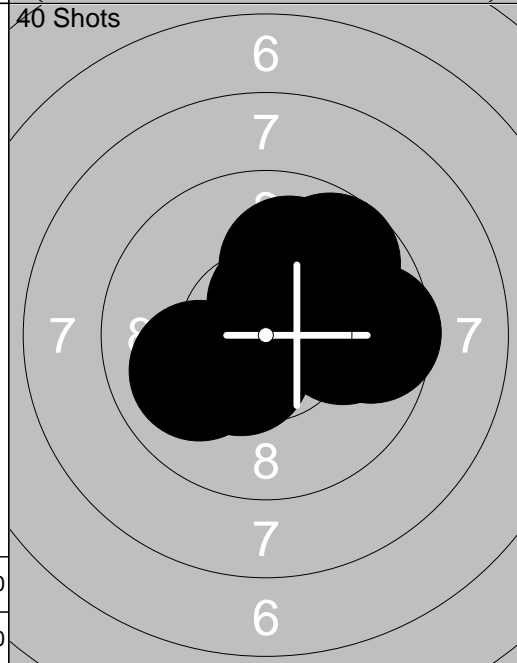

31:	*10.5	↘
32:	10.0	→
33:	9.7	↗
34:	9.6	→
35:	*10.4	↗
36:	10.0	↖
37:	10.0	↑
38:	*10.5	↑
39:	10.1	↗
40:	*10.2	↗
Series		98.0
Total		383.0

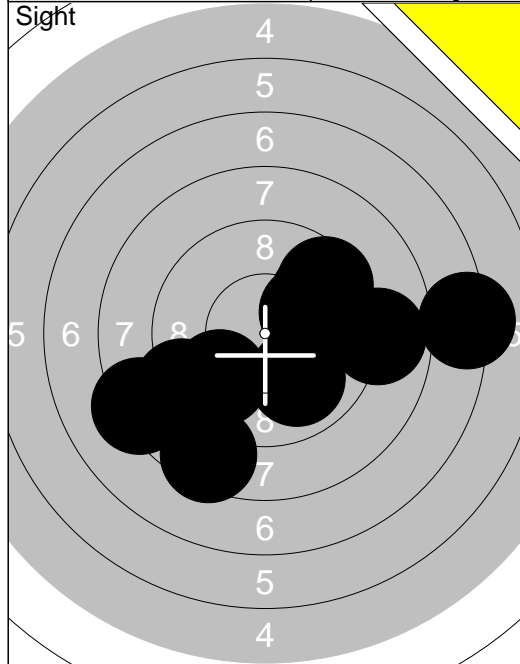

1:	9.8	↙
2:	8.5	↓
3:	8.3	↙
4:	9.1	↙
5:	9.5	↗
6:	7.2	→
7:	8.9	→
8:	9.7	↗
9:	9.9	↓
10:	10.1	↗
Series		86.0
Total		0.0

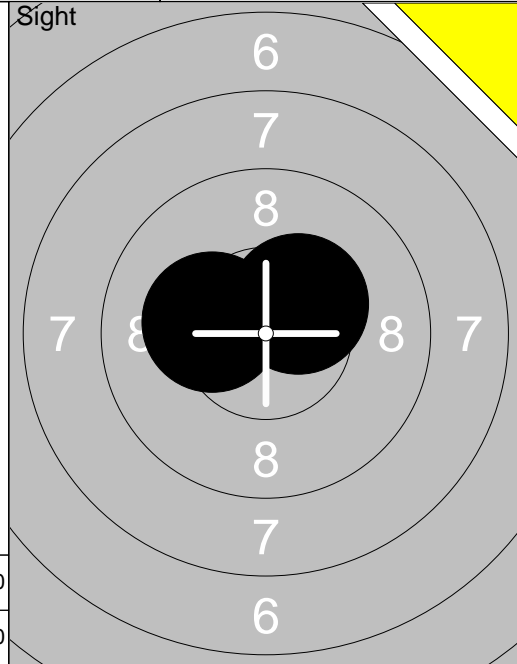

11:	*10.4	↗
12:	*10.3	↖
Series		20.0
Total		0.0

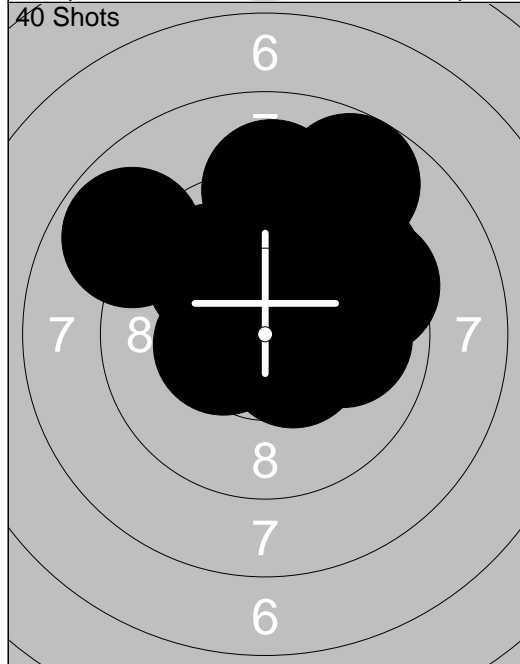

1:	10.1	↗
2:	8.9	↖
3:	*10.4	↖
4:	10.0	→
5:	9.5	↗
6:	9.5	↗
7:	9.9	↗
8:	8.7	↗
9:	*10.5	↓
10:	9.1	↑
Series		92.0
Total		92.0

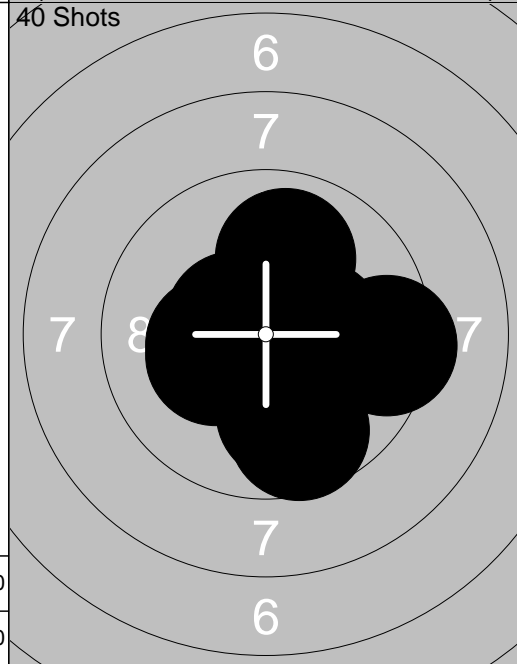

11:	*10.3	↖
12:	9.4	→
13:	9.7	↓
14:	*10.2	↗
15:	*10.5	↖
16:	*10.3	→
17:	9.9	↓
18:	*10.3	↖
19:	10.0	↑
20:	*10.3	→
Series		97.0
Total		189.0

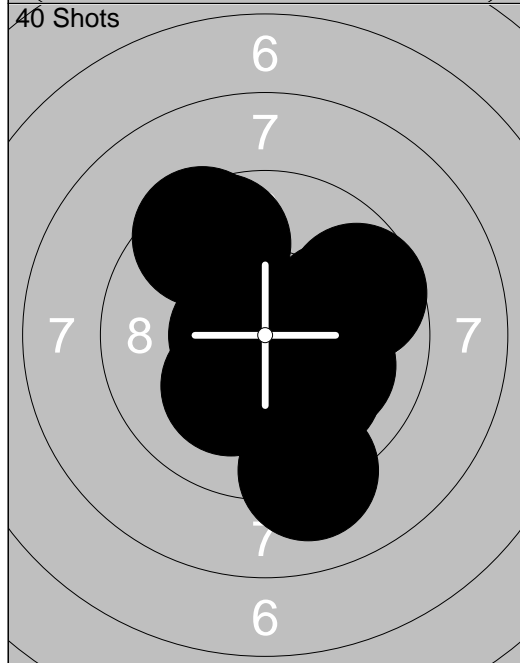

21:	10.1	↗
22:	10.0	→
23:	*10.7	→
24:	9.5	↗
25:	9.7	↗
26:	*10.6	↖
27:	9.1	↓
28:	*10.2	↙
29:	10.1	↓
30:	9.7	↗
Series		96.0
Total		285.0

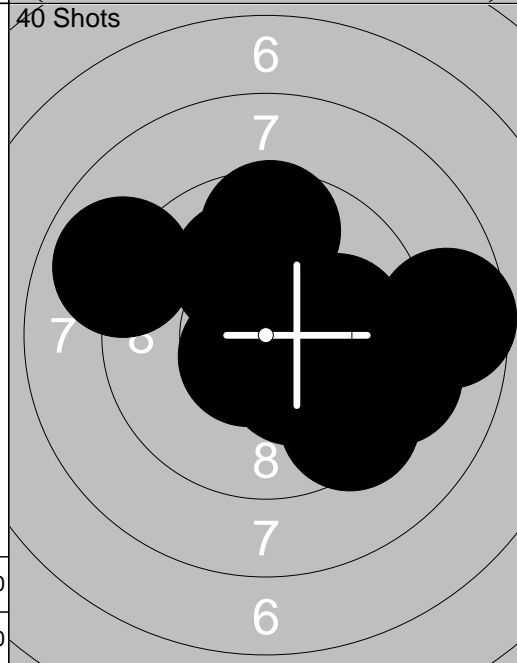

31:	10.0	→
32:	9.4	↓
33:	8.6	→
34:	9.2	↗
35:	*10.3	↓
36:	10.1	↑
37:	*10.6	↙
38:	*10.2	↘
39:	9.6	↑
40:	8.9	↖
Series		93.0
Total		378.0

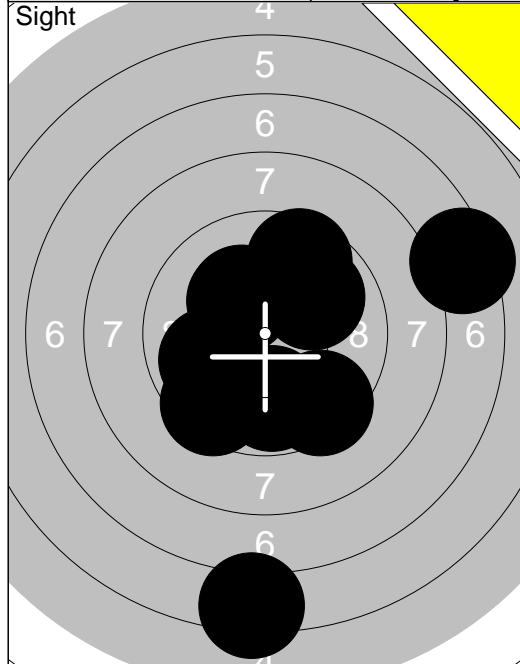

1:	9.9	↙
2:	6.3	↓
3:	9.5	↙
4:	*10.2	↗
5:	9.8	↓
6:	9.6	↗
7:	9.9	↗
8:	*10.2	↗
9:	9.4	↘
10:	7.4	→
Series	87.0	
Total	0.0	

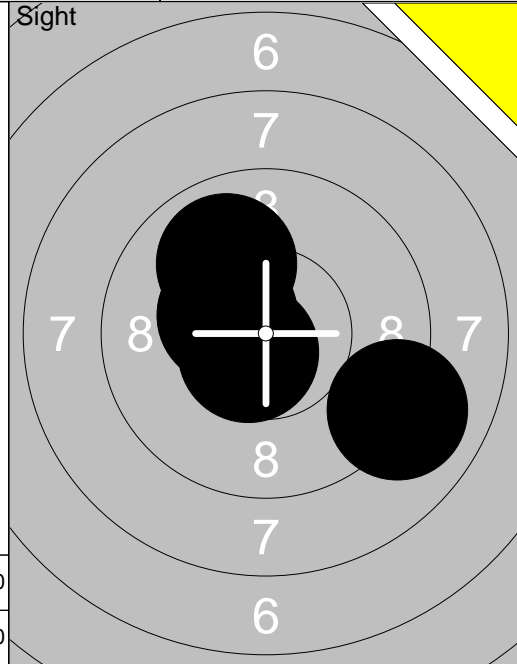

11:	*10.6	↙
12:	9.0	↘
13:	9.9	↗
14:	*10.4	↙
Series	38.0	
Total	0.0	

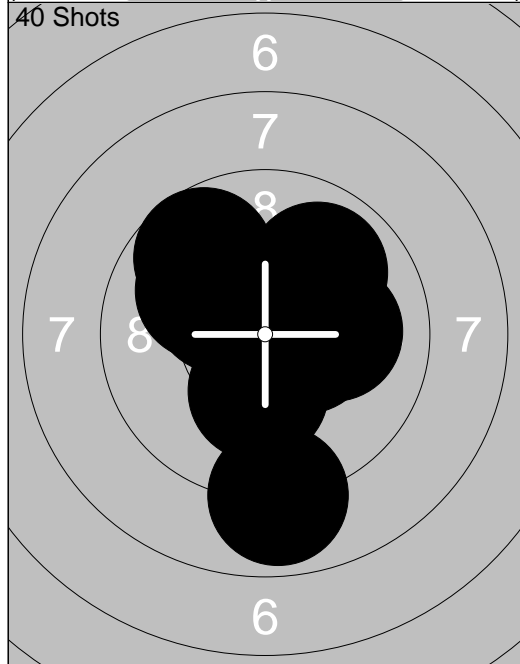

1:	*10.4	↗
2:	*10.4	→
3:	8.9	↓
4:	*10.3	↗
5:	9.7	↗
6:	*10.8	↘
7:	10.1	→
8:	9.9	↗
9:	*10.2	↓
10:	10.0	↙
Series	96.0	
Total	96.0	

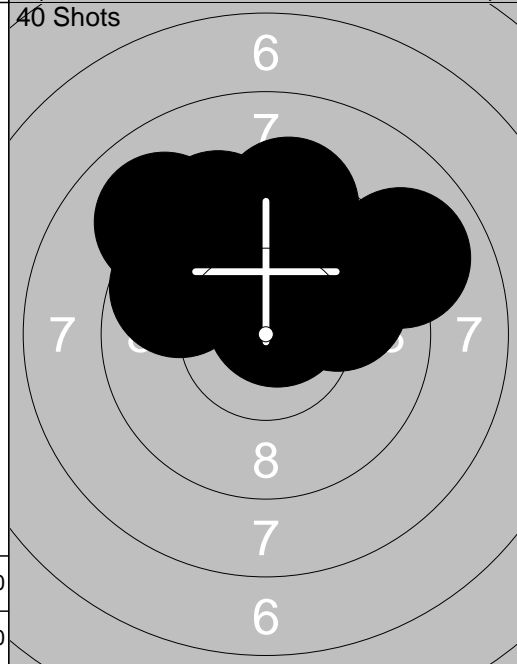

11:	9.9	↗
12:	9.0	↗
13:	*10.7	↗
14:	9.0	↙
15:	*10.3	↗
16:	9.3	↗
17:	9.4	↗
18:	10.1	↗
19:	*10.3	↗
20:	9.7	↙
Series	94.0	
Total	190.0	

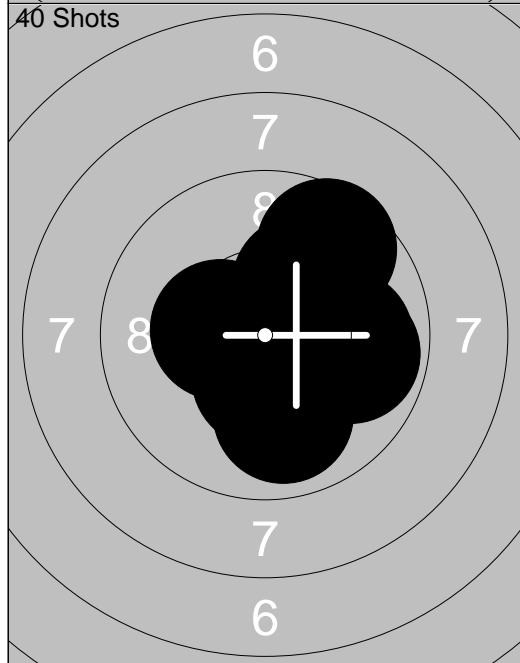

21:	9.9	↓
22:	10.0	→
23:	*10.2	↗
24:	*10.4	↙
25:	*10.3	→
26:	9.6	↗
27:	*10.7	→
28:	*10.4	↓
29:	9.8	→
30:	10.0	→
Series	97.0	
Total	287.0	

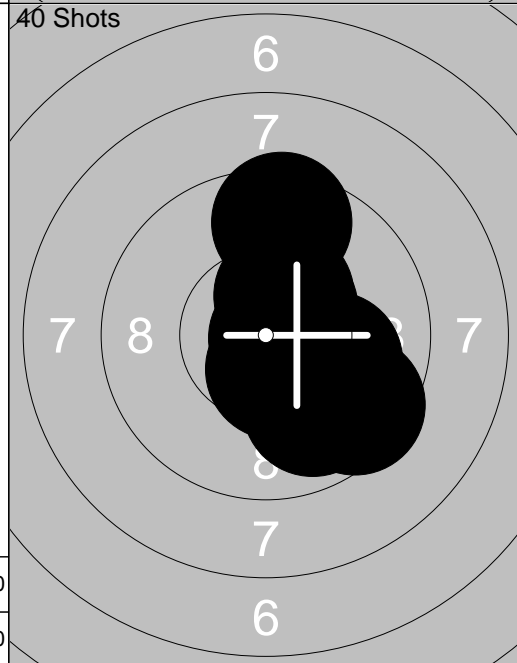

31:	*10.5	↓
32:	9.5	↘
33:	*10.4	↗
34:	*10.6	→
35:	10.0	↘
36:	*10.5	↗
37:	*10.8	→
38:	9.9	↘
39:	10.0	↘
40:	9.5	↗
Series	97.0	
Total	384.0	

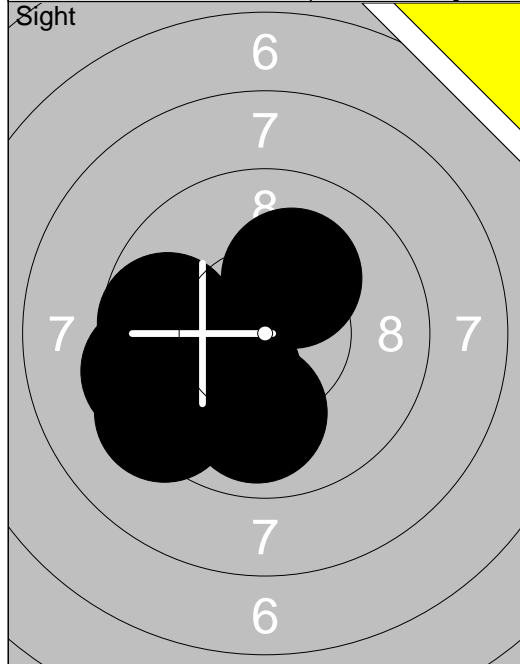

1: *10.2 ↗
2: 9.9 ↓
3: *10.3 ↙
4: 9.9 ←
5: 9.7 ←
6: 9.9 ←
7: 9.5 ←
8: 9.4 ←
9: 9.7 ←
10: 9.3 ↙
Series 92.0
Total 0.0

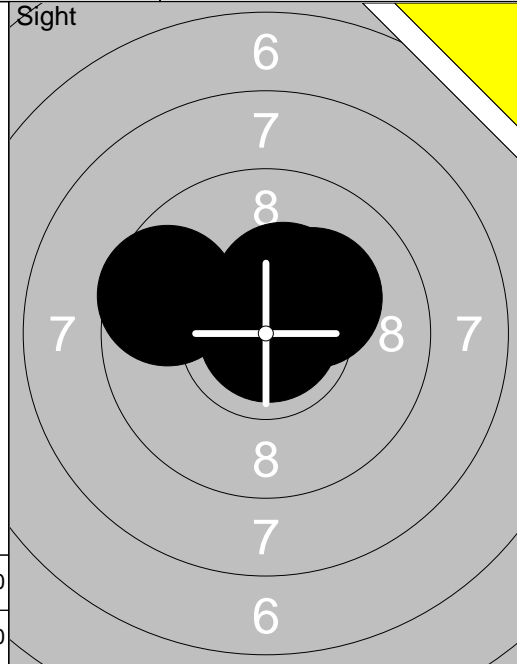

11: *10.2 ↗
12: 9.6 ↖
13: *10.4 ↗
14: *10.9 ↗
Series 39.0
Total 0.0

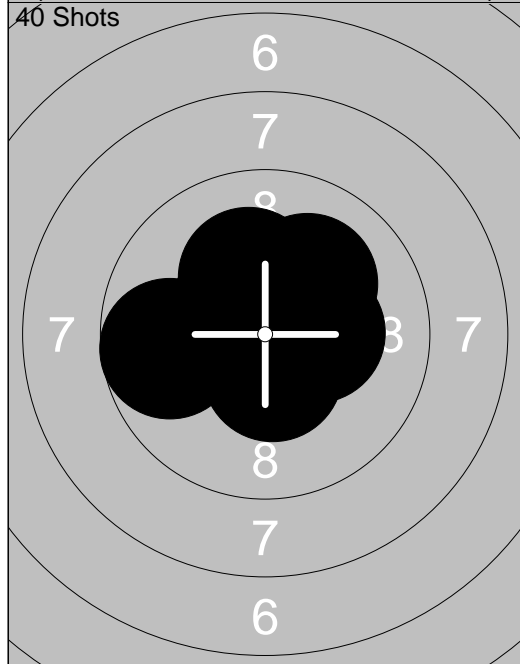

1: *10.6 ←
2: *10.5 ←
3: *10.2 ↗
4: *10.5 ↓
5: *10.3 →
6: 10.1 ↗
7: *10.8 ←
8: 9.7 ←
9: *10.6 ↖
10: *10.5 ↖
Series 99.0
Total 99.0

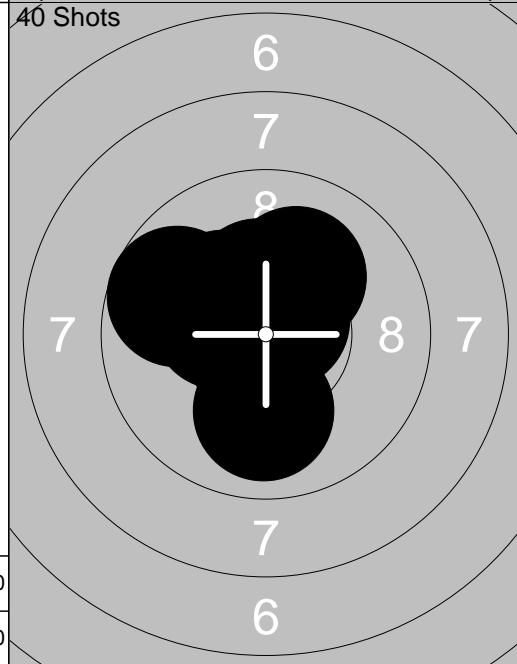

11: 10.1 ↗
12: *10.4 ↖
13: *10.4 ↗
14: *10.7 ↗
15: 9.7 ↖
16: *10.4 ↖
17: *10.3 ↖
18: *10.8 ↖
19: 10.0 ↓
20: *10.3 ↖
Series 99.0
Total 198.0

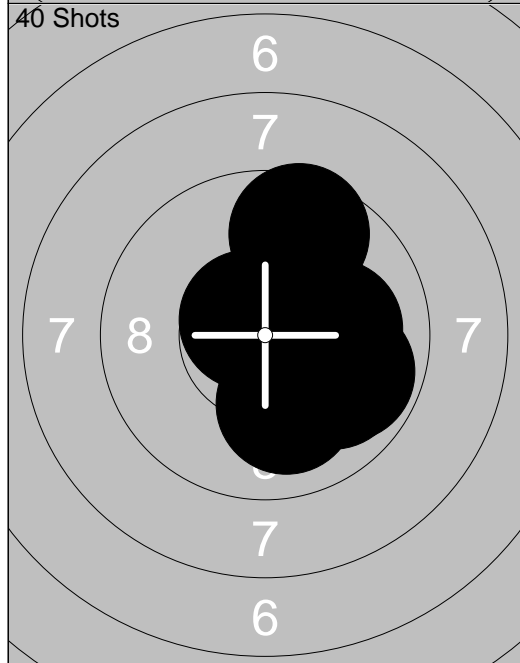

21: *10.8 ↘
22: *10.7 →
23: *10.6 ↗
24: 10.0 ↓
25: 9.9 ↘
26: *10.8 ↗
27: 10.1 →
28: 9.6 ↗
29: 9.8 ↘
30: *10.7 ↖
Series 97.0
Total 295.0

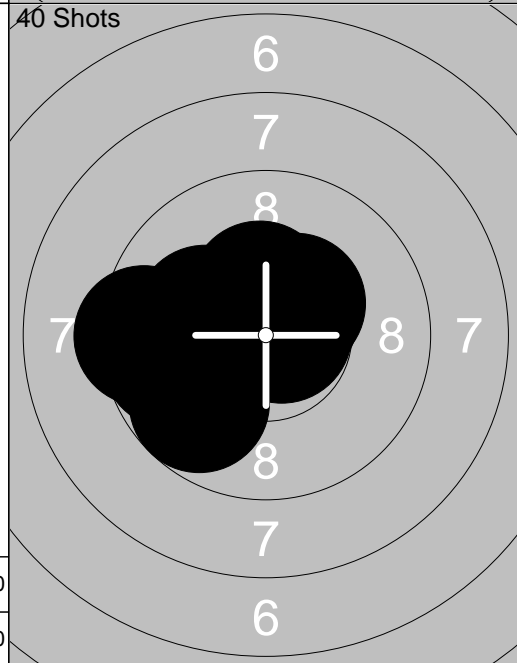

31: 10.1 ↖
32: *10.6 ↗
33: 9.7 ↖
34: *10.4 ↗
35: 9.4 ←
36: *10.4 ↗
37: *10.9 ↗
38: *10.6 ↖
39: 9.7 ↖
40: *10.7 →
Series 97.0
Total 392.0

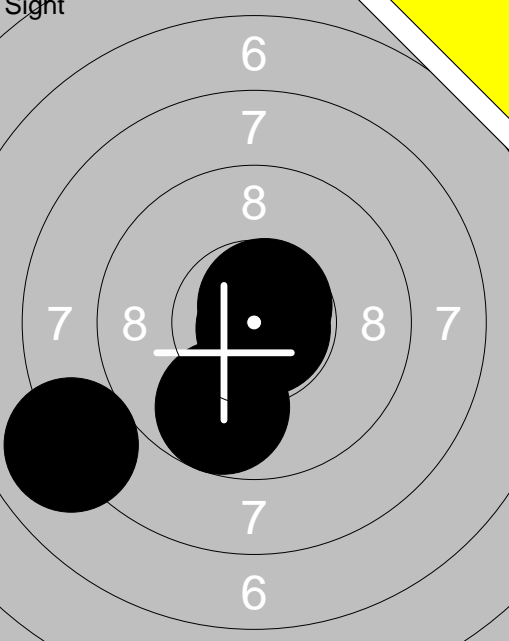
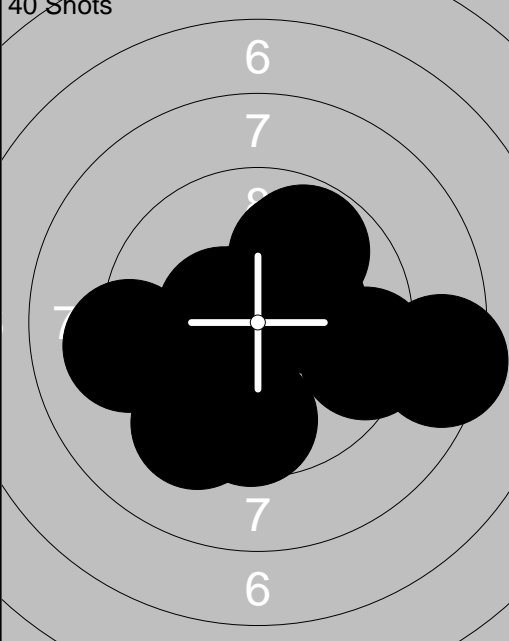
<p>Sight</p> 	<p>40 Shots</p> 	<table border="1" style="width:100%; border-collapse: collapse;"> <tr><td>1: 9.7</td><td>↘</td></tr> <tr><td>2: 8.0</td><td>↙</td></tr> <tr><td>3: *10.8</td><td>↘</td></tr> <tr><td>4: *10.7</td><td>↗</td></tr> <tr><td colspan="2">Series 37.0</td></tr> <tr><td colspan="2">Total 0.0</td></tr> </table>	1: 9.7	↘	2: 8.0	↙	3: *10.8	↘	4: *10.7	↗	Series 37.0		Total 0.0		<table border="1" style="width:100%; border-collapse: collapse;"> <tr><td>1: 8.4</td><td>→</td></tr> <tr><td>2: 9.2</td><td>←</td></tr> <tr><td>3: 9.9</td><td>↗</td></tr> <tr><td>4: *10.3</td><td>→</td></tr> <tr><td>5: 9.8</td><td>↗</td></tr> <tr><td>6: 10.1</td><td>↙</td></tr> <tr><td>7: 9.4</td><td>→</td></tr> <tr><td>8: *10.5</td><td>←</td></tr> <tr><td>9: 9.4</td><td>↙</td></tr> <tr><td>10: 9.6</td><td>↓</td></tr> <tr><td colspan="2">Series 92.0</td></tr> <tr><td colspan="2">Total 92.0</td></tr> </table>	1: 8.4	→	2: 9.2	←	3: 9.9	↗	4: *10.3	→	5: 9.8	↗	6: 10.1	↙	7: 9.4	→	8: *10.5	←	9: 9.4	↙	10: 9.6	↓	Series 92.0		Total 92.0	
1: 9.7	↘																																						
2: 8.0	↙																																						
3: *10.8	↘																																						
4: *10.7	↗																																						
Series 37.0																																							
Total 0.0																																							
1: 8.4	→																																						
2: 9.2	←																																						
3: 9.9	↗																																						
4: *10.3	→																																						
5: 9.8	↗																																						
6: 10.1	↙																																						
7: 9.4	→																																						
8: *10.5	←																																						
9: 9.4	↙																																						
10: 9.6	↓																																						
Series 92.0																																							
Total 92.0																																							

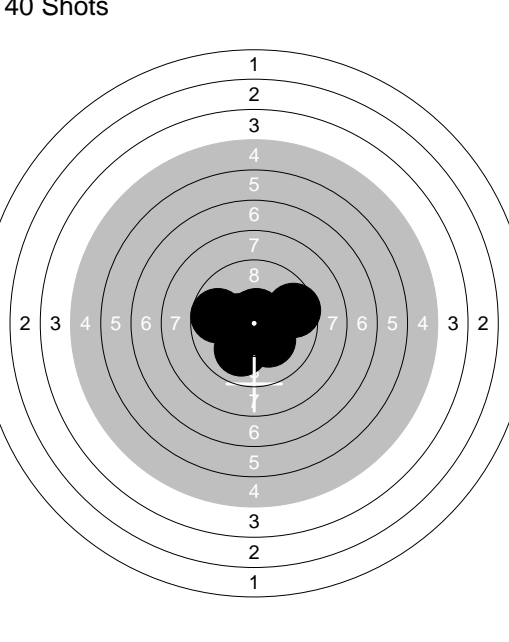
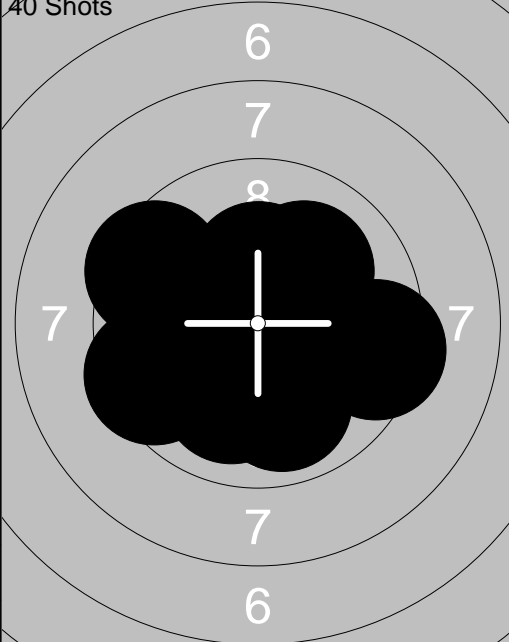
<p>40 Shots</p> 	<p>40 Shots</p> 	<table border="1" style="width:100%; border-collapse: collapse;"> <tr><td>11: *10.5</td><td>↘</td></tr> <tr><td>12: *10.7</td><td>↗</td></tr> <tr><td>13: 0.0</td><td>↓</td></tr> <tr><td>14: 9.6</td><td>→</td></tr> <tr><td>15: 10.0</td><td>↘</td></tr> <tr><td>16: 9.7</td><td>←</td></tr> <tr><td>17: *10.3</td><td>↘</td></tr> <tr><td>18: *10.2</td><td>↘</td></tr> <tr><td>19: *10.4</td><td>↘</td></tr> <tr><td>20: *10.4</td><td>←</td></tr> <tr><td colspan="2">Series 88.0</td></tr> <tr><td colspan="2">Total 180.0</td></tr> </table>	11: *10.5	↘	12: *10.7	↗	13: 0.0	↓	14: 9.6	→	15: 10.0	↘	16: 9.7	←	17: *10.3	↘	18: *10.2	↘	19: *10.4	↘	20: *10.4	←	Series 88.0		Total 180.0		<table border="1" style="width:100%; border-collapse: collapse;"> <tr><td>21: *10.3</td><td>↙</td></tr> <tr><td>22: *10.7</td><td>→</td></tr> <tr><td>23: 9.5</td><td>↙</td></tr> <tr><td>24: 9.5</td><td>↙</td></tr> <tr><td>25: 10.0</td><td>↓</td></tr> <tr><td>26: 9.9</td><td>↓</td></tr> <tr><td>27: *10.3</td><td>↗</td></tr> <tr><td>28: 10.1</td><td>↗</td></tr> <tr><td>29: *10.5</td><td>↗</td></tr> <tr><td>30: 9.4</td><td>→</td></tr> <tr><td colspan="2">Series 96.0</td></tr> <tr><td colspan="2">Total 276.0</td></tr> </table>	21: *10.3	↙	22: *10.7	→	23: 9.5	↙	24: 9.5	↙	25: 10.0	↓	26: 9.9	↓	27: *10.3	↗	28: 10.1	↗	29: *10.5	↗	30: 9.4	→	Series 96.0		Total 276.0	
11: *10.5	↘																																																		
12: *10.7	↗																																																		
13: 0.0	↓																																																		
14: 9.6	→																																																		
15: 10.0	↘																																																		
16: 9.7	←																																																		
17: *10.3	↘																																																		
18: *10.2	↘																																																		
19: *10.4	↘																																																		
20: *10.4	←																																																		
Series 88.0																																																			
Total 180.0																																																			
21: *10.3	↙																																																		
22: *10.7	→																																																		
23: 9.5	↙																																																		
24: 9.5	↙																																																		
25: 10.0	↓																																																		
26: 9.9	↓																																																		
27: *10.3	↗																																																		
28: 10.1	↗																																																		
29: *10.5	↗																																																		
30: 9.4	→																																																		
Series 96.0																																																			
Total 276.0																																																			

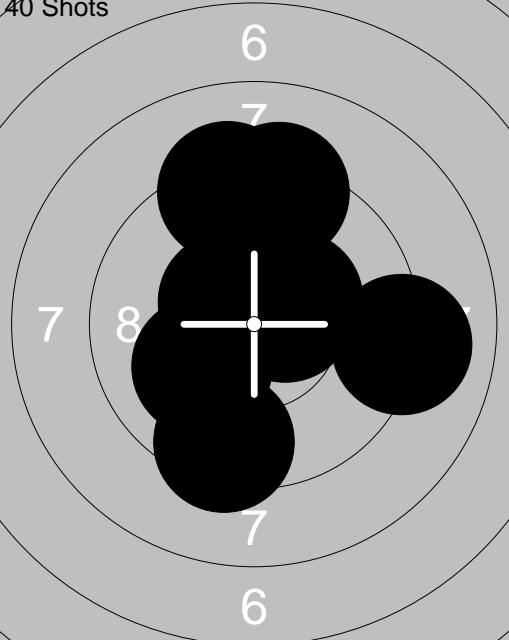
<p>40 Shots</p> 	<table border="1" style="width:100%; border-collapse: collapse;"> <tr><td>31: 9.2</td><td>↗</td></tr> <tr><td>32: 9.2</td><td>↗</td></tr> <tr><td>33: *10.5</td><td>↙</td></tr> <tr><td>34: 9.1</td><td>→</td></tr> <tr><td>35: *10.6</td><td>↗</td></tr> <tr><td>36: 10.1</td><td>↙</td></tr> <tr><td>37: *10.5</td><td>↗</td></tr> <tr><td>38: *10.5</td><td>→</td></tr> <tr><td>39: 9.4</td><td>↓</td></tr> <tr><td>40: *10.4</td><td>↗</td></tr> <tr><td colspan="2">Series 96.0</td></tr> <tr><td colspan="2">Total 372.0</td></tr> </table>	31: 9.2	↗	32: 9.2	↗	33: *10.5	↙	34: 9.1	→	35: *10.6	↗	36: 10.1	↙	37: *10.5	↗	38: *10.5	→	39: 9.4	↓	40: *10.4	↗	Series 96.0		Total 372.0			
31: 9.2	↗																										
32: 9.2	↗																										
33: *10.5	↙																										
34: 9.1	→																										
35: *10.6	↗																										
36: 10.1	↙																										
37: *10.5	↗																										
38: *10.5	→																										
39: 9.4	↓																										
40: *10.4	↗																										
Series 96.0																											
Total 372.0																											

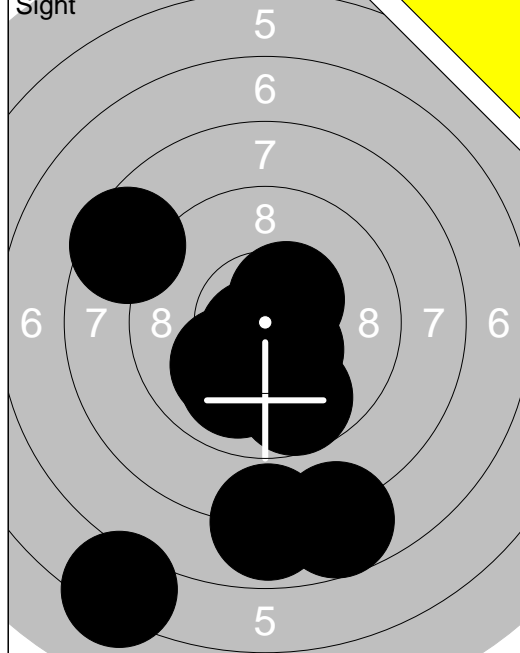

1: 8.5	↖
2: 9.7	↓
3: 10.0	↓
4: 7.9	↓
5: *10.5	↗
6: *10.7	↓
7: 10.1	↙
8: *10.4	↓
9: 7.7	↓
10: 6.3	↙
Series	87.0
Total	0.0

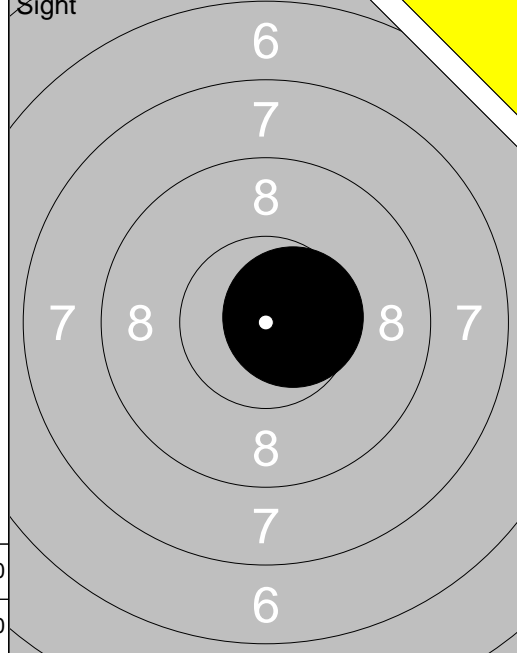

11: *10.6	→
Series	10.0
Total	0.0

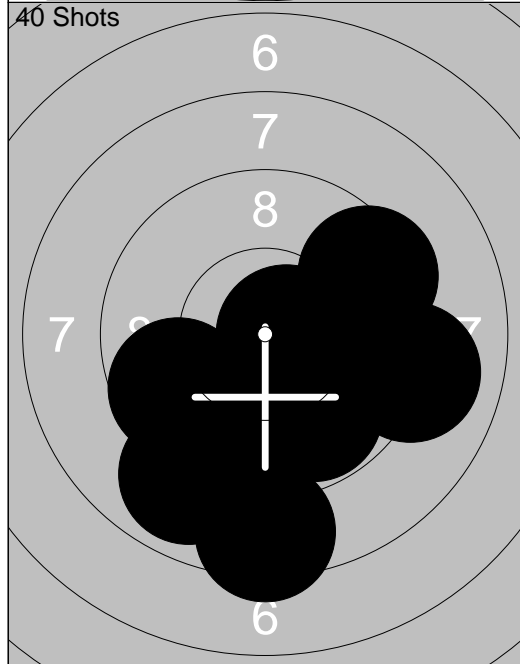

1: *10.7	→
2: 10.1	↓
3: 9.0	→
4: 9.8	↓
5: 9.6	↙
6: 8.4	↓
7: 8.9	↓
8: 9.4	↗
9: 9.7	↙
10: 9.9	↓
Series	90.0
Total	90.0

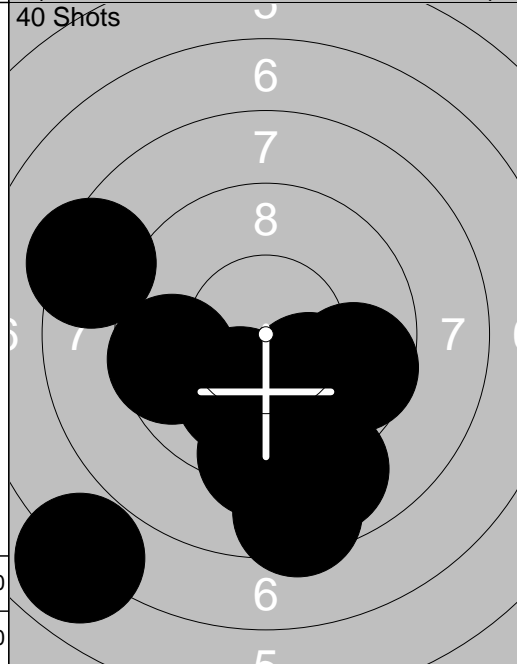

11: 8.9	↓
12: 9.9	↓
13: 9.6	→
14: 9.6	↙
15: 9.3	↓
16: 6.9	↙
17: 10.1	↓
18: 8.4	↓
19: 8.3	↙
20: 10.1	↓
Series	86.0
Total	176.0

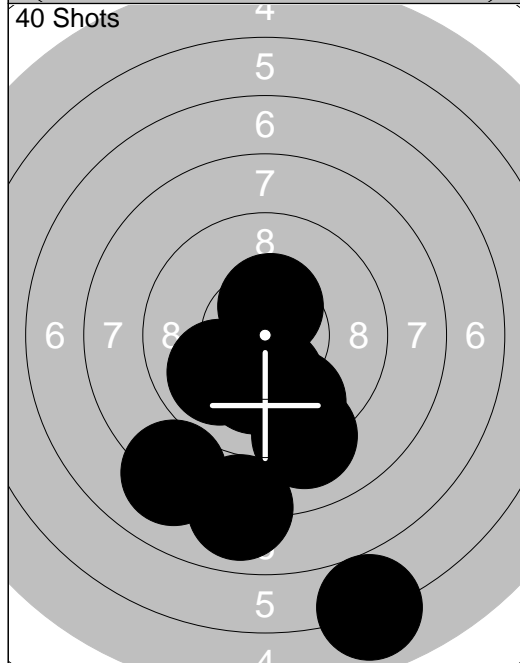

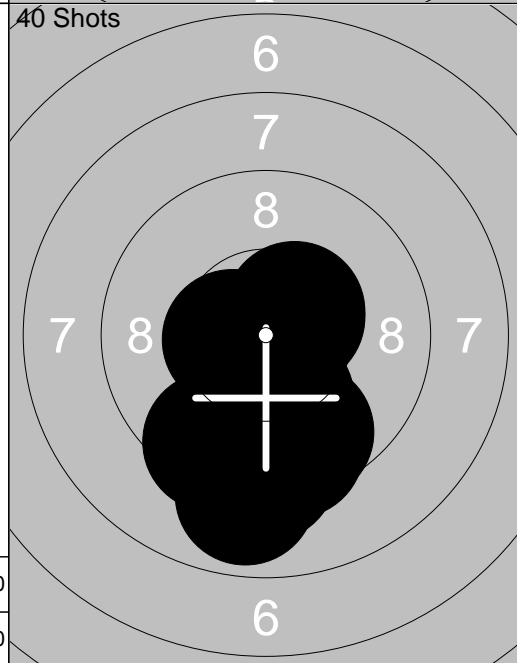

21: *10.2	↓
22: 8.0	↓
23: 9.1	↓
24: 8.1	↙
25: *10.4	↑
26: 6.0	↓
27: *10.5	↓
28: 10.1	↓
29: 9.7	↓
30: 10.0	↙
Series	90.0
Total	266.0



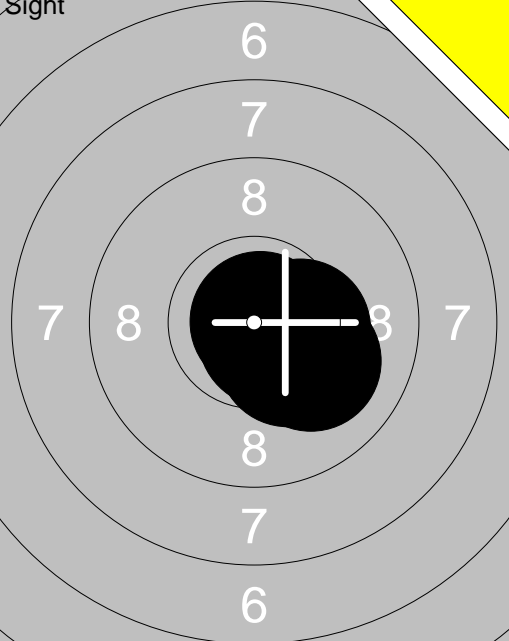
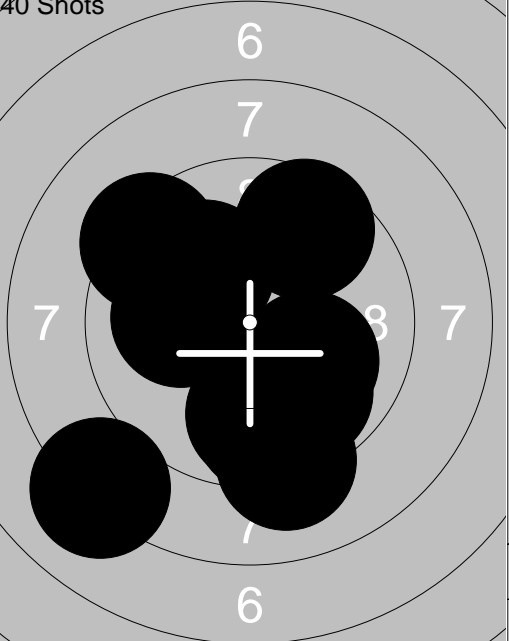

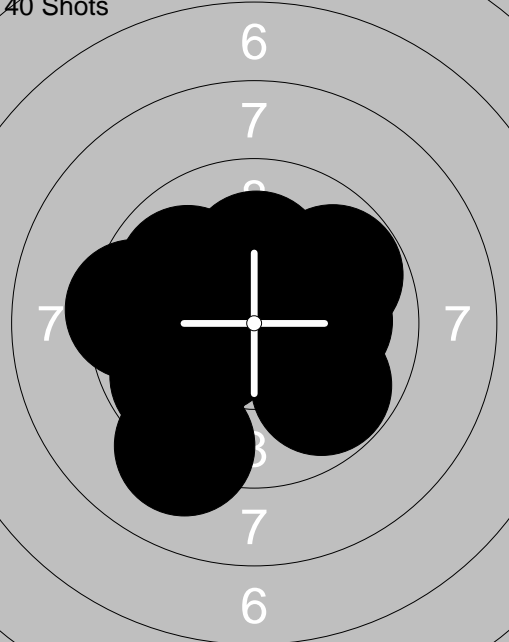
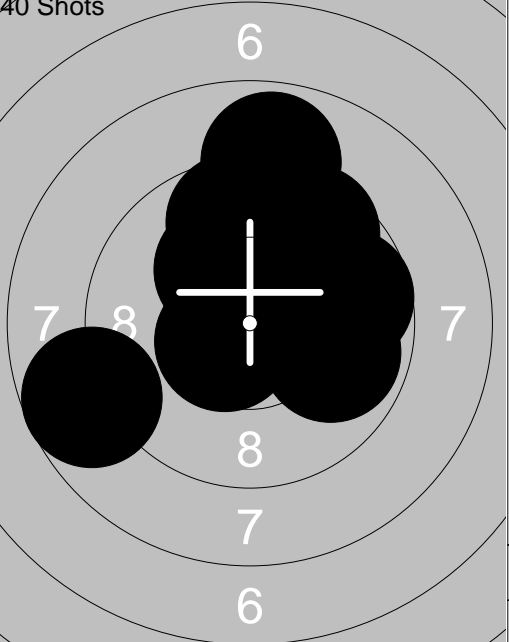
31: 9.5	↓
32: 8.9	↓
33: 9.6	↓
34: 9.2	↓
35: 10.1	↓
36: *10.5	↗
37: *10.5	↙
38: *10.4	↓
39: *10.5	↗
40: 9.4	↙
Series	94.0
Total	360.0

<p>Sight</p> 	<p>40 Shots</p> 	<table style="width:100%; border-collapse: collapse;"> <tr><td>1: 10.1</td><td style="text-align: right;">↘</td></tr> <tr><td>2: *10.3</td><td style="text-align: right;">↘</td></tr> <tr><td>3: *10.7</td><td style="text-align: right;">↘</td></tr> <tr><td>4: *10.4</td><td style="text-align: right;">→</td></tr> <tr><td>5: *10.9</td><td style="text-align: right;">→</td></tr> <tr><td colspan="2">Series 50.0</td></tr> <tr><td colspan="2">Total 0.0</td></tr> </table>	1: 10.1	↘	2: *10.3	↘	3: *10.7	↘	4: *10.4	→	5: *10.9	→	Series 50.0		Total 0.0											
1: 10.1	↘																									
2: *10.3	↘																									
3: *10.7	↘																									
4: *10.4	→																									
5: *10.9	→																									
Series 50.0																										
Total 0.0																										
		<table style="width:100%; border-collapse: collapse;"> <tr><td>1: 10.0</td><td style="text-align: right;">↘</td></tr> <tr><td>2: 9.1</td><td style="text-align: right;">↓</td></tr> <tr><td>3: 9.6</td><td style="text-align: right;">↓</td></tr> <tr><td>4: 9.3</td><td style="text-align: right;">↗</td></tr> <tr><td>5: 9.8</td><td style="text-align: right;">↓</td></tr> <tr><td>6: 9.8</td><td style="text-align: right;">↓</td></tr> <tr><td>7: 9.6</td><td style="text-align: right;">↗</td></tr> <tr><td>8: 8.1</td><td style="text-align: right;">↙</td></tr> <tr><td>9: 10.1</td><td style="text-align: right;">←</td></tr> <tr><td>10: 10.1</td><td style="text-align: right;">↖</td></tr> <tr><td colspan="2">Series 92.0</td></tr> <tr><td colspan="2">Total 92.0</td></tr> </table>	1: 10.0	↘	2: 9.1	↓	3: 9.6	↓	4: 9.3	↗	5: 9.8	↓	6: 9.8	↓	7: 9.6	↗	8: 8.1	↙	9: 10.1	←	10: 10.1	↖	Series 92.0		Total 92.0	
1: 10.0	↘																									
2: 9.1	↓																									
3: 9.6	↓																									
4: 9.3	↗																									
5: 9.8	↓																									
6: 9.8	↓																									
7: 9.6	↗																									
8: 8.1	↙																									
9: 10.1	←																									
10: 10.1	↖																									
Series 92.0																										
Total 92.0																										

<p>40 Shots</p> 	<p>40 Shots</p> 	<table style="width:100%; border-collapse: collapse;"> <tr><td>11: *10.3</td><td style="text-align: right;">↙</td></tr> <tr><td>12: 9.4</td><td style="text-align: right;">←</td></tr> <tr><td>13: *10.2</td><td style="text-align: right;">↑</td></tr> <tr><td>14: 9.2</td><td style="text-align: right;">↘</td></tr> <tr><td>15: 9.8</td><td style="text-align: right;">↙</td></tr> <tr><td>16: 10.0</td><td style="text-align: right;">←</td></tr> <tr><td>17: 10.1</td><td style="text-align: right;">→</td></tr> <tr><td>18: 9.9</td><td style="text-align: right;">↖</td></tr> <tr><td>19: 9.8</td><td style="text-align: right;">↘</td></tr> <tr><td>20: 9.8</td><td style="text-align: right;">↗</td></tr> <tr><td colspan="2">Series 94.0</td></tr> <tr><td colspan="2">Total 186.0</td></tr> </table>	11: *10.3	↙	12: 9.4	←	13: *10.2	↑	14: 9.2	↘	15: 9.8	↙	16: 10.0	←	17: 10.1	→	18: 9.9	↖	19: 9.8	↘	20: 9.8	↗	Series 94.0		Total 186.0	
11: *10.3	↙																									
12: 9.4	←																									
13: *10.2	↑																									
14: 9.2	↘																									
15: 9.8	↙																									
16: 10.0	←																									
17: 10.1	→																									
18: 9.9	↖																									
19: 9.8	↘																									
20: 9.8	↗																									
Series 94.0																										
Total 186.0																										
		<table style="width:100%; border-collapse: collapse;"> <tr><td>21: *10.4</td><td style="text-align: right;">↖</td></tr> <tr><td>22: 8.7</td><td style="text-align: right;">↙</td></tr> <tr><td>23: 9.6</td><td style="text-align: right;">↗</td></tr> <tr><td>24: 9.9</td><td style="text-align: right;">→</td></tr> <tr><td>25: *10.6</td><td style="text-align: right;">↙</td></tr> <tr><td>26: *10.2</td><td style="text-align: right;">↖</td></tr> <tr><td>27: 8.9</td><td style="text-align: right;">↑</td></tr> <tr><td>28: 9.7</td><td style="text-align: right;">→</td></tr> <tr><td>29: 9.7</td><td style="text-align: right;">↑</td></tr> <tr><td>30: *10.7</td><td style="text-align: right;">↙</td></tr> <tr><td colspan="2">Series 92.0</td></tr> <tr><td colspan="2">Total 278.0</td></tr> </table>	21: *10.4	↖	22: 8.7	↙	23: 9.6	↗	24: 9.9	→	25: *10.6	↙	26: *10.2	↖	27: 8.9	↑	28: 9.7	→	29: 9.7	↑	30: *10.7	↙	Series 92.0		Total 278.0	
21: *10.4	↖																									
22: 8.7	↙																									
23: 9.6	↗																									
24: 9.9	→																									
25: *10.6	↙																									
26: *10.2	↖																									
27: 8.9	↑																									
28: 9.7	→																									
29: 9.7	↑																									
30: *10.7	↙																									
Series 92.0																										
Total 278.0																										

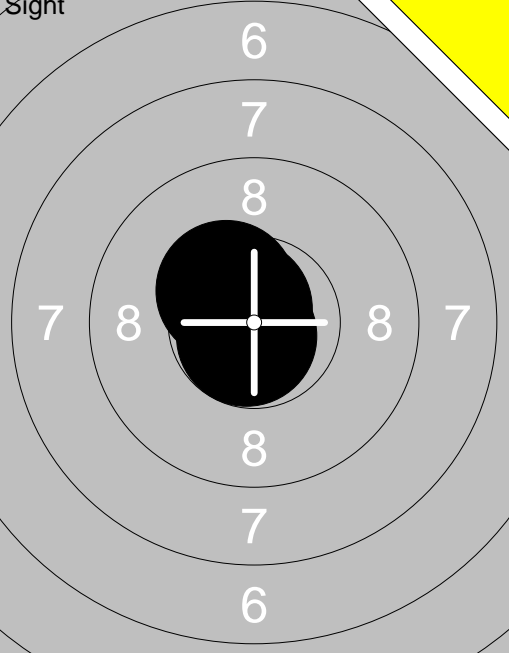
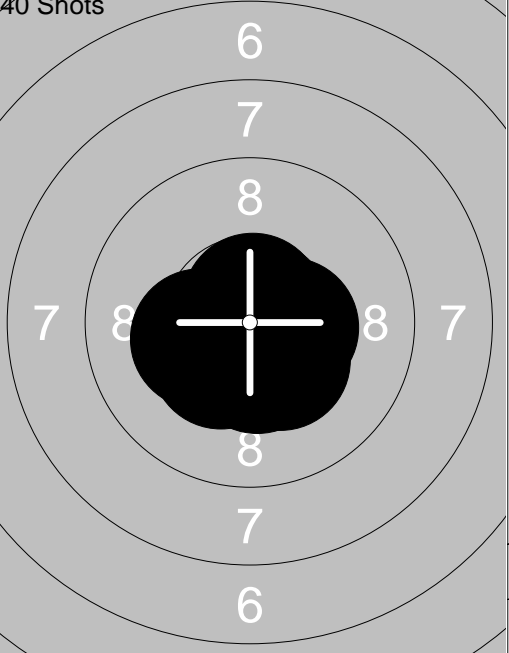
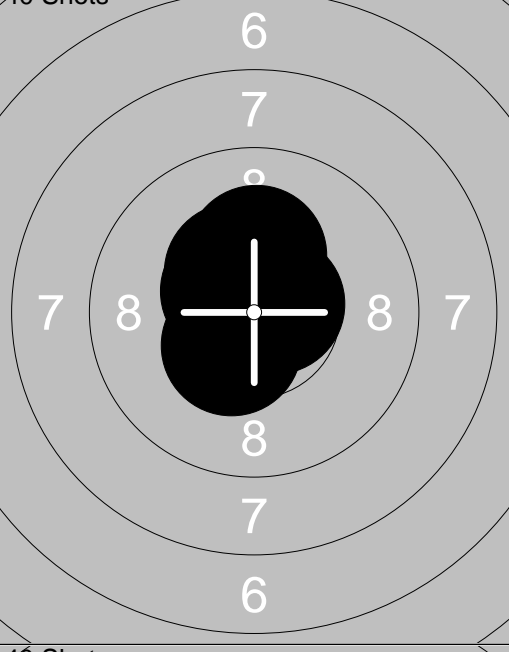
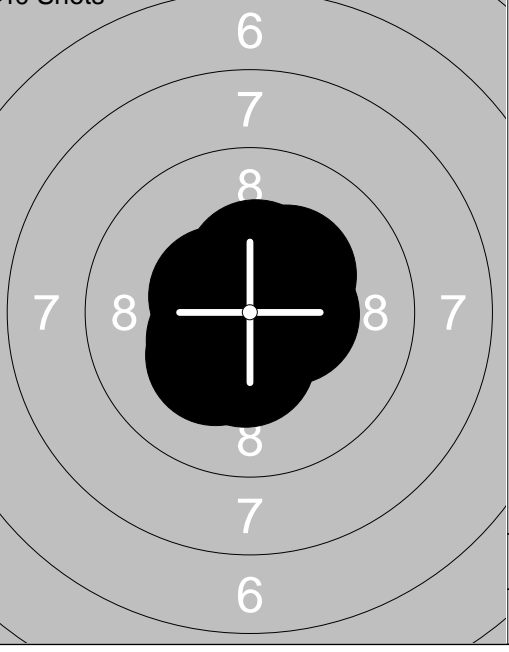
<p>40 Shots</p> 	<table style="width:100%; border-collapse: collapse;"> <tr><td>31: 9.7</td><td style="text-align: right;">↗</td></tr> <tr><td>32: 9.4</td><td style="text-align: right;">↗</td></tr> <tr><td>33: *10.6</td><td style="text-align: right;">→</td></tr> <tr><td>34: *10.5</td><td style="text-align: right;">↙</td></tr> <tr><td>35: 9.4</td><td style="text-align: right;">↖</td></tr> <tr><td>36: 9.6</td><td style="text-align: right;">↑</td></tr> <tr><td>37: 9.6</td><td style="text-align: right;">↗</td></tr> <tr><td>38: 9.7</td><td style="text-align: right;">↗</td></tr> <tr><td>39: 9.8</td><td style="text-align: right;">↑</td></tr> <tr><td>40: *10.6</td><td style="text-align: right;">↘</td></tr> <tr><td colspan="2">Series 93.0</td></tr> <tr><td colspan="2">Total 371.0</td></tr> </table>	31: 9.7	↗	32: 9.4	↗	33: *10.6	→	34: *10.5	↙	35: 9.4	↖	36: 9.6	↑	37: 9.6	↗	38: 9.7	↗	39: 9.8	↑	40: *10.6	↘	Series 93.0		Total 371.0		
31: 9.7	↗																									
32: 9.4	↗																									
33: *10.6	→																									
34: *10.5	↙																									
35: 9.4	↖																									
36: 9.6	↑																									
37: 9.6	↗																									
38: 9.7	↗																									
39: 9.8	↑																									
40: *10.6	↘																									
Series 93.0																										
Total 371.0																										

<p>Sight</p> 	<p>1: *10.4 ↖</p> <p>2: *10.7 ↖</p> <p>3: *10.8 ↓</p>	<p>40 Shots</p> 	<p>1: *10.8 ↓</p> <p>2: *10.8 ↓</p> <p>3: *10.4 ↓</p> <p>4: *10.5 →</p> <p>5: *10.3 ↓</p> <p>6: *10.7 ↓</p> <p>7: *10.3 ←</p> <p>8: *10.7 ↙</p> <p>9: *10.7 ↑</p> <p>10: *10.4 ↙</p>
Series	30.0	Series	100.0
Total	0.0	Total	100.0
<p>40 Shots</p> 	<p>11: *10.2 ↑</p> <p>12: *10.4 ↖</p> <p>13: *10.7 →</p> <p>14: *10.8 ←</p> <p>15: *10.4 ↓</p> <p>16: *10.5 ↖</p> <p>17: *10.9 ↑</p> <p>18: *10.6 ↖</p> <p>19: *10.8 ↖</p> <p>20: *10.4 ↑</p>	<p>40 Shots</p> 	<p>21: *10.5 ↖</p> <p>22: *10.7 ↙</p> <p>23: *10.4 ↙</p> <p>24: *10.4 ↓</p> <p>25: *10.4 ↗</p> <p>26: *10.4 ↑</p> <p>27: *10.3 ↗</p> <p>28: *10.4 →</p> <p>29: *10.7 ↓</p> <p>30: *10.2 ↙</p>
Series	100.0	Series	100.0
Total	200.0	Total	300.0
<p>40 Shots</p> 	<p>31: *10.5 ↓</p> <p>32: *10.5 ↗</p> <p>33: *10.6 ↖</p> <p>34: *10.2 ↙</p> <p>35: *10.7 ←</p> <p>36: *10.4 ↙</p> <p>37: *10.5 →</p> <p>38: *10.5 ↓</p> <p>39: *10.4 ↑</p> <p>40: *10.4 →</p>		
Series	100.0		
Total	400.0		

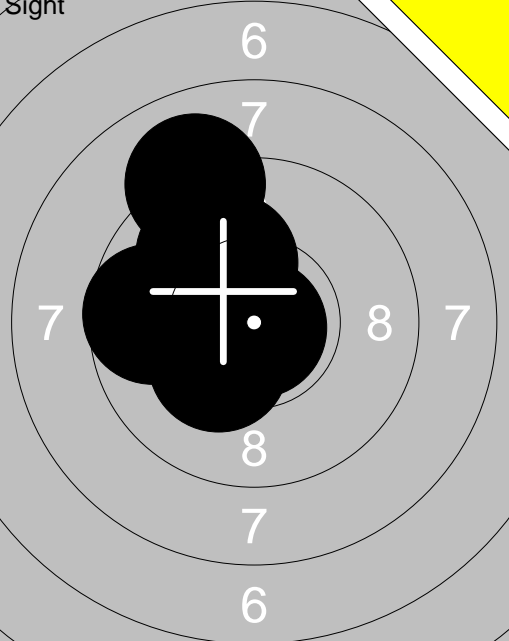
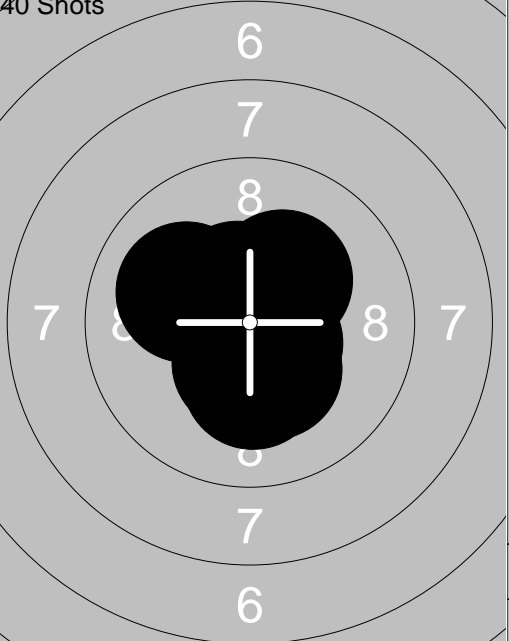
<p>Sight</p> 	<p>1: 9.0 ↗</p> <p>2: 9.9 ↗</p> <p>3: 10.1 ↗</p> <p>4: 10.1 ↗</p> <p>5: 9.6 ←</p> <p>6: *10.3 ↙</p> <p>7: *10.9 ↘</p>	<p>40 Shots</p> 	<p>1: *10.4 ↓</p> <p>2: *10.7 ↗</p> <p>3: *10.6 ↘</p> <p>4: 10.1 ↖</p> <p>5: *10.8 ↙</p> <p>6: *10.3 ↗</p> <p>7: *10.3 ↓</p> <p>8: *10.5 ↗</p> <p>9: *10.2 ↓</p> <p>10: *10.7 ↗</p>
<p>Series 67.0</p>		<p>Series 100.0</p>	
<p>Total 0.0</p>		<p>Total 100.0</p>	

<p>40 Shots</p> 	<p>11: *10.3 ↘</p> <p>12: *10.5 ↘</p> <p>13: *10.5 ←</p> <p>14: *10.6 ↓</p> <p>15: *10.2 ←</p> <p>16: *10.2 ←</p> <p>17: *10.9 ↓</p> <p>18: 10.0 ↘</p> <p>19: *10.3 ↗</p> <p>20: *10.5 ↗</p>	<p>40 Shots</p> 	<p>21: *10.5 ↓</p> <p>22: *10.4 ↓</p> <p>23: *10.7 ↓</p> <p>24: *10.5 →</p> <p>25: *10.7 ←</p> <p>26: *10.3 →</p> <p>27: *10.7 →</p> <p>28: *10.3 ↓</p> <p>29: 10.1 ←</p> <p>30: *10.2 ↗</p>
<p>Series 100.0</p>		<p>Series 100.0</p>	
<p>Total 200.0</p>		<p>Total 300.0</p>	

<p>40 Shots</p> 	<p>31: *10.2 →</p> <p>32: 10.1 ↓</p> <p>33: *10.7 ↓</p> <p>34: *10.4 ↙</p> <p>35: 9.8 ↓</p> <p>36: *10.3 ↗</p> <p>37: 10.1 ↗</p> <p>38: *10.7 ↘</p> <p>39: *10.6 →</p> <p>40: 10.1 ↙</p>	
<p>Series 99.0</p>		
<p>Total 399.0</p>		

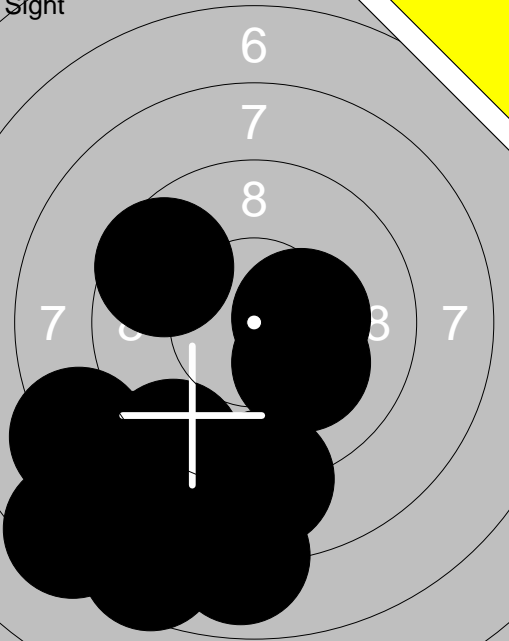
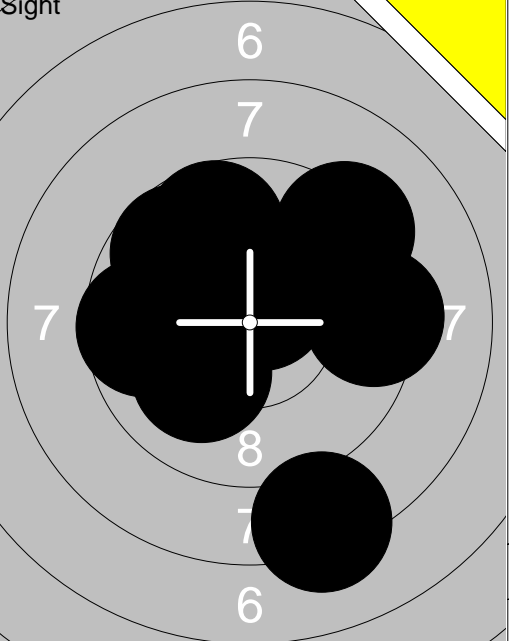

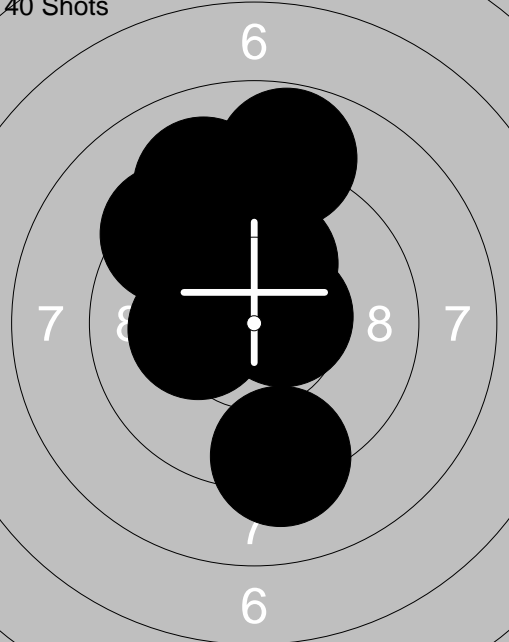
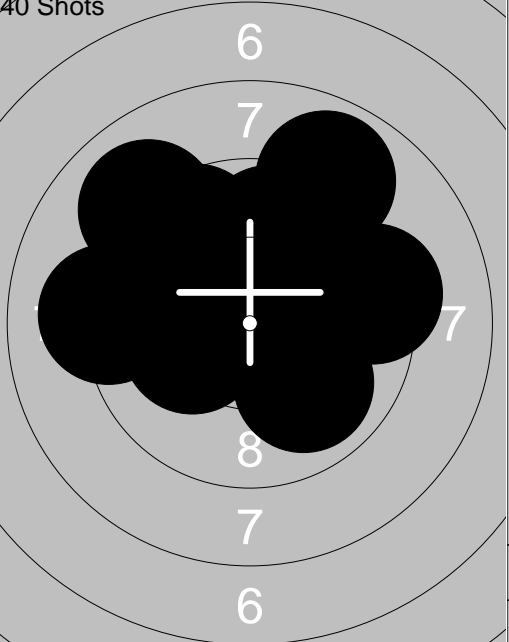
<p>Sight</p> 	<p>1: 9.0 ↘ 2: 8.6 ↘ 3: 7.6 ↘ 4: 8.9 ↓ 5: 7.9 ↓ 6: 7.4 ↙ 7: *10.2 ↘ 8: *10.3 → 9: 8.2 ↙ 10: 9.6 ↖</p>	<p>Sight</p> 	<p>11: 9.6 ← 12: 9.7 ↖ 13: *10.6 ↗ 14: 9.4 → 15: 8.2 ↓ 16: 9.7 ↖ 17: 10.1 ↘ 18: 9.3 ↗ 19: *10.3 ↑</p>
Series 83.0		Series 83.0	
Total 0.0		Total 0.0	

<p>40 Shots</p> 	<p>1: *10.6 → 2: *10.2 ↑ 3: 8.8 ↑ 4: 9.2 ↓ 5: 9.5 ↑ 6: 9.4 ↖ 7: 9.4 ↗ 8: 9.1 ↑ 9: *10.2 ← 10: *10.5 ↖</p>	<p>40 Shots</p> 	<p>11: 9.6 ↖ 12: 8.9 ↗ 13: *10.3 ↑ 14: 9.0 ↖ 15: 9.9 ↓ 16: 9.3 → 17: 9.1 ← 18: 9.8 ↑ 19: *10.2 ← 20: 10.1 ↖</p>
Series 93.0		Series 92.0	
Total 93.0		Total 185.0	

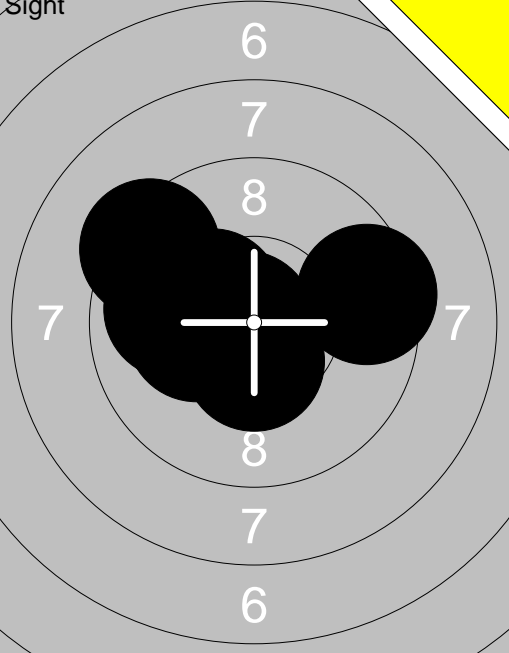
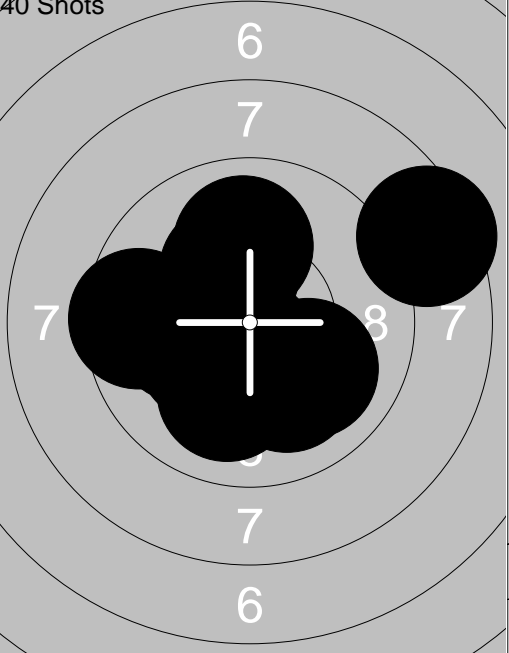
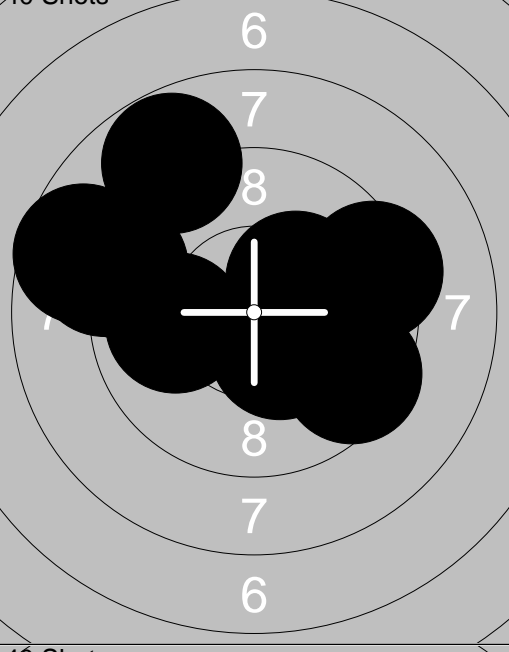
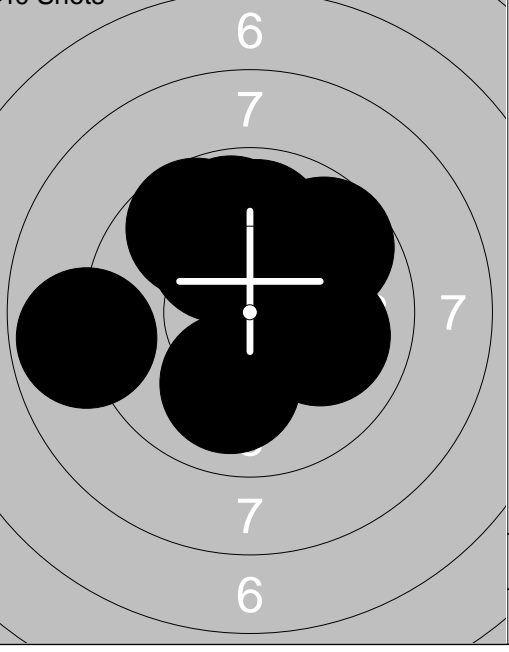
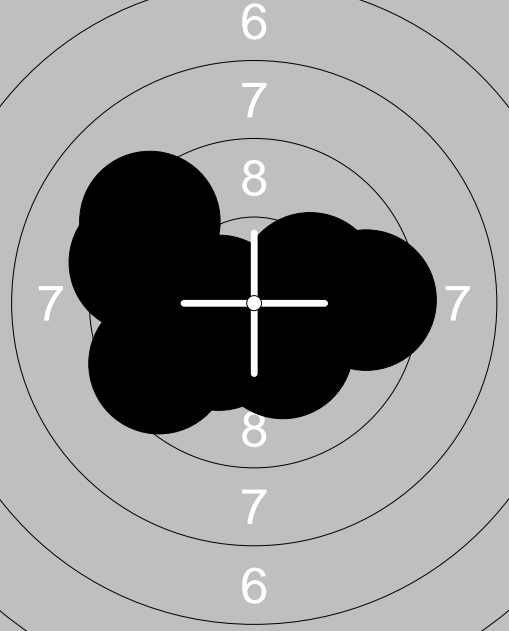
<p>40 Shots</p> 	<p>21: 10.0 → 22: 9.3 ↗ 23: 8.9 ↗ 24: 8.4 ↑ 25: 10.1 ↓ 26: 9.6 ↗ 27: 8.9 ↑ 28: 9.8 ← 29: 9.0 ↖ 30: 9.7 ↖</p>	<p>40 Shots</p> 	<p>31: 9.6 ↑ 32: 9.4 ↗ 33: 9.2 ↑ 34: 9.6 ↖ 35: *10.2 ↑ 36: *10.6 ↗ 37: 8.9 ↑ 38: 8.3 ↗ 39: 10.1 ↖ 40: 9.2 ↑</p>
Series 89.0		Series 91.0	
Total 274.0		Total 365.0	

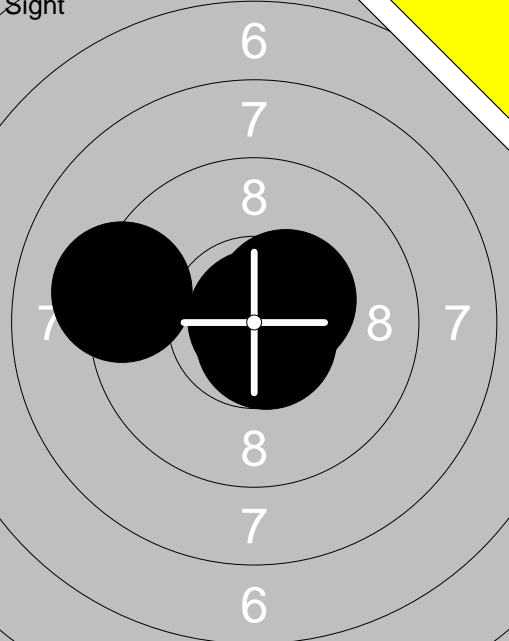
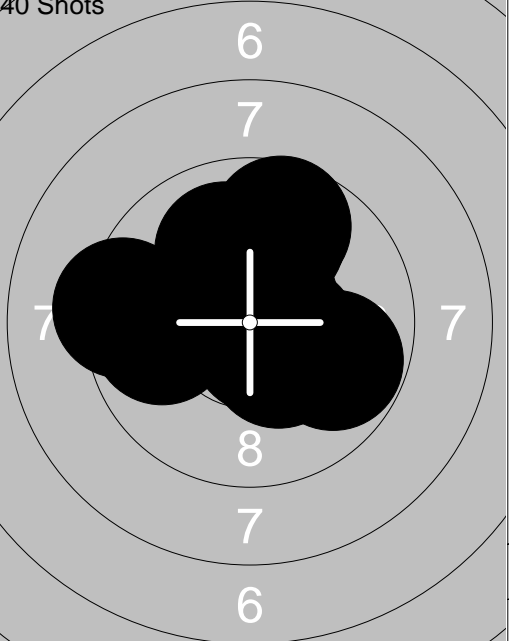
<p>Sight</p> 	<p>1: *10.5 ↓</p> <p>2: *10.2 ←</p> <p>3: *10.3 ↖</p> <p>4: 9.5 →</p> <p>5: 9.3 ↗</p> <p>6: *10.6 ↓</p> <p>7: 9.9 ←</p> <p>8: *10.8 ←</p>	<p>40 Shots</p> 	<p>1: *10.6 ↓</p> <p>2: *10.3 ↖</p> <p>3: 9.5 ←</p> <p>4: 8.4 ↗</p> <p>5: 10.0 ↑</p> <p>6: 10.1 ←</p> <p>7: 10.1 ↓</p> <p>8: 10.0 ↓</p> <p>9: 10.0 ↓</p> <p>10: *10.3 ↗</p>
Series	77.0	Series	97.0
Total	0.0	Total	97.0
<p>40 Shots</p> 	<p>11: 9.5 ↘</p> <p>12: 8.9 ←</p> <p>13: *10.4 ↓</p> <p>14: 9.9 ←</p> <p>15: 9.3 →</p> <p>16: 8.6 ←</p> <p>17: 9.1 ←</p> <p>18: 10.0 →</p> <p>19: 8.8 ↗</p> <p>20: *10.3 ↗</p>	<p>40 Shots</p> 	<p>21: 9.9 ↑</p> <p>22: 10.0 →</p> <p>23: 10.1 ↑</p> <p>24: 10.0 ↑</p> <p>25: 10.1 ↖</p> <p>26: 9.7 ↖</p> <p>27: 9.7 ↗</p> <p>28: 9.8 ↑</p> <p>29: 10.0 ↓</p> <p>30: 8.8 ←</p>
Series	90.0	Series	94.0
Total	187.0	Total	281.0
<p>40 Shots</p> 	<p>31: *10.5 ←</p> <p>32: *10.3 ↖</p> <p>33: *10.2 →</p> <p>34: 9.3 ↖</p> <p>35: *10.3 ←</p> <p>36: 9.5 →</p> <p>37: 9.5 ↖</p> <p>38: *10.2 →</p> <p>39: *10.3 ↓</p> <p>40: 9.4 ←</p>		
Series	96.0		
Total	377.0		

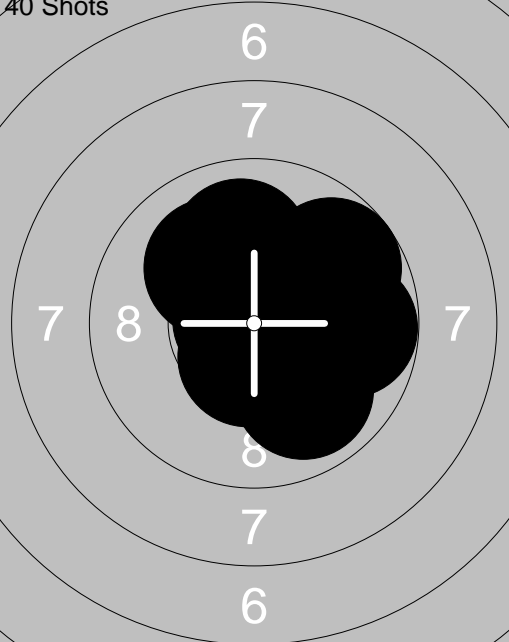
<p>Sight</p>  <p>Target diagram for Sight shot. Concentric circles labeled 6, 7, 8. Black marks at 8 and 7. A yellow triangle is in the top right corner.</p>	<p>1: *10.4 ↗</p> <p>2: 9.2 ←</p> <p>3: *10.7 ↘</p> <p>4: *10.9 ↗</p>	<p>40 Shots</p>  <p>Target diagram for 40 Shots. Concentric circles labeled 6, 7, 8. Black marks clustered in the center.</p>	<p>1: 9.7 ↗</p> <p>2: 9.8 ↗</p> <p>3: 9.8 ←</p> <p>4: 9.3 ←</p> <p>5: *10.4 ↘</p> <p>6: 10.0 ↗</p> <p>7: *10.4 →</p> <p>8: 9.8 →</p> <p>9: *10.6 ↘</p> <p>10: *10.6 ↗</p>
<p>Series 39.0</p>		<p>Series 95.0</p>	
<p>Total 0.0</p>		<p>Total 95.0</p>	

<p>40 Shots</p>  <p>Target diagram for 40 Shots. Concentric circles labeled 6, 7, 8. Black marks clustered in the center.</p>	<p>11: *10.6 ↗</p> <p>12: *10.8 ←</p> <p>13: *10.4 ↗</p> <p>14: 9.8 →</p> <p>15: 10.1 ↗</p> <p>16: 10.0 ↗</p> <p>17: 9.7 ↗</p> <p>18: *10.5 ↘</p> <p>19: 9.9 ↘</p> <p>20: 9.9 →</p>	<p>40 Shots</p>  <p>Target diagram for 40 Shots. Concentric circles labeled 6, 7, 8. Black marks clustered in the center.</p>	<p>21: *10.6 ↘</p> <p>22: 9.2 →</p> <p>23: *10.6 ↘</p> <p>24: *10.3 ←</p> <p>25: *10.3 →</p> <p>26: 10.1 ←</p> <p>27: *10.4 ←</p> <p>28: *10.8 ↗</p> <p>29: *10.2 ↗</p> <p>30: 9.8 ←</p>
<p>Series 96.0</p>		<p>Series 98.0</p>	
<p>Total 191.0</p>		<p>Total 289.0</p>	

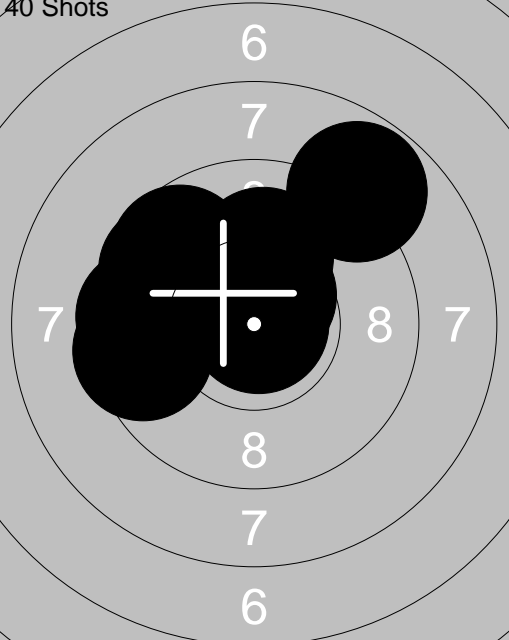
<p>40 Shots</p>  <p>Target diagram for 40 Shots. Concentric circles labeled 6, 7, 8. Black marks clustered in the center.</p>	<p>31: *10.6 ↗</p> <p>32: *10.9 →</p> <p>33: 8.8 ↗</p> <p>34: 9.7 ↗</p> <p>35: 9.5 ←</p> <p>36: *10.6 ↗</p> <p>37: 9.6 ←</p> <p>38: 10.1 ↗</p> <p>39: 9.7 ↗</p> <p>40: 9.9 ←</p>		
<p>Series 93.0</p>			
<p>Total 382.0</p>			

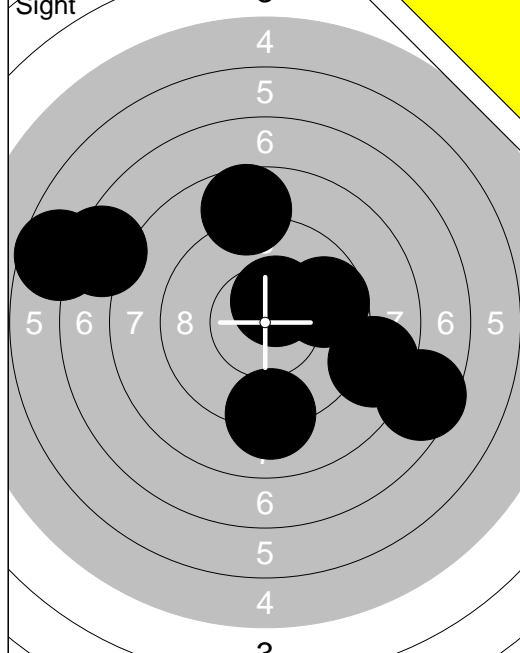

1:	6.6	↖
2:	*10.5	↗
3:	9.7	→
4:	8.7	↑
5:	7.4	↖
6:	7.5	→
7:	8.7	→
8:	9.1	↓
Series		64.0
Total		0.0

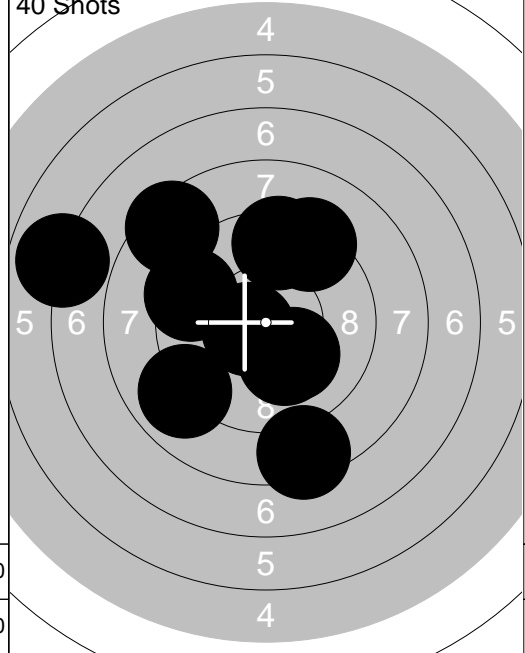

1:	6.9	↖
2:	9.4	↑
3:	*10.2	↘
4:	9.2	↗
5:	8.9	↖
6:	8.4	↘
7:	*10.2	↘
8:	8.4	↗
9:	9.4	↖
10:	*10.6	↖
Series		87.0
Total		87.0

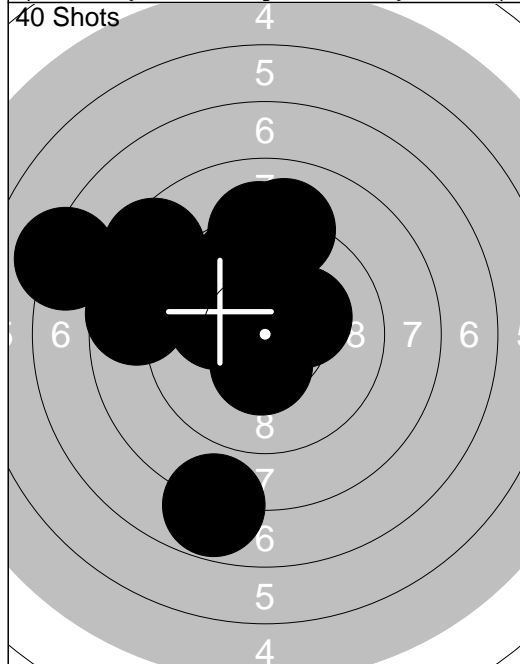

11:	8.5	↖
12:	9.1	↑
13:	7.8	↓
14:	*10.4	↓
15:	9.2	↑
16:	8.7	↖
17:	7.2	↖
18:	10.1	↖
19:	9.7	↑
20:	*10.3	↗
Series		87.0
Total		174.0

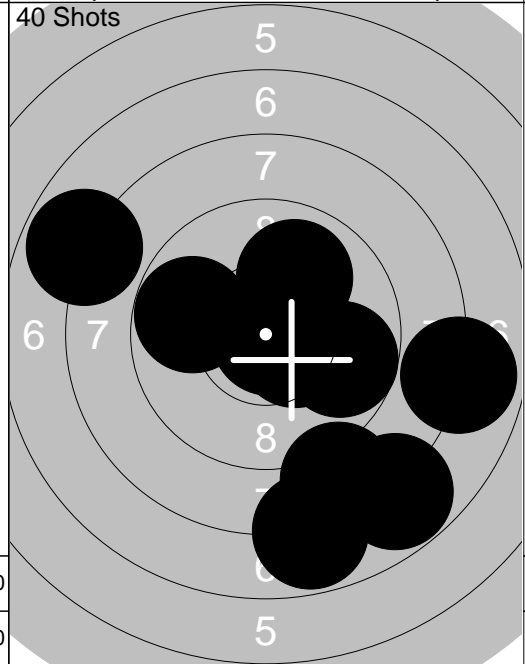

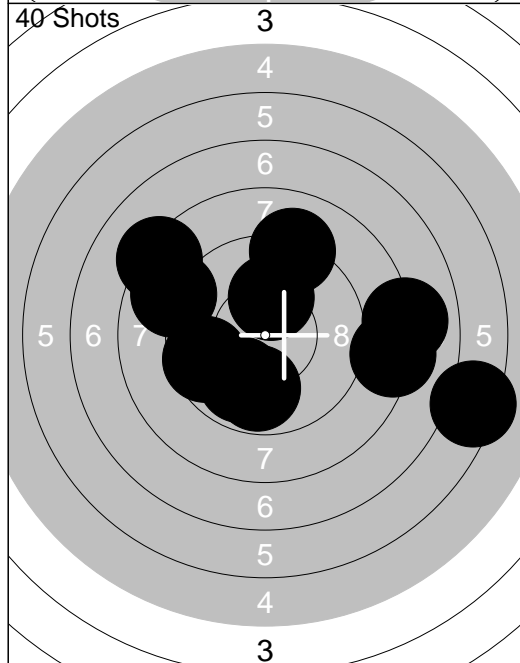

21:	9.8	↖
22:	8.4	↘
23:	7.8	↖
24:	10.0	↗
25:	7.9	→
26:	*10.9	↘
27:	9.7	→
28:	*10.4	↘
29:	7.8	↘
30:	7.8	↓
Series		84.0
Total		258.0

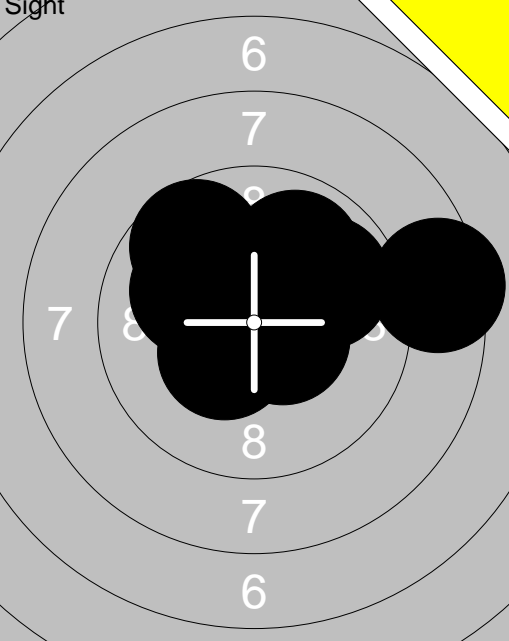
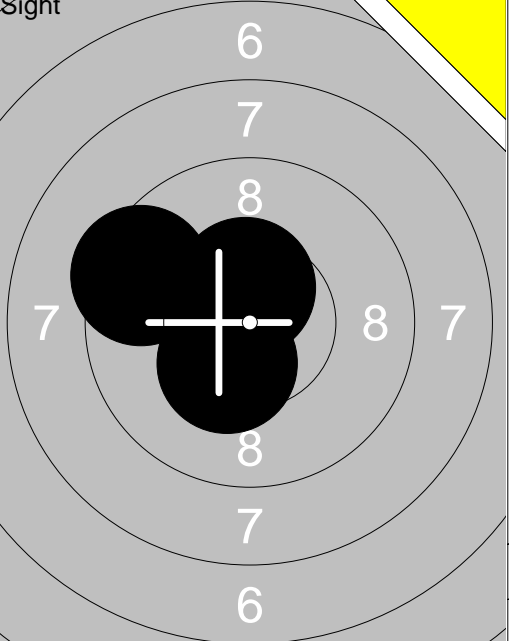

31:	8.0	→
32:	8.2	↖
33:	6.4	→
34:	9.8	↓
35:	8.2	→
36:	9.1	↑
37:	8.9	↖
38:	9.6	↖
39:	9.9	↘
40:	10.1	↑
Series		84.0
Total		342.0

<p>Sight</p>  <table style="width:100%; border-collapse: collapse;"> <tr><td>1: *10.5</td><td>↘</td></tr> <tr><td>2: *10.7</td><td>→</td></tr> <tr><td>3: 10.1</td><td>↖</td></tr> <tr><td>4: *10.4</td><td>↙</td></tr> <tr><td>5: 9.7</td><td>↗</td></tr> <tr><td>6: 10.1</td><td>↖</td></tr> <tr><td>7: 9.9</td><td>↗</td></tr> <tr><td>8: 8.4</td><td>→</td></tr> <tr><td>9: 9.9</td><td>↗</td></tr> <tr><td>10: *10.3</td><td>↖</td></tr> <tr><td colspan="2">Series 95.0</td></tr> <tr><td colspan="2">Total 0.0</td></tr> </table>	1: *10.5	↘	2: *10.7	→	3: 10.1	↖	4: *10.4	↙	5: 9.7	↗	6: 10.1	↖	7: 9.9	↗	8: 8.4	→	9: 9.9	↗	10: *10.3	↖	Series 95.0		Total 0.0		<p>Sight</p>  <table style="width:100%; border-collapse: collapse;"> <tr><td>11: 9.4</td><td>↖</td></tr> <tr><td>12: *10.5</td><td>↑</td></tr> <tr><td>13: *10.4</td><td>↙</td></tr> <tr><td colspan="2">Series 29.0</td></tr> <tr><td colspan="2">Total 0.0</td></tr> </table>	11: 9.4	↖	12: *10.5	↑	13: *10.4	↙	Series 29.0		Total 0.0	
1: *10.5	↘																																		
2: *10.7	→																																		
3: 10.1	↖																																		
4: *10.4	↙																																		
5: 9.7	↗																																		
6: 10.1	↖																																		
7: 9.9	↗																																		
8: 8.4	→																																		
9: 9.9	↗																																		
10: *10.3	↖																																		
Series 95.0																																			
Total 0.0																																			
11: 9.4	↖																																		
12: *10.5	↑																																		
13: *10.4	↙																																		
Series 29.0																																			
Total 0.0																																			

<p>40 Shots</p>  <table style="width:100%; border-collapse: collapse;"> <tr><td>1: 9.5</td><td>↖</td></tr> <tr><td>2: 8.7</td><td>↙</td></tr> <tr><td>3: *10.2</td><td>↙</td></tr> <tr><td>4: *10.2</td><td>↘</td></tr> <tr><td>5: *10.6</td><td>↙</td></tr> <tr><td>6: 10.1</td><td>↖</td></tr> <tr><td>7: 9.0</td><td>→</td></tr> <tr><td>8: *10.3</td><td>↖</td></tr> <tr><td>9: 10.0</td><td>→</td></tr> <tr><td>10: 9.4</td><td>←</td></tr> <tr><td colspan="2">Series 95.0</td></tr> <tr><td colspan="2">Total 95.0</td></tr> </table>	1: 9.5	↖	2: 8.7	↙	3: *10.2	↙	4: *10.2	↘	5: *10.6	↙	6: 10.1	↖	7: 9.0	→	8: *10.3	↖	9: 10.0	→	10: 9.4	←	Series 95.0		Total 95.0		<p>40 Shots</p>  <table style="width:100%; border-collapse: collapse;"> <tr><td>11: 9.9</td><td>↖</td></tr> <tr><td>12: 9.3</td><td>↙</td></tr> <tr><td>13: 9.6</td><td>↙</td></tr> <tr><td>14: 9.4</td><td>↖</td></tr> <tr><td>15: *10.4</td><td>←</td></tr> <tr><td>16: *10.4</td><td>↘</td></tr> <tr><td>17: *10.2</td><td>→</td></tr> <tr><td>18: 9.8</td><td>→</td></tr> <tr><td>19: *10.5</td><td>↙</td></tr> <tr><td>20: *10.2</td><td>↓</td></tr> <tr><td colspan="2">Series 95.0</td></tr> <tr><td colspan="2">Total 190.0</td></tr> </table>	11: 9.9	↖	12: 9.3	↙	13: 9.6	↙	14: 9.4	↖	15: *10.4	←	16: *10.4	↘	17: *10.2	→	18: 9.8	→	19: *10.5	↙	20: *10.2	↓	Series 95.0		Total 190.0	
1: 9.5	↖																																																
2: 8.7	↙																																																
3: *10.2	↙																																																
4: *10.2	↘																																																
5: *10.6	↙																																																
6: 10.1	↖																																																
7: 9.0	→																																																
8: *10.3	↖																																																
9: 10.0	→																																																
10: 9.4	←																																																
Series 95.0																																																	
Total 95.0																																																	
11: 9.9	↖																																																
12: 9.3	↙																																																
13: 9.6	↙																																																
14: 9.4	↖																																																
15: *10.4	←																																																
16: *10.4	↘																																																
17: *10.2	→																																																
18: 9.8	→																																																
19: *10.5	↙																																																
20: *10.2	↓																																																
Series 95.0																																																	
Total 190.0																																																	

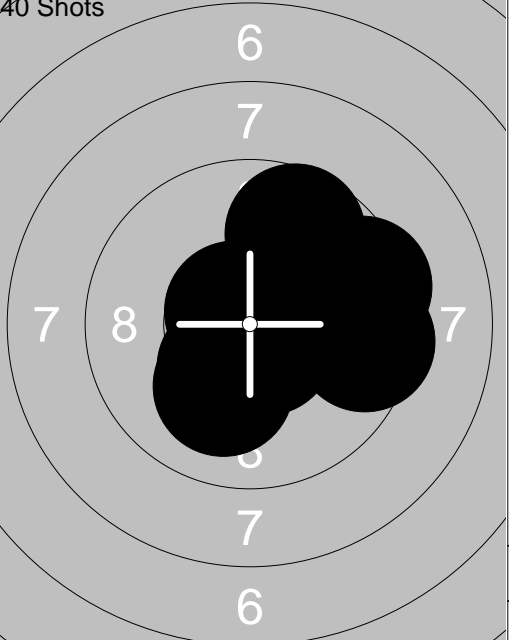
<p>40 Shots</p>  <table style="width:100%; border-collapse: collapse;"> <tr><td>21: *10.3</td><td>↗</td></tr> <tr><td>22: *10.6</td><td>↖</td></tr> <tr><td>23: *10.5</td><td>↓</td></tr> <tr><td>24: 9.8</td><td>←</td></tr> <tr><td>25: 9.9</td><td>↙</td></tr> <tr><td>26: *10.2</td><td>↙</td></tr> <tr><td>27: 10.0</td><td>←</td></tr> <tr><td>28: *10.4</td><td>↓</td></tr> <tr><td>29: *10.6</td><td>↙</td></tr> <tr><td>30: 9.5</td><td>↗</td></tr> <tr><td colspan="2">Series 97.0</td></tr> <tr><td colspan="2">Total 287.0</td></tr> </table>	21: *10.3	↗	22: *10.6	↖	23: *10.5	↓	24: 9.8	←	25: 9.9	↙	26: *10.2	↙	27: 10.0	←	28: *10.4	↓	29: *10.6	↙	30: 9.5	↗	Series 97.0		Total 287.0		<p>40 Shots</p>  <table style="width:100%; border-collapse: collapse;"> <tr><td>31: 9.5</td><td>→</td></tr> <tr><td>32: *10.6</td><td>↗</td></tr> <tr><td>33: 9.4</td><td>→</td></tr> <tr><td>34: *10.3</td><td>↙</td></tr> <tr><td>35: *10.7</td><td>↓</td></tr> <tr><td>36: *10.6</td><td>↙</td></tr> <tr><td>37: 9.7</td><td>↗</td></tr> <tr><td>38: *10.5</td><td>↗</td></tr> <tr><td>39: 10.1</td><td>↙</td></tr> <tr><td>40: *10.7</td><td>↖</td></tr> <tr><td colspan="2">Series 97.0</td></tr> <tr><td colspan="2">Total 384.0</td></tr> </table>	31: 9.5	→	32: *10.6	↗	33: 9.4	→	34: *10.3	↙	35: *10.7	↓	36: *10.6	↙	37: 9.7	↗	38: *10.5	↗	39: 10.1	↙	40: *10.7	↖	Series 97.0		Total 384.0	
21: *10.3	↗																																																
22: *10.6	↖																																																
23: *10.5	↓																																																
24: 9.8	←																																																
25: 9.9	↙																																																
26: *10.2	↙																																																
27: 10.0	←																																																
28: *10.4	↓																																																
29: *10.6	↙																																																
30: 9.5	↗																																																
Series 97.0																																																	
Total 287.0																																																	
31: 9.5	→																																																
32: *10.6	↗																																																
33: 9.4	→																																																
34: *10.3	↙																																																
35: *10.7	↓																																																
36: *10.6	↙																																																
37: 9.7	↗																																																
38: *10.5	↗																																																
39: 10.1	↙																																																
40: *10.7	↖																																																
Series 97.0																																																	
Total 384.0																																																	

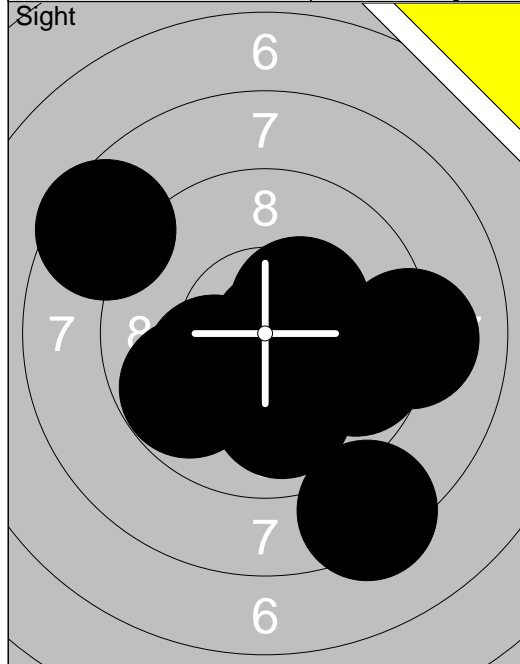

1:	8.3	↘
2:	*10.5	↘
3:	*10.4	↗
4:	9.1	→
5:	10.0	↘
6:	9.8	↙
7:	9.7	↗
8:	*10.8	↗
9:	*10.2	↙
10:	8.5	↖
Series		93.0
Total		0.0

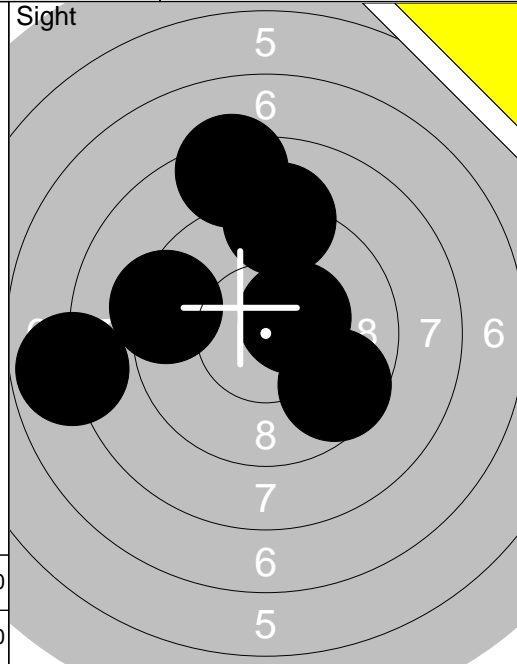

11:	9.6	↘
12:	7.8	←
13:	9.3	↙
14:	*10.4	↗
15:	9.1	↑
16:	8.3	↑
Series		52.0
Total		0.0

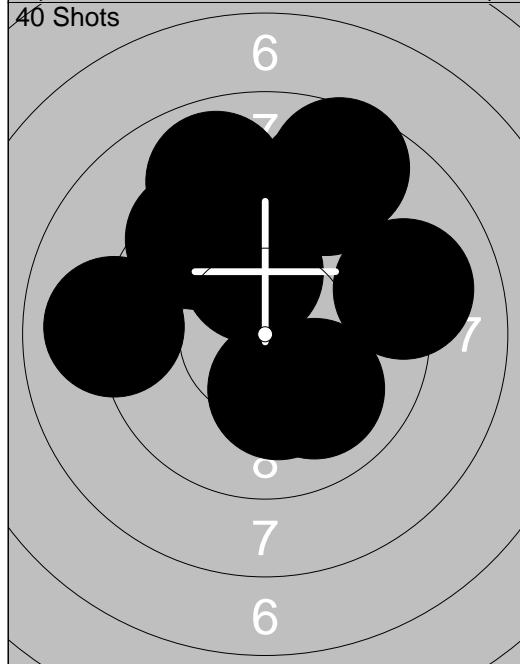

1:	9.4	↑
2:	8.6	↑
3:	8.9	↑
4:	9.1	→
5:	9.0	←
6:	10.1	↑
7:	10.0	↘
8:	*10.2	↘
9:	9.4	↗
10:	8.9	↑
Series		90.0
Total		90.0

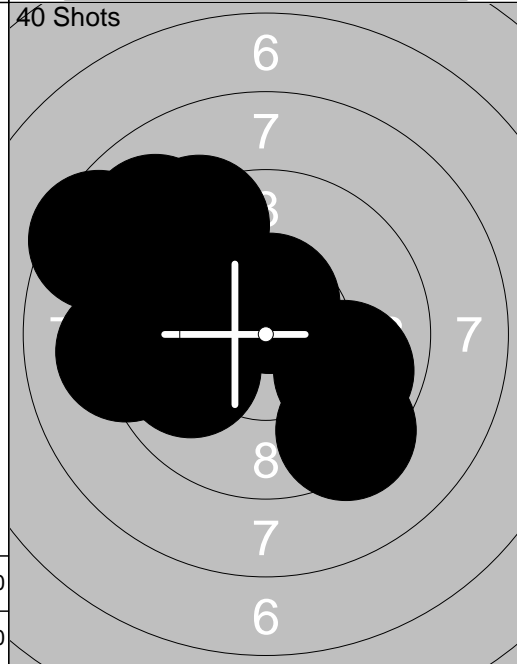

11:	9.9	←
12:	9.2	←
13:	*10.5	↑
14:	9.4	↘
15:	*10.4	↗
16:	9.9	↙
17:	9.0	↗
18:	8.5	↗
19:	9.9	↘
20:	9.3	↗
Series		91.0
Total		181.0

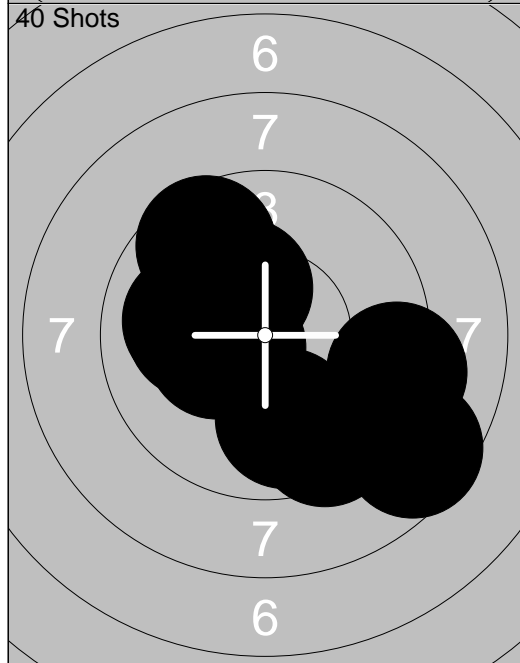

21:	10.1	←
22:	9.4	↘
23:	9.2	↗
24:	9.6	↗
25:	*10.3	←
26:	*10.3	↗
27:	9.9	↘
28:	8.6	↘
29:	*10.5	←
30:	10.0	←
Series		94.0
Total		275.0

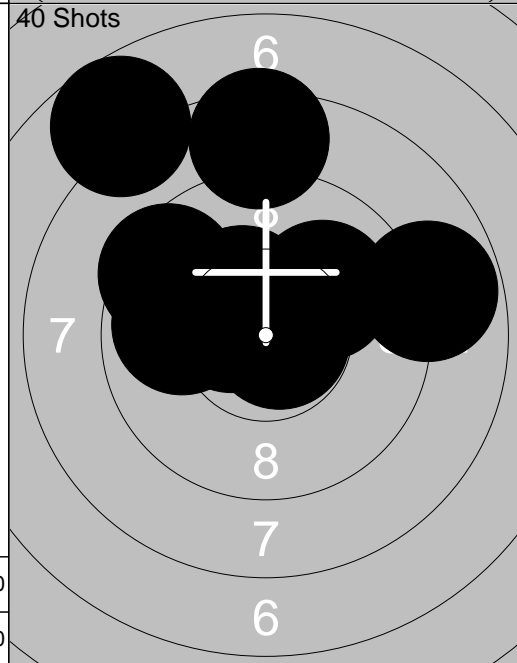

31:	*10.8	↗
32:	*10.4	↗
33:	9.9	←
34:	*10.4	↗
35:	8.8	→
36:	7.7	↗
37:	*10.5	←
38:	10.0	↗
39:	8.4	↑
40:	9.5	↙
Series		91.0
Total		366.0

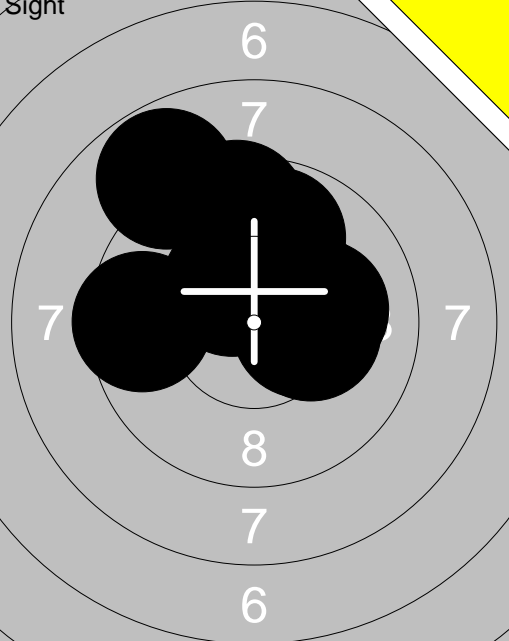
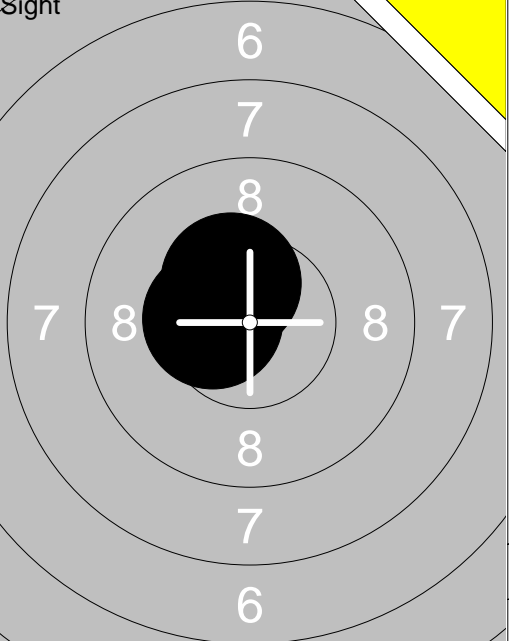

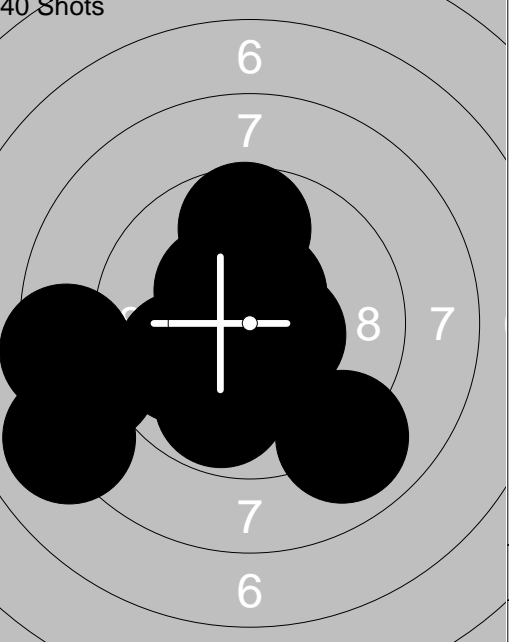
<p>Sight</p> 	<p>1: 8.8 ↖ 2: *10.5 ↑ 3: *10.3 ↗ 4: 10.1 → 5: 9.5 ↑ 6: *10.4 ↖ 7: *10.2 → 8: *10.3 → 9: 9.8 ↑ 10: 9.5 ←</p>	<p>Sight</p> 	<p>11: *10.5 ← 12: *10.4 ↖</p>
Series 95.0		Series 20.0	
Total 0.0		Total 0.0	

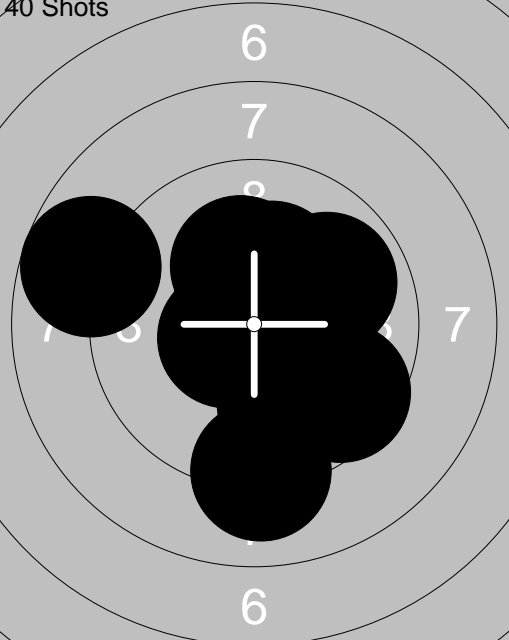
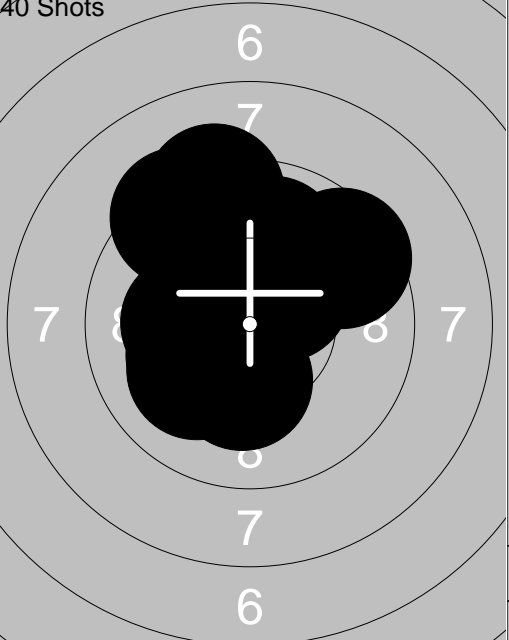
<p>40 Shots</p> 	<p>1: 9.5 ← 2: *10.4 ↗ 3: 8.4 ↖ 4: 9.9 → 5: *10.6 ↙ 6: 9.9 ↘ 7: *10.7 ↘ 8: 9.3 ↘ 9: 9.5 ↗ 10: *10.4 ←</p>	<p>40 Shots</p> 	<p>11: *10.4 ↖ 12: 9.9 ↙ 13: *10.5 → 14: 8.1 ↙ 15: 9.0 ↘ 16: 8.7 ← 17: 9.8 ↘ 18: 9.7 ↑ 19: 8.4 ← 20: *10.5 ↗</p>
Series 93.0		Series 90.0	
Total 93.0		Total 183.0	

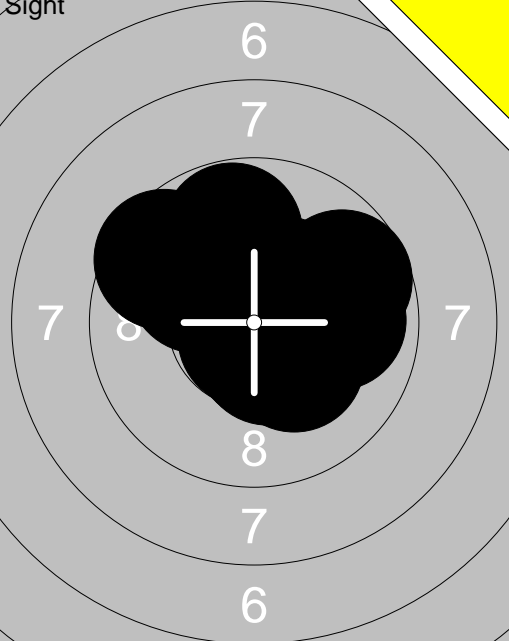
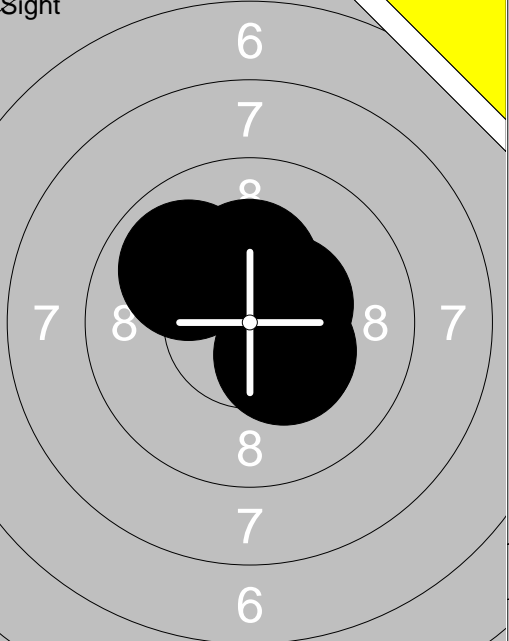
<p>40 Shots</p> 	<p>21: 9.9 ↗ 22: 9.1 ↘ 23: 8.7 ← 24: 9.8 ↘ 25: *10.2 ↗ 26: *10.6 ← 27: *10.2 ↑ 28: 9.5 ↘ 29: *10.2 ↑ 30: *10.6 →</p>	<p>40 Shots</p> 	<p>31: 10.1 ↙ 32: *10.2 ↙ 33: 9.5 ↗ 34: *10.2 ↘ 35: 9.9 ↑ 36: *10.2 ← 37: 10.0 ↗ 38: *10.4 ↗ 39: 9.3 ↖ 40: 9.2 ↗</p>
Series 94.0		Series 96.0	
Total 277.0		Total 373.0	

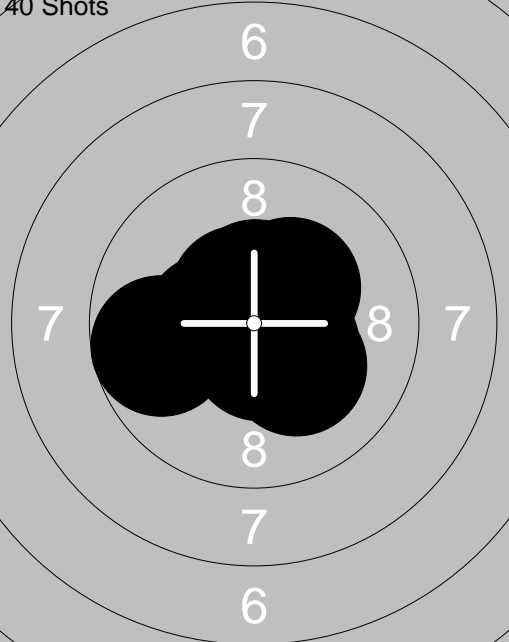
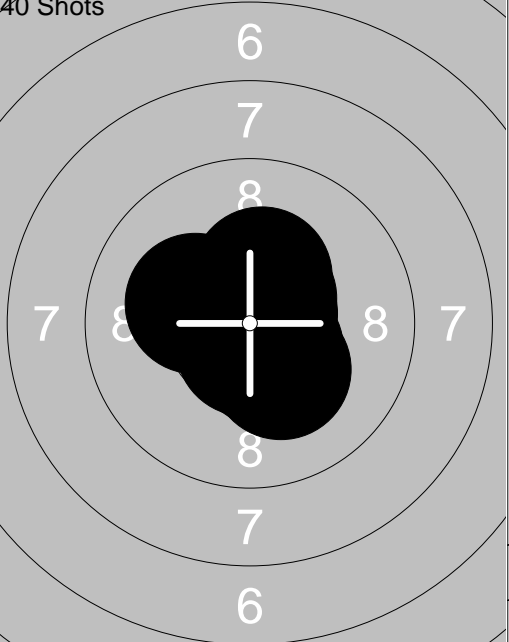
<p>Sight</p> 	<p>1: 10.1 ↖</p> <p>2: *10.4 ↗</p> <p>3: *10.2 ↘</p> <p>4: 9.7 ↗</p> <p>5: *10.6 ↘</p> <p>6: *10.5 ↘</p> <p>7: *10.8 ↘</p> <p>8: 9.5 ↖</p> <p>9: 9.9 →</p> <p>10: 9.8 ↑</p>	<p>Sight</p> 	<p>11: *10.3 ↑</p> <p>12: 9.9 ↖</p> <p>13: *10.4 ↘</p> <p>14: *10.5 ↗</p> <p>15: *10.4 ↘</p>
Series	96.0	Series	49.0
Total	0.0	Total	0.0

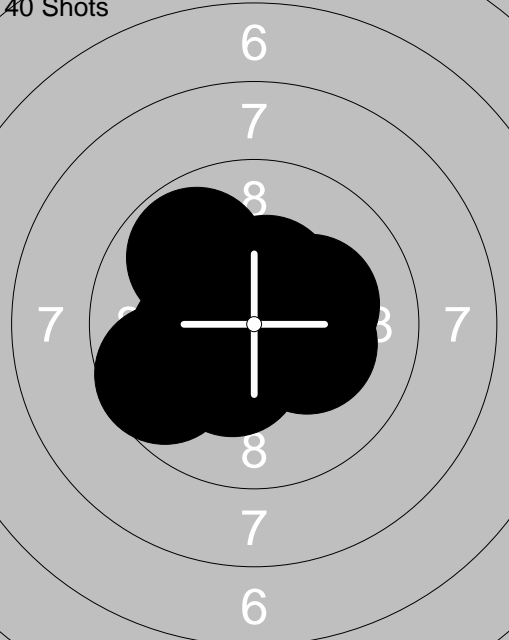
<p>40 Shots</p> 	<p>1: *10.5 ↑</p> <p>2: *10.6 ↖</p> <p>3: 9.7 ←</p> <p>4: *10.6 ↖</p> <p>5: *10.4 ←</p> <p>6: *10.4 ↘</p> <p>7: *10.7 →</p> <p>8: *10.2 ↘</p> <p>9: *10.3 ↗</p> <p>10: *10.6 ↘</p>	<p>40 Shots</p> 	<p>11: *10.2 ↘</p> <p>12: *10.7 ↘</p> <p>13: *10.7 ↖</p> <p>14: *10.6 ↗</p> <p>15: *10.3 ↑</p> <p>16: *10.8 →</p> <p>17: *10.7 ↗</p> <p>18: *10.2 ↖</p> <p>19: *10.5 ↘</p> <p>20: *10.5 ↘</p>
Series	99.0	Series	100.0
Total	99.0	Total	199.0

<p>40 Shots</p> 	<p>21: *10.3 ↘</p> <p>22: *10.2 ←</p> <p>23: 9.8 ↖</p> <p>24: *10.6 →</p> <p>25: *10.7 ↘</p> <p>26: *10.2 ↗</p> <p>27: *10.4 ↑</p> <p>28: 9.6 ↖</p> <p>29: *10.2 →</p> <p>30: *10.7 ↘</p>	<p>40 Shots</p> 	<p>31: *10.8 ↖</p> <p>32: *10.9 ↘</p> <p>33: *10.9 ↘</p> <p>34: *10.8 ↑</p> <p>35: 10.0 ↖</p> <p>36: *10.7 ↘</p> <p>37: *10.6 ↘</p> <p>38: 9.6 →</p> <p>39: *10.2 ↘</p> <p>40: *10.3 ↘</p>
Series	98.0	Series	99.0
Total	297.0	Total	396.0

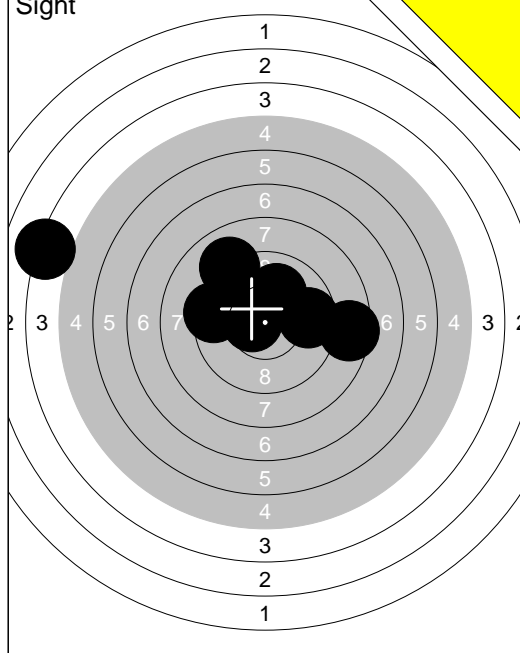

1:	8.5	→
2:	9.4	←
3:	4.1	←
4:	9.7	→
5:	*10.6	←
6:	10.0	↑
7:	9.0	↑
Series		59.0
Total		0.0

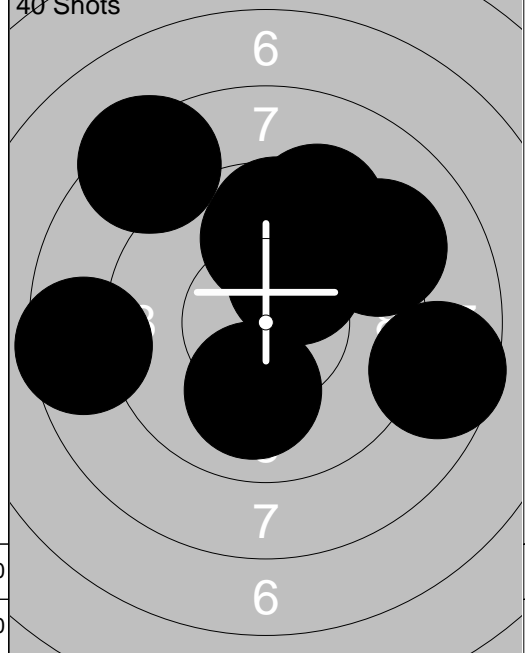

1:	9.4	↗
2:	10.0	↓
3:	8.4	↖
4:	9.2	↗
5:	9.9	↑
6:	9.7	↑
7:	8.5	←
8:	8.6	→
9:	*10.2	↗
10:	8.4	↖
Series		88.0
Total		88.0

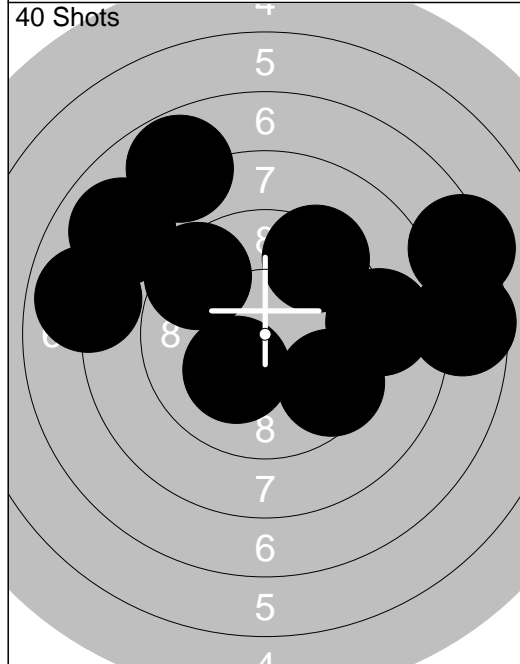

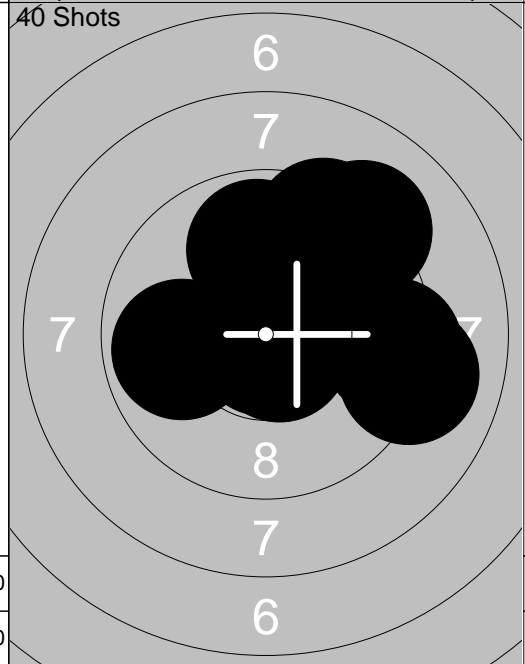

11:	7.8	↗
12:	9.4	↖
13:	7.6	→
14:	7.9	←
15:	9.6	↓
16:	9.4	↗
17:	9.0	→
18:	8.0	↖
19:	7.3	↗
20:	*10.2	↙
Series		82.0
Total		170.0



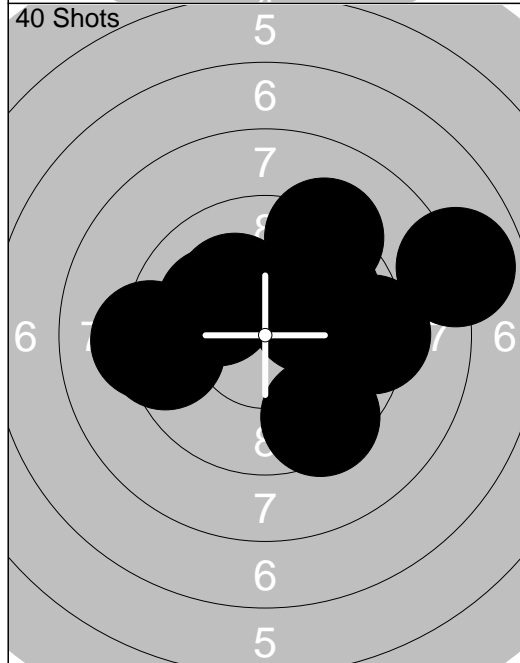



21:	9.3	→
22:	9.4	↗
23:	9.1	→
24:	9.1	↗
25:	9.9	↗
26:	9.9	←
27:	*10.7	↘
28:	9.9	↑
29:	*10.8	↓
30:	*10.7	↗
Series		93.0
Total		263.0



31:	9.2	←
32:	7.9	→
33:	9.9	↗
34:	9.2	↗
35:	9.4	←
36:	9.4	→
37:	9.5	↘
38:	10.1	↖
39:	*10.2	↗
40:	*10.2	↖
Series		91.0
Total		354.0

<p>Sight</p> 	<table border="1" style="width:100%; border-collapse: collapse;"> <tr><td>1:</td><td>9.9</td><td>↘</td></tr> <tr><td>2:</td><td>*10.3</td><td>←</td></tr> <tr><td>3:</td><td>9.9</td><td>↑</td></tr> <tr><td>4:</td><td>9.9</td><td>←</td></tr> <tr><td>5:</td><td>*10.2</td><td>↘</td></tr> <tr><td>6:</td><td>9.3</td><td>↓</td></tr> <tr><td>7:</td><td>9.9</td><td>↘</td></tr> <tr><td>8:</td><td>9.5</td><td>↘</td></tr> <tr><td>9:</td><td>10.0</td><td>↗</td></tr> <tr><td>10:</td><td>*10.7</td><td>↙</td></tr> <tr><td colspan="2">Series</td><td>94.0</td></tr> <tr><td colspan="2">Total</td><td>0.0</td></tr> </table>	1:	9.9	↘	2:	*10.3	←	3:	9.9	↑	4:	9.9	←	5:	*10.2	↘	6:	9.3	↓	7:	9.9	↘	8:	9.5	↘	9:	10.0	↗	10:	*10.7	↙	Series		94.0	Total		0.0	<p>Sight</p>  <table border="1" style="width:100%; border-collapse: collapse;"> <tr><td>11:</td><td>9.7</td><td>↑</td></tr> <tr><td>12:</td><td>9.2</td><td>→</td></tr> <tr><td>13:</td><td>9.7</td><td>↗</td></tr> <tr><td>14:</td><td>9.2</td><td>↗</td></tr> <tr><td>15:</td><td>10.1</td><td>↑</td></tr> <tr><td>16:</td><td>9.5</td><td>→</td></tr> <tr><td>17:</td><td>9.1</td><td>↗</td></tr> <tr><td>18:</td><td>8.9</td><td>↗</td></tr> <tr><td>19:</td><td>9.4</td><td>↘</td></tr> <tr><td>20:</td><td>8.7</td><td>↙</td></tr> <tr><td colspan="2">Series</td><td>89.0</td></tr> <tr><td colspan="2">Total</td><td>0.0</td></tr> </table>	11:	9.7	↑	12:	9.2	→	13:	9.7	↗	14:	9.2	↗	15:	10.1	↑	16:	9.5	→	17:	9.1	↗	18:	8.9	↗	19:	9.4	↘	20:	8.7	↙	Series		89.0	Total		0.0
1:	9.9	↘																																																																								
2:	*10.3	←																																																																								
3:	9.9	↑																																																																								
4:	9.9	←																																																																								
5:	*10.2	↘																																																																								
6:	9.3	↓																																																																								
7:	9.9	↘																																																																								
8:	9.5	↘																																																																								
9:	10.0	↗																																																																								
10:	*10.7	↙																																																																								
Series		94.0																																																																								
Total		0.0																																																																								
11:	9.7	↑																																																																								
12:	9.2	→																																																																								
13:	9.7	↗																																																																								
14:	9.2	↗																																																																								
15:	10.1	↑																																																																								
16:	9.5	→																																																																								
17:	9.1	↗																																																																								
18:	8.9	↗																																																																								
19:	9.4	↘																																																																								
20:	8.7	↙																																																																								
Series		89.0																																																																								
Total		0.0																																																																								

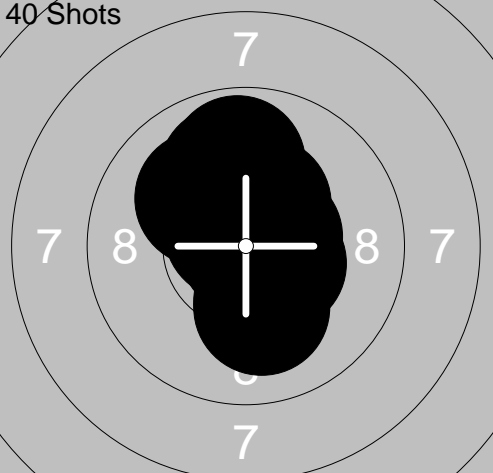
<p>Sight</p>  <table border="1" style="width:100%; border-collapse: collapse;"> <tr><td>21:</td><td>9.0</td><td>→</td></tr> <tr><td>22:</td><td>*10.5</td><td>↘</td></tr> <tr><td>23:</td><td>10.0</td><td>→</td></tr> <tr><td>24:</td><td>*10.7</td><td>↗</td></tr> <tr><td colspan="2">Series</td><td>39.0</td></tr> <tr><td colspan="2">Total</td><td>0.0</td></tr> </table>	21:	9.0	→	22:	*10.5	↘	23:	10.0	→	24:	*10.7	↗	Series		39.0	Total		0.0	<p>40 Shots</p>  <table border="1" style="width:100%; border-collapse: collapse;"> <tr><td>1:</td><td>*10.7</td><td>↘</td></tr> <tr><td>2:</td><td>8.9</td><td>↗</td></tr> <tr><td>3:</td><td>*10.5</td><td>→</td></tr> <tr><td>4:</td><td>*10.7</td><td>↗</td></tr> <tr><td>5:</td><td>9.4</td><td>↗</td></tr> <tr><td>6:</td><td>*10.6</td><td>↑</td></tr> <tr><td>7:</td><td>*10.7</td><td>→</td></tr> <tr><td>8:</td><td>9.6</td><td>↗</td></tr> <tr><td>9:</td><td>*10.7</td><td>↓</td></tr> <tr><td>10:</td><td>9.1</td><td>↗</td></tr> <tr><td colspan="2">Series</td><td>95.0</td></tr> <tr><td colspan="2">Total</td><td>95.0</td></tr> </table>	1:	*10.7	↘	2:	8.9	↗	3:	*10.5	→	4:	*10.7	↗	5:	9.4	↗	6:	*10.6	↑	7:	*10.7	→	8:	9.6	↗	9:	*10.7	↓	10:	9.1	↗	Series		95.0	Total		95.0
21:	9.0	→																																																					
22:	*10.5	↘																																																					
23:	10.0	→																																																					
24:	*10.7	↗																																																					
Series		39.0																																																					
Total		0.0																																																					
1:	*10.7	↘																																																					
2:	8.9	↗																																																					
3:	*10.5	→																																																					
4:	*10.7	↗																																																					
5:	9.4	↗																																																					
6:	*10.6	↑																																																					
7:	*10.7	→																																																					
8:	9.6	↗																																																					
9:	*10.7	↓																																																					
10:	9.1	↗																																																					
Series		95.0																																																					
Total		95.0																																																					

<p>40 Shots</p>  <table border="1" style="width:100%; border-collapse: collapse;"> <tr><td>11:</td><td>10.0</td><td>↑</td></tr> <tr><td>12:</td><td>9.9</td><td>↑</td></tr> <tr><td>13:</td><td>10.1</td><td>↘</td></tr> <tr><td>14:</td><td>*10.4</td><td>↗</td></tr> <tr><td>15:</td><td>*10.5</td><td>↘</td></tr> <tr><td>16:</td><td>*10.6</td><td>→</td></tr> <tr><td>17:</td><td>*10.9</td><td>↘</td></tr> <tr><td>18:</td><td>10.1</td><td>↗</td></tr> <tr><td>19:</td><td>*10.2</td><td>↘</td></tr> <tr><td>20:</td><td>*10.7</td><td>↗</td></tr> <tr><td colspan="2">Series</td><td>99.0</td></tr> <tr><td colspan="2">Total</td><td>194.0</td></tr> </table>	11:	10.0	↑	12:	9.9	↑	13:	10.1	↘	14:	*10.4	↗	15:	*10.5	↘	16:	*10.6	→	17:	*10.9	↘	18:	10.1	↗	19:	*10.2	↘	20:	*10.7	↗	Series		99.0	Total		194.0	<p>40 Shots</p>  <table border="1" style="width:100%; border-collapse: collapse;"> <tr><td>21:</td><td>9.5</td><td>→</td></tr> <tr><td>22:</td><td>9.5</td><td>↗</td></tr> <tr><td>23:</td><td>*10.5</td><td>↘</td></tr> <tr><td>24:</td><td>9.2</td><td>↗</td></tr> <tr><td>25:</td><td>9.1</td><td>→</td></tr> <tr><td>26:</td><td>*10.6</td><td>←</td></tr> <tr><td>27:</td><td>10.1</td><td>↓</td></tr> <tr><td>28:</td><td>*10.2</td><td>↗</td></tr> <tr><td>29:</td><td>9.5</td><td>↗</td></tr> <tr><td>30:</td><td>10.0</td><td>↑</td></tr> <tr><td colspan="2">Series</td><td>95.0</td></tr> <tr><td colspan="2">Total</td><td>289.0</td></tr> </table>	21:	9.5	→	22:	9.5	↗	23:	*10.5	↘	24:	9.2	↗	25:	9.1	→	26:	*10.6	←	27:	10.1	↓	28:	*10.2	↗	29:	9.5	↗	30:	10.0	↑	Series		95.0	Total		289.0
11:	10.0	↑																																																																							
12:	9.9	↑																																																																							
13:	10.1	↘																																																																							
14:	*10.4	↗																																																																							
15:	*10.5	↘																																																																							
16:	*10.6	→																																																																							
17:	*10.9	↘																																																																							
18:	10.1	↗																																																																							
19:	*10.2	↘																																																																							
20:	*10.7	↗																																																																							
Series		99.0																																																																							
Total		194.0																																																																							
21:	9.5	→																																																																							
22:	9.5	↗																																																																							
23:	*10.5	↘																																																																							
24:	9.2	↗																																																																							
25:	9.1	→																																																																							
26:	*10.6	←																																																																							
27:	10.1	↓																																																																							
28:	*10.2	↗																																																																							
29:	9.5	↗																																																																							
30:	10.0	↑																																																																							
Series		95.0																																																																							
Total		289.0																																																																							

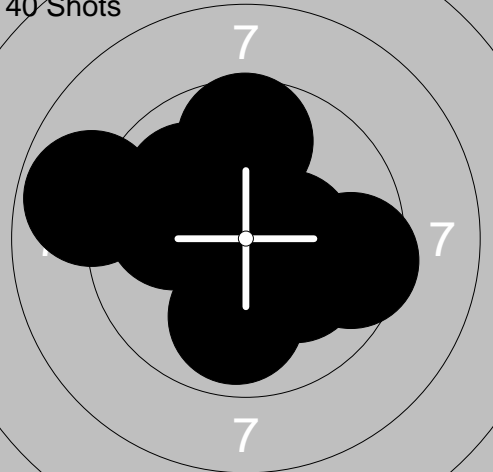
<p>40 Shots</p>  <table border="1" style="width:100%; border-collapse: collapse;"> <tr><td>31:</td><td>*10.7</td><td>↘</td></tr> <tr><td>32:</td><td>10.0</td><td>←</td></tr> <tr><td>33:</td><td>8.8</td><td>←</td></tr> <tr><td>34:</td><td>*10.8</td><td>↑</td></tr> <tr><td>35:</td><td>9.7</td><td>↑</td></tr> <tr><td>36:</td><td>9.5</td><td>→</td></tr> <tr><td>37:</td><td>10.0</td><td>↗</td></tr> <tr><td>38:</td><td>9.9</td><td>↓</td></tr> <tr><td>39:</td><td>*10.4</td><td>→</td></tr> <tr><td>40:</td><td>10.1</td><td>↘</td></tr> <tr><td colspan="2">Series</td><td>95.0</td></tr> <tr><td colspan="2">Total</td><td>384.0</td></tr> </table>	31:	*10.7	↘	32:	10.0	←	33:	8.8	←	34:	*10.8	↑	35:	9.7	↑	36:	9.5	→	37:	10.0	↗	38:	9.9	↓	39:	*10.4	→	40:	10.1	↘	Series		95.0	Total		384.0	
31:	*10.7	↘																																			
32:	10.0	←																																			
33:	8.8	←																																			
34:	*10.8	↑																																			
35:	9.7	↑																																			
36:	9.5	→																																			
37:	10.0	↗																																			
38:	9.9	↓																																			
39:	*10.4	→																																			
40:	10.1	↘																																			
Series		95.0																																			
Total		384.0																																			

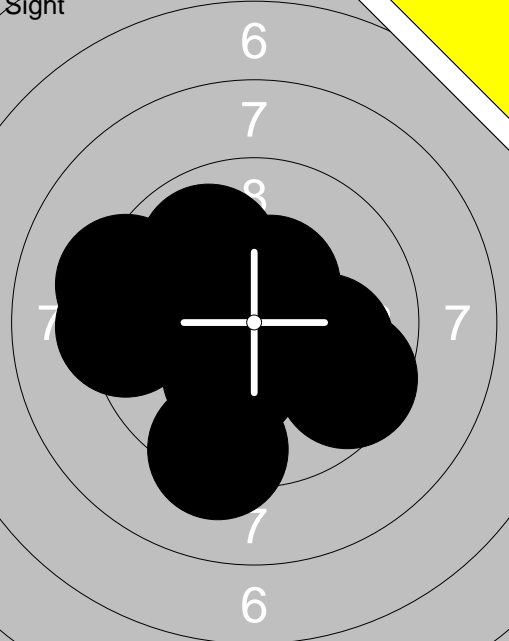
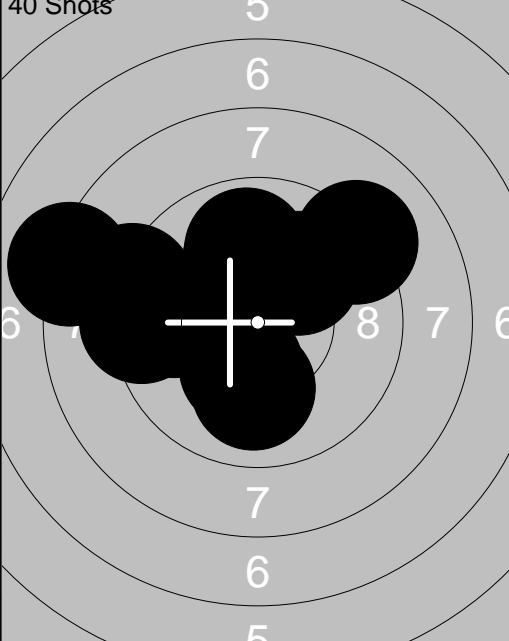
<p>Sight</p> 	<p>40 Shots</p> 	
<p>1: 9.6 →</p> <p>2: 9.9 ↗</p> <p>3: 9.3 ↓</p> <p>4: 10.0 →</p> <p>5: 9.3 ←</p> <p>6: *10.4 ↗</p> <p>7: 9.2 ←</p> <p>8: *10.2 ↓</p>	<p>1: 9.1 ↗</p> <p>2: 9.3 ←</p> <p>3: 10.0 ↗</p> <p>4: 8.1 ←</p> <p>5: 10.0 ↓</p> <p>6: 9.7 ←</p> <p>7: 9.1 ←</p> <p>8: 9.9 ↑</p> <p>9: *10.3 ↓</p> <p>10: 10.0 ↑</p>	
<p>Series 75.0</p> <p>Total 0.0</p>	<p>Series 93.0</p> <p>Total 93.0</p>	

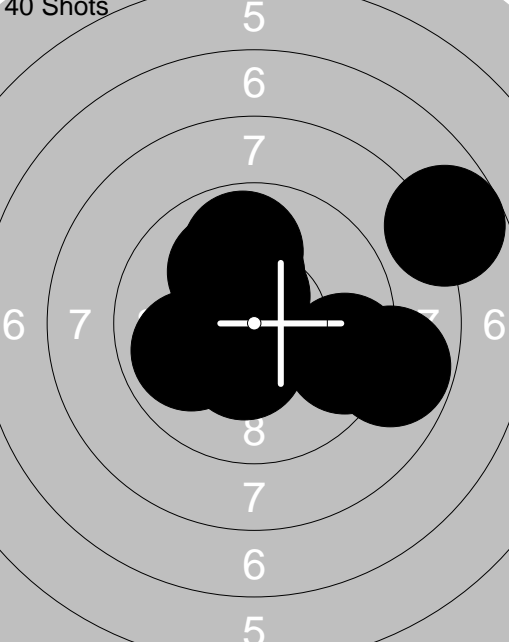
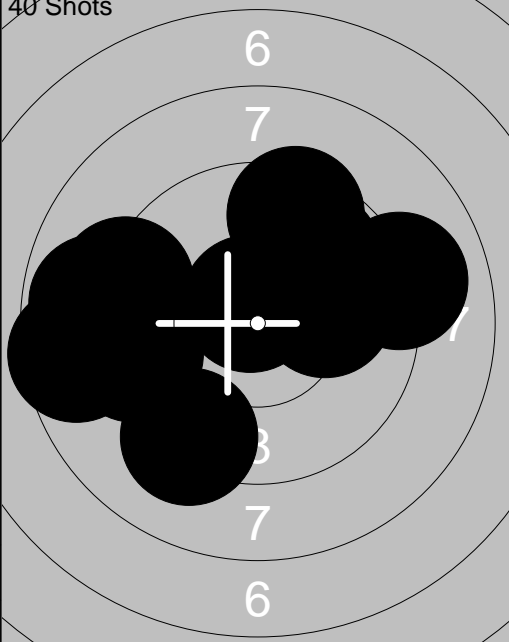
<p>40 Shots</p> 	<p>40 Shots</p> 	
<p>11: 9.9 ←</p> <p>12: *10.2 ↑</p> <p>13: 10.1 ↗</p> <p>14: 9.9 ↑</p> <p>15: 7.7 →</p> <p>16: *10.5 ↑</p> <p>17: *10.6 ↑</p> <p>18: *10.4 ↓</p> <p>19: 8.8 →</p> <p>20: 9.5 →</p>	<p>21: 9.3 ←</p> <p>22: 9.2 ↓</p> <p>23: 8.8 ←</p> <p>24: 9.4 ↑</p> <p>25: 10.1 →</p> <p>26: 8.5 ←</p> <p>27: 9.2 ←</p> <p>28: 9.8 ↗</p> <p>29: *10.7 ↑</p> <p>30: 9.0 →</p>	
<p>Series 92.0</p> <p>Total 185.0</p>	<p>Series 90.0</p> <p>Total 275.0</p>	

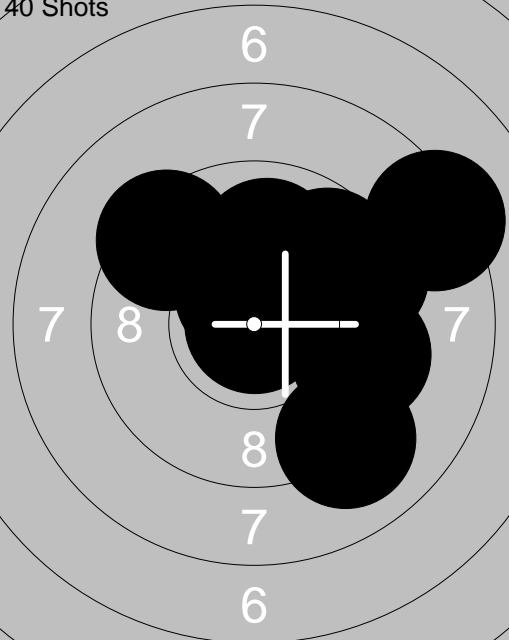
<p>40 Shots</p> 	<p>31: 8.3 →</p> <p>32: 9.7 ↗</p> <p>33: 9.5 →</p> <p>34: 9.1 ↓</p> <p>35: 10.0 ↑</p> <p>36: *10.5 ↑</p> <p>37: *10.2 →</p> <p>38: *10.9 ↗</p> <p>39: 9.4 ↗</p> <p>40: 9.5 →</p>	
<p>Series 93.0</p> <p>Total 368.0</p>		

<p>Sight</p>	<p>40 Shots</p>	<table border="1" style="width:100%; border-collapse: collapse;"> <tr><td>1: *10.4 ↗</td><td>1: 9.2 ←</td></tr> <tr><td>2: *10.7 ↖</td><td>2: *10.3 ↗</td></tr> <tr><td>3: 7.8 ←</td><td>3: 9.9 ↘</td></tr> <tr><td>4: 9.9 ←</td><td>4: 8.0 ←</td></tr> <tr><td>5: 9.2 ↘</td><td>5: 7.9 →</td></tr> <tr><td>6: 9.9 ↗</td><td>6: 6.5 ←</td></tr> <tr><td>7: 8.5 ↗</td><td>7: *10.4 ↘</td></tr> <tr><td>8: 8.6 ↘</td><td>8: *10.7 ↖</td></tr> <tr><td>9: 9.6 ↘</td><td>9: 9.7 ↘</td></tr> <tr><td>Series 79.0</td><td>Series 87.0</td></tr> <tr><td>Total 0.0</td><td>Total 87.0</td></tr> </table>	1: *10.4 ↗	1: 9.2 ←	2: *10.7 ↖	2: *10.3 ↗	3: 7.8 ←	3: 9.9 ↘	4: 9.9 ←	4: 8.0 ←	5: 9.2 ↘	5: 7.9 →	6: 9.9 ↗	6: 6.5 ←	7: 8.5 ↗	7: *10.4 ↘	8: 8.6 ↘	8: *10.7 ↖	9: 9.6 ↘	9: 9.7 ↘	Series 79.0	Series 87.0	Total 0.0	Total 87.0
1: *10.4 ↗	1: 9.2 ←																							
2: *10.7 ↖	2: *10.3 ↗																							
3: 7.8 ←	3: 9.9 ↘																							
4: 9.9 ←	4: 8.0 ←																							
5: 9.2 ↘	5: 7.9 →																							
6: 9.9 ↗	6: 6.5 ←																							
7: 8.5 ↗	7: *10.4 ↘																							
8: 8.6 ↘	8: *10.7 ↖																							
9: 9.6 ↘	9: 9.7 ↘																							
Series 79.0	Series 87.0																							
Total 0.0	Total 87.0																							

<p>40 Shots</p>	<p>40 Shots</p>	<table border="1" style="width:100%; border-collapse: collapse;"> <tr><td>11: 9.8 ↘</td><td>21: 9.8 ←</td></tr> <tr><td>12: 9.6 ↗</td><td>22: 9.9 ↗</td></tr> <tr><td>13: 8.9 ←</td><td>23: 9.5 ↘</td></tr> <tr><td>14: 8.3 ↘</td><td>24: 8.2 ↘</td></tr> <tr><td>15: 8.0 ←</td><td>25: 8.2 →</td></tr> <tr><td>16: 7.5 →</td><td>26: 9.1 ↗</td></tr> <tr><td>17: 8.2 →</td><td>27: 10.1 ↘</td></tr> <tr><td>18: 9.5 →</td><td>28: 9.3 ↗</td></tr> <tr><td>19: *10.5 ↗</td><td>29: 9.9 ↗</td></tr> <tr><td>20: *10.4 ↗</td><td>30: 8.3 ←</td></tr> <tr><td>Series 86.0</td><td>Series 88.0</td></tr> <tr><td>Total 173.0</td><td>Total 261.0</td></tr> </table>	11: 9.8 ↘	21: 9.8 ←	12: 9.6 ↗	22: 9.9 ↗	13: 8.9 ←	23: 9.5 ↘	14: 8.3 ↘	24: 8.2 ↘	15: 8.0 ←	25: 8.2 →	16: 7.5 →	26: 9.1 ↗	17: 8.2 →	27: 10.1 ↘	18: 9.5 →	28: 9.3 ↗	19: *10.5 ↗	29: 9.9 ↗	20: *10.4 ↗	30: 8.3 ←	Series 86.0	Series 88.0	Total 173.0	Total 261.0
11: 9.8 ↘	21: 9.8 ←																									
12: 9.6 ↗	22: 9.9 ↗																									
13: 8.9 ←	23: 9.5 ↘																									
14: 8.3 ↘	24: 8.2 ↘																									
15: 8.0 ←	25: 8.2 →																									
16: 7.5 →	26: 9.1 ↗																									
17: 8.2 →	27: 10.1 ↘																									
18: 9.5 →	28: 9.3 ↗																									
19: *10.5 ↗	29: 9.9 ↗																									
20: *10.4 ↗	30: 8.3 ←																									
Series 86.0	Series 88.0																									
Total 173.0	Total 261.0																									

<p>40 Shots</p>	<table border="1" style="width:100%; border-collapse: collapse;"> <tr><td>31: 8.8 ↗</td></tr> <tr><td>32: 9.4 ↘</td></tr> <tr><td>33: 8.5 ↗</td></tr> <tr><td>34: *10.2 ↗</td></tr> <tr><td>35: *10.2 ↖</td></tr> <tr><td>36: *10.7 ↘</td></tr> <tr><td>37: *10.6 ←</td></tr> <tr><td>38: *10.5 ↗</td></tr> <tr><td>39: 8.0 ↗</td></tr> <tr><td>40: 9.8 ←</td></tr> <tr><td>Series 92.0</td></tr> <tr><td>Total 353.0</td></tr> </table>	31: 8.8 ↗	32: 9.4 ↘	33: 8.5 ↗	34: *10.2 ↗	35: *10.2 ↖	36: *10.7 ↘	37: *10.6 ←	38: *10.5 ↗	39: 8.0 ↗	40: 9.8 ←	Series 92.0	Total 353.0	
31: 8.8 ↗														
32: 9.4 ↘														
33: 8.5 ↗														
34: *10.2 ↗														
35: *10.2 ↖														
36: *10.7 ↘														
37: *10.6 ←														
38: *10.5 ↗														
39: 8.0 ↗														
40: 9.8 ←														
Series 92.0														
Total 353.0														

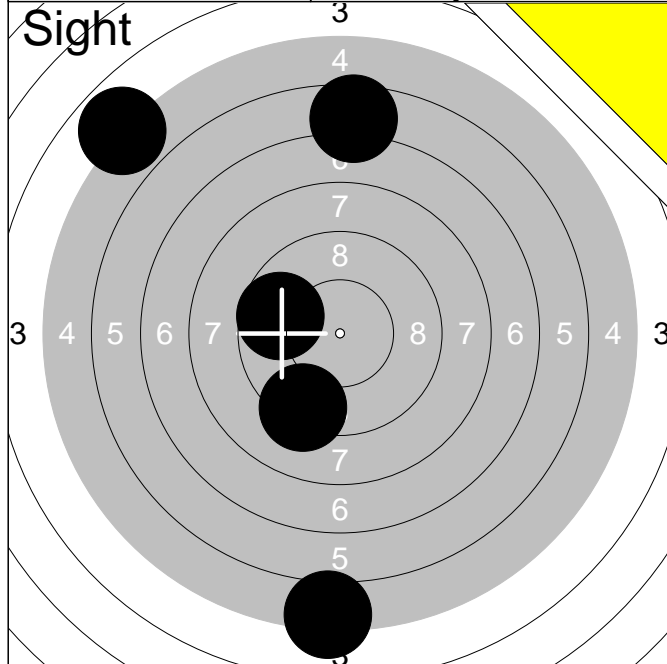

	1:	9.7	←
	2:	6.5	↑
	3:	4.9	↖
	4:	9.2	↘
	5:	5.2	↓
Series			33.0
Total			0.0

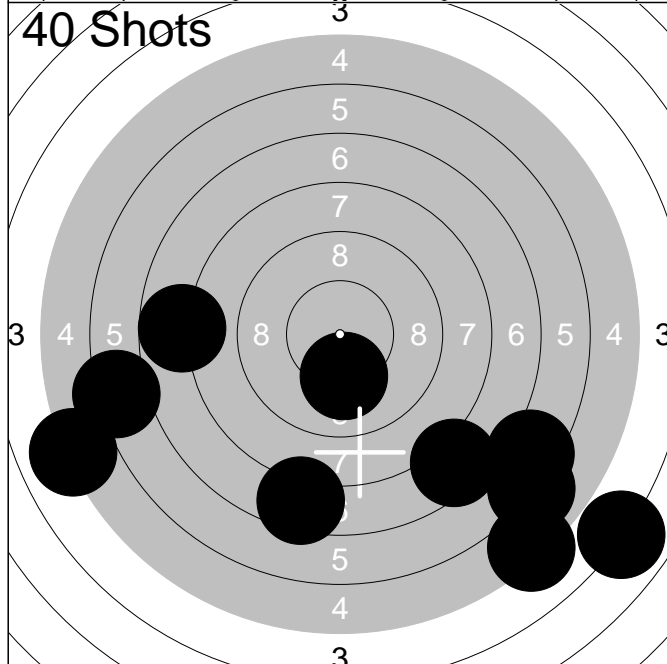

	1:	6.2	←
	2:	10.1	↓
	3:	5.0	↖
	4:	7.4	↘
	5:	6.4	↘
	6:	7.7	←
	7:	7.5	↘
	8:	5.1	↘
	9:	3.9	↘
	10:	5.9	↘
Series			61.0
Total			61.0

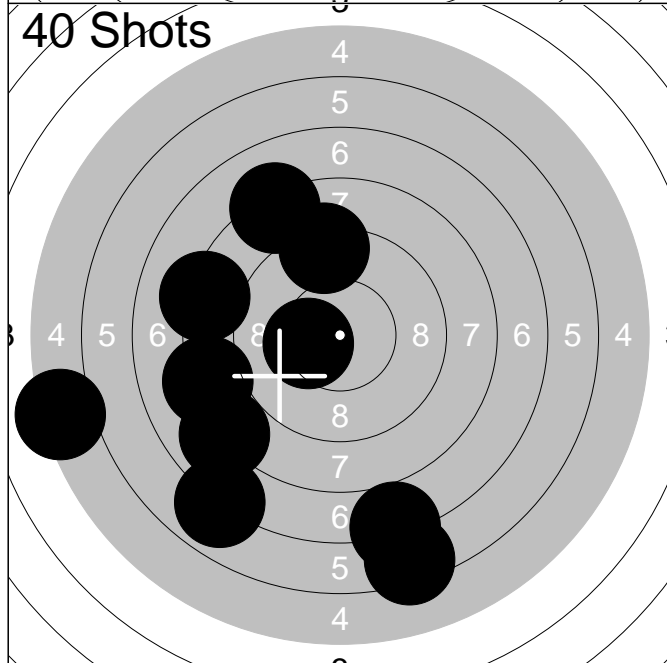

	11:	8.2	←
	12:	7.9	↖
	13:	9.2	↑
	14:	8.2	←
	15:	6.9	↘
	16:	5.2	←
	17:	*10.3	←
	18:	8.1	↑
	19:	7.0	↘
	20:	6.3	↓
Series			74.0
Total			135.0

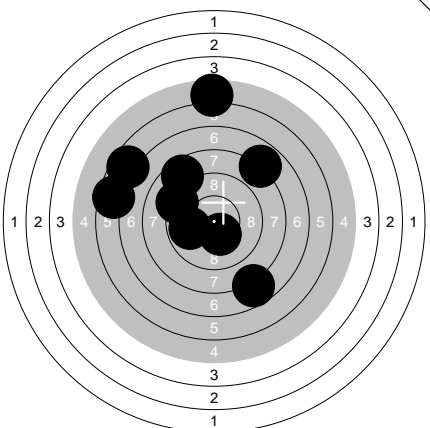
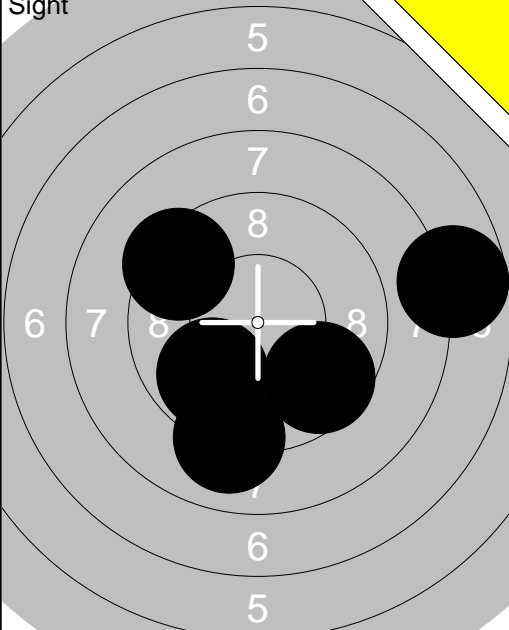
<p>Sight</p> 	<p>Sight</p> 	<table style="width:100%; border-collapse: collapse;"> <tr><td>1:</td><td>9.2</td><td>↖</td></tr> <tr><td>2:</td><td>5.5</td><td>↑</td></tr> <tr><td>3:</td><td>8.6</td><td>↗</td></tr> <tr><td>4:</td><td>0.0</td><td>→</td></tr> <tr><td>5:</td><td>6.5</td><td>←</td></tr> <tr><td>6:</td><td>*10.3</td><td>↓</td></tr> <tr><td>7:</td><td>9.9</td><td>←</td></tr> <tr><td>8:</td><td>7.8</td><td>↗</td></tr> <tr><td>9:</td><td>7.7</td><td>↓</td></tr> <tr><td>10:</td><td>6.5</td><td>↖</td></tr> <tr><td colspan="2">Series</td><td>67.0</td></tr> <tr><td colspan="2">Total</td><td>0.0</td></tr> </table>	1:	9.2	↖	2:	5.5	↑	3:	8.6	↗	4:	0.0	→	5:	6.5	←	6:	*10.3	↓	7:	9.9	←	8:	7.8	↗	9:	7.7	↓	10:	6.5	↖	Series		67.0	Total		0.0
1:	9.2	↖																																				
2:	5.5	↑																																				
3:	8.6	↗																																				
4:	0.0	→																																				
5:	6.5	←																																				
6:	*10.3	↓																																				
7:	9.9	←																																				
8:	7.8	↗																																				
9:	7.7	↓																																				
10:	6.5	↖																																				
Series		67.0																																				
Total		0.0																																				

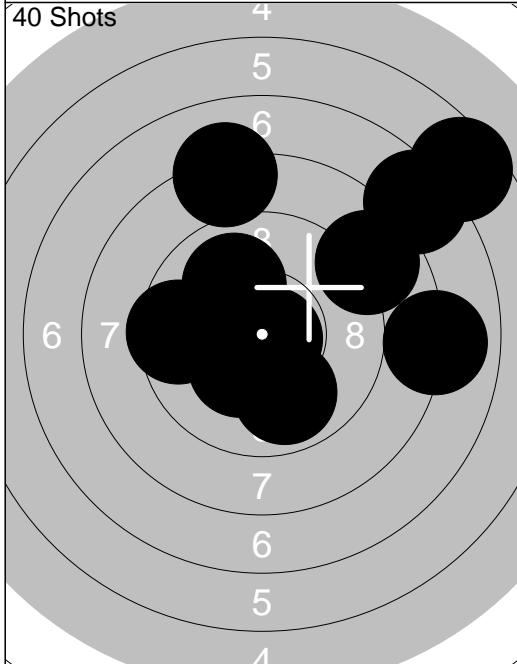
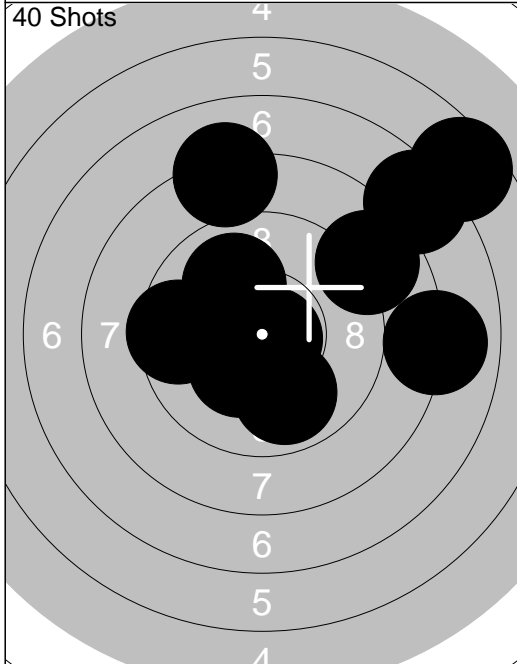
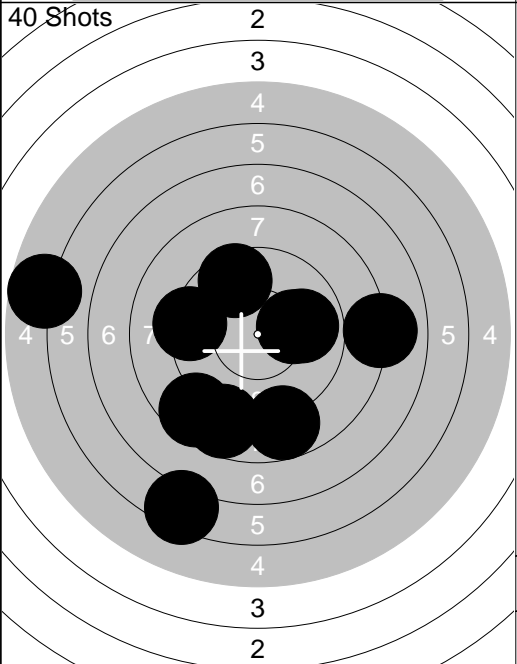
<p>40 Shots</p> 	<p>40 Shots</p> 	<table style="width:100%; border-collapse: collapse;"> <tr><td>11:</td><td>9.8</td><td>↙</td></tr> <tr><td>12:</td><td>9.6</td><td>↘</td></tr> <tr><td>13:</td><td>7.7</td><td>→</td></tr> <tr><td>14:</td><td>9.0</td><td>↓</td></tr> <tr><td>15:</td><td>9.4</td><td>↖</td></tr> <tr><td colspan="2">Series</td><td>43.0</td></tr> <tr><td colspan="2">Total</td><td>0.0</td></tr> </table>	11:	9.8	↙	12:	9.6	↘	13:	7.7	→	14:	9.0	↓	15:	9.4	↖	Series		43.0	Total		0.0															
11:	9.8	↙																																				
12:	9.6	↘																																				
13:	7.7	→																																				
14:	9.0	↓																																				
15:	9.4	↖																																				
Series		43.0																																				
Total		0.0																																				
<p>40 Shots</p> 	<p>40 Shots</p> 	<table style="width:100%; border-collapse: collapse;"> <tr><td>1:</td><td>8.0</td><td>→</td></tr> <tr><td>2:</td><td>8.1</td><td>↑</td></tr> <tr><td>3:</td><td>*10.8</td><td>↘</td></tr> <tr><td>4:</td><td>9.5</td><td>←</td></tr> <tr><td>5:</td><td>8.8</td><td>↗</td></tr> <tr><td>6:</td><td>6.5</td><td>↗</td></tr> <tr><td>7:</td><td>10.0</td><td>↑</td></tr> <tr><td>8:</td><td>*10.3</td><td>↓</td></tr> <tr><td>9:</td><td>7.5</td><td>↗</td></tr> <tr><td>10:</td><td>9.9</td><td>↓</td></tr> <tr><td colspan="2">Series</td><td>85.0</td></tr> <tr><td colspan="2">Total</td><td>85.0</td></tr> </table>	1:	8.0	→	2:	8.1	↑	3:	*10.8	↘	4:	9.5	←	5:	8.8	↗	6:	6.5	↗	7:	10.0	↑	8:	*10.3	↓	9:	7.5	↗	10:	9.9	↓	Series		85.0	Total		85.0
1:	8.0	→																																				
2:	8.1	↑																																				
3:	*10.8	↘																																				
4:	9.5	←																																				
5:	8.8	↗																																				
6:	6.5	↗																																				
7:	10.0	↑																																				
8:	*10.3	↓																																				
9:	7.5	↗																																				
10:	9.9	↓																																				
Series		85.0																																				
Total		85.0																																				

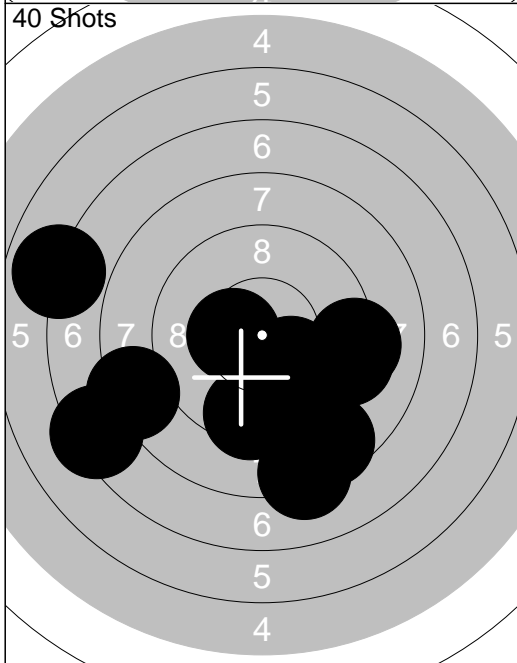
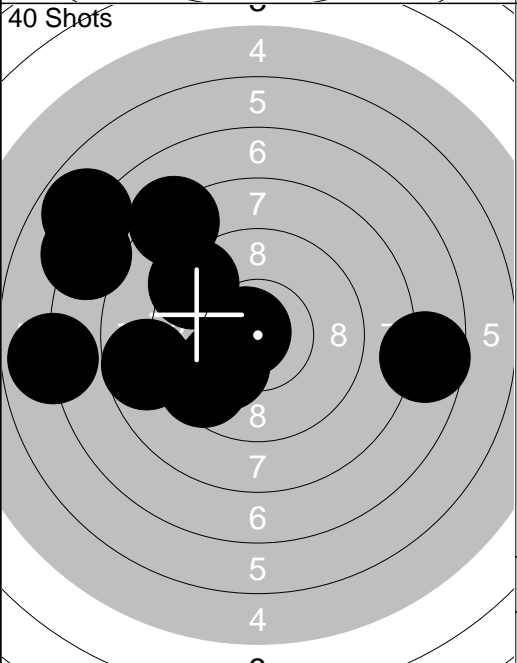
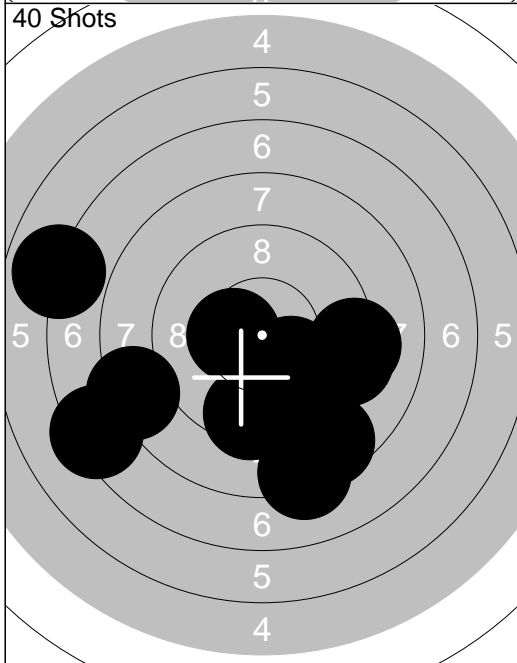
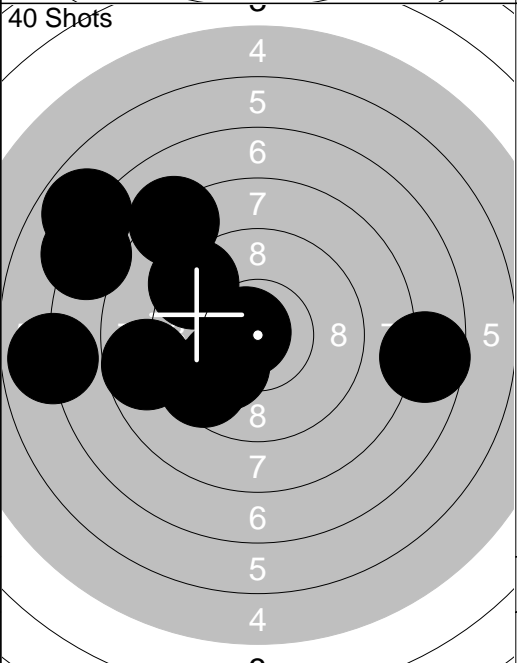
<p>40 Shots</p> 	<p>40 Shots</p> 	<table style="width:100%; border-collapse: collapse;"> <tr><td>11:</td><td>5.7</td><td>←</td></tr> <tr><td>12:</td><td>8.7</td><td>↓</td></tr> <tr><td>13:</td><td>9.9</td><td>→</td></tr> <tr><td>14:</td><td>9.6</td><td>↗</td></tr> <tr><td>15:</td><td>10.1</td><td>→</td></tr> <tr><td>16:</td><td>6.4</td><td>↓</td></tr> <tr><td>17:</td><td>8.0</td><td>→</td></tr> <tr><td>18:</td><td>9.3</td><td>←</td></tr> <tr><td>19:</td><td>8.7</td><td>↓</td></tr> <tr><td>20:</td><td>8.6</td><td>↙</td></tr> <tr><td colspan="2">Series</td><td>80.0</td></tr> <tr><td colspan="2">Total</td><td>165.0</td></tr> </table>	11:	5.7	←	12:	8.7	↓	13:	9.9	→	14:	9.6	↗	15:	10.1	→	16:	6.4	↓	17:	8.0	→	18:	9.3	←	19:	8.7	↓	20:	8.6	↙	Series		80.0	Total		165.0
11:	5.7	←																																				
12:	8.7	↓																																				
13:	9.9	→																																				
14:	9.6	↗																																				
15:	10.1	→																																				
16:	6.4	↓																																				
17:	8.0	→																																				
18:	9.3	←																																				
19:	8.7	↓																																				
20:	8.6	↙																																				
Series		80.0																																				
Total		165.0																																				
<p>40 Shots</p> 	<p>40 Shots</p> 	<table style="width:100%; border-collapse: collapse;"> <tr><td>21:</td><td>8.3</td><td>←</td></tr> <tr><td>22:</td><td>*10.4</td><td>←</td></tr> <tr><td>23:</td><td>*10.2</td><td>↘</td></tr> <tr><td>24:</td><td>8.6</td><td>↘</td></tr> <tr><td>25:</td><td>8.2</td><td>↓</td></tr> <tr><td>26:</td><td>6.9</td><td>←</td></tr> <tr><td>27:</td><td>9.3</td><td>→</td></tr> <tr><td>28:</td><td>9.2</td><td>→</td></tr> <tr><td>29:</td><td>7.3</td><td>←</td></tr> <tr><td>30:</td><td>9.5</td><td>↓</td></tr> <tr><td colspan="2">Series</td><td>84.0</td></tr> <tr><td colspan="2">Total</td><td>249.0</td></tr> </table>	21:	8.3	←	22:	*10.4	←	23:	*10.2	↘	24:	8.6	↘	25:	8.2	↓	26:	6.9	←	27:	9.3	→	28:	9.2	→	29:	7.3	←	30:	9.5	↓	Series		84.0	Total		249.0
21:	8.3	←																																				
22:	*10.4	←																																				
23:	*10.2	↘																																				
24:	8.6	↘																																				
25:	8.2	↓																																				
26:	6.9	←																																				
27:	9.3	→																																				
28:	9.2	→																																				
29:	7.3	←																																				
30:	9.5	↓																																				
Series		84.0																																				
Total		249.0																																				

	<table border="1" style="width:100%; border-collapse: collapse;"> <tr><td>1:</td><td>7.3</td><td>↘</td></tr> <tr><td>2:</td><td>9.9</td><td>↘</td></tr> <tr><td>3:</td><td>10.0</td><td>↘</td></tr> <tr><td>4:</td><td>9.3</td><td>↗</td></tr> <tr><td>5:</td><td>9.2</td><td>↘</td></tr> <tr><td>6:</td><td>9.3</td><td>↘</td></tr> <tr><td>7:</td><td>9.4</td><td>↘</td></tr> <tr><td>8:</td><td>10.0</td><td>→</td></tr> <tr><td>9:</td><td>*10.3</td><td>↓</td></tr> <tr><td>10:</td><td>9.6</td><td>←</td></tr> <tr><td colspan="2">Series</td><td>91.0</td></tr> <tr><td colspan="2">Total</td><td>0.0</td></tr> </table>	1:	7.3	↘	2:	9.9	↘	3:	10.0	↘	4:	9.3	↗	5:	9.2	↘	6:	9.3	↘	7:	9.4	↘	8:	10.0	→	9:	*10.3	↓	10:	9.6	←	Series		91.0	Total		0.0		<table border="1" style="width:100%; border-collapse: collapse;"> <tr><td>11:</td><td>9.6</td><td>←</td></tr> <tr><td>12:</td><td>8.7</td><td>↗</td></tr> <tr><td>13:</td><td>9.2</td><td>→</td></tr> <tr><td>14:</td><td>9.2</td><td>←</td></tr> <tr><td>15:</td><td>9.3</td><td>↓</td></tr> <tr><td>16:</td><td>10.0</td><td>↓</td></tr> <tr><td>17:</td><td>9.4</td><td>←</td></tr> <tr><td>18:</td><td>8.2</td><td>→</td></tr> <tr><td>19:</td><td>8.7</td><td>↗</td></tr> <tr><td>20:</td><td>8.4</td><td>↓</td></tr> <tr><td colspan="2">Series</td><td>87.0</td></tr> <tr><td colspan="2">Total</td><td>0.0</td></tr> </table>	11:	9.6	←	12:	8.7	↗	13:	9.2	→	14:	9.2	←	15:	9.3	↓	16:	10.0	↓	17:	9.4	←	18:	8.2	→	19:	8.7	↗	20:	8.4	↓	Series		87.0	Total		0.0
1:	7.3	↘																																																																									
2:	9.9	↘																																																																									
3:	10.0	↘																																																																									
4:	9.3	↗																																																																									
5:	9.2	↘																																																																									
6:	9.3	↘																																																																									
7:	9.4	↘																																																																									
8:	10.0	→																																																																									
9:	*10.3	↓																																																																									
10:	9.6	←																																																																									
Series		91.0																																																																									
Total		0.0																																																																									
11:	9.6	←																																																																									
12:	8.7	↗																																																																									
13:	9.2	→																																																																									
14:	9.2	←																																																																									
15:	9.3	↓																																																																									
16:	10.0	↓																																																																									
17:	9.4	←																																																																									
18:	8.2	→																																																																									
19:	8.7	↗																																																																									
20:	8.4	↓																																																																									
Series		87.0																																																																									
Total		0.0																																																																									

	<table border="1" style="width:100%; border-collapse: collapse;"> <tr><td>21:</td><td>8.7</td><td>←</td></tr> <tr><td>22:</td><td>*10.2</td><td>↗</td></tr> <tr><td>23:</td><td>9.2</td><td>←</td></tr> <tr><td>24:</td><td>*10.7</td><td>↓</td></tr> <tr><td colspan="2">Series</td><td>37.0</td></tr> <tr><td colspan="2">Total</td><td>0.0</td></tr> </table>	21:	8.7	←	22:	*10.2	↗	23:	9.2	←	24:	*10.7	↓	Series		37.0	Total		0.0		<table border="1" style="width:100%; border-collapse: collapse;"> <tr><td>1:</td><td>*10.6</td><td>↑</td></tr> <tr><td>2:</td><td>8.9</td><td>↑</td></tr> <tr><td>3:</td><td>9.9</td><td>←</td></tr> <tr><td>4:</td><td>7.8</td><td>→</td></tr> <tr><td>5:</td><td>*10.8</td><td>↗</td></tr> <tr><td>6:</td><td>9.2</td><td>↑</td></tr> <tr><td>7:</td><td>9.7</td><td>↙</td></tr> <tr><td>8:</td><td>7.9</td><td>↖</td></tr> <tr><td>9:</td><td>9.0</td><td>←</td></tr> <tr><td>10:</td><td>*10.2</td><td>↓</td></tr> <tr><td colspan="2">Series</td><td>88.0</td></tr> <tr><td colspan="2">Total</td><td>88.0</td></tr> </table>	1:	*10.6	↑	2:	8.9	↑	3:	9.9	←	4:	7.8	→	5:	*10.8	↗	6:	9.2	↑	7:	9.7	↙	8:	7.9	↖	9:	9.0	←	10:	*10.2	↓	Series		88.0	Total		88.0
21:	8.7	←																																																							
22:	*10.2	↗																																																							
23:	9.2	←																																																							
24:	*10.7	↓																																																							
Series		37.0																																																							
Total		0.0																																																							
1:	*10.6	↑																																																							
2:	8.9	↑																																																							
3:	9.9	←																																																							
4:	7.8	→																																																							
5:	*10.8	↗																																																							
6:	9.2	↑																																																							
7:	9.7	↙																																																							
8:	7.9	↖																																																							
9:	9.0	←																																																							
10:	*10.2	↓																																																							
Series		88.0																																																							
Total		88.0																																																							

	<table border="1" style="width:100%; border-collapse: collapse;"> <tr><td>11:</td><td>9.8</td><td>↑</td></tr> <tr><td>12:</td><td>10.1</td><td>↗</td></tr> <tr><td>13:</td><td>8.4</td><td>→</td></tr> <tr><td>14:</td><td>10.1</td><td>←</td></tr> <tr><td>15:</td><td>9.8</td><td>↗</td></tr> <tr><td>16:</td><td>8.8</td><td>↙</td></tr> <tr><td>17:</td><td>9.2</td><td>↗</td></tr> <tr><td>18:</td><td>9.8</td><td>↗</td></tr> <tr><td>19:</td><td>*10.5</td><td>↓</td></tr> <tr><td>20:</td><td>9.8</td><td>↗</td></tr> <tr><td colspan="2">Series</td><td>91.0</td></tr> <tr><td colspan="2">Total</td><td>179.0</td></tr> </table>	11:	9.8	↑	12:	10.1	↗	13:	8.4	→	14:	10.1	←	15:	9.8	↗	16:	8.8	↙	17:	9.2	↗	18:	9.8	↗	19:	*10.5	↓	20:	9.8	↗	Series		91.0	Total		179.0		<table border="1" style="width:100%; border-collapse: collapse;"> <tr><td>21:</td><td>7.8</td><td>↖</td></tr> <tr><td>22:</td><td>9.1</td><td>↑</td></tr> <tr><td>23:</td><td>9.6</td><td>↖</td></tr> <tr><td>24:</td><td>9.1</td><td>↗</td></tr> <tr><td>25:</td><td>*10.5</td><td>↗</td></tr> <tr><td>26:</td><td>9.9</td><td>↘</td></tr> <tr><td>27:</td><td>7.1</td><td>←</td></tr> <tr><td>28:</td><td>9.8</td><td>←</td></tr> <tr><td>29:</td><td>9.5</td><td>↑</td></tr> <tr><td>30:</td><td>9.9</td><td>↓</td></tr> <tr><td colspan="2">Series</td><td>87.0</td></tr> <tr><td colspan="2">Total</td><td>266.0</td></tr> </table>	21:	7.8	↖	22:	9.1	↑	23:	9.6	↖	24:	9.1	↗	25:	*10.5	↗	26:	9.9	↘	27:	7.1	←	28:	9.8	←	29:	9.5	↑	30:	9.9	↓	Series		87.0	Total		266.0
11:	9.8	↑																																																																									
12:	10.1	↗																																																																									
13:	8.4	→																																																																									
14:	10.1	←																																																																									
15:	9.8	↗																																																																									
16:	8.8	↙																																																																									
17:	9.2	↗																																																																									
18:	9.8	↗																																																																									
19:	*10.5	↓																																																																									
20:	9.8	↗																																																																									
Series		91.0																																																																									
Total		179.0																																																																									
21:	7.8	↖																																																																									
22:	9.1	↑																																																																									
23:	9.6	↖																																																																									
24:	9.1	↗																																																																									
25:	*10.5	↗																																																																									
26:	9.9	↘																																																																									
27:	7.1	←																																																																									
28:	9.8	←																																																																									
29:	9.5	↑																																																																									
30:	9.9	↓																																																																									
Series		87.0																																																																									
Total		266.0																																																																									

	<table border="1" style="width:100%; border-collapse: collapse;"> <tr><td>31:</td><td>9.3</td><td>↗</td></tr> <tr><td>32:</td><td>6.9</td><td>↗</td></tr> <tr><td>33:</td><td>8.6</td><td>↗</td></tr> <tr><td>34:</td><td>8.7</td><td>↘</td></tr> <tr><td>35:</td><td>7.3</td><td>↗</td></tr> <tr><td>36:</td><td>*10.7</td><td>↗</td></tr> <tr><td>37:</td><td>9.7</td><td>↗</td></tr> <tr><td>38:</td><td>8.0</td><td>↘</td></tr> <tr><td>39:</td><td>9.5</td><td>↘</td></tr> <tr><td>40:</td><td>9.9</td><td>↓</td></tr> <tr><td colspan="2">Series</td><td>83.0</td></tr> <tr><td colspan="2">Total</td><td>349.0</td></tr> </table>	31:	9.3	↗	32:	6.9	↗	33:	8.6	↗	34:	8.7	↘	35:	7.3	↗	36:	*10.7	↗	37:	9.7	↗	38:	8.0	↘	39:	9.5	↘	40:	9.9	↓	Series		83.0	Total		349.0		
31:	9.3	↗																																					
32:	6.9	↗																																					
33:	8.6	↗																																					
34:	8.7	↘																																					
35:	7.3	↗																																					
36:	*10.7	↗																																					
37:	9.7	↗																																					
38:	8.0	↘																																					
39:	9.5	↘																																					
40:	9.9	↓																																					
Series		83.0																																					
Total		349.0																																					

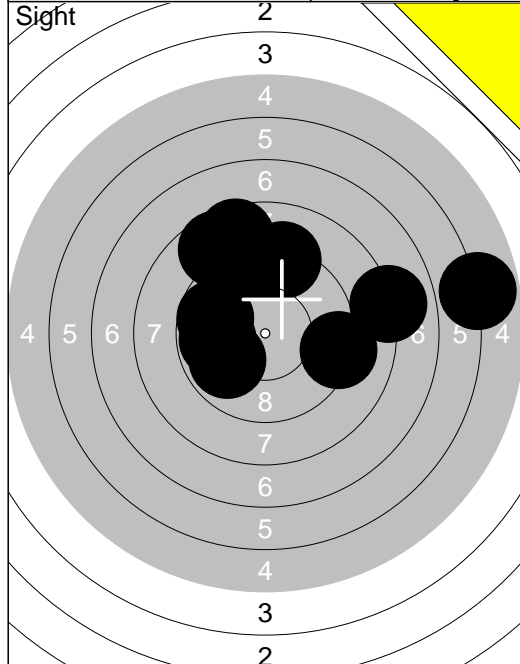

1:	9.2	→
2:	9.8	←
3:	9.9	↙
4:	5.8	→
5:	9.7	↙
6:	9.2	↑
7:	9.3	↑
8:	8.7	↗
9:	8.6	↑
10:	8.0	→
Series		83.0
Total		0.0

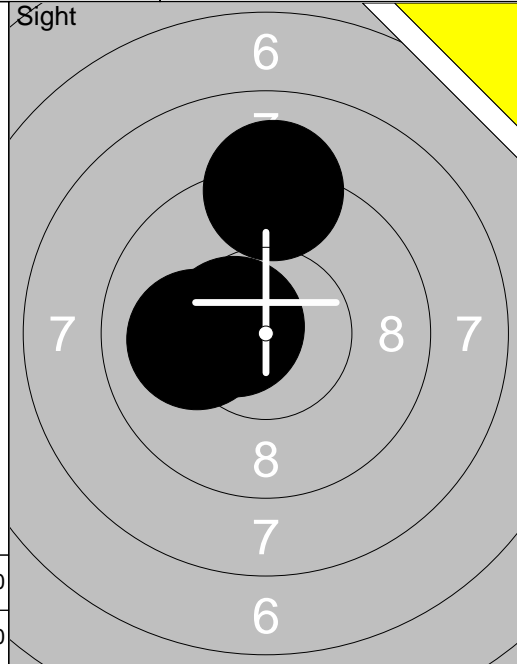

11:	9.1	↑
12:	*10.5	←
13:	10.1	←
Series		29.0
Total		0.0

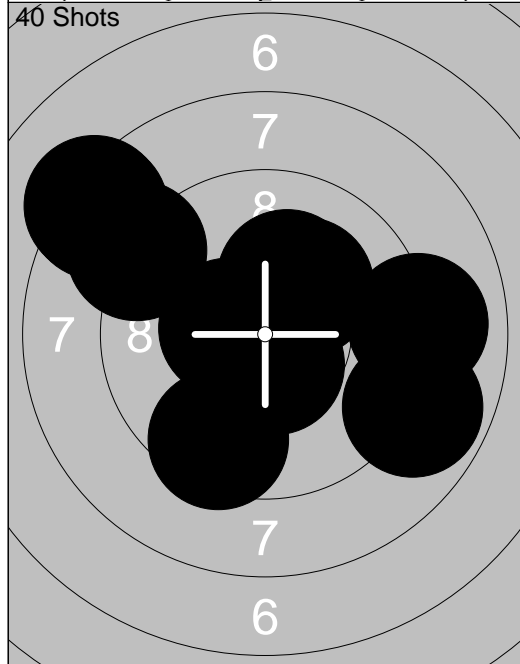

1:	9.5	↙
2:	*10.2	↗
3:	8.9	→
4:	*10.2	↑
5:	9.0	→
6:	*10.5	↙
7:	8.2	↗
8:	9.0	↗
9:	*10.5	←
10:	8.3	↗
Series		91.0
Total		91.0

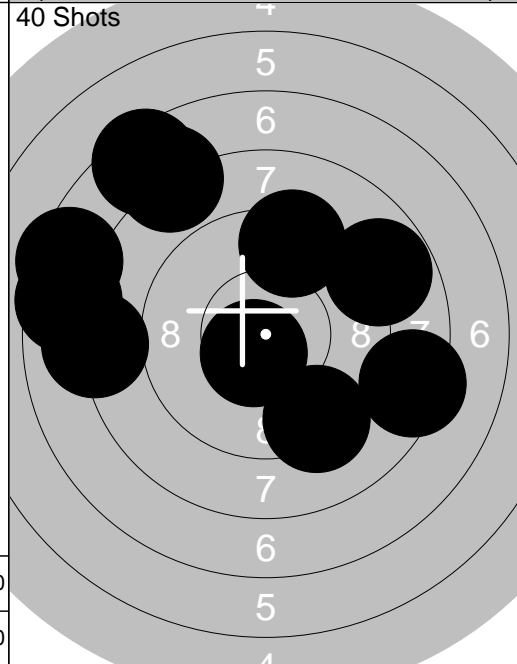

11:	9.4	↑
12:	8.8	↗
13:	7.9	↗
14:	8.1	←
15:	9.3	↙
16:	7.4	↙
17:	7.6	←
18:	7.4	↗
19:	*10.6	↙
20:	8.3	→
Series		80.0
Total		171.0

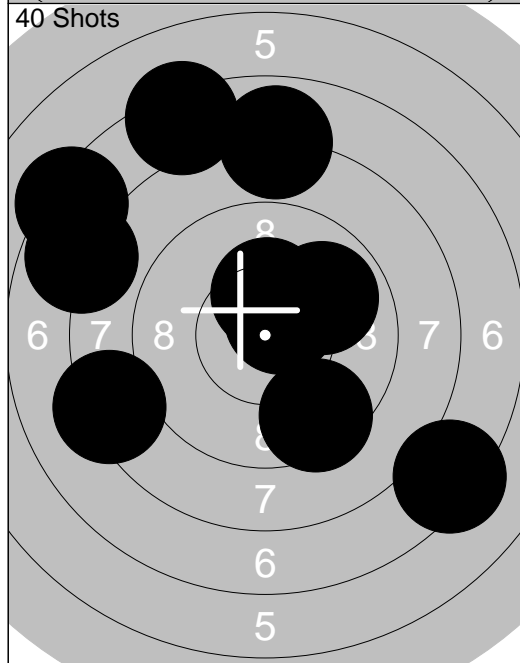

21:	*10.3	↑
22:	7.9	↑
23:	7.3	↘
24:	7.8	↙
25:	7.2	↗
26:	9.5	↘
27:	*10.6	↗
28:	9.9	↗
29:	8.2	←
30:	7.3	↗
Series		81.0
Total		252.0

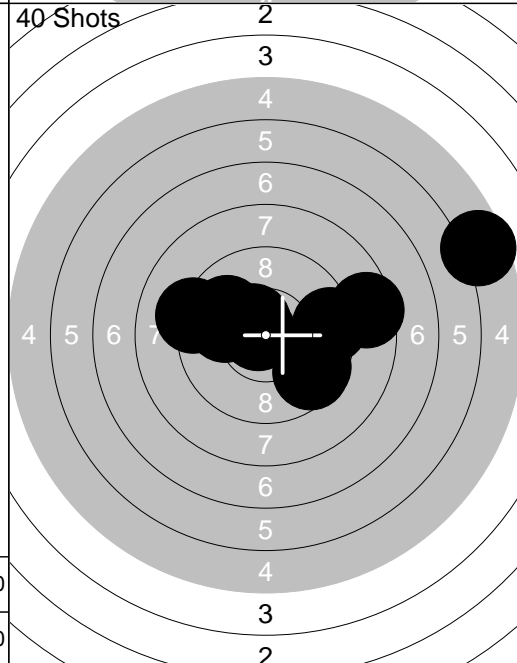

31:	9.9	↙
32:	9.6	↘
33:	10.0	←
34:	9.6	↘
35:	9.4	→
36:	8.5	→
37:	*10.8	←
38:	5.5	↗
39:	9.2	←
40:	*10.5	↗
Series		88.0
Total		340.0

Relay 2	Lane 18	Lina Johansson	
-------------------	-------------------	-----------------------	--

10m	Drängsmark	13S	Vb
-----	------------	-----	----

2012-11-04	Vindelnskyttet 2012	Ramselefors SKF
------------	---------------------	-----------------

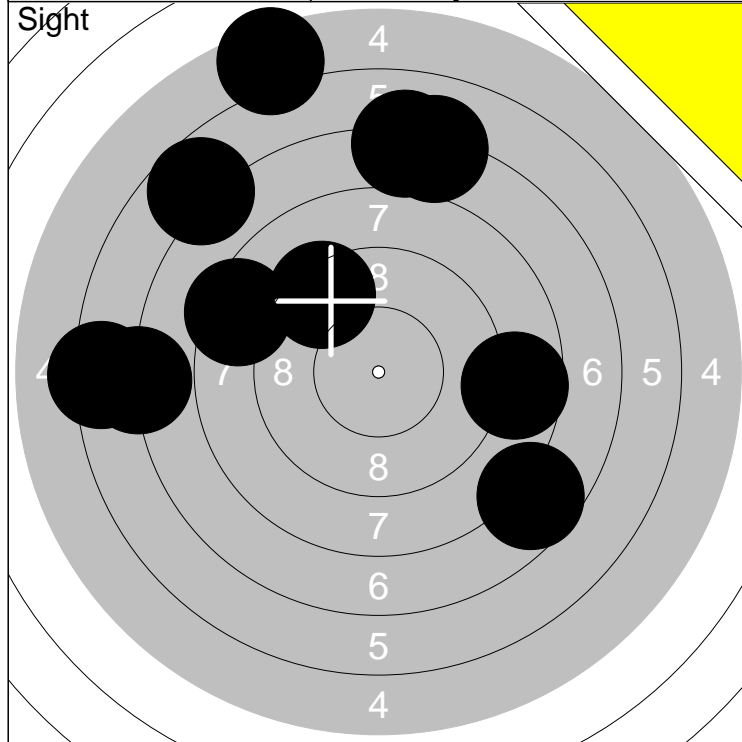

1: 6.3 ←	6: 8.6 →	Series 69.0
2: 9.3 ↗	7: 6.7 ↗	
3: 7.6 ↘	8: 8.4 ←	Total 0.0
4: 6.9 ←	9: 7.1 ↑	
5: 5.4 ↑	10: 7.1 ↑	

11: 7.6 →	Series 7.0
	Total 0.0

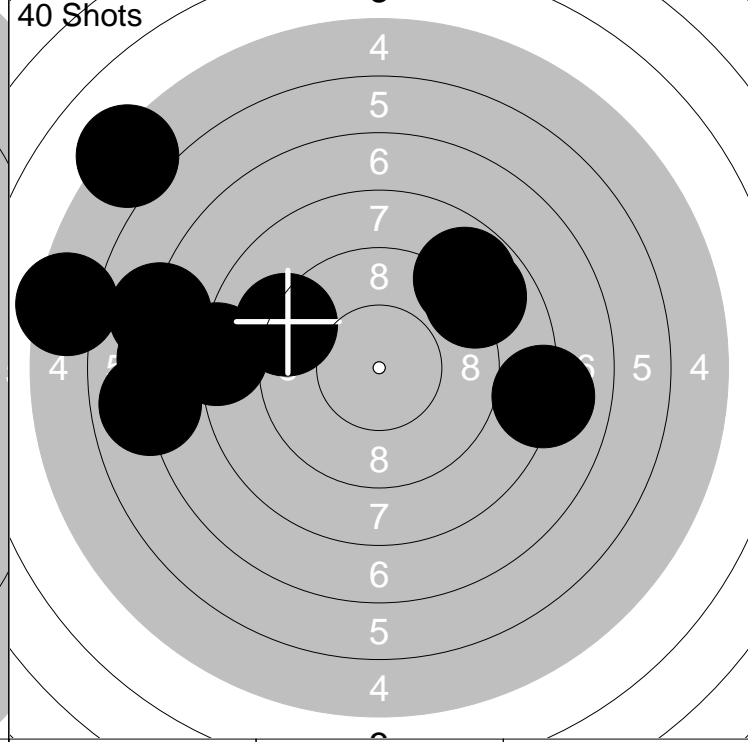
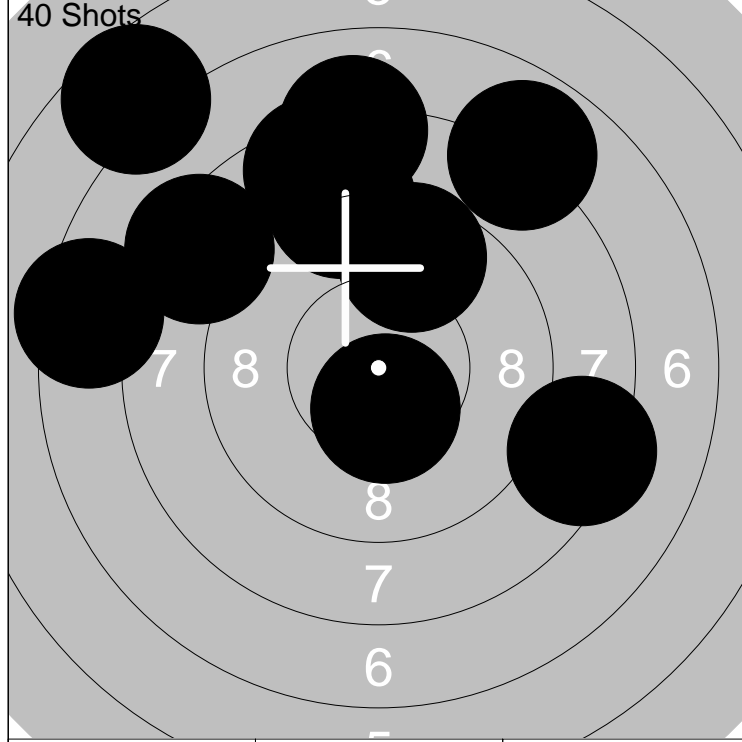

1: 8.1 ↑	6: 8.3 →	Series 79.0
2: 8.4 ↗	7: 9.6 ↑	
3: 7.4 ←	8: 7.9 ↗	Total 79.0
4: 6.6 ↗	9: 8.9 ↑	
5: *10.4 ↓	10: 8.5 ↑	

11: 5.4 ←	16: 7.3 ←	Series 71.0
12: 9.2 ←	17: 7.0 ←	
13: 8.1 ←	18: 8.8 ↗	Total 150.0
14: 8.9 ↗	19: 6.9 ←	
15: 5.2 ↖	20: 8.0 →	

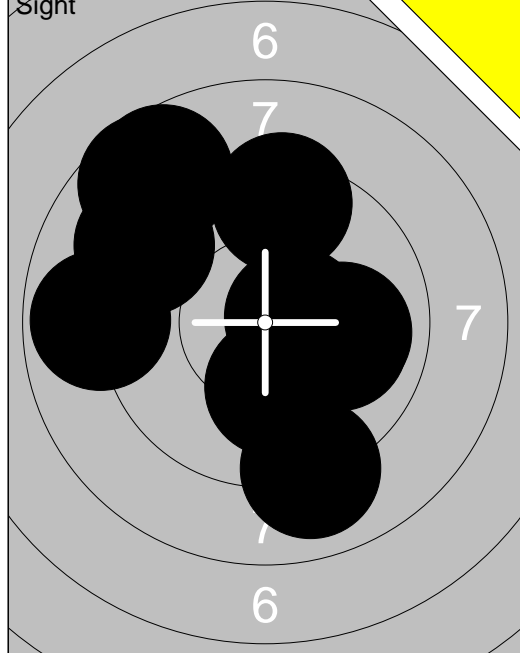

1:	9.4	↑
2:	9.1	↗
3:	8.8	←
4:	9.0	↓
5:	8.6	↗
6:	8.7	↗
7:	*10.6	→
8:	10.0	→
9:	10.0	→
10:	10.1	↓
Series		91.0
Total		0.0

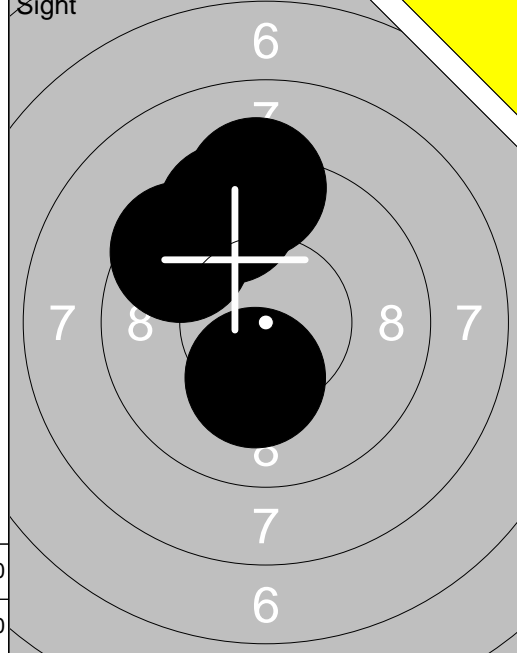

11:	9.5	↑
12:	*10.2	↓
13:	9.5	↖
14:	9.2	↑
Series		37.0
Total		0.0

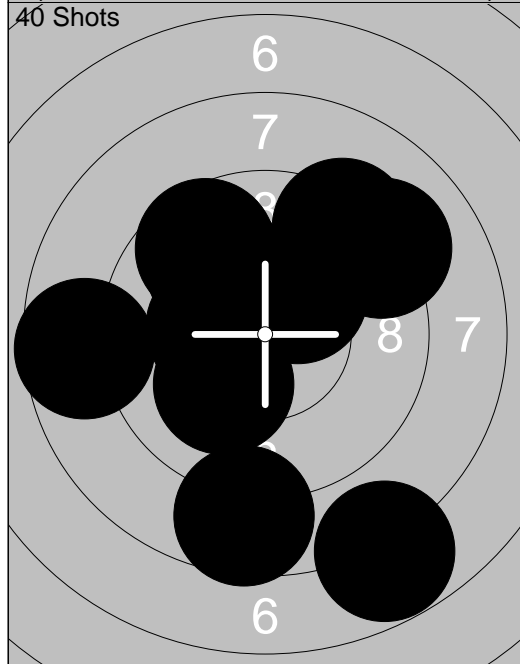

1:	9.9	↗
2:	10.1	↓
3:	8.6	↓
4:	*10.3	←
5:	9.6	↗
6:	*10.3	↗
7:	8.6	←
8:	7.8	↓
9:	9.3	↗
10:	9.1	↗
Series		89.0
Total		89.0

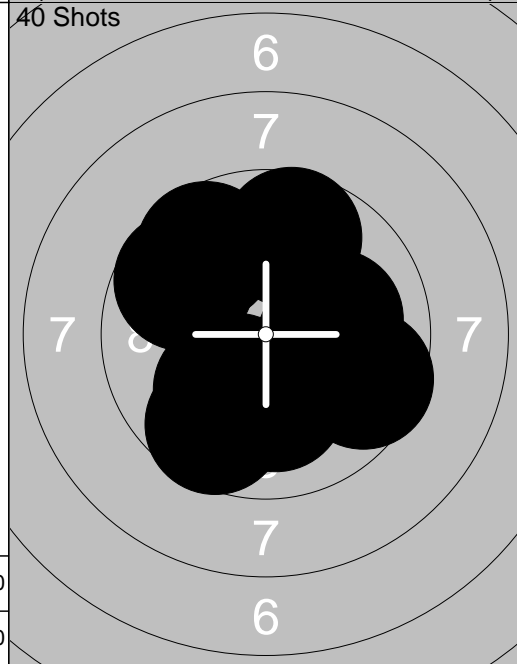

11:	9.6	→
12:	*10.2	↓
13:	10.1	↓
14:	10.1	→
15:	9.7	↑
16:	9.7	↖
17:	9.6	↓
18:	*10.2	→
19:	10.1	↓
20:	9.7	↖
Series		95.0
Total		184.0

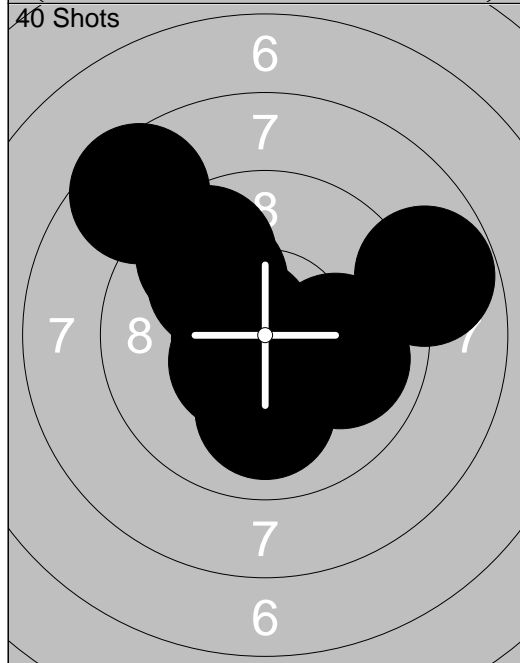

21:	8.5	↖
22:	*10.6	←
23:	10.0	↗
24:	8.8	→
25:	*10.5	↙
26:	10.0	→
27:	*10.7	↖
28:	10.0	↓
29:	9.7	↗
30:	9.9	→
Series		94.0
Total		278.0

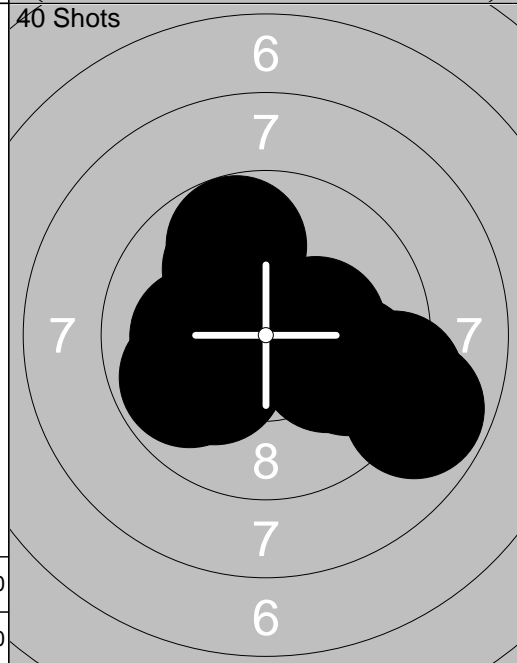

31:	10.0	↖
32:	10.1	↙
33:	8.8	→
34:	9.8	→
35:	9.2	→
36:	*10.3	→
37:	10.1	→
38:	9.8	↙
39:	10.1	←
40:	9.8	↑
Series		94.0
Total		372.0

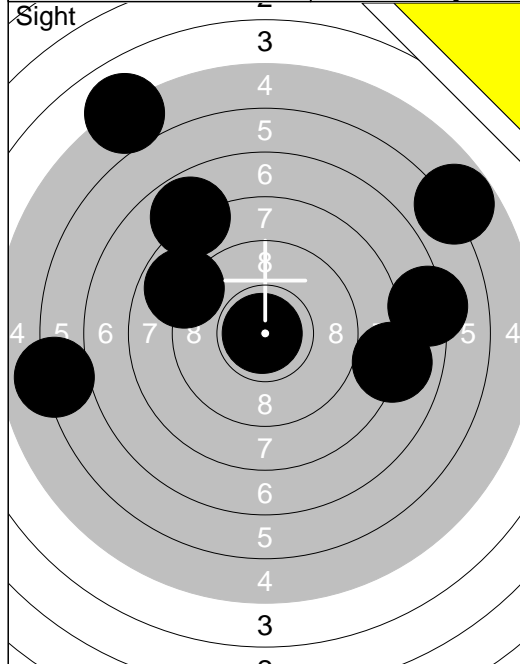

1:	6.1	←
2:	8.0	→
3:	7.2	→
4:	8.8	↖
5:	7.8	↗
6:	5.8	↗
7:	5.1	↗
8:	*10.9	←
Series		56.0
Total		0.0

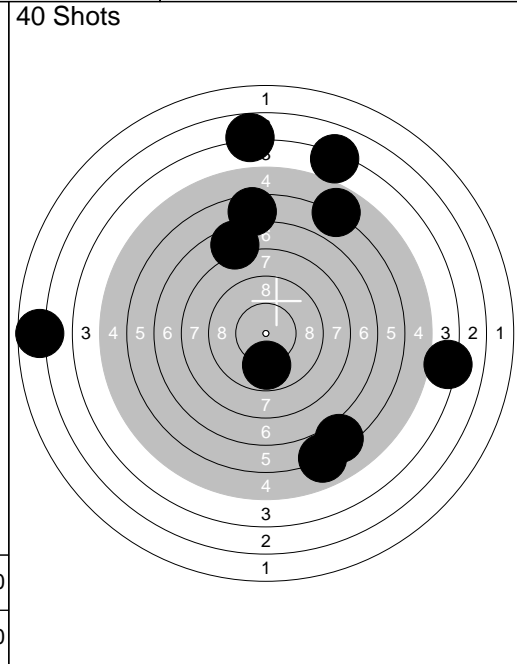

1:	3.7	↑
2:	2.7	←
3:	9.8	↓
4:	7.5	↖
5:	4.1	↖
6:	5.8	↖
7:	5.9	↓
8:	4.2	→
9:	6.5	↑
10:	6.3	↓
Series		51.0
Total		51.0

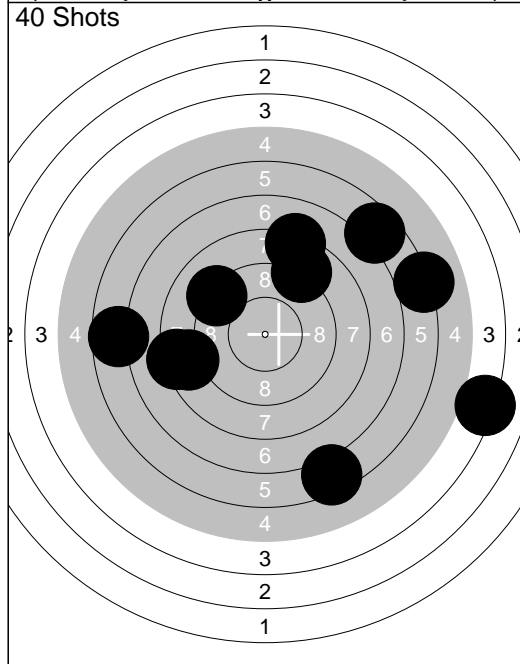

11:	6.6	↗
12:	8.3	←
13:	8.6	←
14:	6.6	←
15:	9.1	↗
16:	6.4	↓
17:	8.1	↗
18:	4.1	→
19:	8.8	↗
20:	6.0	→
Series		69.0
Total		120.0

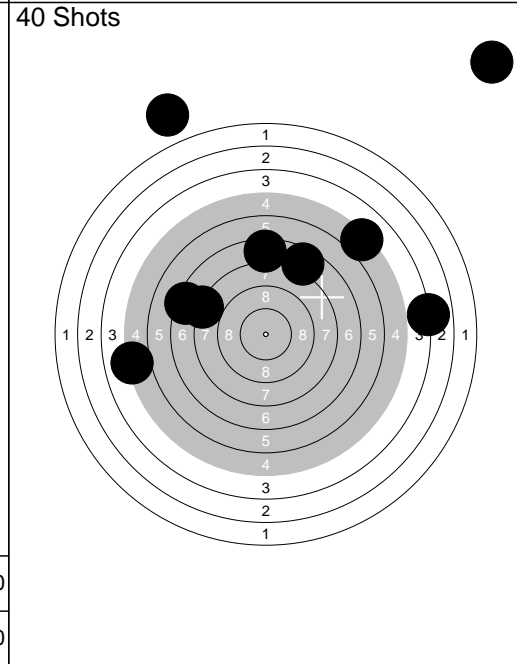

21:	0.0	↖
22:	0.0	↓
23:	5.0	←
24:	5.1	↗
25:	7.5	↖
26:	7.2	←
27:	7.4	↑
28:	0.0	↖
29:	3.9	→
30:	8.0	←
Series		42.0
Total		162.0

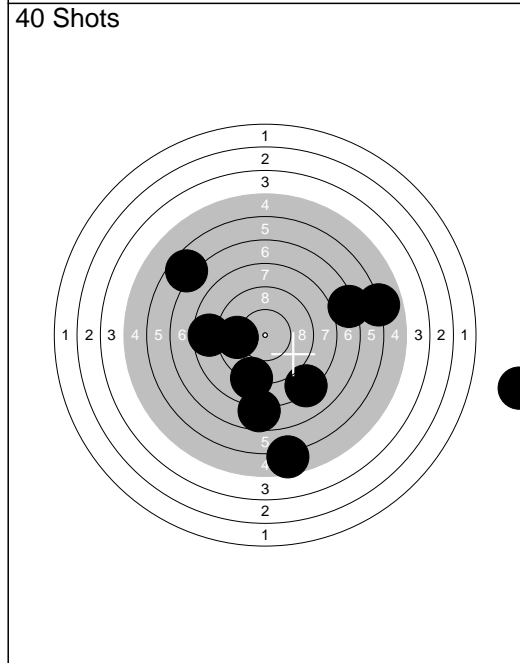

31:	5.9	→
32:	8.5	←
33:	9.0	↓
34:	8.1	↓
35:	9.7	←
36:	0.0	→
37:	7.7	↓
38:	6.6	↖
39:	5.6	↓
40:	7.1	→
Series		64.0
Total		226.0

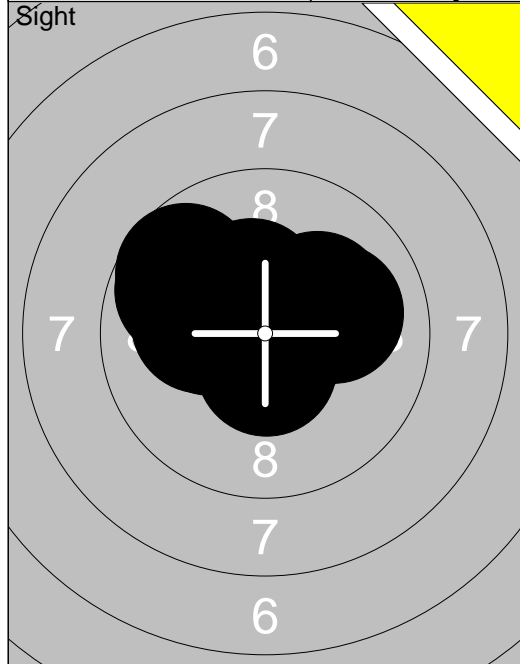

1:	*10.4 ↗
2:	10.1 ←
3:	9.7 ↗
4:	*10.2 ←
5:	*10.5 ↓
6:	*10.5 ↑
7:	*10.2 ↗
8:	10.0 →
9:	9.8 ←
10:	*10.4 ↑
Series 98.0	
Total 0.0	

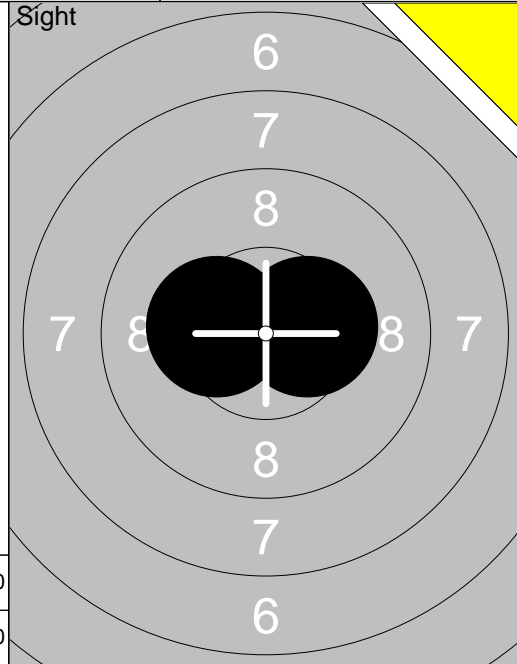

11:	*10.4 →
12:	*10.3 ←
Series 20.0	
Total 0.0	

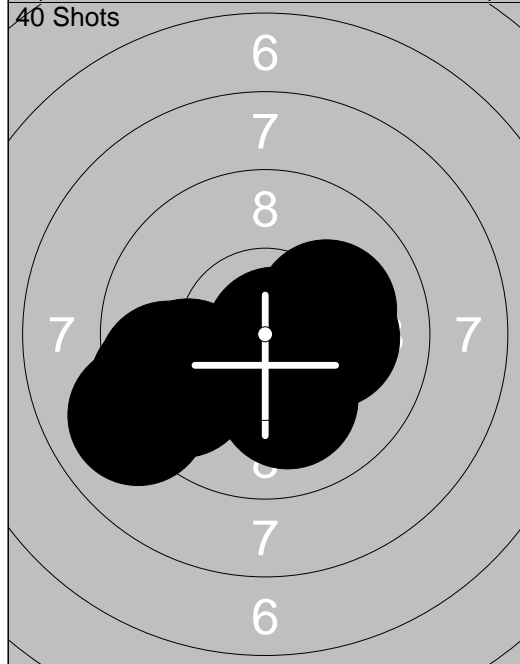

1:	10.1 →
2:	9.9 ←
3:	10.1 →
4:	9.5 ←
5:	10.1 ↓
6:	*10.8 →
7:	9.0 ←
8:	9.6 ←
9:	*10.4 ↓
10:	9.7 ←
Series 95.0	
Total 95.0	

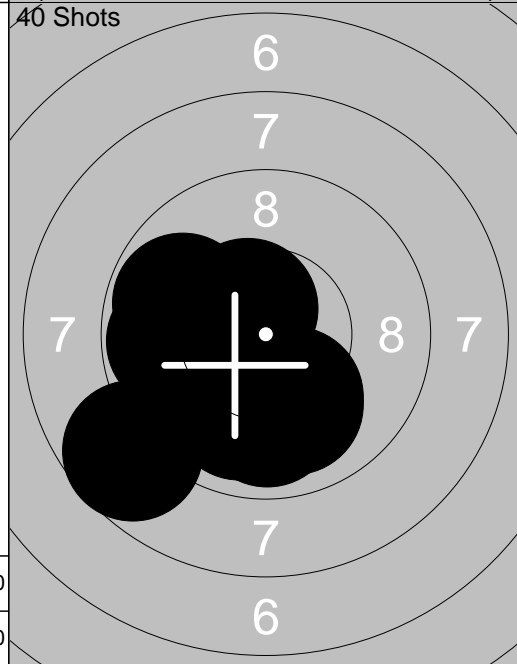

11:	9.9 ↓
12:	9.8 ←
13:	9.9 ↓
14:	8.7 ←
15:	10.1 ↓
16:	9.7 ←
17:	10.0 ↓
18:	9.8 ←
19:	9.9 ←
20:	*10.6 ↗
Series 92.0	
Total 187.0	

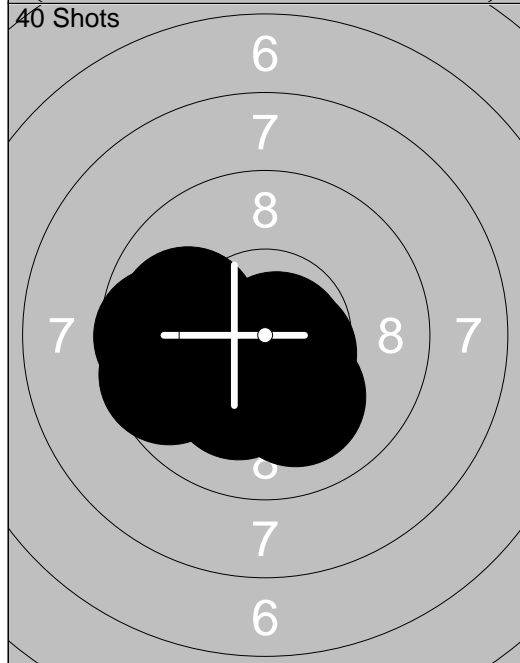

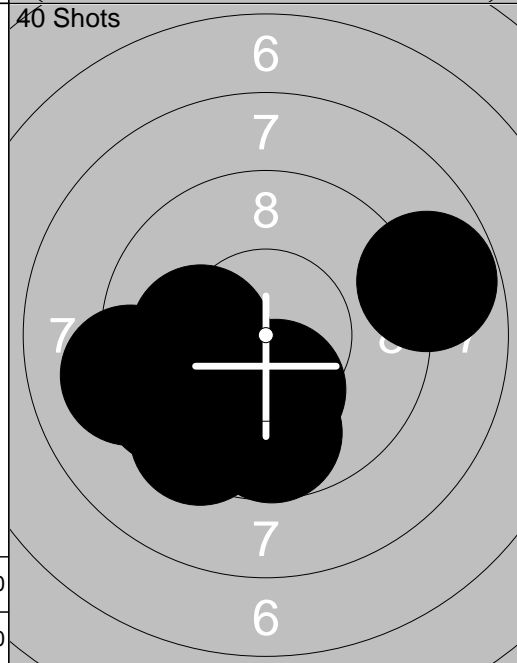

21:	9.9 ←
22:	*10.8 ↓
23:	*10.6 ↓
24:	*10.2 ↓
25:	9.7 ←
26:	9.9 ←
27:	*10.4 ↓
28:	*10.3 ↓
29:	10.1 ↓
30:	9.6 ←
Series 96.0	
Total 283.0	

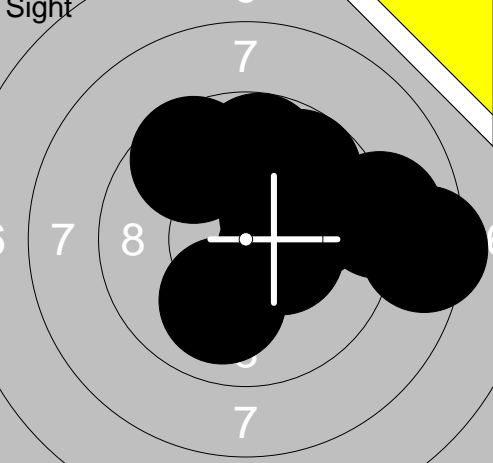
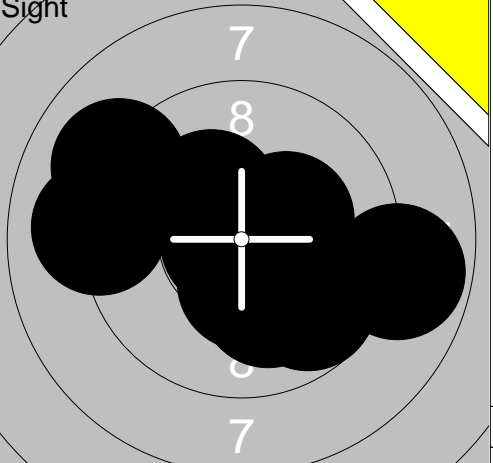

31:	9.7 ↓
32:	10.1 ←
33:	8.8 →
34:	*10.2 ↙
35:	9.5 ←
36:	*10.2 ↓
37:	9.6 ↙
38:	9.4 ↙
39:	9.2 ←
40:	10.0 ↓
Series 93.0	
Total 376.0	

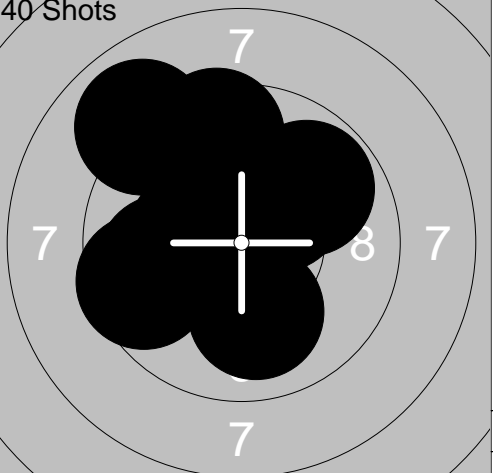
<p>Sight</p> 	<table border="1" style="width:100%; border-collapse: collapse;"> <tr><td>1:</td><td>9.8</td><td>↑</td></tr> <tr><td>2:</td><td>*10.2</td><td>↗</td></tr> <tr><td>3:</td><td>9.6</td><td>↗</td></tr> <tr><td>4:</td><td>*10.3</td><td>↗</td></tr> <tr><td>5:</td><td>9.0</td><td>→</td></tr> <tr><td>6:</td><td>9.7</td><td>↗</td></tr> <tr><td>7:</td><td>10.0</td><td>↓</td></tr> <tr><td>8:</td><td>8.4</td><td>→</td></tr> <tr><td>9:</td><td>10.0</td><td>→</td></tr> <tr><td>10:</td><td>*10.4</td><td>→</td></tr> <tr><td colspan="2">Series</td><td>94.0</td></tr> <tr><td colspan="2">Total</td><td>0.0</td></tr> </table>	1:	9.8	↑	2:	*10.2	↗	3:	9.6	↗	4:	*10.3	↗	5:	9.0	→	6:	9.7	↗	7:	10.0	↓	8:	8.4	→	9:	10.0	→	10:	*10.4	→	Series		94.0	Total		0.0	<p>Sight</p>  <table border="1" style="width:100%; border-collapse: collapse;"> <tr><td>11:</td><td>*10.6</td><td>→</td></tr> <tr><td>12:</td><td>*10.8</td><td>←</td></tr> <tr><td>13:</td><td>9.1</td><td>←</td></tr> <tr><td>14:</td><td>*10.3</td><td>→</td></tr> <tr><td>15:</td><td>9.1</td><td>↗</td></tr> <tr><td>16:</td><td>9.7</td><td>↘</td></tr> <tr><td>17:</td><td>*10.3</td><td>↗</td></tr> <tr><td>18:</td><td>8.8</td><td>→</td></tr> <tr><td>19:</td><td>*10.4</td><td>↓</td></tr> <tr><td>20:</td><td>10.1</td><td>↓</td></tr> <tr><td colspan="2">Series</td><td>95.0</td></tr> <tr><td colspan="2">Total</td><td>0.0</td></tr> </table>	11:	*10.6	→	12:	*10.8	←	13:	9.1	←	14:	*10.3	→	15:	9.1	↗	16:	9.7	↘	17:	*10.3	↗	18:	8.8	→	19:	*10.4	↓	20:	10.1	↓	Series		95.0	Total		0.0
1:	9.8	↑																																																																								
2:	*10.2	↗																																																																								
3:	9.6	↗																																																																								
4:	*10.3	↗																																																																								
5:	9.0	→																																																																								
6:	9.7	↗																																																																								
7:	10.0	↓																																																																								
8:	8.4	→																																																																								
9:	10.0	→																																																																								
10:	*10.4	→																																																																								
Series		94.0																																																																								
Total		0.0																																																																								
11:	*10.6	→																																																																								
12:	*10.8	←																																																																								
13:	9.1	←																																																																								
14:	*10.3	→																																																																								
15:	9.1	↗																																																																								
16:	9.7	↘																																																																								
17:	*10.3	↗																																																																								
18:	8.8	→																																																																								
19:	*10.4	↓																																																																								
20:	10.1	↓																																																																								
Series		95.0																																																																								
Total		0.0																																																																								

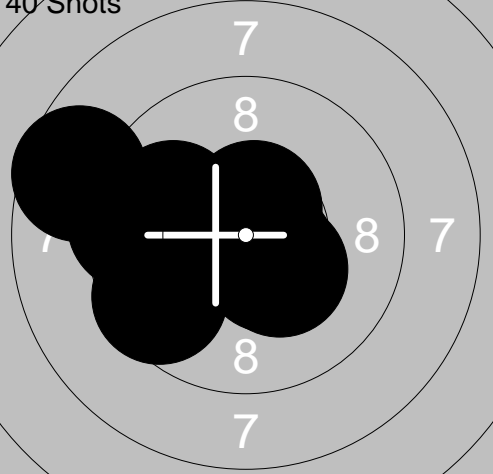
<p>Sight</p>  <table border="1" style="width:100%; border-collapse: collapse;"> <tr><td>21:</td><td>*10.5</td><td>↑</td></tr> <tr><td colspan="2">Series</td><td>10.0</td></tr> <tr><td colspan="2">Total</td><td>0.0</td></tr> </table>	21:	*10.5	↑	Series		10.0	Total		0.0	<p>40 Shots</p>  <table border="1" style="width:100%; border-collapse: collapse;"> <tr><td>1:</td><td>*10.3</td><td>↗</td></tr> <tr><td>2:</td><td>9.8</td><td>↗</td></tr> <tr><td>3:</td><td>*10.7</td><td>←</td></tr> <tr><td>4:</td><td>9.5</td><td>↑</td></tr> <tr><td>5:</td><td>8.9</td><td>↗</td></tr> <tr><td>6:</td><td>9.5</td><td>↗</td></tr> <tr><td>7:</td><td>9.6</td><td>←</td></tr> <tr><td>8:</td><td>9.9</td><td>←</td></tr> <tr><td>9:</td><td>*10.3</td><td>←</td></tr> <tr><td>10:</td><td>10.0</td><td>↓</td></tr> <tr><td colspan="2">Series</td><td>93.0</td></tr> <tr><td colspan="2">Total</td><td>93.0</td></tr> </table>	1:	*10.3	↗	2:	9.8	↗	3:	*10.7	←	4:	9.5	↑	5:	8.9	↗	6:	9.5	↗	7:	9.6	←	8:	9.9	←	9:	*10.3	←	10:	10.0	↓	Series		93.0	Total		93.0
21:	*10.5	↑																																												
Series		10.0																																												
Total		0.0																																												
1:	*10.3	↗																																												
2:	9.8	↗																																												
3:	*10.7	←																																												
4:	9.5	↑																																												
5:	8.9	↗																																												
6:	9.5	↗																																												
7:	9.6	←																																												
8:	9.9	←																																												
9:	*10.3	←																																												
10:	10.0	↓																																												
Series		93.0																																												
Total		93.0																																												

<p>40 Shots</p>  <table border="1" style="width:100%; border-collapse: collapse;"> <tr><td>11:</td><td>9.9</td><td>←</td></tr> <tr><td>12:</td><td>9.9</td><td>←</td></tr> <tr><td>13:</td><td>*10.6</td><td>↑</td></tr> <tr><td>14:</td><td>*10.6</td><td>↘</td></tr> <tr><td>15:</td><td>*10.5</td><td>↘</td></tr> <tr><td>16:</td><td>*10.3</td><td>↘</td></tr> <tr><td>17:</td><td>9.5</td><td>←</td></tr> <tr><td>18:</td><td>*10.8</td><td>↗</td></tr> <tr><td>19:</td><td>9.6</td><td>←</td></tr> <tr><td>20:</td><td>8.6</td><td>↖</td></tr> <tr><td colspan="2">Series</td><td>94.0</td></tr> <tr><td colspan="2">Total</td><td>187.0</td></tr> </table>	11:	9.9	←	12:	9.9	←	13:	*10.6	↑	14:	*10.6	↘	15:	*10.5	↘	16:	*10.3	↘	17:	9.5	←	18:	*10.8	↗	19:	9.6	←	20:	8.6	↖	Series		94.0	Total		187.0	<p>40 Shots</p>  <table border="1" style="width:100%; border-collapse: collapse;"> <tr><td>21:</td><td>*10.2</td><td>←</td></tr> <tr><td>22:</td><td>9.1</td><td>←</td></tr> <tr><td>23:</td><td>9.6</td><td>↓</td></tr> <tr><td>24:</td><td>*10.6</td><td>↓</td></tr> <tr><td>25:</td><td>8.9</td><td>←</td></tr> <tr><td>26:</td><td>8.0</td><td>←</td></tr> <tr><td>27:</td><td>*10.4</td><td>↓</td></tr> <tr><td>28:</td><td>*10.7</td><td>→</td></tr> <tr><td>29:</td><td>*10.3</td><td>↓</td></tr> <tr><td>30:</td><td>*10.5</td><td>↓</td></tr> <tr><td colspan="2">Series</td><td>94.0</td></tr> <tr><td colspan="2">Total</td><td>281.0</td></tr> </table>	21:	*10.2	←	22:	9.1	←	23:	9.6	↓	24:	*10.6	↓	25:	8.9	←	26:	8.0	←	27:	*10.4	↓	28:	*10.7	→	29:	*10.3	↓	30:	*10.5	↓	Series		94.0	Total		281.0
11:	9.9	←																																																																							
12:	9.9	←																																																																							
13:	*10.6	↑																																																																							
14:	*10.6	↘																																																																							
15:	*10.5	↘																																																																							
16:	*10.3	↘																																																																							
17:	9.5	←																																																																							
18:	*10.8	↗																																																																							
19:	9.6	←																																																																							
20:	8.6	↖																																																																							
Series		94.0																																																																							
Total		187.0																																																																							
21:	*10.2	←																																																																							
22:	9.1	←																																																																							
23:	9.6	↓																																																																							
24:	*10.6	↓																																																																							
25:	8.9	←																																																																							
26:	8.0	←																																																																							
27:	*10.4	↓																																																																							
28:	*10.7	→																																																																							
29:	*10.3	↓																																																																							
30:	*10.5	↓																																																																							
Series		94.0																																																																							
Total		281.0																																																																							

<p>40 Shots</p>  <table border="1" style="width:100%; border-collapse: collapse;"> <tr><td>31:</td><td>9.7</td><td>←</td></tr> <tr><td>32:</td><td>*10.2</td><td>↘</td></tr> <tr><td>33:</td><td>9.7</td><td>↘</td></tr> <tr><td>34:</td><td>9.6</td><td>↗</td></tr> <tr><td>35:</td><td>9.5</td><td>↗</td></tr> <tr><td>36:</td><td>9.6</td><td>↖</td></tr> <tr><td>37:</td><td>9.3</td><td>↘</td></tr> <tr><td>38:</td><td>7.6</td><td>↗</td></tr> <tr><td>39:</td><td>9.7</td><td>↓</td></tr> <tr><td>40:</td><td>9.2</td><td>↗</td></tr> <tr><td colspan="2">Series</td><td>89.0</td></tr> <tr><td colspan="2">Total</td><td>370.0</td></tr> </table>	31:	9.7	←	32:	*10.2	↘	33:	9.7	↘	34:	9.6	↗	35:	9.5	↗	36:	9.6	↖	37:	9.3	↘	38:	7.6	↗	39:	9.7	↓	40:	9.2	↗	Series		89.0	Total		370.0	
31:	9.7	←																																			
32:	*10.2	↘																																			
33:	9.7	↘																																			
34:	9.6	↗																																			
35:	9.5	↗																																			
36:	9.6	↖																																			
37:	9.3	↘																																			
38:	7.6	↗																																			
39:	9.7	↓																																			
40:	9.2	↗																																			
Series		89.0																																			
Total		370.0																																			

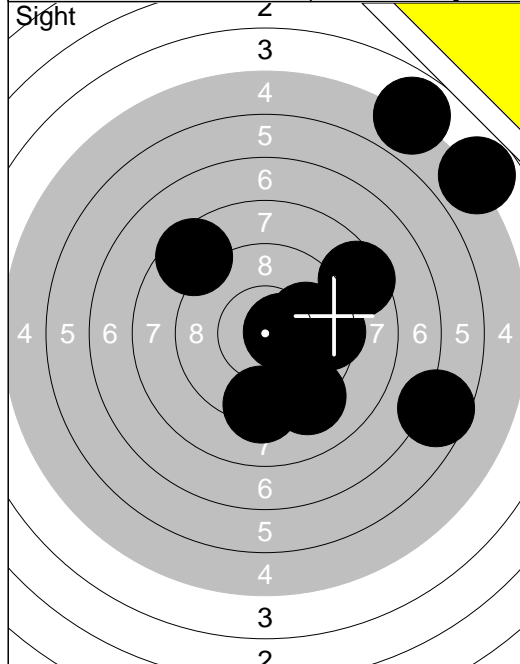

1:	4.8	↗
2:	9.9	→
3:	9.2	↘
4:	*10.6	→
5:	8.5	↗
6:	6.6	→
7:	9.3	↘
8:	9.5	→
9:	4.8	↗
10:	8.5	↖
Series		76.0
Total		0.0

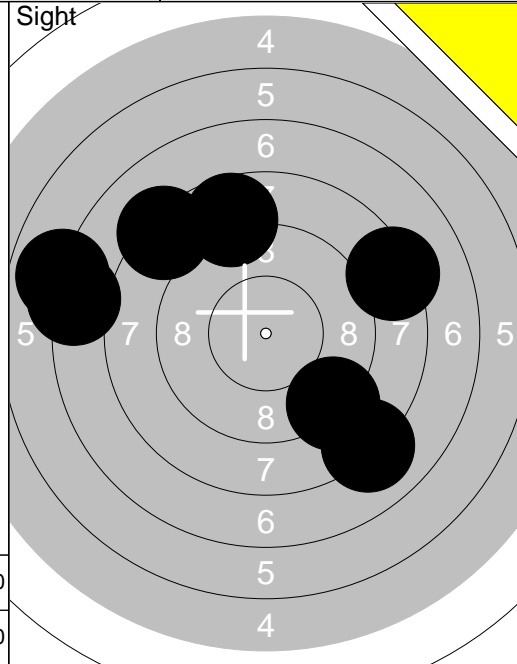

11:	8.0	↘
12:	8.7	↗
13:	8.2	↗
14:	7.2	↖
15:	8.3	↗
16:	9.1	↘
17:	6.9	↖
Series		54.0
Total		0.0

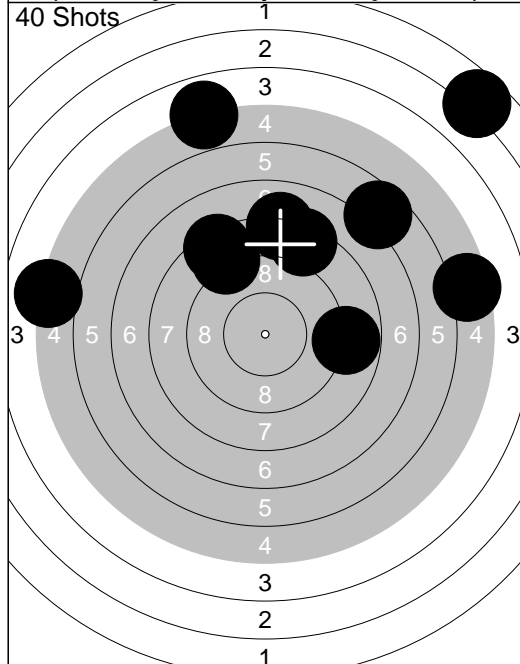

1:	8.1	↑
2:	2.6	↗
3:	6.6	↗
4:	8.8	→
5:	8.3	↗
6:	5.4	→
7:	8.7	↗
8:	4.9	↑
9:	5.1	↖
10:	8.3	↑
Series		62.0
Total		62.0

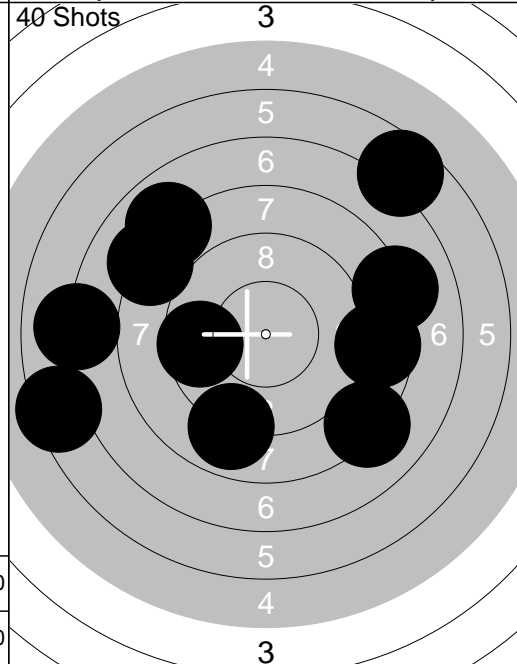

11:	8.1	→
12:	7.0	↖
13:	6.4	↖
14:	7.9	↗
15:	8.9	↘
16:	8.6	→
17:	6.6	↗
18:	8.1	↖
19:	9.6	↖
20:	8.1	↘
Series		75.0
Total		137.0

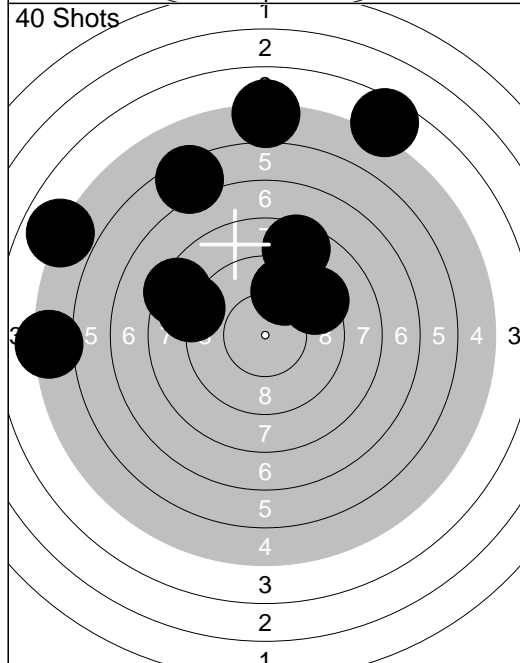

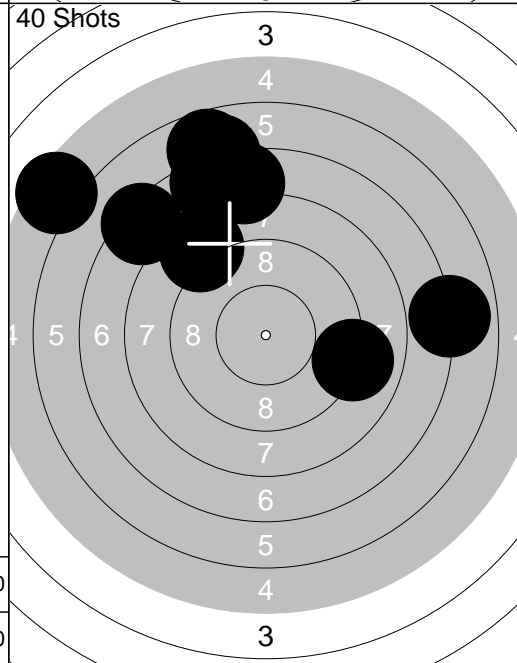

21:	5.2	↖
22:	8.9	↖
23:	9.7	↗
24:	9.3	↗
25:	5.1	↑
26:	4.9	↖
27:	4.5	↗
28:	6.4	↗
29:	8.4	↖
30:	8.5	↑
Series		66.0
Total		203.0

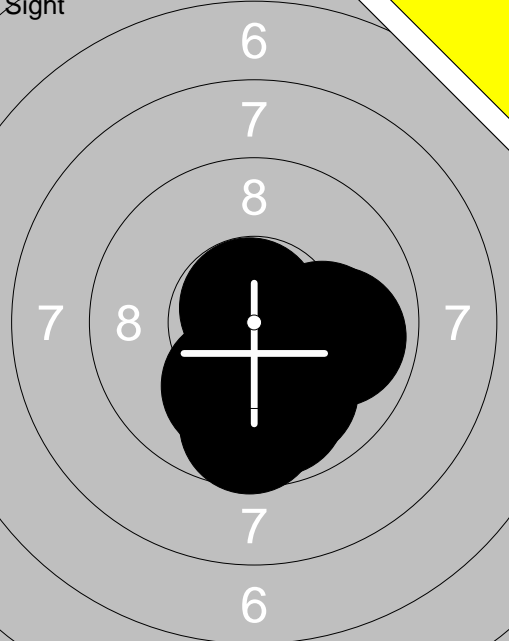
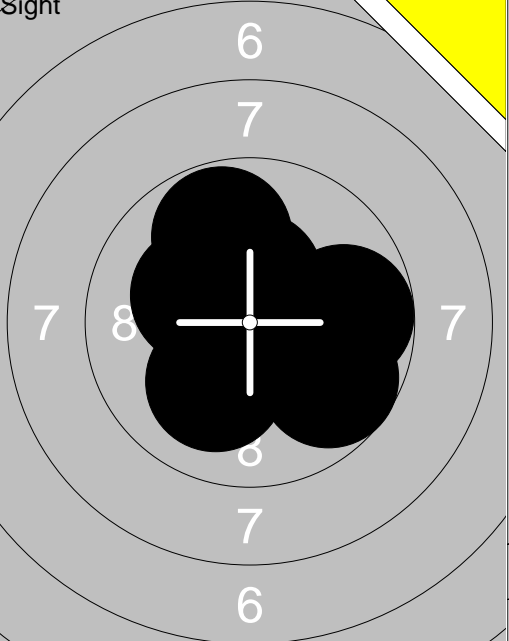

31:	8.6	↗
32:	7.4	↗
33:	9.0	→
34:	5.4	↗
35:	8.6	↗
36:	7.6	↑
37:	6.9	→
38:	7.3	↗
39:	6.7	↗
40:	6.9	↑
Series		69.0
Total		272.0

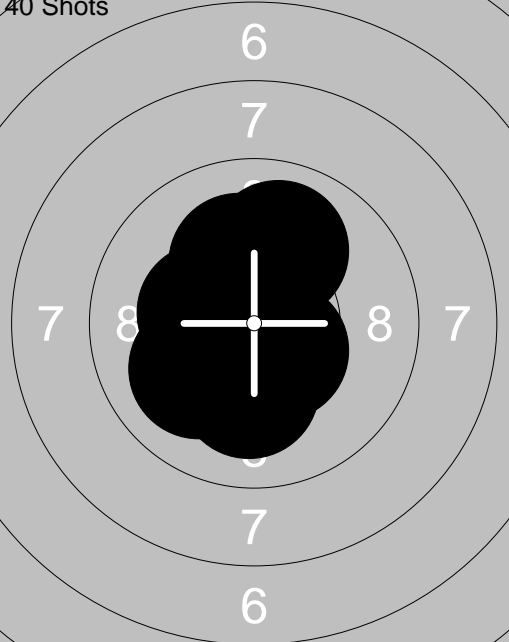
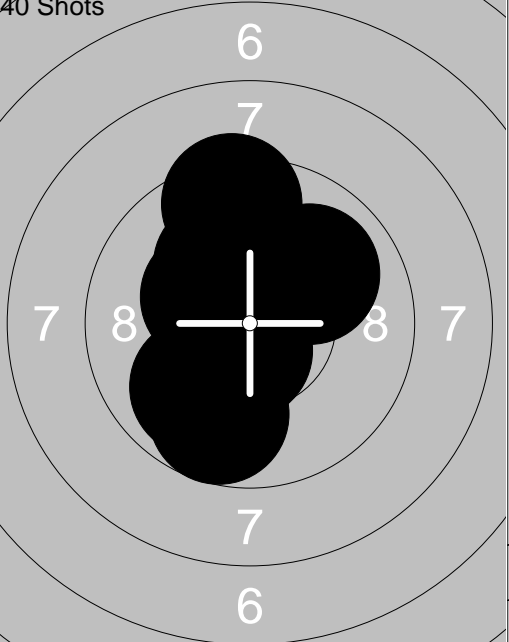
<p>Sight</p> 	<p>Sight</p> 	
<p>1: *10.6 ↓</p> <p>2: *10.7 →</p> <p>3: 9.7 ↓</p> <p>4: 10.1 ↓</p> <p>5: *10.8 ↑</p> <p>6: 10.0 ↓</p> <p>7: *10.5 ↓</p> <p>8: 9.9 ↓</p> <p>9: 9.9 →</p> <p>10: 10.1 →</p>	<p>11: 9.7 →</p> <p>12: 10.1 ↓</p> <p>13: 9.7 ↘</p> <p>14: *10.4 ↖</p> <p>15: *10.4 ↑</p> <p>16: 9.8 ↑</p> <p>17: *10.2 ↖</p>	
Series 97.0	Series 67.0	
Total 0.0	Total 0.0	

<p>40 Shots</p> 	<p>40 Shots</p> 	
<p>1: 10.0 ↑</p> <p>2: *10.5 ↓</p> <p>3: *10.2 ↑</p> <p>4: *10.7 ↖</p> <p>5: 10.1 ↓</p> <p>6: *10.2 ↑</p> <p>7: *10.3 ↖</p> <p>8: *10.6 ↓</p> <p>9: 10.0 ↖</p> <p>10: *10.6 ↖</p>	<p>11: 10.0 ↗</p> <p>12: *10.4 ↓</p> <p>13: *10.2 ↖</p> <p>14: *10.7 ↖</p> <p>15: 10.1 ↓</p> <p>16: *10.6 ↓</p> <p>17: *10.3 ↖</p> <p>18: 9.4 ↑</p> <p>19: 9.7 ↓</p> <p>20: 9.9 ↖</p>	
Series 100.0	Series 97.0	
Total 100.0	Total 197.0	

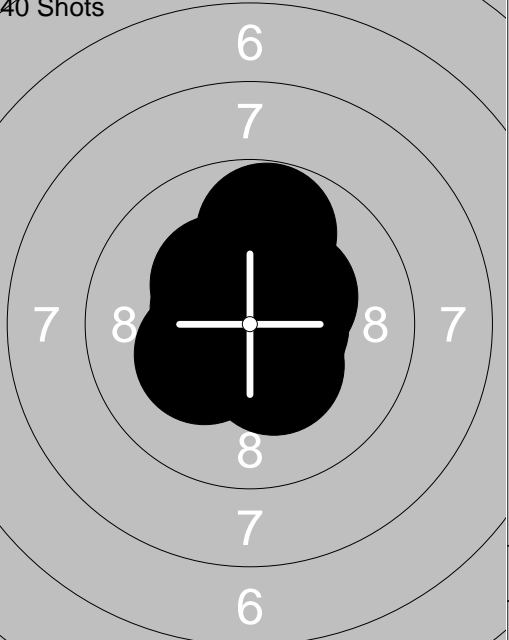
<p>40 Shots</p> 	<p>40 Shots</p> 	
<p>21: *10.5 ↑</p> <p>22: 9.8 ↖</p> <p>23: *10.5 ↓</p> <p>24: 9.9 ↗</p> <p>25: 9.7 ↖</p> <p>26: *10.2 ↖</p> <p>27: *10.2 ↑</p> <p>28: *10.3 ↗</p> <p>29: *10.6 ↑</p> <p>30: *10.2 ↗</p>	<p>31: *10.5 ↓</p> <p>32: *10.3 ↖</p> <p>33: *10.6 →</p> <p>34: *10.5 ↖</p> <p>35: *10.4 ↖</p> <p>36: *10.3 ↖</p> <p>37: *10.3 ↓</p> <p>38: 9.8 ↑</p> <p>39: *10.8 ↖</p> <p>40: *10.4 ↗</p>	
Series 97.0	Series 99.0	
Total 294.0	Total 393.0	

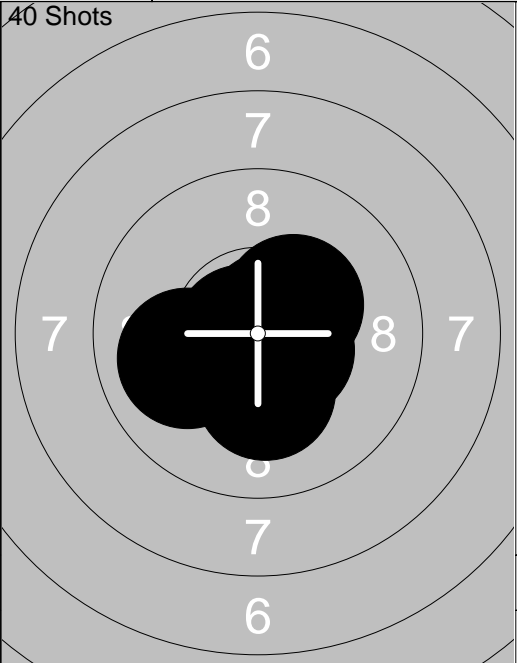
Sight 	1: 9.9 ↓	40 Shots 	1: *10.6 ↓
	2: *10.5 ↓		2: *10.4 ↗
	3: *10.3 ↓		3: *10.6 ↗
	4: *10.7 ↓		4: *10.9 →
	5: *10.7 ↙		5: *10.6 ↘
	6: *10.6 ↗		6: *10.7 ↗
	7: *10.6 ↗		7: *10.6 ↓
	8: *10.7 ↙		8: *10.2 ↓
	9: *10.4 →		9: 10.0 ←
	10: *10.7 ↗		10: *10.8 ←
Series	99.0	Series	100.0
Total	0.0	Total	100.0

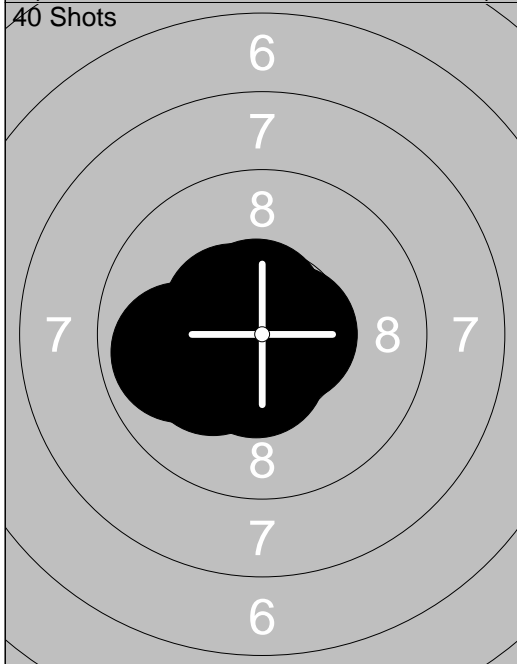
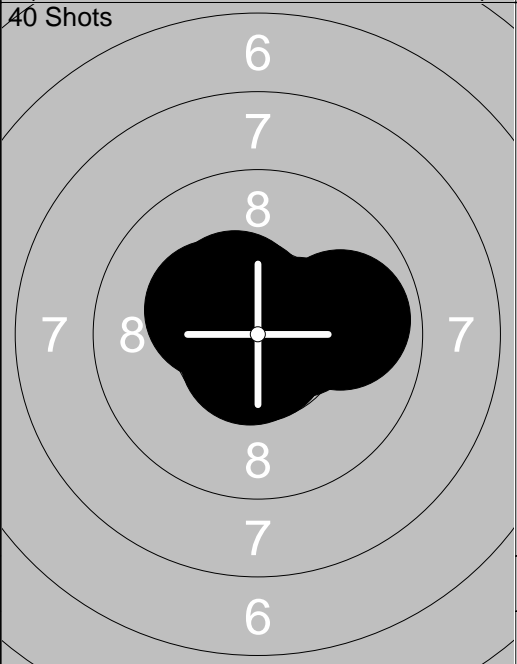
40 Shots 	11: *10.7 ↖	40 Shots 	21: *10.3 ↖
	12: *10.5 ↓		22: *10.4 ↖
	13: *10.6 ↑		23: *10.7 ↓
	14: *10.2 ↙		24: *10.8 ↓
	15: *10.7 ↖		25: *10.8 ↘
	16: 9.9 ←		26: *10.6 ↖
	17: *10.3 ↙		27: *10.8 ←
	18: *10.5 ↖		28: *10.4 →
	19: *10.6 →		29: 9.9 →
	20: *10.7 ↓		30: *10.7 ↓
Series	99.0	Series	99.0
Total	199.0	Total	298.0

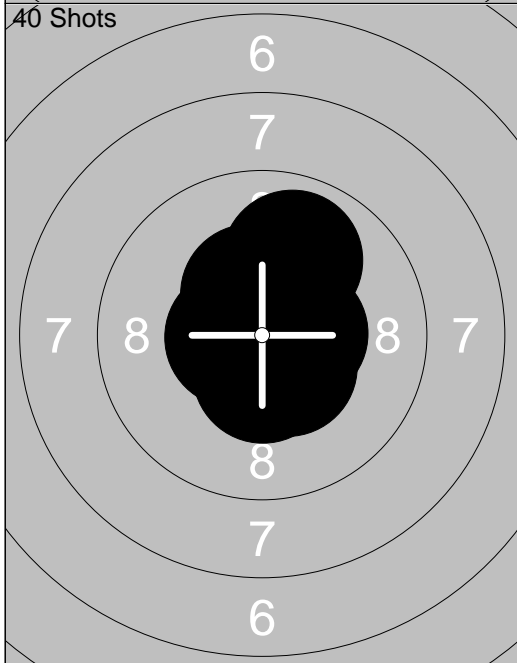
40 Shots 	31: *10.8 ↓	
	32: 9.9 ↗	
	33: *10.6 ↗	
	34: *10.4 ↗	
	35: *10.7 ↓	
	36: *10.5 ↓	
	37: *10.6 ←	
	38: *10.5 →	
	39: *10.4 ↓	
	40: *10.8 ↙	
Series	99.0	
Total	397.0	

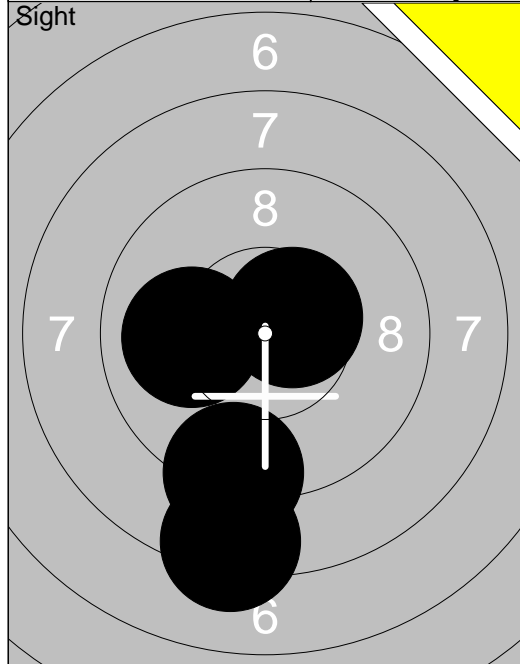

40 Shots

1:	9.1	↓
2:	8.3	↓
3:	10.0	←
4:	*10.5	↗
Series		37.0
Total		0.0

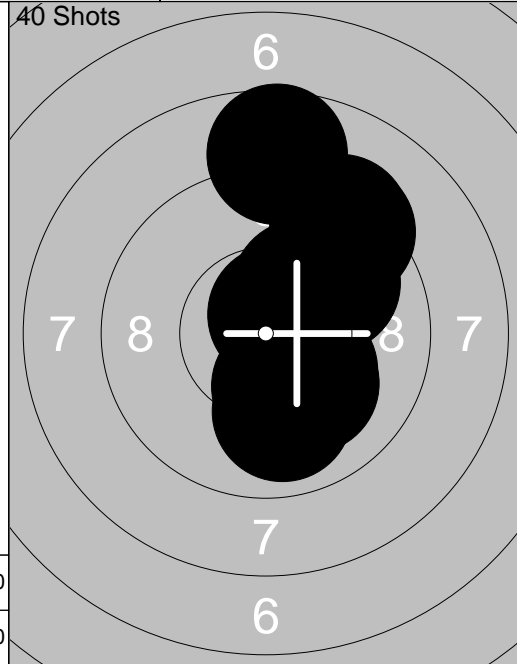

40 Shots

1:	9.9	↓
2:	8.7	↑
3:	*10.2	↗
4:	*10.2	↘
5:	9.9	↗
6:	*10.2	↓
7:	10.1	↘
8:	9.3	↗
9:	9.3	↗
10:	*10.7	↗
Series		94.0
Total		94.0

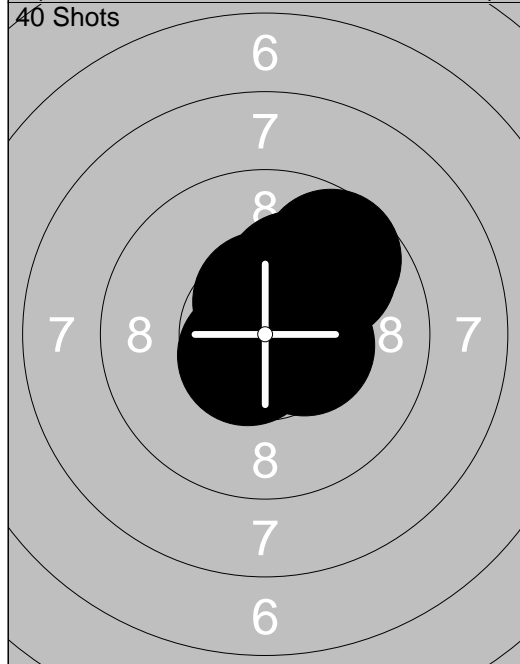

40 Shots

11:	*10.5	↗
12:	*10.5	↑
13:	*10.2	↗
14:	9.8	↗
15:	*10.4	→
16:	*10.4	↑
17:	9.7	↗
18:	*10.7	↗
19:	*10.5	→
20:	*10.6	↘
Series		98.0
Total		192.0

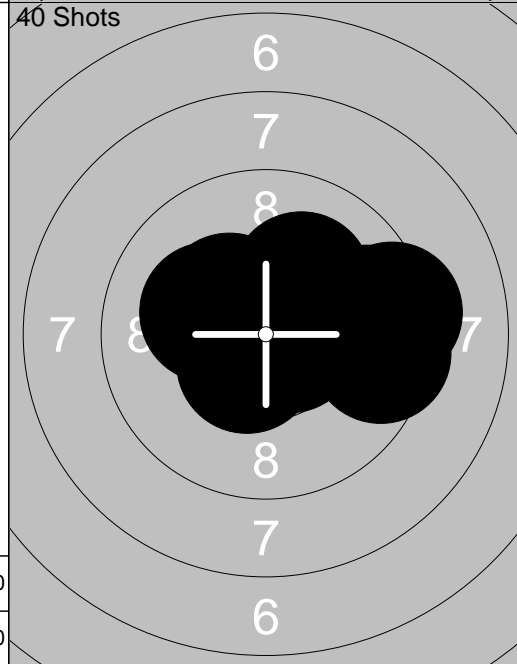

40 Shots

21:	*10.8	↓
22:	10.1	↗
23:	9.5	→
24:	9.3	→
25:	9.6	→
26:	*10.5	↘
27:	*10.2	↖
28:	*10.3	↖
29:	*10.6	→
30:	*10.7	↖
Series		97.0
Total		289.0

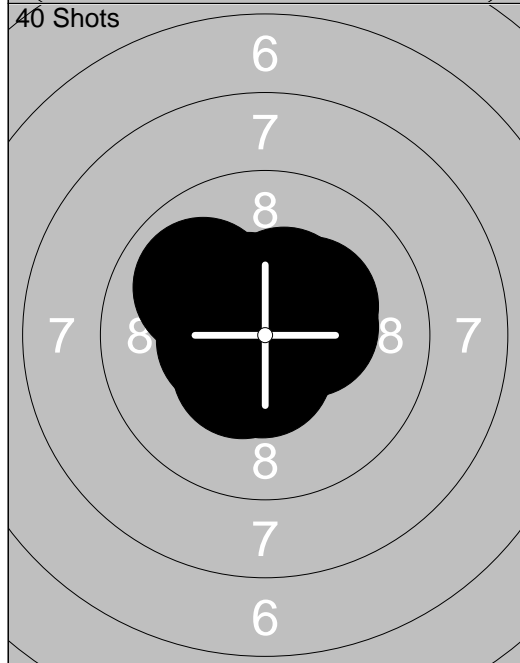

40 Shots

31:	*10.3	↗
32:	*10.4	↘
33:	*10.4	↗
34:	*10.5	↓
35:	*10.6	↓
36:	*10.5	↖
37:	9.9	↖
38:	*10.4	→
39:	*10.5	←
40:	*10.7	↘
Series		99.0
Total		388.0

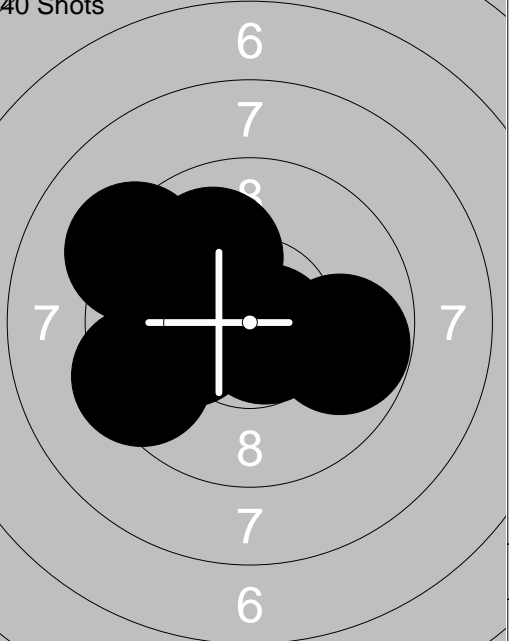
<p>Sight</p>  <p>6 7 8 7 8 7 7 6</p>	<p>1: *10.7 ↘ 2: 10.0 ↓ 3: 10.1 ← 4: *10.4 ↖</p>	<p>40 Shots</p>  <p>6 7 8 7 8 7 8 7 6</p>	<p>1: *10.4 ↖ 2: 9.2 ↗ 3: 9.9 ↗ 4: 9.8 → 5: 10.1 ← 6: 10.1 ← 7: *10.7 ↘ 8: 10.1 ← 9: 10.0 ↗ 10: 9.4 ↙</p>
<p>Series 40.0</p> <p>Total 0.0</p>		<p>Series 96.0</p> <p>Total 96.0</p>	

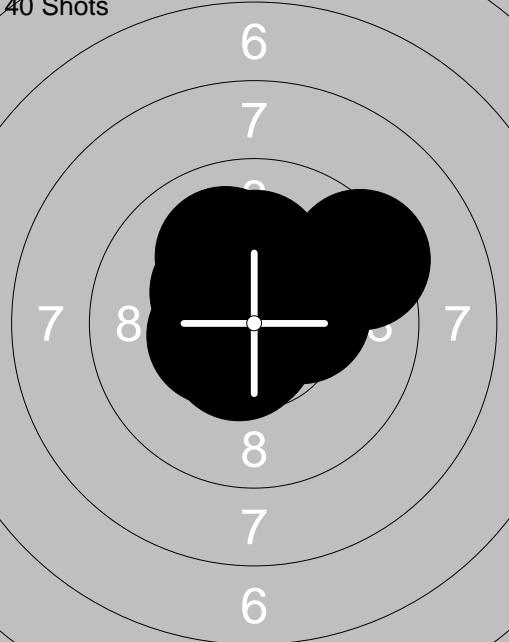
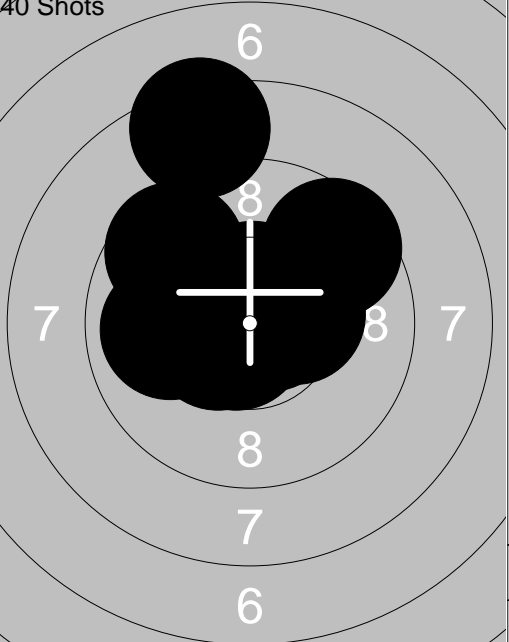
<p>40 Shots</p>  <p>6 7 8 7 8 7 8 7 6</p>	<p>11: *10.3 → 12: *10.2 ↑ 13: *10.6 ↓ 14: *10.6 ↓ 15: 10.1 ↗ 16: *10.6 ↖ 17: 9.4 ↗ 18: *10.5 ← 19: 10.0 ↗ 20: *10.4 ↖</p>	<p>40 Shots</p>  <p>6 8 7 8 7 8 7 6</p>	<p>21: *10.7 ↙ 22: *10.9 ↓ 23: 9.5 ↗ 24: 9.9 ← 25: *10.5 ↑ 26: *10.4 → 27: *10.7 → 28: 9.6 ↖ 29: *10.5 ↙ 30: 8.4 ↑</p>
<p>Series 99.0</p> <p>Total 195.0</p>		<p>Series 95.0</p> <p>Total 290.0</p>	

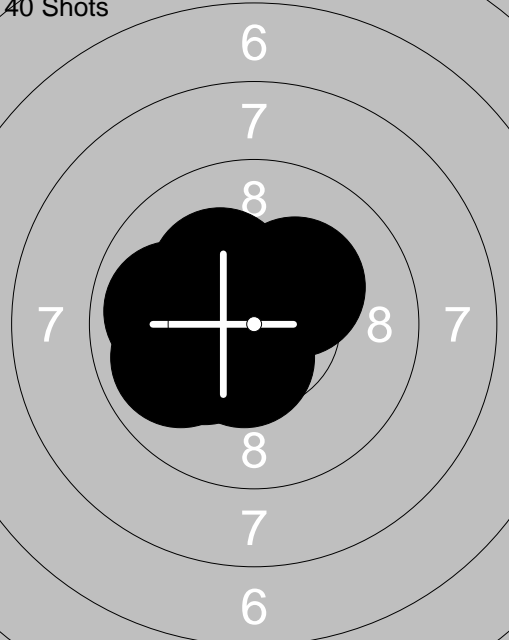
<p>40 Shots</p>  <p>6 7 8 7 8 7 8 7 6</p>	<p>31: *10.2 ↖ 32: *10.6 ↖ 33: 9.9 ← 34: 10.1 ← 35: *10.5 ↓ 36: 9.9 ← 37: *10.2 ↙ 38: *10.2 ↗ 39: *10.3 ← 40: *10.8 ↙</p>		
<p>Series 98.0</p> <p>Total 388.0</p>			

<p>Sight</p>	<p>Sight</p>	<p>11: *10.7 ←</p>
Series 98.0	Series 10.0	
Total 0.0	Total 0.0	

<p>40 Shots</p>	<p>40 Shots</p>	<p>11: *10.5 ↓ 12: *10.8 ↓ 13: *10.6 → 14: 10.0 ← 15: *10.5 ← 16: *10.7 ↓ 17: *10.4 ← 18: *10.7 ↓ 19: *10.8 ↖ 20: *10.7 ↓</p>
Series 100.0	Series 100.0	
Total 100.0	Total 200.0	

<p>40 Shots</p>	<p>40 Shots</p>	<p>31: *10.6 ↓ 32: *10.8 ↙ 33: *10.5 → 34: *10.6 ↓ 35: *10.4 ↓ 36: *10.8 → 37: *10.9 ↖ 38: *10.5 ↙ 39: *10.8 ↓ 40: *10.8 ↓</p>
Series 100.0	Series 100.0	
Total 300.0	Total 400.0	

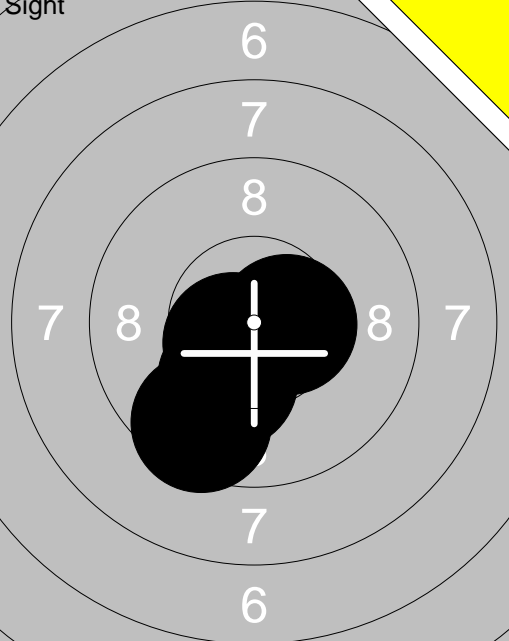
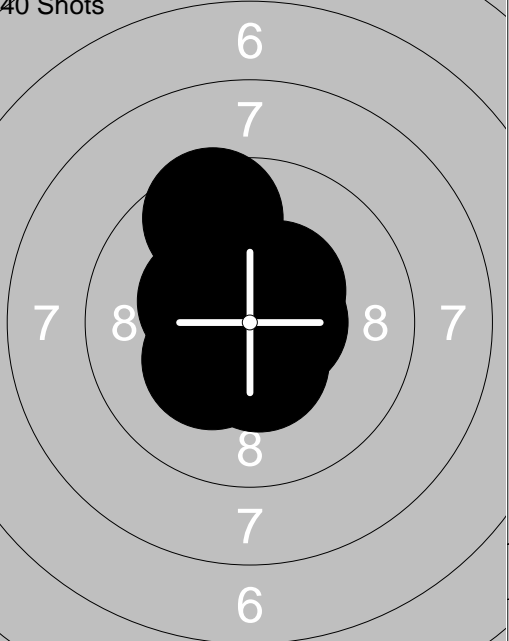
<p>Sight</p>  <p>6 7 8 7 8 8 7 7 6</p>	<p>1: 9.5 ↙ 2: *10.5 → 3: 10.1 ↓ 4: *10.6 ↙</p>	<p>40 Shots</p>  <p>6 7 8 7 8 8 7 8 7 6</p>	<p>1: *10.3 ↙ 2: *10.3 ↖ 3: *10.4 ↓ 4: *10.7 ↙ 5: *10.8 ↓ 6: *10.4 ↗ 7: *10.4 ↖ 8: *10.6 → 9: 9.5 ↗ 10: *10.5 ↗</p>
	<p>Series 39.0 Total 0.0</p>		<p>Series 99.0 Total 99.0</p>

<p>40 Shots</p>  <p>6 7 8 7 8 8 7 8 7 6</p>	<p>11: *10.5 ↓ 12: *10.8 ↖ 13: *10.8 ↑ 14: *10.4 ← 15: *10.8 → 16: *10.3 ↓ 17: *10.8 ↗ 18: *10.6 ↙ 19: *10.6 ↓ 20: *10.8 ↙</p>	<p>40 Shots</p>  <p>6 7 8 7 8 8 7 8 7 6</p>	<p>21: *10.5 ↗ 22: *10.4 ← 23: *10.7 ↓ 24: *10.5 ← 25: *10.6 ↓ 26: *10.5 ↙ 27: *10.6 ↙ 28: *10.7 ↓ 29: *10.9 ↓ 30: *10.6 ↓</p>
	<p>Series 100.0 Total 199.0</p>		<p>Series 100.0 Total 299.0</p>

<p>40 Shots</p>  <p>6 7 8 7 8 8 7 8 7 6</p>	<p>31: 9.8 ↗ 32: *10.4 ↗ 33: *10.6 ↓ 34: *10.7 ↑ 35: *10.4 ↓ 36: *10.4 ↑ 37: *10.4 → 38: *10.7 → 39: *10.3 ← 40: *10.4 ↙</p>	
	<p>Series 99.0 Total 398.0</p>	

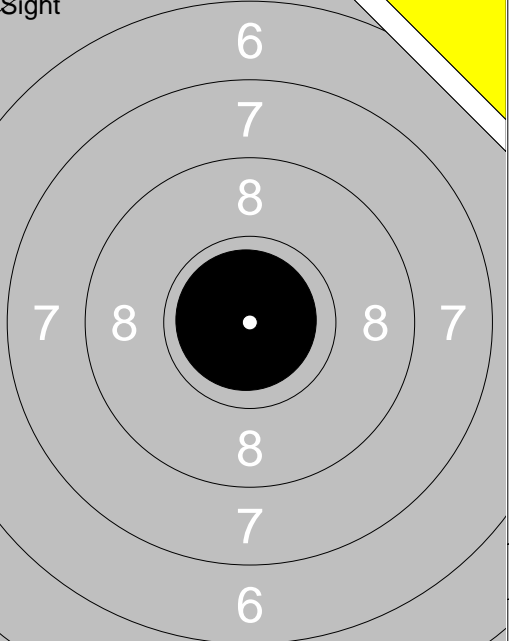
<p>Sight</p> 	<p>1: *10.4 ↓</p> <p>2: 10.1 ↓</p> <p>3: 9.2 ↓</p> <p>4: *10.2 ↓</p> <p>5: 9.8 ↓</p> <p>6: *10.3 ↙</p> <p>7: *10.5 ↓</p> <p>8: *10.3 →</p> <p>9: 9.9 ↙</p> <p>10: *10.4 ↓</p>	<p>Sight</p> 	<p>11: *10.9 ↖</p>
Series	97.0	Series	10.0
Total	0.0	Total	0.0

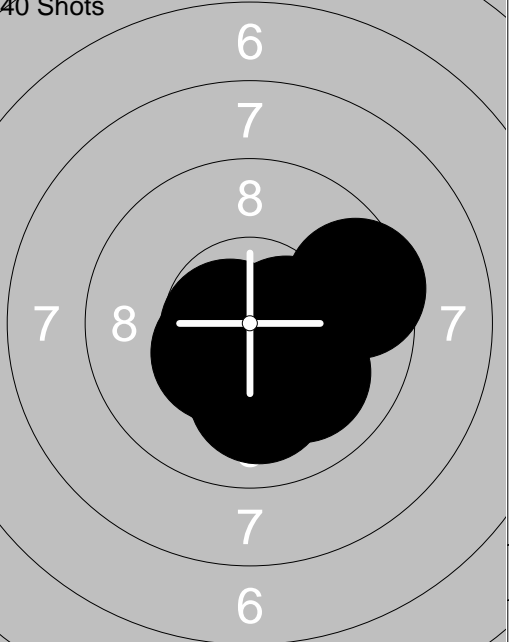
<p>40 Shots</p> 	<p>1: *10.4 ↗</p> <p>2: *10.7 →</p> <p>3: 10.1 ↖</p> <p>4: *10.3 ↗</p> <p>5: 9.4 ↖</p> <p>6: *10.4 ↗</p> <p>7: 10.0 ↓</p> <p>8: *10.3 ↓</p> <p>9: 10.1 ↖</p> <p>10: *10.5 ↙</p>	<p>40 Shots</p> 	<p>11: *10.6 ↙</p> <p>12: *10.5 →</p> <p>13: *10.4 ↓</p> <p>14: *10.7 ↖</p> <p>15: *10.4 ↓</p> <p>16: *10.4 ↖</p> <p>17: 10.1 ↓</p> <p>18: 10.0 ↓</p> <p>19: 9.5 →</p> <p>20: *10.3 ↓</p>
Series	99.0	Series	99.0
Total	99.0	Total	198.0

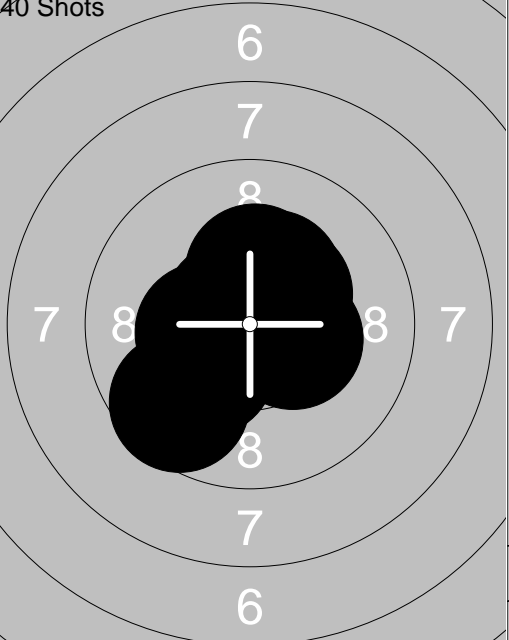
<p>40 Shots</p> 	<p>21: *10.6 ↙</p> <p>22: *10.7 →</p> <p>23: *10.2 ↓</p> <p>24: *10.2 ↖</p> <p>25: 9.9 →</p> <p>26: *10.9 ↙</p> <p>27: *10.6 ↙</p> <p>28: *10.9 ↖</p> <p>29: *10.3 ↙</p> <p>30: *10.8 ↖</p>	<p>40 Shots</p> 	<p>31: *10.4 ↗</p> <p>32: *10.3 ↗</p> <p>33: *10.6 →</p> <p>34: *10.4 ↖</p> <p>35: *10.6 →</p> <p>36: *10.7 ↖</p> <p>37: *10.2 ↖</p> <p>38: 9.6 ↖</p> <p>39: *10.3 ↗</p> <p>40: *10.4 →</p>
Series	99.0	Series	99.0
Total	297.0	Total	396.0

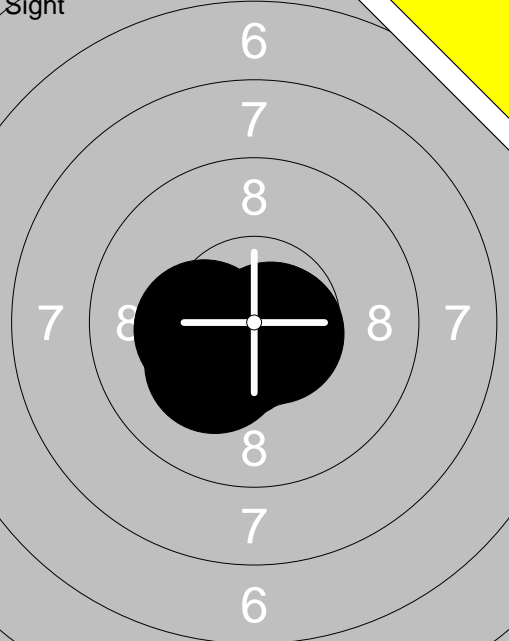
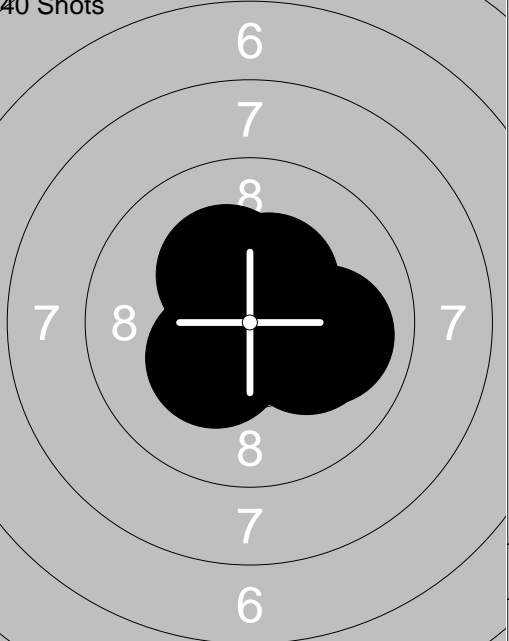
<p>Sight</p> 	<p>40 Shots</p> 	<p>1: *10.3 ←</p> <p>2: *10.5 ↙</p> <p>3: *10.7 →</p> <p>4: *10.2 ↙</p> <p>5: *10.7 →</p>	<p>1: *10.6 →</p> <p>2: *10.3 ↗</p> <p>3: *10.8 ←</p> <p>4: *10.7 ↘</p> <p>5: 10.0 →</p> <p>6: *10.2 ↘</p> <p>7: *10.3 ↙</p> <p>8: *10.4 ↗</p> <p>9: *10.6 →</p> <p>10: *10.7 ↘</p>
Series 50.0	Series 100.0		
Total 0.0	Total 100.0		

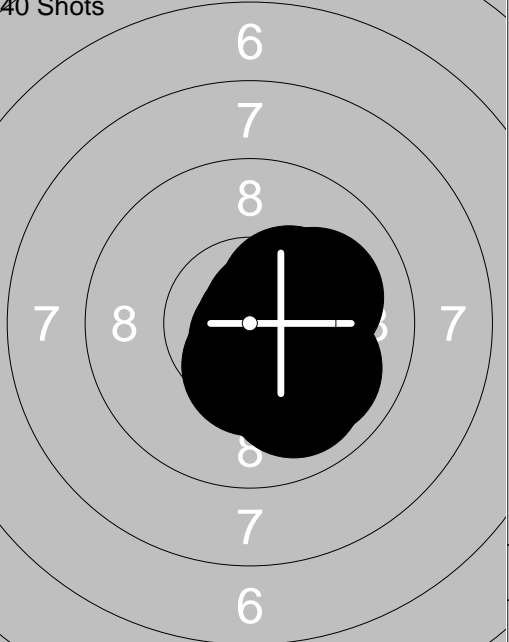
<p>40 Shots</p> 	<p>40 Shots</p> 	<p>11: *10.8 →</p> <p>12: *10.4 →</p> <p>13: *10.6 ←</p> <p>14: 9.9 ↘</p> <p>15: *10.8 ↗</p> <p>16: *10.8 ↘</p> <p>17: 9.9 ↘</p> <p>18: *10.3 ↘</p> <p>19: *10.2 ↘</p> <p>20: *10.3 →</p>	<p>21: *10.3 ↘</p> <p>22: 10.1 →</p> <p>23: *10.3 ↗</p> <p>24: *10.3 ↘</p> <p>25: *10.7 →</p> <p>26: *10.7 ↘</p> <p>27: *10.4 ↘</p> <p>28: 10.0 ↘</p> <p>29: 10.0 ↘</p> <p>30: *10.7 →</p>
Series 98.0	Series 100.0		
Total 198.0	Total 298.0		

<p>40 Shots</p> 	<p>31: *10.6 ←</p> <p>32: 9.9 ↓</p> <p>33: *10.4 ↗</p> <p>34: *10.8 ←</p> <p>35: *10.5 ←</p> <p>36: *10.2 ↘</p> <p>37: *10.7 →</p> <p>38: *10.3 ↘</p> <p>39: *10.3 ↘</p> <p>40: 9.5 →</p>		
Series 98.0			
Total 396.0			

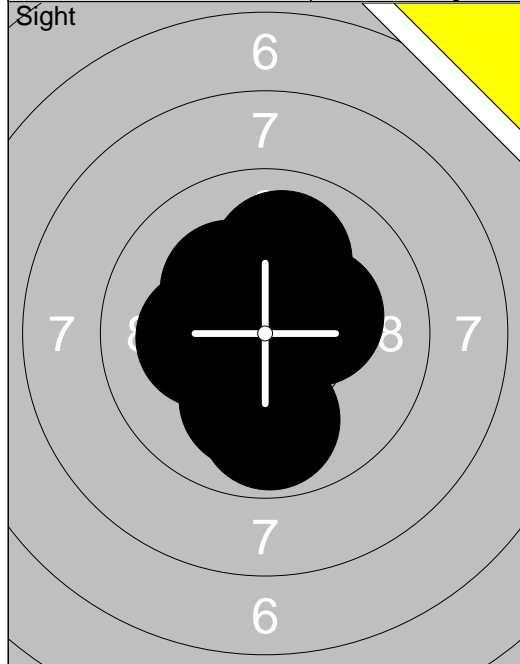

1:	9.8	↓
2:	*10.3	→
3:	10.1	↓
4:	*10.6	↖
5:	*10.7	↖
6:	*10.8	↑
7:	10.0	↑
8:	*10.4	↑
9:	*10.2	↖
10:	*10.2	←
Series		99.0
Total		0.0

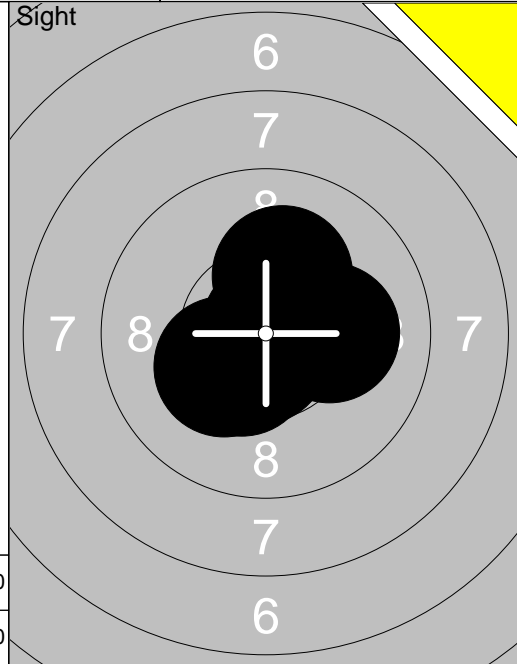

11:	*10.8	↗
12:	*10.2	↑
13:	10.1	→
14:	*10.3	↙
15:	*10.7	↓
16:	*10.4	↙
Series		60.0
Total		0.0

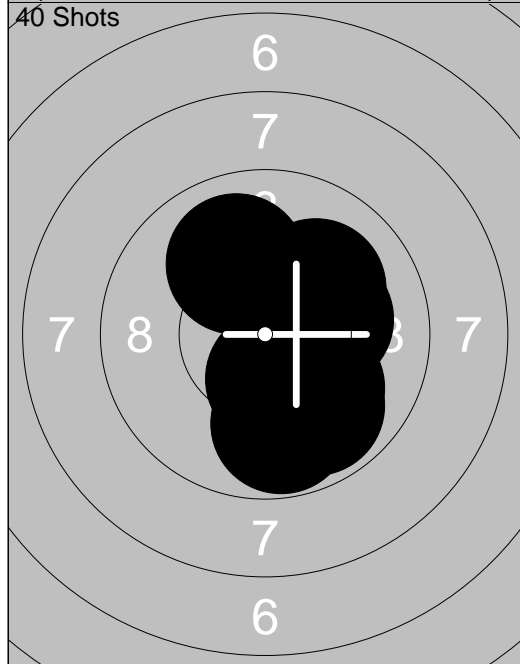

1:	10.1	↗
2:	*10.2	→
3:	*10.2	→
4:	10.0	↓
5:	*10.4	↓
6:	10.0	↑
7:	9.8	↓
8:	9.9	↓
9:	*10.4	↓
10:	9.8	↓
Series		97.0
Total		97.0

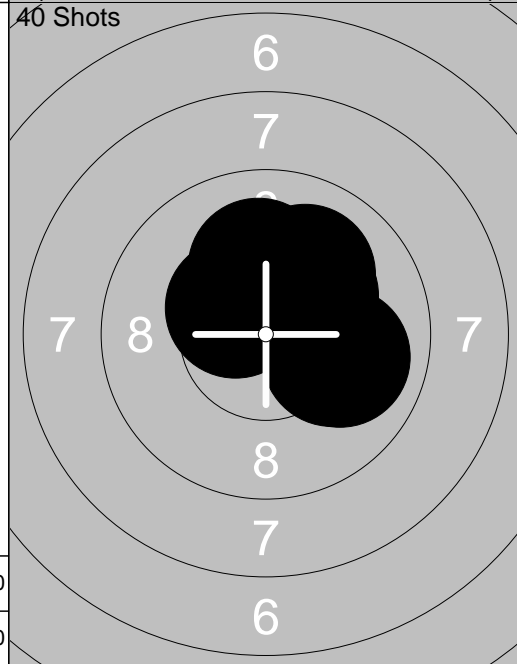

11:	*10.3	↗
12:	*10.3	↑
13:	*10.3	↑
14:	*10.4	↖
15:	10.1	→
16:	*10.2	↗
17:	10.1	↑
18:	10.0	→
19:	10.0	↗
20:	*10.5	↑
Series		100.0
Total		197.0

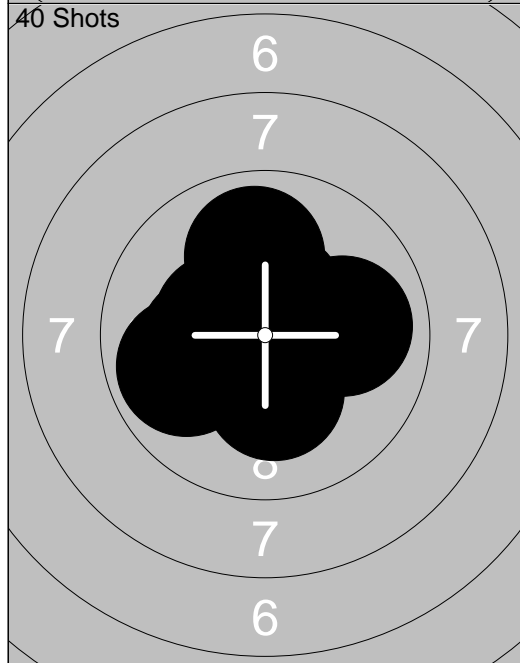

21:	*10.7	↑
22:	*10.4	←
23:	*10.5	↑
24:	9.9	←
25:	*10.2	↓
26:	*10.2	←
27:	10.0	→
28:	*10.8	←
29:	*10.4	←
30:	9.9	↑
Series		98.0
Total		295.0

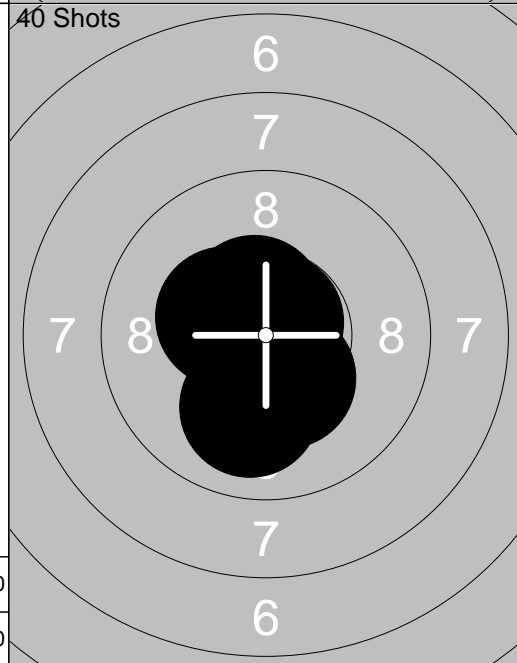

31:	*10.5	↖
32:	*10.4	↓
33:	*10.4	↖
34:	*10.9	↓
35:	*10.8	↗
36:	*10.8	↖
37:	*10.7	↙
38:	*10.5	↓
39:	10.0	↓
40:	*10.5	↖
Series		100.0
Total		395.0

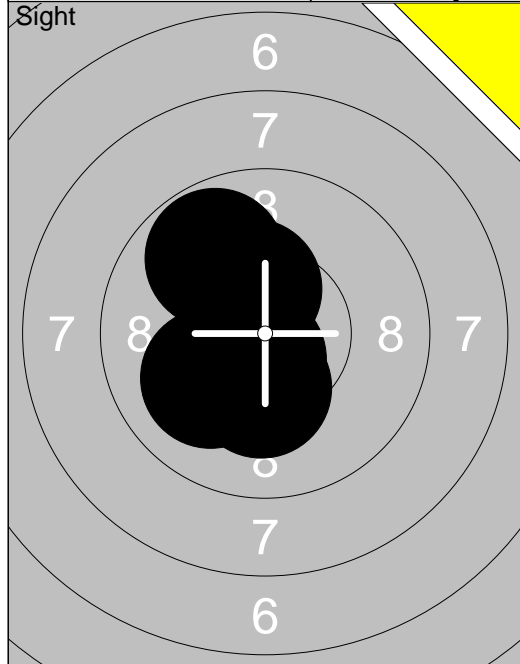

1:	10.0	↙
2:	9.8	↗
3:	*10.3	↓
4:	*10.6	↘
5:	*10.4	↗
Series		49.0
Total		0.0

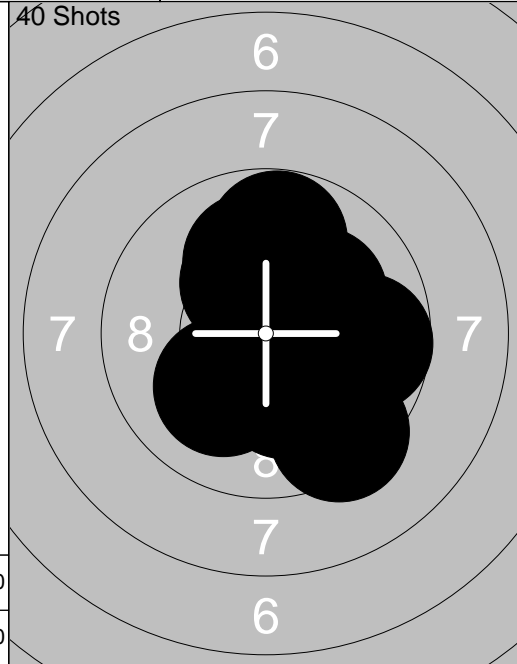

1:	10.0	↘
2:	9.4	↘
3:	10.0	↑
4:	10.0	↑
5:	10.1	↗
6:	9.7	→
7:	*10.2	↘
8:	10.1	↙
9:	*10.3	↑
10:	9.8	↑
Series		97.0
Total		97.0

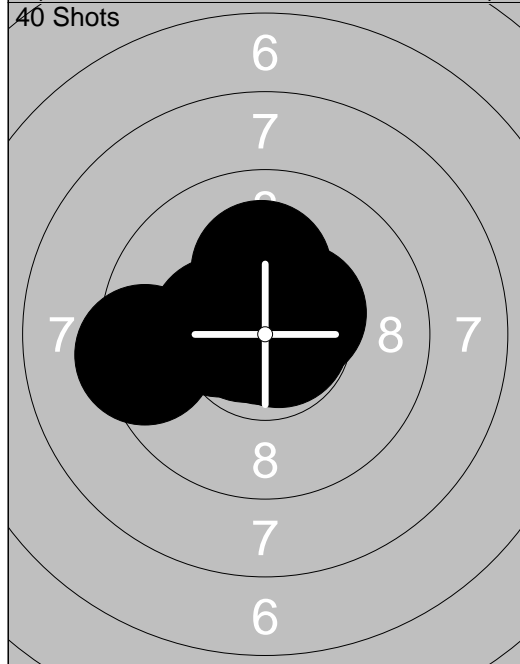

11:	9.4	←
12:	*10.8	→
13:	*10.8	↗
14:	*10.9	←
15:	*10.8	↙
16:	10.1	↑
17:	*10.9	↙
18:	*10.5	↗
19:	*10.7	←
20:	*10.4	←
Series		99.0
Total		196.0

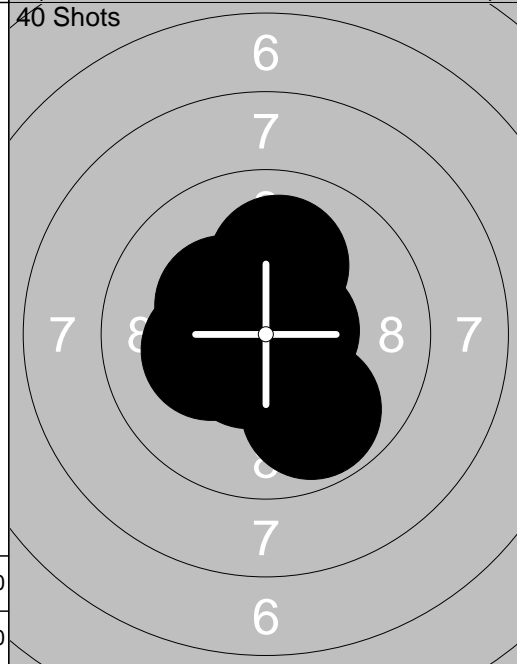

21:	10.1	↑
22:	*10.6	→
23:	*10.6	↙
24:	*10.2	←
25:	9.8	↘
26:	*10.7	↘
27:	*10.8	↗
28:	*10.3	↙
29:	*10.5	←
30:	*10.9	↗
Series		99.0
Total		295.0

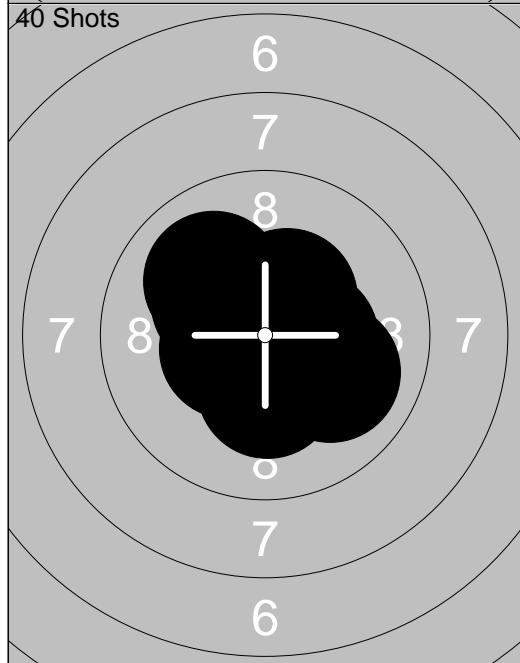

31:	*10.2	↙
32:	*10.4	↗
33:	10.0	↗
34:	*10.8	↘
35:	10.0	↘
36:	*10.3	↓
37:	*10.4	↗
38:	*10.4	→
39:	*10.6	↓
40:	*10.5	←
Series		100.0
Total		395.0

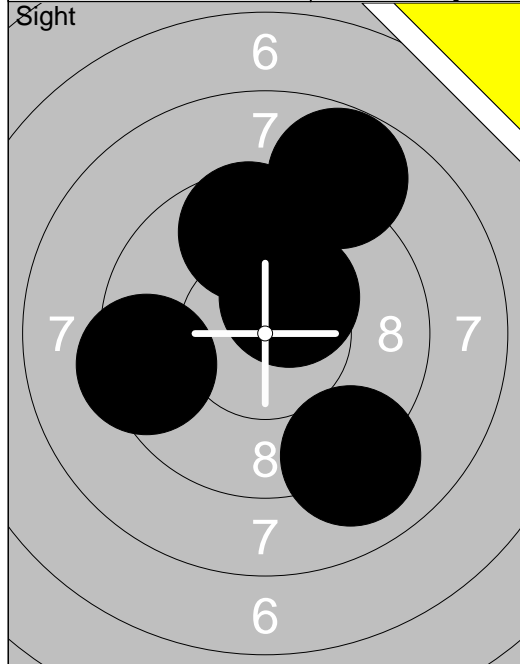

1:	9.0	↘
2:	9.6	↑
3:	9.4	←
4:	8.8	↑
5:	*10.4	↗
Series		45.0
Total		0.0

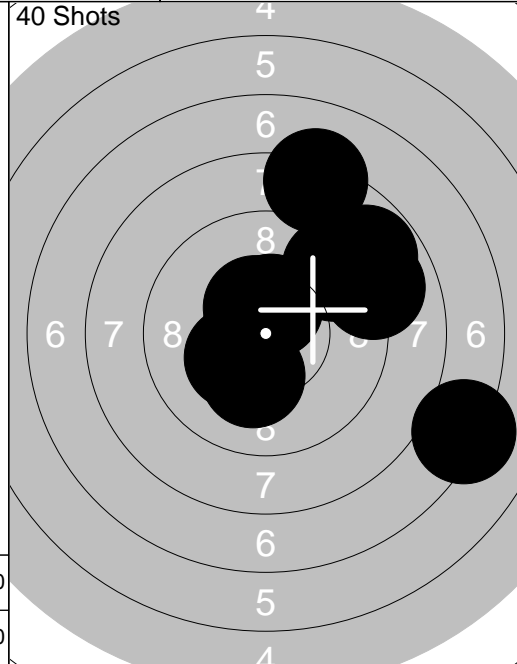

1:	8.2	↑
2:	8.8	↗
3:	*10.5	↑
4:	*10.5	↑
5:	*10.5	↑
6:	8.9	→
7:	*10.3	↙
8:	*10.2	↓
9:	9.3	↗
10:	7.2	↘
Series		90.0
Total		90.0

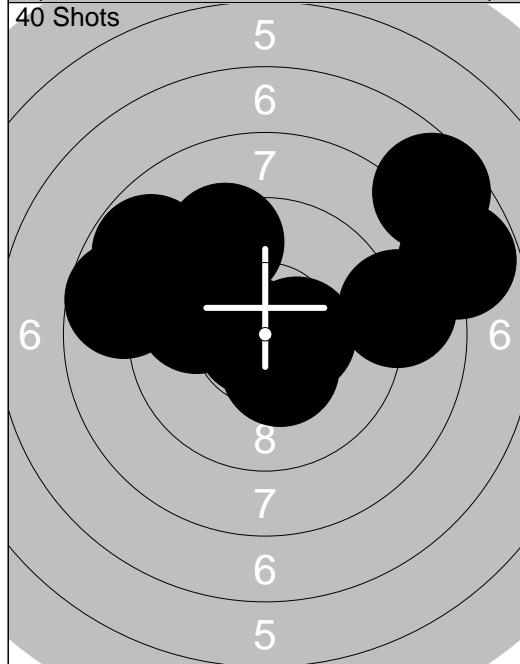

11:	7.8	→
12:	7.6	↗
13:	9.4	↑
14:	*10.4	↓
15:	*10.5	→
16:	8.8	↑
17:	8.7	←
18:	9.9	←
19:	*10.8	←
20:	8.9	→
Series		86.0
Total		176.0

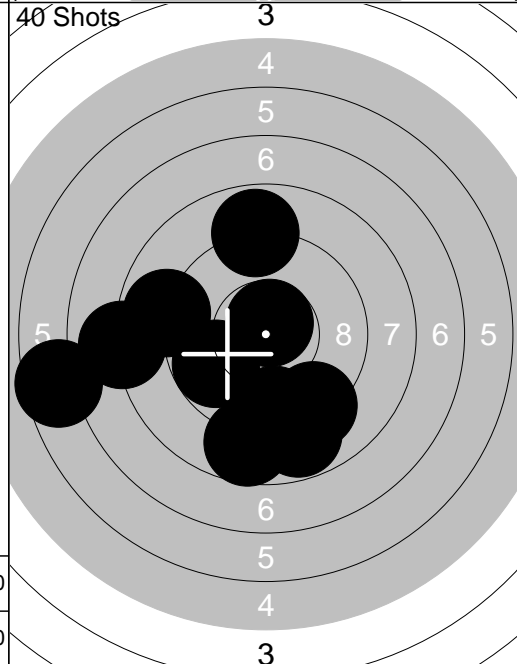

21:	9.8	↙
22:	9.4	↓
23:	8.7	↓
24:	8.8	↓
25:	8.8	↑
26:	8.9	←
27:	9.2	↘
28:	*10.7	↑
29:	8.0	←
30:	6.6	←
Series		83.0
Total		259.0

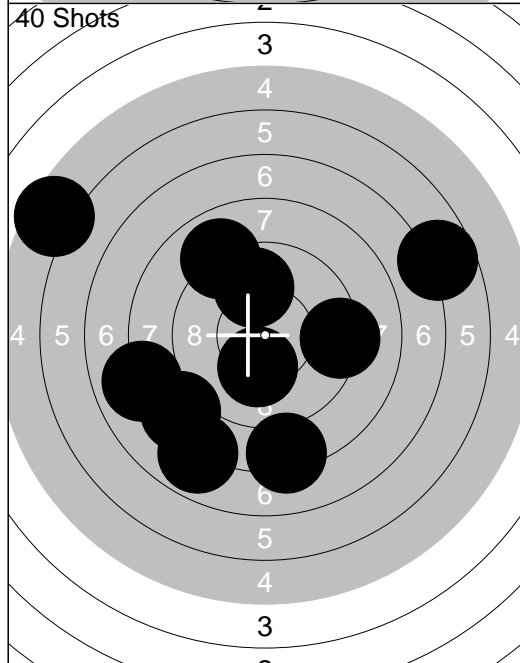

31:	8.0	←
32:	8.9	↑
33:	5.5	↖
34:	9.3	→
35:	6.7	↗
36:	8.2	↓
37:	9.8	↑
38:	8.4	↙
39:	*10.2	↓
40:	7.9	↘
Series		78.0
Total		337.0

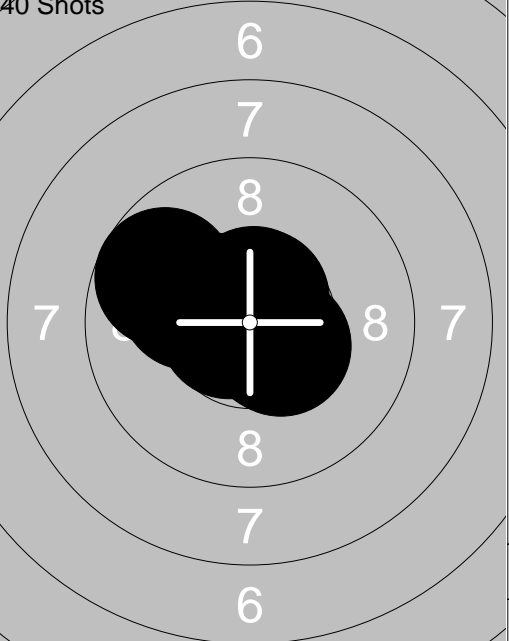
<p>Sight</p> 	<p>40 Shots</p> 	<p>1: *10.3 →</p> <p>2: *10.8 ←</p> <p>3: *10.6 ←</p> <p>4: 10.1 ↑</p> <p>5: 9.9 ↑</p> <p>6: *10.8 ↗</p> <p>7: *10.8 ↓</p> <hr/> <p>Series 69.0</p> <hr/> <p>Total 0.0</p>	<p>1: *10.7 ←</p> <p>2: *10.8 ↑</p> <p>3: *10.5 ↘</p> <p>4: 9.7 ↖</p> <p>5: *10.6 ↑</p> <p>6: *10.7 ↑</p> <p>7: *10.6 ↑</p> <p>8: *10.4 ↘</p> <p>9: 10.1 ↖</p> <p>10: *10.5 ↖</p> <hr/> <p>Series 99.0</p> <hr/> <p>Total 99.0</p>
---	--	--	--

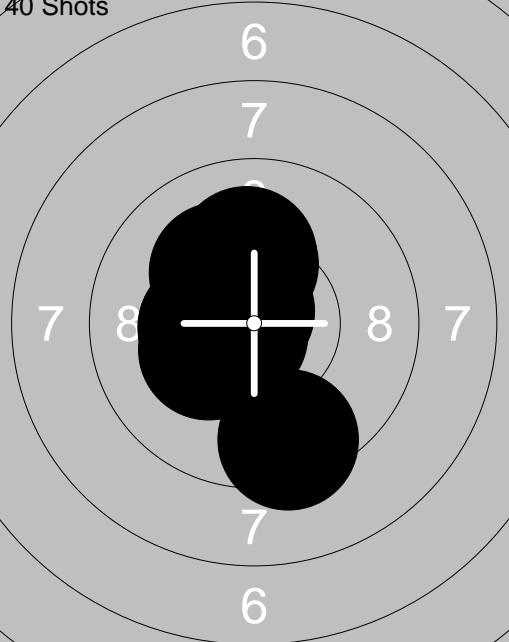
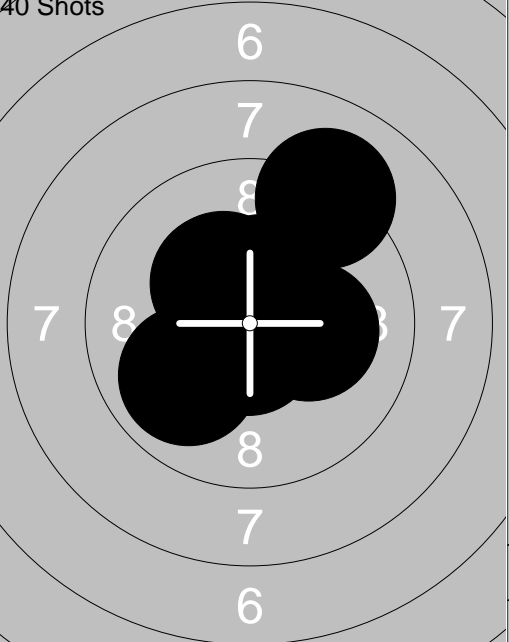
<p>40 Shots</p> 	<p>40 Shots</p> 	<p>11: *10.3 ←</p> <p>12: 9.4 ↓</p> <p>13: *10.8 ↗</p> <p>14: *10.4 ←</p> <p>15: *10.7 ↖</p> <p>16: *10.4 ←</p> <p>17: 10.1 ↑</p> <p>18: *10.2 ↗</p> <p>19: *10.6 ↖</p> <p>20: *10.2 ↑</p> <hr/> <p>Series 99.0</p> <hr/> <p>Total 198.0</p>	<p>21: *10.3 ↖</p> <p>22: 9.9 ↖</p> <p>23: *10.7 ↓</p> <p>24: *10.8 ↖</p> <p>25: 9.1 ↗</p> <p>26: *10.5 ↑</p> <p>27: *10.2 →</p> <p>28: *10.8 →</p> <p>29: *10.4 ↑</p> <p>30: *10.3 ↖</p> <hr/> <p>Series 98.0</p> <hr/> <p>Total 296.0</p>
---	---	--	---

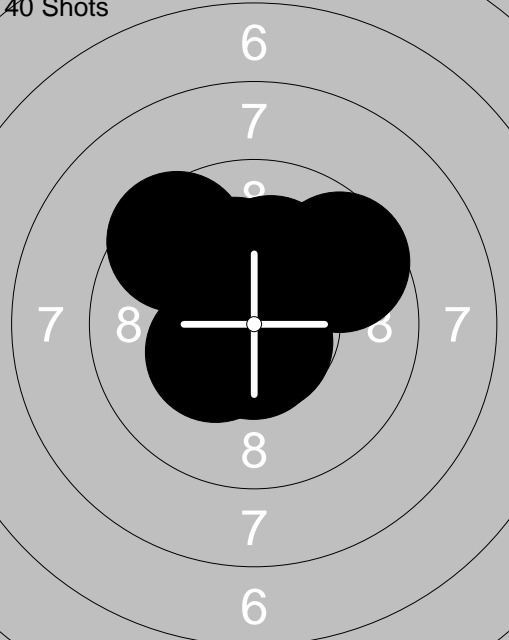
<p>40 Shots</p> 	<p>31: *10.8 ↓</p> <p>32: *10.6 ↓</p> <p>33: *10.2 ↑</p> <p>34: *10.4 ↑</p> <p>35: *10.2 ↑</p> <p>36: *10.5 ↑</p> <p>37: 9.5 ↖</p> <p>38: *10.7 ↓</p> <p>39: *10.3 ↖</p> <p>40: 9.6 ↗</p> <hr/> <p>Series 98.0</p> <hr/> <p>Total 394.0</p>		
--	---	--	--

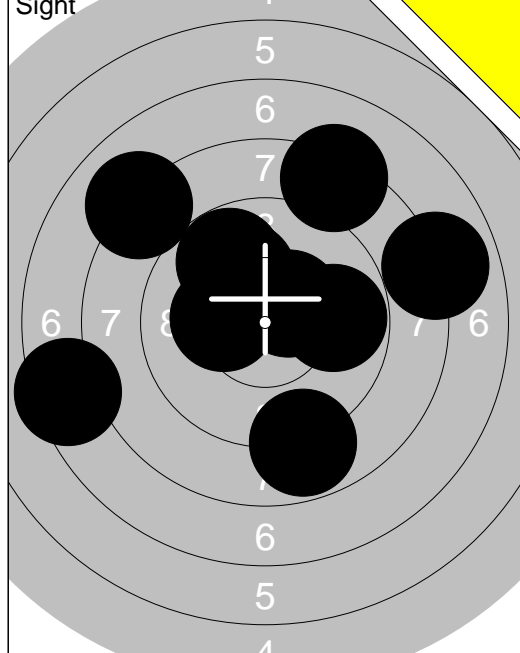

1:	9.8	→
2:	8.8	↓
3:	8.3	↑
4:	9.8	↑
5:	*10.2	←
6:	10.1	↑
7:	7.4	←
8:	8.0	↑
9:	*10.4	↗
10:	7.9	→
Series		86.0
Total		0.0

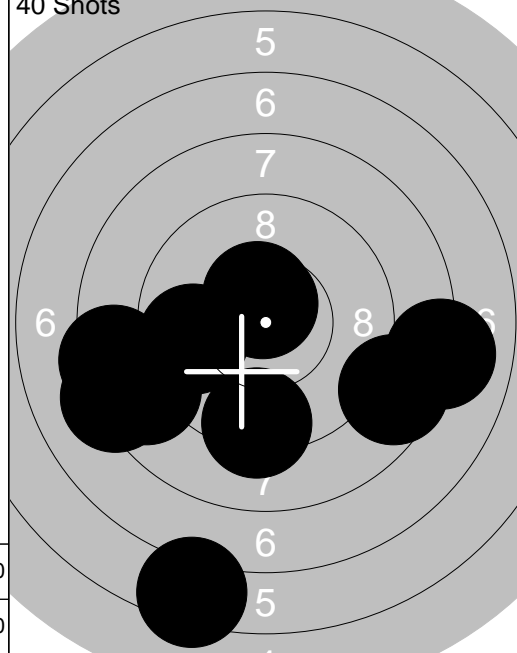

1:	8.7	↙
2:	8.6	↘
3:	*10.5	↑
4:	8.0	→
5:	8.4	←
6:	8.2	↙
7:	9.3	↓
8:	6.4	↓
9:	*10.6	↑
10:	9.7	←
Series		84.0
Total		84.0

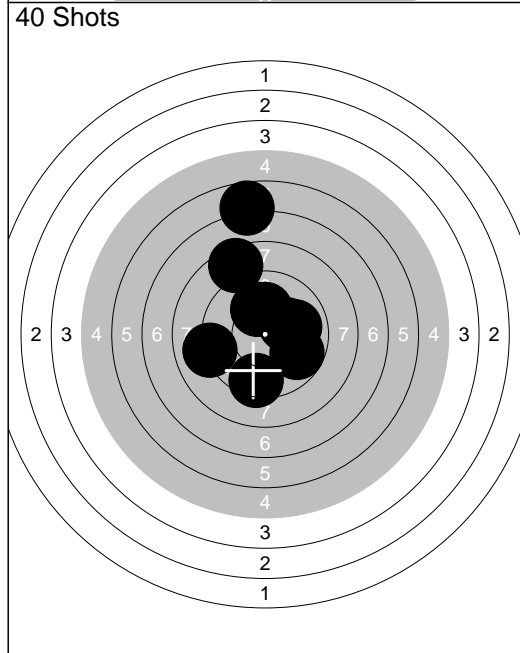



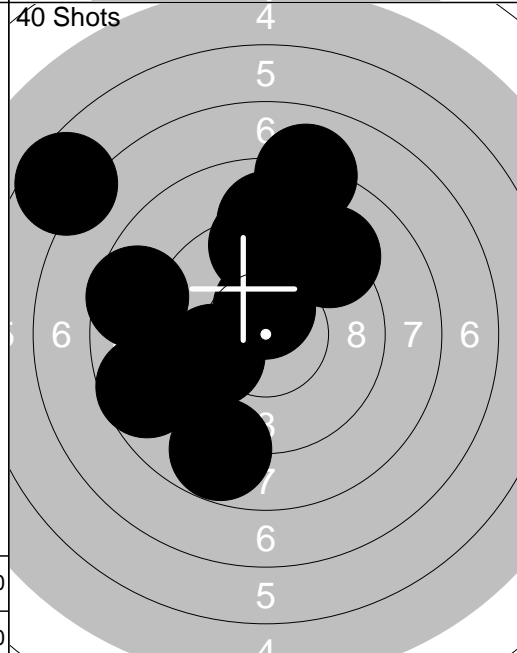

11:	6.7	↑
12:	10.1	↑
13:	9.0	←
14:	*10.2	→
15:	10.1	↑
16:	8.5	↑
17:	9.9	→
18:	9.7	↘
19:	9.4	↓
20:	0.0	↓
Series		80.0
Total		164.0

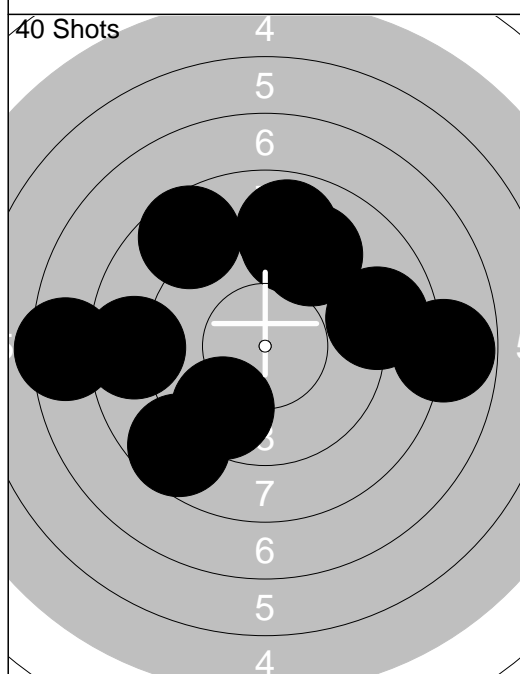



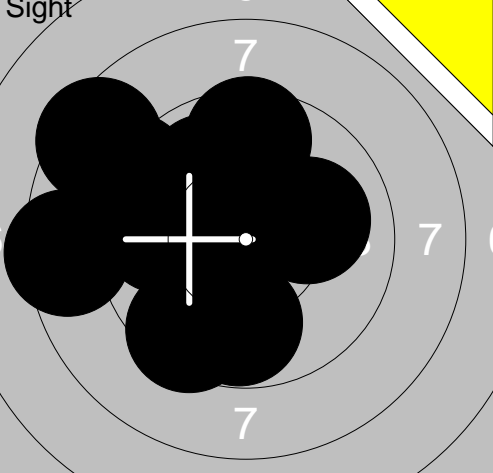
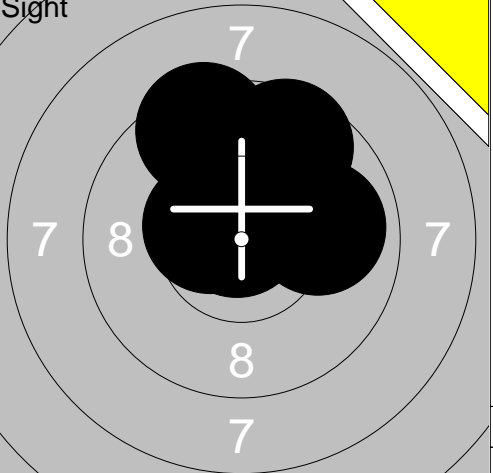

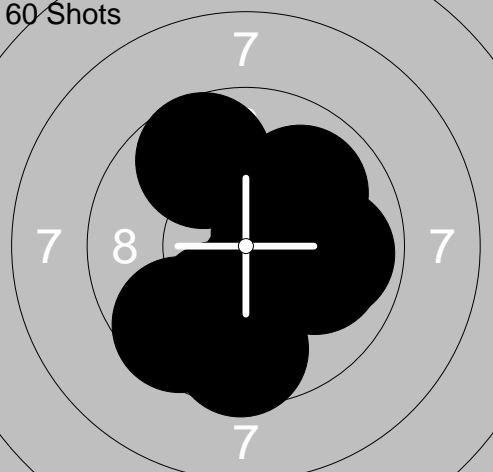

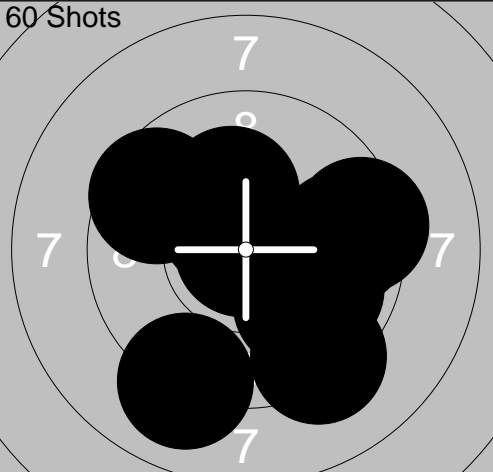
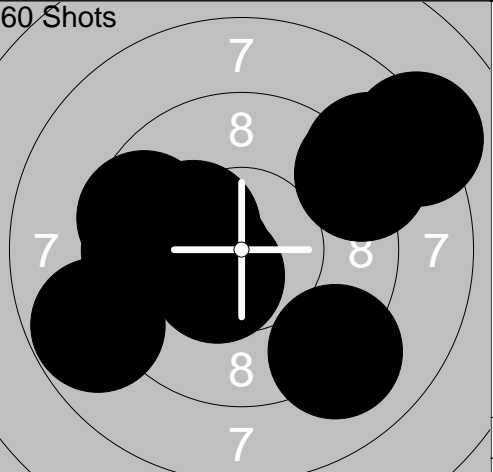
21:	9.0	↑
22:	8.7	↙
23:	8.1	↑
24:	8.6	↙
25:	9.2	↗
26:	6.5	↙
27:	10.0	←
28:	9.4	↑
29:	8.8	↙
30:	*10.5	↑
Series		85.0
Total		249.0

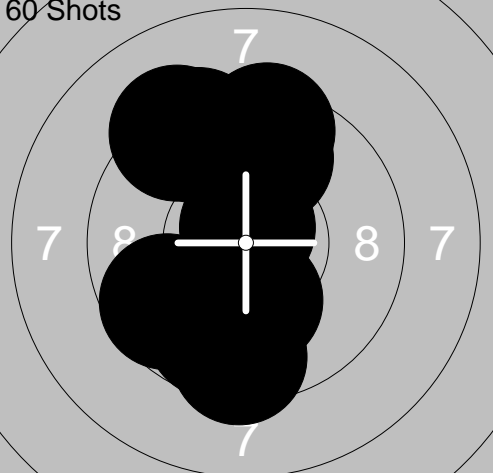

31:	8.6	↙
32:	8.6	↖
33:	9.1	↑
34:	9.0	↑
35:	9.6	↙
36:	8.7	←
37:	8.9	→
38:	8.9	↑
39:	7.8	→
40:	7.4	←
Series		81.0
Total		330.0

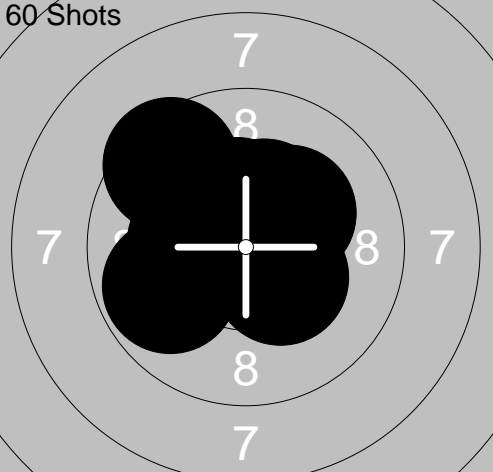
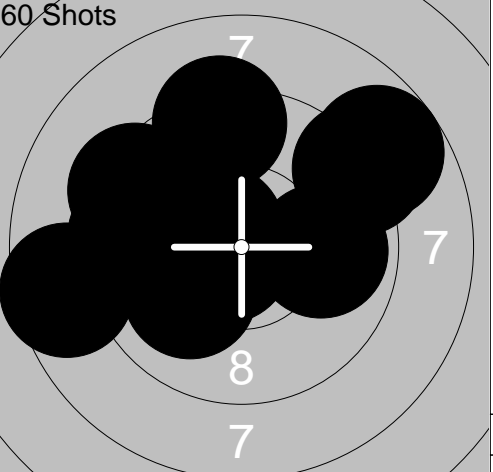
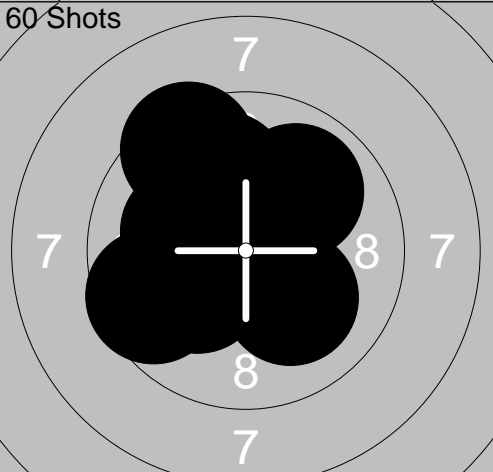
<p>Sight</p> 	<table border="1" style="width:100%; border-collapse: collapse;"> <tr><td>1:</td><td>10.0</td><td>→</td></tr> <tr><td>2:</td><td>9.4</td><td>↘</td></tr> <tr><td>3:</td><td>8.5</td><td>↗</td></tr> <tr><td>4:</td><td>9.8</td><td>↓</td></tr> <tr><td>5:</td><td>8.4</td><td>←</td></tr> <tr><td>6:</td><td>9.5</td><td>↑</td></tr> <tr><td>7:</td><td>*10.3</td><td>←</td></tr> <tr><td>8:</td><td>9.8</td><td>←</td></tr> <tr><td>9:</td><td>9.1</td><td>↗</td></tr> <tr><td>10:</td><td>9.9</td><td>↗</td></tr> <tr><td colspan="2">Series</td><td style="text-align:right;">90.0</td></tr> <tr><td colspan="2">Total</td><td style="text-align:right;">0.0</td></tr> </table>	1:	10.0	→	2:	9.4	↘	3:	8.5	↗	4:	9.8	↓	5:	8.4	←	6:	9.5	↑	7:	*10.3	←	8:	9.8	←	9:	9.1	↗	10:	9.9	↗	Series		90.0	Total		0.0	<p>Sight</p>  <table border="1" style="width:100%; border-collapse: collapse;"> <tr><td>11:</td><td>9.4</td><td>↗</td></tr> <tr><td>12:</td><td>*10.5</td><td>↖</td></tr> <tr><td>13:</td><td>9.6</td><td>↗</td></tr> <tr><td>14:</td><td>9.9</td><td>→</td></tr> <tr><td>15:</td><td>*10.8</td><td>↗</td></tr> <tr><td colspan="2">Series</td><td style="text-align:right;">47.0</td></tr> <tr><td colspan="2">Total</td><td style="text-align:right;">0.0</td></tr> </table>	11:	9.4	↗	12:	*10.5	↖	13:	9.6	↗	14:	9.9	→	15:	*10.8	↗	Series		47.0	Total		0.0															
1:	10.0	→																																																																								
2:	9.4	↘																																																																								
3:	8.5	↗																																																																								
4:	9.8	↓																																																																								
5:	8.4	←																																																																								
6:	9.5	↑																																																																								
7:	*10.3	←																																																																								
8:	9.8	←																																																																								
9:	9.1	↗																																																																								
10:	9.9	↗																																																																								
Series		90.0																																																																								
Total		0.0																																																																								
11:	9.4	↗																																																																								
12:	*10.5	↖																																																																								
13:	9.6	↗																																																																								
14:	9.9	→																																																																								
15:	*10.8	↗																																																																								
Series		47.0																																																																								
Total		0.0																																																																								
<p>60 Shots</p> 	<table border="1" style="width:100%; border-collapse: collapse;"> <tr><td>1:</td><td>*10.2</td><td>↘</td></tr> <tr><td>2:</td><td>9.5</td><td>→</td></tr> <tr><td>3:</td><td>*10.3</td><td>↘</td></tr> <tr><td>4:</td><td>*10.3</td><td>←</td></tr> <tr><td>5:</td><td>*10.5</td><td>↗</td></tr> <tr><td>6:</td><td>*10.2</td><td>↘</td></tr> <tr><td>7:</td><td>9.7</td><td>↗</td></tr> <tr><td>8:</td><td>10.1</td><td>↑</td></tr> <tr><td>9:</td><td>9.5</td><td>↘</td></tr> <tr><td>10:</td><td>10.0</td><td>←</td></tr> <tr><td colspan="2">Series</td><td style="text-align:right;">97.0</td></tr> <tr><td colspan="2">Total</td><td style="text-align:right;">97.0</td></tr> </table>	1:	*10.2	↘	2:	9.5	→	3:	*10.3	↘	4:	*10.3	←	5:	*10.5	↗	6:	*10.2	↘	7:	9.7	↗	8:	10.1	↑	9:	9.5	↘	10:	10.0	←	Series		97.0	Total		97.0	<p>60 Shots</p>  <table border="1" style="width:100%; border-collapse: collapse;"> <tr><td>11:</td><td>*10.7</td><td>↑</td></tr> <tr><td>12:</td><td>*10.7</td><td>↑</td></tr> <tr><td>13:</td><td>8.9</td><td>→</td></tr> <tr><td>14:</td><td>9.3</td><td>↗</td></tr> <tr><td>15:</td><td>*10.8</td><td>←</td></tr> <tr><td>16:</td><td>8.7</td><td>→</td></tr> <tr><td>17:</td><td>*10.2</td><td>←</td></tr> <tr><td>18:</td><td>9.6</td><td>←</td></tr> <tr><td>19:</td><td>10.0</td><td>↓</td></tr> <tr><td>20:</td><td>*10.7</td><td>↓</td></tr> <tr><td colspan="2">Series</td><td style="text-align:right;">94.0</td></tr> <tr><td colspan="2">Total</td><td style="text-align:right;">191.0</td></tr> </table>	11:	*10.7	↑	12:	*10.7	↑	13:	8.9	→	14:	9.3	↗	15:	*10.8	←	16:	8.7	→	17:	*10.2	←	18:	9.6	←	19:	10.0	↓	20:	*10.7	↓	Series		94.0	Total		191.0
1:	*10.2	↘																																																																								
2:	9.5	→																																																																								
3:	*10.3	↘																																																																								
4:	*10.3	←																																																																								
5:	*10.5	↗																																																																								
6:	*10.2	↘																																																																								
7:	9.7	↗																																																																								
8:	10.1	↑																																																																								
9:	9.5	↘																																																																								
10:	10.0	←																																																																								
Series		97.0																																																																								
Total		97.0																																																																								
11:	*10.7	↑																																																																								
12:	*10.7	↑																																																																								
13:	8.9	→																																																																								
14:	9.3	↗																																																																								
15:	*10.8	←																																																																								
16:	8.7	→																																																																								
17:	*10.2	←																																																																								
18:	9.6	←																																																																								
19:	10.0	↓																																																																								
20:	*10.7	↓																																																																								
Series		94.0																																																																								
Total		191.0																																																																								
<p>60 Shots</p> 	<table border="1" style="width:100%; border-collapse: collapse;"> <tr><td>21:</td><td>*10.5</td><td>→</td></tr> <tr><td>22:</td><td>9.9</td><td>↗</td></tr> <tr><td>23:</td><td>10.1</td><td>→</td></tr> <tr><td>24:</td><td>9.7</td><td>↗</td></tr> <tr><td>25:</td><td>10.1</td><td>↘</td></tr> <tr><td>26:</td><td>10.0</td><td>↘</td></tr> <tr><td>27:</td><td>9.9</td><td>→</td></tr> <tr><td>28:</td><td>9.6</td><td>↓</td></tr> <tr><td>29:</td><td>*10.5</td><td>↘</td></tr> <tr><td>30:</td><td>9.6</td><td>↘</td></tr> <tr><td colspan="2">Series</td><td style="text-align:right;">95.0</td></tr> <tr><td colspan="2">Total</td><td style="text-align:right;">286.0</td></tr> </table>	21:	*10.5	→	22:	9.9	↗	23:	10.1	→	24:	9.7	↗	25:	10.1	↘	26:	10.0	↘	27:	9.9	→	28:	9.6	↓	29:	*10.5	↘	30:	9.6	↘	Series		95.0	Total		286.0	<p>60 Shots</p>  <table border="1" style="width:100%; border-collapse: collapse;"> <tr><td>31:</td><td>9.4</td><td>↖</td></tr> <tr><td>32:</td><td>9.4</td><td>←</td></tr> <tr><td>33:</td><td>10.0</td><td>↘</td></tr> <tr><td>34:</td><td>*10.4</td><td>↗</td></tr> <tr><td>35:</td><td>*10.7</td><td>↗</td></tr> <tr><td>36:</td><td>9.9</td><td>↖</td></tr> <tr><td>37:</td><td>*10.2</td><td>→</td></tr> <tr><td>38:</td><td>9.9</td><td>→</td></tr> <tr><td>39:</td><td>*10.7</td><td>↗</td></tr> <tr><td>40:</td><td>9.3</td><td>↖</td></tr> <tr><td colspan="2">Series</td><td style="text-align:right;">95.0</td></tr> <tr><td colspan="2">Total</td><td style="text-align:right;">381.0</td></tr> </table>	31:	9.4	↖	32:	9.4	←	33:	10.0	↘	34:	*10.4	↗	35:	*10.7	↗	36:	9.9	↖	37:	*10.2	→	38:	9.9	→	39:	*10.7	↗	40:	9.3	↖	Series		95.0	Total		381.0
21:	*10.5	→																																																																								
22:	9.9	↗																																																																								
23:	10.1	→																																																																								
24:	9.7	↗																																																																								
25:	10.1	↘																																																																								
26:	10.0	↘																																																																								
27:	9.9	→																																																																								
28:	9.6	↓																																																																								
29:	*10.5	↘																																																																								
30:	9.6	↘																																																																								
Series		95.0																																																																								
Total		286.0																																																																								
31:	9.4	↖																																																																								
32:	9.4	←																																																																								
33:	10.0	↘																																																																								
34:	*10.4	↗																																																																								
35:	*10.7	↗																																																																								
36:	9.9	↖																																																																								
37:	*10.2	→																																																																								
38:	9.9	→																																																																								
39:	*10.7	↗																																																																								
40:	9.3	↖																																																																								
Series		95.0																																																																								
Total		381.0																																																																								
<p>60 Shots</p> 	<table border="1" style="width:100%; border-collapse: collapse;"> <tr><td>41:</td><td>9.6</td><td>↖</td></tr> <tr><td>42:</td><td>9.7</td><td>→</td></tr> <tr><td>43:</td><td>*10.2</td><td>↑</td></tr> <tr><td>44:</td><td>9.4</td><td>→</td></tr> <tr><td>45:</td><td>*10.5</td><td>↗</td></tr> <tr><td>46:</td><td>9.9</td><td>↘</td></tr> <tr><td>47:</td><td>9.2</td><td>↘</td></tr> <tr><td>48:</td><td>9.9</td><td>↘</td></tr> <tr><td>49:</td><td>*10.9</td><td>←</td></tr> <tr><td>50:</td><td>9.0</td><td>↘</td></tr> <tr><td colspan="2">Series</td><td style="text-align:right;">93.0</td></tr> <tr><td colspan="2">Total</td><td style="text-align:right;">474.0</td></tr> </table>	41:	9.6	↖	42:	9.7	→	43:	*10.2	↑	44:	9.4	→	45:	*10.5	↗	46:	9.9	↘	47:	9.2	↘	48:	9.9	↘	49:	*10.9	←	50:	9.0	↘	Series		93.0	Total		474.0	<p>60 Shots</p>  <table border="1" style="width:100%; border-collapse: collapse;"> <tr><td>51:</td><td>*10.5</td><td>↘</td></tr> <tr><td>52:</td><td>*10.2</td><td>↖</td></tr> <tr><td>53:</td><td>8.8</td><td>←</td></tr> <tr><td>54:</td><td>9.1</td><td>↘</td></tr> <tr><td>55:</td><td>9.6</td><td>←</td></tr> <tr><td>56:</td><td>9.7</td><td>←</td></tr> <tr><td>57:</td><td>*10.5</td><td>←</td></tr> <tr><td>58:</td><td>9.1</td><td>↗</td></tr> <tr><td>59:</td><td>8.9</td><td>↗</td></tr> <tr><td>60:</td><td>8.2</td><td>↗</td></tr> <tr><td colspan="2">Series</td><td style="text-align:right;">90.0</td></tr> <tr><td colspan="2">Total</td><td style="text-align:right;">564.0</td></tr> </table>	51:	*10.5	↘	52:	*10.2	↖	53:	8.8	←	54:	9.1	↘	55:	9.6	←	56:	9.7	←	57:	*10.5	←	58:	9.1	↗	59:	8.9	↗	60:	8.2	↗	Series		90.0	Total		564.0
41:	9.6	↖																																																																								
42:	9.7	→																																																																								
43:	*10.2	↑																																																																								
44:	9.4	→																																																																								
45:	*10.5	↗																																																																								
46:	9.9	↘																																																																								
47:	9.2	↘																																																																								
48:	9.9	↘																																																																								
49:	*10.9	←																																																																								
50:	9.0	↘																																																																								
Series		93.0																																																																								
Total		474.0																																																																								
51:	*10.5	↘																																																																								
52:	*10.2	↖																																																																								
53:	8.8	←																																																																								
54:	9.1	↘																																																																								
55:	9.6	←																																																																								
56:	9.7	←																																																																								
57:	*10.5	←																																																																								
58:	9.1	↗																																																																								
59:	8.9	↗																																																																								
60:	8.2	↗																																																																								
Series		90.0																																																																								
Total		564.0																																																																								

Relay	Lane	Joar Karlsson	
3	2		
10m	Söderala	17	Gä
2012-11-04	Vindelnskytten 2012	Ramselefors SKF	
Sight		1: 9.3 ↖ 2: *10.7 ← 3: 9.3 ↗ 4: *10.6 ← 5: 9.5 ↗ 6: *10.6 ↗ 7: *10.8 → 8: *10.2 ↖ Series 77.0 Total 0.0	60 Shots  1: *10.5 ↗ 2: *10.4 ↖ 3: 10.0 ← 4: 9.4 ↗ 5: 10.0 ↘ 6: 8.5 ↖ 7: 9.4 ← 8: 8.9 ↗ 9: *10.7 ↗ 10: 10.0 ↗ Series 94.0 Total 94.0
60 Shots		11: *10.2 ↘ 12: 9.8 ↗ 13: *10.7 ↗ 14: 9.5 ↗ 15: 9.7 ↘ 16: 9.7 ↖ 17: 9.5 ↗ 18: 9.2 ↗ 19: 9.4 ↘ 20: 9.4 ↗ Series 92.0 Total 186.0	60 Shots  21: *10.6 ↖ 22: 9.3 ↘ 23: 9.5 ↖ 24: *10.5 ↘ 25: 9.1 ← 26: *10.3 ↗ 27: *10.2 ↗ 28: *10.2 ← 29: 9.9 ↗ 30: 10.0 ↖ Series 96.0 Total 282.0
60 Shots		31: *10.6 ↗ 32: *10.7 ↗ 33: *10.2 ↗ 34: *10.4 ↗ 35: *10.3 ← 36: *10.4 ↗ 37: 9.8 ← 38: 9.5 ↗ 39: *10.3 ↘ 40: *10.6 → Series 98.0 Total 380.0	60 Shots  41: 10.0 ↖ 42: 9.9 → 43: *10.7 ↖ 44: 9.3 ↗ 45: 8.5 ← 46: 9.5 ← 47: 9.3 ↖ 48: 9.1 ↗ 49: *10.6 ↖ 50: 8.7 ↗ Series 91.0 Total 471.0
60 Shots		51: 10.1 ↘ 52: 9.9 ↗ 53: 10.0 ↗ 54: *10.2 ↖ 55: *10.2 ↗ 56: 9.4 ↗ 57: *10.7 ↘ 58: 9.6 ← 59: *10.7 ↗ 60: *10.2 ↖ Series 97.0 Total 568.0	

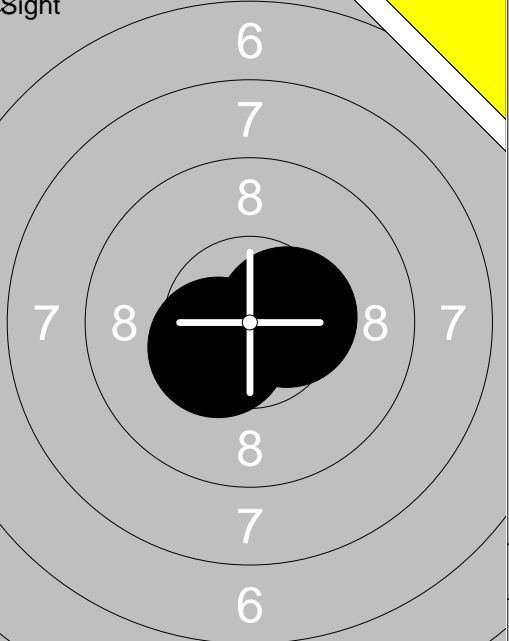
<p>Sight</p> 	<p>1: 9.7 →</p> <p>2: *10.5 ↗</p> <p>3: 8.3 ↑</p> <p>4: 8.7 ←</p> <p>5: 7.7 ↗</p> <p>6: 7.3 →</p> <p>7: 9.5 ↗</p> <p>8: 8.5 ↗</p> <p>9: 9.4 ↗</p> <p>10: 9.4 ↑</p>	<p>Sight</p> 	<p>11: *10.5 →</p> <p>12: *10.4 ↙</p>
Series	84.0	Series	20.0
Total	0.0	Total	0.0

<p>60 Shots</p> 	<p>1: *10.2 ↙</p> <p>2: 9.0 ←</p> <p>3: 8.5 ↗</p> <p>4: 9.0 ↙</p> <p>5: 8.3 ↙</p> <p>6: 9.8 →</p> <p>7: 9.4 ↗</p> <p>8: *10.5 ↗</p> <p>9: 9.9 ↙</p> <p>10: 8.8 ↗</p>	<p>60 Shots</p> 	<p>11: 7.6 ↗</p> <p>12: 8.8 ↙</p> <p>13: 9.1 ↙</p> <p>14: 9.9 ↑</p> <p>15: 9.7 ↑</p> <p>16: *10.6 ↓</p> <p>17: 9.3 ↑</p> <p>18: *10.3 ↙</p> <p>19: 9.5 →</p> <p>20: 7.3 ↗</p>
Series	89.0	Series	87.0
Total	89.0	Total	176.0

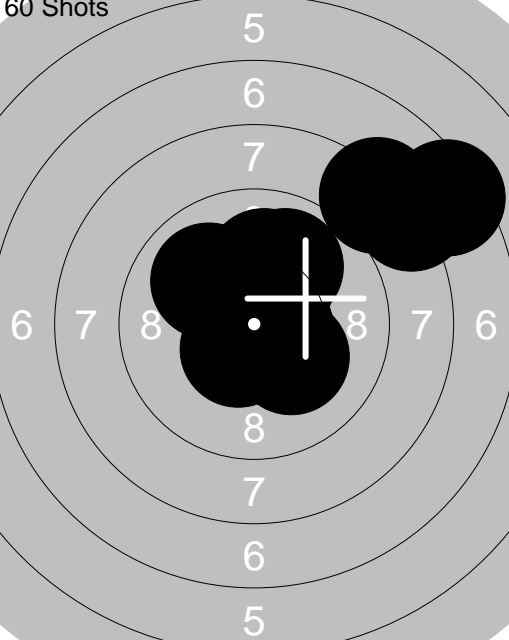
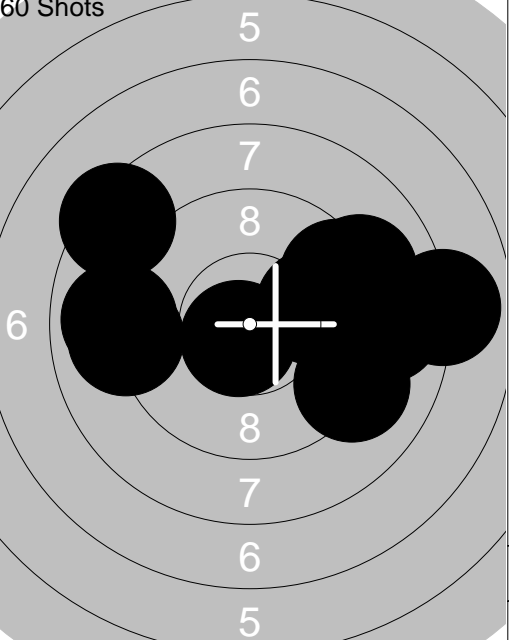
<p>60 Shots</p> 	<p>21: *10.2 ↗</p> <p>22: 8.0 ↗</p> <p>23: 7.4 ↗</p> <p>24: 10.0 ↙</p> <p>25: 8.2 ↗</p> <p>26: 10.0 ↑</p> <p>27: *10.5 ↙</p> <p>28: *10.2 ↙</p> <p>29: *10.6 →</p> <p>30: 9.9 ↗</p>	<p>60 Shots</p> 	<p>31: 9.0 ←</p> <p>32: 9.4 ↗</p> <p>33: 9.1 ↗</p> <p>34: 8.9 ←</p> <p>35: *10.7 ↙</p> <p>36: 8.0 →</p> <p>37: 9.9 ↗</p> <p>38: 9.1 ↙</p> <p>39: 8.9 →</p> <p>40: 8.4 ↙</p>
Series	92.0	Series	87.0
Total	268.0	Total	355.0

	<table border="1" style="width:100%; border-collapse: collapse;"> <tr><td>1:</td><td>6.5</td><td>↘</td></tr> <tr><td>2:</td><td>9.7</td><td>↓</td></tr> <tr><td>3:</td><td>*10.2</td><td>→</td></tr> <tr><td>4:</td><td>8.6</td><td>↘</td></tr> <tr><td>5:</td><td>7.8</td><td>→</td></tr> <tr><td>6:</td><td>7.7</td><td>→</td></tr> <tr><td>7:</td><td>7.7</td><td>→</td></tr> <tr><td>8:</td><td>7.7</td><td>↘</td></tr> <tr><td>9:</td><td>3.2</td><td>→</td></tr> <tr><td>10:</td><td>9.8</td><td>↘</td></tr> <tr><td colspan="2">Series</td><td>73.0</td></tr> <tr><td colspan="2">Total</td><td>0.0</td></tr> </table>	1:	6.5	↘	2:	9.7	↓	3:	*10.2	→	4:	8.6	↘	5:	7.8	→	6:	7.7	→	7:	7.7	→	8:	7.7	↘	9:	3.2	→	10:	9.8	↘	Series		73.0	Total		0.0		<table border="1" style="width:100%; border-collapse: collapse;"> <tr><td>11:</td><td>*10.4</td><td>↖</td></tr> </table>	11:	*10.4	↖
1:	6.5	↘																																								
2:	9.7	↓																																								
3:	*10.2	→																																								
4:	8.6	↘																																								
5:	7.8	→																																								
6:	7.7	→																																								
7:	7.7	→																																								
8:	7.7	↘																																								
9:	3.2	→																																								
10:	9.8	↘																																								
Series		73.0																																								
Total		0.0																																								
11:	*10.4	↖																																								

	<table border="1" style="width:100%; border-collapse: collapse;"> <tr><td>1:</td><td>9.3</td><td>↘</td></tr> <tr><td>2:</td><td>9.2</td><td>↙</td></tr> <tr><td>3:</td><td>6.2</td><td>←</td></tr> <tr><td>4:</td><td>9.3</td><td>↙</td></tr> <tr><td>5:</td><td>*10.4</td><td>↗</td></tr> <tr><td>6:</td><td>9.8</td><td>↗</td></tr> <tr><td>7:</td><td>10.0</td><td>↗</td></tr> <tr><td>8:</td><td>7.6</td><td>←</td></tr> <tr><td>9:</td><td>10.0</td><td>↑</td></tr> <tr><td>10:</td><td>9.8</td><td>↗</td></tr> <tr><td colspan="2">Series</td><td>88.0</td></tr> <tr><td colspan="2">Total</td><td>88.0</td></tr> </table>	1:	9.3	↘	2:	9.2	↙	3:	6.2	←	4:	9.3	↙	5:	*10.4	↗	6:	9.8	↗	7:	10.0	↗	8:	7.6	←	9:	10.0	↑	10:	9.8	↗	Series		88.0	Total		88.0		<table border="1" style="width:100%; border-collapse: collapse;"> <tr><td>11:</td><td>10.0</td><td>→</td></tr> <tr><td>12:</td><td>8.2</td><td>←</td></tr> <tr><td>13:</td><td>10.0</td><td>→</td></tr> <tr><td>14:</td><td>8.7</td><td>↙</td></tr> <tr><td>15:</td><td>9.3</td><td>←</td></tr> <tr><td>16:</td><td>*10.6</td><td>↗</td></tr> <tr><td>17:</td><td>9.4</td><td>↗</td></tr> <tr><td>18:</td><td>*10.2</td><td>↗</td></tr> <tr><td>19:</td><td>8.2</td><td>→</td></tr> <tr><td>20:</td><td>8.9</td><td>→</td></tr> <tr><td colspan="2">Series</td><td>90.0</td></tr> <tr><td colspan="2">Total</td><td>178.0</td></tr> </table>	11:	10.0	→	12:	8.2	←	13:	10.0	→	14:	8.7	↙	15:	9.3	←	16:	*10.6	↗	17:	9.4	↗	18:	*10.2	↗	19:	8.2	→	20:	8.9	→	Series		90.0	Total		178.0
1:	9.3	↘																																																																									
2:	9.2	↙																																																																									
3:	6.2	←																																																																									
4:	9.3	↙																																																																									
5:	*10.4	↗																																																																									
6:	9.8	↗																																																																									
7:	10.0	↗																																																																									
8:	7.6	←																																																																									
9:	10.0	↑																																																																									
10:	9.8	↗																																																																									
Series		88.0																																																																									
Total		88.0																																																																									
11:	10.0	→																																																																									
12:	8.2	←																																																																									
13:	10.0	→																																																																									
14:	8.7	↙																																																																									
15:	9.3	←																																																																									
16:	*10.6	↗																																																																									
17:	9.4	↗																																																																									
18:	*10.2	↗																																																																									
19:	8.2	→																																																																									
20:	8.9	→																																																																									
Series		90.0																																																																									
Total		178.0																																																																									

	<table border="1" style="width:100%; border-collapse: collapse;"> <tr><td>21:</td><td>8.4</td><td>↗</td></tr> <tr><td>22:</td><td>8.7</td><td>←</td></tr> <tr><td>23:</td><td>7.2</td><td>→</td></tr> <tr><td>24:</td><td>9.8</td><td>←</td></tr> <tr><td>25:</td><td>8.5</td><td>←</td></tr> <tr><td>26:</td><td>9.8</td><td>↘</td></tr> <tr><td>27:</td><td>9.7</td><td>↗</td></tr> <tr><td>28:</td><td>8.3</td><td>↙</td></tr> <tr><td>29:</td><td>7.3</td><td>←</td></tr> <tr><td>30:</td><td>*10.7</td><td>↗</td></tr> <tr><td colspan="2">Series</td><td>83.0</td></tr> <tr><td colspan="2">Total</td><td>261.0</td></tr> </table>	21:	8.4	↗	22:	8.7	←	23:	7.2	→	24:	9.8	←	25:	8.5	←	26:	9.8	↘	27:	9.7	↗	28:	8.3	↙	29:	7.3	←	30:	*10.7	↗	Series		83.0	Total		261.0		<table border="1" style="width:100%; border-collapse: collapse;"> <tr><td>31:</td><td>5.8</td><td>←</td></tr> <tr><td>32:</td><td>8.6</td><td>↗</td></tr> <tr><td>33:</td><td>9.2</td><td>←</td></tr> <tr><td>34:</td><td>9.9</td><td>↗</td></tr> <tr><td>35:</td><td>9.6</td><td>↘</td></tr> <tr><td>36:</td><td>*10.2</td><td>→</td></tr> <tr><td>37:</td><td>8.0</td><td>↗</td></tr> <tr><td>38:</td><td>9.9</td><td>↗</td></tr> <tr><td>39:</td><td>8.8</td><td>←</td></tr> <tr><td>40:</td><td>9.6</td><td>←</td></tr> <tr><td colspan="2">Series</td><td>84.0</td></tr> <tr><td colspan="2">Total</td><td>345.0</td></tr> </table>	31:	5.8	←	32:	8.6	↗	33:	9.2	←	34:	9.9	↗	35:	9.6	↘	36:	*10.2	→	37:	8.0	↗	38:	9.9	↗	39:	8.8	←	40:	9.6	←	Series		84.0	Total		345.0
21:	8.4	↗																																																																									
22:	8.7	←																																																																									
23:	7.2	→																																																																									
24:	9.8	←																																																																									
25:	8.5	←																																																																									
26:	9.8	↘																																																																									
27:	9.7	↗																																																																									
28:	8.3	↙																																																																									
29:	7.3	←																																																																									
30:	*10.7	↗																																																																									
Series		83.0																																																																									
Total		261.0																																																																									
31:	5.8	←																																																																									
32:	8.6	↗																																																																									
33:	9.2	←																																																																									
34:	9.9	↗																																																																									
35:	9.6	↘																																																																									
36:	*10.2	→																																																																									
37:	8.0	↗																																																																									
38:	9.9	↗																																																																									
39:	8.8	←																																																																									
40:	9.6	←																																																																									
Series		84.0																																																																									
Total		345.0																																																																									

	<table border="1" style="width:100%; border-collapse: collapse;"> <tr><td>41:</td><td>9.6</td><td>↑</td></tr> <tr><td>42:</td><td>8.8</td><td>↗</td></tr> <tr><td>43:</td><td>8.4</td><td>↗</td></tr> <tr><td>44:</td><td>8.0</td><td>↗</td></tr> <tr><td>45:</td><td>*10.7</td><td>→</td></tr> <tr><td>46:</td><td>9.9</td><td>←</td></tr> <tr><td>47:</td><td>8.7</td><td>→</td></tr> <tr><td>48:</td><td>8.5</td><td>←</td></tr> <tr><td>49:</td><td>8.9</td><td>↘</td></tr> <tr><td>50:</td><td>10.0</td><td>←</td></tr> <tr><td colspan="2">Series</td><td>86.0</td></tr> <tr><td colspan="2">Total</td><td>431.0</td></tr> </table>	41:	9.6	↑	42:	8.8	↗	43:	8.4	↗	44:	8.0	↗	45:	*10.7	→	46:	9.9	←	47:	8.7	→	48:	8.5	←	49:	8.9	↘	50:	10.0	←	Series		86.0	Total		431.0		<table border="1" style="width:100%; border-collapse: collapse;"> <tr><td>51:</td><td>8.8</td><td>→</td></tr> <tr><td>52:</td><td>6.8</td><td>→</td></tr> <tr><td>53:</td><td>*10.7</td><td>↗</td></tr> <tr><td>54:</td><td>10.1</td><td>↘</td></tr> <tr><td>55:</td><td>6.8</td><td>↑</td></tr> <tr><td>56:</td><td>9.3</td><td>↗</td></tr> <tr><td>57:</td><td>*10.3</td><td>→</td></tr> <tr><td>58:</td><td>9.7</td><td>←</td></tr> <tr><td>59:</td><td>9.2</td><td>↑</td></tr> <tr><td>60:</td><td>9.6</td><td>→</td></tr> <tr><td colspan="2">Series</td><td>86.0</td></tr> <tr><td colspan="2">Total</td><td>517.0</td></tr> </table>	51:	8.8	→	52:	6.8	→	53:	*10.7	↗	54:	10.1	↘	55:	6.8	↑	56:	9.3	↗	57:	*10.3	→	58:	9.7	←	59:	9.2	↑	60:	9.6	→	Series		86.0	Total		517.0
41:	9.6	↑																																																																									
42:	8.8	↗																																																																									
43:	8.4	↗																																																																									
44:	8.0	↗																																																																									
45:	*10.7	→																																																																									
46:	9.9	←																																																																									
47:	8.7	→																																																																									
48:	8.5	←																																																																									
49:	8.9	↘																																																																									
50:	10.0	←																																																																									
Series		86.0																																																																									
Total		431.0																																																																									
51:	8.8	→																																																																									
52:	6.8	→																																																																									
53:	*10.7	↗																																																																									
54:	10.1	↘																																																																									
55:	6.8	↑																																																																									
56:	9.3	↗																																																																									
57:	*10.3	→																																																																									
58:	9.7	←																																																																									
59:	9.2	↑																																																																									
60:	9.6	→																																																																									
Series		86.0																																																																									
Total		517.0																																																																									

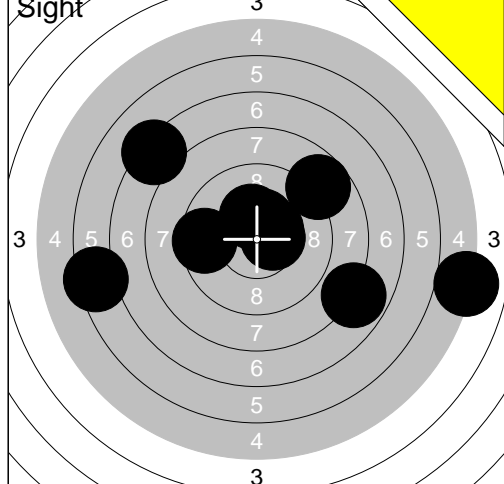

1:	9.5	←
2:	*10.5	→
3:	7.2	↗
4:	8.7	↗
5:	6.3	←
6:	*10.5	↗
7:	*10.4	↑
8:	5.0	→
9:	*10.3	↑
10:	7.9	↘
Series		82.0
Total		0.0

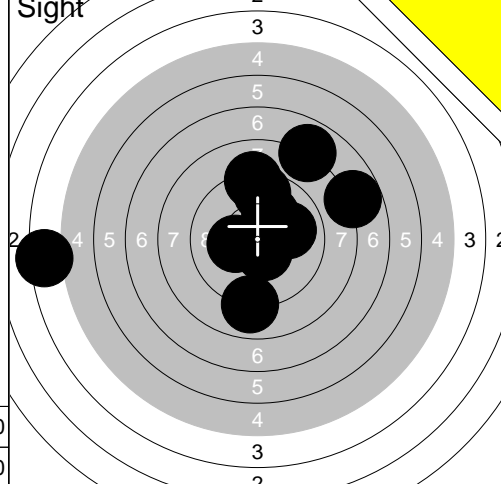

11:	10.0	→
12:	*10.3	←
13:	10.1	↗
14:	9.1	↑
15:	7.7	→
16:	*10.5	↘
17:	4.3	←
18:	9.5	↑
19:	7.8	↗
20:	8.9	↘
Series		84.0
Total		0.0

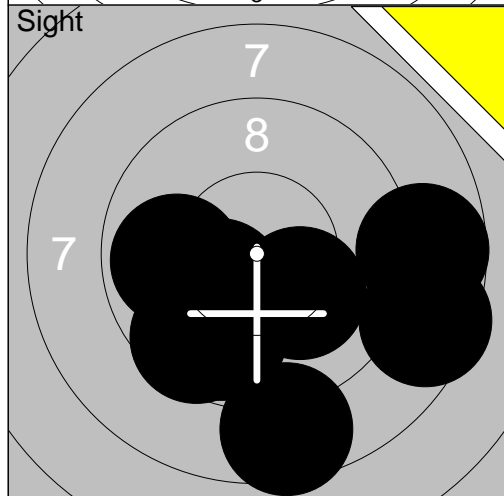

21:	9.6	↙
22:	8.7	→
23:	8.6	↘
24:	*10.3	↙
25:	9.8	↘
26:	8.5	↘
27:	*10.2	↘
28:	9.9	←
Series		71.0
Total		0.0

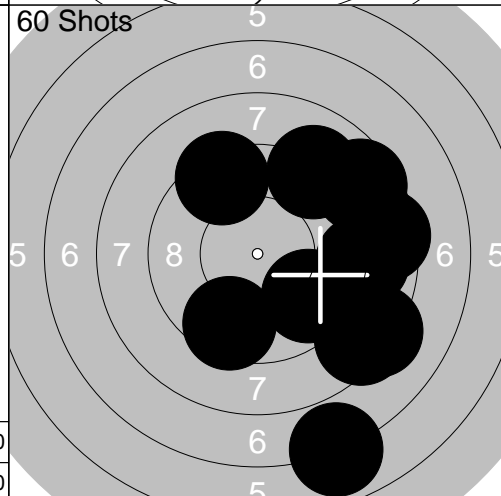

1:	9.0	↗
2:	8.5	→
3:	6.9	↘
4:	8.2	↘
5:	8.6	↗
6:	9.5	↘
7:	8.4	↘
8:	9.7	↘
9:	9.3	↗
10:	8.9	→
Series		82.0
Total		82.0

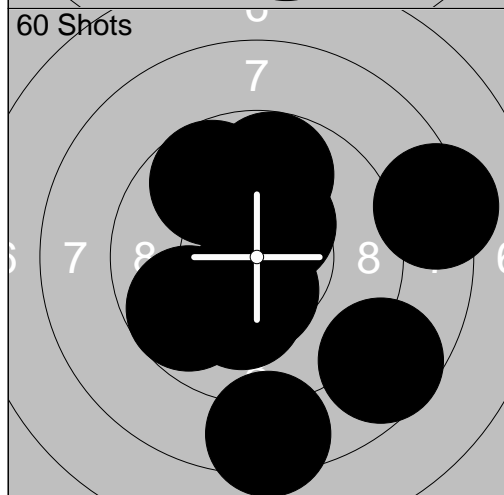



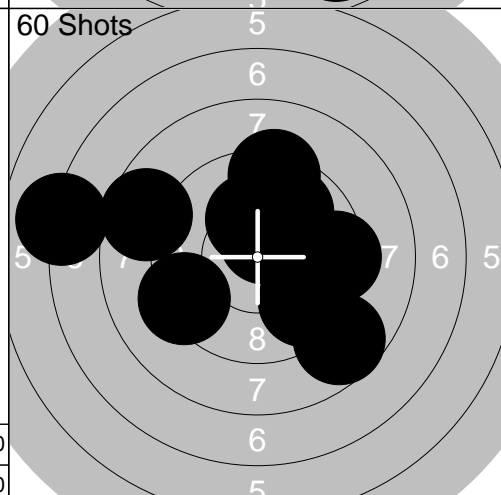

11:	8.6	↘
12:	*10.5	↘
13:	9.8	↑
14:	8.3	→
15:	9.7	↗
16:	*10.2	↘
17:	*10.6	↘
18:	9.7	←
19:	8.4	↘
20:	*10.4	↗
Series		91.0
Total		173.0





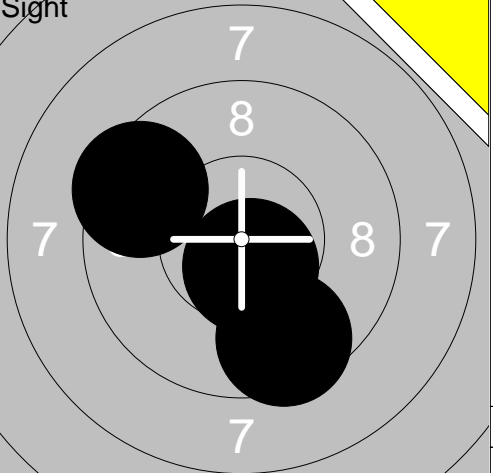

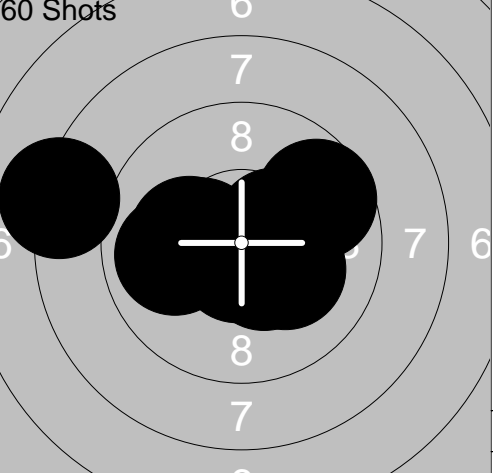
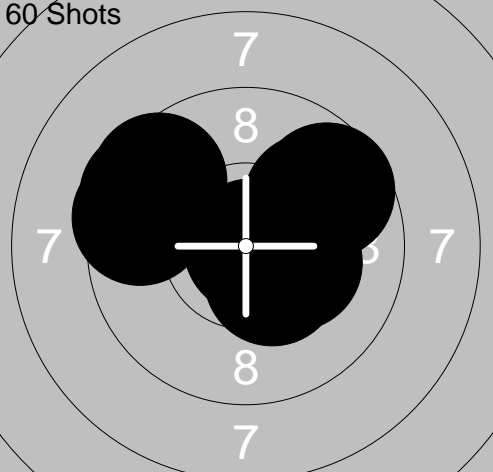
21:	9.4	→
22:	9.9	↗
23:	*10.5	↗
24:	9.3	←
25:	9.7	↘
26:	8.6	←
27:	8.7	↘
28:	7.0	←
29:	*10.2	↑
30:	9.3	↑
Series		88.0
Total		261.0

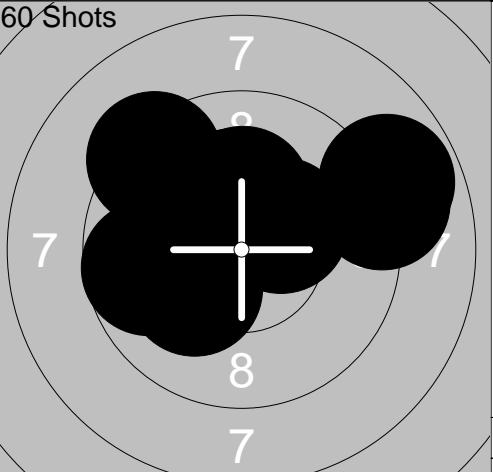

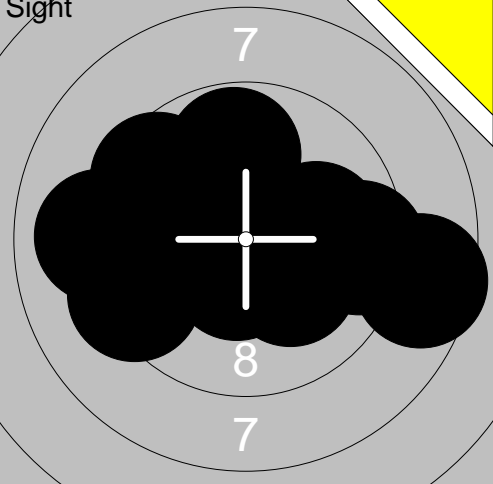
31:	9.7	↖
32:	9.8	↘
33:	*10.2	↗
34:	9.9	←
35:	7.9	↗
36:	9.6	←
37:	9.5	↘
38:	7.7	↘
39:	9.4	→
40:	8.2	←
Series		86.0
Total		347.0

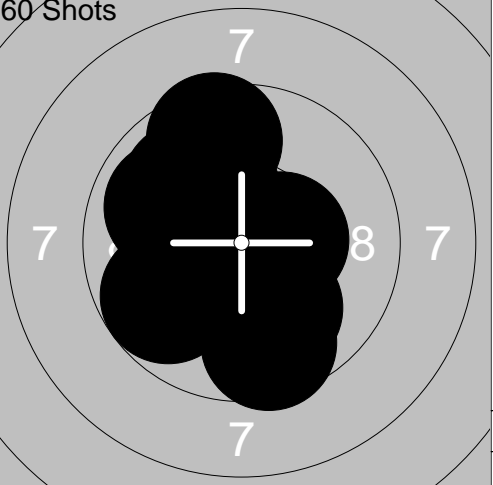
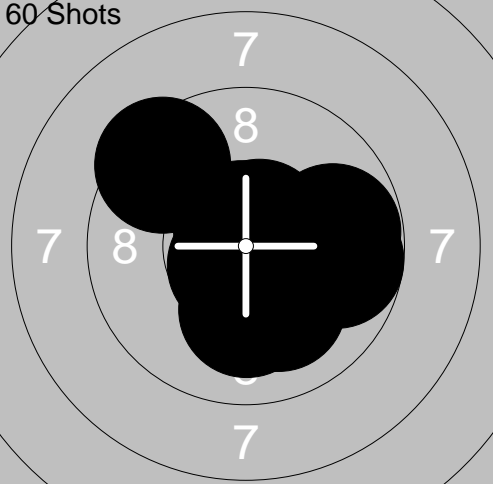
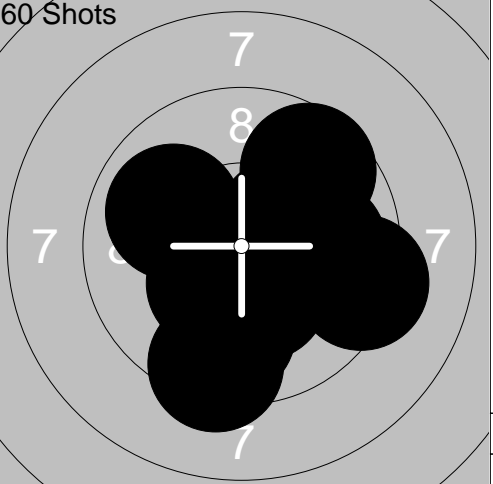
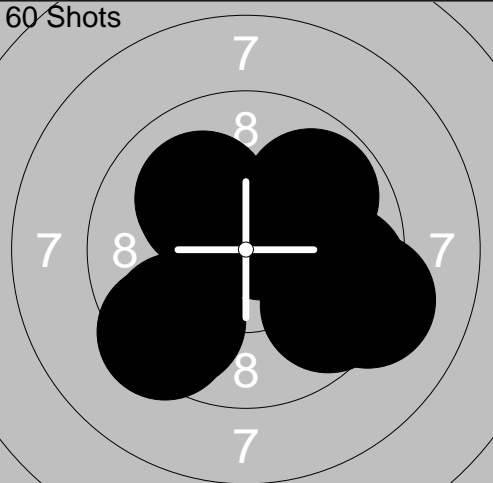
<p>Sight</p> 	<table border="1" style="width:100%; border-collapse: collapse;"> <tr><td>1:</td><td>9.3</td><td>↑</td></tr> <tr><td>2:</td><td>9.4</td><td>↑</td></tr> <tr><td>3:</td><td>*10.2</td><td>↗</td></tr> <tr><td>4:</td><td>*10.3</td><td>↑</td></tr> <tr><td>5:</td><td>10.1</td><td>←</td></tr> <tr><td>6:</td><td>*10.5</td><td>↘</td></tr> <tr><td>7:</td><td>9.9</td><td>↑</td></tr> <tr><td>8:</td><td>9.5</td><td>→</td></tr> <tr><td>9:</td><td>*10.3</td><td>↙</td></tr> <tr><td>10:</td><td>9.5</td><td>↗</td></tr> <tr><td colspan="2">Series</td><td>95.0</td></tr> <tr><td colspan="2">Total</td><td>0.0</td></tr> </table>	1:	9.3	↑	2:	9.4	↑	3:	*10.2	↗	4:	*10.3	↑	5:	10.1	←	6:	*10.5	↘	7:	9.9	↑	8:	9.5	→	9:	*10.3	↙	10:	9.5	↗	Series		95.0	Total		0.0	<p>Sight</p>  <table border="1" style="width:100%; border-collapse: collapse;"> <tr><td>11:</td><td>9.5</td><td>↖</td></tr> <tr><td>12:</td><td>9.5</td><td>↓</td></tr> <tr><td>13:</td><td>*10.6</td><td>↓</td></tr> <tr><td colspan="2">Series</td><td>28.0</td></tr> <tr><td colspan="2">Total</td><td>0.0</td></tr> </table>	11:	9.5	↖	12:	9.5	↓	13:	*10.6	↓	Series		28.0	Total		0.0																					
1:	9.3	↑																																																																								
2:	9.4	↑																																																																								
3:	*10.2	↗																																																																								
4:	*10.3	↑																																																																								
5:	10.1	←																																																																								
6:	*10.5	↘																																																																								
7:	9.9	↑																																																																								
8:	9.5	→																																																																								
9:	*10.3	↙																																																																								
10:	9.5	↗																																																																								
Series		95.0																																																																								
Total		0.0																																																																								
11:	9.5	↖																																																																								
12:	9.5	↓																																																																								
13:	*10.6	↓																																																																								
Series		28.0																																																																								
Total		0.0																																																																								
<p>60 Shots</p> 	<table border="1" style="width:100%; border-collapse: collapse;"> <tr><td>1:</td><td>*10.2</td><td>↖</td></tr> <tr><td>2:</td><td>*10.8</td><td>↗</td></tr> <tr><td>3:</td><td>9.9</td><td>↑</td></tr> <tr><td>4:</td><td>10.1</td><td>↑</td></tr> <tr><td>5:</td><td>10.0</td><td>→</td></tr> <tr><td>6:</td><td>8.8</td><td>↗</td></tr> <tr><td>7:</td><td>9.8</td><td>↙</td></tr> <tr><td>8:</td><td>10.0</td><td>→</td></tr> <tr><td>9:</td><td>*10.3</td><td>↘</td></tr> <tr><td>10:</td><td>9.5</td><td>←</td></tr> <tr><td colspan="2">Series</td><td>95.0</td></tr> <tr><td colspan="2">Total</td><td>95.0</td></tr> </table>	1:	*10.2	↖	2:	*10.8	↗	3:	9.9	↑	4:	10.1	↑	5:	10.0	→	6:	8.8	↗	7:	9.8	↙	8:	10.0	→	9:	*10.3	↘	10:	9.5	←	Series		95.0	Total		95.0	<p>60 Shots</p>  <table border="1" style="width:100%; border-collapse: collapse;"> <tr><td>11:</td><td>8.1</td><td>←</td></tr> <tr><td>12:</td><td>*10.3</td><td>←</td></tr> <tr><td>13:</td><td>9.7</td><td>↗</td></tr> <tr><td>14:</td><td>*10.4</td><td>→</td></tr> <tr><td>15:</td><td>*10.2</td><td>↘</td></tr> <tr><td>16:</td><td>*10.2</td><td>←</td></tr> <tr><td>17:</td><td>*10.4</td><td>↘</td></tr> <tr><td>18:</td><td>*10.6</td><td>↓</td></tr> <tr><td>19:</td><td>9.9</td><td>←</td></tr> <tr><td>20:</td><td>*10.4</td><td>↗</td></tr> <tr><td colspan="2">Series</td><td>96.0</td></tr> <tr><td colspan="2">Total</td><td>191.0</td></tr> </table>	11:	8.1	←	12:	*10.3	←	13:	9.7	↗	14:	*10.4	→	15:	*10.2	↘	16:	*10.2	←	17:	*10.4	↘	18:	*10.6	↓	19:	9.9	←	20:	*10.4	↗	Series		96.0	Total		191.0
1:	*10.2	↖																																																																								
2:	*10.8	↗																																																																								
3:	9.9	↑																																																																								
4:	10.1	↑																																																																								
5:	10.0	→																																																																								
6:	8.8	↗																																																																								
7:	9.8	↙																																																																								
8:	10.0	→																																																																								
9:	*10.3	↘																																																																								
10:	9.5	←																																																																								
Series		95.0																																																																								
Total		95.0																																																																								
11:	8.1	←																																																																								
12:	*10.3	←																																																																								
13:	9.7	↗																																																																								
14:	*10.4	→																																																																								
15:	*10.2	↘																																																																								
16:	*10.2	←																																																																								
17:	*10.4	↘																																																																								
18:	*10.6	↓																																																																								
19:	9.9	←																																																																								
20:	*10.4	↗																																																																								
Series		96.0																																																																								
Total		191.0																																																																								
<p>60 Shots</p> 	<table border="1" style="width:100%; border-collapse: collapse;"> <tr><td>21:</td><td>9.5</td><td>↖</td></tr> <tr><td>22:</td><td>9.5</td><td>↖</td></tr> <tr><td>23:</td><td>*10.5</td><td>↘</td></tr> <tr><td>24:</td><td>9.9</td><td>↗</td></tr> <tr><td>25:</td><td>9.5</td><td>↖</td></tr> <tr><td>26:</td><td>*10.9</td><td>→</td></tr> <tr><td>27:</td><td>*10.3</td><td>↘</td></tr> <tr><td>28:</td><td>9.7</td><td>↗</td></tr> <tr><td>29:</td><td>*10.3</td><td>→</td></tr> <tr><td>30:</td><td>*10.4</td><td>↘</td></tr> <tr><td colspan="2">Series</td><td>95.0</td></tr> <tr><td colspan="2">Total</td><td>286.0</td></tr> </table>	21:	9.5	↖	22:	9.5	↖	23:	*10.5	↘	24:	9.9	↗	25:	9.5	↖	26:	*10.9	→	27:	*10.3	↘	28:	9.7	↗	29:	*10.3	→	30:	*10.4	↘	Series		95.0	Total		286.0	<p>60 Shots</p>  <table border="1" style="width:100%; border-collapse: collapse;"> <tr><td>31:</td><td>*10.5</td><td>↗</td></tr> <tr><td>32:</td><td>*10.2</td><td>↙</td></tr> <tr><td>33:</td><td>*10.6</td><td>↓</td></tr> <tr><td>34:</td><td>*10.7</td><td>↗</td></tr> <tr><td>35:</td><td>*10.4</td><td>→</td></tr> <tr><td>36:</td><td>9.5</td><td>←</td></tr> <tr><td>37:</td><td>9.6</td><td>↖</td></tr> <tr><td>38:</td><td>10.0</td><td>↘</td></tr> <tr><td>39:</td><td>10.1</td><td>→</td></tr> <tr><td>40:</td><td>*10.2</td><td>↗</td></tr> <tr><td colspan="2">Series</td><td>98.0</td></tr> <tr><td colspan="2">Total</td><td>384.0</td></tr> </table>	31:	*10.5	↗	32:	*10.2	↙	33:	*10.6	↓	34:	*10.7	↗	35:	*10.4	→	36:	9.5	←	37:	9.6	↖	38:	10.0	↘	39:	10.1	→	40:	*10.2	↗	Series		98.0	Total		384.0
21:	9.5	↖																																																																								
22:	9.5	↖																																																																								
23:	*10.5	↘																																																																								
24:	9.9	↗																																																																								
25:	9.5	↖																																																																								
26:	*10.9	→																																																																								
27:	*10.3	↘																																																																								
28:	9.7	↗																																																																								
29:	*10.3	→																																																																								
30:	*10.4	↘																																																																								
Series		95.0																																																																								
Total		286.0																																																																								
31:	*10.5	↗																																																																								
32:	*10.2	↙																																																																								
33:	*10.6	↓																																																																								
34:	*10.7	↗																																																																								
35:	*10.4	→																																																																								
36:	9.5	←																																																																								
37:	9.6	↖																																																																								
38:	10.0	↘																																																																								
39:	10.1	→																																																																								
40:	*10.2	↗																																																																								
Series		98.0																																																																								
Total		384.0																																																																								
<p>60 Shots</p> 	<table border="1" style="width:100%; border-collapse: collapse;"> <tr><td>41:</td><td>9.6</td><td>←</td></tr> <tr><td>42:</td><td>9.4</td><td>↗</td></tr> <tr><td>43:</td><td>*10.5</td><td>→</td></tr> <tr><td>44:</td><td>*10.5</td><td>↘</td></tr> <tr><td>45:</td><td>*10.3</td><td>→</td></tr> <tr><td>46:</td><td>*10.5</td><td>↑</td></tr> <tr><td>47:</td><td>*10.6</td><td>↓</td></tr> <tr><td>48:</td><td>10.1</td><td>→</td></tr> <tr><td>49:</td><td>*10.7</td><td>↓</td></tr> <tr><td>50:</td><td>*10.8</td><td>↙</td></tr> <tr><td colspan="2">Series</td><td>98.0</td></tr> <tr><td colspan="2">Total</td><td>482.0</td></tr> </table>	41:	9.6	←	42:	9.4	↗	43:	*10.5	→	44:	*10.5	↘	45:	*10.3	→	46:	*10.5	↑	47:	*10.6	↓	48:	10.1	→	49:	*10.7	↓	50:	*10.8	↙	Series		98.0	Total		482.0	<p>60 Shots</p>  <table border="1" style="width:100%; border-collapse: collapse;"> <tr><td>51:</td><td>*10.3</td><td>↗</td></tr> <tr><td>52:</td><td>*10.2</td><td>←</td></tr> <tr><td>53:</td><td>10.1</td><td>←</td></tr> <tr><td>54:</td><td>*10.2</td><td>↑</td></tr> <tr><td>55:</td><td>9.7</td><td>←</td></tr> <tr><td>56:</td><td>9.3</td><td>↖</td></tr> <tr><td>57:</td><td>*10.2</td><td>↙</td></tr> <tr><td>58:</td><td>9.0</td><td>→</td></tr> <tr><td>59:</td><td>*10.2</td><td>↑</td></tr> <tr><td>60:</td><td>8.8</td><td>↗</td></tr> <tr><td colspan="2">Series</td><td>95.0</td></tr> <tr><td colspan="2">Total</td><td>577.0</td></tr> </table>	51:	*10.3	↗	52:	*10.2	←	53:	10.1	←	54:	*10.2	↑	55:	9.7	←	56:	9.3	↖	57:	*10.2	↙	58:	9.0	→	59:	*10.2	↑	60:	8.8	↗	Series		95.0	Total		577.0
41:	9.6	←																																																																								
42:	9.4	↗																																																																								
43:	*10.5	→																																																																								
44:	*10.5	↘																																																																								
45:	*10.3	→																																																																								
46:	*10.5	↑																																																																								
47:	*10.6	↓																																																																								
48:	10.1	→																																																																								
49:	*10.7	↓																																																																								
50:	*10.8	↙																																																																								
Series		98.0																																																																								
Total		482.0																																																																								
51:	*10.3	↗																																																																								
52:	*10.2	←																																																																								
53:	10.1	←																																																																								
54:	*10.2	↑																																																																								
55:	9.7	←																																																																								
56:	9.3	↖																																																																								
57:	*10.2	↙																																																																								
58:	9.0	→																																																																								
59:	*10.2	↑																																																																								
60:	8.8	↗																																																																								
Series		95.0																																																																								
Total		577.0																																																																								

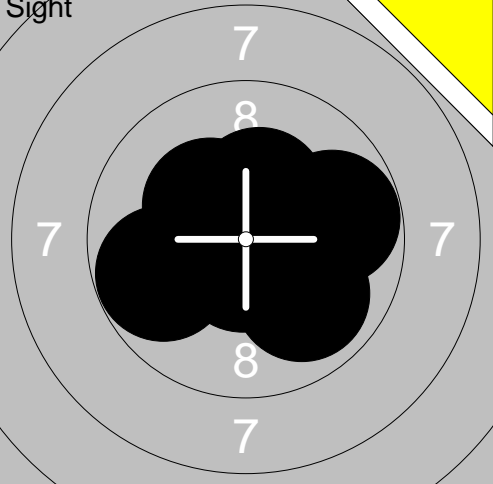
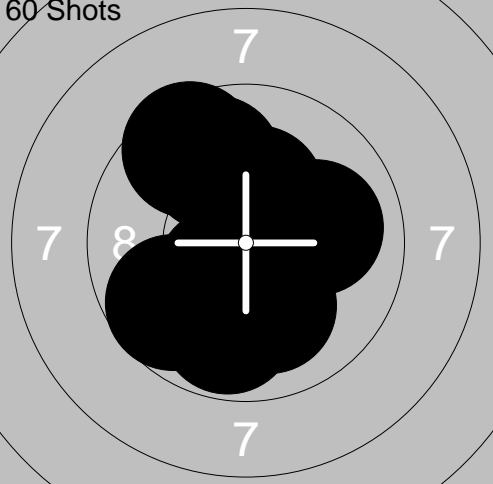
<p>Sight</p> 	<table border="1" style="width:100%; border-collapse: collapse;"> <tr><td>1:</td><td>9.4</td><td>→</td></tr> <tr><td>2:</td><td>*10.5</td><td>↓</td></tr> <tr><td>3:</td><td>9.8</td><td>↑</td></tr> <tr><td>4:</td><td>8.5</td><td>→</td></tr> <tr><td>5:</td><td>9.3</td><td>←</td></tr> <tr><td>6:</td><td>10.0</td><td>→</td></tr> <tr><td>7:</td><td>9.0</td><td>←</td></tr> <tr><td>8:</td><td>9.5</td><td>↗</td></tr> <tr><td>9:</td><td>10.1</td><td>↓</td></tr> <tr><td colspan="2">Series</td><td>83.0</td></tr> <tr><td colspan="2">Total</td><td>0.0</td></tr> </table>	1:	9.4	→	2:	*10.5	↓	3:	9.8	↑	4:	8.5	→	5:	9.3	←	6:	10.0	→	7:	9.0	←	8:	9.5	↗	9:	10.1	↓	Series		83.0	Total		0.0	<p>60 Shots</p>  <table border="1" style="width:100%; border-collapse: collapse;"> <tr><td>1:</td><td>9.6</td><td>←</td></tr> <tr><td>2:</td><td>10.1</td><td>↓</td></tr> <tr><td>3:</td><td>9.5</td><td>←</td></tr> <tr><td>4:</td><td>9.3</td><td>→</td></tr> <tr><td>5:</td><td>9.8</td><td>↗</td></tr> <tr><td>6:</td><td>8.9</td><td>↗</td></tr> <tr><td>7:</td><td>*10.3</td><td>↓</td></tr> <tr><td>8:</td><td>9.7</td><td>↑</td></tr> <tr><td>9:</td><td>10.1</td><td>↗</td></tr> <tr><td>10:</td><td>10.0</td><td>↓</td></tr> <tr><td colspan="2">Series</td><td>93.0</td></tr> <tr><td colspan="2">Total</td><td>93.0</td></tr> </table>	1:	9.6	←	2:	10.1	↓	3:	9.5	←	4:	9.3	→	5:	9.8	↗	6:	8.9	↗	7:	*10.3	↓	8:	9.7	↑	9:	10.1	↗	10:	10.0	↓	Series		93.0	Total		93.0			
1:	9.4	→																																																																								
2:	*10.5	↓																																																																								
3:	9.8	↑																																																																								
4:	8.5	→																																																																								
5:	9.3	←																																																																								
6:	10.0	→																																																																								
7:	9.0	←																																																																								
8:	9.5	↗																																																																								
9:	10.1	↓																																																																								
Series		83.0																																																																								
Total		0.0																																																																								
1:	9.6	←																																																																								
2:	10.1	↓																																																																								
3:	9.5	←																																																																								
4:	9.3	→																																																																								
5:	9.8	↗																																																																								
6:	8.9	↗																																																																								
7:	*10.3	↓																																																																								
8:	9.7	↑																																																																								
9:	10.1	↗																																																																								
10:	10.0	↓																																																																								
Series		93.0																																																																								
Total		93.0																																																																								
<p>60 Shots</p> 	<table border="1" style="width:100%; border-collapse: collapse;"> <tr><td>11:</td><td>9.4</td><td>↗</td></tr> <tr><td>12:</td><td>*10.3</td><td>↗</td></tr> <tr><td>13:</td><td>9.3</td><td>→</td></tr> <tr><td>14:</td><td>9.8</td><td>←</td></tr> <tr><td>15:</td><td>9.2</td><td>↗</td></tr> <tr><td>16:</td><td>*10.5</td><td>↗</td></tr> <tr><td>17:</td><td>*10.6</td><td>↓</td></tr> <tr><td>18:</td><td>10.1</td><td>→</td></tr> <tr><td>19:</td><td>*10.6</td><td>↙</td></tr> <tr><td>20:</td><td>*10.2</td><td>↗</td></tr> <tr><td colspan="2">Series</td><td>96.0</td></tr> <tr><td colspan="2">Total</td><td>189.0</td></tr> </table>	11:	9.4	↗	12:	*10.3	↗	13:	9.3	→	14:	9.8	←	15:	9.2	↗	16:	*10.5	↗	17:	*10.6	↓	18:	10.1	→	19:	*10.6	↙	20:	*10.2	↗	Series		96.0	Total		189.0	<p>60 Shots</p>  <table border="1" style="width:100%; border-collapse: collapse;"> <tr><td>21:</td><td>9.6</td><td>↓</td></tr> <tr><td>22:</td><td>*10.4</td><td>→</td></tr> <tr><td>23:</td><td>9.6</td><td>↑</td></tr> <tr><td>24:</td><td>10.0</td><td>↓</td></tr> <tr><td>25:</td><td>*10.5</td><td>↓</td></tr> <tr><td>26:</td><td>9.9</td><td>↗</td></tr> <tr><td>27:</td><td>10.0</td><td>↗</td></tr> <tr><td>28:</td><td>*10.6</td><td>↓</td></tr> <tr><td>29:</td><td>*10.2</td><td>↗</td></tr> <tr><td>30:</td><td>9.8</td><td>↙</td></tr> <tr><td colspan="2">Series</td><td>96.0</td></tr> <tr><td colspan="2">Total</td><td>285.0</td></tr> </table>	21:	9.6	↓	22:	*10.4	→	23:	9.6	↑	24:	10.0	↓	25:	*10.5	↓	26:	9.9	↗	27:	10.0	↗	28:	*10.6	↓	29:	*10.2	↗	30:	9.8	↙	Series		96.0	Total		285.0
11:	9.4	↗																																																																								
12:	*10.3	↗																																																																								
13:	9.3	→																																																																								
14:	9.8	←																																																																								
15:	9.2	↗																																																																								
16:	*10.5	↗																																																																								
17:	*10.6	↓																																																																								
18:	10.1	→																																																																								
19:	*10.6	↙																																																																								
20:	*10.2	↗																																																																								
Series		96.0																																																																								
Total		189.0																																																																								
21:	9.6	↓																																																																								
22:	*10.4	→																																																																								
23:	9.6	↑																																																																								
24:	10.0	↓																																																																								
25:	*10.5	↓																																																																								
26:	9.9	↗																																																																								
27:	10.0	↗																																																																								
28:	*10.6	↓																																																																								
29:	*10.2	↗																																																																								
30:	9.8	↙																																																																								
Series		96.0																																																																								
Total		285.0																																																																								
<p>60 Shots</p> 	<table border="1" style="width:100%; border-collapse: collapse;"> <tr><td>31:</td><td>*10.6</td><td>↗</td></tr> <tr><td>32:</td><td>*10.7</td><td>↓</td></tr> <tr><td>33:</td><td>*10.7</td><td>↑</td></tr> <tr><td>34:</td><td>*10.3</td><td>↓</td></tr> <tr><td>35:</td><td>10.1</td><td>↓</td></tr> <tr><td>36:</td><td>9.4</td><td>↗</td></tr> <tr><td>37:</td><td>9.8</td><td>→</td></tr> <tr><td>38:</td><td>10.1</td><td>↓</td></tr> <tr><td>39:</td><td>*10.2</td><td>↓</td></tr> <tr><td>40:</td><td>9.7</td><td>→</td></tr> <tr><td colspan="2">Series</td><td>97.0</td></tr> <tr><td colspan="2">Total</td><td>382.0</td></tr> </table>	31:	*10.6	↗	32:	*10.7	↓	33:	*10.7	↑	34:	*10.3	↓	35:	10.1	↓	36:	9.4	↗	37:	9.8	→	38:	10.1	↓	39:	*10.2	↓	40:	9.7	→	Series		97.0	Total		382.0	<p>60 Shots</p>  <table border="1" style="width:100%; border-collapse: collapse;"> <tr><td>41:</td><td>*10.3</td><td>↓</td></tr> <tr><td>42:</td><td>*10.3</td><td>→</td></tr> <tr><td>43:</td><td>9.9</td><td>↗</td></tr> <tr><td>44:</td><td>9.3</td><td>→</td></tr> <tr><td>45:</td><td>*10.3</td><td>↓</td></tr> <tr><td>46:</td><td>9.6</td><td>↗</td></tr> <tr><td>47:</td><td>9.8</td><td>↓</td></tr> <tr><td>48:</td><td>*10.3</td><td>↗</td></tr> <tr><td>49:</td><td>9.4</td><td>↓</td></tr> <tr><td>50:</td><td>9.9</td><td>→</td></tr> <tr><td colspan="2">Series</td><td>94.0</td></tr> <tr><td colspan="2">Total</td><td>476.0</td></tr> </table>	41:	*10.3	↓	42:	*10.3	→	43:	9.9	↗	44:	9.3	→	45:	*10.3	↓	46:	9.6	↗	47:	9.8	↓	48:	*10.3	↗	49:	9.4	↓	50:	9.9	→	Series		94.0	Total		476.0
31:	*10.6	↗																																																																								
32:	*10.7	↓																																																																								
33:	*10.7	↑																																																																								
34:	*10.3	↓																																																																								
35:	10.1	↓																																																																								
36:	9.4	↗																																																																								
37:	9.8	→																																																																								
38:	10.1	↓																																																																								
39:	*10.2	↓																																																																								
40:	9.7	→																																																																								
Series		97.0																																																																								
Total		382.0																																																																								
41:	*10.3	↓																																																																								
42:	*10.3	→																																																																								
43:	9.9	↗																																																																								
44:	9.3	→																																																																								
45:	*10.3	↓																																																																								
46:	9.6	↗																																																																								
47:	9.8	↓																																																																								
48:	*10.3	↗																																																																								
49:	9.4	↓																																																																								
50:	9.9	→																																																																								
Series		94.0																																																																								
Total		476.0																																																																								
<p>60 Shots</p> 	<table border="1" style="width:100%; border-collapse: collapse;"> <tr><td>51:</td><td>9.7</td><td>↙</td></tr> <tr><td>52:</td><td>9.4</td><td>↙</td></tr> <tr><td>53:</td><td>10.1</td><td>↗</td></tr> <tr><td>54:</td><td>9.7</td><td>→</td></tr> <tr><td>55:</td><td>9.6</td><td>↓</td></tr> <tr><td>56:</td><td>9.7</td><td>↙</td></tr> <tr><td>57:</td><td>*10.2</td><td>↗</td></tr> <tr><td>58:</td><td>9.2</td><td>↙</td></tr> <tr><td>59:</td><td>9.8</td><td>↗</td></tr> <tr><td>60:</td><td>*10.6</td><td>↗</td></tr> <tr><td colspan="2">Series</td><td>93.0</td></tr> <tr><td colspan="2">Total</td><td>569.0</td></tr> </table>	51:	9.7	↙	52:	9.4	↙	53:	10.1	↗	54:	9.7	→	55:	9.6	↓	56:	9.7	↙	57:	*10.2	↗	58:	9.2	↙	59:	9.8	↗	60:	*10.6	↗	Series		93.0	Total		569.0																																					
51:	9.7	↙																																																																								
52:	9.4	↙																																																																								
53:	10.1	↗																																																																								
54:	9.7	→																																																																								
55:	9.6	↓																																																																								
56:	9.7	↙																																																																								
57:	*10.2	↗																																																																								
58:	9.2	↙																																																																								
59:	9.8	↗																																																																								
60:	*10.6	↗																																																																								
Series		93.0																																																																								
Total		569.0																																																																								



Relay	Lane	Tomas Hed	
3	8		
10m	Forsa	Sen	Gä
2012-11-04	Vindelnskytten 2012	Ramselefors SKF	
Sight		1: 9.8 → 2: *10.3 ↗ 3: *10.3 → 4: *10.5 ↗ 5: *10.3 ↑ 6: 9.8 ← 7: *10.5 → 8: *10.6 ↓ 9: 9.9 ↓ 10: *10.4 ← Series 97.0 Total 0.0	Sight
			11: *10.8 ↗ 12: *10.7 ← Series 20.0 Total 0.0
60 Shots		1: 10.0 → 2: *10.3 ↑ 3: 10.1 ↓ 4: *10.4 ↓ 5: *10.4 ↓ 6: *10.4 ↓ 7: 9.8 ↓ 8: 9.5 ↗ 9: 9.7 ↙ 10: 9.8 ↗ Series 96.0 Total 96.0	60 Shots
			11: *10.5 ← 12: 9.4 ← 13: 9.8 ← 14: *10.4 ↗ 15: *10.8 → 16: 10.0 ← 17: *10.6 → 18: 8.5 → 19: *10.2 ↓ 20: 9.6 → Series 95.0 Total 191.0
60 Shots		21: 10.1 → 22: 10.0 ↓ 23: 9.3 ↘ 24: 10.1 ↓ 25: *10.2 ↗ 26: 9.8 ↓ 27: *10.8 ← 28: *10.8 → 29: *10.7 ↓ 30: 10.1 ← Series 98.0 Total 289.0	60 Shots
			31: *10.6 ↑ 32: 9.9 → 33: 10.1 ↓ 34: 9.6 ← 35: *10.6 ← 36: *10.7 ← 37: 9.6 ↑ 38: *10.6 ↗ 39: *10.6 ↓ 40: 9.8 ↑ Series 96.0 Total 385.0
60 Shots		41: 9.3 ↘ 42: 10.1 ↗ 43: 10.1 → 44: *10.3 → 45: 9.8 ← 46: *10.2 ↗ 47: 9.4 ↘ 48: *10.9 ↗ 49: *10.7 ↗ 50: 9.7 ↗ Series 96.0 Total 481.0	60 Shots
			51: 9.1 → 52: 10.0 ← 53: *10.4 ↓ 54: 9.9 ↓ 55: *10.7 ↓ 56: 9.7 ↘ 57: 9.9 ↑ 58: 10.1 ↑ 59: *10.5 → 60: 9.8 ← Series 95.0 Total 576.0



	1: 9.3 ↘		11: *10.2 ←
	2: 10.0 ↗		12: 9.7 ↗
	3: 9.0 ↘		13: 8.6 →
	4: 9.6 →		14: 9.6 ↗
	5: 8.7 ↘		15: 10.1 →
	6: *10.7 ↗		16: 9.3 ←
	7: 10.1 ↗		17: 9.6 ↘
	8: 10.1 ↗		
	9: 7.5 ↗		
	10: 7.9 ↘		
Series	89.0	Series	64.0
Total	0.0	Total	0.0

	1: *10.4 ←		11: *10.6 ↓
	2: *10.2 ↓		12: 8.8 ↖
	3: *10.2 ↗		13: 8.0 ←
	4: 10.0 ←		14: 9.7 ↓
	5: *10.3 →		15: *10.3 ↖
	6: *10.3 ↗		16: *10.3 →
	7: 9.2 ↘		17: 8.5 ↓
	8: 9.6 →		18: 10.0 ↖
	9: 9.8 ↓		19: 9.3 ↓
	10: 9.3 ↘		20: 9.6 ↗
Series	96.0	Series	91.0
Total	96.0	Total	187.0

	21: 9.9 ↗		31: 8.4 ↓
	22: *10.6 ↓		32: 8.8 ↓
	23: 9.9 ↘		33: 9.4 ←
	24: 10.0 ↗		34: 9.4 ↗
	25: 8.7 ↗		35: 9.3 ←
	26: 9.8 ↘		36: 9.8 ↖
	27: 9.6 ↘		37: 9.7 →
	28: 8.5 ↘		38: *10.6 ↗
	29: 9.5 ↗		39: *10.2 ←
	30: 9.1 ←		40: 9.9 →
Series	90.0	Series	90.0
Total	277.0	Total	367.0

	41: 9.6 ←		51: 8.6 ↗
	42: 7.6 →		52: 9.8 ↗
	43: 8.0 ↗		53: 9.5 ↓
	44: 8.1 →		54: 8.7 ←
	45: *10.3 ←		55: 9.1 ↓
	46: *10.2 ↗		56: 8.8 ↓
	47: 8.7 →		57: 9.9 ↓
	48: 8.7 ↗		58: *10.2 ↗
	49: 10.0 ↗		59: 9.5 ↖
	50: 8.5 ↗		60: 6.9 ↘
Series	86.0	Series	85.0
Total	453.0	Total	538.0

<p>Sight</p> 	<p>1: *10.3 ↗</p> <p>2: 9.8 →</p> <p>3: 9.7 ↑</p> <p>4: 9.8 ↓</p> <p>5: *10.2 ↓</p> <p>6: 9.3 →</p> <p>7: 10.1 →</p> <p>8: 9.0 ↑</p> <p>9: 9.9 ↓</p> <p>10: *10.2 ↘</p>	<p>Sight</p> 	<p>11: *10.2 ←</p> <p>12: *10.6 ↗</p> <p>13: 8.2 →</p> <p>14: 8.8 ←</p> <p>15: *10.6 ↗</p> <p>16: *10.5 →</p> <p>17: 10.1 ←</p>
Series 94.0		Series 66.0	
Total 0.0		Total 0.0	

<p>40 Shots</p> 	<p>1: *10.3 ↓</p> <p>2: 10.1 →</p> <p>3: 9.8 ←</p> <p>4: *10.4 →</p> <p>5: 9.6 →</p> <p>6: 9.1 ↗</p> <p>7: *10.2 ↗</p> <p>8: 10.1 ↑</p> <p>9: 10.0 ←</p> <p>10: 9.8 ↗</p>	<p>40 Shots</p> 	<p>11: 9.8 →</p> <p>12: 10.1 ←</p> <p>13: *10.7 ↓</p> <p>14: 9.2 →</p> <p>15: 10.1 ↗</p> <p>16: 9.8 →</p> <p>17: *10.4 ↗</p> <p>18: *10.2 ↗</p> <p>19: 10.1 →</p> <p>20: 9.4 ←</p>
Series 96.0		Series 96.0	
Total 96.0		Total 192.0	

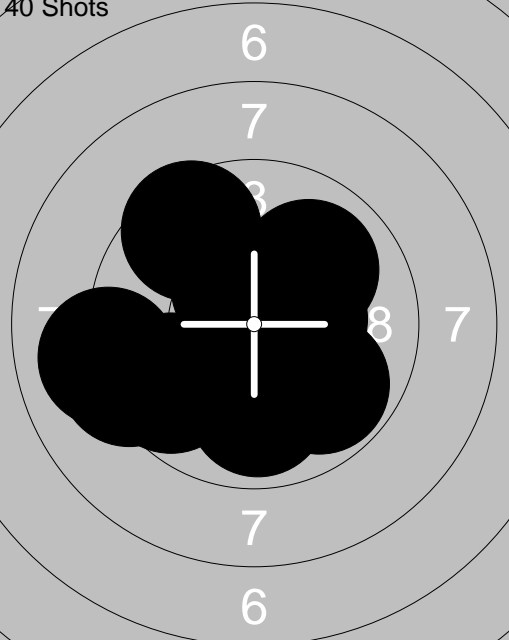
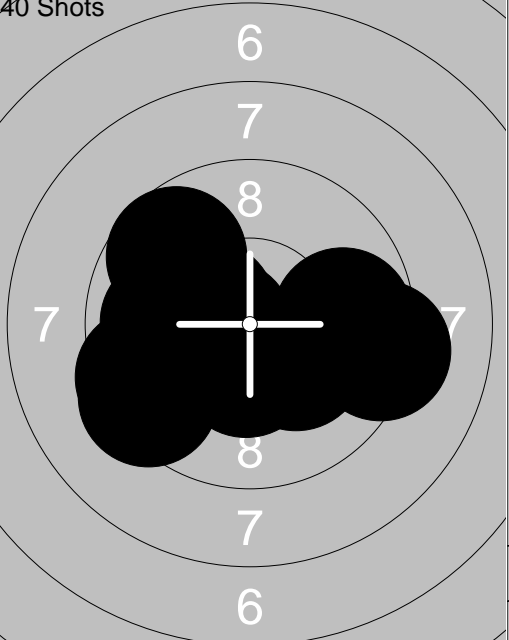
<p>40 Shots</p> 	<p>21: 9.9 ↓</p> <p>22: *10.5 ↓</p> <p>23: 9.0 ←</p> <p>24: 9.2 ←</p> <p>25: *10.4 →</p> <p>26: 9.6 ←</p> <p>27: *10.5 ↑</p> <p>28: 9.8 ↓</p> <p>29: 9.5 ↗</p> <p>30: 10.0 ↗</p>	<p>40 Shots</p> 	<p>31: *10.4 ↓</p> <p>32: *10.2 ↘</p> <p>33: 9.4 ←</p> <p>34: *10.6 ←</p> <p>35: 9.5 ←</p> <p>36: 9.7 ↗</p> <p>37: *10.4 ←</p> <p>38: 9.2 →</p> <p>39: 9.9 ←</p> <p>40: 9.8 →</p>
Series 94.0		Series 94.0	
Total 286.0		Total 380.0	

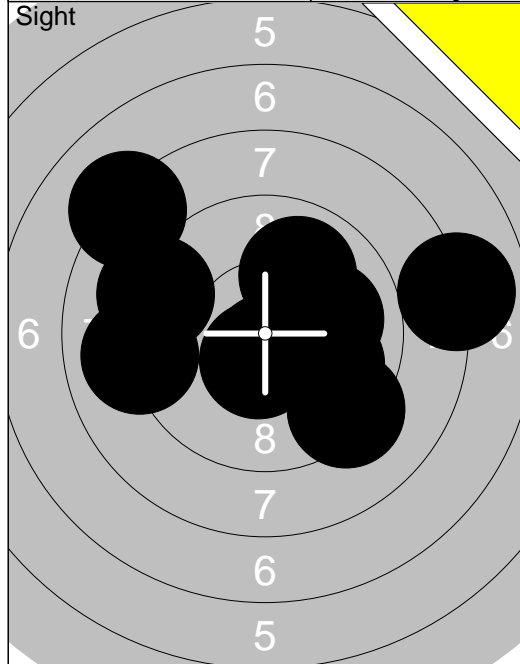

1:	10.0	→
2:	9.9	↗
3:	8.1	↗
4:	9.9	↘
5:	9.2	↖
6:	9.3	↘
7:	*10.7	↓
8:	*10.5	↓
9:	8.0	→
10:	9.0	←
Series		91.0
Total		0.0

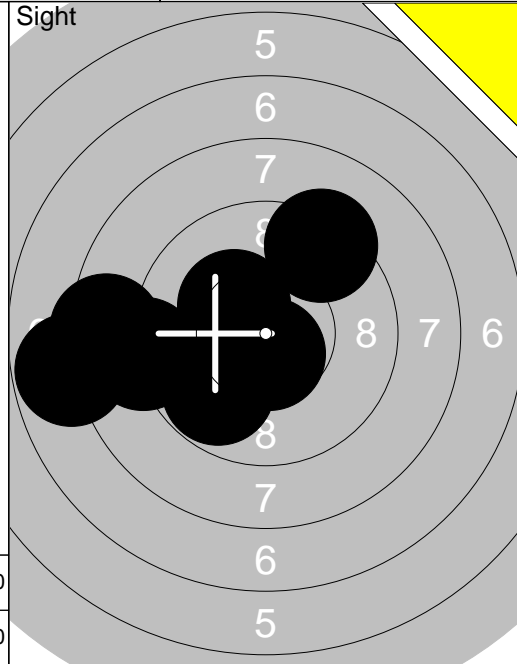

11:	9.3	↗
12:	9.8	↙
13:	*10.3	↖
14:	9.0	←
15:	*10.6	↓
16:	7.8	←
17:	8.4	←
18:	*10.5	↙
Series		72.0
Total		0.0

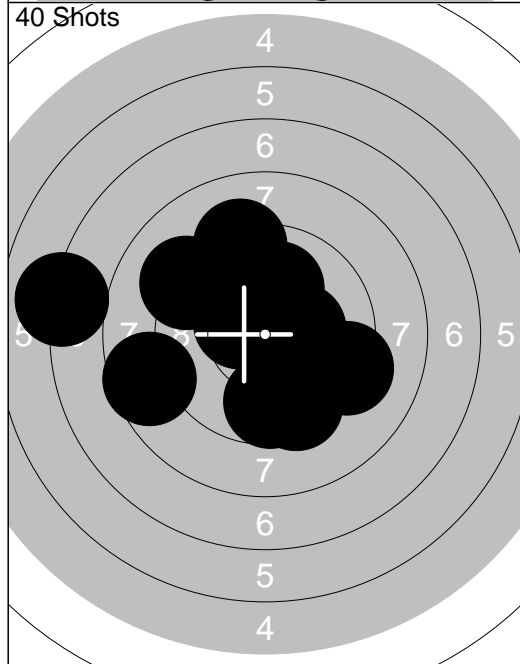

1:	9.5	↘
2:	9.3	→
3:	8.6	←
4:	9.2	↗
5:	*10.4	↖
6:	9.2	↗
7:	10.0	↗
8:	7.0	←
9:	*10.3	→
10:	9.7	↓
Series		90.0
Total		90.0

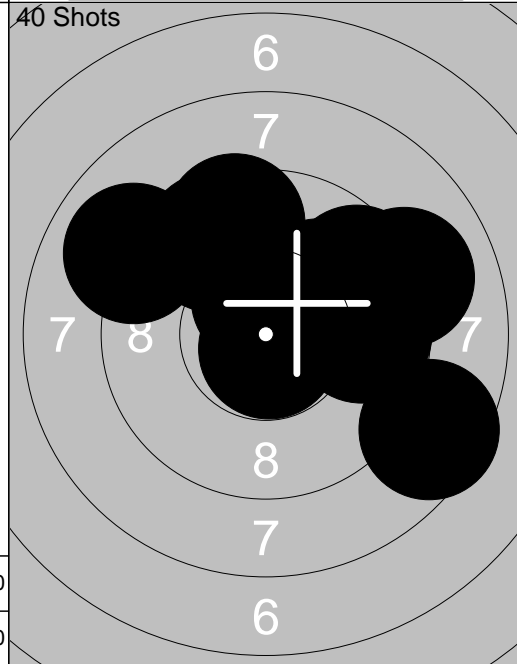

11:	9.0	↖
12:	8.5	→
13:	9.6	↗
14:	9.5	↗
15:	*10.5	↗
16:	9.0	→
17:	9.6	↗
18:	9.7	→
19:	*10.8	↓
20:	10.1	↗
Series		92.0
Total		182.0

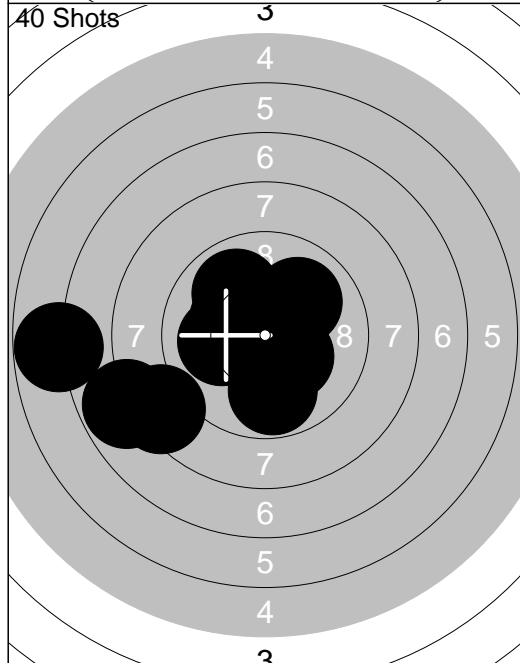

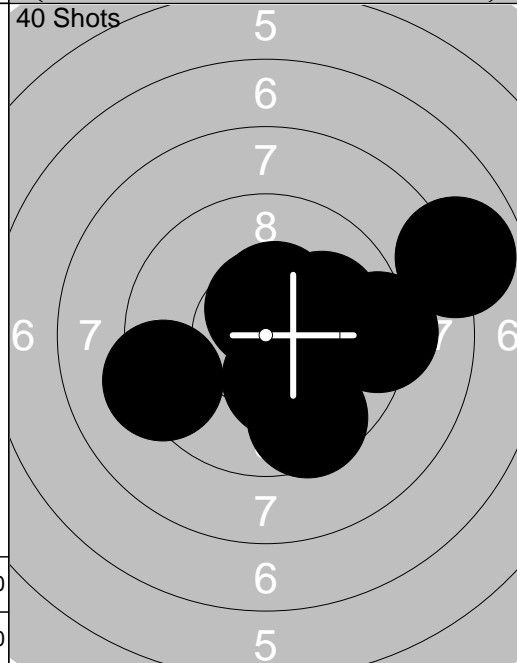

21:	10.0	↗
22:	10.1	←
23:	*10.3	↘
24:	9.8	↓
25:	6.8	←
26:	8.4	↙
27:	7.8	←
28:	9.9	↗
29:	*10.3	↗
30:	*10.2	↖
Series		89.0
Total		271.0

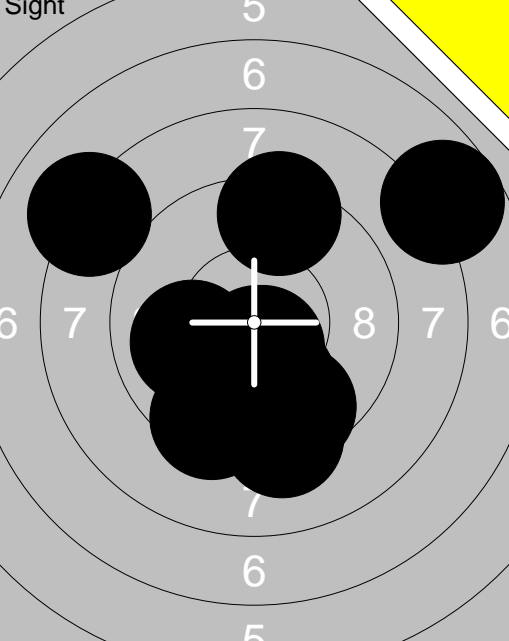
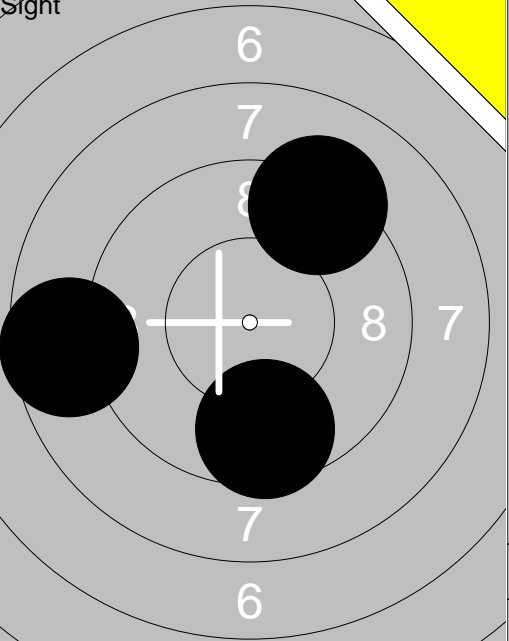

31:	*10.3	↓
32:	9.3	→
33:	*10.4	↗
34:	*10.6	↗
35:	7.9	→
36:	9.6	↘
37:	*10.4	→
38:	*10.4	→
39:	10.0	→
40:	9.3	←
Series		94.0
Total		365.0

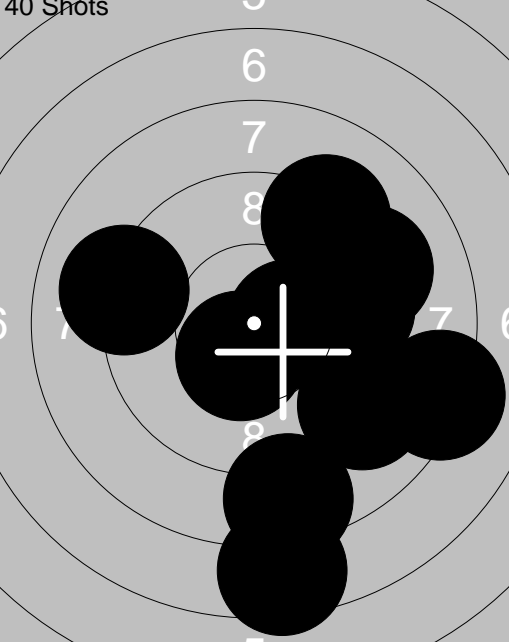
<p>Sight</p> 	<p>Sight</p> 	
<p>1: 7.7 ↗</p> <p>2: 10.0 ←</p> <p>3: 8.1 ↖</p> <p>4: 9.4 ↓</p> <p>5: 9.3 ↓</p> <p>6: *10.6 ↓</p> <p>7: 9.3 ↑</p> <p>8: 9.6 ↓</p> <p>9: *10.6 ↓</p> <p>10: 10.0 ↓</p>	<p>11: 8.6 ←</p> <p>12: 9.2 ↗</p> <p>13: 9.6 ↓</p>	
<p>Series 91.0</p> <p>Total 0.0</p>	<p>Series 26.0</p> <p>Total 0.0</p>	

<p>40 Shots</p> 	<p>40 Shots</p> 	
<p>1: 8.5 ↓</p> <p>2: *10.5 ↓</p> <p>3: 7.5 ↓</p> <p>4: 9.1 ←</p> <p>5: 9.1 ↓</p> <p>6: 8.2 →</p> <p>7: 9.2 ↗</p> <p>8: 9.2 →</p> <p>9: *10.4 →</p> <p>10: 9.6 →</p>	<p>11: 9.3 ↑</p> <p>12: *10.2 →</p> <p>13: 9.4 ↖</p> <p>14: 10.1 ↗</p> <p>15: 9.7 ↑</p> <p>16: 9.8 ↗</p> <p>17: 9.4 ←</p> <p>18: 9.5 ↑</p> <p>19: 9.0 ←</p> <p>20: 8.4 →</p>	
<p>Series 88.0</p> <p>Total 88.0</p>	<p>Series 91.0</p> <p>Total 179.0</p>	

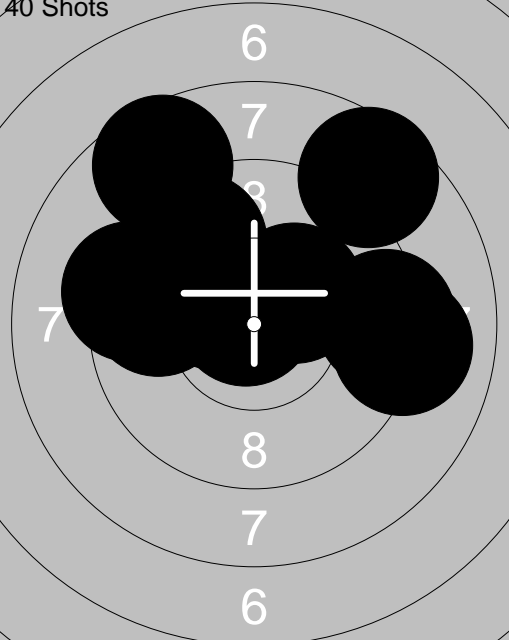
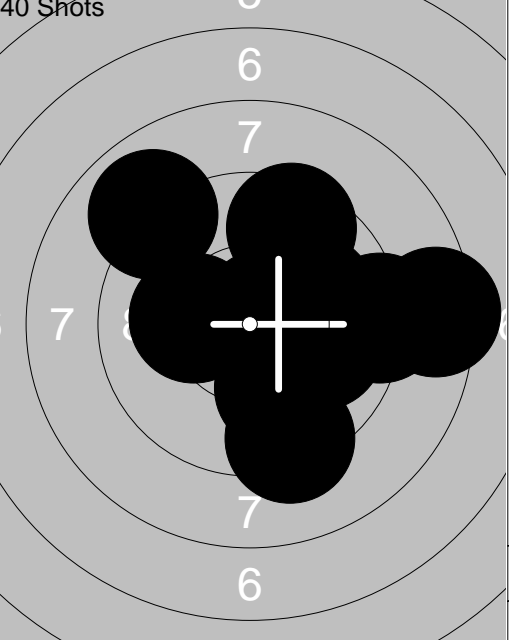
<p>40 Shots</p> 	<p>40 Shots</p> 	
<p>21: *10.4 ↖</p> <p>22: *10.3 ↗</p> <p>23: 9.7 ←</p> <p>24: 9.3 ←</p> <p>25: 9.3 →</p> <p>26: 9.7 ↗</p> <p>27: 9.0 →</p> <p>28: 8.6 ↗</p> <p>29: 8.6 ↗</p> <p>30: *10.8 ↖</p>	<p>31: 8.4 →</p> <p>32: 9.3 ↓</p> <p>33: *10.2 ←</p> <p>34: 9.1 →</p> <p>35: 10.0 ↗</p> <p>36: *10.7 ↗</p> <p>37: 8.9 ↗</p> <p>38: 9.9 →</p> <p>39: 9.5 ↑</p> <p>40: 10.0 ↓</p>	
<p>Series 91.0</p> <p>Total 270.0</p>	<p>Series 92.0</p> <p>Total 362.0</p>	

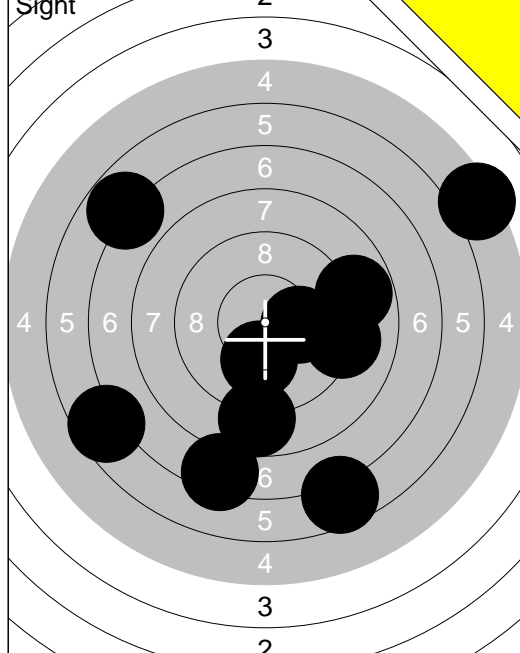

1:	6.6	↙
2:	9.1	→
3:	6.6	↘
4:	7.3	↘
5:	10.1	↘
6:	*10.2	→
7:	5.3	↗
8:	8.7	↘
9:	6.8	↖
10:	8.8	→
Series	75.0	
Total	0.0	

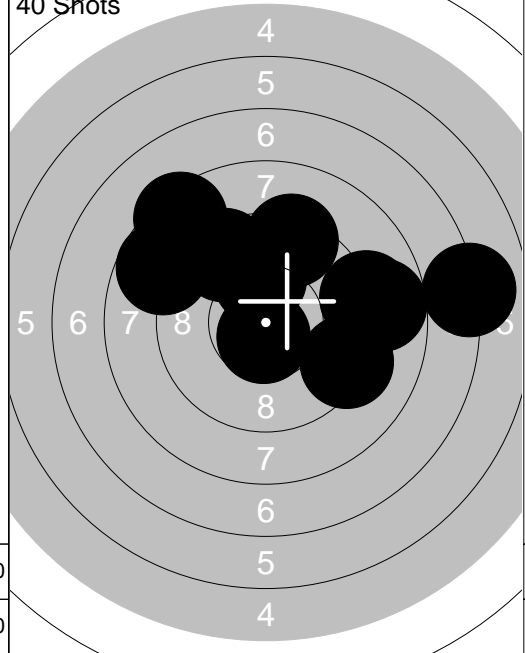

1:	*10.7	↓
2:	10.1	↑
3:	8.4	↗
4:	7.0	→
5:	9.3	↑
6:	9.0	→
7:	9.2	↘
8:	9.4	↗
9:	8.7	→
10:	8.7	↖
Series	87.0	
Total	87.0	

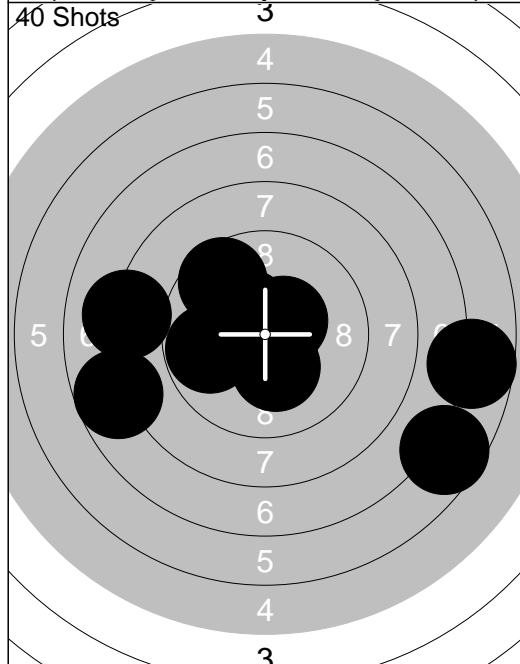

11:	9.6	↗
12:	8.1	←
13:	*10.5	↗
14:	9.8	←
15:	*10.9	↘
16:	6.6	↘
17:	7.7	←
18:	*10.4	↗
19:	6.7	→
20:	*10.3	↘
Series	85.0	
Total	172.0	

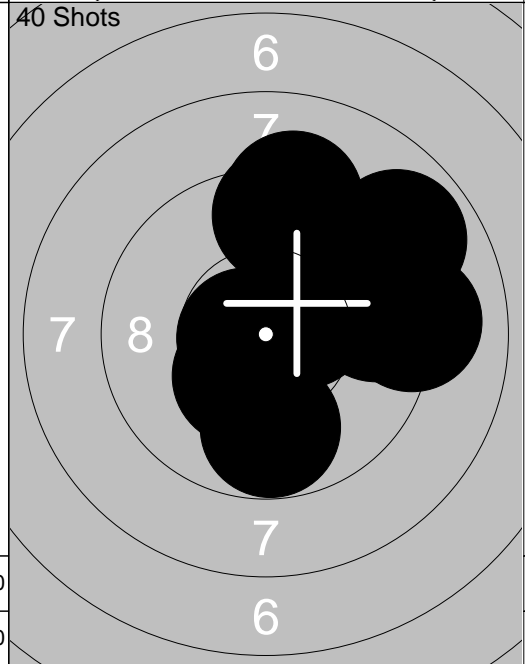

21:	9.8	↓
22:	9.4	↑
23:	*10.4	↗
24:	9.5	→
25:	9.5	↑
26:	9.1	→
27:	*10.7	←
28:	9.2	↑
29:	*10.3	↘
30:	8.9	↗
Series	92.0	
Total	264.0	

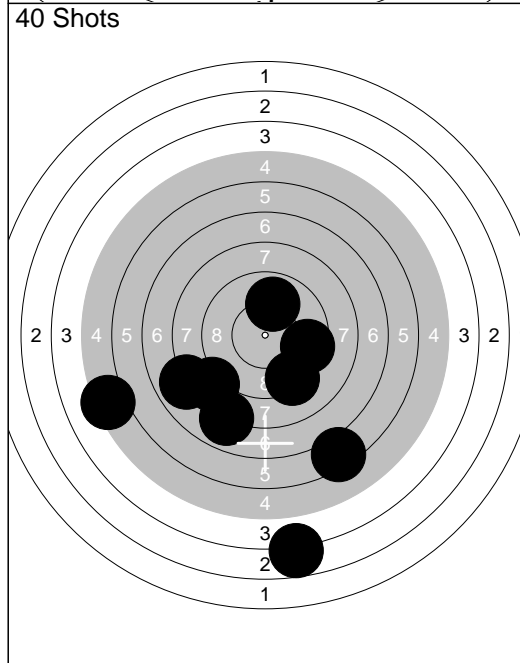

31:	9.9	↑
32:	6.3	↘
33:	9.5	→
34:	5.3	←
35:	9.3	↘
36:	8.6	↖
37:	0.0	↘
38:	7.9	←
39:	3.7	↘
40:	7.9	↘
Series	63.0	
Total	327.0	

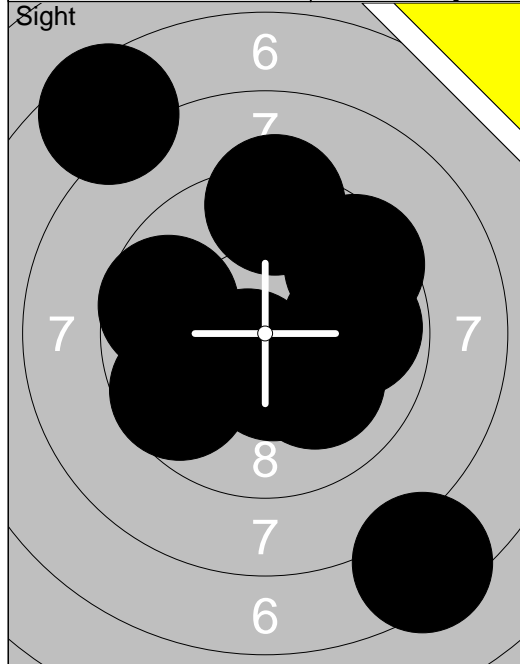

1:	9.6	↖
2:	7.4	↘
3:	9.3	↑
4:	9.5	↗
5:	*10.6	↙
6:	*10.5	↓
7:	10.1	↘
8:	9.8	→
9:	7.5	↗
10:	9.7	↖
Series		89.0
Total		0.0

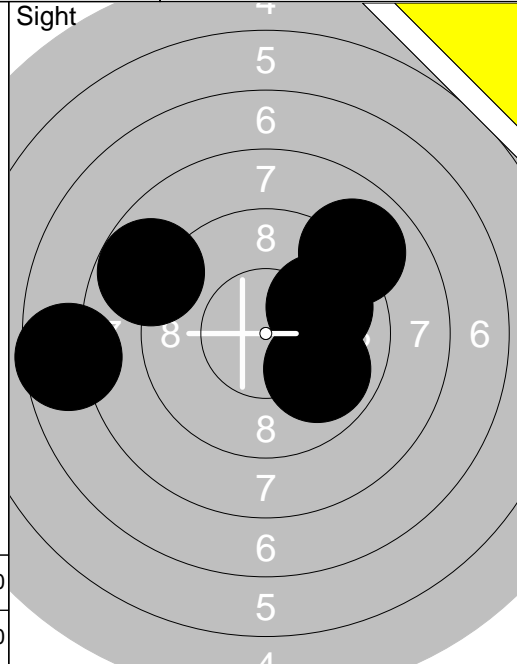

11:	8.8	↖
12:	7.6	←
13:	9.0	↗
14:	9.9	↘
15:	9.9	↗
Series		42.0
Total		0.0

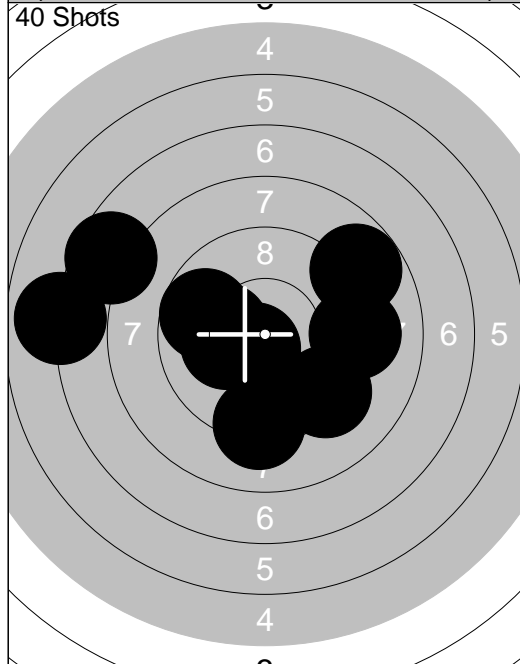

1:	7.6	↖
2:	6.9	←
3:	10.1	←
4:	*10.2	←
5:	9.2	↓
6:	9.7	←
7:	*10.6	↙
8:	9.3	↘
9:	9.2	→
10:	8.8	↗
Series		87.0
Total		87.0

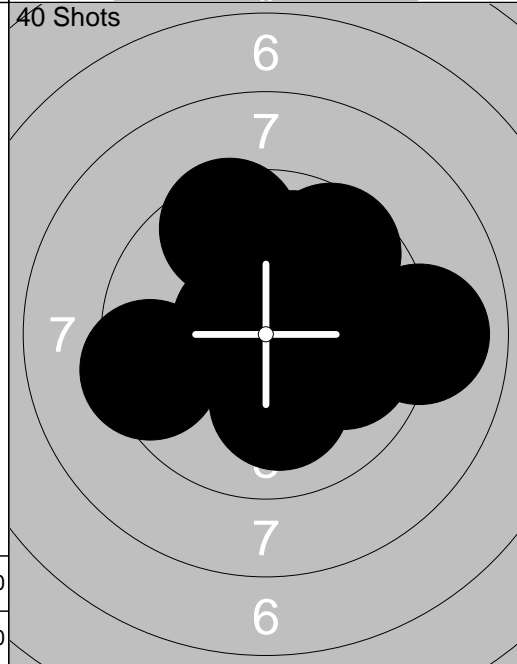

11:	9.4	←
12:	9.0	→
13:	9.6	↗
14:	10.0	↑
15:	9.9	→
16:	9.5	↑
17:	9.9	→
18:	*10.6	↖
19:	*10.2	↗
20:	10.1	↓
Series		94.0
Total		181.0

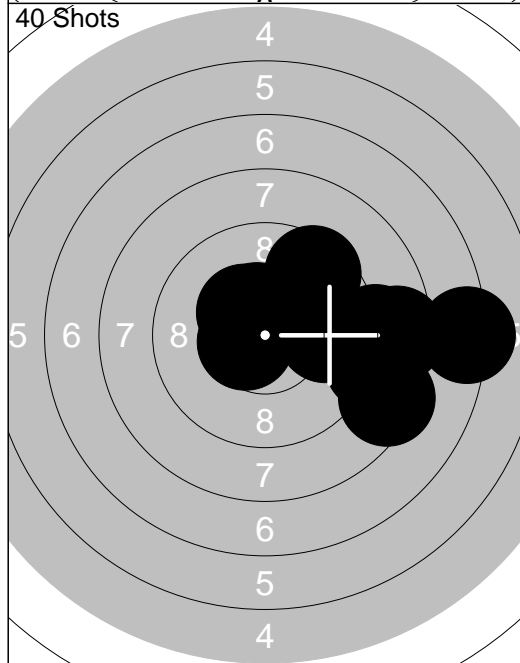

21:	8.9	→
22:	7.2	→
23:	8.9	→
24:	9.8	→
25:	*10.4	↗
26:	*10.6	←
27:	8.5	→
28:	8.4	↘
29:	9.5	↗
30:	*10.5	↗
Series		87.0
Total		268.0

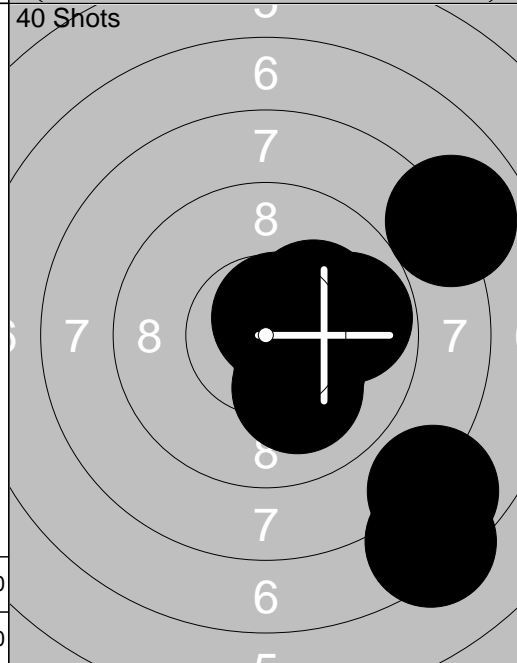

31:	*10.4	→
32:	*10.7	↗
33:	*10.3	↘
34:	7.3	↘
35:	8.0	↗
36:	9.8	→
37:	*10.5	↗
38:	*10.2	↗
39:	7.8	↘
40:	10.1	↘
Series		91.0
Total		359.0

<p>Sight</p>	<p>Sight</p>
---------------------	---------------------

<p>40 Shots</p>	<p>40 Shots</p>
------------------------	------------------------

<p>40 Shots</p>	<p>40 Shots</p>
------------------------	------------------------

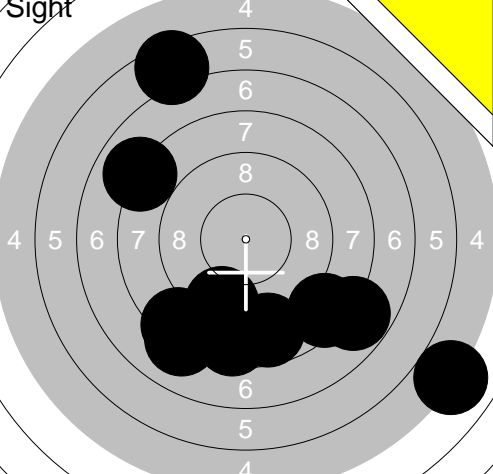
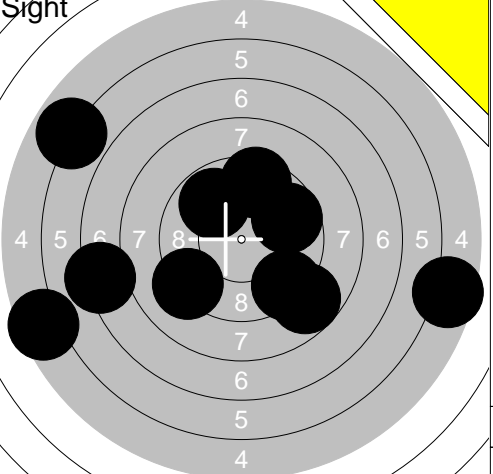
Sight 	<table border="1" style="width:100%; border-collapse: collapse;"> <tr><td>1:</td><td>8.5</td><td>↘</td></tr> <tr><td>2:</td><td>8.1</td><td>↘</td></tr> <tr><td>3:</td><td>8.3</td><td>↘</td></tr> <tr><td>4:</td><td>6.4</td><td>↗</td></tr> <tr><td>5:</td><td>8.7</td><td>↘</td></tr> <tr><td>6:</td><td>5.0</td><td>↘</td></tr> <tr><td>7:</td><td>7.8</td><td>↘</td></tr> <tr><td>8:</td><td>8.4</td><td>↘</td></tr> <tr><td>9:</td><td>7.9</td><td>↗</td></tr> <tr><td>10:</td><td>9.3</td><td>↘</td></tr> <tr><td colspan="2">Series</td><td>74.0</td></tr> <tr><td colspan="2">Total</td><td>0.0</td></tr> </table>	1:	8.5	↘	2:	8.1	↘	3:	8.3	↘	4:	6.4	↗	5:	8.7	↘	6:	5.0	↘	7:	7.8	↘	8:	8.4	↘	9:	7.9	↗	10:	9.3	↘	Series		74.0	Total		0.0	Sight  <table border="1" style="width:100%; border-collapse: collapse;"> <tr><td>11:</td><td>5.5</td><td>→</td></tr> <tr><td>12:</td><td>7.2</td><td>←</td></tr> <tr><td>13:</td><td>9.8</td><td>↗</td></tr> <tr><td>14:</td><td>9.3</td><td>↘</td></tr> <tr><td>15:</td><td>8.7</td><td>↘</td></tr> <tr><td>16:</td><td>9.7</td><td>↗</td></tr> <tr><td>17:</td><td>9.2</td><td>↘</td></tr> <tr><td>18:</td><td>9.5</td><td>↑</td></tr> <tr><td>19:</td><td>5.5</td><td>←</td></tr> <tr><td>20:</td><td>5.8</td><td>↖</td></tr> <tr><td colspan="2">Series</td><td>75.0</td></tr> <tr><td colspan="2">Total</td><td>0.0</td></tr> </table>	11:	5.5	→	12:	7.2	←	13:	9.8	↗	14:	9.3	↘	15:	8.7	↘	16:	9.7	↗	17:	9.2	↘	18:	9.5	↑	19:	5.5	←	20:	5.8	↖	Series		75.0	Total		0.0
1:	8.5	↘																																																																								
2:	8.1	↘																																																																								
3:	8.3	↘																																																																								
4:	6.4	↗																																																																								
5:	8.7	↘																																																																								
6:	5.0	↘																																																																								
7:	7.8	↘																																																																								
8:	8.4	↘																																																																								
9:	7.9	↗																																																																								
10:	9.3	↘																																																																								
Series		74.0																																																																								
Total		0.0																																																																								
11:	5.5	→																																																																								
12:	7.2	←																																																																								
13:	9.8	↗																																																																								
14:	9.3	↘																																																																								
15:	8.7	↘																																																																								
16:	9.7	↗																																																																								
17:	9.2	↘																																																																								
18:	9.5	↑																																																																								
19:	5.5	←																																																																								
20:	5.8	↖																																																																								
Series		75.0																																																																								
Total		0.0																																																																								

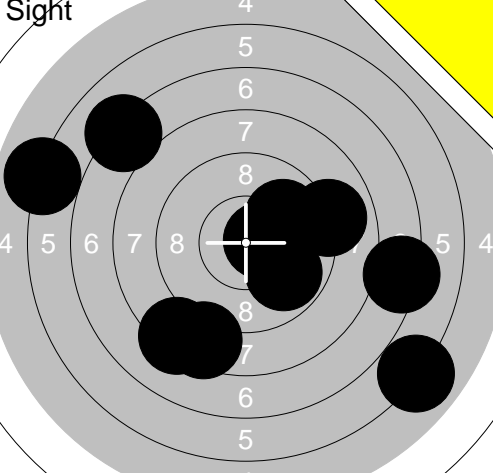
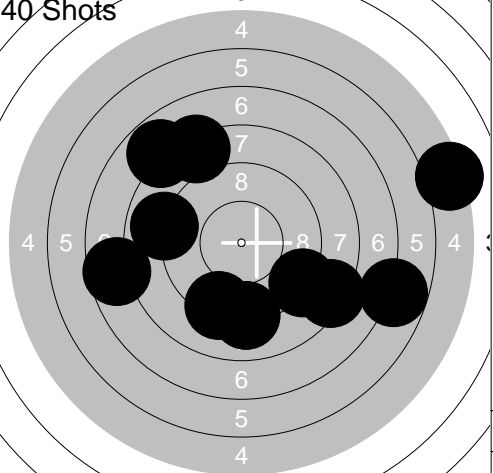
Sight 	<table border="1" style="width:100%; border-collapse: collapse;"> <tr><td>21:</td><td>8.5</td><td>↘</td></tr> <tr><td>22:</td><td>8.3</td><td>↘</td></tr> <tr><td>23:</td><td>7.1</td><td>↗</td></tr> <tr><td>24:</td><td>*10.6</td><td>→</td></tr> <tr><td>25:</td><td>7.2</td><td>→</td></tr> <tr><td>26:</td><td>6.0</td><td>↖</td></tr> <tr><td>27:</td><td>9.8</td><td>↘</td></tr> <tr><td>28:</td><td>8.9</td><td>→</td></tr> <tr><td>29:</td><td>5.9</td><td>↘</td></tr> <tr><td>30:</td><td>9.9</td><td>↗</td></tr> <tr><td colspan="2">Series</td><td>77.0</td></tr> <tr><td colspan="2">Total</td><td>0.0</td></tr> </table>	21:	8.5	↘	22:	8.3	↘	23:	7.1	↗	24:	*10.6	→	25:	7.2	→	26:	6.0	↖	27:	9.8	↘	28:	8.9	→	29:	5.9	↘	30:	9.9	↗	Series		77.0	Total		0.0	40 Shots  <table border="1" style="width:100%; border-collapse: collapse;"> <tr><td>1:</td><td>9.0</td><td>↘</td></tr> <tr><td>2:</td><td>9.0</td><td>↘</td></tr> <tr><td>3:</td><td>8.2</td><td>↗</td></tr> <tr><td>4:</td><td>6.8</td><td>→</td></tr> <tr><td>5:</td><td>5.2</td><td>→</td></tr> <tr><td>6:</td><td>7.8</td><td>↗</td></tr> <tr><td>7:</td><td>8.9</td><td>←</td></tr> <tr><td>8:</td><td>9.2</td><td>↘</td></tr> <tr><td>9:</td><td>8.3</td><td>↘</td></tr> <tr><td>10:</td><td>7.6</td><td>←</td></tr> <tr><td colspan="2">Series</td><td>76.0</td></tr> <tr><td colspan="2">Total</td><td>76.0</td></tr> </table>	1:	9.0	↘	2:	9.0	↘	3:	8.2	↗	4:	6.8	→	5:	5.2	→	6:	7.8	↗	7:	8.9	←	8:	9.2	↘	9:	8.3	↘	10:	7.6	←	Series		76.0	Total		76.0
21:	8.5	↘																																																																								
22:	8.3	↘																																																																								
23:	7.1	↗																																																																								
24:	*10.6	→																																																																								
25:	7.2	→																																																																								
26:	6.0	↖																																																																								
27:	9.8	↘																																																																								
28:	8.9	→																																																																								
29:	5.9	↘																																																																								
30:	9.9	↗																																																																								
Series		77.0																																																																								
Total		0.0																																																																								
1:	9.0	↘																																																																								
2:	9.0	↘																																																																								
3:	8.2	↗																																																																								
4:	6.8	→																																																																								
5:	5.2	→																																																																								
6:	7.8	↗																																																																								
7:	8.9	←																																																																								
8:	9.2	↘																																																																								
9:	8.3	↘																																																																								
10:	7.6	←																																																																								
Series		76.0																																																																								
Total		76.0																																																																								

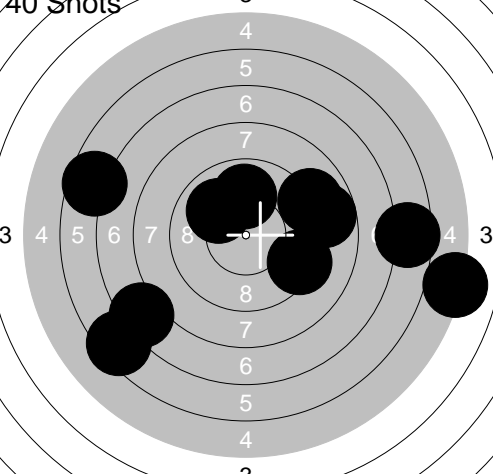
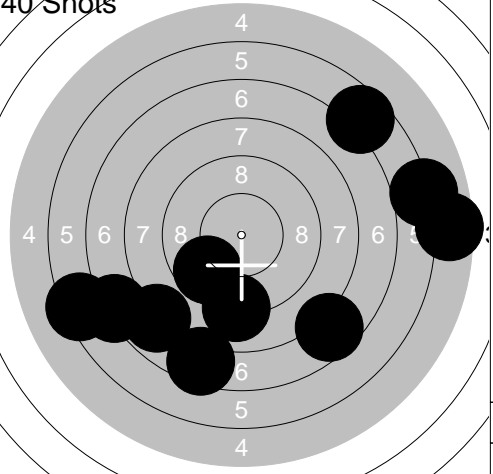
40 Shots 	<table border="1" style="width:100%; border-collapse: collapse;"> <tr><td>11:</td><td>7.3</td><td>←</td></tr> <tr><td>12:</td><td>9.9</td><td>↑</td></tr> <tr><td>13:</td><td>9.3</td><td>↘</td></tr> <tr><td>14:</td><td>8.9</td><td>↗</td></tr> <tr><td>15:</td><td>10.0</td><td>↗</td></tr> <tr><td>16:</td><td>8.8</td><td>→</td></tr> <tr><td>17:</td><td>6.5</td><td>→</td></tr> <tr><td>18:</td><td>5.1</td><td>→</td></tr> <tr><td>19:</td><td>6.6</td><td>↖</td></tr> <tr><td>20:</td><td>6.4</td><td>↘</td></tr> <tr><td colspan="2">Series</td><td>74.0</td></tr> <tr><td colspan="2">Total</td><td>150.0</td></tr> </table>	11:	7.3	←	12:	9.9	↑	13:	9.3	↘	14:	8.9	↗	15:	10.0	↗	16:	8.8	→	17:	6.5	→	18:	5.1	→	19:	6.6	↖	20:	6.4	↘	Series		74.0	Total		150.0	40 Shots  <table border="1" style="width:100%; border-collapse: collapse;"> <tr><td>21:</td><td>9.7</td><td>↘</td></tr> <tr><td>22:</td><td>6.0</td><td>→</td></tr> <tr><td>23:</td><td>5.5</td><td>→</td></tr> <tr><td>24:</td><td>7.6</td><td>↘</td></tr> <tr><td>25:</td><td>6.6</td><td>↗</td></tr> <tr><td>26:</td><td>9.0</td><td>↘</td></tr> <tr><td>27:</td><td>7.4</td><td>↘</td></tr> <tr><td>28:</td><td>6.3</td><td>←</td></tr> <tr><td>29:</td><td>7.8</td><td>↘</td></tr> <tr><td>30:</td><td>7.1</td><td>↘</td></tr> <tr><td colspan="2">Series</td><td>69.0</td></tr> <tr><td colspan="2">Total</td><td>219.0</td></tr> </table>	21:	9.7	↘	22:	6.0	→	23:	5.5	→	24:	7.6	↘	25:	6.6	↗	26:	9.0	↘	27:	7.4	↘	28:	6.3	←	29:	7.8	↘	30:	7.1	↘	Series		69.0	Total		219.0
11:	7.3	←																																																																								
12:	9.9	↑																																																																								
13:	9.3	↘																																																																								
14:	8.9	↗																																																																								
15:	10.0	↗																																																																								
16:	8.8	→																																																																								
17:	6.5	→																																																																								
18:	5.1	→																																																																								
19:	6.6	↖																																																																								
20:	6.4	↘																																																																								
Series		74.0																																																																								
Total		150.0																																																																								
21:	9.7	↘																																																																								
22:	6.0	→																																																																								
23:	5.5	→																																																																								
24:	7.6	↘																																																																								
25:	6.6	↗																																																																								
26:	9.0	↘																																																																								
27:	7.4	↘																																																																								
28:	6.3	←																																																																								
29:	7.8	↘																																																																								
30:	7.1	↘																																																																								
Series		69.0																																																																								
Total		219.0																																																																								

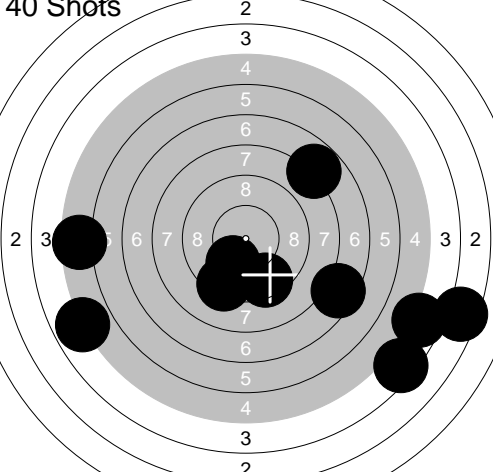
40 Shots 	<table border="1" style="width:100%; border-collapse: collapse;"> <tr><td>31:</td><td>4.6</td><td>↘</td></tr> <tr><td>32:</td><td>9.3</td><td>↘</td></tr> <tr><td>33:</td><td>7.4</td><td>↘</td></tr> <tr><td>34:</td><td>7.8</td><td>↗</td></tr> <tr><td>35:</td><td>4.9</td><td>←</td></tr> <tr><td>36:</td><td>9.4</td><td>↘</td></tr> <tr><td>37:</td><td>3.4</td><td>→</td></tr> <tr><td>38:</td><td>10.0</td><td>↘</td></tr> <tr><td>39:</td><td>5.5</td><td>←</td></tr> <tr><td>40:</td><td>4.3</td><td>↘</td></tr> <tr><td colspan="2">Series</td><td>62.0</td></tr> <tr><td colspan="2">Total</td><td>281.0</td></tr> </table>	31:	4.6	↘	32:	9.3	↘	33:	7.4	↘	34:	7.8	↗	35:	4.9	←	36:	9.4	↘	37:	3.4	→	38:	10.0	↘	39:	5.5	←	40:	4.3	↘	Series		62.0	Total		281.0	
31:	4.6	↘																																				
32:	9.3	↘																																				
33:	7.4	↘																																				
34:	7.8	↗																																				
35:	4.9	←																																				
36:	9.4	↘																																				
37:	3.4	→																																				
38:	10.0	↘																																				
39:	5.5	←																																				
40:	4.3	↘																																				
Series		62.0																																				
Total		281.0																																				

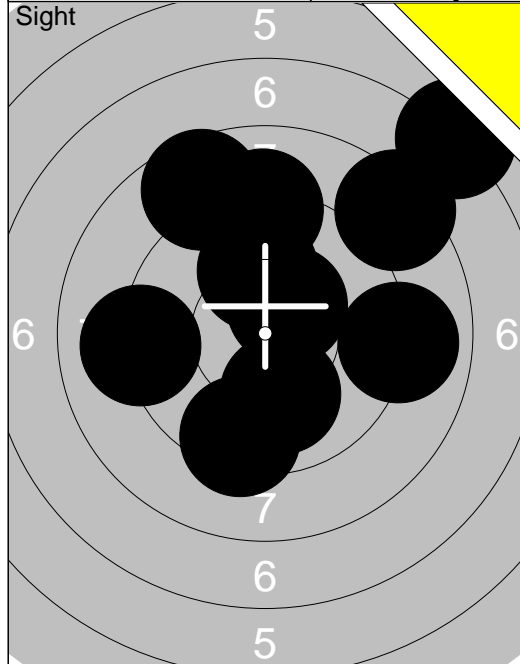

1:	9.1	↑
2:	8.6	↖
3:	9.4	↓
4:	9.1	←
5:	10.0	↓
6:	6.9	↗
7:	*10.4	↗
8:	10.0	↑
9:	9.0	→
10:	8.3	↗
Series		88.0
Total		0.0

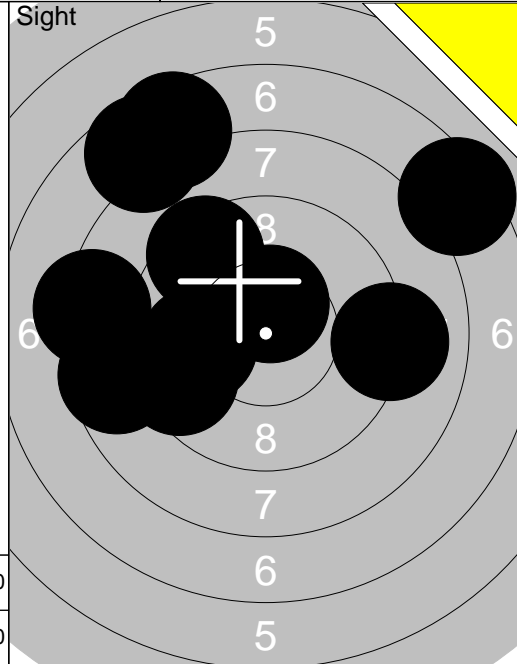

11:	9.4	↖
12:	8.3	←
13:	9.9	←
14:	7.4	↗
15:	8.6	←
16:	7.6	↖
17:	9.5	↖
18:	*10.5	↑
19:	7.6	↖
20:	9.1	→
Series		83.0
Total		0.0

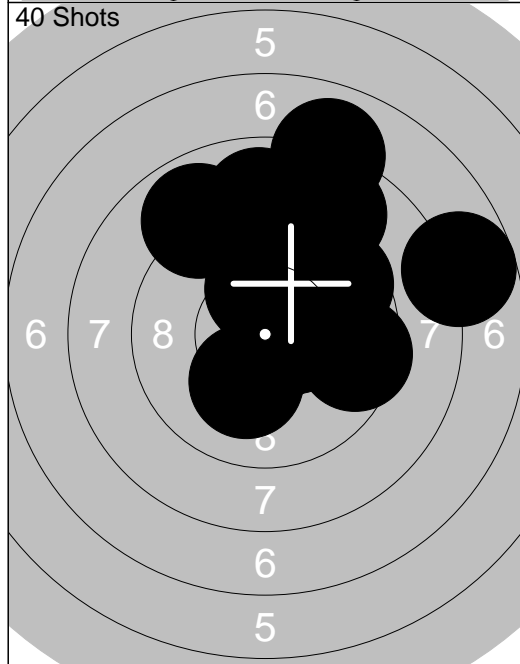

1:	9.5	→
2:	8.9	↖
3:	8.9	↑
4:	9.6	↗
5:	8.0	↑
6:	*10.2	↓
7:	*10.5	→
8:	7.7	→
9:	8.8	↖
10:	*10.2	↑
Series		87.0
Total		87.0

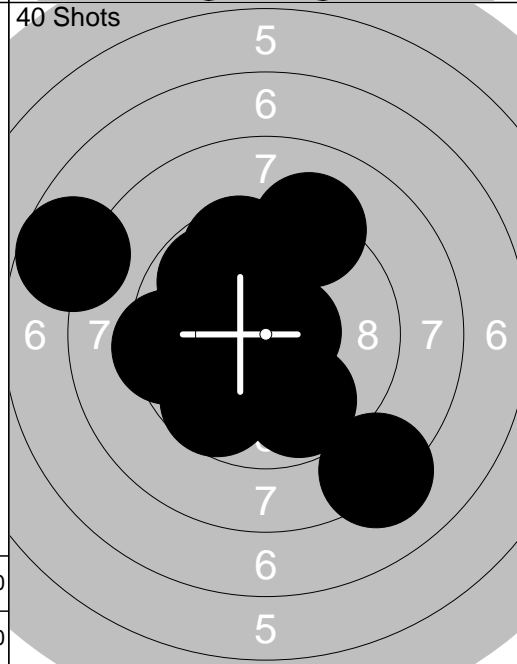



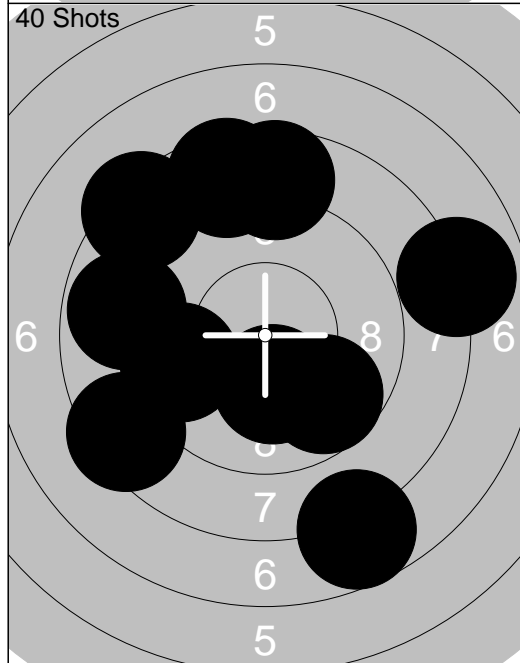

11:	8.2	↘
12:	7.7	↖
13:	9.2	↑
14:	9.8	↖
15:	*10.7	→
16:	9.8	↘
17:	9.7	↘
18:	9.6	↑
19:	9.4	←
20:	9.6	←
Series		88.0
Total		175.0

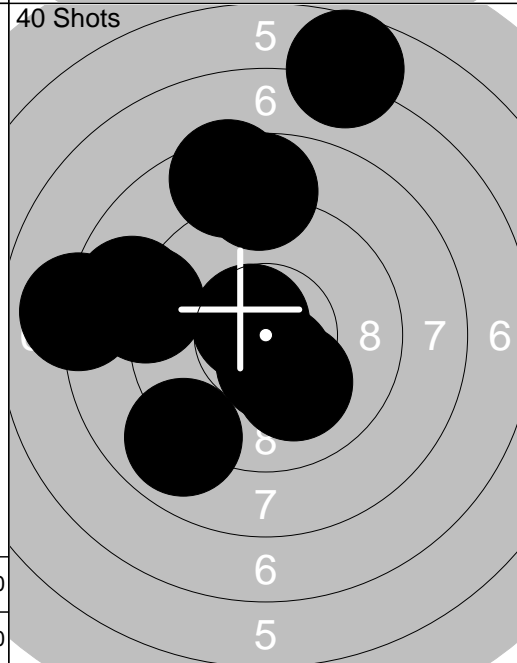

21:	8.5	↑
22:	*10.2	↓
23:	7.9	→
24:	9.6	←
25:	8.8	←
26:	8.6	↑
27:	8.3	↖
28:	7.7	↓
29:	8.4	↖
30:	9.7	↘
Series		82.0
Total		257.0

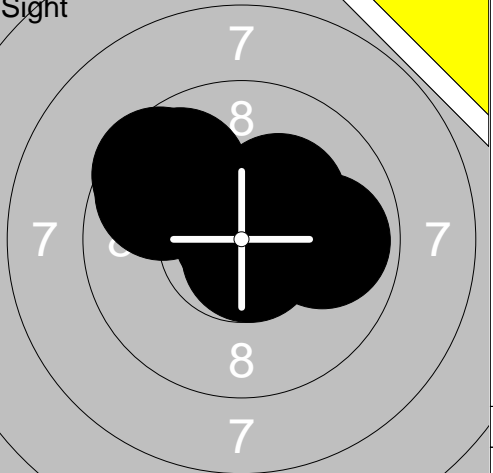

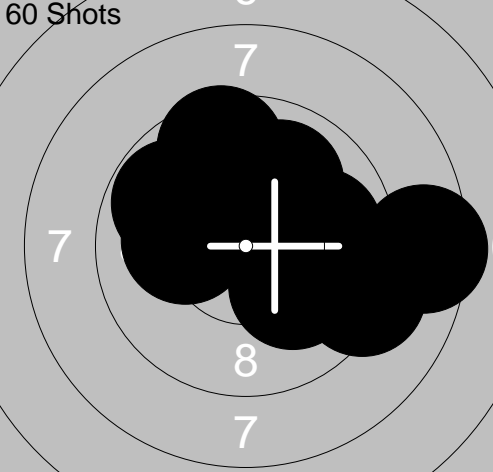
31:	6.7	↑
32:	8.8	↖
33:	8.9	↘
34:	8.0	←
35:	9.0	←
36:	*10.5	↓
37:	10.1	↘
38:	8.5	↑
39:	8.7	↑
40:	*10.6	↖
Series		85.0
Total		342.0

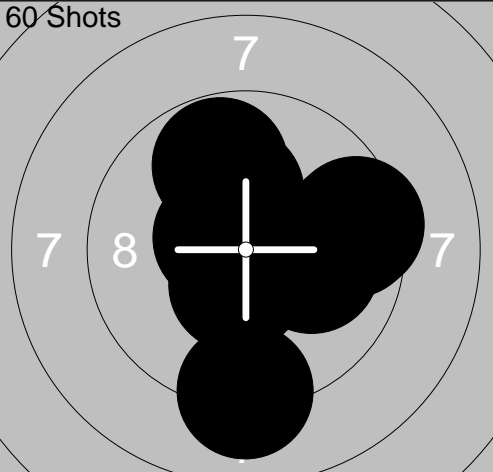
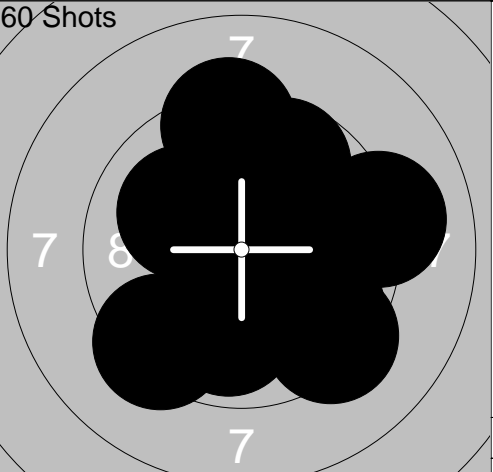
Sight		Sight																																																	
	<table border="1" style="width:100%; border-collapse: collapse;"> <tr><td>1: 9.7</td><td>→</td></tr> <tr><td>2: 10.1</td><td>↗</td></tr> <tr><td>3: *10.2</td><td>→</td></tr> <tr><td>4: 9.1</td><td>↗</td></tr> <tr><td>5: 9.8</td><td>→</td></tr> <tr><td>6: 9.6</td><td>↗</td></tr> <tr><td>7: 9.8</td><td>↗</td></tr> <tr><td>8: 9.3</td><td>↗</td></tr> <tr><td>9: *10.3</td><td>→</td></tr> <tr><td>10: *10.2</td><td>↓</td></tr> <tr><td colspan="2">Series 94.0</td></tr> <tr><td colspan="2">Total 0.0</td></tr> </table>	1: 9.7	→	2: 10.1	↗	3: *10.2	→	4: 9.1	↗	5: 9.8	→	6: 9.6	↗	7: 9.8	↗	8: 9.3	↗	9: *10.3	→	10: *10.2	↓	Series 94.0		Total 0.0			<table border="1" style="width:100%; border-collapse: collapse;"> <tr><td>11: 9.8</td><td>↖</td></tr> <tr><td>12: *10.7</td><td>↓</td></tr> <tr><td>13: 9.6</td><td>↖</td></tr> <tr><td>14: *10.3</td><td>↗</td></tr> <tr><td>15: 9.9</td><td>→</td></tr> <tr><td>16: 9.7</td><td>↖</td></tr> <tr><td>17: *10.9</td><td>↑</td></tr> <tr><td colspan="2">Series 66.0</td></tr> <tr><td colspan="2">Total 0.0</td></tr> </table>	11: 9.8	↖	12: *10.7	↓	13: 9.6	↖	14: *10.3	↗	15: 9.9	→	16: 9.7	↖	17: *10.9	↑	Series 66.0		Total 0.0							
1: 9.7	→																																																		
2: 10.1	↗																																																		
3: *10.2	→																																																		
4: 9.1	↗																																																		
5: 9.8	→																																																		
6: 9.6	↗																																																		
7: 9.8	↗																																																		
8: 9.3	↗																																																		
9: *10.3	→																																																		
10: *10.2	↓																																																		
Series 94.0																																																			
Total 0.0																																																			
11: 9.8	↖																																																		
12: *10.7	↓																																																		
13: 9.6	↖																																																		
14: *10.3	↗																																																		
15: 9.9	→																																																		
16: 9.7	↖																																																		
17: *10.9	↑																																																		
Series 66.0																																																			
Total 0.0																																																			
	<table border="1" style="width:100%; border-collapse: collapse;"> <tr><td>1: 9.6</td><td>→</td></tr> <tr><td>2: 10.0</td><td>↑</td></tr> <tr><td>3: 9.7</td><td>↑</td></tr> <tr><td>4: *10.4</td><td>↑</td></tr> <tr><td>5: 10.0</td><td>←</td></tr> <tr><td>6: 10.0</td><td>↘</td></tr> <tr><td>7: 9.0</td><td>↗</td></tr> <tr><td>8: 9.7</td><td>↗</td></tr> <tr><td>9: *10.5</td><td>↖</td></tr> <tr><td>10: 9.9</td><td>↖</td></tr> <tr><td colspan="2">Series 95.0</td></tr> <tr><td colspan="2">Total 95.0</td></tr> </table>	1: 9.6	→	2: 10.0	↑	3: 9.7	↑	4: *10.4	↑	5: 10.0	←	6: 10.0	↘	7: 9.0	↗	8: 9.7	↗	9: *10.5	↖	10: 9.9	↖	Series 95.0		Total 95.0			<table border="1" style="width:100%; border-collapse: collapse;"> <tr><td>11: *10.6</td><td>↘</td></tr> <tr><td>12: *10.4</td><td>↑</td></tr> <tr><td>13: 9.8</td><td>↗</td></tr> <tr><td>14: *10.6</td><td>↑</td></tr> <tr><td>15: *10.4</td><td>↖</td></tr> <tr><td>16: 9.5</td><td>↗</td></tr> <tr><td>17: 9.7</td><td>↗</td></tr> <tr><td>18: 9.0</td><td>↗</td></tr> <tr><td>19: 9.7</td><td>→</td></tr> <tr><td>20: *10.3</td><td>↓</td></tr> <tr><td colspan="2">Series 95.0</td></tr> <tr><td colspan="2">Total 190.0</td></tr> </table>	11: *10.6	↘	12: *10.4	↑	13: 9.8	↗	14: *10.6	↑	15: *10.4	↖	16: 9.5	↗	17: 9.7	↗	18: 9.0	↗	19: 9.7	→	20: *10.3	↓	Series 95.0		Total 190.0	
1: 9.6	→																																																		
2: 10.0	↑																																																		
3: 9.7	↑																																																		
4: *10.4	↑																																																		
5: 10.0	←																																																		
6: 10.0	↘																																																		
7: 9.0	↗																																																		
8: 9.7	↗																																																		
9: *10.5	↖																																																		
10: 9.9	↖																																																		
Series 95.0																																																			
Total 95.0																																																			
11: *10.6	↘																																																		
12: *10.4	↑																																																		
13: 9.8	↗																																																		
14: *10.6	↑																																																		
15: *10.4	↖																																																		
16: 9.5	↗																																																		
17: 9.7	↗																																																		
18: 9.0	↗																																																		
19: 9.7	→																																																		
20: *10.3	↓																																																		
Series 95.0																																																			
Total 190.0																																																			
	<table border="1" style="width:100%; border-collapse: collapse;"> <tr><td>21: 9.9</td><td>→</td></tr> <tr><td>22: 9.8</td><td>↖</td></tr> <tr><td>23: 9.2</td><td>↘</td></tr> <tr><td>24: *10.2</td><td>↗</td></tr> <tr><td>25: 10.0</td><td>↗</td></tr> <tr><td>26: 9.9</td><td>↘</td></tr> <tr><td>27: 8.5</td><td>→</td></tr> <tr><td>28: 9.6</td><td>↑</td></tr> <tr><td>29: 10.1</td><td>←</td></tr> <tr><td>30: 10.1</td><td>↘</td></tr> <tr><td colspan="2">Series 93.0</td></tr> <tr><td colspan="2">Total 283.0</td></tr> </table>	21: 9.9	→	22: 9.8	↖	23: 9.2	↘	24: *10.2	↗	25: 10.0	↗	26: 9.9	↘	27: 8.5	→	28: 9.6	↑	29: 10.1	←	30: 10.1	↘	Series 93.0		Total 283.0			<table border="1" style="width:100%; border-collapse: collapse;"> <tr><td>31: *10.8</td><td>↙</td></tr> <tr><td>32: 9.6</td><td>→</td></tr> <tr><td>33: *10.4</td><td>↗</td></tr> <tr><td>34: 9.7</td><td>→</td></tr> <tr><td>35: 9.8</td><td>↙</td></tr> <tr><td>36: *10.7</td><td>→</td></tr> <tr><td>37: 9.0</td><td>→</td></tr> <tr><td>38: 10.0</td><td>↗</td></tr> <tr><td>39: 10.0</td><td>↑</td></tr> <tr><td>40: 9.5</td><td>↘</td></tr> <tr><td colspan="2">Series 95.0</td></tr> <tr><td colspan="2">Total 378.0</td></tr> </table>	31: *10.8	↙	32: 9.6	→	33: *10.4	↗	34: 9.7	→	35: 9.8	↙	36: *10.7	→	37: 9.0	→	38: 10.0	↗	39: 10.0	↑	40: 9.5	↘	Series 95.0		Total 378.0	
21: 9.9	→																																																		
22: 9.8	↖																																																		
23: 9.2	↘																																																		
24: *10.2	↗																																																		
25: 10.0	↗																																																		
26: 9.9	↘																																																		
27: 8.5	→																																																		
28: 9.6	↑																																																		
29: 10.1	←																																																		
30: 10.1	↘																																																		
Series 93.0																																																			
Total 283.0																																																			
31: *10.8	↙																																																		
32: 9.6	→																																																		
33: *10.4	↗																																																		
34: 9.7	→																																																		
35: 9.8	↙																																																		
36: *10.7	→																																																		
37: 9.0	→																																																		
38: 10.0	↗																																																		
39: 10.0	↑																																																		
40: 9.5	↘																																																		
Series 95.0																																																			
Total 378.0																																																			
	<table border="1" style="width:100%; border-collapse: collapse;"> <tr><td>41: *10.2</td><td>↑</td></tr> <tr><td>42: 9.5</td><td>→</td></tr> <tr><td>43: *10.5</td><td>↓</td></tr> <tr><td>44: *10.3</td><td>↑</td></tr> <tr><td>45: *10.6</td><td>↖</td></tr> <tr><td>46: 10.1</td><td>↘</td></tr> <tr><td>47: 9.5</td><td>→</td></tr> <tr><td>48: *10.8</td><td>↘</td></tr> <tr><td>49: 9.1</td><td>↓</td></tr> <tr><td>50: 9.8</td><td>↑</td></tr> <tr><td colspan="2">Series 96.0</td></tr> <tr><td colspan="2">Total 474.0</td></tr> </table>	41: *10.2	↑	42: 9.5	→	43: *10.5	↓	44: *10.3	↑	45: *10.6	↖	46: 10.1	↘	47: 9.5	→	48: *10.8	↘	49: 9.1	↓	50: 9.8	↑	Series 96.0		Total 474.0			<table border="1" style="width:100%; border-collapse: collapse;"> <tr><td>51: 9.7</td><td>↗</td></tr> <tr><td>52: *10.5</td><td>→</td></tr> <tr><td>53: 10.1</td><td>↖</td></tr> <tr><td>54: 9.7</td><td>↘</td></tr> <tr><td>55: *10.2</td><td>→</td></tr> <tr><td>56: 9.3</td><td>↙</td></tr> <tr><td>57: 9.3</td><td>↘</td></tr> <tr><td>58: 9.3</td><td>↑</td></tr> <tr><td>59: 9.1</td><td>→</td></tr> <tr><td>60: 9.9</td><td>↓</td></tr> <tr><td colspan="2">Series 93.0</td></tr> <tr><td colspan="2">Total 567.0</td></tr> </table>	51: 9.7	↗	52: *10.5	→	53: 10.1	↖	54: 9.7	↘	55: *10.2	→	56: 9.3	↙	57: 9.3	↘	58: 9.3	↑	59: 9.1	→	60: 9.9	↓	Series 93.0		Total 567.0	
41: *10.2	↑																																																		
42: 9.5	→																																																		
43: *10.5	↓																																																		
44: *10.3	↑																																																		
45: *10.6	↖																																																		
46: 10.1	↘																																																		
47: 9.5	→																																																		
48: *10.8	↘																																																		
49: 9.1	↓																																																		
50: 9.8	↑																																																		
Series 96.0																																																			
Total 474.0																																																			
51: 9.7	↗																																																		
52: *10.5	→																																																		
53: 10.1	↖																																																		
54: 9.7	↘																																																		
55: *10.2	→																																																		
56: 9.3	↙																																																		
57: 9.3	↘																																																		
58: 9.3	↑																																																		
59: 9.1	→																																																		
60: 9.9	↓																																																		
Series 93.0																																																			
Total 567.0																																																			

	<p>40 Shots</p> <table style="width:100%; border-collapse: collapse;"> <tr><td>1:</td><td>8.4</td><td>→</td></tr> <tr><td>2:</td><td>8.5</td><td>↘</td></tr> <tr><td>3:</td><td>4.3</td><td>↓</td></tr> <tr><td>4:</td><td>4.9</td><td>↘</td></tr> <tr><td>5:</td><td>8.1</td><td>↘</td></tr> <tr><td>6:</td><td>8.2</td><td>↘</td></tr> <tr><td>7:</td><td>7.0</td><td>↓</td></tr> <tr><td>8:</td><td>7.7</td><td>↓</td></tr> <tr><td>9:</td><td>10.0</td><td>↘</td></tr> <tr><td>10:</td><td>9.3</td><td>←</td></tr> </table>	1:	8.4	→	2:	8.5	↘	3:	4.3	↓	4:	4.9	↘	5:	8.1	↘	6:	8.2	↘	7:	7.0	↓	8:	7.7	↓	9:	10.0	↘	10:	9.3	←		<table style="width:100%; border-collapse: collapse;"> <tr><td>1:</td><td>7.7</td><td>↓</td></tr> <tr><td>2:</td><td>0.0</td><td>↙</td></tr> <tr><td>3:</td><td>7.2</td><td>↑</td></tr> <tr><td>4:</td><td>9.0</td><td>↓</td></tr> <tr><td>5:</td><td>8.4</td><td>↑</td></tr> <tr><td>6:</td><td>1.9</td><td>↗</td></tr> <tr><td>7:</td><td>7.2</td><td>↙</td></tr> <tr><td>8:</td><td>6.2</td><td>←</td></tr> <tr><td>9:</td><td>*10.3</td><td>↖</td></tr> <tr><td>10:</td><td>8.9</td><td>↙</td></tr> </table>	1:	7.7	↓	2:	0.0	↙	3:	7.2	↑	4:	9.0	↓	5:	8.4	↑	6:	1.9	↗	7:	7.2	↙	8:	6.2	←	9:	*10.3	↖	10:	8.9	↙
1:	8.4	→																																																													
2:	8.5	↘																																																													
3:	4.3	↓																																																													
4:	4.9	↘																																																													
5:	8.1	↘																																																													
6:	8.2	↘																																																													
7:	7.0	↓																																																													
8:	7.7	↓																																																													
9:	10.0	↘																																																													
10:	9.3	←																																																													
1:	7.7	↓																																																													
2:	0.0	↙																																																													
3:	7.2	↑																																																													
4:	9.0	↓																																																													
5:	8.4	↑																																																													
6:	1.9	↗																																																													
7:	7.2	↙																																																													
8:	6.2	←																																																													
9:	*10.3	↖																																																													
10:	8.9	↙																																																													
<table style="width:100%; border-collapse: collapse;"> <tr> <td style="width:50%;">Series</td> <td style="width:50%; text-align:right;">73.0</td> </tr> <tr> <td>Total</td> <td style="text-align:right;">0.0</td> </tr> </table>		Series	73.0	Total	0.0	<table style="width:100%; border-collapse: collapse;"> <tr> <td style="width:50%;">Series</td> <td style="width:50%; text-align:right;">63.0</td> </tr> <tr> <td>Total</td> <td style="text-align:right;">63.0</td> </tr> </table>		Series	63.0	Total	63.0																																																				
Series	73.0																																																														
Total	0.0																																																														
Series	63.0																																																														
Total	63.0																																																														

	<p>40 Shots</p> <table style="width:100%; border-collapse: collapse;"> <tr><td>11:</td><td>6.5</td><td>↖</td></tr> <tr><td>12:</td><td>7.4</td><td>↗</td></tr> <tr><td>13:</td><td>8.8</td><td>→</td></tr> <tr><td>14:</td><td>6.6</td><td>↑</td></tr> <tr><td>15:</td><td>8.8</td><td>→</td></tr> <tr><td>16:</td><td>7.5</td><td>↘</td></tr> <tr><td>17:</td><td>9.3</td><td>↗</td></tr> <tr><td>18:</td><td>9.1</td><td>↑</td></tr> <tr><td>19:</td><td>6.7</td><td>←</td></tr> <tr><td>20:</td><td>5.2</td><td>↖</td></tr> </table>	11:	6.5	↖	12:	7.4	↗	13:	8.8	→	14:	6.6	↑	15:	8.8	→	16:	7.5	↘	17:	9.3	↗	18:	9.1	↑	19:	6.7	←	20:	5.2	↖		<table style="width:100%; border-collapse: collapse;"> <tr><td>21:</td><td>8.3</td><td>↘</td></tr> <tr><td>22:</td><td>7.6</td><td>↙</td></tr> <tr><td>23:</td><td>9.1</td><td>←</td></tr> <tr><td>24:</td><td>8.6</td><td>↗</td></tr> <tr><td>25:</td><td>10.0</td><td>↖</td></tr> <tr><td>26:</td><td>8.2</td><td>↑</td></tr> <tr><td>27:</td><td>10.1</td><td>↓</td></tr> <tr><td>28:</td><td>9.3</td><td>↓</td></tr> <tr><td>29:</td><td>9.7</td><td>←</td></tr> <tr><td>30:</td><td>8.2</td><td>↖</td></tr> </table>	21:	8.3	↘	22:	7.6	↙	23:	9.1	←	24:	8.6	↗	25:	10.0	↖	26:	8.2	↑	27:	10.1	↓	28:	9.3	↓	29:	9.7	←	30:	8.2	↖
11:	6.5	↖																																																													
12:	7.4	↗																																																													
13:	8.8	→																																																													
14:	6.6	↑																																																													
15:	8.8	→																																																													
16:	7.5	↘																																																													
17:	9.3	↗																																																													
18:	9.1	↑																																																													
19:	6.7	←																																																													
20:	5.2	↖																																																													
21:	8.3	↘																																																													
22:	7.6	↙																																																													
23:	9.1	←																																																													
24:	8.6	↗																																																													
25:	10.0	↖																																																													
26:	8.2	↑																																																													
27:	10.1	↓																																																													
28:	9.3	↓																																																													
29:	9.7	←																																																													
30:	8.2	↖																																																													
<table style="width:100%; border-collapse: collapse;"> <tr> <td style="width:50%;">Series</td> <td style="width:50%; text-align:right;">71.0</td> </tr> <tr> <td>Total</td> <td style="text-align:right;">134.0</td> </tr> </table>		Series	71.0	Total	134.0	<table style="width:100%; border-collapse: collapse;"> <tr> <td style="width:50%;">Series</td> <td style="width:50%; text-align:right;">86.0</td> </tr> <tr> <td>Total</td> <td style="text-align:right;">220.0</td> </tr> </table>		Series	86.0	Total	220.0																																																				
Series	71.0																																																														
Total	134.0																																																														
Series	86.0																																																														
Total	220.0																																																														

	<p>40 Shots</p> <table style="width:100%; border-collapse: collapse;"> <tr><td>31:</td><td>10.0</td><td>↗</td></tr> <tr><td>32:</td><td>7.5</td><td>↖</td></tr> <tr><td>33:</td><td>6.5</td><td>→</td></tr> <tr><td>34:</td><td>6.6</td><td>←</td></tr> <tr><td>35:</td><td>8.8</td><td>←</td></tr> <tr><td>36:</td><td>10.0</td><td>↓</td></tr> <tr><td>37:</td><td>3.7</td><td>←</td></tr> <tr><td>38:</td><td>7.5</td><td>↖</td></tr> <tr><td>39:</td><td>6.5</td><td>↘</td></tr> <tr><td>40:</td><td>9.0</td><td>↓</td></tr> </table>	31:	10.0	↗	32:	7.5	↖	33:	6.5	→	34:	6.6	←	35:	8.8	←	36:	10.0	↓	37:	3.7	←	38:	7.5	↖	39:	6.5	↘	40:	9.0	↓		
31:	10.0	↗																															
32:	7.5	↖																															
33:	6.5	→																															
34:	6.6	←																															
35:	8.8	←																															
36:	10.0	↓																															
37:	3.7	←																															
38:	7.5	↖																															
39:	6.5	↘																															
40:	9.0	↓																															
<table style="width:100%; border-collapse: collapse;"> <tr> <td style="width:50%;">Series</td> <td style="width:50%; text-align:right;">72.0</td> </tr> <tr> <td>Total</td> <td style="text-align:right;">292.0</td> </tr> </table>		Series	72.0	Total	292.0																												
Series	72.0																																
Total	292.0																																

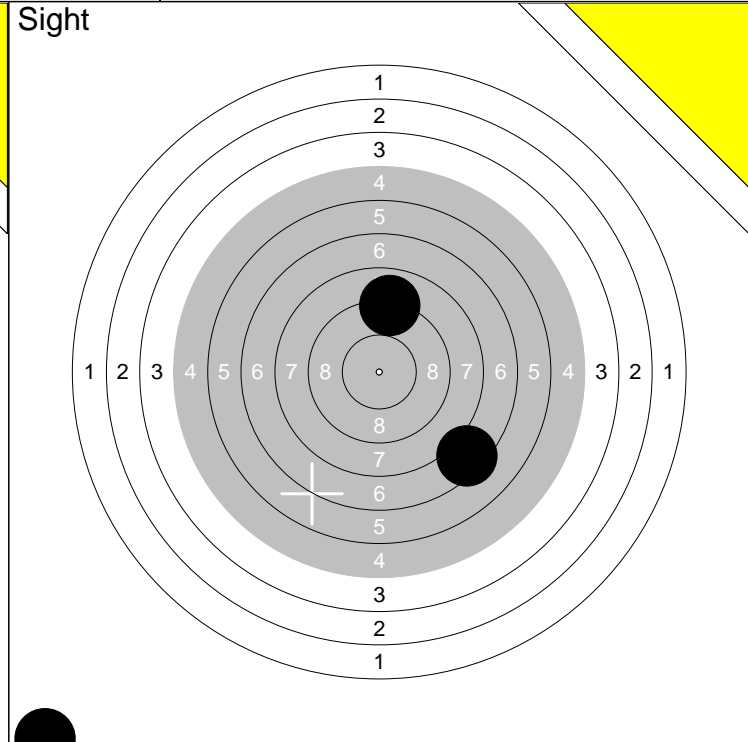
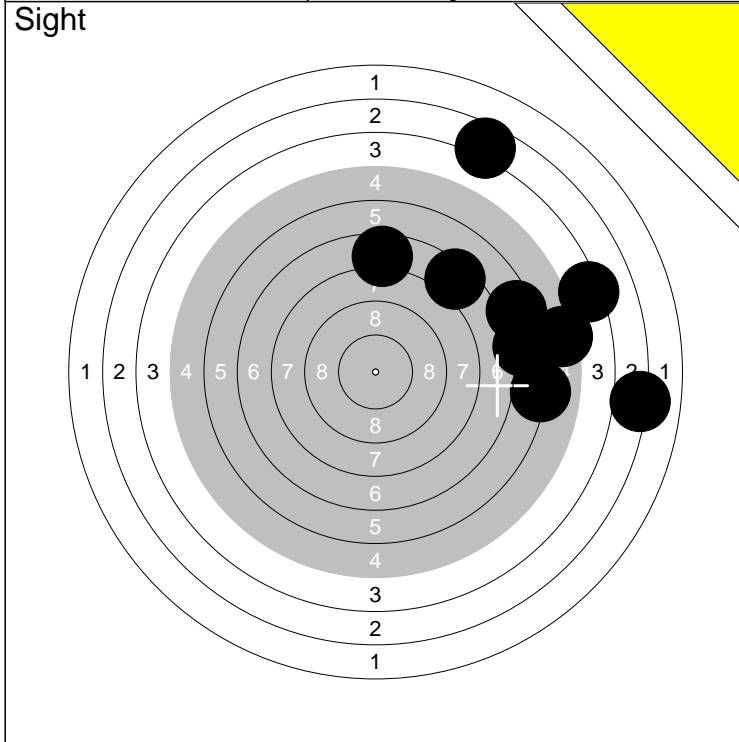

1: 0.0 ↓	6: 7.3 ↗	Series	47.0
2: 3.5 ↗	7: 6.4 →		
3: 4.2 →	8: 5.3 →	Total	0.0
4: 6.5 →	9: 7.5 ↑		
5: 3.0 →	10: 6.0 →		

11: 7.3 ↘	Series	16.0
12: 0.0 ↙		
13: 9.0 ↑	Total	0.0

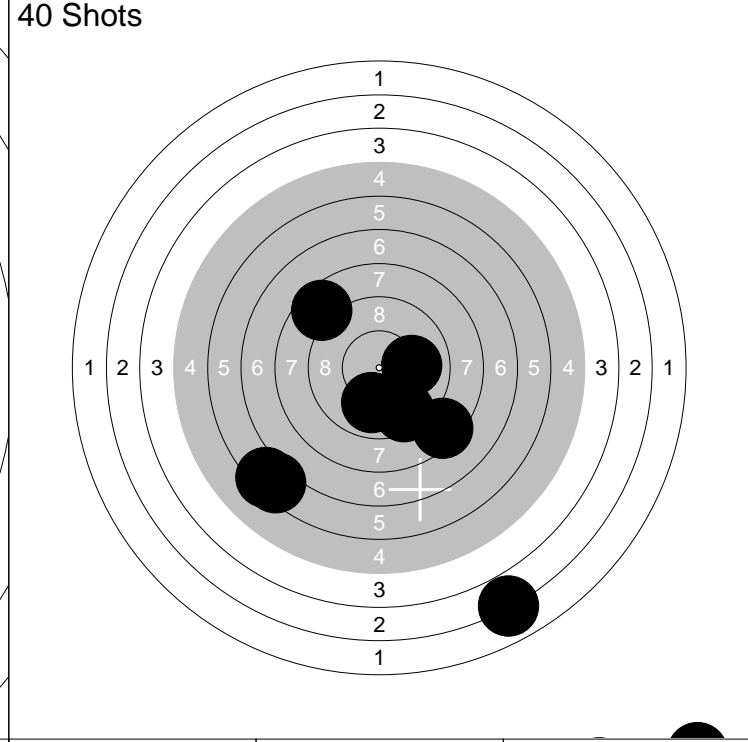
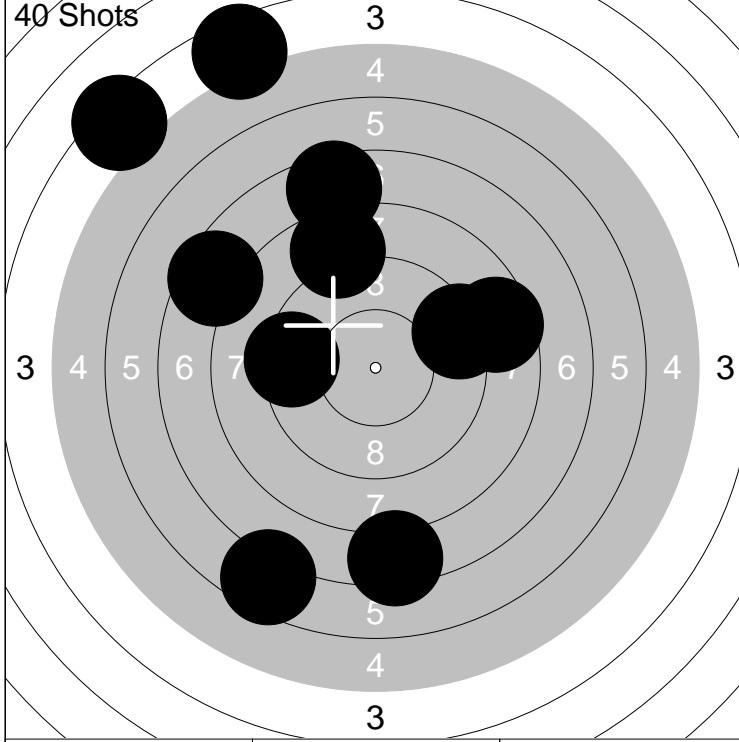

1: 4.3 ↗	6: 9.4 ←	Series	69.0
2: 8.5 →	7: 6.5 ↓		
3: 7.5 ↗	8: 7.5 ↖	Total	69.0
4: 8.6 ↗	9: 7.3 ↓		
5: 4.5 ↗	10: 9.2 →		

11: 8.5 ↗	16: 10.0 →	Series	58.0
12: 9.9 ↓	17: 6.4 ↙		
13: 6.3 ↙	18: 9.4 ↓	Total	127.0
14: 2.9 ↓	19: 0.0 ↓		
15: 0.0 ↓	20: 8.4 ↓		

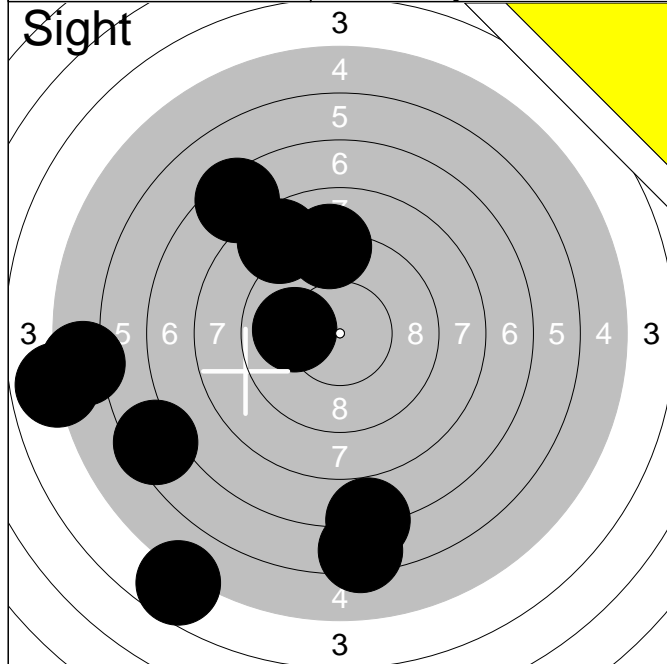

1:	7.0	↓
2:	4.6	↙
3:	5.5	←
4:	6.3	↓
5:	4.9	←
6:	6.4	↙
7:	7.4	↗
8:	9.1	↑
9:	8.6	↗
10:	10.0	←
Series		66.0
Total		0.0

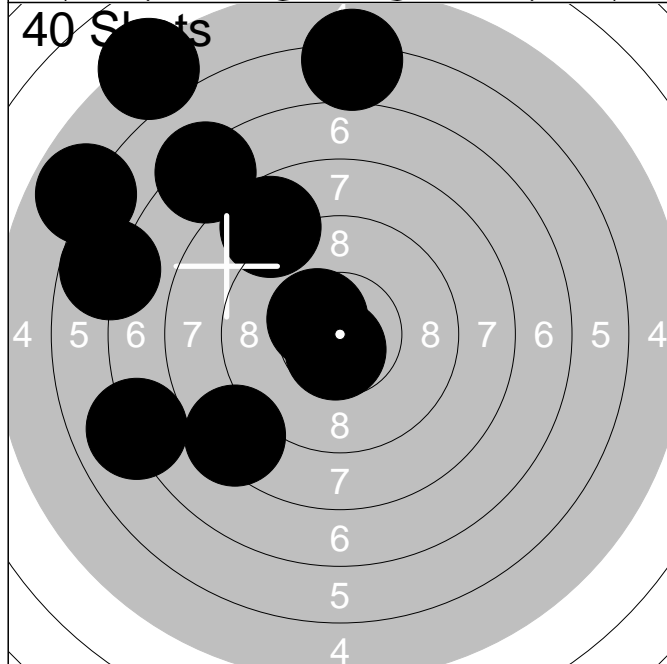

1:	6.7	←
2:	8.4	↙
3:	8.7	↗
4:	5.2	↗
5:	7.0	←
6:	*10.5	↗
7:	5.8	↗
8:	7.2	↗
9:	*10.7	↓
10:	6.1	↑
Series		72.0
Total		72.0

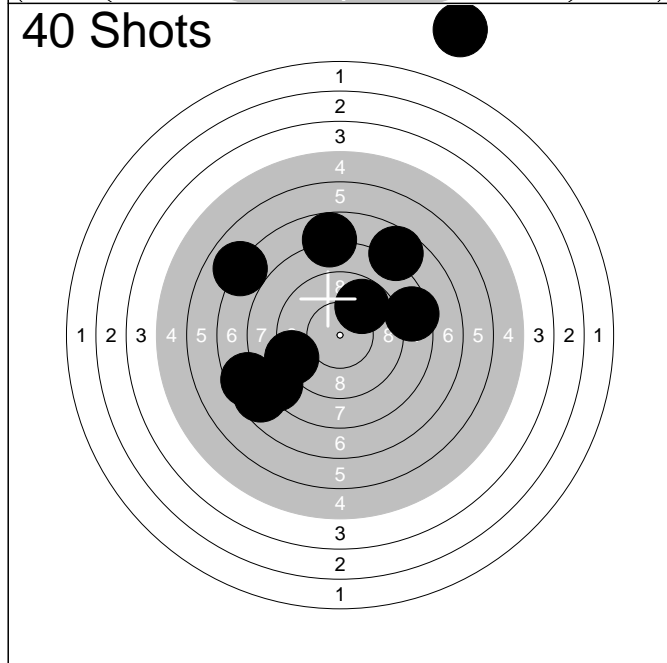

11:	0.0	↑
12:	7.7	↗
13:	9.2	←
14:	8.3	↙
15:	7.0	↙
16:	8.5	→
17:	7.7	↙
18:	7.5	↙
19:	7.8	↑
20:	9.8	↗
Series		69.0
Total		141.0



1:	8.7	↙
2:	*10.2	←
3:	*10.3	↙
4:	9.5	↘
5:	9.9	↗
6:	*10.2	→
7:	*10.4	→
8:	9.7	↙
9:	10.1	↘
Series		85.0
Total		0.0

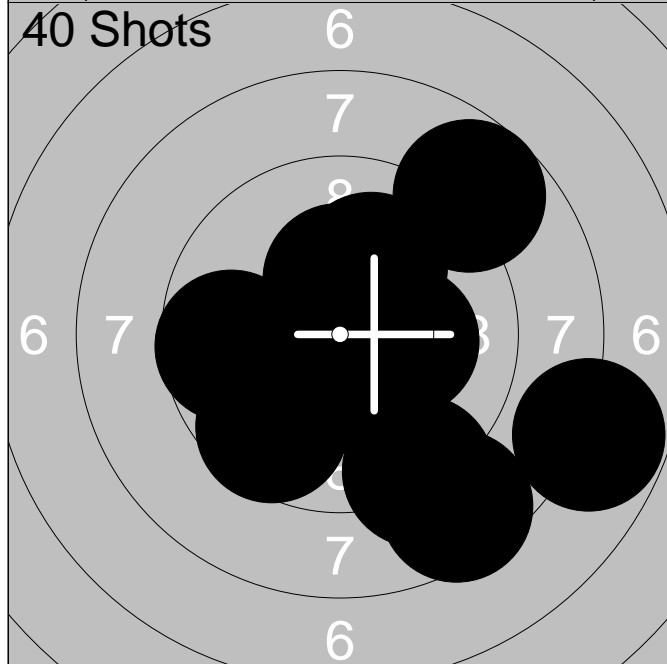

1:	9.1	↘
2:	10.1	↗
3:	9.7	←
4:	9.6	↙
5:	8.7	↗
6:	*10.2	→
7:	*10.3	↑
8:	8.5	↘
9:	7.8	→
10:	*10.2	↙
Series		90.0
Total		90.0

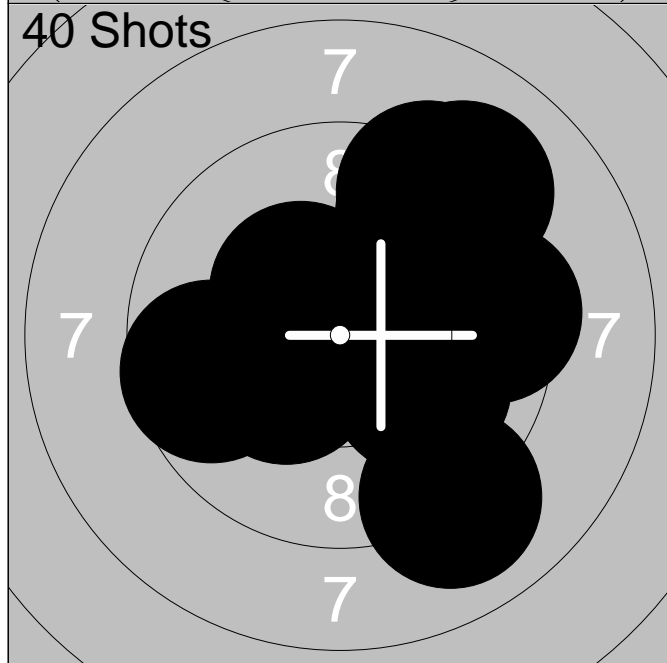

11:	*10.4	↗
12:	9.5	→
13:	10.0	↘
14:	9.3	↗
15:	9.5	↗
16:	9.6	←
17:	*10.3	↙
18:	*10.3	→
19:	9.1	↗
20:	9.0	↘
Series		94.0
Total		184.0

2012-11-04	Vindelskyttet 2012	Ramselefors SKF
------------	--------------------	-----------------

<p>Sight</p>	<table style="width:100%; border-collapse: collapse;"> <tr><td style="text-align: right;">1:</td><td style="text-align: right;">*10.3</td><td style="text-align: right;">↙</td></tr> <tr><td style="text-align: right;">2:</td><td style="text-align: right;">9.4</td><td style="text-align: right;">↙</td></tr> <tr><td style="text-align: right;">3:</td><td style="text-align: right;">9.6</td><td style="text-align: right;">↙</td></tr> <tr><td style="text-align: right;">4:</td><td style="text-align: right;">9.1</td><td style="text-align: right;">←</td></tr> <tr><td style="text-align: right;">5:</td><td style="text-align: right;">*10.7</td><td style="text-align: right;">↑</td></tr> <tr><td style="text-align: right;">6:</td><td style="text-align: right;">9.8</td><td style="text-align: right;">↑</td></tr> <tr><td style="text-align: right;">7:</td><td style="text-align: right;">9.5</td><td style="text-align: right;">↙</td></tr> <tr><td style="text-align: right;">8:</td><td style="text-align: right;">9.0</td><td style="text-align: right;">↗</td></tr> <tr><td style="text-align: right;">9:</td><td style="text-align: right;">9.6</td><td style="text-align: right;">↗</td></tr> <tr><td style="text-align: right;">10:</td><td style="text-align: right;">9.2</td><td style="text-align: right;">↗</td></tr> <tr><td colspan="2">Series</td><td style="text-align: right;">92.0</td></tr> <tr><td colspan="2">Total</td><td style="text-align: right;">0.0</td></tr> </table>	1:	*10.3	↙	2:	9.4	↙	3:	9.6	↙	4:	9.1	←	5:	*10.7	↑	6:	9.8	↑	7:	9.5	↙	8:	9.0	↗	9:	9.6	↗	10:	9.2	↗	Series		92.0	Total		0.0
1:	*10.3	↙																																			
2:	9.4	↙																																			
3:	9.6	↙																																			
4:	9.1	←																																			
5:	*10.7	↑																																			
6:	9.8	↑																																			
7:	9.5	↙																																			
8:	9.0	↗																																			
9:	9.6	↗																																			
10:	9.2	↗																																			
Series		92.0																																			
Total		0.0																																			
<p>40 Shots</p>	<table style="width:100%; border-collapse: collapse;"> <tr><td style="text-align: right;">1:</td><td style="text-align: right;">*10.5</td><td style="text-align: right;">↗</td></tr> <tr><td style="text-align: right;">2:</td><td style="text-align: right;">9.9</td><td style="text-align: right;">↑</td></tr> <tr><td style="text-align: right;">3:</td><td style="text-align: right;">*10.8</td><td style="text-align: right;">→</td></tr> <tr><td style="text-align: right;">4:</td><td style="text-align: right;">8.7</td><td style="text-align: right;">↗</td></tr> <tr><td style="text-align: right;">5:</td><td style="text-align: right;">8.7</td><td style="text-align: right;">↗</td></tr> <tr><td style="text-align: right;">6:</td><td style="text-align: right;">8.9</td><td style="text-align: right;">↗</td></tr> <tr><td style="text-align: right;">7:</td><td style="text-align: right;">*10.4</td><td style="text-align: right;">↙</td></tr> <tr><td style="text-align: right;">8:</td><td style="text-align: right;">9.5</td><td style="text-align: right;">↗</td></tr> <tr><td style="text-align: right;">9:</td><td style="text-align: right;">*10.5</td><td style="text-align: right;">↓</td></tr> <tr><td style="text-align: right;">10:</td><td style="text-align: right;">*10.5</td><td style="text-align: right;">↓</td></tr> <tr><td colspan="2">Series</td><td style="text-align: right;">92.0</td></tr> <tr><td colspan="2">Total</td><td style="text-align: right;">92.0</td></tr> </table>	1:	*10.5	↗	2:	9.9	↑	3:	*10.8	→	4:	8.7	↗	5:	8.7	↗	6:	8.9	↗	7:	*10.4	↙	8:	9.5	↗	9:	*10.5	↓	10:	*10.5	↓	Series		92.0	Total		92.0
1:	*10.5	↗																																			
2:	9.9	↑																																			
3:	*10.8	→																																			
4:	8.7	↗																																			
5:	8.7	↗																																			
6:	8.9	↗																																			
7:	*10.4	↙																																			
8:	9.5	↗																																			
9:	*10.5	↓																																			
10:	*10.5	↓																																			
Series		92.0																																			
Total		92.0																																			
<p>40 Shots</p>	<table style="width:100%; border-collapse: collapse;"> <tr><td style="text-align: right;">11:</td><td style="text-align: right;">9.8</td><td style="text-align: right;">↘</td></tr> <tr><td style="text-align: right;">12:</td><td style="text-align: right;">*10.3</td><td style="text-align: right;">↗</td></tr> <tr><td style="text-align: right;">13:</td><td style="text-align: right;">*10.2</td><td style="text-align: right;">↓</td></tr> <tr><td style="text-align: right;">14:</td><td style="text-align: right;">9.8</td><td style="text-align: right;">↑</td></tr> <tr><td style="text-align: right;">15:</td><td style="text-align: right;">9.7</td><td style="text-align: right;">←</td></tr> <tr><td style="text-align: right;">16:</td><td style="text-align: right;">*10.3</td><td style="text-align: right;">↗</td></tr> <tr><td style="text-align: right;">17:</td><td style="text-align: right;">*10.4</td><td style="text-align: right;">↗</td></tr> <tr><td style="text-align: right;">18:</td><td style="text-align: right;">9.9</td><td style="text-align: right;">←</td></tr> <tr><td style="text-align: right;">19:</td><td style="text-align: right;">9.1</td><td style="text-align: right;">↙</td></tr> <tr><td style="text-align: right;">20:</td><td style="text-align: right;">*10.5</td><td style="text-align: right;">↘</td></tr> <tr><td colspan="2">Series</td><td style="text-align: right;">95.0</td></tr> <tr><td colspan="2">Total</td><td style="text-align: right;">187.0</td></tr> </table>	11:	9.8	↘	12:	*10.3	↗	13:	*10.2	↓	14:	9.8	↑	15:	9.7	←	16:	*10.3	↗	17:	*10.4	↗	18:	9.9	←	19:	9.1	↙	20:	*10.5	↘	Series		95.0	Total		187.0
11:	9.8	↘																																			
12:	*10.3	↗																																			
13:	*10.2	↓																																			
14:	9.8	↑																																			
15:	9.7	←																																			
16:	*10.3	↗																																			
17:	*10.4	↗																																			
18:	9.9	←																																			
19:	9.1	↙																																			
20:	*10.5	↘																																			
Series		95.0																																			
Total		187.0																																			

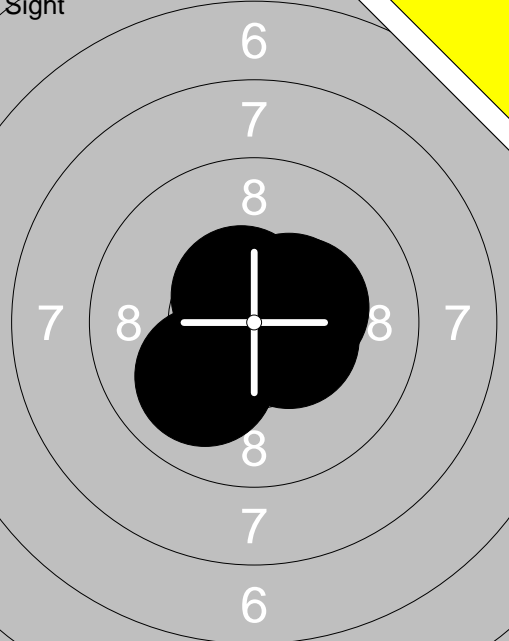
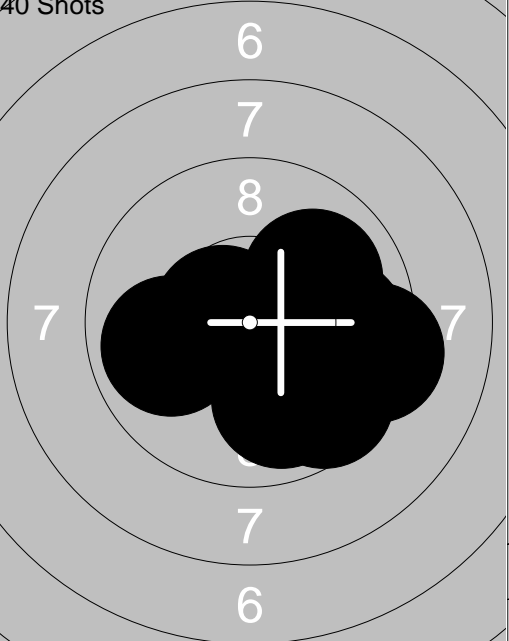
<p>Sight</p> 	<p>40 Shots</p> 	<p>1: 10.0 ↗</p> <p>2: 9.6 ↘</p> <p>3: 9.3 →</p> <p>4: *10.6 ↘</p> <p>5: *10.3 →</p> <p>6: *10.6 ←</p> <p>7: 9.9 ←</p> <p>8: *10.4 ↘</p> <p>9: 9.9 →</p> <p>10: 9.9 ↘</p>
<p>Series 50.0</p> <p>Total 0.0</p>	<p>Series 95.0</p> <p>Total 95.0</p>	

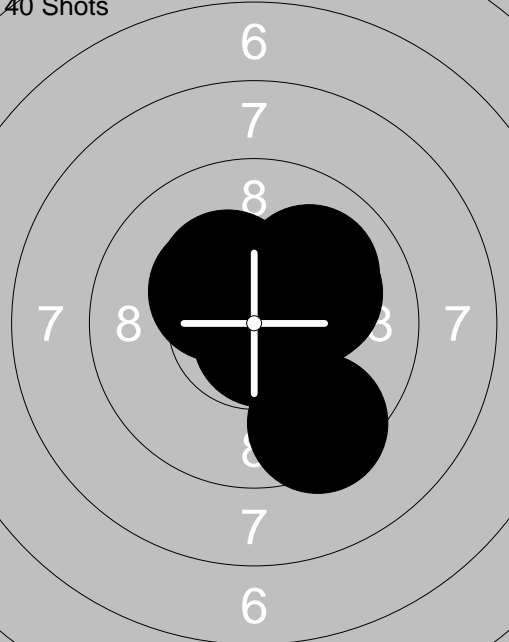
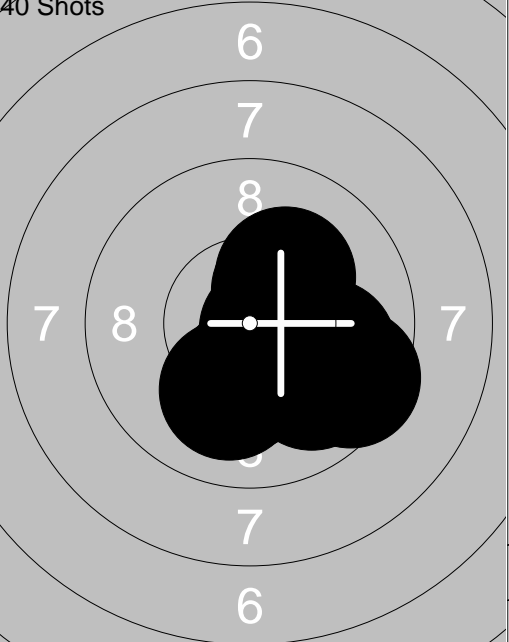
<p>40 Shots</p> 	<p>40 Shots</p> 	<p>11: *10.8 ↗</p> <p>12: *10.3 ↗</p> <p>13: *10.2 →</p> <p>14: 10.1 →</p> <p>15: 10.1 →</p> <p>16: *10.7 ↘</p> <p>17: 10.0 ↗</p> <p>18: *10.3 ↗</p> <p>19: *10.6 ↗</p> <p>20: 9.4 ↘</p> <p>21: 10.1 ↘</p> <p>22: *10.4 ↗</p> <p>23: 9.5 ↘</p> <p>24: 9.9 ↘</p> <p>25: *10.4 →</p> <p>26: *10.7 →</p> <p>27: *10.2 ↘</p> <p>28: 9.9 →</p> <p>29: *10.5 ↘</p> <p>30: *10.2 ↗</p>
<p>Series 99.0</p> <p>Total 194.0</p>	<p>Series 97.0</p> <p>Total 291.0</p>	

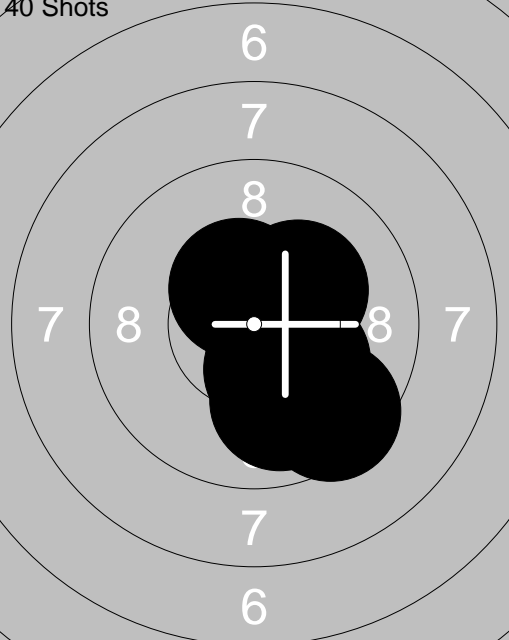
<p>40 Shots</p> 	<p>31: *10.2 ↘</p> <p>32: *10.2 ↗</p> <p>33: 9.5 ↘</p> <p>34: *10.3 ↘</p> <p>35: *10.7 →</p> <p>36: 10.1 ↘</p> <p>37: *10.5 ↗</p> <p>38: 9.9 ↘</p> <p>39: *10.2 ↘</p> <p>40: *10.5 ↗</p>	<p>Series 98.0</p> <p>Total 389.0</p>
---	--	---------------------------------------

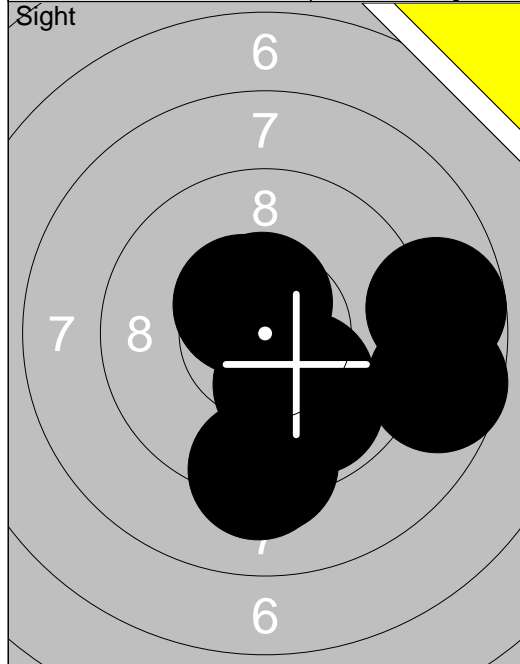

1: *10.5	↑
2: 9.9	↘
3: *10.5	↗
4: 9.9	↘
5: *10.3	↘
6: 9.2	↘
7: *10.2	↘
8: 9.3	↘
9: 8.7	→
10: 8.7	→
Series 92.0	
Total 0.0	

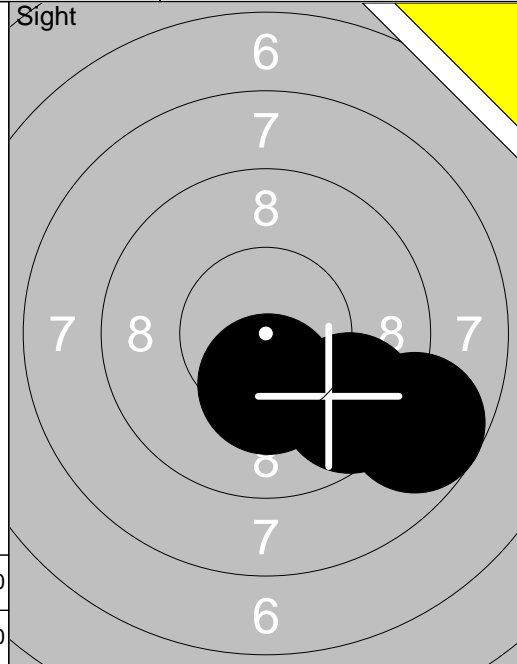

11: 8.7	↘
12: 9.6	↘
13: *10.3	↓
Series 27.0	
Total 0.0	

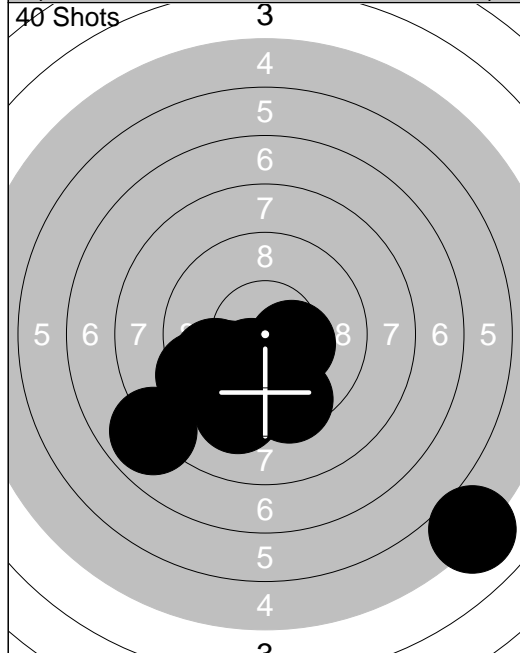

1: 7.9	↙
2: 9.4	↙
3: 9.8	↙
4: 5.1	↘
5: *10.3	↘
6: *10.4	→
7: 9.3	↘
8: 10.0	↙
9: 10.1	↘
10: 9.5	↘
Series 88.0	
Total 88.0	

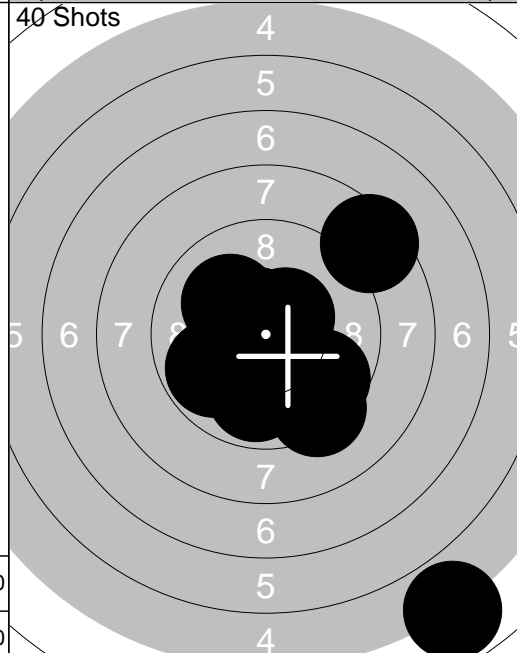

11: 10.1	↖
12: 8.4	↗
13: 9.8	↙
14: *10.6	↗
15: *10.2	↘
16: 9.3	↘
17: *10.5	↗
18: 9.9	↘
19: 4.9	↘
20: 9.7	↘
Series 88.0	
Total 176.0	

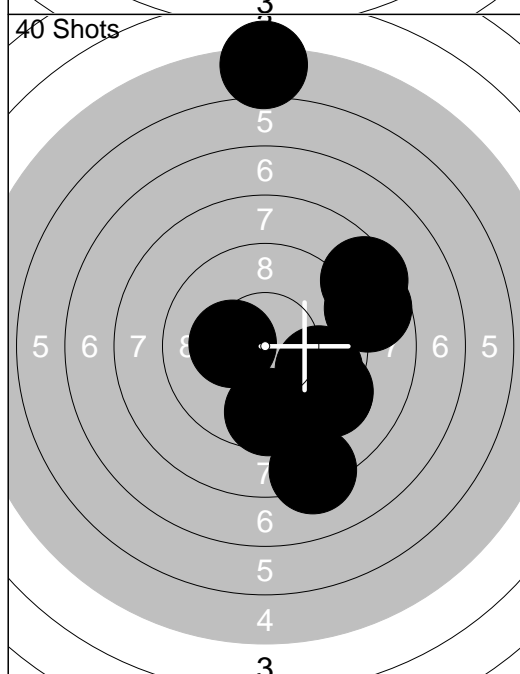

21: 9.6	↘
22: 8.7	→
23: 9.3	↘
24: 5.2	↑
25: 9.7	↘
26: 9.6	↘
27: 8.5	↗
28: 8.2	↘
29: 9.3	↘
30: *10.3	←
Series 84.0	
Total 260.0	

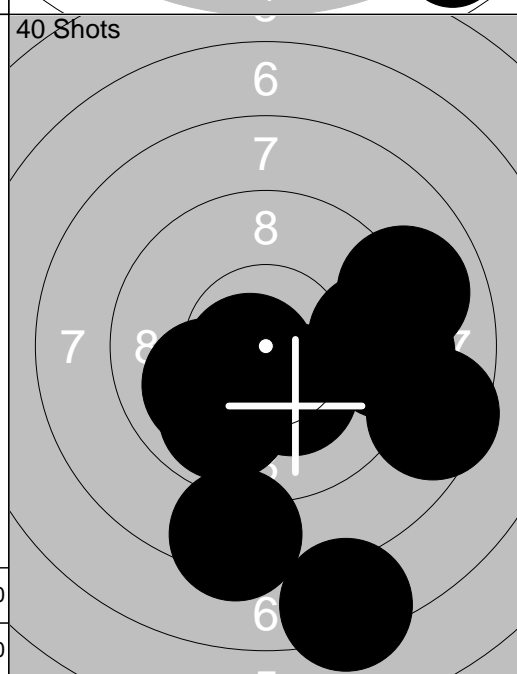



31: 9.3	→
32: *10.7	↙
33: 8.4	↘
34: 7.3	↘
35: 10.0	↙
36: 9.5	→
37: 9.9	↙
38: *10.3	↘
39: 9.0	↗
40: 8.5	↘
Series 89.0	
Total 349.0	

<p>Sight</p>	<p>Sight</p>
<p>1: 8.9 ↗ 2: *10.7 ↘ 3: 9.3 ← 4: 9.6 ← 5: *10.3 ← 6: 9.2 ↘ 7: *10.6 ↘ 8: 8.7 ↗ 9: *10.4 ↘ 10: 8.2 ↘</p>	<p>11: 9.0 ↗ 12: 9.9 ↗ 13: 9.6 ↗ 14: 10.1 ↗ 15: *10.3 → 16: 9.9 ↗</p>
<p>Series 91.0 Total 0.0</p>	<p>Series 56.0 Total 0.0</p>

<p>40 Shots</p>	<p>40 Shots</p>
<p>1: 9.3 ↗ 2: 9.8 ↗ 3: 9.3 ↘ 4: 9.6 → 5: 10.0 ← 6: 7.6 ↗ 7: 9.5 ↗ 8: 9.7 → 9: 7.7 ↗ 10: 8.6 →</p>	<p>11: 10.1 ↗ 12: 10.1 ↗ 13: 8.5 ↗ 14: *10.2 → 15: 7.8 ↗ 16: 6.7 → 17: 10.1 ↘ 18: *10.5 ↗ 19: *10.3 ↘ 20: 9.0 ↗</p>
<p>Series 86.0 Total 86.0</p>	<p>Series 90.0 Total 176.0</p>

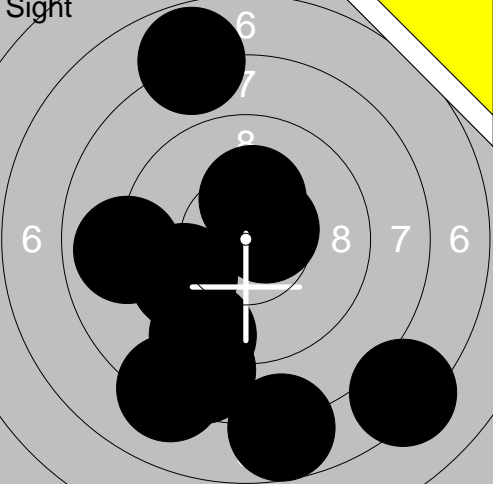
<p>40 Shots</p>	<p>40 Shots</p>
<p>21: 9.8 ↗ 22: 9.6 ↗ 23: 9.5 ↗ 24: 9.7 ↗ 25: *10.8 ↗ 26: *10.6 ↗ 27: 9.9 ↘ 28: *10.6 ↘ 29: *10.3 ↘ 30: *10.4 ↗</p>	<p>31: 9.4 → 32: 8.4 → 33: 8.7 ↗ 34: 9.3 ↗ 35: *10.2 ↗ 36: 9.8 ↗ 37: 9.5 → 38: 9.2 ↘ 39: 9.7 → 40: 9.7 ↗</p>
<p>Series 95.0 Total 271.0</p>	<p>Series 89.0 Total 360.0</p>

	<table style="width:100%; border-collapse: collapse;"> <tr><td>1:</td><td>7.8</td><td>↑</td></tr> <tr><td>2:</td><td>9.2</td><td>↓</td></tr> <tr><td>3:</td><td>7.7</td><td>↓</td></tr> <tr><td>4:</td><td>8.6</td><td>↓</td></tr> <tr><td>5:</td><td>8.1</td><td>↓</td></tr> <tr><td>6:</td><td>*10.6</td><td>→</td></tr> <tr><td>7:</td><td>*10.3</td><td>↑</td></tr> <tr><td>8:</td><td>7.3</td><td>↓</td></tr> <tr><td>9:</td><td>9.7</td><td>←</td></tr> <tr><td>10:</td><td>8.9</td><td>←</td></tr> <tr><td colspan="2">Series</td><td>83.0</td></tr> <tr><td colspan="2">Total</td><td>0.0</td></tr> </table>	1:	7.8	↑	2:	9.2	↓	3:	7.7	↓	4:	8.6	↓	5:	8.1	↓	6:	*10.6	→	7:	*10.3	↑	8:	7.3	↓	9:	9.7	←	10:	8.9	←	Series		83.0	Total		0.0		<table style="width:100%; border-collapse: collapse;"> <tr><td>11:</td><td>9.5</td><td>↑</td></tr> <tr><td>12:</td><td>9.0</td><td>↓</td></tr> <tr><td>13:</td><td>9.8</td><td>↓</td></tr> <tr><td>14:</td><td>9.8</td><td>←</td></tr> <tr><td>15:</td><td>8.3</td><td>↓</td></tr> <tr><td>16:</td><td>9.3</td><td>↓</td></tr> <tr><td>17:</td><td>9.1</td><td>→</td></tr> <tr><td>18:</td><td>8.8</td><td>←</td></tr> <tr><td>19:</td><td>6.9</td><td>→</td></tr> <tr><td>20:</td><td>*10.6</td><td>↓</td></tr> <tr><td colspan="2">Series</td><td>86.0</td></tr> <tr><td colspan="2">Total</td><td>0.0</td></tr> </table>	11:	9.5	↑	12:	9.0	↓	13:	9.8	↓	14:	9.8	←	15:	8.3	↓	16:	9.3	↓	17:	9.1	→	18:	8.8	←	19:	6.9	→	20:	*10.6	↓	Series		86.0	Total		0.0
1:	7.8	↑																																																																									
2:	9.2	↓																																																																									
3:	7.7	↓																																																																									
4:	8.6	↓																																																																									
5:	8.1	↓																																																																									
6:	*10.6	→																																																																									
7:	*10.3	↑																																																																									
8:	7.3	↓																																																																									
9:	9.7	←																																																																									
10:	8.9	←																																																																									
Series		83.0																																																																									
Total		0.0																																																																									
11:	9.5	↑																																																																									
12:	9.0	↓																																																																									
13:	9.8	↓																																																																									
14:	9.8	←																																																																									
15:	8.3	↓																																																																									
16:	9.3	↓																																																																									
17:	9.1	→																																																																									
18:	8.8	←																																																																									
19:	6.9	→																																																																									
20:	*10.6	↓																																																																									
Series		86.0																																																																									
Total		0.0																																																																									

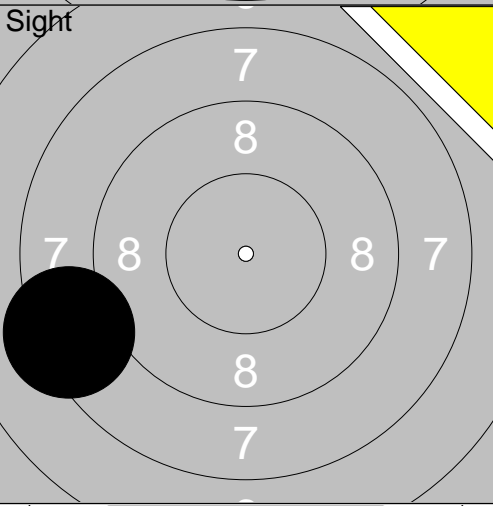
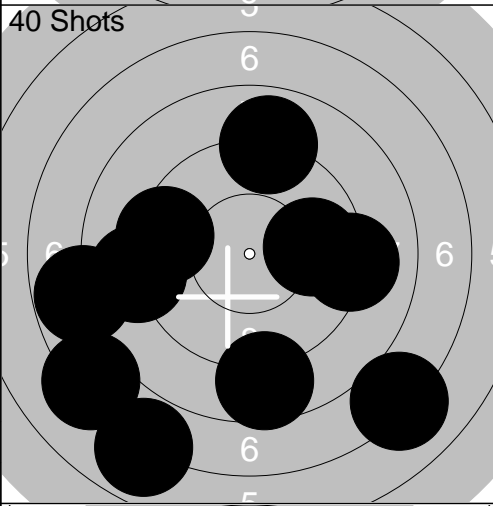
	<table style="width:100%; border-collapse: collapse;"> <tr><td>21:</td><td>8.3</td><td>←</td></tr> <tr><td colspan="2">Series</td><td>8.0</td></tr> <tr><td colspan="2">Total</td><td>0.0</td></tr> </table>	21:	8.3	←	Series		8.0	Total		0.0		<table style="width:100%; border-collapse: collapse;"> <tr><td>1:</td><td>7.8</td><td>←</td></tr> <tr><td>2:</td><td>6.9</td><td>↓</td></tr> <tr><td>3:</td><td>8.9</td><td>←</td></tr> <tr><td>4:</td><td>8.6</td><td>↓</td></tr> <tr><td>5:</td><td>9.4</td><td>←</td></tr> <tr><td>6:</td><td>8.9</td><td>↑</td></tr> <tr><td>7:</td><td>7.2</td><td>↓</td></tr> <tr><td>8:</td><td>9.1</td><td>→</td></tr> <tr><td>9:</td><td>9.8</td><td>→</td></tr> <tr><td>10:</td><td>7.1</td><td>↓</td></tr> <tr><td colspan="2">Series</td><td>78.0</td></tr> <tr><td colspan="2">Total</td><td>78.0</td></tr> </table>	1:	7.8	←	2:	6.9	↓	3:	8.9	←	4:	8.6	↓	5:	9.4	←	6:	8.9	↑	7:	7.2	↓	8:	9.1	→	9:	9.8	→	10:	7.1	↓	Series		78.0	Total		78.0
21:	8.3	←																																														
Series		8.0																																														
Total		0.0																																														
1:	7.8	←																																														
2:	6.9	↓																																														
3:	8.9	←																																														
4:	8.6	↓																																														
5:	9.4	←																																														
6:	8.9	↑																																														
7:	7.2	↓																																														
8:	9.1	→																																														
9:	9.8	→																																														
10:	7.1	↓																																														
Series		78.0																																														
Total		78.0																																														

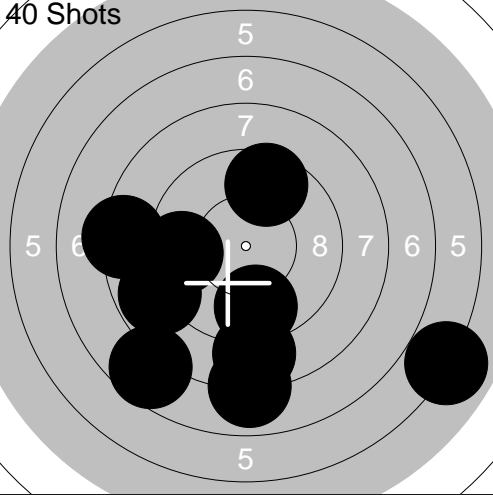
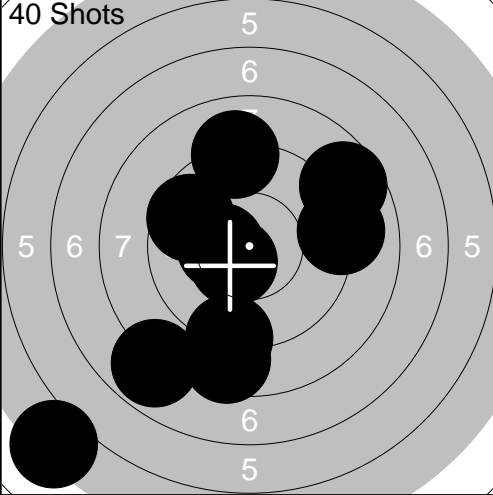
	<table style="width:100%; border-collapse: collapse;"> <tr><td>11:</td><td>9.6</td><td>↓</td></tr> <tr><td>12:</td><td>9.6</td><td>↑</td></tr> <tr><td>13:</td><td>8.3</td><td>←</td></tr> <tr><td>14:</td><td>5.9</td><td>↓</td></tr> <tr><td>15:</td><td>8.8</td><td>←</td></tr> <tr><td>16:</td><td>9.6</td><td>←</td></tr> <tr><td>17:</td><td>7.6</td><td>↓</td></tr> <tr><td>18:</td><td>9.3</td><td>←</td></tr> <tr><td>19:</td><td>7.9</td><td>↓</td></tr> <tr><td>20:</td><td>8.6</td><td>↓</td></tr> <tr><td colspan="2">Series</td><td>79.0</td></tr> <tr><td colspan="2">Total</td><td>157.0</td></tr> </table>	11:	9.6	↓	12:	9.6	↑	13:	8.3	←	14:	5.9	↓	15:	8.8	←	16:	9.6	←	17:	7.6	↓	18:	9.3	←	19:	7.9	↓	20:	8.6	↓	Series		79.0	Total		157.0		<table style="width:100%; border-collapse: collapse;"> <tr><td>21:</td><td>*10.4</td><td>←</td></tr> <tr><td>22:</td><td>9.6</td><td>←</td></tr> <tr><td>23:</td><td>8.6</td><td>↓</td></tr> <tr><td>24:</td><td>9.0</td><td>↓</td></tr> <tr><td>25:</td><td>9.0</td><td>↑</td></tr> <tr><td>26:</td><td>8.7</td><td>→</td></tr> <tr><td>27:</td><td>9.0</td><td>→</td></tr> <tr><td>28:</td><td>*10.5</td><td>↓</td></tr> <tr><td>29:</td><td>7.8</td><td>↓</td></tr> <tr><td>30:</td><td>5.2</td><td>↓</td></tr> <tr><td colspan="2">Series</td><td>84.0</td></tr> <tr><td colspan="2">Total</td><td>241.0</td></tr> </table>	21:	*10.4	←	22:	9.6	←	23:	8.6	↓	24:	9.0	↓	25:	9.0	↑	26:	8.7	→	27:	9.0	→	28:	*10.5	↓	29:	7.8	↓	30:	5.2	↓	Series		84.0	Total		241.0
11:	9.6	↓																																																																									
12:	9.6	↑																																																																									
13:	8.3	←																																																																									
14:	5.9	↓																																																																									
15:	8.8	←																																																																									
16:	9.6	←																																																																									
17:	7.6	↓																																																																									
18:	9.3	←																																																																									
19:	7.9	↓																																																																									
20:	8.6	↓																																																																									
Series		79.0																																																																									
Total		157.0																																																																									
21:	*10.4	←																																																																									
22:	9.6	←																																																																									
23:	8.6	↓																																																																									
24:	9.0	↓																																																																									
25:	9.0	↑																																																																									
26:	8.7	→																																																																									
27:	9.0	→																																																																									
28:	*10.5	↓																																																																									
29:	7.8	↓																																																																									
30:	5.2	↓																																																																									
Series		84.0																																																																									
Total		241.0																																																																									

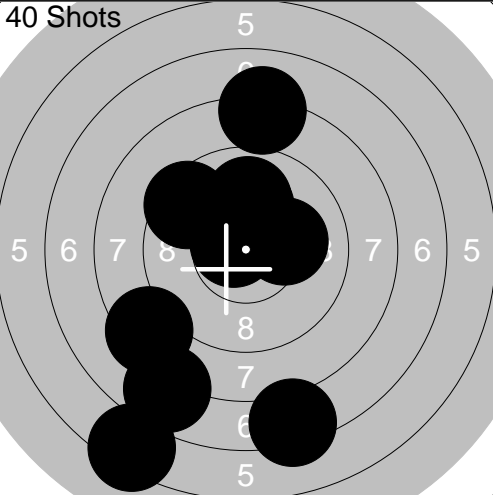
	<table style="width:100%; border-collapse: collapse;"> <tr><td>31:</td><td>8.1</td><td>↑</td></tr> <tr><td>32:</td><td>7.3</td><td>↓</td></tr> <tr><td>33:</td><td>10.1</td><td>→</td></tr> <tr><td>34:</td><td>8.4</td><td>↓</td></tr> <tr><td>35:</td><td>10.1</td><td>↑</td></tr> <tr><td>36:</td><td>9.9</td><td>↑</td></tr> <tr><td>37:</td><td>6.3</td><td>↓</td></tr> <tr><td>38:</td><td>9.5</td><td>↗</td></tr> <tr><td>39:</td><td>7.7</td><td>↓</td></tr> <tr><td>40:</td><td>*10.7</td><td>↖</td></tr> <tr><td colspan="2">Series</td><td>84.0</td></tr> <tr><td colspan="2">Total</td><td>325.0</td></tr> </table>	31:	8.1	↑	32:	7.3	↓	33:	10.1	→	34:	8.4	↓	35:	10.1	↑	36:	9.9	↑	37:	6.3	↓	38:	9.5	↗	39:	7.7	↓	40:	*10.7	↖	Series		84.0	Total		325.0	
31:	8.1	↑																																				
32:	7.3	↓																																				
33:	10.1	→																																				
34:	8.4	↓																																				
35:	10.1	↑																																				
36:	9.9	↑																																				
37:	6.3	↓																																				
38:	9.5	↗																																				
39:	7.7	↓																																				
40:	*10.7	↖																																				
Series		84.0																																				
Total		325.0																																				

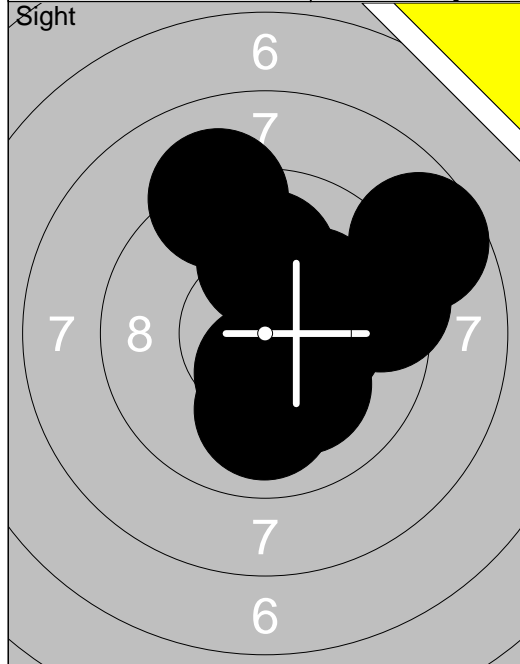

1:	9.4	→
2:	10.0	↓
3:	8.7	↗
4:	*10.3	→
5:	*10.2	↗
6:	*10.4	↓
7:	10.0	↑
8:	9.1	↗
9:	*10.4	↘
10:	*10.2	↘
Series	96.0	
Total	0.0	

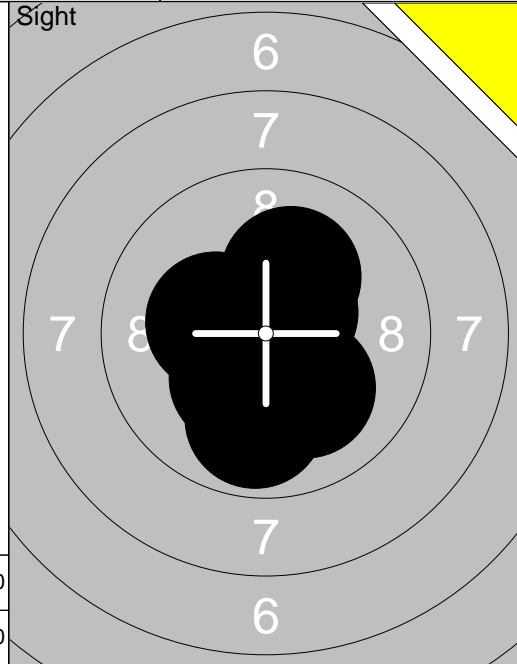

11:	*10.3	←
12:	*10.3	↙
13:	10.1	↘
14:	*10.6	↗
15:	9.9	↓
16:	*10.2	↗
Series	59.0	
Total	0.0	

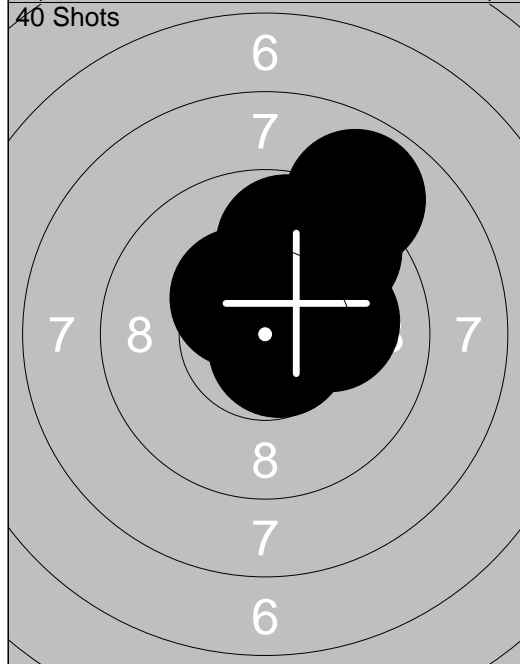

1:	9.7	↗
2:	9.6	↗
3:	9.9	↑
4:	9.8	↑
5:	8.9	↗
6:	10.1	↑
7:	10.1	→
8:	*10.7	↘
9:	*10.2	↑
10:	*10.4	↖
Series	94.0	
Total	94.0	

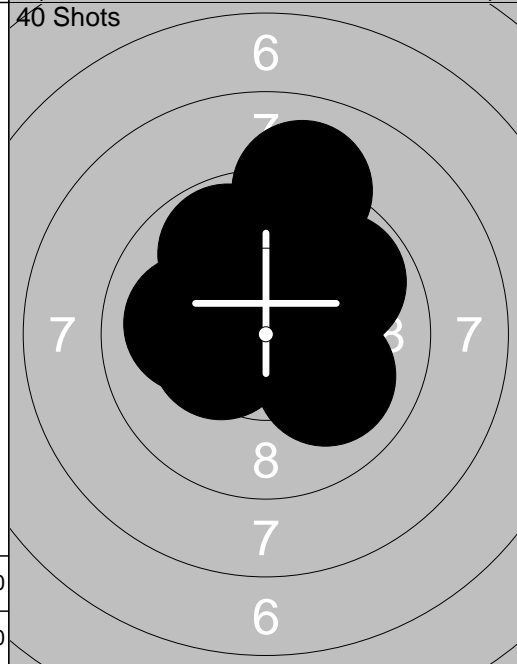

11:	10.0	↘
12:	*10.3	↑
13:	9.8	↗
14:	*10.3	←
15:	*10.4	↗
16:	*10.4	↗
17:	10.0	←
18:	9.1	↑
19:	9.8	↖
20:	*10.5	↖
Series	97.0	
Total	191.0	

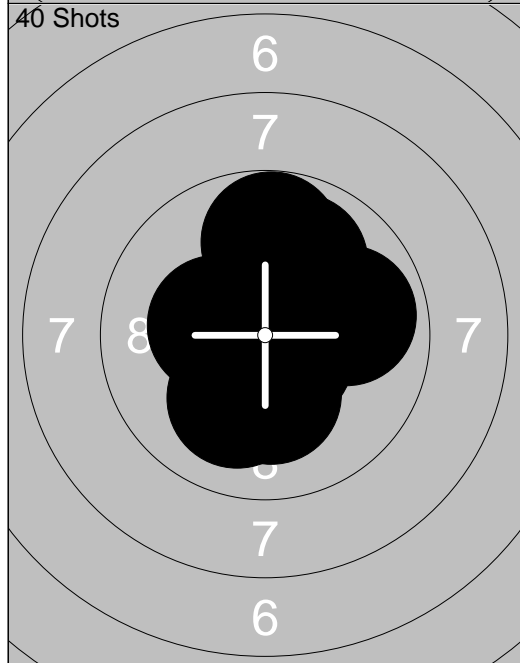

21:	*10.6	↘
22:	*10.4	↙
23:	*10.2	↓
24:	9.9	→
25:	9.8	↑
26:	9.9	↗
27:	*10.3	←
28:	*10.5	↙
29:	*10.2	↑
30:	10.1	↘
Series	97.0	
Total	288.0	

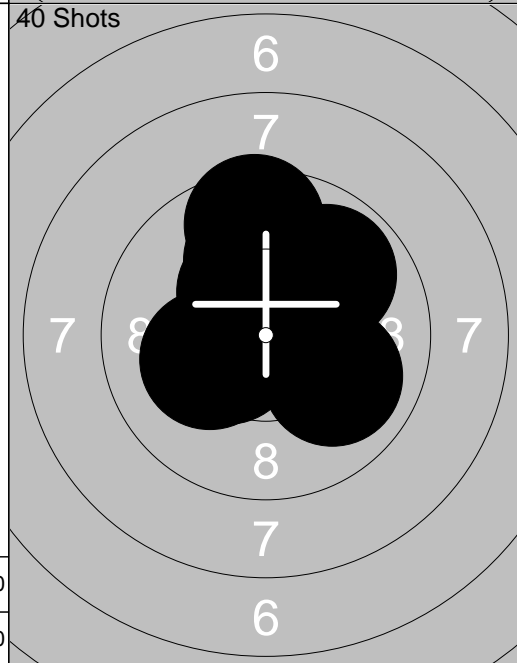

31:	10.0	↑
32:	10.0	↗
33:	10.1	↗
34:	9.9	↘
35:	*10.3	↖
36:	*10.4	←
37:	*10.2	↑
38:	*10.2	←
39:	9.5	↑
40:	9.9	↗
Series	97.0	
Total	385.0	

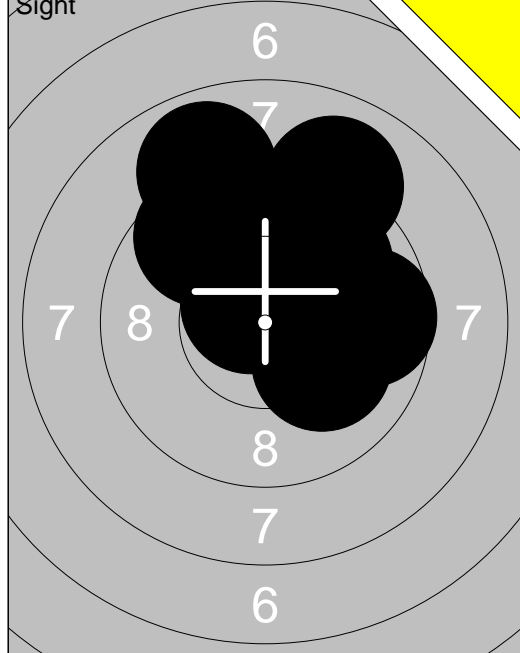

1:	9.6	↗
2:	10.1	↘
3:	8.9	↗
4:	*10.3	→
5:	9.9	↗
6:	*10.2	→
7:	10.1	↗
8:	*10.6	↖
9:	9.7	→
10:	9.0	↗
Series		94.0
Total		0.0

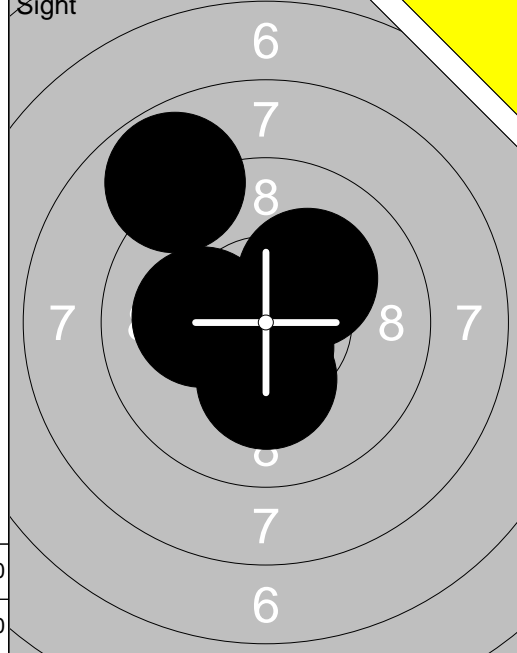

11:	*10.2	↗
12:	*10.6	↘
13:	8.8	↖
14:	*10.2	↘
15:	10.1	←
Series		48.0
Total		0.0

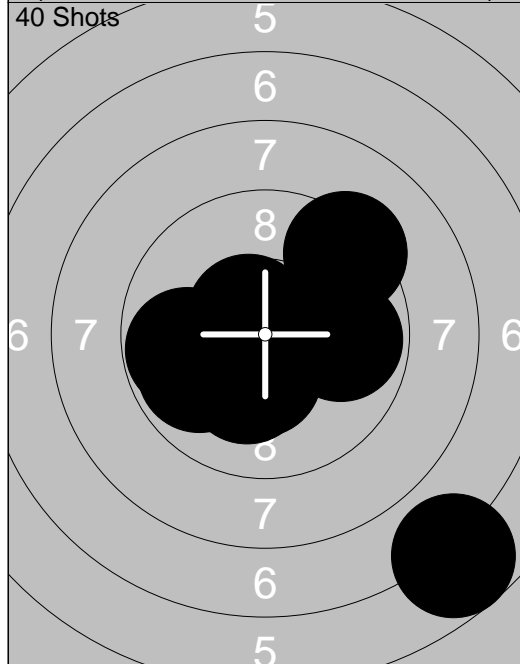

1:	*10.6	↗
2:	6.7	↘
3:	*10.8	↗
4:	9.9	←
5:	*10.2	↘
6:	*10.7	↘
7:	*10.4	↘
8:	9.9	→
9:	9.8	←
10:	9.3	↗
Series		92.0
Total		92.0

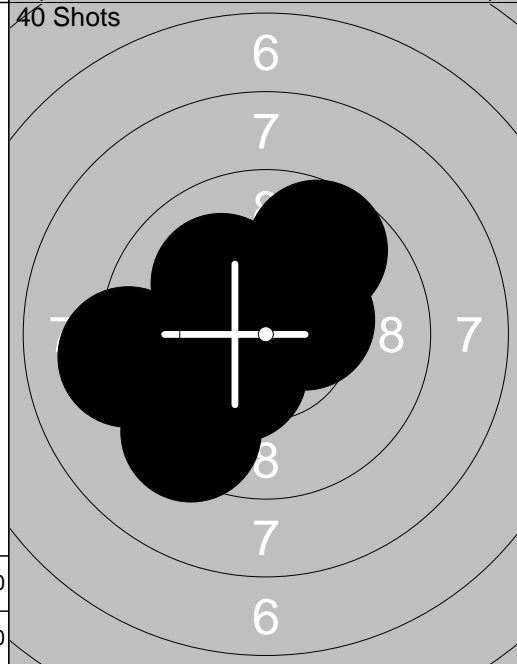

11:	9.4	↘
12:	9.7	↗
13:	*10.4	↖
14:	*10.6	↖
15:	*10.2	←
16:	9.2	←
17:	10.1	↖
18:	*10.4	→
19:	*10.3	↘
20:	9.6	↘
Series		96.0
Total		188.0

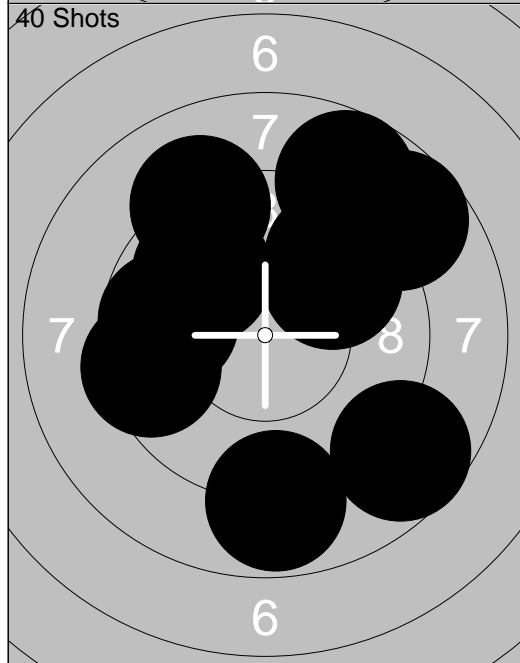

21:	9.8	↗
22:	9.4	←
23:	9.6	↗
24:	8.7	↘
25:	9.1	↗
26:	8.8	↘
27:	9.7	←
28:	8.7	↗
29:	9.8	↖
30:	8.7	↗
Series		86.0
Total		274.0

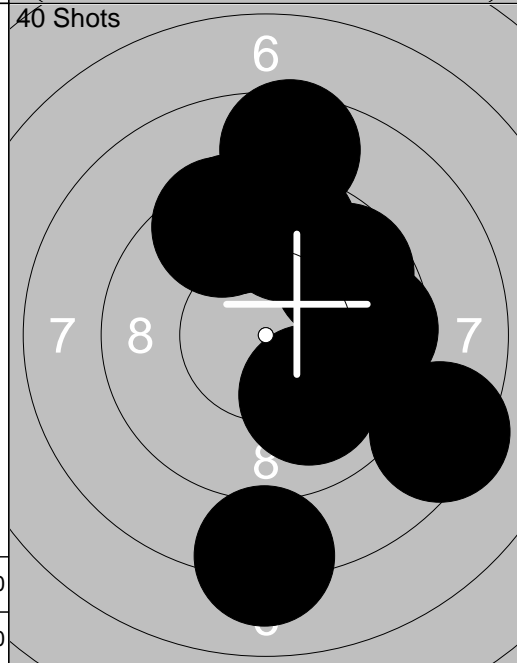

31:	8.6	↗
32:	9.6	→
33:	9.5	↖
34:	8.4	↘
35:	8.1	↘
36:	9.5	↖
37:	9.6	↖
38:	9.5	↖
39:	9.7	↗
40:	10.0	↘
Series		88.0
Total		362.0

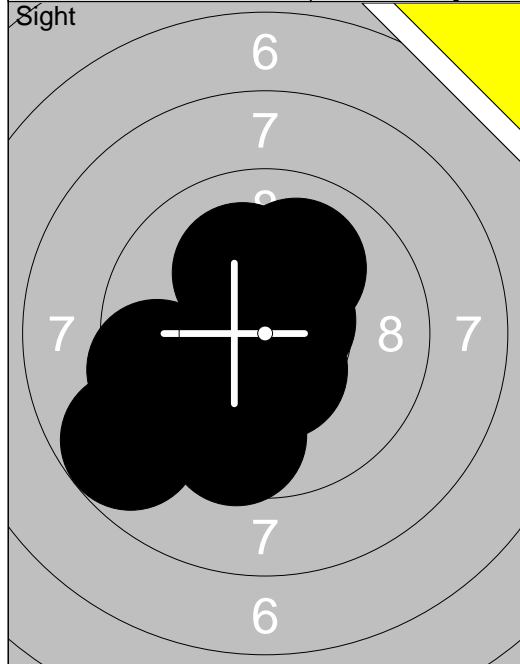

1:	8.8	↙
2:	9.5	←
3:	9.8	↙
4:	9.6	↓
5:	*10.4	↓
6:	*10.5	↓
7:	10.0	↑
8:	*10.6	↗
9:	10.1	↑
10:	10.1	↙
Series		95.0
Total		0.0

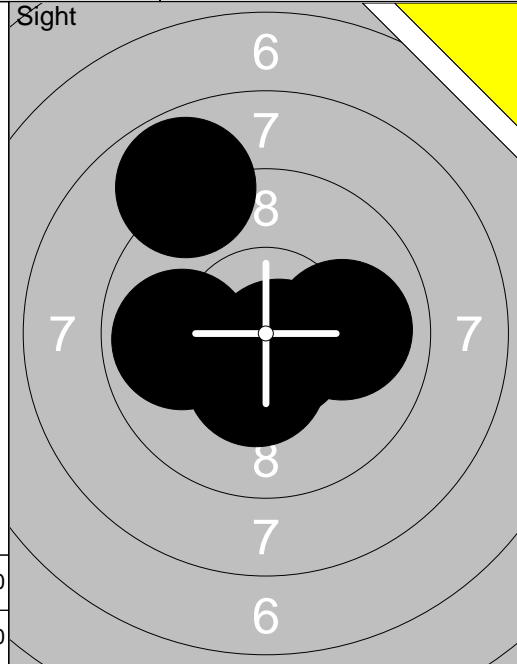

11:	9.9	←
12:	8.8	↗
13:	10.0	→
14:	*10.7	↘
15:	*10.4	↓
Series		47.0
Total		0.0

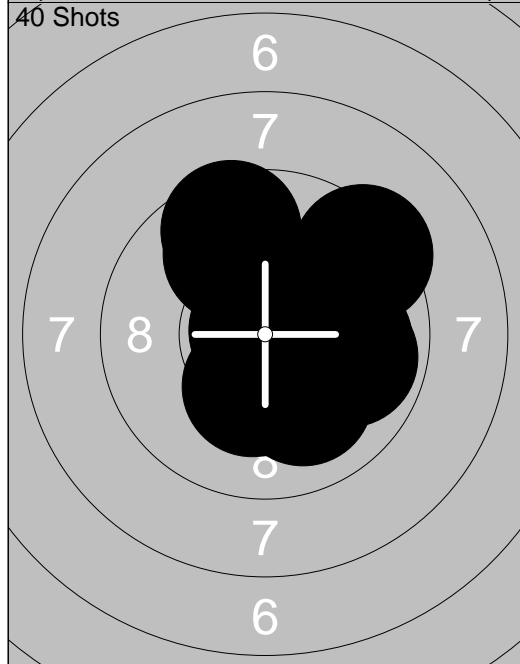

1:	10.0	↘
2:	9.8	↗
3:	9.3	↗
4:	*10.2	↘
5:	*10.6	↑
6:	9.9	→
7:	*10.9	↖
8:	9.6	↑
9:	10.0	→
10:	*10.3	↓
Series		96.0
Total		96.0

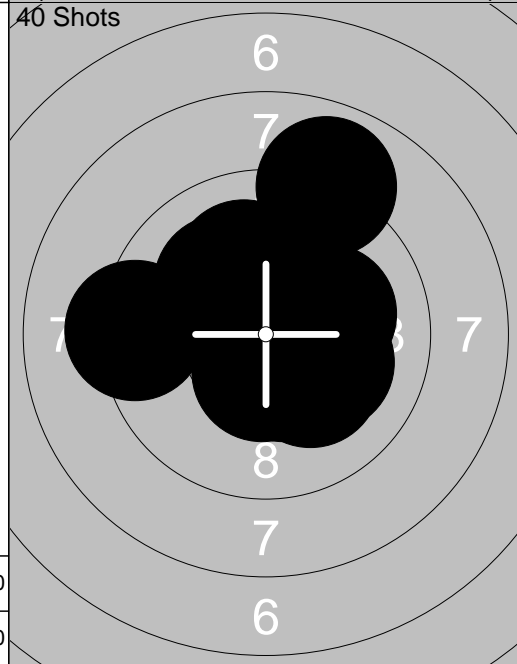

11:	10.1	↗
12:	*10.2	↘
13:	10.1	↘
14:	10.1	↗
15:	*10.4	↘
16:	9.3	←
17:	*10.3	↗
18:	10.1	↗
19:	*10.5	↓
20:	8.9	↗
Series		97.0
Total		193.0

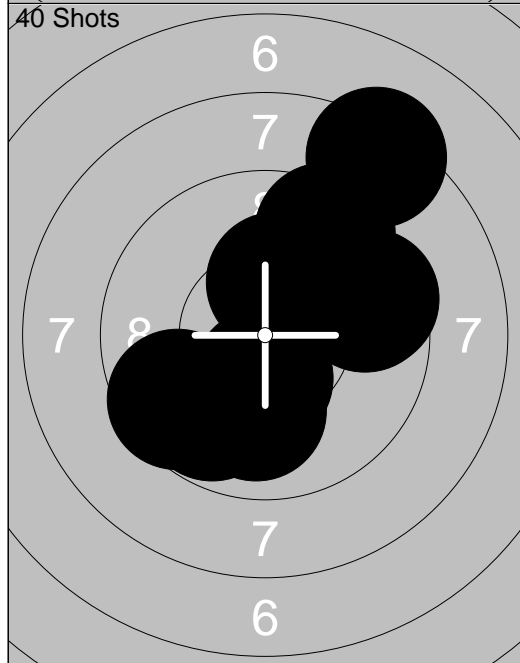

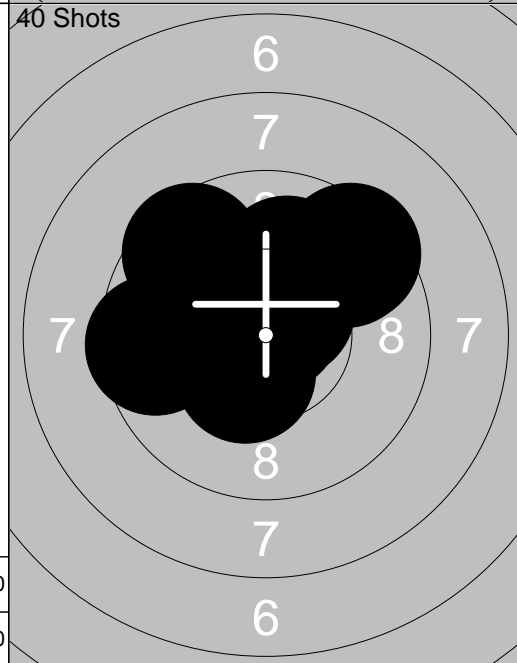

21:	*10.3	↑
22:	9.6	→
23:	8.3	↗
24:	10.0	↓
25:	9.6	→
26:	9.4	↗
27:	9.8	↘
28:	*10.3	↓
29:	9.6	↖
30:	*10.4	↓
Series		93.0
Total		286.0

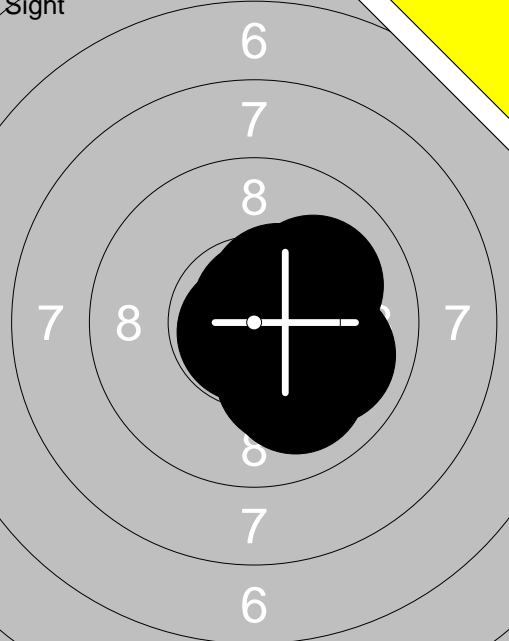
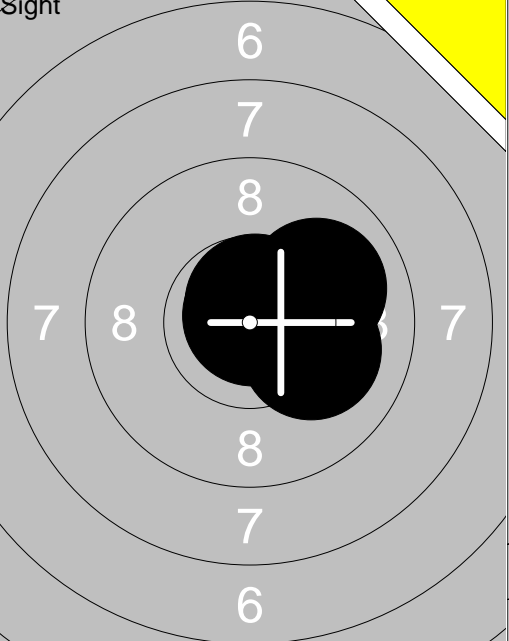

31:	*10.5	↗
32:	*10.4	↘
33:	9.5	↗
34:	*10.8	↗
35:	9.4	↗
36:	*10.6	↖
37:	9.5	←
38:	*10.6	↗
39:	9.5	↖
40:	10.0	↗
Series		96.0
Total		382.0

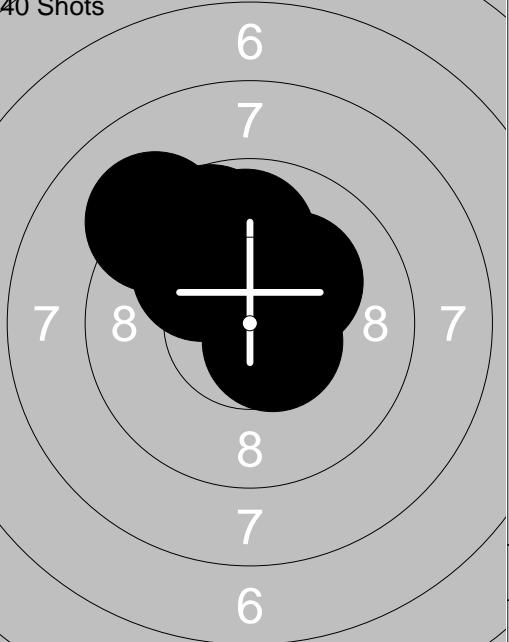
<p>Sight</p>  <p>1: *10.3 → 2: 9.9 → 3: 10.0 ↓ 4: *10.2 ↓ 5: *10.2 ↓ 6: *10.8 ↗ 7: *10.8 ↓ 8: 10.1 ↗ 9: *10.5 ↗ 10: *10.8 ↗</p> <p>Series 99.0 Total 0.0</p>		<p>Sight</p>  <p>11: 10.0 ↗ 12: 10.1 → 13: *10.7 ↑ 14: *10.9 ↑</p> <p>Series 40.0 Total 0.0</p>
--	--	---

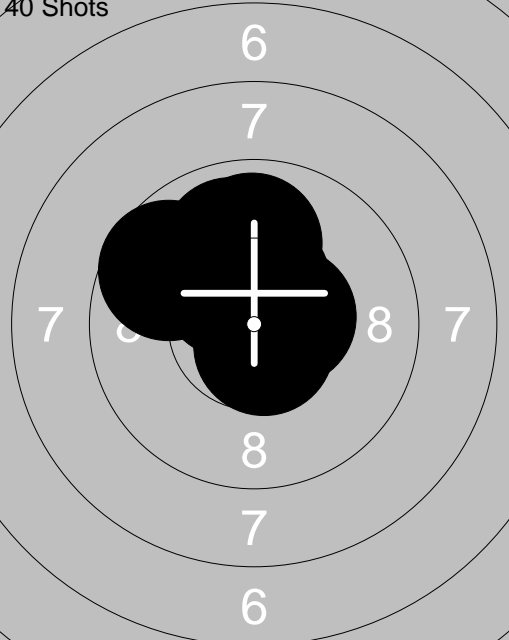
<p>40 Shots</p>  <p>1: *10.4 → 2: *10.7 ↓ 3: *10.4 ↑ 4: *10.3 ↑ 5: *10.2 ↑ 6: *10.6 ← 7: *10.5 ← 8: *10.4 ← 9: *10.2 ↑ 10: 10.1 ↑</p> <p>Series 100.0 Total 100.0</p>		<p>40 Shots</p>  <p>11: 9.9 ↑ 12: 10.0 ↖ 13: *10.2 ↑ 14: 9.2 ↖ 15: 10.1 ↑ 16: *10.3 ↑ 17: *10.2 ↗ 18: *10.2 ↑ 19: *10.6 ↘ 20: 9.7 ↖</p> <p>Series 97.0 Total 197.0</p>
--	--	---

<p>40 Shots</p>  <p>21: 10.1 ↑ 22: *10.4 ↑ 23: *10.7 ↓ 24: *10.3 ↑ 25: 9.9 ↑ 26: *10.5 ↑ 27: *10.5 → 28: *10.4 ↖ 29: 9.7 ↖ 30: 9.9 ↑</p> <p>Series 97.0 Total 294.0</p>		<p>40 Shots</p>  <p>31: 10.1 ↖ 32: 9.9 ↖ 33: *10.5 ↓ 34: *10.4 ↗ 35: 10.1 → 36: *10.2 ↑ 37: 10.0 ↖ 38: *10.4 ↗ 39: 10.1 ↑ 40: *10.4 ↗</p> <p>Series 99.0 Total 393.0</p>
---	--	--

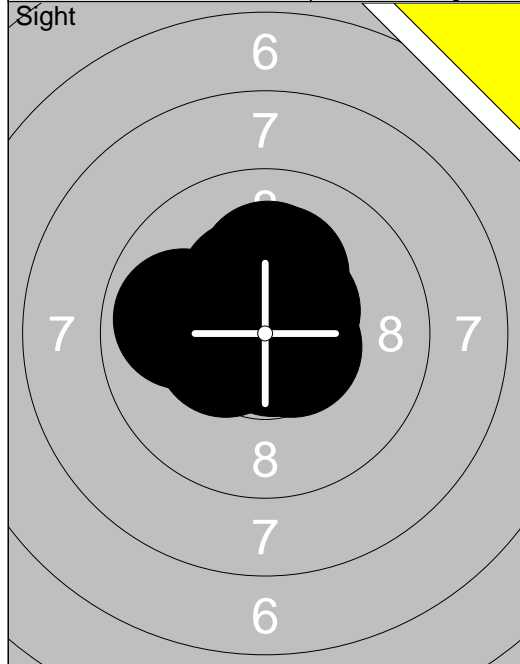

1:	*10.4	←
2:	*10.5	↗
3:	*10.8	↓
4:	*10.7	↗
5:	*10.6	↘
6:	*10.3	↑
7:	9.9	←
8:	*10.5	↑
9:	*10.2	↑
10:	*10.2	↑
Series		99.0
Total		0.0

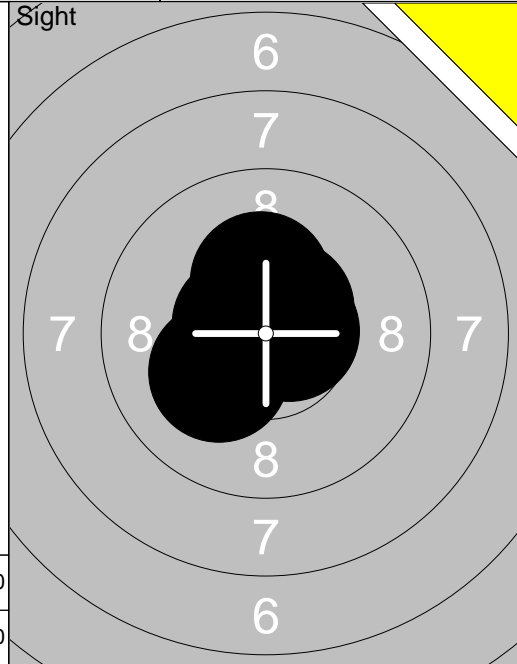

11:	*10.3	↑
12:	*10.6	↖
13:	*10.6	↗
14:	*10.2	↙
15:	*10.6	→
Series		50.0
Total		0.0

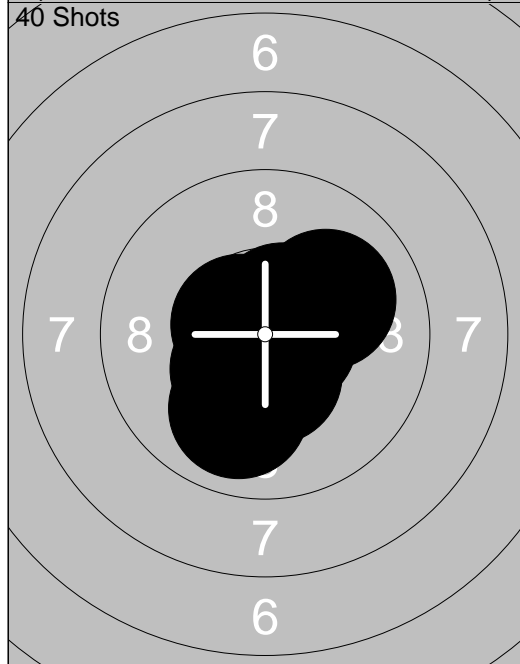

1:	*10.4	↓
2:	*10.8	↑
3:	*10.7	→
4:	*10.4	↙
5:	9.9	↓
6:	10.1	↗
7:	*10.6	↗
8:	*10.7	↓
9:	*10.6	←
10:	*10.6	↓
Series		99.0
Total		99.0

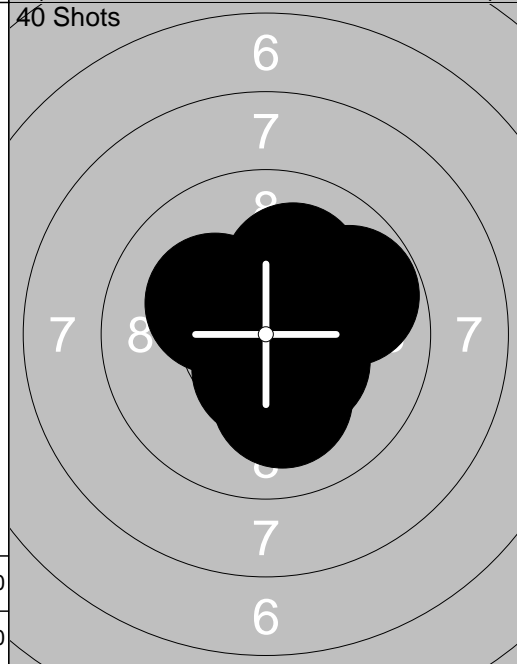

11:	*10.4	↘
12:	*10.5	↑
13:	*10.7	↑
14:	*10.4	↑
15:	10.1	↑
16:	*10.5	↓
17:	*10.2	↖
18:	9.8	↗
19:	*10.6	→
20:	10.1	↓
Series		99.0
Total		198.0

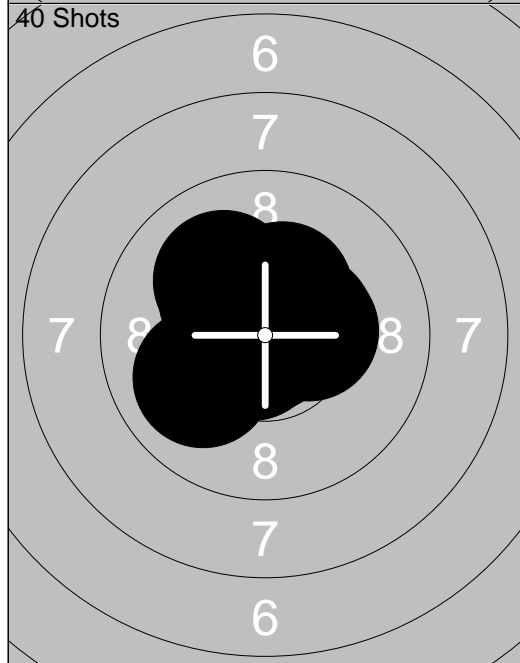

21:	*10.7	↙
22:	*10.3	↖
23:	*10.4	→
24:	*10.7	↗
25:	*10.4	→
26:	10.0	↖
27:	10.1	↗
28:	*10.9	↘
29:	*10.4	↑
30:	*10.9	↓
Series		100.0
Total		298.0

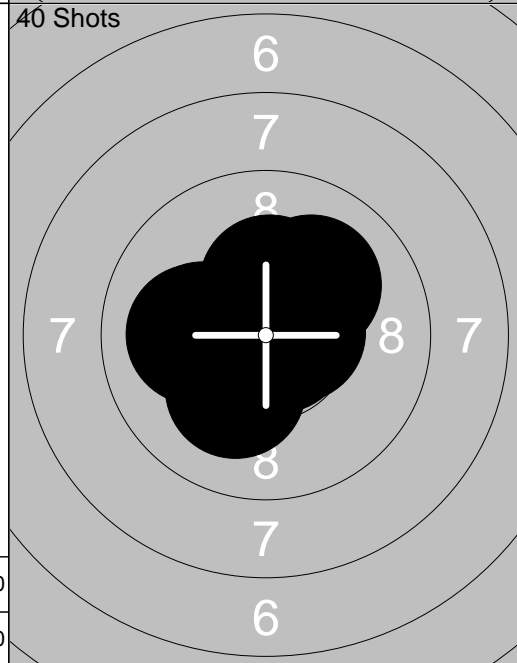

31:	*10.6	→
32:	*10.2	↙
33:	*10.8	↘
34:	10.1	←
35:	*10.5	↙
36:	*10.3	↑
37:	10.1	↗
38:	10.1	←
39:	*10.9	→
40:	*10.6	←
Series		100.0
Total		398.0

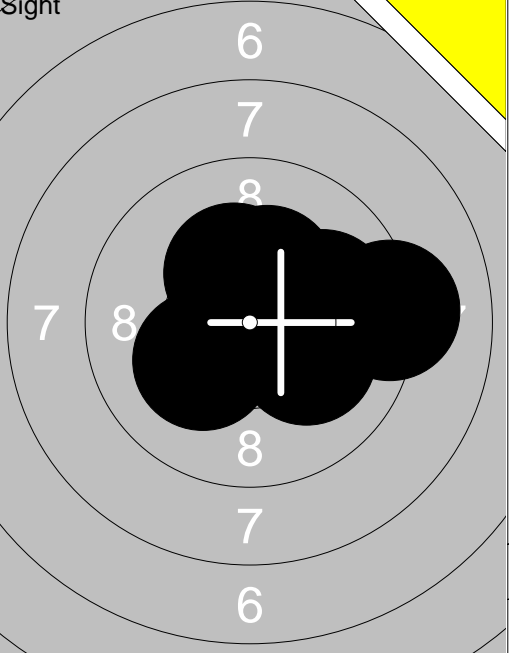
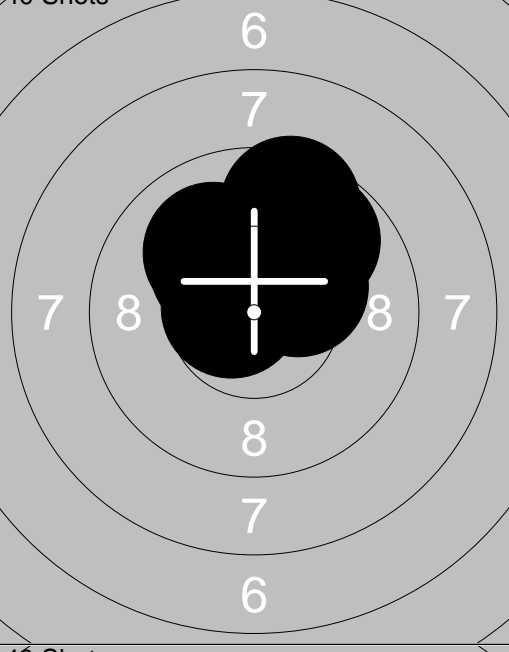
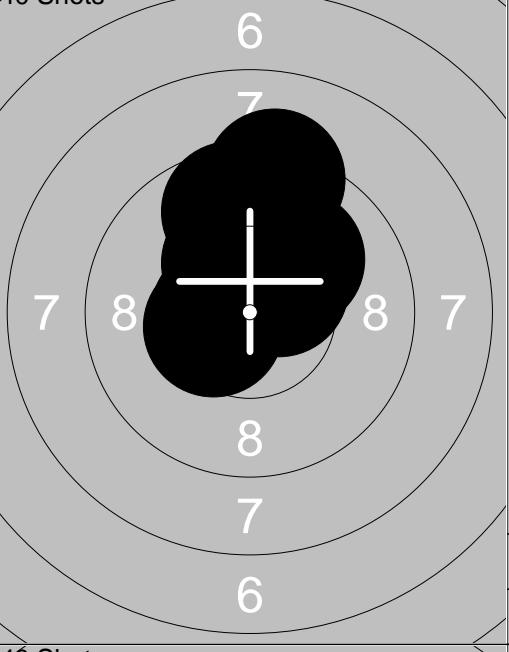
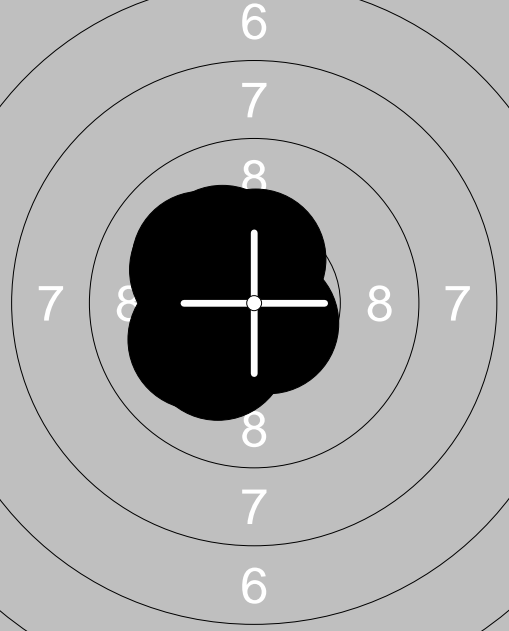
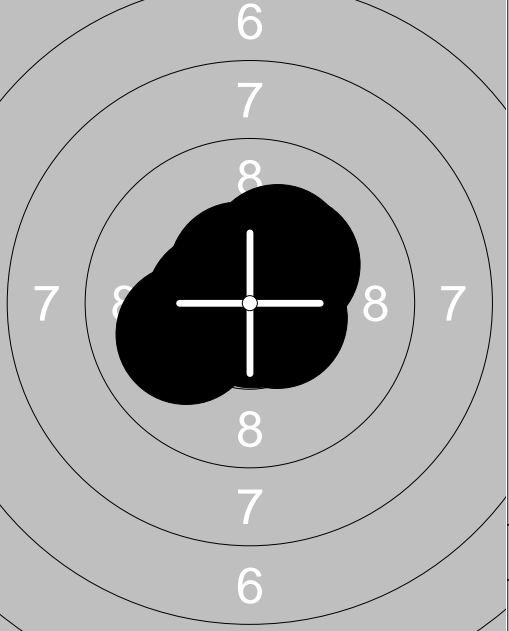
<p>Sight</p> 	<p>Sight</p> 	
<p>1: 9.3 ↗</p> <p>2: 9.5 ↑</p> <p>3: 10.0 ↑</p> <p>4: 9.9 ↑</p> <p>5: 9.3 ↑</p> <p>6: *10.2 ←</p> <p>7: *10.5 ↖</p> <p>8: *10.4 ↓</p> <p>9: 10.0 ↓</p> <p>10: *10.3 ↗</p>	<p>11: *10.3 ↑</p> <p>12: 10.0 →</p> <p>13: 9.2 →</p> <p>14: 10.1 ↘</p> <p>15: *10.6 ↑</p> <p>16: *10.2 ↙</p> <p>17: *10.3 ↑</p>	
Series 96.0	Series 69.0	
Total 0.0	Total 0.0	
<p>40 Shots</p> 	<p>40 Shots</p> 	<p>11: 9.6 ↑</p> <p>12: 10.1 ↗</p> <p>13: 9.2 ↑</p> <p>14: *10.6 ←</p> <p>15: *10.5 ↑</p> <p>16: *10.5 ↗</p> <p>17: *10.4 ↑</p> <p>18: *10.3 ↑</p> <p>19: *10.2 ↑</p> <p>20: *10.5 ↙</p>
<p>1: *10.3 ↗</p> <p>2: *10.2 ↖</p> <p>3: 9.8 ↗</p> <p>4: *10.2 ↗</p> <p>5: *10.6 ↑</p> <p>6: *10.3 ↑</p> <p>7: *10.7 ←</p> <p>8: 9.5 ↑</p> <p>9: *10.3 ↑</p> <p>10: 10.0 ↖</p>	<p>Series 98.0</p> <p>Total 98.0</p>	<p>Series 98.0</p> <p>Total 196.0</p>
<p>40 Shots</p> 	<p>40 Shots</p> 	<p>21: *10.6 ↑</p> <p>22: *10.6 ←</p> <p>23: *10.2 ↖</p> <p>24: *10.7 ↙</p> <p>25: *10.4 ↑</p> <p>26: 10.1 ↖</p> <p>27: *10.6 ↓</p> <p>28: 10.1 ↖</p> <p>29: *10.2 ↓</p> <p>30: 10.1 ↙</p>
<p>Series 100.0</p> <p>Total 296.0</p>	<p>Series 100.0</p> <p>Total 396.0</p>	

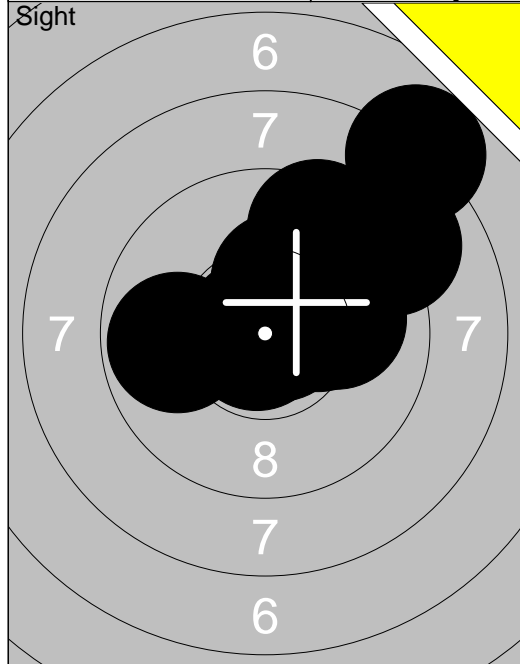

Series	95.0
Total	0.0

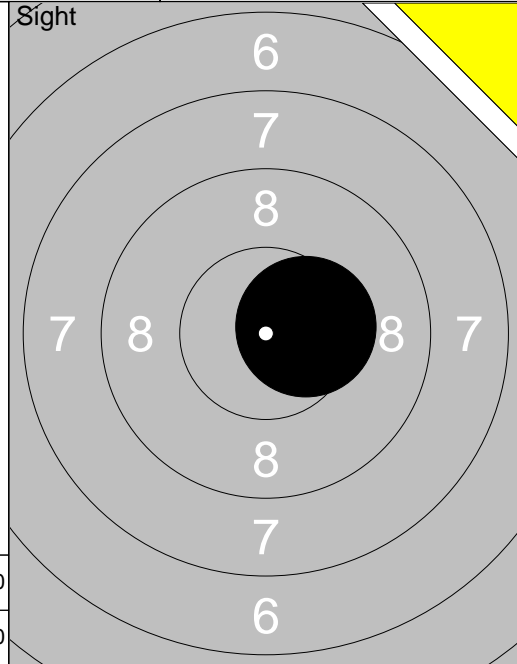

Series	10.0
Total	0.0

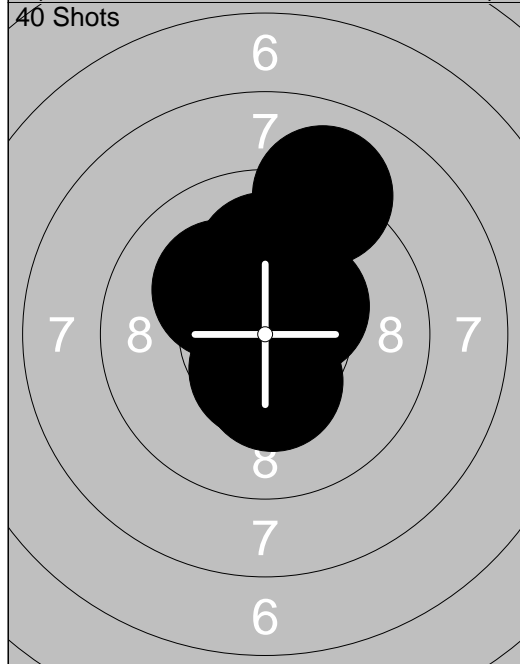

Series	99.0
Total	99.0

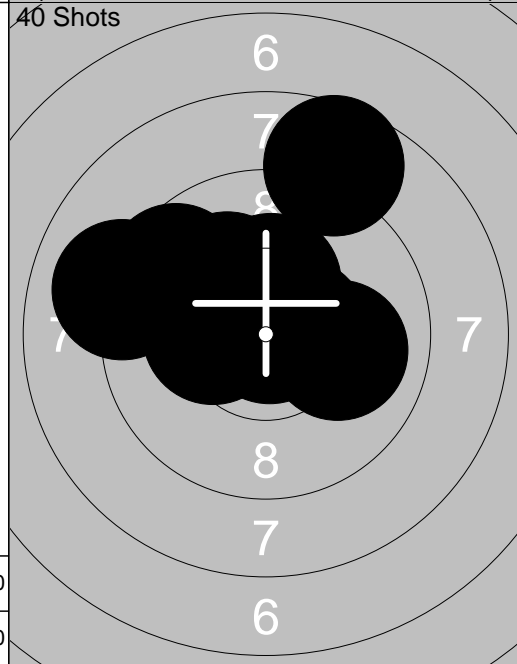

Series	96.0
Total	195.0

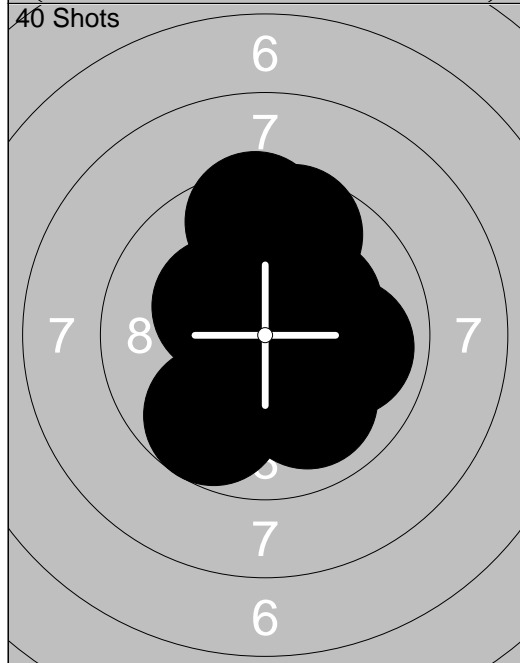

Series	96.0
Total	291.0

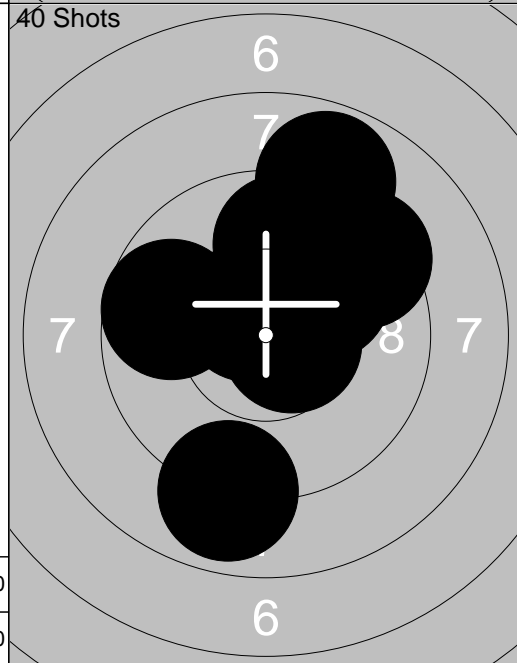

Series	93.0
Total	384.0

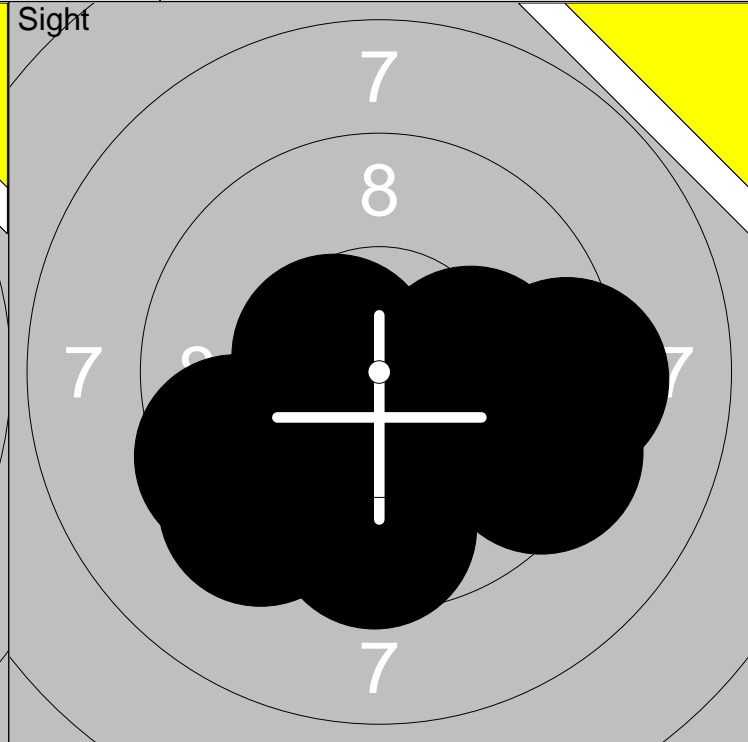

1: 9.4 ↓	6: 9.4 →	Series	90.0
2: 10.1 ↓	7: 10.0 →		
3: 9.4 ↓	8: *10.2 ↓	Total	0.0
4: 8.9 ↓	9: 9.8 ↗		
5: 9.0 ↓	10: 7.8 ↓		

11: 9.5 ↙	16: 10.1 →	Series	75.0
12: 9.4 →	17: 9.4 ↓		
13: 10.1 ↓	18: *10.5 ↙	Total	0.0
14: 9.6 ↓			
15: 9.3 →			

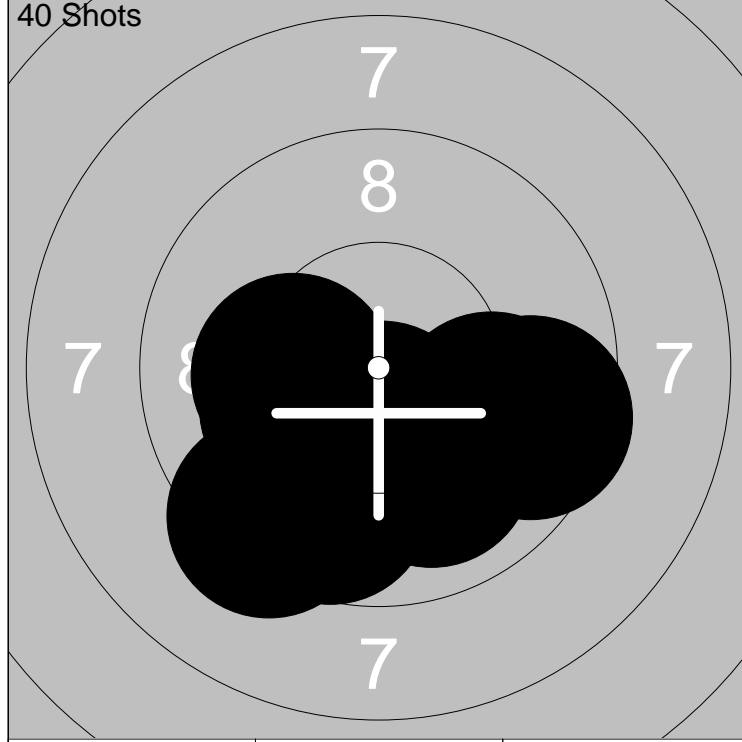

1: *10.2 ↙	6: 9.9 →	Series	95.0
2: 9.5 →	7: 10.0 ↓		
3: *10.5 ↓	8: 9.3 ↓	Total	95.0
4: 10.0 ↓	9: 9.7 ↓		
5: 9.7 ↓	10: *10.2 ←		

11: 10.0 ↓	16: *10.5 →	Series	98.0
12: 9.8 ↓	17: *10.3 ↙		
13: *10.4 ←	18: *10.2 ↓	Total	193.0
14: 9.9 ↗	19: 10.1 ↖		
15: *10.5 ↖	20: *10.8 ↗		

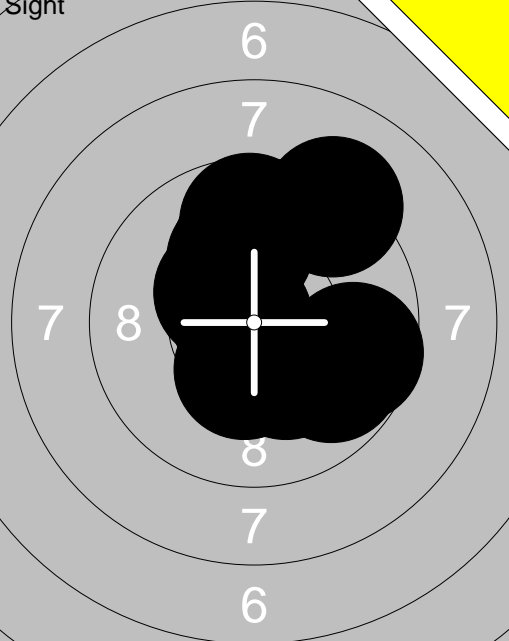
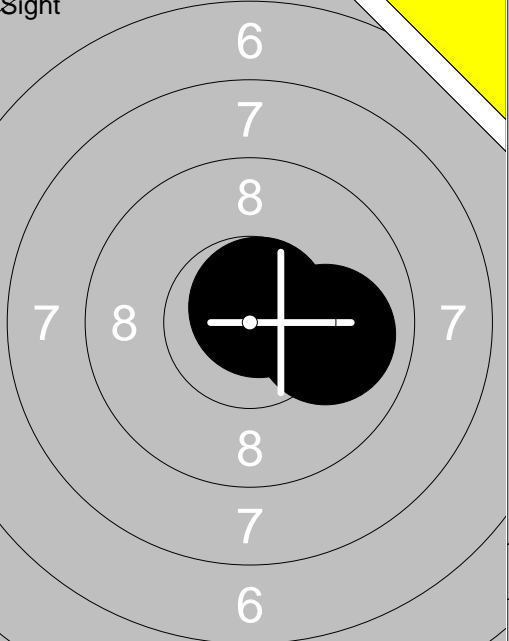
<p>Sight</p> 	<p>Sight</p> 	
1: 10.1 ↑ 2: 9.2 ↗ 3: *10.4 ↖ 4: 9.7 ↑ 5: 10.0 ↑ 6: 9.8 ↘ 7: *10.8 ← 8: 9.6 → 9: *10.3 ↓ 10: *10.2 ↘	11: 10.0 → 12: *10.7 ↗	
Series 96.0	Series 20.0	
Total 0.0	Total 0.0	

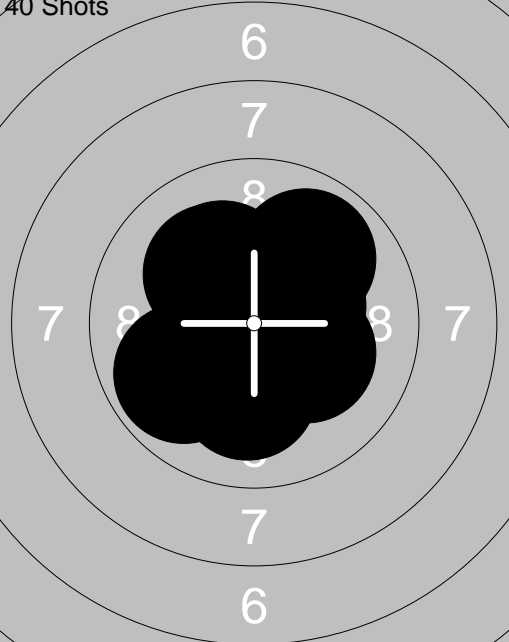
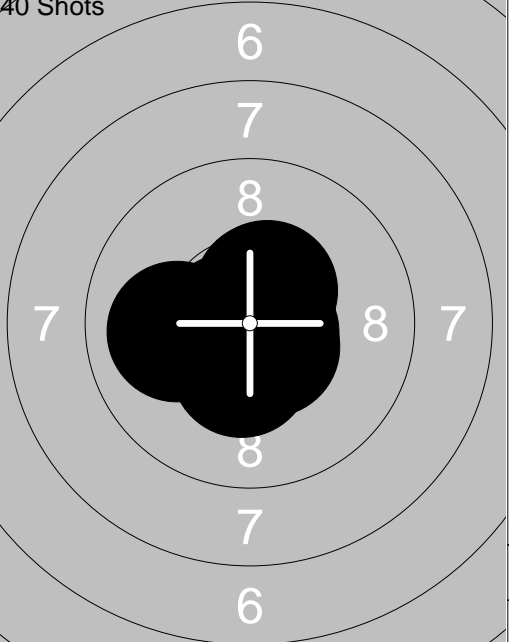
<p>40 Shots</p> 	<p>40 Shots</p> 	
1: *10.4 → 2: 10.1 ↖ 3: *10.8 ↓ 4: *10.4 → 5: 9.9 ↗ 6: 10.1 ↓ 7: 9.8 ← 8: *10.2 → 9: *10.2 ↗ 10: *10.7 ↗	11: *10.5 ↗ 12: *10.6 ↘ 13: *10.8 ← 14: *10.7 ← 15: 10.0 ← 16: *10.8 ← 17: *10.7 → 18: *10.5 ↗ 19: *10.5 ↓ 20: *10.4 ↓	
Series 98.0	Series 100.0	
Total 98.0	Total 198.0	

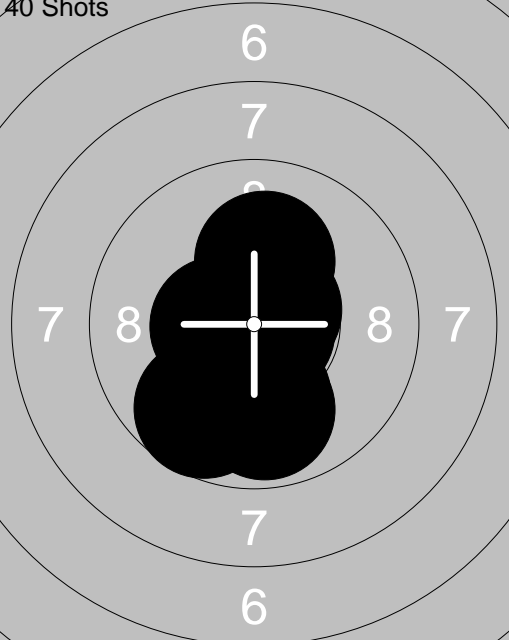
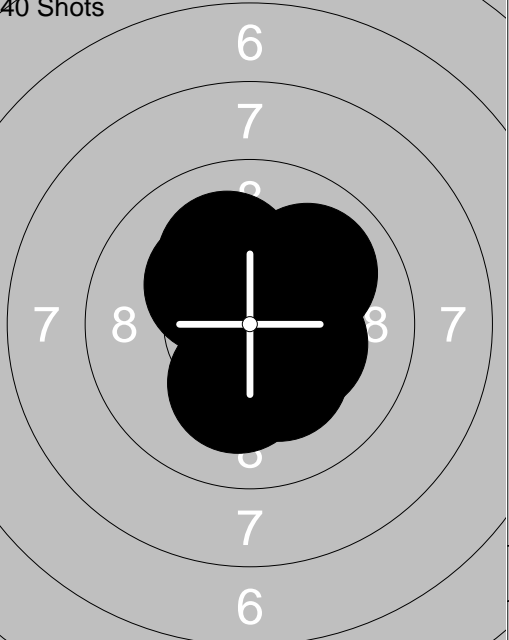
<p>40 Shots</p> 	<p>40 Shots</p> 	
21: 10.0 ↓ 22: *10.7 ↗ 23: 9.8 ↓ 24: *10.8 ↓ 25: 10.1 ↑ 26: *10.5 ↓ 27: *10.8 → 28: 9.7 ↘ 29: *10.5 ← 30: *10.7 ↑	31: *10.3 ↗ 32: *10.8 → 33: 10.0 ↗ 34: *10.3 ↖ 35: *10.5 ↑ 36: *10.2 ↘ 37: 10.1 ↗ 38: *10.5 ↑ 39: *10.2 ↓ 40: *10.3 →	
Series 98.0	Series 100.0	
Total 296.0	Total 396.0	

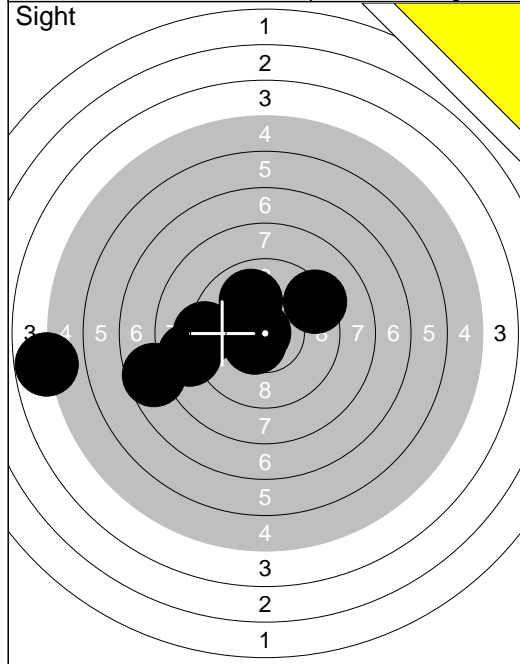

1:	4.8	←
2:	7.6	←
3:	8.7	←
4:	9.3	↗
5:	*10.6	↙
6:	10.0	↗
7:	9.3	←
8:	*10.8	←
Series		67.0
Total		0.0

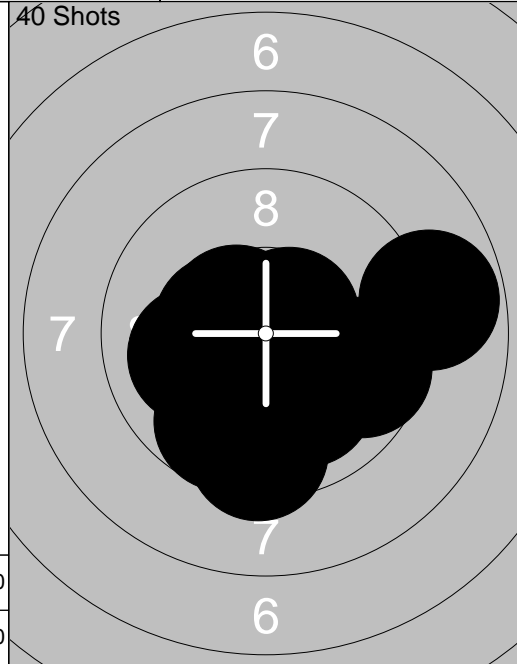

1:	*10.6	↗
2:	9.6	→
3:	9.7	↙
4:	10.0	←
5:	10.0	↙
6:	*10.5	↗
7:	*10.4	←
8:	*10.5	↓
9:	8.8	→
10:	9.4	↓
Series		95.0
Total		95.0

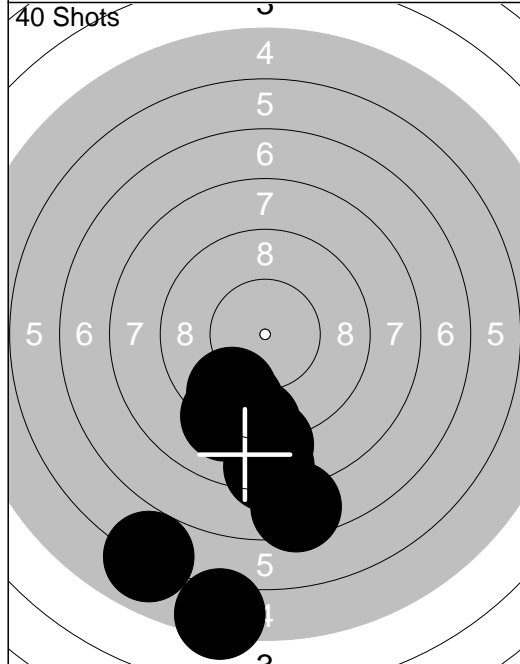

11:	9.5	↙
12:	8.7	↓
13:	7.5	↓
14:	5.9	↙
15:	5.3	↓
16:	9.1	↓
17:	8.3	↓
18:	9.4	↓
19:	9.6	↙
20:	9.1	↙
Series		78.0
Total		173.0

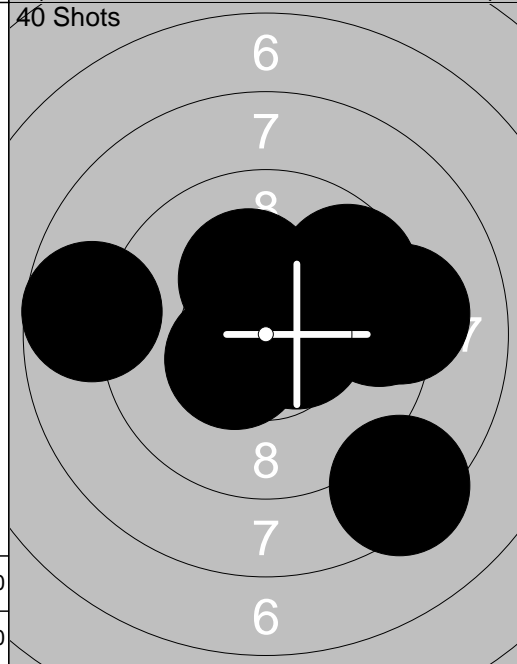

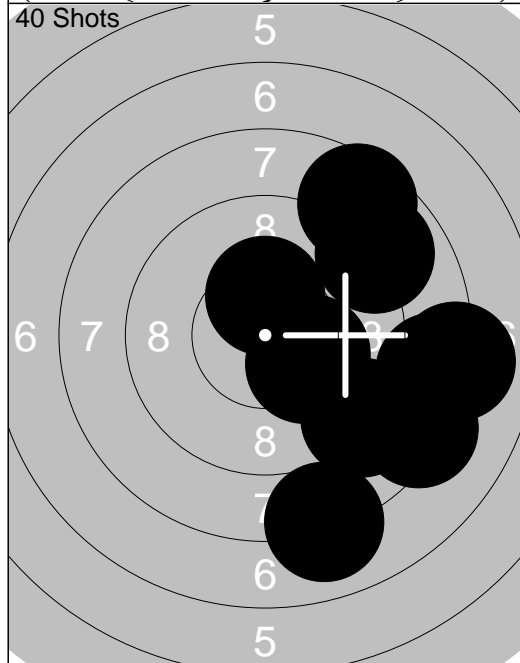

21:	*10.4	↙
22:	8.7	←
23:	*10.6	→
24:	9.7	→
25:	9.5	→
26:	*10.2	↗
27:	*10.8	↗
28:	9.7	↗
29:	8.4	↙
30:	9.2	→
Series		92.0
Total		265.0

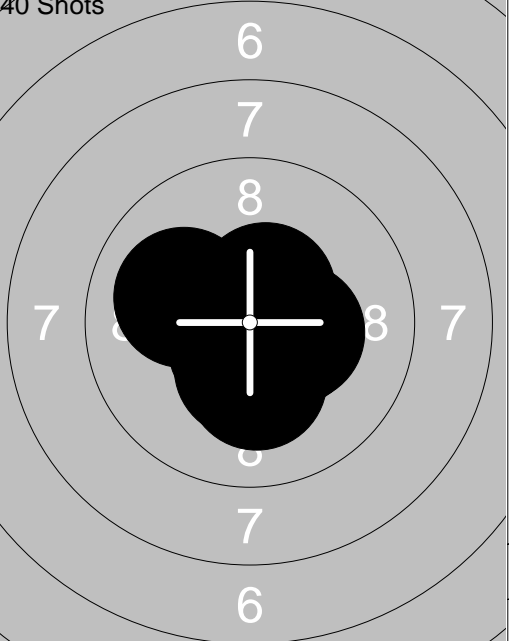

31:	8.3	→
32:	8.0	↓
33:	8.5	↗
34:	*10.2	↙
35:	8.9	↗
36:	8.3	↙
37:	*10.2	→
38:	*10.4	↗
39:	9.1	↙
40:	8.1	→
Series		87.0
Total		352.0

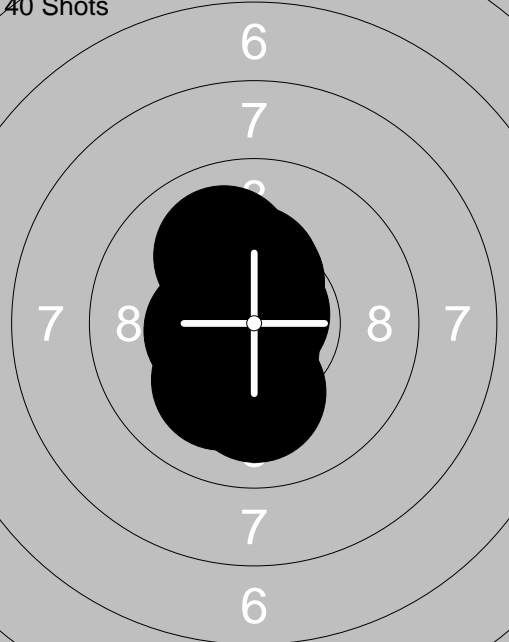
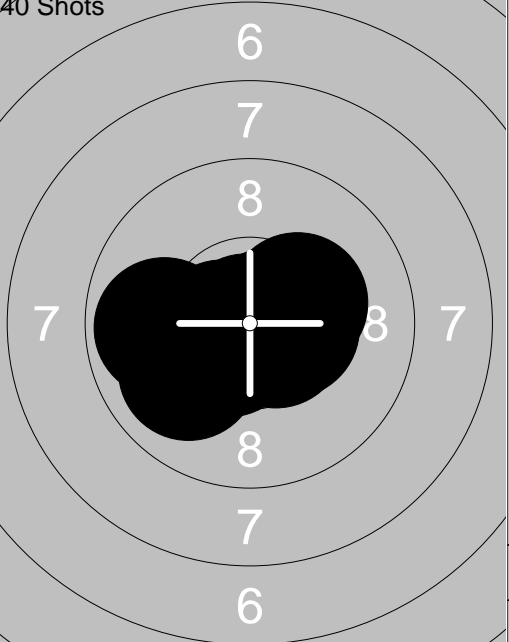
<p>Sight</p> 	<p>40 Shots</p> 	
<p>1: 9.6 ↑</p> <p>2: *10.4 ↗</p> <p>3: *10.5 ←</p> <p>4: 9.9 ↗</p> <p>5: 9.5 ↖</p> <p>6: *10.6 ↑</p> <p>7: *10.2 ↑</p> <p>8: *10.3 →</p> <p>9: *10.4 ↓</p> <p>10: *10.7 ↙</p>	<p>1: *10.4 ↓</p> <p>2: *10.2 ↓</p> <p>3: *10.7 ↑</p> <p>4: *10.6 ↓</p> <p>5: *10.4 →</p> <p>6: *10.4 →</p> <p>7: *10.5 →</p> <p>8: *10.7 →</p> <p>9: 10.1 ↖</p> <p>10: *10.5 ↗</p>	
Series 97.0	Series 100.0	
Total 0.0	Total 100.0	

<p>40 Shots</p> 	<p>40 Shots</p> 	
<p>11: *10.4 ↙</p> <p>12: *10.3 ↑</p> <p>13: *10.5 ←</p> <p>14: 10.0 ↖</p> <p>15: *10.4 ↑</p> <p>16: 10.1 ↓</p> <p>17: 10.1 ↙</p> <p>18: *10.8 ↗</p> <p>19: *10.6 ↓</p> <p>20: *10.4 ←</p>	<p>21: *10.3 ↗</p> <p>22: 9.9 ←</p> <p>23: *10.9 ←</p> <p>24: *10.4 →</p> <p>25: *10.7 →</p> <p>26: *10.6 →</p> <p>27: 10.0 ↙</p> <p>28: *10.5 ↙</p> <p>29: *10.8 ↓</p> <p>30: *10.6 ←</p>	
Series 100.0	Series 99.0	
Total 200.0	Total 299.0	

<p>40 Shots</p> 	<p>40 Shots</p> 	
<p>31: *10.7 ↑</p> <p>32: *10.6 ↑</p> <p>33: *10.7 ←</p> <p>34: 9.9 ↓</p> <p>35: *10.4 ↓</p> <p>36: *10.4 ↗</p> <p>37: *10.8 ←</p> <p>38: *10.4 ↙</p> <p>39: 9.9 ↑</p> <p>40: *10.8 ↖</p>		
Series 98.0		
Total 397.0		

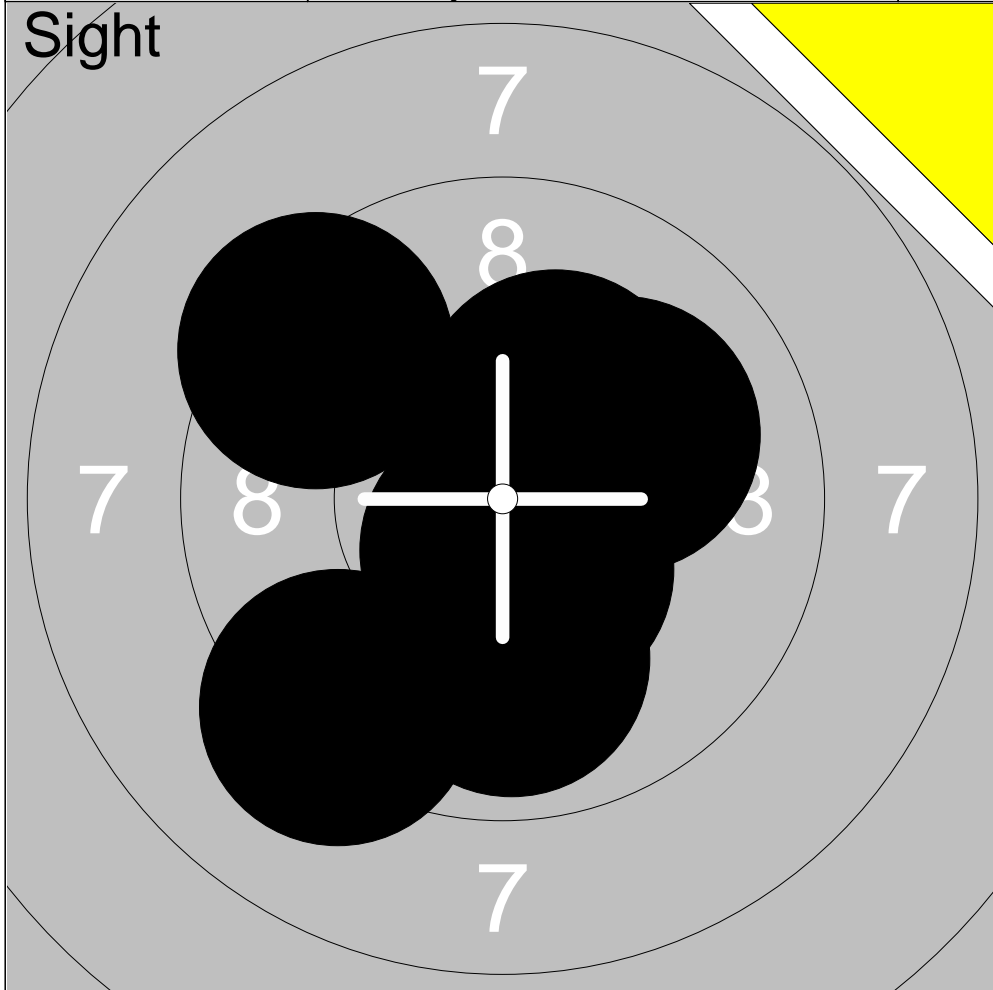

1:	9.2	↙
2:	9.9	↓
3:	*10.6	↓
4:	*10.3	↗
5:	9.4	↗
6:	*10.4	↓
7:	10.1	↗

Series	67.0
Total	0.0



1:	9.3	←
2:	*10.7	↗
3:	*10.3	↓

Series	29.0
Total	29.0



1:	9.9	↗
2:	9.9	↗
3:	9.5	↓
4:	*10.3	↑
5:	9.7	↖
6:	*10.6	↖

Series	56.0
Total	0.0



1:	9.9	↘
2:	9.2	↖
3:	9.4	→

Series	27.0
Total	27.0



1:	*10.2				↓
2:	*10.8				↙
3:	*10.3				←
4:	*10.6				↑
5:	*10.3				↖
6:	*10.4				↘
7:	*10.9				↓
8:	*10.5				↙
Series					80.0
Total					0.0



1:	*10.7				↙
2:	*10.5				↗
3:	*10.7				←
4:	*10.6				↘
5:	*10.7				↗
6:	*10.5				↙
7:	*10.2				→
8:	*10.7				↙
9:	*10.7				↑
10:	*10.6				↓
Series					100.0
Total					100.0



	11:	10.1			→
Series					10.0
Total					110.0



1:	*10.8	↙
2:	*10.4	→
3:	*10.7	↑
4:	*10.7	↗
5:	10.1	→
6:	*10.5	→
7:	*10.5	→
8:	*10.4	↘
9:	*10.4	↘
10:	*10.8	↘
Series		100.0
Total		0.0



1:	*10.5	↙
2:	*10.5	↙
3:	10.0	↙
4:	*10.5	↘
5:	*10.7	↘
6:	*10.6	↘
7:	*10.2	↘
8:	*10.5	↘
9:	*10.9	↗
10:	*10.3	↘
Series		100.0
Total		100.0



11:	*10.6	↙
Series		10.0
Total		110.0

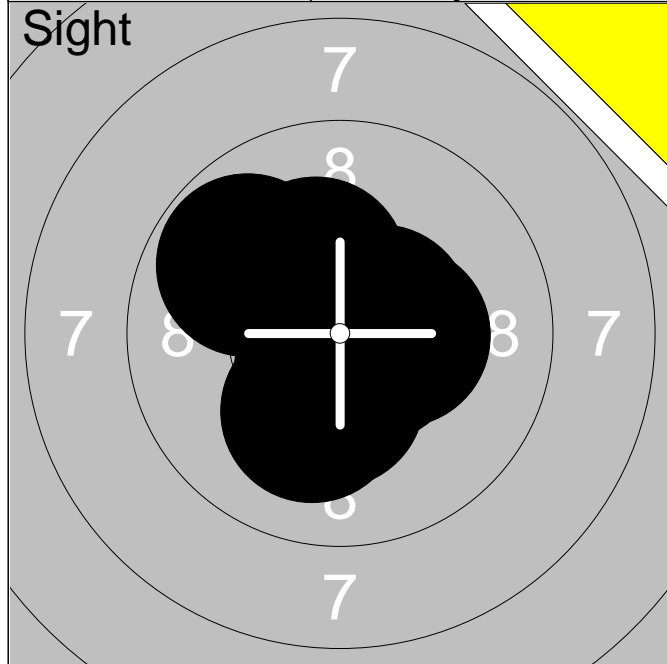

1:	10.1	↘
2:	*10.5	↘
3:	*10.6	→
4:	9.8	↗
5:	*10.3	↗
6:	*10.3	↘
7:	*10.7	↑
8:	*10.4	→
9:	*10.5	↗
10:	*10.6	↘

Series	99.0
--------	------

Total	0.0
-------	-----



11:	10.0	↖
12:	*10.8	↖
13:	*10.7	↘
14:	*10.4	↗
15:	*10.7	↘

Series	50.0
--------	------

Total	0.0
-------	-----



1:	10.0	↓
2:	*10.9	↑
3:	8.8	↙

Series	28.0
--------	------

Total	28.0
-------	------



1:	9.4	↑
2:	9.5	↑
3:	*10.5	↗
4:	9.9	↘
5:	*10.6	↗
6:	*10.5	←
7:	*10.7	↘
8:	9.9	←
9:	*10.7	↗
10:	*10.9	↘

Series	96.0
Total	0.0



1:	*10.4	→
2:	9.8	↑
3:	*10.3	↘

Series	29.0
Total	29.0