

1:	*10.7	↗
2:	9.8	→
3:	*10.5	↘
4:	*10.6	→
5:	*10.5	↖
6:	10.1	→
7:	*10.4	↗
8:	*10.3	→
9:	*10.7	↘
10:	*10.2	↗

Series	103.8
--------	-------

Total	0.0
-------	-----

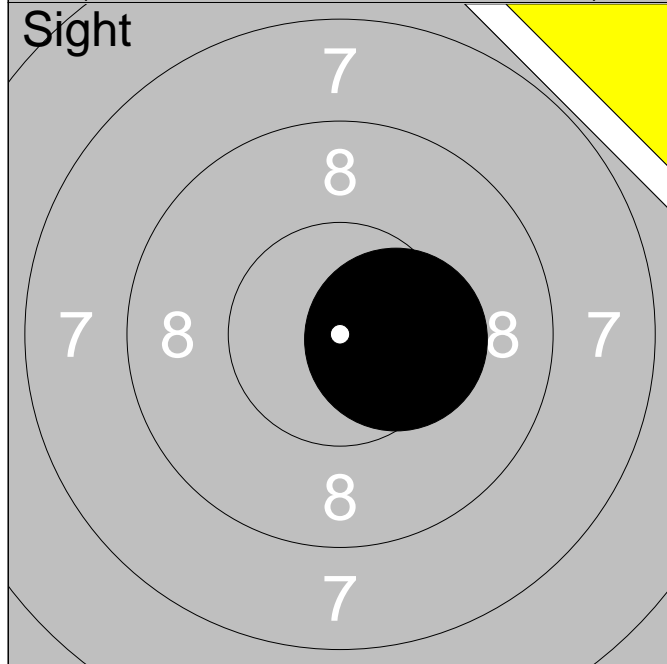

11:	*10.4	→
-----	-------	---

Series	10.4
--------	------

Total	0.0
-------	-----



1:	*10.5	↗
2:	*10.9	↖
3:	*10.3	↑
4:	10.0	↑
5:	*10.2	↘
6:	*10.6	↑
7:	10.1	→
8:	*10.3	↘
9:	*10.9	↑
10:	*10.2	↙

Series	104.0
--------	-------

Total	104.0
-------	-------



1:	*10.5	↘
2:	10.1	↘
3:	*10.5	↘
4:	*10.3	↘
5:	*10.4	↘
6:	*10.3	↙
7:	*10.5	↘
8:	*10.4	↘
9:	10.1	↓
10:	*10.3	↘
<b>Series</b>		<b>103.4</b>
<b>Total</b>		<b>0.0</b>

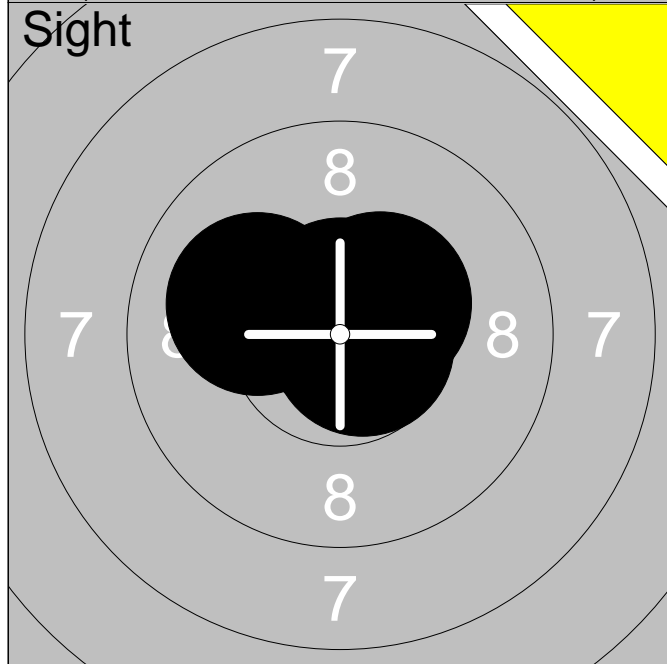

11:	10.1	↖
12:	*10.7	↘
13:	*10.5	↗
14:	*10.7	↑
15:	*10.8	↑
<b>Series</b>		<b>52.8</b>
<b>Total</b>		<b>0.0</b>



1:	*10.7	↑
2:	*10.6	↙
3:	*10.5	↘
4:	*10.5	↑
5:	10.1	↗
6:	*10.3	↙
7:	*10.5	←
8:	*10.4	←
9:	*10.3	↗
10:	*10.6	↓
<b>Series</b>		<b>104.5</b>
<b>Total</b>		<b>104.5</b>

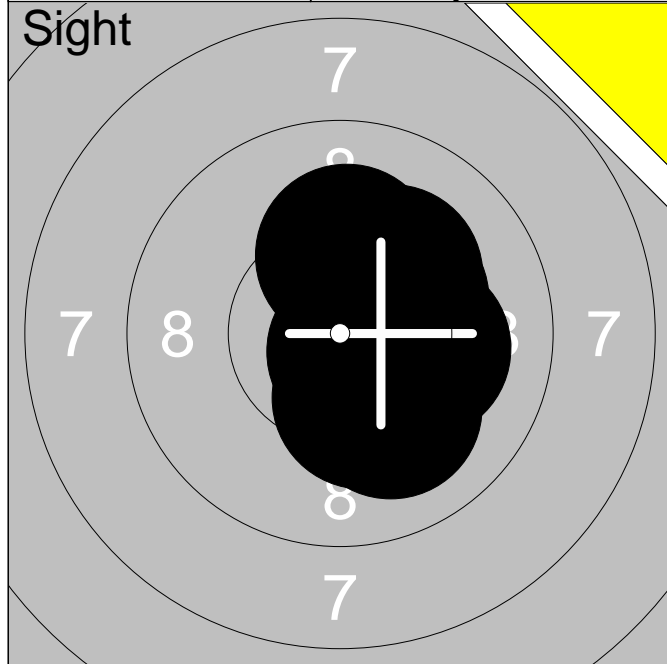

1:	*10.3	↗
2:	*10.2	↑
3:	*10.3	↗
4:	*10.2	↗
5:	10.1	↓
6:	*10.2	→
7:	*10.6	→
8:	*10.7	↓
9:	*10.3	↓
10:	*10.4	↘

Series	103.3
Total	0.0



11:	*10.3	↘
12:	*10.4	↙
13:	*10.8	←
14:	*10.8	←
15:	*10.7	↙

Series	53.0
Total	0.0



1:	10.0	↙
2:	*10.7	→
3:	*10.5	↗
4:	*10.6	↗
5:	10.0	←
6:	*10.2	←
7:	*10.4	↑
8:	10.1	→
9:	*10.5	↓
10:	*10.6	↙

Series	103.6
Total	103.6

<p><b>Sight</b></p>	1:	*10.8	↓
	2:	*10.8	←
	3:	*10.8	↓
	4:	*10.6	↑
	5:	*10.5	↗
	6:	*10.2	↖
	7:	*10.4	↗
	8:	*10.3	↓
	9:	*10.5	↑
	10:	*10.7	↖
	Series		
Total			0.0

<p><b>Sight</b></p>	11:	10.0	↓
	12:	*10.7	↓
	13:	9.7	↓
	14:	*10.5	←
	15:	*10.3	↗
	16:	*10.2	↓
	17:	*10.6	↓
	18:	*10.7	→
	Series		
Total			0.0

<p><b>40 Shots</b></p>	1:	*10.5	↗
	2:	*10.6	↓
	3:	*10.9	←
	4:	*10.6	↖
	5:	*10.2	↑
	6:	*10.8	↑
	7:	*10.6	↑
	8:	*10.8	↑
	9:	*10.5	→
	10:	*10.7	→
	Series		
Total			106.2

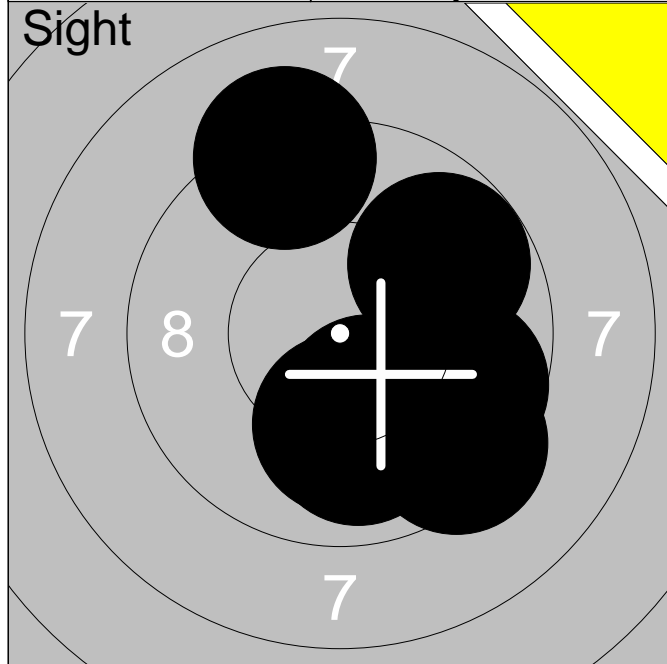

1:	9.4	↘
2:	9.8	↘
3:	10.1	↘
4:	9.8	↘
5:	9.9	↘
6:	9.7	↘
7:	9.1	↗
8:	*10.2	↘
9:	10.1	↘
10:	9.8	↗

Series	97.9
Total	0.0

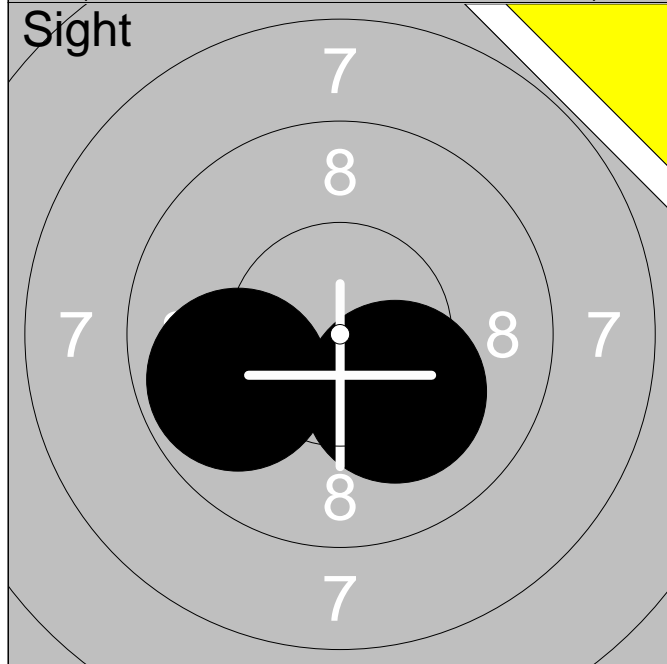

11:	9.8	↙
12:	*10.2	↘

Series	20.0
Total	0.0



1:	*10.4	↗
2:	9.7	↑
3:	*10.2	↘
4:	*10.7	↗
5:	10.0	↗
6:	*10.4	↗
7:	9.6	←
8:	9.9	←
9:	9.9	←
10:	*10.7	↗

Series	101.5
Total	101.5

Relay <b>6</b>	Lane <b>16</b>	<b>Lina Johansson</b>
-------------------	-------------------	-----------------------

10m	Drängsmark	Sitt	Vb
-----	------------	------	----

2012-11-04	Vindelnskytten 2012	Ramselefors SKF
------------	---------------------	-----------------



1:	*10.7	→
2:	*10.5	↘
3:	*10.8	↘
4:	*10.5	↗
5:	*10.2	↑
6:	*10.7	↘
7:	*10.7	↑
8:	*10.6	→

Series	84.7
Total	0.0



1:	*10.4	↗
2:	*10.3	→
3:	*10.2	↗
4:	*10.3	←
5:	*10.4	↑
6:	*10.8	↗
7:	*10.5	↑
8:	*10.6	←
9:	*10.6	↗
10:	10.1	↗

Series	104.2
Total	104.2

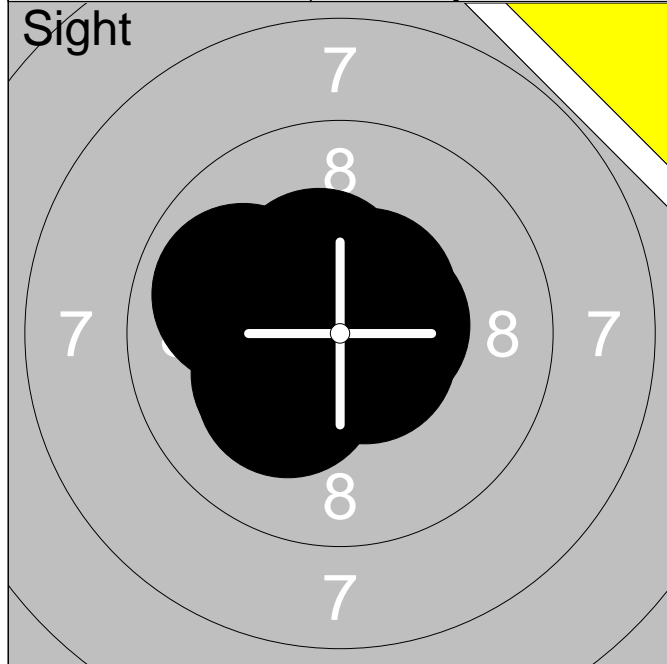

1:	*10.4	↖
2:	*10.6	↑
3:	*10.3	↙
4:	*10.2	↘
5:	*10.5	↗
6:	*10.6	→
7:	*10.6	↘
8:	9.9	↖
9:	*10.7	↑
10:	*10.3	↙
<b>Series</b>		<b>104.1</b>
<b>Total</b>		<b>0.0</b>

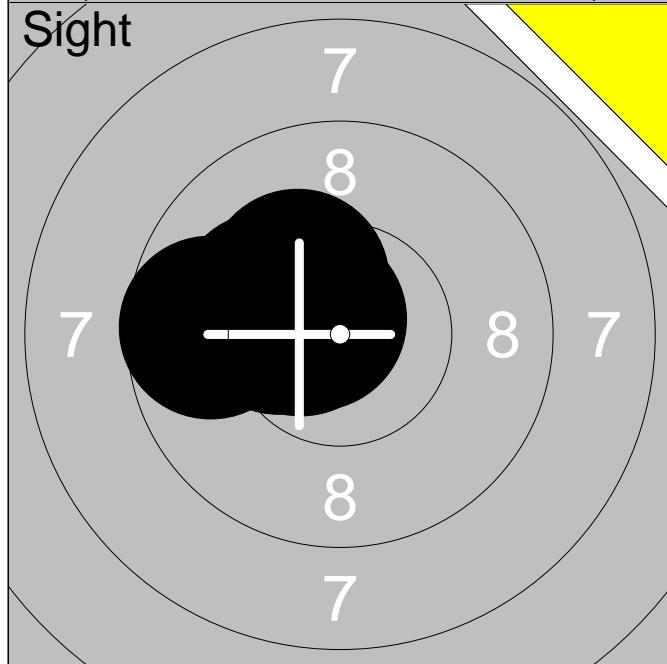

11:	*10.2	↖
12:	*10.7	↗
13:	*10.3	↖
14:	*10.3	↗
15:	9.7	↖
16:	*10.6	↖
<b>Series</b>		<b>61.8</b>
<b>Total</b>		<b>0.0</b>



1:	*10.3	↖
2:	10.1	↗
3:	*10.6	←
4:	*10.7	↓
5:	10.1	↑
6:	*10.4	↑
7:	9.8	↙
8:	*10.4	↑
9:	*10.4	↓
10:	*10.2	↗
<b>Series</b>		<b>103.0</b>
<b>Total</b>		<b>103.0</b>



1:	*10.6	↖
2:	*10.4	↓
3:	*10.4	↑
4:	*10.6	↓
5:	9.9	↖
6:	*10.3	↖
7:	*10.9	←
8:	*10.5	↖
9:	*10.7	↖
10:	*10.6	↓

Series	104.9
--------	-------

Total	0.0
-------	-----

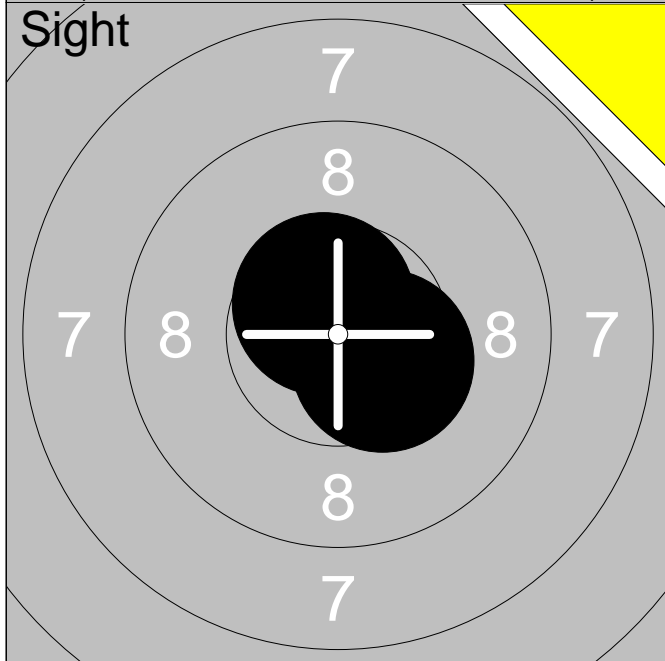

11:	*10.4	↘
12:	*10.6	↖

Series	21.0
--------	------

Total	0.0
-------	-----



1:	*10.5	↑
2:	*10.6	→
3:	*10.3	↗
4:	*10.6	→
5:	*10.5	↖
6:	*10.7	↖
7:	*10.5	←
8:	*10.4	↑
9:	*10.3	↑
10:	*10.8	↑

Series	105.2
--------	-------

Total	105.2
-------	-------





1:	*10.3	↙
2:	10.0	↘
3:	*10.2	↘
4:	9.7	↗
5:	*10.6	↑
6:	*10.4	↗
7:	10.0	↘
8:	*10.3	→
9:	10.1	↙
10:	*10.5	→

Series	102.1
Total	0.0



1:	9.9	↖
2:	10.1	←
3:	*10.4	↘
4:	10.1	→
5:	*10.5	↓
6:	10.0	↗
7:	*10.3	→
8:	10.1	↓
9:	*10.7	↙
10:	10.1	↘

Series	102.2
Total	102.2



1:	*10.6	↓
2:	10.1	↓
3:	*10.2	↙
4:	*10.5	↓
5:	10.0	←
6:	*10.5	↙
7:	*10.5	←
8:	*10.7	↗
9:	10.1	←
10:	*10.4	↑

Series	103.6
--------	-------

Total	0.0
-------	-----



11:	*10.3	←
12:	*10.6	↓
13:	*10.4	←

Series	31.3
--------	------

Total	0.0
-------	-----

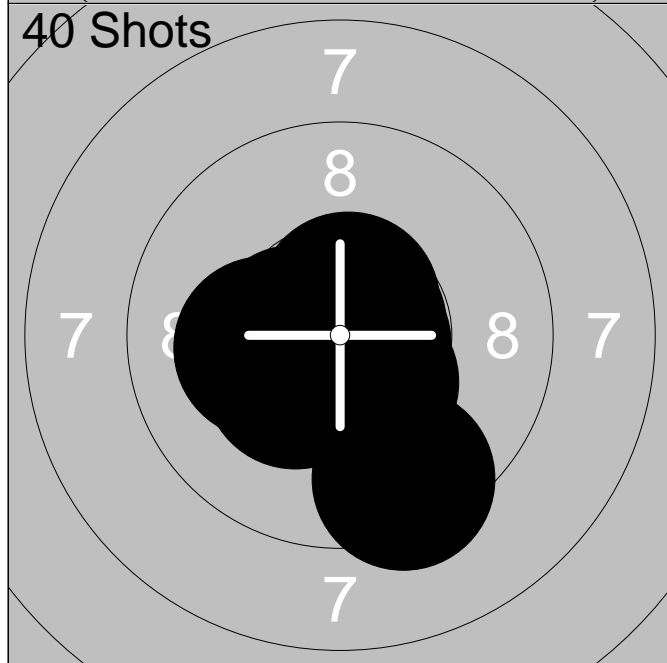

1:	9.4	↓
2:	*10.5	↓
3:	*10.8	→
4:	*10.8	↗
5:	*10.7	↘
6:	*10.4	↓
7:	*10.3	↙
8:	*10.2	←
9:	*10.5	←
10:	*10.6	↑

Series	104.2
--------	-------

Total	104.2
-------	-------



1: *10.2 →	6: *10.2 ↓	Series	81.4
2: *10.3 ↓	7: 10.1 →		
3: *10.7 →	8: *10.3 ↓	Total	0.0
4: 9.9 →			
5: 9.7 ↓			

1: *10.2 ←	6: *10.2 →	Series	101.7
2: *10.7 ↓	7: *10.3 ↓		
3: *10.6 →	8: *10.3 ↓	Total	101.7
4: 9.6 ←	9: *10.4 ↓		
5: 9.6 ↓	10: 9.8 ←		

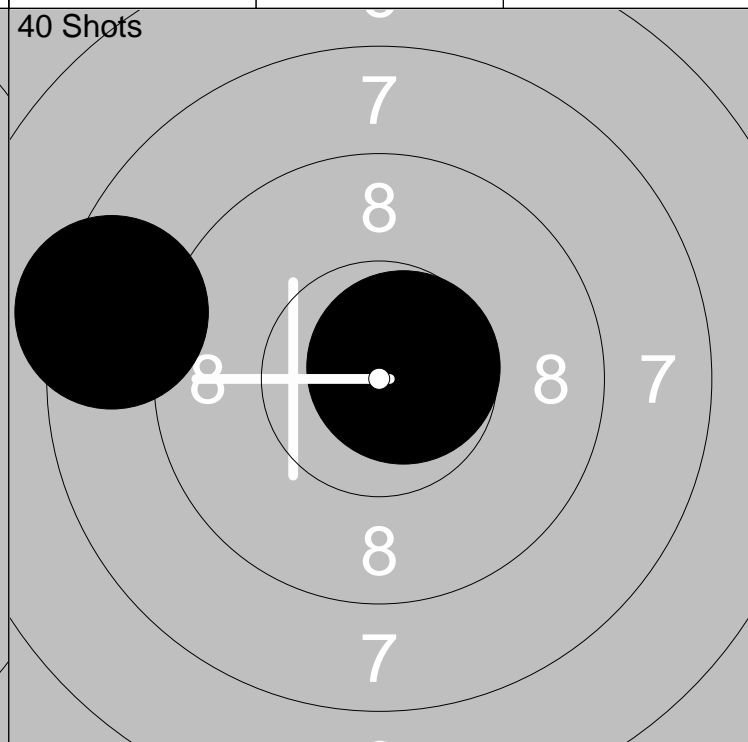
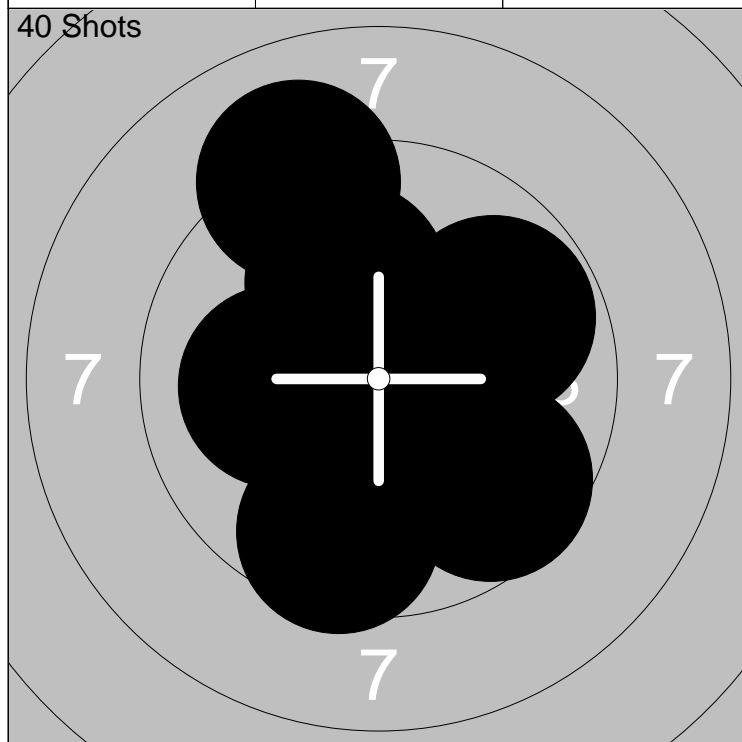

11: *10.2 ←	16: 9.6 ↓	Series	100.2
12: 9.8 ↗	17: 10.1 ↗		
13: *10.5 ←	18: 9.1 ↗	Total	201.9
14: 9.6 ↓	19: *10.8 ↓		
15: *10.4 →	20: 10.1 ←		

21: 8.4 ←	Series	19.1
22: *10.7 ↗		
	Total	221.0



1:	*10.2	↙
2:	10.1	↗
3:	*10.4	↖
4:	*10.3	↓
5:	10.1	↗
6:	*10.7	→

Series	61.8
Total	0.0



1:	9.4	↗
2:	*10.7	↖
3:	9.5	↖
4:	*10.6	↘
5:	*10.4	↖
6:	9.7	↗
7:	9.2	↗
8:	8.9	↘
9:	*10.3	↘
10:	8.7	→

Series	97.4
Total	97.4



1:	*10.6	↓
2:	*10.8	←
3:	*10.3	↓
4:	10.1	←
5:	10.1	↓
6:	9.9	←
7:	9.7	↖
<b>Series</b>		71.5
<b>Total</b>		0.0

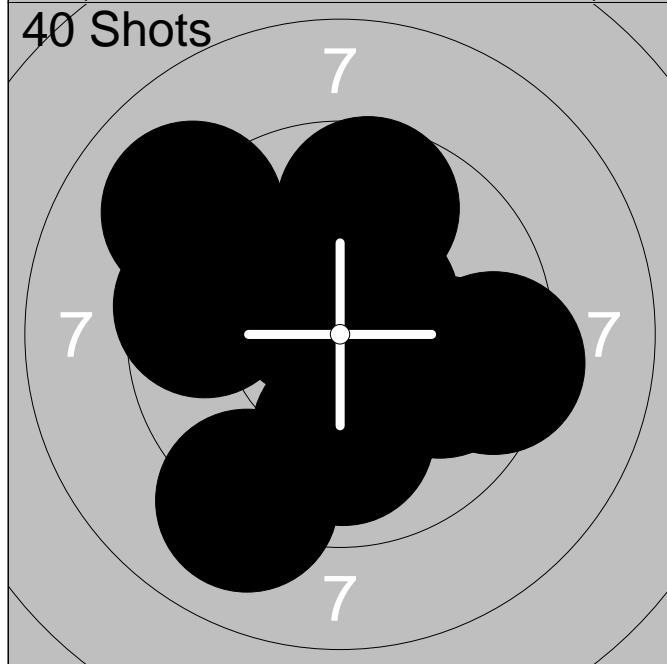

1:	9.1	↗
2:	10.0	↓
3:	9.7	↑
4:	9.1	↘
5:	*10.3	↓
6:	*10.6	↗
7:	9.4	→
8:	*10.5	↗
9:	9.9	↘
10:	9.6	←
<b>Series</b>		98.2
<b>Total</b>		98.2



11:	9.1	↗
12:	10.1	↗
<b>Series</b>		19.2
<b>Total</b>		117.4

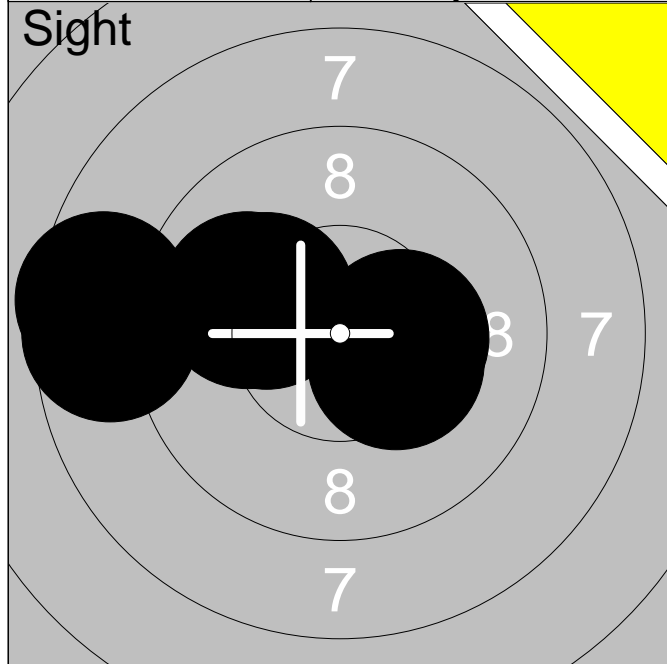

1:	10.1	↗
2:	*10.3	↘
3:	9.9	↗
4:	*10.4	↘
5:	8.6	↖
6:	8.5	↖
7:	*10.3	↘
Series		68.1
Total		0.0



1:	9.9	↘
2:	9.8	↗
3:	*10.5	↖
4:	*10.3	↗
5:	*10.3	↗
6:	*10.4	↖
7:	9.7	↖
8:	*10.4	↗
9:	*10.5	↘
10:	8.8	↖
Series		100.6
Total		100.6

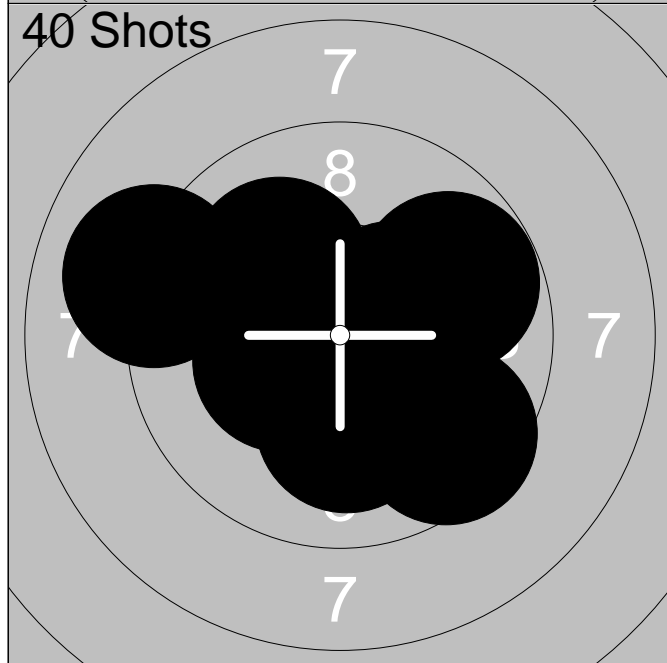

11:	9.8	↗
12:	*10.3	↖
13:	10.1	↘
14:	*10.4	↘
15:	*10.8	↘
16:	*10.6	↖
17:	*10.4	↗
18:	9.5	↘
19:	9.0	↖
20:	10.1	↗
Series		101.0
Total		201.6

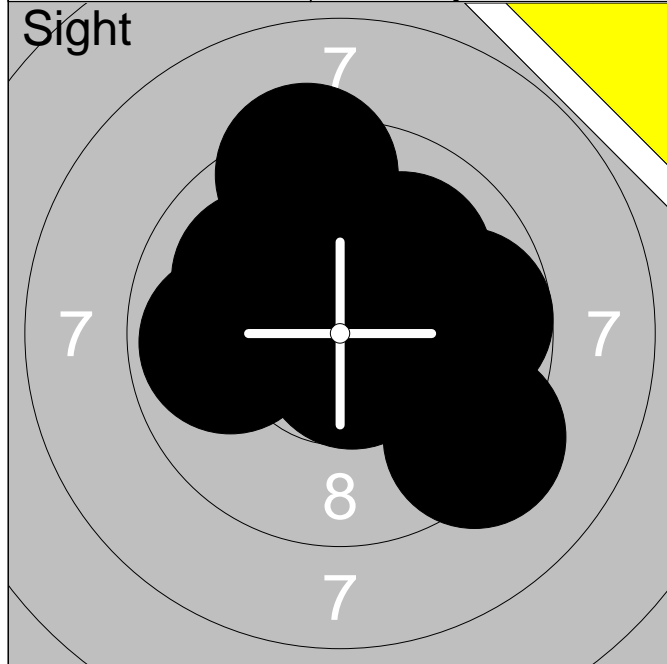

1:	9.3	↘
2:	9.9	←
3:	*10.7	→
4:	10.0	↗
5:	9.7	→
6:	*10.7	↘
7:	9.4	↑
8:	10.0	↗
<b>Series</b>		<b>79.7</b>
<b>Total</b>		<b>0.0</b>

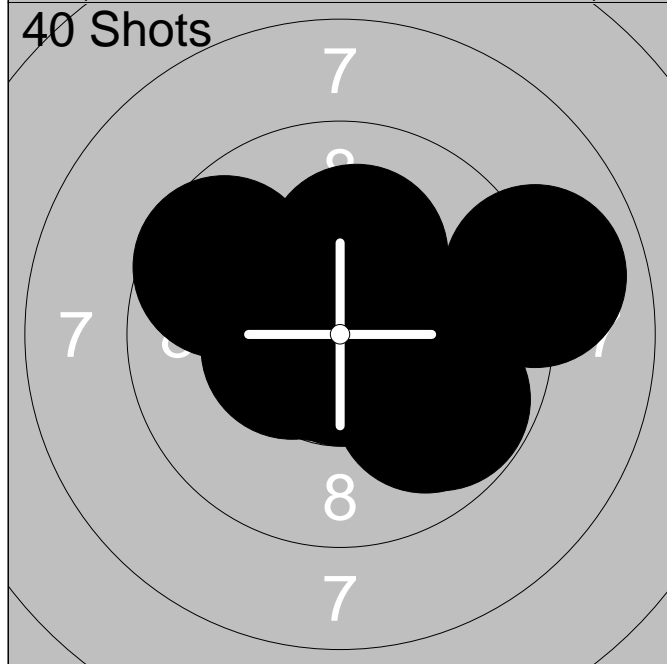

1:	*10.6	↗
2:	*10.7	↘
3:	9.8	↘
4:	*10.4	↑
5:	8.9	→
6:	*10.5	←
7:	9.6	↗
8:	9.9	↘
9:	*10.7	↙
10:	*10.2	↑
<b>Series</b>		<b>101.3</b>
<b>Total</b>		<b>101.3</b>

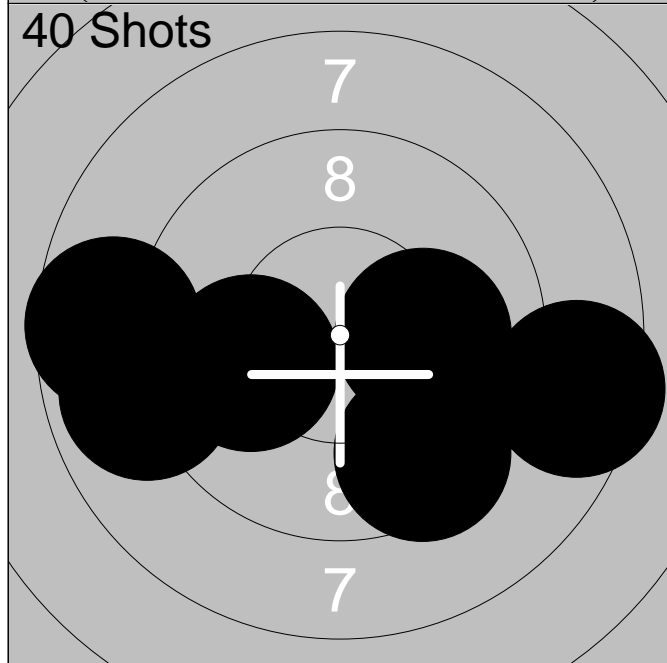

11:	10.0	←
12:	9.5	↘
13:	10.1	→
14:	8.9	←
15:	8.5	→
16:	8.6	←
<b>Series</b>		<b>55.6</b>
<b>Total</b>		<b>156.9</b>

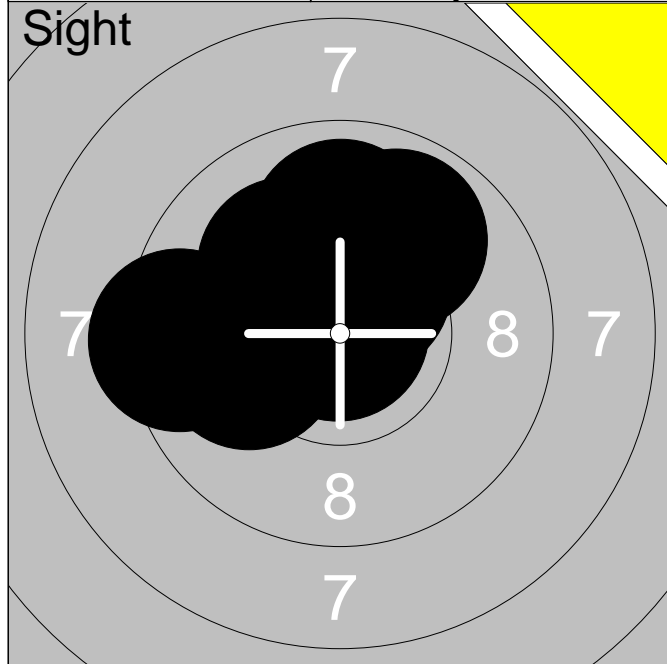

1:	9.9	↗
2:	10.1	↗
3:	*10.9	↗
4:	10.0	←
5:	*10.4	↗
6:	9.9	↑
7:	9.4	←
Series		70.6
Total		0.0

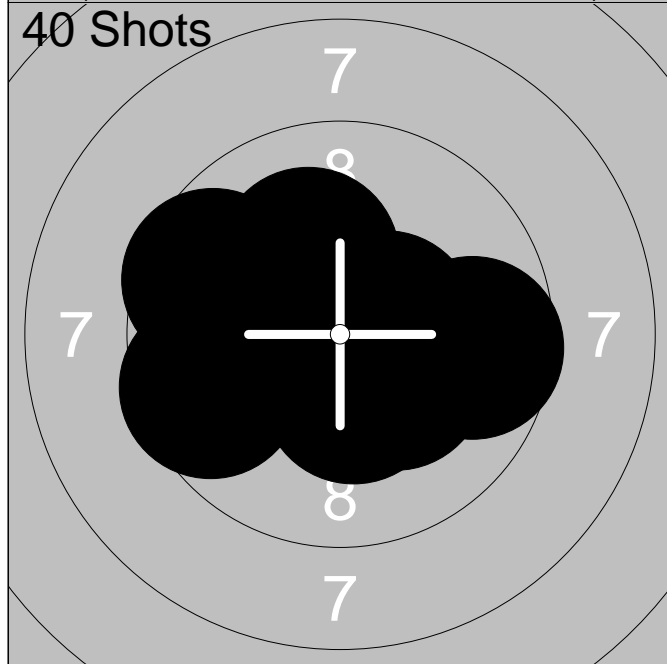

1:	*10.3	↗
2:	*10.5	→
3:	*10.4	↓
4:	*10.3	↓
5:	9.6	→
6:	10.0	↗
7:	*10.6	→
8:	9.6	←
9:	9.6	↗
10:	10.1	↗
Series		101.0
Total		101.0

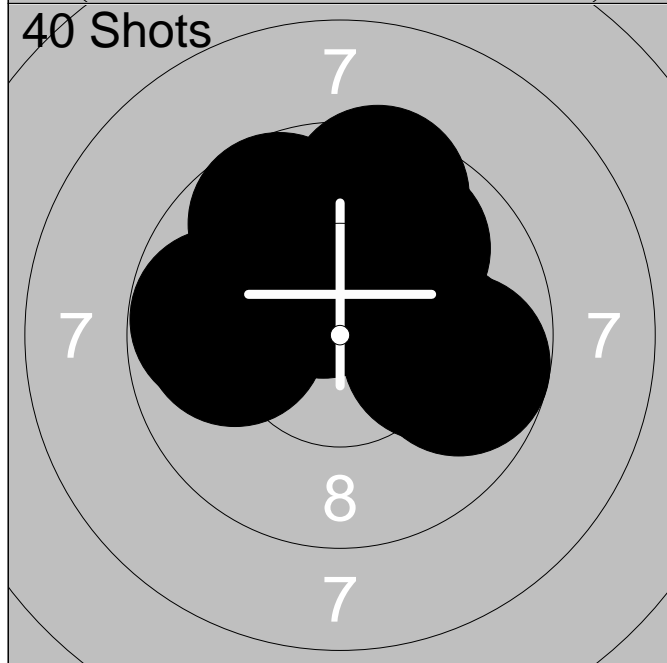

11:	9.7	→
12:	*10.4	↗
13:	10.0	→
14:	9.9	↗
15:	9.5	↗
16:	9.7	↗
17:	9.8	←
18:	9.9	←
Series		78.9
Total		179.9



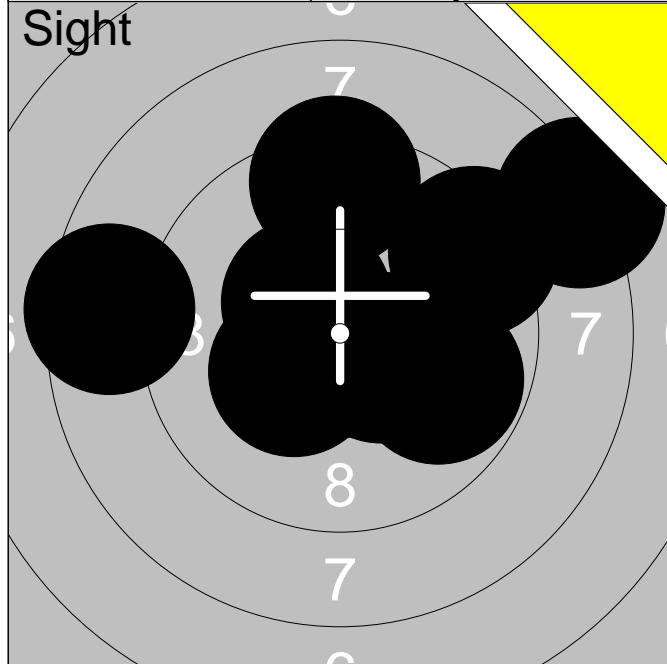

1:	8.1	↗
2:	9.3	↗
3:	9.3	↑
4:	9.8	↘
5:	8.5	←
6:	*10.4	↘
7:	*10.5	↗
8:	*10.3	↙

Series	76.2
Total	0.0

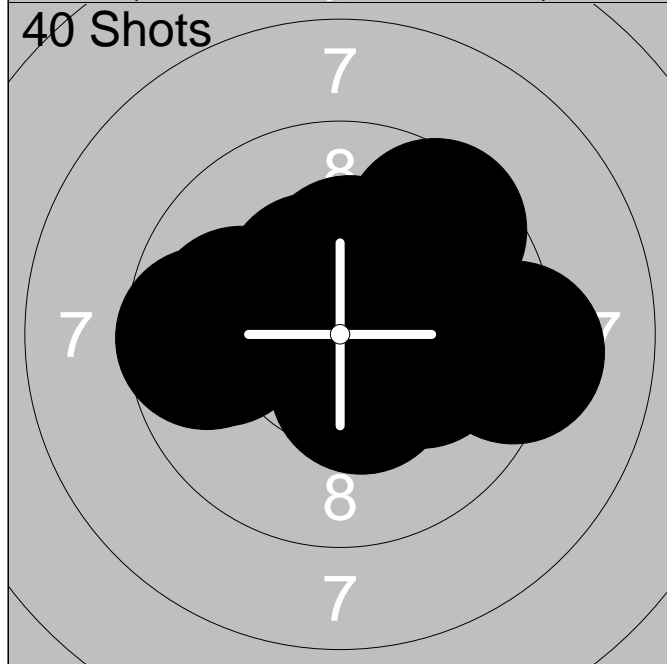

1:	9.6	↗
2:	9.9	←
3:	*10.4	↗
4:	10.0	←
5:	9.2	→
6:	9.8	←
7:	10.1	→
8:	9.6	←
9:	*10.4	↘
10:	*10.3	↑

Series	99.3
Total	99.3

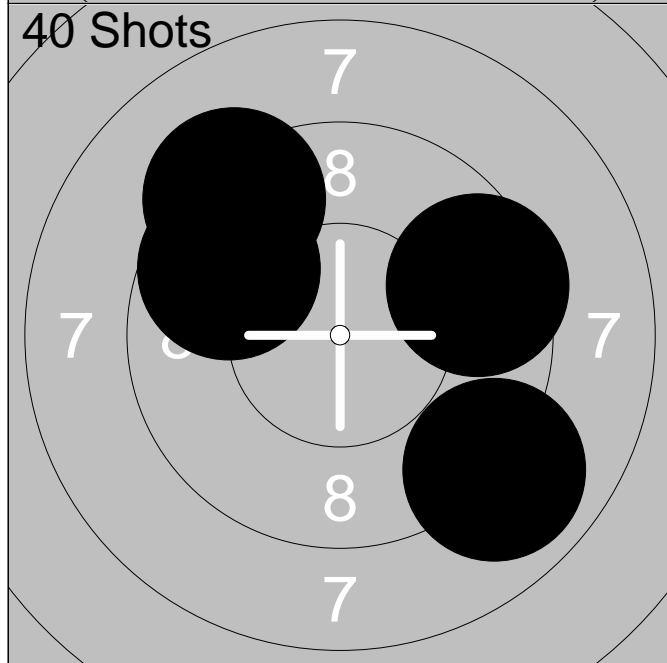

11:	9.5	↗
12:	9.3	↗
13:	9.7	↗
14:	8.9	↘

Series	37.4
Total	136.7

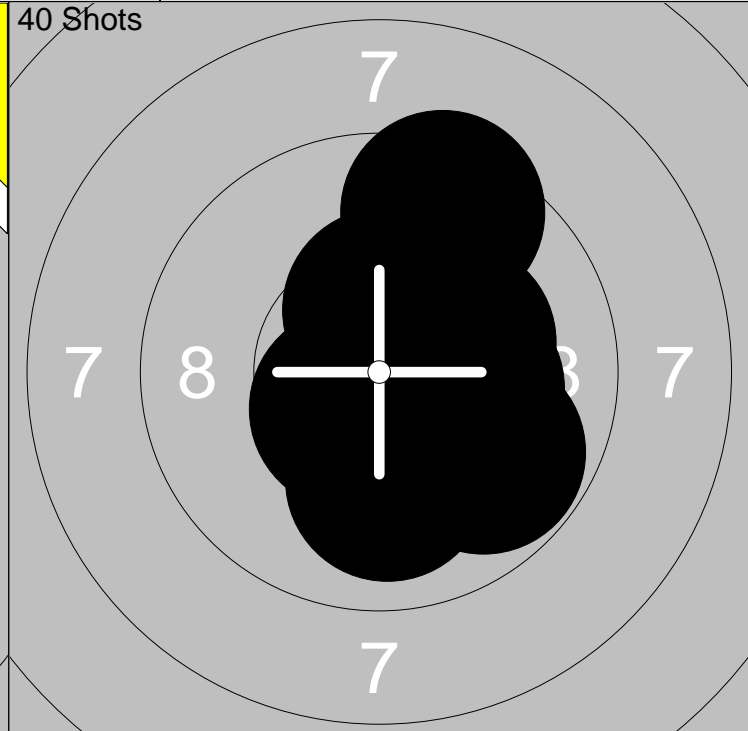
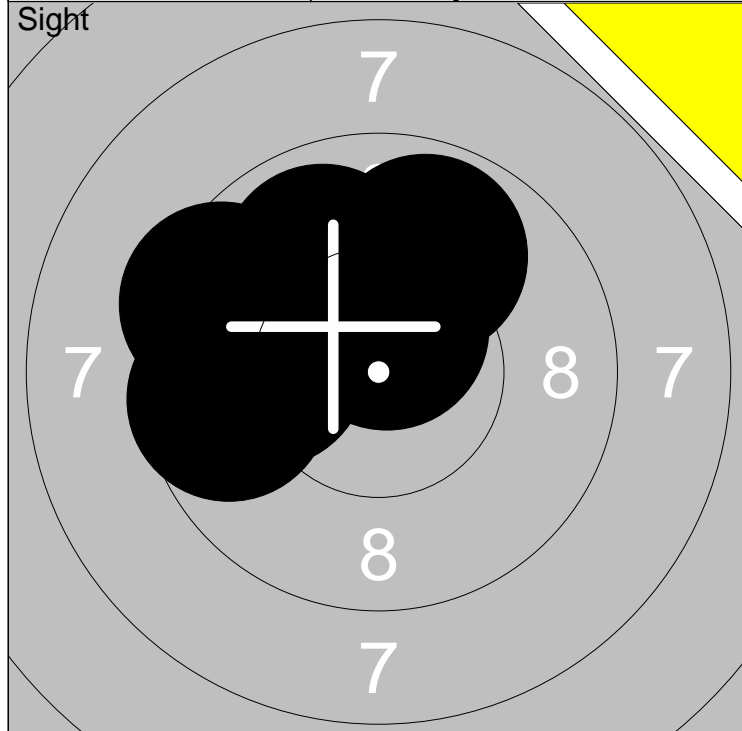

1: 9.9 ↗	6: *10.6 ↗	Series 59.4
2: 9.6 ↖		
3: 10.0 ↖		Total 0.0
4: 9.9 ↗		
5: 9.4 ↖		

1: *10.7 →	6: *10.5 ↗	Series 102.4
2: *10.2 →	7: *10.5 ↘	
3: *10.4 ↗	8: *10.7 ↘	Total 102.4
4: 10.0 ↘	9: *10.2 →	
5: 9.8 ↘	10: 9.4 ↗	

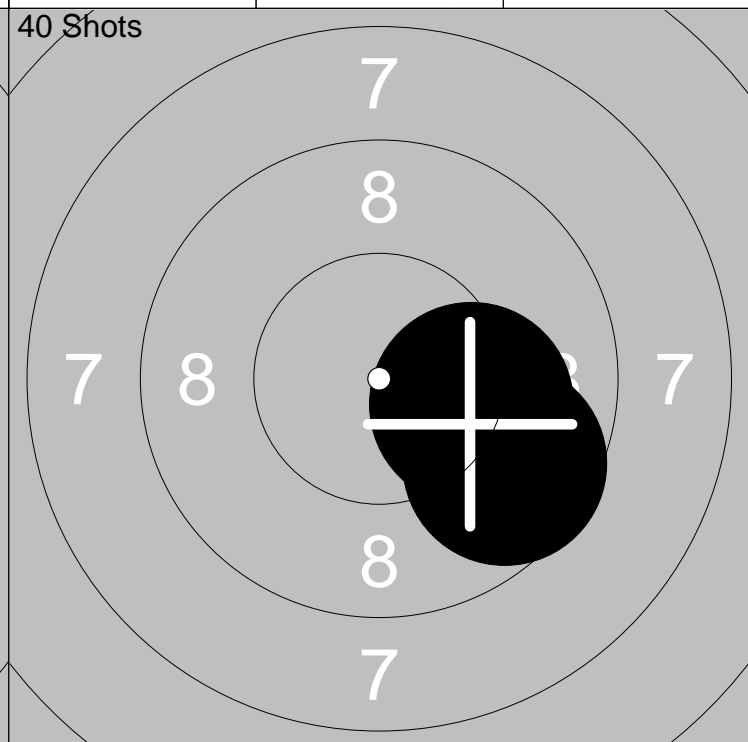
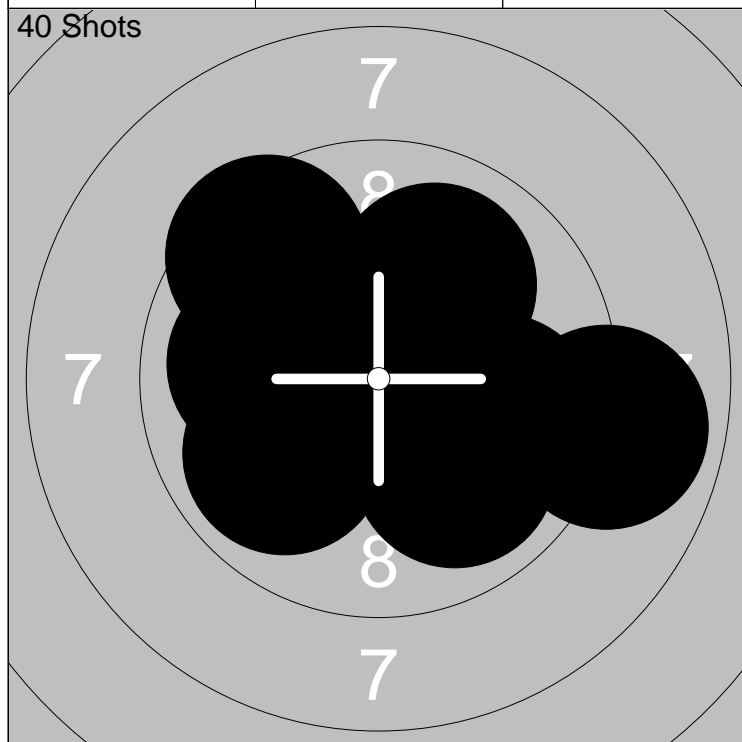

11: 9.9 ↖	16: 9.9 →	Series 99.4
12: 10.1 ↘	17: 10.0 ↗	
13: 8.9 →	18: *10.6 ↘	Total 201.8
14: *10.6 →	19: 9.9 ↘	
15: 10.0 ↖	20: 9.5 ↗	

21: 10.1 →	Series 19.7
22: 9.6 ↘	
	Total 221.5