

Relay	Lane	Jimmy Eriksson		
300m		Ramselefors	C	Vb
2013-07-07		Tavelträffen A 2013	Ramselefors SKF	
5 Shots Sight		1: 9.1 → 2: 9.1 ↗ 3: 8.7 ↘ 4: 10.3 ↗ 5: 8.1 →	1. Series 5 Shots	1: 10.1 ↘ 2: 10.2 → 3: 9.7 ↘ 4: 10.3 ↘ 5: 10.2 ↘
		Series 44.0		Series 49.0
		Total 0.0		Total 49.0
2. Series 5 Shots		1: 9.5 ↗ 2: 10.1 ↘ 3: 9.7 → 4: 10.0 ↗ 5: 9.9 ↗	3. Series 5 Shots	1: 9.6 ↖ 2: 10.1 ↗ 3: 9.9 ↖ 4: 8.5 ↗ 5: 10.1 ↗
		Series 47.0		Series 46.0
		Total 96.0		Total 142.0
4. Series 10 Shots		1: 7.1 ↗ 2: 7.3 ↗ 3: 6.7 ↗ 4: 5.4 ↖ 5: 8.2 ↗	4. Series 10 Shots	6: 4.6 ↗ 7: 8.9 ↗ 8: 8.2 ↗ 9: 7.3 ↗ 10: 7.9 ↗
		Series 33.0		Series 34.0
		Total 175.0		Total 209.0

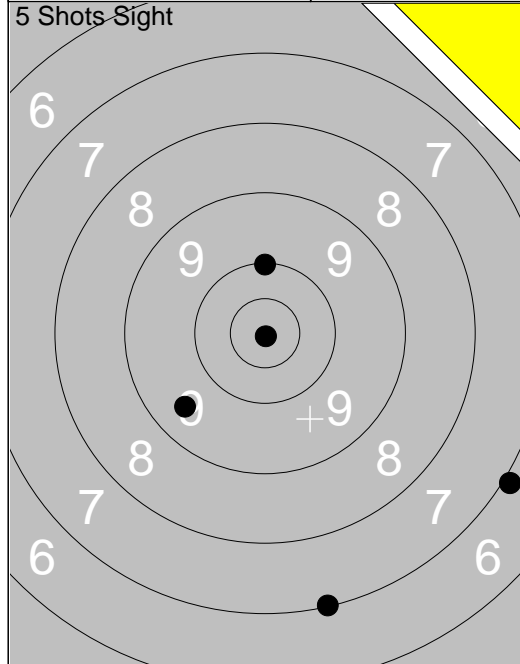

1: 6.9 ↘	
2: 7.0 ↓	
3: 9.5 ↙	
4: 10.0 ↑	
5: *10.9 ↘	
Series 42.0	
Total 0.0	

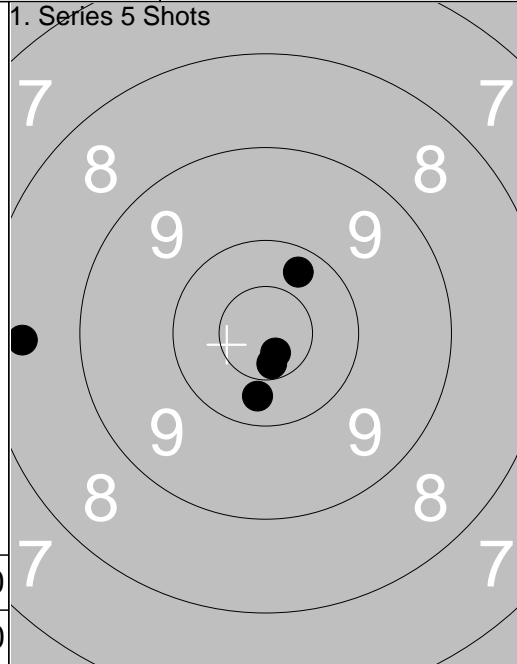

1: 10.3 ↗	
2: 8.4 ←	
3: 10.3 ↓	
4: *10.6 ↘	
5: *10.7 ↘	
Series 48.0	
Total 48.0	

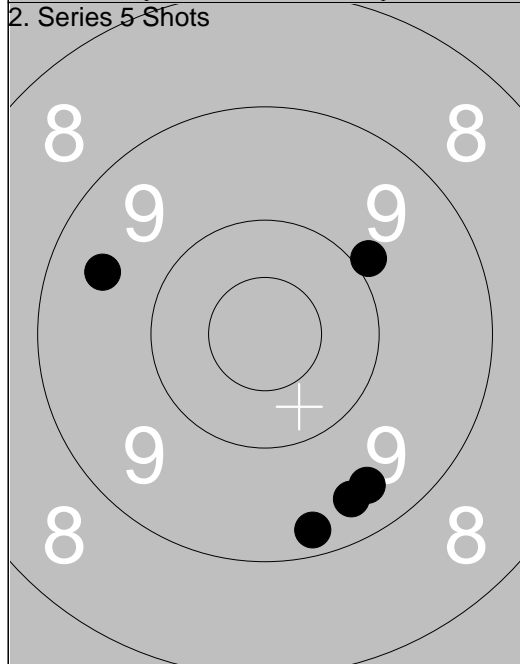

1: 9.5 ←	
2: 9.4 ↓	
3: 9.3 ↓	
4: 9.9 ↗	
5: 9.4 ↓	
Series 45.0	
Total 93.0	

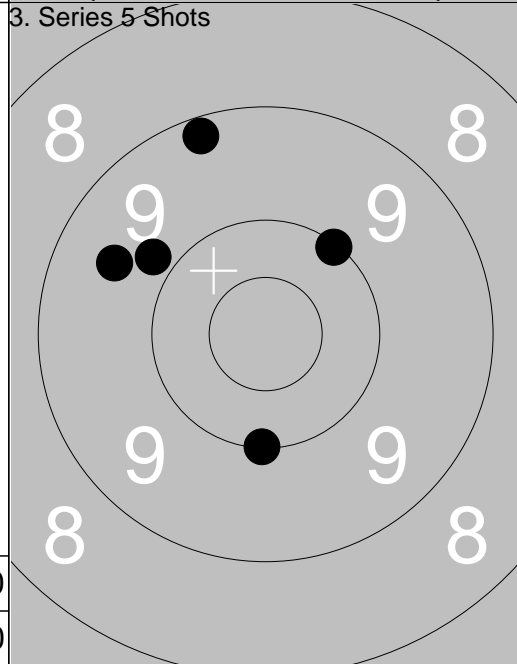

1: 10.1 ↗	
2: 9.2 ↑	
3: 9.6 ←	
4: 9.8 ←	
5: 10.0 ↓	
Series 47.0	
Total 140.0	

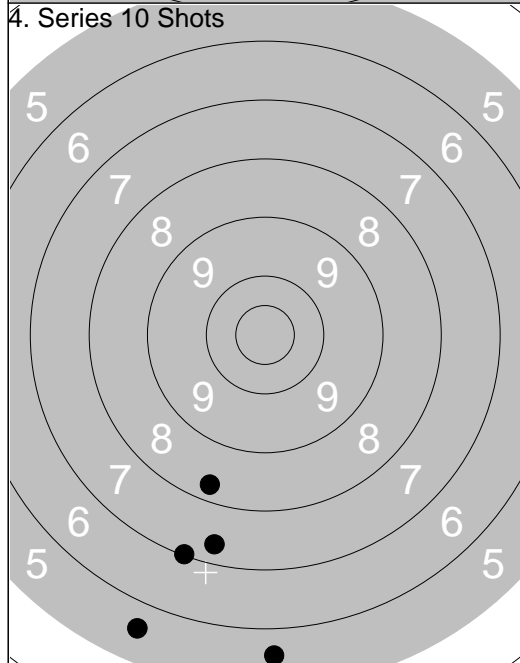

1: 5.6 ↓	
2: 7.1 ↓	
3: 8.3 ↓	
4: 5.6 ↓	
5: 7.4 ↓	
Series 32.0	
Total 172.0	

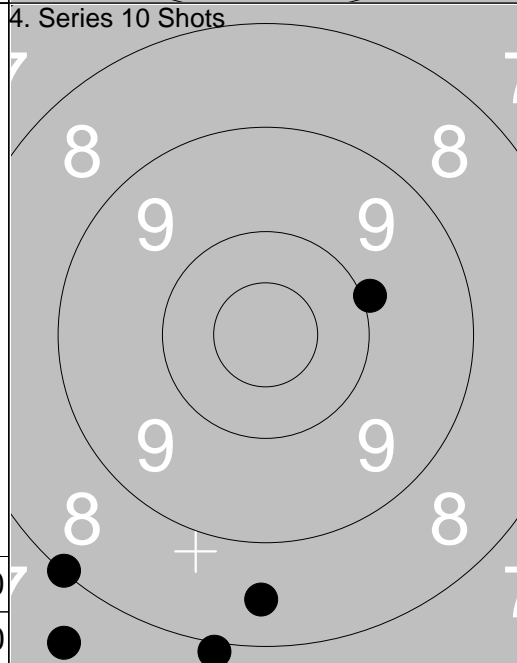

6: 10.0 ↗	
7: 7.9 ↓	
8: 8.5 ↓	
9: 7.5 ↙	
10: 8.0 ↙	
Series 40.0	
Total 212.0	

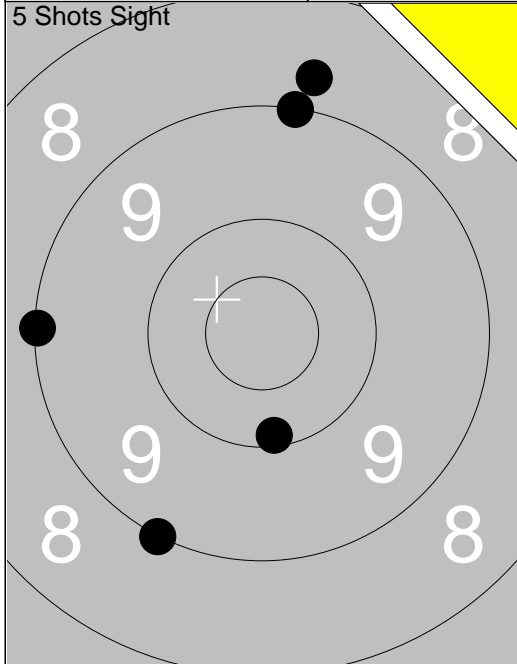

1: 8.7	↑
2: 9.0	↑
3: 9.1	←
4: 10.1	↓
5: 9.0	↙
Series 45.0	
Total 0.0	

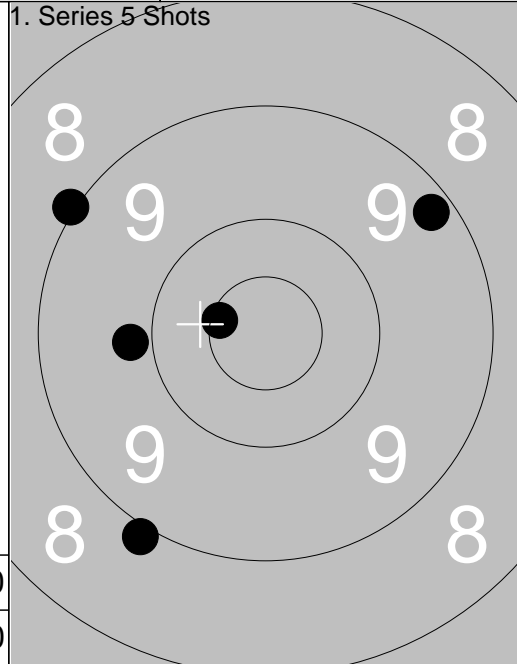

1: 9.0	↖
2: 9.8	←
3: 8.9	↙
4: *10.6	↖
5: 9.2	↗
Series 45.0	
Total 45.0	

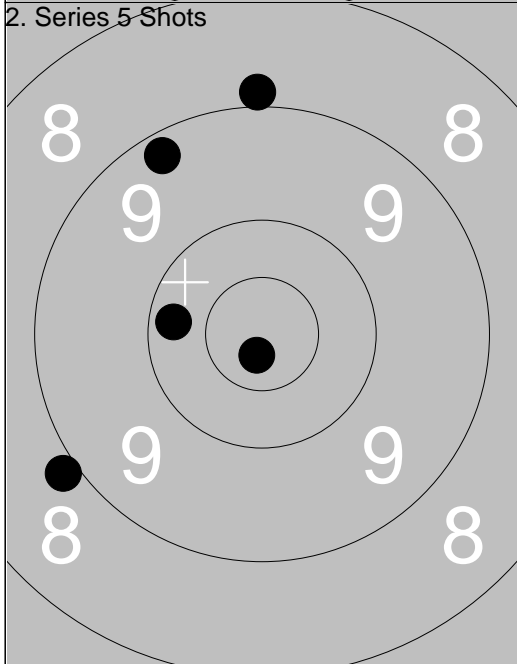

1: 10.2	←
2: 9.2	↖
3: 8.9	↑
4: 8.9	←
5: *10.8	↓
Series 45.0	
Total 90.0	

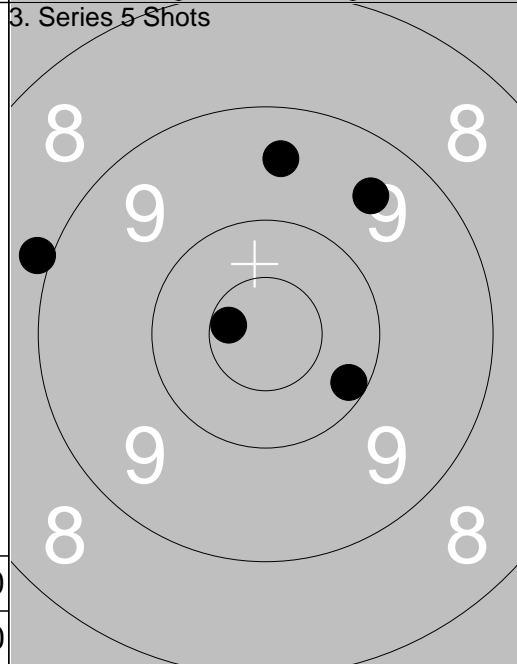

1: 8.9	←
2: *10.6	↖
3: 9.5	↗
4: 10.2	↘
5: 9.5	↑
Series 46.0	
Total 136.0	

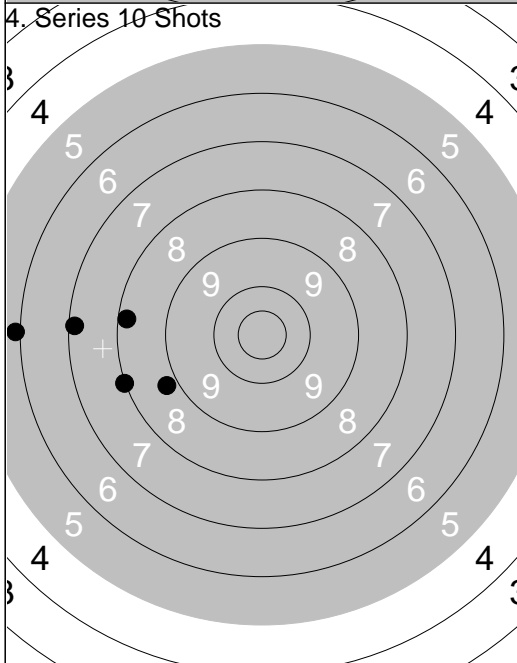

1: 8.8	←
2: 8.0	←
3: 8.2	←
4: 7.2	←
5: 5.9	←
Series 36.0	
Total 172.0	

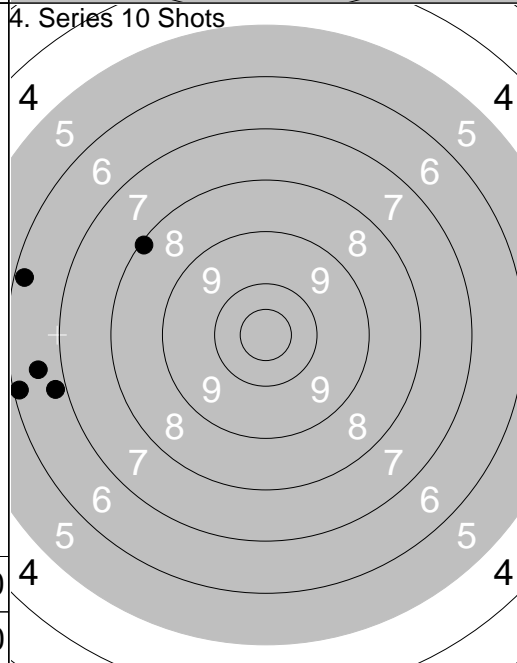

6: 6.2	←
7: 6.1	←
8: 8.1	↖
9: 6.6	←
10: 6.8	←
Series 32.0	
Total 204.0	

<p>5 Shots Sight</p>	<p>1. Series 5 Shots</p>	
Series 48.0		Series 49.0
Total 0.0		Total 49.0

<p>2. Series 5 Shots</p>	<p>3. Series 5 Shots</p>	
Series 49.0		Series 48.0
Total 98.0		Total 146.0

<p>4. Series 10 Shots</p>	<p>4. Series 10 Shots</p>	
Series 32.0		Series 36.0
Total 178.0		Total 214.0

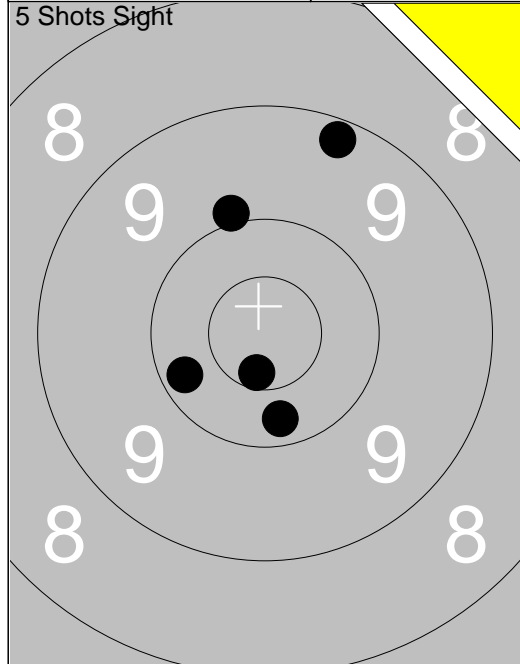

1: 9.2 ↗	
2: 9.9 ↗	
3: 10.2 ↓	
4: 10.2 ↙	
5: *10.6 ↓	
Series 48.0	
Total 0.0	

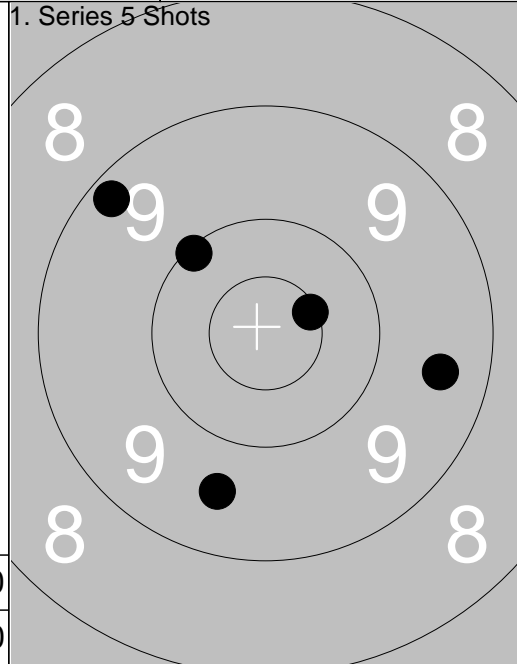

1: 9.2 ↖	
2: 9.6 ↓	
3: 9.5 →	
4: 10.1 ↖	
5: *10.6 ↗	
Series 47.0	
Total 47.0	

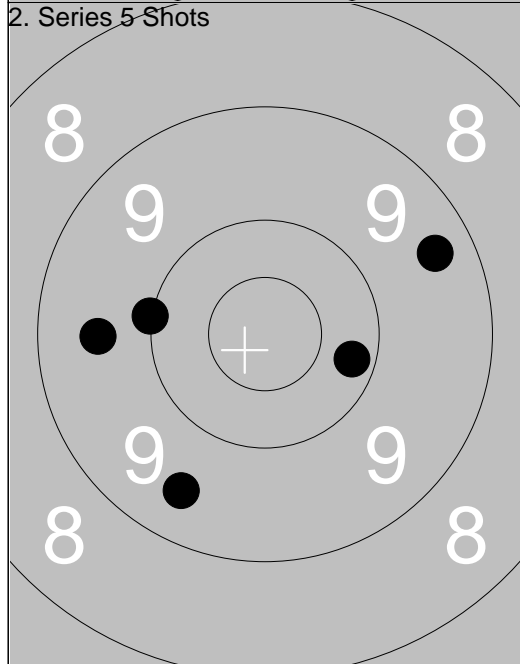

1: 10.0 ↙	
2: 9.5 ↓	
3: 9.6 ←	
4: 9.4 →	
5: 10.2 →	
Series 47.0	
Total 94.0	

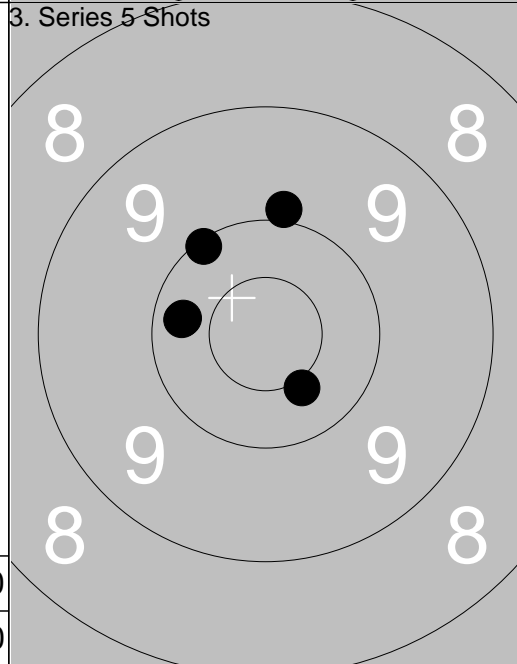

1: 10.1 ↖	
2: *10.4 ↓	
3: 10.3 ↙	
4: 10.3 ↙	
5: 9.9 ↗	
Series 49.0	
Total 143.0	

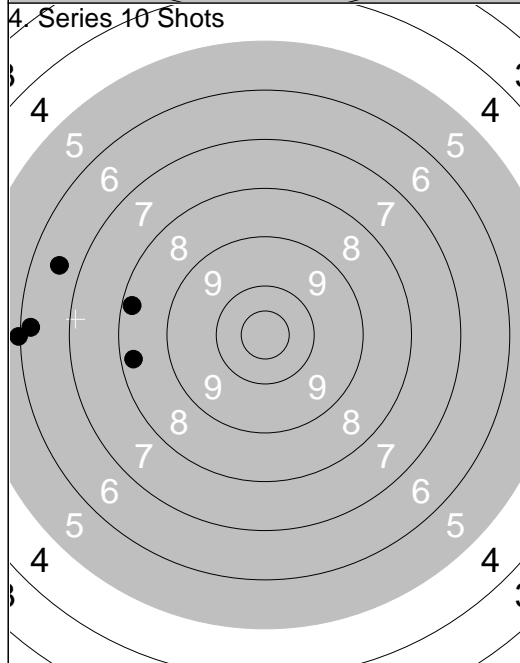

1: 8.2 ←	
2: 6.0 ←	
3: 6.2 ←	
4: 8.3 ←	
5: 6.6 ←	
Series 34.0	
Total 177.0	

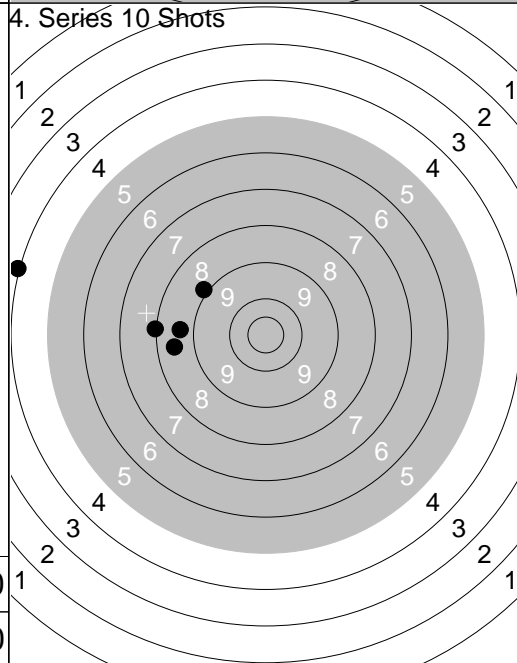

6: 8.9 ↖	
7: 8.0 ←	
8: 8.7 ←	
9: 4.0 ←	
10: 8.5 ←	
Series 36.0	
Total 213.0	

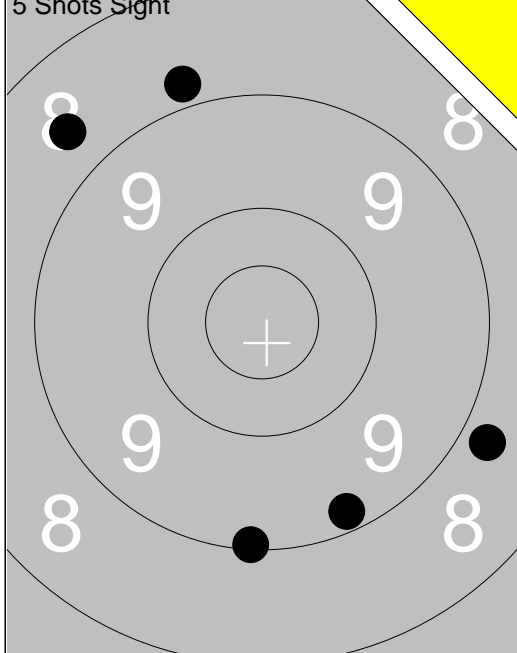

1: 8.8	↘
2: 8.8	↗
3: 8.6	↗
4: 9.1	↓
5: 9.2	↓
Series 42.0	
Total 0.0	

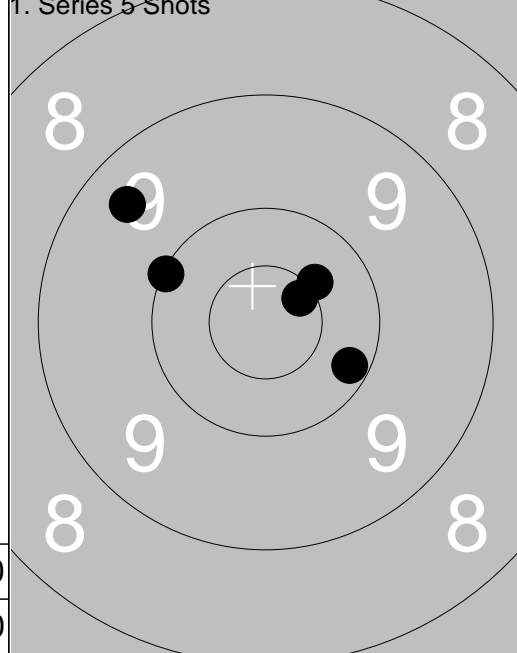

1: 9.4	↖
2: *10.6	↗
3: 10.0	↖
4: *10.4	↗
5: 10.2	↘
Series 49.0	
Total 49.0	

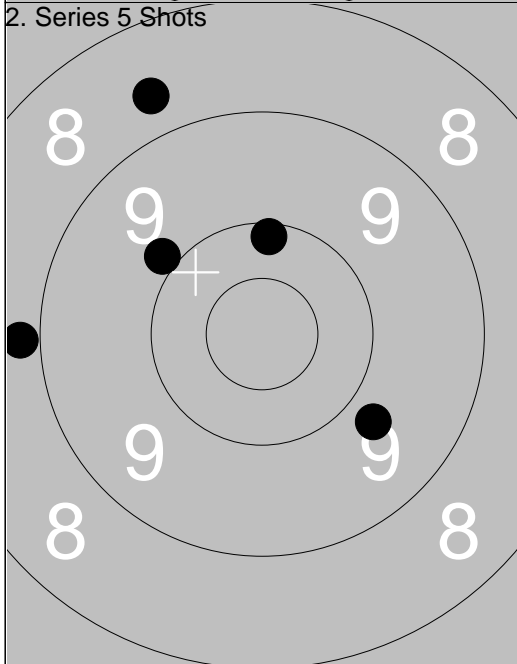

1: 8.9	←
2: 8.7	↗
3: 10.1	↑
4: 9.8	↘
5: 9.9	↗
Series 44.0	
Total 93.0	

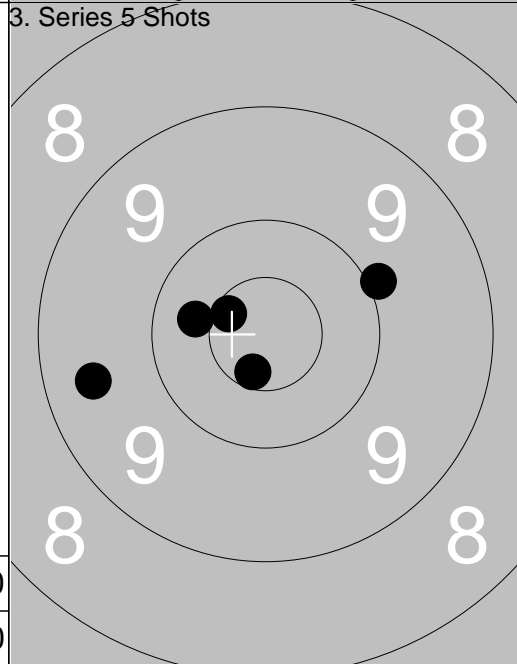

1: 9.5	←
2: *10.6	↘
3: *10.6	↖
4: 10.4	←
5: 9.9	↗
Series 48.0	
Total 141.0	

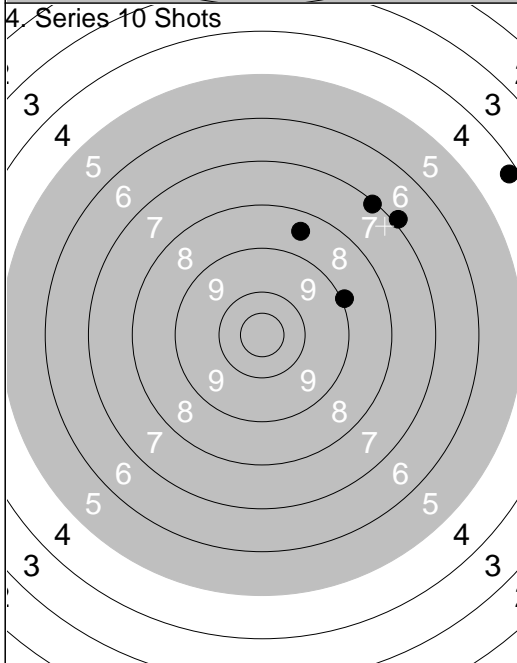

1: 9.0	↗
2: 6.9	↗
3: 4.2	↗
4: 7.1	↗
5: 8.5	↑
Series 34.0	
Total 175.0	

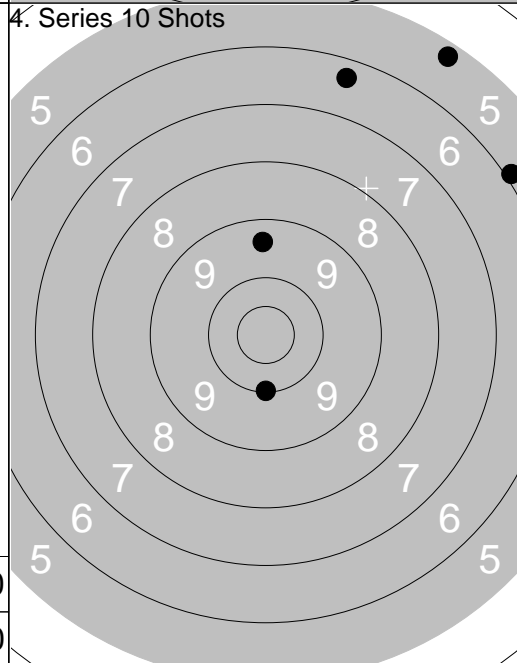

6: 9.4	↑
7: 5.3	↗
8: 6.4	↑
9: 5.9	↗
10: 10.0	↓
Series 35.0	
Total 210.0	

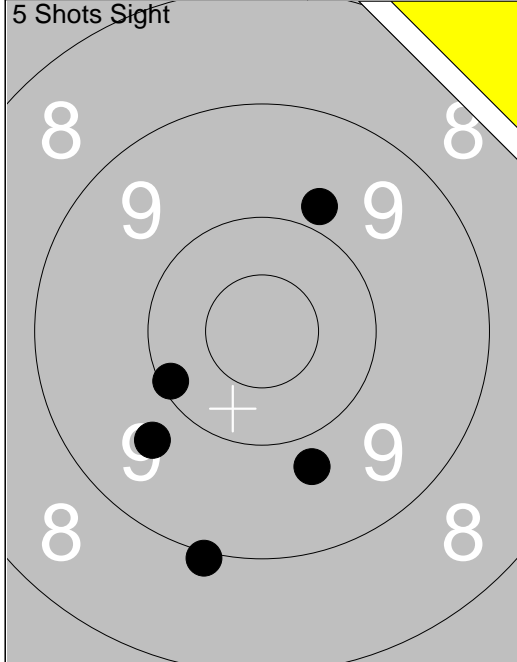

1:	9.7	↙
2:	9.0	↓
3:	9.8	↗
4:	9.8	↓
5:	10.1	↙
Series		46.0
Total		0.0

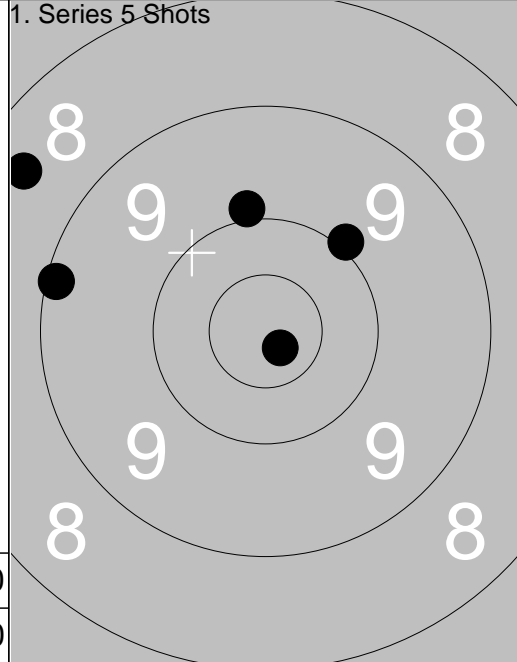

1:	8.5	↖
2:	9.1	←
3:	9.9	↗
4:	10.0	↗
5:	*10.8	↘
Series		46.0
Total		46.0

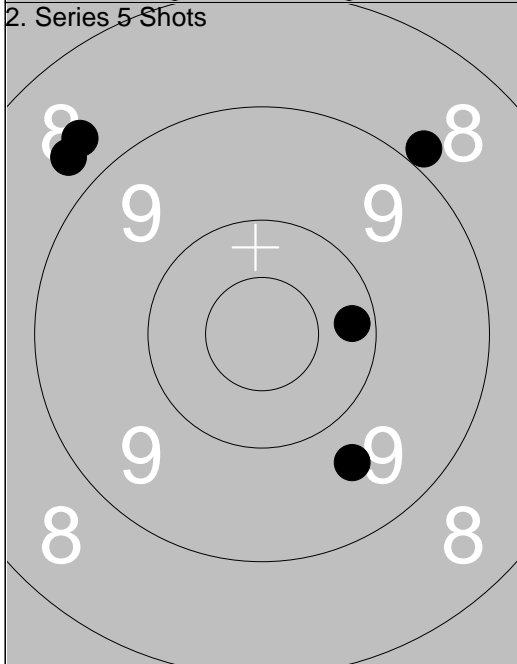

1:	8.7	↖
2:	8.7	↖
3:	10.2	→
4:	8.9	↗
5:	9.7	↓
Series		43.0
Total		89.0

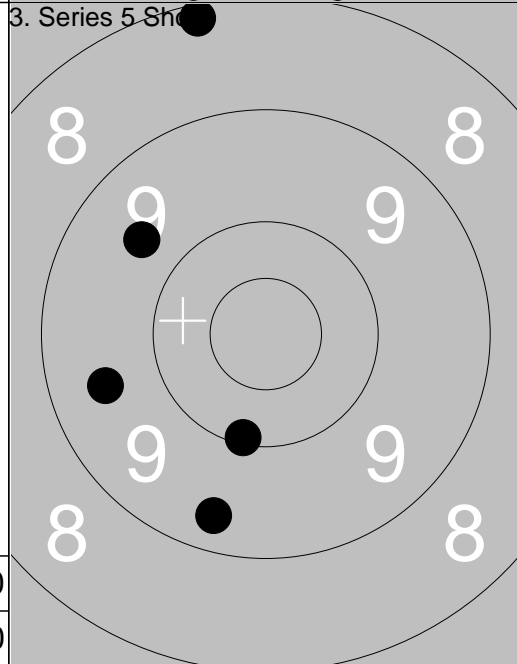

1:	9.3	↓
2:	9.6	↖
3:	9.5	←
4:	8.2	↗
5:	10.1	↓
Series		45.0
Total		134.0

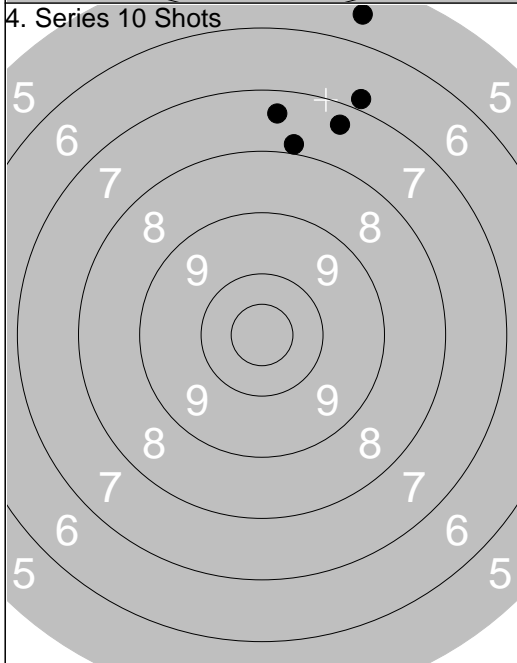

1:	6.9	↗
2:	5.6	↗
3:	7.4	↗
4:	7.9	↗
5:	7.4	↗
Series		32.0
Total		166.0

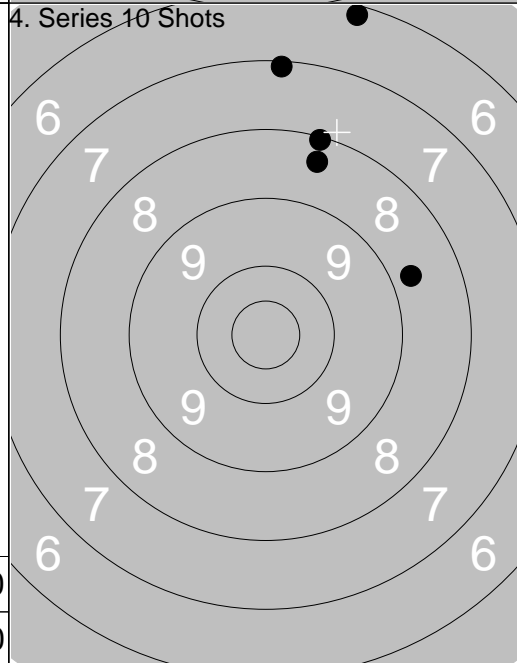

6:	8.4	↗
7:	7.1	↗
8:	6.2	↗
9:	8.1	↗
10:	8.7	↗
Series		37.0
Total		203.0

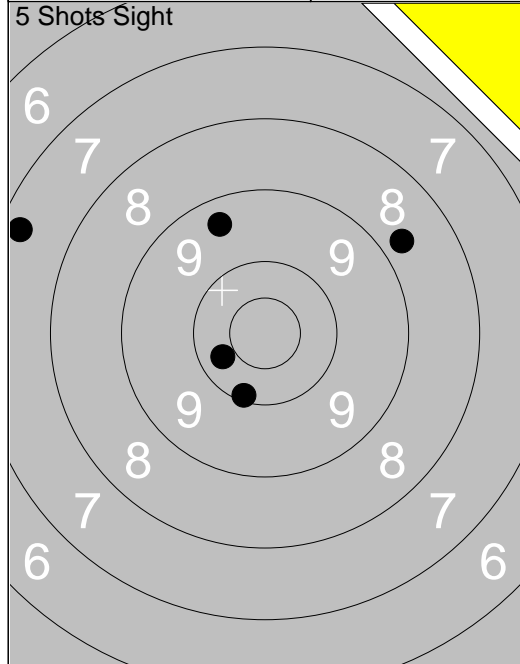

1: 7.3	↙
2: 8.7	↗
3: 9.4	↖
4: 10.3	↙
5: 10.1	↓
Series 44.0	
Total 0.0	

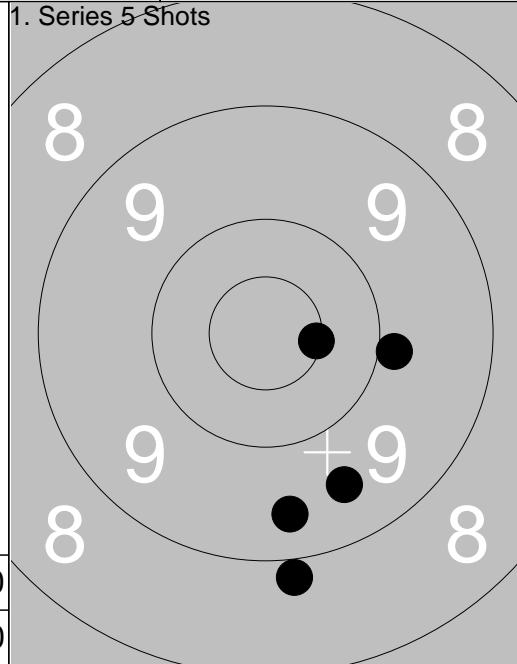

1: 8.9	↓
2: 9.5	↓
3: *10.5	→
4: 9.9	→
5: 9.4	↓
Series 45.0	
Total 45.0	

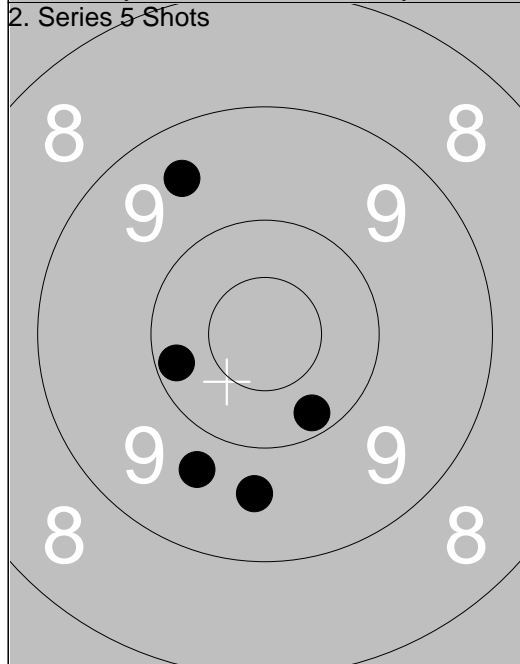

1: 9.7	↓
2: 9.5	↖
3: 10.2	↙
4: 10.2	↓
5: 9.6	↓
Series 47.0	
Total 92.0	

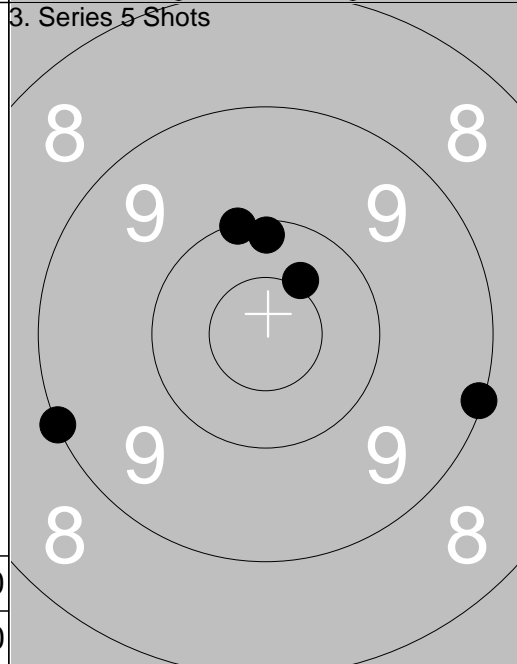

1: 10.1	↑
2: 10.0	↖
3: 9.0	↙
4: *10.4	↗
5: 9.1	→
Series 48.0	
Total 140.0	

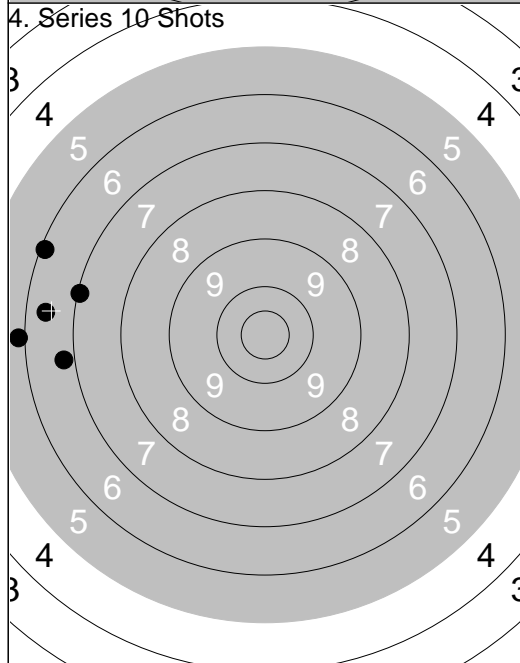

1: 6.8	↙
2: 6.4	↙
3: 7.1	↙
4: 6.1	↙
5: 5.9	↙
Series 30.0	
Total 170.0	

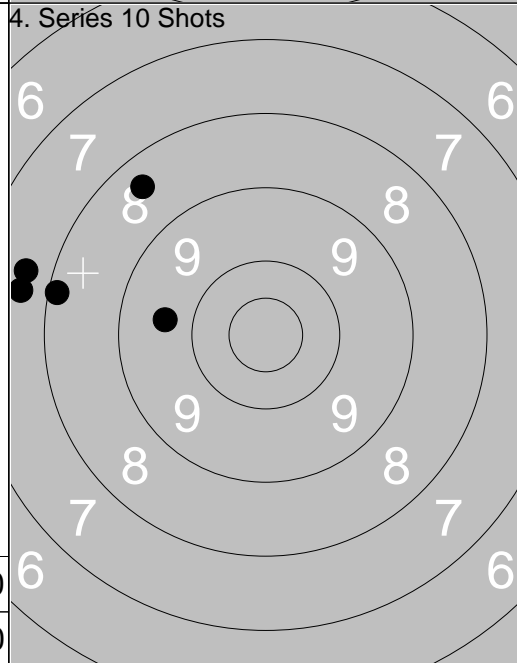

6: 9.7	↙
7: 7.7	↙
8: 7.7	↙
9: 8.1	↙
10: 8.4	↖
Series 39.0	
Total 209.0	

<p>5 Shots Sight</p>	<p>1: 7.7 →</p> <p>2: 9.7 ←</p> <p>3: 8.7 ↖</p> <p>4: *10.7 ↓</p> <p>5: 10.2 ←</p>	<p>1. Series 5 Shots</p>	<p>1: 9.3 ↖</p> <p>2: 10.0 ↓</p> <p>3: 9.8 ↖</p> <p>4: 9.5 ↖</p> <p>5: 10.0 →</p>
Series 44.0		Series 47.0	
Total 0.0		Total 47.0	

<p>2. Series 5 Shots</p>	<p>1: *10.9 ↓</p> <p>2: 9.1 ←</p> <p>3: 10.3 ↗</p> <p>4: 10.1 →</p> <p>5: 9.4 ↗</p>	<p>3. Series 5 Shots</p>	<p>1: *10.5 →</p> <p>2: 9.7 ↑</p> <p>3: 9.2 ↑</p> <p>4: 9.6 ↖</p> <p>5: 9.4 ↗</p>
Series 48.0		Series 46.0	
Total 95.0		Total 141.0	

<p>4. Series 10 Shots</p>	<p>1: 7.8 ↖</p> <p>2: 7.9 ↑</p> <p>3: 7.5 ↑</p> <p>4: 8.6 ↑</p> <p>5: 8.1 ↑</p>	<p>4. Series 10 Shots</p>	<p>6: 8.2 ↑</p> <p>7: 7.1 ↑</p> <p>8: 6.0 ↑</p> <p>9: 6.1 ↑</p> <p>10: 7.9 ↑</p>
Series 37.0		Series 34.0	
Total 178.0		Total 212.0	

<p>5 Shots Sight</p>	<p>1. Series 5 Shots</p>	<p>Series 46.0</p> <p>Total 0.0</p>	<p>Series 47.0</p> <p>Total 47.0</p>
----------------------	--------------------------	-------------------------------------	--------------------------------------

<p>2. Series 5 Shots</p>	<p>3. Series 5 Shots</p>	<p>Series 46.0</p> <p>Total 93.0</p>	<p>Series 44.0</p> <p>Total 137.0</p>
--------------------------	--------------------------	--------------------------------------	---------------------------------------

<p>4. Series 10 Shots</p>	<p>4. Series 10 Shots</p>	<p>Series 40.0</p> <p>Total 177.0</p>	<p>Series 32.0</p> <p>Total 209.0</p>
---------------------------	---------------------------	---------------------------------------	---------------------------------------

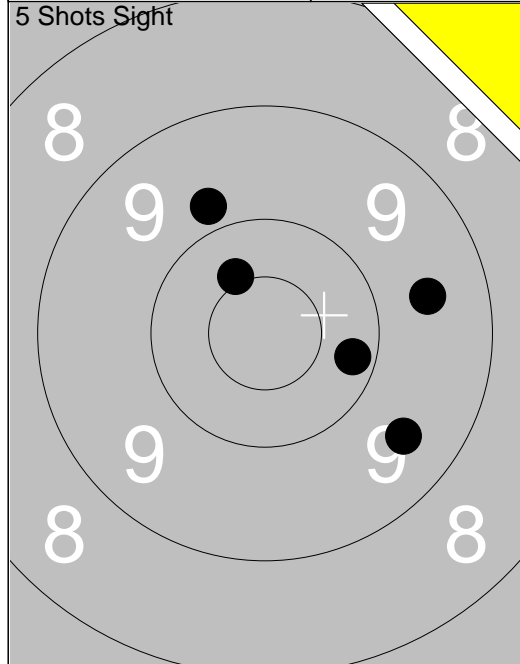

1:	10.2	↘
2:	9.6	→
3:	9.8	↗
4:	9.5	↘
5:	*10.4	↗
Series		47.0
Total		0.0

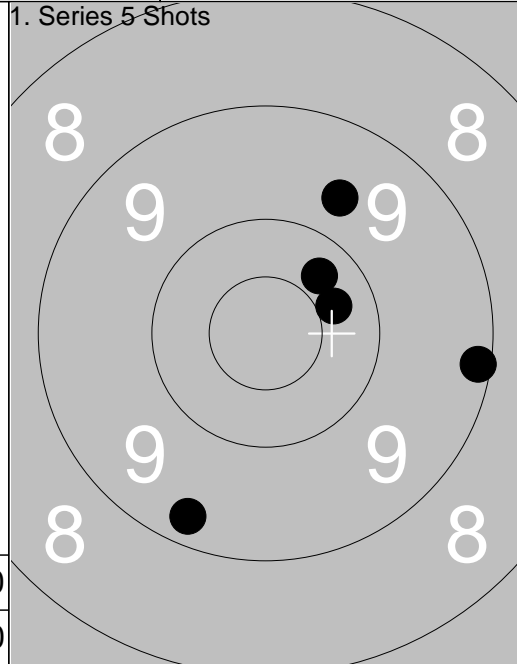

1:	10.3	↗
2:	9.7	↗
3:	9.1	→
4:	9.3	↘
5:	10.4	↗
Series		47.0
Total		47.0

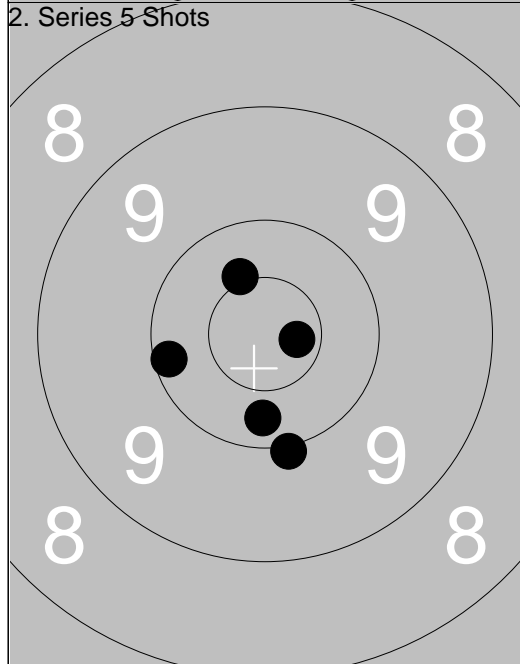

1:	*10.4	↗
2:	10.3	↘
3:	10.0	↘
4:	10.1	←
5:	*10.7	↗
Series		50.0
Total		97.0

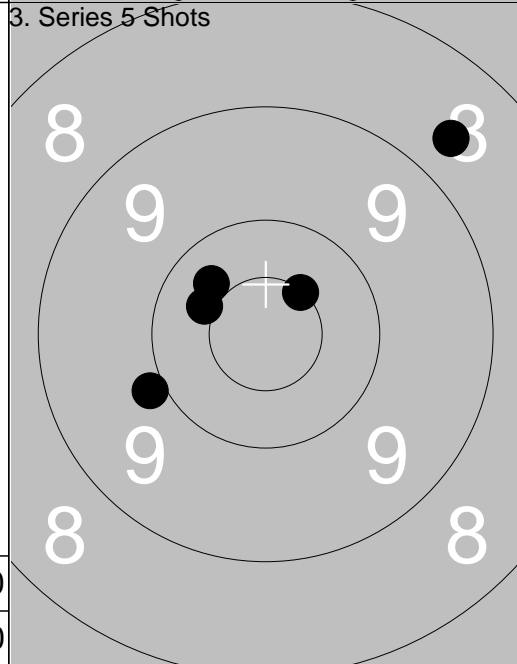

1:	10.3	↗
2:	8.7	↗
3:	10.4	↖
4:	9.9	←
5:	*10.5	↗
Series		47.0
Total		144.0

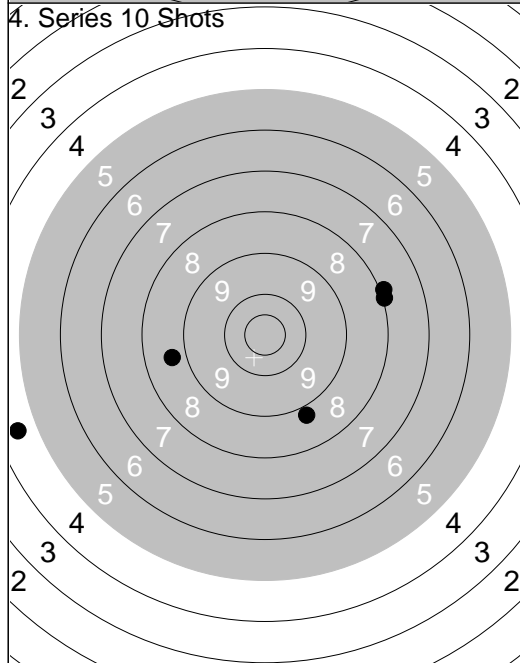

1:	8.8	↘
2:	7.9	→
3:	8.0	→
4:	8.7	←
5:	4.6	←
Series		35.0
Total		179.0

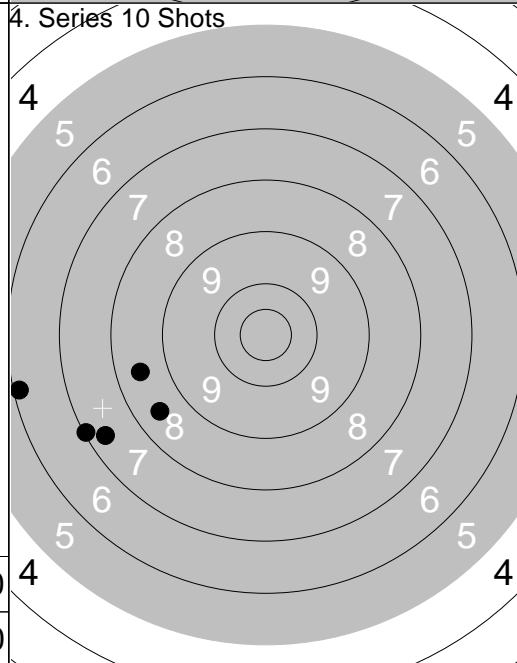

6:	7.4	←
7:	8.5	←
8:	7.1	←
9:	6.1	←
10:	8.5	←
Series		36.0
Total		215.0

<p>5 Shots Sight</p>	<p>1. Series 5 Shots</p>								
<table border="1" style="width:100%; border-collapse: collapse;"> <tr><td>Series</td><td>47.0</td></tr> <tr><td>Total</td><td>0.0</td></tr> </table>	Series	47.0	Total	0.0	<table border="1" style="width:100%; border-collapse: collapse;"> <tr><td>Series</td><td>49.0</td></tr> <tr><td>Total</td><td>49.0</td></tr> </table>	Series	49.0	Total	49.0
Series	47.0								
Total	0.0								
Series	49.0								
Total	49.0								

<p>2. Series 5 Shots</p>	<p>3. Series 5 Shots</p>								
<table border="1" style="width:100%; border-collapse: collapse;"> <tr><td>Series</td><td>50.0</td></tr> <tr><td>Total</td><td>99.0</td></tr> </table>	Series	50.0	Total	99.0	<table border="1" style="width:100%; border-collapse: collapse;"> <tr><td>Series</td><td>50.0</td></tr> <tr><td>Total</td><td>149.0</td></tr> </table>	Series	50.0	Total	149.0
Series	50.0								
Total	99.0								
Series	50.0								
Total	149.0								

<p>4. Series 10 Shots</p>	<p>4. Series 10 Shots</p>								
<table border="1" style="width:100%; border-collapse: collapse;"> <tr><td>Series</td><td>36.0</td></tr> <tr><td>Total</td><td>185.0</td></tr> </table>	Series	36.0	Total	185.0	<table border="1" style="width:100%; border-collapse: collapse;"> <tr><td>Series</td><td>40.0</td></tr> <tr><td>Total</td><td>225.0</td></tr> </table>	Series	40.0	Total	225.0
Series	36.0								
Total	185.0								
Series	40.0								
Total	225.0								

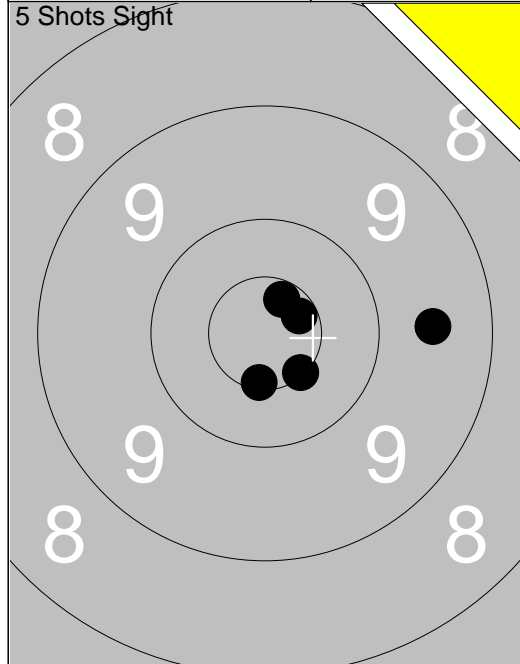

1:	9.6	→
2:	*10.5	↓
3:	*10.6	↗
4:	*10.6	→
5:	*10.5	↘
Series		49.0
Total		0.0

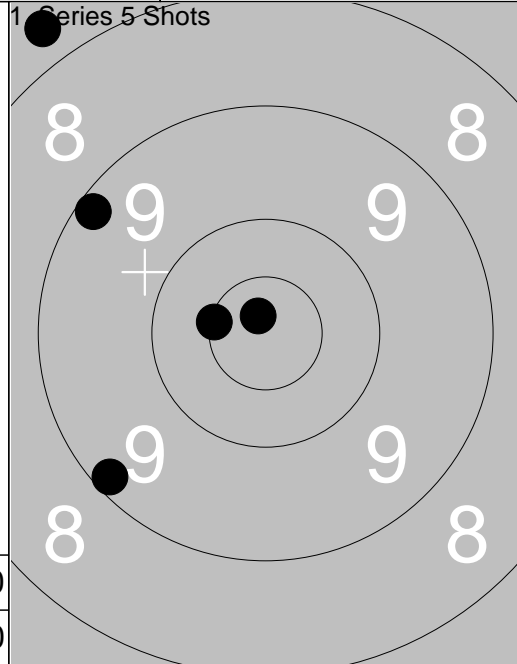

1:	*10.8	↗
2:	9.2	↙
3:	*10.5	↖
4:	9.2	↖
5:	7.7	↗
Series		45.0
Total		45.0

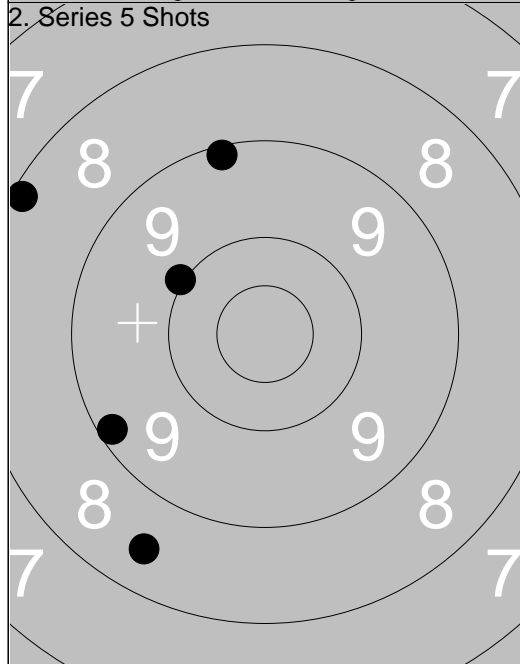

1:	9.1	↗
2:	8.1	↖
3:	10.0	↖
4:	8.5	↘
5:	9.2	↙
Series		44.0
Total		89.0

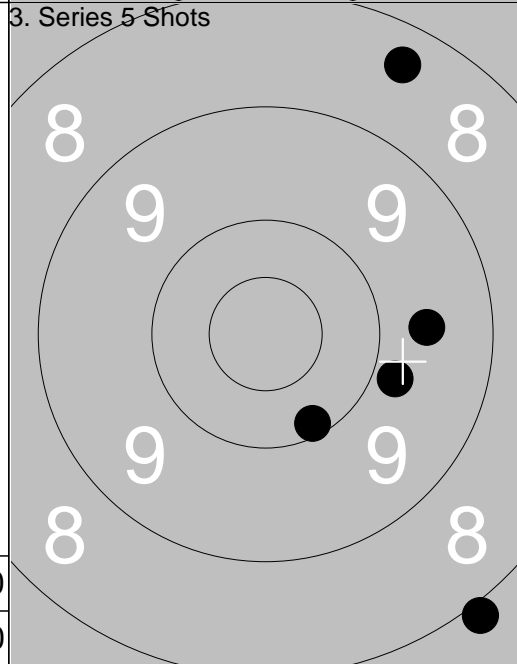

1:	7.9	↘
2:	10.1	↘
3:	9.8	→
4:	9.6	→
5:	8.4	↗
Series		43.0
Total		132.0

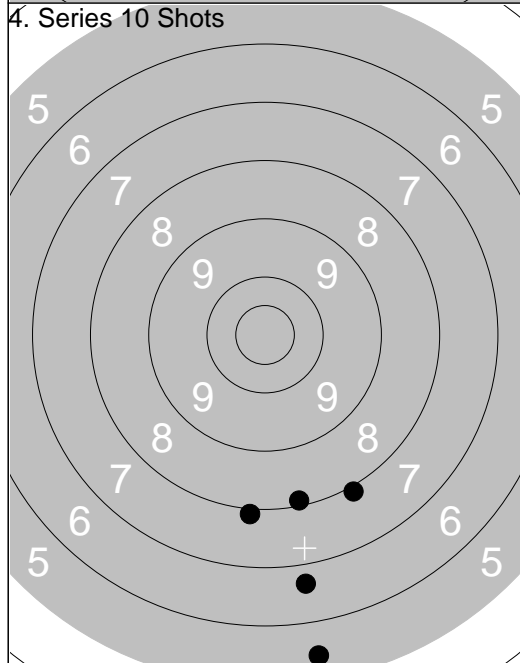

1:	8.1	↓
2:	7.9	↓
3:	5.5	↓
4:	7.9	↓
5:	6.7	↓
Series		33.0
Total		165.0

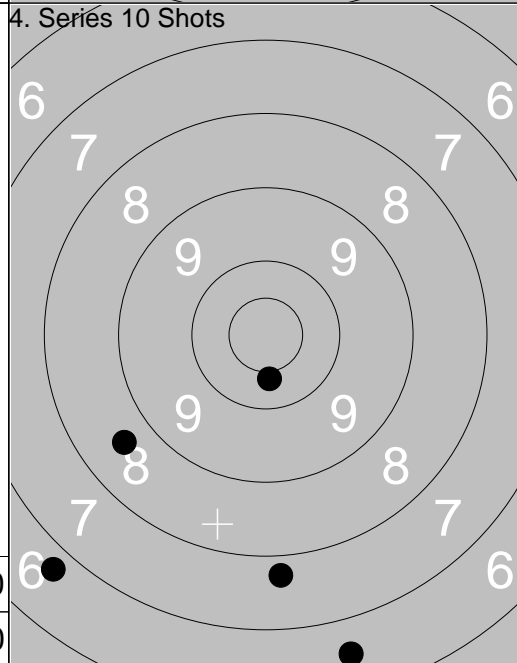

6:	6.6	↓
7:	6.7	↙
8:	7.8	↓
9:	8.6	↙
10:	10.4	↓
Series		37.0
Total		202.0

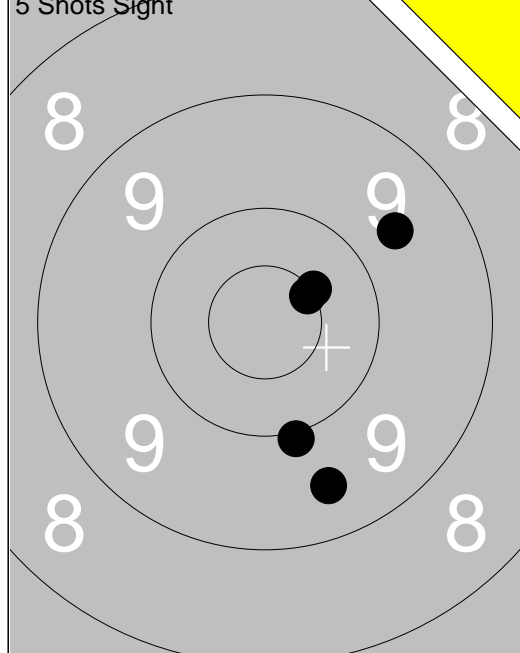

1: 9.6 ↗
2: 9.5 ↓
3: 10.0 ↓
4: *10.5 ↗
5: *10.5 ↗
Series 48.0
Total 0.0

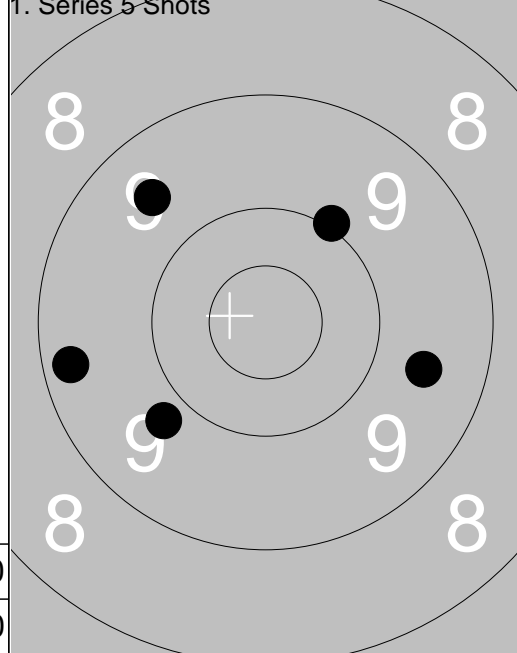

1: 9.8 ↙
2: 9.6 →
3: 10.0 ↗
4: 9.5 ↖
5: 9.3 ←
Series 46.0
Total 46.0

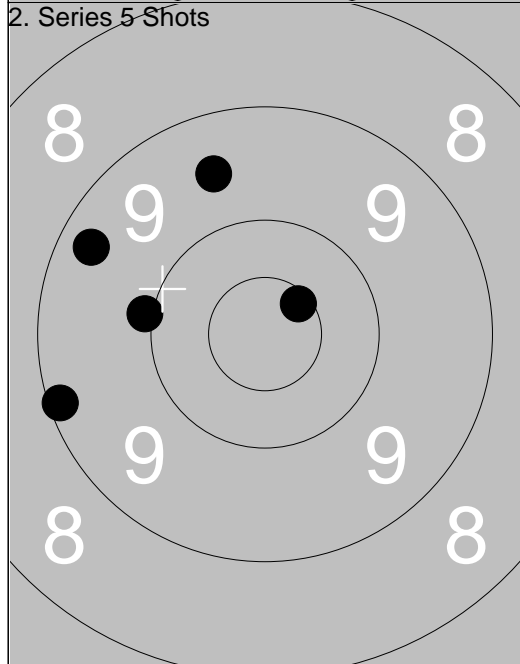

1: *10.6 ↗
2: 10.0 ←
3: 9.6 ↑
4: 9.3 ↖
5: 9.1 ←
Series 47.0
Total 93.0

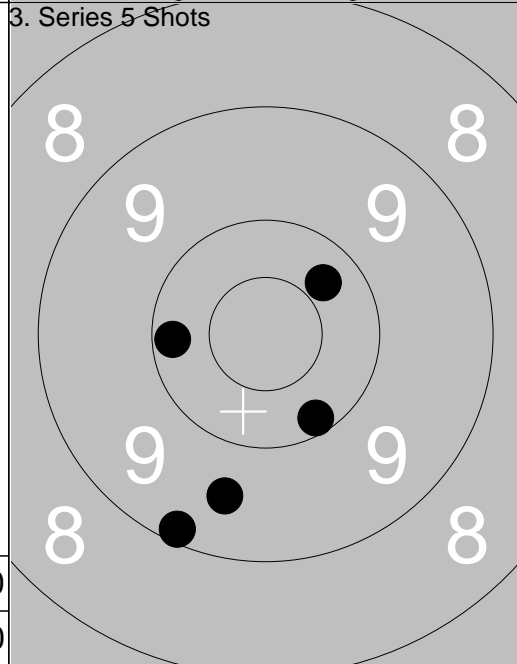

1: 10.3 ↗
2: 9.1 ↓
3: 10.2 ↓
4: 10.2 ←
5: 9.6 ↓
Series 48.0
Total 141.0

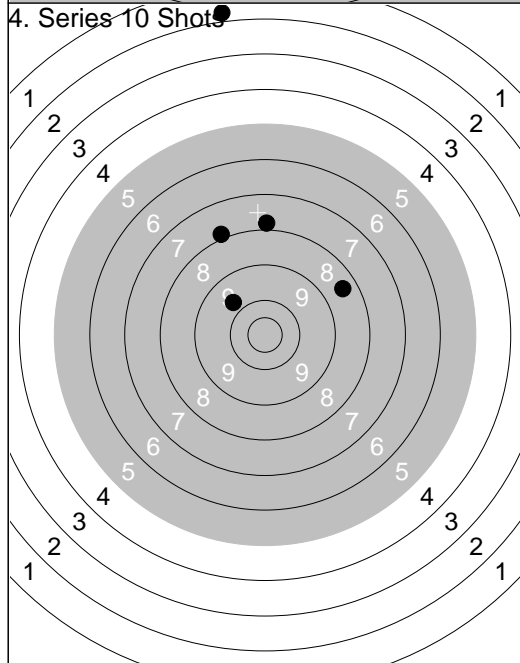

1: 9.7 ↖
2: 7.9 ↑
3: 1.8 ↑
4: 8.4 ↗
5: 7.8 ↑
Series 32.0
Total 173.0

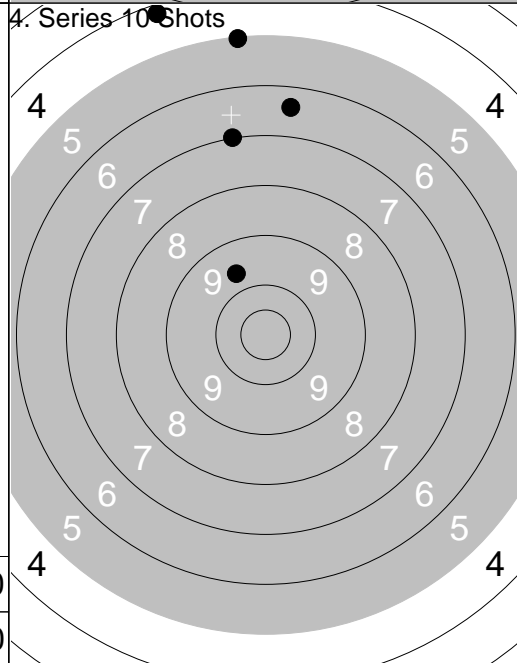

6: 5.1 ↑
7: 6.4 ↑
8: 4.2 ↖
9: 7.0 ↑
10: 9.7 ↖
Series 31.0
Total 204.0

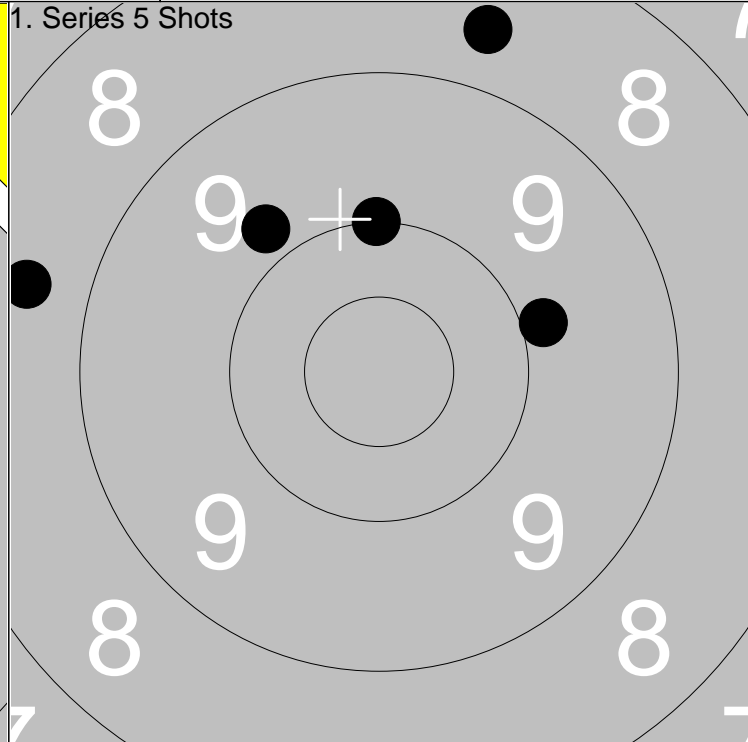
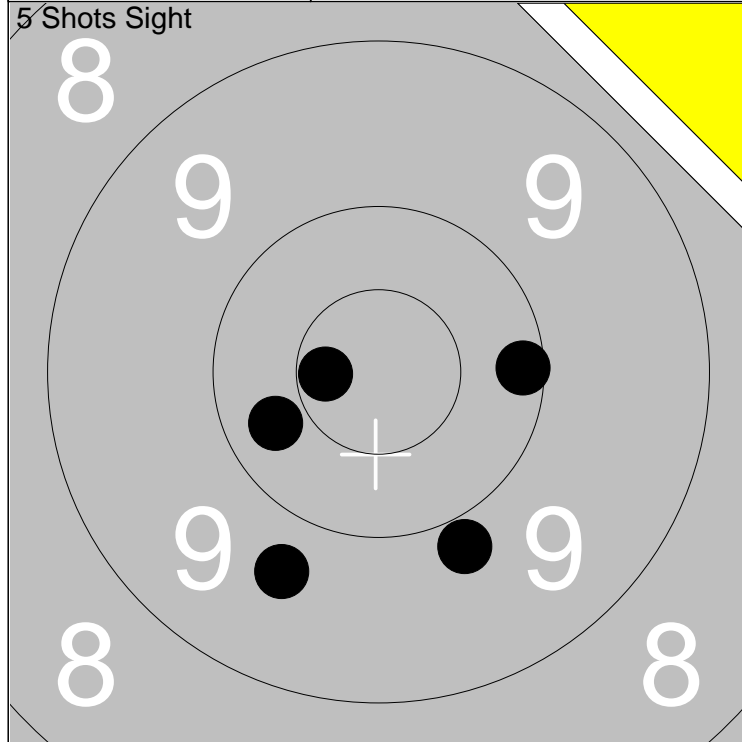

1: 9.7 ↘	Series	48.0
2: 10.1 →		
3: 9.9 ↘	Total	0.0
4: *10.7 ←		
5: 10.3 ↙		

1: 9.8 ↖	Series	44.0
2: 10.0 ↑		
3: 8.6 ↑	Total	44.0
4: 9.9 →		
5: 8.6 ←		

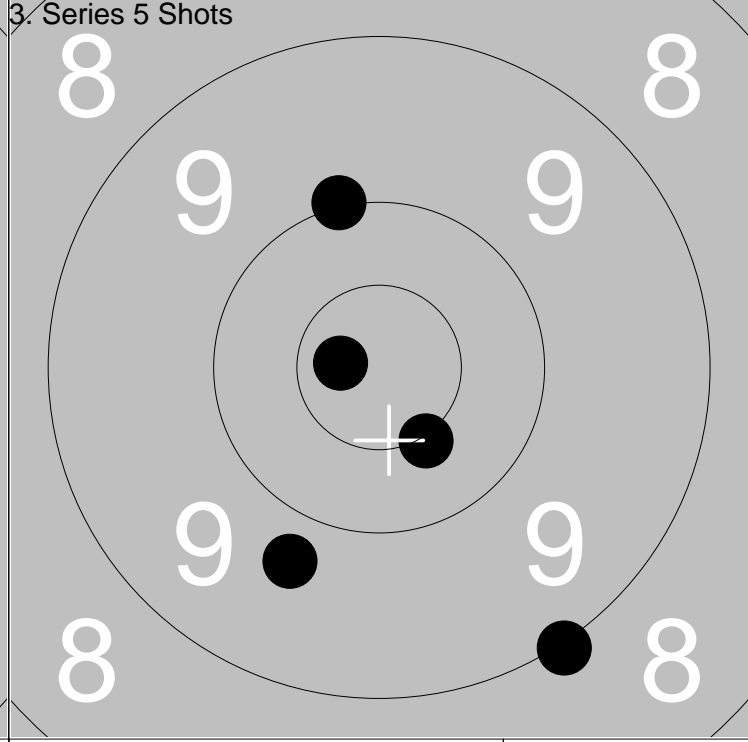
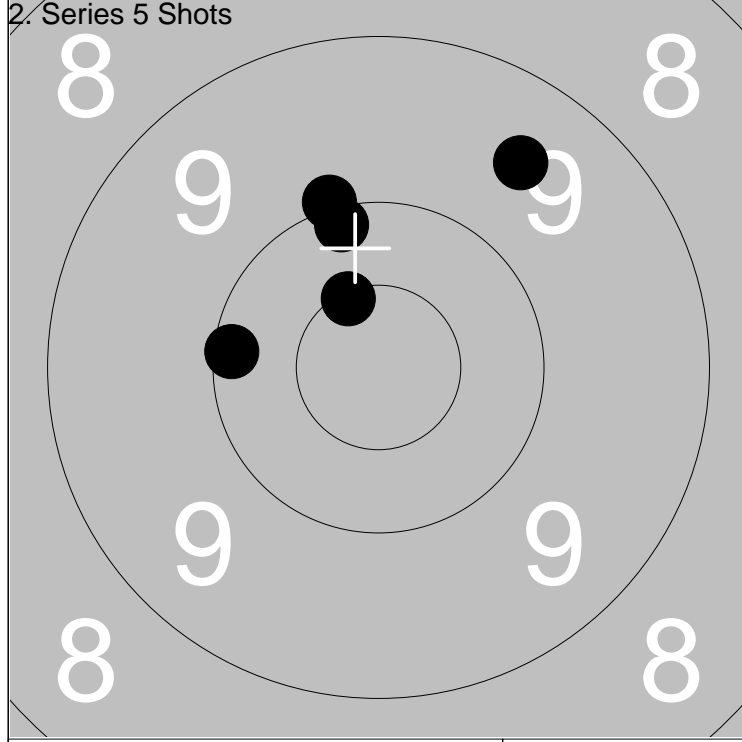

1: 10.0 ↑	Series	49.0
2: 9.5 ↗		
3: 10.1 ←	Total	93.0
4: 10.1 ↑		
5: *10.5 ↗		

1: *10.5 ↘	Series	48.0
2: 9.7 ↘		
3: *10.7 ←	Total	141.0
4: 9.0 ↘		
5: 10.0 ↑		

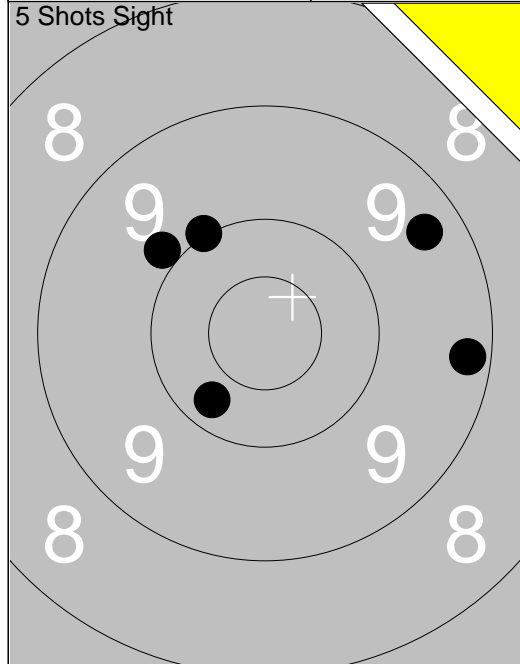

1:	9.4	↗
2:	10.0	↖
3:	9.2	→
4:	10.3	↙
5:	9.9	↖
Series		47.0
Total		0.0

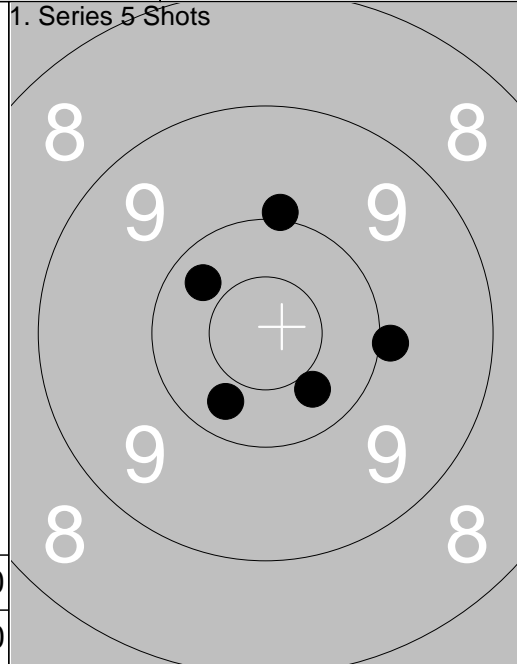

1:	10.4	↘
2:	10.3	↙
3:	9.9	→
4:	10.0	↑
5:	10.3	↖
Series		49.0
Total		49.0

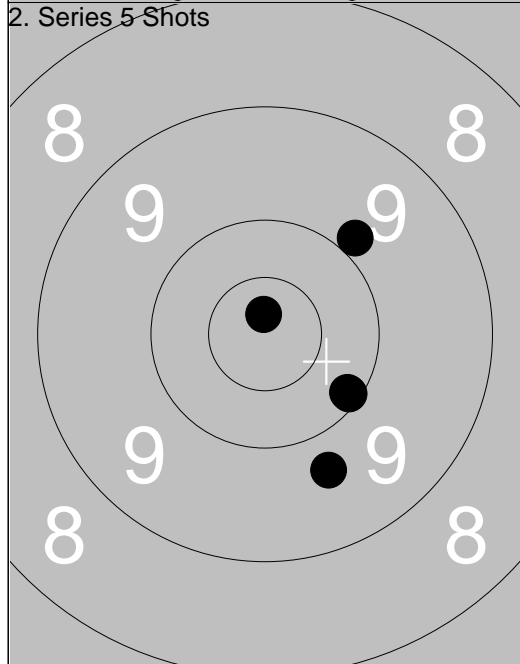

1:	10.1	↘
2:	9.7	↓
3:	9.9	↗
4:	10.1	↘
5:	*10.8	↑
Series		48.0
Total		97.0

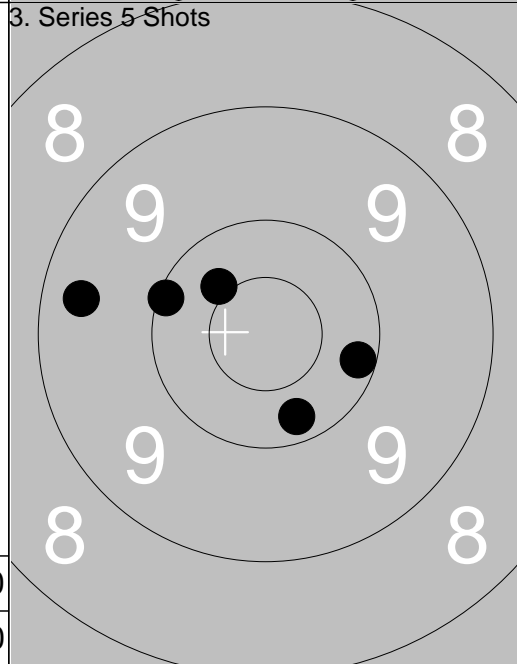

1:	10.2	→
2:	10.2	↘
3:	10.4	↖
4:	9.4	←
5:	10.1	↖
Series		49.0
Total		146.0

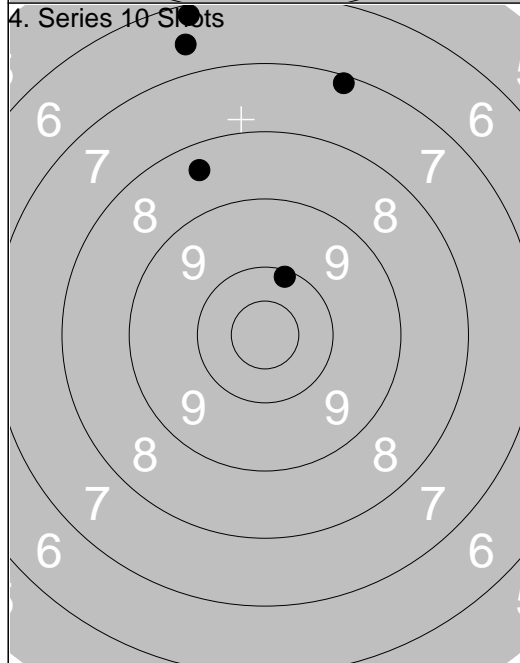

1:	7.1	↑
2:	10.1	↑
3:	6.2	↑
4:	8.4	↑
5:	6.6	↑
Series		37.0
Total		183.0

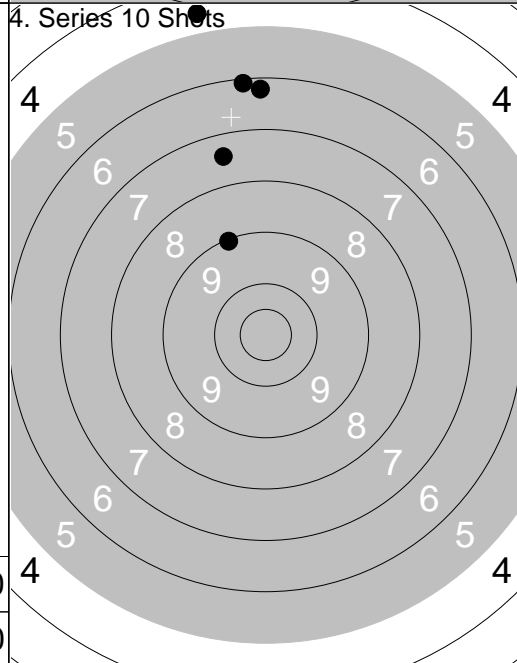

6:	6.3	↑
7:	9.1	↖
8:	6.1	↑
9:	7.5	↑
10:	4.6	↑
Series		32.0
Total		215.0

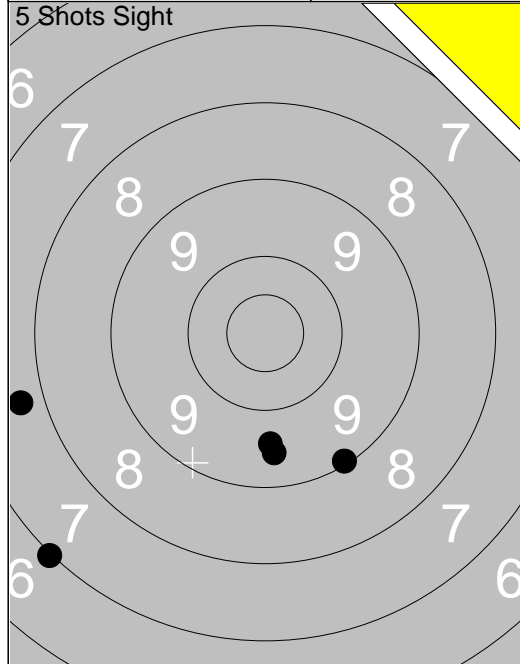

1: 9.1	↘
2: 7.0	↙
3: 9.6	↓
4: 9.5	↓
5: 7.7	←
Series 41.0	
Total 0.0	

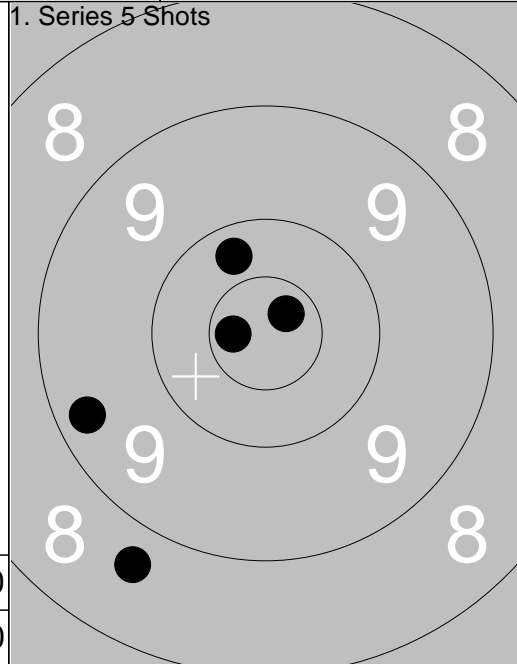

1: *10.7	↗
2: 8.7	↙
3: *10.7	←
4: 9.3	↙
5: 10.3	↖
Series 47.0	
Total 47.0	

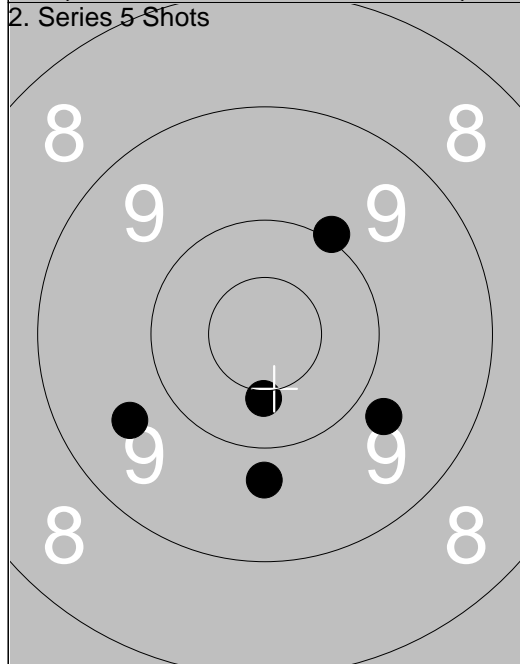

1: 9.8	↘
2: 9.6	↙
3: *10.4	↓
4: 9.8	↓
5: 10.0	↗
Series 47.0	
Total 94.0	

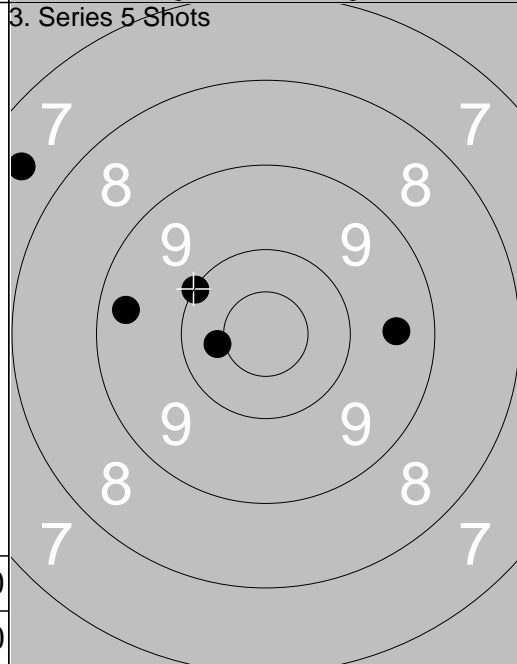

1: 9.5	→
2: 10.4	←
3: 9.4	←
4: 7.5	↙
5: 10.0	↙
Series 45.0	
Total 139.0	

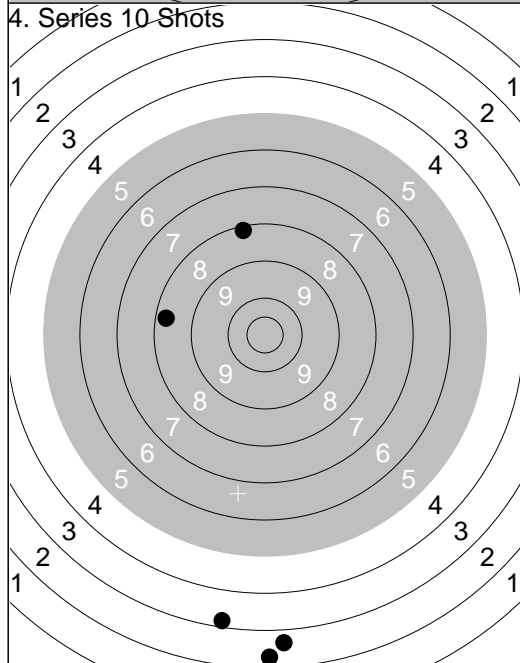

1: 2.3	↓
2: 2.7	↓
3: 3.2	↓
4: 8.1	↑
5: 8.3	←
Series 23.0	
Total 162.0	

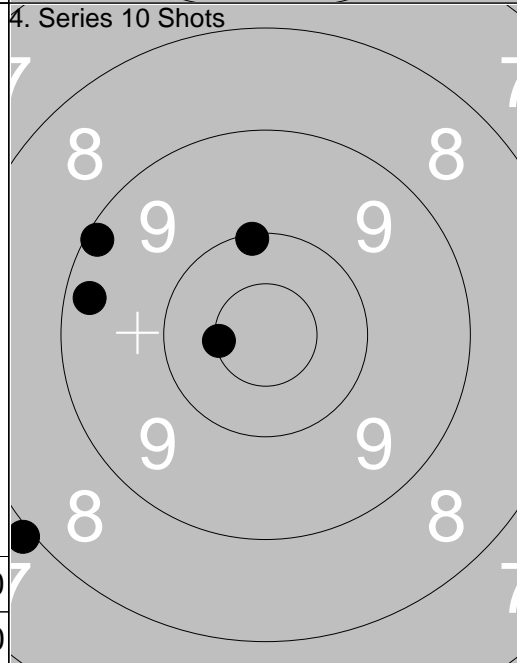

6: 9.1	↙
7: *10.5	←
8: 7.9	↙
9: 10.1	↑
10: 9.3	↙
Series 45.0	
Total 207.0	

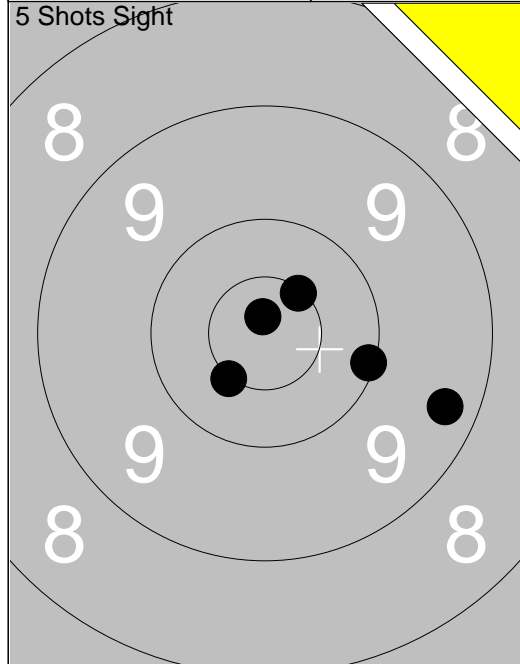

1: *10.5 ↗
2: 9.3 →
3: *10.5 ↘
4: 10.1 →
5: *10.8 ↑
Series 49.0
Total 0.0

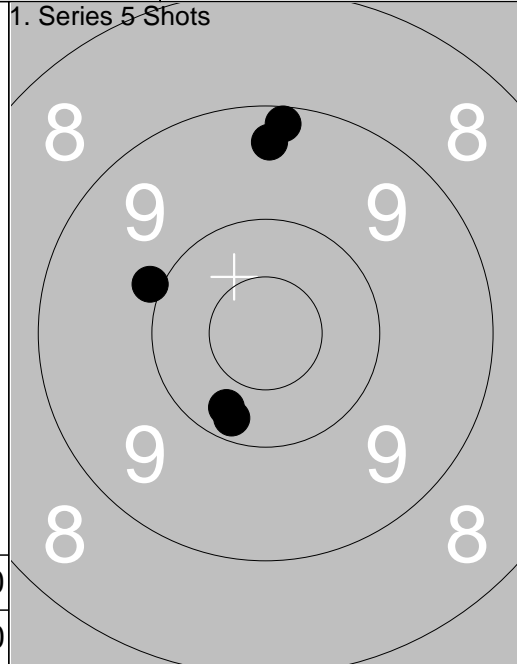

1: 9.4 ↑
2: 9.2 ↑
3: 10.2 ↘
4: 10.3 ↘
5: 9.9 ←
Series 47.0
Total 47.0

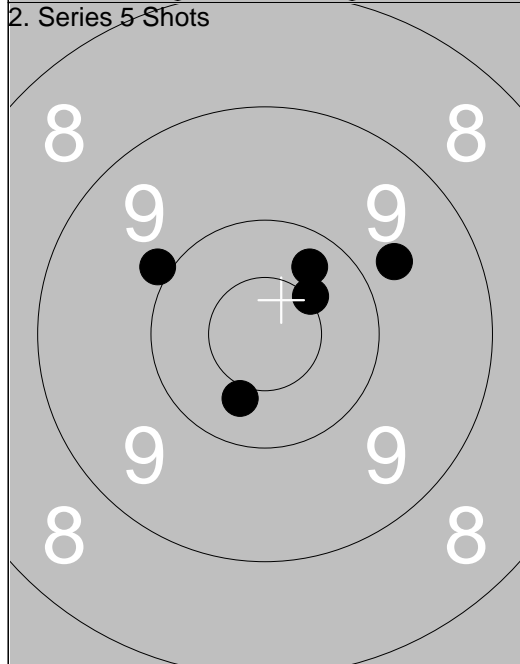

1: 9.7 →
2: *10.5 ↗
3: 10.3 ↗
4: 9.9 ←
5: 10.4 ↘
Series 48.0
Total 95.0

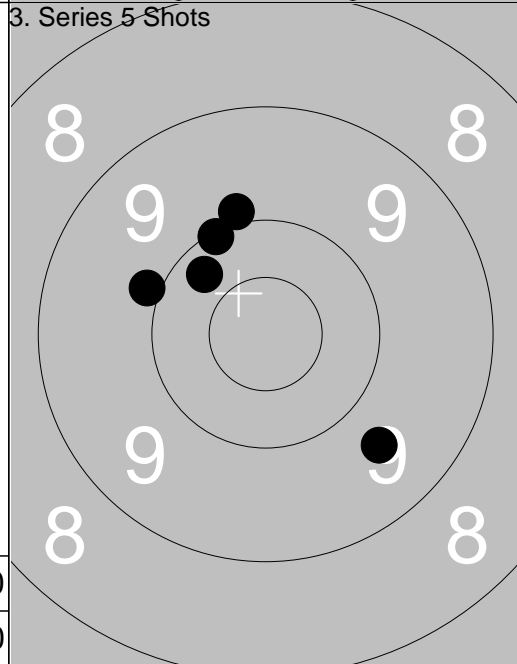

1: 9.6 ↘
2: 9.9 ↑
3: 9.9 ←
4: 10.3 ↗
5: 10.1 ↑
Series 47.0
Total 142.0

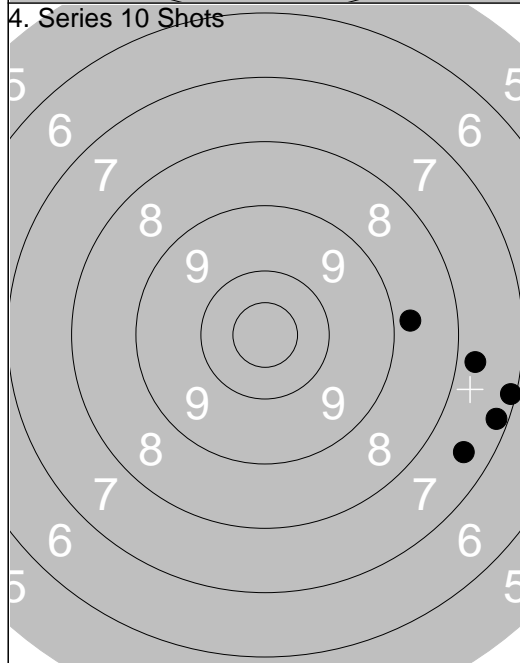

1: 7.7 →
2: 8.8 →
3: 7.4 →
4: 7.2 →
5: 7.1 →
Series 36.0
Total 178.0

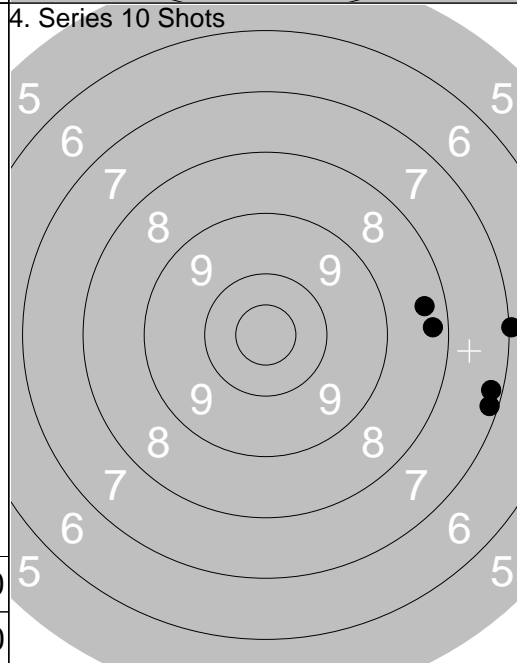

6: 7.0 →
7: 7.2 →
8: 7.2 →
9: 8.4 →
10: 8.3 →
Series 37.0
Total 215.0

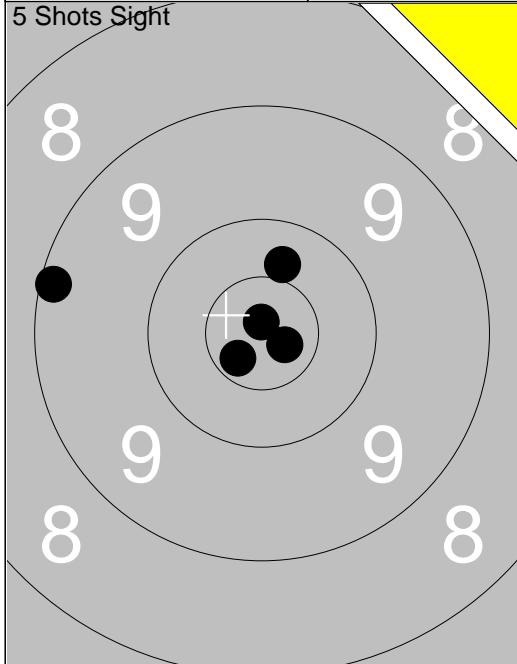

1:	10.4 ↗
2:	*10.7 ↘
3:	*10.9 ↗
4:	*10.7 ↘
5:	9.1 ←
Series 49.0	
Total 0.0	

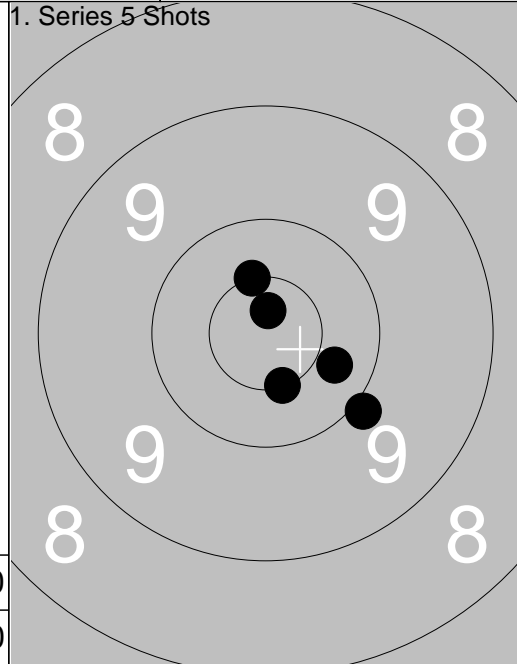

1:	*10.5 ↗
2:	9.9 ↘
3:	10.3 ↘
4:	*10.8 ↗
5:	*10.5 ↘
Series 49.0	
Total 49.0	

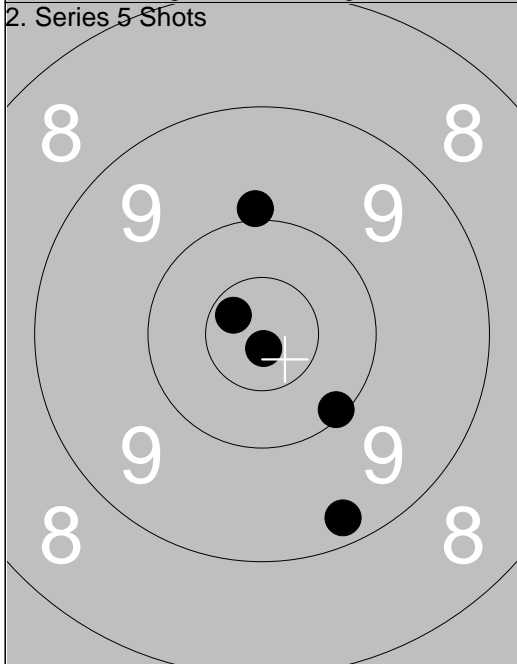

1:	10.1 ↘
2:	9.9 ↗
3:	*10.8 ↘
4:	9.3 ↘
5:	*10.7 ↘
Series 48.0	
Total 97.0	

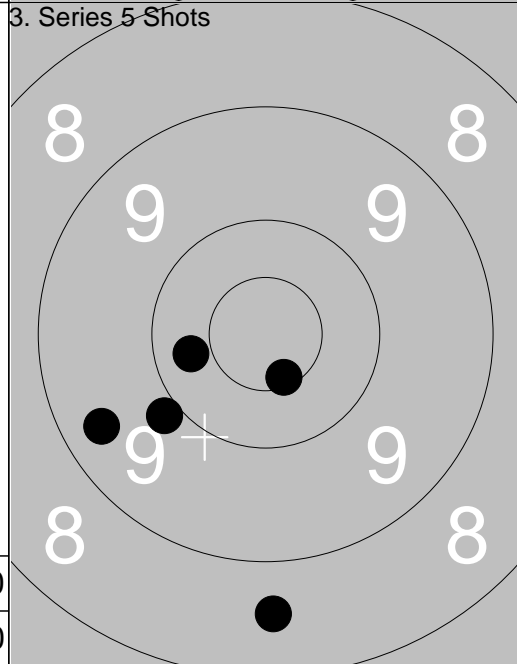

1:	9.4 ↙
2:	8.6 ↓
3:	*10.6 ↘
4:	9.9 ↙
5:	10.3 ↙
Series 46.0	
Total 143.0	

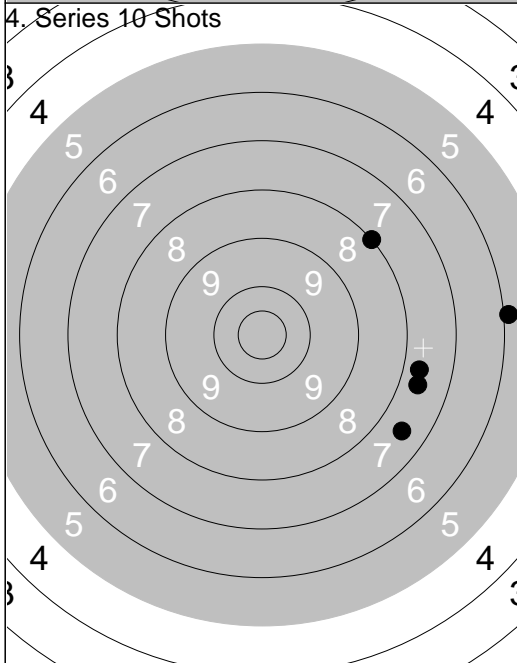

1:	5.9 →
2:	7.5 ↘
3:	7.7 →
4:	8.0 ↗
5:	7.7 →
Series 34.0	
Total 177.0	

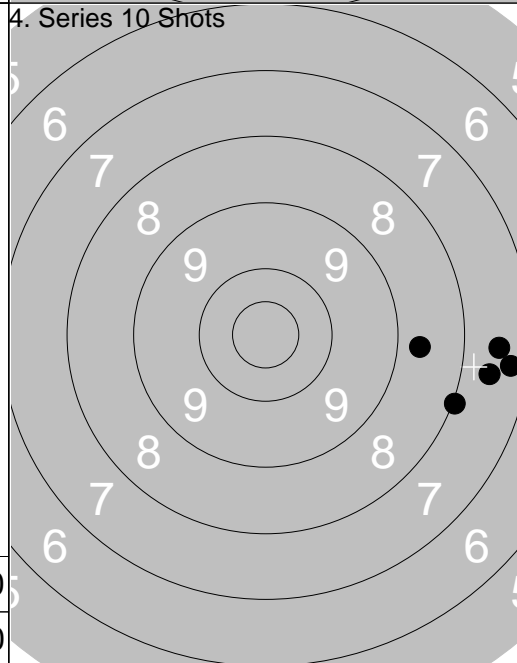

6:	7.6 →
7:	7.5 →
8:	8.0 →
9:	7.3 →
10:	8.7 →
Series 37.0	
Total 214.0	

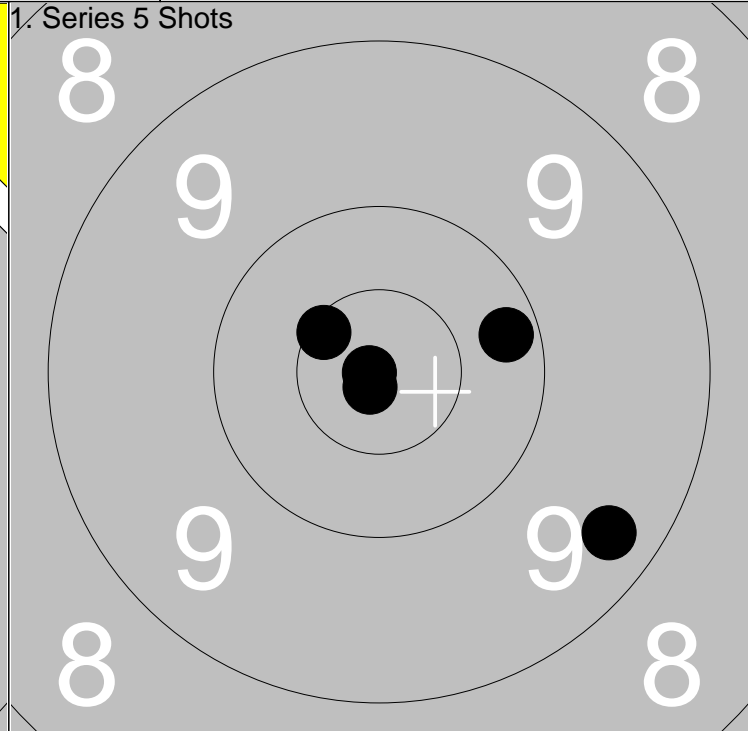
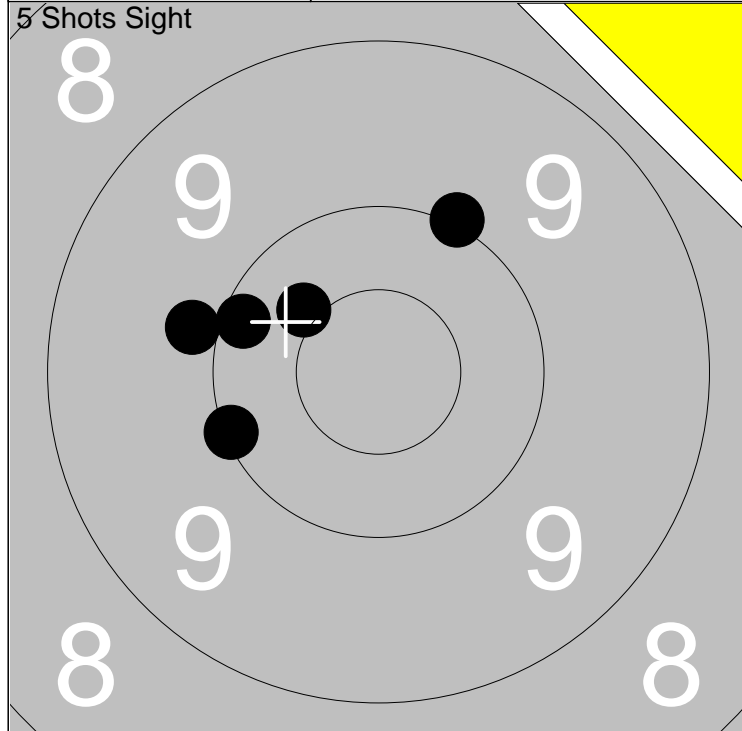

1: 10.0 ↗	Series 49.0
2: 9.9 ←	
3: 10.4 ↘	
4: 10.1 ←	
5: 10.1 ←	
Total 0.0	

1: *10.6 ↖	Series 49.0
2: 9.3 ↘	
3: *10.9 ↙	
4: 10.2 →	
5: *10.9 ←	
Total 49.0	

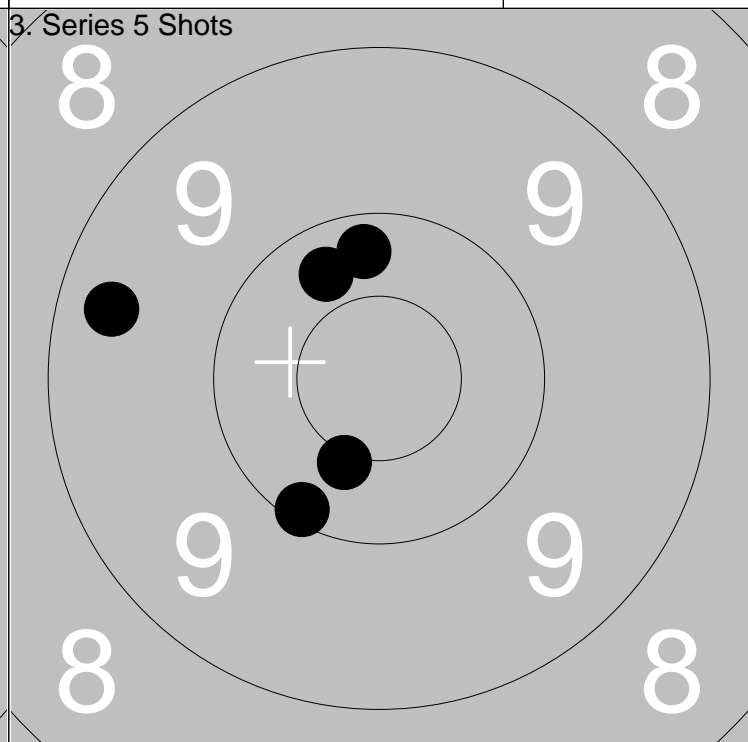
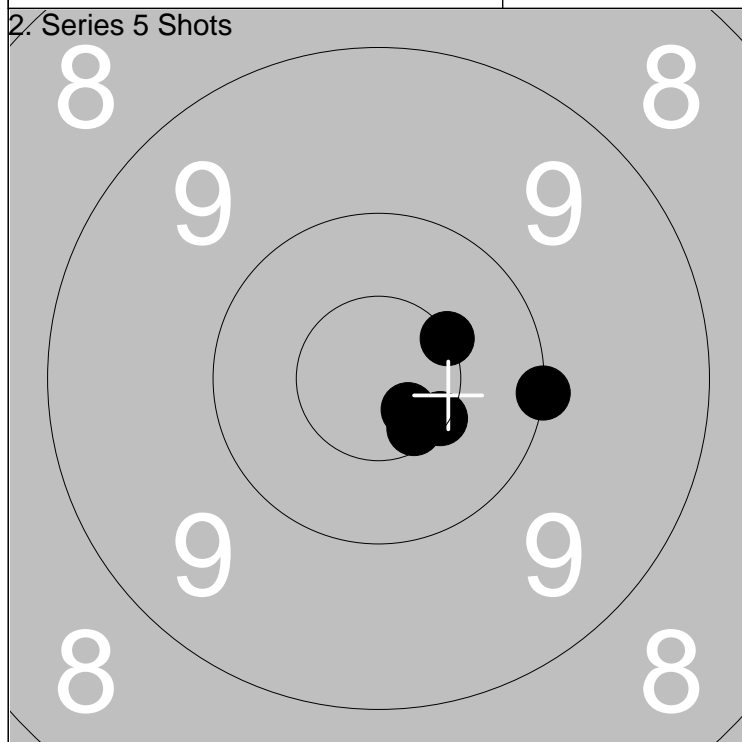

1: *10.5 →	Series 50.0
2: 10.0 →	
3: *10.6 ↘	
4: *10.5 ↘	
5: *10.7 ↘	
Total 99.0	

1: 9.4 ←	Series 49.0
2: 10.3 ↗	
3: 10.1 ↘	
4: 10.2 ↑	
5: *10.4 ↙	
Total 148.0	

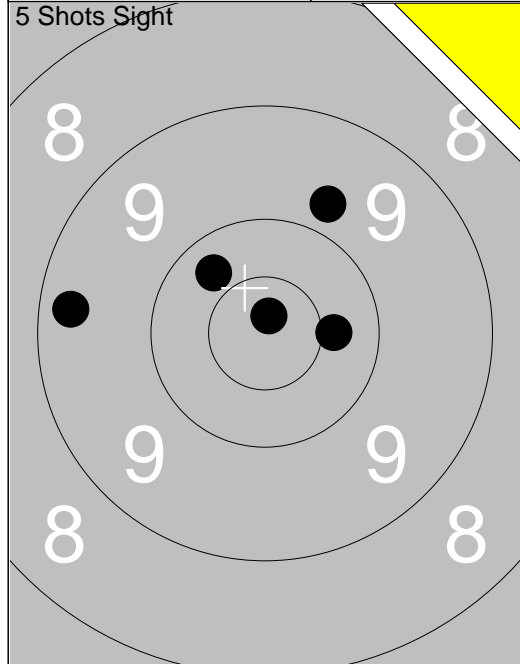

1: 9.8 ↗	
2: *10.8 ↑	
3: 10.4 →	
4: 10.3 ↘	
5: 9.3 ←	
Series 48.0	
Total 0.0	

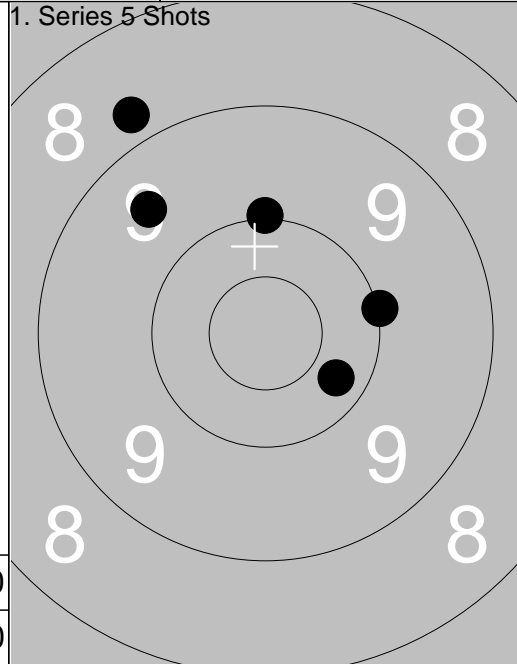

1: 8.8 ↖	
2: 10.0 ↑	
3: 10.0 →	
4: 10.3 ↘	
5: 9.5 ↗	
Series 47.0	
Total 47.0	

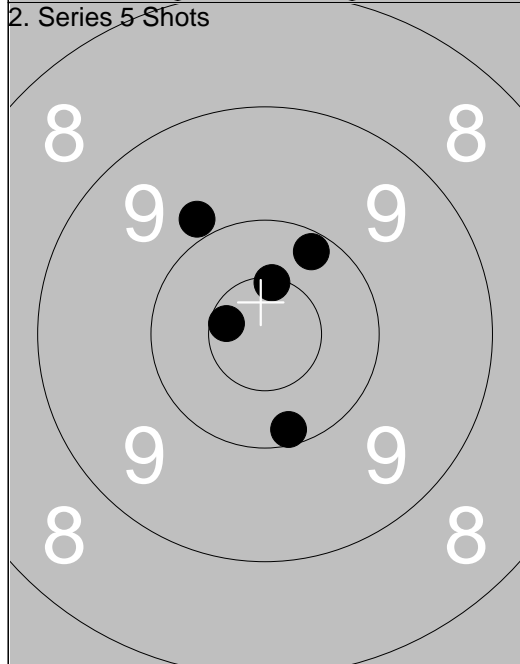

1: *10.5 ↑	
2: 10.2 ↓	
3: *10.6 ↖	
4: 10.2 ↗	
5: 9.9 ↗	
Series 49.0	
Total 96.0	

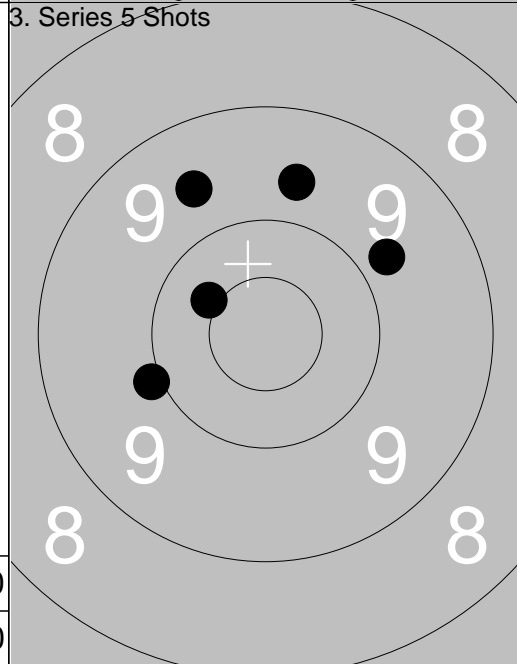

1: 9.8 ↗	
2: *10.4 ↖	
3: 9.7 ↑	
4: 9.9 ←	
5: 9.6 ↗	
Series 46.0	
Total 142.0	

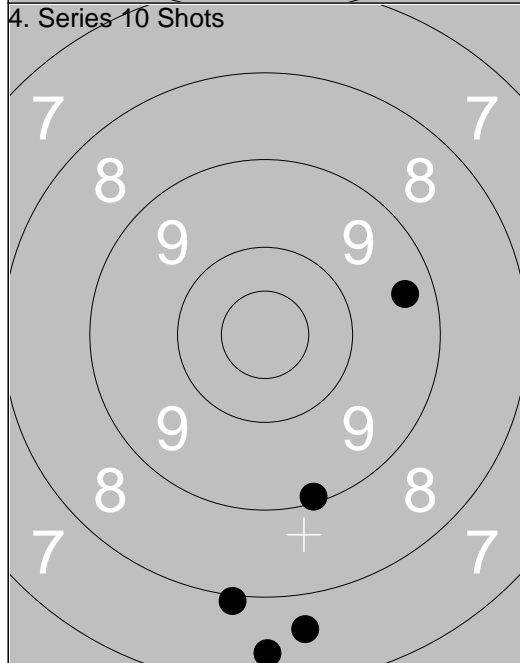

1: 9.4 →	
2: 9.1 ↓	
3: 7.4 ↓	
4: 8.0 ↓	
5: 7.6 ↓	
Series 40.0	
Total 182.0	

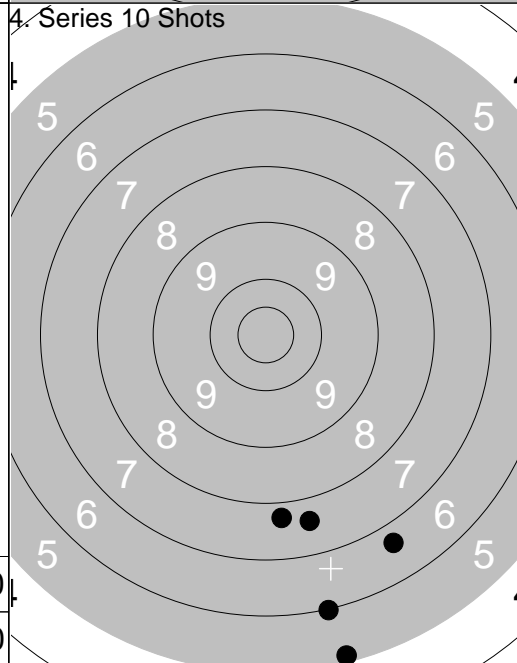

6: 7.8 ↓	
7: 6.0 ↓	
8: 7.6 ↓	
9: 6.7 ↓	
10: 5.1 ↓	
Series 31.0	
Total 213.0	

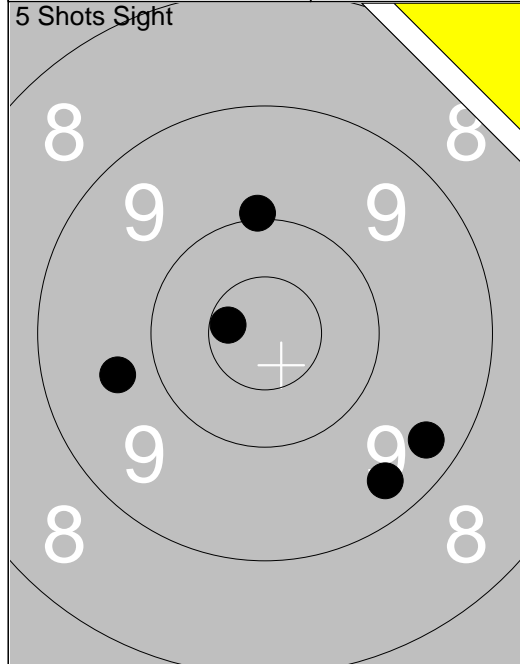

1:	10.0	↑
2:	9.4	↘
3:	*10.6	↖
4:	9.7	←
5:	9.3	↘
<hr/>		
Series	47.0	
Total	0.0	

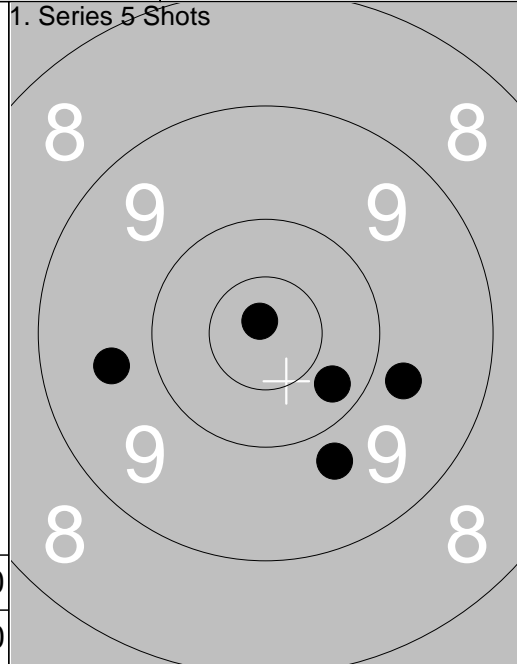

1:	9.8	↘
2:	9.6	←
3:	9.8	→
4:	10.3	↘
5:	*10.8	↖
<hr/>		
Series	47.0	
Total	47.0	

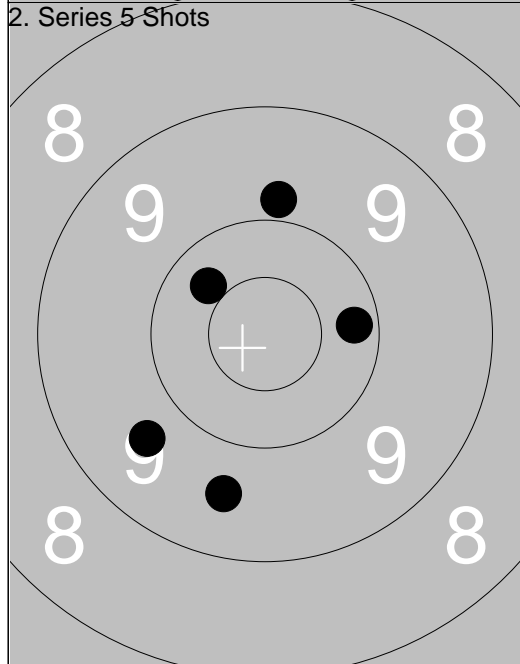

1:	10.2	→
2:	10.3	↖
3:	9.8	↑
4:	9.6	↙
5:	9.6	↘
<hr/>		
Series	47.0	
Total	94.0	

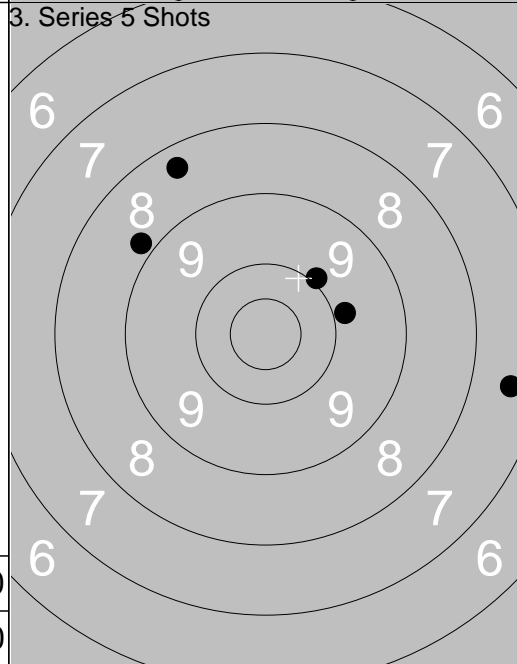

1:	8.8	↖
2:	8.4	↗
3:	9.9	→
4:	10.0	↗
5:	7.5	→
<hr/>		
Series	42.0	
Total	136.0	

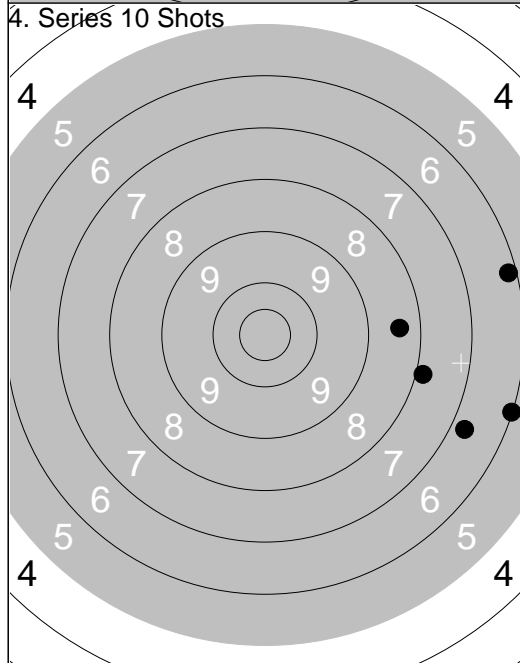

1:	7.9	→
2:	8.4	→
3:	6.0	→
4:	6.2	→
5:	6.8	↘
<hr/>		
Series	33.0	
Total	169.0	

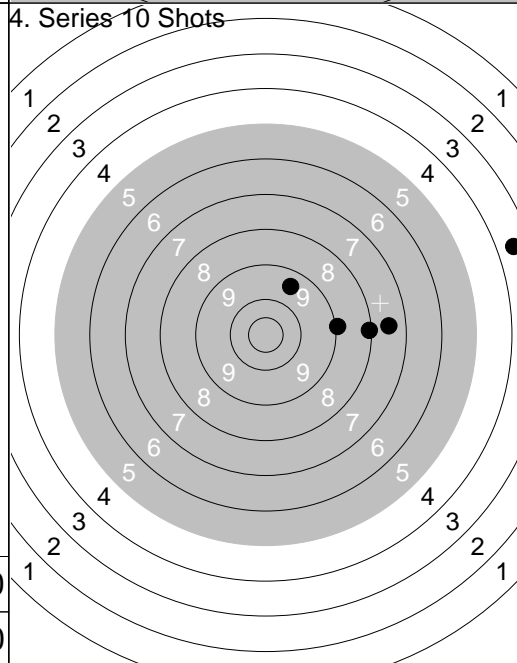

6:	7.5	→
7:	9.0	→
8:	8.1	→
9:	3.6	→
10:	9.5	↗
<hr/>		
Series	36.0	
Total	205.0	

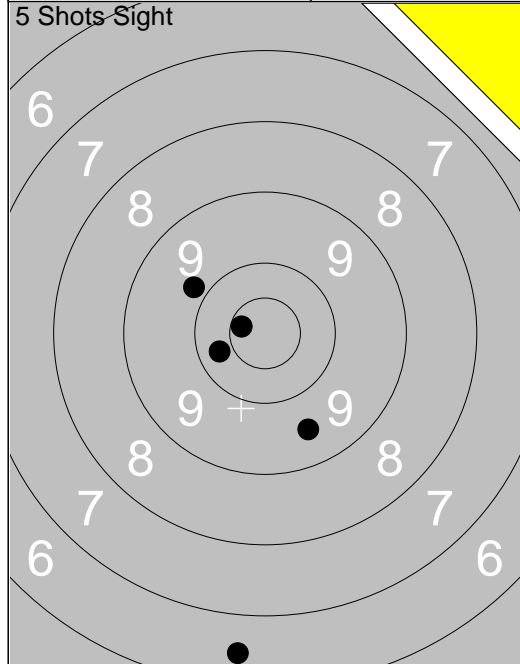

1: 6.5 ↓	
2: 9.5 ↓	
3: 10.3 ↙	
4: *10.6 ↙	
5: 9.8 ↙	
Series 44.0	
Total 0.0	

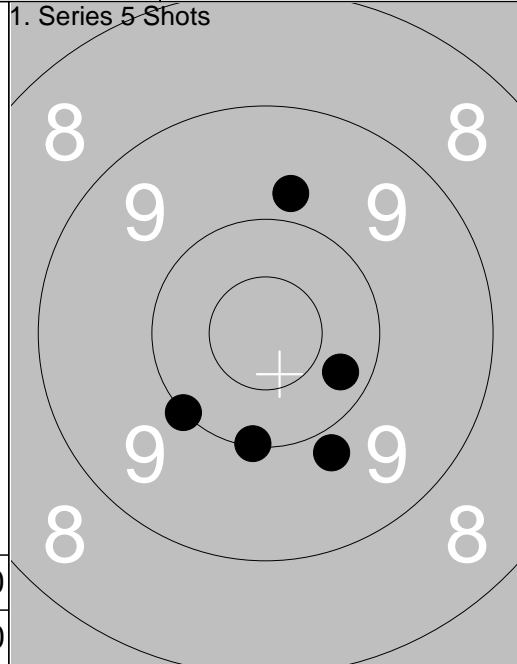

1: 10.0 ↓	
2: 10.0 ↙	
3: 10.3 →	
4: 9.8 ↓	
5: 9.8 ↑	
Series 48.0	
Total 48.0	

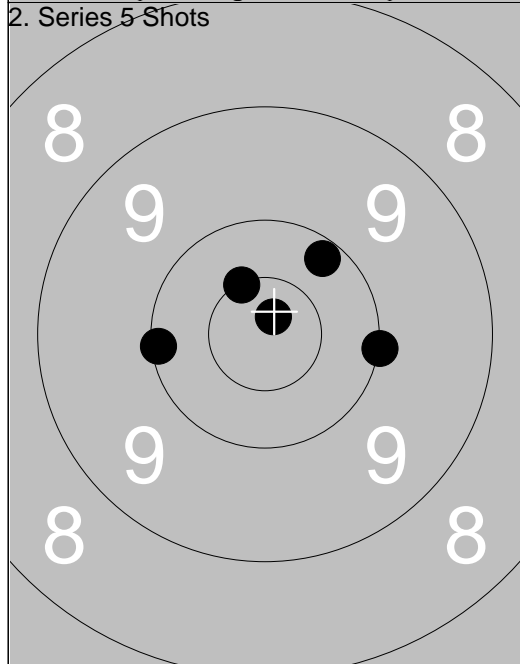

1: *10.5 ↖	
2: 10.2 ↗	
3: 10.0 →	
4: 10.1 ←	
5: *10.8 ↗	
Series 50.0	
Total 98.0	

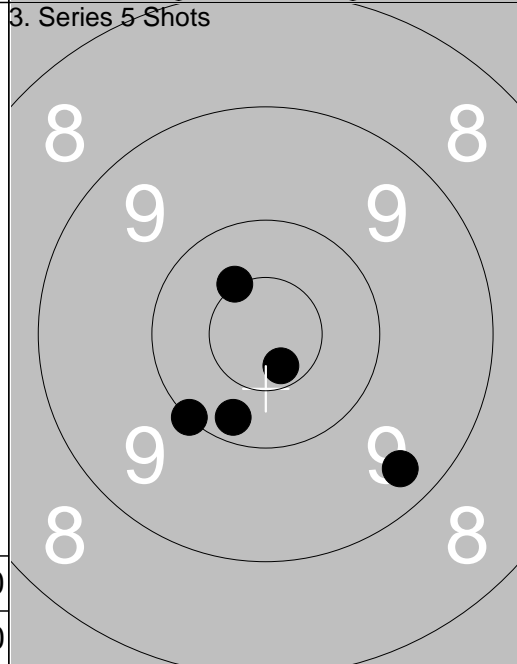

1: 10.0 ↙	
2: 10.2 ↓	
3: *10.7 ↘	
4: *10.5 ↖	
5: 9.4 ↓	
Series 49.0	
Total 147.0	

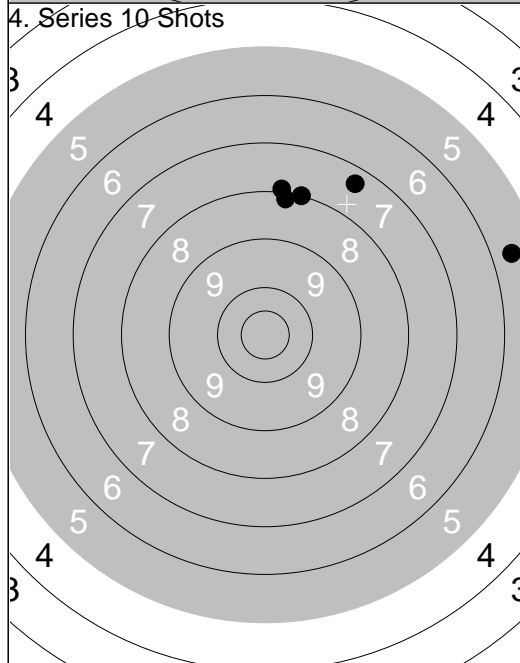

1: 7.4 ↗	
2: 8.0 ↑	
3: 8.2 ↑	
4: 8.0 ↑	
5: 5.6 →	
Series 36.0	
Total 183.0	

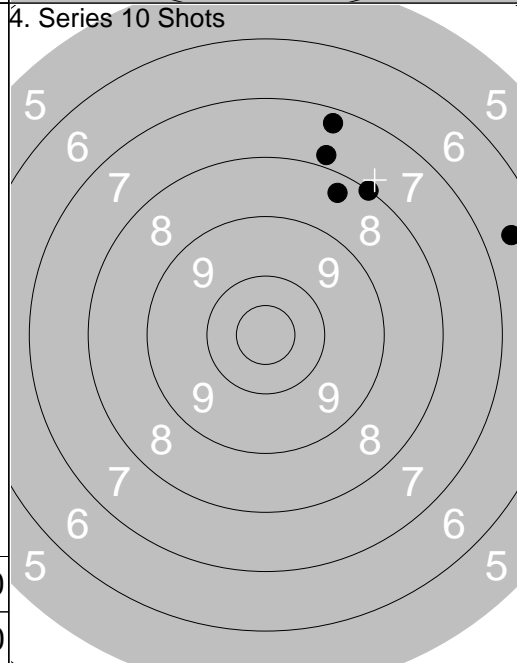

6: 8.3 ↗	
7: 6.6 →	
8: 7.3 ↑	
9: 7.8 ↑	
10: 8.0 ↗	
Series 36.0	
Total 219.0	

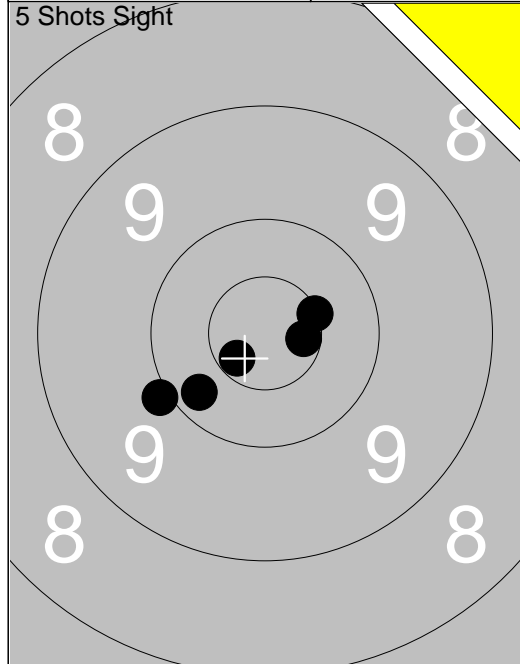

1: *10.6	➔
2: *10.6	↙
3: *10.5	➔
4: 10.2	↙
5: 9.9	↙
Series 49.0	
Total 0.0	

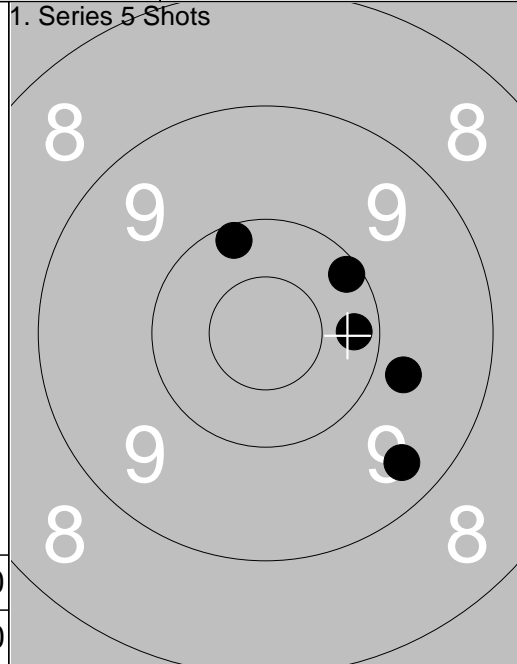

1: 10.1	↖
2: 10.1	↗
3: 9.4	↘
4: 10.2	➔
5: 9.8	➔
Series 48.0	
Total 48.0	

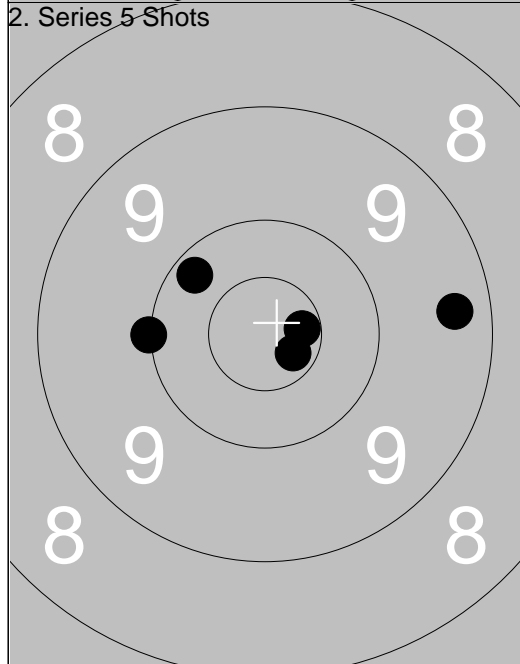

1: 10.2	↖
2: *10.6	➔
3: 10.0	↙
4: 9.4	➔
5: *10.7	↘
Series 49.0	
Total 97.0	

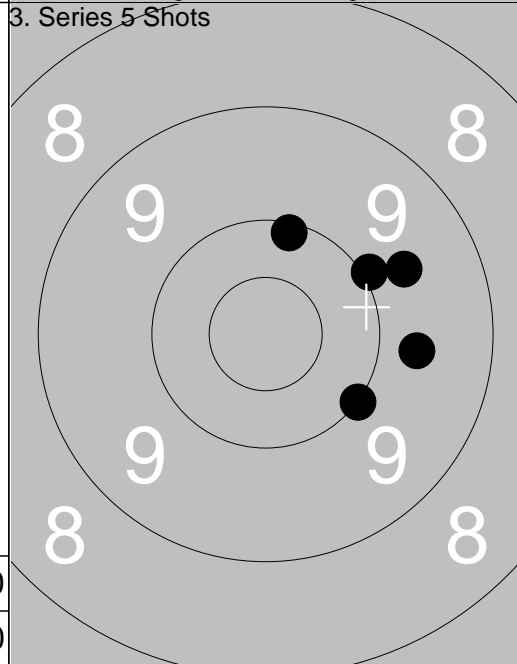

1: 10.0	↗
2: 10.0	↘
3: 10.1	↖
4: 9.7	➔
5: 9.7	↗
Series 48.0	
Total 145.0	

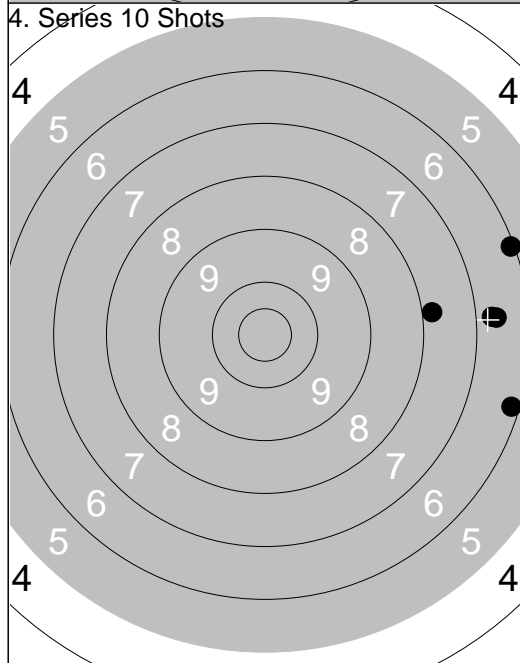

1: 7.9	➔
2: 6.2	➔
3: 6.1	➔
4: 6.7	➔
5: 6.7	➔
Series 31.0	
Total 176.0	

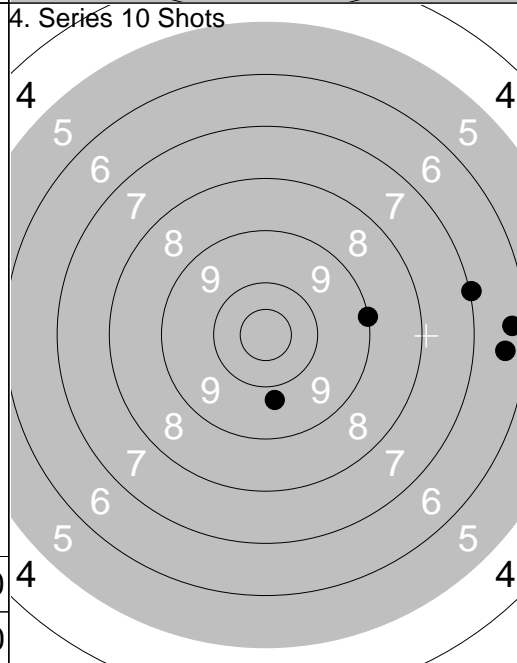

6: 7.0	➔
7: 6.4	➔
8: 6.3	➔
9: 9.0	➔
10: 9.8	↘
Series 37.0	
Total 213.0	

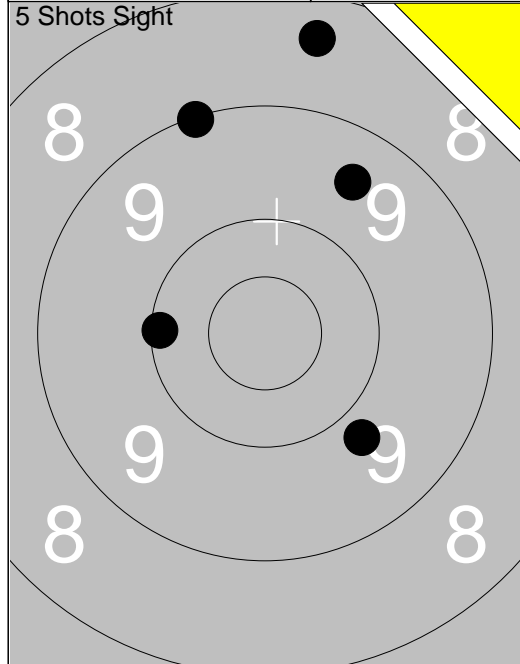

1:	8.4	↑
2:	9.1	↑
3:	10.1	←
4:	9.5	↑
5:	9.8	↘
Series		45.0
Total		0.0

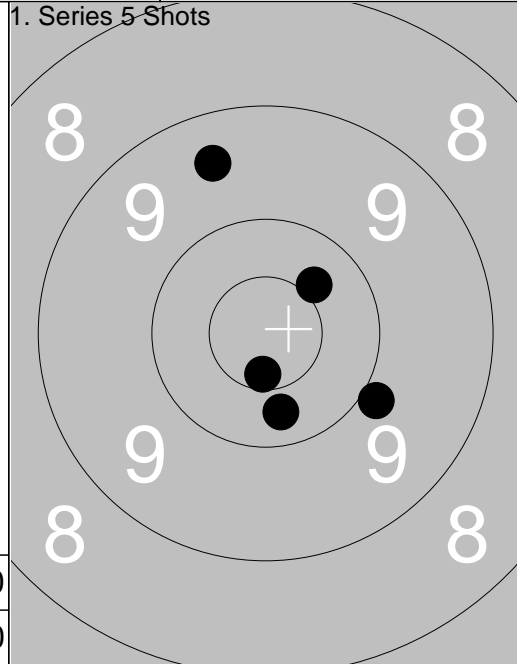

1:	9.5	↑
2:	10.4	↗
3:	*10.6	↓
4:	9.9	↘
5:	10.3	↓
Series		48.0
Total		48.0

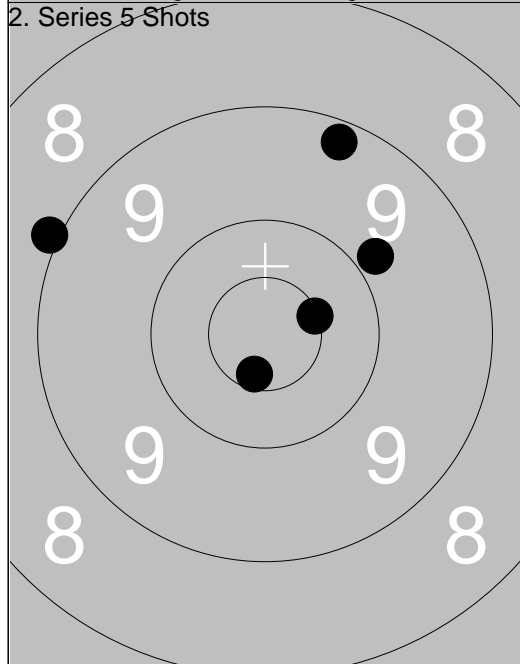

1:	9.2	↑
2:	9.8	↗
3:	9.0	←
4:	*10.5	→
5:	*10.6	↓
Series		47.0
Total		95.0

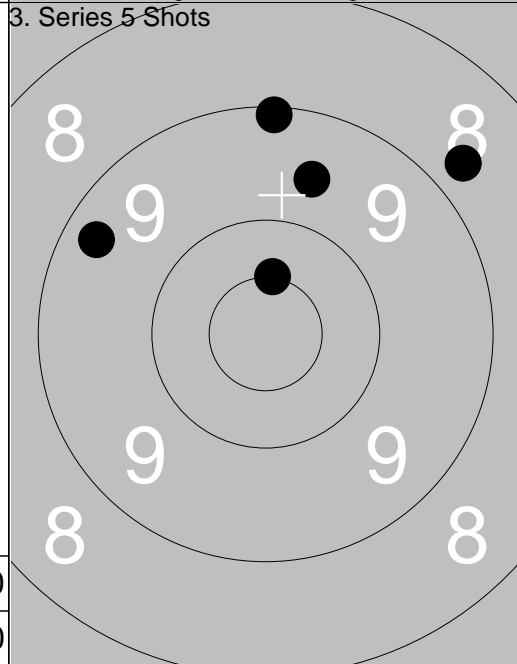

1:	9.6	↑
2:	9.3	↖
3:	*10.5	↑
4:	9.1	↑
5:	8.7	↗
Series		45.0
Total		140.0

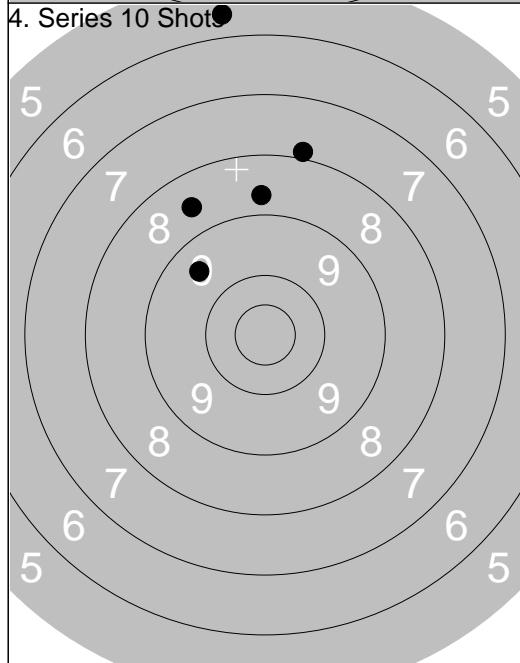

1:	5.6	↑
2:	8.6	↖
3:	8.7	↑
4:	7.9	↑
5:	9.5	↖
Series		37.0
Total		177.0

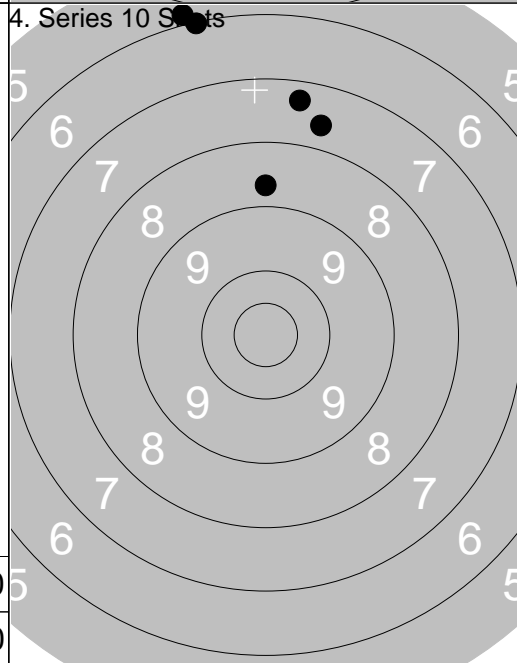

6:	7.3	↑
7:	5.9	↑
8:	7.7	↑
9:	8.7	↑
10:	6.1	↑
Series		33.0
Total		210.0

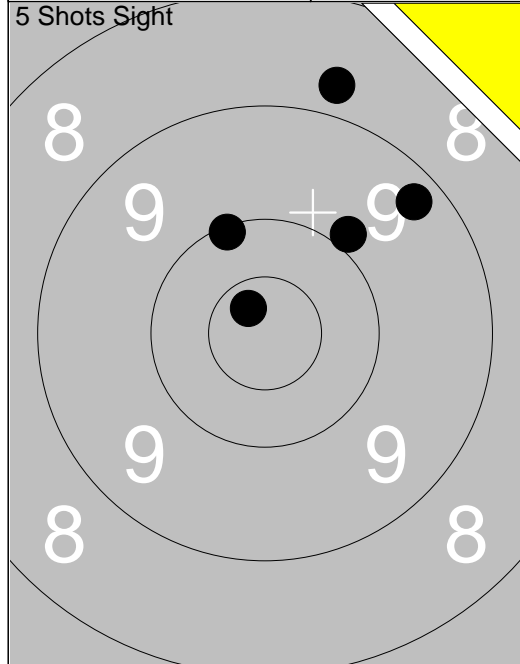

1:	10.1	↑
2:	8.8	↑
3:	9.3	↗
4:	9.9	↗
5:	*10.7	↖
Series		46.0
Total		0.0

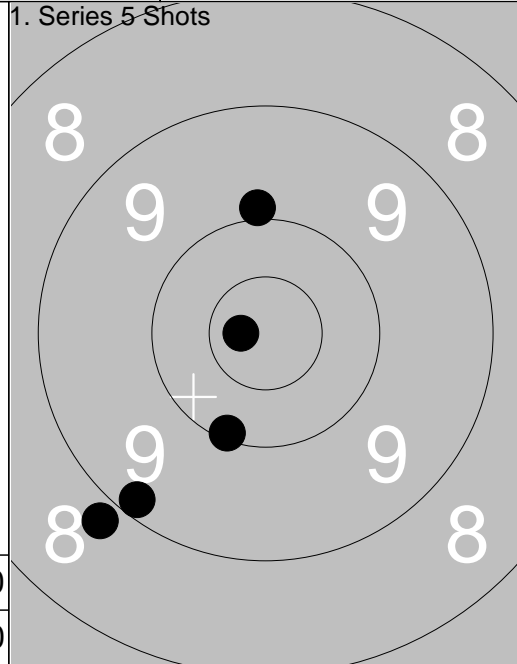

1:	9.9	↑
2:	9.2	↘
3:	*10.7	↖
4:	10.1	↘
5:	8.8	↘
Series		46.0
Total		46.0

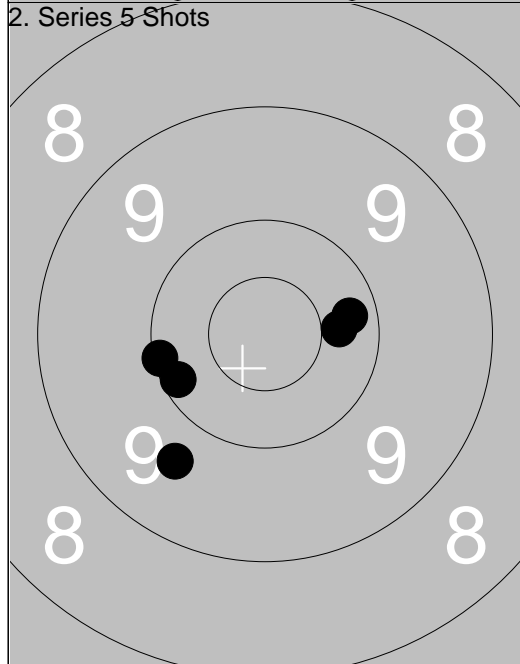

1:	10.1	←
2:	10.2	↙
3:	9.7	↘
4:	10.3	→
5:	10.2	→
Series		49.0
Total		95.0

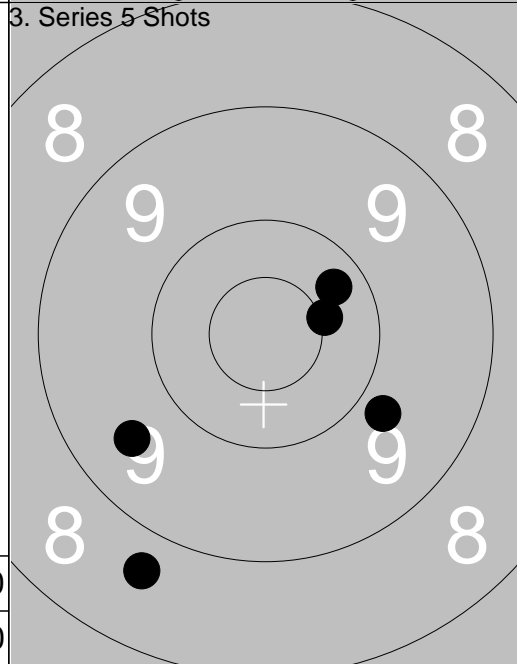

1:	9.5	↙
2:	*10.5	↗
3:	10.3	↗
4:	8.7	↘
5:	9.8	↘
Series		46.0
Total		141.0

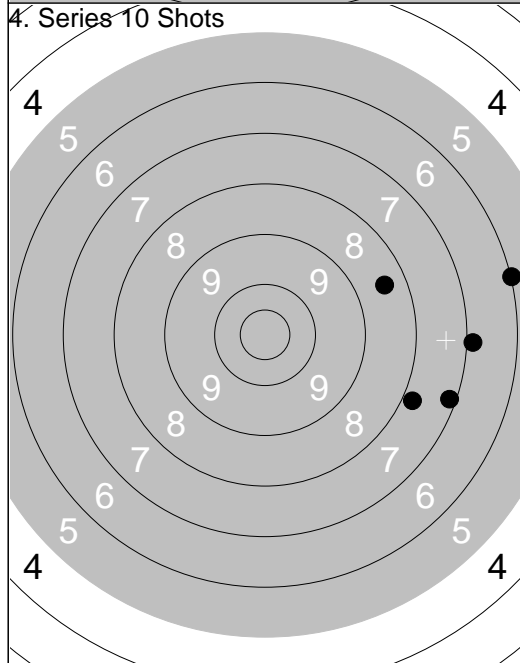

1:	8.5	→
2:	7.2	→
3:	6.0	→
4:	6.9	→
5:	7.8	→
Series		34.0
Total		175.0

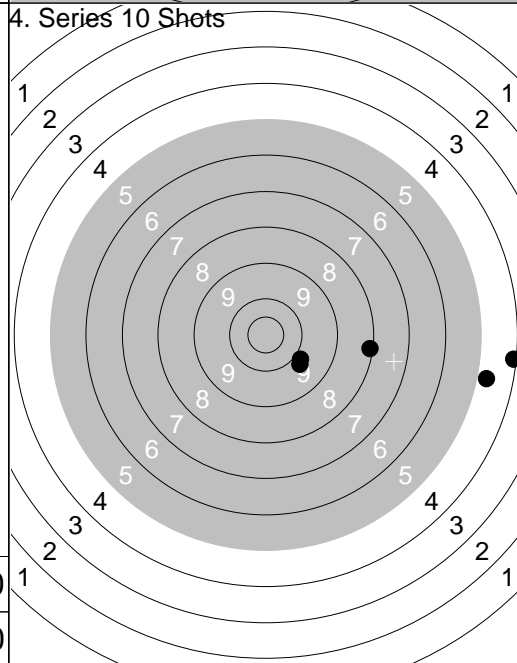

6:	9.9	↘
7:	8.1	→
8:	4.1	→
9:	4.8	→
10:	9.8	↘
Series		34.0
Total		209.0

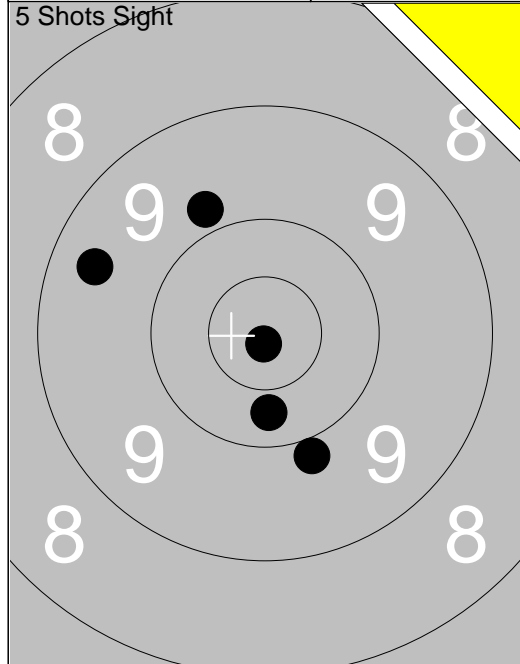

1:	10.3	↓
2:	9.8	↗
3:	*10.9	↓
4:	9.9	↓
5:	9.4	↖
Series		47.0
Total		0.0

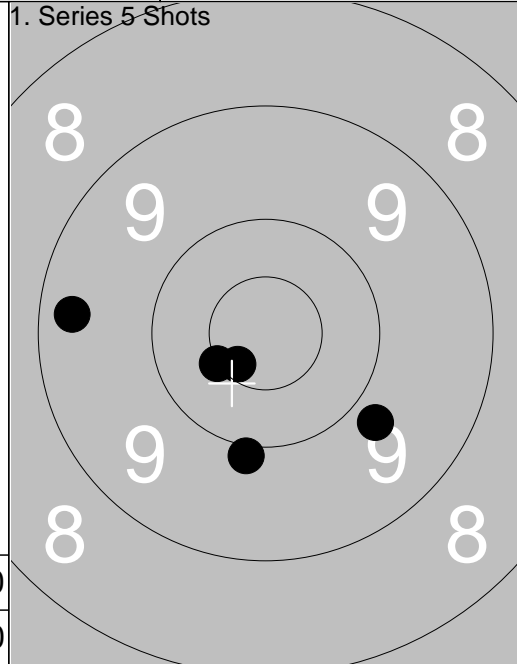

1:	*10.5	↘
2:	9.3	←
3:	9.9	↓
4:	*10.6	↘
5:	9.8	↘
Series		47.0
Total		47.0

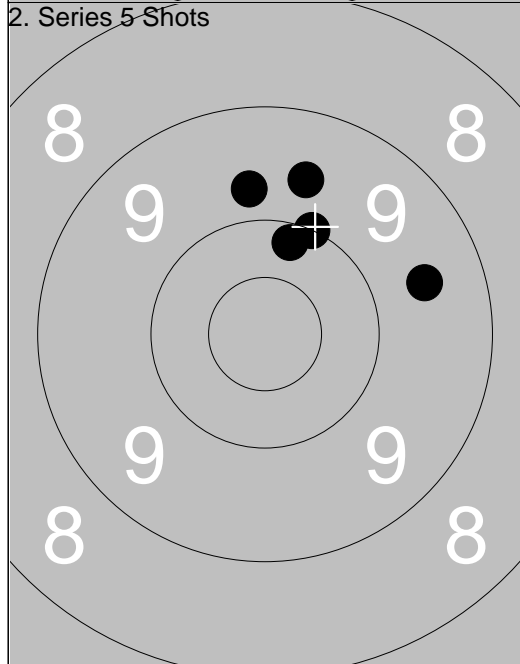

1:	9.6	→
2:	10.2	↑
3:	9.7	↑
4:	9.6	↑
5:	10.0	↗
Series		47.0
Total		94.0

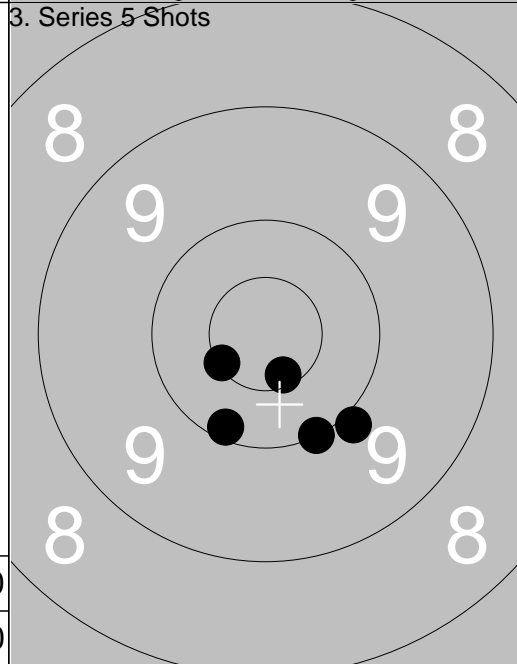

1:	10.0	↓
2:	*10.5	↘
3:	9.9	↘
4:	10.1	↓
5:	*10.6	↘
Series		49.0
Total		143.0

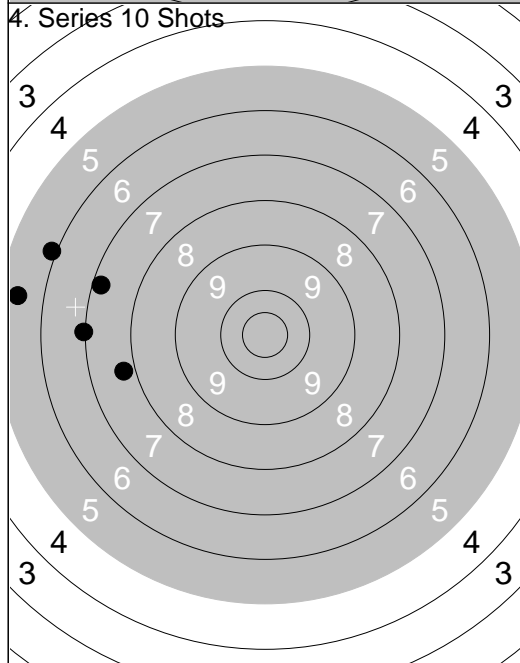

1:	7.2	←
2:	7.8	←
3:	5.5	←
4:	5.9	←
5:	7.0	←
Series		31.0
Total		174.0

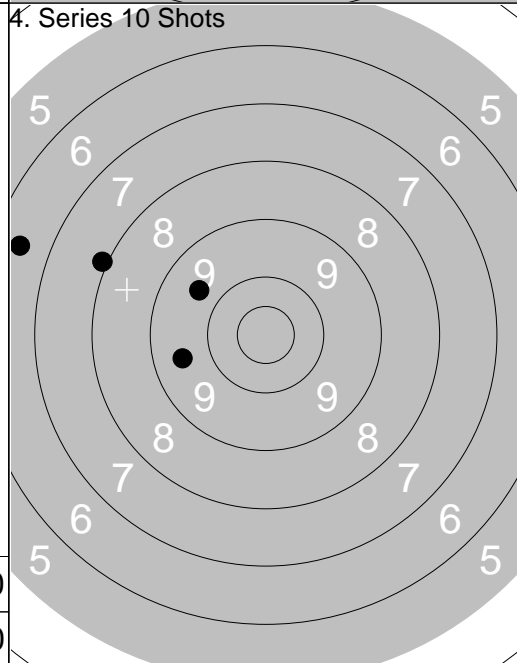

6:	6.5	←
7:	7.9	←
8:	9.6	←
9:	9.5	←
Series		31.0
Total		205.0

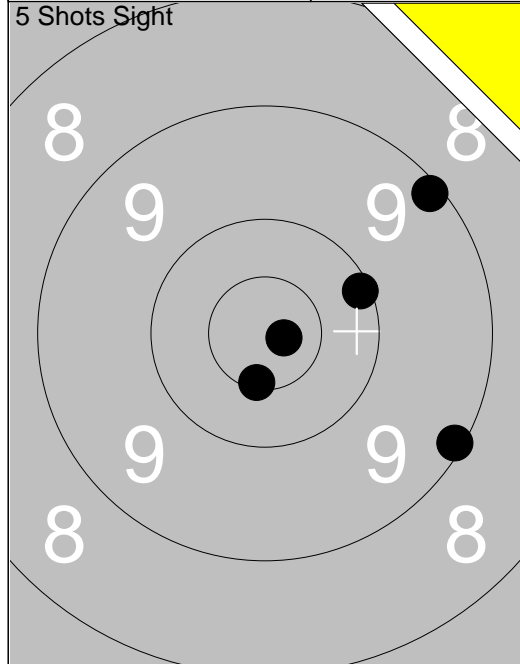

1:	9.1	↘
2:	9.1	↗
3:	10.1	→
4:	*10.8	→
5:	*10.5	↓
Series		48.0
Total		0.0

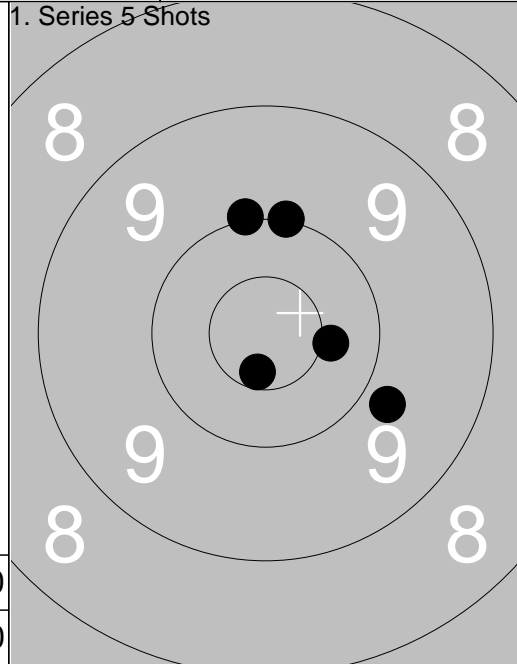

1:	9.8	↘
2:	10.0	↑
3:	10.0	↑
4:	*10.4	→
5:	*10.6	↓
Series		49.0
Total		49.0

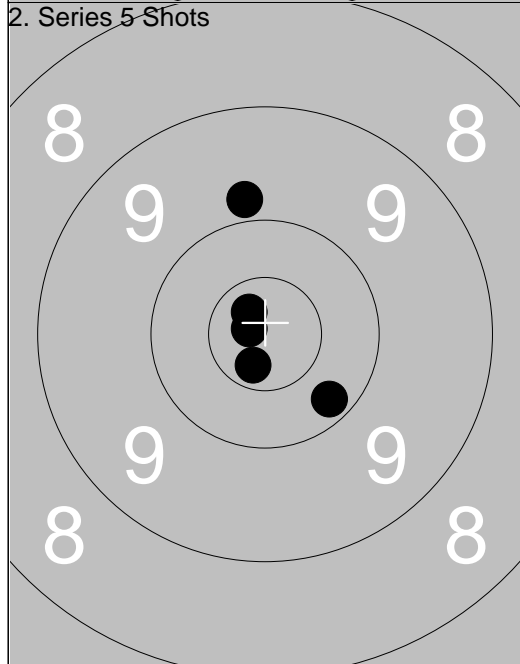

1:	*10.8	↖
2:	9.8	↑
3:	10.2	↘
4:	*10.7	↓
5:	*10.7	↗
Series		49.0
Total		98.0

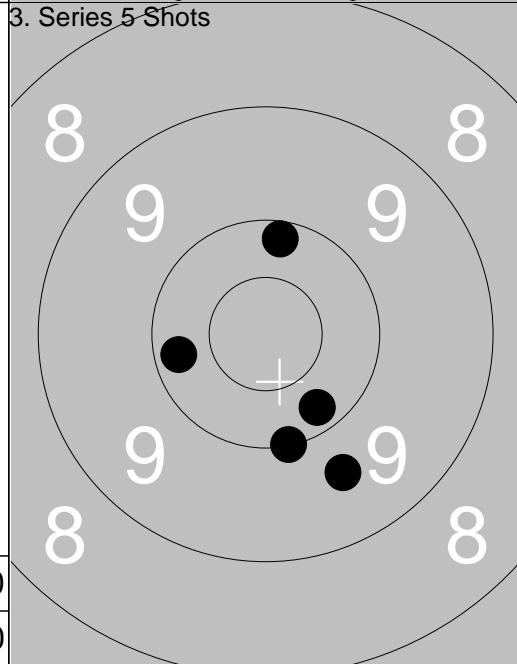

1:	10.2	↑
2:	10.2	↖
3:	10.2	↘
4:	10.0	↓
5:	9.6	↘
Series		49.0
Total		147.0

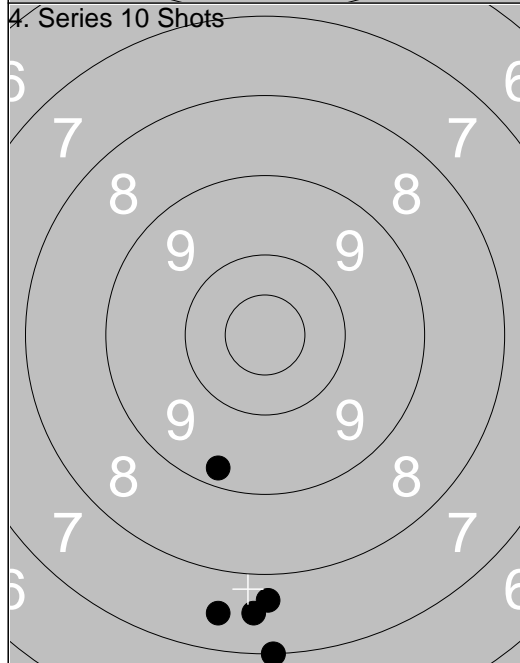

1:	9.3	↓
2:	7.7	↓
3:	7.0	↓
4:	7.5	↓
5:	7.5	↓
Series		37.0
Total		184.0

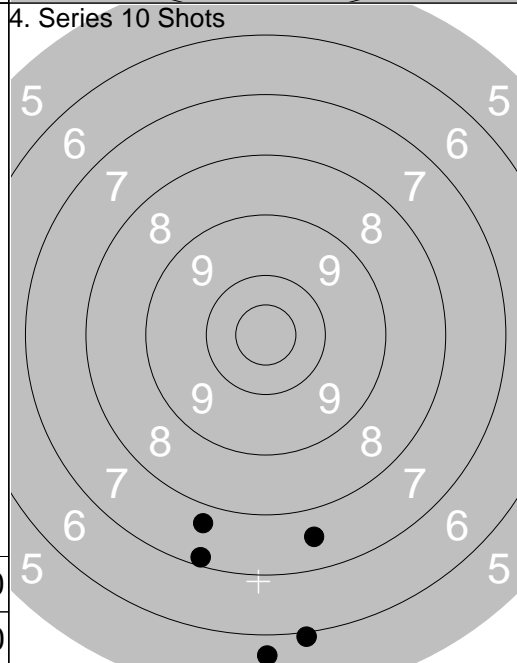

6:	7.2	↓
7:	5.7	↓
8:	7.7	↓
9:	6.0	↓
10:	7.6	↓
Series		32.0
Total		216.0

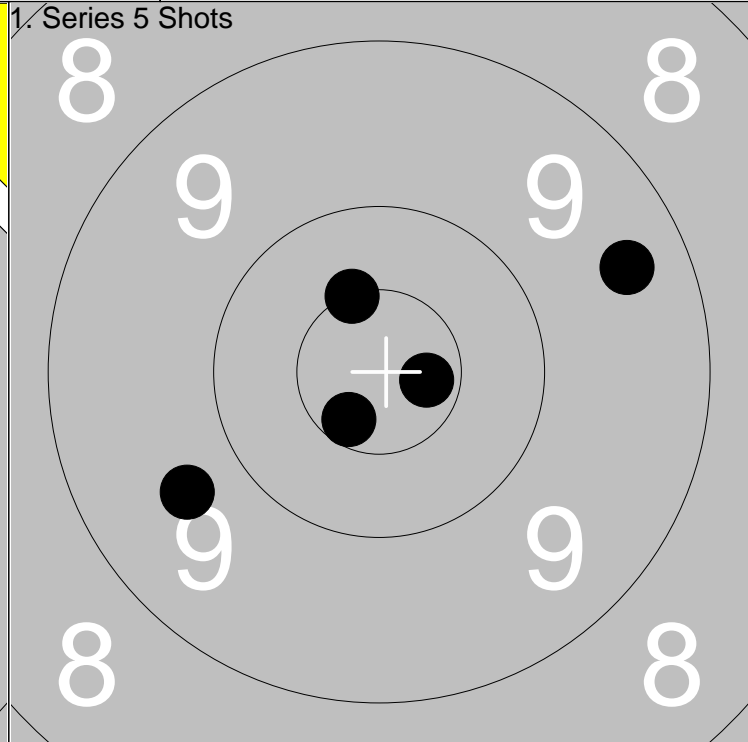
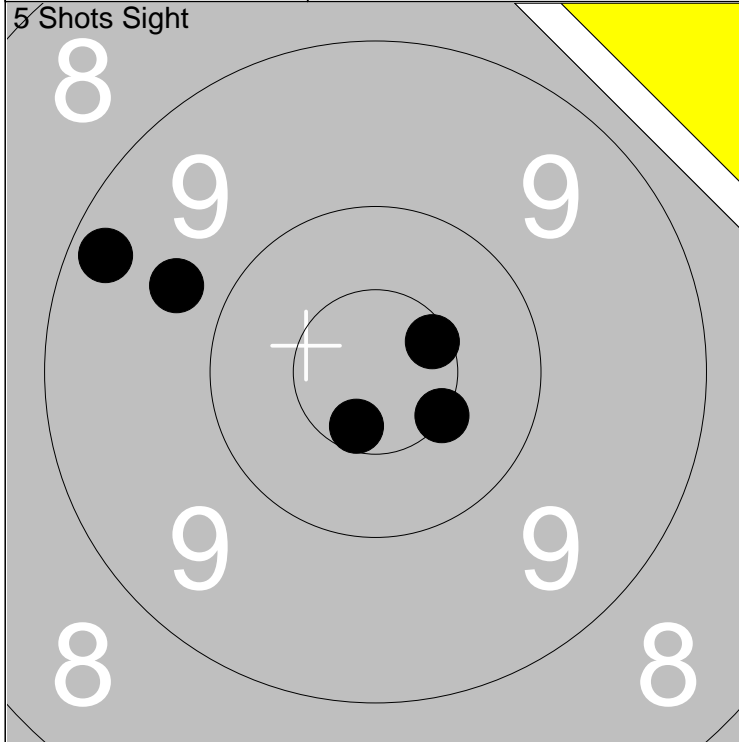

1: 9.3 ↙	Series	48.0
2: *10.6 ↗		
3: *10.6 ↓	Total	0.0
4: 9.7 ↙		
5: *10.5 ↘		

1: 9.4 ↗	Series	48.0
2: *10.6 ↓		
3: 9.7 ↙	Total	48.0
4: *10.5 ↖		
5: *10.7 →		

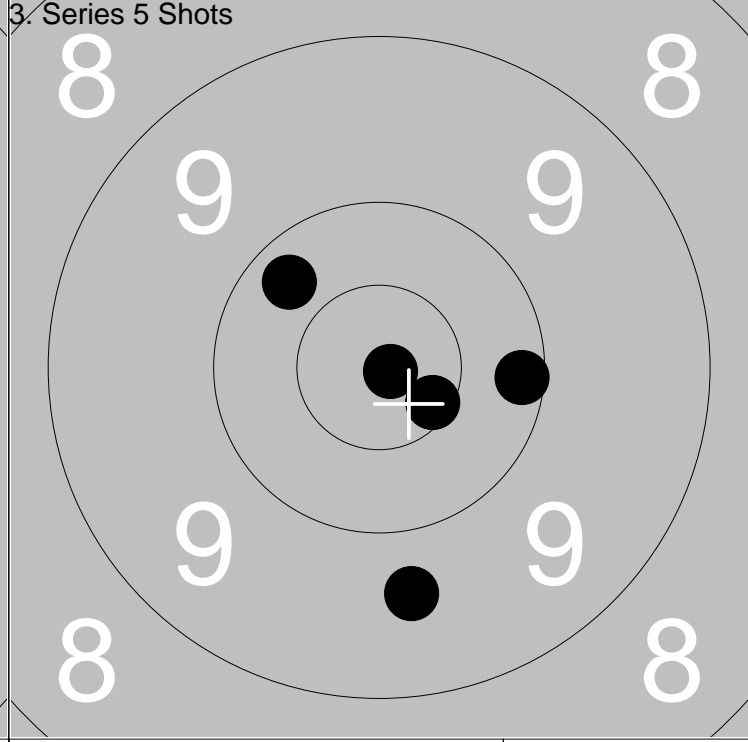
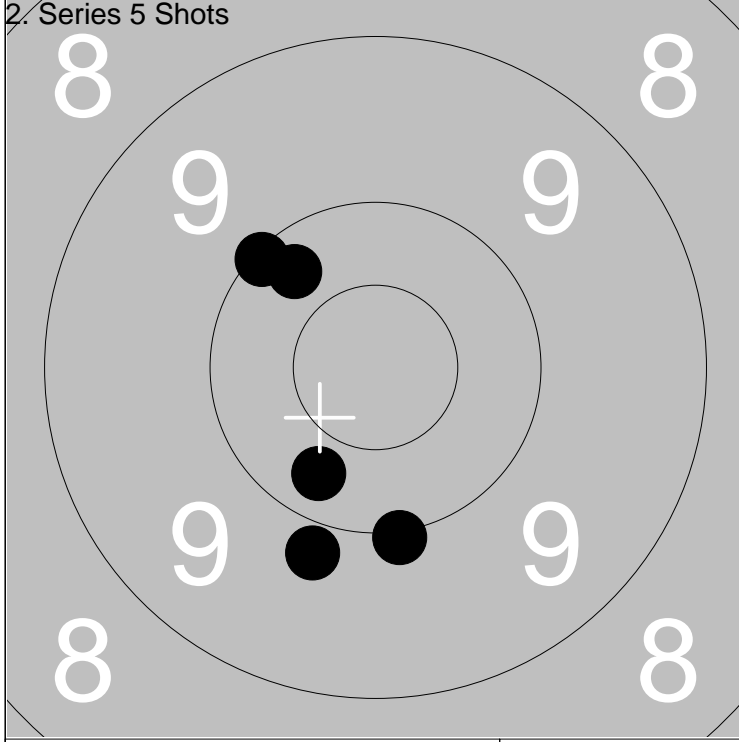

1: 10.1 ↖	Series	49.0
2: 10.2 ↖		
3: 10.3 ↓	Total	97.0
4: 10.0 ↓		
5: 9.8 ↓		

1: 9.6 ↓	Series	49.0
2: 10.3 ↖		
3: 10.1 →	Total	146.0
4: *10.6 ↘		
5: *10.9 ↘		

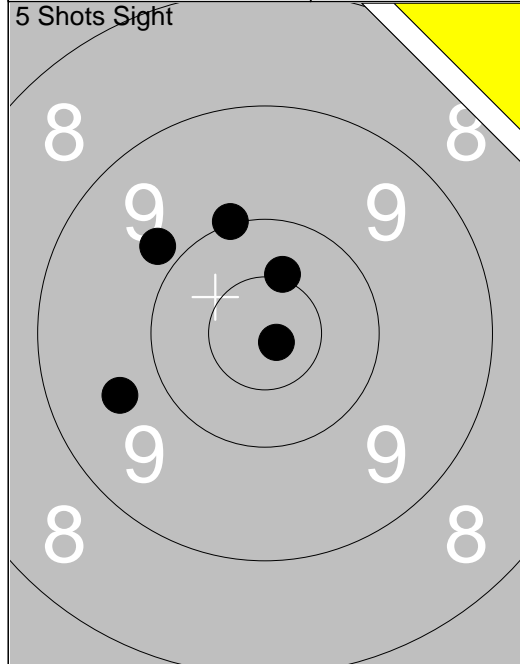

1:	9.8 ↖
2:	9.6 ↙
3:	*10.5 ↗
4:	*10.8 ↘
5:	10.0 ↗
Series 48.0	
Total 0.0	

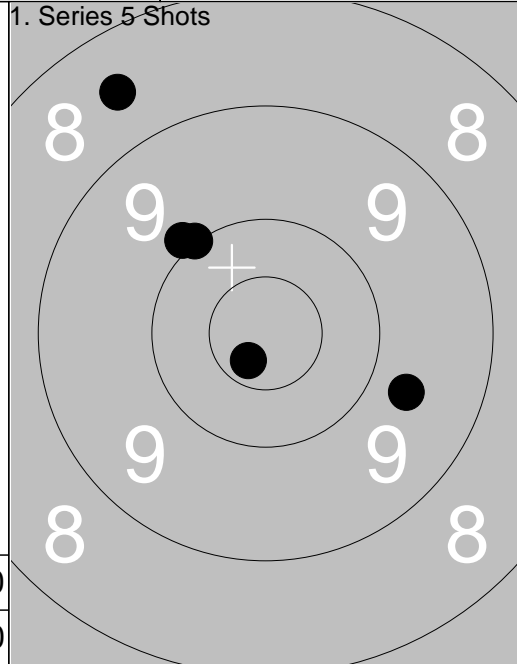

1:	*10.7 ↘
2:	9.9 ↗
3:	10.0 ↗
4:	8.5 ↗
5:	9.7 ↘
Series 46.0	
Total 46.0	

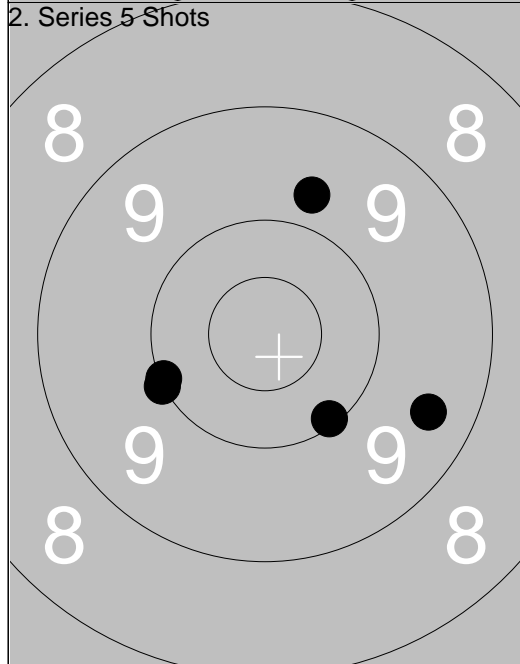

1:	9.7 ↗
2:	9.4 →
3:	10.1 ↘
4:	10.0 ↙
5:	10.0 ↙
Series 48.0	
Total 94.0	

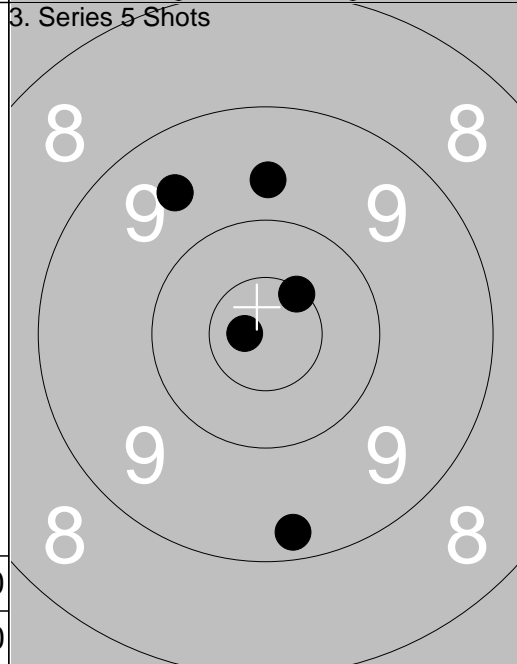

1:	9.6 ↖
2:	*10.5 ↗
3:	9.7 ↗
4:	*10.8 ↙
5:	9.3 ↓
Series 47.0	
Total 141.0	

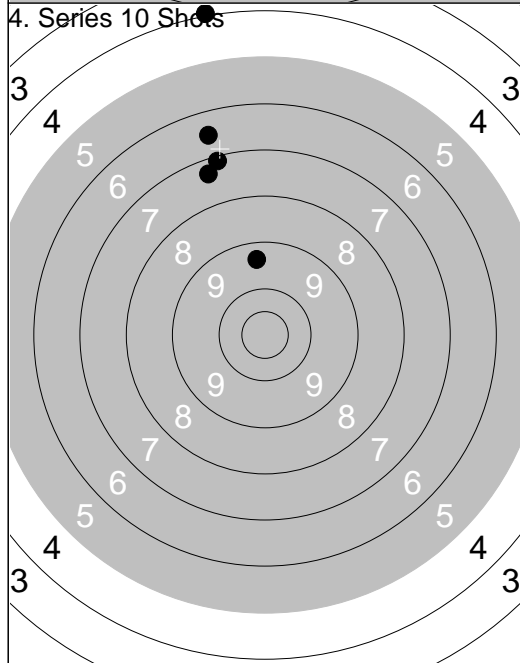

1:	9.4 ↗
2:	7.1 ↗
3:	7.3 ↗
4:	6.5 ↗
5:	4.0 ↗
Series 33.0	
Total 174.0	

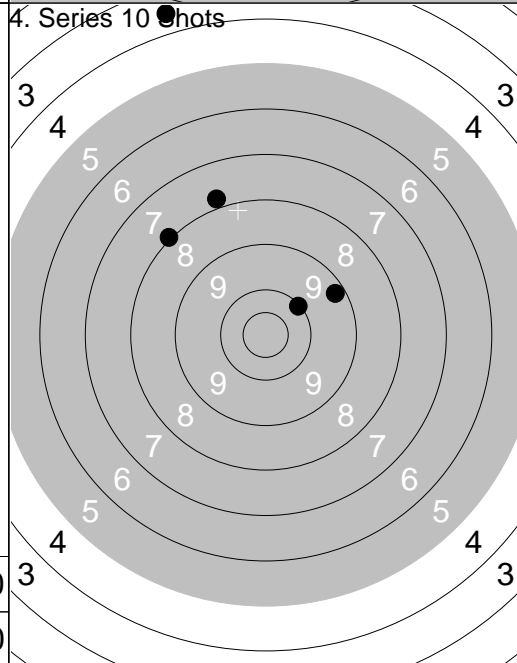

6:	3.6 ↗
7:	7.8 ↗
8:	8.0 ↖
9:	10.1 ↗
10:	9.2 ↗
Series 37.0	
Total 211.0	

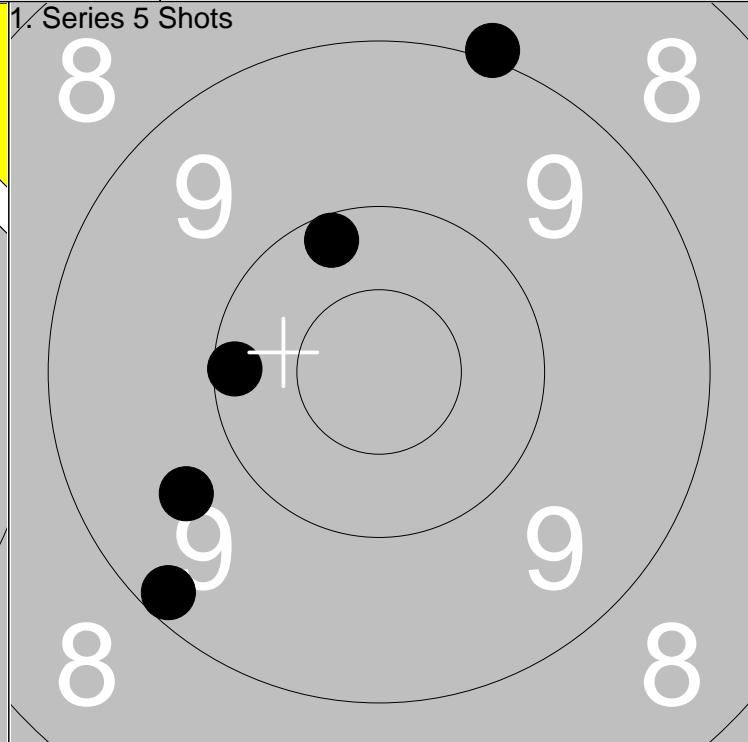
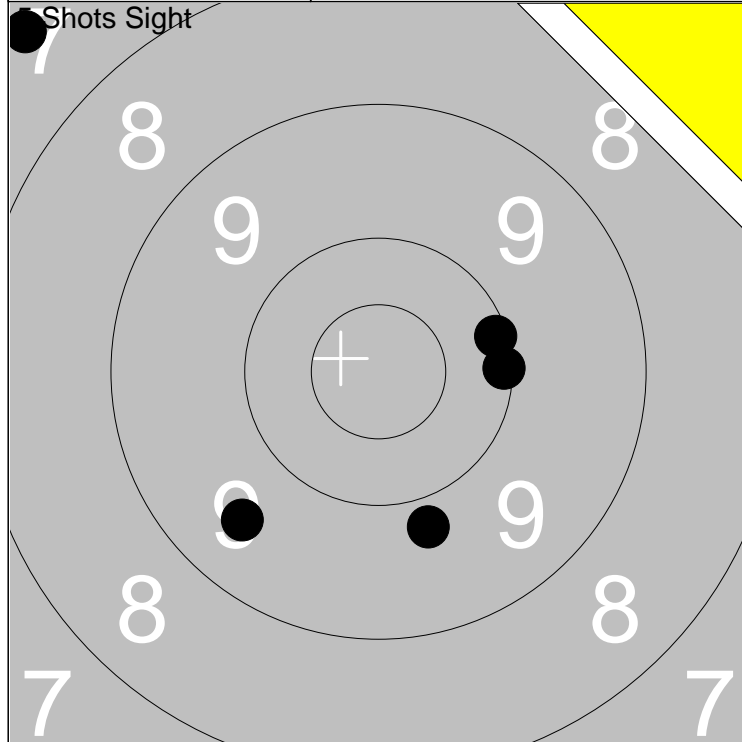

1: 7.4 ↗	Series 45.0
2: 10.1 →	
3: 9.8 ↓	Total 0.0
4: 10.1 →	
5: 9.5 ↘	

1: 10.2 ↖	Series 47.0
2: 9.0 ↗	
3: 10.1 ←	Total 47.0
4: 9.7 ↙	
5: 9.2 ↘	

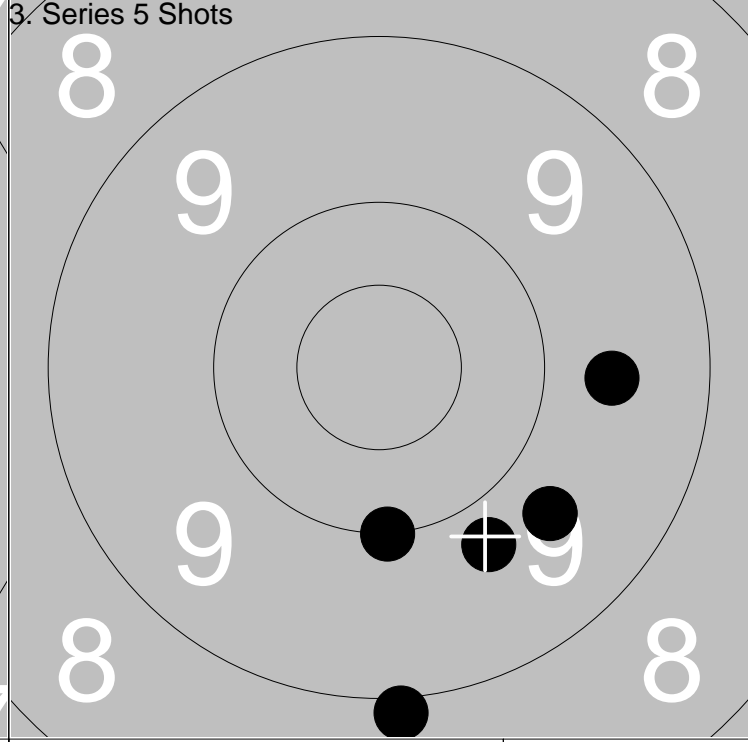
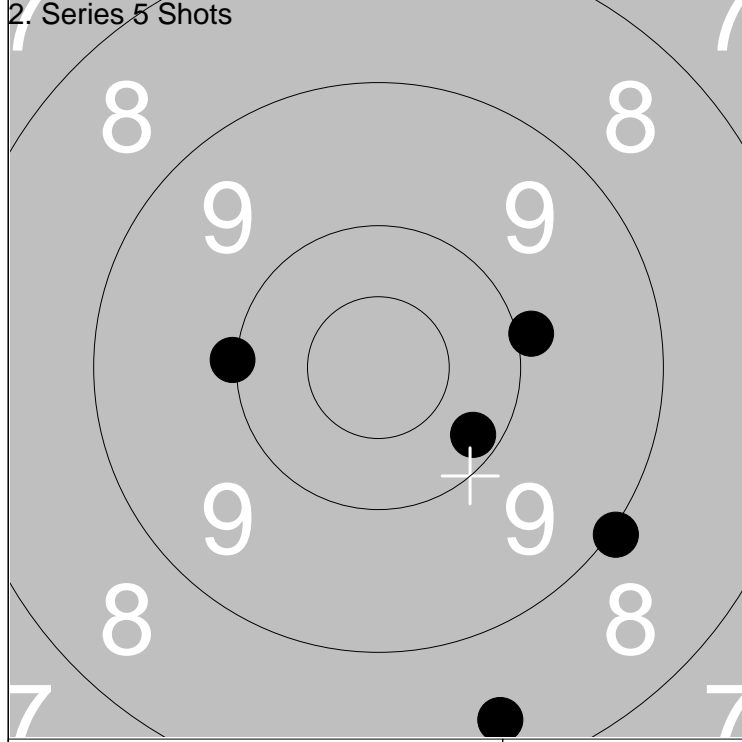

1: 10.0 ←	Series 46.0
2: 9.9 →	
3: 8.4 ↓	Total 93.0
4: 10.2 ↘	
5: 9.0 ↘	

1: 9.7 ↘	Series 45.0
2: 8.9 ↓	
3: 10.0 ↓	Total 138.0
4: 9.8 ↘	
5: 9.6 →	

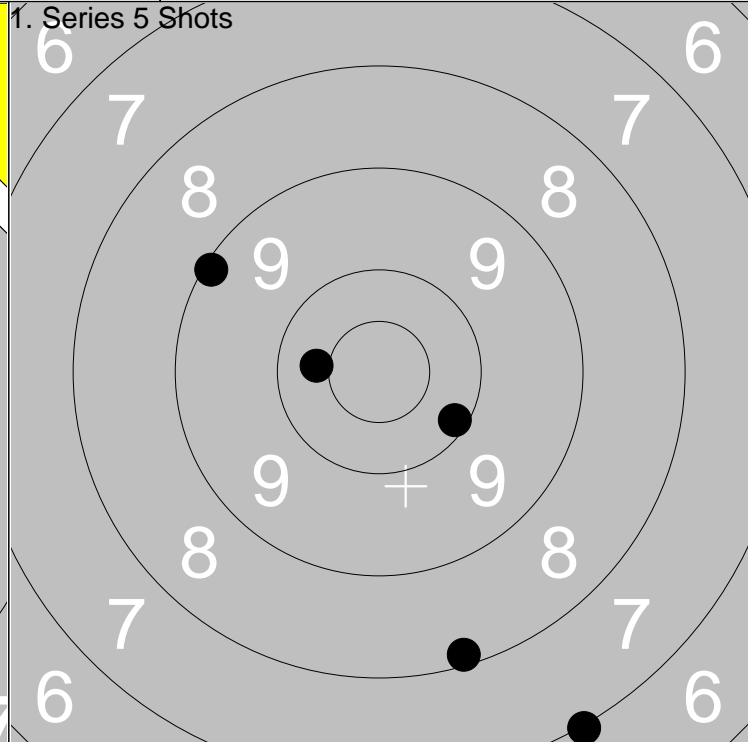
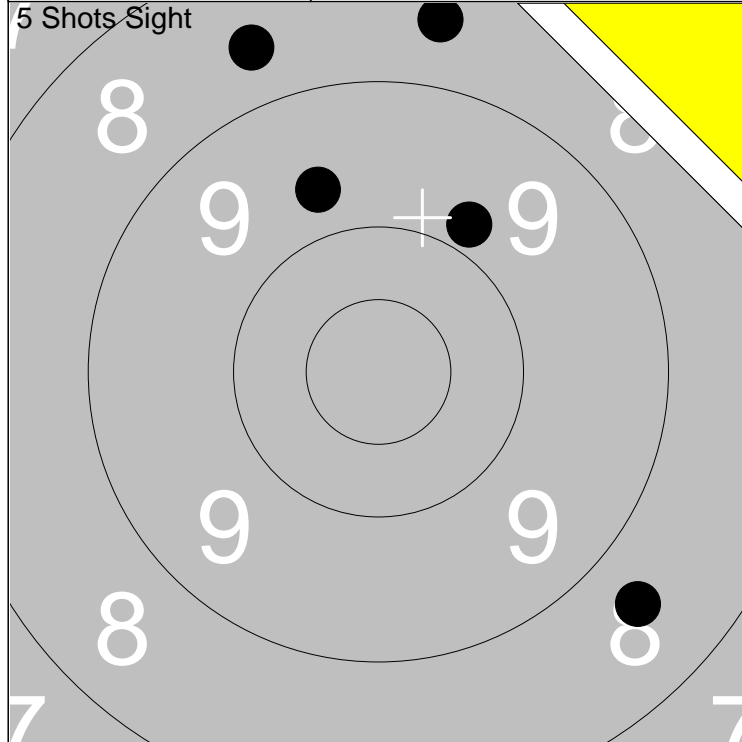

1: 8.6	↑
2: 8.6	↘
3: 9.7	↑
4: 9.8	↗
5: 8.6	↑

Series	42.0
Total	0.0

1: 8.1	↓
2: 9.1	↖
3: 10.1	↘
4: 7.0	↓
5: 10.4	←

Series	44.0
Total	44.0

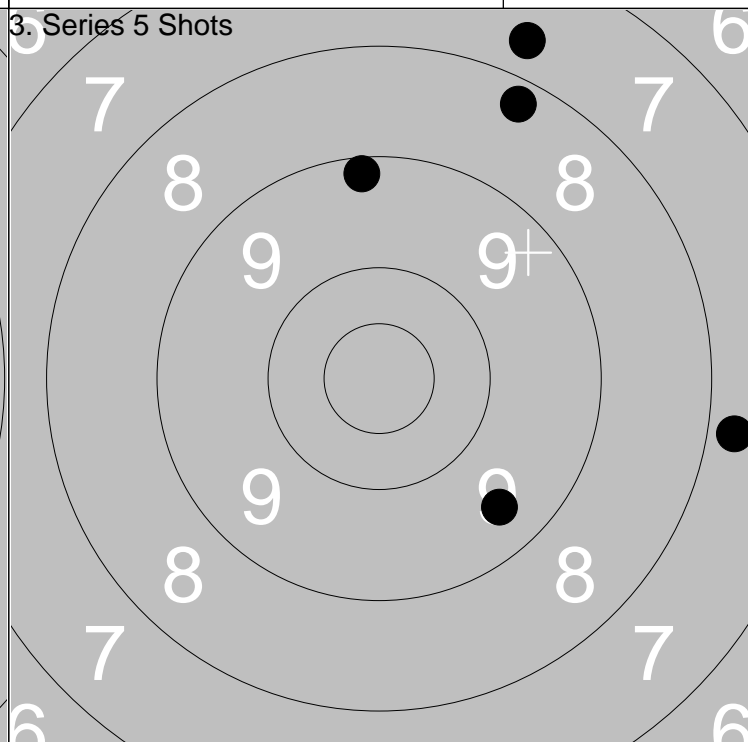
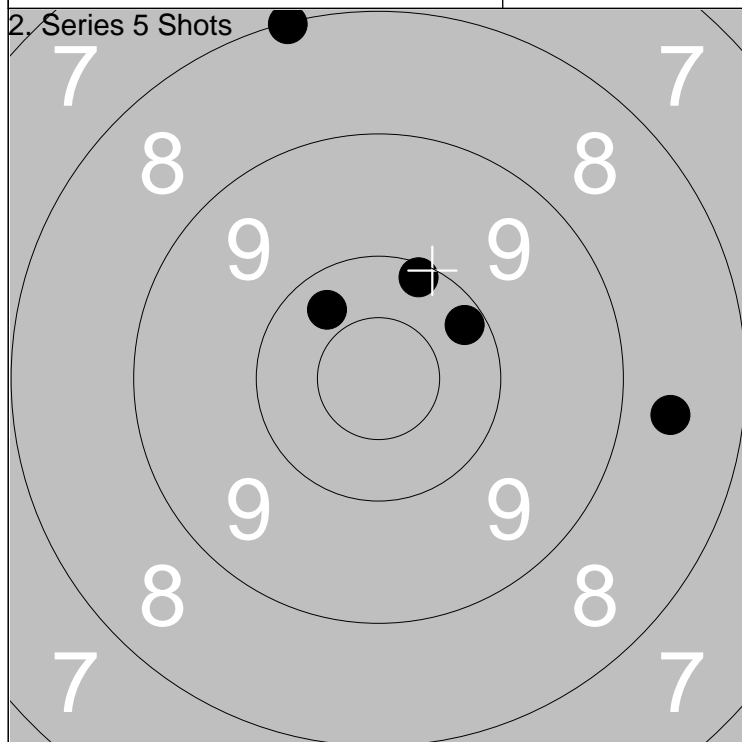

1: 8.0	↑
2: 10.2	↗
3: 10.1	↑
4: 10.3	↖
5: 8.6	→

Series	46.0
Total	90.0

1: 8.3	↗
2: 7.8	→
3: 7.7	↑
4: 9.2	↑
5: 9.4	↘

Series	40.0
Total	130.0

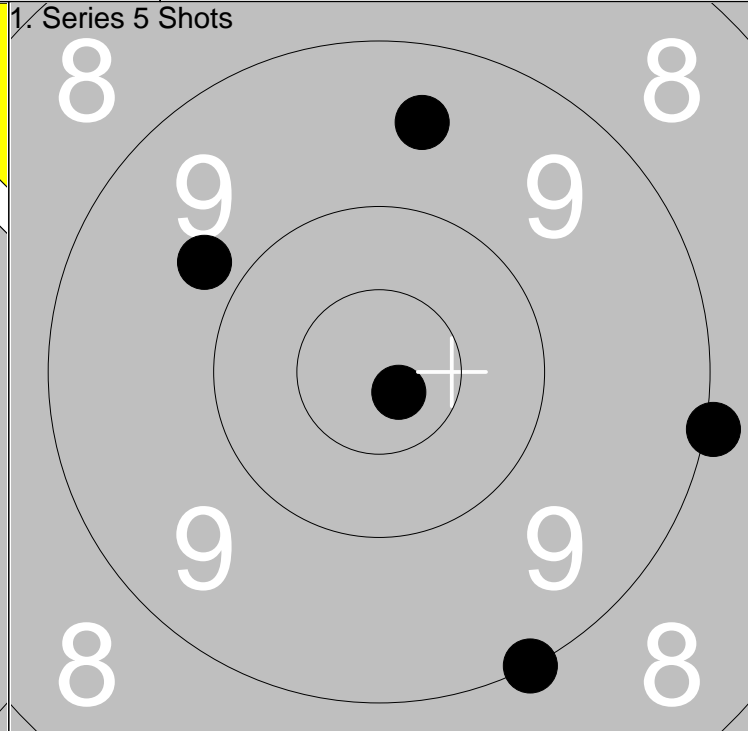
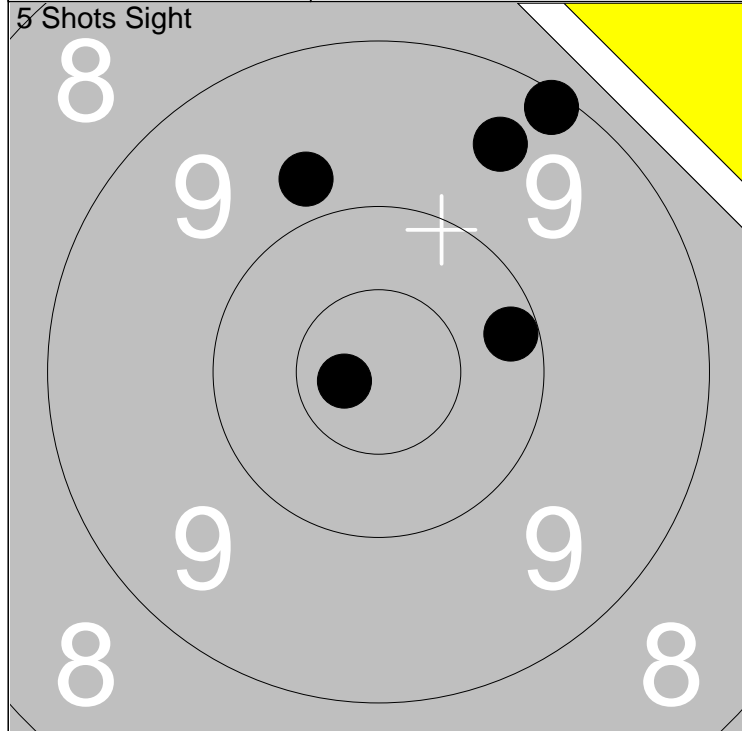

1: 9.8 ↖	Series	47.0
2: 9.1 ↗		
3: 9.5 ↗	Total	0.0
4: 10.2 →		
5: *10.8 ↙		

1: 9.8 ↗	Series	46.0
2: 9.5 ↑		
3: 9.0 ↘	Total	46.0
4: 9.0 →		
5: *10.8 ↘		

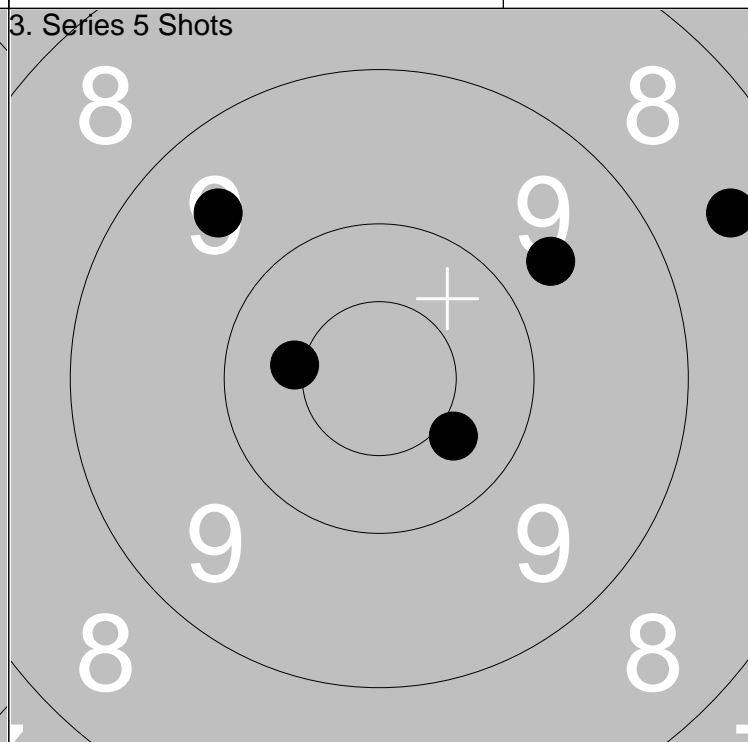
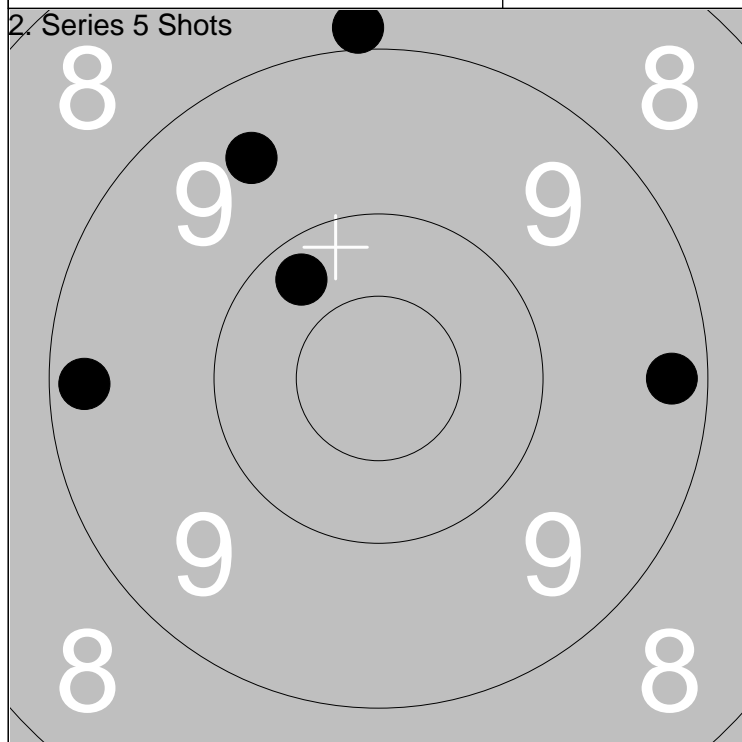

1: 9.2 ←	Series	45.0
2: 10.2 ↗		
3: 9.5 ↗	Total	91.0
4: 8.9 ↑		
5: 9.2 →		

1: *10.4 ↙	Series	46.0
2: 9.7 ↗		
3: 10.4 ↘	Total	137.0
4: 8.5 ↗		
5: 9.5 ↖		

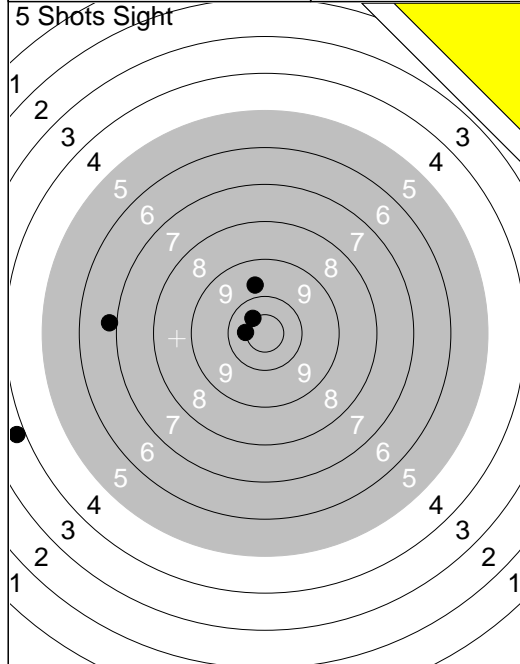

Series	38.0
Total	0.0

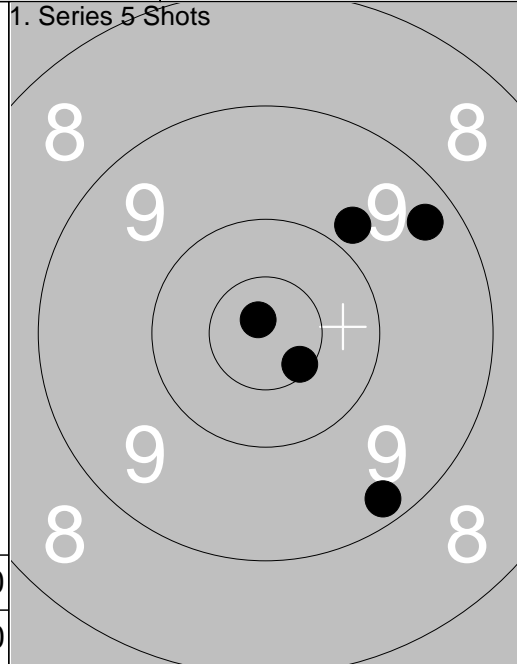

Series	47.0
Total	47.0

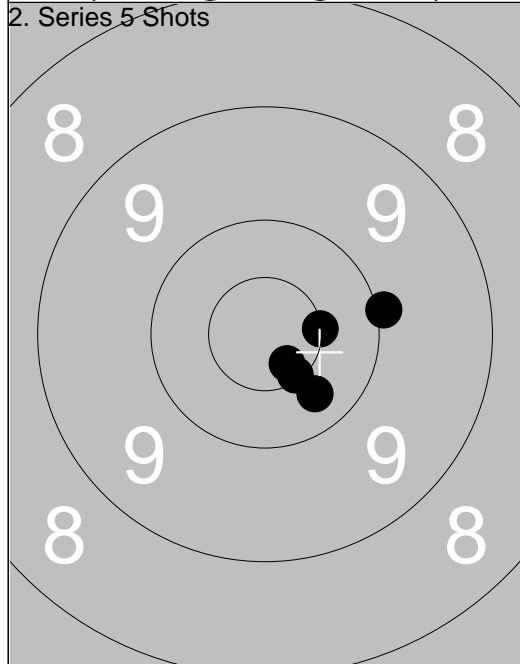

Series	50.0
Total	97.0

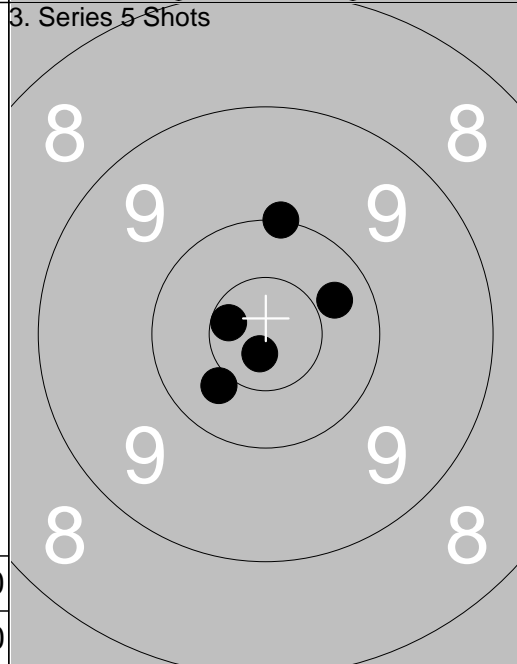

Series	50.0
Total	147.0

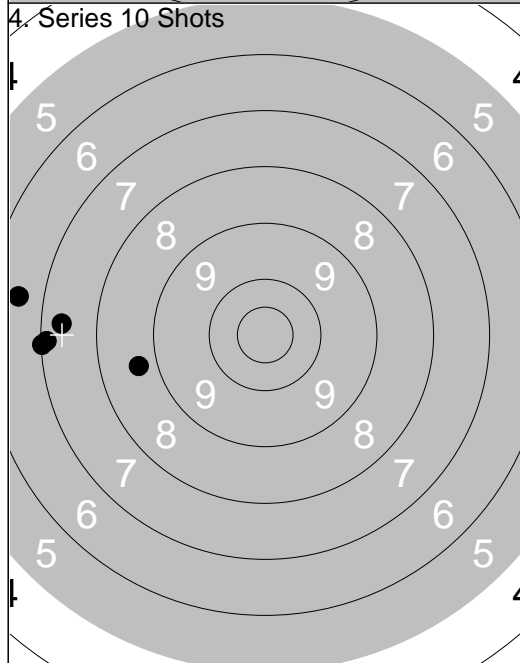

Series	35.0
Total	182.0

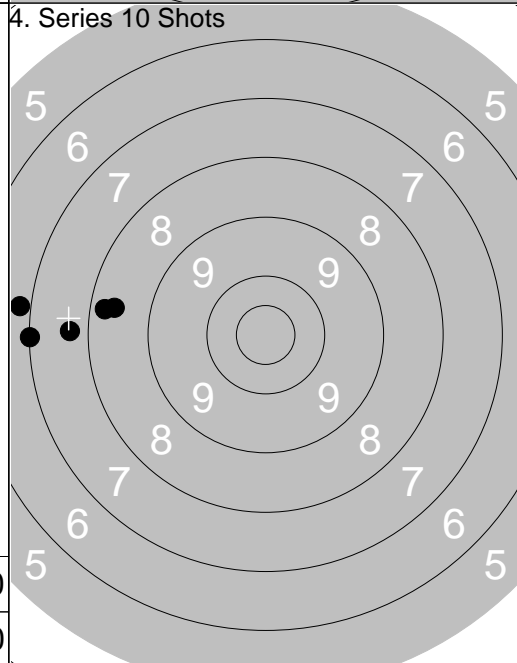

Series	36.0
Total	218.0

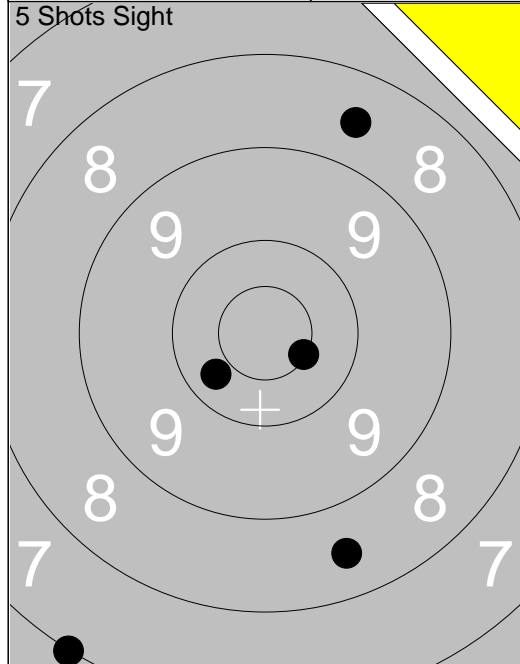

1: 7.0	↘
2: 8.6	↗
3: *10.5	↘
4: 8.5	↘
5: 10.3	↘
Series 43.0	
Total 0.0	

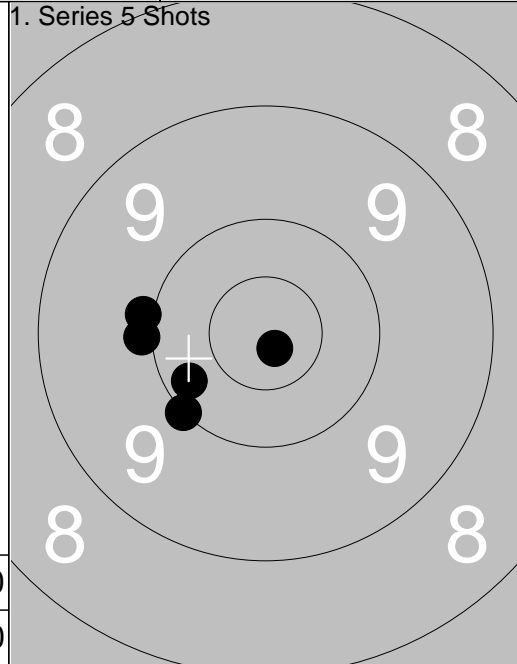

1: 9.9	←
2: *10.8	↘
3: 9.9	←
4: 10.0	↘
5: 10.2	↘
Series 48.0	
Total 48.0	

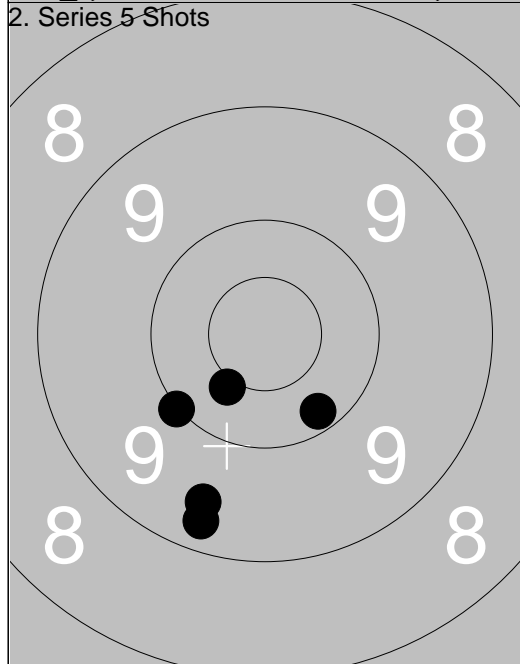

1: 9.5	↘
2: *10.4	↘
3: 10.2	↘
4: 9.3	↘
5: 10.0	↘
Series 48.0	
Total 96.0	

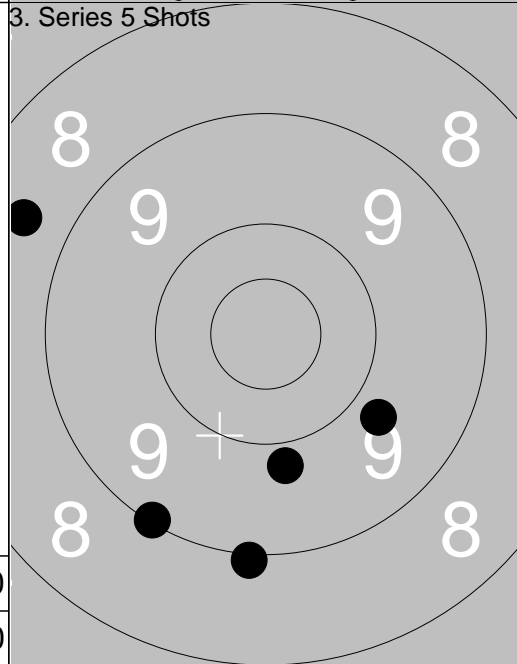

1: 8.6	↖
2: 9.0	↘
3: 9.8	↘
4: 9.1	↘
5: 9.8	↘
Series 44.0	
Total 140.0	

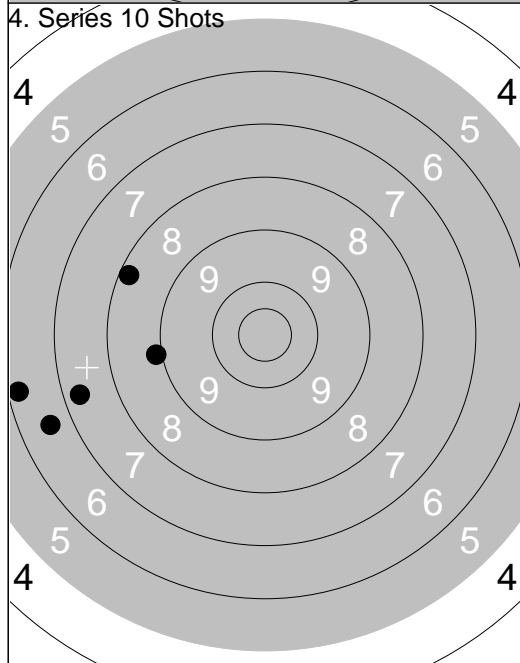

1: 8.9	←
2: 6.2	←
3: 7.3	←
4: 6.6	←
5: 8.2	↖
Series 35.0	
Total 175.0	

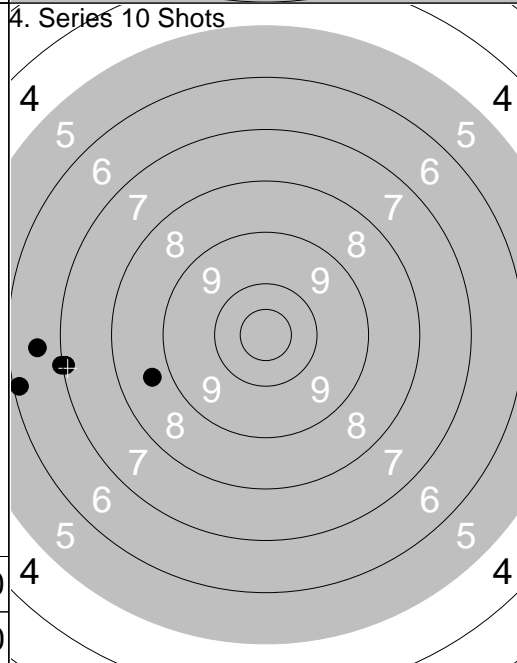

6: 8.7	←
7: 7.1	←
8: 6.1	←
9: 6.6	←
10: 7.0	←
Series 34.0	
Total 209.0	

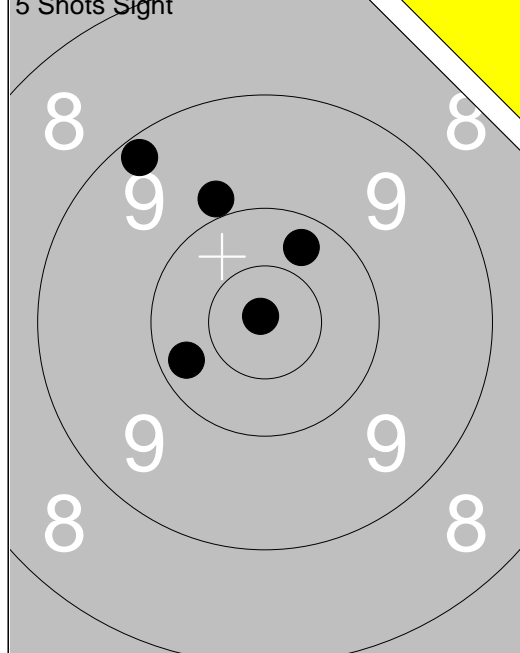

1:	9.9	↖
2:	10.3	↗
3:	10.2	↙
4:	9.2	↖
5:	*10.9	↙
Series		48.0
Total		0.0

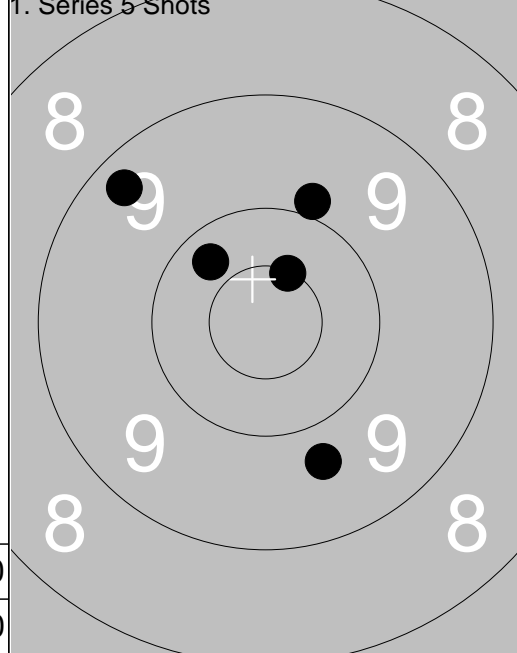

1:	*10.5	↗
2:	10.3	↖
3:	9.3	↖
4:	9.9	↗
5:	9.7	↘
Series		47.0
Total		47.0

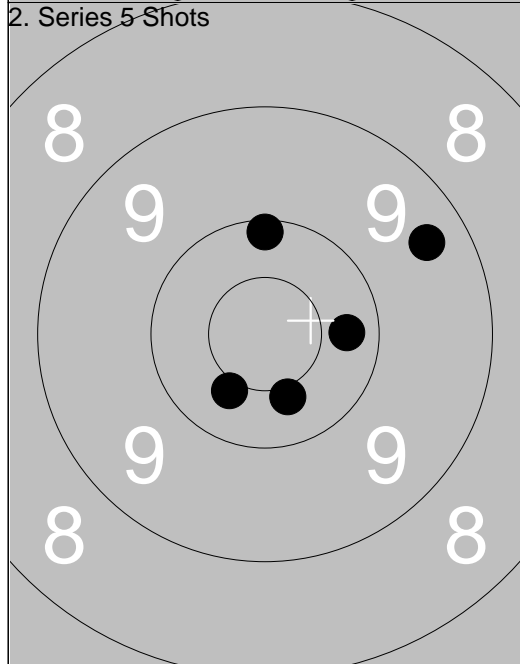

1:	9.4	↗
2:	10.1	↑
3:	10.3	→
4:	10.4	↘
5:	10.4	↙
Series		49.0
Total		96.0

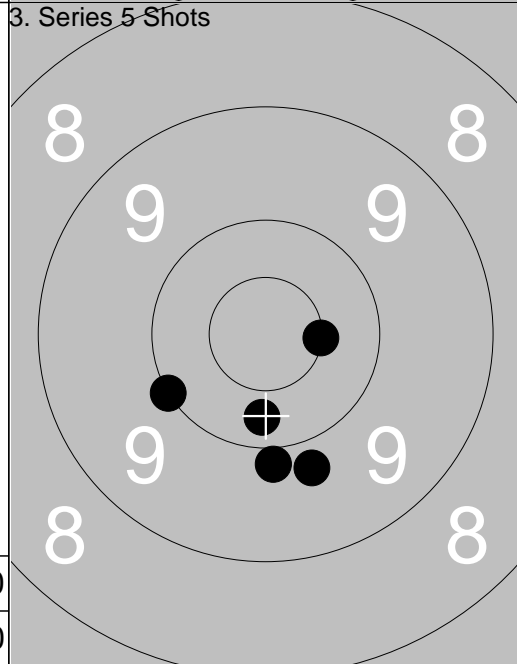

1:	*10.5	→
2:	9.9	↘
3:	10.0	↙
4:	9.8	↘
5:	10.3	↘
Series		48.0
Total		144.0

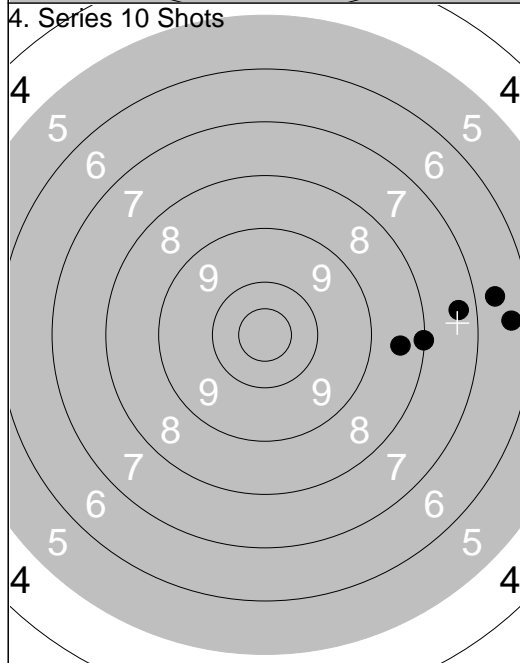

1:	6.4	→
2:	7.4	→
3:	6.7	→
4:	8.0	→
5:	8.5	→
Series		35.0
Total		179.0

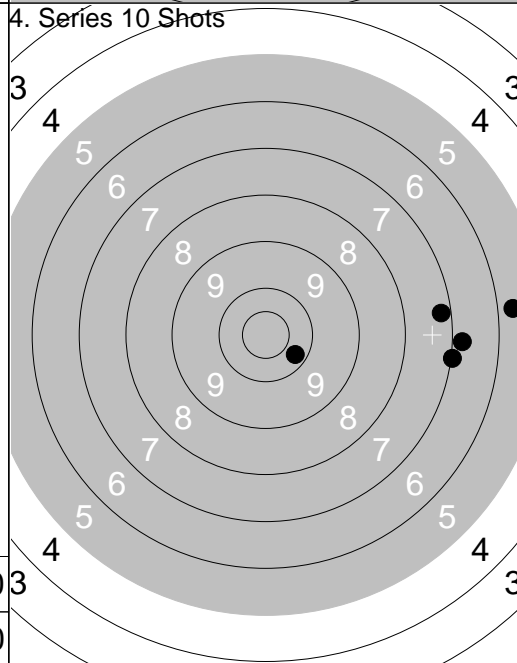

6:	7.2	→
7:	6.8	→
8:	5.7	→
9:	7.0	→
10:	10.3	↘
Series		35.0
Total		214.0

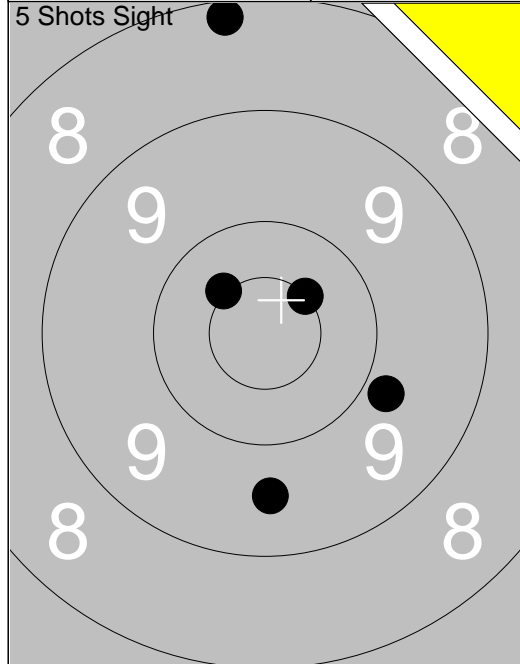

1:	9.8	→
2:	*10.5	↘
3:	*10.5	↗
4:	8.2	↑
5:	9.6	↓
Series		46.0
Total		0.0

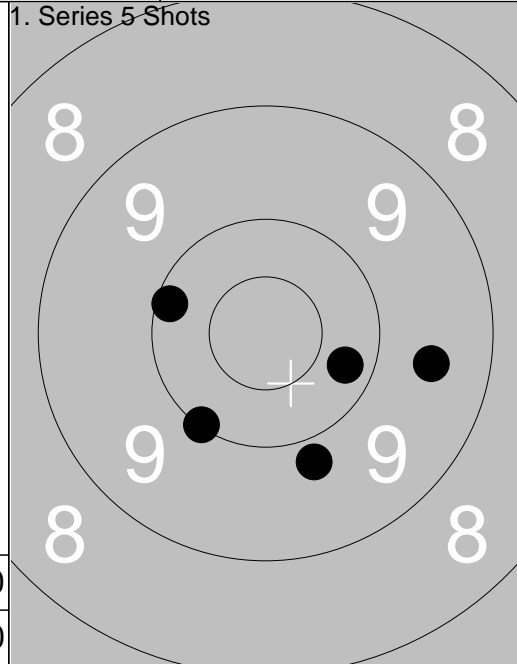

1:	10.1	↖
2:	10.3	→
3:	9.6	→
4:	9.8	↓
5:	10.0	↙
Series		48.0
Total		48.0

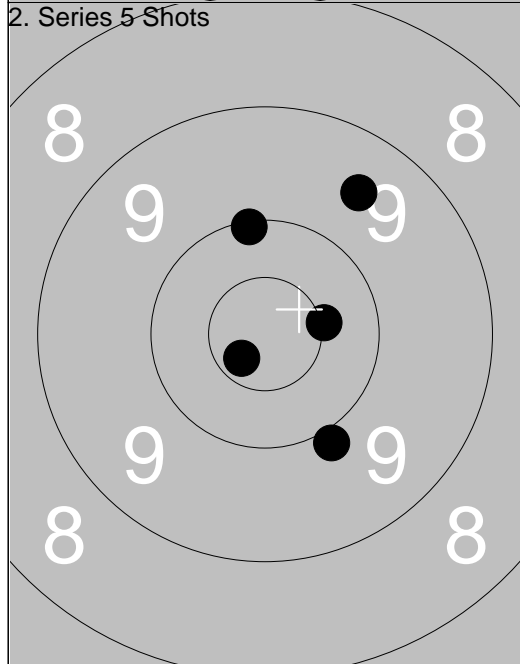

1:	10.1	↑
2:	9.5	↗
3:	*10.7	↙
4:	*10.5	→
5:	9.9	↓
Series		48.0
Total		96.0

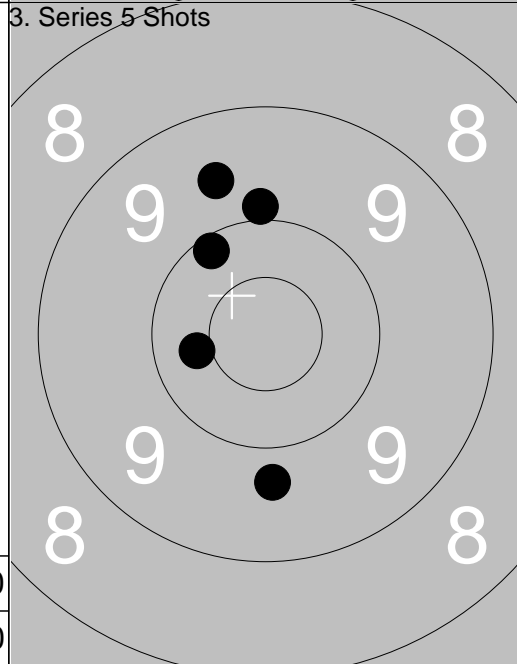

1:	9.6	↖
2:	9.9	↑
3:	10.4	↖
4:	9.7	↓
5:	10.1	↖
Series		47.0
Total		143.0

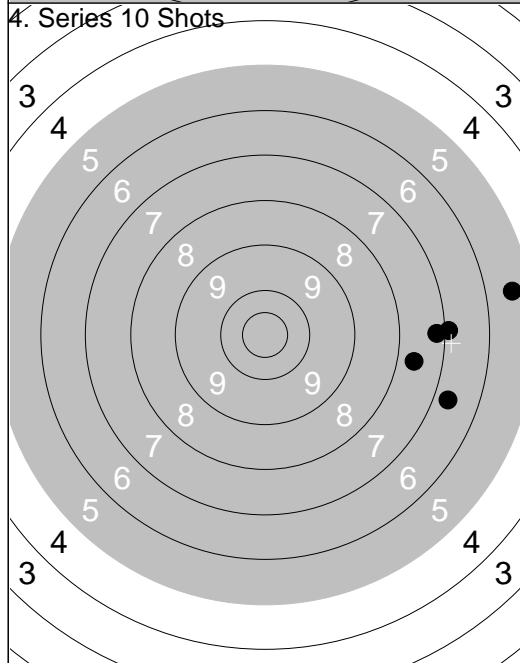

1:	5.4	→
2:	6.9	→
3:	7.2	→
4:	7.7	→
5:	6.7	→
Series		31.0
Total		174.0

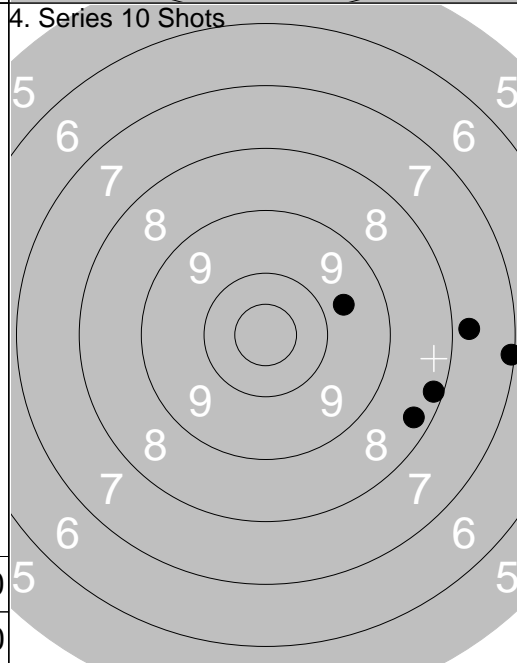

6:	7.8	→
7:	7.1	→
8:	8.3	↘
9:	8.2	→
10:	9.7	↗
Series		39.0
Total		213.0

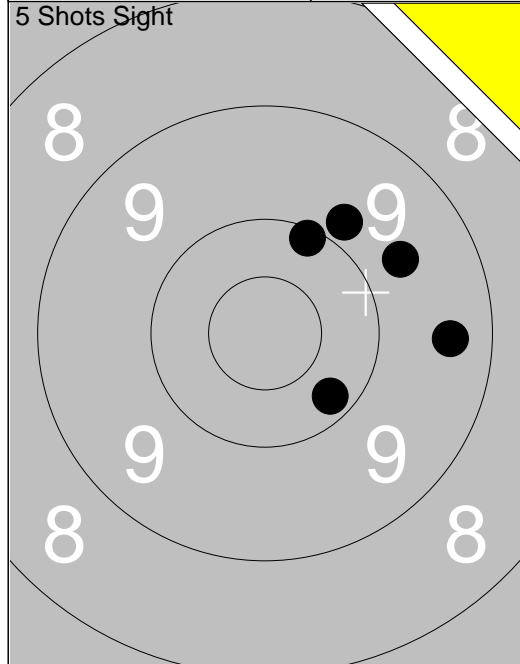

1:	10.2 ↘
2:	10.1 ↗
3:	9.7 ↗
4:	9.4 →
5:	9.8 ↗
Series 47.0	
Total 0.0	

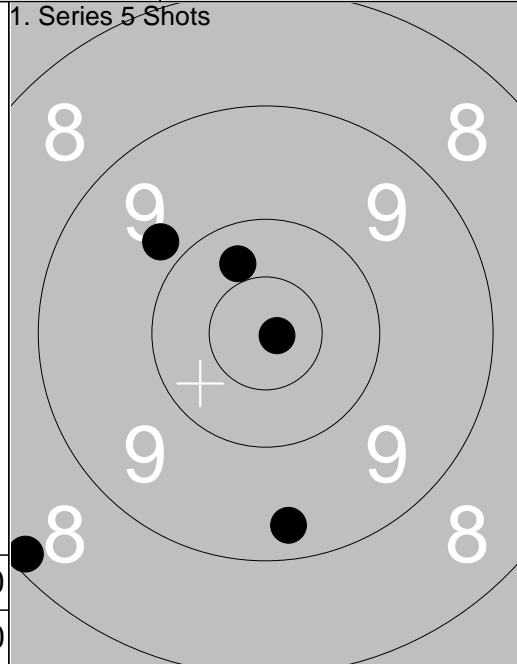

1:	9.8 ↖
2:	*10.9 →
3:	10.3 ↗
4:	9.3 ↓
5:	8.2 ↙
Series 46.0	
Total 46.0	

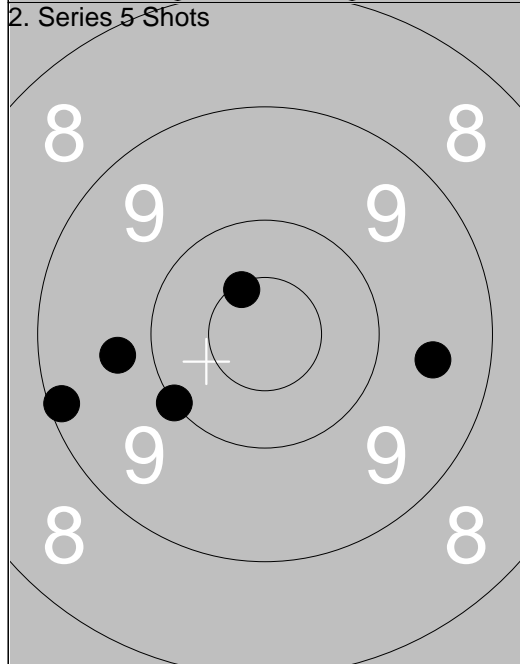

1:	9.5 →
2:	*10.5 ↖
3:	10.0 ↙
4:	9.7 ←
5:	9.1 ←
Series 47.0	
Total 93.0	

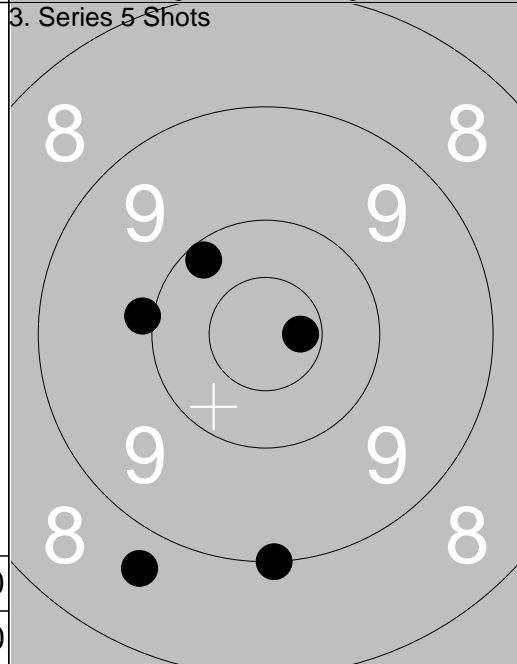

1:	9.9 ←
2:	9.0 ↓
3:	10.2 ↖
4:	8.7 ↓
5:	*10.7 →
Series 46.0	
Total 139.0	

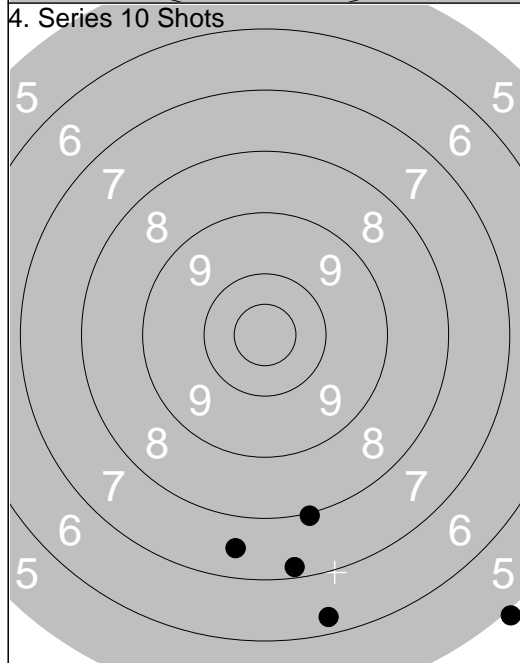

1:	8.0 ↓
2:	7.2 ↓
3:	4.9 ↘
4:	6.3 ↓
5:	7.5 ↓
Series 32.0	
Total 171.0	

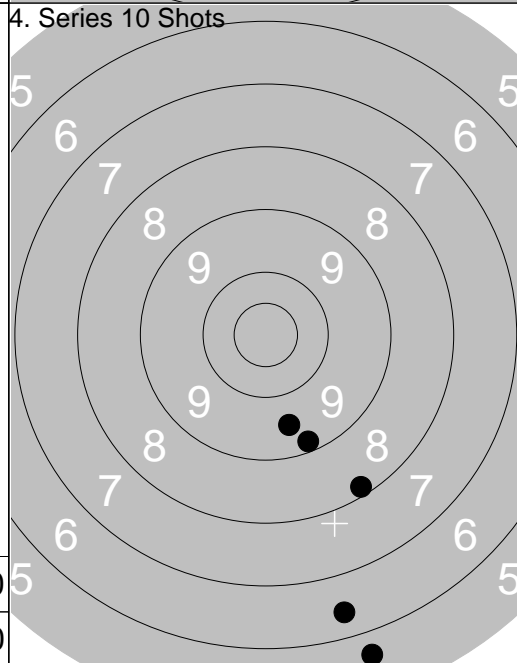

6:	8.2 ↓
7:	6.4 ↓
8:	9.2 ↓
9:	5.7 ↓
10:	9.5 ↓
Series 37.0	
Total 208.0	

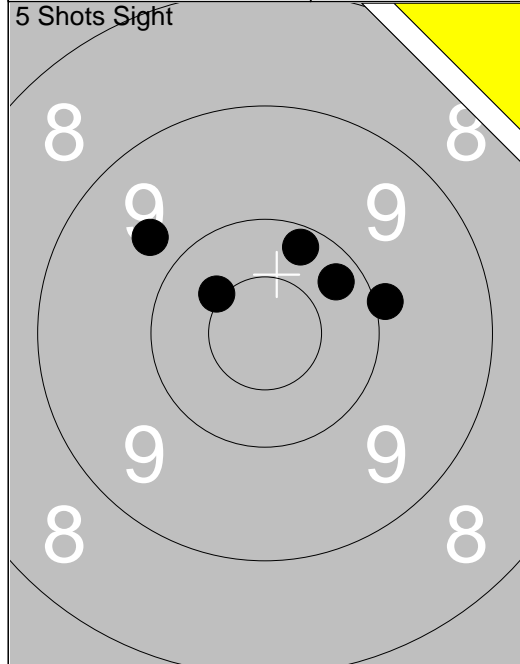

1: 9.9	→
2: *10.4	↖
3: 10.2	↗
4: 10.2	↑
5: 9.7	↖
Series 48.0	
Total 0.0	

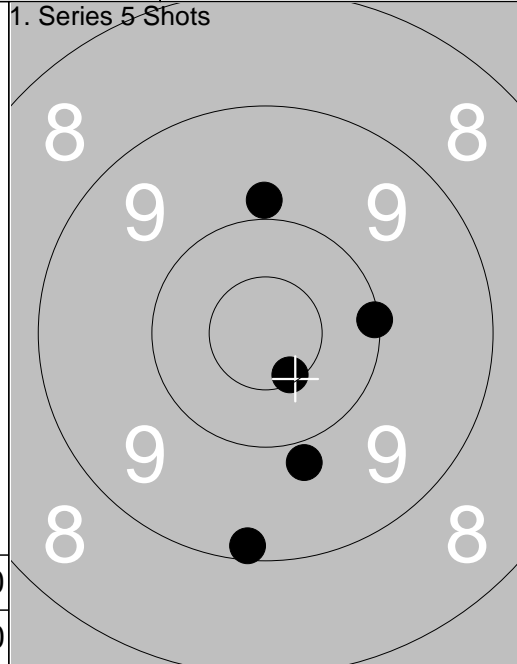

1: 9.9	↑
2: 10.1	→
3: *10.6	↘
4: 9.8	↓
5: 9.2	↓
Series 47.0	
Total 47.0	

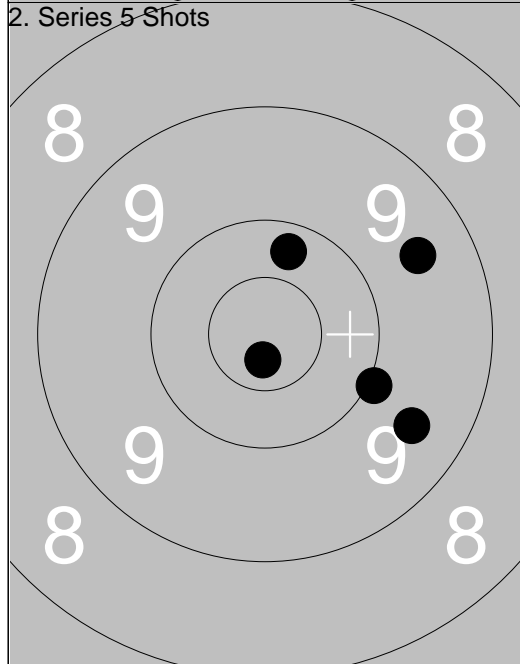

1: 9.5	↗
2: *10.7	↓
3: 10.3	↑
4: 9.5	↘
5: 10.0	↘
Series 48.0	
Total 95.0	

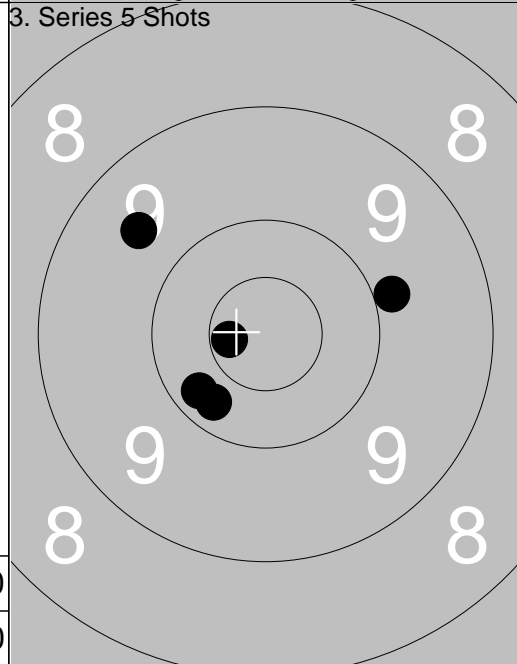

1: 9.6	↖
2: 10.2	↘
3: 10.2	↘
4: 9.9	→
5: *10.7	↖
Series 48.0	
Total 143.0	

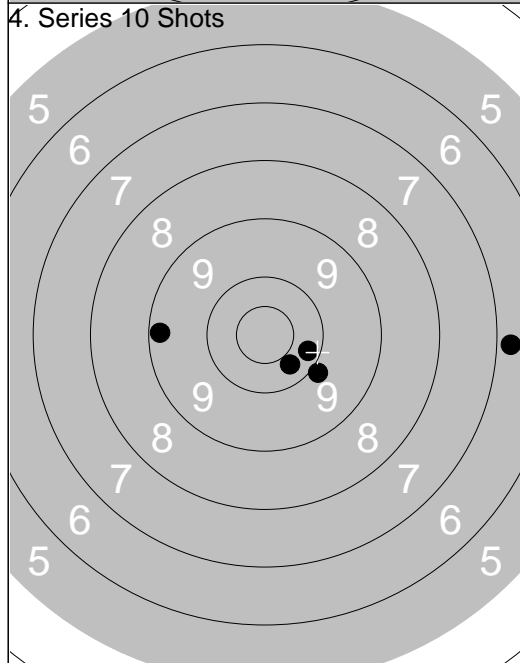

1: 9.2	←
2: 9.9	↘
3: 10.2	→
4: 10.3	↘
5: 6.8	→
Series 44.0	
Total 187.0	

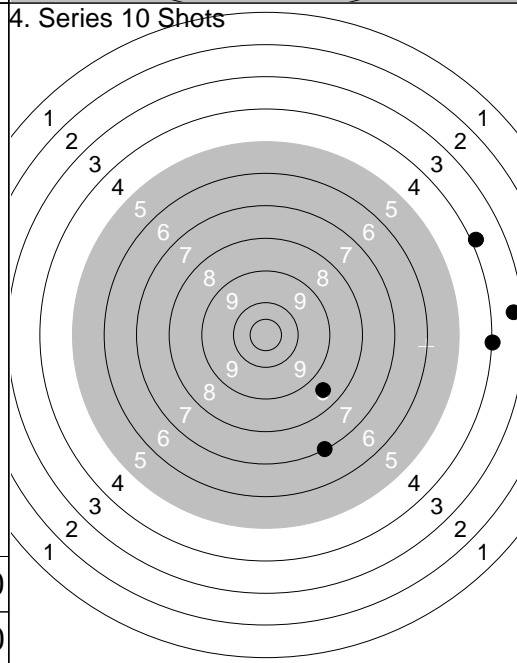

6: 8.6	↘
7: 7.1	↘
8: 4.0	→
9: 3.9	→
10: 3.3	→
Series 25.0	
Total 212.0	

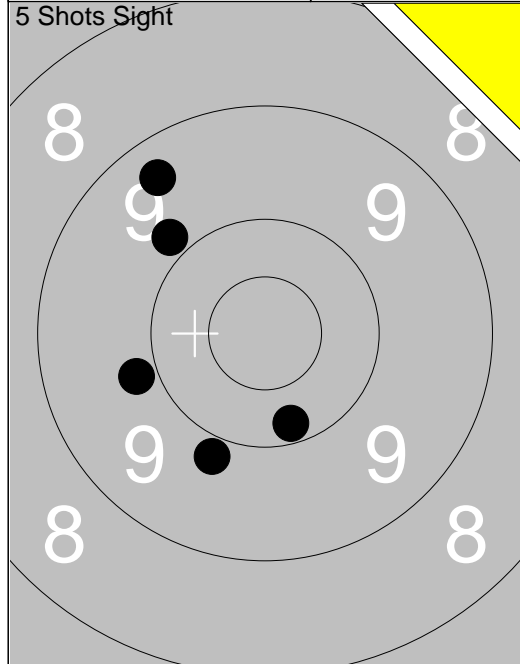

1:	9.8	↖
2:	9.4	↖
3:	10.2	↓
4:	9.8	←
5:	9.9	↓
Series		46.0
Total		0.0

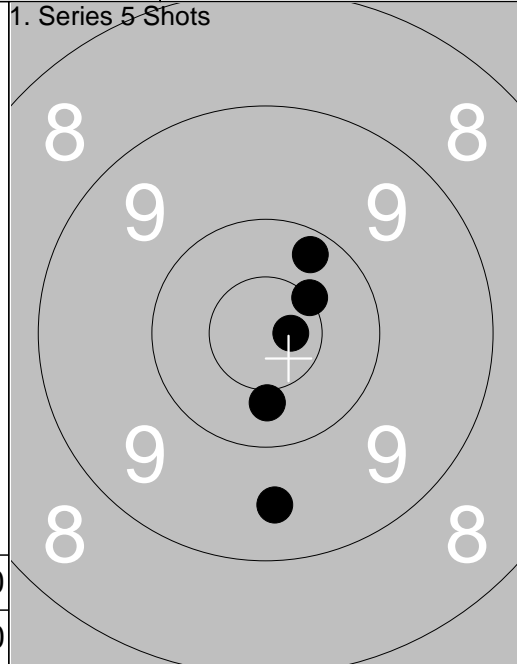

1:	9.5	↓
2:	*10.7	→
3:	10.2	↗
4:	*10.5	↗
5:	10.4	↓
Series		49.0
Total		49.0

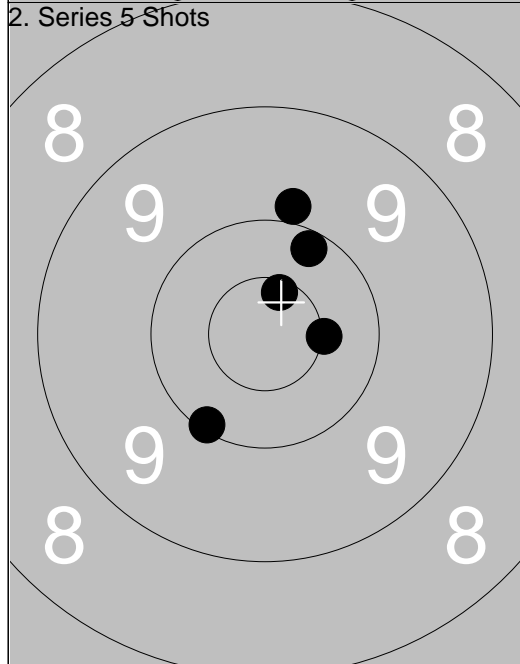

1:	10.2	↗
2:	*10.6	↗
3:	10.1	↘
4:	9.9	↑
5:	*10.5	→
Series		49.0
Total		98.0

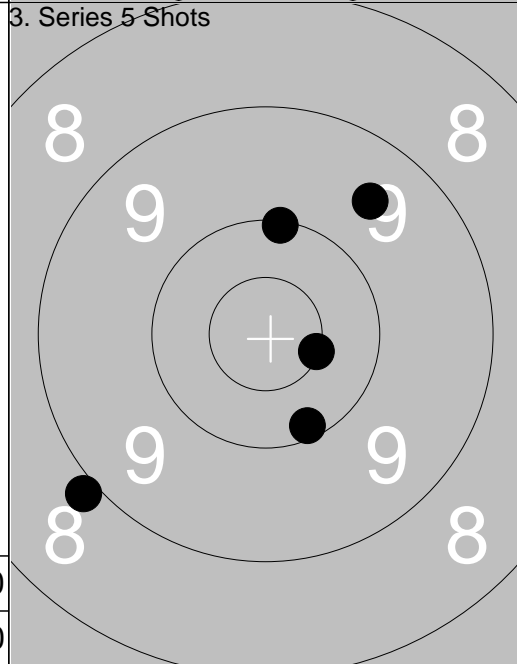

1:	10.1	↘
2:	10.1	↑
3:	8.9	↙
4:	9.5	↗
5:	*10.5	→
Series		47.0
Total		145.0

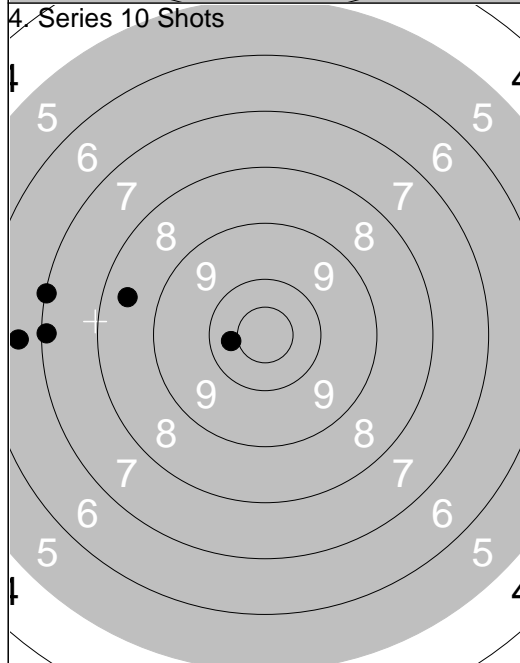

1:	10.4	←
2:	7.1	←
3:	8.5	←
4:	6.6	←
5:	7.1	←
Series		38.0
Total		183.0

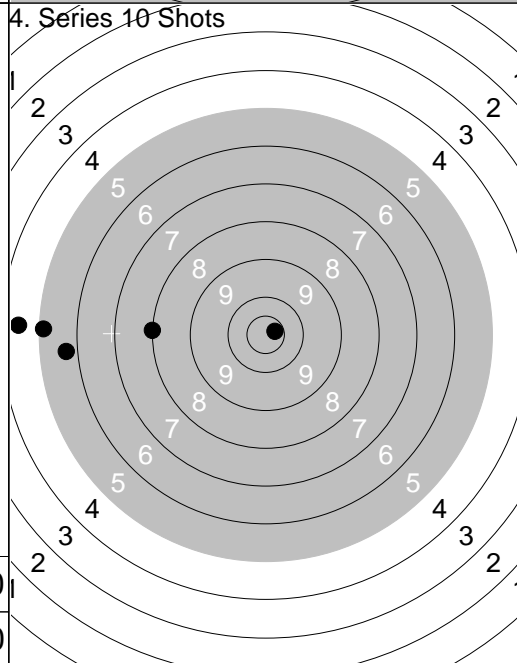

6:	4.5	←
7:	8.0	←
8:	5.2	←
9:	5.7	←
10:	*10.7	→
Series		32.0
Total		215.0

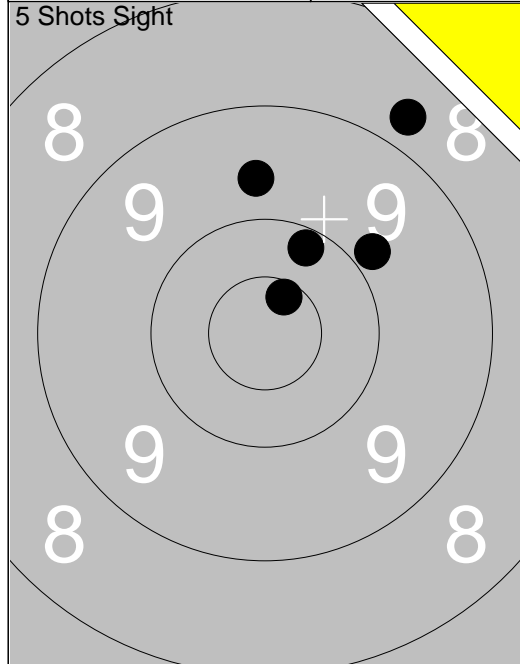

1:	8.8 ↗
2:	9.7 ↑
3:	10.2 ↗
4:	9.8 ↗
5:	*10.6 ↗
Series	46.0
Total	0.0

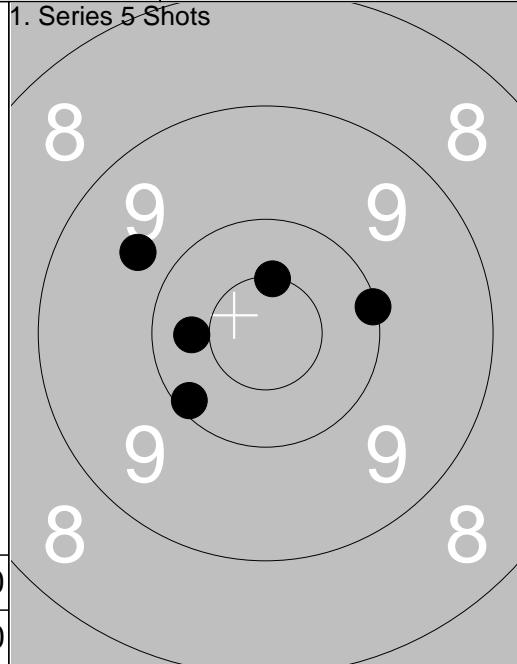

1:	9.7 ↖
2:	10.1 →
3:	10.1 ↙
4:	*10.5 ↑
5:	10.3 ←
Series	49.0
Total	49.0

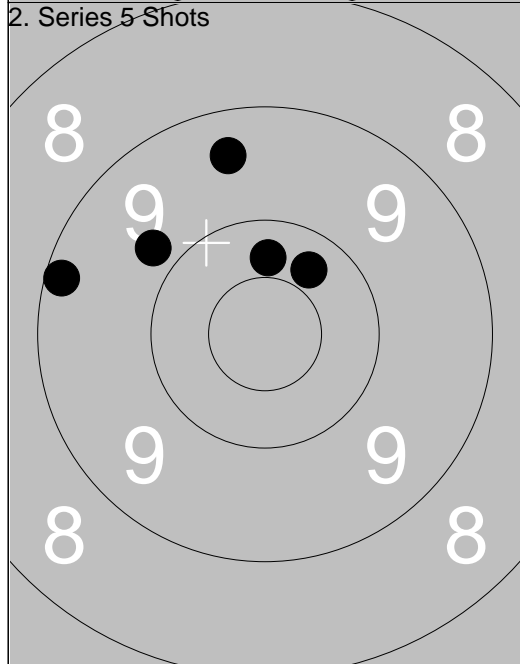

1:	9.2 ←
2:	10.3 ↑
3:	9.4 ↑
4:	9.8 ↖
5:	10.3 ↗
Series	47.0
Total	96.0

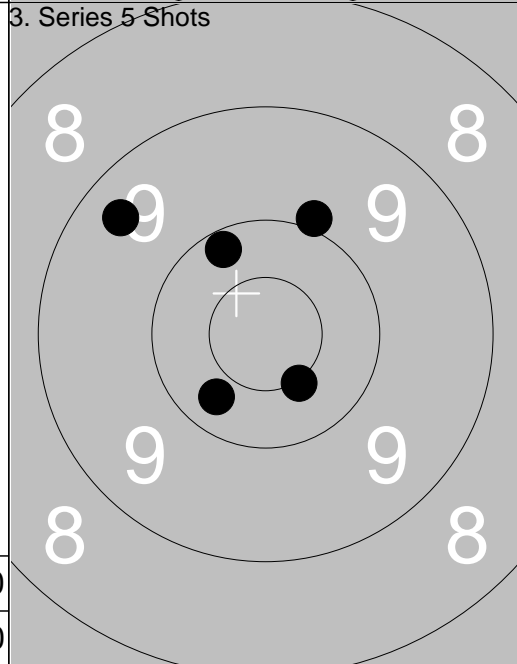

1:	*10.5 ↘
2:	10.3 ↙
3:	9.4 ↖
4:	10.2 ↗
5:	9.9 ↑
Series	48.0
Total	144.0

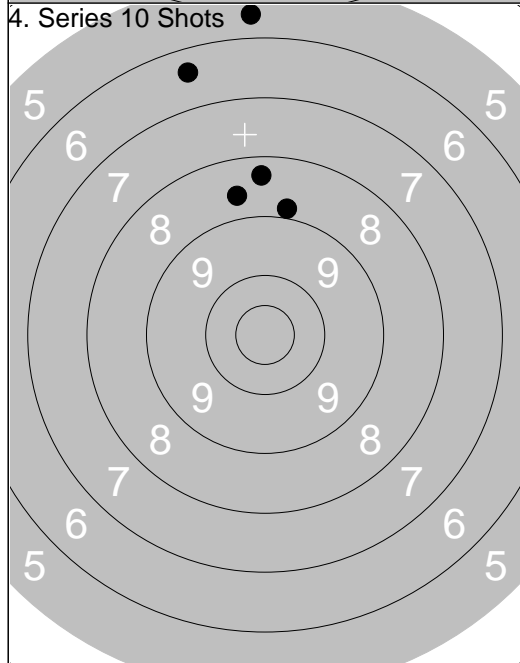

1:	8.9 ↑
2:	8.6 ↑
3:	8.3 ↑
4:	5.6 ↑
5:	6.4 ↑
Series	35.0
Total	179.0

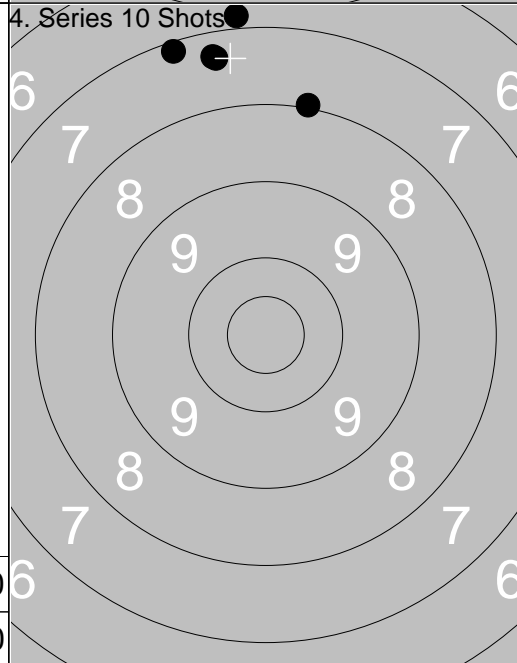

6:	7.1 ↑
7:	8.0 ↑
8:	7.3 ↑
9:	7.4 ↑
10:	6.9 ↑
Series	35.0
Total	214.0

5 Shots Sight

1:	9.5	↗
2:	*10.6	↙
3:	10.2	↖
4:	10.0	←
5:	9.3	↗
Series		48.0
Total		0.0

1:	10.2	↖
2:	9.9	↓
3:	10.2	↗
4:	10.4	→
5:	9.6	↗
Series		48.0
Total		48.0

1. Series 5 Shots

Series		48.0
Total		48.0

Series		48.0
Total		48.0

2. Series 5 Shots

1:	9.9	↓
2:	*10.6	←
3:	9.7	↖
4:	10.3	→
5:	9.2	←
Series		47.0
Total		95.0

1:	10.1	→
2:	10.3	↘
3:	10.2	→
4:	10.4	↗
5:	10.0	↘
Series		50.0
Total		145.0

3. Series 5 Shots

Series		50.0
Total		145.0

Series		50.0
Total		145.0

4. Series 5 Shots

1:	8.8	↗
2:	6.6	↗
3:	8.9	↗
4:	7.9	↗
5:	7.4	↗
Series		36.0
Total		181.0

6:	6.0	↗
7:	6.9	↗
8:	7.0	↗
9:	8.3	↗
10:	6.5	↖
Series		33.0
Total		214.0

4. Series 10 Shots

Series		33.0
Total		214.0

Series		33.0
Total		214.0

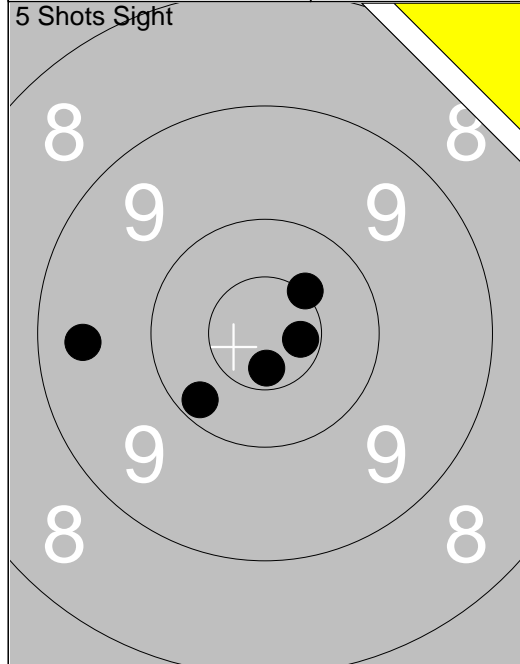

1: *10.7	↓
2: *10.5	↗
3: 9.4	←
4: 10.2	↙
5: *10.7	→
Series 49.0	
Total 0.0	

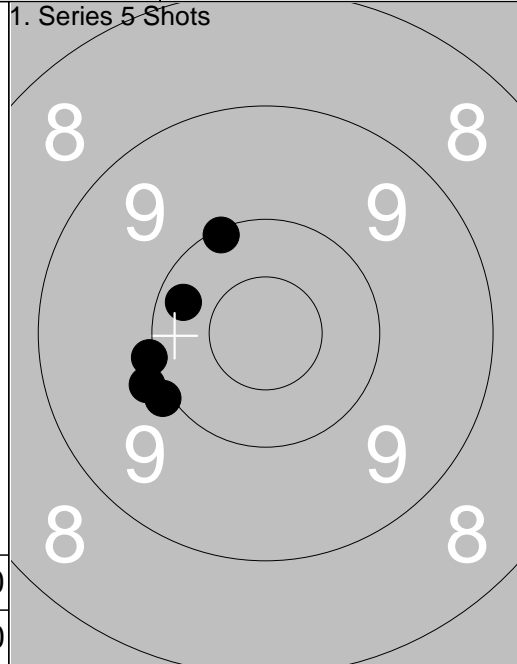

1: 10.0	←
2: 10.2	↖
3: 10.1	↗
4: 10.0	↙
5: 9.9	←
Series 49.0	
Total 49.0	

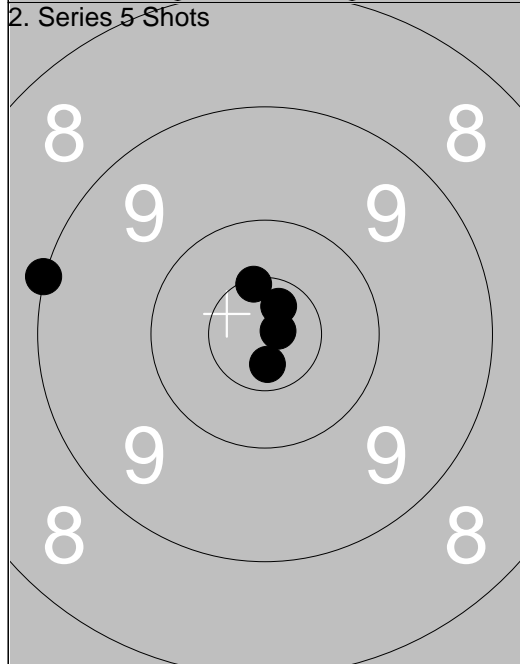

1: *10.7	↗
2: *10.8	→
3: 9.0	←
4: *10.5	↗
5: *10.7	↓
Series 49.0	
Total 98.0	

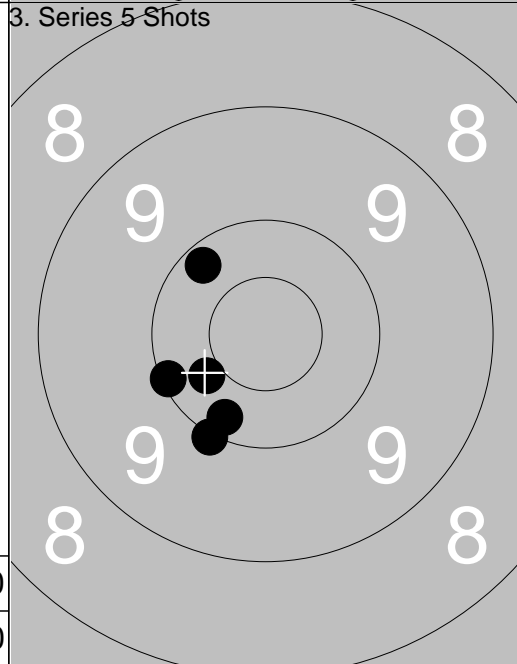

1: 10.0	↙
2: 10.4	↙
3: 10.2	↖
4: 10.1	←
5: 10.2	↙
Series 50.0	
Total 148.0	

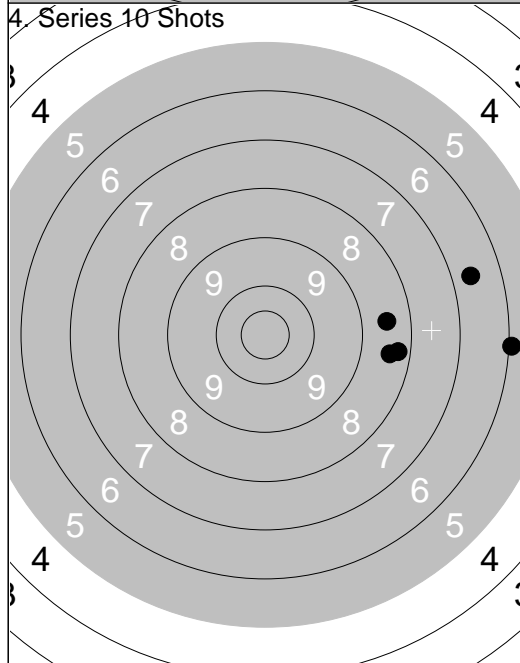

1: 8.5	→
2: 6.0	→
3: 6.7	→
4: 8.3	→
5: 8.4	→
Series 36.0	
Total 184.0	

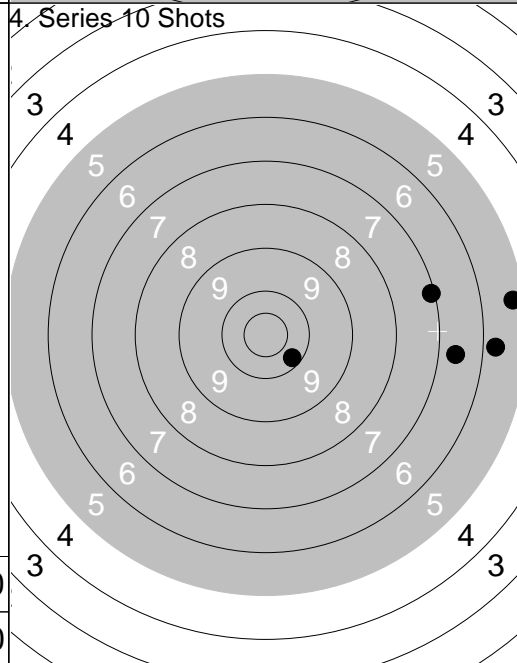

6: 6.6	→
7: 5.7	→
8: 5.3	→
9: 10.2	↙
10: 7.1	→
Series 33.0	
Total 217.0	

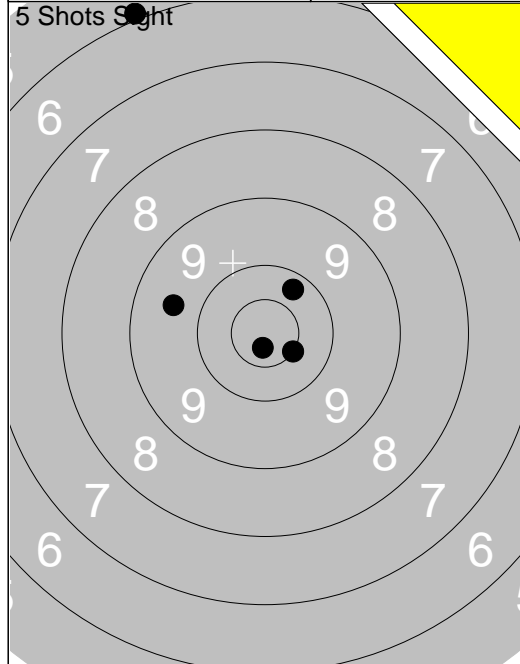

1: 9.6	←
2: *10.5	↘
3: 5.9	↑
4: *10.7	↓
5: 10.2	↗
Series 44.0	
Total 0.0	

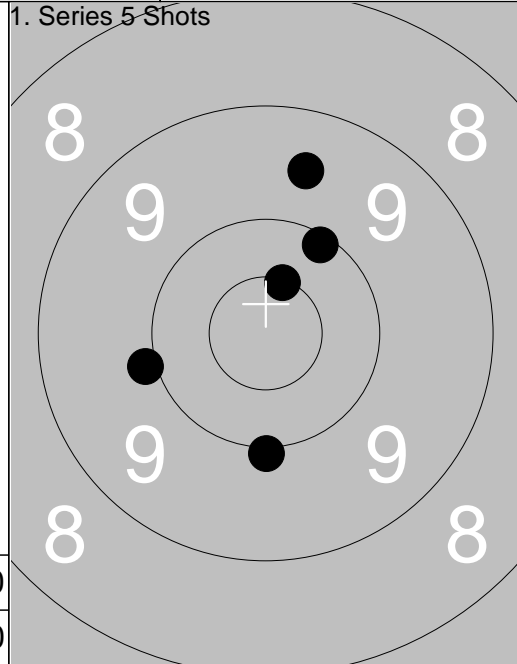

1: 10.1	↗
2: *10.5	↗
3: 9.6	↑
4: 9.9	←
5: 10.0	↓
Series 48.0	
Total 48.0	

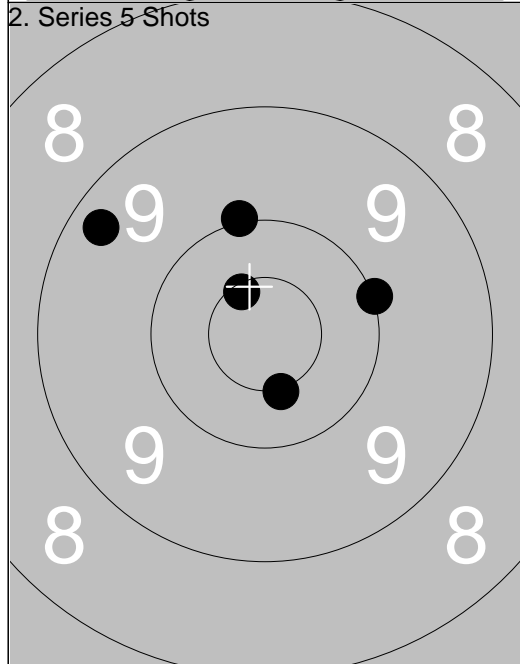

1: *10.6	↖
2: 10.0	→
3: *10.5	↓
4: 9.3	↖
5: 10.0	↑
Series 49.0	
Total 97.0	

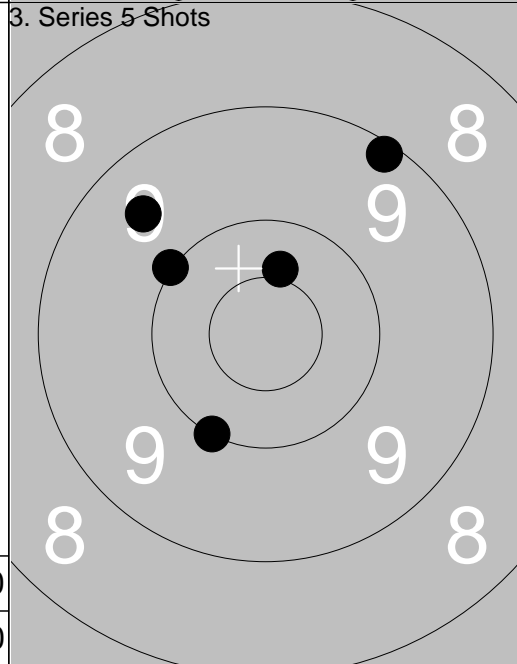

1: 9.5	↖
2: 9.1	↗
3: 10.0	↘
4: 10.0	↖
5: 10.4	↑
Series 48.0	
Total 145.0	

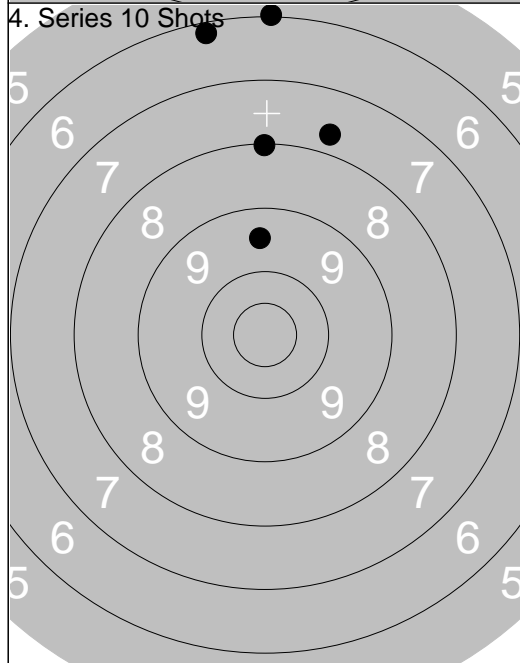

1: 9.5	↑
2: 7.7	↑
3: 8.0	↑
4: 6.0	↑
5: 6.2	↑
Series 36.0	
Total 181.0	

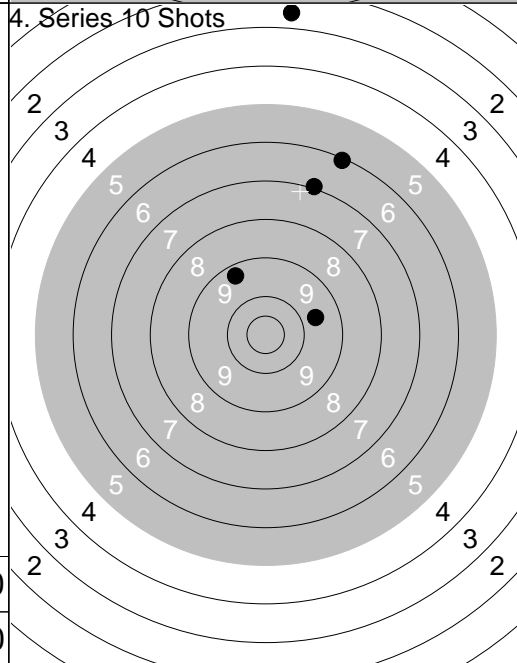

6: 9.3	↖
7: 9.7	→
8: 6.1	↑
9: 7.0	↑
10: 2.6	↑
Series 33.0	
Total 214.0	

<p>5 Shots Sight</p>	<p>1. Series 5 Shots</p>	<p>1: 9.4 ↙ 2: 9.4 ↖ 3: *10.6 ↘ 4: 9.7 ← 5: *10.7↑</p> <p>Series 47.0 Total 0.0</p>	<p>1: *10.5↘ 2: 10.3 ↘ 3: 10.0← 4: 9.0 ← 5: *10.6↑</p> <p>Series 49.0 Total 49.0</p>
----------------------	--------------------------	---	--

<p>2. Series 5 Shots</p>	<p>3. Series 5 Shots</p>	<p>1: 10.3 ↘ 2: 8.7 → 3: 10.1 ↗ 4: 10.2 ↓ 5: *10.7↑</p> <p>Series 48.0 Total 97.0</p>	<p>1: *10.6↘ 2: 9.1 ↘ 3: 10.0↗ 4: 10.0↗ 5: 9.8 →</p> <p>Series 48.0 Total 145.0</p>
--------------------------	--------------------------	---	---

<p>4. Series 10 Shots</p>	<p>4. Series 10 Shots</p>	<p>1: 7.7 ↓ 2: 6.9 ↓ 3: 9.0 ↙ 4: 7.2 ↓ 5: 6.2 ↓</p> <p>Series 35.0 Total 180.0</p>	<p>6: 7.8 ↓ 7: 7.9 ↓ 8: 8.6 ↓ 9: 7.7 ↓ 10: 5.5 ↓</p> <p>Series 34.0 Total 214.0</p>
---------------------------	---------------------------	--	---

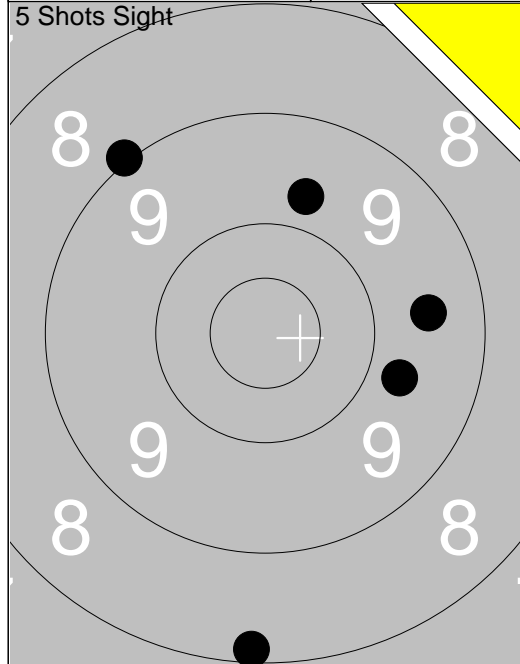

1:	8.1	↓
2:	9.7	→
3:	9.7	↑
4:	9.0	↖
5:	9.5	→
Series		44.0
Total		0.0

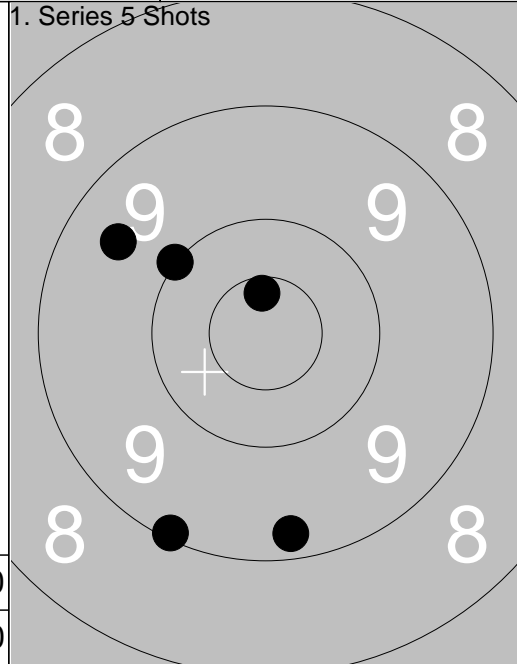

1:	10.0	↖
2:	9.1	↓
3:	9.3	↓
4:	9.5	↖
5:	*10.6	↑
Series		47.0
Total		47.0

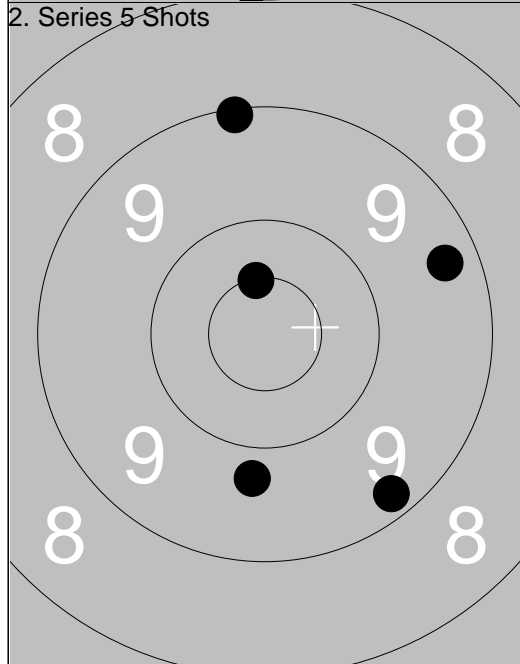

1:	*10.5	↑
2:	9.8	↓
3:	9.2	↘
4:	9.3	→
5:	9.1	↑
Series		46.0
Total		93.0

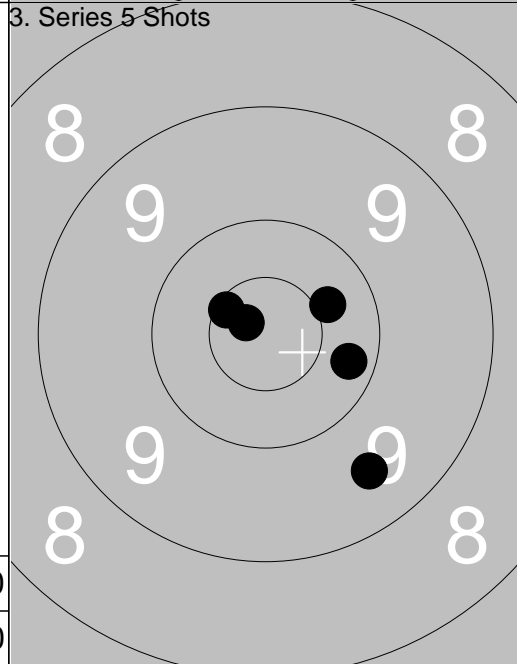

1:	9.5	↘
2:	10.2	→
3:	10.4	↗
4:	*10.6	↖
5:	*10.8	↖
Series		49.0
Total		142.0

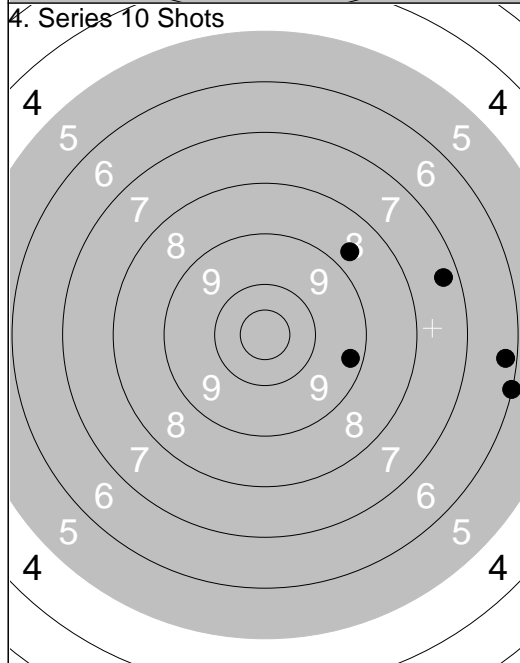

1:	9.3	→
2:	8.7	↗
3:	6.3	→
4:	7.3	→
5:	6.0	→
Series		36.0
Total		178.0

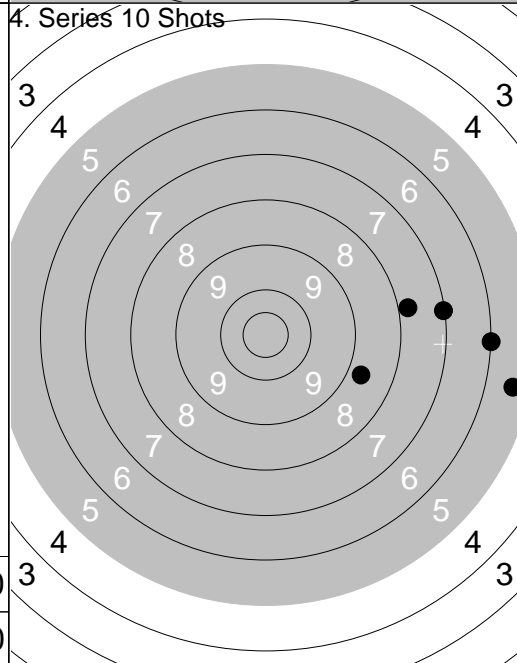

6:	6.0	→
7:	7.8	→
8:	5.4	→
9:	7.0	→
10:	8.7	→
Series		33.0
Total		211.0

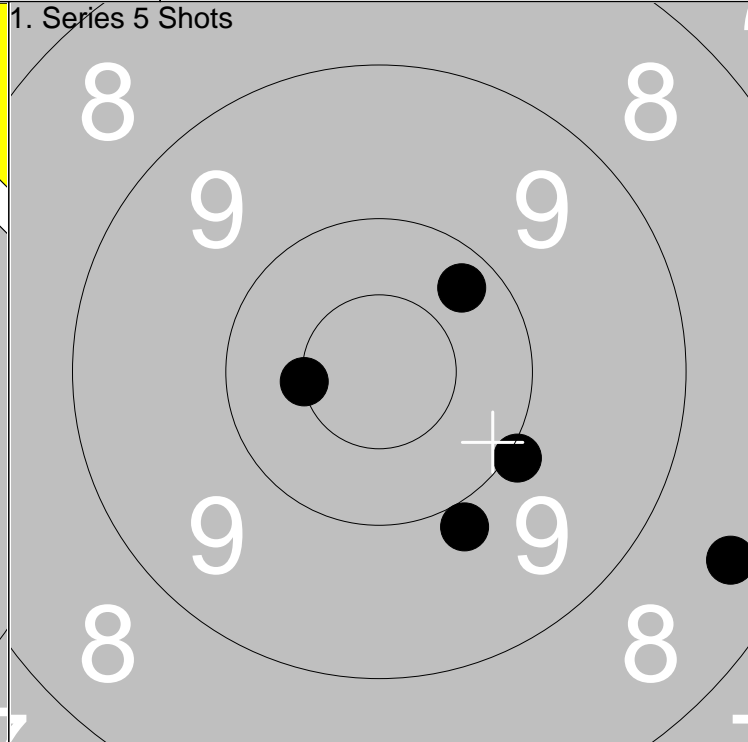
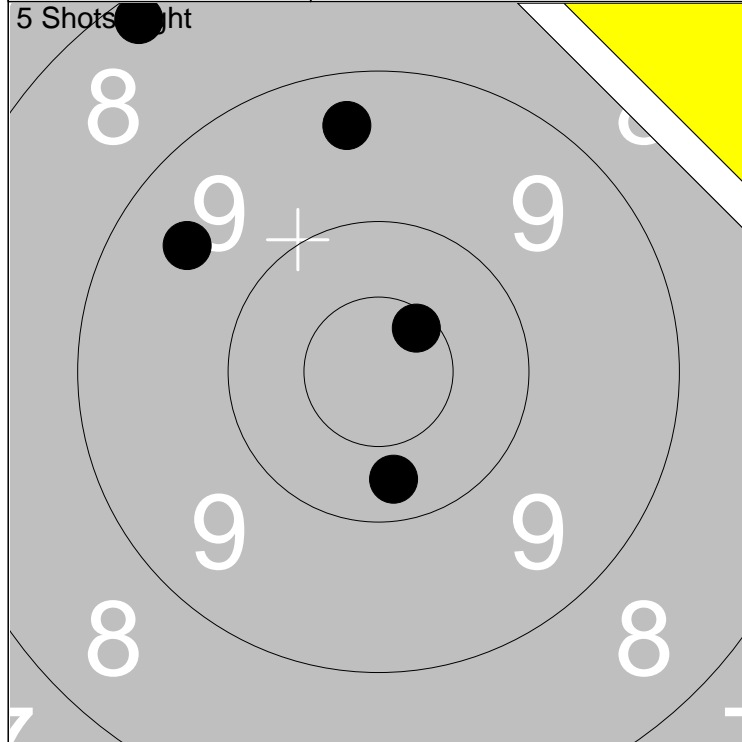

1: 8.2 ↖	Series	46.0
2: 9.4 ↑		
3: 10.3 ↓	Total	0.0
4: *10.6 ↗		
5: 9.5 ↖		

1: 8.4 ➡	Series	47.0
2: 10.2 ↗		
3: 10.0 ➡	Total	47.0
4: 9.9 ↓		
5: *10.5 ←		

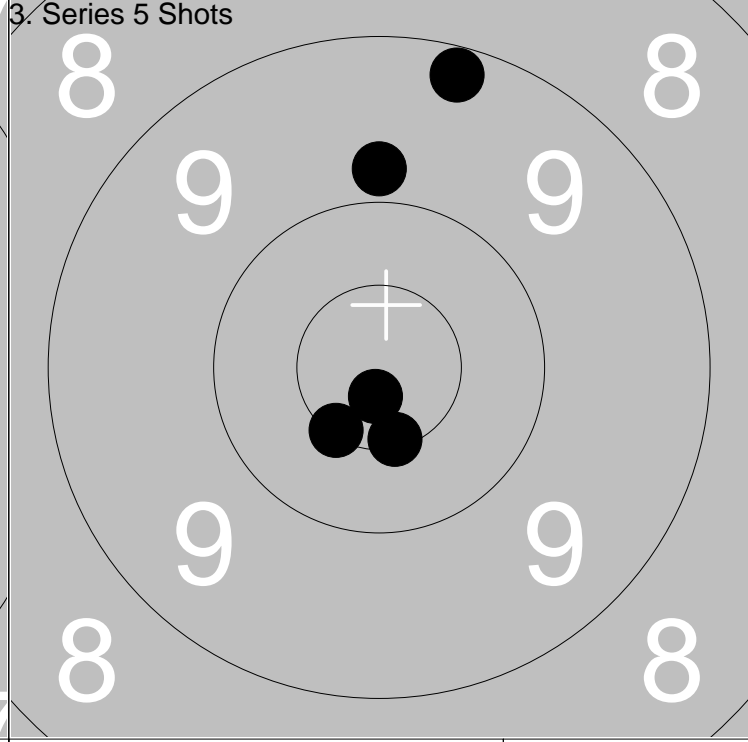
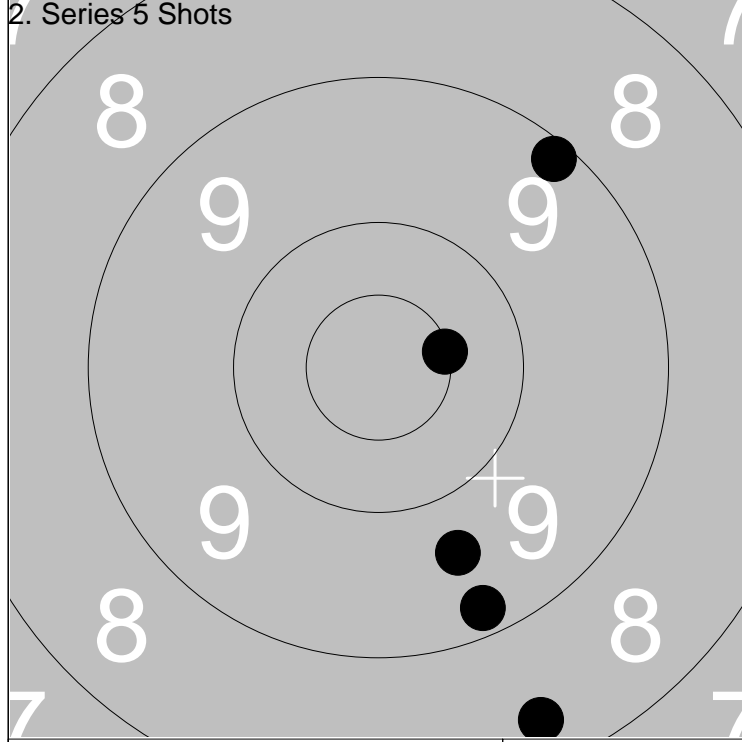

1: 9.2 ↓	Series	45.0
2: *10.5 ➡		
3: 8.4 ↓	Total	92.0
4: 9.6 ↓		
5: 9.2 ↗		

1: 9.2 ↑	Series	48.0
2: *10.8 ↓		
3: *10.5 ↙	Total	140.0
4: *10.5 ↓		
5: 9.8 ↑		

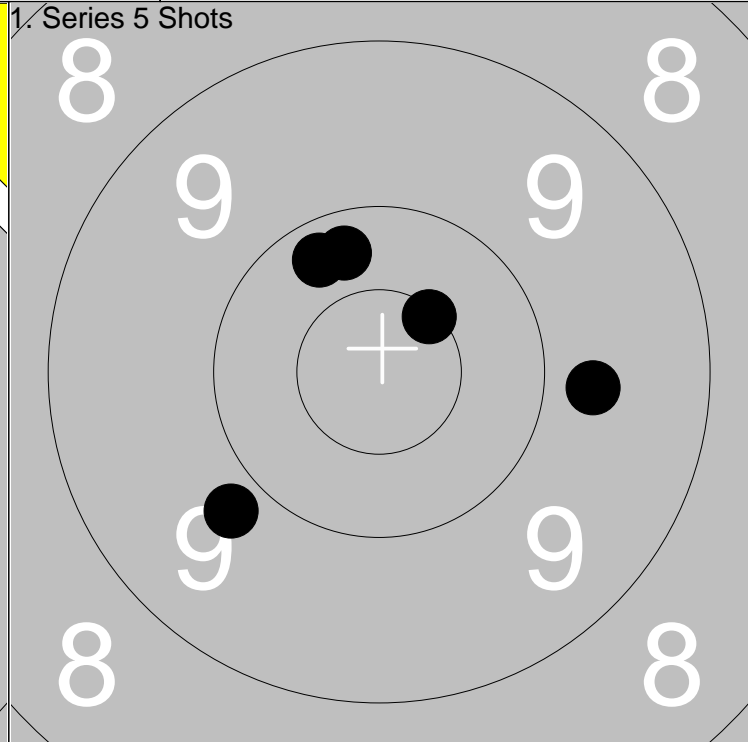
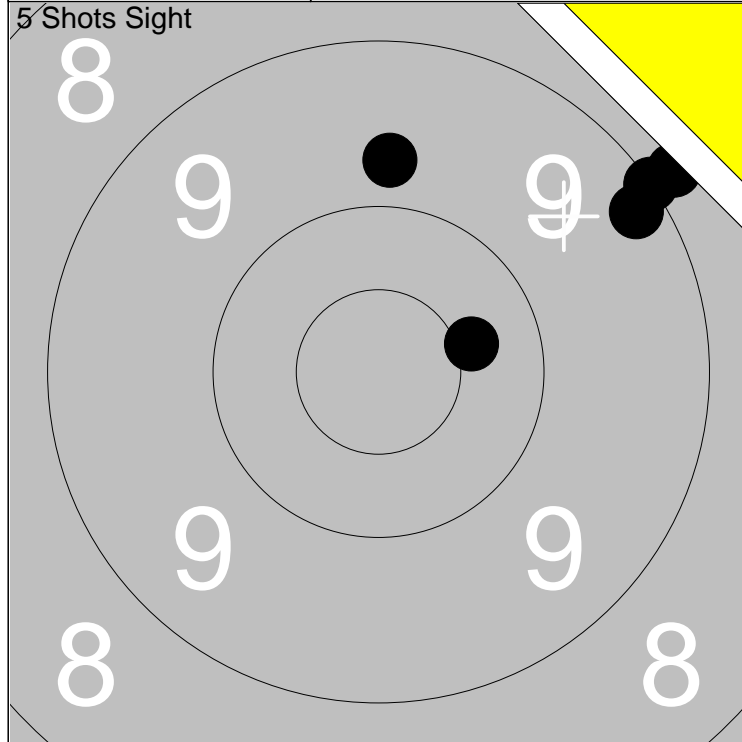

1: 8.9 ↗	Series	45.0
2: 10.4 →		
3: 9.0 ↗	Total	0.0
4: 9.8 ↑		
5: 9.2 ↗		

1: 9.7 →	Series	48.0
2: 10.2 ↖		
3: 10.3 ↖	Total	48.0
4: 9.8 ↙		
5: *10.5 ↗		

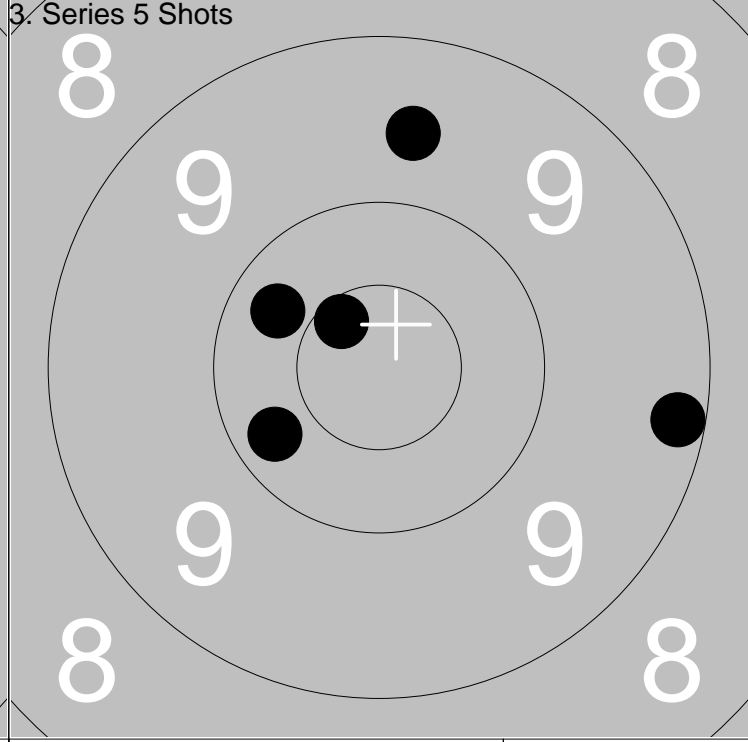
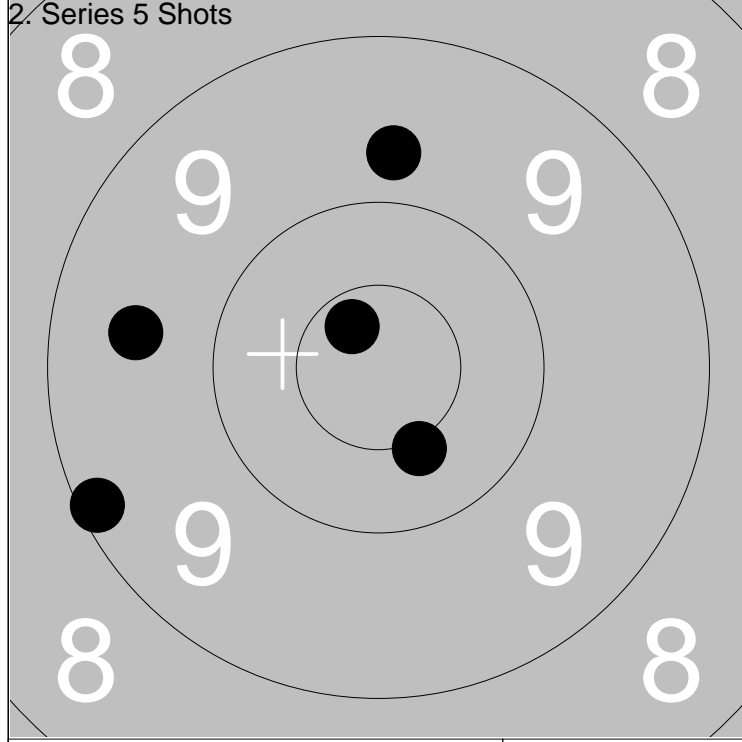

1: 9.7 ↑	Series	47.0
2: *10.4 ↘		
3: *10.7 ↖	Total	95.0
4: 9.5 ←		
5: 9.1 ↙		

1: 9.6 ↑	Series	48.0
2: 10.3 ↖		
3: 10.3 ↙	Total	143.0
4: 9.2 →		
5: *10.6 ↖		

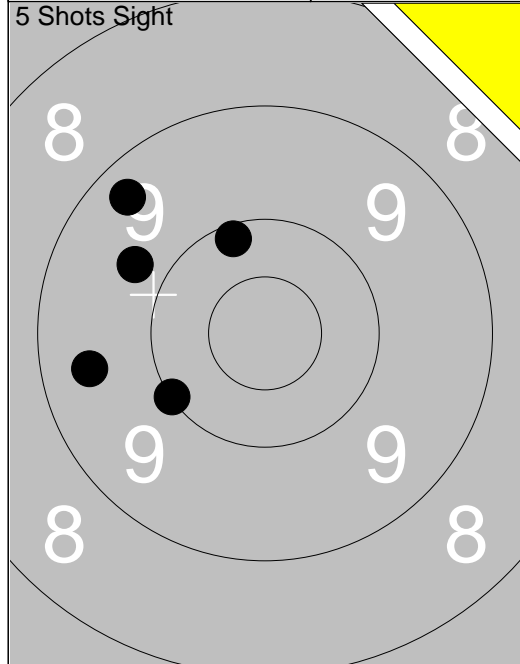

1:	10.1	↗
2:	9.7	↖
3:	9.3	↖
4:	10.0	↙
5:	9.5	←
Series		47.0
Total		0.0

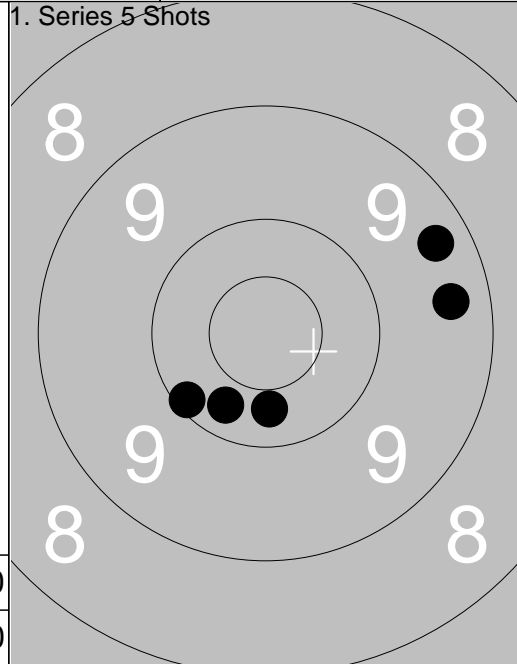

1:	9.3	↗
2:	9.4	→
3:	10.3	↓
4:	10.3	↙
5:	10.1	↙
Series		48.0
Total		48.0

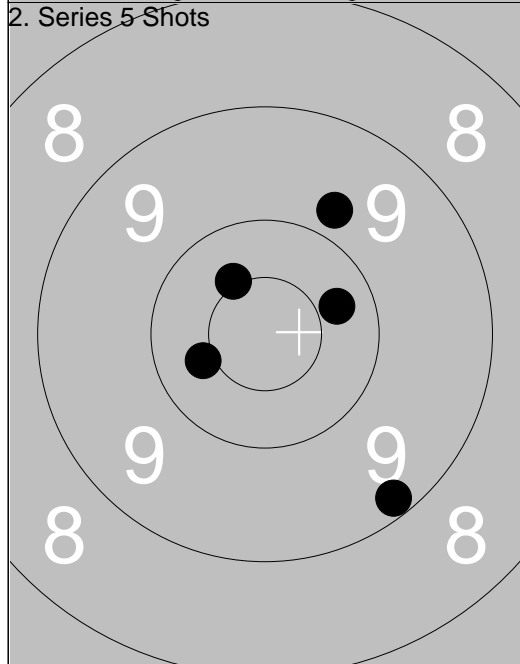

1:	*10.4	↖
2:	10.4	↙
3:	9.8	↗
4:	9.2	↘
5:	10.3	→
Series		48.0
Total		96.0

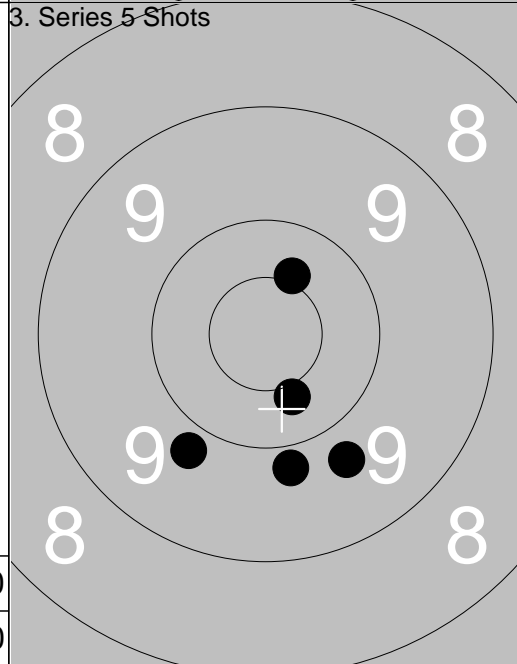

1:	9.8	↓
2:	*10.4	↗
3:	9.8	↙
4:	9.7	↘
5:	10.4	↘
Series		47.0
Total		143.0

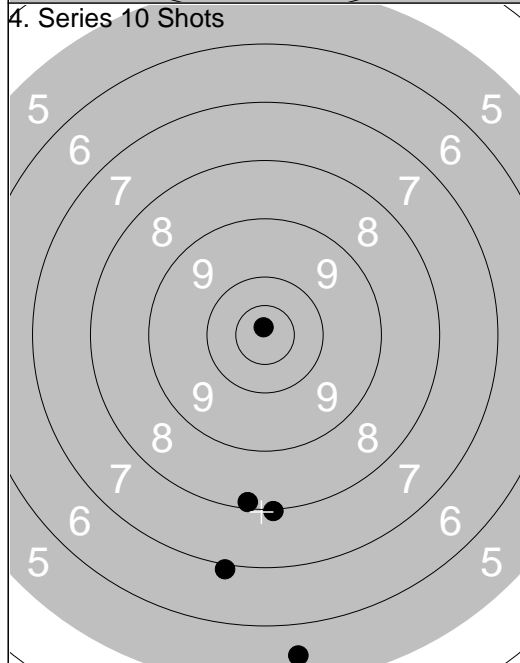

1:	8.1	↓
2:	5.5	↓
3:	8.0	↓
4:	6.9	↓
5:	*10.8	↗
Series		37.0
Total		180.0

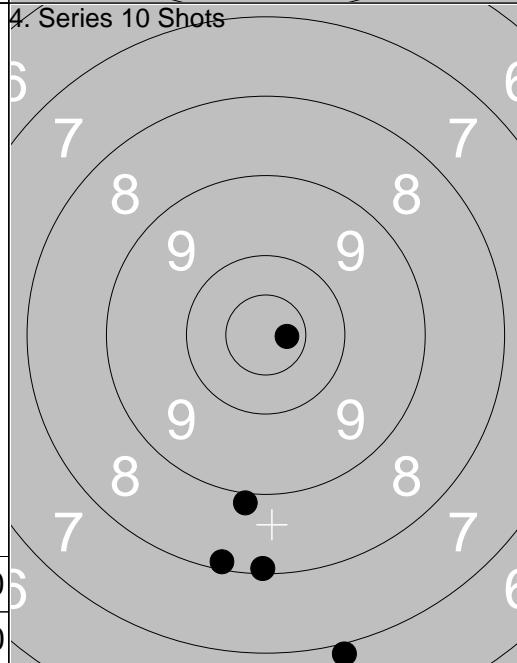

6:	8.9	↓
7:	8.1	↓
8:	6.9	↓
9:	8.1	↓
10:	*10.7	→
Series		40.0
Total		220.0

<p>5 Shots Sight</p>	<p>1. Series 5 Shots</p>	<p>1: 8.8 ↗ 2: 9.8 ↓ 3: 9.3 → 4: 9.7 → 5: 10.3 ↓</p>
Series 50.0	Series 45.0	
Total 0.0	Total 45.0	

<p>2. Series 5 Shots</p>	<p>3. Series 5 Shots</p>	<p>1: 9.8 ↓ 2: *10.4 ↗ 3: 9.3 ↗ 4: 9.9 ↗ 5: 8.8 →</p>
Series 47.0	Series 45.0	
Total 92.0	Total 137.0	

<p>4. Series 10 Shots</p>	<p>4. Series 10 Shots</p>	<p>6: 4.2 ↓ 7: 10.3 ↖ 8: 6.2 ↓ 9: 9.1 ↓ 10: 4.0 ↓</p>
Series 36.0	Series 33.0	
Total 173.0	Total 206.0	

<p>5 Shots Sight</p>	<p>1. Series 5 Shots</p>	<table border="1" style="width:100%; border-collapse: collapse;"> <tr> <td style="text-align:right;">Series</td> <td style="text-align:left;">45.0</td> </tr> <tr> <td style="text-align:right;">Total</td> <td style="text-align:left;">0.0</td> </tr> </table>	Series	45.0	Total	0.0
Series	45.0					
Total	0.0					
<p>2. Series 5 Shots</p>	<p>3. Series 5 Shots</p>	<table border="1" style="width:100%; border-collapse: collapse;"> <tr> <td style="text-align:right;">Series</td> <td style="text-align:left;">46.0</td> </tr> <tr> <td style="text-align:right;">Total</td> <td style="text-align:left;">91.0</td> </tr> </table>	Series	46.0	Total	91.0
Series	46.0					
Total	91.0					

<p>4. Series 10 Shots</p>	<p>4. Series 10 Shots</p>	<table border="1" style="width:100%; border-collapse: collapse;"> <tr> <td style="text-align:right;">Series</td> <td style="text-align:left;">48.0</td> </tr> <tr> <td style="text-align:right;">Total</td> <td style="text-align:left;">139.0</td> </tr> </table>	Series	48.0	Total	139.0				
Series	48.0									
Total	139.0									
<table border="1" style="width:100%; border-collapse: collapse;"> <tr> <td style="text-align:right;">Series</td> <td style="text-align:left;">38.0</td> </tr> <tr> <td style="text-align:right;">Total</td> <td style="text-align:left;">177.0</td> </tr> </table>	Series	38.0	Total	177.0	<table border="1" style="width:100%; border-collapse: collapse;"> <tr> <td style="text-align:right;">Series</td> <td style="text-align:left;">33.0</td> </tr> <tr> <td style="text-align:right;">Total</td> <td style="text-align:left;">210.0</td> </tr> </table>	Series	33.0	Total	210.0	
Series	38.0									
Total	177.0									
Series	33.0									
Total	210.0									

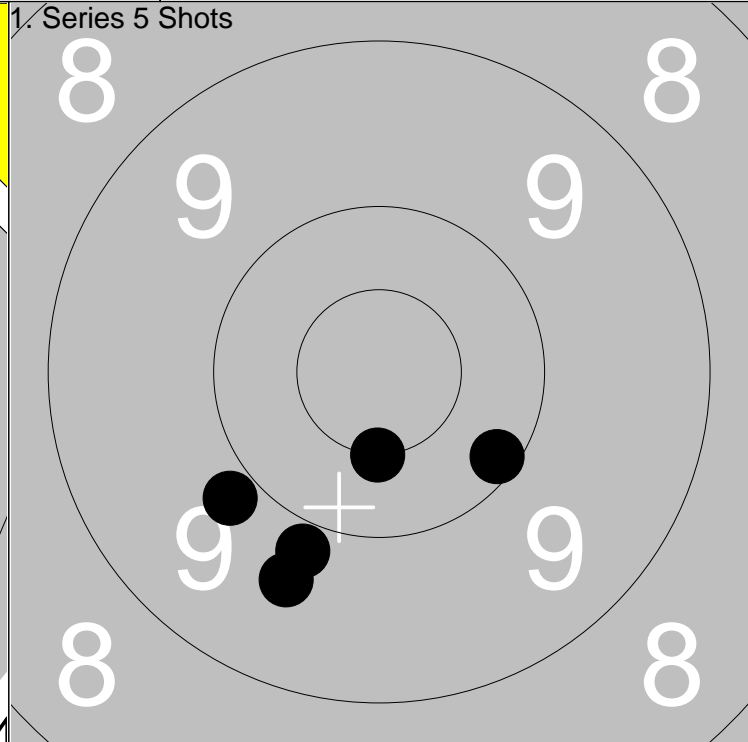
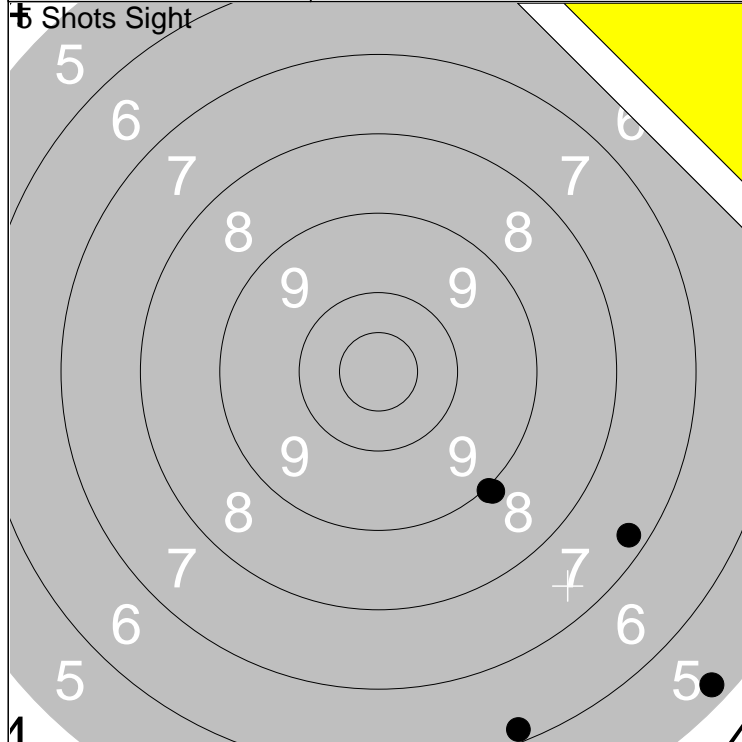

1: 7.3 ↘
2: 5.3 ↘
3: 6.2 ↘
4: 9.0 ↘
5: 8.9 ↘

Series	35.0
Total	0.0

1: *10.5 ↓
2: 9.7 ↘
3: 9.9 ↘
4: 9.9 ↘
5: 10.1 ↘

Series	47.0
Total	47.0

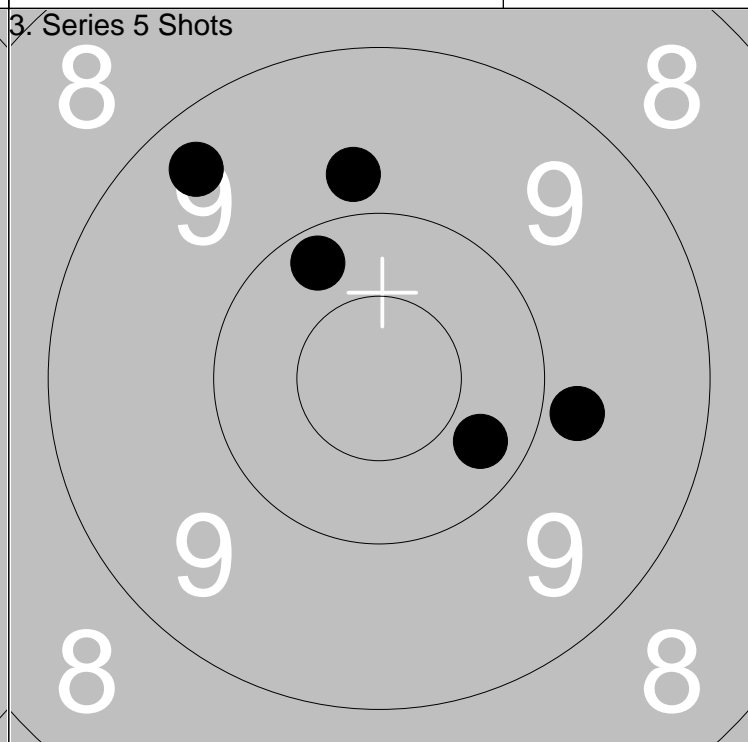
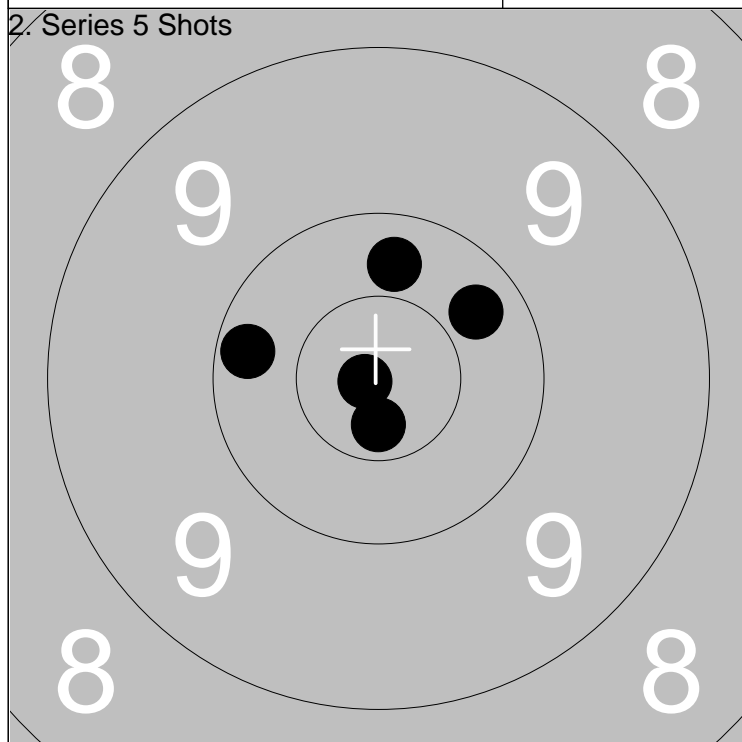

1: *10.7 ↓
2: *10.9 ↘
3: 10.3 ↗
4: 10.3 ↑
5: 10.2 ←

Series	50.0
Total	97.0

1: 9.3 ↖
2: 10.3 ↘
3: 10.2 ↖
4: 9.8 ↑
5: 9.8 →

Series	47.0
Total	144.0

Relay **3** Lane **10** **Erik Björndahl**

300m Kvistbro E Ör

2013-07-07 Tavelträffen A 2013 Ramselefors SKF

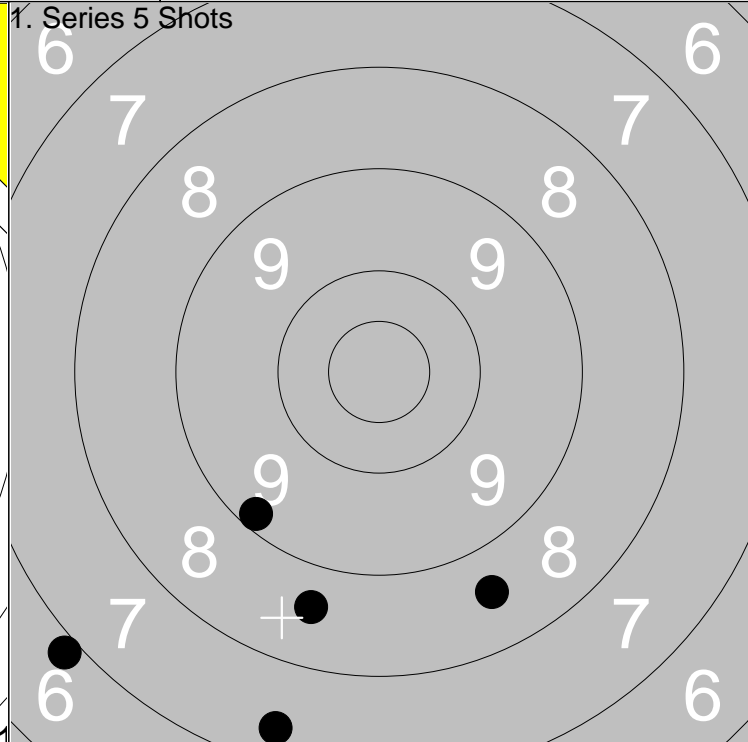
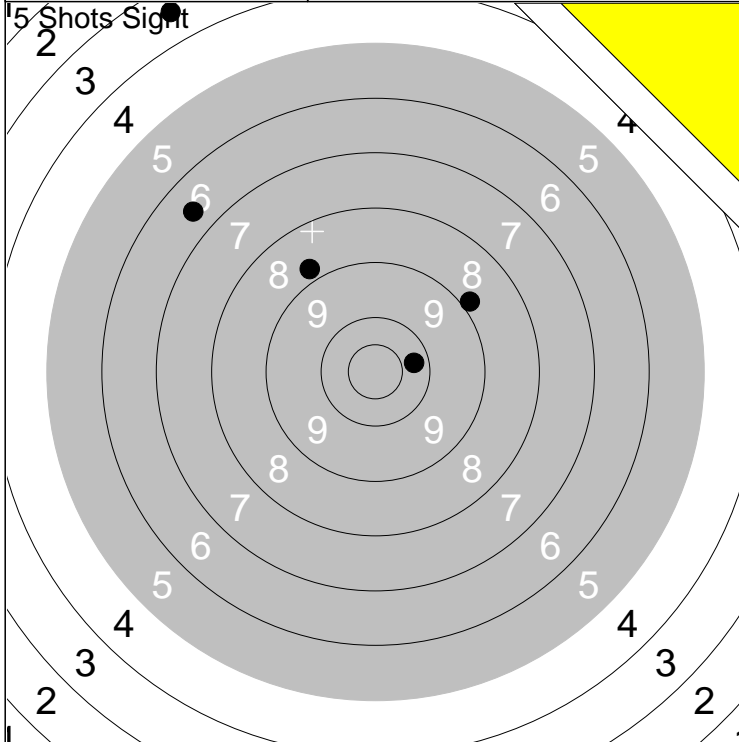

1:	3.5	↗
2:	6.6	↗
3:	8.9	↗
4:	8.8	↗
5:	10.3	→

Series	35.0
Total	0.0

1:	7.4	↘
2:	6.9	↙
3:	8.6	↘
4:	9.2	↘
5:	8.6	↘

Series	38.0
Total	38.0

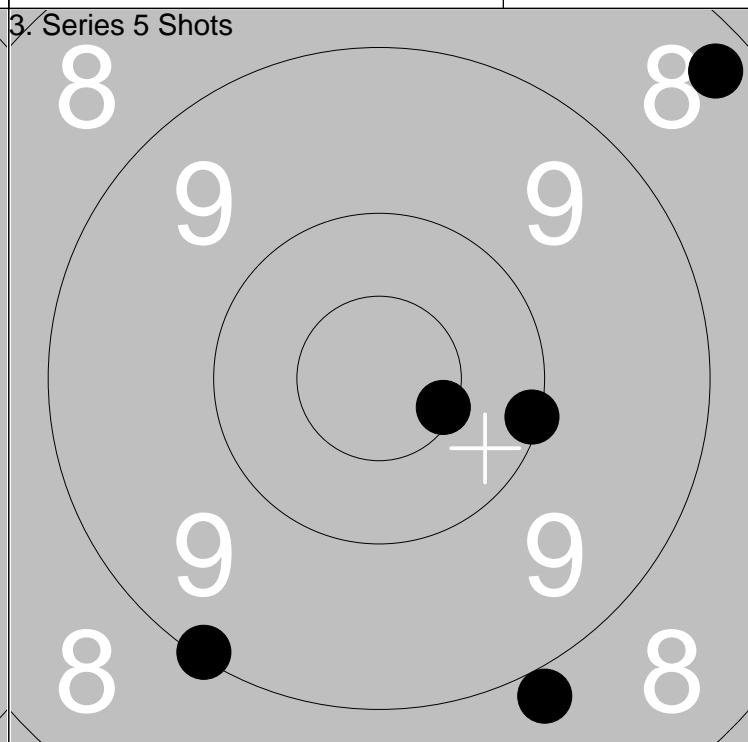
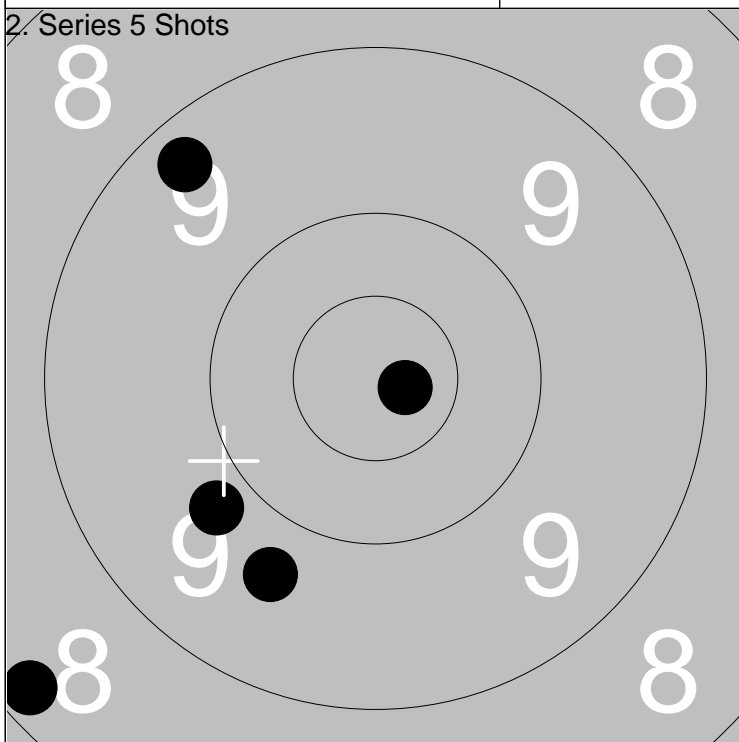

1:	*10.8	→
2:	9.3	↗
3:	9.7	↘
4:	9.8	↙
5:	8.2	↘

Series	45.0
Total	83.0

1:	8.9	↘
2:	8.3	↗
3:	10.1	→
4:	*10.6	→
5:	9.1	↘

Series	45.0
Total	128.0

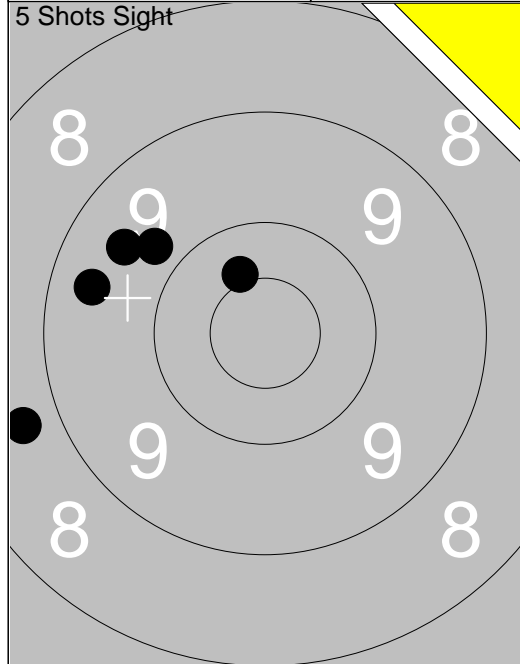

1:	*10.4 ↗
2:	9.4 ↖
3:	8.7 ↖
4:	9.8 ↗
5:	9.5 ↖
Series 45.0	
Total 0.0	

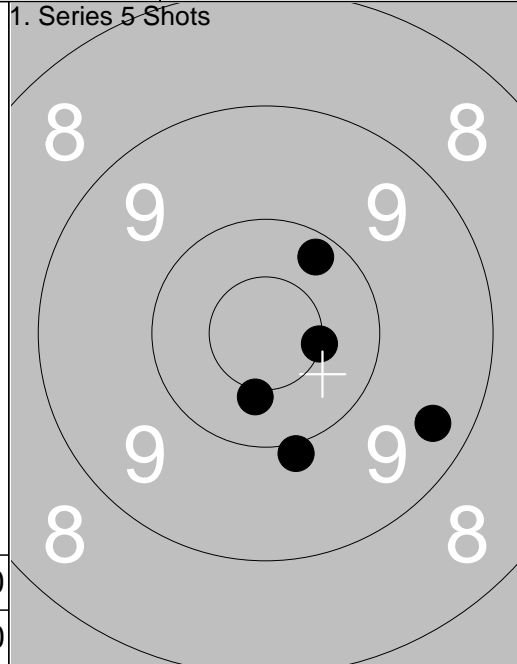

1:	10.2 ↗
2:	9.4 ↘
3:	9.9 ↓
4:	*10.4 ↓
5:	*10.5 →
Series 48.0	
Total 48.0	

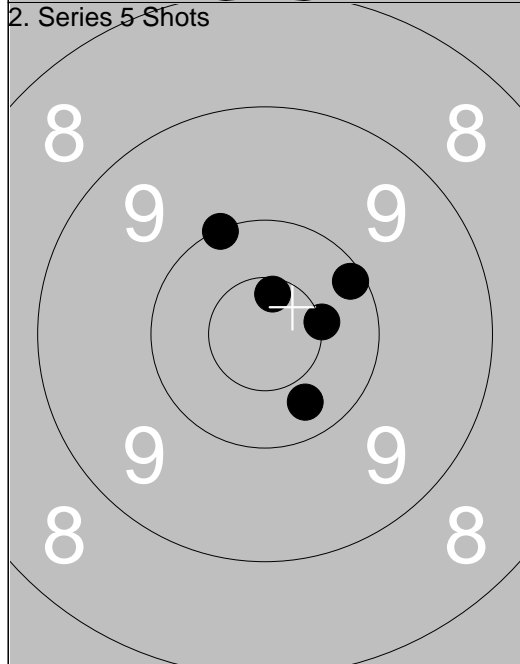

1:	10.1 ↗
2:	*10.6 ↑
3:	10.0 ↗
4:	*10.5 →
5:	10.3 ↓
Series 50.0	
Total 98.0	

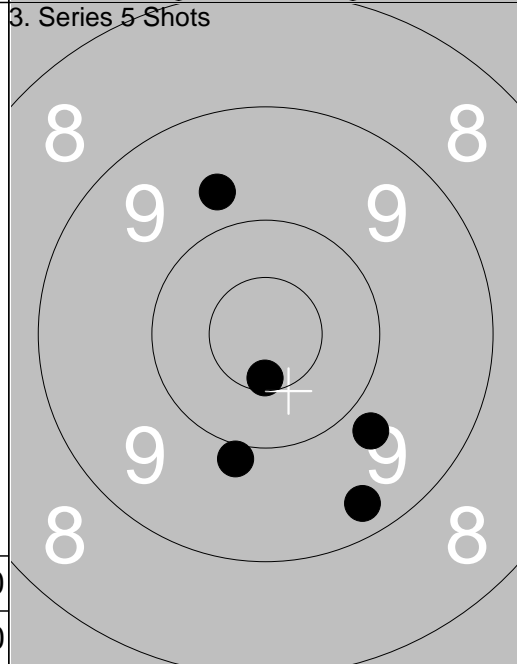

1:	9.9 ↓
2:	9.8 ↘
3:	9.7 ↗
4:	9.3 ↓
5:	*10.6 ↓
Series 46.0	
Total 144.0	

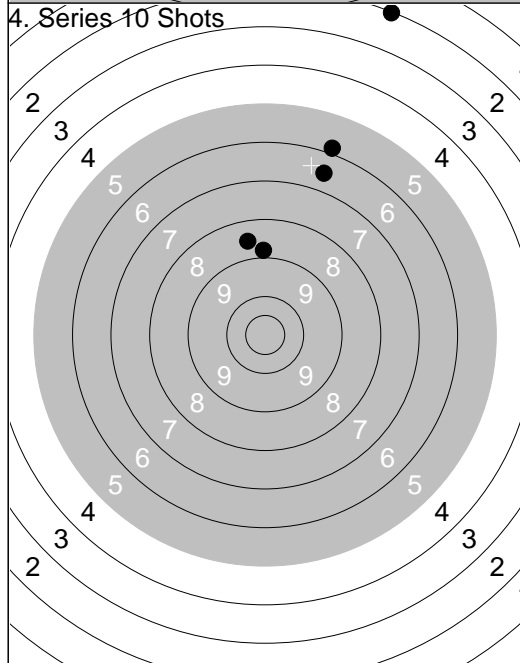

1:	8.6 ↑
2:	2.1 ↑
3:	8.8 ↑
4:	5.9 ↑
5:	6.6 ↑
Series 29.0	
Total 173.0	

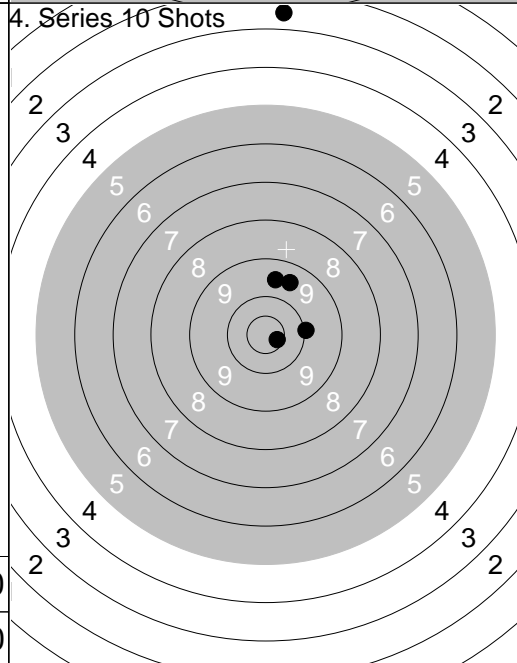

6:	9.5 ↗
7:	*10.6 →
8:	9.6 ↑
9:	10.0 →
10:	2.6 ↑
Series 40.0	
Total 213.0	

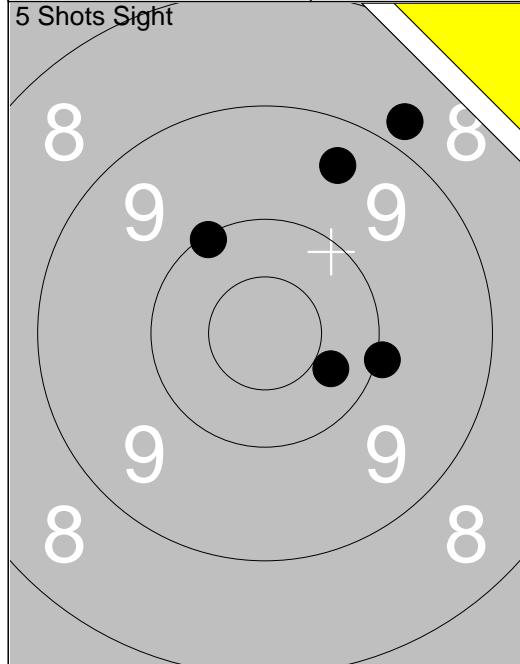

1:	9.4	↗
2:	10.1	↖
3:	8.8	↗
4:	10.0	→
5:	10.3	↘
Series		47.0
Total		0.0

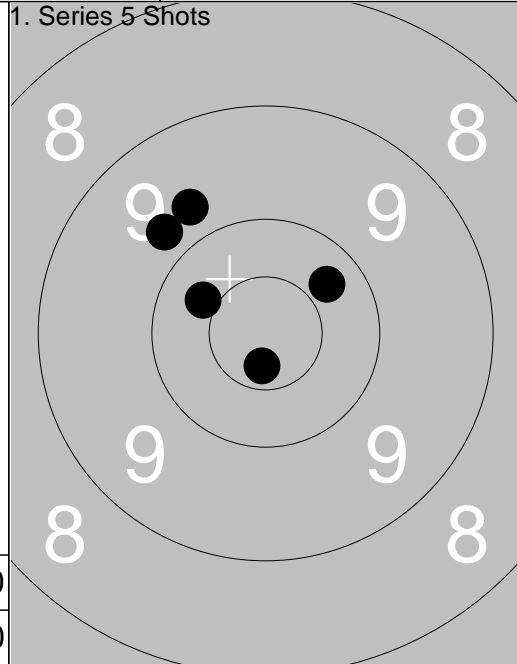

1:	9.8	↖
2:	10.4	↖
3:	*10.7	↓
4:	9.7	↖
5:	10.3	↗
Series		48.0
Total		48.0

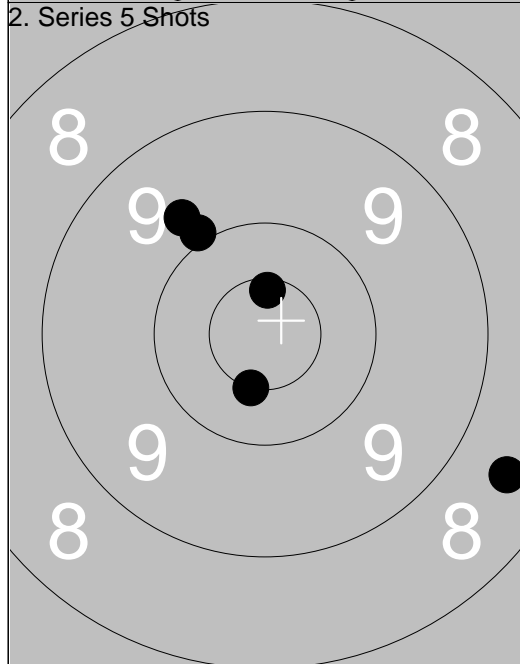

1:	9.9	↖
2:	9.7	↖
3:	8.5	↘
4:	*10.6	↑
5:	*10.5	↓
Series		46.0
Total		94.0

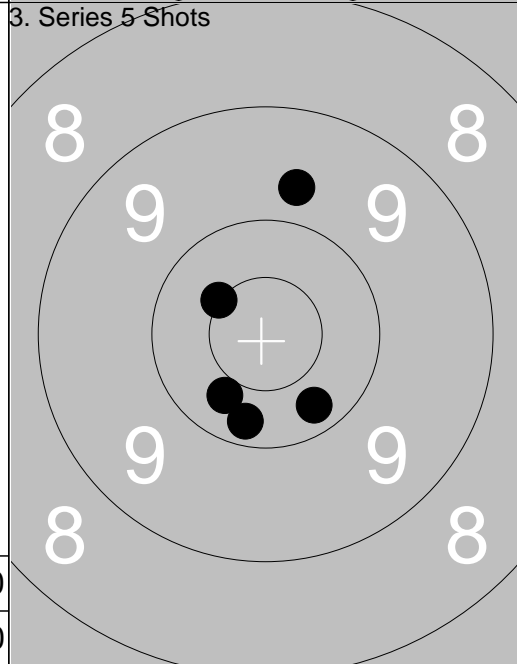

1:	10.2	↓
2:	*10.5	↖
3:	9.7	↑
4:	10.4	↘
5:	10.3	↘
Series		49.0
Total		143.0

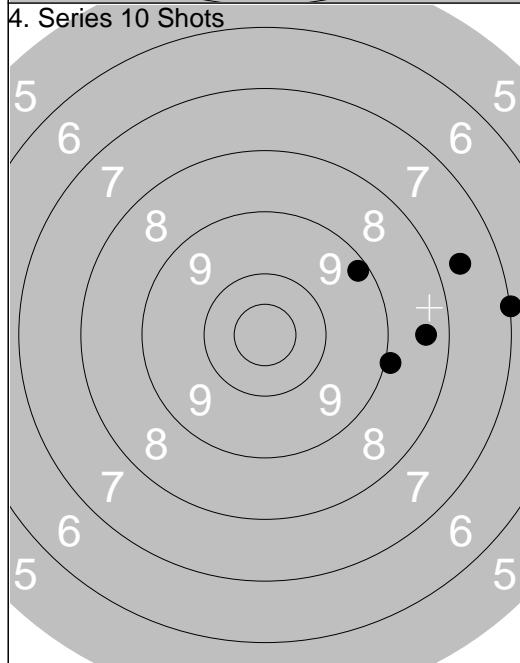

1:	7.7	→
2:	8.4	→
3:	8.9	→
4:	9.2	↗
5:	7.0	→
Series		39.02
Total		182.0

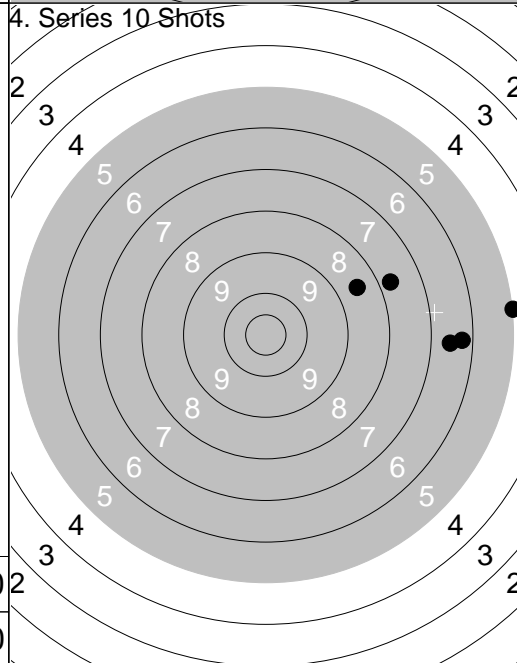

6:	8.5	↗
7:	6.6	→
8:	7.7	↗
9:	5.0	→
10:	6.3	→
Series		32.0
Total		214.0

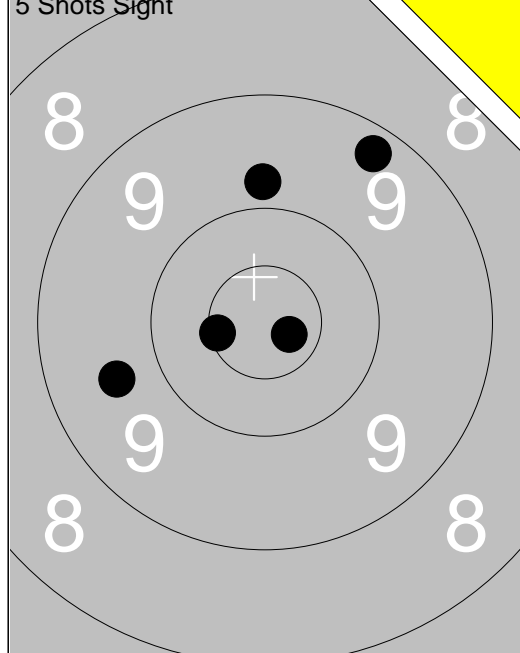

1:	9.3	↗
2:	*10.7	↘
3:	9.6	←
4:	*10.6	←
5:	9.8	↑
Series		47.0
Total		0.0

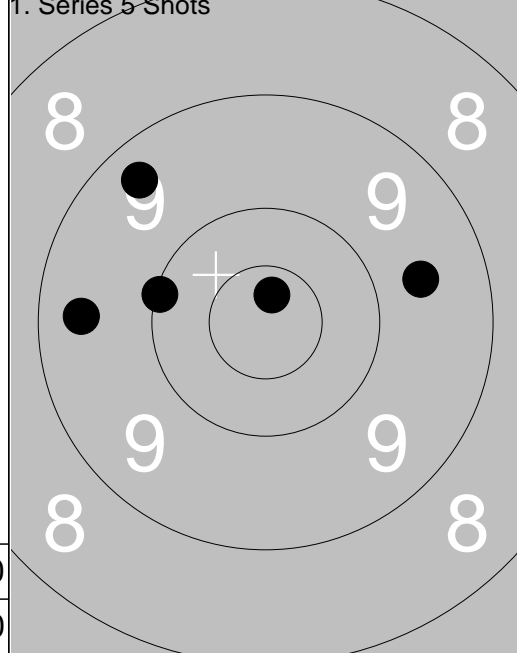

1:	9.4	←
2:	9.4	↖
3:	9.6	→
4:	*10.7	↑
5:	10.1	←
Series		47.0
Total		47.0

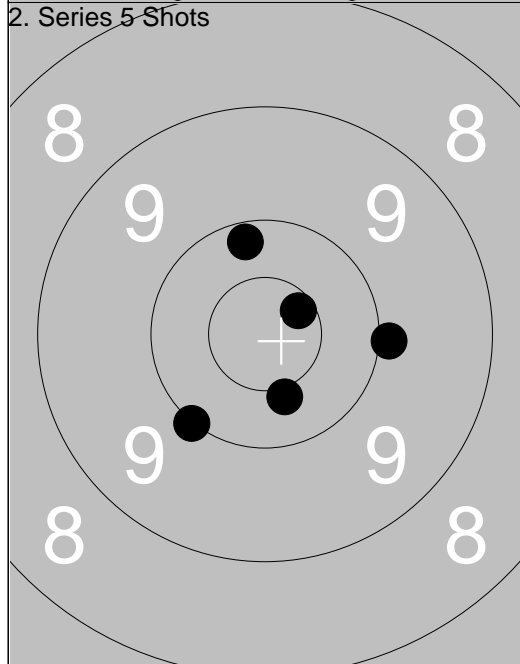

1:	10.2	↑
2:	10.0	↙
3:	*10.6	↗
4:	9.9	→
5:	*10.4	↘
Series		49.0
Total		96.0

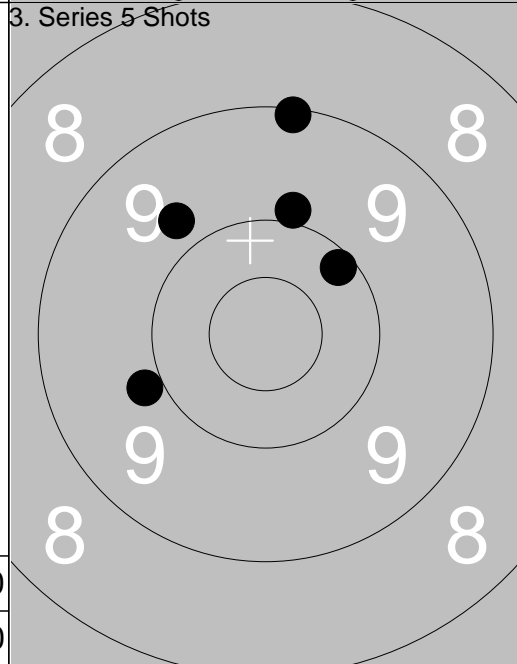

1:	10.2	↗
2:	9.8	↖
3:	9.9	←
4:	9.9	↑
5:	9.1	↑
Series		46.0
Total		142.0

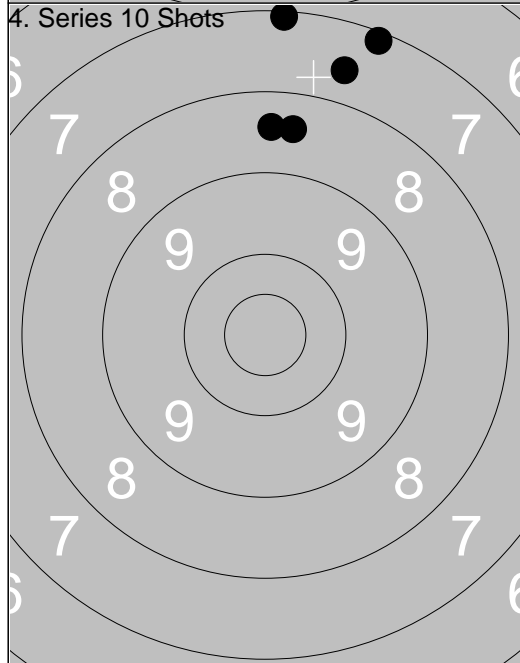

1:	7.1	↑
2:	8.5	↑
3:	7.6	↑
4:	7.1	↑
5:	8.5	↑
Series		37.0
Total		179.0

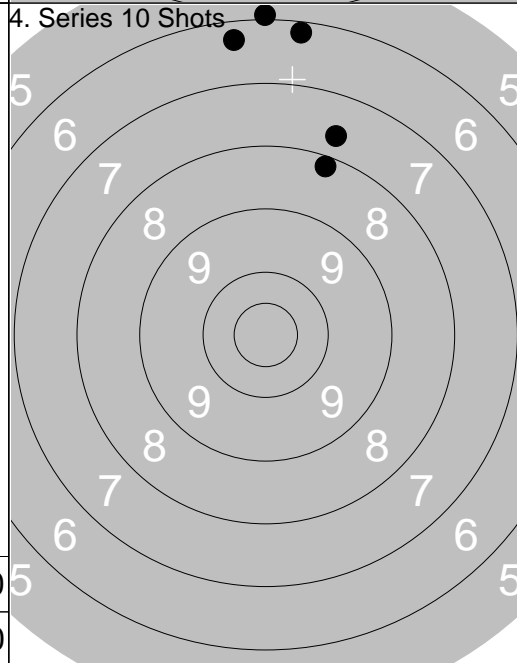

6:	6.2	↑
7:	6.0	↑
8:	8.2	↑
9:	7.7	↑
10:	6.3	↑
Series		33.0
Total		212.0

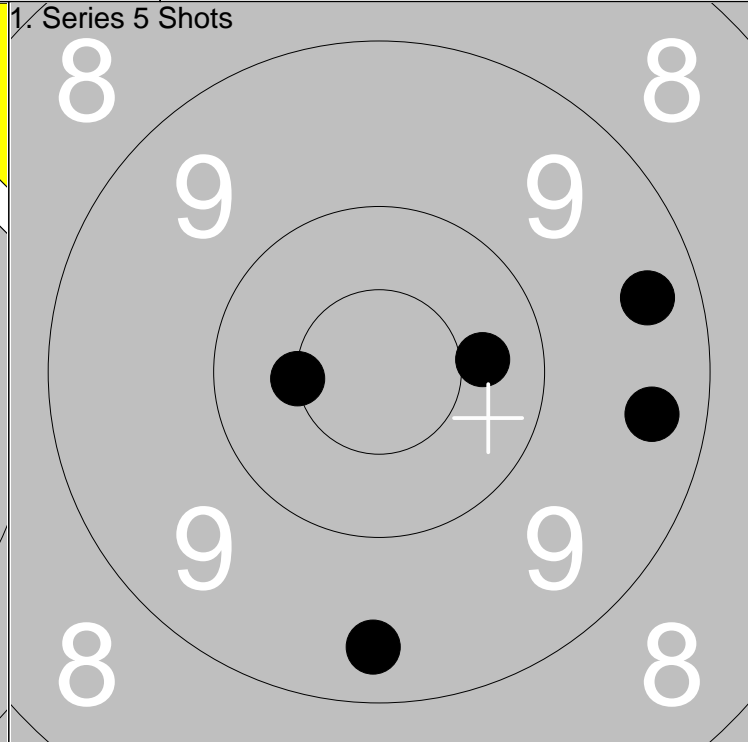
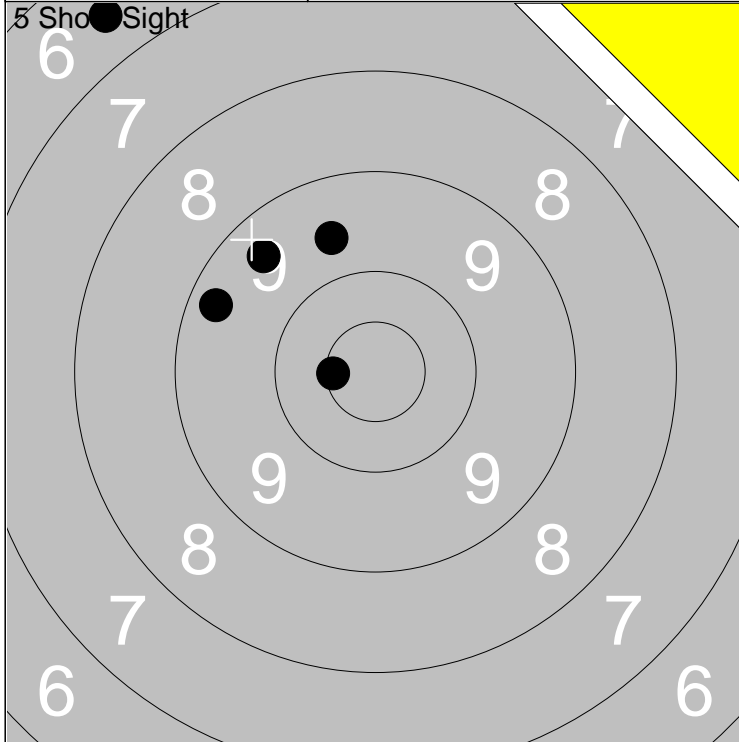

1: 6.6 ↗	Series	43.0
2: 9.4 ↗		
3: *10.6 ←	Total	0.0
4: 9.3 ↖		
5: 9.6 ↗		

1: *10.5 ←	Series	47.0
2: 9.3 →		
3: 9.4 ↓	Total	47.0
4: 10.4 →		
5: 9.4 →		

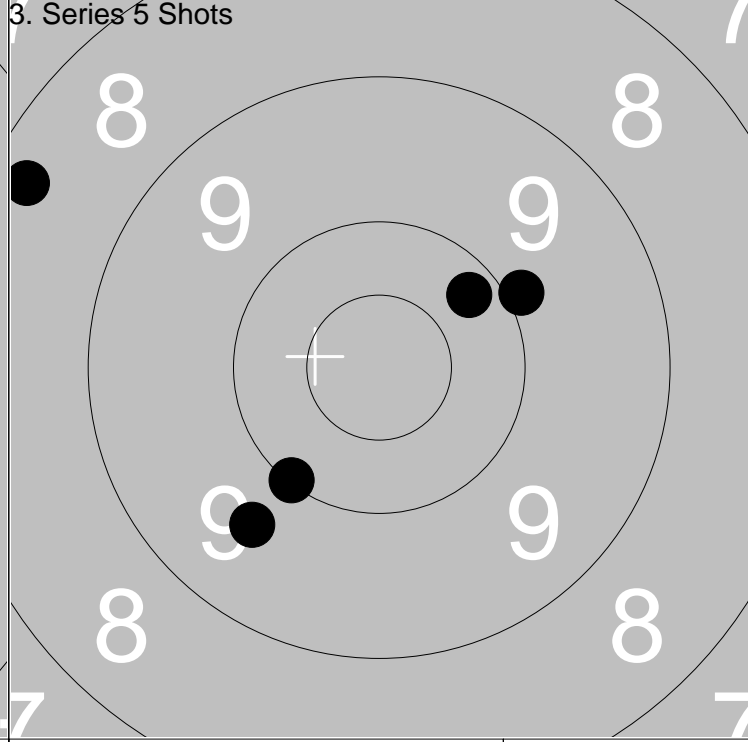
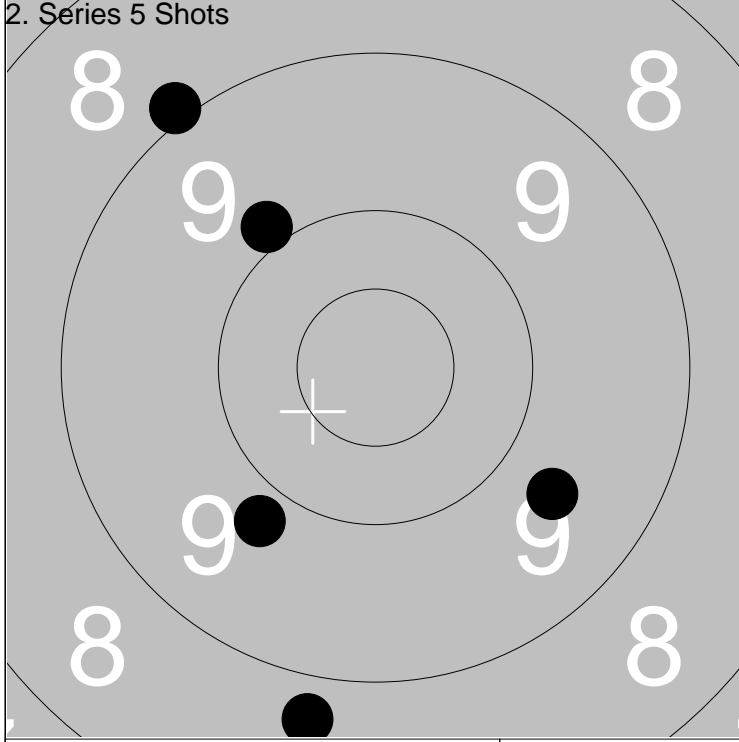

1: 9.8 ↙	Series	43.0
2: 8.9 ↗		
3: 8.8 ↓	Total	90.0
4: 9.9 ↗		
5: 9.6 ↘		

1: 10.0 ↙	Series	46.0
2: 9.6 ↙		
3: 8.3 ↖	Total	136.0
4: 9.9 ↗		
5: 10.2 ↗		

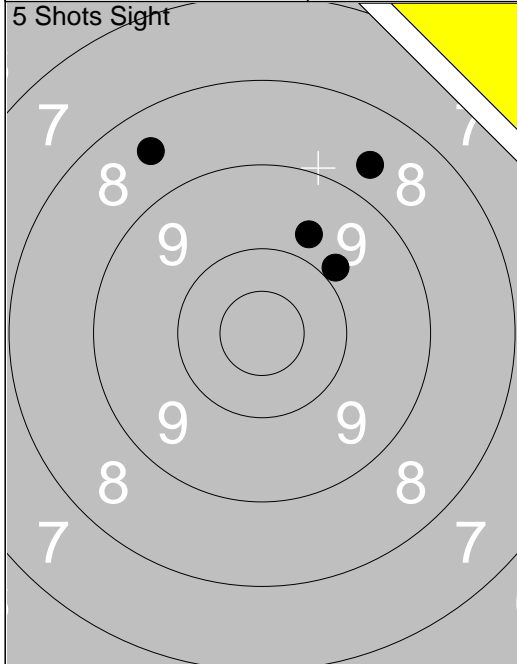

1:	6.8	↗
2:	9.7	↗
3:	8.7	↗
4:	9.9	↗
5:	8.5	↖
Series		40.0
Total		0.0

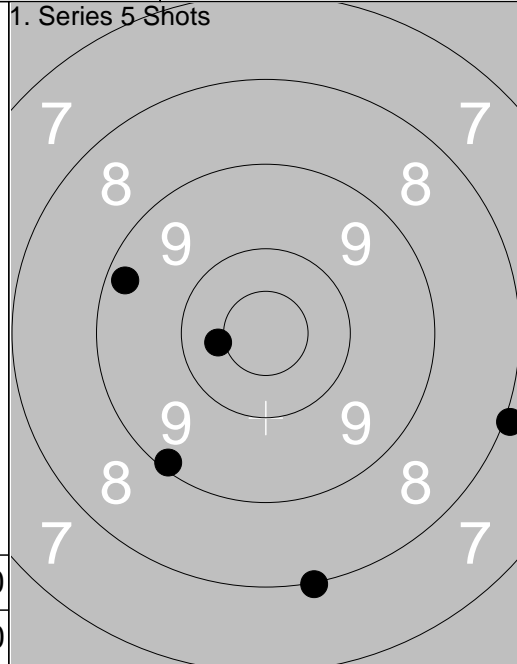

1:	9.3	↖
2:	8.0	→
3:	*10.4	↖
4:	8.0	↓
5:	9.1	↙
Series		44.0
Total		44.0

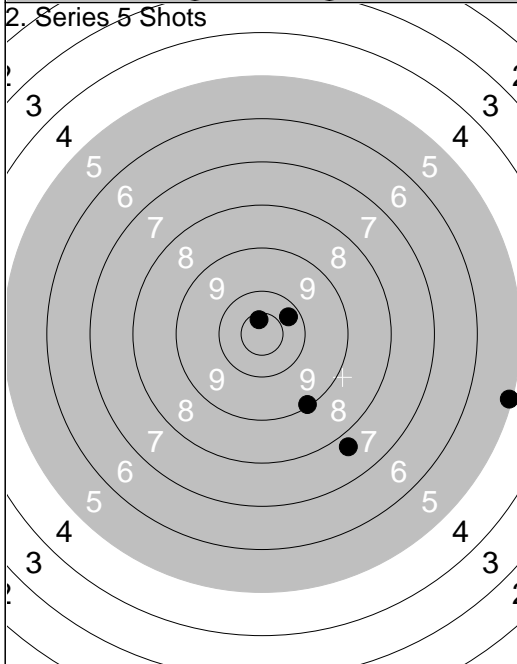

1:	*10.6	↗
2:	7.7	↓
3:	5.1	→
4:	10.3	↗
5:	9.1	↓
Series		41.0
Total		85.0

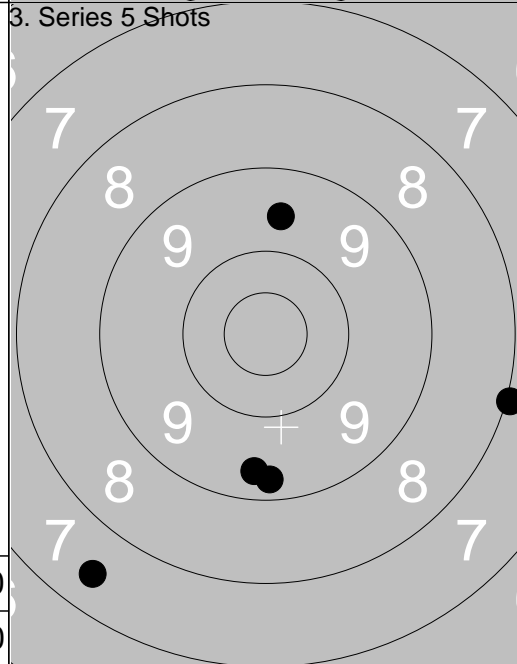

1:	9.3	↓
2:	7.5	↙
3:	9.6	↗
4:	8.0	→
5:	9.4	↓
Series		42.0
Total		127.0

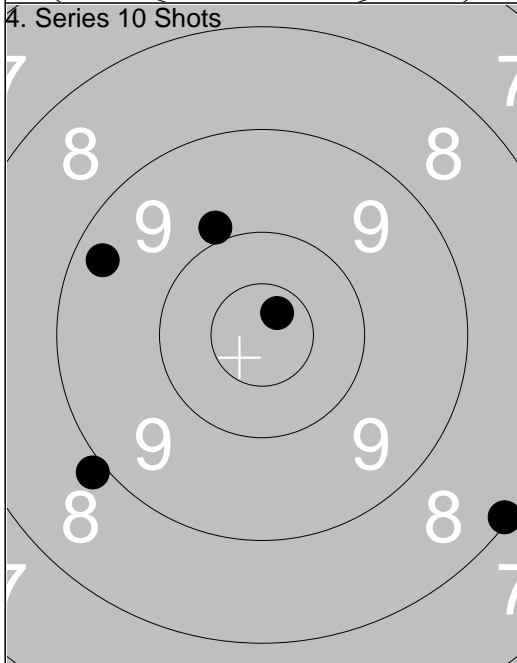

1:	9.3	↖
2:	8.1	↘
3:	*10.7	↗
4:	9.9	↗
5:	8.9	↖
Series		44.0
Total		171.0

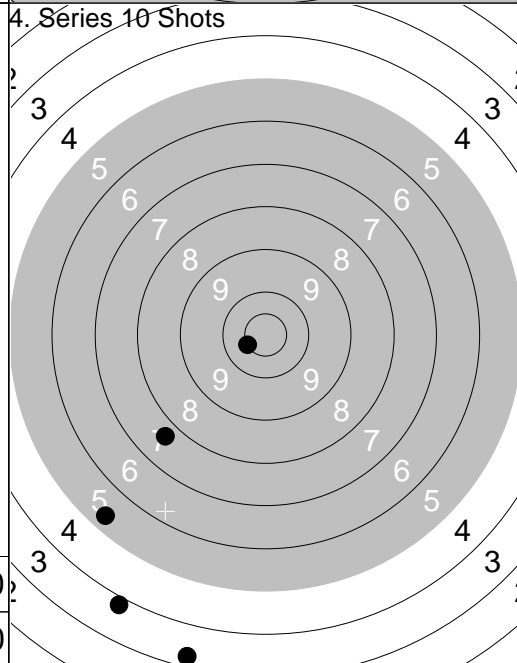

6:	7.7	↙
7:	5.4	↙
8:	3.3	↓
9:	*10.5	↖
10:	3.8	↙
Series		28.0
Total		199.0

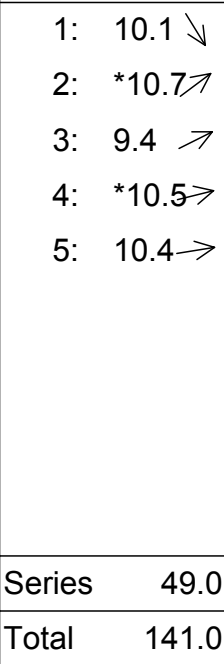
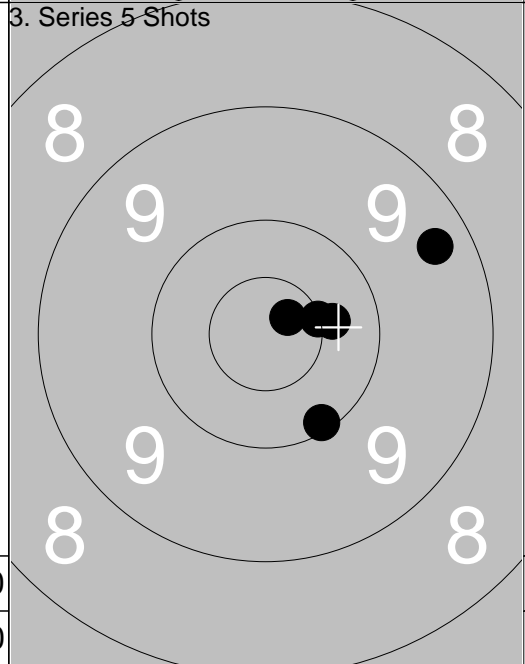
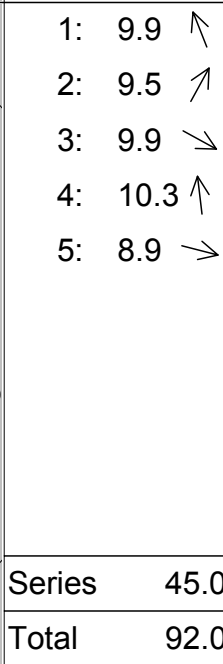
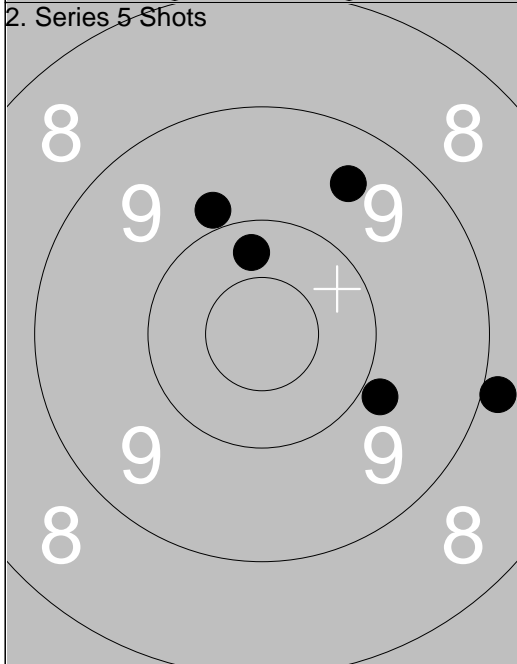
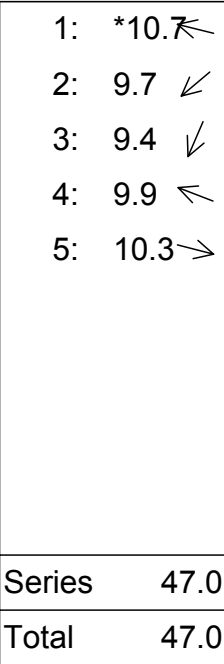
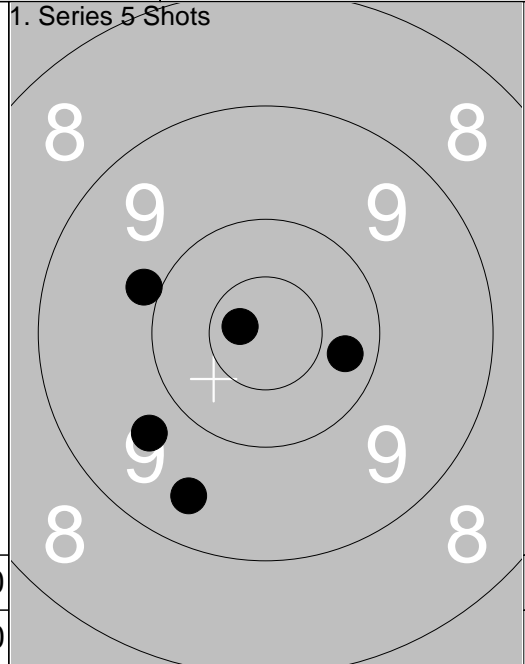
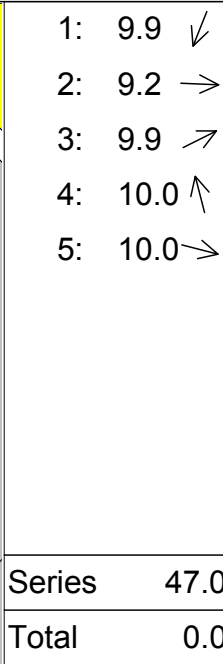
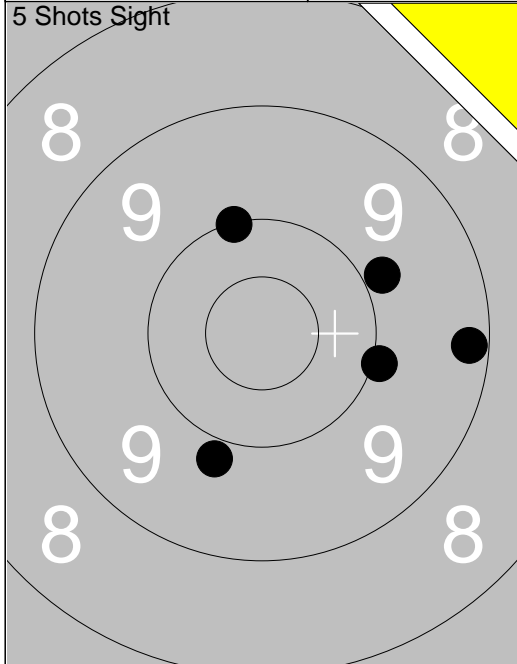

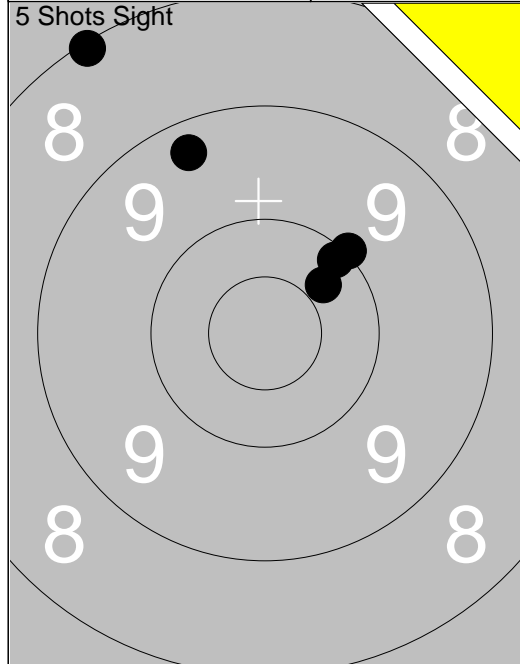

1:	8.1	↖
2:	9.3	↖
3:	10.1	↗
4:	10.3	↗
5:	10.0	↗
Series		47.0
Total		0.0

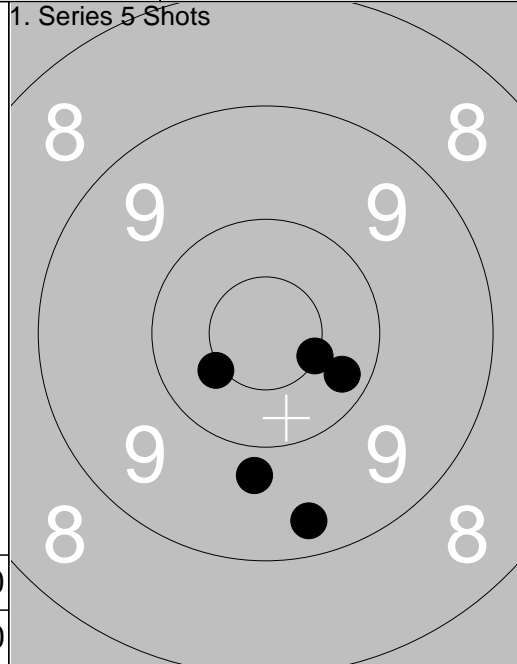

1:	10.2	→
2:	9.3	↓
3:	*10.5	→
4:	*10.4	↙
5:	9.8	↓
Series		48.0
Total		48.0

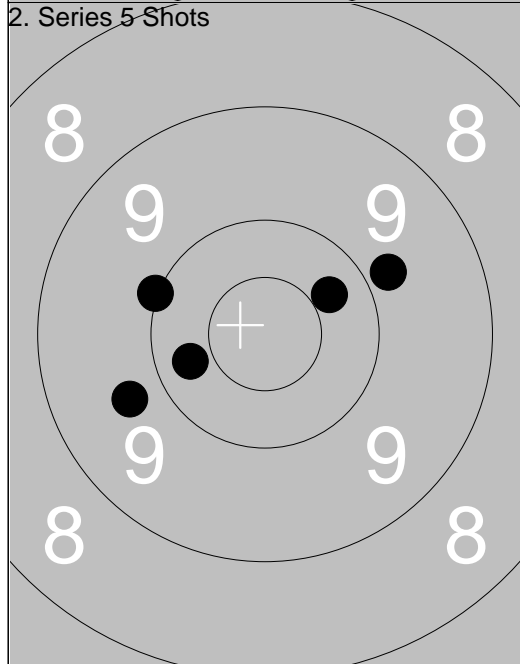

1:	10.0	↙
2:	9.7	↙
3:	10.3	↙
4:	9.8	↗
5:	10.3	↗
Series		48.0
Total		96.0

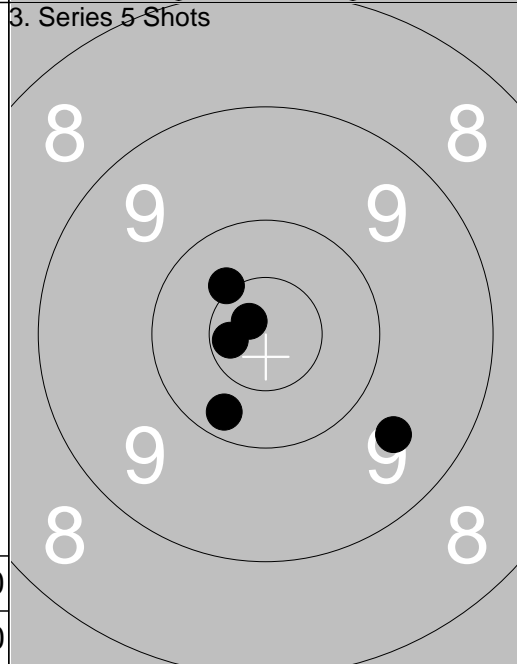

1:	*10.7	↙
2:	*10.4	↙
3:	*10.8	↙
4:	10.2	↓
5:	9.6	↘
Series		49.0
Total		145.0

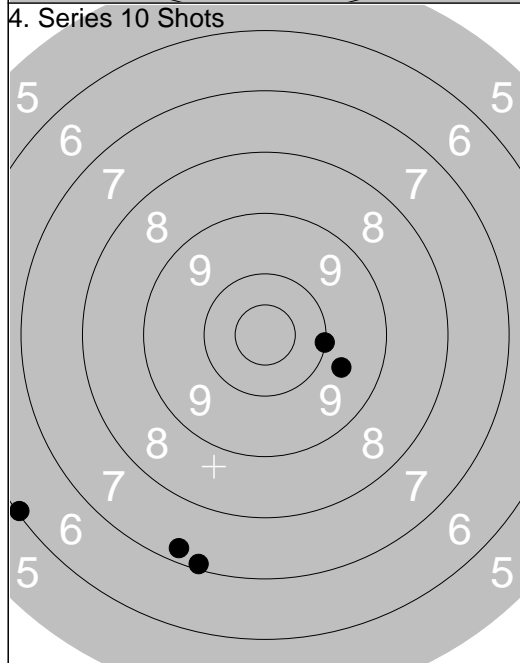

1:	10.0	→
2:	9.7	→
3:	7.3	↓
4:	7.1	↓
5:	6.1	↙
Series		39.0
Total		184.0

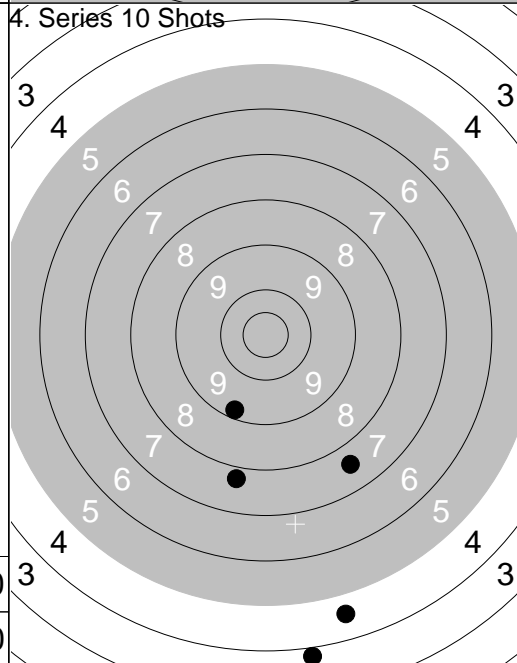

6:	7.8	↓
7:	7.6	↓
8:	4.6	↓
9:	3.8	↓
10:	9.2	↘
Series		30.0
Total		214.0

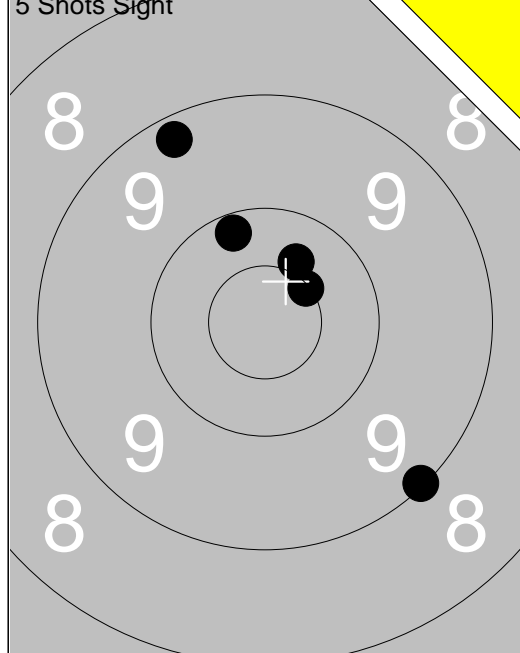

1: 9.2 ↖	
2: 10.2 ↖	
3: *10.5 ↗	
4: 10.4 ↗	
5: 9.1 ↘	
Series 48.0	
Total 0.0	

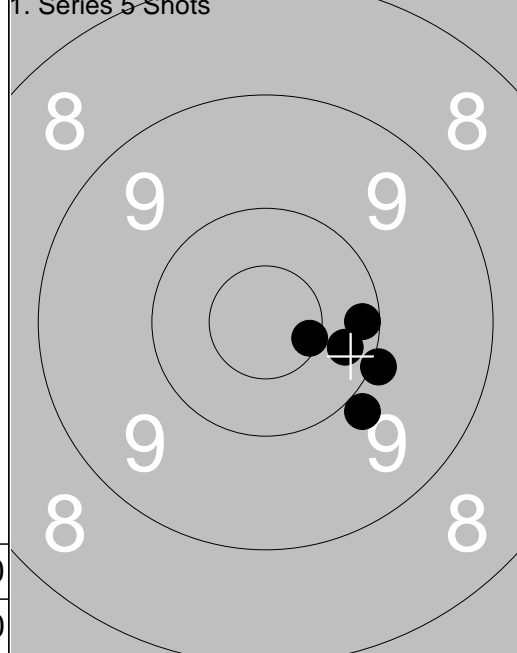

1: 10.3 →	
2: 10.0 →	
3: *10.6 →	
4: 10.2 →	
5: 9.9 ↘	
Series 49.0	
Total 49.0	

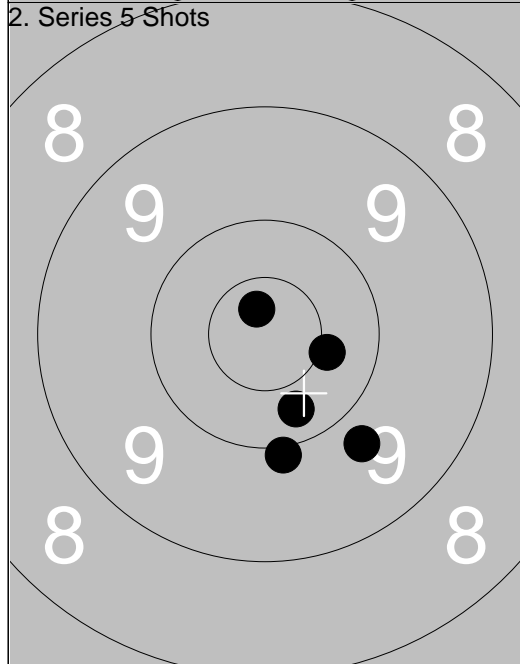

1: *10.7 ↖	
2: 10.3 ↘	
3: 10.0 ↘	
4: 9.7 ↘	
5: *10.4 →	
Series 49.0	
Total 98.0	

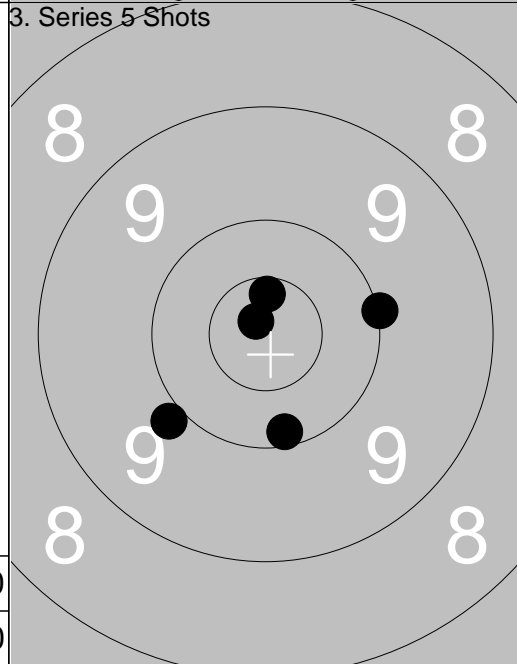

1: 9.9 ↙	
2: *10.6 ↖	
3: *10.8 ↖	
4: 10.0 →	
5: 10.1 ↘	
Series 49.0	
Total 147.0	

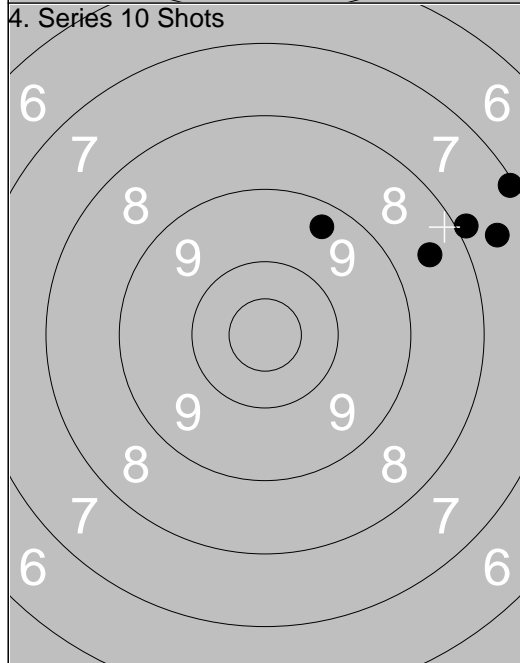

1: 7.9 →	
2: 9.4 ↖	
3: 8.5 →	
4: 7.1 →	
5: 7.6 →	
Series 38.0	
Total 185.0	

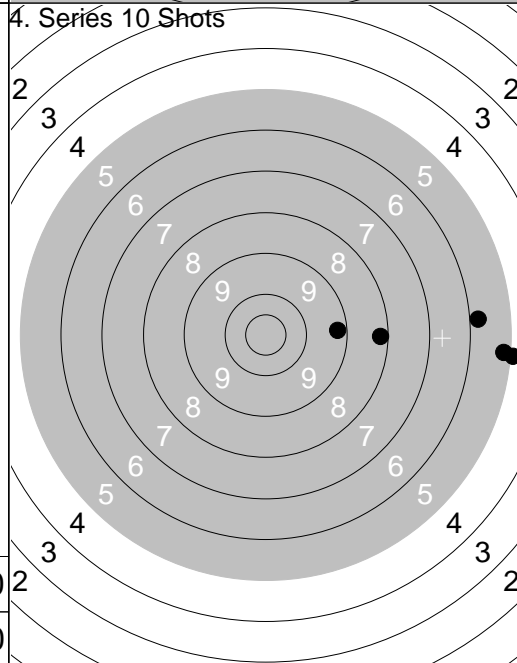

6: 5.8 →	
7: 8.2 →	
8: 5.0 →	
9: 5.2 →	
10: 9.3 →	
Series 32.0	
Total 217.0	

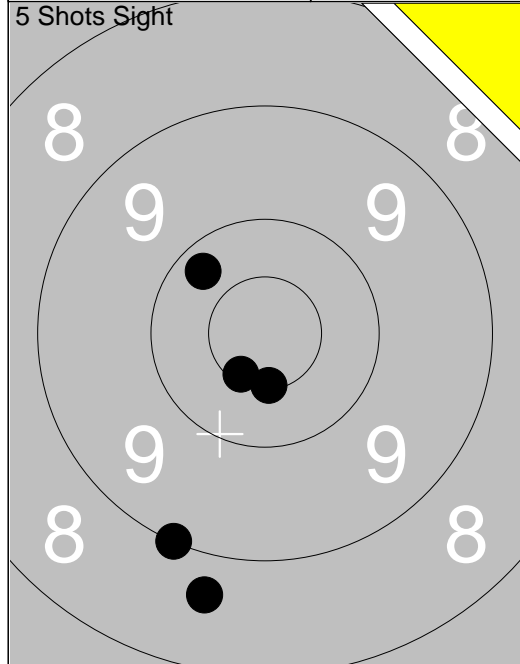

1: 8.7 ↓
2: 10.2 ↖
3: *10.6 ↘
4: *10.5 ↓
5: 9.0 ↓
Series 47.0
Total 0.0

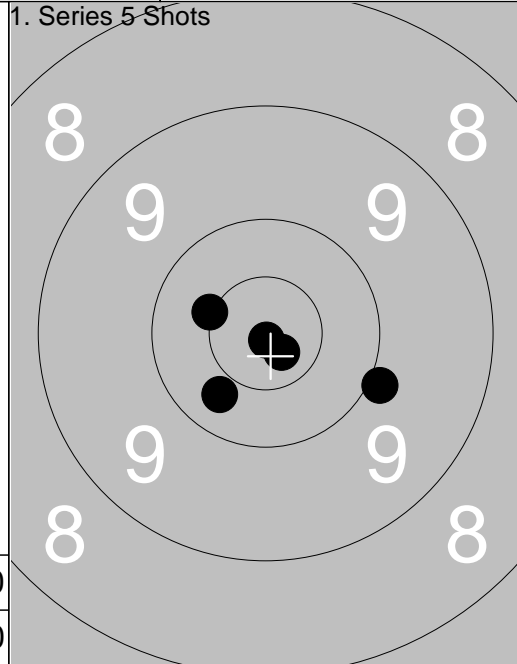

1: *10.7 ↘
2: 9.9 →
3: *10.5 ↖
4: *10.9 ↓
5: 10.3 ↘
Series 49.0
Total 49.0

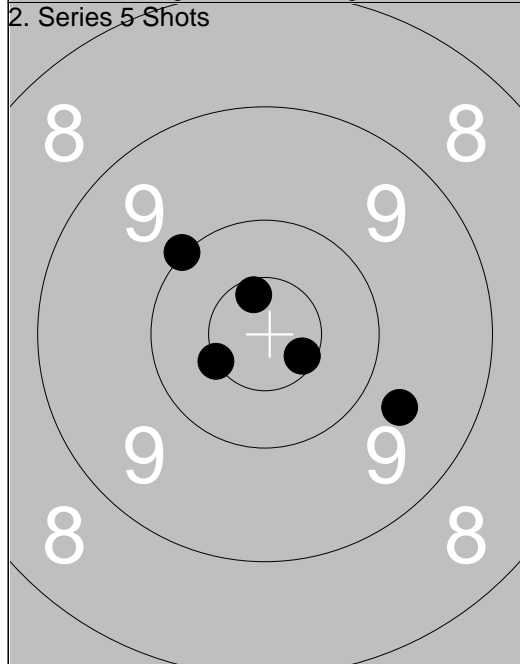

1: *10.6 ↗
2: *10.5 ↘
3: 10.0 ↖
4: 9.7 →
5: *10.6 ↘
Series 49.0
Total 98.0

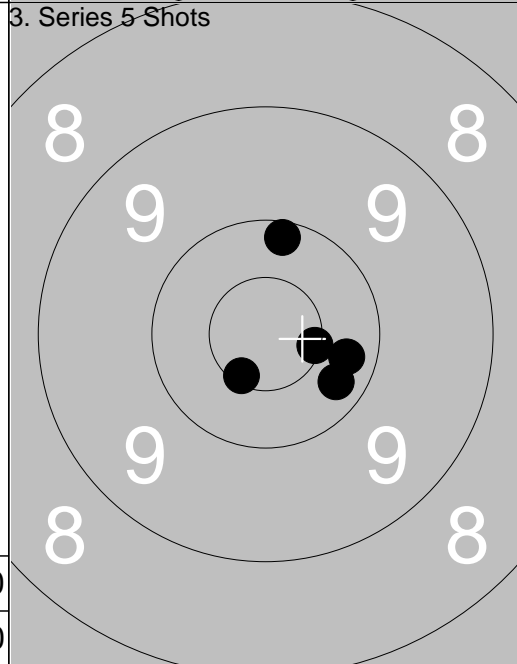

1: 10.3 →
2: *10.6 ↘
3: *10.5 →
4: 10.3 →
5: 10.1 ↑
Series 50.0
Total 148.0

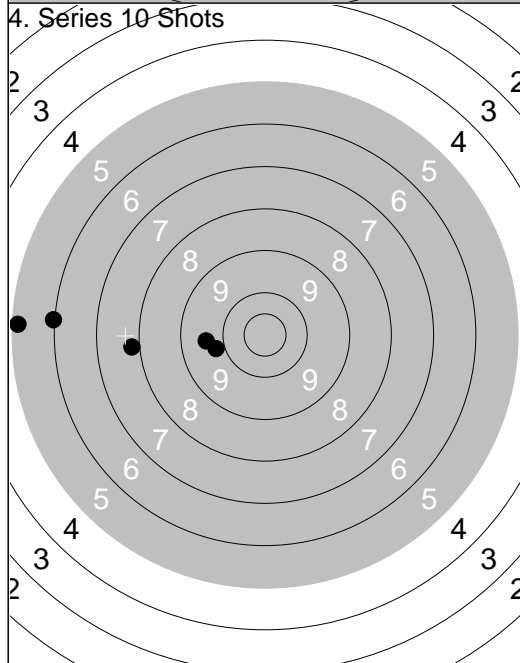

1: 9.6 ←
2: 6.0 ←
3: 7.9 ←
4: 5.2 ←
5: 9.8 ←
Series 36.0
Total 184.0

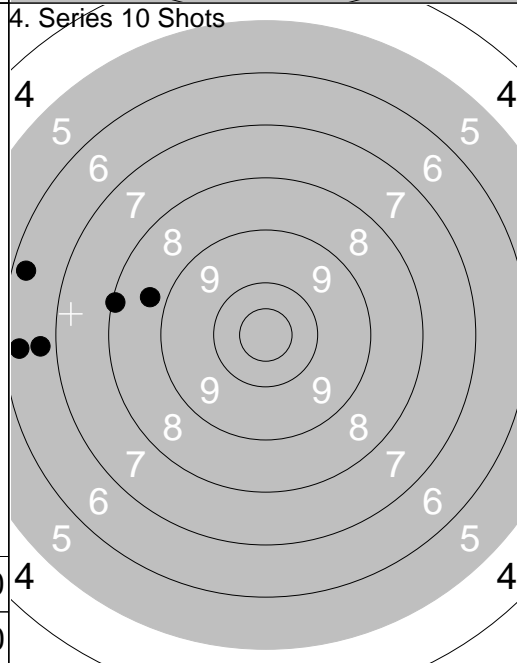

6: 8.1 ←
7: 6.3 ←
8: 6.7 ←
9: 6.3 ←
10: 8.7 ←
Series 34.0
Total 218.0

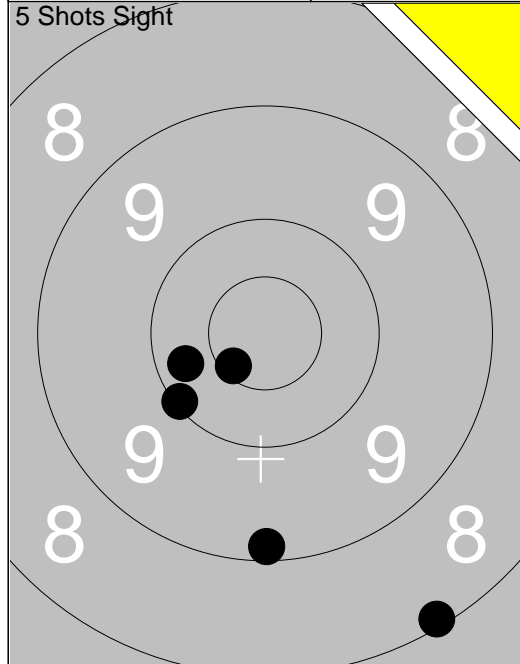

1:	9.2	↓
2:	10.3	↙
3:	8.1	↓
4:	10.1	↙
5:	*10.6	↙
Series		47.0
Total		0.0

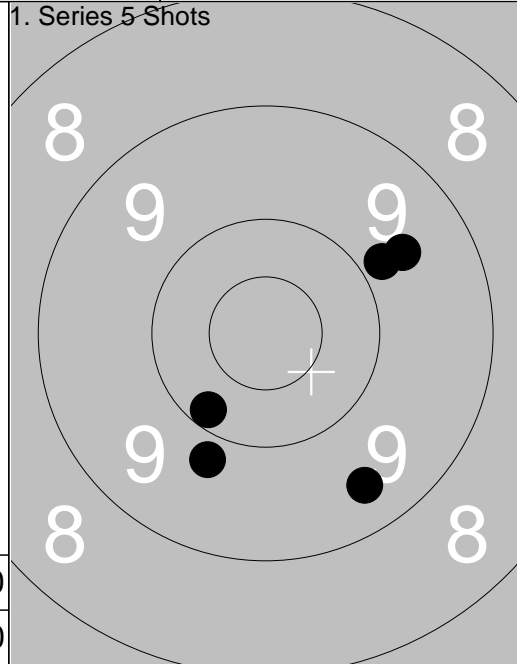

1:	9.6	↗
2:	9.4	↓
3:	9.8	↗
4:	10.2	↙
5:	9.8	↓
Series		46.0
Total		46.0

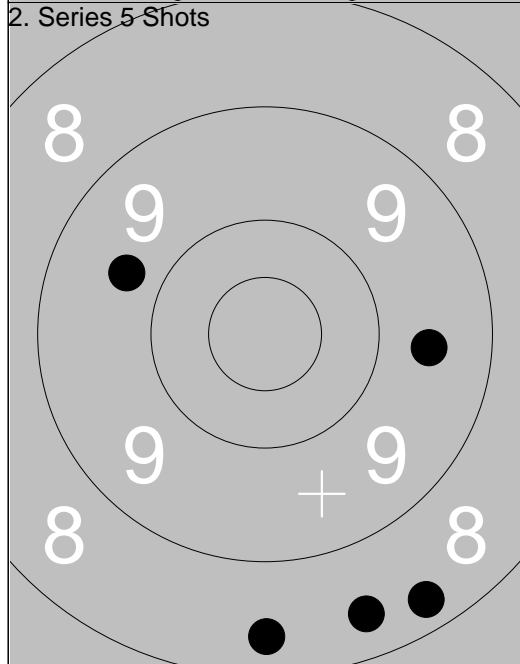

1:	9.7	↖
2:	8.3	↓
3:	8.4	↓
4:	9.6	↗
5:	8.4	↓
Series		42.0
Total		88.0

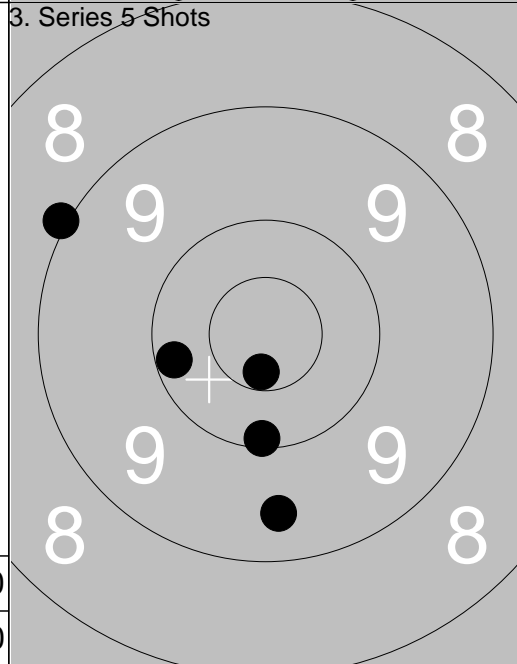

1:	*10.6	↙
2:	10.1	↓
3:	9.5	↓
4:	9.0	↖
5:	10.2	↖
Series		48.0
Total		136.0

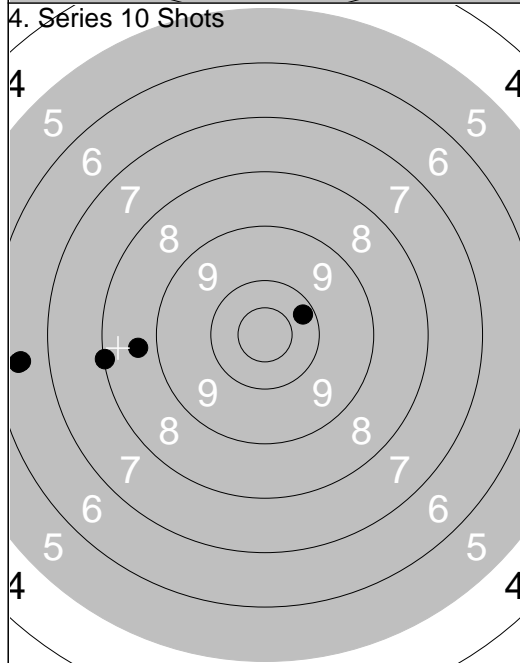

1:	8.7	↖
2:	10.2	↗
3:	6.5	↖
4:	6.5	↖
5:	8.1	↖
Series		38.0
Total		174.0

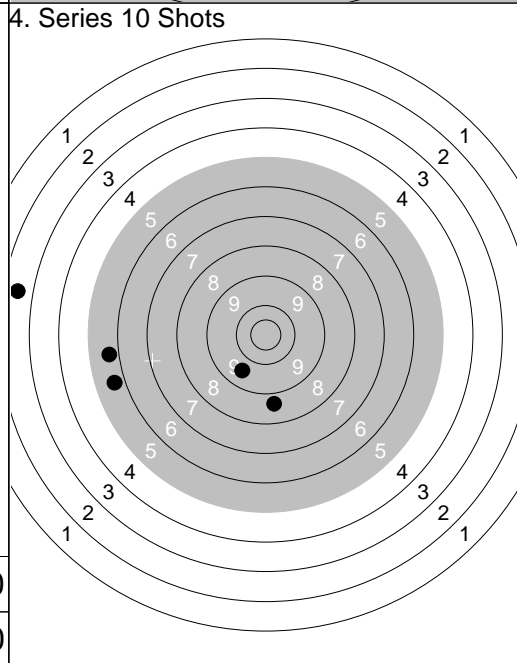

6:	5.7	↖
7:	5.7	↖
8:	2.5	↖
9:	8.7	↓
10:	9.6	↙
Series		29.0
Total		203.0

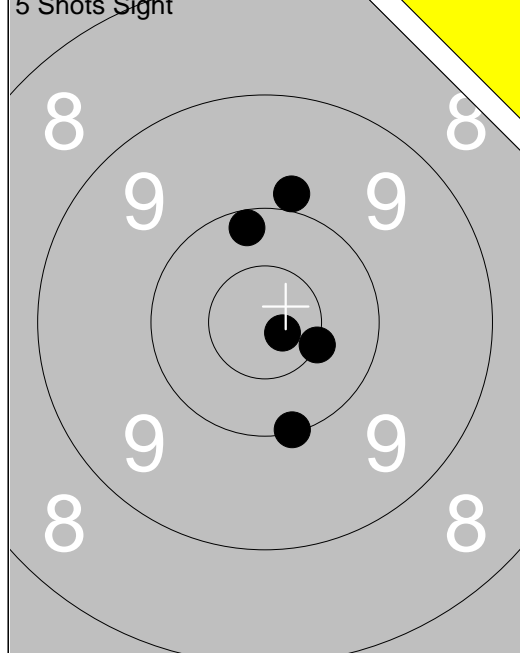

1: 9.9 ↑
2: *10.5 →
3: 10.1 ↓
4: 10.2 ↑
5: *10.8 →
Series 49.0
Total 0.0

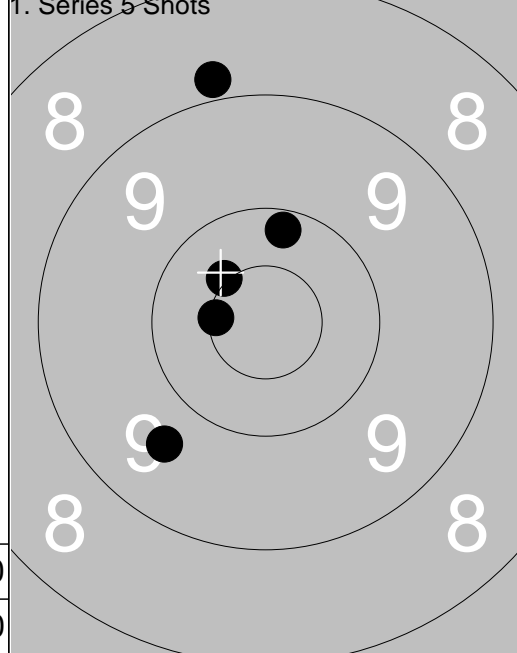

1: 10.2 ↑
2: 9.6 ↙
3: *10.5 ↘
4: 8.8 ↑
5: *10.5 ↘
Series 47.0
Total 47.0

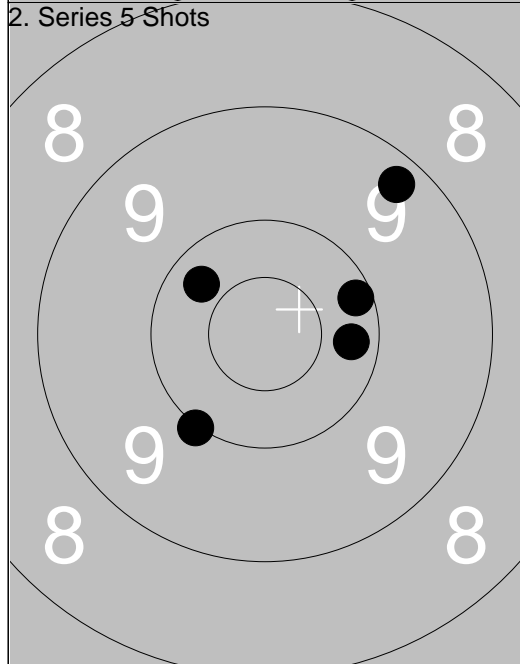

1: 10.0 ↙
2: 10.3 ↘
3: 9.3 ↗
4: 10.2 →
5: 10.2 →
Series 49.0
Total 96.0

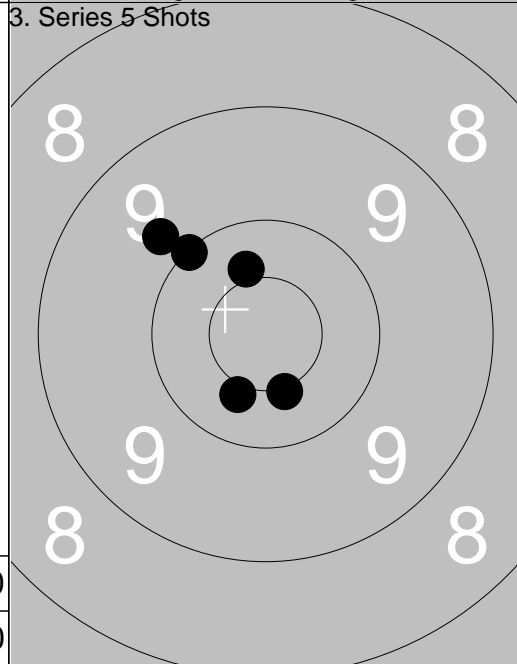

1: 9.8 ↖
2: 10.0 ↘
3: 10.4 ↑
4: 10.4 ↓
5: *10.5 ↓
Series 49.0
Total 145.0

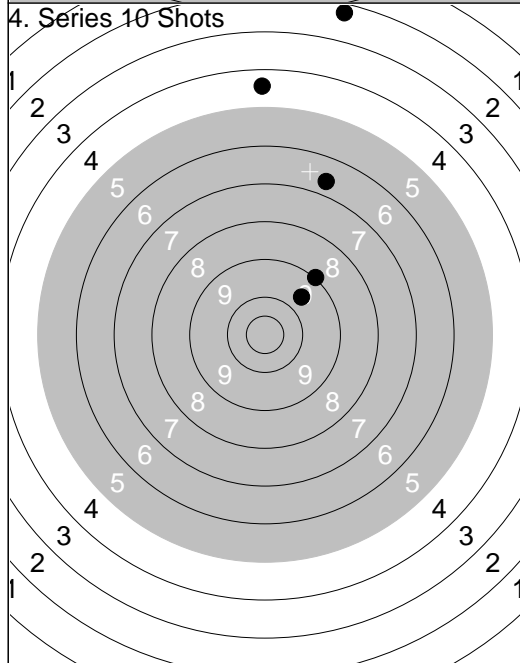

1: 2.3 ↑
2: 4.5 ↑
3: 6.7 ↑
4: 9.7 ↗
5: 9.0 ↗
Series 30.0
Total 175.0

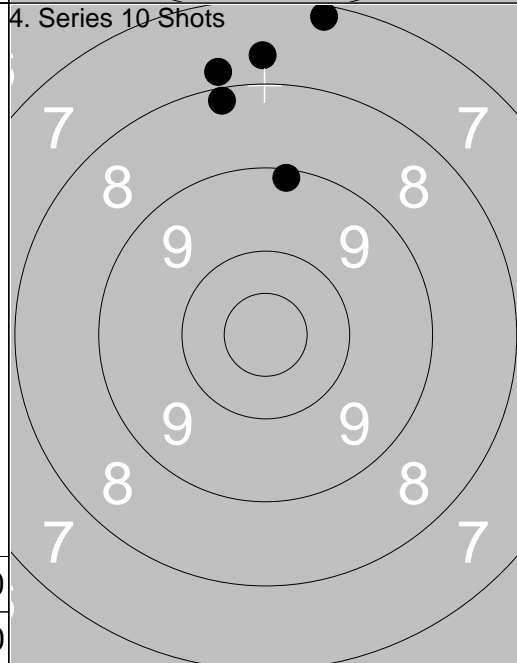

6: 9.1 ↑
7: 8.2 ↑
8: 7.2 ↑
9: 7.7 ↑
10: 7.8 ↑
Series 38.0
Total 213.0

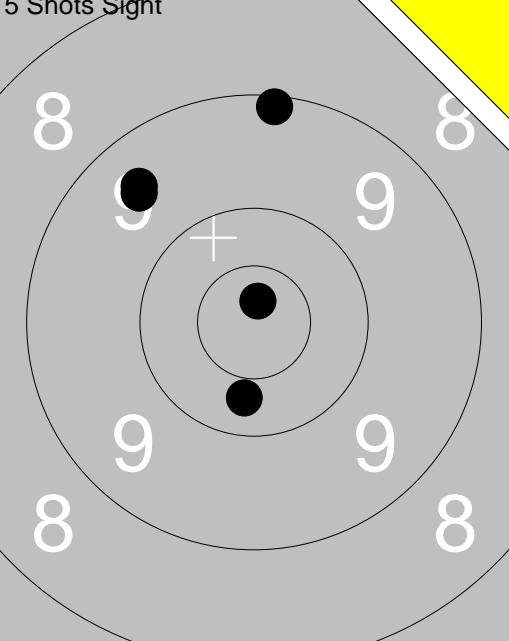
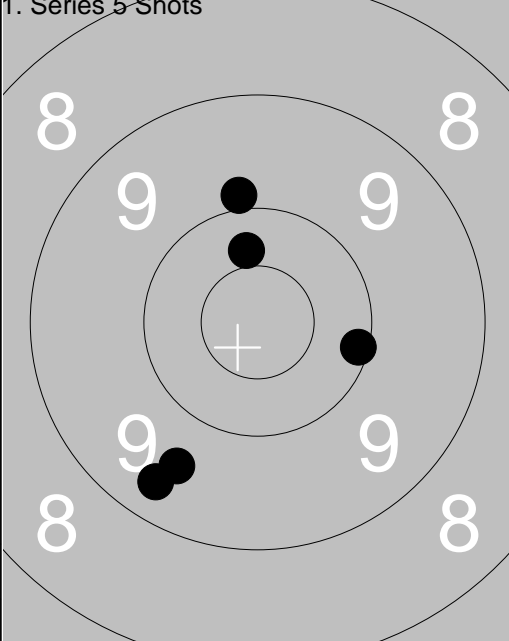
<p>5 Shots Sight</p> 	<p>1. Series 5 Shots</p> 	
1: 9.5 ↖ 2: 10.3 ↓ 3: 9.1 ↑ 4: *10.8 ↑ 5: 9.5 ↖	1: 9.4 ↙ 2: 10.1 → 3: 10.4 ↑ 4: 9.6 ↙ 5: 9.9 ↑	
Series 47.0 Total 0.0	Series 47.0 Total 47.0	

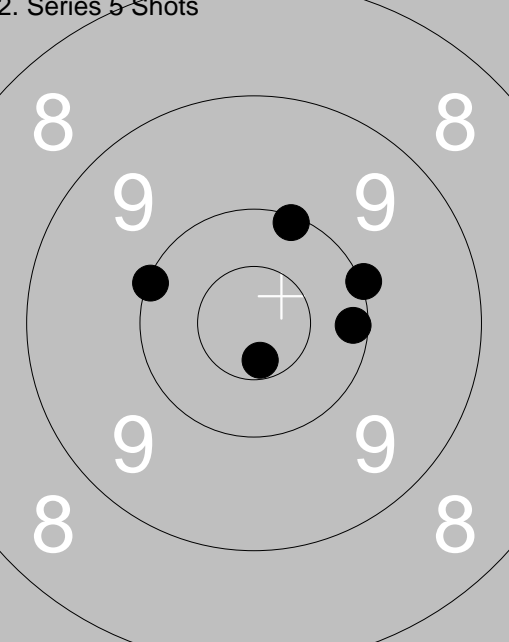
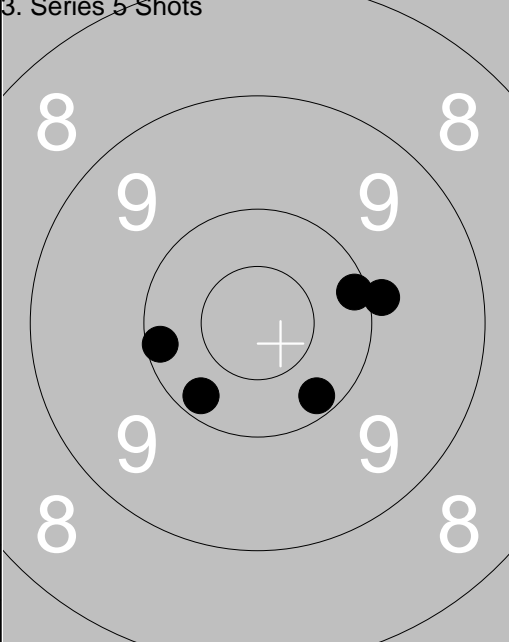
<p>2. Series 5 Shots</p> 	<p>3. Series 5 Shots</p> 	
1: 10.0 ↖ 2: 10.1 ↑ 3: *10.6 ↓ 4: 10.1 → 5: 10.0 →	1: 10.2 ↘ 2: 10.1 ← 3: 10.2 ↙ 4: 10.1 → 5: 9.9 →	
Series 50.0 Total 97.0	Series 49.0 Total 146.0	

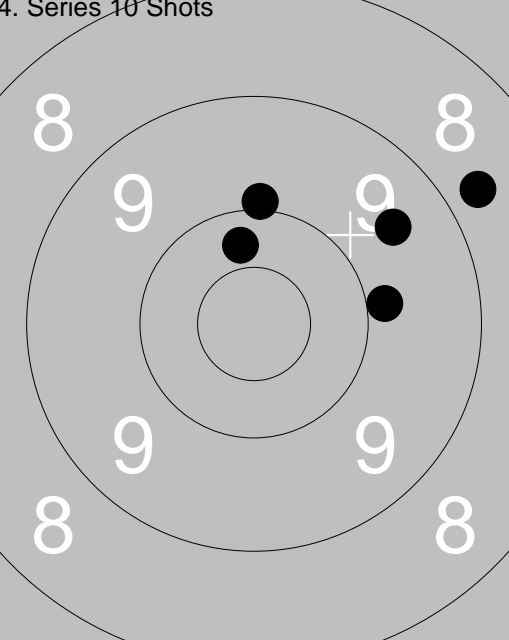
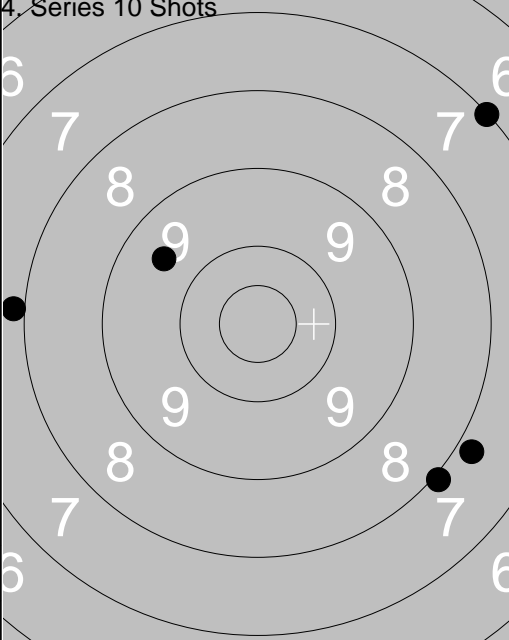
<p>4. Series 10 Shots</p> 	<p>4. Series 10 Shots</p> 	
1: 8.7 ↗ 2: 10.0 ↑ 3: 9.5 ↗ 4: 9.9 → 5: 10.3 ↑	6: 9.6 ↖ 7: 7.9 ← 8: 7.8 ↘ 9: 8.0 ↘ 10: 7.0 ↗	
Series 46.0 Total 192.0	Series 38.0 Total 230.0	