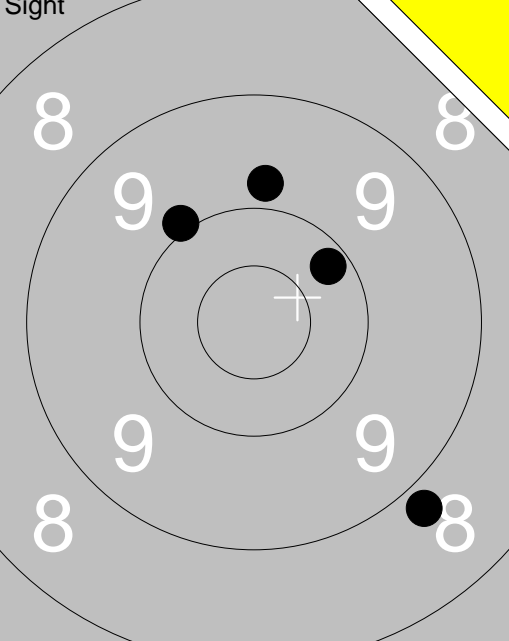
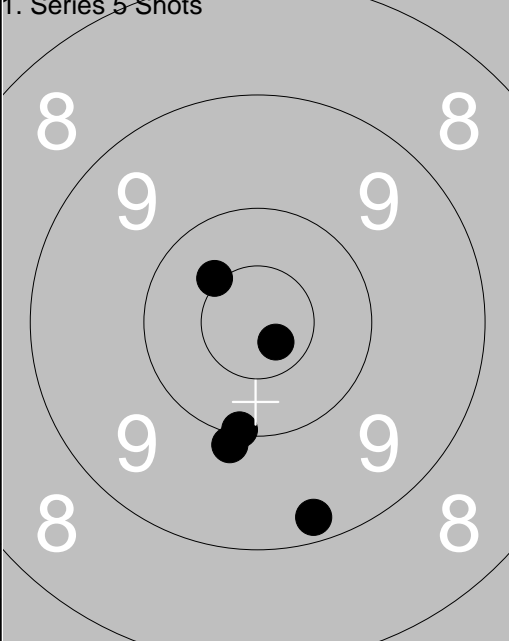
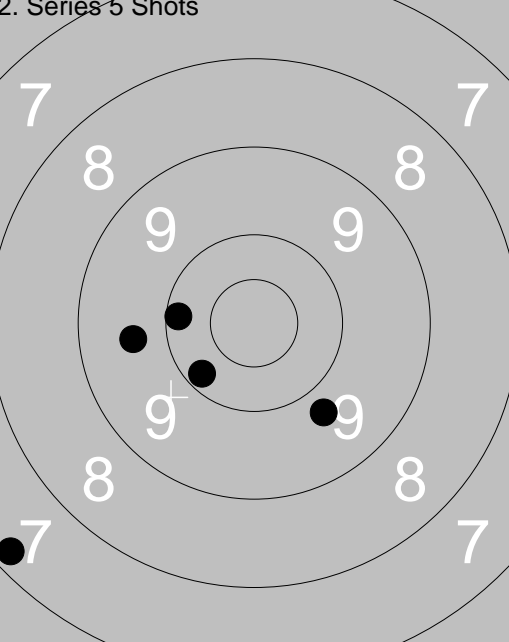
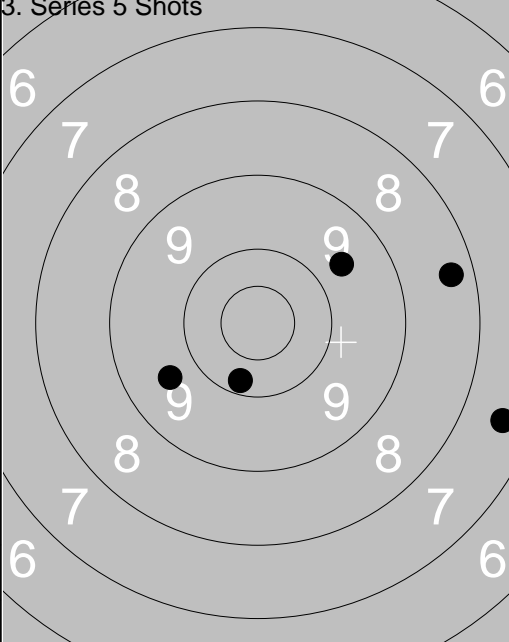
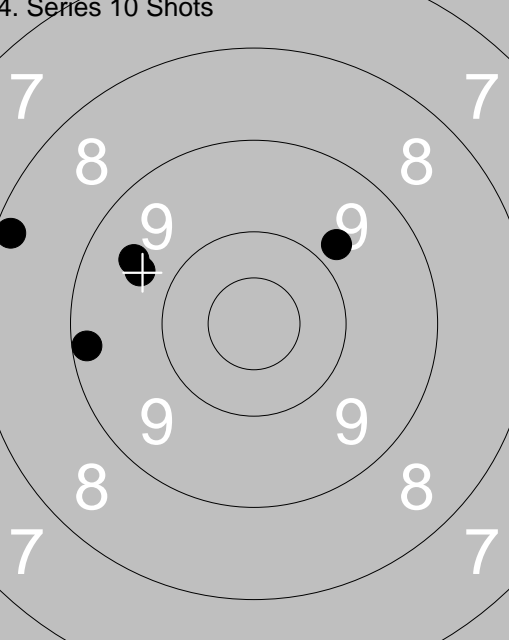
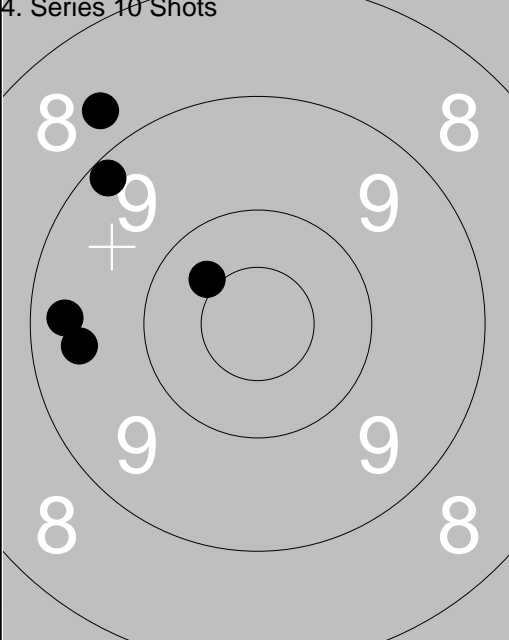
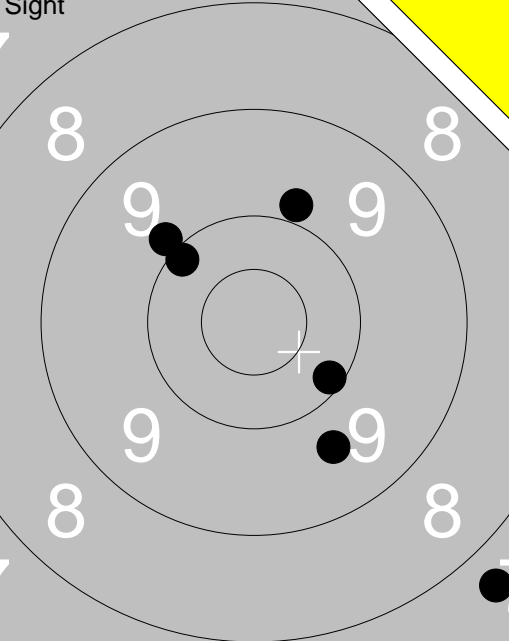
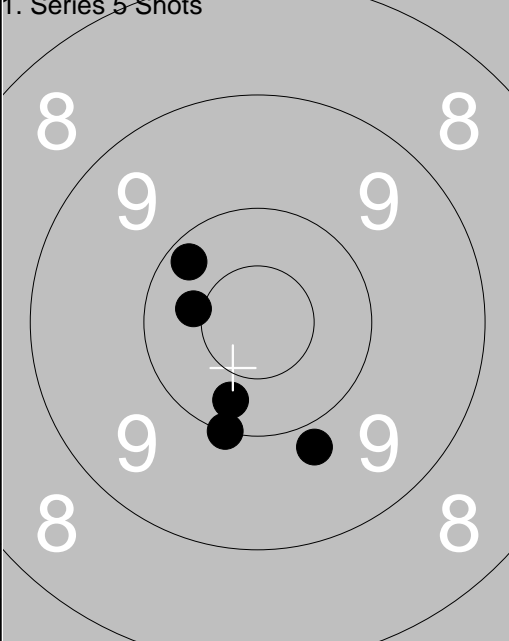

<p>Sight</p> 	<p>1: 9.8 ↑ 2: 8.8 ↘ 3: 10.2 ↗ 4: 10.0 ↖</p>	<p>1. Series 5 Shots</p> 		<p>1: 9.9 ↓ 2: 10.1 ↓ 3: *10.5 ↖ 4: 9.2 ↓ 5: *10.7 ↘</p>	
Series 37.0				Series 48.0	
Total 0.0				Total 48.0	

<p>2. Series 5 Shots</p> 	<p>1: 9.6 ← 2: 7.2 ↓ 3: 9.7 ↓ 4: 10.2 ↙ 5: 10.1 ←</p>	<p>3. Series 5 Shots</p> 		<p>1: 9.6 ↙ 2: 9.6 ↗ 3: 8.3 → 4: 7.5 ↘ 5: 10.2 ↓</p>	
Series 45.0				Series 43.0	
Total 93.0				Total 136.0	

<p>4. Series 10 Shots</p> 	<p>1: 9.5 ↙ 2: 9.8 ↗ 3: 9.2 ← 4: 8.2 ← 5: 9.7 ↙</p>	<p>4. Series 10 Shots</p> 		<p>6: 9.2 ↖ 7: 9.3 ← 8: 9.5 ← 9: 10.4 ↖ 10: 8.7 ↖</p>	
Series 44.0				Series 45.0	
Total 180.0				Total 225.0	

<p>Sight</p> 	<p>1: 9.9 ↗ 2: 9.6 ↘ 3: 9.9 ↗ 4: 10.1 ↗ 5: 10.1 ↘ 6: 7.7 ↘</p>	<p>1. Series 5 Shots</p> 		<p>1: 9.8 ↘ 2: *10.4 ↗ 3: 10.0 ↘ 4: 10.2 ↗ 5: 10.3 ↘</p>
Series 54.0		Series 49.0		
Total 0.0		Total 49.0		

<p>2. Series 5 Shots</p> 	<p>1: 7.9 ↗ 2: 10.1 → 3: 6.4 ← 4: 7.5 ↗ 5: 8.5 ←</p>	<p>3. Series 5 Shots</p> 		<p>1: 6.8 ↘ 2: 8.9 ↘ 3: 5.1 ↘ 4: 6.5 ↘ 5: 9.1 ↘</p>
Series 38.0		Series 34.0		
Total 87.0		Total 121.0		

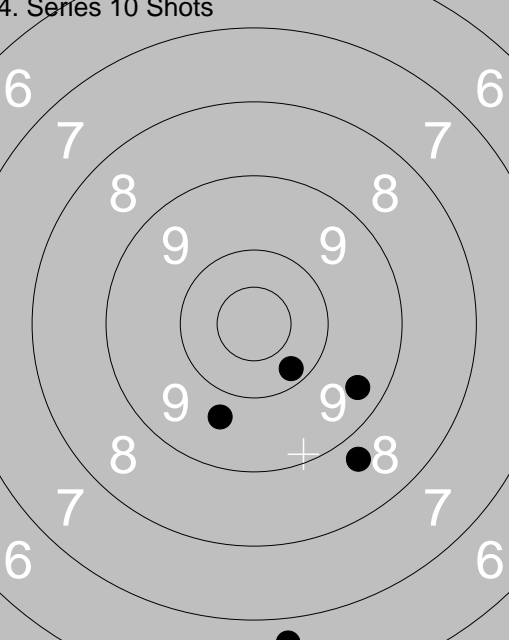
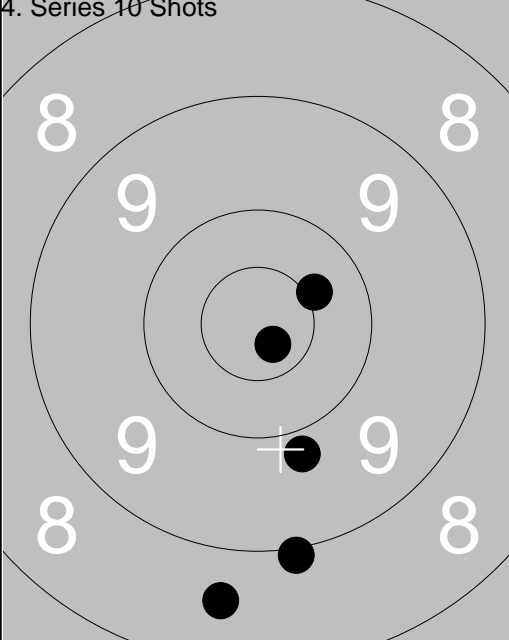
<p>4. Series 10 Shots</p> 	<p>1: 10.2 ↘ 2: 6.7 ↘ 3: 9.7 ↘ 4: 9.4 ↘ 5: 8.7 ↘</p>	<p>4. Series 10 Shots</p> 		<p>6: 9.0 ↘ 7: 8.6 ↘ 8: *10.4 ↗ 9: *10.7 ↘ 10: 9.8 ↘</p>
Series 42.0		Series 46.0		
Total 163.0		Total 209.0		

<p>Sight</p>	<p>1. Series 5 Shots</p>	<p>1: 9.3 ←</p> <p>2: 10.2 ↓</p> <p>3: 9.8 ↗</p> <p>4: 9.2 ↓</p> <p>5: 8.7 ↑</p> <p>6: 9.9 ↗</p>
Series 54.0	Series 47.0	
Total 0.0	Total 47.0	

<p>2. Series 5 Shots</p>	<p>3. Series 5 Shots</p>	<p>1: 9.1 →</p> <p>2: 7.8 ←</p> <p>3: 7.5 ←</p> <p>4: 8.3 ←</p> <p>5: 9.4 ↓</p>
Series 40.0	Series 38.0	
Total 87.0	Total 125.0	

<p>4. Series 10 Shots</p>	<p>4. Series 10 Shots</p>	<p>1: 10.0 ↗</p> <p>2: 9.1 ↗</p> <p>3: 8.5 ↑</p> <p>4: 9.3 →</p> <p>5: 9.4 ↑</p>
Series 45.0	Series 44.0	
Total 170.0	Total 214.0	

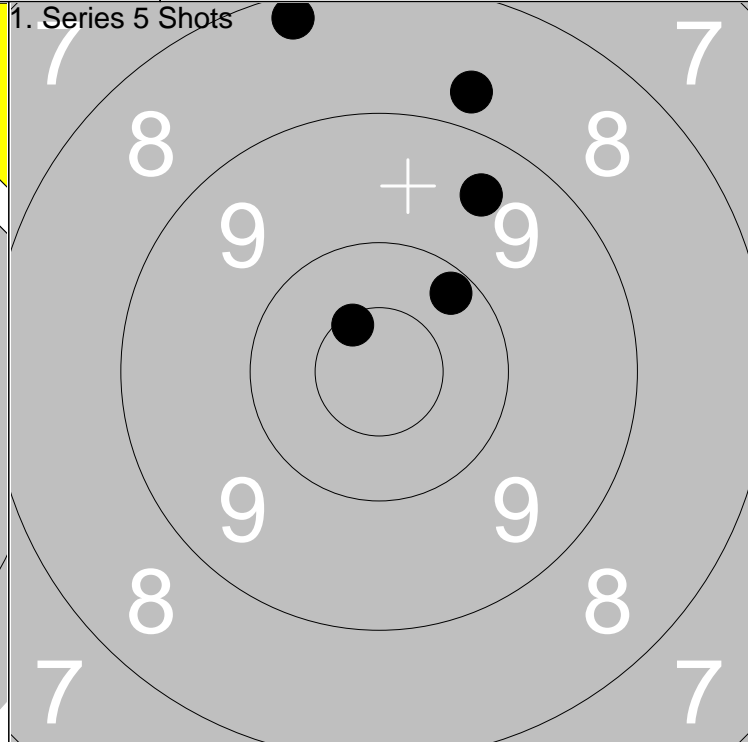
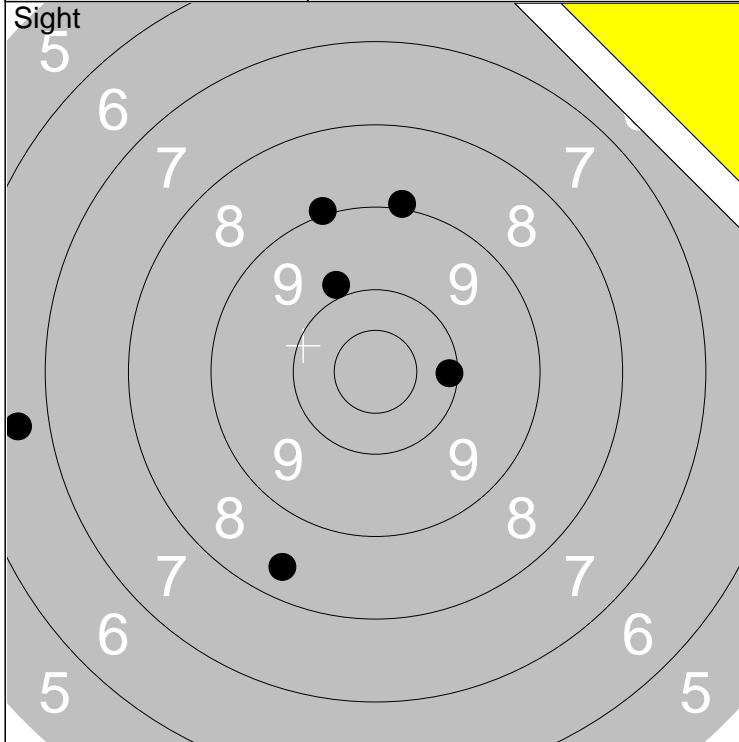

1: 9.0 ↑	6: 6.6 ←		
2: 10.1 →		Series	51.0
3: 9.0 ↑			
4: 9.9 ↑		Total	0.0
5: 8.4 ↓			

1: 8.7 ↑			
2: *10.6 ↖		Series	45.0
3: 10.2 ↗			
4: 9.4 ↑		Total	45.0
5: 8.2 ↑			

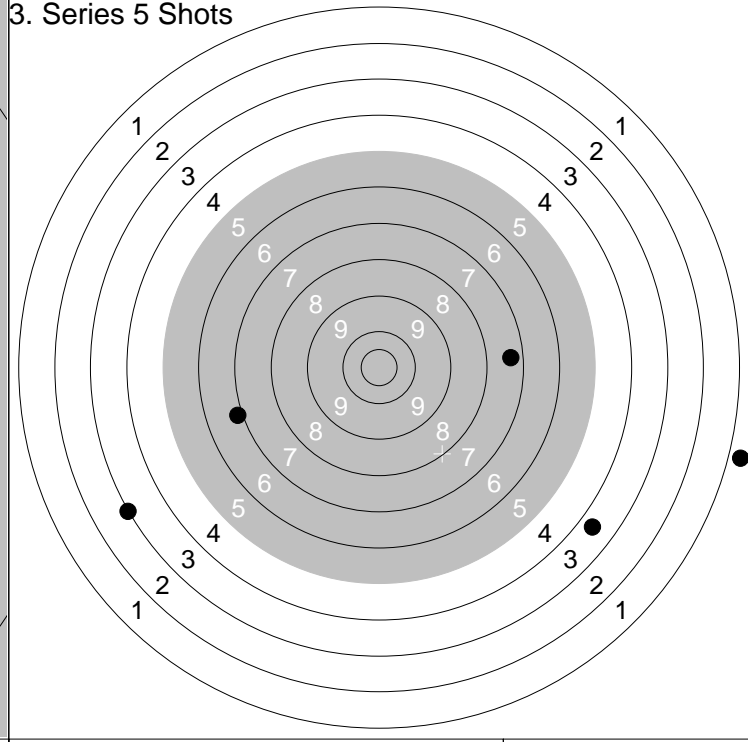
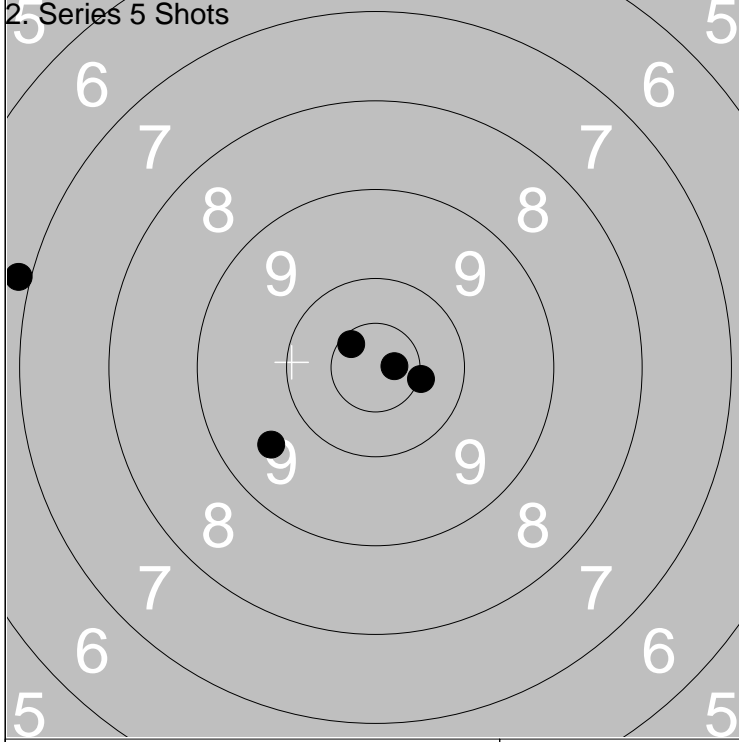

1: *10.6 ↖			
2: *10.5 →		Series	45.0
3: *10.8 →			
4: 9.6 ←		Total	90.0
5: 6.9 ←			

1: 7.4 →			
2: 6.9 ←		Series	19.0
3: 0.0 →			
4: 3.7 ↘		Total	109.0
5: 3.0 ←			

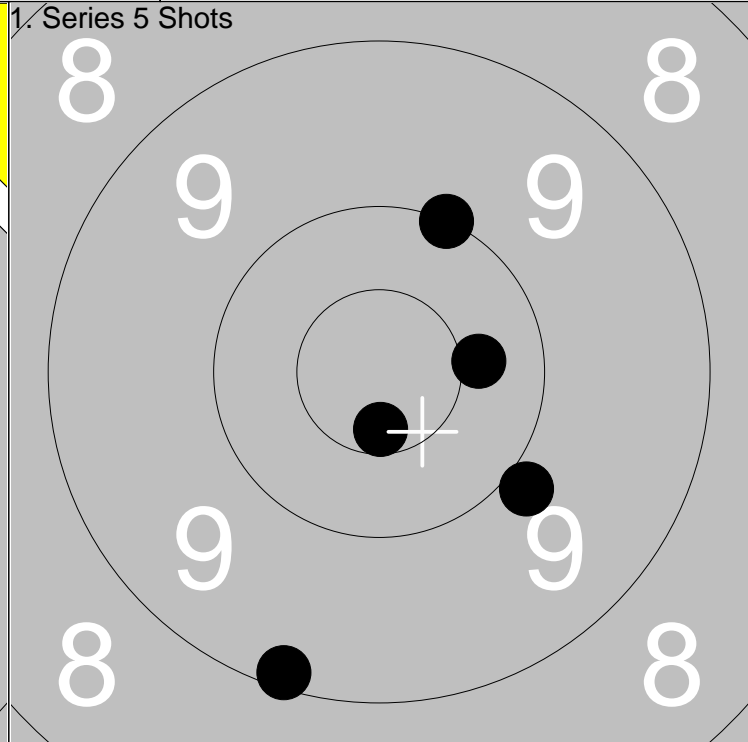
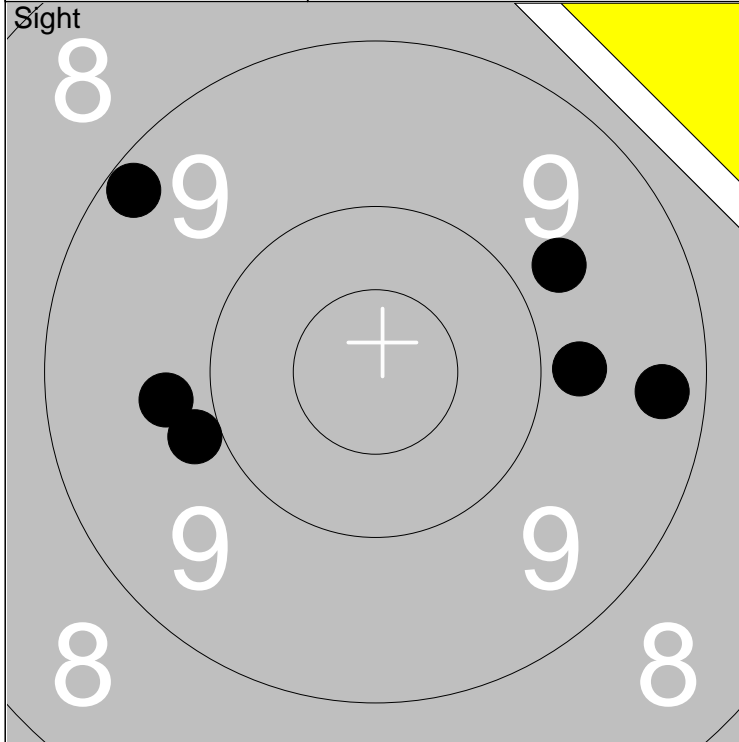

1: 9.2 ↖	6: 9.8 →		
2: 9.3 →		Series	54.0
3: 9.7 ↗			
4: 9.9 ←		Total	0.0
5: 9.8 ←			

1: 10.0 ↗			
2: *10.6 ↓		Series	48.0
3: 9.9 ↘			
4: 10.4 →		Total	48.0
5: 9.1 ↓			

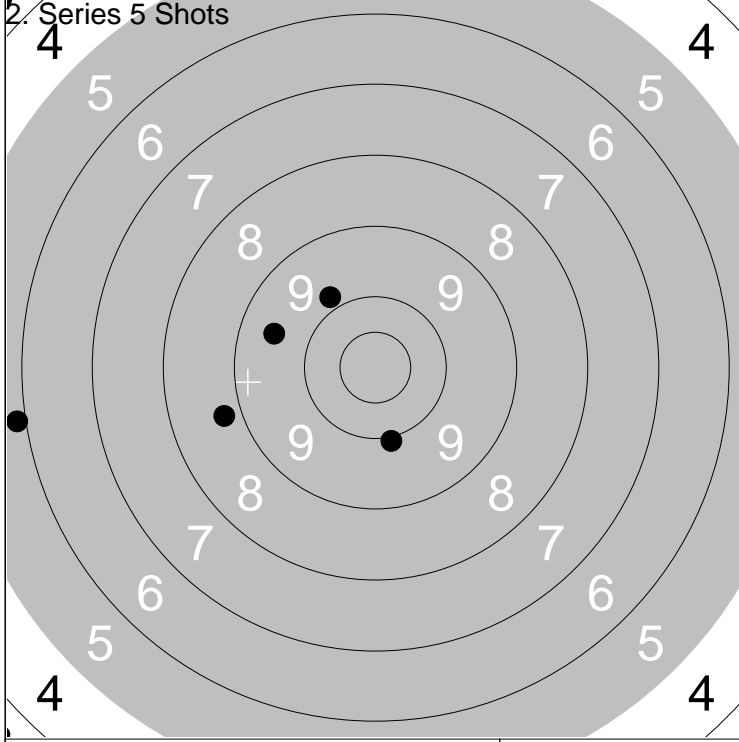

1: 8.8 ←			
2: 9.5 ←		Series	41.0
3: 9.9 ↗			
4: 10.0 ↓		Total	89.0
5: 5.9 ←			

1: 9.7 ↓			
2: 9.3 →		Series	40.0
3: 8.5 ←			
4: 7.8 ↓		Total	129.0
5: 7.7 →			

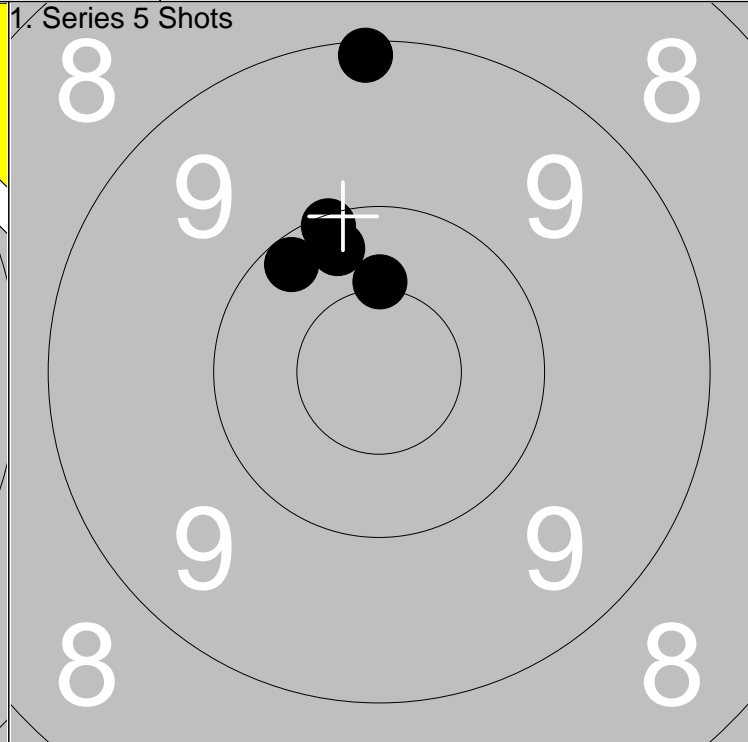
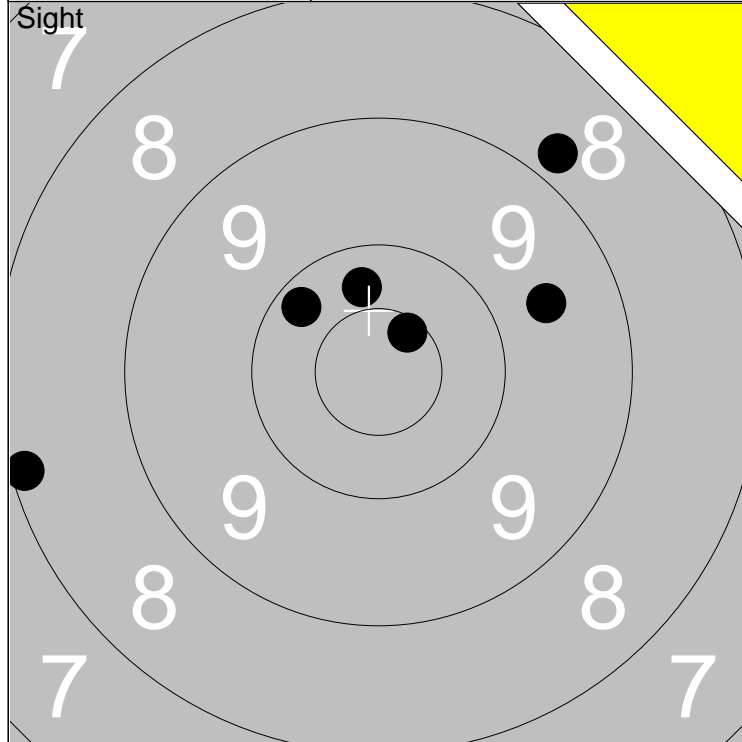

1: 9.6 →	6: 8.1 ←		
2: 8.8 ↗		Series	55.0
3: *10.6 ↗			
4: 10.2 ↖		Total	0.0
5: 10.3 ↑			

1: 9.1 ↑			
2: *10.4 ↑		Series	49.0
3: 10.1 ↖			
4: 10.2 ↖		Total	49.0
5: 10.2 ↖			

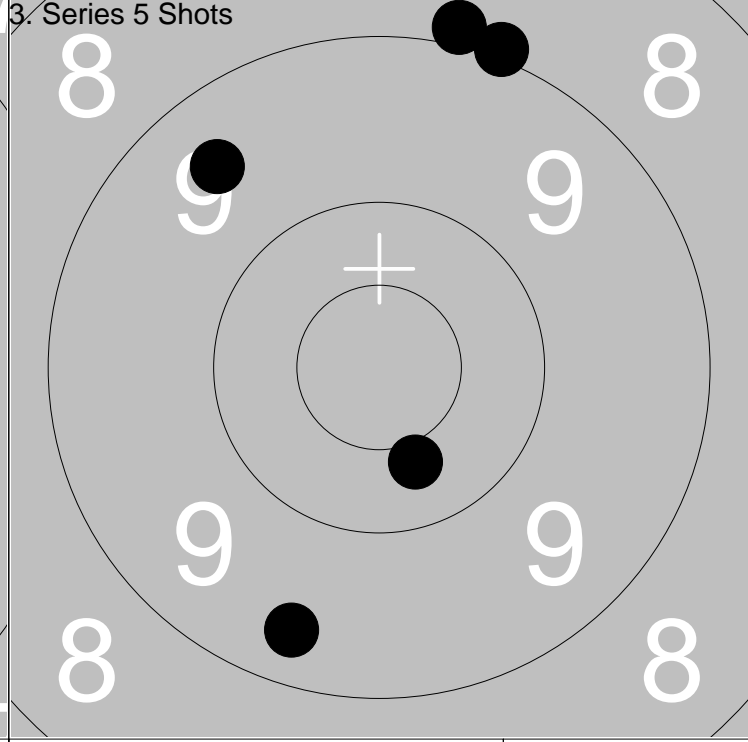
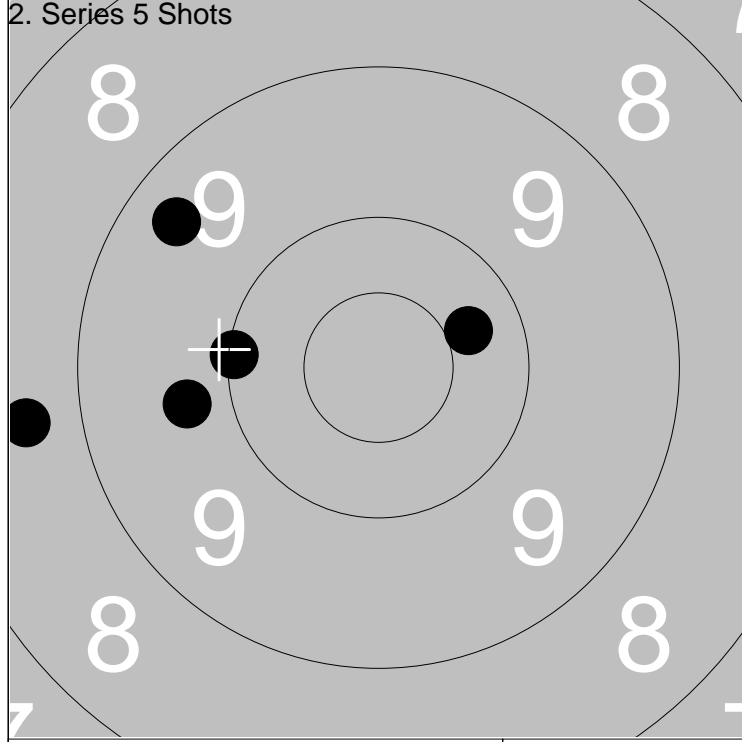

1: 9.7 ←			
2: 8.7 ←		Series	46.0
3: 10.3 →			
4: 10.1 ←		Total	95.0
5: 9.4 ↖			

1: 8.9 ↑			
2: 9.5 ↖		Series	45.0
3: 10.4 ↓			
4: 9.4 ↓		Total	140.0
5: 9.0 ↑			

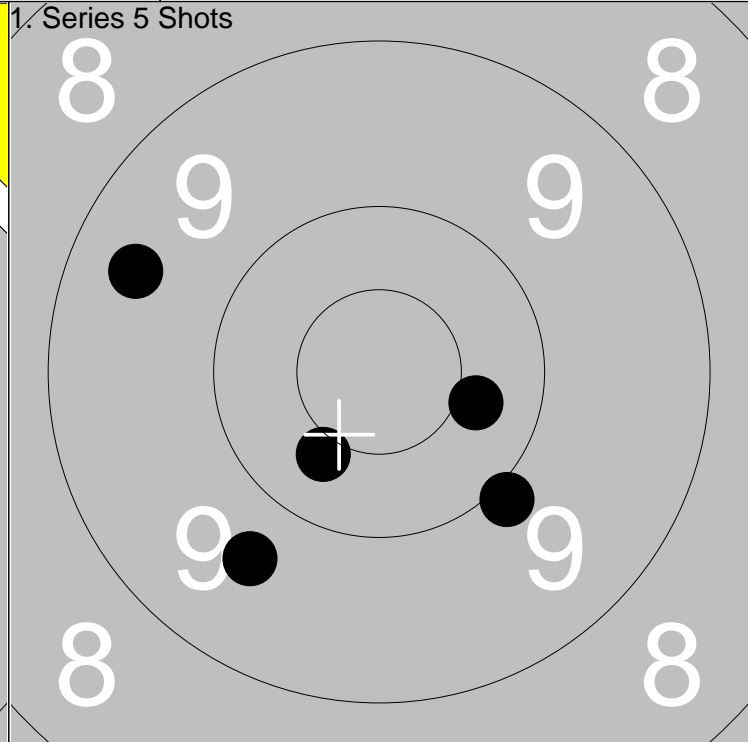
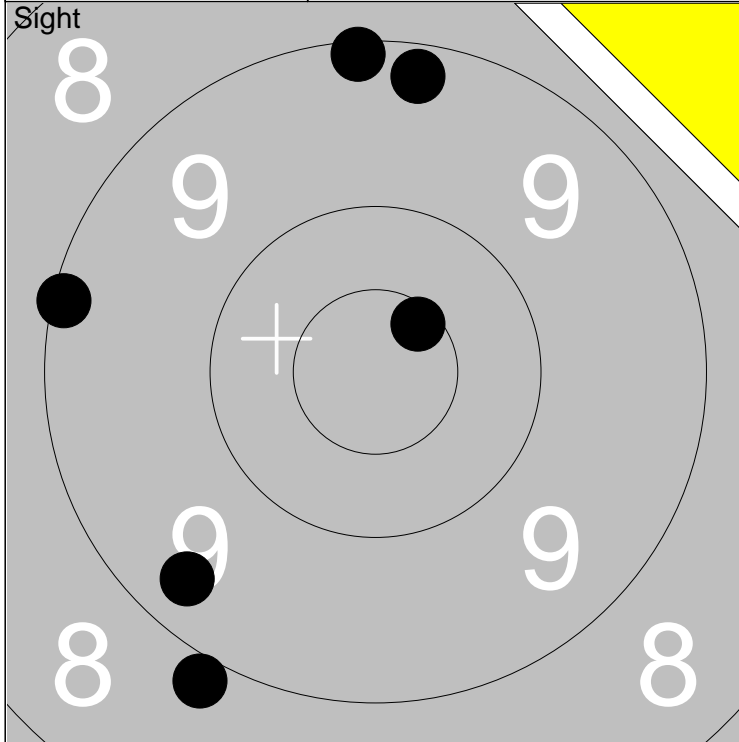

1: 9.1 ←	6: 9.3 ↙		
2: 9.2 ↑		Series	54.0
3: 9.1 ↑			
4: *10.6 ↗		Total	0.0
5: 8.9 ↘			

1: 10.4 ↘			
2: 10.4 →		Series	47.0
3: 9.7 ↘			
4: 9.4 ←		Total	47.0
5: 9.9 ↘			

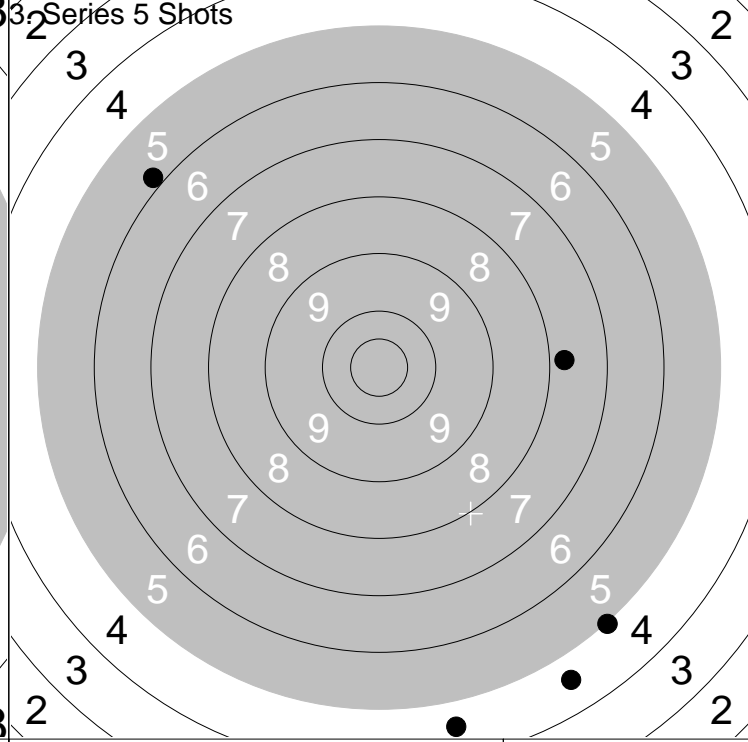
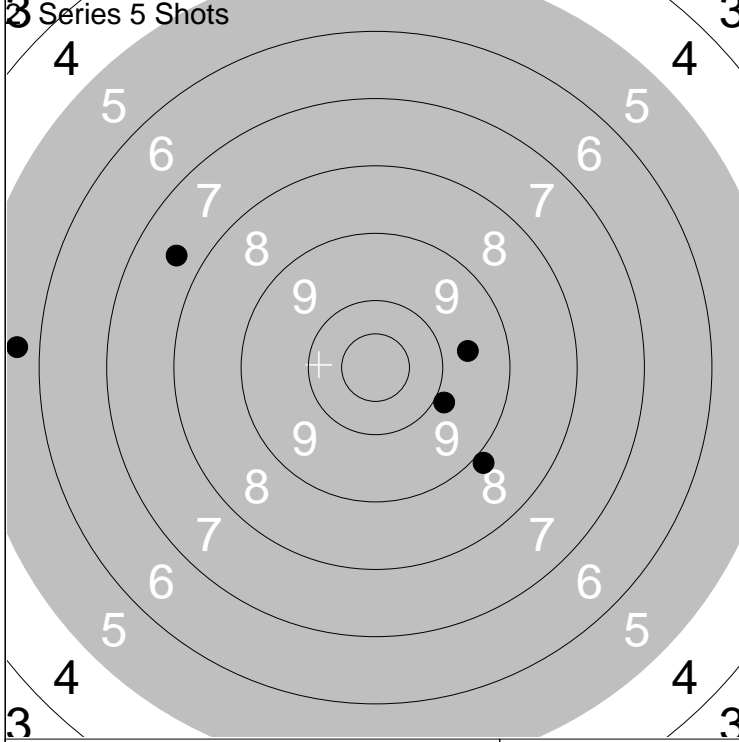

1: 7.6 ↖			
2: 9.9 ↘		Series	38.0
3: 9.6 →			
4: 8.9 ↘		Total	85.0
5: 5.7 ←			

1: 4.6 ↘			
2: 5.9 ↗		Series	25.0
3: 4.6 ↘			
4: 7.8 →		Total	110.0
5: 5.0 ↘			

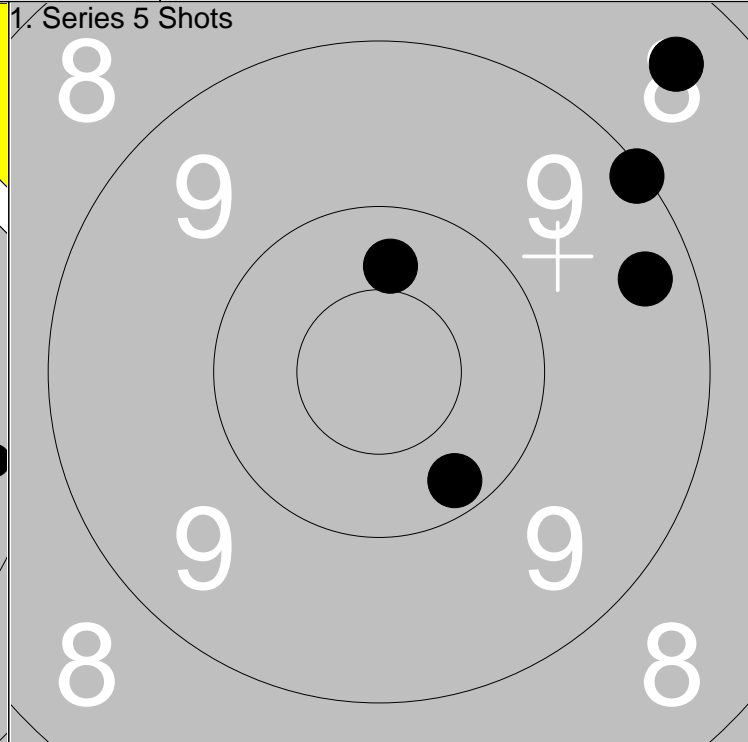
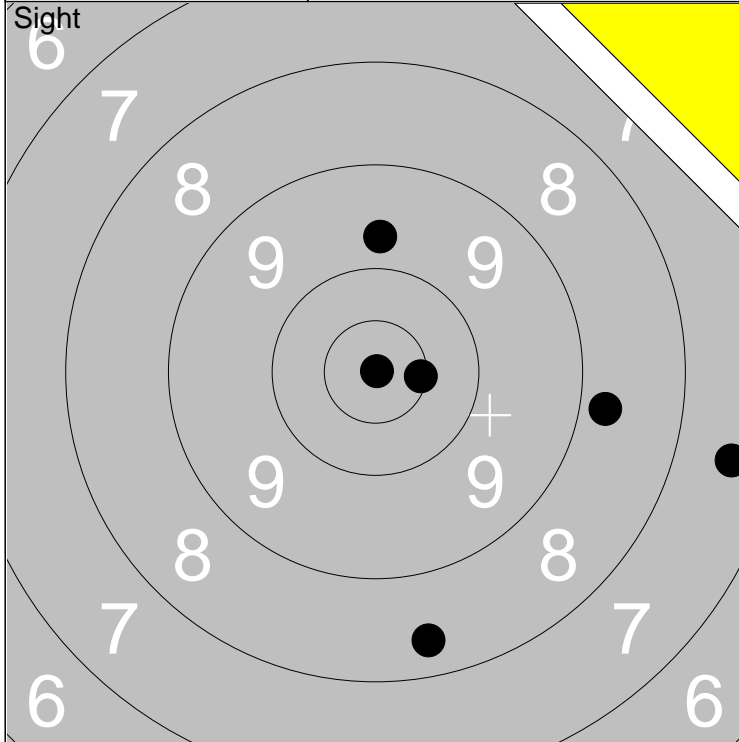

1: 7.5 →	6: *10.9 ↗	Series	52.0
2: 8.8 →			
3: *10.5 →			
4: 9.7 ↑		Total	0.0
5: 8.4 ↓			

1: 9.1 ↗	Series	46.0
2: 10.2 ↓		
3: 10.4 ↑		
4: 9.3 →	Total	46.0
5: 8.4 ↗		

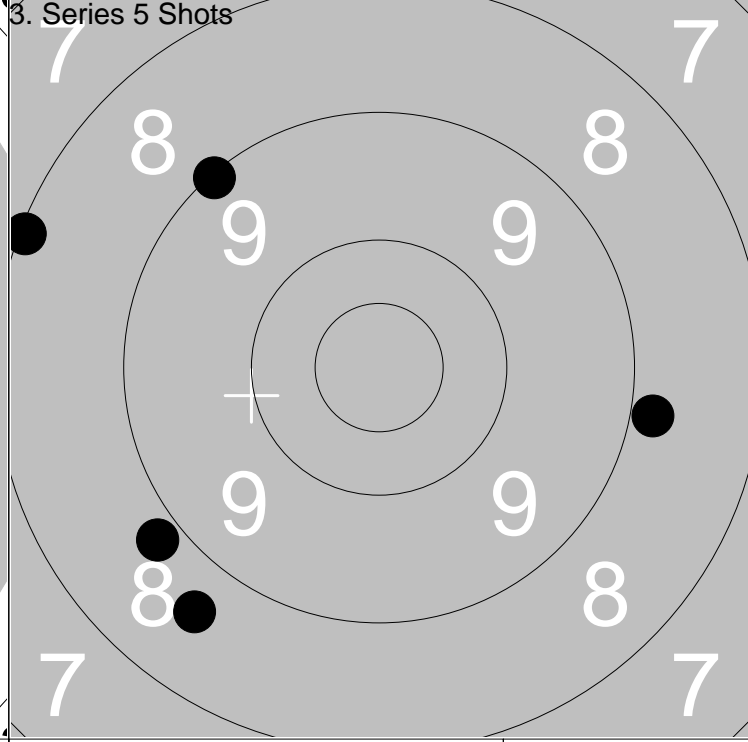
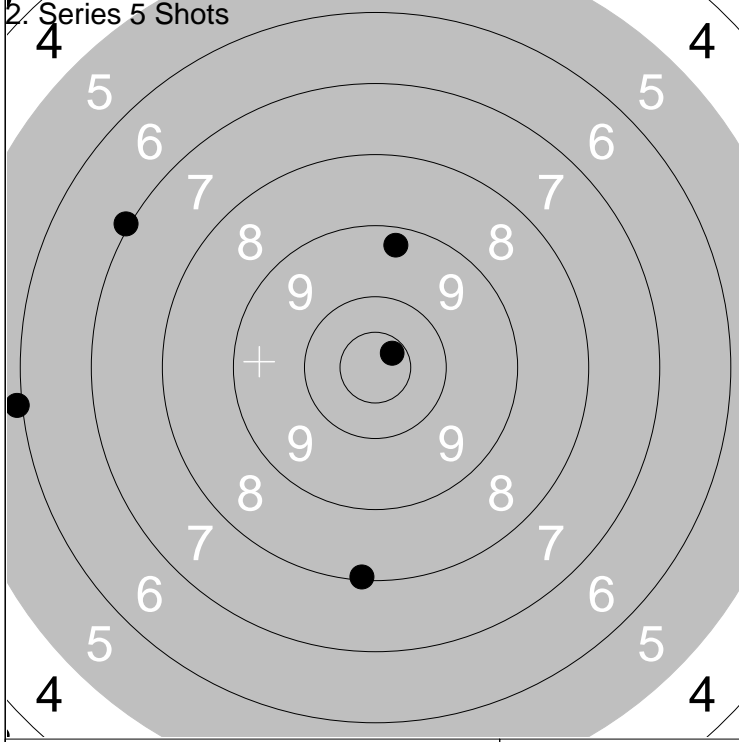

1: *10.7 ↗	Series	40.0
2: 6.0 ←		
3: 8.1 ↓		
4: 9.3 ↑	Total	86.0
5: 7.0 ←		

1: 8.8 ↙	Series	41.0
2: 8.6 ↙		
3: 9.1 ↗		
4: 8.9 →	Total	127.0
5: 8.1 ←		

Relay 1	Lane 9	Linda Gustavsson	
-------------------	------------------	-------------------------	--

300m	Moälven-Modo	A	Vn
------	--------------	---	----

2013-07-08	Tavelträffen B 2013	Ramselefors SKF
------------	---------------------	-----------------

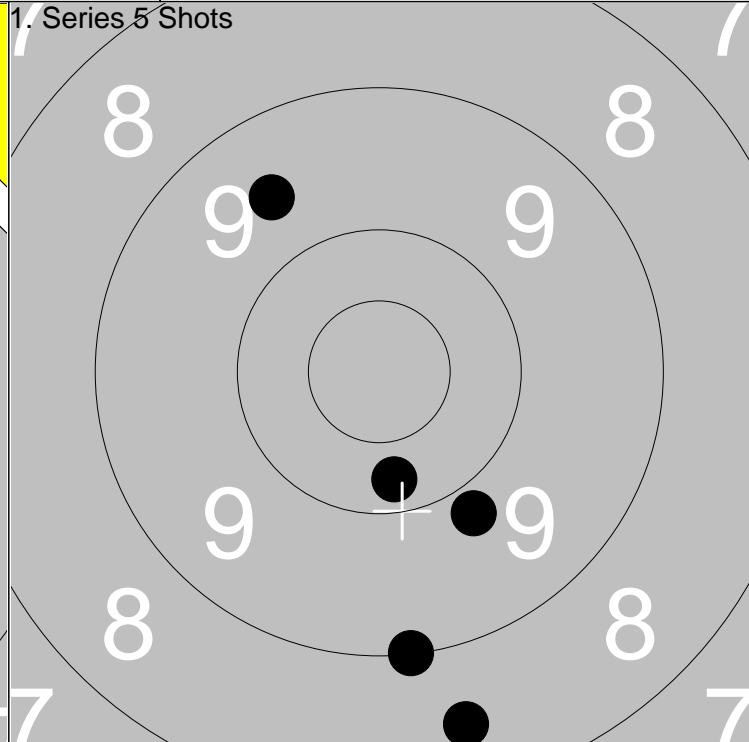
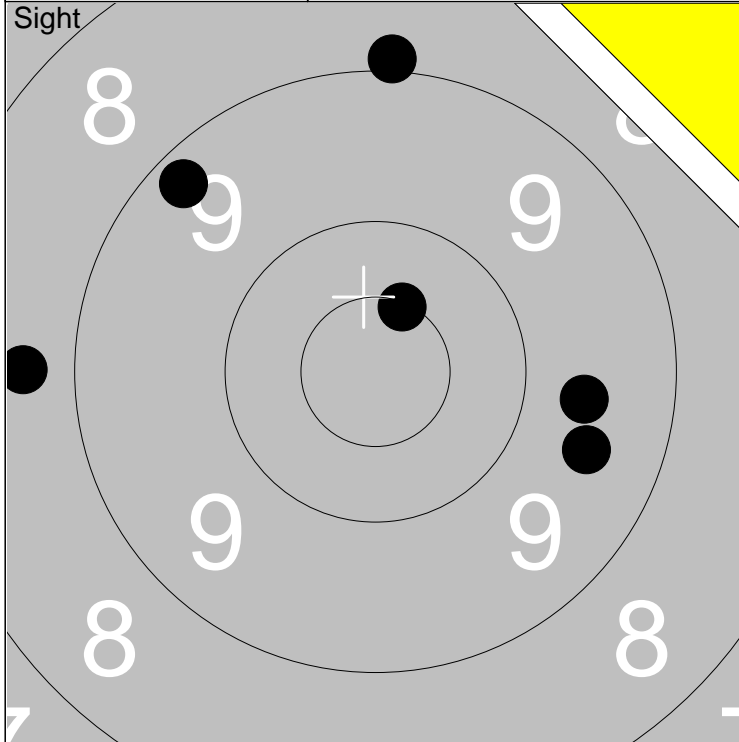

1: 9.5 →	6: 8.7 ←	Series 53.0
2: 9.6 →		
3: *10.5 ↗		Total 0.0
4: 9.2 ↖		
5: 8.9 ↑		

1: 9.6 ↗	Series 45.0
2: 8.5 ↓	
3: 10.2 ↓	Total 45.0
4: 9.8 ↓	
5: 9.0 ↓	

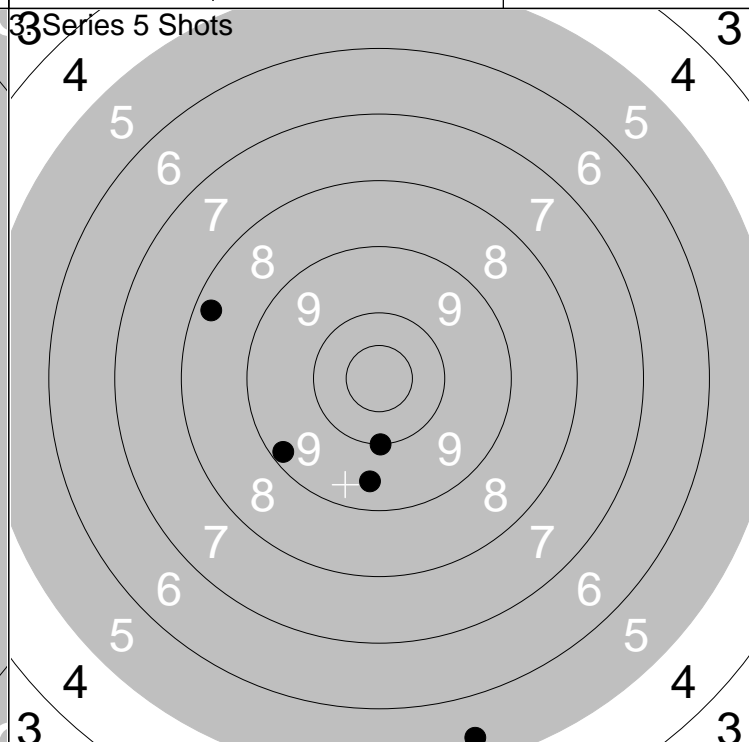
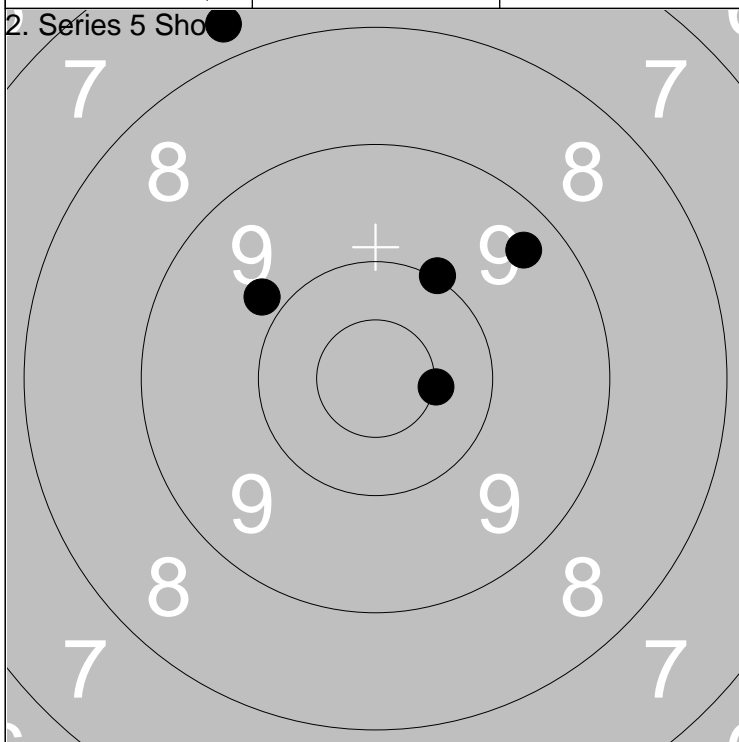

1: 9.4 ↗	Series 45.0
2: 9.8 ↖	
3: 10.0 ↗	Total 90.0
4: 7.7 ↗	
5: *10.5 →	

1: 5.4 ↓	Series 41.0
2: 9.5 ↓	
3: 10.0 ↓	Total 131.0
4: 8.3 ↖	
5: 9.2 ↖	

Relay **1** Lane **10** **Erik Björndahl**

300m Kvistbro E Ör

2013-07-08 Tavelträffen B 2013 Ramselefors SKF

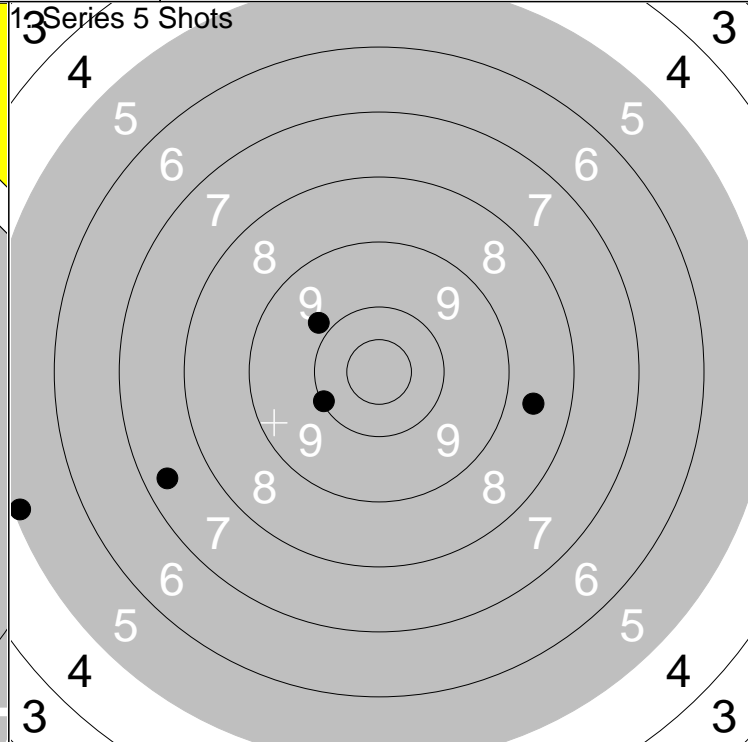
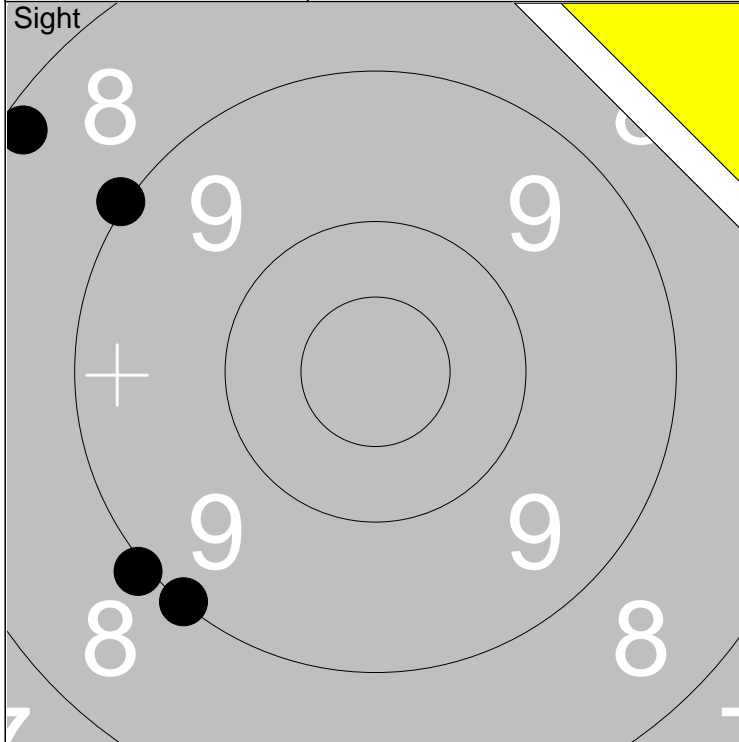

1: 9.0 ↙	Series 35.0
2: 9.0 ↙	
3: 8.2 ↖	Total 0.0
4: 9.0 ↖	

1: 10.1 ↙	Series 39.0
2: 5.1 ↙	
3: 8.6 →	Total 39.0
4: 7.4 ↙	
5: 9.8 ↖	

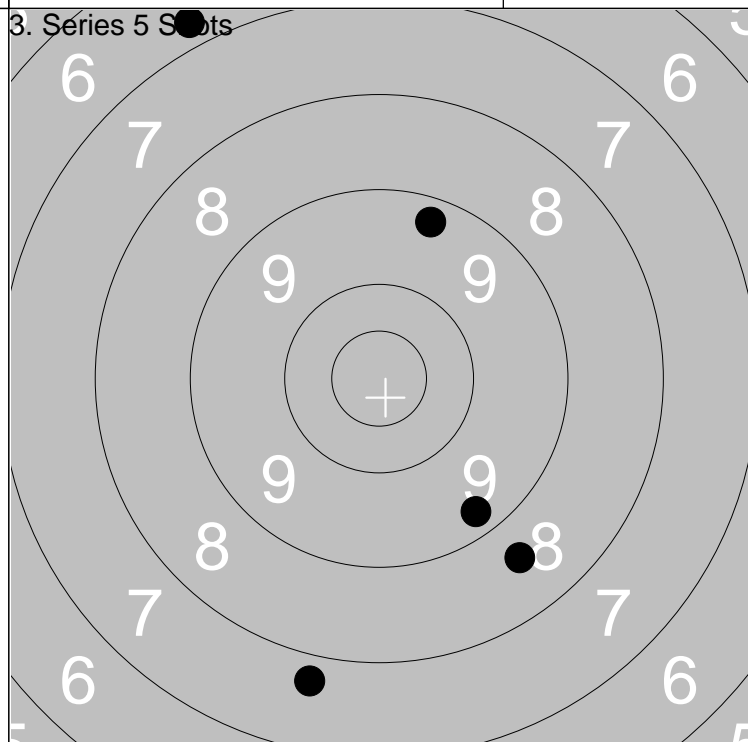
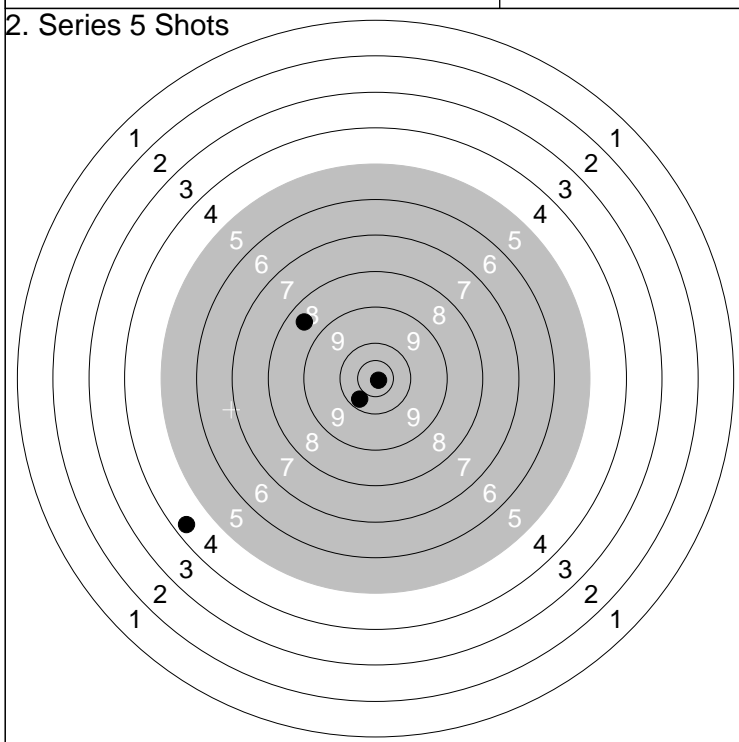

1: 0.0 ←	Series 32.0
2: 4.4 ↙	
3: 10.3 ↙	Total 71.0
4: *10.9 ↘	
5: 8.5 ↖	

1: 9.3 ↙	Series 39.0
2: 8.6 ↙	
3: 9.3 ↗	Total 110.0
4: 6.8 ↗	
5: 7.8 ↓	

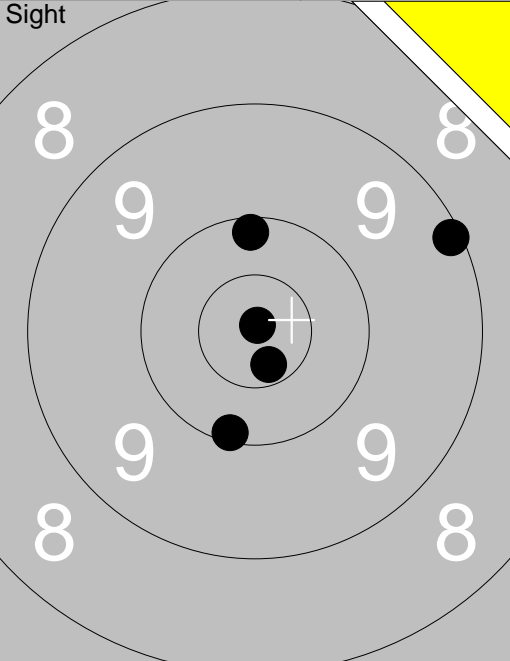
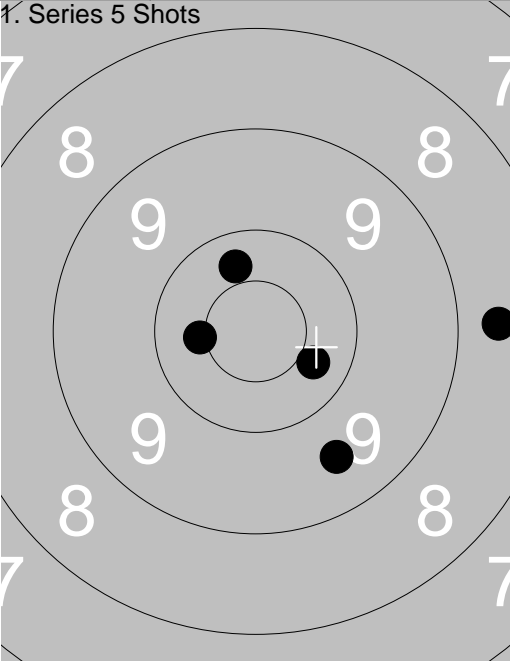
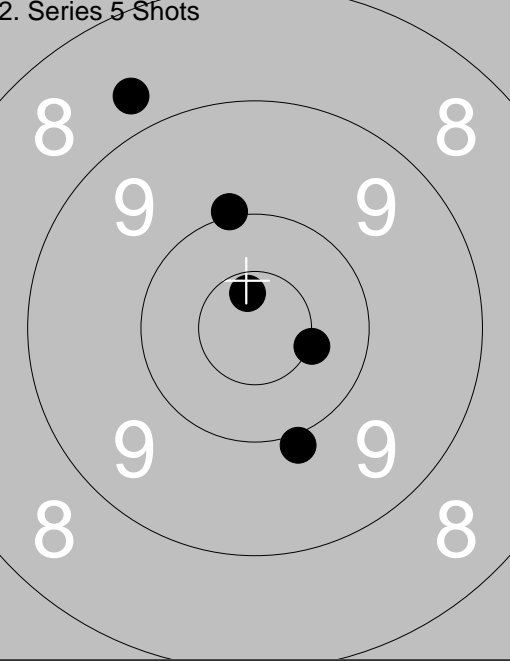
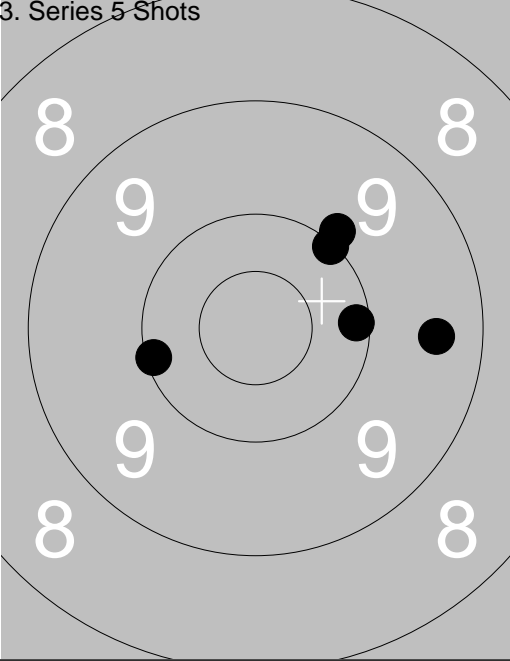
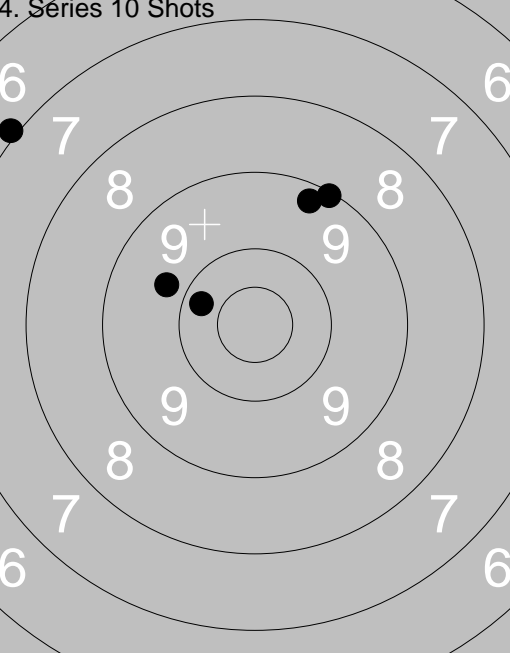
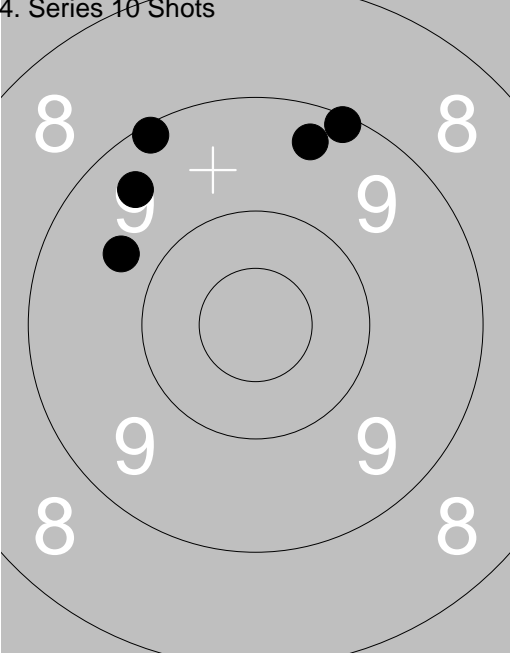
Relay	Lane	Håkan Lidman	
300m		Skellefteå	D Vb
2013-07-08		Tavelträffen B 2013	Ramselefors SKF
Sight		1: 9.1 → 2: *10.7 ↓ 3: *10.9 ↑ 4: 10.1 ↑ 5: 10.1 ↓	1. Series 5 Shots 1: 8.6 → 2: *10.4 ← 3: 10.3 ↑ 4: 9.6 ↓ 5: 10.3 →
		Series 49.0 Total 0.0	 Series 47.0 Total 47.0
2. Series 5 Shots		1: 9.9 ↓ 2: *10.5 → 3: *10.7 ↑ 4: 8.7 ↑ 5: 10.0 ↑	3. Series 5 Shots 1: 9.4 → 2: 10.1 → 3: 9.9 ↗ 4: 10.0 ↗ 5: 10.1 ←
		Series 47.0 Total 94.0	 Series 48.0 Total 142.0
4. Series 10 Shots		1: 9.3 ↑ 2: 9.1 ↑ 3: 9.8 ← 4: 10.2 ← 5: 6.9 ←	4. Series 10 Shots 6: 9.1 ↖ 7: 9.4 ↖ 8: 9.4 ↑ 9: 9.1 ↑ 10: 9.7 ↖
		Series 43.0 Total 185.0	 Series 45.0 Total 230.0

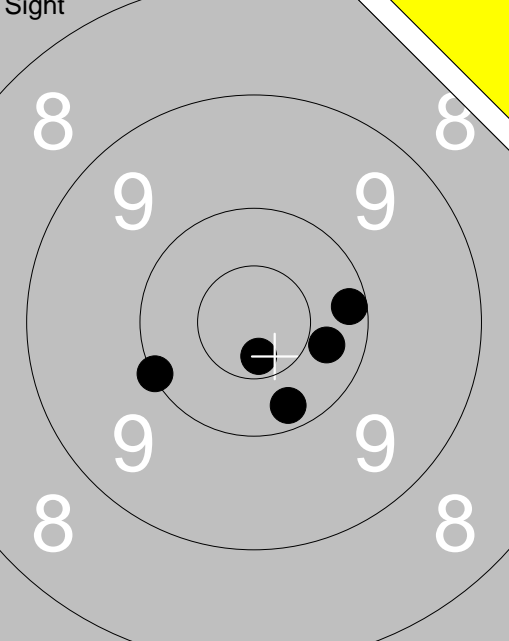
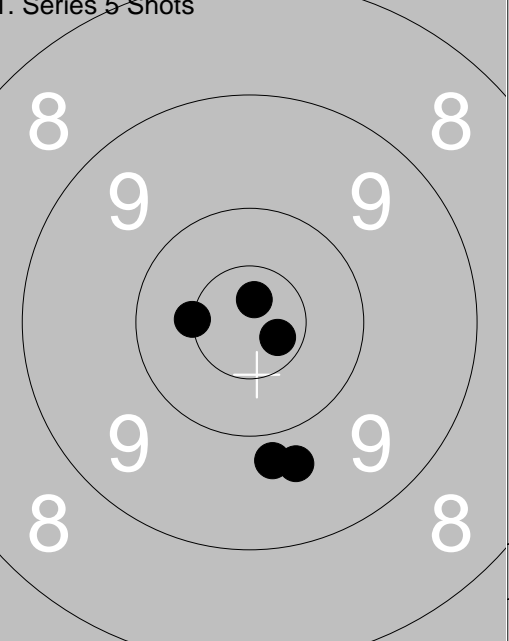
<p>Sight</p>  <p>1: 10.0 ↙ 2: *10.7 ↓ 3: 10.3 → 4: 10.2 → 5: 10.2 ↓</p> <table border="1" style="width:100%; border-collapse: collapse;"> <tr><td>Series</td><td>50.0</td></tr> <tr><td>Total</td><td>0.0</td></tr> </table>	Series	50.0	Total	0.0	<p>1. Series 5 Shots</p>  <p>1: *10.5 ↙ 2: 9.8 ↓ 3: *10.7 → 4: 9.7 ↓ 5: *10.8 ↗</p> <table border="1" style="width:100%; border-collapse: collapse;"> <tr><td>Series</td><td>48.0</td></tr> <tr><td>Total</td><td>48.0</td></tr> </table>	Series	48.0	Total	48.0	
Series	50.0									
Total	0.0									
Series	48.0									
Total	48.0									

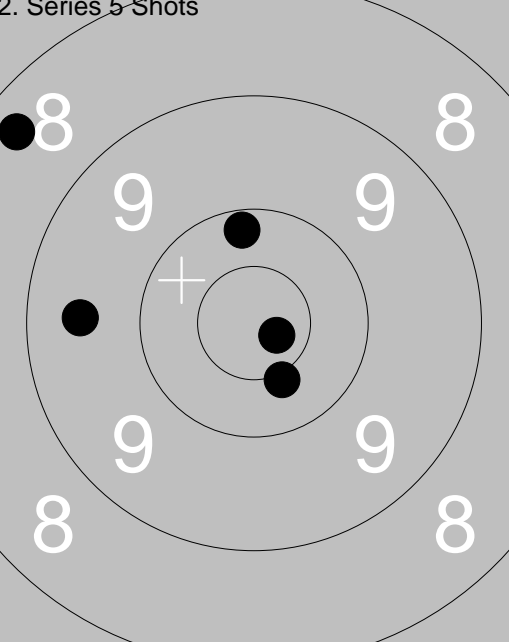
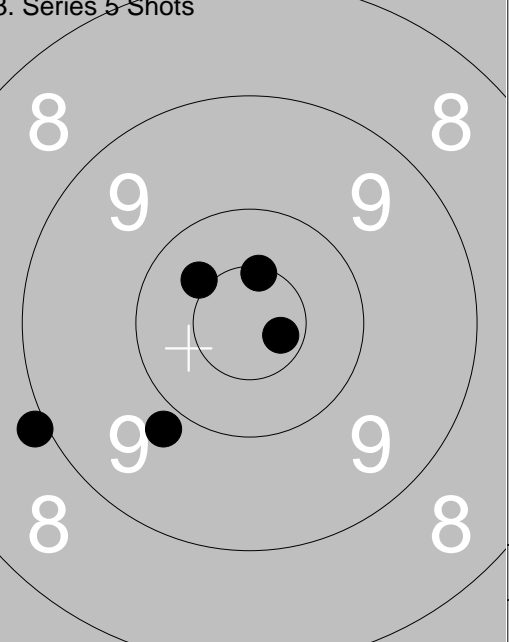
<p>2. Series 5 Shots</p>  <p>1: 8.4 ↖ 2: 10.2 ↑ 3: *10.7 → 4: 9.5 ← 5: *10.4 ↓</p> <table border="1" style="width:100%; border-collapse: collapse;"> <tr><td>Series</td><td>47.0</td></tr> <tr><td>Total</td><td>95.0</td></tr> </table>	Series	47.0	Total	95.0	<p>3. Series 5 Shots</p>  <p>1: *10.7 → 2: 8.9 ↙ 3: *10.5 ↗ 4: 9.8 ↙ 5: 10.4 ↖</p> <table border="1" style="width:100%; border-collapse: collapse;"> <tr><td>Series</td><td>47.0</td></tr> <tr><td>Total</td><td>142.0</td></tr> </table>	Series	47.0	Total	142.0	
Series	47.0									
Total	95.0									
Series	47.0									
Total	142.0									

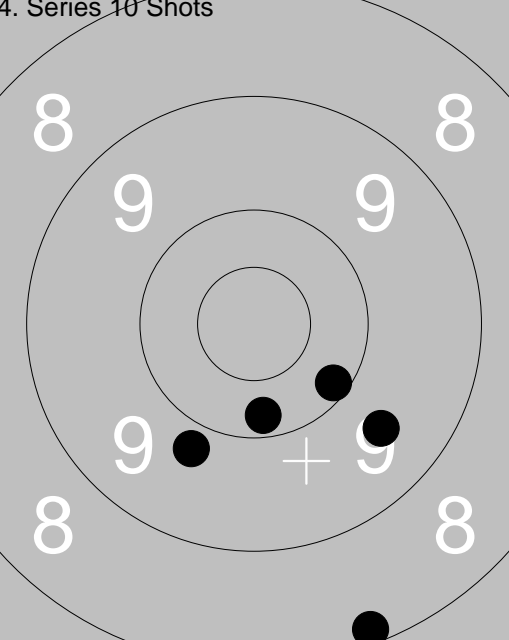
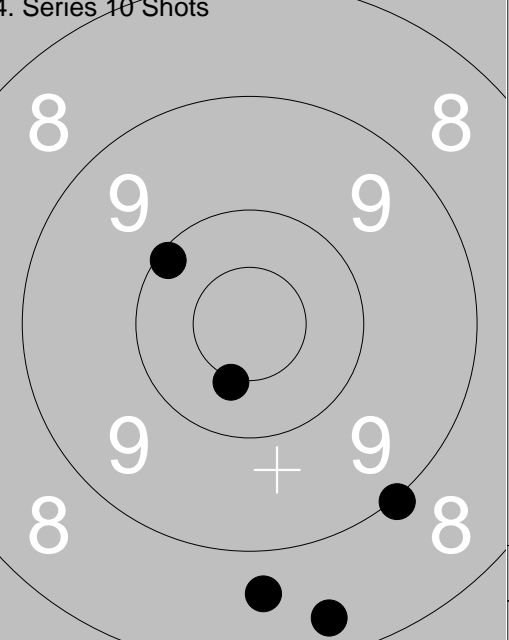
<p>4. Series 10 Shots</p>  <p>1: 10.1 → 2: 9.6 → 3: 9.8 ↓ 4: 8.2 ↓ 5: 10.2 ↓</p> <table border="1" style="width:100%; border-collapse: collapse;"> <tr><td>Series</td><td>46.0</td></tr> <tr><td>Total</td><td>188.0</td></tr> </table>	Series	46.0	Total	188.0	<p>4. Series 10 Shots</p>  <p>6: *10.5 ↓ 7: 10.1 ↖ 8: 9.0 ↓ 9: 8.7 ↓ 10: 8.4 ↓</p> <table border="1" style="width:100%; border-collapse: collapse;"> <tr><td>Series</td><td>45.0</td></tr> <tr><td>Total</td><td>233.0</td></tr> </table>	Series	45.0	Total	233.0	
Series	46.0									
Total	188.0									
Series	45.0									
Total	233.0									

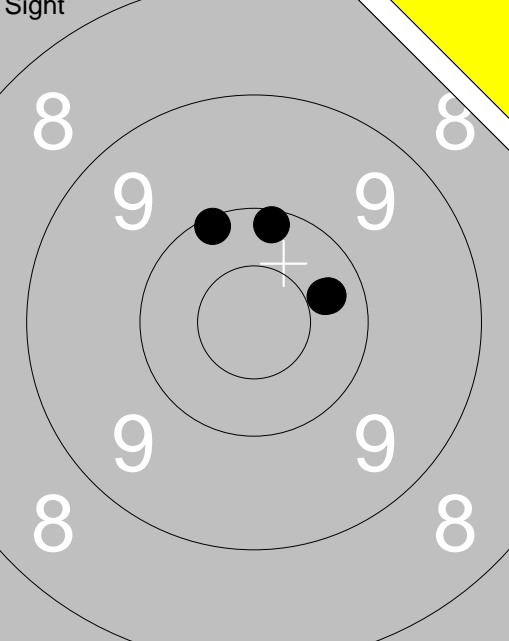
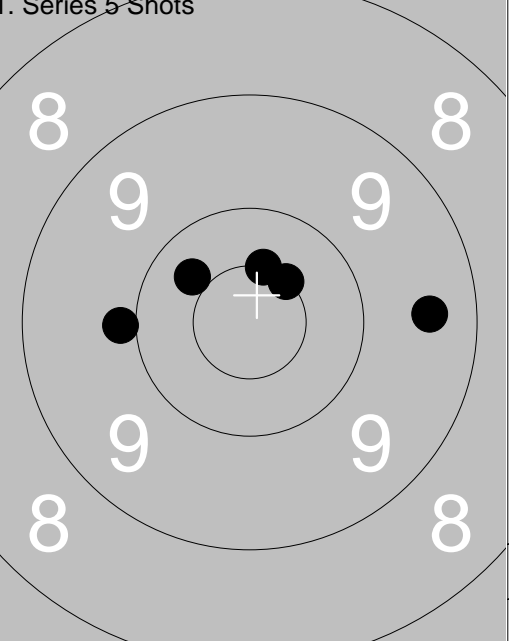
<p>Sight</p> 	<p>1: 10.3 →</p> <p>2: 10.3 →</p> <p>3: 10.1 ↖</p> <p>4: 10.1 ↑</p>	<p>1. Series 5 Shots</p> 	<p>1: *10.5 ↗</p> <p>2: *10.5 ↗</p> <p>3: 10.4 ↖</p> <p>4: 9.4 →</p> <p>5: 9.9 ←</p>
Series 40.0		Series 48.0	
Total 0.0		Total 48.0	

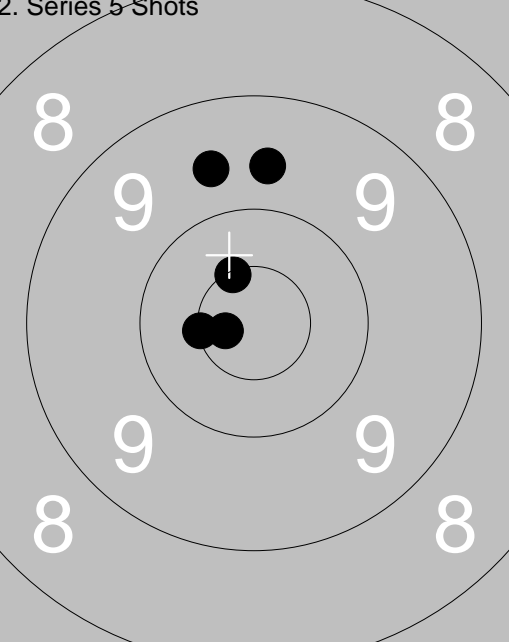
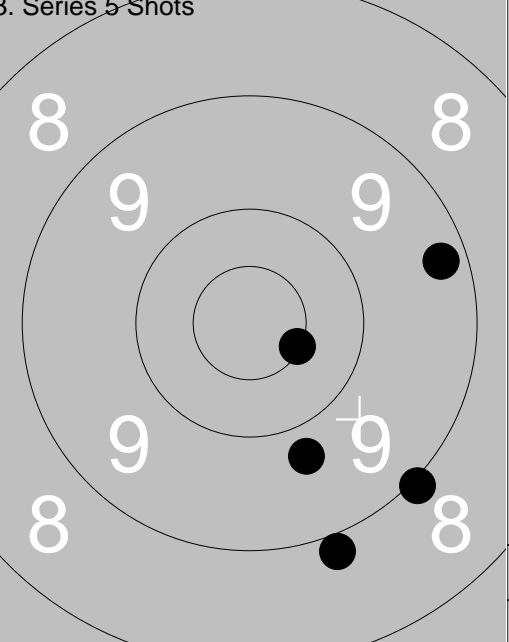
<p>2. Series 5 Shots</p> 	<p>1: *10.5 ↖</p> <p>2: 9.6 ↑</p> <p>3: 9.6 ↑</p> <p>4: *10.7 ↖</p> <p>5: *10.5 ↖</p>	<p>3. Series 5 Shots</p> 	<p>1: *10.5 ↗</p> <p>2: 9.3 →</p> <p>3: 9.8 ↘</p> <p>4: 9.0 ↘</p> <p>5: 8.9 ↘</p>
Series 48.0		Series 45.0	
Total 96.0		Total 141.0	

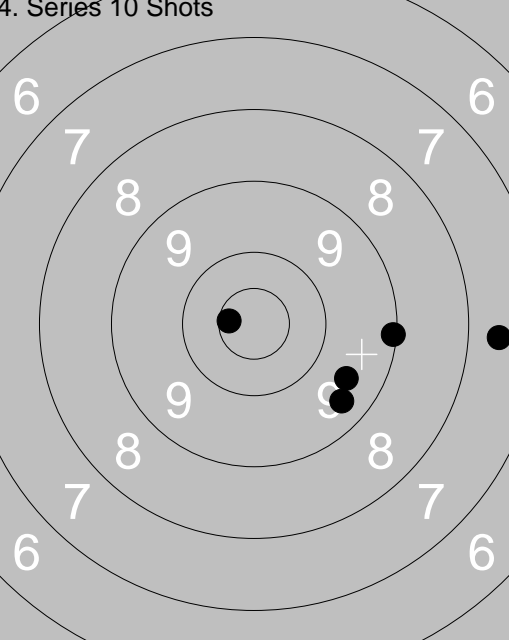
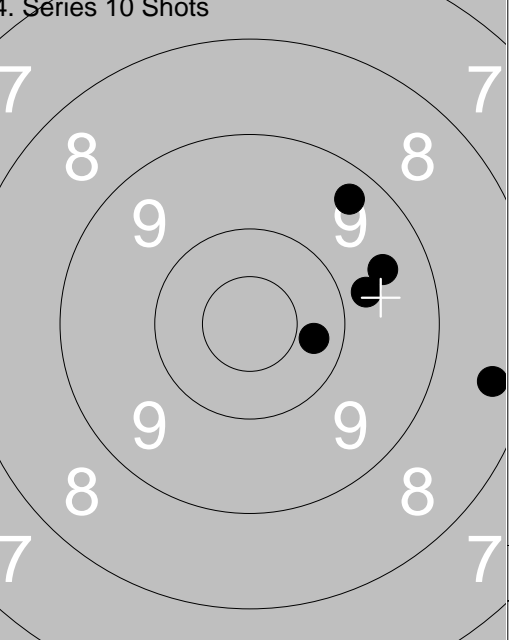
<p>4. Series 10 Shots</p> 	<p>1: 7.6 →</p> <p>2: 9.4 ↘</p> <p>3: 9.5 ↘</p> <p>4: 9.1 →</p> <p>5: *10.6 ↖</p>	<p>4. Series 10 Shots</p> 	<p>6: 9.4 ↗</p> <p>7: 9.5 →</p> <p>8: 9.8 →</p> <p>9: 10.3 →</p> <p>10: 8.4 →</p>
Series 44.0		Series 45.0	
Total 185.0		Total 230.0	

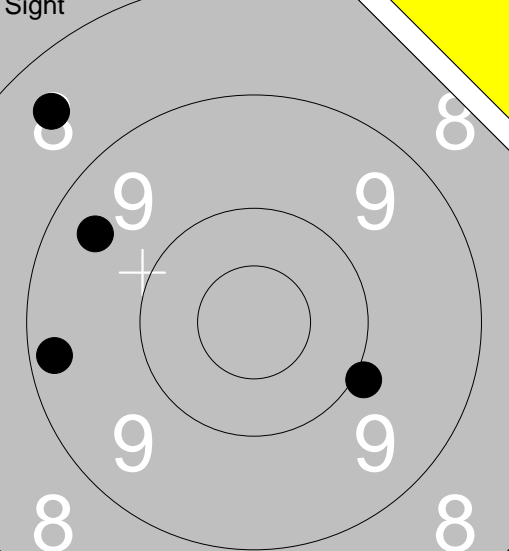
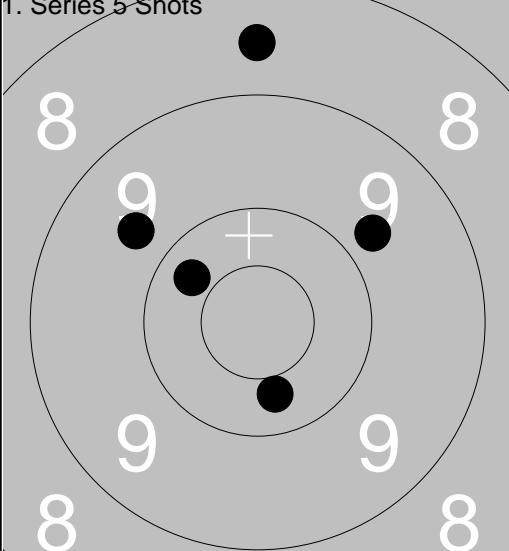
<p>Sight</p> 	<p>1. Series 5 Shots</p> 	<p>1: 8.5 ↗ 2: 9.4 ↖ 3: 9.9 → 4: 9.3 ←</p> <p>1: 10.4 ↓ 2: 10.3 ↖ 3: 9.7 ↖ 4: 9.8 ↗ 5: 8.6 ↑</p>
Series 35.0	Series 46.0	
Total 0.0	Total 46.0	

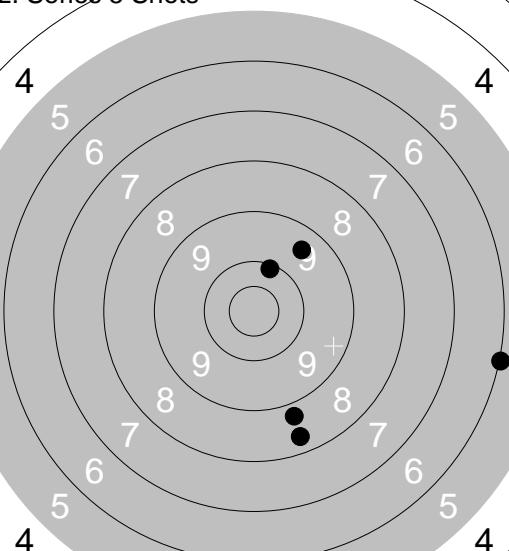
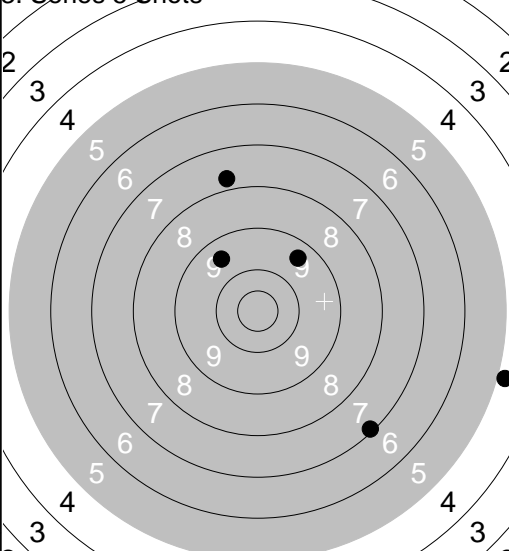
<p>2. Series 5 Shots</p> 	<p>3. Series 5 Shots</p> 	<p>1: 8.4 ↓ 2: 9.5 ↗ 3: 6.0 → 4: 8.8 ↓ 5: 10.1 ↑</p> <p>1: 7.1 ↓ 2: 4.9 → 3: 9.4 ↗ 4: 9.5 ↖ 5: 7.8 ↑</p>
Series 41.02	Series 36.0	
Total 87.0	Total 123.0	

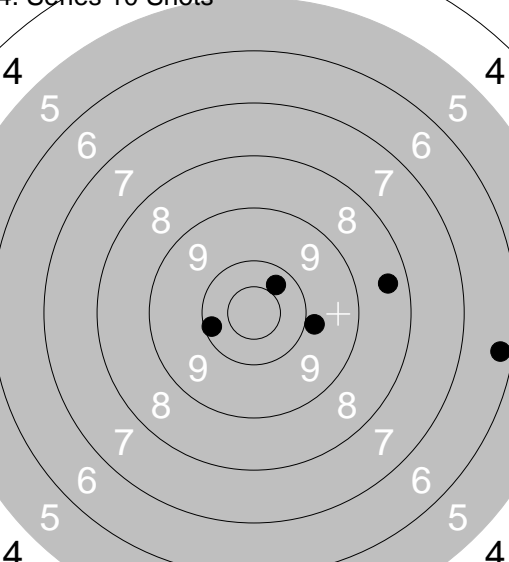
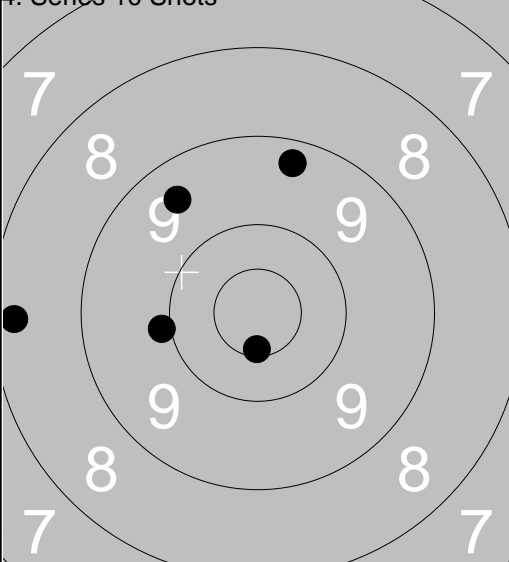
<p>4. Series 10 Shots</p> 	<p>4. Series 10 Shots</p> 	<p>1: 6.3 → 2: 8.4 → 3: 10.2 ← 4: 10.3 ↗ 5: 9.9 →</p> <p>6: 9.3 ↑ 7: *10.6 ↓ 8: 9.5 ↖ 9: 8.3 ← 10: 9.9 ←</p>
Series 43.0	Series 45.0	
Total 166.0	Total 211.0	

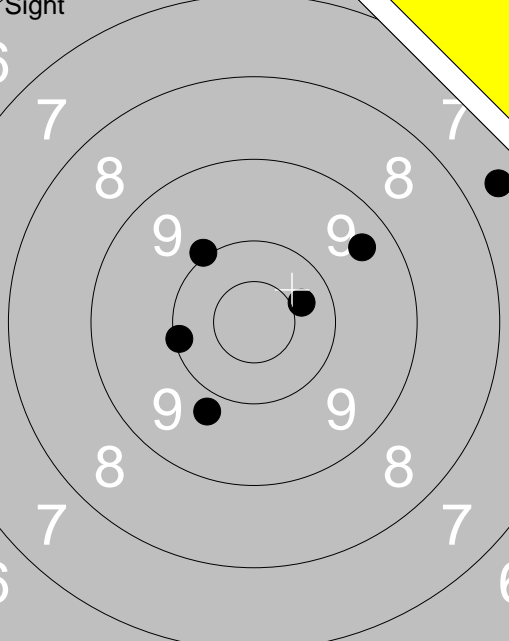
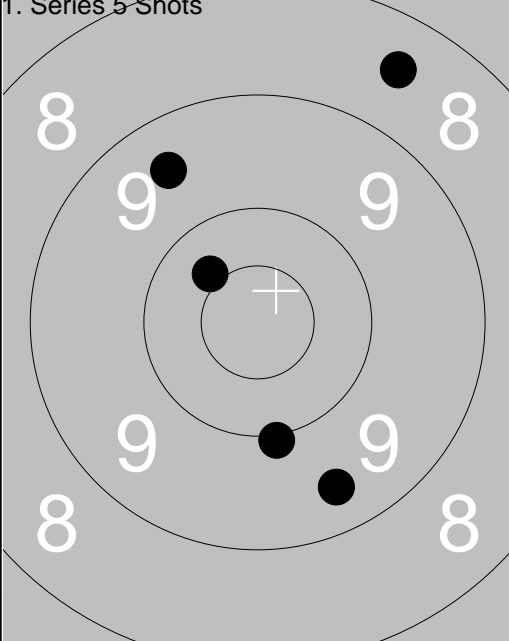
 <p>Target diagram for Series 1 showing 6 shots. Scores: 9.4, 7.6, 10.0, 9.8, 10.4, 10.1. A yellow triangle is present in the top right corner.</p>	<p>1. Series 5 Shots</p>  <p>Target diagram for Series 1 showing 5 shots. Scores: 10.4, 9.5, 8.5, 10.0, 9.4.</p>	<p>1: 9.4 ↗ 2: 7.6 ↗ 3: 10.0 ↖ 4: 9.8 ↓ 5: 10.4 → 6: 10.1 ←</p> <p>Series 55.0 Total 0.0</p>	<p>1: 10.4 ↖ 2: 9.5 ↖ 3: 8.5 ↗ 4: 10.0 ↓ 5: 9.4 ↓</p> <p>Series 46.0 Total 46.0</p>
---	--	--	---

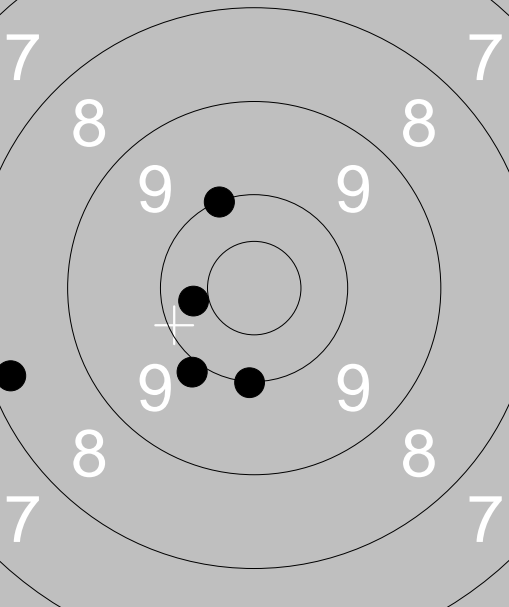
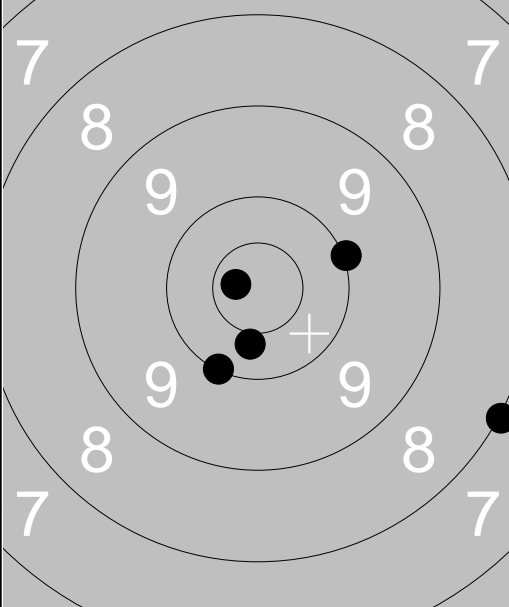
<p>2. Series 5 Shots</p>  <p>Target diagram for Series 2 showing 5 shots. Scores: 10.0, 9.9, 10.3, 10.0, 8.3.</p>	<p>3. Series 5 Shots</p>  <p>Target diagram for Series 3 showing 5 shots. Scores: 8.0, *10.7, 10.0, 10.0, 10.4.</p>	<p>1: 10.0 ↖ 2: 9.9 ↓ 3: 10.3 ← 4: 10.0 ↓ 5: 8.3 ←</p> <p>Series 47.0 Total 93.0</p>	<p>1: 8.0 → 2: *10.7 ↖ 3: 10.0 ↓ 4: 10.0 → 5: 10.4 ↓</p> <p>Series 48.0 Total 141.0</p>
--	--	--	---

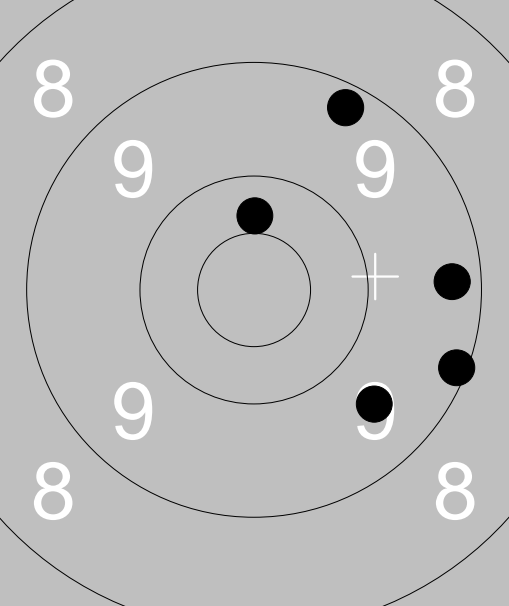
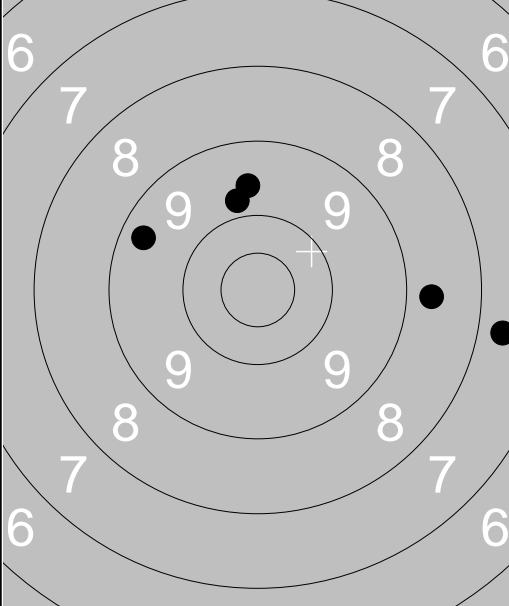
<p>4. Series 10 Shots</p>  <p>Target diagram for Series 4 showing 10 shots. Scores: 9.1, 9.3, 9.2, 10.3, 9.6.</p>	<p>4. Series 10 Shots</p>  <p>Target diagram for Series 4 showing 10 shots. Scores: 7.7, 8.7, 9.6, 9.8, 9.4.</p>	<p>1: 9.1 → 2: 9.3 → 3: 9.2 ↗ 4: 10.3 ↑ 5: 9.6 ↓</p> <p>Series 46.0 Total 187.0</p>	<p>6: 7.7 → 7: 8.7 → 8: 9.6 ↑ 9: 9.8 ↑ 10: 9.4 ↖</p> <p>Series 42.0 Total 229.0</p>
---	--	---	---

	1: 8.6 → 2: 9.4 ↗ 3: 8.9 ↓ 4: 9.4 ↓ 5: 9.2 ← 6: 10.1 ←		1: 10.2 ↓ 2: *10.7 ↓ 3: 9.4 ↘ 4: 9.1 ↖ 5: 10.1 ↑
	Series 53.0 Total 0.0		Series 48.0 Total 48.0

	1: 9.0 ↓ 2: 9.1 ↖ 3: 9.9 ← 4: 9.4 → 5: *10.5 ↑		1: 7.6 → 2: 8.1 ↗ 3: 9.6 ↘ 4: 10.3 → 5: 10.2 ←
	Series 46.0 Total 94.0		Series 44.0 Total 138.0

	1: 10.4 ← 2: 8.3 ← 3: 7.7 ← 4: 9.4 ↘ 5: 10.3 ↓		6: 9.8 ← 7: 9.8 ↖ 8: 10.4 ← 9: 8.7 ← 10: 8.1 ↓
	Series 44.0 Total 182.0		Series 44.0 Total 226.0

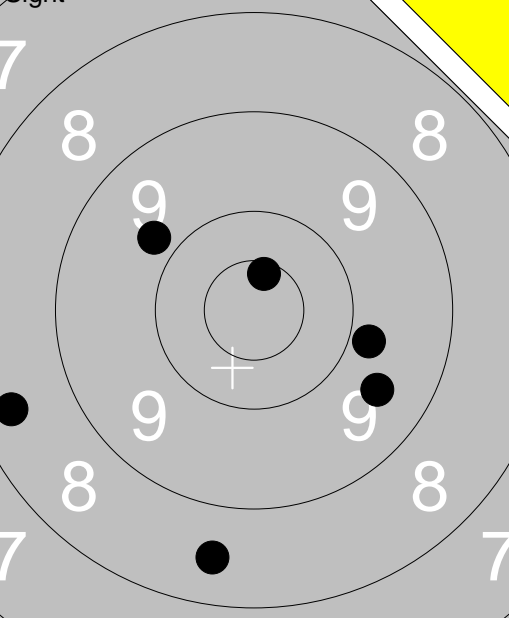
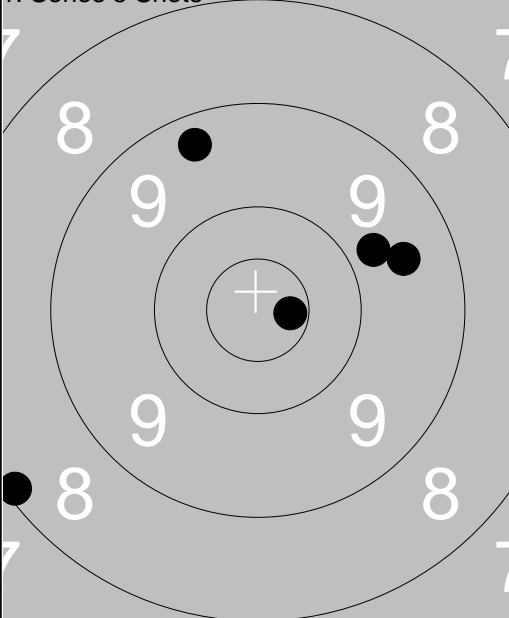
<p>Sight</p> 	<p>1: 9.6 →</p> <p>2: 9.8 →</p> <p>3: 8.5 ↓</p> <p>4: 8.4 ←</p> <p>5: *10.6 ↑</p> <p>6: 9.8 ↖</p>	<p>1. Series 5 Shots</p> 		<p>1: 8.1 ↖</p> <p>2: 9.3 ↖</p> <p>3: *10.7 →</p> <p>4: 9.5 →</p> <p>5: 9.8 →</p>
Series 53.0		Series 45.0		Series 45.0
Total 0.0		Total 45.0		Total 45.0

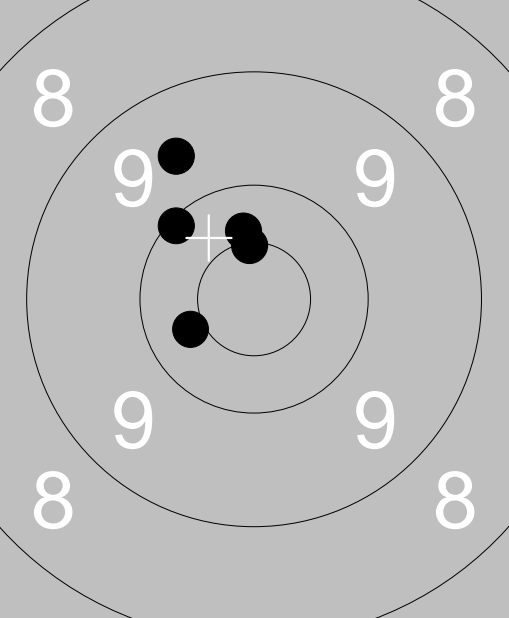
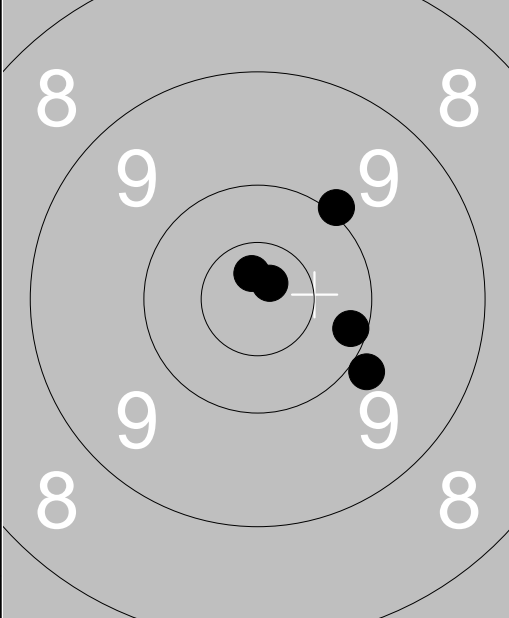
<p>2. Series 5 Shots</p> 	<p>1: 9.6 ↖</p> <p>2: 10.1 ↖</p> <p>3: *10.5 ↑</p> <p>4: 10.4 ←</p> <p>5: 10.4 ↑</p>	<p>3. Series 5 Shots</p> 		<p>1: 10.2 →</p> <p>2: *10.7 ↑</p> <p>3: 10.0 ↗</p> <p>4: 9.9 ↘</p> <p>5: *10.8 ↗</p>
Series 49.0		Series 49.0		Series 49.0
Total 94.0		Total 143.0		Total 143.0

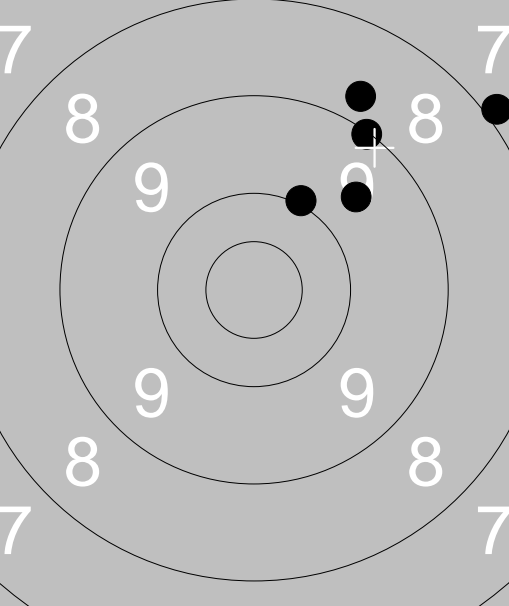
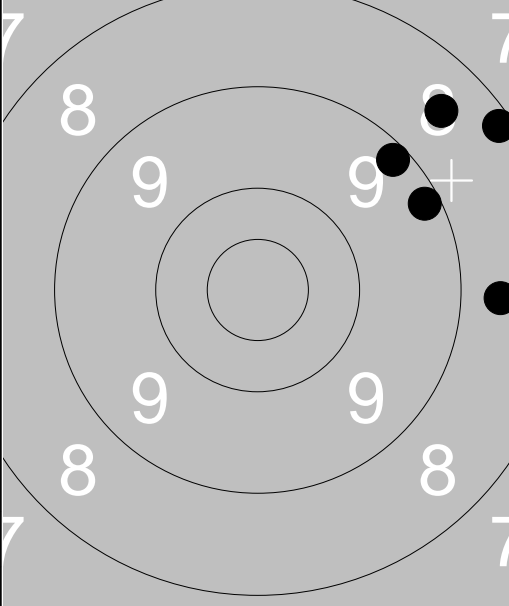
<p>4. Series 10 Shots</p> 	<p>1: 7.9 ↗</p> <p>2: 9.6 ↗</p> <p>3: 8.8 ↑</p> <p>4: 10.0 ↑</p> <p>5: 9.1 ↗</p>	<p>4. Series 10 Shots</p> 		<p>6: 8.5 ↗</p> <p>7: 9.2 ↗</p> <p>8: 8.2 ↗</p> <p>9: 9.2 →</p> <p>10: 8.6 →</p>
Series 43.0		Series 42.0		Series 42.0
Total 186.0		Total 228.0		Total 228.0

Sight 	1: 9.1 → 2: *10.4 → 3: 9.9 → 4: 9.9 ↑ 5: *10.6 ↗ 6: *10.5 ↖	1. Series 5 Shots 	1: 9.4 ↓ 2: *10.5 ↓ 3: 10.2 ↓ 4: 10.1 ↑ 5: 10.1 →
	Series 57.0 Total 0.0		Series 49.0 Total 49.0

2. Series 5 Shots 	1: 10.3 ↓ 2: 10.0 ← 3: 9.4 → 4: 9.1 ↓ 5: 9.0 ←	3. Series 5 Shots 	1: 9.7 ↘ 2: 9.0 ↖ 3: 8.8 ↗ 4: 10.3 ↑ 5: 9.0 ↓
	Series 47.0 Total 96.0		Series 45.0 Total 141.0

4. Series 10 Shots 	1: 9.7 ↗ 2: 10.3 ↗ 3: *10.5 ↓ 4: 8.4 ↗ 5: 9.3 ←	4. Series 10 Shots 	6: 7.4 ← 7: 8.7 ← 8: 8.9 ← 9: 9.7 ← 10: 7.5 ↓
	Series 46.0 Total 187.0		Series 39.0 Total 226.0

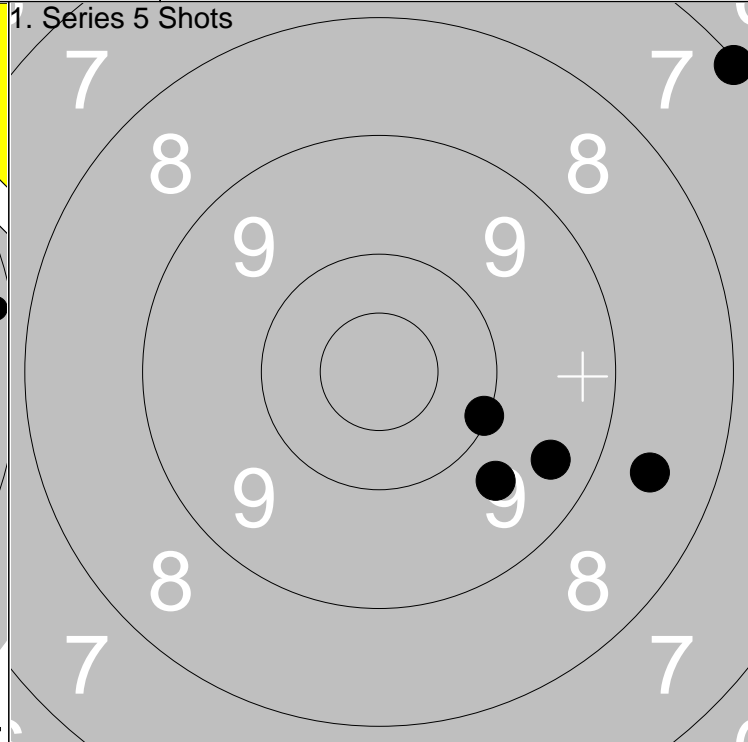
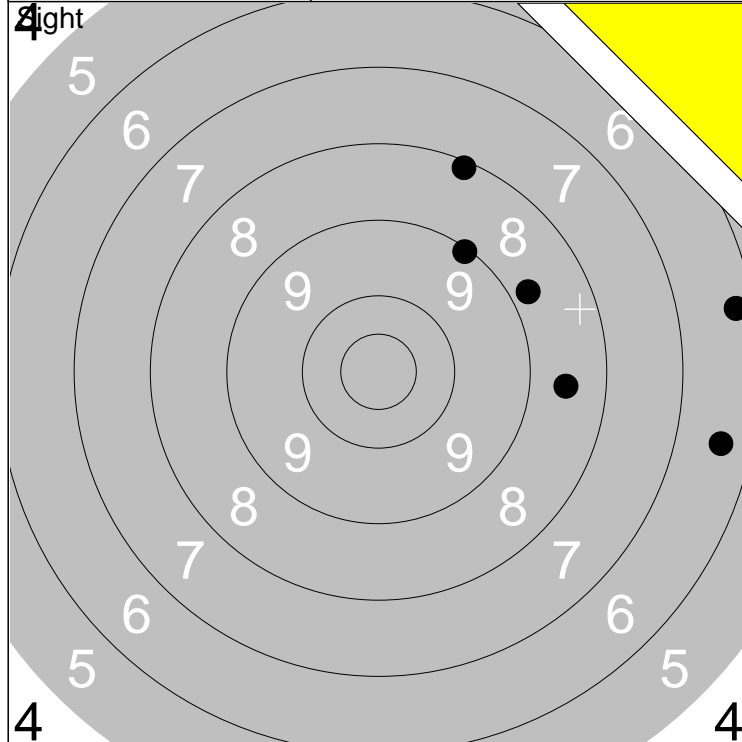

1: 8.6 →	6: 6.4 →				
2: 8.1 ↗		Series	45.0		
3: 8.8 ↗					
4: 9.1 ↗		Total	0.0		
5: 6.3 →					

1: 10.1 →					
2: 9.4 →		Series	43.0		
3: 8.6 →					
4: 7.1 ↗		Total	43.0		
5: 9.7 ↘					

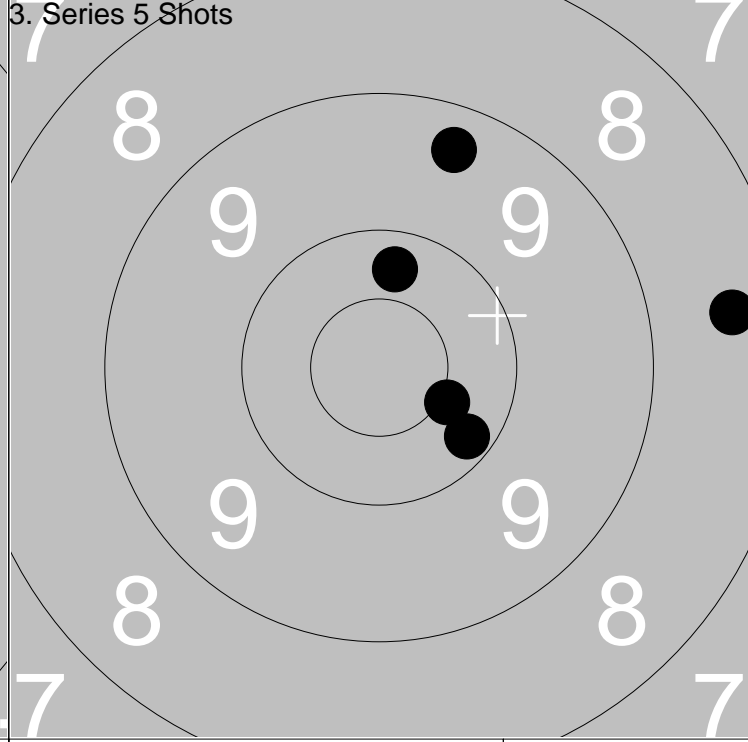
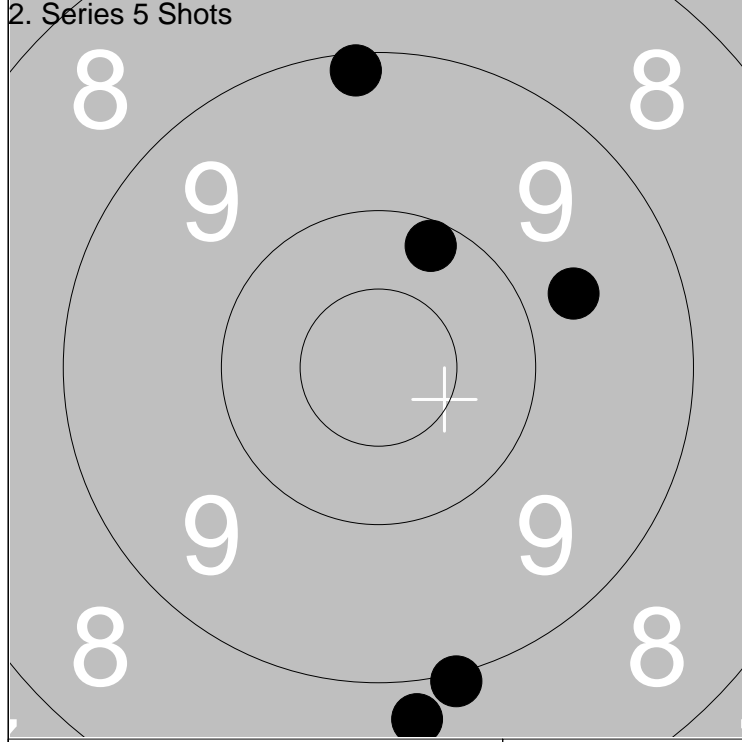

1: 9.0 ↓					
2: 8.8 ↓		Series	45.0		
3: 9.7 ↗					
4: 10.2 ↗		Total	88.0		
5: 9.1 ↗					

1: 8.4 →					
2: 9.4 ↗		Series	47.0		
3: 10.2 ↘					
4: 10.3 ↗		Total	135.0		
5: *10.4 ↘					

Relay	Lane	Ella Carlsson	
1	22		

300m	Ramsberg	U	Ör
------	----------	---	----

2013-07-08	Tavelträffen B 2013	Ramselefors SKF
------------	---------------------	-----------------

	1. Series 5 Shots								
	<table border="1"> <tr><td>Series</td><td>56.0</td></tr> <tr><td>Total</td><td>0.0</td></tr> </table>		Series	56.0	Total	0.0	<table border="1"> <tr><td>Series</td><td>49.0</td></tr> <tr><td>Total</td><td>49.0</td></tr> </table>	Series	49.0
Series	56.0								
Total	0.0								
Series	49.0								
Total	49.0								

	3. Series 5 Shots								
	<table border="1"> <tr><td>Series</td><td>49.0</td></tr> <tr><td>Total</td><td>98.0</td></tr> </table>		Series	49.0	Total	98.0	<table border="1"> <tr><td>Series</td><td>48.0</td></tr> <tr><td>Total</td><td>146.0</td></tr> </table>	Series	48.0
Series	49.0								
Total	98.0								
Series	48.0								
Total	146.0								

	4. Series 10 Shots								
	<table border="1"> <tr><td>Series</td><td>46.0</td></tr> <tr><td>Total</td><td>192.0</td></tr> </table>		Series	46.0	Total	192.0	<table border="1"> <tr><td>Series</td><td>45.0</td></tr> <tr><td>Total</td><td>237.0</td></tr> </table>	Series	45.0
Series	46.0								
Total	192.0								
Series	45.0								
Total	237.0								

<p>Sight</p>	<p>1. Series 5 Shots</p>	<p>1: 10.2 ↘ 2: 9.3 ↘ 3: 9.3 ↘ 4: 9.5 ↗ 5: 8.7 → 6: 10.2 ↘</p> <p>1: 9.3 ↘ 2: 9.8 ↖ 3: 9.3 ↘ 4: 9.8 ↖ 5: 10.3 ↖</p>
Series 55.0		Series 46.0
Total 0.0		Total 46.0

<p>2. Series 5 Shots</p>	<p>3. Series 5 Shots</p>	<p>1: 10.2 → 2: 10.3 ↗ 3: 9.7 → 4: 10.1 ↗ 5: 10.2 ↖</p> <p>1: 9.0 ↘ 2: 9.7 ↘ 3: 8.7 ↖ 4: *10.5 ↗ 5: 9.2 ↘</p>
Series 49.0		Series 45.0
Total 95.0		Total 140.0

<p>4. Series 10 Shots</p>	<p>4. Series 10 Shots</p>	<p>1: 8.5 ↘ 2: 10.1 ↘ 3: 10.3 ↘ 4: 9.9 ↘ 5: *10.7 →</p> <p>6: 8.8 ↘ 7: 6.4 ↘ 8: *10.6 → 9: 9.0 ↘ 10: 9.1 ↘</p>
Series 47.0		Series 42.0
Total 187.0		Total 229.0

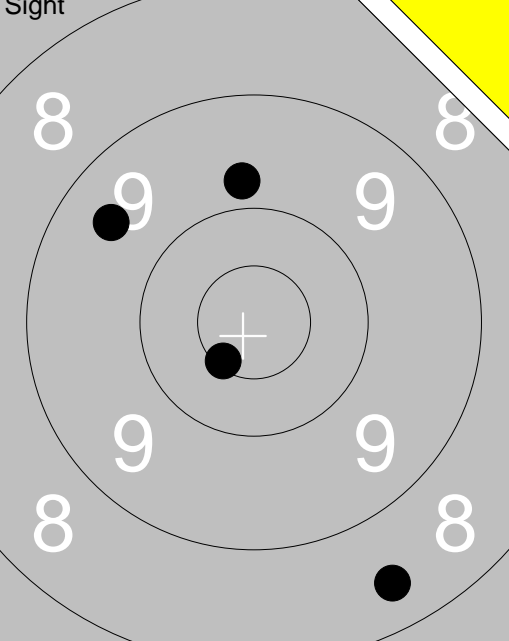
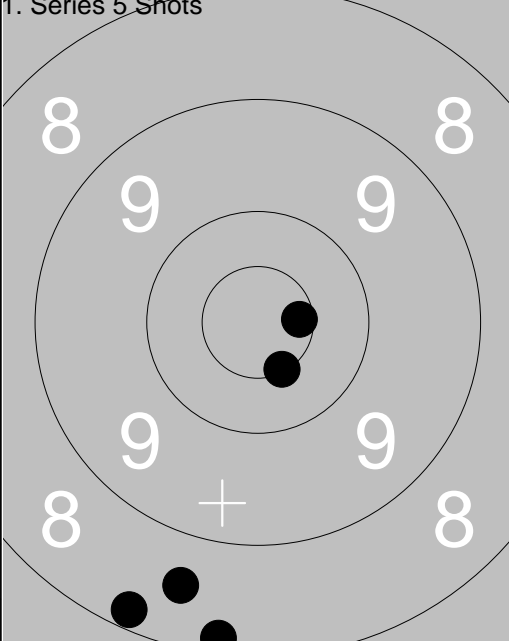
<p>Sight</p> 	<p>1. Series 5 Shots</p> 	<p>1: 9.5 ↙ 2: 9.8 ↑ 3: *10.5 ↘ 4: 8.4 ↓</p> <p>1: 8.2 ↓ 2: 8.6 ↓ 3: 8.2 ↓ 4: *10.6 → 5: *10.5 ↘</p>
Series 36.0	Series 44.0	
Total 0.0	Total 44.0	

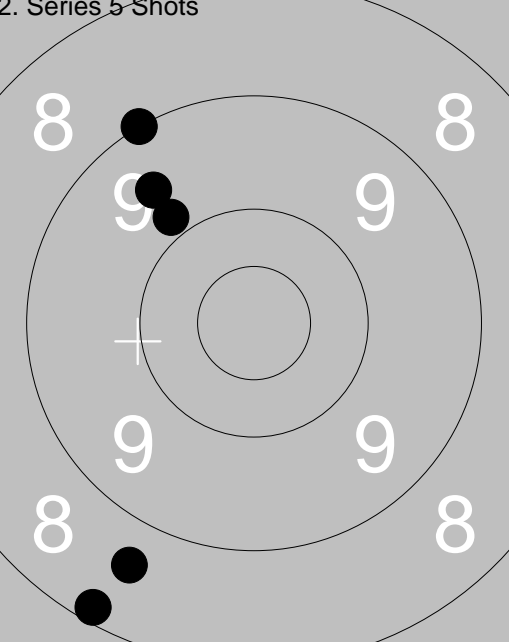
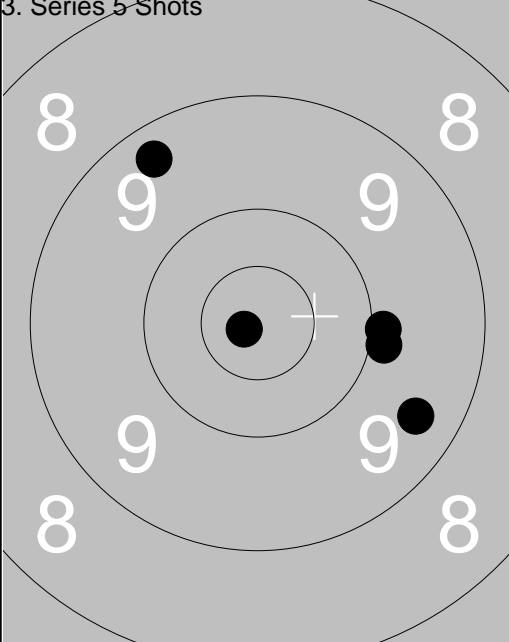
<p>2. Series 5 Shots</p> 	<p>3. Series 5 Shots</p> 	<p>1: 8.6 ↓ 2: 8.2 ↓ 3: 9.6 ↗ 4: 9.0 ↗ 5: 9.9 ↗</p> <p>1: 9.4 ↘ 2: *10.8 ↘ 3: 9.9 → 4: 9.3 ↗ 5: 9.9 →</p>
Series 43.0	Series 46.0	
Total 87.0	Total 133.0	

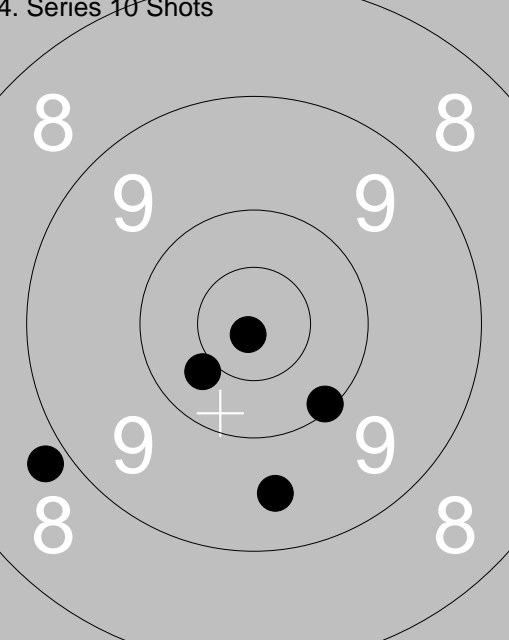
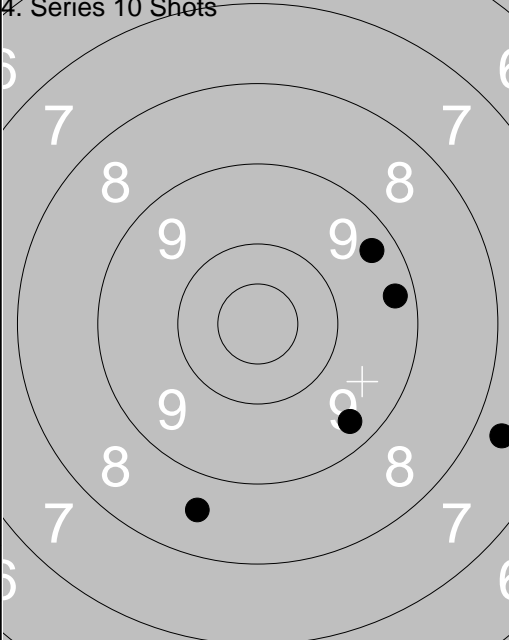
<p>4. Series 10 Shots</p> 	<p>4. Series 10 Shots</p> 	<p>1: 8.8 ↙ 2: *10.9 ↘ 3: 10.4 ↘ 4: 9.5 ↓ 5: 10.1 ↘</p> <p>6: 8.6 ↓ 7: 9.4 ↓ 8: 7.7 → 9: 9.3 → 10: 9.3 ↗</p>
Series 47.0	Series 42.0	
Total 180.0	Total 222.0	

<p>Sight</p>	<p>1: 9.2 ↗ 2: 7.2 ↗ 3: 9.4 ↓ 4: 8.9 ↑ 5: 7.2 ← 6: 7.4 ←</p>	<p>1. Series 5 Shots</p>	<p>1: 9.8 ↗ 2: 10.4 ↘ 3: 9.7 ↖ 4: 9.9 ↑ 5: 9.0 ←</p>
Series 47.0		Series 46.0	
Total 0.0		Total 46.0	

<p>2. Series 5 Shots</p>	<p>1: 8.6 ↓ 2: 10.0 ↗ 3: 9.1 ↖ 4: 9.2 → 5: 9.4 →</p>	<p>3. Series 5 Shots</p>	<p>1: 8.8 → 2: 9.0 ← 3: 9.0 ← 4: 7.9 → 5: 8.7 ↓</p>
Series 45.0		Series 41.0	
Total 91.0		Total 132.0	

<p>4. Series 10 Shots</p>	<p>1: 8.5 ↑ 2: 8.8 ↓ 3: 9.1 ↑ 4: 7.7 ↖ 5: *10.4 ↑</p>	<p>4. Series 10 Shots</p>	<p>6: *10.5 ↑ 7: 9.2 ↖ 8: 9.7 ↖ 9: 10.1 ← 10: 8.8 ↖</p>
Series 42.0		Series 46.0	
Total 174.0		Total 220.0	

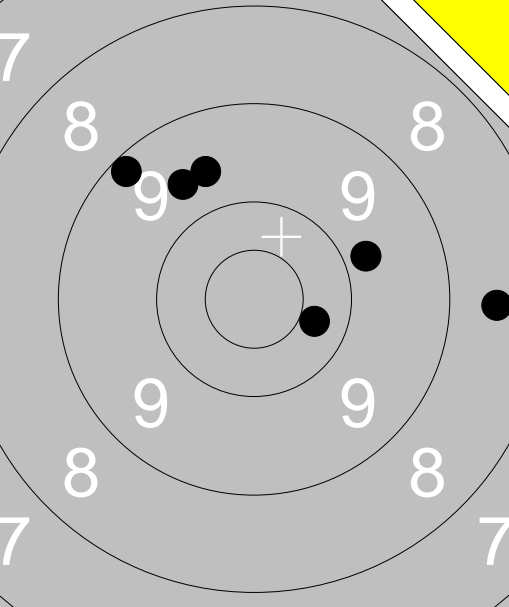
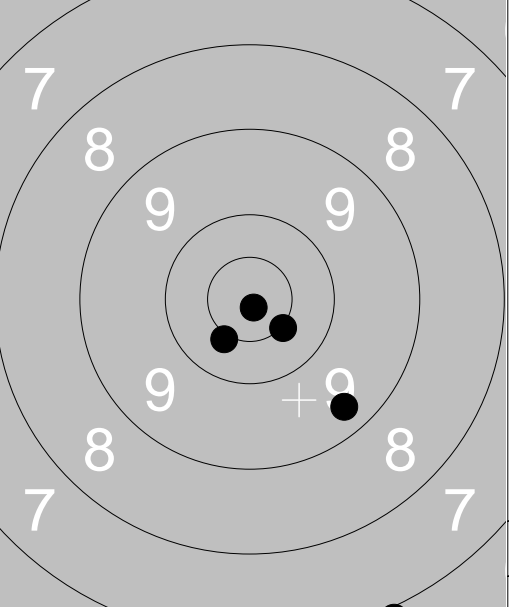
<p>Sight</p> 	<p>1: 9.2 ↗ 2: 9.6 ↗ 3: 9.6 ↗ 4: 10.3 → 5: 8.5 → 6: 9.8 →</p>	<p>1. Series 5 Shots</p> 	<p>1: 6.9 ↓ 2: 9.3 ↓ 3: *10.5 ↘ 4: *10.4 ↘ 5: *10.9 ↘</p>
Series 54.0		Series 45.0	
Total 0.0		Total 45.0	

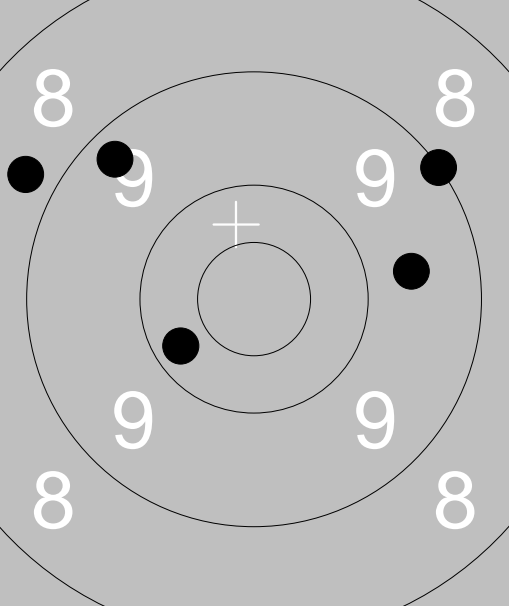
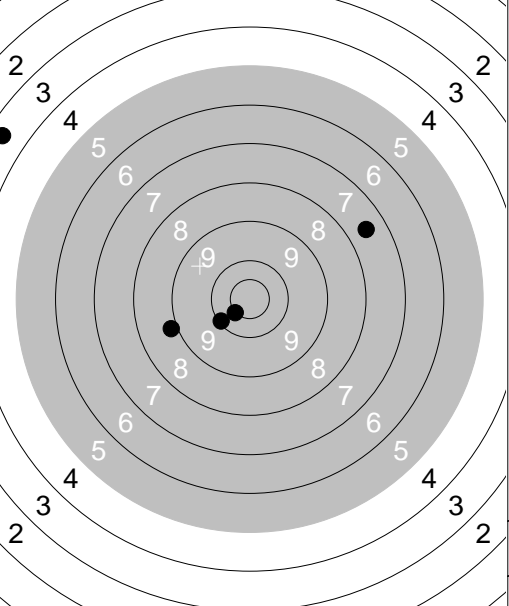
<p>2. Series 5 Shots</p> 	<p>1: 9.6 → 2: 9.0 ↗ 3: 8.7 ↖ 4: 10.2 ↙ 5: 9.3 ↗</p>	<p>3. Series 5 Shots</p> 	<p>1: 7.6 ↗ 2: *10.5 ↘ 3: 3.4 ↖ 4: 10.1 ↙ 5: 8.9 ↖</p>
Series 45.0		Series 38.0	
Total 90.0		Total 128.0	

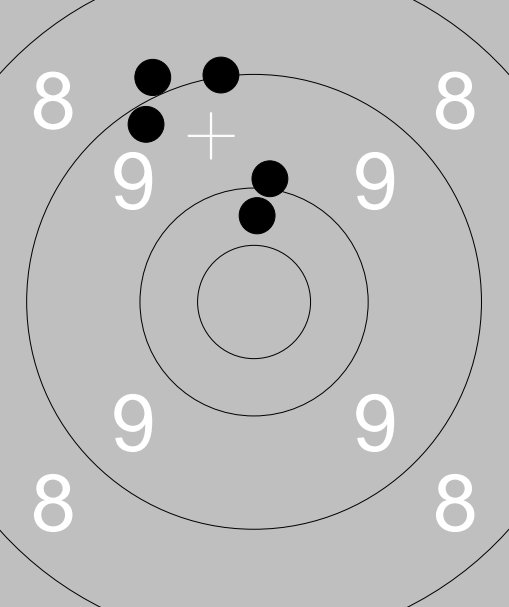
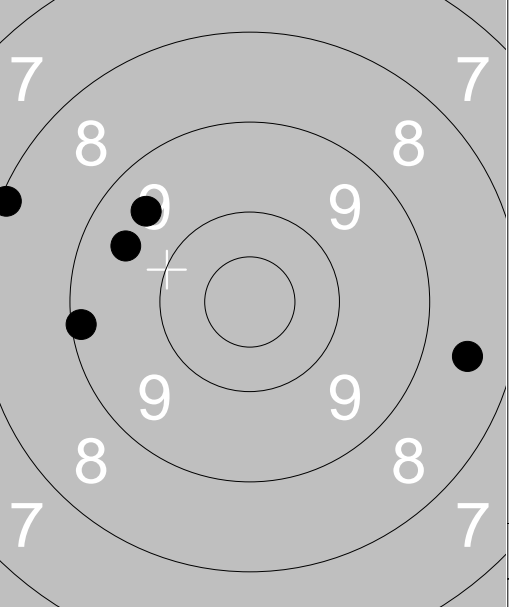
<p>4. Series 10 Shots</p> 	<p>1: 10.2 ↑ 2: 9.9 ↑ 3: 9.2 ↖ 4: 9.0 ↑ 5: 8.9 ↗</p>	<p>4. Series 10 Shots</p> 	<p>6: 9.5 ↖ 7: 9.5 ↖ 8: 9.1 ← 9: 8.1 ↖ 10: 8.5 →</p>
Series 45.0		Series 43.0	
Total 173.0		Total 216.0	

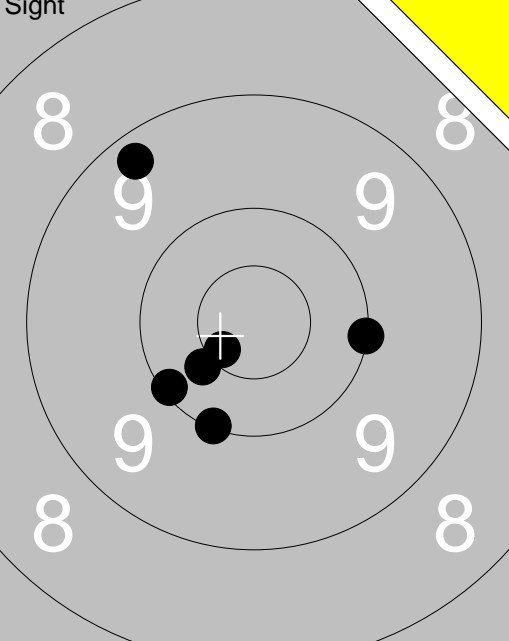
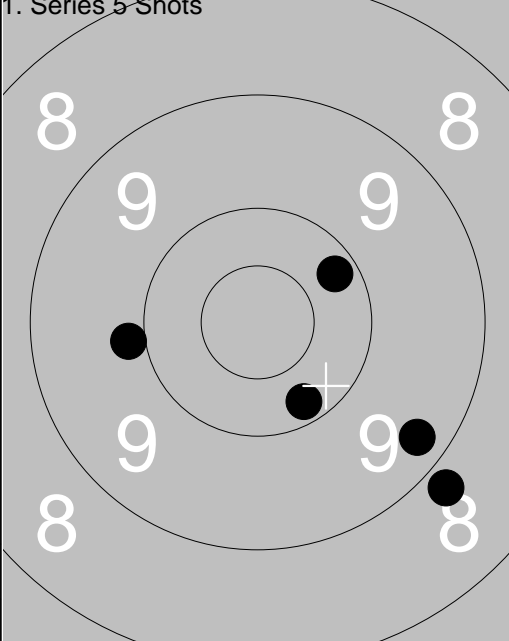
<p>Sight</p> 	<p>1. Series 5 Shots</p> 	
<p>1: 9.3 ↖ 2: *10.6 ↘ 3: 10.1 ↘ 4: 10.0 → 5: 10.4 ↘ 6: 10.0 ↘</p>	<p>1: 10.2 ↗ 2: 9.3 ↘ 3: 8.8 ↘ 4: 9.9 ← 5: 10.2 ↘</p>	
<p>Series 59.0 Total 0.0</p>	<p>Series 46.0 Total 46.0</p>	

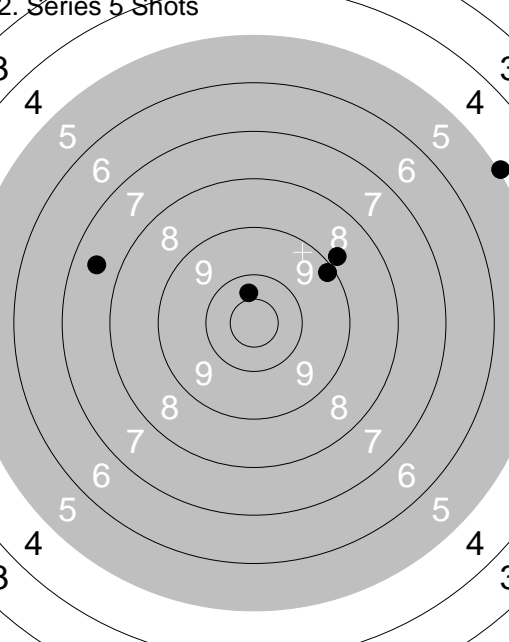
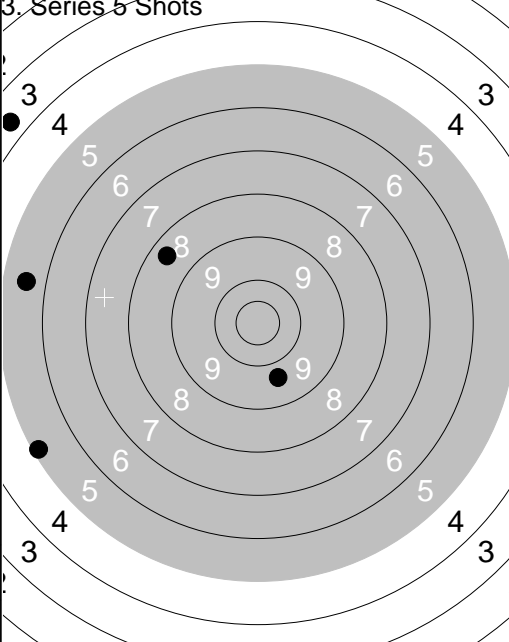
<p>2. Series 5 Shots</p> 	<p>3. Series 5 Shots</p> 	
<p>1: 10.4 ↑ 2: 8.8 ↗ 3: 5.0 ↗ 4: 9.2 ↗ 5: 7.5 ←</p>	<p>1: 8.4 ↖ 2: 5.2 ↘ 3: 5.6 ← 4: 3.6 ↖ 5: 9.7 ↘</p>	
<p>Series 39.0 Total 85.0</p>	<p>Series 30.0 Total 115.0</p>	

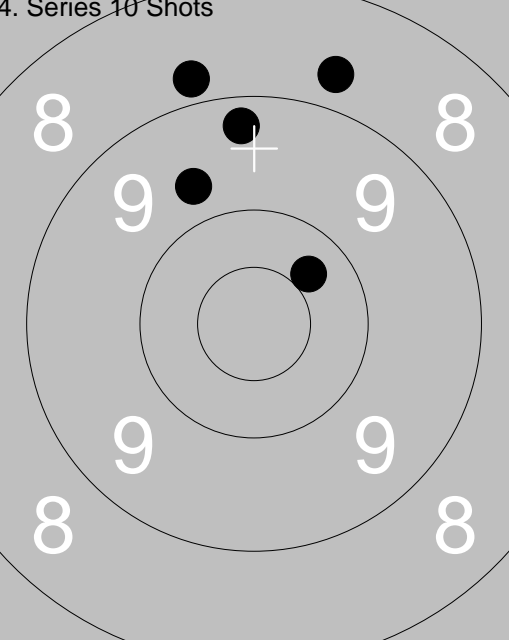
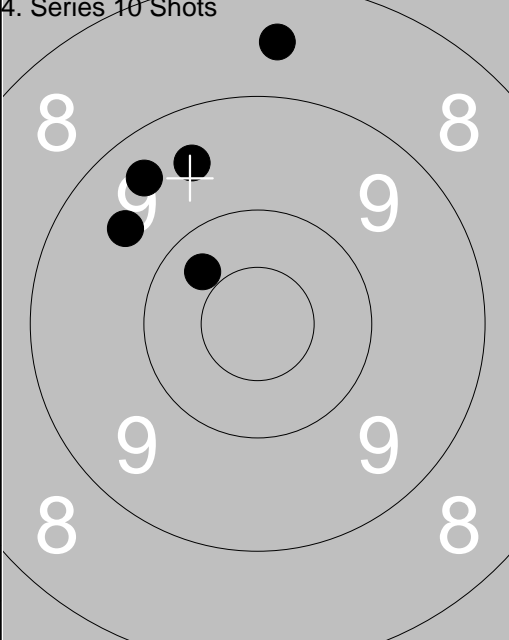
<p>4. Series 10 Shots</p> 	<p>4. Series 10 Shots</p> 	
<p>1: 10.4 ↗ 2: 8.7 ↑ 3: 9.3 ↑ 4: 8.8 ↑ 5: 9.7 ↑</p>	<p>6: 8.6 ↑ 7: 10.3 ↖ 8: 9.4 ↖ 9: 9.5 ↑ 10: 9.6 ↖</p>	
<p>Series 44.0 Total 159.0</p>	<p>Series 45.0 Total 204.0</p>	

<p>Sight</p>	<p>1: 9.2 ↙ 2: 9.6 ← 3: 9.3 ↘ 4: 9.8 ↓ 5: 10.3 ↑ 6: 9.7 ↘</p>	<p>1. Series 5 Shots</p>	<p>1: 9.2 → 2: *10.5 ↘ 3: 10.0 ↗ 4: 9.9 ← 5: 9.5 ←</p>
Series 55.0		Series 47.0	
Total 0.0		Total 47.0	

<p>2. Series 5 Shots</p>	<p>1: 8.8 ← 2: 8.9 ← 3: *10.5 → 4: 9.7 ↗ 5: 9.1 ←</p>	<p>3. Series 5 Shots</p>	<p>1: 8.1 ↗ 2: 5.7 ↗ 3: 7.5 ↓ 4: 7.3 ↓ 5: 9.6 →</p>
Series 44.0		Series 36.0	
Total 91.0		Total 127.0	

<p>4. Series 10 Shots</p>	<p>1: 8.5 ↘ 2: 9.4 → 3: 8.4 ↘ 4: 9.3 ↑ 5: 9.3 ←</p>	<p>4. Series 10 Shots</p>	<p>6: 8.4 ← 7: 9.8 ← 8: 9.0 ← 9: 8.5 ← 10: 10.0 ←</p>
Series 43.0		Series 44.0	
Total 170.0		Total 214.0	

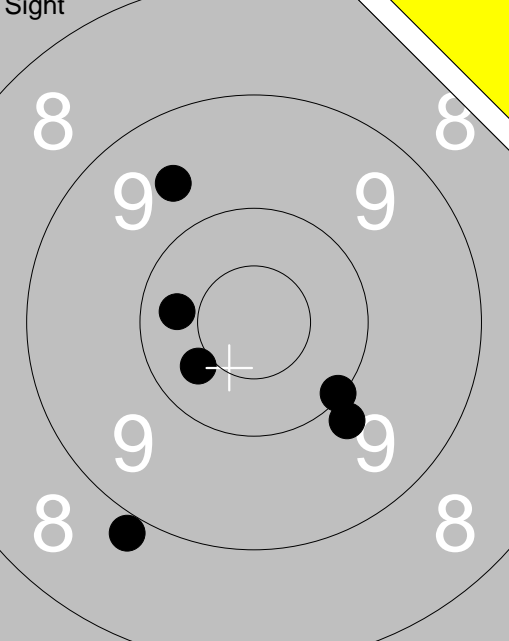
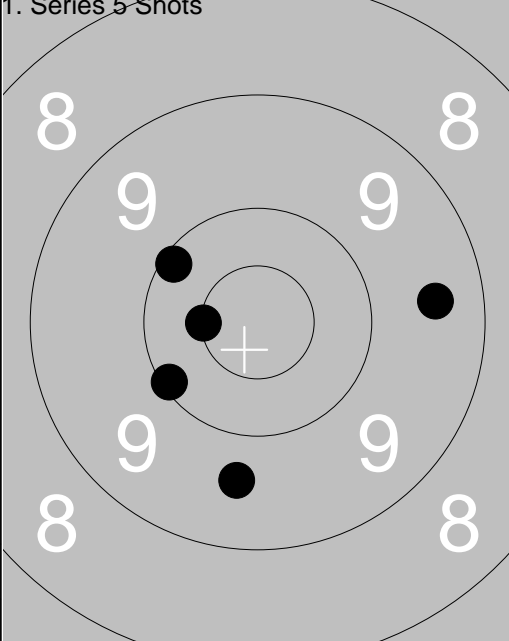
<p>Sight</p> 	<p>1: 10.4 ↙ 2: 9.8 ↘ 3: 9.6 ↗ 4: 10.1 ↘ 5: 10.3 ← 6: 8.9 ↘</p>	<p>1. Series 5 Shots</p> 		<p>1: 9.5 → 2: 10.1 ↖ 3: 10.1 ↙ 4: *10.5 ← 5: 9.6 ↓</p>
Series 56.0		Series 48.0		
Total 0.0		Total 48.0		

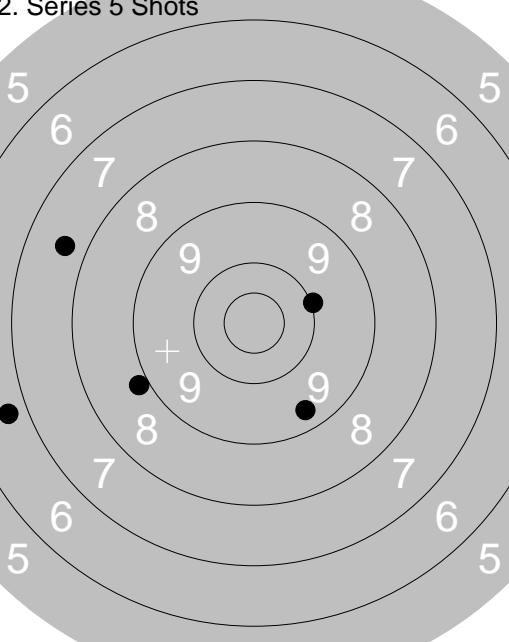
<p>2. Series 5 Shots</p> 	<p>1: 6.7 ← 2: 7.7 ← 3: 10.0 → 4: 8.9 ← 5: 9.4 ↓</p>	<p>3. Series 5 Shots</p> 		<p>1: 9.2 ↑ 2: 8.9 ↘ 3: *10.7 ↖ 4: 8.4 ↑ 5: 9.2 ↘</p>
Series 40.0		Series 44.0		
Total 88.0		Total 132.0		

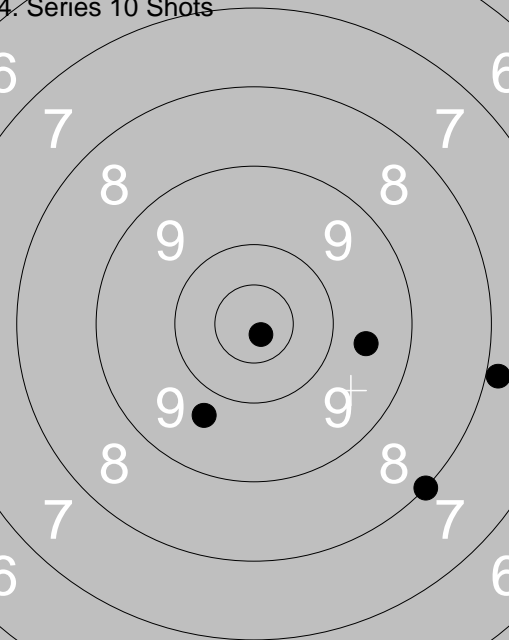
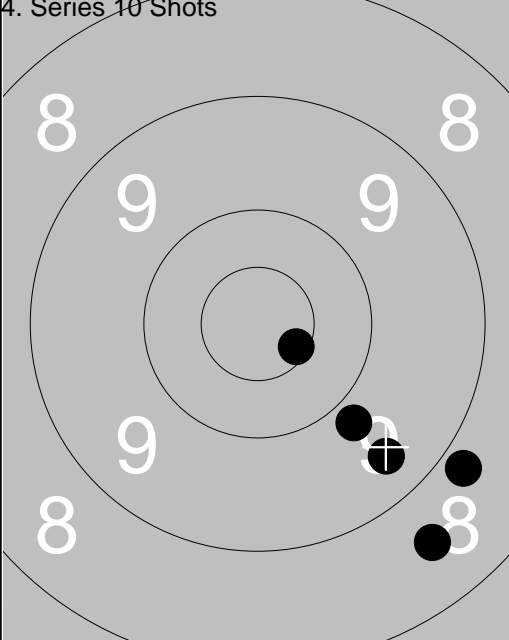
<p>4. Series 10 Shots</p> 	<p>1: 7.9 → 2: 9.7 ↘ 3: *10.8 ↘ 4: 8.0 ↘ 5: 9.6 →</p>	<p>4. Series 10 Shots</p> 		<p>6: *10.6 ↘ 7: 9.4 ↘ 8: 8.6 ↘ 9: 8.8 ↘ 10: 9.8 ↘</p>
Series 43.0		Series 44.0		
Total 175.0		Total 219.0		

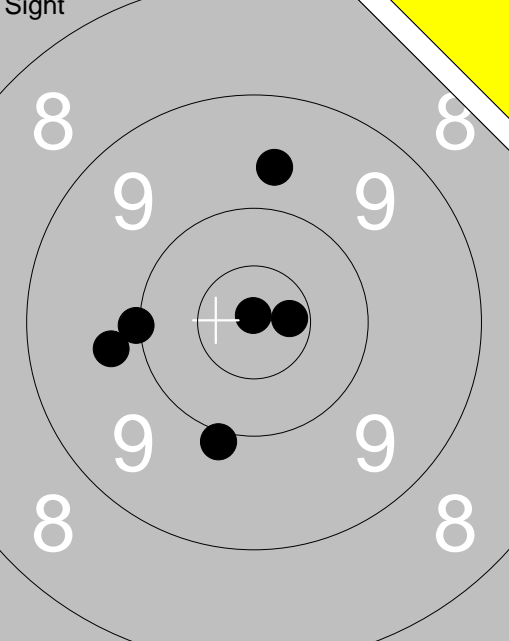
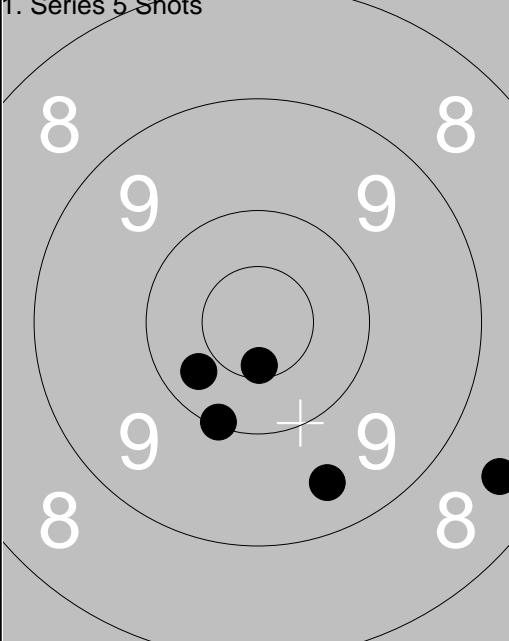
<p>Sight</p> 	<p>1. Series 5 Shots</p> 	<p>1: 8.5 → 2: 10.1 ↓ 3: 10.3 ↙ 4: *10.6 ↓ 5: 9.5 ↓</p>
Series 57.0	Series 47.0	
Total 0.0	Total 47.0	

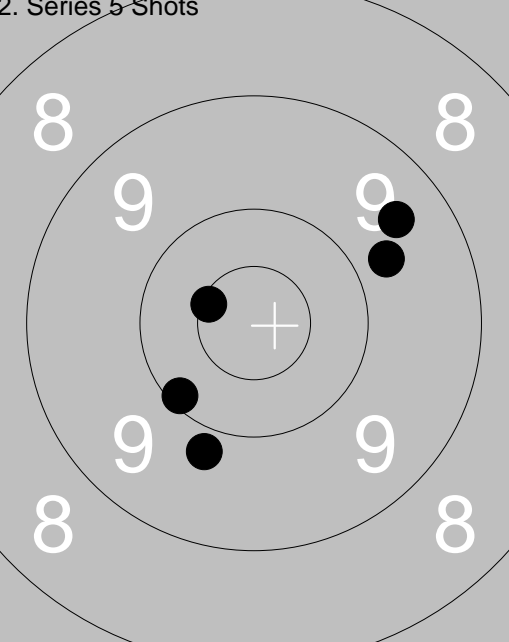
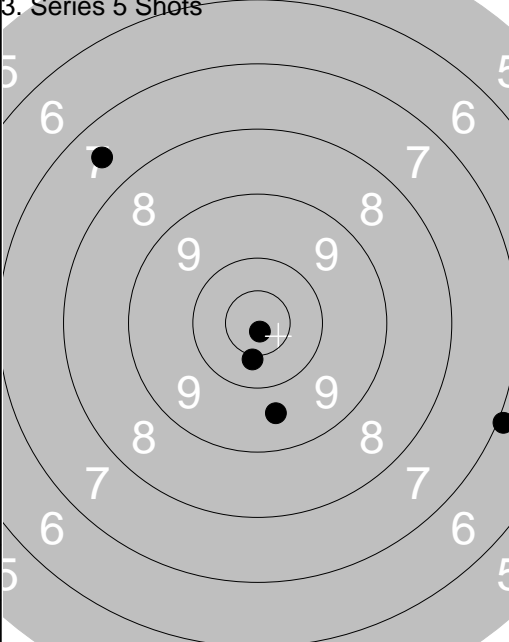
<p>2. Series 5 Shots</p> 	<p>3. Series 5 Shots</p> 	<p>1: 9.7 → 2: *10.5 ↙ 3: 9.5 ↗ 4: 10.1 ↙ 5: 9.8 ↓</p>
Series 47.0	Series 42.0	
Total 94.0	Total 136.0	

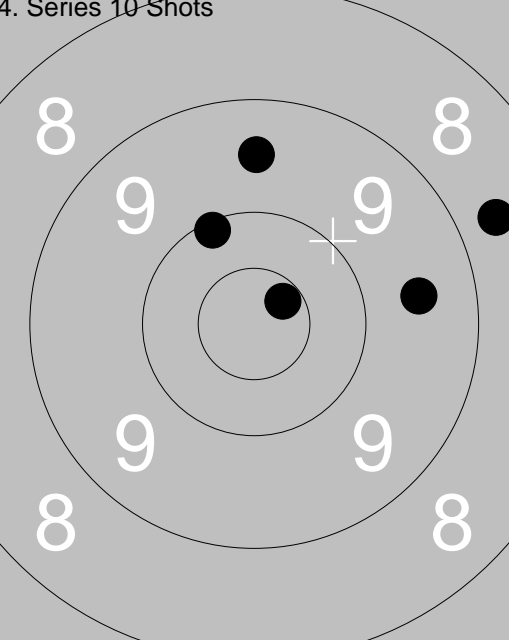
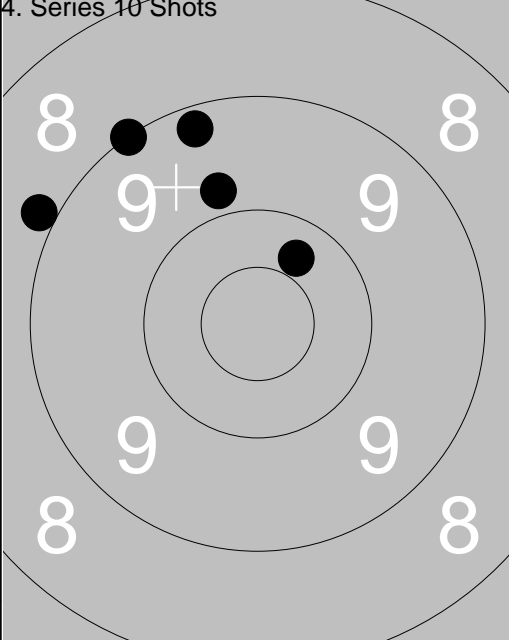
<p>4. Series 10 Shots</p> 	<p>4. Series 10 Shots</p> 	<p>1: 8.7 → 2: 9.5 → 3: *10.6 ↗ 4: 10.1 ↗ 5: 9.5 ↑</p>
Series 46.0	Series 45.0	
Total 182.0	Total 227.0	

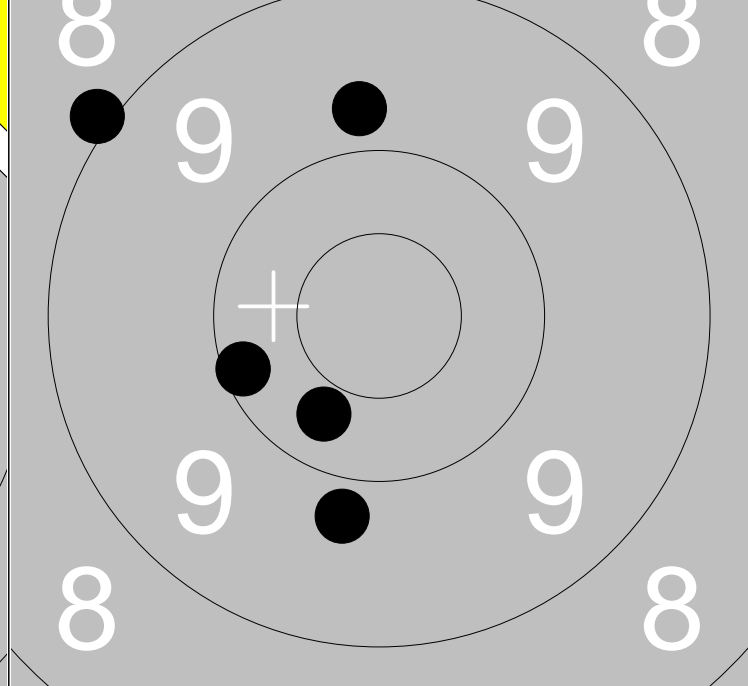
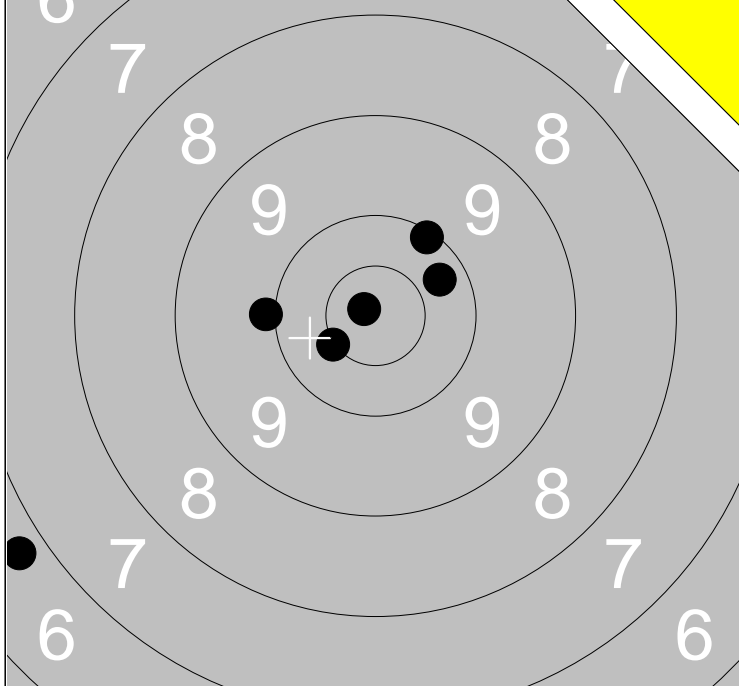

1: *10.5 ↙	6: 6.8 ↙				
2: 9.9 ←		Series	55.0		
3: 10.3 ↗					
4: 10.1 ↗		Total	0.0		
5: *10.8 ↘					

1: 9.8 ↑					
2: 10.3 ↙		Series	46.0		
3: 9.8 ↘					
4: 10.1 ↙		Total	46.0		
5: 8.9 ↙					

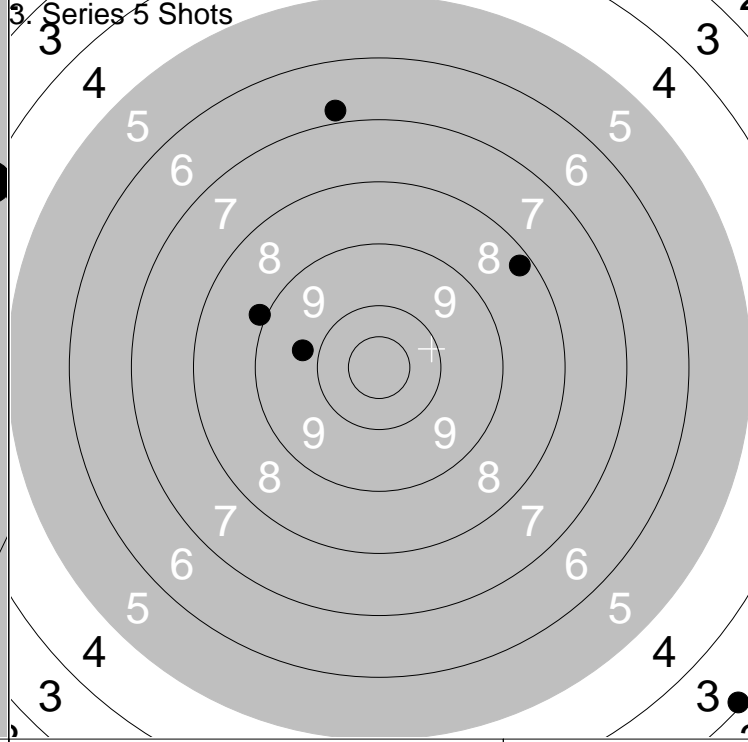
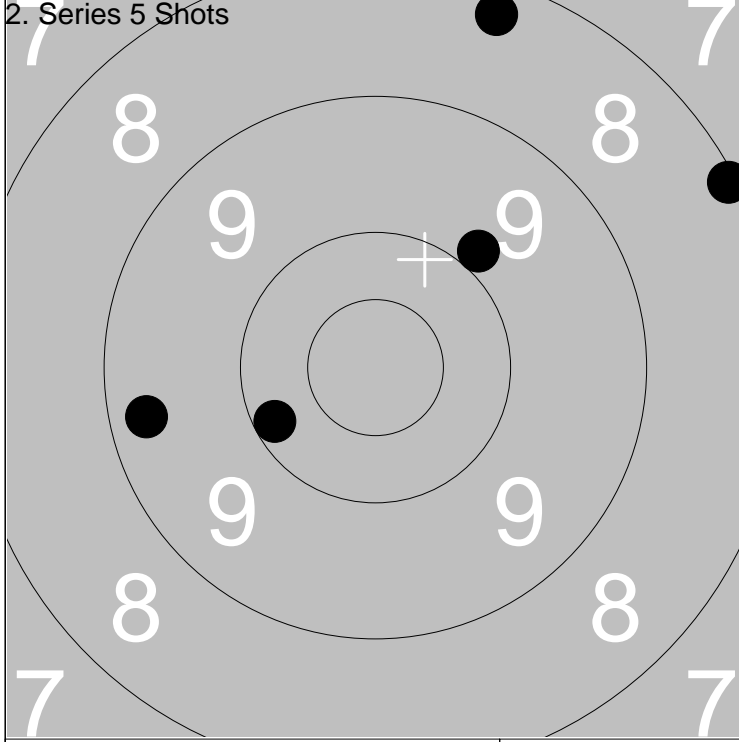

1: 9.3 ←					
2: 10.2 ↙		Series	44.0		
3: 9.9 ↗					
4: 8.1 ↗		Total	90.0		
5: 8.3 ↑					

1: 3.1 ↘					
2: 9.8 ←		Series	34.0		
3: 8.2 ↗					
4: 6.8 ↑		Total	124.0		
5: 8.9 ↙					

Relay 2	Lane 8	Stefan Lundqvist	
-------------------	------------------	-------------------------	--

300m	Ununge	A	St
------	--------	---	----

2013-07-08	Tavelträffen B 2013	Ramselefors SKF
------------	---------------------	-----------------

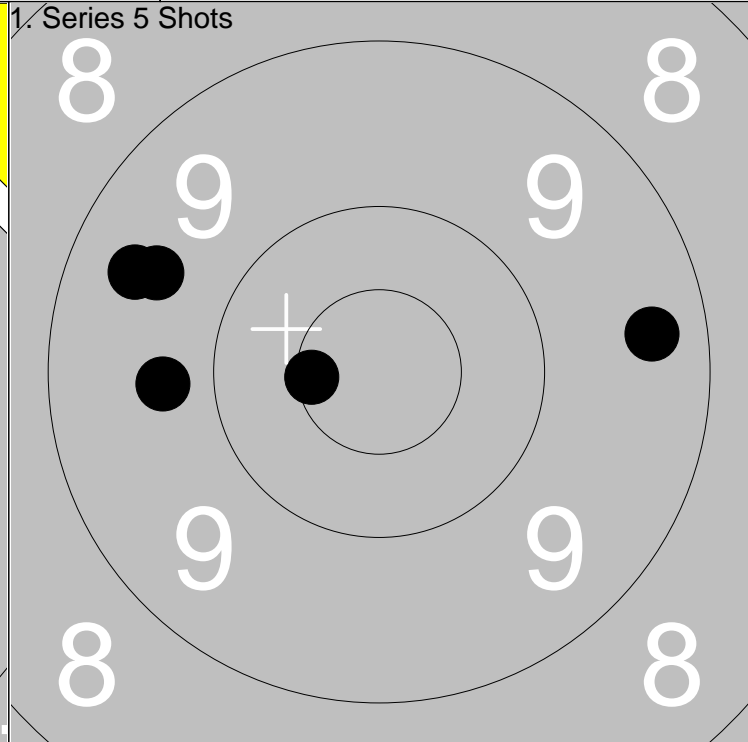
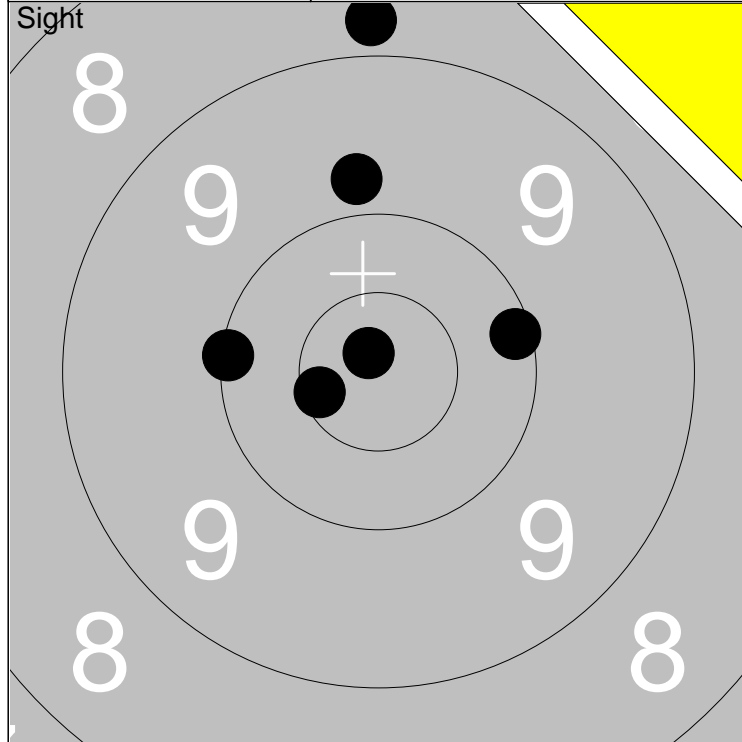

1: 10.1 ←	6: *10.8 ↖	Series	57.0
2: 9.8 ↑		Total	0.0
3: 10.1 →			
4: *10.6 ↙			
5: 8.8 ↑			

1: 9.4 →	Series	46.0
2: 9.6 ↖	Total	46.0
3: 9.4 ↖		
4: 9.7 ←		
5: *10.6 ↙		

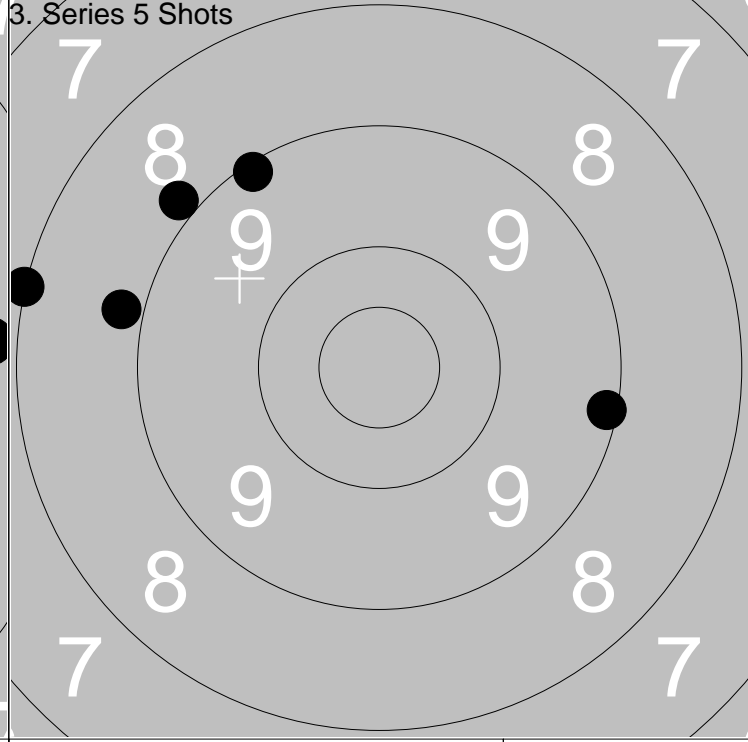
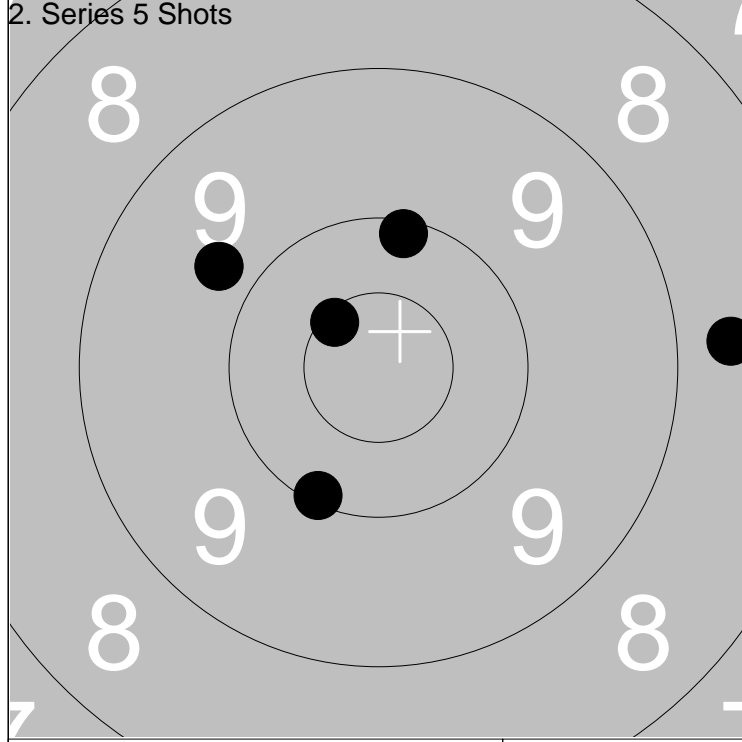

1: *10.6 ↖	Series	47.0
2: 9.8 ↖	Total	93.0
3: 10.1 ↑		
4: 10.1 ↘		
5: 8.7 →		

1: 8.0 ←	Series	42.0
2: 9.1 ↗	Total	135.0
3: 8.8 ←		
4: 9.1 →		
5: 8.9 ↗		

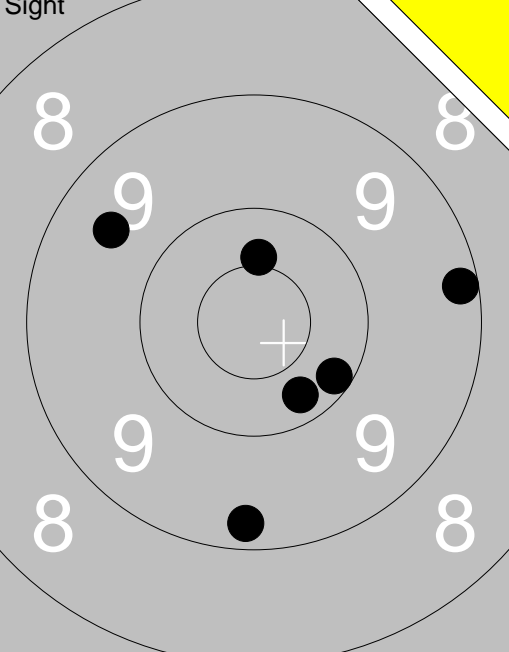
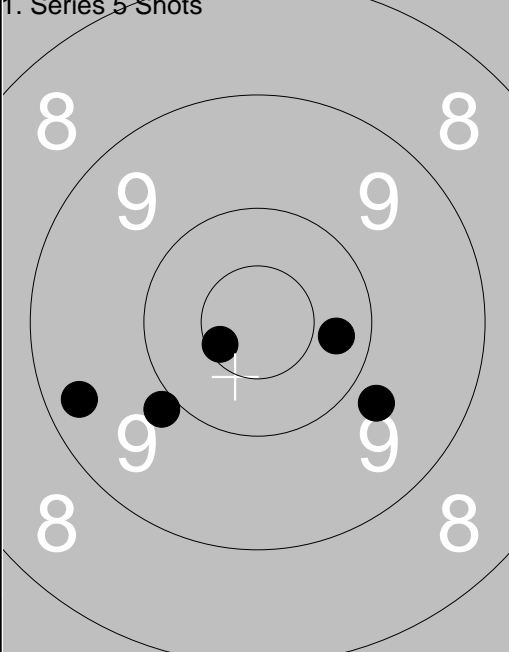
<p>Sight</p> 	<p>1. Series 5 Shots</p> 	<p>1: 9.2 →</p> <p>2: *10.4↑</p> <p>3: 9.5 ↖</p> <p>4: 9.3 ↓</p> <p>5: 10.2 ↘</p> <p>6: 10.3 ↘</p>	<p>1: 10.3→</p> <p>2: 9.8 ↘</p> <p>3: 9.9 ↙</p> <p>4: 9.3 ↖</p> <p>5: *10.6↙</p>
Series 57.0	Series 47.0		
Total 0.0	Total 47.0		

<p>2. Series 5 Shots</p> 	<p>3. Series 5 Shots</p> 	<p>1: 9.1 ←</p> <p>2: 8.7 ↖</p> <p>3: 8.4 →</p> <p>4: 10.2↖</p> <p>5: *10.8↖</p>	<p>1: 9.4 ↑</p> <p>2: 10.2↑</p> <p>3: *10.8↖</p> <p>4: 8.4 ↑</p> <p>5: 9.6 ↑</p>
Series 45.0	Series 46.0		
Total 92.0	Total 138.0		

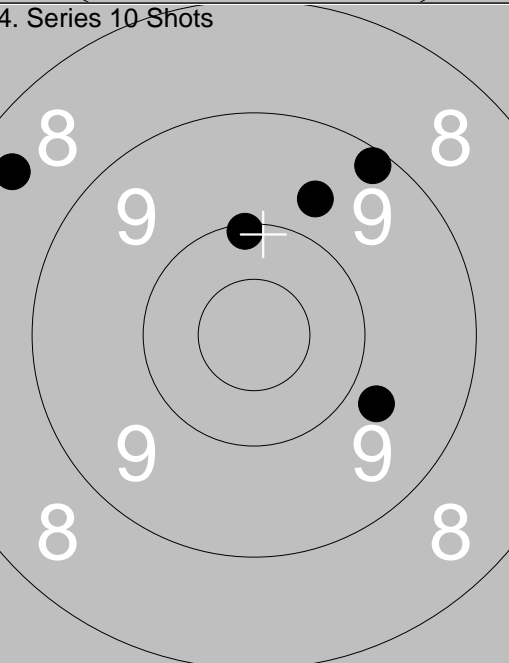
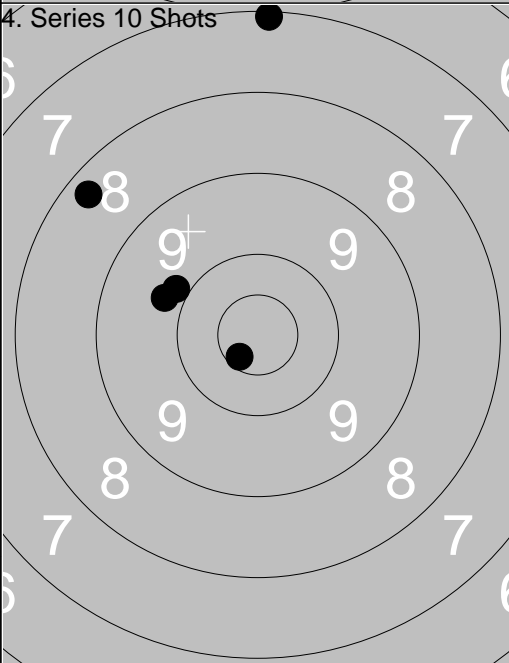
<p>4. Series 10 Shots</p> 	<p>4. Series 10 Shots</p> 	<p>1: 9.7 ↑</p> <p>2: 9.2 ↗</p> <p>3: 9.8 ↘</p> <p>4: 8.4 ↖</p> <p>5: 10.1 ↑</p>	<p>6: 7.1 ↑</p> <p>7: 9.8 ↖</p> <p>8: 9.9 ↖</p> <p>9: 8.3 ↖</p> <p>10: *10.6↙</p>
Series 45.0	Series 43.0		
Total 183.0	Total 226.0		

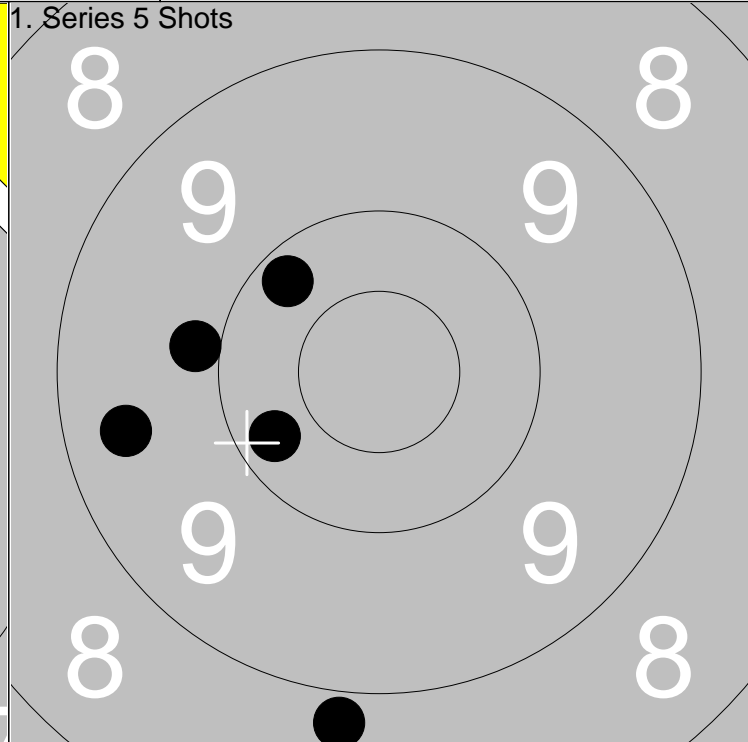
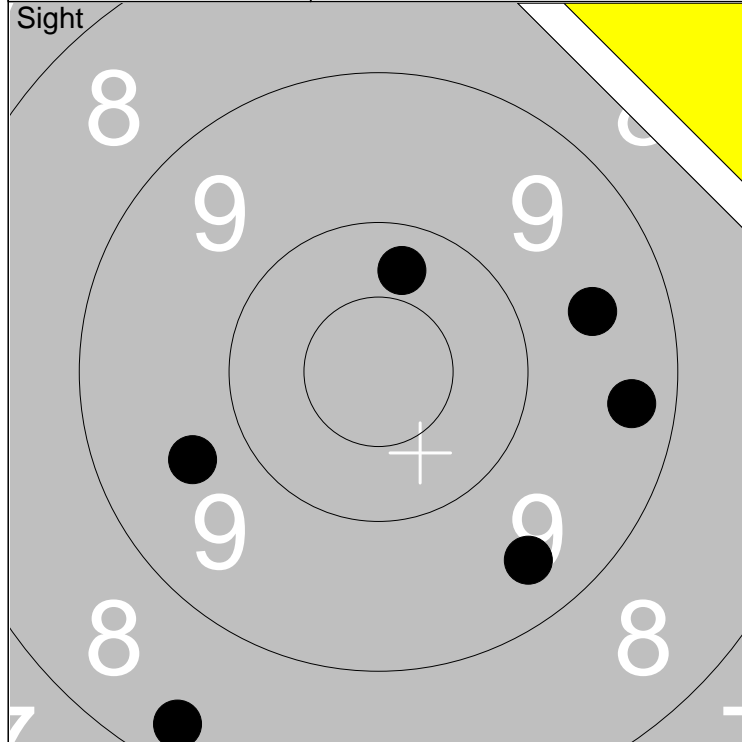

1: 9.3 →	6: 9.7 ←	Series	54.0
2: 9.5 →			
3: 8.3 ↓			
4: 9.4 ↘		Total	0.0
5: 10.3 ↑			

1: 9.4 ←	Series	46.0
2: 10.2 ↙		
3: 10.2 ↖		
4: 8.8 ↓	Total	46.0
5: 9.9 ←		

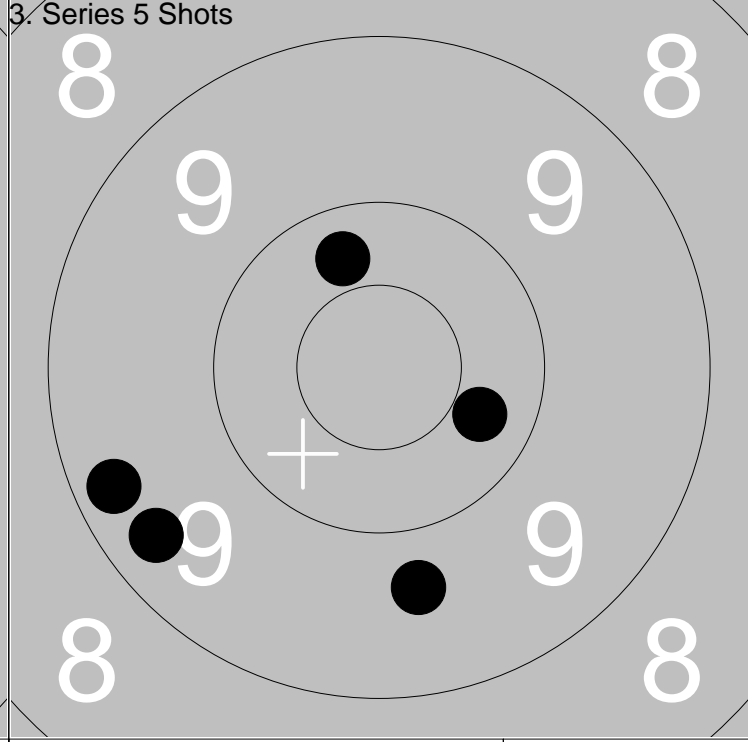
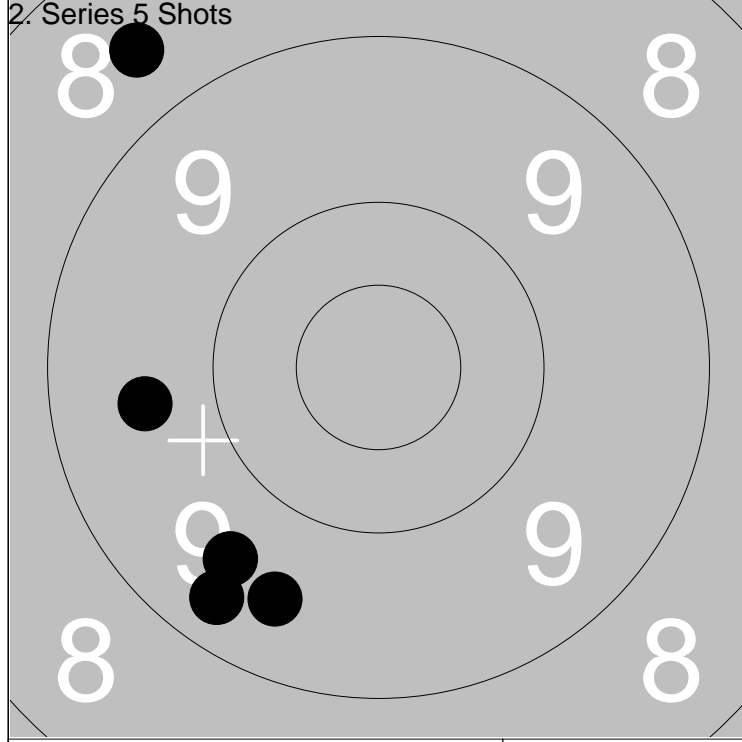

1: 8.6 ↖	Series	44.0
2: 9.6 ←		
3: 9.5 ↓		
4: 9.6 ↓	Total	90.0
5: 9.3 ↓		

1: 10.3 ↑	Series	47.0
2: 10.3 →		
3: 9.3 ←		
4: 9.3 ←	Total	137.0
5: 9.7 ↓		

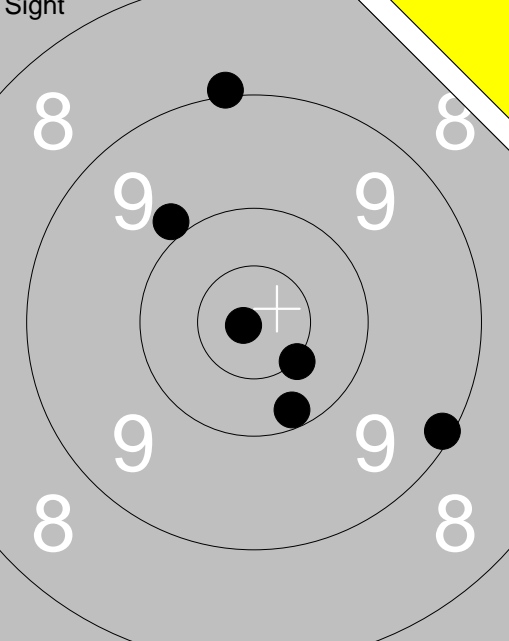
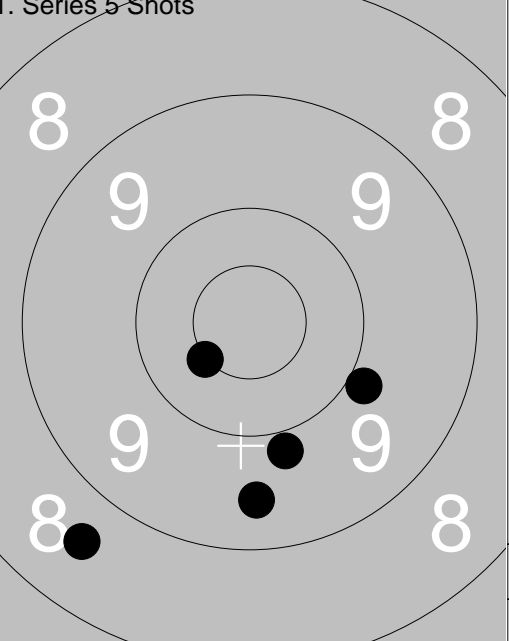
<p>Sight</p> 	<p>1. Series 5 Shots</p> 	<p>1: *10.5 ↘ 2: 9.9 ↗ 3: *10.9 ↗ 4: 10.2 ↓ 5: 9.0 ↑ 6: 9.1 ↘</p> <p>1: 9.5 ↓ 2: 8.6 ↙ 3: 9.9 ↓ 4: *10.5 ↘ 5: 9.9 ↘</p>
Series 57.0	Series 45.0	
Total 0.0	Total 45.0	

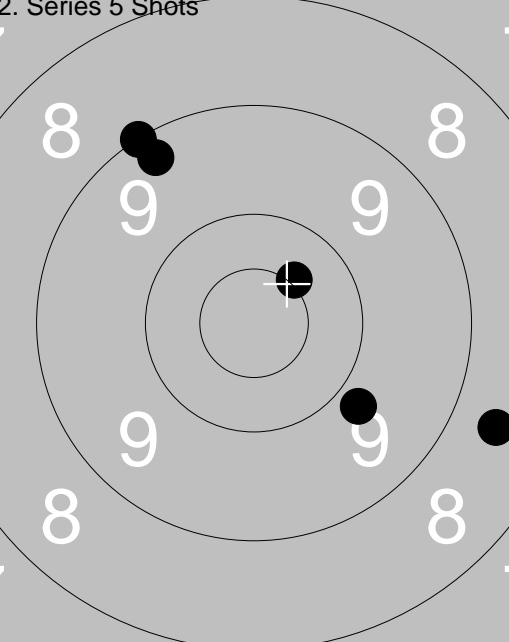
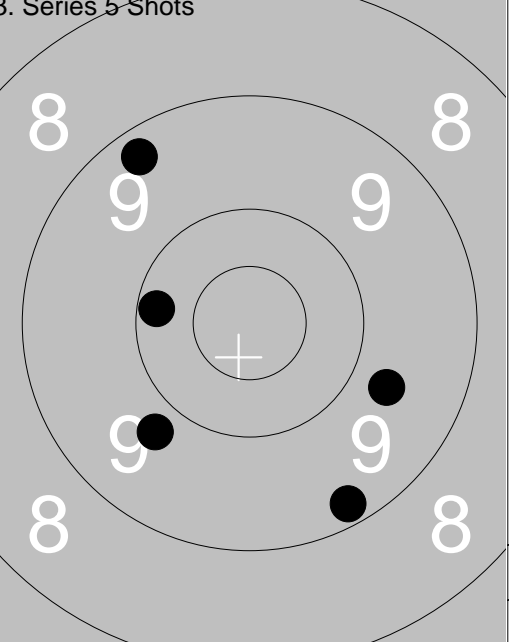
<p>2. Series 5 Shots</p> 	<p>3. Series 5 Shots</p> 	<p>1: 9.0 ↗ 2: 9.8 ↘ 3: 8.6 ↘ 4: *10.5 ↗ 5: 9.3 ↗</p> <p>1: 9.3 ↗ 2: 10.2 ← 3: 9.8 ↙ 4: 9.7 ↘ 5: 9.2 ↓</p>
Series 45.0	Series 46.0	
Total 90.0	Total 136.0	

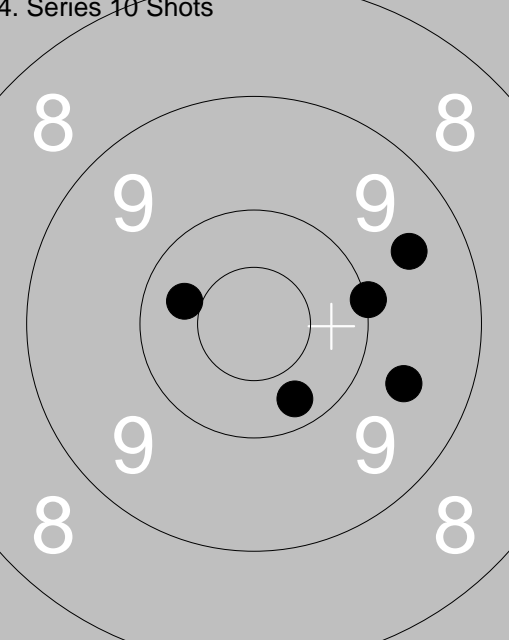
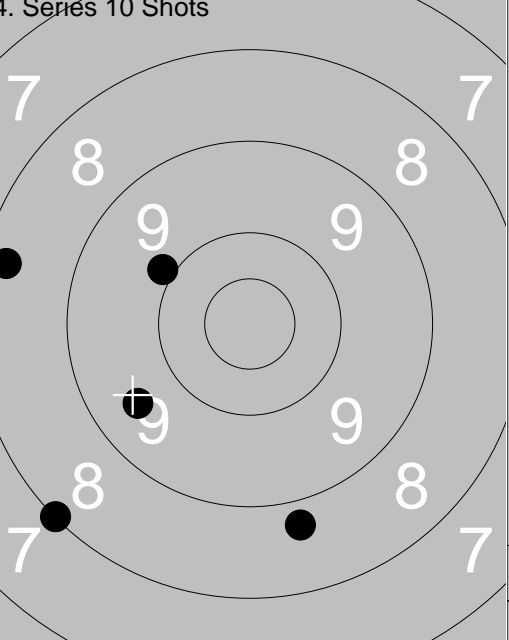
<p>4. Series 10 Shots</p> 	<p>4. Series 10 Shots</p> 	<p>1: 9.5 → 2: 10.3 ↓ 3: 10.4 ← 4: 10.0 → 5: 9.6 →</p> <p>6: 9.9 ↖ 7: 8.0 ↙ 8: 8.8 ↓ 9: 8.3 ← 10: 9.5 ↙</p>
Series 48.0	Series 42.0	
Total 184.0	Total 226.0	

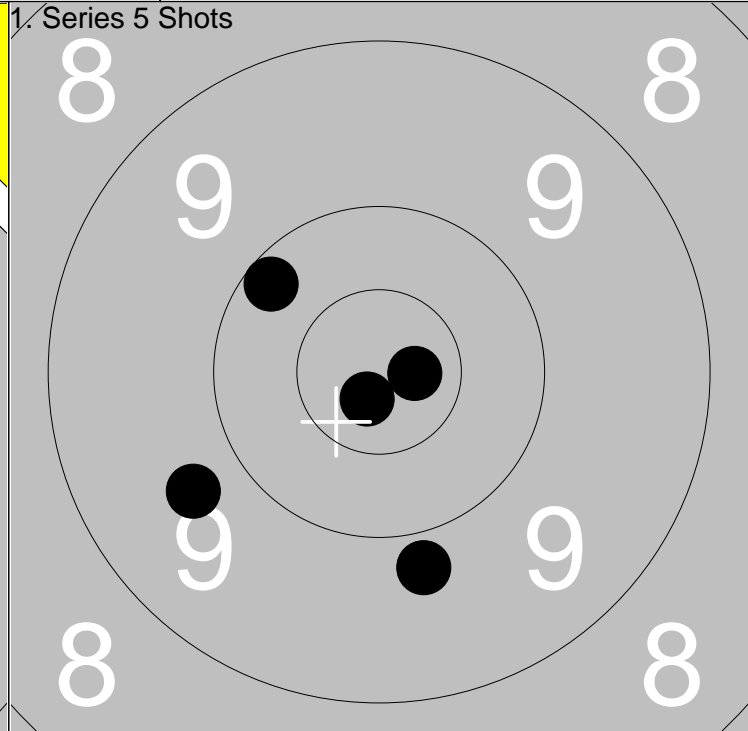
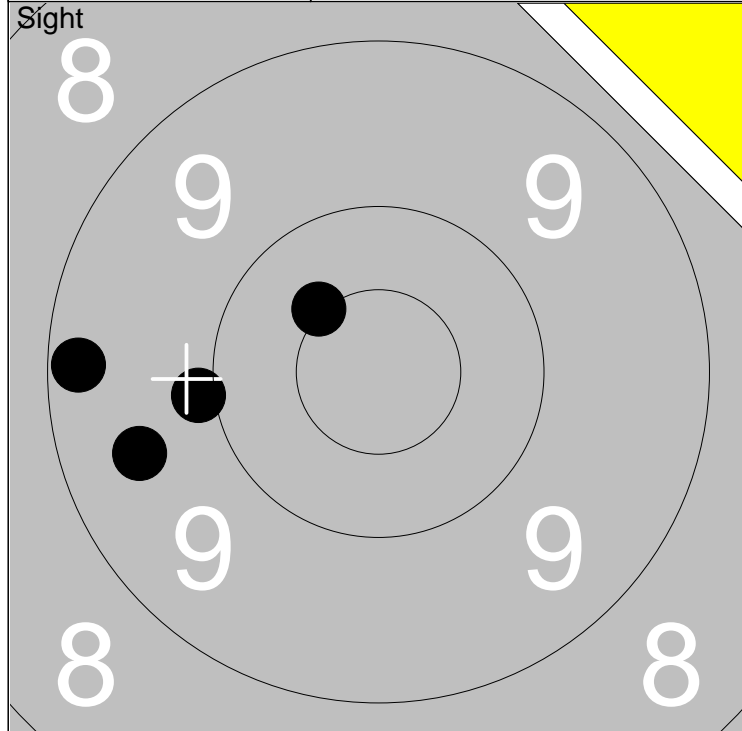

1: 9.5 ←	Series	37.0
2: *10.5 ↖		
3: 9.9 ←	Total	0.0
4: 9.2 ←		

1: 9.8 ↓	Series	48.0
2: *10.8 ↓		
3: 9.7 ←	Total	48.0
4: *10.7 →		
5: 10.2 ↖		

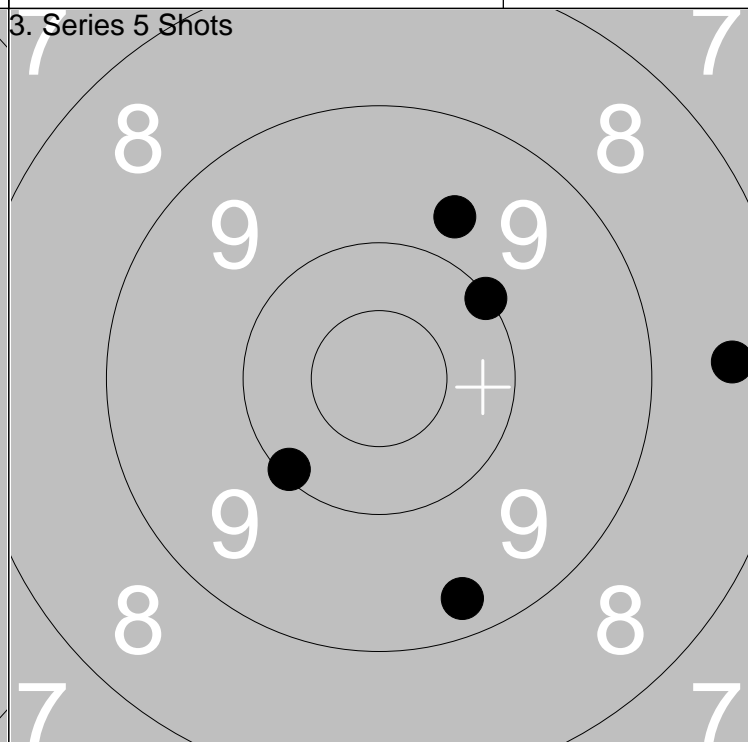
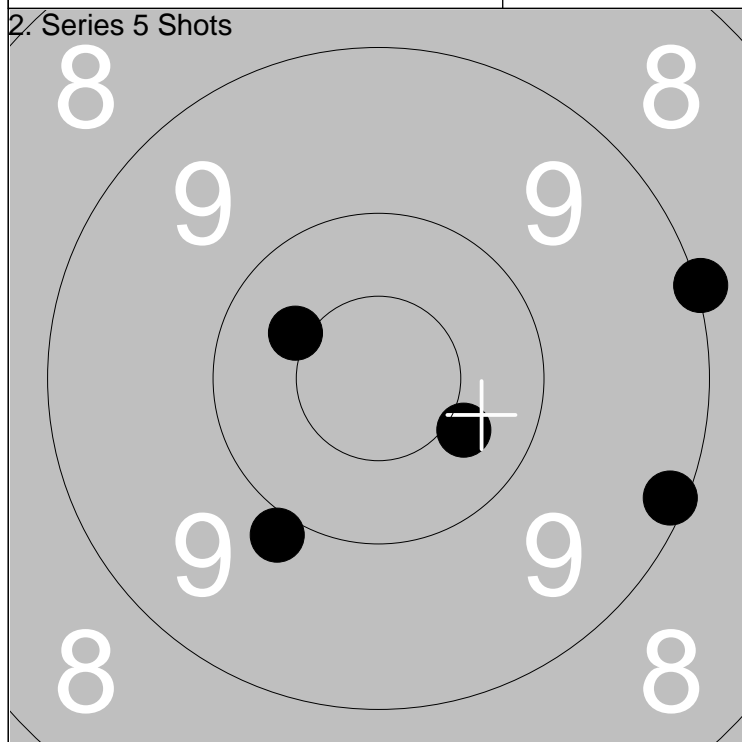

1: *10.4 ↖	Series	47.0
2: 9.9 ↓		
3: 9.0 →	Total	95.0
4: 9.1 →		
5: 10.4 ↘		

1: 8.4 →	Series	46.0
2: 9.3 ↓		
3: 10.1 ↙	Total	141.0
4: 9.7 ↗		
5: 10.0 ↘		

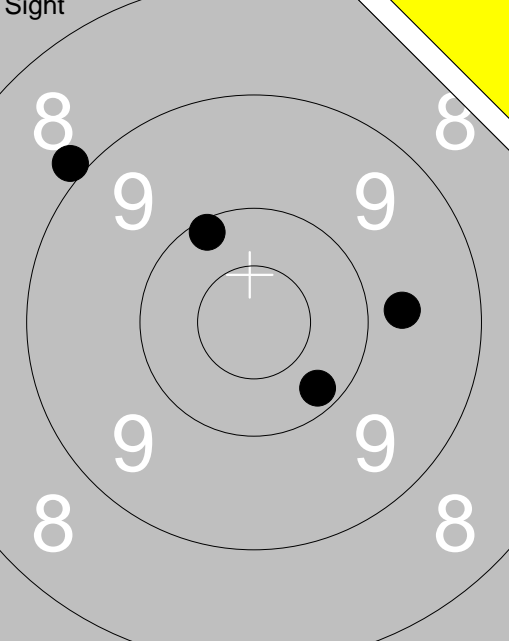
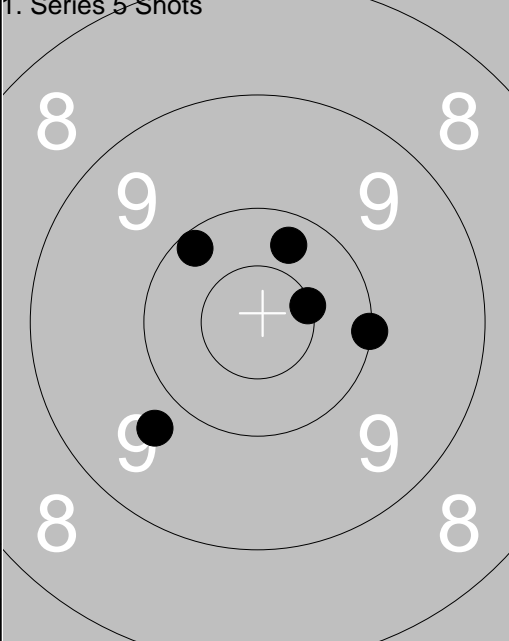
<p>Sight</p>  <p>1: 8.9 ↗ 2: 9.7 → 3: 10.2 ↘ 4: 10.1 ↗</p> <table border="1" style="width:100%; border-collapse: collapse;"> <tr><td>Series</td><td>37.0</td></tr> <tr><td>Total</td><td>0.0</td></tr> </table>	Series	37.0	Total	0.0	<p>1. Series 5 Shots</p>  <p>1: *10.5↗ 2: 9.7 ↘ 3: 10.0→ 4: 10.3 ↗ 5: 10.2 ↗</p> <table border="1" style="width:100%; border-collapse: collapse;"> <tr><td>Series</td><td>49.0</td></tr> <tr><td>Total</td><td>49.0</td></tr> </table>	Series	49.0	Total	49.0
Series	37.0								
Total	0.0								
Series	49.0								
Total	49.0								

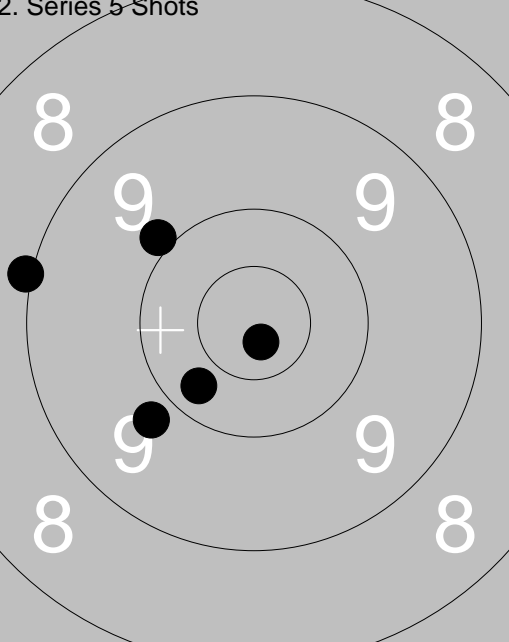
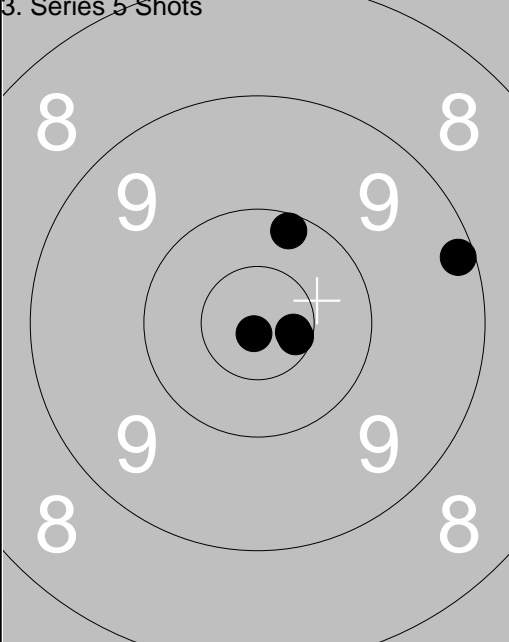
<p>2. Series 5 Shots</p>  <p>1: 9.9 ↗ 2: 10.3 ↘ 3: *10.8↘ 4: 9.8 ↘ 5: 9.0 ←</p> <table border="1" style="width:100%; border-collapse: collapse;"> <tr><td>Series</td><td>47.0</td></tr> <tr><td>Total</td><td>96.0</td></tr> </table>	Series	47.0	Total	96.0	<p>3. Series 5 Shots</p>  <p>1: 9.2 → 2: *10.7↗ 3: 10.2 ↗ 4: *10.6↗ 5: *10.9↘</p> <table border="1" style="width:100%; border-collapse: collapse;"> <tr><td>Series</td><td>49.0</td></tr> <tr><td>Total</td><td>145.0</td></tr> </table>	Series	49.0	Total	145.0
Series	47.0								
Total	96.0								
Series	49.0								
Total	145.0								

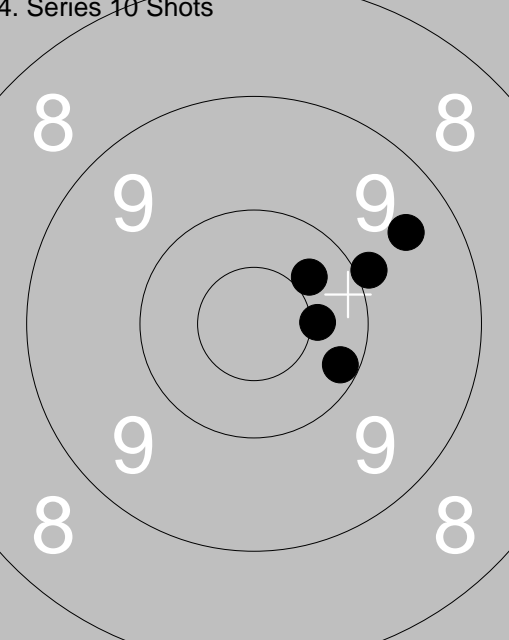
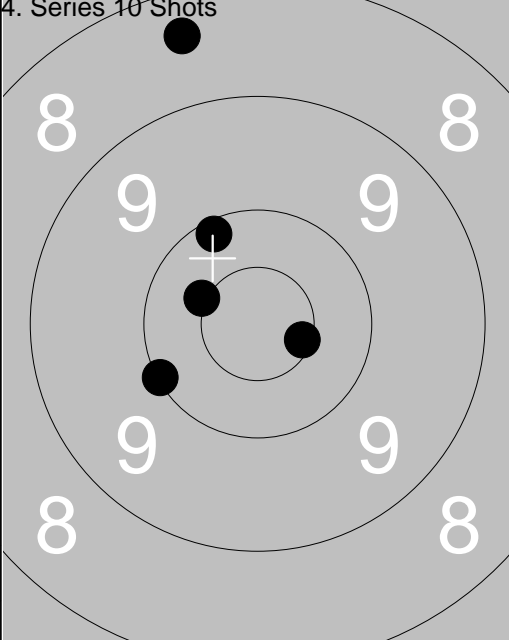
<p>4. Series 10 Shots</p>  <p>1: 10.4 ↗ 2: 9.5 ↗ 3: 10.2→ 4: 9.9 → 5: *10.4→</p> <table border="1" style="width:100%; border-collapse: collapse;"> <tr><td>Series</td><td>48.0</td></tr> <tr><td>Total</td><td>193.0</td></tr> </table>	Series	48.0	Total	193.0	<p>4. Series 10 Shots</p>  <p>6: 8.4 ↗ 7: *10.5↘ 8: *10.6↗ 9: 10.1 ↗ 10: 10.0↘</p> <table border="1" style="width:100%; border-collapse: collapse;"> <tr><td>Series</td><td>48.0</td></tr> <tr><td>Total</td><td>241.0</td></tr> </table>	Series	48.0	Total	241.0
Series	48.0								
Total	193.0								
Series	48.0								
Total	241.0								

<p>Sight</p>	<p>1. Series 5 Shots</p>	<p>1: 10.0 ←</p> <p>2: 10.0 ↓</p> <p>3: *10.5 ↑</p> <p>4: 9.9 →</p> <p>5: 9.8 ↑</p> <p>6: 9.7 ↙</p>	<p>1: 9.6 ↑</p> <p>2: *10.4 ↙</p> <p>3: 10.4 ←</p> <p>4: 10.1 ↓</p> <p>5: 10.4 ↓</p>
Series 57.0	Series 49.0	Total 0.0	Total 49.0

<p>2. Series 5 Shots</p>	<p>3. Series 5 Shots</p>	<p>1: 9.9 ↙</p> <p>2: *10.7 ↘</p> <p>3: 9.4 →</p> <p>4: 10.2 →</p> <p>5: 9.4 ↙</p>	<p>1: *10.6 ↗</p> <p>2: *10.5 ↑</p> <p>3: 9.4 ↑</p> <p>4: 8.5 ↗</p> <p>5: 10.3 ↘</p>
Series 47.0	Series 47.0	Total 96.0	Total 143.0

<p>4. Series 10 Shots</p>	<p>4. Series 10 Shots</p>	<p>1: 9.8 ↘</p> <p>2: 8.7 →</p> <p>3: *10.5 →</p> <p>4: 9.7 →</p> <p>5: 9.0 →</p>	<p>6: *10.7 ↘</p> <p>7: 10.3 →</p> <p>8: 8.6 →</p> <p>9: 9.6 ↗</p> <p>10: 9.2 →</p>
Series 45.0	Series 46.0	Total 188.0	Total 234.0

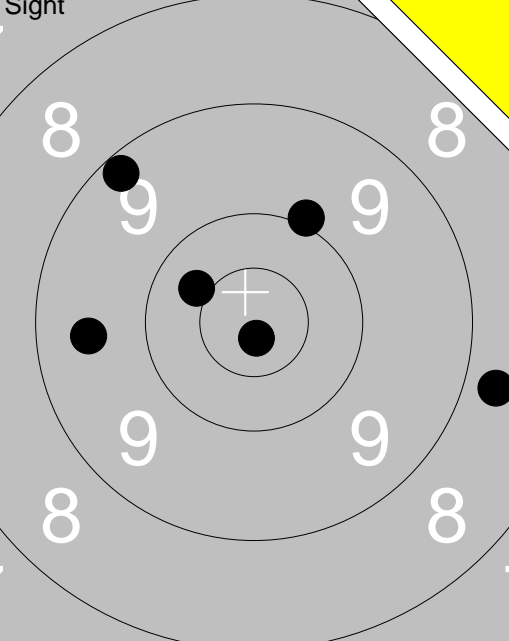
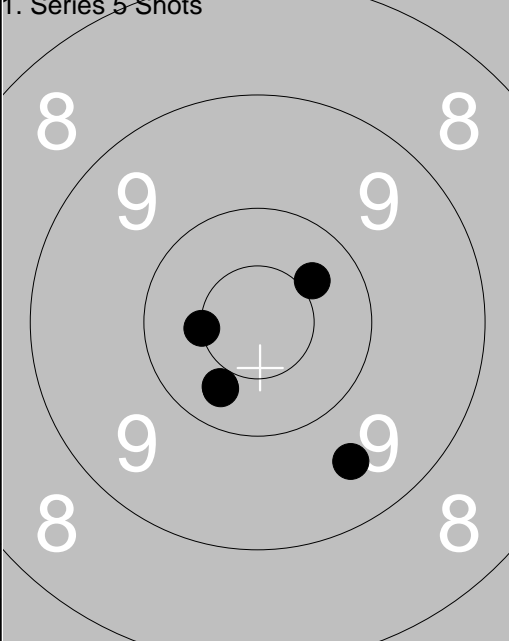
<p>Sight</p> 	<p>1: 9.5 ← 2: 9.2 ↗ 3: 10.0 ↗ 4: *10.8 ↓ 5: 10.4 ↖ 6: 8.7 →</p>	<p>1. Series 5 Shots</p> 		<p>1: 10.4 ↗ 2: 9.6 ↓ 3: *10.5 ↖ 4: 10.3 ↓ 5: 10.3 ↓</p>
Series 56.0		Series 49.0		
Total 0.0		Total 49.0		

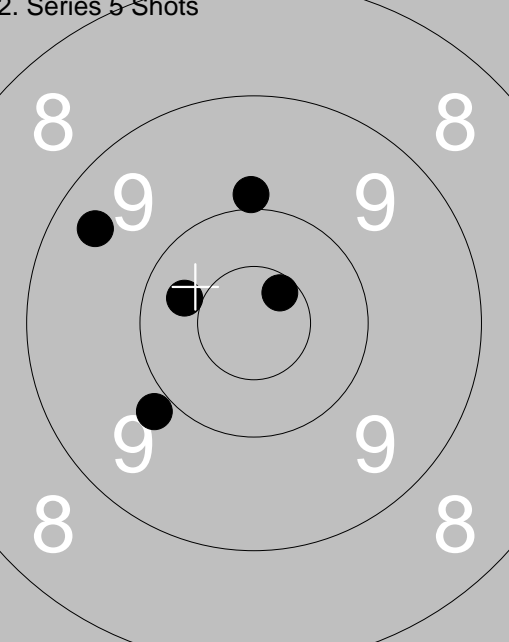
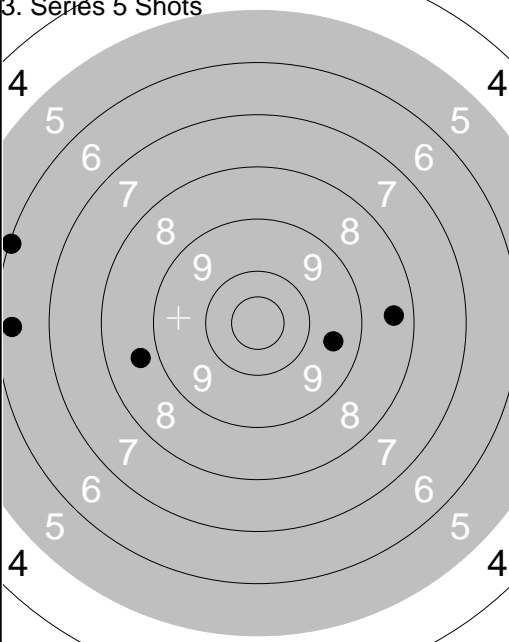
<p>2. Series 5 Shots</p> 	<p>1: 9.4 ↖ 2: 10.3 ↖ 3: *10.6 ↗ 4: 9.9 ↑ 5: 9.9 ↖</p>	<p>3. Series 5 Shots</p> 		<p>1: 6.1 ↖ 2: 8.4 → 3: 9.5 → 4: 6.3 ← 5: 8.7 ↖</p>
Series 47.0		Series 37.0		
Total 96.0		Total 133.0		

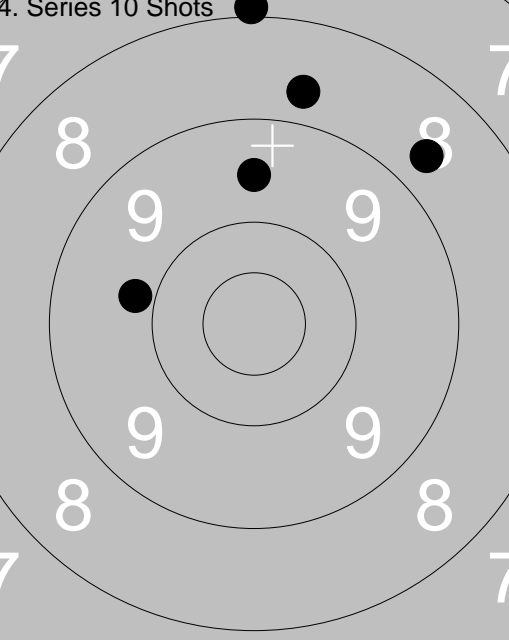
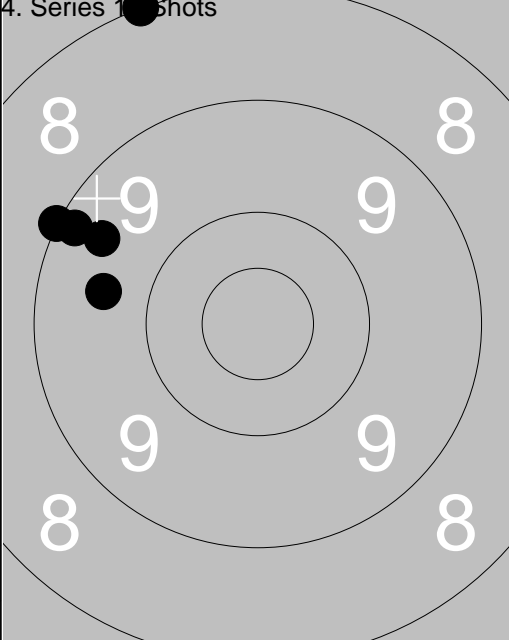
<p>4. Series 10 Shots</p> 	<p>1: 8.7 ↗ 2: 9.6 ↑ 3: 7.9 ↑ 4: 8.7 ↑ 5: 9.8 ←</p>	<p>4. Series 10 Shots</p> 		<p>6: 8.0 ↑ 7: 9.0 ↖ 8: 9.4 ↖ 9: 9.2 ↖ 10: 9.6 ↖</p>
Series 41.0		Series 44.0		
Total 174.0		Total 218.0		

<p>Sight</p>	<p>1. Series 5 Shots</p>	<p>1: 9.0 ↓ 2: 9.0 ↓ 3: *10.5 ↑ 4: 10.2 → 5: 8.8 → 6: 9.5 ↗</p> <p>1: 9.1 → 2: *10.4 ↙ 3: 9.8 → 4: 9.7 → 5: 9.6 ↑</p>
<p>Series 55.0 Total 0.0</p>	<p>Series 46.0 Total 46.0</p>	

<p>2. Series 5 Shots</p>	<p>3. Series 5 Shots</p>	<p>1: 9.7 ↗ 2: 9.8 ↑ 3: 7.6 → 4: 6.3 ← 5: 8.9 →</p> <p>1: *10.4 ↗ 2: 8.0 ↑ 3: 8.8 ← 4: 8.3 ↑ 5: 3.9 →</p>
<p>Series 39.0 Total 85.0</p>	<p>Series 37.0 Total 122.0</p>	

<p>4. Series 10 Shots</p>	<p>4. Series 10 Shots</p>	<p>1: 9.7 ↗ 2: *10.5 ↘ 3: 10.1 → 4: 9.2 ← 5: 10.0 ↙</p> <p>6: 8.5 ↗ 7: *10.5 ↘ 8: 7.6 ← 9: *10.4 ↙ 10: 8.5 ←</p>
<p>Series 48.0 Total 170.0</p>	<p>Series 43.0 Total 213.0</p>	

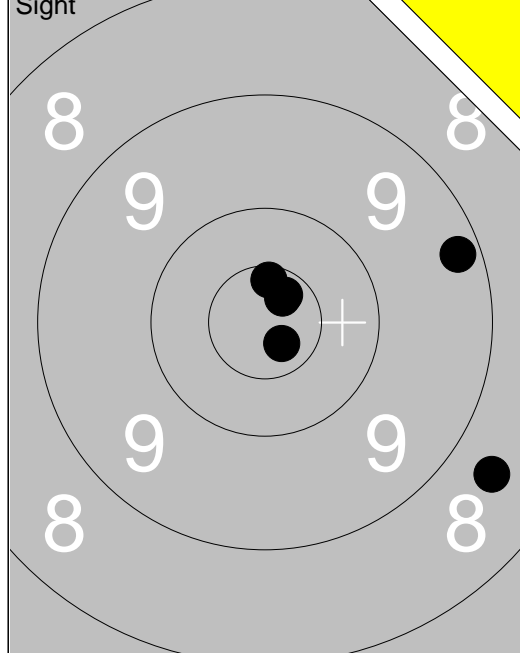

1: *10.7 ↗
2: 9.2 →
3: *10.7 ↗
4: *10.6 ↑
5: 8.6 ↘
6: *10.7 ↘
Series 57.0
Total 0.0

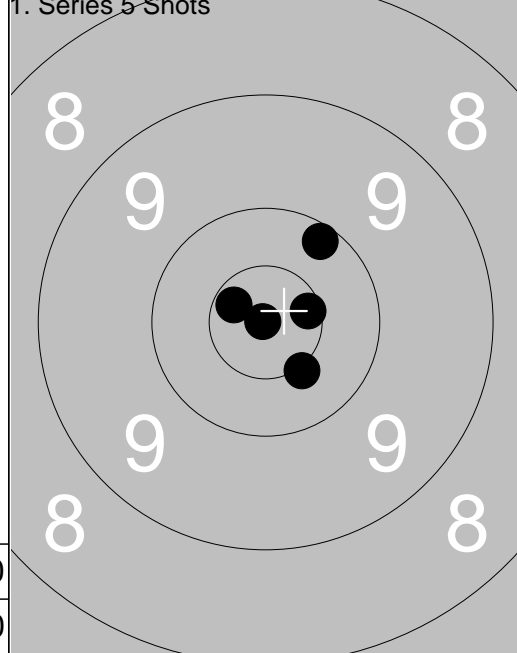

1: *10.7 ↗
2: *10.6 →
3: *10.5 ↘
4: *10.9 ↗
5: 10.2 ↗
Series 50.0
Total 50.0

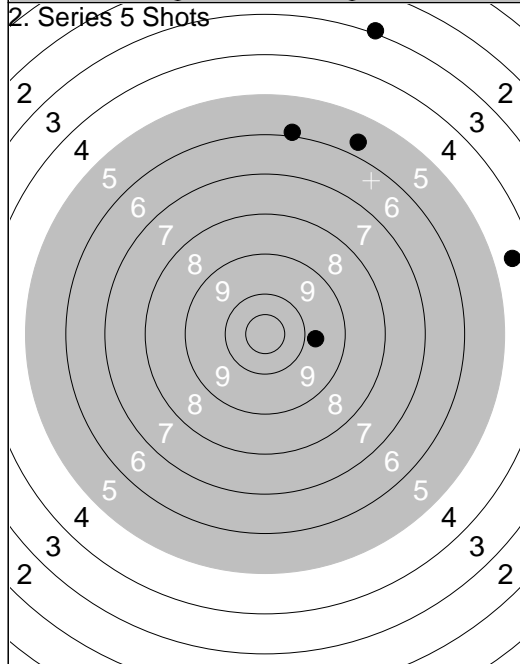

1: 5.9 ↑
2: 9.8 →
3: 3.0 ↑
4: 4.6 →
5: 5.7 ↑
Series 26.0
Total 76.0

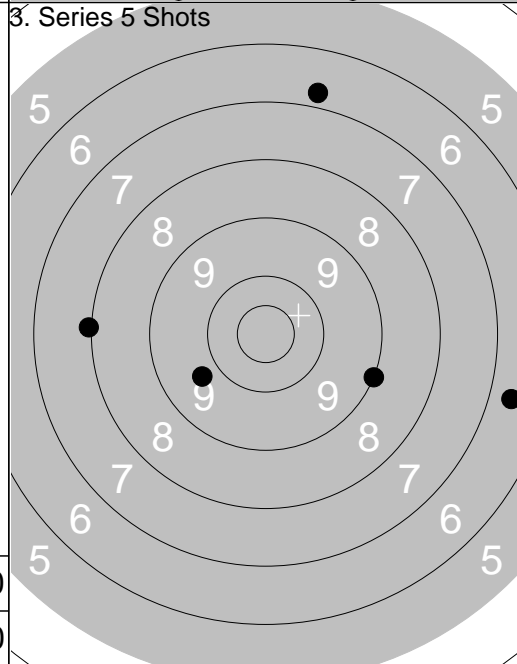

1: 6.7 →
2: 8.0 ←
3: 9.7 ↙
4: 6.8 ↑
5: 9.0 →
Series 38.0
Total 114.0

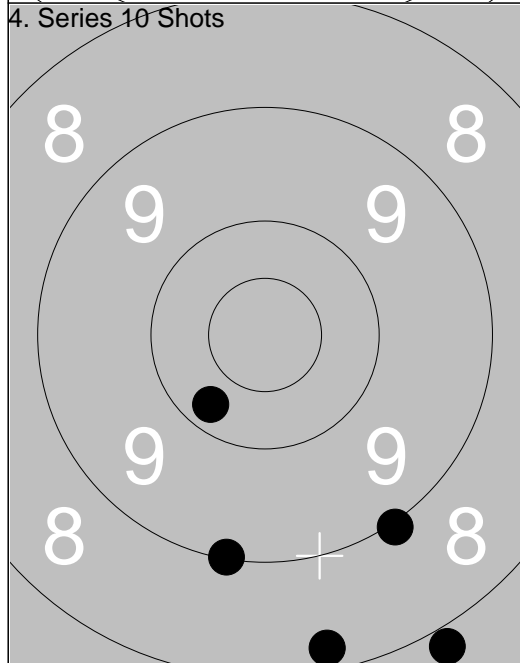

1: 9.1 ↓
2: 9.0 ↓
3: 10.2 ↘
4: 7.9 ↓
5: 8.2 ↓
Series 43.0
Total 157.0

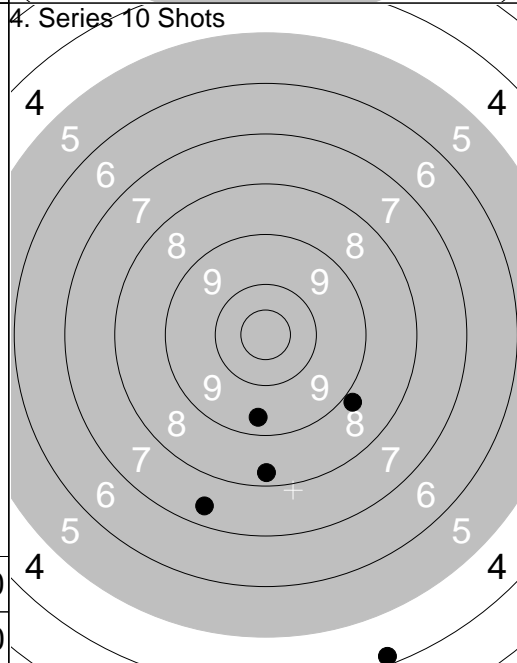

6: 8.3 ↓
7: 9.4 ↓
8: 4.2 ↓
9: 8.8 ↘
10: 7.4 ↓
Series 36.0
Total 193.0

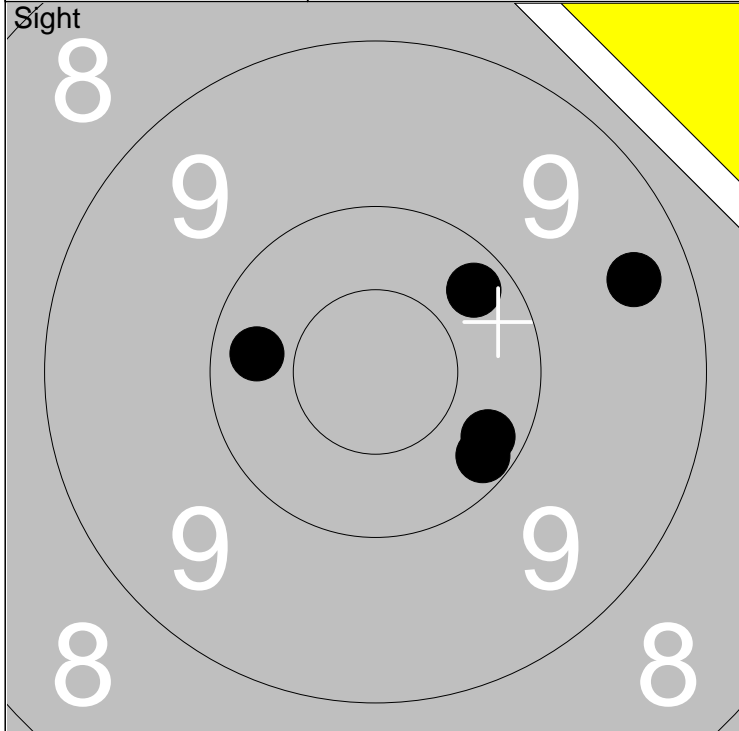

1: 10.2 ↗	6: 8.7 ↗	Series	57.0
2: 10.2 ↘			
3: 10.3 ←			
4: 10.2 ↘		Total	0.0
5: 9.4 →			

1: *10.6 →	Series	49.0
2: *10.7 ↑		
3: *10.6 ↑		
4: 9.2 ←	Total	49.0
5: *10.7 ↑		

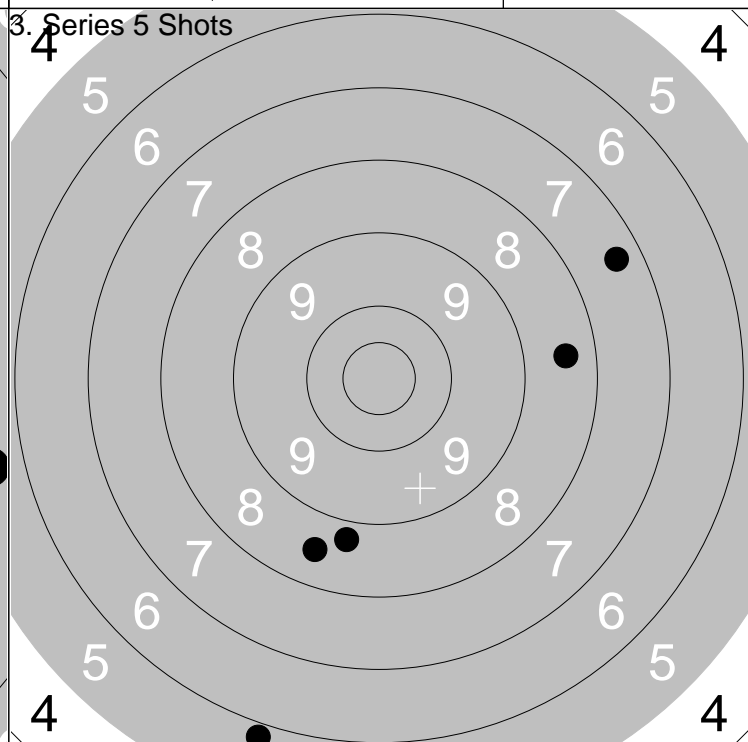
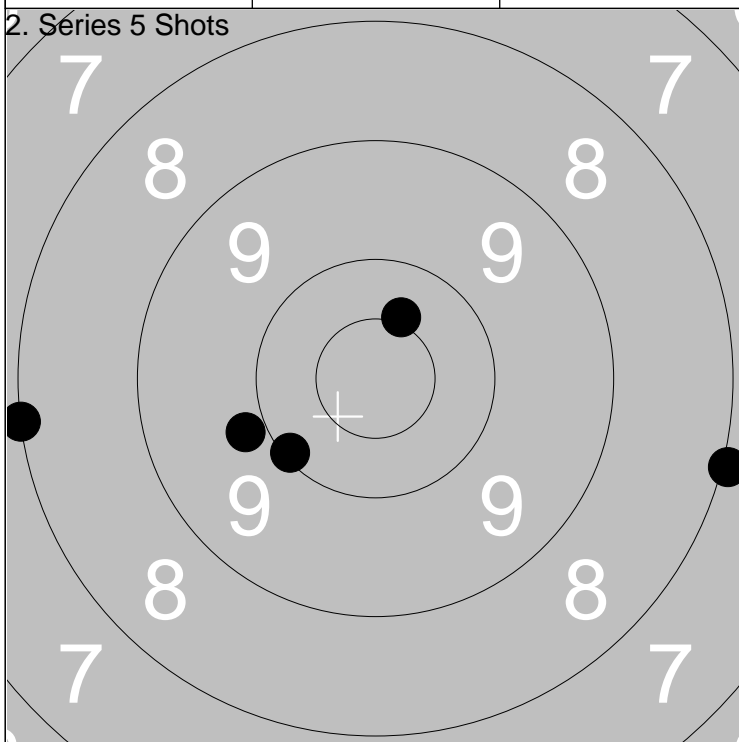

1: 10.1 ↙		Series	45.0
2: 9.8 ←			
3: 8.0 ←			
4: 8.0 →		Total	94.0
5: *10.4 ↑			

1: 8.8 ↓	Series	36.0
2: 8.5 ↓		
3: 7.4 ↗		
4: 8.5 →	Total	130.0
5: 5.8 ↓		

	1: 8.2 ↓ 2: 9.6 ↑ 3: *10.6 ↙ 4: *10.7 ↓ 5: 9.1 ← 6: 9.1 ↓	1. Series 5 Shots 	1: 9.8 ↙ 2: 10.3 ↙ 3: 9.5 ↓ 4: 9.7 ↓ 5: 9.9 →
	Series 55.0		Series 46.0
	Total 0.0		Total 46.0

2. Series 5 Shots 	1: 8.5 ↓ 2: 8.8 ↙ 3: 9.0 ↗ 4: 10.1 ↓ 5: 9.9 ↑	3. Series 5 Shots 	1: 9.0 ↓ 2: *10.7 ↓ 3: 9.9 ↓ 4: 7.7 ↓ 5: 8.9 ↙
	Series 44.0		Series 43.0
	Total 90.0		Total 133.0

4. Series 10 Shots 	1: 8.9 → 2: 10.0 ↙ 3: 9.4 ↓ 4: *10.6 ↙ 5: 9.8 ↓	4. Series 10 Shots 	6: 9.9 ↓ 7: 9.0 ↙ 8: 10.2 ↘ 9: 9.8 ↙ 10: 10.1 ↙
	Series 46.0		Series 47.0
	Total 179.0		Total 226.0

<p>Sight</p>	<p>1. Series 5 Shots</p>	<p>1: 9.9 ←</p> <p>2: *10.7 ↙</p> <p>3: 8.8 ↑</p> <p>4: *10.4 ↑</p> <p>5: 10.3 →</p> <p>6: 9.9 ↓</p>	<p>1: 10.3 ↗</p> <p>2: *10.4 ↖</p> <p>3: 10.3 ↑</p> <p>4: *10.5 ↗</p> <p>5: 10.2 ↙</p>
Series 56.0	Series 50.0	Series 56.0	Series 50.0
Total 0.0	Total 50.0	Total 0.0	Total 50.0

<p>2. Series 5 Shots</p>	<p>3. Series 5 Shots</p>	<p>1: 10.4 ↖</p> <p>2: 9.3 ↗</p> <p>3: 8.2 ↑</p> <p>4: 8.3 ←</p> <p>5: 9.2 ←</p>	<p>1: 8.8 ←</p> <p>2: 9.1 →</p> <p>3: 7.3 ↗</p> <p>4: 8.2 ↑</p> <p>5: 10.2 ↖</p>
Series 44.0	Series 42.0	Series 44.0	Series 42.0
Total 94.0	Total 136.0	Total 94.0	Total 136.0

<p>4. Series 10 Shots</p>	<p>4. Series 10 Shots</p>	<p>1: 10.2 ↑</p> <p>2: 10.3 ↖</p> <p>3: 10.1 ↖</p> <p>4: 9.9 ↑</p> <p>5: 8.8 ↑</p>	<p>6: 9.6 ↖</p> <p>7: 8.9 ↑</p> <p>8: 9.2 ↖</p> <p>9: 10.2 ↑</p> <p>10: 9.2 ↖</p>
Series 47.0	Series 45.0	Series 47.0	Series 45.0
Total 183.0	Total 228.0	Total 183.0	Total 228.0

<p>Sight</p>	<p>1. Series 5 Shots</p>	<p>1: *10.9 ↙ 2: 10.0 ↘ 3: 9.6 ← 4: 9.8 ↓ 5: 8.8 ← 6: 8.6 ↓</p> <p>1: 9.4 ← 2: 10.0 ↑ 3: 9.6 ↓ 4: 10.4 ↓ 5: 10.1 ↗</p>
Series 54.0	Series 48.0	
Total 0.0	Total 48.0	

<p>2. Series 5 Shots</p>	<p>3. Series 5 Shots</p>	<p>1: 9.6 ↘ 2: 10.3 ↙ 3: 8.7 ← 4: 7.9 → 5: 7.8 →</p> <p>1: 9.5 ← 2: 5.7 ← 3: 9.0 ↗ 4: 9.5 ↑ 5: 3.5 ↗</p>
Series 41.0	Series 35.0	
Total 89.0	Total 124.0	

<p>4. Series 10 Shots</p>	<p>4. Series 10 Shots</p>	<p>1: 8.6 ↓ 2: 9.9 ↓ 3: 9.4 ↓ 4: 10.1 ↓ 5: 9.1 ↓</p> <p>6: 9.7 ↓ 7: 9.6 ↓ 8: 9.7 ↓ 9: 8.7 ↓ 10: 8.5 ↓</p>
Series 45.0	Series 43.0	
Total 169.0	Total 212.0	

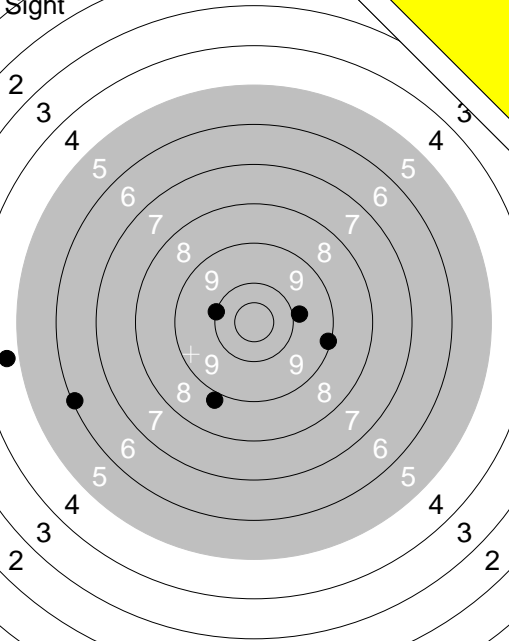
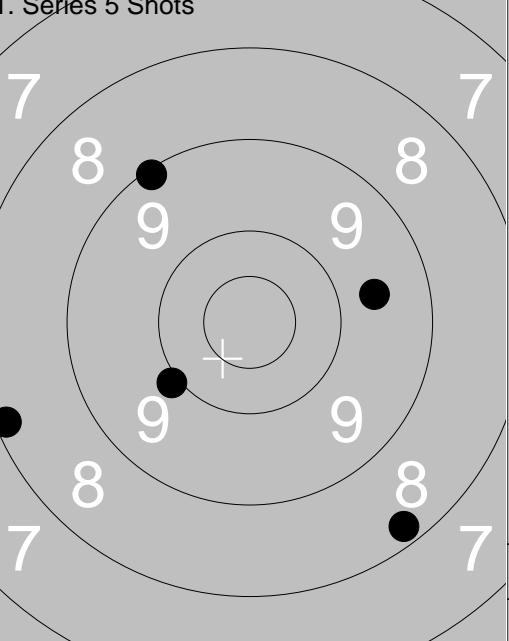
 <p>Sight</p>	<p>1: 9.1 →</p> <p>2: 9.9 →</p> <p>3: 10.0 ←</p> <p>4: 8.8 ↓</p> <p>5: 6.1 ←</p> <p>6: 4.7 ←</p>	<p>1. Series 5 Shots</p>  <p>1: 8.2 ↓</p> <p>2: 9.6 →</p> <p>3: 9.1 ↗</p> <p>4: 9.9 ↙</p> <p>5: 8.2 ←</p>
Series 46.0	Series 43.0	Series 43.0
Total 0.0	Total 43.0	Total 43.0

<p>2. Series 5 Shots</p> 	<p>1: 8.1 ←</p> <p>2: 8.0 ←</p> <p>3: 6.4 ←</p> <p>4: 6.5 ←</p> <p>5: 10.1 ↙</p>	<p>3. Series 5 Shots</p>  <p>1: 9.3 →</p> <p>2: 7.3 ↗</p> <p>3: 7.6 ↓</p> <p>4: 5.7 ↘</p> <p>5: 4.5 ↘</p>
Series 38.0	Series 32.0	Series 32.0
Total 81.0	Total 113.0	Total 113.0

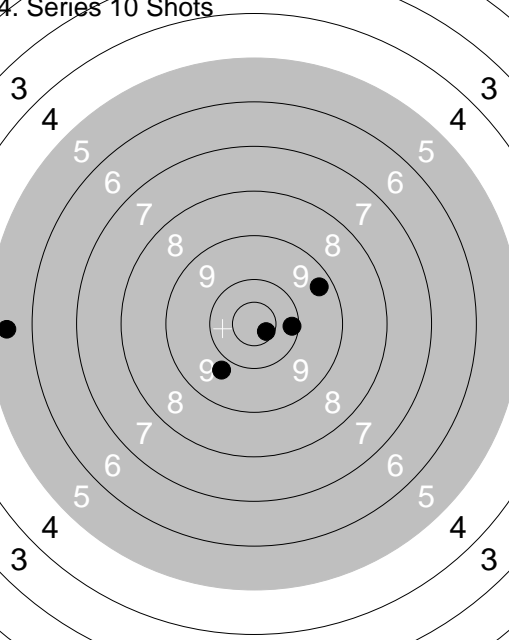
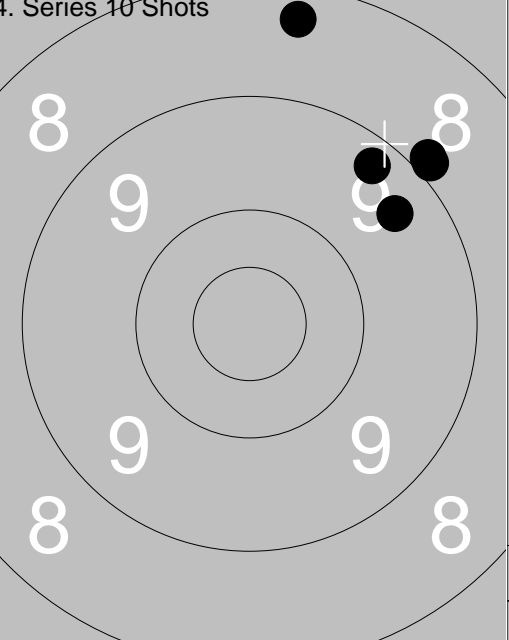
<p>4. Series 10 Shots</p> 	<p>1: 5.5 ←</p> <p>2: *10.7 ↘</p> <p>3: 10.2 →</p> <p>4: 9.3 →</p> <p>5: 9.8 ↓</p>	<p>4. Series 10 Shots</p>  <p>6: 8.9 ↗</p> <p>7: 9.3 ↗</p> <p>8: 8.9 ↗</p> <p>9: 9.4 ↗</p> <p>10: 8.3 ↑</p>
Series 43.0	Series 42.0	Series 42.0
Total 156.0	Total 198.0	Total 198.0

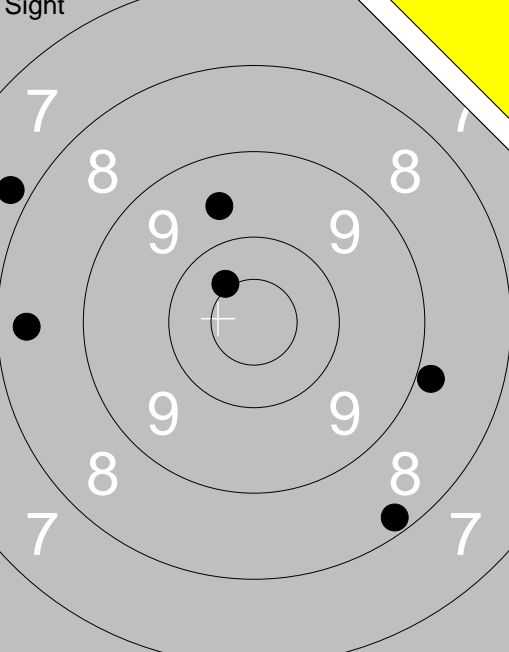
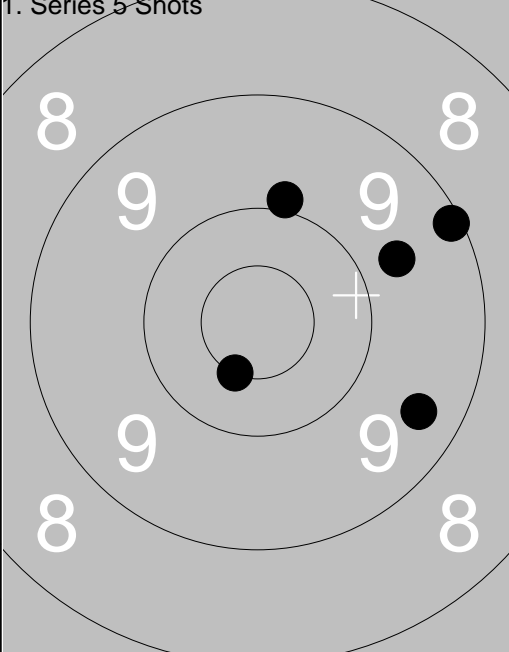
<p>Sight</p> 	<p>1: 8.4 ←</p> <p>2: *10.4 ↗</p> <p>3: 8.9 →</p> <p>4: 9.6 ↑</p> <p>5: 7.8 ↖</p> <p>6: 8.2 ↓</p>	<p>1. Series 5 Shots</p> 	<p>1: 9.9 ↑</p> <p>2: *10.5 ↓</p> <p>3: 9.7 →</p> <p>4: 9.1 ↗</p> <p>5: 9.4 →</p>
Series 50.0		Series 46.0	
Total 0.0		Total 46.0	

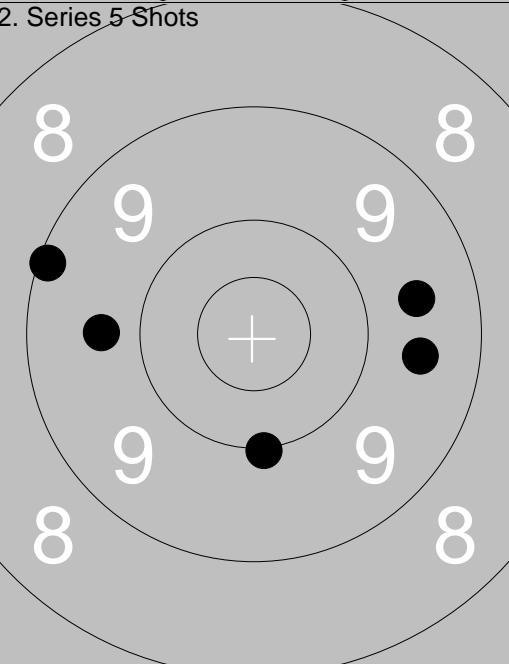
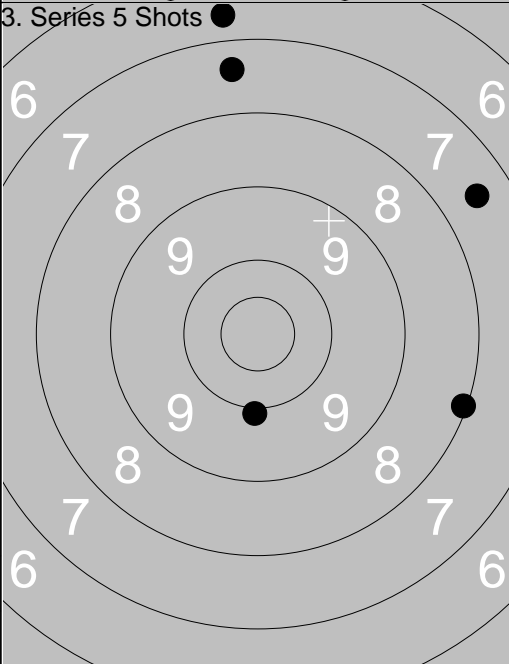
<p>2. Series 5 Shots</p> 	<p>1: 9.6 →</p> <p>2: 10.0 ↓</p> <p>3: 9.7 ←</p> <p>4: 9.1 ←</p> <p>5: 9.6 →</p>	<p>3. Series 5 Shots</p> 	<p>1: 7.4 ↑</p> <p>2: 7.5 ↗</p> <p>3: 6.7 ↑</p> <p>4: 10.0 ↓</p> <p>5: 8.1 →</p>
Series 46.0		Series 38.0	
Total 92.0		Total 130.0	

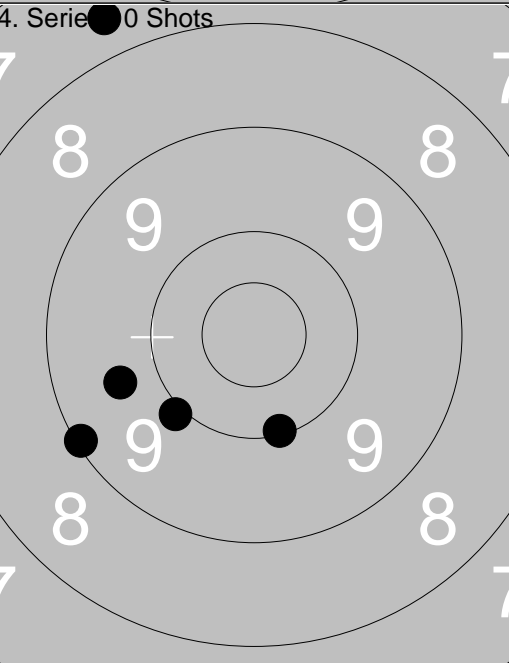
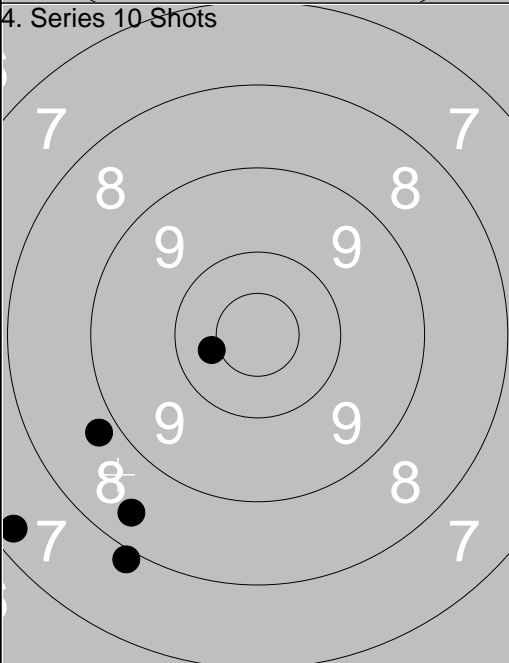
<p>4. Series 5 Shots</p> 	<p>1: 7.7 ↑</p> <p>2: 10.1 ↓</p> <p>3: 9.1 ←</p> <p>4: 9.7 ←</p> <p>5: 10.0 ↓</p>	<p>4. Series 10 Shots</p> 	<p>6: 7.3 ↙</p> <p>7: 7.9 ↓</p> <p>8: 8.8 ←</p> <p>9: 10.4 ←</p> <p>10: 8.4 ↓</p>
Series 45.0		Series 40.0	
Total 175.0		Total 215.0	

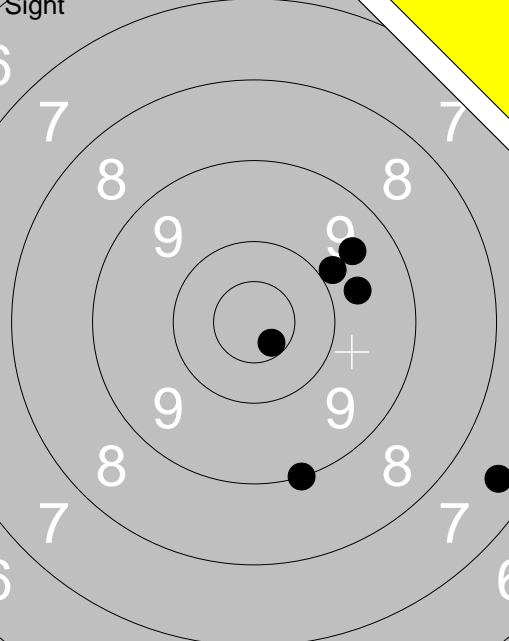
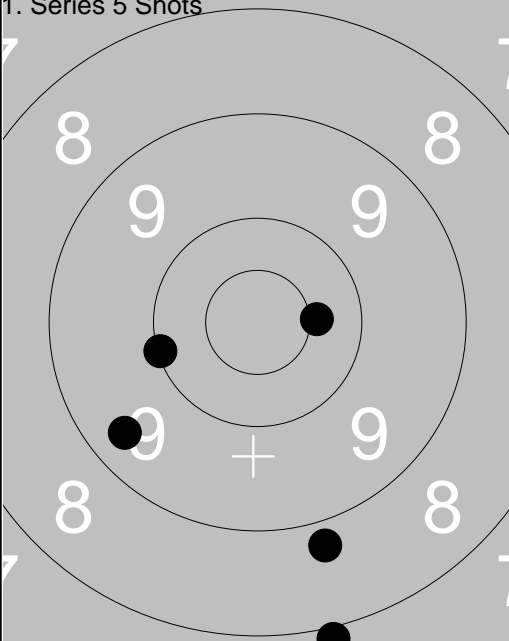
 <p>Target diagram for Series 1 showing 5 shots. Scores: 9.9, 7.4, 9.5, *10.6, 9.7, 9.0.</p>	<p>1. Series 5 Shots</p> <p>1: 9.9 ↗ 2: 7.4 → 3: 9.5 ↗ 4: *10.6 ↘ 5: 9.7 → 6: 9.0 ↓</p>	 <p>Target diagram for Series 2 showing 5 shots. Scores: *10.4, 10.0, 7.9, 8.8, 9.4.</p>
Series 53.0		Series 44.0
Total 0.0		Total 44.0

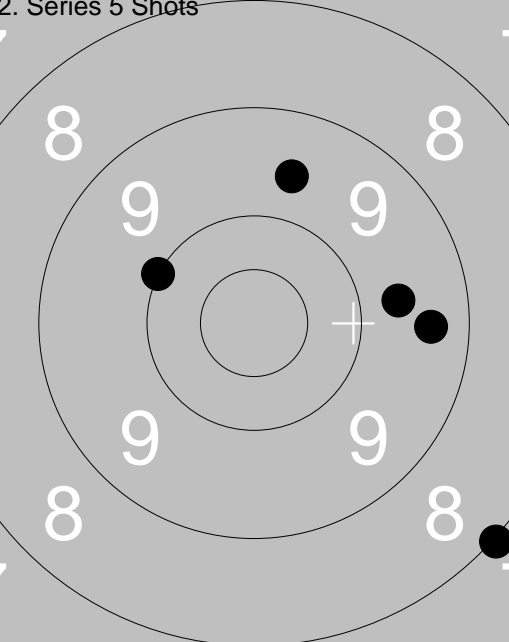
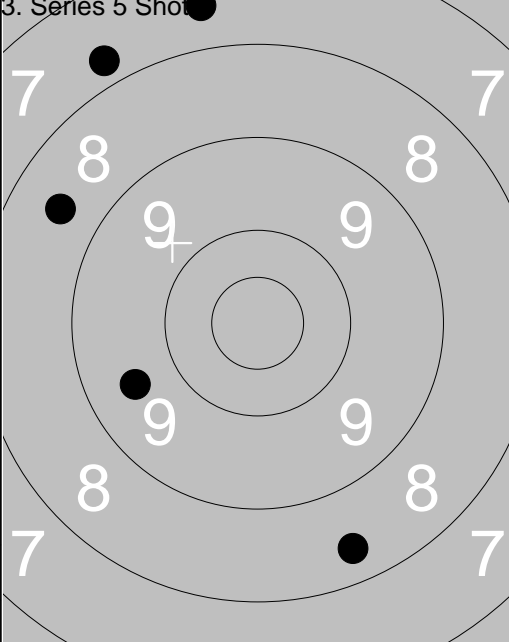
 <p>Target diagram for Series 3 showing 5 shots. Scores: 9.6, 10.0, 9.7, 8.0, 9.4.</p>	<p>2. Series 5 Shots</p> <p>1: 9.6 ↑ 2: 10.0 ← 3: 9.7 → 4: 8.0 ↘ 5: 9.4 →</p>	 <p>Target diagram for Series 4 showing 5 shots. Scores: 7.8, 8.6, 7.6, 9.6, 8.4.</p>
Series 45.0		Series 39.0
Total 89.0		Total 128.0

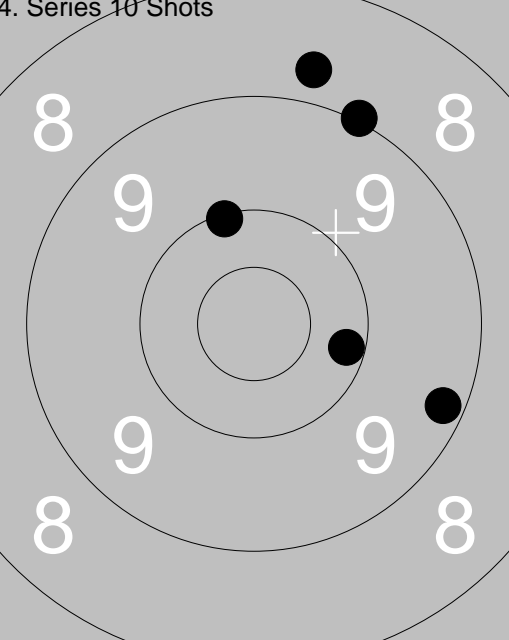
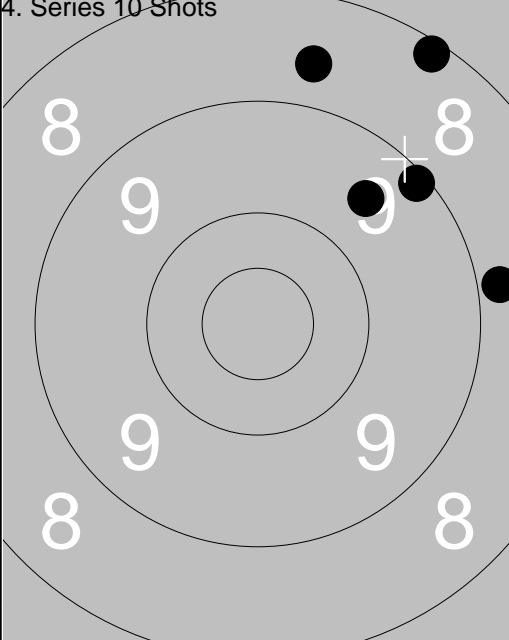
 <p>Target diagram for Series 5 showing 10 shots. Scores: 10.2, 9.2, 9.0, 8.7, 10.1.</p>	<p>3. Series 5 Shots</p> <p>1: 7.8 ↖ 2: 8.6 ↖ 3: 7.6 ↑ 4: 9.6 ← 5: 8.4 ↓</p>	 <p>Target diagram for Series 6 showing 10 shots. Scores: 8.6, 8.2, 8.8, 9.1, 9.5.</p>
Series 46.0		Series 42.0
Total 174.0		Total 216.0

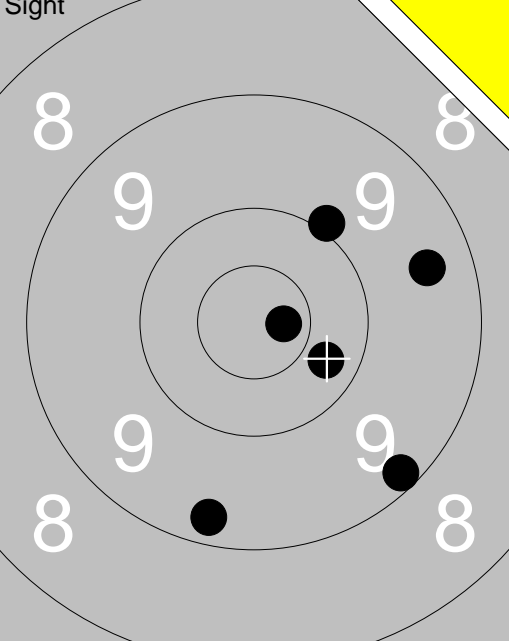
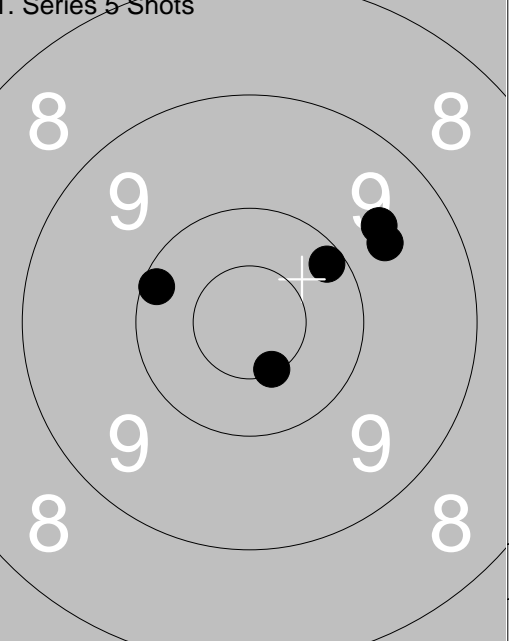
<p>Sight</p>  <p>1: 9.3 ↓ 2: 10.3 → 3: 9.2 ↓ 4: *10.7 → 5: 9.4 → 6: 10.0 ↗</p> <p>Series 57.0 Total 0.0</p>	<p>1. Series 5 Shots</p>  <p>1: 10.1 ← 2: *10.5 ↓ 3: 9.7 → 4: 9.6 ↗ 5: 10.2 ↗</p> <p>Series 48.0 Total 48.0</p>	
---	---	--

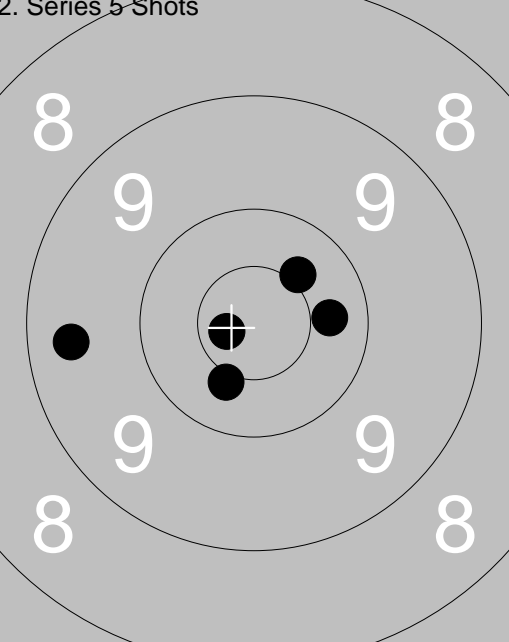
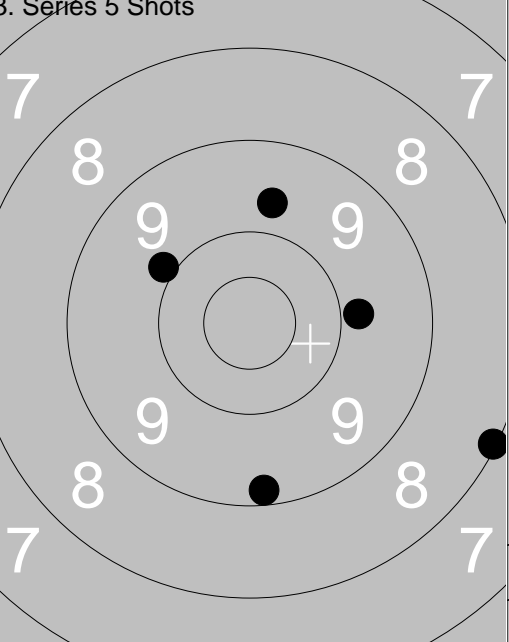
<p>2. Series 5 Shots</p>  <p>1: *10.7 ↗ 2: *10.4 ↓ 3: *10.4 ↗ 4: 9.4 ← 5: 10.3 →</p> <p>Series 49.0 Total 97.0</p>	<p>3. Series 5 Shots</p>  <p>1: 9.2 ↓ 2: 9.8 → 3: 8.1 → 4: 9.9 ← 5: 9.7 ↑</p> <p>Series 44.0 Total 141.0</p>	
---	---	--

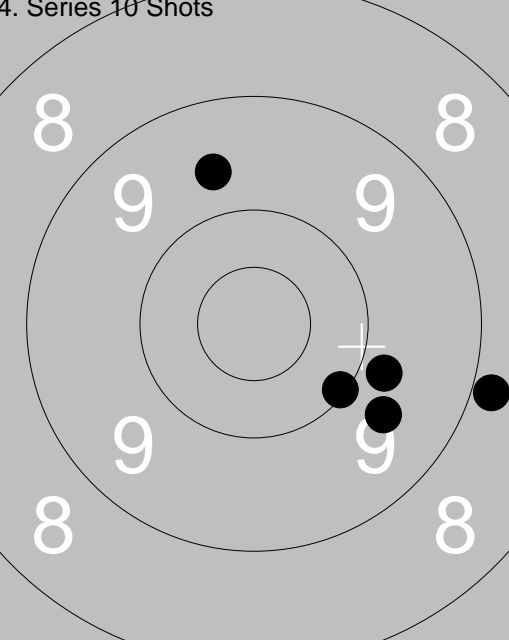
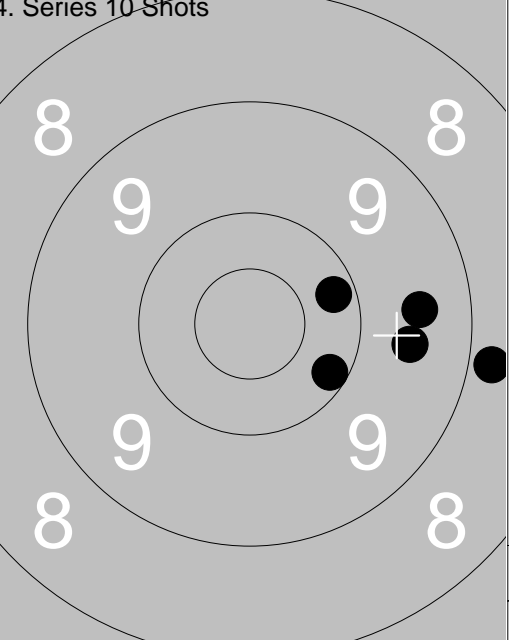
<p>4. Series 10 Shots</p>  <p>1: 10.1 ↓ 2: 9.6 ↓ 3: 8.9 → 4: 9.8 → 5: 9.6 ↑</p> <p>Series 45.0 Total 186.0</p>	<p>4. Series 10 Shots</p>  <p>6: 9.5 → 7: 8.8 → 8: 10.2 → 9: 10.2 ↓ 10: 9.6 →</p> <p>Series 46.0 Total 232.0</p>	
--	--	--

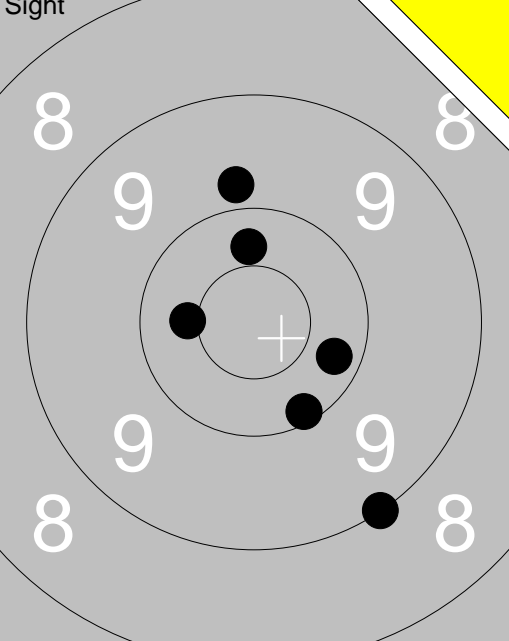
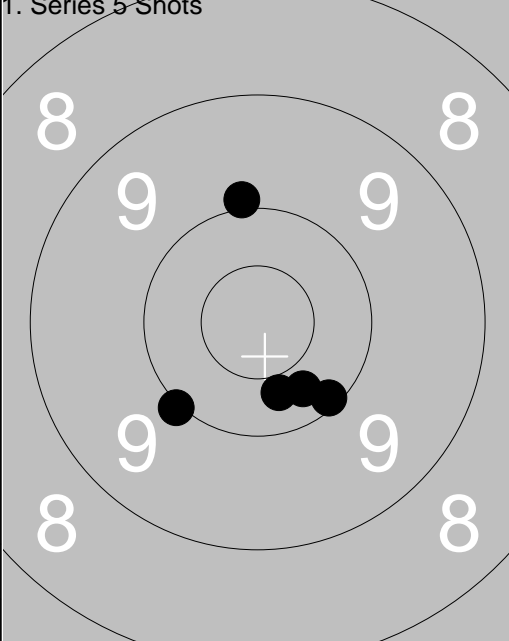
<p>Sight</p> 	<p>1: 10.4 ←</p> <p>2: 10.2 →</p> <p>3: 10.1 ↓</p> <p>4: 9.0 ↓</p> <p>5: 10.3 ↑</p> <p>6: 9.8 ↑</p>	<p>1. Series 5 Shots</p> 		<p>1: 9.9 ↑</p> <p>2: 10.4 ↓</p> <p>3: 10.3 ↓</p> <p>4: 10.1 ↓</p> <p>5: 10.0 ↙</p>
Series 58.0				Series 49.0
Total 0.0				Total 49.0

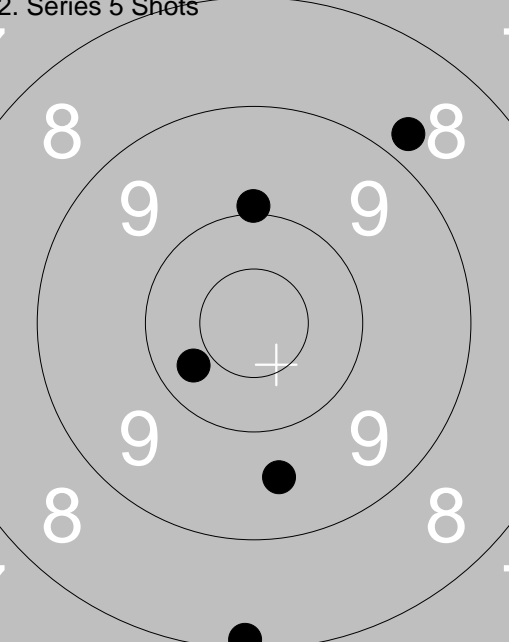
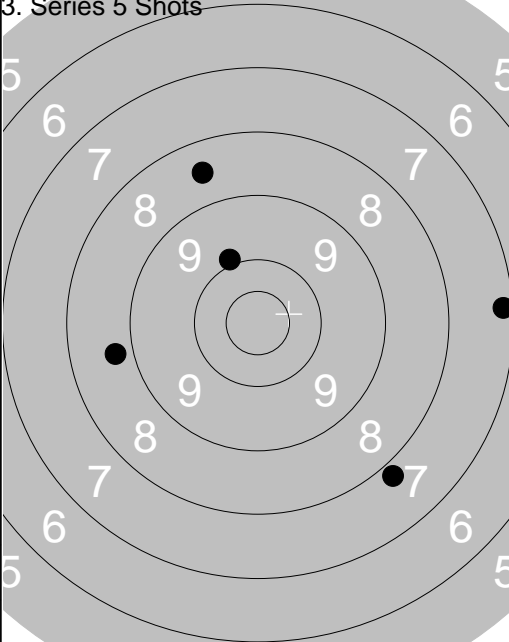
<p>2. Series 5 Shots</p> 	<p>1: 8.8 ↗</p> <p>2: 10.3 ↙</p> <p>3: 10.0 ↑</p> <p>4: 9.6 ↓</p> <p>5: 8.1 ↓</p>	<p>3. Series 5 Shots</p> 		<p>1: 8.8 ←</p> <p>2: 7.2 →</p> <p>3: 7.8 ↓</p> <p>4: 8.5 ↑</p> <p>5: 9.9 ↑</p>
Series 45.0				Series 39.0
Total 94.0				Total 133.0

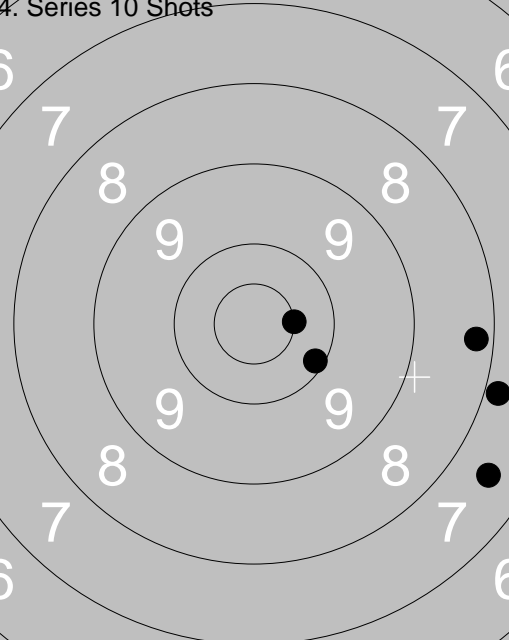
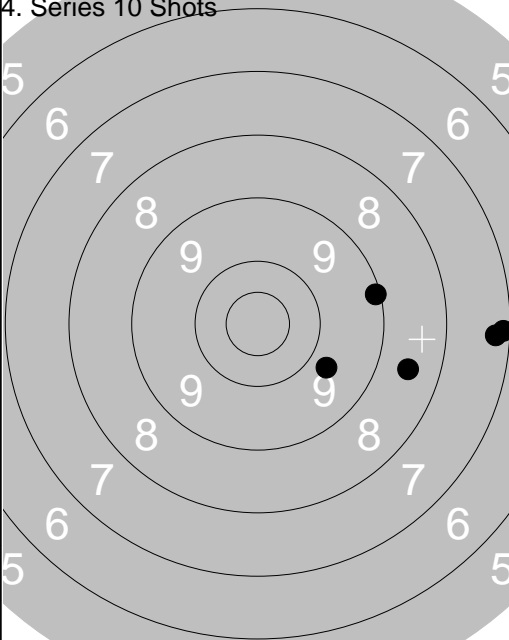
<p>4. Series 10 Shots</p> 	<p>1: 10.1 ↓</p> <p>2: 7.9 →</p> <p>3: 7.5 →</p> <p>4: *10.5 →</p> <p>5: 8.2 →</p>	<p>4. Series 10 Shots</p> 		<p>6: 9.1 →</p> <p>7: 7.1 →</p> <p>8: 8.5 →</p> <p>9: 7.2 →</p> <p>10: 9.7 ↘</p>
Series 42.0				Series 40.0
Total 175.0				Total 215.0

<p>Sight</p>	<p>1. Series 5 Shots</p>	<p>1: *10.5 ↘ 2: 9.0 ↘ 3: 9.6 ↘ 4: 10.0 → 5: 8.2 ↗ 6: 10.4 ←</p> <p>1: 10.2 ← 2: 10.2 ↑ 3: 10.3 ↑ 4: 9.4 ↘ 5: *10.5 ↘</p>
<p>Series 56.0</p> <p>Total 0.0</p>	<p>Series 49.0</p> <p>Total 49.0</p>	

<p>2. Series 5 Shots</p>	<p>3. Series 5 Shots</p>	<p>1: 9.7 ↓ 2: 7.7 ↗ 3: 9.6 ← 4: 9.0 ↑ 5: *10.6 ↘</p> <p>1: 8.1 ↗ 2: 6.7 ↑ 3: 8.7 ↗ 4: 7.9 → 5: 9.4 ←</p>
<p>Series 44.0</p> <p>Total 93.0</p>	<p>Series 38.0</p> <p>Total 131.0</p>	

<p>4. Series 10 Shots</p>	<p>4. Series 10 Shots</p>	<p>1: 7.7 ↓ 2: 9.6 ↓ 3: 9.9 ↓ 4: 8.8 ↘ 5: 10.3 ↘</p> <p>6: 8.4 ↓ 7: 8.9 → 8: 8.9 ↓ 9: 9.5 ↓ 10: 8.9 ↘</p>
<p>Series 43.0</p> <p>Total 174.0</p>	<p>Series 41.0</p> <p>Total 215.0</p>	

<p>Sight</p>	<p>1: 10.2 ↙ 2: 10.2 ↗ 3: 9.9 ↓ 4: 8.7 ↓ 5: 10.0 ↗ 6: 9.4 →</p>	<p>1. Series 5 Shots</p>	<p>1: 9.3 ↖ 2: 10.0 ↖ 3: 10.1 ↑ 4: 9.7 ↗ 5: 10.0 ↙</p>
Series 56.0		Series 48.0	
Total 0.0		Total 48.0	

<p>2. Series 5 Shots</p>	<p>1: 9.6 ↖ 2: 10.0 ↙ 3: 9.1 ↘ 4: 7.1 → 5: 9.9 ↑</p>	<p>3. Series 5 Shots</p>	<p>1: 7.6 ↑ 2: 8.8 ← 3: 8.7 ↓ 4: 9.4 ↘ 5: 7.3 →</p>
Series 44.0		Series 39.0	
Total 92.0		Total 131.0	

<p>4. Series 10 Shots</p>	<p>1: 8.5 ↓ 2: 10.0 ↙ 3: 10.0 ↖ 4: 9.1 ← 5: 8.4 ↓</p>	<p>4. Series 10 Shots</p>	<p>6: *10.5 → 7: 8.9 → 8: 8.3 ↓ 9: 9.6 ↓ 10: 9.1 ↙</p>
Series 45.0		Series 44.0	
Total 176.0		Total 220.0	

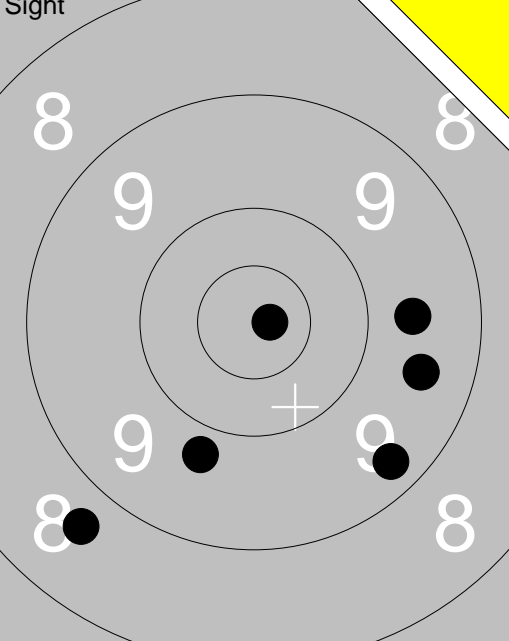
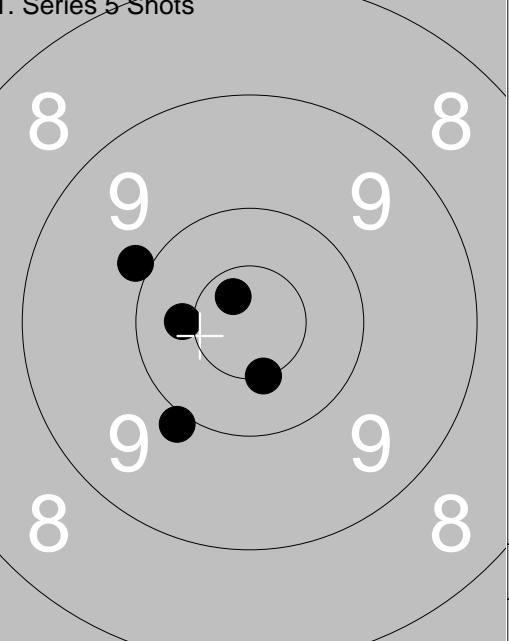
<p>Sight</p>  <p>Target diagram for Sight shot. Concentric circles labeled 8, 9, 10. A yellow triangle is in the top right corner. A white crosshair is at the center. Five black dots represent shots: one in the 8 ring, one in the 9 ring, and three in the 10 ring.</p>	<p>1: 8.7 ↙ 2: 9.8 ↓ 3: *10.8 → 4: 9.3 ↓ 5: 9.5 → 6: 9.6 →</p>	<p>1. Series 5 Shots</p>  <p>Target diagram for 1. Series 5 Shots. Concentric circles labeled 8, 9, 10. Five black dots represent shots: one in the 8 ring, one in the 9 ring, and three in the 10 ring.</p>	<p>1: 9.9 ↖ 2: 9.9 ↓ 3: 10.4 ← 4: *10.7 ↗ 5: *10.5 ↓</p>
Series 54.0		Series 48.0	
Total 0.0		Total 48.0	

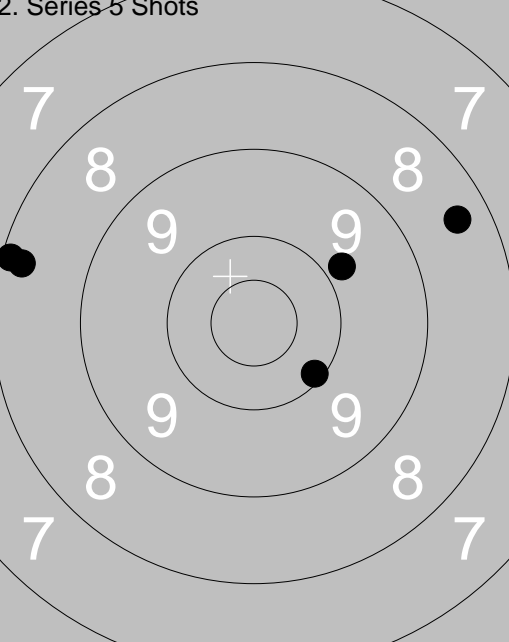
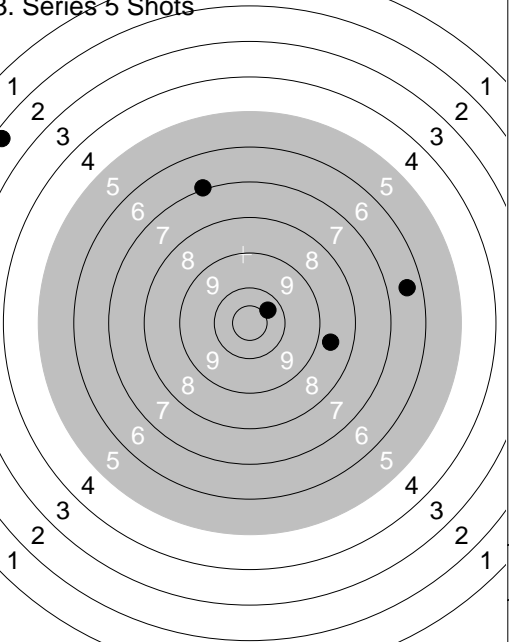
<p>2. Series 5 Shots</p>  <p>Target diagram for 2. Series 5 Shots. Concentric circles labeled 7, 8, 9, 10. Five black dots represent shots: one in the 7 ring, one in the 8 ring, and three in the 9 ring.</p>	<p>1: 8.3 ← 2: 8.1 ← 3: 8.4 → 4: 9.8 → 5: 10.1 ↓</p>	<p>3. Series 5 Shots</p>  <p>Target diagram for 3. Series 5 Shots. Concentric circles labeled 1-10. Five black dots represent shots: one in the 1 ring, one in the 2 ring, and three in the 9 ring.</p>	<p>1: 6.5 → 2: 7.0 ↗ 3: 10.4 ↗ 4: 2.3 ← 5: 8.7 →</p>
Series 43.0		Series 33.0	
Total 91.0		Total 124.0	

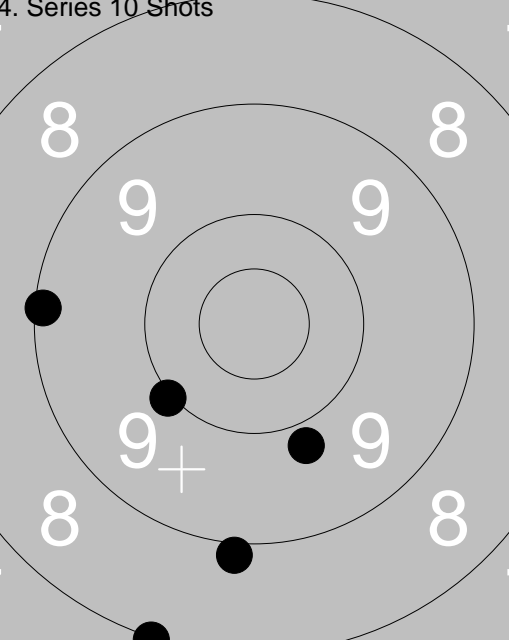
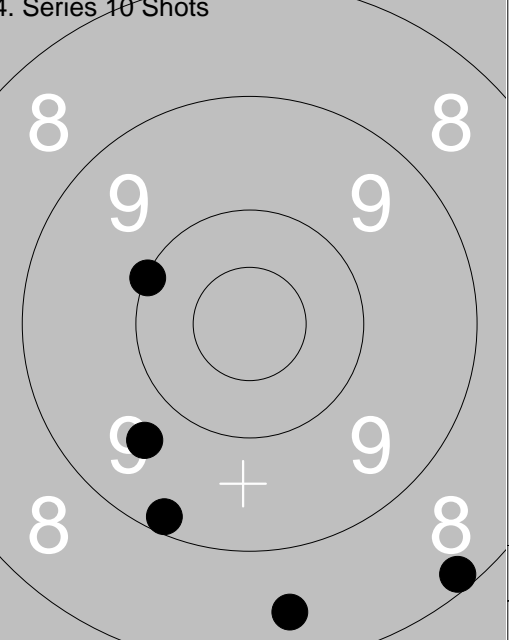
<p>4. Series 10 Shots</p>  <p>Target diagram for 4. Series 10 Shots. Concentric circles labeled 8, 9, 10. Ten black dots represent shots: one in the 8 ring, one in the 9 ring, and eight in the 10 ring.</p>	<p>1: 10.0 ↙ 2: 8.9 ↓ 3: 9.1 ← 4: 9.8 ↓ 5: 8.0 ↓</p>	<p>4. Series 10 Shots</p>  <p>Target diagram for 4. Series 10 Shots. Concentric circles labeled 8, 9, 10. Ten black dots represent shots: one in the 8 ring, one in the 9 ring, and eight in the 10 ring.</p>	<p>6: 10.0 ↖ 7: 8.5 ↓ 8: 8.2 ↓ 9: 9.7 ↙ 10: 9.2 ↓</p>
Series 44.0		Series 44.0	
Total 168.0		Total 212.0	

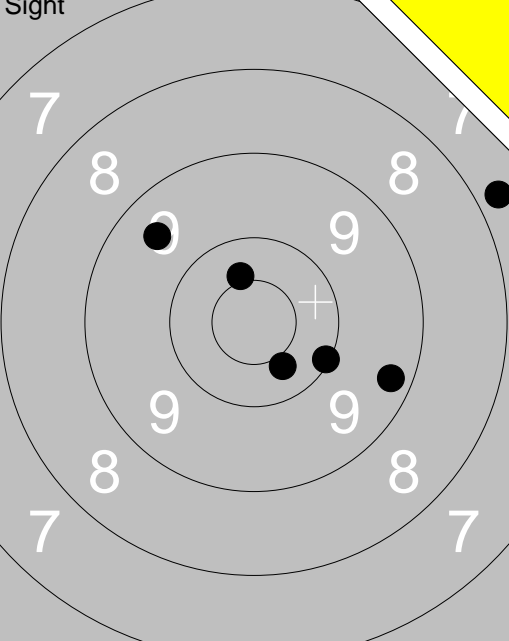
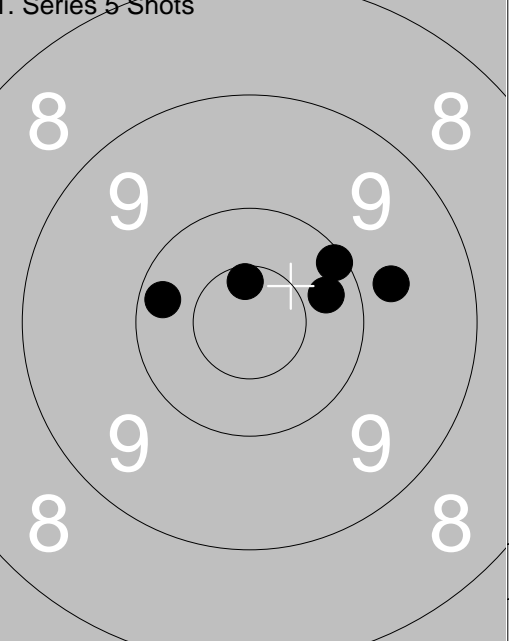
<p>Sight</p> 	<p>1: 9.5 ↗ 2: 10.1 → 3: *10.4 ↗ 4: 9.3 → 5: 10.4 ↓ 6: 7.8 ↗</p>	<p>1. Series 5 Shots</p> 	<p>1: 9.7 → 2: 10.1 ↗ 3: 10.3 → 4: 10.2 ← 5: *10.6 ↗</p>
Series 55.0		Series 49.0	
Total 0.0		Total 49.0	

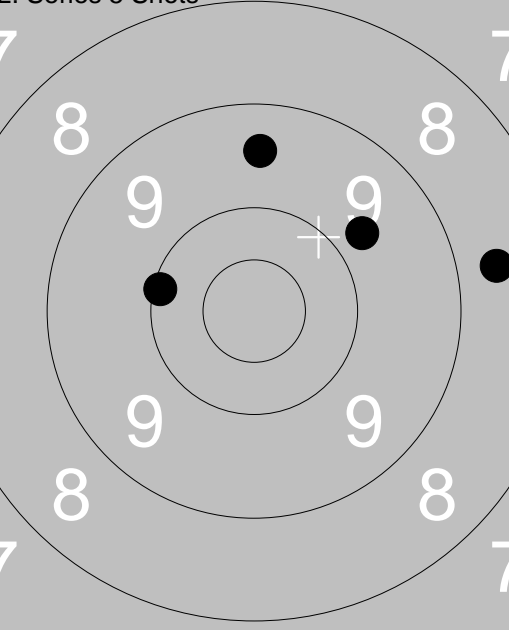
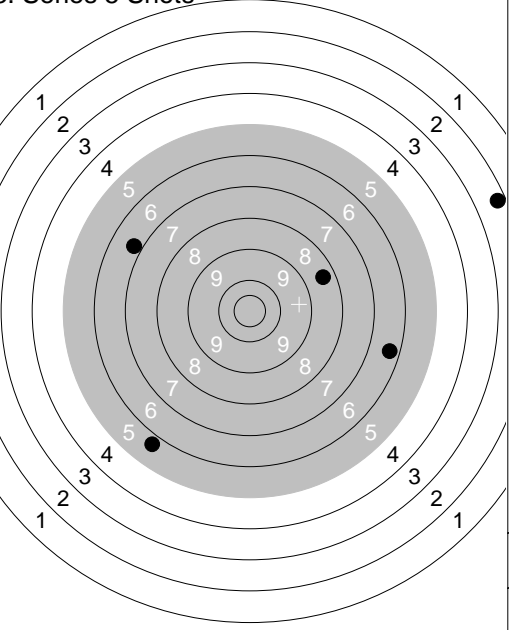
<p>2. Series 5 Shots</p> 	<p>1: 9.7 ↗ 2: 8.6 → 3: 10.1 ← 4: 9.5 ↑ 5: 0.0</p>	<p>3. Series 5 Shots</p> 	<p>1: 6.8 ↖ 2: 8.4 → 3: 2.3 ↗ 4: 6.4 → 5: 5.7 ↘</p>
Series 36.0		Series 27.0	
Total 85.0		Total 112.0	

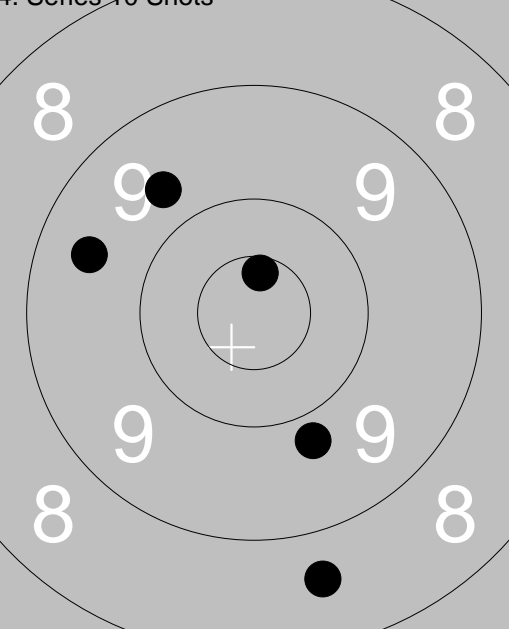
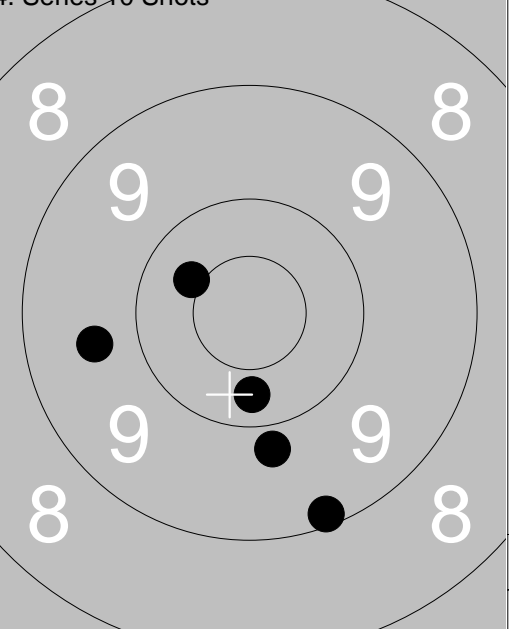
<p>4. Series 10 Shots</p> 	<p>1: 8.6 ↓ 2: 9.8 ↓ 3: *10.6 ↗ 4: 9.5 ← 5: 9.7 ↗</p>	<p>4. Series 10 Shots</p> 	<p>6: 10.4 ↖ 7: 9.8 ↓ 8: 9.1 ↓ 9: 10.3 ↓ 10: 9.6 ←</p>
Series 45.0		Series 47.0	
Total 157.0		Total 204.0	

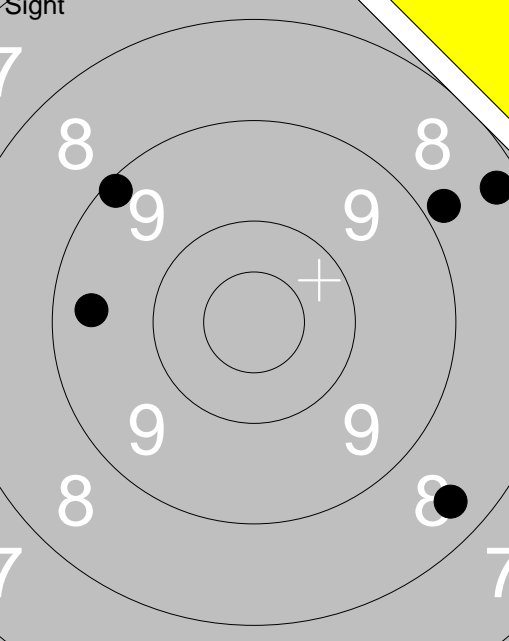
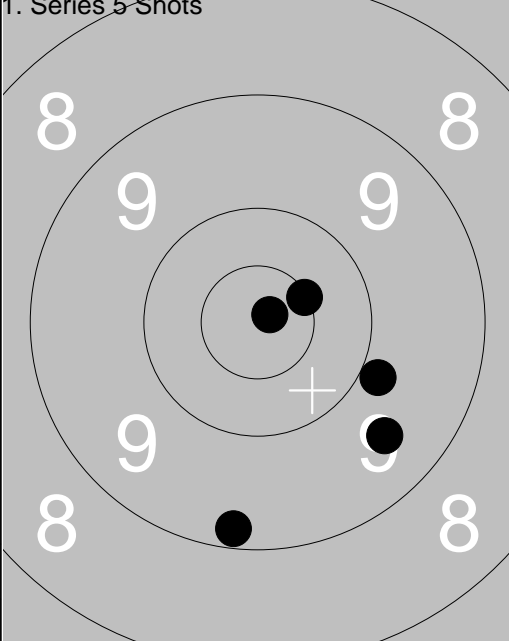
 <p>7 8 9 9 8 7</p>	<p>1: 8.8 ↗ 2: 9.4 ← 3: 8.4 ↘ 4: 9.1 ↗ 5: 8.3 ↗</p>	<p>1. Series 5 Shots</p>  <p>8 9 9 8 8</p>	<p>1: *10.5↗ 2: *10.8↗ 3: 9.5 ↘ 4: 9.2 ↓ 5: 9.9 ↘</p>
Series 42.0		Series 47.0	
Total 0.0		Total 47.0	

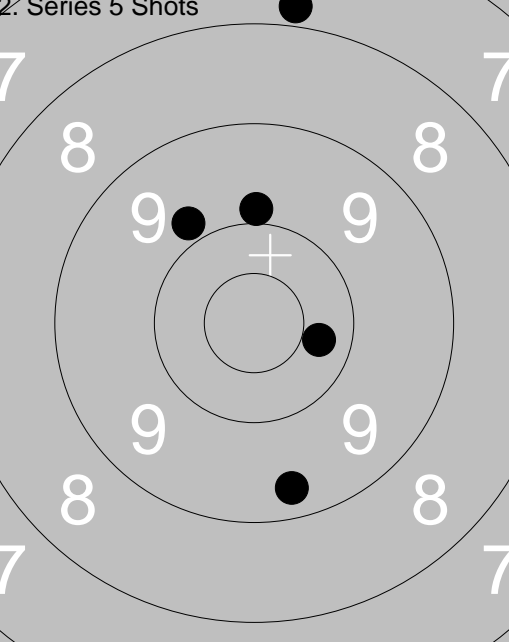
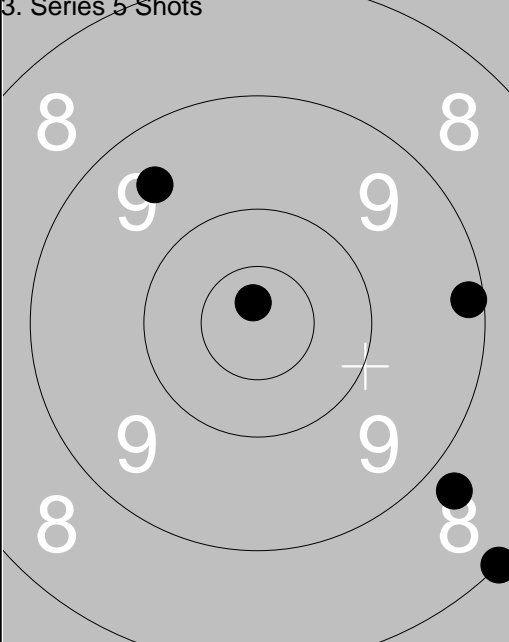
<p>2. Series 5 Shots</p>  <p>7 8 9 9 8 7</p>	<p>1: 7.8 ↑ 2: 9.8 ↗ 3: 10.3 → 4: 9.9 ↑ 5: 9.3 ↓</p>	<p>3. Series 5 Shots</p>  <p>8 9 9 8 8</p>	<p>1: 8.0 ↘ 2: 9.5 ↗ 3: 9.2 → 4: 8.8 ↘ 5: *10.8↑</p>
Series 44.0		Series 44.0	
Total 91.0		Total 135.0	

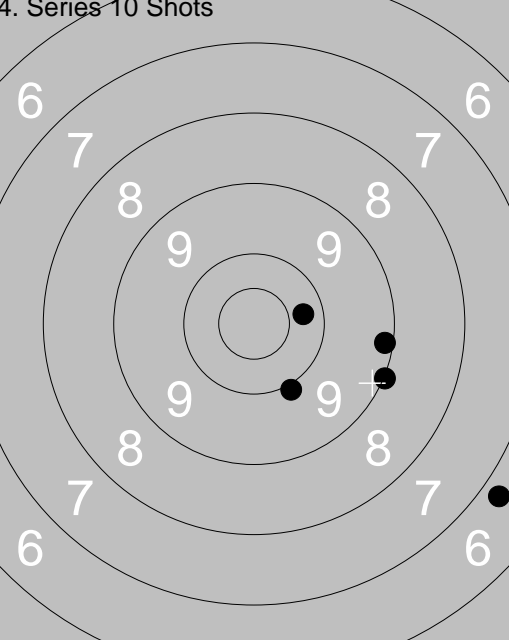
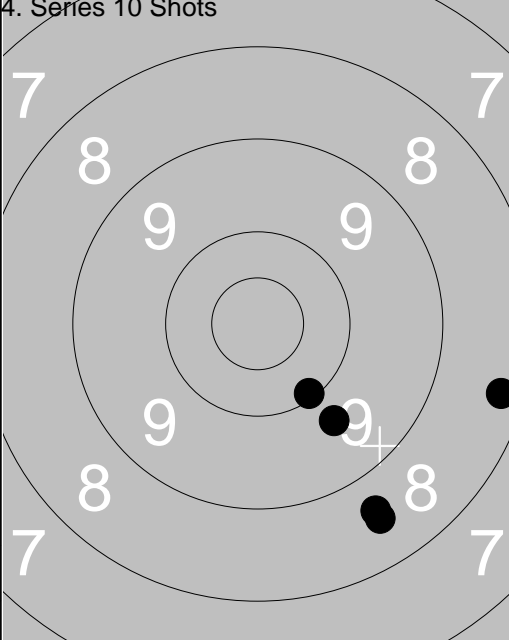
<p>4. Series 10 Shots</p>  <p>6 7 8 9 9 8 7 6</p>	<p>1: 9.2 → 2: 6.8 ↘ 3: 9.0 → 4: 10.3 → 5: 10.0 ↓</p>	<p>4. Series 10 Shots</p>  <p>7 8 9 9 8 7</p>	<p>6: 8.6 ↘ 7: 9.7 ↘ 8: 8.3 → 9: 8.5 ↘ 10: 10.1 ↓</p>
Series 44.0		Series 43.0	
Total 179.0		Total 222.0	

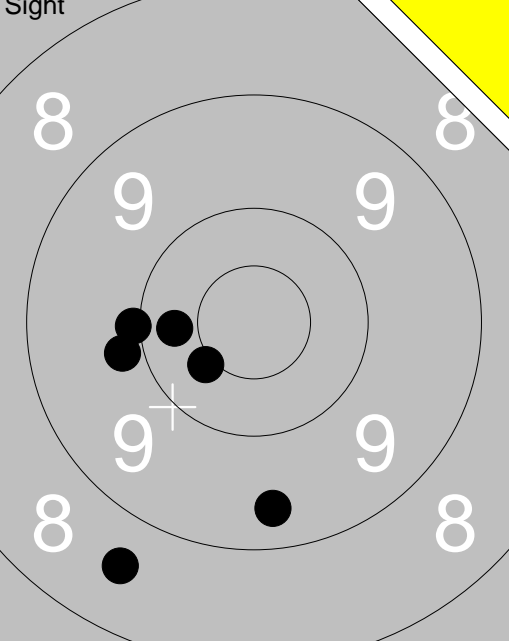
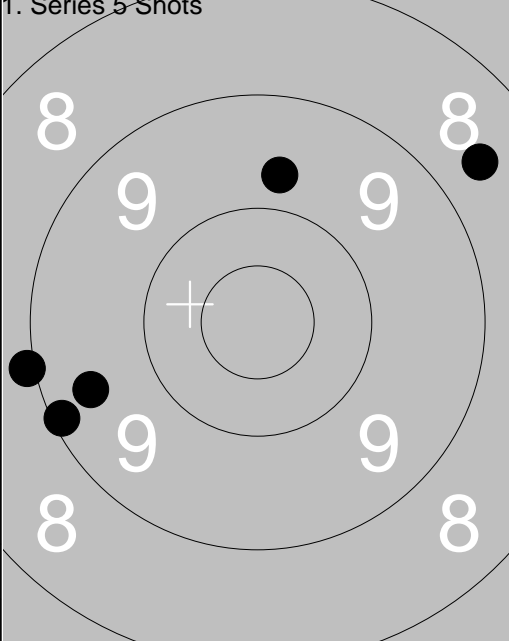
<p>Sight</p> 	<p>1: 10.0 ←</p> <p>2: *10.4 ↘</p> <p>3: 8.6 ↓</p> <p>4: 9.4 ↓</p> <p>5: 9.8 ←</p> <p>6: 10.3 ←</p>	<p>1. Series 5 Shots</p> 		<p>1: 9.1 ←</p> <p>2: 8.6 ↗</p> <p>3: 9.7 ↑</p> <p>4: 9.5 ←</p> <p>5: 9.0 ←</p>
Series 56.0		Series 44.0		
Total 0.0		Total 44.0		

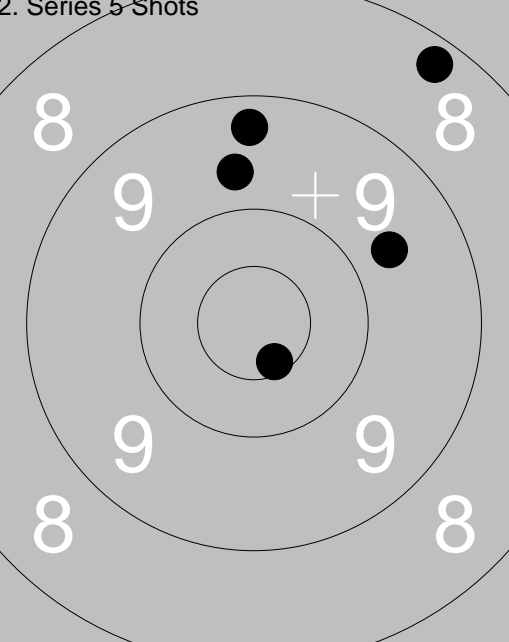
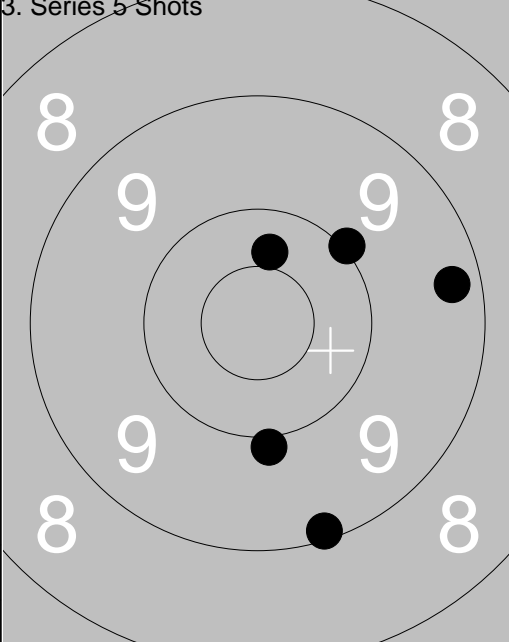
<p>2. Series 5 Shots</p> 	<p>1: *10.6 ↘</p> <p>2: 9.7 ↗</p> <p>3: 8.3 ↗</p> <p>4: 9.7 ↑</p> <p>5: 9.3 ↑</p>	<p>3. Series 5 Shots</p> 		<p>1: 9.1 ↓</p> <p>2: 9.9 ↓</p> <p>3: 10.0 ↗</p> <p>4: 10.4 ↑</p> <p>5: 9.3 →</p>
Series 45.0		Series 47.0		
Total 89.0		Total 136.0		

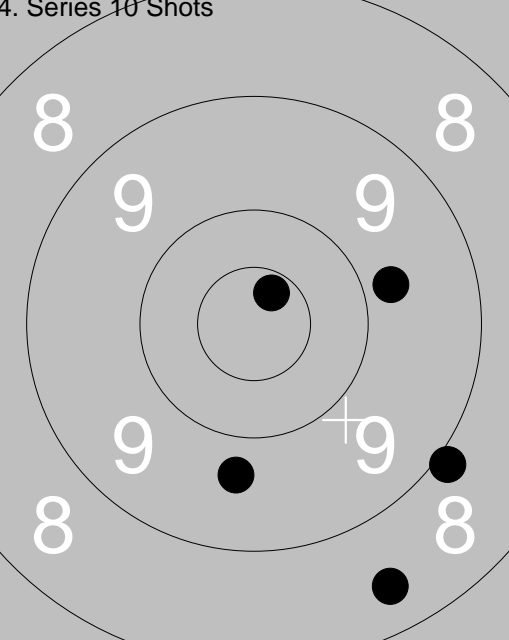
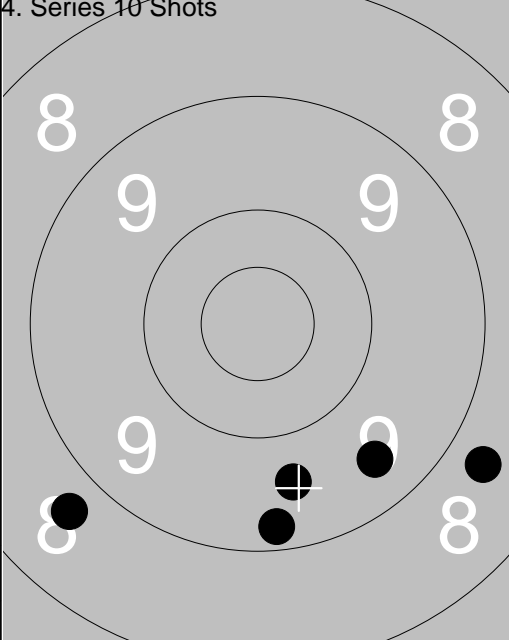
<p>4. Series 10 Shots</p> 	<p>1: 8.4 ↓</p> <p>2: 9.8 →</p> <p>3: *10.7 ↗</p> <p>4: 9.7 ↓</p> <p>5: 8.9 ↘</p>	<p>4. Series 10 Shots</p> 		<p>6: 9.6 ↓</p> <p>7: 8.7 ↘</p> <p>8: 9.5 ↘</p> <p>9: 8.7 ↘</p> <p>10: 9.2 ↓</p>
Series 44.0		Series 43.0		
Total 180.0		Total 223.0		

<p>Sight</p>	<p>1. Series 5 Shots</p>	<p>1: 10.2 →</p> <p>2: 10.0 ↙</p> <p>3: 9.2 ↗</p> <p>4: *10.4 ↙</p> <p>5: *10.7 ↗</p> <p>6: 10.4 ↘</p>	<p>1: 9.9 ↗</p> <p>2: 9.8 →</p> <p>3: 10.1 ↘</p> <p>4: *10.9 ↙</p> <p>5: 10.3 ↘</p>
Series 59.0		Series 48.0	
Total 0.0		Total 48.0	

<p>2. Series 5 Shots</p>	<p>3. Series 5 Shots</p>	<p>1: 9.8 →</p> <p>2: 10.0 →</p> <p>3: 9.3 ←</p> <p>4: 9.6 ↙</p> <p>5: 9.6 ↗</p>	<p>1: 9.0 ↘</p> <p>2: 9.5 →</p> <p>3: 9.8 ←</p> <p>4: 8.2 ↗</p> <p>5: 7.3 ←</p>
Series 46.0		Series 42.0	
Total 94.0		Total 136.0	

<p>4. Series 10 Shots</p>	<p>4. Series 10 Shots</p>	<p>1: 10.3 →</p> <p>2: *10.5 ↗</p> <p>3: *10.7 ↗</p> <p>4: 10.3 →</p> <p>5: 8.9 →</p>	<p>6: 9.1 →</p> <p>7: 10.0 ↗</p> <p>8: 10.3 ↗</p> <p>9: 10.3 ←</p> <p>10: 10.2 →</p>
Series 48.0		Series 49.0	
Total 184.0		Total 233.0	

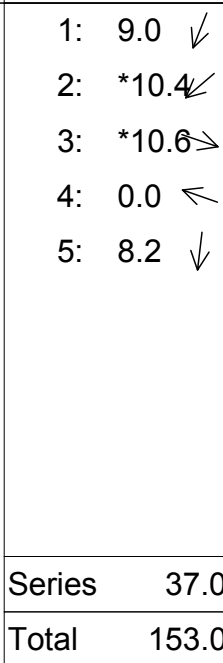
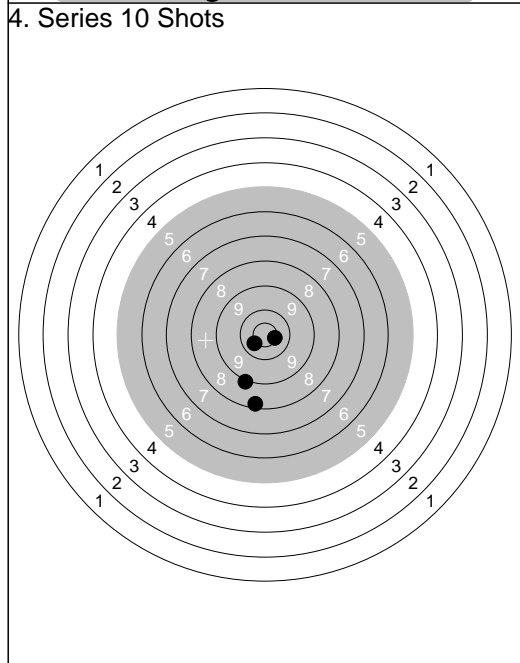
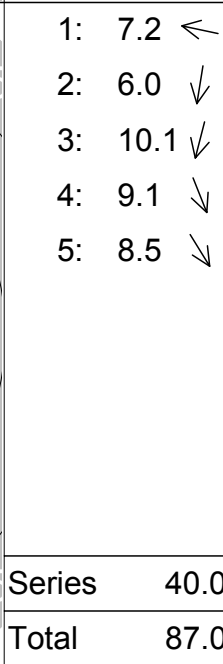
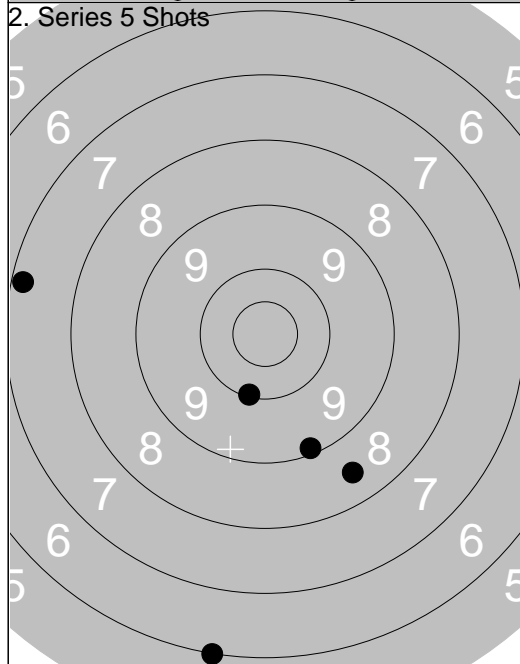
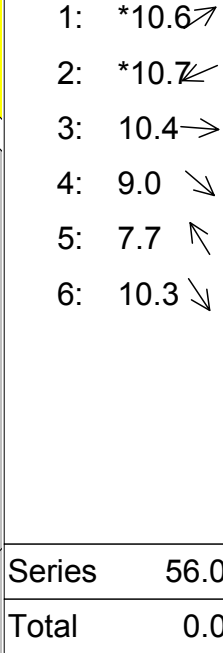
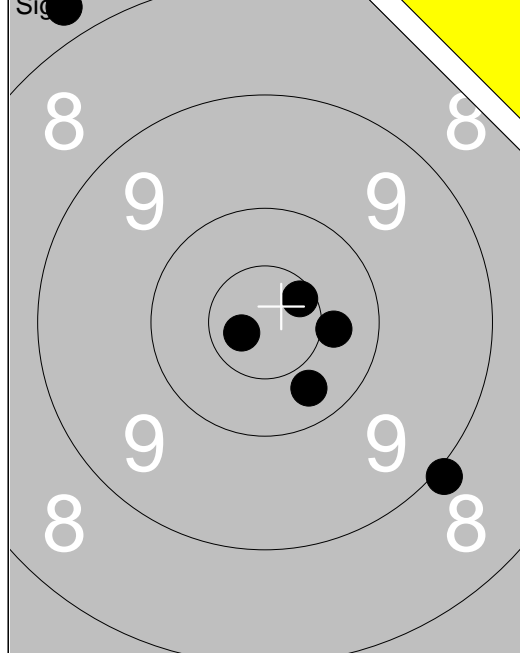

	1: 9.5 ↗ 2: 9.4 → 3: 10.3 ↗ 4: 10.1 ← 5: 10.3 ↖ 6: 9.6 →	1. Series 5 Shots 	1: 9.7 ↓ 2: 9.7 ↖ 3: 10.0 ↓ 4: *10.5 ↗ 5: 9.8 ←
	Series 57.0 Total 0.0		Series 47.0 Total 47.0

2. Series 5 Shots 	1: 9.5 ← 2: 8.8 ↖ 3: 10.0 → 4: 9.3 ← 5: 9.4 ←	3. Series 5 Shots 	1: 0.0 2: 8.8 ↓ 3: 7.0 ↓ 4: 8.5 ← 5: 8.9 ↖
	Series 45.0 Total 92.0		Series 31.0 Total 123.0

4. Series 10 Shots 	1: 10.0 ← 2: 9.9 → 3: 8.2 ← 4: 8.3 ← 5: *10.7 ↗	4. Series 10 Shots 	6: 8.5 ← 7: *10.6 ↘ 8: 10.2 ← 9: 7.3 ← 10: 7.9 ←
	Series 45.0 Total 168.0		Series 42.0 Total 210.0

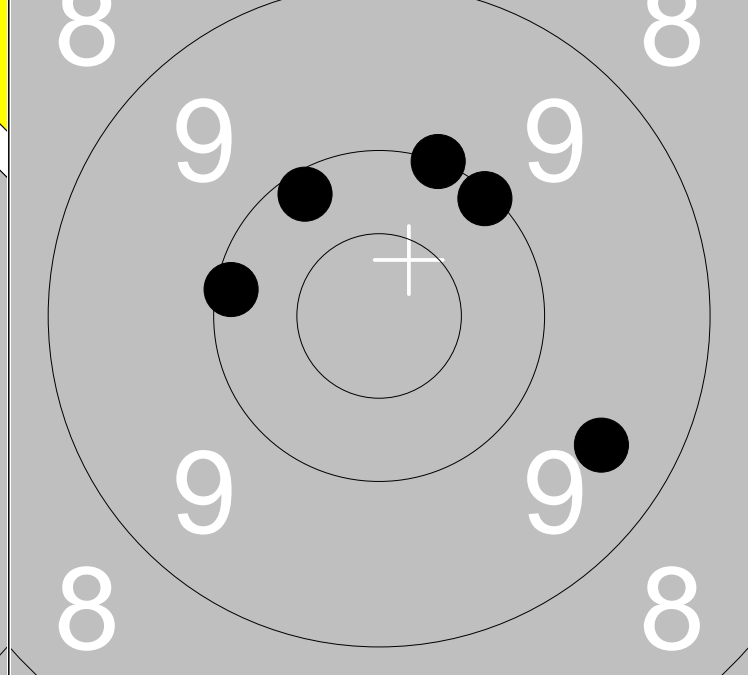
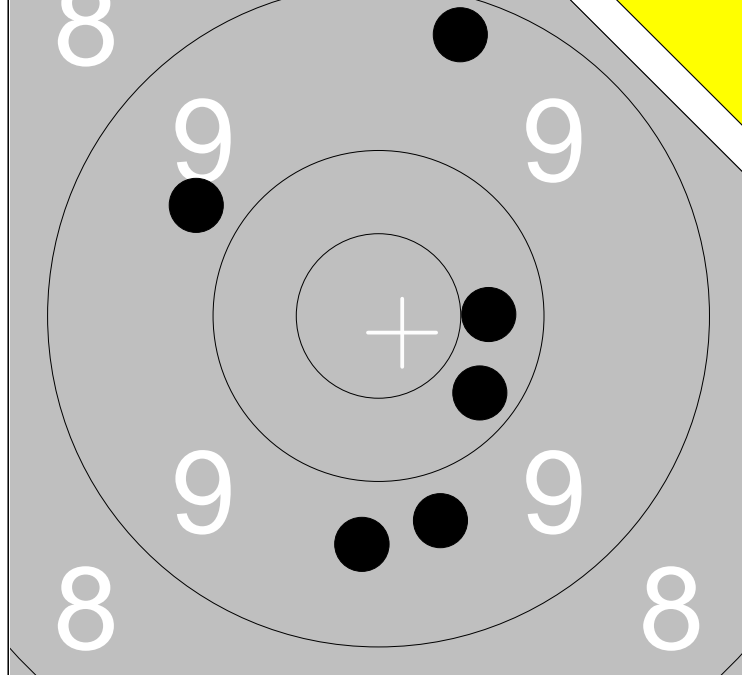

1: 9.6 ↓	6: 10.2 ↘		
2: 9.3 ↑		Series	56.0
3: 9.7 ↓			
4: 10.3 →		Total	0.0
5: 9.7 ↙			

1: 10.0 ↑			
2: 10.2 ↖		Series	49.0
3: 9.5 ↘			
4: 10.1 ↗		Total	49.0
5: 10.1 ←			

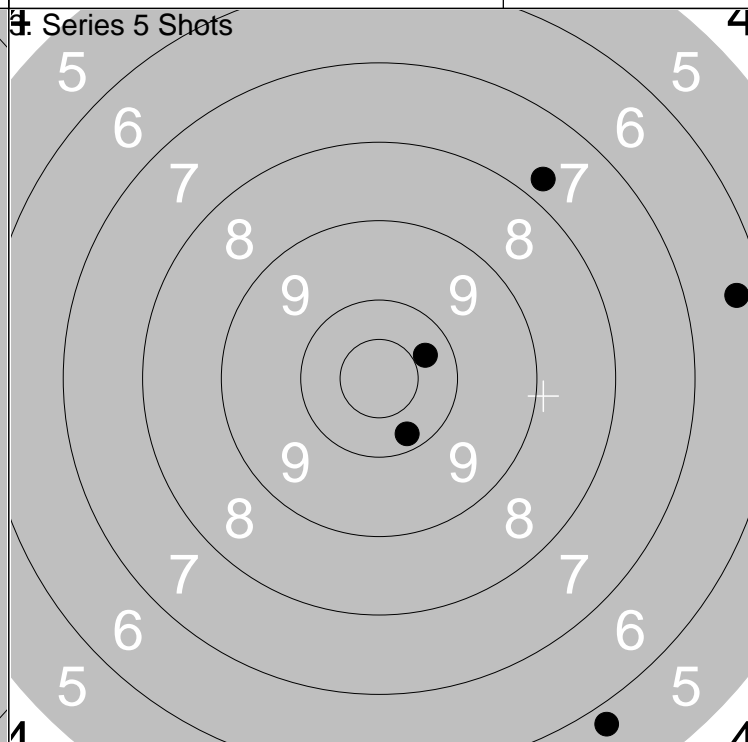
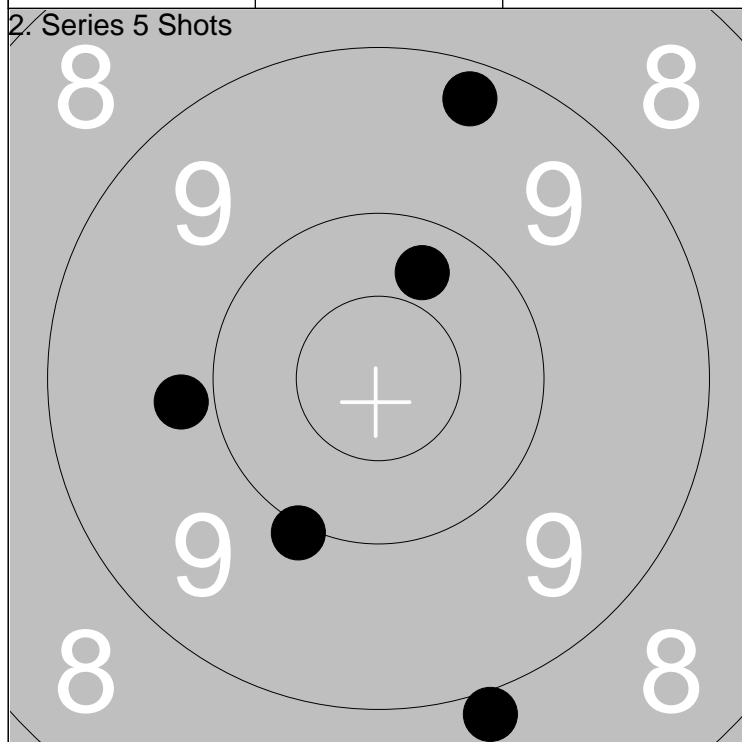

1: 10.3 ↑			
2: 9.3 ↑		Series	46.0
3: 10.0 ↓			
4: 8.9 ↓		Total	95.0
5: 9.8 ←			

1: 7.8 ↗			
2: 5.8 ↓		Series	38.0
3: 10.3 ↗			
4: 6.4 →		Total	133.0
5: 10.2 ↓			

<p>Sight</p>	<p>1: 9.5 ↓</p> <p>2: 9.7 →</p> <p>3: 9.7 →</p> <p>4: 9.7 →</p> <p>5: 8.5 →</p> <p>6: 9.5 →</p>	<p>1. Series 5 Shots</p>	<p>1: 9.2 ↗</p> <p>2: 9.7 ←</p> <p>3: 9.8 →</p> <p>4: 9.7 ↖</p> <p>5: 9.5 ↖</p>
Series 53.0		Series 45.0	
Total 0.0		Total 45.0	

<p>2. Series 5 Shots</p>	<p>1: 9.5 ↗</p> <p>2: *10.5 ↑</p> <p>3: 9.7 ↖</p> <p>4: 9.1 ←</p> <p>5: 9.0 ↗</p>	<p>3. Series 5 Shots</p>	<p>1: 9.7 ↗</p> <p>2: 7.2 ←</p> <p>3: 8.4 ↑</p> <p>4: 5.9 ↖</p> <p>5: 5.5 ↑</p>
Series 46.0		Series 34.0	
Total 91.0		Total 125.0	

<p>4. Series 10 Shots</p>	<p>1: 10.1 →</p> <p>2: 10.2 →</p> <p>3: 10.4 ↗</p> <p>4: 9.1 ↗</p> <p>5: 9.5 ↑</p>	<p>4. Series 10 Shots</p>	<p>6: 8.0 ↗</p> <p>7: 8.4 →</p> <p>8: 10.1 ↗</p> <p>9: 10.2 →</p> <p>10: 9.1 ↗</p>
Series 48.0		Series 45.0	
Total 173.0		Total 218.0	

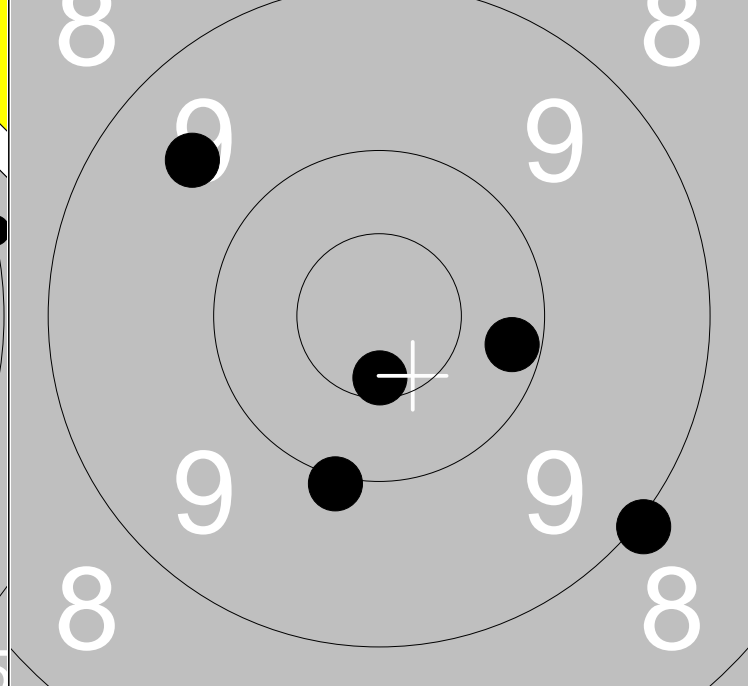
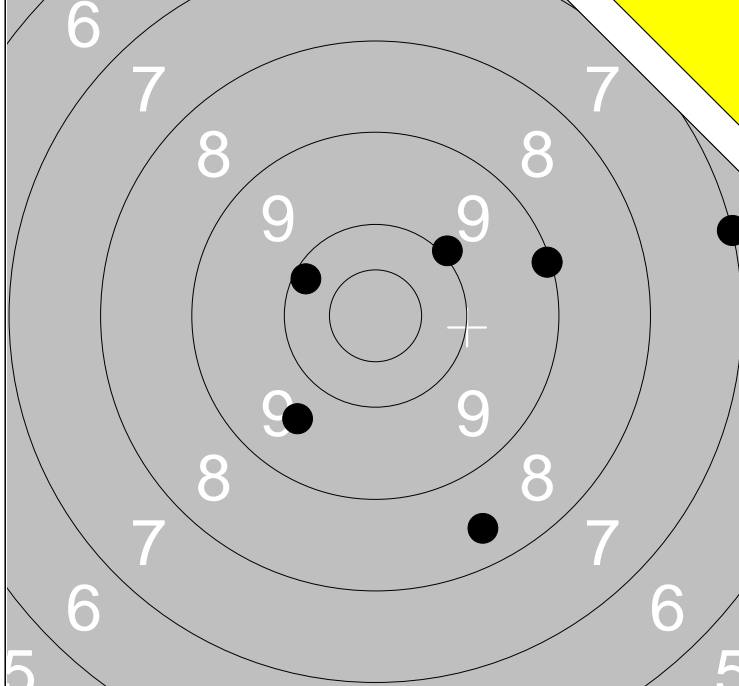

1: 8.4 ↘	6: 7.0 →		
2: 9.1 →		Series	53.0
3: 10.0 ↗			
4: 9.6 ↙		Total	0.0
5: 10.2 ↖			

1: 10.2 →			
2: *10.6 ↓		Series	48.0
3: 9.0 ↘			
4: 9.6 ↖		Total	48.0
5: 10.0 ↓			

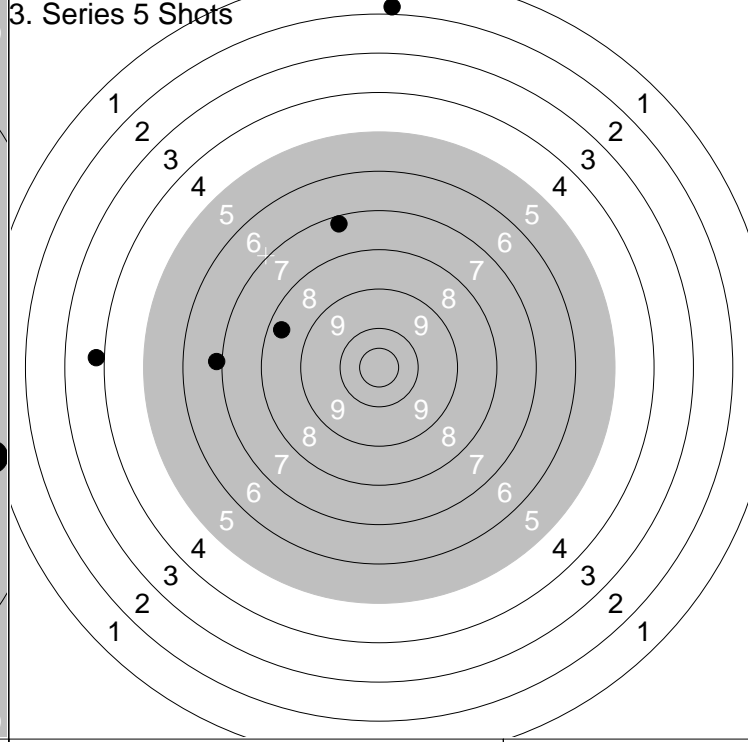
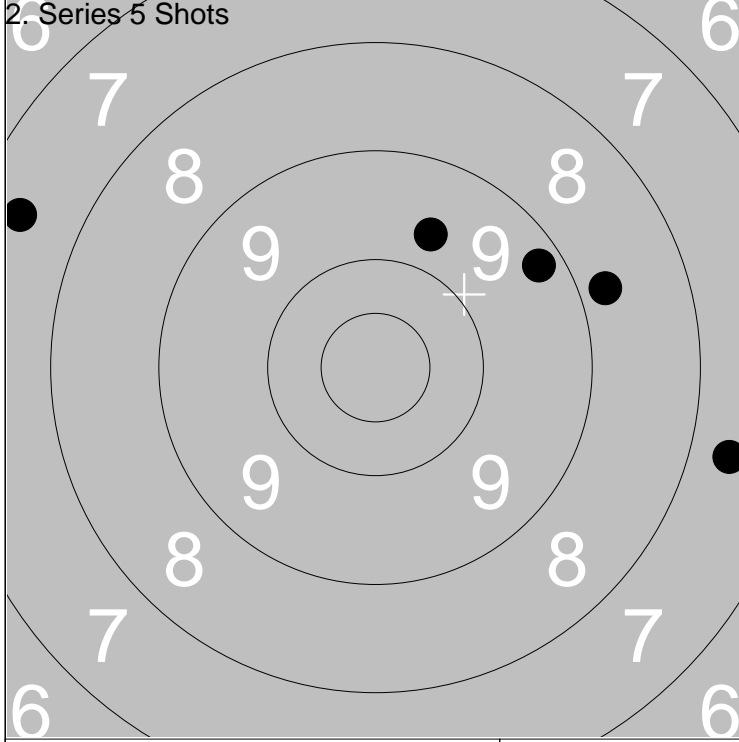

1: 7.5 ↖			
2: 9.3 ↗		Series	40.0
3: 9.7 ↑			
4: 8.8 →		Total	88.0
5: 7.7 →			

1: 1.9 ↑			
2: 8.4 ↖		Series	25.0
3: 3.8 ←			
4: 7.2 ↑		Total	113.0
5: 6.9 ←			

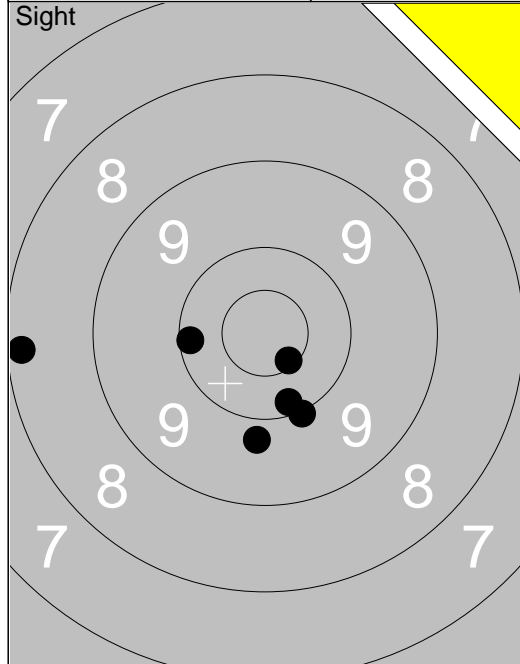

1:	10.1	←
2:	9.8	↓
3:	10.2	↓
4:	*10.6	↘
5:	8.2	←
6:	10.0	↓
Series	57.0	
Total	0.0	

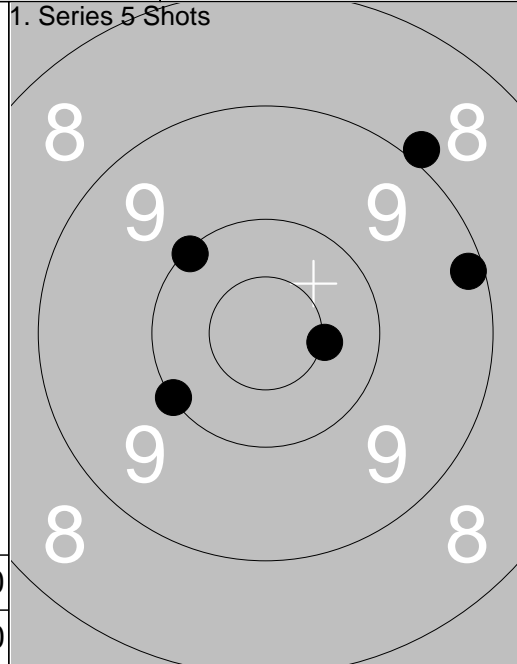

1:	10.1	↖
2:	8.9	↗
3:	*10.5	→
4:	10.0	↙
5:	9.2	→
Series	47.0	
Total	47.0	

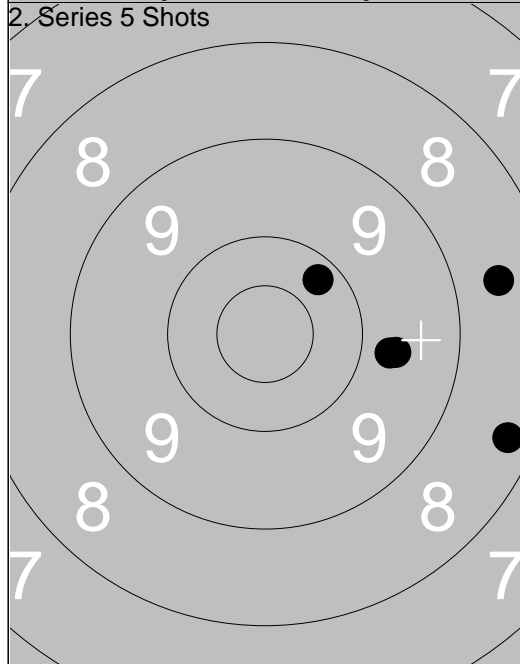

1:	8.6	→
2:	9.7	→
3:	10.2	↗
4:	9.7	→
5:	8.3	→
Series	44.02	
Total	91.0	

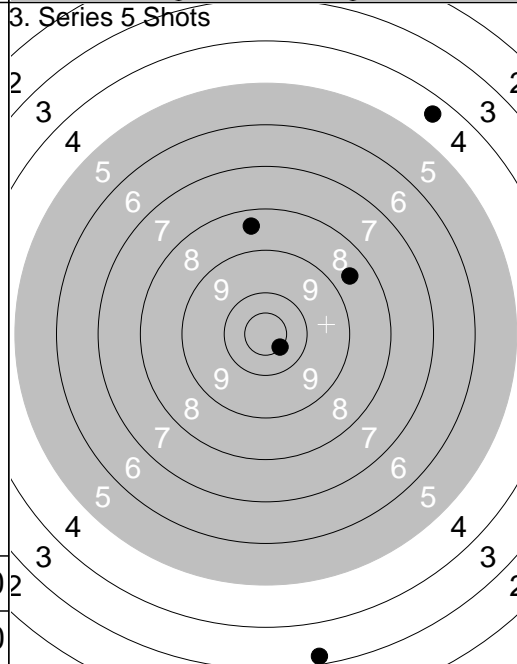

1:	*10.5	↘
2:	8.4	↑
3:	4.4	↗
4:	8.6	↗
5:	3.2	↓
Series	33.0	
Total	124.0	

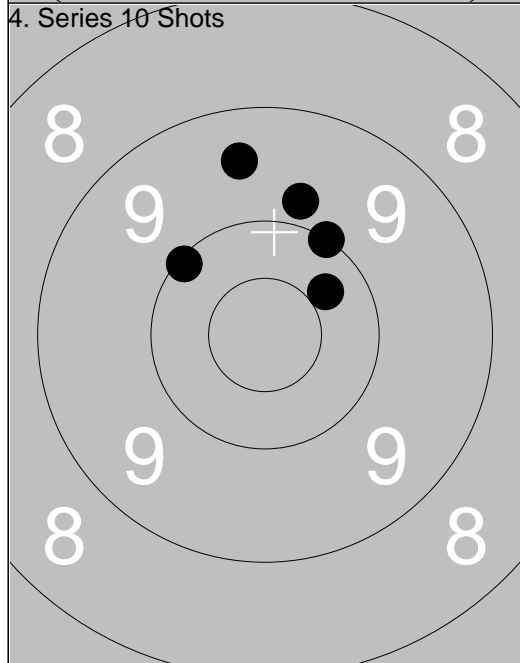

1:	9.8	↑
2:	10.3	↗
3:	10.1	↖
4:	10.0	↗
5:	9.5	↑
Series	48.0	
Total	172.0	

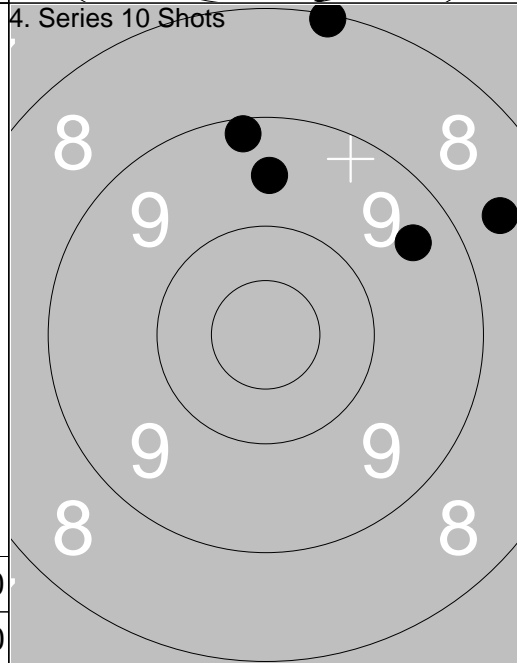

6:	9.4	↗
7:	8.6	↗
8:	9.6	↑
9:	8.1	↑
10:	9.2	↑
Series	43.0	
Total	215.0	

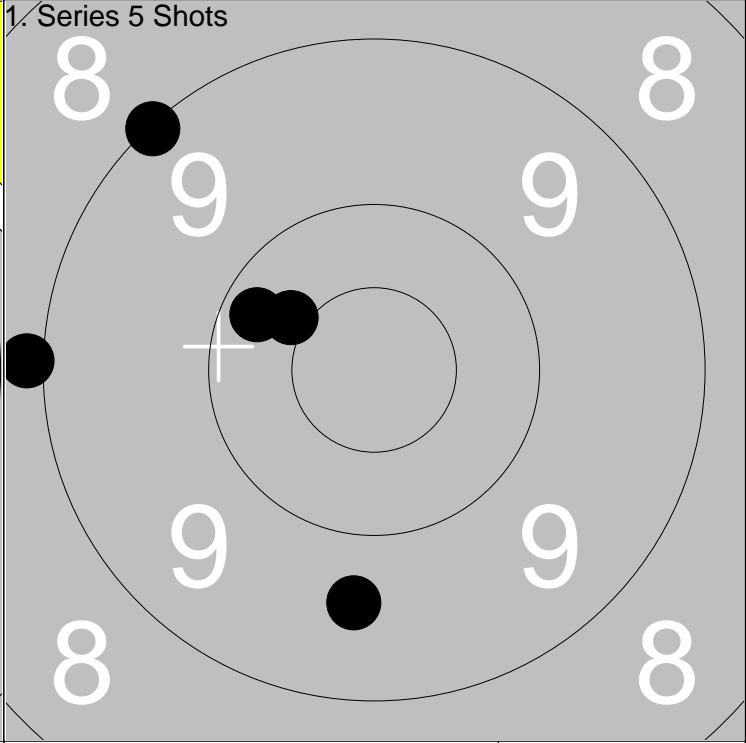
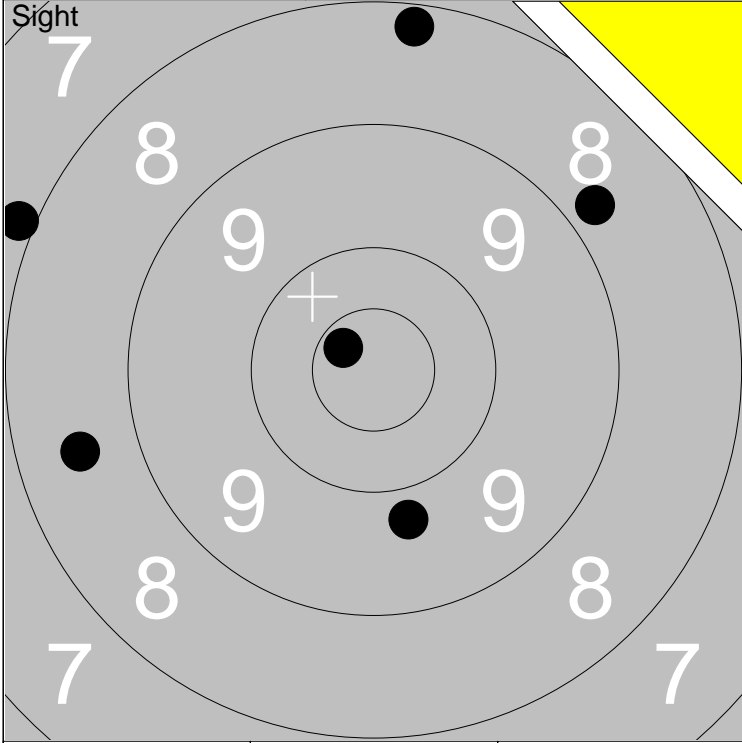

1: 8.8 ↗	6: 7.9 ↖	Series	50.0
2: 9.8 ↓		Total	0.0
3: *10.7 ↘			
4: 8.5 ←			
5: 8.2 ↑			

1: 9.1 ↖	Series	46.0
2: 9.6 ↓	Total	46.0
3: 10.4 ↘		
4: 10.2 ↖		
5: 8.9 ←		

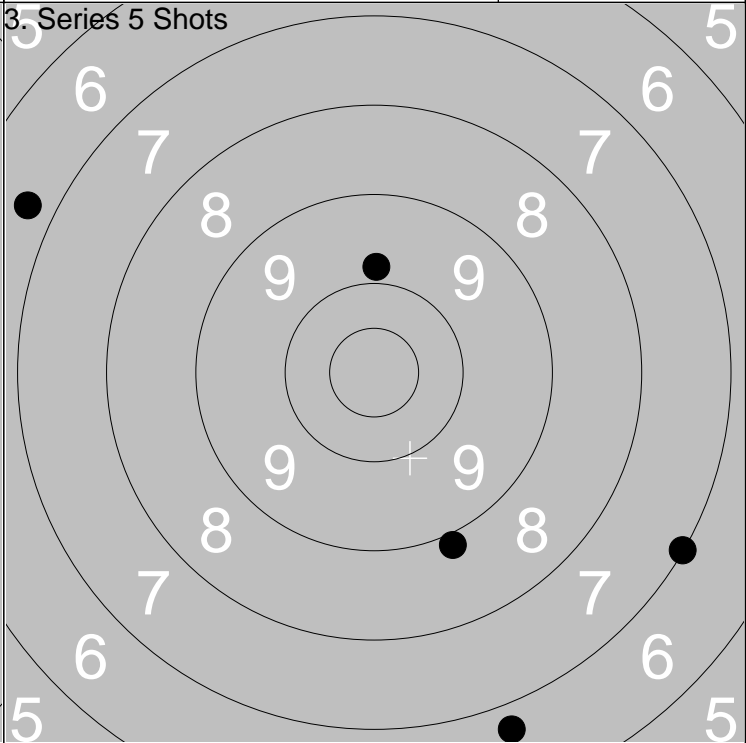
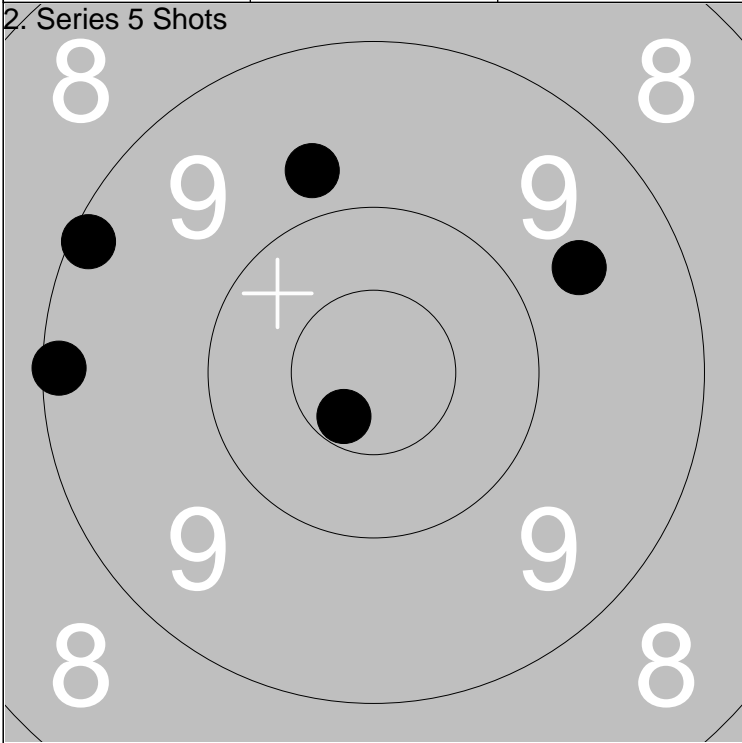

1: 9.8 ↑	Series	46.0
2: 9.1 ↖	Total	92.0
3: 9.1 ←		
4: 9.6 ↗		
5: *10.7 ↘		

1: 6.7 ↖	Series	36.0
2: 8.9 ↓	Total	128.0
3: 6.7 ↓		
4: 7.0 ↗		
5: 9.8 ↑		

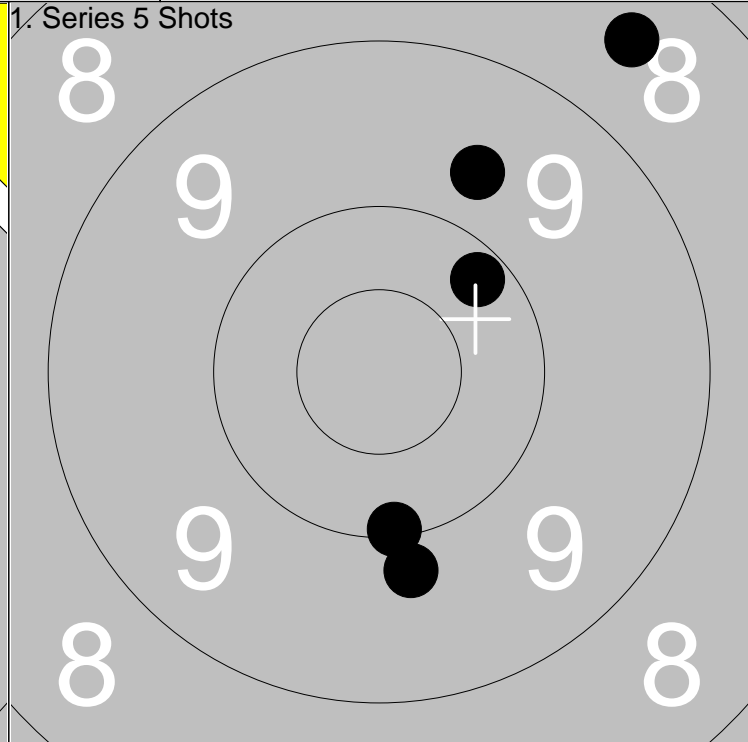
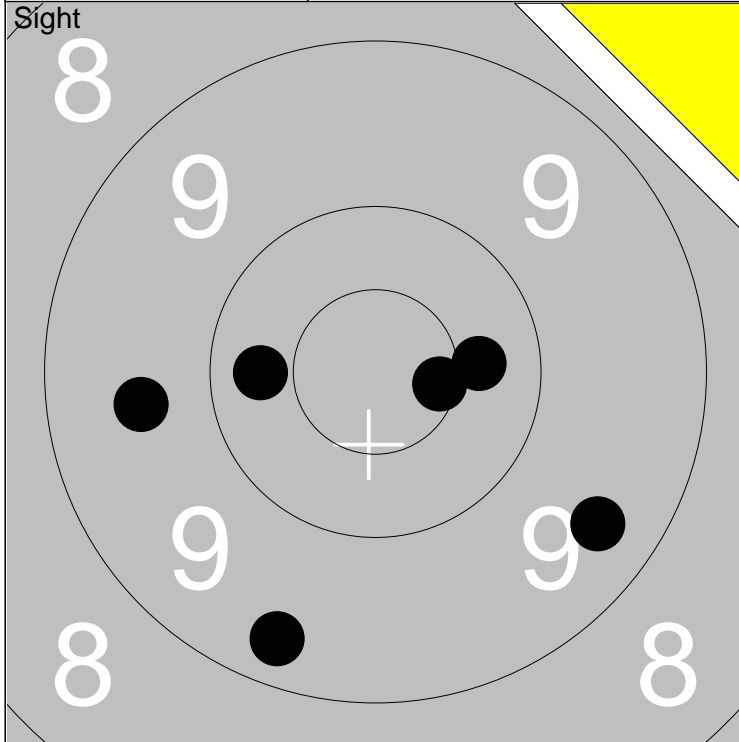

1: 9.6 ←	6: 9.4 ↘	Series	57.0
2: 10.4 →		Total	0.0
3: 10.3 ←			
4: 9.3 ↓			
5: *10.6 →			

1: 9.8 ↓	Series	46.0
2: 8.5 ↗	Total	46.0
3: 10.2 ↗		
4: 9.7 ↗		
5: 10.1 ↓		

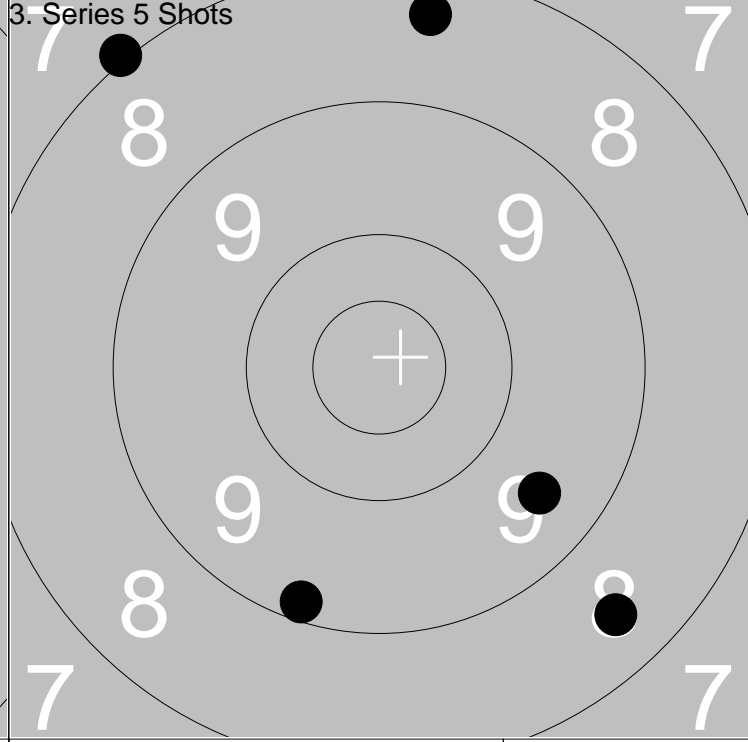
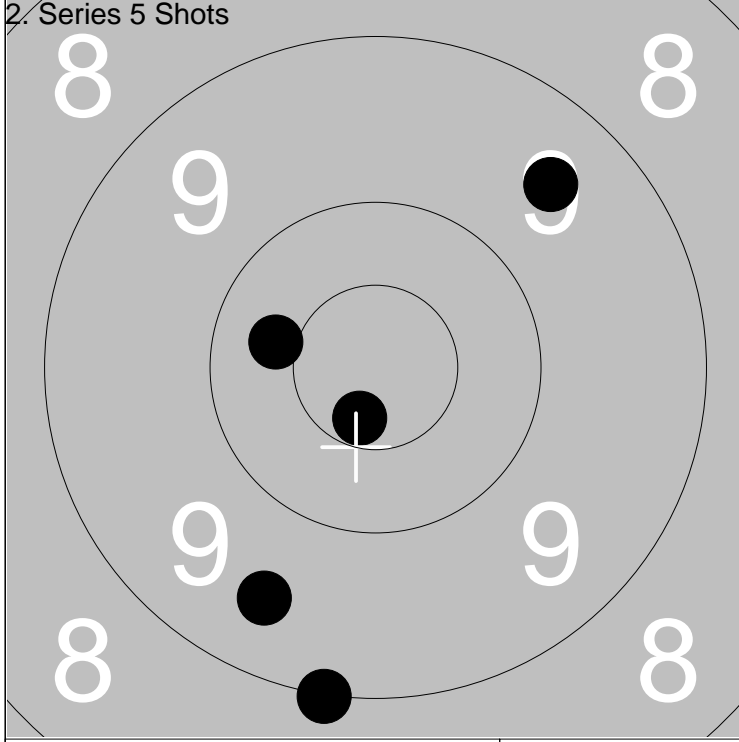

1: 9.5 ↗		Series	47.0
2: 10.4 ←		Total	93.0
3: *10.7 ↓			
4: 9.0 ↓			
5: 9.5 ↓			

1: 8.3 ↑	Series	42.0
2: 8.0 ↗	Total	135.0
3: 8.5 ↓		
4: 9.2 ↓		
5: 9.5 ↓		

<p>Sight</p>	<p>1. Series 5 Shots</p>	
Series 59.0 Total 0.0	Series 49.0 Total 49.0	

<p>2. Series 5 Shots</p>	<p>3. Series 5 Shots</p>	
Series 45.0 Total 94.0	Series 38.0 Total 132.0	

<p>4. Series 10 Shots</p>	<p>4. Series 10 Shots</p>	
Series 45.0 Total 177.0	Series 45.0 Total 222.0	