

1:	8.6	↗
2:	9.7	↗
3:	8.5	↘
4:	10.1	↗
5:	10.3	↗
Series		45.0
Total		0.0

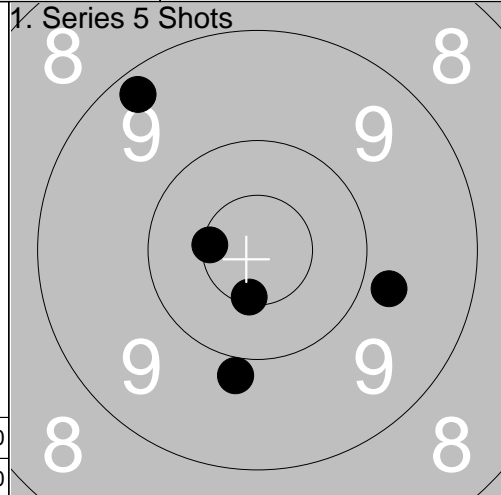

1:	9.8	→
2:	*10.5	←
3:	*10.6	↘
4:	9.9	↘
5:	9.2	↗
Series		47.0
Total		47.0

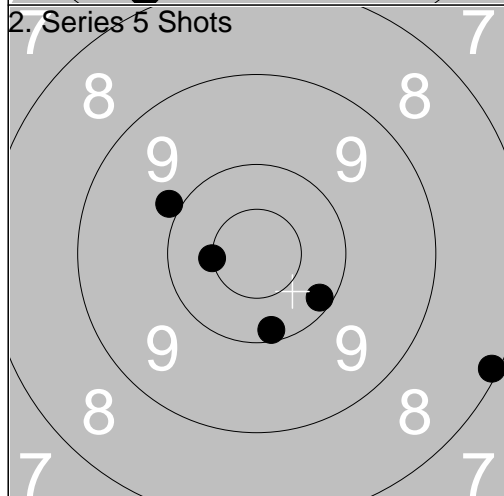

1:	*10.5	←
2:	9.9	↗
3:	8.1	↘
4:	10.1	↘
5:	10.2	↘
Series		47.0
Total		94.0

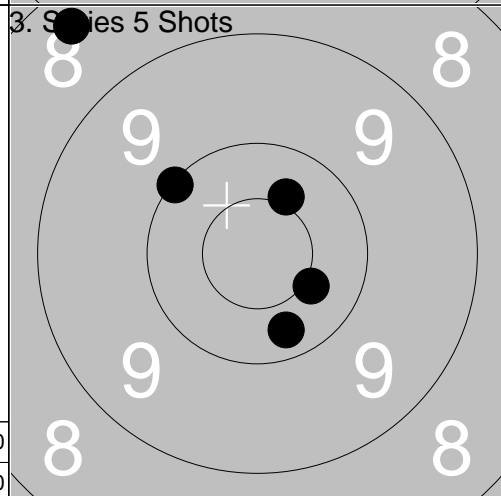

1:	10.0	↖
2:	10.3	↘
3:	*10.4	↘
4:	8.4	↗
5:	*10.4	↗
Series		48.0
Total		142.0

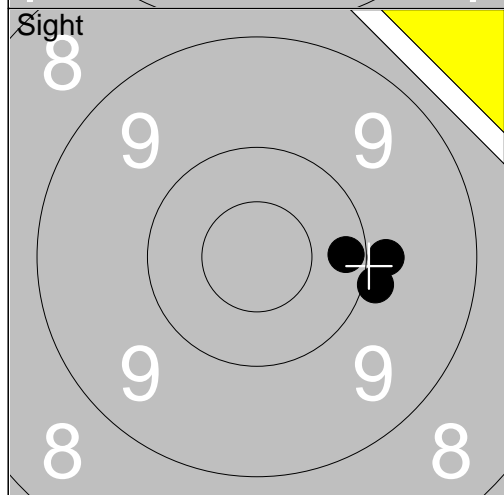

1:	9.9	→
2:	10.2	→
3:	9.9	→
Series		28.0
Total		142.0

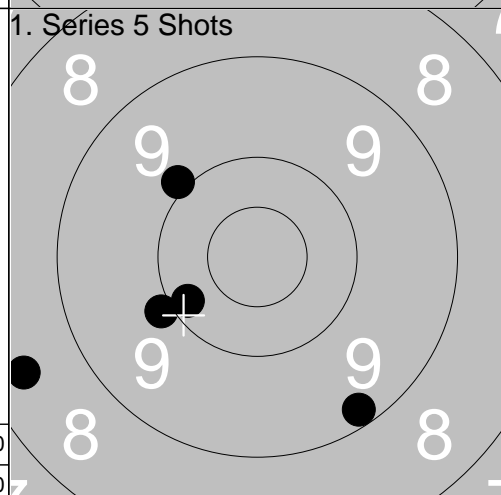

1:	10.2	←
2:	9.2	↘
3:	9.9	←
4:	9.9	↗
5:	8.4	←
Series		45.0
Total		187.0

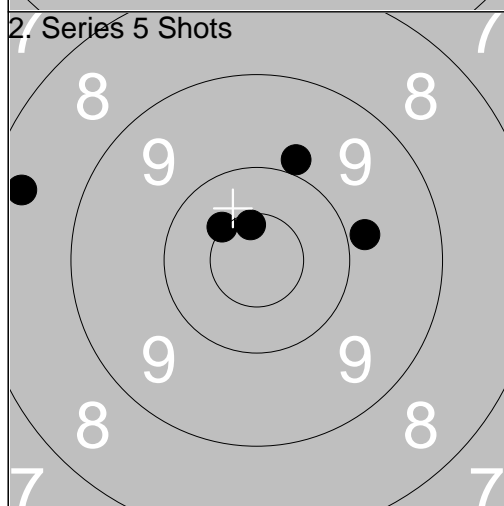

1:	9.8	→
2:	9.9	↗
3:	*10.5	↗
4:	*10.6	↗
5:	8.4	↖
Series		46.0
Total		233.0

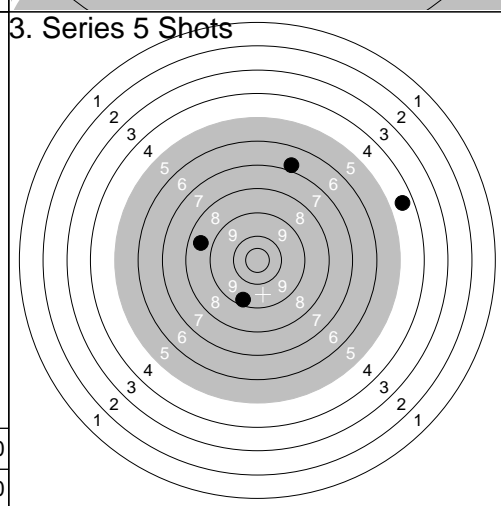

1:	4.5	↗
2:	6.8	↗
3:	8.5	←
4:	0.0	↘
5:	9.3	↘
Series		27.0
Total		260.0

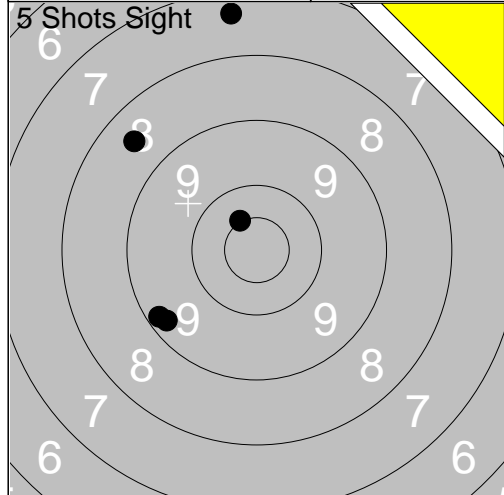

1:	8.3	↑
2:	8.9	↗
3:	10.2	↗
4:	10.0	↙
5:	9.6	↙
Series		45.0
Total		45.0

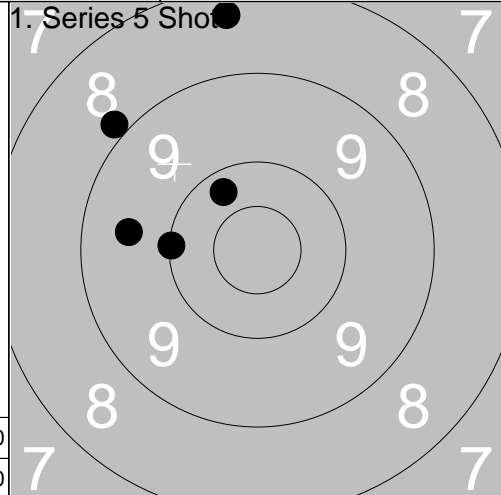

1:	*10.8	↙
2:	9.1	→
3:	9.6	↗
4:	8.5	↗
5:	*10.6	↙
Series		46.0
Total		134.0

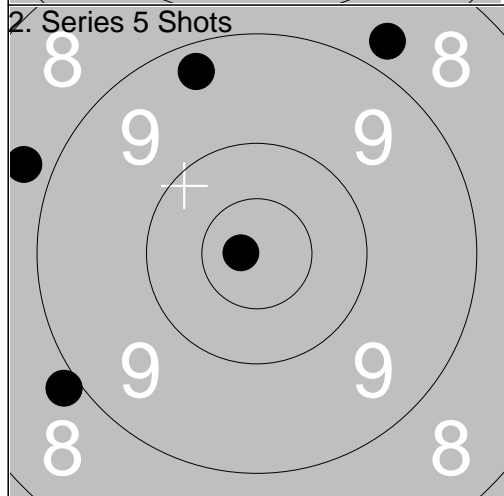

1:	*10.9	↙
2:	8.4	↙
3:	9.6	↗
4:	10.3	↙
5:	9.9	↙
Series		46.0
Total		180.0

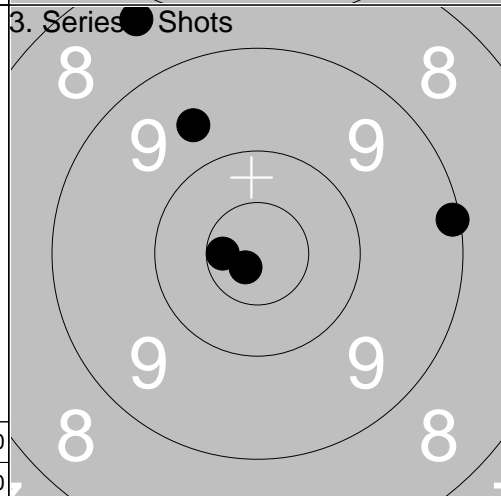

1:	9.2	↘
2:	8.1	↗
3:	7.9	↑
4:	5.6	↘
5:	6.9	↑
Series		35.0
Total		260.0

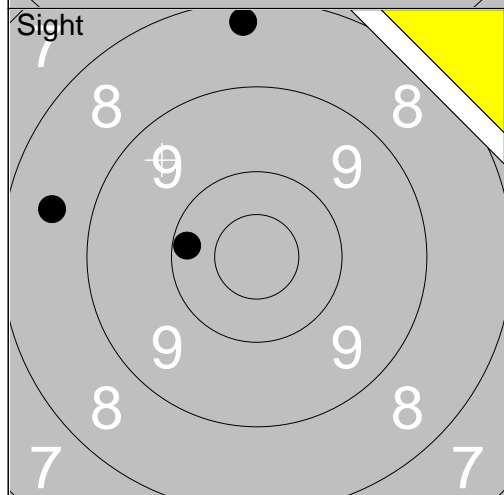

1:	9.2	↘
2:	8.1	↗
3:	7.9	↑
4:	5.6	↘
5:	6.9	↑
Series		35.0
Total		260.0

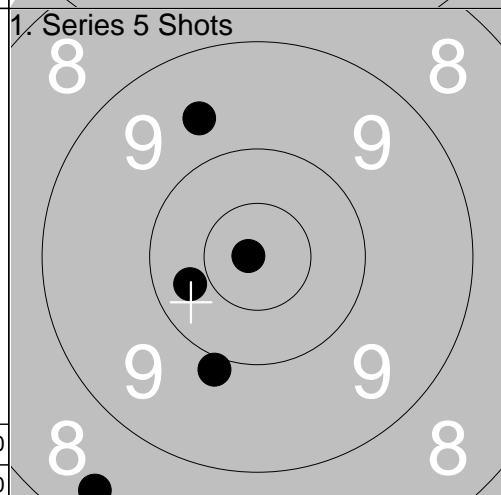

1:	9.2	↘
2:	8.1	↗
3:	7.9	↑
4:	5.6	↘
5:	6.9	↑
Series		35.0
Total		260.0

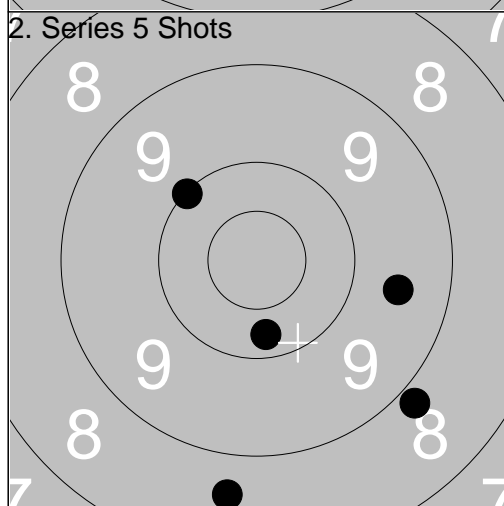

1:	9.2	↘
2:	8.1	↗
3:	7.9	↑
4:	5.6	↘
5:	6.9	↑
Series		35.0
Total		260.0

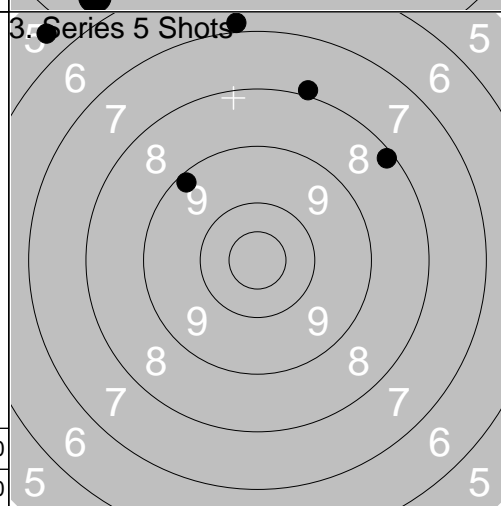

1:	9.2	↘
2:	8.1	↗
3:	7.9	↑
4:	5.6	↘
5:	6.9	↑
Series		35.0
Total		260.0

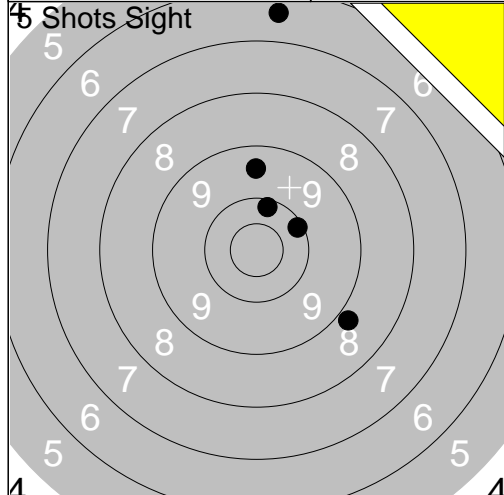

1:	6.5	↑
2:	10.1	↗
3:	8.8	↘
4:	10.2	↑
5:	9.5	↑
Series		43.0
Total		0.0

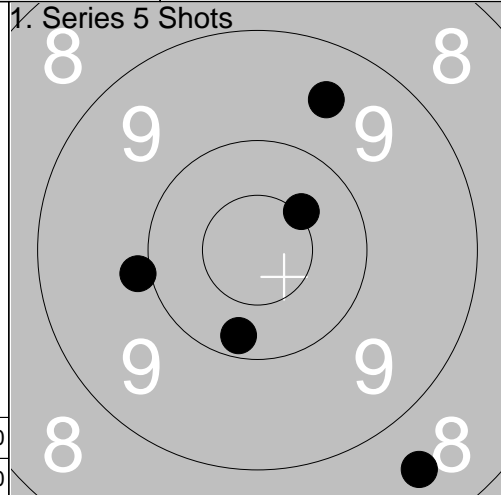

1:	9.5	↑
2:	*10.5	↗
3:	10.2	↓
4:	9.9	←
5:	8.6	↘
Series		46.0
Total		46.0

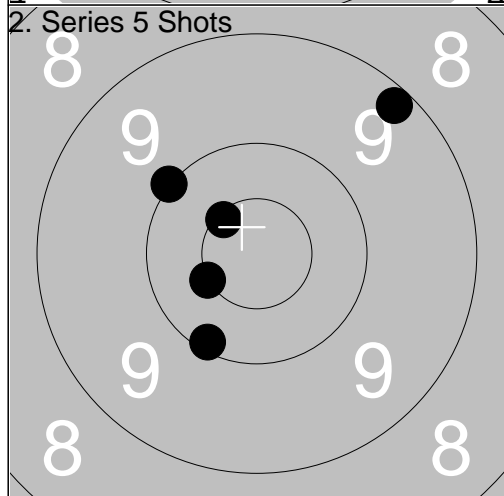

1:	9.2	↗
2:	*10.5	←
3:	10.1	↘
4:	10.0	↖
5:	*10.6	↗
Series		49.0
Total		95.0

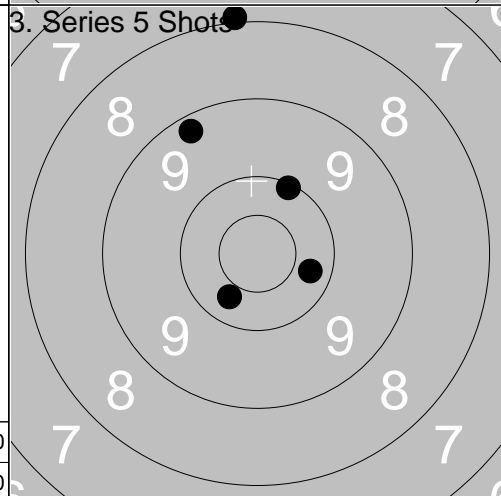

1:	9.2	↖
2:	10.3	↘
3:	10.1	↗
4:	8.0	↑
5:	10.3	→
Series		47.0
Total		142.0

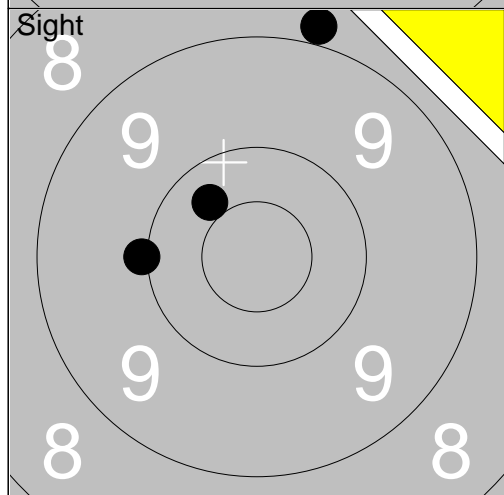

1:	10.0	←
2:	10.3	↗
3:	8.9	↑
Series		28.0
Total		142.0

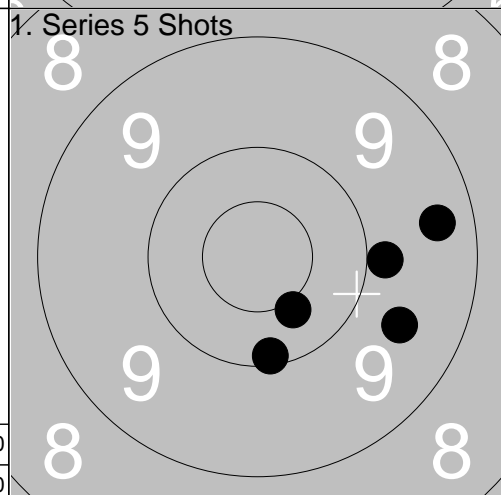

1:	10.1	↓
2:	9.4	→
3:	9.6	↘
4:	9.9	→
5:	*10.4	↘
Series		47.0
Total		189.0

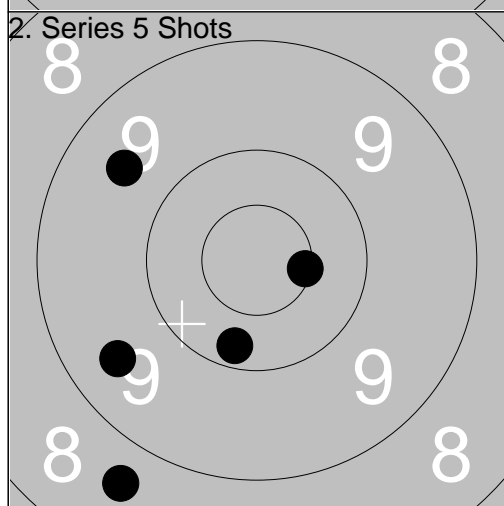

1:	9.6	↖
2:	*10.5	→
3:	9.5	↖
4:	10.2	↓
5:	8.7	↘
Series		46.0
Total		235.0

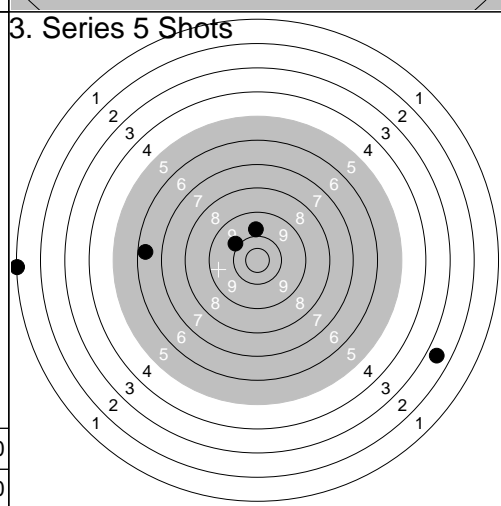

1:	6.4	←
2:	9.7	↑
3:	9.9	↗
4:	1.0	←
5:	2.6	↘
Series		27.0
Total		262.0

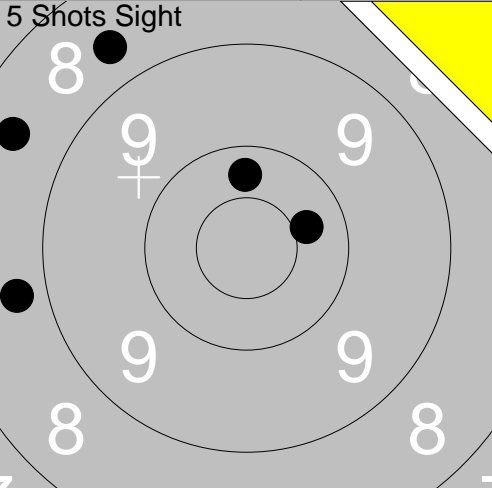
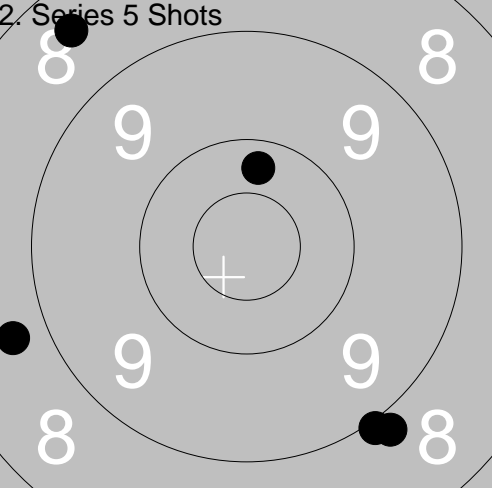
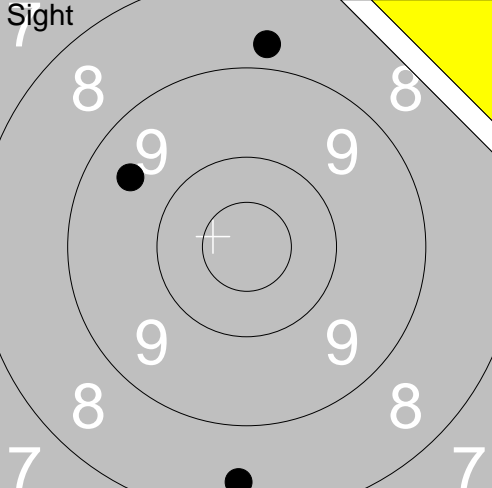
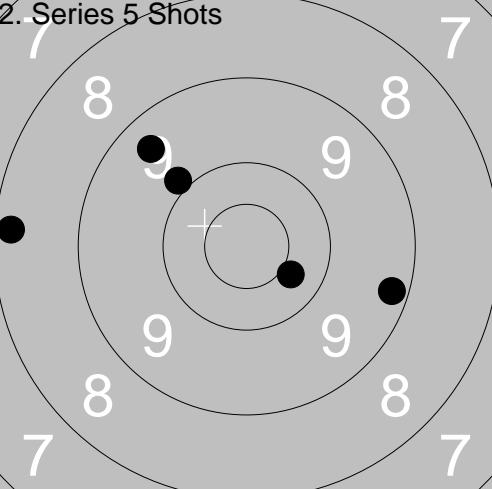
Relay	Lane	Bo Andersson	
300m	Nässjö	Ä	
2013-07-27	Postens Riksmästerskap 2013	Ramselefors SKF	
5 Shots Sight		1: 8.5 ↖ 2: 10.3 ↑ 3: 10.4 → 4: 8.6 ↗ 5: 8.7 ←	1: 7.3 ↖ 2: 9.5 ↗ 3: 10.2 ↖ 4: 8.9 ↘ 5: 8.8 ↘
		Series 44.0	Series 42.0
		Total 0.0	Total 42.0
2. Series 5 Shots		1: 8.9 ↘ 2: 8.7 ← 3: 9.0 ↘ 4: 10.3 ↑ 5: 8.4 ↗	1: 8.6 ← 2: 10.3 ← 3: 9.2 ← 4: 7.3 ↖ 5: 9.6 ↗
		Series 43.0	Series 43.0
		Total 85.0	Total 128.0
Sight		1: 8.8 ↑ 2: 9.5 ↗ 3: 8.4 ↓	1: 10.2 ↘ 2: 8.2 ↘ 3: 9.8 → 4: 9.0 ↖ 5: 10.4 ↓
		Series 25.0	Series 46.0
		Total 128.0	Total 174.0
2. Series 5 Shots		1: 9.4 ↗ 2: 9.9 ↗ 3: 8.2 ← 4: 9.2 ↘ 5: 10.4 ↘	1: 3.6 ← 2: 8.7 → 3: 4.7 ↑ 4: 0.0 5: 3.7 ←
		Series 45.0	Series 18.0
		Total 219.0	Total 237.0

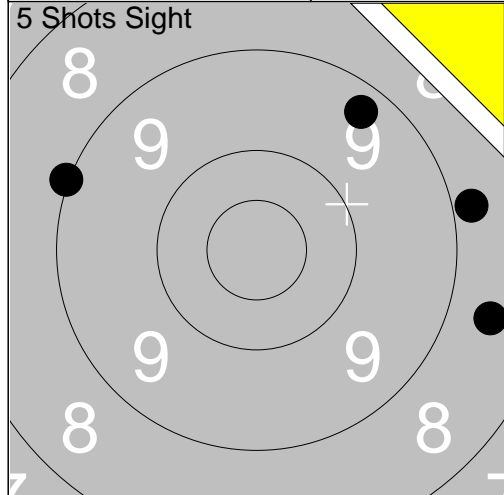

1:	9.3	↗
2:	9.0	↖
3:	8.6	↘
4:	8.8	→
Series		34.0
Total		0.0

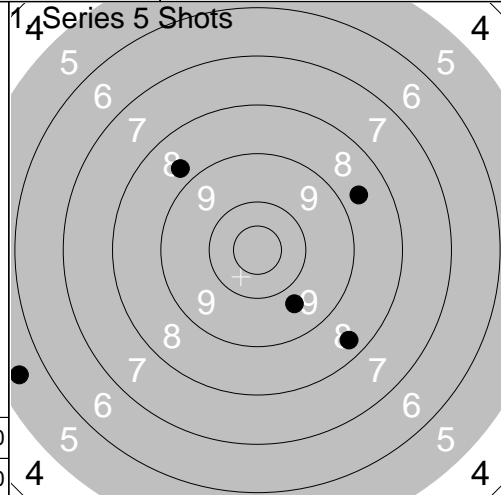

1:	8.7	↗
2:	5.5	↖
3:	8.7	↗
4:	9.7	↘
5:	8.4	↘
Series		38.0
Total		38.0

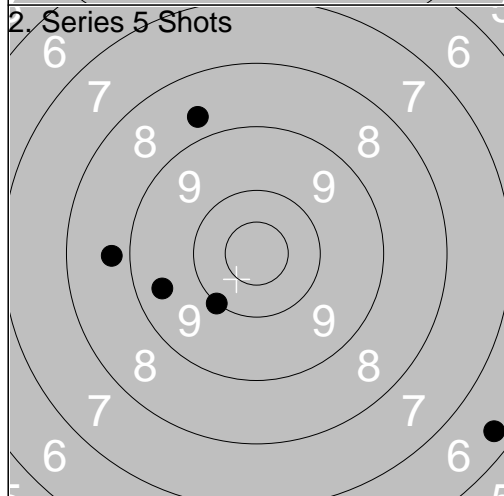

1:	8.7	↗
2:	8.7	↖
3:	10.0	↘
4:	9.4	↖
5:	6.4	↘
Series		41.0
Total		79.0

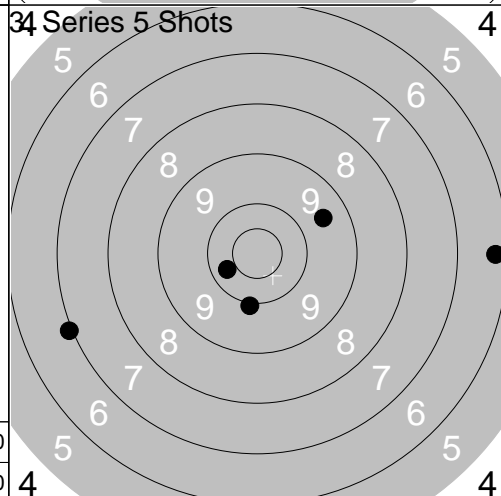

1:	10.3	↖
2:	9.5	↗
3:	7.0	↖
4:	10.0	↘
5:	6.3	→
Series		42.0
Total		121.0

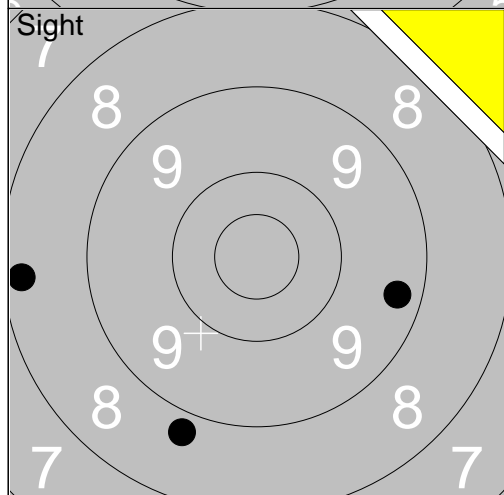

1:	8.8	↘
2:	8.3	↖
3:	9.3	↘
Series		25.0
Total		121.0

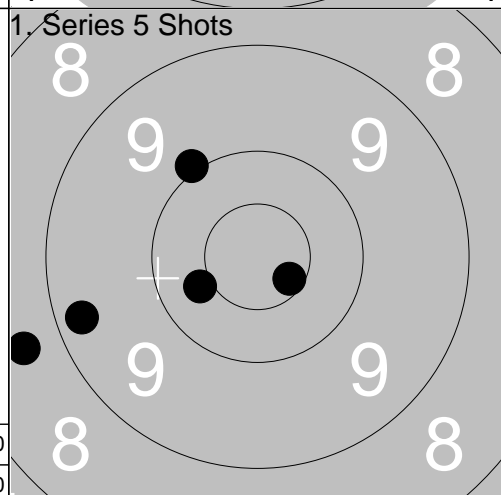

1:	10.4	↖
2:	8.7	↖
3:	*10.6	↘
4:	9.3	↖
5:	10.0	↗
Series		47.0
Total		168.0

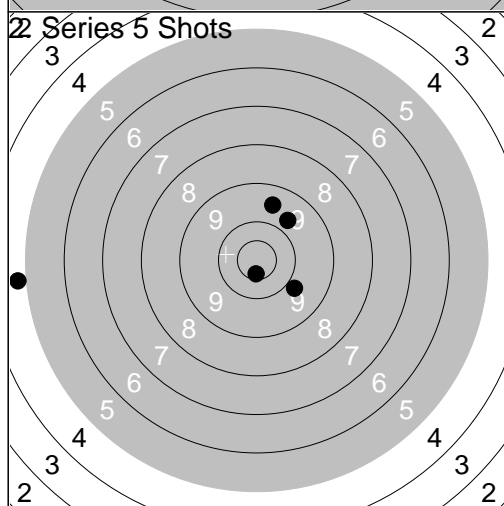

1:	4.8	↖
2:	9.5	↗
3:	9.7	↗
4:	9.8	↘
5:	*10.6	↘
Series		41.0
Total		209.0

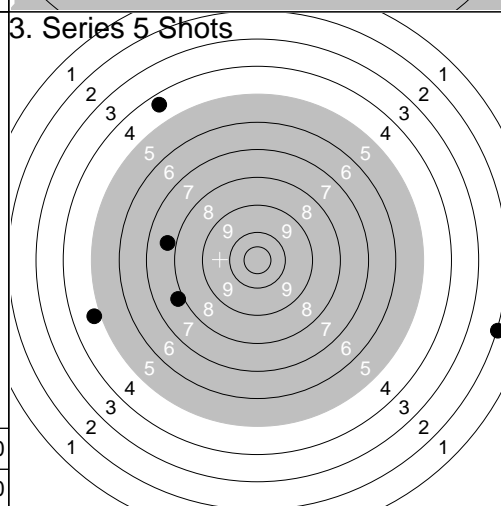

1:	7.8	↖
2:	4.4	↗
3:	4.8	↖
4:	7.7	↖
5:	2.0	↘
Series		24.0
Total		233.0

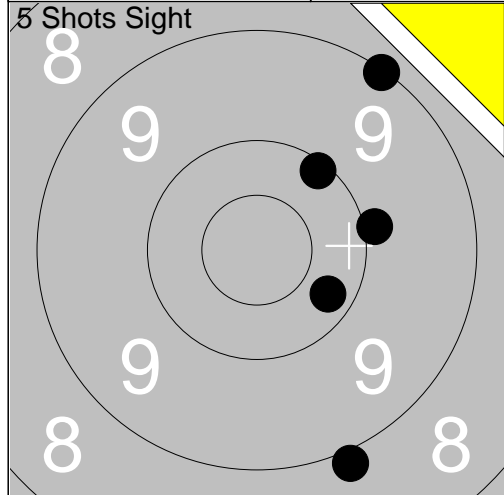

1:	8.9	↘
2:	10.1	↗
3:	9.1	↗
4:	9.9	→
5:	10.2	↘
Series		46.0
Total		0.0

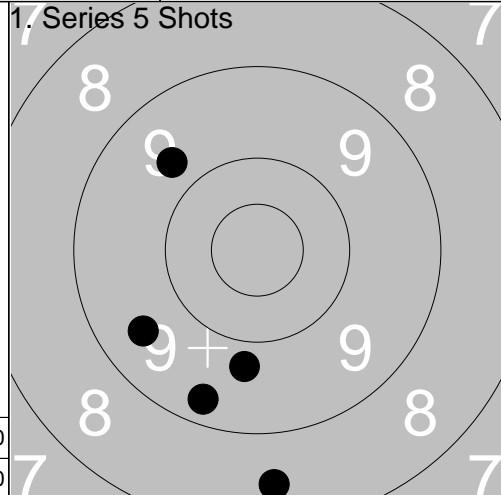

1:	9.7	↖
2:	9.5	↙
3:	8.5	↓
4:	9.8	↓
5:	9.3	↓
Series		44.0
Total		44.0

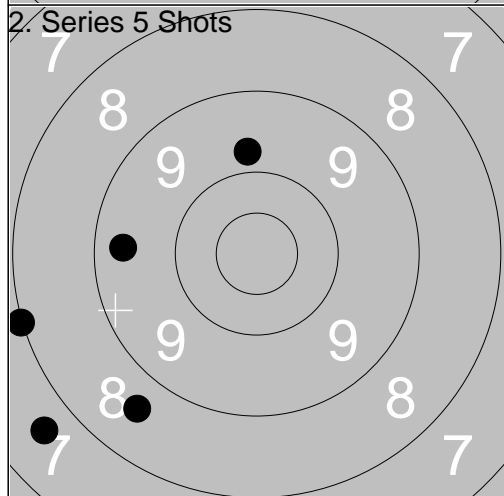

1:	9.8	↑
2:	9.4	←
3:	8.0	←
4:	8.6	↘
5:	7.6	↙
Series		41.0
Total		85.0

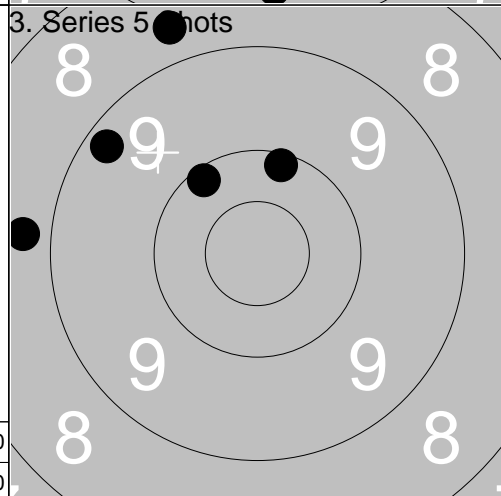

1:	8.7	↑
2:	10.1	↗
3:	9.2	↖
4:	8.8	←
5:	10.1	↑
Series		45.0
Total		130.0

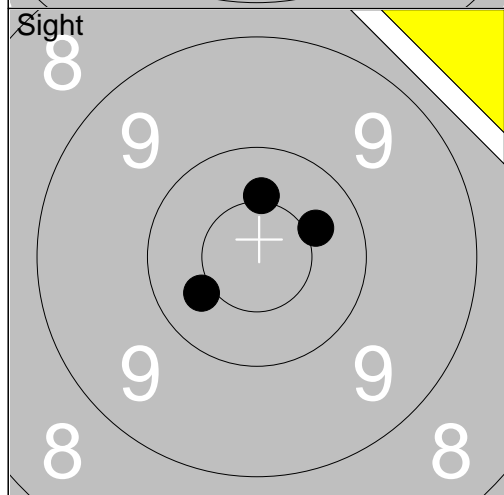

1:	10.4	↗
2:	10.4	↙
3:	*10.4	↑
Series		30.0
Total		130.0

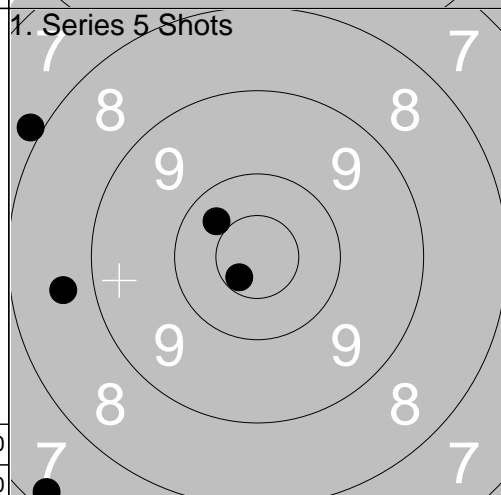

1:	7.2	↘
2:	8.7	←
3:	10.3	↗
4:	7.9	↖
5:	*10.6	↘
Series		42.0
Total		172.0

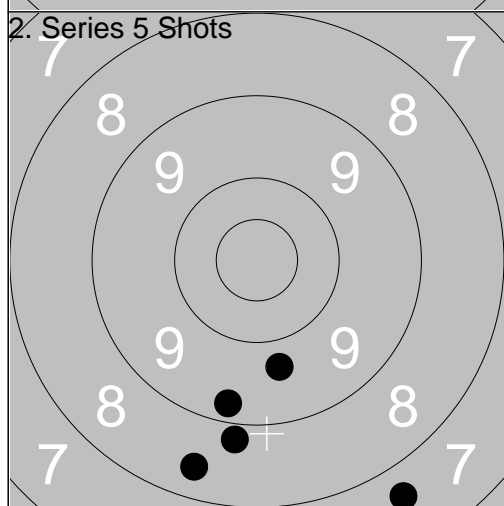

1:	7.7	↘
2:	8.4	↘
3:	9.7	↘
4:	9.3	↘
5:	8.8	↘
Series		41.0
Total		213.0

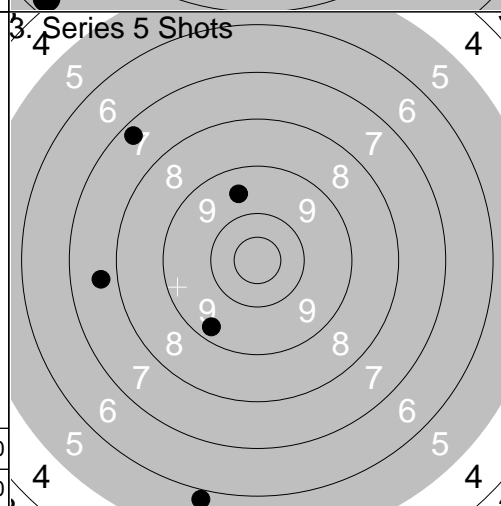

1:	9.3	↘
2:	9.6	↑
3:	7.3	↖
4:	5.8	↘
5:	7.7	←
Series		37.0
Total		250.0

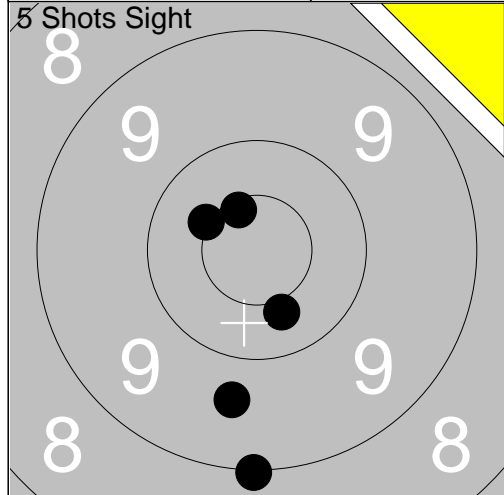

1:	9.0	↓
2:	9.6	↓
3:	*10.6	↗
4:	*10.5	↗
5:	10.4	↓
Series		48.0
Total		0.0

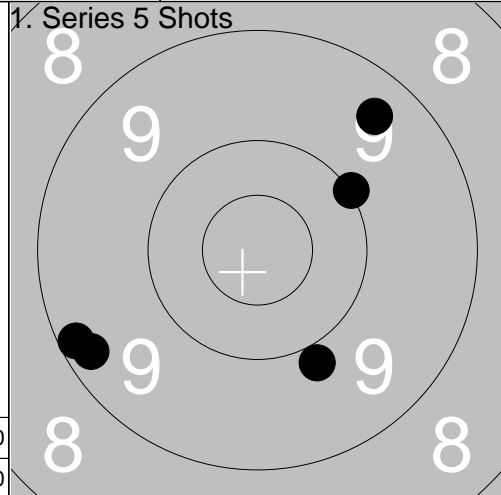

1:	10.0	↗
2:	9.3	↖
3:	9.2	↖
4:	9.4	↗
5:	9.9	↓
Series		46.0
Total		46.0

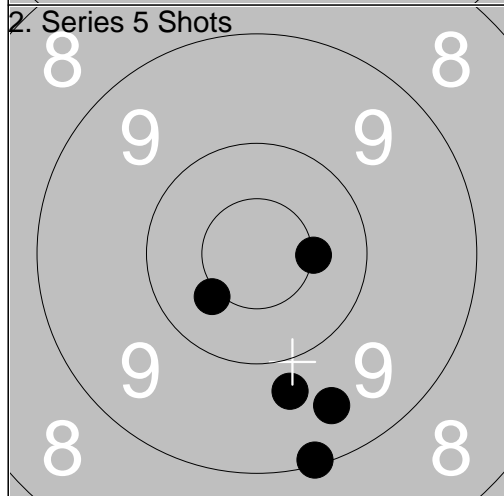

1:	*10.4	↖
2:	*10.5	→
3:	9.1	↓
4:	9.7	↓
5:	9.5	↓
Series		47.0
Total		93.0

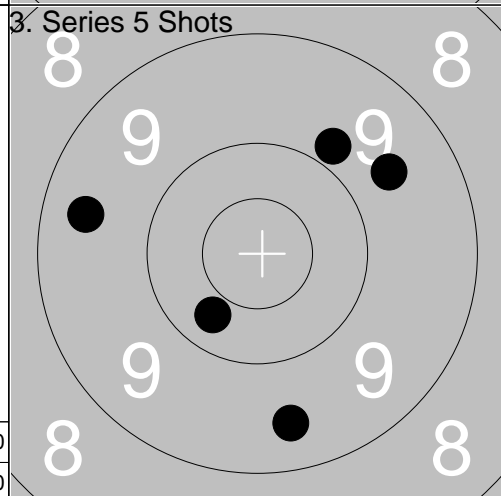

1:	9.4	↖
2:	9.5	↓
3:	9.6	↗
4:	10.3	↓
5:	9.8	↗
Series		46.0
Total		139.0

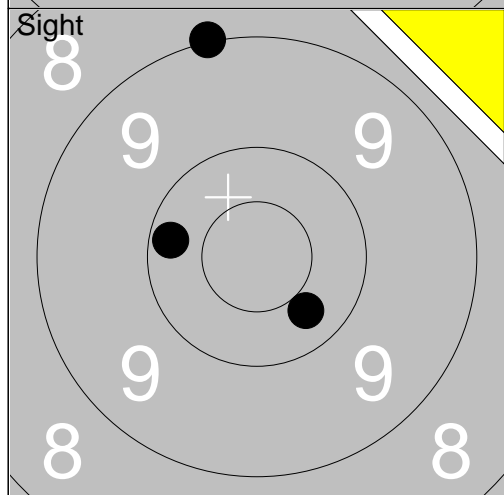

1:	10.2	↖
2:	9.0	↑
3:	10.3	↓
Series		29.0
Total		139.0

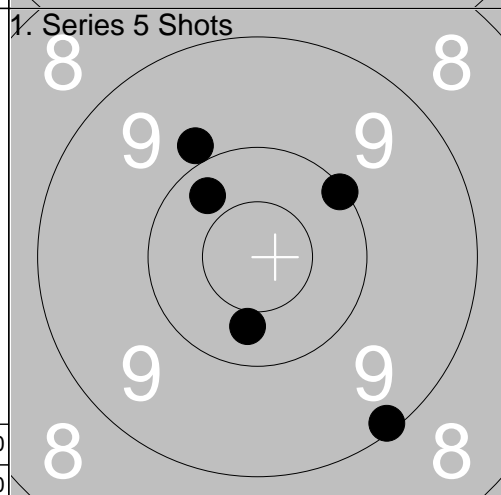

1:	10.3	↗
2:	10.4	↓
3:	9.1	↓
4:	9.9	↗
5:	10.1	↗
Series		48.0
Total		187.0

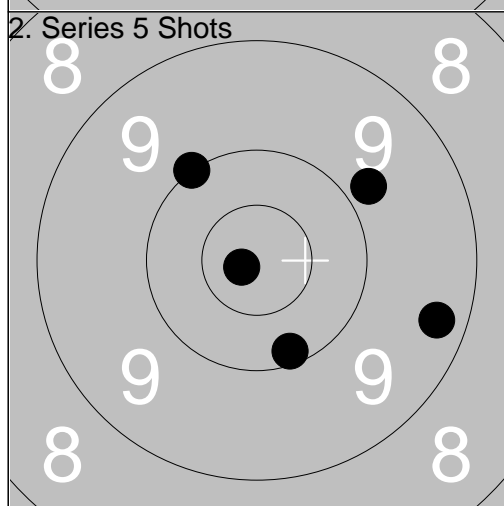

1:	10.0	↗
2:	*10.8	↖
3:	9.3	↗
4:	10.1	↓
5:	9.8	↗
Series		48.0
Total		235.0

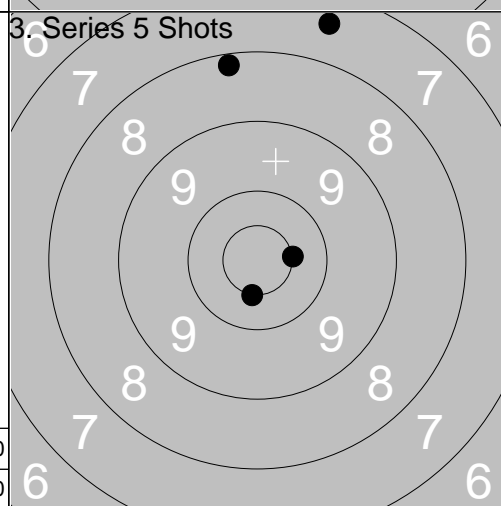

1:	*10.5	↓
2:	7.5	↑
3:	*10.5	→
4:	0.0	
5:	8.2	↑
Series		35.0
Total		270.0

<p>5 Shots Sight</p>	<p>1. Series 5 Shots</p>	<p>1: 9.3 → 2: 9.4 ↓ 3: 9.1 ← 4: 9.9 ↘ 5: 10.4 ↙</p> <p>Series 46.0 Total 0.0</p>	<p>1: 8.4 ↗ 2: 9.4 ↓ 3: 9.7 ↘ 4: 9.4 ← 5: 7.5 ↗</p> <p>Series 42.0 Total 42.0</p>
----------------------	--------------------------	---	---

<p>2. Series 5 Shots</p>	<p>3. Series 5 Shots</p>	<p>1: 10.3 ↗ 2: *10.6 ↓ 3: 9.9 ← 4: 9.2 → 5: 0.0</p> <p>Series 38.0 Total 80.0</p>	<p>1: 10.2 ↗ 2: 9.8 ← 3: 8.7 ↗ 4: 8.9 ↗ 5: 9.4 ↗</p> <p>Series 44.0 Total 124.0</p>
--------------------------	--------------------------	--	---

<p>Sight</p>	<p>1. Series 5 Shots</p>	<p>1: *10.5 → 2: 8.6 ← 3: 9.3 →</p> <p>Series 27.0 Total 124.0</p>	<p>1: 8.7 → 2: 7.8 ↓ 3: 10.3 ↑ 4: 5.8 ↗ 5: 10.0 ←</p> <p>Series 40.0 Total 164.0</p>
--------------	--------------------------	--	--

<p>2. Series 5 Shots</p>	<p>1: 8.9 ← 2: *10.5 ↓ 3: 9.6 ↘ 4: *10.6 ↗ 5: 9.2 ↗</p> <p>Series 46.0 Total 210.0</p>		
--------------------------	--	--	--

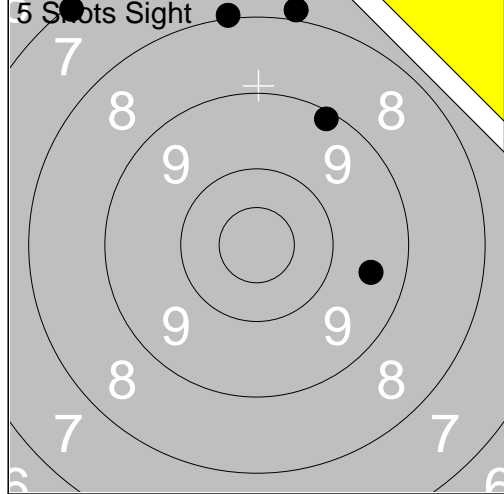

1:	7.9	↑
2:	8.0	↑
3:	9.5	→
4:	9.1	↗
5:	7.1	↗
Series		40.0
Total		0.0

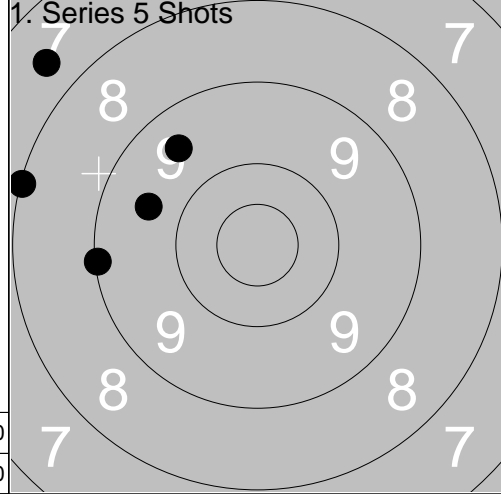

1:	7.6	↖
2:	9.6	↖
3:	9.1	↖
4:	9.5	↗
5:	8.1	↖
Series		42.0
Total		42.0

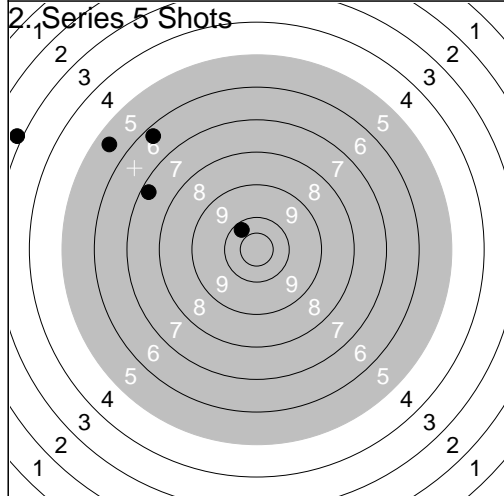

1:	6.3	↖
2:	5.5	↗
3:	7.3	↗
4:	2.9	↗
5:	10.2	↗
Series		30.0
Total		72.0

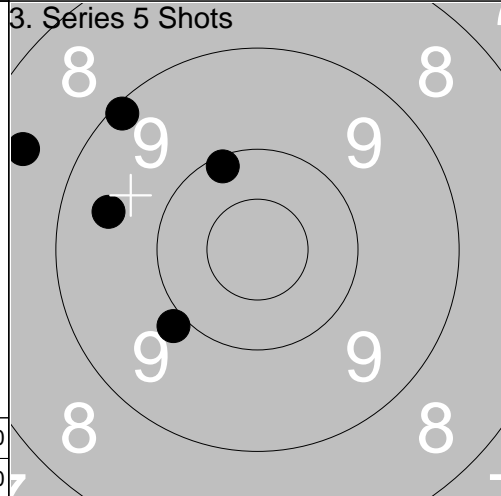

1:	9.5	↖
2:	10.1	↗
3:	9.1	↗
4:	8.5	↖
5:	9.9	↙
Series		45.0
Total		117.0

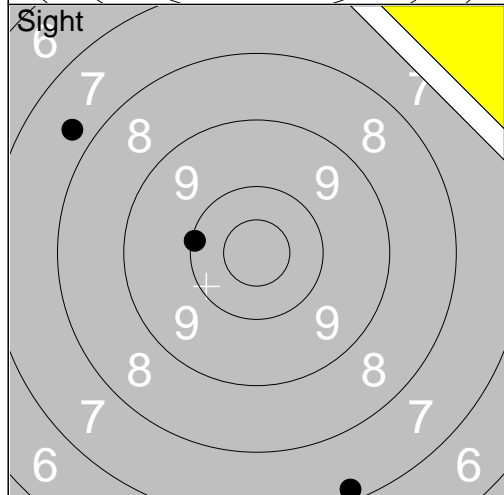

1:	7.2	↘
2:	10.1	↖
3:	7.7	↗
Series		24.0
Total		117.0

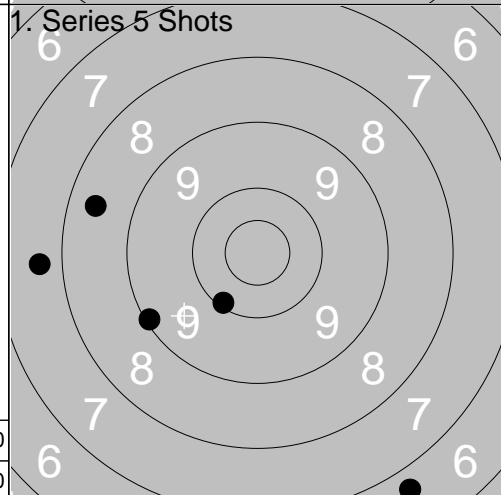

1:	7.7	↖
2:	8.5	↖
3:	10.1	↘
4:	6.7	↘
5:	9.1	↖
Series		40.0
Total		157.0

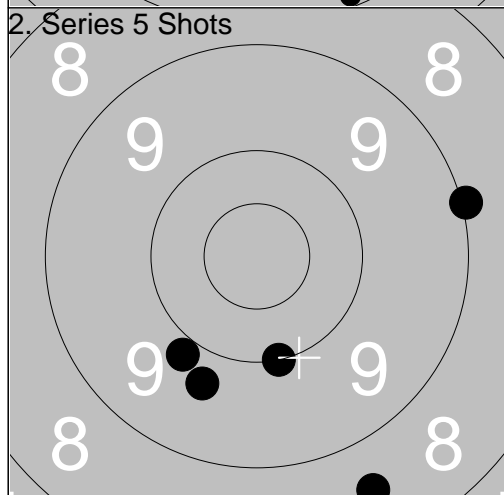

1:	10.0	↘
2:	9.9	↘
3:	8.6	↘
4:	9.0	→
5:	9.7	↘
Series		45.0
Total		202.0

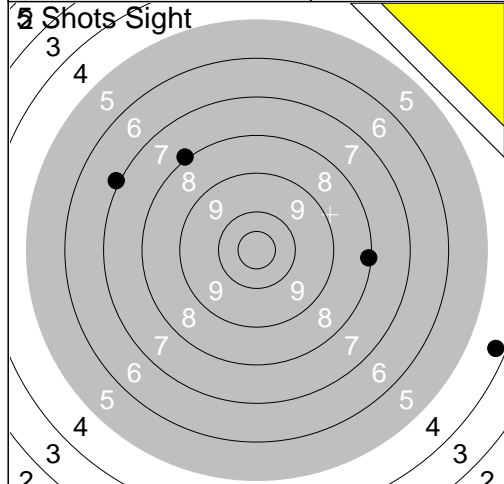

1:	8.1	→
2:	4.3	→
3:	6.9	↗
4:	8.0	↗
5:	4.2	↗
Series		30.0
Total		0.0

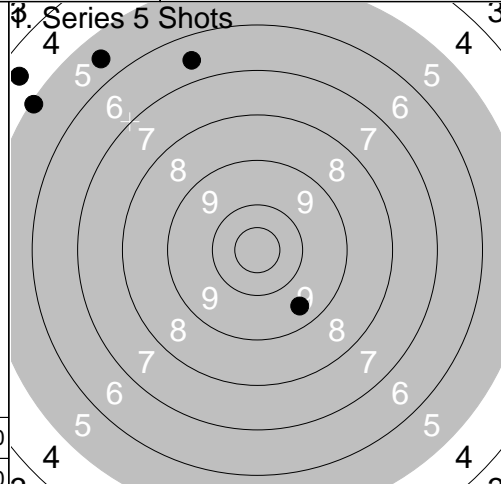

1:	6.6	↗
2:	9.5	↘
3:	5.5	↗
4:	4.5	↗
5:	5.1	↗
Series		29.0
Total		29.0

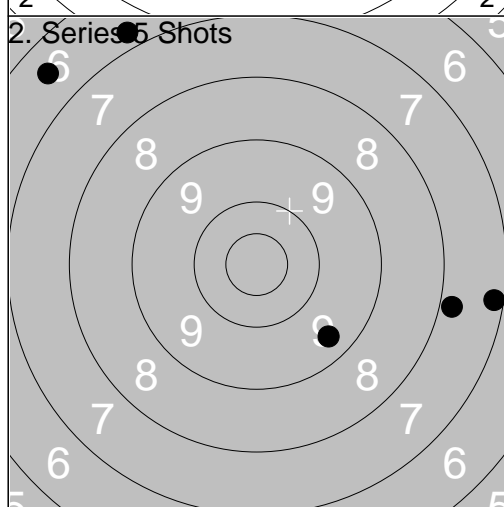

1:	9.4	↘
2:	7.8	→
3:	7.2	→
4:	6.8	↗
5:	6.5	↗
Series		35.0
Total		64.0

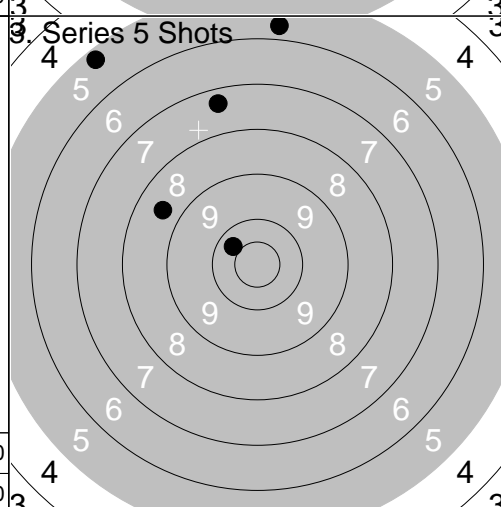

1:	8.6	↖
2:	10.3	↗
3:	5.3	↗
4:	7.4	↗
5:	5.7	↑
Series		35.0
Total		99.0

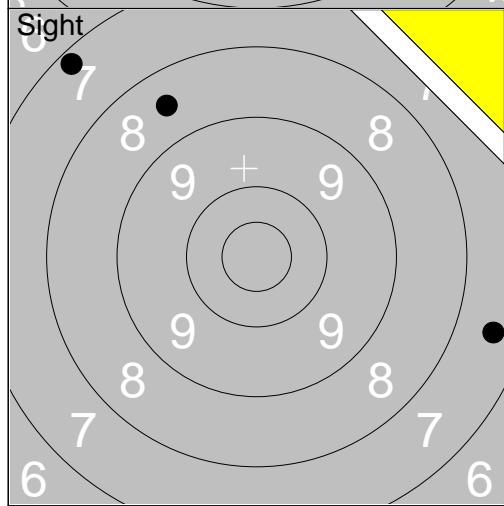

1:	7.5	→
2:	8.5	↗
3:	7.2	↗
Series		22.0
Total		99.0

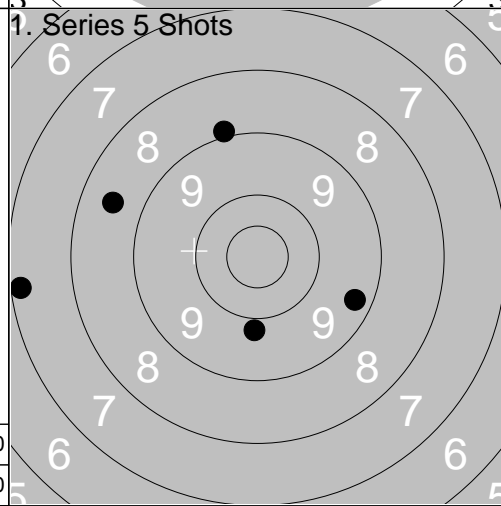

1:	8.9	↑
2:	8.5	↖
3:	9.3	→
4:	7.2	↖
5:	9.8	↘
Series		41.0
Total		140.0

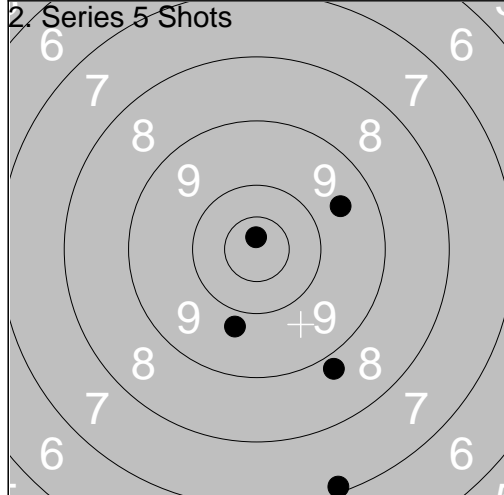

1:	9.8	↘
2:	*10.8	↑
3:	9.6	↗
4:	8.8	↘
5:	7.1	↘
Series		43.0
Total		183.0

<p>4 Shots Sight</p>	<p>1: 8.3 ↗ 2: 10.1 → 3: 9.3 ↑ 4: 6.0 → 5: 8.5 ↓</p>	<p>1. Series 5 Shots</p>	<p>1: 9.6 ↘ 2: 9.3 ↓ 3: 7.2 ↑ 4: 7.4 → 5: 9.4 ↗</p>
Series	41.0	Series	41.0
Total	0.0	Total	41.0

<p>2. Series 5 Shots</p>	<p>1: 9.2 → 2: 8.8 ← 3: 7.3 ← 4: *10.8 ↓ 5: 4.5 ↓</p>	<p>3. Series 5 Shots</p>	<p>1: 8.7 ↑ 2: 8.4 → 3: 8.8 ↓ 4: 8.5 ↑ 5: 10.0 ↓</p>
Series	38.0	Series	42.0
Total	79.0	Total	121.0

<p>Sight</p>	<p>1: 10.4 ↗ 2: 9.0 ↗ 3: 9.6 ↗</p>	<p>1. Series 5 Shots</p>	<p>1: 8.9 ↑ 2: 9.4 ← 3: 9.9 ↓ 4: 10.4 ← 5: 9.7 ↓</p>
Series	28.0	Series	45.0
Total	121.0	Total	166.0

<p>2. Series 5 Shots</p>	<p>1: 9.2 ↗ 2: 7.9 ↘ 3: 8.9 ↓ 4: *10.7 ↓ 5: 7.5 ↓</p>		
Series	41.0		
Total	207.0		

<p>5 Shots Sight</p>	<p>1: 1.0 ↑</p> <p>2: 0.0 ↑</p> <p>3: 0.0</p> <p>4: 0.0</p> <p>5: 0.0 ↑</p>	<p>1. Series 5 Shots</p>	<p>1: 0.0</p> <p>2: 0.0</p> <p>3: 0.0</p> <p>4: 0.0</p> <p>5: 0.0 ↑</p>
Series 1.0	Total 0.0	Series 0.0	Total 0.0

<p>2. Series 5 Shots</p>	<p>1: 8.2 ↓</p> <p>2: 3.3 ↓</p> <p>3: 4.5 ↙</p> <p>4: 2.8 ↓</p> <p>5: 0.0</p>	<p>3. Series 5 Shots</p>	<p>1: 7.8 ↓</p> <p>2: 2.4 ↓</p> <p>3: 0.0 ↓</p> <p>4: 1.2 ←</p> <p>5: 0.0</p>
Series 17.0	Total 17.0	Series 10.0	Total 27.0

<p>3. Series 5 Shots</p>	<p>1: 8.0 ↗</p> <p>2: 6.1 ↓</p>	<p>4. Series 5 Shots</p>	<p>1: 4.4 ↘</p> <p>2: 8.7 ↗</p> <p>3: 0.0</p> <p>4: 0.0</p> <p>5: 0.0</p>
Series 14.0	Total 27.0	Series 12.0	Total 39.0

<p>2. Series 5 Shots</p>	<p>1: 2.5 ↓</p> <p>2: 0.0 ↓</p> <p>3: 3.5 ↓</p> <p>4: 2.3 ↓</p> <p>5: 0.0</p>		
Series 7.0	Total 46.0		

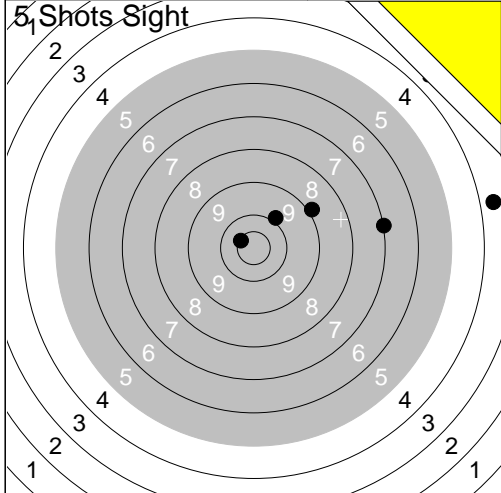

1:	3.6	→
2:	8.9	↗
3:	9.9	↗
4:	7.0	→
5:	*10.5	↖
Series		37.0
Total		0.0

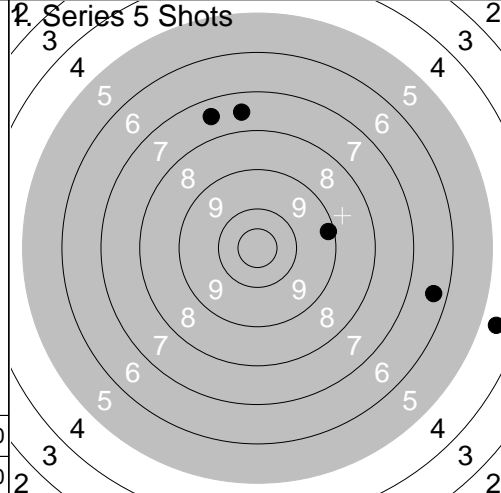

1:	6.4	→
2:	9.2	→
3:	7.5	↗
4:	7.5	↗
5:	4.6	→
Series		33.0
Total		33.0

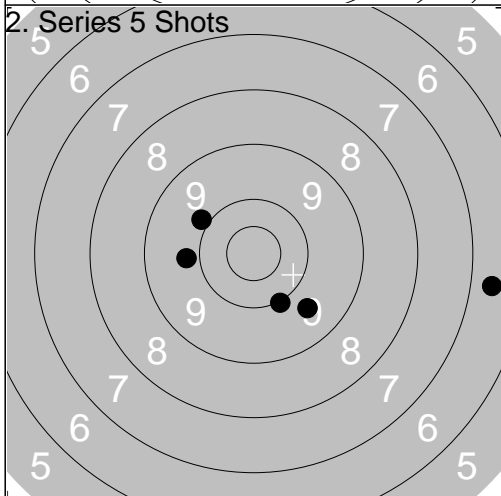

1:	6.6	→
2:	9.6	↘
3:	9.9	↗
4:	10.0	↘
5:	9.8	←
Series		43.0
Total		76.0

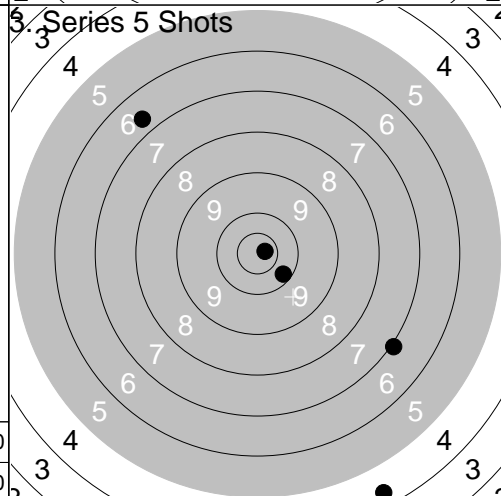

1:	6.7	↗
2:	10.2	↘
3:	*10.8	→
4:	7.0	↘
5:	4.4	↘
Series		37.0
Total		113.0

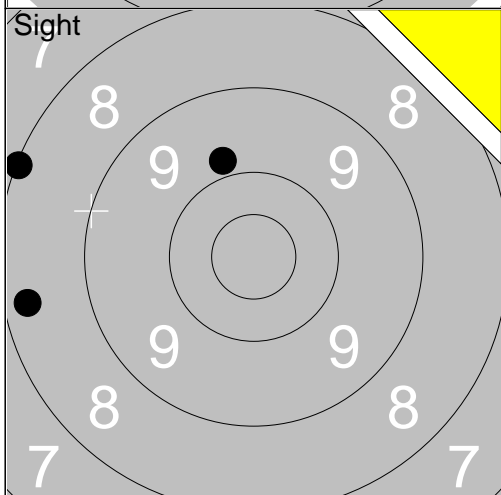

1:	9.8	↖
2:	8.3	←
3:	8.1	←
Series		25.0
Total		113.0

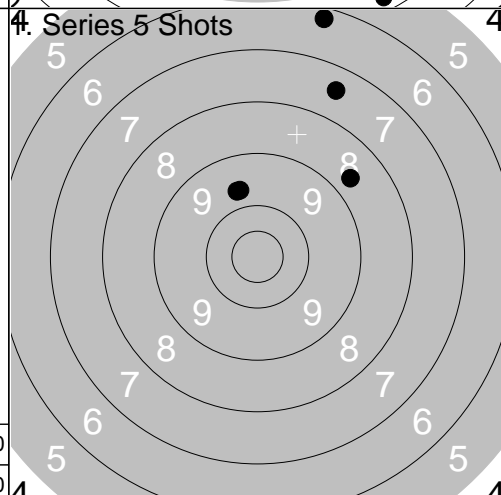

1:	6.3	↖
2:	7.5	↖
3:	9.7	↖
4:	8.7	↗
5:	9.7	↖
Series		39.0
Total		152.0

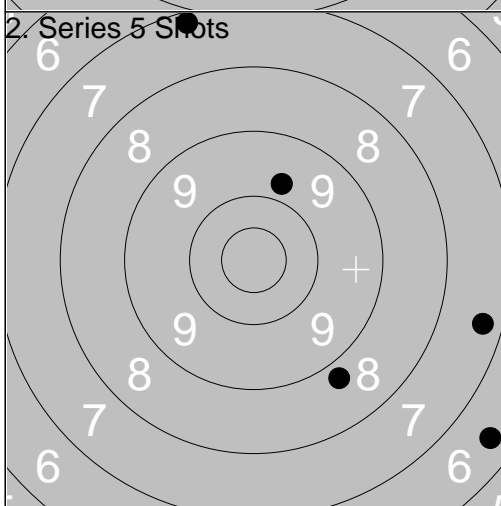

1:	6.4	↘
2:	9.8	↖
3:	8.8	↘
4:	7.2	↖
5:	7.3	↘
Series		37.0
Total		189.0

Series		33.0
Total		33.0

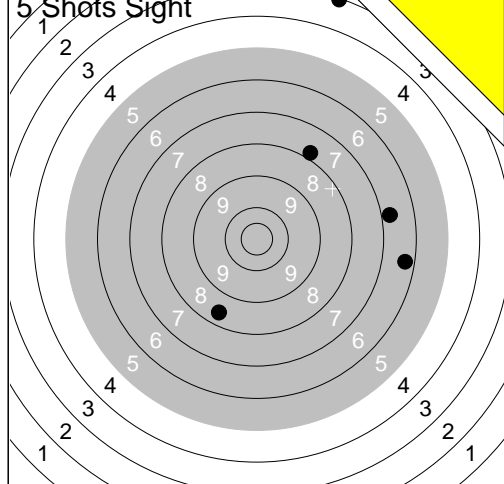

1:	9.9	↑
2:	10.1	↗
3:	7.5	↗
4:	9.6	←
5:	4.8	↘
Series	39.0	
Total	39.0	

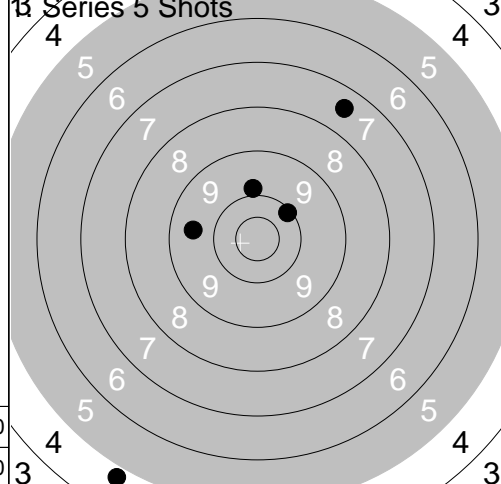

1:	7.5	↘
2:	8.4	↗
3:	7.4	↗
4:	9.9	↘
5:	8.9	↘
Series	39.0	
Total	117.0	

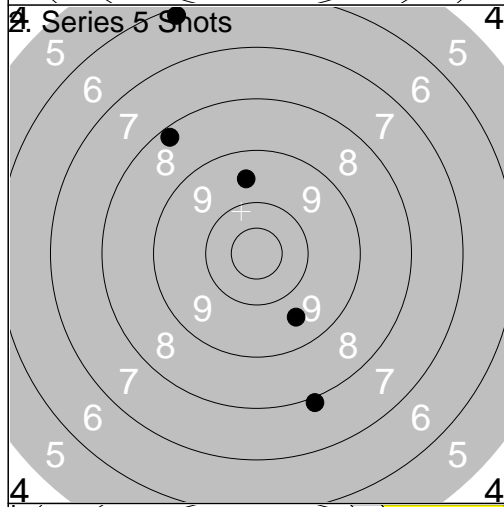

1:	6.6	←
2:	9.4	↗
3:	8.0	↗
4:	6.7	↘
5:	8.3	↗
Series	37.0	
Total	154.0	

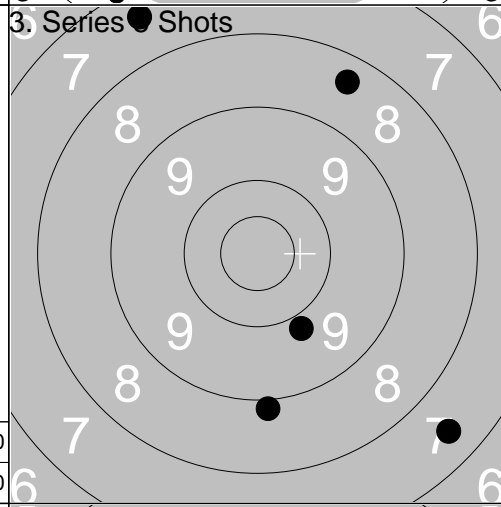

1:	9.3	↗
2:	8.6	↗
3:	9.3	→
4:	7.5	↘
5:	8.4	↗
Series	41.0	
Total	195.0	

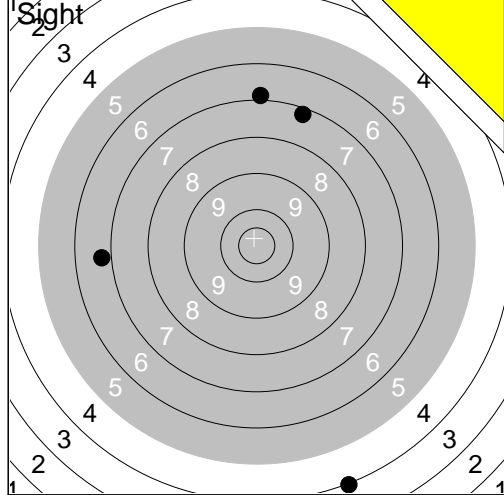

1:	9.3	↗
2:	8.6	↗
3:	9.3	→
4:	7.5	↘
5:	8.4	↗
Series	41.0	
Total	195.0	

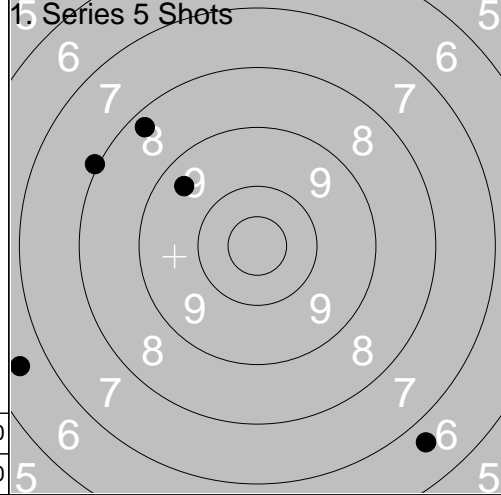

1:	9.3	↗
2:	8.6	↗
3:	9.3	→
4:	7.5	↘
5:	8.4	↗
Series	41.0	
Total	195.0	

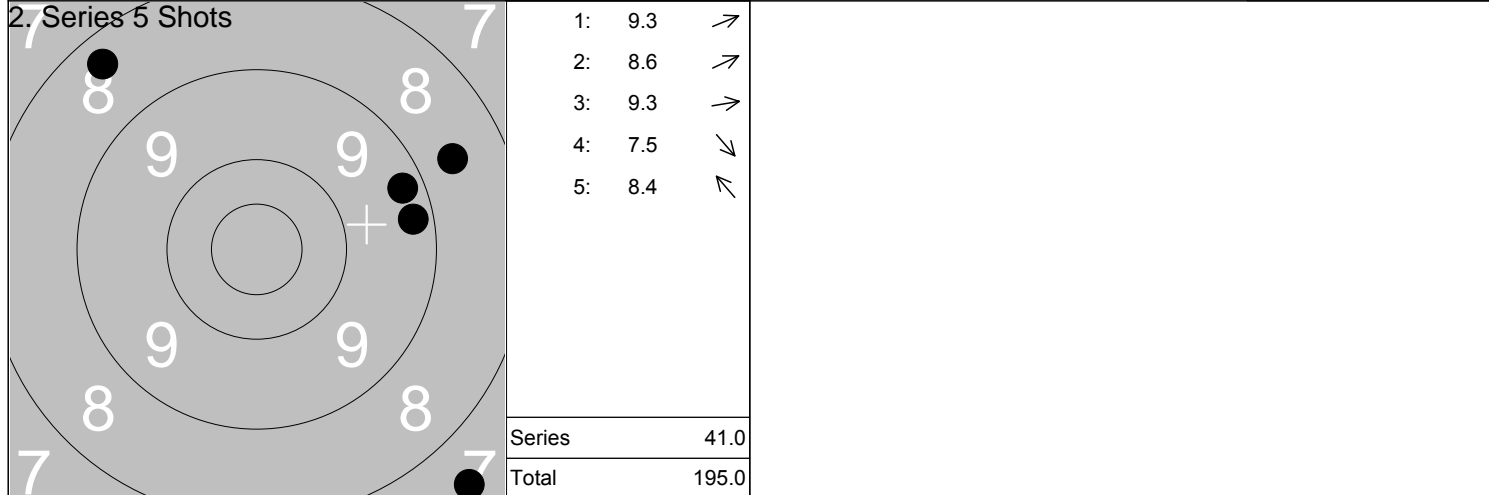



1:	8.7	↑
2:	8.3	↓
3:	5.6	↗
4:	5.0	↗
5:	9.4	↑
Series		35.0
Total		0.0

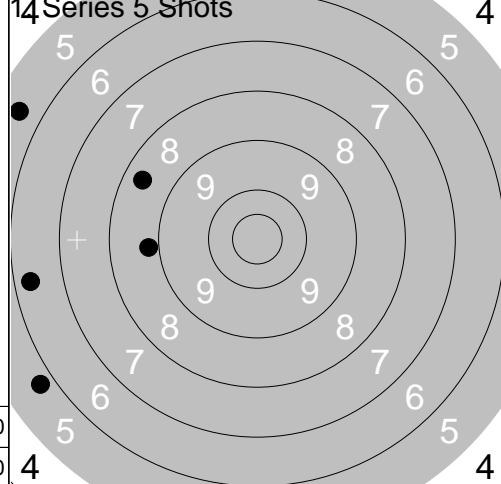

1:	6.4	←
2:	8.8	←
3:	5.7	↙
4:	5.6	↗
5:	8.4	↗
Series		32.0
Total		32.0

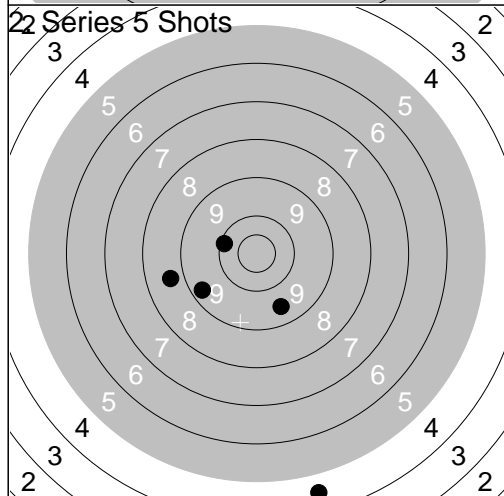

1:	9.3	←
2:	9.5	↓
3:	8.7	←
4:	4.5	↓
5:	10.1	←
Series		40.0
Total		72.0

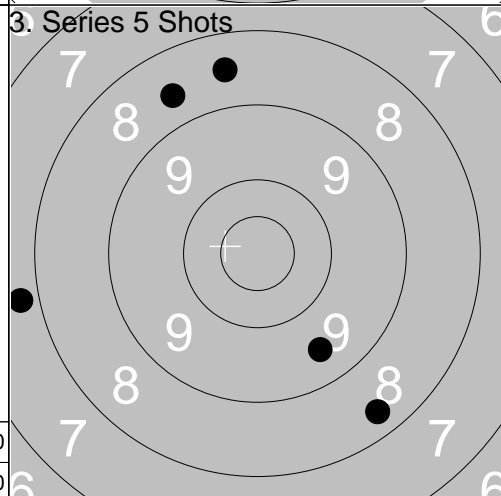

1:	8.6	↗
2:	9.5	↘
3:	8.5	↑
4:	7.8	←
5:	8.4	↘
Series		40.0
Total		112.0

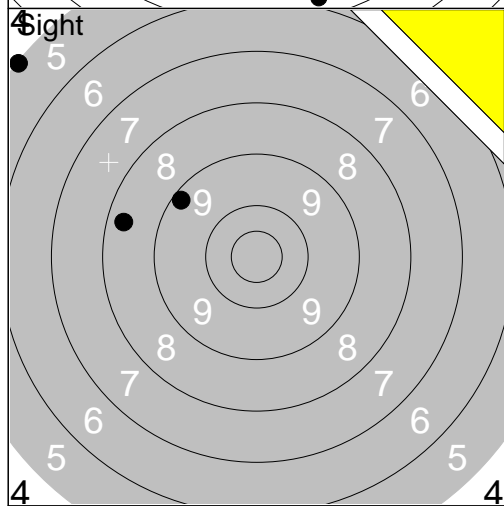

1:	5.1	↗
2:	8.3	←
3:	9.2	↗
Series		22.0
Total		112.0

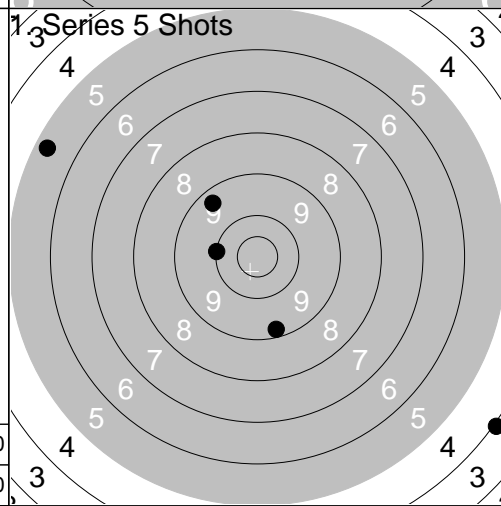

1:	9.3	↗
2:	5.3	←
3:	4.0	↘
4:	10.0	←
5:	9.2	↓
Series		37.0
Total		149.0

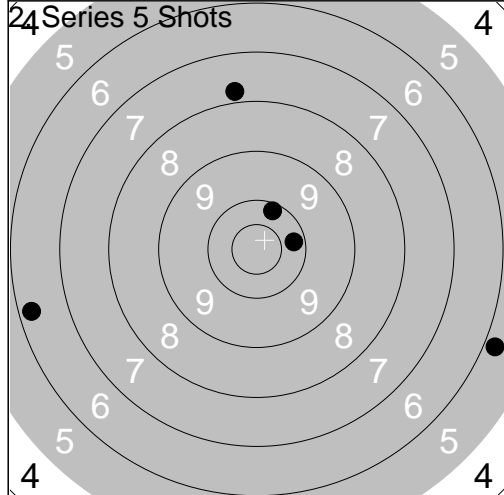

1:	10.2	→
2:	6.3	←
3:	7.8	↑
4:	10.2	↗
5:	5.8	↘
Series		38.0
Total		187.0

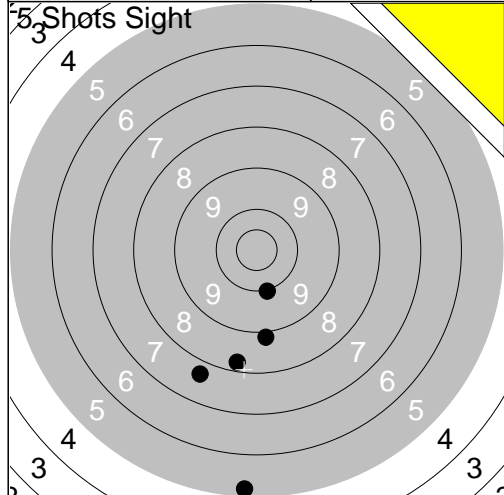

1:	8.3	↓
2:	7.7	↓
3:	10.0	↓
4:	8.9	↓
5:	5.2	↓
Series		38.0
Total		0.0

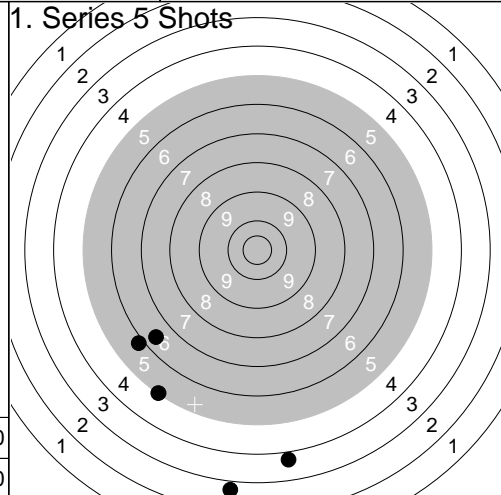

1:	5.9	↙
2:	3.8	↓
3:	6.4	↙
4:	2.7	↓
5:	5.0	↓
Series		21.0
Total		21.0

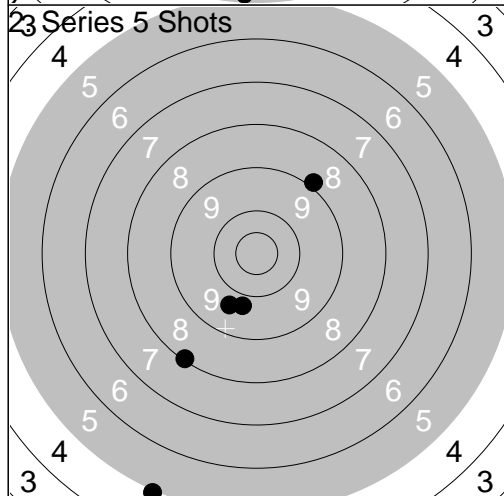

1:	8.9	↗
2:	5.0	↓
3:	8.1	↓
4:	9.8	↓
5:	9.7	↓
Series		39.0
Total		60.0

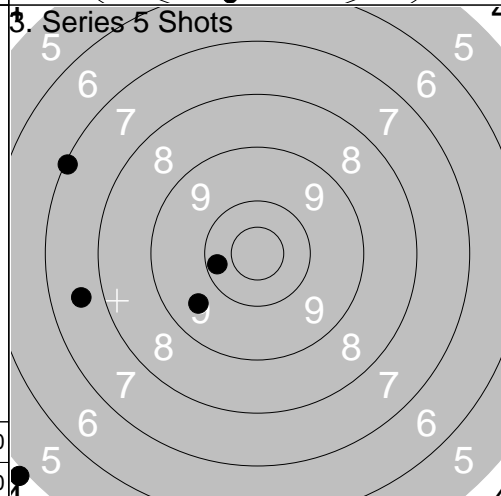

1:	7.6	←
2:	4.9	↙
3:	9.6	↙
4:	10.2	←
5:	7.1	↙
Series		37.0
Total		97.0

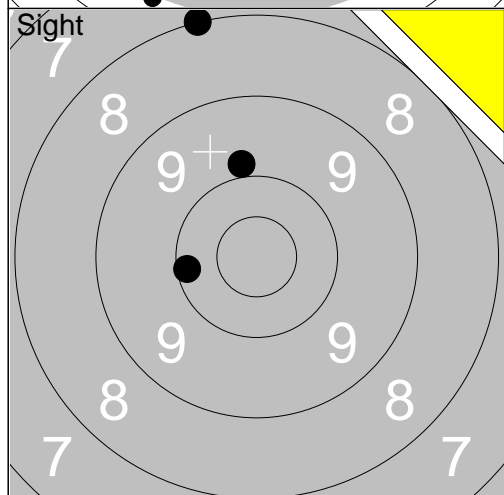

1:	10.1	←
2:	8.0	↑
3:	9.9	↑
Series		27.0
Total		97.0

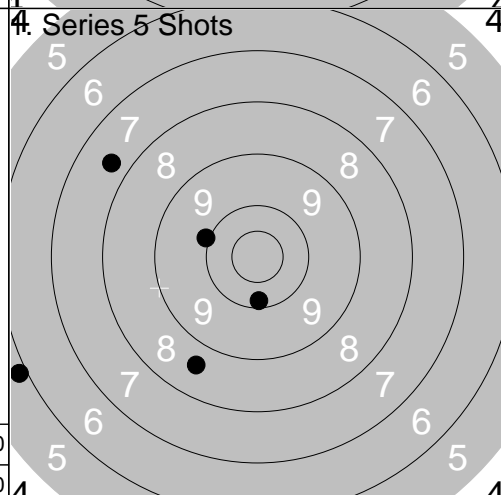

1:	7.7	↖
2:	10.0	←
3:	5.9	↙
4:	10.2	↓
5:	8.6	↓
Series		40.0
Total		137.0

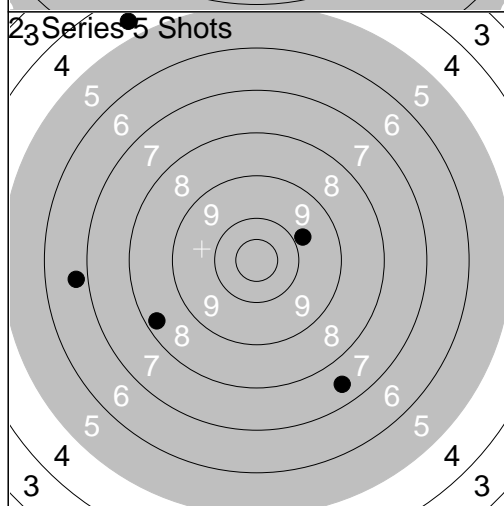

1:	9.8	↗
2:	6.7	←
3:	7.5	↓
4:	4.6	↗
5:	8.3	↙
Series		34.0
Total		171.0