

1: 8.7 ↙	Series 26.0
2: 8.7 ↗	
3: 10.3 ↙	
Total 142.0	

1: *10.6 ↘	Series 46.0
2: 9.3 ↗	
3: 9.3 ↖	
4: 10.2 ↙	Total 188.0
5: 8.6 ↖	

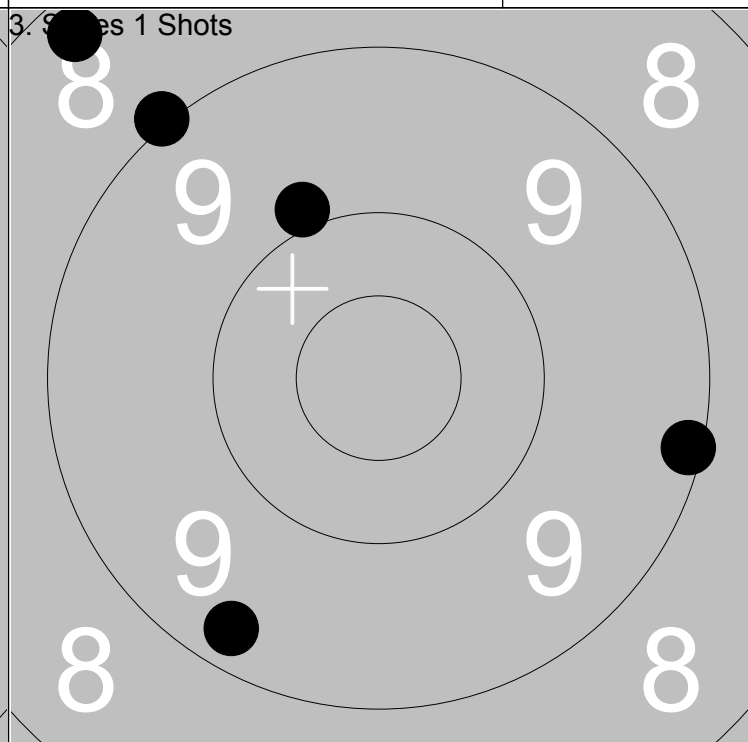
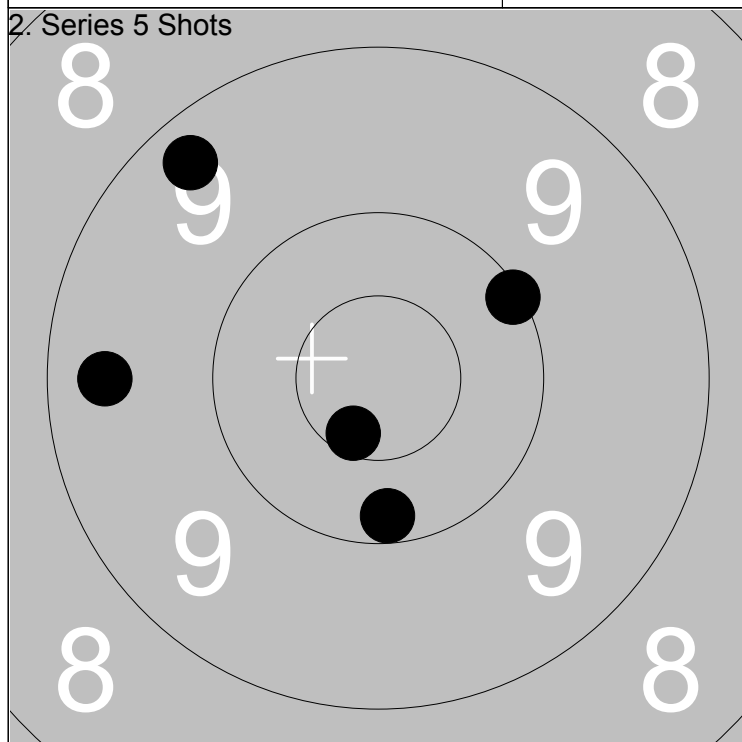

1: *10.6 ↘	Series 48.0
2: 9.3 ↖	
3: 10.2 ↓	
4: 9.4 ←	Total 236.0
5: 10.1 ↗	

1: 9.0 ↗	Series 44.0
2: 9.9 ↗	
3: 8.3 ↗	
4: 9.3 ↙	Total 280.0
5: 9.1 ↘	

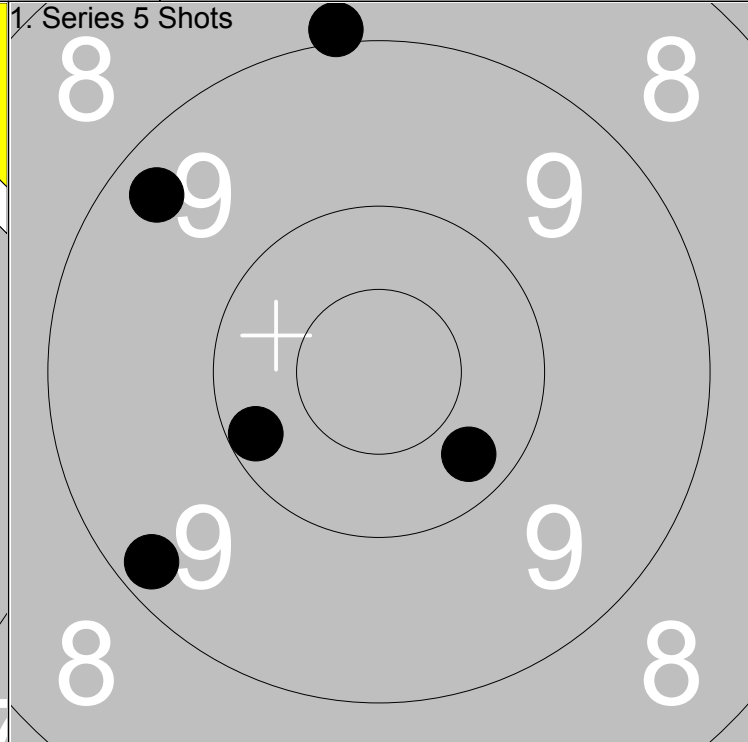
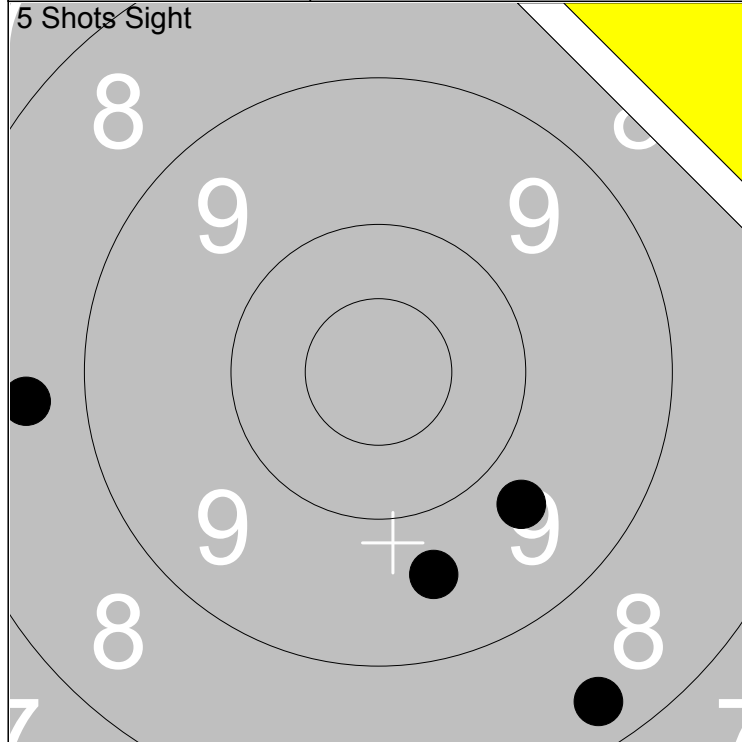

1: 8.3 ↓	Series	34.0
2: 8.6 ←		
3: 9.7 ↓		
4: 9.6 ↓		
Total		139.0

1: 9.2 ↙	Series	46.0
2: 9.3 ↖		
3: 10.3 ↓		
4: 8.9 ↑		
5: 10.2 ↙		
Total		185.0

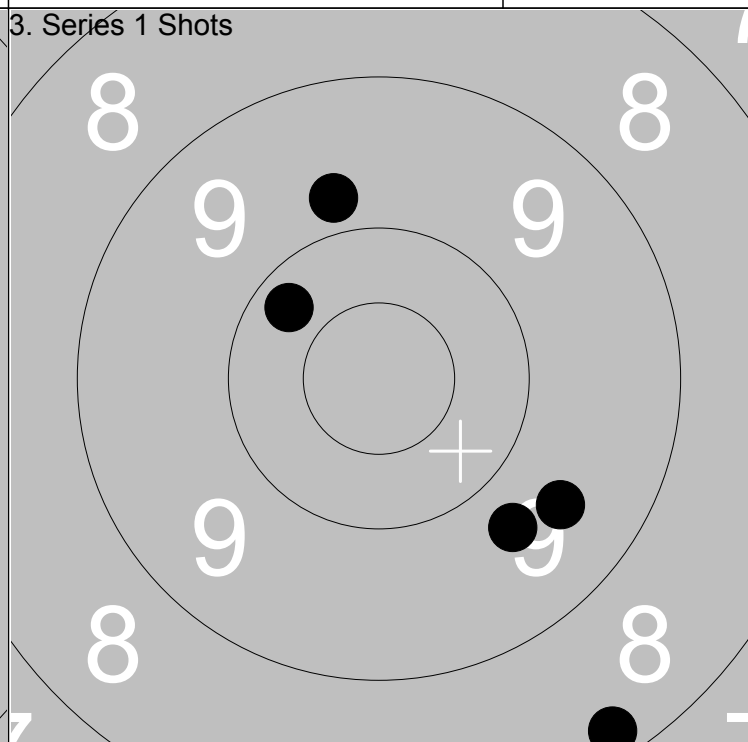
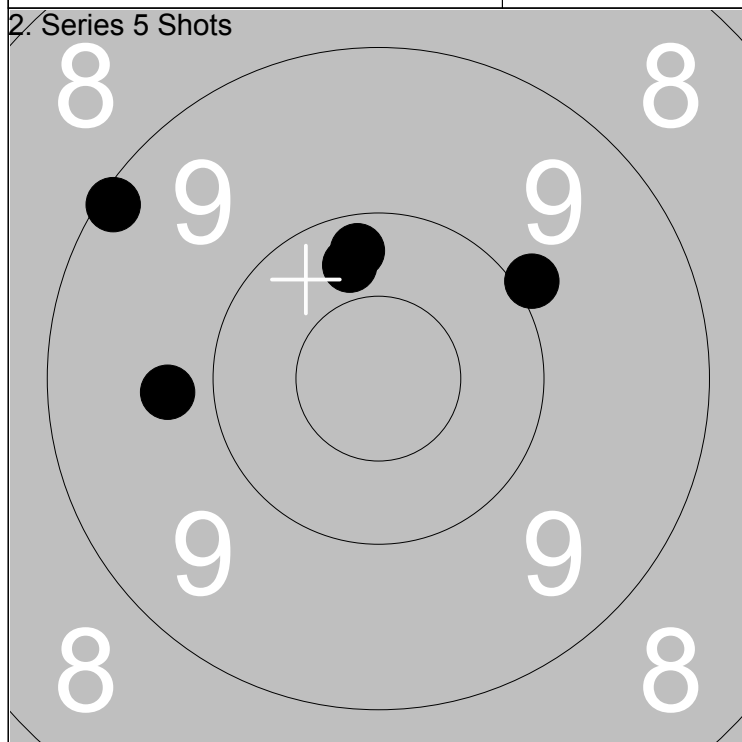

1: 9.8 ←	Series	47.0
2: 10.3 ↑		
3: 9.1 ↖		
4: 10.2 ↑		
5: 9.9 ↗		
Total		232.0

1: 8.2 ↓	Series	45.0
2: 10.2 ↗		
3: 9.7 ↓		
4: 9.8 ↑		
5: 9.6 ↓		
Total		277.0

Relay 4	Lane 3	Leif Sigfridsson	
-------------------	------------------	-------------------------	--

300m	Ramselefors	E	Vb
------	-------------	---	----

06.07.2014	Tavelträffen 2014	Ramselefors SKF	
------------	-------------------	-----------------	--

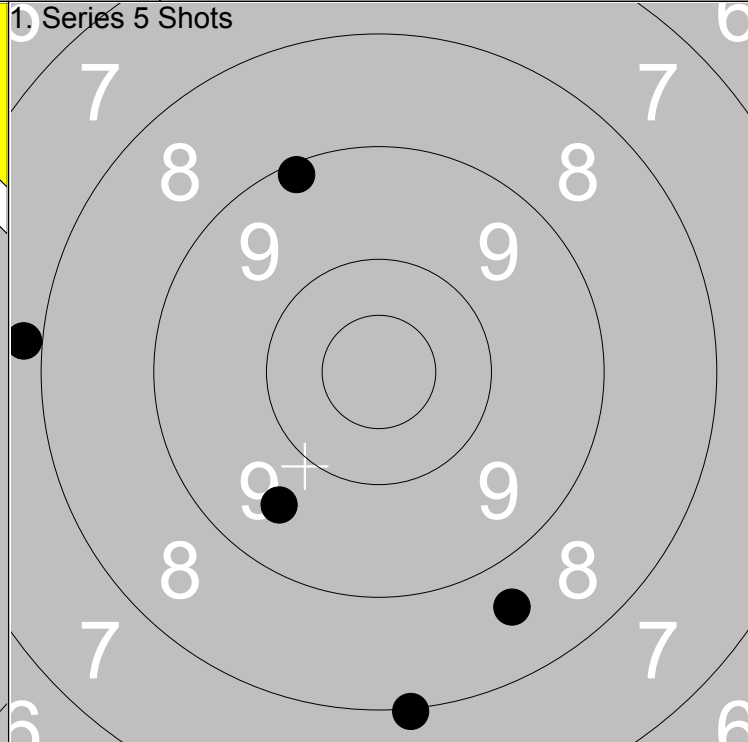
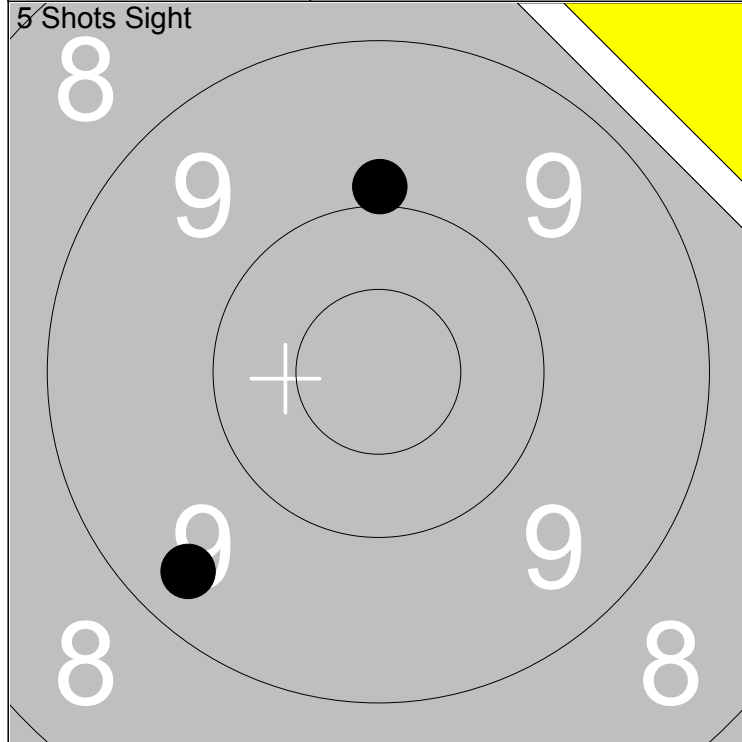

1: 9.9 ↑	Series	18.0
2: 9.4 ↙		
Total		136.0

1: 9.1 ↖	Series	41.0
2: 8.6 ↘		
3: 7.9 ←	Total	177.0
4: 9.6 ↙		
5: 8.0 ↓		

1: 9.1 ↖	Series	41.0
2: 8.6 ↘		
3: 7.9 ←	Total	177.0
4: 9.6 ↙		
5: 8.0 ↓		

1: 9.1 ↖	Series	41.0
2: 8.6 ↘		
3: 7.9 ←	Total	177.0
4: 9.6 ↙		
5: 8.0 ↓		

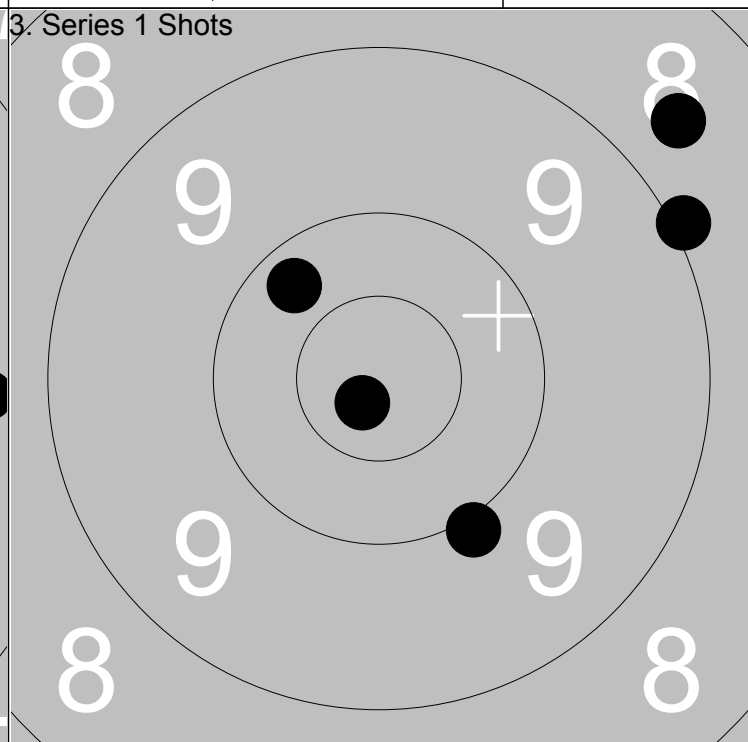
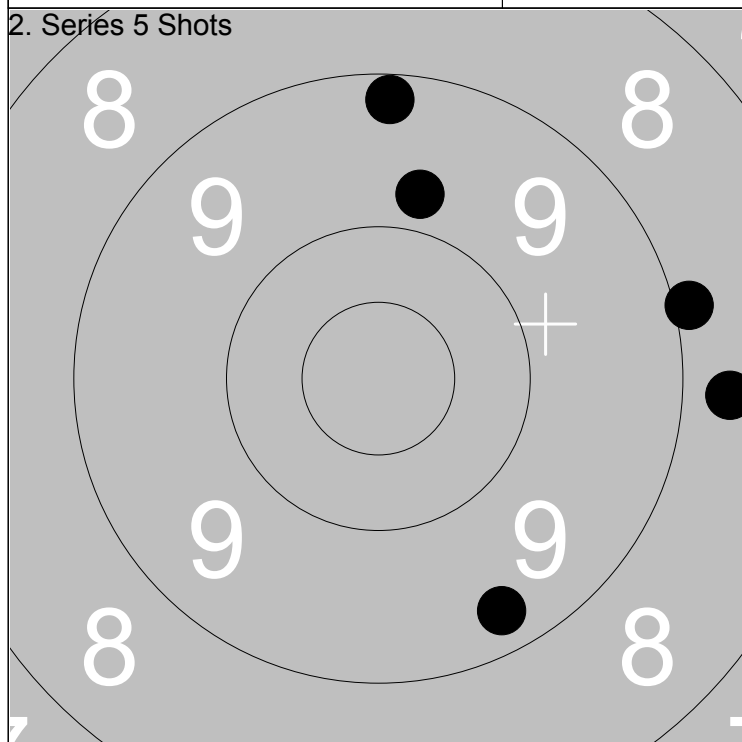

1: 9.8 ↑	Series	43.0
2: 8.9 →		
3: 9.2 ↑	Total	220.0
4: 8.7 →		
5: 9.3 ↘		

1: 8.6 ↗	Series	47.0
2: 9.0 →		
3: 10.0 ↓	Total	267.0
4: *10.8 ↙		
5: 10.2 ↖		

1: 8.6 ↗	Series	47.0
2: 9.0 →		
3: 10.0 ↓	Total	267.0
4: *10.8 ↙		
5: 10.2 ↖		

1: 8.6 ↗	Series	47.0
2: 9.0 →		
3: 10.0 ↓	Total	267.0
4: *10.8 ↙		
5: 10.2 ↖		

Relay 4	Lane 4	Emil Björndahl	
-------------------	------------------	-----------------------	--

300m	Kvistbro	E	Ör
------	----------	---	----

06.07.2014	Tavelträffen 2014	Ramselefors SKF
------------	-------------------	-----------------

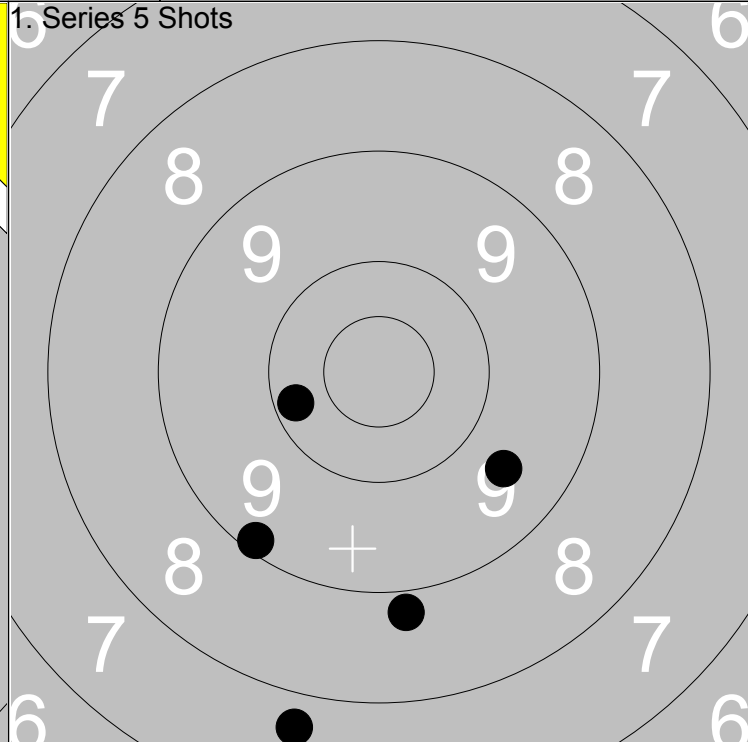
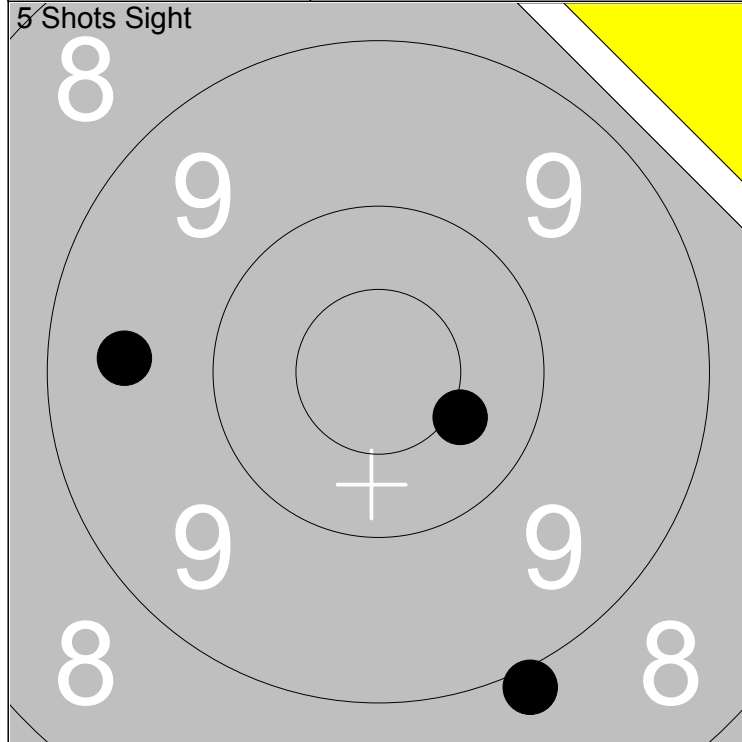

1: 8.9 ↘	Series	27.0
2: *10.4 ↘		
3: 9.5 ←		
Total		136.0

1: 9.6 ↘	Series	43.0
2: 8.8 ↘		
3: 7.7 ↘		
4: 9.1 ↘		
5: 10.2 ↙		
Total		179.0

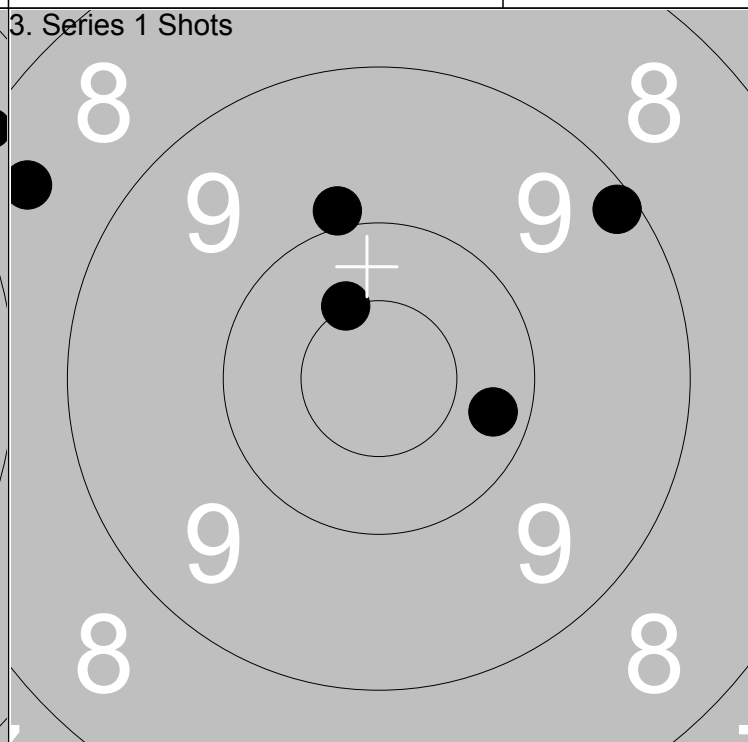
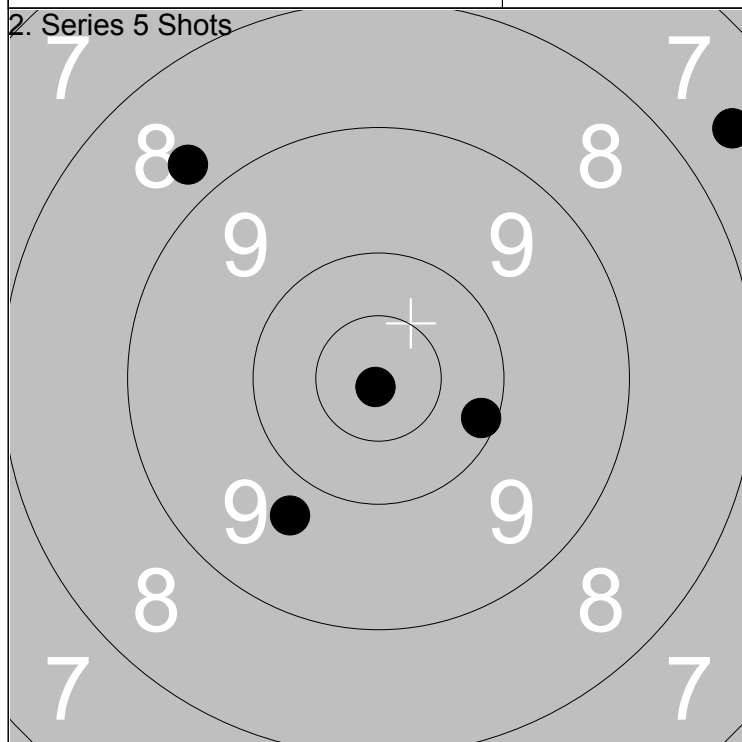

1: 10.1 →	Series	44.0
2: 9.7 ↘		
3: 7.6 ↗		
4: 8.7 ↖		
5: *10.9 ↘		
Total		223.0

1: 9.9 ↑	Series	46.0
2: 8.5 ↖		
3: *10.5 ↖		
4: 9.2 ↗		
5: 10.2 →		
Total		269.0

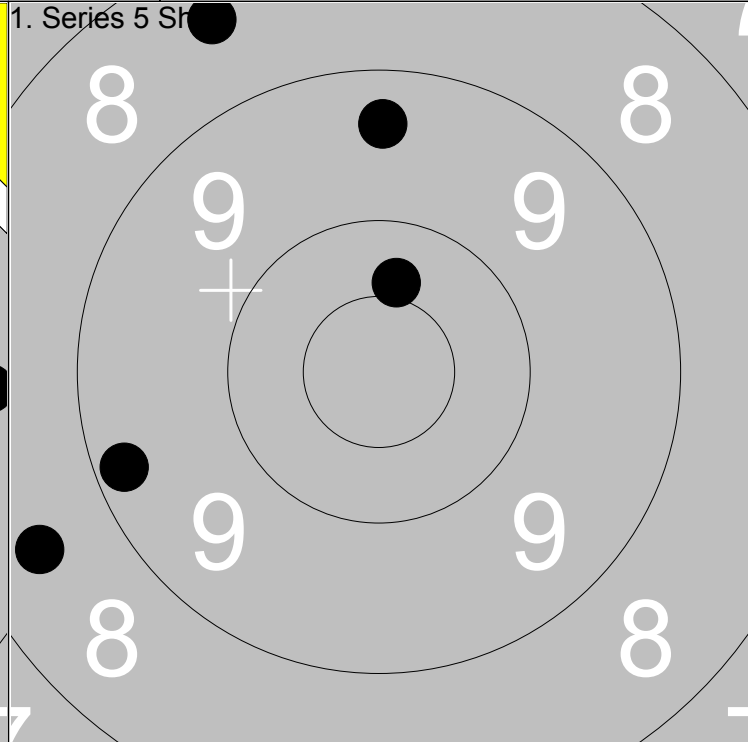
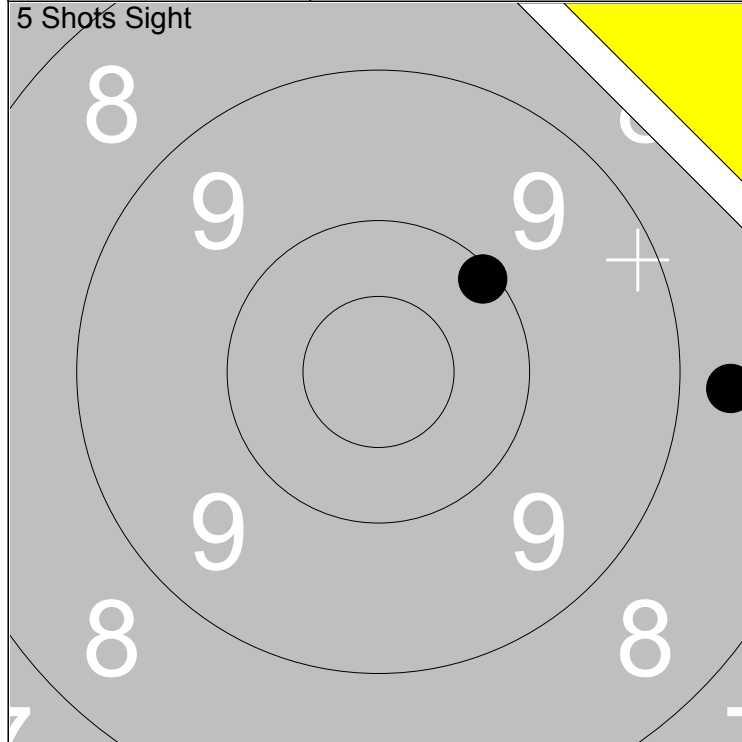

1: 8.2 ↗	Series	26.0
2: 8.7 →		
3: 10.1 ↗		
Total		134.0

1: 8.4 ↖	Series	44.0
2: 10.4 ↑		
3: 8.5 ↙		
Total		178.0

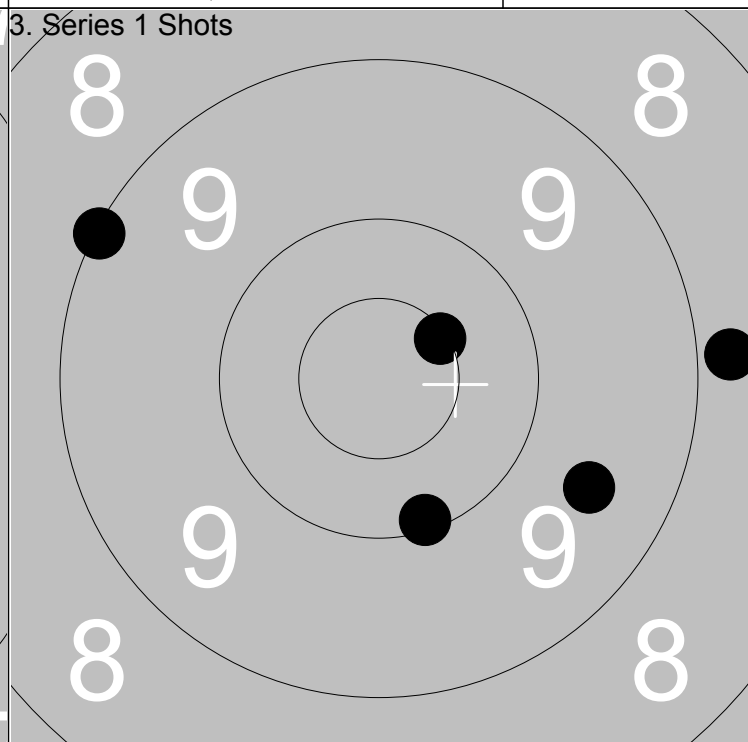
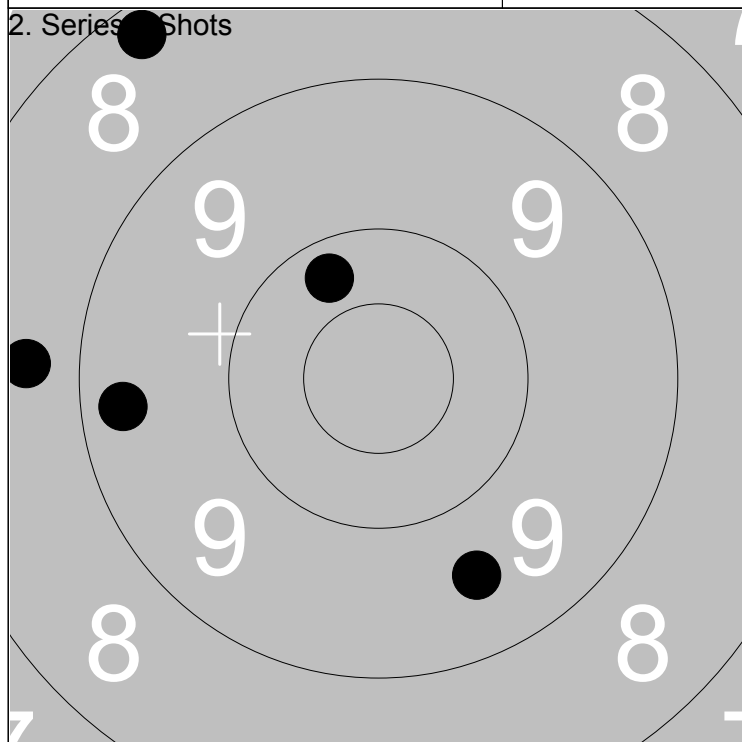

1: 8.2 ↗	Series	44.0
2: 10.3 ↗		
3: 9.6 ↘		
Total		222.0

1: 9.1 ↖	Series	46.0
2: *10.5 ↗		
3: 8.8 →		
Total		268.0

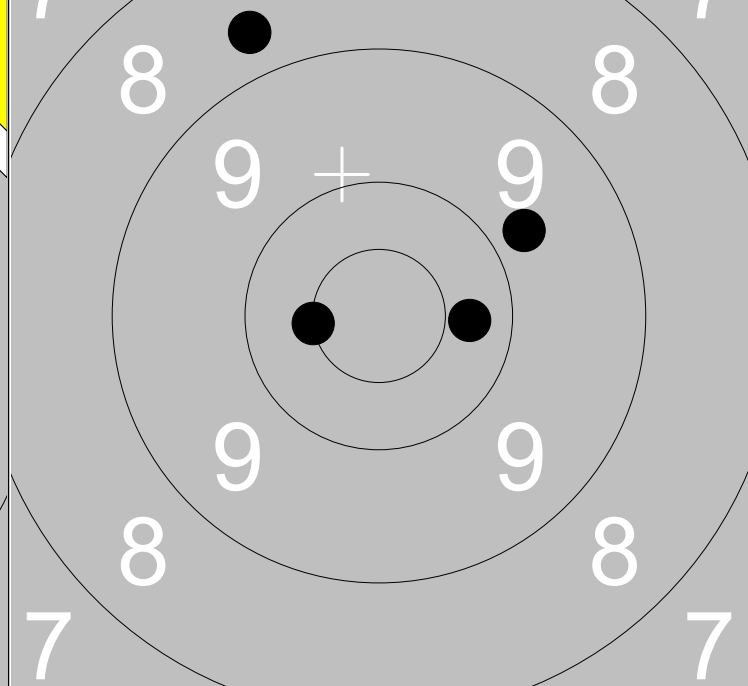
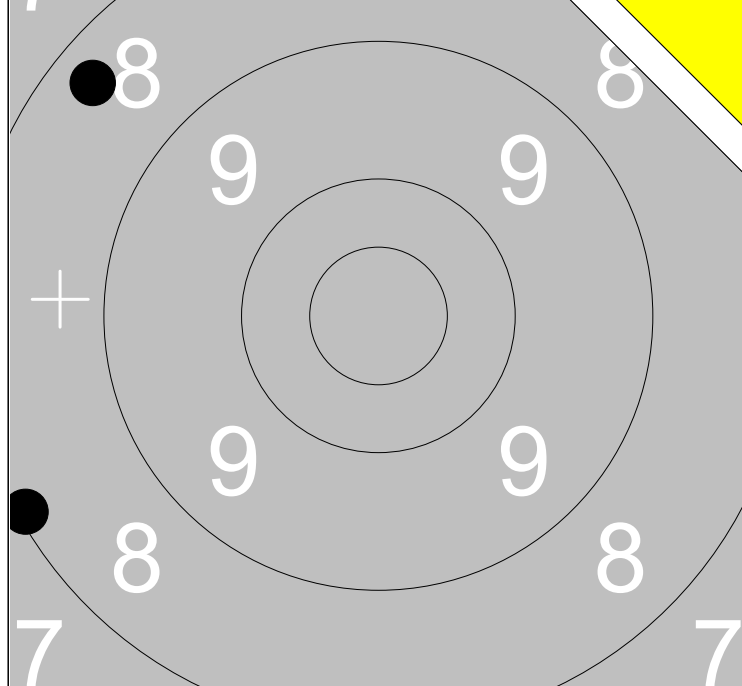

1: 8.1 ↙	Series	16.0
2: 8.3 ↖		
Total		120.0

1: 8.7 ↗	Series	44.0
2: 10.3 →		
3: 9.8 ↗		
4: *10.5 ↙		
5: 7.9 ↖		
Total		164.0

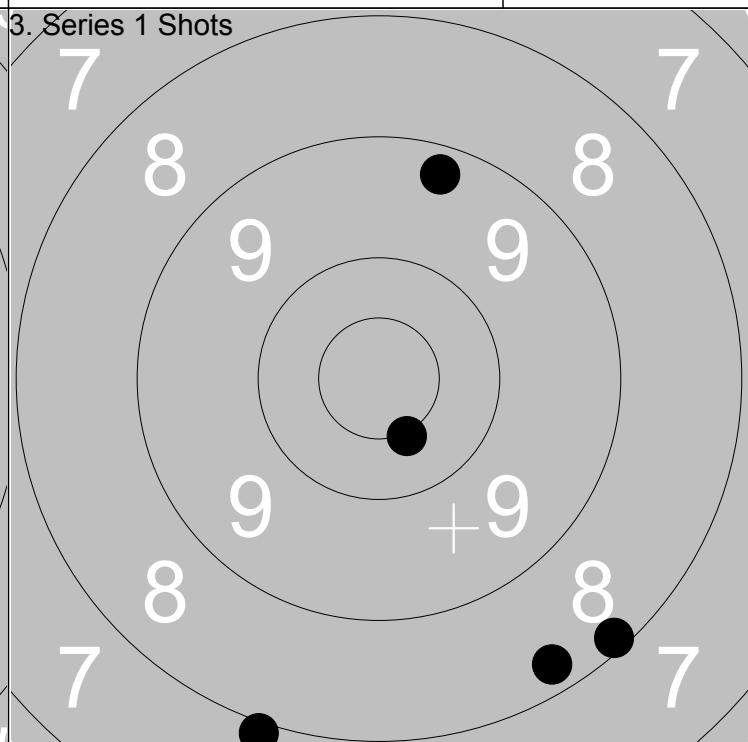
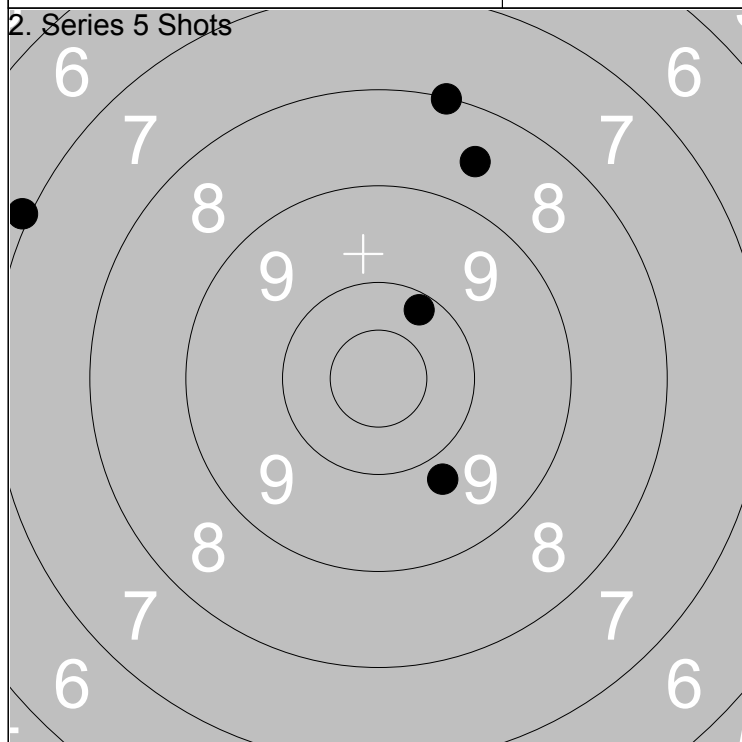

1: 6.9 ↙	Series	41.0
2: 8.6 ↗		
3: 8.0 ↗		
4: 9.8 ↘		
5: 10.2 ↗		
Total		205.0

1: *10.5 ↘	Series	42.0
2: 7.9 ↘		
3: 9.3 ↗		
4: 8.3 ↘		
5: 8.1 ↘		
Total		247.0

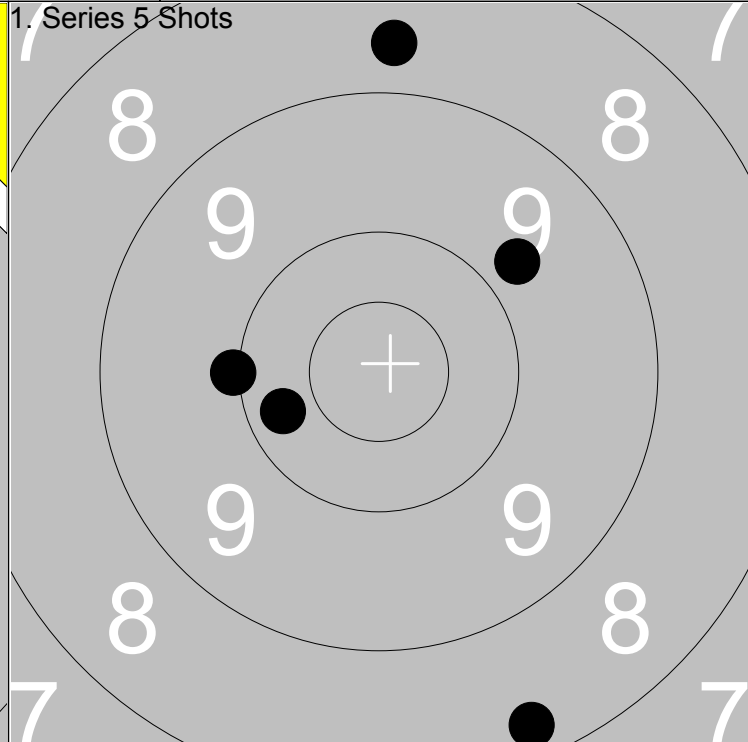
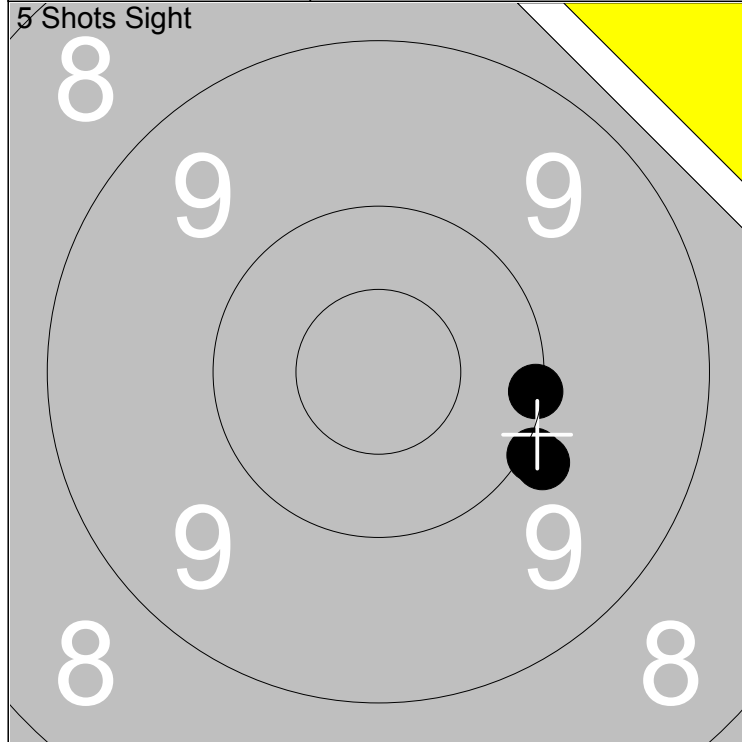

1: 10.1 →	Series	29.0
2: 10.0 ↘		
3: 9.9 ↘		
Total		143.0

1: 10.3 ←	Series	45.0
2: 10.0 ←		
3: 9.8 ↗		
Total		188.0

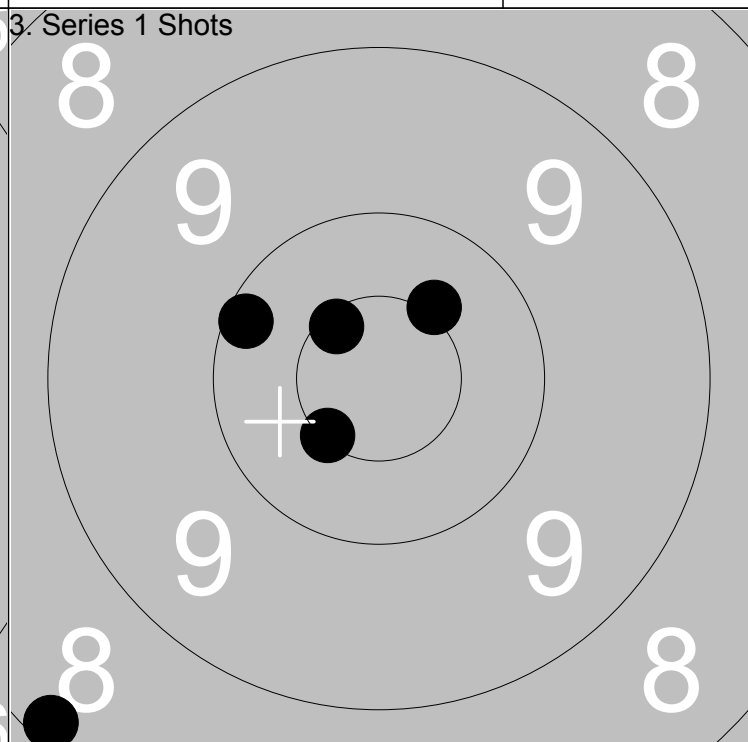
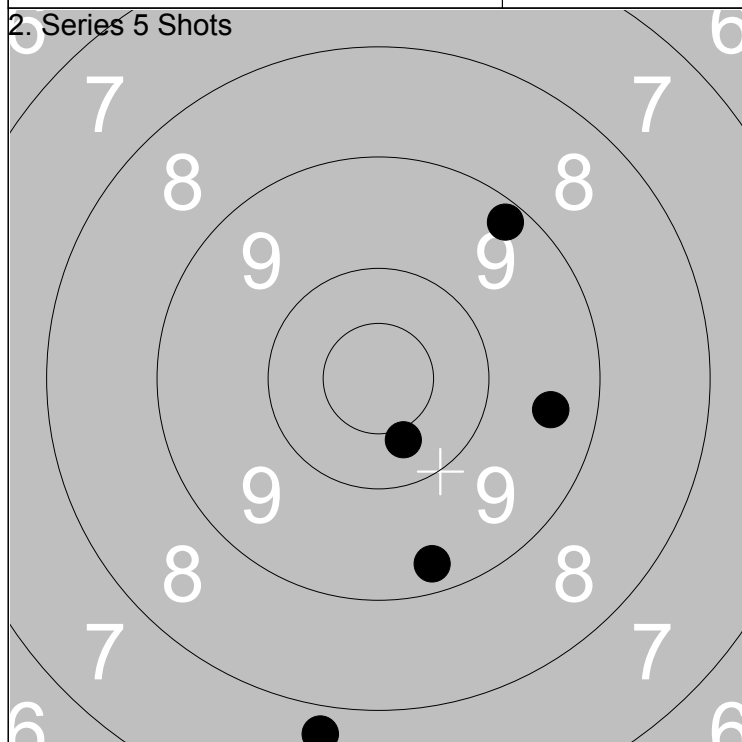

1: 9.2 ↗	Series	44.0
2: 9.4 →		
3: 10.4 ↓		
Total		232.0

1: *10.6 ↖	Series	48.0
2: *10.4 ↗		
3: 10.1 ↖		
Total		280.0

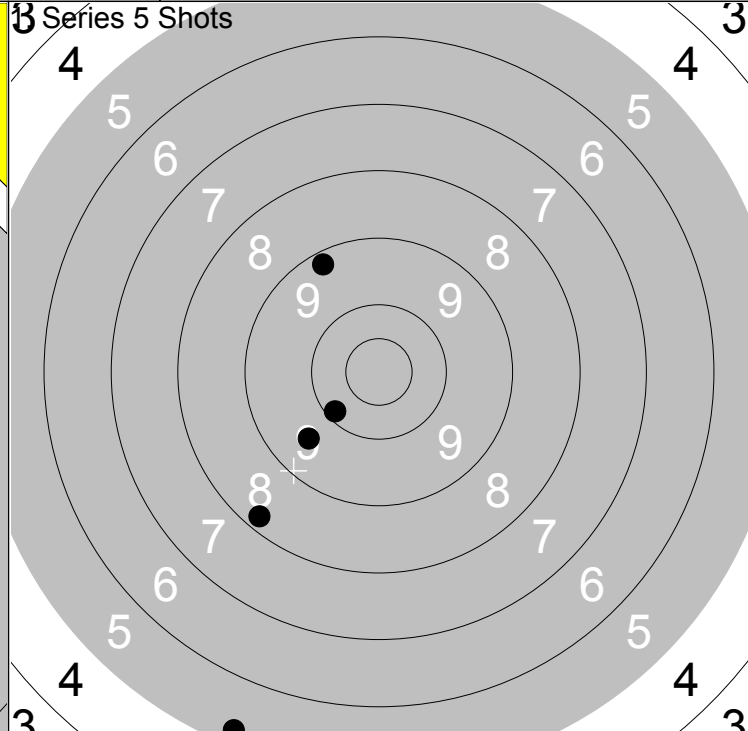
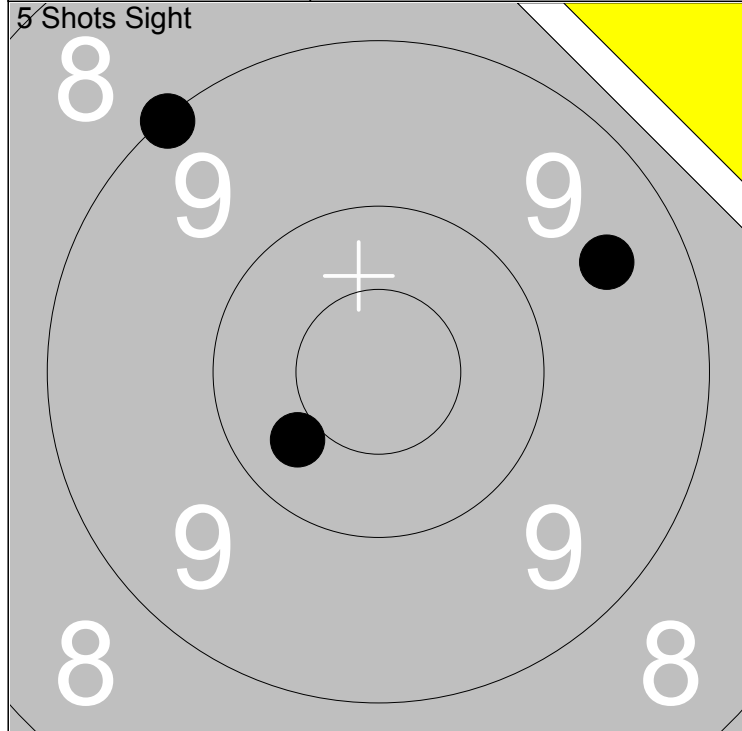

1: 9.1 ↖	Series 28.0
2: 9.5 ↗	
3: 10.4 ↙	
Total 141.0	

1: 8.2 ↙	Series 41.0
2: 5.3 ↓	
3: 9.6 ↙	
4: 9.2 ↖	
5: 10.1 ↙	
Total 182.0	

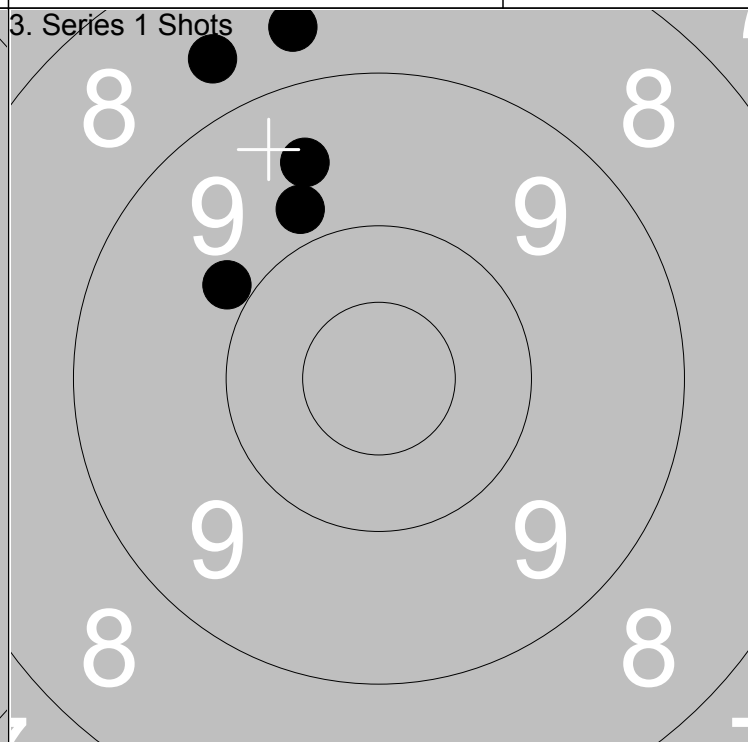
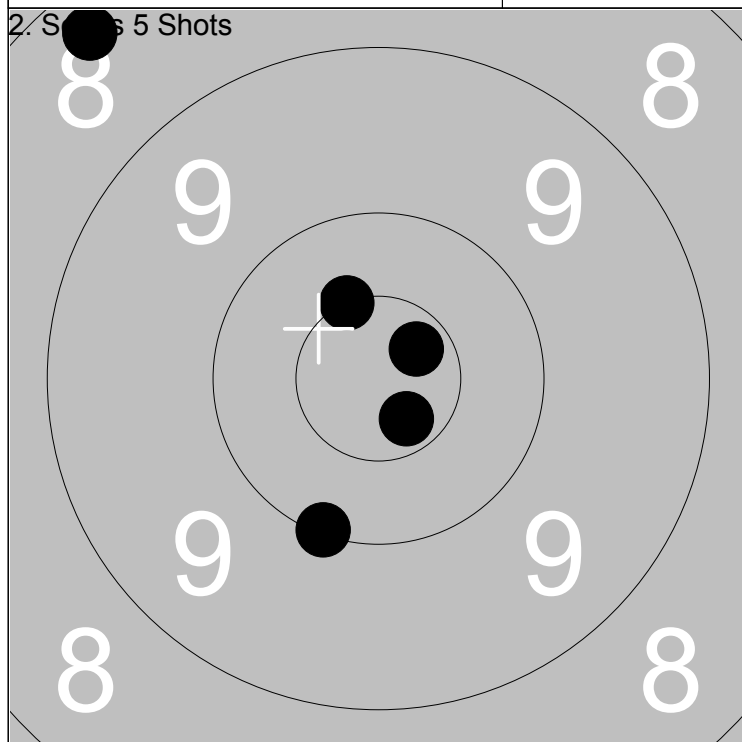

1: 8.3 ↖	Series 48.0
2: *10.5 ↖	
3: *10.7 ↗	
4: 10.0 ↓	
5: *10.7 ↙	
Total 230.0	

1: 8.7 ↖	Series 43.0
2: 8.7 ↖	
3: 9.5 ↖	
4: 9.8 ↖	
5: 9.9 ↙	
Total 273.0	

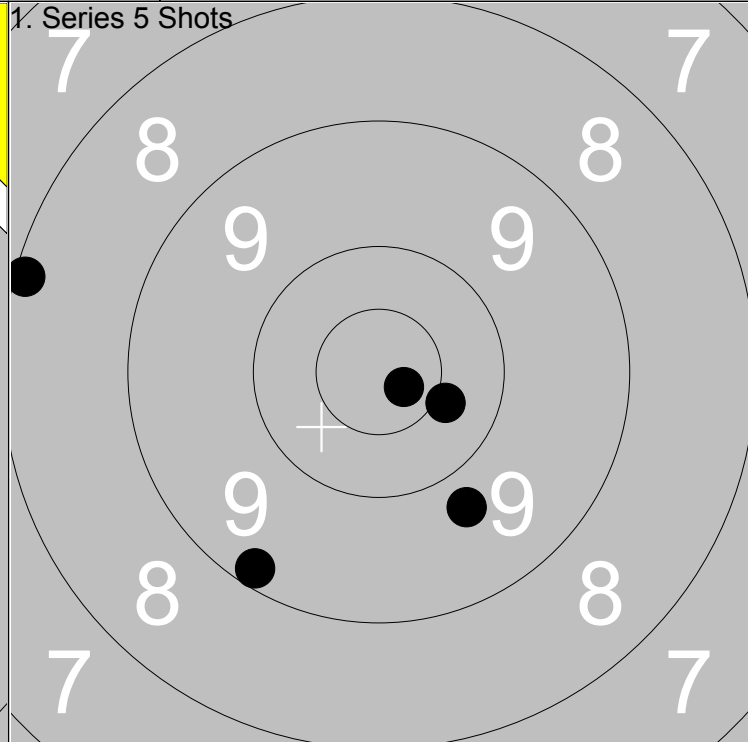
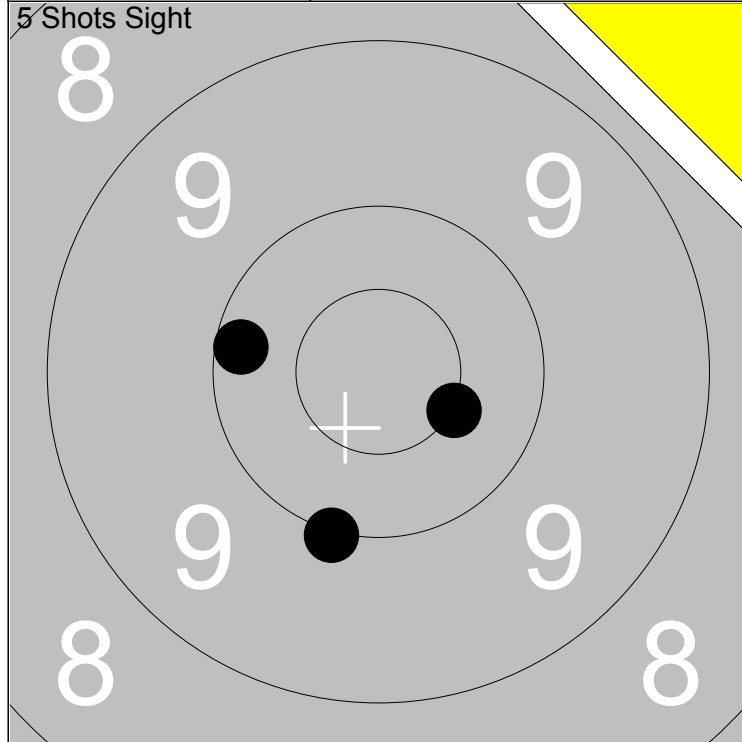

1: 10.0 ↓	Series	30.0
2: *10.5 ↘		
3: 10.2 ←		
Total		139.0

1: *10.7 ↘	Series	46.0
2: 8.1 ←		
3: 10.4 ↘		
4: 9.7 ↓		
5: 9.2 ↓		
Total		185.0

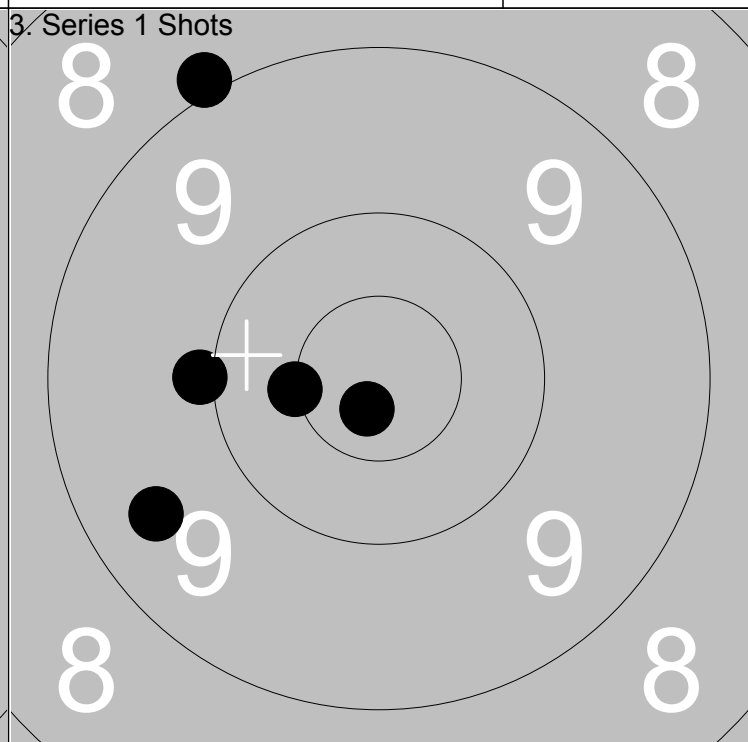
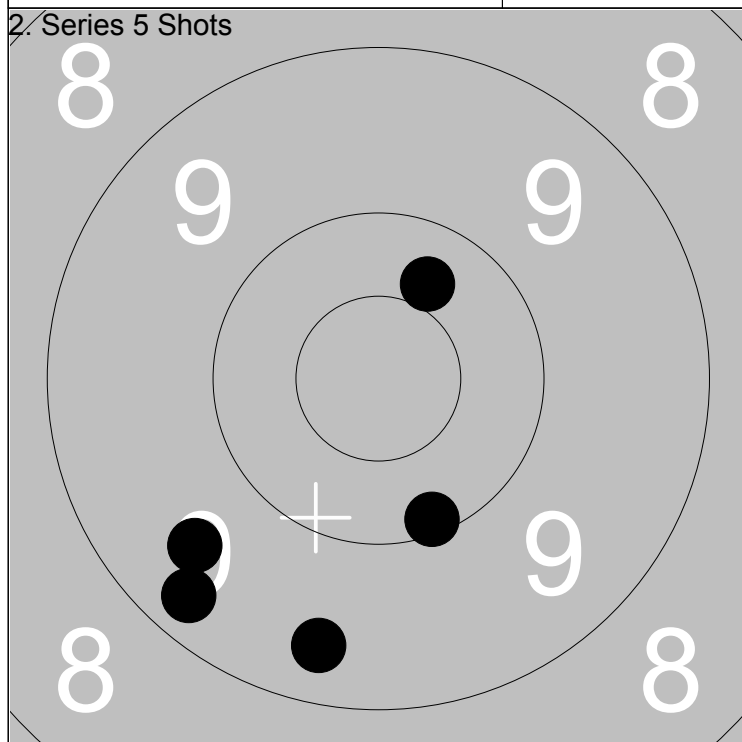

1: 10.4 ↗	Series	47.0
2: 10.1 ↓		
3: 9.5 ←		
4: 9.4 ↓		
5: 9.3 ↓		
Total		232.0

1: *10.8 ↓	Series	46.0
2: 8.9 ↗		
3: 9.9 ←		
4: 9.5 ←		
5: *10.5 ←		
Total		278.0

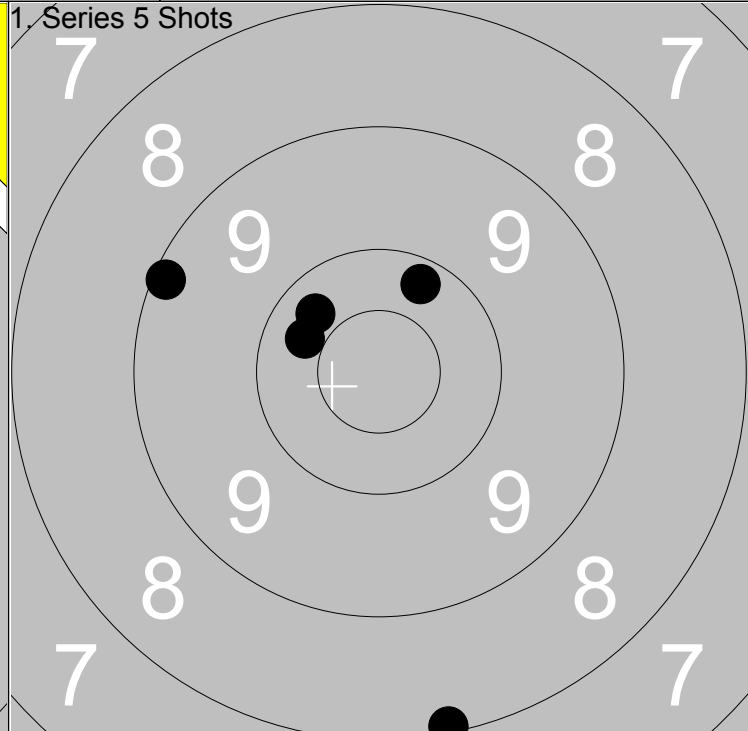
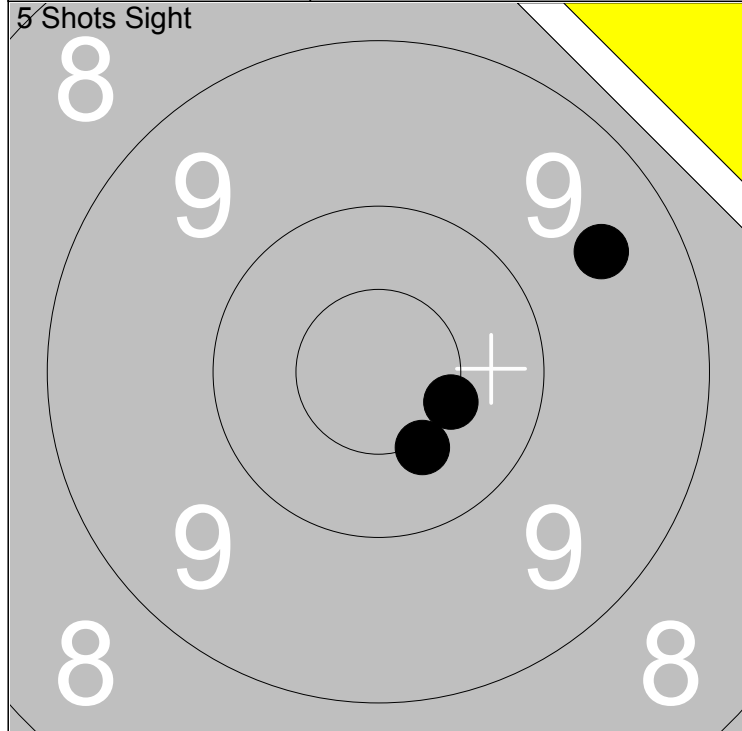

1: 9.5 ↗	Series	29.0
2: *10.5 ↘		
3: *10.5 ↗		
Total		136.0

1: 10.3 ↖	Series	47.0
2: 10.3 ↖		
3: 8.1 ↓		
4: 10.2 ↗		
5: 9.1 ↖		
Total		183.0

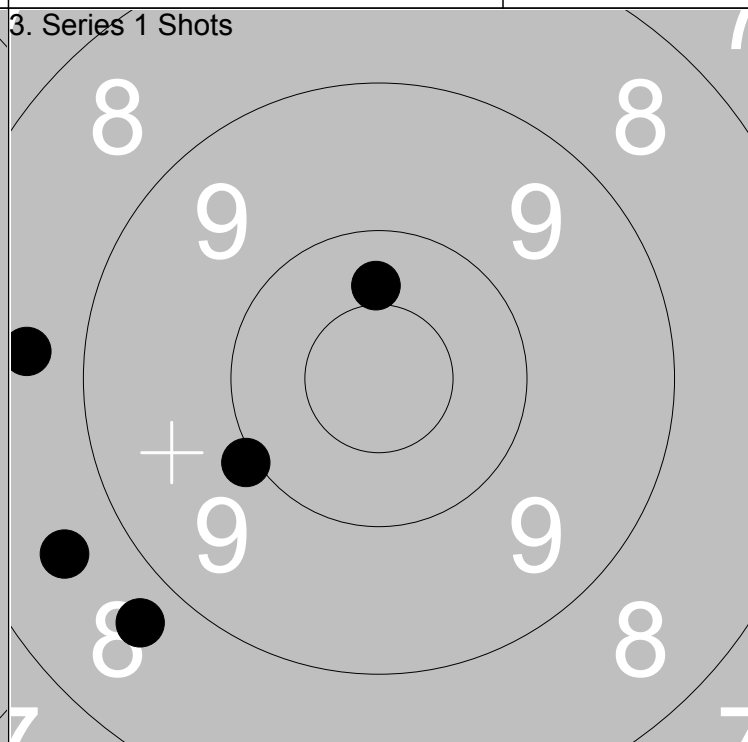
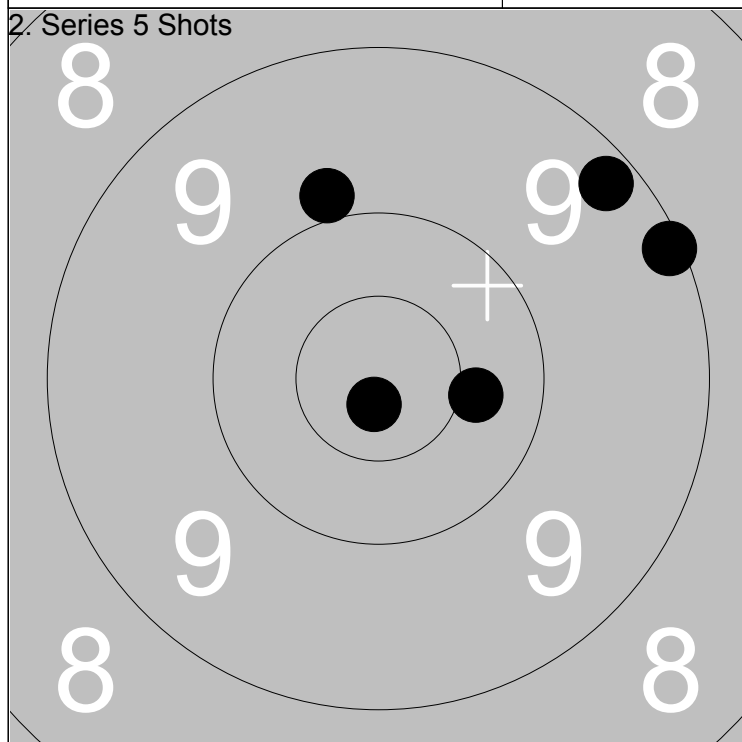

1: 9.1 ↗	Series	47.0
2: 9.2 ↗		
3: 9.9 ↑		
4: 10.4 →		
5: *10.8 ↘		
Total		230.0

1: 10.4 ↑	Series	44.0
2: 10.0 ↖		
3: 8.6 ←		
4: 8.6 ↖		
5: 8.7 ↖		
Total		274.0

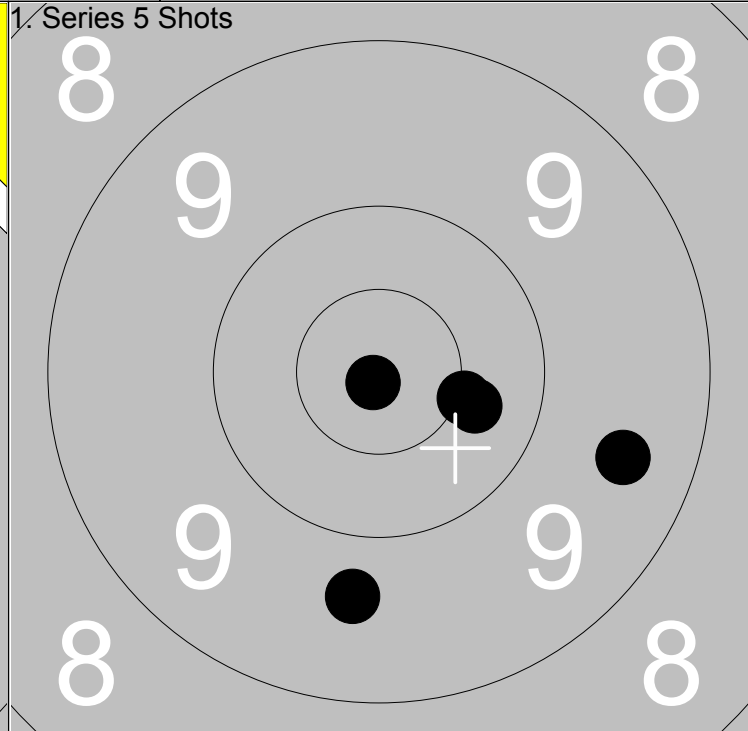
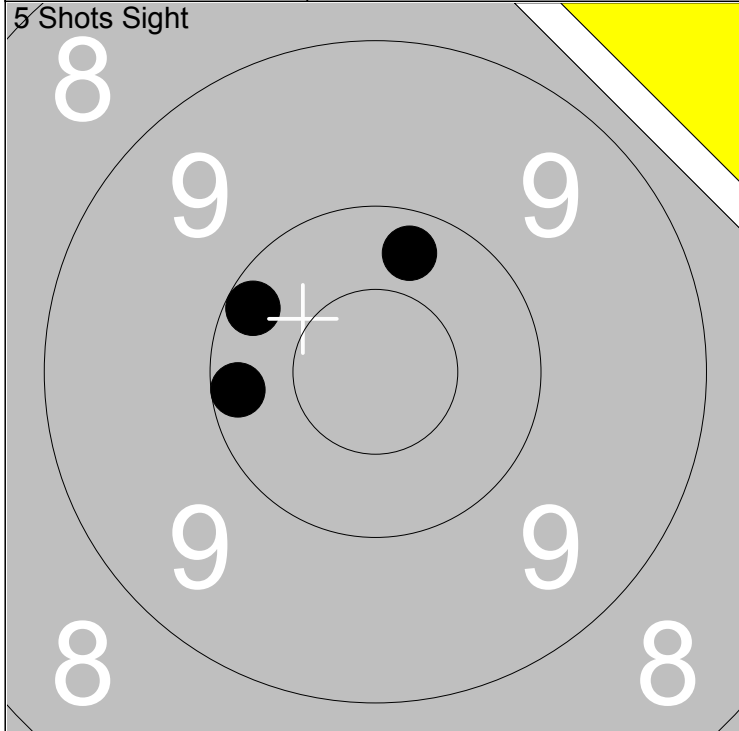

1: 10.2 ↙	Series	30.0
2: 10.2 ←		
3: 10.3 ↑		
Total		143.0

1: *10.4 ➔	Series	48.0
2: 9.5 ➔		
3: *10.9 ↙		
Total		191.0

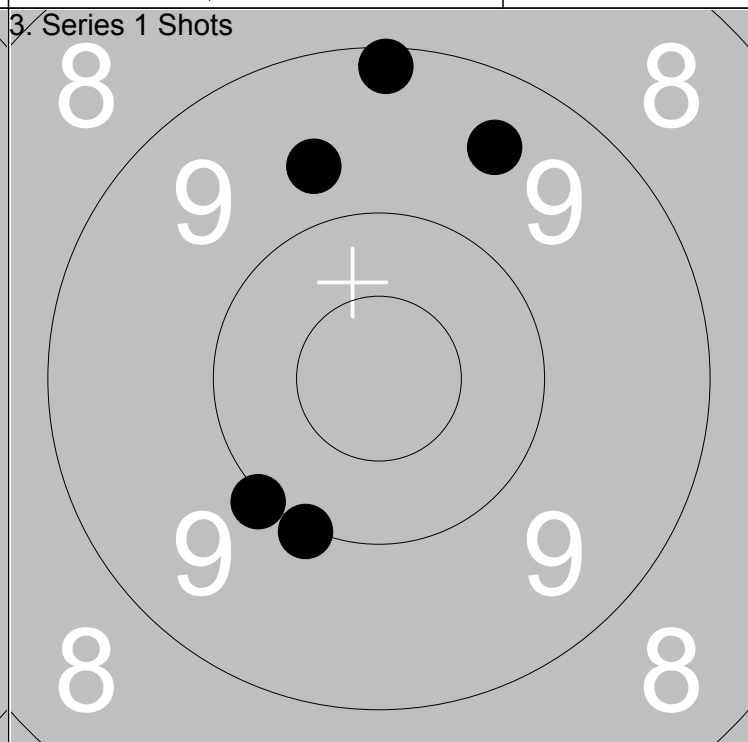
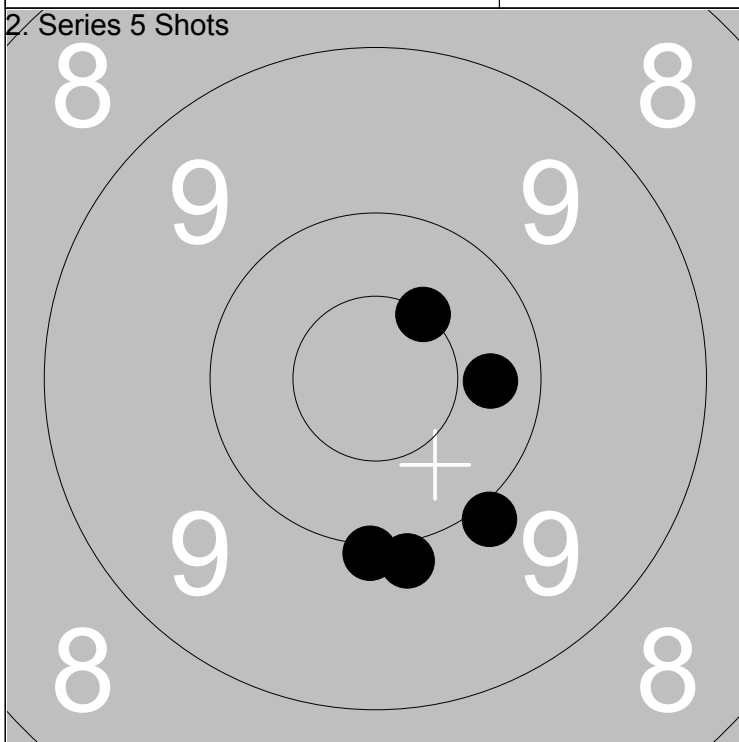

1: *10.5 ↗	Series	48.0
2: 9.9 ↘		
3: 10.0 ↓		
Total		239.0

1: 10.0 ↙	Series	47.0
2: 9.5 ↗		
3: 9.1 ↑		
Total		286.0

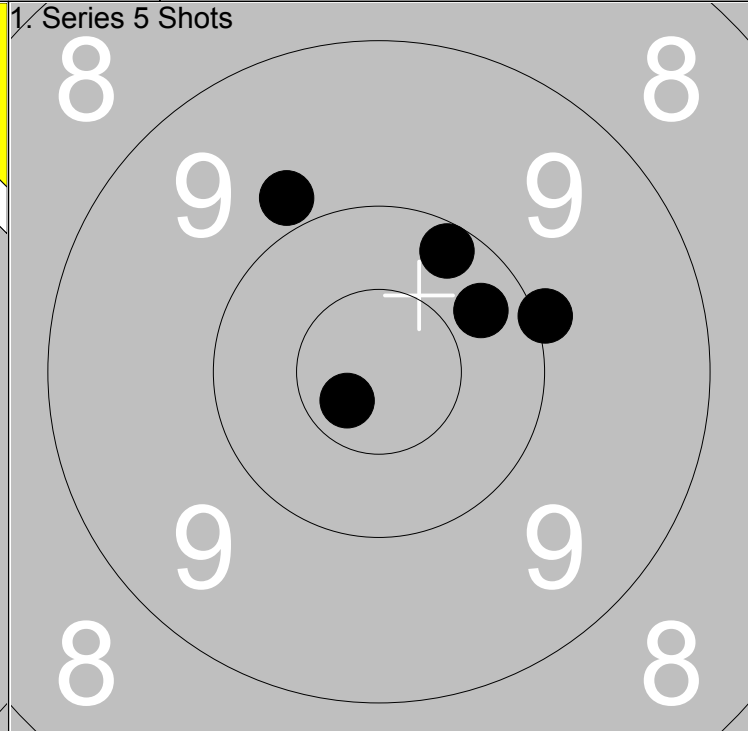
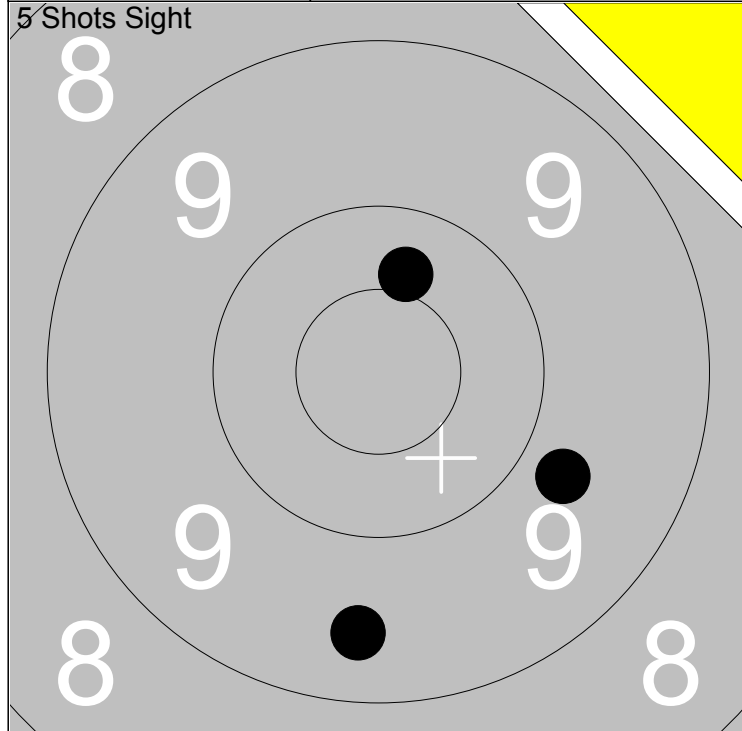

1: 9.7 ➔	Series	28.0
2: 9.4 ↓		
3: 10.4 ↑		
Total		142.0

1: 10.0 ➔	Series	49.0
2: 10.2 ↗		
3: *10.7 ↙		
4: 10.3 ↗		
5: 9.8 ↖		
Total		191.0

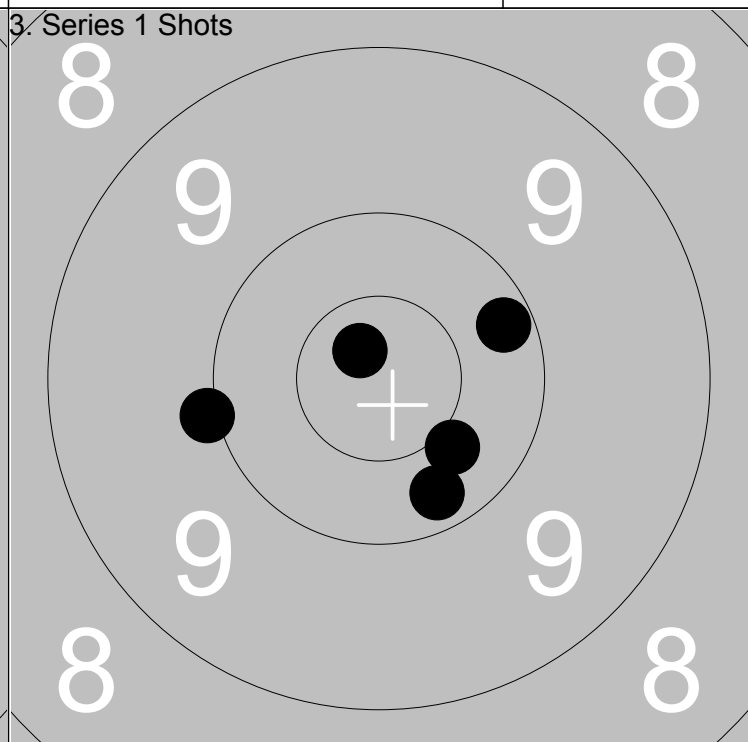
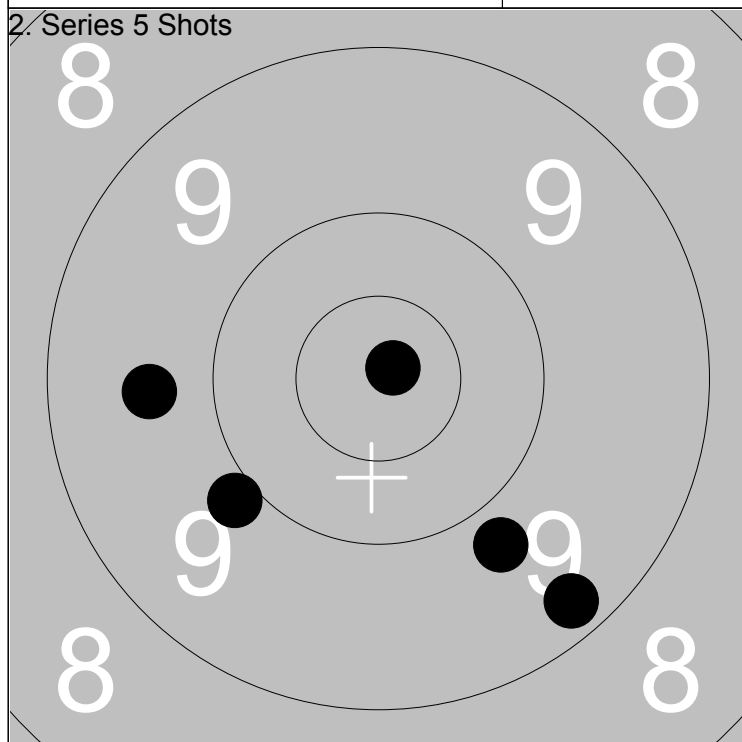

1: *10.9 ↗	Series	46.0
2: 9.6 ←		
3: 9.9 ↙		
4: 9.3 ↘		
5: 9.8 ↘		
Total		237.0

1: 10.2 ↓	Series	50.0
2: 10.4 ↘		
3: 10.0 ←		
4: 10.2 ➔		
5: *10.8 ↖		
Total		287.0

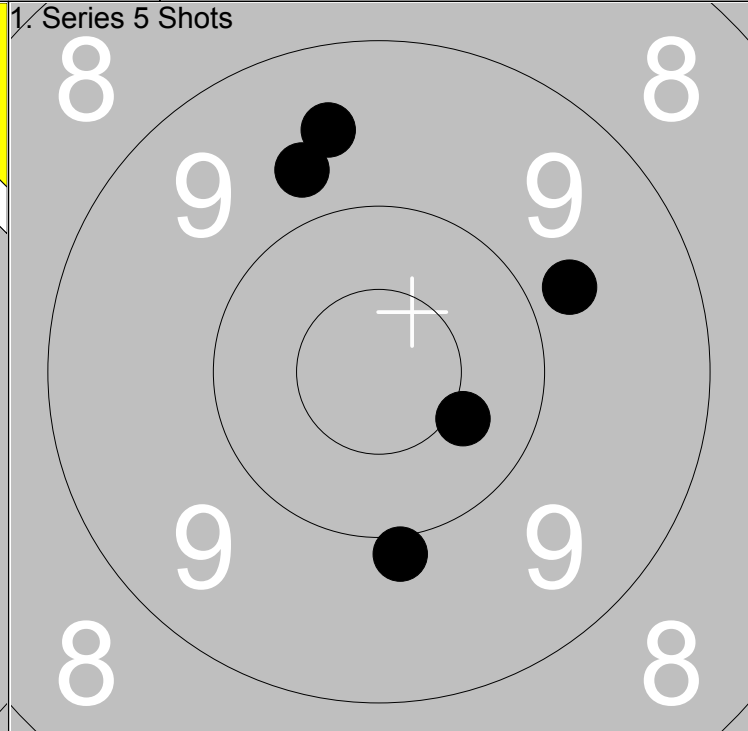
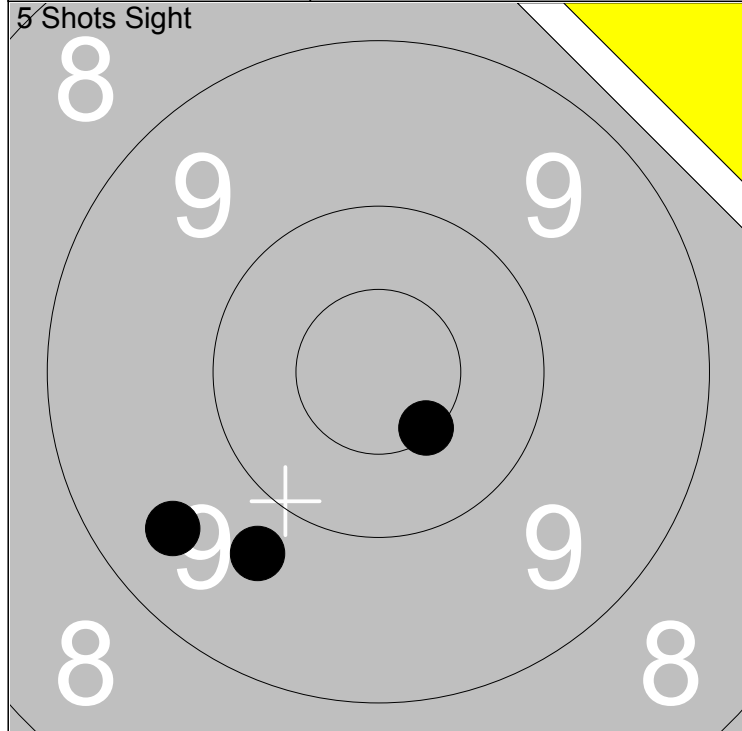

1: 9.5 ↙	Series	28.0
2: 9.7 ↘		
3: *10.5 ↘		
Total		141.0

1: 9.7 ↖	Series	46.0
2: 9.8 ↗		
3: 9.5 ↖		
Total		187.0

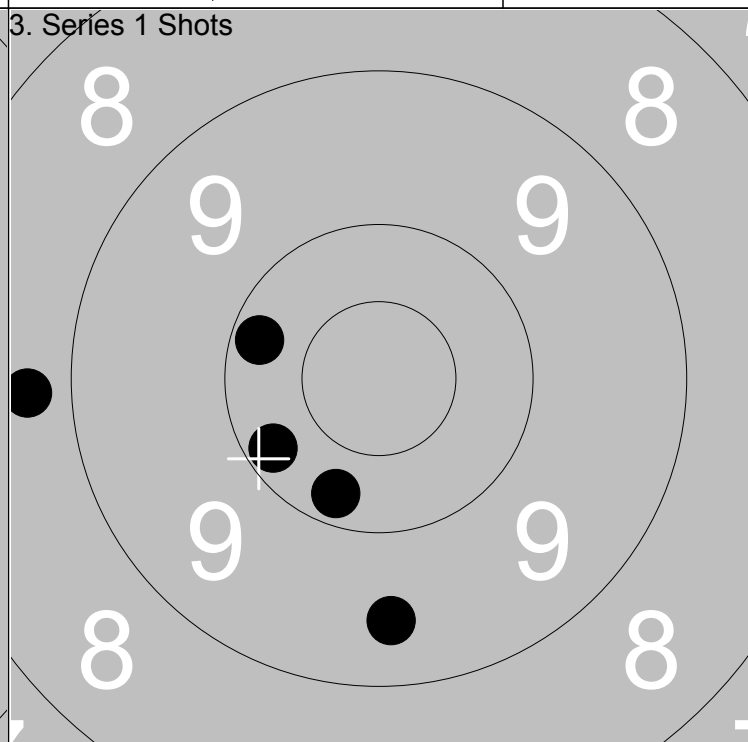
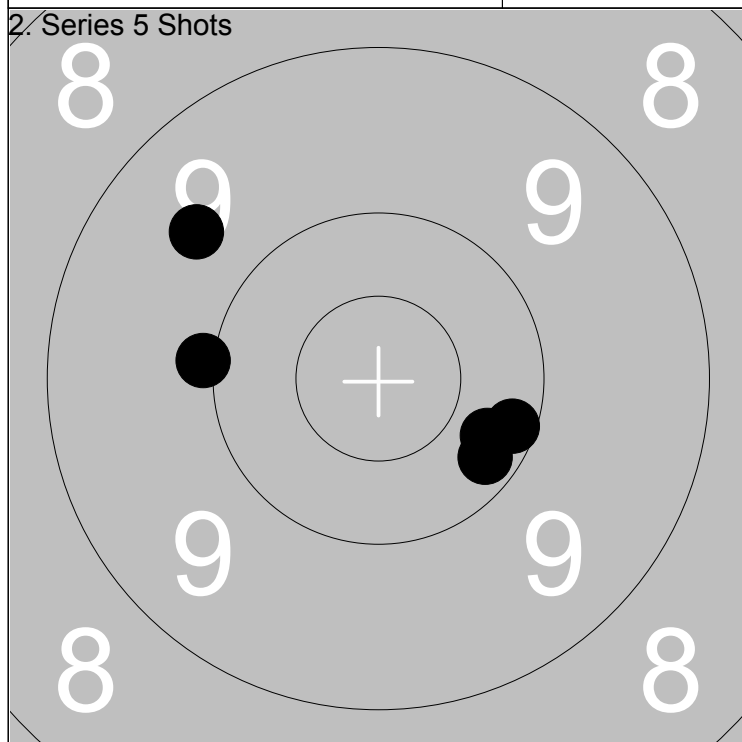

1: 10.2 ↘	Series	49.0
2: 10.3 ↘		
3: 9.6 ↗		
Total		236.0

1: 10.2 ↙	Series	47.0
2: 9.5 ↓		
3: 10.2 ↖		
Total		283.0

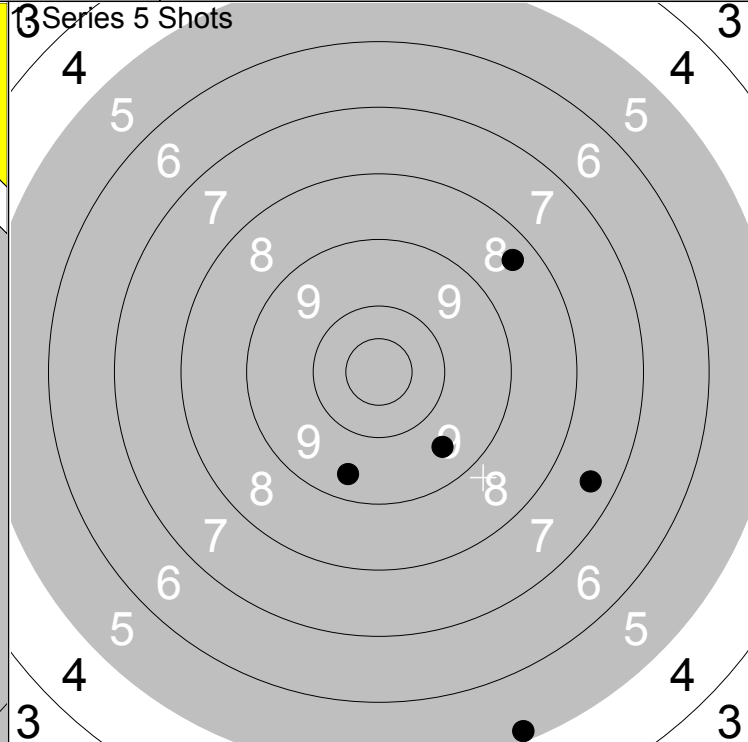
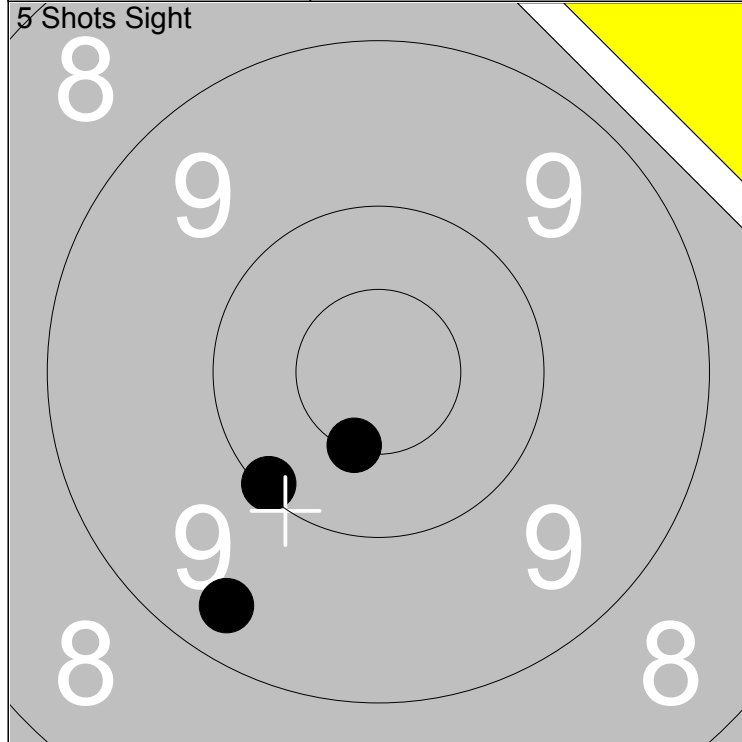

1: 9.3 ↘	Series	29.0
2: 10.1 ↘		
3: *10.5 ↘		
Total		128.0

1: 8.4 ↗	Series	38.0
2: 5.2 ↘		
3: 9.4 ↘		
4: 7.4 →		
5: 9.5 ↘		
Total		166.0

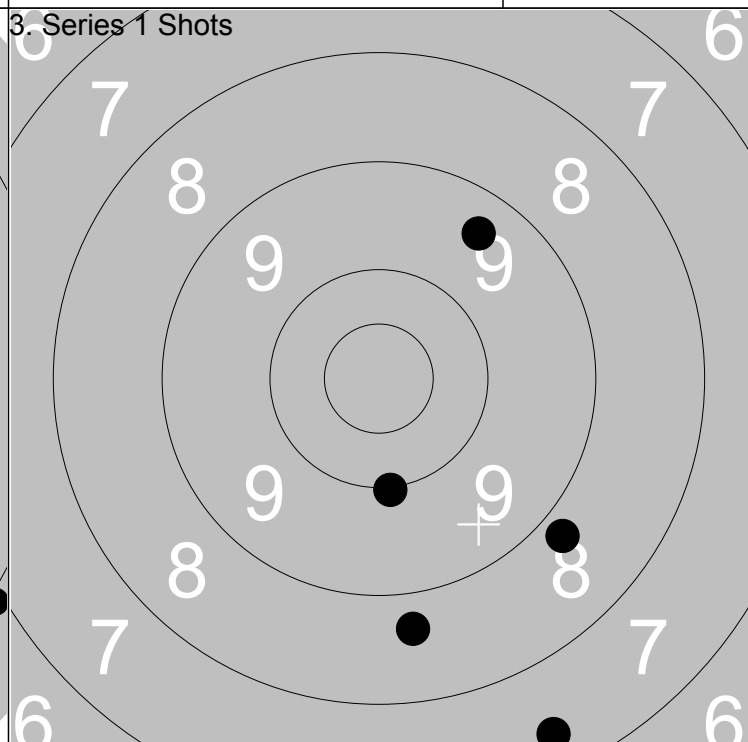
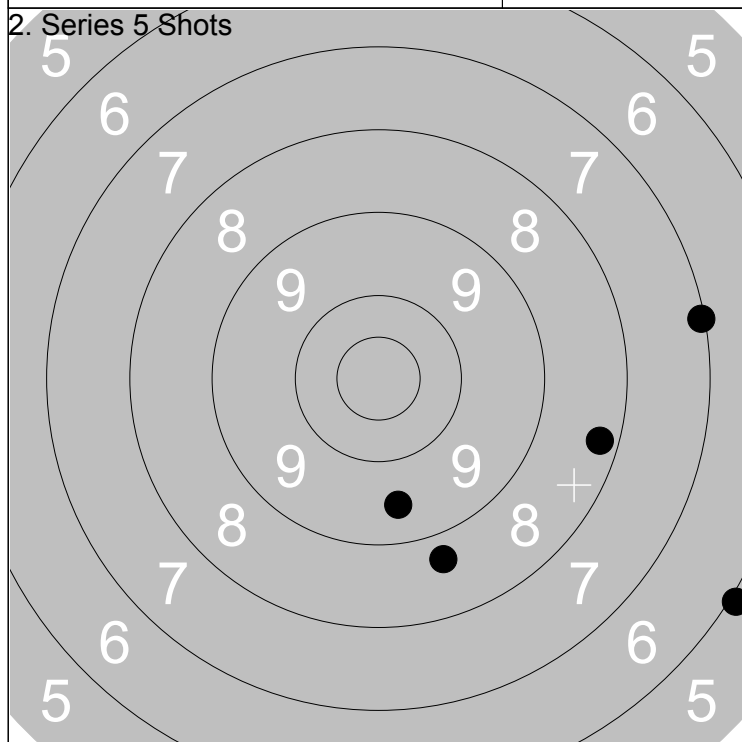

1: 8.3 →	Series	38.0
2: 8.7 ↘		
3: 9.5 ↘		
4: 7.1 →		
5: 6.0 ↘		
Total		204.0

1: 7.4 ↘	Series	42.0
2: 9.4 ↗		
3: 8.7 ↘		
4: 10.0 ↘		
5: 8.8 ↘		
Total		246.0

Relay 5	Lane 1	Donald Johansson	
-------------------	------------------	-------------------------	--

300m	Ale	B	No
------	-----	---	----

06.07.2014	Tavelträffen 2014	Ramselefors SKF
------------	-------------------	-----------------

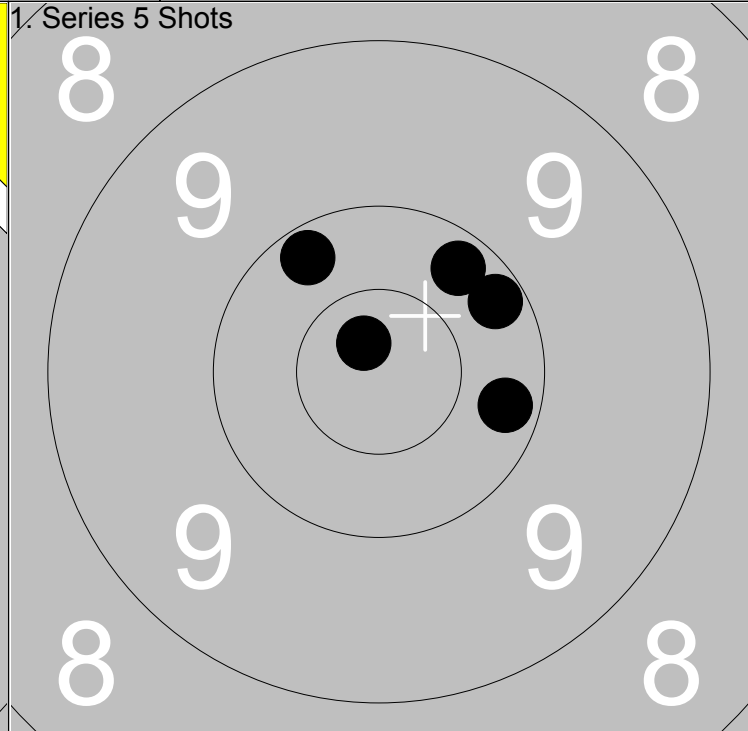
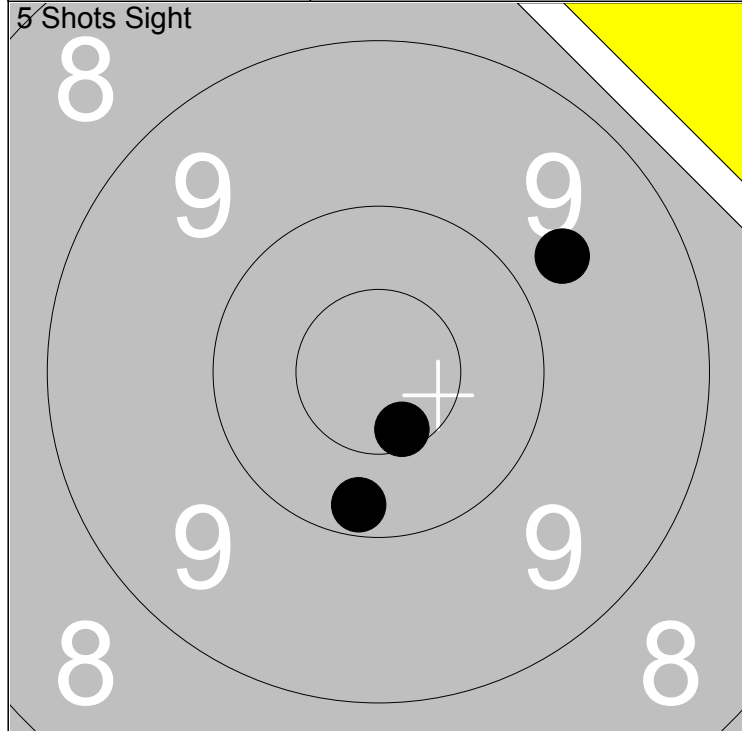

1: *10.6 ↓	Series	29.0
2: 10.2 ↓		
3: 9.7 ↗		
Total		149.0

1: 10.2 ↗	Series	50.0
2: 10.2 ↗		
3: 10.2 →		
4: 10.2 ↖		
5: *10.8 ↖		
Total		199.0

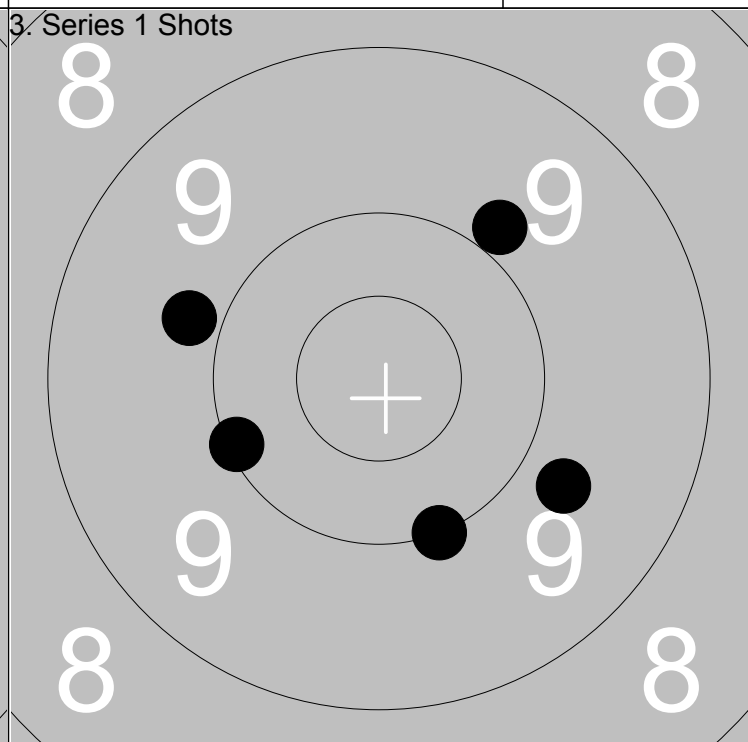
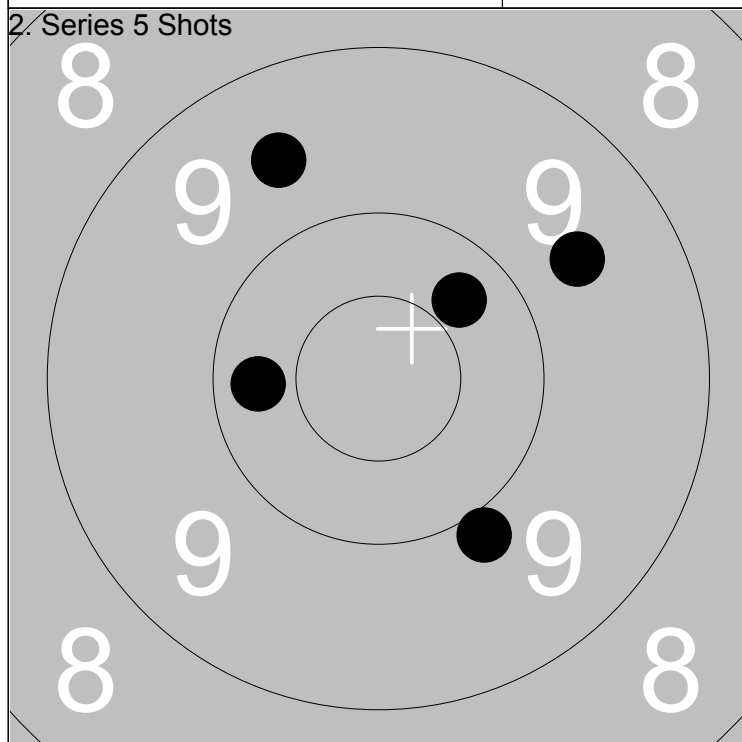

1: 10.3 ↗	Series	47.0
2: 9.6 ↗		
3: 9.6 ↖		
4: 10.3 ←		
5: 9.9 ↓		
Total		246.0

1: 9.7 →	Series	47.0
2: 10.1 ←		
3: 10.0 ↓		
4: 9.9 ↗		
5: 9.8 ←		
Total		293.0

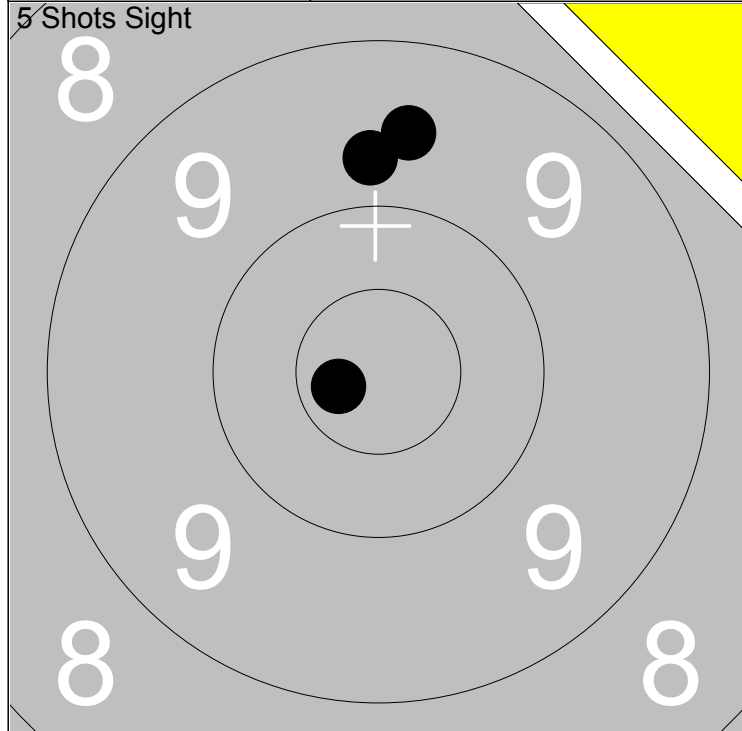

1: 9.6 ↑	Series	28.0
2: *10.7 ←		
3: 9.7 ↑		
Total		147.0

1: *10.8 ↓	Series	48.0
2: 10.3 →		
3: 9.6 ↓		
Total		195.0

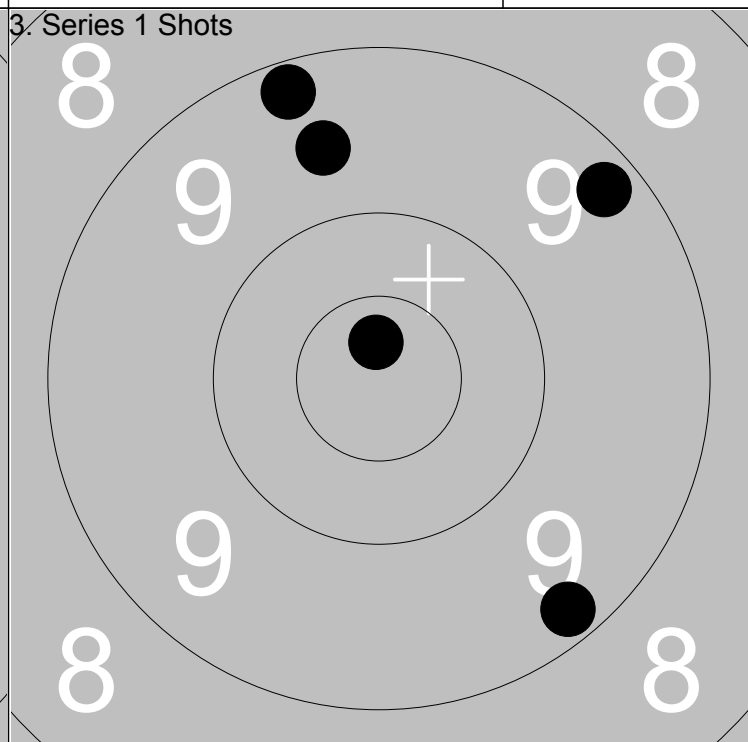
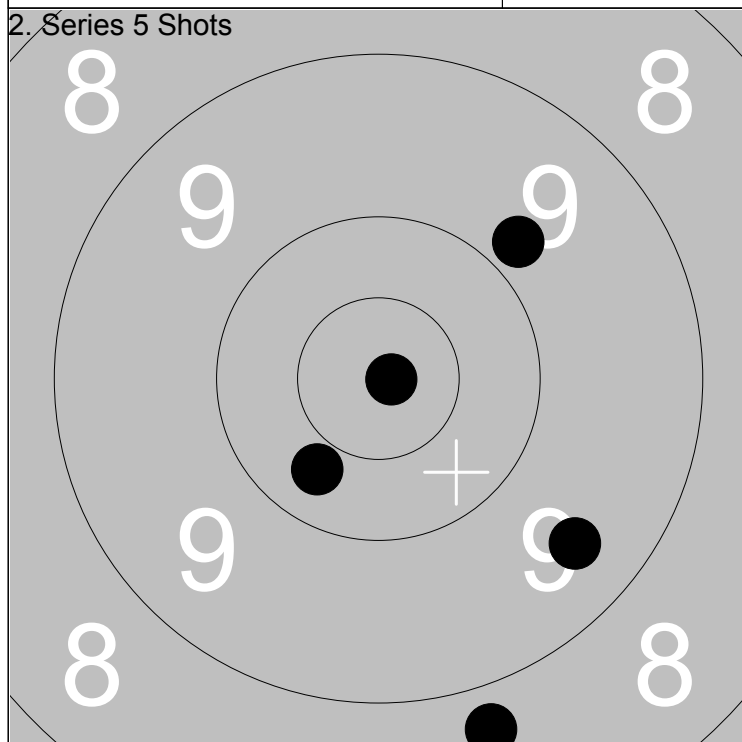

1: 8.8 ↓	Series	46.0
2: 9.8 ↗		
3: 9.4 ↓		
Total		241.0

1: 9.2 ↓	Series	46.0
2: 9.2 ↑		
3: 9.3 ↗		
Total		287.0

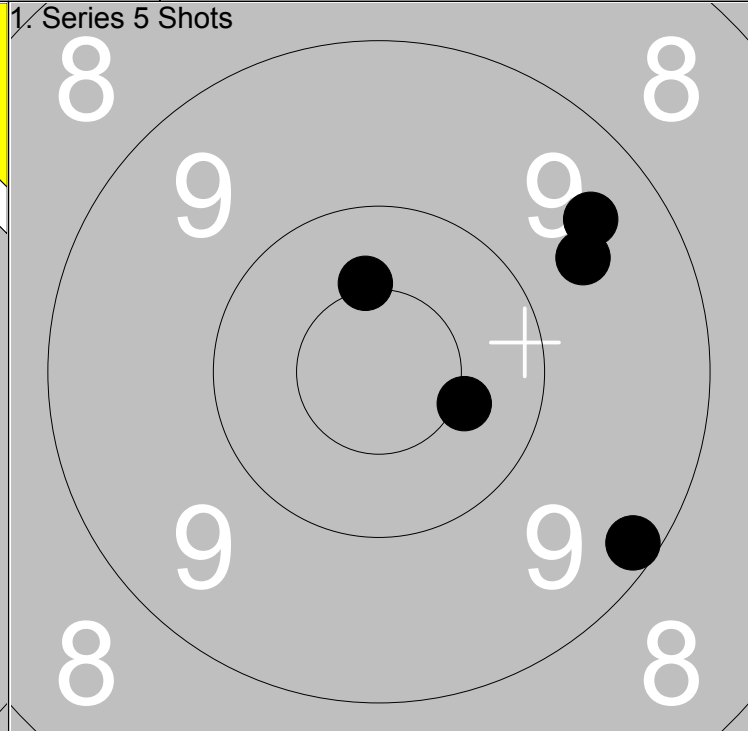
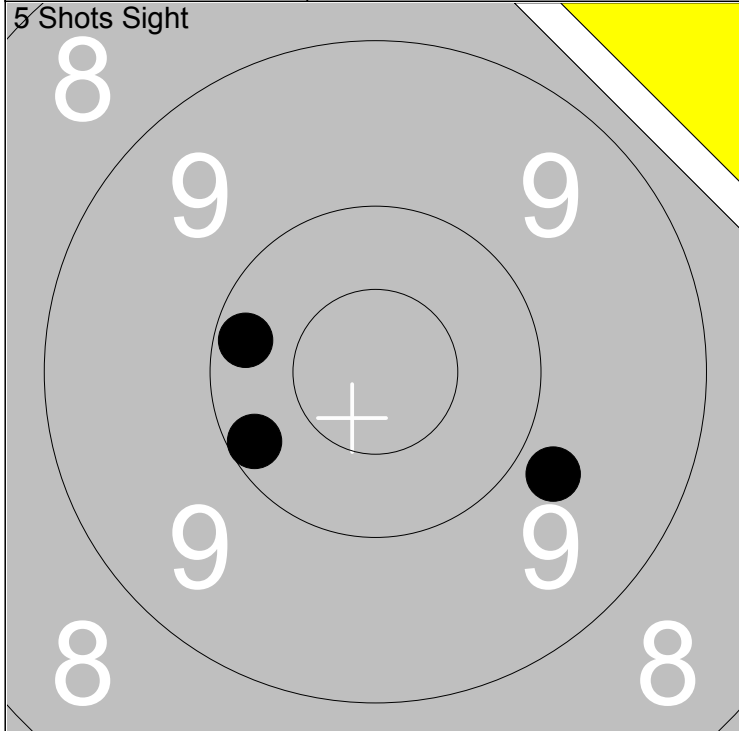

1: 10.2 ←	Series	29.0
2: 10.2 ↙		
3: 9.8 ↘		
Total		145.0

1: *10.4 ↑	Series	47.0
2: 9.2 ↘		
3: 9.5 ↗		
Total		192.0

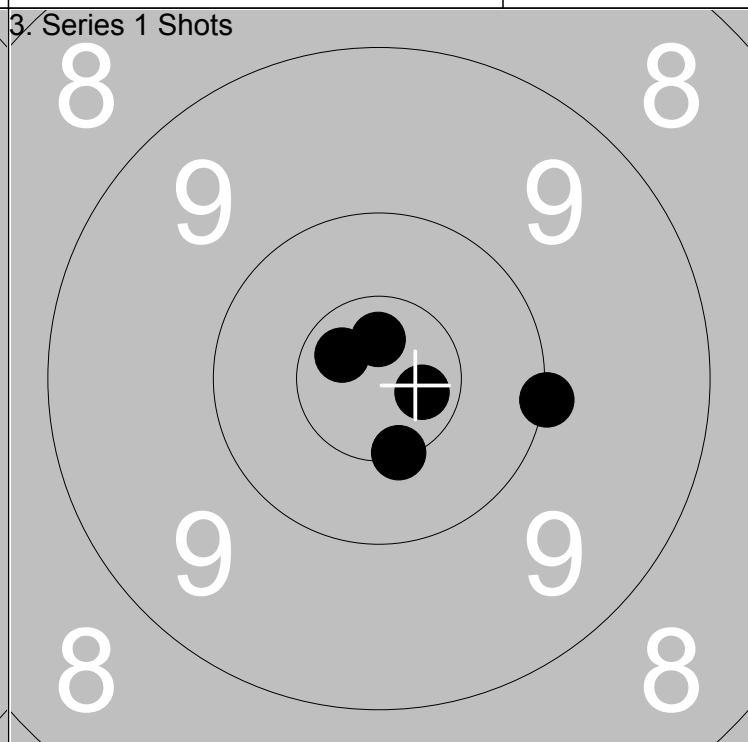
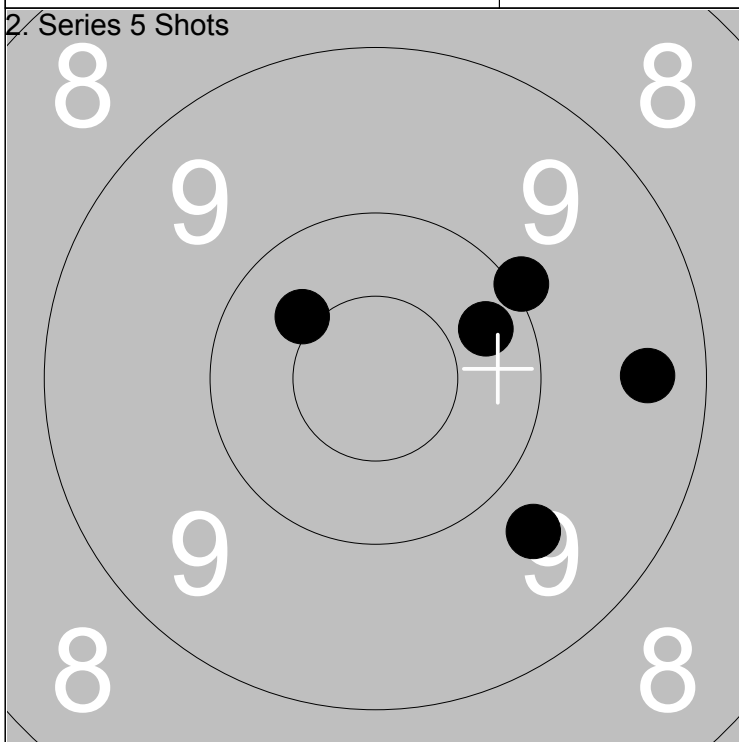

1: 9.4 →	Series	48.0
2: 9.7 ↘		
3: 10.3 ↗		
Total		240.0

1: *10.7 →	Series	50.0
2: *10.5 ↓		
3: 10.0 →		
Total		290.0

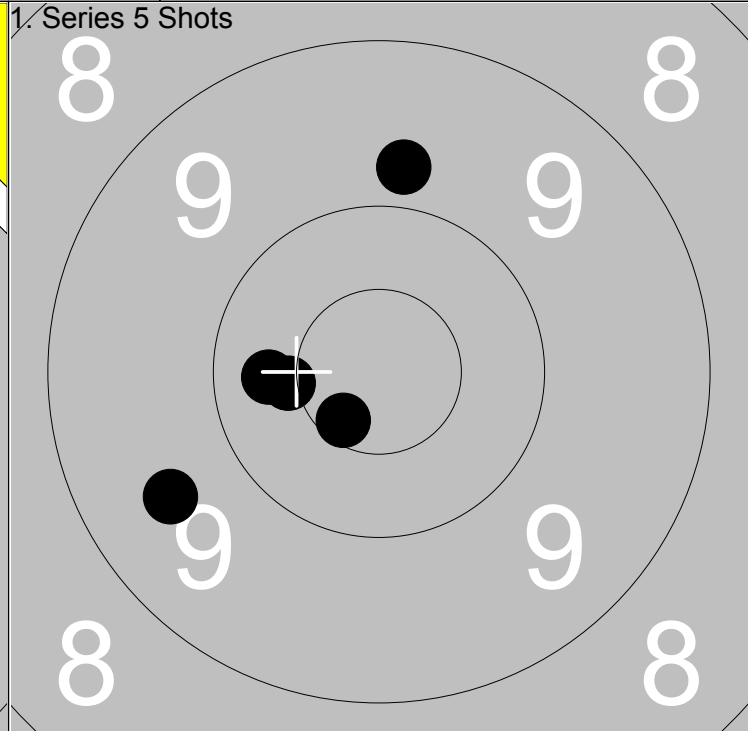
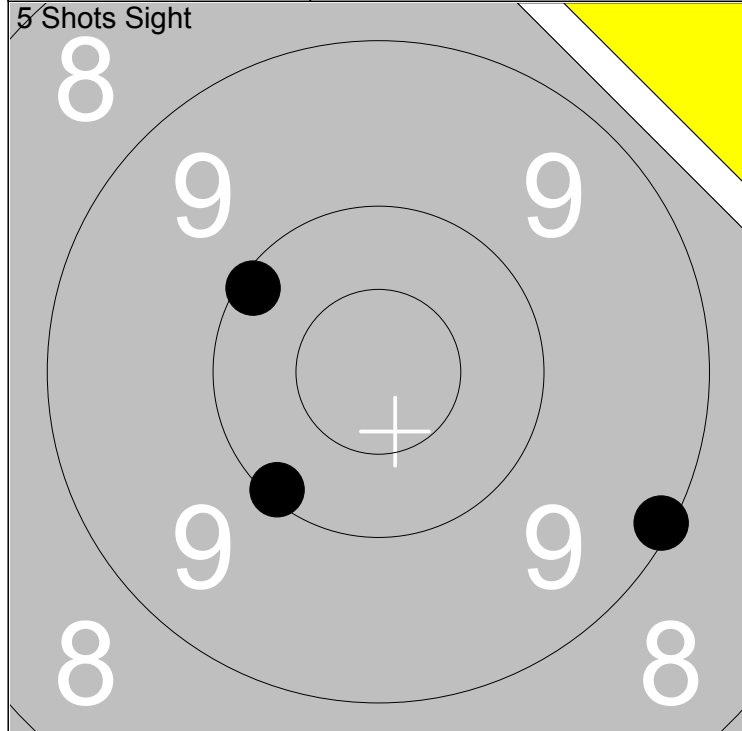

1: 10.1 ↙	Series	29.0
2: 10.1 ↖		
3: 9.1 →		
Total		144.0

1: 9.8 ↑	Series	48.0
2: *10.6 ↙		
3: *10.4 ←		
4: 10.3 ←		
5: 9.6 ↙		
Total		192.0

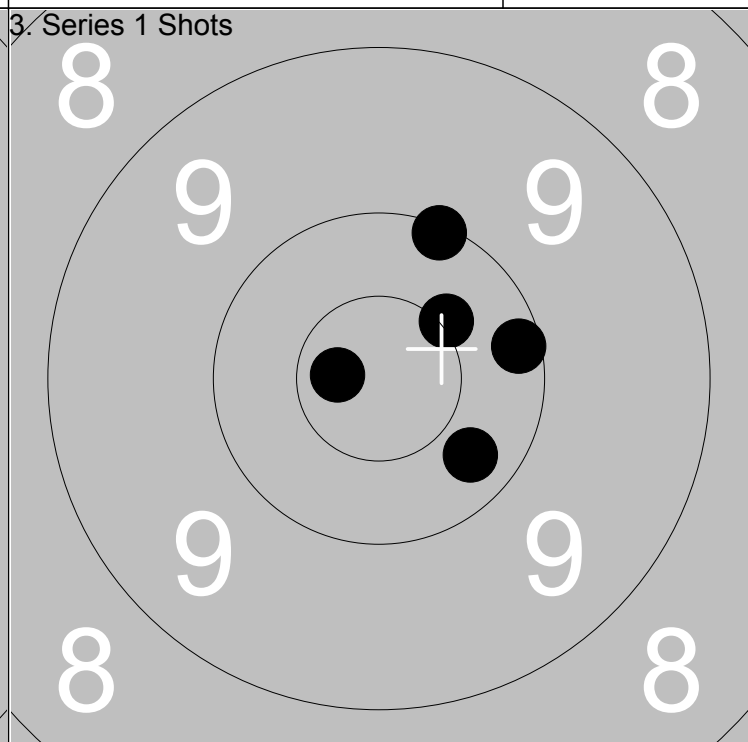
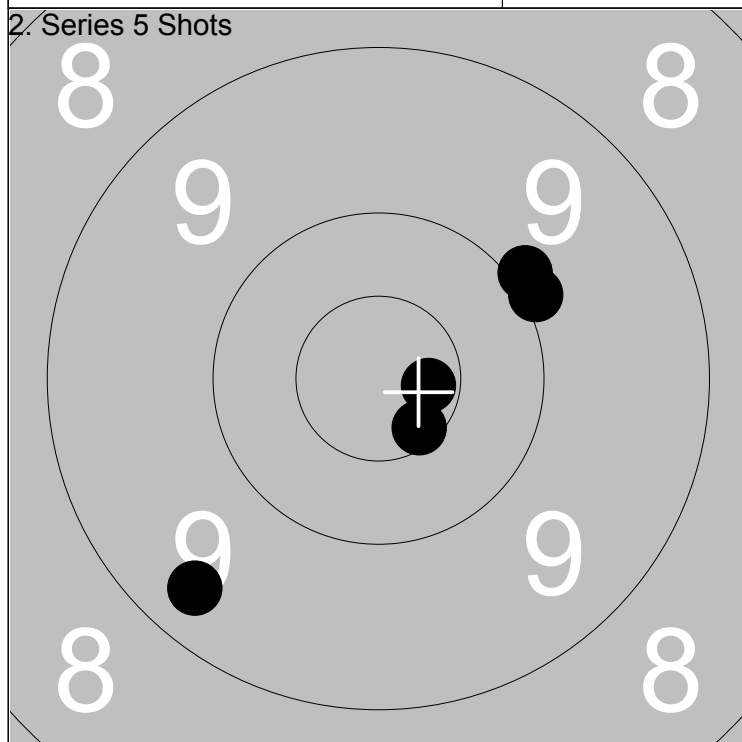

1: 9.9 ↗	Series	48.0
2: 10.0 ↗		
3: *10.7 →		
4: 9.3 ↙		
5: *10.6 ↙		
Total		240.0

1: 10.3 ↘	Series	50.0
2: 10.1 →		
3: *10.7 ←		
4: *10.5 ↗		
5: 10.1 ↑		
Total		290.0

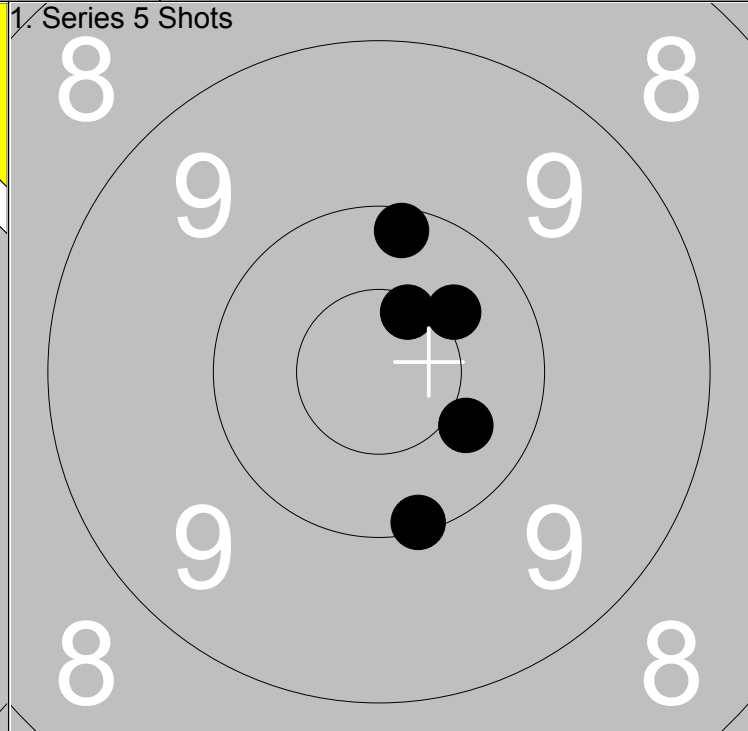
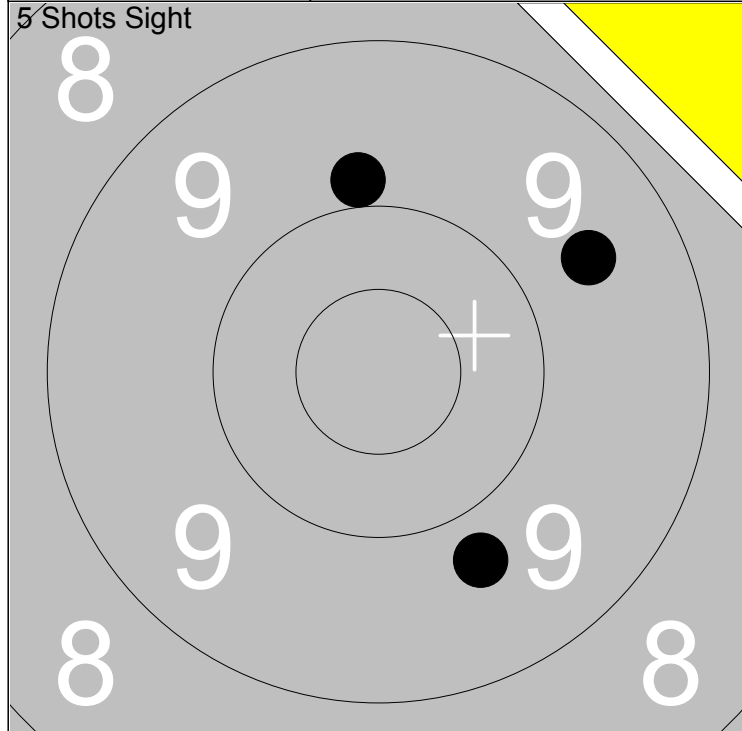

1: 9.6 ↗	Series	27.0
2: 9.9 ↑		
3: 9.7 ↓		
Total		144.0

1: 10.1 ↑	Series	50.0
2: *10.6 ↗		
3: 10.4 ↘		
Total		194.0

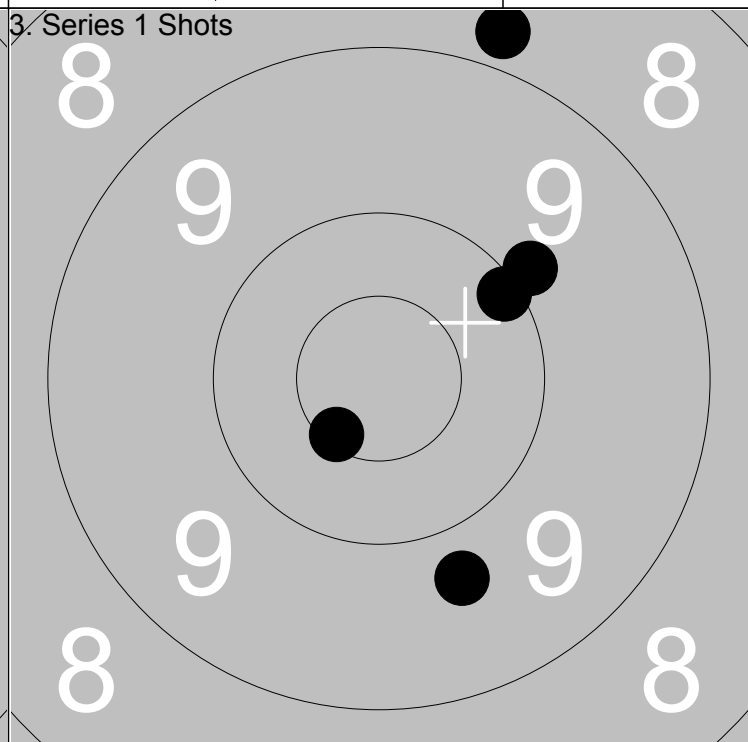
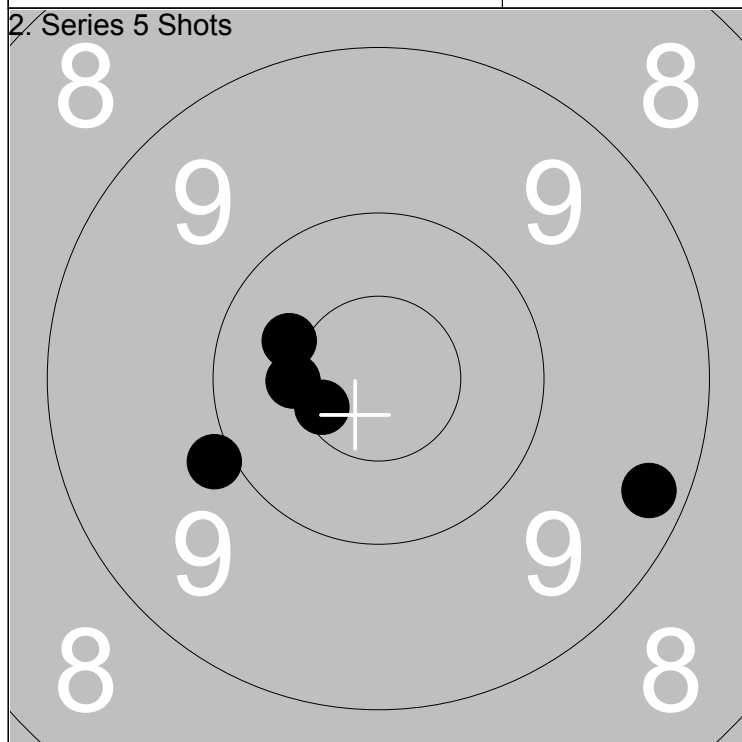

1: 9.3 ↘	Series	48.0
2: 10.4 ↖		
3: *10.5 ↖		
Total		242.0

1: 9.7 ↓	Series	46.0
2: 8.8 ↑		
3: 9.9 ↗		
Total		288.0

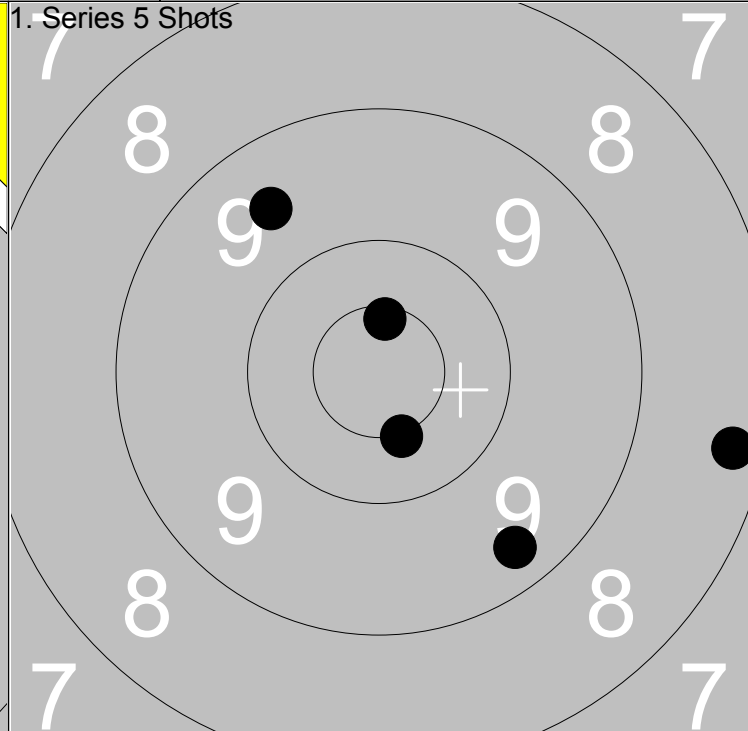
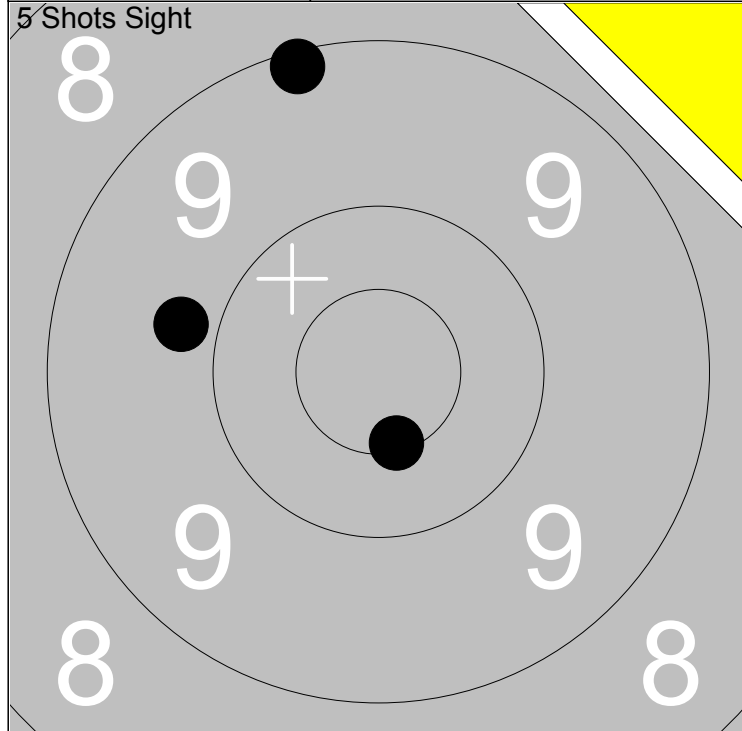

1: 9.1 ↑	Series	28.0
2: 9.8 ←		
3: *10.5 ↓		
Total		144.0

1: 9.5 ↖	Series	46.0
2: 8.3 →		
3: 9.3 ↘		
4: *10.5 ↓		
5: *10.6 ↑		
Total		190.0

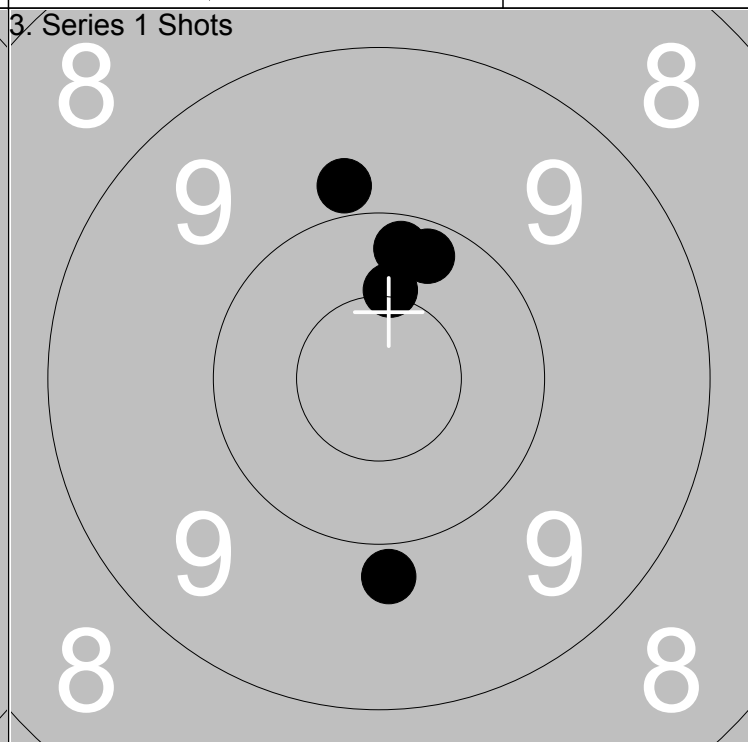
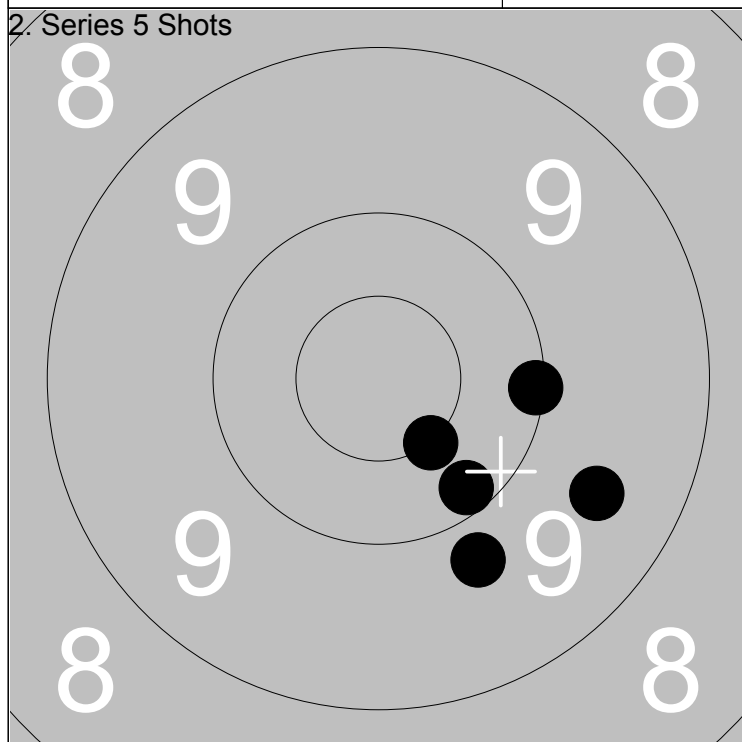

1: 9.5 ↘	Series	48.0
2: 10.2 ↘		
3: 9.8 ↘		
4: *10.5 ↓		
5: 10.1 →		
Total		238.0

1: 10.2 ↑	Series	48.0
2: 9.8 ↑		
3: 10.2 ↑		
4: 9.8 ↓		
5: *10.4 ↑		
Total		286.0

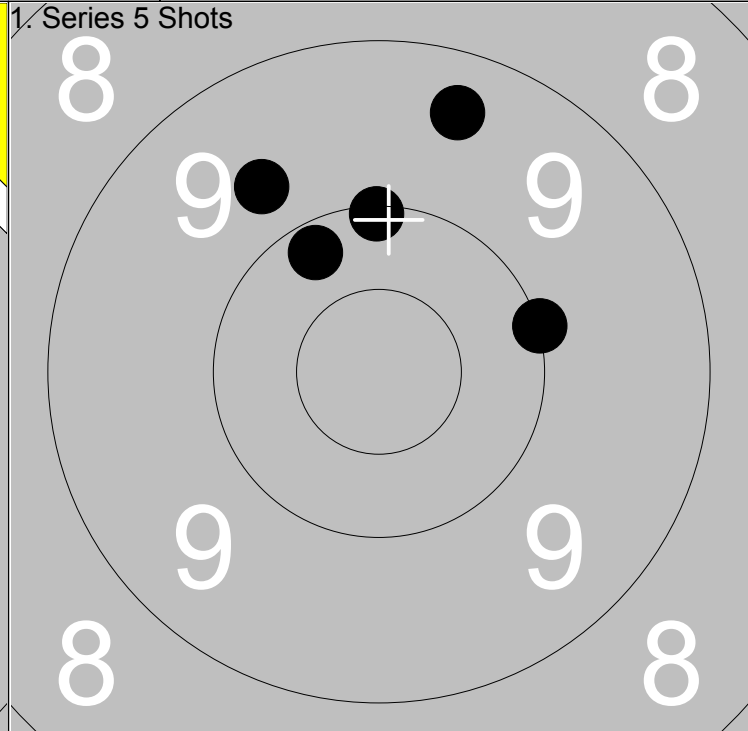
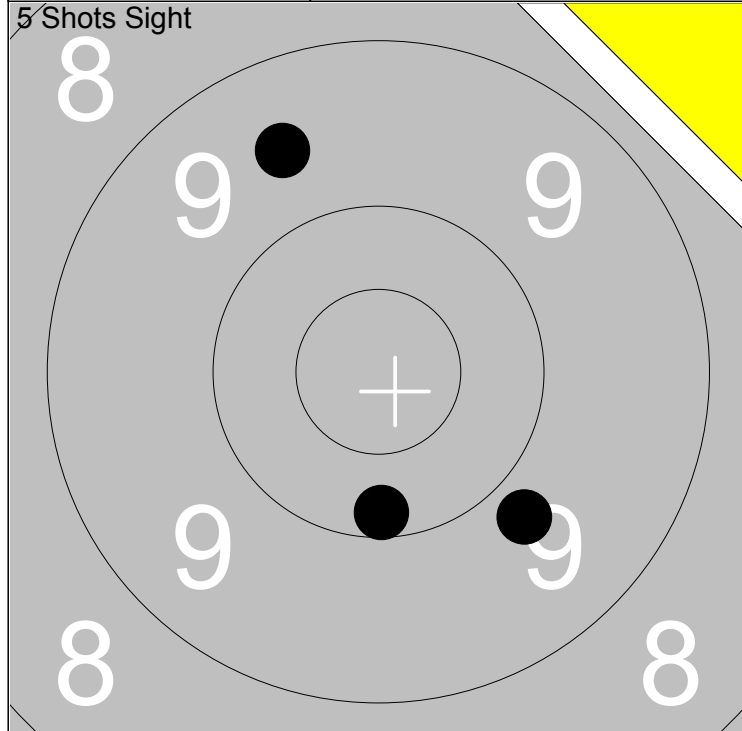

1: 9.6 ↗	Series	28.0
2: 10.2 ↓		
3: 9.8 ↘		
Total		143.0

1: 9.7 ↖	Series	48.0
2: 10.0 →		
3: 10.2 ↖		
4: 10.1 ↑		
5: 9.4 ↑		
Total		191.0

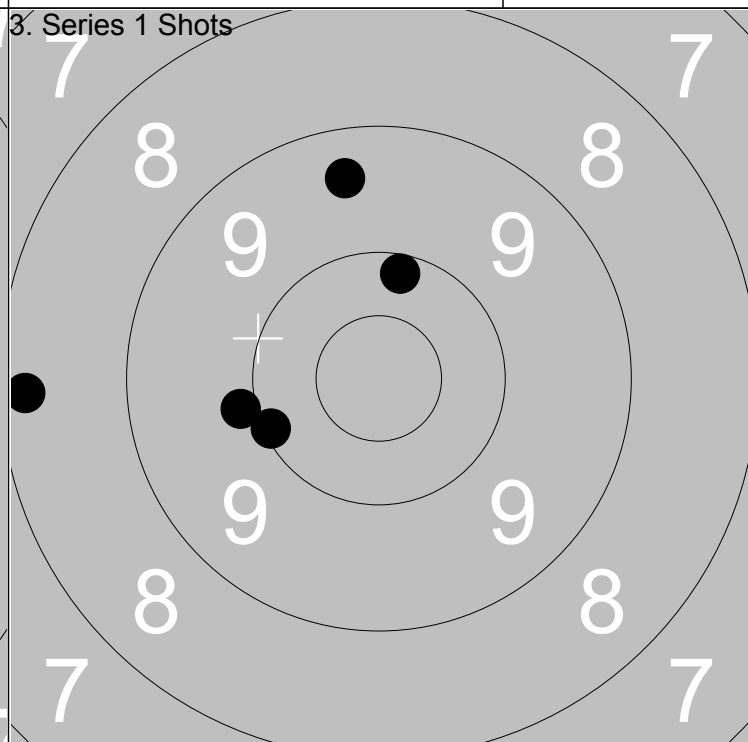
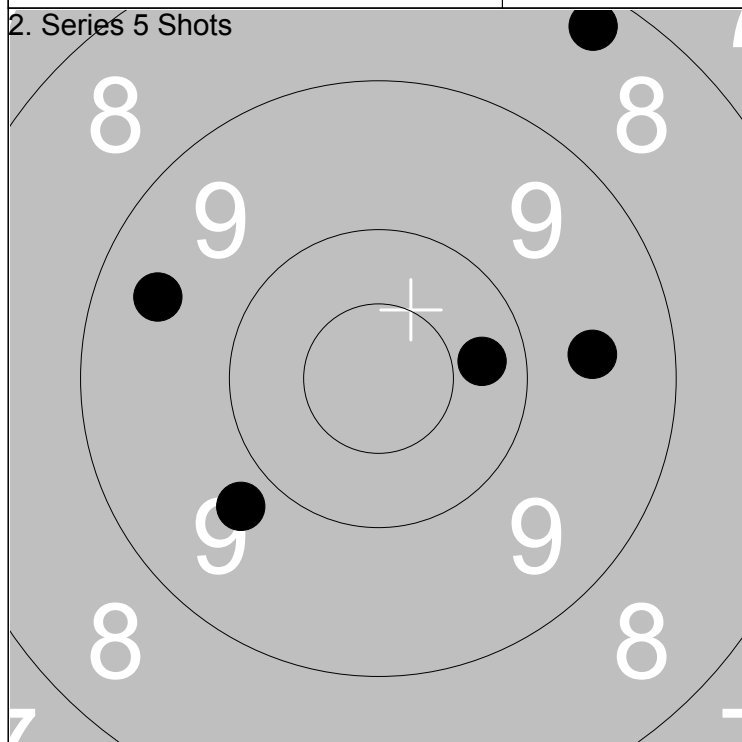

1: 8.3 ↗	Series	45.0
2: 9.6 →		
3: 10.3 →		
4: 9.4 ↖		
5: 9.8 ↘		
Total		236.0

1: 8.2 ←	Series	46.0
2: 10.2 ↑		
3: 10.1 ↖		
4: 9.9 ←		
5: 9.4 ↑		
Total		282.0

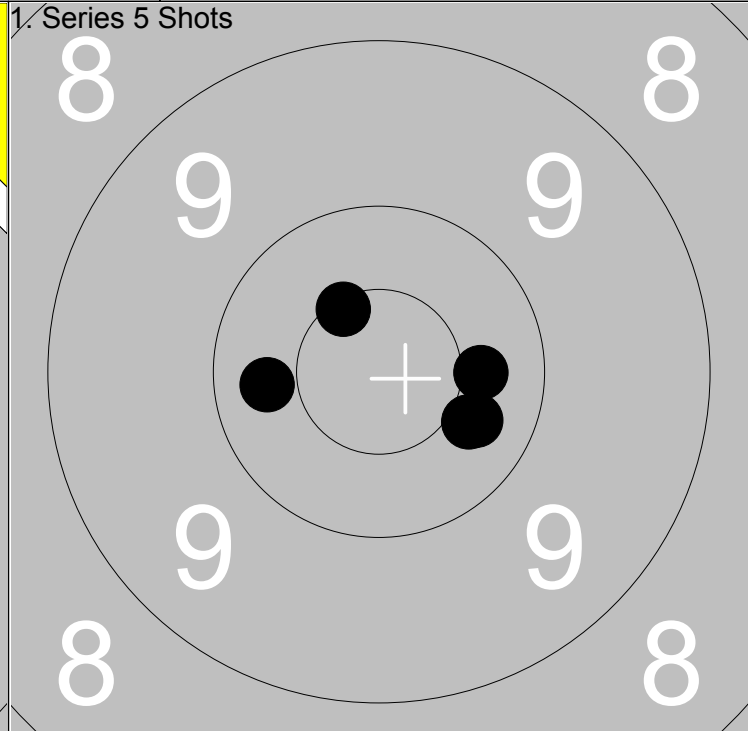
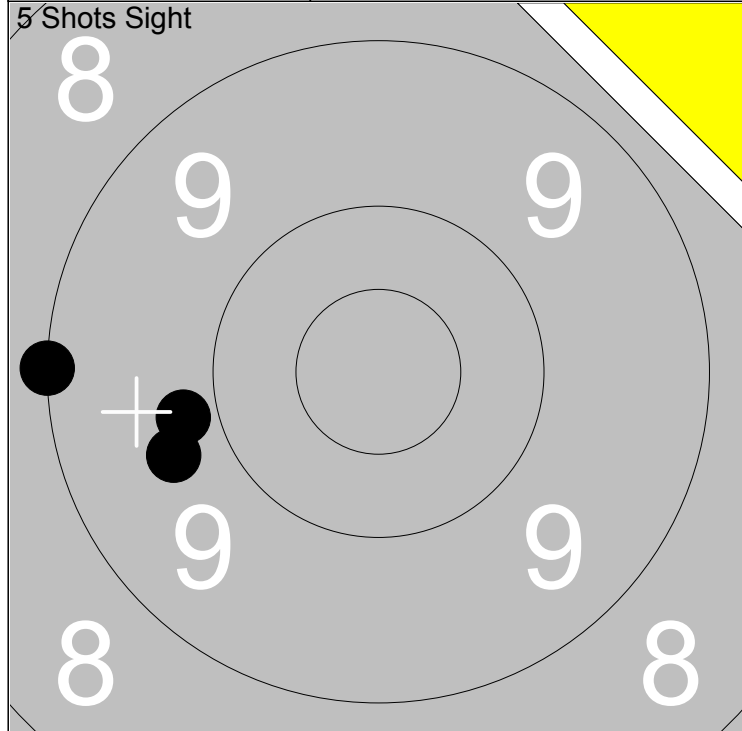

1: 9.8 ←	Series	27.0
2: 9.0 ←		
3: 9.7 ←		
		Total 143.0

1: 10.3 ←	Series	50.0
2: *10.5 ↖		
3: 10.4 ↗		
4: 10.4 →		
5: 10.3 ↘		
		Total 193.0

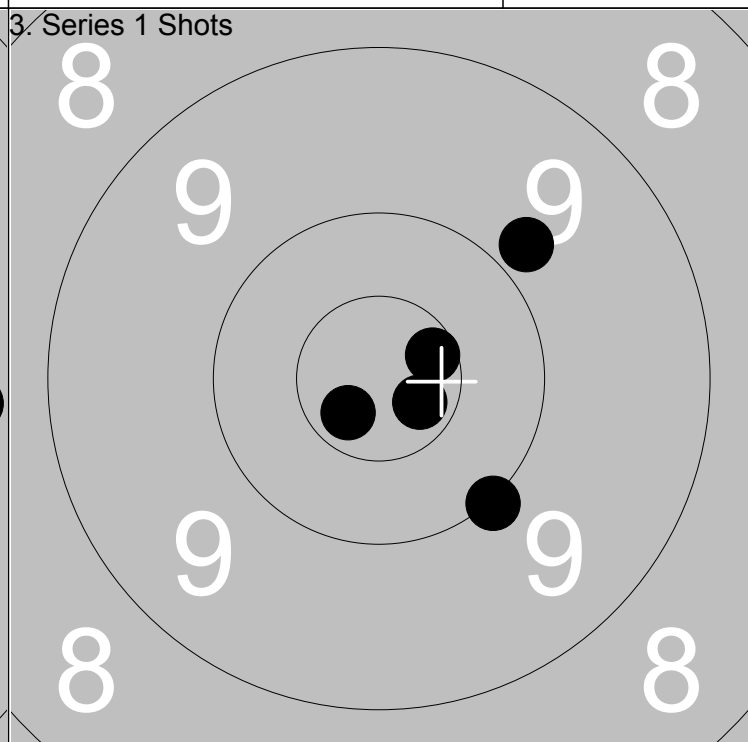
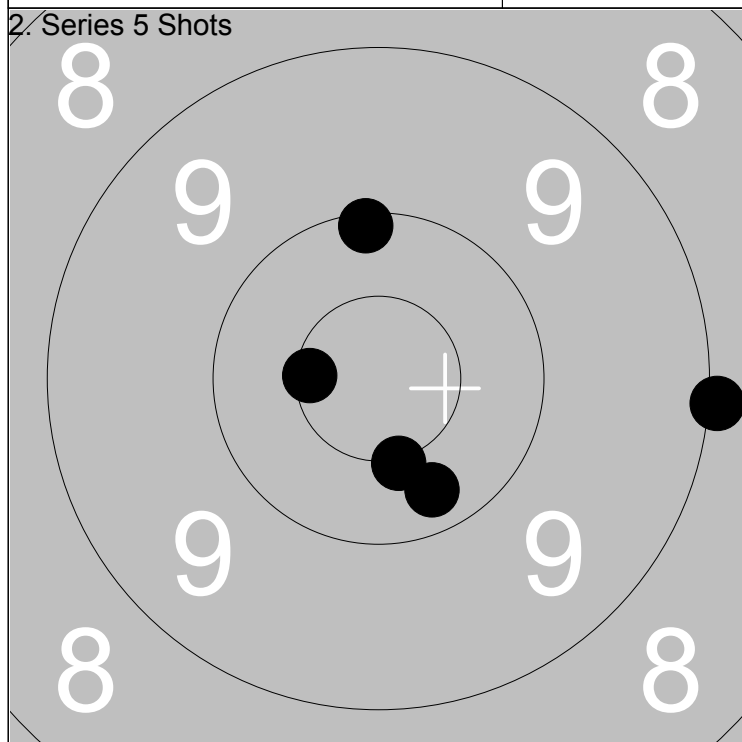

1: 9.0 →	Series	49.0
2: *10.5 ↓		
3: 10.1 ↑		
4: 10.3 ↓		
5: *10.6 ←		
		Total 242.0

1: 10.0 ↘	Series	49.0
2: 9.8 ↗		
3: *10.7 ↙		
4: *10.6 ↗		
5: *10.7 ↘		
		Total 291.0

Relay 5	Lane 11	Alf Edin
-------------------	-------------------	-----------------

300m	Ale	B	No
------	-----	---	----

06.07.2014	Tavelträffen 2014	Ramselefors SKF
------------	-------------------	-----------------

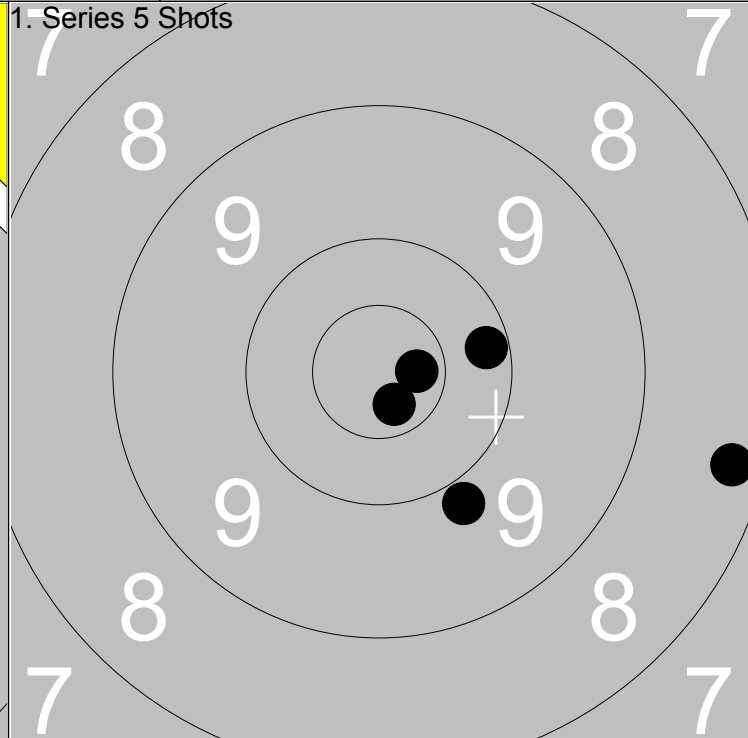
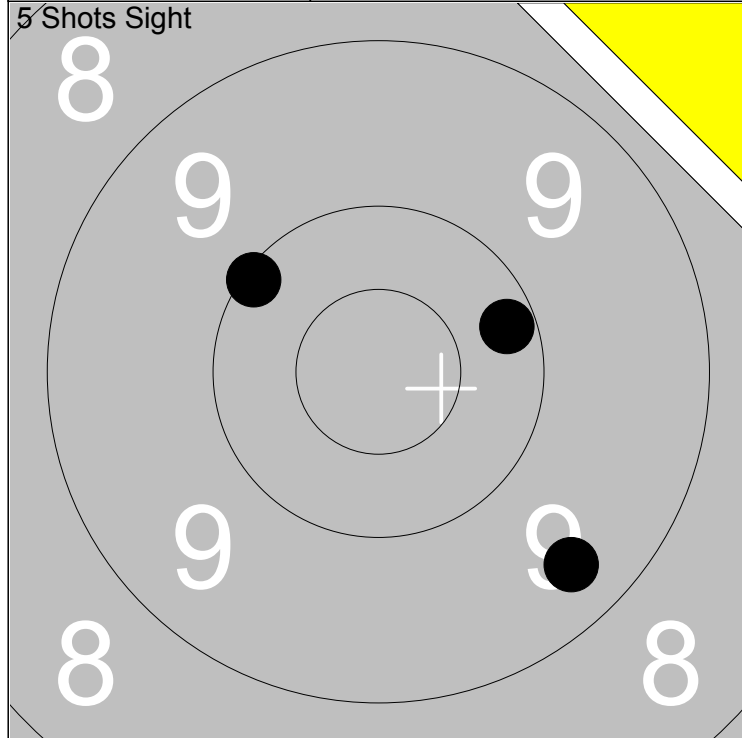

1: 10.2 →	Series	29.0
2: 9.4 ↘		
3: 10.1 ↖		
Total		142.0

1: *10.7 →	Series	47.0
2: *10.7 ↘		
3: 8.3 →		
4: 10.2 →		
5: 9.9 ↘		
Total		189.0

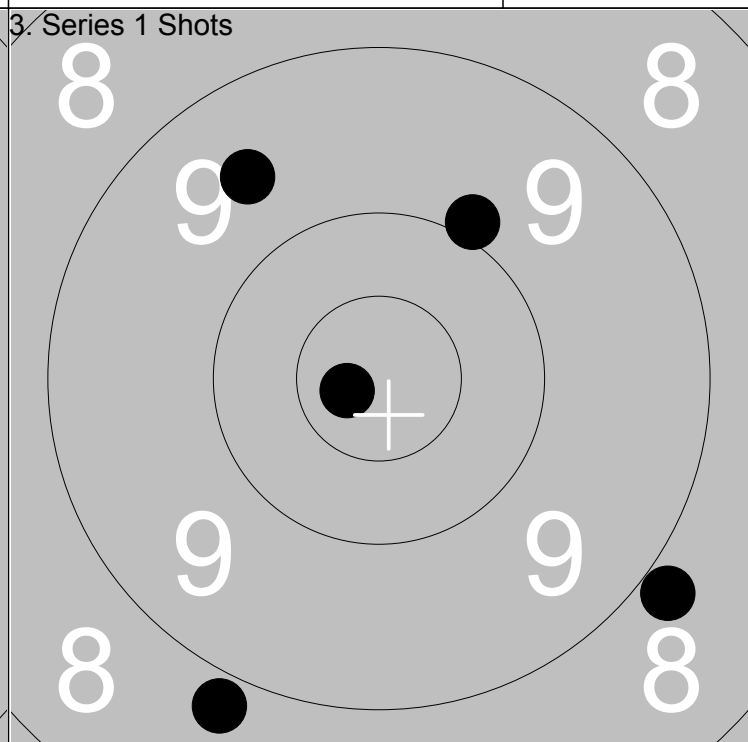
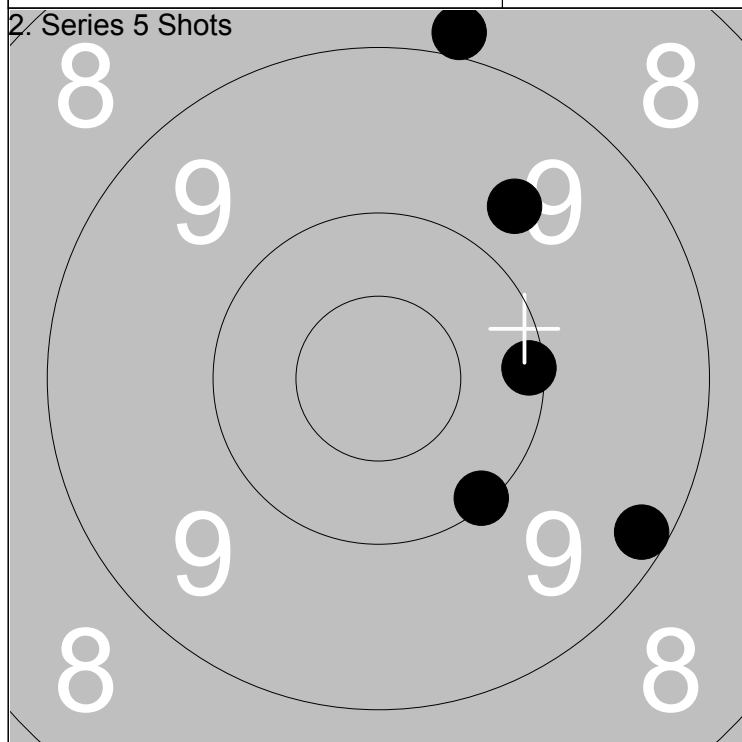

1: 9.7 ↗	Series	46.0
2: 8.9 ↑		
3: 10.1 →		
4: 9.2 ↘		
5: 10.1 ↘		
Total		235.0

1: 9.9 ↗	Series	44.0
2: 9.6 ↖		
3: *10.8 ↙		
4: 8.9 ↘		
5: 8.8 ↘		
Total		279.0

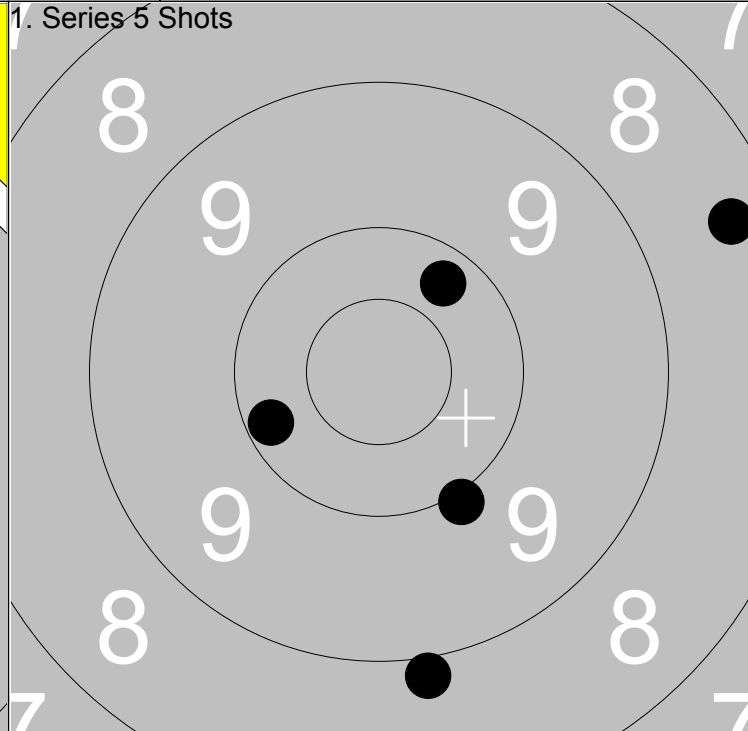
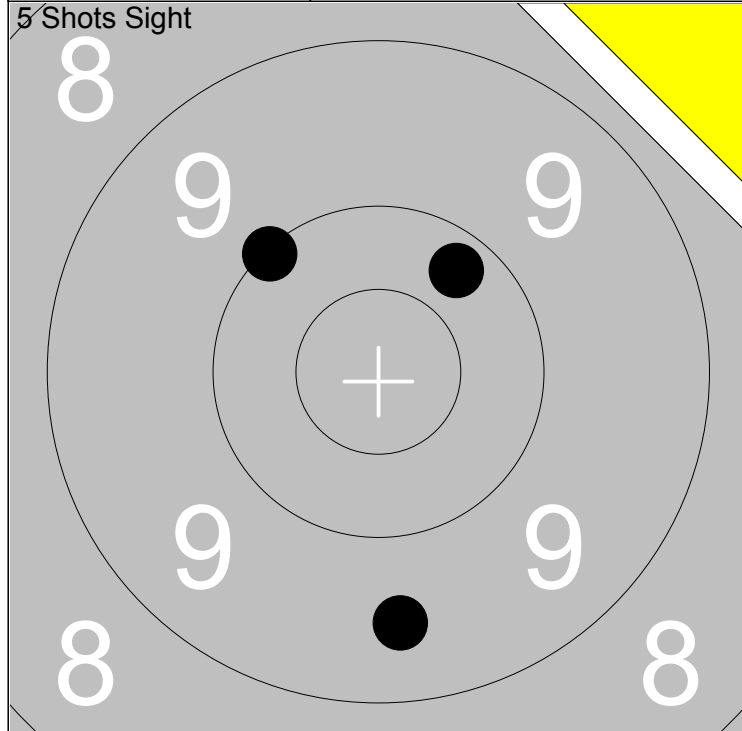

1: 10.2 ↗	Series	29.0
2: 10.0 ↖		
3: 9.5 ↓		
Total		141.0

1: 10.0 ↓	Series	46.0
2: 8.4 →		
3: 10.2 ↗		
Total		187.0

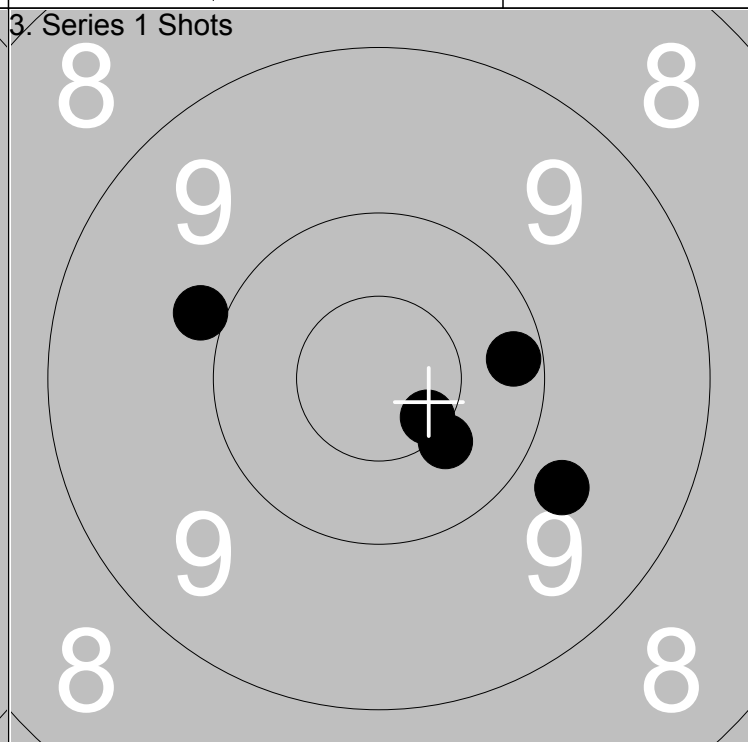
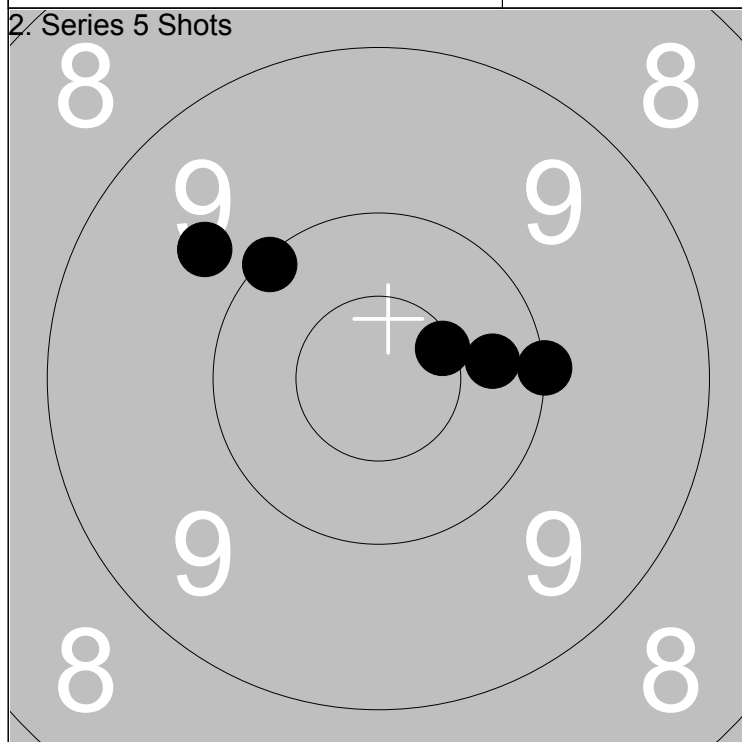

1: 10.3 →	Series	49.0
2: 10.0 →		
3: *10.6 →		
Total		236.0

1: 9.9 ↖	Series	48.0
2: *10.4 ↓		
3: 10.2 →		
Total		284.0

Relay 5	Lane 13	Johan Nilsson	
-------------------	-------------------	----------------------	--

300m	Ramselefors	B	Vb
------	-------------	---	----

06.07.2014	Tavelträffen 2014	Ramselefors SKF	
------------	-------------------	-----------------	--

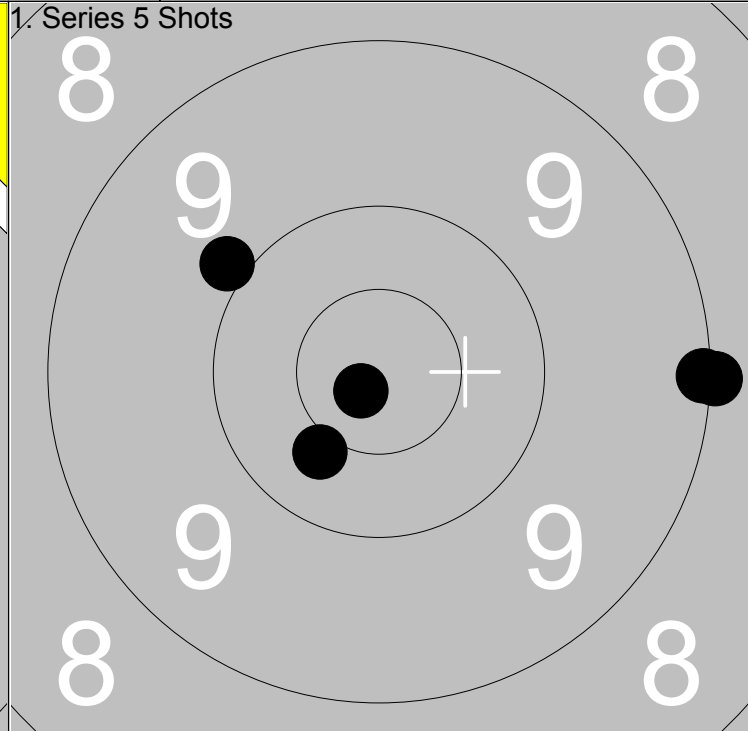
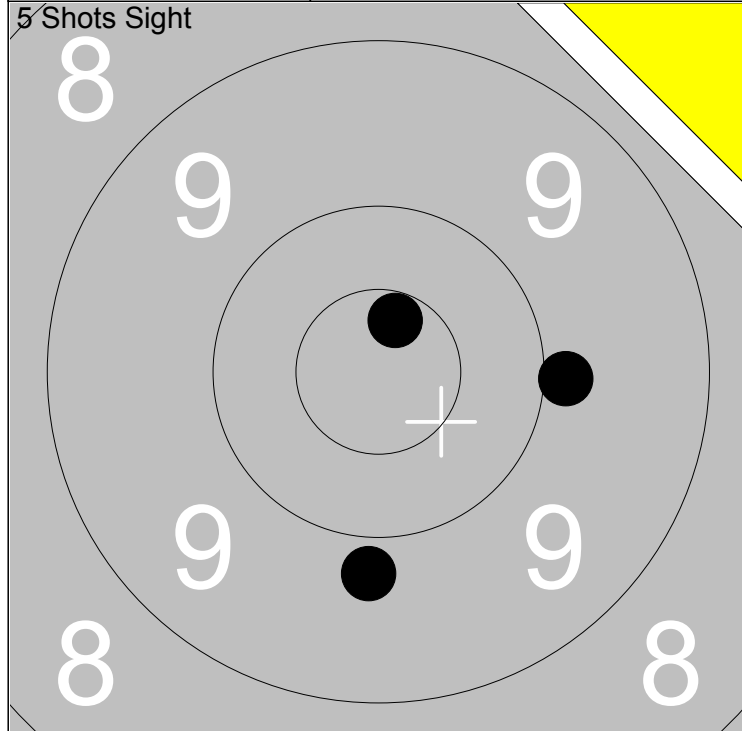

1: 9.9 →	Series	28.0
2: *10.6 ↑		
3: 9.8 ↓		
Total		141.0

1: *10.8 ↙	Series	47.0
2: 10.4 ↘		
3: 9.9 ↖		
4: 9.0 →		
5: 9.1 →		
Total		188.0

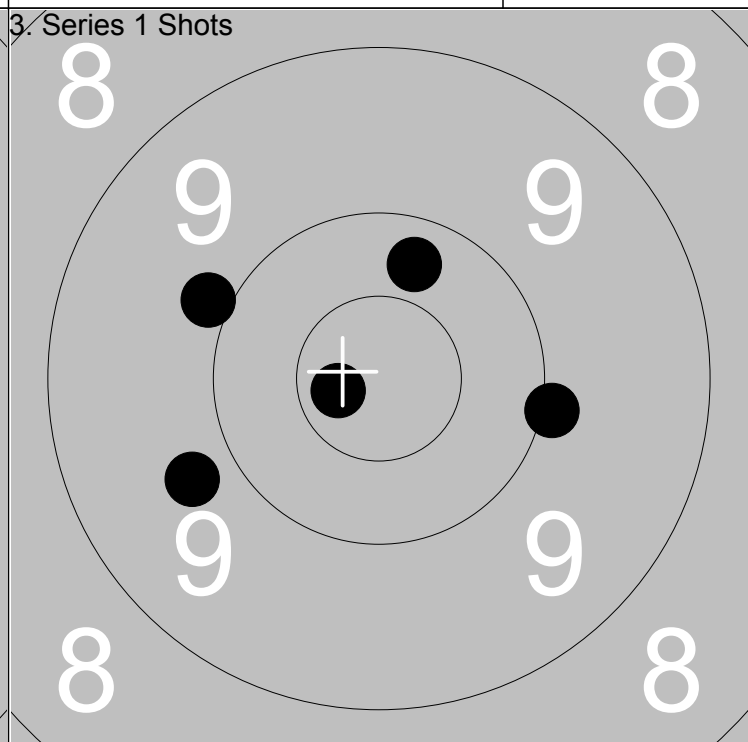
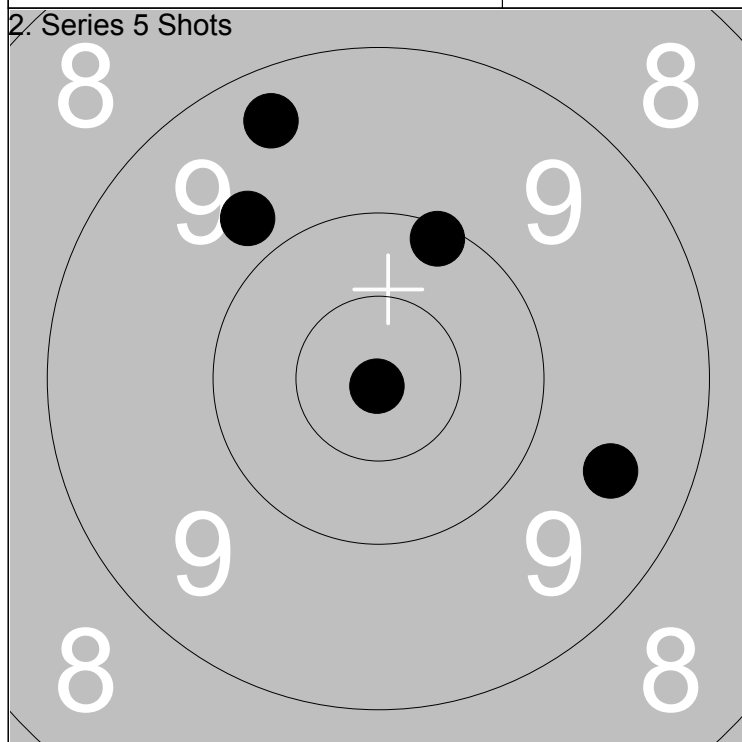

1: 9.8 ↖	Series	47.0
2: 9.5 →		
3: *10.9 ↓		
4: 10.1 ↑		
5: 9.3 ↗		
Total		235.0

1: 10.3 ↑	Series	48.0
2: 9.9 ↖		
3: 9.8 ↙		
4: *10.7 ↙		
5: 10.0 →		
Total		283.0

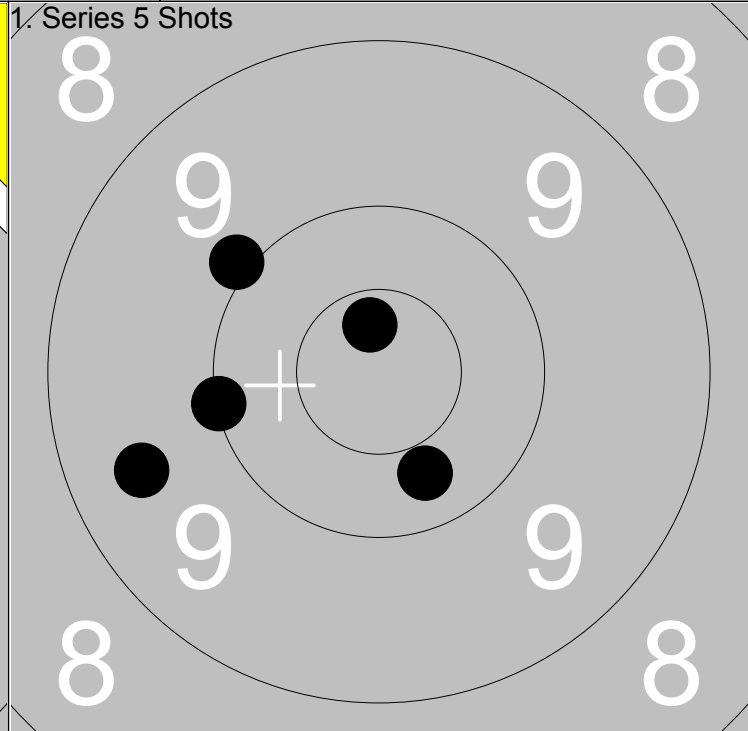
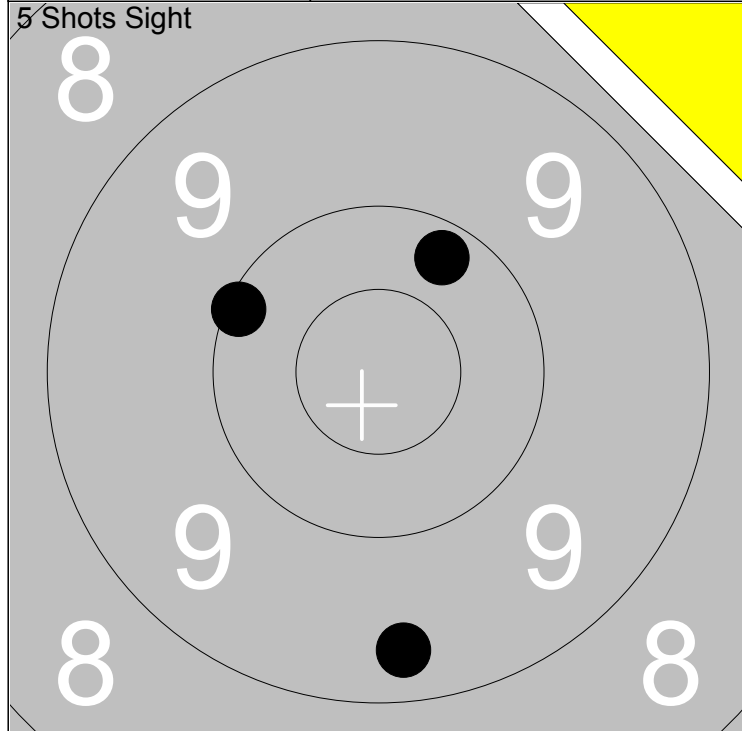

1: 9.3 ↓	Series	29.0
2: 10.2 ↗		
3: 10.1 ↖		
Total		141.0

1: 9.9 ↖	Series	48.0
2: 10.0 ←		
3: *10.7 ↗		
Total		189.0

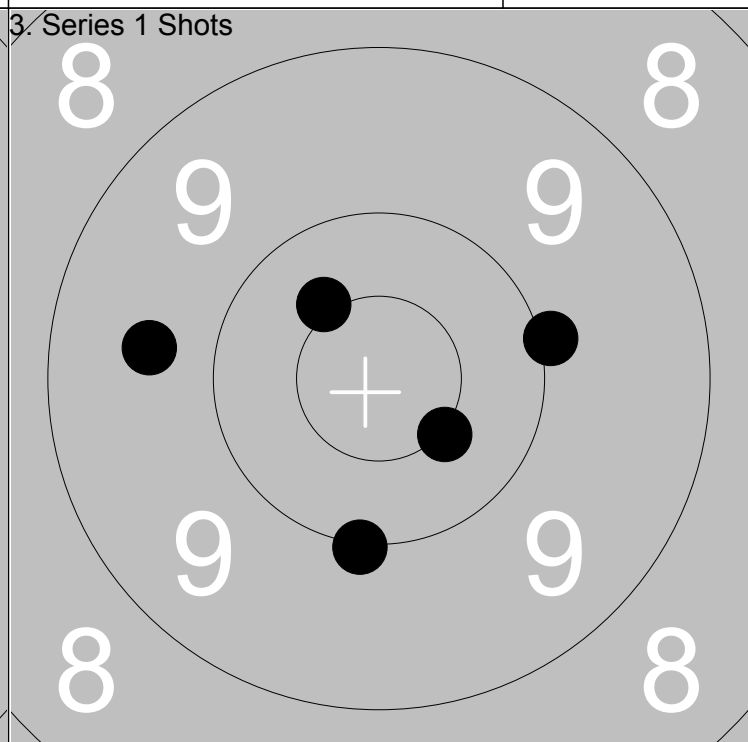
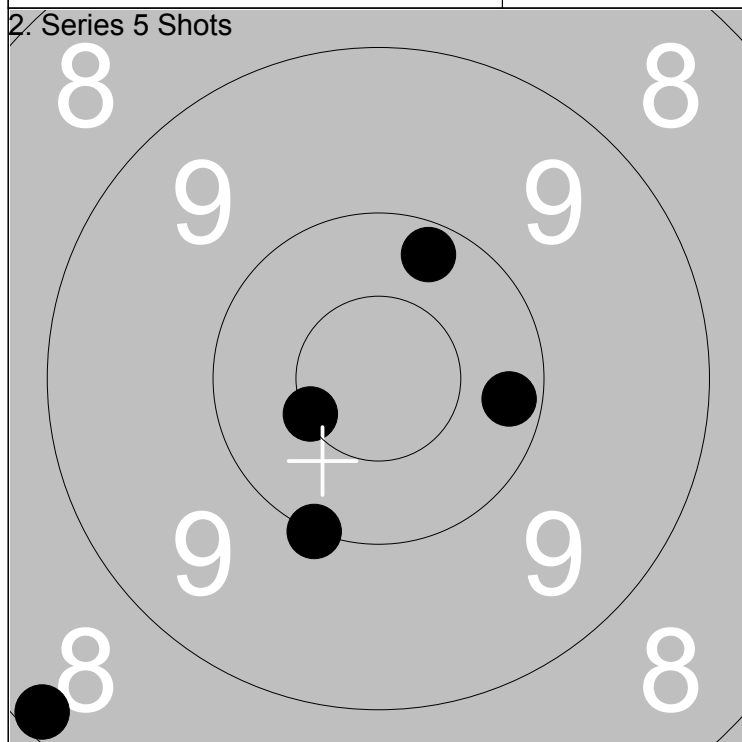

1: 10.0 ↘	Series	48.0
2: 10.2 ↗		
3: 10.2 →		
Total		237.0

1: 9.6 ←	Series	49.0
2: *10.4 ↖		
3: 10.0 →		
Total		286.0

Relay 5	Lane 15	Stefan Jonasson		
-------------------	-------------------	------------------------	--	--

300m	Hogdal	B	Jä
------	--------	---	----

06.07.2014	Tavelträffen 2014	Ramselefors SKF
------------	-------------------	-----------------

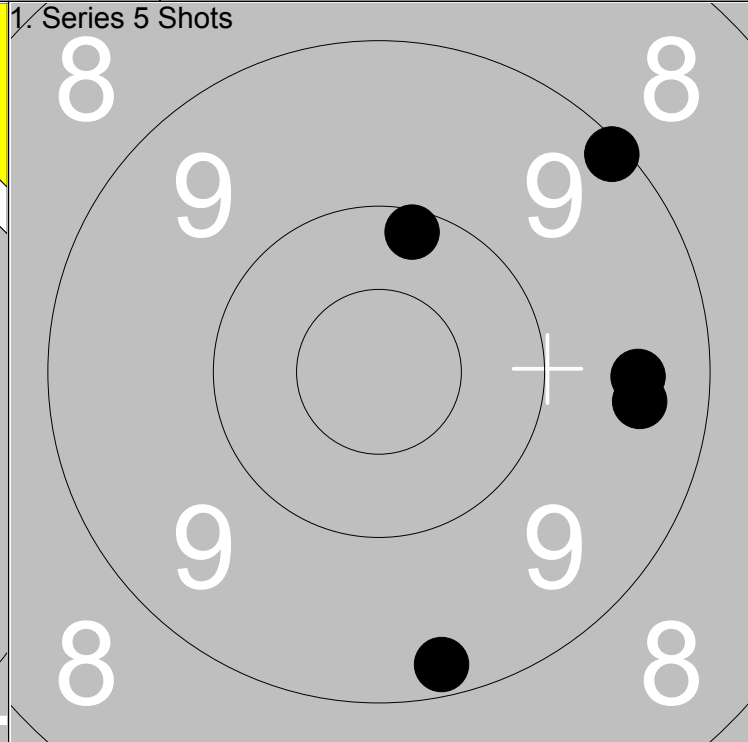
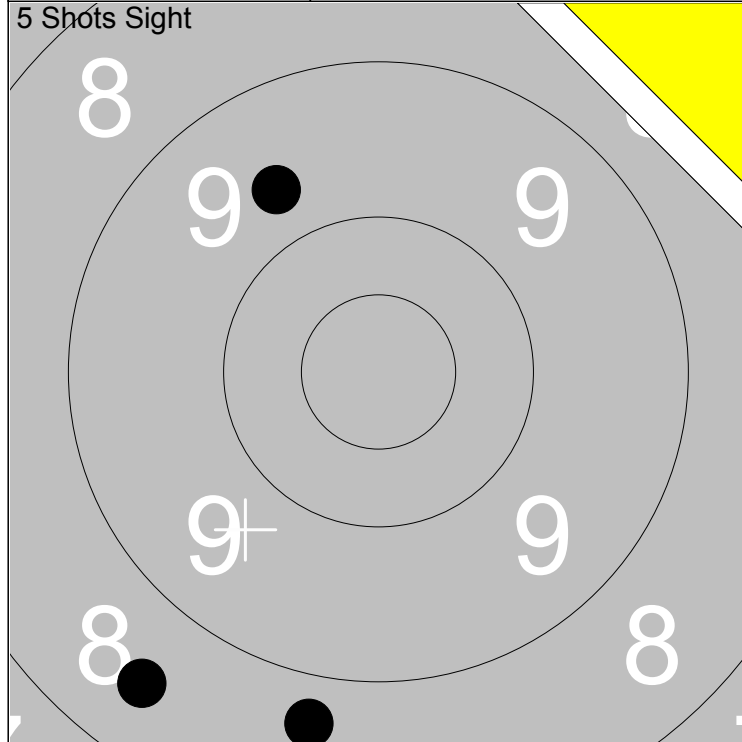

1: 9.7 ↗	Series	25.0
2: 8.5 ↘		
3: 8.7 ↓		
Total		141.0

1: 9.4 →	Series	46.0
2: 10.1 ↑		
3: 9.1 ↗		
Total		187.0

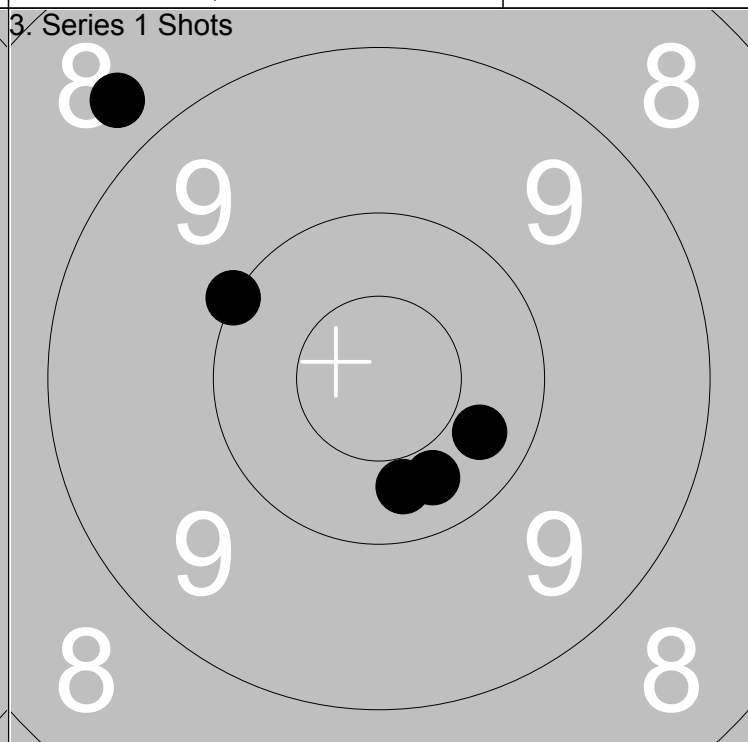
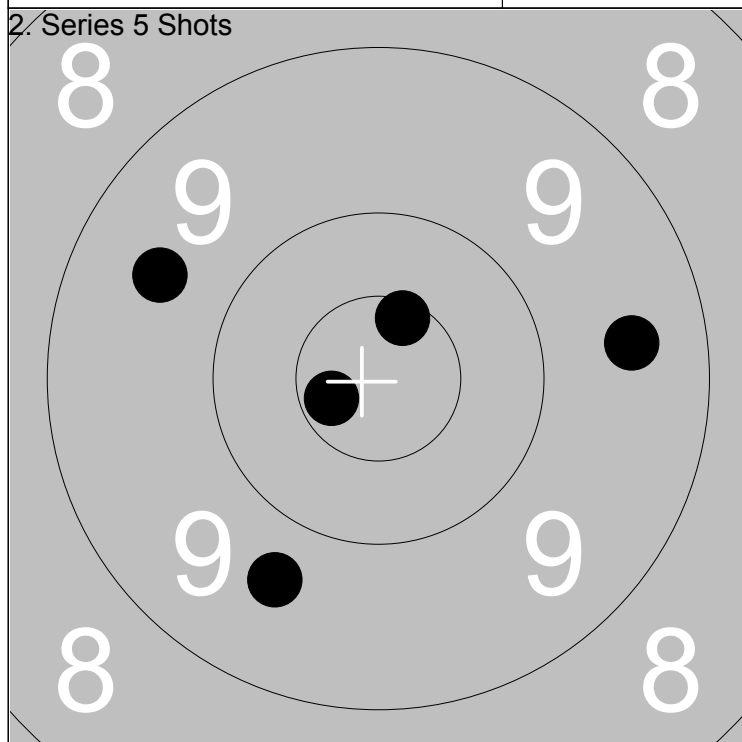

1: *10.6 ↗	Series	47.0
2: *10.7 ↙		
3: 9.5 →		
Total		234.0

1: 8.7 ↗	Series	48.0
2: 10.0 ↙		
3: 10.3 ↓		
Total		282.0

Relay	Lane	Linda Bergman	
5	16		

300m	Ununge	B	St
------	--------	---	----

06.07.2014	Tavelträffen 2014	Ramselefors SKF
------------	-------------------	-----------------

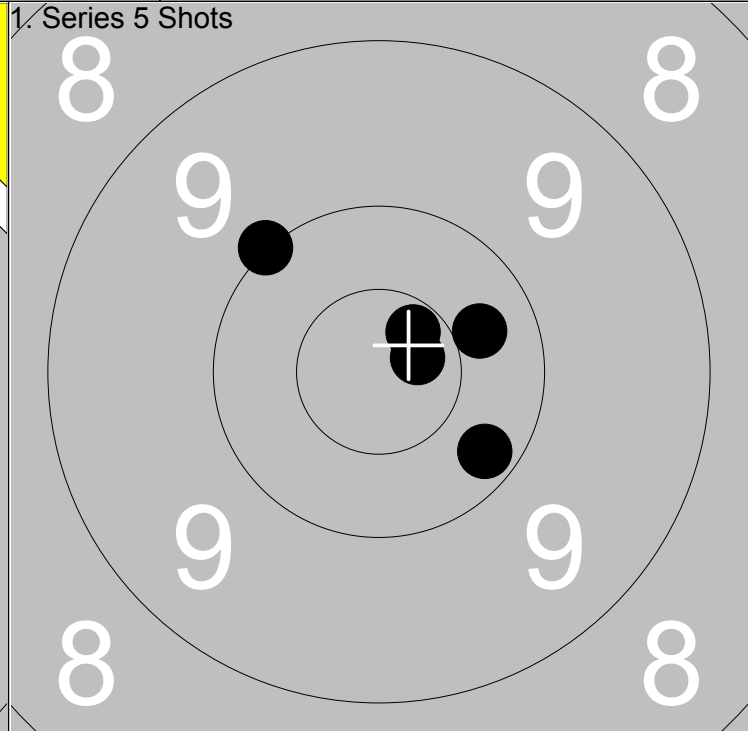
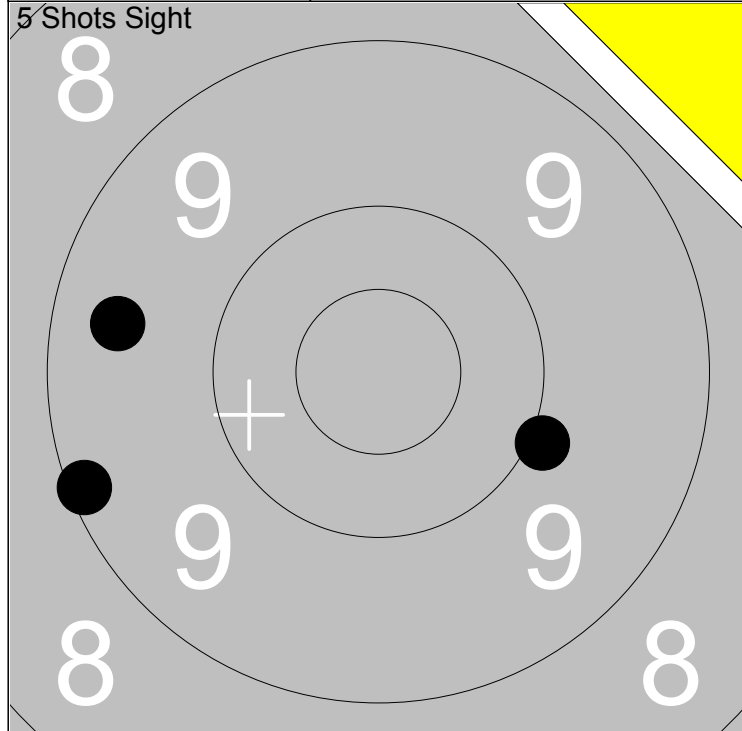

1: 9.1 ←	Series	27.0
2: 9.4 ←		
3: 9.9 →		
Total		140.0

1: *10.7 ↗	Series	50.0
2: 10.3 →		
3: *10.7 →		
4: 10.0 ↖		
5: 10.2 ↘		
Total		190.0

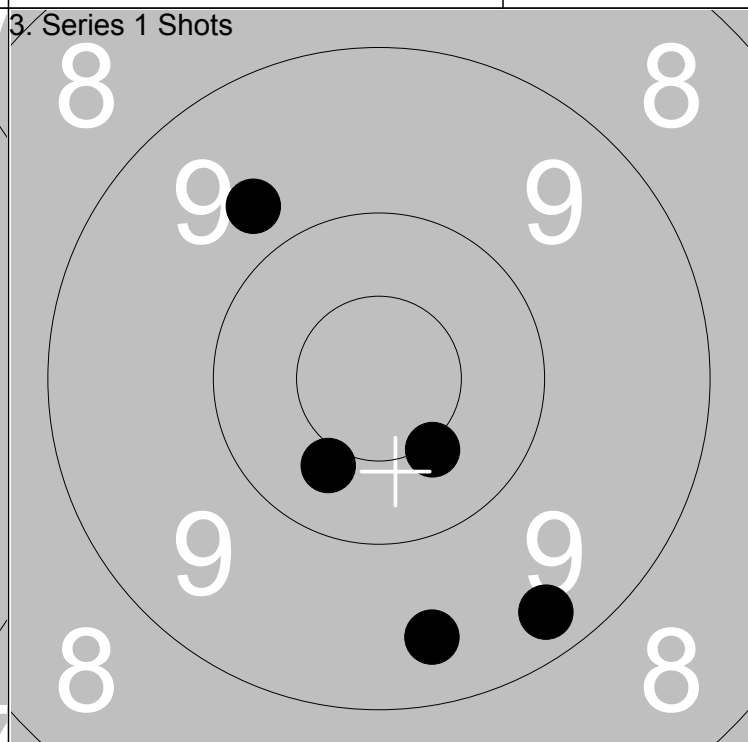
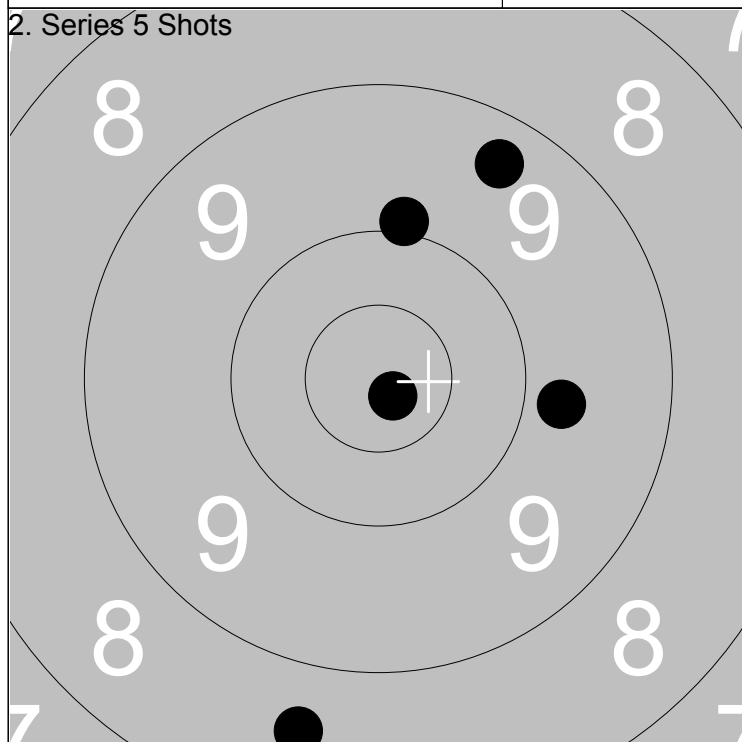

1: 9.9 ↑	Series	45.0
2: 9.4 ↗		
3: 9.8 →		
4: *10.8 ↘		
5: 8.6 ↓		
Total		235.0

1: 9.4 ↓	Series	47.0
2: *10.5 ↘		
3: 9.3 ↘		
4: 9.7 ↗		
5: 10.4 ↘		
Total		282.0

Relay 5	Lane 17	Tony Jansson	
-------------------	-------------------	---------------------	--

300m	Ununge	B	St
------	--------	---	----

06.07.2014	Tavelträffen 2014	Ramselefors SKF
------------	-------------------	-----------------

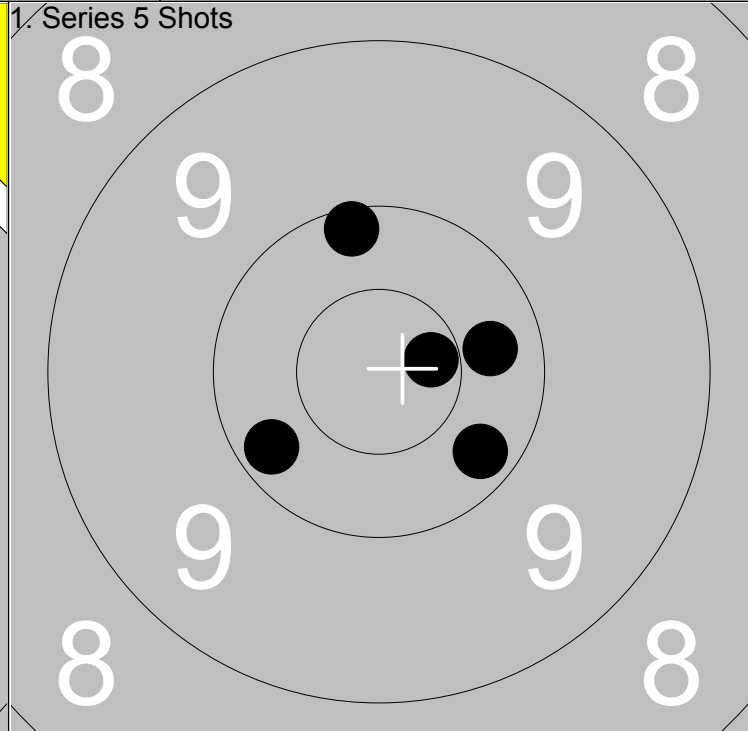
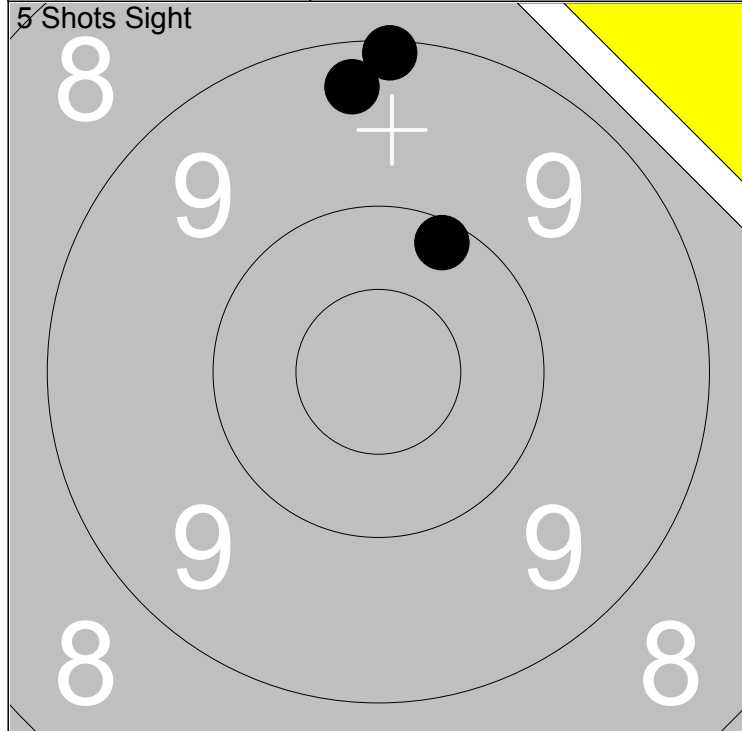

1: 9.1 ↑	Series	28.0
2: 10.1 ↗		
3: 9.3 ↑		
Total		140.0

1: 10.2 ↙	Series	50.0
2: *10.6 →		
3: 10.1 ↑		
4: 10.3 →		
5: 10.2 ↘		
Total		190.0

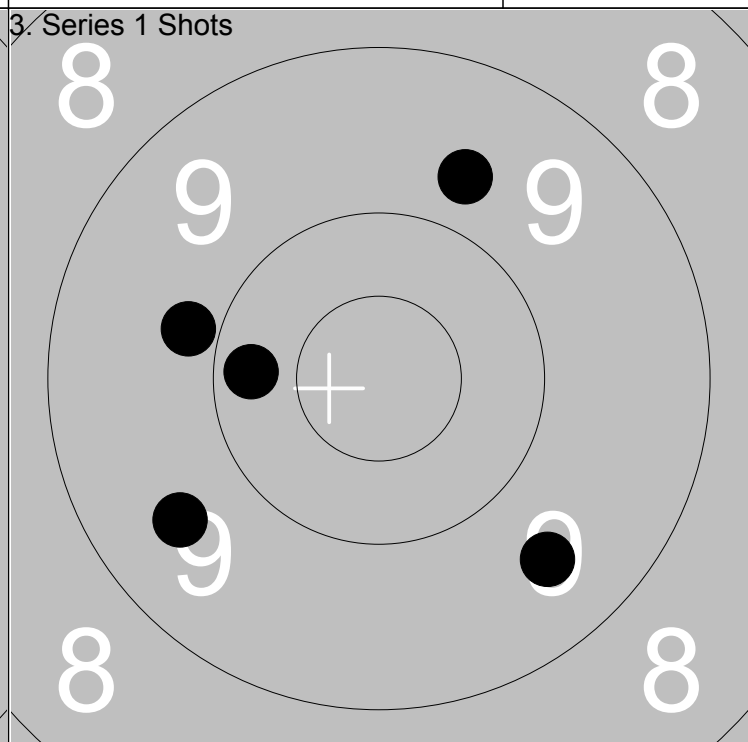
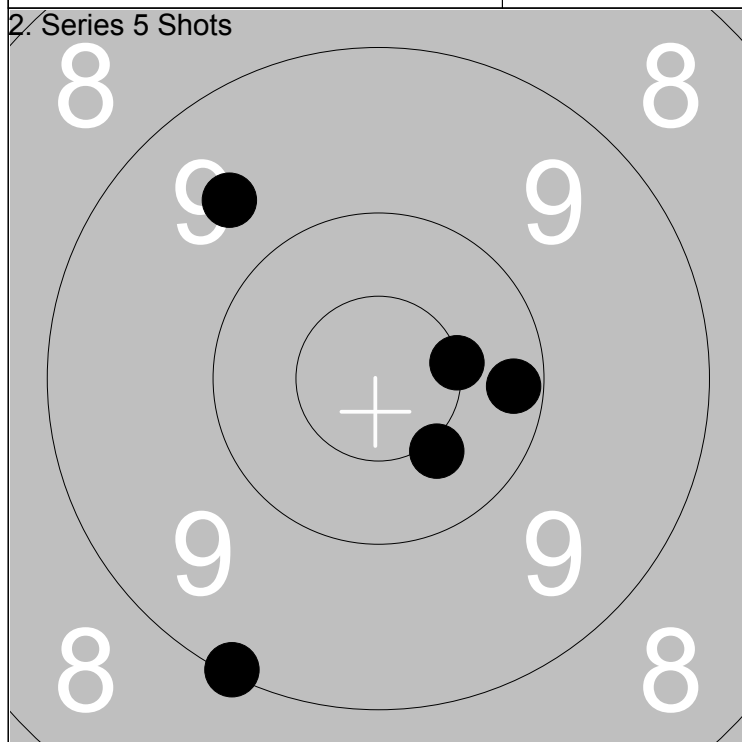

1: 9.6 ↖	Series	48.0
2: *10.5 →		
3: 10.2 →		
4: *10.4 ↘		
5: 9.1 ↙		
Total		238.0

1: 9.7 ↗	Series	46.0
2: 9.5 ↘		
3: 9.8 ←		
4: 10.2 ←		
5: 9.6 ↙		
Total		284.0

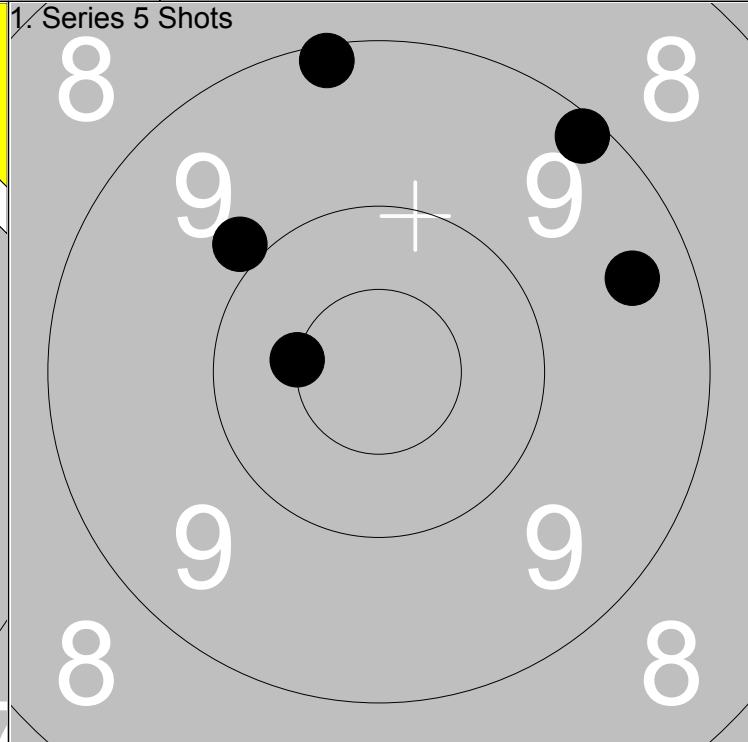
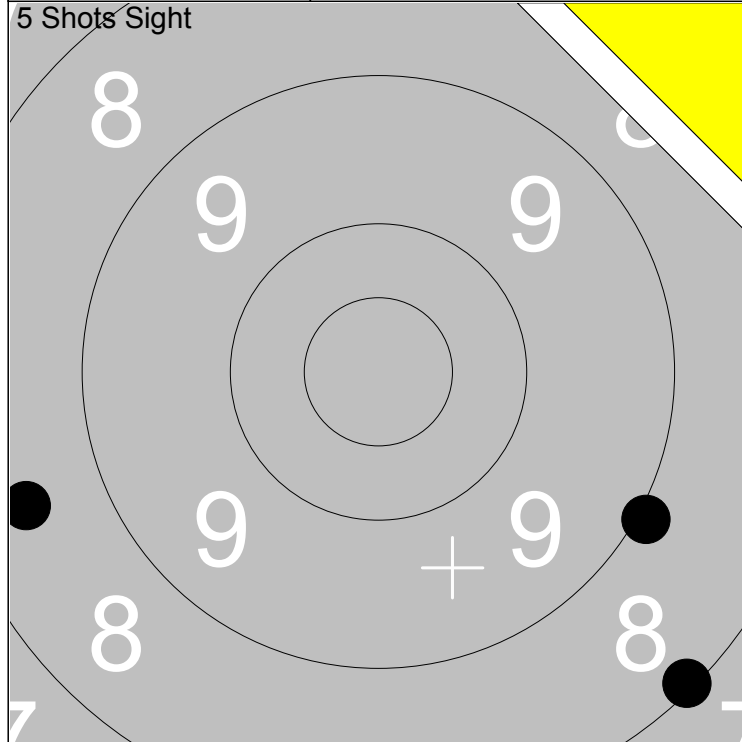

1: 8.1 ↘	Series	25.0
2: 9.0 ↘		
3: 8.5 ←		
Total		139.0

1: *10.5 ←	Series	46.0
2: 9.9 ↖		
3: 9.1 ↗		
4: 9.4 →		
5: 9.1 ↑		
Total		185.0

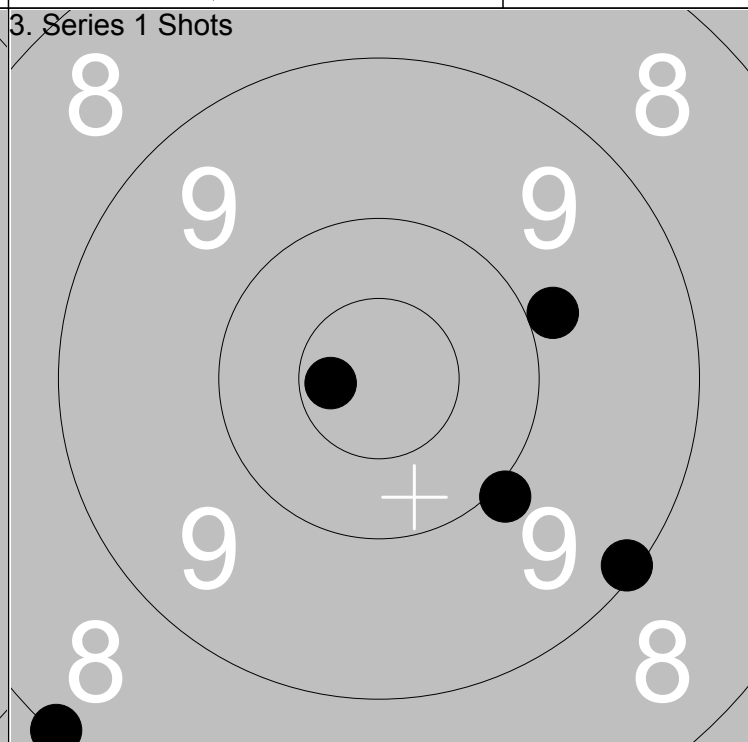
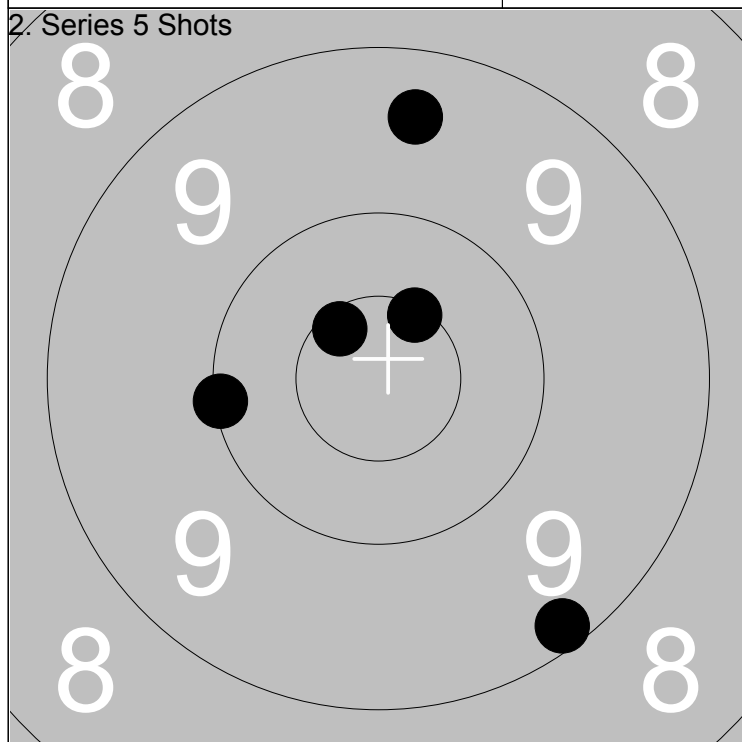

1: *10.6 ↖	Series	48.0
2: 9.4 ↑		
3: *10.5 ↗		
4: 10.1 ←		
5: 9.2 ↘		
Total		233.0

1: 10.0 ↘	Series	46.0
2: 9.1 ↘		
3: 8.1 ↘		
4: *10.7 ←		
5: 9.9 →		
Total		279.0

Relay 5	Lane 19	Anders Andersson	
-------------------	-------------------	-------------------------	--

300m	Hammerdal	B	Jä
------	-----------	---	----

06.07.2014	Tavelträffen 2014	Ramselefors SKF
------------	-------------------	-----------------

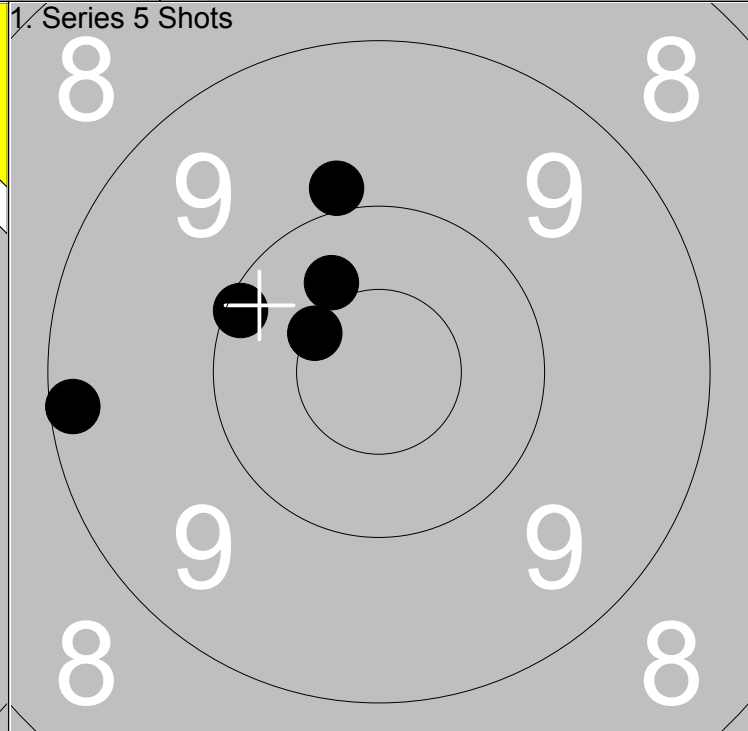
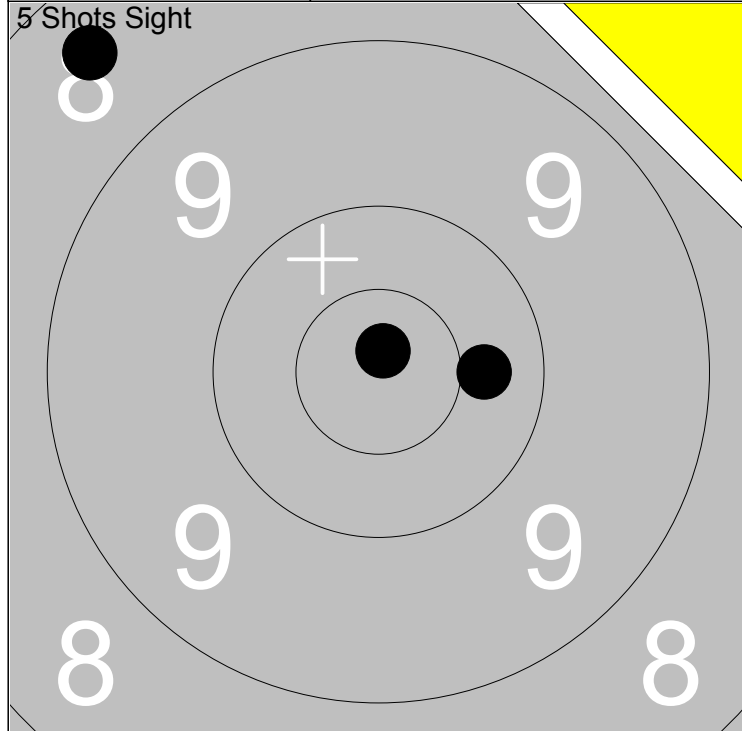

1: 8.4 ↗	Series 28.0
2: 10.4 →	
3: *10.8 ↑	
Total 138.0	

1: 9.2 ←	Series 48.0
2: *10.5 ↘	
3: 10.1 ↖	
Total 186.0	

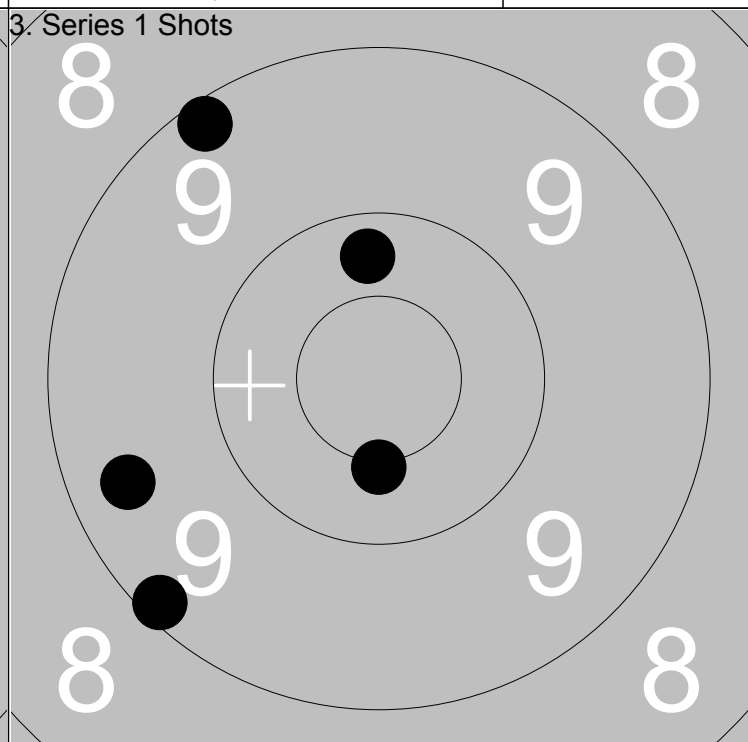
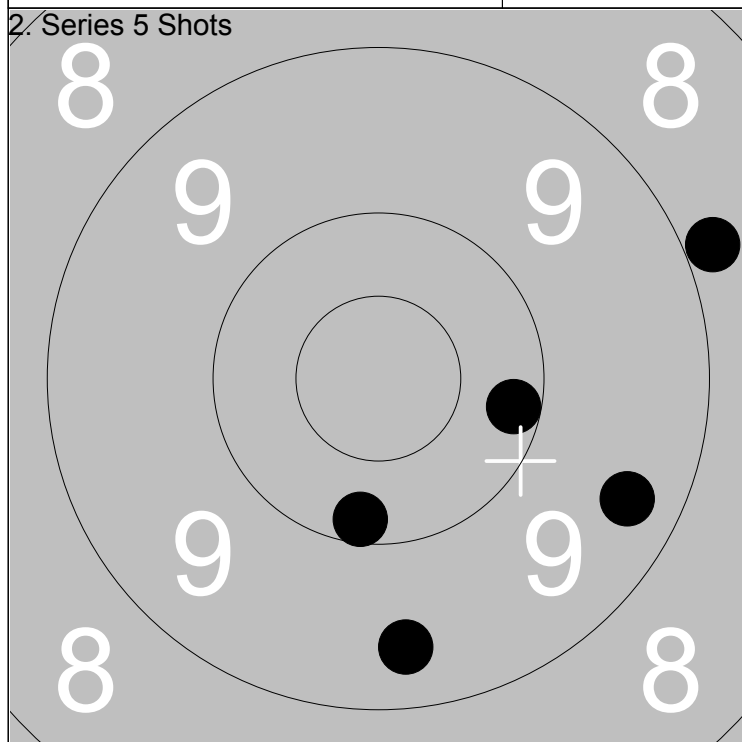

1: 10.2 →	Series 46.0
2: 9.4 ↘	
3: 8.9 ↗	
Total 232.0	

1: 10.3 ↑	Series 47.0
2: 9.2 ↖	
3: 9.1 ↘	
Total 279.0	

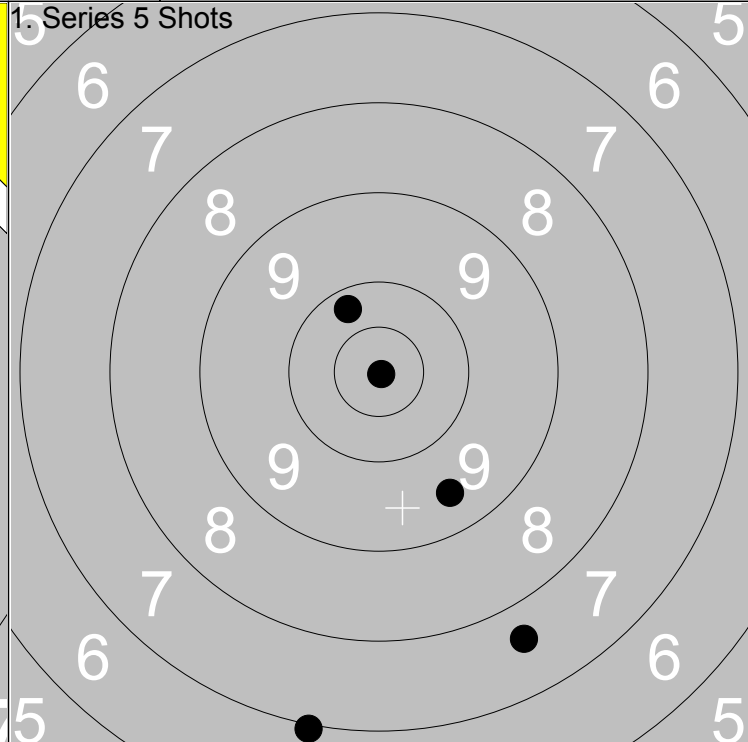
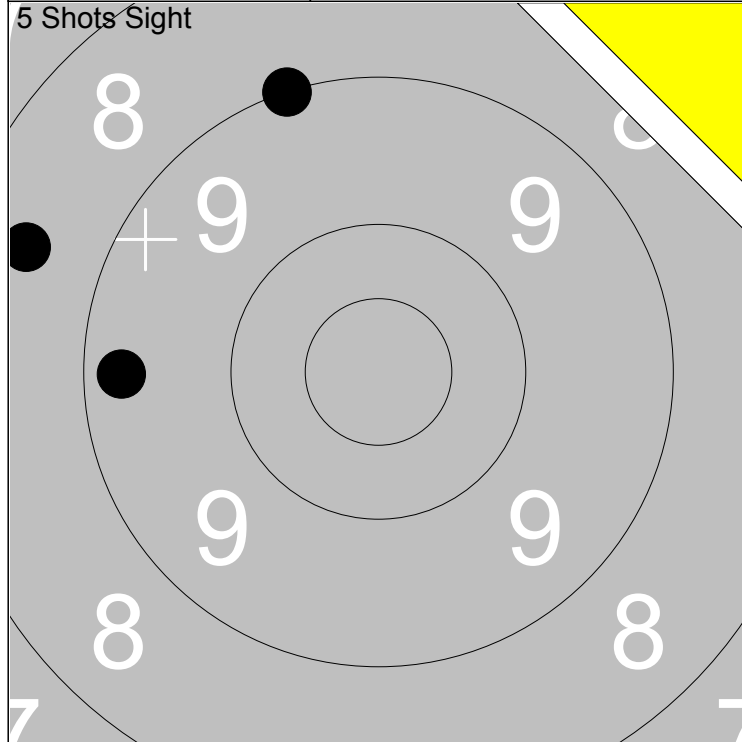

1: 8.5 ←	Series	26.0
2: 9.0 ↑		
3: 9.3 ←		
Total		120.0

1: 10.2 ↗	Series	43.0
2: 7.0 ↓		
3: *10.9 ↘		
4: 9.5 ↓		
5: 7.6 ↓		
Total		163.0

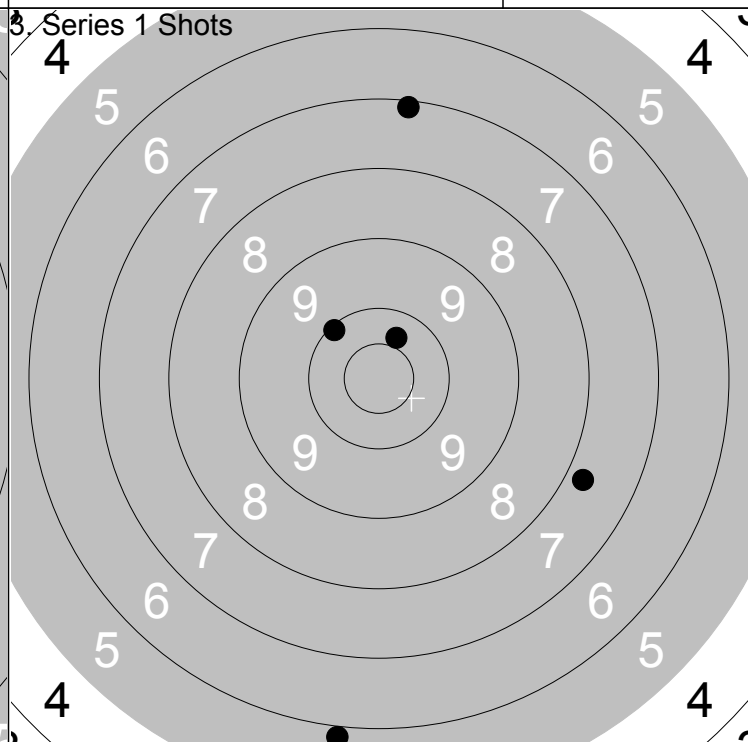
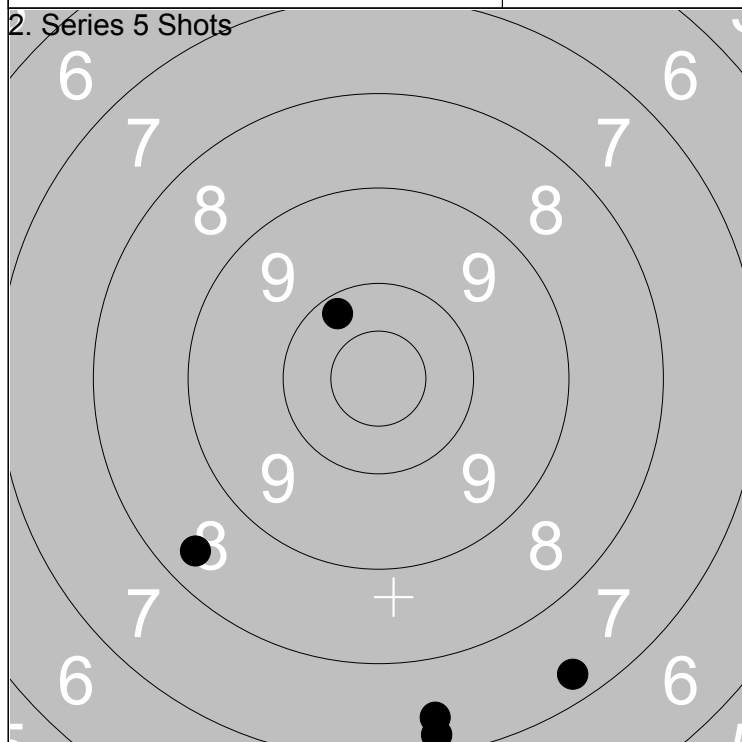

1: 8.4 ↙	Series	39.0
2: 7.3 ↘		
3: 7.4 ↓		
4: 7.2 ↓		
5: 10.2 ↗		
Total		202.0

1: 5.9 ↓	Series	39.0
2: 10.4 ↗		
3: 7.1 ↑		
4: 7.8 ↘		
5: 10.1 ↗		
Total		241.0

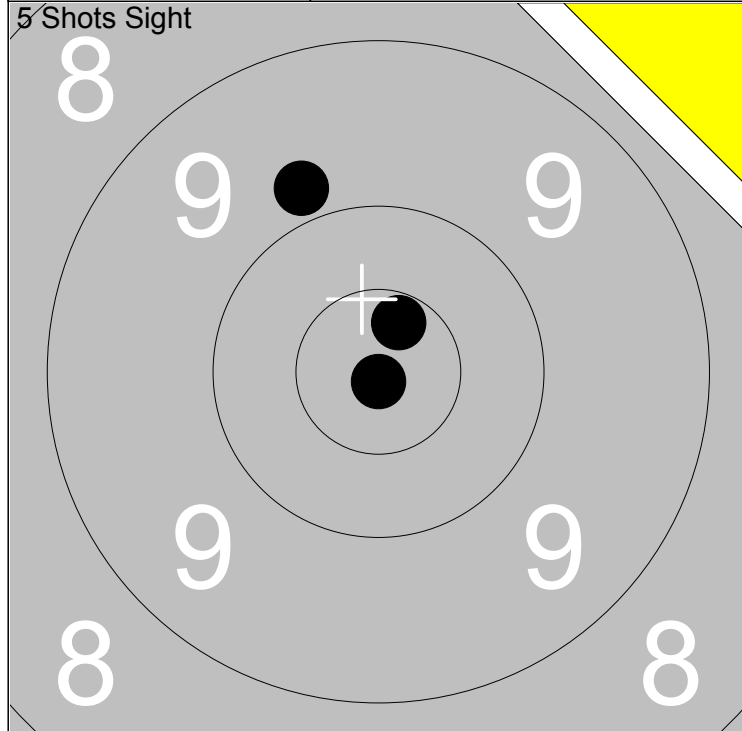

1: *10.7 ↗	Series	29.0
2: 9.8 ↖		
3: *10.9 ↓		
Total		142.0

1: 8.7 ↖	Series	47.0
2: *10.9 ↖		
3: *10.6 ↗		
4: 10.4 ↗		
5: 9.6 ↘		
Total		189.0

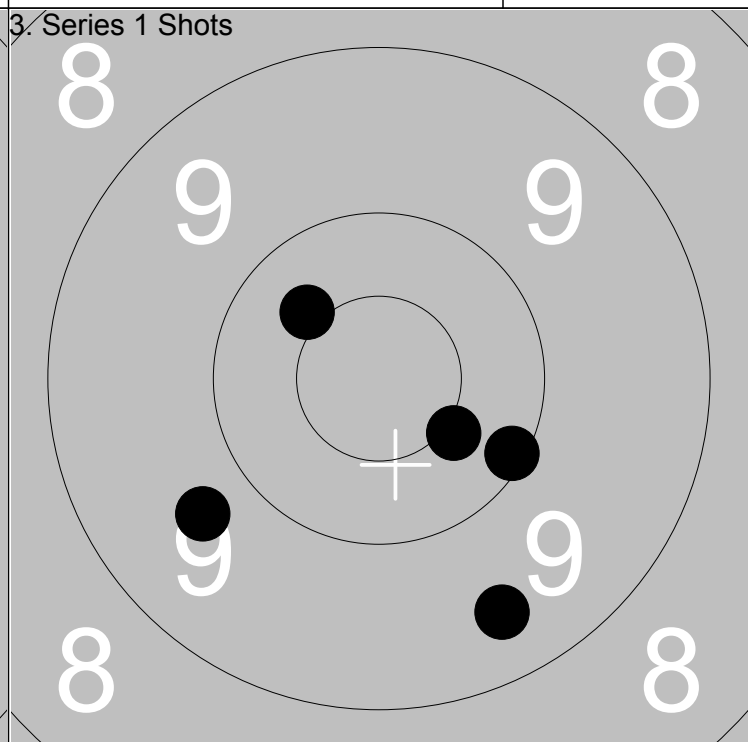
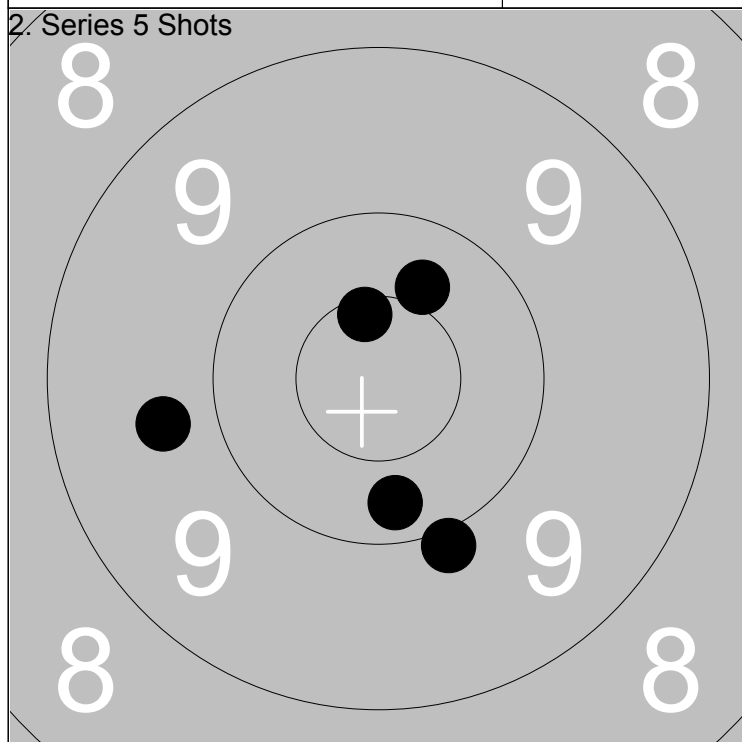

1: 10.3 ↓	Series	48.0
2: 9.7 ←		
3: *10.6 ↗		
4: 10.4 ↗		
5: 9.9 ↓		
Total		237.0

1: *10.4 ↘	Series	48.0
2: 9.4 ↓		
3: 10.1 ↘		
4: 10.4 ↖		
5: 9.7 ↖		
Total		285.0

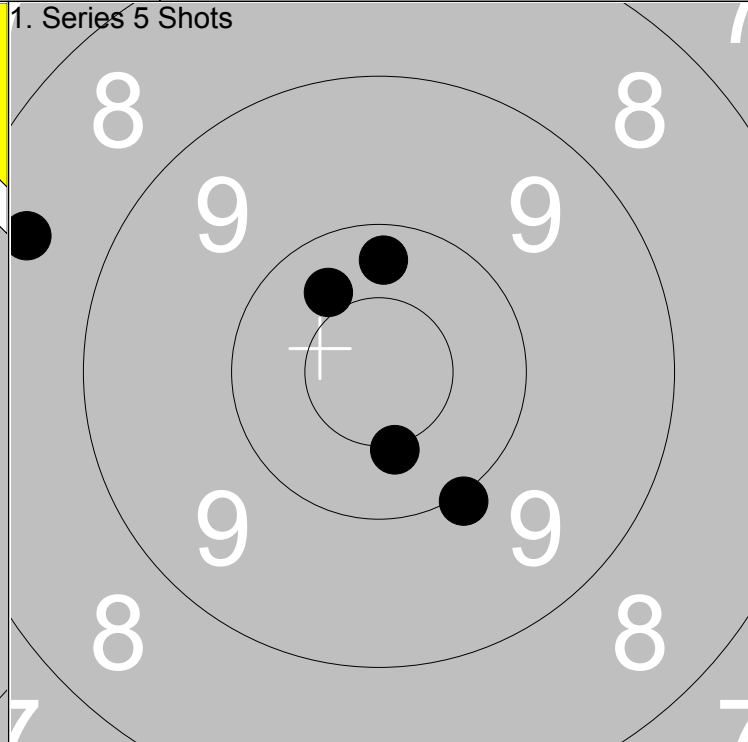
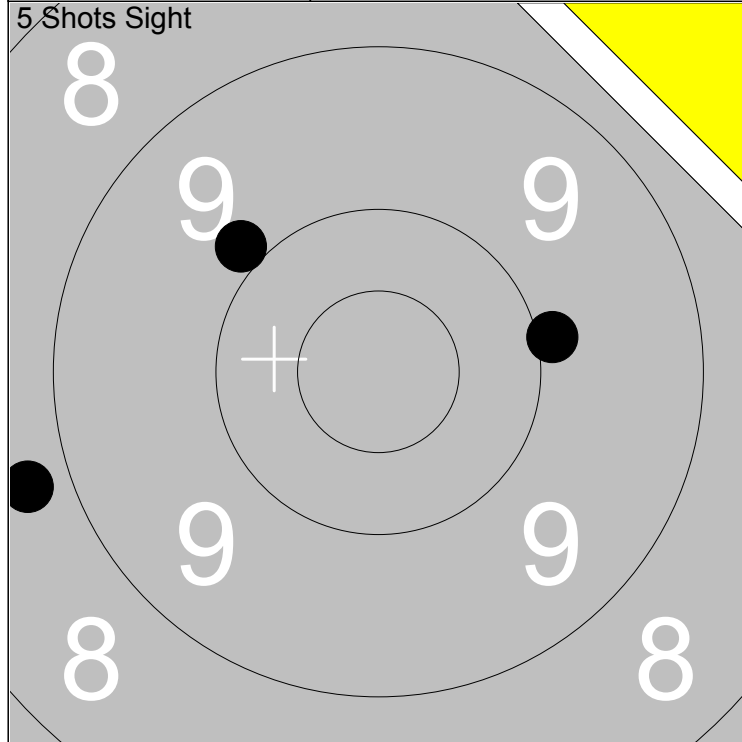

1: 9.9 →	Series	26.0
2: 9.9 ↗		
3: 8.8 ←		
Total		138.0

1: 10.2 ↑	Series	48.0
2: 10.0 ↓		
3: 8.5 ←		
Total		186.0

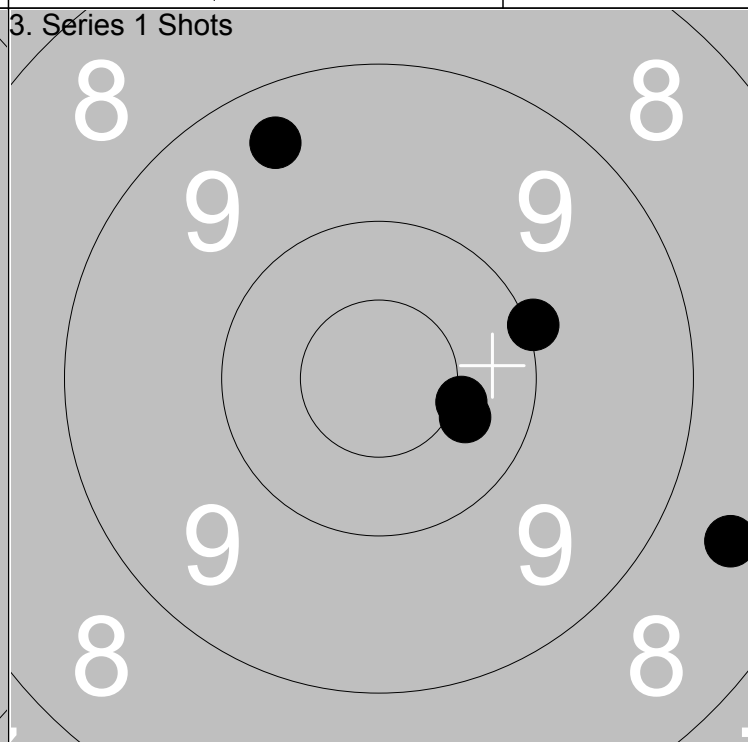
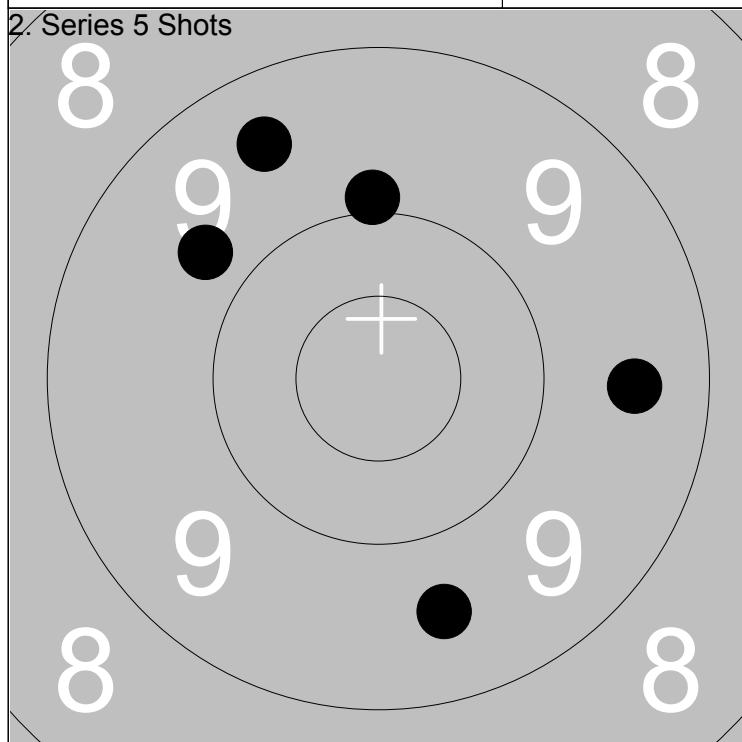

1: 9.7 ↖	Series	45.0
2: 9.5 ↗		
3: 9.5 →		
Total		231.0

1: 10.4 →	Series	47.0
2: 10.0 →		
3: 8.6 →		
Total		278.0

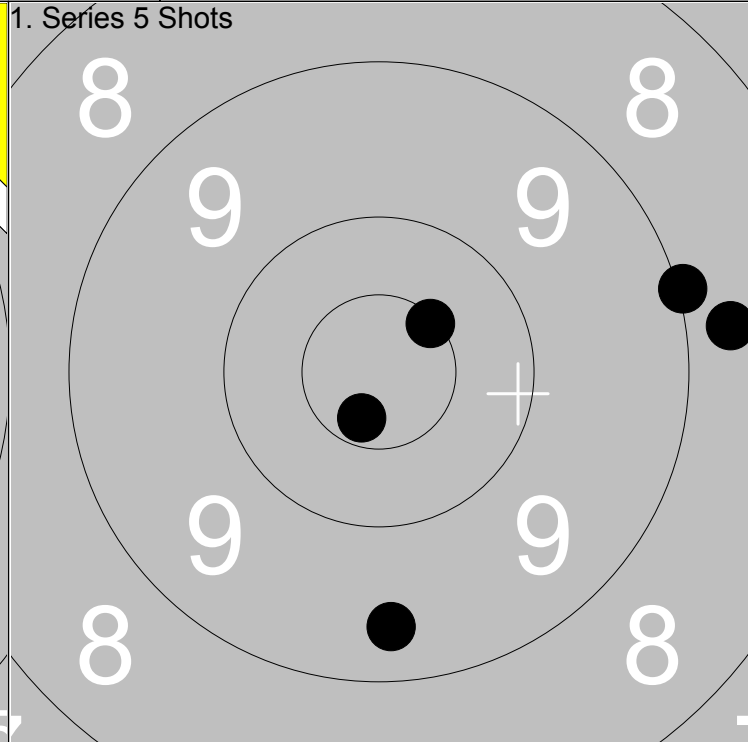
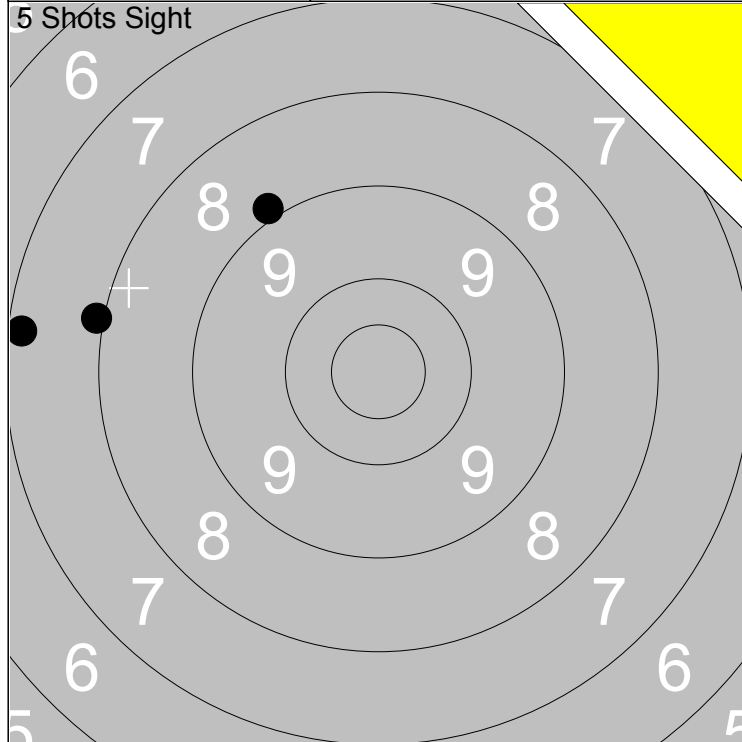

1: 8.9 ↗	Series	22.0
2: 7.2 ←		
3: 7.9 ←		
Total		138.0

1: *10.5 ↗	Series	46.0
2: 8.7 →		
3: 9.4 ↓		
Total		184.0

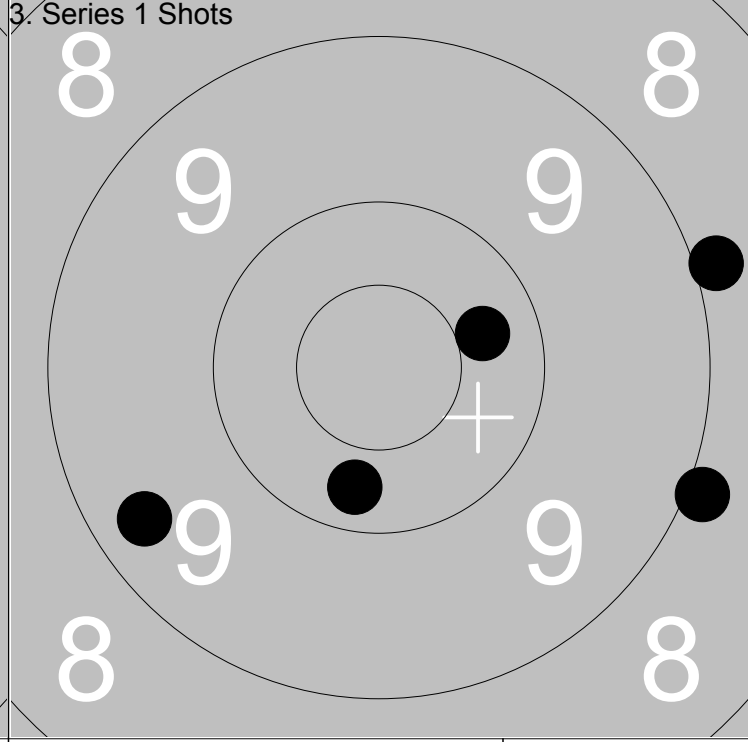
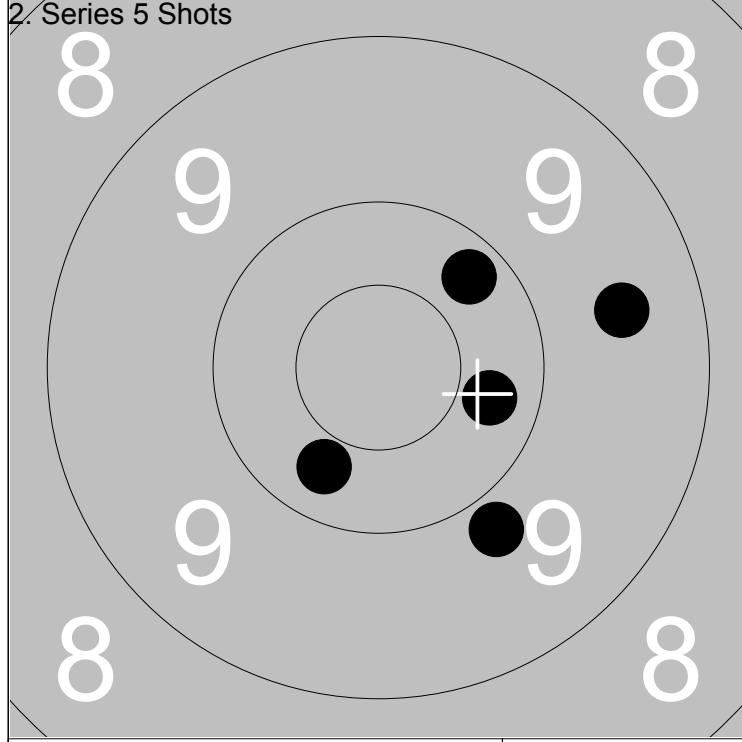

1: 10.2 ↗	Series	48.0
2: 9.5 →		
3: 9.8 ↓		
Total		232.0

1: 10.3 →	Series	45.0
2: 9.3 ←		
3: 10.3 ↓		
Total		277.0

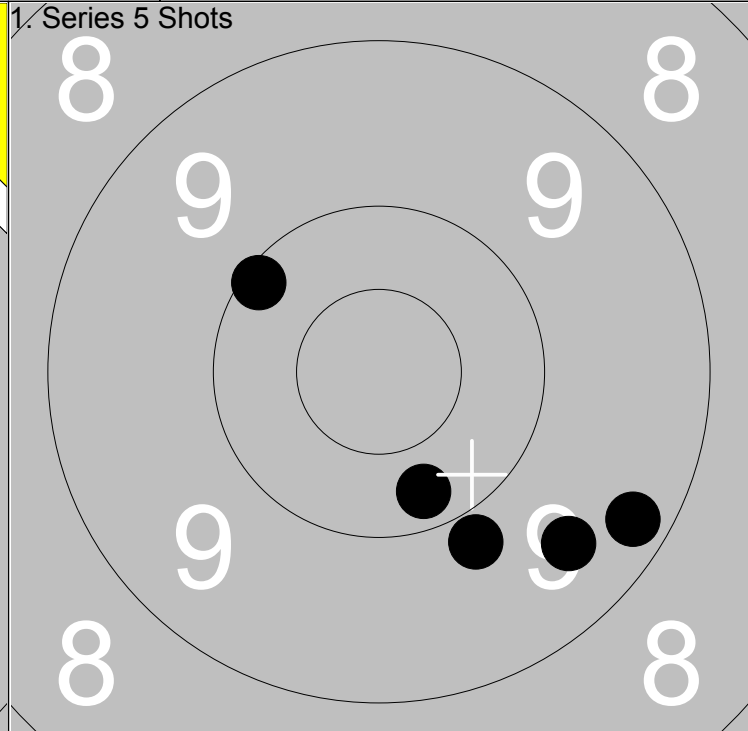
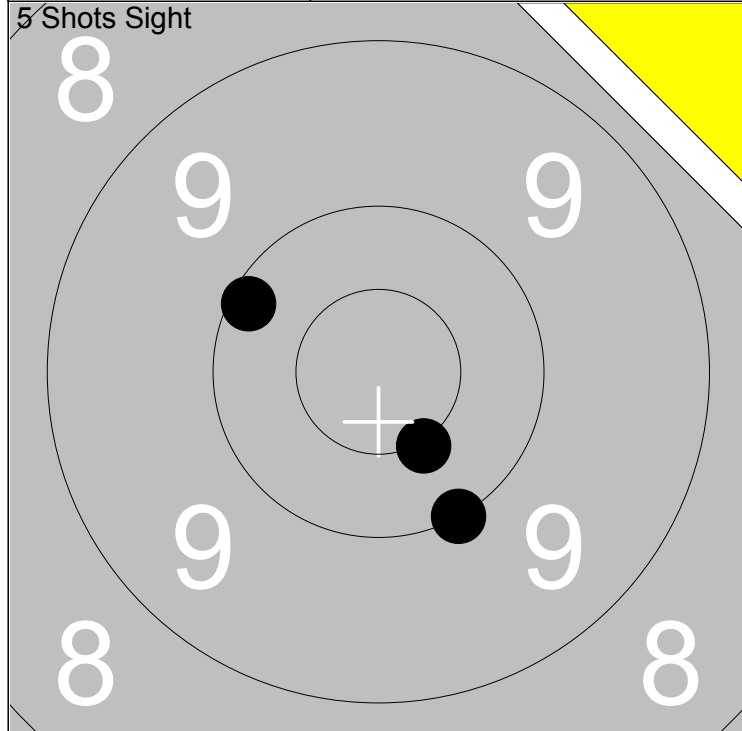

1: 10.0 ↘	Series	30.0
2: *10.5 ↘		
3: 10.1 ↖		
Total		138.0

1: 9.8 ↘	Series	47.0
2: 10.2 ↘		
3: 10.1 ↗		
4: 9.5 ↘		
5: 9.3 ↘		
Total		185.0

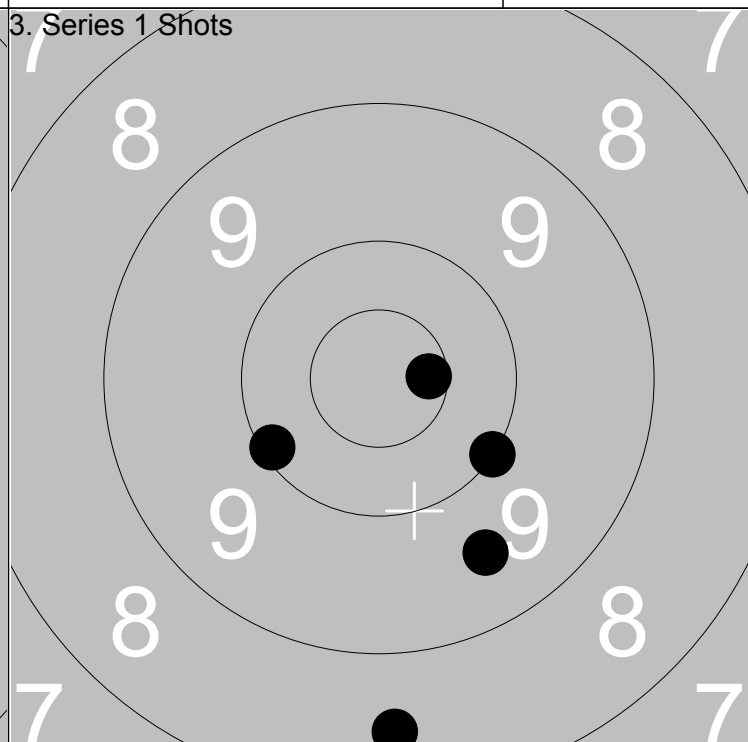
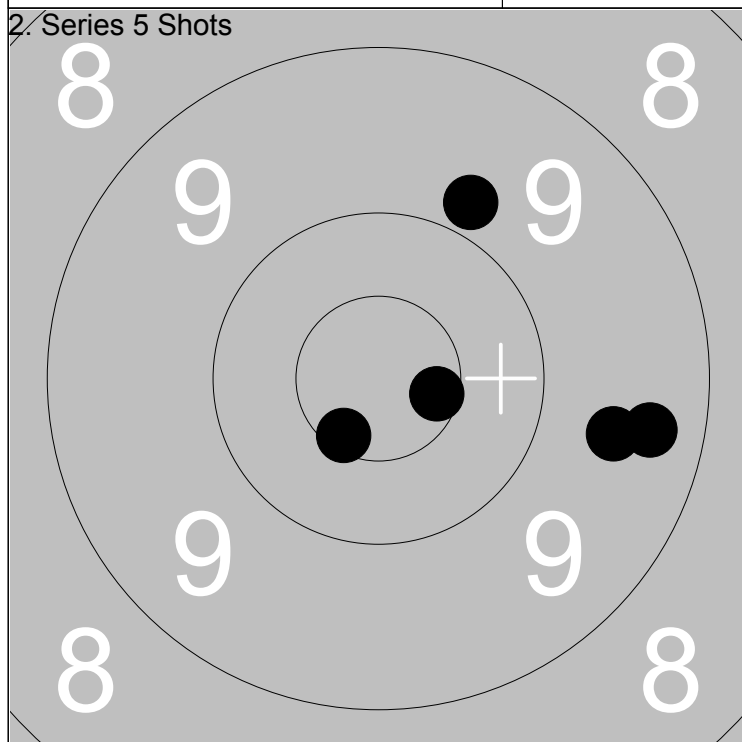

1: *10.6 →	Series	47.0
2: 9.6 →		
3: *10.6 ↘		
4: 9.4 →		
5: 9.8 ↗		
Total		232.0

1: 8.5 ↓	Series	47.0
2: 10.1 ↖		
3: 9.5 ↘		
4: 10.0 ↘		
5: *10.6 →		
Total		279.0

Relay 6	Lane 5	Elina Johansson	
-------------------	------------------	------------------------	--

300m	Ale	C	No
------	-----	---	----

06.07.2014	Tavelträffen 2014	Ramselefors SKF
------------	-------------------	-----------------

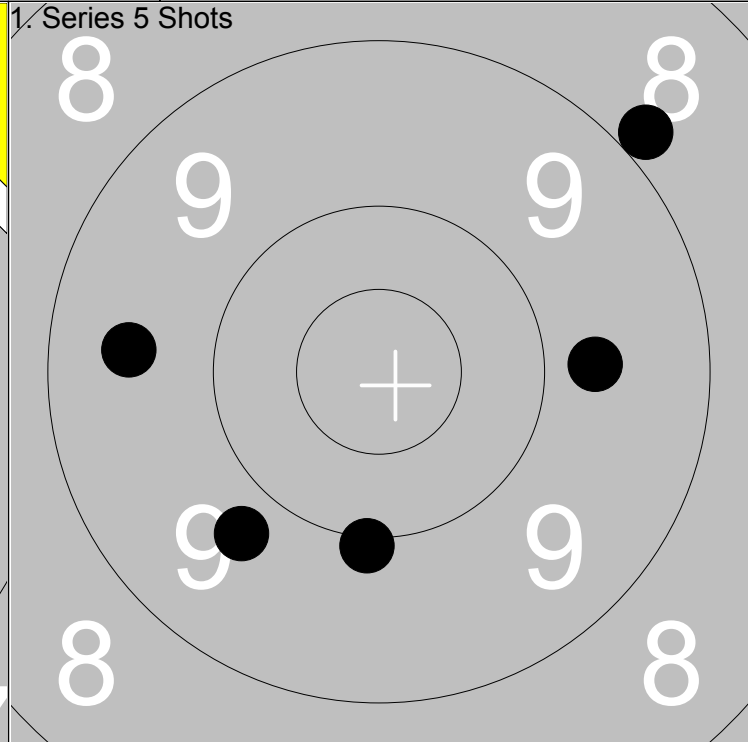
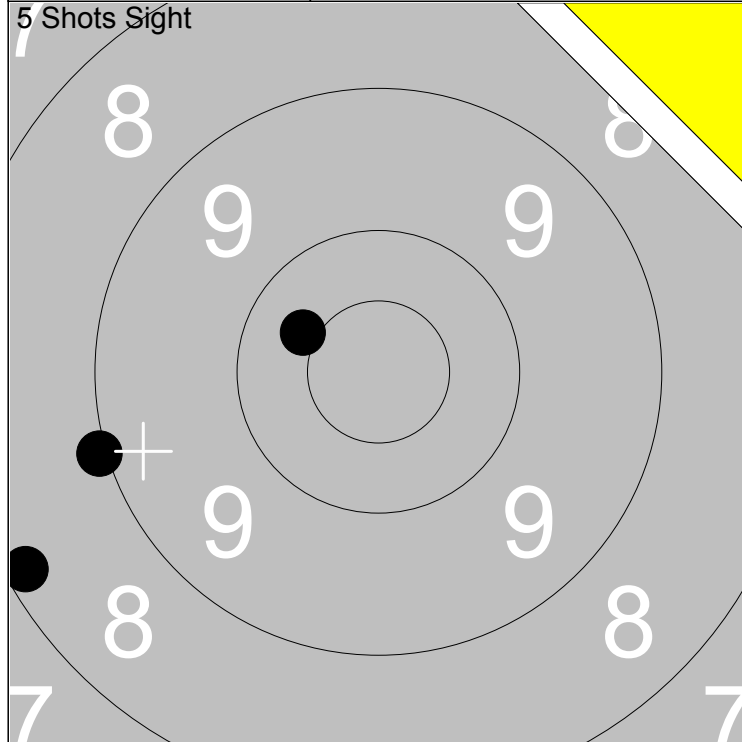

1: 8.2 ↙	Series	27.0
2: 9.0 ↙		
3: 10.4 ↖		
Total		128.0

1: 8.9 ↗	Series	45.0
2: 9.7 →		
3: 9.7 ↙		
4: 9.5 ←		
5: 10.0 ↓		
Total		173.0

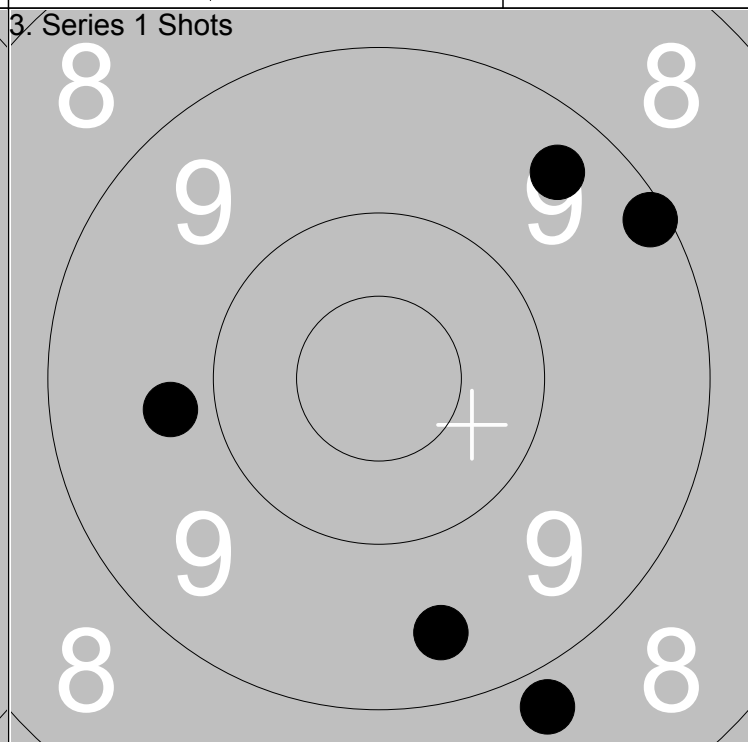
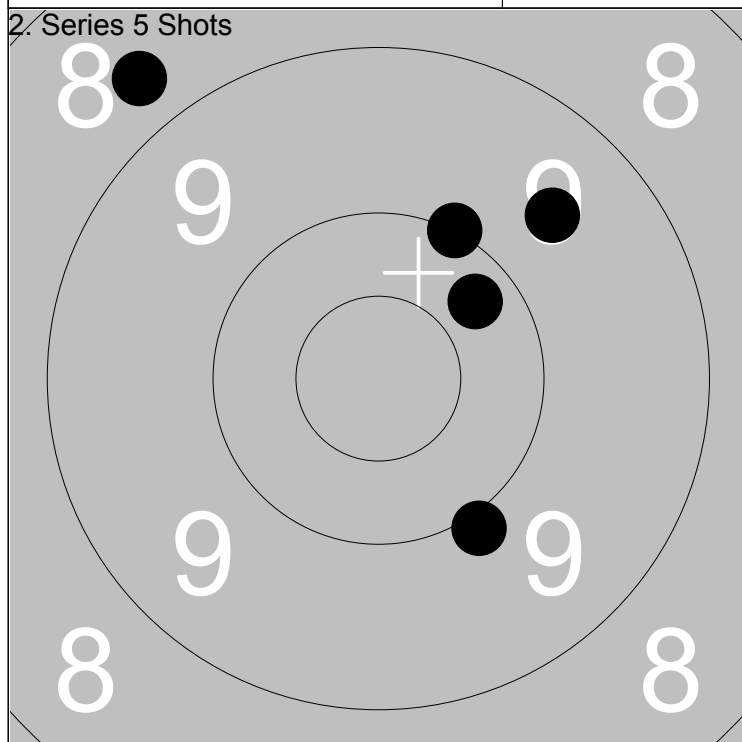

1: 10.0 ↗	Series	46.0
2: 10.3 ↗		
3: 8.7 ↖		
4: 9.6 ↗		
5: 9.9 ↓		
Total		219.0

1: 8.8 ↓	Series	44.0
2: 9.5 ↓		
3: 9.4 ↗		
4: 9.1 ↗		
5: 9.8 ←		
Total		263.0

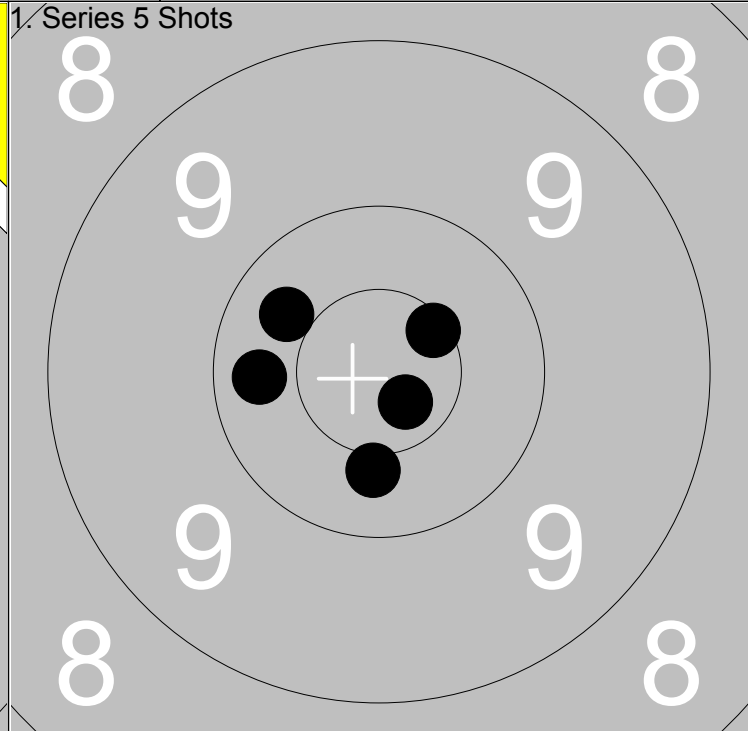
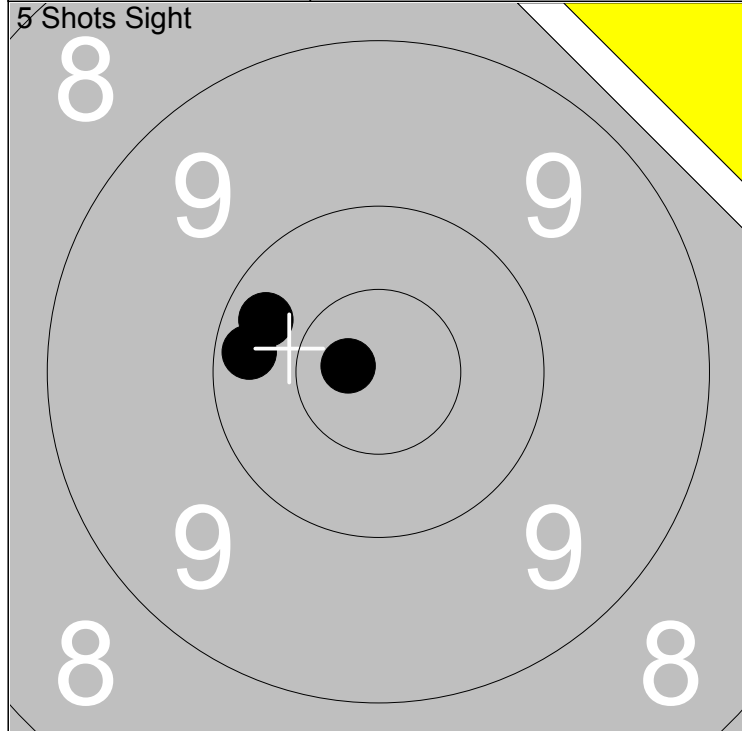

1: *10.8 ↙	Series	30.0
2: 10.2 ↙		
3: 10.3 ↙		
Total		147.0

1: *10.7 ↘	Series	50.0
2: 10.4 ↓		
3: 10.3 ↙		
4: *10.6 ↗	Total	197.0
5: 10.3 ↙		

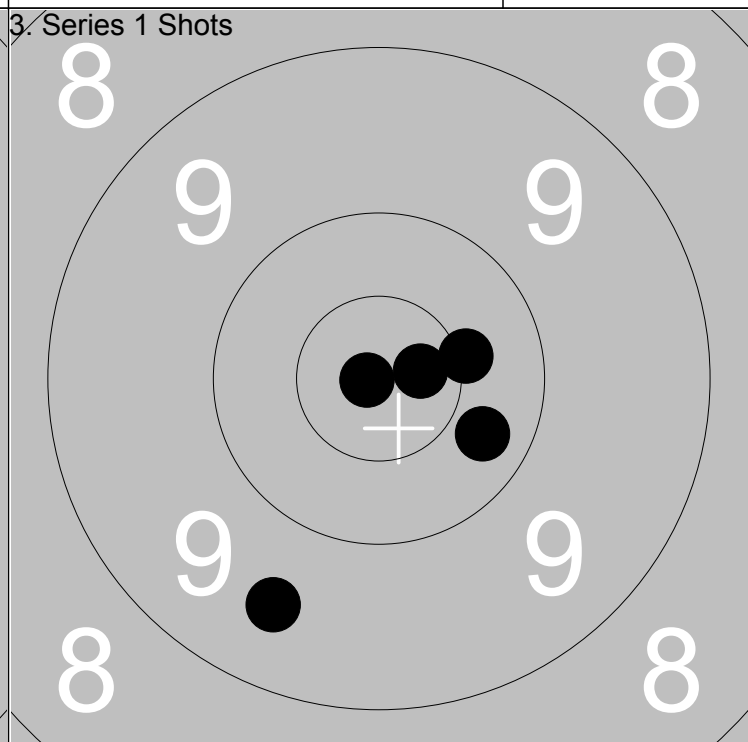
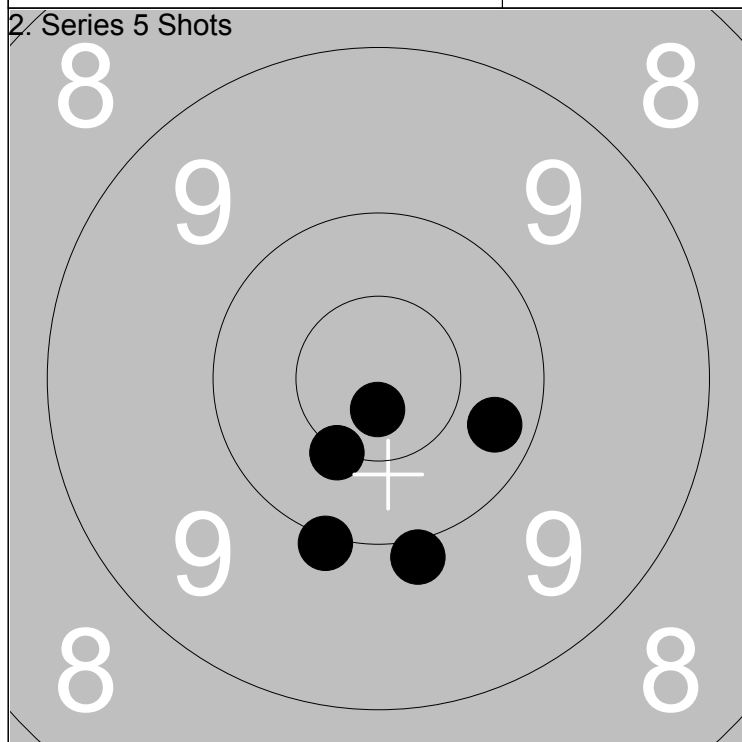

1: 9.9 ↓	Series	49.0
2: *10.5 ↘		
3: *10.8 ↓		
4: 10.3 →	Total	246.0
5: 10.0 ↓		

1: *10.9 ↙	Series	49.0
2: *10.7 →		
3: 10.3 →		
4: *10.4 →	Total	295.0
5: 9.5 ↓		

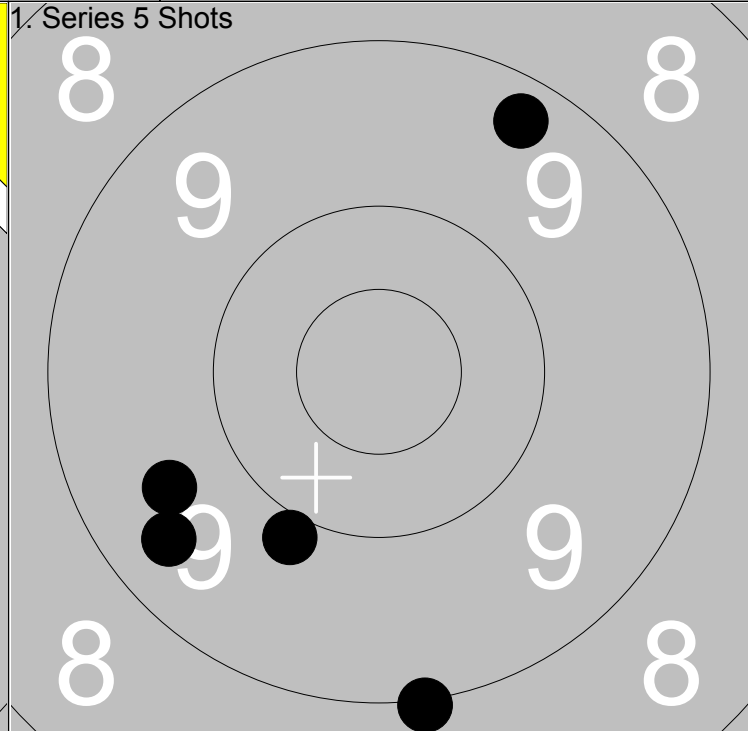
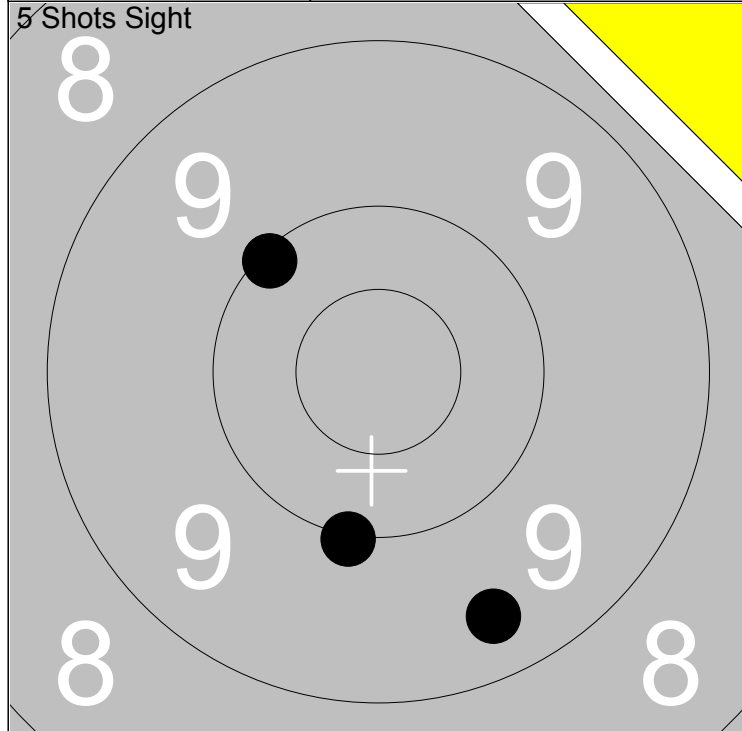

1: 9.4 ↓	Series	29.0
2: 10.1 ↗		
3: 10.0 ↓		
Total		146.0

1: 9.9 ↙	Series	45.0
2: 9.0 ↓		
3: 9.4 ↙		
4: 9.3 ↗		
5: 9.6 ↙		
Total		191.0

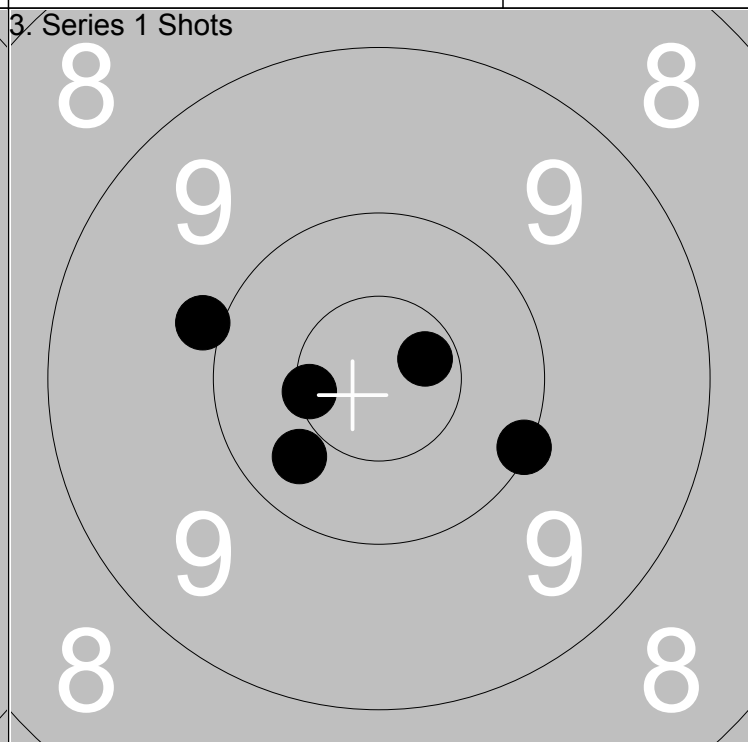
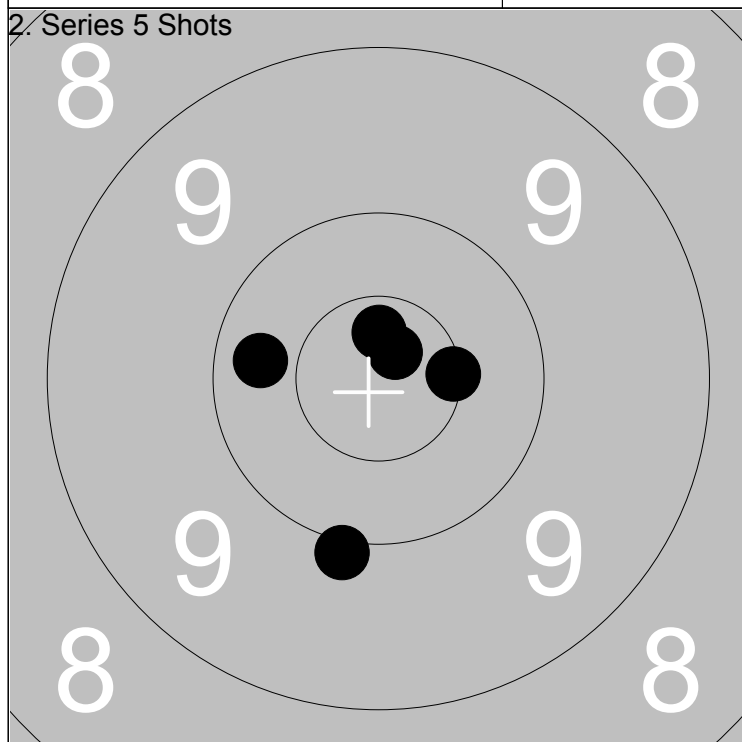

1: *10.5→	Series	50.0
2: 10.3 ←		
3: *10.7↑		
4: *10.8↗		
5: 10.0 ↓		
Total		241.0

1: *10.7→	Series	49.0
2: 9.9 ←		
3: 10.3 ↙		
4: *10.6←		
5: 10.0 →		
Total		290.0

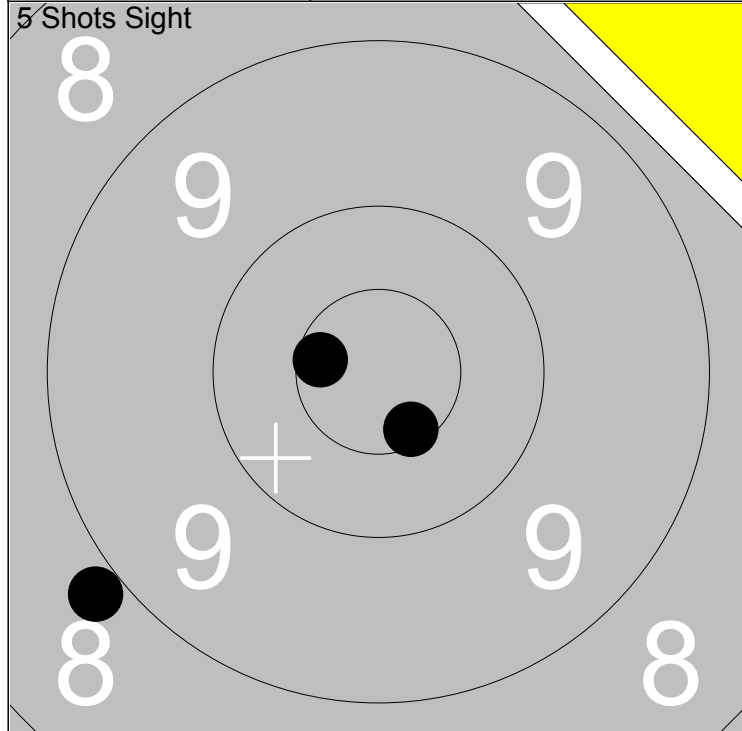

1: *10.6 ↘	Series	28.0
2: *10.6 ↙		
3: 8.9 ↙		
Total		146.0

1: 10.1 ↗	Series	48.0
2: 9.9 ↗		
3: *10.7 ↘		
Total		194.0

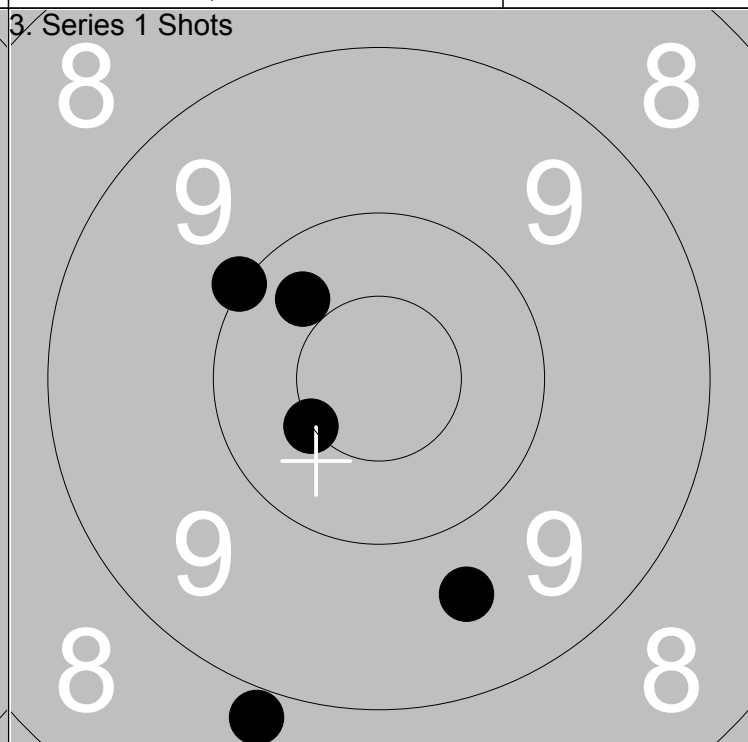
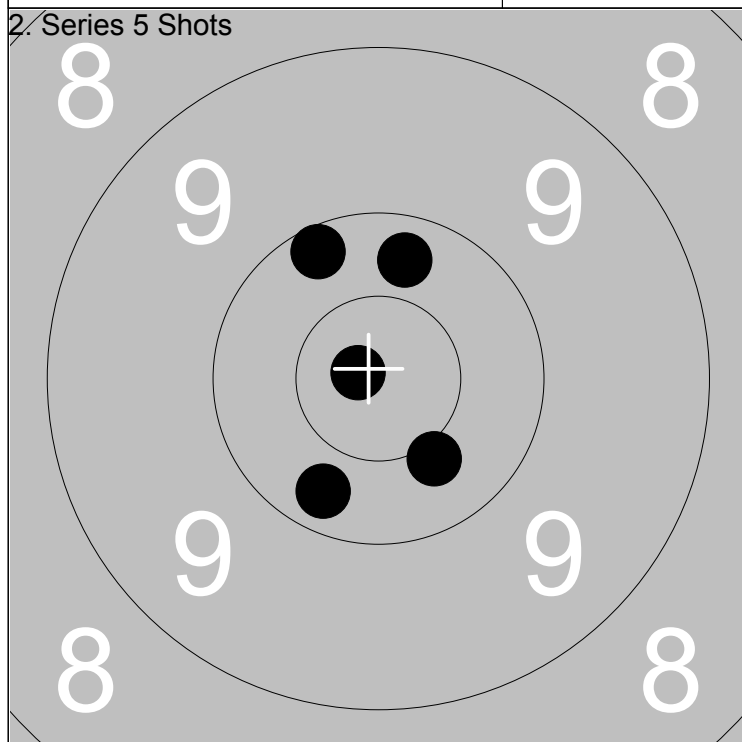

1: *10.8 ↙	Series	50.0
2: 10.2 ↗		
3: 10.2 ↘		
Total		244.0

1: 10.0 ↙	Series	47.0
2: *10.5 ↙		
3: 8.9 ↘		
Total		291.0

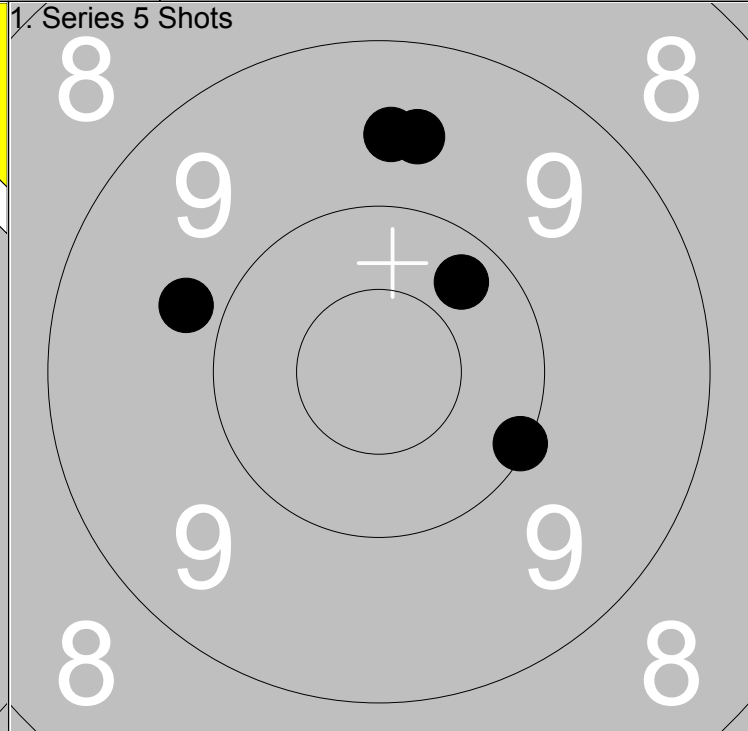
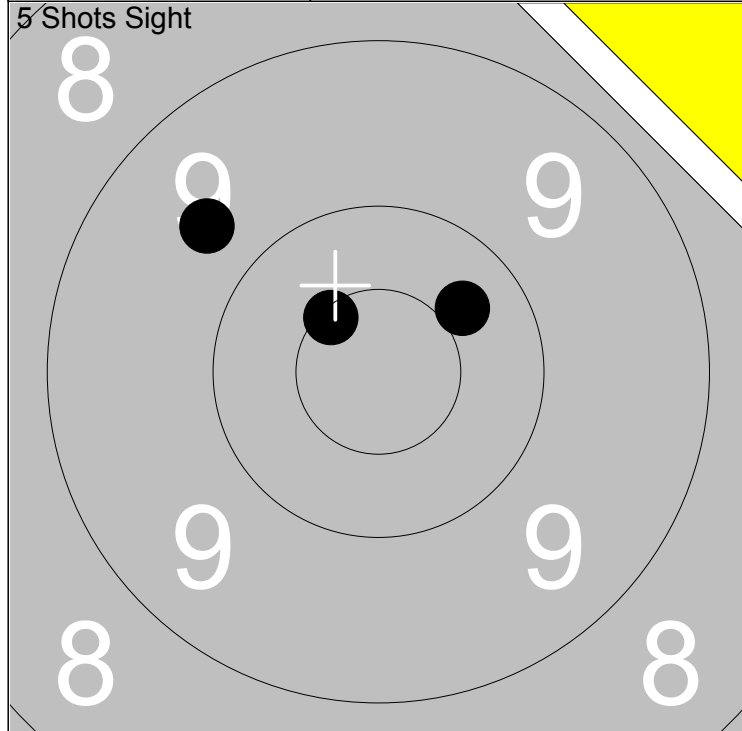

1: 9.7 ↖	Series	29.0
2: *10.5 ↖		
3: 10.4 ↗		
Total		145.0

1: 9.8 ←	Series	47.0
2: 10.3 ↗		
3: 9.6 ↑		
Total		192.0

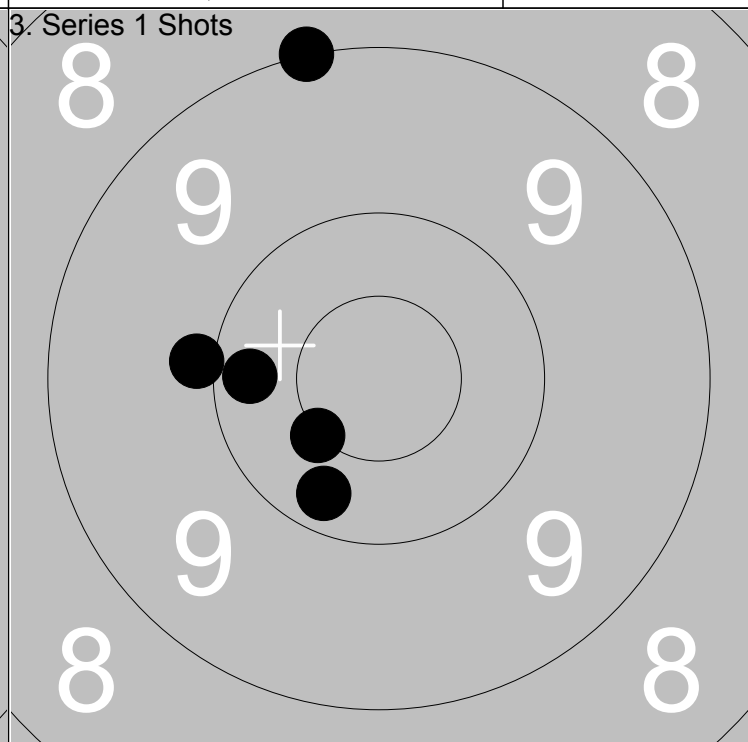
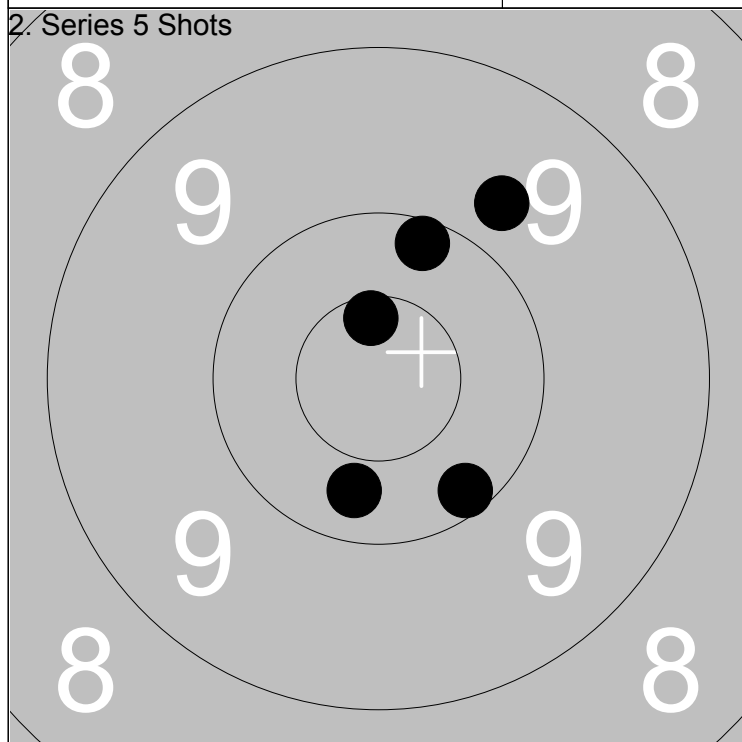

1: *10.6 ↑	Series	49.0
2: 10.3 ↓		
3: 10.2 ↑		
Total		241.0

1: 9.9 ←	Series	48.0
2: 10.2 ←		
3: *10.5 ↖		
Total		289.0

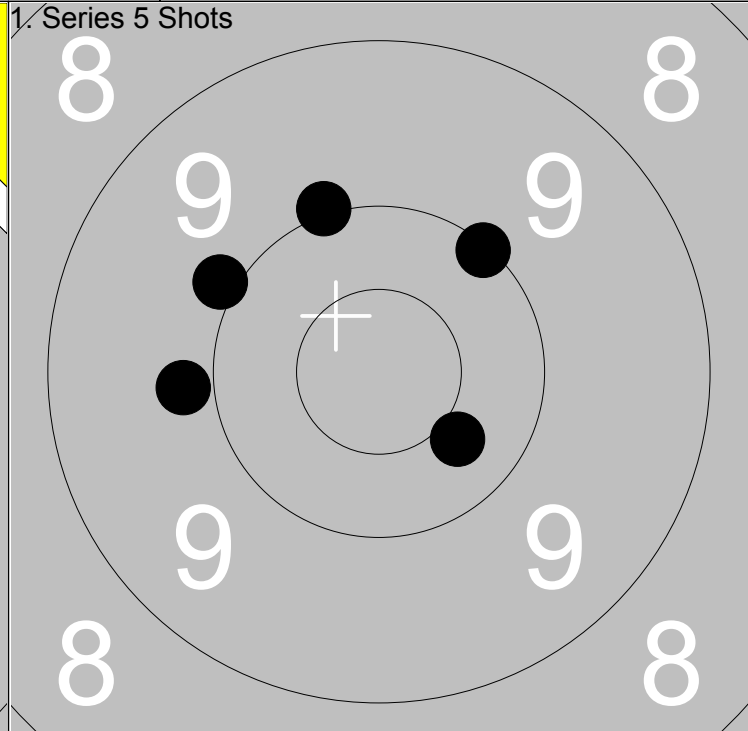
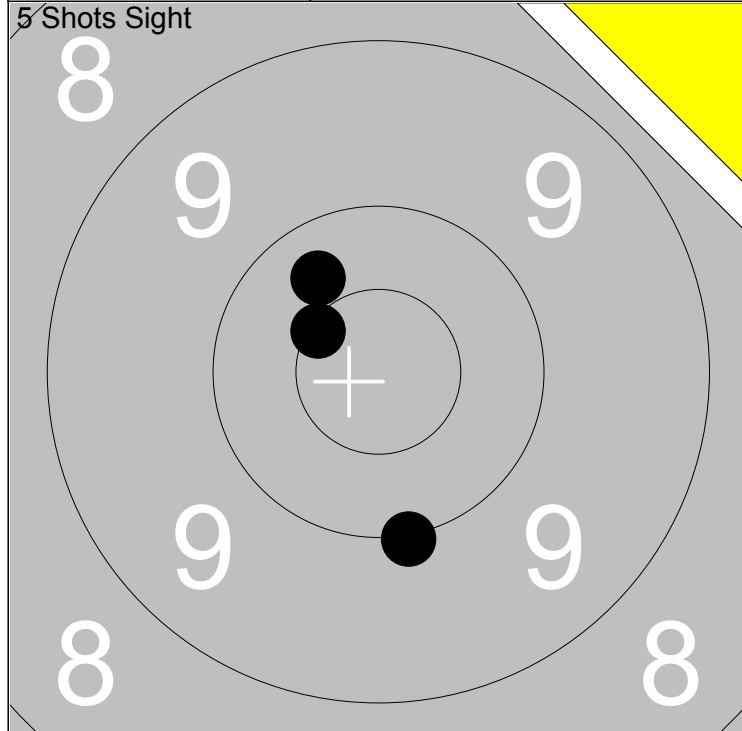

1: 10.3 ↗	Series	30.0
2: 10.0 ↓		
3: *10.5 ↖		
Total		144.0

1: 9.9 ↖	Series	48.0
2: 9.8 ←		
3: 10.1 ↗		
Total		192.0

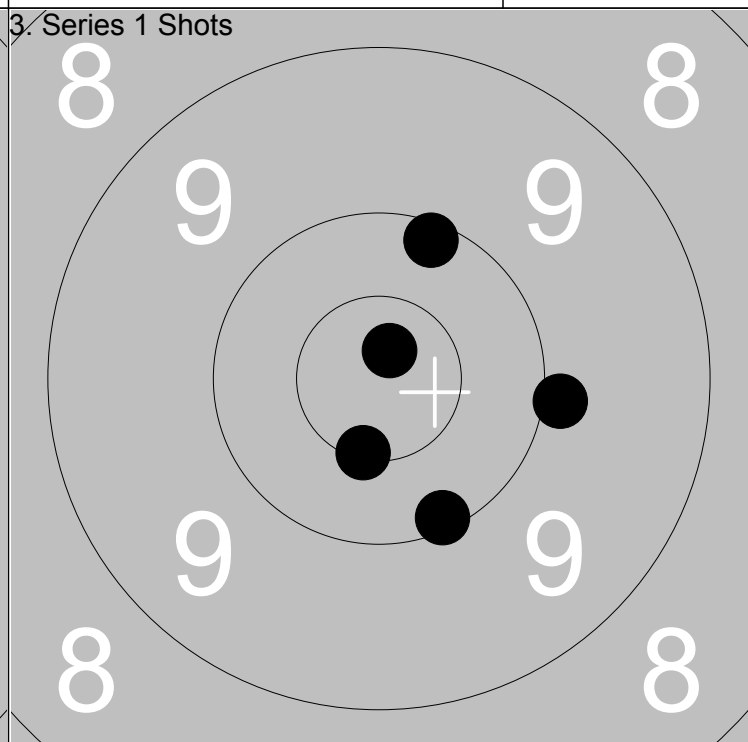
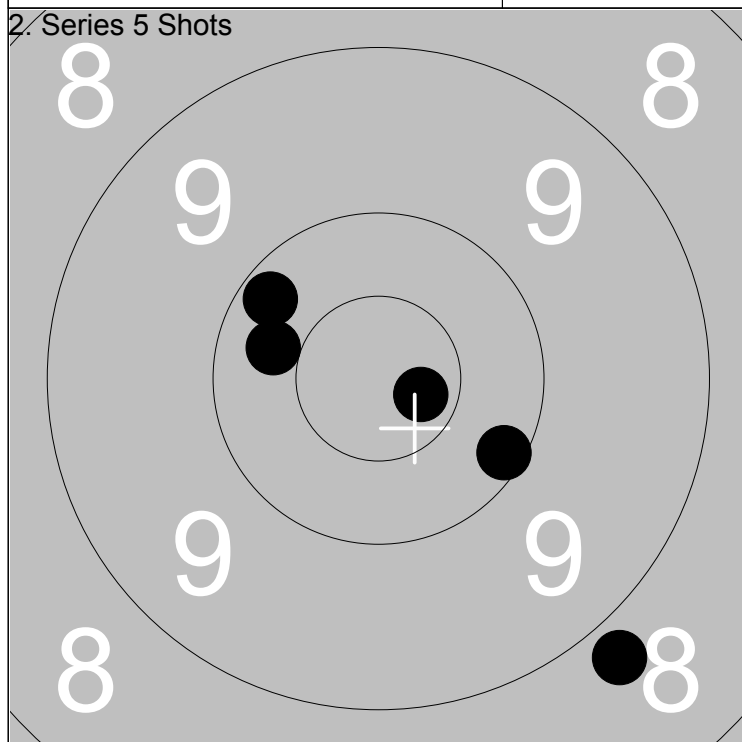

1: *10.7 →	Series	48.0
2: 8.8 ↓		
3: 10.1 ↓		
Total		240.0

1: *10.8 ↗	Series	49.0
2: 10.1 ↓		
3: *10.5 ↓		
Total		289.0

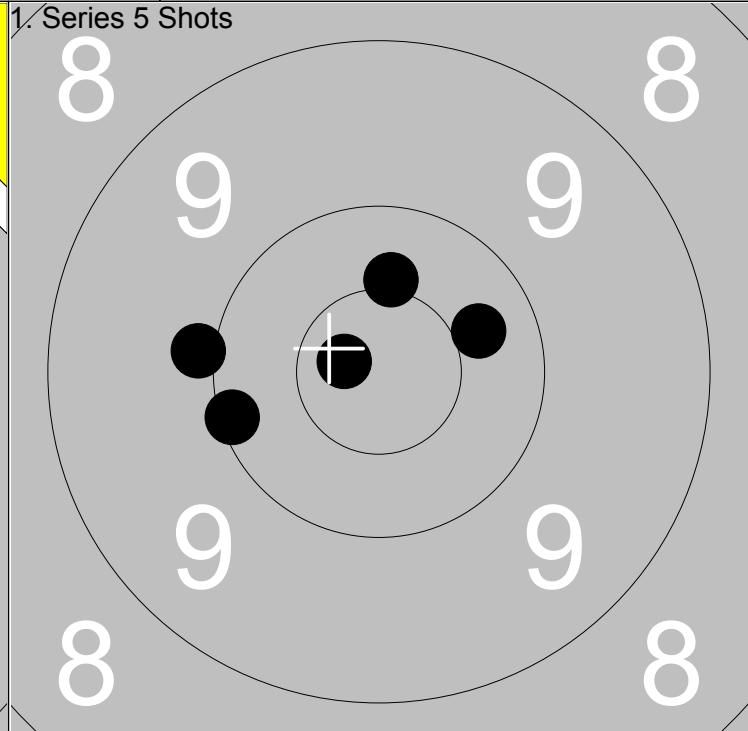
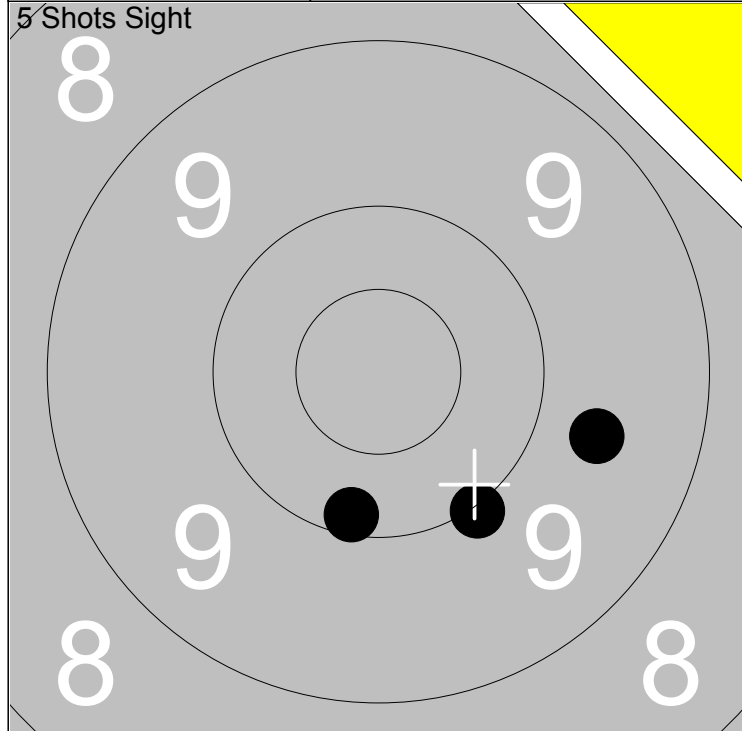

1: 10.0 ↘	Series	29.0
2: 9.7 →		
3: 10.1 ↓		
Total		142.0

1: 9.9 ←	Series	49.0
2: 10.1 ←		
3: 10.3 →		
4: *10.7 ↙		
5: *10.4 ↑		
Total		191.0

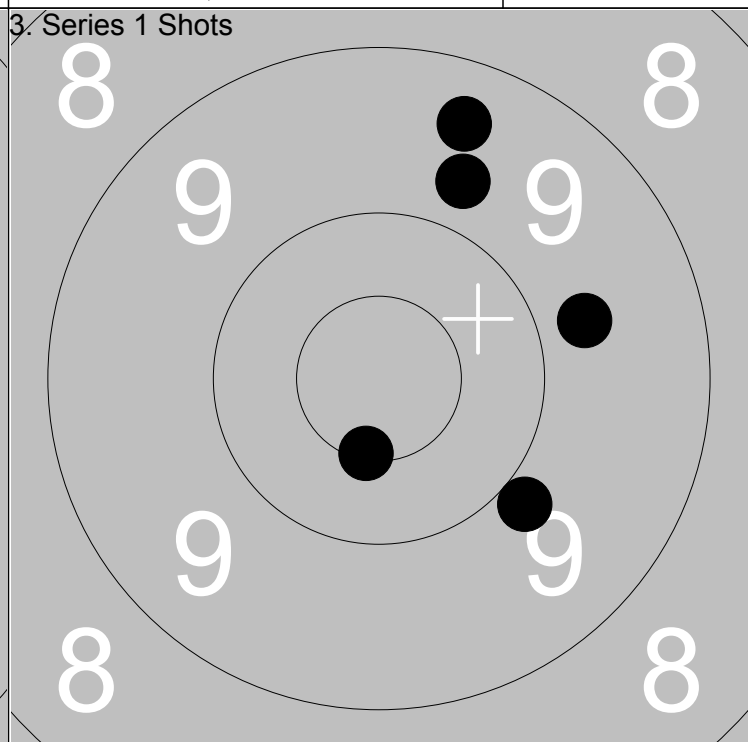
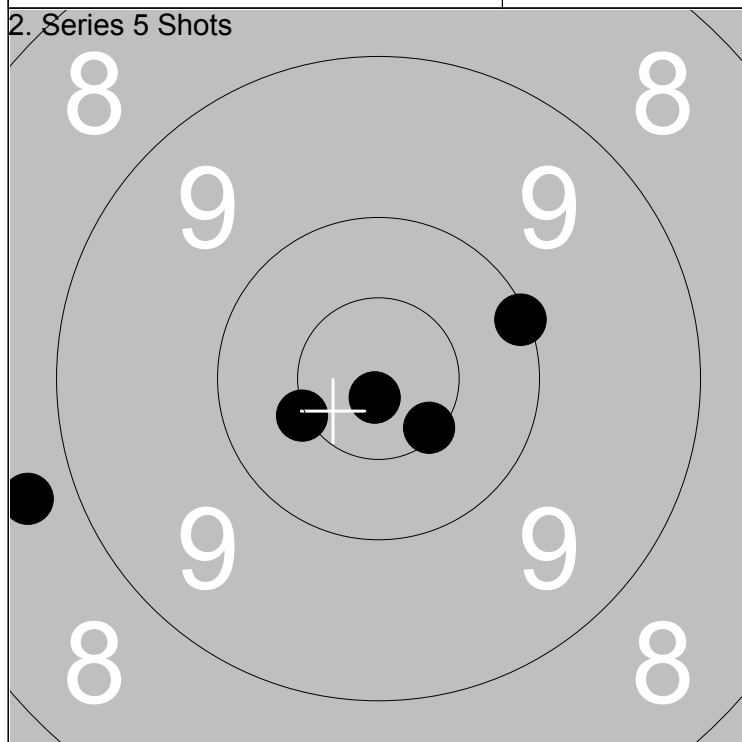

1: *10.5 ↘	Series	48.0
2: 10.1 →		
3: *10.8 ↓		
4: 8.7 ←		
5: *10.5 ↙		
Total		239.0

1: 9.4 ↑	Series	46.0
2: 9.7 →		
3: 9.7 ↑		
4: *10.5 ↓		
5: 9.9 ↘		
Total		285.0

Relay 6	Lane 15	Martin Nilsson
-------------------	-------------------	-----------------------

300m	Kvistbro	A	Ör
------	----------	---	----

06.07.2014	Tavelträffen 2014	Ramselefors SKF
------------	-------------------	-----------------

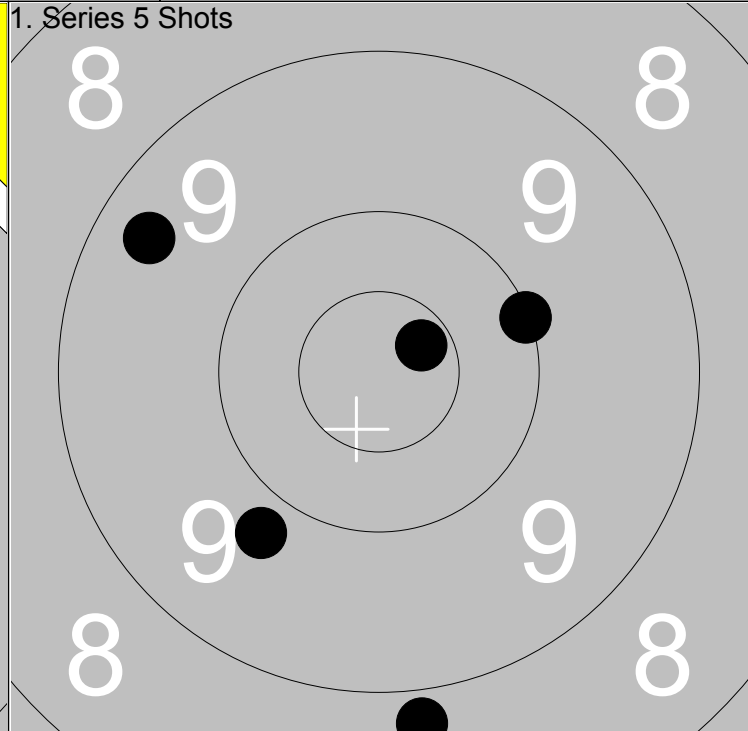
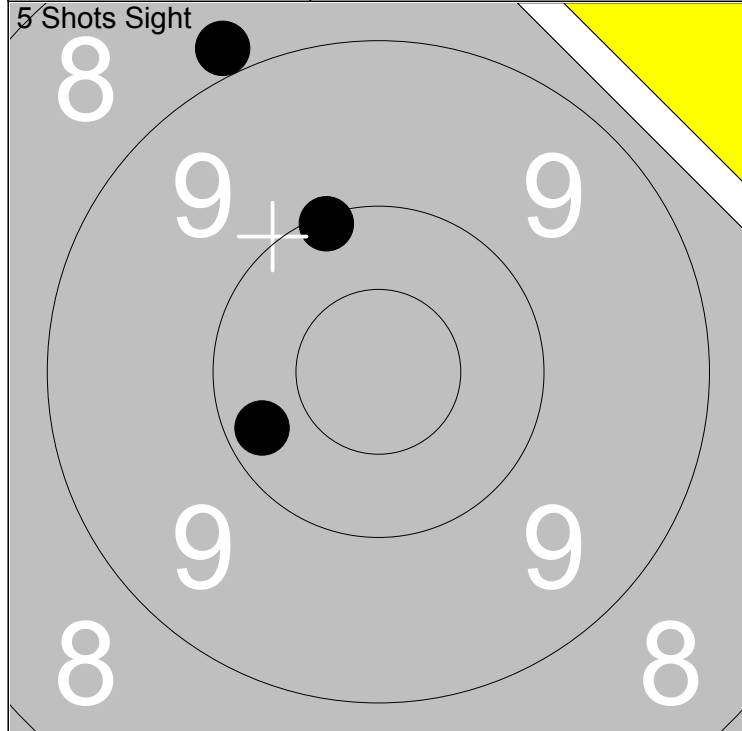

1: 8.9 ↖	Series	28.0
2: 10.1 ↗		
3: 10.2 ↙		
Total		142.0

1: 9.4 ↖	Series	46.0
2: 10.0 →		
3: *10.7 ↗		
4: 9.8 ↙		
5: 8.8 ↓		
Total		188.0

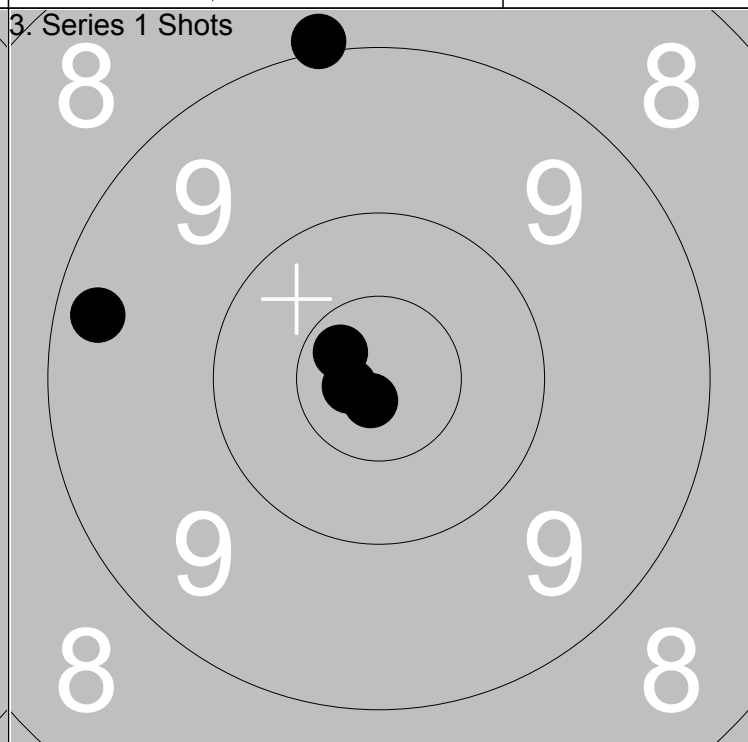
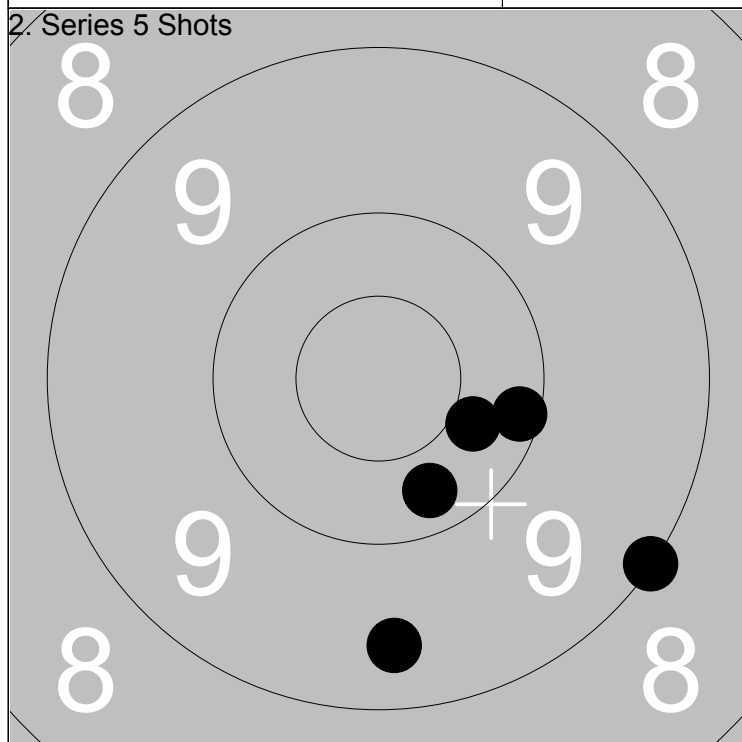

1: 10.1 →	Series	48.0
2: 9.4 ↓		
3: 10.4 →		
4: 10.3 ↓		
5: 9.0 ↘		
Total		236.0

1: 9.3 ↖	Series	48.0
2: *10.8 ↙		
3: *10.8 ↙		
4: 9.0 ↗		
5: *10.7 ↙		
Total		284.0

Relay 6	Lane 16	Björn Johansson	
-------------------	-------------------	------------------------	--

300m	Kvistbro	A	Ör
------	----------	---	----

06.07.2014	Tavelträffen 2014	Ramselefors SKF
------------	-------------------	-----------------

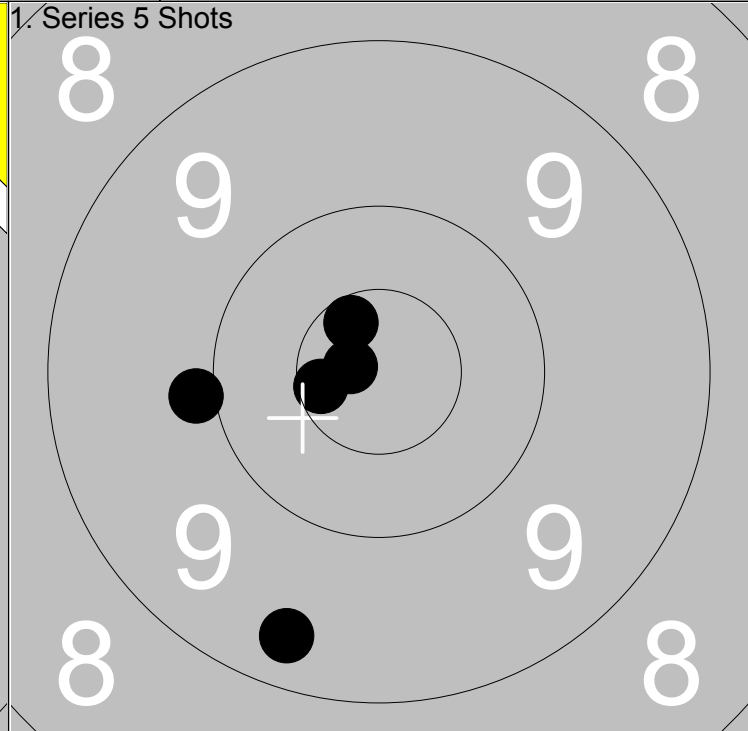
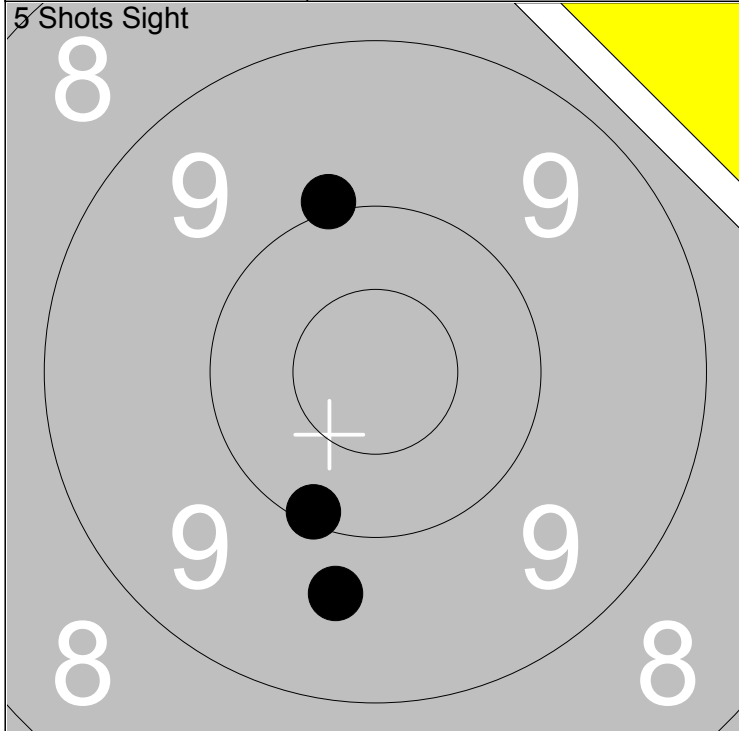

1: 10.0 ↑	Series	29.0
2: 9.7 ↓		
3: 10.1 ↓		
Total		141.0

1: *10.6 ↖	Series	48.0
2: *10.6 ↙		
3: *10.8 ↙		
4: 9.9 ←		
5: 9.3 ↓		
Total		189.0

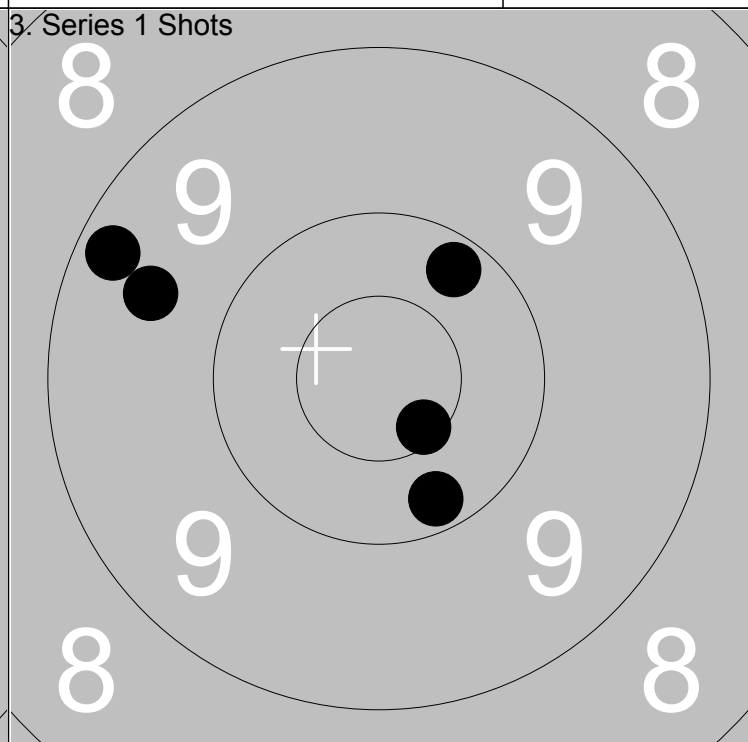
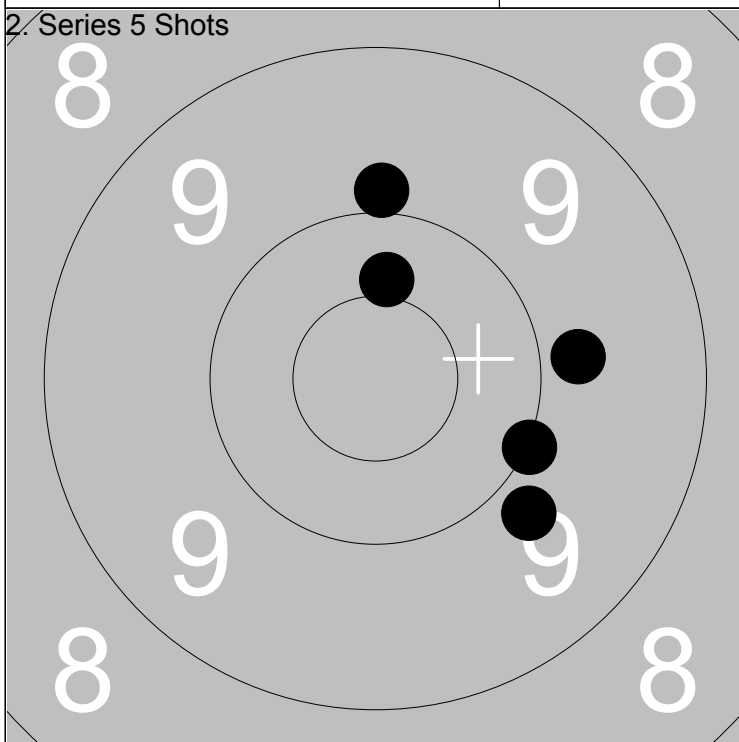

1: 9.8 →	Series	47.0
2: 10.4 ↑		
3: 9.9 ↑		
4: 10.0 →		
5: 9.8 ↘		
Total		236.0

1: 9.6 ↖	Series	48.0
2: 9.3 ↙		
3: 10.2 ↗		
4: 10.2 ↓		
5: *10.6 ↘		
Total		284.0

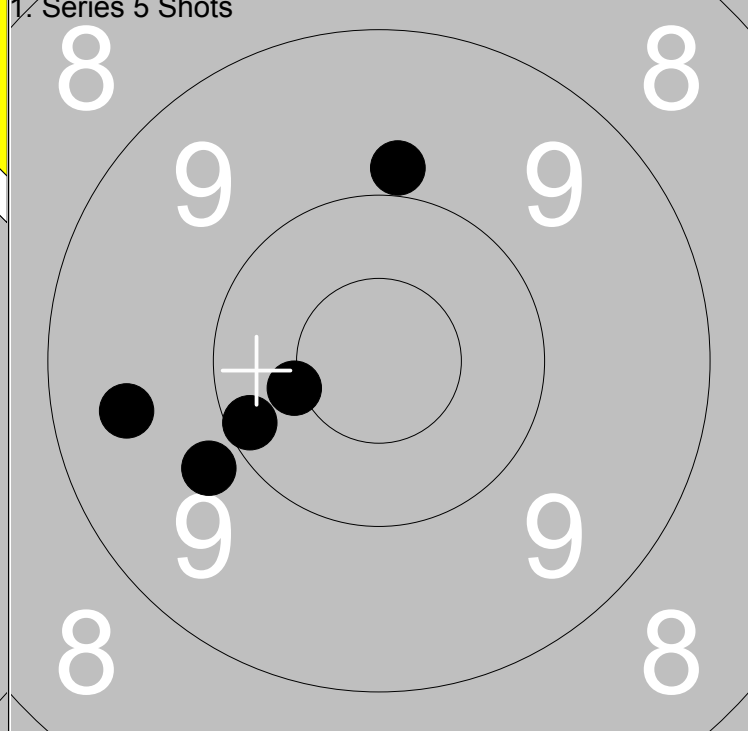
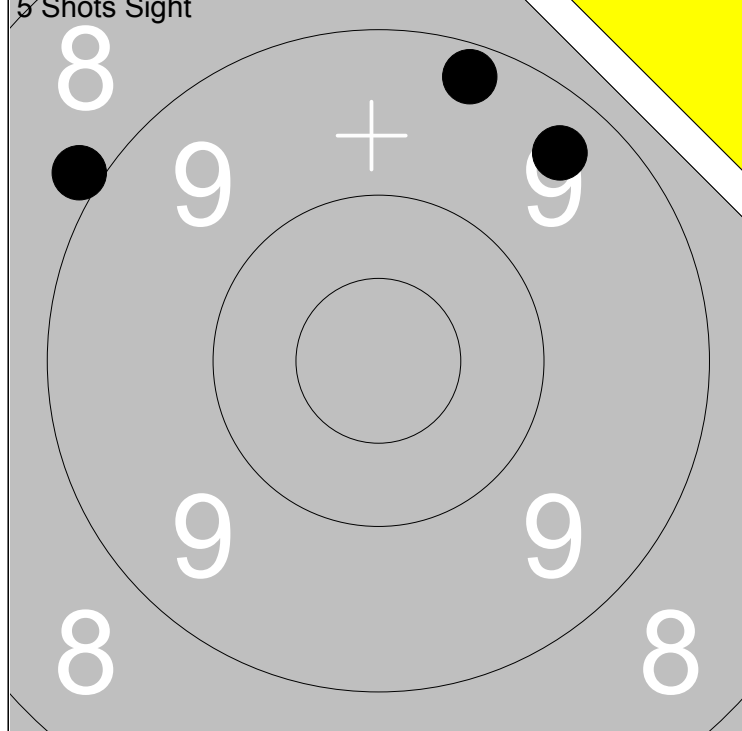

1: 9.2 ↑	Series	26.0
2: 9.4 ↗		
3: 8.9 ↖		
Total		140.0

1: *10.5 ↙	Series	47.0
2: 9.8 ↙		
3: 10.1 ↙		
Total		187.0

4: 9.9 ↑	Series	47.0
5: 9.5 ↙		
Total		

1: *10.6 →	Series	50.0
2: 10.3 ↑		
3: *10.4 ↙		
Total		237.0

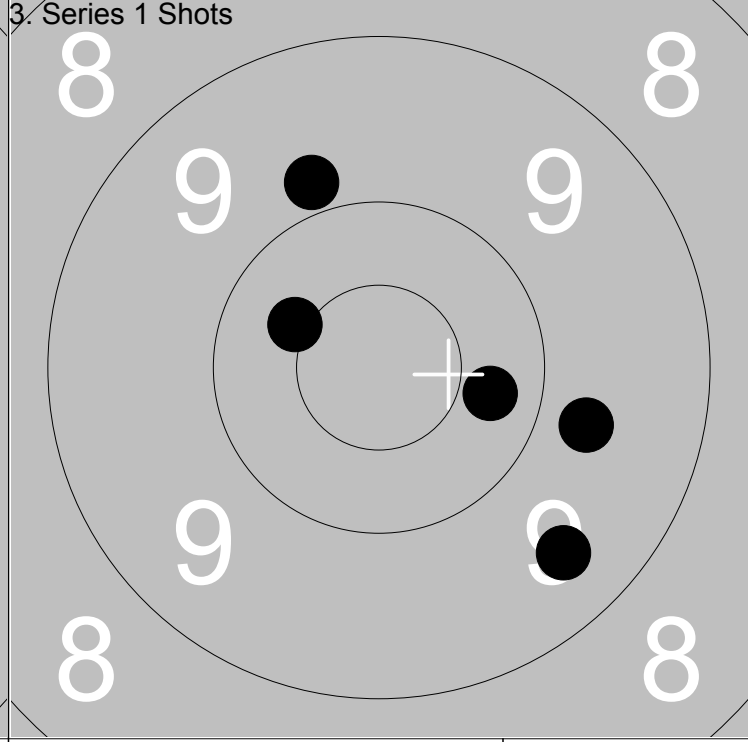
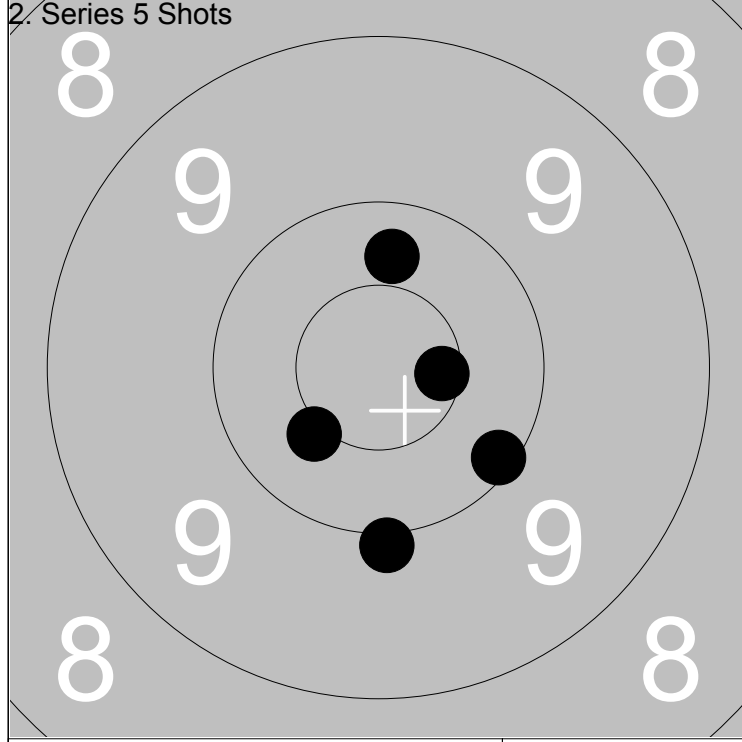

1: 9.8 ↑	Series	47.0
2: *10.4 ↙		
3: 9.7 →		
Total		284.0

4: 10.3 →	Series	47.0
5: 9.5 ↙		
Total		

1: 9.8 ↑	Series	47.0
2: *10.4 ↙		
3: 9.7 →		
Total		284.0

4: 10.3 →	Series	47.0
5: 9.5 ↙		
Total		

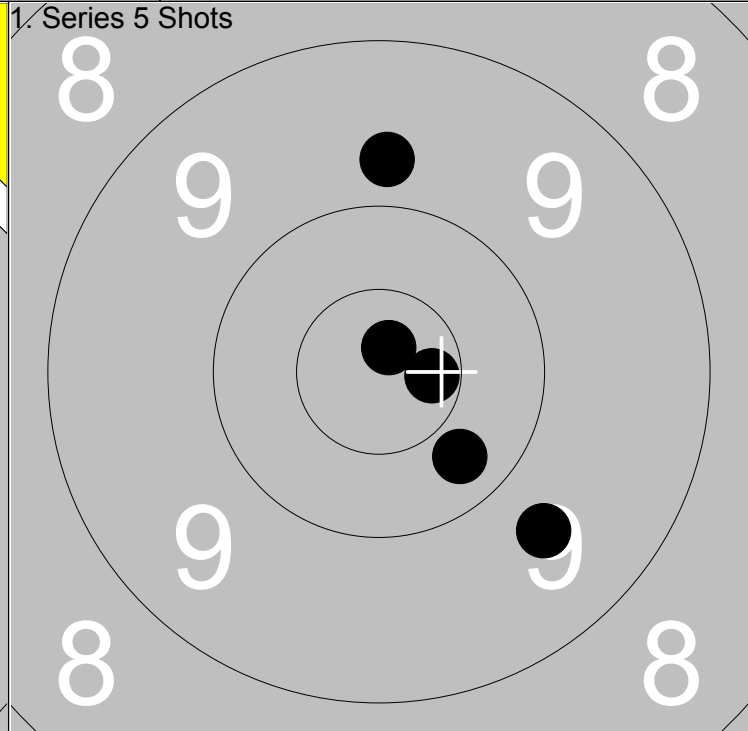
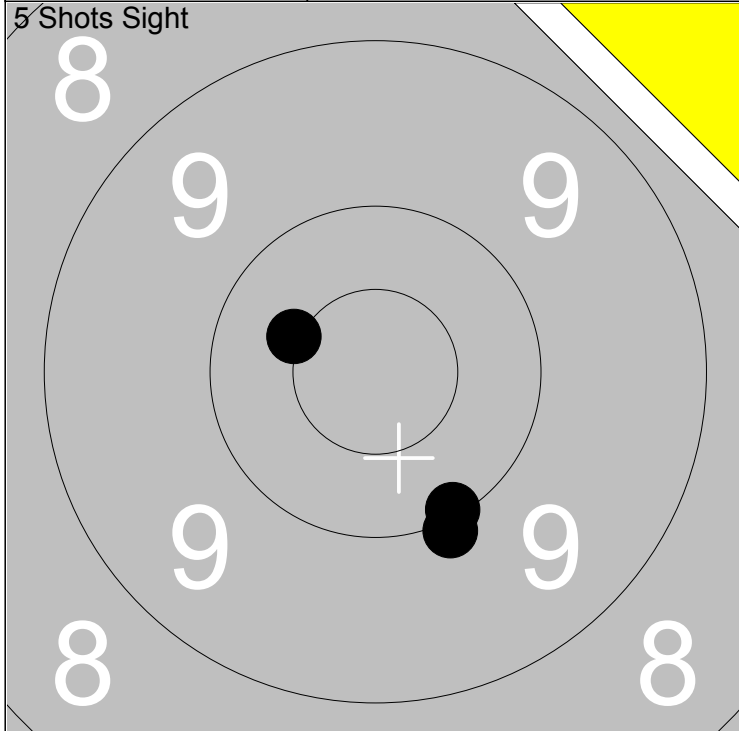

1: *10.5 ↙	Series	30.0
2: 10.1 ↓		
3: 10.0 ↓		
Total		140.0

1: 9.7 ↑	Series	48.0
2: *10.8 ↗		
3: *10.7 →		
Total		188.0

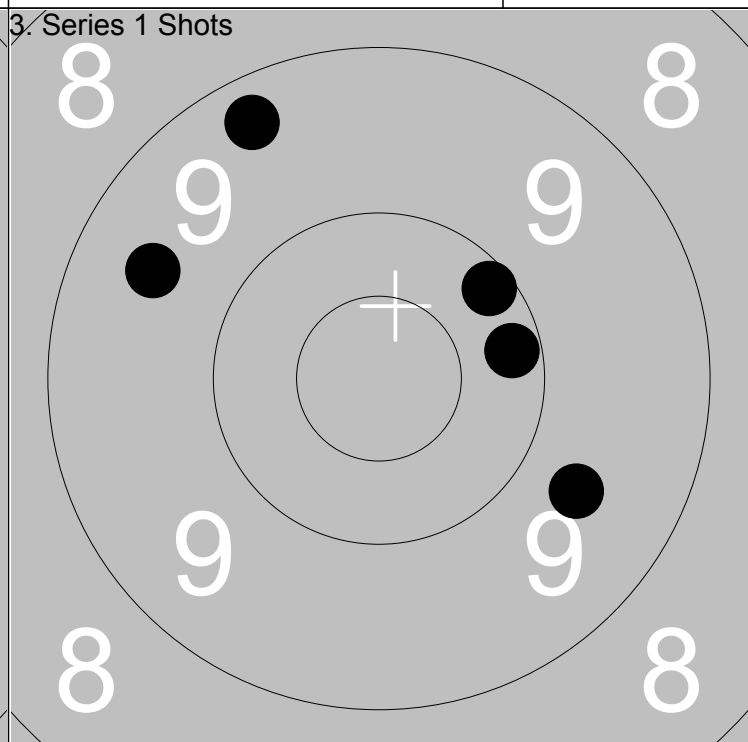
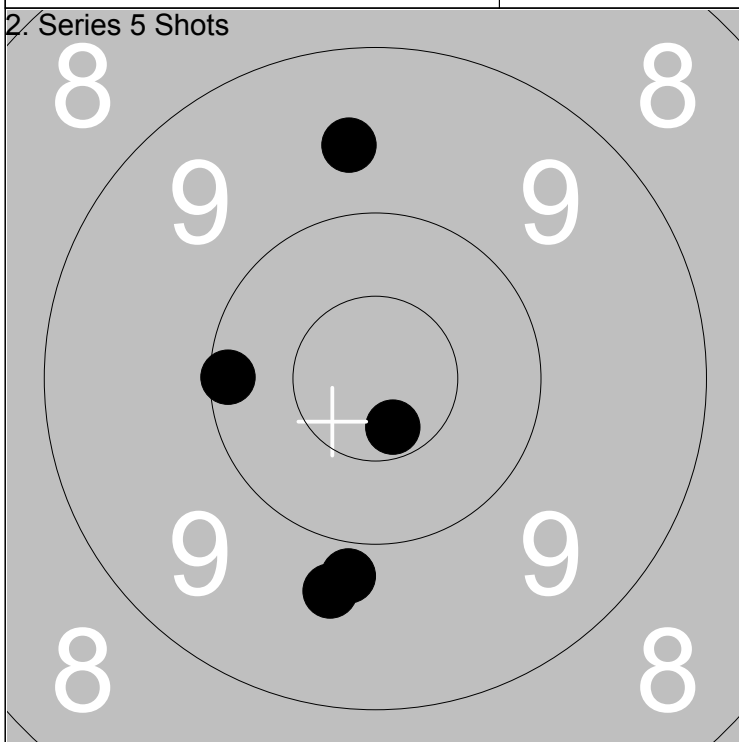

1: 9.6 ↑	Series	47.0
2: 10.1 ←		
3: *10.7 ↓		
Total		235.0

1: 9.3 ↖	Series	47.0
2: 9.5 ↙		
3: 9.7 ↘		
Total		282.0