

- 1: 9.9 ↑
- 2: 9.7 ←
- 3: 10.8 ↗
- 4: 10.8 ↗
- 5: 10.3 ↓
- 6: 8.0 ←
- 7: 10.7 ↘
- 8: 9.8 ↓

Serie 75.0
Total 191.0

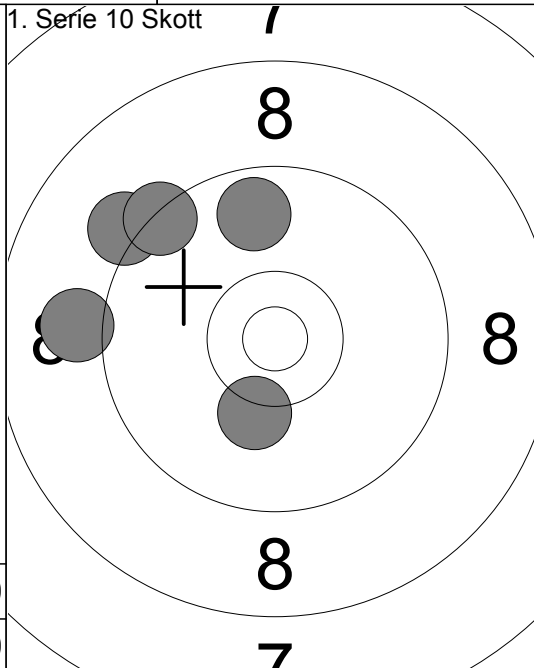

- 1: 9.2 ↖
- 2: 9.4 ↖
- 3: 9.7 ↑
- 4: 10.2 ↓
- 5: 9.1 ←

Serie 46.0
Total 237.0

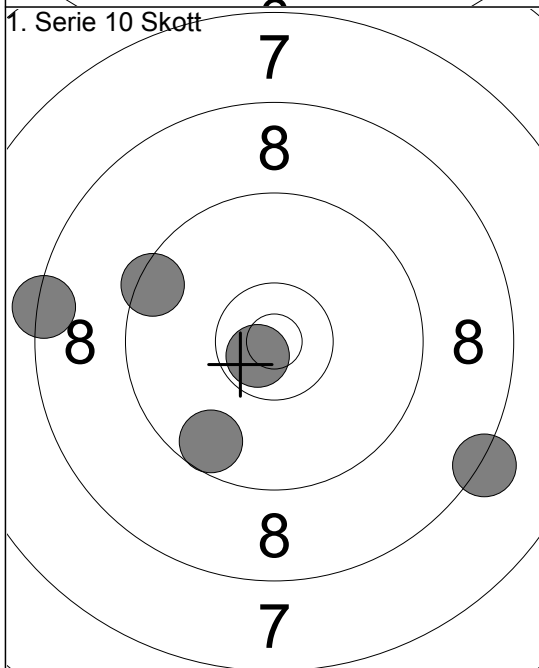

- 6: 10.7 ↘
- 7: 9.6 ↓
- 8: 8.2 ↘
- 9: 8.4 ←
- 10: 9.5 ←

Serie 44.0
Total 281.0

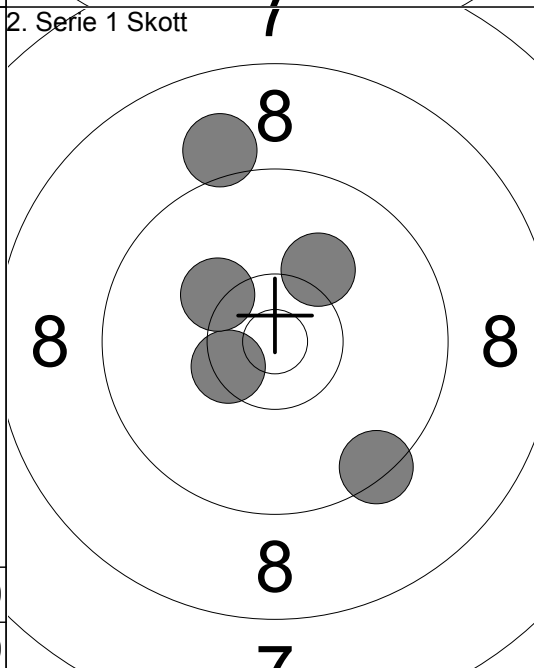

- 1: 9.1 ↑
- 2: 9.4 ↘
- 3: 10.2 ↗
- 4: 10.4 ↘
- 5: 10.2 ↖

Serie 48.0
Total 329.0

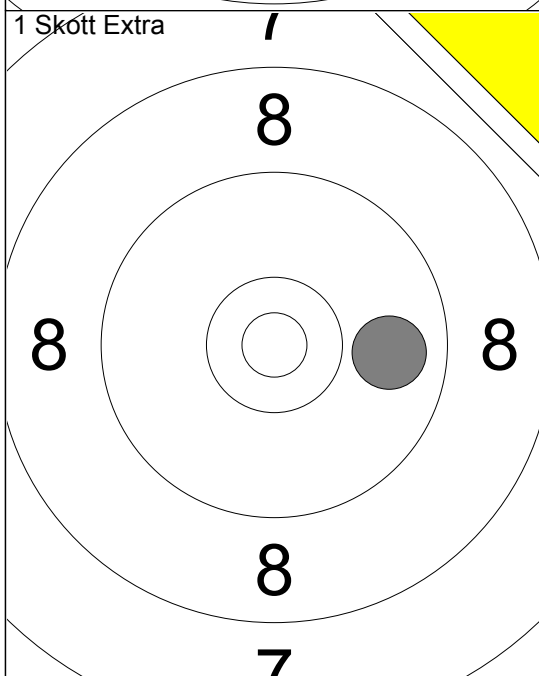

- 1: 9.9 →

Serie 9.0
Total 329.0

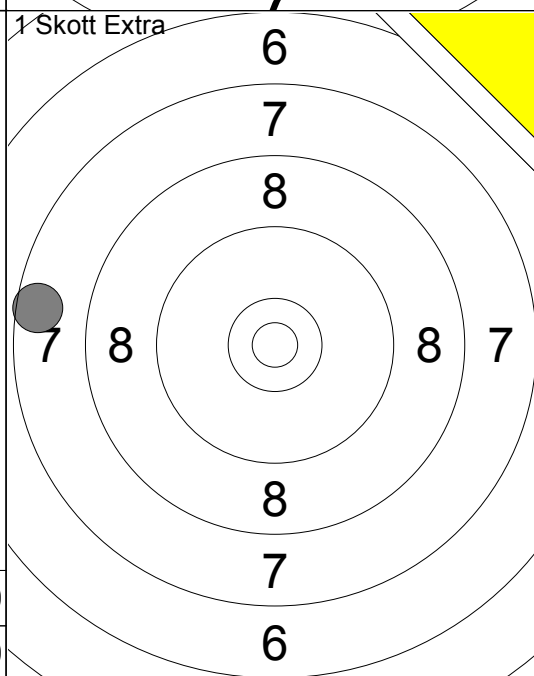

- 1: 7.6 ←

Serie 7.0
Total 329.0

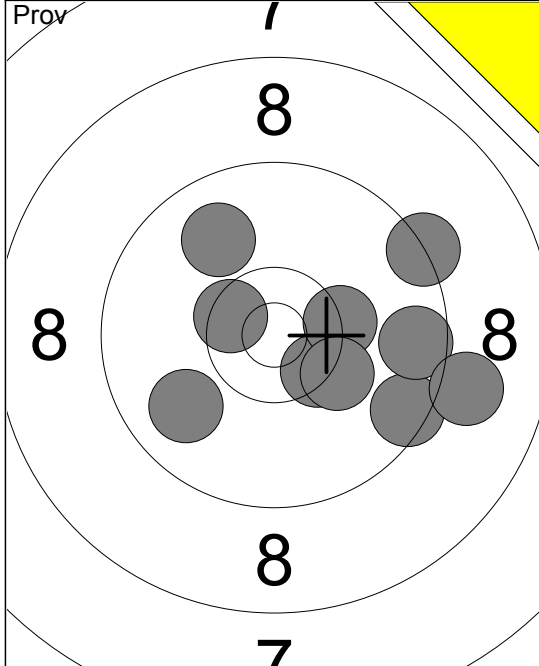

1:	9.9 ↙
2:	10.4x↘
3:	9.9 ↗
4:	10.5x↘
5:	9.3 ↗
6:	9.5 ↘
7:	10.3x↗
8:	10.2 ↘
9:	9.6 →
10:	9.0 ↘
Serie 94.0	
Total 186.0	

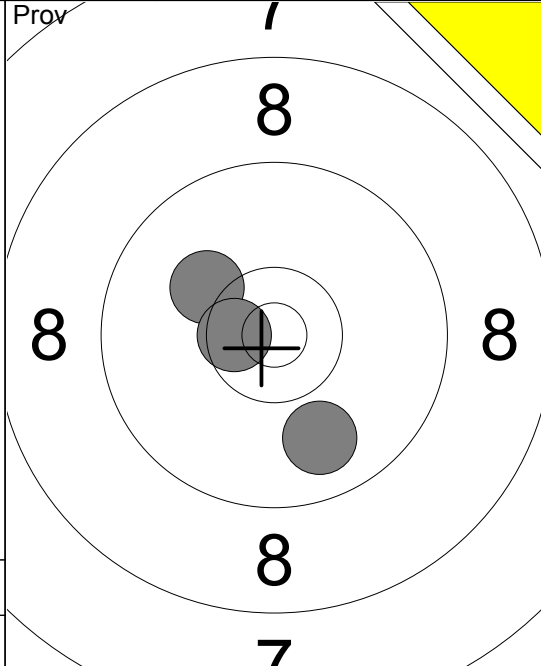

11:	10.2 ↖
12:	9.9 ↘
13:	10.6x↖
Serie 29.0	
Total 186.0	

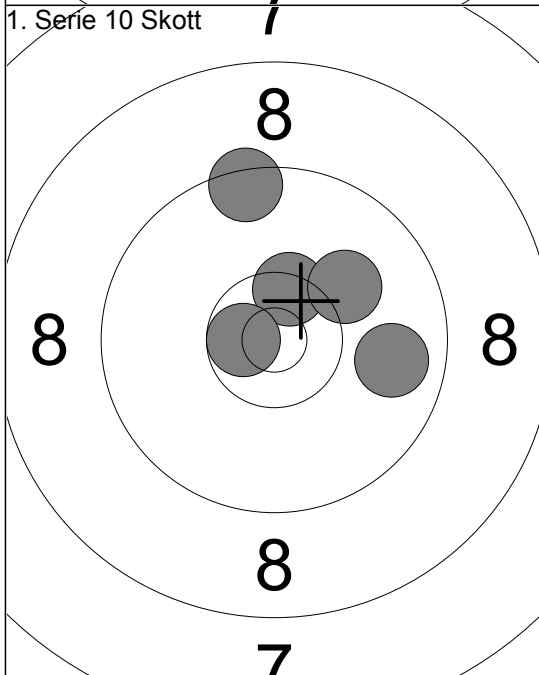

1:	9.8 →
2:	9.5 ↑
3:	10.5x↗
4:	10.7x↖
5:	10.1 ↗
Serie 48.0	
Total 234.0	

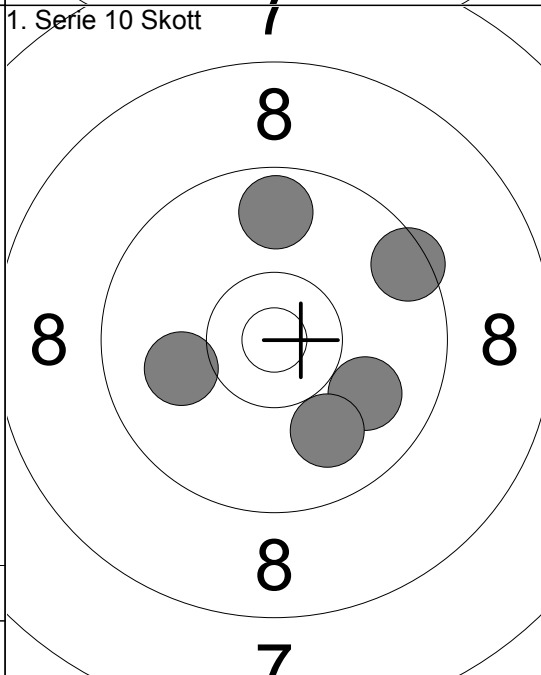

6:	9.9 ↘
7:	10.0↖
8:	9.7 ↑
9:	9.9 ↘
10:	9.5 ↗
Serie 46.0	
Total 280.0	

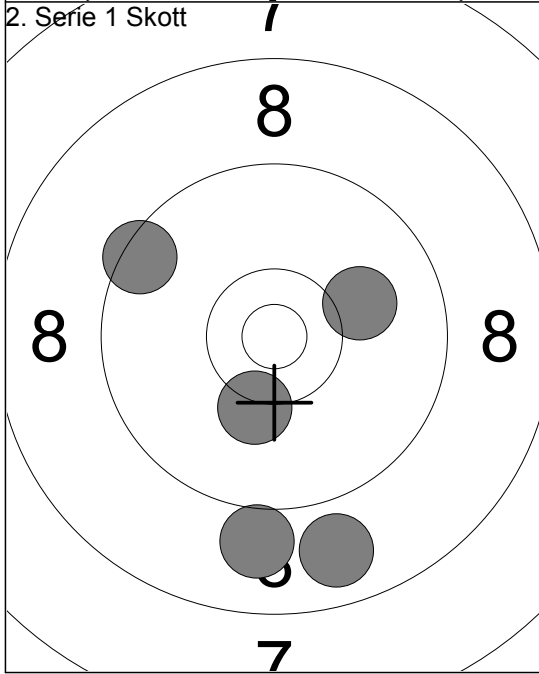

1:	9.0 ↓
2:	8.8 ↓
3:	9.5 ↖
4:	10.1↗
5:	10.2 ↓
Serie 46.0	
Total 326.0	

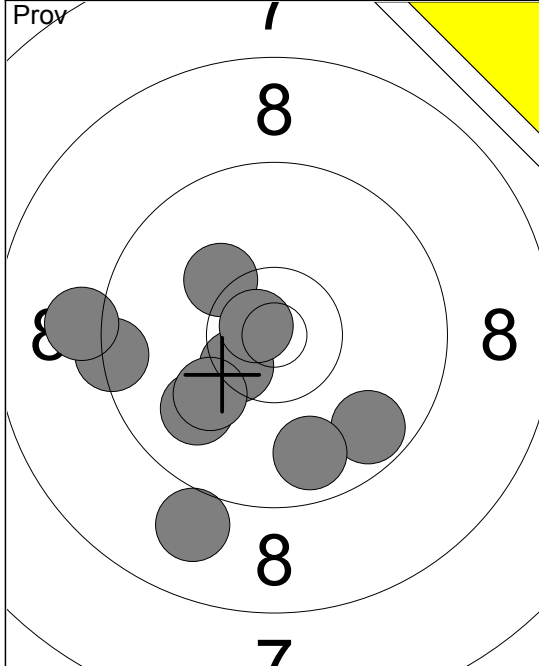

1:	9.9	↙
2:	9.4	←
3:	9.1	←
4:	9.7	↘
5:	10.2	↗
6:	10.5	✕
7:	9.0	↓
8:	10.8	✕
9:	10.1	↙
10:	9.8	↓
Serie	94.0	
Total	186.0	

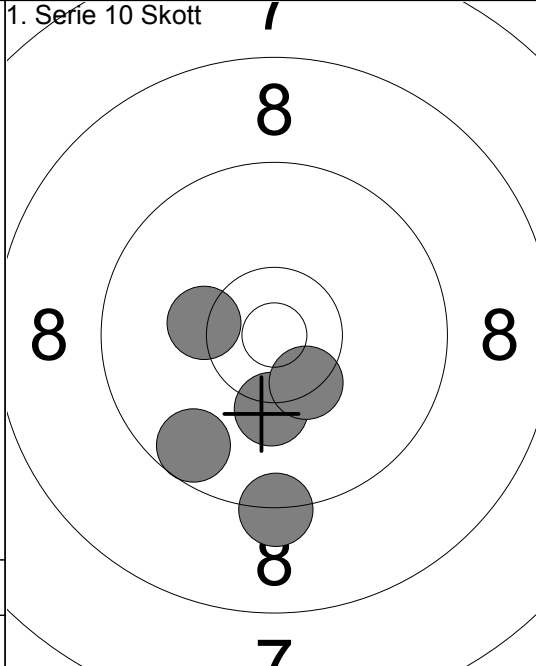

1:	10.3	↙
2:	10.2	↓
3:	9.6	↘
4:	10.4	✕
5:	9.3	↓
Serie	48.0	
Total	234.0	

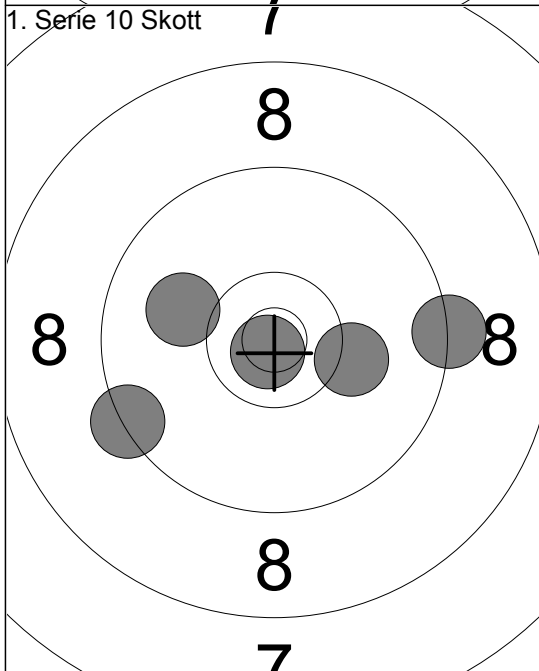

6:	9.4	↙
7:	9.3	→
8:	10.0	↙
9:	10.2	→
10:	10.8	✕
Serie	48.0	
Total	282.0	

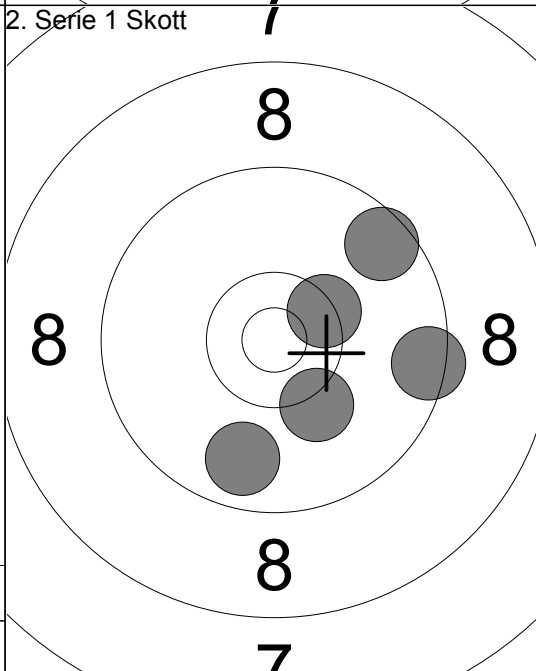

1:	10.4	↗
2:	9.6	↗
3:	10.2	↘
4:	9.5	→
5:	9.8	↓
Serie	47.0	
Total	329.0	

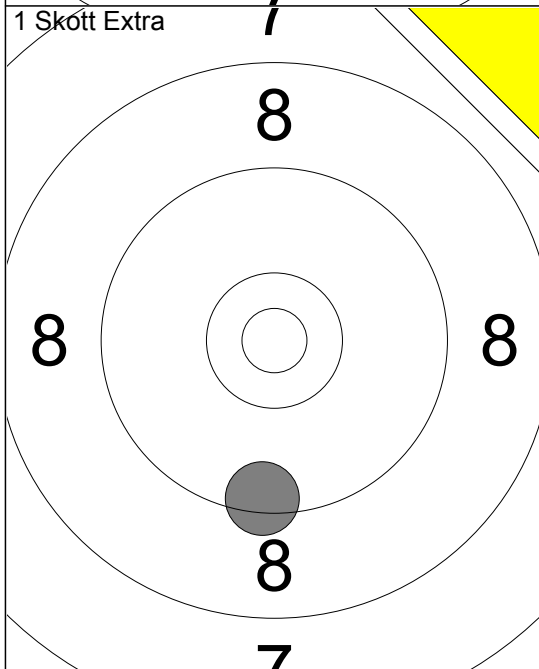

1:	9.4	↓
Serie	9.0	
Total	329.0	

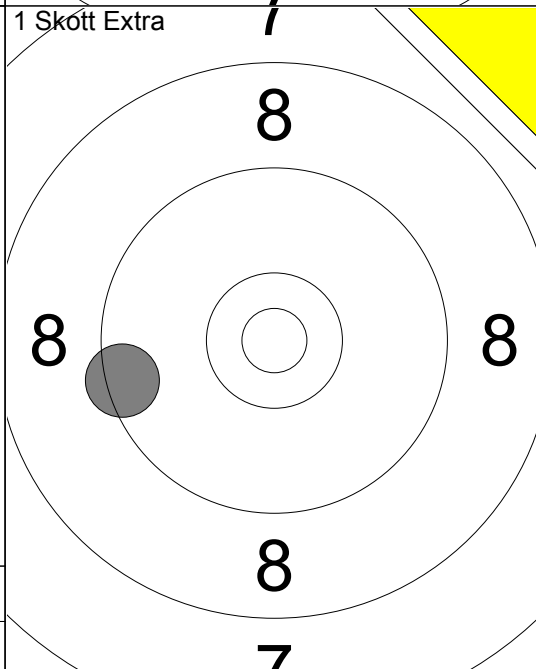

1:	9.5	←
Serie	9.0	
Total	329.0	

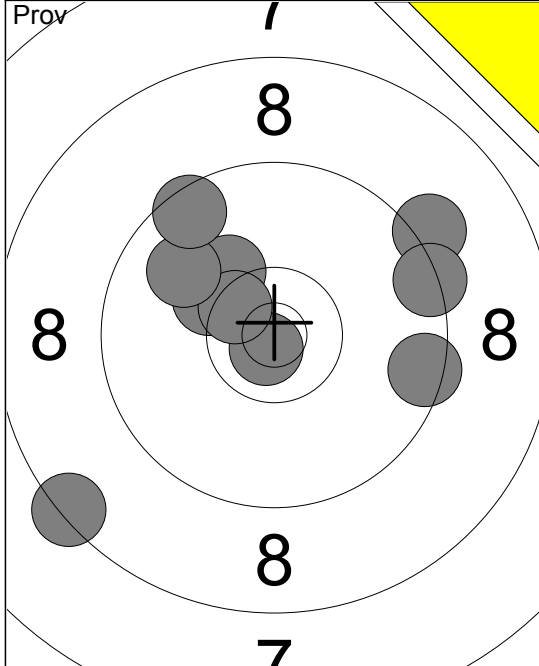

1:	10.2	↖
2:	9.2	↗
3:	9.4	→
4:	9.5	→
5:	10.2	↖
6:	10.8	↘
7:	10.5	↘
8:	9.9	↖
9:	8.4	↙
10:	9.5	↖
Serie		93.0
Total		182.0

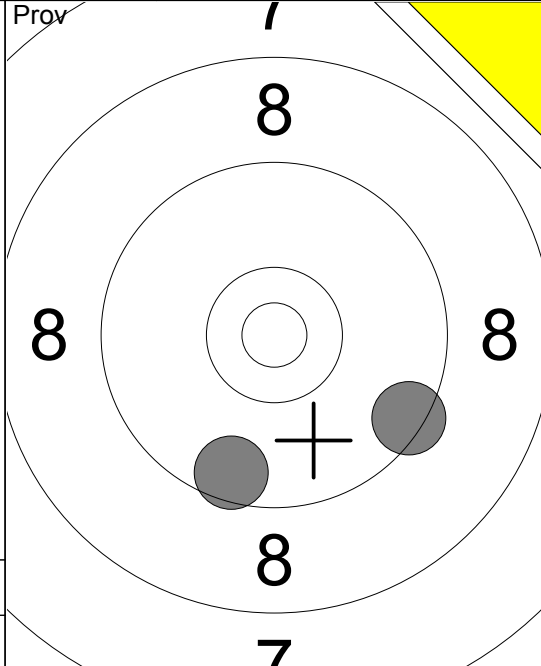

11:	9.4	↘
12:	9.6	↘
Serie		18.0
Total		182.0

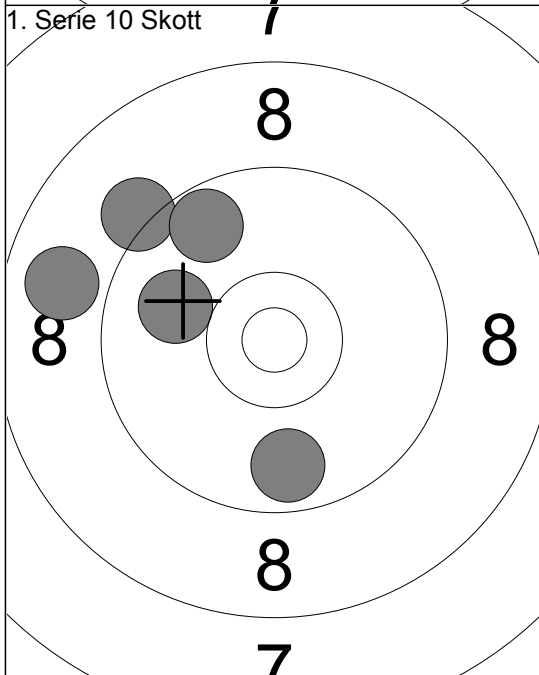

1:	8.9	←
2:	10.0	↖
3:	9.2	↗
4:	9.7	↗
5:	9.8	↘
Serie		45.0
Total		227.0

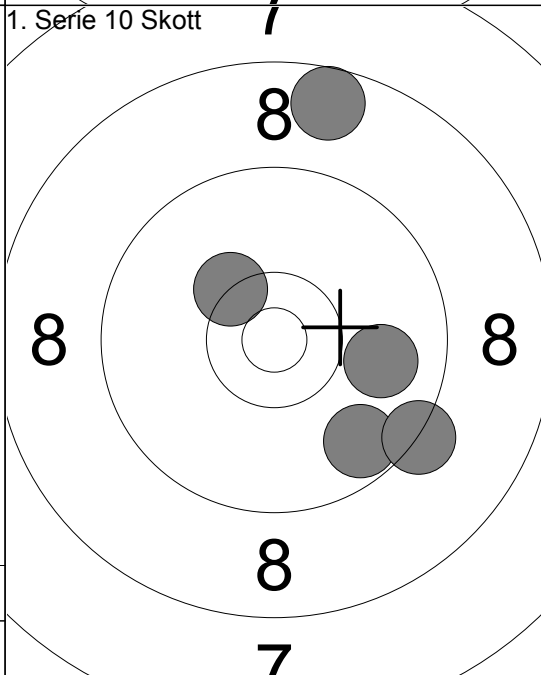

6:	8.6	↑
7:	9.9	→
8:	10.3	↘
9:	9.7	↘
10:	9.3	↘
Serie		45.0
Total		272.0

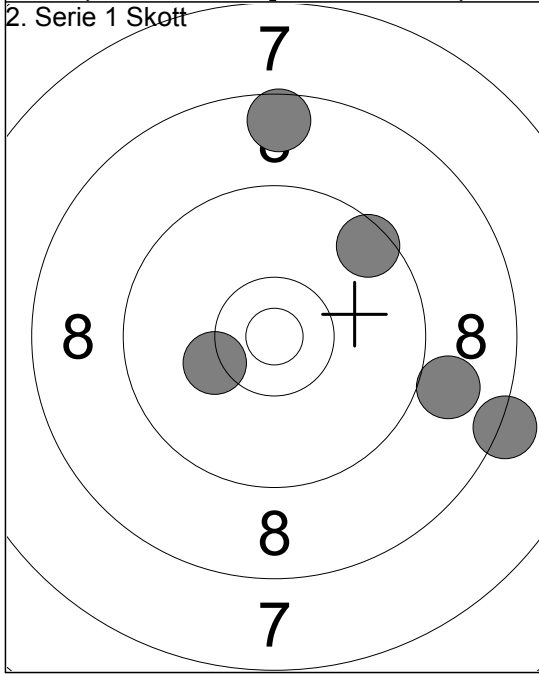

1:	8.6	↑
2:	8.2	→
3:	9.5	↗
4:	9.0	→
5:	10.2	↖
Serie		44.0
Total		316.0

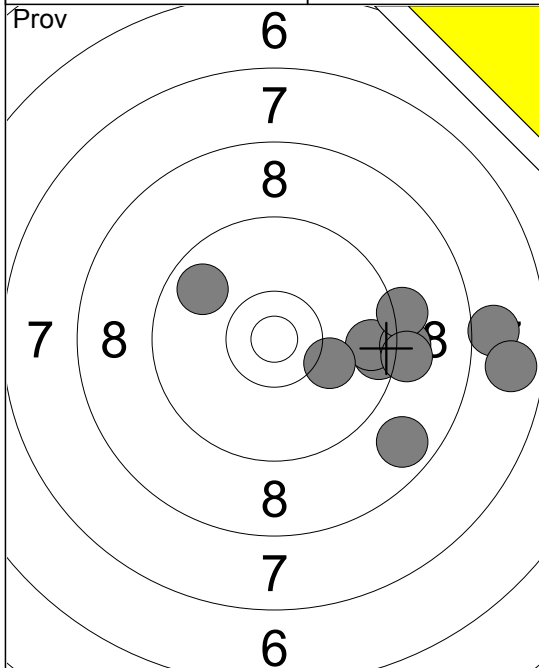

1:	9.5	→
2:	9.6	→
3:	9.2	→
4:	9.8	↗
5:	8.7	↘
6:	10.1	↘
7:	8.0	→
8:	9.2	→
9:	9.2	→
10:	7.8	→
Serie	87.0	
Total	180.0	

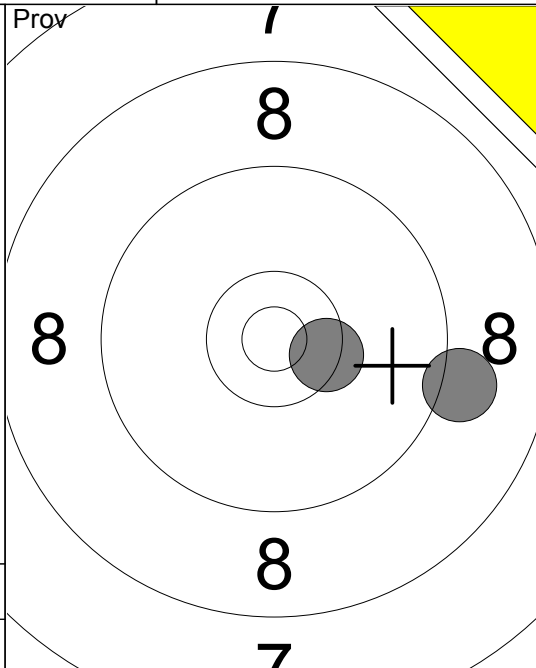

11:	9.1	→
12:	10.4x	→
Serie	19.0	
Total	180.0	

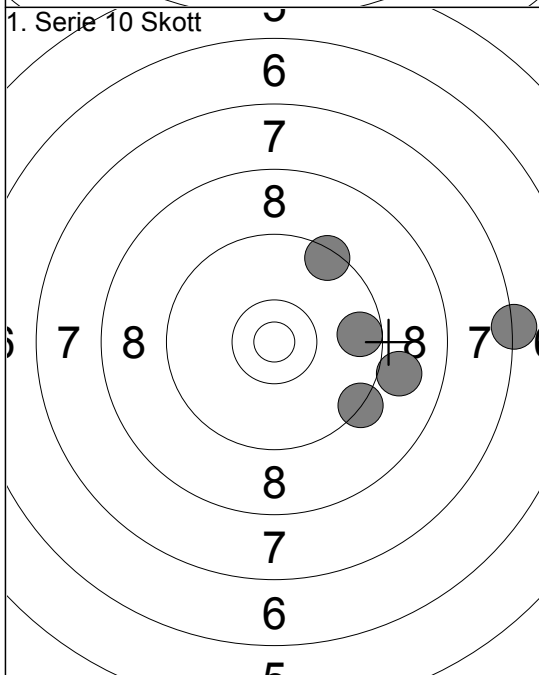

1:	9.0	→
2:	7.3	→
3:	9.4	↗
4:	9.6	→
5:	9.3	↘
Serie	43.0	
Total	223.0	

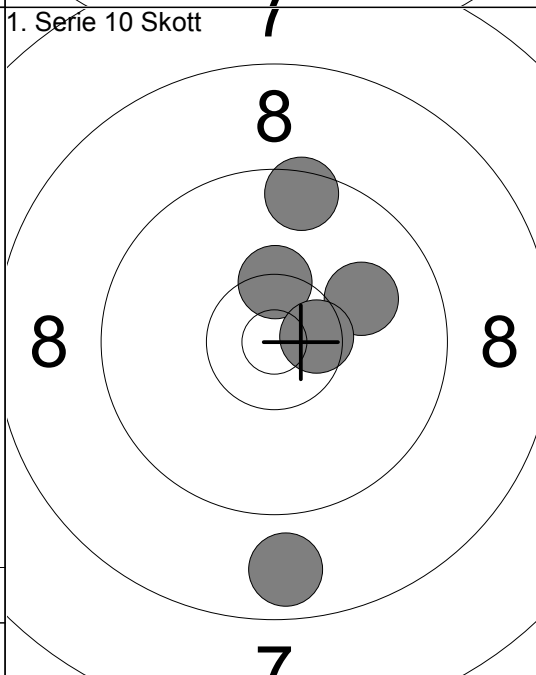

6:	8.8	↓
7:	10.4x	↗
8:	10.0	↗
9:	10.5x	→
10:	9.5	↑
Serie	47.0	
Total	270.0	

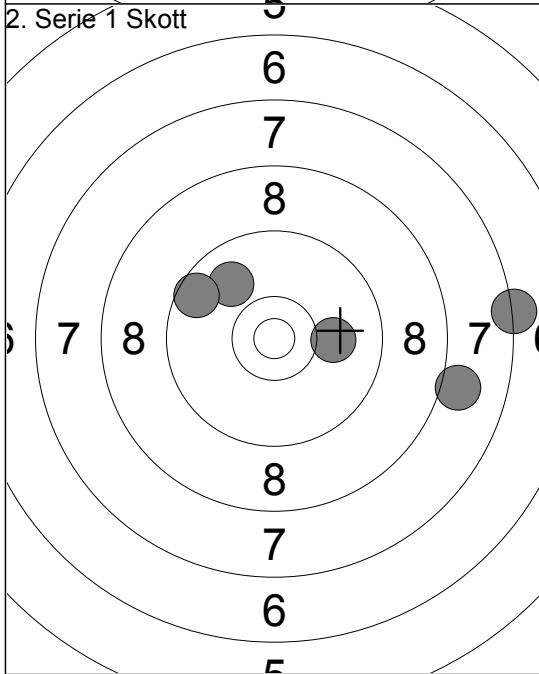

1:	9.9	↗
2:	8.0	→
3:	7.3	→
4:	9.6	↖
5:	10.0	→
Serie	43.0	
Total	313.0	

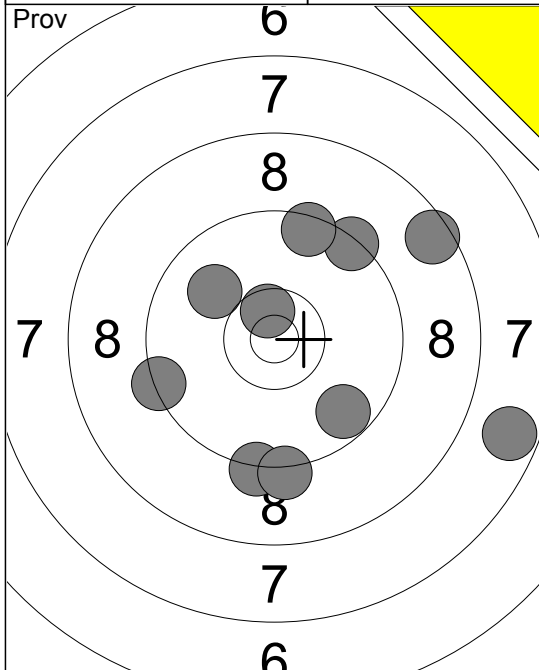

1:	7.7	→
2:	10.0	↖
3:	9.4	←
4:	9.7	↘
5:	9.4	↗
6:	9.3	↓
7:	9.2	↓
8:	8.5	↗
9:	10.6	↗
10:	9.5	↑
Serie		89.0
Total		174.0

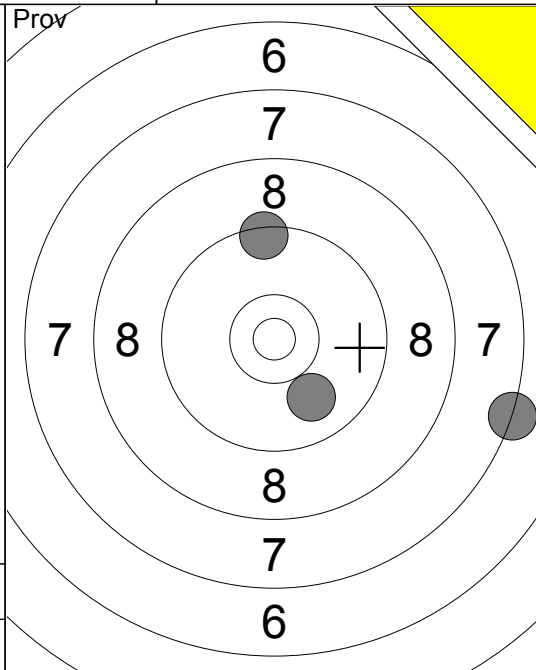

11:	9.4	↑
12:	7.3	→
13:	9.9	↘
Serie		25.0
Total		174.0

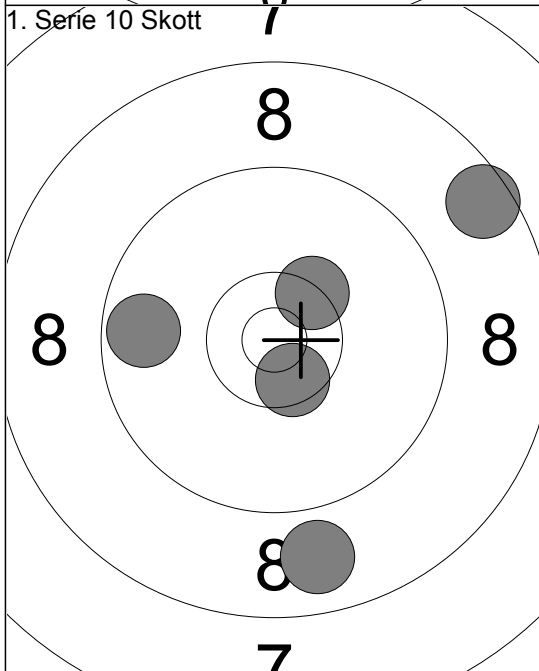

1:	8.8	↓
2:	10.4	↗
3:	9.7	←
4:	10.5	↘
5:	8.6	↗
Serie		45.0
Total		219.0

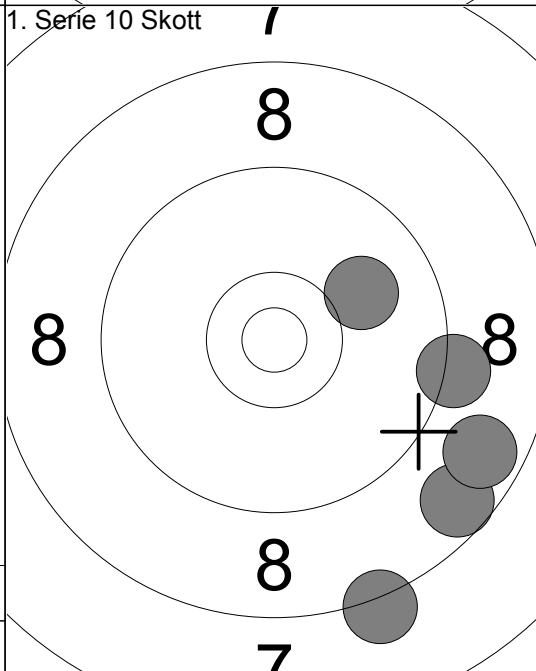

6:	8.6	↘
7:	9.2	→
8:	8.7	↘
9:	8.2	↓
10:	10.0	↗
Serie		43.0
Total		262.0

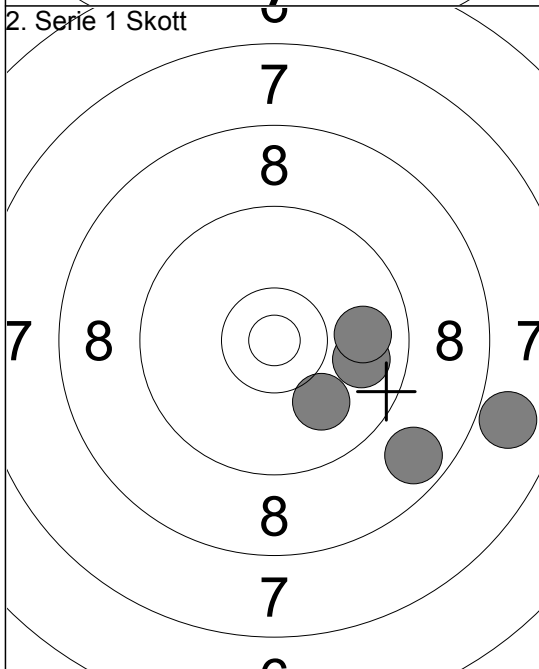

1:	10.0	↘
2:	8.7	↘
3:	9.9	→
4:	7.9	→
5:	9.9	→
Serie		43.0
Total		305.0

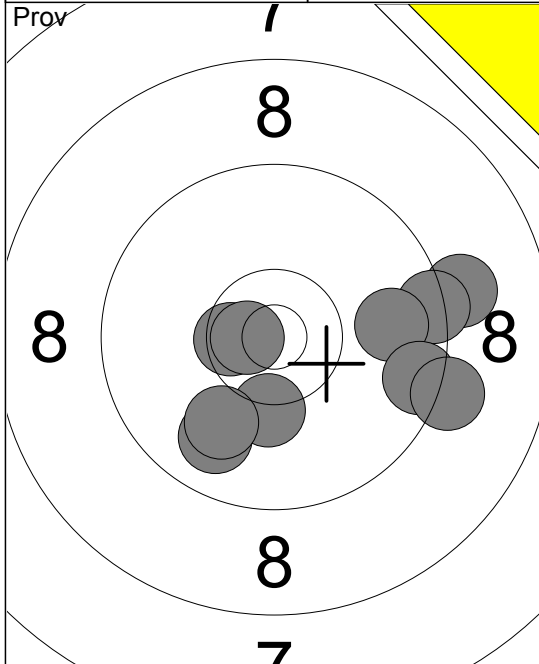

Prov

1:	9.1	→
2:	10.5	✕
3:	9.4	→
4:	9.8	→
5:	9.5	→
6:	10.7	✕
7:	9.8	↓
8:	9.2	→
9:	10.2	↓
10:	10.0	↓
Serie	94.0	
Total	189.0	

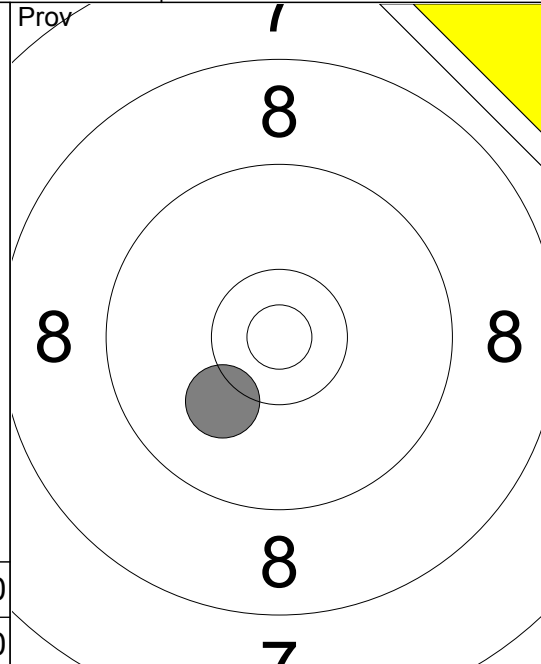

Prov

11:	10.1	↓
Serie	10.0	
Total	189.0	

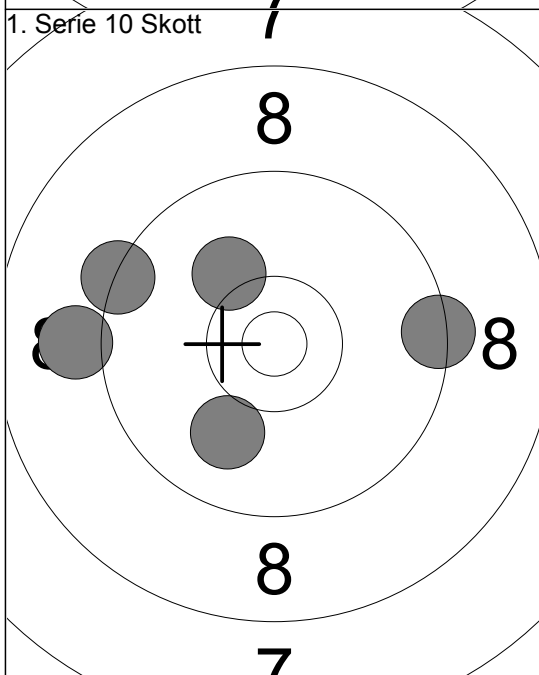

1:	10.0	↓
2:	9.4	→
3:	10.2	↖
4:	9.3	↖
5:	9.1	←
Serie	47.0	
Total	236.0	

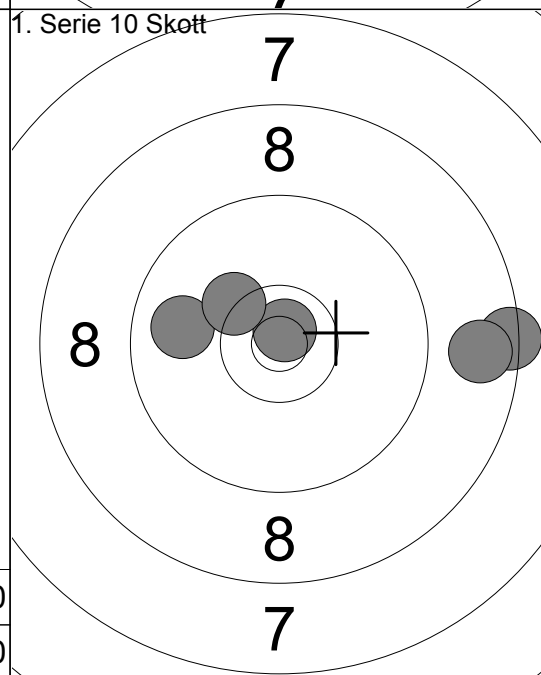

6:	9.9	←
7:	10.8	↗
8:	10.3	↖
9:	8.4	→
10:	8.7	→
Serie	45.0	
Total	281.0	

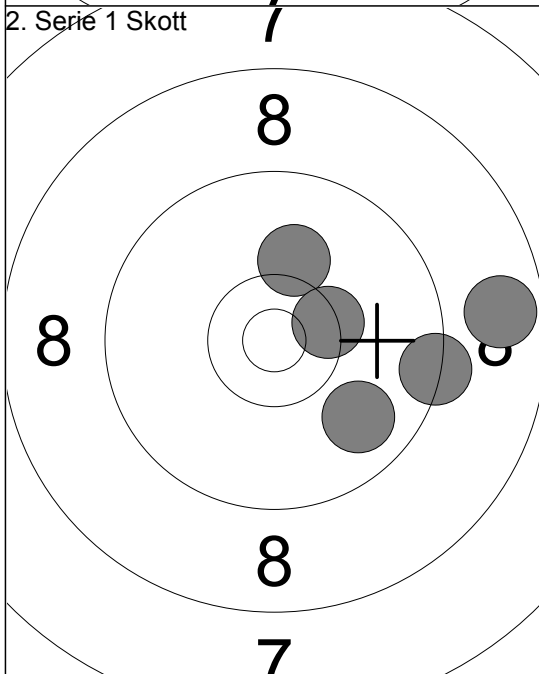

1:	10.1	↑
2:	8.7	→
3:	9.8	↓
4:	10.4	↗
5:	9.4	→
Serie	46.0	
Total	327.0	

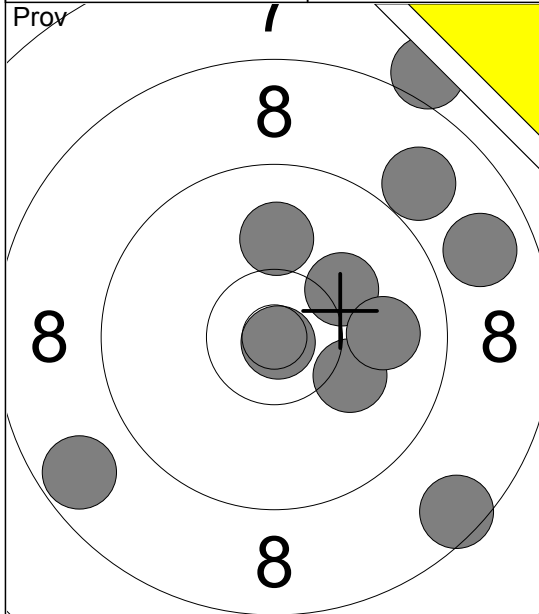

- 1: 8.0 ↗
- 2: 10.2 ↗
- 3: 8.8 →
- 4: 10.1 →
- 5: 8.5 ↓
- 6: 9.9 →
- 7: 10.9x↓
- 8: 10.0 ↑
- 9: 8.7 ↙
- 10: 8.9 ↗

Serie 89.0
Total 181.0

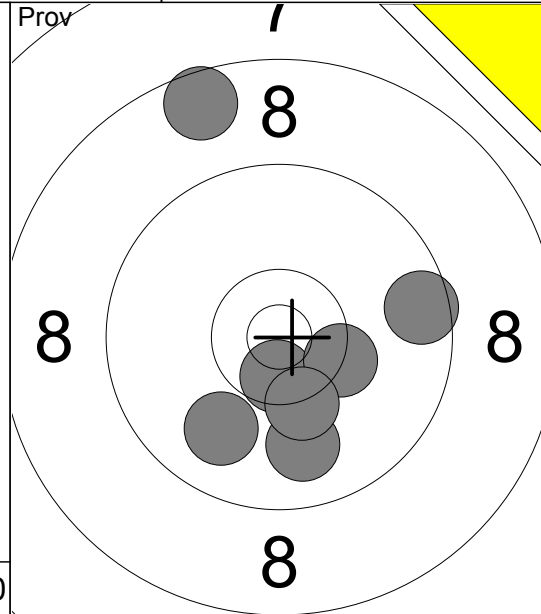

- 11: 10.6x↓
- 12: 10.3x→
- 13: 9.9 ↓
- 14: 9.9 ↙
- 15: 10.3↓
- 16: 8.6 ↑
- 17: 9.6 →

Serie 65.0
Total 181.0

1. Serie 10 Skott

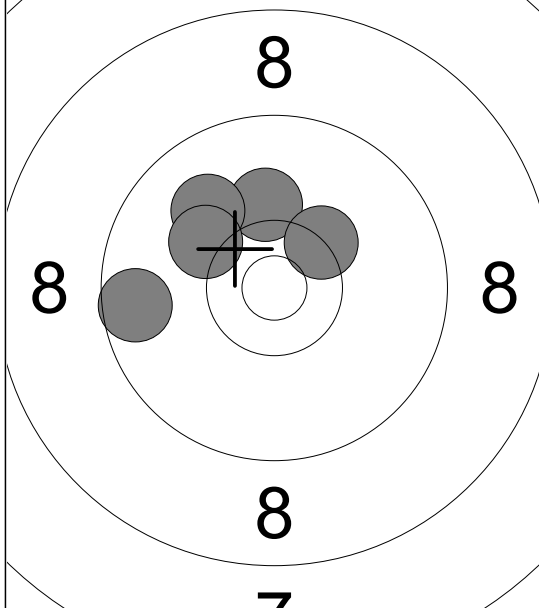

- 1: 10.2 ↑
- 2: 9.6 ←
- 3: 10.3x↗
- 4: 10.0 ↖
- 5: 10.2 ↖

Serie 49.0
Total 230.0

1. Serie 10 Skott

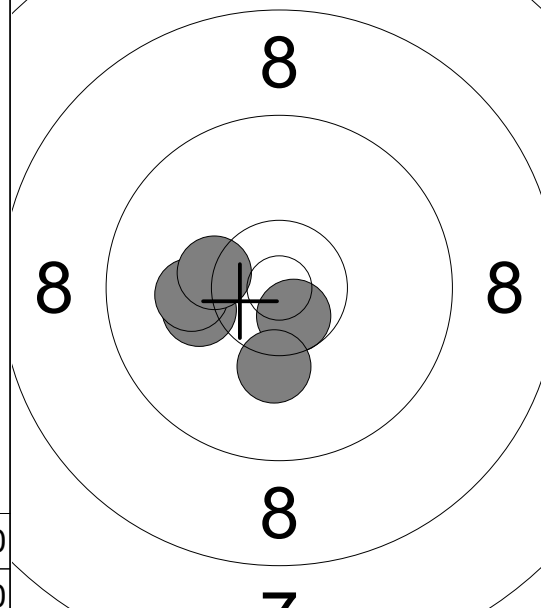

- 6: 10.2←
- 7: 10.1←
- 8: 10.3x↖
- 9: 10.6x↓
- 10: 10.2↓

Serie 50.0
Total 280.0

2. Serie 1 Skott

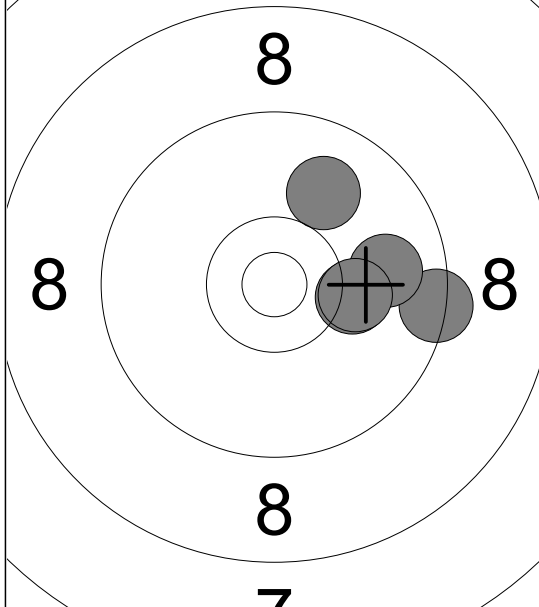

- 1: 10.2→
- 2: 9.4 →
- 3: 10.0 ↗
- 4: 9.9 →
- 5: 10.2→

Serie 48.0
Total 328.0

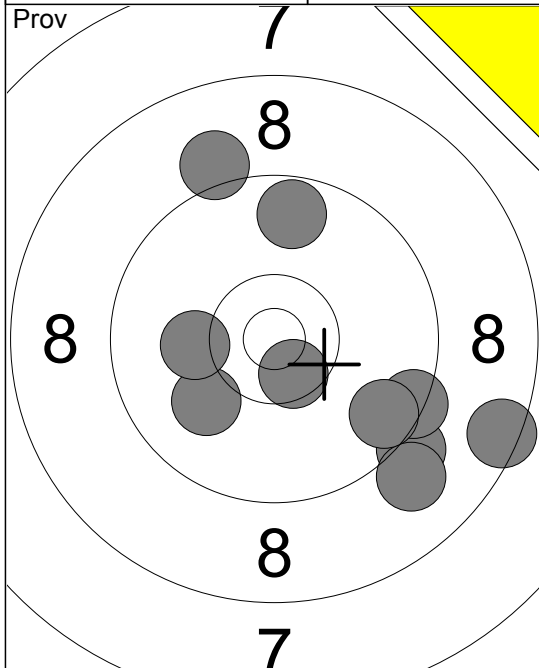

- 1: 10.6x ↘
- 2: 10.0 ↙
- 3: 9.2 ↘
- 4: 9.7 ↑
- 5: 9.1 ↑
- 6: 9.0 ↘
- 7: 9.4 ↘
- 8: 10.1 ←
- 9: 8.5 ↘
- 10: 9.6 ↘

Serie 92.0

Total 177.0

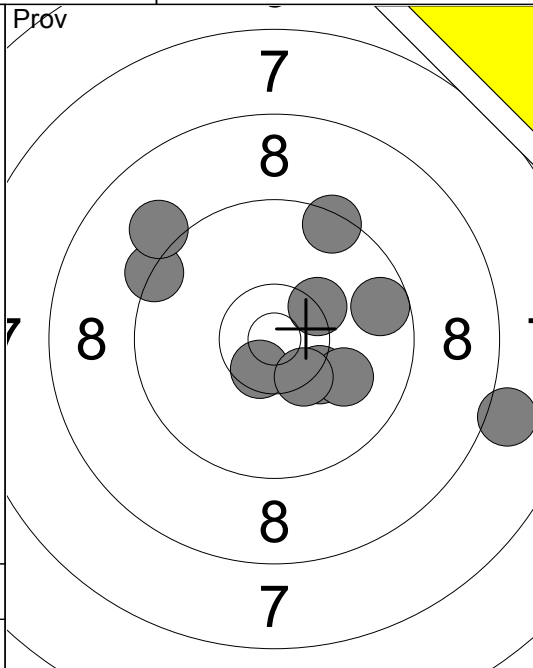

- 11: 8.1 →
- 12: 9.4 ↗
- 13: 9.3 ↖
- 14: 10.3 ↘
- 15: 10.0 ↘
- 16: 9.6 →
- 17: 10.6x ↘
- 18: 9.1 ↖
- 19: 10.3x ↗
- 20: 10.4x ↘

Serie 94.0

Total 177.0

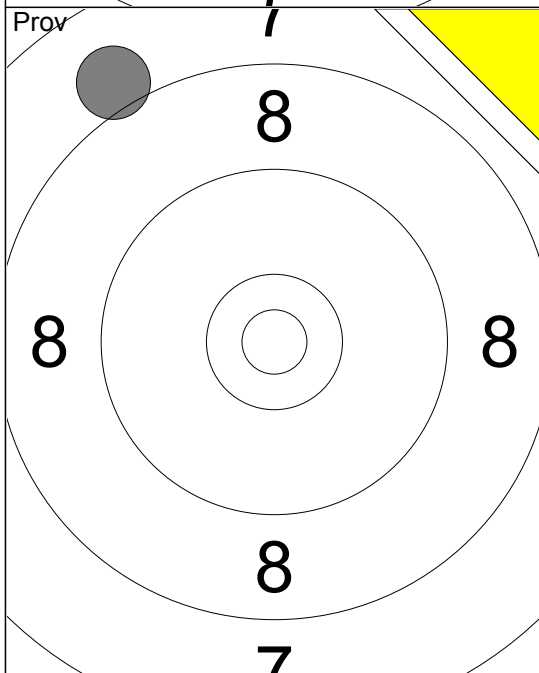

- 21: 8.0 ↗

Serie 8.0

Total 177.0

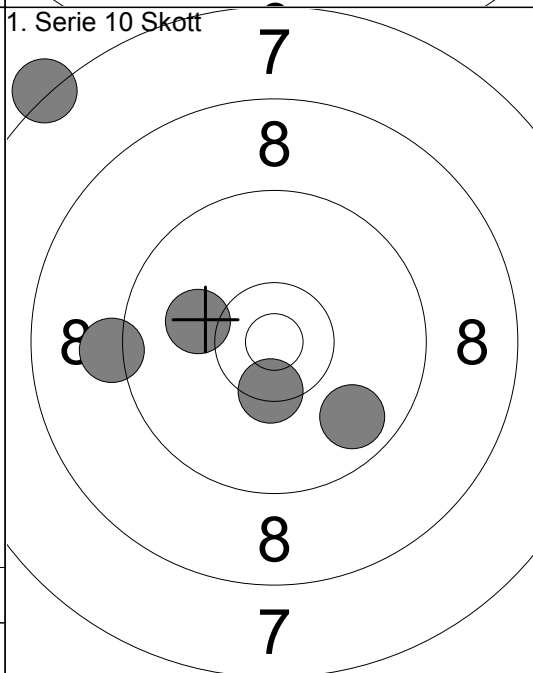

1. Serie 10 Skott

- 1: 10.1 ←
- 2: 7.3 ↗
- 3: 9.8 ↘
- 4: 9.2 ←
- 5: 10.4x ↘

Serie 45.0

Total 222.0

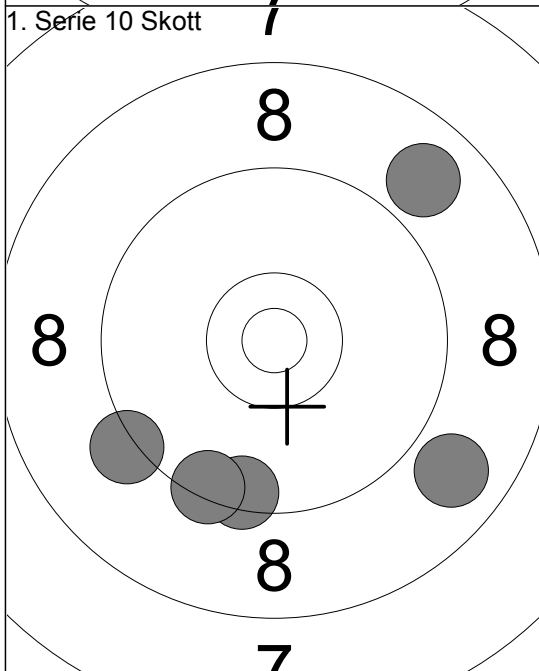

1. Serie 10 Skott

- 6: 8.9 ↗
- 7: 9.5 ↘
- 8: 9.4 ↘
- 9: 9.2 ↖
- 10: 8.9 ↘

Serie 43.0

Total 265.0

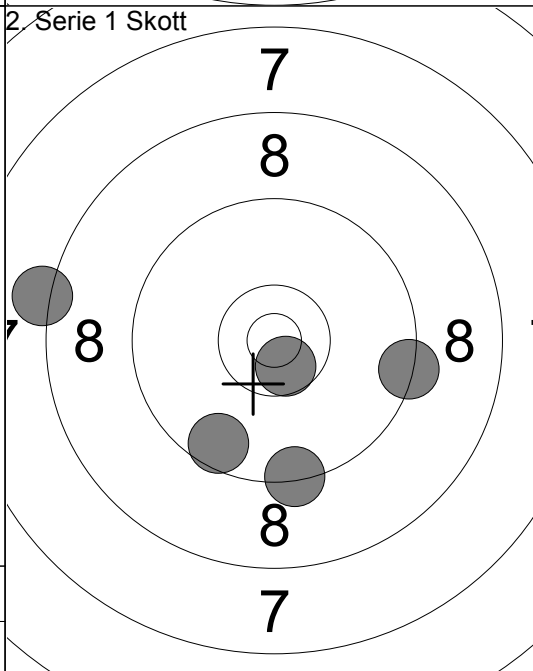

2. Serie 1 Skott

- 1: 8.2 ←
- 2: 10.6x ↘
- 3: 9.4 ↘
- 4: 9.6 ↘
- 5: 9.4 →

Serie 45.0

Total 310.0

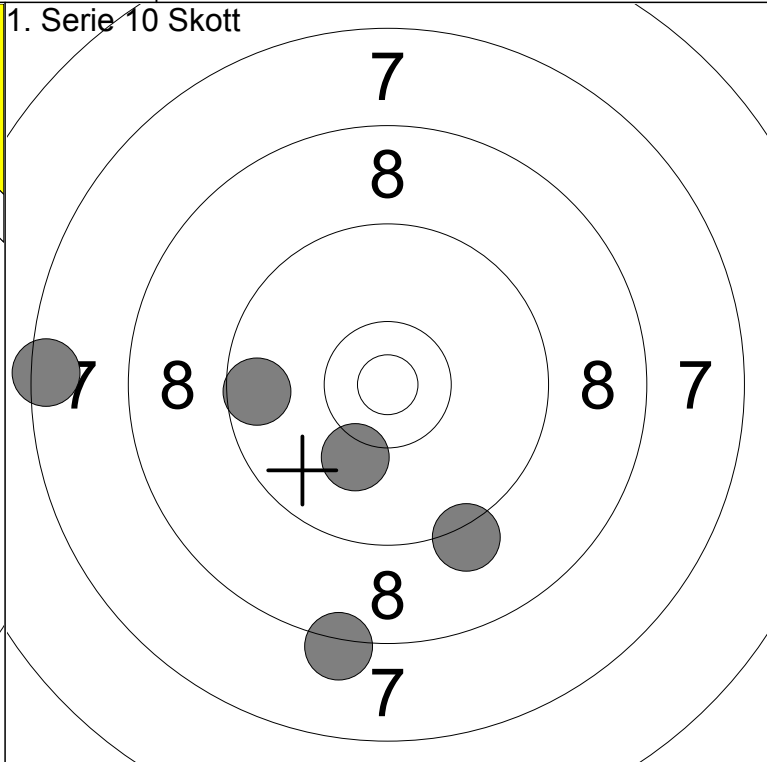
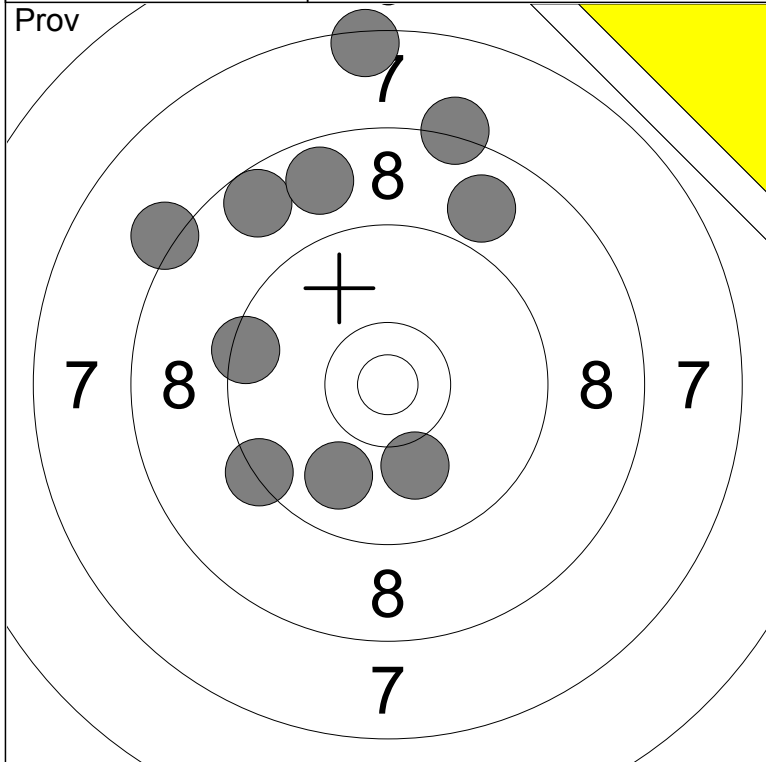

1: 8.2 ↑	6: 8.7 ↑	Serie	84
2: 7.4 ↑	7: 9.3 ↙		
3: 8.7 ↗	8: 9.9 ↘	Total	168
4: 8.9 ↗	9: 10.1 ↘		
5: 8.2 ↖	10: 9.4 ←		

1: 8.2 ↓	Serie	43
2: 10.1 ↓		
3: 7.5 ←	Total	211
4: 9.6 ←		
5: 9.2 ↓		

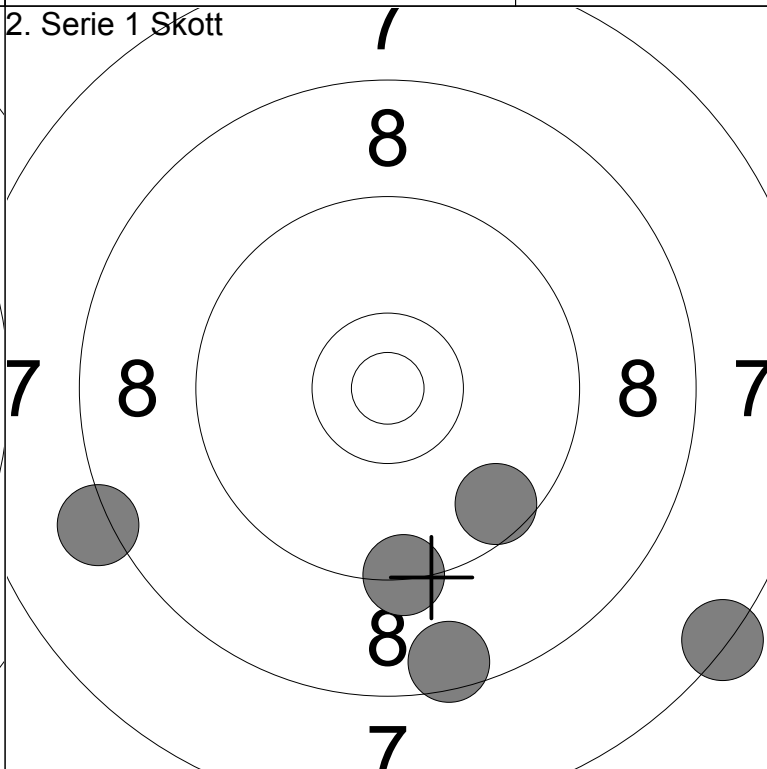
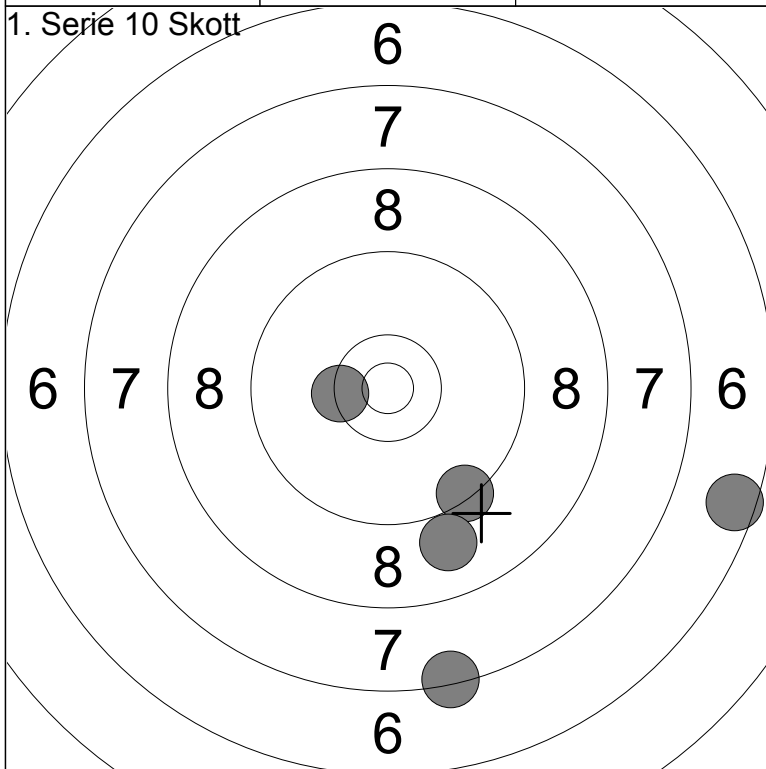

6: 7.4 ↓	Serie	41
7: 9.4 ↓		
8: 9.0 ↓	Total	252
9: 6.6 →		
10: 10.4x ←		

1: 9.3 ↓	Serie	41
2: 7.3 ↓		
3: 9.6 ↓	Total	293
4: 8.2 ←		
5: 8.5 ↓		

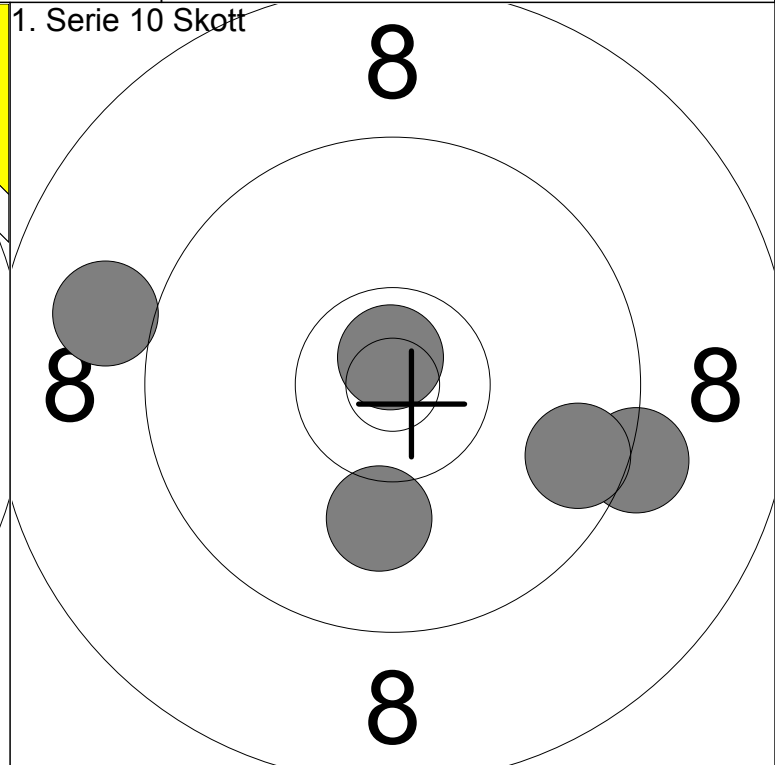
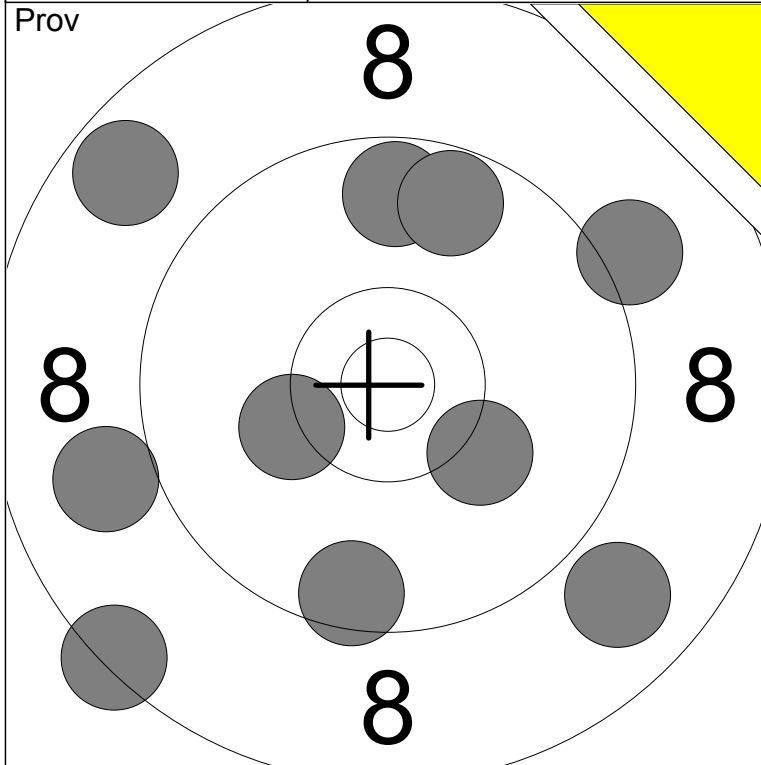

1: 10.3 ←	6: 8.9 ↘	Serie	89
2: 8.7 ↖	7: 10.2 ↘		
3: 9.1 ↗	8: 9.7 ↗	Total	190
4: 9.7 ↑	9: 9.0 ←		
5: 9.5 ↓	10: 8.4 ↙		

1: 10.8x ↑	Serie	47
2: 9.3 →		
3: 10.1 ↓	Total	237
4: 9.0 ←		
5: 9.6 →		

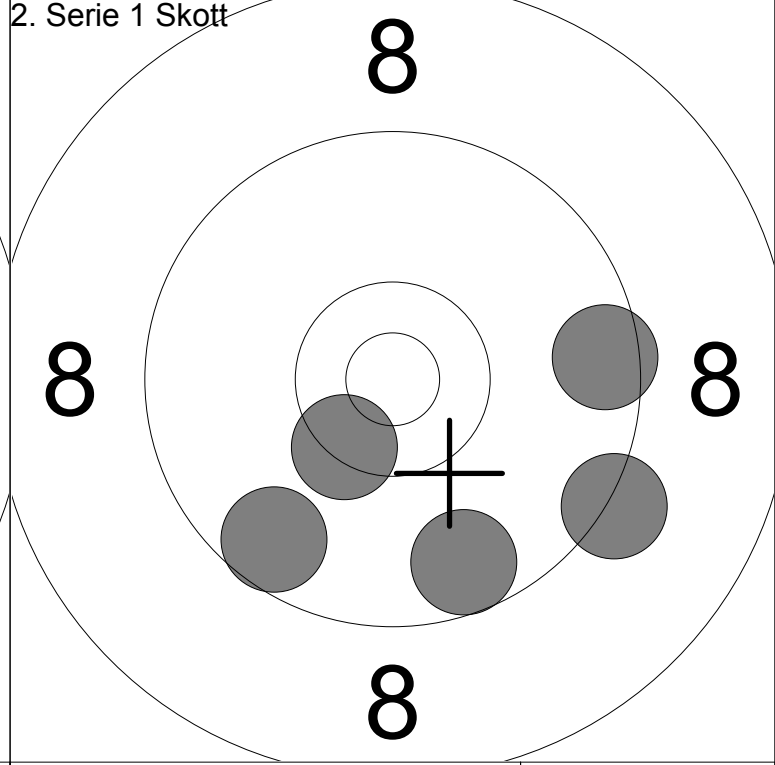
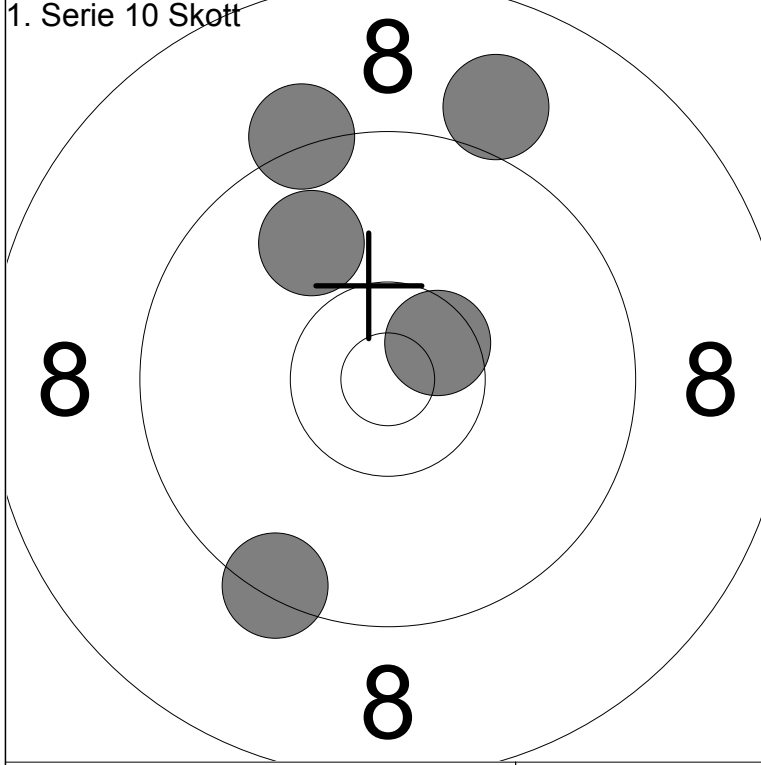

6: 9.0 ↗	Serie	46
7: 9.4 ↘		
8: 9.2 ↗	Total	283
9: 10.5x ↗		
10: 9.9 ↖		

1: 9.5 →	Serie	46
2: 9.3 ↘		
3: 9.6 ↘	Total	329
4: 9.6 ↘		
5: 10.4x ↘		

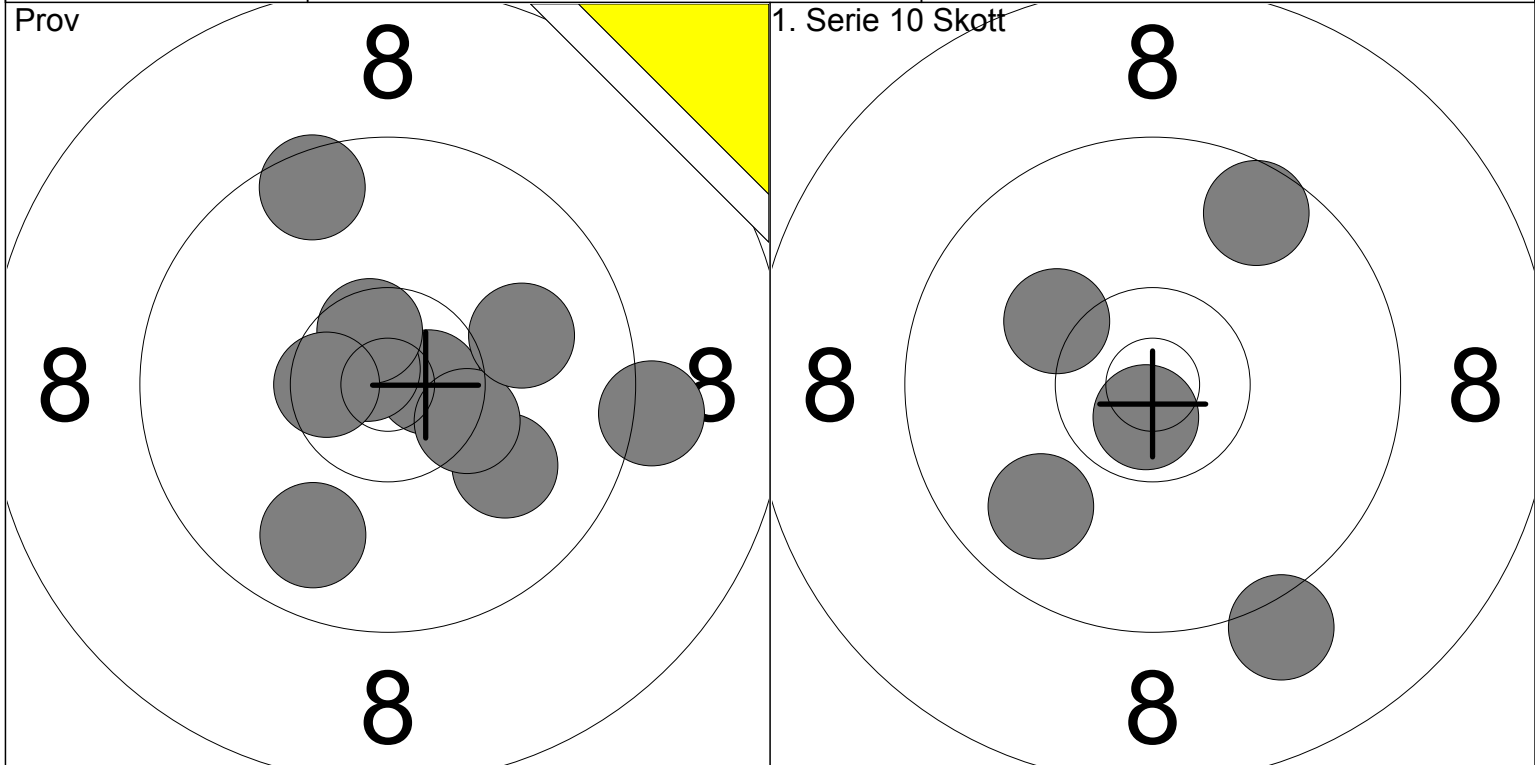

1: 9.5 ↗	6: 10.4x →	Serie 97	1: 9.6 ↗	Serie 47
2: 10.0 ↘	7: 10.0 →		2: 10.2 ↖	
3: 10.7x →	8: 9.8 ↘	Total 189	3: 9.8 ↘	Total 236
4: 10.8x ↗	9: 10.5x ←		4: 10.7x ↘	
5: 10.6x ↗	10: 9.2 →		5: 9.1 ↘	

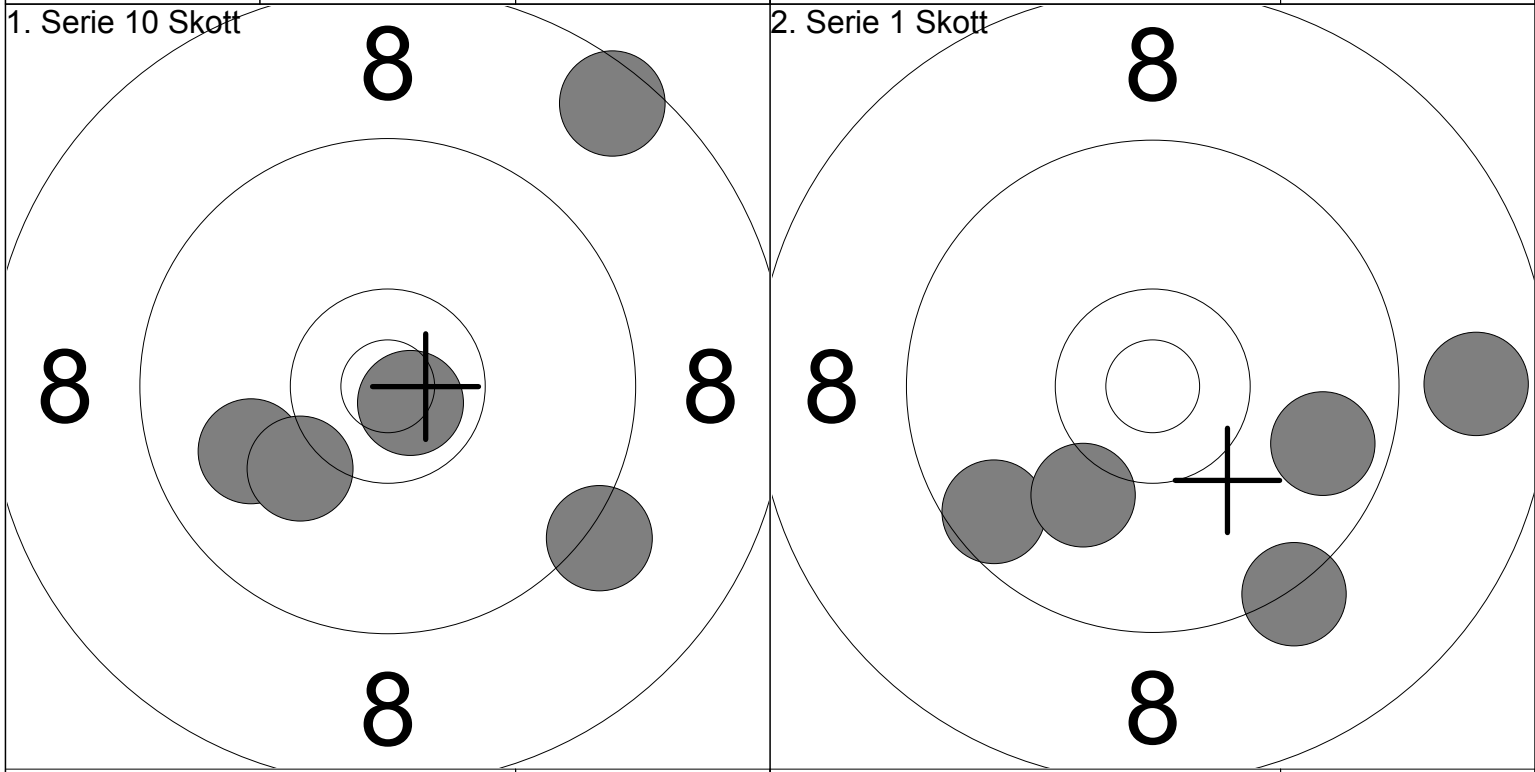

6: 9.2 ↘	Serie 46	1: 9.6 ↖	Serie 45
7: 10.8x ↘		2: 9.3 ↘	
8: 8.5 ↗	Total 282	3: 8.8 →	Total 327
9: 9.9 ←		4: 9.7 ↘	
10: 10.2 ↘		5: 10.1 ↘	

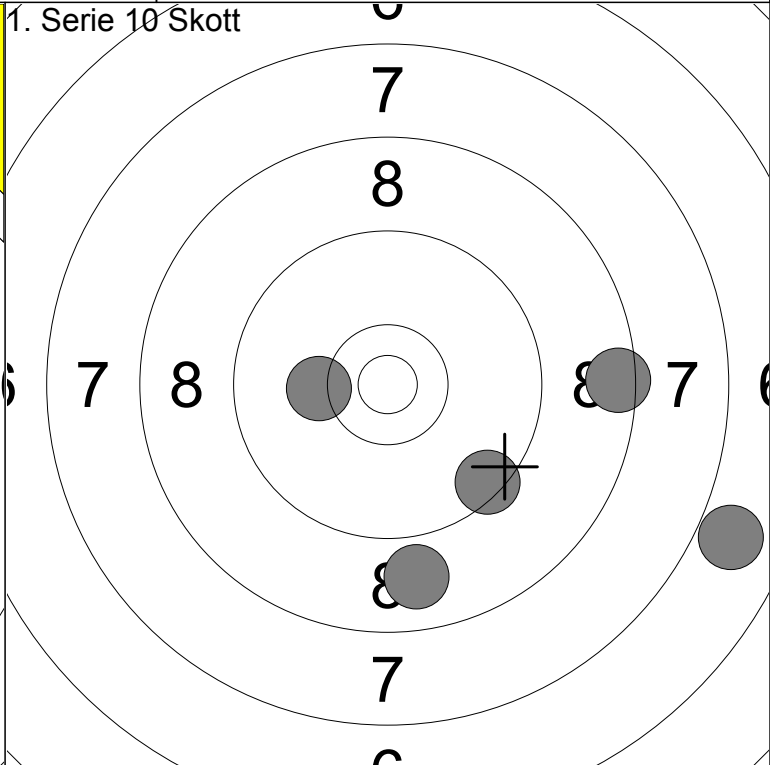
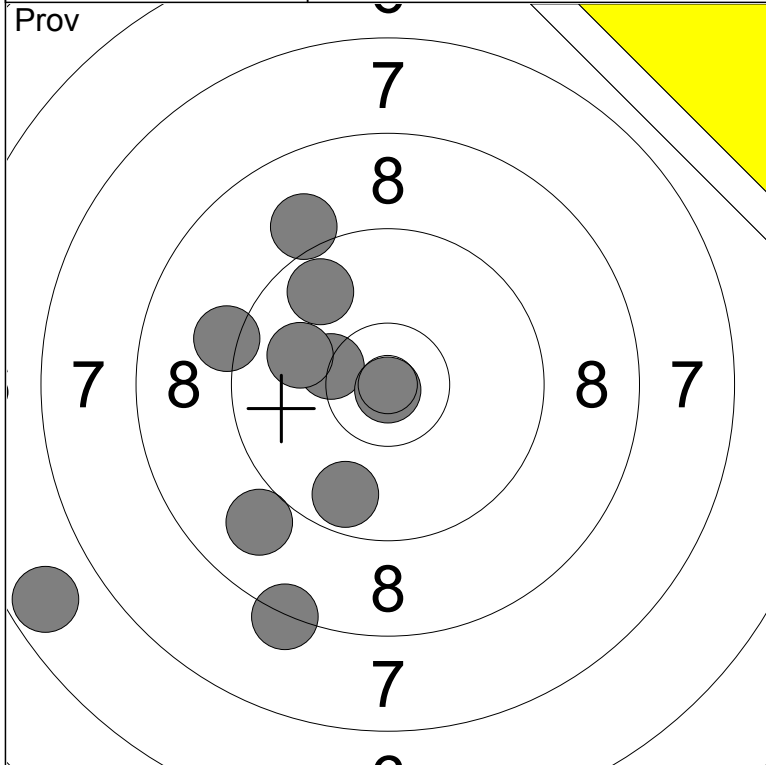

1: 6.7 ↙	6: 10.0 ←	Serie	89
2: 9.2 ←	7: 9.7 ↗		
3: 10.3x ↙	8: 9.0 ↘	Total	173
4: 10.9x ↓	9: 9.7 ↓		
5: 9.1 ↗	10: 8.3 ↓		

1: 9.5 ↘	Serie	41
2: 6.9 ↘		
3: 10.2 ←	Total	214
4: 8.5 →		
5: 8.9 ↓		

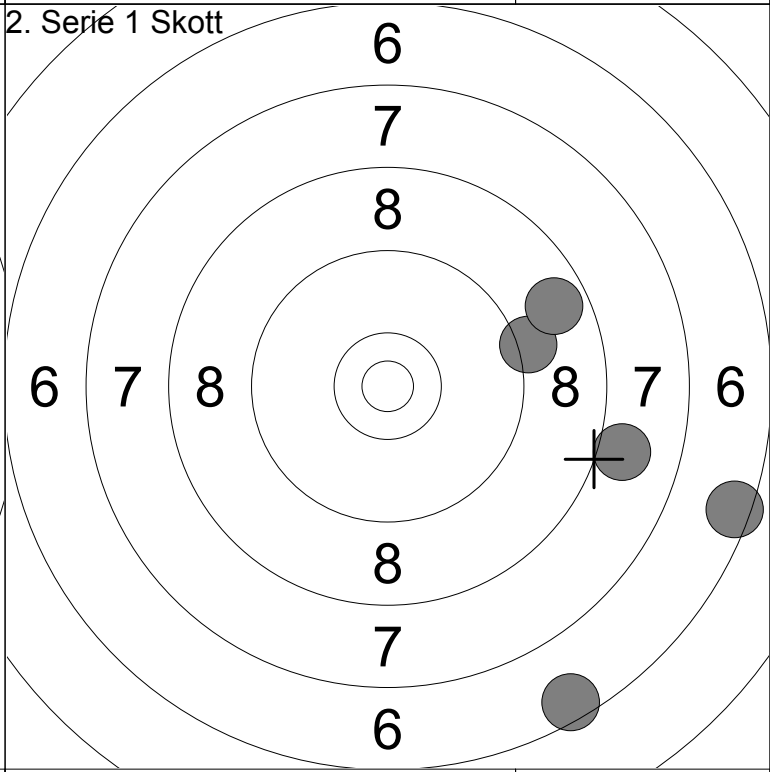
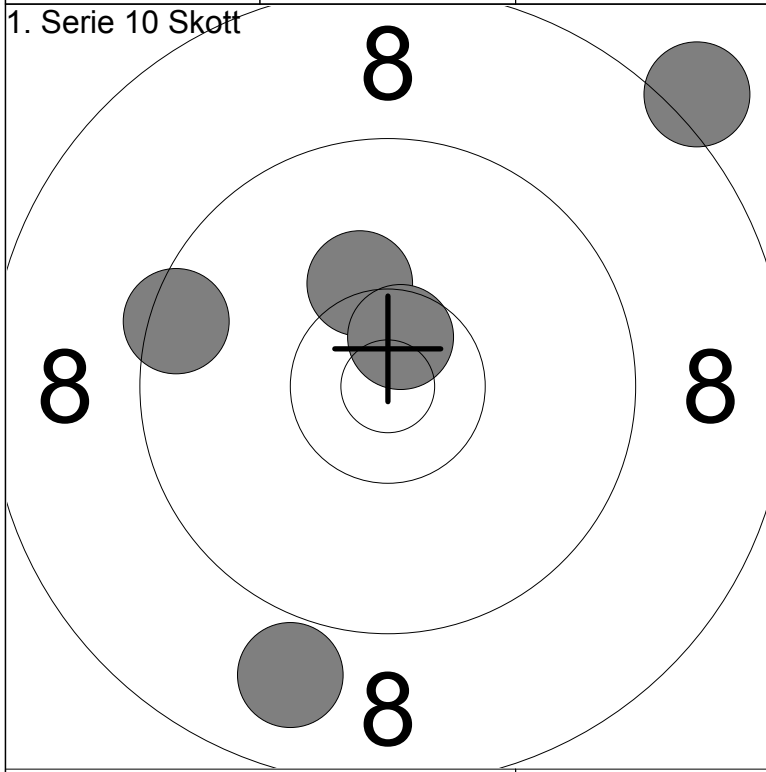

6: 10.2 ↑	Serie	45
7: 9.5 ←		
8: 10.6x ↑	Total	259
9: 8.1 ↗		
10: 8.9 ↓		

1: 9.2 →	Serie	37
2: 6.5 ↘		
3: 8.0 →	Total	296
4: 8.7 →		
5: 6.5 ↓		

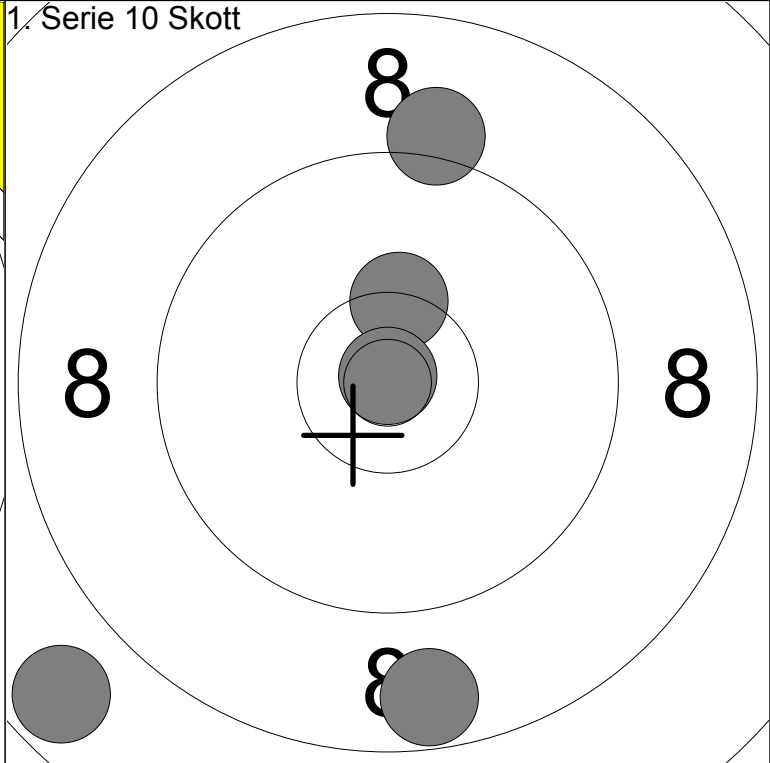
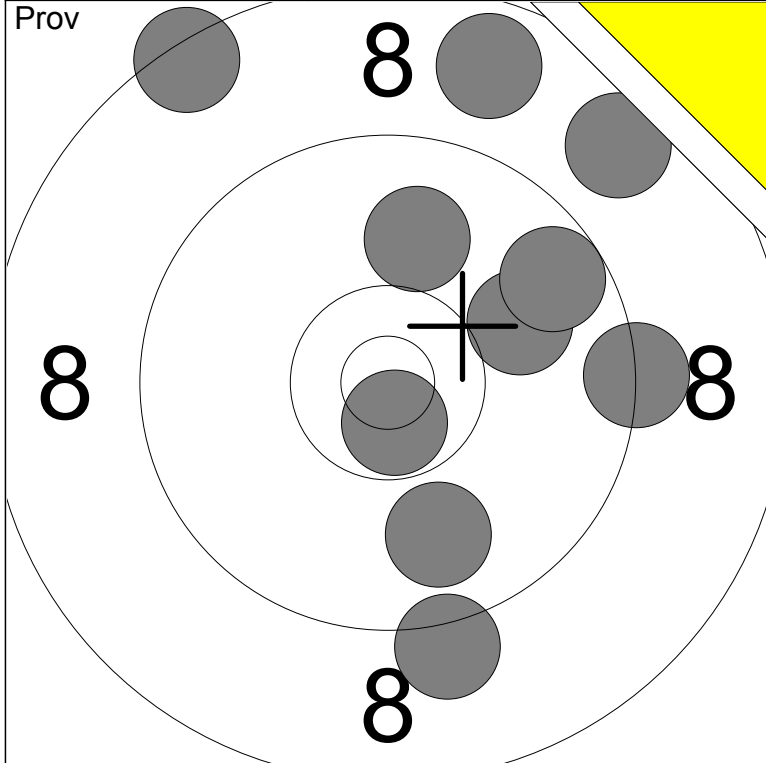

1: 10.0 →	6: 9.7 ↗	Serie	90
2: 8.7 ↑	7: 9.1 ↓		
3: 9.3 →	8: 10.7x ↓	Total	173
4: 8.7 ↗	9: 9.9 ↓		
5: 8.4 ↖	10: 10.0 ↑		

1: 10.4x ↑	Serie	44
2: 9.2 ↑		
3: 10.9x ↑	Total	217
4: 8.7 ↓		
5: 7.7 ↙		

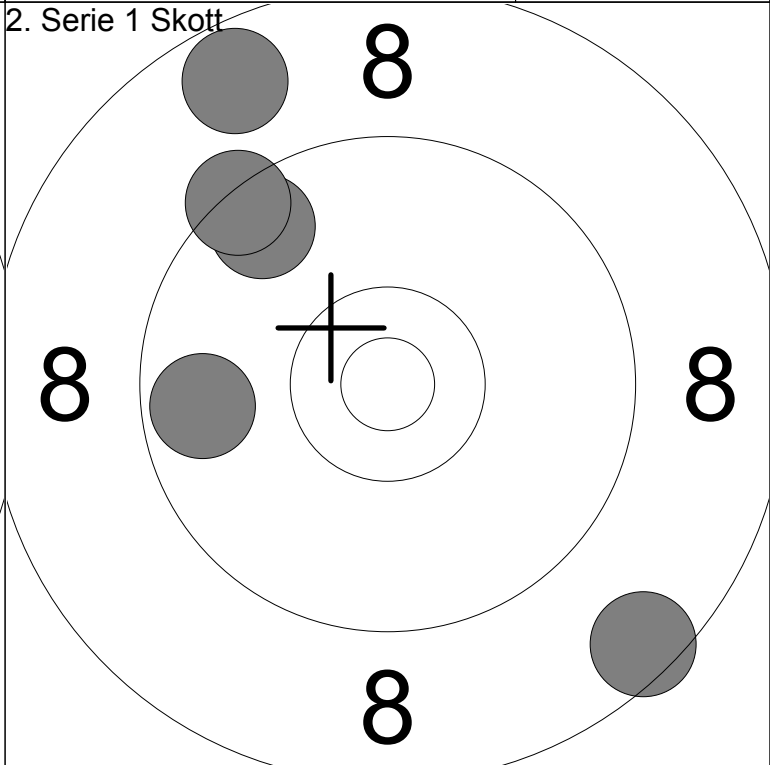
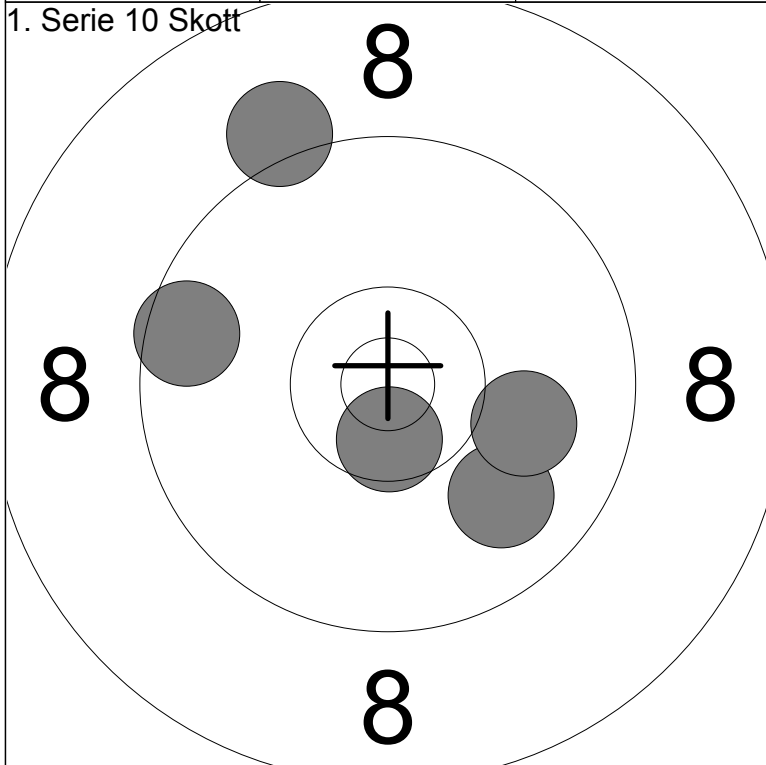

6: 9.6 ←	Serie	47
7: 9.9 ↓		
8: 10.0 →	Total	264
9: 10.6x ↓		
10: 9.1 ↗		

1: 9.7 ←	Serie	43
2: 9.6 ↗		
3: 9.4 ↗	Total	307
4: 8.7 ↗		
5: 8.5 ↓		

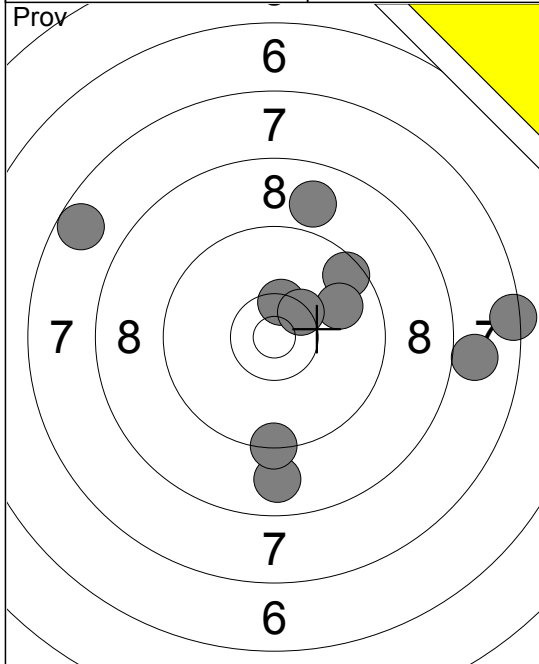

Prov

1:	7.4	→
2:	9.5	↗
3:	10.4	x↗
4:	9.9	↗
5:	7.7	↖
6:	8.9	↑
7:	8.8	↓
8:	9.3	↓
9:	10.4	x↗
10:	8.0	→
Serie	85.0	
Total	165.0	

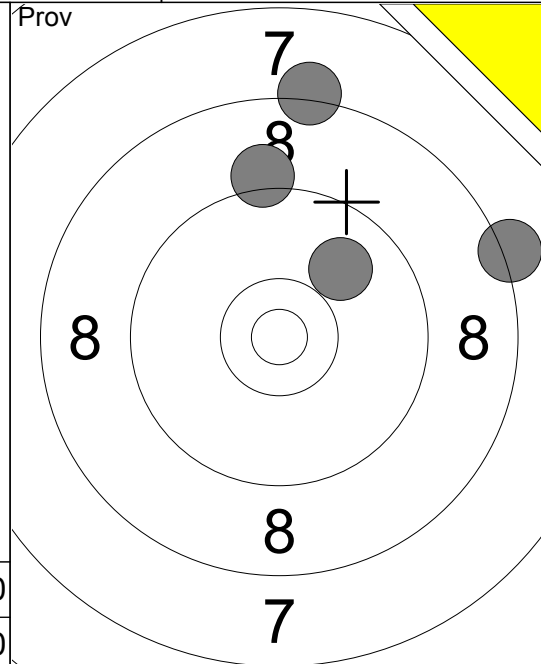

Prov

11:	8.2	→
12:	9.2	↑
13:	8.2	↑
14:	9.9	↗
Serie	34.0	
Total	165.0	

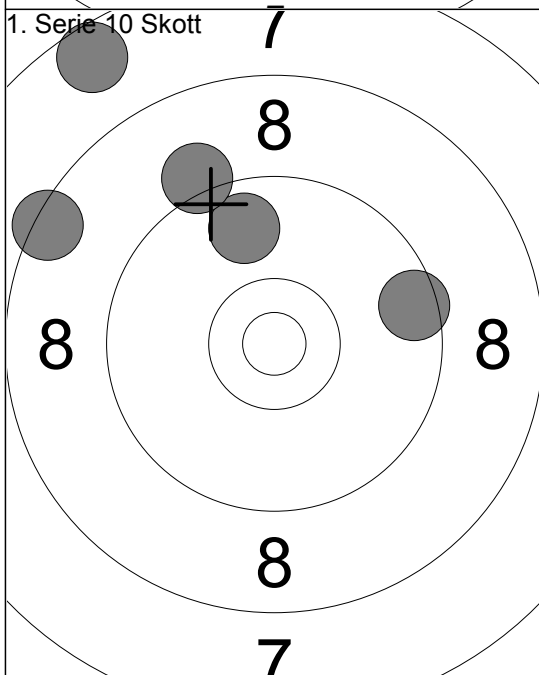

1:	9.5	→
2:	7.6	↗
3:	8.4	↖
4:	9.8	↑
5:	9.2	↗
Serie	42.0	
Total	207.0	

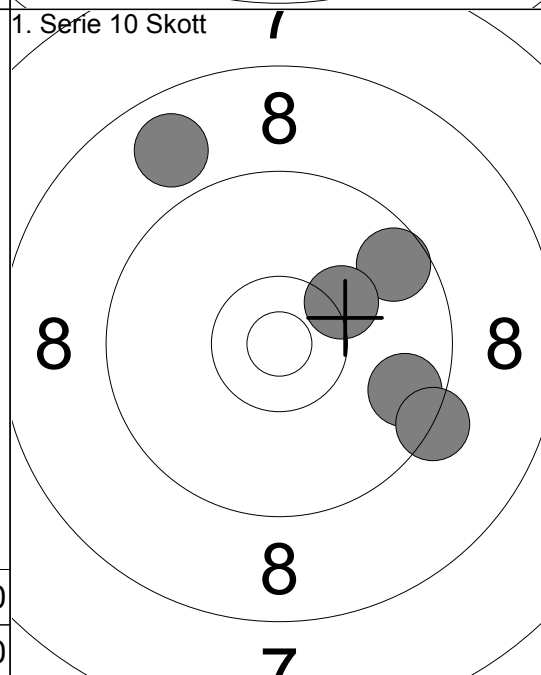

6:	9.7	→
7:	8.8	↗
8:	9.3	↘
9:	9.6	↗
10:	10.2	↗
Serie	45.0	
Total	252.0	

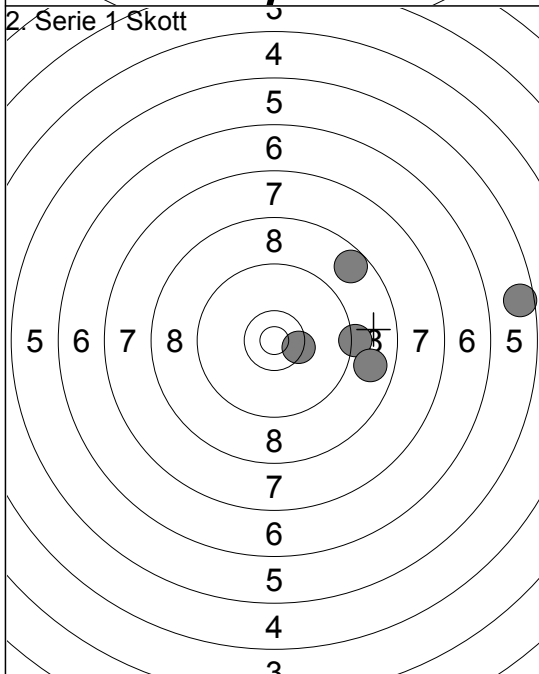

1:	10.4	x>
2:	8.7	↗
3:	9.2	→
4:	5.6	→
5:	8.8	→
Serie	40.0	
Total	292.0	

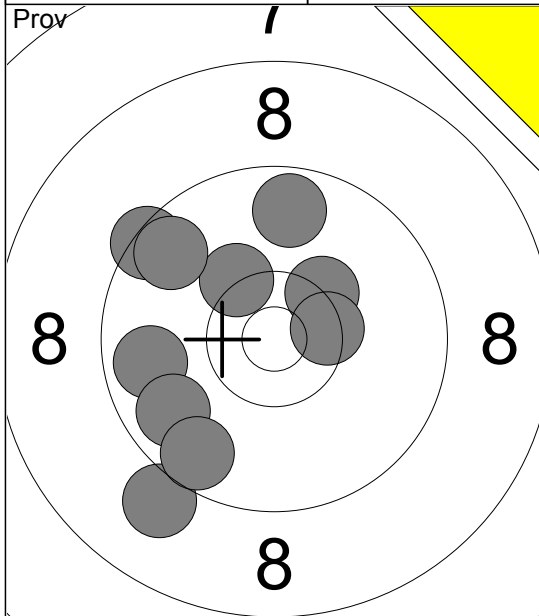

- 1: 9.1 ↙
- 2: 10.3 ↖
- 3: 10.3x ↗
- 4: 9.4 ↖
- 5: 9.7 ←
- 6: 10.4x →
- 7: 9.7 ↖
- 8: 9.8 ↙
- 9: 9.6 ↙
- 10: 9.7 ↑

Serie 93.0

Total 193.0

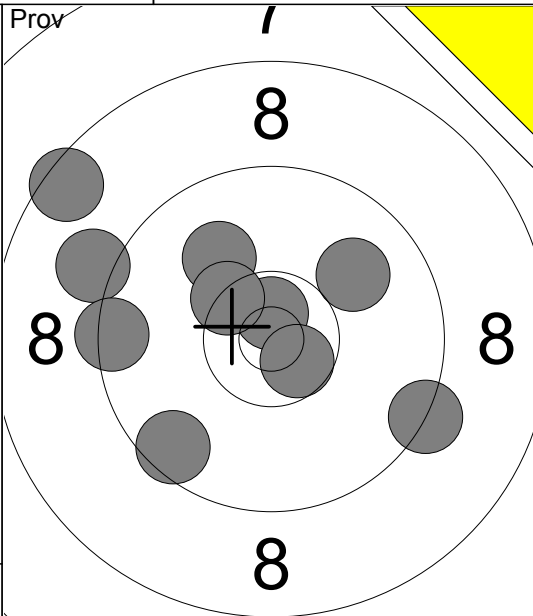

- 11: 9.1 ↖
- 12: 10.0 ↖
- 13: 9.6 ↙
- 14: 10.0 ↗
- 15: 10.7x ↑
- 16: 10.4x ↖
- 17: 9.3 ↘
- 18: 10.6x ↘
- 19: 8.5 ↖
- 20: 9.4 ←

Serie 94.0

Total 193.0

1. Serie 10 Skott

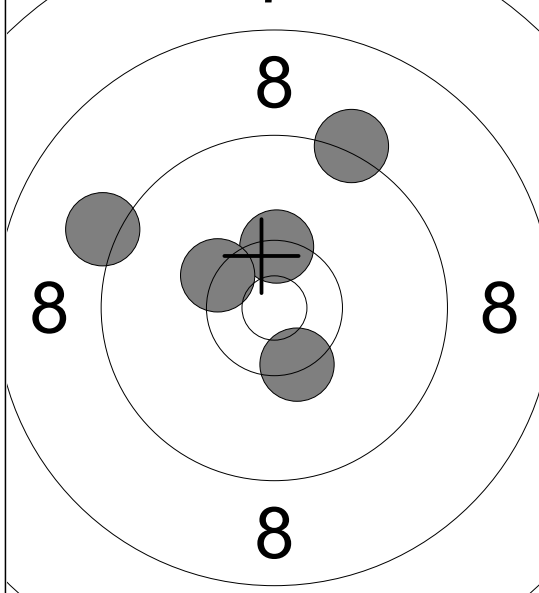

- 1: 9.2 ↑
- 2: 10.4x ↑
- 3: 10.3x ↖
- 4: 9.2 ↖
- 5: 10.4x ↘

Serie 48.0

Total 241.0

1. Serie 10 Skott

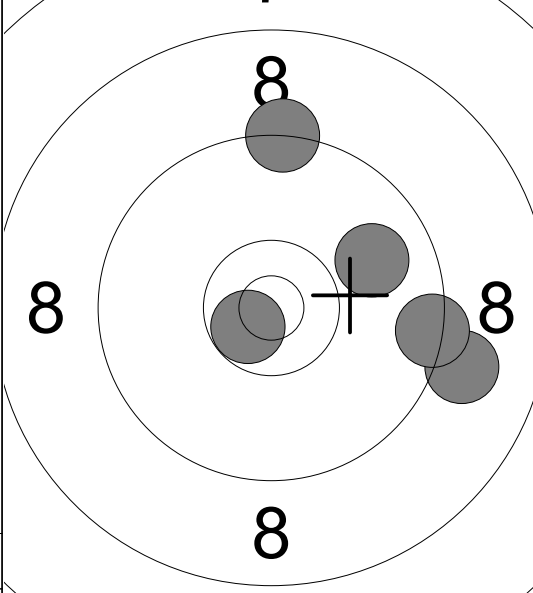

- 6: 9.0 →
- 7: 9.3 ↑
- 8: 10.7x ↘
- 9: 9.9 ↗
- 10: 9.4 →

Serie 46.0

Total 287.0

2. Serie 1 Skott

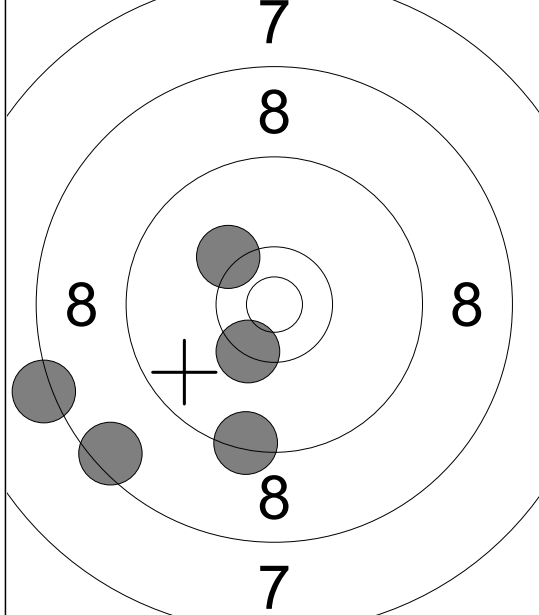

- 1: 8.5 ↙
- 2: 8.2 ↖
- 3: 9.4 ↙
- 4: 10.2 ↖
- 5: 10.4x ↘

Serie 45.0

Total 332.0

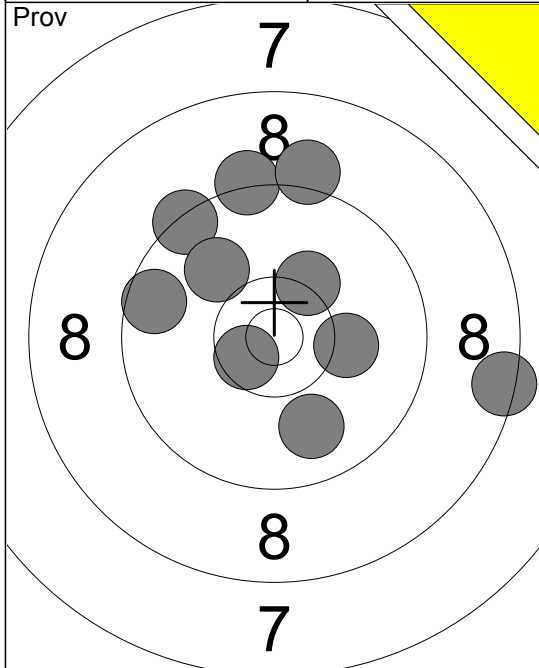

- 1: 9.9 ↓
- 2: 9.6 ←
- 3: 9.4 ↗
- 4: 9.3 ↑
- 5: 9.1 ↑
- 6: 10.2 →
- 7: 8.4 →
- 8: 10.6x ↘
- 9: 10.3 ↗
- 10: 10.0 ↙

Serie 93.0
Total 190.0

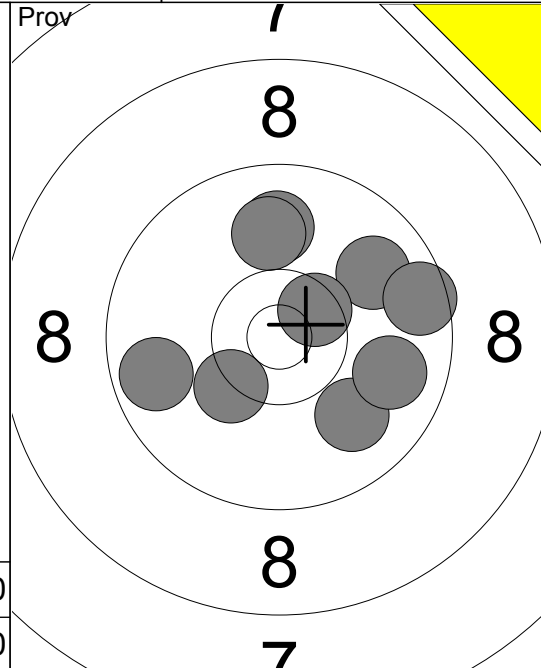

- 11: 9.9 ↓
- 12: 9.9 ↗
- 13: 9.9 ↑
- 14: 9.6 →
- 15: 10.5x ↗
- 16: 10.3x ↘
- 17: 9.8 →
- 18: 10.0 ↑
- 19: 9.7 ←

Serie 84.0
Total 190.0

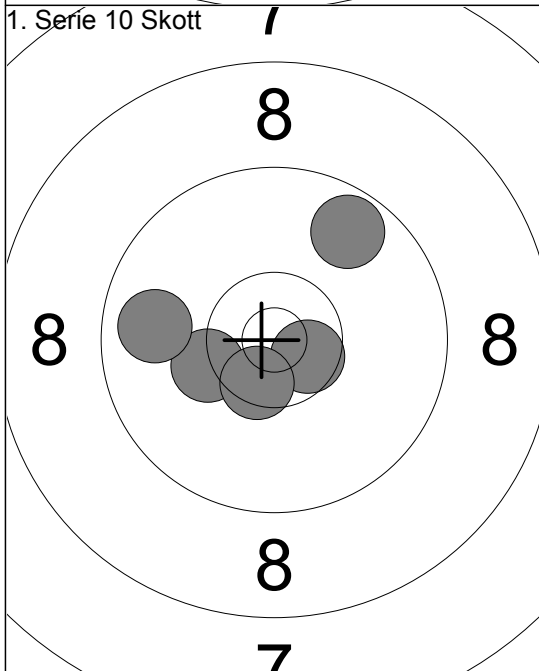

- 1: 10.3 ←
- 2: 10.6x ↘
- 3: 9.8 ←
- 4: 10.5x ↘
- 5: 9.7 ↗

Serie 48.0
Total 238.0

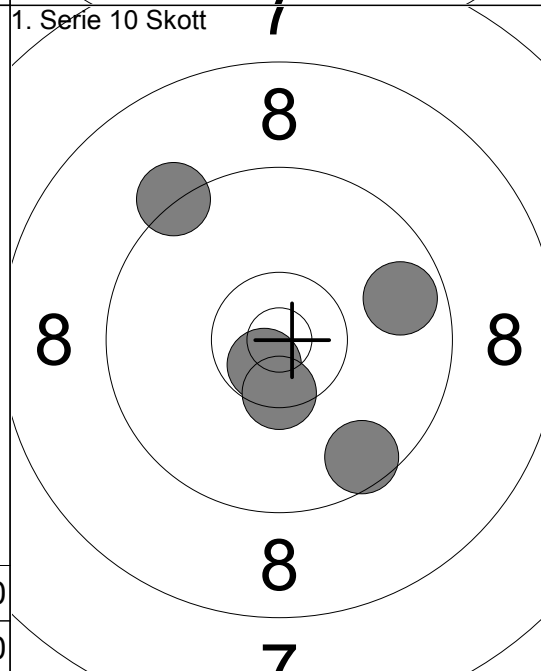

- 6: 9.7 →
- 7: 9.6 ↓
- 8: 10.7x ↘
- 9: 9.3 ↙
- 10: 10.4x ↘

Serie 47.0
Total 285.0

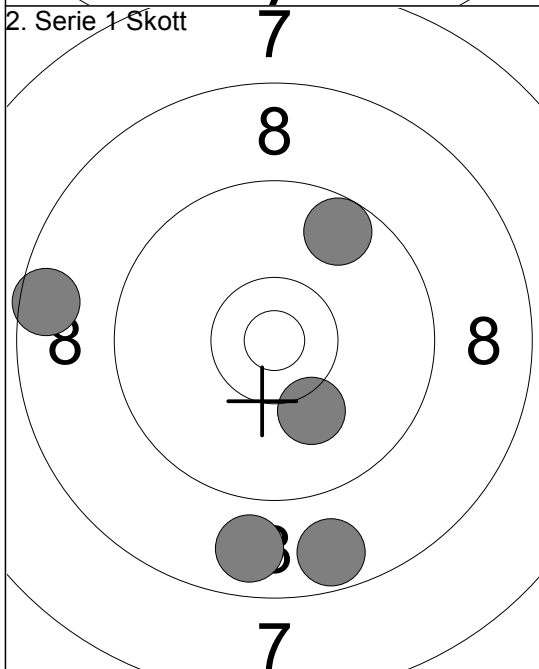

- 1: 8.8 ↓
- 2: 8.7 ↓
- 3: 9.7 ↗
- 4: 8.6 ←
- 5: 10.1 ↓

Serie 43.0
Total 328.0

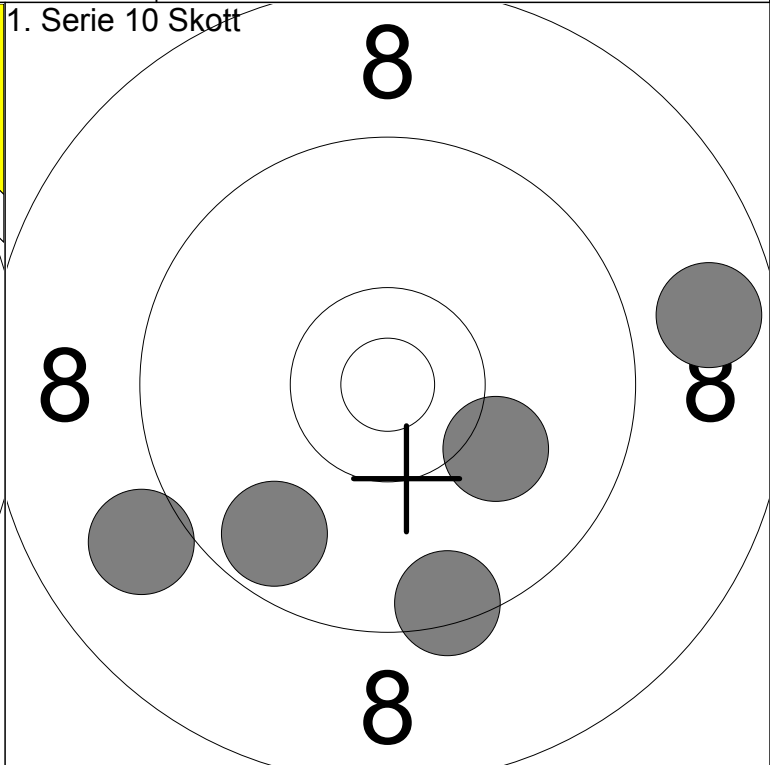
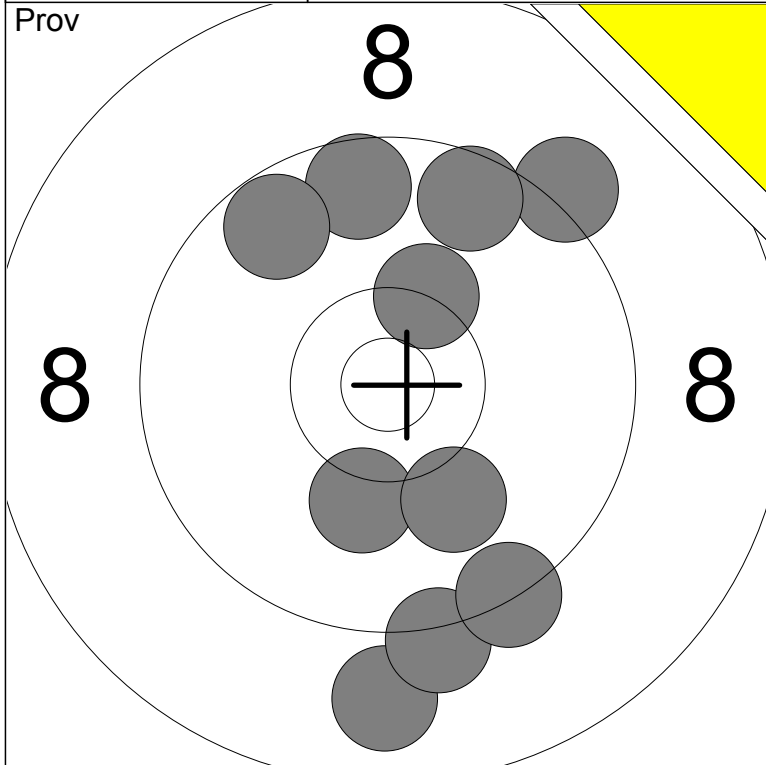

1: 9.6 ↑	6: 8.9 ↓	Serie	92
2: 9.2 ↗	7: 10.2 ↓		
3: 9.6 ↗	8: 9.2 ↓	Total	190
4: 9.7 ↖	9: 10.1 ↓		
5: 10.3x ↗	10: 9.3 ↓		

1: 9.4 ↓	Serie	45
2: 9.7 ↘		
3: 10.1 ↘	Total	235
4: 9.0 ↙		
5: 8.8 →		

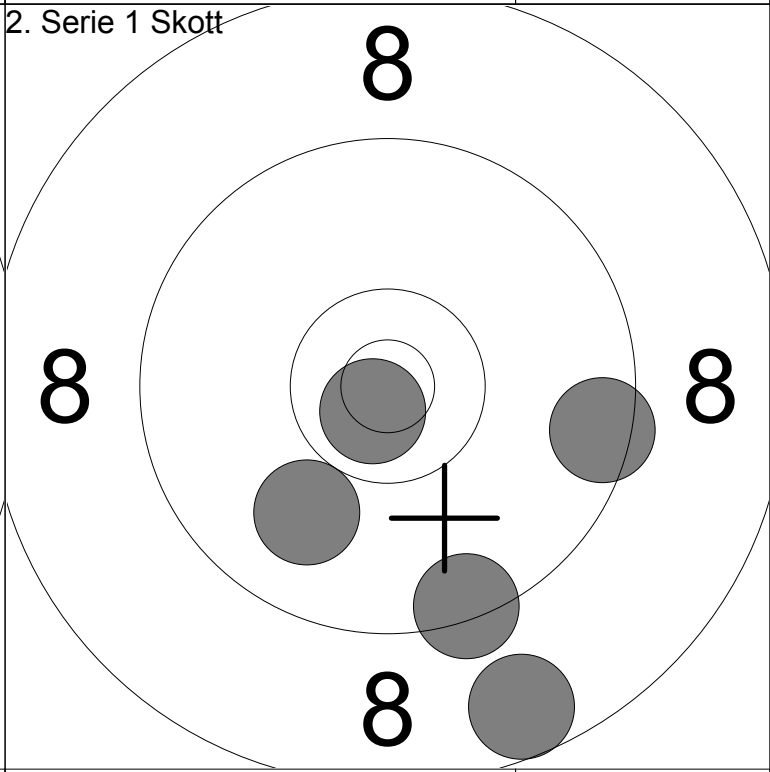
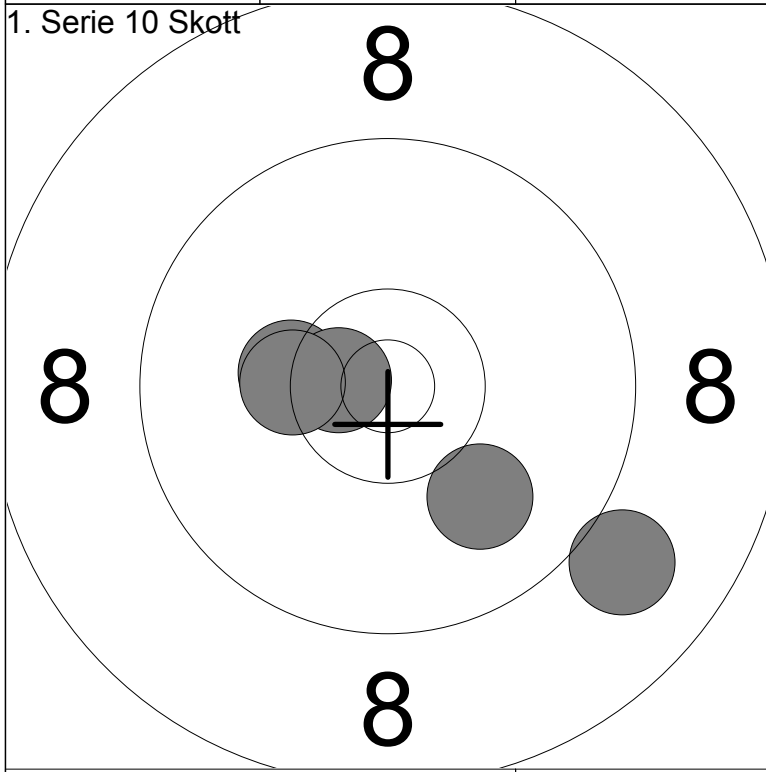

6: 9.0 ↘	Serie	49
7: 10.3x ↖		
8: 10.0 ↘	Total	284
9: 10.6x ↖		
10: 10.3x ↖		

1: 9.4 ↓	Serie	46
2: 8.6 ↓		
3: 9.5 →	Total	330
4: 10.8x ↘		
5: 10.0 ↘		

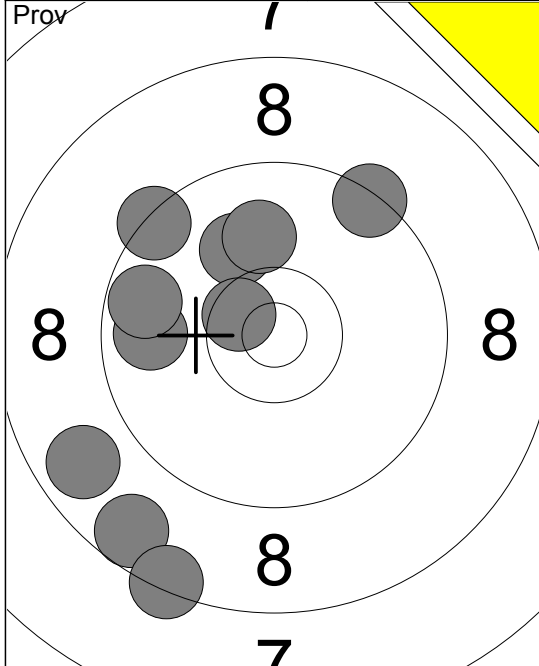

- 1: 10.1 ↖
- 2: 10.6 ↘
- 3: 9.4 ↗
- 4: 9.4 ↖
- 5: 8.6 ↘
- 6: 9.8 ←
- 7: 8.4 ↘
- 8: 8.8 ↖
- 9: 9.7 ←
- 10: 10.0 ↑

Serie 90.0
Total 188.0

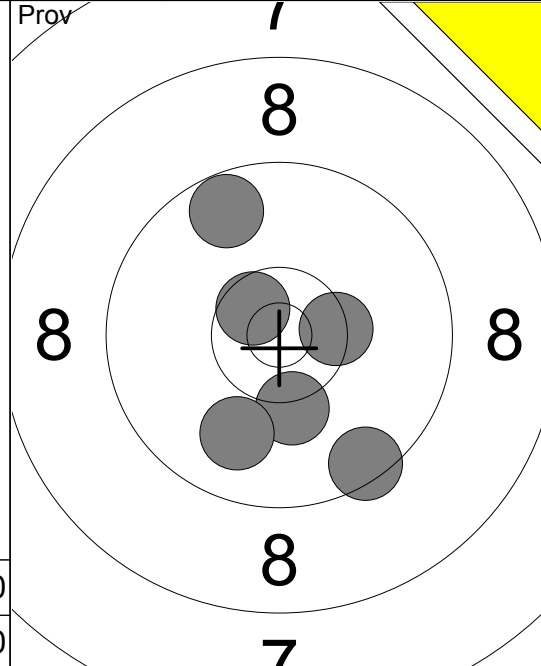

- 11: 10.2 ↘
- 12: 9.7 ↗
- 13: 10.6 ↘
- 14: 9.5 ↘
- 15: 9.9 ↘
- 16: 10.4x →

Serie 57.0
Total 188.0

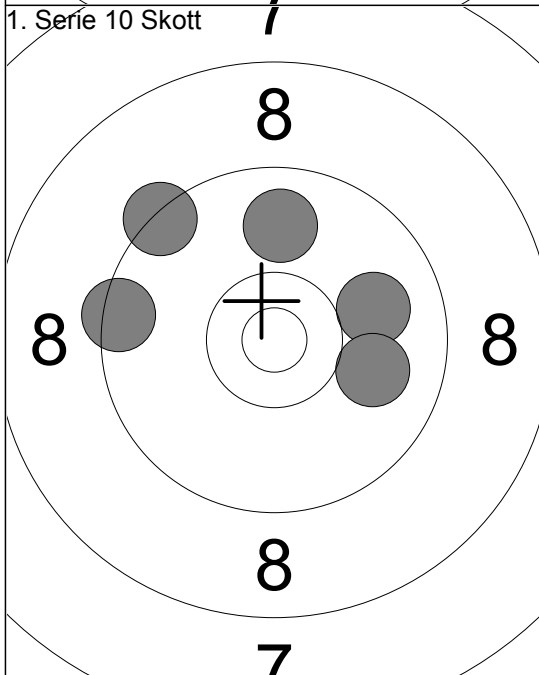

- 1: 9.4 ↖
- 2: 10.0 →
- 3: 9.4 ←
- 4: 9.9 ↑
- 5: 10.0 →

Serie 47.0
Total 235.0

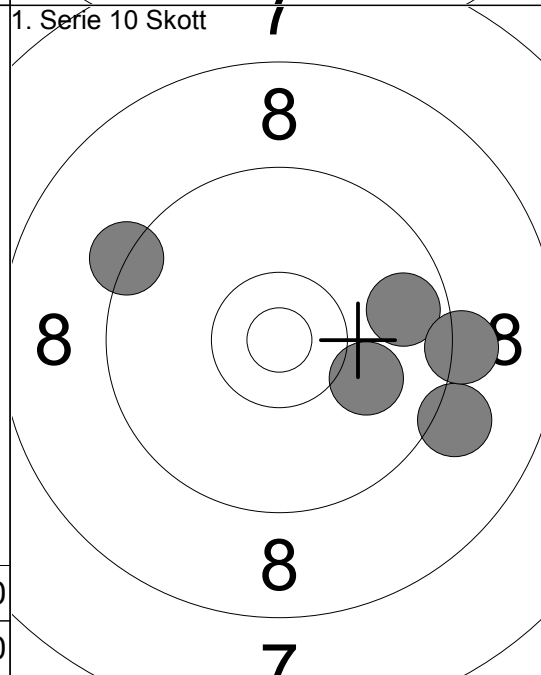

- 6: 10.0 →
- 7: 9.1 →
- 8: 9.7 →
- 9: 9.3 ↖
- 10: 9.2 →

Serie 46.0
Total 281.0

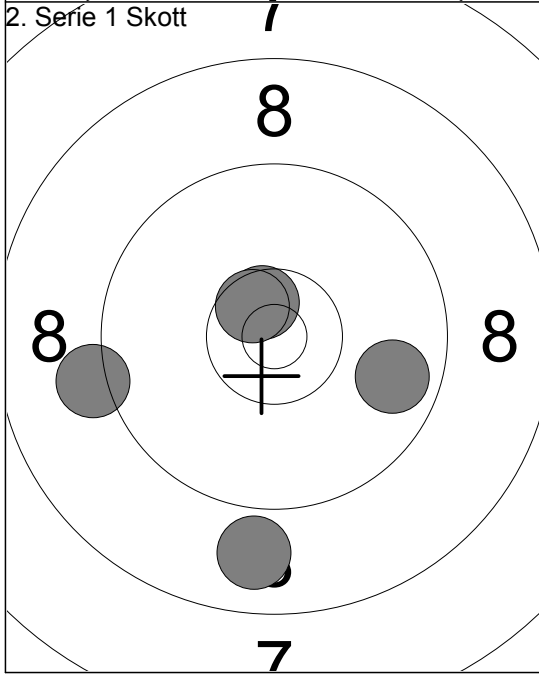

- 1: 10.6x ↖
- 2: 8.9 ↘
- 3: 9.8 →
- 4: 9.2 ←
- 5: 10.6x ↘

Serie 46.0
Total 327.0

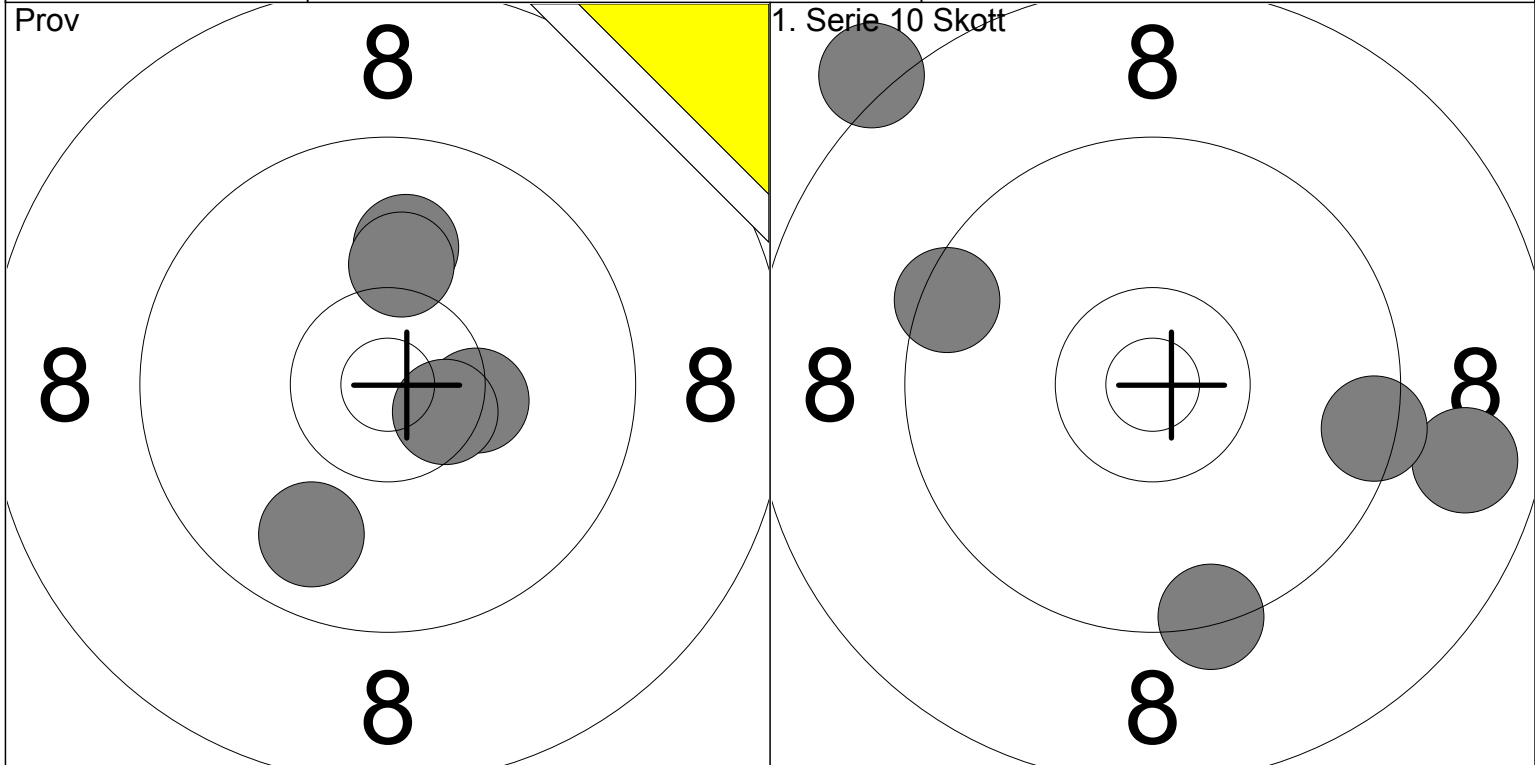

1:	10.4x	→
2:	9.8	↙
3:	10.5x	↘
4:	10.0	↑
5:	10.1	↑

Serie	49
Total	185

1:	9.4	↙
2:	8.8	→
3:	8.2	↗
4:	9.5	↖
5:	9.4	→

Serie	43
Total	228

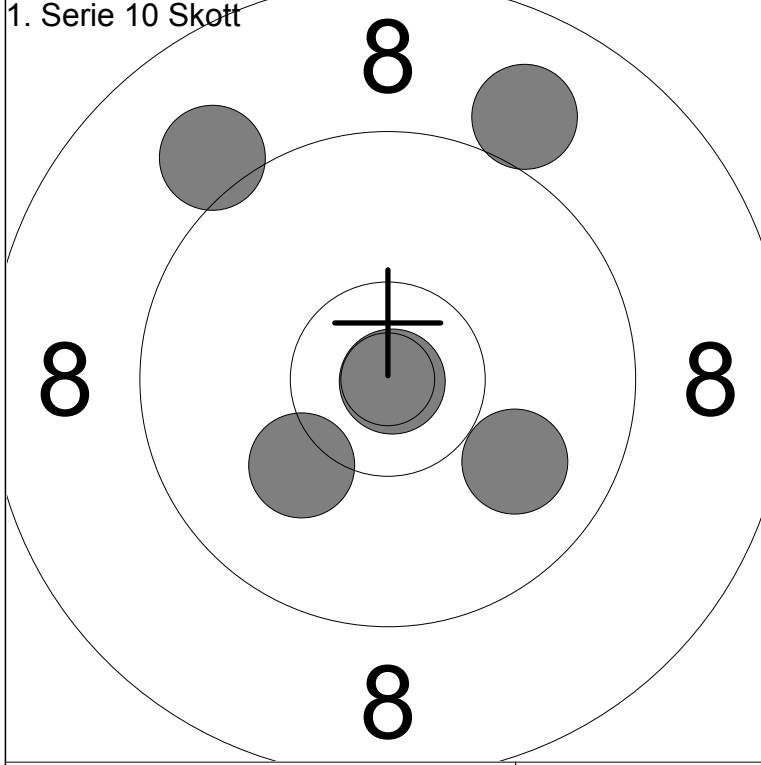

6:	10.1	↙
7:	9.9	↘
8:	9.1	↗
9:	10.9x	↘
10:	9.0	↖

Serie	47
Total	275

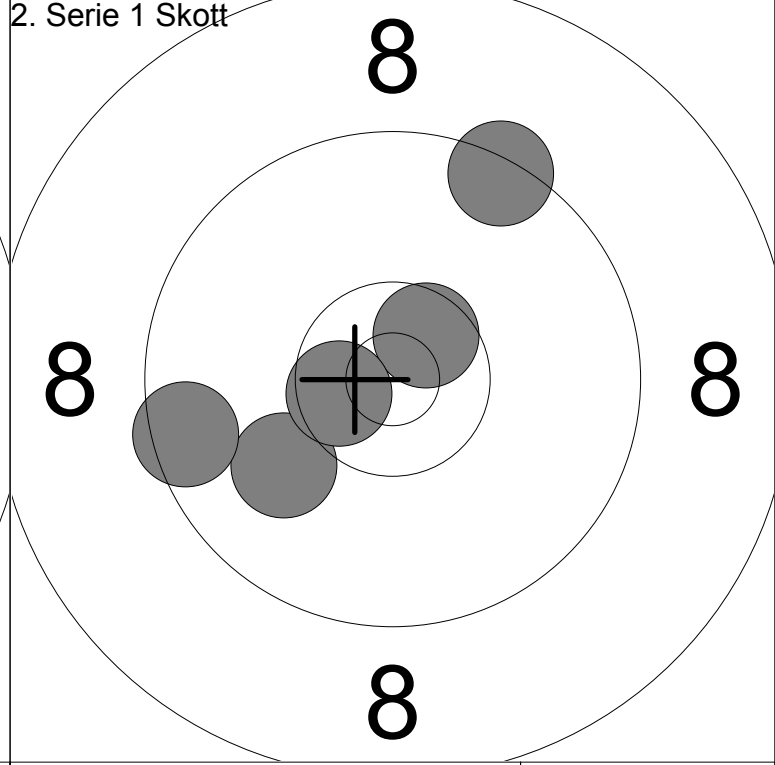

1:	10.0	↙
2:	9.4	↖
3:	10.6x	↗
4:	9.5	↖
5:	10.6x	↖

Serie	48
Total	323

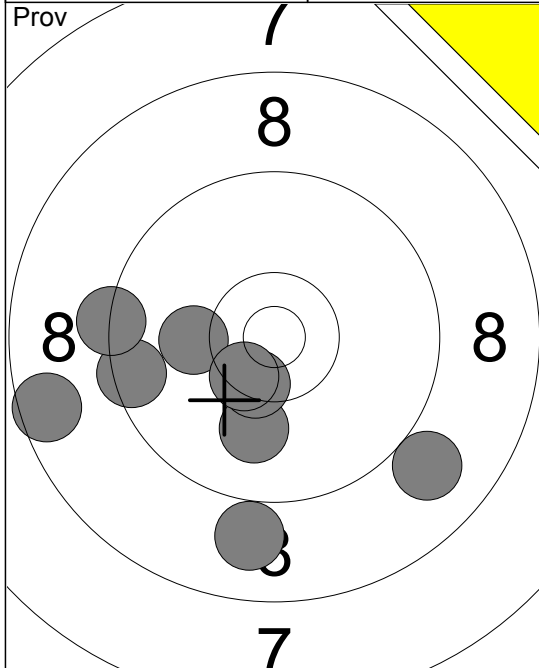

- 1: 10.0 ↓
- 2: 9.5 ←
- 3: 8.6 ←
- 4: 9.3 ←
- 5: 9.0 ↓
- 6: 8.9 ↓
- 7: 10.4x ↓
- 9: 10.1 ←
- 10: 10.5x ↓

Serie 83.0
Total 184.0

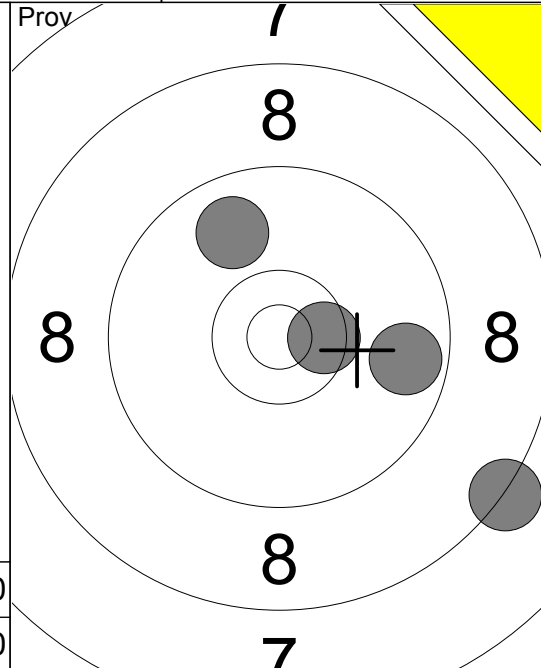

- 11: 10.5x →
- 12: 8.3 ↘
- 13: 9.7 →
- 14: 9.8 ↗

Serie 36.0
Total 184.0

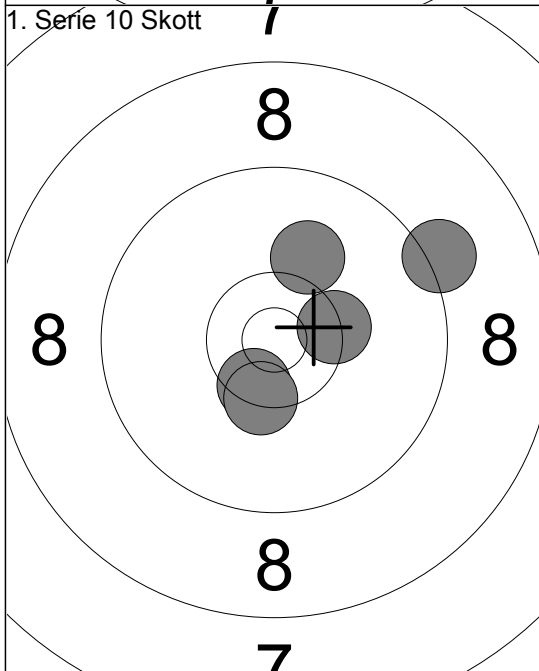

- 1: 10.4x →
- 2: 10.5x ↓
- 3: 10.4x ↓
- 4: 10.1 ↗
- 5: 9.2 →

Serie 49.0
Total 233.0

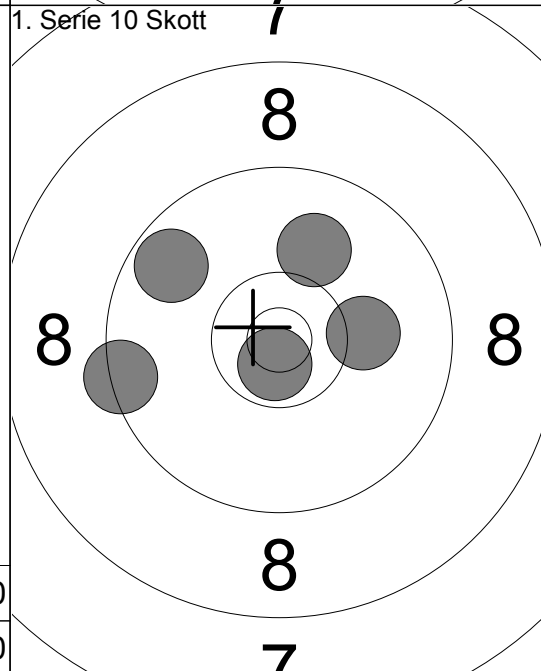

- 6: 10.1 →
- 7: 10.7x ↓
- 8: 9.7 ↖
- 9: 10.0 ↗
- 10: 9.4 ←

Serie 48.0
Total 281.0

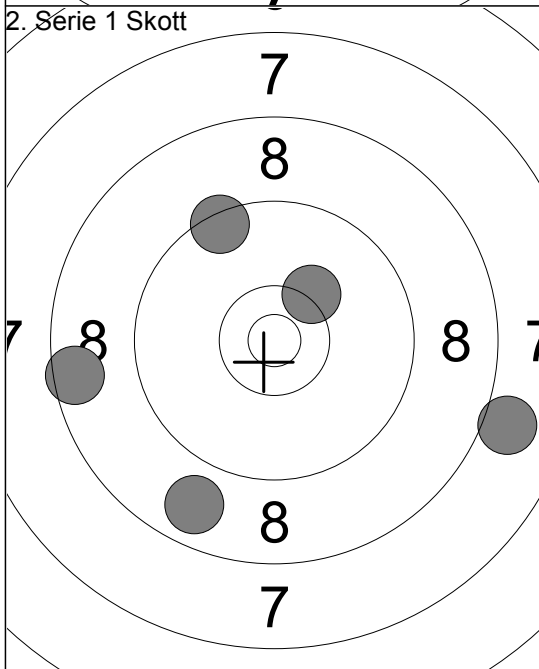

- 1: 9.4 ↖
- 2: 10.3 ↗
- 3: 8.6 ←
- 4: 8.8 ↓
- 5: 8.0 →

Serie 43.0
Total 324.0

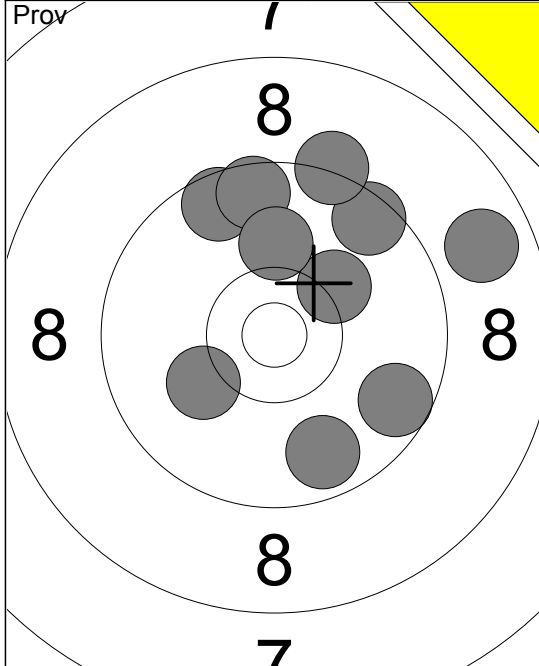

- 1: 8.8 →
- 2: 9.5 ↗
- 3: 9.3 ↑
- 4: 9.6 →
- 5: 10.1 ↙
- 6: 10.2 ↗
- 7: 9.6 ↑
- 8: 9.6 ↑
- 9: 10.1 ↑
- 10: 9.7 ↓

Serie 92.0
Total 182.0

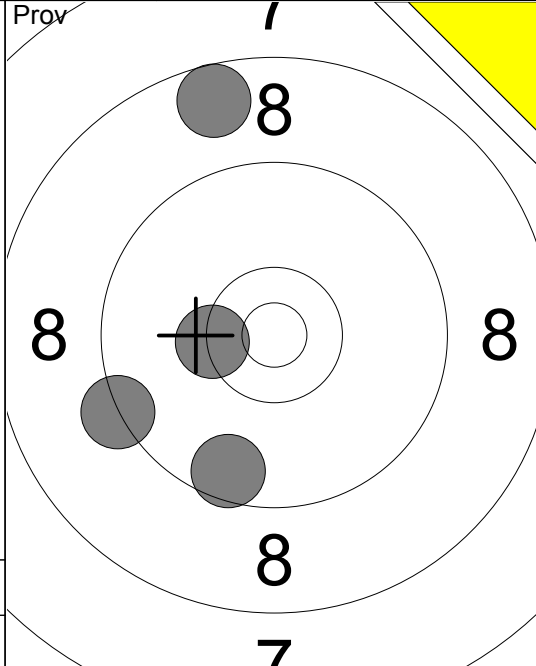

- 11: 9.3 ↙
- 12: 8.6 ↑
- 13: 9.6 ↓
- 14: 10.4 ✖

Serie 36.0
Total 182.0

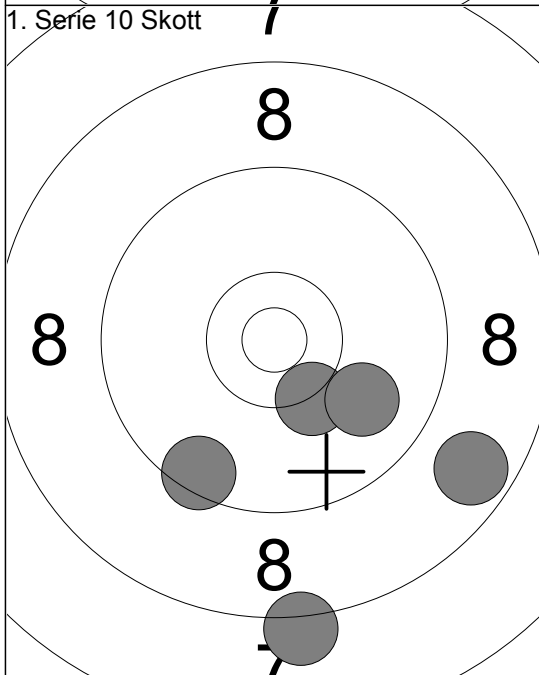

- 1: 10.3 ↓
- 2: 9.5 ↓
- 3: 8.2 ↓
- 4: 9.9 →
- 5: 8.7 ↓

Serie 44.0
Total 226.0

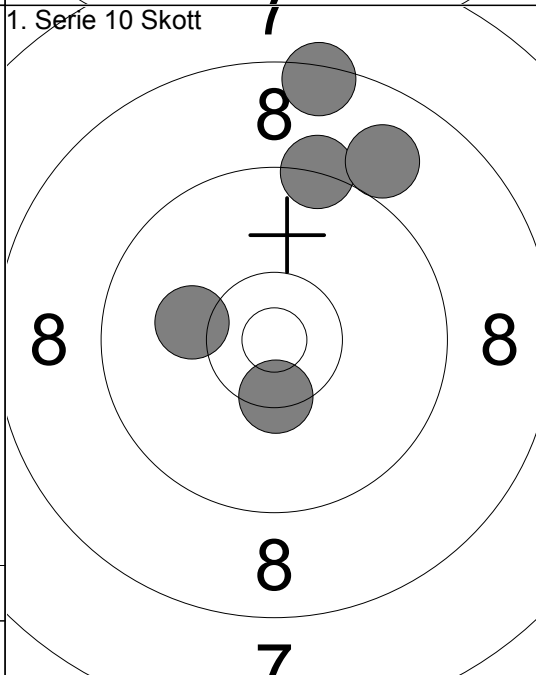

- 6: 10.1 ↙
- 7: 10.4x ↓
- 8: 8.4 ↑
- 9: 9.3 ↑
- 10: 9.0 ↗

Serie 46.0
Total 272.0

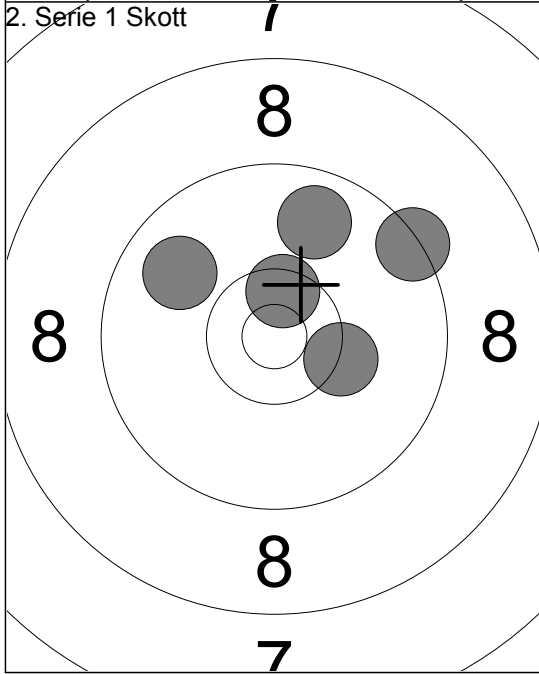

- 1: 10.5x ↗
- 2: 9.4 ↗
- 3: 10.3 →
- 4: 9.8 ↑
- 5: 9.9 ↙

Serie 47.0
Total 319.0

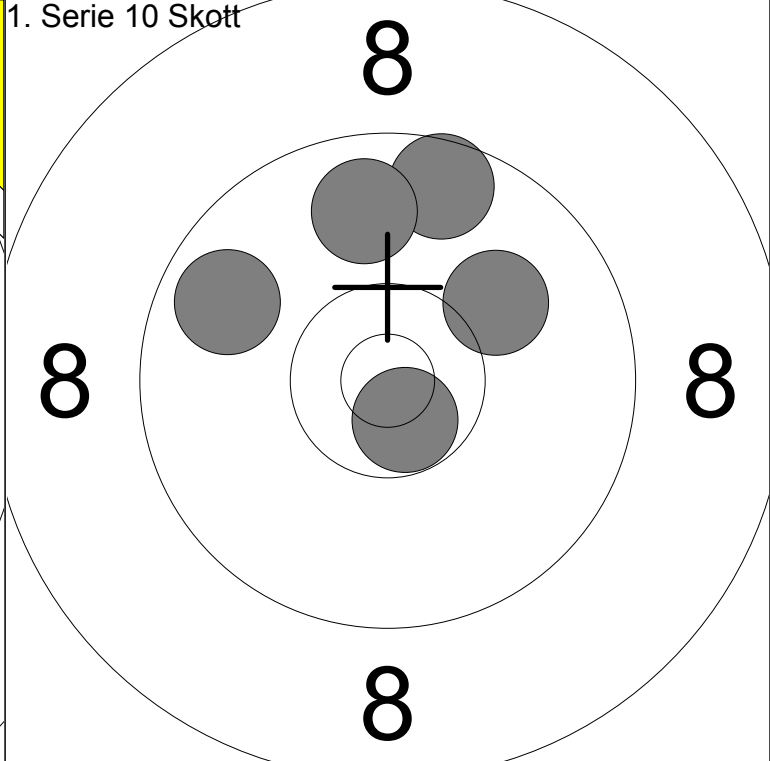
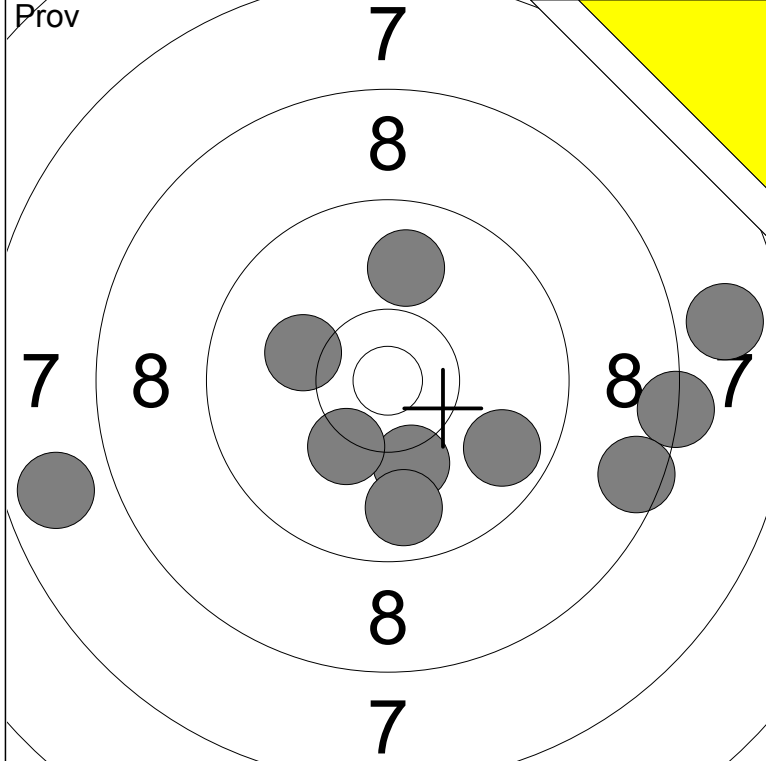

1: 8.3 →	6: 7.8 ←	Serie	87
2: 8.5 →	7: 9.7 ↘		
3: 7.8 →	8: 10.2 ↙	Total	177
4: 9.9 ↑	9: 9.8 ↓		
5: 10.2 ↓	10: 10.1 ←		

1: 9.6 ↑	Serie	47
2: 9.8 ←		
3: 10.7x ↓	Total	224
4: 10.1 ↗		
5: 9.8 ↑		

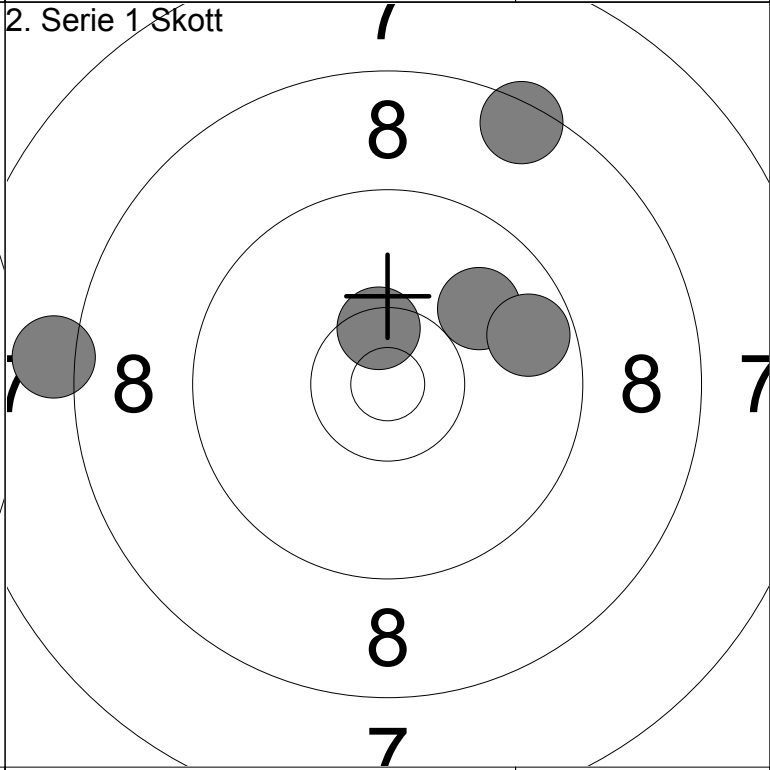
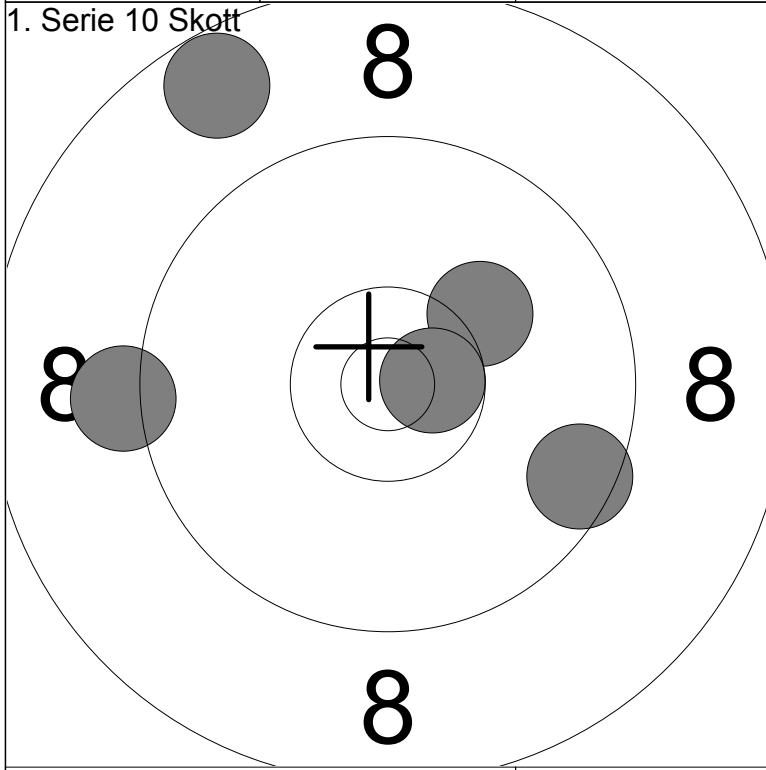

6: 10.2 ↗	Serie	46
7: 9.2 ←		
8: 8.7 ↑	Total	270
9: 9.5 ↘		
10: 10.7x →		

1: 8.1 ←	Serie	44
2: 10.5x ↑		
3: 9.9 ↗	Total	314
4: 9.7 →		
5: 8.5 ↑		

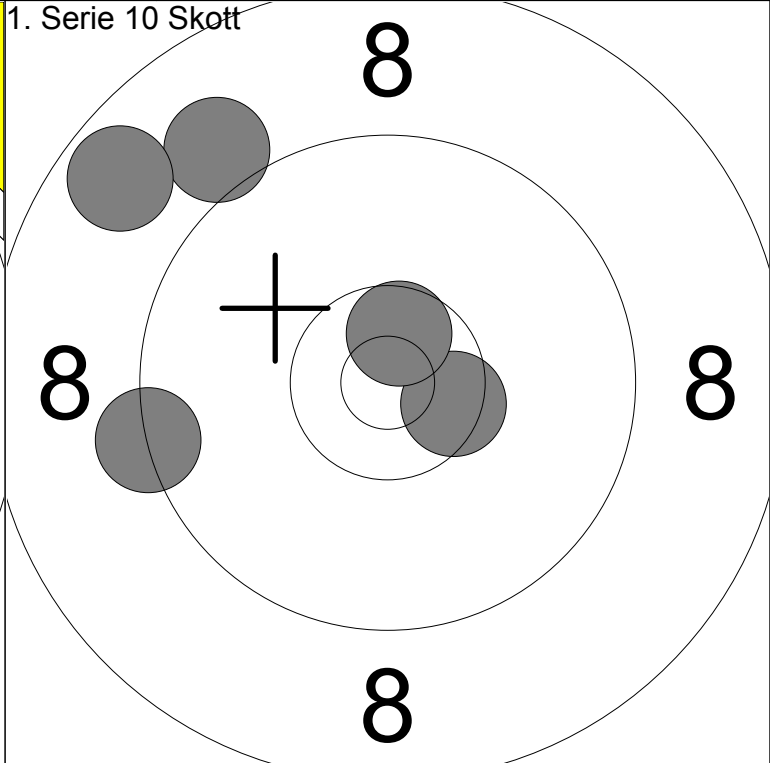
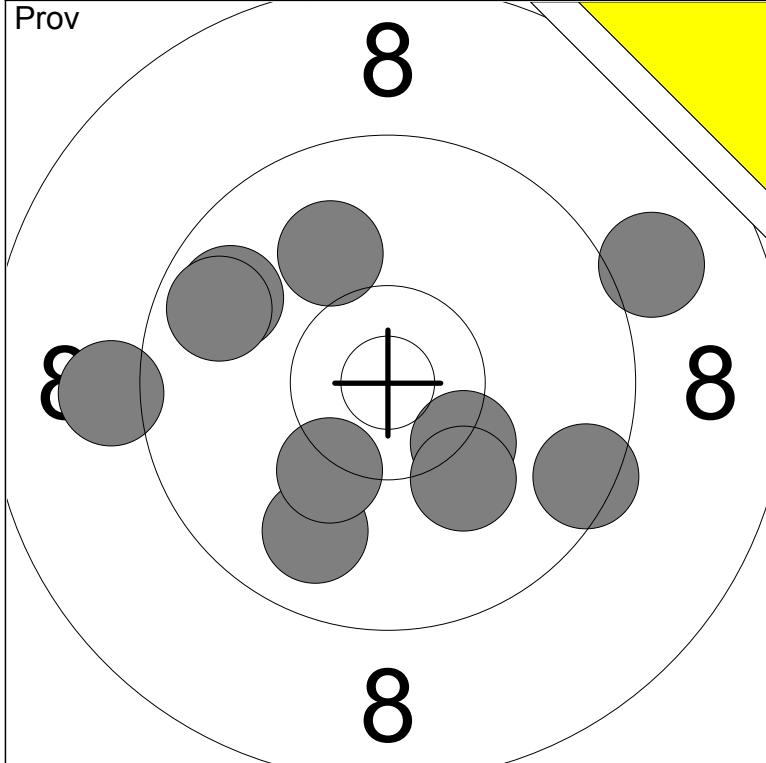

1: 9.5 →	6: 9.0 →	Serie	94
2: 9.9 ↓	7: 10.2 ↓		
3: 10.0 ↗	8: 10.1 ↓	Total	169
4: 9.1 ←	9: 9.8 ↗		
5: 10.3x ↓	10: 9.7 ↖		

1: 9.0 ↗	Serie	46
2: 8.7 ↗		
3: 10.5x →	Total	215
4: 10.6x ↑		
5: 9.3 ←		

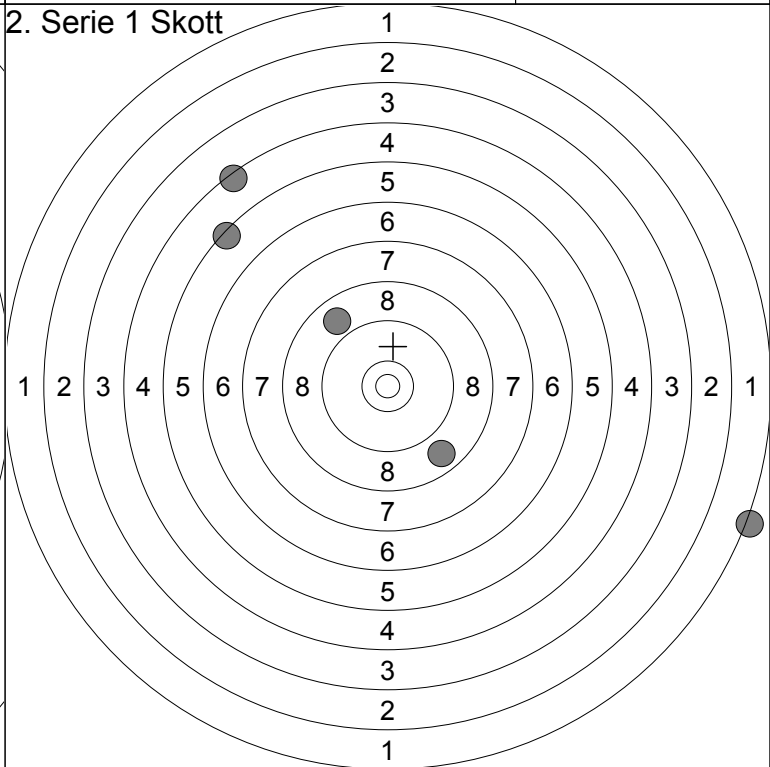
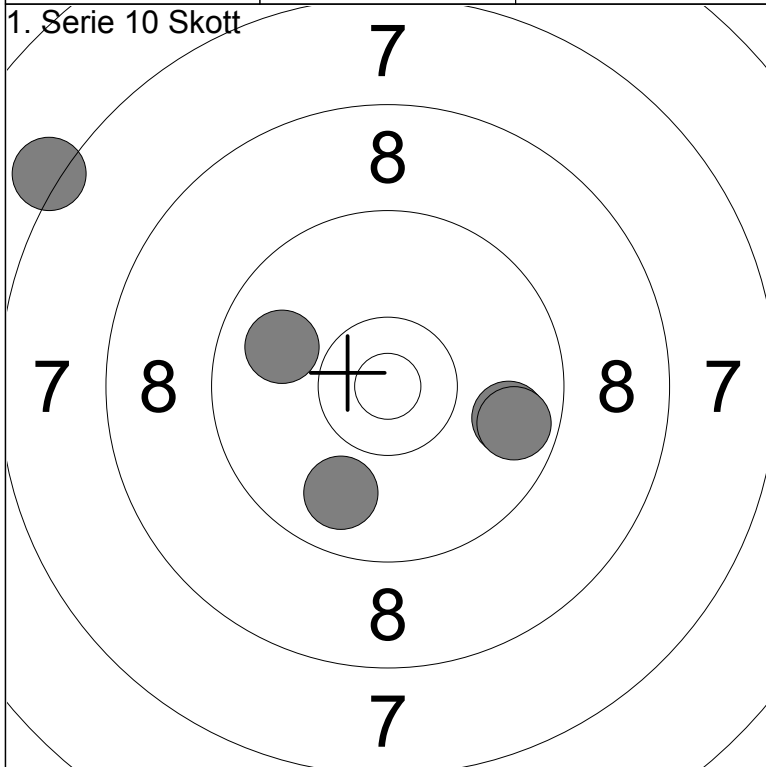

6: 9.8 →	Serie	43
7: 9.9 ↓		
8: 9.7 →	Total	258
9: 7.2 ↗		
10: 9.9 ←		

1: 8.9 ↗	Serie	26
2: 8.8 ↓		
3: 5.4 ↗	Total	284
4: 1.2 ↓		
5: 4.4 ↗		

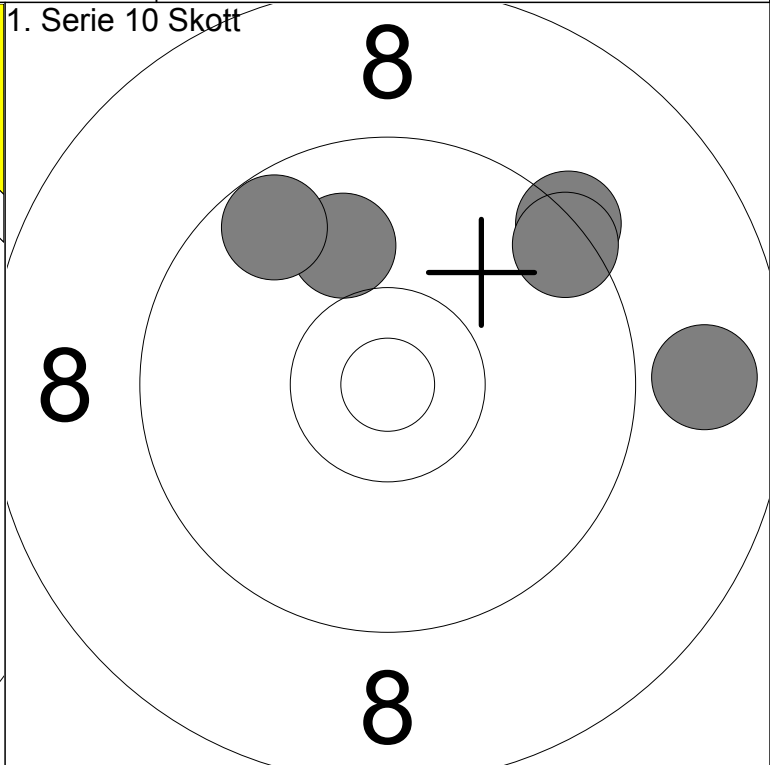
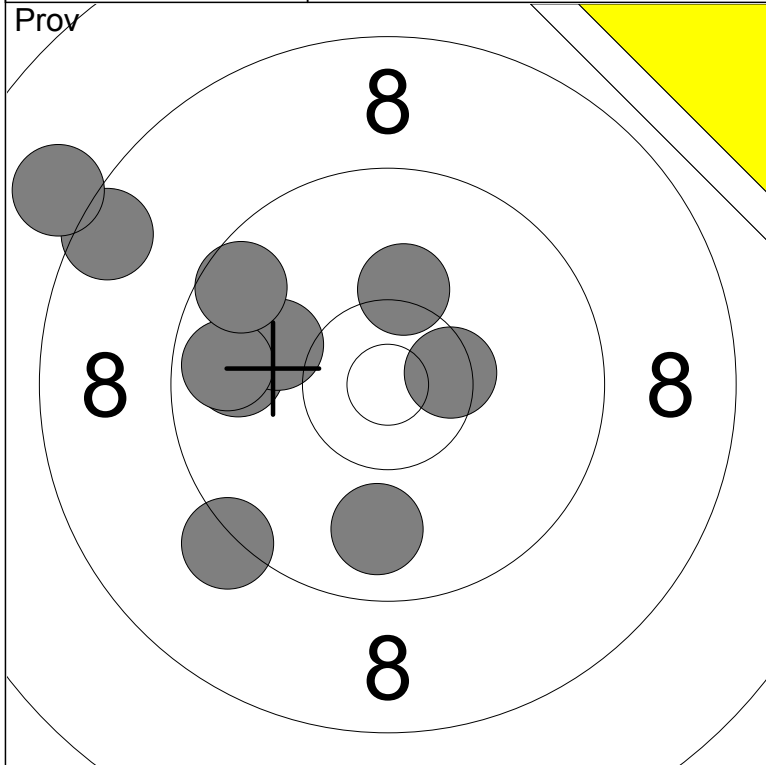

1: 9.8 ↓	6: 10.5x →	Serie	91
2: 9.2 ↘	7: 10.2 ↑		
3: 9.8 ←	8: 9.7 ←	Total	168
4: 8.5 ↖	9: 9.6 ↖		
5: 10.1 ↙	10: 8.0 ↙		

1: 10.0 ↑	Serie	45
2: 9.7 ↖		
3: 9.3 ↗	Total	213
4: 9.4 ↗		
5: 8.8 →		

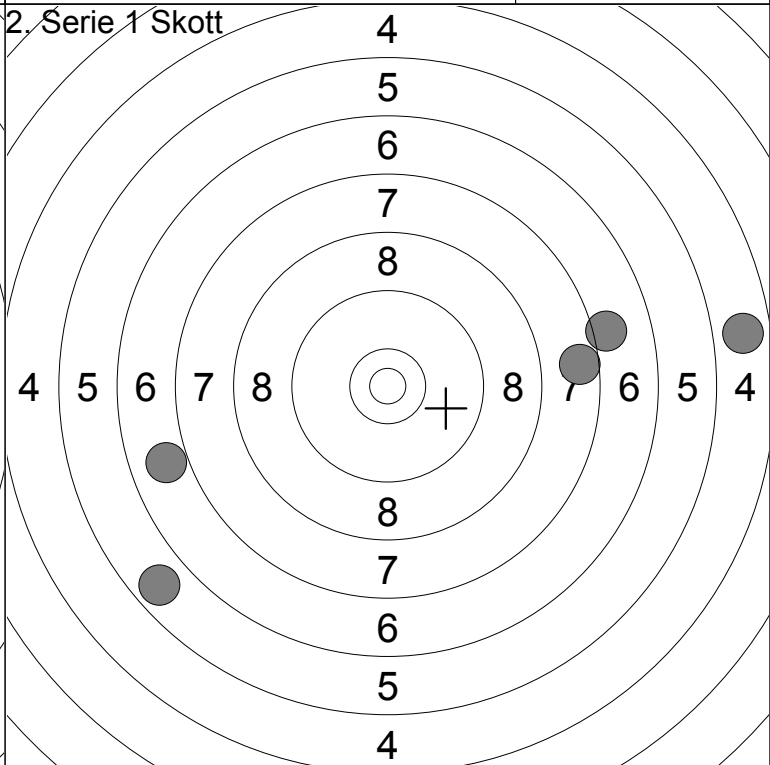
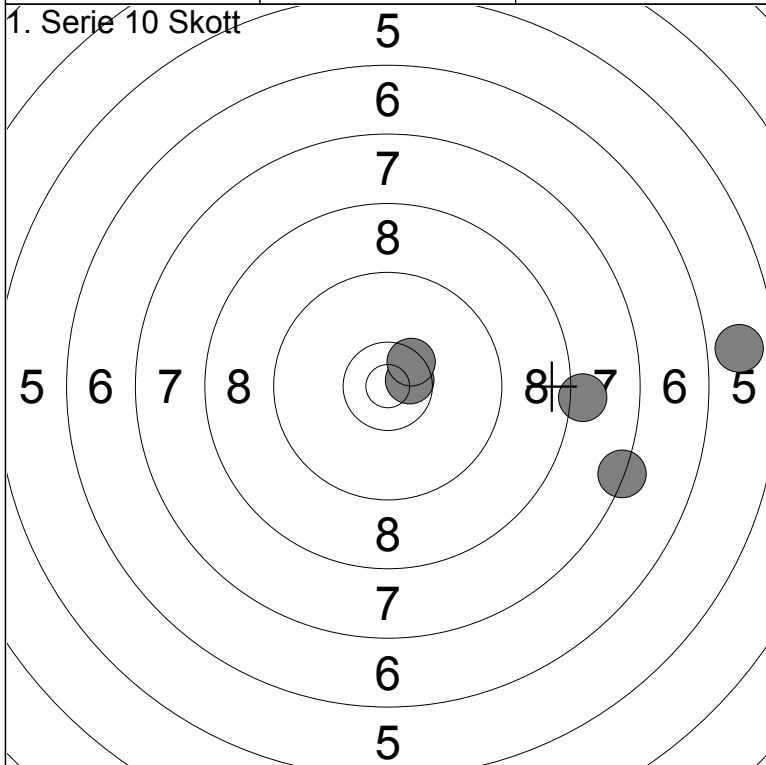

6: 5.8 →	Serie	40
7: 8.1 →		
8: 7.3 →	Total	253
9: 10.6x →		
10: 10.5x ↗		

1: 7.6 →	Serie	29
2: 7.1 →		
3: 4.8 →	Total	282
4: 5.8 ↘		
5: 6.9 ←		

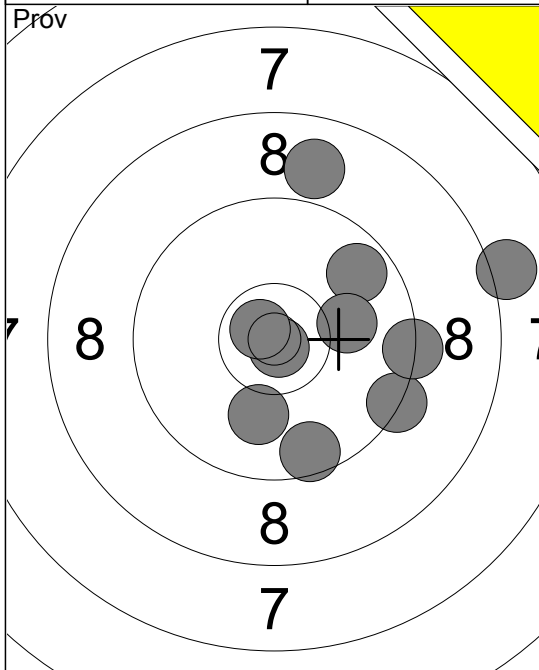

1:	10.0	↓
2:	9.3	→
3:	9.7	↗
4:	8.9	↑
5:	10.8	x↓
6:	10.1	→
7:	8.1	→
8:	9.6	↓
9:	9.3	→
10:	10.7	x↘
Serie	92.0	
Total	161.0	

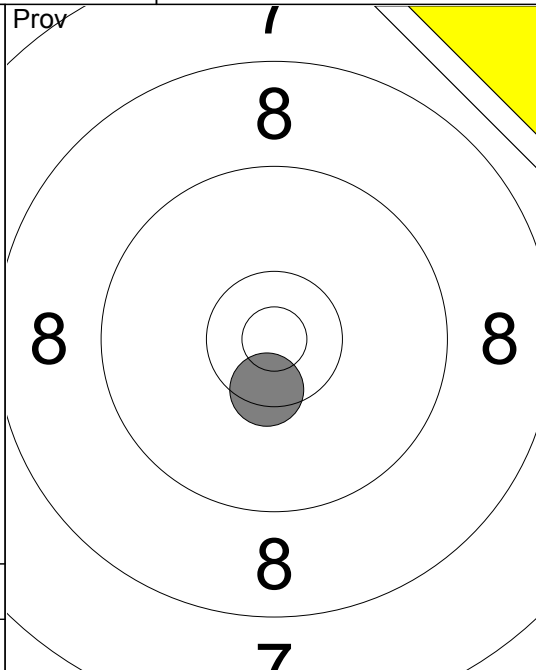

11:	10.5	x↓
Serie	10.0	
Total	161.0	

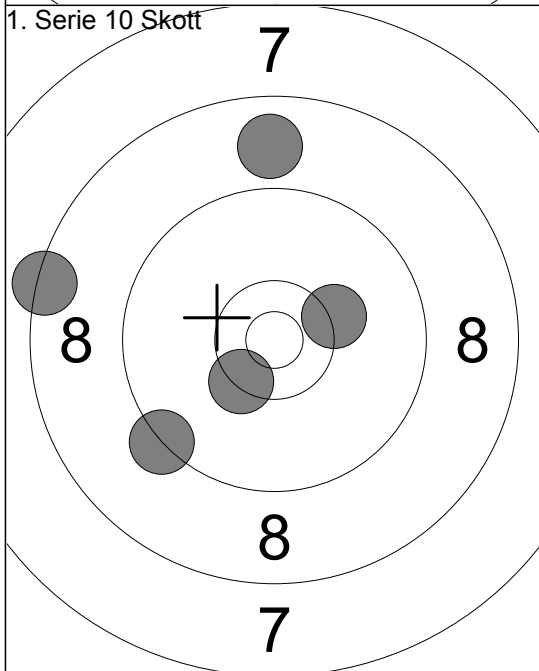

1:	9.3	↙
2:	8.4	←
3:	8.9	↑
4:	10.3	→
5:	10.4	x↘
Serie	45.0	
Total	206.0	

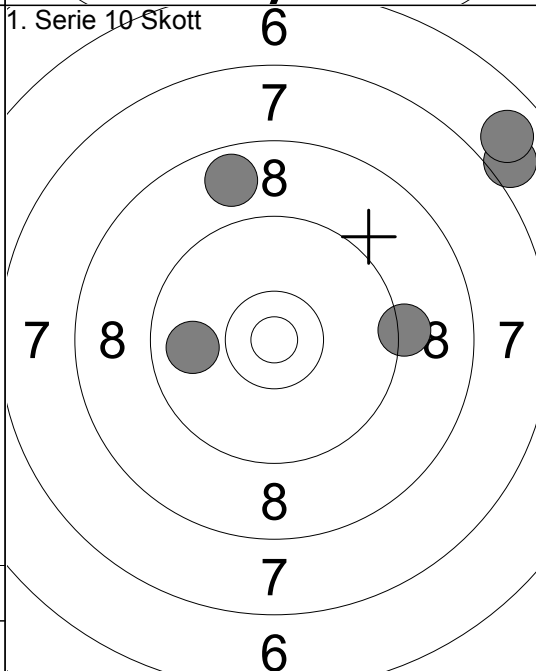

6:	9.2	→
7:	8.8	↑
8:	7.0	↗
9:	9.9	←
10:	6.8	↗
Serie	39.0	
Total	245.0	

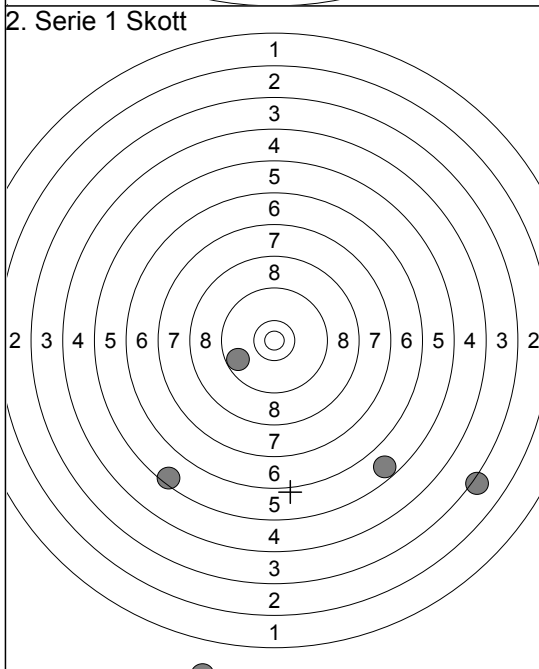

1:	5.5	↙
2:	9.7	↙
3:	0.0	↓
4:	5.7	↘
5:	3.2	↘
Serie	22.0	
Total	267.0	

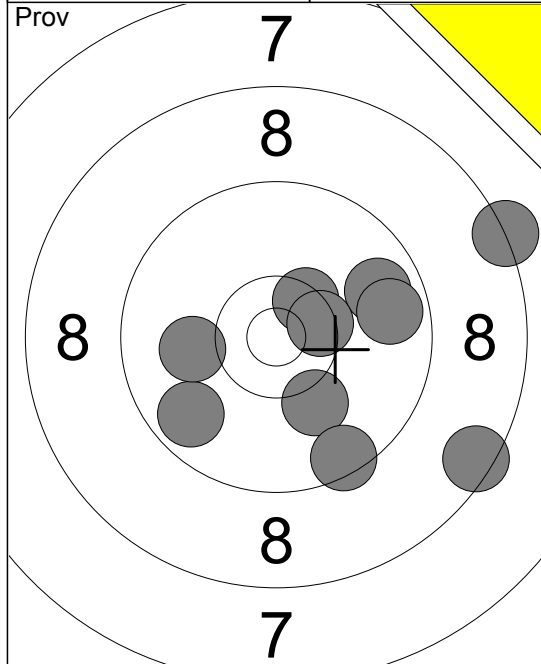

1:	8.3	➔
2:	8.5	➘
3:	9.8	➔
4:	10.1	➘
5:	9.5	➘
6:	10.5x	↗
7:	9.7	➔
8:	9.7	➘
9:	10.5x	➔
10:	10.1	➔
Serie		92.0
Total		161.0

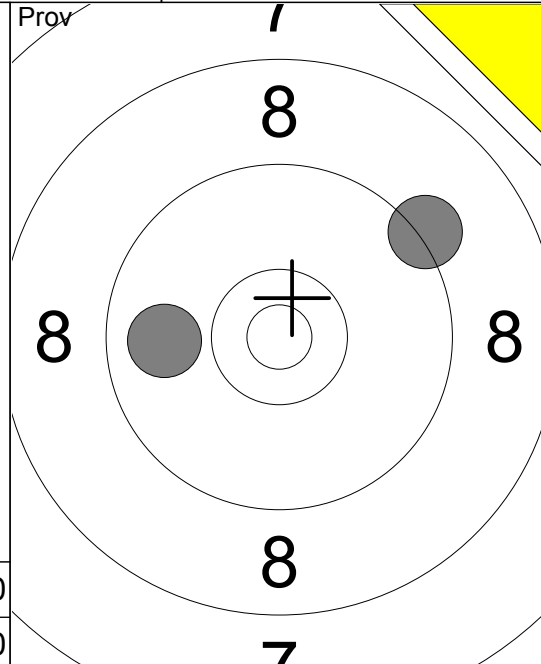

11:	9.2	↗
12:	9.9	➔
Serie		18.0
Total		161.0

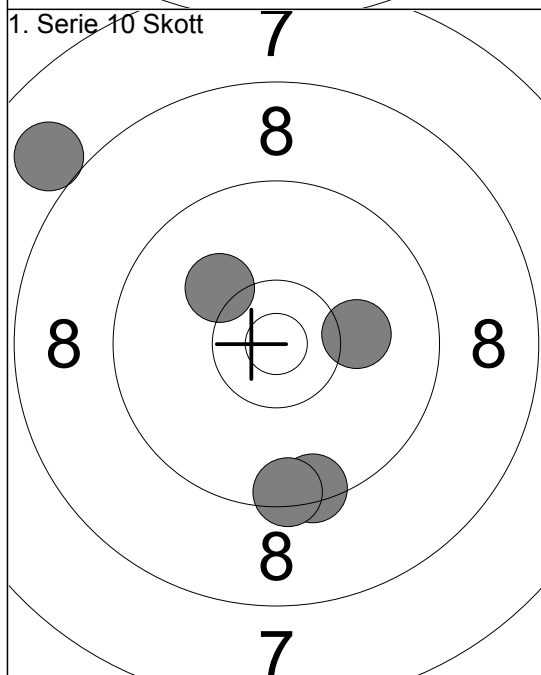

1:	10.1	➔
2:	10.1	↖
3:	8.0	↗
4:	9.4	➘
5:	9.4	➘
Serie		46.0
Total		207.0

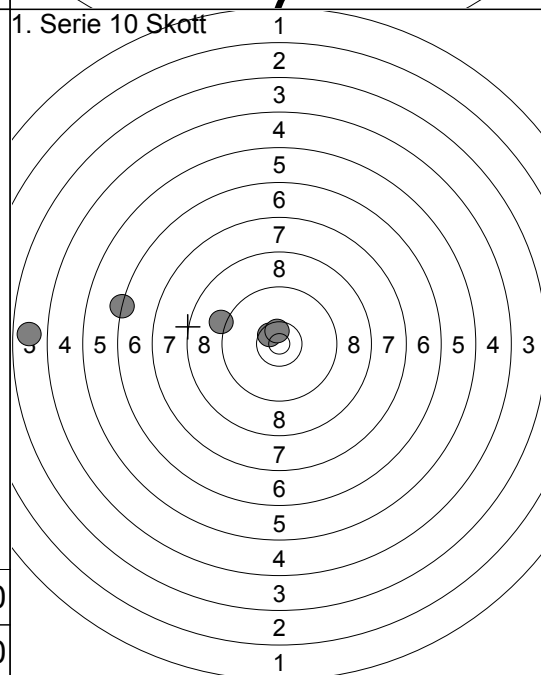

6:	9.2	➔
7:	6.3	➔
8:	3.8	➔
9:	10.6x	↗
10:	10.6x	↗
Serie		38.0
Total		245.0

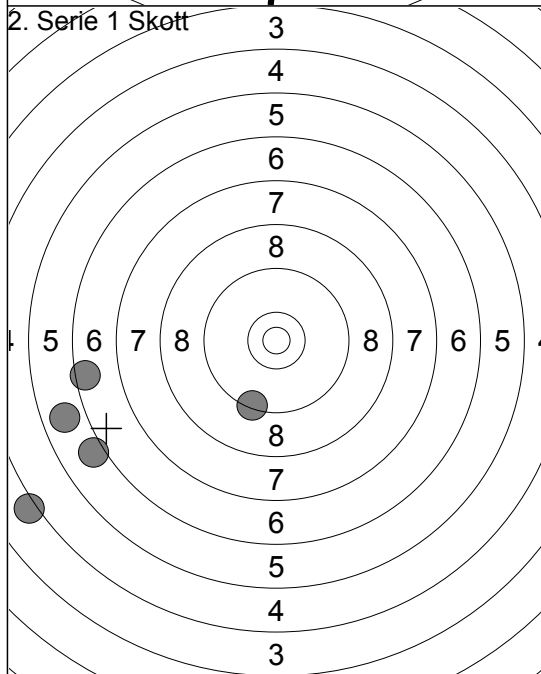

1:	5.8	➔
2:	4.1	➔
3:	9.4	➘
4:	6.5	➔
5:	6.1	➔
Serie		30.0
Total		275.0

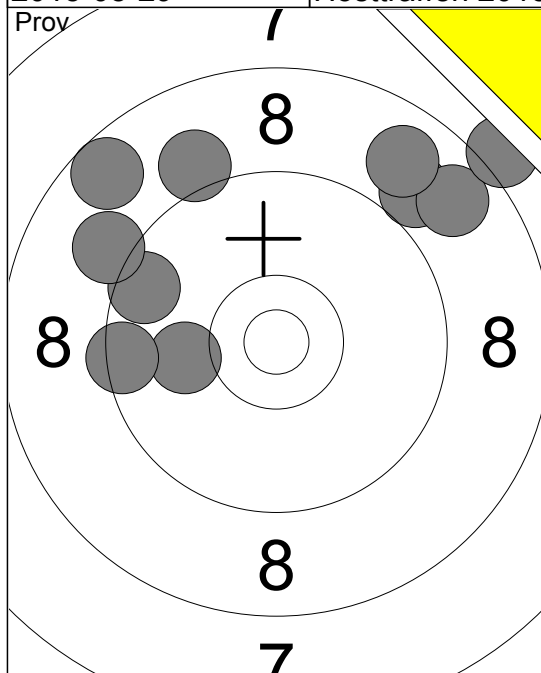

1:	10.1	←
2:	9.0	↗
3:	8.8	↗
4:	8.1	↗
5:	8.6	↖
6:	9.6	←
7:	9.1	↖
8:	8.8	↗
9:	9.1	↖
10:	9.5	←
Serie		87.0
Total		169.0

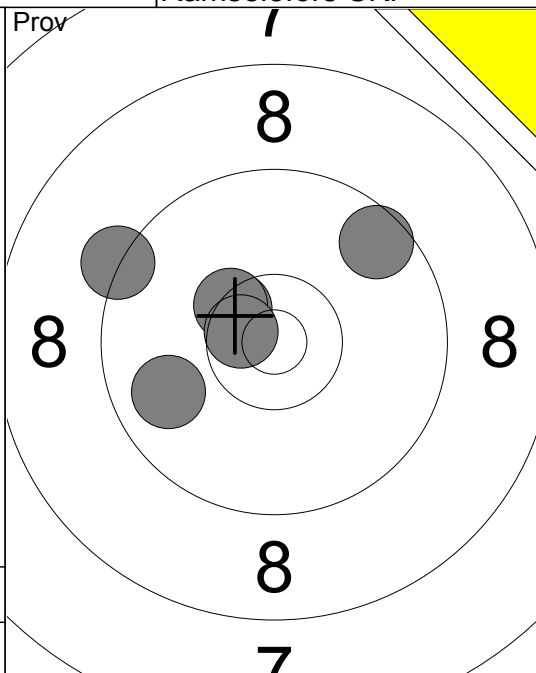

11:	10.5	↘
12:	10.4	↘
13:	9.8	←
14:	10.6	↘
15:	9.3	↖
16:	9.6	↗
Serie		57.0
Total		169.0

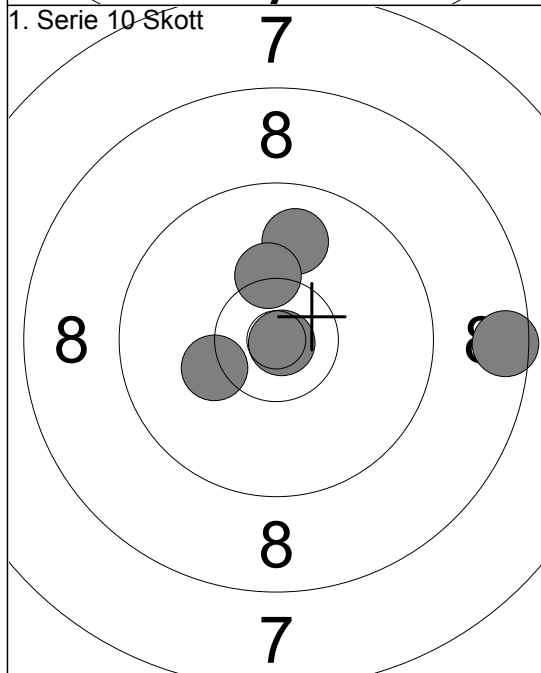

1:	8.5	→
2:	9.9	↑
3:	10.3	↑
4:	10.2	←
5:	10.9	↘
Serie		47.0
Total		216.0

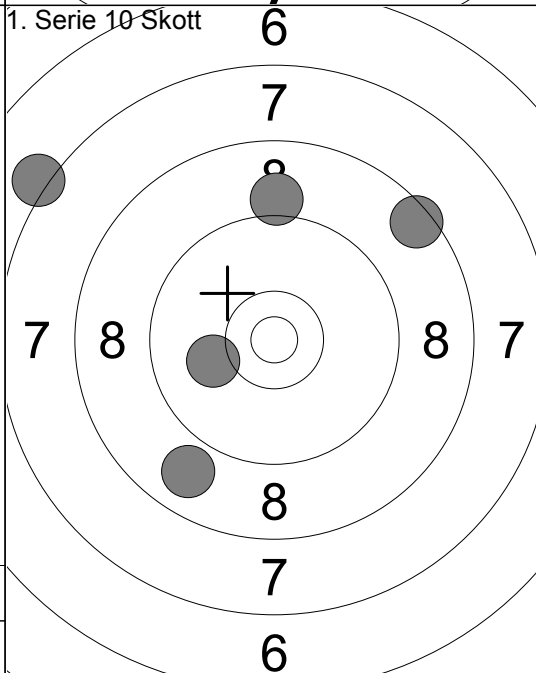

6:	9.1	↑
7:	7.2	↖
8:	8.9	↘
9:	10.1	←
10:	8.5	↗
Serie		42.0
Total		258.0

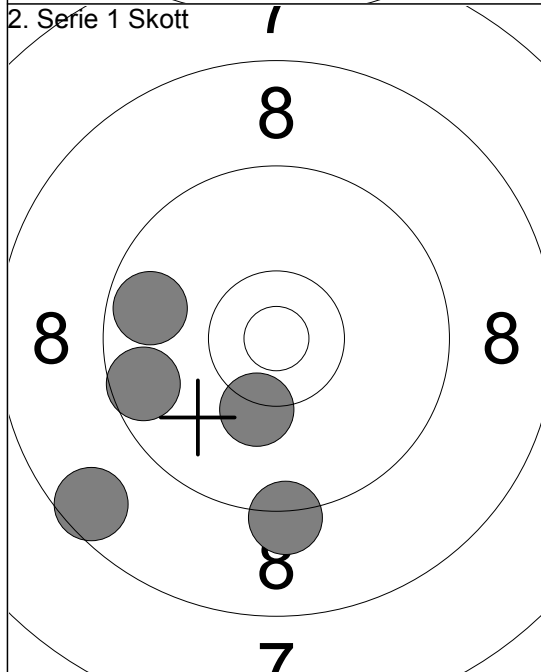

1:	10.2	↓
2:	9.2	↓
3:	8.6	↘
4:	9.6	←
5:	9.7	←
Serie		45.0
Total		303.0

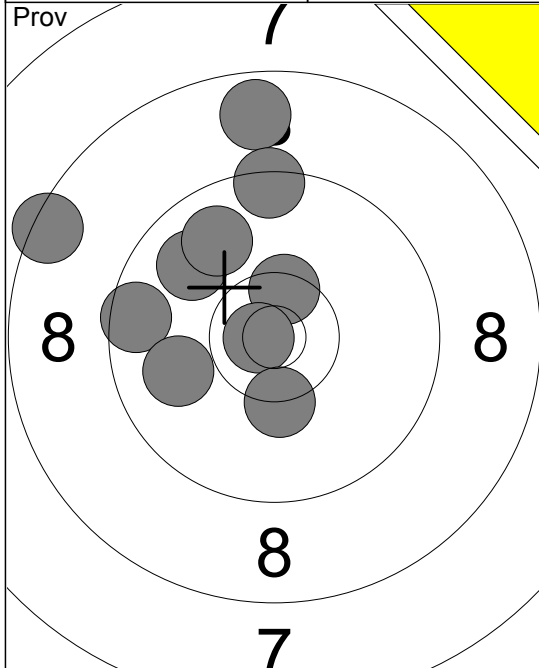

1:	8.7	↑
2:	9.6	←
3:	10.5	↗
4:	8.4	↖
5:	10.8	←
6:	9.9	↗
7:	9.8	↗
8:	9.9	←
9:	9.4	↑
10:	10.3	↘
Serie	91.0	
Total	170.0	

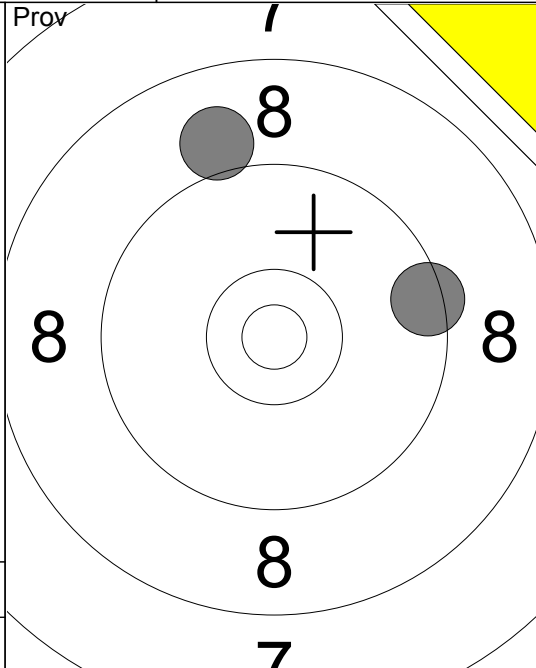

11:	9.0	↖
12:	9.4	→
Serie	18.0	
Total	170.0	

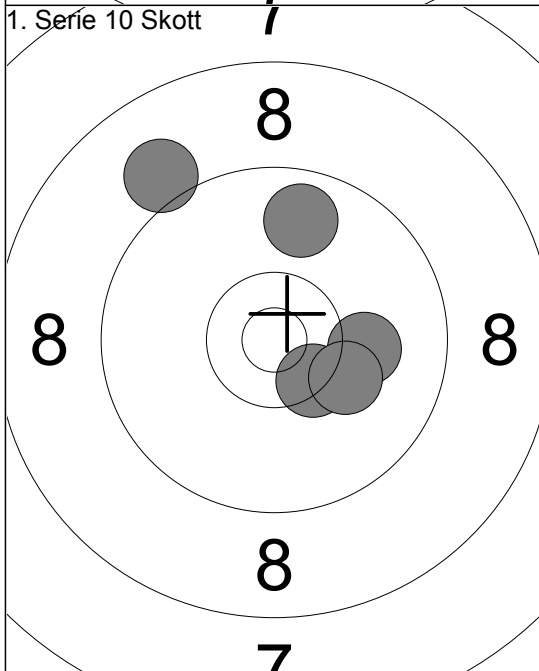

1:	10.1	→
2:	9.8	↑
3:	9.0	↗
4:	10.4	↘
5:	10.2	↘
Serie	48.0	
Total	218.0	

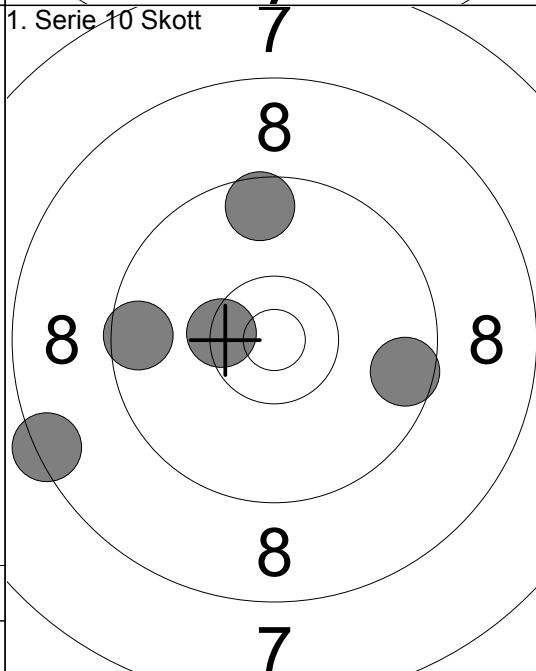

6:	9.6	↑
7:	9.6	←
8:	8.4	←
9:	10.4	←
10:	9.6	→
Serie	45.0	
Total	263.0	

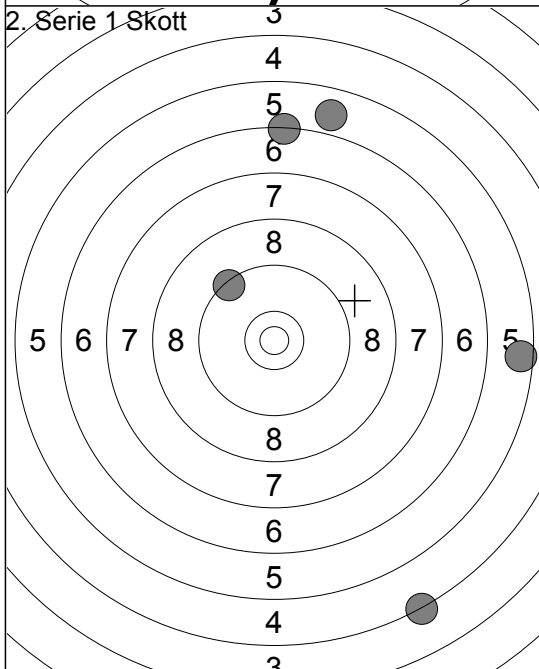

1:	6.3	↑
2:	5.6	→
3:	5.9	↑
4:	4.3	↘
5:	9.4	↗
Serie	29.0	
Total	292.0	

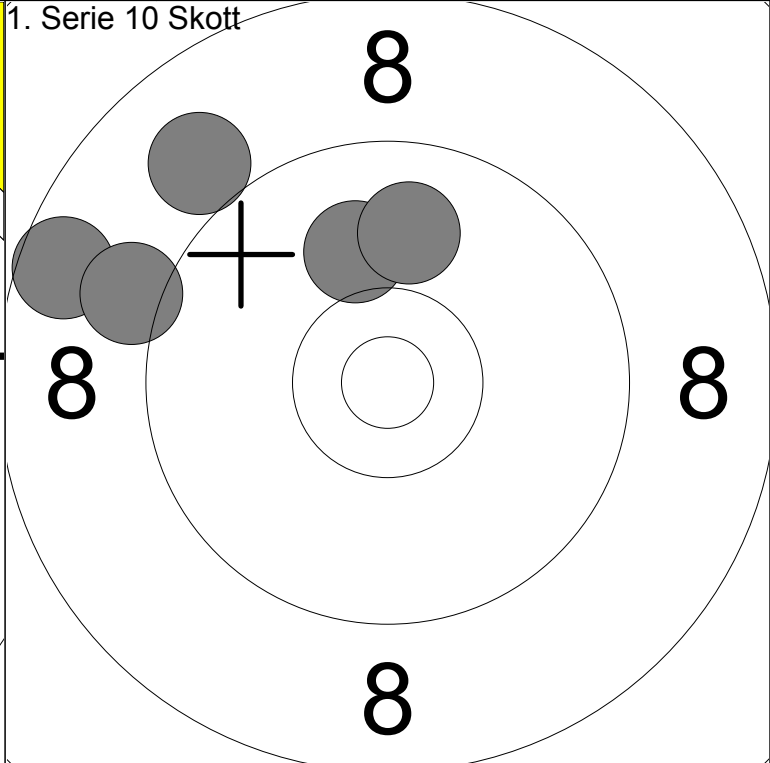
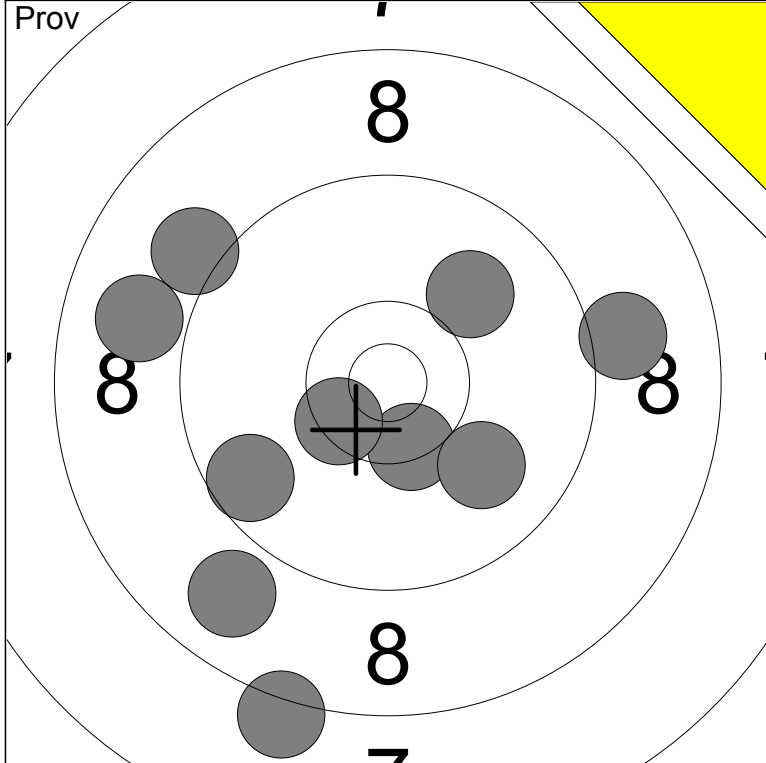

1: 9.0 →	6: 8.9 ←	Serie	91
2: 10.0 ↗	7: 10.4x ↓		
3: 9.1 ↖	8: 8.2 ↓	Total	169
4: 8.9 ↘	9: 10.5x ←		
5: 9.6 ↙	10: 10.0 ↘		

1: 8.6 ←	Serie	45
2: 10.0 ↑		
3: 9.1 ↖	Total	214
4: 9.0 ↗		
5: 9.9 ↑		

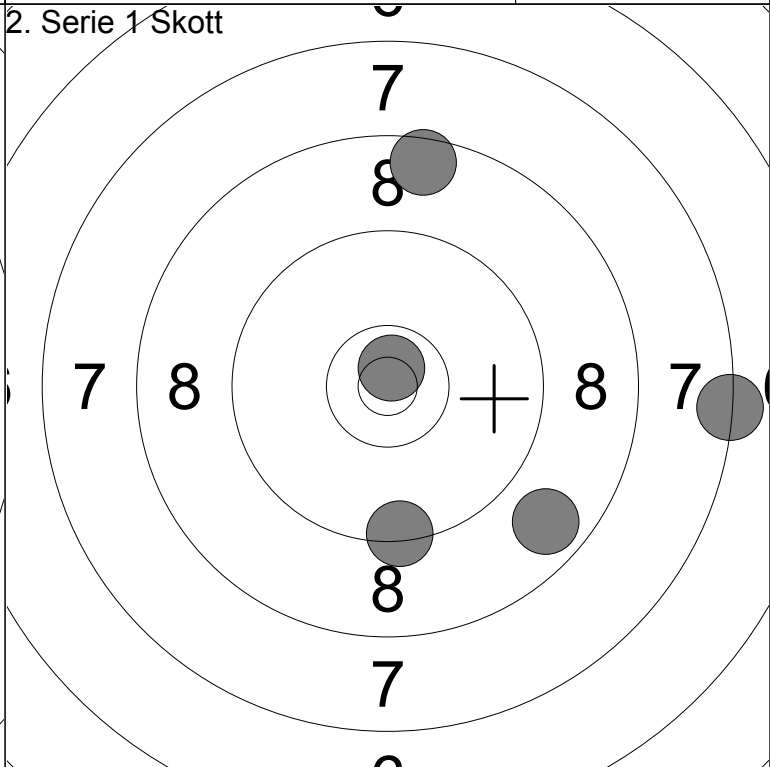
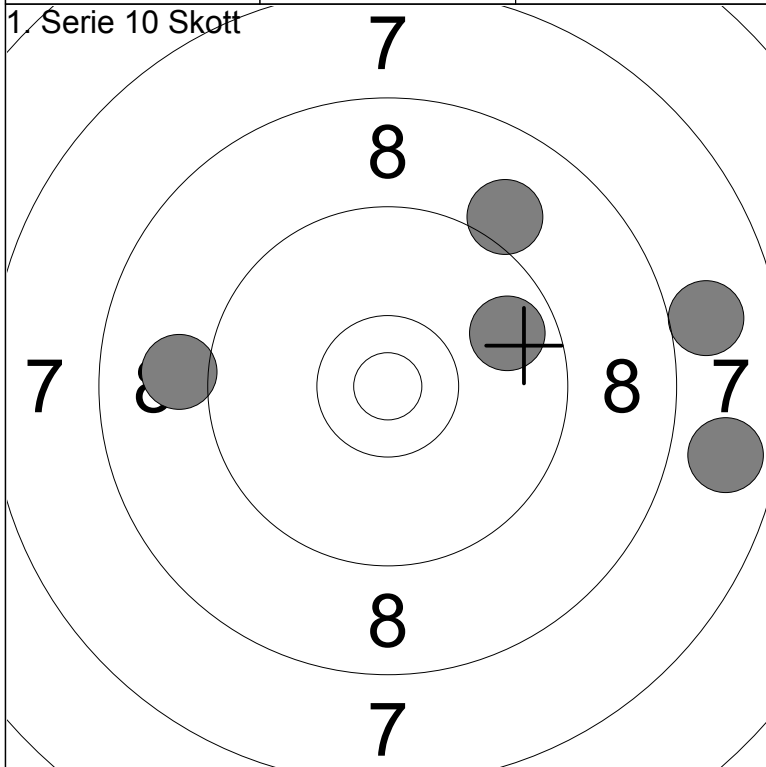

6: 9.0 ←	Serie	42
7: 7.8 →		
8: 9.8 ↗	Total	256
9: 8.0 →		
10: 9.1 ↗		

1: 8.8 ↘	Serie	42
2: 7.3 →		
3: 9.4 ↓	Total	298
4: 8.6 ↑		
5: 10.8x ↑		

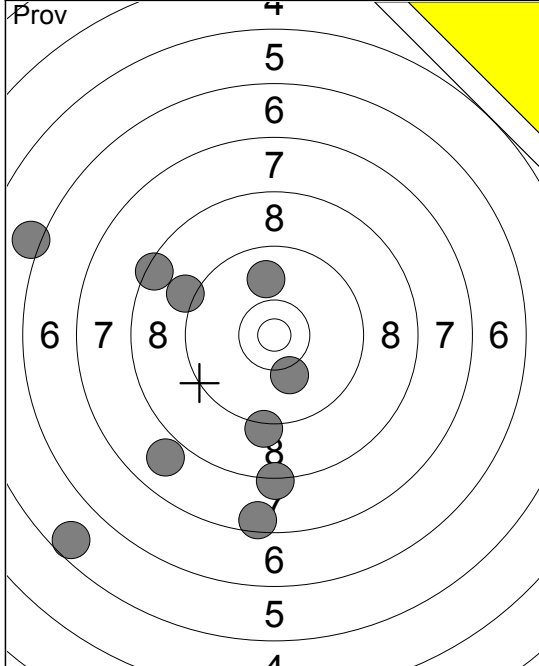

1:	5.6	↙
2:	8.3	↓
3:	7.5	↓
4:	6.1	↙
5:	9.1	↙
6:	10.2	↓
7:	9.2	↓
8:	8.4	↙
9:	9.9	↑
10:	7.9	↙
Serie	78.0	
Total	139.0	

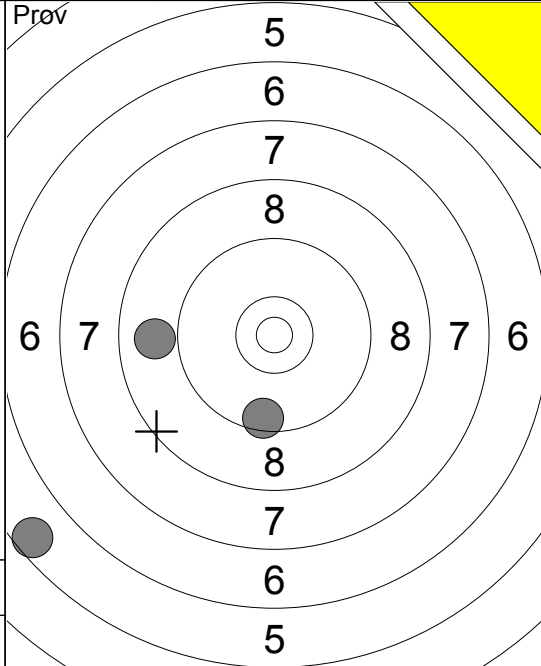

11:	5.6	↙
12:	9.5	↓
13:	8.9	↙
Serie	22.0	
Total	139.0	

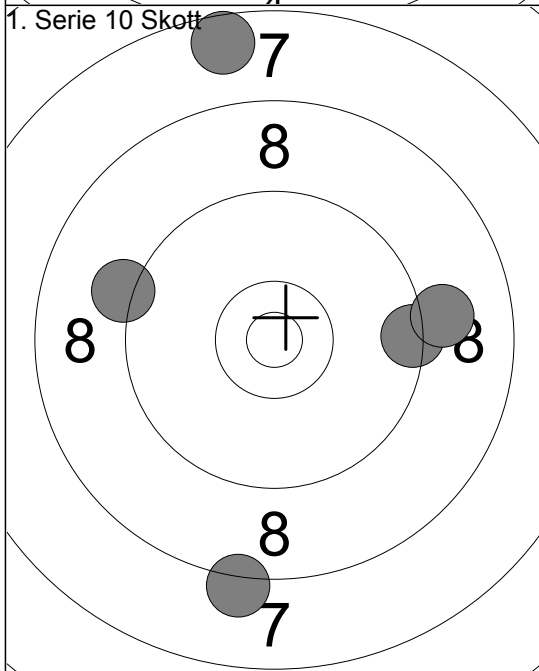

1:	8.2	↓
2:	9.2	↙
3:	7.6	↑
4:	9.4	→
5:	9.1	→
Serie	42.0	
Total	181.0	

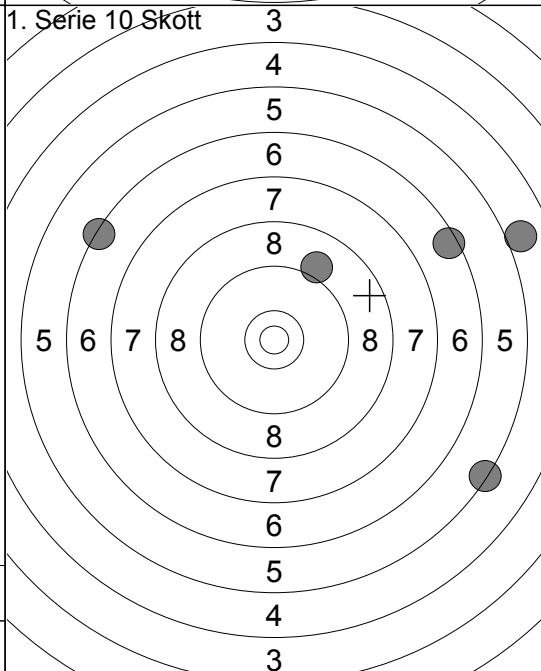

6:	6.4	↙
7:	6.5	↗
8:	5.0	↗
9:	9.1	↗
10:	5.3	↘
Serie	31.0	
Total	212.0	

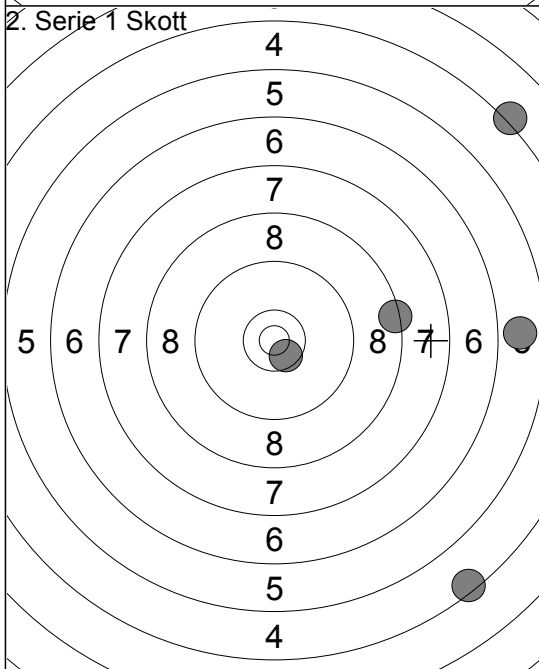

1:	10.6x	↘
2:	4.2	↗
3:	5.8	→
4:	8.4	→
5:	4.4	↘
Serie	31.0	
Total	243.0	