

1:	9.5	↘
2:	10.3	←
3:	10.4x	←
4:	8.8	↗
5:	9.8	←
6:	9.7	↑
7:	5.7	↗
8:	10.0	↖
9:	9.6	←
10:	8.5	↖
Series		87.0
Total		0.0

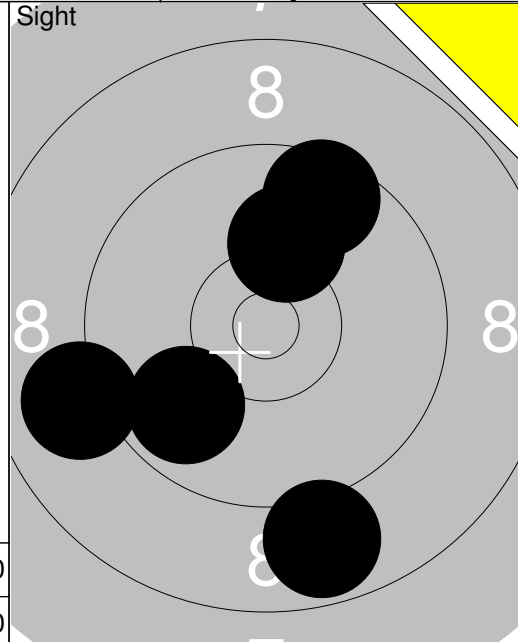

11:	9.1	↖
12:	10.1	↗
13:	8.9	↘
14:	9.9	↖
15:	9.6	↗
Series		45.0
Total		0.0

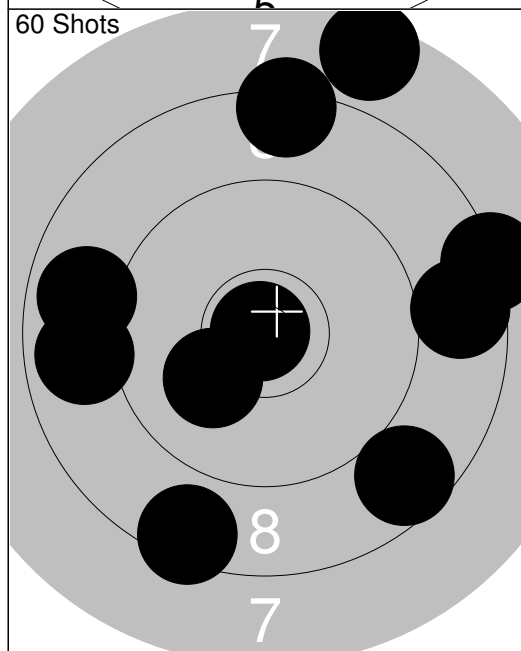

1:	8.5	↘
2:	10.9x	←
3:	8.3	→
4:	10.2	↘
5:	8.9	←
6:	8.9	←
7:	7.6	↗
8:	8.4	↗
9:	8.7	↘
10:	8.7	→
Series		83.0
Total		83.0

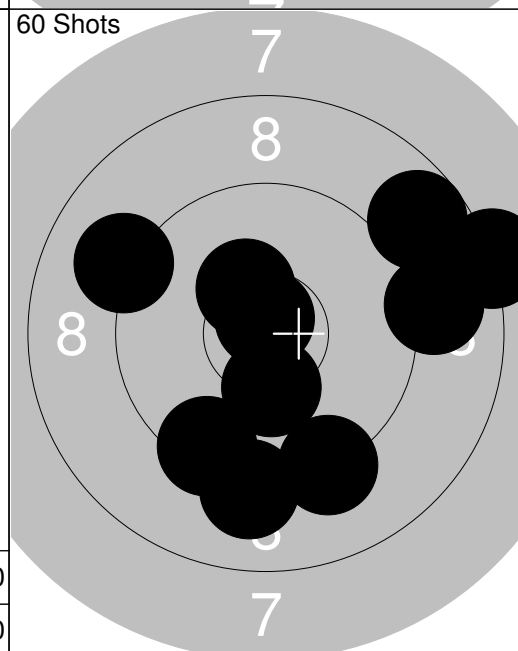

11:	9.0	→
12:	9.1	↖
13:	8.2	→
14:	9.2	↘
15:	9.3	↘
16:	9.5	↘
17:	10.3	↘
18:	10.4x	↖
19:	8.8	↗
20:	10.8x	↗
Series		91.0
Total		174.0

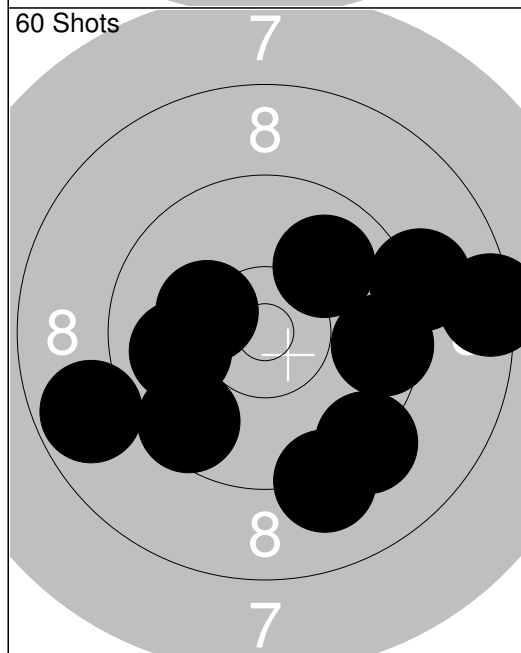

21:	9.7	↘
22:	10.0	↗
23:	9.2	→
24:	8.9	←
25:	10.0	←
26:	9.7	→
27:	8.5	→
28:	9.2	↘
29:	10.3	←
30:	9.3	↘
Series		91.0
Total		265.0

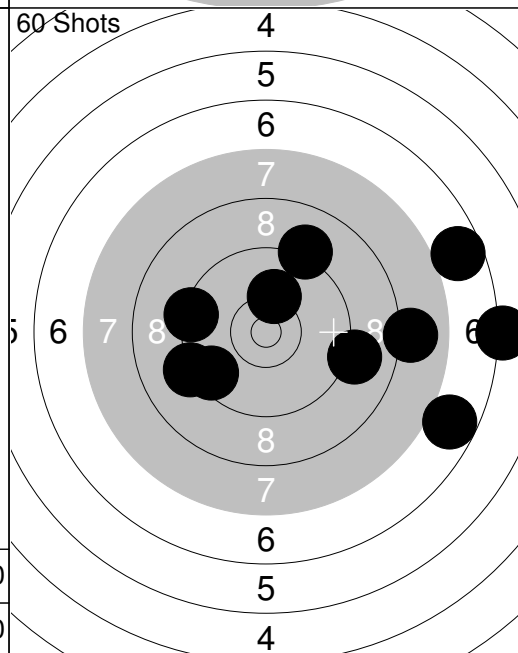

31:	6.1	→
32:	8.0	→
33:	9.1	↗
34:	9.1	→
35:	9.4	←
36:	6.7	↗
37:	10.2	↗
38:	6.8	→
39:	9.6	↖
40:	9.2	↖
Series		81.0
Total		346.0

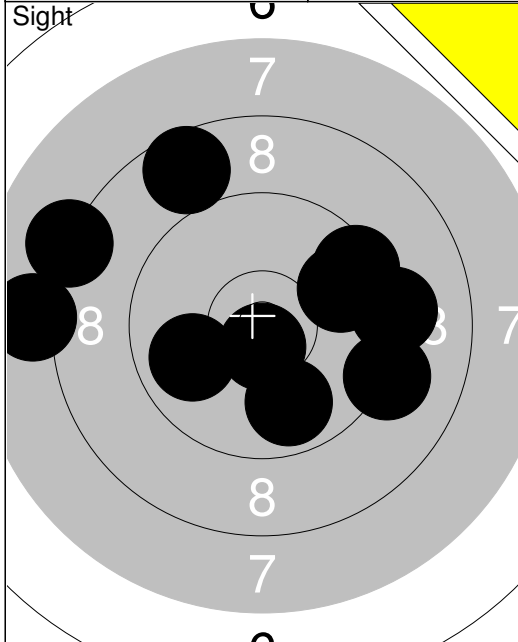

1:	9.2	↘
2:	8.0	←
3:	9.5	↗
4:	9.9	↓
5:	10.0	←
6:	8.7	↑
7:	8.2	←
8:	9.2	→
9:	10.7x	↓
10:	9.8	↗
Series		89.0
Total		0.0

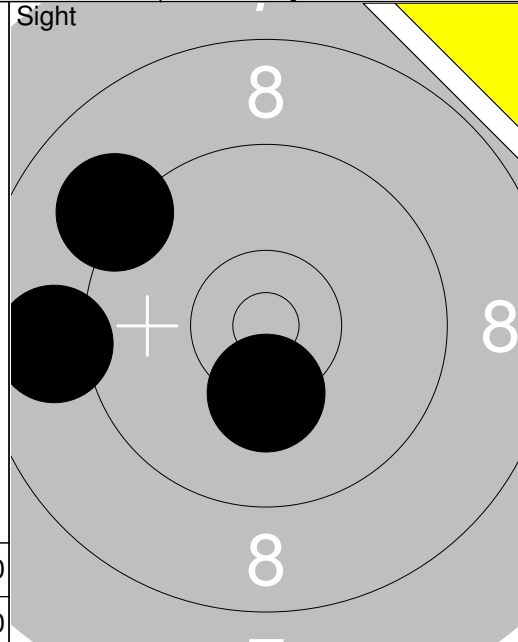

11:	9.2	↖
12:	8.9	←
13:	10.3	↓
Series		27.0
Total		0.0

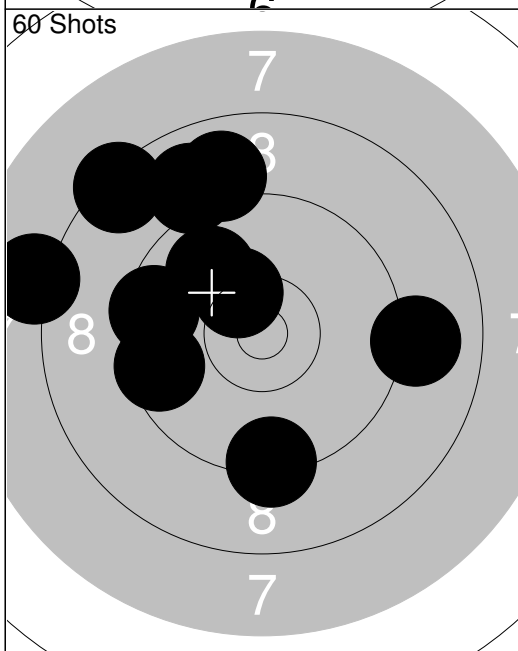

1:	8.1	←
2:	8.9	↑
3:	8.4	↗
4:	10.4x	↗
5:	9.0	↑
6:	10.0	↗
7:	9.6	←
8:	9.6	←
9:	9.4	↓
10:	9.1	→
Series		89.0
Total		89.0

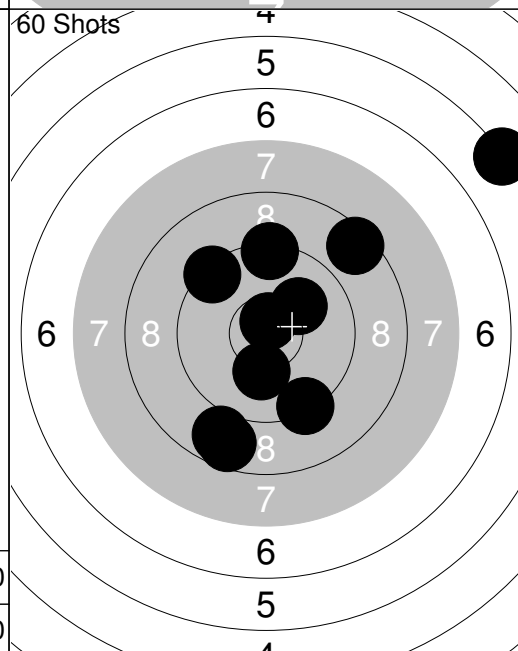

11:	9.4	↓
12:	10.1	↗
13:	9.4	↖
14:	8.5	↗
15:	9.4	↑
16:	10.2	↓
17:	5.3	↗
18:	8.8	↓
19:	8.7	↓
20:	10.7x	↑
Series		86.0
Total		175.0

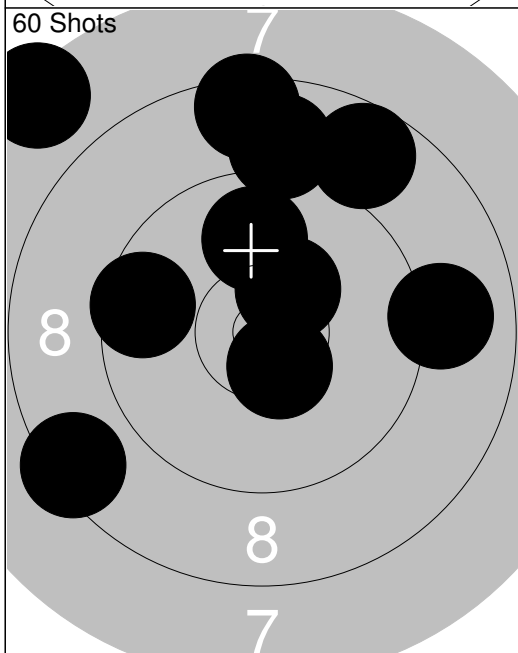

21:	8.5	↖
22:	9.6	←
23:	9.0	↑
24:	7.5	↖
25:	10.4x	↗
26:	8.5	↑
27:	9.9	↑
28:	10.5x	↓
29:	9.0	→
30:	8.8	↗
Series		87.0
Total		262.0

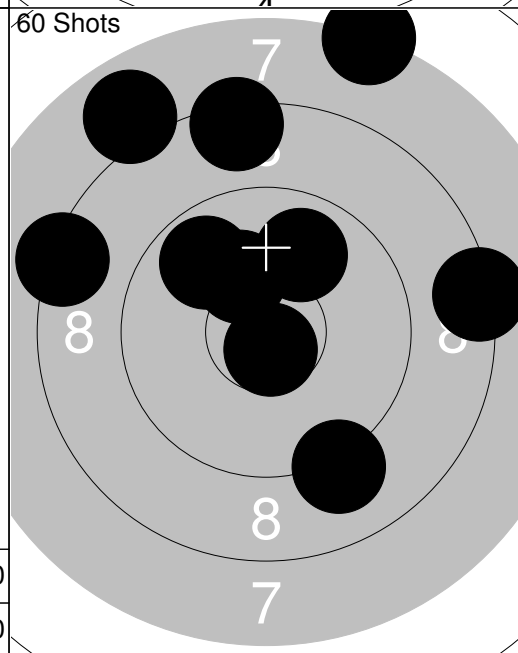

31:	7.9	↖
32:	9.1	↓
33:	9.9	↖
34:	7.3	↑
35:	9.9	↑
36:	8.4	→
37:	8.4	←
38:	10.2	↖
39:	8.5	↑
40:	10.7x	↓
Series		85.0
Total		347.0

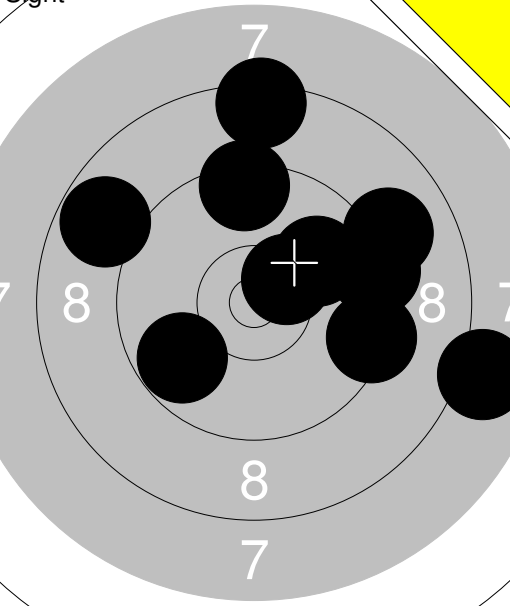
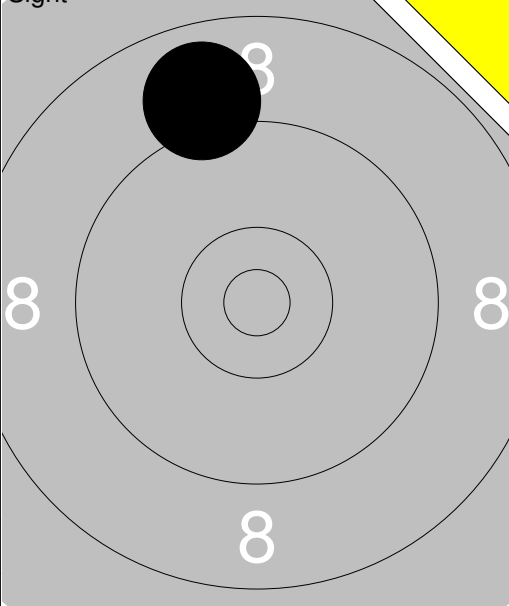
<p>Sight</p> 	<p>1: 9.4 →</p> <p>2: 8.5 ↑</p> <p>3: 10.5x ↗</p> <p>4: 8.8 ↖</p> <p>5: 9.4 →</p> <p>6: 9.1 →</p> <p>7: 8.0 →</p> <p>8: 10.0 ↗</p> <p>9: 9.8 ↙</p> <p>10: 9.5 ↑</p>	<p>Sight</p> 	<p>11: 9.0 ↑</p>
Series 89.0		Series 9.0	
Total 0.0		Total 0.0	

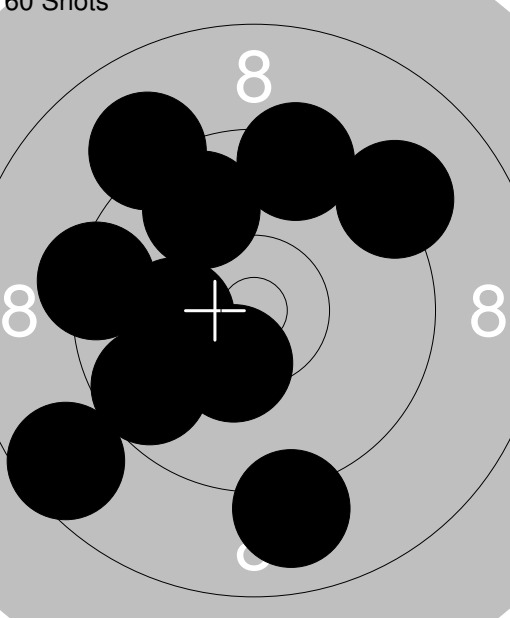
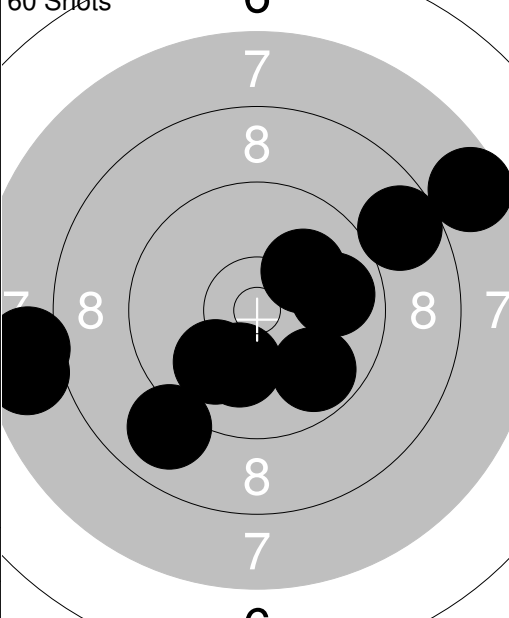
<p>60 Shots</p> 	<p>1: 8.7 ↙</p> <p>2: 9.0 ↓</p> <p>3: 9.4 ←</p> <p>4: 9.1 ↗</p> <p>5: 9.9 ↗</p> <p>6: 9.3 ↗</p> <p>7: 9.7 ↙</p> <p>8: 9.5 ↑</p> <p>9: 10.2 ←</p> <p>10: 10.4x ↓</p>	<p>60 Shots</p> 	<p>11: 10.2 ↓</p> <p>12: 10.1 ↗</p> <p>13: 10.1 ↙</p> <p>14: 7.7 ↗</p> <p>15: 9.9 →</p> <p>16: 9.0 ↙</p> <p>17: 9.9 ↘</p> <p>18: 7.8 ←</p> <p>19: 7.8 ←</p> <p>20: 8.8 ↗</p>
Series 91.0		Series 86.0	
Total 91.0		Total 177.0	

<p>60 Shots</p> 	<p>21: 9.8 ↑</p> <p>22: 8.5 →</p> <p>23: 10.6x →</p> <p>24: 9.1 ↗</p> <p>25: 10.1 ↓</p> <p>26: 9.2 ←</p> <p>27: 9.1 ↘</p> <p>28: 10.8x ↗</p> <p>29: 9.2 ↖</p> <p>30: 8.6 ↑</p>	<p>60 Shots</p> 	<p>31: 8.4 ↓</p> <p>32: 9.3 ↓</p> <p>33: 9.0 ↖</p> <p>34: 10.4x ↙</p> <p>35: 10.1 ↗</p> <p>36: 10.3 ↓</p> <p>37: 6.7 ↗</p> <p>38: 6.5 ↘</p> <p>39: 9.0 ↗</p> <p>40: 8.0 →</p>
Series 91.0		Series 85.0	
Total 268.0		Total 353.0	

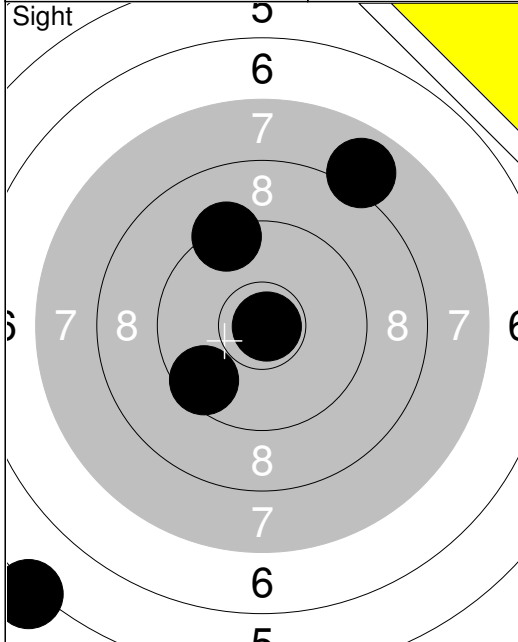

1:	8.0	↗
2:	5.1	↘
3:	9.6	↘
4:	9.4	↗
5:	10.9x	→
Series		41.0
Total		0.0

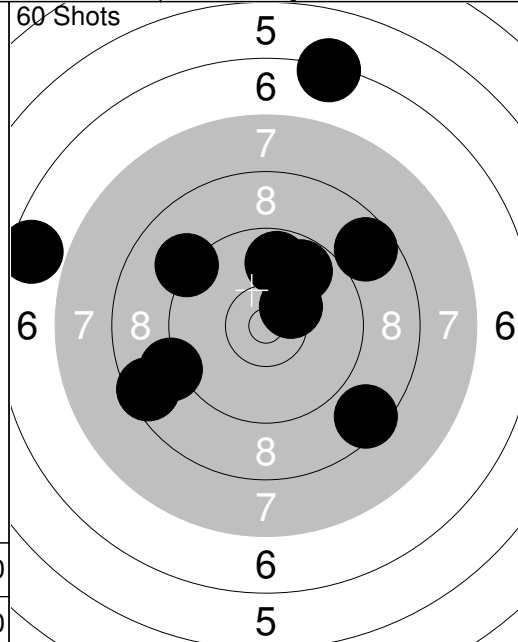

1:	8.7	↗
2:	9.8	↗
3:	8.6	↖
4:	10.4x	↗
5:	9.2	↖
6:	9.8	↑
7:	9.1	↖
8:	6.3	↑
9:	8.6	↘
10:	6.6	↖
Series		82.0
Total		82.0

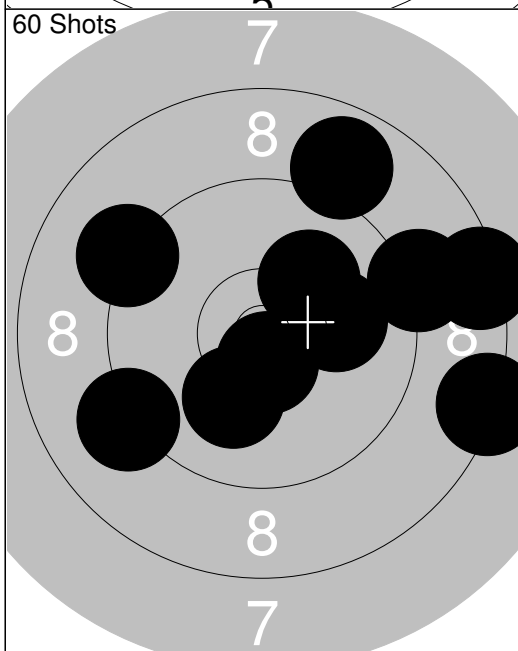

11:	10.2	↗
12:	9.1	→
13:	9.2	↖
14:	10.6x	↘
15:	8.5	→
16:	10.1	→
17:	8.9	↗
18:	10.2	↘
19:	9.2	↖
20:	8.3	→
Series		91.0
Total		173.0

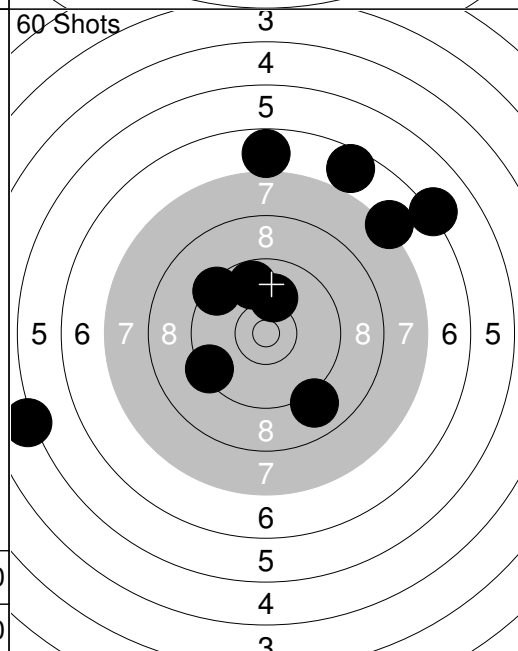

21:	9.8	↑
22:	9.5	↖
23:	9.4	↖
24:	9.0	↘
25:	6.2	↗
26:	5.1	↖
27:	10.1	↑
28:	7.2	↗
29:	6.8	↑
30:	6.7	↗
Series		76.0
Total		249.0

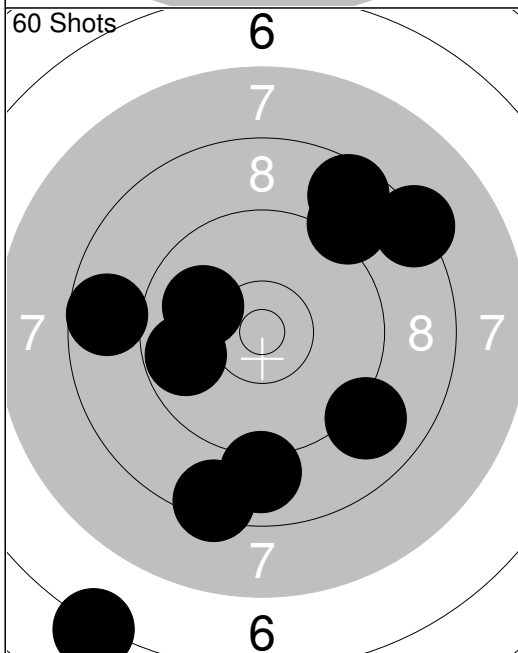

31:	8.7	↗
32:	9.1	↘
33:	6.2	↘
34:	9.0	↗
35:	8.5	↘
36:	8.4	↗
37:	10.0	↖
38:	9.0	↘
39:	9.8	↖
40:	8.8	↖
Series		84.0
Total		333.0

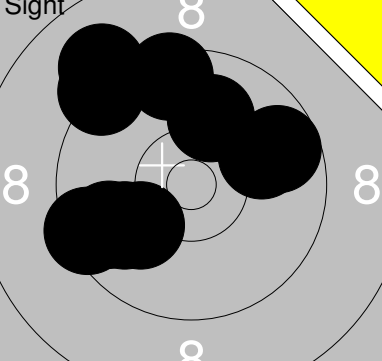
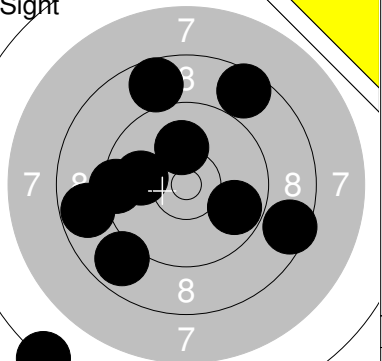
Sight		Sight	
	1: 9.5 ↑ 2: 9.3 ↖ 3: 9.8 → 4: 9.8 ← 5: 10.1 ↙ 6: 10.1 ↑ 7: 9.5 ← 8: 9.1 ↗ 9: 10.0 ↙ 10: 10.0 →		11: 8.8 ← 12: 10.0 ← 13: 8.8 ↑ 14: 10.2 ↑ 15: 8.7 ↗ 16: 9.5 ← 17: 6.3 ↙ 18: 8.6 ↘ 19: 9.8 ↘ 20: 8.9 ↙
Series	94.0	Series	84.0
Total	0.0	Total	0.0

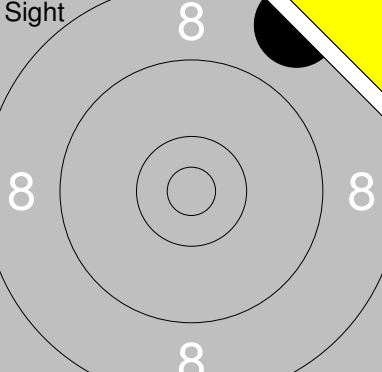
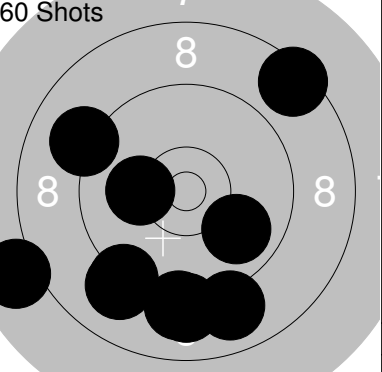
Sight		60 Shots	
	21: 8.4 ↗		1: 8.5 ↗ 2: 9.1 ↓ 3: 9.1 ↗ 4: 9.2 ↘ 5: 9.0 ↘ 6: 9.9 ↘ 7: 7.9 ← 8: 9.1 ↘ 9: 10.2 ← 10: 9.1 ↓
Series	8.0	Series	88.0
Total	0.0	Total	88.0

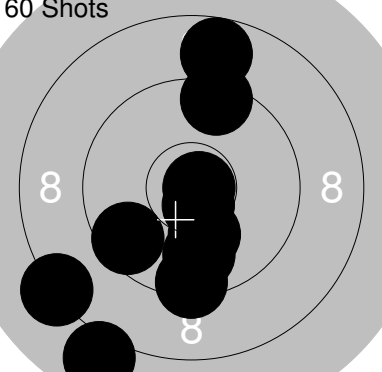
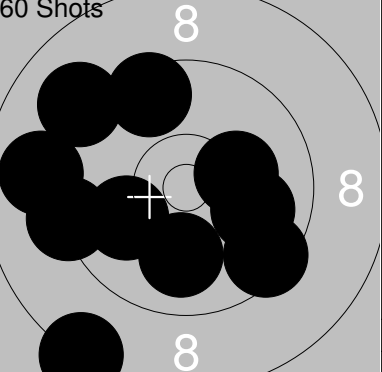
60 Shots		60 Shots	
	11: 9.5 ↑ 12: 8.3 ↙ 13: 9.7 ↙ 14: 10.2 ↘ 15: 7.9 ↙ 16: 10.8x → 17: 9.9 ↘ 18: 10.7x ↘ 19: 8.8 ↗ 20: 9.5 ↘		21: 10.0 ↓ 22: 10.3 → 23: 10.0 → 24: 10.0 ← 25: 9.0 ← 26: 8.3 ↘ 27: 9.6 ↘ 28: 9.1 ↗ 29: 9.6 ↗ 30: 9.3 ←
Series	89.0	Series	93.0
Total	177.0	Total	270.0

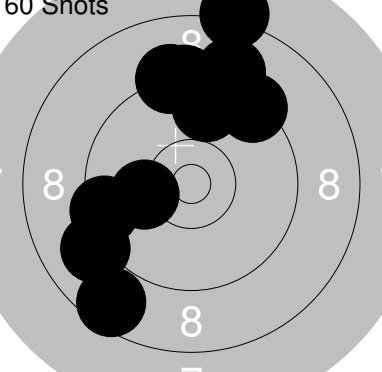
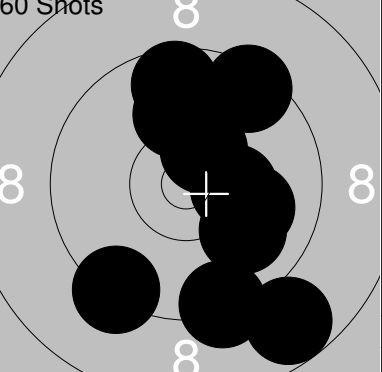
60 Shots		60 Shots	
	31: 9.1 ← 32: 10.2 ← 33: 8.1 ↑ 34: 9.2 ↑ 35: 9.7 ↑ 36: 9.0 ↑ 37: 9.3 ↑ 38: 9.4 ↗ 39: 8.7 ↘ 40: 9.5 ←		41: 9.7 ↑ 42: 10.1 → 43: 9.3 ↘ 44: 10.1 ↑ 45: 10.5x ↗ 46: 10.3 → 47: 9.4 ↘ 48: 10.0 ↘ 49: 9.5 ↗ 50: 8.8 ↘
Series	89.0	Series	94.0
Total	359.0	Total	453.0

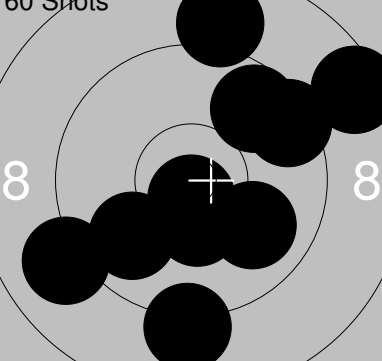

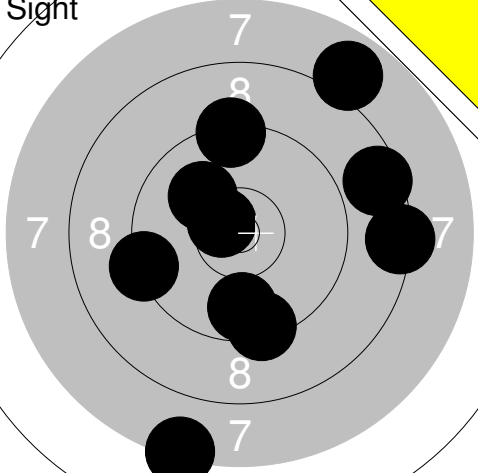
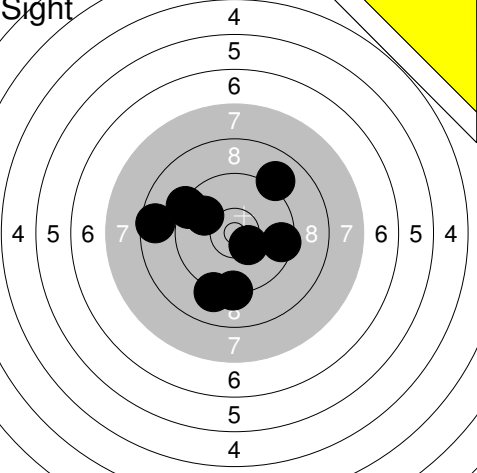
60 Shots			
	51: 9.5 → 52: 9.7 ↗ 53: 10.4x ↘ 54: 10.7x ↘ 55: 9.1 ↘ 56: 8.6 → 57: 8.9 ↑ 58: 9.1 ← 59: 10.0 ↘ 60: 9.9 ↘		
Series	91.0		
Total	544.0		

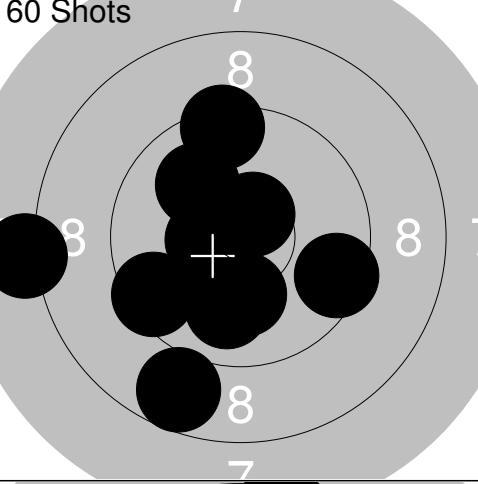
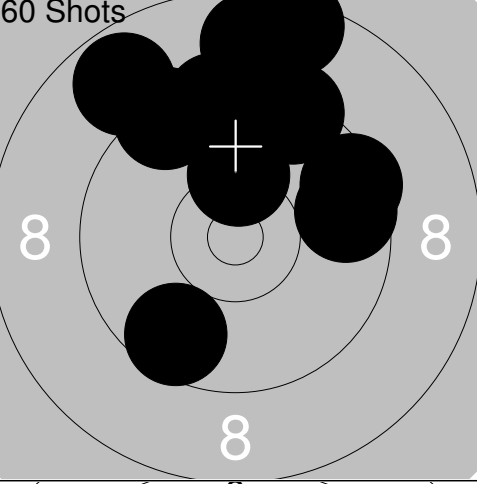
<p>Sight</p> 	<p>1: 9.3 ← 2: 7.3 ↓ 3: 10.6x ↖ 4: 9.4 ↓ 5: 7.9 ↗ 6: 8.4 → 7: 8.6 → 8: 10.1 ↗ 9: 9.3 ↑ 10: 9.8 ↓</p> <p>Series 86.0 Total 0.0</p>	<p>Sight</p> 	<p>11: 9.2 ↓ 12: 9.0 ↗ 13: 9.9 ↖ 14: 9.3 ↓ 15: 9.5 ↖ 16: 9.3 ↖ 17: 1.9 ↗ 18: 9.6 → 19: 8.6 ← 20: 10.4x ↘</p> <p>Series 82.0 Total 0.0</p>
-----------------------------------------------------------------------------------------------	---------------------------------------------------------------------------------------------------------------------------------------------------------------------------	-------------------------------------------------------------------------------------------------	-----------------------------------------------------------------------------------------------------------------------------------------------------------------------------------

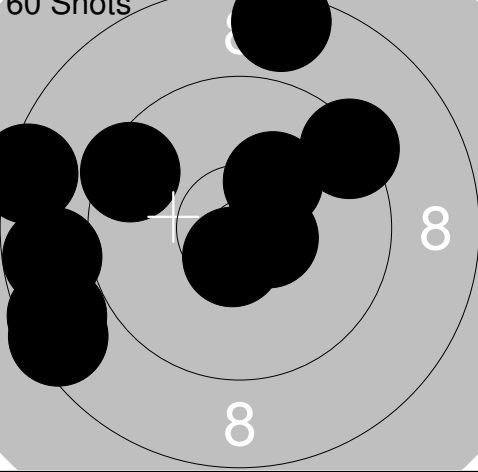
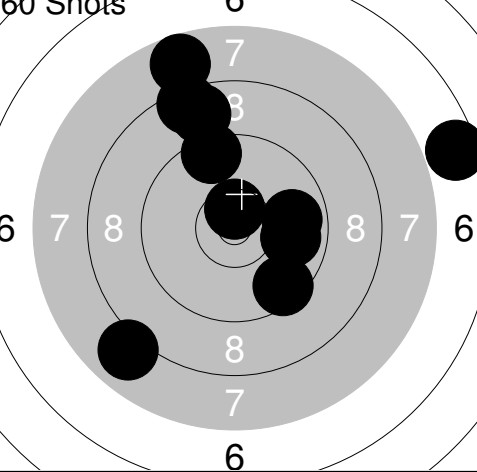
<p>60 Shots</p> 	<p>1: 10.1 ↗ 2: 9.5 ↑ 3: 8.8 ↓ 4: 9.6 ↖ 5: 9.6 → 6: 10.6x ↗ 7: 10.2 ↓ 8: 10.0 ↓ 9: 10.5x ← 10: 8.1 ←</p> <p>Series 93.0 Total 93.0</p>	<p>60 Shots</p> 	<p>11: 9.6 → 12: 8.9 ↖ 13: 9.5 ↑ 14: 8.5 ↑ 15: 9.7 ↓ 16: 9.4 ↑ 17: 9.4 ↗ 18: 8.8 ↑ 19: 10.3 ↑ 20: 9.7 →</p> <p>Series 88.0 Total 181.0</p>
---------------------------------------------------------------------------------------------------	--------------------------------------------------------------------------------------------------------------------------------------------------------------------------------	-----------------------------------------------------------------------------------------------------	------------------------------------------------------------------------------------------------------------------------------------------------------------------------------------

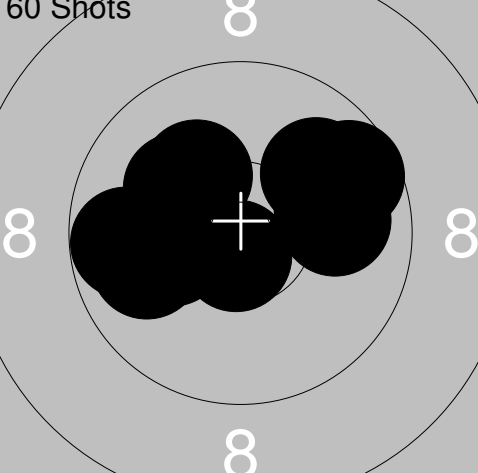
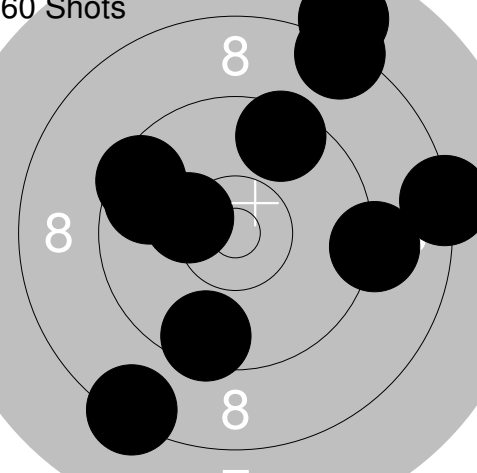
<p>60 Shots</p> 	<p>21: 9.6 ↖ 22: 10.3 ↗ 23: 8.8 ← 24: 8.7 ← 25: 9.4 ↗ 26: 8.6 ← 27: 8.6 ↑ 28: 10.6x → 29: 8.5 ← 30: 10.6x ↓</p> <p>Series 88.0 Total 269.0</p>	<p>60 Shots</p> 	<p>31: 10.6x ↑ 32: 8.5 ↑ 33: 8.0 ↖ 34: 7.8 ↑ 35: 9.9 → 36: 8.8 ↑ 37: 9.6 ↓ 38: 9.5 ↑ 39: 9.9 → 40: 6.6 →</p> <p>Series 83.0 Total 352.0</p>
----------------------------------------------------------------------------------------------------	----------------------------------------------------------------------------------------------------------------------------------------------------------------------------------------	------------------------------------------------------------------------------------------------------	-------------------------------------------------------------------------------------------------------------------------------------------------------------------------------------

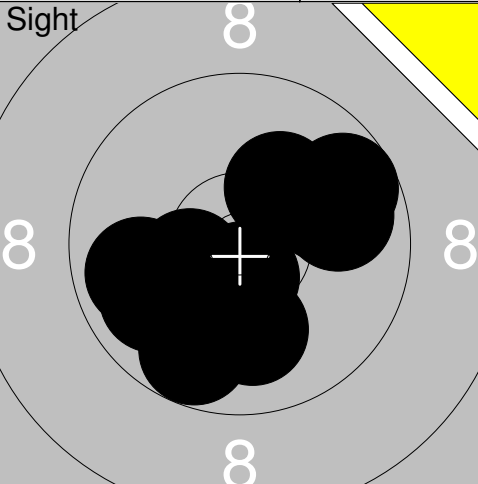
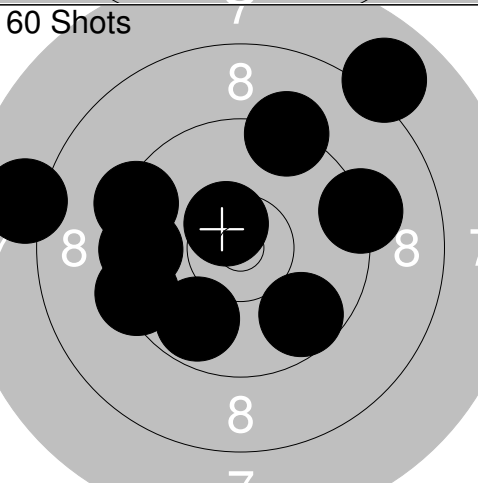
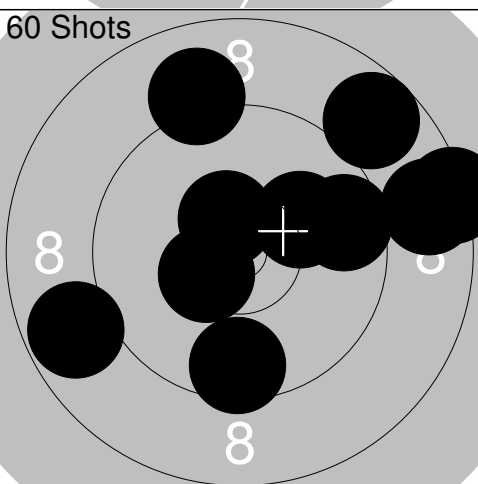
<p>60 Shots</p> 	<p>41: 9.7 ↗ 42: 10.2 ← 43: 10.7x ↓ 44: 10.2 ↗ 45: 10.2 ↖ 46: 10.0 ← 47: 10.0 → 48: 9.8 ← 49: 10.0 → 50: 10.0 ↗</p> <p>Series 98.0 Total 450.0</p>	<p>60 Shots</p> 	<p>51: 9.6 ↓ 52: 8.3 → 53: 9.6 ↑ 54: 9.2 → 55: 8.3 ↑ 56: 9.6 ↖ 57: 7.9 ↗ 58: 9.8 ← 59: 10.3 ← 60: 8.4 ↓</p> <p>Series 86.0 Total 536.0</p>
----------------------------------------------------------------------------------------------------	--------------------------------------------------------------------------------------------------------------------------------------------------------------------------------------------	------------------------------------------------------------------------------------------------------	------------------------------------------------------------------------------------------------------------------------------------------------------------------------------------

Relay	Lane	Tomas Backlund	
S	9	Umeå PK	
27.02.2016	Distriksmästerskap 2016	Umeå skytteallians	
Sight		1: 9.8 → 2: 9.9 → 3: 10.4x ← 4: 9.8 ↓ 5: 10.1 ↓ 6: 10.3 ↗ 7: 10.6x ↓ 8: 10.0 → 9: 9.9 ← 10: 9.9 ←	11: 9.5 → 12: 10.2 ↓ 13: 9.3 ↗ 14: 10.1 ← 15: 9.9 ↑
		Series 95.0	Series 47.0
		Total 0.0	Total 0.0
60 Shots		1: 9.3 ↗ 2: 10.6x ↗ 3: 8.0 ← 4: 9.4 ← 5: 9.4 ← 6: 9.8 ↓ 7: 9.3 → 8: 9.6 ← 9: 9.8 ↓ 10: 8.0 ↗	11: 9.5 ← 12: 8.9 ← 13: 10.0 ← 14: 9.9 ← 15: 10.7x ↗ 16: 8.6 ↓ 17: 9.4 ↗ 18: 10.6x ↑ 19: 9.2 → 20: 9.0 ↓
		Series 89.0	Series 91.0
		Total 89.0	Total 180.0
60 Shots		21: 8.8 ↗ 22: 8.4 → 23: 10.5x ← 24: 10.5x ↗ 25: 10.1 → 26: 9.7 → 27: 9.6 ↓ 28: 8.7 → 29: 8.8 ← 30: 9.1 ↑	31: 9.6 → 32: 10.2 → 33: 10.0 → 34: 9.8 ↓ 35: 10.5x ↗ 36: 9.2 ↑ 37: 9.7 ↑ 38: 10.3 ↑ 39: 9.3 ← 40: 10.1 ↗
		Series 89.0	Series 95.0
		Total 269.0	Total 364.0
60 Shots		41: 9.4 ← 42: 10.3 ↗ 43: 10.6x ← 44: 10.7x ← 45: 10.5x ↓ 46: 9.7 ← 47: 10.2 ← 48: 8.5 ↑ 49: 10.2 ← 50: 10.2 →	51: 10.6x ← 52: 10.2 ↓ 53: 10.5x ↓ 54: 10.3 ↑ 55: 9.7 ← 56: 10.4x ↑ 57: 9.2 ↑ 58: 9.6 ↓ 59: 9.6 ↗ 60: 10.0 ↓
		Series 96.0	Series 96.0
		Total 460.0	Total 556.0

Relay	Lane	Ulf Eriksson	
1	10		

S	Nysätra PK		
---	------------	--	--

27.02.2016	Distriksmästerskap 2016	Umeå skytteallians
------------	-------------------------	--------------------

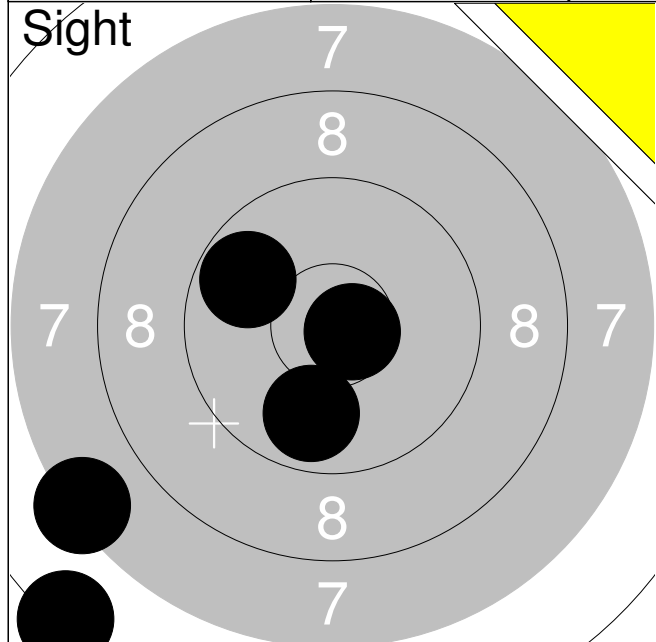

1:	9.9	↓
2:	7.4	↙
3:	6.4	↘
4:	9.8	↗
5:	10.7x	→
Series		41.0
Total		0.0

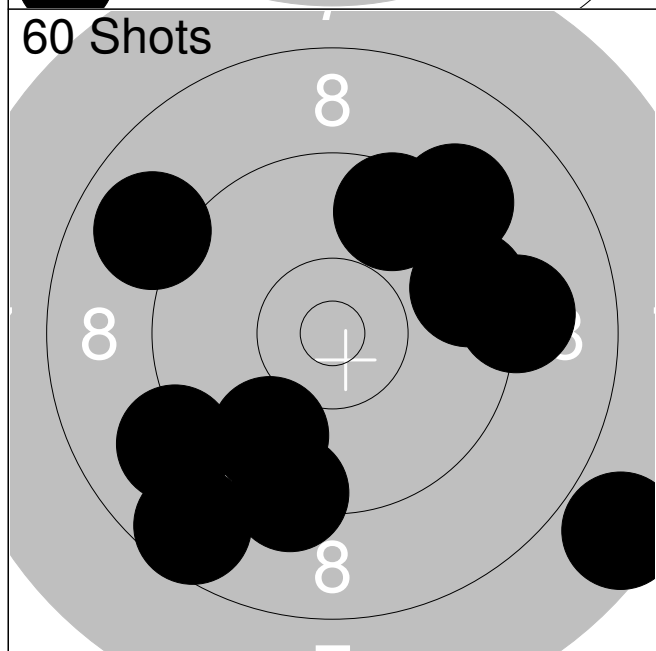

1:	9.4	↓
2:	9.8	↙
3:	9.6	→
4:	9.0	↖
5:	9.7	↗
6:	7.6	↘
7:	9.2	→
8:	8.7	↙
9:	9.2	↗
10:	9.1	↘
Series		87.0
Total		87.0

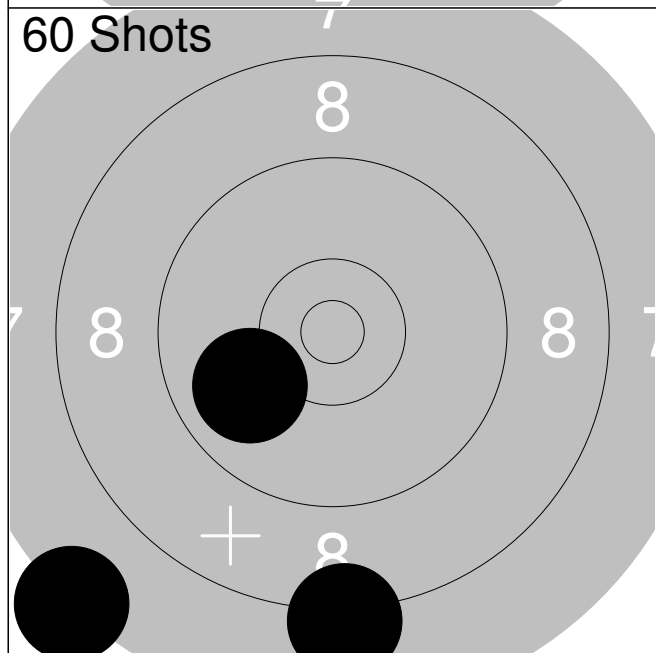

11:	8.1	↓
12:	7.2	↙
13:	10.0	↘
Series		25.0
Total		112.0

Relay **1** Lane **11** **Ulf Eriksson**

S Nysätra PK

27.02.2016 Distriktsmästerskap 2016 Umeå skytteallians

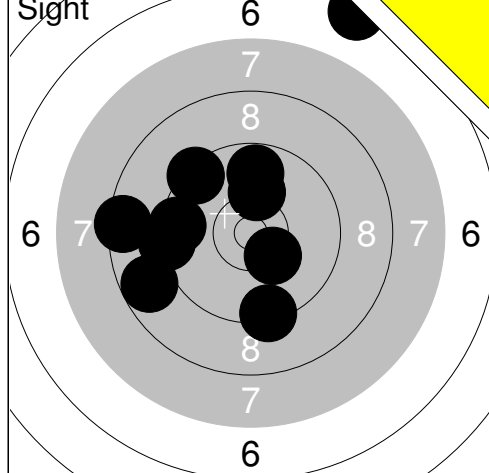

1:	8.8	↙
2:	8.5	←
3:	9.3	←
4:	9.5	←
5:	9.4	↗
6:	6.2	↗
7:	10.3	↘
8:	9.4	↓
9:	9.8	↑
10:	10.2	↑
Series	87.0	
Total	0.0	

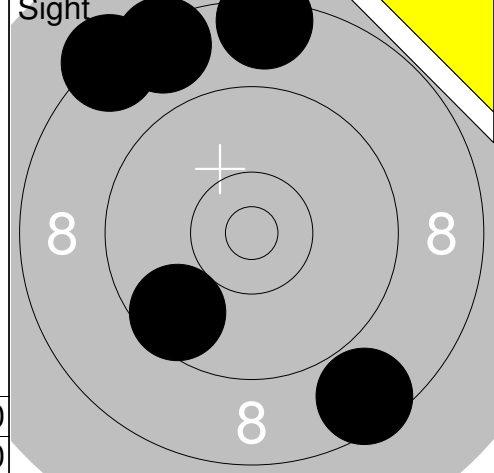

11:	8.6	↘
12:	8.5	↗
13:	8.4	↗
14:	9.7	↘
15:	8.5	↑
Series	41.0	
Total	0.0	

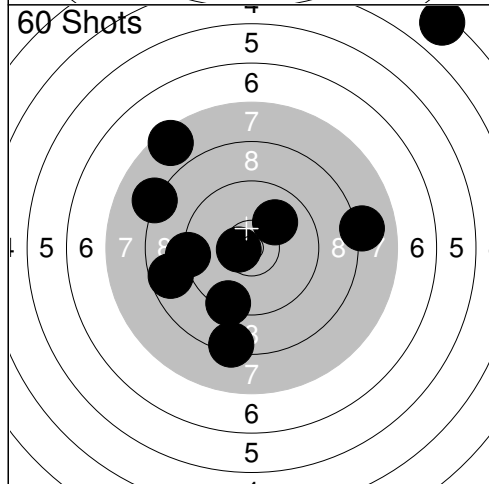

1:	8.2	↖
2:	8.1	→
3:	10.1	↗
4:	9.4	↓
5:	8.8	←
6:	8.4	↓
7:	3.4	↗
8:	10.6x	←
9:	9.3	←
10:	7.6	↗
Series	80.0	
Total	80.0	

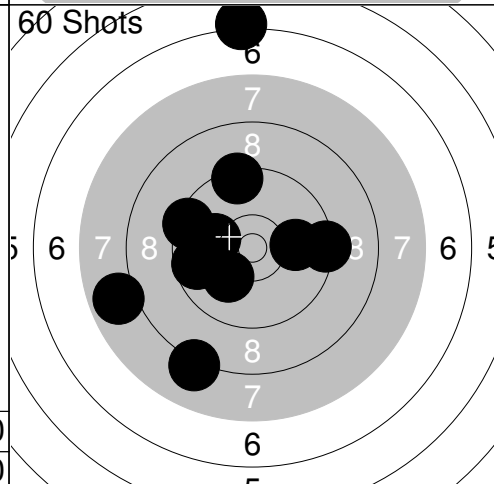

11:	9.7	←
12:	10.0	→
13:	7.9	←
14:	8.1	↓
15:	9.5	←
16:	9.4	→
17:	10.1	↘
18:	6.1	↑
19:	10.1	←
20:	9.4	↑
Series	87.0	
Total	167.0	

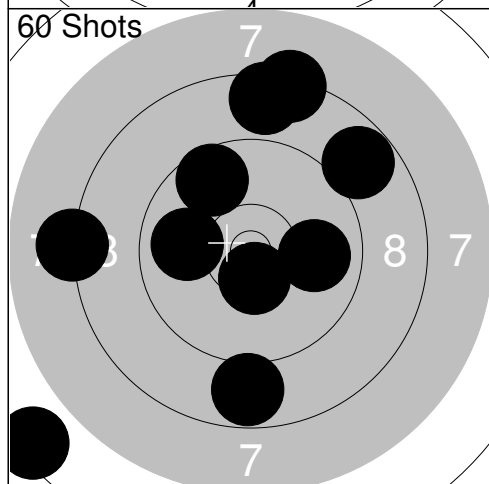

21:	10.0	←
22:	9.7	↗
23:	8.2	←
24:	8.6	↑
25:	8.8	↗
26:	8.8	↓
27:	8.3	↑
28:	10.5x	↓
29:	6.5	↙
30:	10.0	→
Series	85.0	
Total	252.0	

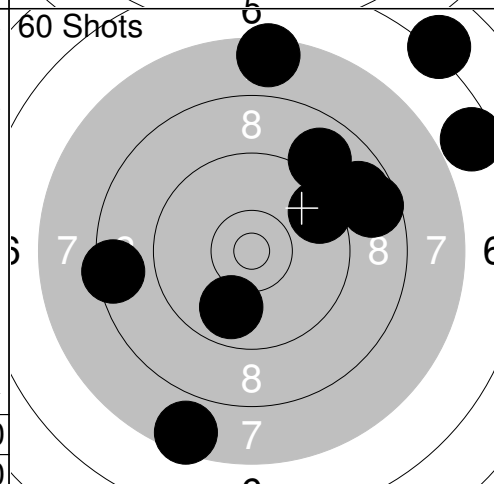

31:	6.6	↗
32:	9.0	↗
33:	9.9	↓
34:	9.6	↗
35:	7.5	↑
36:	6.1	↗
37:	8.8	↗
38:	8.7	→
39:	8.5	←
40:	7.6	↓
Series	77.0	
Total	329.0	

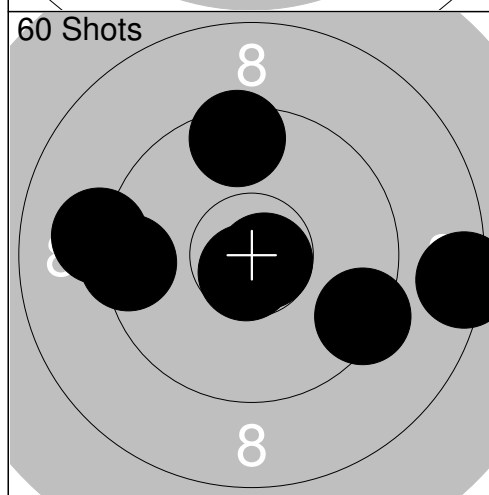

41:	10.7x	↓
42:	10.8x	→
43:	9.5	←
44:	9.2	←
45:	9.6	↑
46:	8.5	→
47:	9.5	↘
Series	64.0	
Total	393.0	

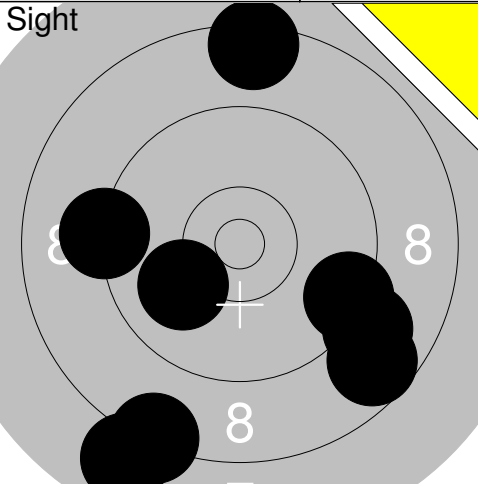
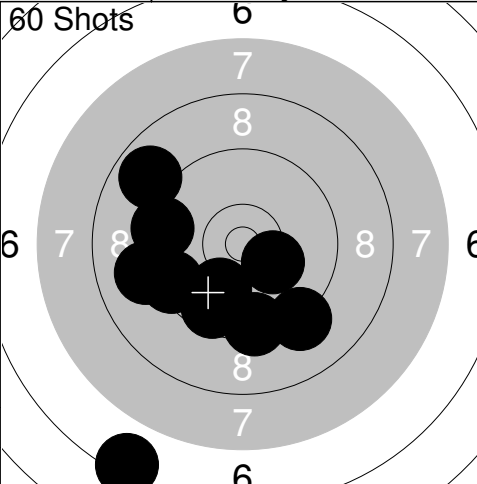
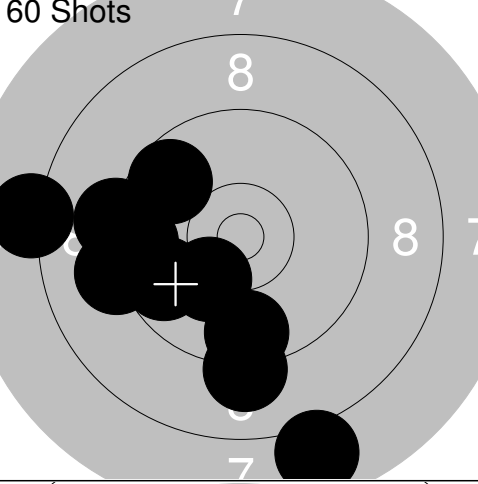
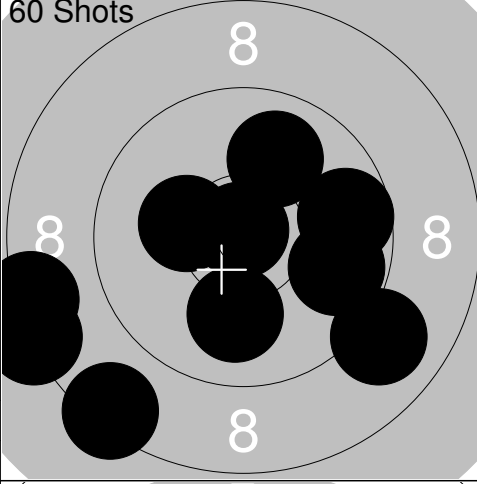
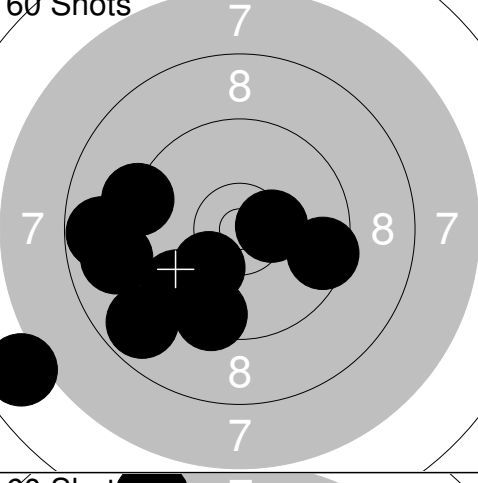
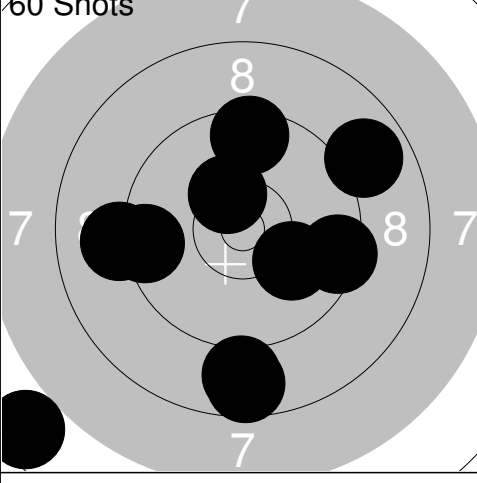
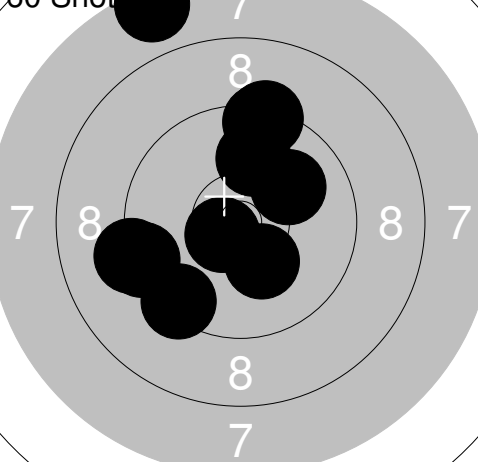
Relay	Lane	Patrik Frost	
1	12		
S	Skellefteå PK		
27.02.2016	Distriktsmästerskap 2016	Umeå skytteallians	
Sight		1: 9.0 ↘ 2: 8.7 ↘ 3: 7.9 ↓ 4: 10.1 ↙ 5: 8.5 ↑ 6: 9.4 ↘ 7: 8.3 ↓ 8: 9.3 ←	60 Shots 
	Series 68.0		1: 9.5 ↓ 2: 6.4 ↓ 3: 9.5 ← 4: 9.1 ← 5: 10.3 ↘ 6: 9.5 ← 7: 9.7 ↓ 8: 8.9 ↗ 9: 10.0 ↓ 10: 9.2 ↓
	Total 0.0		Series 88.0
60 Shots		11: 7.9 ↓ 12: 9.3 ← 13: 9.7 ↓ 14: 10.2 ↘ 15: 9.2 ↓ 16: 9.2 ← 17: 8.1 ← 18: 9.7 ↗ 19: 9.8 ↙ 20: 9.5 ←	60 Shots 
	Series 88.0		21: 9.8 → 22: 8.4 ↓ 23: 10.1 ↓ 24: 8.3 ← 25: 10.9x ↗ 26: 10.0 ↗ 27: 8.4 ← 28: 9.8 → 29: 10.3 ← 30: 9.0 ↘
	Total 176.0		Series 91.0
60 Shots		31: 9.6 ↙ 32: 9.5 ↓ 33: 6.9 ↙ 34: 8.8 ← 35: 9.3 ← 36: 8.9 ↙ 37: 9.6 → 38: 10.5x → 39: 10.2 ↙ 40: 9.0 ←	60 Shots 
	Series 87.0		41: 10.1 ↘ 42: 9.5 ← 43: 9.2 ← 44: 8.7 ↓ 45: 8.9 ↗ 46: 8.8 ↓ 47: 6.7 ↙ 48: 10.4x ↗ 49: 9.5 → 50: 9.6 ↑
	Total 354.0		Series 86.0
60 Shot		51: 10.0 ↑ 52: 10.3 ↓ 53: 9.4 ← 54: 9.5 ↙ 55: 9.5 ↑ 56: 9.4 ↑ 57: 9.3 ← 58: 10.6x ↙ 59: 10.1 ↗ 60: 7.5 ↗	
	Series 92.0		
	Total 532.0		

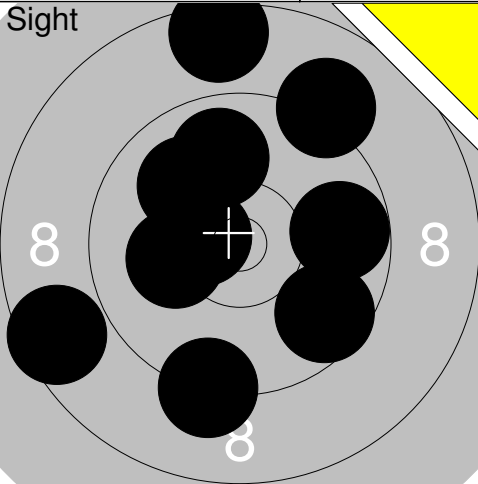
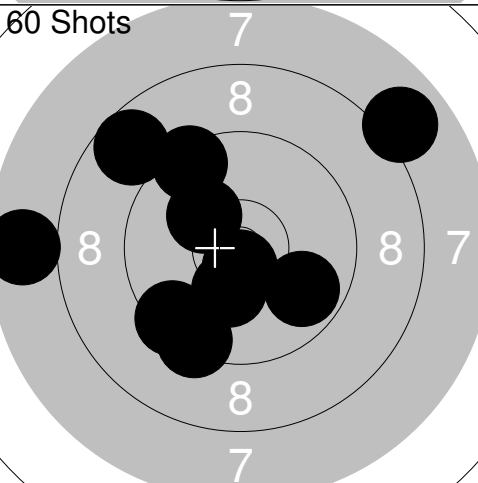
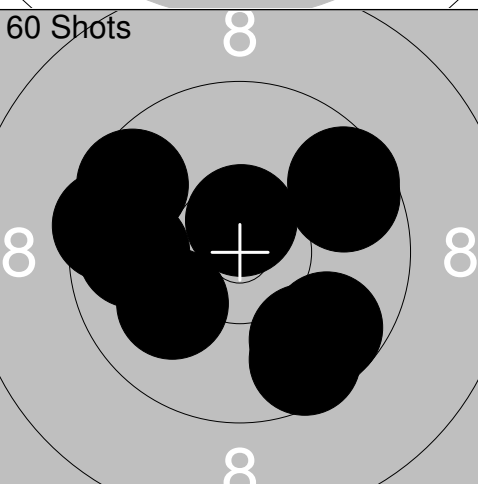
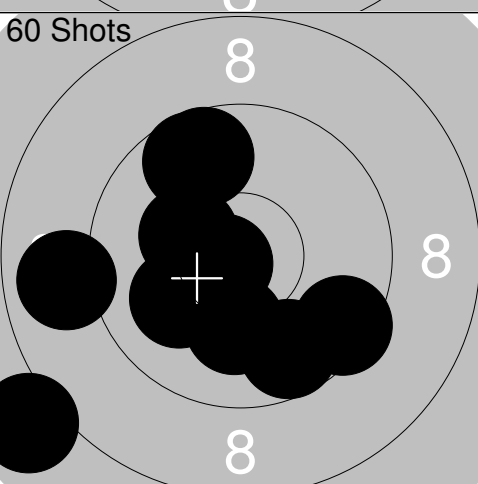
Relay	Lane	Lennart Selander	
S	13	Örnsköldsvik PK	
27.02.2016	Distriktsmästerskap 2016	Umeå skytteallians	
Sight		1: 8.6 ↙ 2: 9.7 ↘ 3: 9.3 ↓ 4: 10.2 ← 5: 9.8 → 6: 10.1 ↗ 7: 9.9 ↑ 8: 8.5 ↑ 9: 9.1 ↗ 10: 10.5x ←	Sight
		Series 91.0	11: 8.4 →
		Total 0.0	Series 8.0
			Total 0.0
60 Shots		1: 10.3 ↓ 2: 9.9 ↘ 3: 9.5 ↗ 4: 8.8 ↗ 5: 9.4 ↓ 6: 7.7 ← 7: 8.0 ↗ 8: 9.5 ↓ 9: 10.7x ↓ 10: 10.2 ↗	60 Shots
		Series 89.0	11: 10.0 ↗
		Total 89.0	12: 9.4 ↑
			13: 8.1 →
			14: 10.2 →
			15: 10.4x ↓
			16: 9.2 ←
			17: 10.6x ←
			18: 10.3 ↓
			19: 8.8 ↑
			20: 9.8 ↑
			Series 93.0
			Total 182.0
60 Shots		21: 9.7 ↓ 22: 9.6 ← 23: 9.7 ↗ 24: 10.1 ← 25: 9.7 ↗ 26: 9.9 ↓ 27: 9.8 ↗ 28: 10.6x ↑ 29: 9.9 ← 30: 9.8 ↓	60 Shots
		Series 92.0	31: 9.8 ↑
		Total 274.0	32: 7.0 ←
			33: 9.5 ↗
			34: 8.4 ←
			35: 10.1 ↓
			36: 10.7x ←
			37: 10.3 ↑
			38: 10.6x ←
			39: 9.5 ↗
			40: 9.9 →
			Series 91.0
			Total 365.0
60 Shots		41: 9.7 ↗ 42: 10.1 ← 43: 9.8 ↗ 44: 10.7x ← 45: 9.6 ↓ 46: 9.0 ← 47: 10.2 ↓ 48: 7.9 ← 49: 9.8 ↓ 50: 10.3 ←	60 Shots
		Series 92.0	51: 10.1 ←
		Total 457.0	52: 9.4 ←
			53: 9.7 ↗
			54: 8.9 ←
			55: 9.4 ↑
			56: 10.4x ↑
			57: 9.7 ↑
			58: 10.7x ↑
			59: 9.3 →
			60: 10.1 ↓
			Series 93.0
			Total 550.0

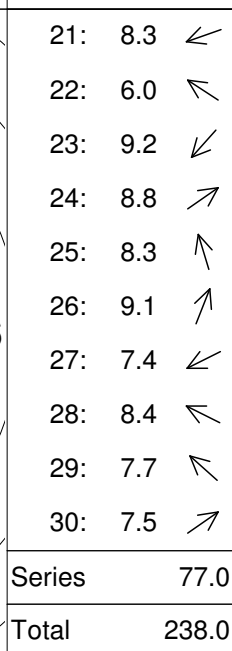
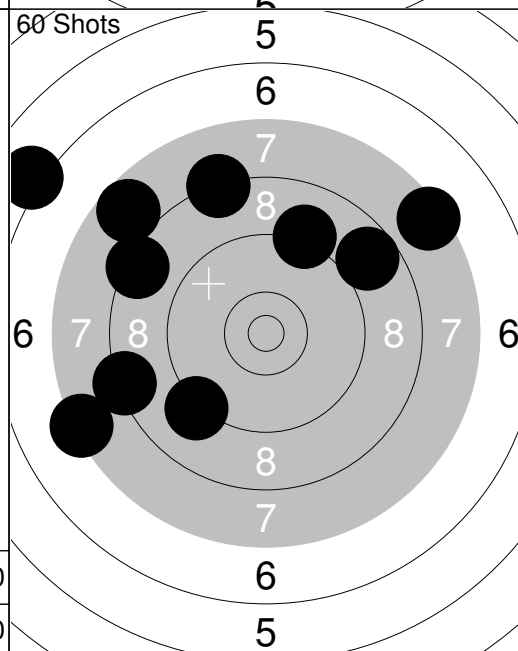
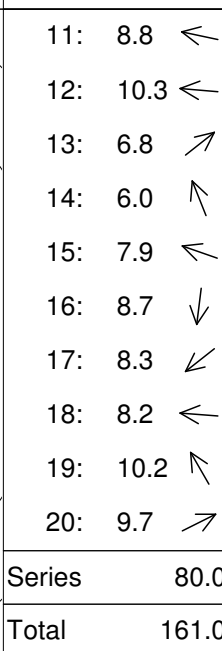
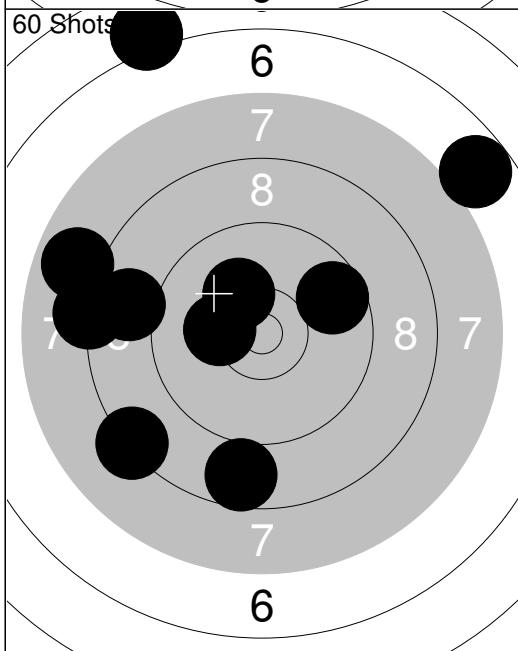
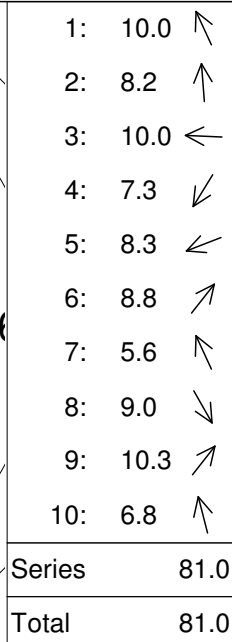
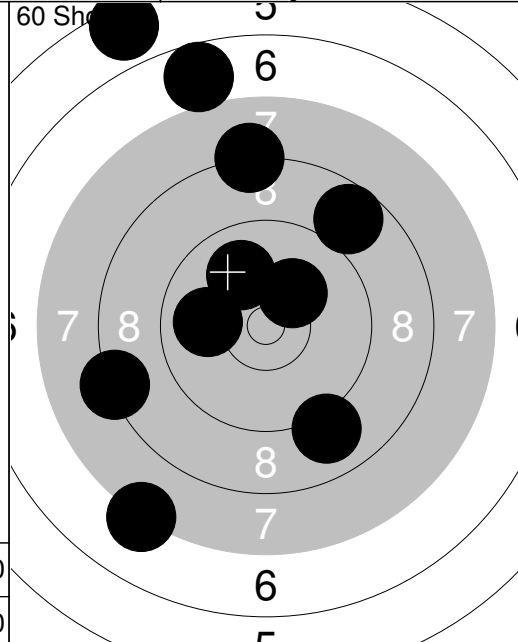
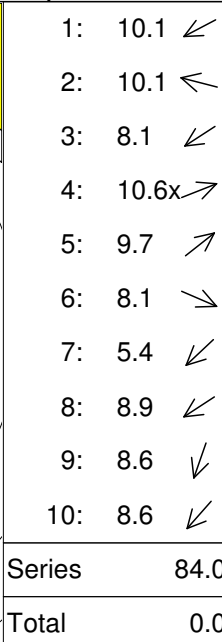
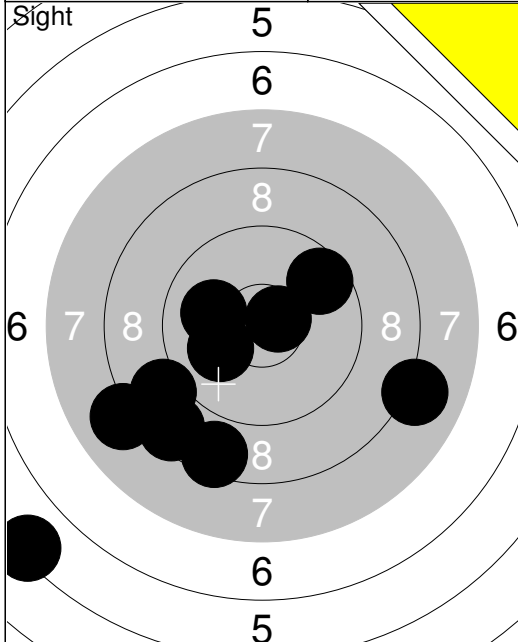

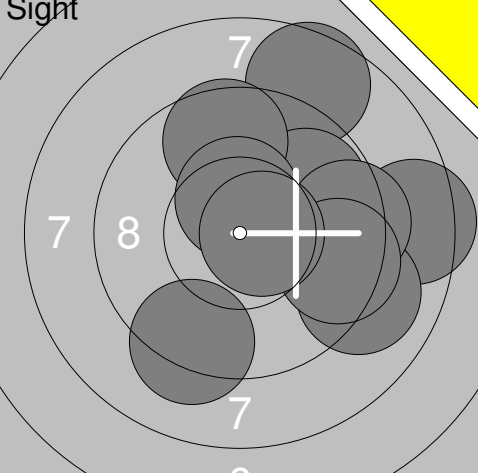
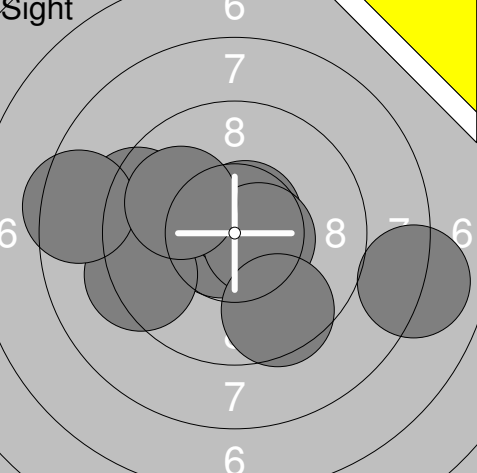
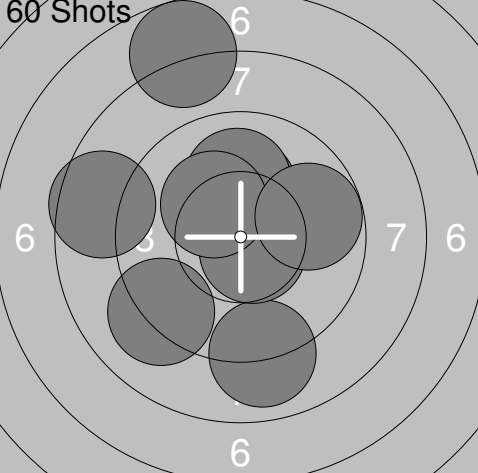
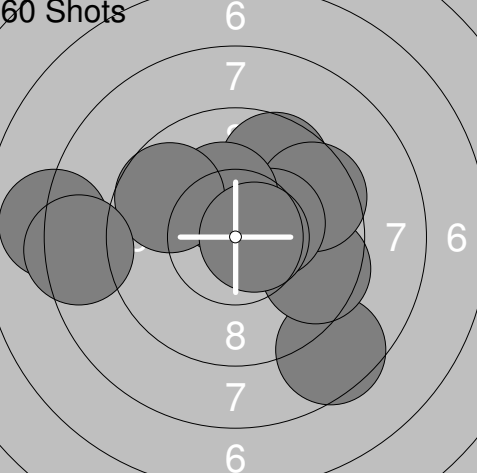
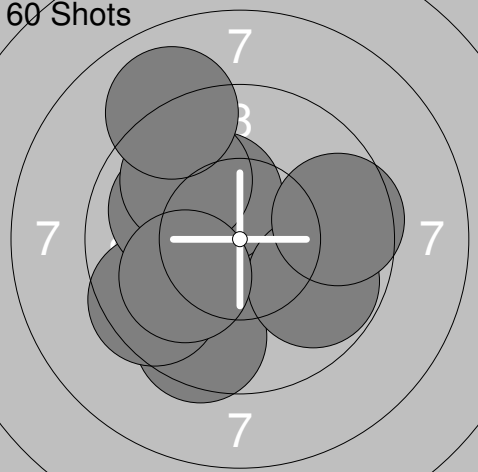
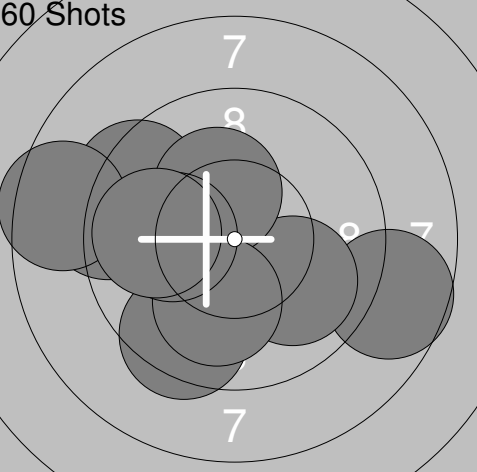
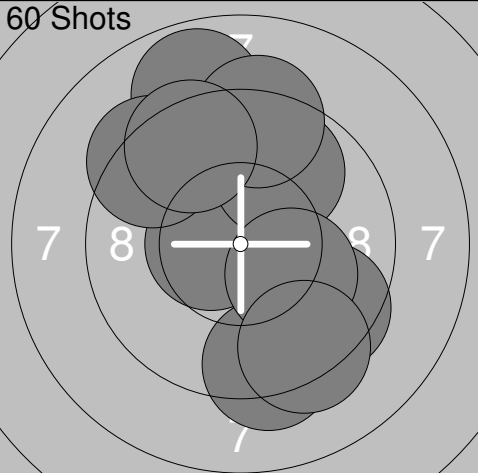
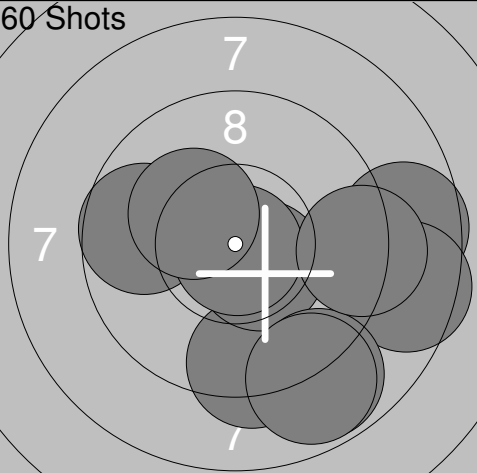
<p>Sight</p> 	<p>1: 8.6 ↗ 2: 8.4 → 3: 9.8 ↗ 4: 9.6 ↑ 5: 9.0 ↘ 6: 9.2 ↓ 7: 10.5x ↑ 8: 9.4 → 9: 9.5 ↘ 10: 10.6x →</p> <p>Series 94.6 Total 0.0</p>	<p>Sight</p> 	<p>11: 10.7x ↙ 12: 10.6x ↗ 13: 9.4 ↖ 14: 10.6x → 15: 8.0 → 16: 9.3 ↖ 17: 8.5 ↖ 18: 9.5 ↓ 19: 10.0 ↗</p> <p>Series 86.6 Total 0.0</p>
<p>60 Shots</p> 	<p>1: 10.2x ↑ 2: 8.6 ↖ 3: 10.7x ↗ 4: 9.0 ↓ 5: 10.0 ↑ 6: 9.1 ↖ 7: 10.7x ↓ 8: 10.3x ↗ 9: 7.7 ↑ 10: 9.8 →</p> <p>Series 96.1 Total 96.1</p>	<p>60 Shots</p> 	<p>11: 9.7 ↗ 12: 8.6 ↓ 13: 9.6 → 14: 9.6 ↗ 15: 10.3x → 16: 10.3x ↑ 17: 8.0 ↖ 18: 9.7 ↗ 19: 8.4 ↖ 20: 10.6x →</p> <p>Series 94.8 Total 190.9</p>
<p>60 Shots</p> 	<p>21: 10.3x ↖ 22: 9.5 ↓ 23: 10.3x ↗ 24: 9.5 ↖ 25: 9.8 ↘ 26: 10.0 ↗ 27: 9.6 → 28: 9.9 ↗ 29: 9.0 ↗ 30: 10.1 ↖</p> <p>Series 98.0 Total 288.9</p>	<p>60 Shots</p> 	<p>31: 9.2 ↖ 32: 8.7 → 33: 10.0 ↓ 34: 9.4 ↗ 35: 10.3x ↗ 36: 8.5 ↖ 37: 9.4 ↓ 38: 10.1 ↓ 39: 10.1 ↖ 40: 9.9 ↖</p> <p>Series 95.6 Total 384.5</p>
<p>60 Shots</p> 	<p>41: 10.6x ↖ 42: 8.9 ↑ 43: 9.8 ↗ 44: 9.3 ↓ 45: 9.5 ↘ 46: 9.3 ↑ 47: 10.2x ↘ 48: 9.3 ↗ 49: 9.5 ↗ 50: 9.3 ↓</p> <p>Series 95.7 Total 480.2</p>	<p>60 Shots</p> 	<p>51: 8.6 → 52: 8.5 → 53: 9.3 ↓ 54: 10.5x ↓ 55: 9.7 ↖ 56: 8.8 ↓ 57: 10.9x ↓ 58: 8.8 ↓ 59: 10.2x ↗ 60: 9.2 →</p> <p>Series 94.5 Total 574.7</p>

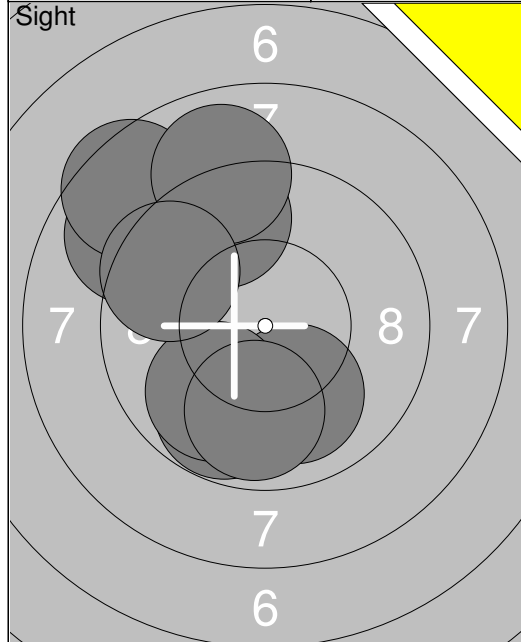

1: 9.5 ↗
2: 9.8 ↘
3: 8.9 ↖
4: 8.5 ↗
5: 8.9 ↗
6: 10.0 ↘
7: 9.9 ↘
9: 9.9 ↘
10: 9.5 ↖
Series 84.9
Total 0.0

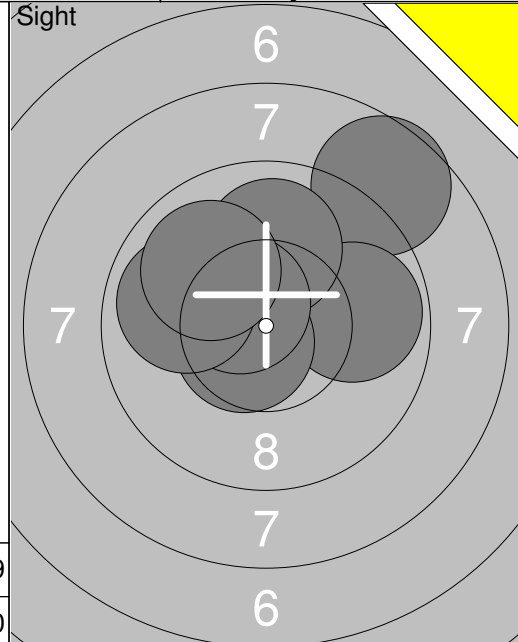

11: 8.6 ↗
12: 9.8 →
13: 10.0 ↑
14: 10.6x ↙
15: 10.2x ↖
16: 10.5x ↖
17: 9.9 ←
18: 10.0 ↖
Series 79.6
Total 0.0

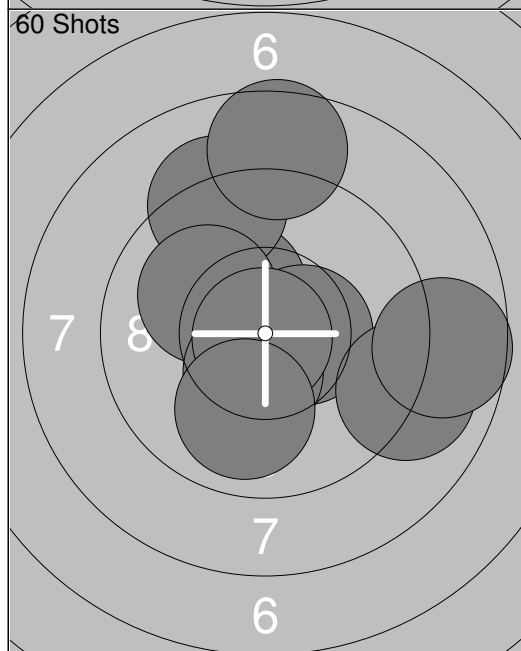

1: 10.3x ↖
2: 9.2 ↗
3: 10.5x →
4: 8.6 ↗
5: 10.1 ↖
6: 10.4x ↘
7: 10.9x ↘
8: 9.0 →
9: 8.7 →
10: 10.0 ↘
Series 97.7
Total 97.7

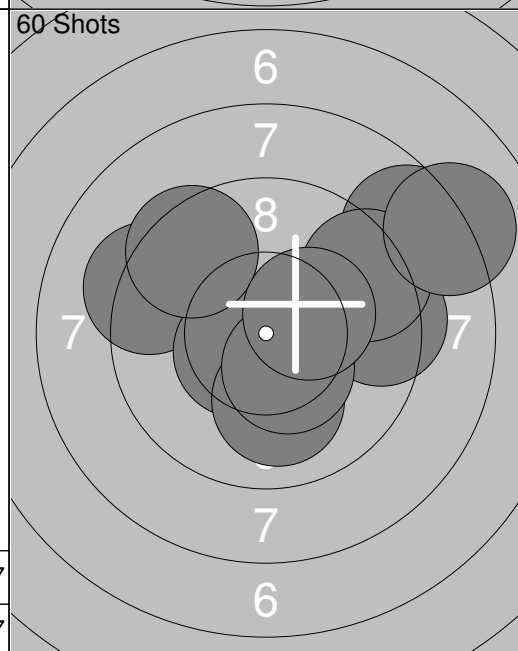

11: 8.6 ↗
12: 9.4 →
13: 9.3 ←
14: 10.5x ↙
15: 9.4 ↗
16: 8.1 ↗
17: 10.0 ↘
18: 10.4x ↘
19: 9.5 ↖
20: 10.3x →
Series 95.5
Total 193.2

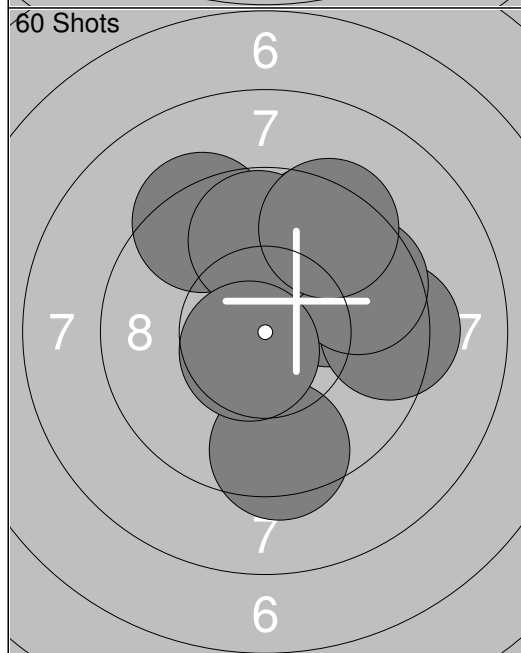

21: 9.4 ↘
22: 9.5 ↗
23: 10.0 →
24: 9.5 ↗
25: 9.3 ↖
26: 9.4 →
27: 9.6 →
28: 9.8 ↗
29: 10.6x ↙
30: 9.4 ↗
Series 96.5
Total 289.7

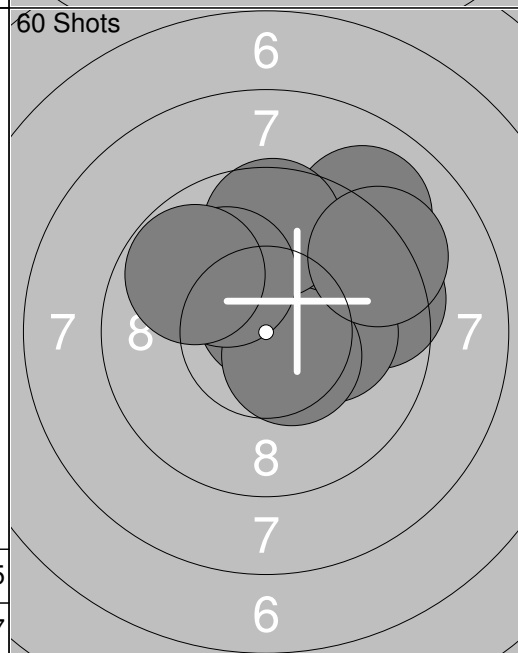

31: 9.5 →
32: 10.4x ↗
33: 9.0 ↗
34: 10.7x ↗
35: 10.2x →
36: 10.5x ↘
37: 9.6 ↗
38: 10.1 ↖
39: 9.8 ↖
40: 9.2 ↗
Series 99.0
Total 388.7

<p>Sight</p>  <p style="text-align: center;">3 4 5 6 7 8 4 5 6 8 5 4 6 5 4 3</p>	<p>1: 9.9 ↙</p> <p>2: 8.1 →</p> <p>3: 10.4x ↙</p> <p>4: 10.2x ↓</p> <p>5: 8.2 →</p> <p>6: 9.3 ↓</p> <p>7: 8.2 ↓</p> <p>8: 7.9 ↓</p> <p>9: 9.1 ←</p> <p>10: 5.8 →</p> <hr/> <p>Series 87.1</p> <hr/> <p>Total 0.0</p>	<p>Sight</p>  <p style="text-align: center;">3 4 5 6 7 8 5 6 7 8 6 5 6 5 4 3</p>	<p>11: 10.2x ↓</p> <p>12: 9.0 ↓</p> <p>13: 9.1 →</p> <p>14: 6.3 →</p> <p>15: 9.2 ↓</p> <p>16: 10.1 ↓</p> <p>17: 8.1 ↓</p> <hr/> <p>Series 62.0</p> <hr/> <p>Total 0.0</p>
-----------------------------------------------------------------------------------------------------------------------------------------------------------------------------------------------------------------	----------------------------------------------------------------------------------------------------------------------------------------------------------------------------------------------------------------------	-------------------------------------------------------------------------------------------------------------------------------------------------------------------------------------------------------------------	---------------------------------------------------------------------------------------------------------------------------------------------------------------------------

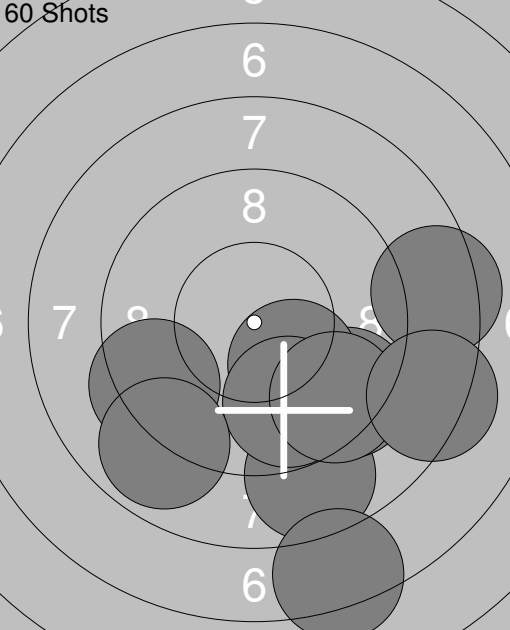
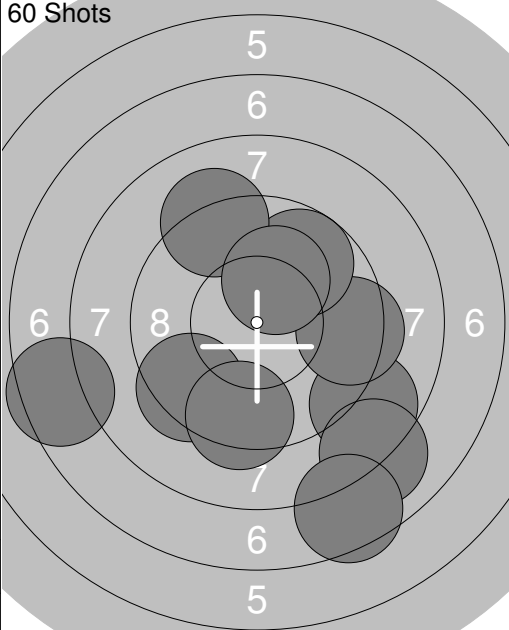
<p>60 Shots</p>  <p style="text-align: center;">6 7 8 7 8 8 8 8 7 6</p>	<p>1: 8.7 ↓</p> <p>2: 9.4 ↓</p> <p>3: 10.2x ↓</p> <p>4: 9.8 ↓</p> <p>5: 7.3 ↓</p> <p>6: 8.4 →</p> <p>7: 9.3 ←</p> <p>8: 9.4 ↓</p> <p>9: 8.9 ↓</p> <p>10: 8.3 →</p> <hr/> <p>Series 89.7</p> <hr/> <p>Total 89.7</p>	<p>60 Shots</p>  <p style="text-align: center;">5 6 7 6 7 8 7 6 7 6 5</p>	<p>11: 8.7 ↓</p> <p>12: 7.5 ←</p> <p>13: 9.4 ↙</p> <p>14: 9.4 →</p> <p>15: 9.4 ↓</p> <p>16: 9.7 ↗</p> <p>17: 9.2 ↗</p> <p>18: 8.1 ↓</p> <p>19: 7.5 ↓</p> <p>20: 10.2x ↗</p> <hr/> <p>Series 89.1</p> <hr/> <p>Total 178.8</p>
-------------------------------------------------------------------------------------------------------------------------------------------------------------------------------------	---------------------------------------------------------------------------------------------------------------------------------------------------------------------------------------------------------------------	---------------------------------------------------------------------------------------------------------------------------------------------------------------------------------------------	-------------------------------------------------------------------------------------------------------------------------------------------------------------------------------------------------------------------------------

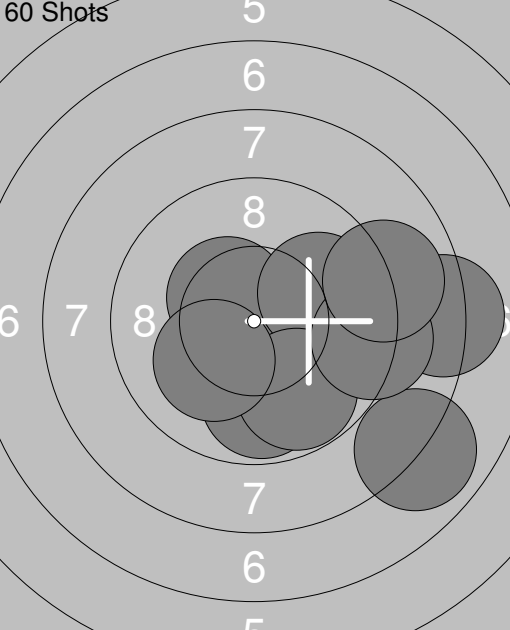
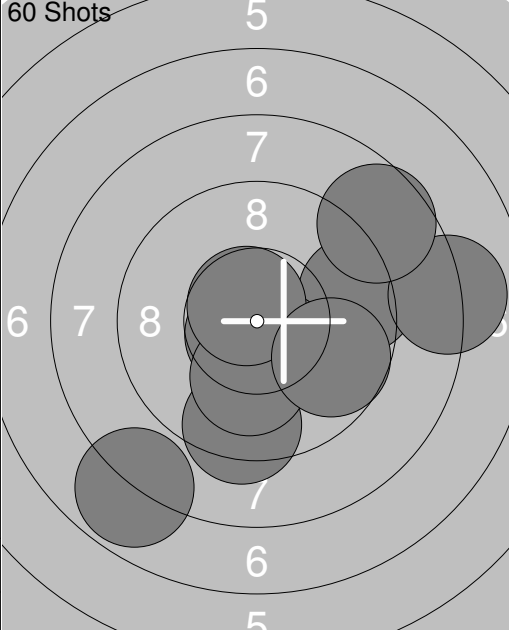
<p>60 Shots</p>  <p style="text-align: center;">5 6 7 8 6 7 8 8 8 7 6 5</p>	<p>21: 8.2 →</p> <p>22: 7.9 ↓</p> <p>23: 9.8 →</p> <p>24: 10.4x ↗</p> <p>25: 9.8 ↓</p> <p>26: 9.9 →</p> <p>27: 9.8 ↓</p> <p>28: 10.1 ←</p> <p>29: 9.2 →</p> <p>30: 9.0 →</p> <hr/> <p>Series 94.1</p> <hr/> <p>Total 272.9</p>	<p>60 Shots</p>  <p style="text-align: center;">5 6 7 8 6 7 8 8 8 7 6 5</p>	<p>31: 9.4 ↓</p> <p>32: 9.4 →</p> <p>33: 7.8 ↙</p> <p>34: 10.4x ↓</p> <p>35: 8.1 →</p> <p>36: 10.7x ↙</p> <p>37: 8.6 ↗</p> <p>38: 10.1 ↓</p> <p>39: 10.7x ↗</p> <p>40: 9.7 →</p> <hr/> <p>Series 94.9</p> <hr/> <p>Total 367.8</p>
--------------------------------------------------------------------------------------------------------------------------------------------------------------------------------------------------	--------------------------------------------------------------------------------------------------------------------------------------------------------------------------------------------------------------------------------	----------------------------------------------------------------------------------------------------------------------------------------------------------------------------------------------------	------------------------------------------------------------------------------------------------------------------------------------------------------------------------------------------------------------------------------------

<p>Sight</p>	<p>Sight</p>	
---------------------	---------------------	--

<p>60 Shots</p>	<p>60 Shots</p>	
------------------------	------------------------	--

<p>60 Shots</p>	<p>60 Shots</p>	
------------------------	------------------------	--

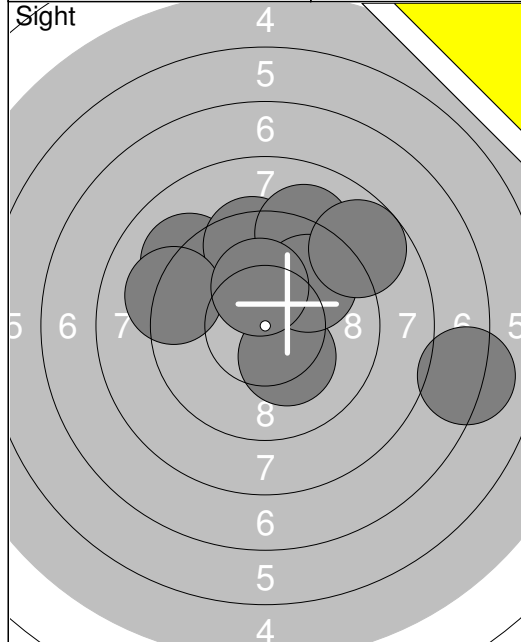

1:	10.3x ↘
2:	9.1 ↗
3:	9.5 ↑
4:	9.1 ↗
5:	9.2 ←
6:	9.8 ↗
7:	10.2x ↑
8:	8.8 ↗
9:	7.2 →
Series 83.2	
Total 0.0	

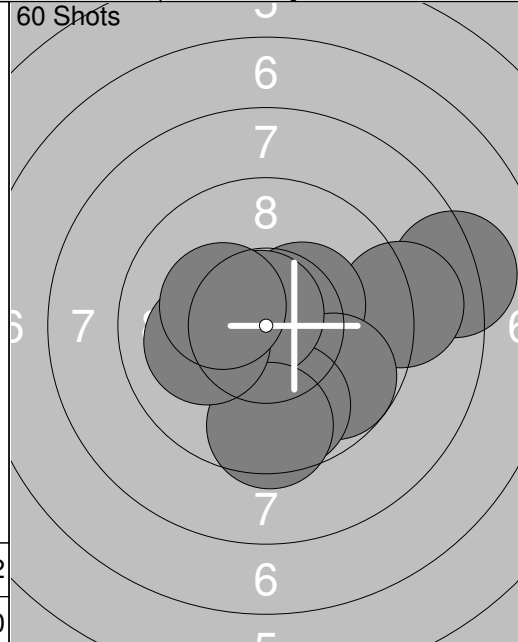

1:	8.2 →
2:	10.3x →
3:	9.0 →
4:	10.4x ↗
5:	9.8 ↘
6:	9.8 ↓
7:	10.8x ↗
8:	9.5 ↓
9:	10.1 ←
10:	10.3x ↖
Series 98.2	
Total 98.2	

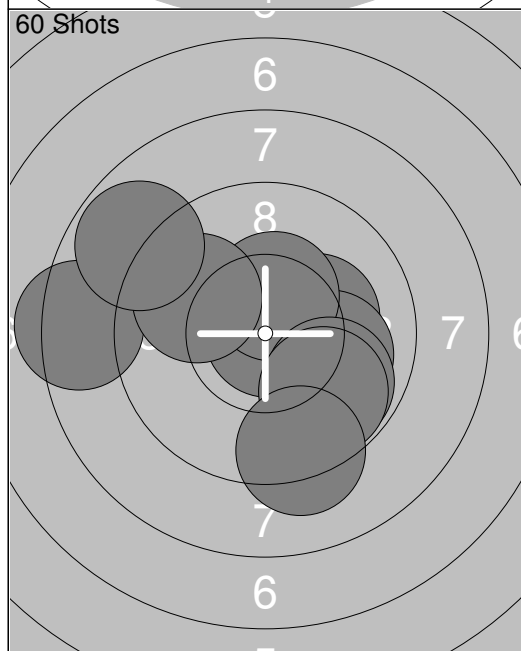

11:	10.2x →
12:	10.0 →
13:	10.9x →
14:	10.4x ↑
15:	8.4 ←
16:	9.8 ↓
17:	9.8 ↓
18:	9.3 ↓
19:	9.9 ↗
20:	8.8 ↗
Series 97.5	
Total 195.7	

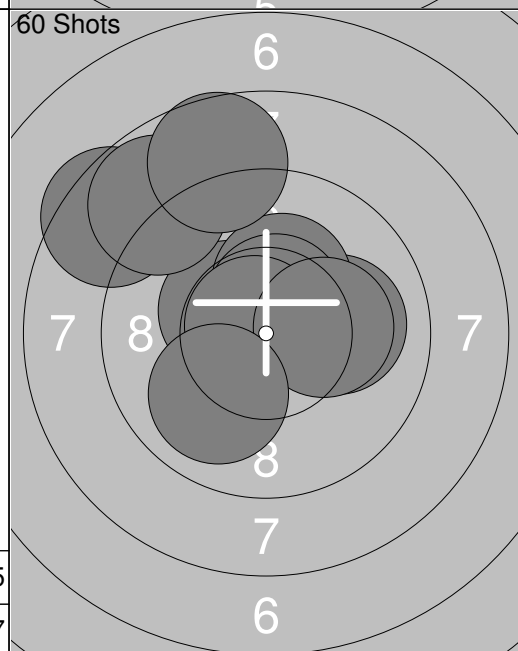

21:	8.5 ↖
22:	10.4x ↖
23:	10.0 →
24:	10.3x ↑
25:	10.5x ↑
26:	10.8x ↖
27:	8.8 ↖
28:	10.2x →
29:	10.0 ↘
30:	8.7 ↑
Series 98.2	
Total 293.9	

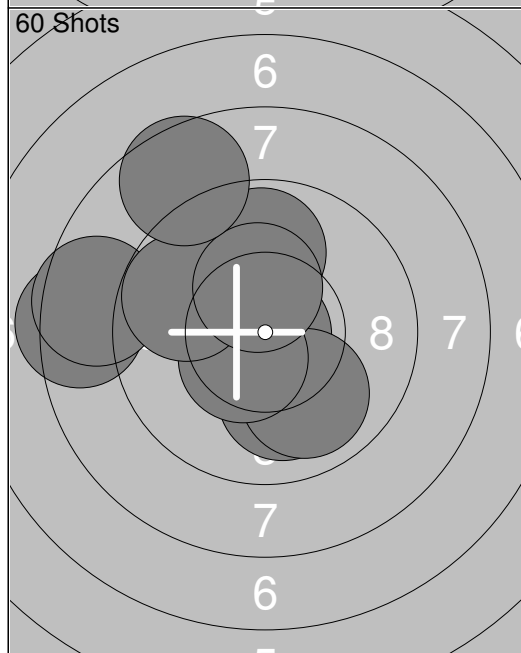

31:	9.9 ↑
32:	8.4 ←
33:	10.9x ↘
34:	10.0 ↓
35:	9.9 ↓
36:	10.5x ↘
37:	8.6 ←
38:	9.8 ↖
39:	10.3x ↑
40:	8.6 ↗
Series 96.9	
Total 390.8	

<p>Sight</p> 	<p>1: 9.9 ←</p> <p>2: 7.6 ↓</p> <p>3: 6.9 ←</p> <p>4: 6.5 →</p> <p>5: 10.8x ↓</p> <p>6: 10.1 ←</p> <p>7: 7.3 ←</p> <p>8: 5.9 ←</p> <p>9: 7.3 ↓</p> <p>10: 8.6 ↓</p> <hr/> <p>Series 80.9</p> <hr/> <p>Total 0.0</p>	<p>60 Shots</p> 	<p>1: 8.7 ←</p> <p>2: 10.6x →</p> <p>3: 5.5 →</p> <p>4: 7.8 ↓</p> <p>5: 9.4 ↓</p> <p>6: 7.3 ↓</p> <p>7: 8.4 ←</p> <p>8: 8.1 →</p> <p>9: 4.4 ↓</p> <p>10: 7.9 ←</p> <hr/> <p>Series 78.1</p> <hr/> <p>Total 78.1</p>
-----------------------------------------------------------------------------------------------	---------------------------------------------------------------------------------------------------------------------------------------------------------------------------------------------------------------------	----------------------------------------------------------------------------------------------------	---------------------------------------------------------------------------------------------------------------------------------------------------------------------------------------------------------------------

<p>60 Shots</p> 	<p>11: 7.0 ↗</p> <p>12: 8.5 ←</p> <p>13: 5.8 ↗</p> <p>14: 8.0 ←</p> <p>15: 10.3x →</p> <p>16: 10.3x ↓</p> <p>17: 5.8 ←</p> <p>18: 9.4 →</p> <p>19: 9.3 ←</p> <p>20: 7.4 ←</p> <hr/> <p>Series 81.8</p> <hr/> <p>Total 159.9</p>	<p>60 Shots</p> 	<p>21: 8.9 →</p> <p>22: 10.7x ↗</p> <p>23: 10.5x ↓</p> <p>24: 9.6 ←</p> <p>25: 9.9 ←</p> <p>26: 10.5x ←</p> <p>27: 9.6 ←</p> <p>28: 9.5 →</p> <p>29: 4.1 ←</p> <p>30: 7.2 ↗</p> <hr/> <p>Series 90.5</p> <hr/> <p>Total 250.4</p>
---------------------------------------------------------------------------------------------------	---------------------------------------------------------------------------------------------------------------------------------------------------------------------------------------------------------------------------------	-----------------------------------------------------------------------------------------------------	-----------------------------------------------------------------------------------------------------------------------------------------------------------------------------------------------------------------------------------

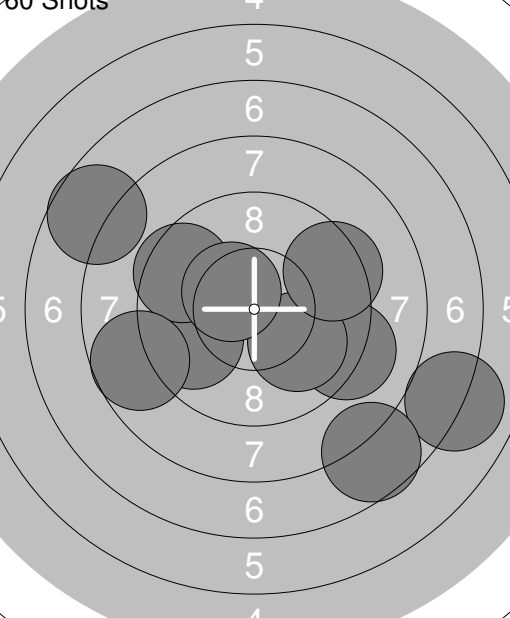
<p>60 Shots</p> 	<p>31: 9.1 →</p> <p>32: 7.7 ↗</p> <p>33: 7.0 →</p> <p>34: 10.0 ↓</p> <p>35: 7.6 ↓</p> <p>36: 9.7 ←</p> <p>37: 9.4 →</p> <p>38: 9.5 ←</p> <p>39: 10.4x ↗</p> <p>40: 8.7 ←</p> <hr/> <p>Series 89.1</p> <hr/> <p>Total 339.5</p>		
----------------------------------------------------------------------------------------------------	--------------------------------------------------------------------------------------------------------------------------------------------------------------------------------------------------------------------------------	--	--

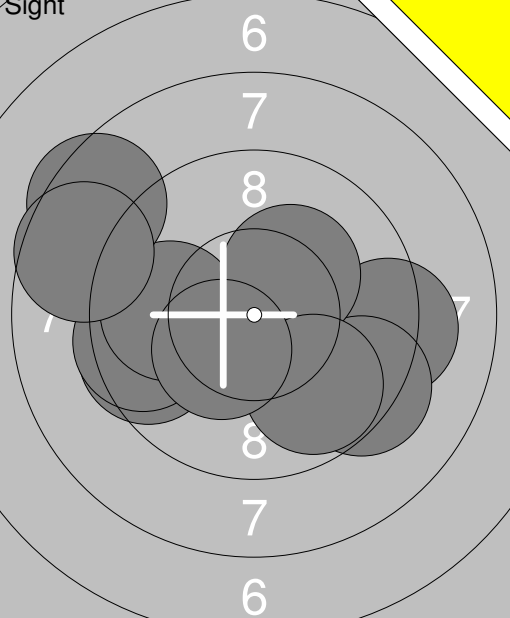
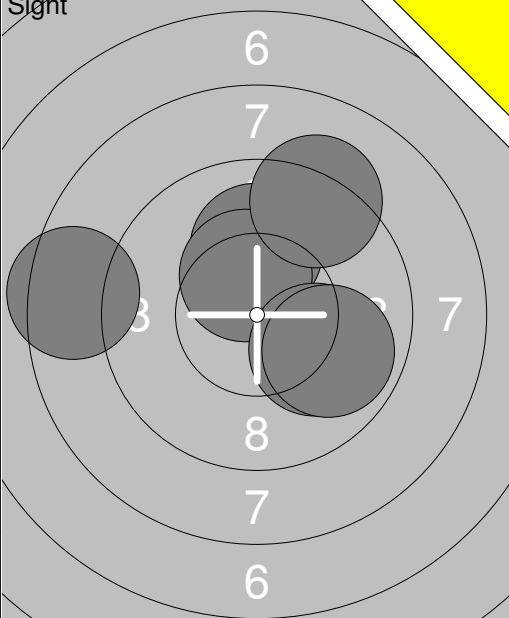
 <p style="text-align:center;">Sight</p>	<p>1: 9.5 ←</p> <p>2: 9.5 ←</p> <p>3: 9.2 →</p> <p>4: 9.9 ←</p> <p>5: 9.3 ↘</p> <p>6: 8.5 ↗</p> <p>7: 10.3x ↗</p> <p>8: 8.6 ←</p> <p>9: 9.8 ↘</p> <p>10: 10.3x ↘</p>	 <p style="text-align:center;">Sight</p>	<p>11: 10.1 ↑</p> <p>12: 10.4x ↗</p> <p>13: 9.2 ↗</p> <p>14: 8.4 ←</p> <p>15: 10.0 ↘</p> <p>16: 9.9 ↘</p>
Series	94.9	Series	58.0
Total	0.0	Total	0.0

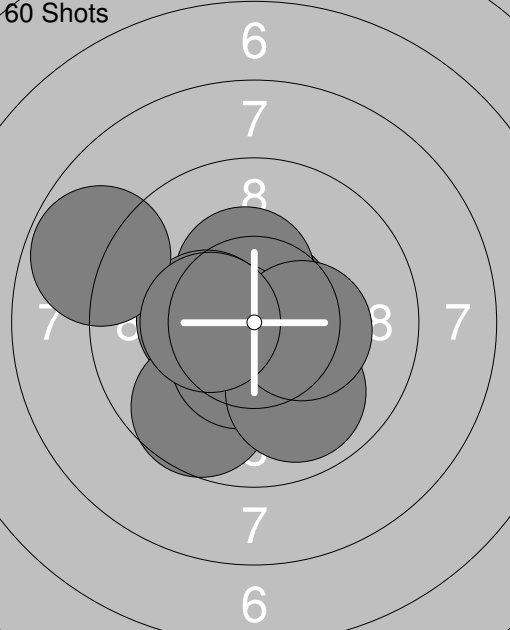
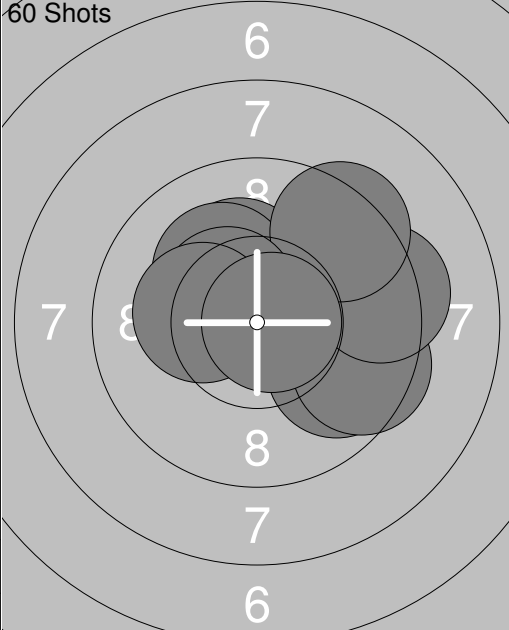
 <p style="text-align:center;">60 Shots</p>	<p>1: 10.7x ↗</p> <p>2: 10.4x ↑</p> <p>3: 10.3x ←</p> <p>4: 10.6x ←</p> <p>5: 9.7 ↘</p> <p>6: 10.5x ↘</p> <p>7: 9.9 ↘</p> <p>8: 8.8 ←</p> <p>9: 10.3x →</p> <p>10: 10.4x ←</p>	 <p style="text-align:center;">60 Shots</p>	<p>11: 10.2x ↗</p> <p>12: 10.7x ↗</p> <p>13: 9.8 ↘</p> <p>14: 10.2x ↗</p> <p>15: 9.5 ↘</p> <p>16: 9.3 →</p> <p>17: 9.4 ↗</p> <p>18: 10.4x ↗</p> <p>19: 10.2x ←</p> <p>20: 10.8x →</p>
Series	101.6	Series	100.5
Total	101.6	Total	202.1

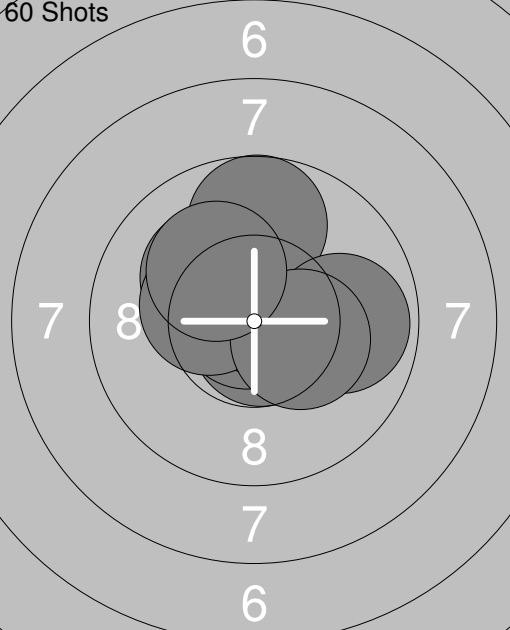
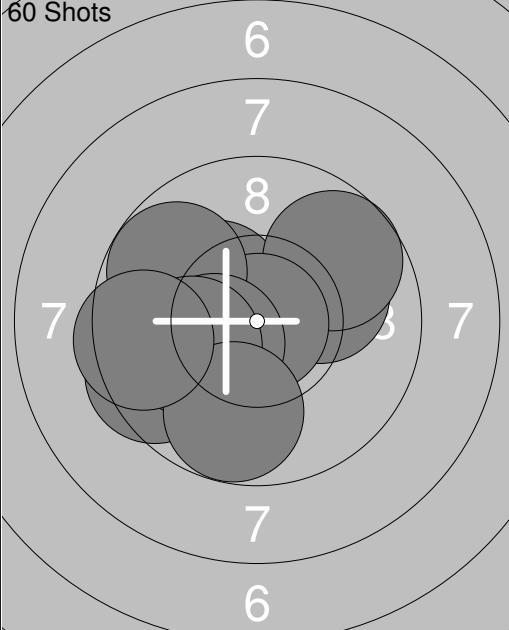
 <p style="text-align:center;">60 Shots</p>	<p>21: 10.7x ↘</p> <p>22: 10.2x ↗</p> <p>23: 10.9x ←</p> <p>24: 10.7x ↗</p> <p>25: 10.3x ↑</p> <p>26: 9.7 ↑</p> <p>27: 9.9 →</p> <p>28: 10.3x ←</p> <p>29: 10.3x →</p> <p>30: 10.1 ↗</p>	 <p style="text-align:center;">60 Shots</p>	<p>31: 10.1 →</p> <p>32: 10.3x ↗</p> <p>33: 9.7 ↗</p> <p>34: 10.9x ↘</p> <p>35: 9.5 ←</p> <p>36: 9.8 ←</p> <p>37: 10.3x ←</p> <p>38: 10.1 ←</p> <p>39: 9.8 ↘</p> <p>40: 9.5 ←</p>
Series	103.1	Series	100.0
Total	305.2	Total	405.2