

Relay 1	Lane 1	Emanuel Söderlund		
S		Kristinehamns Skf		
2016-04-17		Startskottet 2016		Umeå skytteallians
Sight Prone 	1: 8.7 →	Sight Prone 	11: 10.1 →	
	2: 8.9 ↓		12: 9.5 →	
	3: 9.8 ↓		13: 10.1 ↓	
	4: 10.3x ↓		14: 10.1 ↓	
	5: 9.3 ↓		15: 9.6 ←	
	6: 10.5x ↓		16: 9.8 ←	
	7: 10.0 ↓		17: 9.4 ↓	
	8: 9.6 ↓		18: 9.9 ↓	
	9: 9.6 →		19: 9.7 ↑	
	10: 10.5x ↑		20: 10.4x ↓	
Series	97.2	Series	98.6	
Total	0.0	Total	0.0	
Sight Prone 	21: 10.3 →	60 Prone 	1: 10.3x ↓	
	22: 10.6x ↑		2: 10.0 ←	
	23: 9.6 ←		3: 10.2 ↓	
	24: 10.6x ←		4: 9.8 ↓	
Series	41.1		5: 10.7x ↑	
Total	0.0		6: 9.9 →	
			7: 10.2 ↑	
			8: 9.7 ←	
			9: 10.3x ↑	
			10: 10.5x ↑	
Series	102.7	Series	101.6	
Total	204.3	Total	101.6	
60 Prone 	11: 10.0 ↑	60 Prone 	21: 10.7x ↓	
	12: 10.1 ↑		22: 10.5x ↓	
	13: 10.4x ↓		23: 9.3 ↓	
	14: 10.5x ↓		24: 10.1 ↑	
	15: 10.7x →		25: 10.1 ↓	
	16: 9.8 ↓		26: 9.3 ↓	
	17: 10.4x ↓		27: 10.4x ↓	
	18: 10.4x →		28: 10.3 ←	
	19: 9.9 →		29: 9.0 ↑	
	20: 10.5x ↓		30: 9.8 ↑	
Series	102.3	Series	99.5	
Total	406.1	Total	303.8	
60 Prone 	31: 10.1 ↑	60 Prone 	41: 10.2 ↑	
	32: 10.3 ↓		42: 10.7x ↑	
	33: 10.3x ↓		43: 10.4x ←	
	34: 9.9 ↓		44: 10.2 ↑	
	35: 10.2 ↑		45: 10.1 ↑	
	36: 10.4x →		46: 9.8 →	
	37: 10.4x ←		47: 10.4x ↑	
	38: 9.8 ↓		48: 10.8x ↑	
	39: 10.6x ↓		49: 10.0 ←	
	40: 10.3x ↑		50: 9.9 ↓	
Series	101.0	Series	102.5	
Total	609.6	Total	508.6	
60 Prone 	51: 10.5x ↓	Sight Stand 	1: 8.4 →	
	52: 10.7x ↓		2: 9.6 ↓	
	53: 10.1 →		3: 9.2 →	
	54: 10.2 →		4: 9.3 →	
	55: 9.8 ↓		5: 9.4 ↓	
	56: 9.8 ↑		6: 9.2 ↑	
	57: 10.4x ↑		7: 9.5 →	
	58: 9.7 ↓		8: 10.1 ↑	
	59: 9.5 ↓		9: 9.1 ↑	
	60: 10.3 ↑		10: 9.9 ↑	
Series	76.6	Series	93.7	
Total	609.6	Total	609.6	
Sight Stand 	11: 10.0 ↑	2. Series 40 Stand 	1: 9.7 ↓	
	12: 10.0 ↑		2: 9.6 ↓	
	13: 9.8 ↓		3: 9.0 ←	
	14: 9.4 ↓		4: 9.2 ←	
	15: 8.8 ↓		5: 8.5 ←	
	16: 9.9 ↑		6: 9.6 →	
	17: 8.8 ↓		7: 9.7 ←	
	18: 9.9 ↑		8: 8.6 ↑	
Series	76.6	Series	92.1	
Total	609.6	Total	701.7	

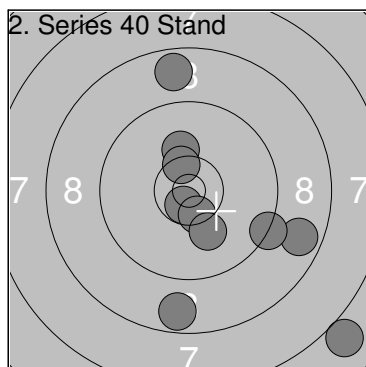

11:	8.7	↑
12:	8.7	→
13:	10.7x	↓
14:	10.2	↑
15:	9.3	↓
16:	7.0	↓
17:	10.5x	↓
18:	8.7	↓
19:	10.1	↓
20:	10.4x	↑

Series	94.3
Total	796.0

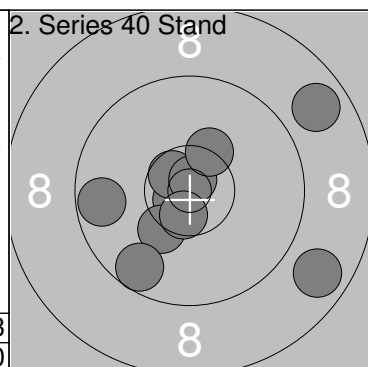

21:	9.7	←
22:	10.7x	↙
23:	10.6x	↗
24:	10.3	↓
25:	9.6	↓
26:	8.8	↗
27:	10.8x	↑
28:	8.8	↓
29:	10.3x	↑
30:	10.6x	↓

Series	100.2
Total	896.2

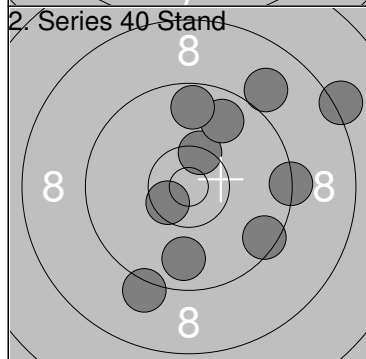

31:	9.3	→
32:	10.5x	↙
33:	10.4x	↑
34:	9.8	↑
35:	9.0	↗
36:	9.5	↘
37:	9.8	↓
38:	9.7	↑
39:	9.2	↓
40:	8.2	↗

Series	95.4
Total	991.6

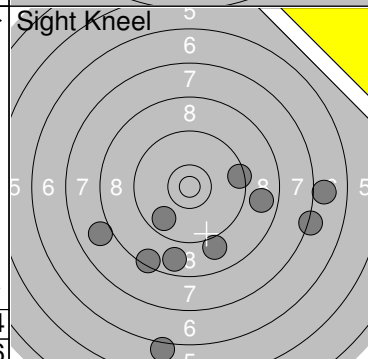

1:	7.0	→
2:	9.0	↓
3:	8.8	↓
4:	8.8	→
5:	9.7	↙
6:	8.5	↘
7:	7.2	↓
8:	6.1	↘
9:	8.0	↙
10:	9.4	→

Series	82.5
Total	991.6

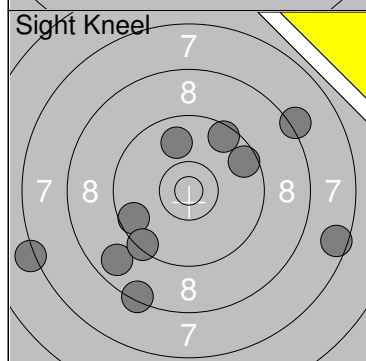

11:	7.2	←
12:	8.8	↙
13:	8.4	↘
14:	9.6	←
15:	9.4	↘
16:	9.5	↑
17:	8.2	↗
18:	9.6	↗
19:	9.9	↑
20:	7.6	↘

Series	88.2
Total	991.6

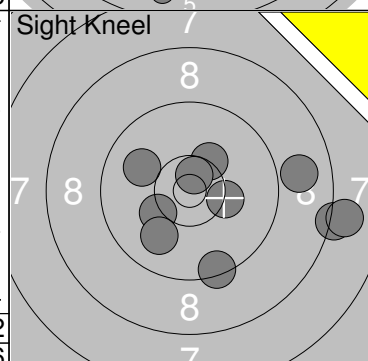

21:	10.2	↙
22:	10.0	↗
23:	8.2	→
24:	10.3	↗
25:	10.3x	↑
26:	10.6x	↑
27:	9.4	↓
28:	8.9	→
29:	8.0	→
30:	9.9	↘

Series	95.8
Total	991.6

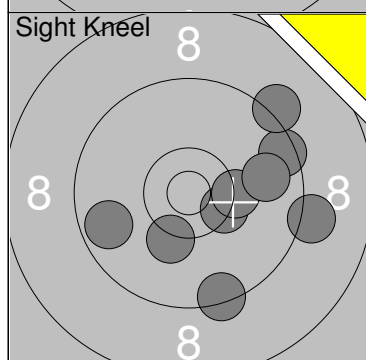

31:	10.2	↓
32:	9.4	↘
33:	9.5	↘
34:	9.2	↗
35:	9.7	←
36:	9.2	→
37:	10.4x	↘
38:	10.3	→
39:	9.8	→

Series	87.7
Total	991.6

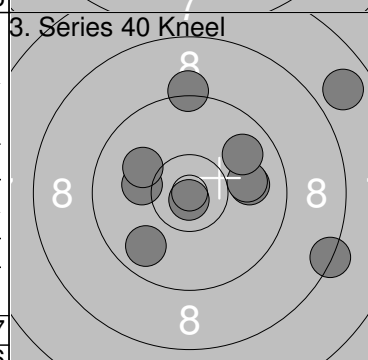

1:	7.8	↗
2:	10.8x	↓
3:	9.2	↑
4:	10.1	←
5:	10.0	↗
6:	9.8	↘
7:	8.3	↘
8:	9.9	→
9:	10.0	→
10:	9.8	↗

Series	95.7
Total	1087.3

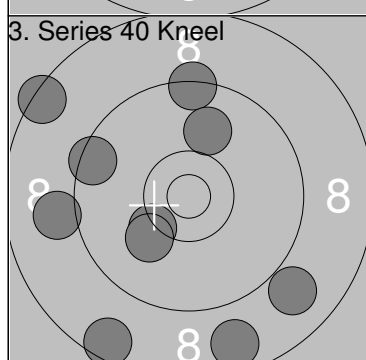

11:	10.3	↙
12:	8.9	↘
13:	8.7	↘
14:	10.1	↙
15:	9.4	↑
16:	9.5	↑
17:	9.0	←
18:	8.4	↗
19:	10.0	↑
20:	8.6	↓

Series	92.9
Total	1180.2

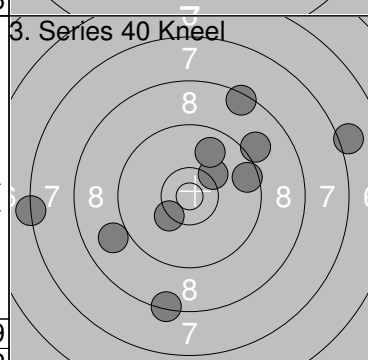

21:	8.4	↓
22:	9.0	↙
23:	10.3x	↙
24:	7.3	←
25:	7.1	→
26:	10.2	↗
27:	8.4	↑
28:	9.1	↗
29:	9.6	→
30:	9.8	↑

Series	89.2
Total	1269.4

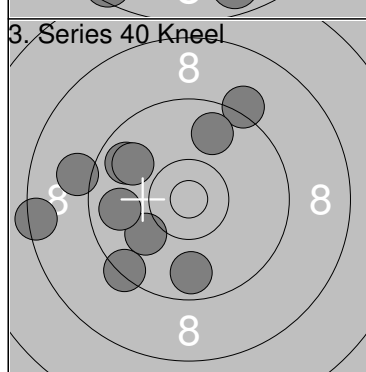

31:	9.8	↗
32:	9.8	↓
33:	9.4	↘
34:	10.0	↙
35:	8.4	←
36:	9.2	↑
37:	9.8	←
38:	9.1	↙
39:	9.8	↑
40:	9.9	↗

Series	95.2
Total	1364.6

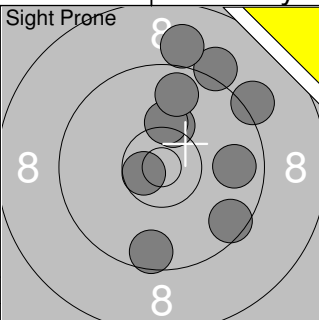
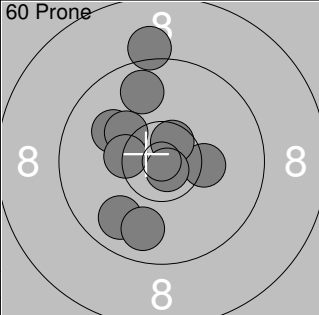
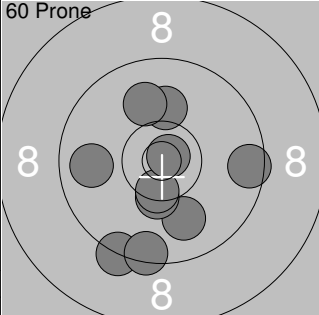
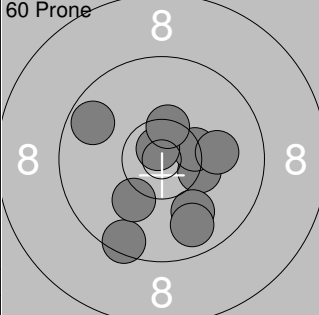
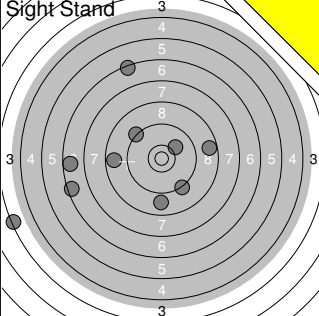
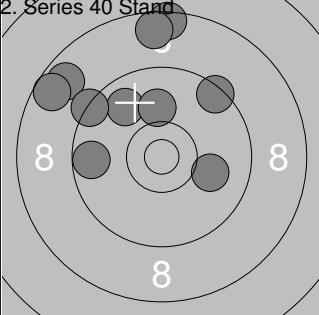
Relay	Lane	Mikael Lundell	
S		Rasbo Skf	
2016-04-17		Startskottet 2016	Umeå skytteallians
Sight Prone		1: 6.7 2: 7.4 3: 9.9 4: 9.9 5: 9.2 6: 10.2 7: 10.0 8: 10.3x 9: 9.8 10: 10.1 Series 93.5 Total 0.0	Sight Prone  11: 9.2 12: 9.6 13: 10.3 14: 9.2 15: 9.0 16: 9.8 17: 9.5 18: 10.2 19: 10.6x 20: 9.8 Series 97.2 Total 0.0
Sight Prone		21: 9.9 22: 10.2 23: 10.7x 24: 9.8 25: 9.7 26: 9.7 27: 9.8 28: 9.9 29: 9.7 30: 8.6 Series 98.0 Total 0.0	60 Prone  1: 9.8 2: 10.0 3: 10.3 4: 9.1 5: 9.8 6: 10.2 7: 10.6x 8: 9.8 9: 10.8x 10: 10.4x Series 100.8 Total 100.8
60 Prone		11: 9.1 12: 10.3x 13: 10.2 14: 10.5x 15: 9.8 16: 10.4x 17: 10.6x 18: 10.0 19: 10.0 20: 10.2 Series 101.1 Total 201.9	60 Prone  21: 10.0 22: 10.4x 23: 9.3 24: 10.1 25: 10.5x 26: 9.5 27: 9.4 28: 10.8x 29: 10.0 30: 9.8 Series 99.8 Total 301.7
60 Prone		31: 9.4 32: 9.6 33: 10.3x 34: 10.3x 35: 10.2 36: 10.2 37: 9.6 38: 9.6 39: 9.0 40: 10.6x Series 98.8 Total 400.5	60 Prone  41: 9.7 42: 10.3x 43: 10.4x 44: 10.1 45: 10.0 46: 9.5 47: 10.1 48: 9.8 49: 10.8x 50: 10.4x Series 101.1 Total 501.6
60 Prone		51: 10.2 52: 10.3x 53: 10.1 54: 9.4 55: 10.5x 56: 10.7x 57: 9.5 58: 10.0 59: 10.4x 60: 10.6x Series 101.7 Total 603.3	Sight Stand  1: 3.4 2: 6.5 3: 6.6 4: 8.9 5: 10.1 6: 9.3 7: 9.3 8: 8.7 9: 6.4 10: 8.7 Series 77.9 Total 603.3
Sight Stand		11: 8.9 12: 8.3 13: 8.7 14: 7.8 15: 9.0 16: 9.9 17: 9.1 18: 8.5 19: 7.9 20: 9.6 Series 87.7 Total 603.3	2. Series 40 Stand  1: 8.7 2: 8.6 3: 9.4 4: 10.0 5: 9.8 6: 9.7 7: 9.4 8: 8.5 9: 8.6 10: 10.0 Series 92.7 Total 696.0

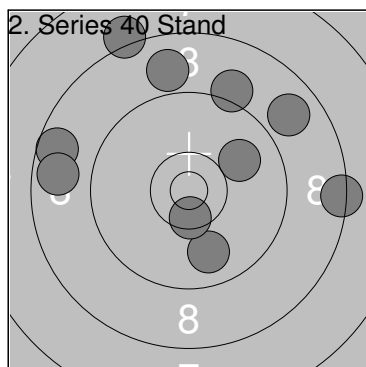

11:	8.6	←
12:	8.4	→
13:	8.7	←
14:	9.1	↗
15:	8.9	↗
16:	8.9	↗
17:	8.2	↗
18:	10.0	→
19:	9.9	↓
20:	10.5x	↓

Series	91.2
Total	787.2

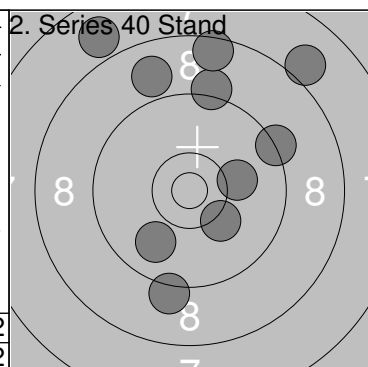

21:	9.2	↓
22:	10.1	→
23:	9.3	↗
24:	9.2	↑
25:	8.9	↑
26:	8.5	↑
27:	7.9	↗
28:	8.0	↗
29:	10.2	↓
30:	9.9	↓

Series	91.2
Total	878.4

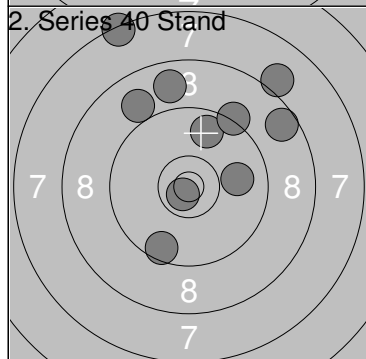

31:	9.7	↑
32:	8.1	↗
33:	9.3	↗
34:	9.9	→
35:	10.7x	↖
36:	7.4	↖
37:	9.0	↖
38:	8.6	↖
39:	8.8	↑
40:	9.6	↓

Series	91.1
Total	969.5

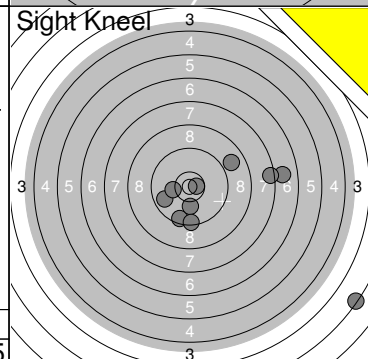

1:	2.4	↘
2:	9.5	↓
3:	7.0	→
4:	8.9	↗
5:	7.5	→
6:	10.1	↓
7:	9.8	←
8:	10.7x	→
9:	10.2	←
10:	9.4	↓

Series	85.5
Total	969.5

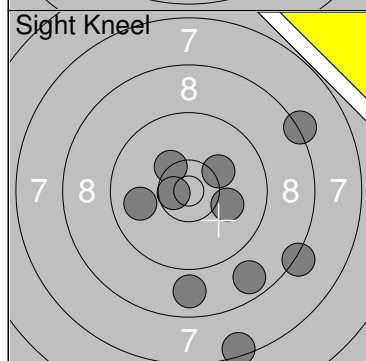

11:	10.3x	↗
12:	10.1	→
13:	8.8	↓
14:	9.9	←
15:	10.6x	←
16:	7.5	↘
17:	8.7	↘
18:	8.2	↘
19:	8.3	→
20:	10.2	→

Series	92.6
Total	969.5

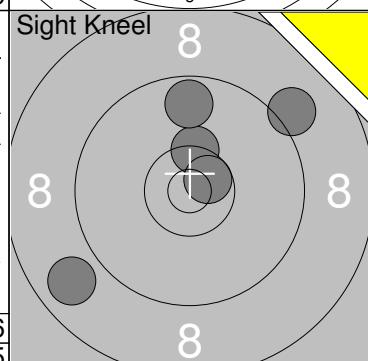

21:	10.4x	↑
22:	9.1	↗
23:	10.6x	↗
24:	9.7	↑
25:	8.8	↖

Series	48.6
Total	969.5

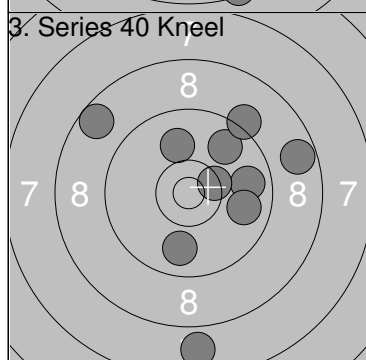

1:	8.7	→
2:	10.0	↑
3:	9.8	↑
4:	9.2	↗
5:	9.8	→
6:	9.9	↓
7:	9.8	→
8:	10.4x	→
9:	7.9	↓
10:	8.6	↖

Series	94.1
Total	1063.6

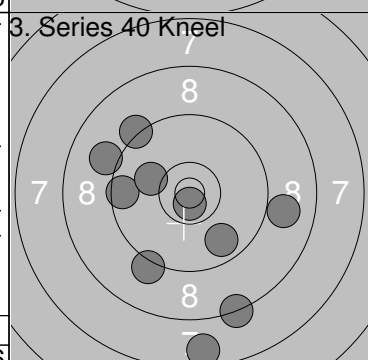

11:	9.3	↗
12:	9.1	↖
13:	9.5	←
14:	9.8	↘
15:	8.3	↘
16:	9.2	↘
17:	7.6	↘
18:	10.7x	↘
19:	10.1	↖
20:	9.0	→

Series	92.6
Total	1156.2

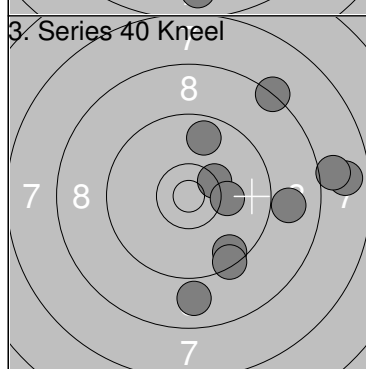

21:	8.3	↗
22:	10.3x	↗
23:	10.2	→
24:	9.7	↑
25:	8.9	↓
26:	7.8	→
27:	8.9	→
28:	9.6	↘
29:	9.4	↘
30:	8.0	→

Series	91.1
Total	1247.3

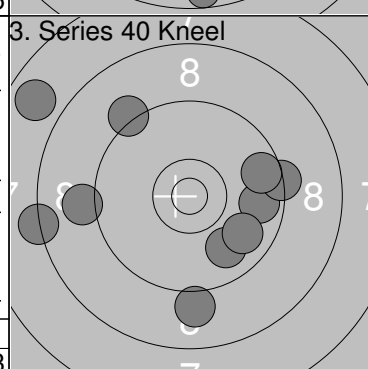

31:	9.7	→
32:	9.9	↘
33:	9.3	→
34:	9.6	→
35:	9.8	↘
36:	9.0	↘
37:	7.8	↖
38:	9.2	↖
39:	8.3	←
40:	9.1	←

Series	91.7
Total	1339.0

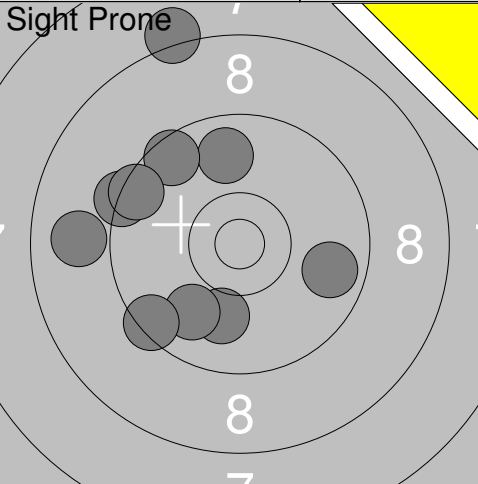
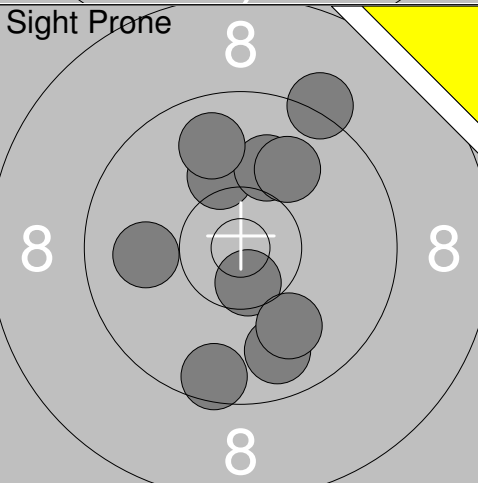
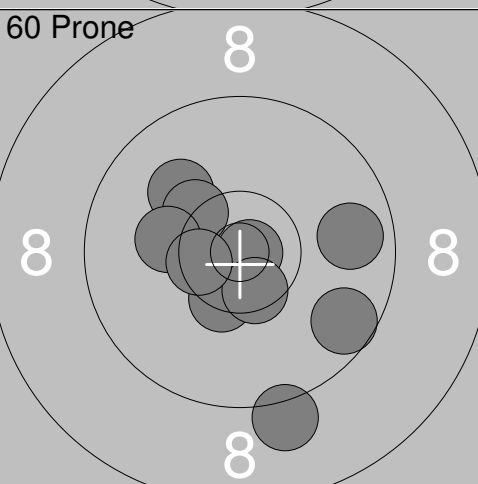
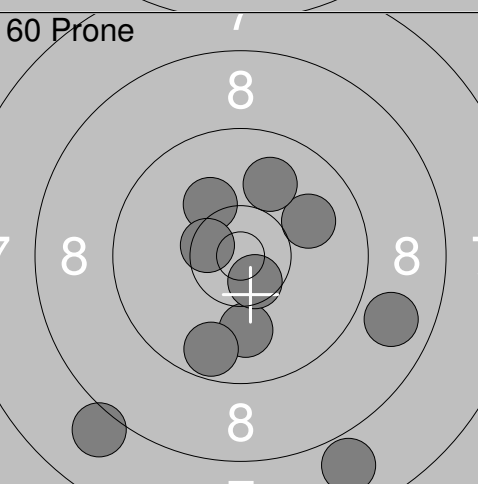
Relay	Lane	Emma Eriksson	
S		Ramselefors	
2016-04-17		Startskottet 2016	Umeå skytteallians
Sight Prone		1: 8.2 ↗ 2: 10.0 ↓ 3: 9.8 → 4: 9.8 ↑ 5: 9.6 ↗ 6: 8.9 ← 7: 9.9 ↓ 8: 9.5 ↙ 9: 9.4 ↖ 10: 9.5 ↖ Series 94.6 Total 0.0	11: 9.2 → 12: 9.7 ↗ 13: 9.1 ↑ 14: 8.1 → 15: 10.0 → 16: 10.0 ↗ 17: 10.2 ↓ 18: 9.8 ↙ 19: 9.8 ↖ 20: 10.0 ↖ Series 95.9 Total 0.0
Sight Prone		21: 9.2 ↗ 22: 10.2 ↑ 23: 10.1 ↑ 24: 10.0 ↗ 25: 9.8 ↑ 26: 9.6 ↓ 27: 10.6x ↓ 28: 9.9 ← 29: 9.8 ↓ 30: 10.0 ↓ Series 99.2 Total 0.0	31: 9.8 ↓ 32: 10.3x ↑ 33: 9.3 ← 34: 8.5 ↙ Series 37.9 Total 0.0
60 Prone		1: 9.8 → 2: 10.1 ↗ 3: 10.3x ↗ 4: 10.4x ↓ 5: 10.2 ← 6: 10.8x → 7: 9.1 ↓ 8: 10.5x ↓ 9: 10.5x ← 10: 9.6 ↘ Series 101.3 Total 101.3	11: 10.5x ← 12: 9.6 ← 13: 10.2 ↑ 14: 10.0 → 15: 10.3 → 16: 10.2 ← 17: 10.0 ↑ 18: 10.1 ↗ 19: 9.3 ↗ 20: 10.4x ↖ Series 100.6 Total 201.9
60 Prone		21: 10.0 ↗ 22: 10.0 ↓ 23: 9.9 ↑ 24: 10.2 ↗ 25: 10.5x ← 26: 9.7 ↓ 27: 10.6x ↓ 28: 7.9 ↓ 29: 8.8 → 30: 8.1 ↙ Series 95.7 Total 297.6	31: 8.5 ↓ 32: 9.9 ← 33: 10.5x ↓ 34: 8.5 ↘ 35: 8.2 ↓ 36: 10.5x ← 37: 10.1 ↗ 38: 10.8x ↗ 39: 10.7x ↓ 40: 9.5 ↗ Series 97.2 Total 394.8



1:	10.6x	↖
2:	8.9	↗
3:	8.5	↖
4:	10.5x	↘
5:	10.5x	↖
6:	9.9	↗
7:	10.5x	↗
8:	9.6	↗
9:	9.9	↖
10:	7.5	↖
Series		96.4
Total		0.0

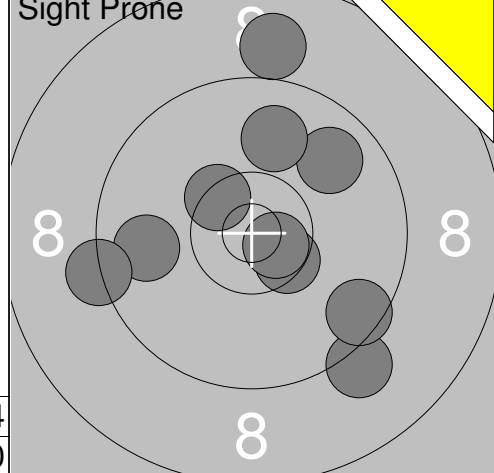

11:	10.4x	↖
12:	9.8	↖
13:	9.0	↖
14:	9.3	↖
15:	9.2	↘
16:	9.8	↗
17:	9.9	↖
18:	9.5	↘
19:	10.5x	↘
20:	10.7x	↘
Series		98.1
Total		0.0

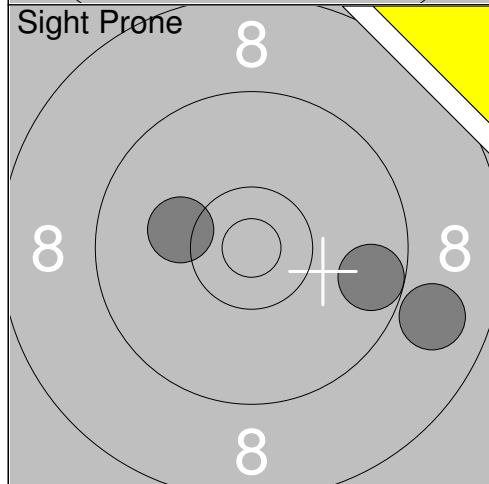

21:	9.6	→
22:	8.9	→
23:	10.2	↖
Series		28.7
Total		0.0

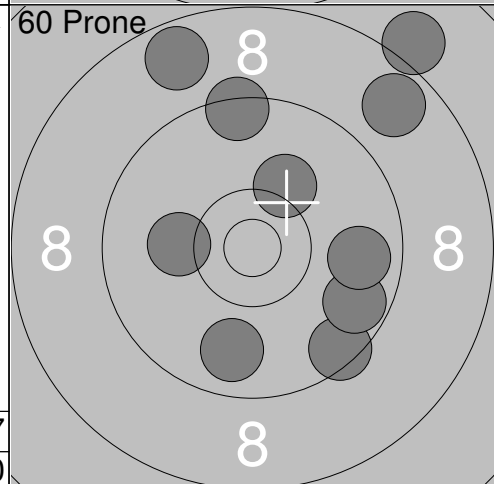

1:	10.1	↖
2:	8.7	↖
3:	9.5	↘
4:	8.1	↗
5:	9.7	↘
6:	9.8	→
7:	9.8	↘
8:	9.4	↖
9:	8.7	↗
10:	10.2	↖
Series		94.0
Total		94.0

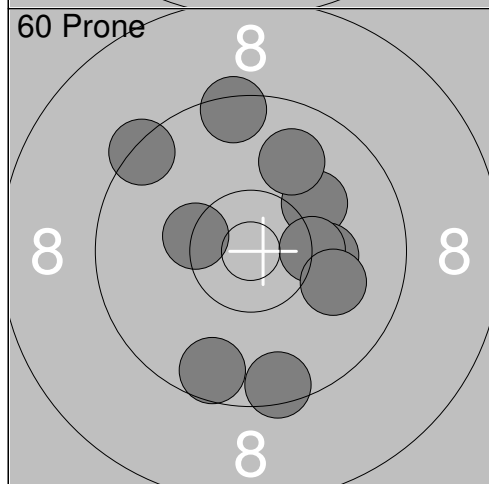

11:	9.4	↖
12:	10.1	↗
13:	9.6	↘
14:	10.2	→
15:	9.9	↖
16:	9.5	↘
17:	9.4	↖
18:	10.3x	→
19:	10.3x	↖
20:	10.0	→
Series		98.7
Total		192.7

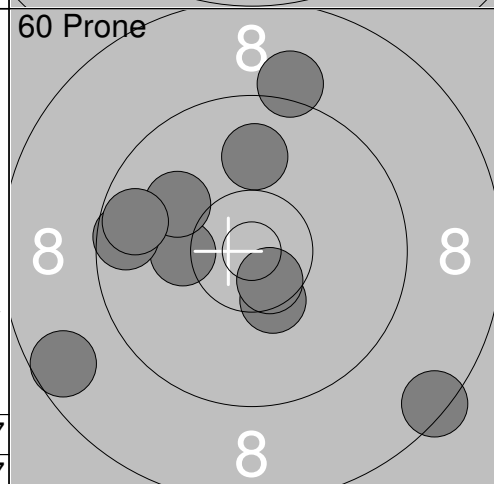

21:	10.4x	↘
22:	8.6	↖
23:	9.1	↖
24:	10.2	↖
25:	10.0	↖
26:	9.6	↖
27:	9.7	↖
28:	8.4	↘
29:	10.6x	↘
30:	9.9	↖
Series		96.5
Total		289.2

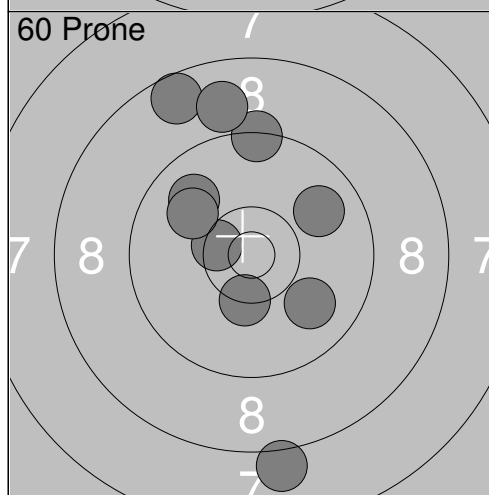

31:	10.5x	↖
32:	9.9	↖
33:	9.4	↖
34:	9.9	↖
35:	8.1	↘
36:	10.0	↖
37:	10.3x	↘
38:	8.6	↖
39:	8.9	↖
40:	9.9	↘
Series		95.5
Total		384.7

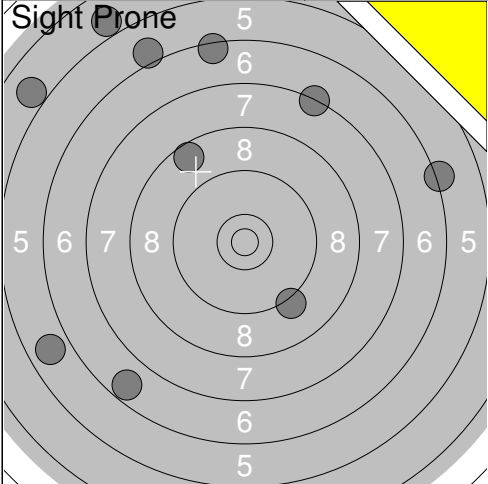
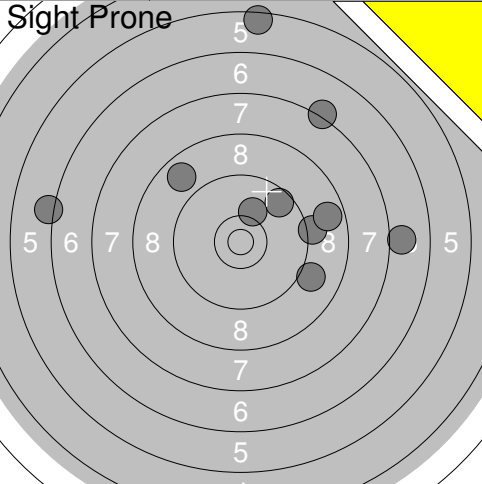
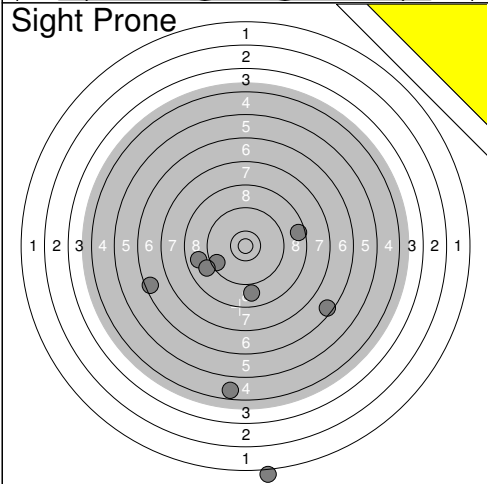
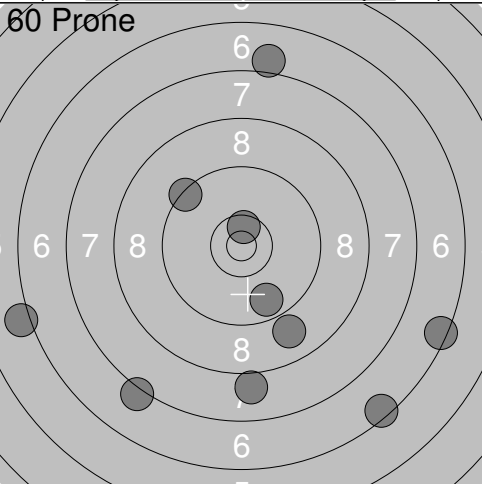
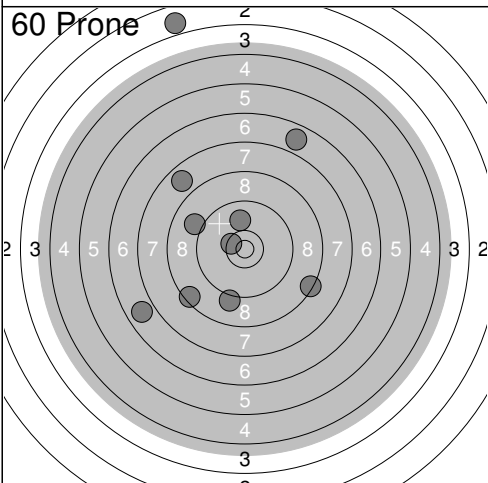
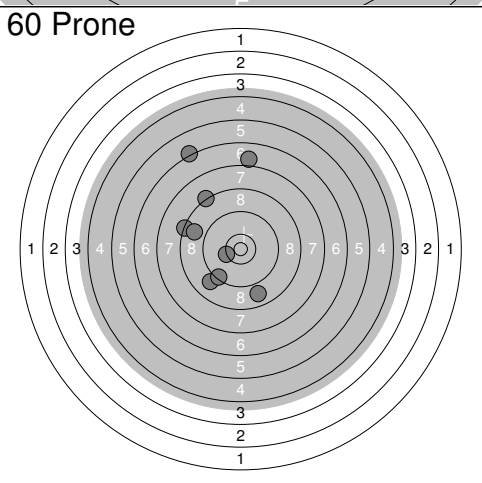
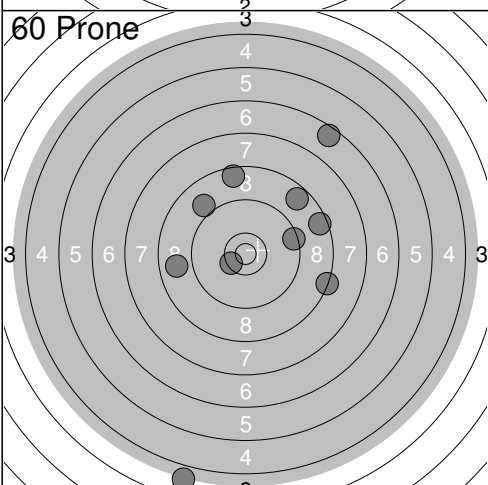
Relay 1	Lane 7	Linus Lind	
S		Skoga-Ekshärad	
2016-04-17		Startskottet 2016	Umeå skytteallians
Sight Prone			1: 4.9 ↗ 2: 8.6 ↗ 3: 6.4 ↗ 4: 6.1 ↗ 5: 5.8 ↙ 6: 6.7 ↙ 7: 9.2 ↙ 8: 7.3 ↗ 9: 5.0 ↗ 10: 6.2 → Series 66.2 Total 0.0
Sight Prone			11: 9.6 ↗ 12: 7.0 → 13: 8.8 ↗ 14: 9.2 → 15: 6.2 ↙ 16: 7.2 ↗ 17: 9.0 ↘ 18: 5.5 ↑ 19: 10.2 ↗ 20: 8.7 → Series 81.4 Total 0.0
Sight Prone			21: 8.9 ↓ 22: 9.5 ↙ 23: 8.9 ↙ 24: 6.5 ↙ 25: 4.7 ↓ 26: 9.0 ↙ 27: 6.5 ↘ 28: 1.1 ↓ 29: 8.6 → Series 63.7 Total 0.0
60 Prone			1: 10.6x ↑ 2: 9.4 ↗ 3: 6.4 → 4: 6.5 ↘ 5: 8.9 ↘ 6: 7.2 ↘ 7: 8.0 ↓ 8: 7.1 ↑ 9: 9.7 ↘ 10: 6.1 ↙ Series 79.9 Total 79.9
60 Prone			11: 9.0 ↙ 12: 7.8 ↗ 13: 6.8 ↗ 14: 2.9 ↗ 15: 8.5 ↙ 16: 10.4x ↙ 17: 6.8 ↙ 18: 10.0 ↑ 19: 9.1 ↓ 20: 8.4 ↘ Series 79.7 Total 159.6
60 Prone			21: 8.9 ↓ 22: 0.0 → 23: 6.2 ↗ 24: 8.3 ↙ 25: 9.0 ↘ 26: 10.3x ↙ 27: 8.3 ↗ 28: 9.4 ↘ 29: 8.8 ↙ 30: 7.0 ↑ Series 76.2 Total 235.8
60 Prone			31: 8.5 → 32: 10.4x ↙ 33: 9.0 ↗ 34: 9.4 → 35: 8.3 ↘ 36: 6.6 ↗ 37: 8.8 ↙ 38: 3.9 ↓ 39: 8.7 ↗ 40: 8.6 ↑ Series 82.2 Total 318.0

Relay	Lane	Anton Lind	
S		Skoga-Ekshärad	
2016-04-17		Startskottet 2016	Umeå skytteallians
Sight Prone		1: 8.6 ↘ 2: 9.7 → 3: 10.1 ← 4: 9.9 ↑ 5: 9.7 ↘ 6: 9.2 ↘ 7: 9.0 ↗ 8: 8.5 ↗ 9: 9.9 → 10: 9.9 ↑ Series 94.5 Total 0.0	Sight Prone
			11: 10.3 ↓ 12: 9.6 → 13: 9.5 ↑ 14: 7.1 ↘ 15: 8.2 ↘ 16: 9.9 ↘ 17: 10.0 ↘ 18: 8.7 ← 19: 9.1 ↑ 20: 10.4x → Series 92.8 Total 0.0
Sight Prone		21: 8.8 ↑ 22: 9.2 ↘ 23: 10.2 ← 24: 10.3x ↑ 25: 9.7 ↘ 26: 8.7 ↑ 27: 9.7 ↗ 28: 10.4x ↑ Series 77.0 Total 0.0	60 Prone
			1: 9.6 ← 2: 9.0 ↗ 3: 9.9 ↘ 4: 10.0 ↑ 5: 8.8 ↗ 6: 9.1 ↗ 7: 9.3 ↘ 8: 7.4 → 9: 9.9 ↘ 10: 9.2 → Series 92.2 Total 92.2
60 Prone		11: 9.6 ↑ 12: 10.6x ↗ 13: 10.2 ↘ 14: 10.4x ← 15: 9.9 ↘ 16: 9.6 ↘ 17: 8.4 ↗ 18: 9.9 ← 19: 10.2 ↑ 20: 10.0 ↑ Series 98.8 Total 191.0	60 Prone
			21: 10.3x ↑ 22: 9.9 ← 23: 9.2 ↑ 24: 10.4x ← 25: 10.4x ← 26: 10.3x ↘ 27: 9.0 ↗ 28: 8.8 ↑ 29: 10.0 ↑ 30: 9.5 ↓ Series 97.8 Total 288.8
60 Prone		31: 9.1 ↘ 32: 9.9 ↘ 33: 9.8 ↑ 34: 9.8 ← 35: 9.2 ↘ 36: 8.9 → 37: 9.8 → 38: 10.7x ↘ 39: 8.7 ↑ 40: 8.4 ↘ Series 94.3 Total 383.1	

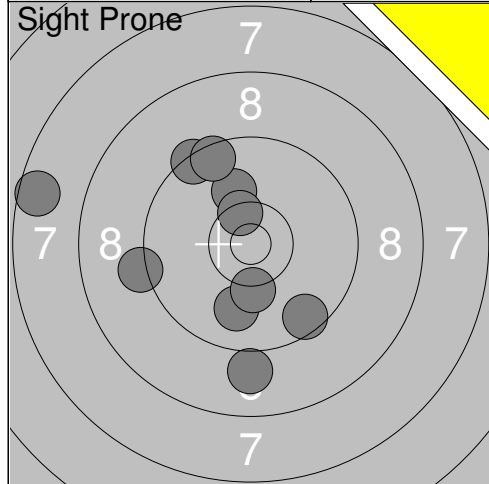

1:	9.9	↓
2:	9.6	↓
3:	7.6	←
4:	9.2	←
5:	9.0	↓
6:	10.2	↓
7:	10.1	↑
8:	10.4x	↑
9:	9.4	↗
10:	9.5	↗
Series		94.9
Total		0.0

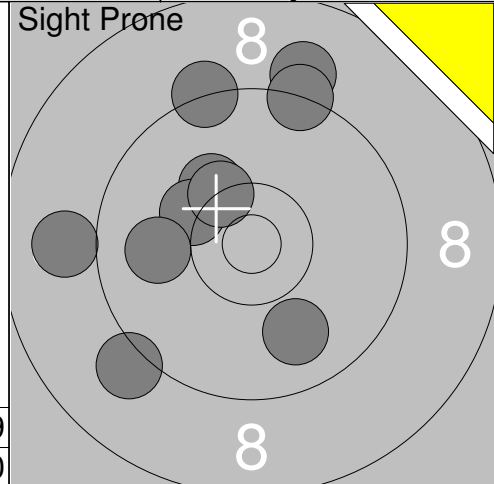

11:	9.3	↑
12:	9.1	↙
13:	9.9	↓
14:	10.2	↗
15:	9.1	↑
16:	9.0	←
17:	10.2	↖
18:	10.0	←
19:	9.3	↑
20:	10.3x	↗
Series		96.4
Total		0.0

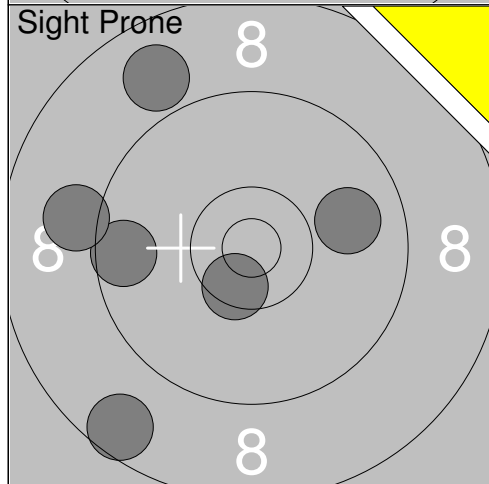

21:	8.6	↙
22:	10.5x	↓
23:	9.6	←
24:	8.9	↗
25:	9.9	→
26:	9.1	←
Series		56.6
Total		0.0

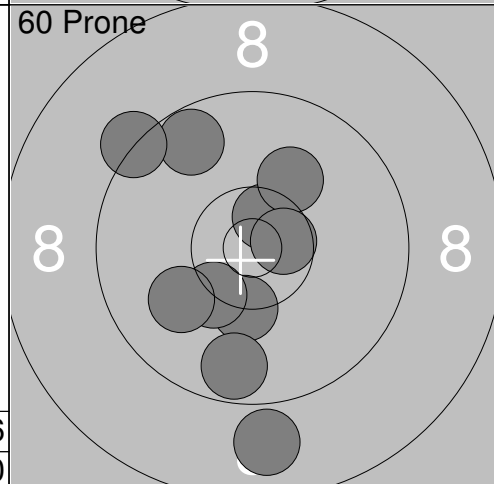

1:	10.3x	↓
2:	10.6x	↑
3:	10.3x	↙
4:	10.1	↗
5:	10.0	←
6:	9.7	↓
7:	8.9	↓
8:	9.7	↗
9:	10.6x	→
10:	9.3	↖
Series		99.5
Total		99.5

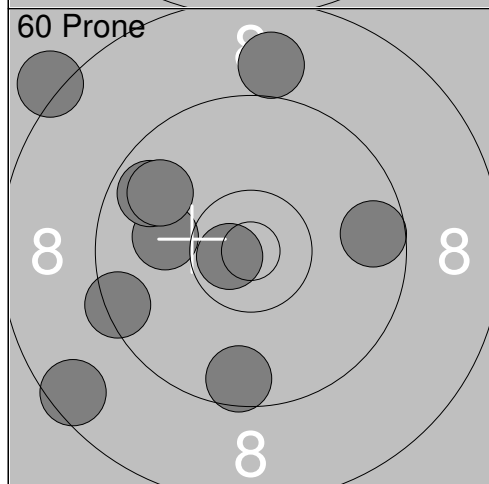

11:	8.2	↖
12:	10.0	←
13:	9.7	↖
14:	9.6	↓
15:	8.5	↙
16:	10.7x	←
17:	9.4	←
18:	9.8	↗
19:	9.0	↑
20:	9.6	→
Series		94.5
Total		194.0

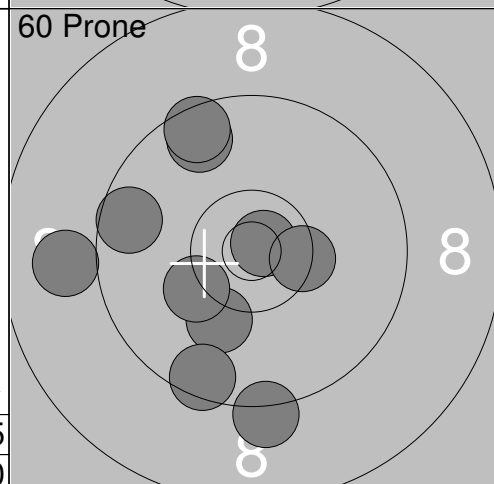

21:	10.1	↙
22:	9.2	↓
23:	9.6	↗
24:	10.8x	↗
25:	9.6	←
26:	9.0	←
27:	10.4x	→
28:	9.5	↓
29:	10.2	↙
30:	9.5	↗
Series		97.9
Total		291.9

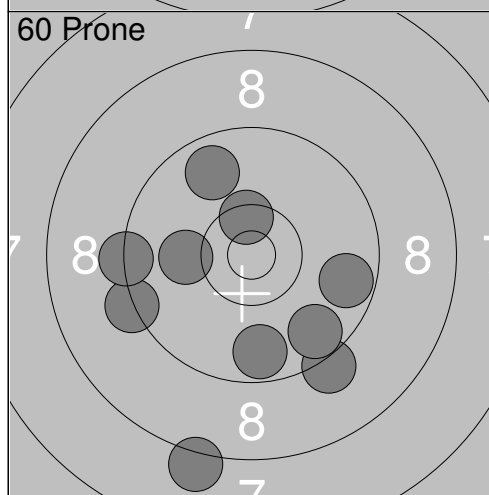

31:	9.3	←
32:	9.3	←
33:	9.7	→
34:	9.2	↓
35:	8.1	↓
36:	9.7	↓
37:	10.5x	↑
38:	9.8	↗
39:	10.1	←
40:	9.7	↓
Series		95.4
Total		387.3

Relay	Lane	Daniel Wallberg			
S		Ramselefors			
2016-04-17		Startskottet 2016	Umeå skytteallians		
Sight Prone		1: 10.3x ↙ 2: 10.5x ↘ 3: 10.4x ↗ 4: 10.0 → 5: 9.9 ← 6: 10.2 ↗ 7: 10.7x ↘ 8: 9.9 ↗ 9: 9.9 ↗ 10: 10.4x ↗ Series 102.2 Total 0.0	Sight Prone		11: 10.4x → 12: 10.1 ↗ 13: 9.7 ↘ 14: 9.2 → 15: 10.3x ↙ 16: 9.6 ← 17: 10.6x ↙ Series 69.9 Total 0.0
60 Prone		1: 10.0 → 2: 10.3 ↘ 3: 10.5x ↘ 4: 10.0 ↘ 5: 10.8x → 6: 9.2 ↘ 7: 9.4 ↘ 8: 9.1 ← 9: 9.4 ↘ 10: 10.8x ↘ Series 99.5 Total 99.5	60 Prone		11: 10.7x ↘ 12: 10.6x ↗ 13: 10.5x ↗ 14: 9.5 ↘ 15: 10.5x ↙ 16: 10.1 ↙ 17: 10.0 ↗ 18: 10.3 → 19: 10.7x ↙ 20: 10.7x → Series 103.6 Total 203.1
60 Prone		21: 10.2 → 22: 10.6x ↗ 23: 10.3x ↗ 24: 0.0 25: 9.8 ↗ 26: 10.3x → 27: 10.4x ↗ 28: 10.3 ↙ 29: 10.0 → 30: 9.3 ↘ Series 91.2 Total 294.3	60 Prone		31: 10.7x ↗ 32: 9.6 ↙ 33: 10.4x ↘ 34: 10.4x ↙ 35: 10.4x ← 36: 10.5x → 37: 10.0 ↘ 38: 10.4x → 39: 10.7x ↙ 40: 9.9 ↘ Series 103.0 Total 397.3
60 Prone		41: 10.3 ↗ 42: 9.9 ← 43: 10.5x ↙ 44: 10.4x ↗ 45: 10.6x ↗ 46: 9.2 → 47: 9.7 → 48: 9.8 ↗ 49: 10.6x ↗ 50: 10.1 ↗ Series 101.1 Total 498.4	60 Prone		51: 10.5x ↗ 52: 9.5 ↘ 53: 10.0 ↘ 54: 10.2 → 55: 10.1 ↗ 56: 10.6x ↙ 57: 10.3x ↗ 58: 10.6x ↘ 59: 10.2 ↗ 60: 10.6x ← Series 102.6 Total 601.0
Sight Stand		1: 9.2 → 2: 9.7 ↘ 3: 8.4 → 4: 8.5 → 5: 10.0 ↗ 6: 9.8 ↙ 7: 10.5x ↙ 8: 10.6x ↘ 9: 9.2 ↗ 10: 9.4 ↘ Series 95.3 Total 601.0	Sight Stand		11: 9.8 ↙ 12: 9.0 ← 13: 10.4x ↘ 14: 9.4 ↙ 15: 10.3x ↗ Series 48.9 Total 601.0

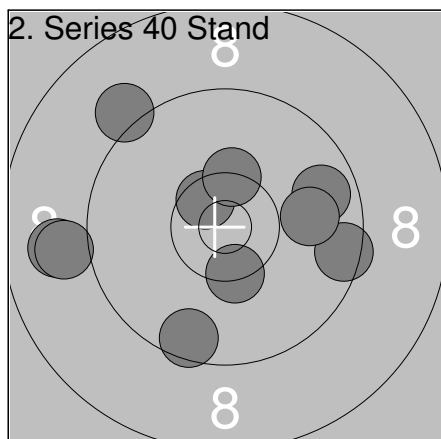

1:	10.5x	↗
2:	8.9	←
3:	9.7	→
4:	10.4x	↑
5:	9.6	↘
6:	9.1	↗
7:	9.0	←
8:	9.5	→
9:	9.9	→
10:	10.4x	↓
Series		97.0
Total		698.0

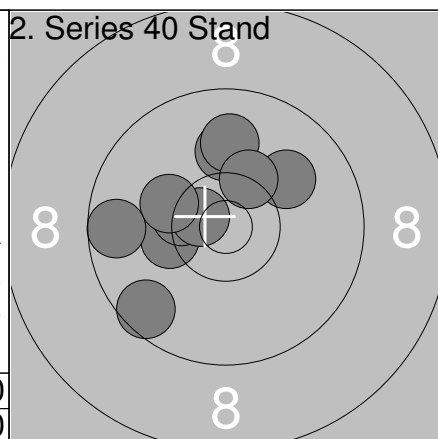

11:	9.6	↘
12:	10.3	←
13:	10.4x	←
14:	10.6x	↖
15:	10.1	↑
16:	10.2	↖
17:	9.6	←
18:	9.9	↑
19:	10.0	↗
20:	10.3x	↗
Series		101.0
Total		799.0

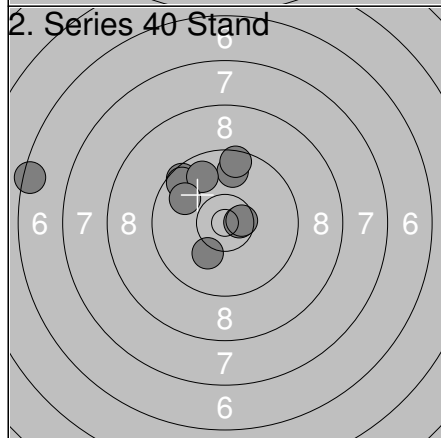

21:	10.6x	→
22:	9.8	↑
23:	6.5	←
24:	9.6	↑
25:	10.2	↘
26:	9.6	↗
27:	9.6	↗
28:	10.6x	→
29:	9.8	↗
30:	9.9	↗
Series		96.2
Total		895.2

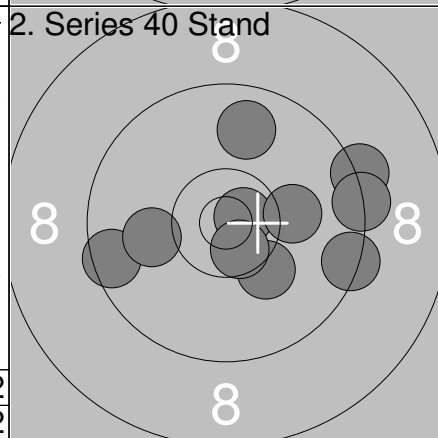

31:	9.8	↑
32:	9.5	←
33:	9.4	→
34:	9.3	→
35:	10.7x	→
36:	10.2	↘
37:	9.3	→
38:	10.6x	↘
39:	10.1	←
40:	10.1	→
Series		99.0
Total		994.2

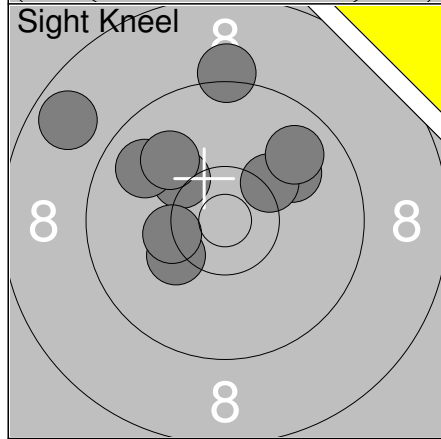

1:	9.2	↑
2:	8.7	↗
3:	10.2	↗
4:	9.8	↗
5:	10.2	↖
6:	10.0	↗
7:	10.0	↗
8:	10.3	↗
9:	10.3x	←
10:	9.8	↗
Series		98.5
Total		994.2

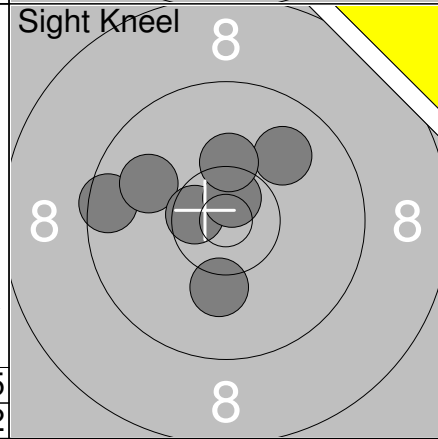

11:	9.5	←
12:	9.9	↗
13:	9.9	↖
14:	10.2	↓
15:	10.6x	←
16:	10.7x	↑
17:	10.3	↑
Series		71.1
Total		994.2

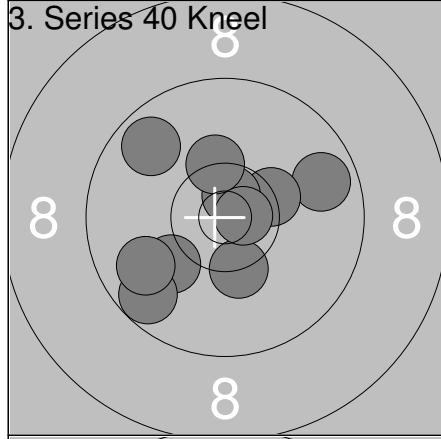

1:	9.7	→
2:	10.1	↘
3:	9.7	↘
4:	10.3x	↘
5:	9.8	↖
6:	9.7	↗
7:	10.4x	→
8:	10.7x	↑
9:	10.3x	↑
10:	10.7x	→
Series		101.4
Total		1095.6

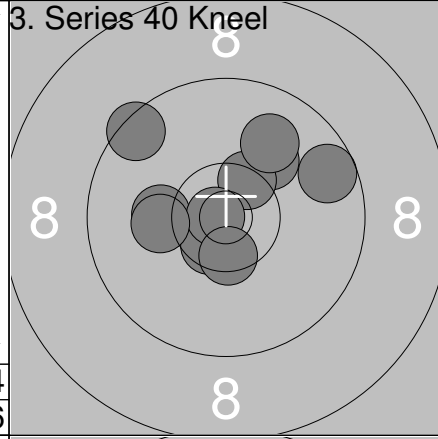

11:	10.1	↗
12:	10.4x	↗
13:	10.6x	↘
14:	10.2	←
15:	10.8x	←
16:	10.2	←
17:	9.9	↗
18:	10.5x	↓
19:	9.6	→
20:	9.5	↖
Series		101.8
Total		1197.4

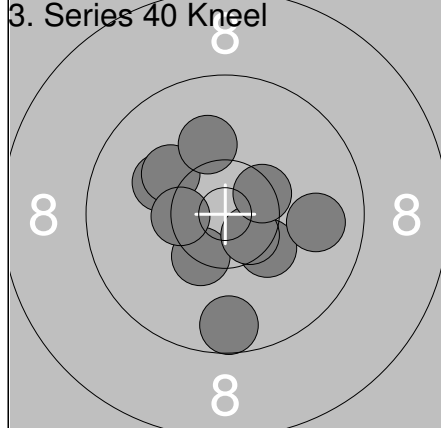

21:	10.1	↖
22:	10.4x	↘
23:	10.1	↗
24:	10.3x	↘
25:	10.6x	↘
26:	10.1	↗
27:	10.4x	←
28:	9.9	→
29:	10.4x	↗
30:	9.6	↓
Series		101.9
Total		1299.3

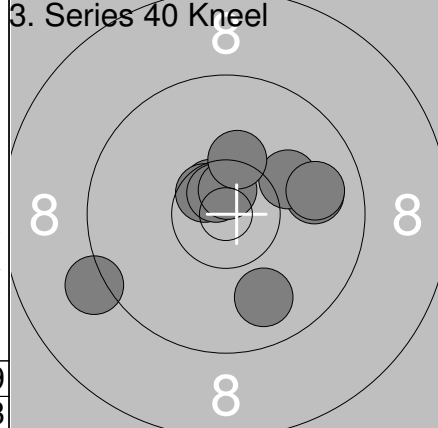

31:	9.9	→
32:	10.6x	↖
33:	9.9	↓
34:	10.6x	↖
35:	9.2	↖
36:	10.7x	↖
37:	10.1	↗
38:	9.9	→
39:	10.7x	↑
40:	10.3x	↑
Series		101.9
Total		1401.2

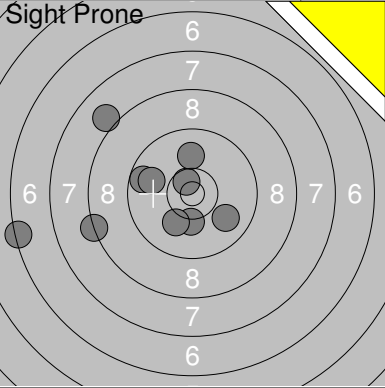
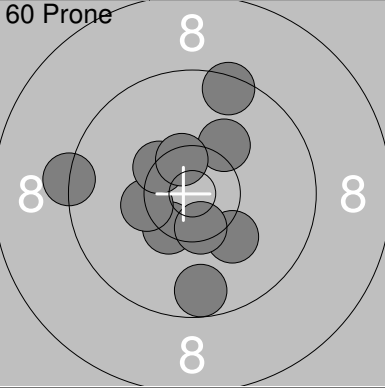
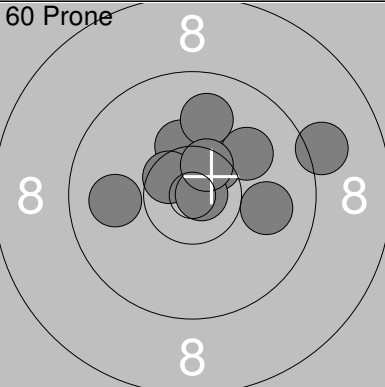
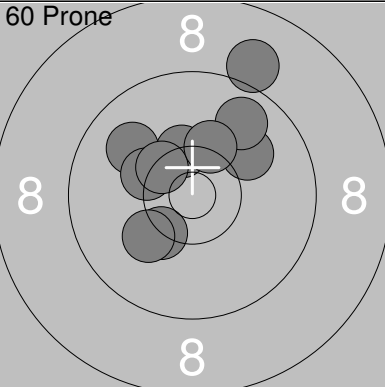
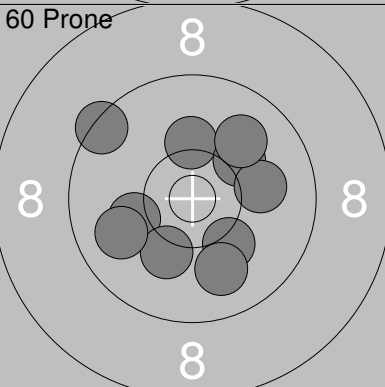
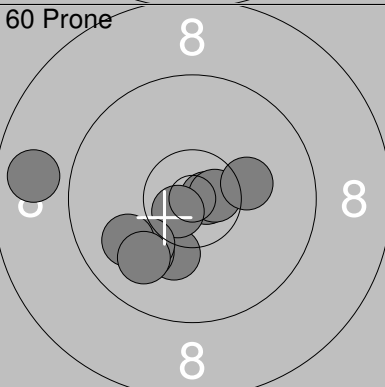
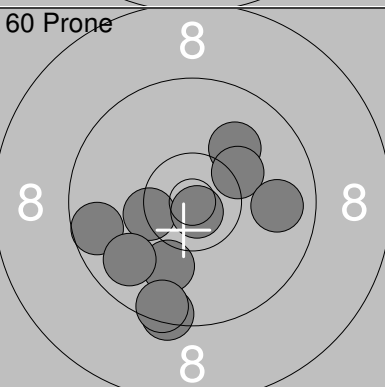
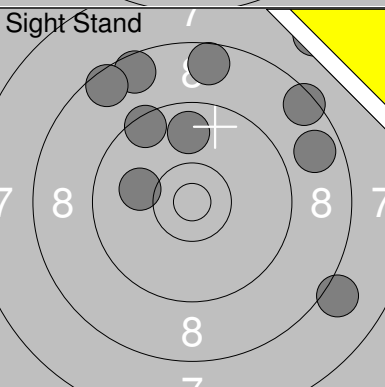
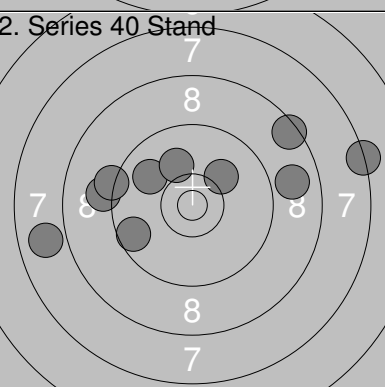
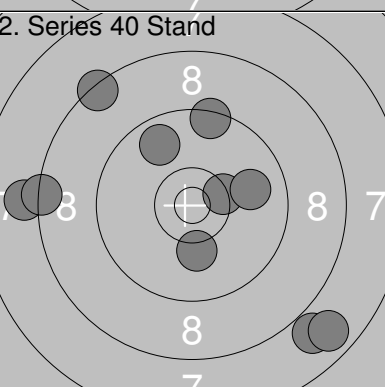
Relay	Lane	Lars Möllsten	
S		Umeå	
2016-04-17		Startskottet 2016	Umeå skytteallians
Sight Prone		1: 6.4 ← 2: 8.0 ↗ 3: 8.3 ← 4: 10.6x ↗ 5: 9.7 ← 6: 9.9 ← 7: 10.0 ↑ 8: 10.2 ↓ 9: 9.9 ↓ 10: 10.1 ↓ Series 93.1 Total 0.0	60 Prone  1: 9.3 ← 2: 10.2 ↓ 3: 9.7 ↓ 4: 10.4x ↓ 5: 10.5x ↓ 6: 10.3x ← 7: 10.4x ↗ 8: 10.2 ↗ 9: 10.5x ↑ 10: 9.5 ↑ Series 101.0 Total 101.0
60 Prone		11: 9.1 → 12: 10.3 ↑ 13: 10.4x ↑ 14: 10.0 ↗ 15: 9.9 ← 16: 10.6x ← 17: 9.9 ↑ 18: 10.8x → 19: 10.5x ↗ 20: 9.9 → Series 101.4 Total 202.4	60 Prone  21: 10.3x ↓ 22: 9.9 ↗ 23: 10.3 ← 24: 10.0 ↗ 25: 9.8 ↗ 26: 10.3x ↑ 27: 10.2 ↗ 28: 9.1 ↗ 29: 10.4x ↗ 30: 10.3 ↑ Series 100.6 Total 303.0
60 Prone		31: 10.2 ↑ 32: 10.1 ↗ 33: 10.0 → 34: 10.2 ↓ 35: 10.0 ↗ 36: 10.1 ← 37: 9.9 ↓ 38: 10.2 ↓ 39: 9.4 ↗ 40: 9.9 ← Series 100.0 Total 403.0	60 Prone  41: 10.2 ↓ 42: 10.8x → 43: 10.6x → 44: 10.7x ↓ 45: 10.0 ↓ 46: 10.2 → 47: 10.1 ↓ 48: 9.9 ↓ 49: 9.9 ↓ 50: 8.8 ← Series 101.2 Total 504.2
60 Prone		51: 10.0 ↗ 52: 10.0 ↓ 53: 9.6 ← 54: 10.4x ← 55: 10.2 ↗ 56: 9.4 ↓ 57: 9.8 ← 58: 10.8x ↓ 59: 9.8 → 60: 9.5 ↓ Series 99.5 Total 603.7	Sight Stand  1: 10.1 ← 2: 8.7 → 3: 8.1 ↓ 4: 8.5 ↗ 5: 8.6 ↗ 6: 9.8 ↑ 7: 7.5 ↗ 8: 8.6 ↑ 9: 8.5 ↗ 10: 9.5 ↗ Series 87.9 Total 603.7
2. Series 40 Stand		1: 9.9 ← 2: 8.9 → 3: 9.6 ← 4: 10.1 ↗ 5: 10.1 ↗ 6: 7.9 ← 7: 7.3 → 8: 8.5 ↗ 9: 9.1 ← 10: 9.2 ← Series 90.6 Total 694.3	2. Series 40 Stand  11: 8.1 ← 12: 7.9 ↓ 13: 8.4 ↗ 14: 10.2 ↓ 15: 8.4 ← 16: 9.8 ↗ 17: 10.4x → 18: 9.9 → 19: 7.8 ↓ 20: 9.4 ↑ Series 90.3 Total 784.6

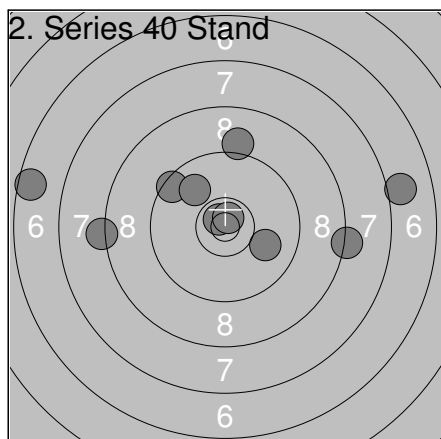

21:	8.2	←
22:	7.0	→
23:	10.0	↘
24:	9.1	↑
25:	6.6	←
26:	9.5	↗
27:	8.3	→
28:	10.7x	↗
29:	10.7x	↑
30:	9.9	↗
Series		90.0
Total		874.6

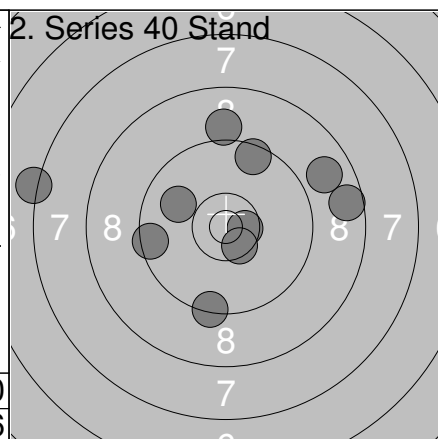

31:	7.2	←
32:	9.9	↖
33:	10.6x	→
34:	8.6	→
35:	9.4	↓
36:	8.8	↗
37:	10.5x	↘
38:	9.5	←
39:	9.5	↑
40:	9.1	↑
Series		93.1
Total		967.7

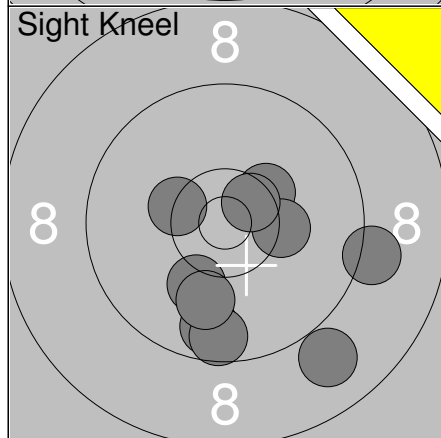

1:	9.7	↓
2:	8.9	↓
3:	10.3x	↗
4:	10.3	→
5:	10.1	↓
6:	9.6	↓
7:	9.2	→
8:	10.6x	↗
9:	10.0	↓
10:	10.4x	←
Series		99.1
Total		967.7

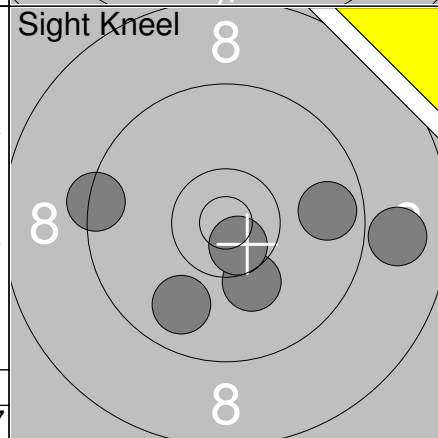

11:	9.4	←
12:	9.8	↘
13:	9.7	→
14:	8.9	→
15:	10.2	↓
16:	10.6x	↘
Series		58.6
Total		967.7

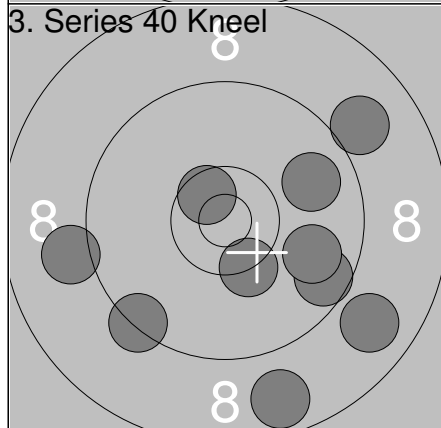

1:	10.3x	↓
2:	10.6x	↗
3:	9.6	↘
4:	9.4	↘
5:	8.8	↘
6:	9.8	→
7:	9.0	↗
8:	9.9	→
9:	9.1	←
10:	8.7	↓
Series		95.2
Total		1062.9

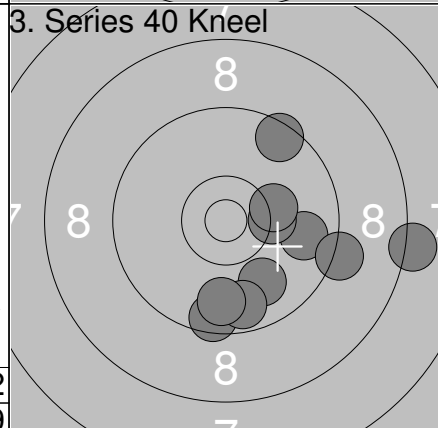

11:	9.5	↓
12:	9.8	→
13:	10.3	→
14:	10.2	→
15:	8.2	→
16:	9.9	↘
17:	9.2	↗
18:	9.7	↓
19:	9.8	↓
20:	9.5	↗
Series		96.1
Total		1159.0

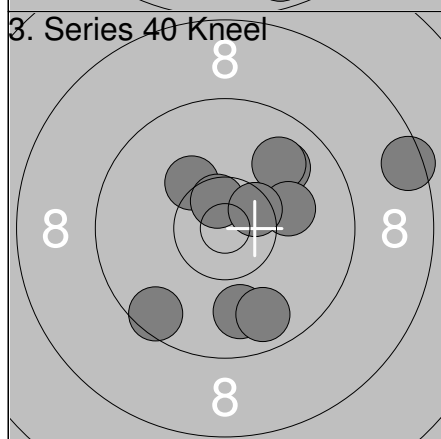

21:	9.9	↗
22:	9.9	↗
23:	10.2	↗
24:	10.6x	↗
25:	9.9	↓
26:	9.8	↓
27:	8.5	→
28:	10.1	→
29:	9.5	↘
30:	10.5x	↗
Series		98.9
Total		1257.9

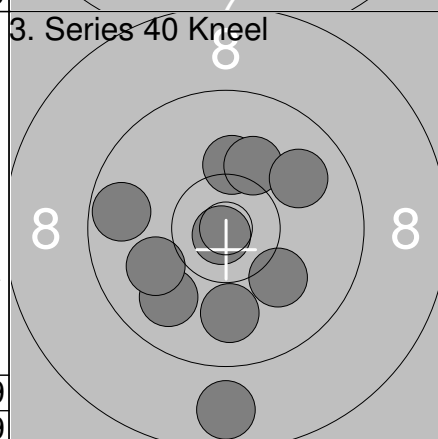

31:	8.8	↓
32:	9.9	↘
33:	10.9x	↘
34:	10.2	↑
35:	10.0	↖
36:	10.1	↑
37:	9.7	←
38:	9.9	↓
39:	9.9	↗
40:	10.1	↘
Series		99.5
Total		1357.4

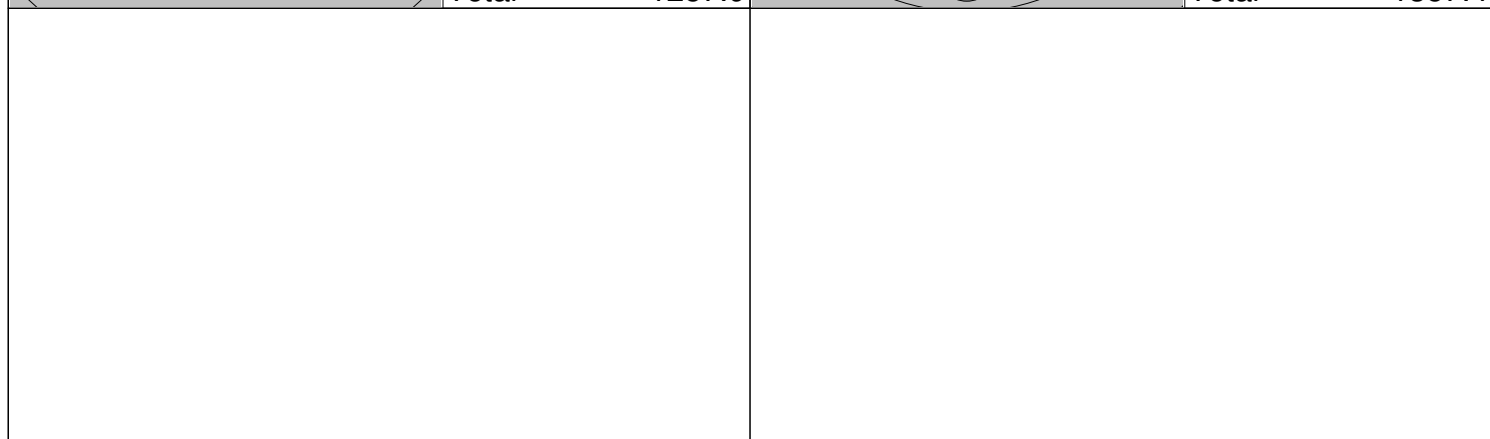

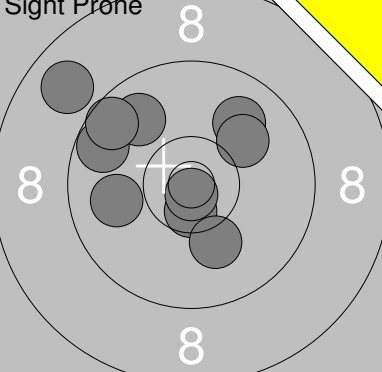
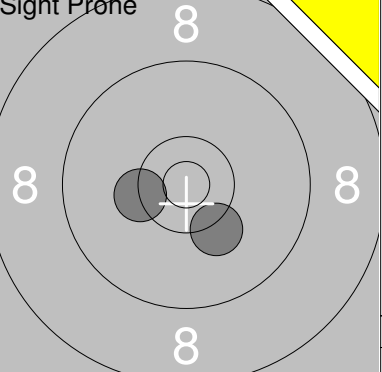
Sight Prone 	1: 9.9 ← 2: 8.8 ↗ 3: 9.8 ↗ 4: 10.6x ↓ 5: 9.9 ↗ 6: 10.0 ↗ 7: 9.7 ↖ 8: 9.6 ↗ 9: 10.8x ↓ 10: 10.1 ↓ Series 99.2 Total 0.0	Sight Prone 	11: 10.2 ↓ 12: 10.3x ← Series 20.5 Total 0.0
---	---	---	---

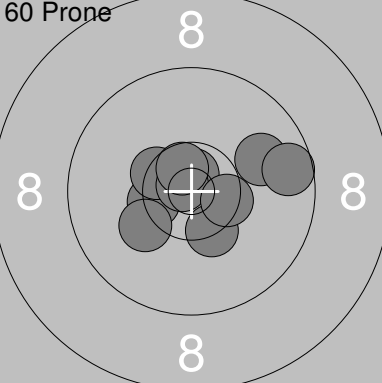
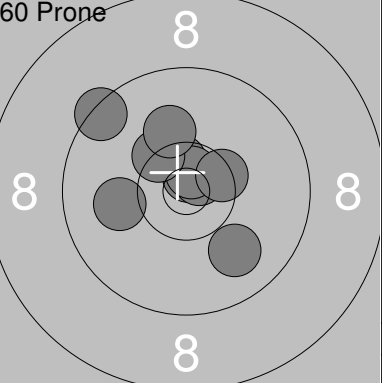
60 Prone 	1: 9.9 → 2: 10.4x ↓ 3: 10.4x ↓ 4: 10.2 ← 5: 10.4x ↗ 6: 9.6 → 7: 10.7x ↗ 8: 10.8x ↗ 9: 10.5x ↗ 10: 10.6x ↗ Series 103.5 Total 103.5	60 Prone 	11: 10.5x ↑ 12: 10.7x ↑ 13: 10.7x ↗ 14: 10.7x ↑ 15: 10.4x ↗ 16: 10.4x ↗ 17: 10.0 ← 18: 9.4 ↗ 19: 10.1 ↗ 20: 9.9 ↓ Series 102.8 Total 206.3
--	---	--	---

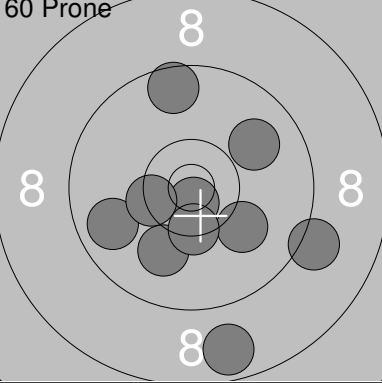
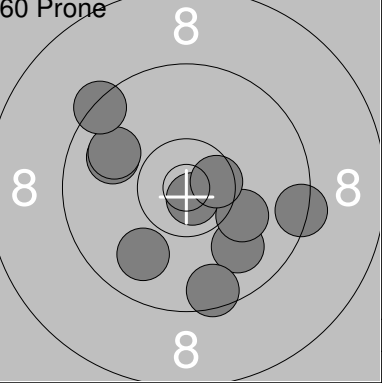
60 Prone 	21: 9.8 ← 22: 9.1 ↓ 23: 9.9 ↗ 24: 10.7x ↓ 25: 10.0 ↓ 26: 9.6 ↗ 27: 8.7 ↗ 28: 10.1 ↓ 29: 10.4x ↓ 30: 10.4x ↓ Series 98.7 Total 305.0	60 Prone 	31: 9.9 ↗ 32: 10.8x ↓ 33: 9.9 ↓ 34: 10.1 ↓ 35: 9.4 → 36: 10.5x → 37: 9.9 ↗ 38: 9.4 ↗ 39: 9.9 ↓ 40: 9.5 ↓ Series 99.3 Total 404.3
---	--	---	---

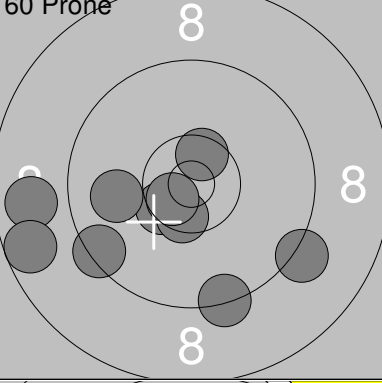
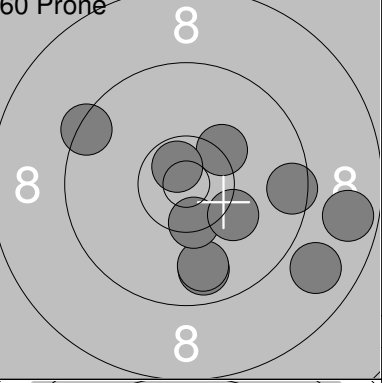
60 Prone 	41: 8.8 ← 42: 8.7 ← 43: 9.3 ↓ 44: 9.4 ← 45: 10.4x ← 46: 10.5x ↗ 47: 9.9 ← 48: 10.5x ↓ 49: 9.2 ↓ 50: 10.6x ← Series 97.3 Total 501.6	60 Prone 	51: 8.7 → 52: 10.3x ↗ 53: 9.5 → 54: 9.8 ↓ 55: 10.7x ↗ 56: 9.4 ↗ 57: 9.8 ↓ 58: 10.4x ↓ 59: 8.9 ↓ 60: 10.2 ↓ Series 97.7 Total 599.3
--	--	--	---

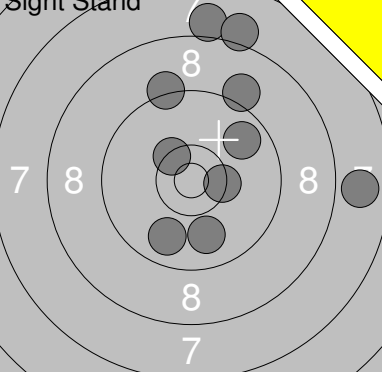
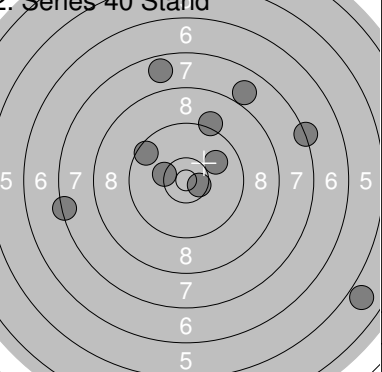
Sight Stand 	1: 8.0 ↑ 2: 9.1 ↑ 3: 9.8 ↓ 4: 7.8 → 5: 9.8 ↗ 6: 9.9 ↓ 7: 10.4x → 8: 8.1 ↗ 9: 9.2 ↗ 10: 10.4x ↗ Series 92.5 Total 599.3	2. Series 40 Stand 	1: 7.9 ↗ 2: 7.7 ↑ 3: 9.2 ↗ 4: 10.3x ← 5: 4.9 ↓ 6: 7.3 → 7: 10.5x → 8: 10.0 ↗ 9: 9.6 ↗ 10: 7.4 ← Series 84.8 Total 684.1
---	---	--	--

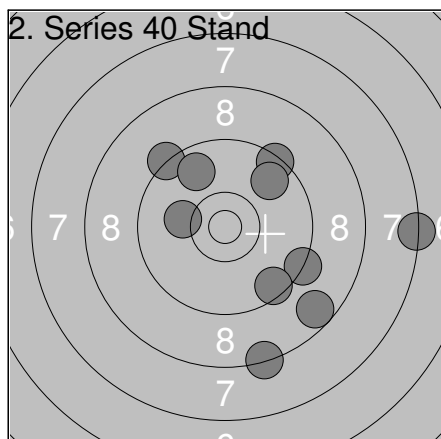

11:	8.3	↓
12:	10.1	←
13:	9.4	↗
14:	8.7	↓
15:	9.3	↓
16:	7.3	→
17:	9.3	↗
18:	9.7	↗
19:	9.5	↓
20:	9.8	↗
Series		91.4
Total		775.5

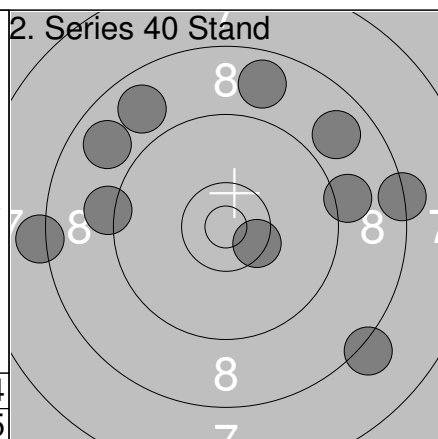

21:	8.8	↑
22:	8.8	↗
23:	10.4x	↘
24:	8.8	↗
25:	9.1	→
26:	8.2	↓
27:	8.8	↗
28:	8.3	→
29:	9.2	←
30:	8.2	←
Series		88.6
Total		864.1

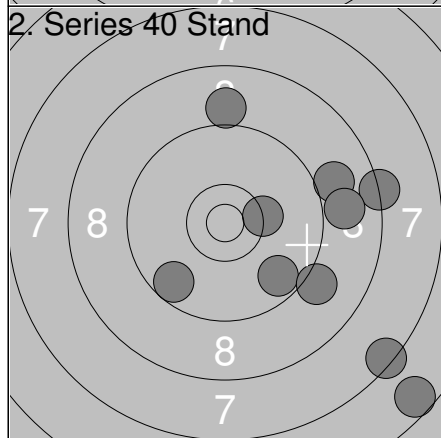

31:	8.3	→
32:	6.6	↓
33:	9.0	↑
34:	9.0	→
35:	7.4	↓
36:	9.7	↓
37:	10.3x	→
38:	9.1	↓
39:	9.6	↙
40:	8.9	→
Series		87.9
Total		952.0

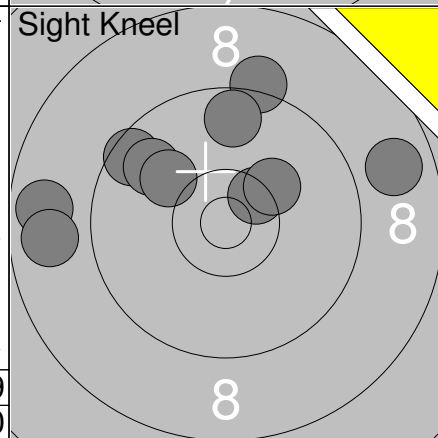

1:	9.6	↖
2:	8.7	←
3:	8.8	←
4:	10.5x	↗
5:	8.8	→
6:	9.8	↖
7:	9.2	↑
8:	9.7	↑
9:	10.2	↗
10:	10.1	↖
Series		95.4
Total		952.0

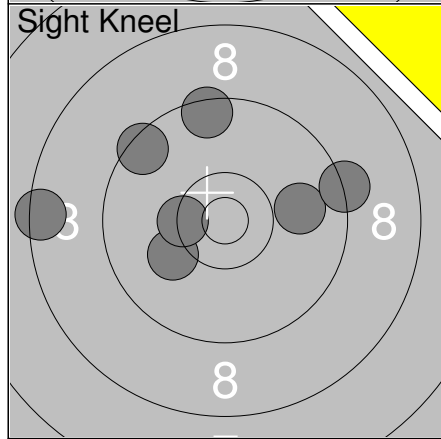

11:	8.5	←
12:	9.9	→
13:	10.1	←
14:	9.3	→
15:	9.5	↑
16:	9.5	↗
17:	10.4x	←
Series		67.2
Total		952.0

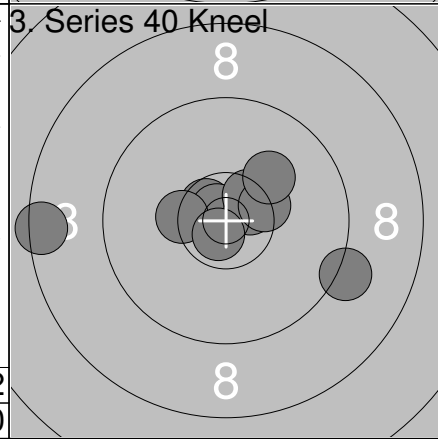

1:	8.5	←
2:	10.6x	↖
3:	10.8x	↖
4:	10.6x	→
5:	10.4x	←
6:	9.2	↘
7:	10.5x	↗
8:	10.4x	→
9:	10.7x	↙
10:	10.1	↗
Series		101.8
Total		1053.8

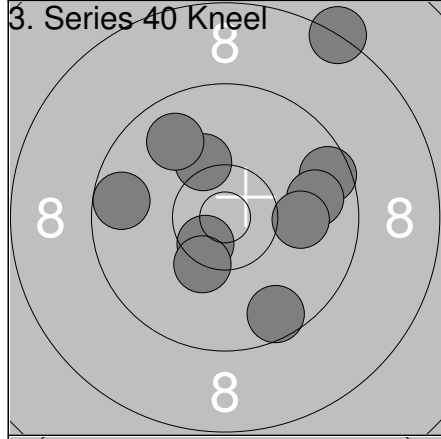

11:	9.6	→
12:	10.5x	↙
13:	10.2	↗
14:	10.3x	↙
15:	9.8	↗
16:	9.8	→
17:	8.3	↗
18:	10.0	→
19:	9.7	←
20:	9.6	↓
Series		97.8
Total		1151.6

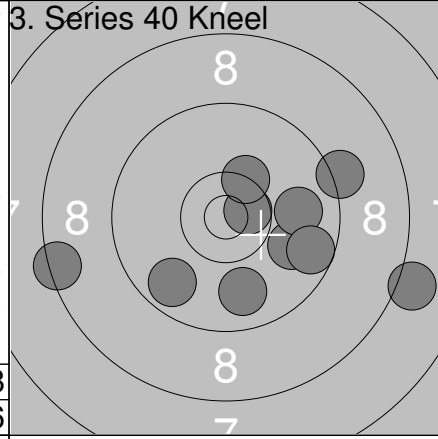

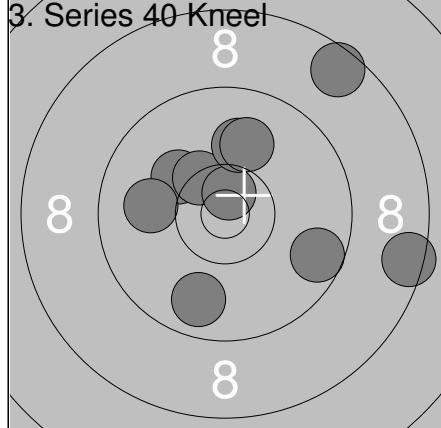

21:	9.9	↘
22:	9.2	→
23:	9.9	↓
24:	8.1	→
25:	9.7	↙
26:	10.6x	→
27:	9.9	→
28:	8.4	←
29:	10.3x	↑
30:	9.6	↘
Series		95.6
Total		1247.2



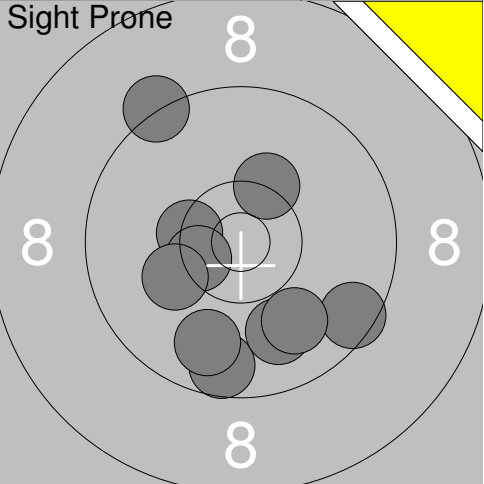

31:	9.8	↓
32:	10.2	↗
33:	10.4x	↗
34:	10.7x	↑
35:	10.0	↑
36:	8.5	→
37:	8.6	↗
38:	10.0	↑
39:	9.6	↘
40:	10.0	←
Series		97.8
Total		1345.0

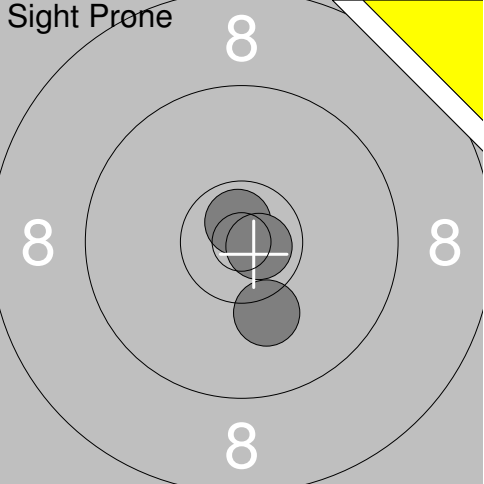
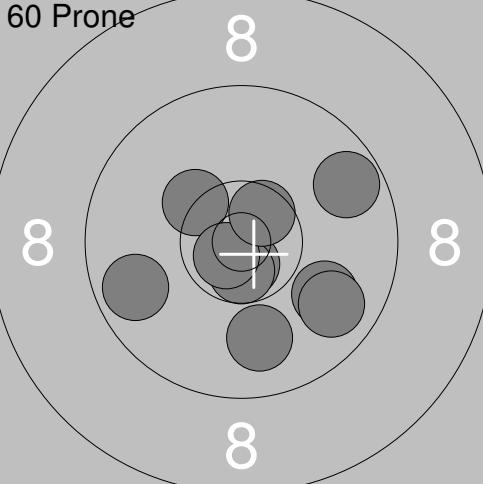
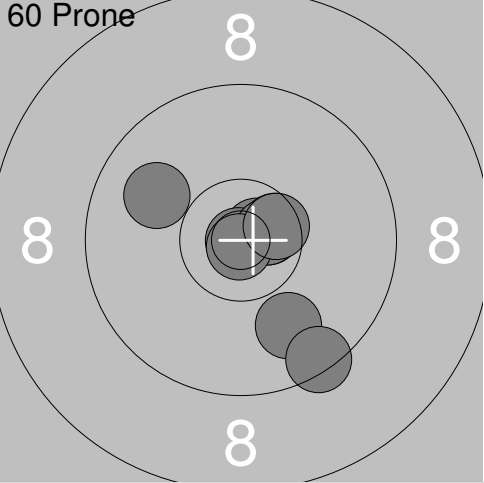
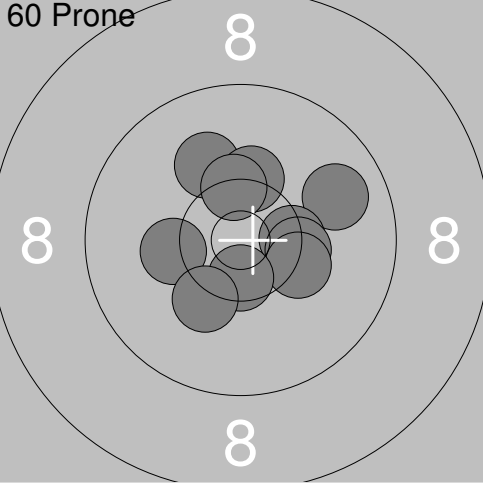
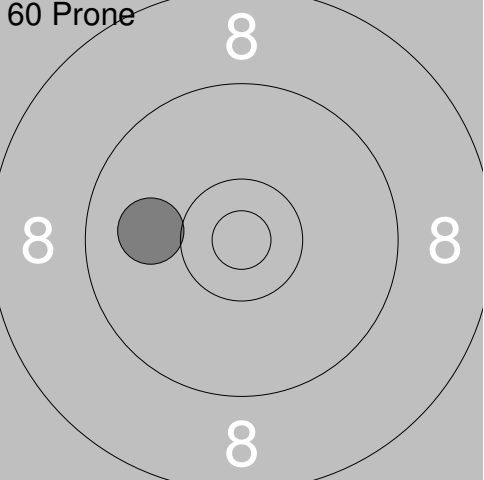
Relay	Lane	Håkan Lidman	
S		Piteå Skf	
2016-04-17		Startskottet 2016	Umeå skytteallians
Sight Prone	7	1: 9.9 ↑ 2: 7.7 ↓ 3: 9.6 ↓ 4: 10.1 → 5: 10.1 → 6: 10.4x ↑ 7: 10.2 → 8: 10.4x ↗ 9: 9.9 ↗ 10: 10.1 ↗ Series 98.4 Total 0.0	Sight Prone 8 11: 9.0 ↓ 12: 10.1 ↗ 13: 10.2 → 14: 10.2 → 15: 9.8 ↓ 16: 10.2 ← 17: 9.3 ← 18: 9.5 ↑ 19: 9.0 ↑ 20: 10.1 ↓ Series 97.4 Total 0.0
60 Prone	8	1: 9.8 ← 2: 9.1 ↗ 3: 10.0 ↓ 4: 10.9x ↗ 5: 9.3 ↓ 6: 10.7x ↑ 7: 9.5 ↑ 8: 10.2 ↓ 9: 9.1 ↑ 10: 10.2 ↑ Series 98.8 Total 98.8	60 Prone 8 11: 10.5x ↖ 12: 9.4 ↗ 13: 10.5x ↑ 14: 9.8 → 15: 9.4 ↑ 16: 10.4x ↗ 17: 9.9 ↗ 18: 10.2 ↓ 19: 10.7x ↑ 20: 10.7x → Series 101.5 Total 200.3
60 Prone	8	21: 10.1 ↓ 22: 10.5x ↗ 23: 10.6x ↗ 24: 9.6 ↑ 25: 9.4 ↓ 26: 10.6x ↓ 27: 9.5 ↓ 28: 9.4 ↗ 29: 9.9 ↗ 30: 9.5 ↓ Series 99.1 Total 299.4	60 Prone 8 31: 10.3x ↓ 32: 10.4x ← 33: 9.7 ← 34: 10.5x ↗ 35: 9.6 ↑ 36: 9.6 ← 37: 10.2 ↗ 38: 10.3 ↑ 39: 9.8 → 40: 10.4x ↖ Series 100.8 Total 400.2
60 Prone	8	41: 9.4 ↑ 42: 10.7x ← 43: 10.7x ↗ 44: 10.3 ↑ 45: 10.1 → 46: 10.0 ↑ 47: 9.8 ↑ 48: 9.0 ← 49: 9.4 ↑ 50: 10.1 ↗ Series 99.5 Total 499.7	60 Prone 8 51: 10.7x ↗ 52: 9.6 ↑ 53: 9.3 ↑ 54: 8.9 ↗ 55: 8.2 ↓ 56: 10.4x ← 57: 10.6x ↓ 58: 9.6 ↓ 59: 10.2 ↗ 60: 10.2 ↓ Series 97.7 Total 597.4

Relay	Lane	Mika Tikkanen			
S		Lapin ampujat (FIN)			
2016-04-17		Startskottet 2016	Umeå skytteallians		
Sight Prone		1: 9.3 ↗ 2: 9.6 ↓ 3: 9.8 ↓ 4: 9.9 ↓ 5: 10.4x ← 6: 10.5x ← 7: 10.3x ↗ 8: 9.5 ↓ 9: 9.9 ↓ 10: 10.2 ← Series 99.4 Total 0.0	Sight Prone		11: 10.2 ↑ 12: 10.5x ↓ 13: 10.4x ← 14: 10.6x ↓ 15: 9.9 ↓ 16: 10.4x ↗ 17: 10.4x ↗ 18: 10.6x ← 19: 10.7x ↗ 20: 10.2 ↗ Series 103.9 Total 0.0
Sight Prone		21: 10.7x ↑ 22: 10.2 ↓ 23: 10.8x → Series 31.7 Total 0.0	60 Prone		1: 10.7x ↓ 2: 10.3x ↗ 3: 9.9 → 4: 9.9 ↓ 5: 10.6x ↓ 6: 10.7x ↙ 7: 10.6x ↗ 8: 9.8 → 9: 9.7 ← 10: 9.7 → Series 101.9 Total 101.9
60 Prone		11: 9.9 ↓ 12: 10.8x ↗ 13: 10.9x ← 14: 9.9 ← 15: 10.6x → 16: 9.4 ↓ 17: 10.6x → 18: 10.7x → 19: 10.9x ↓ 20: 10.5x → Series 104.2 Total 206.1	60 Prone		21: 10.2 ← 22: 10.1 ↗ 23: 10.3x ↑ 24: 9.8 → 25: 10.4x → 26: 10.3x → 27: 10.3 → 28: 10.4x ↑ 29: 10.6x ↓ 30: 10.2 ↓ Series 102.6 Total 308.7
60 Prone		31: 10.0 ← Series 10.0 Total 318.7			

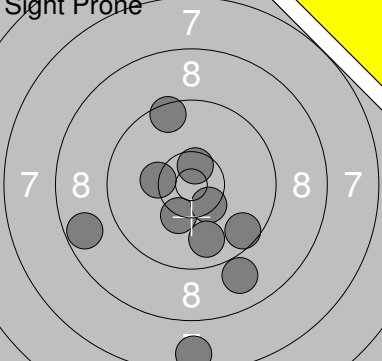
<p>Sight Prone</p>	<p>Sight Prone</p>	
<p>60 Prone</p>	<p>60 Prone</p>	
<p>60 Prone</p>	<p>60 Prone</p>	
<p>60 Prone</p>	<p>60 Prone</p>	

Sight Prone 	1: 8.7 ← 2: 7.7 ↓ 3: 10.3x ↓ 4: 9.5 ↓ 5: 9.6 ↓ 6: 10.4x ↓ 7: 10.6x ↑ 8: 10.3x ← 9: 8.9 ↓ 10: 9.9 ↓	Sight Prone 	11: 9.8 ↓ 12: 10.2 ↓ 13: 8.2 ↓ 14: 10.1 ↓ 15: 8.6 ↓ 16: 9.1 ↓ 17: 7.8 ↓ 18: 8.6 ↓ 19: 8.9 ↓ 20: 7.6 ↓
	Series 95.9		Series 88.9
	Total 0.0		Total 0.0

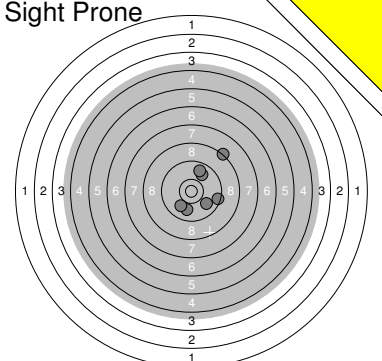
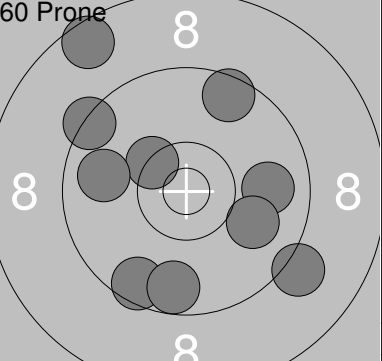
Sight Prone 	21: 9.9 ↓ 22: 10.0 ↓ 23: 9.4 → 24: 0.0 ↓ 25: 9.9 ↓ 26: 8.3 ↓ 27: 9.9 ↑ 28: 9.8 ↑	60 Prone 	1: 9.6 ↑ 2: 8.6 ↑ 3: 10.4x ↑ 4: 9.4 ↑ 5: 9.9 → 6: 10.0 ↓ 7: 9.8 ← 8: 9.6 ↓ 9: 9.1 ↓ 10: 9.7 ↓
	Series 67.2		Series 96.1
	Total 0.0		Total 96.1

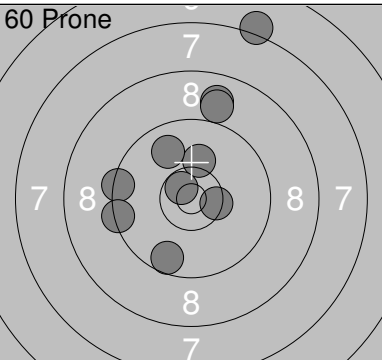
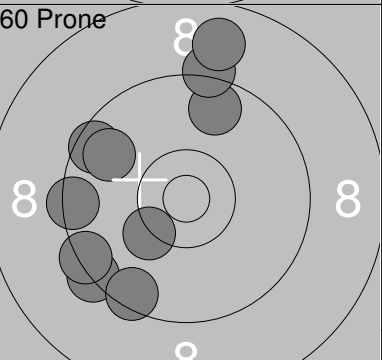
60 Prone 	11: 9.4 ← 12: 7.2 ↑ 13: 9.6 ↓ 14: 8.9 ↑ 15: 9.4 ← 16: 9.0 ↑ 17: 10.4x → 18: 10.2 ↑ 19: 10.7x ↑ 20: 9.9 ↑	60 Prone 	21: 9.6 ↑ 22: 9.4 ← 23: 9.7 ↑ 24: 9.3 ↓ 25: 9.4 ← 26: 10.3 ↓ 27: 9.2 ↑ 28: 9.8 ↑ 29: 9.5 ↓ 30: 8.8 ↑
	Series 94.7		Series 95.0
	Total 190.8		Total 285.8

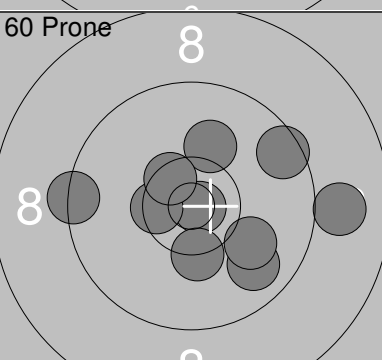
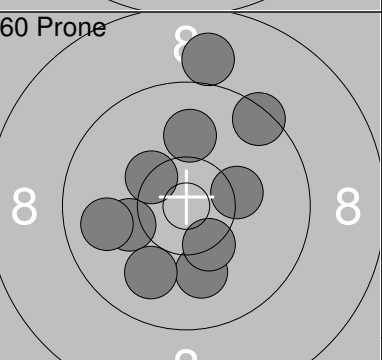
60 Prone 	31: 10.8x → 32: 9.0 → 33: 9.8 ↓ 34: 10.0 ↓ 35: 10.1 ↑ 36: 10.5x ← 37: 9.4 ← 38: 9.5 → 39: 10.3x ↓ 40: 10.5x ↑	60 Prone 	41: 10.1 ← 42: 9.4 ↑ 43: 10.3 → 44: 9.9 ← 45: 9.0 ↑ 46: 10.3x ↑ 47: 10.1 ↓ 48: 10.0 ↑ 49: 10.4x ↓ 50: 9.9 ↓
	Series 99.9		Series 99.4
	Total 385.7		Total 485.1

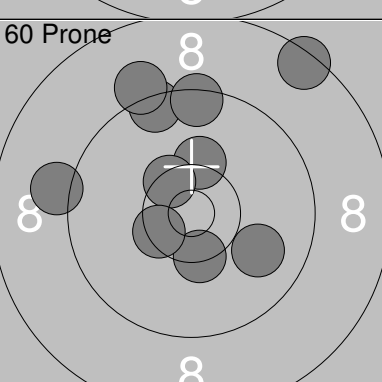
60 Prone 	51: 10.4x ↓ 52: 9.4 ↑ 53: 10.3 ↑ 54: 8.4 ↑ 55: 9.4 ↑ 56: 9.9 ↓ 57: 9.1 ← 58: 10.4x ↑ 59: 9.1 ↑ 60: 10.5x ←		
	Series 96.9		
	Total 582.0		

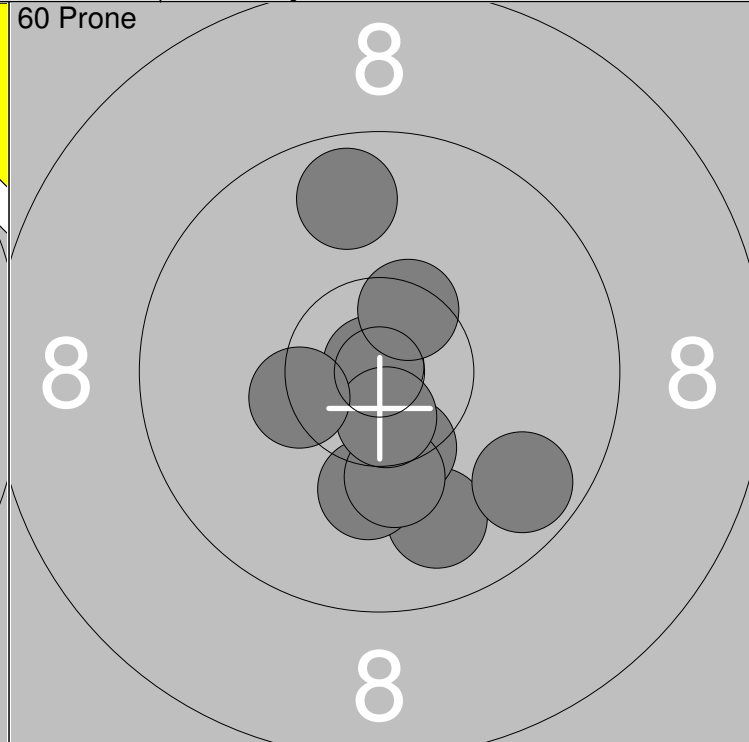
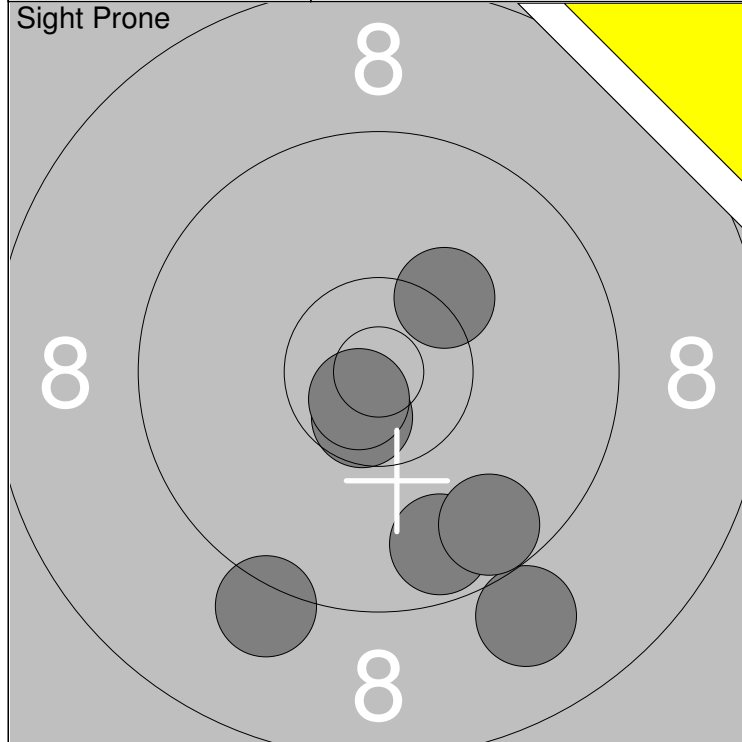

1: 9.2	↓	6: 10.6x	↓	Series	69.2
2: 9.0	↓	7: 10.7x	↓		
3: 9.7	↓			Total	0.0
4: 9.7	↓				
5: 10.3	↗				

1: 10.9x	↖	6: 9.7	↓	Series	102.4
2: 9.9	↓	7: 10.4x	↓		
3: 10.5x	↗			Total	102.4
4: 9.7	↗				
5: 10.1	↓	9: 10.6x	↓		
			10: 10.4x	←	

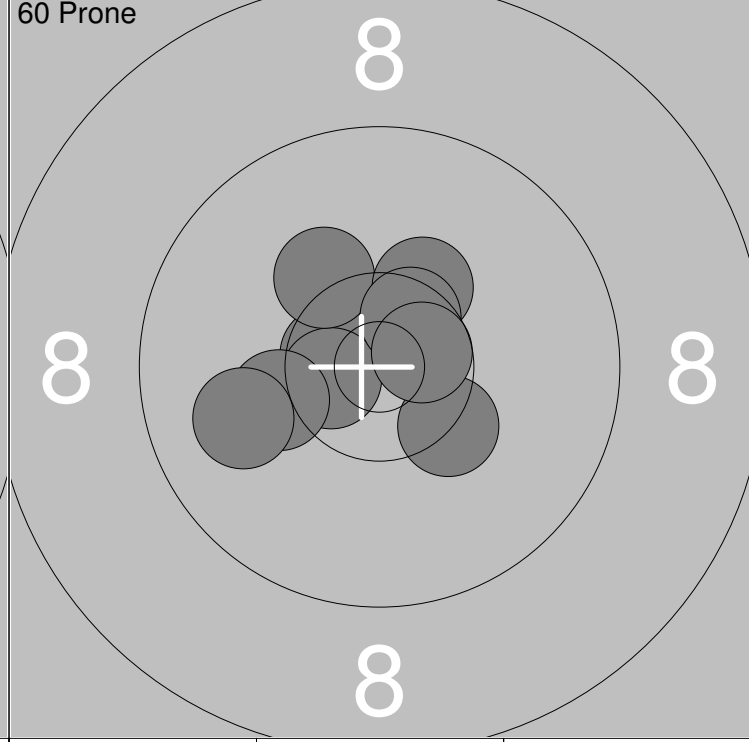
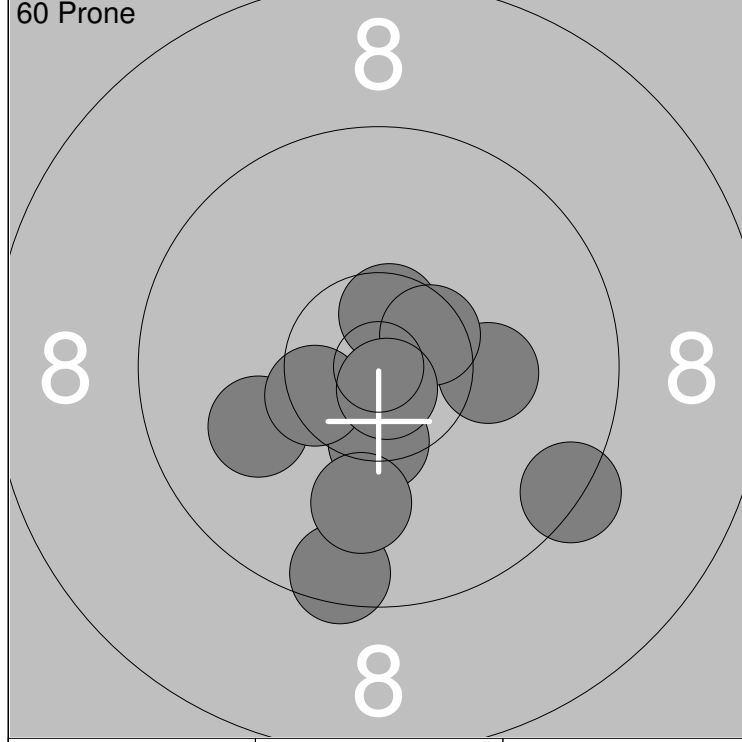

11: 10.2	→	16: 10.0	↓	Series	101.9
12: 10.0	←	17: 10.6x	↗		
13: 9.4	↘			Total	204.3
14: 9.5	↓				
15: 10.4x	↓	18: 10.5x	↗		
			19: 10.5x	←	
			20: 10.8x	↓	

21: 10.6x	←	26: 10.6x	↗	Series	93.3
22: 10.6x	←	27: 10.3x	↘		
23: 10.2	↗			Total	297.6
24: 10.3x	↗				
			28: 10.6x	→	
			29: 9.9	←	
25: 10.2	←				

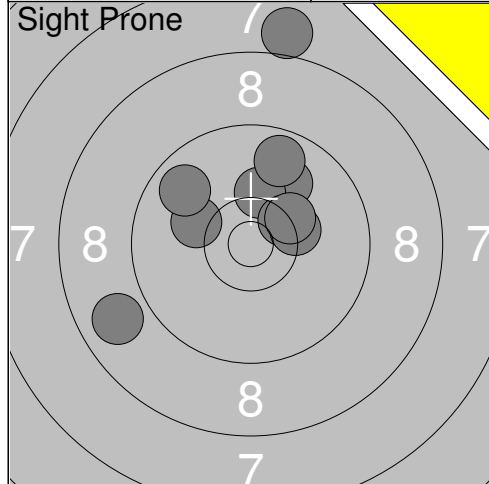

1:	8.0	↑
2:	10.0	↗
3:	10.2	↑
4:	8.8	↖
5:	10.4x	↗
6:	10.3x	→
7:	10.1	↖
8:	10.3x	↗
9:	9.7	↑
10:	9.8	↖
Series		97.6
Total		0.0

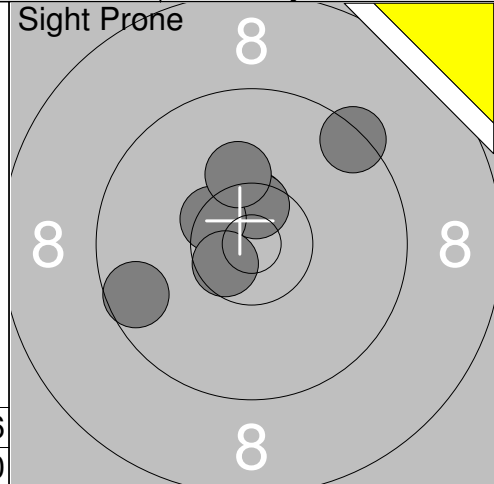

11:	10.5x	↑
12:	9.4	↗
13:	10.5x	↑
14:	10.5x	↖
15:	10.2	↑
16:	10.6x	↖
17:	9.6	↖
Series		71.3
Total		0.0

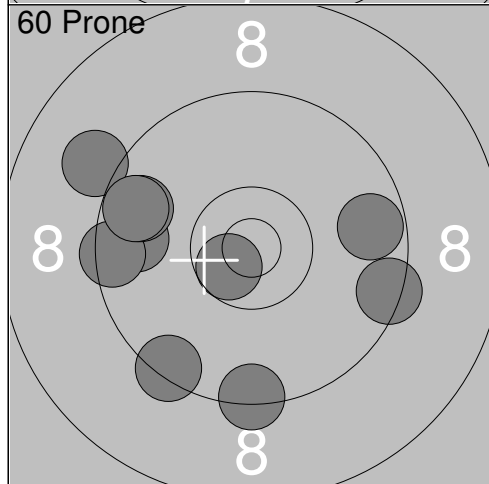

1:	9.4	→
2:	10.6x	↖
3:	9.7	↖
4:	9.4	↓
5:	9.4	↓
6:	9.5	↖
7:	9.1	↗
8:	9.7	↖
9:	9.7	→
10:	9.7	↖
Series		96.2
Total		96.2

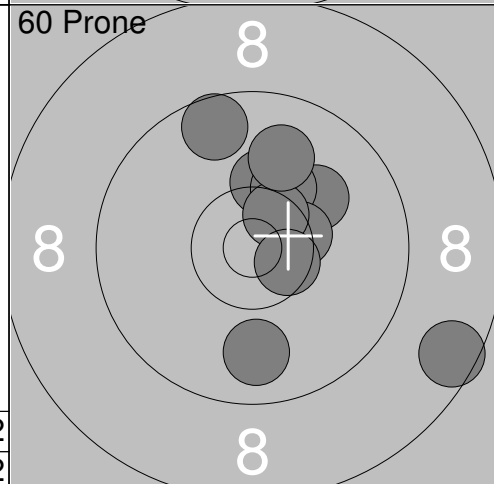

11:	9.6	↑
12:	10.2	↑
13:	10.1	↗
14:	9.8	↓
15:	10.2	↑
16:	10.4x	→
17:	10.5x	↗
18:	8.6	→
19:	10.6x	→
20:	10.0	↑
Series		100.0
Total		196.2

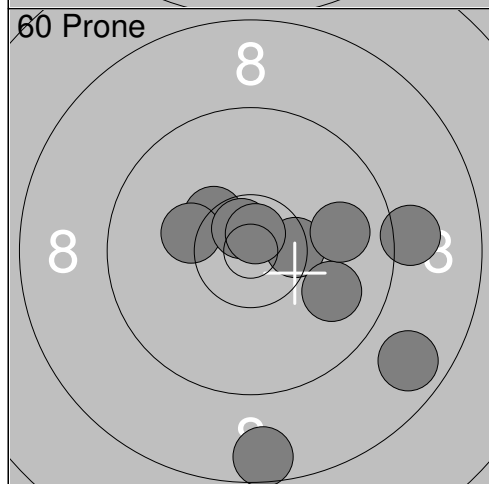

21:	8.6	↓
22:	10.4x	→
23:	9.9	→
24:	10.4x	↗
25:	10.2	↖
26:	10.7x	↗
27:	9.9	→
28:	10.7x	↑
29:	8.8	↘
30:	9.1	→
Series		98.7
Total		294.9

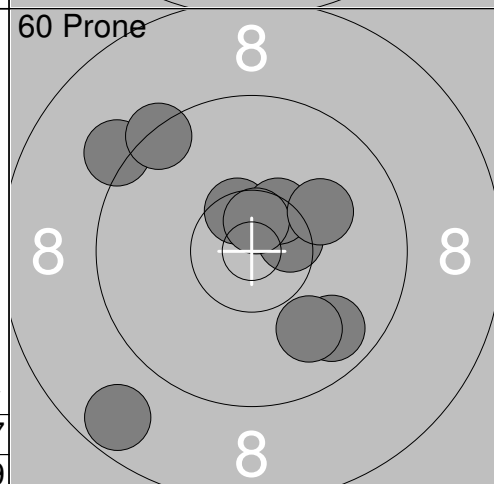

31:	10.5x	↖
32:	10.5x	→
33:	10.4x	↗
34:	10.6x	↑
35:	8.7	↘
36:	9.8	↘
37:	10.1	↗
38:	9.9	↘
39:	9.2	↖
40:	9.4	↖
Series		99.1
Total		394.0

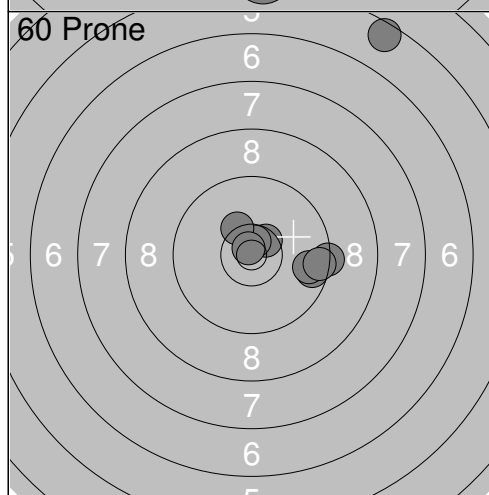

41:	9.4	→
42:	10.5x	↗
43:	10.7x	↑
44:	9.6	→
45:	10.3x	↗
46:	5.6	↑
47:	9.6	→
48:	10.8x	↑
49:	9.7	→
50:	9.5	→
Series		95.7
Total		489.7

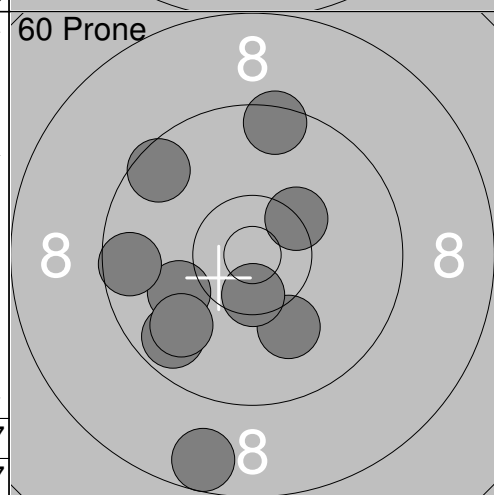

51:	10.0	↖
52:	10.1	↓
53:	9.7	↘
54:	9.9	↘
55:	8.6	↓
56:	10.3x	↗
57:	9.5	↑
58:	9.6	↖
59:	10.5x	↓
60:	9.6	↖
Series		97.8
Total		587.5

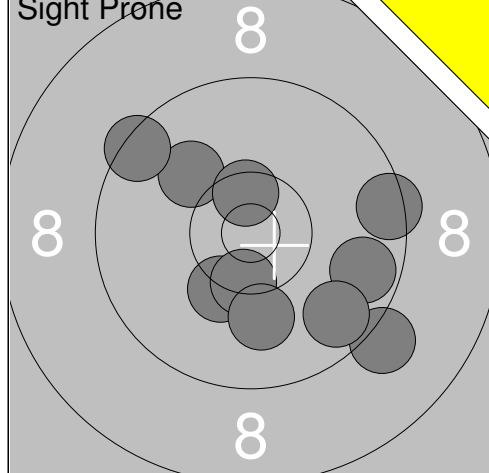

1:	10.1	↗
2:	10.3	↘
3:	9.5	↗
4:	9.7	→
5:	10.4x	↘
6:	9.5	→
7:	9.2	↘
8:	10.5x	↑
9:	9.7	↘
10:	10.1	↘
Series		99.0
Total		0.0

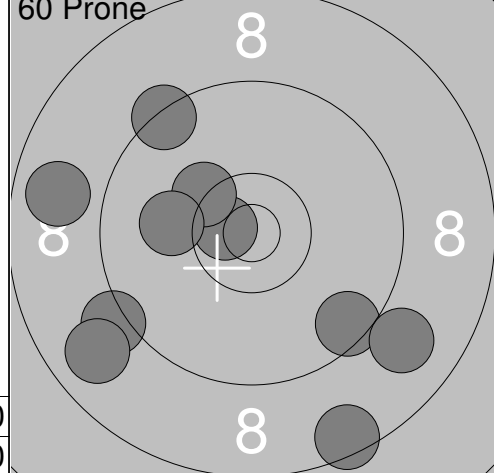

1:	9.5	↘
2:	8.8	←
3:	10.7x	←
4:	8.5	↘
5:	9.4	↗
6:	9.2	←
7:	8.8	←
8:	10.3	↗
9:	10.1	←
10:	8.9	↘
Series		94.2
Total		94.2

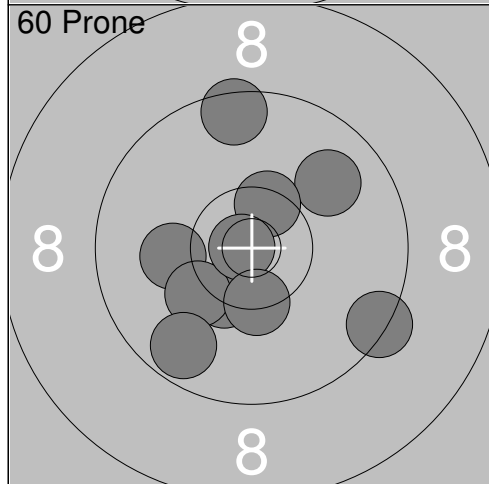

11:	9.9	↗
12:	10.4x	↘
13:	10.1	←
14:	10.5x	↑
15:	10.2	←
16:	10.8x	←
17:	10.4x	↘
18:	9.5	↑
19:	9.4	→
20:	9.7	↘
Series		100.9
Total		195.1

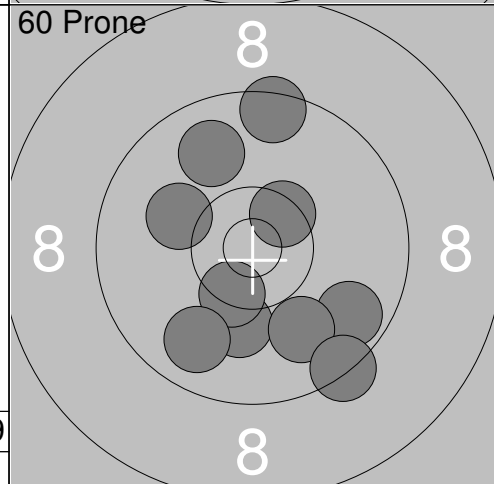

21:	10.1	↘
22:	9.7	↘
23:	9.9	↗
24:	10.4x	↘
25:	9.9	↘
26:	9.4	↘
27:	10.5x	↗
28:	9.5	↑
29:	10.1	←
30:	9.8	↘
Series		99.3
Total		294.4

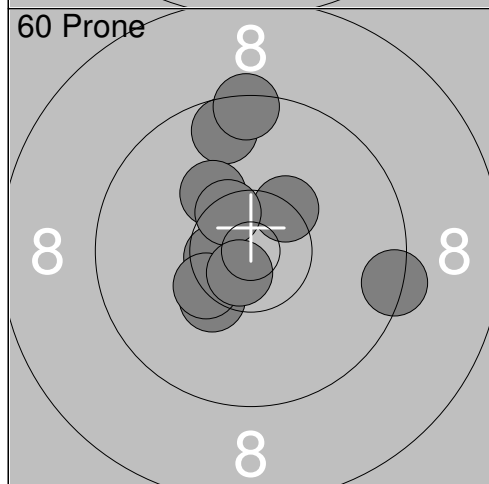

31:	10.6x	←
32:	9.7	↑
33:	9.4	→
34:	10.2	↗
35:	10.3x	↘
36:	10.4x	↗
37:	9.4	↑
38:	10.5x	↗
39:	10.4x	←
40:	10.7x	↘
Series		101.6
Total		396.0

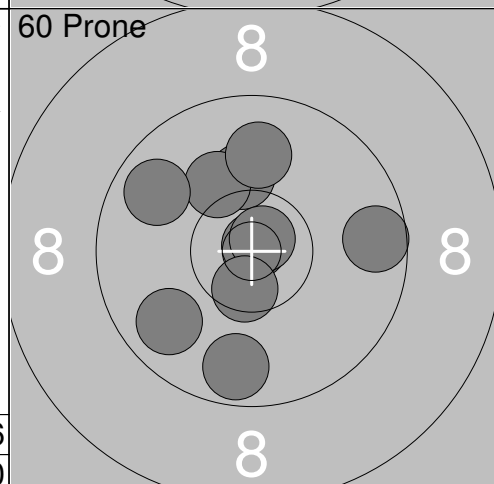

41:	9.8	↙
42:	10.2	↑
43:	10.2	↗
44:	10.9x	↗
45:	9.9	↑
46:	10.8x	↗
47:	9.8	↙
48:	9.6	→
49:	9.7	↘
50:	10.5x	↘
Series		101.4
Total		497.4

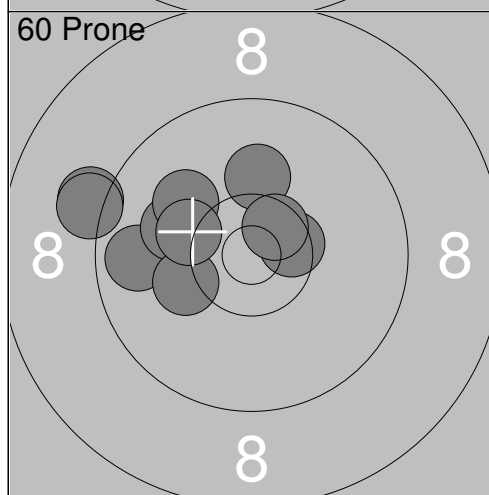

51:	9.8	←
52:	10.5x	→
53:	10.1	←
54:	10.1	↗
55:	9.2	↙
56:	9.2	↙
57:	10.1	↑
58:	10.2	←
59:	10.6x	↗
60:	10.2	←
Series		100.0
Total		597.4

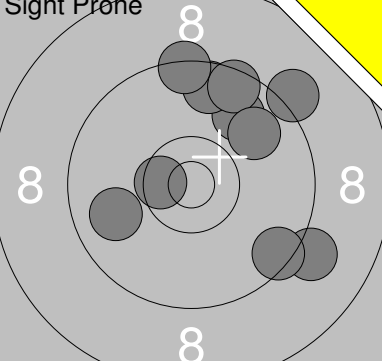
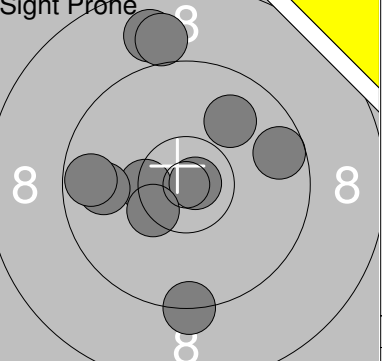
	1: 9.1 ↗ 2: 9.8 ↗ 3: 9.6 ↑ 4: 9.1 → 5: 9.5 ↑ 6: 9.4 ↑ 7: 9.5 → 8: 9.9 ↗ 9: 10.5x ← 10: 9.9 ← <hr/> Series 96.3 Total 0.0		11: 9.9 ↗ 12: 10.4x ← 13: 9.8 ← 14: 8.9 ↑ 15: 9.6 → 16: 9.0 ↑ 17: 10.8x → 18: 10.4x ↙ 19: 9.7 ← 20: 9.3 ↓ <hr/> Series 97.8 Total 0.0
--	---	--	--

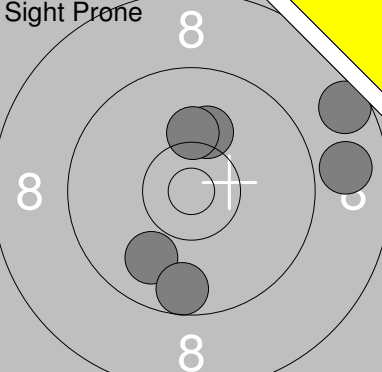
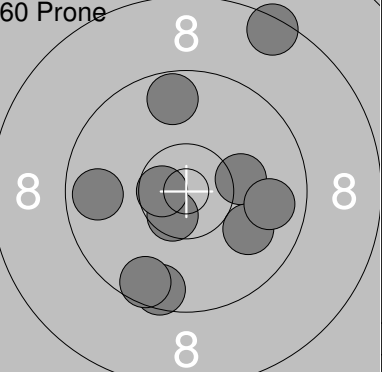
	21: 9.9 ↓ 22: 10.1 ↑ 23: 8.6 → 24: 10.2 ↑ 25: 8.9 → 26: 9.6 ↓ <hr/> Series 57.3 Total 0.0		1: 10.6x ↓ 2: 9.6 ↓ 3: 8.5 ↗ 4: 9.7 ← 5: 9.7 ↑ 6: 10.6x ← 7: 10.2 → 8: 10.0 ↓ 9: 9.6 ↓ 10: 9.8 → <hr/> Series 98.3 Total 98.3
--	--	--	--

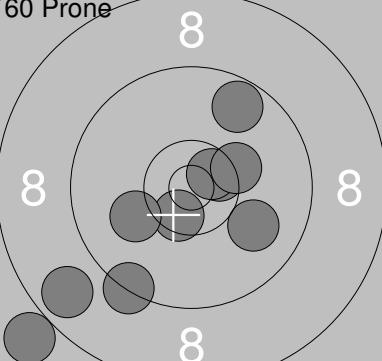
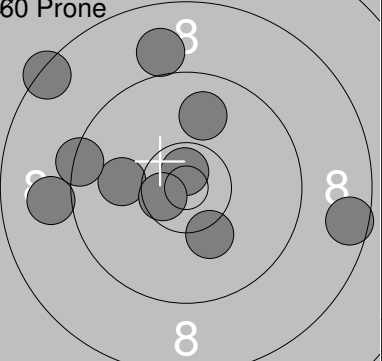
	11: 10.5x → 12: 9.7 ↗ 13: 7.9 ↙ 14: 9.3 ↙ 15: 10.5x ↙ 16: 8.7 ↙ 17: 10.1 ← 18: 10.6x → 19: 10.3 → 20: 10.0 ↘ <hr/> Series 97.6 Total 195.9		21: 10.2 ↓ 22: 9.0 ← 23: 10.0 ← 24: 9.9 ↑ 25: 8.4 ↗ 26: 10.7x ↑ 27: 9.0 ↑ 28: 9.4 ← 29: 10.6x ← 30: 8.6 → <hr/> Series 95.8 Total 291.7
---	---	---	--

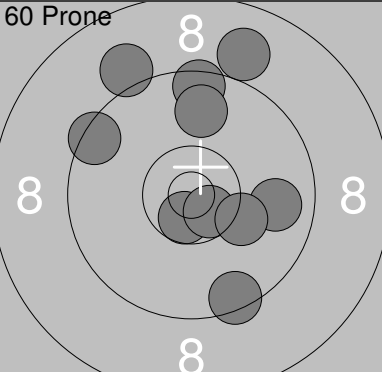
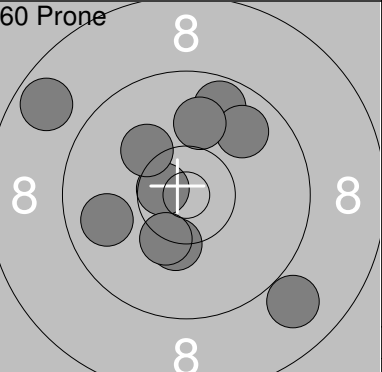
	31: 10.6x ↓ 32: 9.5 ↓ 33: 8.9 ↗ 34: 9.8 → 35: 9.5 ↑ 36: 9.1 ↗ 37: 9.5 ↗ 38: 10.6x ↘ 39: 9.8 ↑ 40: 10.2 ↘ <hr/> Series 97.5 Total 389.2		41: 9.8 ← 42: 10.6x ← 43: 10.3 ↓ 44: 9.7 ↗ 45: 8.7 ↗ 46: 9.8 ↗ 47: 10.2 ↗ 48: 10.0 ↑ 49: 8.9 ↓ 50: 10.3x ↓ <hr/> Series 98.3 Total 487.5
--	---	--	---

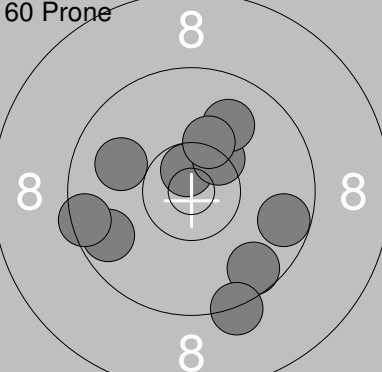
	51: 9.6 ↓ 52: 10.7x ↑ 53: 9.7 ← 54: 9.5 ← 55: 9.3 ↓ 56: 10.4x ↗ 57: 9.7 → 58: 9.9 ↗ 59: 10.0 ← 60: 10.3 ↑ <hr/> Series 99.1 Total 586.6		
--	--	--	--