

1:	10.8x	➔
2:	9.5	↑
3:	9.8	↗
4:	10.2	↘
5:	9.3	←

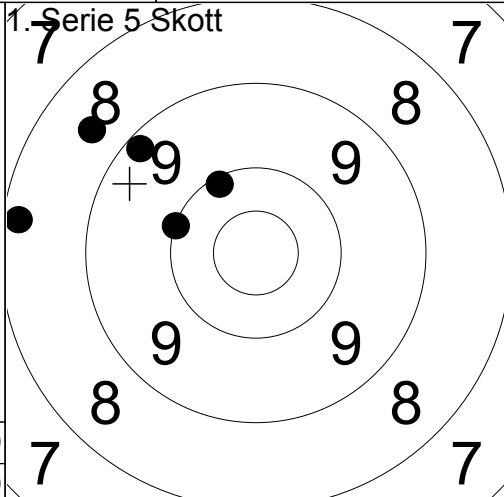

1:	10.0	↗
2:	9.2	↗
3:	8.6	↗
4:	10.1	↗
5:	8.2	←

Serie	47.0
Total	0.0

Serie	45.0
Total	45.0

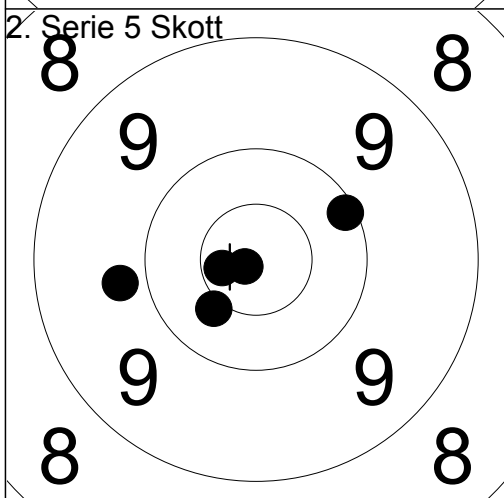

1:	10.7x	←
2:	9.8	←
3:	10.8x	←
4:	10.1	↗
5:	10.4	↘

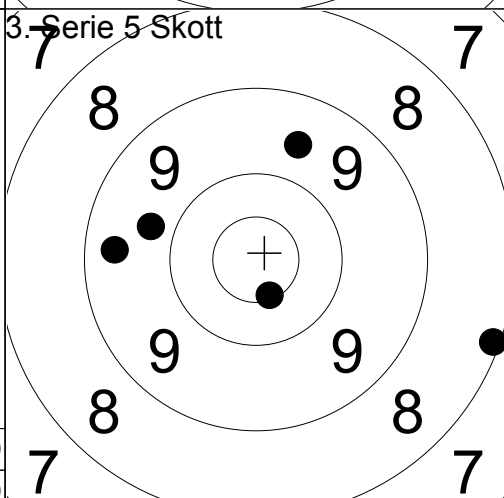

1:	9.6	↑
2:	8.1	➔
3:	10.5x	↘
4:	9.4	←
5:	9.7	←

Serie	49.0
Total	94.0

Serie	45.0
Total	139.0

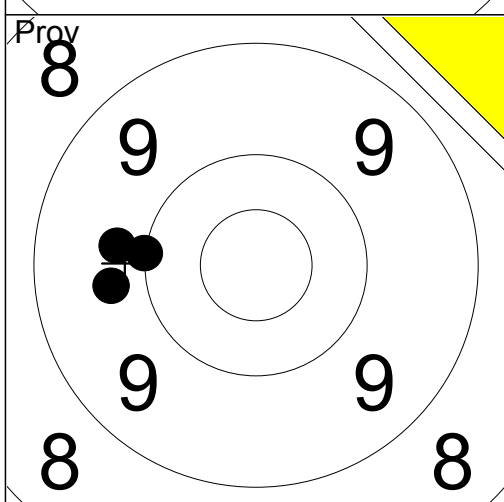

1:	10.0	←
2:	9.8	←
3:	9.7	←

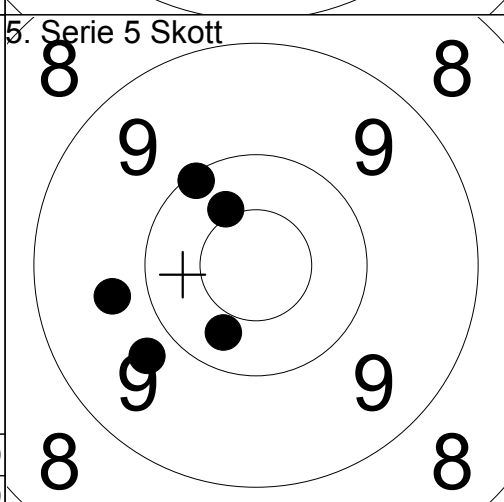

1:	10.3	↘
2:	9.7	←
3:	10.4x	↗
4:	10.1	↗
5:	9.8	↘

Serie	28.0
Total	139.0

Serie	48.0
Total	187.0

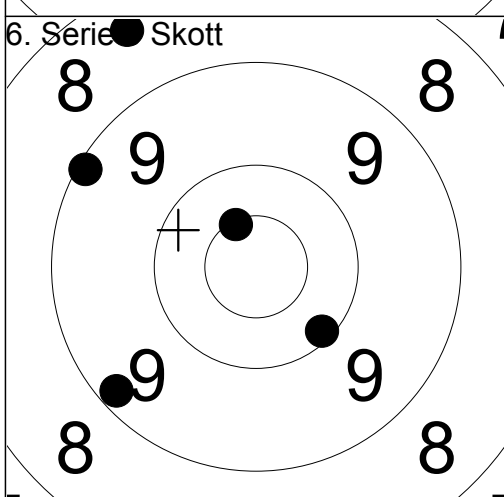

1:	9.2	↘
2:	9.1	↗
3:	10.5x	↗
4:	10.1	↘
5:	8.4	↗

Serie	46.0
Total	233.0

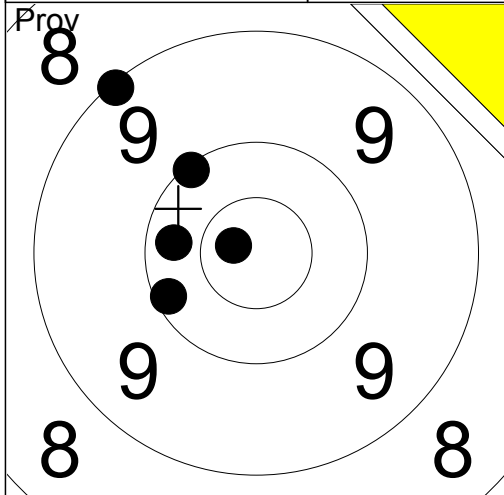

1:	10.7x	↖
2:	9.1	↗
3:	10.1	↖
4:	10.1	↗
5:	10.3	↖

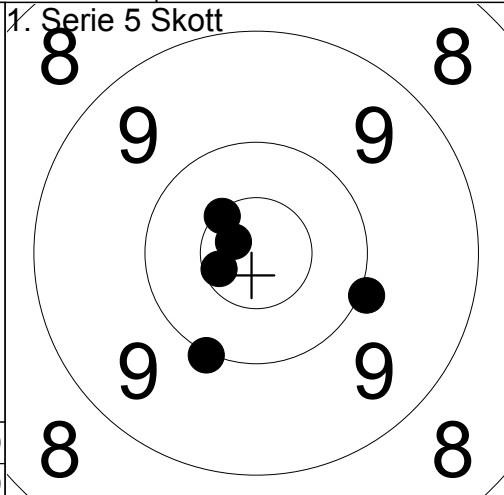

1:	10.0	↗
2:	10.5x	↗
3:	10.6x	↖
4:	10.0	↖
5:	10.7x	↗

Serie	49.0
Total	0.0

Serie	50.0
Total	50.0

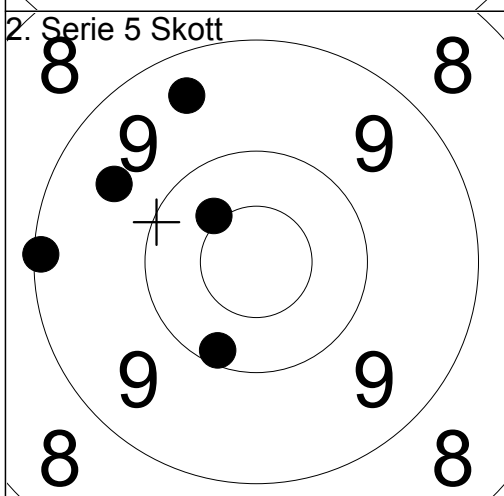

1:	9.4	↗
2:	10.4x	↗
3:	9.1	↖
4:	9.6	↗
5:	10.1	↘

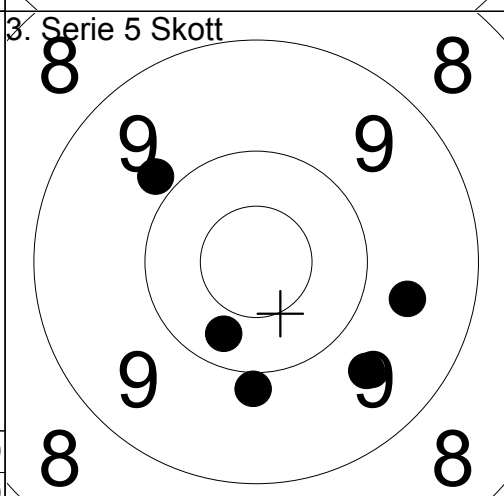

1:	9.6	↗
2:	9.6	↘
3:	9.8	↗
4:	10.3	↘
5:	9.9	↘

Serie	47.0
Total	97.0

Serie	46.0
Total	143.0

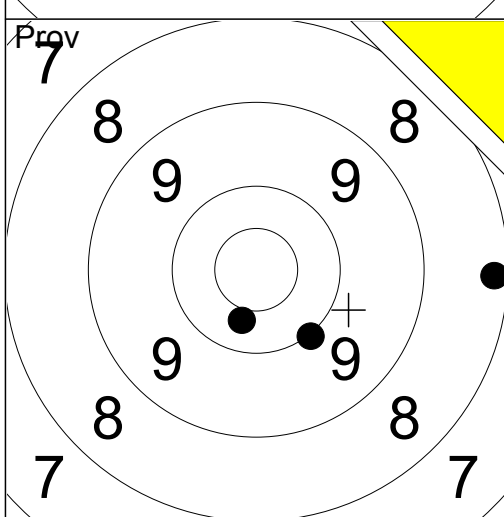

1:	8.2	→
2:	10.4	↘
3:	10.0	↘

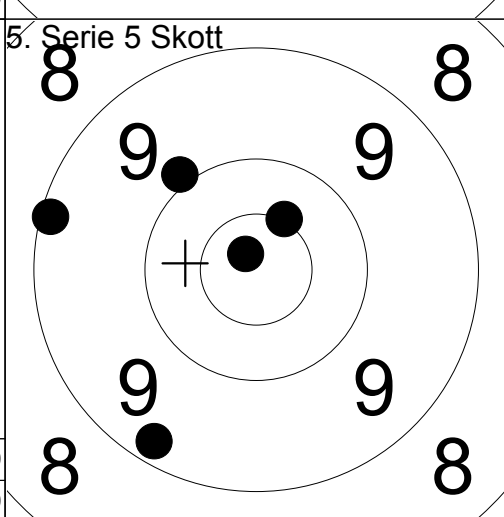

1:	10.8x	↗
2:	9.1	↖
3:	10.5x	↗
4:	9.9	↗
5:	9.2	↘

Serie	28.0
Total	143.0

Serie	47.0
Total	190.0

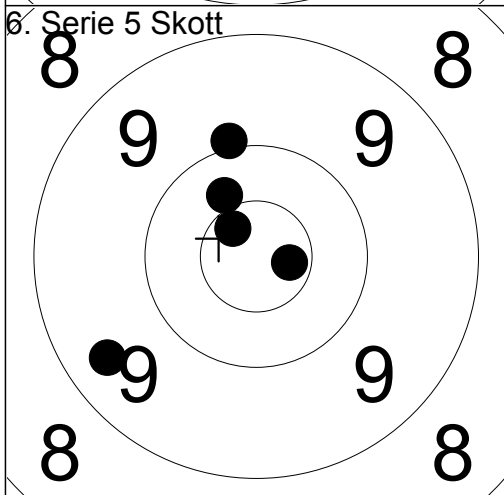

1:	9.4	↖
2:	10.4	↗
3:	10.6x	↗
4:	10.0	↗
5:	10.7x	→

Serie	49.0
Total	239.0

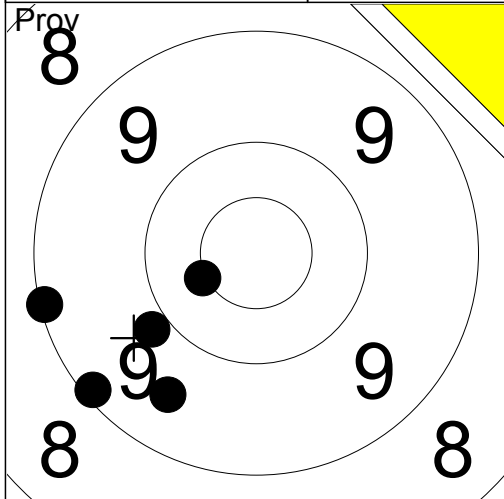

- 1: 9.1 ←
- 2: 9.1 ↙
- 3: 9.5 ↘
- 4: 9.9 ←
- 5: 10.5x ←

Serie 46.0
Total 0.0

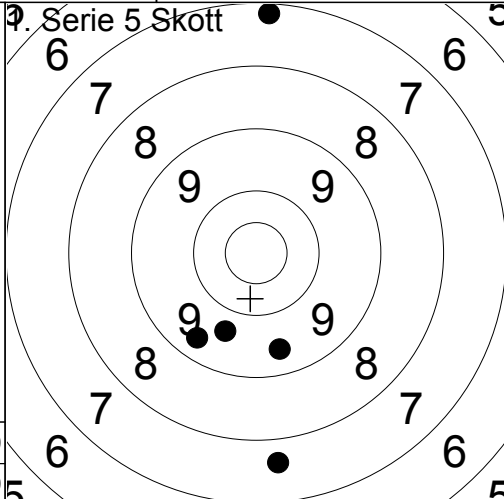

- 1: 9.4 ↘
- 2: 9.5 ↘
- 3: 7.7 ↘
- 4: 9.7 ↘
- 5: 7.2 ↑

Serie 41.0
Total 41.0

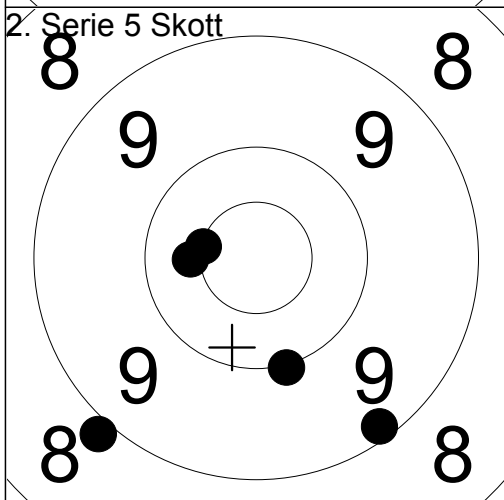

- 1: 10.0 ↘
- 2: 10.4 ←
- 3: 9.2 ↘
- 4: 8.9 ↘
- 5: 10.5x ←

Serie 47.0
Total 88.0

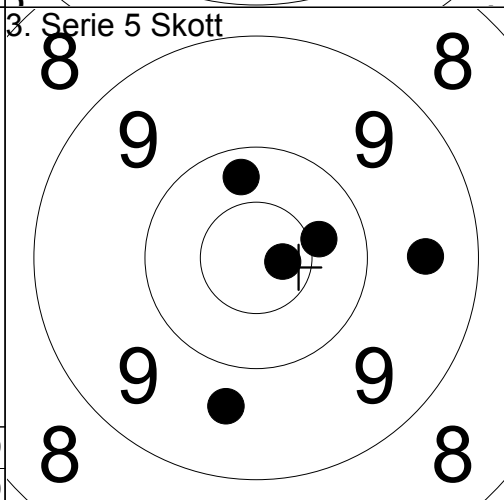

- 1: 10.3 ↑
- 2: 10.4 →
- 3: 9.5 →
- 4: 10.7x →
- 5: 9.7 ↘

Serie 48.0
Total 136.0

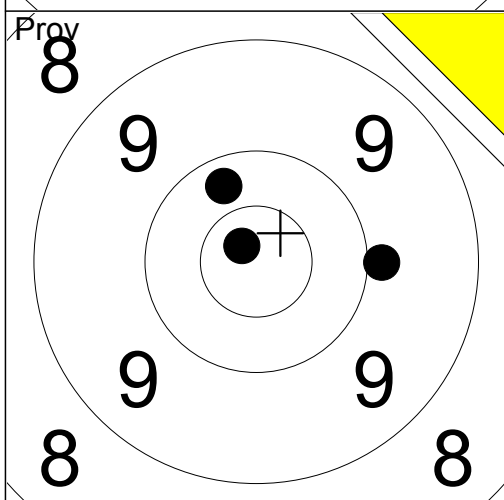

- 1: 10.3 ↗
- 2: 10.8x ↗
- 3: 9.9 →

Serie 29.0
Total 136.0

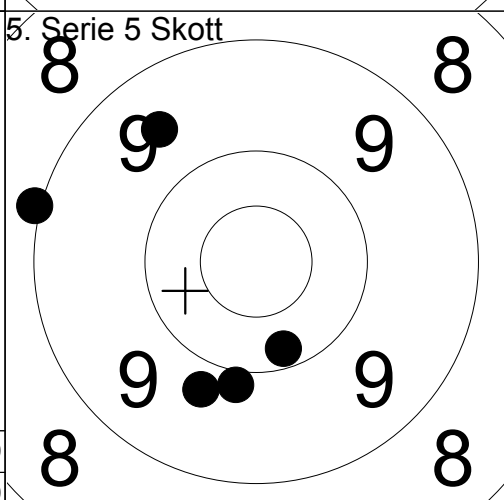

- 1: 9.6 ↗
- 2: 9.9 ↘
- 3: 9.8 ↘
- 4: 10.2 ↘
- 5: 9.0 ←

Serie 46.0
Total 182.0

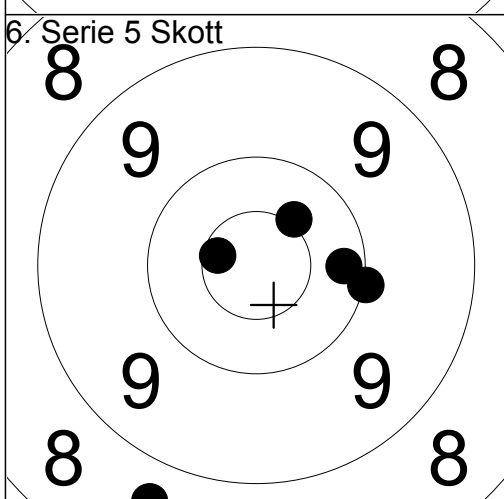

- 1: 10.4x ↗
- 2: 10.6x ←
- 3: 10.2 →
- 4: 8.7 ↘
- 5: 10.0 →

Serie 48.0
Total 230.0

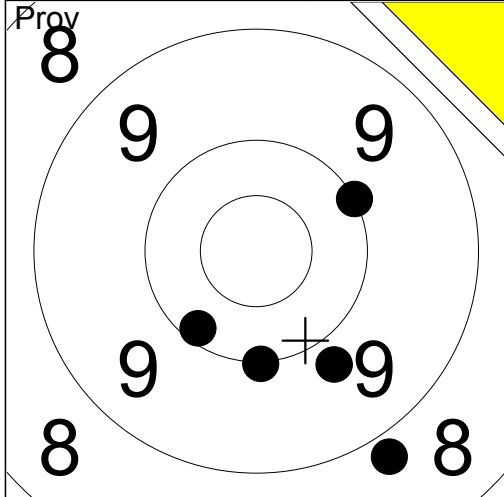

1:	10.0	↓
2:	8.8	↓
3:	9.8	↓
4:	10.1	↓
5:	10.0	↗
Serie		47.0
Total		0.0

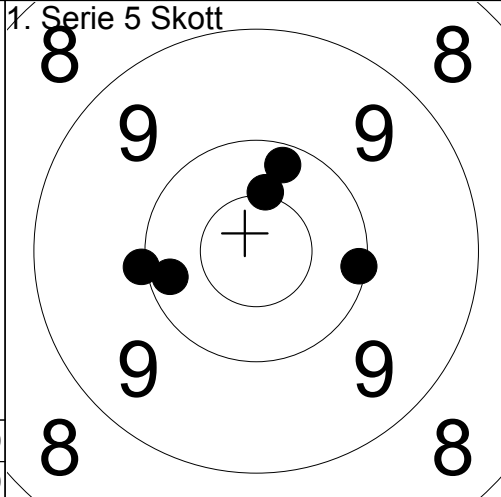

1:	10.2	←
2:	10.0	←
3:	10.1	→
4:	10.2	↑
5:	10.5x	↑
Serie		50.0
Total		50.0

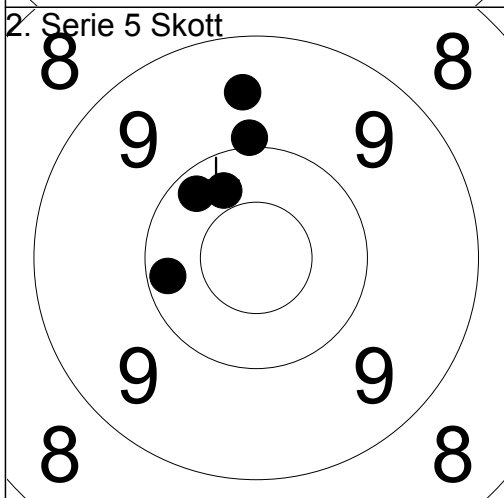

1:	10.3	↗
2:	10.2	←
3:	9.5	↑
4:	9.9	↑
5:	10.2	↗
Serie		48.0
Total		98.0

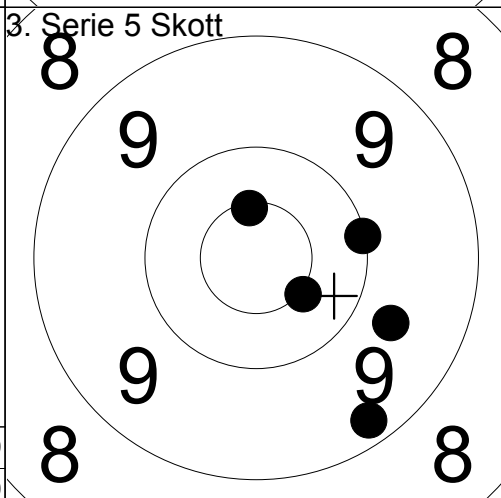

1:	9.3	↓
2:	10.5x	↓
3:	9.7	↘
4:	10.0	→
5:	10.5x	↑
Serie		48.0
Total		146.0

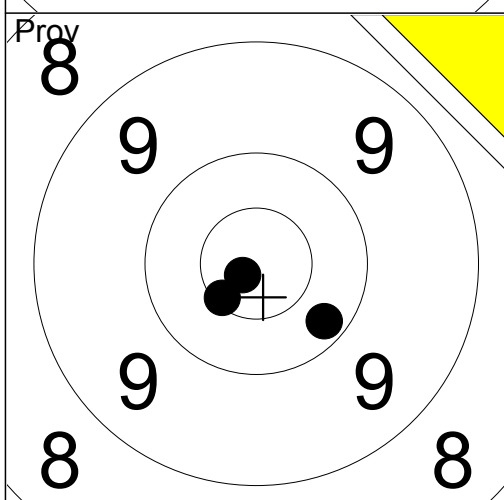

1:	10.8x	↙
2:	10.5x	↙
3:	10.2	↘
Serie		30.0
Total		146.0

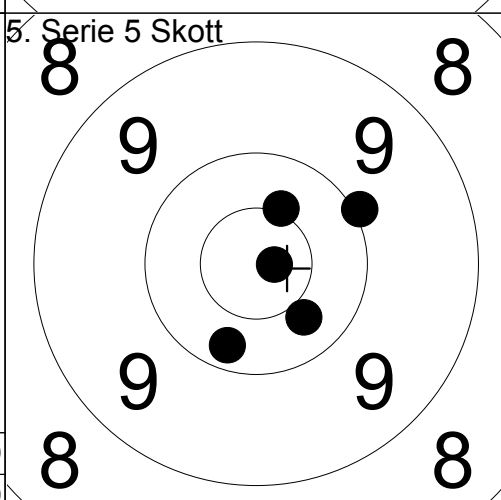

1:	10.4	↘
2:	10.2	↓
3:	10.0	↗
4:	10.8x	→
5:	10.4x	↑
Serie		50.0
Total		196.0

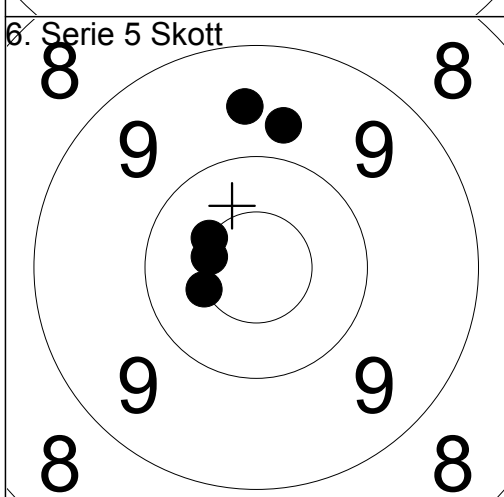

1:	10.5x	←
2:	10.5x	←
3:	9.6	↑
4:	10.5x	↖
5:	9.7	↑
Serie		48.0
Total		244.0

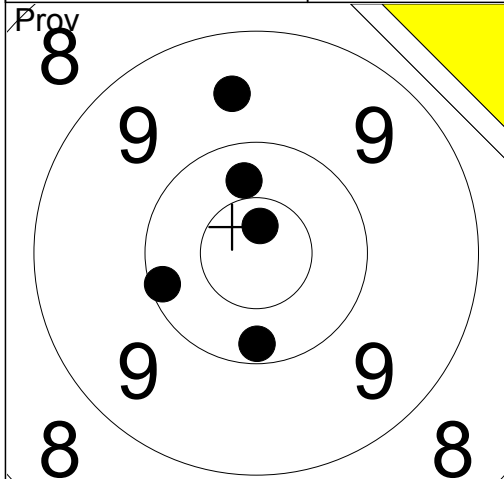

1:	9.6	↑
2:	10.7x	↑
3:	10.2	↓
4:	10.1	←
5:	10.3	↑
Serie		49.0
Total		0.0

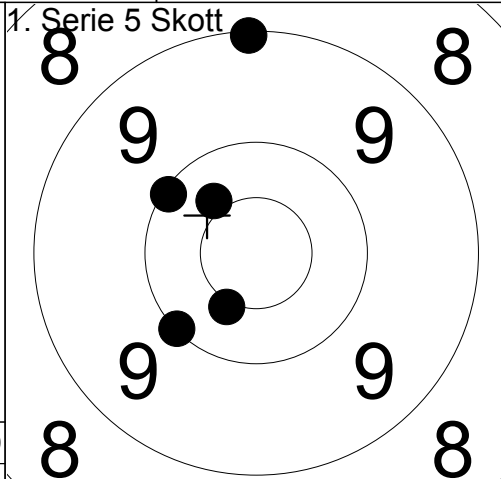

1:	9.1	↑
2:	10.4x	↓
3:	10.4	↗
4:	10.1	↗
5:	10.0	↘
Serie		49.0
Total		49.0

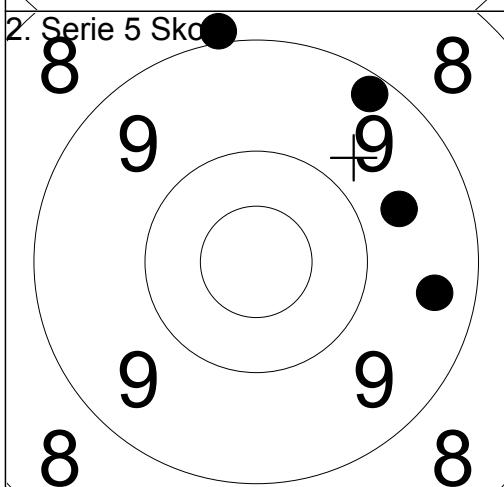

1:	9.7	→
2:	9.2	↗
3:	8.9	↑
4:	9.4	→
5:	0.0	
Serie		35.0
Total		84.0

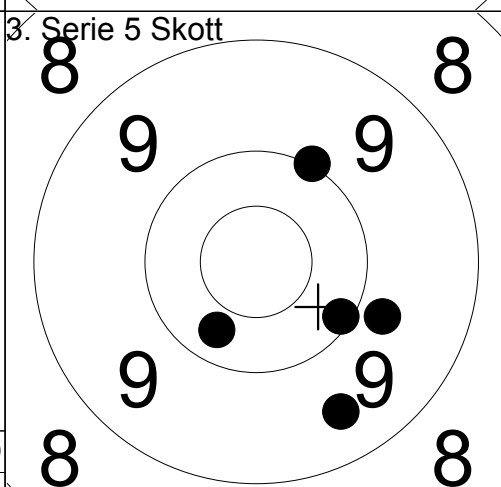

1:	10.0	↗
2:	10.3	↓
3:	10.1	↘
4:	9.8	→
5:	9.5	↘
Serie		48.0
Total		132.0

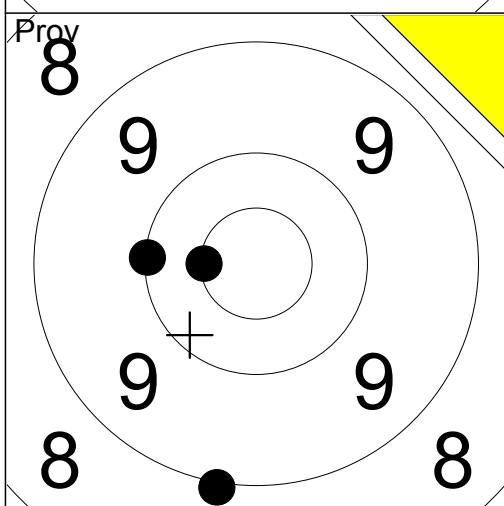

1:	10.0	←
2:	9.0	↓
3:	10.5x	←
Serie		29.0
Total		132.0

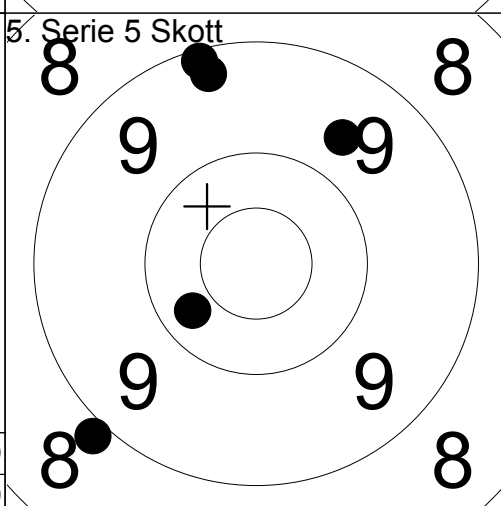

1:	9.7	↗
2:	9.3	↑
3:	8.9	↘
4:	10.3	↘
5:	9.1	↑
Serie		45.0
Total		177.0

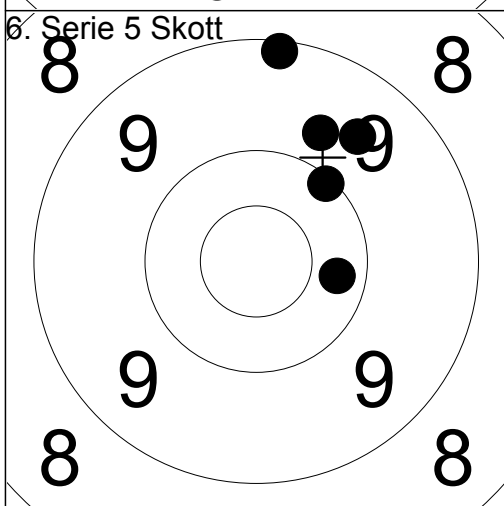

1:	9.1	↑
2:	10.3	→
3:	9.6	↗
4:	10.1	↗
5:	9.7	↗
Serie		47.0
Total		224.0

Skjutlag 1 Tavla 6 **Rune Skarpsvärd**

300m Pajala B No

10.07.2016 Tavelträffen 2016 Ramselefors SKF

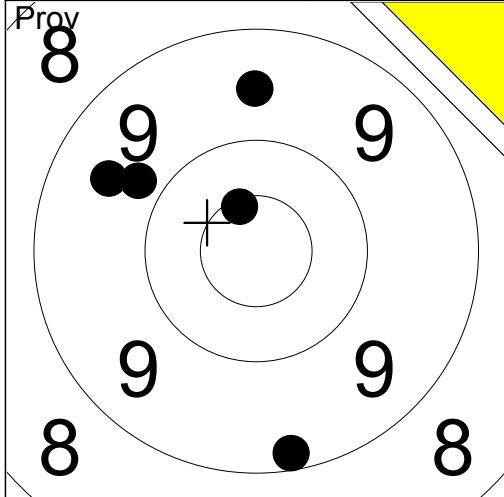

1:	9.6	↑
2:	9.8	↖
3:	9.2	↓
5:	10.6x	↑
6:	9.6	↖
Serie	46.0	
Total	0.0	

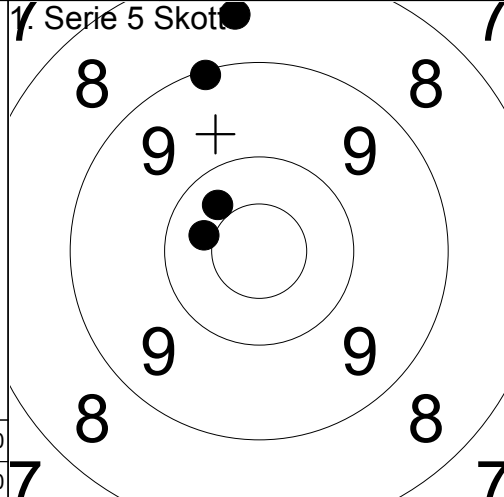

1:	9.1	↑
2:	10.4	↖
3:	10.3	↗
4:	8.5	↑
5:	0.0	
Serie	37.0	
Total	37.0	

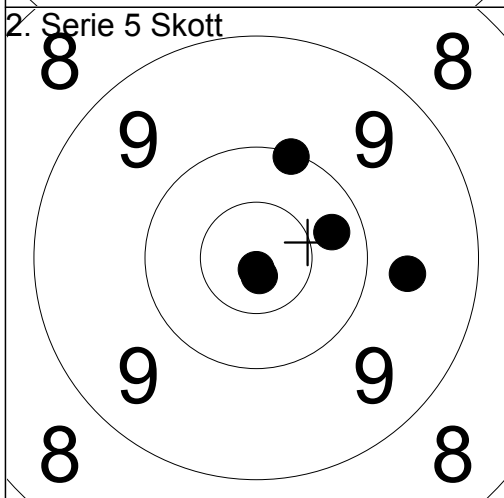

1:	10.8x	↓
2:	10.9x	↓
3:	10.3	→
4:	10.1	↑
5:	9.7	→
Serie	49.0	
Total	86.0	

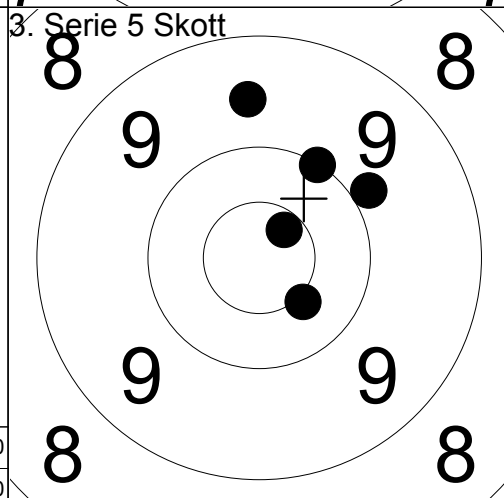

1:	10.0	↗
2:	9.6	↑
3:	10.6x	↗
4:	10.4x	↘
5:	9.9	↗
Serie	48.0	
Total	134.0	

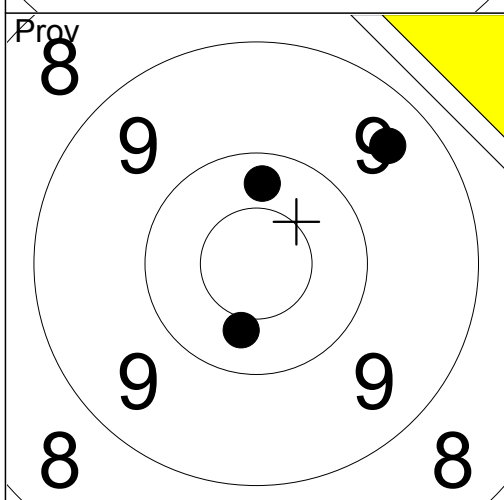

1:	10.4	↓
2:	9.4	↗
3:	10.3	↑
Serie	29.0	
Total	134.0	

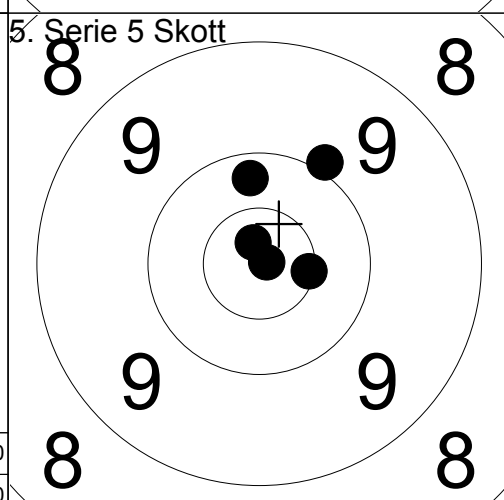

1:	9.9	↗
2:	10.9x	→
3:	10.2	↑
4:	10.5x	→
5:	10.8x	↑
Serie	49.0	
Total	183.0	

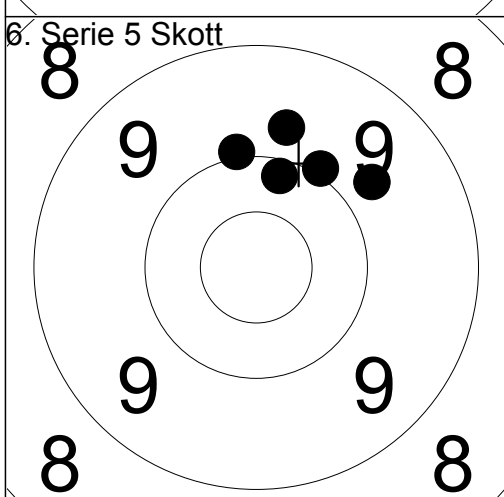

1:	9.7	↑
2:	9.7	↗
3:	10.0	↗
4:	10.2	↑
5:	10.0	↑
Serie	48.0	
Total	231.0	

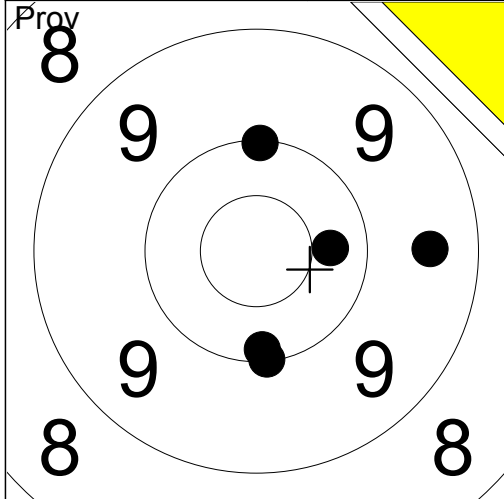

1:	9.5	→
2:	10.0	↑
3:	10.1	↓
4:	10.0	↓
5:	10.3	→
Serie		49.0
Total		0.0

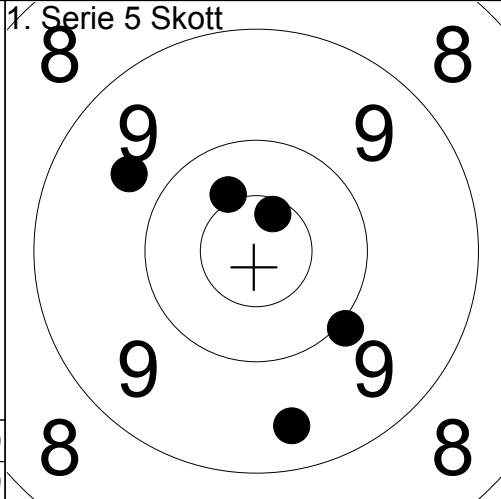

1:	10.6x	↗
2:	9.7	↗
3:	10.0	↘
4:	9.4	↓
5:	10.4x	↗
Serie		48.0
Total		48.0

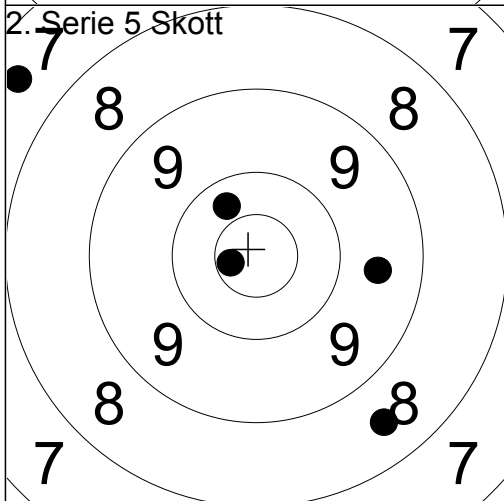

1:	7.5	↗
2:	10.3	↗
3:	8.5	↘
4:	9.6	→
5:	10.7x	←
Serie		44.0
Total		92.0

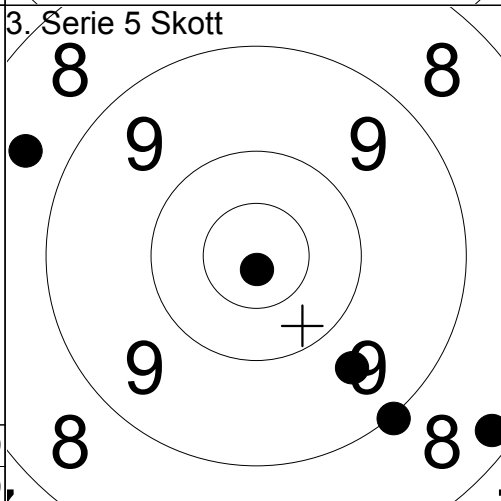

1:	8.2	↘
2:	9.0	↘
3:	10.8x	↘
4:	8.6	↗
5:	9.6	↘
Serie		44.0
Total		136.0

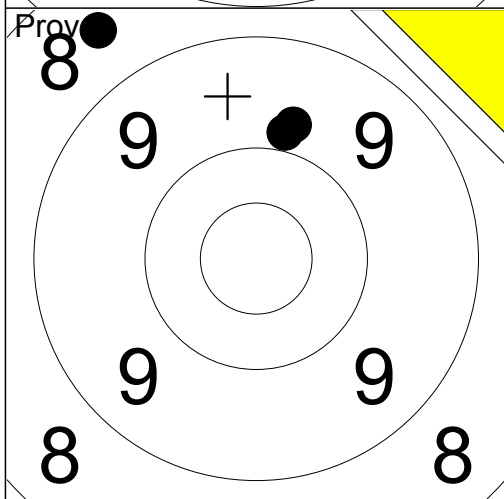

1:	8.5	↗
2:	9.8	↑
3:	9.9	↑
Serie		26.0
Total		136.0

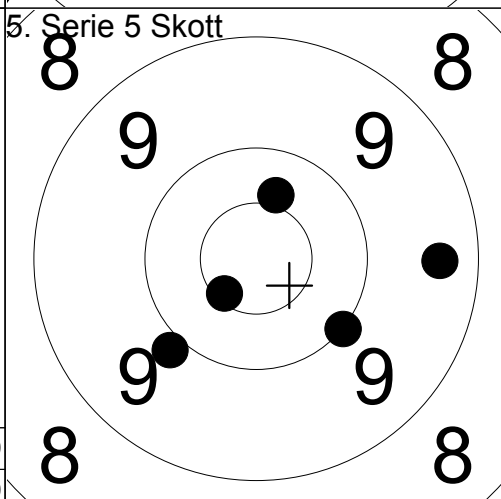

1:	10.4	↑
2:	10.6x	↙
3:	10.0	↘
4:	9.4	→
5:	9.9	↙
Serie		48.0
Total		184.0

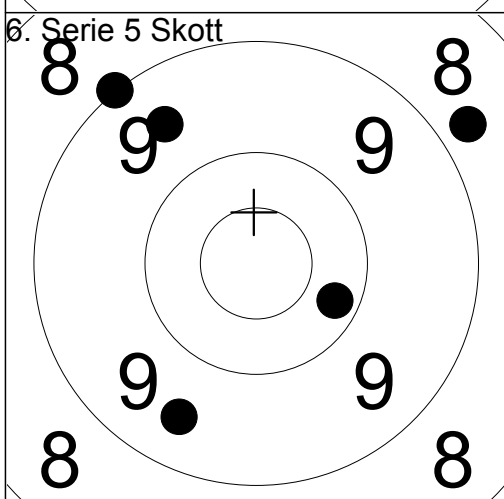

1:	9.5	↗
2:	9.5	↘
3:	9.0	↗
4:	10.2	↘
5:	8.8	↗
Serie		45.0
Total		229.0

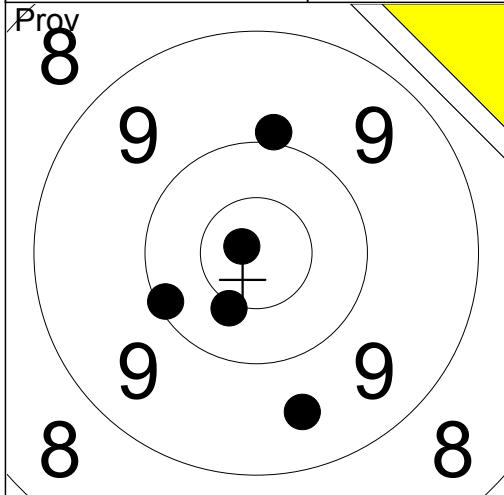

1:	10.1	↙
2:	10.4x	↘
3:	9.5	↘
4:	10.8x	↖
5:	9.9	↑

Serie	48.0
Total	0.0

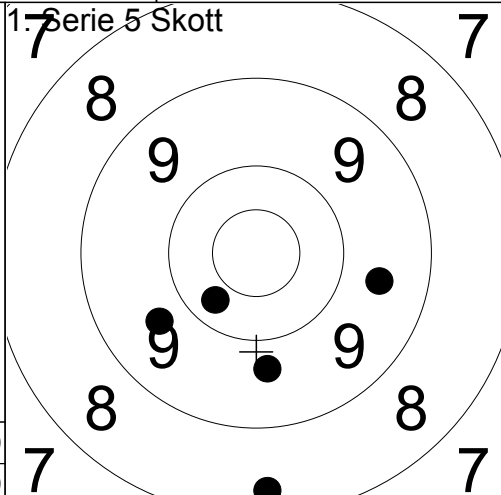

1:	10.3	↙
2:	9.7	↙
3:	9.7	↘
4:	8.3	↘
5:	9.6	→

Serie	45.0
Total	45.0

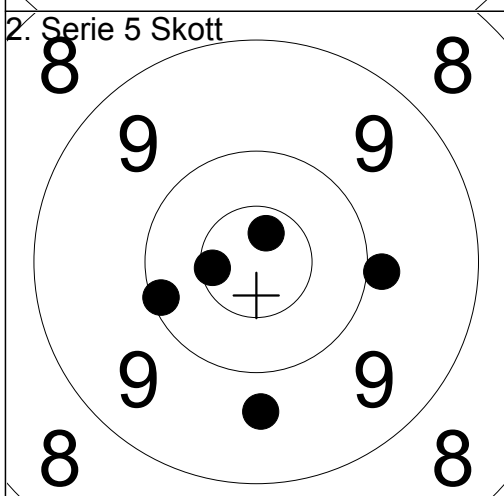

1:	9.9	→
2:	10.1	↙
3:	10.6x	↙
4:	9.7	↘
5:	10.7x	↗

Serie	48.0
Total	93.0

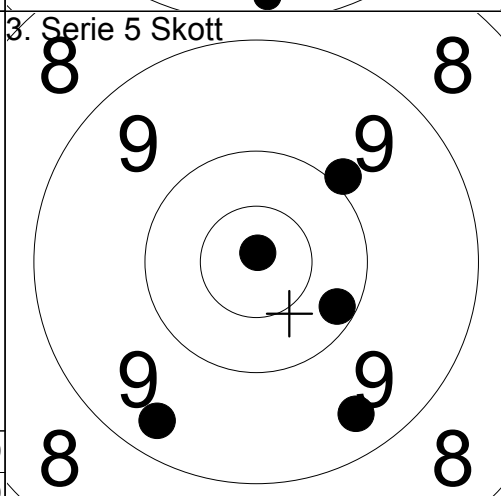

1:	9.9	↗
2:	10.2	→
3:	10.9x	↑
4:	9.4	↘
5:	9.3	↘

Serie	47.0
Total	140.0

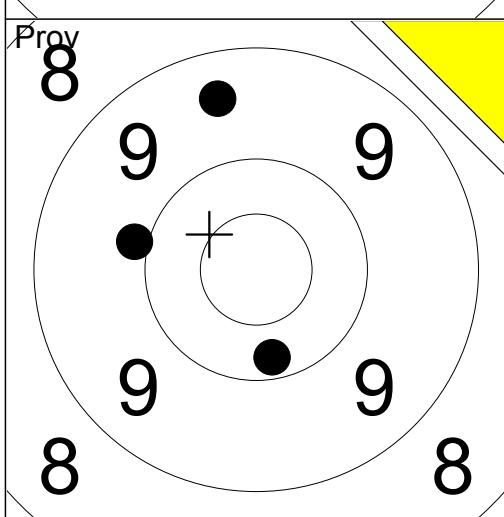

1:	9.5	↑
2:	9.9	↙
3:	10.2	↘

Serie	28.0
Total	140.0

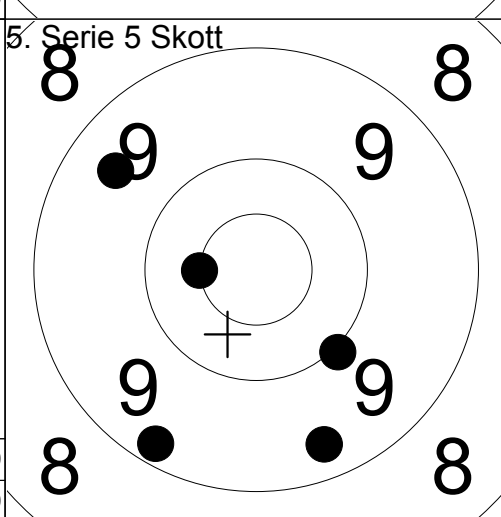

1:	9.5	↙
2:	10.5x	↙
3:	9.2	↘
4:	10.0	↘
5:	9.3	↘

Serie	47.0
Total	187.0

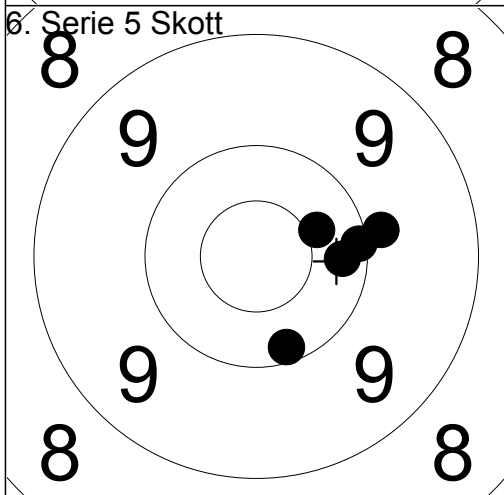

1:	10.1	→
2:	10.2	→
3:	9.9	→
4:	10.2	↘
5:	10.4	↗

Serie	49.0
Total	236.0

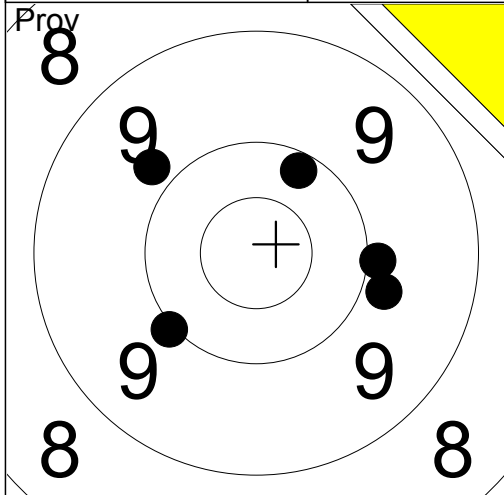

1:	9.8	→
2:	9.9	→
3:	9.8	↗
4:	10.0	↙
5:	10.2	↗

Serie	47.0
Total	0.0

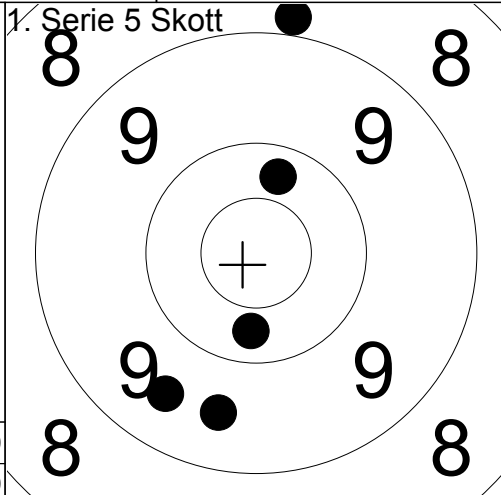

1:	10.3	↗
2:	9.5	↘
3:	9.5	↘
4:	8.9	↗
5:	10.3	↘

Serie	46.0
Total	46.0

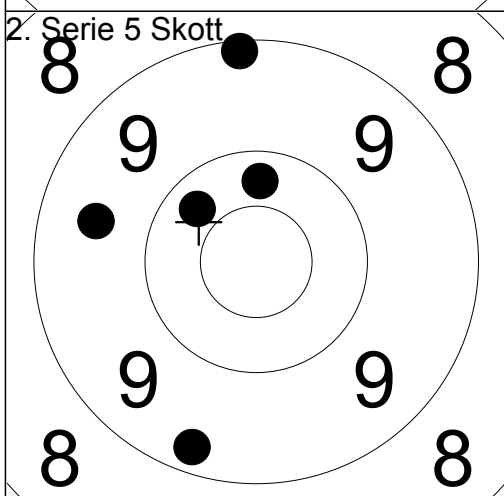

1:	9.1	↗
2:	10.3	↗
3:	10.3	↗
4:	9.5	↖
5:	9.3	↘

Serie	47.0
Total	93.0

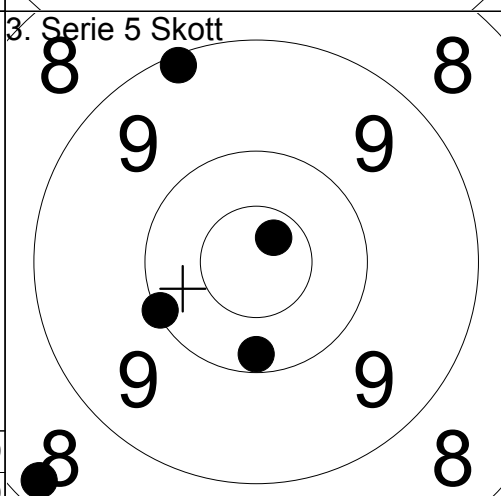

1:	10.2	↘
2:	10.7x	↗
3:	9.1	↗
4:	8.3	↘
5:	10.1	↖

Serie	47.0
Total	140.0

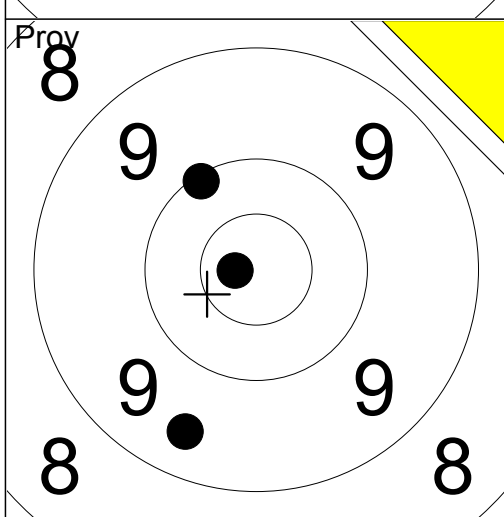

1:	10.8x	←
2:	10.1	↗
3:	9.4	↘

Serie	29.0
Total	140.0

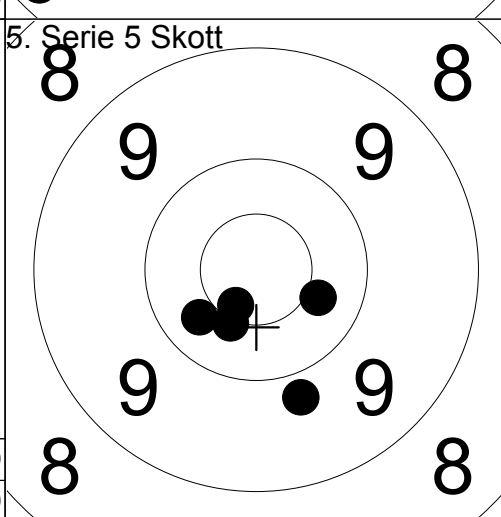

1:	10.4	→
2:	9.8	↘
3:	10.3	↘
4:	10.5x	↘
5:	10.6x	↘

Serie	49.0
Total	189.0

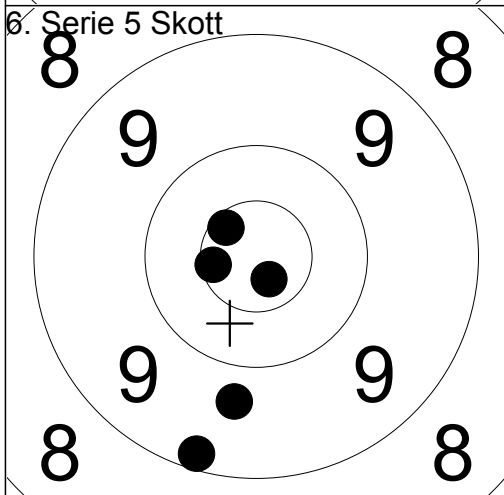

1:	10.6x	↗
2:	9.2	↘
3:	10.7x	↘
4:	9.7	↘
5:	10.6x	←

Serie	48.0
Total	237.0

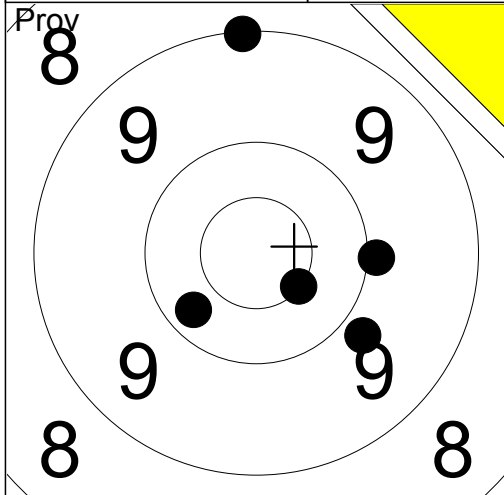

1:	10.5x	↘
2:	10.2	↙
3:	9.8	↘
4:	9.9	→
5:	9.1	↑

Serie	47.0
Total	0.0

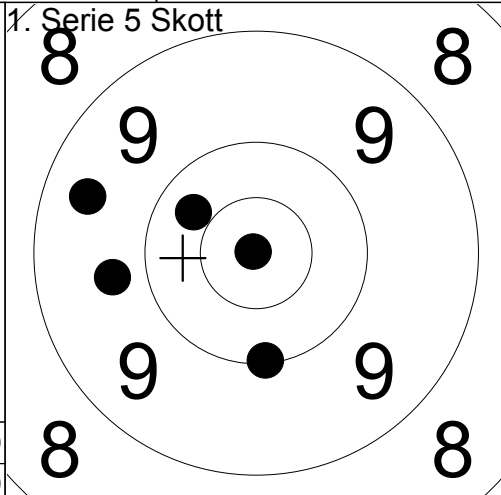

1:	9.7	←
2:	10.1	↓
3:	10.9x	↖
4:	10.3	↗
5:	9.4	↖

Serie	48.0
Total	48.0

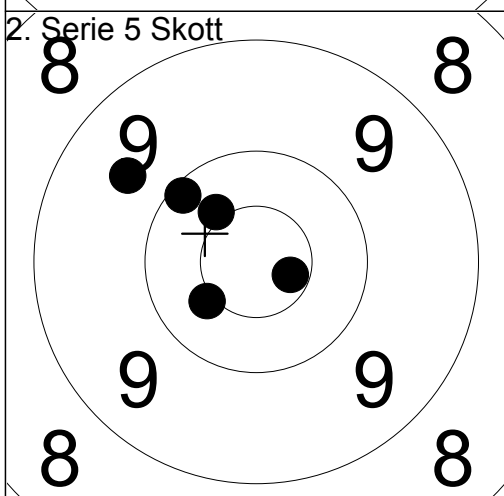

1:	10.6x	→
2:	10.4x	↙
3:	9.6	↗
4:	10.1	↗
5:	10.4x	↗

Serie	49.0
Total	97.0

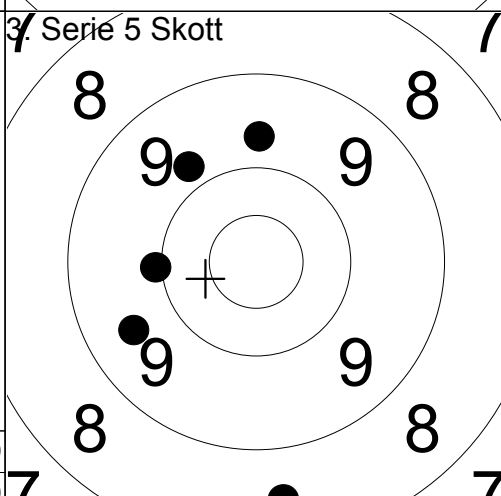

1:	8.5	↓
2:	9.5	↙
3:	10.0	←
4:	9.7	↑
5:	9.8	↗

Serie	45.0
Total	142.0

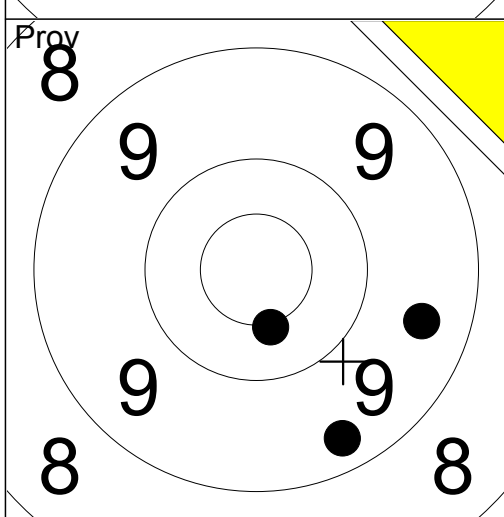

1:	10.5x	↘
2:	9.3	↘
3:	9.5	↘

Serie	28.0
Total	142.0

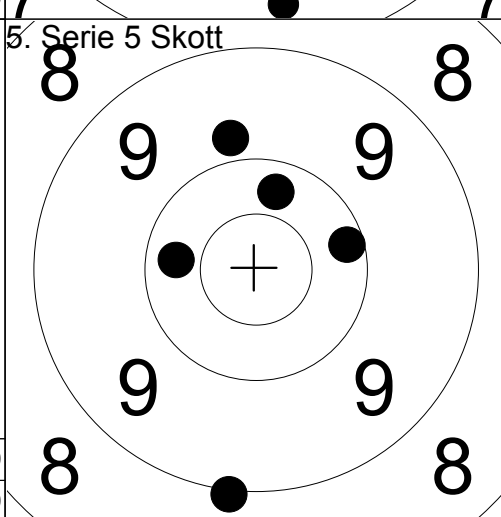

1:	9.8	↑
2:	9.0	↓
3:	10.3	←
4:	10.2	→
5:	10.3	↑

Serie	48.0
Total	190.0

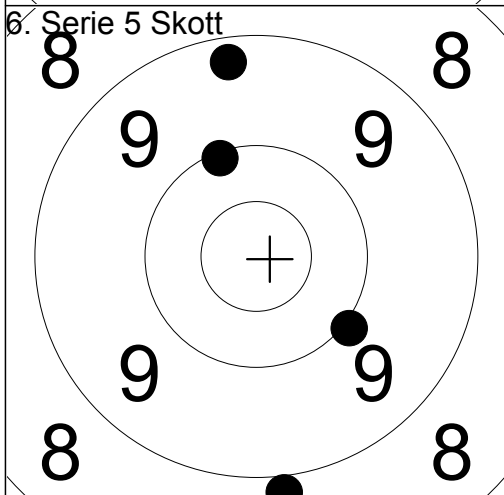

1:	10.1	↑
2:	10.0	↘
3:	0.0	
4:	9.3	↑
5:	8.9	↓

Serie	37.0
Total	227.0

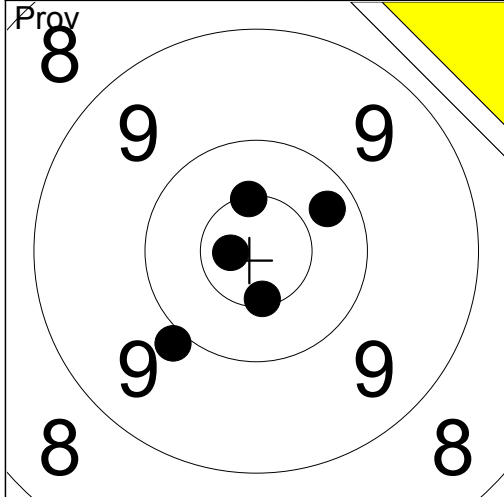

1. Serie 5 Skott

1:	10.6x	↓
2:	10.7x	←
3:	9.9	↙
4:	10.5x	↑
5:	10.3	↗
Serie		49.0
Total		0.0

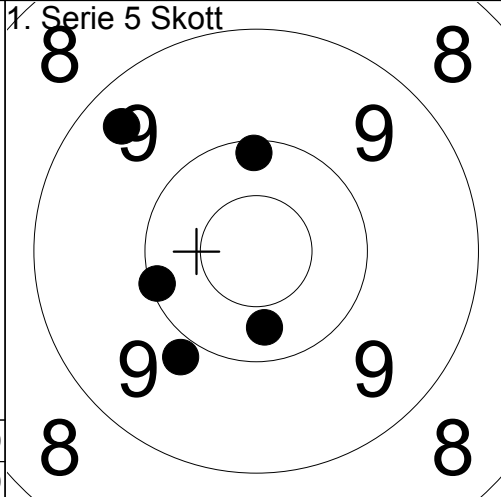

1:	10.1	↑
2:	10.1	←
3:	10.3	↓
4:	9.4	↗
5:	9.9	↙
Serie		48.0
Total		48.0

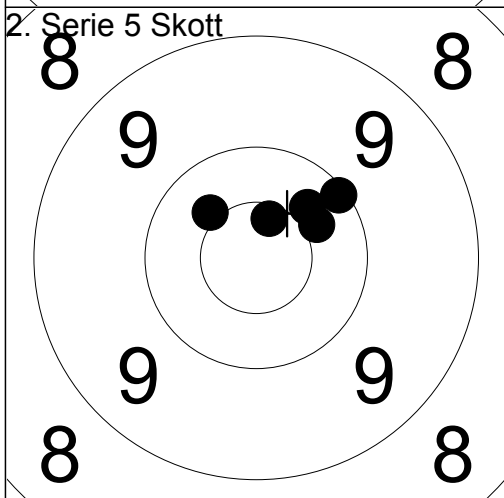

1:	10.6x	↑
2:	10.4	↗
3:	10.1	↗
4:	10.4x	↖
5:	10.3	↗
Serie		50.0
Total		98.0

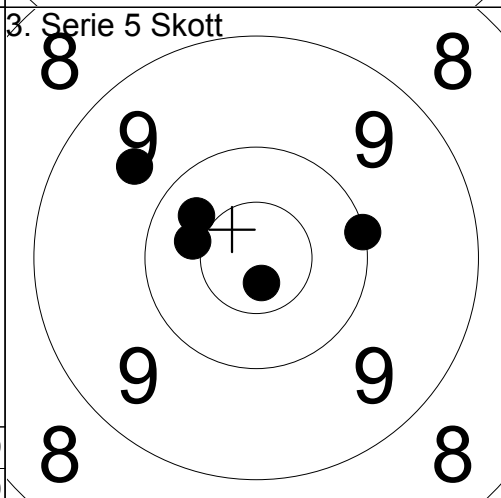

1:	10.0	→
2:	10.7x	↓
3:	10.4	←
4:	9.7	↗
5:	10.3	↗
Serie		49.0
Total		147.0

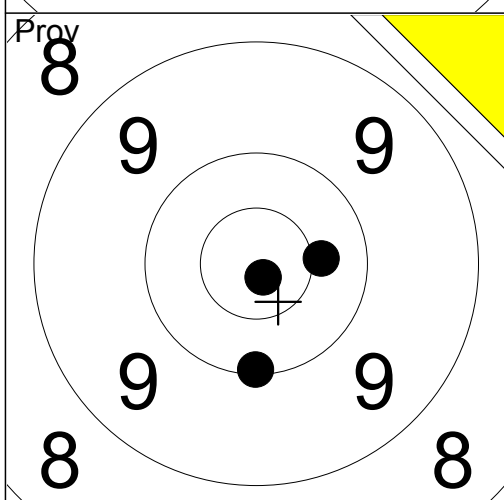

1:	10.8x	↓
2:	10.1	↓
3:	10.4	→
Serie		30.0
Total		147.0

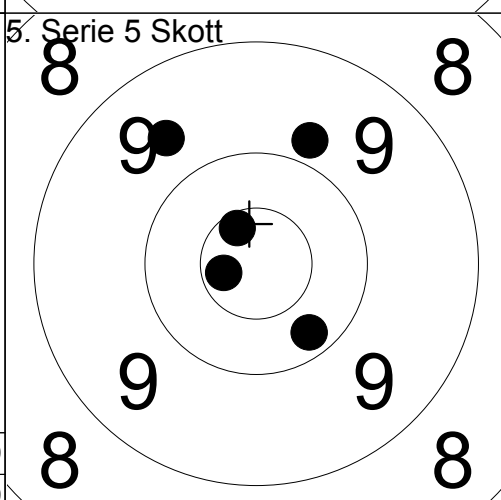

1:	9.8	↑
2:	10.6x	↑
3:	10.7x	←
4:	9.6	↗
5:	10.2	↓
Serie		48.0
Total		195.0

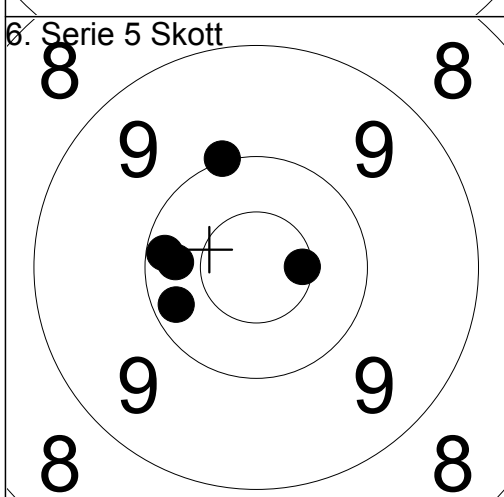

1:	10.6x	→
2:	10.0	↑
3:	10.2	←
4:	10.3	←
5:	10.2	↙
Serie		50.0
Total		245.0

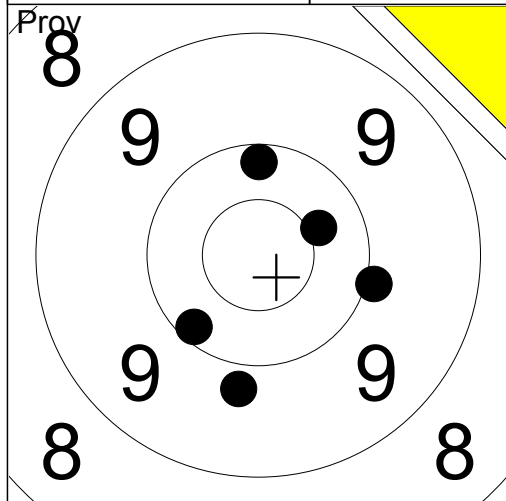

1:	10.4	→
2:	10.1	↙
3:	10.0	→
4:	10.2	↑
5:	9.8	↓

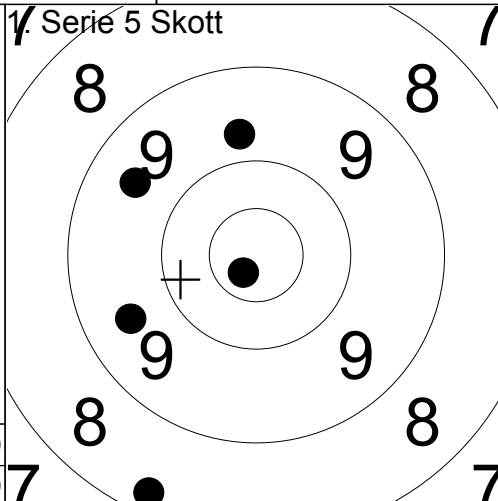

1:	8.3	↘
2:	9.7	↑
3:	9.5	↙
4:	9.5	↖
5:	10.7x	↘

Serie	49.0
Total	0.0

Serie	45.0
Total	45.0

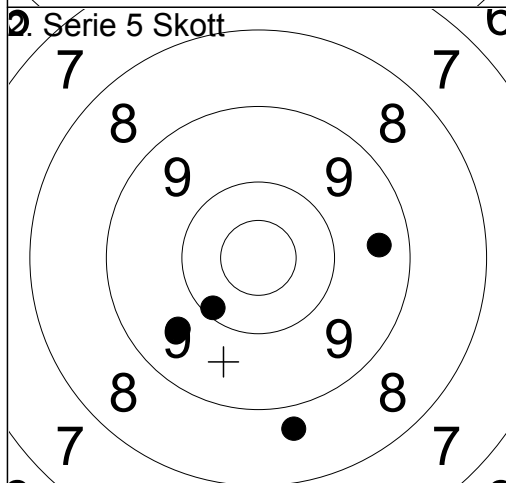

1:	8.7	↓
2:	6.8	↙
3:	9.6	↙
4:	9.4	→
5:	10.1	↘

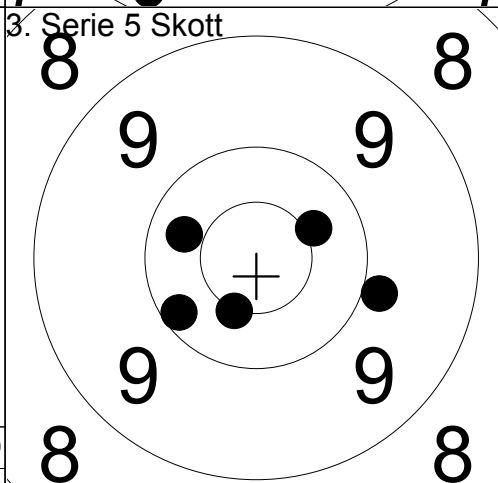

1:	10.4x	→
2:	9.9	→
3:	10.3	↖
4:	10.2	↙
5:	10.5x	↘

Serie	42.0
Total	87.0

Serie	49.0
Total	136.0

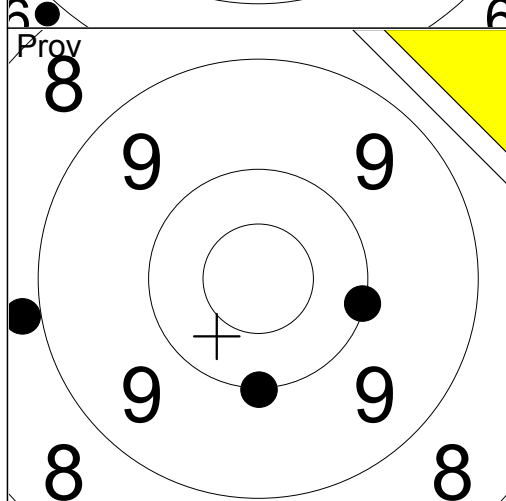

1:	10.0	→
2:	10.0	↓
3:	8.9	←

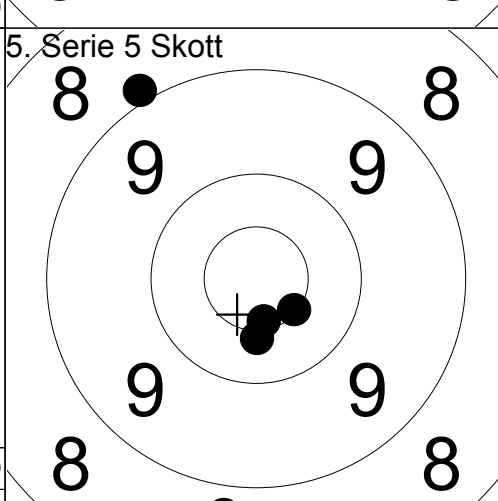

1:	10.5x	↘
2:	10.6x	↘
3:	8.9	↗
4:	10.4x	↘
5:	8.8	↘

Serie	28.0
Total	136.0

Serie	46.0
Total	182.0

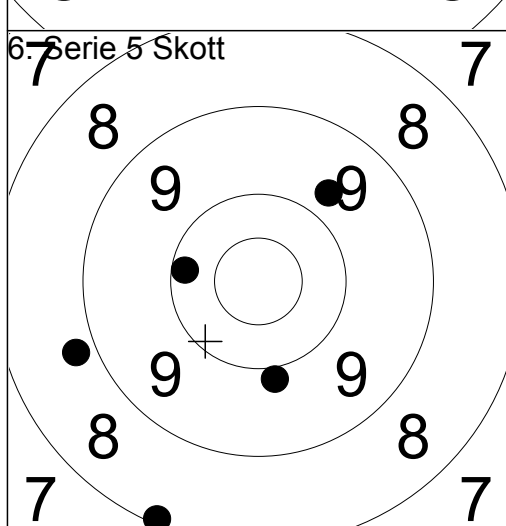

1:	8.1	↘
2:	9.9	↘
3:	10.2	←
4:	9.7	↗
5:	8.8	←

Serie	44.0
Total	226.0

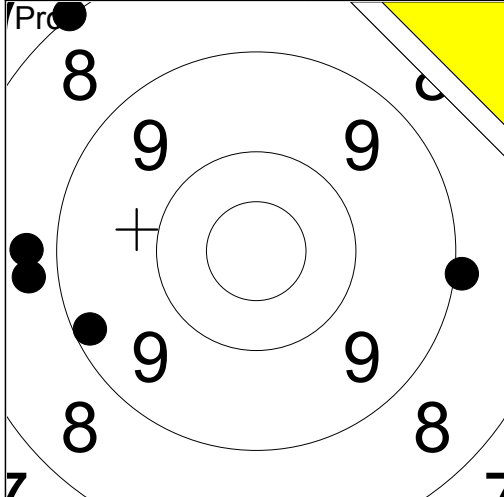

1:	9.0	→
2:	9.2	←
3:	8.0	↗
4:	8.7	←
5:	8.7	←
Serie	42.0	
Total	0.0	

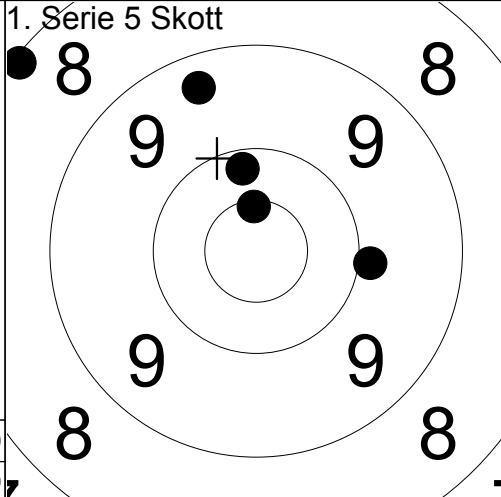

1:	10.5x	↑
2:	8.1	↗
3:	9.9	→
4:	10.2	↑
5:	9.3	↗
Serie	46.0	
Total	46.0	

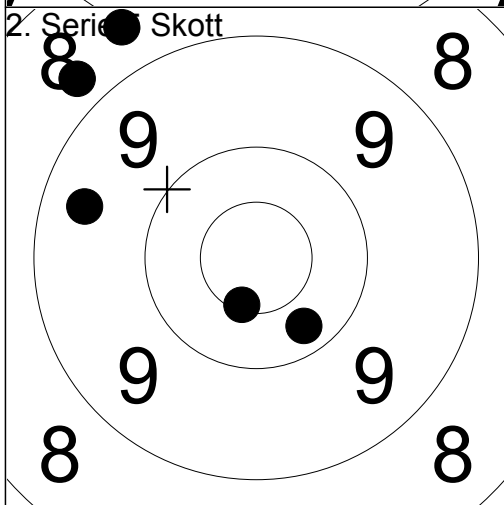

1:	10.5x	↓
2:	9.4	←
3:	8.6	↗
4:	8.8	↗
5:	10.3	↘
Serie	45.0	
Total	91.0	

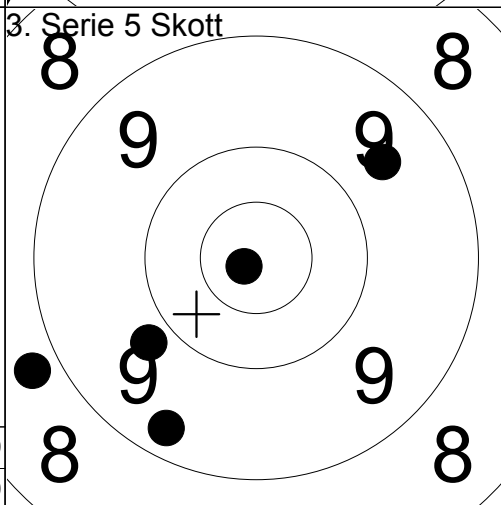

1:	9.6	↗
2:	8.8	←
3:	9.3	↓
4:	9.8	←
5:	10.8x	←
Serie	45.0	
Total	136.0	

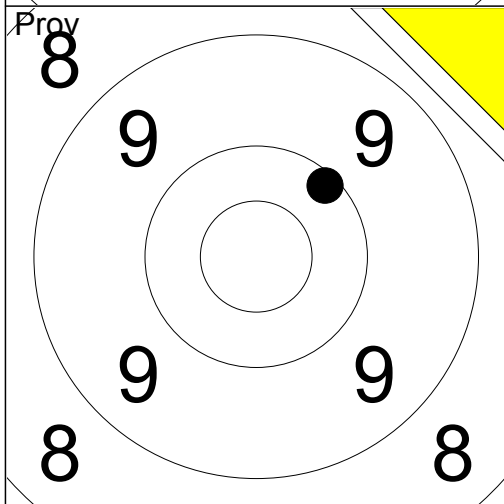

1:	10.1	↗
Serie	10.0	
Total	136.0	

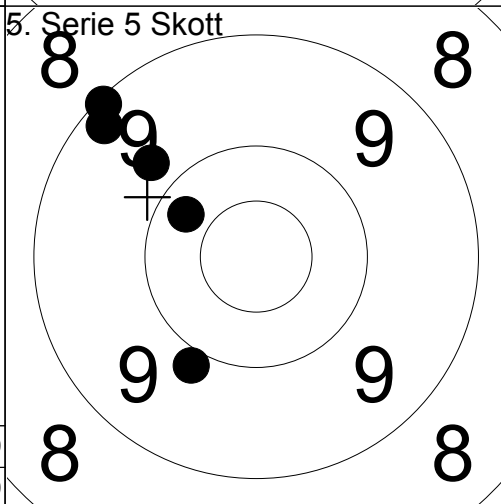

1:	9.1	↗
2:	9.2	↗
3:	9.9	↘
4:	10.3	↗
5:	9.8	↗
Serie	46.0	
Total	182.0	

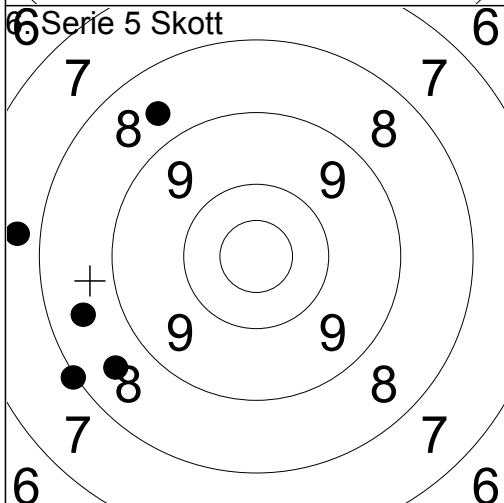

1:	8.6	↗
2:	8.0	←
3:	8.5	↘
4:	8.5	←
5:	7.7	←
Serie	39.0	
Total	221.0	

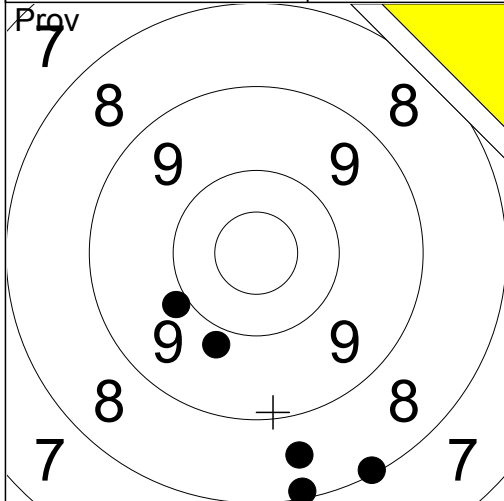

1:	9.8	↘
2:	8.6	↘
3:	9.9	↙
4:	8.1	↘
5:	8.1	↘
Serie	42.0	
Total	0.0	

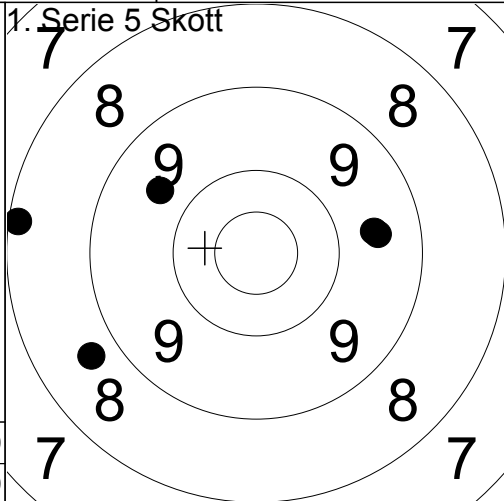

1:	8.1	←
2:	9.6	↗
3:	8.7	↙
4:	9.5	→
5:	9.6	→
Serie	43.0	
Total	43.0	

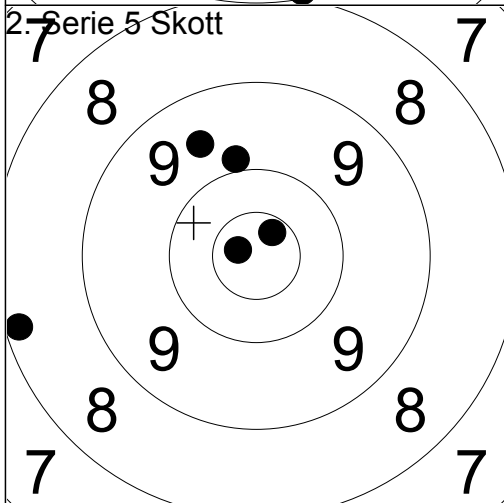

1:	9.9	↑
2:	9.6	↗
3:	8.2	↙
4:	10.7x	↙
5:	10.7x	↗
Serie	46.0	
Total	89.0	

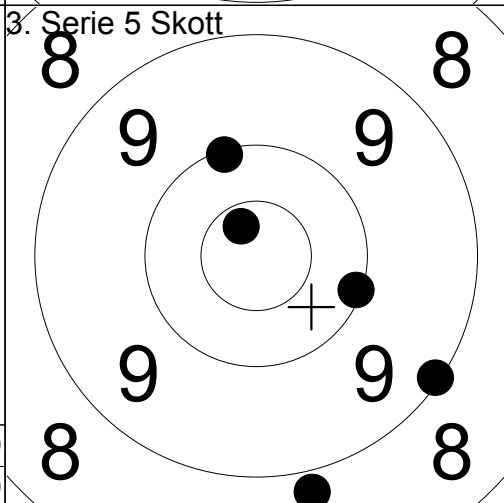

1:	8.8	↘
2:	10.7x	↗
3:	10.1	↘
4:	9.1	↘
5:	10.1	↗
Serie	47.0	
Total	136.0	

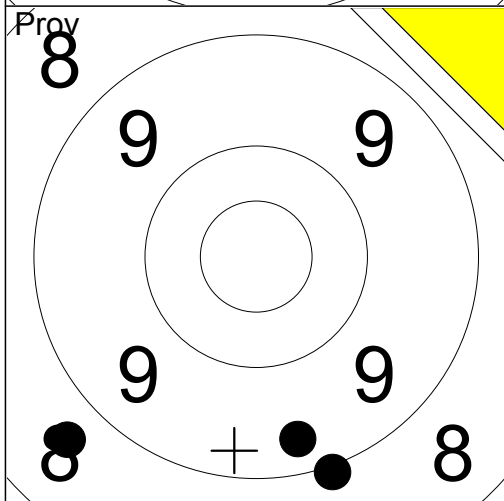

1:	8.7	↙
2:	9.0	↘
3:	9.4	↘
Serie	26.0	
Total	136.0	

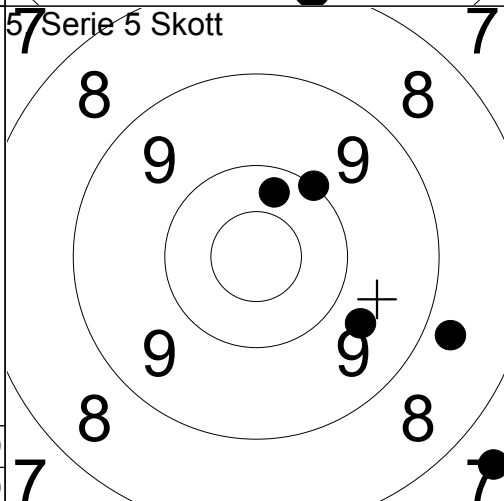

1:	10.3	↗
2:	10.0	↗
3:	8.7	↘
4:	9.7	↘
5:	7.6	↘
Serie	44.0	
Total	180.0	

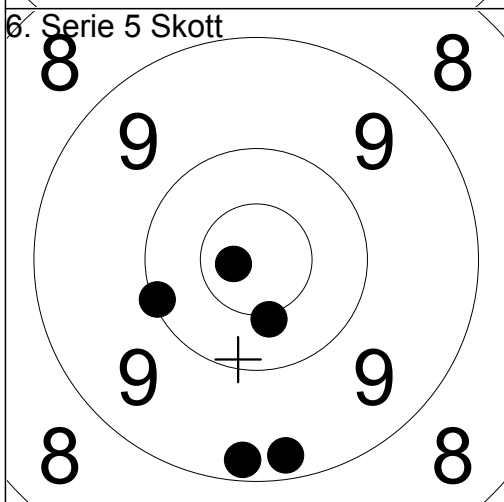

1:	10.8x	←
2:	10.4x	↘
3:	9.2	↘
4:	10.1	↙
5:	9.3	↘
Serie	48.0	
Total	228.0	

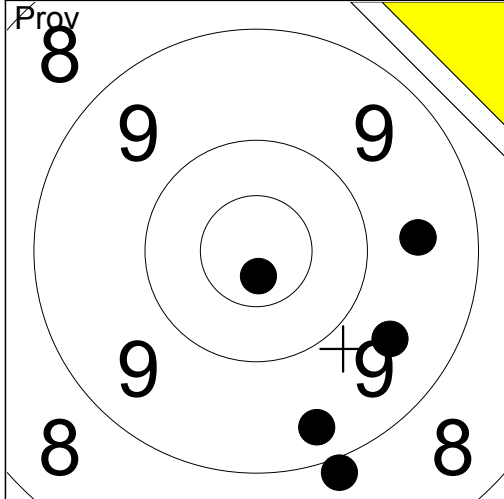

1. Serie 5 Skott

1:	10.7x	↓
2:	9.6	→
3:	9.6	↓
4:	9.4	↓
5:	8.9	↓
Serie	45.0	
Total	0.0	

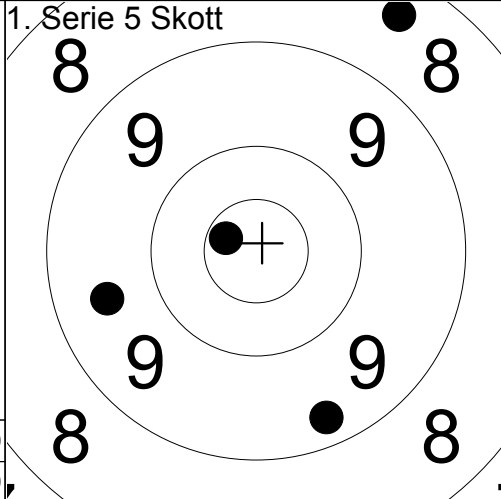

1:	8.4	↗
2:	9.3	↓
3:	10.7x	↖
4:	9.5	←
5:	0.0	
Serie	36.0	
Total	36.0	

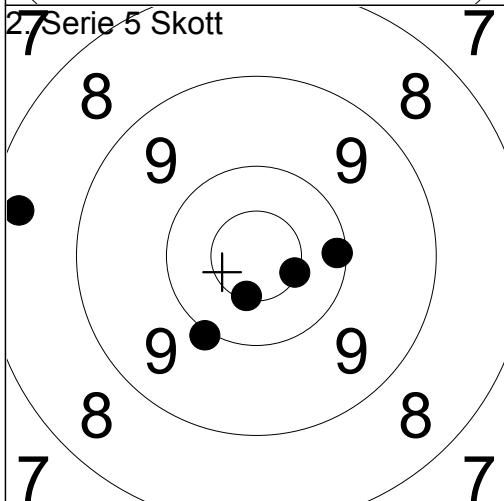

2. Serie 5 Skott

1:	10.0	↙
2:	10.5x	↓
3:	10.5x	↘
4:	8.3	←
5:	10.1	→
Serie	48.0	
Total	84.0	

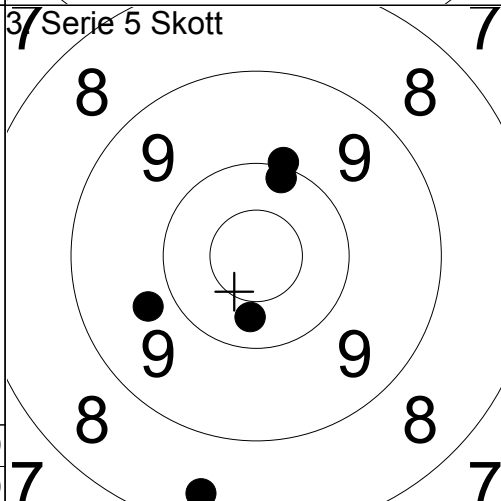

3. Serie 5 Skott

1:	10.3	↓
2:	10.1	↑
3:	10.0	↑
4:	9.7	↖
5:	8.4	↓
Serie	47.0	
Total	131.0	

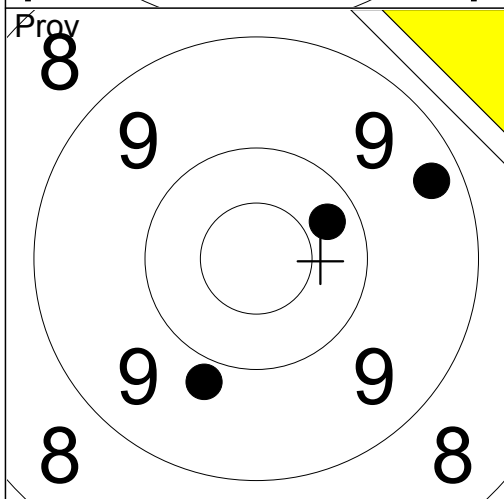

4. Serie 5 Skott

1:	9.8	↓
2:	10.3	→
3:	9.3	→
Serie	28.0	
Total	131.0	

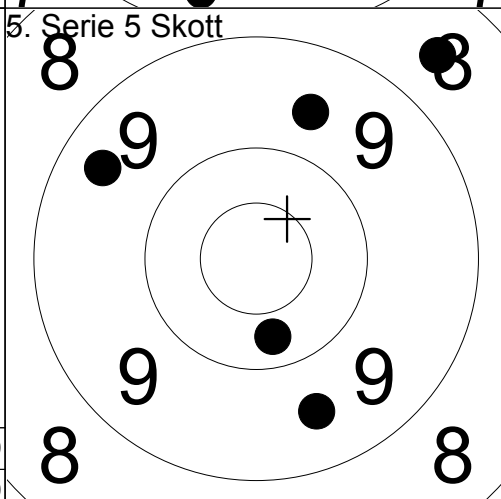

5. Serie 5 Skott

1:	9.6	↑
2:	9.6	↓
3:	10.3	↓
4:	9.4	↖
5:	8.6	↗
Serie	45.0	
Total	176.0	

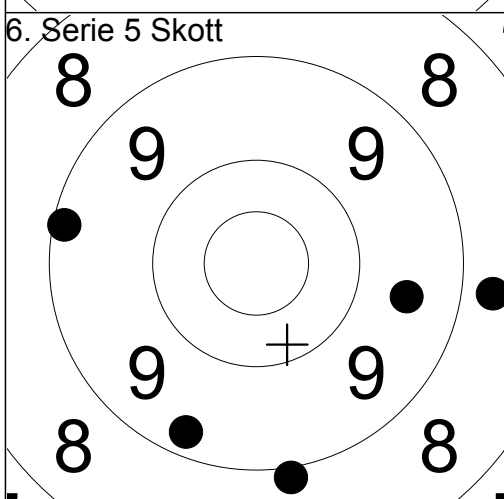

6. Serie 5 Skott

1:	8.9	↓
2:	9.1	←
3:	9.5	→
4:	8.7	→
5:	9.3	↓
Serie	43.0	
Total	219.0	

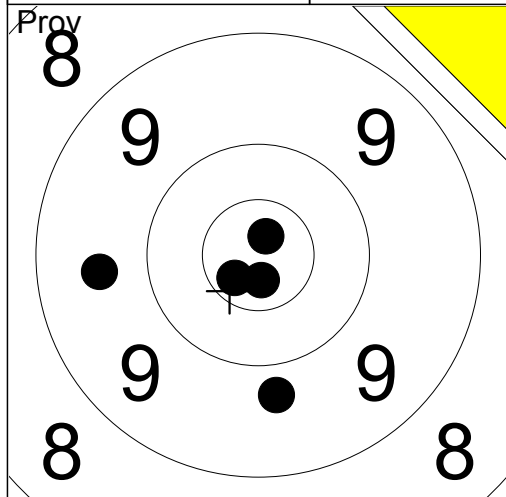

1. Serie 5 Skott

1:	10.7x	↙
2:	9.8	↓
3:	10.8x	↗
4:	9.6	←
5:	10.7x	↓
Serie	48.0	
Total	0.0	

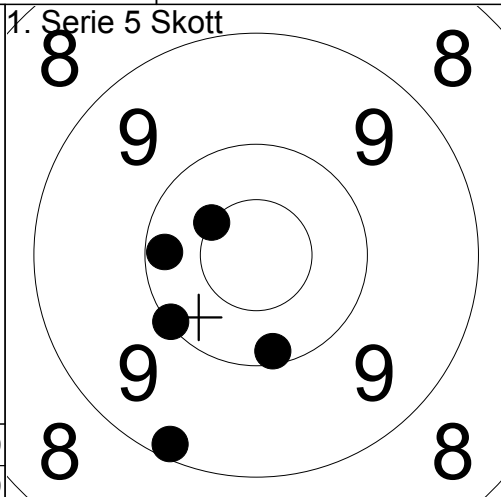

1:	10.5x	↗
2:	10.2	←
3:	10.0	↙
4:	10.1	↓
5:	9.2	↓
Serie	49.0	
Total	49.0	

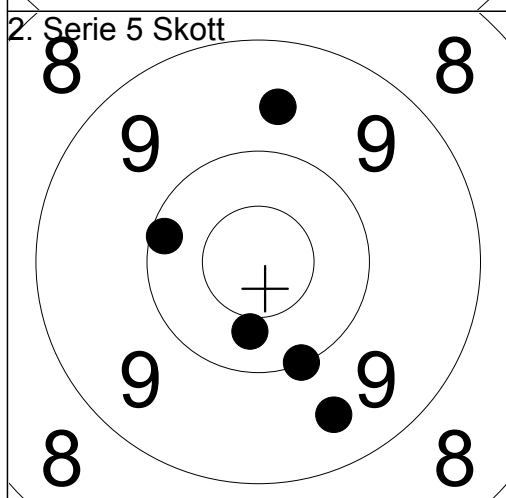

1:	10.0	↓
2:	10.4	↓
3:	9.5	↓
4:	9.6	↑
5:	10.1	←
Serie	48.0	
Total	97.0	

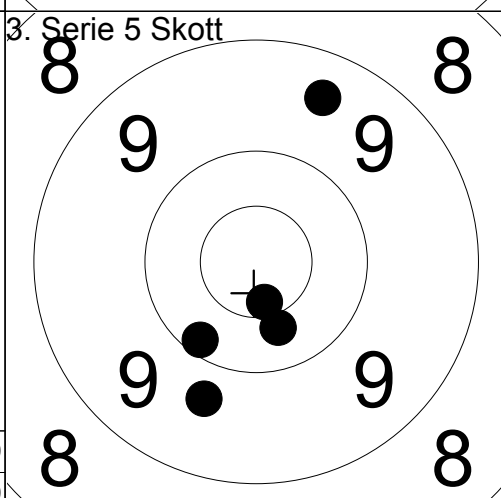

1:	9.4	↗
2:	9.7	↓
3:	10.6x	↓
4:	10.4	↓
5:	10.2	↙
Serie	48.0	
Total	145.0	

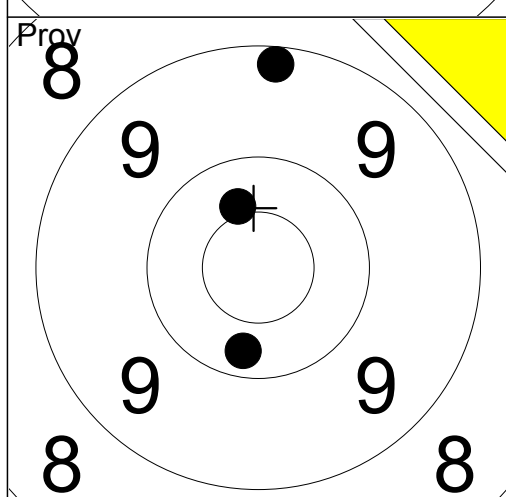

5. Serie 5 Skott

1:	10.4	↑
2:	9.2	↑
3:	10.2	↓
Serie	29.0	
Total	145.0	

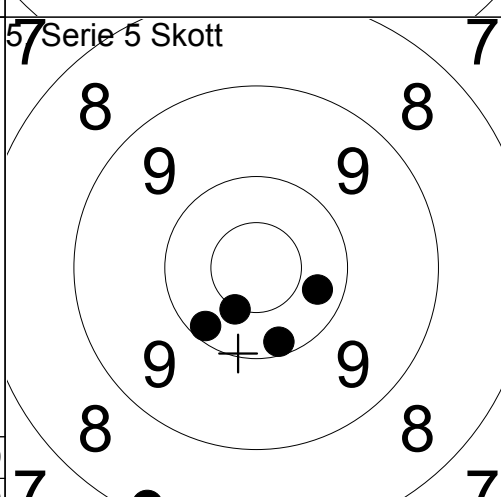

1:	10.2	↙
2:	8.2	↓
3:	10.5x	↙
4:	10.2	↓
5:	10.3	↗
Serie	48.0	
Total	193.0	

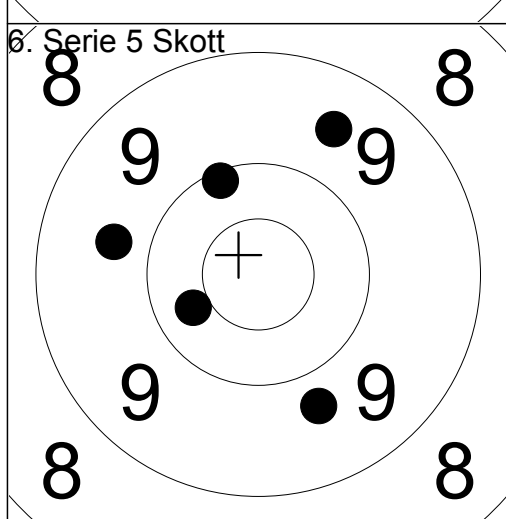

1:	10.3	←
2:	9.7	↓
3:	10.1	↗
4:	9.7	←
5:	9.6	↗
Serie	47.0	
Total	240.0	

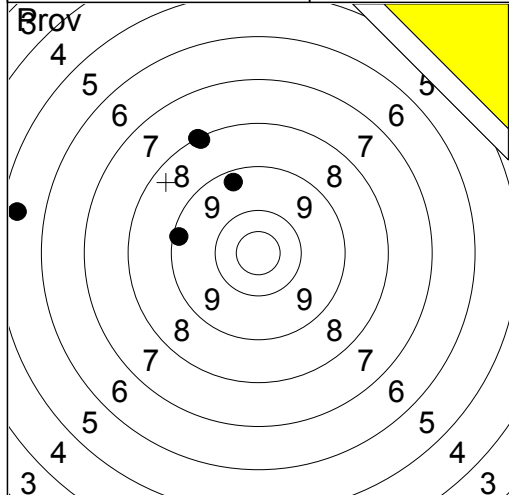

1:	9.3	↗
2:	9.2	←
3:	5.4	←
4:	8.1	↗
5:	8.0	↗

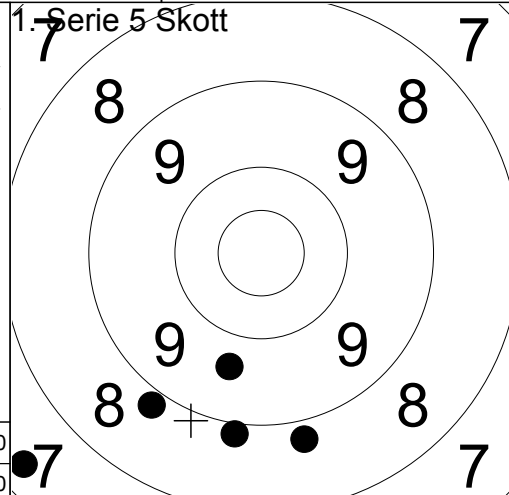

1:	8.8	↓
2:	8.9	↘
3:	7.3	↘
4:	9.7	↓
5:	8.9	↓

Serie	39.0
Total	0.0

Serie	40.0
Total	40.0

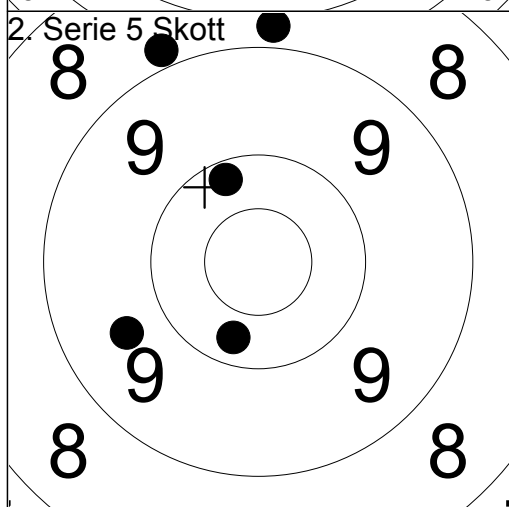

1:	8.9	↗
2:	8.8	↑
3:	10.2	↑
4:	9.6	↖
5:	10.3	↓

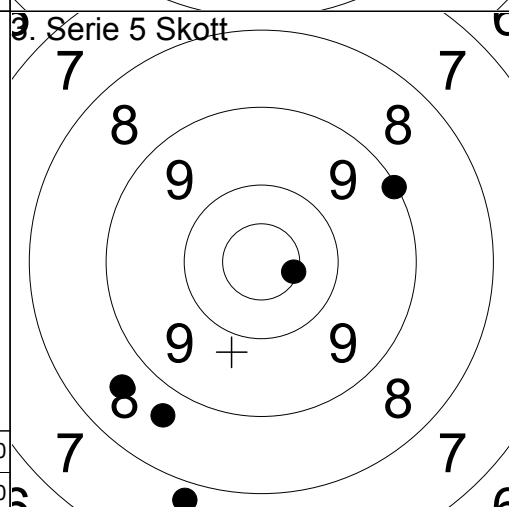

1:	10.5x	→
2:	7.8	↓
3:	8.6	↖
4:	8.7	↖
5:	9.1	↗

Serie	45.0
Total	85.0

Serie	42.0
Total	127.0

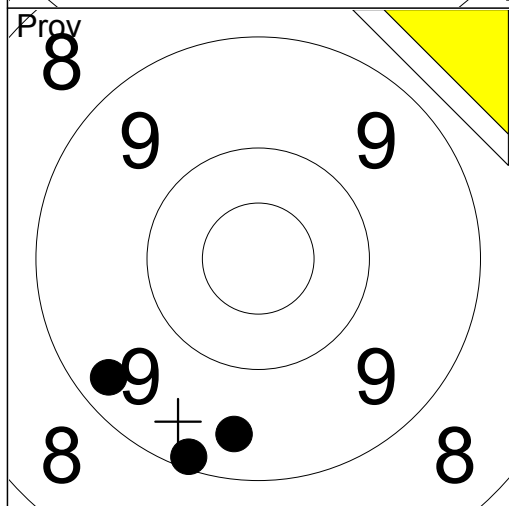

1:	9.3	↖
2:	9.1	↓
3:	9.4	↓

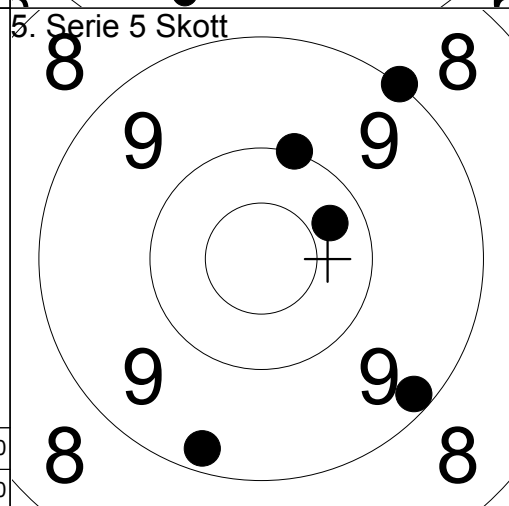

1:	10.0	↑
2:	10.3	→
3:	9.2	↓
4:	9.0	↑
5:	9.2	↘

Serie	27.0
Total	127.0

Serie	47.0
Total	174.0

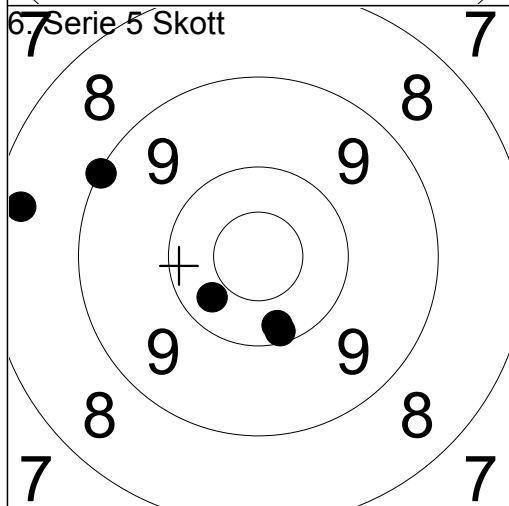

1:	10.3	↖
2:	8.3	←
3:	10.2	↓
4:	9.1	↗
5:	10.1	↓

Serie	47.0
Total	221.0

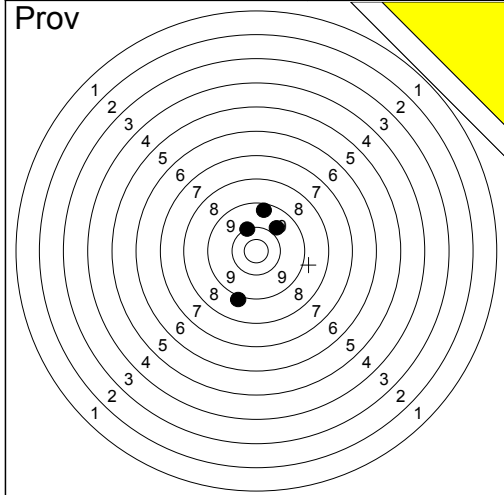

1:	8.9	↘
2:	9.3	↑
3:	10.0	↑
4:	9.7	↗
5:	0.0	→

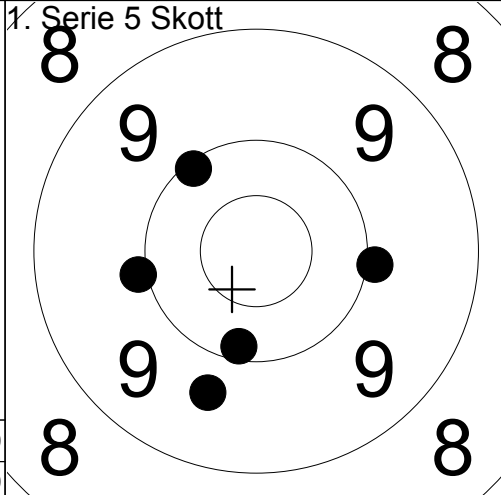

1:	9.9	←
2:	9.7	↘
3:	10.0	→
4:	10.1	↘
5:	10.1	↗

Serie	36.0
Total	0.0

Serie	48.0
Total	48.0

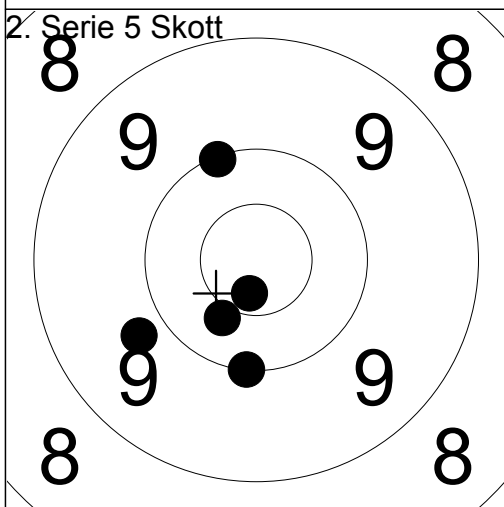

1:	9.8	↙
2:	10.1	↑
3:	10.7x	↘
4:	10.0	↘
5:	10.4	↘

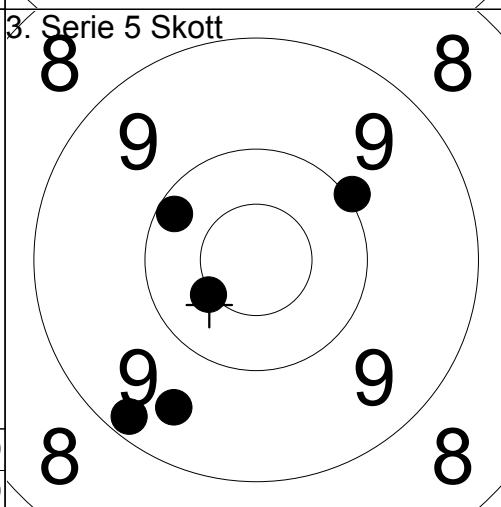

1:	10.2	↖
2:	9.5	↘
3:	9.2	↘
4:	10.0	↗
5:	10.5x	↖

Serie	49.0
Total	97.0

Serie	48.0
Total	145.0

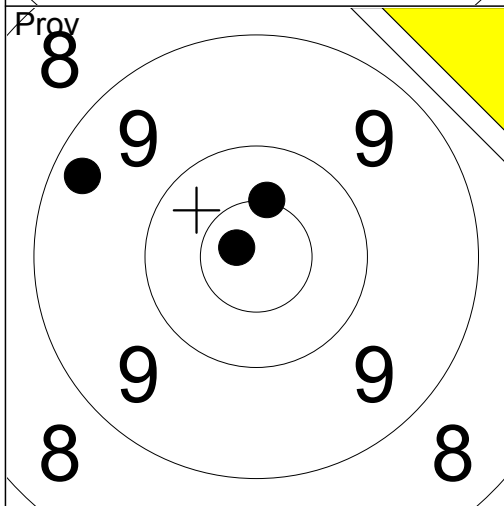

1:	10.8x	←
2:	9.3	↖
3:	10.5x	↑

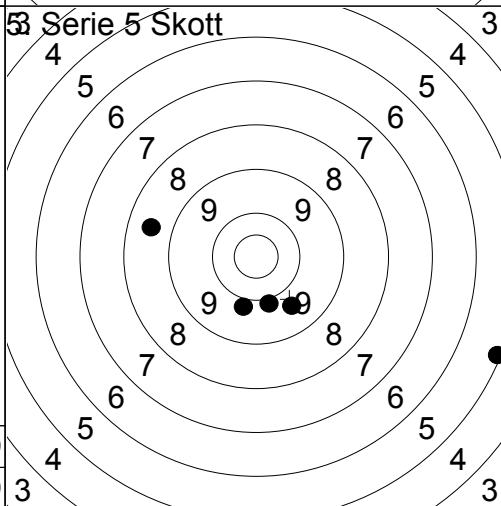

1:	5.1	→
2:	9.9	↘
3:	8.5	↖
4:	9.7	↘
5:	9.9	↘

Serie	29.0
Total	145.0

Serie	40.0
Total	185.0

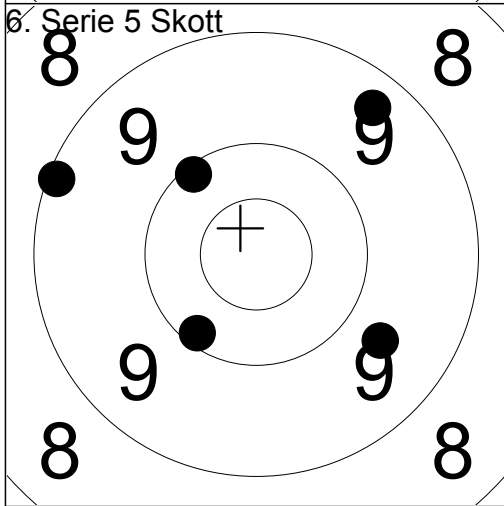

1:	10.1	↗
2:	9.1	↖
3:	10.1	↘
4:	9.7	↘
5:	9.3	↗

Serie	47.0
Total	232.0

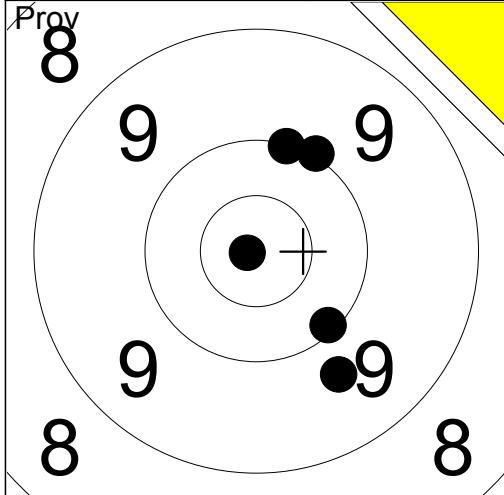

1:	10.1	↘
2:	10.9x	←
3:	9.7	↘
4:	10.0	↗
5:	10.0	↑

Serie	49.0
Total	0.0

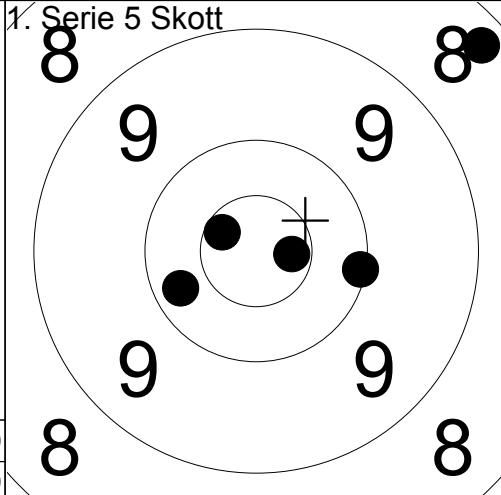

1:	10.6x	↖
2:	10.7x	→
3:	8.3	↗
4:	10.1	→
5:	10.2	↙

Serie	48.0
Total	48.0

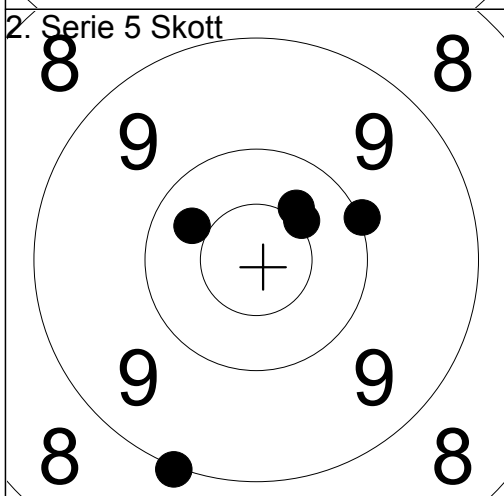

1:	10.3	↖
2:	10.0	→
3:	10.4x	↗
4:	10.4	↗
5:	9.0	↘

Serie	49.0
Total	97.0

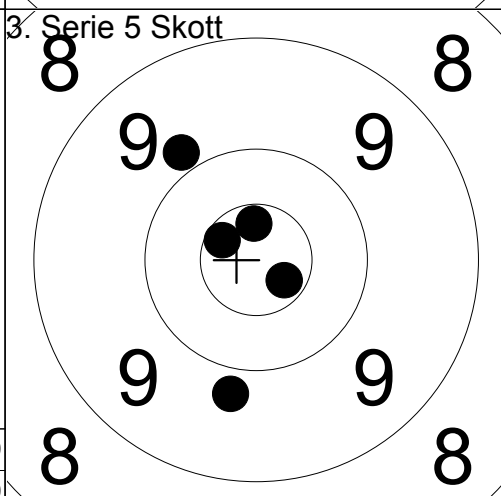

1:	10.7x	↘
2:	9.8	↓
3:	10.6x	↖
4:	10.6x	↑
5:	9.9	↗

Serie	48.0
Total	145.0

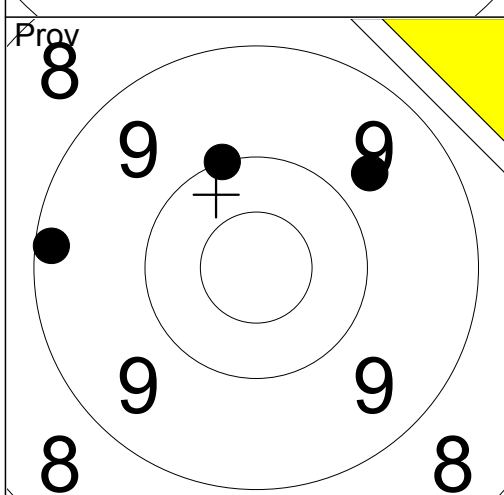

1:	10.0	↑
2:	9.7	↗
3:	9.2	←

Serie	28.0
Total	145.0

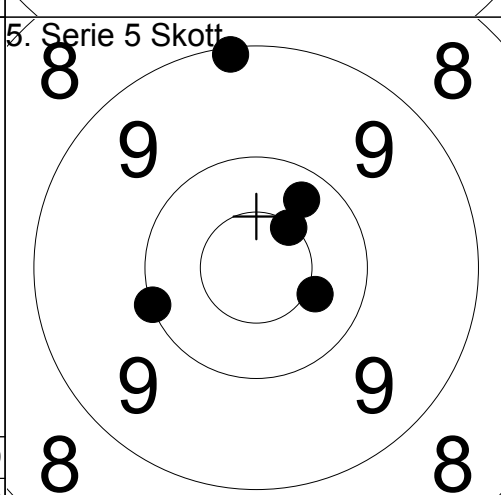

1:	10.3	↗
2:	10.4	→
3:	9.1	↑
4:	10.5x	↗
5:	10.0	←

Serie	49.0
Total	194.0

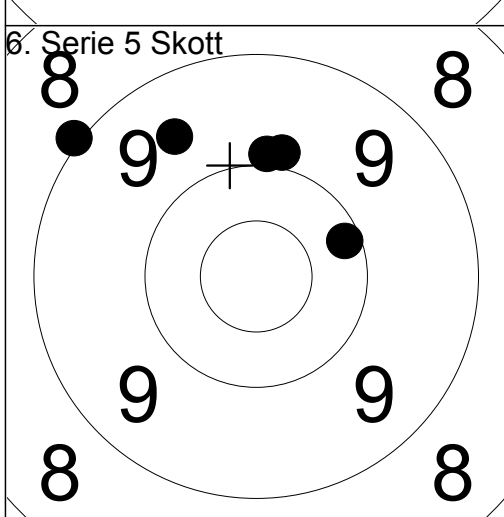

1:	9.0	↗
2:	9.6	↗
3:	10.2	↗
4:	9.9	↑
5:	9.9	↑

Serie	46.0
Total	240.0

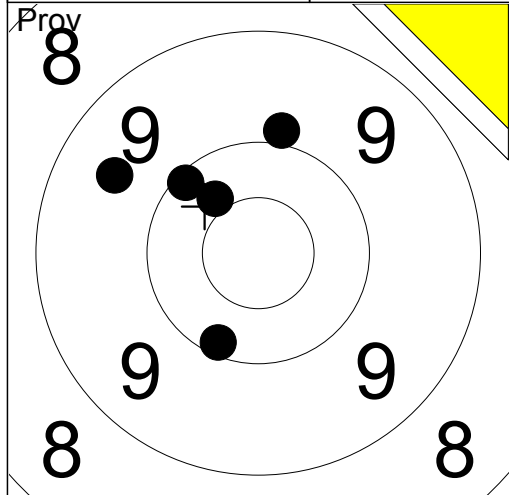

1:	9.6	↗
2:	9.9	↑
3:	10.4	↗
4:	10.1	↗
5:	10.1	↓

Serie	48.0
Total	0.0

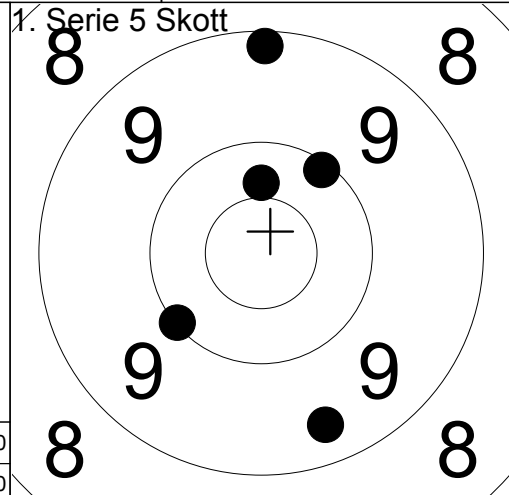

1:	9.2	↑
2:	9.4	↓
3:	10.4	↑
4:	10.0	↙
5:	10.1	↗

Serie	48.0
Total	48.0

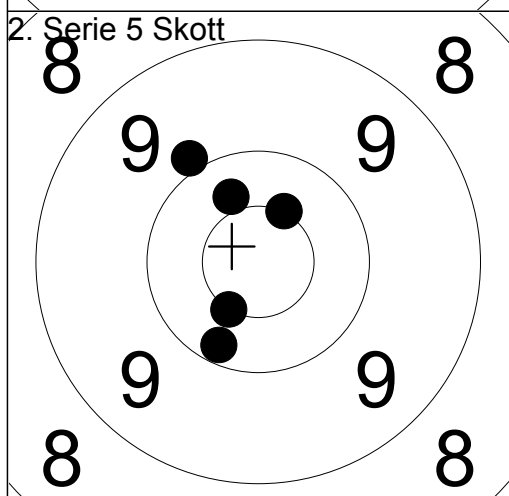

1:	10.5x	↗
2:	10.4	↑
3:	10.2	↓
4:	10.5x	↙
5:	9.9	↗

Serie	49.0
Total	97.0

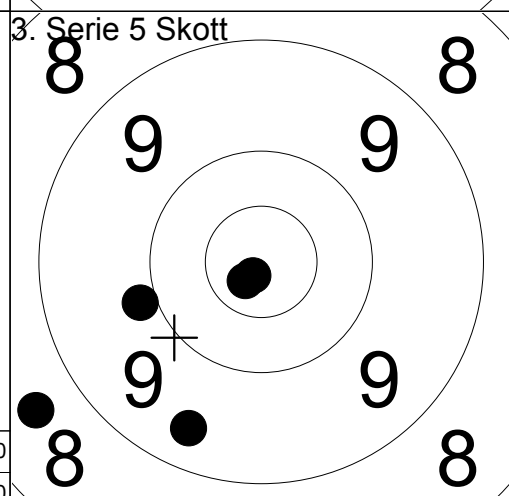

1:	10.8x	↙
2:	9.4	↓
3:	10.7x	↙
4:	8.6	↙
5:	9.9	←

Serie	46.0
Total	143.0

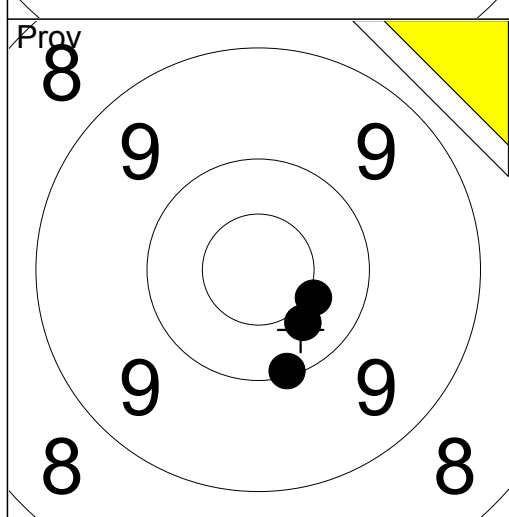

1:	10.4x	↘
2:	10.1	↘
3:	10.4	↘

Serie	30.0
Total	143.0

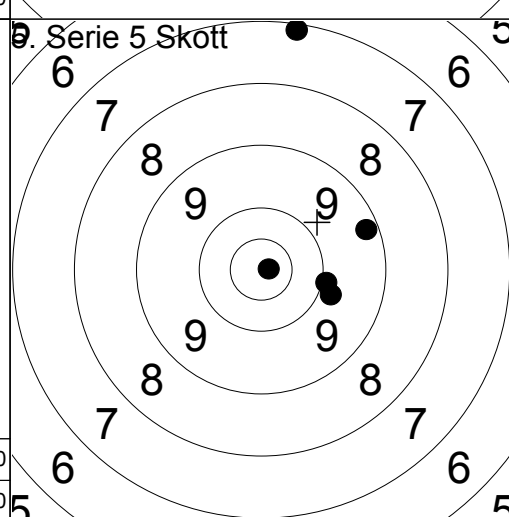

1:	7.1	↑
2:	9.8	→
3:	10.0	→
4:	9.2	→
5:	10.8x	→

Serie	45.0
Total	188.0

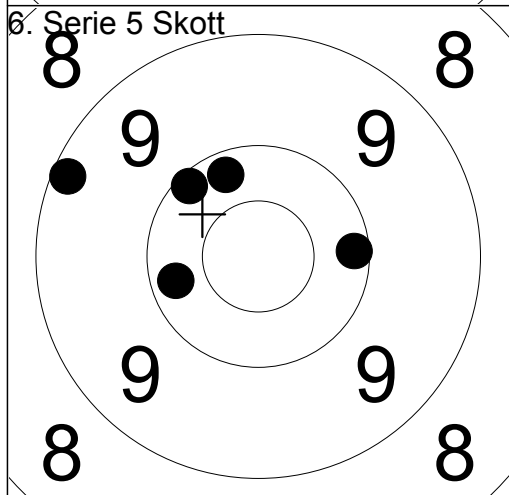

1:	10.1	↗
2:	10.1	→
3:	10.2	←
4:	9.2	↗
5:	10.2	↗

Serie	49.0
Total	237.0

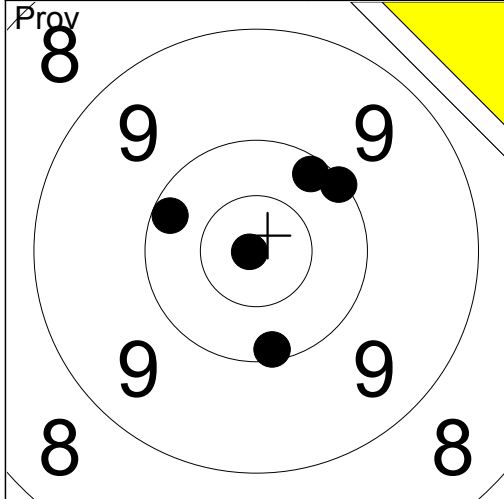

1. Serie 5 Skott

1:	10.2	↗
2:	10.2	↖
3:	10.1	↗
4:	10.1	↓
5:	10.9x	←
Serie	50.0	
Total	0.0	

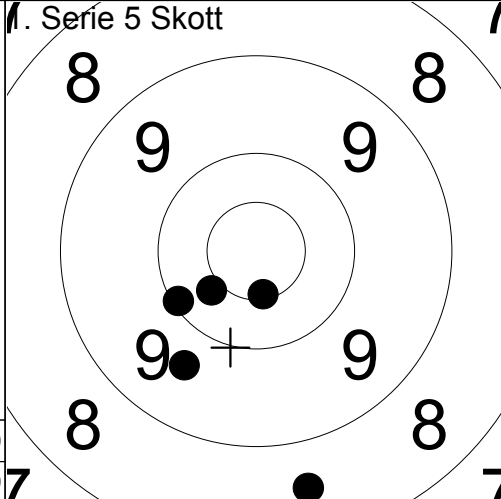

1:	8.6	↓
2:	10.1	↖
3:	9.7	↘
4:	10.4	↖
5:	10.5x	↓
Serie	47.0	
Total	47.0	

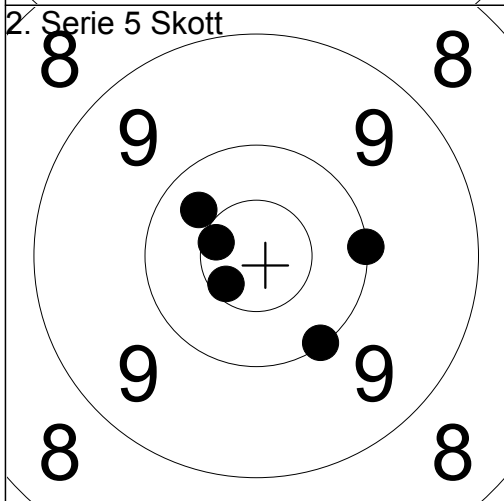

1:	10.0	→
2:	10.3	↗
3:	10.1	↘
4:	10.6x	↖
5:	10.6x	↖
Serie	50.0	
Total	97.0	

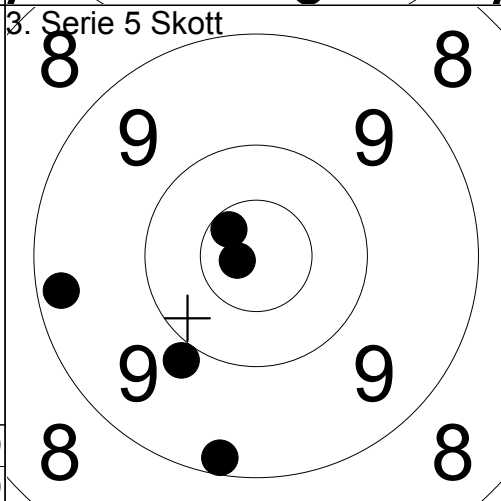

1:	9.9	↘
2:	10.6x	↗
3:	9.2	↓
4:	10.8x	←
5:	9.3	←
Serie	47.0	
Total	144.0	

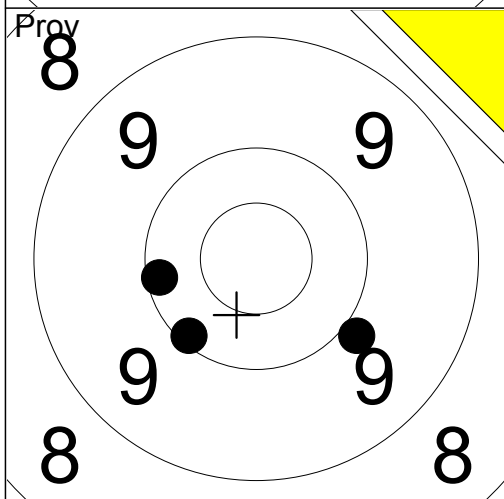

1:	9.9	↘
2:	10.1	←
3:	10.1	↘
Serie	29.0	
Total	144.0	

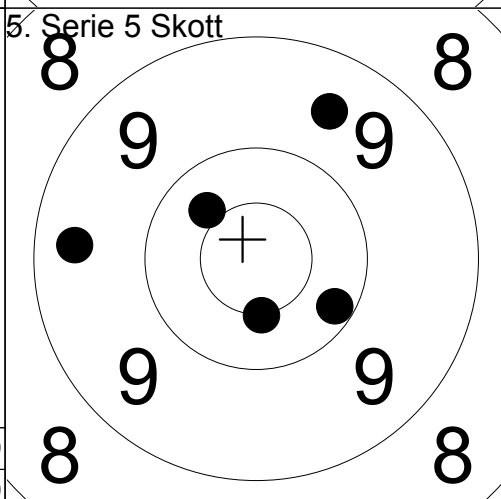

1:	10.5x	↓
2:	10.2	↗
3:	9.5	↗
4:	10.4	↗
5:	9.4	←
Serie	48.0	
Total	192.0	

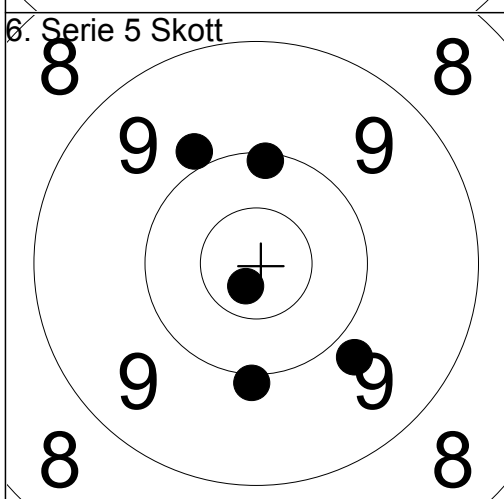

1:	9.8	↘
2:	10.0	↓
3:	10.7x	↘
4:	10.1	↑
5:	9.9	↗
Serie	48.0	
Total	240.0	

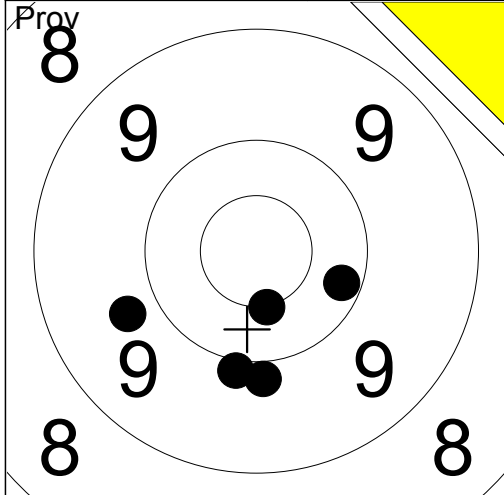

- 1: 9.7 ↙
- 2: 10.5x ↓
- 3: 9.9 ↓
- 4: 9.9 ↓
- 5: 10.2 →

Serie 47.0
Total 0.0

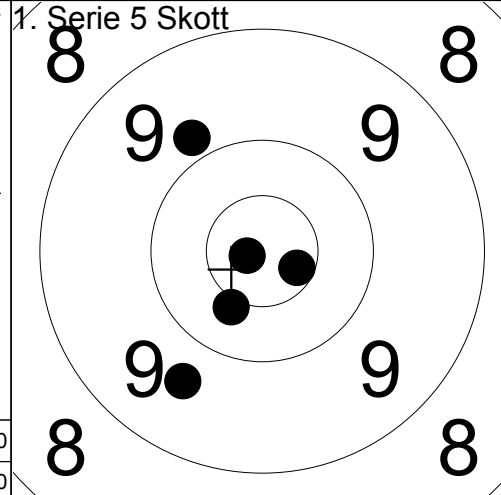

- 1: 10.6x →
- 2: 9.8 ↗
- 3: 10.4x ↓
- 4: 10.8x ←
- 5: 9.7 ↓

Serie 48.0
Total 48.0

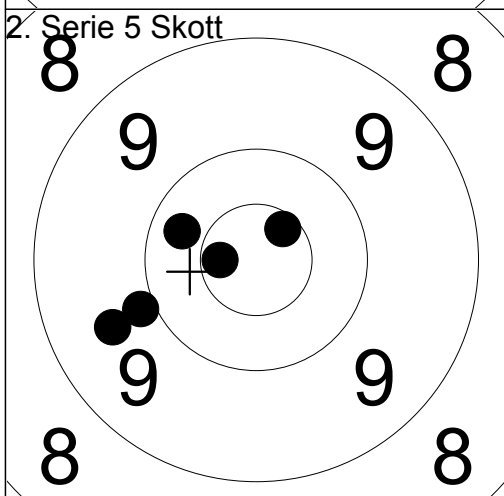

- 1: 10.6x ↗
- 2: 10.3 ↙
- 3: 9.6 ↙
- 4: 10.6x ←
- 5: 9.9 ↙

Serie 48.0
Total 96.0

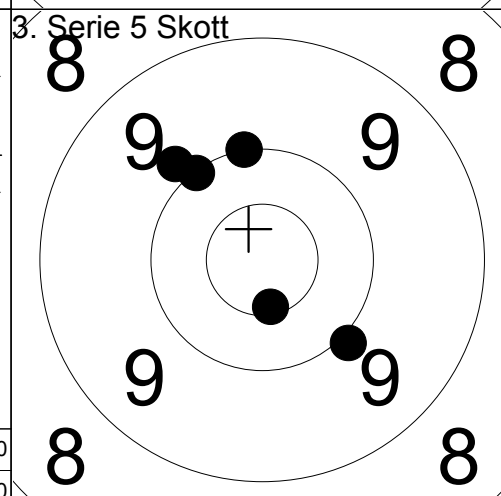

- 1: 10.0 ↑
- 2: 9.9 ↗
- 3: 10.0 ↓
- 4: 10.6x ↓
- 5: 10.0 ↗

Serie 49.0
Total 145.0

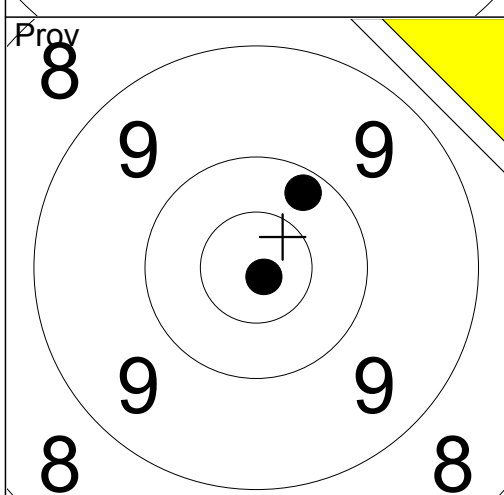

- 1: 10.2 ↗
- 2: 10.9x ↓

Serie 20.0
Total 145.0

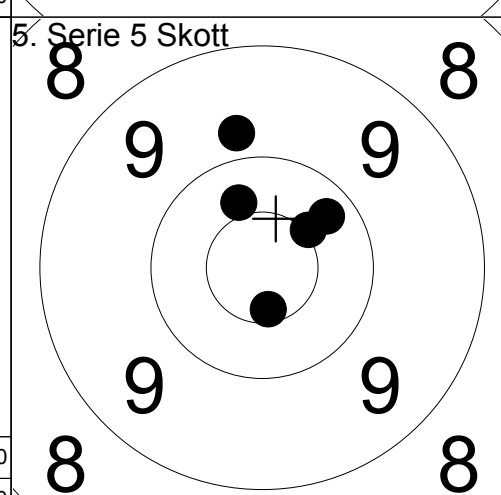

- 1: 10.5x ↗
- 2: 9.8 ↑
- 3: 10.3 ↗
- 4: 10.6x ↓
- 5: 10.4 ↗

Serie 49.0
Total 194.0

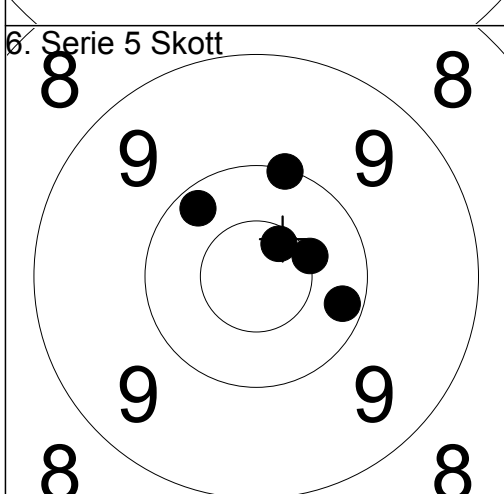

- 1: 10.5x →
- 2: 10.0 ↑
- 3: 10.2 ↗
- 4: 10.6x ↗
- 5: 10.2 →

Serie 50.0
Total 244.0

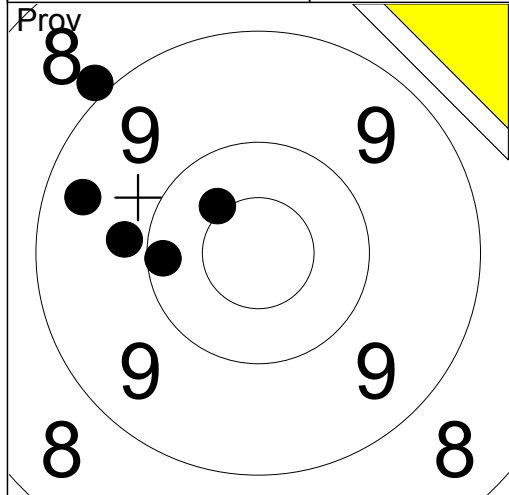

1:	10.2	←
2:	10.4x	↗
3:	9.8	←
5:	8.9	↗
6:	9.4	↖

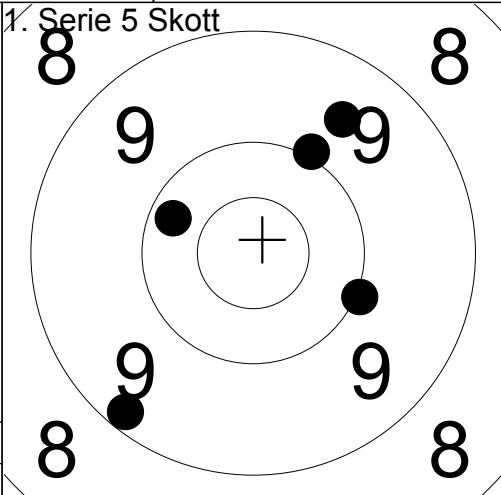

1:	10.0	↗
2:	9.6	↗
3:	10.0	→
4:	10.2	↖
5:	9.2	↘

Serie	46.0
Total	0.0

Serie	48.0
Total	48.0

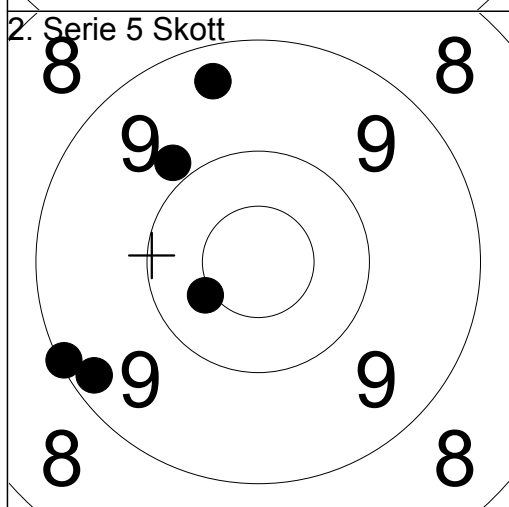

1:	9.4	↖
2:	9.9	↗
3:	10.4x	↙
4:	9.2	↙
5:	9.1	↙

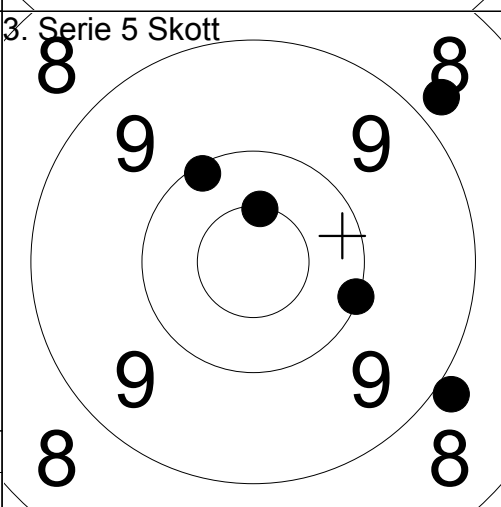

1:	10.5x	↖
2:	8.8	↗
3:	8.9	↘
4:	10.0	→
5:	10.1	↗

Serie	46.0
Total	94.0

Serie	46.0
Total	140.0

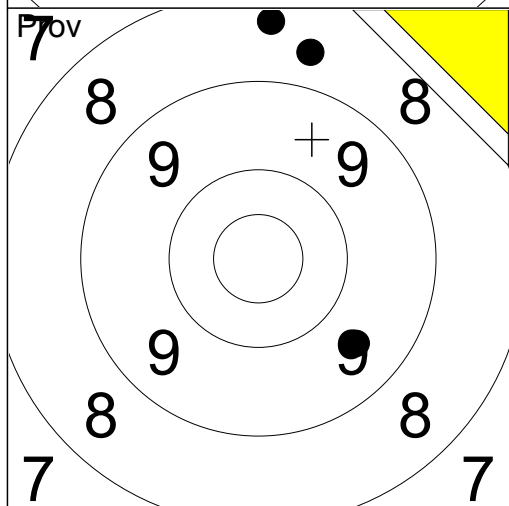

1:	8.6	↖
2:	8.4	↖
3:	9.6	↘

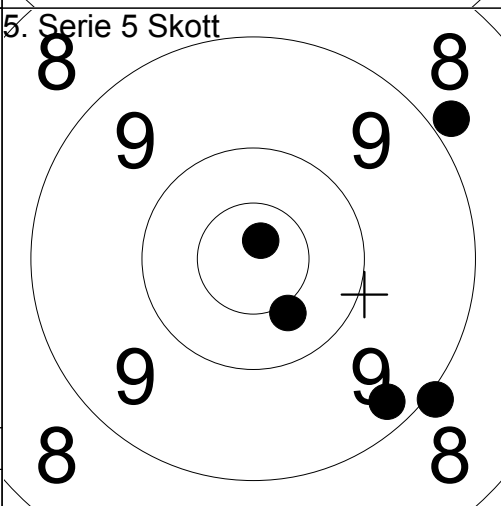

1:	8.9	↗
2:	9.3	↘
3:	9.0	↘
4:	10.8x	↖
5:	10.4	↘

Serie	25.0
Total	140.0

Serie	46.0
Total	186.0

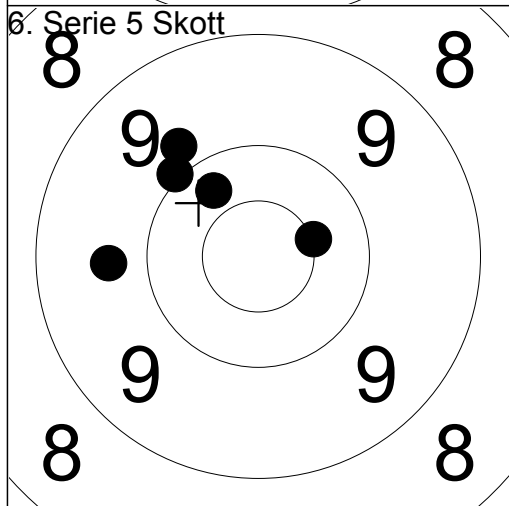

1:	10.5x	→
2:	10.3	↗
3:	10.0	↗
4:	9.8	↗
5:	9.7	←

Serie	48.0
Total	234.0

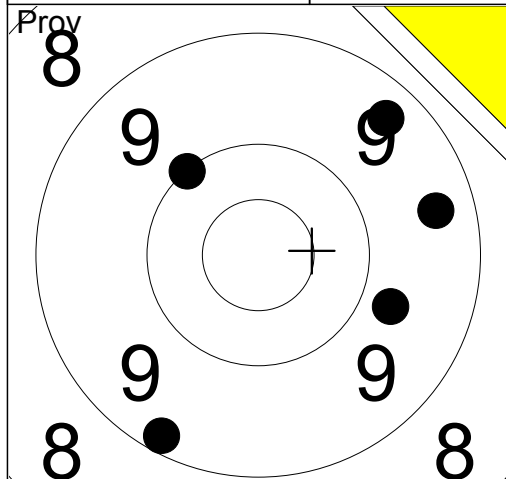

- 1: 10.0 ↗
- 2: 9.4 →
- 3: 9.3 ↗
- 4: 9.8 →
- 5: 9.2 ↓

Serie 46.0
Total 0.0

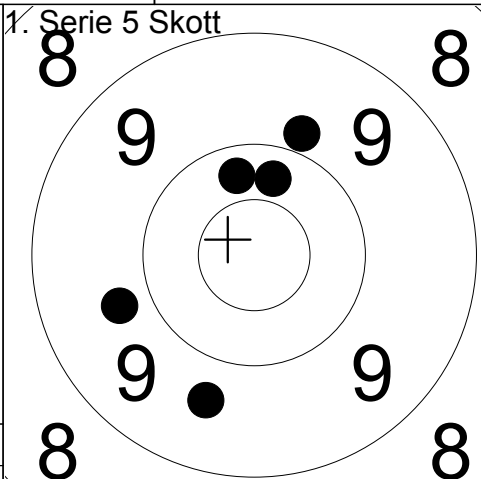

- 1: 9.9 ↗
- 2: 10.3 ↗
- 3: 9.7 ↓
- 4: 10.3 ↗
- 5: 9.7 ←

Serie 47.0
Total 47.0

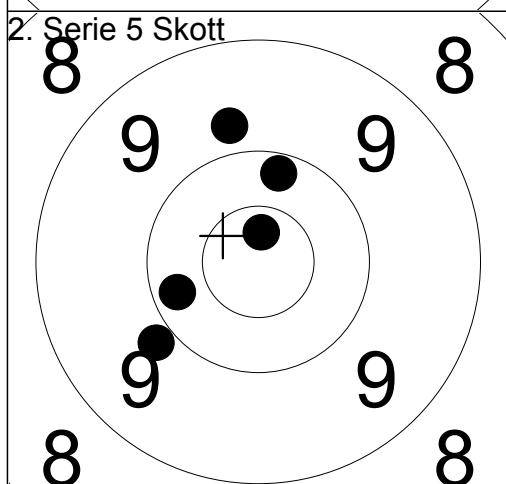

- 1: 10.2 ←
- 2: 10.2 ↗
- 3: 10.7x ↗
- 4: 9.8 ↗
- 5: 9.9 ↘

Serie 48.0
Total 95.0

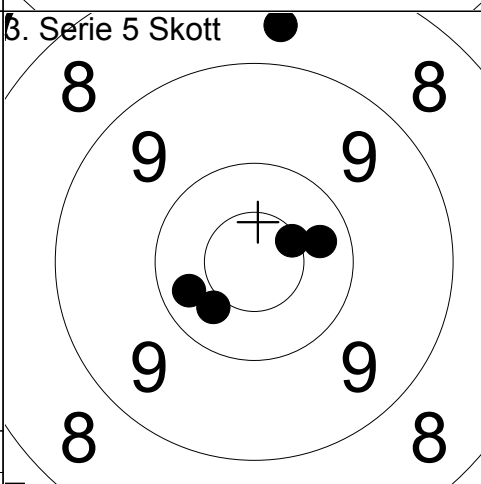

- 1: 10.3 →
- 2: 10.3 ←
- 3: 8.6 ↗
- 4: 10.4 ↓
- 5: 10.5x ↗

Serie 48.0
Total 143.0

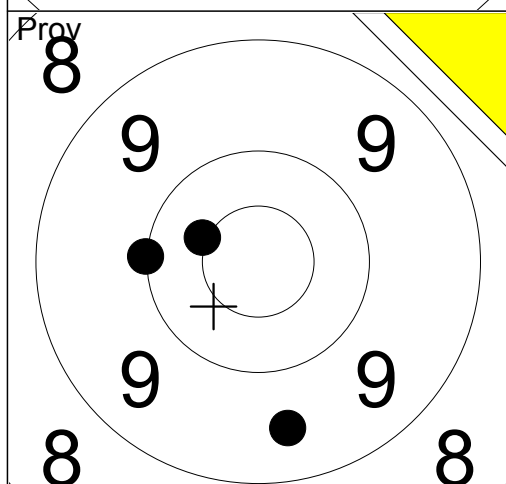

- 1: 10.4x ←
- 2: 10.0 ←
- 3: 9.5 ↓

Serie 29.0
Total 143.0

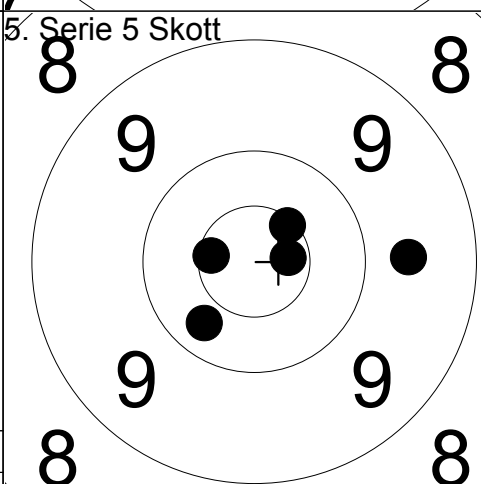

- 1: 9.6 →
- 2: 10.5x ↗
- 3: 10.7x →
- 4: 10.6x ←
- 5: 10.3 ↓

Serie 49.0
Total 192.0

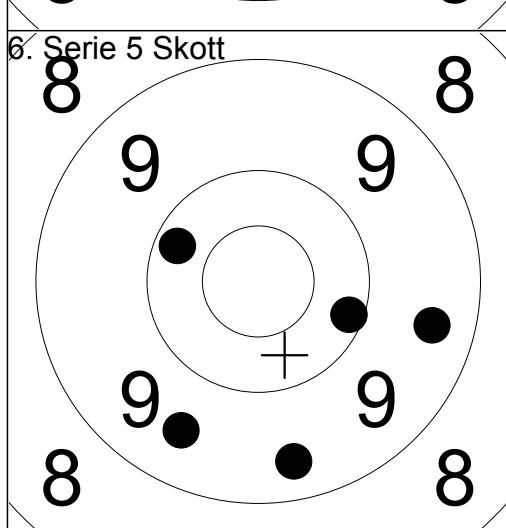

- 1: 9.4 →
- 2: 10.1 ↘
- 3: 10.2 ↗
- 4: 9.4 ↓
- 5: 9.5 ↘

Serie 47.0
Total 239.0

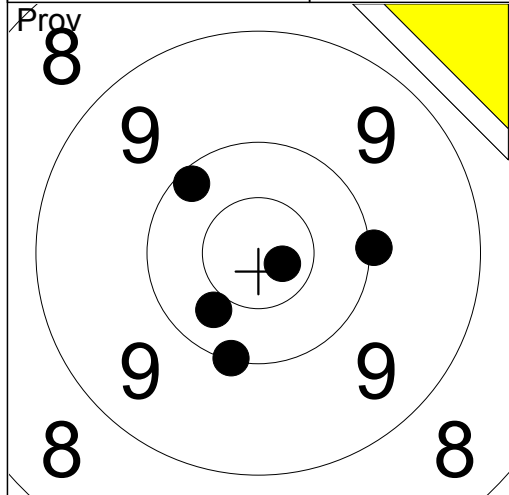

1:	10.0	↘
2:	10.0	→
3:	10.7x	↘
4:	10.1	↗
5:	10.3	↘

Serie	50.0
Total	0.0

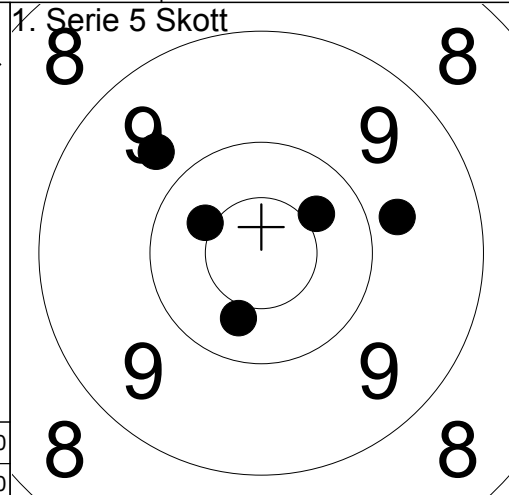

1:	9.8	→
2:	10.4	↗
3:	10.4	↘
4:	9.7	↗
5:	10.4x	↗

Serie	48.0
Total	48.0

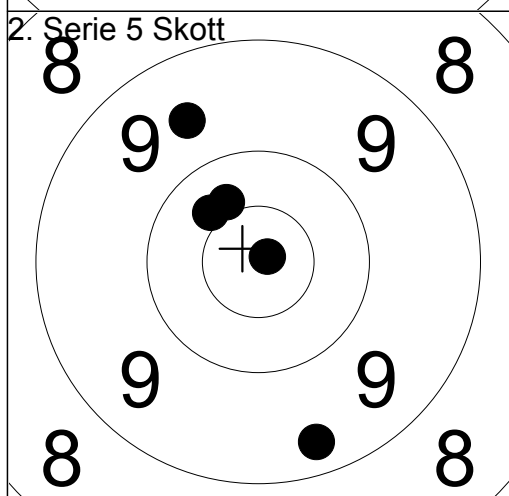

1:	9.3	↘
2:	10.9x	↗
3:	9.6	↗
4:	10.4	↗
5:	10.4	↗

Serie	48.0
Total	96.0

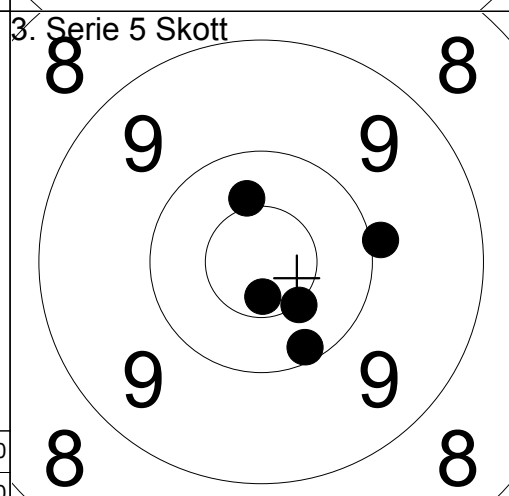

1:	9.9	→
2:	10.5x	↘
3:	10.4	↗
4:	10.7x	↘
5:	10.1	↘

Serie	49.0
Total	145.0

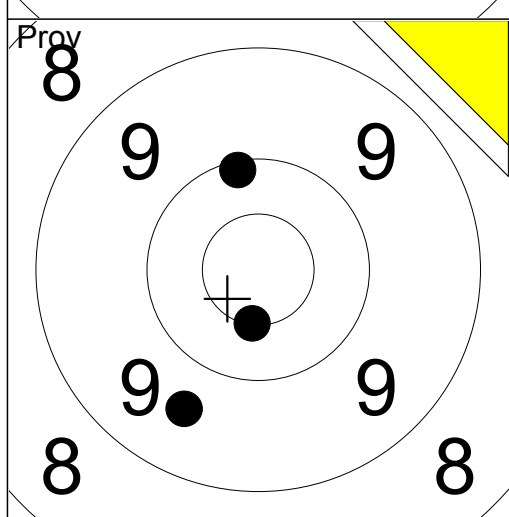

1:	10.5x	↘
2:	10.1	↑
3:	9.6	↘

Serie	29.0
Total	145.0

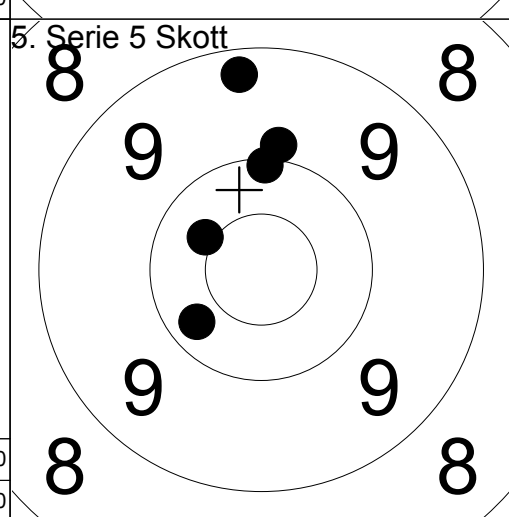

1:	10.3	↖
2:	9.9	↑
3:	9.3	↑
4:	10.4	↖
5:	10.1	↑

Serie	48.0
Total	193.0

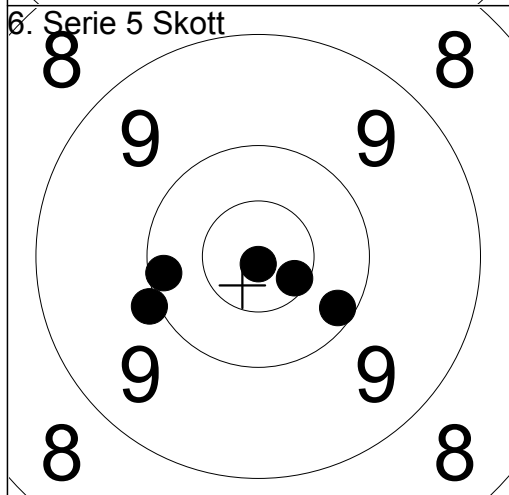

1:	10.6x	↘
2:	10.0	↖
3:	10.9x	↘
4:	10.2	↖
5:	10.2	↘

Serie	50.0
Total	243.0

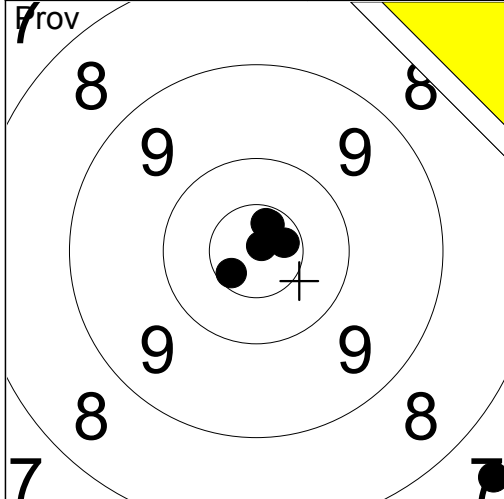

1:	10.6x	↙
2:	10.7x	↗
3:	10.9x	↗
4:	7.5	↘
5:	10.7x	↗
6:	10.7x	→

Serie	57.0
Total	0.0

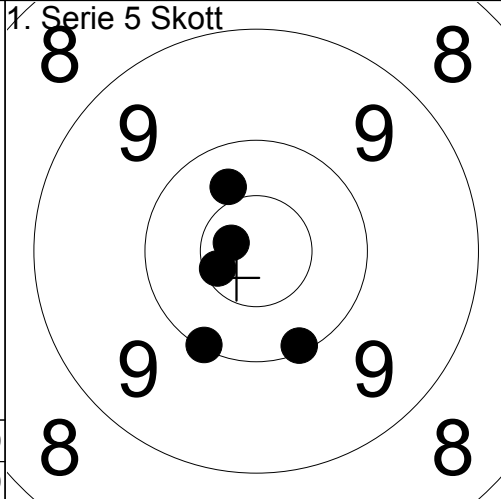

1:	10.4	↗
2:	10.1	↘
3:	10.7x	↖
4:	10.1	↘
5:	10.6x	↖

Serie	50.0
Total	50.0

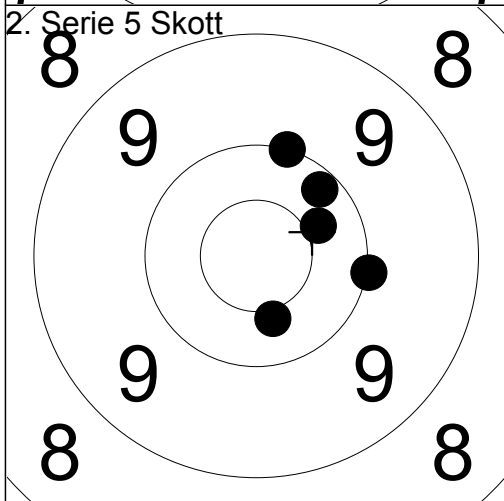

1:	10.2	↗
2:	10.4	↘
3:	10.0	→
4:	10.4	↗
5:	10.0	↗

Serie	50.0
Total	100.0

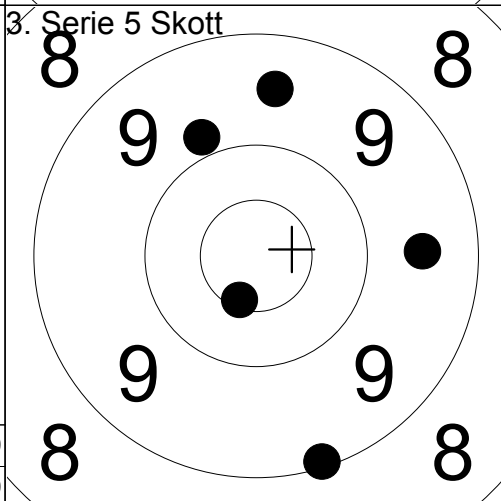

1:	9.5	→
2:	10.6x	↘
3:	9.9	↗
4:	9.5	↗
5:	9.1	↘

Serie	46.0
Total	146.0

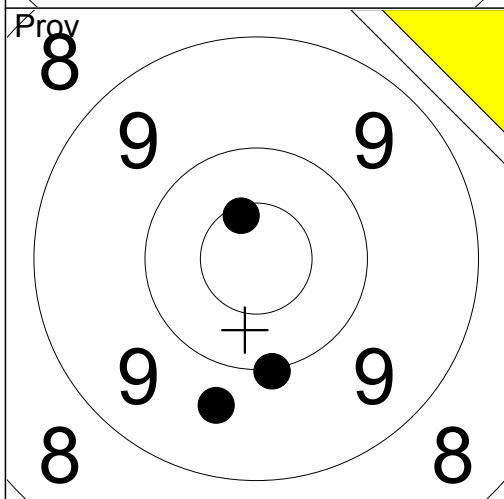

1:	10.6x	↗
2:	10.0	↘
3:	9.7	↘

Serie	29.0
Total	146.0

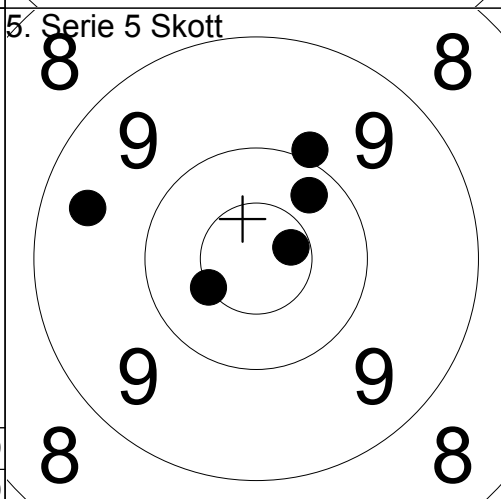

1:	10.5x	↖
2:	10.3	↗
3:	9.9	↗
4:	9.4	↖
5:	10.6x	→

Serie	48.0
Total	194.0

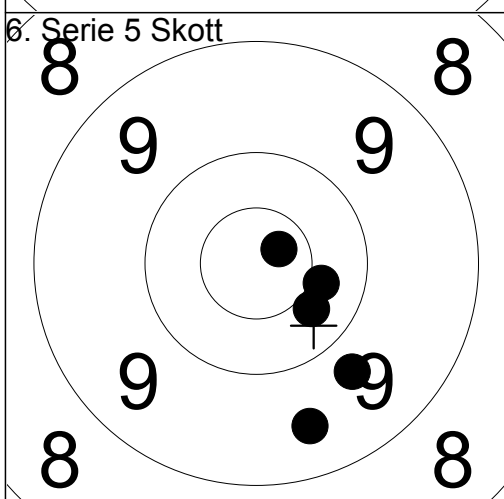

1:	10.4	→
2:	9.7	↘
3:	10.7x	↗
4:	10.4	↘
5:	9.5	↘

Serie	48.0
Total	242.0

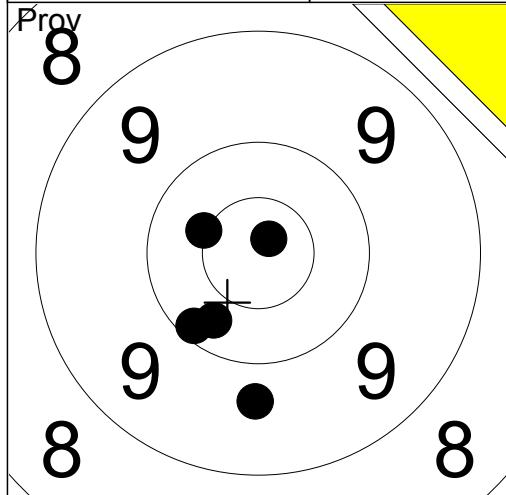

1:	10.1	↙
2:	10.8x	↗
3:	9.7	↓
4:	10.5x	↖
5:	10.3	↘
Serie		49.0
Total		0.0

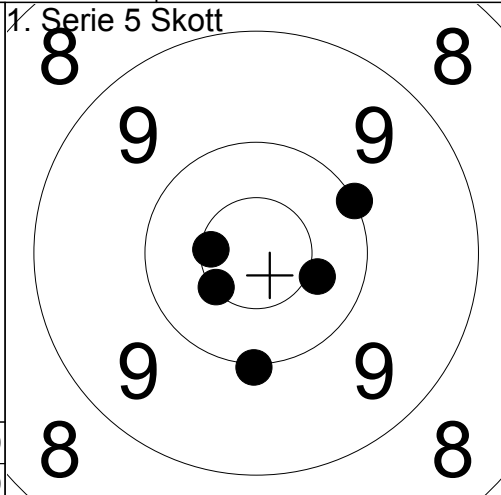

1:	10.0	↗
2:	10.4	➡
3:	10.5x	↙
4:	10.6x	↖
5:	10.0	↓
Serie		50.0
Total		50.0

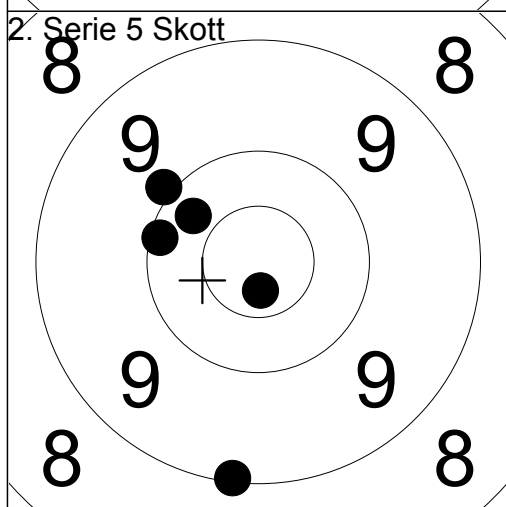

1:	9.1	↓
2:	10.7x	↓
3:	10.3	↗
4:	10.1	↖
5:	9.9	↗
Serie		48.0
Total		98.0

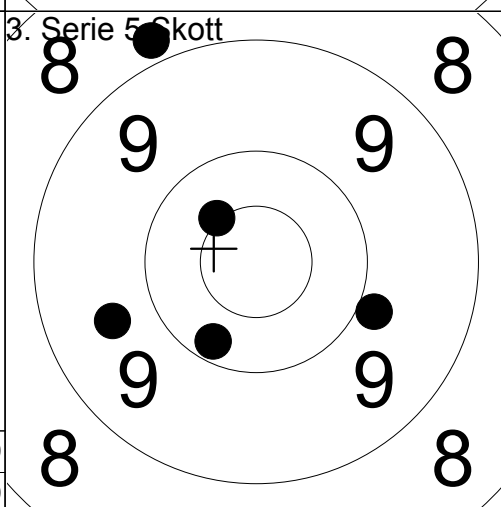

1:	8.8	↗
2:	10.5x	↗
3:	10.2	↙
4:	9.9	➡
5:	9.6	↖
Serie		46.0
Total		144.0

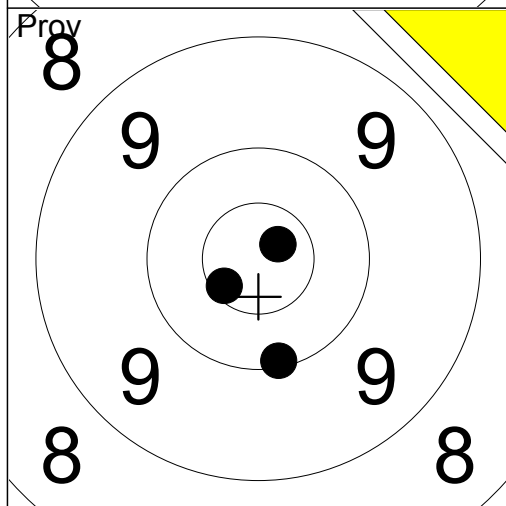

1:	10.1	↓
2:	10.7x	↗
3:	10.6x	↙
Serie		30.0
Total		144.0

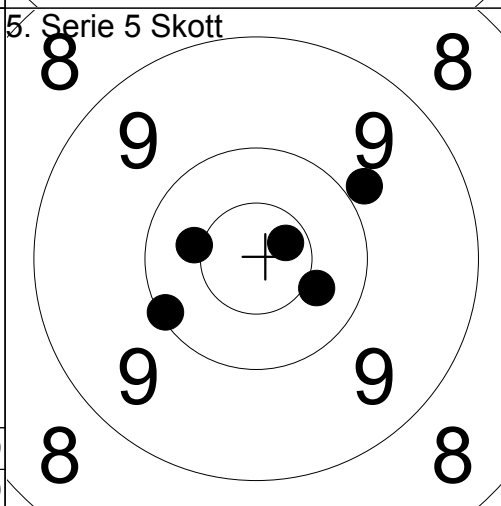

1:	9.9	↗
2:	10.1	↖
3:	10.4	➡
4:	10.4x	↖
5:	10.7x	↗
Serie		49.0
Total		193.0

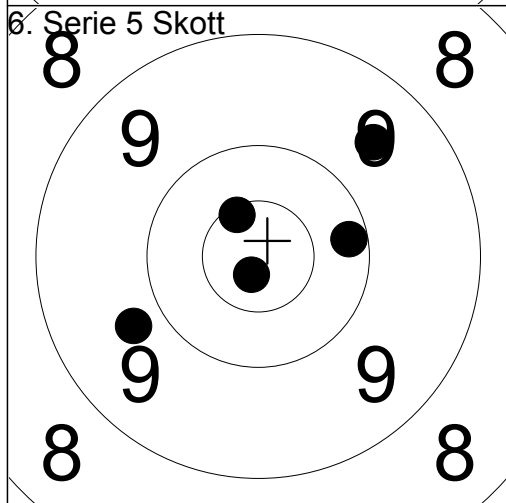

1:	9.6	↗
2:	10.2	➡
3:	10.6x	↗
4:	9.7	↖
5:	10.8x	↘
Serie		48.0
Total		241.0

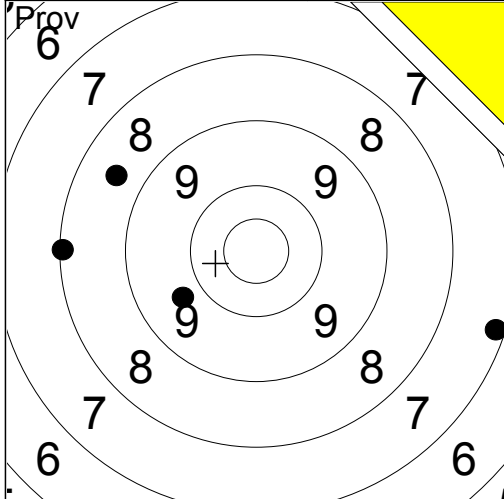

1. Serie 5 Skott

1:	7.2	↘
2:	9.7	↙
3:	8.1	←
4:	8.6	↗
Serie	32.0	
Total	0.0	

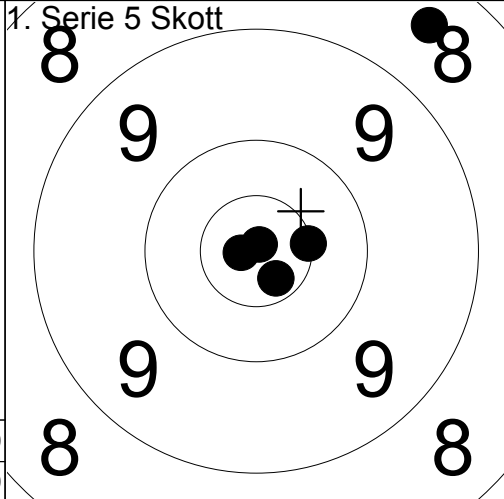

1. Serie 5 Skott

1:	8.5	↗
2:	10.7x	↘
3:	10.9x	↗
4:	10.8x	←
5:	10.5x	→
Serie	48.0	
Total	48.0	

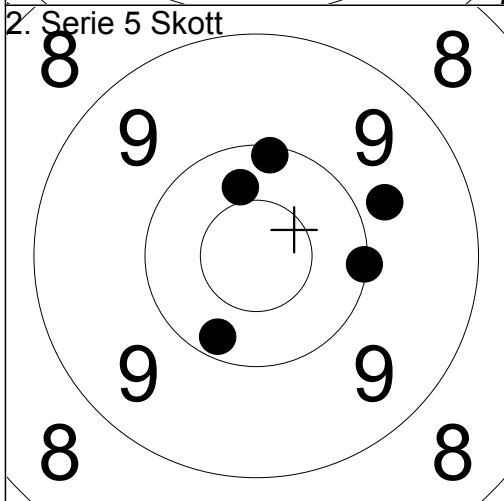

2. Serie 5 Skott

1:	10.2	↙
2:	10.0	→
3:	9.8	↗
4:	10.1	↑
5:	10.4	↑
Serie	49.0	
Total	97.0	

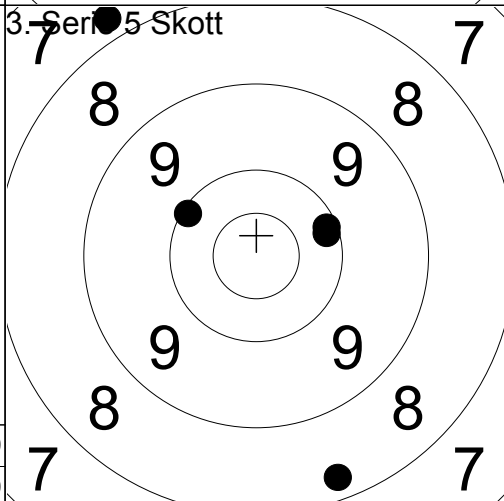

3. Serie 5 Skott

1:	10.1	↖
2:	8.3	↘
3:	10.2	→
4:	10.1	↗
5:	7.8	↖
Serie	45.0	
Total	142.0	

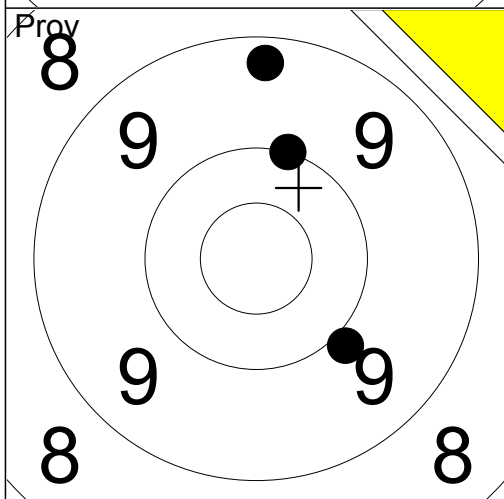

5. Serie 5 Skott

1:	9.9	↘
2:	10.0	↑
3:	9.3	↑
Serie	28.0	
Total	142.0	

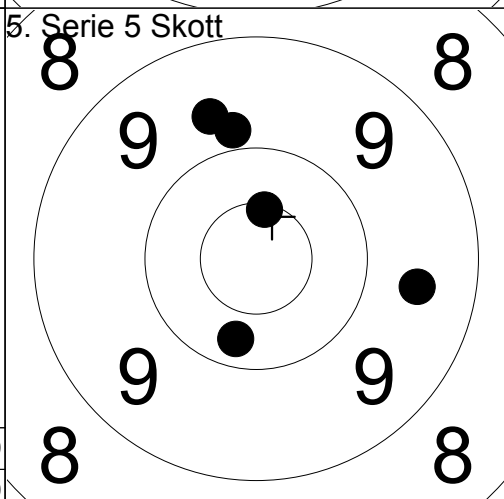

5. Serie 5 Skott

1:	9.6	→
2:	9.7	↑
3:	10.5x	↑
4:	9.9	↑
5:	10.3	↘
Serie	47.0	
Total	189.0	

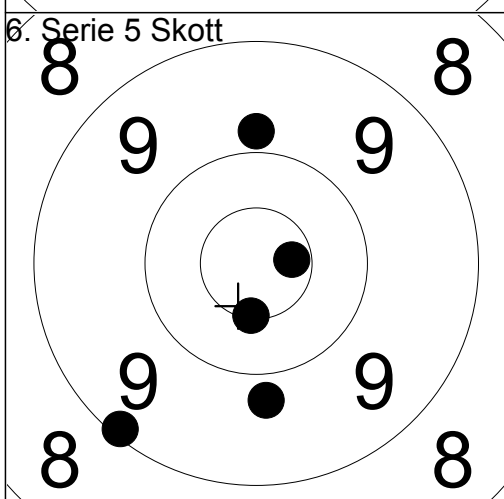

6. Serie 5 Skott

1:	9.8	↑
2:	9.8	↘
3:	10.7x	→
4:	9.1	↙
5:	10.5x	↘
Serie	47.0	
Total	236.0	

6. Serie 5 Skott

1:	8.5	↗
2:	10.7x	↘
3:	10.9x	↗
4:	10.8x	←
5:	10.5x	→
Serie	48.0	
Total	48.0	

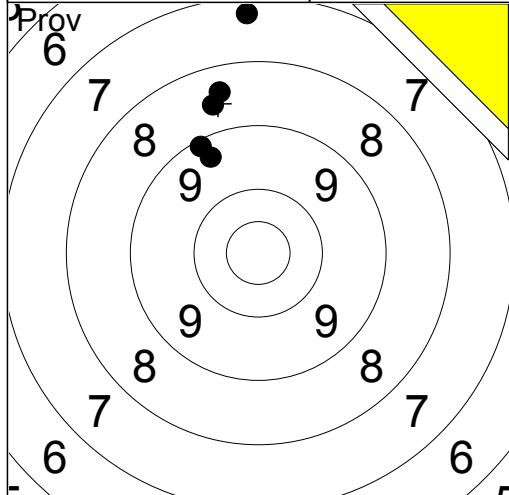

1:	8.6	↑
2:	8.4	↑
3:	9.1	↑
4:	7.3	↑
5:	9.4	↑

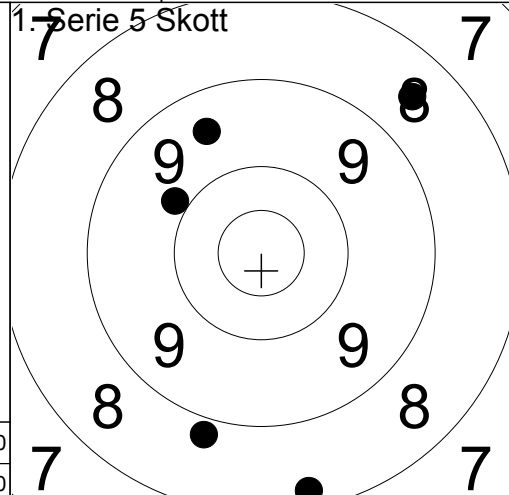

1:	8.5	↗
2:	9.9	↗
3:	9.5	↑
4:	8.2	↓
5:	8.8	↓

Serie	41.0
Total	0.0

Serie	42.0
Total	42.0

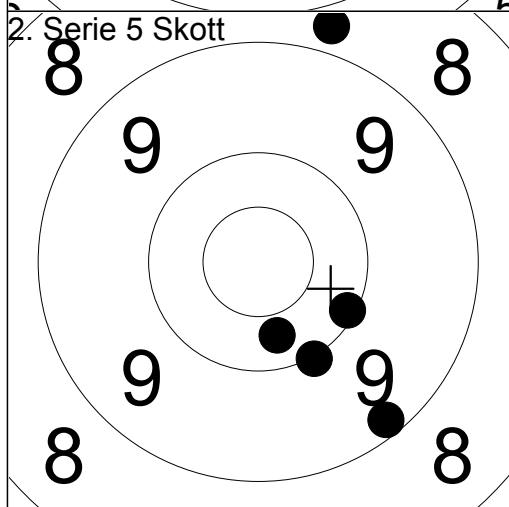

1:	10.0	↓
2:	9.2	↓
3:	10.1	↓
4:	10.3	↓
5:	8.8	↑

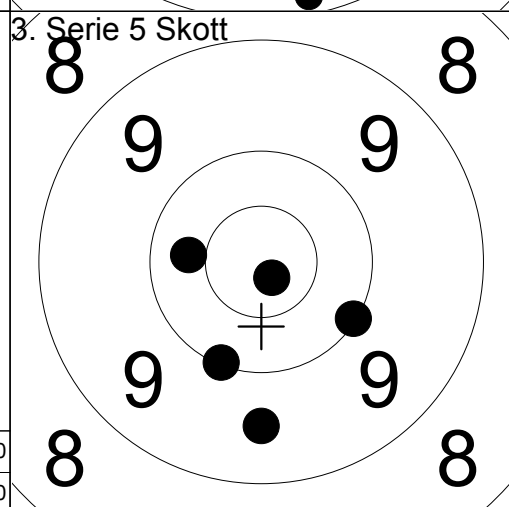

1:	10.1	↘
2:	10.0	↓
3:	9.6	↓
4:	10.8x	↘
5:	10.3	←

Serie	47.0
Total	89.0

Serie	49.0
Total	138.0

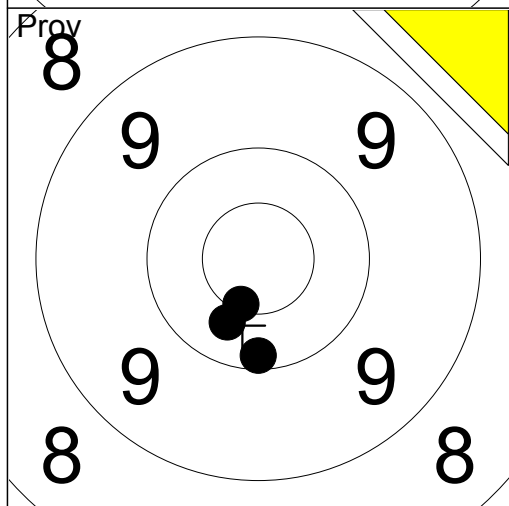

1:	10.1	↓
2:	10.4	↓
3:	10.5x	↓

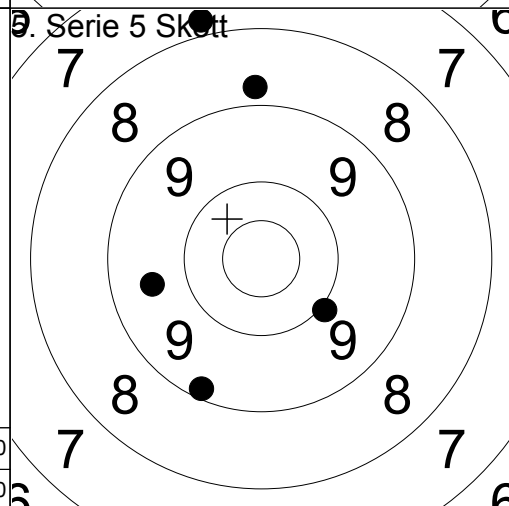

1:	7.8	↑
2:	9.6	←
3:	10.0	↘
4:	8.8	↑
5:	9.2	↓

Serie	30.0
Total	138.0

Serie	43.0
Total	181.0

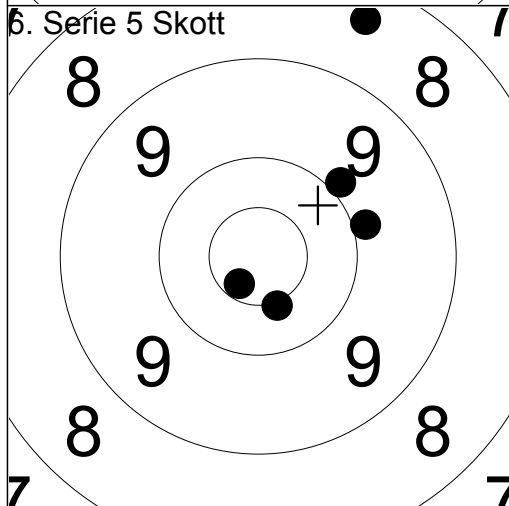

1:	8.4	↑
2:	9.9	↗
3:	9.9	→
4:	10.5x	↓
5:	10.6x	↘

Serie	46.0
Total	227.0

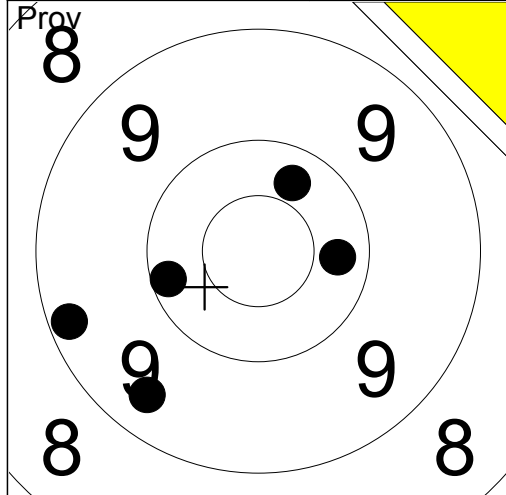

1:	9.2	←
2:	10.3	→
3:	10.3	↗
4:	9.4	↘
5:	10.2	←

Serie	48.0
Total	0.0

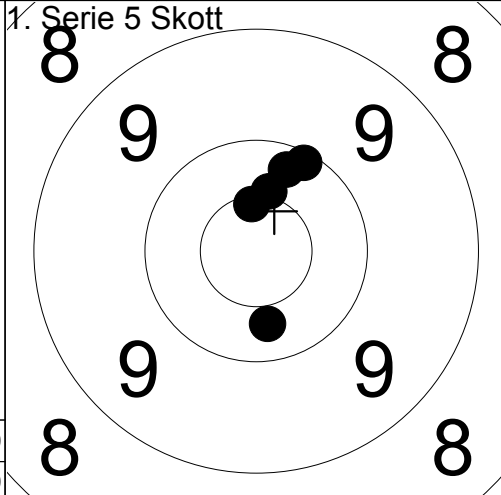

1:	10.2	↗
2:	10.6x	↗
3:	10.4x	↗
4:	10.3	↘
5:	10.1	↗

Serie	50.0
Total	50.0

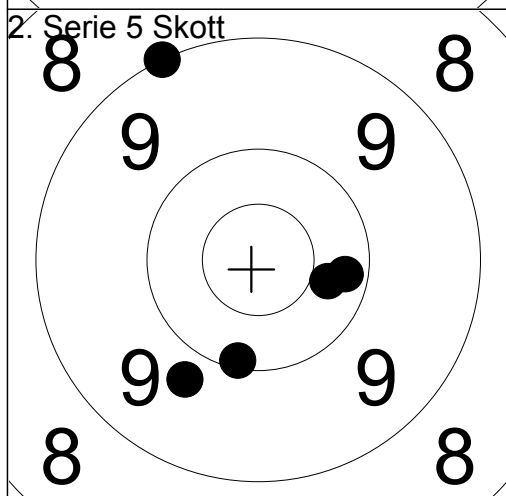

1:	10.2	→
2:	10.3	→
3:	9.8	↘
4:	10.1	↘
5:	9.0	↗

Serie	48.0
Total	98.0

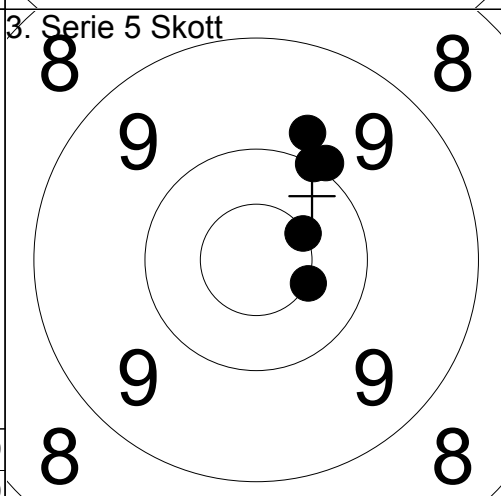

1:	10.0	↗
2:	10.5x	↗
3:	9.8	↗
4:	10.0	↗
5:	10.5x	→

Serie	49.0
Total	147.0

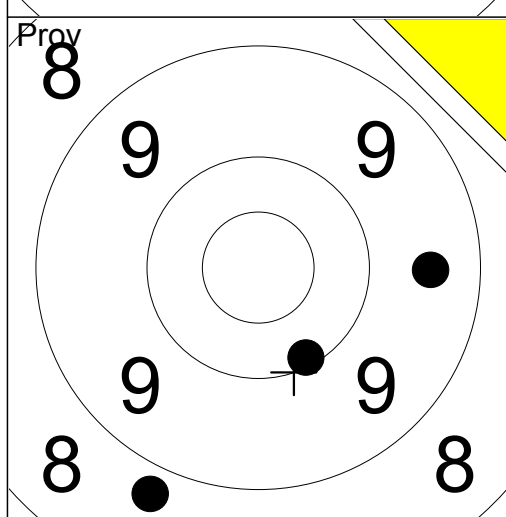

1:	8.8	↘
2:	10.1	↘
3:	9.5	→

Serie	27.0
Total	147.0

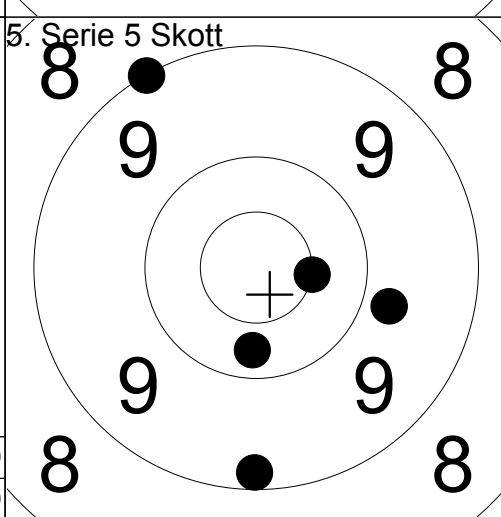

1:	9.8	→
2:	9.0	↗
3:	10.5x	→
4:	10.3	↘
5:	9.2	↘

Serie	47.0
Total	194.0

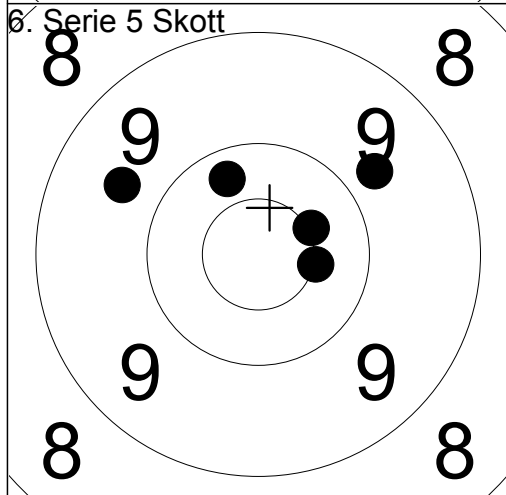

1:	10.5x	↗
2:	10.3	↗
3:	9.7	↗
4:	9.7	↖
5:	10.5x	→

Serie	48.0
Total	242.0

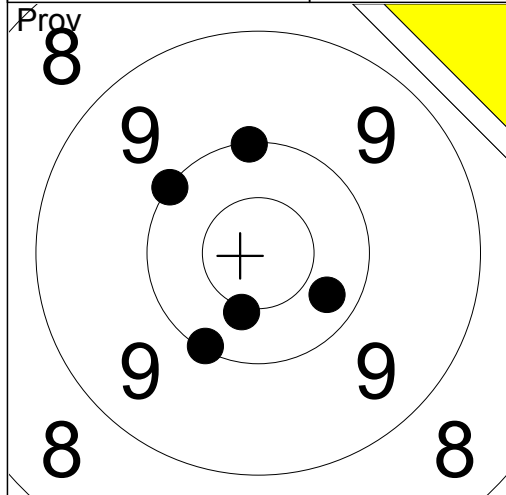

1:	10.0	↑
2:	10.3	↘
3:	10.0	↗
4:	10.1	↘
5:	10.4x	↓

Serie	50.0
Total	0.0

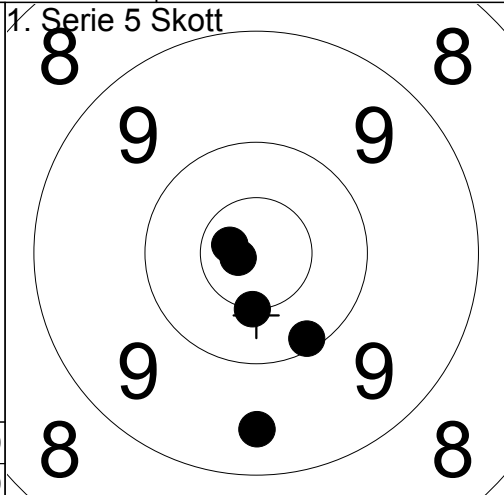

1:	10.1	↘
2:	9.4	↓
3:	10.7x	←
4:	10.8x	←
5:	10.5x	↓

Serie	49.0
Total	49.0

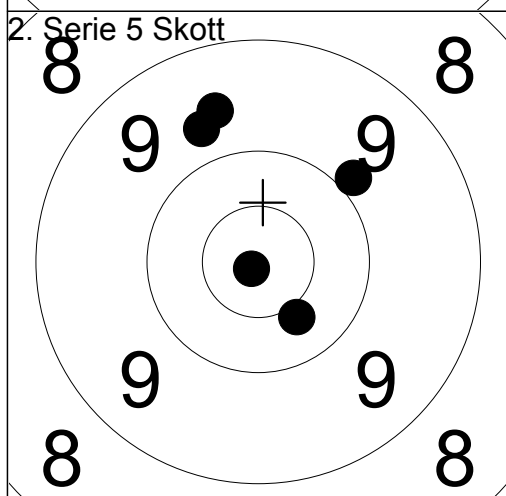

1:	9.9	↗
2:	9.7	↗
3:	9.6	↗
4:	10.9x	↘
5:	10.4	↘

Serie	47.0
Total	96.0

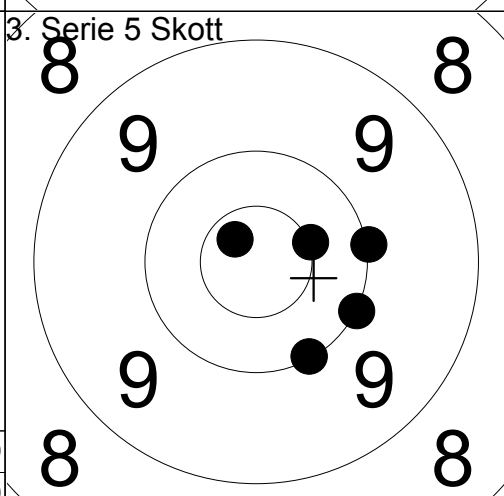

1:	10.0	→
2:	10.0	↘
3:	10.7x	↗
4:	10.5x	→
5:	10.0	↘

Serie	50.0
Total	146.0

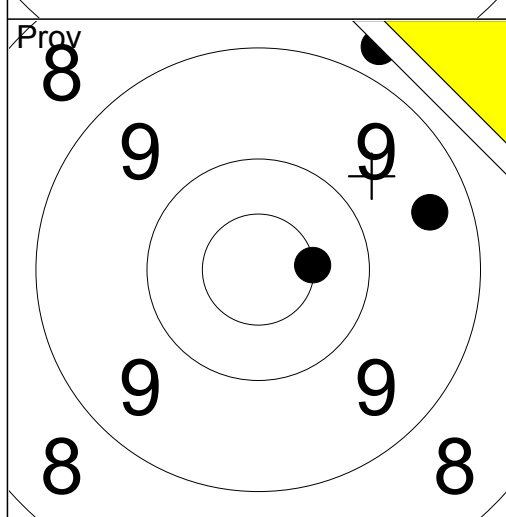

1:	8.7	↗
2:	9.4	→
3:	10.5x	→

Serie	27.0
Total	146.0

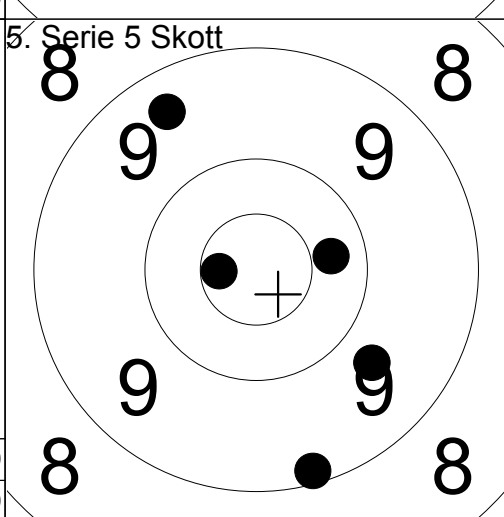

1:	9.7	↘
2:	9.4	↗
3:	10.3	→
4:	9.2	↘
5:	10.6x	←

Serie	47.0
Total	193.0

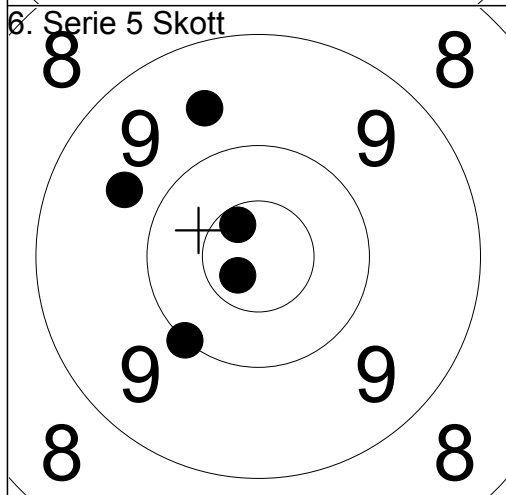

1:	9.7	↗
2:	10.7x	↘
3:	9.6	↗
4:	10.6x	↗
5:	10.0	↘

Serie	48.0
Total	241.0

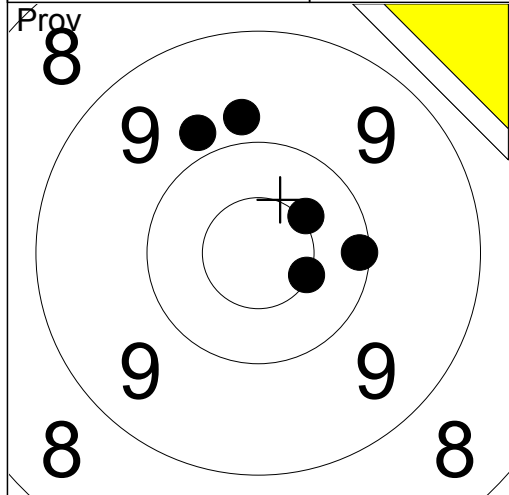

1:	9.8	↖
2:	10.1	→
3:	10.4x	↗
4:	10.5x	↘
5:	9.8	↑
Serie	48.0	
Total	0.0	

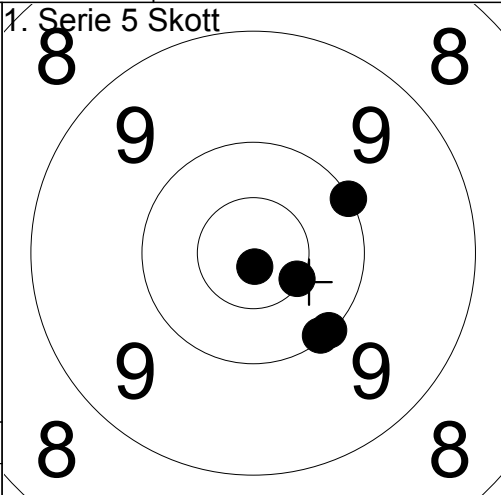

1:	10.0	↗
2:	10.1	↘
3:	10.1	↘
4:	10.5x	↘
5:	10.8x	↓
Serie	50.0	
Total	50.0	

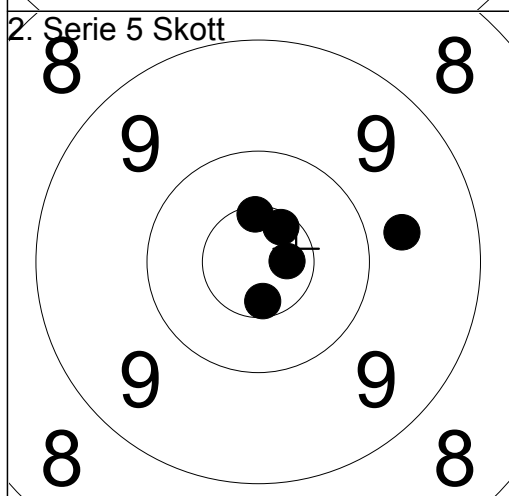

1:	9.7	→
2:	10.7x	→
3:	10.6x	↗
4:	10.6x	↑
5:	10.6x	↓
Serie	49.0	
Total	99.0	

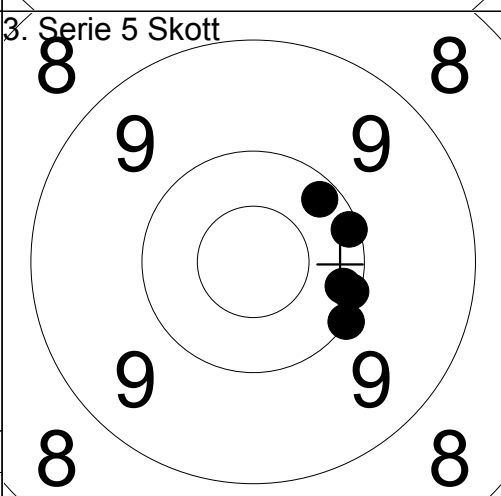

1:	10.1	↗
2:	10.2	↗
3:	10.0	↘
4:	10.2	→
5:	10.1	↘
Serie	50.0	
Total	149.0	

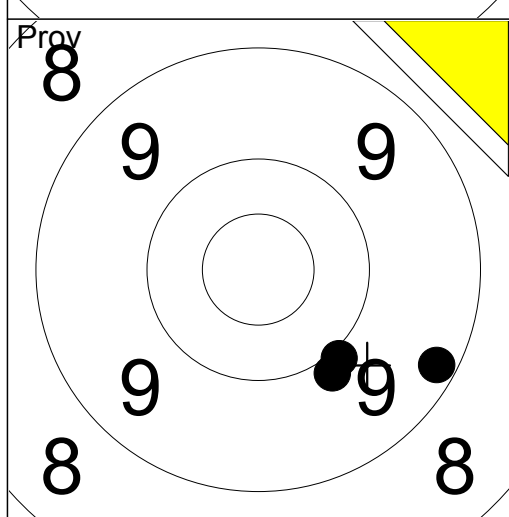

1:	9.9	↘
2:	10.0	↘
3:	9.2	↘
Serie	28.0	
Total	149.0	

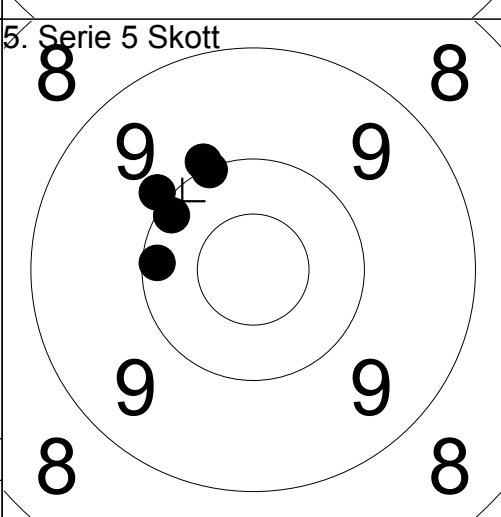

1:	9.9	↗
2:	10.1	↗
3:	10.0	↗
4:	10.0	↗
5:	10.2	←
Serie	49.0	
Total	198.0	

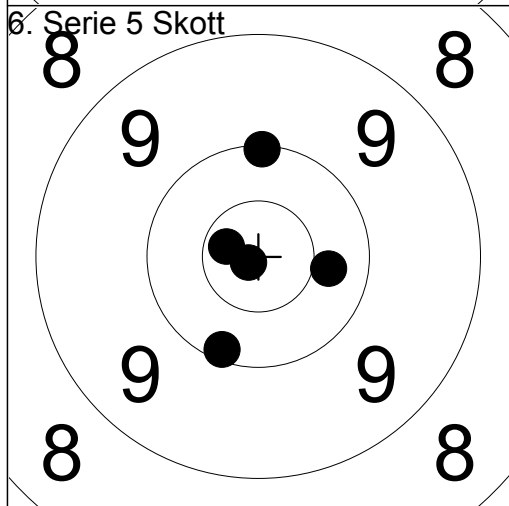

1:	10.1	↑
2:	10.7x	←
3:	10.4	→
4:	10.1	↓
5:	10.9x	↙
Serie	50.0	
Total	248.0	

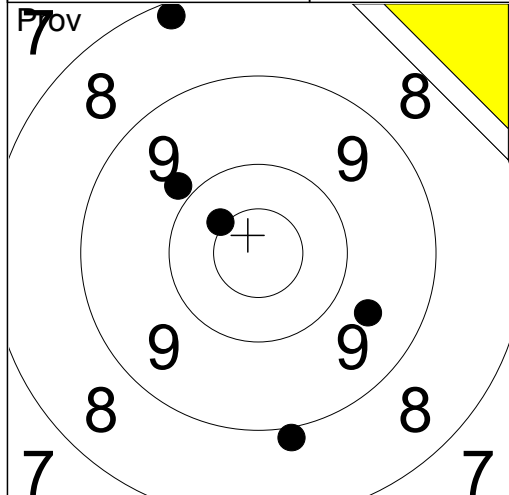

1:	8.9	↘
2:	9.9	↗
3:	9.6	↘
4:	10.4x	↗
5:	8.2	↗
Serie	44.0	
Total	0.0	

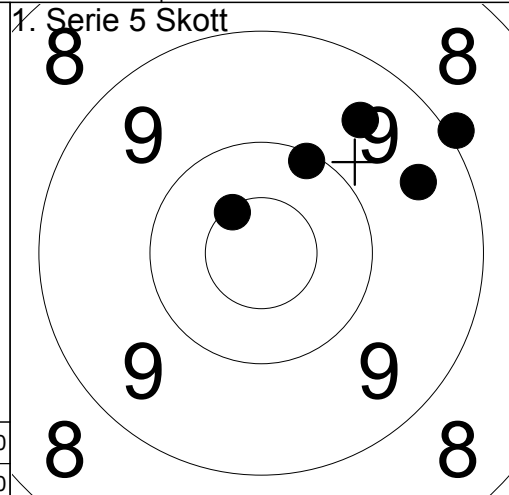

1:	10.5x	↖
2:	9.5	↗
3:	9.5	↗
4:	9.0	↗
5:	10.1	↗
Serie	47.0	
Total	47.0	

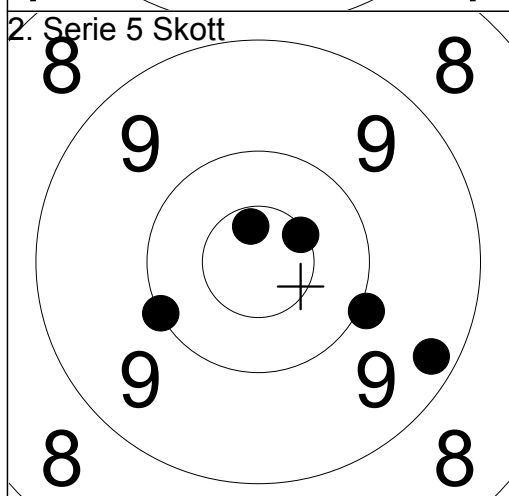

1:	10.5x	↗
2:	10.0	↖
3:	10.0	↘
4:	10.6x	↗
5:	9.3	↘
Serie	49.0	
Total	96.0	

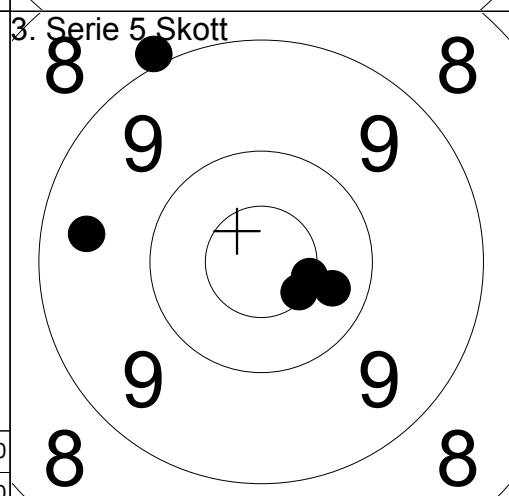

1:	10.5x	↘
2:	10.3	↘
3:	8.9	↗
4:	9.4	↖
5:	10.5x	↘
Serie	47.0	
Total	143.0	

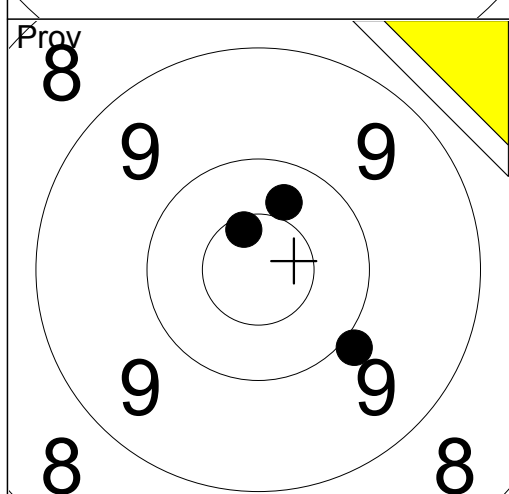

1:	9.9	↘
2:	10.6x	↗
3:	10.3	↗
Serie	29.0	
Total	143.0	

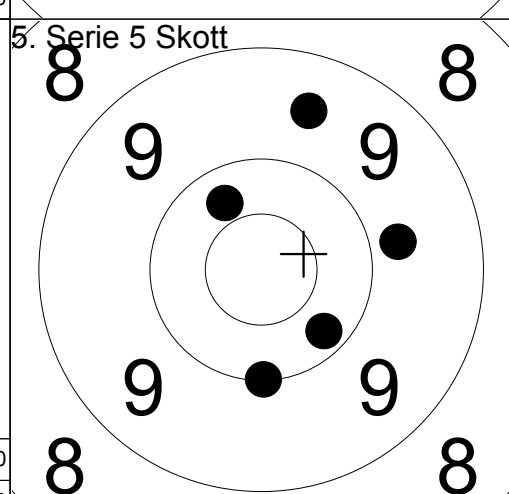

1:	9.5	↗
2:	9.8	→
3:	10.3	↗
4:	10.0	↘
5:	10.2	↘
Serie	48.0	
Total	191.0	

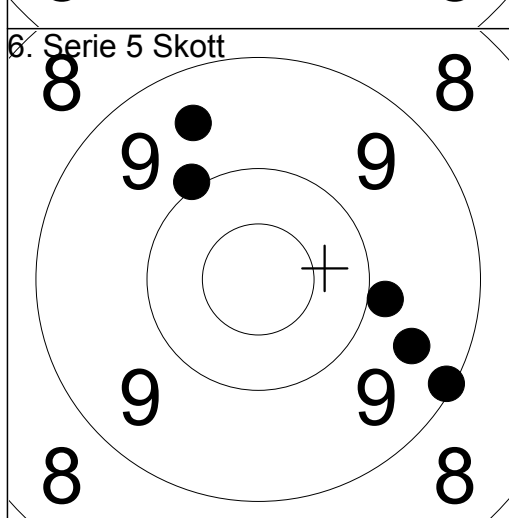

1:	9.1	↘
2:	9.5	↗
3:	9.9	→
4:	10.0	↗
5:	9.5	↘
Serie	46.0	
Total	237.0	

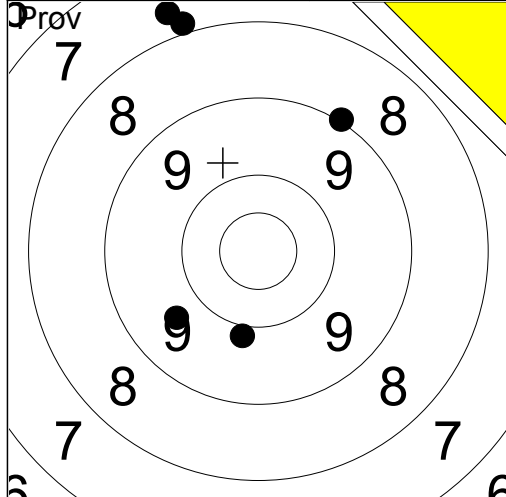

1:	9.7	↙
2:	9.9	↓
3:	7.9	↑
4:	9.0	↗
5:	7.7	↑

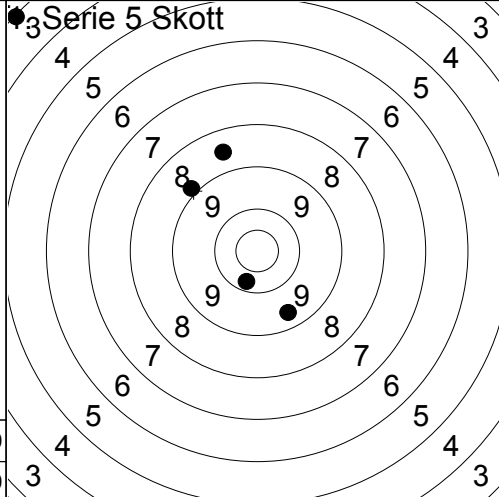

1:	8.5	↑
2:	9.4	↓
3:	8.9	↗
4:	10.2	↓
5:	3.1	↗

Serie	41.0
Total	0.0

Serie	38.0
Total	38.0

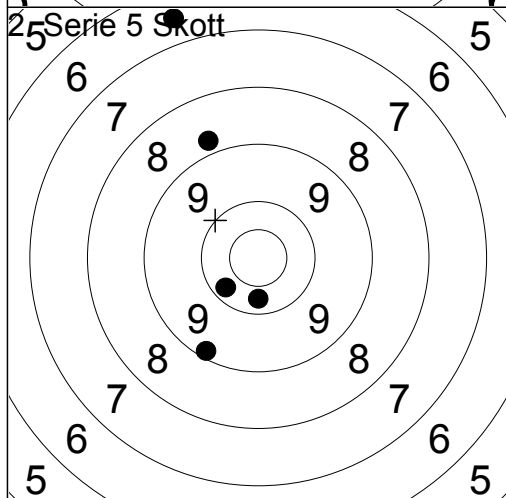

1:	10.3	↓
2:	10.2	↙
3:	8.8	↑
4:	9.2	↓
5:	6.6	↑

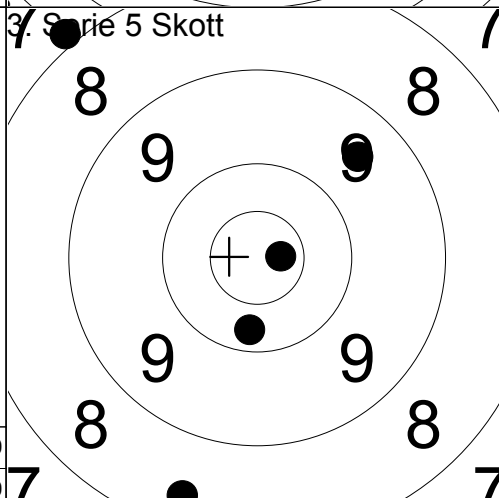

1:	8.4	↓
2:	7.9	↗
3:	10.2	↓
4:	10.7x	→
5:	9.5	↗

Serie	43.0
Total	81.0

Serie	44.0
Total	125.0

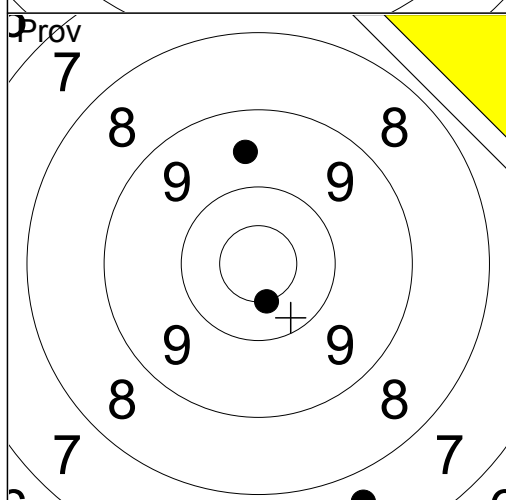

1:	9.6	↑
2:	10.5x	↓
3:	7.7	↓

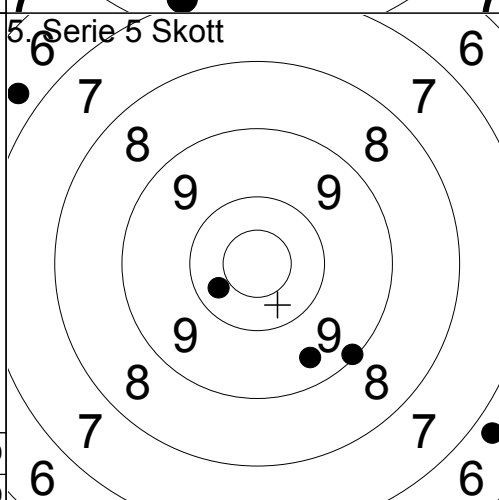

1:	6.7	↘
2:	10.3	↙
3:	9.1	↘
4:	9.4	↘
5:	6.7	↗

Serie	26.0
Total	125.0

Serie	40.0
Total	165.0

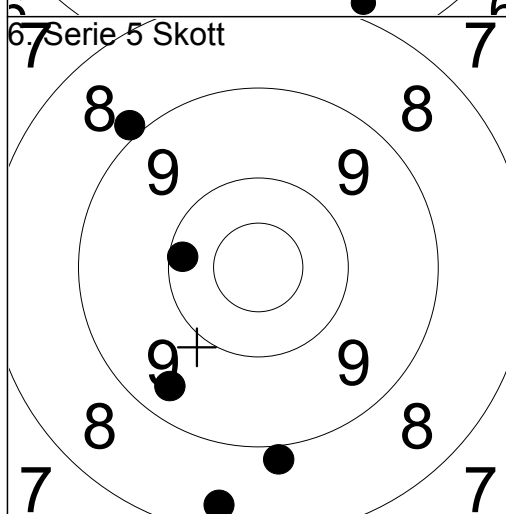

1:	8.9	↗
2:	8.9	↓
3:	9.4	↘
4:	8.4	↓
5:	10.2	←

Serie	43.0
Total	208.0

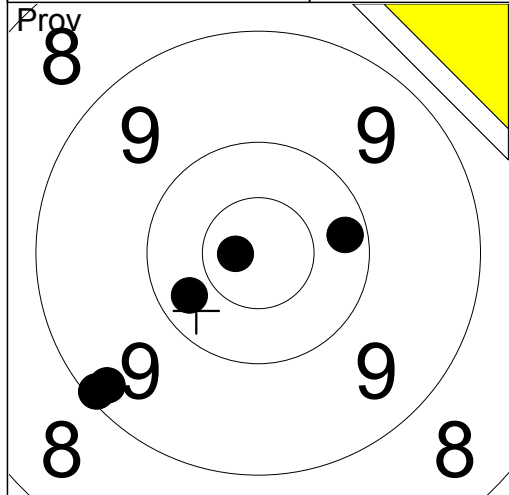

1:	9.1	↙
2:	9.2	↙
3:	10.3	↙
4:	10.8x	←
5:	10.2	→

Serie	48.0
Total	0.0

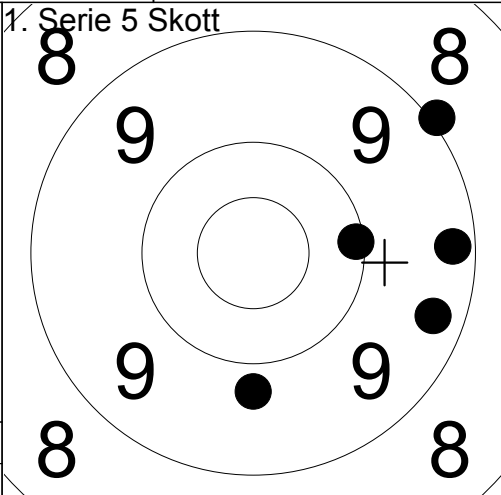

1:	9.0	↗
2:	9.3	↘
3:	9.8	↓
4:	9.2	→
5:	10.1	→

Serie	46.0
Total	46.0

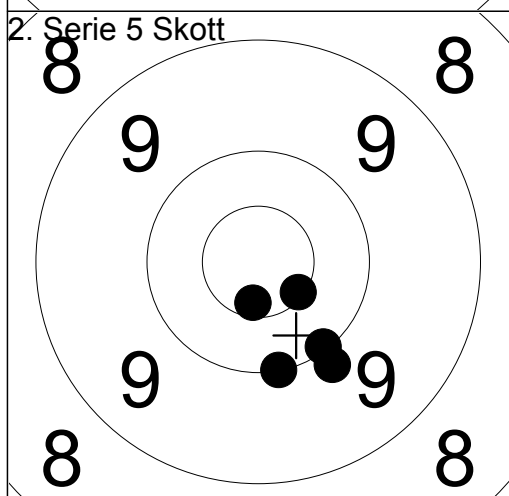

1:	10.6x	↓
2:	9.9	↘
3:	10.5x	↘
4:	10.0	↓
5:	10.1	↘

Serie	49.0
Total	95.0

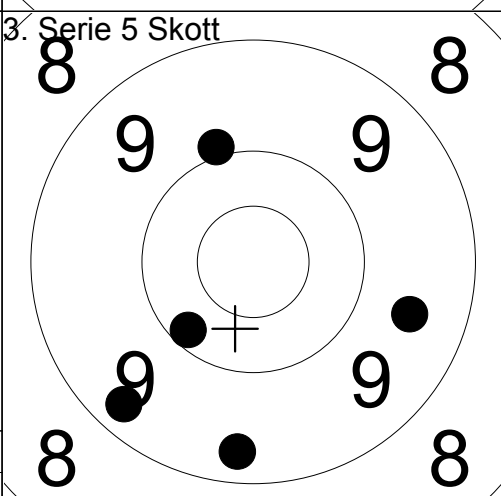

1:	9.5	→
2:	10.2	↙
3:	9.3	↙
4:	9.9	↑
5:	9.3	↓

Serie	46.0
Total	141.0

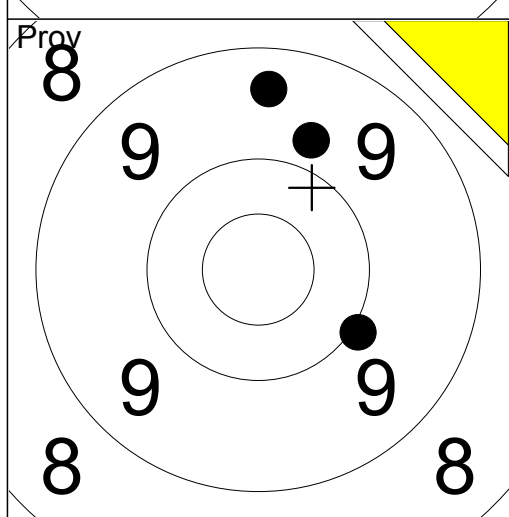

1:	9.8	↑
2:	9.4	↑
3:	10.0	↘

Serie	28.0
Total	141.0

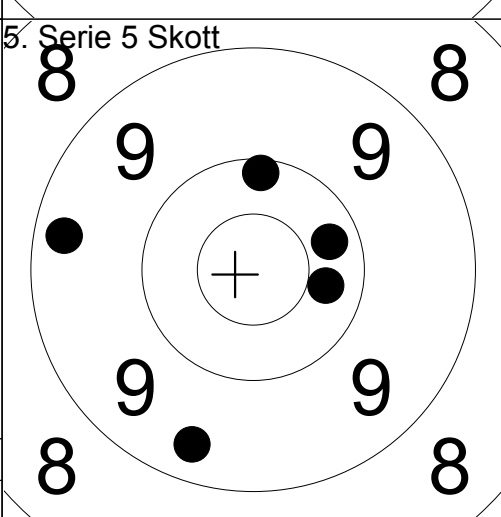

1:	10.1	↑
2:	9.3	←
3:	10.3	→
4:	10.3	→
5:	9.4	↓

Serie	48.0
Total	189.0

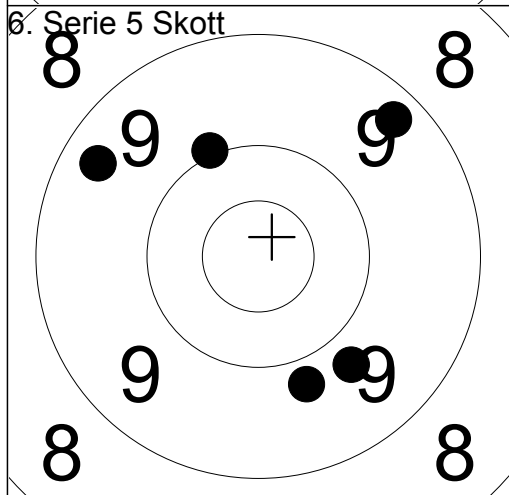

1:	9.4	↗
2:	9.7	↘
3:	9.3	↗
4:	10.0	↗
5:	9.8	↘

Serie	46.0
Total	235.0

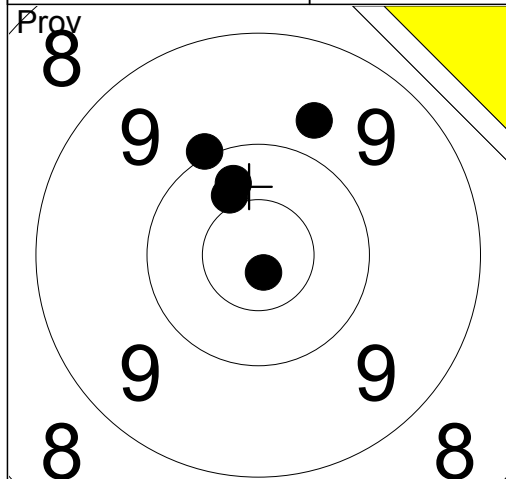

- 1: 10.8x ↘
- 2: 10.3 ↗
- 3: 10.0 ↗
- 4: 9.7 ↗
- 5: 10.4 ↗

Serie 49.0
Total 0.0

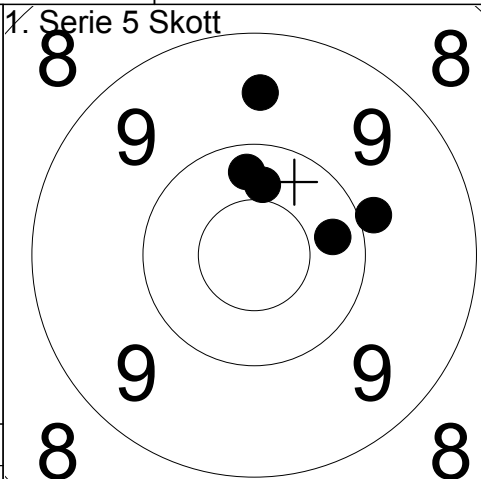

- 1: 10.3 →
- 2: 10.4 ↑
- 3: 9.6 ↑
- 4: 9.9 →
- 5: 10.3 ↑

Serie 48.0
Total 48.0

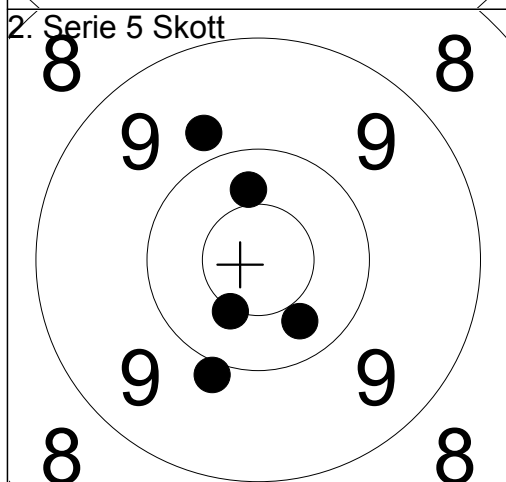

- 1: 9.8 ↑
- 2: 10.3 ↘
- 3: 10.5x ↘
- 4: 9.9 ↘
- 5: 10.4 ↑

Serie 48.0
Total 96.0

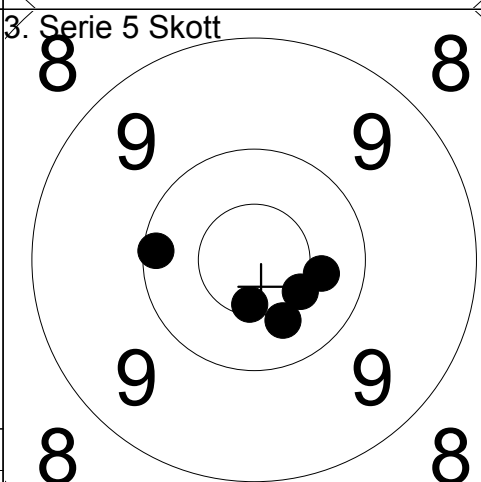

- 1: 10.4 ↘
- 2: 10.4 →
- 3: 10.6x ↘
- 4: 10.1 ←
- 5: 10.5x ↘

Serie 50.0
Total 146.0

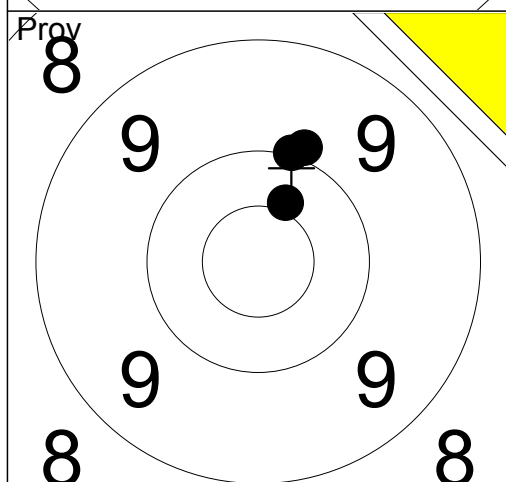

- 1: 10.0 ↑
- 2: 10.4 ↑
- 3: 9.9 ↑

Serie 29.0
Total 146.0

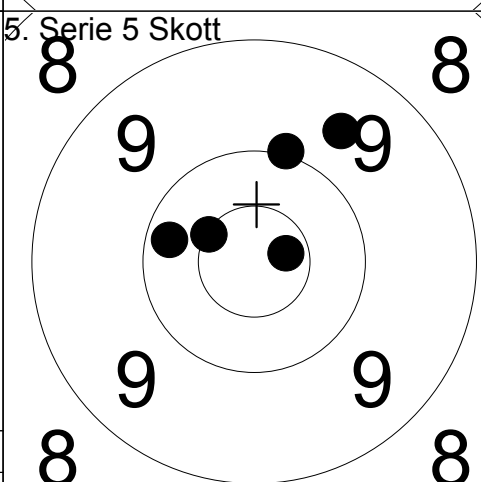

- 1: 10.0 ↑
- 2: 10.7x →
- 3: 10.5x ↗
- 4: 10.2 ←
- 5: 9.6 ↗

Serie 49.0
Total 195.0

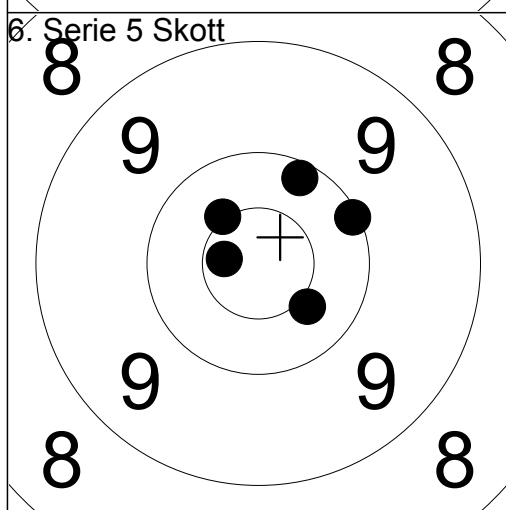

- 1: 10.1 →
- 2: 10.4 ↘
- 3: 10.2 ↑
- 4: 10.7x ←
- 5: 10.5x ↗

Serie 50.0
Total 245.0

Skjutlag
2

Tavla
22

Gustaf Björndahl

300m

Kvistbro

U

Ör

10.07.2016

Tavelträffen 2016

Ramselefors SKF

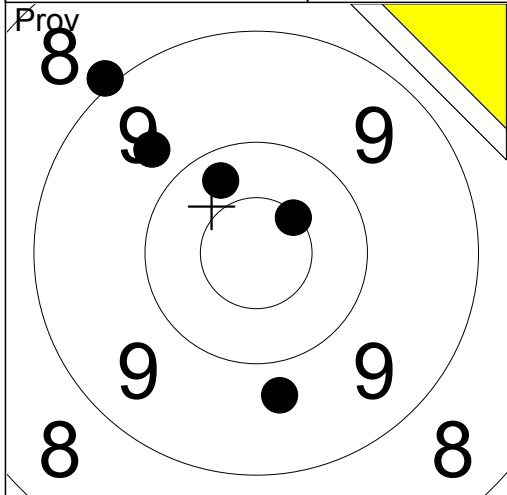

1:	9.0	↗
2:	10.5x	↗
3:	10.3	↗
4:	9.7	↗
5:	9.7	↓

Serie	47.0
Total	0.0

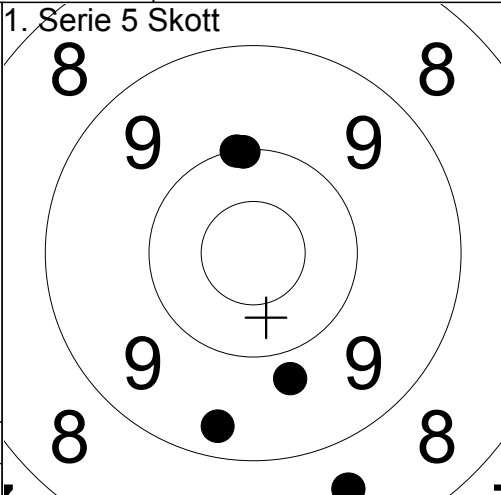

1:	8.6	↓
2:	9.3	↓
3:	10.0	↑
4:	10.0	↑
5:	9.8	↓

Serie	46.0
Total	46.0

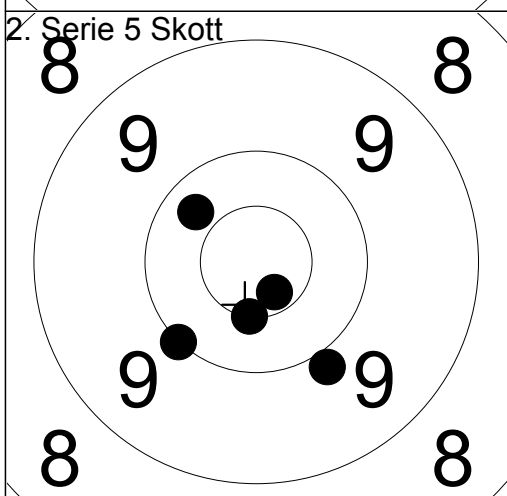

1:	10.3	↗
2:	10.7x	↓
3:	9.9	↓
4:	10.0	↓
5:	10.5x	↓

Serie	49.0
Total	95.0

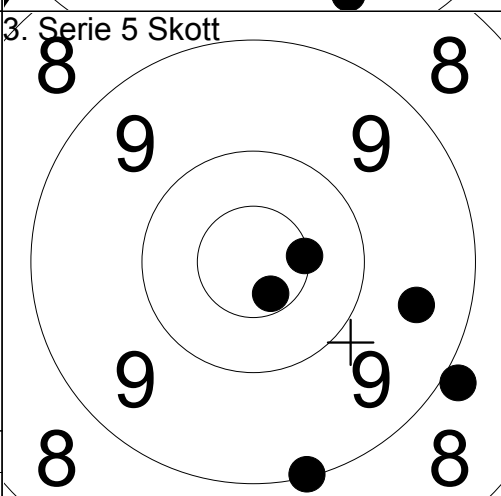

1:	10.6x	↓
2:	9.1	↓
3:	10.5x	→
4:	9.5	→
5:	8.9	↓

Serie	46.0
Total	141.0

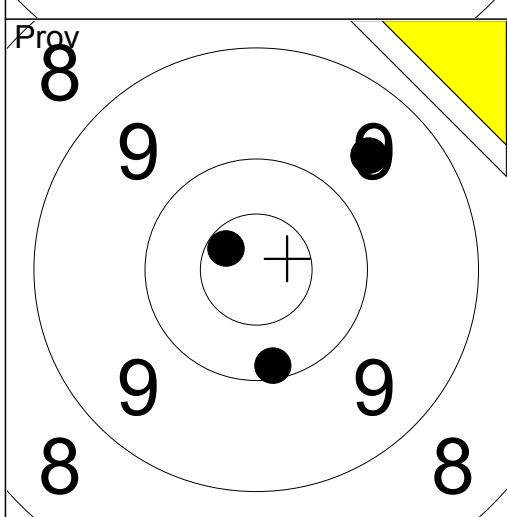

1:	10.6x	↖
2:	9.6	↗
3:	10.1	↓

Serie	29.0
Total	141.0

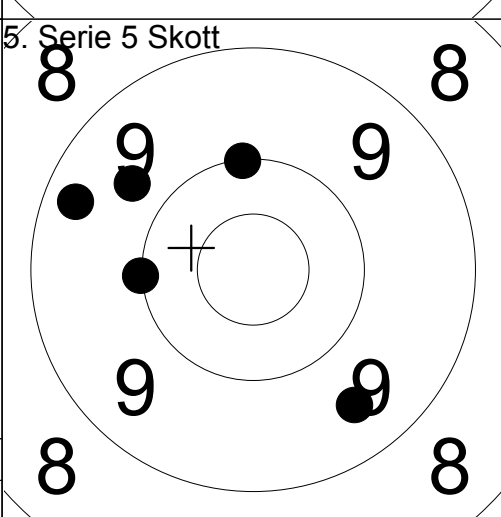

1:	9.5	↓
2:	10.0	↑
3:	9.7	↗
4:	9.3	↖
5:	10.0	←

Serie	47.0
Total	188.0

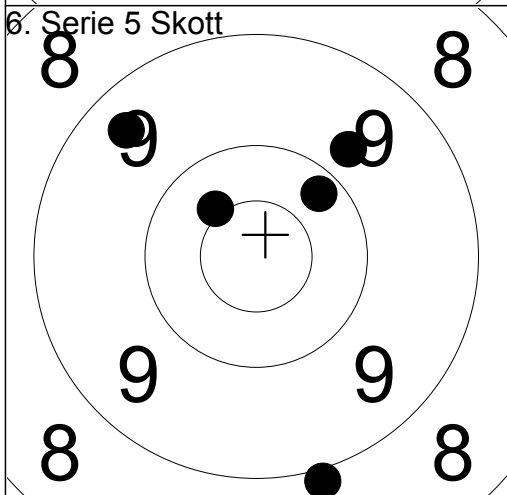

1:	10.2	↗
2:	9.8	↗
3:	9.4	↗
4:	10.4x	↗
5:	8.9	↓

Serie	46.0
Total	234.0

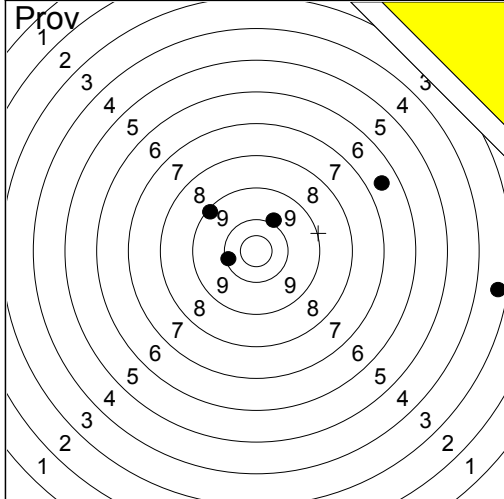

1:	9.1	↖
2:	3.3	→
3:	10.1	↙
4:	6.6	↗
5:	9.9	↗
Serie	37.0	
Total	0.0	

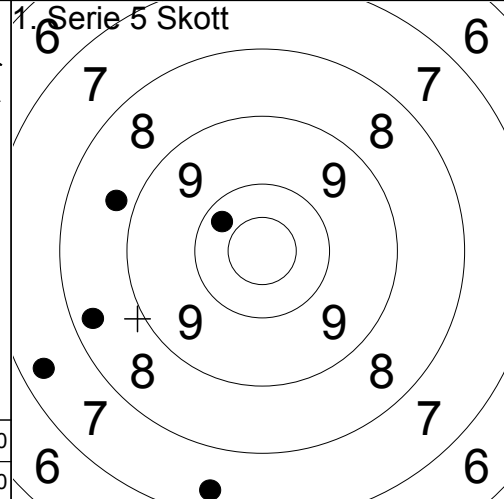

1:	8.3	↙
2:	10.3	↗
3:	7.4	↙
4:	8.7	↙
5:	7.4	↓
Serie	40.0	
Total	40.0	

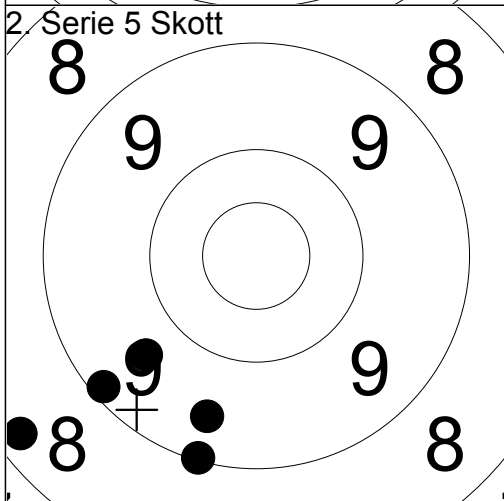

1:	8.3	↙
2:	9.5	↓
3:	9.6	↙
4:	9.1	↙
5:	9.1	↓
Serie	44.0	
Total	84.0	

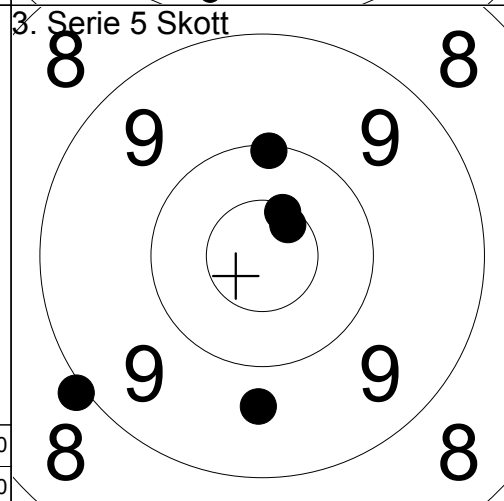

1:	9.0	↙
2:	9.7	↓
3:	10.6x	↗
4:	10.1	↑
5:	10.5x	↗
Serie	48.0	
Total	132.0	

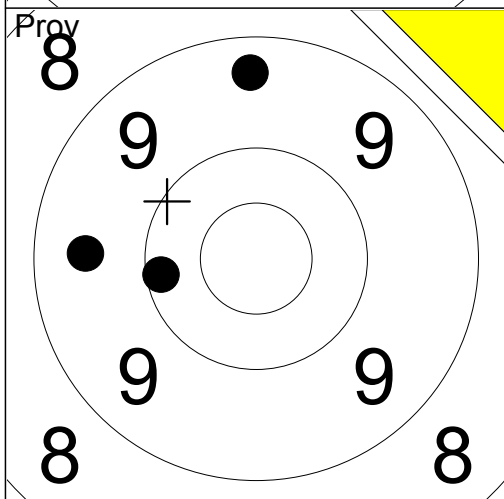

1:	9.5	←
2:	10.1	←
3:	9.4	↑
Serie	28.0	
Total	132.0	

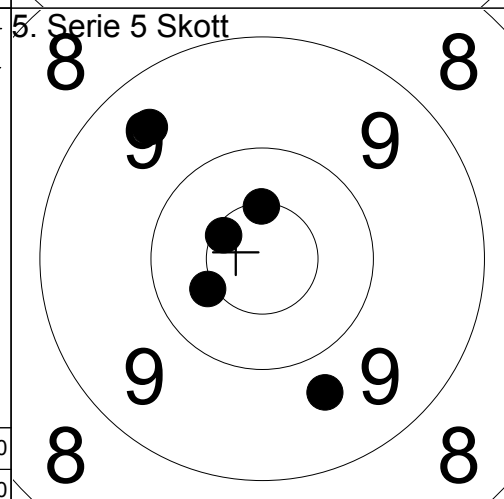

1:	9.7	↓
2:	9.5	↗
3:	10.6x	↗
4:	10.4x	↙
5:	10.5x	↑
Serie	48.0	
Total	180.0	

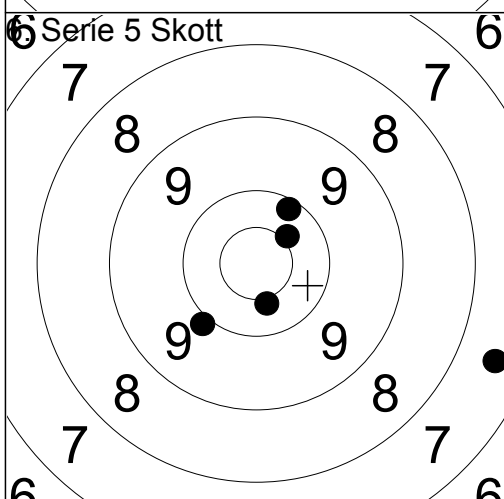

1:	10.4x	↗
2:	7.5	→
3:	10.4x	↓
4:	9.9	↙
5:	10.1	↗
Serie	46.0	
Total	226.0	

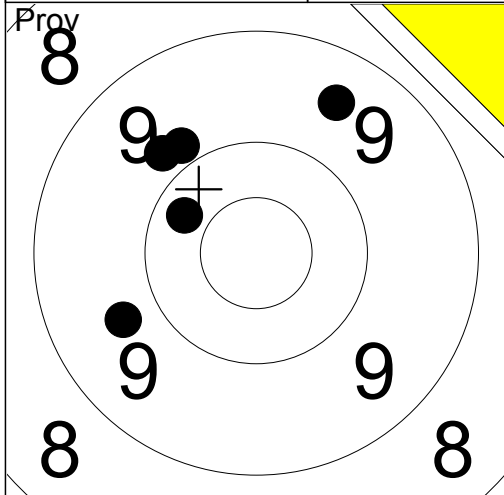

- 1: 10.3 ↖
- 2: 9.8 ↗
- 3: 9.7 ↖
- 4: 9.9 ↗
- 5: 9.5 ↗

Serie 46.0
Total 0.0

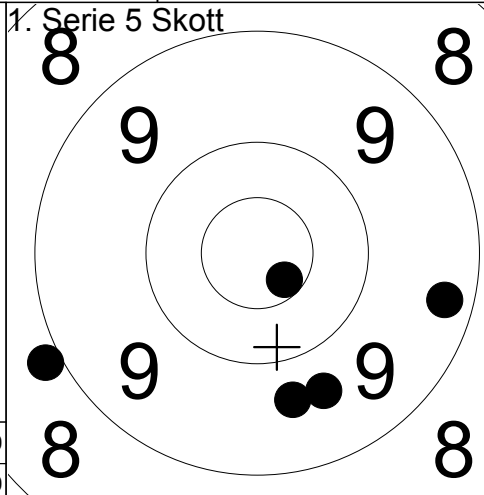

- 1: 8.9 ↖
- 2: 10.6x ↘
- 3: 9.7 ↘
- 4: 9.3 →
- 5: 9.7 ↘

Serie 45.0
Total 45.0

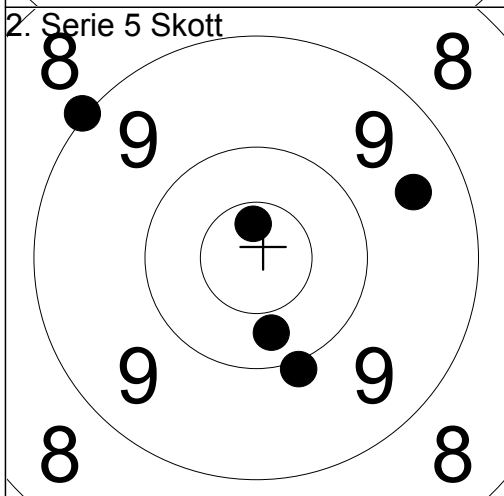

- 1: 9.5 →
- 2: 9.0 ↗
- 3: 10.7x ↑
- 4: 10.3 ↘
- 5: 10.0 ↘

Serie 48.0
Total 93.0

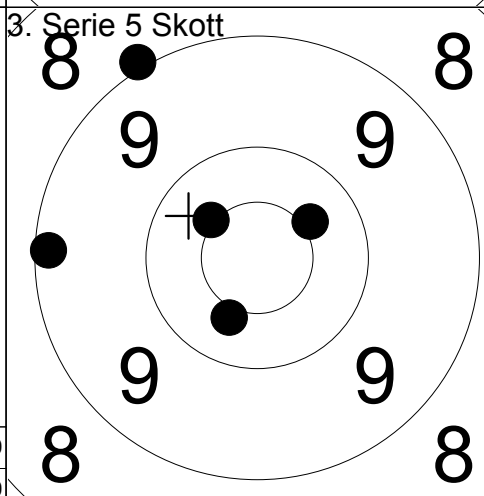

- 1: 10.4 ↘
- 2: 9.2 ←
- 3: 10.5x ↗
- 4: 9.0 ↗
- 5: 10.4x ↗

Serie 48.0
Total 141.0

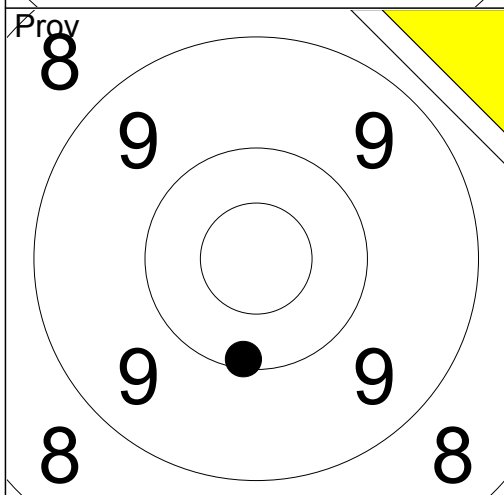

- 1: 10.1 ↘

Serie 10.0
Total 141.0

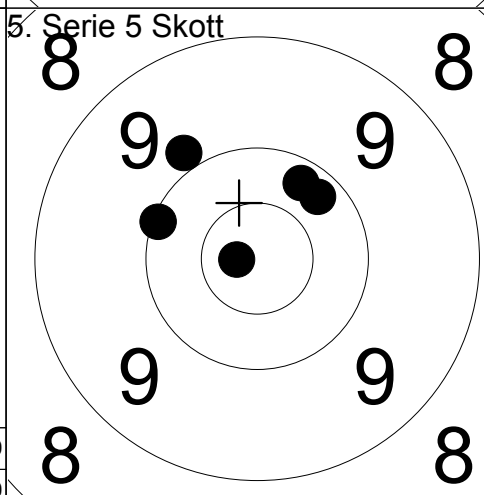

- 1: 10.2 ↗
- 2: 9.9 ↗
- 3: 10.1 ↖
- 4: 10.2 ↗
- 5: 10.8x ←

Serie 49.0
Total 190.0

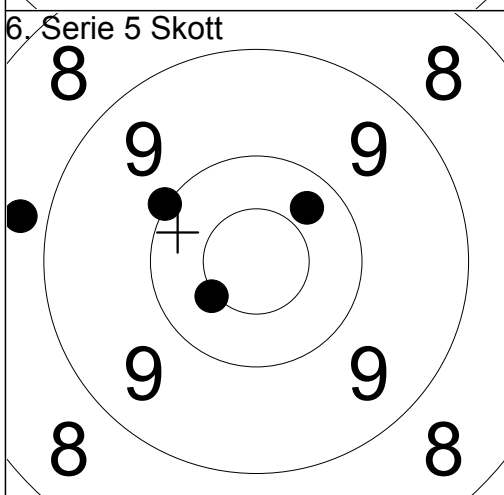

- 1: 8.8 ←
- 2: 10.0 ↖
- 3: 10.3 ↗
- 4: 10.5x ↖
- 5: 0.0

Serie 38.0
Total 228.0

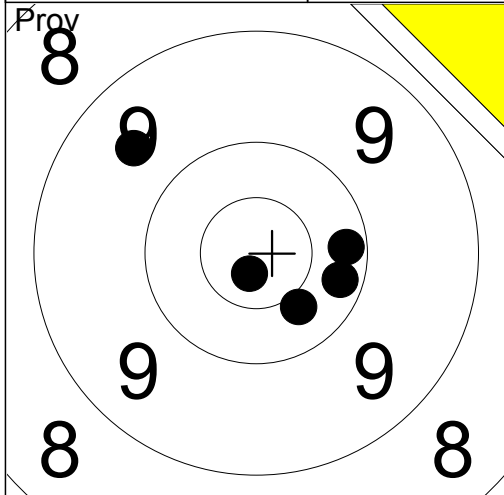

1:	9.6	↗
2:	10.8x	↘
3:	10.4	↘
4:	10.2	→
5:	10.2	→

Serie	49.0
Total	0.0

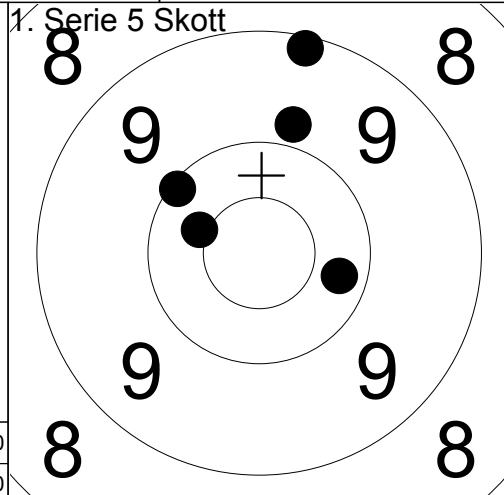

1:	9.8	↑
2:	10.1	↗
3:	10.4x	↖
4:	9.1	↑
5:	10.3	→

Serie	48.0
Total	48.0

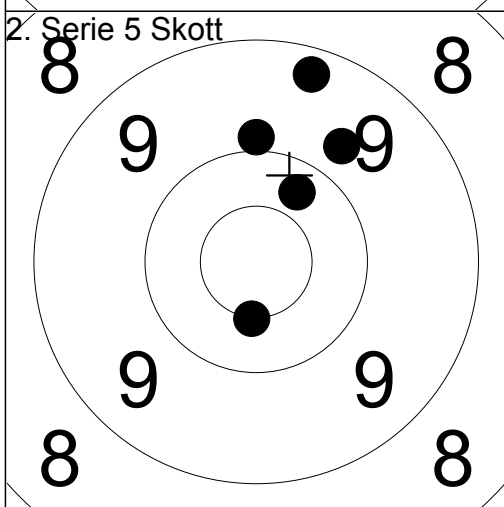

1:	10.3	↗
2:	9.7	↗
3:	9.3	↑
4:	10.5x	↘
5:	9.9	↑

Serie	47.0
Total	95.0

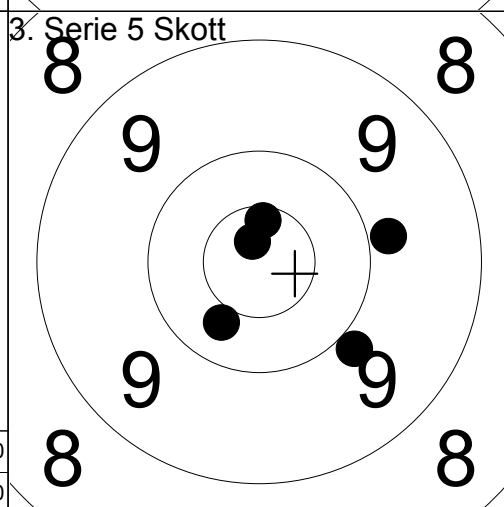

1:	9.8	→
2:	10.8x	↑
3:	9.9	↘
4:	10.4	↘
5:	10.6x	↑

Serie	48.0
Total	143.0

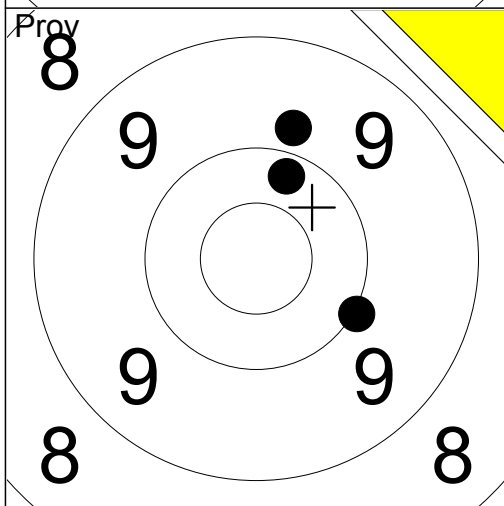

1:	9.8	↑
2:	10.2	↑
3:	10.0	↘

Serie	29.0
Total	143.0

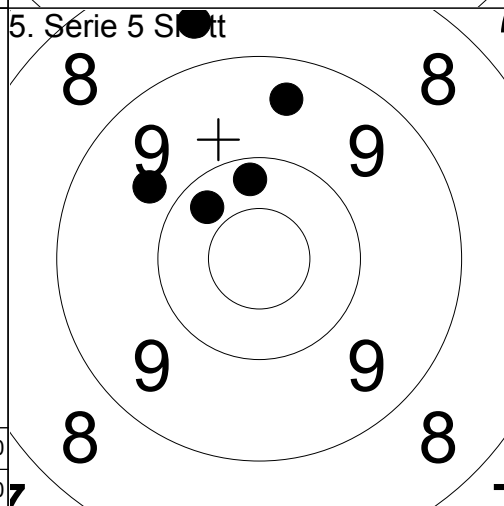

1:	10.2	↑
2:	9.4	↑
3:	9.7	↗
4:	10.3	↗
5:	8.6	↑

Serie	46.0
Total	189.0

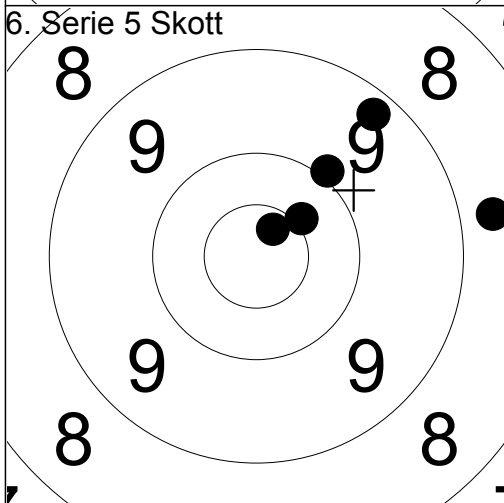

1:	9.3	↗
2:	8.7	→
3:	10.0	↗
4:	10.7x	↗
5:	10.4x	↗

Serie	47.0
Total	236.0

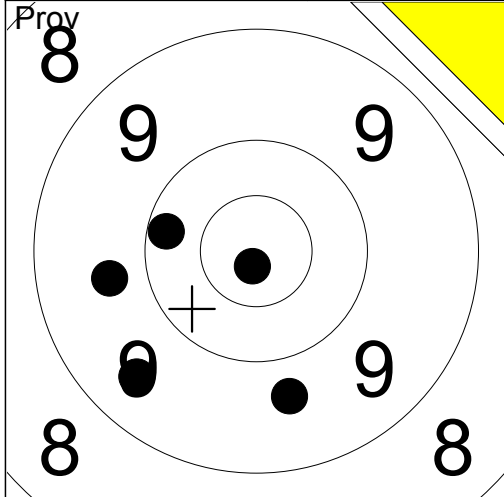

1:	9.7	↘
2:	9.5	↙
3:	9.7	←
4:	10.8x	↘
5:	10.2	←

Serie	47.0
Total	0.0

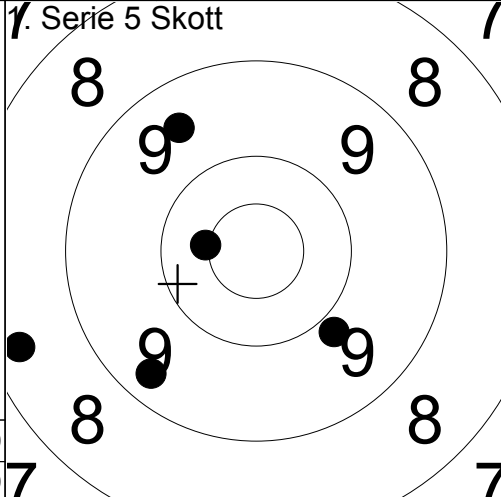

Serie	45.0
Total	45.0

1:	9.5	↗
2:	9.3	↙
3:	8.4	←
4:	10.5x	←
5:	9.9	↘

Serie	45.0
Total	45.0

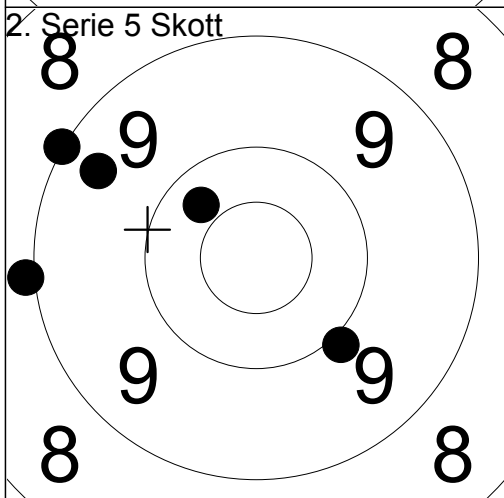

1:	10.3	↗
2:	8.9	←
3:	9.0	↗
4:	9.4	↗
5:	9.9	↘

Serie	45.0
Total	90.0

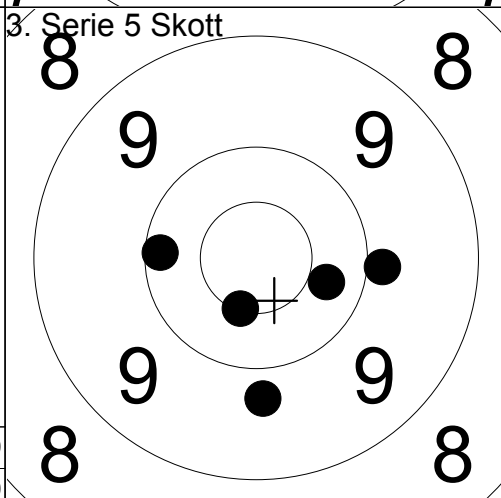

Serie	48.0
Total	138.0

1:	10.1	←
2:	10.3	→
3:	9.9	→
4:	10.5x	↘
5:	9.8	↘

Serie	48.0
Total	138.0

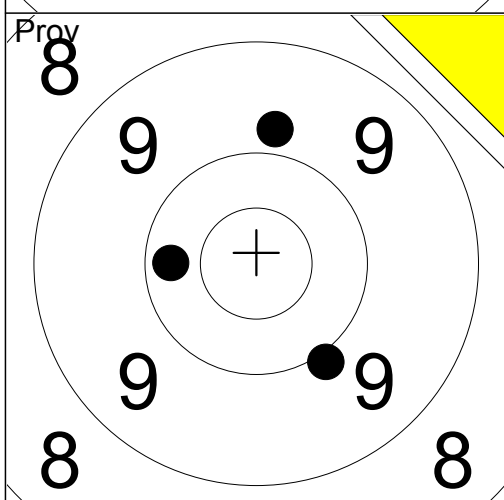

1:	9.9	↘
2:	9.8	↑
3:	10.2	←

Serie	28.0
Total	138.0

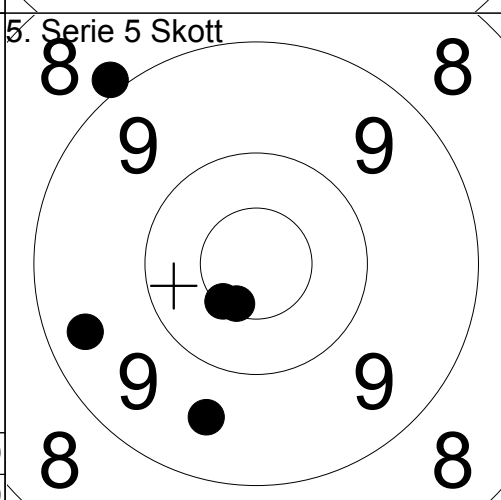

Serie	46.0
Total	184.0

1:	8.9	↗
2:	10.6x	↘
3:	10.5x	↘
4:	9.4	←
5:	9.6	↘

Serie	46.0
Total	184.0

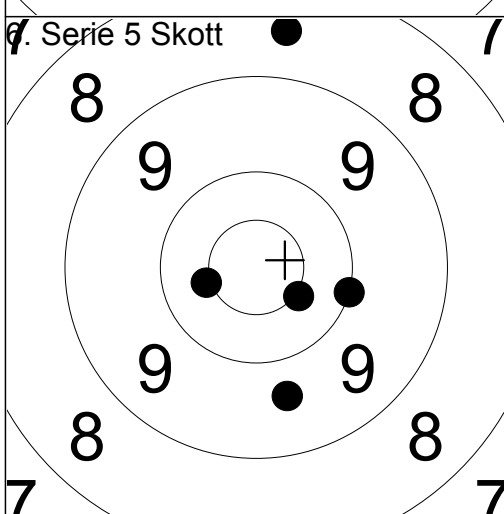

1:	10.5x	↘
2:	10.0	→
3:	8.5	↑
4:	10.4x	←
5:	9.6	↘

Serie	47.0
Total	231.0

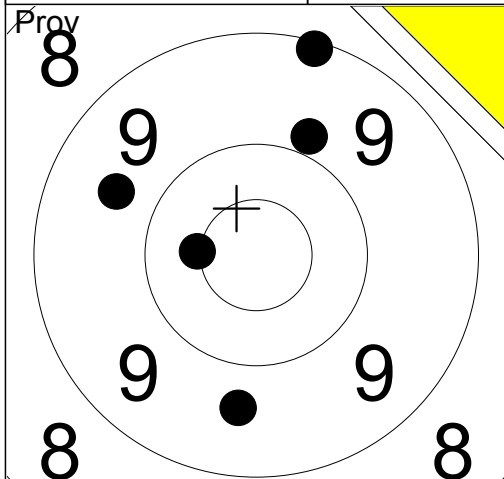

- 1: 9.1 ↗
- 2: 9.9 ↗
- 3: 9.6 ↓
- 4: 10.5x ←
- 5: 9.6 ↖

Serie 46.0
Total 0.0

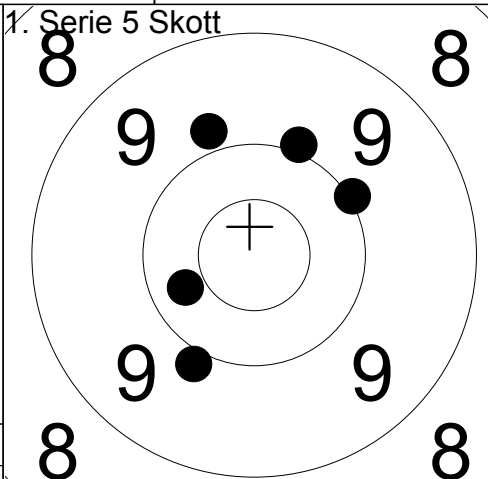

- 1: 9.9 ↓
- 2: 10.3 ↖
- 3: 10.0 ↗
- 4: 9.8 ↗
- 5: 10.0 ↗

Serie 48.0
Total 48.0

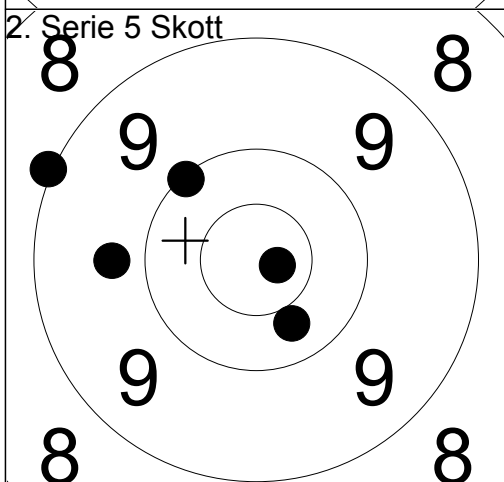

- 1: 10.8x →
- 2: 10.3 ↓
- 3: 10.1 ↗
- 4: 9.7 ←
- 5: 9.0 ↗

Serie 48.0
Total 96.0

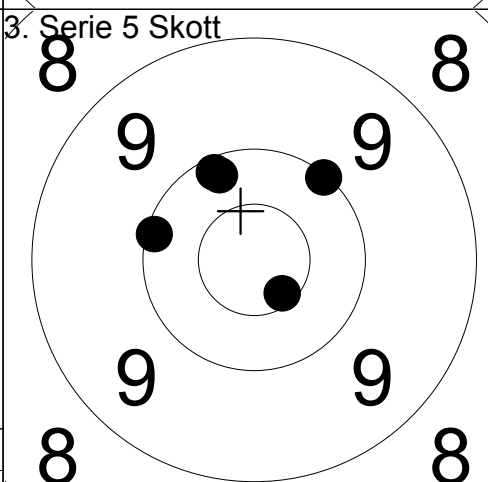

- 1: 10.1 ←
- 2: 10.1 ↗
- 3: 10.1 ↗
- 4: 10.2 ↗
- 5: 10.6x ↓

Serie 50.0
Total 146.0

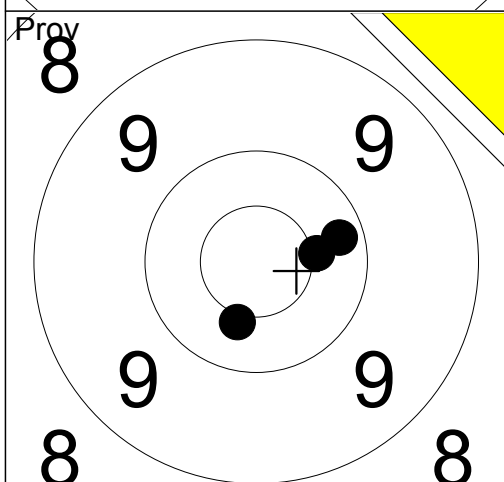

- 1: 10.4x ↓
- 2: 10.2 →
- 3: 10.4x →

Serie 30.0
Total 146.0

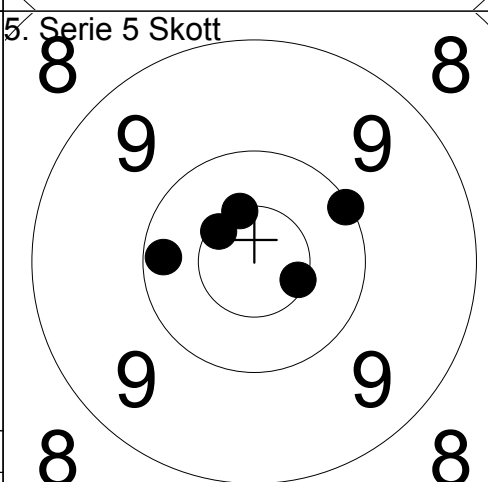

- 1: 10.5x ↗
- 2: 10.6x →
- 3: 10.1 ↗
- 4: 10.6x ↗
- 5: 10.2 ←

Serie 50.0
Total 196.0

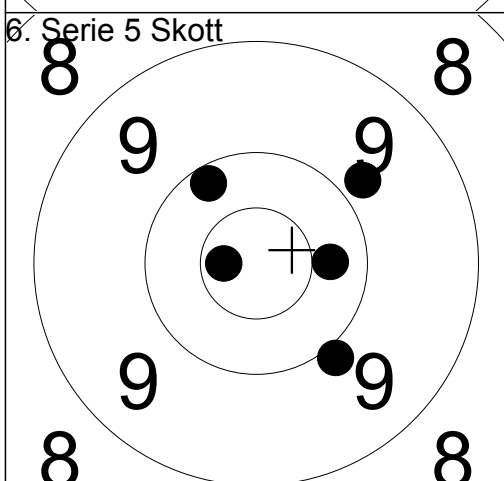

- 1: 10.3 →
- 2: 9.8 ↗
- 3: 9.9 ↓
- 4: 10.2 ↗
- 5: 10.7x ←

Serie 48.0
Total 244.0

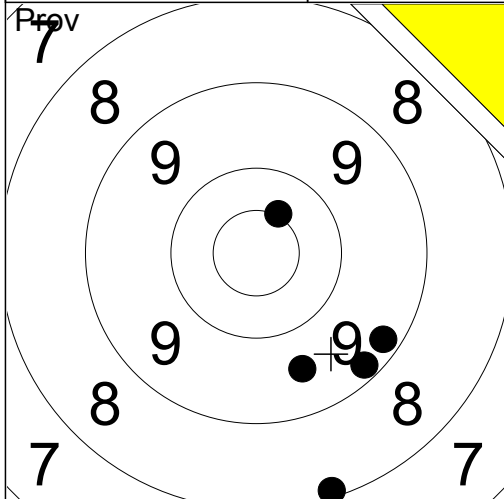

1:	9.2	↘
2:	8.1	↘
3:	9.2	↘
4:	10.5x	↗
5:	9.6	↘

Serie	45.0
Total	0.0

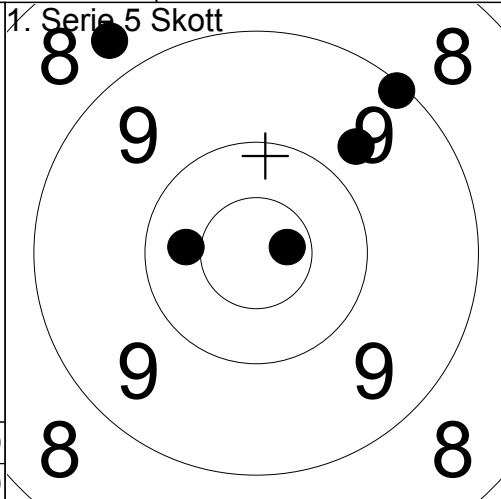

1:	9.7	↗
2:	8.7	↖
3:	9.1	↗
4:	10.7x	→
5:	10.4	←

Serie	46.0
Total	46.0

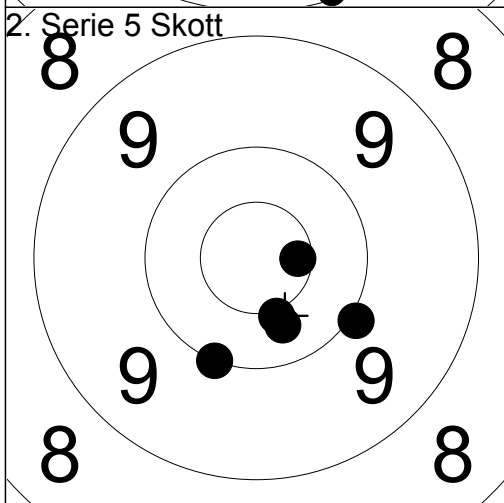

1:	10.4x	↘
2:	10.6x	→
3:	10.0	↘
4:	10.3	↘
5:	10.0	↘

Serie	50.0
Total	96.0

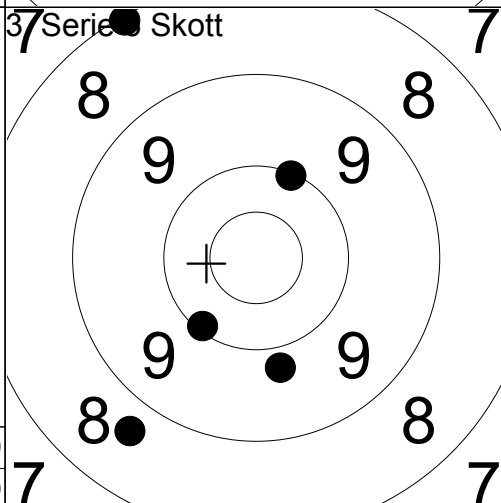

1:	10.1	↘
2:	9.8	↘
3:	10.0	↗
4:	8.7	↘
5:	8.1	↖

Serie	45.0
Total	141.0

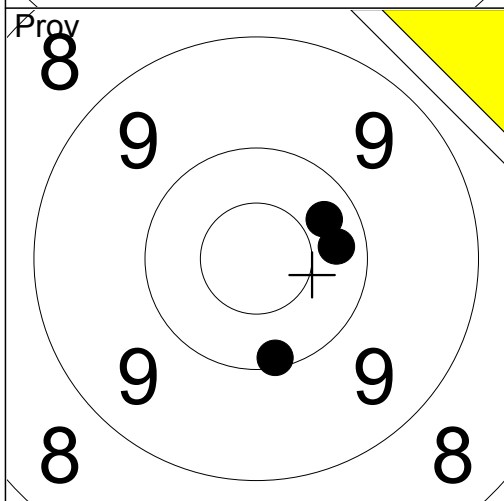

1:	10.3	→
2:	10.3	↗
3:	10.1	↘

Serie	30.0
Total	141.0

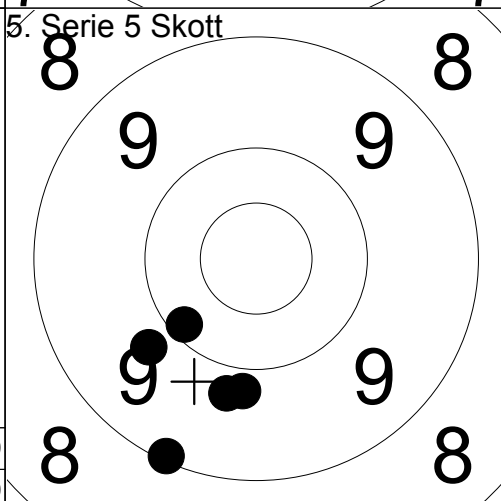

1:	9.1	↘
2:	10.1	↖
3:	9.8	↘
4:	9.8	↘
5:	9.8	↖

Serie	46.0
Total	187.0

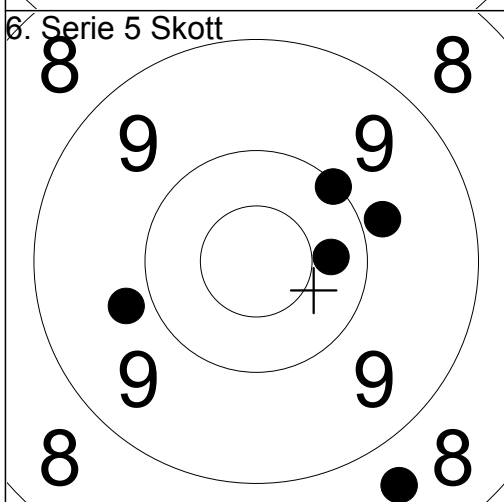

1:	9.8	←
2:	10.1	↗
3:	10.3	→
4:	9.8	→
5:	8.6	↘

Serie	46.0
Total	233.0

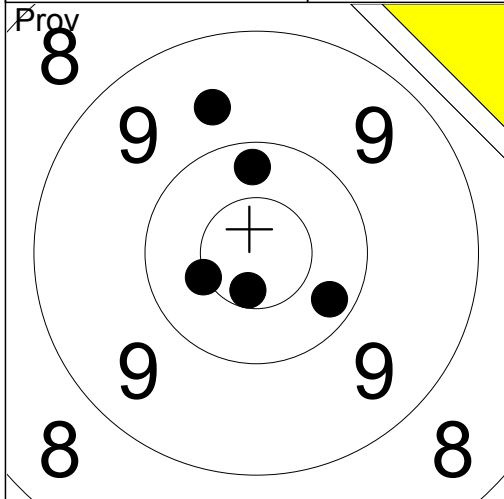

- 1: 10.2 ↗
- 2: 9.7 ↗
- 3: 10.6x ↓
- 4: 10.5x ←
- 5: 10.2 ↘

Serie 49.0
Total 0.0

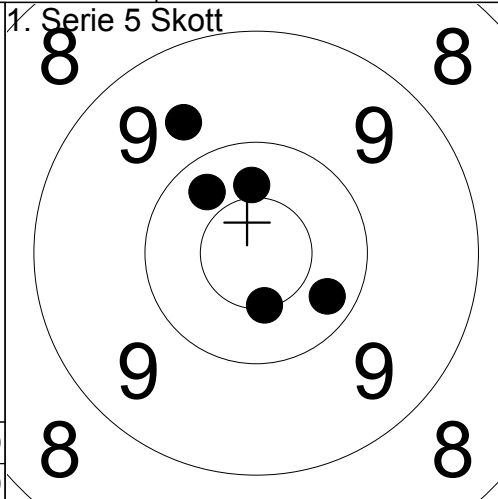

- 1: 9.7 ↗
- 2: 10.3 ↗
- 3: 10.5x ↓
- 4: 10.3 ↘
- 5: 10.4 ↗

Serie 49.0
Total 49.0

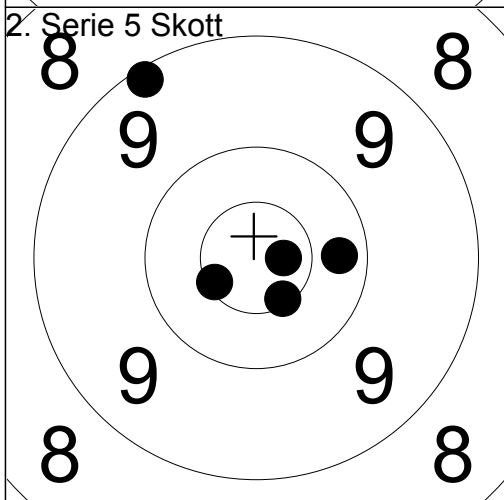

- 1: 10.3 →
- 2: 9.1 ↗
- 3: 10.7x →
- 4: 10.6x ←
- 5: 10.5x ↘

Serie 49.0
Total 98.0

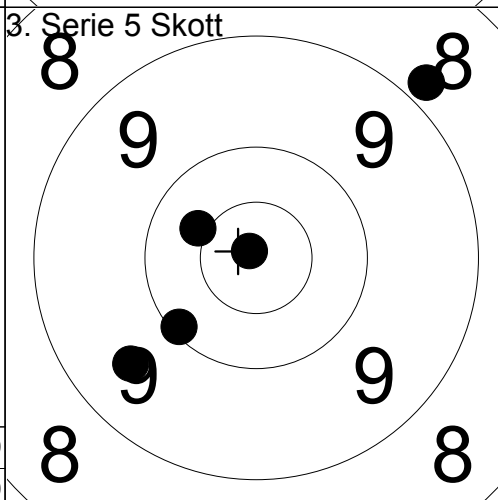

- 1: 10.9x ↗
- 2: 8.8 ↗
- 3: 10.1 ↘
- 4: 9.6 ↘
- 5: 10.4 ↗

Serie 47.0
Total 145.0

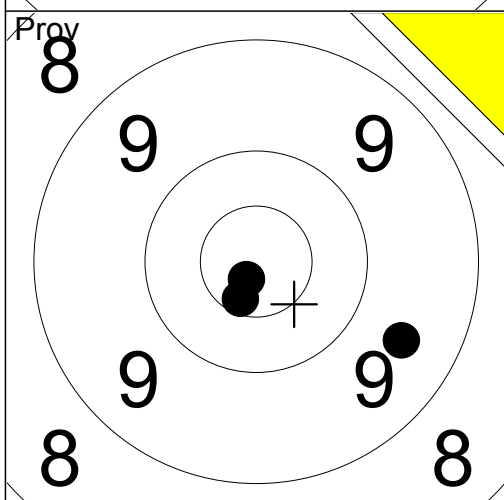

- 1: 10.6x ↓
- 2: 9.5 ↘
- 3: 10.8x ↓

Serie 29.0
Total 145.0

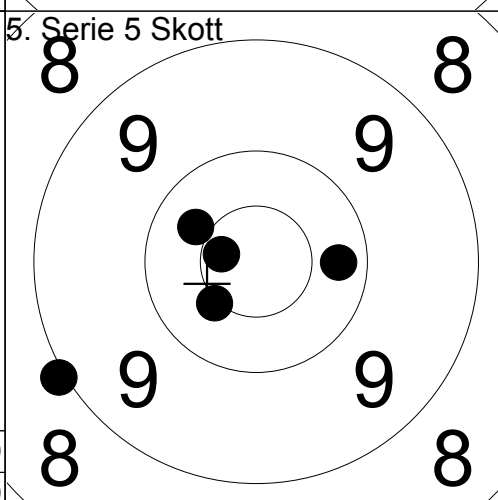

- 1: 10.3 →
- 2: 10.7x ←
- 3: 10.5x ↘
- 4: 9.0 ←
- 5: 10.4 ↗

Serie 49.0
Total 194.0

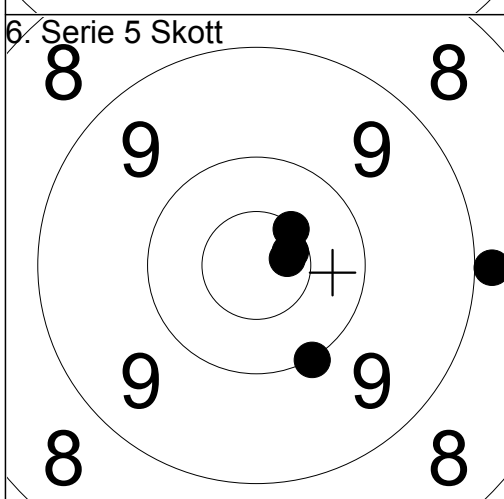

- 1: 10.5x ↗
- 2: 10.6x →
- 3: 10.0 ↓
- 4: 8.9 →
- 5: 10.7x →

Serie 48.0
Total 242.0

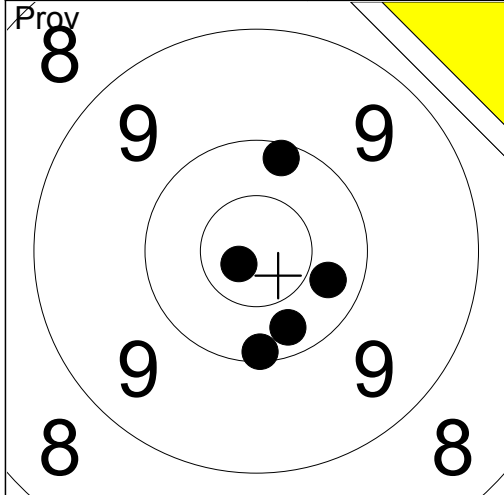

1:	10.3	↘
2:	10.1	↑
3:	10.3	→
4:	10.1	↓
5:	10.8x	↙
Serie		50.0
Total		0.0

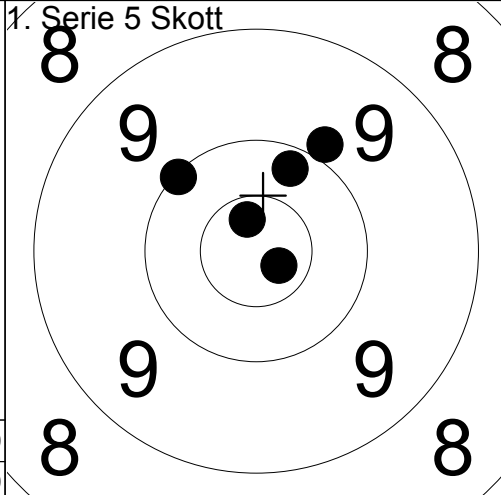

1:	10.7x	↘
2:	9.9	↗
3:	10.1	↗
4:	10.2	↗
5:	10.7x	↗
Serie		49.0
Total		49.0

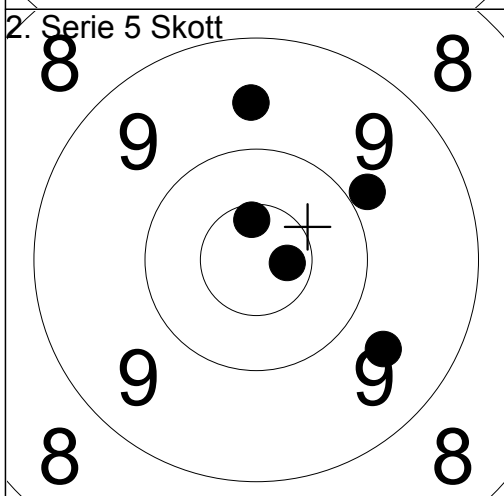

1:	10.6x	↑
2:	9.6	↘
3:	9.9	↗
4:	10.7x	→
5:	9.6	↑
Serie		47.0
Total		96.0

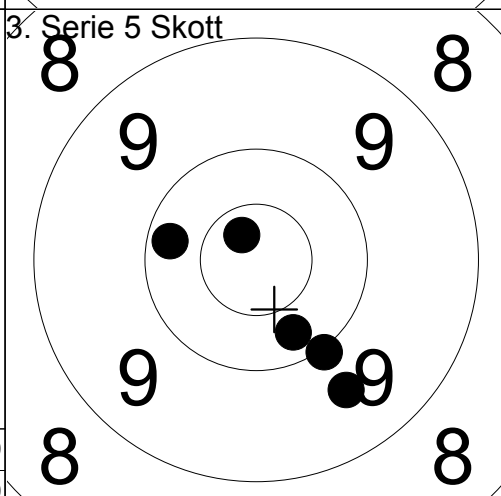

1:	10.3	↘
2:	10.7x	↗
3:	10.0	↘
4:	10.2	↖
5:	9.6	↘
Serie		49.0
Total		145.0

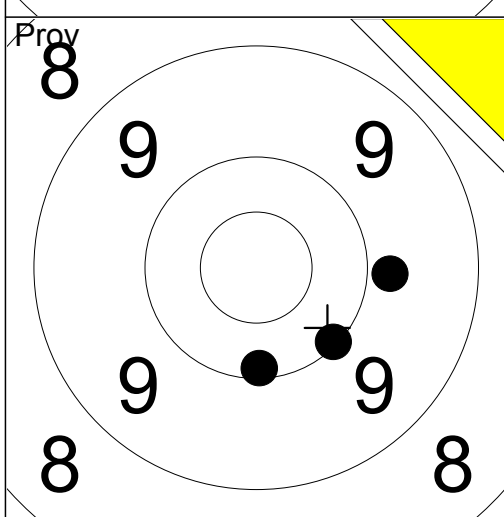

1:	10.1	↘
2:	9.8	→
3:	10.1	↓
Serie		29.0
Total		145.0

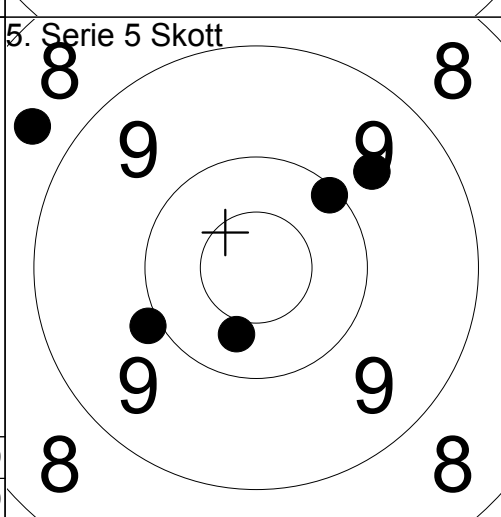

1:	8.7	↖
2:	9.7	↗
3:	10.1	↗
4:	10.4	↘
5:	9.9	↖
Serie		46.0
Total		191.0

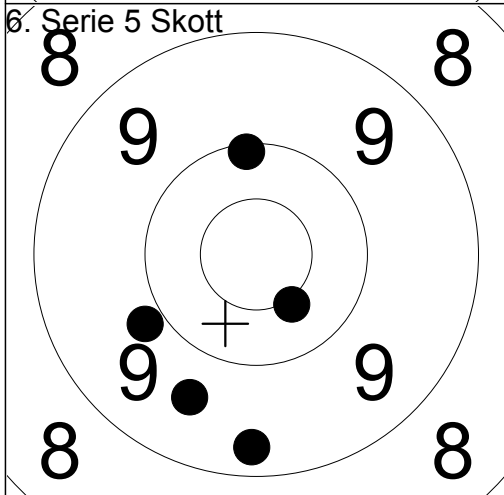

1:	10.4x	↘
2:	10.1	↑
3:	9.8	↖
4:	9.6	↘
5:	9.3	↓
Serie		47.0
Total		238.0

10.07.2016

Tavelträffen 2016

Ramselefors SKF

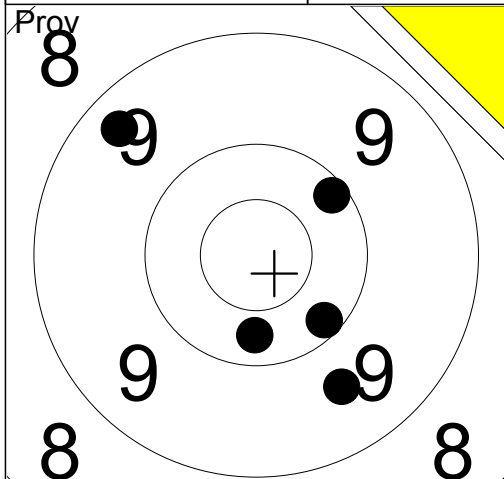

- 1: 10.2 ↘
- 2: 9.6 ↘
- 3: 9.4 ↗
- 4: 10.3 ↓
- 5: 10.1 ↗

Serie 48.0
Total 0.0

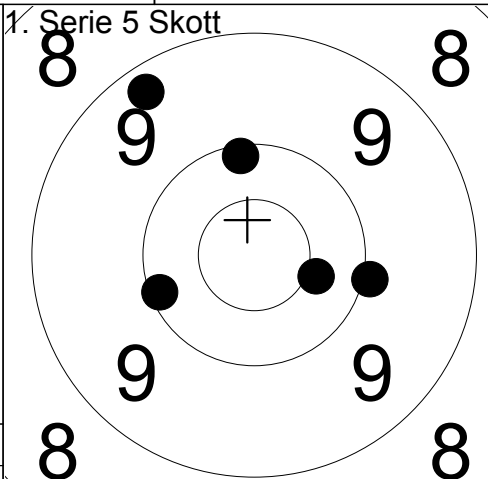

- 1: 9.3 ↗
- 2: 10.1 ←
- 3: 10.1 ↑
- 4: 10.0 →
- 5: 10.4 ↘

Serie 49.0
Total 49.0

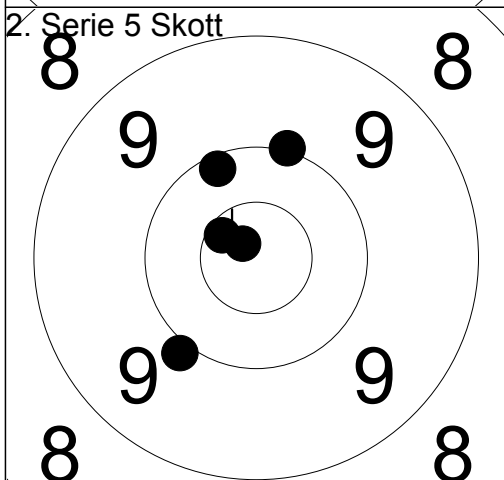

- 1: 10.0 ↑
- 2: 10.1 ↑
- 3: 10.8x ↗
- 4: 10.6x ↗
- 5: 9.9 ↘

Serie 49.0
Total 98.0

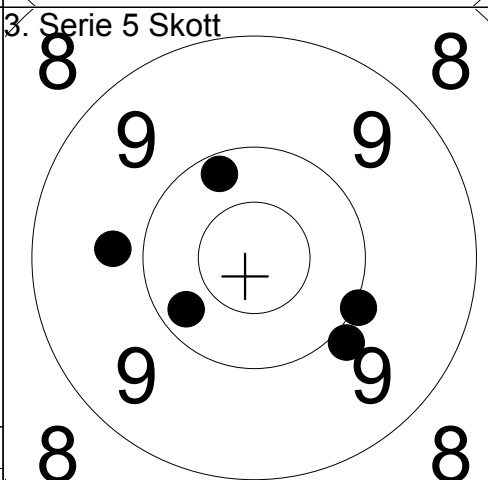

- 1: 10.2 ↑
- 2: 10.2 ↘
- 3: 9.8 ←
- 4: 9.9 ↘
- 5: 10.0 ↘

Serie 48.0
Total 146.0

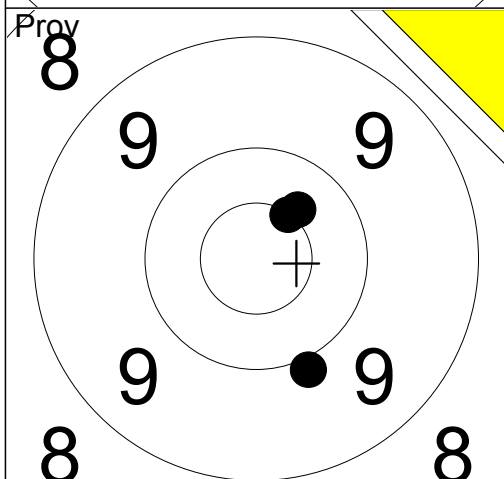

- 1: 10.4x ↗
- 2: 9.9 ↓
- 3: 10.5x ↗

Serie 29.0
Total 146.0

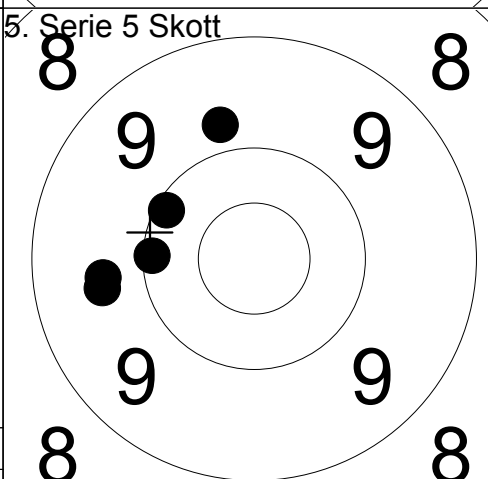

- 1: 9.8 ↑
- 2: 9.7 ←
- 3: 10.1 ↗
- 4: 9.6 ←
- 5: 10.1 ←

Serie 47.0
Total 193.0

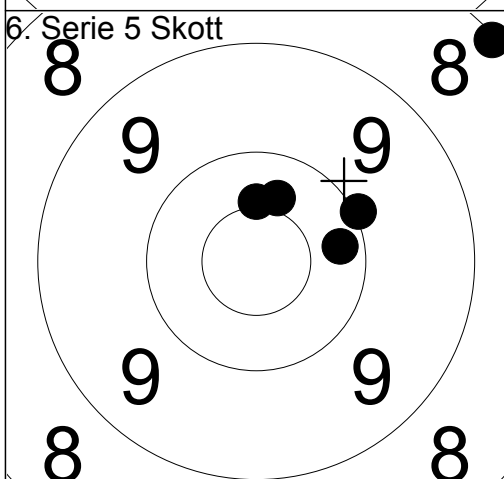

- 1: 8.1 ↗
- 2: 10.4 ↑
- 3: 10.4x ↑
- 4: 10.2 →
- 5: 10.0 ↗

Serie 48.0
Total 241.0

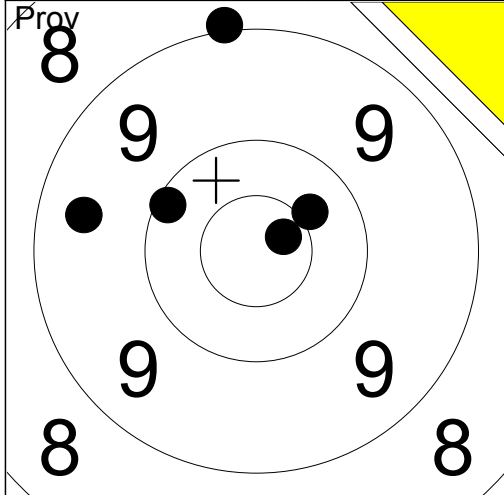

1:	10.7x	↗
2:	9.4	←
3:	9.0	↑
4:	10.1	↖
5:	10.4	↗

Serie	48.0
Total	0.0

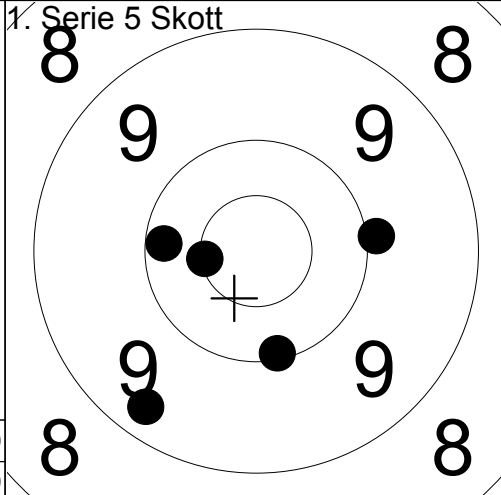

1:	9.3	↘
2:	10.2	←
3:	10.5x	←
4:	10.1	↘
5:	9.9	→

Serie	48.0
Total	48.0

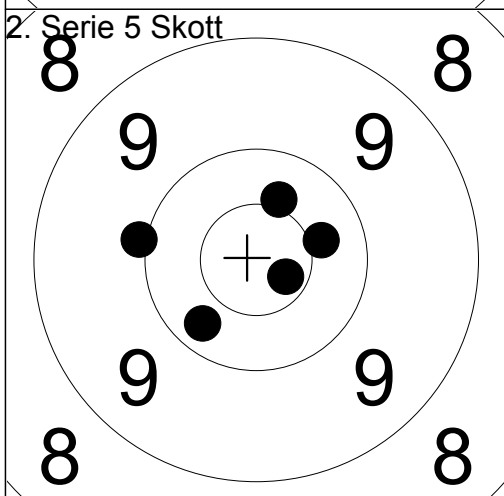

1:	10.3	↙
2:	10.4	→
3:	10.4x	↑
4:	10.7x	↘
5:	10.0	←

Serie	50.0
Total	98.0

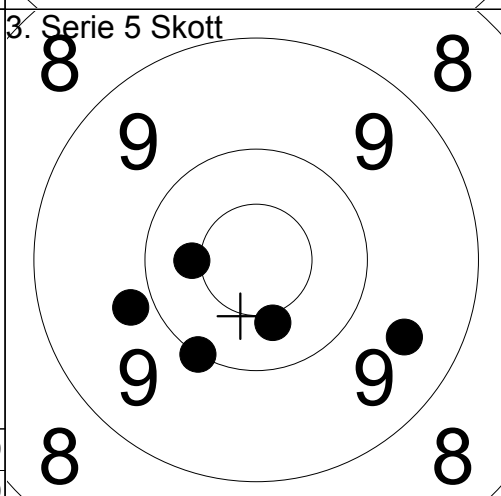

1:	9.8	←
2:	10.0	↘
3:	10.4	↘
4:	9.5	↘
5:	10.4x	←

Serie	48.0
Total	146.0

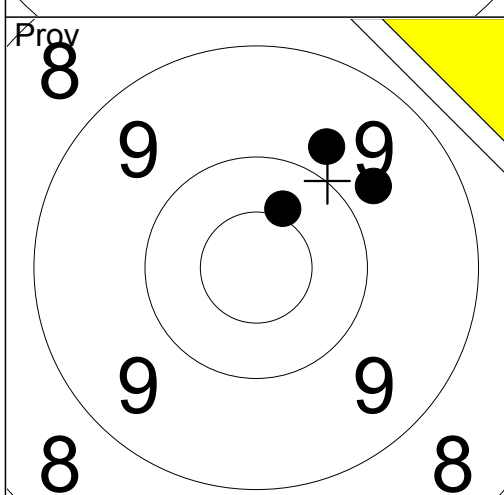

1:	10.4	↑
2:	9.8	↑
3:	9.7	↗

Serie	28.0
Total	146.0

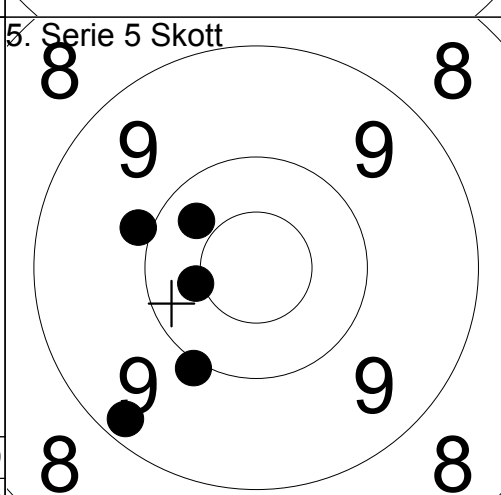

1:	9.9	←
2:	9.2	↘
3:	10.3	↗
4:	10.0	↘
5:	10.4x	←

Serie	48.0
Total	194.0

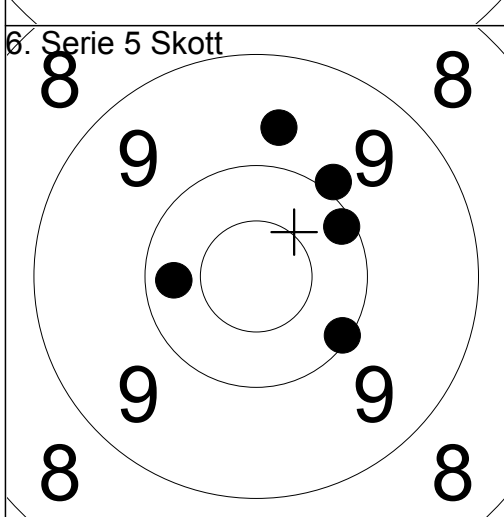

1:	9.9	↗
2:	10.1	↗
3:	10.1	↘
4:	9.7	↑
5:	10.3	←

Serie	48.0
Total	242.0

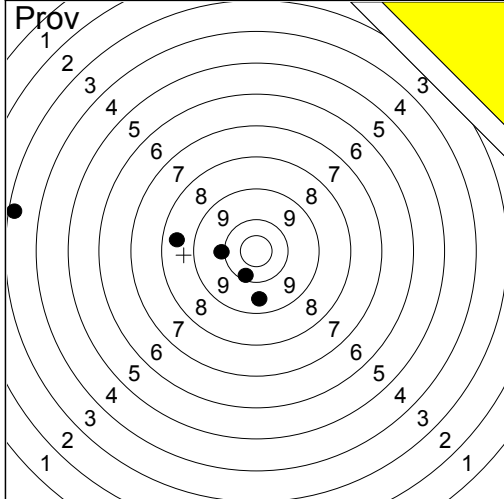

1:	3.2	←
2:	9.5	↓
3:	9.9	←
4:	10.2	↓
5:	8.5	←

Serie	39.0
Total	0.0

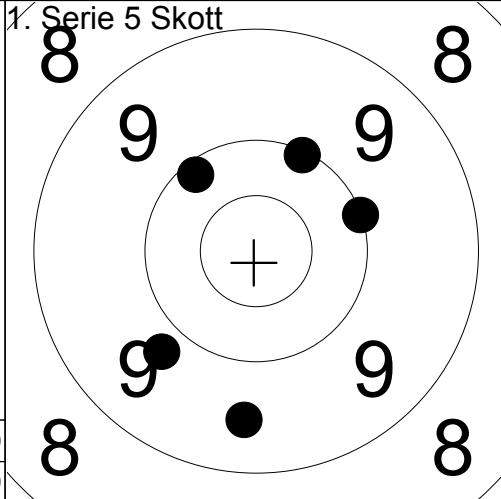

1:	10.1	↗
2:	9.8	↙
3:	9.5	↓
4:	10.0	→
5:	10.1	↗

Serie	48.0
Total	48.0

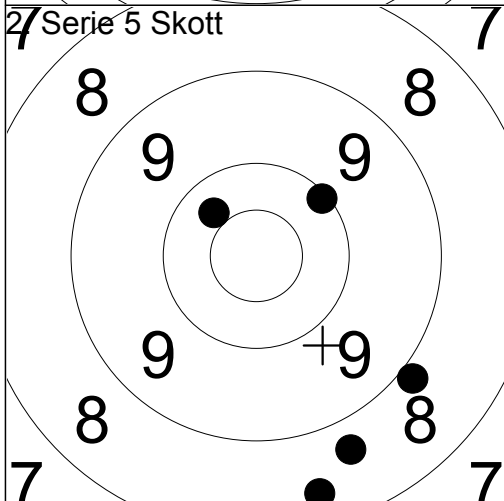

1:	10.1	↗
2:	8.7	↓
3:	10.3	↗
4:	8.9	↓
5:	8.4	↓

Serie	44.0
Total	92.0

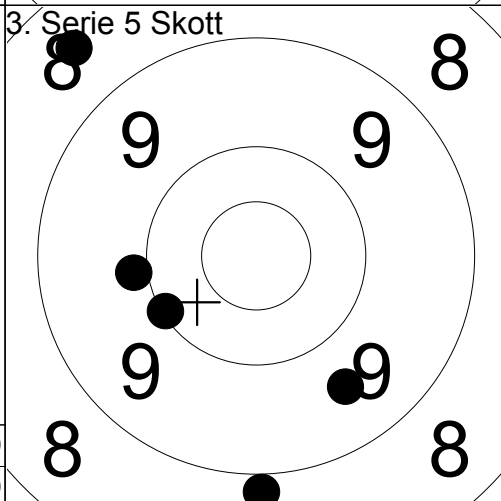

1:	8.5	↗
2:	8.9	↓
3:	9.9	←
4:	10.1	↙
5:	9.6	↓

Serie	44.0
Total	136.0

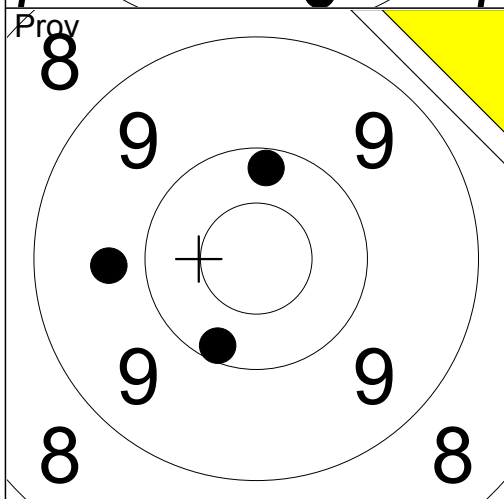

1:	9.7	←
2:	10.2	↓
3:	10.2	↑

Serie	29.0
Total	136.0

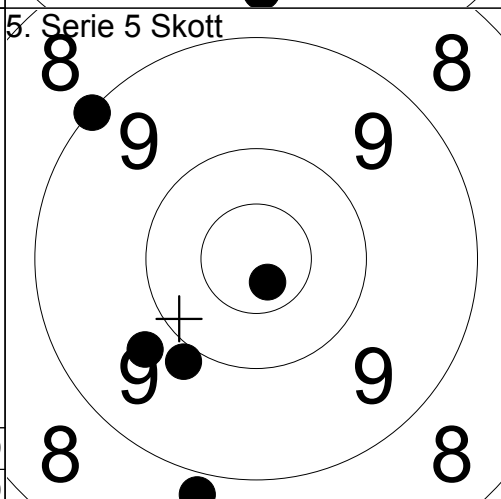

1:	8.8	↓
2:	9.0	↗
3:	9.7	↙
4:	10.7x	↓
5:	9.9	↙

Serie	45.0
Total	181.0

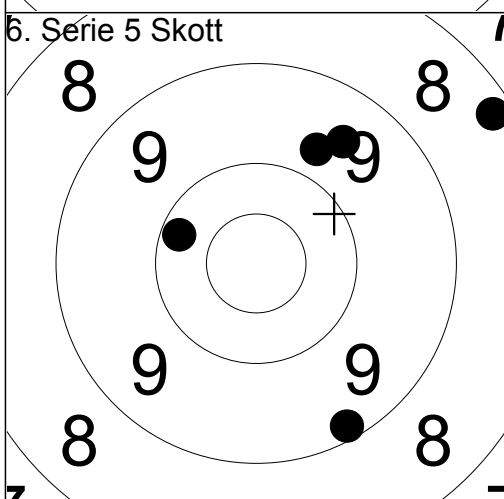

1:	9.7	↗
2:	10.2	←
3:	9.5	↗
4:	9.2	↓
5:	8.2	↗

Serie	45.0
Total	226.0

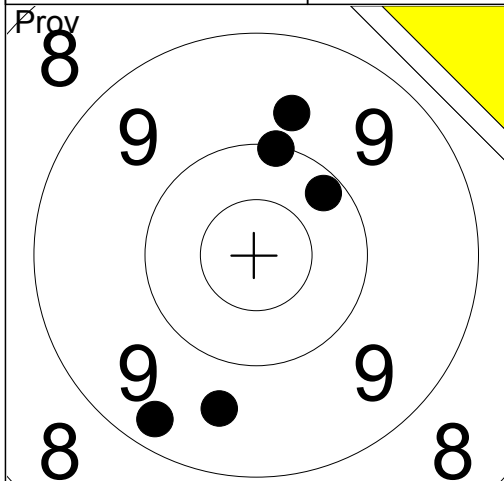

- 1: 9.6 ↓
- 2: 9.3 ↓
- 3: 10.0 ↑
- 4: 9.7 ↑
- 5: 10.2 ↗

Serie 47.0
Total 0.0

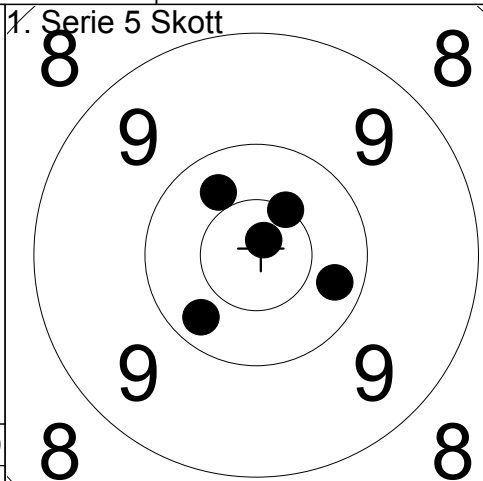

- 1: 10.3 ↗
- 2: 10.3 →
- 3: 10.3 ↓
- 4: 10.5x ↗
- 5: 10.8x ↗

Serie 50.0
Total 50.0

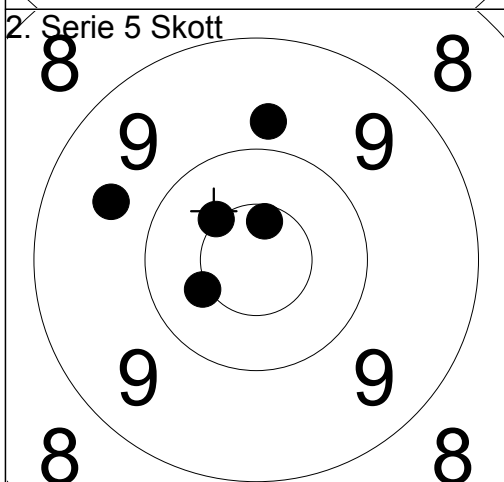

- 1: 9.8 ↑
- 2: 10.5x ↗
- 3: 10.4x ↖
- 4: 10.6x ↑
- 5: 9.6 ↖

Serie 48.0
Total 98.0

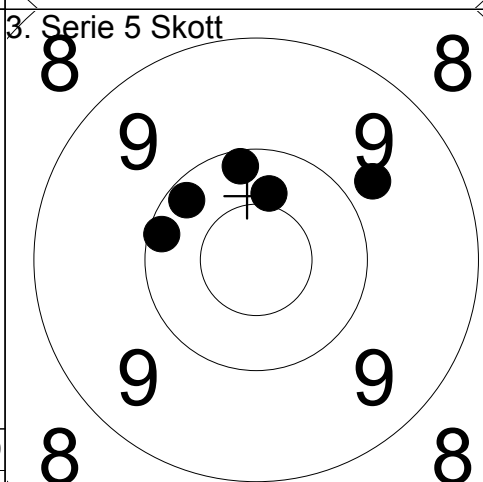

- 1: 10.4 ↑
- 2: 10.2 ↗
- 3: 10.1 ↖
- 4: 9.8 ↗
- 5: 10.2 ↑

Serie 49.0
Total 147.0

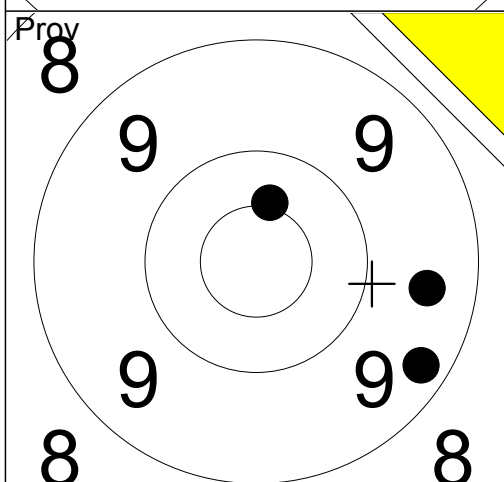

- 1: 9.5 →
- 2: 9.3 ↘
- 3: 10.4x ↑

Serie 28.0
Total 147.0

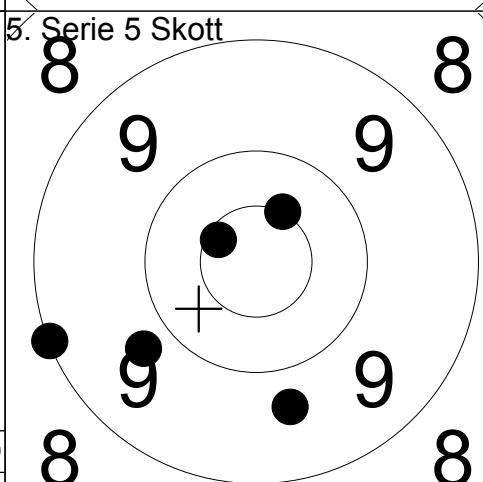

- 1: 10.6x ↖
- 2: 9.0 ↖
- 3: 9.7 ↓
- 4: 9.8 ↖
- 5: 10.5x ↗

Serie 47.0
Total 194.0

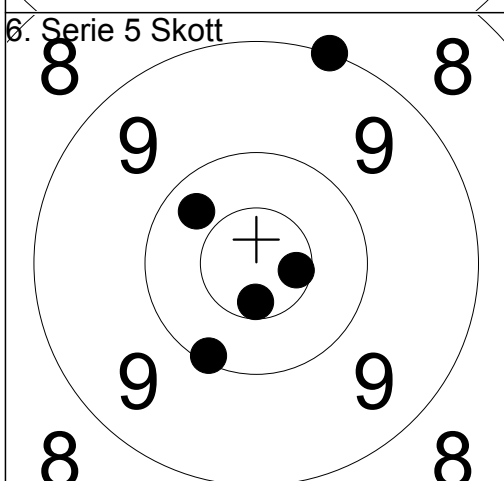

- 1: 9.0 ↑
- 2: 10.3 ↗
- 3: 10.6x ↓
- 4: 10.1 ↓
- 5: 10.6x →

Serie 49.0
Total 243.0

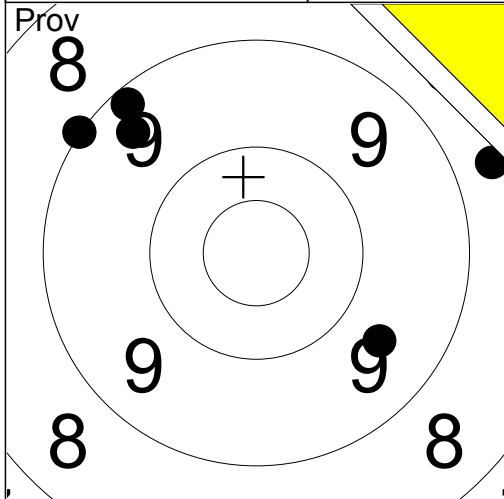

- 1: 9.6 ↘
- 2: 9.4 ↗
- 3: 9.0 ↗
- 4: 9.2 ↗
- 5: 8.7 →

Serie 44.0
Total 0.0

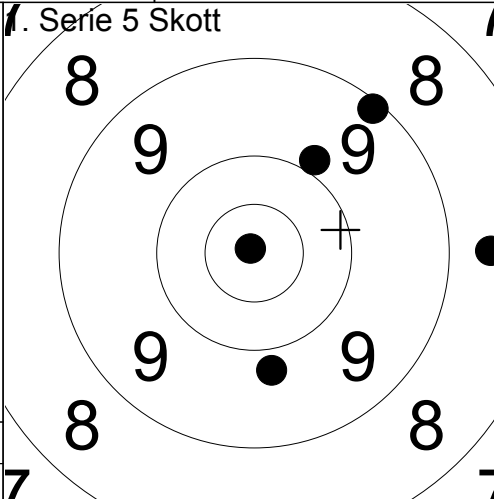

- 1: 10.9x ↗
- 2: 9.1 ↗
- 3: 8.6 →
- 4: 9.9 ↗
- 5: 9.8 ↓

Serie 45.0
Total 45.0

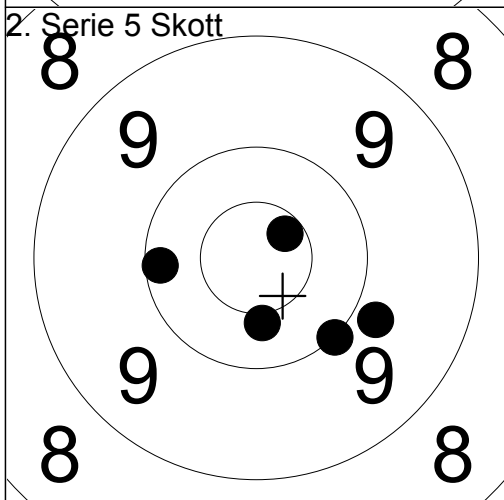

- 1: 10.1 ←
- 2: 10.4 ↓
- 3: 9.8 ↘
- 4: 10.6x ↗
- 5: 10.0 ↘

Serie 49.0
Total 94.0

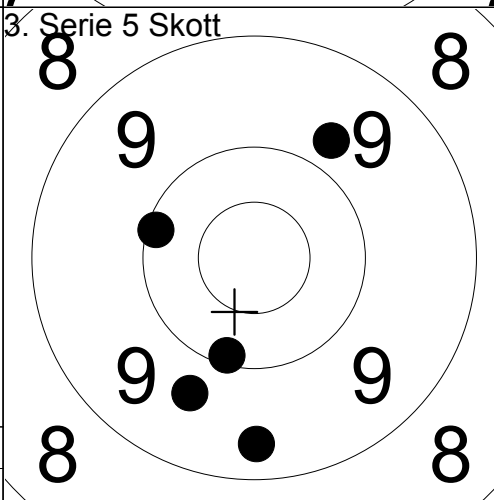

- 1: 9.7 ↓
- 2: 9.8 ↗
- 3: 9.4 ↓
- 4: 10.1 ←
- 5: 10.1 ↓

Serie 47.0
Total 141.0

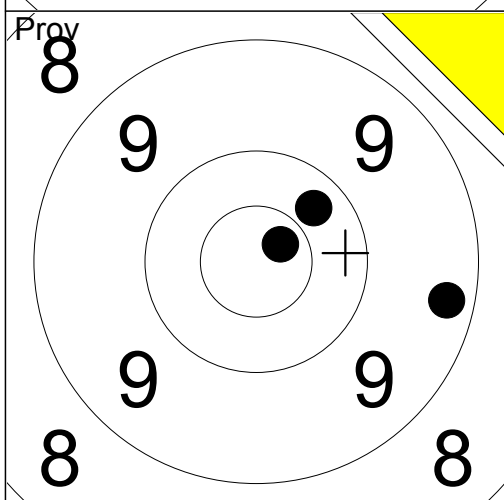

- 1: 9.3 →
- 2: 10.7x ↗
- 3: 10.3 ↗

Serie 29.0
Total 141.0

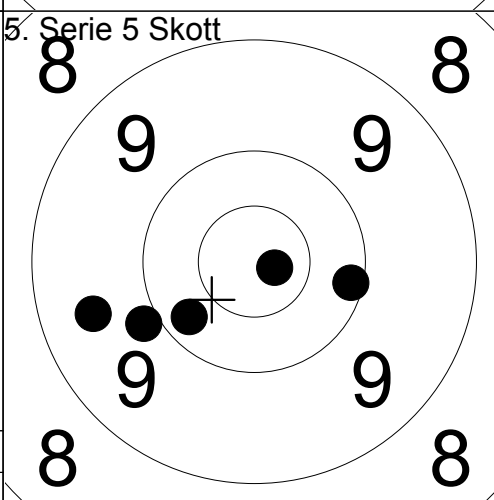

- 1: 10.2 ↘
- 2: 9.9 ←
- 3: 9.5 ←
- 4: 10.1 →
- 5: 10.8x →

Serie 48.0
Total 189.0

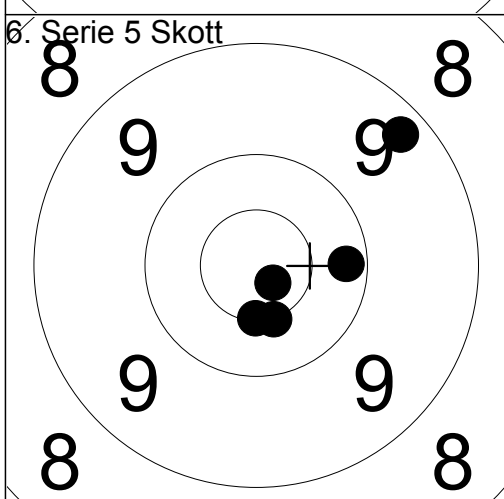

- 1: 9.3 ↗
- 2: 10.5x ↓
- 3: 10.2 →
- 4: 10.5x ↓
- 5: 10.7x ↘

Serie 49.0
Total 238.0

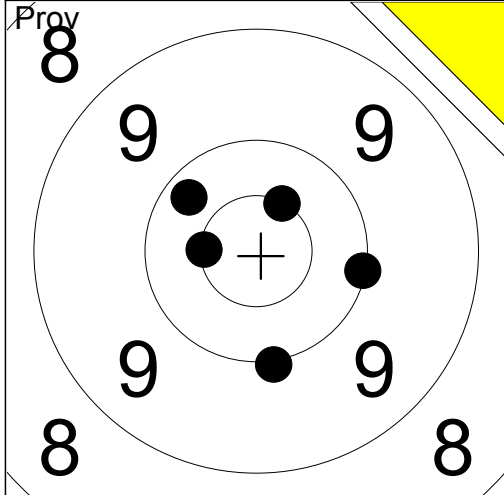

1:	10.0	→
2:	10.5x	←
3:	10.0	↓
4:	10.2	↗
5:	10.5x	↗

Serie	50.0
Total	0.0

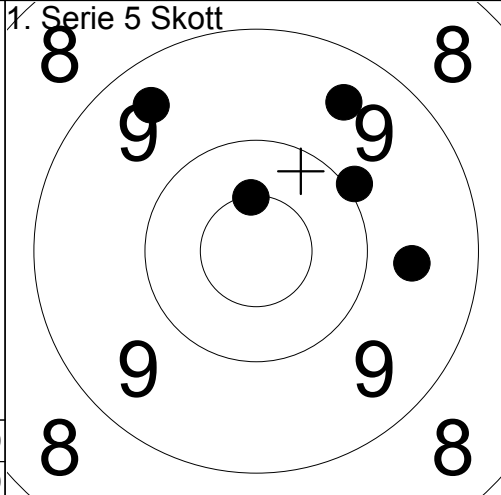

1:	9.4	↖
2:	9.6	→
3:	9.5	↗
4:	10.0	↗
5:	10.5x	↑

Serie	47.0
Total	47.0

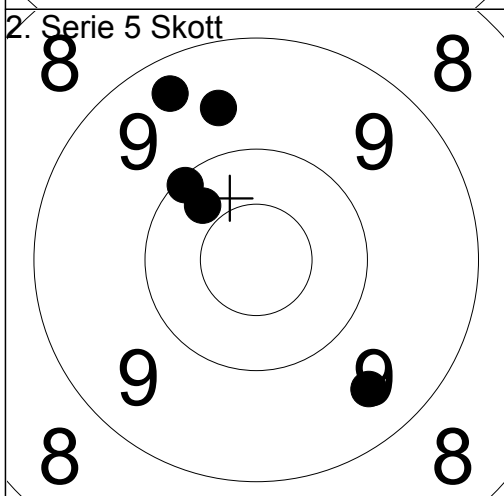

1:	10.3	↗
2:	9.6	↗
3:	10.1	↗
4:	9.3	↗
5:	9.5	↓

Serie	47.0
Total	94.0

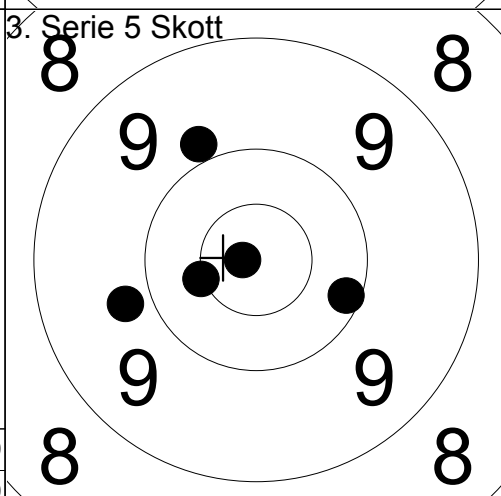

1:	9.8	←
2:	9.9	↖
3:	10.5x	←
4:	10.1	→
5:	10.8x	←

Serie	48.0
Total	142.0

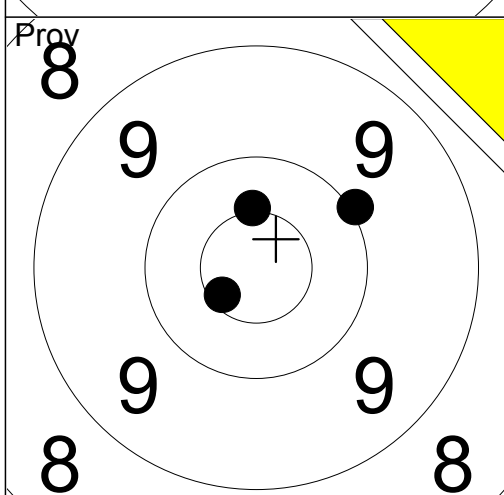

1:	10.5x	↑
2:	10.6x	↙
3:	10.0	↗

Serie	30.0
Total	142.0

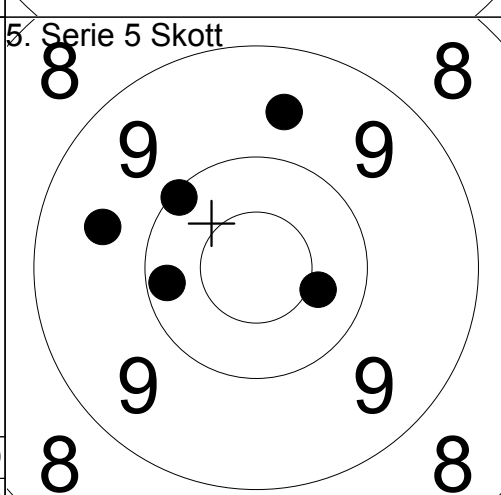

1:	10.1	↖
2:	9.6	↑
3:	9.6	←
4:	10.2	←
5:	10.4	→

Serie	48.0
Total	190.0

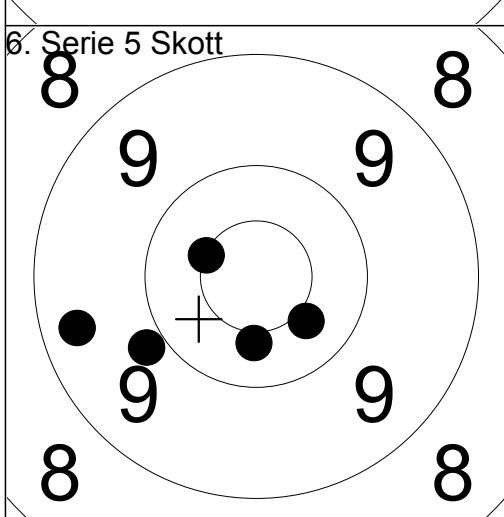

1:	10.5x	↖
2:	9.9	↙
3:	10.4	↘
4:	9.4	←
5:	10.4	↓

Serie	48.0
Total	238.0

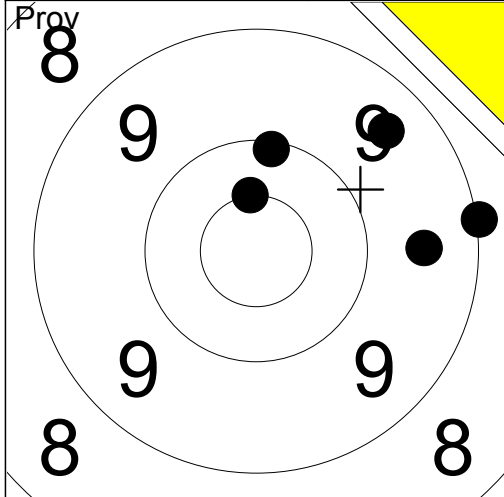

1. Serie 5 Skott

1:	10.5x	↑
2:	9.4	↗
3:	10.1	↑
4:	9.5	→
5:	9.0	→
Serie	47.0	
Total	0.0	

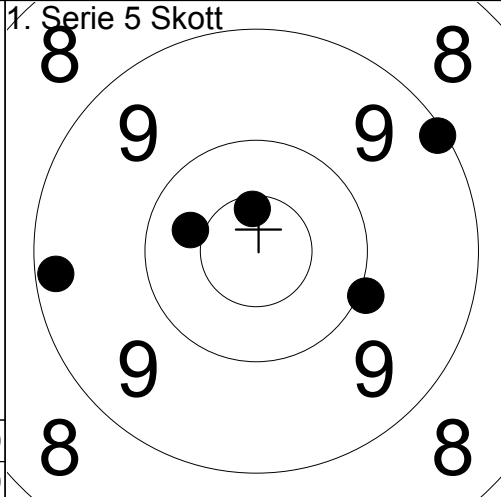

1. Serie 5 Skott

1:	10.6x	↑
2:	10.4	←
3:	9.1	↗
4:	9.2	←
5:	10.0	↘
Serie	48.0	
Total	48.0	

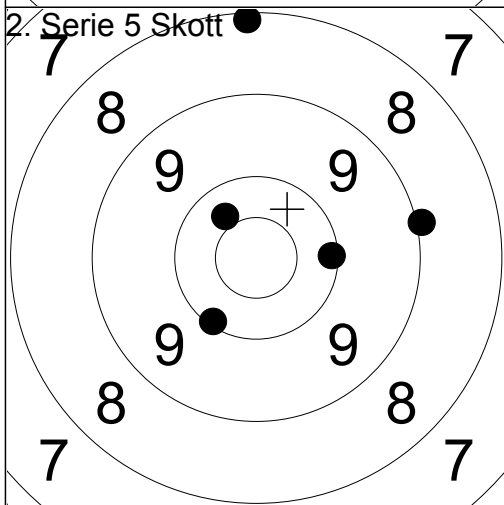

2. Serie 5 Skott

1:	10.1	↙
2:	8.1	↑
3:	10.1	→
4:	10.4	↗
5:	9.0	→
Serie	47.0	
Total	95.0	

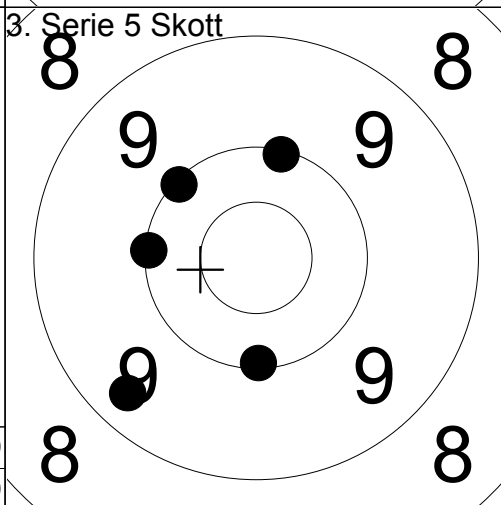

3. Serie 5 Skott

1:	10.1	↓
2:	9.3	↙
3:	10.1	↗
4:	10.1	←
5:	10.1	↑
Serie	49.0	
Total	144.0	

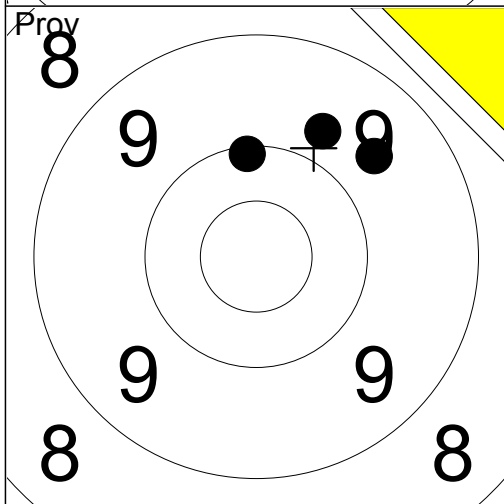

5. Serie 5 Skott

1:	9.8	↑
2:	10.1	↑
3:	9.6	↗
Serie	28.0	
Total	144.0	

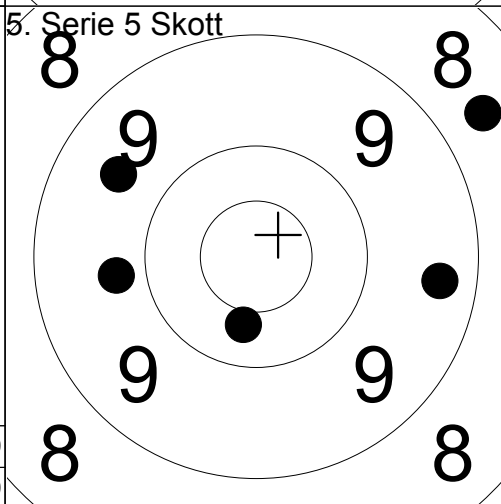

5. Serie 5 Skott

1:	8.6	↗
2:	9.6	↗
3:	9.4	→
4:	9.8	←
5:	10.4	↓
Serie	45.0	
Total	189.0	

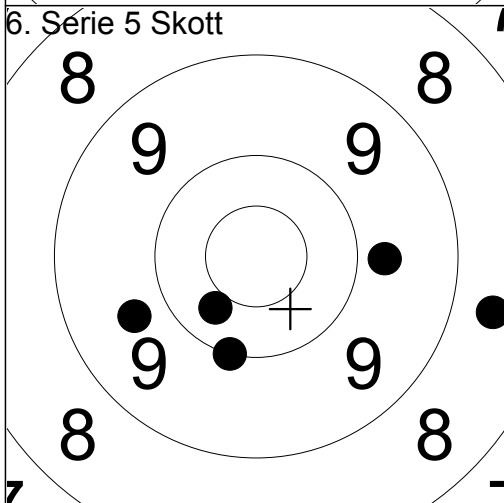

6. Serie 5 Skott

1:	9.8	→
2:	10.0	↓
3:	9.7	←
4:	10.3	↙
5:	8.6	→
Serie	46.0	
Total	235.0	

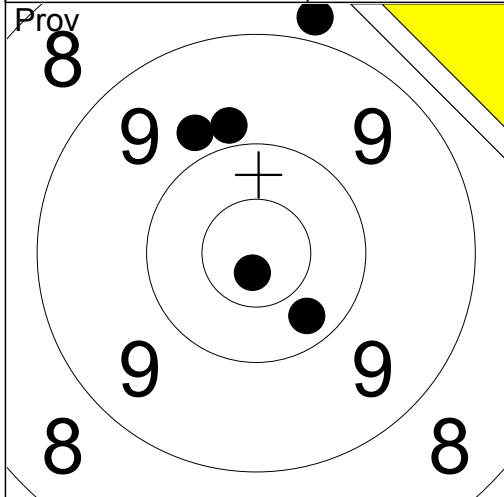

1:	8.8	↑
2:	10.8x	↓
3:	9.8	↑
4:	9.8	↑
5:	10.3	↓

Serie	46.0
Total	0.0

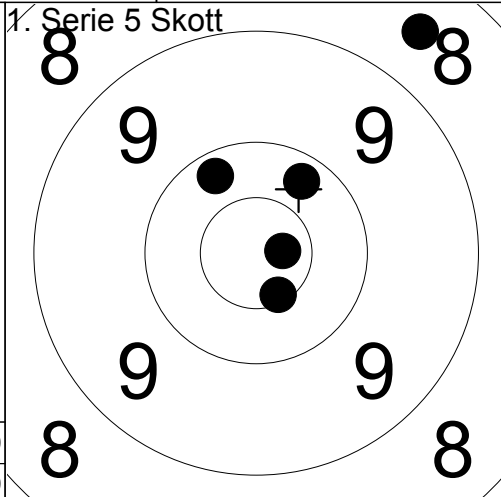

1:	10.7x	→
2:	8.5	↑
3:	10.6x	↓
4:	10.2	↑
5:	10.2	↑

Serie	48.0
Total	48.0

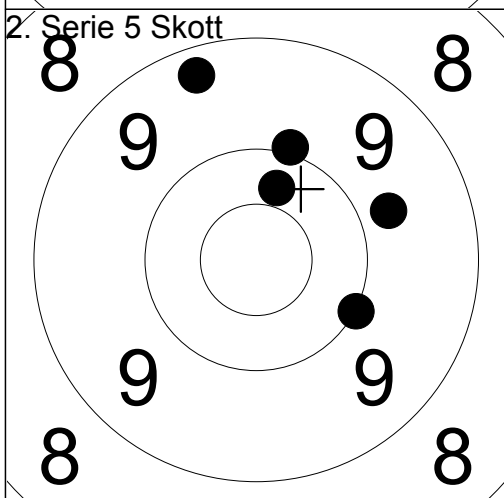

1:	10.0	↑
2:	10.3	↑
3:	9.3	↑
4:	9.8	→
5:	10.0	↓

Serie	48.0
Total	96.0

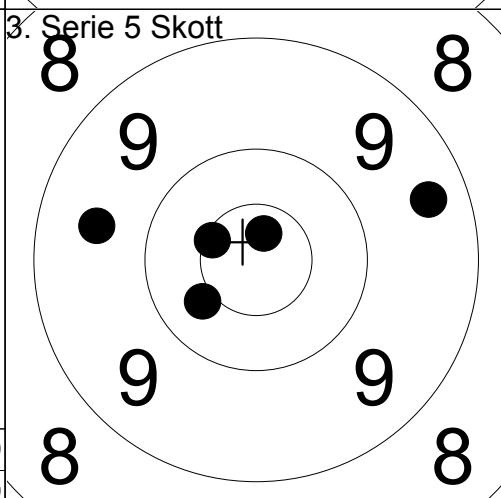

1:	10.4	↙
2:	10.7x	↑
3:	9.6	↙
4:	10.6x	↙
5:	9.4	→

Serie	48.0
Total	144.0

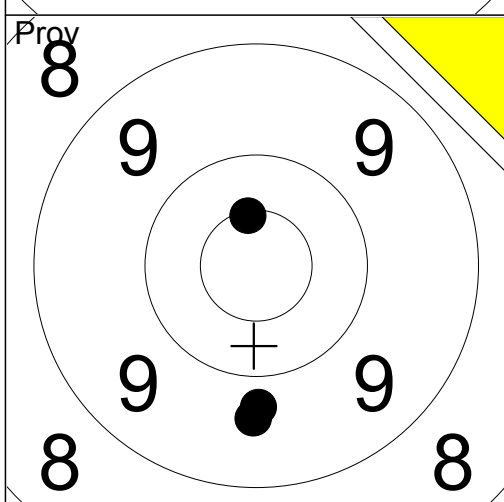

1:	10.5x	↑
2:	9.7	↓
3:	9.8	↓

Serie	28.0
Total	144.0

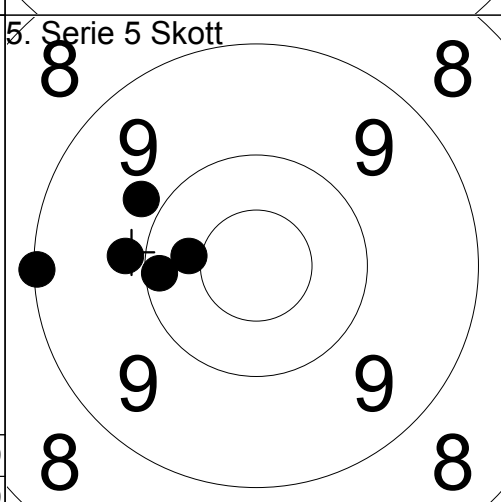

1:	9.8	↙
2:	10.1	←
3:	9.9	←
4:	9.1	←
5:	10.4	←

Serie	47.0
Total	191.0

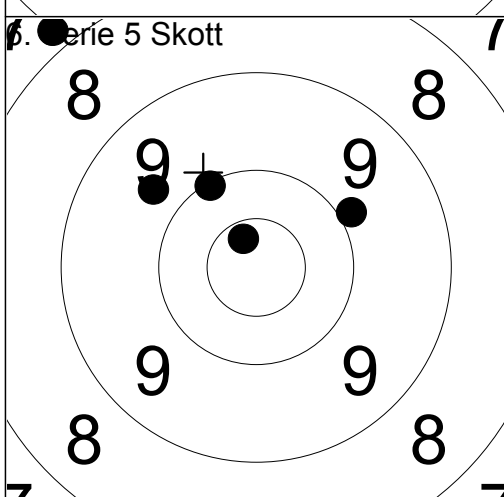

1:	10.7x	↑
2:	9.7	↑
3:	9.9	→
4:	7.8	↑
5:	10.1	↑

Serie	45.0
Total	236.0

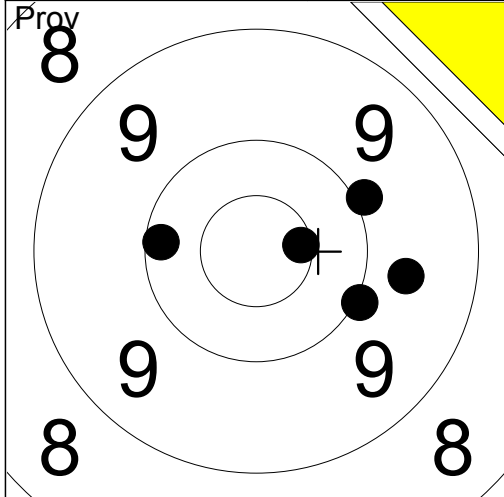

1:	10.0	↘
2:	10.2	←
3:	10.6x	→
4:	9.7	→
5:	9.9	↗
Serie	48.0	
Total	0.0	

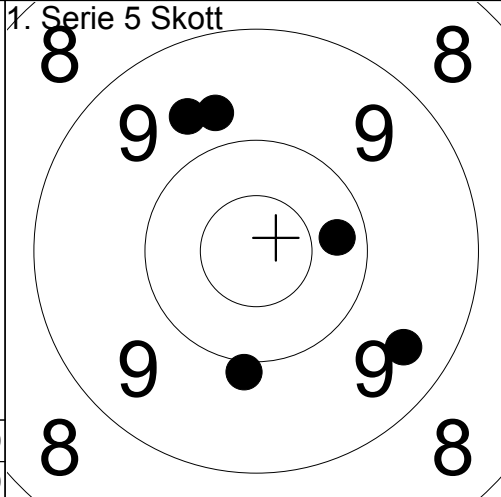

1:	9.7	↗
2:	9.7	↗
3:	9.9	↓
4:	10.3	→
5:	9.4	↘
Serie	46.0	
Total	46.0	

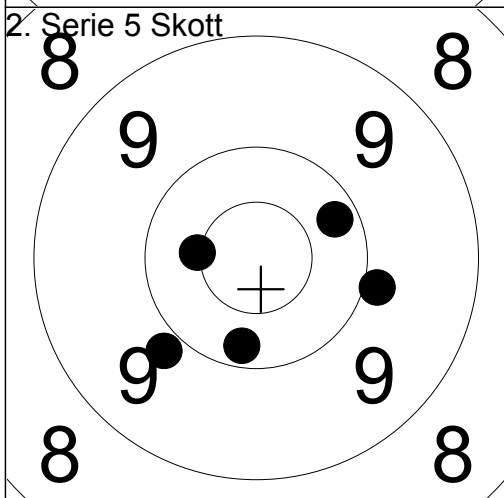

1:	10.2	↓
2:	10.2	↗
3:	10.5x	←
4:	9.9	→
5:	9.9	↘
Serie	48.0	
Total	94.0	

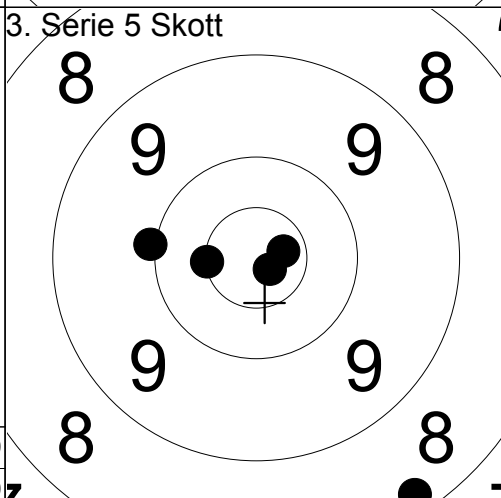

1:	10.7x	→
2:	10.0	←
3:	10.5x	←
4:	10.8x	↘
5:	8.2	↘
Serie	48.0	
Total	142.0	

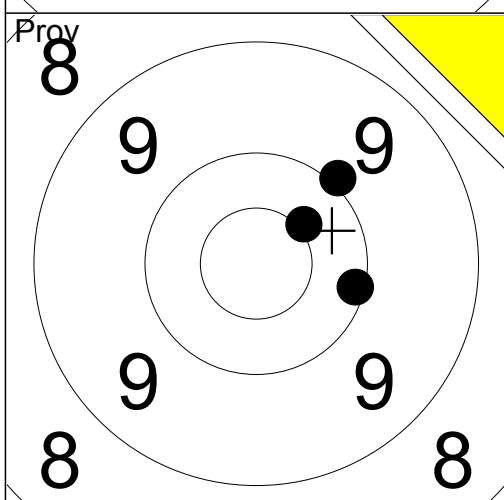

1:	10.4x	↗
2:	10.1	→
3:	10.0	↗
Serie	30.0	
Total	142.0	

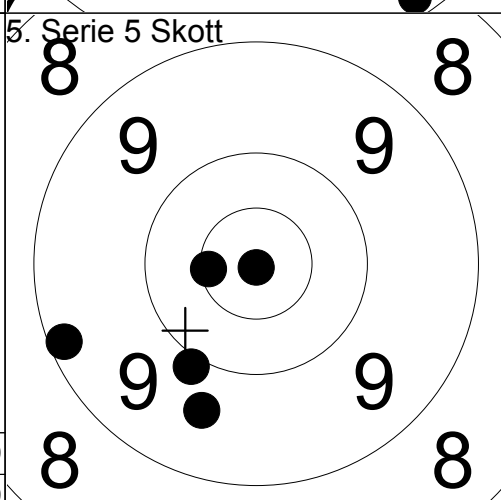

1:	9.2	←
2:	10.5x	←
3:	9.9	↘
4:	9.6	↘
5:	10.9x	↓
Serie	47.0	
Total	189.0	

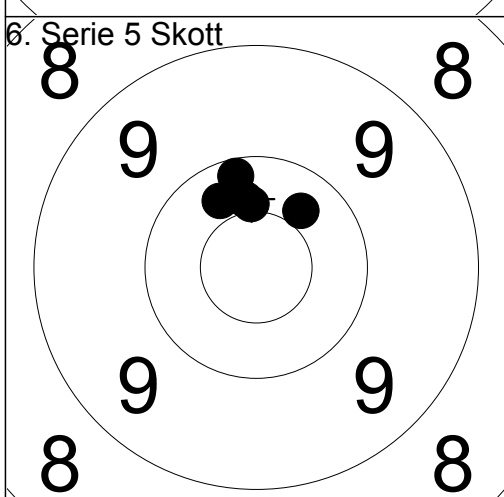

1:	10.4	↑
2:	10.2	↑
3:	10.4x	↑
4:	10.3	↗
5:	10.3	↗
Serie	50.0	
Total	239.0	

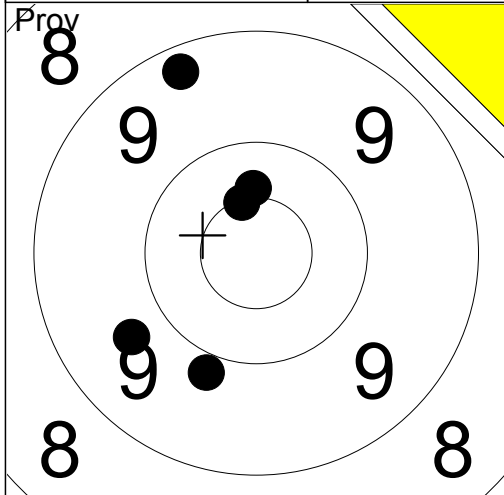

1:	9.7	↙
2:	10.5x	↑
3:	9.9	↘
4:	9.3	↑
5:	10.4	↑

Serie	47.0
Total	0.0

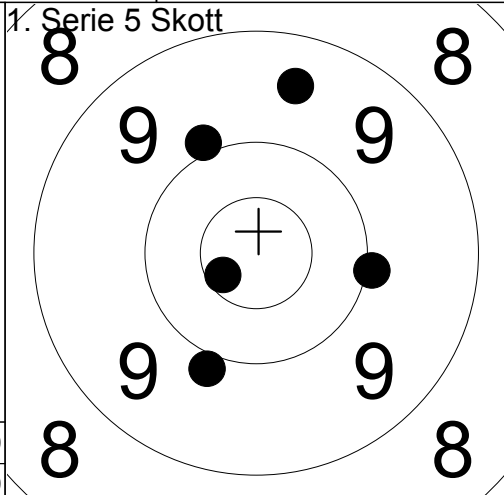

1:	9.9	↗
2:	9.5	↑
3:	9.9	↘
4:	10.6x	↙
5:	10.0	→

Serie	47.0
Total	47.0

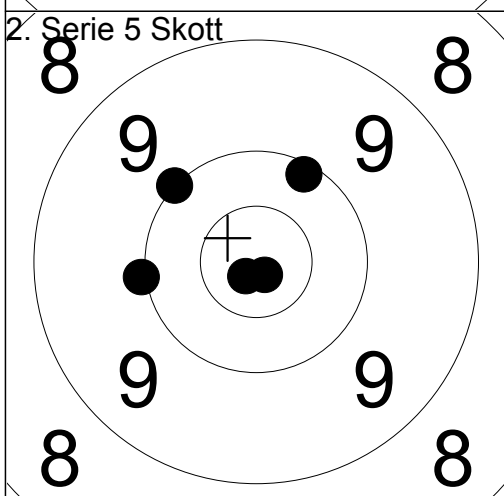

1:	10.8x	↘
2:	10.1	↑
3:	10.8x	↘
4:	10.0	↑
5:	10.0	←

Serie	50.0
Total	97.0

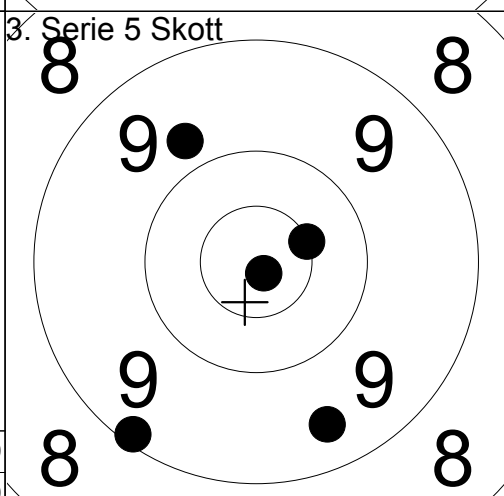

1:	9.1	↘
2:	9.8	↑
3:	9.4	↘
4:	10.5x	→
5:	10.8x	↘

Serie	47.0
Total	144.0

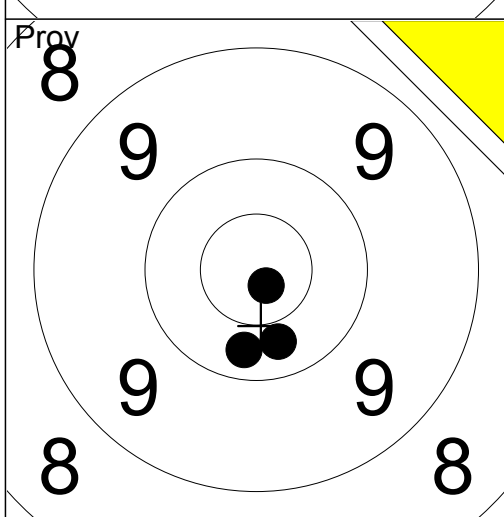

1:	10.8x	↘
2:	10.3	↘
3:	10.3	↘

Serie	30.0
Total	144.0

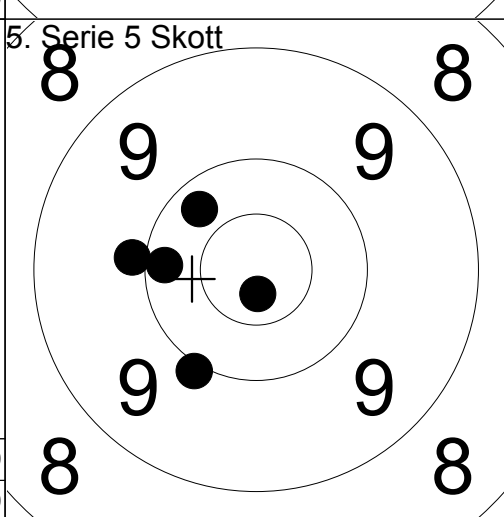

1:	9.9	←
2:	10.0	↘
3:	10.7x	↘
4:	10.3	↑
5:	10.2	←

Serie	49.0
Total	193.0

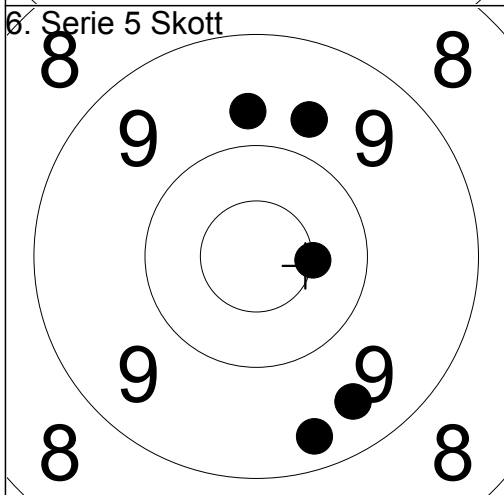

1:	9.7	↑
2:	9.3	↘
3:	9.5	↘
4:	10.5x	→
5:	9.7	↑

Serie	46.0
Total	239.0

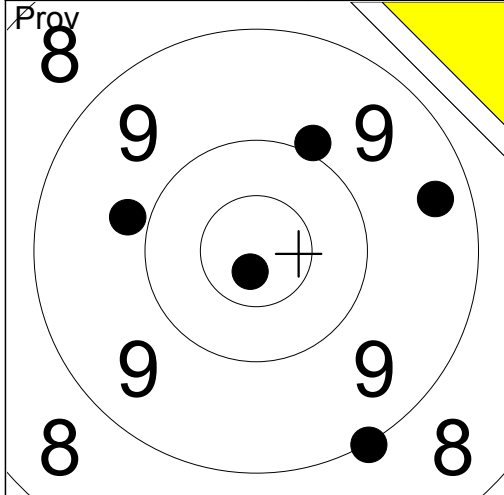

1:	9.4	→
2:	9.9	↗
3:	9.8	←
4:	10.8x	↘
5:	9.0	↘

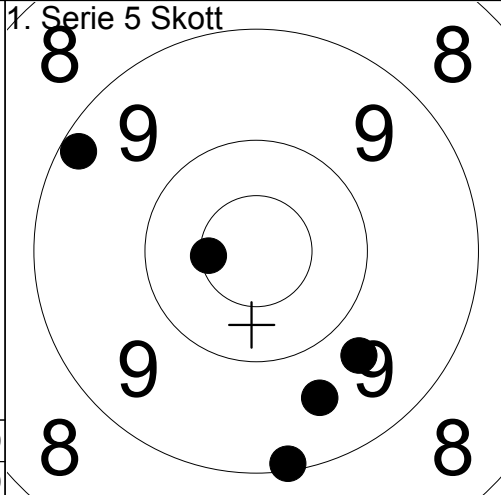

1:	10.6x	←
2:	9.1	↘
3:	9.2	↗
4:	9.6	↘
5:	9.7	↘

Serie	46.0
Total	0.0

Serie	46.0
Total	46.0

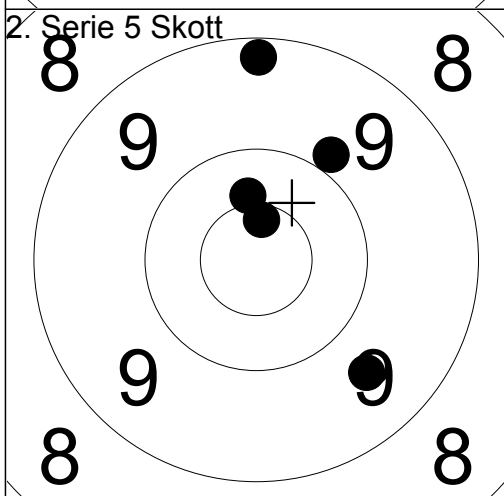

1:	9.2	↑
2:	9.6	↘
3:	10.4	↑
4:	10.6x	↑
5:	9.9	↗

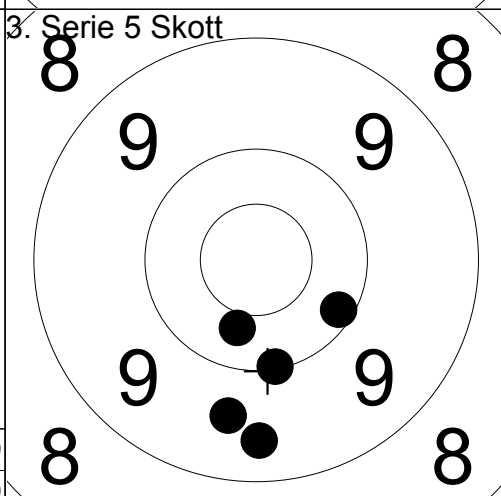

1:	10.1	↘
2:	10.4	↘
3:	9.6	↘
4:	9.4	↘
5:	10.0	↘

Serie	47.0
Total	93.0

Serie	48.0
Total	141.0

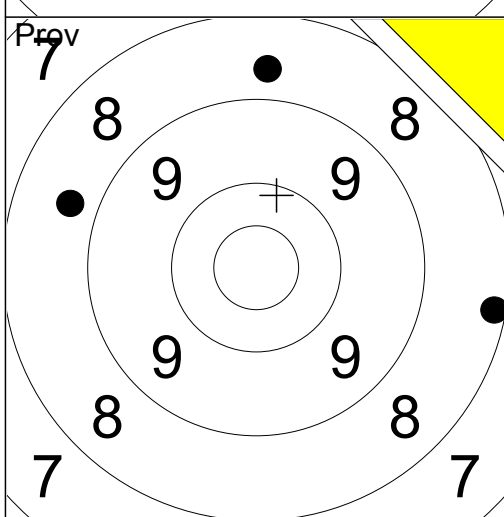

1:	8.7	←
2:	8.2	→
3:	8.7	↑

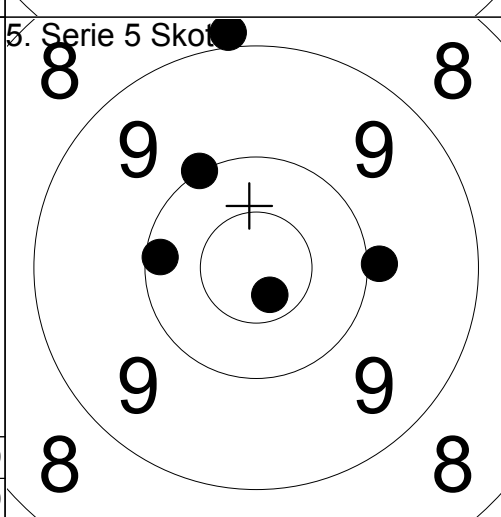

1:	10.1	←
2:	10.7x	↘
3:	10.0	↗
4:	8.9	↑
5:	9.9	→

Serie	24.0
Total	141.0

Serie	47.0
Total	188.0

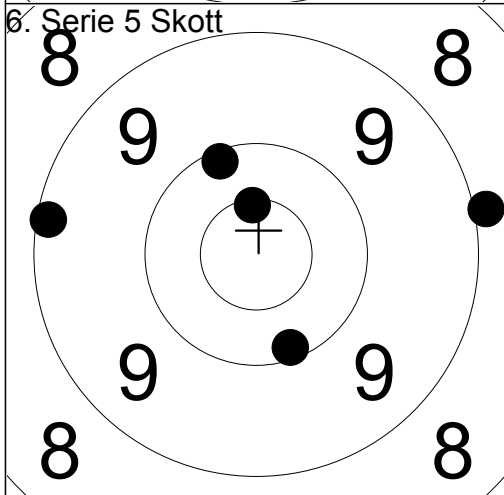

1:	10.5x	↑
2:	10.1	↘
3:	9.1	←
4:	8.9	→
5:	10.1	↗

Serie	47.0
Total	235.0

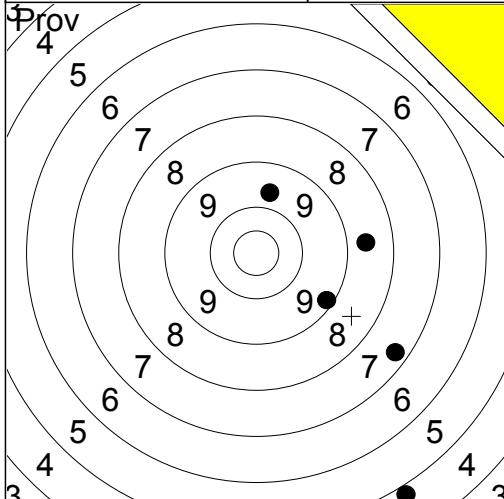

1:	4.8	↘
2:	7.3	↘
3:	9.2	↘
4:	8.6	→
5:	9.7	↑

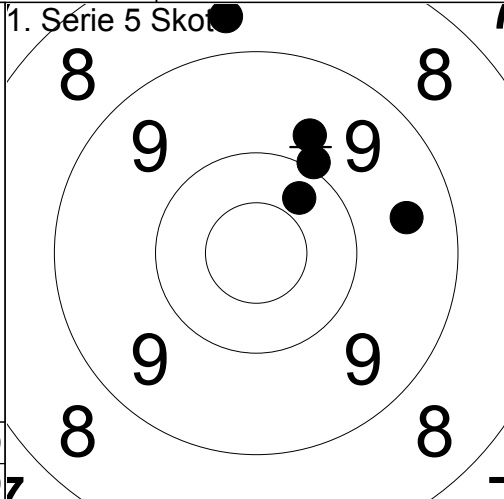

1:	10.0	↗
2:	10.3	↗
3:	9.7	↗
4:	9.5	→
5:	8.7	↑

Serie	37.0
Total	0.0

Serie	46.0
Total	46.0

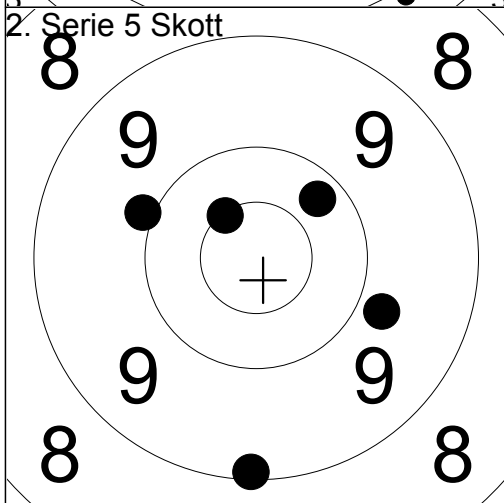

1:	10.2	↗
2:	9.8	↘
3:	10.5x	↗
4:	9.9	↗
5:	9.1	↓

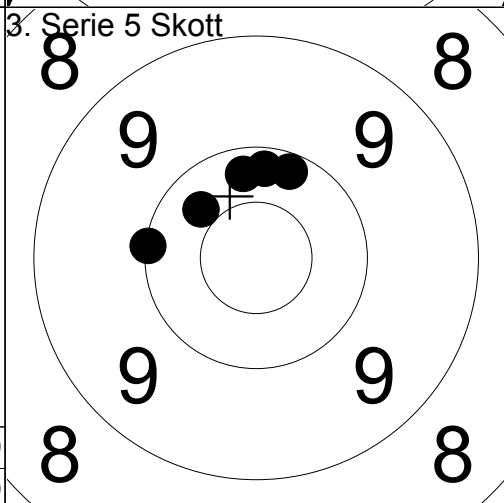

1:	10.2	↑
2:	10.2	↑
3:	10.2	↑
4:	10.0	←
5:	10.3	↖

Serie	47.0
Total	93.0

Serie	50.0
Total	143.0

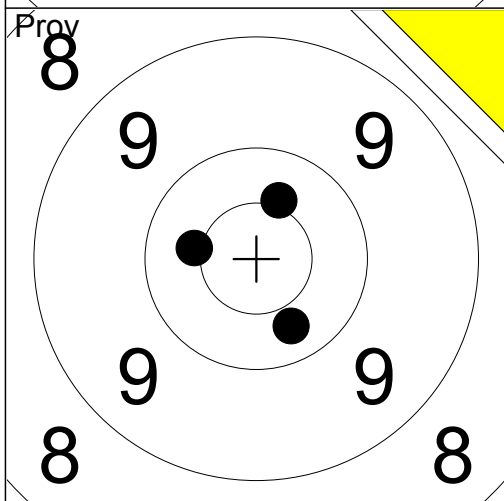

1:	10.4x	↑
2:	10.3	↘
3:	10.4x	←

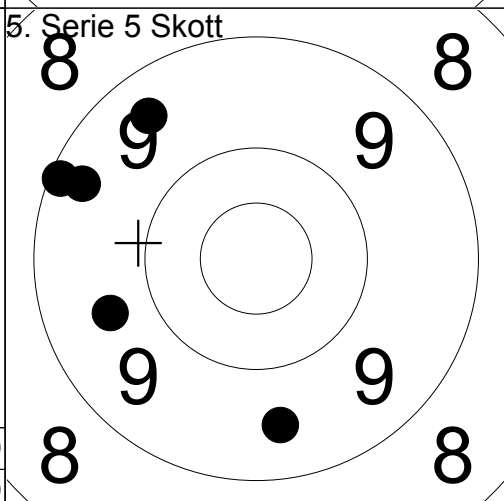

1:	9.4	↗
2:	9.1	↖
3:	9.6	←
4:	9.3	↖
5:	9.5	↓

Serie	30.0
Total	143.0

Serie	45.0
Total	188.0

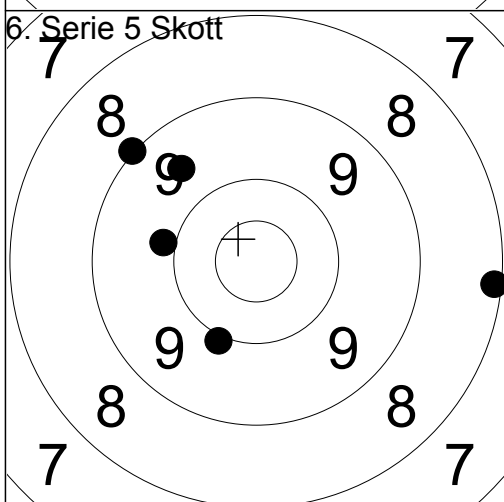

1:	9.9	←
2:	9.0	↗
3:	10.0	↘
4:	8.1	→
5:	9.6	↗

Serie	45.0
Total	233.0

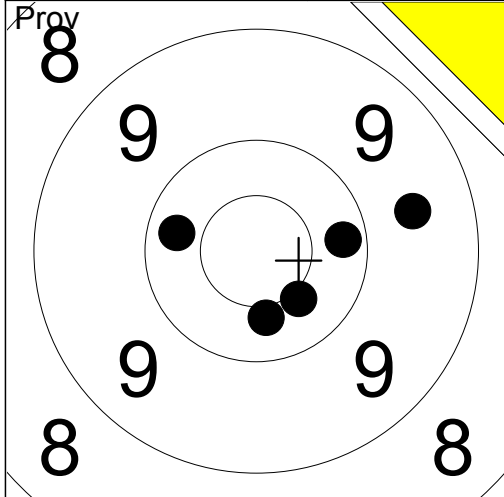

- 1: 10.2 →
- 2: 10.4x ↘
- 3: 10.4 ↘
- 4: 9.6 →
- 5: 10.3 ←

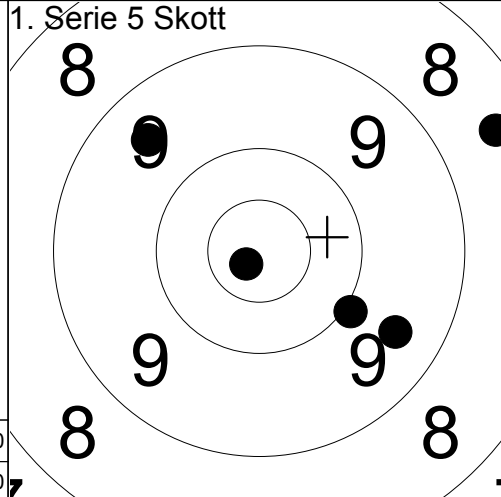

- 1: 9.5 ↗
- 2: 8.4 →
- 3: 10.0 ↘
- 4: 10.8x ↘
- 5: 9.5 ↘

Serie	49.0
Total	0.0

Serie	46.0
Total	46.0

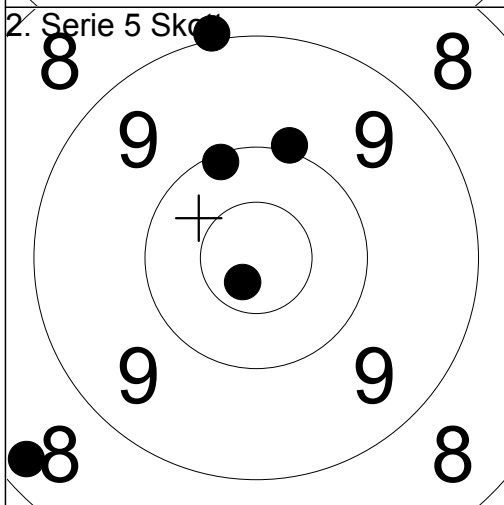

- 1: 10.0 ↑
- 2: 9.0 ↑
- 3: 10.7x ↘
- 4: 10.1 ↑
- 5: 8.3 ↘

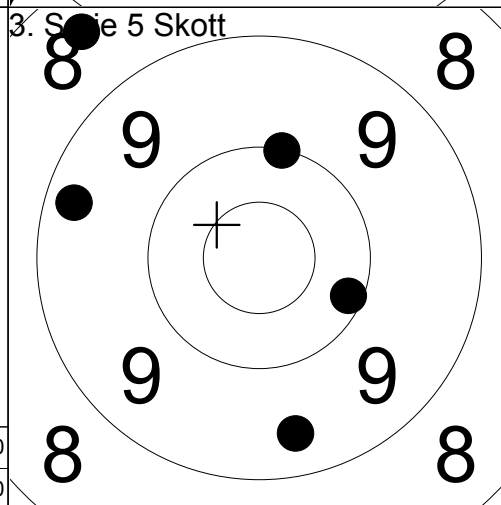

- 1: 10.1 →
- 2: 10.0 ↑
- 3: 8.4 ↗
- 4: 9.3 ←
- 5: 9.4 ↘

Serie	47.0
Total	93.0

Serie	46.0
Total	139.0

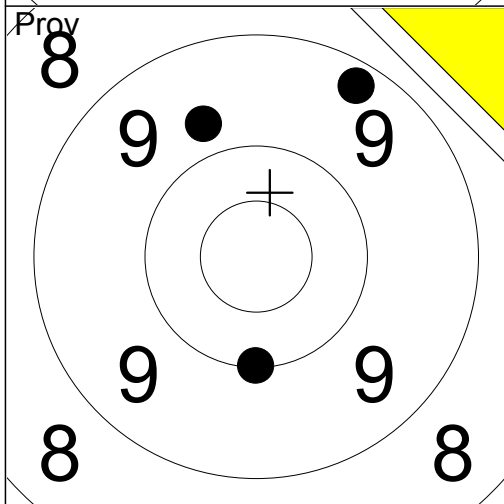

- 1: 9.3 ↗
- 2: 9.7 ↗
- 3: 10.0 ↘

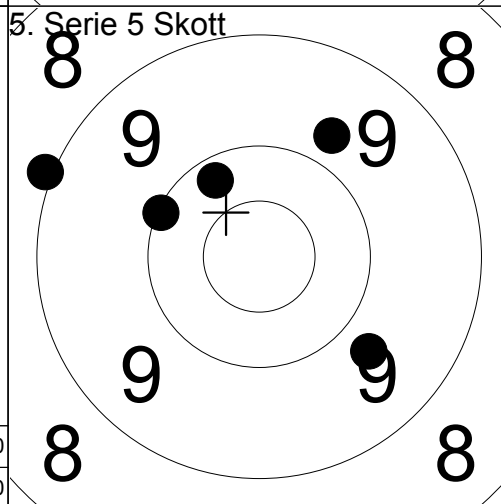

- 1: 9.0 ↗
- 2: 10.2 ↗
- 3: 9.7 ↘
- 4: 9.8 ↗
- 5: 10.1 ↗

Serie	28.0
Total	139.0

Serie	47.0
Total	186.0

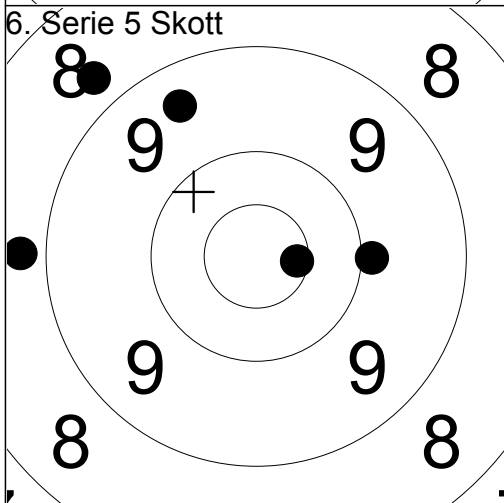

- 1: 9.9 →
- 2: 9.4 ↗
- 3: 8.7 ↗
- 4: 10.6x →
- 5: 8.8 ←

Serie	44.0
Total	230.0

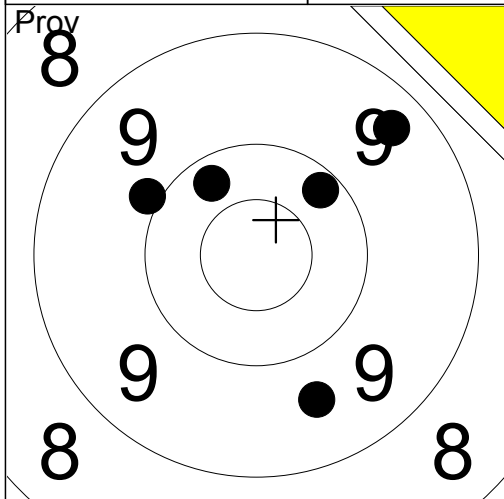

1:	9.9	↗
2:	10.2	↗
3:	9.4	↗
4:	9.6	↘
5:	10.2	↗

Serie	47.0
Total	0.0

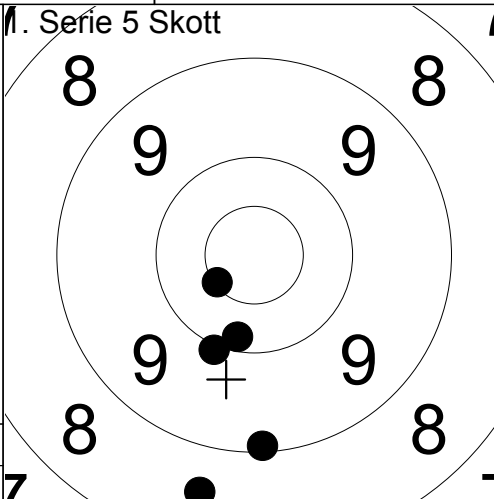

1:	10.0	↘
2:	9.1	↘
3:	10.2	↘
4:	8.6	↘
5:	10.5x	↙

Serie	47.0
Total	47.0

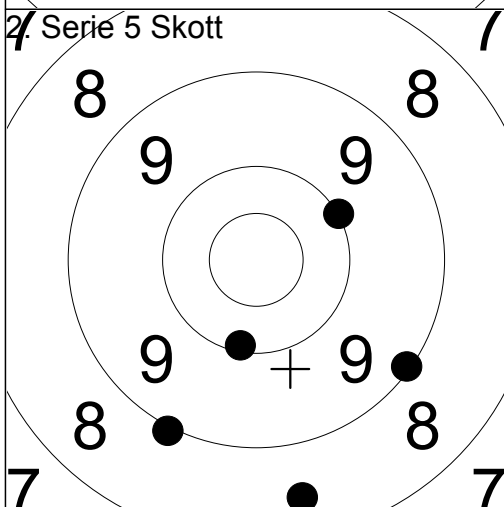

1:	10.0	↗
2:	9.1	↘
3:	10.1	↘
4:	8.5	↘
5:	9.0	↘

Serie	46.0
Total	93.0

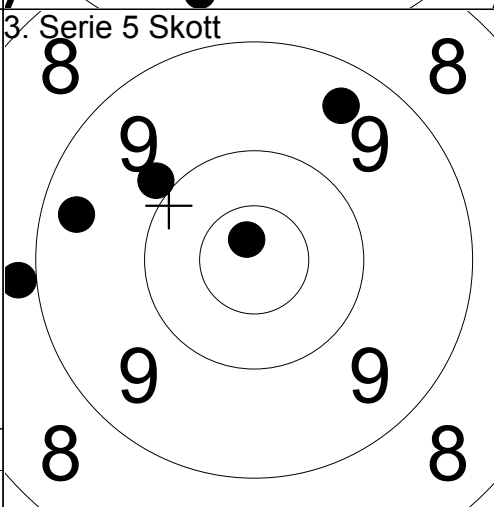

1:	9.9	↗
2:	9.4	↖
3:	10.8x	↗
4:	8.9	↖
5:	9.4	↗

Serie	45.0
Total	138.0

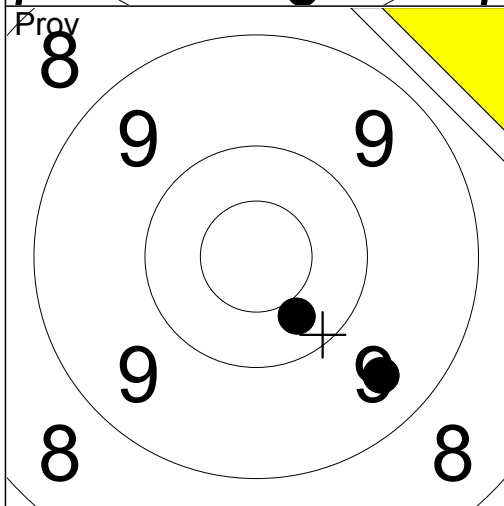

1:	9.5	↘
2:	10.3	↘
3:	10.4	↘

Serie	29.0
Total	138.0

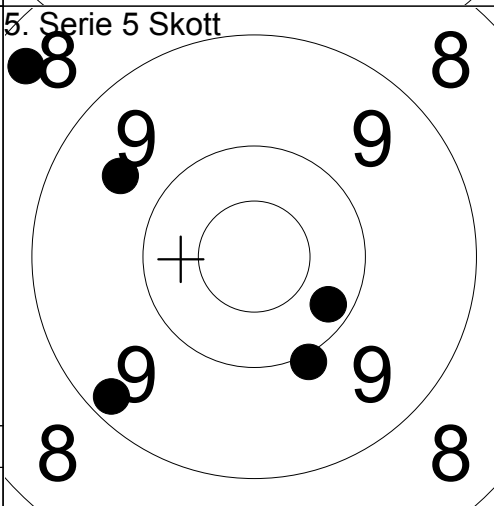

1:	8.4	↗
2:	9.2	↘
3:	10.0	↘
4:	9.6	↗
5:	10.2	↘

Serie	46.0
Total	184.0

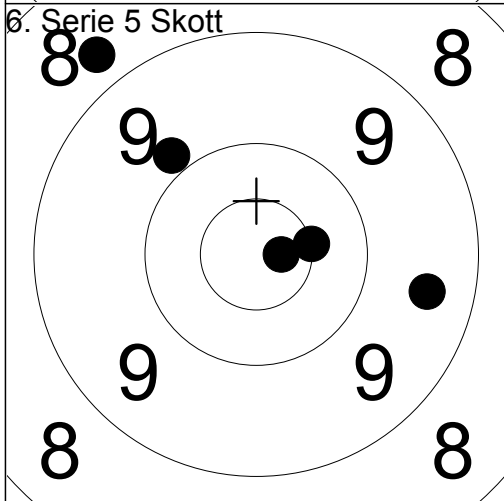

1:	8.7	↗
2:	10.7x	→
3:	10.5x	→
4:	9.9	↗
5:	9.5	↘

Serie	46.0
Total	230.0

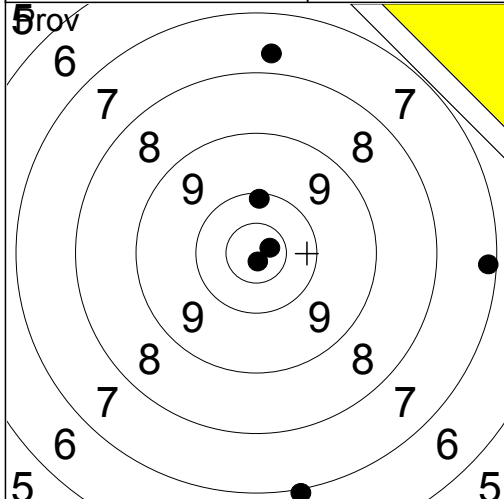

1:	10.8x	↓
2:	7.0	↓
3:	7.7	↑
4:	7.2	→
5:	10.7x	→
6:	10.1	↑

Serie	51.0
Total	0.0

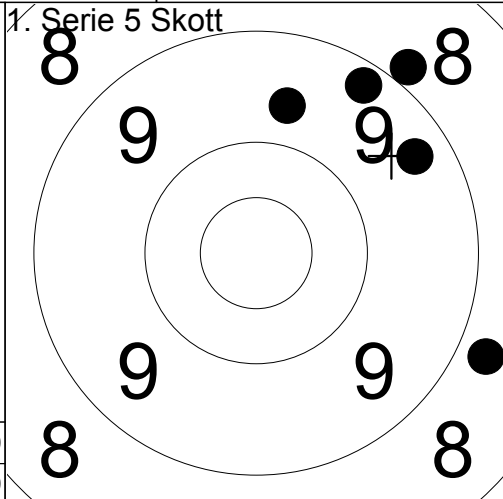

1:	9.7	↑
2:	9.4	↗
3:	8.9	↗
4:	8.8	→
5:	9.2	↗

Serie	43.0
Total	43.0

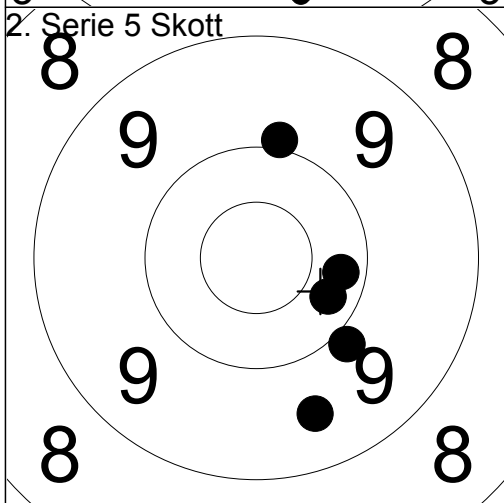

1:	10.3	↘
2:	9.9	↑
3:	9.5	↓
4:	10.2	→
5:	9.9	↘

Serie	47.0
Total	90.0

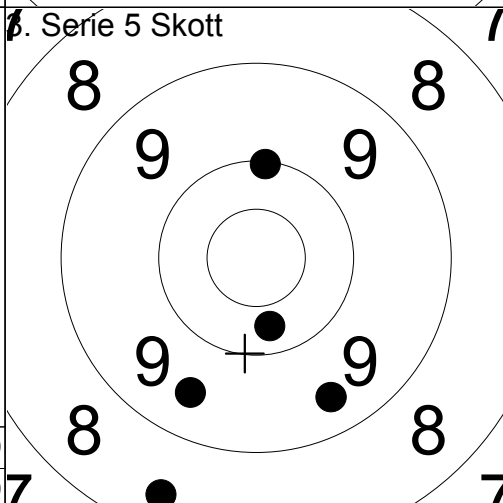

1:	10.3	↓
2:	9.5	↓
3:	10.1	↑
4:	9.4	↓
5:	8.4	↓

Serie	46.0
Total	136.0

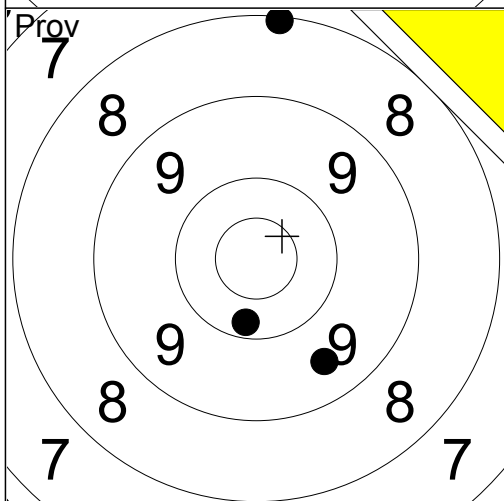

1:	8.1	↑
2:	9.5	↓
3:	10.2	↓

Serie	27.0
Total	136.0

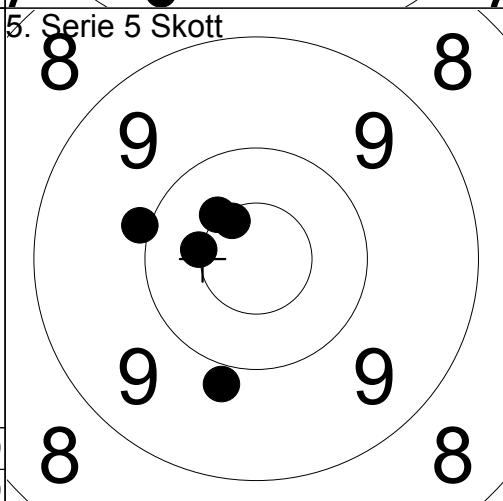

1:	10.6x	↗
2:	9.9	←
3:	10.5x	←
4:	9.9	↓
5:	10.5x	↗

Serie	48.0
Total	184.0

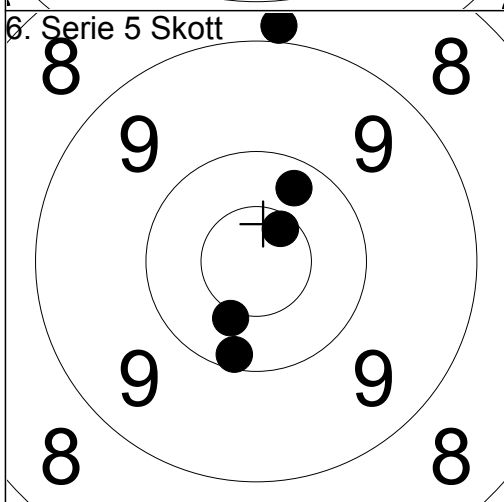

1:	10.6x	↗
2:	8.9	↑
3:	10.1	↓
4:	10.3	↗
5:	10.4x	↘

Serie	48.0
Total	232.0

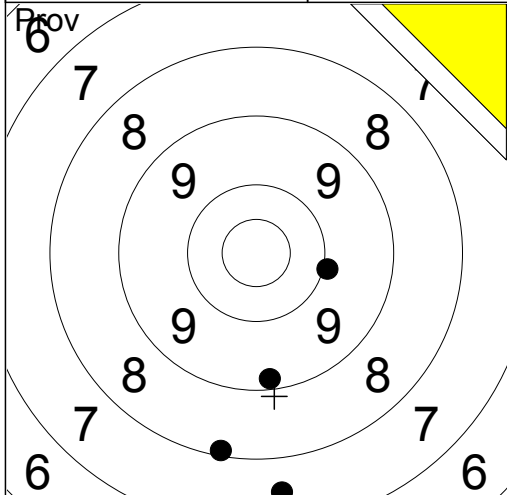

1:	10.0	→
2:	7.5	↓
3:	9.2	↓
4:	8.1	↓

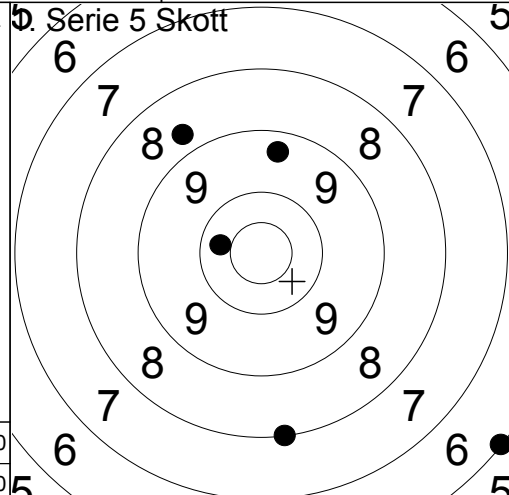

1:	8.0	↓
2:	9.4	↑
3:	10.3	←
4:	8.7	↗
5:	6.1	↘

Serie	34.0
Total	0.0

Serie	41.0
Total	41.0

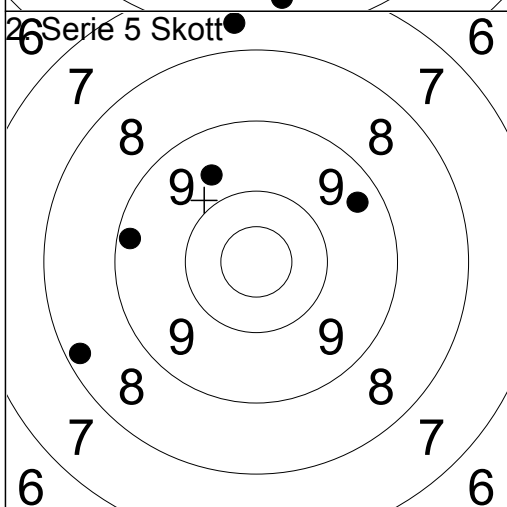

1:	7.6	↑
2:	8.2	←
3:	9.2	←
4:	9.4	↗
5:	9.6	↗

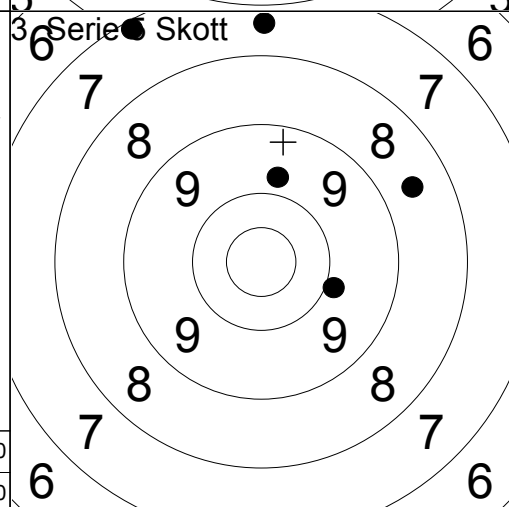

1:	7.6	↑
2:	9.8	↑
3:	7.2	↗
4:	8.6	↗
5:	9.9	→

Serie	42.0
Total	83.0

Serie	40.0
Total	123.0

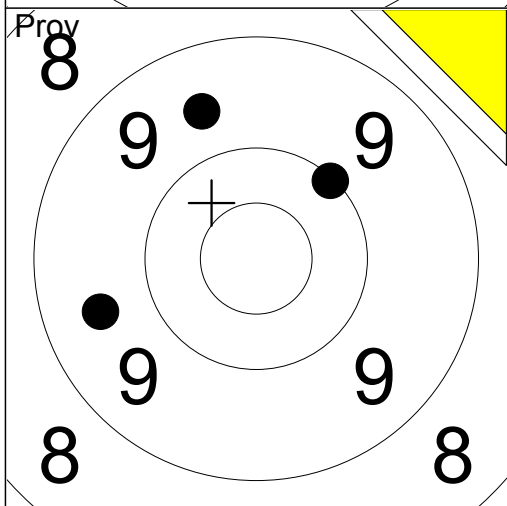

1:	10.1	↗
2:	9.5	←
3:	9.6	↑

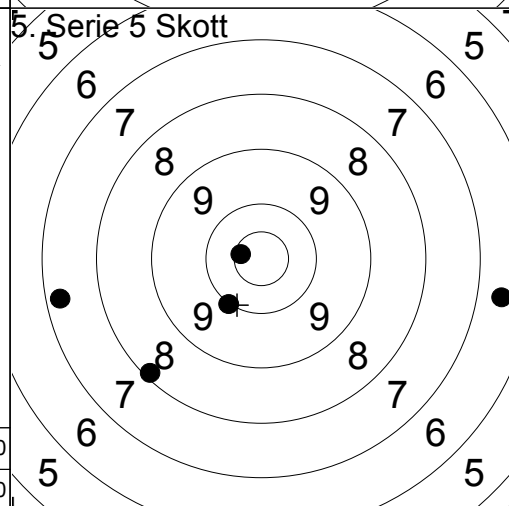

1:	7.3	←
2:	10.6x	←
3:	8.1	↘
4:	10.0	↘
5:	6.6	→

Serie	28.0
Total	123.0

Serie	41.0
Total	164.0

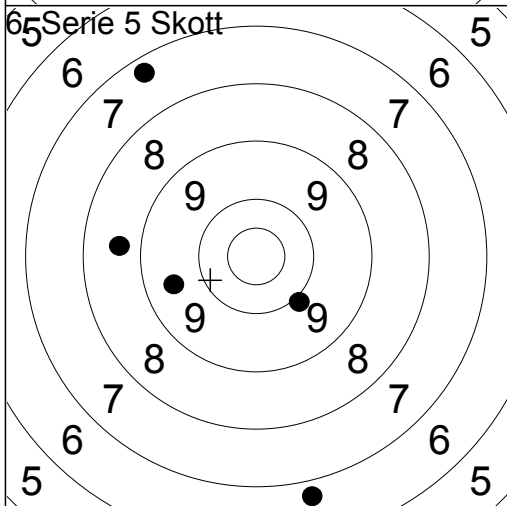

1:	8.6	←
2:	9.5	←
3:	7.3	↗
4:	10.0	↘
5:	6.8	↓

Serie	40.0
Total	204.0