

1:	10.2	↑
2:	9.9	↑
3:	0.0	
Serie		19.0
Total		0.0

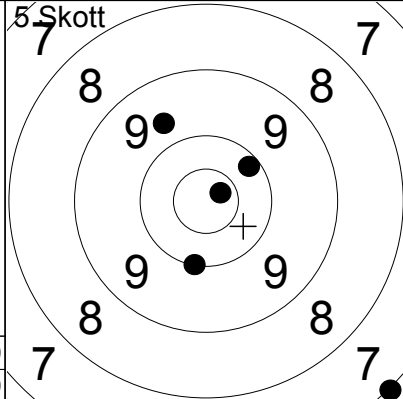

1:	10.7x	↗
2:	9.7	↗
3:	10.0	↓
4:	7.0	↘
5:	10.2	↗
Serie		46.0
Total		46.0

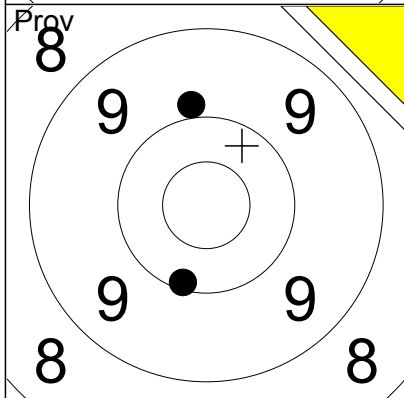

1:	9.9	↑
2:	8.6	↗
3:	10.1	↓
Serie		27.0
Total		46.0

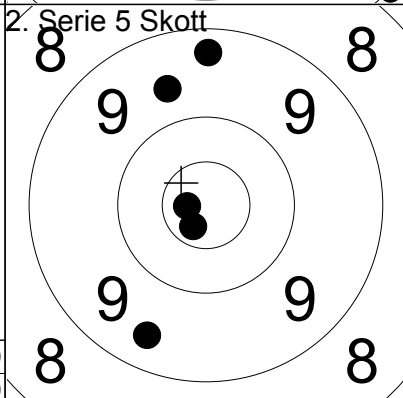

1:	9.6	↑
2:	9.4	↓
3:	10.8x	←
4:	9.3	↑
5:	10.7x	↘
Serie		47.0
Total		93.0

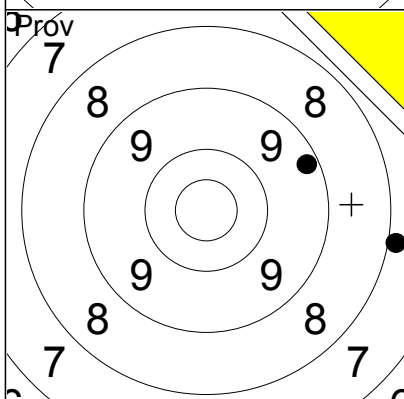

1:	7.9	→
2:	9.2	→
Serie		16.0
Total		93.0

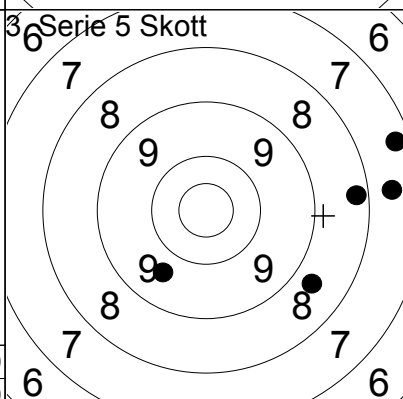

1:	8.3	→
2:	7.3	→
3:	9.6	↘
4:	8.7	↘
5:	7.6	→
Serie		39.0
Total		132.0

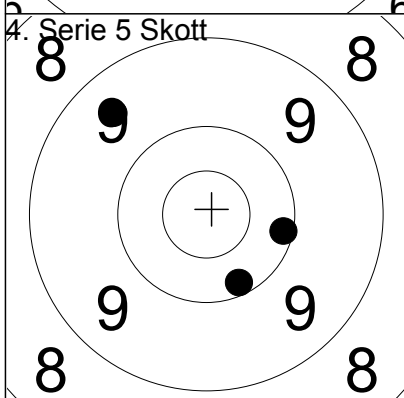

1:	10.1	→
2:	9.5	↗
3:	10.2	↘
Serie		29.0
Total		161.0

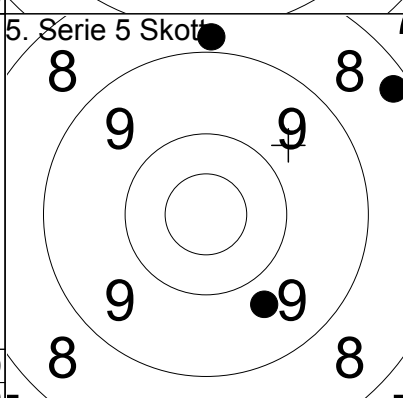

1:	9.7	↘
2:	8.8	↑
3:	8.2	↗
Serie		25.0
Total		186.0

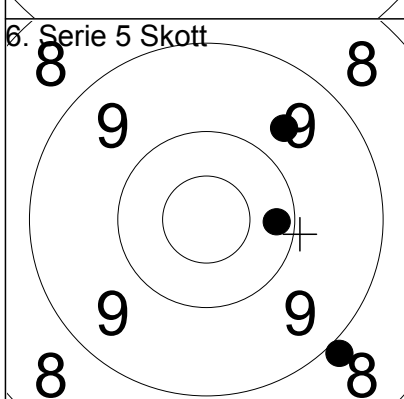

1:	10.2	→
2:	9.7	↗
3:	8.9	↘
Serie		27.0
Total		213.0

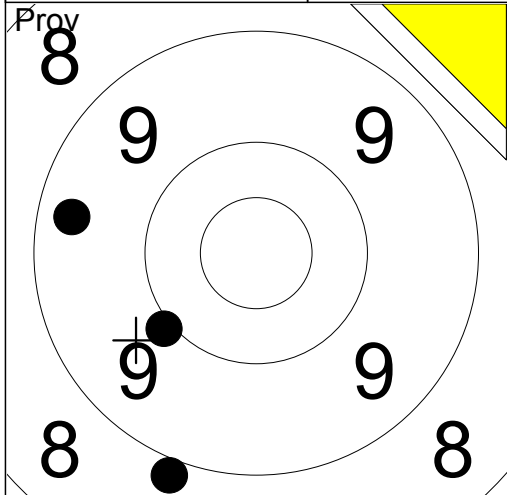

5 Skott

1:	9.3	←
2:	8.9	↓
3:	10.0	↙
<hr/>		
Serie	27.0	
Total	0.0	

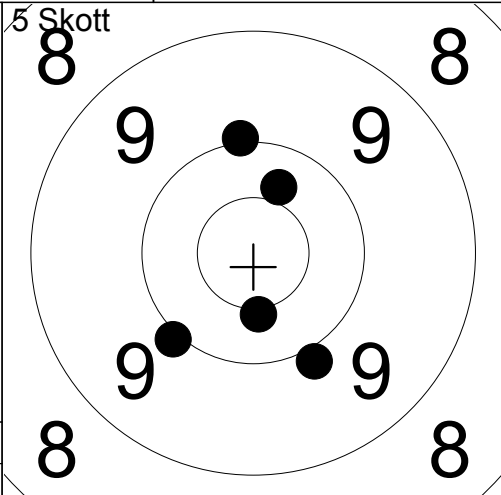

1:	9.9	↓
2:	10.4x	↓
3:	10.4	↗
4:	10.0	↙
5:	10.0	↑
<hr/>		
Serie	49.0	
Total	49.0	

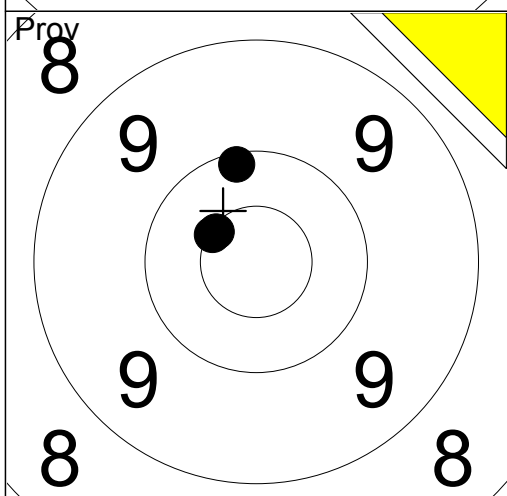

2. Serie 5 Skott

1:	10.5x	↖
2:	10.1	↑
3:	10.5x	↖
<hr/>		
Serie	30.0	
Total	49.0	

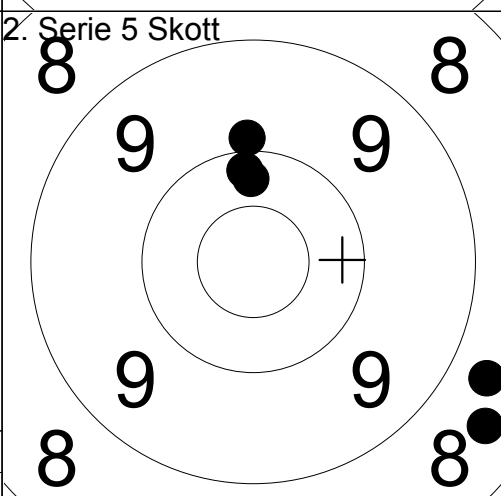

1:	10.2	↑
2:	9.9	↑
3:	8.7	↘
4:	10.3	↑
5:	8.5	↘
<hr/>		
Serie	45.0	
Total	94.0	

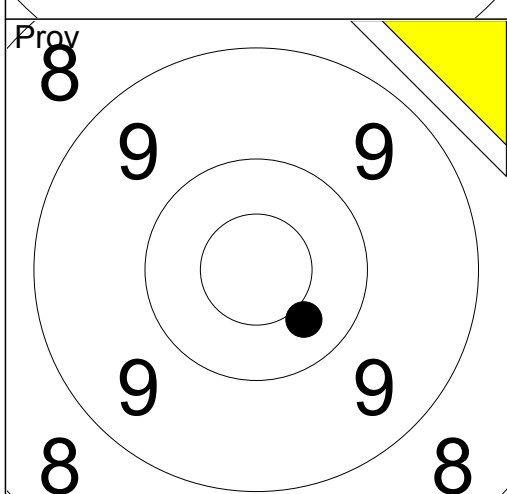

6 Serie 5 Skott

1:	10.4	↘
<hr/>		
Serie	10.0	
Total	94.0	

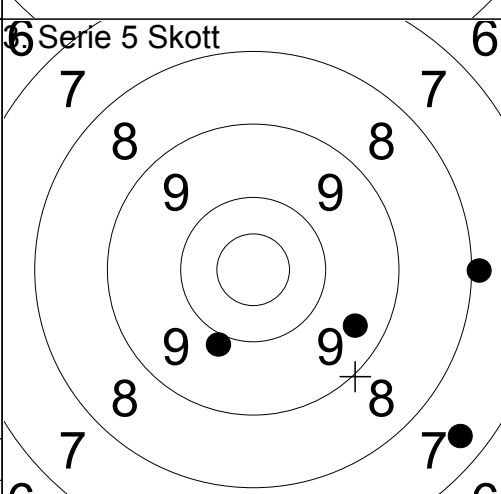

1:	7.7	↓
2:	7.4	↓
3:	7.9	→
4:	9.4	↘
5:	9.9	↓
<hr/>		
Serie	39.0	
Total	133.0	

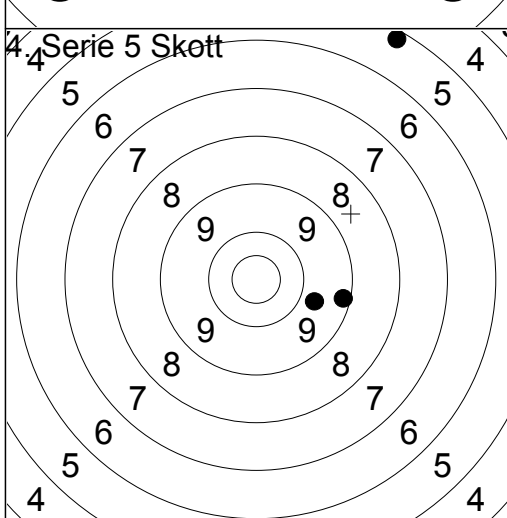

1:	9.2	→
2:	9.7	→
3:	5.2	↗
<hr/>		
Serie	23.0	
Total	156.0	

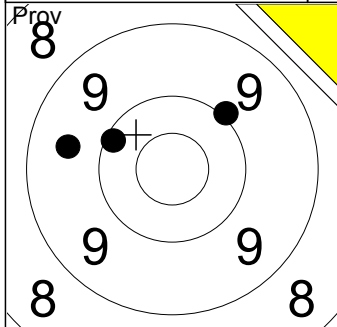

1: 10.0 ↗
2: 10.1 ↖
3: 9.6 ←

Serie 29.0
Total 0.0

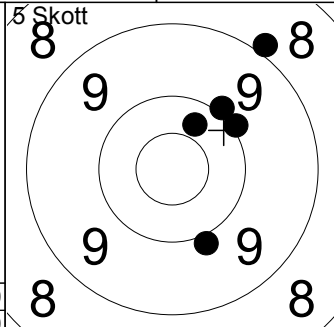

1: 8.9 ↗
2: 10.3 ↗
3: 10.0 ↗
4: 10.0 ↗
5: 9.9 ↓

Serie 47.0
Total 47.0

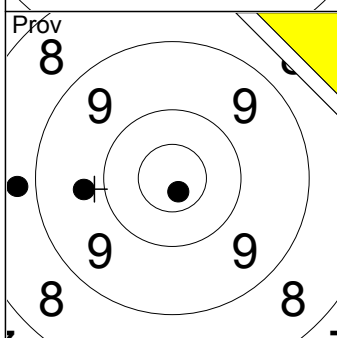

1: 9.7 ↖
2: 8.8 ←
3: 10.8x ↓

Serie 27.0
Total 47.0

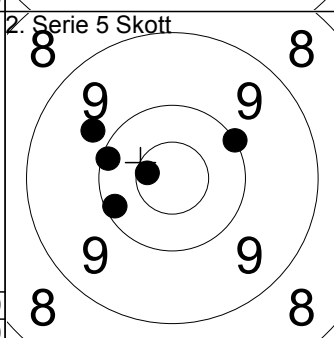

1: 10.0 ↗
2: 9.8 ↖
3: 10.1 ←
4: 10.1 ←
5: 10.6x ←

Serie 49.0
Total 96.0

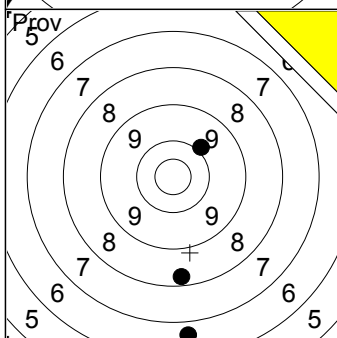

1: 8.3 ↓
2: 6.7 ↓
3: 9.9 ↗

Serie 23.0
Total 96.0

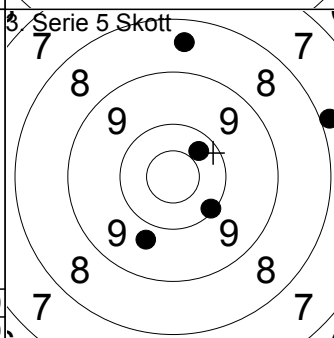

1: 9.7 ↓
2: 10.1 ↘
3: 8.5 ↑
4: 7.9 →
5: 10.3 ↗

Serie 44.0
Total 140.0

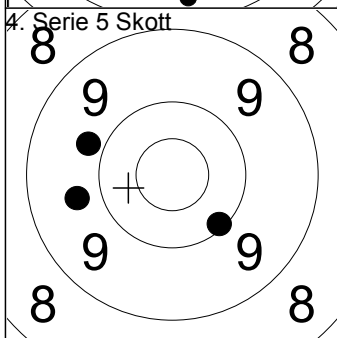

1: 9.8 ↖
2: 10.1 ↘
3: 9.7 ←

Serie 28.0
Total 168.0

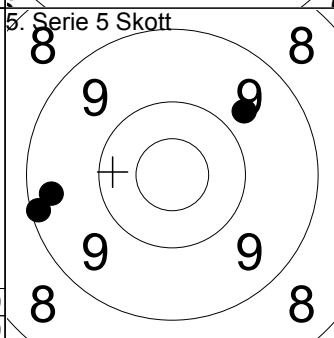

1: 9.1 ←
2: 9.7 ↗
3: 9.3 ←

Serie 27.0
Total 195.0

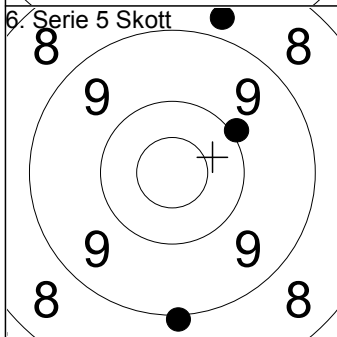

1: 9.0 ↓
2: 8.8 ↑
3: 10.0 ↗

Serie 27.0
Total 222.0

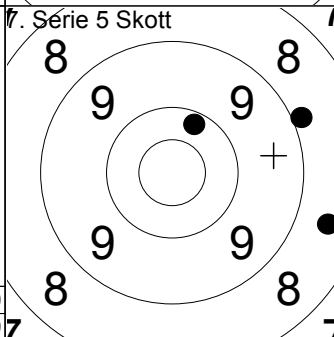

1: 10.2 ↗
2: 8.5 →
3: 8.9 ↗

Serie 26.0
Total 248.0

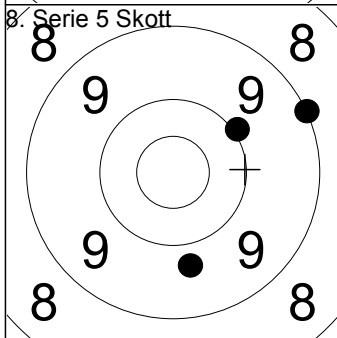

1: 10.0 ↗
2: 9.7 ↓
3: 9.0 ↗

Serie 28.0
Total 276.0

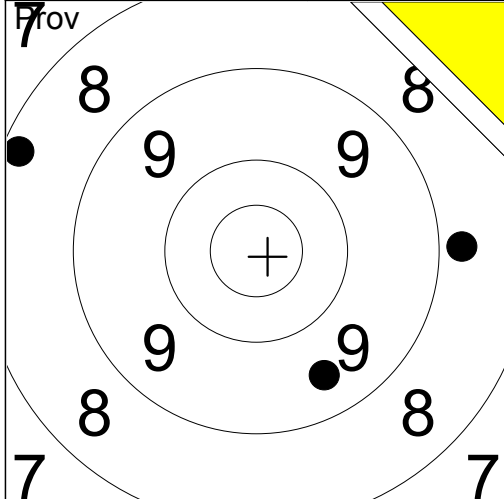

1:	8.8	→
2:	8.2	↖
3:	9.5	↘
Serie		25.0
Total		0.0

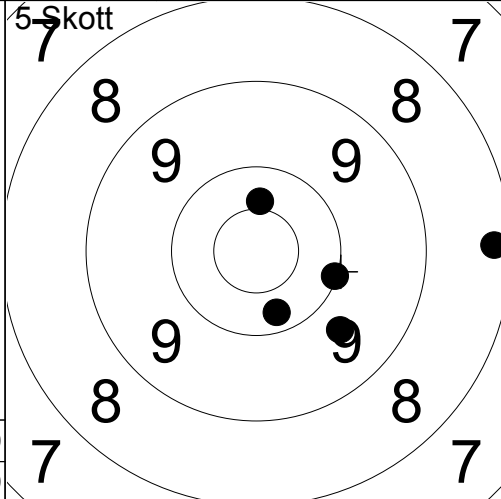

1:	9.7	↘
2:	10.4	↑
3:	10.2	↘
4:	8.2	→
5:	10.0	→
Serie		47.0
Total		47.0

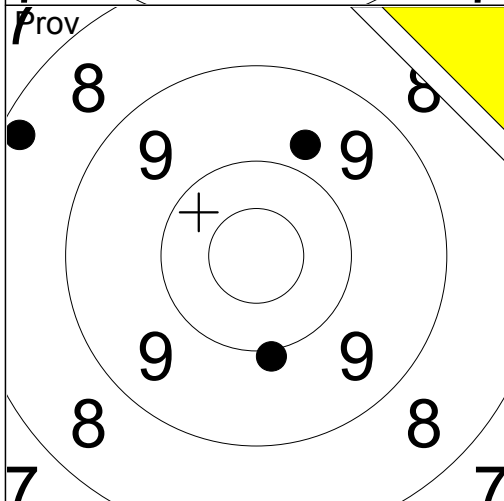

1:	10.0	↘
2:	9.7	↗
3:	8.2	↖
Serie		27.0
Total		47.0

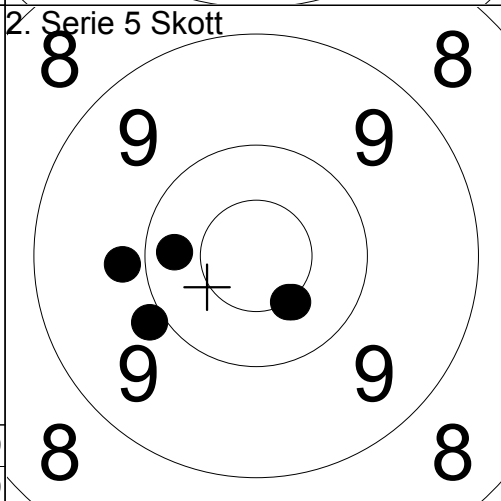

1:	10.3	←
2:	10.5x	↘
3:	9.8	←
4:	10.5x	↘
5:	9.9	↖
Serie		48.0
Total		95.0

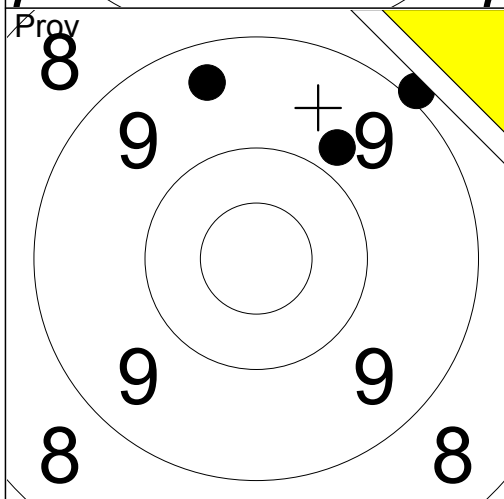

1:	9.4	↗
2:	9.8	↗
3:	8.9	↗
Serie		26.0
Total		95.0

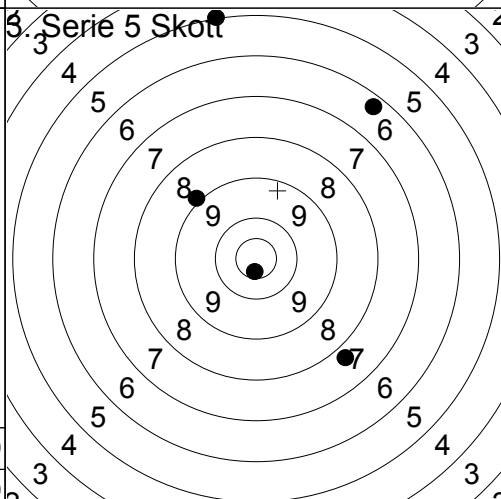

1:	10.7x	↘
2:	6.3	↗
3:	7.8	↘
4:	8.9	↗
5:	5.0	↑
Serie		36.0
Total		131.0

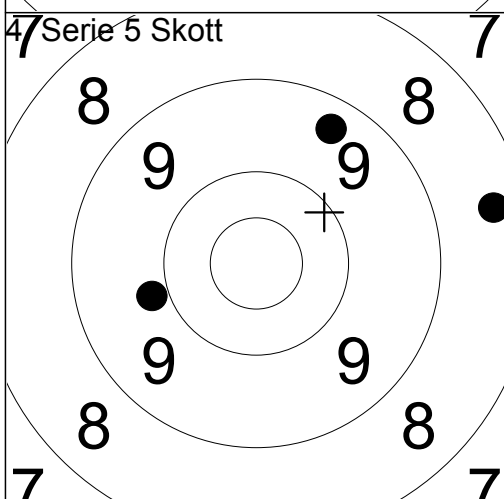

1:	9.4	↗
2:	9.8	←
3:	8.4	→
Serie		26.0
Total		157.0

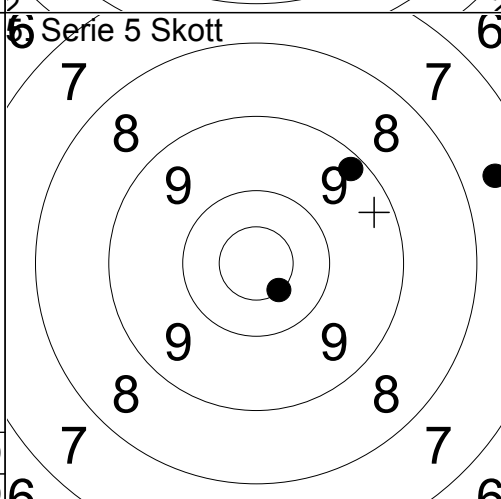

1:	9.2	↗
2:	10.5x	↘
3:	7.6	→
Serie		26.0
Total		183.0

Skjutlag
1

Tavla
10

Ramselefors 1

300m

Maja L, Dan-Ivan K, Marie W

Lag

10.07.2016

Tavelträffen Lagtävling 2016

Ramselefors SKF

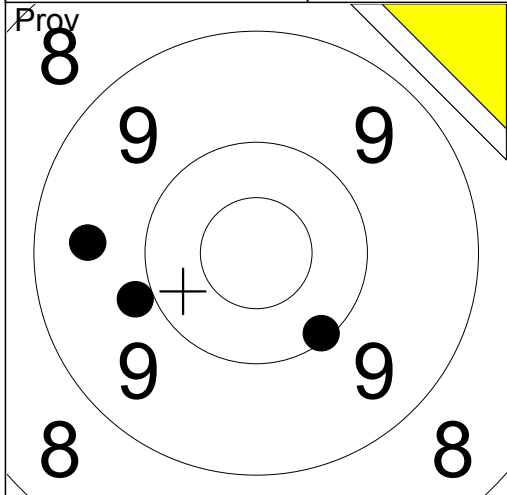

5 Skott

1:	10.1	↘
2:	9.5	←
3:	9.9	←
Serie	28.0	
Total	0.0	

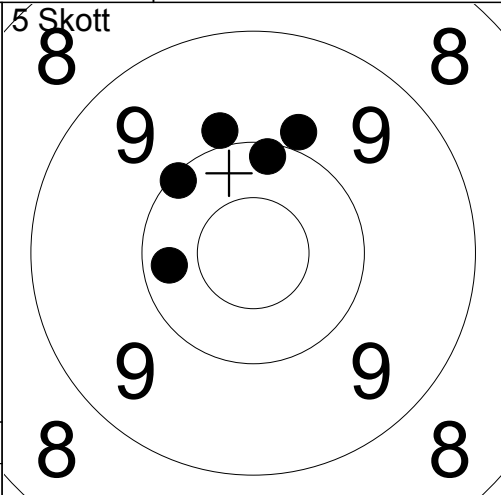

1:	9.9	↑
2:	10.2	←
3:	10.1	↗
4:	10.1	↑
5:	9.9	↗
Serie	48.0	
Total	48.0	

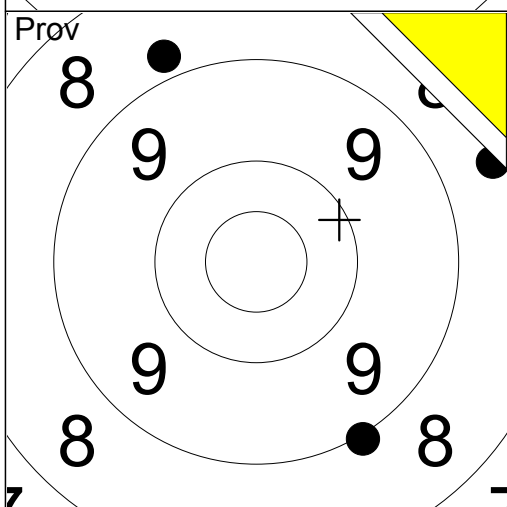

2. Serie 5 Skott

1:	8.8	↗
2:	8.5	→
3:	9.0	↘
Serie	25.0	
Total	48.0	

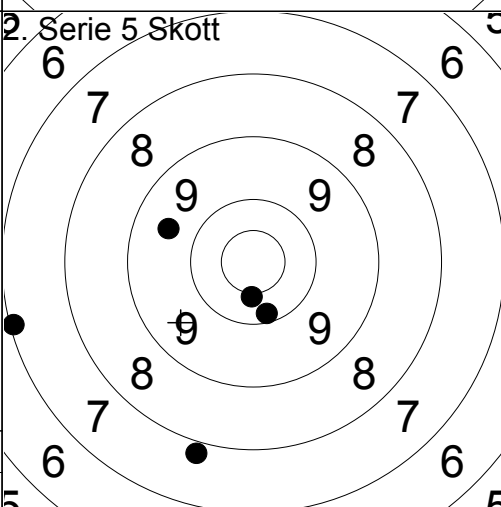

1:	7.9	↘
2:	10.2	↘
3:	10.4x	↘
4:	9.6	↖
5:	7.1	←
Serie	43.0	
Total	91.0	

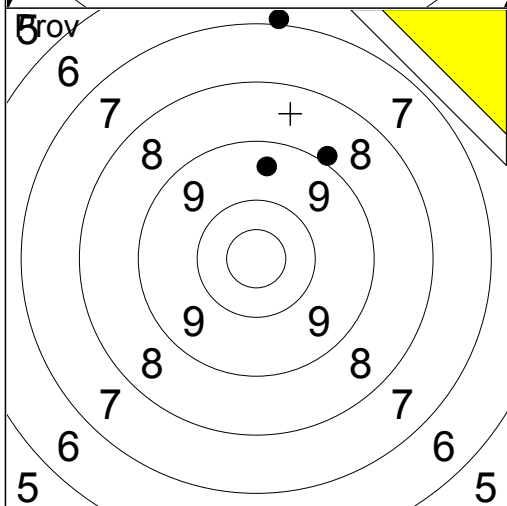

3. Serie 5 Skott

1:	9.5	↑
2:	8.9	↗
3:	6.9	↑
Serie	23.0	
Total	91.0	

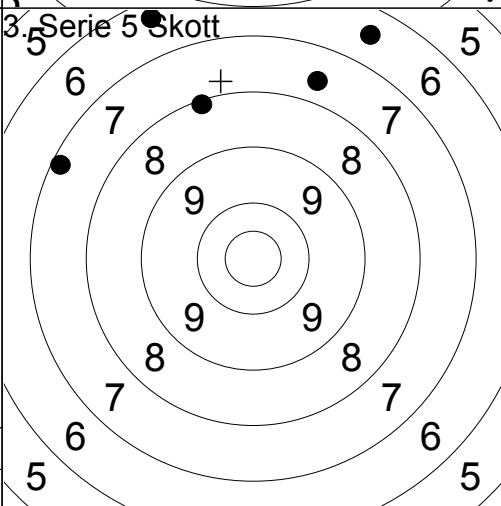

1:	7.6	↑
2:	8.1	↑
3:	6.5	↗
4:	6.4	↑
5:	7.2	↖
Serie	34.0	
Total	125.0	

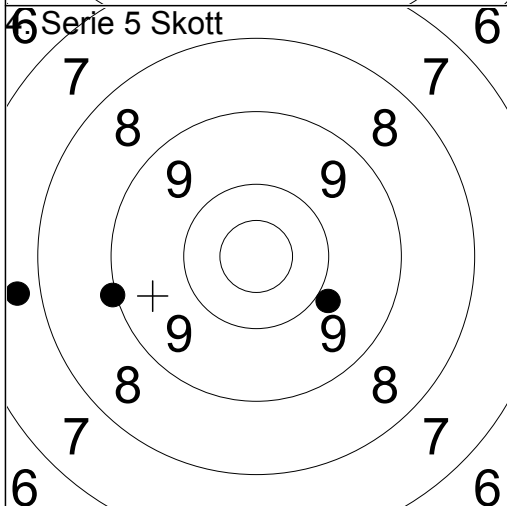

1:	9.9	↘
2:	9.0	←
3:	7.7	←
Serie	25.0	
Total	150.0	

Skjutlag 1 12 Tavla **Ununge**

300m Roger H, Peter L, Linda B Lag

10.07.2016 Tavelträffen Lagtävling 2016 Ramselefors SKF

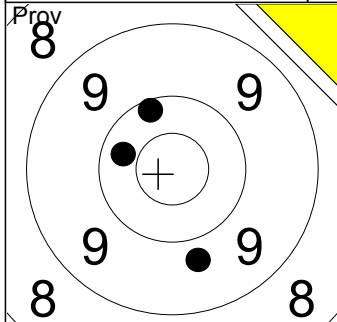

1: 10.1 ↗
 2: 10.3 ←
 3: 9.7 ↓

Serie 29.0
 Total 0.0

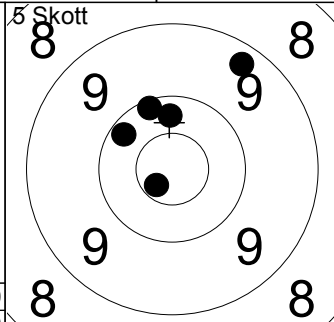

1: 10.7x ↖
 2: 9.3 ↗
 3: 10.1 ↗
 4: 10.2 ↖
 5: 10.3 ↑

Serie 49.0
 Total 49.0

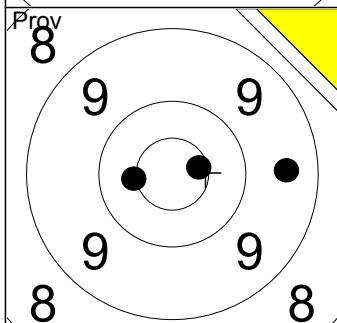

1: 10.6x →
 2: 9.5 →
 3: 10.5x ←

Serie 29.0
 Total 49.0

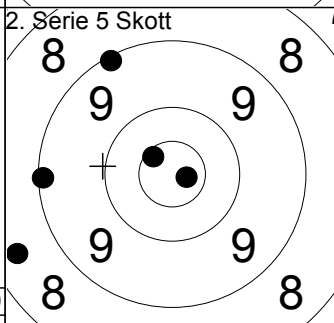

1: 9.1 ↗
 2: 9.1 ←
 3: 8.4 ←
 4: 10.8x →
 5: 10.6x ↗

Serie 46.0
 Total 95.0

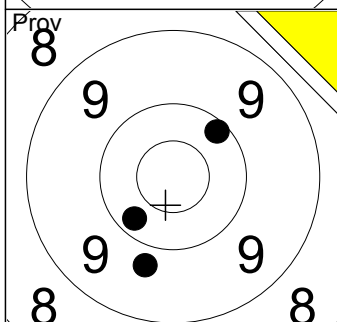

1: 10.2 ↖
 2: 10.2 ↗
 3: 9.8 ↓

Serie 29.0
 Total 95.0

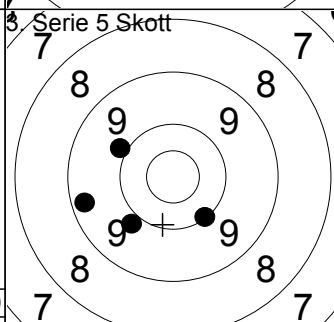

1: 9.9 ↖
 2: 9.8 ↖
 3: 7.5 ↖
 4: 9.3 ←
 5: 10.1 ↖

Serie 44.0
 Total 139.0

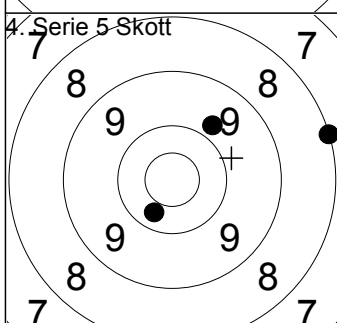

1: 10.3 ↖
 2: 8.0 →
 3: 9.8 ↗

Serie 27.0
 Total 166.0

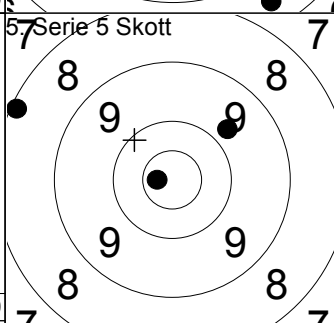

1: 10.7x ←
 2: 8.1 ↖
 3: 9.8 ↗

Serie 27.0
 Total 193.0

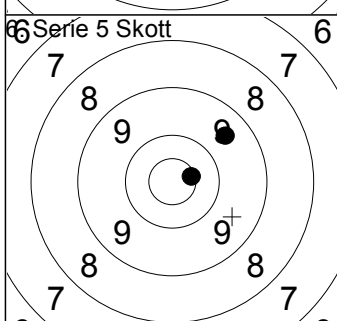

1: 10.6x →
 2: 9.5 ↗
 3: 7.0 ↓

Serie 26.0
 Total 219.0

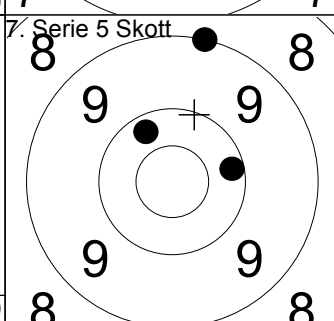

1: 10.2 ↗
 2: 9.0 ↑
 3: 10.2 →

Serie 29.0
 Total 248.0

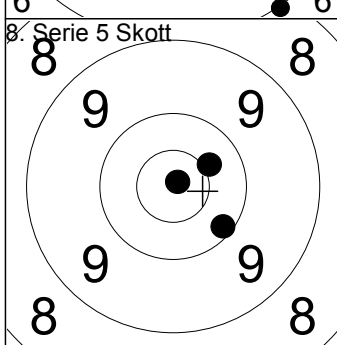

1: 10.9x ↗
 2: 10.1 ↘
 3: 10.4x ↗

Serie 30.0
 Total 278.0

1. Prov 	5. Skott 	
Serie 26.0	Serie 46.0	
Total 0.0	Total 46.0	

2. Prov 	2. Serie 5 Skott 	
Serie 29.0	Serie 47.0	
Total 46.0	Total 93.0	

3. Prov 	3. Serie 5 Skott 	
Serie 27.0	Serie 45.0	
Total 93.0	Total 138.0	

4. Serie 5 Skott 	5. Serie 5 Skott 	
Serie 24.0	Serie 26.0	
Total 162.0	Total 188.0	

6. Serie 5 Skott 	7. Serie 5 Skott 	
Serie 29.0	Serie 26.0	
Total 217.0	Total 243.0	

300m Elina L, Markus A, Sara B Lag

10.07.2016 Tavelträffen Lagtävling 2016 Ramselefors SKF

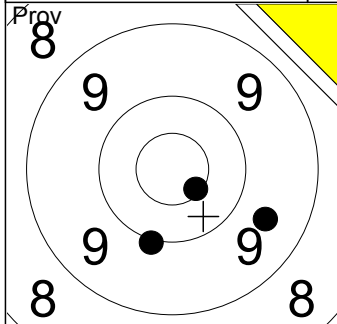

1: 10.6x
2: 9.6
3: 10.0

Serie 29.0
Total 0.0

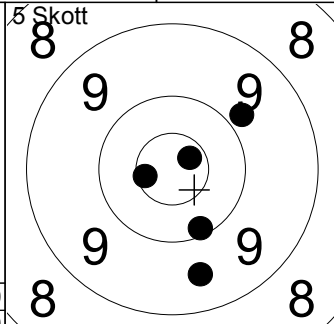

5 Skott

1: 9.8
2: 10.7x
3: 9.5
4: 10.6x
5: 10.1

Serie 48.0
Total 48.0

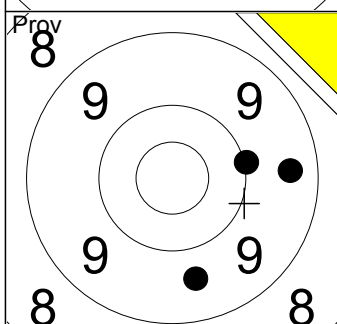

1: 10.0
2: 9.6
3: 9.4

Serie 28.0
Total 48.0

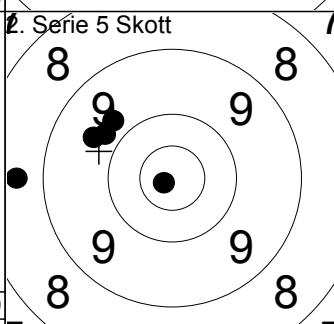

2. Serie 5 Skott

1: 9.7
2: 9.7
3: 10.8x
4: 8.6
5: 9.8

Serie 45.0
Total 93.0

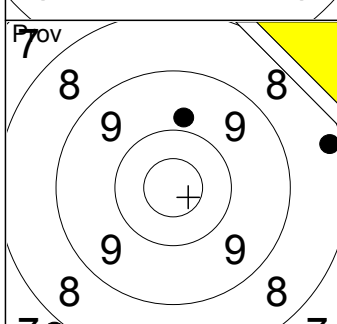

1: 8.2
2: 7.8
3: 9.8

Serie 24.0
Total 93.0

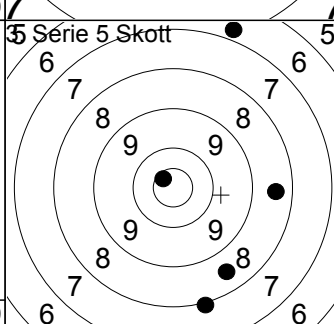

5 Serie 5 Skott

1: 8.4
2: 6.8
3: 8.0
4: 10.6x
5: 8.5

Serie 40.0
Total 133.0

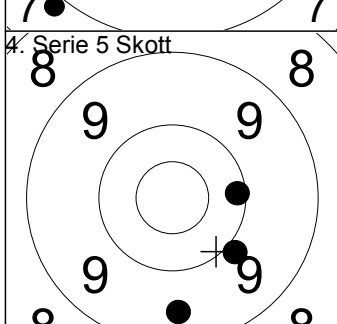

4. Serie 5 Skott

1: 9.9
2: 9.5
3: 10.1

Serie 28.0
Total 161.0

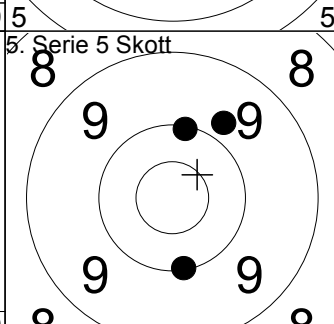

5. Serie 5 Skott

1: 10.0
2: 10.1
3: 9.8

Serie 29.0
Total 190.0

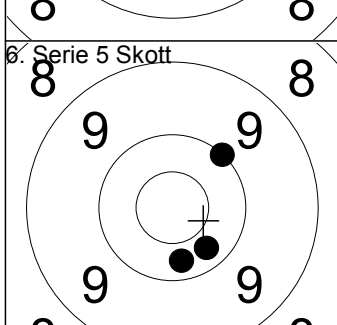

6. Serie 5 Skott

1: 10.0
2: 10.3
3: 10.3

Serie 30.0
Total 220.0

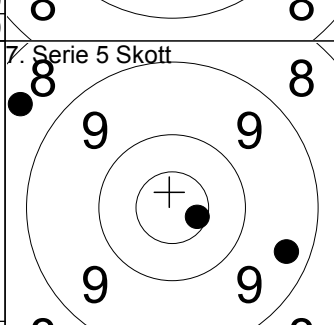

7. Serie 5 Skott

1: 10.6x
2: 9.4
3: 8.5

Serie 27.0
Total 247.0

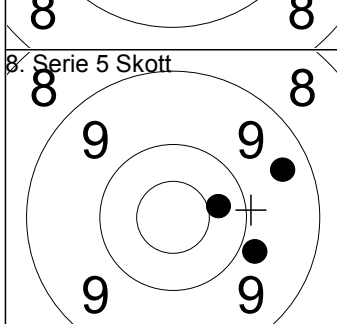

8. Serie 5 Skott

1: 10.4
2: 9.8
3: 9.4

Serie 28.0
Total 275.0

Skjutlag
1

Tavla
18

Fyrkanten

300m

Håkan L, Tomas L, Roger A

Lag

10.07.2016

Tavelträffen Lagtävling 2016

Ramselefors SKF

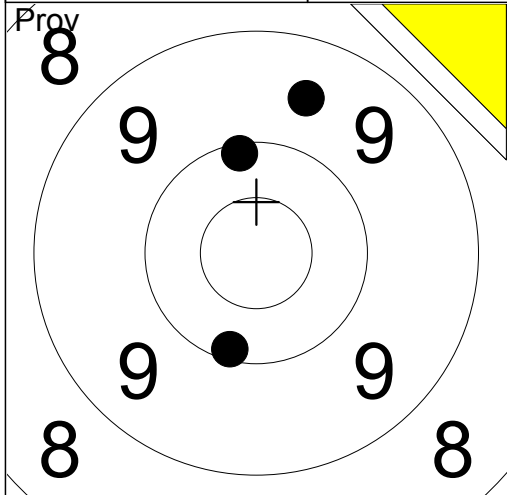

1: 9.6 ↗
2: 10.1 ↗
3: 10.1 ↘

Serie 29.0
Total 0.0

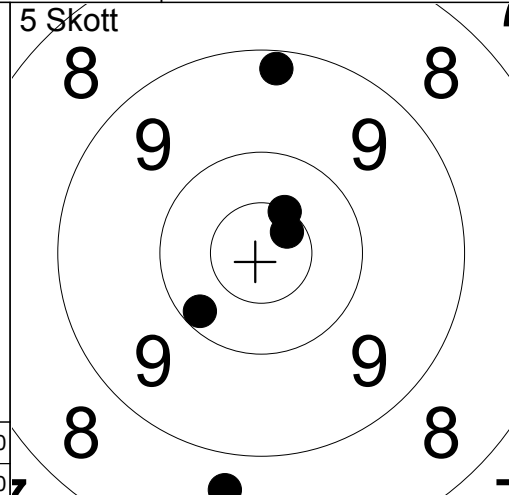

1: 9.2 ↗
2: 10.2 ↘
3: 10.6x ↗
4: 10.5x ↗
5: 8.7 ↘

Serie 47.0
Total 47.0

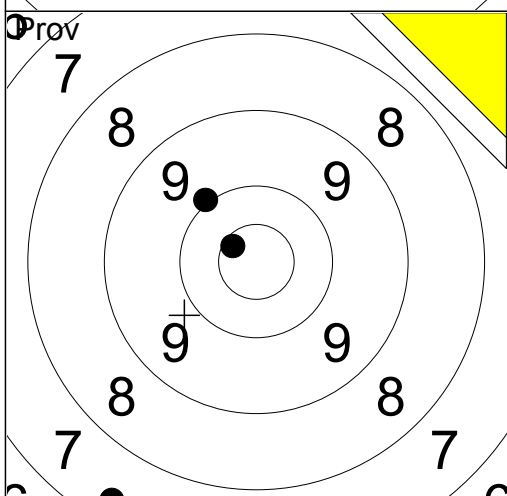

1: 10.6x ↘
2: 7.4 ↘
3: 10.0 ↗

Serie 27.0
Total 47.0

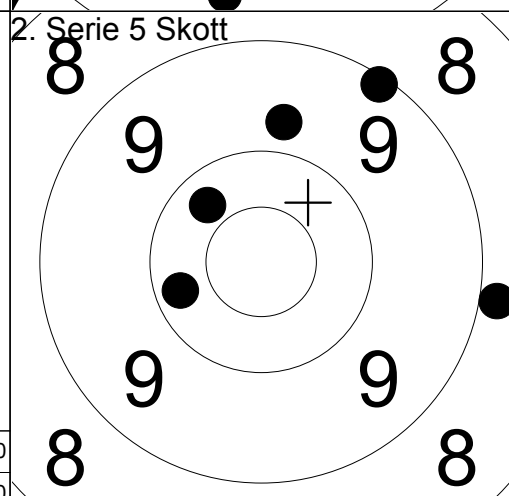

1: 10.2 ↖
2: 9.8 ↗
3: 10.3 ↗
4: 8.9 →
5: 9.1 ↗

Serie 46.0
Total 93.0

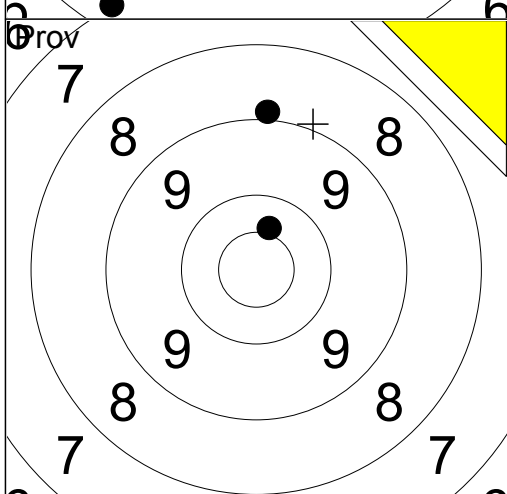

1: 7.3 ↗
2: 8.9 ↗
3: 10.4x ↗

Serie 25.0
Total 93.0

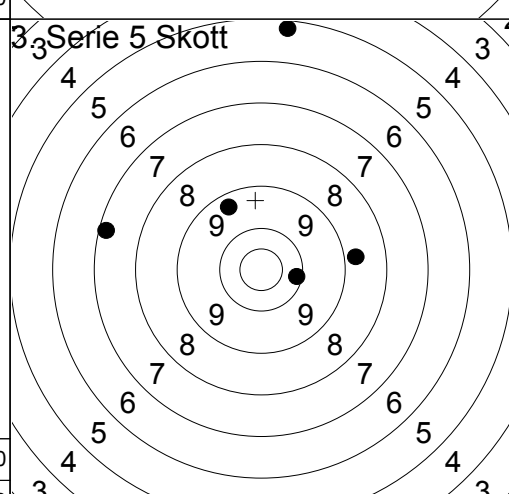

1: 10.2 →
2: 5.2 ↗
3: 8.7 →
4: 7.2 ↖
5: 9.3 ↗

Serie 39.0
Total 132.0

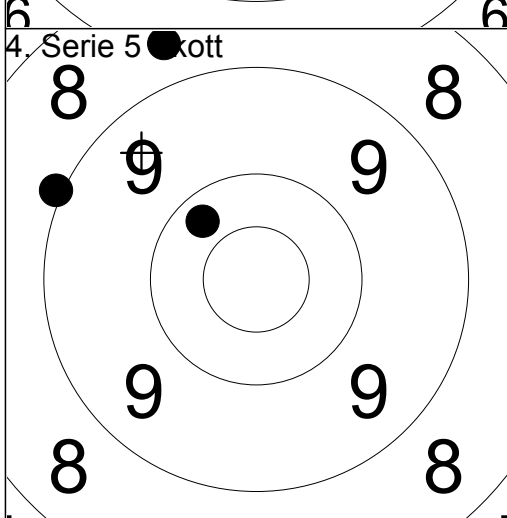

1: 10.3 ↖
2: 9.0 ↖
3: 8.6 ↗

Serie 27.0
Total 159.0

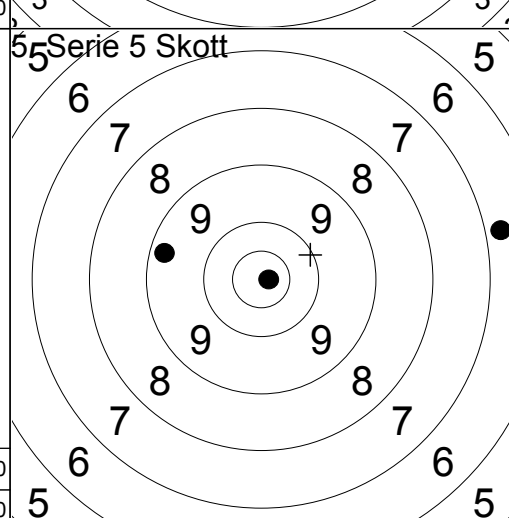

1: 10.8x →
2: 9.3 ↖
3: 6.8 →

Serie 25.0
Total 184.0

Skjutlag
1 20

Två norrmän och en svensk

300m Felicia A, Hans B, Oddvar H Lag

10.07.2016 Tavelträffen Lagtävling 2016 Ramselefors SKF

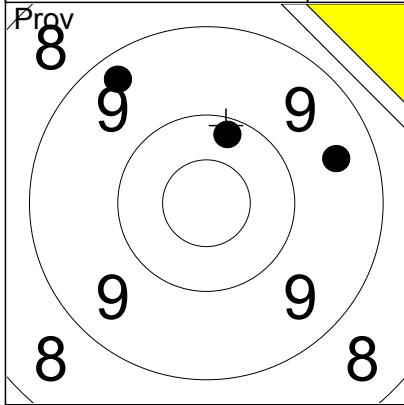

1: 10.2 ↑
2: 9.3 ↗
3: 9.5 →

Serie 28.0
Total 0.0

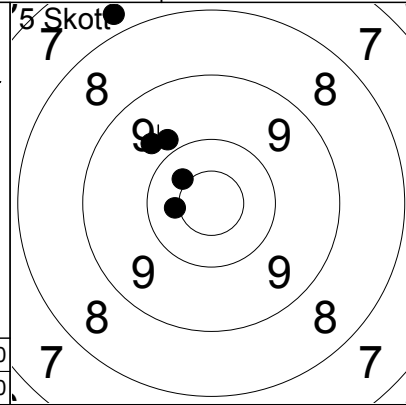

1: 7.7 ↗
2: 9.8 ↗
3: 9.7 ↗
4: 10.4 ↗
5: 10.4x ←

Serie 45.0
Total 45.0

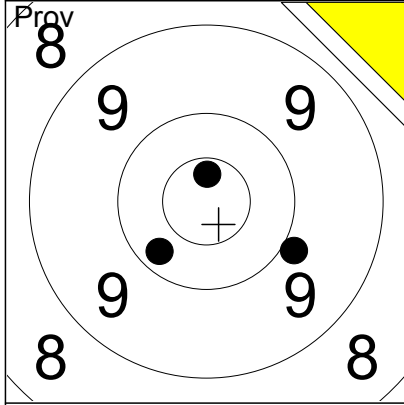

1: 9.9 →
2: 10.7x ↑
3: 10.2 ↘

Serie 29.0
Total 45.0

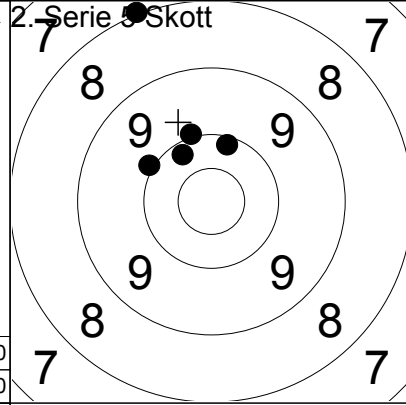

1: 8.0 ↑
2: 10.0 ↑
3: 10.1 ↑
4: 10.2 ↗
5: 10.0 ↑

Serie 48.0
Total 93.0

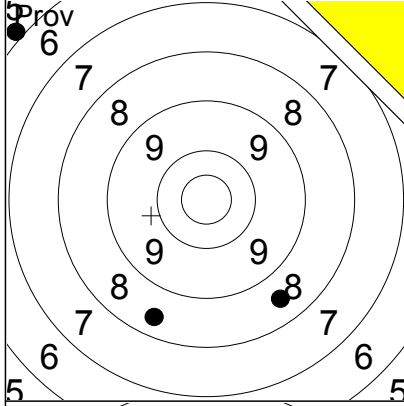

1: 5.9 ↗
2: 8.5 ↘
3: 8.4 ↘

Serie 21.0
Total 93.0

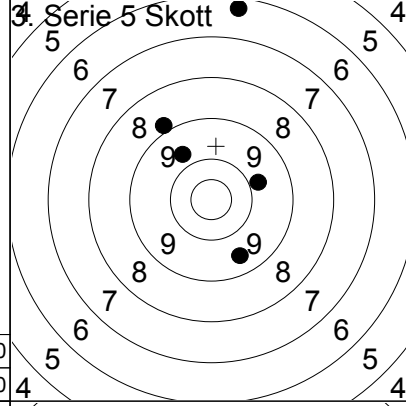

1: 9.5 ↓
2: 6.3 ↑
3: 8.9 ↗
4: 9.7 ↗
5: 9.8 →

Serie 41.0
Total 134.0

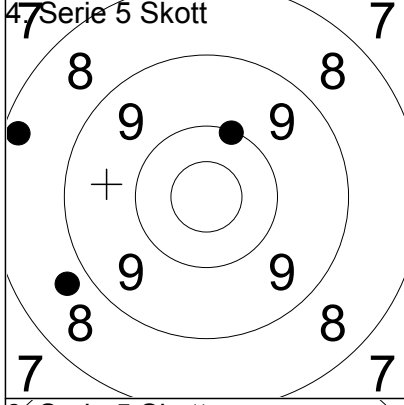

1: 10.1 ↑
2: 8.7 ←
3: 8.2 ←

Serie 26.0
Total 160.0

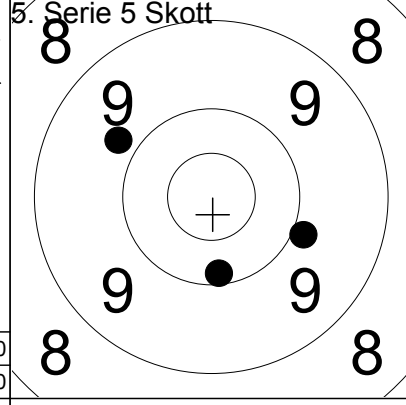

1: 9.8 ↗
2: 9.9 →
3: 10.1 ↓

Serie 28.0
Total 188.0

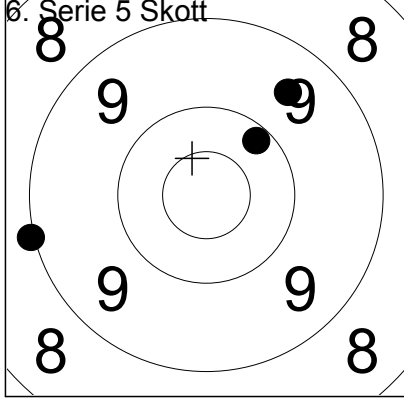

1: 9.5 ↗
2: 10.2 ↗
3: 9.0 ←

Serie 28.0
Total 216.0