

1:	10.2	↑
2:	9.5	↖
3:	9.0	←
4:	10.4	↗
5:	10.0	←
6:	9.6	←
7:	10.3	↗
8:	9.8	↘
9:	10.2	→
10:	10.4	↘
Serie	96.0	
Total	0.0	

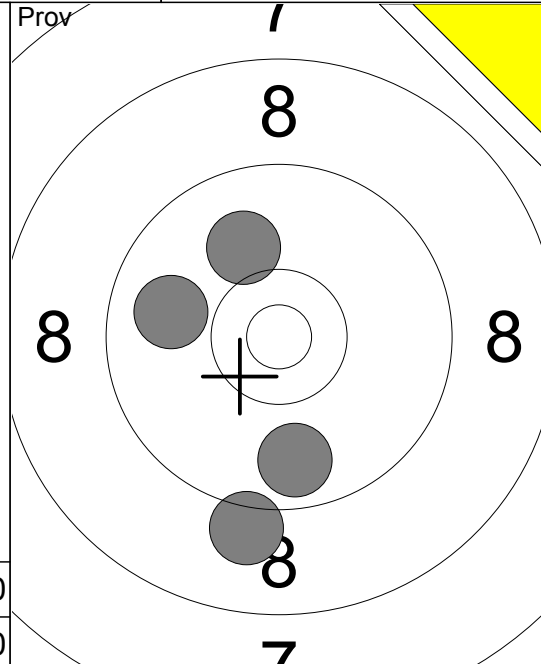

11:	9.9	←
12:	10.0	↗
13:	9.1	↓
14:	9.8	↘
Serie	37.0	
Total	0.0	

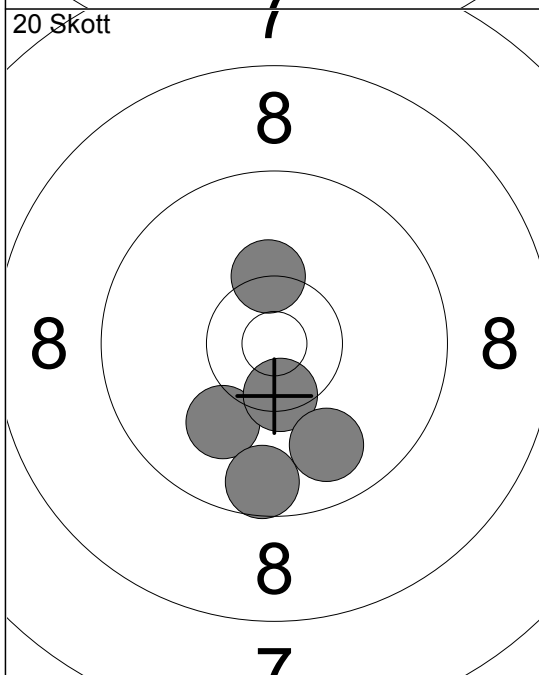

1:	10.1	↘
2:	9.6	↓
3:	10.5	↘
4:	10.3	↗
5:	9.9	↘
Serie	48.0	
Total	48.0	

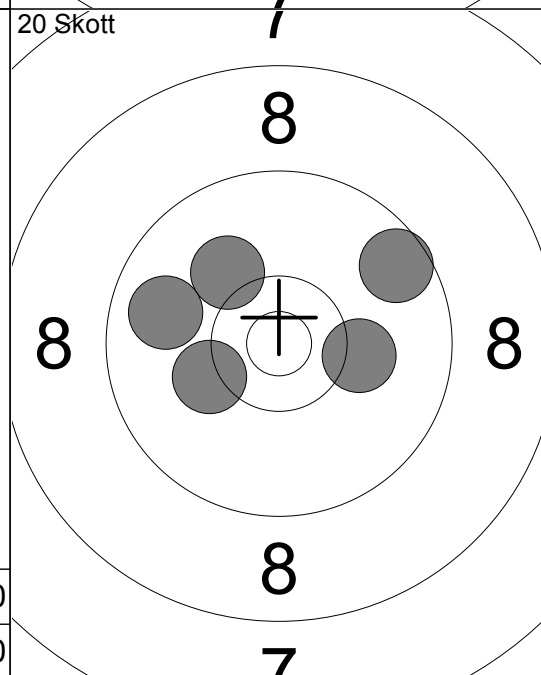

6:	9.6	↗
7:	10.1	↗
8:	9.8	←
9:	10.2	→
10:	10.2	↙
Serie	48.0	
Total	96.0	

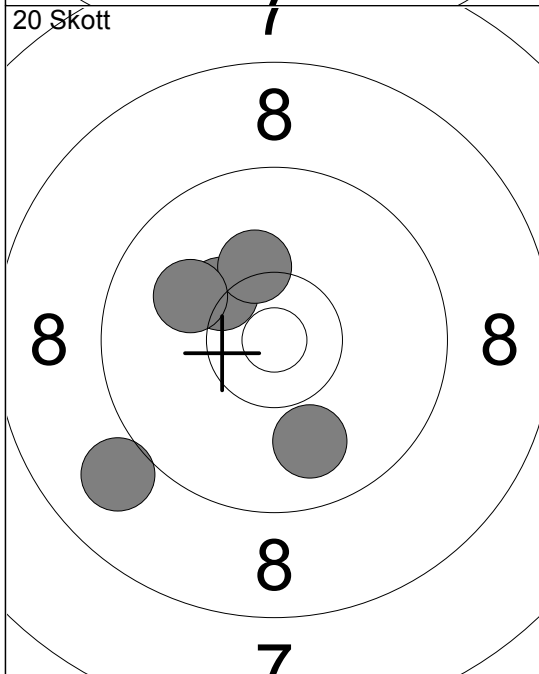

11:	10.3	↖
12:	9.9	↓
13:	9.0	←
14:	10.2	↑
15:	10.0	↖
Serie	48.0	
Total	144.0	

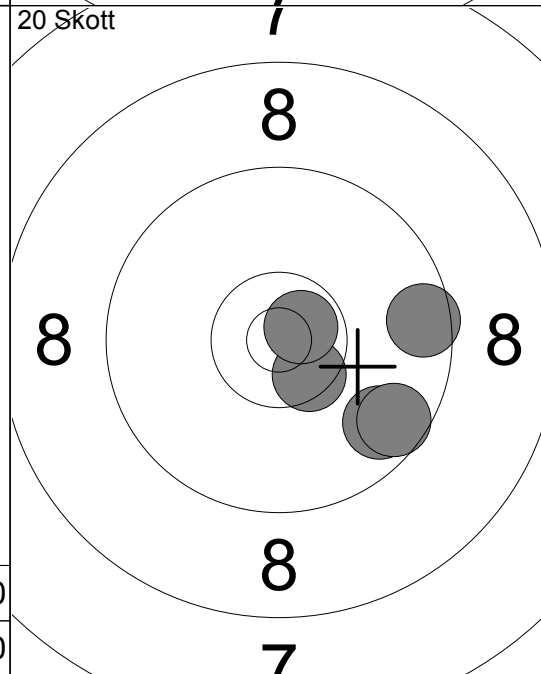

16:	10.5	↘
17:	9.6	→
18:	10.7	↗
19:	9.7	↘
20:	9.6	↘
Serie	47.0	
Total	191.0	

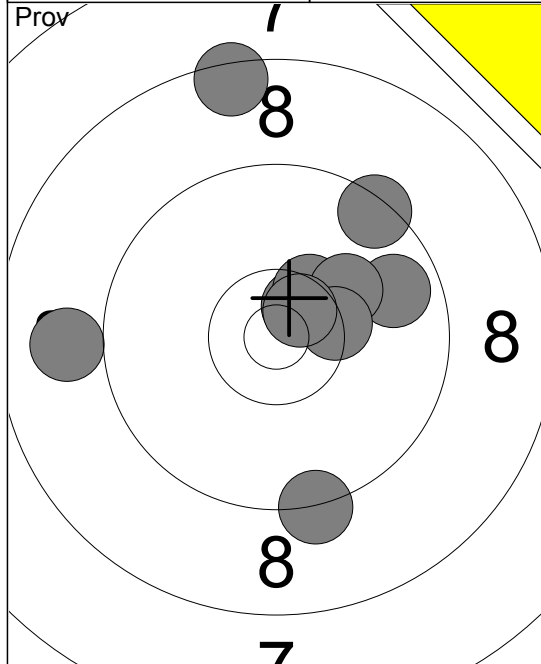

1:	9.3	↓
2:	9.8	→
3:	10.6	↗
4:	8.5	↑
5:	10.4	↗
6:	9.0	←
7:	10.2	↗
8:	9.4	↗
9:	10.4	→
10:	10.6	↗
Serie		94.0
Total		0.0

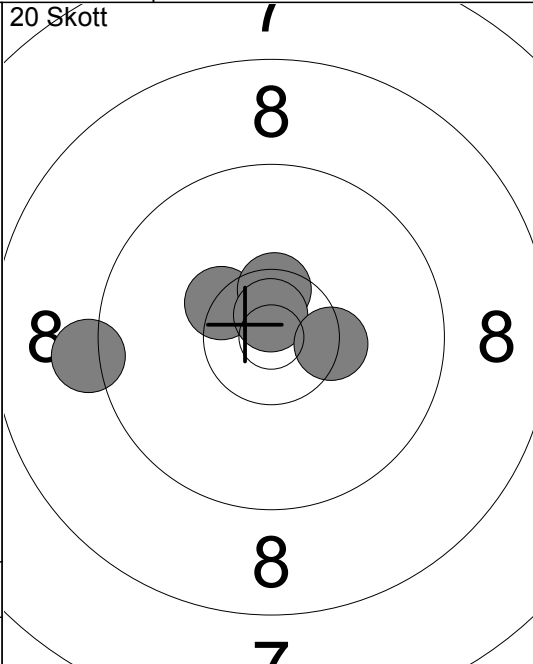

1:	10.4	↘
2:	10.5	↑
3:	9.2	←
4:	10.7	↗
5:	10.4	→
Serie		49.0
Total		49.0

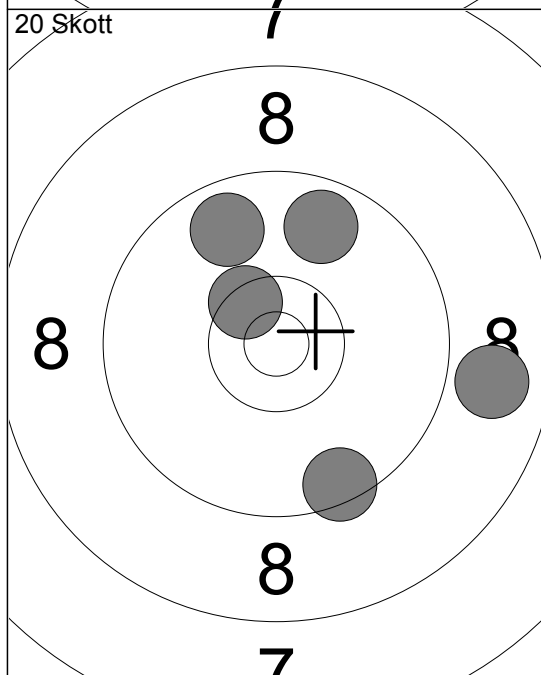

6:	9.5	↓
7:	8.9	→
8:	9.8	↑
9:	9.8	↑
10:	10.5	↘
Serie		45.0
Total		94.0

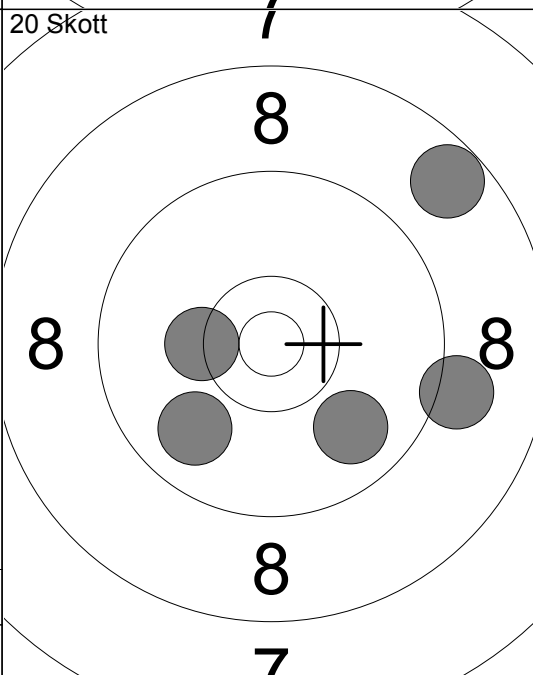

11:	8.7	↗
12:	9.1	→
13:	9.9	↙
14:	10.3	←
15:	9.9	↘
Serie		45.0
Total		139.0

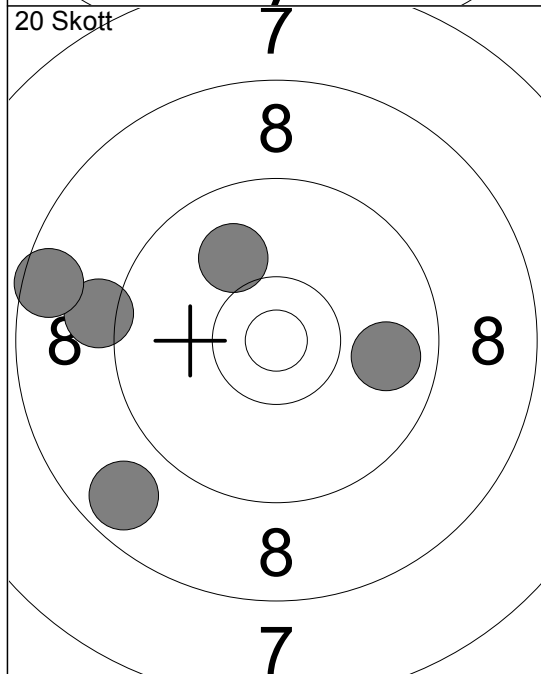

16:	9.8	→
17:	8.7	↙
18:	10.0	↖
19:	9.1	←
20:	8.6	←
Serie		44.0
Total		183.0

Skjutlag 1 Tavla 3 **Torvald Andersson**

50m Bälunge-Jumkil Vet-L Up

12.07.2016 Tavelträffen Korthåll 2016 Ramselefors SKF

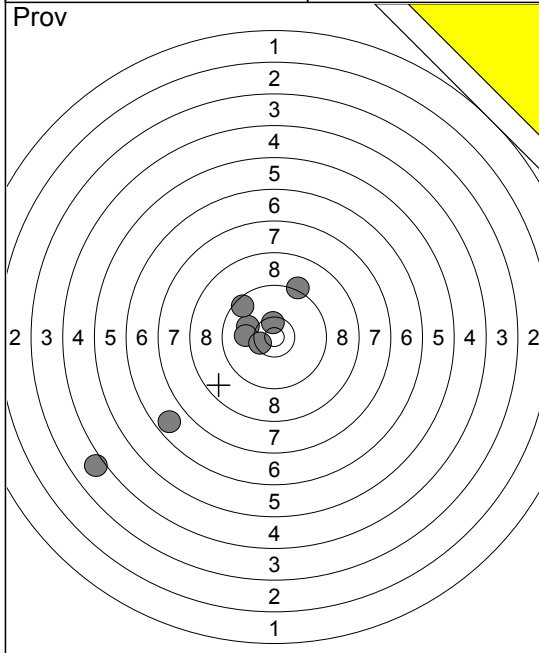

1:	0.0	↓
2:	4.0	↙
3:	6.7	↙
4:	10.1	↖
5:	10.1	↖
6:	10.5	↘
7:	9.6	↖
8:	10.5	↗
9:	9.2	↗
Serie	68.0	
Total	0.0	

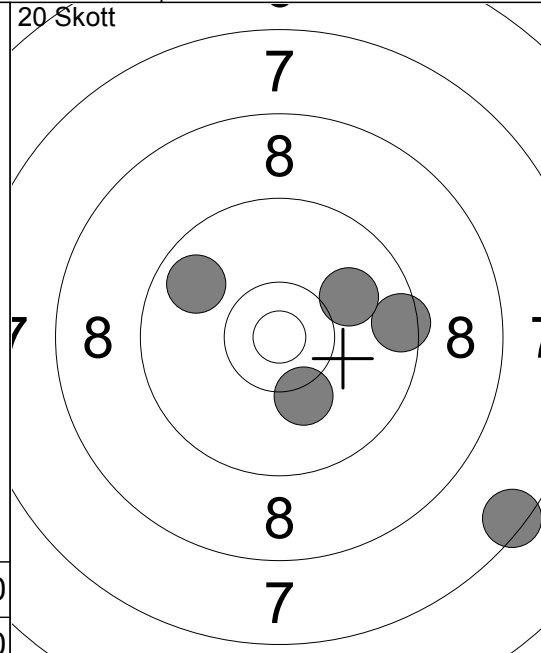

1:	7.5	↘
2:	9.5	→
3:	9.8	↖
4:	10.0	↗
5:	10.2	↓
Serie	45.0	
Total	45.0	

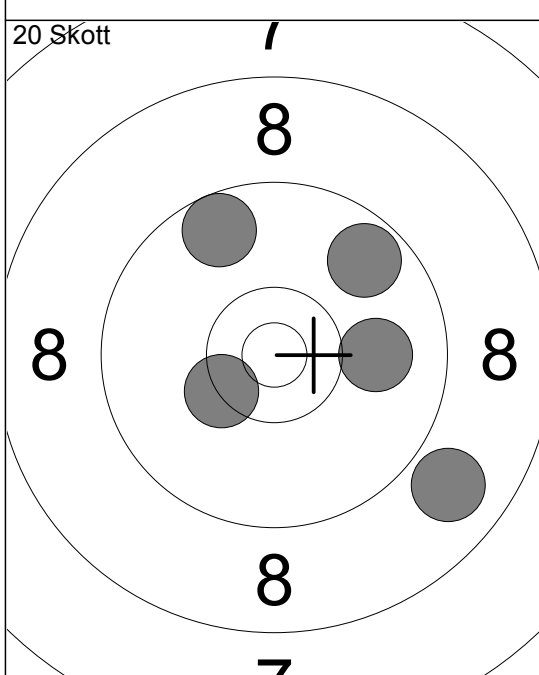

6:	9.7	↗
7:	10.0	→
8:	8.9	↘
9:	9.6	↗
10:	10.3	↘
Serie	46.0	
Total	91.0	

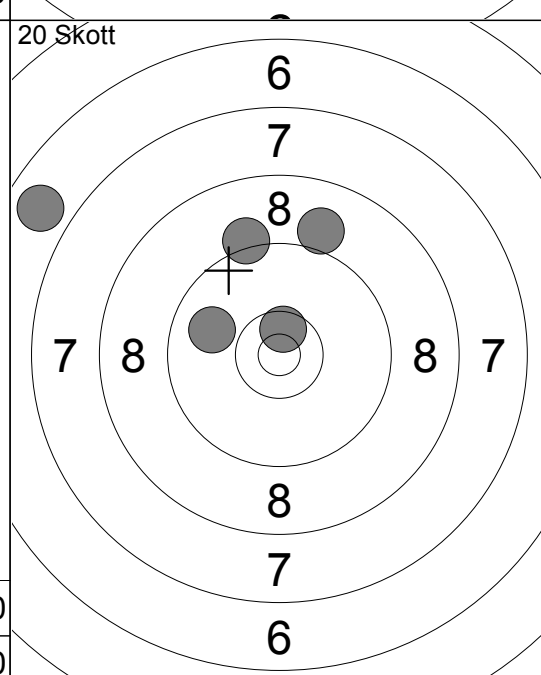

11:	6.8	↖
12:	9.2	↗
13:	10.6	↗
14:	9.9	↖
15:	9.0	↗
Serie	43.0	
Total	134.0	

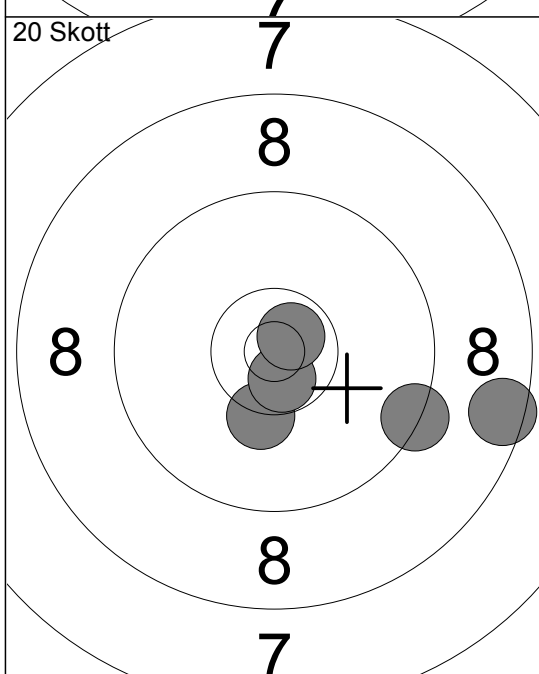

16:	10.3	↓
17:	8.5	→
18:	10.7	↘
19:	9.4	→
20:	10.7	↗
Serie	47.0	
Total	181.0	

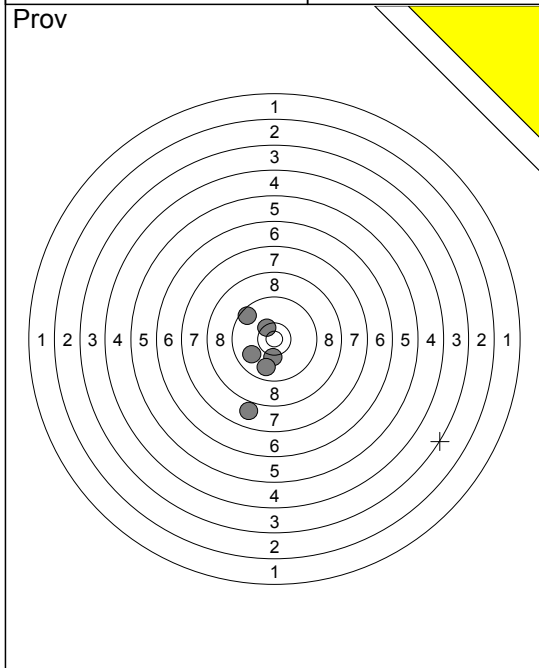

- 1: 0.0 ↘
- 2: 0.0 ↘
- 3: 0.0 →
- 4: 0.0 →
- 5: 7.9 ↓
- 6: 10.4x ↘
- 7: 9.5 ↗
- 8: 10.2 ↓
- 9: 9.9 ↙
- 10: 9.8 ↓

Serie 54.0
Total 0.0

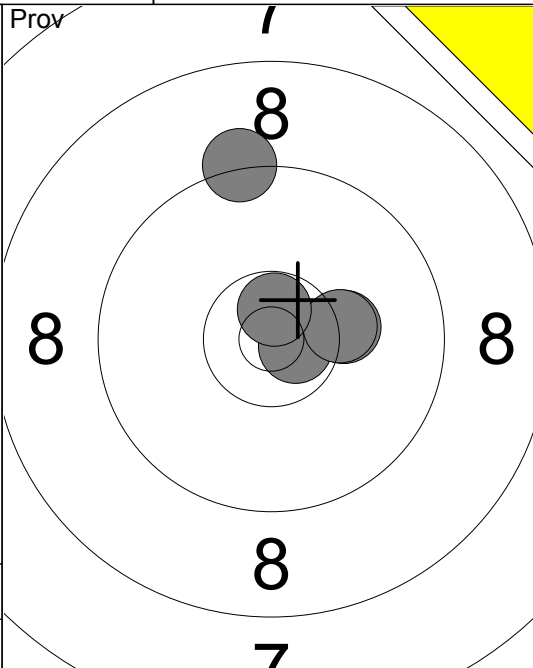

- 11: 9.3 ↑
- 12: 10.2 →
- 13: 10.7x →
- 14: 10.3 →
- 15: 10.7x ↑

Serie 49.0
Total 0.0

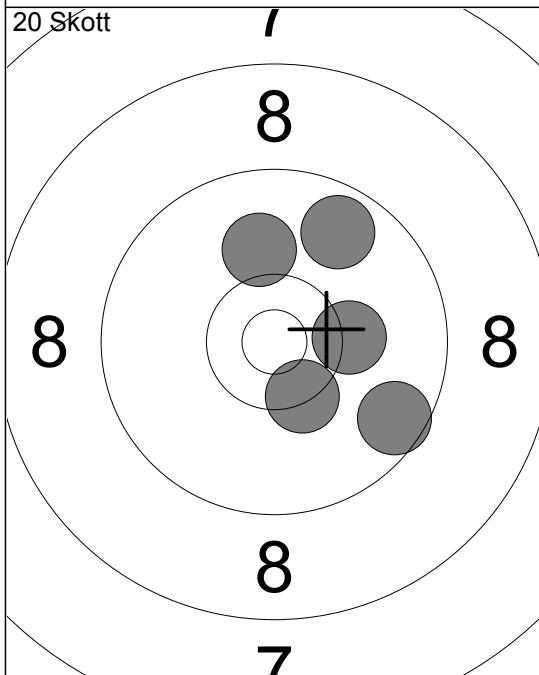

- 1: 9.6 ↘
- 2: 10.2 →
- 3: 10.4x ↓
- 4: 10.1 ↑
- 5: 9.7 ↗

Serie 48.0
Total 48.0

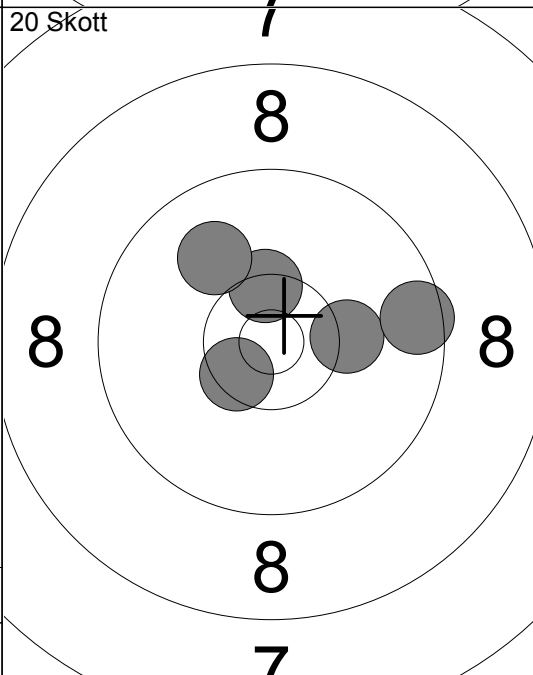

- 6: 10.4x ↑
- 7: 10.2 →
- 8: 9.5 →
- 9: 10.0 ↗
- 10: 10.5x ↘

Serie 49.0
Total 97.0

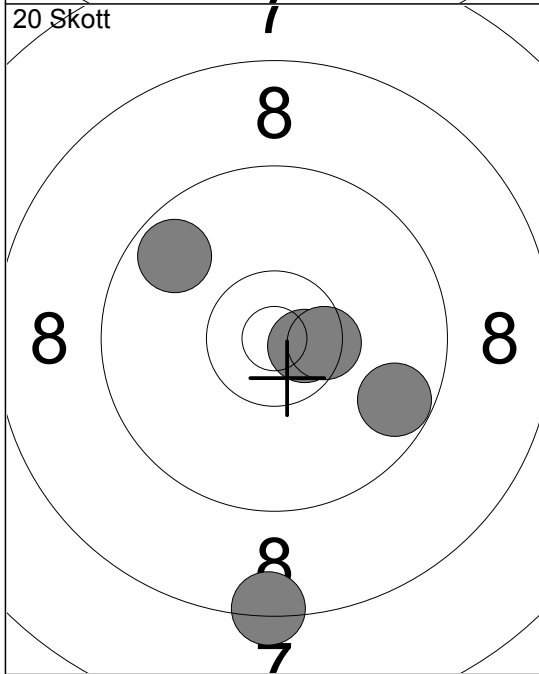

- 11: 9.7 ↙
- 12: 10.7x →
- 13: 10.5x →
- 14: 9.7 →
- 15: 8.4 ↓

Serie 46.0
Total 143.0

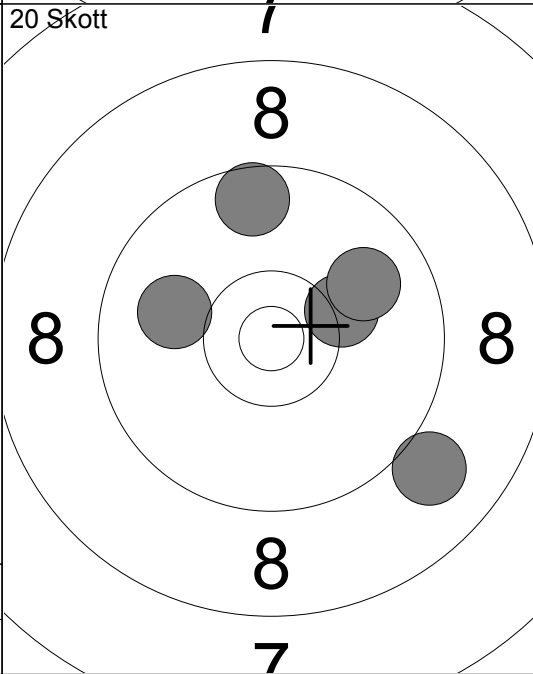

- 16: 10.0 ←
- 17: 9.0 ↓
- 18: 9.6 ↑
- 19: 10.2 →
- 20: 9.9 ↗

Serie 47.0
Total 190.0

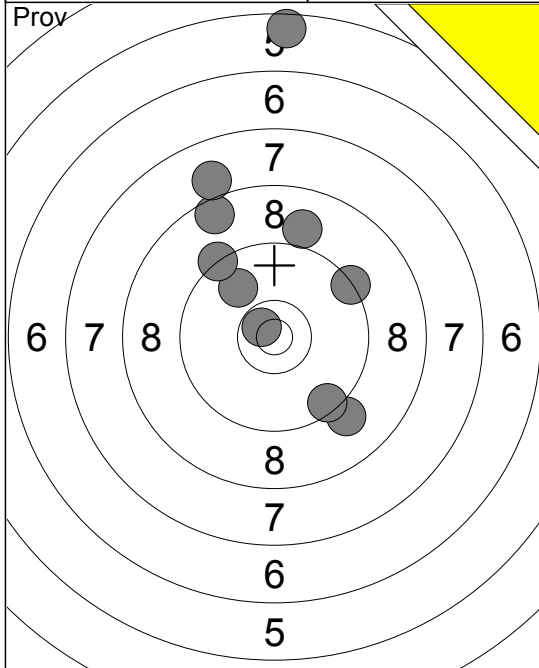

1:	5.6	↑
2:	8.6	↑
3:	9.0	↑
4:	9.3	↗
5:	8.0	↑
6:	9.9	↗
7:	9.3	↗
8:	10.7	↘
9:	9.1	↓
10:	9.5	↓
Serie	85.0	
Total	0.0	

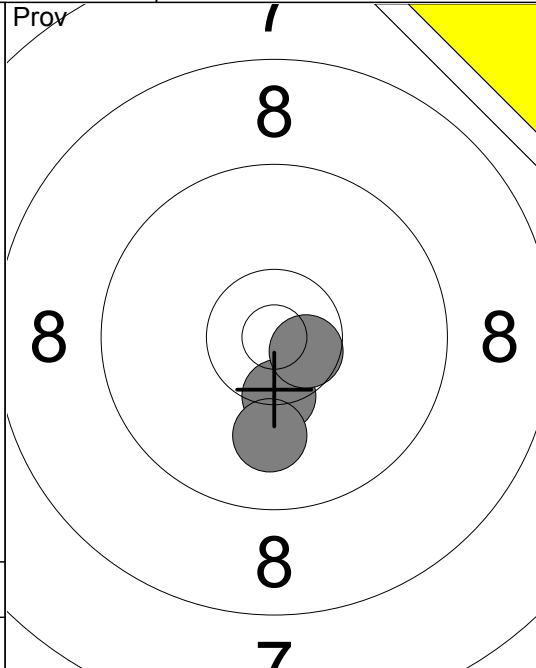

11:	10.4	↘
12:	10.6	↘
13:	10.0	↓
Serie	30.0	
Total	0.0	

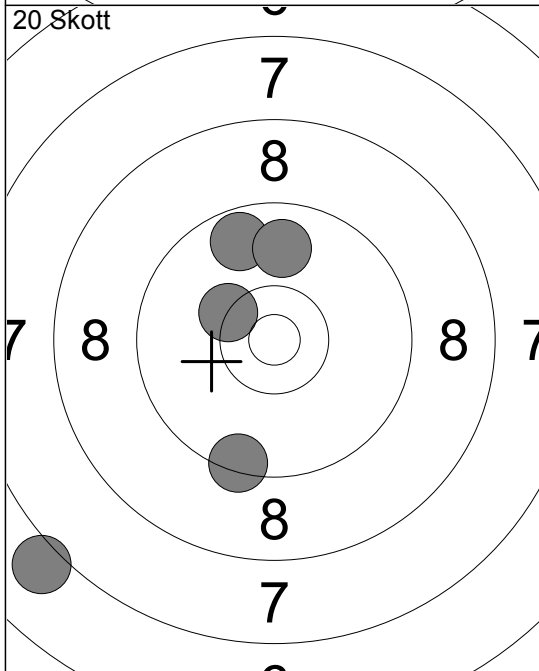

1:	9.7	↑
2:	9.4	↓
3:	9.8	↑
4:	10.3	↘
5:	7.1	↙
Serie	44.0	
Total	44.0	

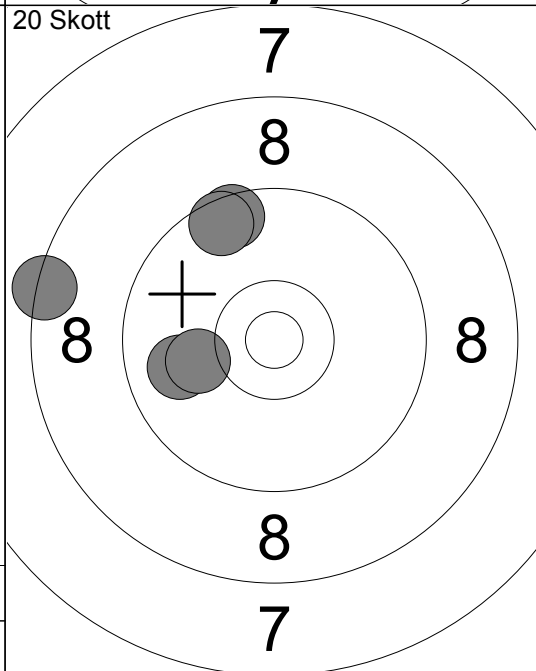

6:	9.5	↑
7:	9.9	←
8:	10.1	←
9:	9.6	↑
10:	8.4	←
Serie	45.0	
Total	89.0	

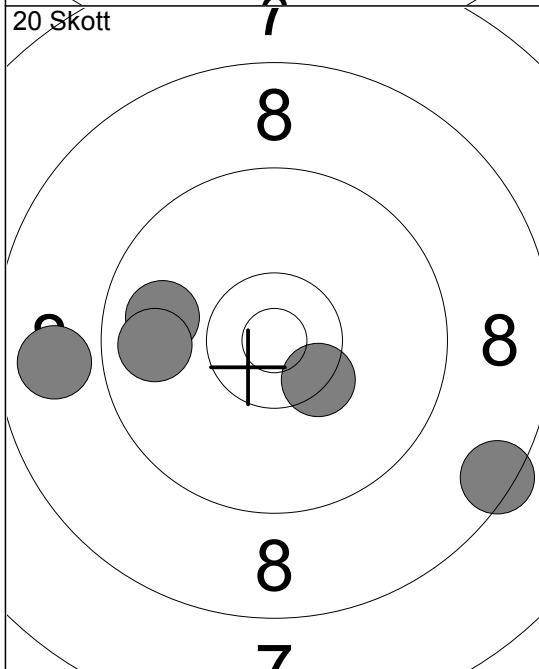

11:	8.5	↘
12:	10.4	↘
13:	8.8	←
14:	9.9	←
15:	9.8	←
Serie	44.0	
Total	133.0	

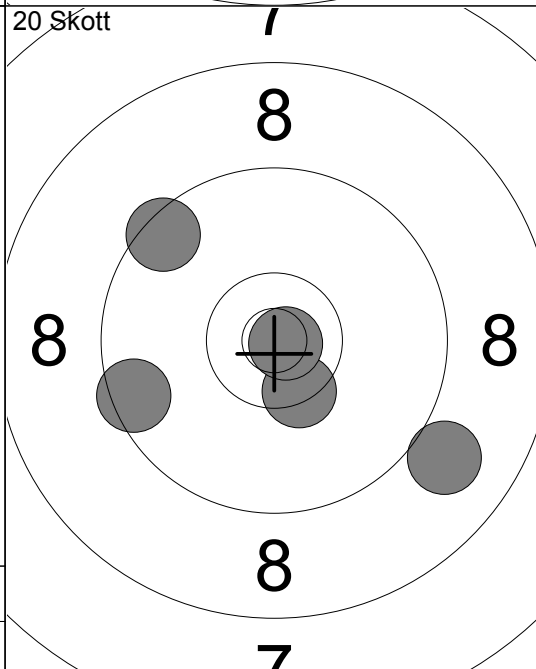

16:	10.4	↘
17:	10.8	↘
18:	9.0	↘
19:	9.5	↗
20:	9.5	←
Serie	47.0	
Total	180.0	

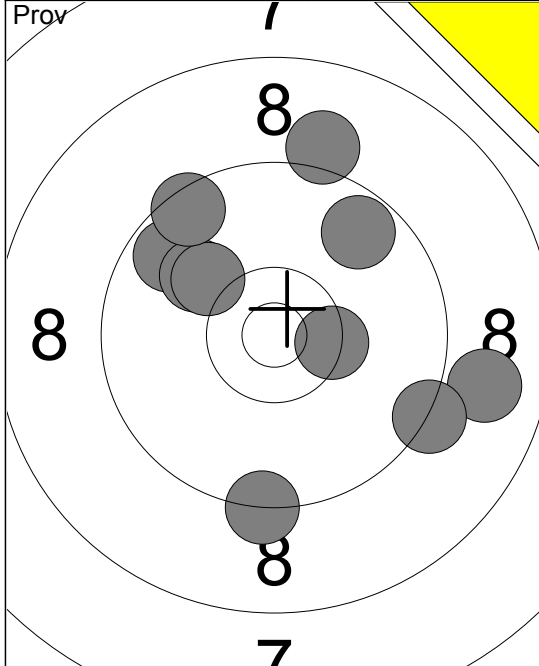

1:	9.3	↓
2:	9.7	↖
3:	10.0	↖
4:	10.1	↖
5:	9.5	↗
6:	9.7	↗
7:	9.1	↑
8:	10.4x	→
9:	8.9	→
10:	9.3	↘
Serie		92.0
Total		0.0

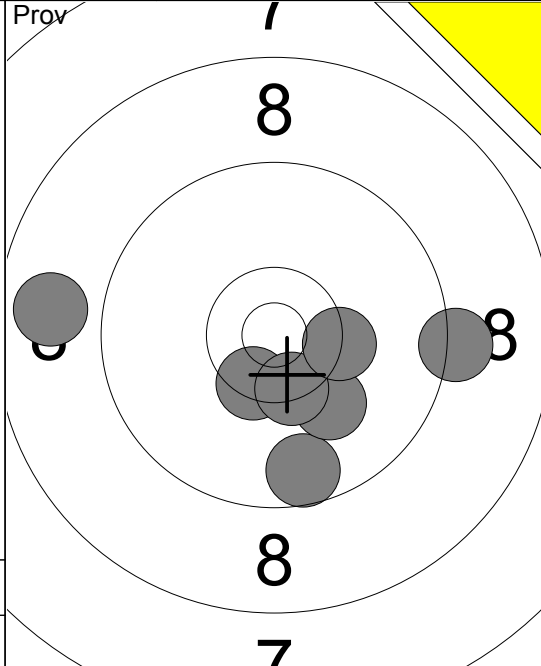

11:	8.8	←
12:	9.6	↓
13:	10.4x	↘
14:	9.2	→
15:	10.1	↘
16:	10.4x	↘
17:	10.3x	→
Serie		66.0
Total		0.0

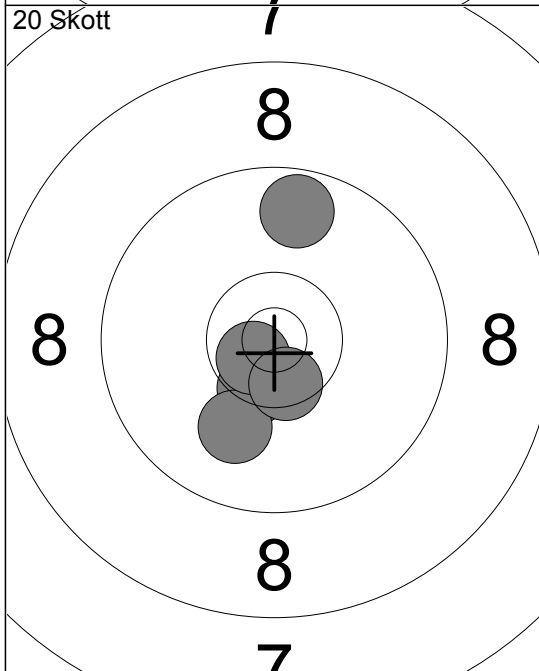

1:	10.4x	↘
2:	10.0	↓
3:	9.7	↑
4:	10.7x	↘
5:	10.5x	↘
Serie		49.0
Total		49.0

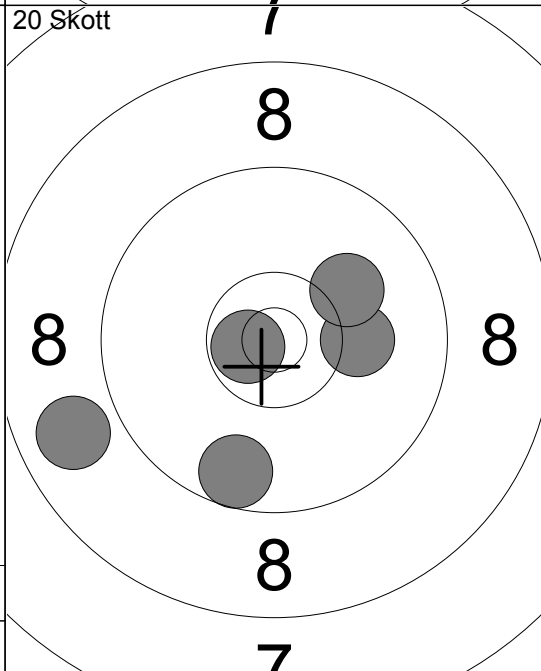

6:	10.2	→
7:	8.8	←
8:	9.6	↓
9:	10.1	↗
10:	10.7x	↘
Serie		47.0
Total		96.0

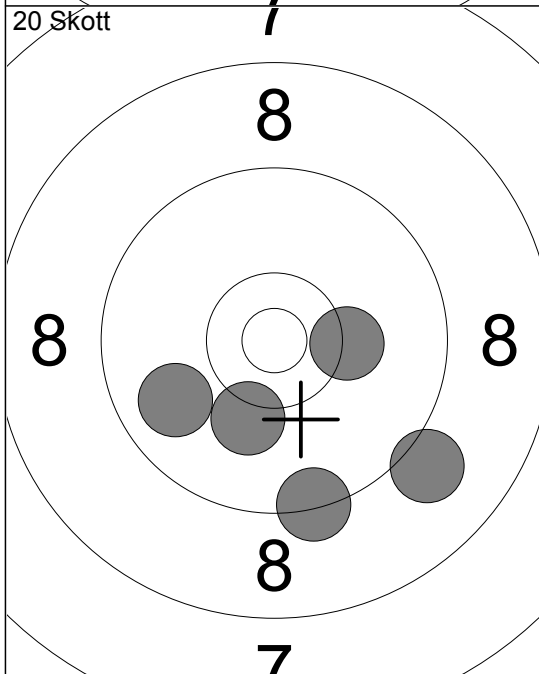

11:	9.1	↘
12:	10.2	↓
13:	10.3	→
14:	9.8	←
15:	9.3	↓
Serie		47.0
Total		143.0

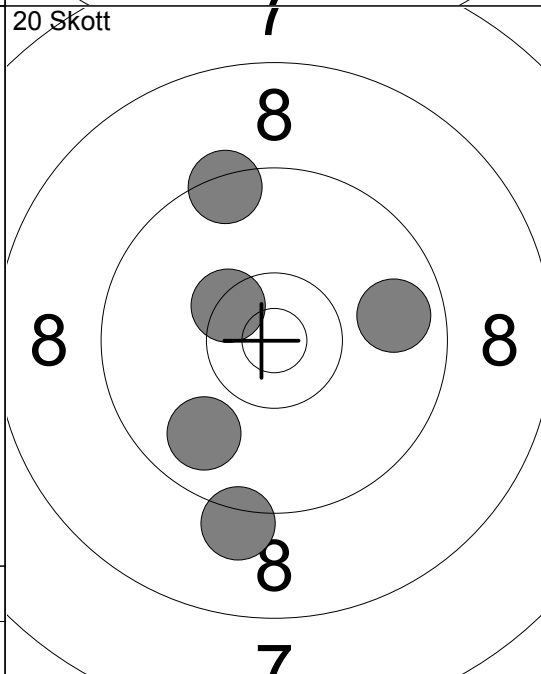

16:	9.2	↓
17:	9.8	↘
18:	10.4x	↘
19:	9.4	↑
20:	9.8	→
Serie		46.0
Total		189.0

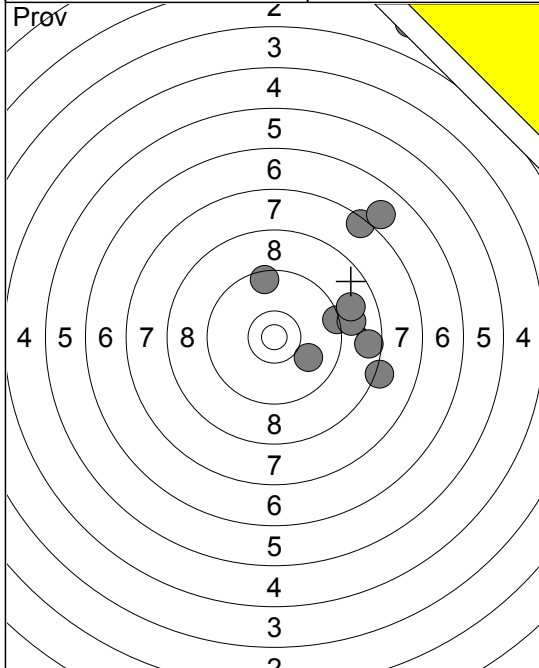

1:	2.5	↗
2:	7.4	↗
3:	8.6	→
4:	9.4	→
5:	8.2	→
6:	6.9	↗
7:	10.0	↘
8:	9.5	↑
9:	9.0	→
10:	8.9	→
Serie	76.0	
Total	0.0	

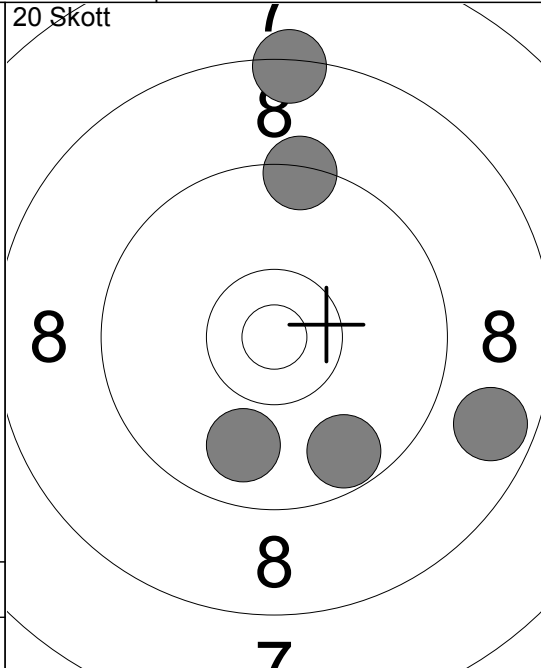

1:	9.7	↘
2:	8.7	→
3:	9.4	↑
4:	8.4	↑
5:	9.9	↘
Serie	43.0	
Total	43.0	

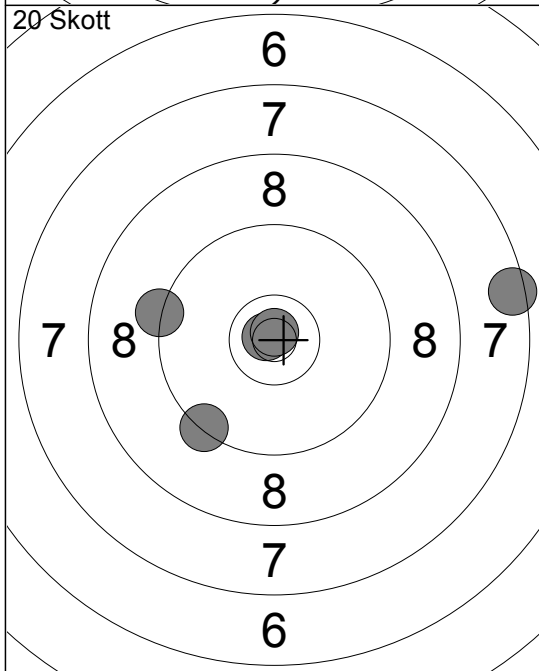

6:	9.3	←
7:	10.8	✗
8:	7.5	→
9:	10.8	↗
10:	9.3	↘
Serie	45.0	
Total	88.0	

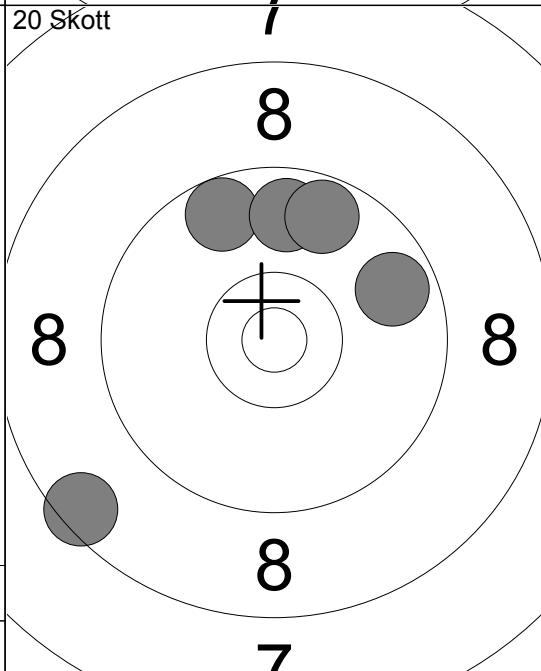

11:	9.7	↗
12:	9.8	↑
13:	8.5	↙
14:	9.7	↗
15:	9.7	→
Serie	44.0	
Total	132.0	

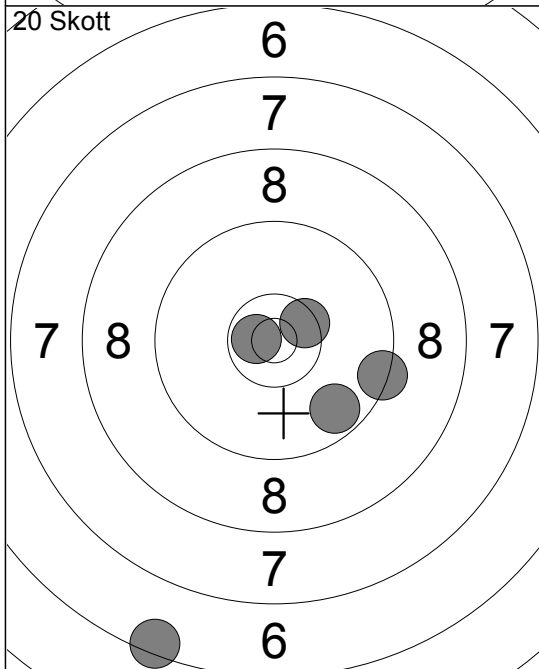

16:	6.4	↘
17:	10.5	↗
18:	9.4	→
19:	9.7	↘
20:	10.7	✗
Serie	44.0	
Total	176.0	

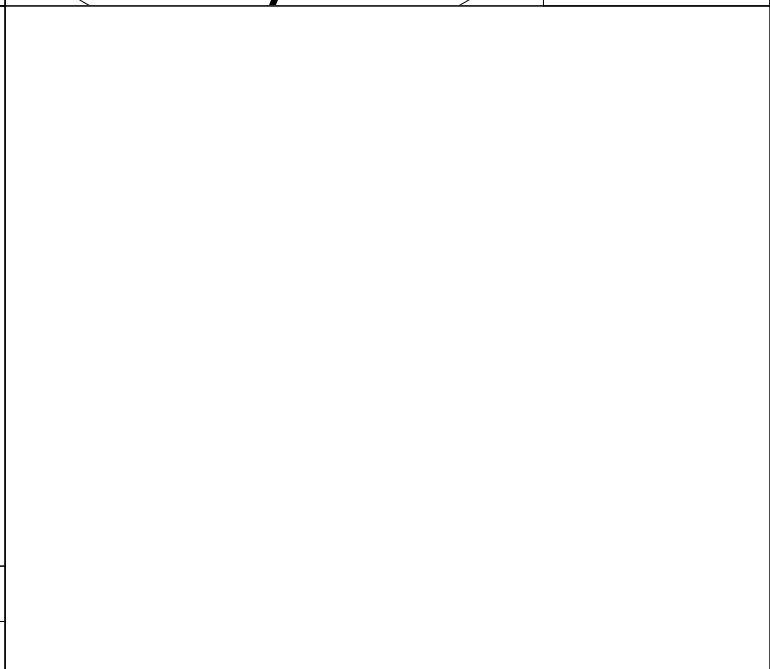

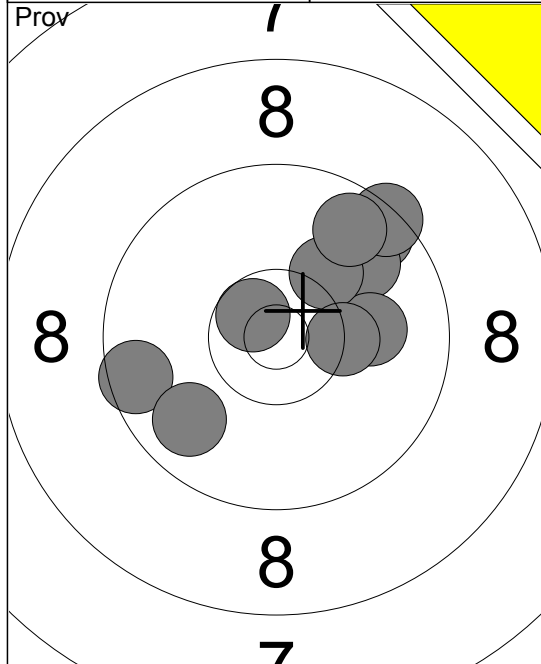

1:	9.6 ↗
2:	9.9 ↗
3:	9.4 ↗
4:	9.6 ←
5:	10.1 →
6:	9.8 ↙
7:	10.2 ↗
8:	9.7 ↗
9:	10.3x ➤
10:	10.6x ↘
Serie 94.0	
Total 0.0	

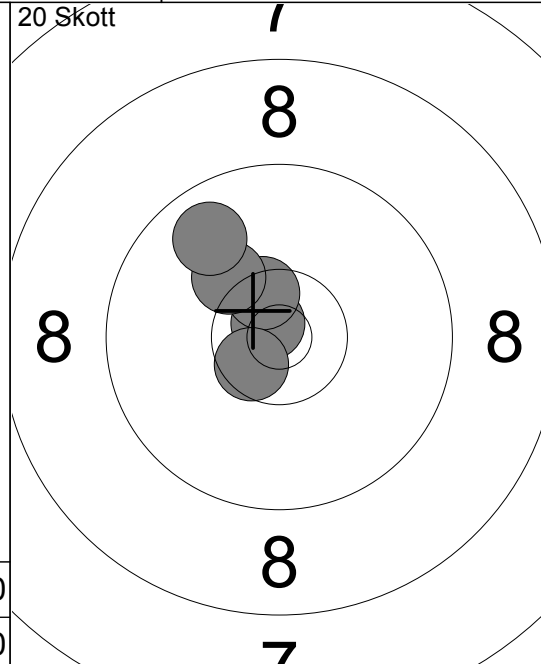

1:	10.8x ↘
2:	10.5x ↘
3:	10.6x ↘
4:	10.2 ↗
5:	9.8 ↗
Serie 49.0	
Total 49.0	

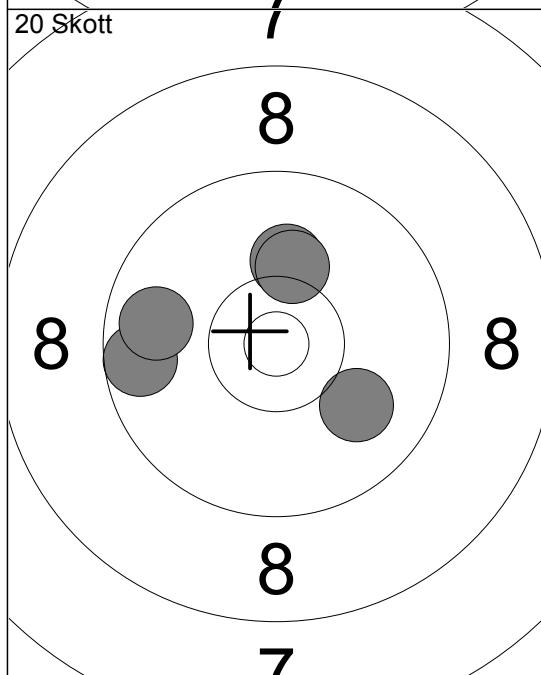

6:	10.2 ↑
7:	10.0 ↘
8:	9.6 ←
9:	9.8 ←
10:	10.2 ↑
Serie 48.0	
Total 97.0	

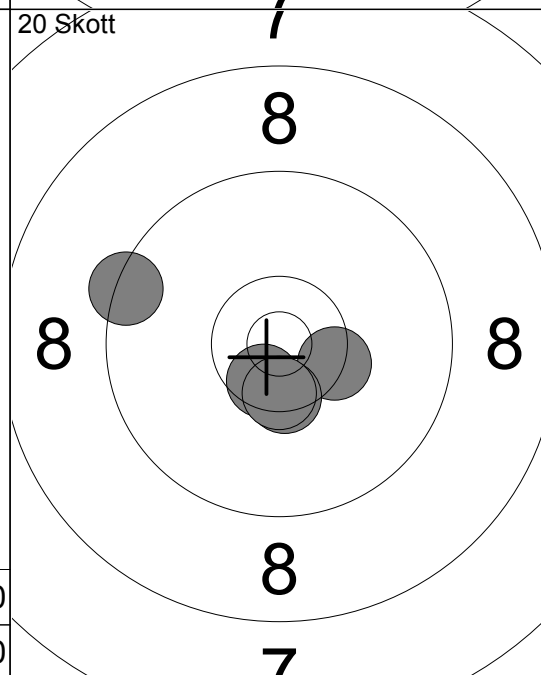

11:	9.4 ←
12:	10.4x ➤
13:	10.4x ↓
14:	10.6x ↘
15:	10.5x ↓
Serie 49.0	
Total 146.0	

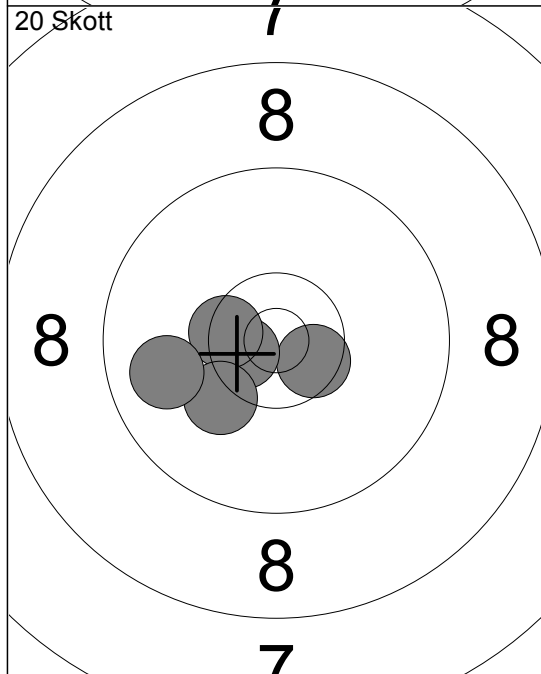

16:	10.5x ↘
17:	10.6x ↘
18:	10.5x ↘
19:	10.2 ↙
20:	9.9 ←
Serie 49.0	
Total 195.0	

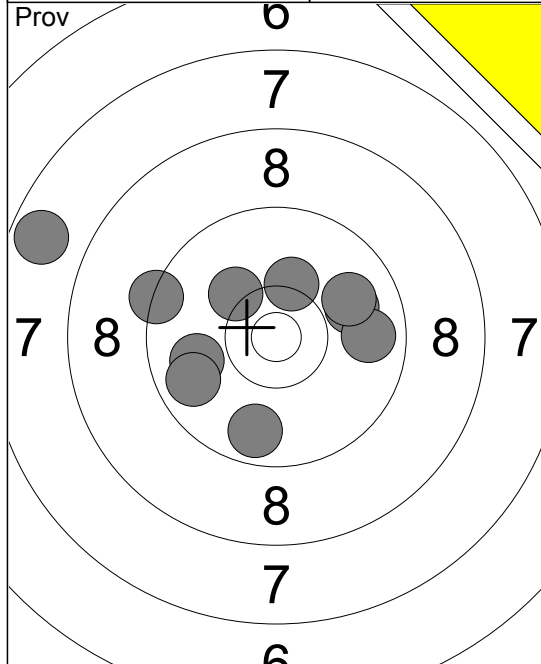

1:	7.7	↙
2:	9.3	↙
3:	10.2	↖
4:	10.3	↗
5:	9.9	→
6:	9.8	→
7:	9.9	↗
8:	9.9	↙
9:	9.8	↙
10:	9.7	↓
Serie	90.0	
Total	0.0	

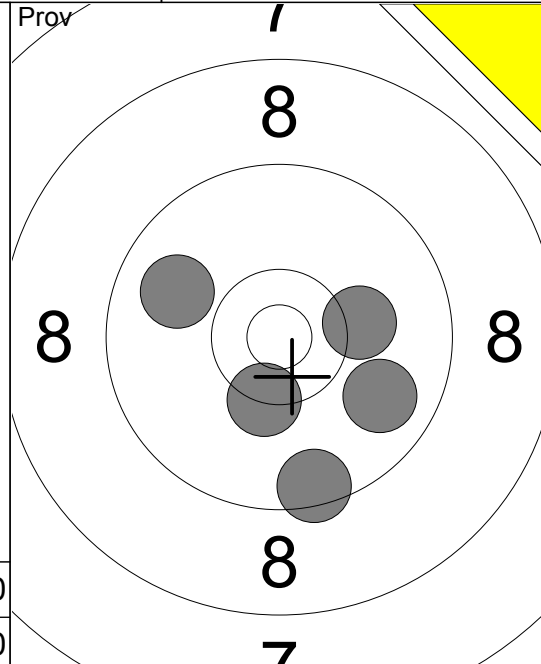

11:	9.5	↓
12:	9.8	↘
13:	10.2	→
14:	10.3	↘
15:	9.9	↙
Serie	47.0	
Total	0.0	

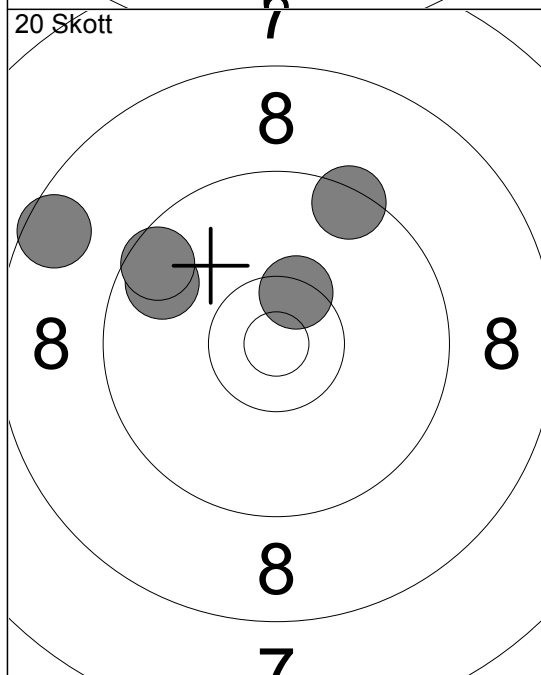

1:	9.7	↙
2:	10.4	↗
3:	9.6	↙
4:	8.6	↙
5:	9.4	↗
Serie	45.0	
Total	45.0	

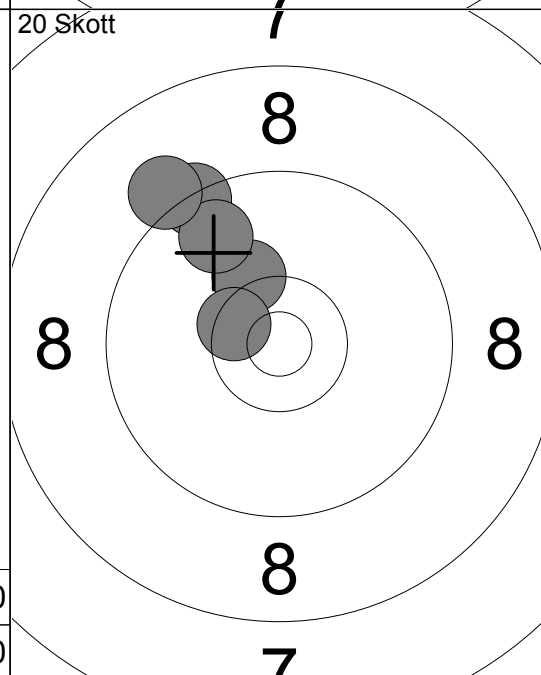

6:	9.4	↗
7:	10.2	↖
8:	10.5	↘
9:	9.8	↗
10:	9.1	↖
Serie	47.0	
Total	92.0	

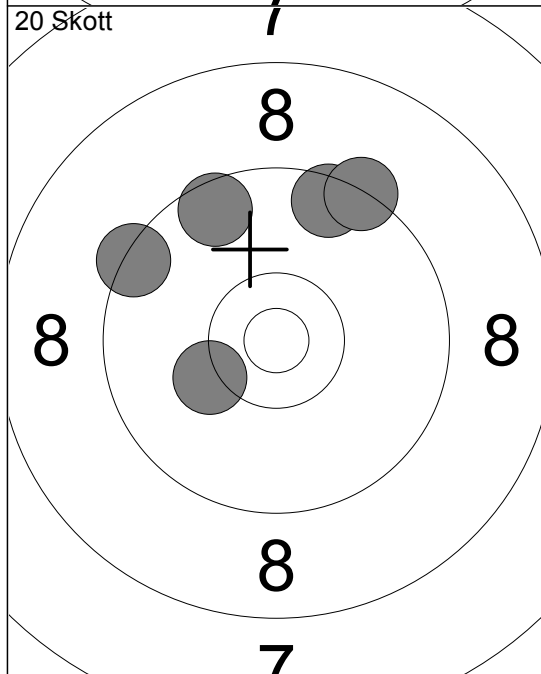

11:	9.4	↙
12:	10.2	↙
13:	9.6	↗
14:	9.5	↗
15:	9.3	↗
Serie	46.0	
Total	138.0	

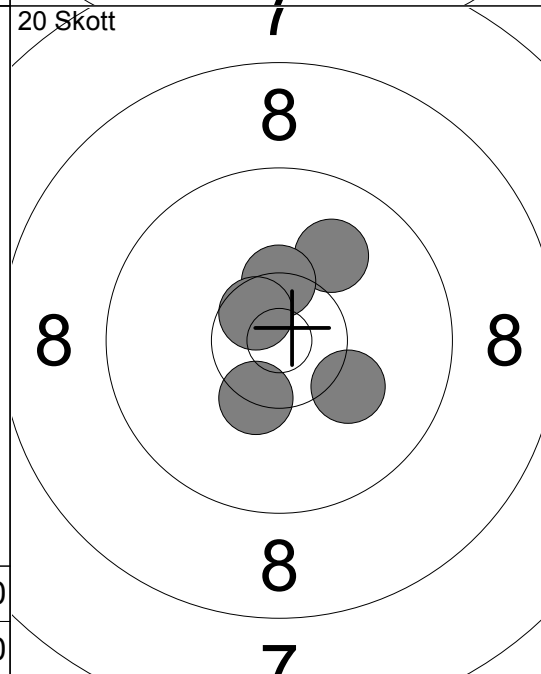

16:	10.0	↗
17:	10.4	↗
18:	10.2	↘
19:	10.4	↘
20:	10.6	↘
Serie	50.0	
Total	188.0	

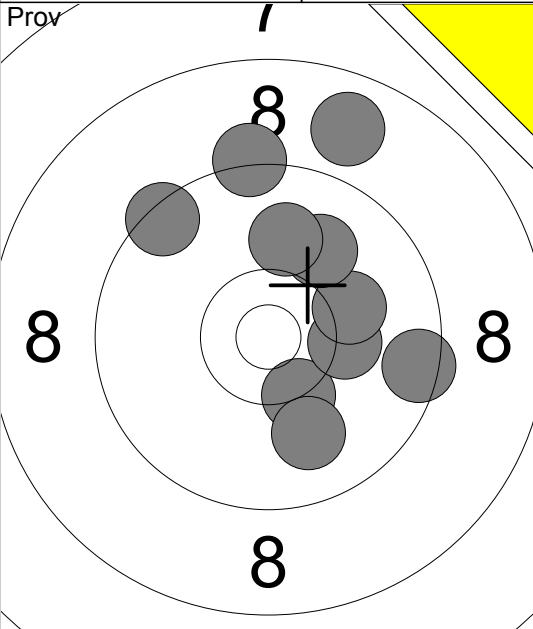
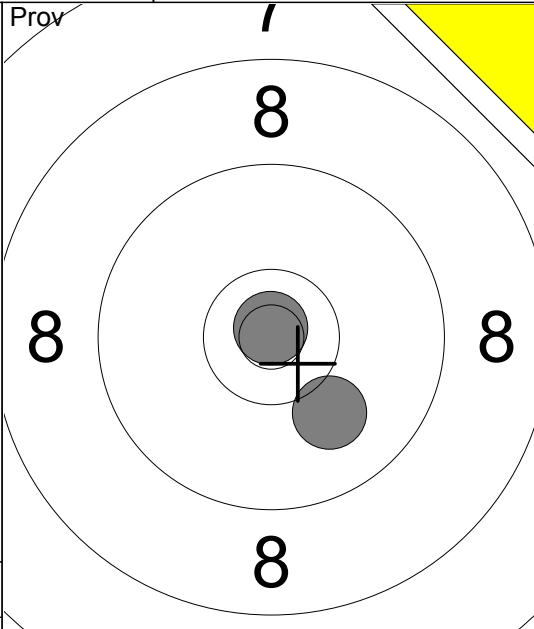
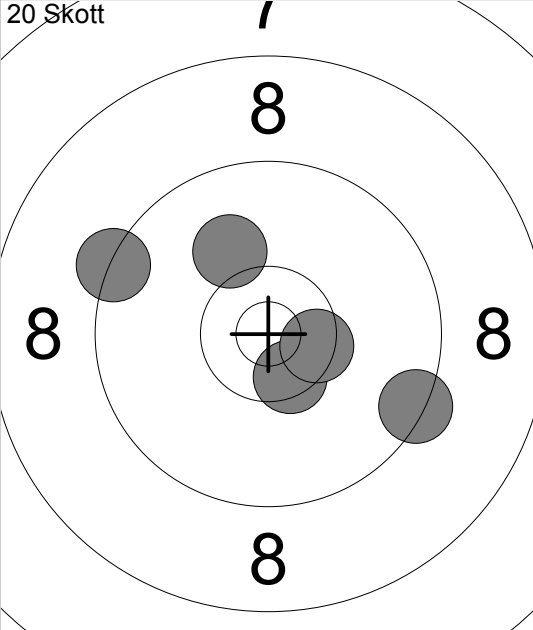
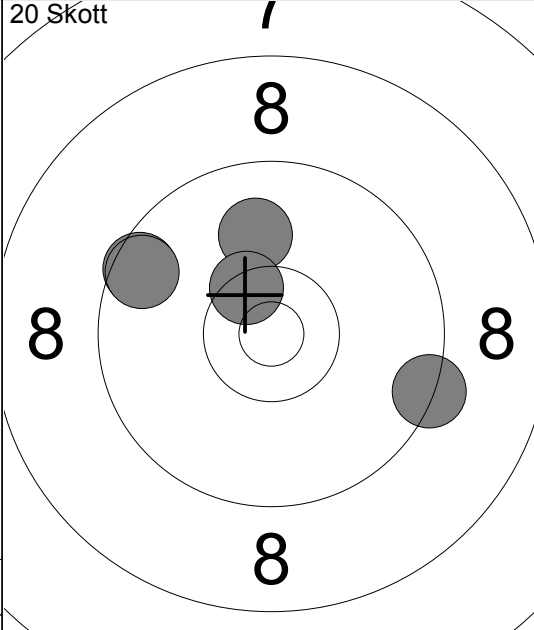
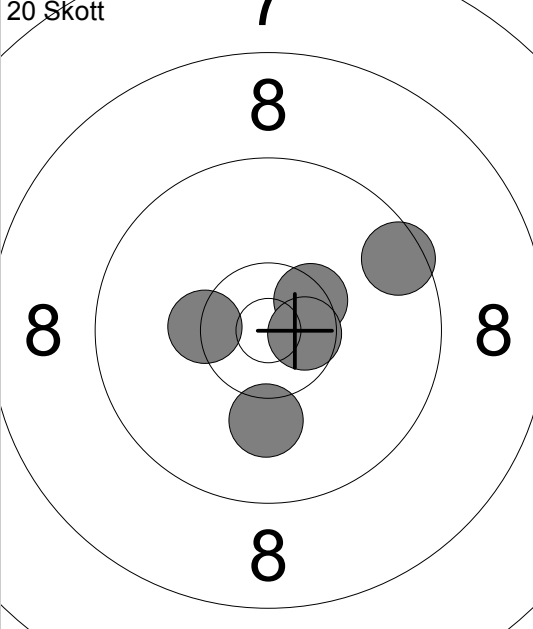
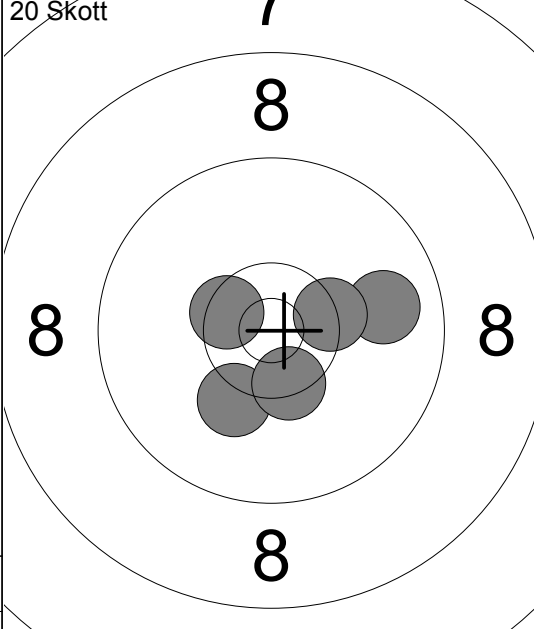
Skjutlag	Tavla	Martin Nilsson		50m	Kvistbro	Sen-L	Ör
1	10			12.07.2016	Tavelträffen Korthåll 2016	Ramselefors SKF	
Prov	7		1: 8.8 ↗ 2: 9.3 ↑ 3: 10.3x↘ 4: 10.2 → 5: 10.1 → 6: 10.0 ↗ 7: 9.5 → 8: 10.0 ↑ 9: 9.4 ↖ 10: 10.0 ↘	Prov	7		11: 10.0 ↘ 12: 10.9x↑
			Serie 95.0				Serie 20.0
			Total 0.0				Total 0.0
20 Skott	7		1: 9.3 ↖ 2: 10.5x↘ 3: 9.4 → 4: 10.5x> 5: 10.1 ↗	20 Skott	7		6: 9.4 → 7: 10.0 ↑ 8: 10.5x↗ 9: 9.6 ↖ 10: 9.6 ↖
			Serie 48.0				Serie 47.0
			Total 48.0				Total 95.0
20 Skott	7		11: 10.3x↖ 12: 10.1 ↓ 13: 10.5x↗ 14: 10.6x> 15: 9.5 ↗	20 Skott	7		16: 10.5x↖ 17: 10.2 ↘ 18: 10.4x↘ 19: 9.9 → 20: 10.4x>
			Serie 49.0				Serie 49.0
			Total 144.0				Total 193.0

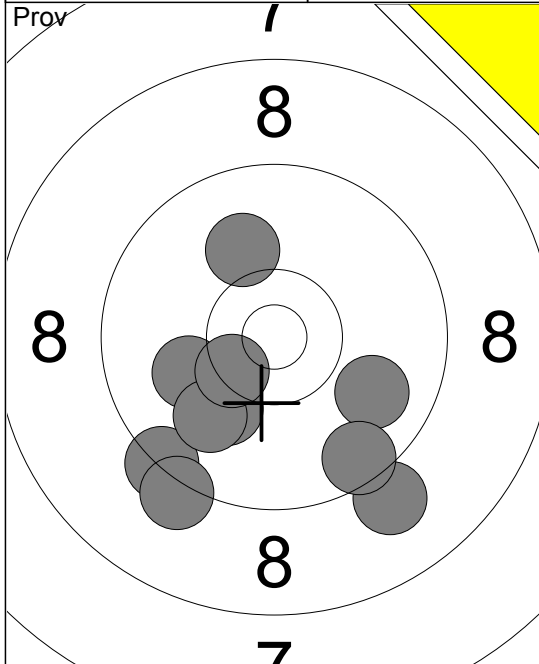

1:	9.1	↘
2:	9.9	↘
3:	10.1	↙
4:	9.3	↙
5:	10.1	↘
6:	10.0	↘
7:	9.5	↘
8:	10.4	✕
9:	10.1	↗
10:	9.2	↘
Serie	95.0	
Total	0.0	

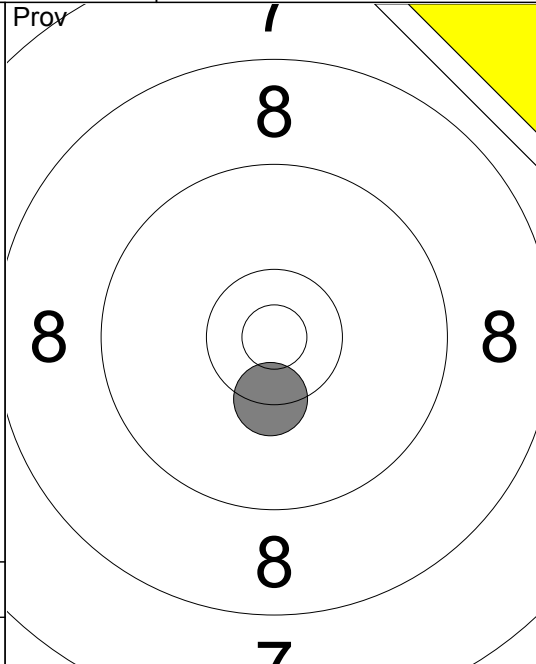

11:	10.4	✕
Serie	10.0	
Total	0.0	

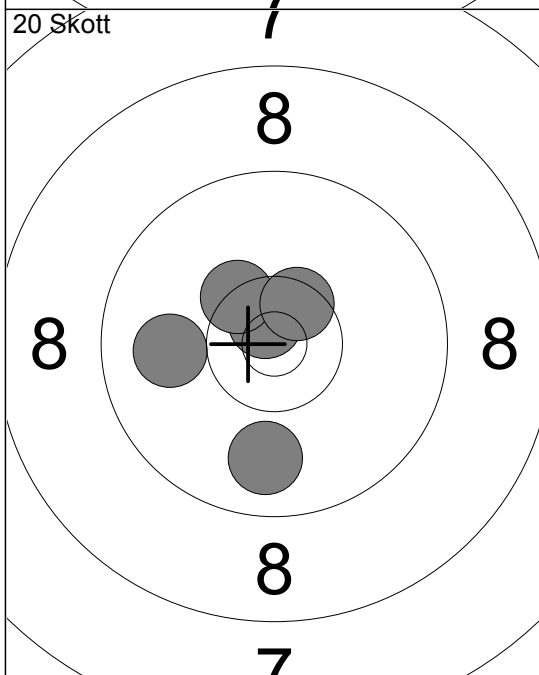

1:	10.7	↗
2:	10.0	↙
3:	10.4	↗
4:	10.5	↗
5:	9.9	↓
Serie	49.0	
Total	49.0	

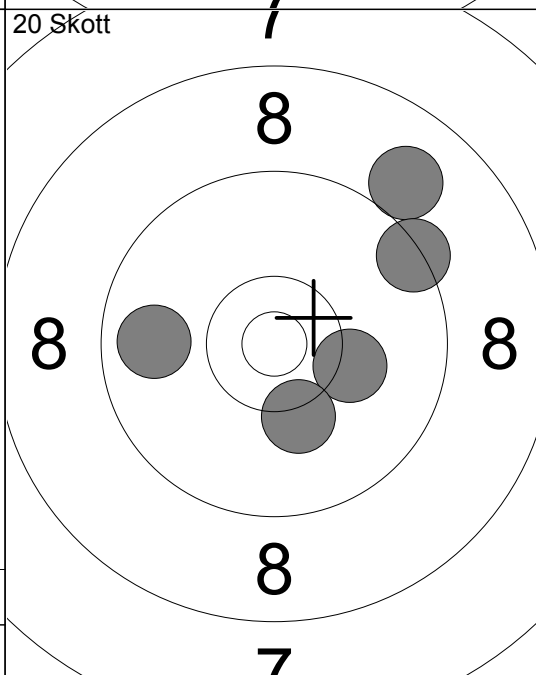

6:	9.0	↗
7:	9.4	↗
8:	9.8	←
9:	10.2	→
10:	10.2	↓
Serie	47.0	
Total	96.0	

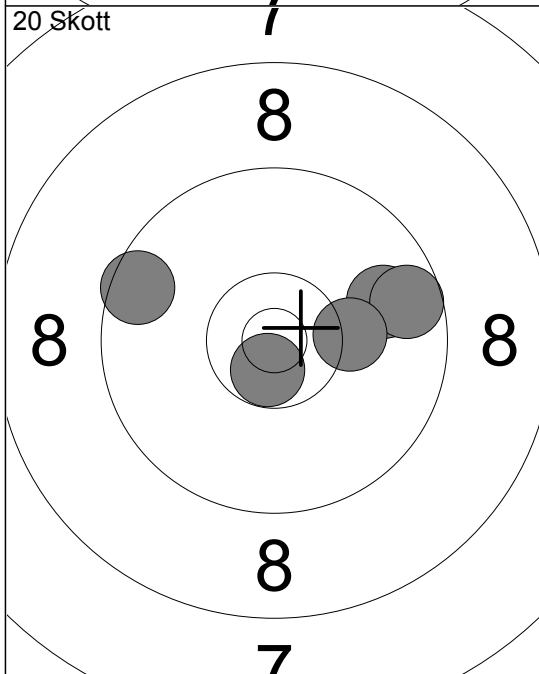

11:	9.8	→
12:	9.6	→
13:	10.7	✕
14:	9.6	←
15:	10.2	→
Serie	47.0	
Total	143.0	

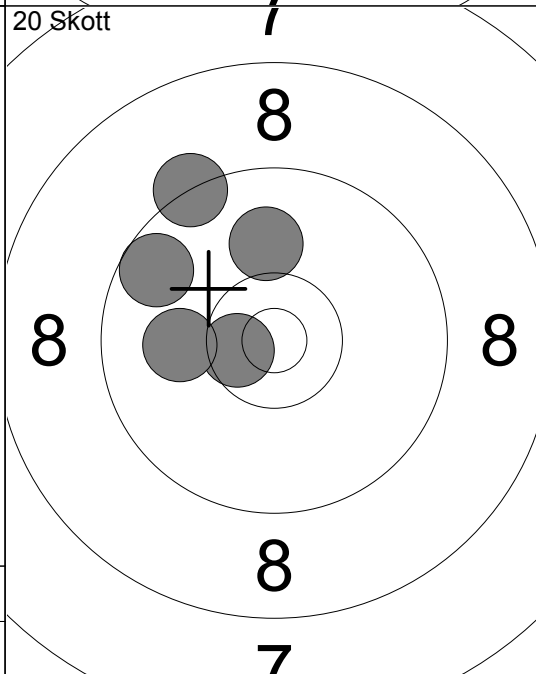

16:	9.3	↖
17:	9.6	↖
18:	10.6	✕
19:	10.0	↑
20:	10.0	←
Serie	48.0	
Total	191.0	

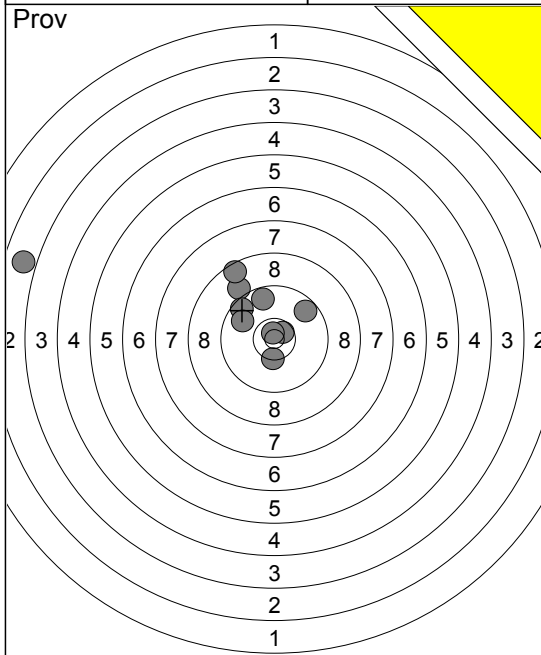

1:	2.9	←
2:	9.1	↗
3:	9.7	↗
4:	9.6	↗
5:	8.6	↗
6:	9.7	↗
7:	10.6	↗
8:	10.3	↓
9:	9.8	↖
10:	10.8	↗
Serie	85.0	
Total	0.0	

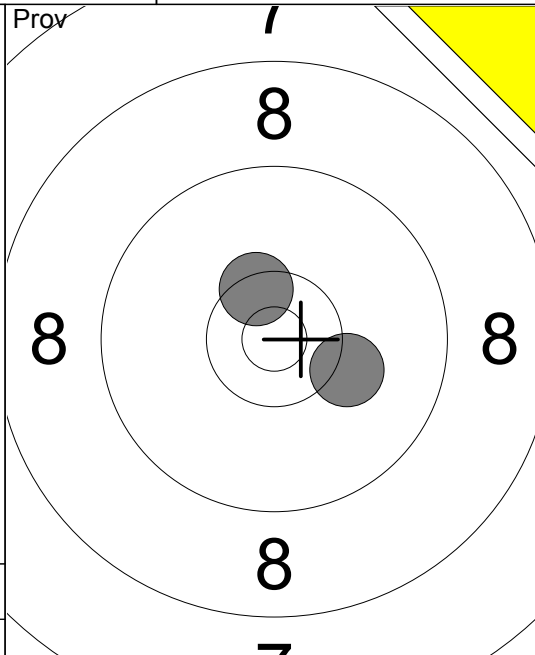

11:	10.4	↗
12:	10.2	↘
Serie	20.0	
Total	0.0	

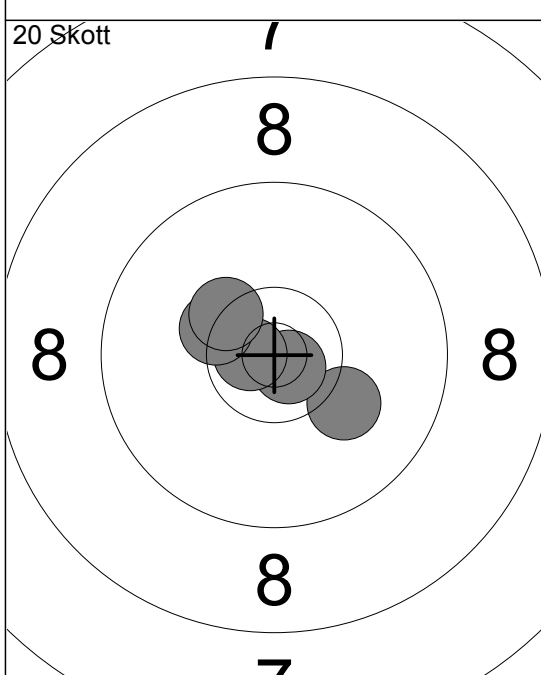

1:	10.1	↘
2:	10.8	↘
3:	10.7	←
4:	10.3	←
5:	10.3	↘
Serie	50.0	
Total	50.0	

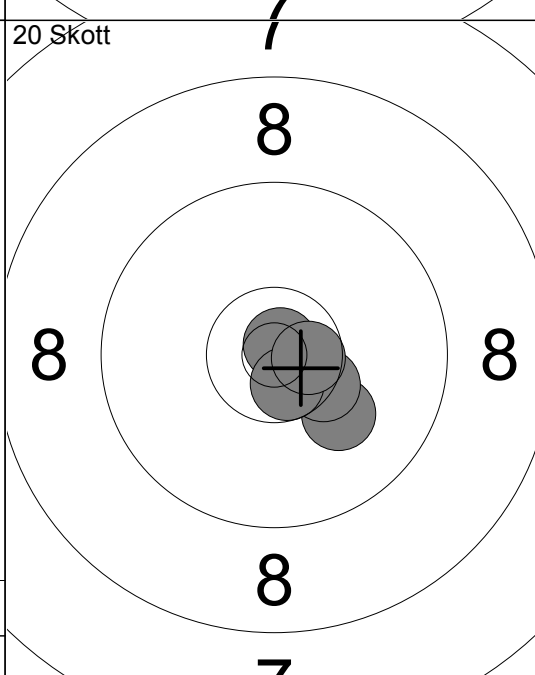

6:	10.1	↘
7:	10.4	↘
8:	10.8	↗
9:	10.7	↘
10:	10.6	↘
Serie	50.0	
Total	100.0	

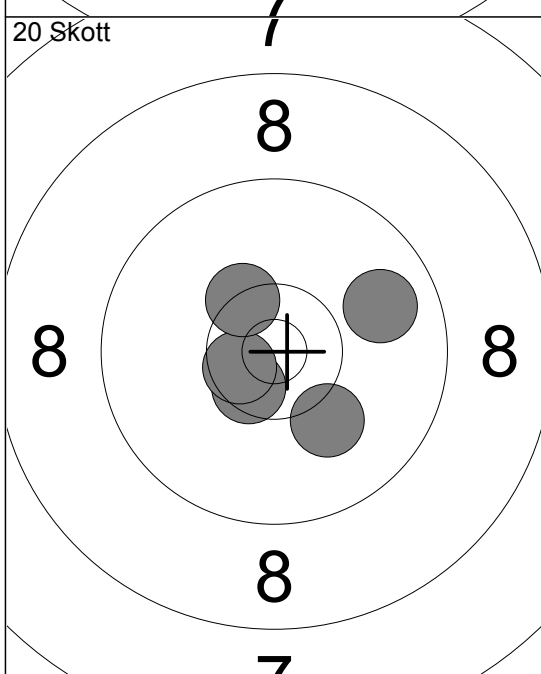

11:	9.9	↗
12:	10.5	↘
13:	10.6	←
14:	10.1	↓
15:	10.4	↗
Serie	49.0	
Total	149.0	

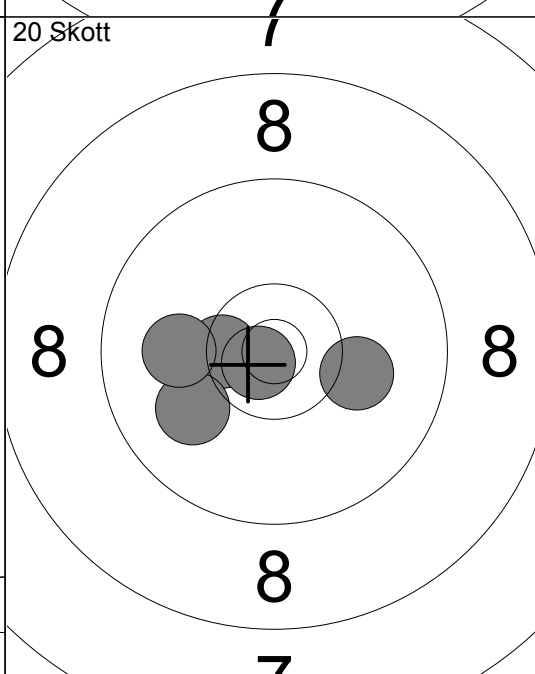

16:	10.5	←
17:	10.0	↖
18:	10.1	↘
19:	10.8	←
20:	10.0	←
Serie	50.0	
Total	199.0	

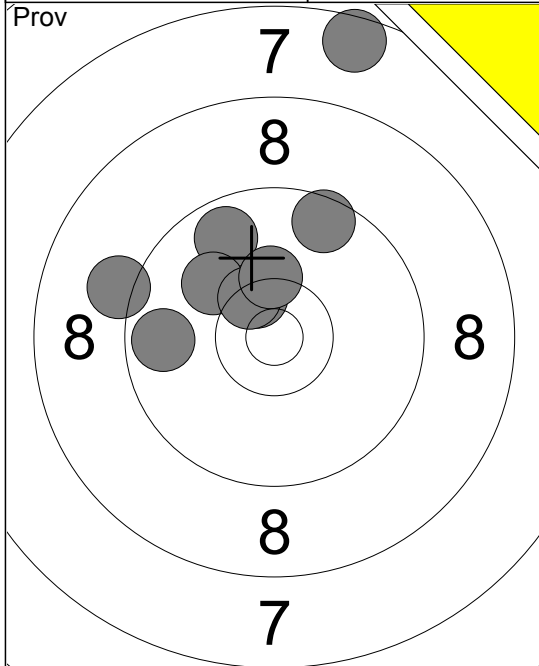

1:	7.6	↗
2:	10.2	↖
3:	9.7	↗
4:	9.2	↖
5:	9.7	↖
6:	10.5	↖
7:	10.1	↖
8:	10.4	↖
9:	9.6	↗
10:	10.3	↖
Serie	93.0	
Total	0.0	

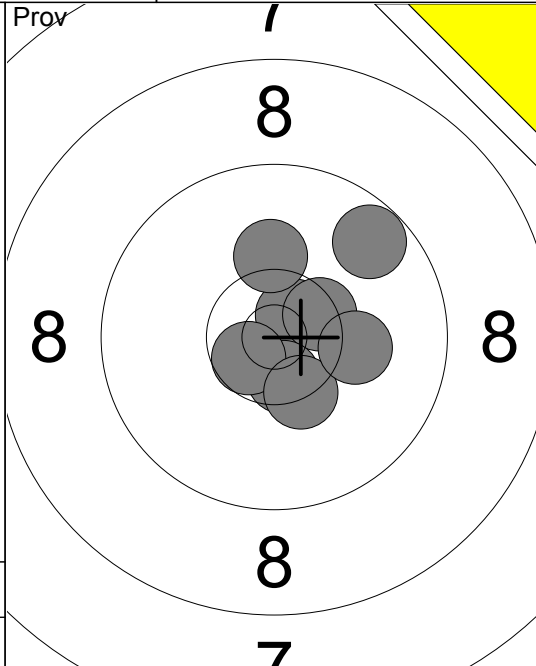

11:	10.7	↖
12:	10.5	↖
13:	10.2	↗
14:	9.7	↗
15:	10.6	↘
16:	10.6	↘
17:	10.4	↘
18:	10.2	→
Serie	79.0	
Total	0.0	

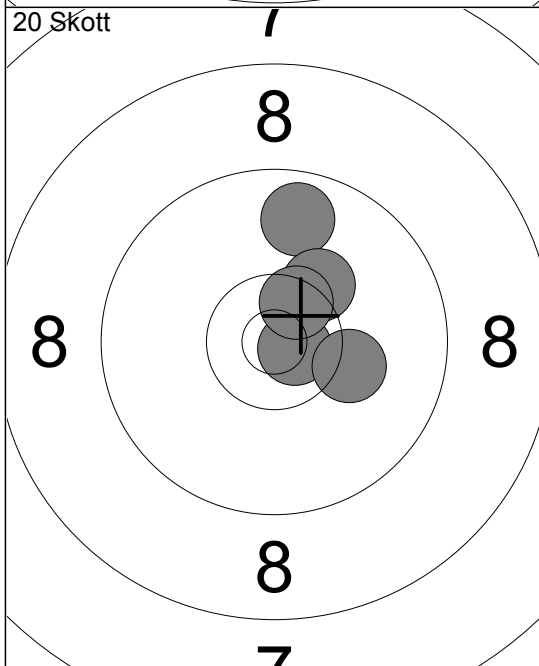

1:	10.7	↘
2:	10.2	→
3:	9.8	↗
4:	10.3	↗
5:	10.5	↖
Serie	49.0	
Total	49.0	

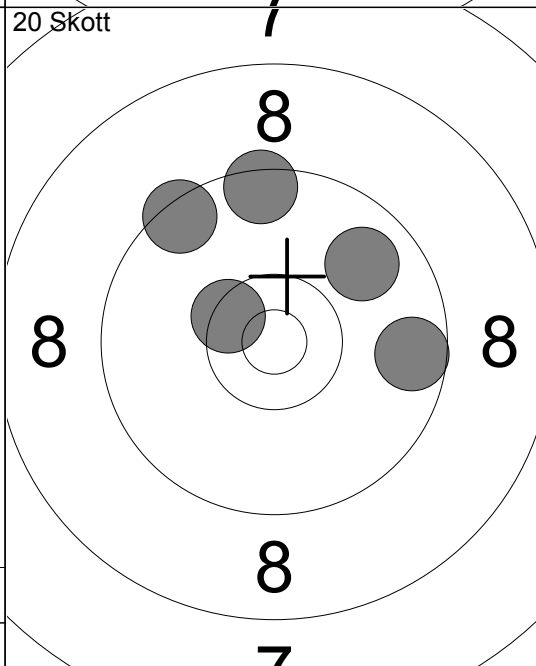

6:	9.8	↗
7:	9.5	↗
8:	9.5	↖
9:	10.4	↖
10:	9.6	→
Serie	46.0	
Total	95.0	

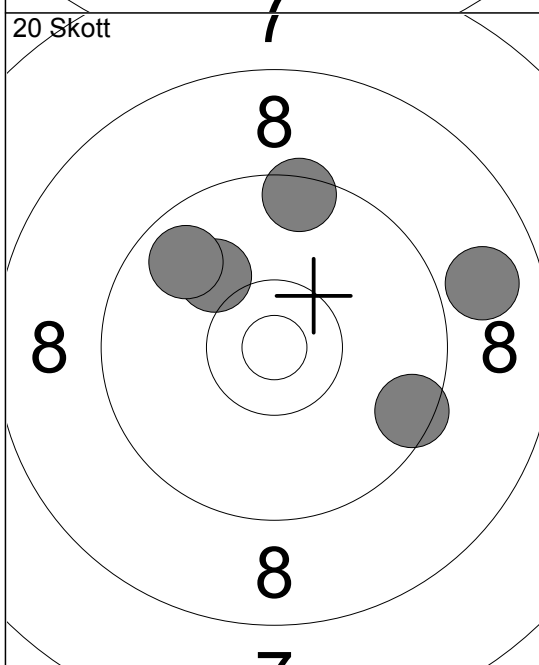

11:	9.5	→
12:	8.9	→
13:	10.1	↖
14:	9.8	↖
15:	9.5	↗
Serie	45.0	
Total	140.0	

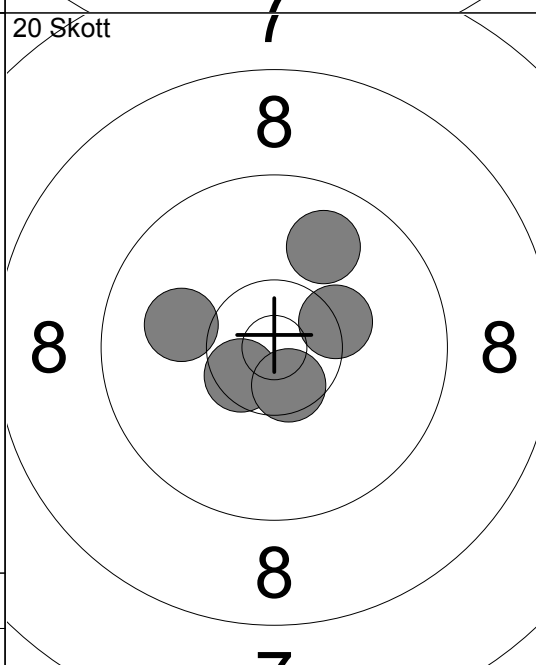

16:	9.9	↗
17:	10.3	↖
18:	10.0	↖
19:	10.5	↖
20:	10.6	↘
Serie	49.0	
Total	189.0	

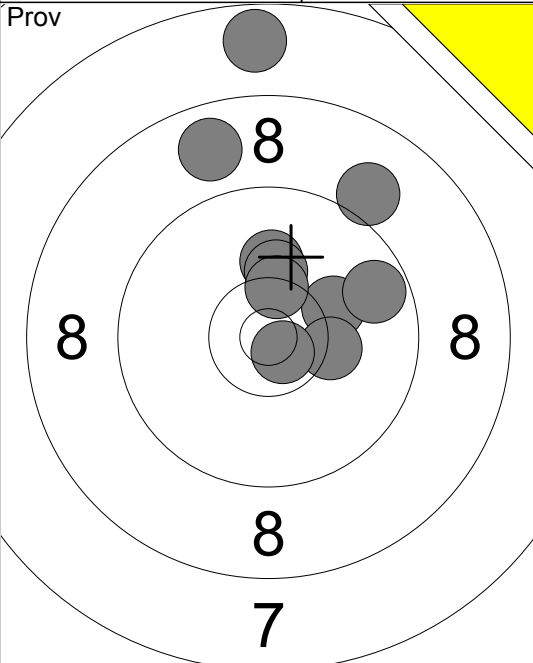
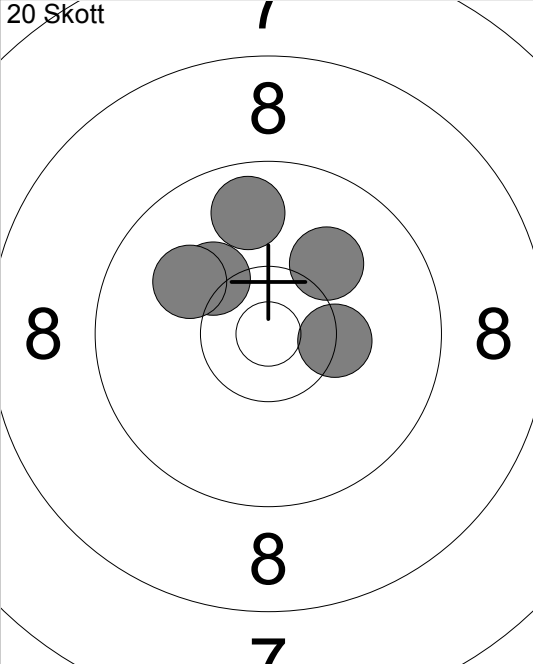
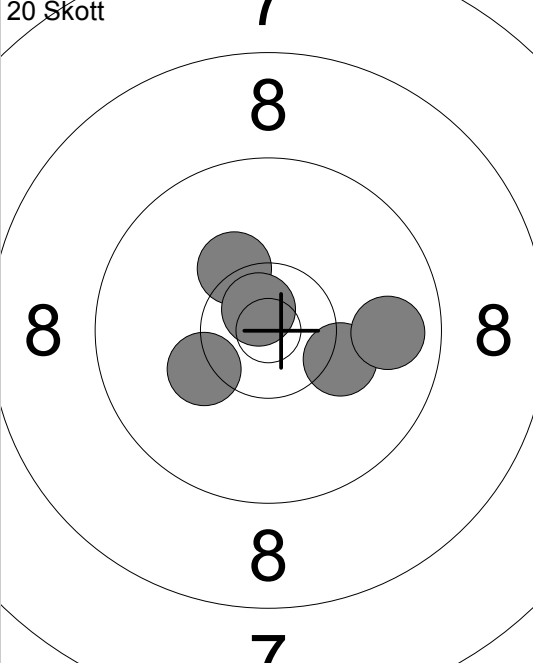
Skjutlag	Tavla	Hilde Karlsson		Sen-L	Vb
1	14	50m	Ramselefors		
12.07.2016	Tavelträffen Korthäll 2016	Ramselefors SKF			
Prov		1: 8.8 ↑ 2: 9.0 ↗ 3: 7.7 ↑ 4: 10.1 ↑ 5: 10.2 ↑ 6: 10.2 → 7: 10.3 → 8: 9.7 → 9: 10.7x ↘ 10: 10.4x ↑	Prov	11: 10.7x ↘ 12: 9.7 ← 13: 10.3x ↘	
		Serie 93.0		Serie 29.0	
		Total 0.0		Total 0.0	
20 Skott		1: 10.2 ↘ 2: 9.8 ↑ 3: 10.0 ↘ 4: 10.3x → 5: 10.1 ↗	20 Skott	6: 10.5x → 7: 10.1 → 8: 9.9 ← 9: 10.1 ↘ 10: 10.6x ↑	
		Serie 49.0		Serie 49.0	
		Total 49.0		Total 98.0	
20 Skott		11: 10.2 ↙ 12: 10.2 → 13: 10.3 ↘ 14: 9.8 → 15: 10.7x ↘	20 Skott	16: 10.6x ↘ 17: 10.3x → 18: 10.4x ↑ 19: 10.3 → 20: 10.0 ↗	
		Serie 49.0		Serie 50.0	
		Total 147.0		Total 197.0	

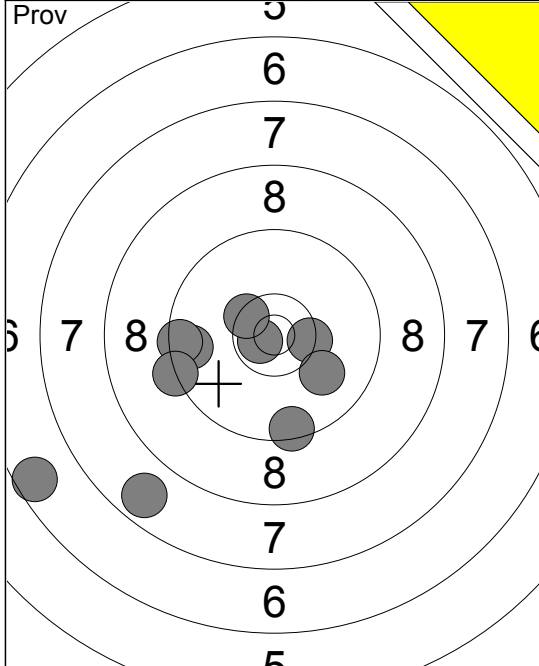

1:	7.7	↙
2:	6.6	↙
3:	9.6	←
4:	9.5	←
5:	9.3	↙
6:	10.4	→
7:	10.0	↘
8:	10.7	↘
9:	9.5	↓
10:	10.4	↘
Serie		89.0
Total		0.0

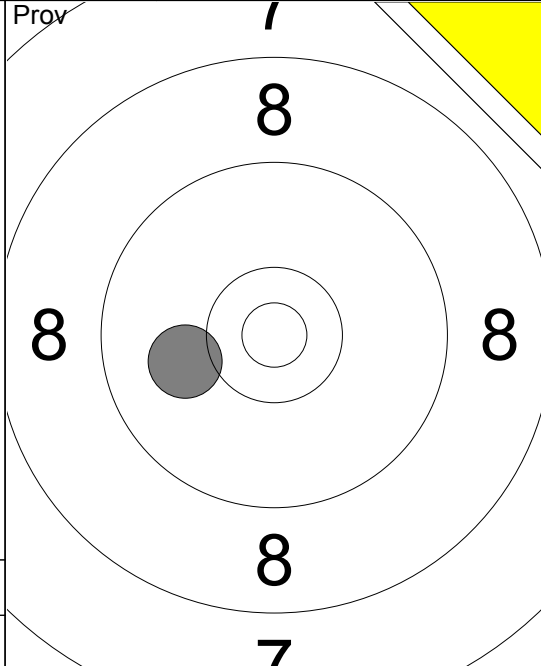

11:	10.1	↙
Serie		10.0
Total		0.0

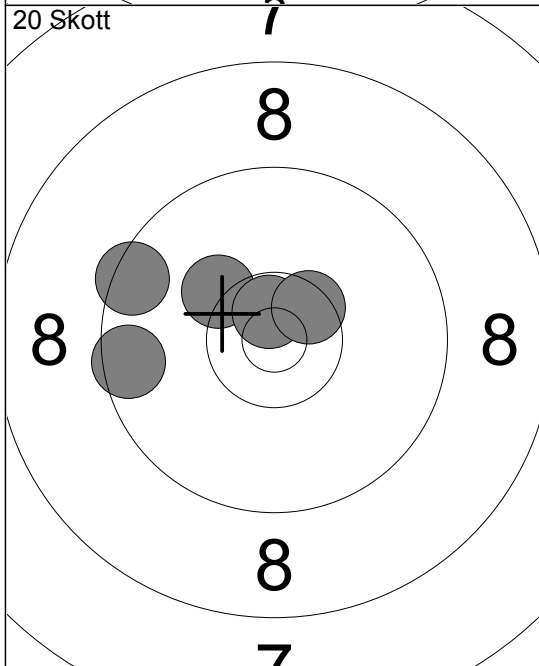

1:	9.5	↙
2:	10.2	↖
3:	10.7	↗
4:	10.5	↗
5:	9.5	←
Serie		48.0
Total		48.0

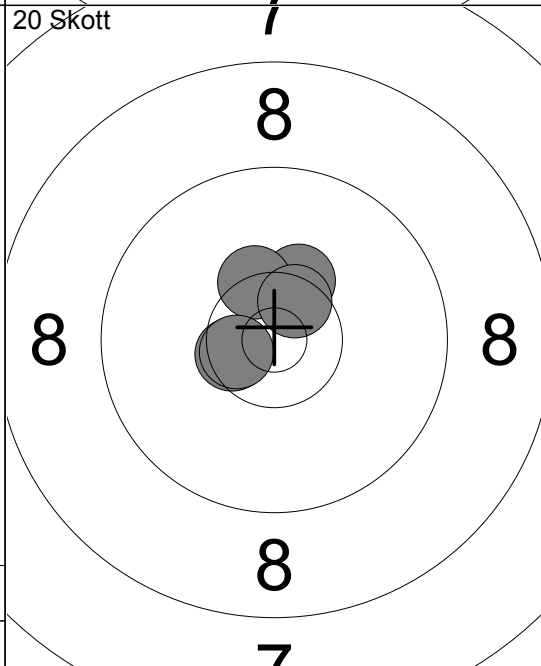

6:	10.3	↗
7:	10.4	↗
8:	10.5	↘
9:	10.6	↘
10:	10.5	↗
Serie		50.0
Total		98.0

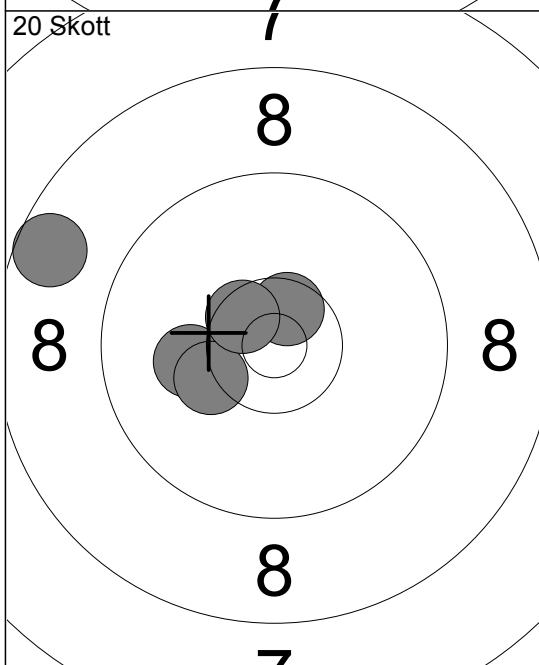

11:	10.1	↙
12:	8.6	↙
13:	10.3	↙
14:	10.6	↗
15:	10.5	↘
Serie		48.0
Total		146.0

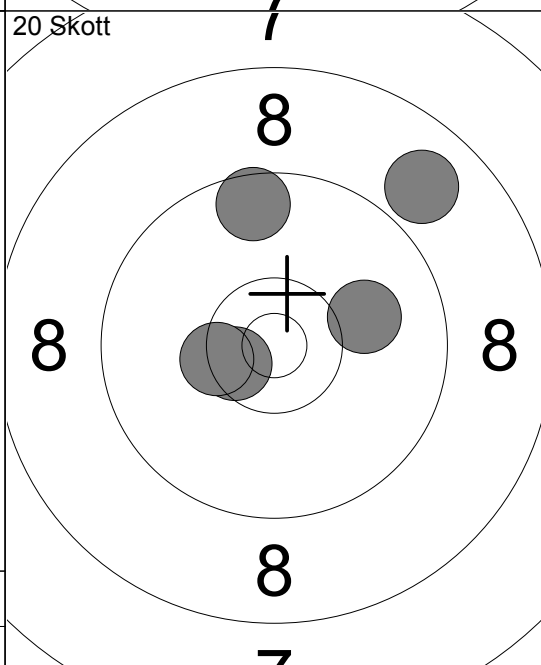

16:	8.9	↗
17:	10.1	→
18:	9.6	↑
19:	10.5	↘
20:	10.4	↘
Serie		47.0
Total		193.0

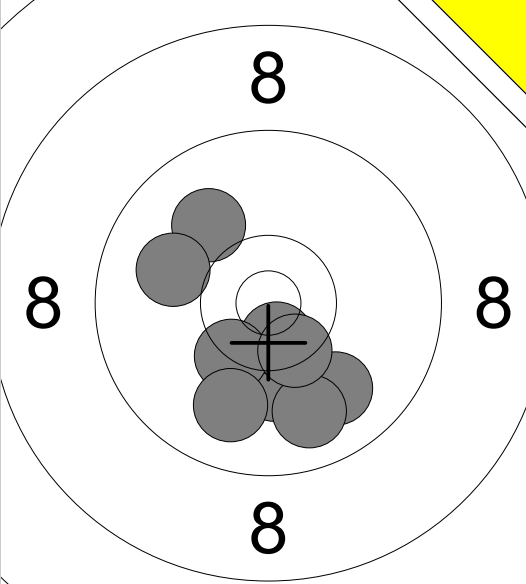
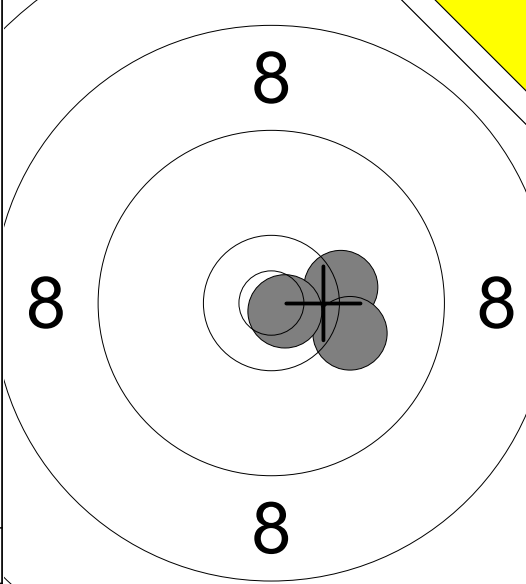
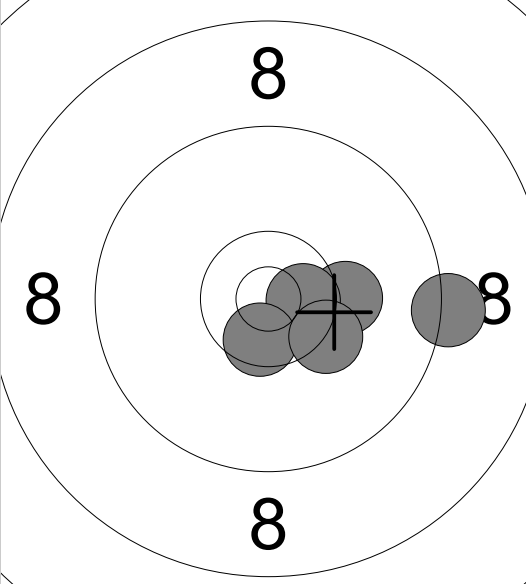
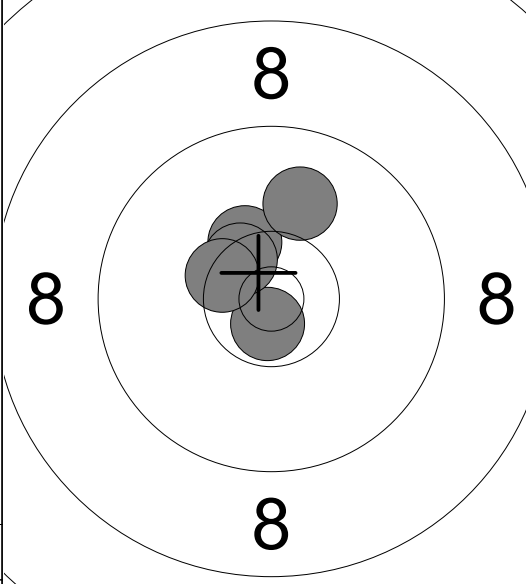
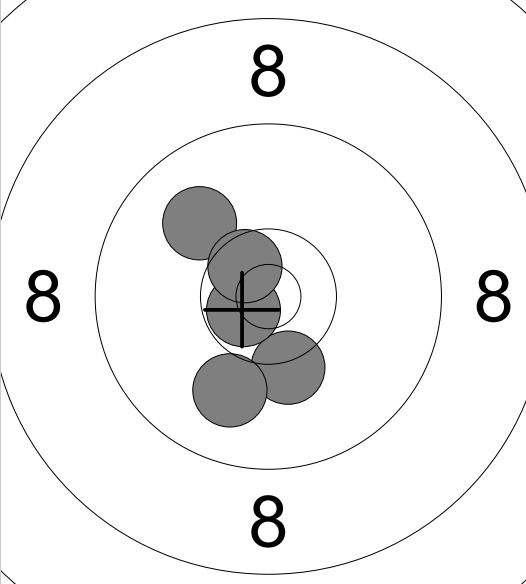
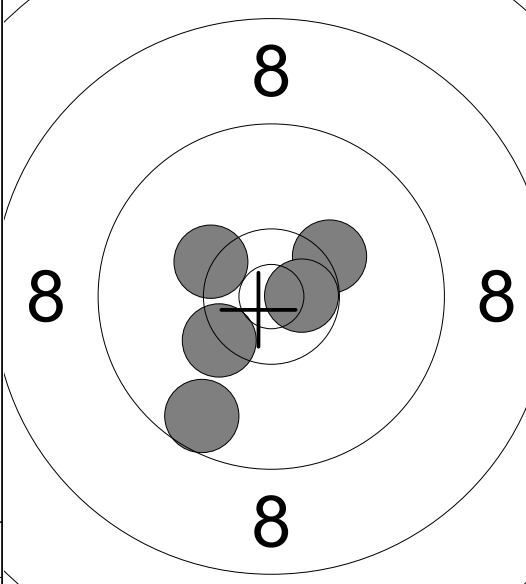
Skjutlag	Tavla	Marlene Forsell		Sen-L	Vb
1	16				
50m		Ramselefors			
12.07.2016		Tavelträffen Korthåll 2016		Ramselefors SKF	
Prov	7		Prov	7	
	8	1: 10.2 ↓ 2: 9.9 ↓ 3: 10.2 ↓ 4: 10.6x ↓ 5: 10.3x ↓ 6: 10.0 ↗ 7: 9.8 ↓ 8: 10.0 ← 9: 10.4x ↓ 10: 9.9 ↓		11: 10.3 → 12: 10.1 ↗ 13: 10.8x ↘	
	8	Serie 97.0		Serie 30.0	
	8	Total 0.0		Total 0.0	
20 Skott	7		20 Skott	7	
	8	1: 10.2 → 2: 10.6x → 3: 10.6x ↓ 4: 10.3x ↘ 5: 9.2 →		6: 10.7x ↓ 7: 10.4x ↗ 8: 10.0 ↑ 9: 10.5x ↗ 10: 10.4x ↗	
	8	Serie 49.0		Serie 50.0	
	8	Total 49.0		Total 99.0	
20 Skott	7		20 Skott	7	
	8	11: 10.0 ↗ 12: 10.2 ↓ 13: 10.7x ↘ 14: 10.6x ↗ 15: 10.0 ↓		16: 10.3 ↗ 17: 9.6 ↓ 18: 10.7x → 19: 10.3x ↘ 20: 10.3 ↗	
	8	Serie 50.0		Serie 49.0	
	7	Total 149.0		Total 198.0	

Skjutlag	Tavla	Marie Wingård		Sen-L	Vb
1	17	Marie Wingård			
50m		Ramselefors		Sen-L	Vb
12.07.2016		Tavelträffen Korthåll 2016		Ramselefors SKF	
Prov		1: 5.8 ↗ 2: 9.4 ↗ 3: 8.2 ↗ 4: 7.8 ↗ 5: 8.8 ↗ 6: 8.7 ↗ 7: 9.7 ↗ 8: 10.5x↗ 9: 10.0↖ 10: 10.6x↘ Serie 84.0 Total 0.0	Prov		11: 9.6 ↗ 12: 9.5 ↘ Serie 18.0 Total 0.0
20 Skott		1: 9.6 ↗ 2: 10.6x↗ 3: 10.0 ↗ 4: 10.7x↗ 5: 10.8x↗ Serie 49.0 Total 49.0	20 Skott		6: 10.5x➤ 7: 9.9 ↗ 8: 10.6x↗ 9: 9.9 ↘ 10: 10.5x↖ Serie 48.0 Total 97.0
20 Skott		11: 10.4x↗ 12: 10.5x↘ 13: 10.6x➤ 14: 10.1 ↘ 15: 10.4x➤ Serie 50.0 Total 147.0	20 Skott		16: 10.4x➤ 17: 10.3 ↗ 18: 10.5x➤ 19: 10.3x↗ 20: 9.7 ➔ Serie 49.0 Total 196.0

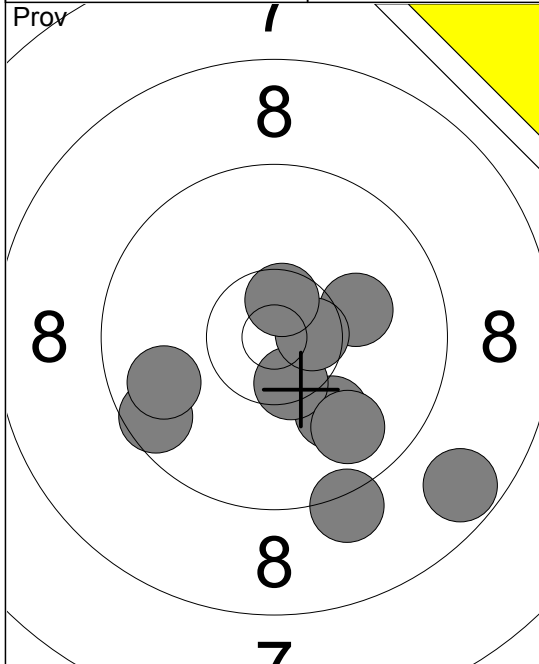

1:	10.1	→
2:	10.0	↓
3:	8.7	↓
4:	10.5	x↓
5:	10.6	x→
6:	9.2	↓
7:	9.8	↓
8:	10.6	x↑
9:	9.6	←
10:	9.8	←
Serie		94.0
Total		0.0

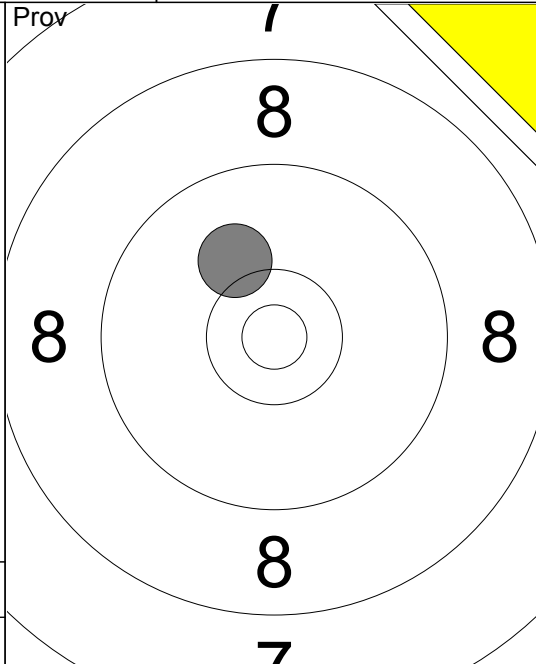

11:	10.1	↖
Serie		10.0
Total		0.0

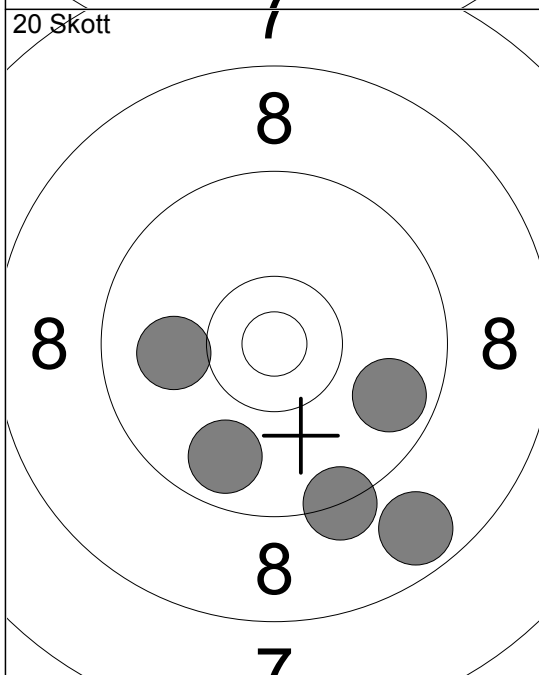

1:	9.3	↓
2:	9.8	→
3:	10.0	←
4:	8.7	↓
5:	9.8	↓
Serie		45.0
Total		45.0

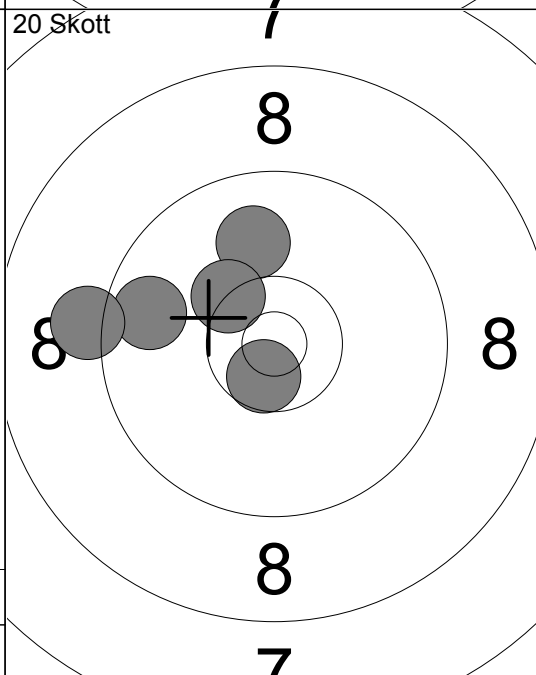

6:	9.7	←
7:	10.6	x↓
8:	10.0	↑
9:	9.2	←
10:	10.3	x↘
Serie		48.0
Total		93.0

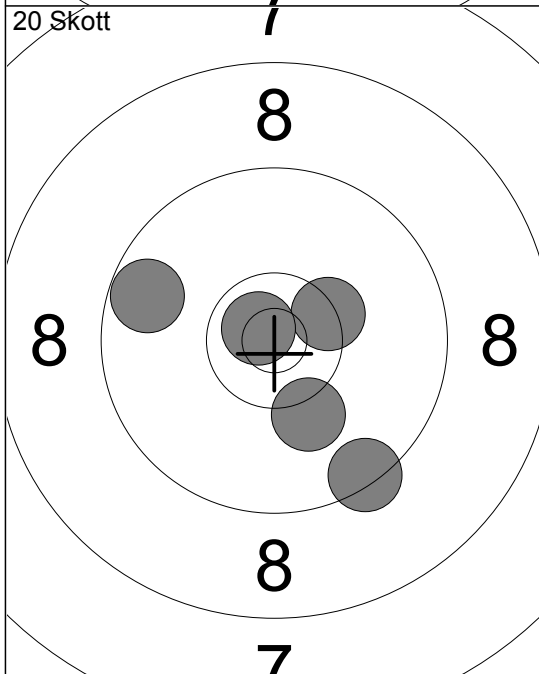

11:	9.4	↓
12:	10.4	x→
13:	9.7	←
14:	10.8	x↘
15:	10.2	↓
Serie		48.0
Total		141.0

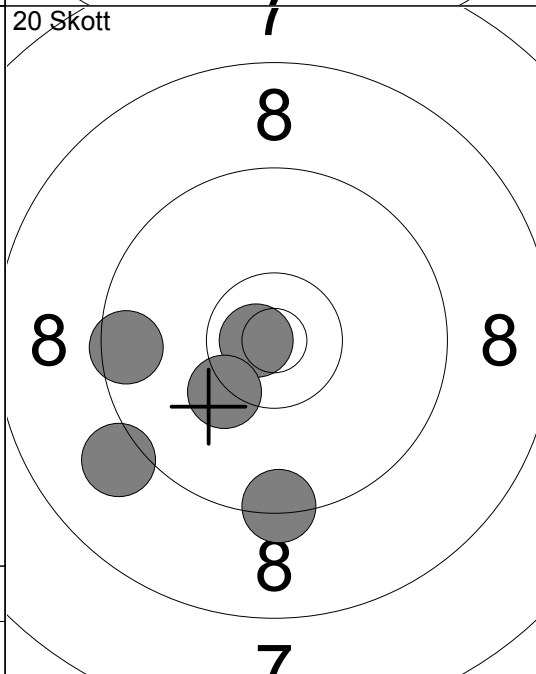

16:	9.5	←
17:	9.4	↓
18:	10.8	x←
19:	10.3	x↙
20:	9.1	←
Serie		47.0
Total		188.0

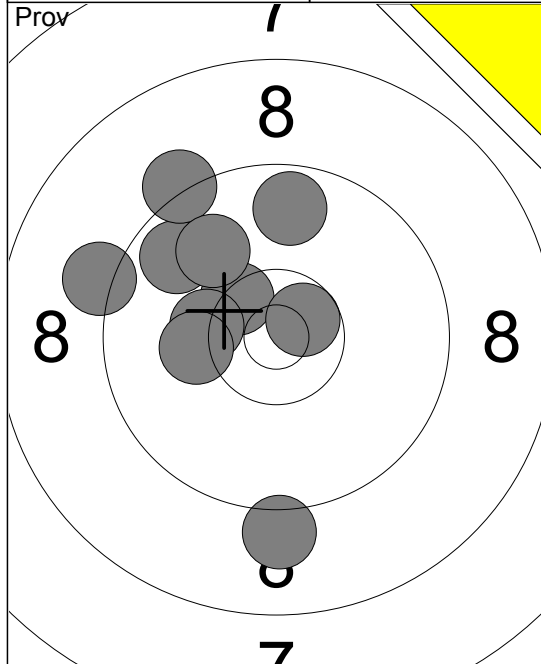

1:	9.1	↓
2:	9.2	←
3:	10.4	↘
4:	10.3	←
5:	9.7	↗
6:	9.2	↗
7:	10.2	←
8:	9.7	↑
9:	9.9	↗
10:	10.6	↘
Serie		94.0
Total		0.0

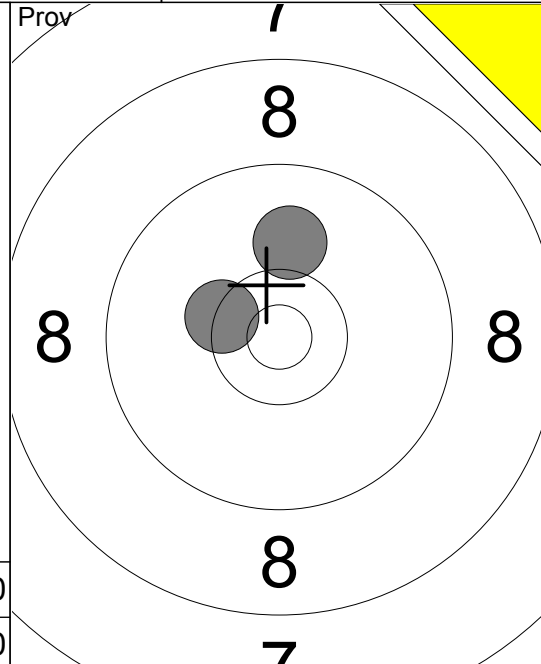

11:	10.0	↑
12:	10.4	↘
Serie		20.0
Total		0.0

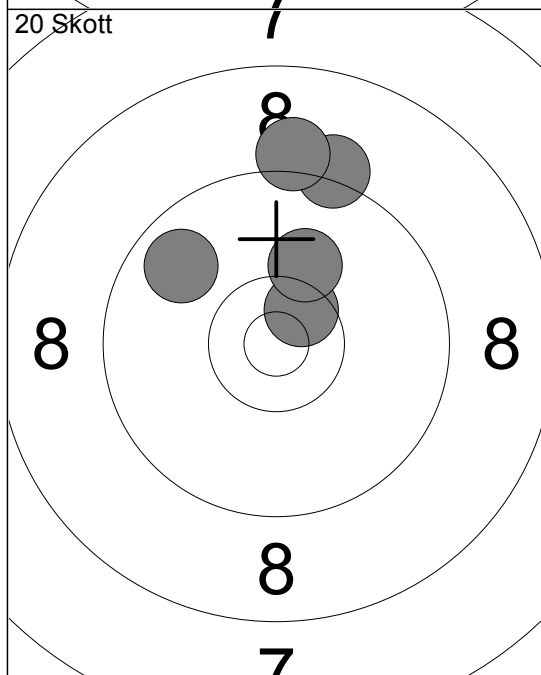

1:	9.8	↖
2:	10.5	↗
3:	9.2	↑
4:	9.1	↑
5:	10.2	↑
Serie		47.0
Total		47.0

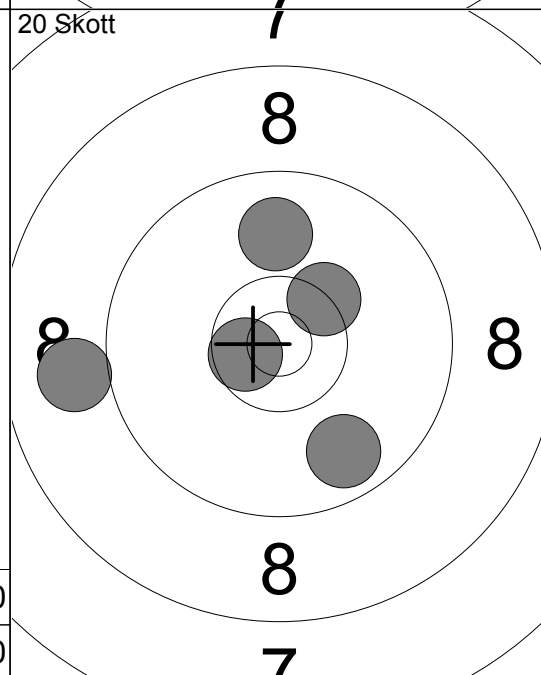

6:	10.4	↘
7:	9.9	↑
8:	9.8	↘
9:	9.0	←
10:	10.6	↘
Serie		47.0
Total		94.0

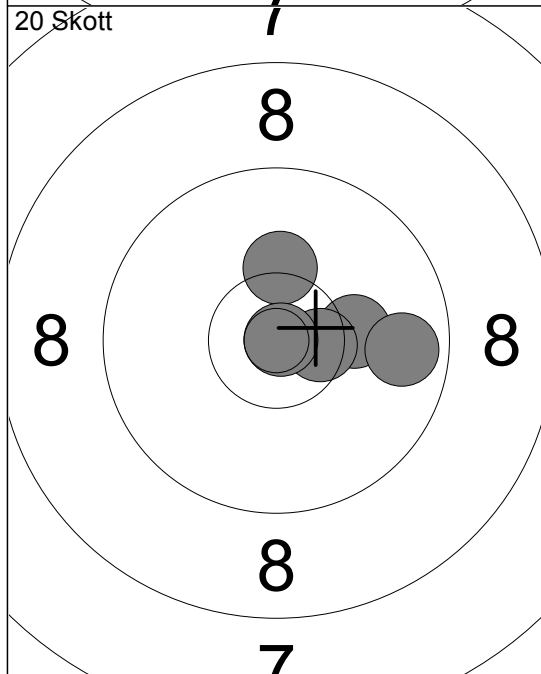

11:	10.2	→
12:	10.3	↑
13:	9.8	→
14:	10.5	→
15:	10.9	→
Serie		49.0
Total		143.0

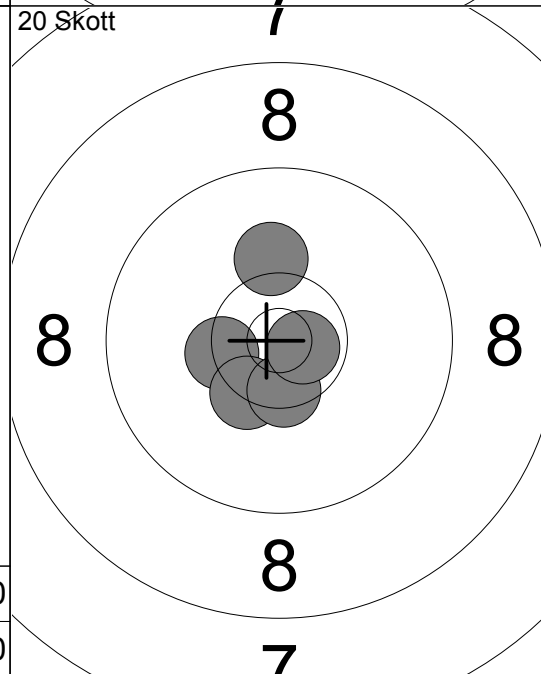

16:	10.4	↘
17:	10.4	↘
18:	10.5	↘
19:	10.7	→
20:	10.2	↑
Serie		50.0
Total		193.0

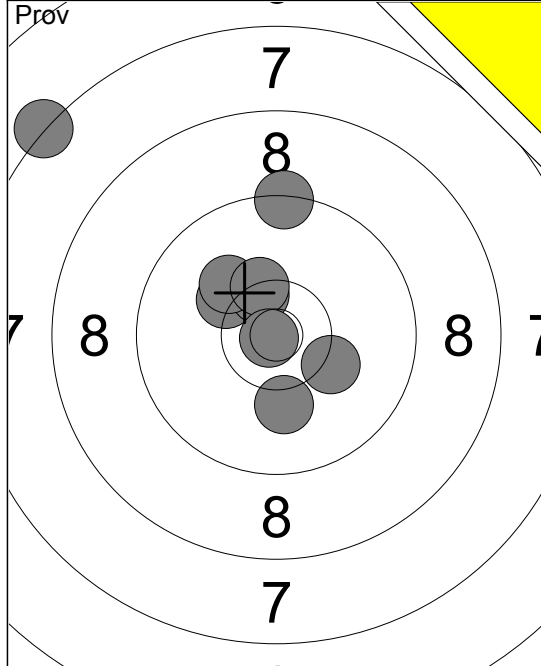

- 1: 7.3 ↖
- 2: 9.4 ↑
- 3: 10.2 ↖
- 4: 10.4 ↗
- 5: 10.1 ↖
- 6: 10.3 ↗
- 7: 10.2 →
- 8: 10.1 ↓
- 9: 10.9 ↘

Serie 86.0
Total 0.0

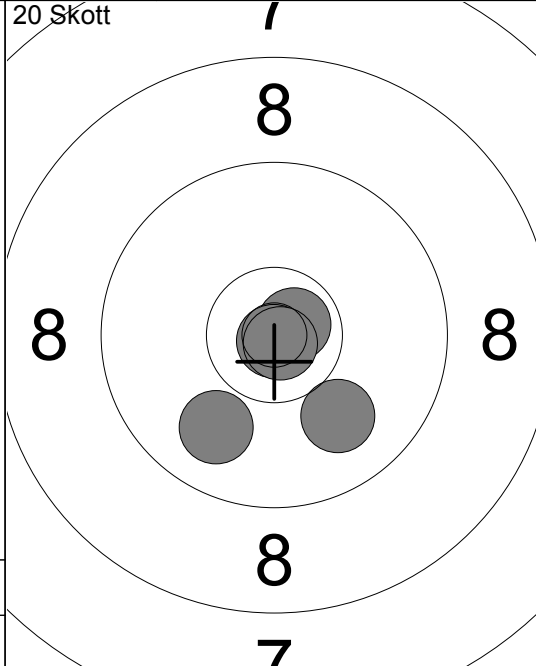

- 1: 10.7x ↗
- 2: 10.0 ↘
- 3: 10.9x ↘
- 4: 10.8x ↘
- 5: 9.9 ↘

Serie 49.0
Total 49.0

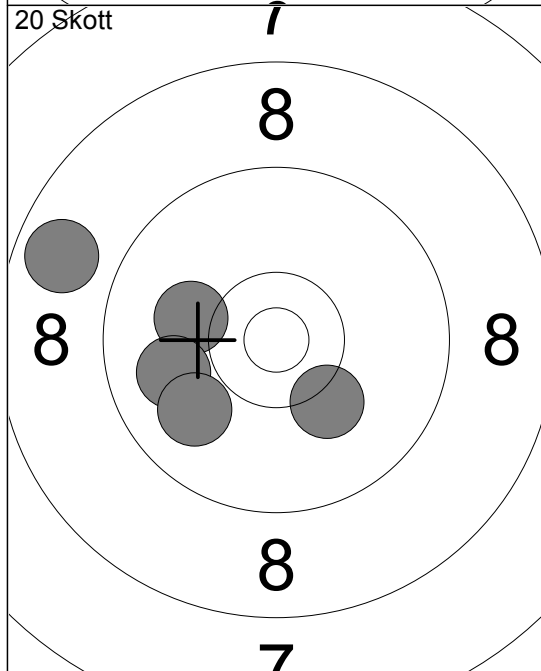

- 6: 10.1 ←
- 7: 8.8 ↖
- 8: 9.9 ←
- 9: 10.2 ↘
- 10: 9.9 ↖

Serie 46.0
Total 95.0

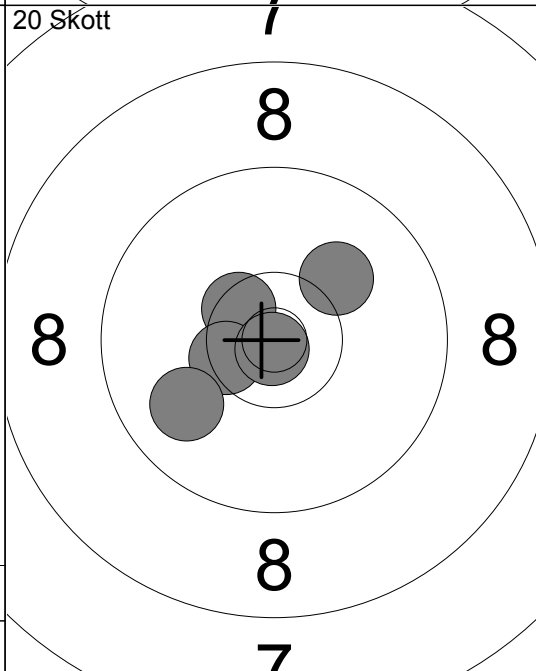

- 11: 10.5x ↘
- 12: 10.5x ↘
- 13: 9.9 ↖
- 14: 10.9x ↘
- 15: 10.1 ↗

Serie 49.0
Total 144.0

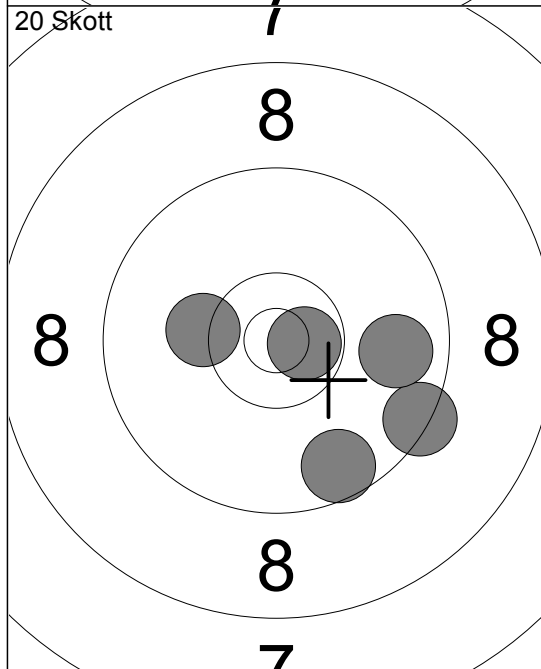

- 16: 10.2 ←
- 17: 9.6 ↘
- 18: 9.4 ↘
- 19: 10.7x →
- 20: 9.8 →

Serie 47.0
Total 191.0

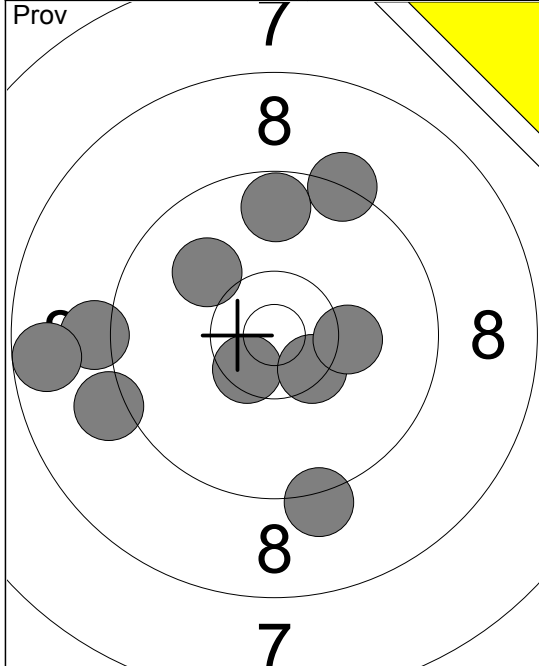

- 1: 9.1 ←
- 2: 8.6 ←
- 3: 9.2 ↓
- 4: 10.5x ↘
- 5: 10.4x ↘
- 6: 9.1 ←
- 7: 9.3 ↗
- 8: 9.7 ↑
- 9: 10.0 ↖
- 10: 10.2 →

Serie 93.0
Total 0.0

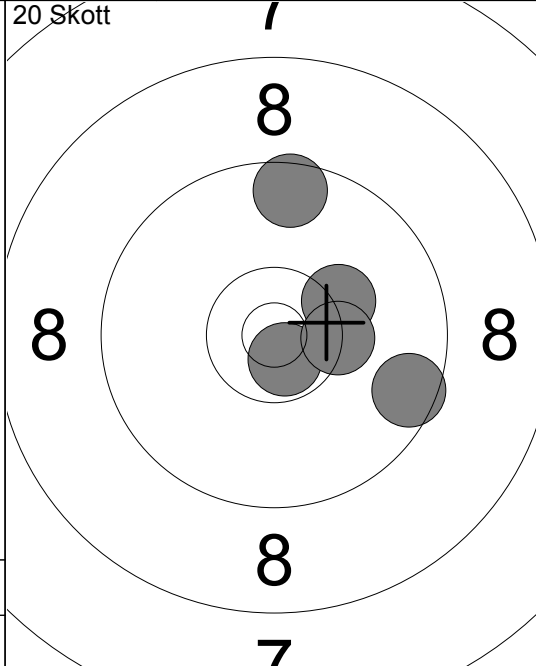

- 1: 10.7x ↘
- 2: 9.6 ↑
- 3: 9.6 →
- 4: 10.3 ↗
- 5: 10.3x →

Serie 48.0
Total 48.0

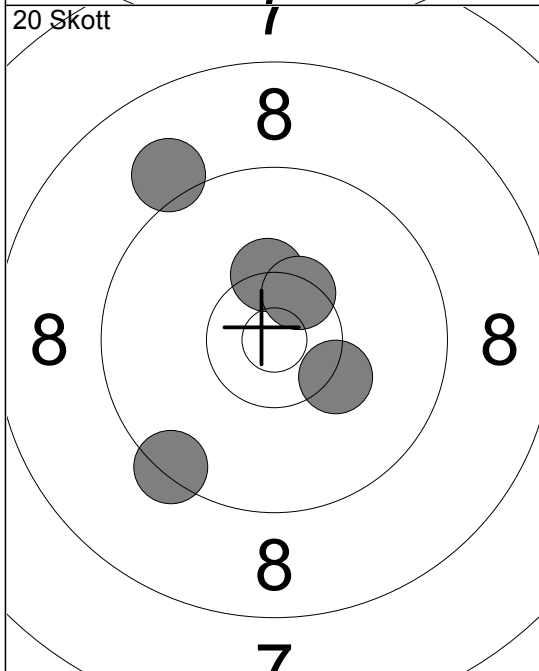

- 6: 10.3x ↗
- 7: 9.1 ↖
- 8: 10.3 →
- 9: 9.4 ↘
- 10: 10.4x ↗

Serie 48.0
Total 96.0

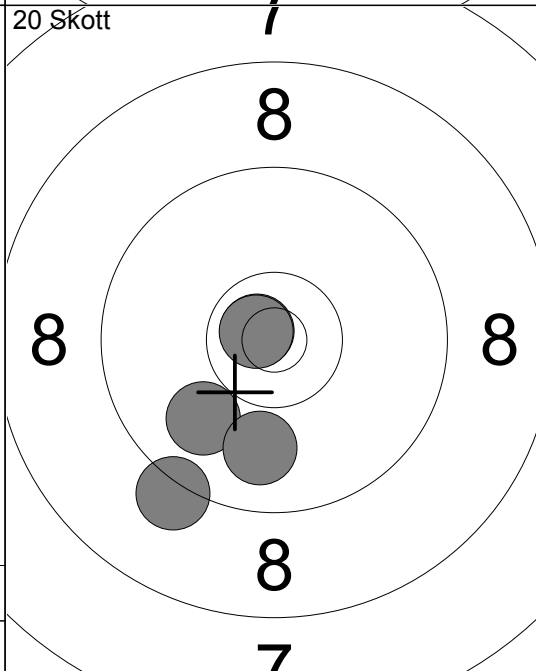

- 11: 9.9 ↘
- 12: 9.2 ↘
- 13: 9.9 ↓
- 14: 10.8x ↘
- 15: 10.8x ↘

Serie 47.0
Total 143.0

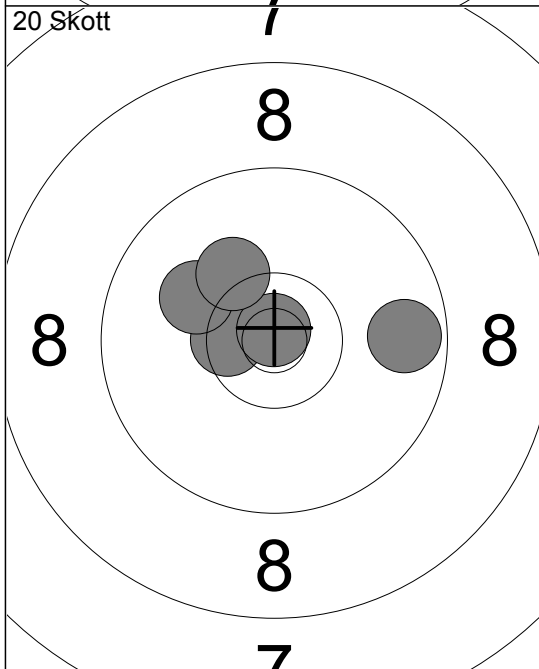

- 16: 10.5x ←
- 17: 10.8x ↗
- 18: 10.1 ↖
- 19: 9.7 →
- 20: 10.2 ↖

Serie 49.0
Total 192.0

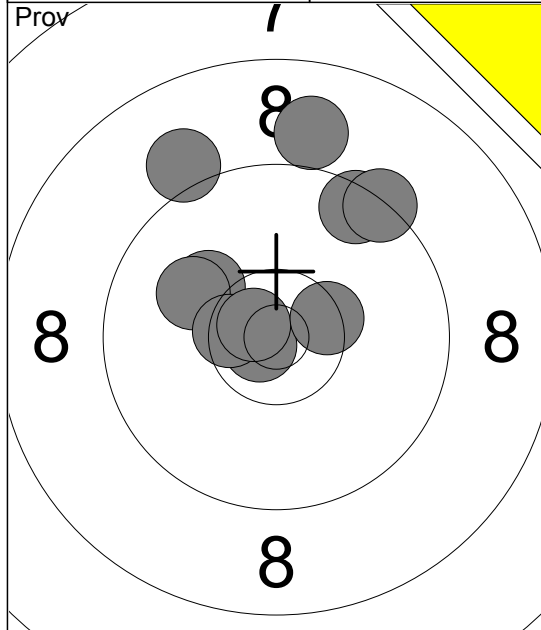

1:	10.8x
2:	9.1
3:	9.0
4:	10.1
5:	10.1
6:	9.5
7:	10.5x
8:	10.7x
9:	10.4x
10:	9.4
Serie	96.0
Total	0.0

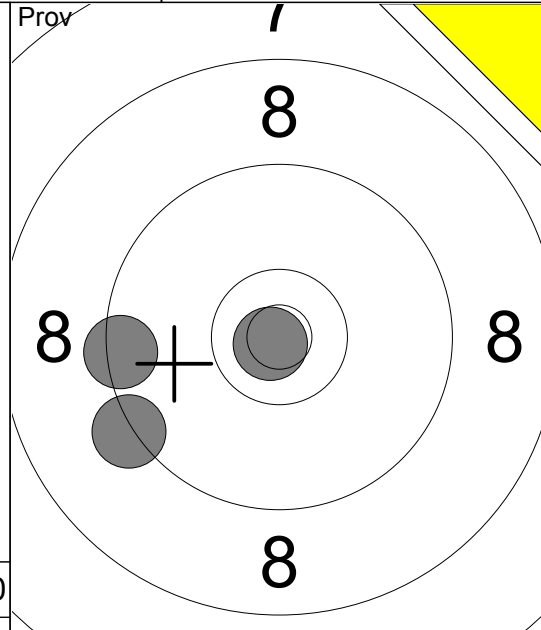

11:	9.4
12:	9.3
13:	10.8x
Serie	28.0
Total	0.0

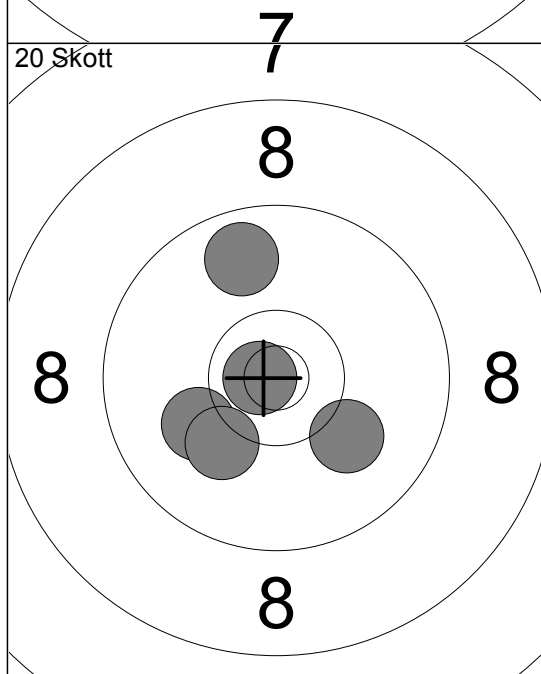

1:	10.8x
2:	9.8
3:	10.1
4:	10.1
5:	10.1
Serie	49.0
Total	49.0

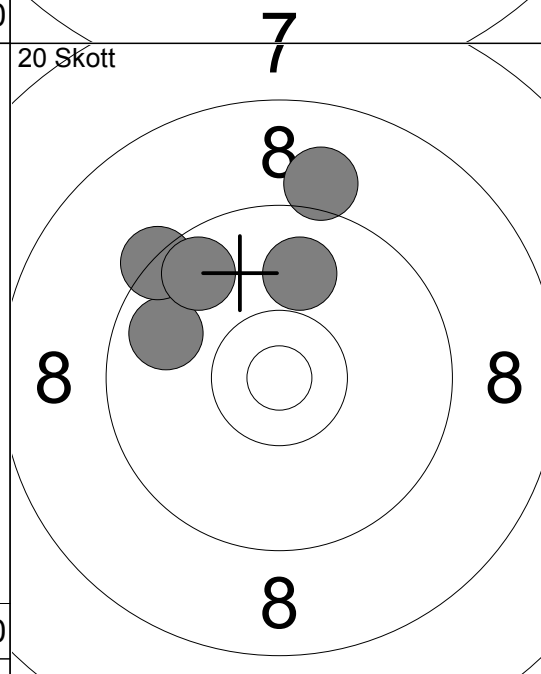

6:	9.8
7:	9.1
8:	9.4
9:	9.7
10:	9.9
Serie	45.0
Total	94.0

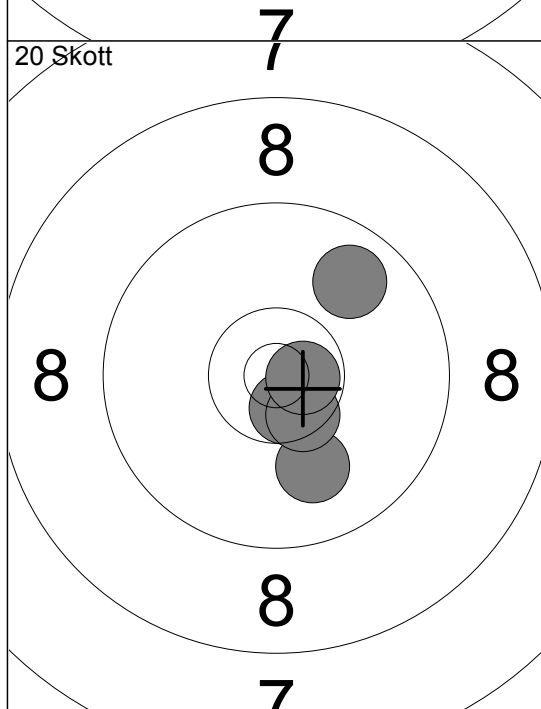

11:	10.6x
12:	10.0
13:	9.8
14:	10.5x
15:	10.7x
Serie	49.0
Total	143.0

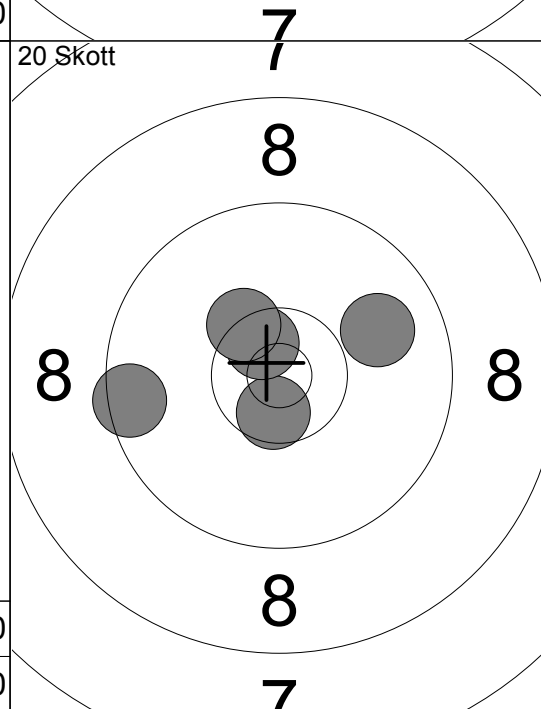

16:	9.9
17:	9.5
18:	10.6x
19:	10.6x
20:	10.4x
Serie	48.0
Total	191.0

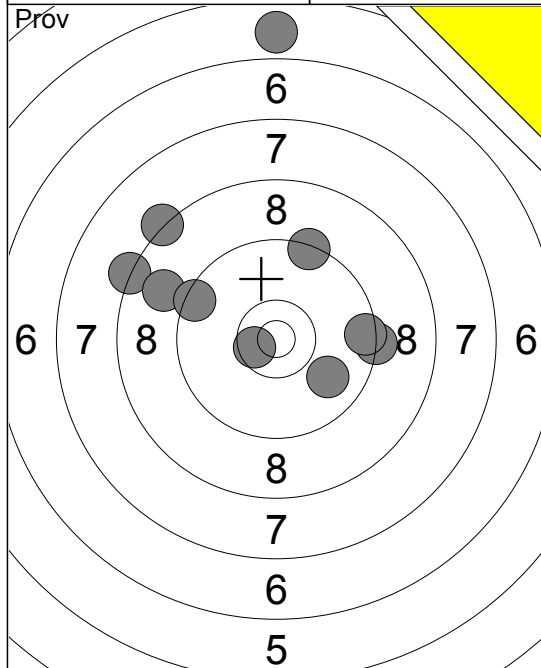

1:	5.9	↑
2:	8.3	↖
3:	8.3	↖
4:	8.9	↖
5:	9.9	↘
6:	9.4	↑
7:	10.6	✕
8:	9.3	→
9:	9.5	↖
10:	9.5	→
Serie	84.0	
Total	0.0	

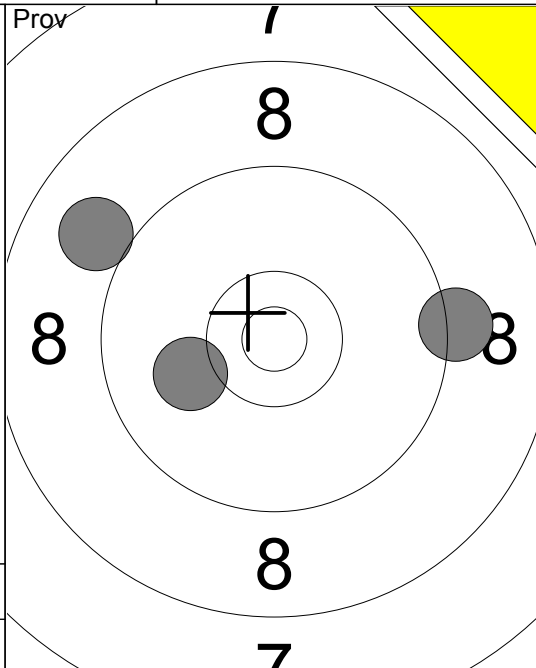

11:	9.2	→
12:	10.1	↖
13:	9.0	↖
Serie	28.0	
Total	0.0	

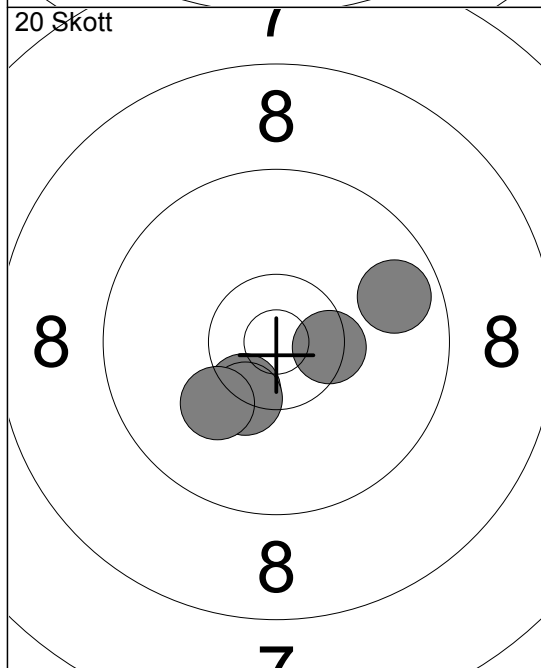

1:	10.4	↘
2:	10.4	↘
3:	9.7	→
4:	10.3	↘
5:	10.1	↘
Serie	49.0	
Total	49.0	

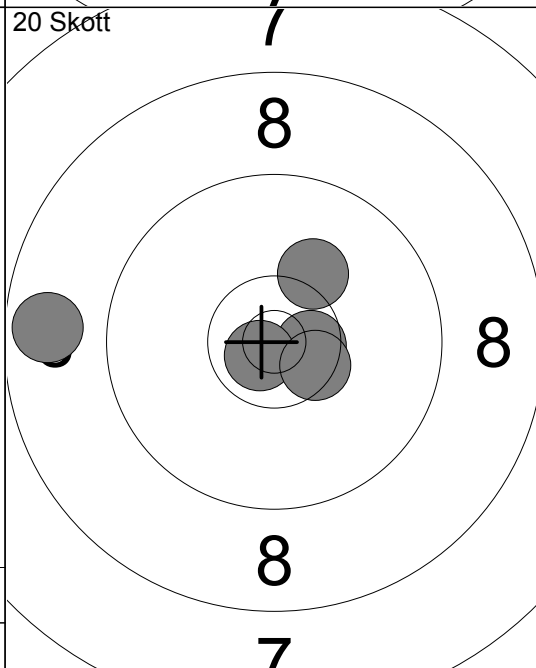

6:	10.2	↗
7:	10.6	↘
8:	10.8	↘
9:	8.7	↖
10:	10.5	↘
Serie	48.0	
Total	97.0	

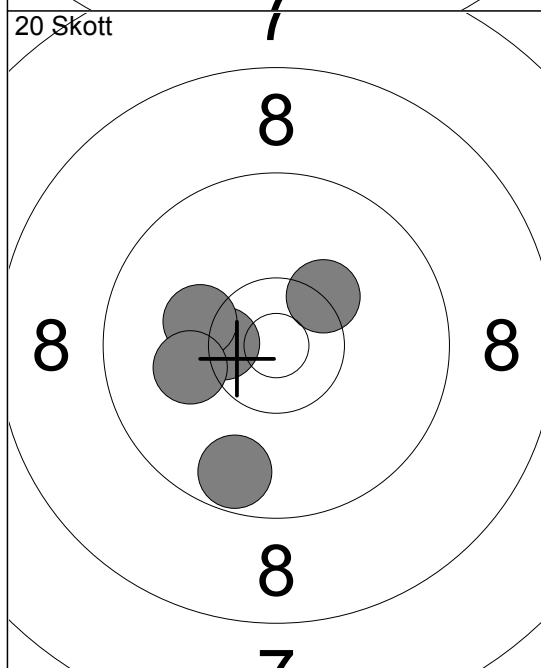

11:	9.7	↘
12:	10.4	↖
13:	10.3	↗
14:	10.2	↖
15:	10.1	↖
Serie	49.0	
Total	146.0	

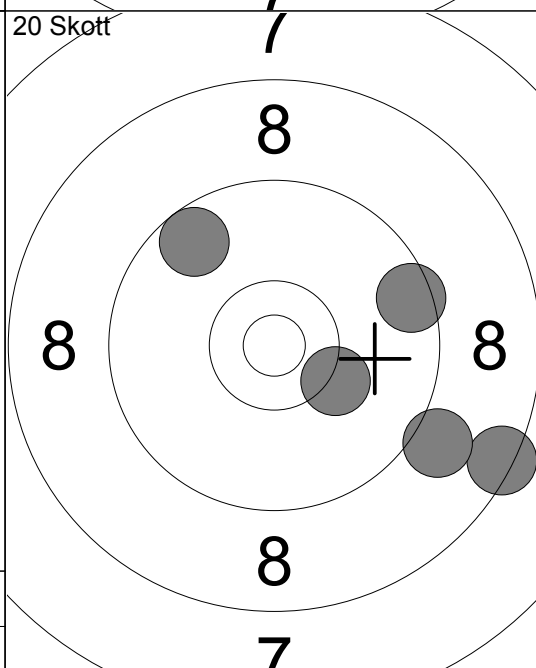

16:	9.6	↖
17:	10.2	↘
18:	8.4	↘
19:	9.5	→
20:	9.1	↘
Serie	45.0	
Total	191.0	

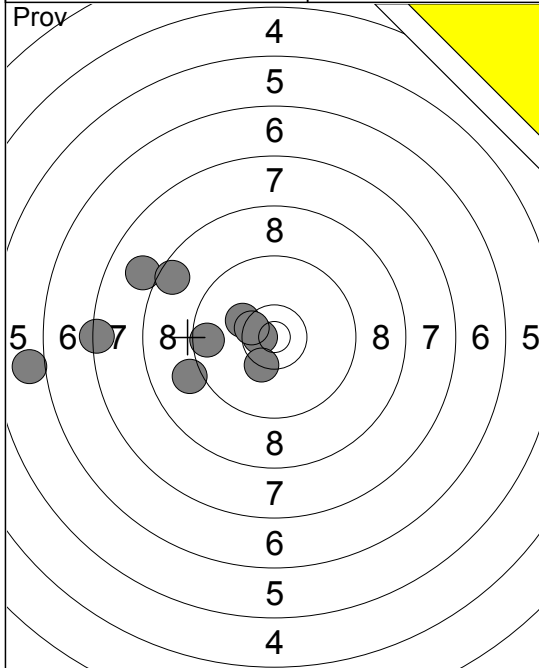

1:	6.0	←
2:	8.0	↖
3:	7.4	←
4:	8.6	↖
5:	10.2	↖
6:	9.6	←
7:	10.7	↖
8:	10.5	↖
9:	10.3	↘
10:	9.1	←
Serie	87.0	
Total	0.0	

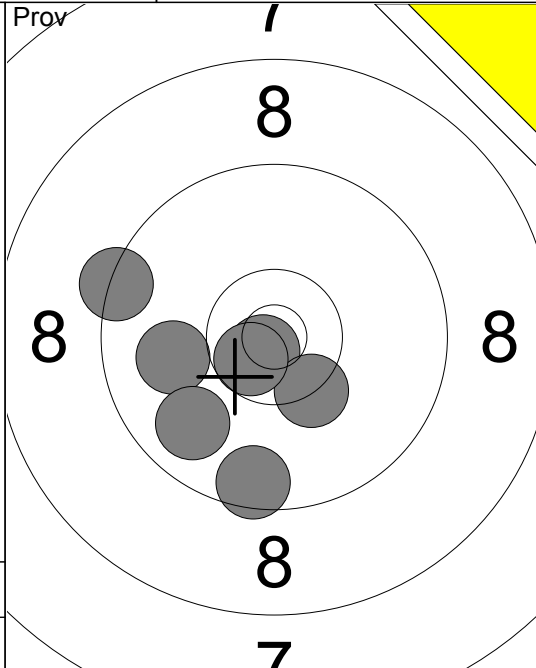

11:	10.8	↘
12:	9.6	↓
13:	10.3	↘
14:	10.0	←
15:	9.4	←
16:	9.8	↘
17:	10.6	↘
Serie	67.0	
Total	0.0	

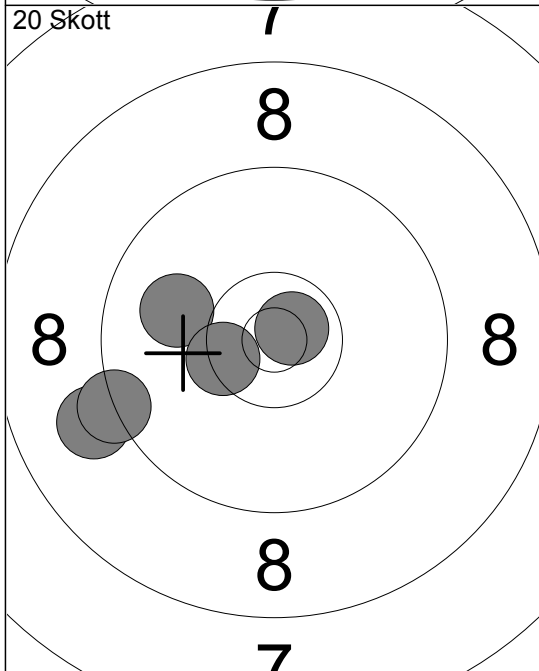

1:	10.0	←
2:	9.1	←
3:	9.3	←
4:	10.8	↗
5:	10.4	↖
Serie	48.0	
Total	48.0	

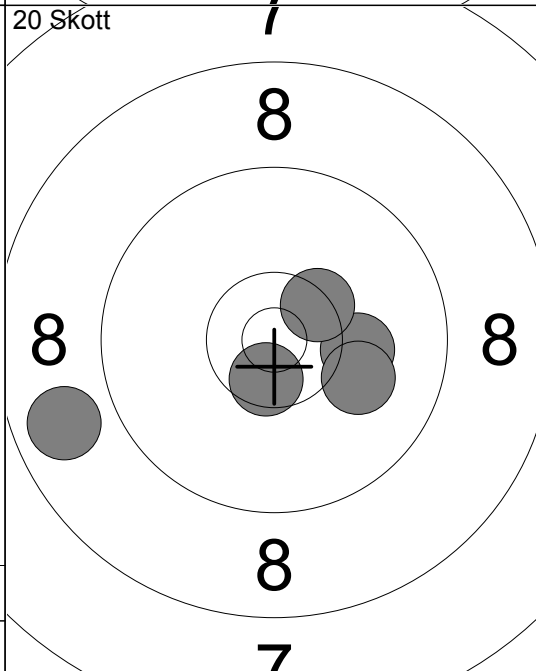

6:	10.6	↘
7:	10.2	→
8:	10.1	→
9:	8.8	←
10:	10.4	↗
Serie	48.0	
Total	96.0	

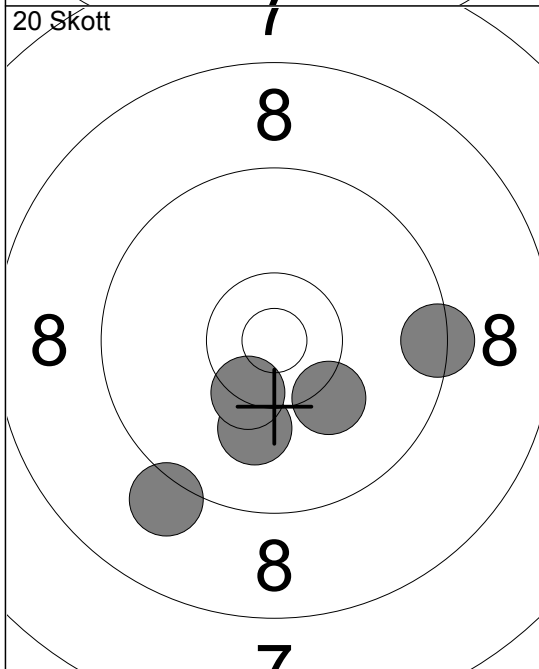

11:	9.1	↘
12:	10.1	↓
13:	9.4	→
14:	10.2	↘
15:	10.4	↘
Serie	48.0	
Total	144.0	

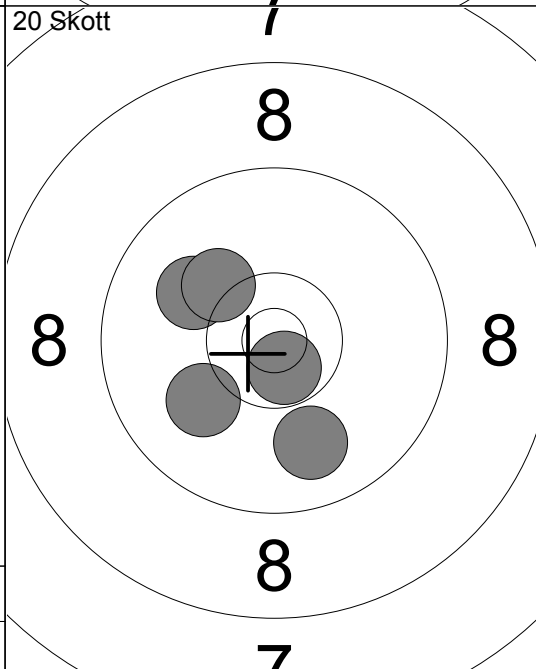

16:	10.1	↖
17:	10.7	↘
18:	10.1	↖
19:	10.2	↖
20:	9.9	↓
Serie	49.0	
Total	193.0	

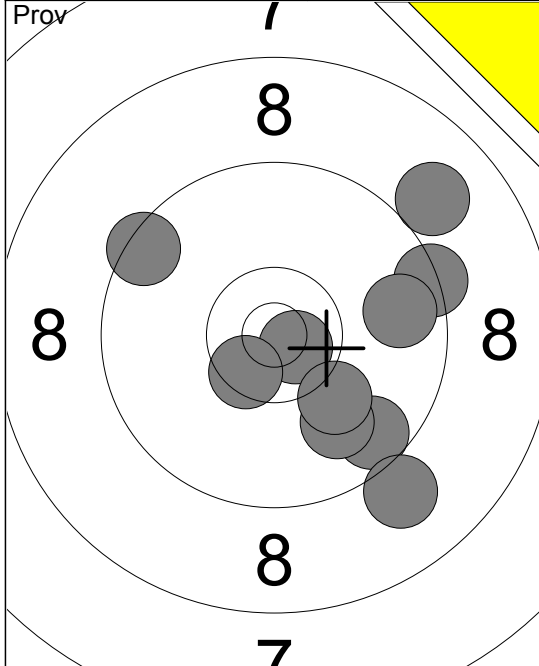

1:	9.0 ↗
2:	9.6 ↘
3:	9.0 ↘
4:	10.7x↘
5:	9.9 ↘
6:	9.5 ↗
7:	10.1 ↘
8:	9.4 →
9:	9.7 →
10:	10.5x↘
Serie 93.0	
Total 0.0	

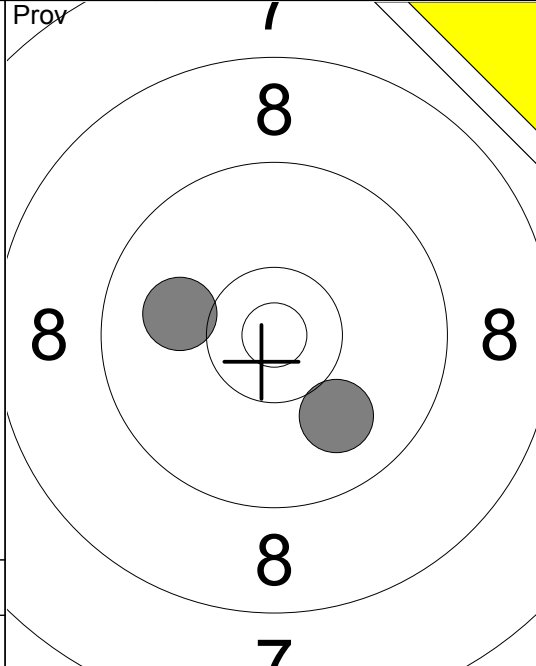

11:	10.0 ←
12:	10.0 ↘
Serie 20.0	
Total 0.0	

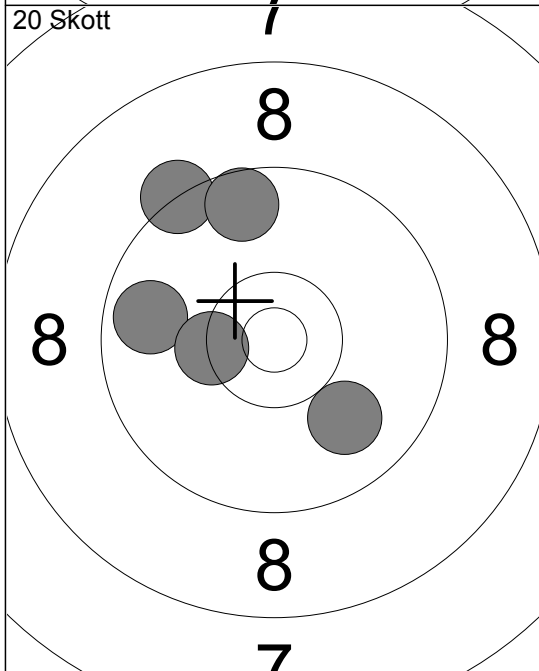

1:	9.3 ↗
2:	9.7 ←
3:	9.6 ↗
4:	10.3x←
5:	10.0 ↘
Serie 47.0	
Total 47.0	

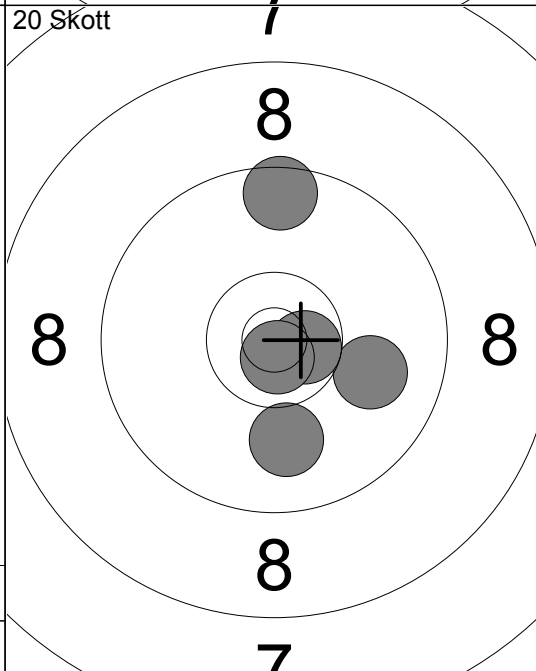

6:	10.0 ↘
7:	10.0 →
8:	10.7x→
9:	9.5 ↗
10:	10.8x↘
Serie 49.0	
Total 96.0	

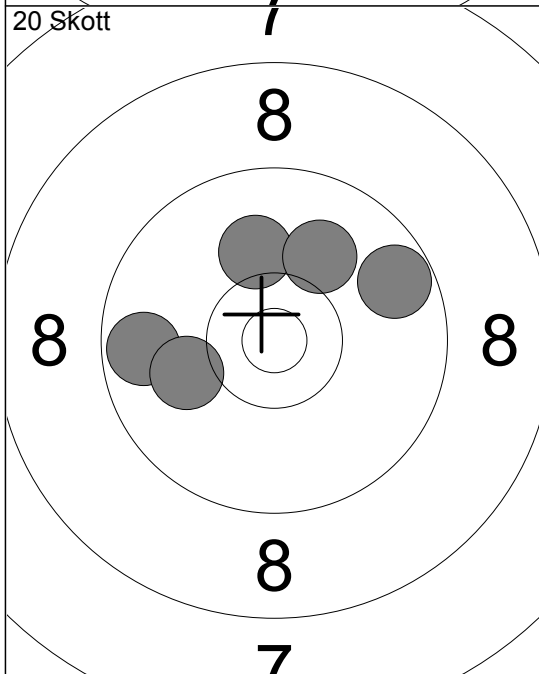

11:	10.1 ↗
12:	9.7 ←
13:	10.1 ←
14:	10.0 ↗
15:	9.7 →
Serie 48.0	
Total 144.0	

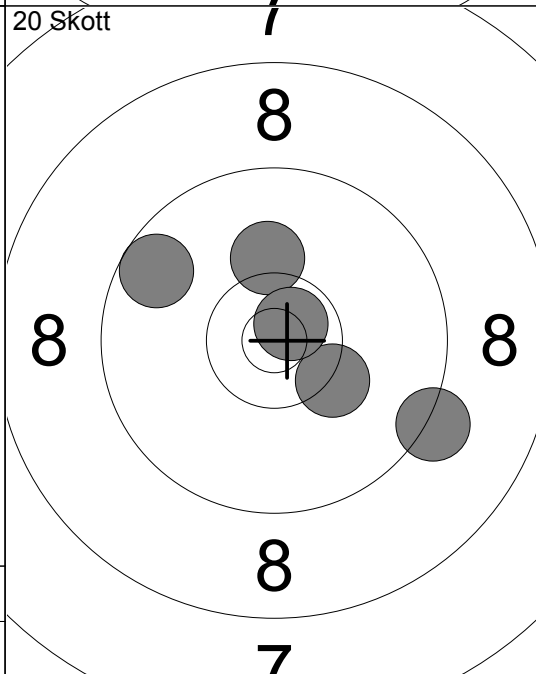

16:	9.2 ↘
17:	10.3 ↘
18:	10.2 ↗
19:	9.6 ←
20:	10.7x↗
Serie 48.0	
Total 192.0	

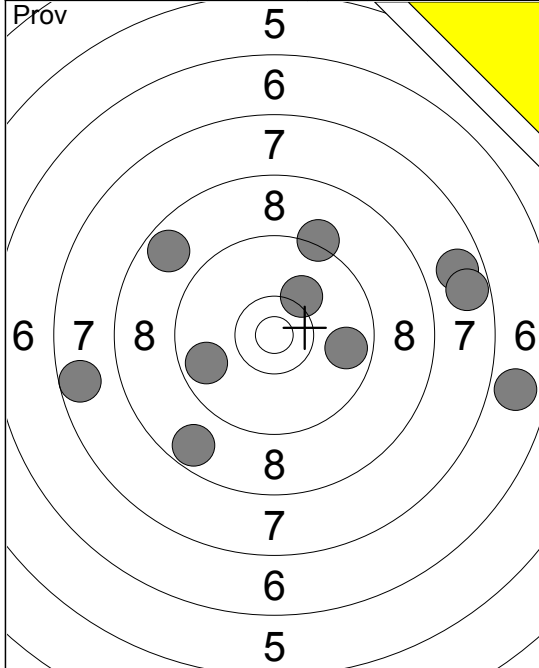

1:	8.7	↘
2:	7.6	←
3:	10.2	↗
4:	9.7	←
5:	9.2	↗
6:	8.7	↖
7:	6.9	→
8:	7.7	→
9:	9.7	→
10:	7.7	→
Serie	80.0	
Total	0.0	

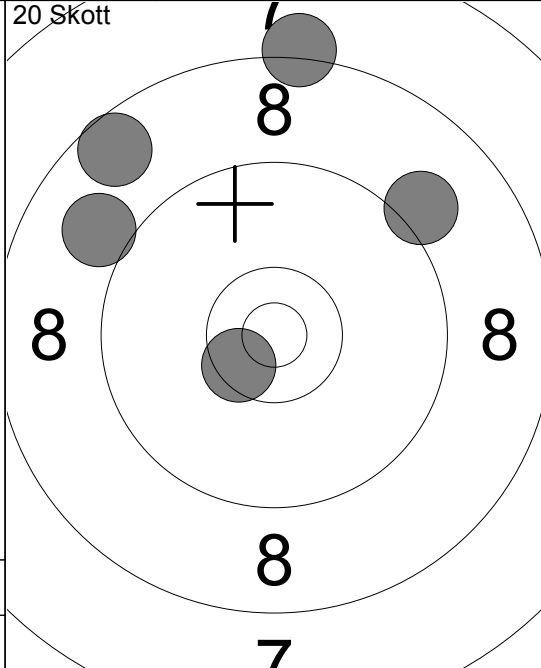

1:	10.5	↘
2:	9.1	↗
3:	9.0	↖
4:	8.2	↑
5:	8.6	↖
Serie	44.0	
Total	44.0	

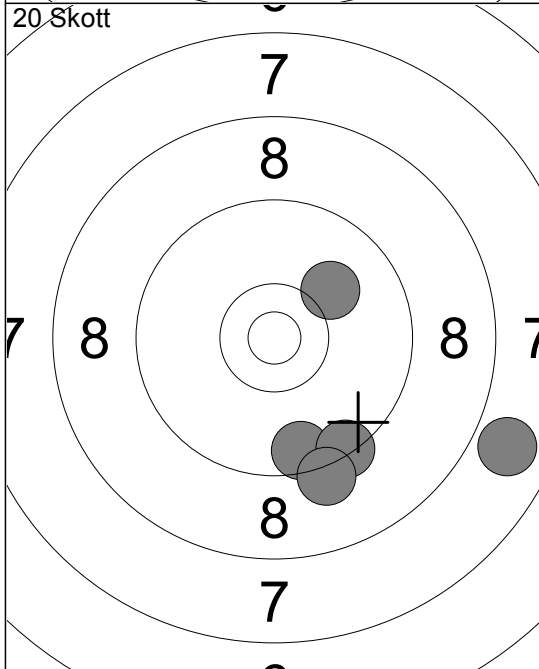

6:	9.6	↓
7:	10.1	↗
8:	9.4	↓
9:	9.2	↓
10:	7.9	→
Serie	44.0	
Total	88.0	

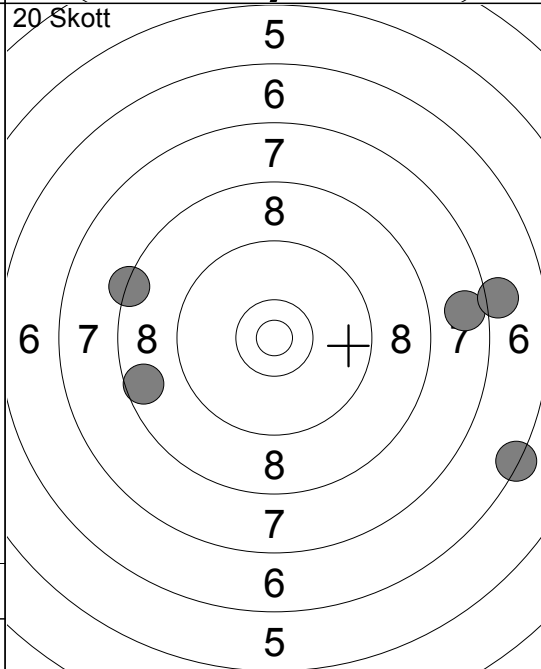

11:	7.7	→
12:	8.6	←
13:	8.3	←
14:	7.1	→
15:	6.3	↘
Serie	36.0	
Total	124.0	

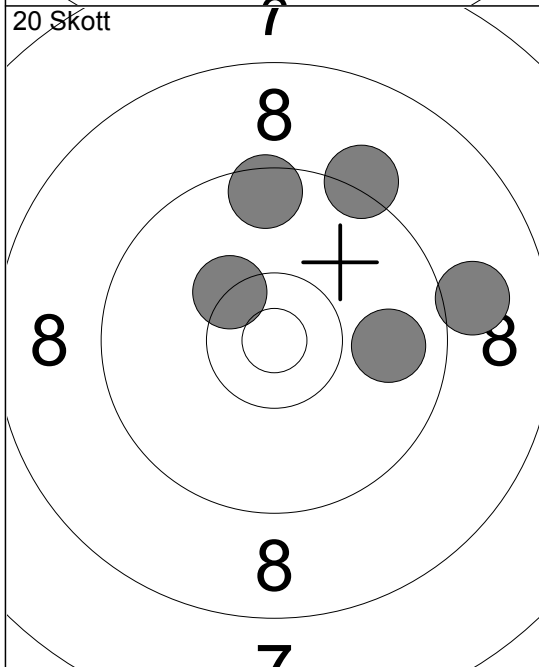

16:	9.0	→
17:	9.2	↗
18:	9.5	↑
19:	10.3	↘
20:	9.9	→
Serie	46.0	
Total	170.0	

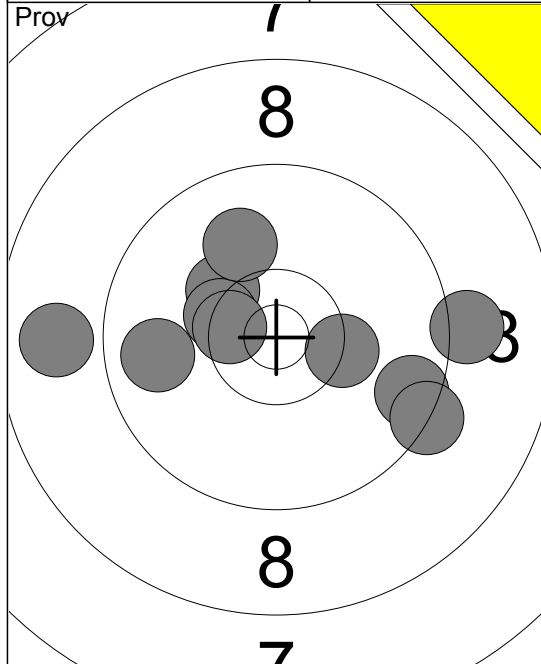

1:	8.9	←
2:	9.8	←
3:	9.6	→
4:	9.1	→
5:	10.3	↖
6:	10.4	↖
7:	10.0	↗
8:	10.3	→
9:	10.5	↖
10:	9.3	→
Serie	94.0	
Total	0.0	

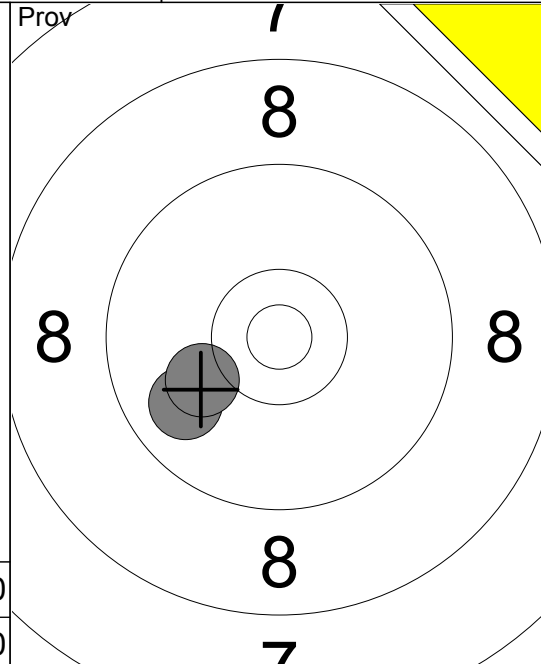

11:	9.9	↖
12:	10.1	↖
Serie	19.0	
Total	0.0	

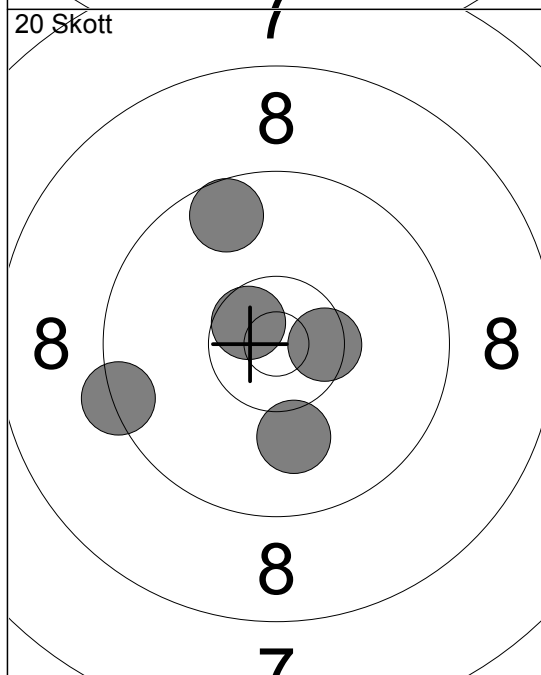

1:	10.0	↓
2:	9.6	↑
3:	9.4	←
4:	10.6	↖
5:	10.5	→
Serie	48.0	
Total	48.0	

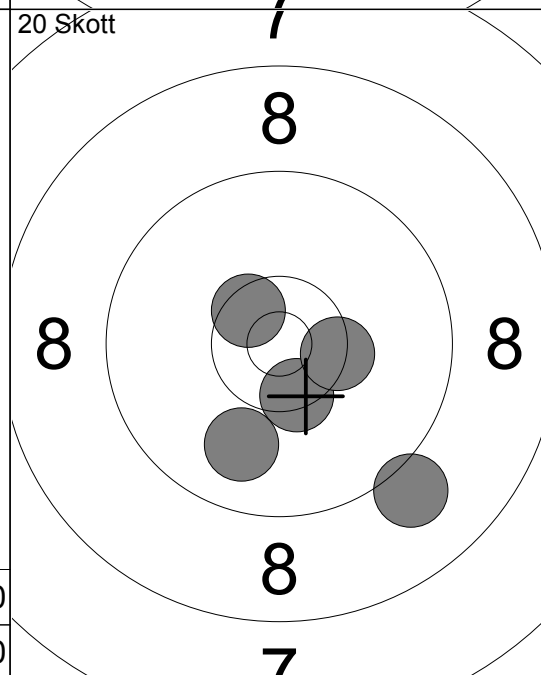

6:	10.5	↖
7:	9.1	↘
8:	10.4	↘
9:	9.9	↓
10:	10.4	→
Serie	48.0	
Total	96.0	

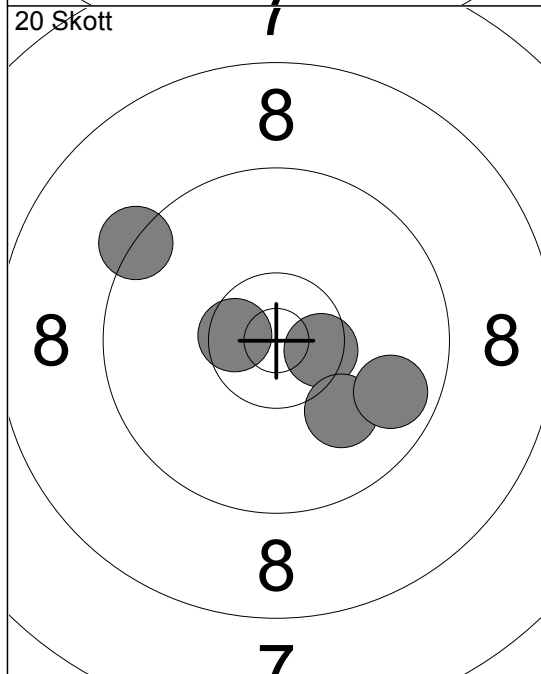

11:	10.5	→
12:	9.3	↖
13:	10.0	↘
14:	10.6	↖
15:	9.8	→
Serie	48.0	
Total	144.0	

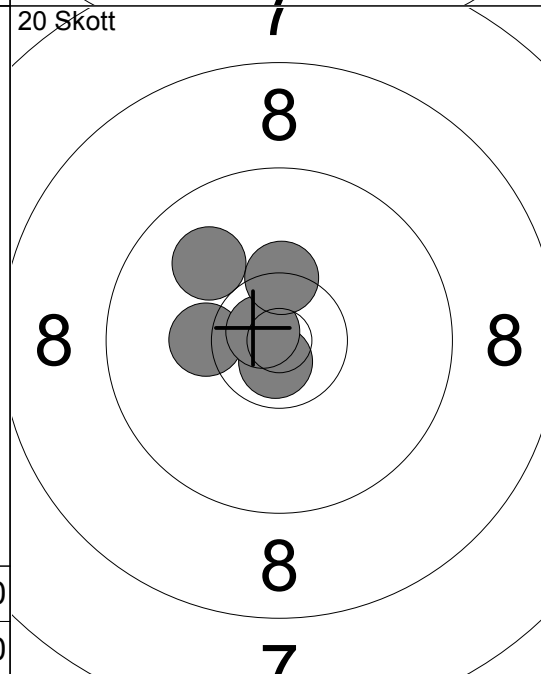

16:	10.7	↘
17:	10.2	←
18:	10.8	↖
19:	10.0	↖
20:	10.4	↗
Serie	50.0	
Total	194.0	

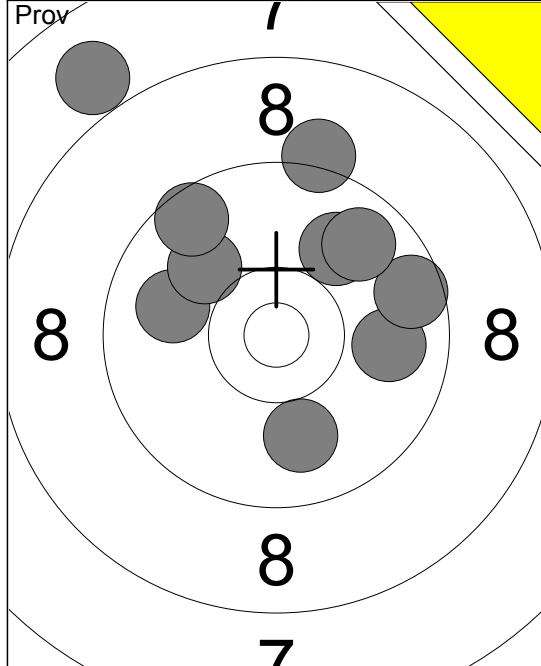

- 1: 7.9 ↖
- 2: 9.9 →
- 3: 9.2 ↑
- 4: 9.9 ←
- 5: 10.0 ↓
- 6: 9.6 →
- 7: 10.0 ↖
- 8: 9.6 ↖
- 9: 9.9 ↗
- 10: 9.8 ↗

Serie 90.0
Total 0.0

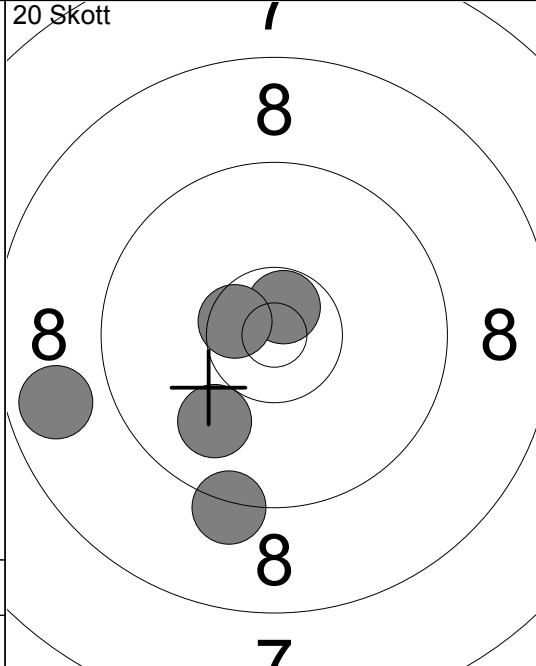

- 1: 10.7x ↗
- 2: 10.0 ↓
- 3: 10.6x ↘
- 4: 9.2 ↓
- 5: 8.8 ←

Serie 47.0
Total 47.0

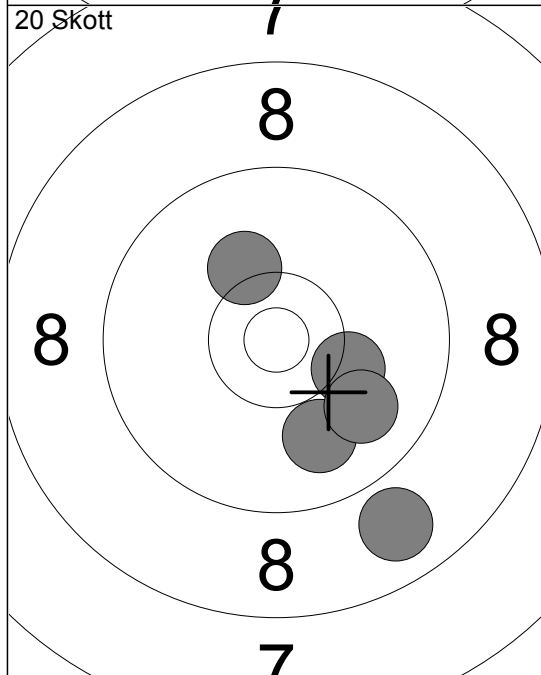

- 6: 8.9 ↓
- 7: 9.9 ↓
- 8: 10.2 ↗
- 9: 10.2 →
- 10: 9.9 ↓

Serie 46.0
Total 93.0

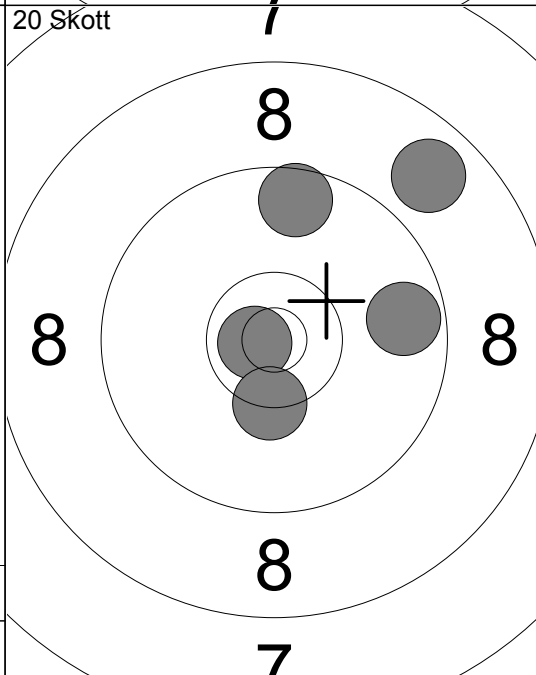

- 11: 10.8x ↘
- 12: 8.8 ↗
- 13: 9.6 ↑
- 14: 10.3x ↓
- 15: 9.7 →

Serie 46.0
Total 139.0

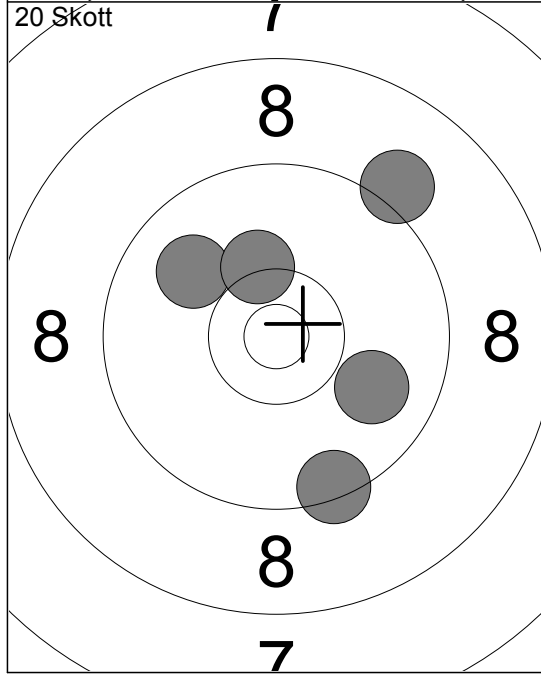

- 16: 9.9 ↖
- 17: 9.9 →
- 18: 9.4 ↓
- 19: 10.3 ↗
- 20: 9.1 ↗

Serie 46.0
Total 185.0

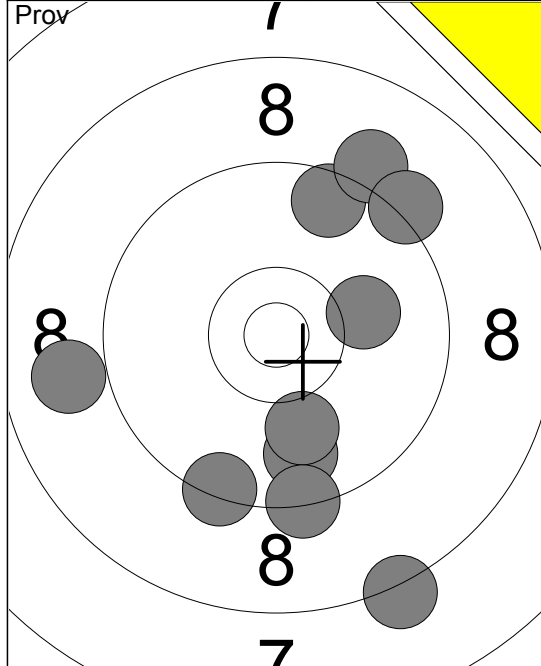

1:	8.9	←
2:	9.6	↗
3:	9.1	↗
4:	9.2	↗
5:	10.1	→
6:	8.2	↓
7:	9.4	↓
8:	9.8	↓
9:	10.0	↓
10:	9.3	↓
Serie	90.0	
Total	0.0	

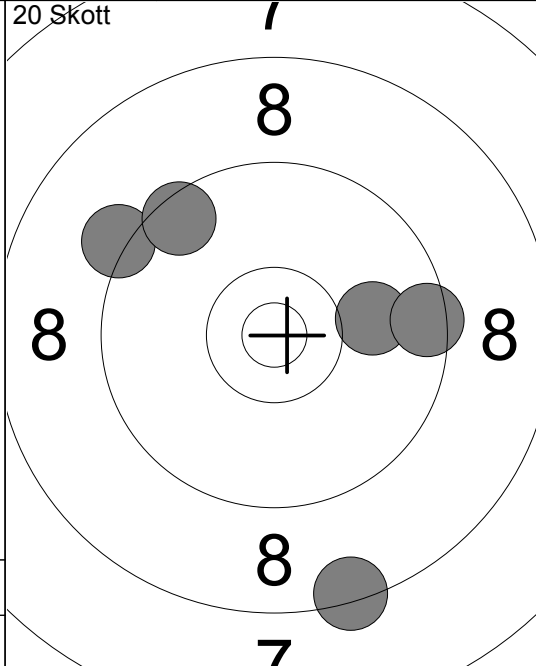

1:	8.4	↓
2:	9.2	↖
3:	9.5	↗
4:	10.0	→
5:	9.5	→
Serie	45.0	
Total	45.0	

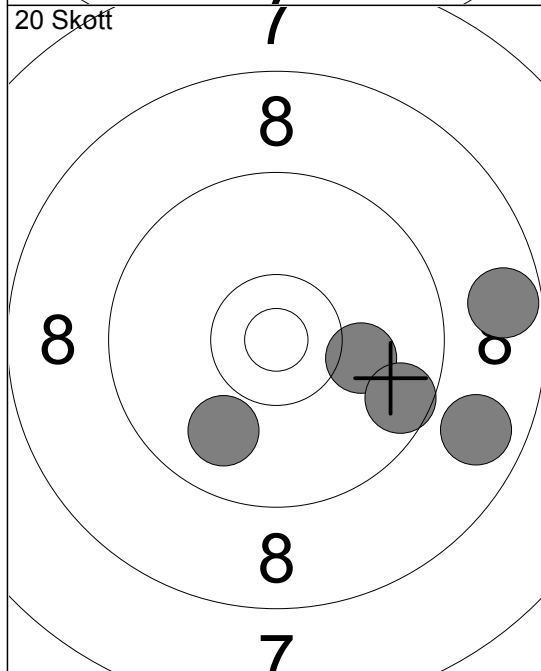

6:	10.1	→
7:	8.7	→
8:	8.8	→
9:	9.6	→
10:	9.9	↓
Serie	44.0	
Total	89.0	

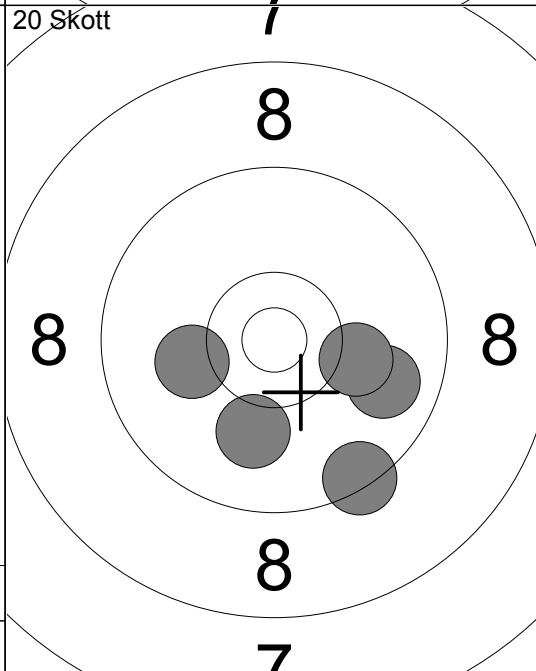

11:	9.8	→
12:	10.1	→
13:	10.1	↓
14:	9.4	↓
15:	10.1	←
Serie	48.0	
Total	137.0	

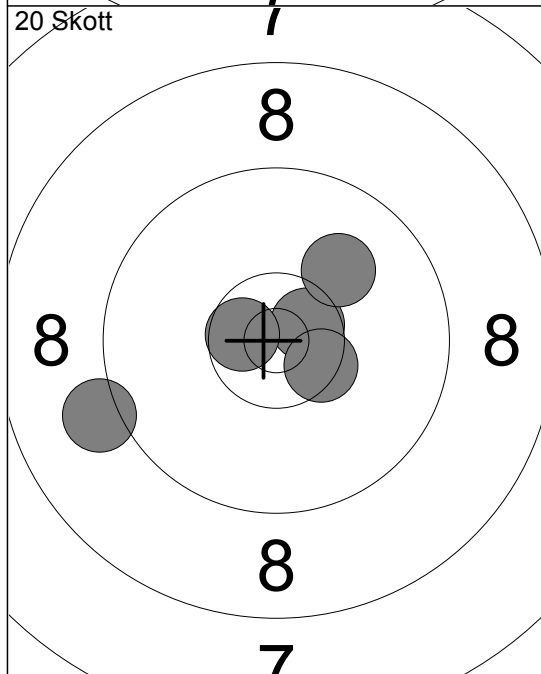

16:	10.6	↗
17:	10.6	↖
18:	10.1	↗
19:	10.5	↘
20:	9.1	←
Serie	49.0	
Total	186.0	

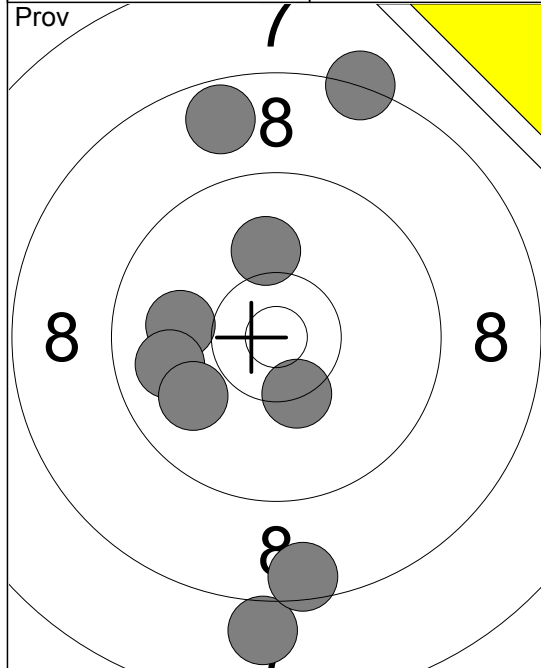

- 1: 8.7 ↑
- 2: 8.3 ↑
- 3: 10.1 ↑
- 4: 8.0 ↓
- 5: 8.5 ↓
- 6: 10.0 ←
- 7: 10.3x ↓
- 8: 9.8 ←
- 9: 9.9 ↙

Serie 80.0
Total 0.0

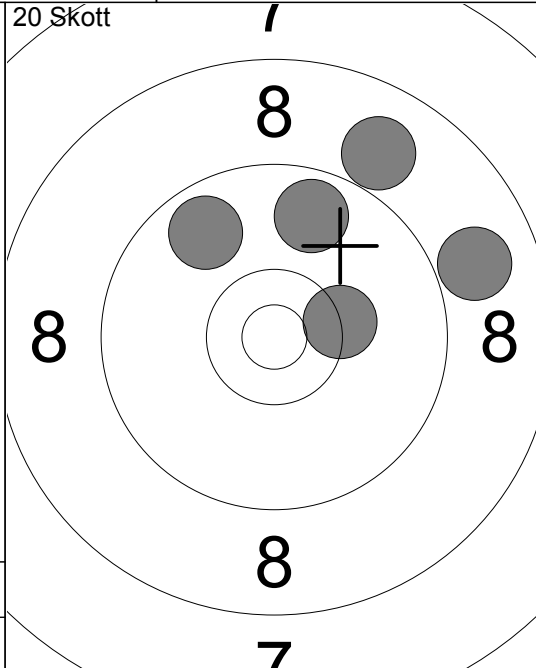

- 1: 8.9 →
- 2: 10.3x →
- 3: 9.7 ↑
- 4: 8.9 ↗
- 5: 9.8 ↖

Serie 44.0
Total 44.0

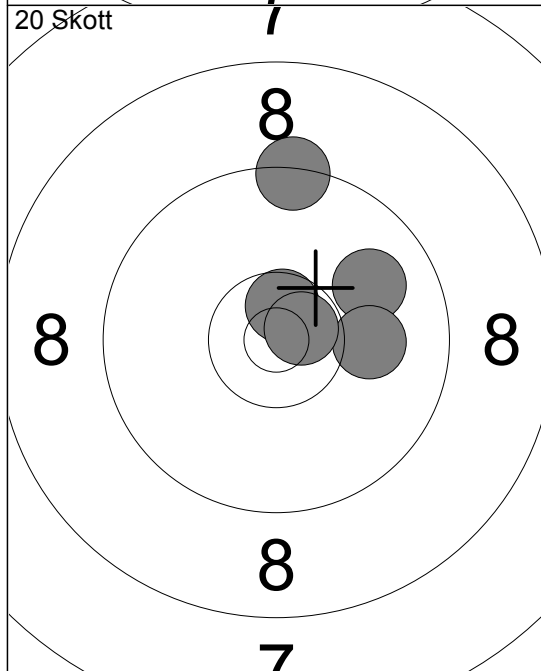

- 6: 10.6x ↑
- 7: 9.9 →
- 8: 9.4 ↑
- 9: 10.1 →
- 10: 10.7x →

Serie 48.0
Total 92.0

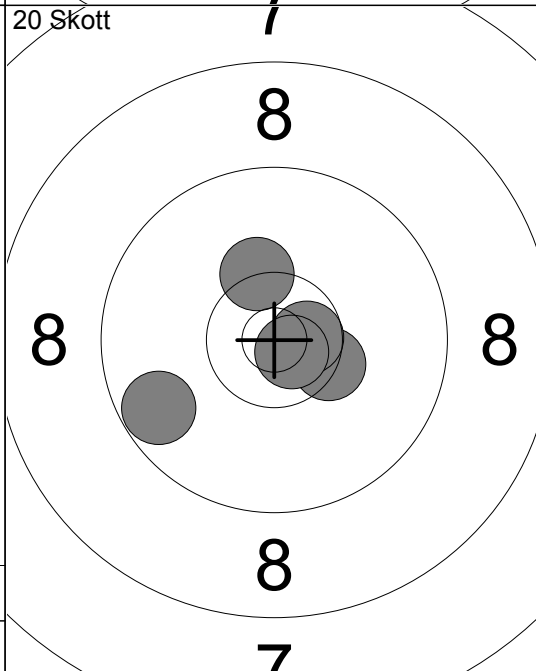

- 11: 10.3x ↑
- 12: 10.4x →
- 13: 9.7 ←
- 14: 10.6x →
- 15: 10.7x →

Serie 49.0
Total 141.0

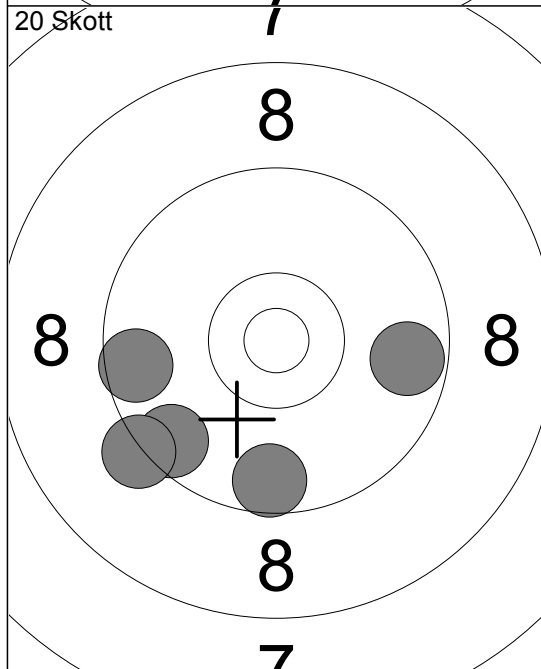

- 16: 9.6 ↙
- 17: 9.7 →
- 18: 9.6 ↓
- 19: 9.3 ↙
- 20: 9.6 ←

Serie 45.0
Total 186.0

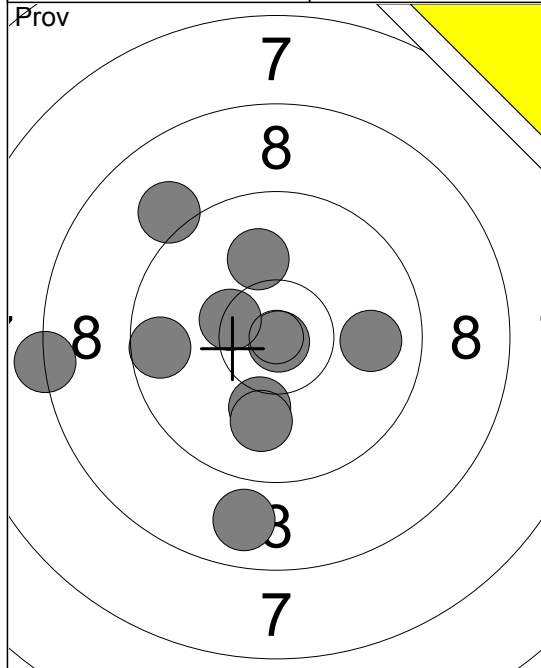

1: 10.1 ↓
2: 10.9x ↓
3: 10.0 ↑
4: 10.0 ↓
5: 9.1 ↗
6: 10.4x ↗
7: 8.3 ←
8: 8.8 ↓
9: 9.9 →
10: 9.6 ←

Serie 93.0
Total 0.0

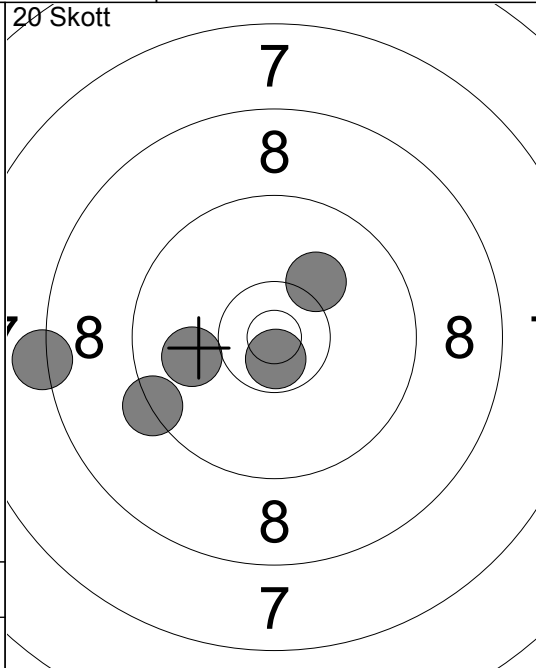

1: 10.1 ↗
2: 9.3 ↙
3: 8.2 ←
4: 10.0 ←
5: 10.7x ↓

Serie 47.0
Total 47.0

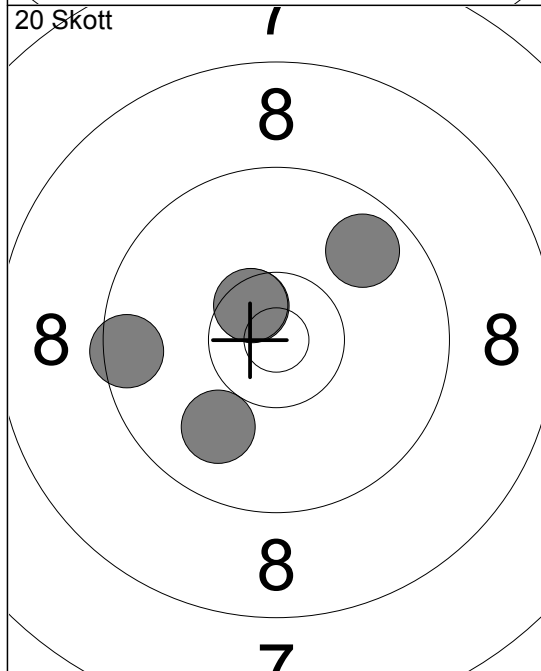

6: 10.5x ↘
7: 10.0 ↓
8: 9.8 ↗
9: 10.5x ↘
10: 9.5 ←

Serie 48.0
Total 95.0

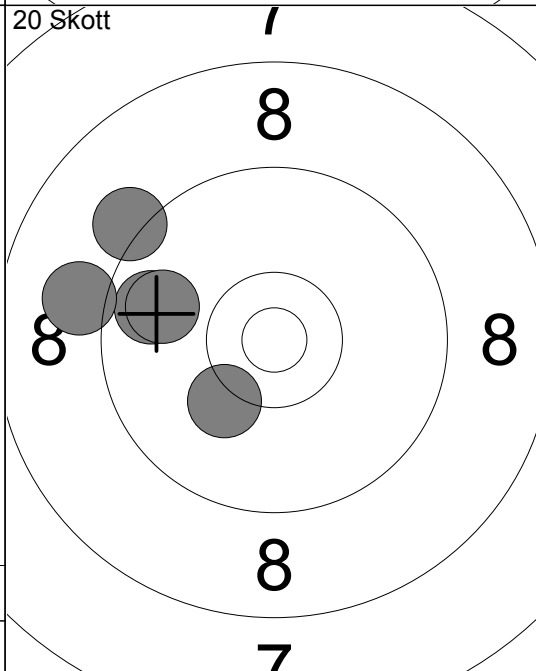

11: 9.7 ←
12: 10.2 ↓
13: 9.0 ←
14: 9.2 ↙
15: 9.8 ←

Serie 46.0
Total 141.0

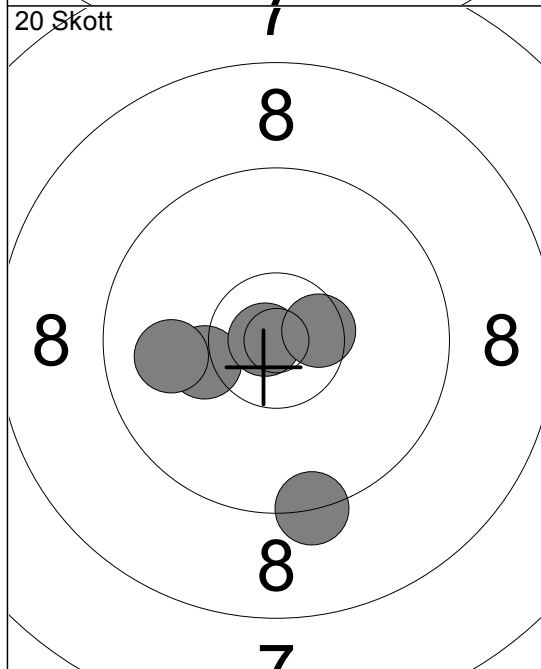

16: 10.2 ←
17: 10.8x ←
18: 9.3 ↓
19: 10.5x →
20: 9.9 ←

Serie 48.0
Total 189.0

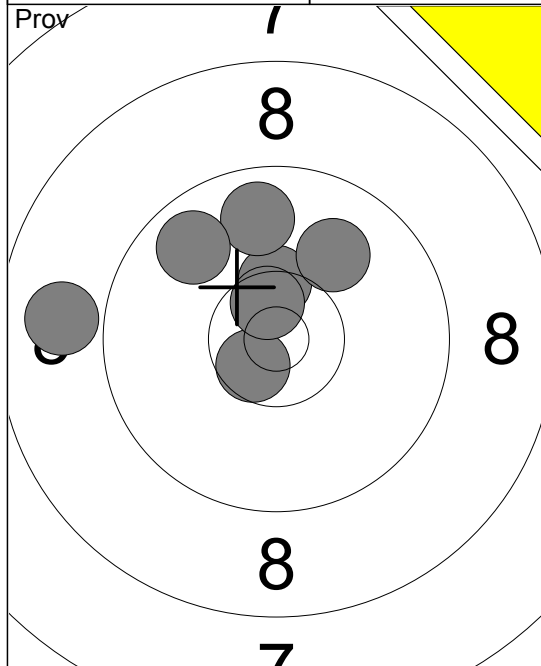

- 1: 10.6x ↘
- 2: 10.4x ↑
- 3: 8.9 ←
- 4: 9.8 ↑
- 5: 9.8 ↖
- 6: 10.0 ↗
- 7: 10.6x ↑

Serie 66.0

Total 0.0

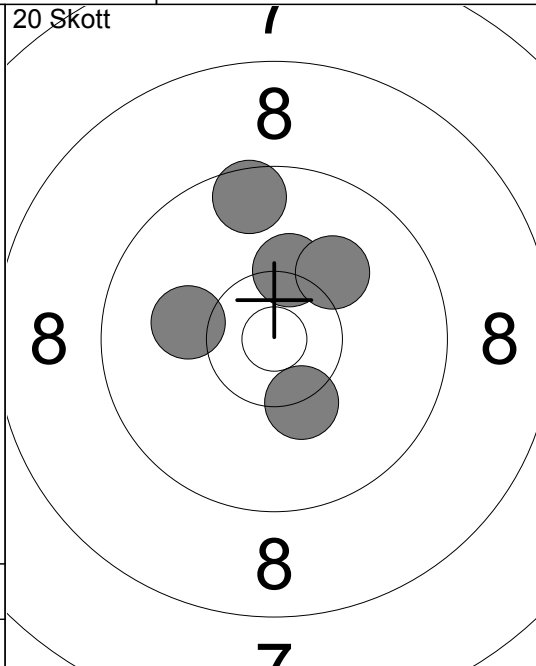

- 1: 10.3x ↘
- 2: 10.1 ←
- 3: 10.3 ↑
- 4: 10.1 ↗
- 5: 9.6 ↑

Serie 49.0

Total 49.0

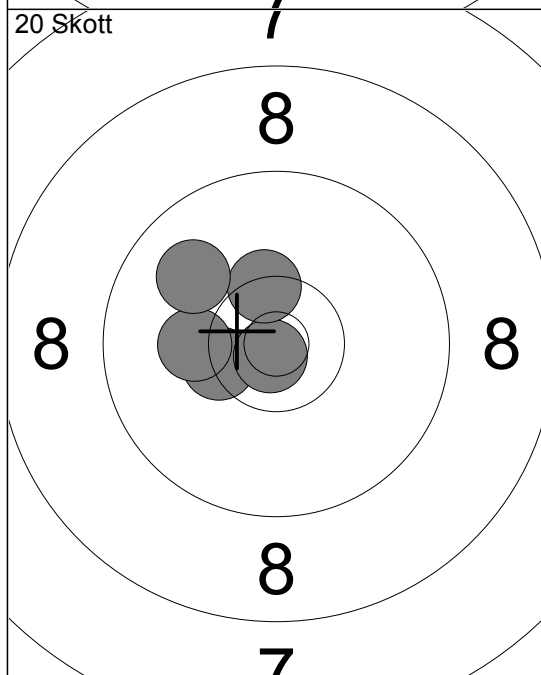

- 6: 10.4x ↘
- 7: 10.2 ←
- 8: 10.8x ↘
- 9: 10.4x ↑
- 10: 9.9 ↖

Serie 49.0

Total 98.0

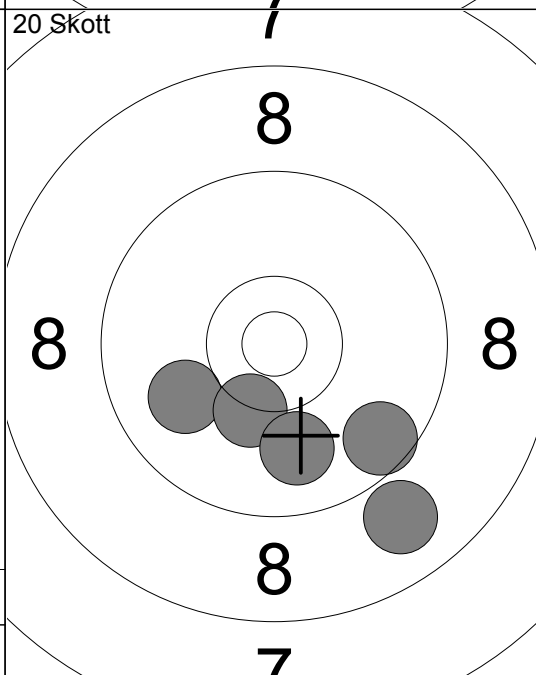

- 11: 10.0 ↙
- 12: 10.3 ↓
- 13: 8.9 ↘
- 14: 9.6 ↘
- 15: 9.9 ↓

Serie 46.0

Total 144.0

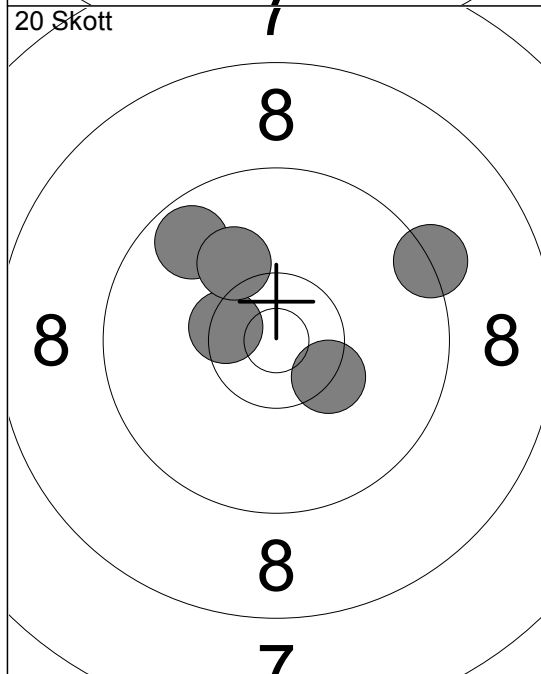

- 16: 9.7 ↖
- 17: 10.4x ↘
- 18: 9.3 ↗
- 19: 10.1 ↑
- 20: 10.3x ↘

Serie 48.0

Total 192.0

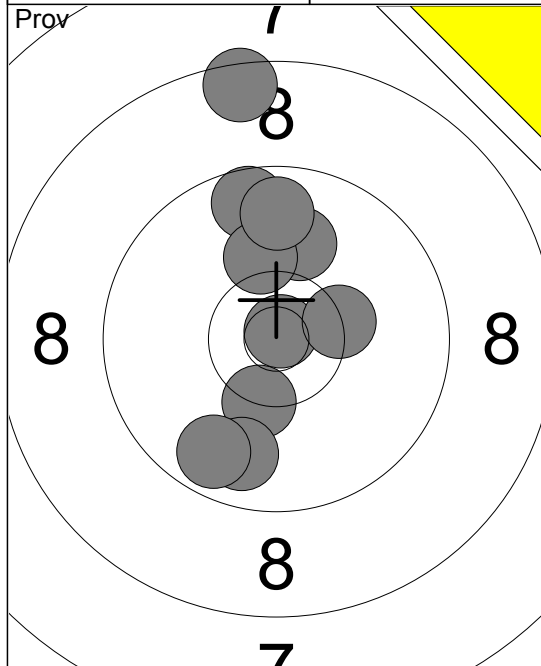

- 1: 8.5 ↑
- 2: 10.0 ↑
- 3: 9.6 ↑
- 4: 10.3x↓
- 5: 10.2 ↑
- 6: 9.8 ↓
- 7: 9.7 ↓
- 8: 10.9x↑
- 9: 10.3x→
- 10: 9.8 ↑

Serie 94.0
Total 0.0

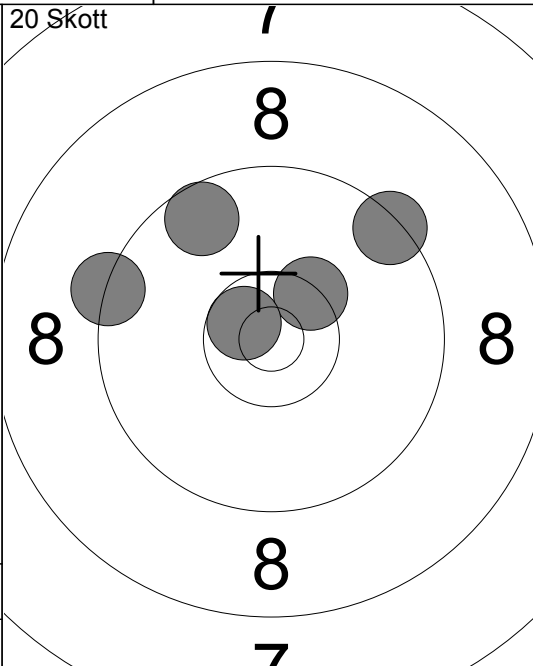

- 1: 9.3 ←
- 2: 9.6 ↑
- 3: 10.4x↗
- 4: 10.6x↖
- 5: 9.4 ↗

Serie 47.0
Total 47.0

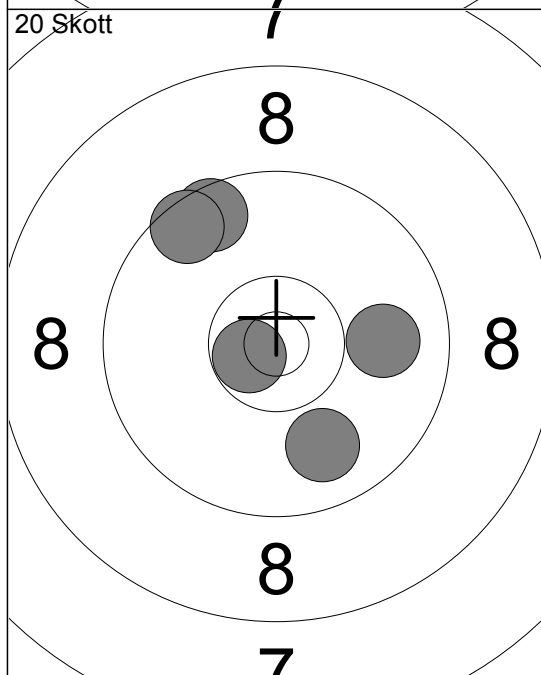

- 6: 9.6 ↑
- 7: 10.7x↖
- 8: 9.9 →
- 9: 9.9 ↓
- 10: 9.5 ↑

Serie 46.0
Total 93.0

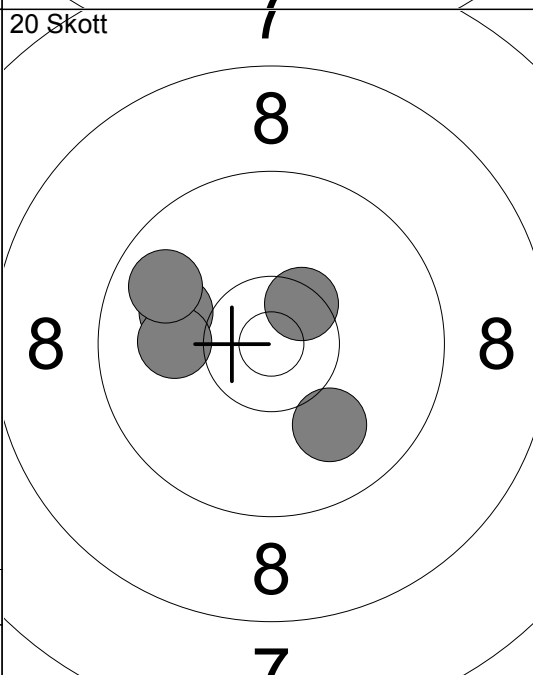

- 11: 10.0↖
- 12: 10.0↖
- 13: 10.5x↗
- 14: 10.0 ↓
- 15: 9.8 ←

Serie 49.0
Total 142.0

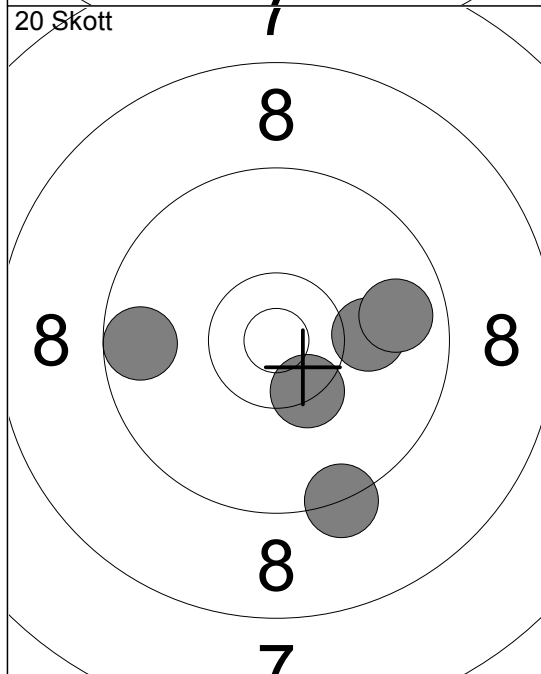

- 16: 9.6 ←
- 17: 9.3 ↓
- 18: 10.1 →
- 19: 10.4x↓
- 20: 9.8 →

Serie 47.0
Total 189.0

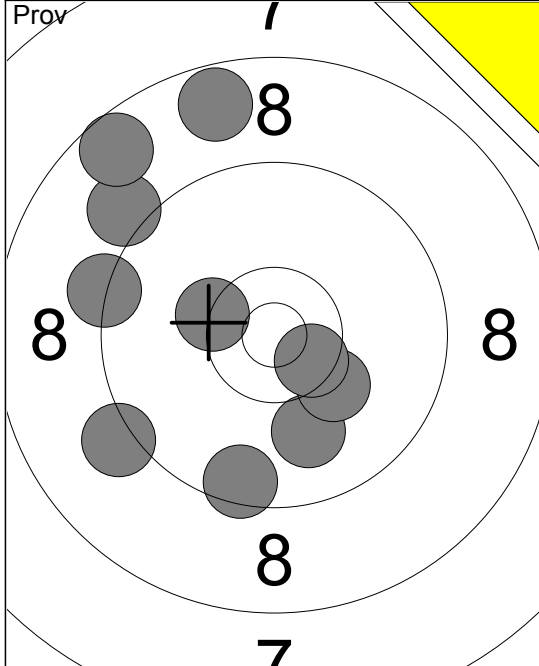

1: 9.3	←
2: 10.0	↓
3: 10.2	↓
4: 9.1	↗
5: 8.6	↗
6: 9.2	←
7: 8.7	↗
8: 10.5	x↘
9: 10.3	x↘
10: 9.5	↓
Serie 92.0	
Total 0.0	

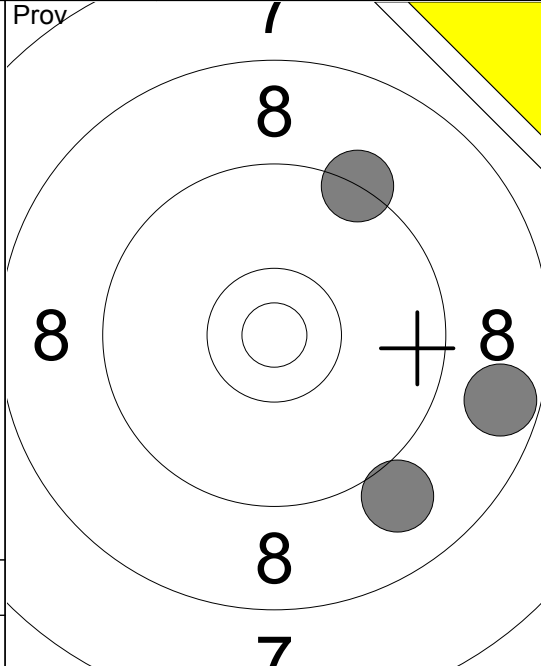

11: 9.0	↘
12: 9.3	↗
13: 8.7	→
Serie 26.0	
Total 0.0	

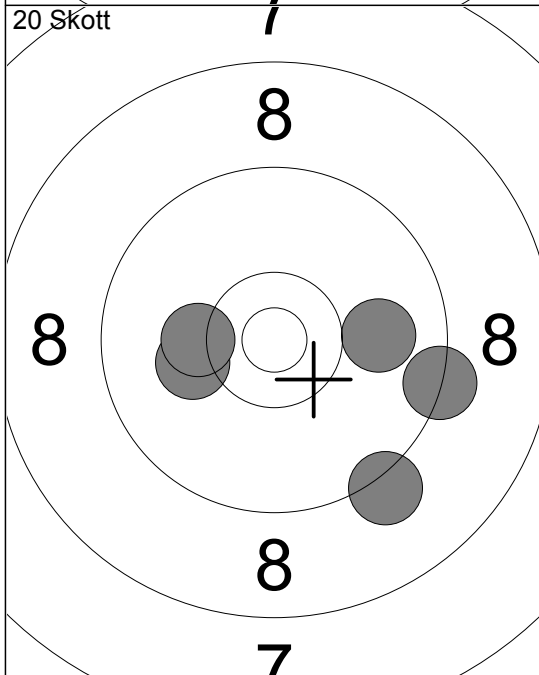

1: 10.1	←
2: 9.3	→
3: 10.0	→
4: 9.2	↓
5: 10.2	←
Serie 48.0	
Total 48.0	

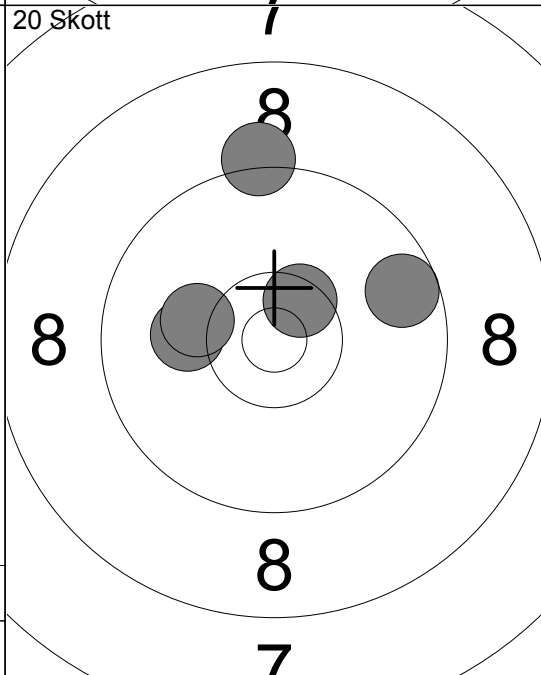

6: 9.2	↑
7: 10.1	←
8: 10.5	x↗
9: 9.6	→
10: 10.2	←
Serie 48.0	
Total 96.0	

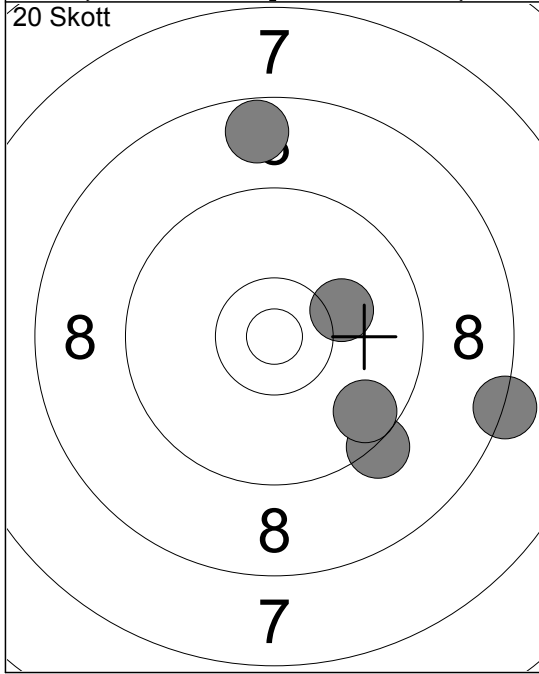

11: 10.2	→
12: 8.3	→
13: 8.7	↑
14: 9.3	↓
15: 9.6	↓
Serie 44.0	
Total 140.0	

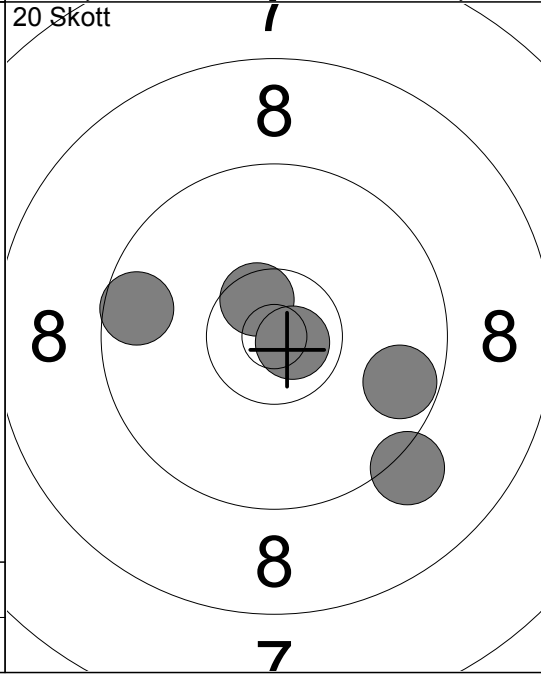

16: 9.7	→
17: 9.6	←
18: 10.6	x↗
19: 10.8	x↘
20: 9.2	↓
Serie 47.0	
Total 187.0	

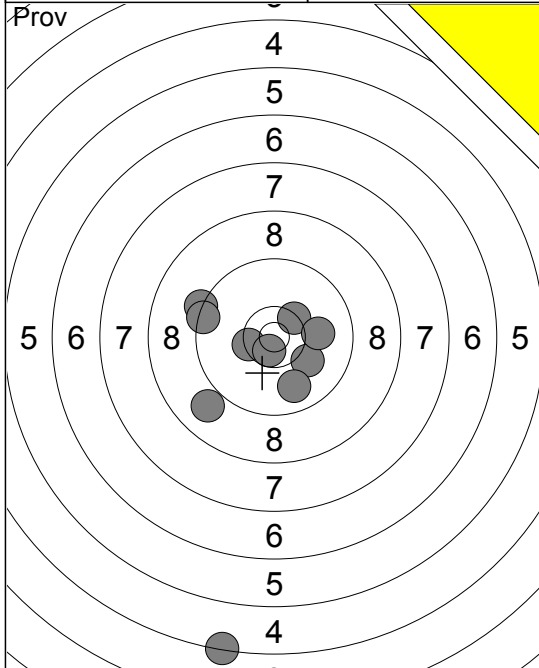

20 Skott

1:	10.4 ↗
2:	10.1 ↘
3:	9.3 ←
4:	10.0 →
5:	10.4 ✕
6:	10.6 ✕
7:	4.3 ↓
8:	8.9 ↙
9:	9.8 ↓
10:	9.4 ←
Serie	89.0
Total	0.0

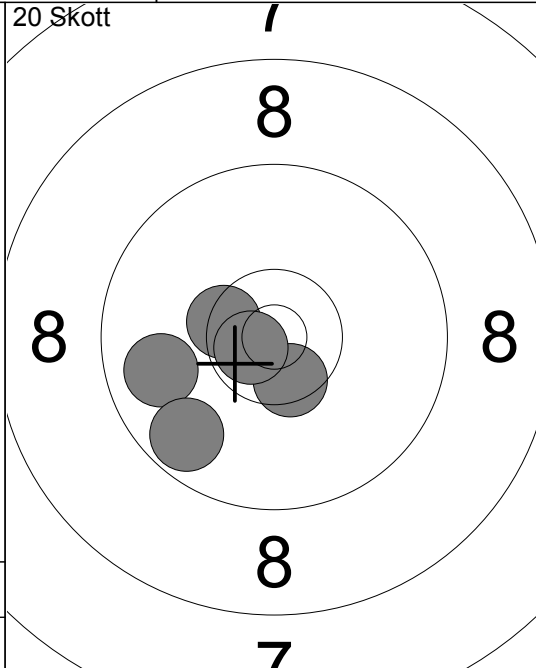

20 Skott

1:	10.4 ✕
2:	10.5 ✕
3:	10.7 ✕
4:	9.8 ←
5:	9.7 ↙
Serie	48.0
Total	48.0

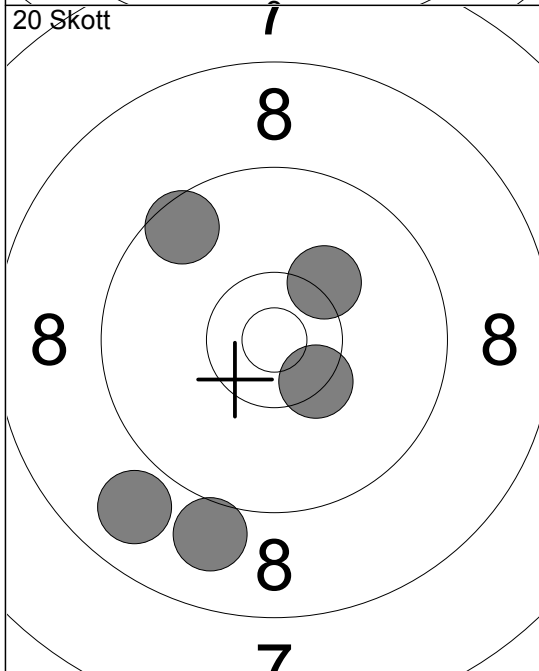

20 Skott

6:	10.4 ✕
7:	8.9 ↙
8:	9.6 ↗
9:	10.2 ↗
10:	9.0 ↓
Serie	46.0
Total	94.0

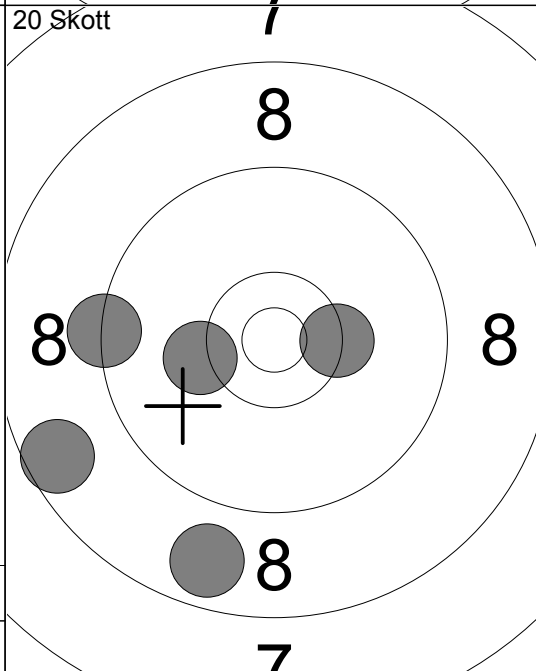

20 Skott

11:	8.8 ↓
12:	10.2 ←
13:	10.4 ✕
14:	8.6 ←
15:	9.3 ←
Serie	45.0
Total	139.0

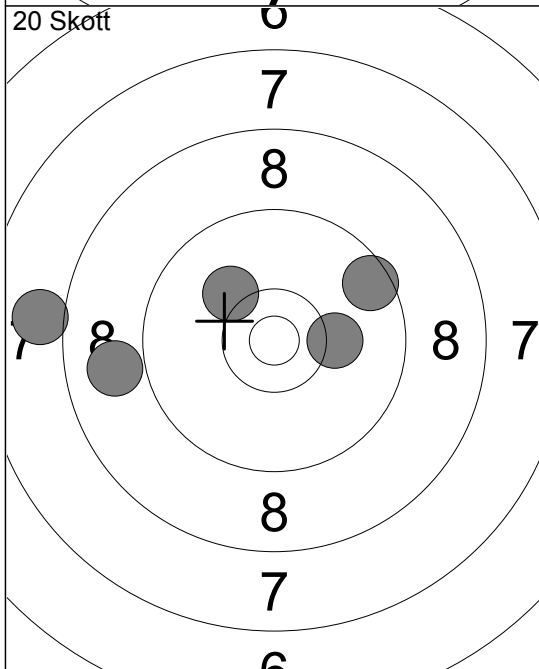

20 Skott

16:	10.2 →
17:	10.1 ↖
18:	8.9 ←
19:	8.0 ←
20:	9.5 ↗
Serie	45.0
Total	184.0

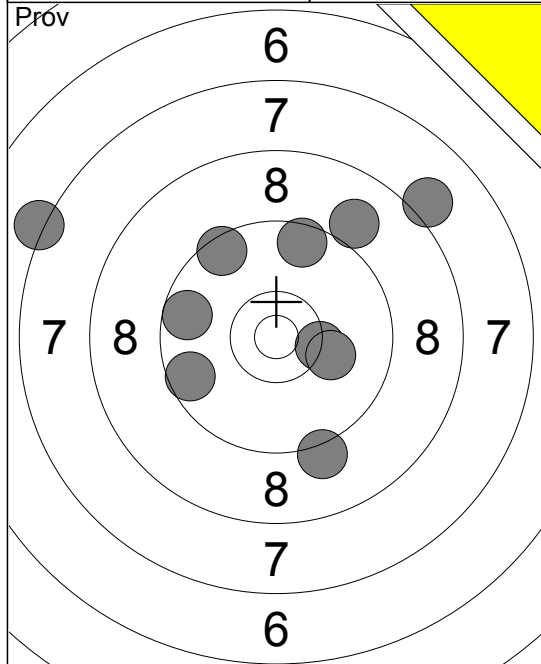

1:	9.2	↘
2:	10.3x	→
3:	9.6	↑
4:	7.2	↙
5:	10.1	→
6:	9.6	↙
7:	8.1	↗
8:	9.6	↙
9:	9.0	↗
10:	9.5	↖
Serie		89.0
Total		0.0

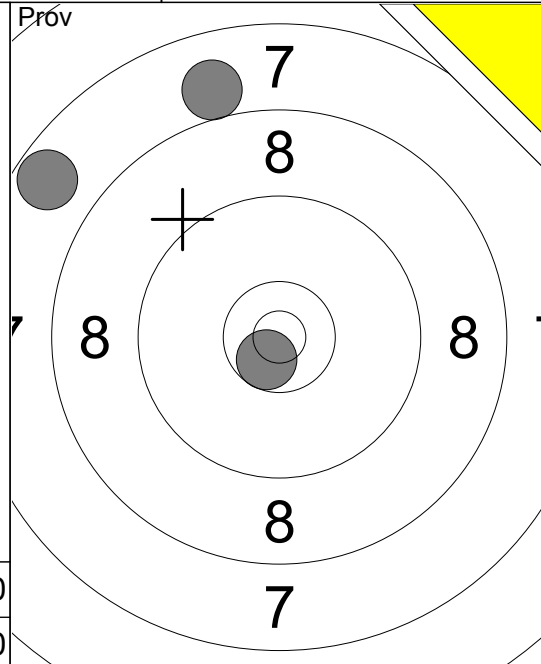

11:	7.7	↖
12:	10.6x	↘
13:	8.0	↑
Serie		25.0
Total		0.0

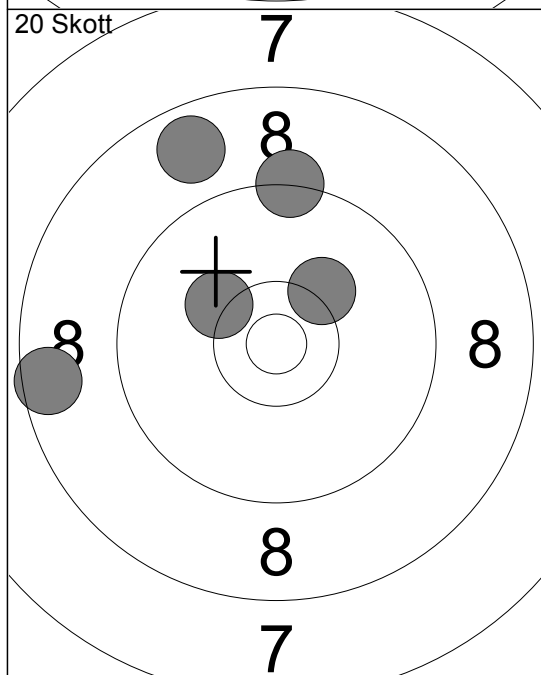

1:	9.3	↑
2:	10.2	↗
3:	8.8	↑
4:	10.2	↙
5:	8.6	↙
Serie		45.0
Total		45.0

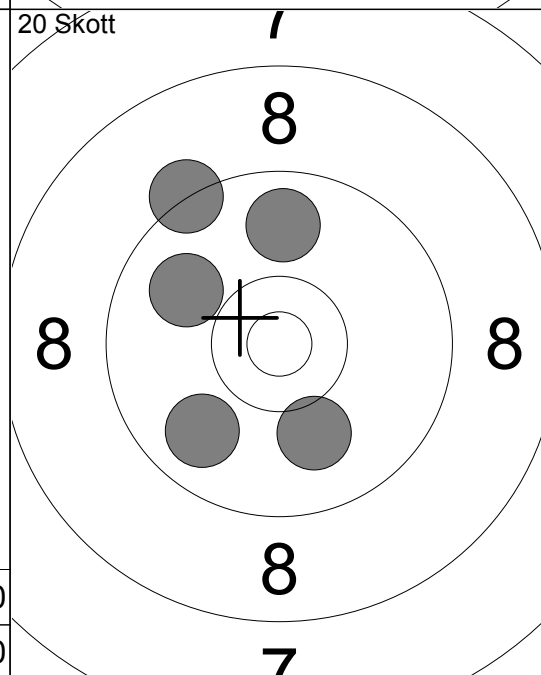

6:	9.9	↙
7:	9.8	↑
8:	9.8	↙
9:	10.0	↘
10:	9.3	↗
Serie		46.0
Total		91.0

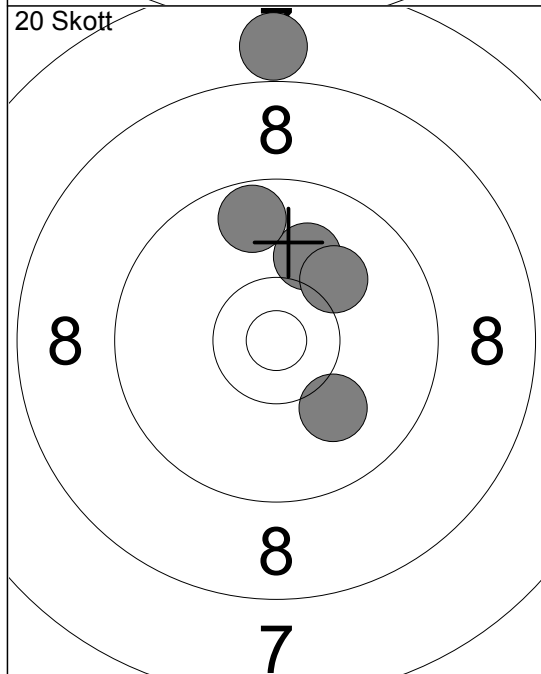

11:	10.0	↑
12:	10.1	↘
13:	9.7	↑
14:	10.1	↗
15:	7.9	↑
Serie		46.0
Total		137.0

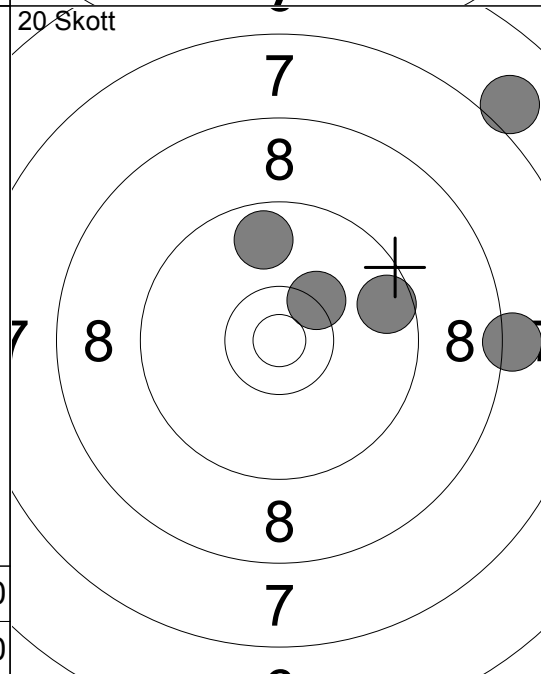

16:	10.3x	↗
17:	8.2	→
18:	7.0	↗
19:	9.7	↑
20:	9.6	→
Serie		43.0
Total		180.0

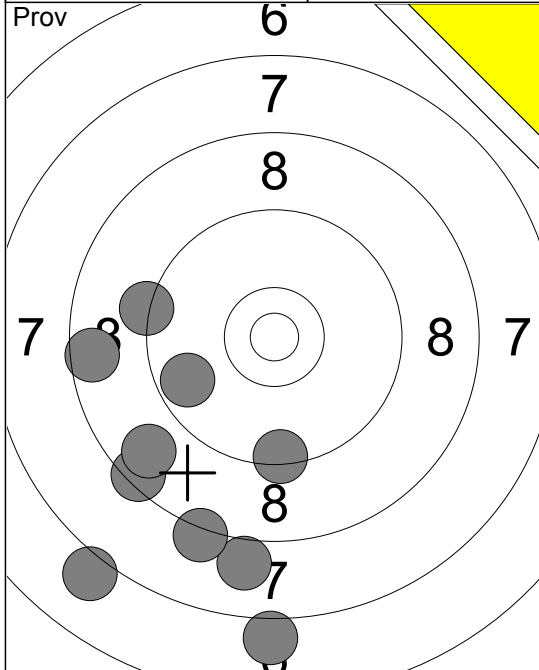

1:	8.6	←
2:	8.0	↓
3:	9.7	←
4:	9.4	↓
5:	7.1	↓
6:	9.3	←
7:	7.1	↓
8:	8.2	↓
9:	8.4	←
10:	8.8	←
Serie	81.0	
Total	0.0	

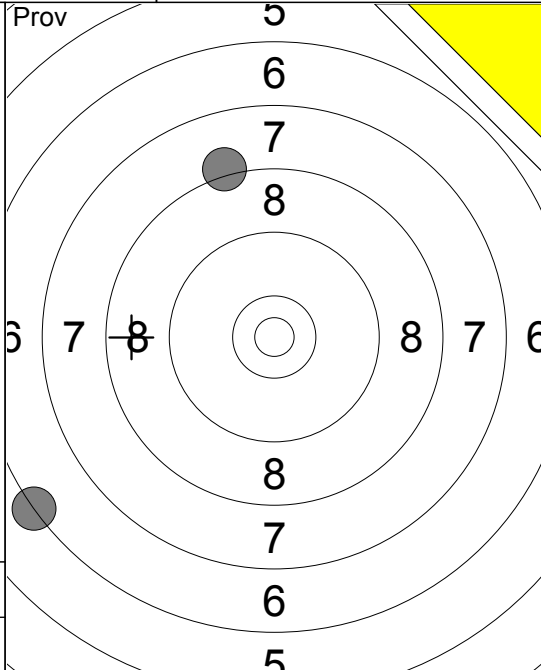

11:	6.3	←
12:	8.2	↑
Serie	14.0	
Total	0.0	

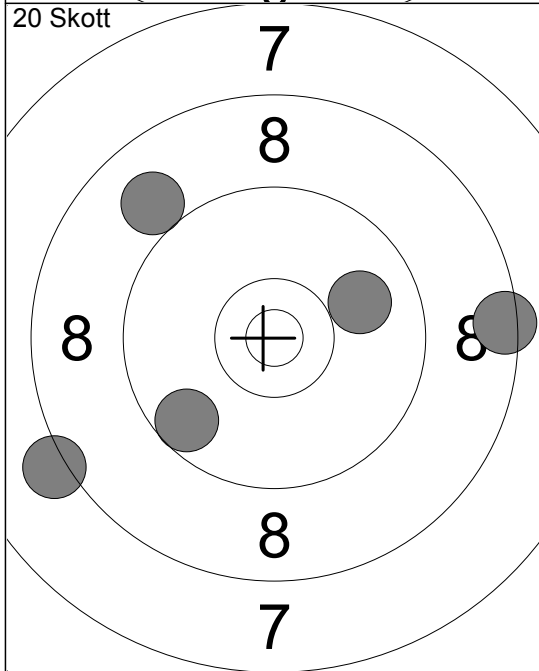

1:	9.9	→
2:	9.6	←
3:	9.0	↑
4:	8.2	←
5:	8.4	→
Serie	43.0	
Total	43.0	

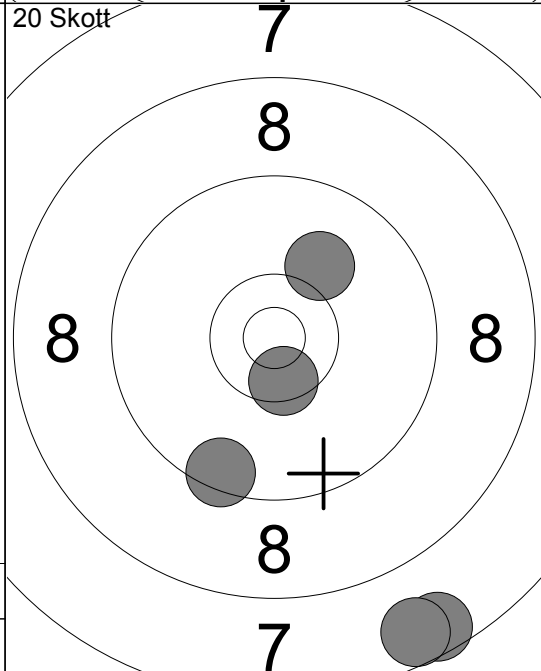

6:	10.5	↓
7:	7.6	↓
8:	7.6	↓
9:	9.5	↓
10:	10.1	↗
Serie	43.0	
Total	86.0	

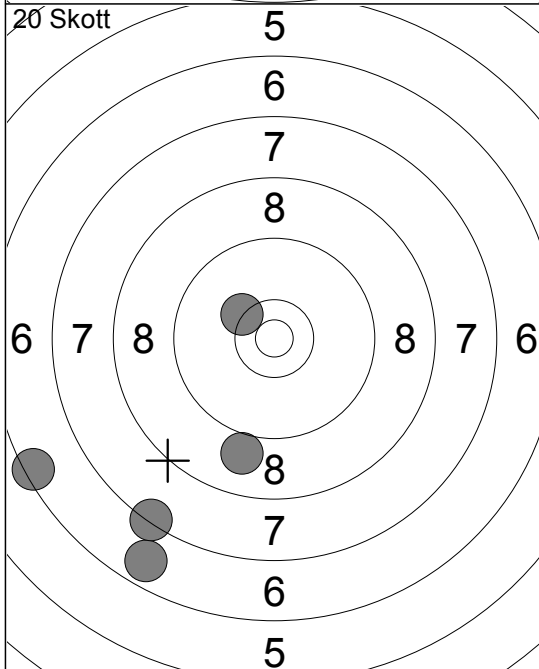

11:	6.7	↓
12:	10.3	↖
13:	7.3	↓
14:	9.0	↓
15:	6.4	←
Serie	38.0	
Total	124.0	

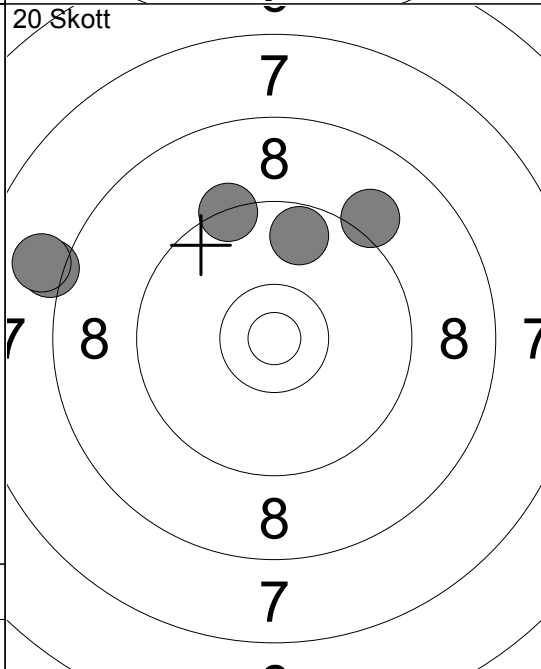

16:	8.1	←
17:	9.3	↑
18:	8.0	←
19:	9.7	↑
20:	9.1	↗
Serie	43.0	
Total	167.0	

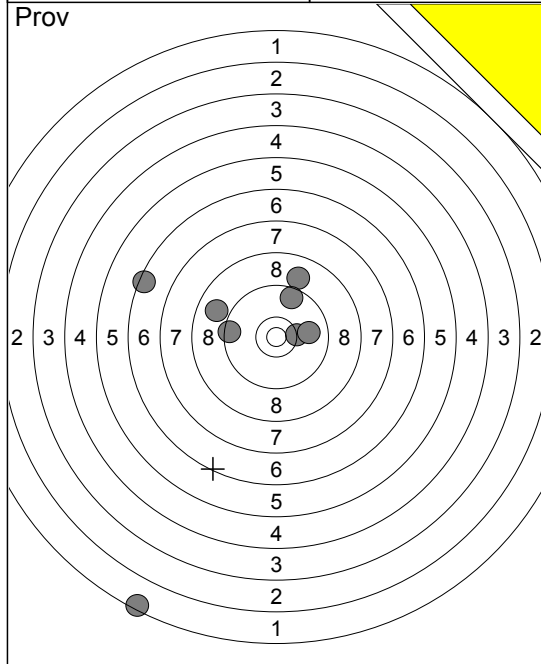

1:	0.0	↘
2:	0.0	↘
3:	1.4	↘
4:	6.4	↙
5:	9.0	↗
6:	9.5	↙
7:	8.9	↙
8:	10.3x	➤
9:	9.9	➔
10:	9.6	↗
Serie	61.0	
Total	0.0	

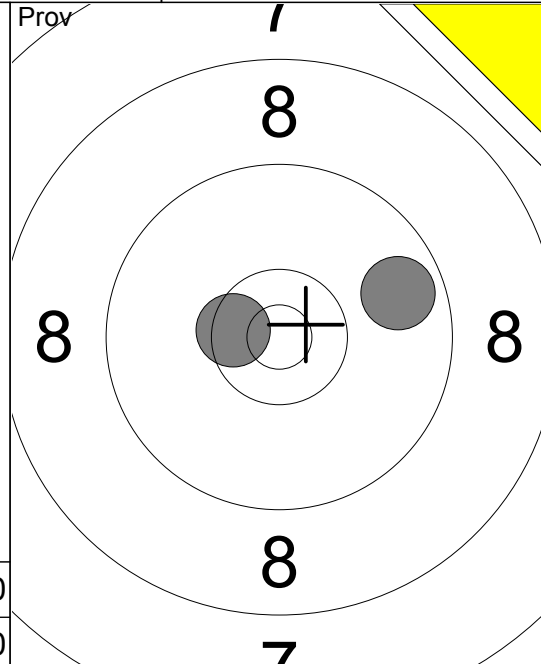

11:	9.7	➔
12:	10.5x	↖
Serie	19.0	
Total	0.0	

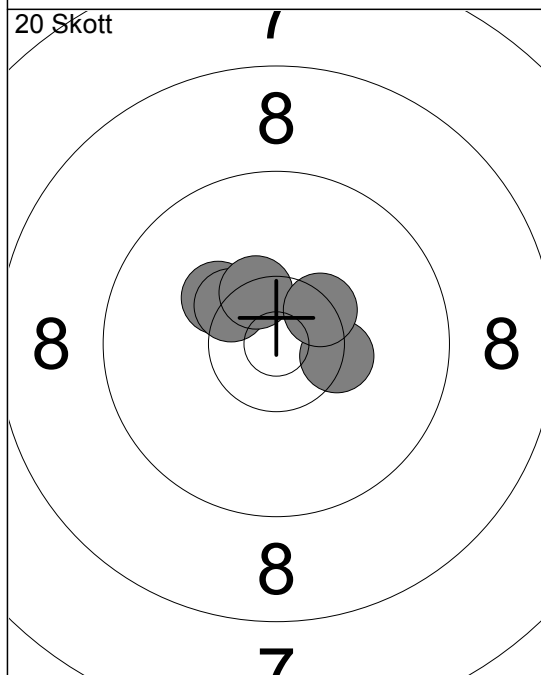

1:	10.2	↖
2:	10.4x	➤
3:	10.4x	↖
4:	10.4x	↗
5:	10.4x	➤
Serie	50.0	
Total	50.0	

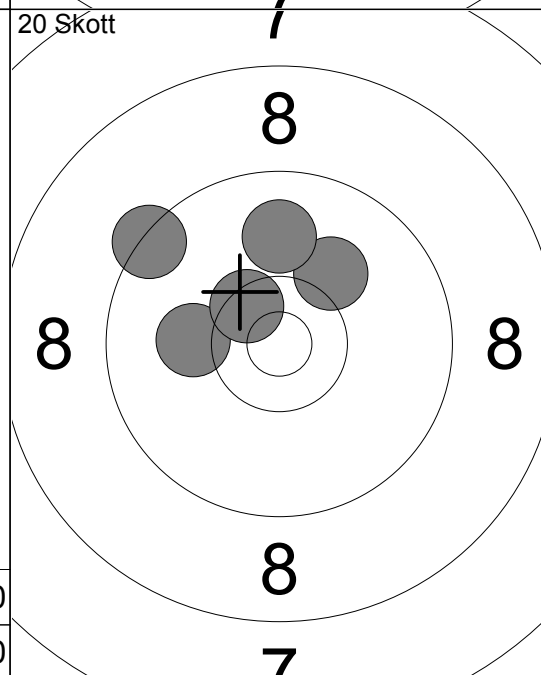

6:	10.1	↙
7:	10.1	↗
8:	9.9	↗
9:	10.5x	↖
10:	9.4	↙
Serie	48.0	
Total	98.0	

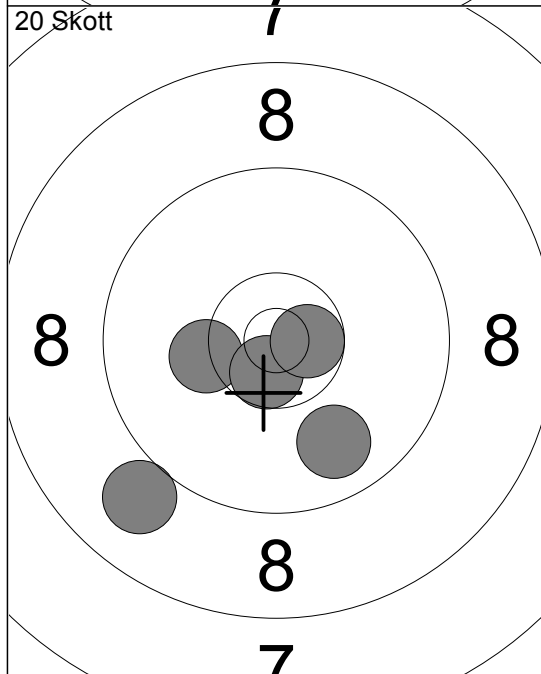

11:	9.8	↘
12:	10.3	↙
13:	9.0	↘
14:	10.6x	↘
15:	10.7x	➤
Serie	48.0	
Total	146.0	

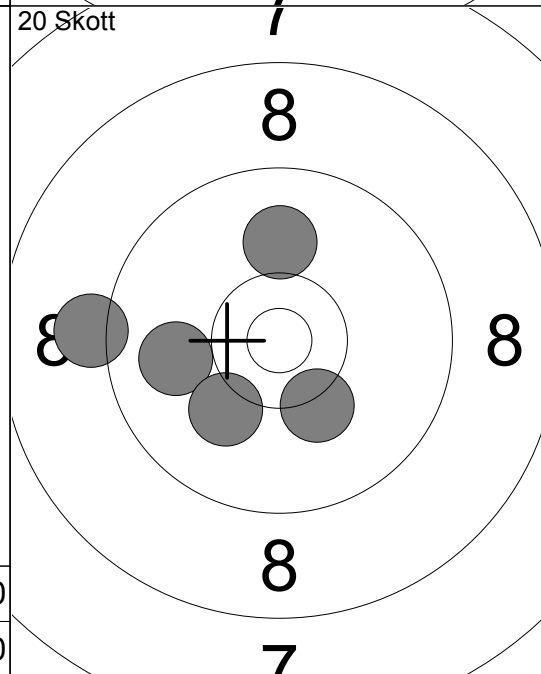

16:	10.2	↘
17:	10.0	↙
18:	10.0	↗
19:	9.2	↙
20:	10.1	↘
Serie	49.0	
Total	195.0	

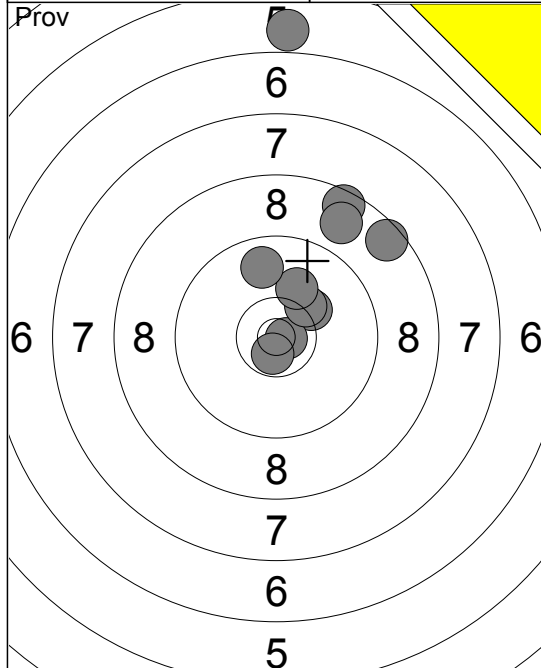

1:	6.0	↑
2:	8.5	↗
3:	10.2	↗
4:	8.6	↗
5:	8.8	↗
6:	10.8x	→
7:	10.3	↗
8:	10.7x	↘
9:	10.1	↗
10:	9.8	↑
Serie	89.0	
Total	0.0	

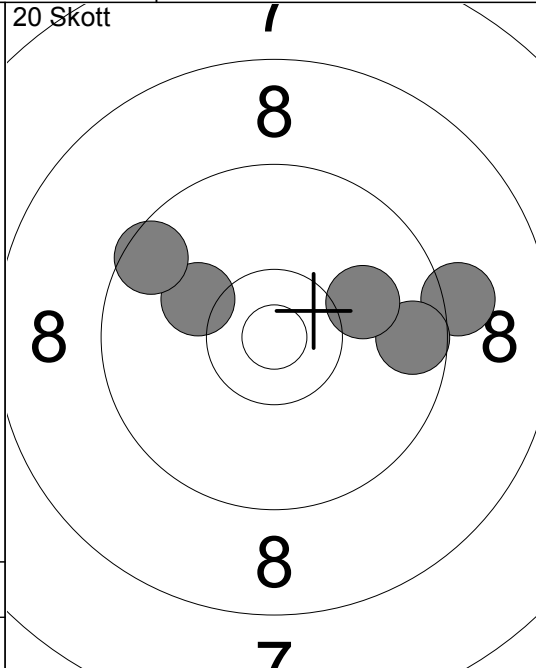

1:	10.1	↖
2:	9.2	→
3:	9.6	↖
4:	9.6	→
5:	10.0	↗
Serie	47.0	
Total	47.0	

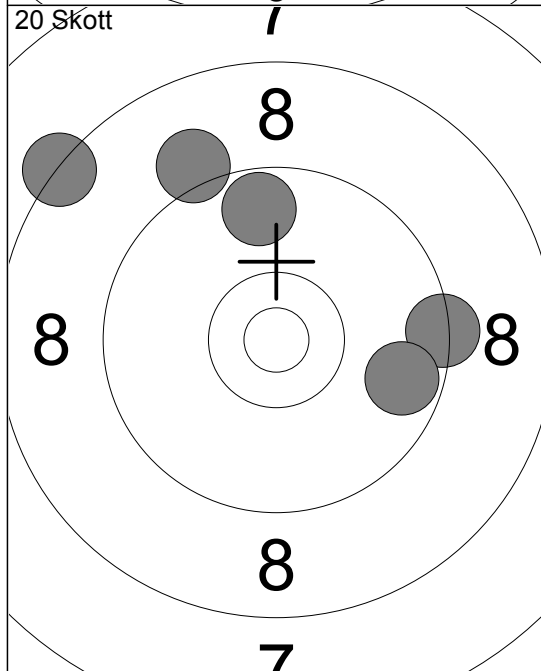

6:	9.7	↑
7:	8.3	↖
8:	9.4	→
9:	9.7	→
10:	9.1	↗
Serie	44.0	
Total	91.0	

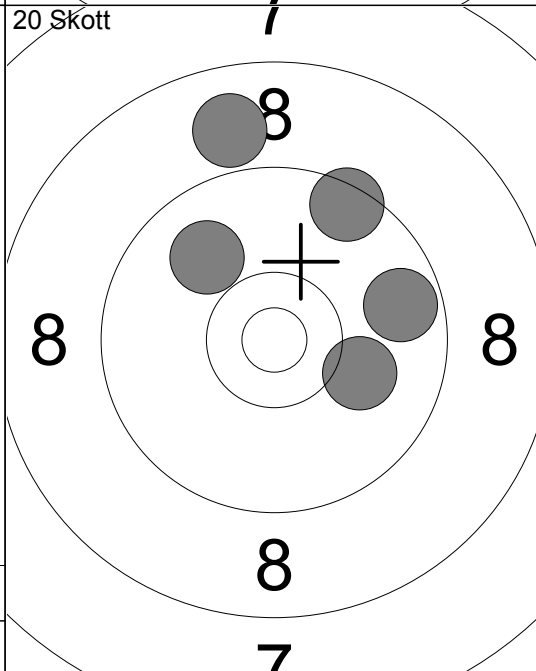

11:	9.5	↗
12:	10.1	→
13:	8.9	↑
14:	9.9	↖
15:	9.7	→
Serie	45.0	
Total	136.0	

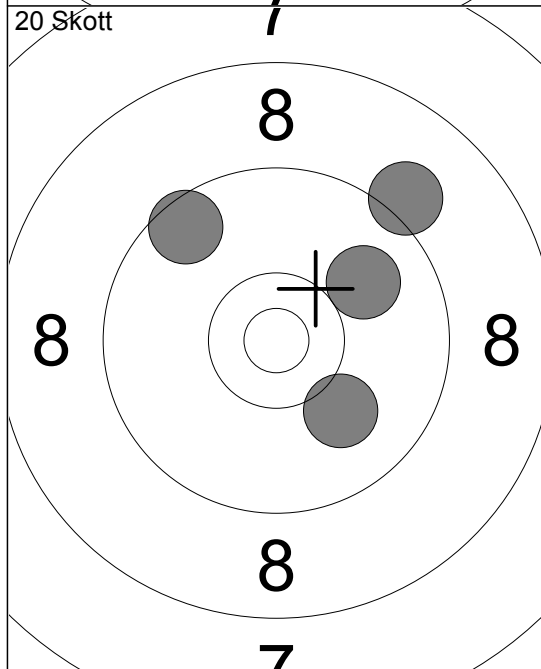

16:	10.0	↗
17:	9.6	↖
18:	10.0	↘
19:	9.1	↗
20:	0.0	
Serie	38.0	
Total	174.0	

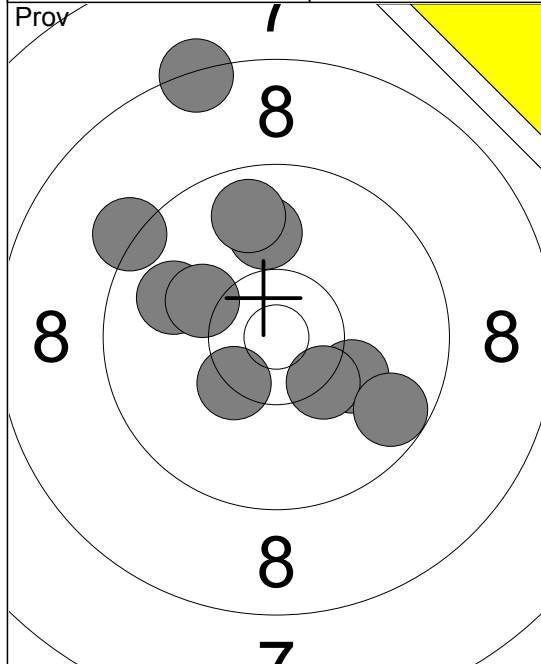

1:	8.3	↑
2:	9.9	↑
3:	9.8	↑
4:	10.1	↘
5:	9.2	↗
6:	10.3	↘
7:	9.9	↖
8:	10.4	↘
9:	10.2	↖
10:	9.7	↘
Serie	93.0	
Total	0.0	

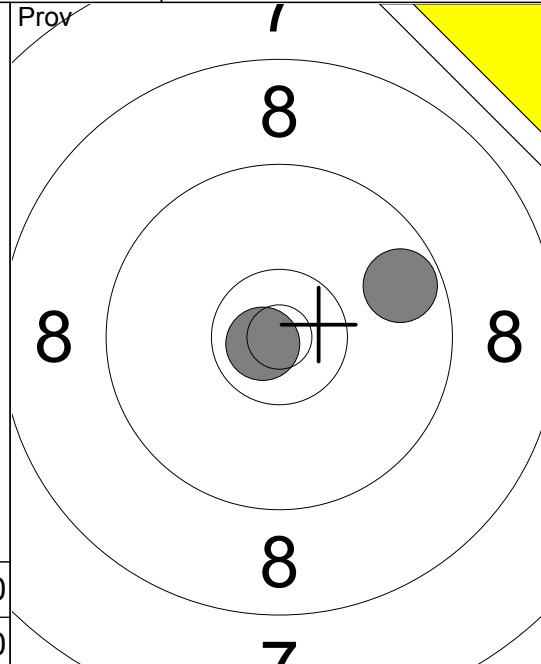

11:	9.7	↗
12:	10.8	↘
Serie	19.0	
Total	0.0	

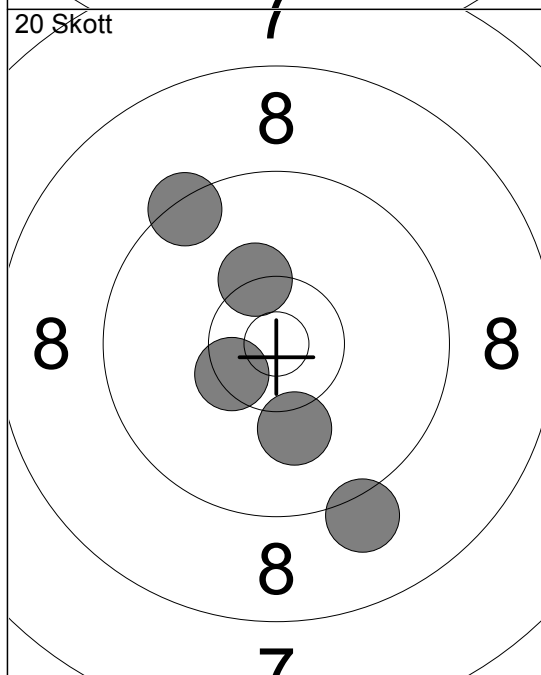

1:	9.4	↗
2:	10.3	↘
3:	10.1	↓
4:	10.4	↘
5:	9.1	↓
Serie	48.0	
Total	48.0	

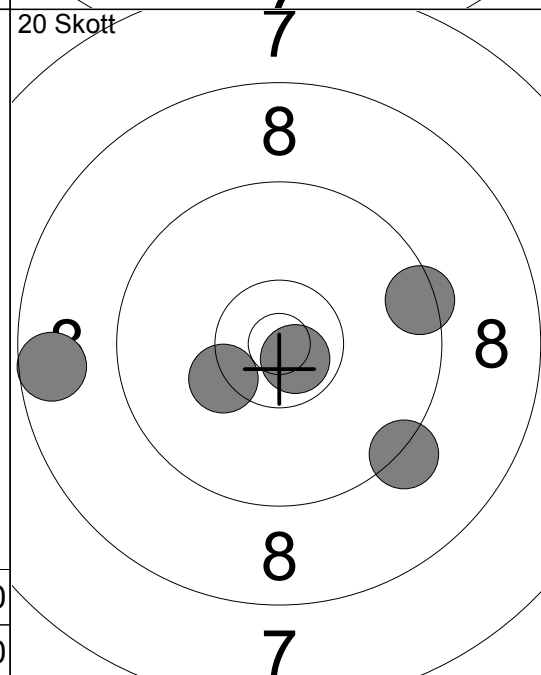

6:	10.3	↙
7:	9.5	↗
8:	9.3	↘
9:	8.6	↖
10:	10.7	↘
Serie	46.0	
Total	94.0	

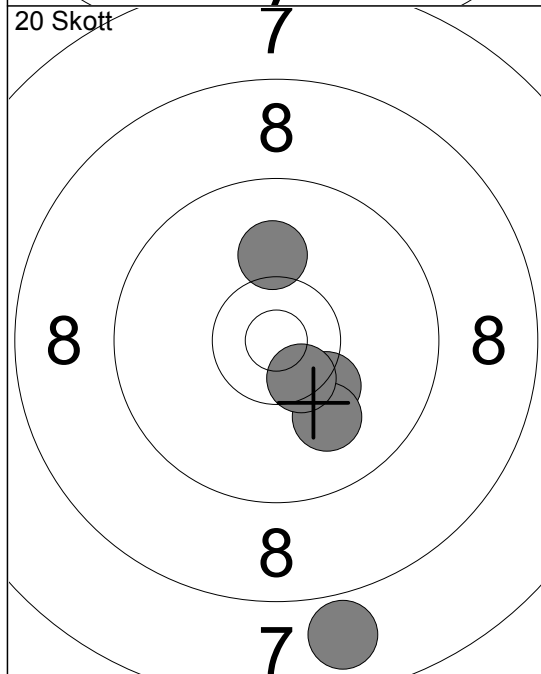

11:	10.3	↘
12:	10.0	↓
13:	10.5	↘
14:	7.9	↓
15:	10.1	↑
Serie	47.0	
Total	141.0	

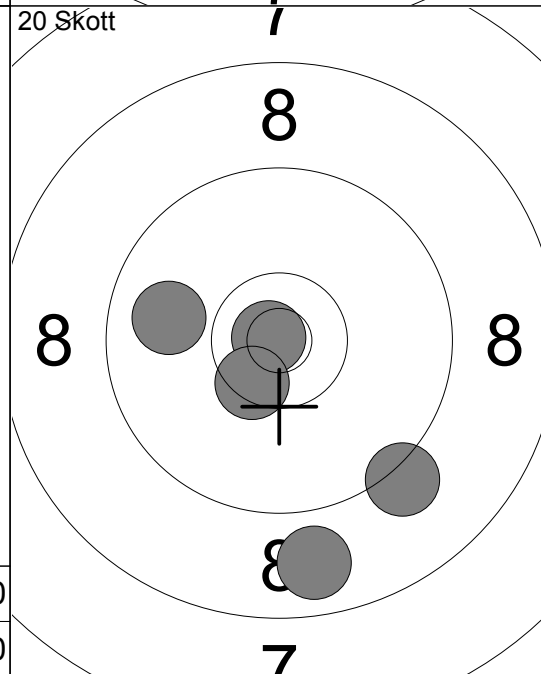

16:	10.8	↘
17:	8.8	↓
18:	9.9	↖
19:	10.5	↘
20:	9.2	↘
Serie	46.0	
Total	187.0	

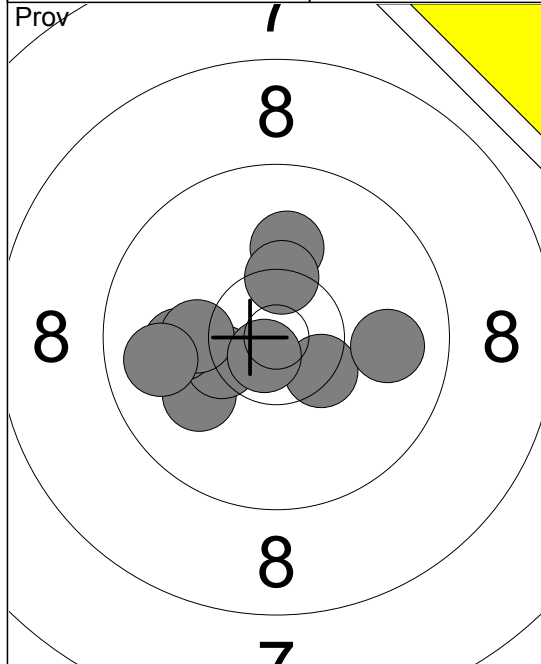

1:	10.1 ↑
2:	10.0 ↙
3:	10.4 ✕
4:	10.4 ↗
5:	10.0 ←
6:	10.2 ←
7:	9.8 ←
8:	10.4 ✕
9:	9.9 →
10:	10.7 ✕
Serie 98.0	
Total 0.0	

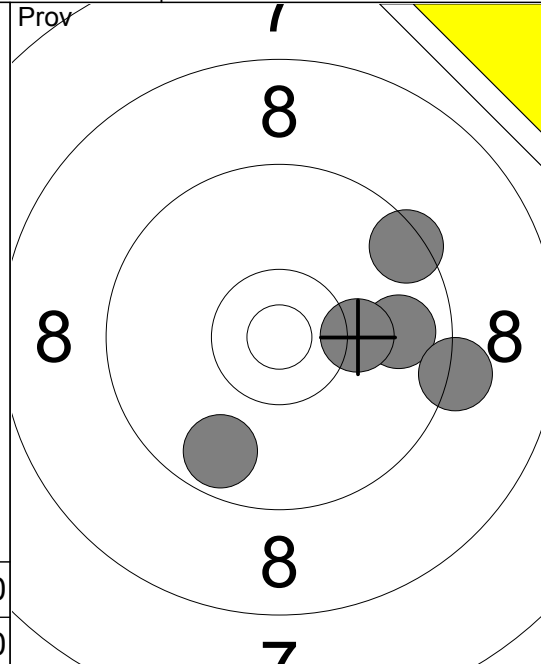

11:	9.5 ↗
12:	9.8 →
13:	9.2 →
14:	9.7 ↘
15:	10.2 →
Serie 46.0	
Total 0.0	

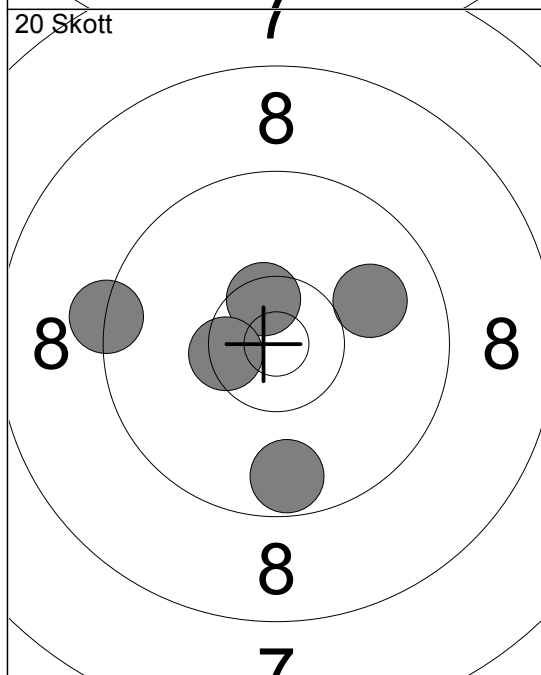

1:	10.0 →
2:	10.5 ↗
3:	10.5 ✕
4:	9.3 ←
5:	9.7 ↓
Serie 48.0	
Total 48.0	

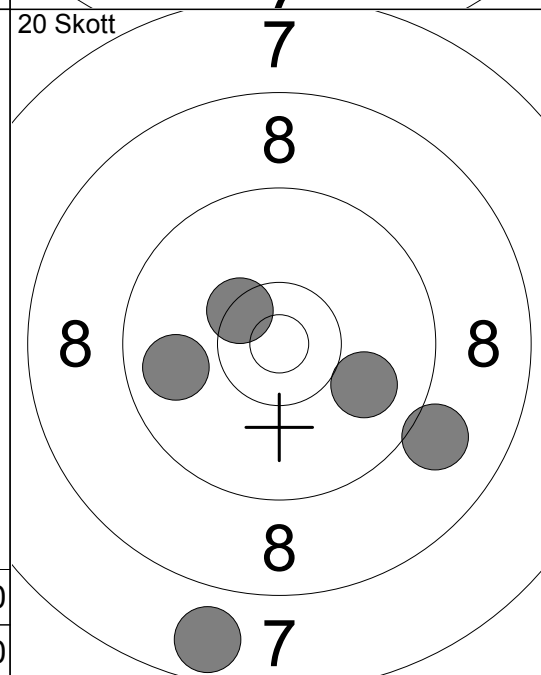

6:	10.4 ✕
7:	9.8 ←
8:	7.8 ↓
9:	9.0 ↗
10:	10.0 ↘
Serie 45.0	
Total 93.0	

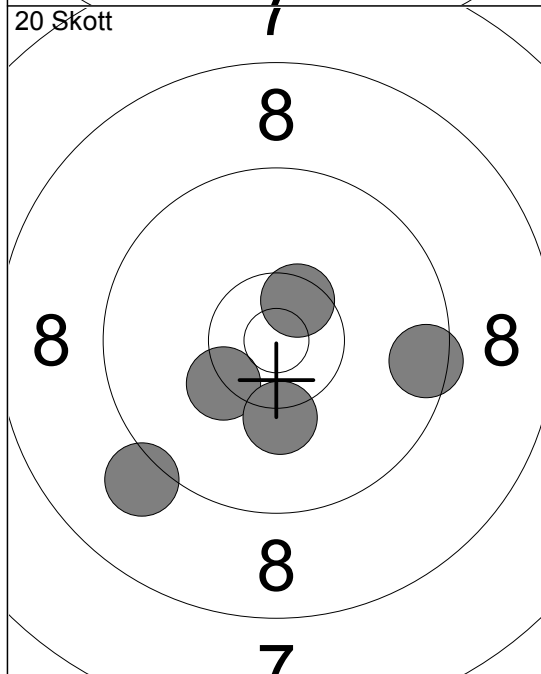

11:	9.1 ↘
12:	9.5 →
13:	10.5 ↗
14:	10.3 ✕
15:	10.2 ↓
Serie 48.0	
Total 141.0	

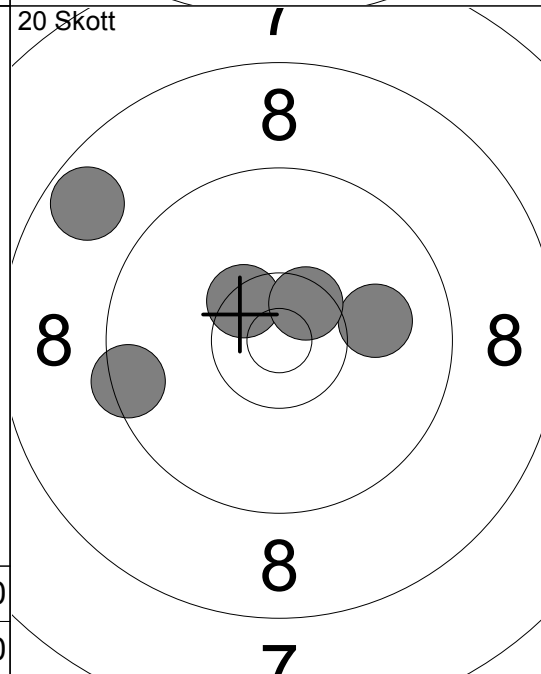

16:	10.0 →
17:	8.7 ↖
18:	10.4 ✕
19:	10.5 ↗
20:	9.5 ←
Serie 47.0	
Total 188.0	

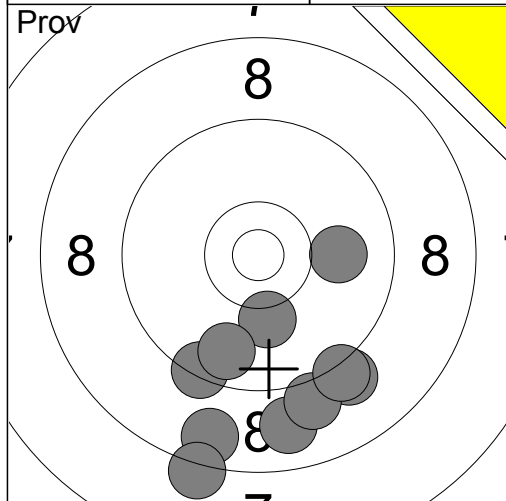

1:	9.1	↘
2:	8.7	↘
3:	8.9	↘
4:	10.2	↘
5:	9.1	↘
6:	9.4	↘
7:	8.2	↘
8:	9.2	↘
9:	10.0	→
10:	9.7	↘
Serie		89.0
Total		0.0

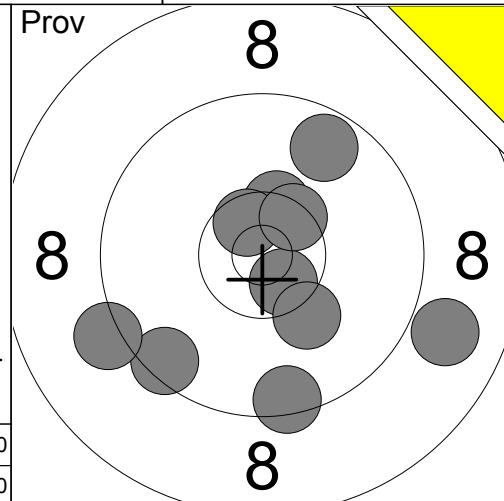

11:	9.5	↘
12:	10.6x	↘
13:	10.2	↘
14:	8.9	↗
15:	10.4x	↗
16:	10.6x	↗
17:	9.7	↗
18:	9.5	↘
19:	10.5x	↗
20:	9.2	↙
Serie		94.0
Total		0.0

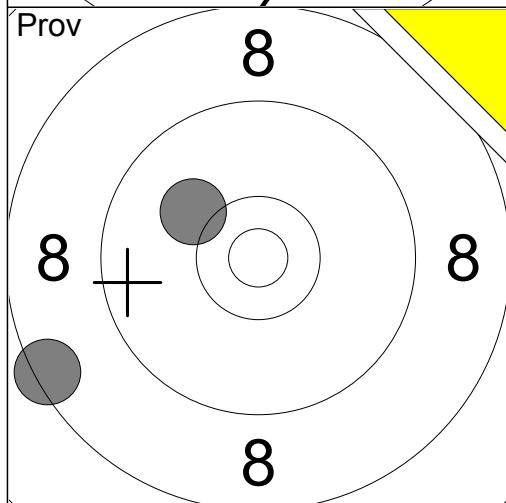

21:	10.1	↗
22:	8.4	↙
Serie		18.0
Total		0.0

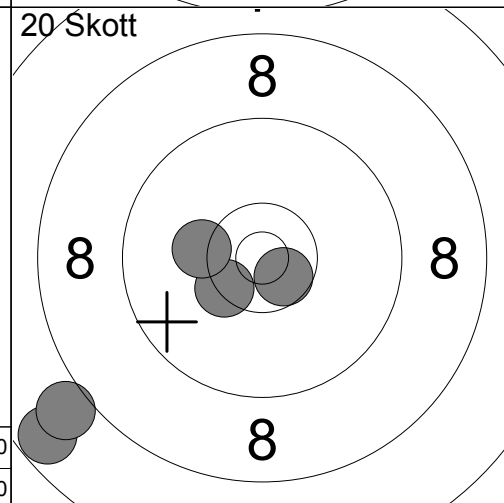

1:	10.6x	↘
2:	7.7	↙
3:	10.4x	↙
4:	8.0	↙
5:	10.2	←
Serie		45.0
Total		45.0

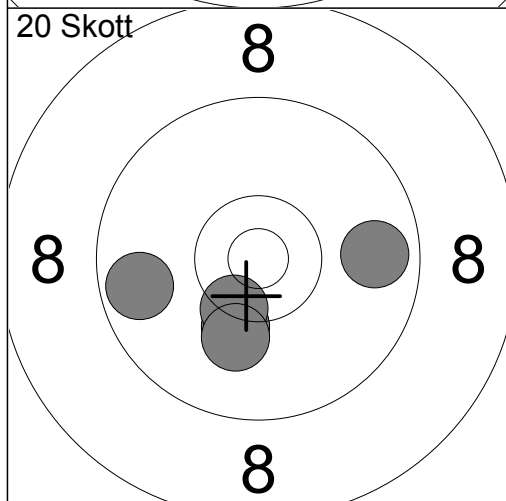

6:	10.2	↘
7:	10.4x	↘
8:	9.7	←
9:	10.1	↘
10:	9.8	→
Serie		48.0
Total		93.0

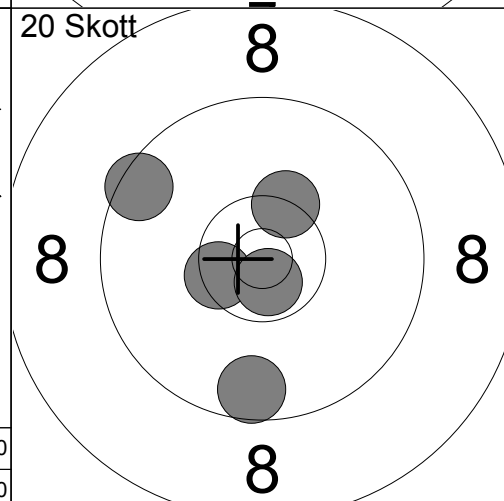

11:	10.5x	←
12:	9.5	↖
13:	9.6	↘
14:	10.3x	↗
15:	10.7x	↘
Serie		48.0
Total		141.0

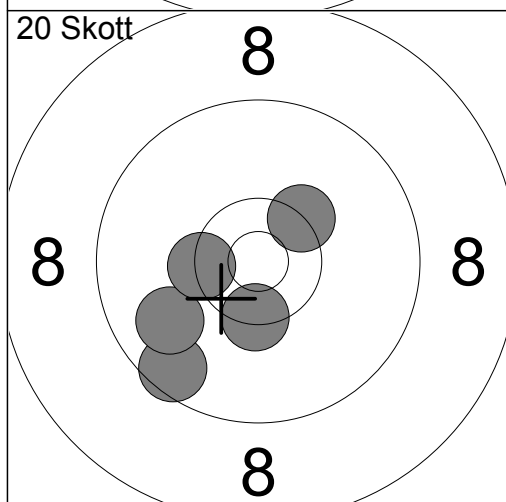

16:	10.3x	↗
17:	9.6	↘
18:	9.9	↙
19:	10.4x	↘
20:	10.4x	←
Serie		48.0
Total		189.0

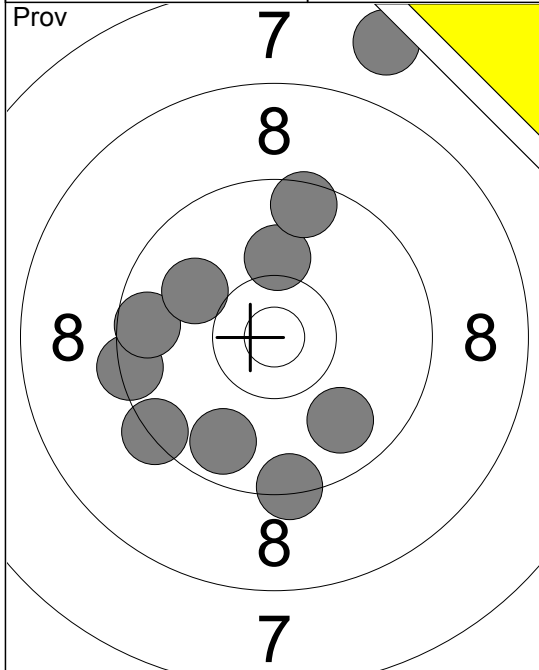

1:	7.7	↗
2:	10.1	↑
3:	9.7	↘
4:	9.8	↘
5:	9.4	←
6:	9.5	↑
7:	9.6	←
8:	9.4	↙
9:	9.4	↓
10:	10.0	↖
Serie	90.0	
Total	0.0	

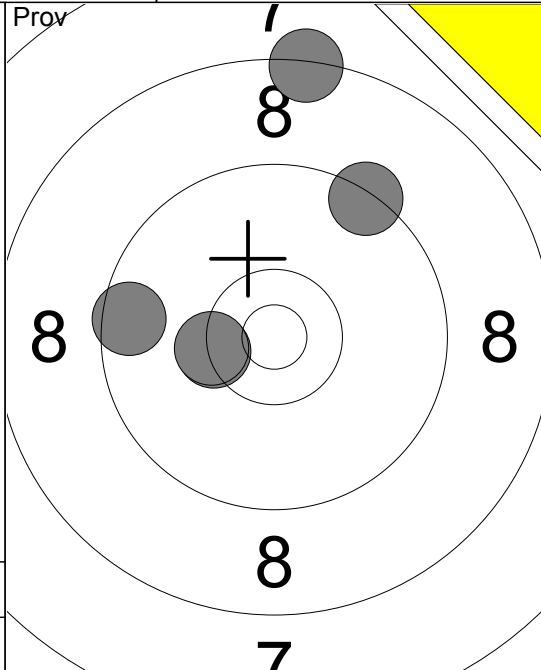

11:	10.4	↖
12:	10.3	↖
13:	9.6	←
14:	8.3	↑
15:	9.4	↗
Serie	46.0	
Total	0.0	

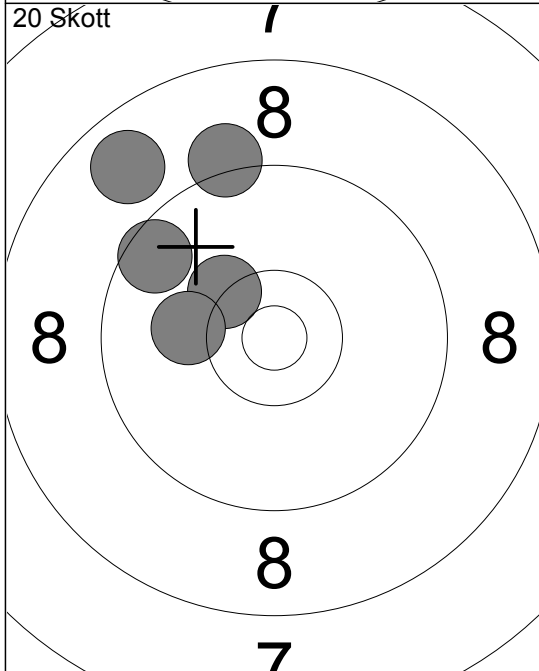

1:	10.3	↖
2:	8.8	↖
3:	10.1	←
4:	9.2	↑
5:	9.6	↖
Serie	46.0	
Total	46.0	

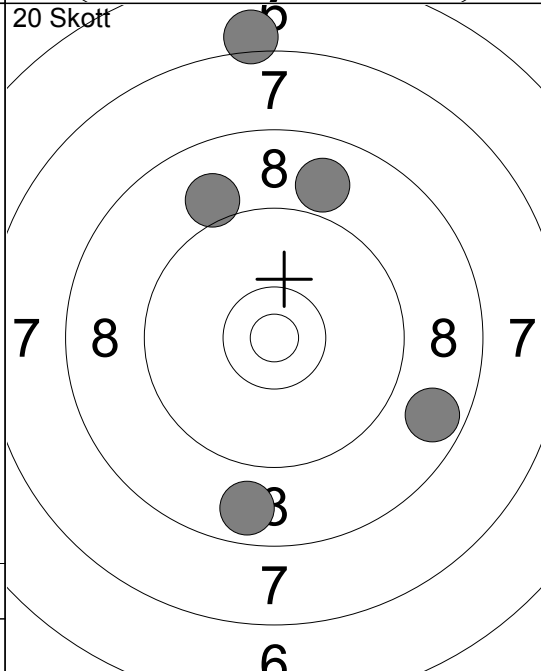

6:	9.0	↗
7:	7.1	↑
8:	8.7	↘
9:	8.9	↑
10:	8.8	↓
Serie	40.0	
Total	86.0	

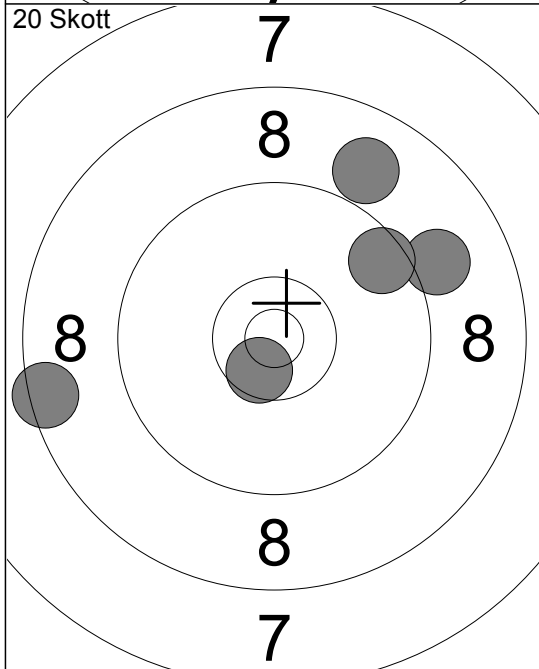

11:	8.5	←
12:	9.1	→
13:	9.6	↗
14:	10.6	↖
15:	8.9	↗
Serie	44.0	
Total	130.0	

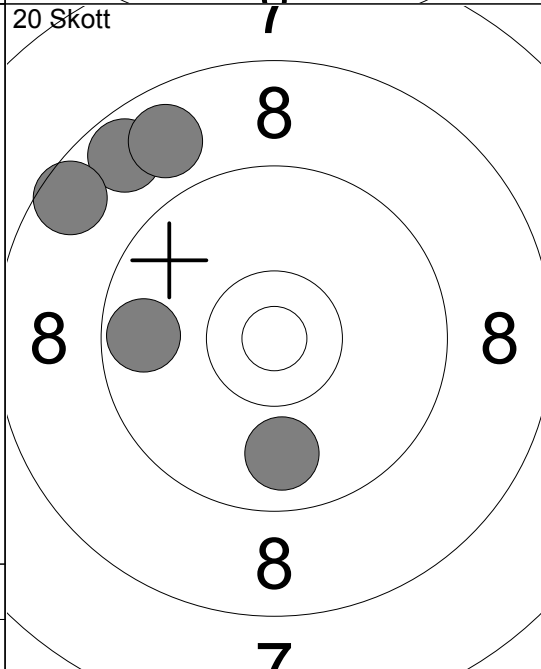

16:	8.7	↖
17:	8.6	↖
18:	8.8	↗
19:	9.9	↓
20:	9.7	←
Serie	42.0	
Total	172.0	

Skjutlag
2

Tavla
22

Saga Ebbhagen

50m

Ramselefors

13

Vb

12.07.2016

Tavelträffen Korthåll 2016

Ramselefors SKF

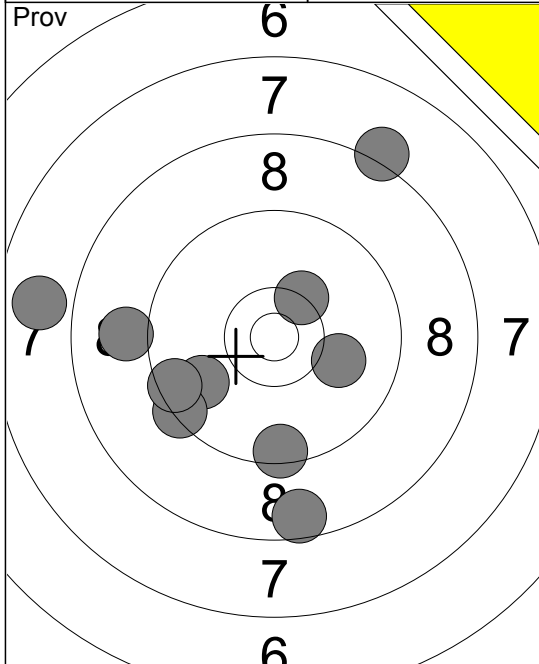

- 1: 9.0 ←
- 2: 7.9 ←
- 3: 9.5 ↓
- 4: 9.8 ←
- 5: 8.6 ↓
- 6: 9.4 ←
- 7: 9.5 ←
- 8: 10.1 →
- 9: 8.2 ↗
- 10: 10.3x↗

Serie 88.0
Total 0.0

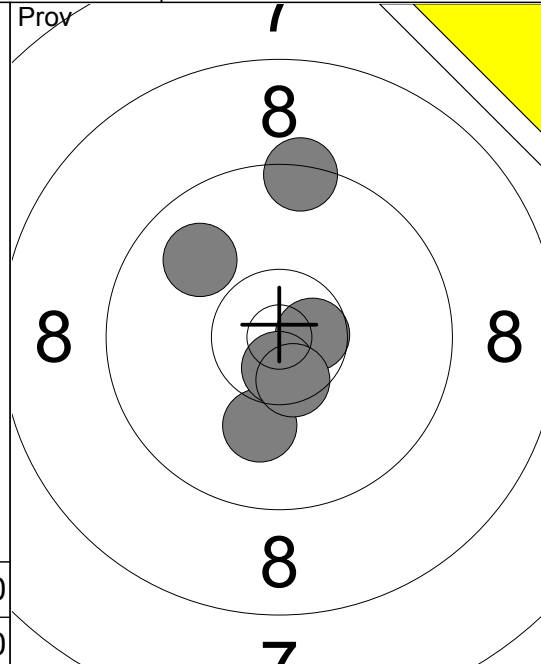

- 11: 9.4 ↑
- 12: 9.9 ↖
- 13: 10.1 ↓
- 14: 10.6x→
- 15: 10.7x↓
- 16: 10.5x↓

Serie 58.0
Total 0.0

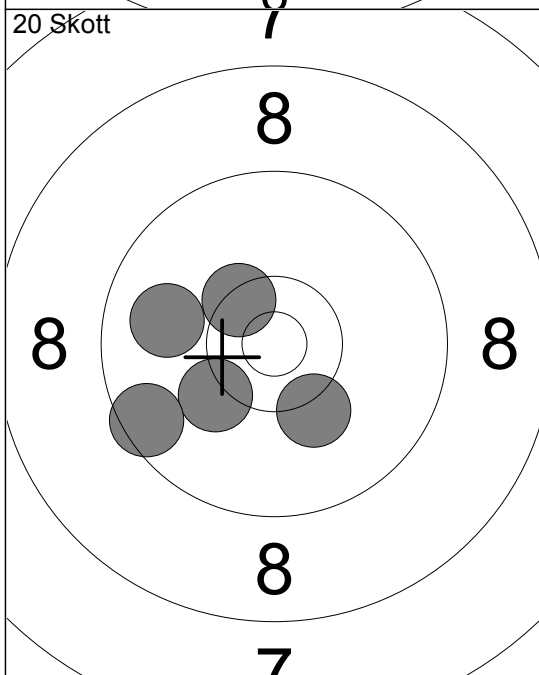

- 1: 10.4x↘
- 2: 9.9 ←
- 3: 10.2 ↙
- 4: 10.2 ↓
- 5: 9.5 ←

Serie 48.0
Total 48.0

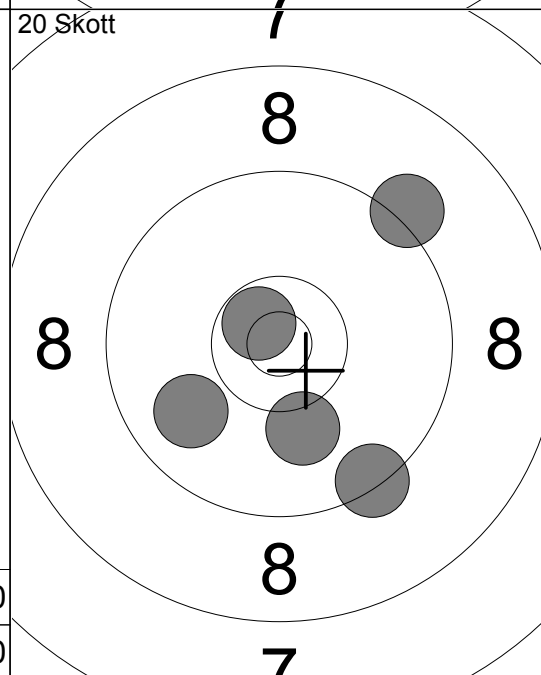

- 6: 9.9 ↙
- 7: 10.7x↘
- 8: 9.4 ↓
- 9: 10.1 ↓
- 10: 9.2 ↗

Serie 47.0
Total 95.0

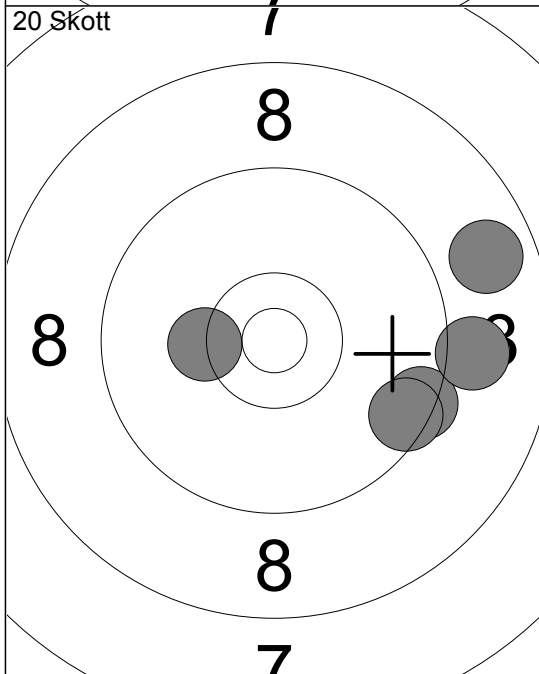

- 11: 9.4 →
- 12: 9.5 →
- 13: 10.3x←
- 14: 9.1 →
- 15: 8.8 →

Serie 45.0
Total 140.0

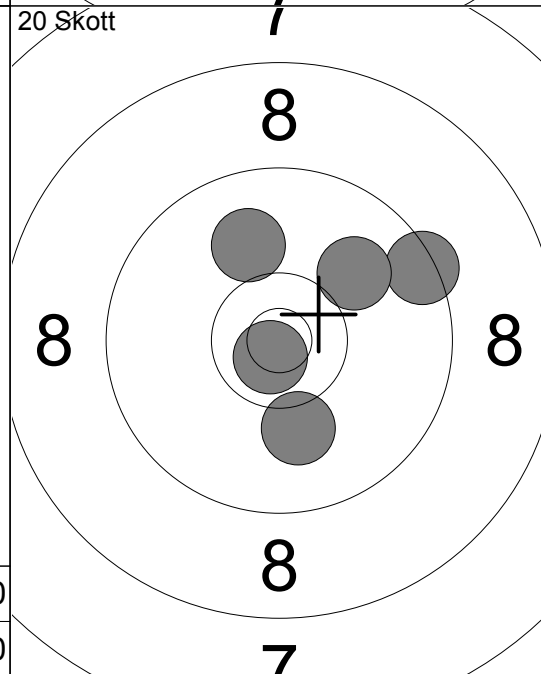

- 16: 10.0 ↑
- 17: 10.1 ↓
- 18: 9.4 ↗
- 19: 10.8x↘
- 20: 10.0 ↗

Serie 49.0
Total 189.0

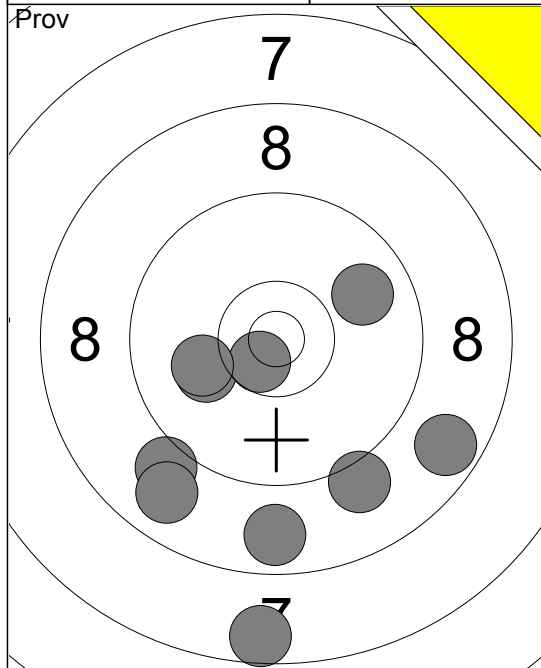

1:	9.1	↙
2:	8.8	↙
3:	7.6	↓
4:	9.1	↙
5:	8.7	↘
6:	10.1	↙
7:	10.6	↘
8:	9.9	↗
9:	8.8	↓
10:	10.1	↙
Serie	88.0	
Total	0.0	

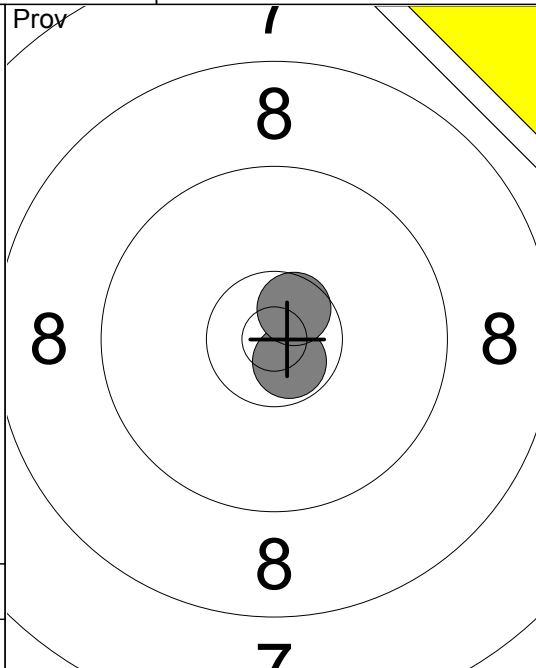

11:	10.7	↘
12:	10.6	↗
Serie	20.0	
Total	0.0	

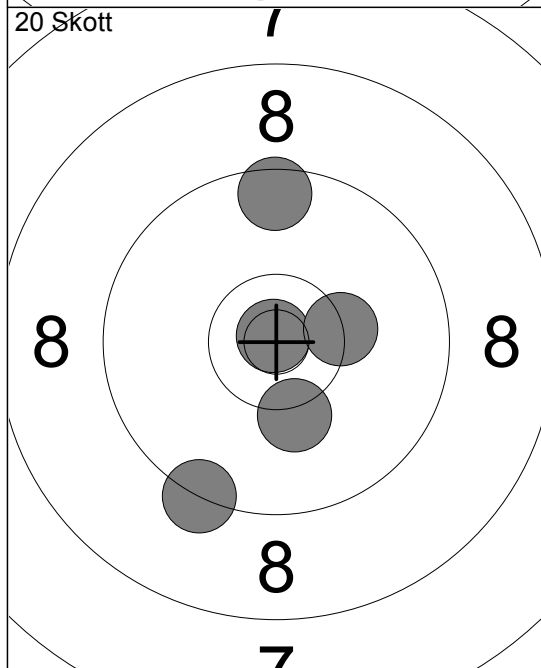

1:	10.9	↘
2:	10.3	→
3:	9.5	↑
4:	9.3	↙
5:	10.2	↓
Serie	48.0	
Total	48.0	

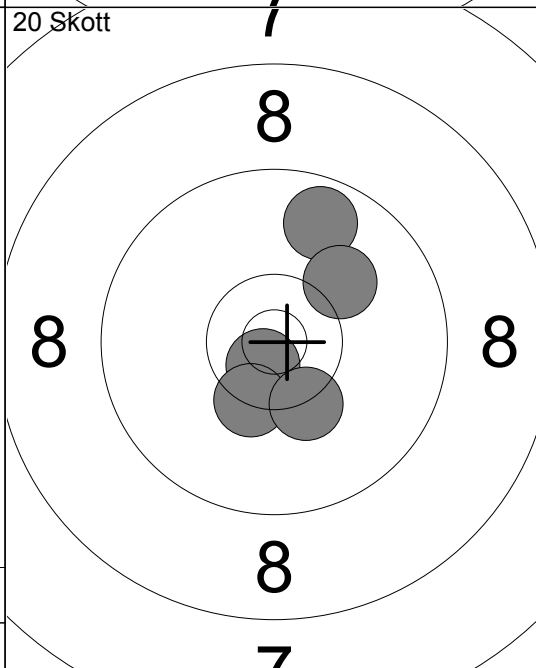

6:	10.7	↘
7:	10.4	↘
8:	9.7	↑
9:	10.1	↗
10:	10.3	↘
Serie	49.0	
Total	97.0	

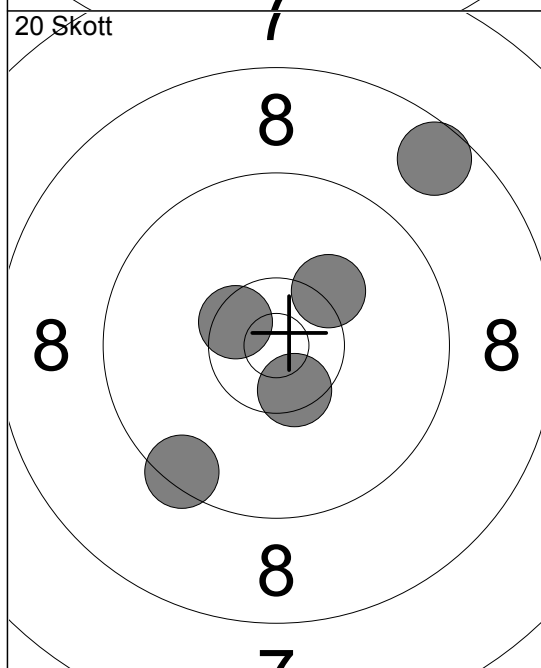

11:	10.2	↗
12:	10.5	↘
13:	9.4	↙
14:	8.6	↗
15:	10.5	↘
Serie	47.0	
Total	144.0	

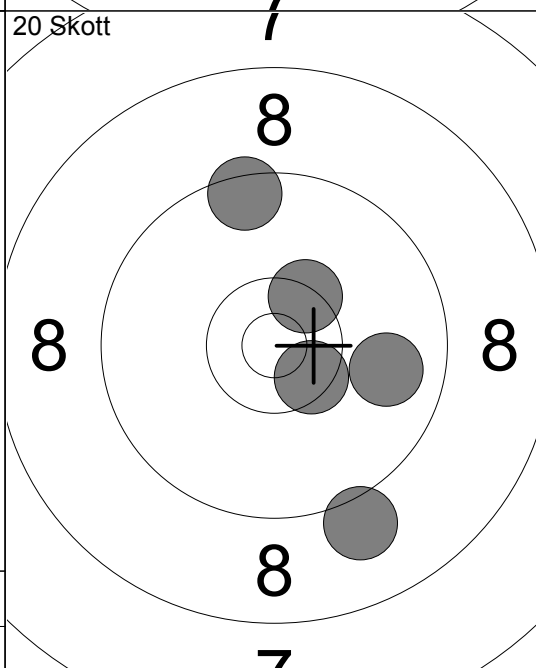

16:	9.9	→
17:	10.5	↘
18:	9.1	↓
19:	9.5	↑
20:	10.4	↗
Serie	47.0	
Total	191.0	

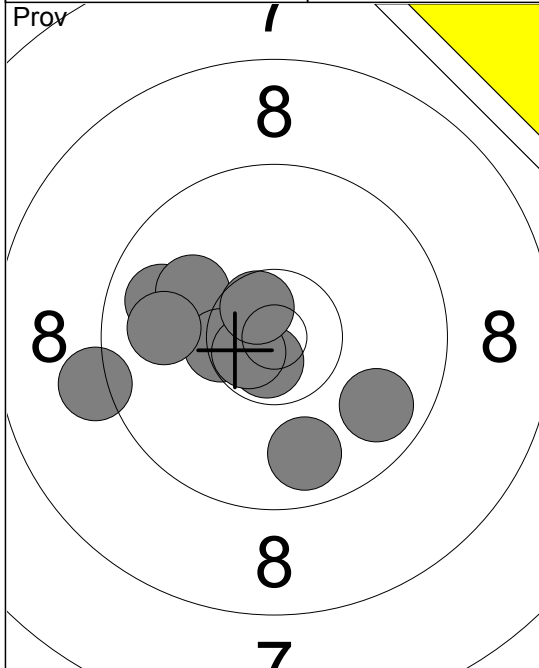

1:	9.8	←
2:	9.8	↘
3:	10.1	↖
4:	10.4	✕
5:	9.2	←
6:	9.9	←
7:	10.7	↘
8:	9.8	↓
9:	10.7	✕
10:	10.6	↘
Serie	95.0	
Total	0.0	

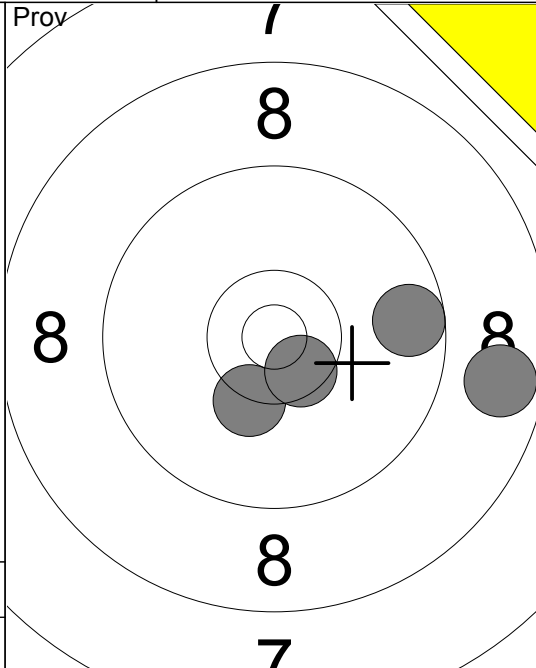

11:	10.3	↘
12:	9.6	→
13:	8.7	→
14:	10.5	↘
Serie	37.0	
Total	0.0	

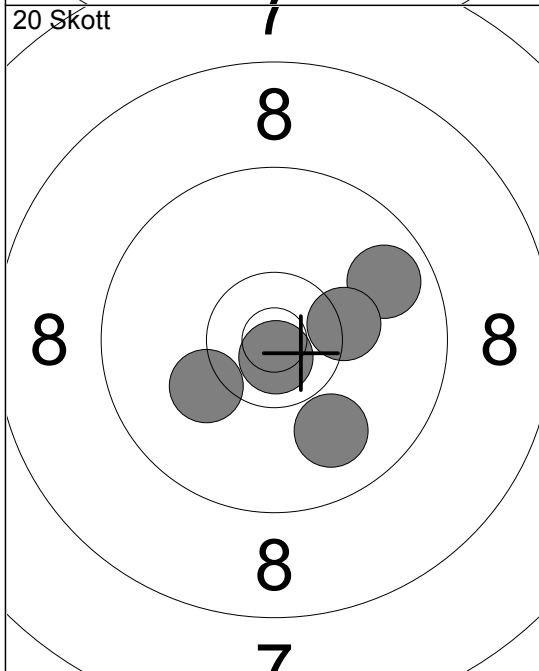

1:	9.8	→
2:	10.8	↘
3:	10.3	→
4:	10.2	↖
5:	9.9	↓
Serie	48.0	
Total	48.0	

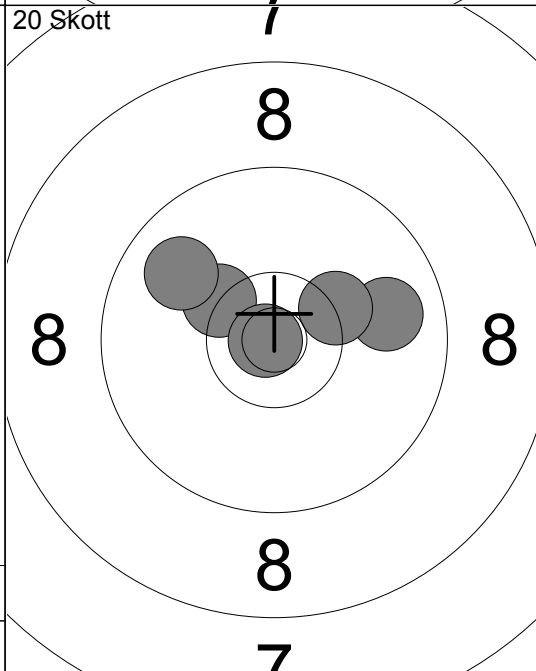

6:	10.3	↘
7:	9.9	↖
8:	9.9	→
9:	10.9	✕
10:	10.3	↗
Serie	48.0	
Total	96.0	

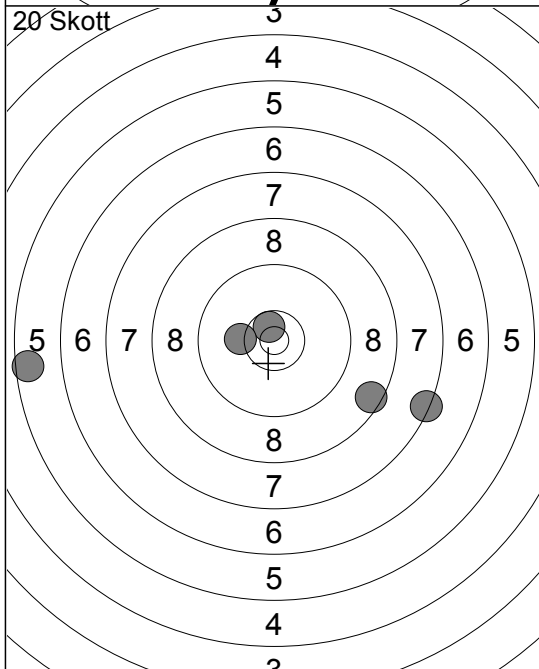

11:	10.6	↘
12:	10.2	←
13:	7.4	→
14:	8.5	↘
15:	5.6	←
Serie	40.0	
Total	136.0	

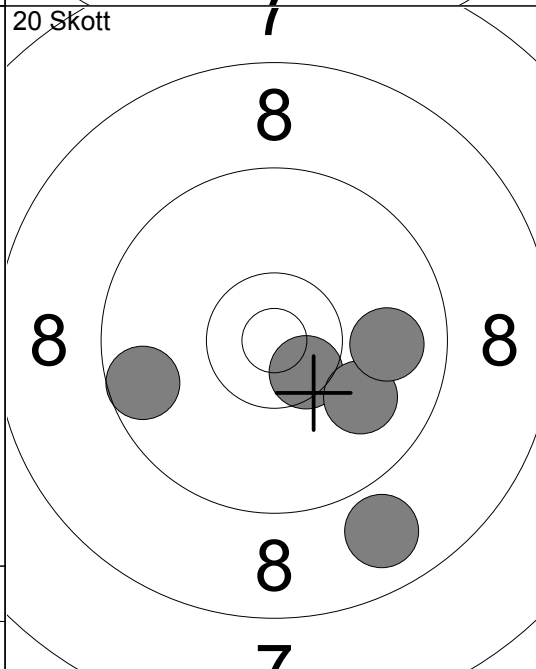

16:	9.6	←
17:	10.5	↘
18:	8.9	↓
19:	10.0	↘
20:	9.9	→
Serie	46.0	
Total	182.0	

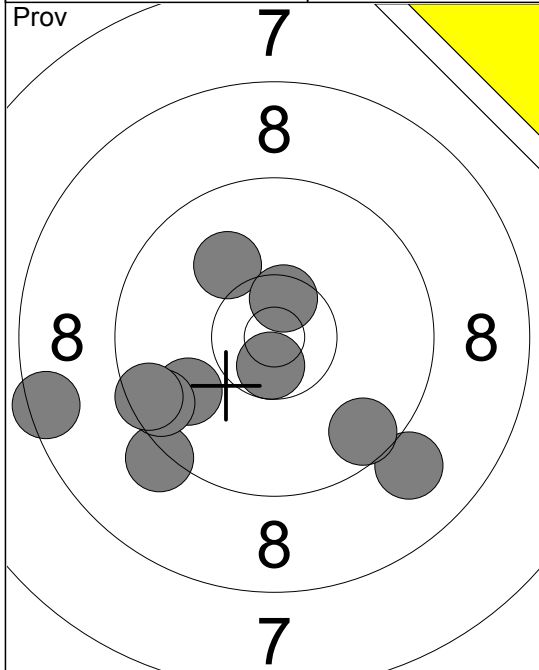

1:	9.9	↙
2:	10.7	x↓
3:	10.1	↖
4:	9.0	↘
5:	10.5	x↑
6:	9.2	↙
7:	9.6	↙
8:	9.5	↙
9:	8.5	↙
10:	9.6	↘
Serie	92.0	
Total	0.0	

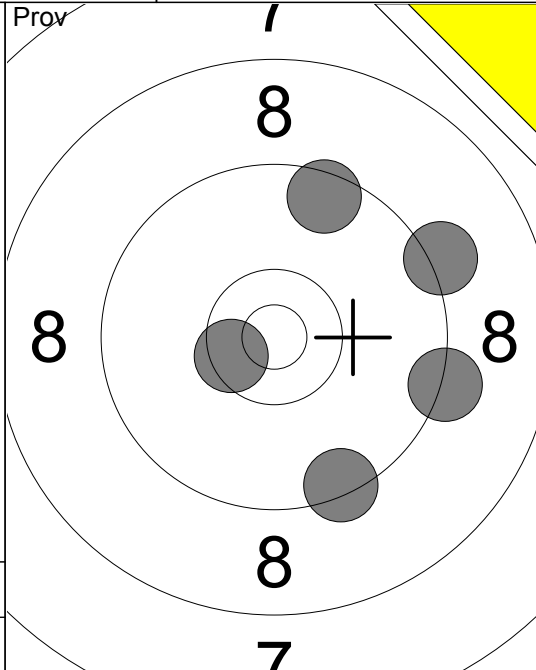

11:	9.3	→
12:	10.5	x↙
13:	9.4	↘
14:	9.2	↗
15:	9.5	↖
Serie	46.0	
Total	0.0	

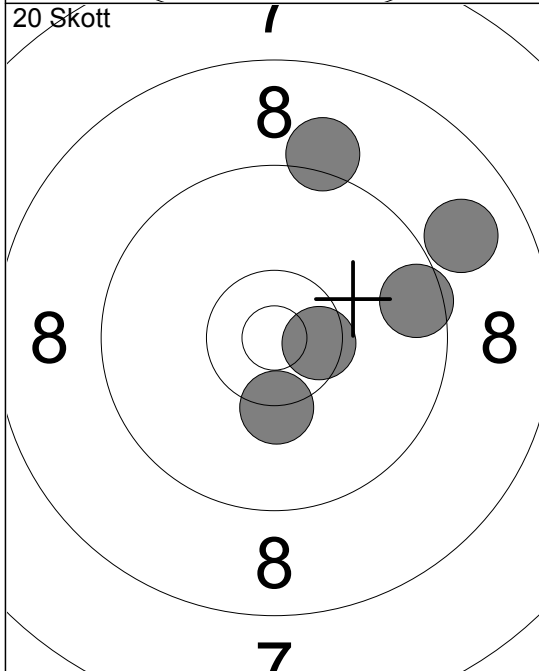

1:	9.1	↖
2:	9.5	→
3:	8.9	↗
4:	10.5	x→
5:	10.3	x↓
Serie	46.0	
Total	46.0	

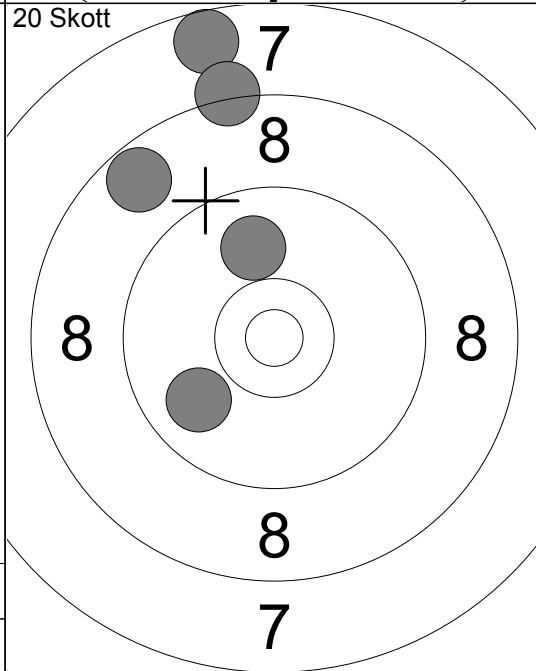

6:	7.6	↖
7:	8.7	↙
8:	8.2	↖
9:	9.9	↖
10:	9.9	↙
Serie	41.0	
Total	87.0	

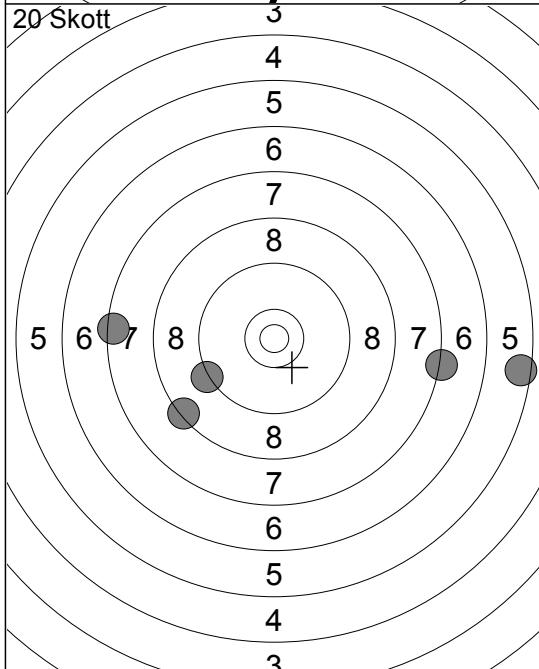

11:	5.5	→
12:	9.3	↙
13:	7.3	→
14:	7.4	↙
15:	8.4	↙
Serie	36.0	
Total	123.0	

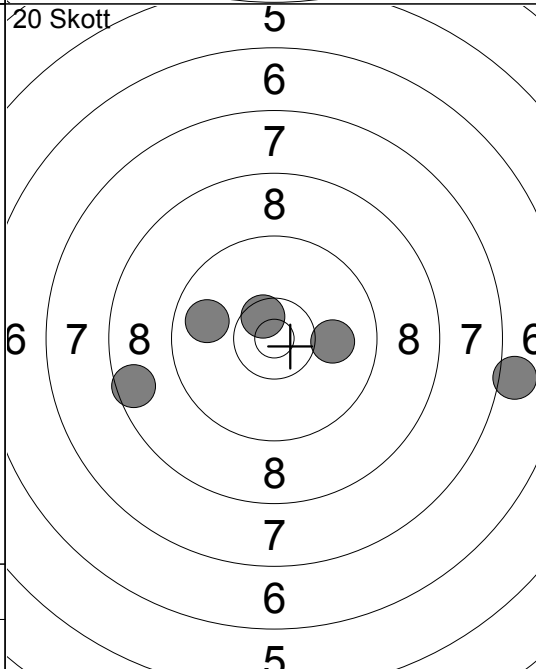

16:	7.1	→
17:	10.0	→
18:	8.6	↙
19:	10.6	x↙
20:	9.8	↙
Serie	44.0	
Total	167.0	

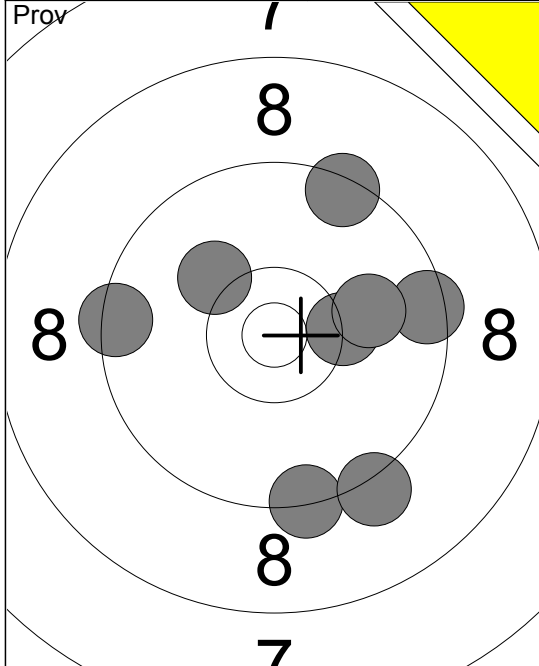

20 Skott

1:	9.3	↓
2:	9.2	↓
3:	10.3	→
4:	9.5	→
5:	10.0	→
6:	9.4	↑
7:	9.4	←
8:	10.2	↖
Serie	75.0	
Total	0.0	

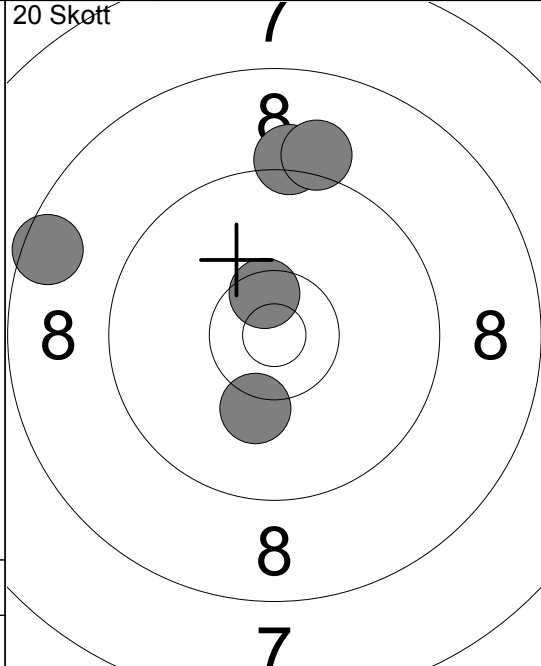

20 Skott

1:	8.5	↖
2:	10.2	↓
3:	9.2	↑
4:	9.1	↑
5:	10.5	↗
Serie	46.0	
Total	46.0	

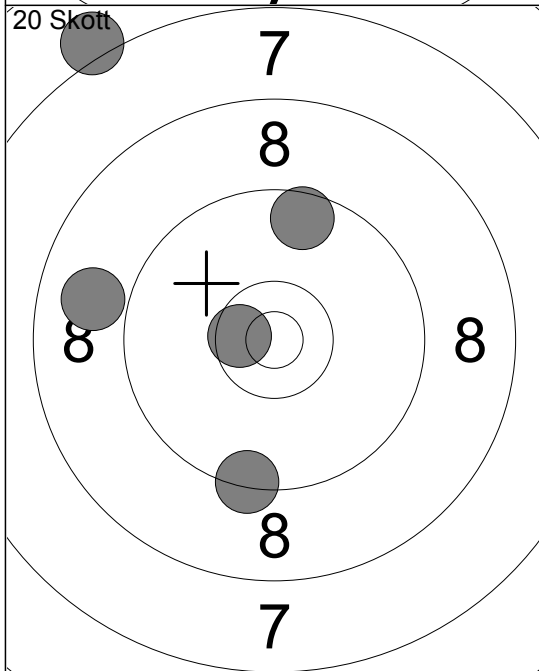

20 Skott

6:	9.4	↓
7:	8.9	←
8:	9.6	↑
9:	10.6	↖
10:	7.1	↗
Serie	43.0	
Total	89.0	

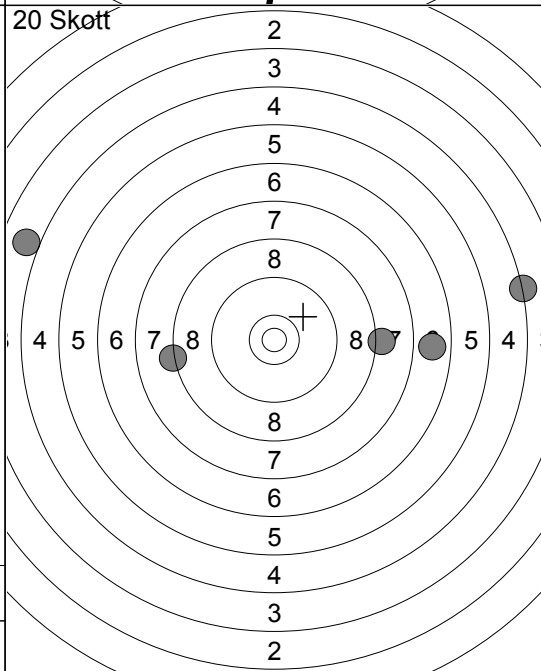

20 Skott

11:	8.2	←
12:	8.1	→
13:	6.8	→
14:	4.3	→
15:	4.0	↖
Serie	30.0	
Total	119.0	

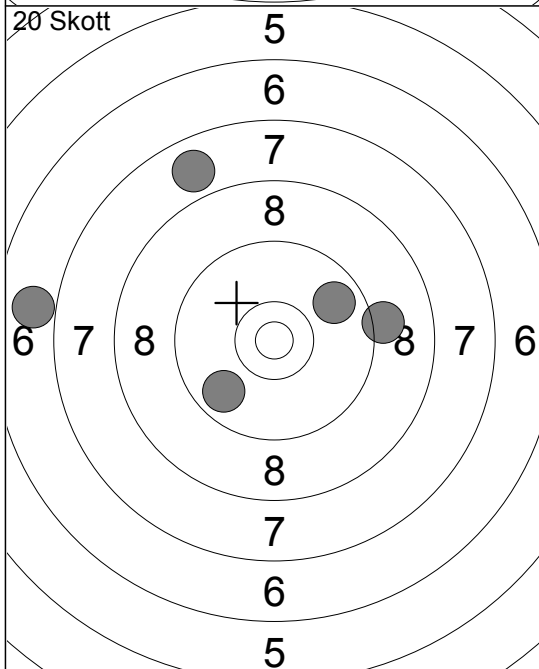

20 Skott

16:	9.8	↗
17:	9.8	↖
18:	7.9	↗
19:	9.1	→
20:	6.9	←
Serie	40.0	
Total	159.0	

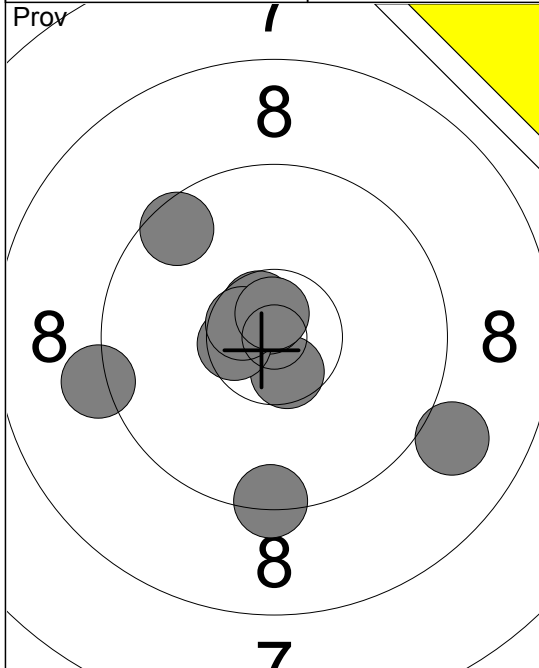

1:	9.0	➤
2:	10.6	↗
3:	10.6	↘
4:	10.8	↗
5:	10.6	✗
6:	9.6	↗
7:	9.4	↓
8:	9.2	←
9:	10.6	✗
10:	10.7	↗
Serie	96.0	
Total	0.0	

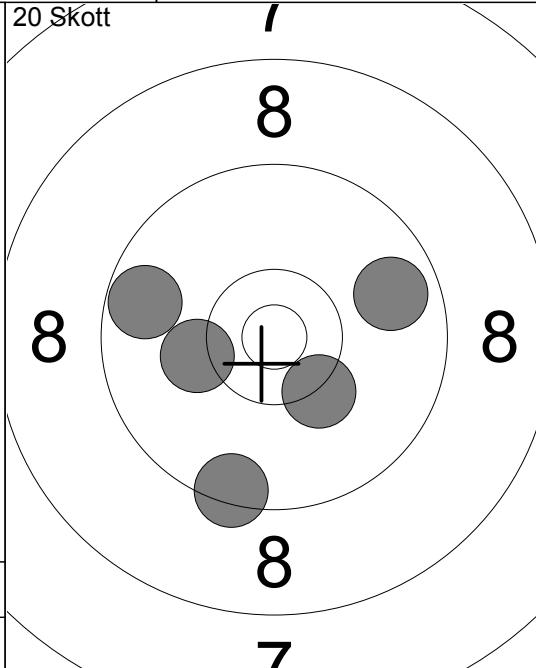

1:	9.8	➤
2:	10.2	←
3:	9.4	↓
4:	10.3	↘
5:	9.7	←
Serie	47.0	
Total	47.0	

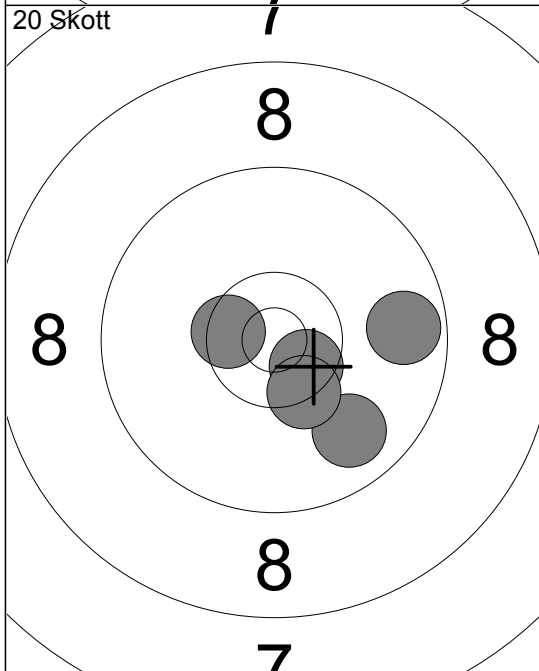

6:	9.7	➤
7:	10.6	↘
8:	9.8	↘
9:	10.5	✗
10:	10.4	↘
Serie	48.0	
Total	95.0	

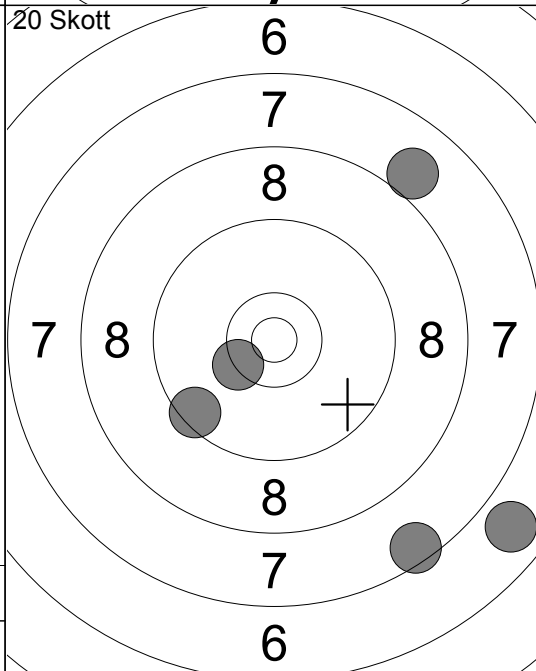

11:	8.0	↗
12:	7.5	↘
13:	9.5	↙
14:	10.3	✗
15:	6.8	↘
Serie	40.0	
Total	135.0	

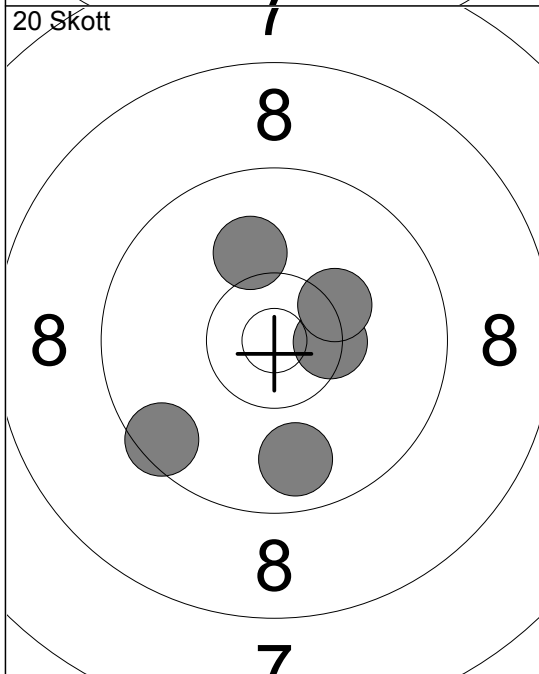

16:	10.4	➤
17:	10.3	↗
18:	10.1	↗
19:	9.5	↙
20:	9.8	↓
Serie	48.0	
Total	183.0	

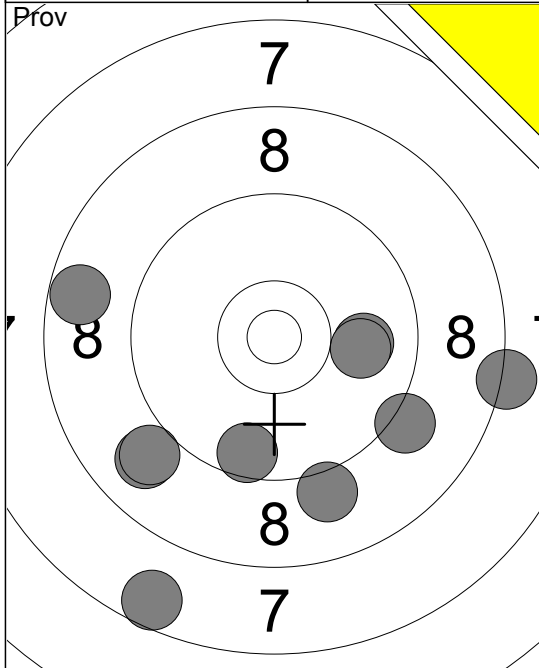

1:	8.2	→
2:	8.7	←
3:	8.9	↙
4:	9.1	↘
5:	9.1	↘
6:	7.6	↙
7:	9.6	↙
8:	9.0	↙
9:	9.9	→
10:	10.0	→
Serie	86.0	
Total	0.0	

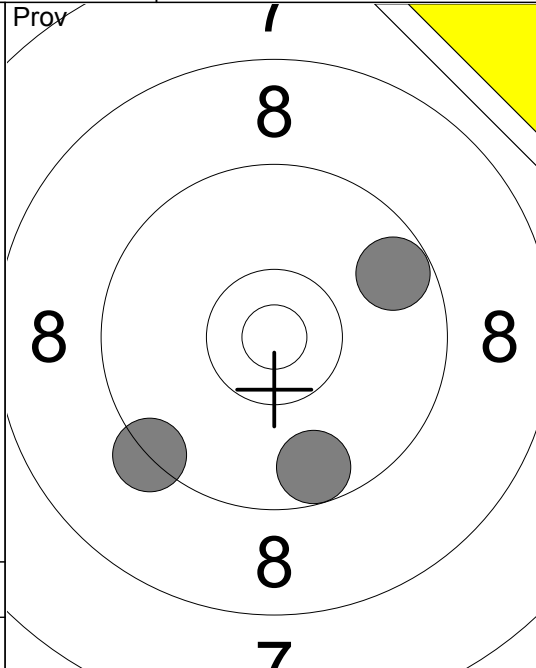

11:	9.3	↙
12:	9.7	↘
13:	9.7	↗
Serie	27.0	
Total	0.0	

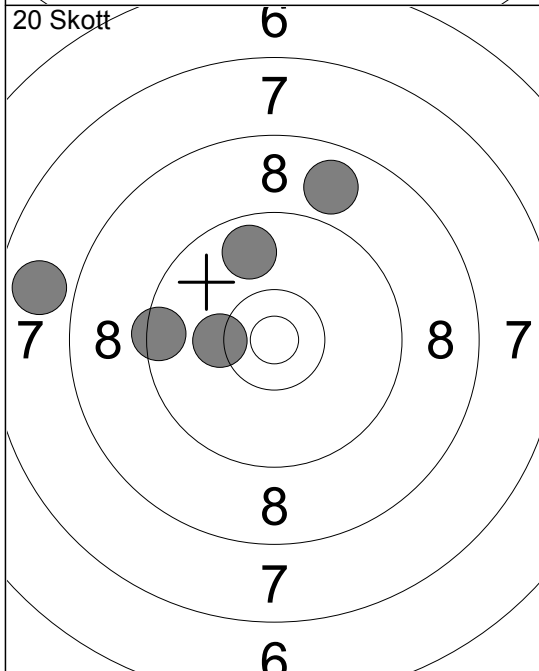

1:	7.8	←
2:	10.2	←
3:	9.8	↑
4:	9.5	←
5:	8.8	↑
Serie	43.0	
Total	43.0	

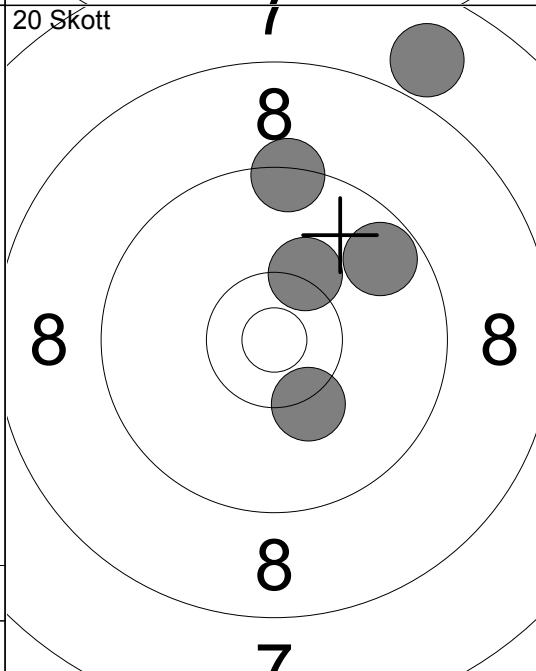

6:	10.3	↗
7:	9.7	↗
8:	7.9	↗
9:	10.3	↘
10:	9.4	↑
Serie	45.0	
Total	88.0	

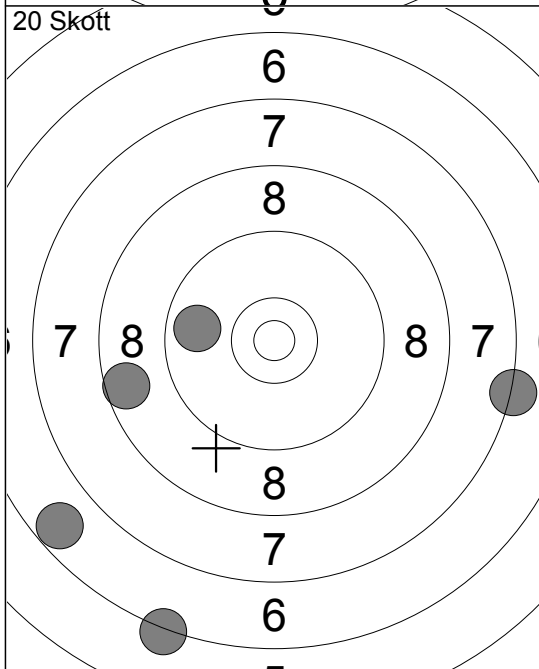

11:	6.2	↘
12:	7.3	→
13:	9.8	←
14:	8.6	←
15:	6.7	↙
Serie	36.0	
Total	124.0	

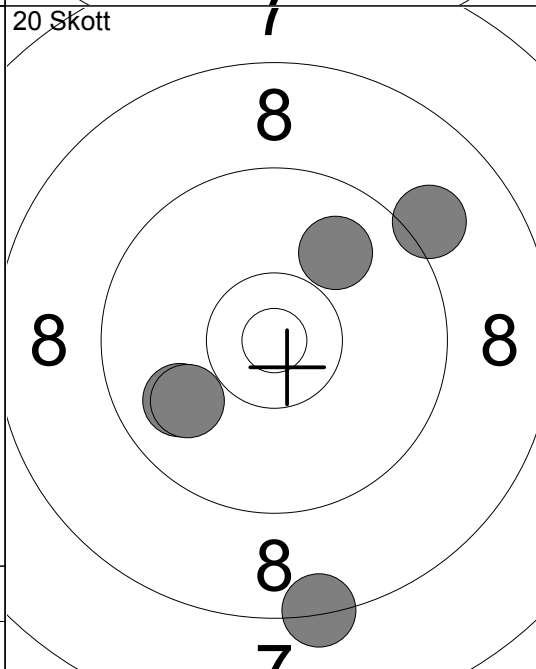

16:	8.3	↘
17:	9.9	←
18:	9.9	←
19:	9.9	↗
20:	9.1	↗
Serie	44.0	
Total	168.0	

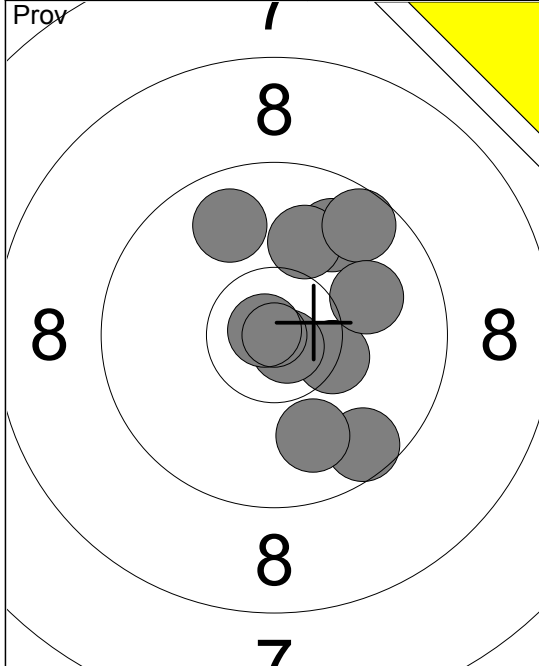

1:	9.8	↖
2:	9.9	↗
3:	10.0	↗
4:	9.6	↗
5:	10.4	↘
6:	10.8	↘
7:	10.0	→
8:	10.8	↘
9:	9.6	↘
10:	9.9	↘
Serie		95.0
Total		0.0

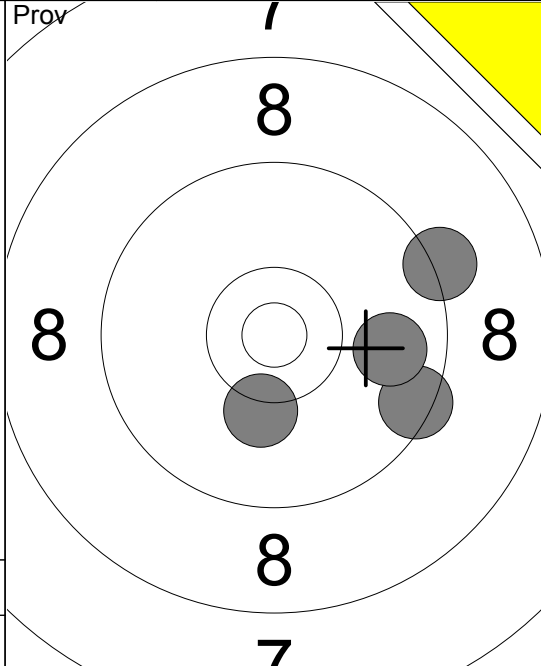

11:	10.2	↘
12:	9.5	→
13:	9.2	↗
14:	9.8	→
Serie		37.0
Total		0.0

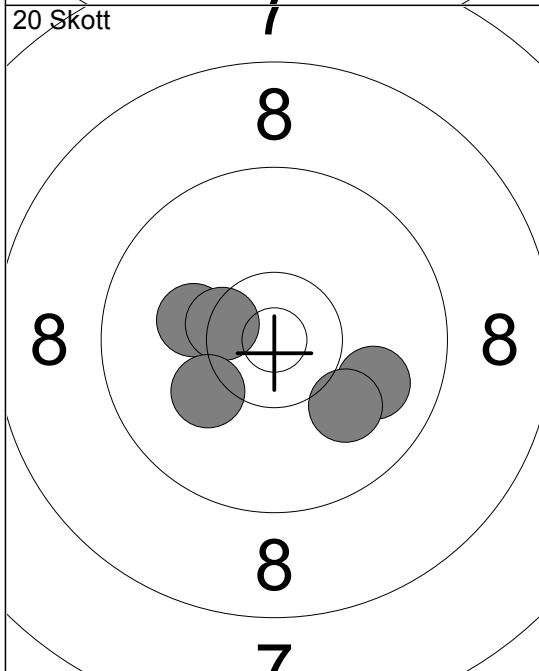

1:	10.2	↖
2:	10.4	↘
3:	10.1	↖
4:	9.9	→
5:	10.0	↘
Serie		49.0
Total		49.0

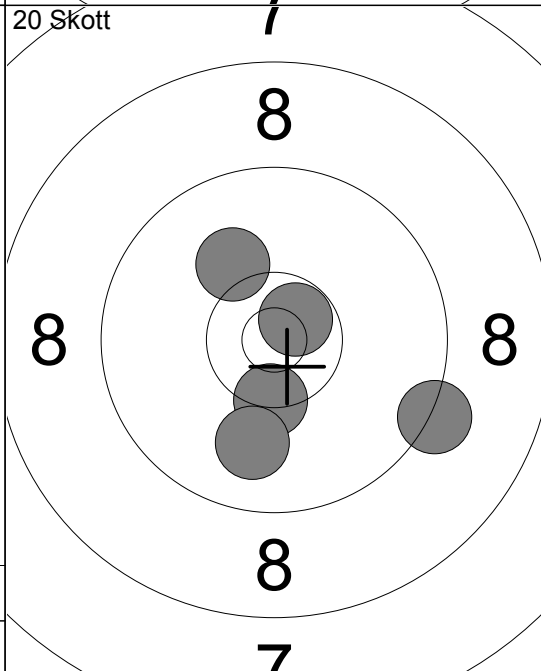

6:	10.4	↘
7:	9.3	→
8:	10.1	↖
9:	10.7	↗
10:	9.9	↘
Serie		48.0
Total		97.0

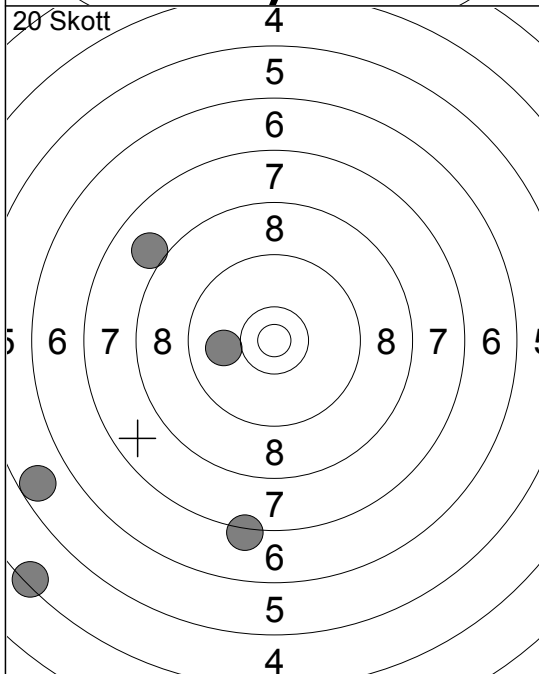

11:	8.0	↖
12:	4.4	↖
13:	5.7	↖
14:	10.0	↖
15:	7.2	↘
Serie		34.0
Total		131.0

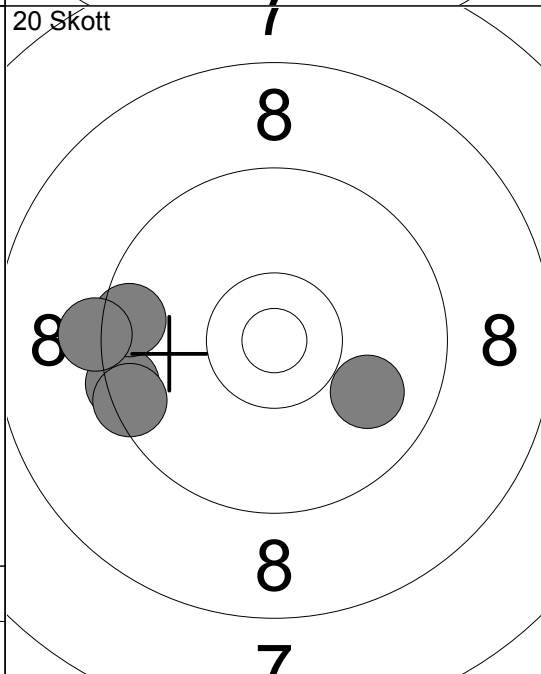

16:	9.4	↖
17:	9.9	→
18:	9.6	↖
19:	9.5	↖
20:	9.2	↖
Serie		45.0
Total		176.0

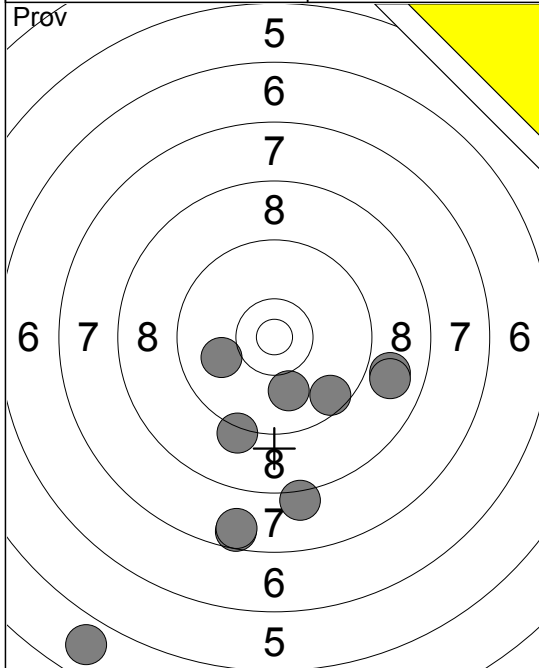

1:	4.9	↘
2:	7.6	↘
3:	7.7	↘
4:	8.9	→
5:	9.2	↘
6:	9.6	↘
7:	8.2	↘
8:	10.0	←
9:	10.0	↘
10:	8.9	→
Serie	80.0	
Total	0.0	

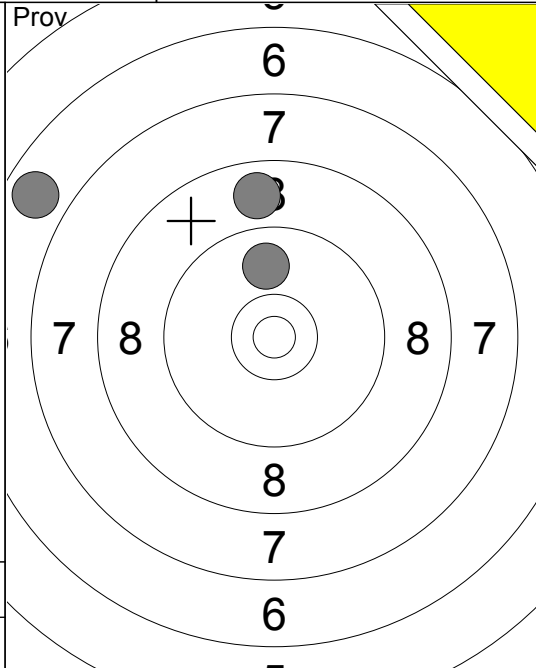

11:	8.8	↑
12:	9.9	↑
13:	6.8	↖
Serie	23.0	
Total	0.0	

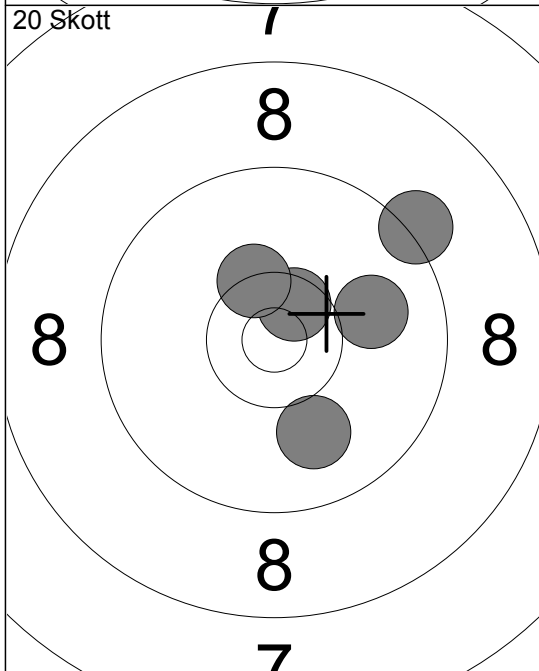

1:	10.6x	↗
2:	10.4x	↗
3:	9.2	↗
4:	10.0	↘
5:	10.0	→
Serie	49.0	
Total	49.0	

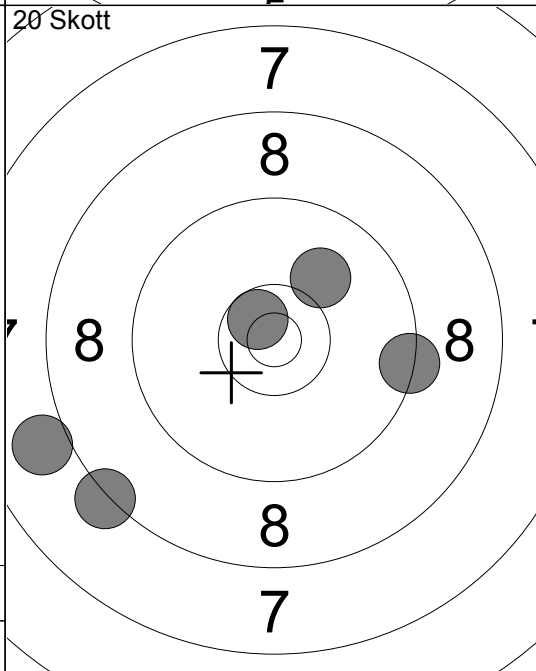

6:	10.1	↗
7:	9.4	→
8:	8.0	←
9:	10.6x	↗
10:	8.3	↘
Serie	45.0	
Total	94.0	

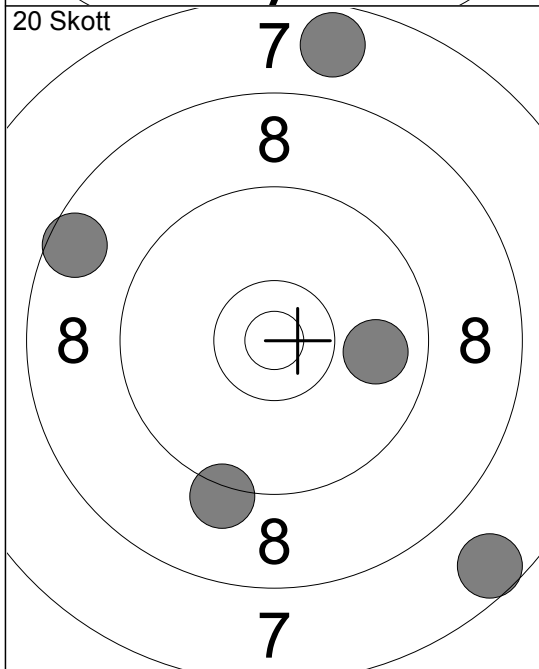

11:	7.7	↑
12:	8.6	↖
13:	7.6	↘
14:	9.2	↘
15:	9.9	→
Serie	40.0	
Total	134.0	

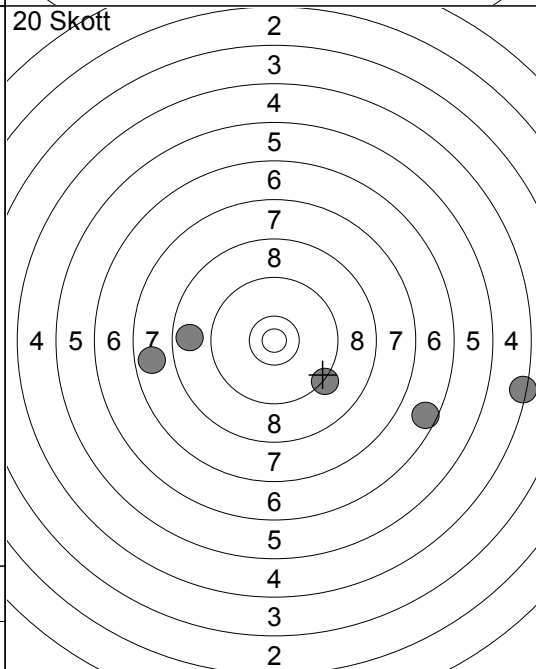

16:	6.6	↘
17:	4.4	→
18:	7.7	←
19:	8.8	←
20:	9.3	↘
Serie	34.0	
Total	168.0	

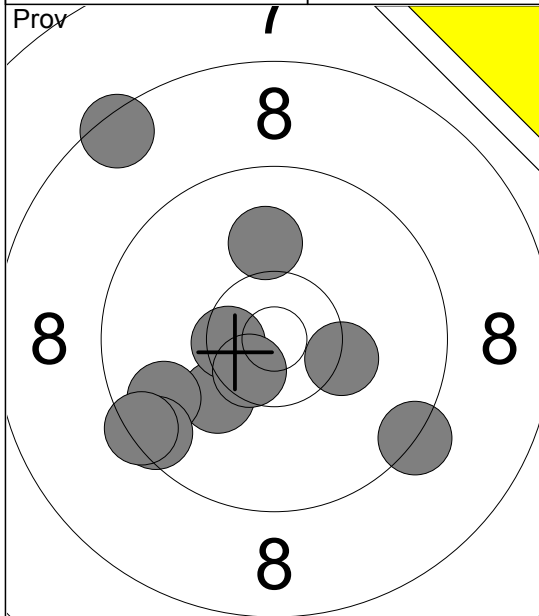

- 1: 8.5 ↖
- 2: 10.2 ↙
- 3: 10.3 →
- 4: 10.5 ✕
- 5: 9.8 ↙
- 6: 9.5 ↙
- 7: 10.6 ✕
- 8: 9.4 ↙
- 9: 9.3 ↘
- 10: 10.0 ↑

Serie 94.0
Total 0.0

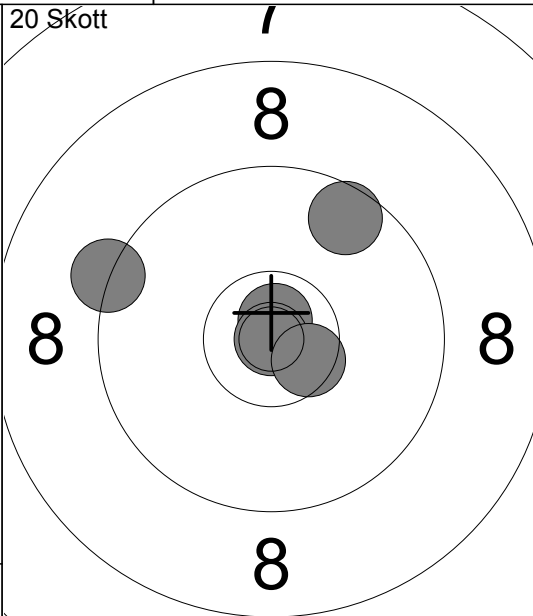

- 1: 9.3 ↖
- 2: 10.8 ✕
- 3: 10.9 ✕
- 4: 9.6 ↗
- 5: 10.5 ✕

Serie 48.0
Total 48.0

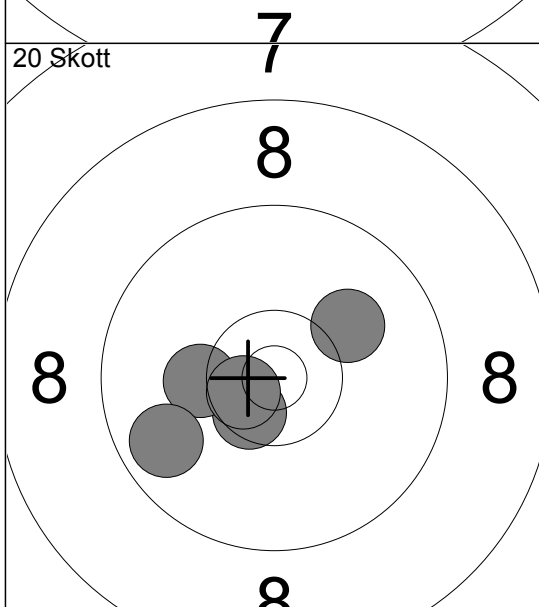

- 6: 10.5 ✕
- 7: 10.2 ↙
- 8: 9.8 ↙
- 9: 10.6 ✕
- 10: 10.1 ↗

Serie 49.0
Total 97.0

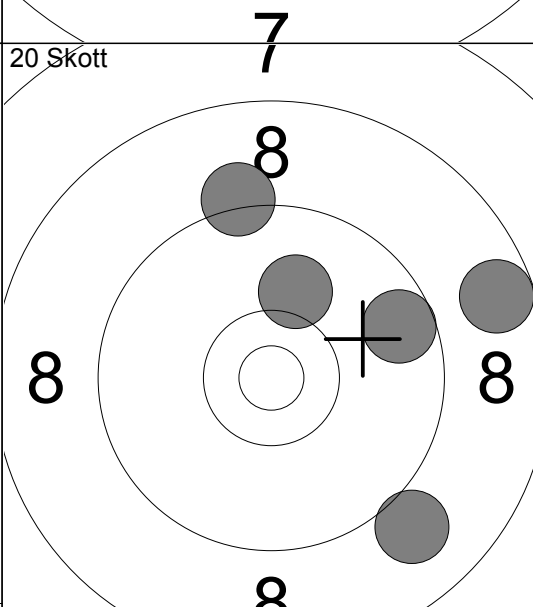

- 11: 8.7 →
- 12: 9.0 ↘
- 13: 10.1 ↑
- 14: 9.6 →
- 15: 9.2 ↑

Serie 45.0
Total 142.0

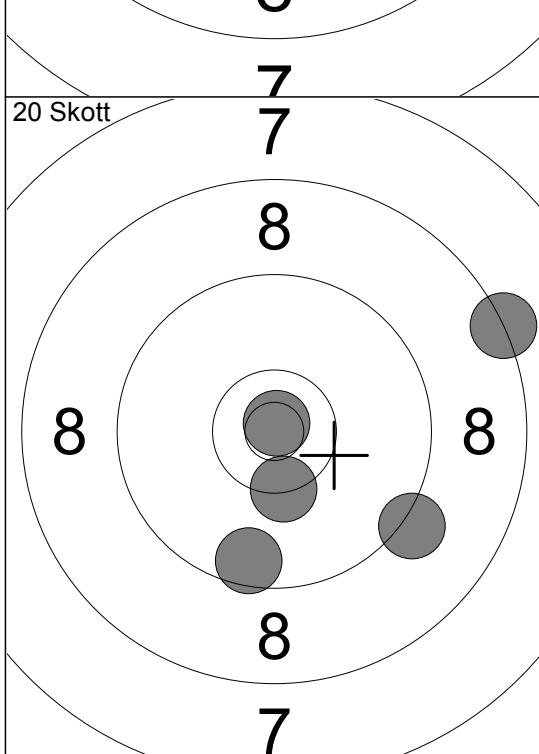

- 16: 8.3 →
- 17: 9.2 ↘
- 18: 9.6 ↓
- 19: 10.3 ✕
- 20: 10.9 ✕

Serie 46.0
Total 188.0

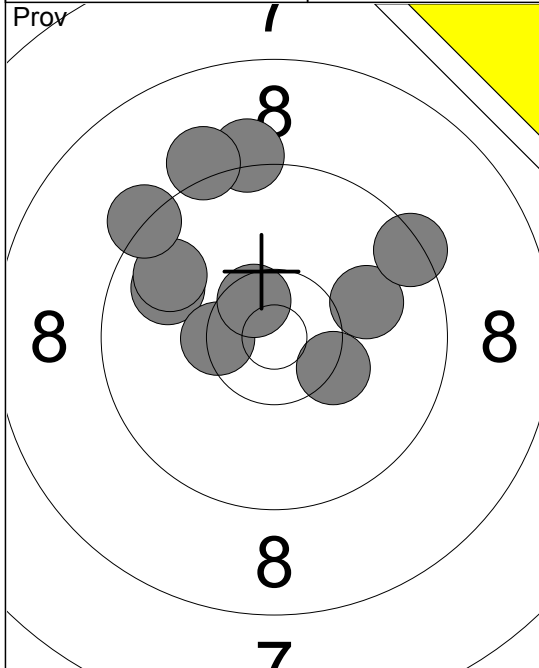

1:	10.0	→
2:	9.2	↑
3:	9.8	←
4:	9.8	↖
5:	9.3	↖
6:	10.4	✕
7:	10.3	✕
8:	9.2	↑
9:	10.6	✕
10:	9.4	↗
Serie		94.0
Total		0.0

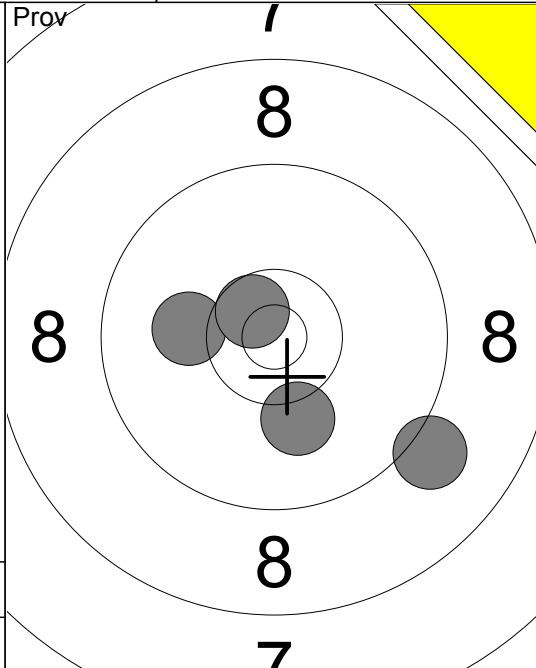

11:	10.1	↓
12:	9.1	↘
13:	10.1	←
14:	10.6	✕
Serie		39.0
Total		0.0

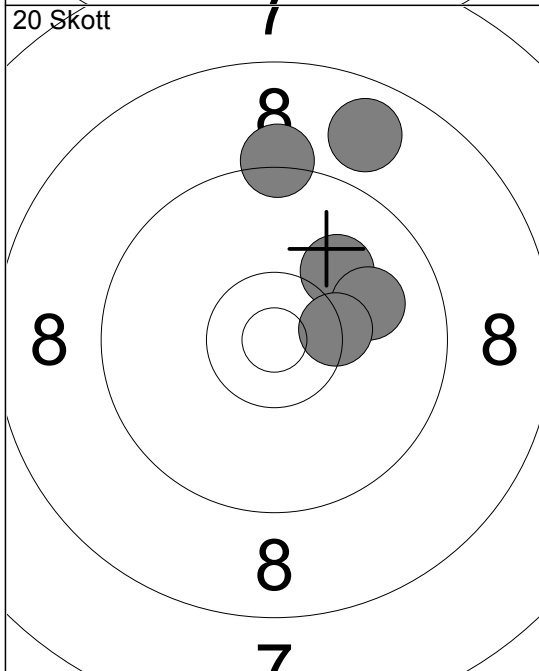

1:	10.1	↗
2:	10.0	→
3:	10.4	✕
4:	9.2	↑
5:	8.8	↗
Serie		47.0
Total		47.0

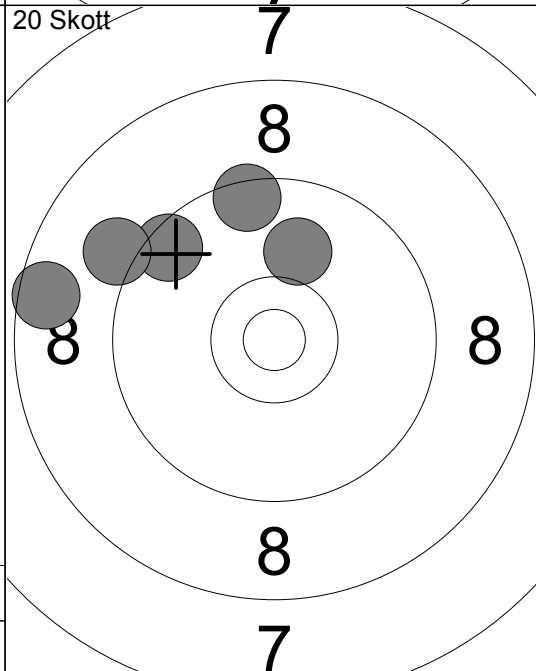

6:	9.5	↖
7:	9.5	↑
8:	10.0	↑
9:	8.6	←
10:	9.1	↖
Serie		45.0
Total		92.0

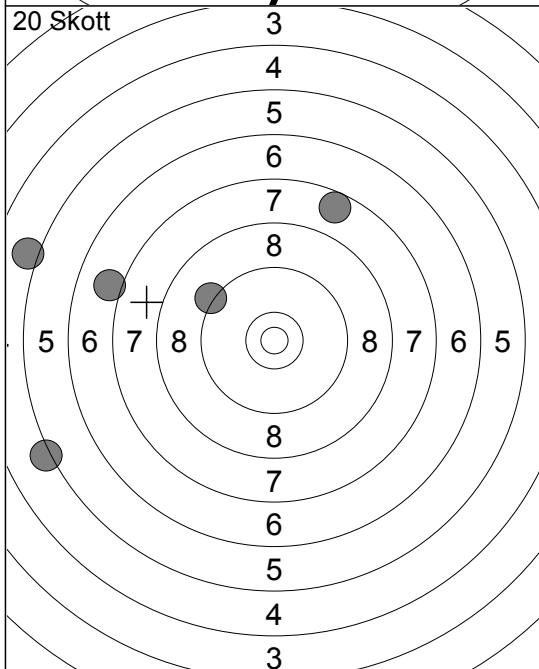

11:	7.7	↗
12:	5.2	←
13:	5.1	←
14:	7.0	←
15:	9.2	↖
Serie		33.0
Total		125.0

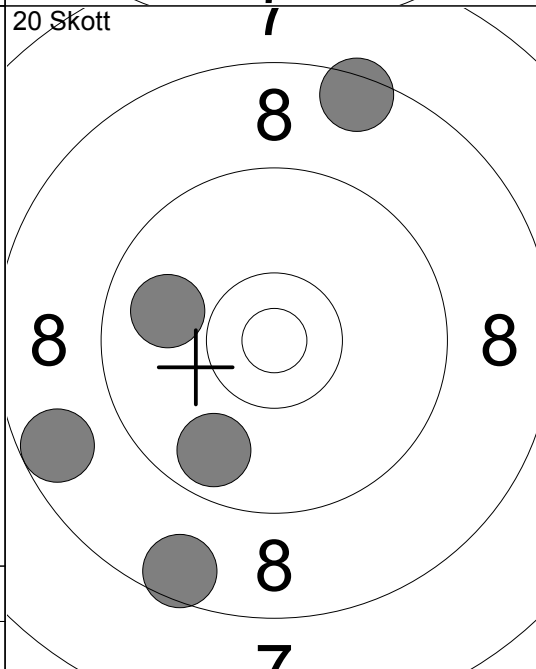

16:	8.6	↓
17:	9.9	←
18:	9.8	↘
19:	8.5	↗
20:	8.7	←
Serie		42.0
Total		167.0

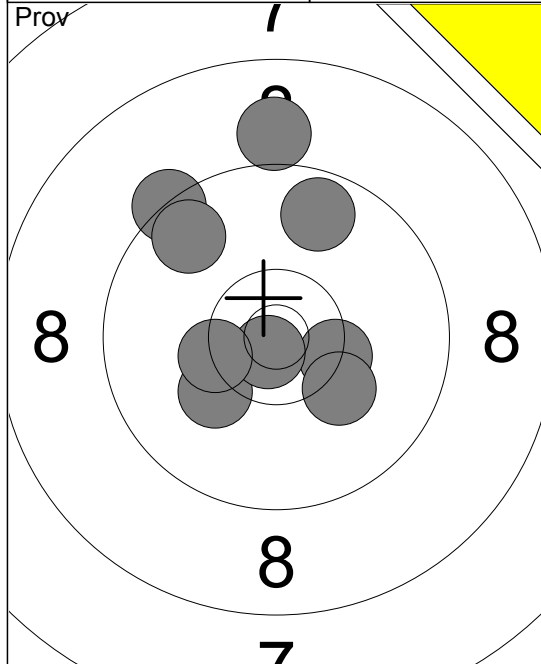

1:	10.4x	➤
2:	10.2	↘
3:	9.7	↗
4:	10.2	↙
5:	9.3	↖
6:	9.7	↖
7:	10.8x	↙
8:	9.0	↗
9:	10.3x	↘
Serie		86.0
Total		0.0

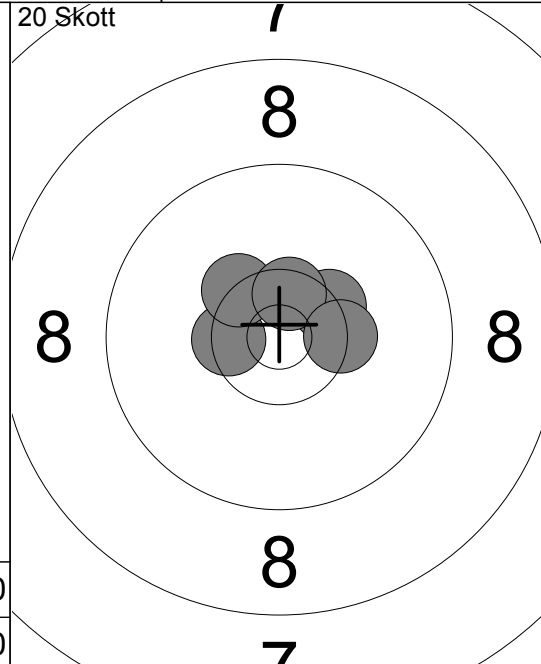

1:	10.4x	↘
2:	10.5x	↙
3:	10.4x	↘
4:	10.5x	↗
5:	10.4x	➤
Serie		50.0
Total		50.0

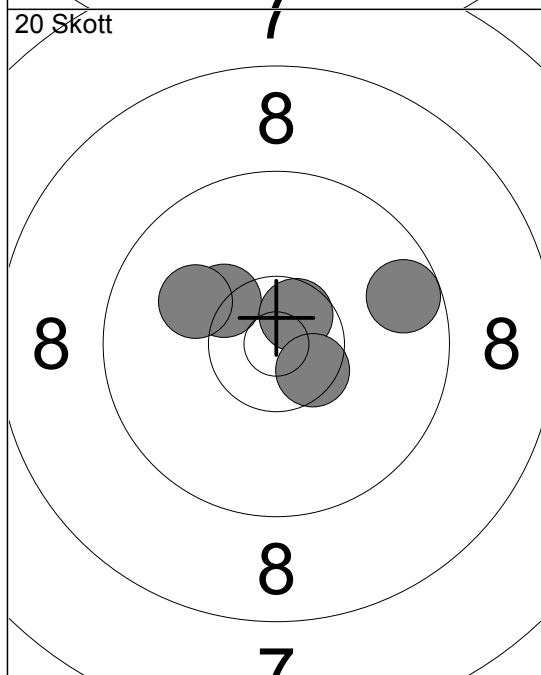

6:	10.3x	↘
7:	9.7	➔
8:	10.6x	↗
9:	10.1	↙
10:	10.5x	↘
Serie		49.0
Total		99.0

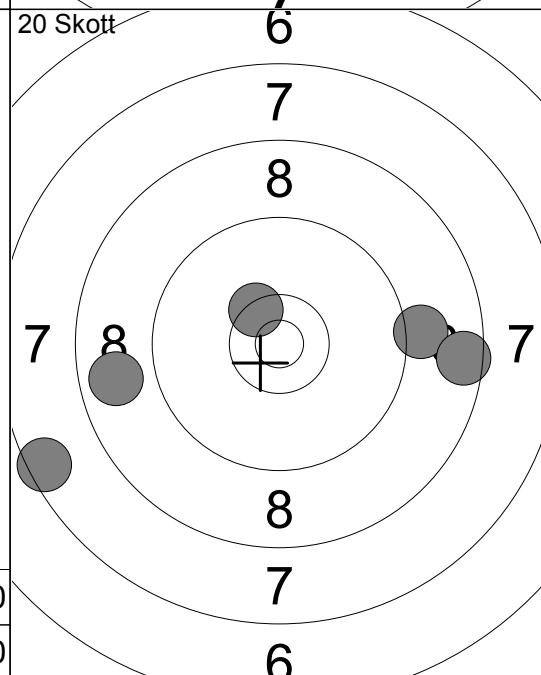

11:	8.8	←
12:	7.5	←
13:	9.1	➔
14:	8.5	➔
15:	10.4x	↘
Serie		42.0
Total		141.0

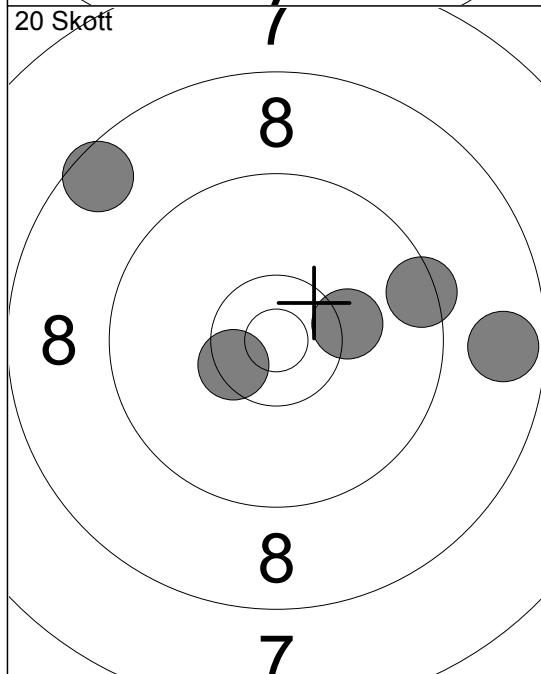

16:	10.5x	↙
17:	8.7	➔
18:	8.6	↖
19:	10.2	➔
20:	9.4	➔
Serie		45.0
Total		186.0

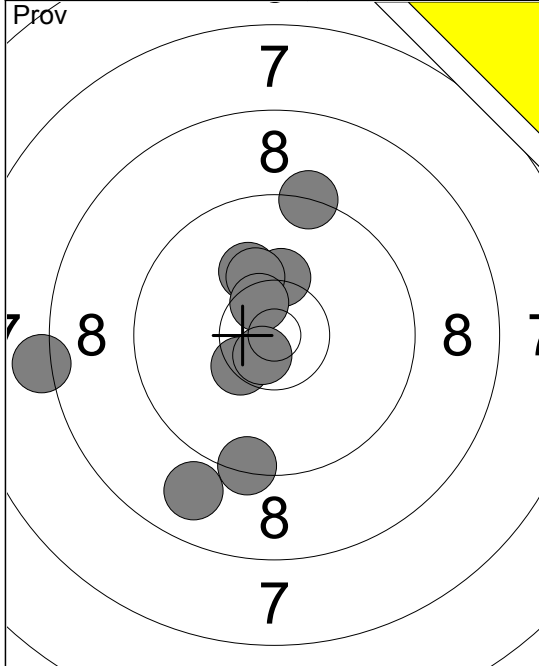

1:	10.3	↑
2:	10.1	↖
3:	9.3	↑
4:	10.2	↖
5:	8.2	←
6:	10.5	↖
7:	10.4	↘
8:	10.7	↘
9:	9.4	↓
10:	8.9	↓
Serie		94.0
Total		0.0

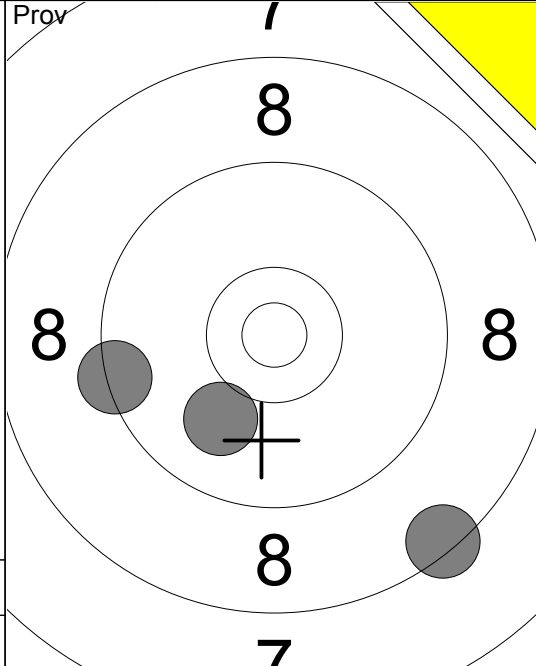

11:	10.0	↘
12:	8.4	↘
13:	9.4	←
Serie		27.0
Total		0.0

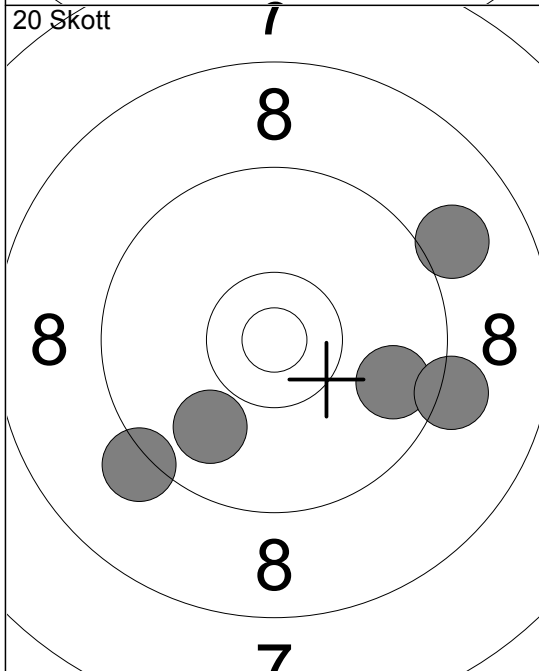

1:	9.9	↘
2:	9.7	→
3:	9.0	↗
4:	9.2	→
5:	9.2	↙
Serie		45.0
Total		45.0

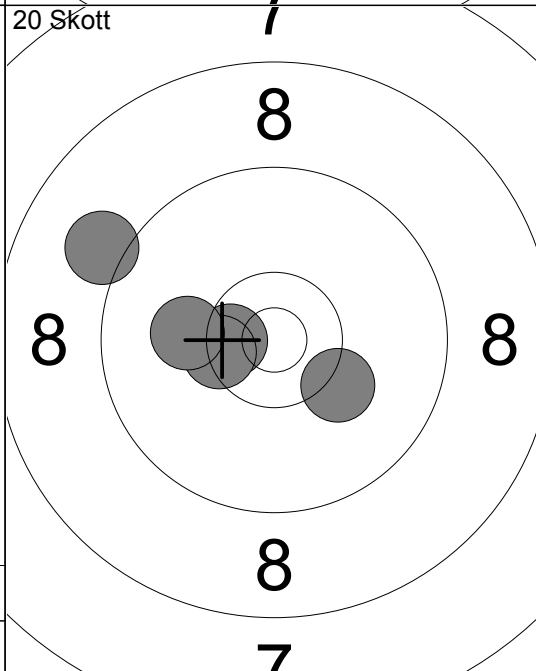

6:	10.5	↘
7:	10.4	↘
8:	10.2	↘
9:	9.1	↖
10:	10.1	←
Serie		49.0
Total		94.0

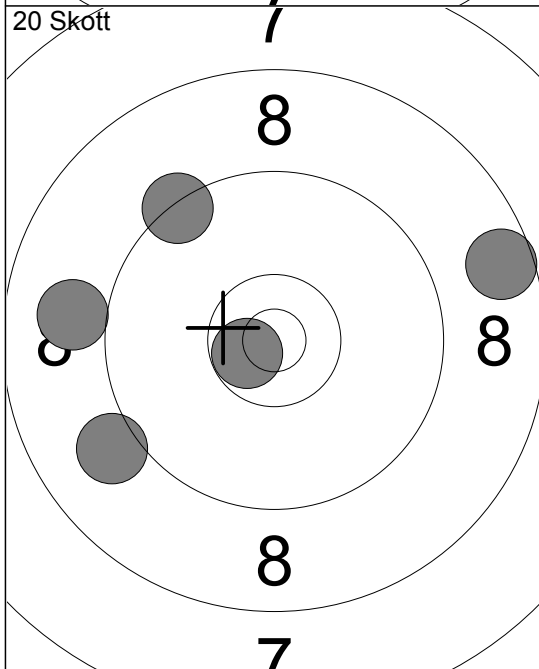

11:	9.3	↖
12:	9.0	↖
13:	10.7	↘
14:	9.0	←
15:	8.6	→
Serie		45.0
Total		139.0

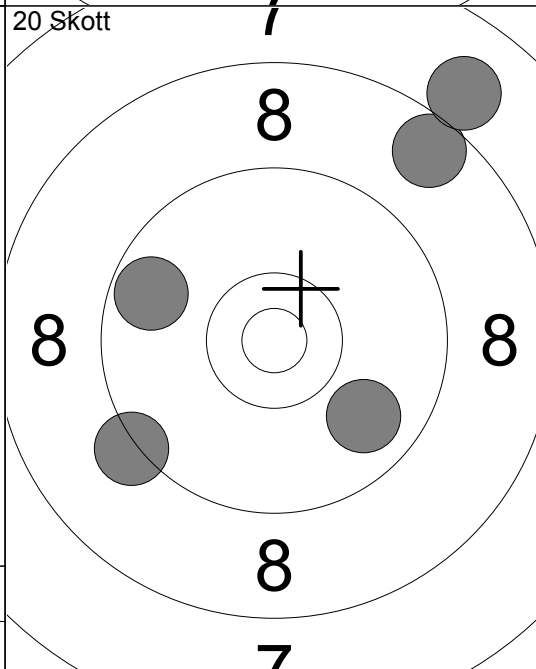

16:	9.2	↖
17:	9.8	↘
18:	8.6	↗
19:	8.0	↗
20:	9.7	←
Serie		43.0
Total		182.0

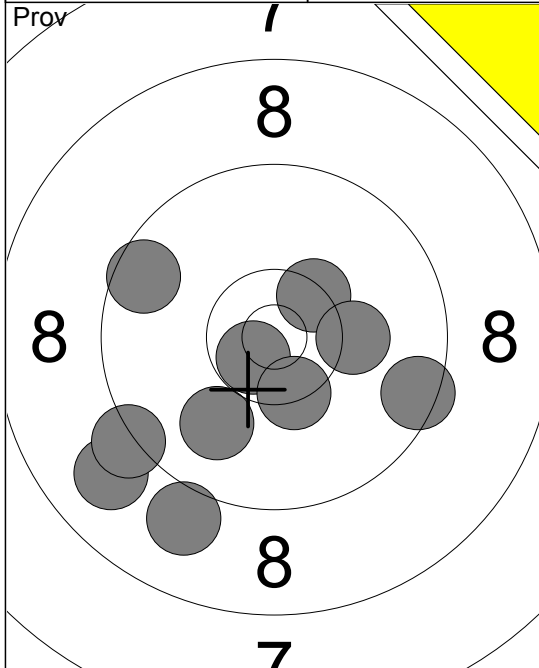

1:	8.9	↙
2:	10.7	↘
3:	9.0	↙
4:	9.5	➔
5:	9.6	↖
6:	9.2	↙
7:	10.4	↘
8:	10.4	↗
9:	10.2	➔
10:	10.0	↙
Serie	94.0	
Total	0.0	

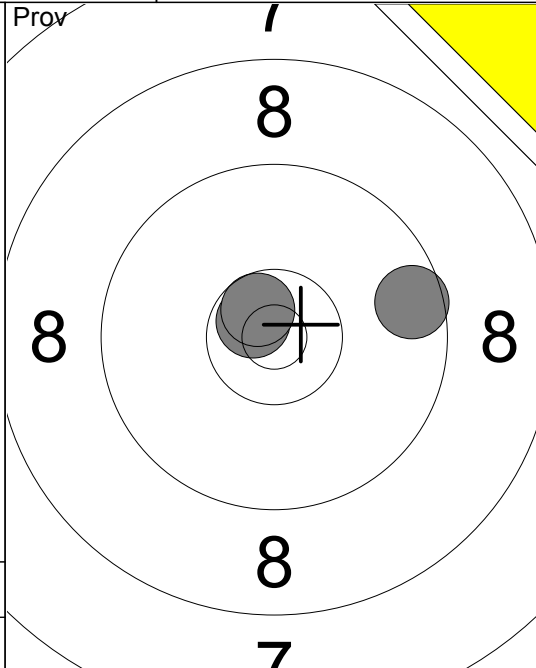

11:	9.6	➔
12:	10.7	↘
13:	10.6	↘
Serie	29.0	
Total	0.0	

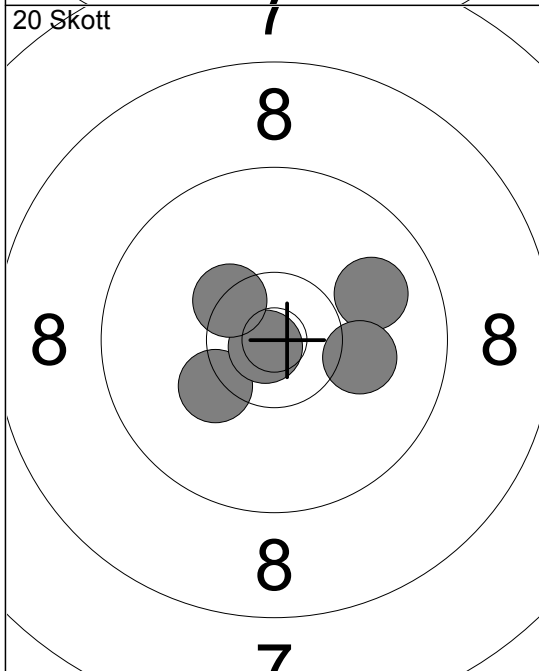

1:	10.2	↙
2:	9.9	➔
3:	10.1	➔
4:	10.8	↘
5:	10.4	↘
Serie	49.0	
Total	49.0	

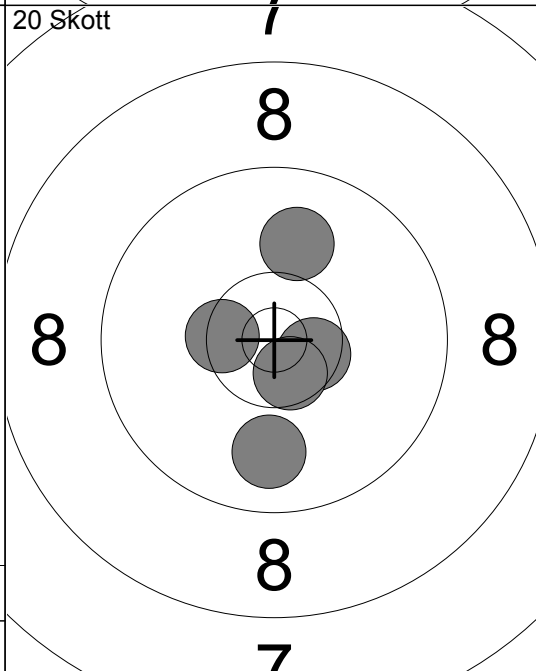

6:	10.5	➔
7:	9.9	↙
8:	10.6	↘
9:	10.4	↖
10:	10.0	↑
Serie	49.0	
Total	98.0	

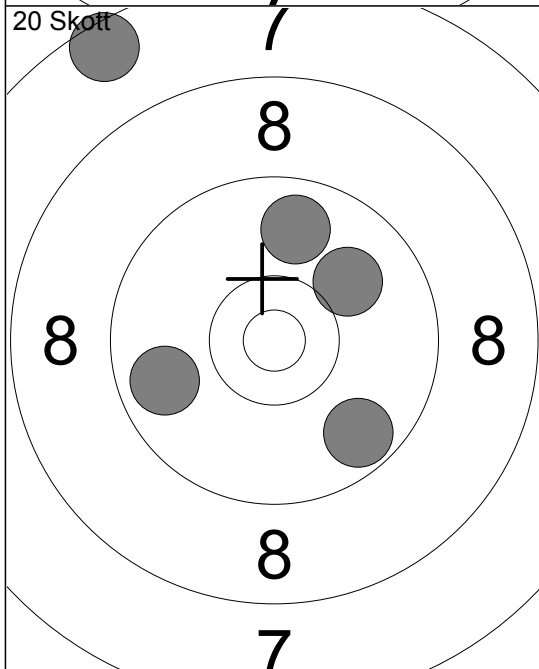

11:	9.7	↙
12:	10.0	↗
13:	9.8	↖
14:	7.5	↖
15:	9.8	↑
Serie	44.0	
Total	142.0	

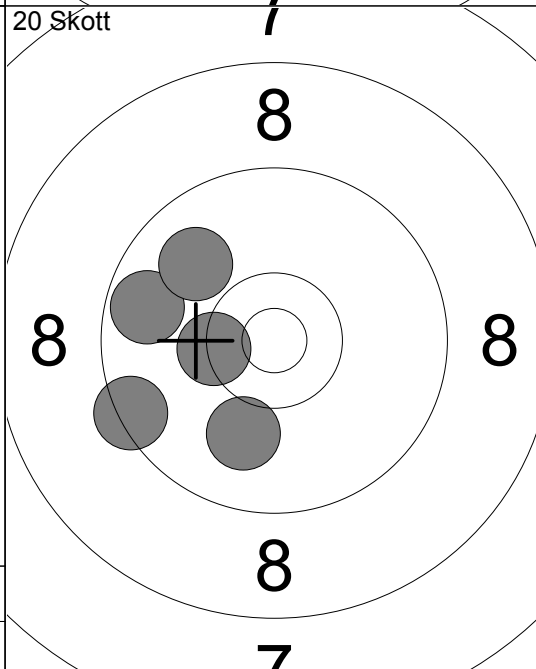

16:	10.0	↙
17:	9.4	↖
18:	9.7	↖
19:	9.9	↖
20:	10.4	↖
Serie	47.0	
Total	189.0	

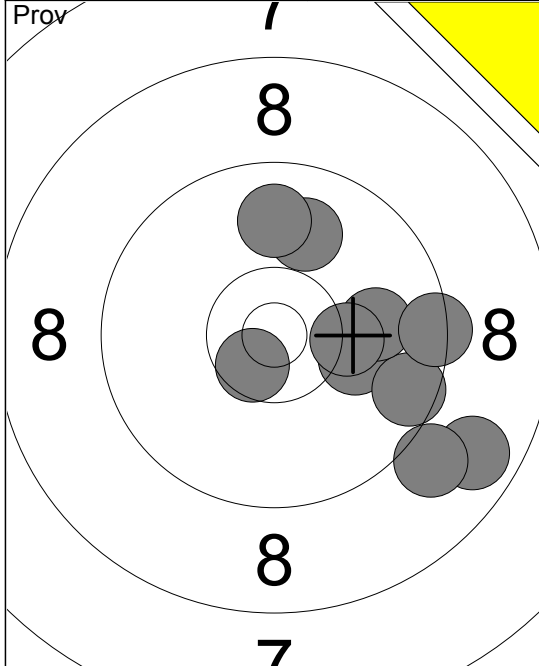

1:	10.1	→
2:	9.6	→
3:	8.7	↘
4:	10.0	→
5:	9.0	↘
6:	9.4	→
7:	10.3	→
8:	9.9	↑
9:	9.9	↑
10:	10.6	↘
Serie	93.0	
Total	0.0	

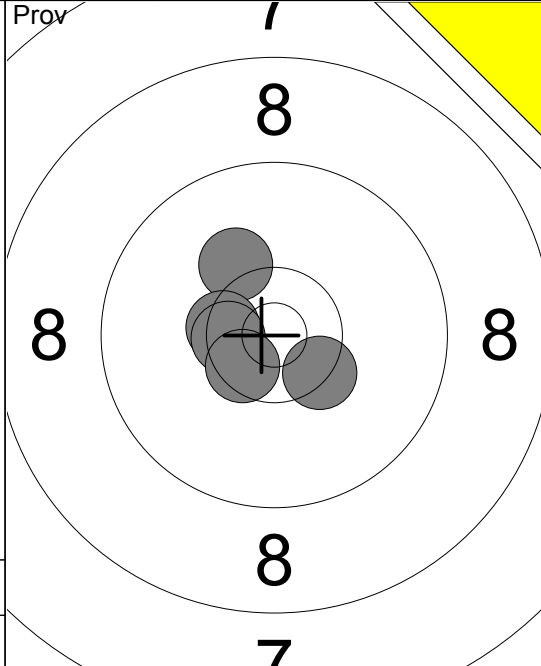

11:	10.4	↘
12:	10.2	↖
13:	10.5	↘
14:	10.5	↘
15:	10.5	↘
Serie	50.0	
Total	0.0	

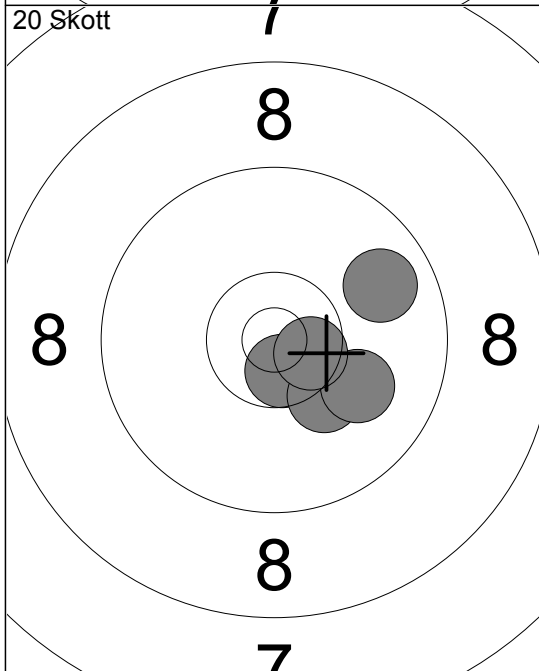

1:	9.8	→
2:	10.6	↘
3:	10.2	↘
4:	10.0	→
5:	10.6	↘
Serie	49.0	
Total	49.0	

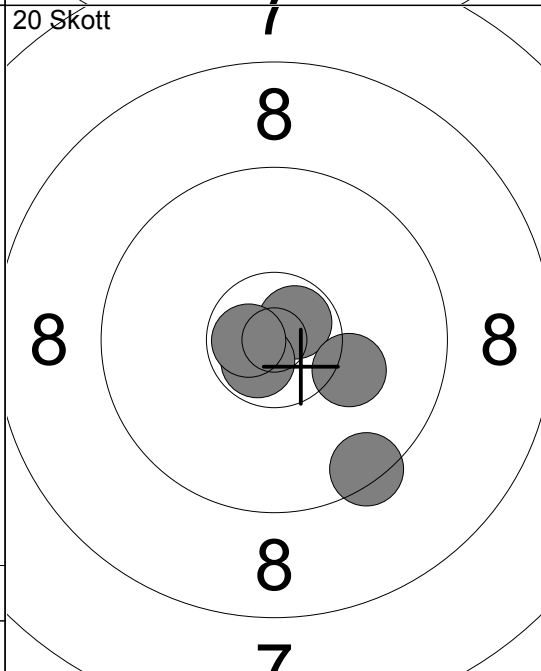

6:	9.4	↘
7:	10.7	↗
8:	10.7	↘
9:	10.2	→
10:	10.7	↘
Serie	49.0	
Total	98.0	

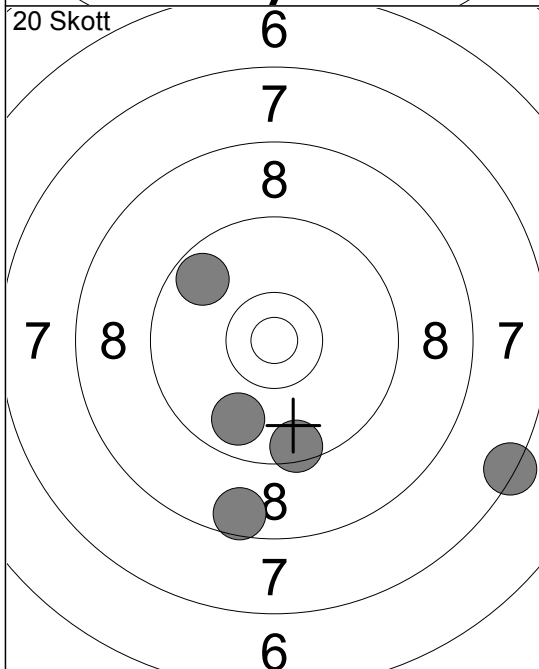

11:	8.6	↘
12:	9.5	↘
13:	7.4	↘
14:	9.7	↗
15:	9.8	↘
Serie	42.0	
Total	140.0	

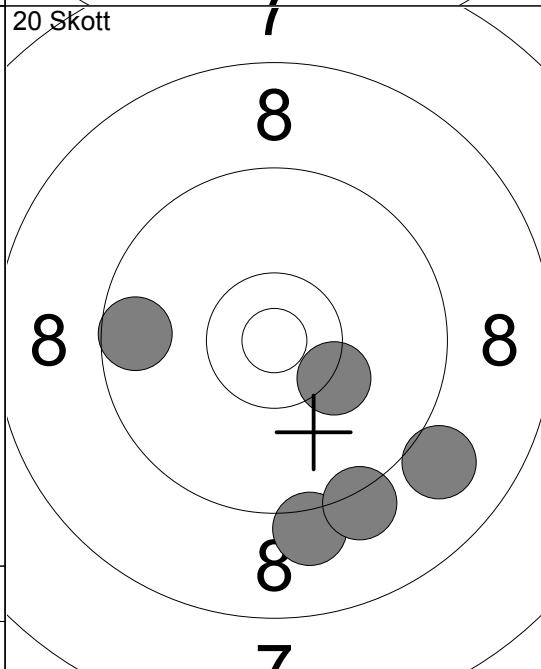

16:	9.1	↘
17:	9.0	↘
18:	10.3	↘
19:	9.2	↘
20:	9.6	←
Serie	46.0	
Total	186.0	

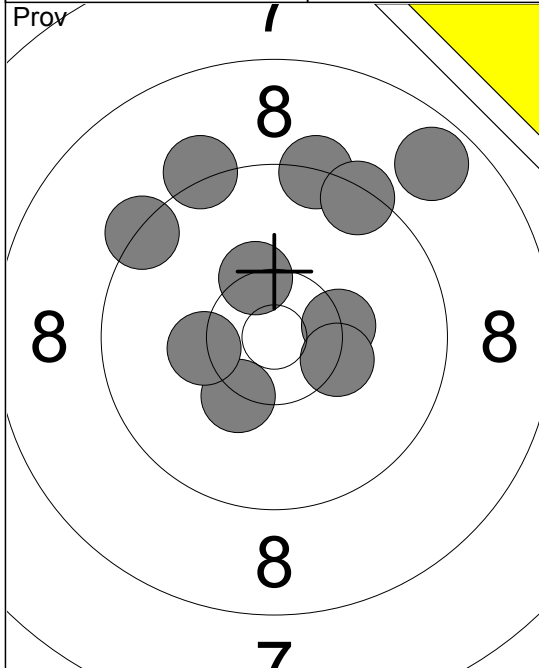

1:	8.7 ↗
2:	9.3 ↑
3:	10.3x ➤
4:	9.2 ↑
5:	9.4 ↗
6:	10.3x ➤
7:	10.3x ↘
8:	9.3 ↖
9:	10.4x ↗
10:	10.3 ←
Serie	94.0
Total	0.0

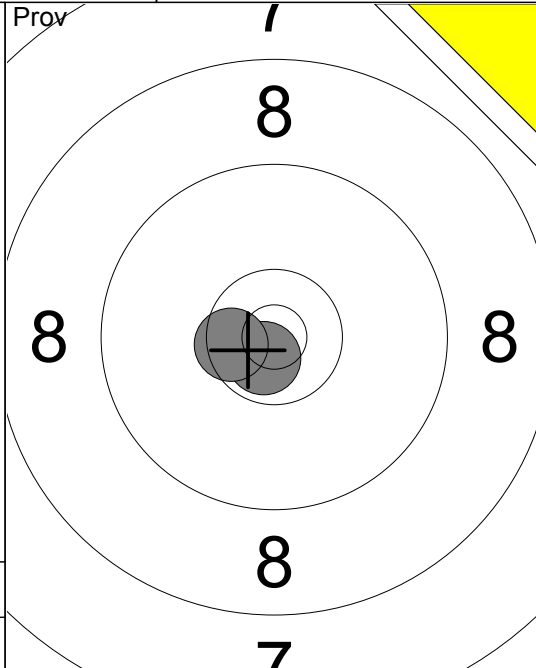

11:	10.7x ↘
12:	10.5x ↘
Serie	20.0
Total	0.0

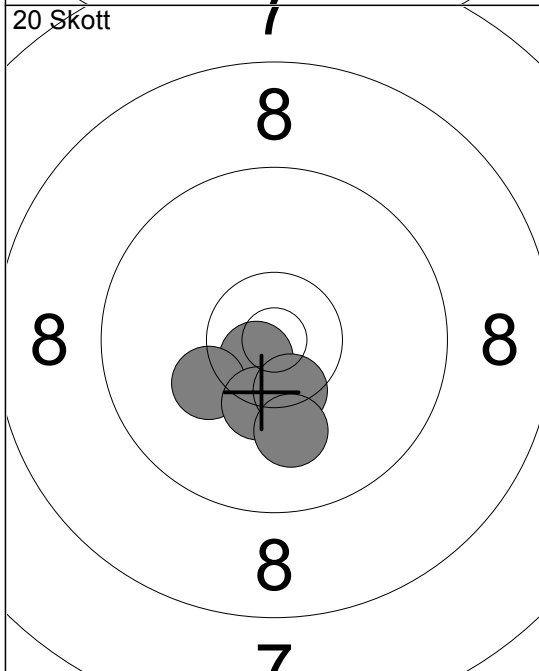

1:	10.7x ↘
2:	10.2 ↙
3:	10.3x ↘
4:	10.4x ↘
5:	10.1 ↓
Serie	50.0
Total	50.0

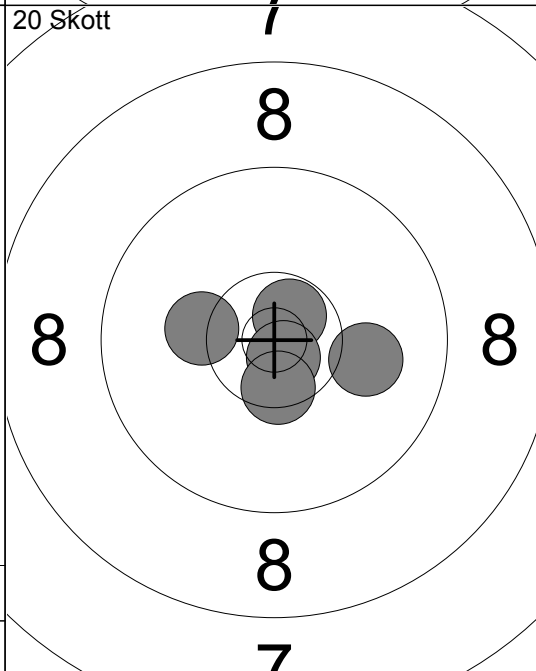

6:	10.3 ←
7:	10.7x ↗
8:	10.1 ➔
9:	10.8x ↘
10:	10.5x ↘
Serie	50.0
Total	100.0

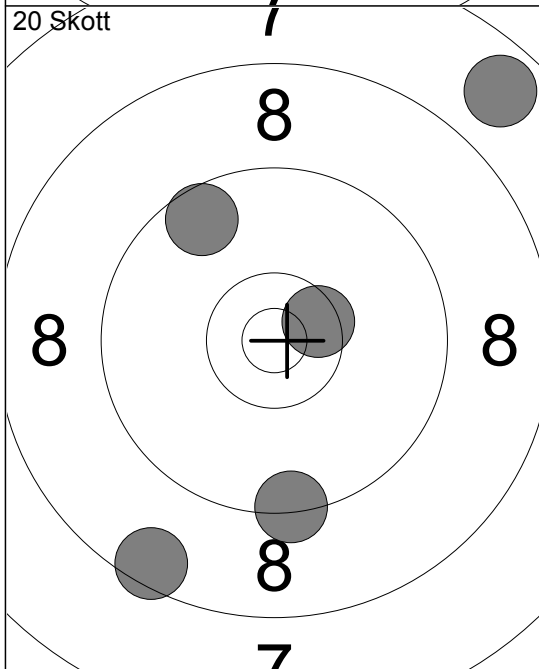

11:	7.7 ↗
12:	9.6 ↖
13:	10.5x ➤
14:	9.4 ↓
15:	8.5 ↘
Serie	43.0
Total	143.0

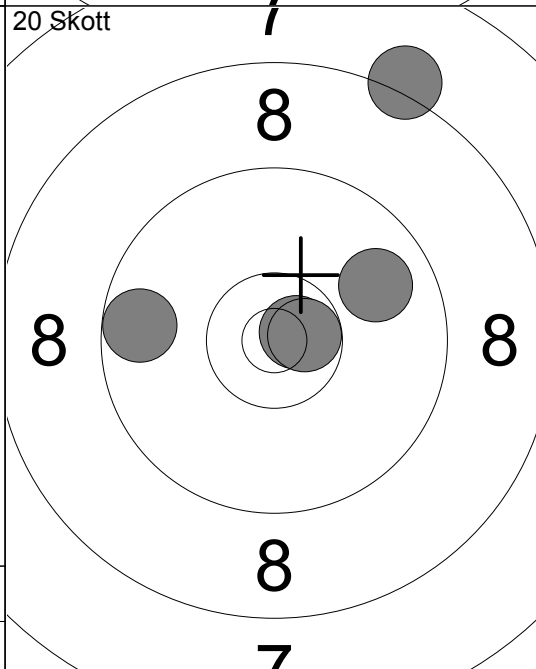

16:	8.2 ↗
17:	10.7x ➤
18:	9.7 ←
19:	10.7x ➤
20:	9.8 ↗
Serie	46.0
Total	189.0

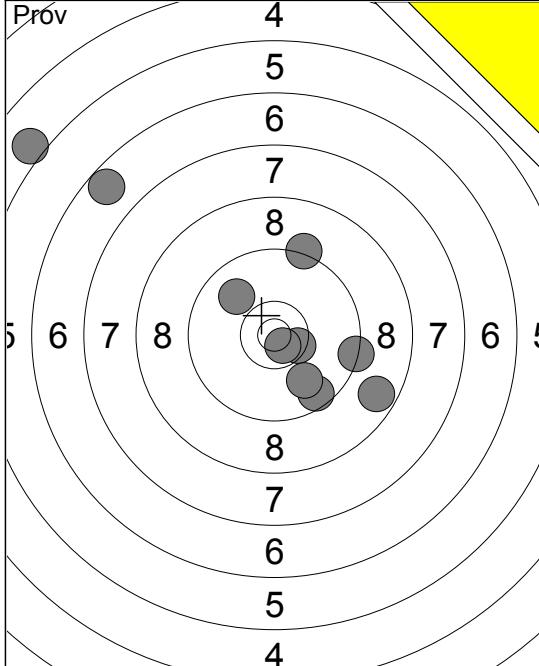

1:	5.0	↖
2:	6.7	↖
3:	9.2	↗
4:	9.9	↗
5:	10.5	↘
6:	9.6	↘
7:	8.7	↘
8:	9.9	↘
9:	9.3	→
10:	10.7	↘
Serie		84.0
Total		0.0

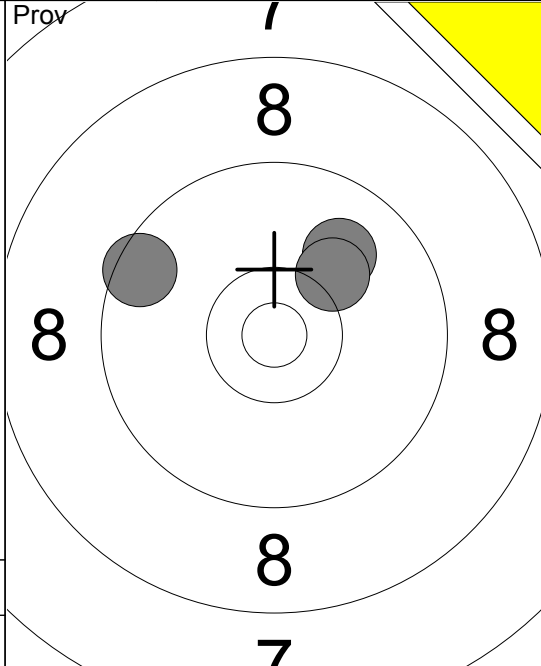

11:	10.0	↗
12:	10.2	↗
13:	9.5	↖
Serie		29.0
Total		0.0

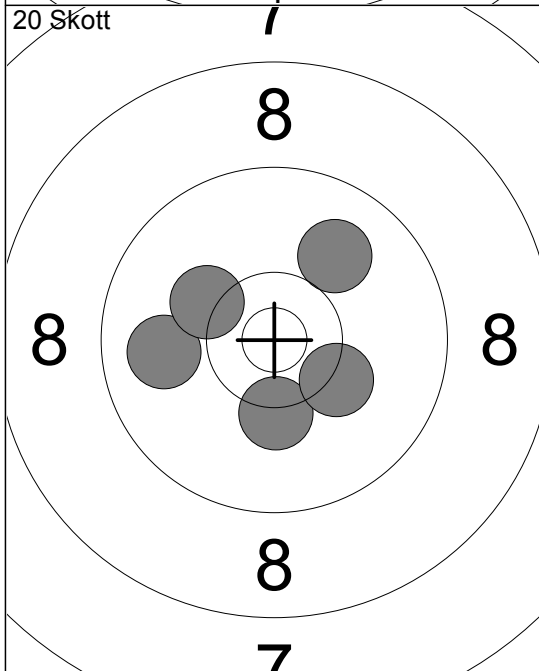

1:	9.9	←
2:	10.2	↖
3:	10.3	↓
4:	10.2	↗
5:	10.0	↗
Serie		49.0
Total		49.0

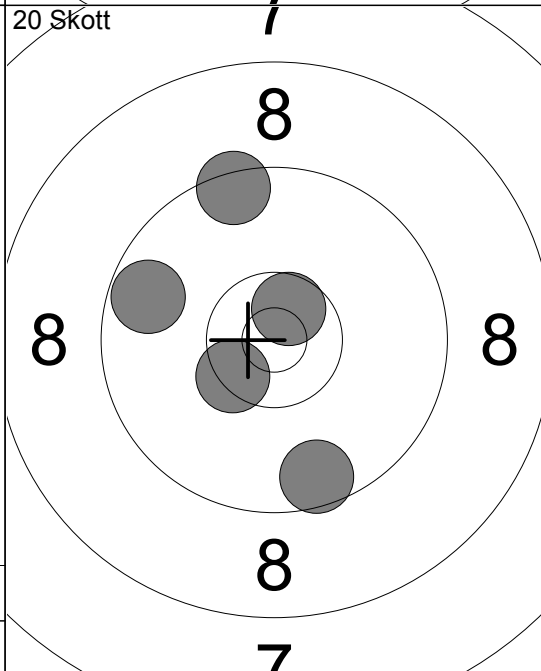

6:	9.5	↑
7:	9.7	↖
8:	10.6	↗
9:	9.6	↓
10:	10.4	↘
Serie		47.0
Total		96.0

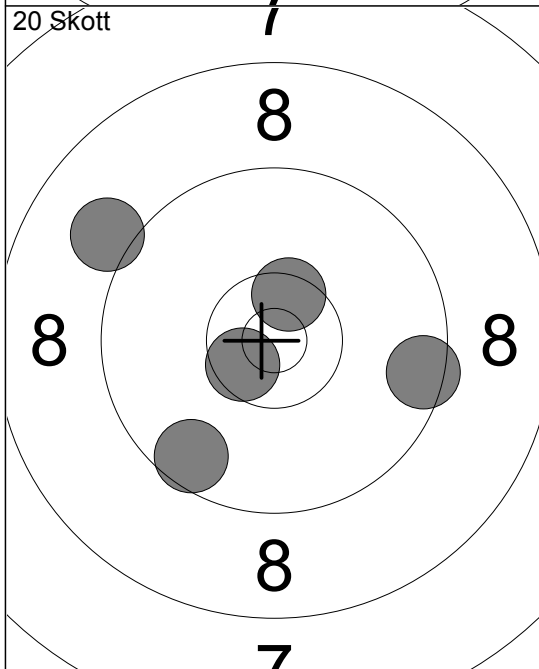

11:	9.1	↖
12:	10.5	↗
13:	9.6	↘
14:	9.5	→
15:	10.6	↘
Serie		47.0
Total		143.0

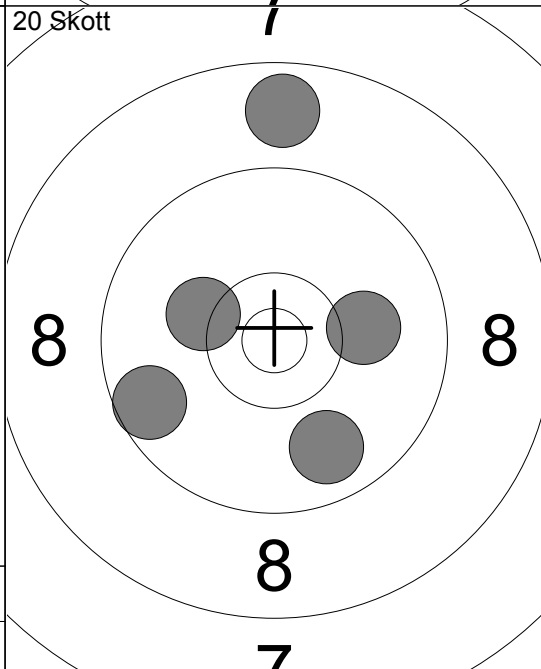

16:	8.8	↑
17:	10.1	→
18:	9.6	↖
19:	10.2	↖
20:	9.8	↓
Serie		46.0
Total		189.0

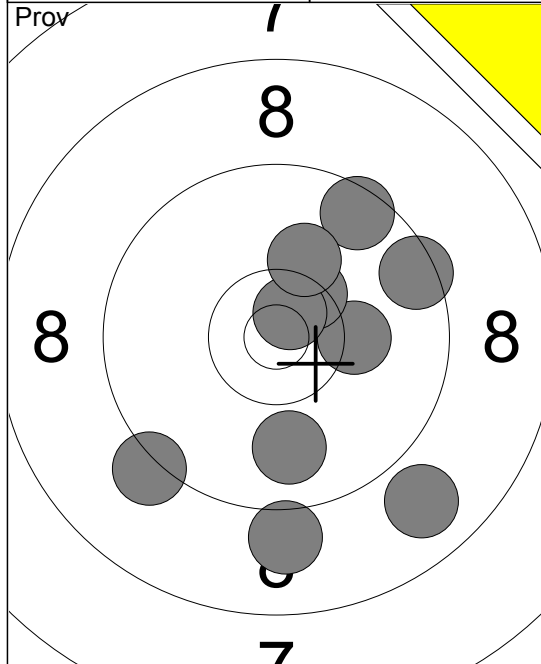

1:	8.9	↘
2:	9.0	↓
3:	9.9	↓
4:	9.2	↙
5:	10.2	→
6:	9.5	↗
7:	10.4	↗
8:	9.5	→
9:	10.7	↗
10:	10.2	↗
Serie		93.0
Total		0.0

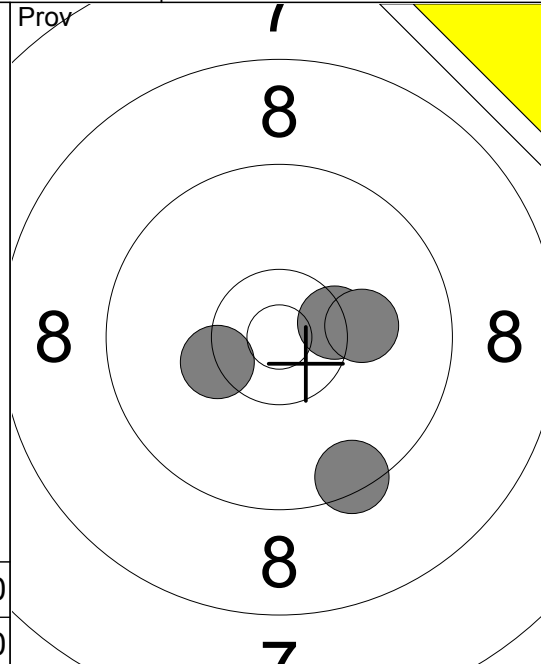

11:	9.4	↘
12:	10.4	↗
13:	10.3	↙
14:	10.2	→
Serie		39.0
Total		0.0

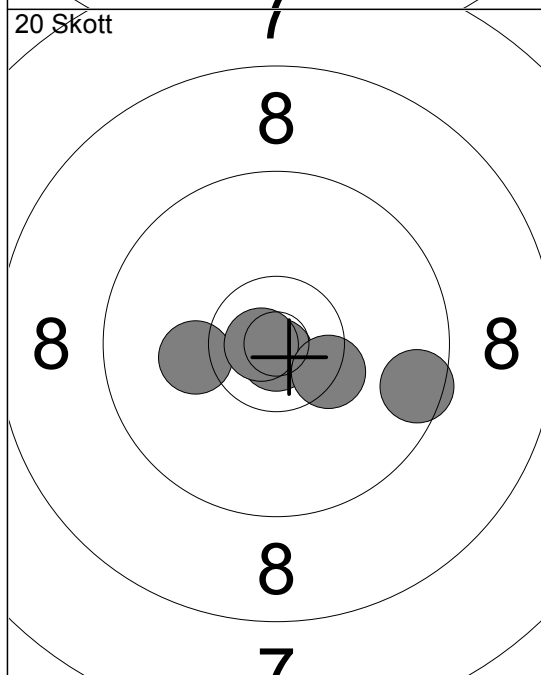

1:	10.2	←
2:	10.8	↘
3:	9.6	→
4:	10.8	←
5:	10.4	↘
Serie		49.0
Total		49.0

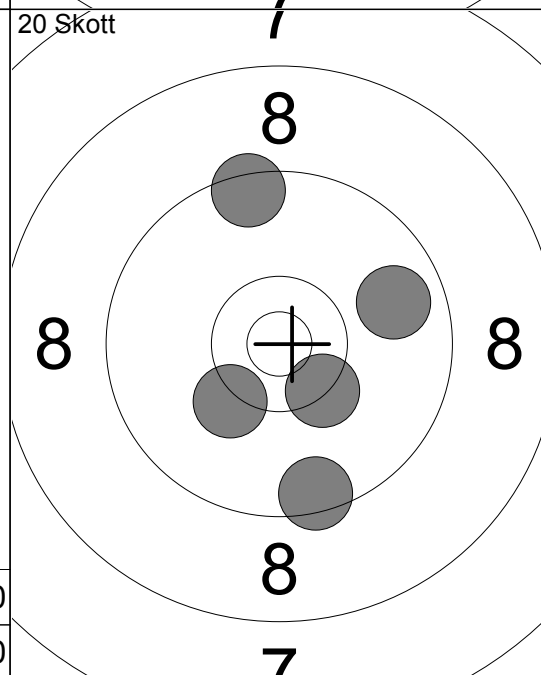

6:	9.5	↗
7:	9.5	↓
8:	9.8	→
9:	10.3	↘
10:	10.2	↘
Serie		47.0
Total		96.0

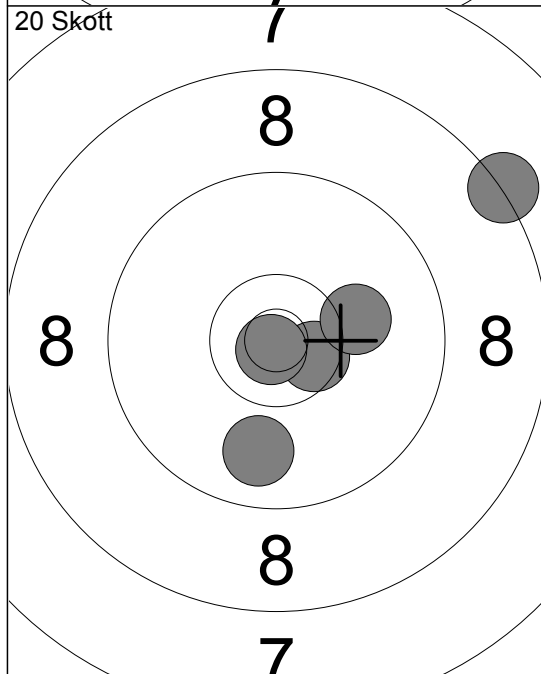

11:	8.3	↗
12:	9.9	↓
13:	10.5	↘
14:	10.1	→
15:	10.8	↘
Serie		47.0
Total		143.0

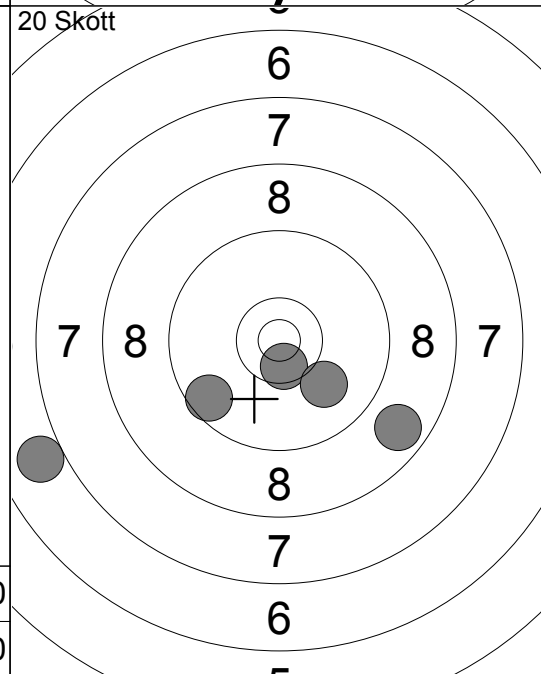

16:	10.6	↘
17:	7.0	←
18:	9.6	↙
19:	8.8	↘
20:	10.0	↘
Serie		44.0
Total		187.0

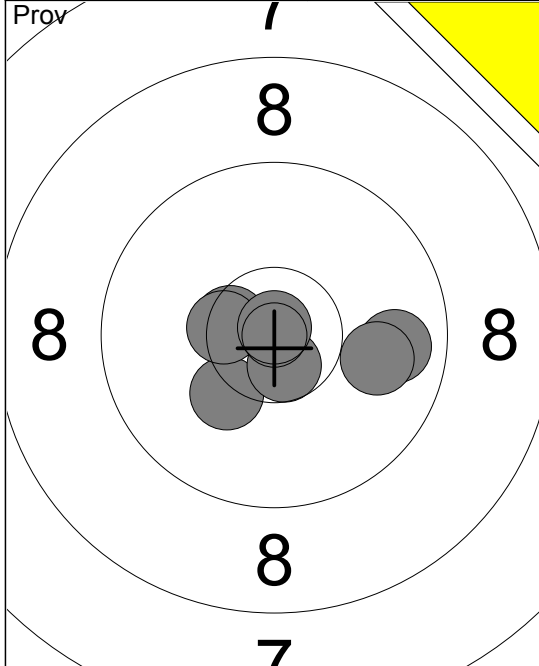

1:	10.2 ↙
2:	10.5 ✕
3:	10.5 ✕
4:	9.8 →
5:	10.6 ✕↓
6:	9.9 →
7:	10.9 ✕↑
Serie 68.0	
Total 0.0	

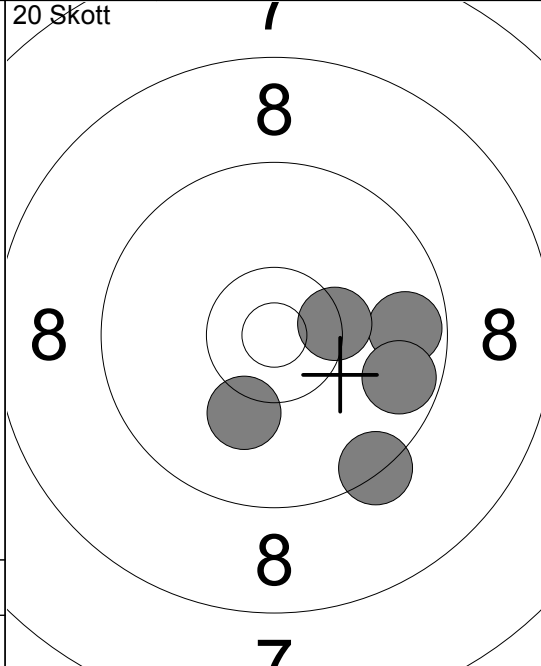

1:	9.4 ↙
2:	9.7 →
3:	10.4 ✕➤
4:	9.7 ➤
5:	10.2 ↙
Serie 47.0	
Total 47.0	

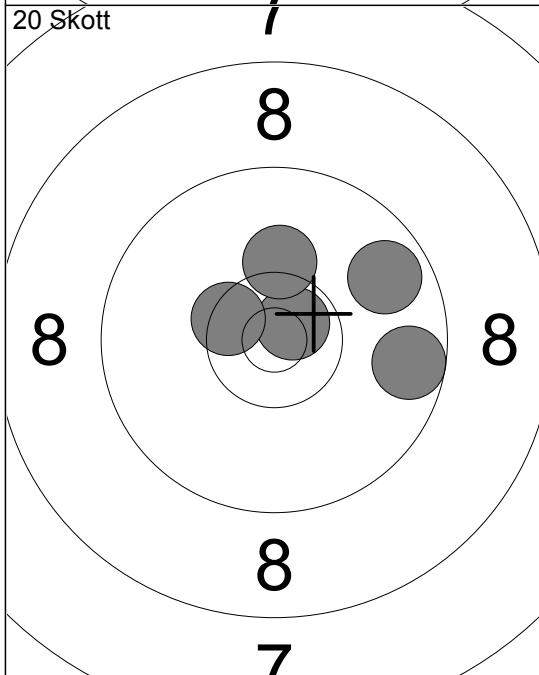

6:	9.6 →
7:	10.7 ✕↗
8:	10.5 ✕
9:	10.2 ↑
10:	9.7 ➤
Serie 48.0	
Total 95.0	

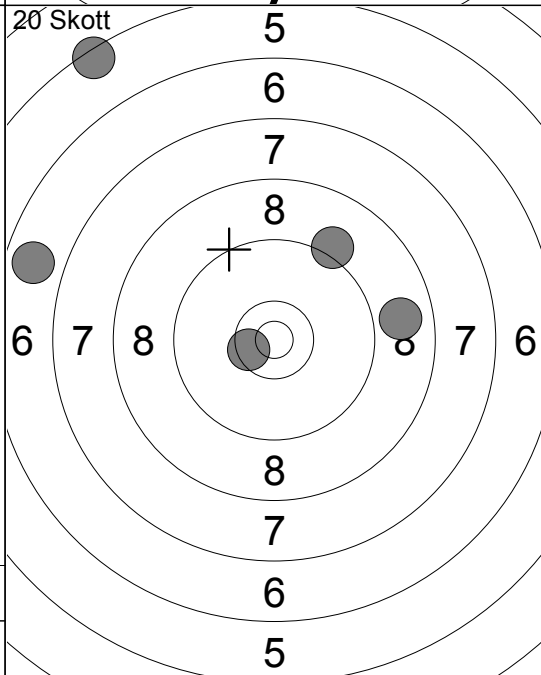

11:	6.8 ←
12:	8.8 →
13:	5.4 ↗
14:	9.2 ↗
15:	10.5 ✕
Serie 38.0	
Total 133.0	

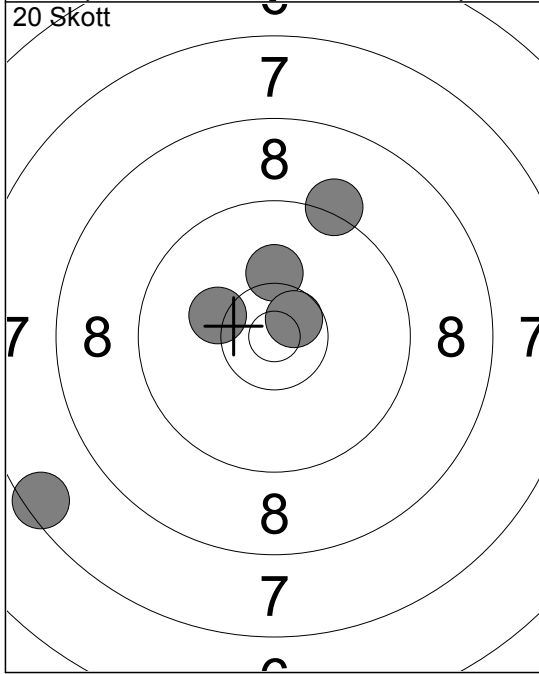

16:	10.2 ↑
17:	10.2 ↙
18:	10.6 ✕↗
19:	9.2 ↗
20:	7.5 ↙
Serie 46.0	
Total 179.0	

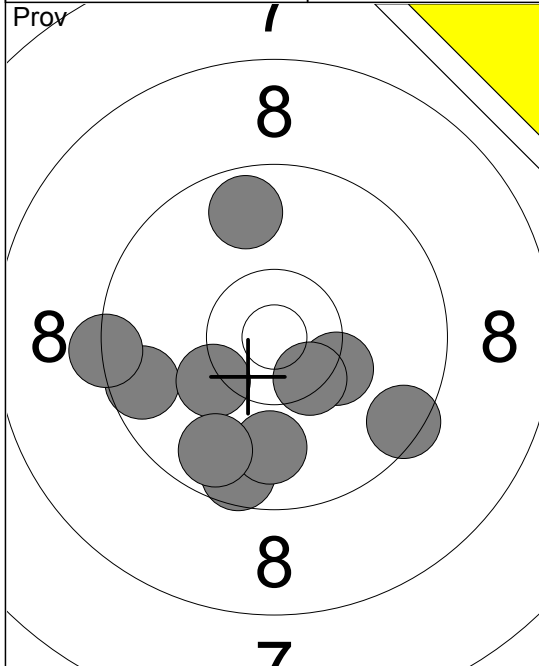

- 1: 9.7 ↗
- 2: 9.6 ↖
- 3: 9.5 ↘
- 4: 10.2 ↙
- 5: 9.6 ↘
- 6: 10.3 ↗
- 7: 9.3 ↖
- 8: 10.4x ↘
- 9: 9.9 ↘
- 10: 9.7 ↘

Serie 93.0
Total 0.0

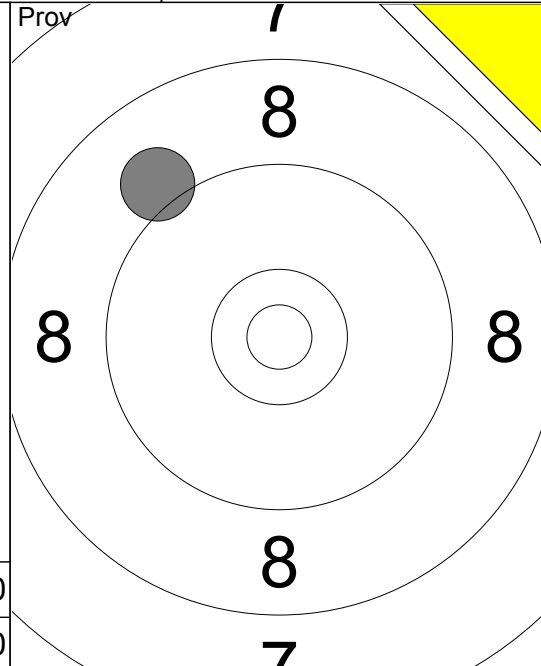

- 11: 9.1 ↖

Serie 9.0
Total 0.0

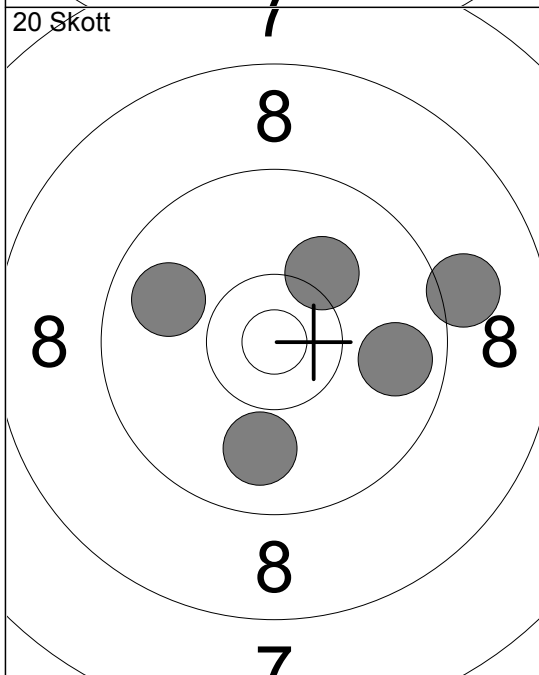

- 1: 9.9 ↘
- 2: 10.2 ↗
- 3: 9.1 →
- 4: 9.8 →
- 5: 9.9 ↖

Serie 46.0
Total 46.0

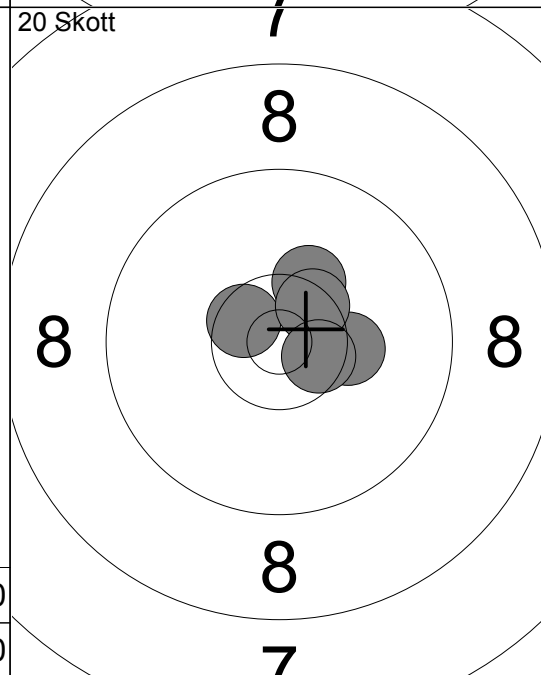

- 6: 10.3x →
- 7: 10.6x ↖
- 8: 10.3x ↗
- 9: 10.5x ↗
- 10: 10.6x →

Serie 50.0
Total 96.0

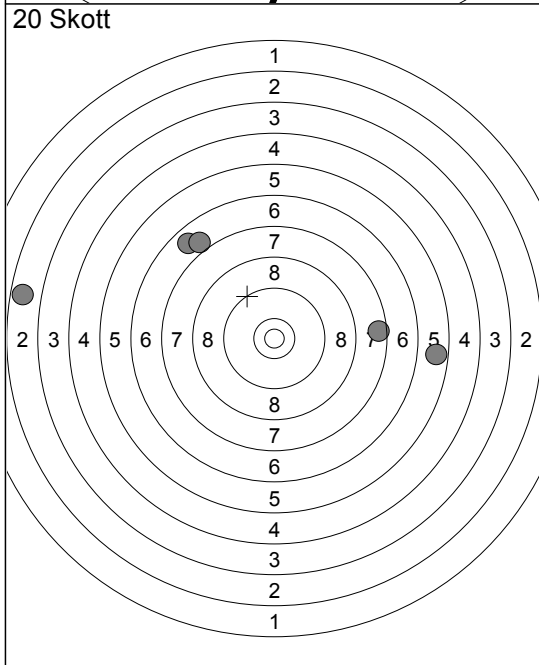

- 11: 5.7 →
- 12: 2.7 ↖
- 13: 6.8 ↗
- 14: 7.0 ↗
- 15: 7.6 →

Serie 27.0
Total 123.0

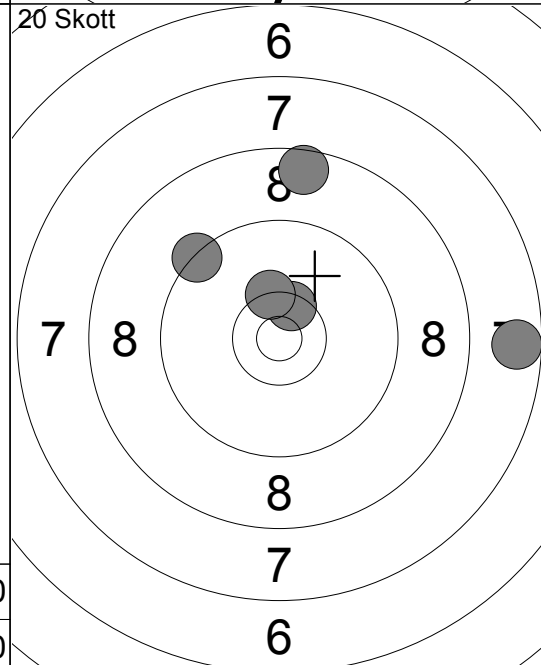

- 16: 9.3 ↖
- 17: 10.5x ↗
- 18: 10.3x ↗
- 19: 7.6 →
- 20: 8.6 ↗

Serie 44.0
Total 167.0

Skjutlag
3

Tavla
19

Jan Wallerström

50m

Ununge

Sen-S

St

12.07.2016

Tavelträffen Korthåll 2016

Ramselefors SKF

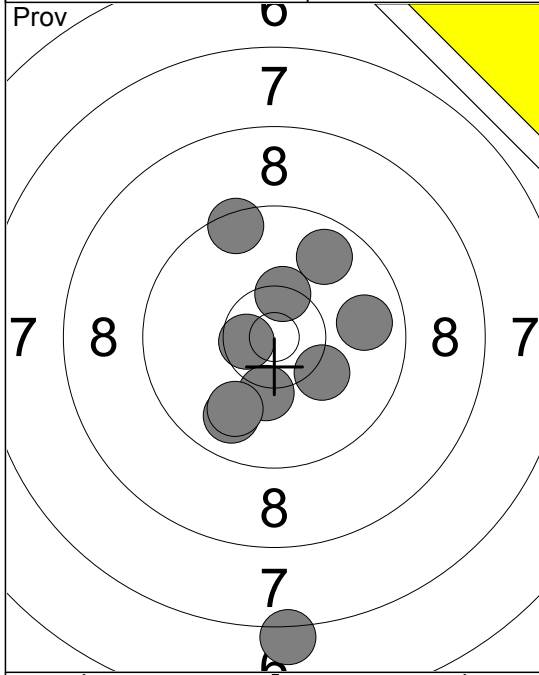

- 1: 7.2 ↓
- 2: 9.8 ↗
- 3: 9.8 →
- 4: 9.5 ↑
- 5: 10.2 ↓
- 6: 9.8 ↓
- 7: 9.9 ↓
- 8: 10.4x ↗
- 9: 10.6x ↗
- 10: 10.2 ↘

Serie 92.0
Total 0.0

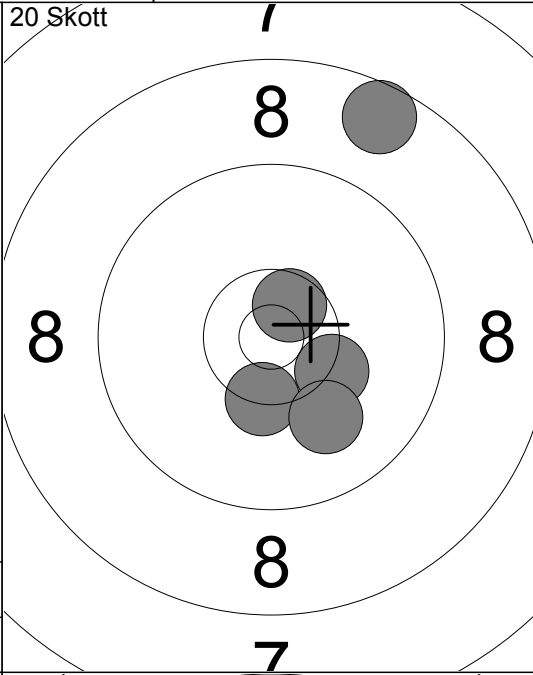

- 1: 10.6x ↗
- 2: 10.3 ↘
- 3: 10.4x ↓
- 4: 8.6 ↗
- 5: 10.0 ↘

Serie 48.0
Total 48.0

- 6: 8.8 ←
- 7: 10.0 ↘
- 8: 10.3x ↗
- 9: 9.5 →
- 10: 10.0 ↓

Serie 47.0
Total 95.0

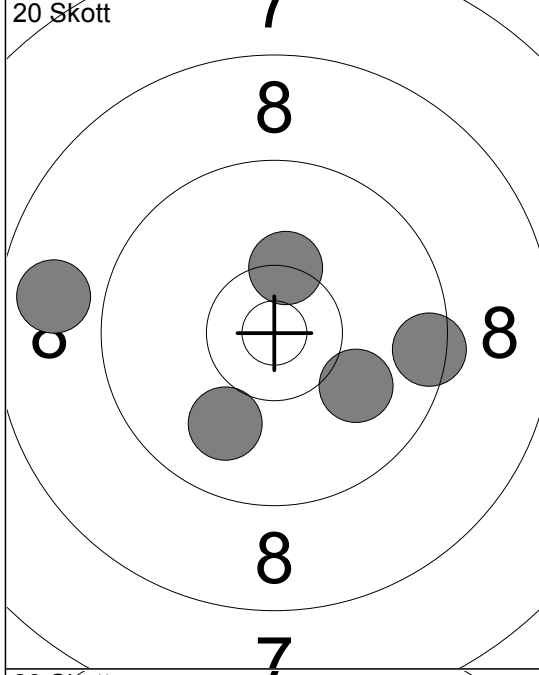

- 11: 7.0 ↗
- 12: 7.7 ↖
- 13: 6.1 ↖
- 14: 8.4 ↗
- 15: 9.3 ←

Serie 37.0
Total 132.0

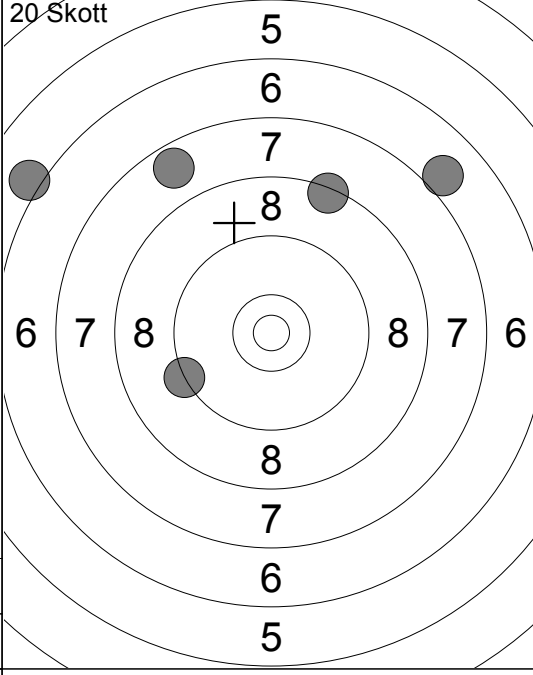

- 16: 9.3 ↖
- 17: 9.8 ←
- 18: 9.3 ↗
- 19: 10.2 ↑
- 20: 10.5x ↓

Serie 47.0
Total 179.0

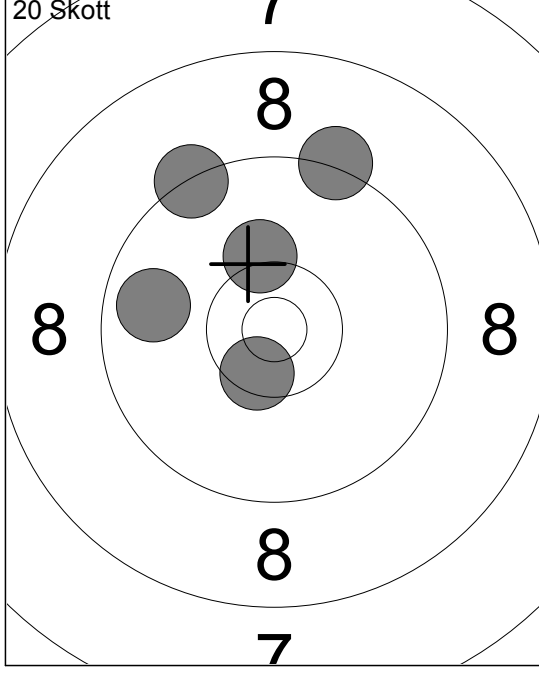

- 16: 9.3 ↖
- 17: 9.8 ←
- 18: 9.3 ↗
- 19: 10.2 ↑
- 20: 10.5x ↓

Serie 47.0
Total 179.0

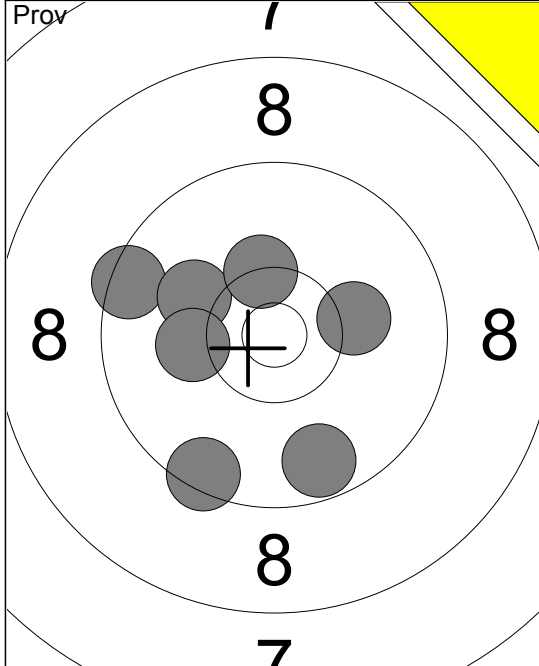

20 Skott

1:	9.5	↙
2:	10.1	↙
3:	10.2	→
4:	10.2	↙
5:	10.3	↗
6:	9.5	↘
7:	9.7	↘
Serie	67.0	
Total	0.0	

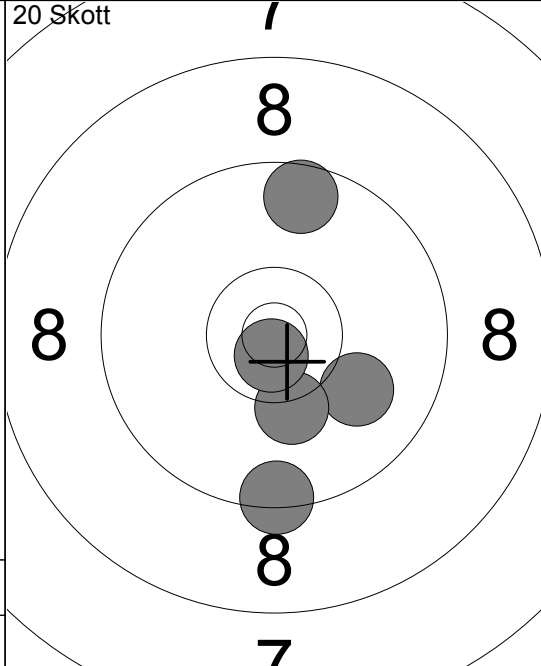

20 Skott

1:	10.0	↘
2:	10.2	↘
3:	9.4	↘
4:	9.6	↗
5:	10.8	↘
Serie	48.0	
Total	48.0	

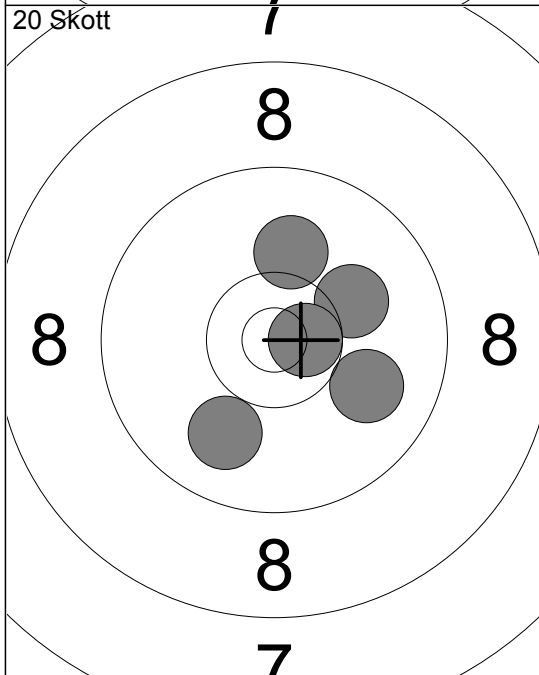

20 Skott

6:	10.1	→
7:	10.1	↗
8:	9.9	↘
9:	10.7	↗
10:	10.0	↘
Serie	49.0	
Total	97.0	

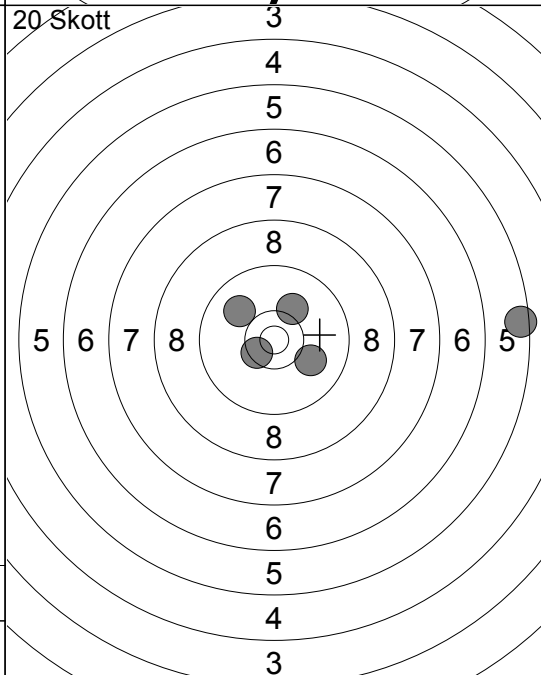

20 Skott

11:	10.2	↗
12:	10.5	↘
13:	5.5	→
14:	10.0	↘
15:	10.0	↙
Serie	45.0	
Total	142.0	

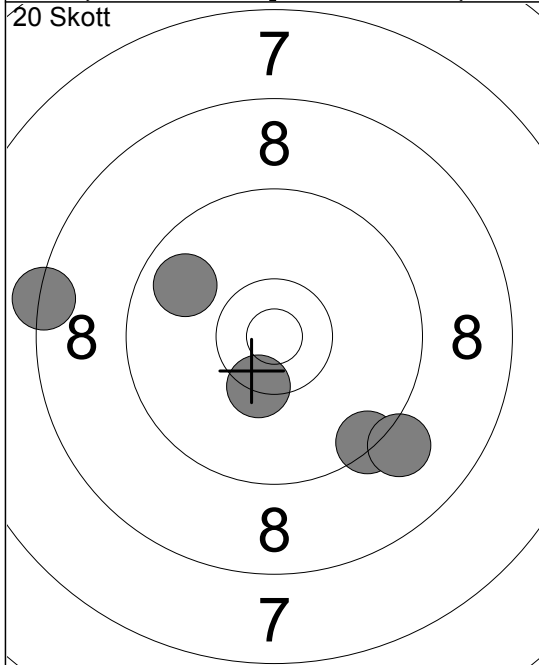

20 Skott

16:	9.4	↘
17:	10.4	↘
18:	9.1	↘
19:	8.3	↙
20:	9.8	↙
Serie	45.0	
Total	187.0	

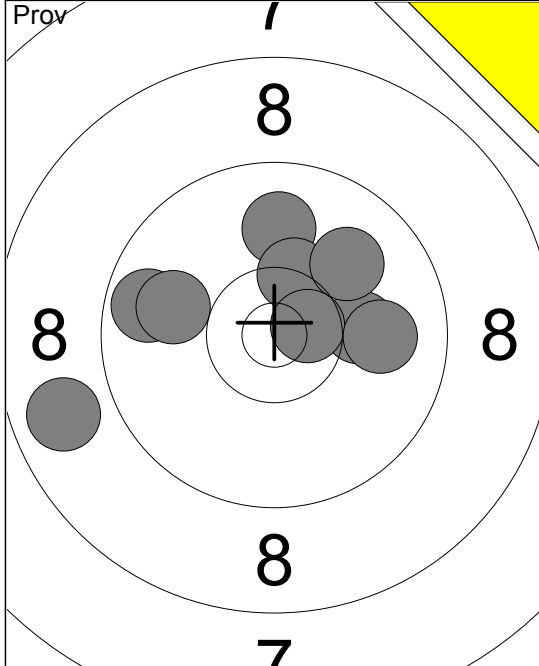

20 Skott

1:	8.8	←
2:	9.9	↑
3:	10.3	↗
4:	9.7	←
5:	9.9	←
6:	10.1	→
7:	10.6	↗
8:	9.9	→
9:	10.0	↗
Serie	84.0	
Total	0.0	

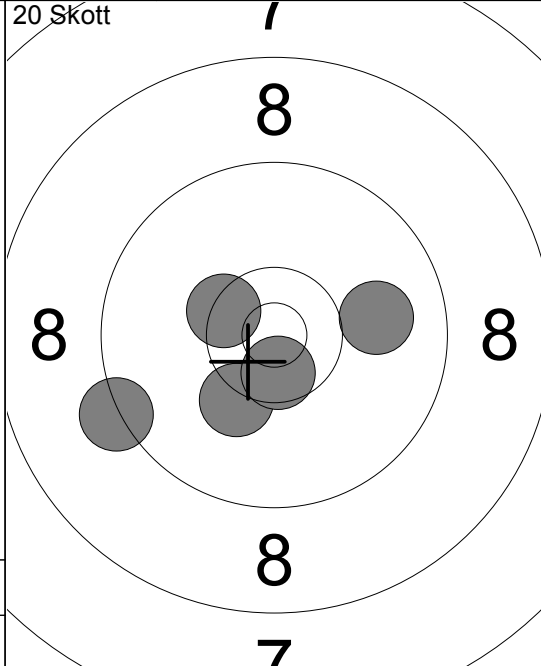

20 Skott

1:	10.0	→
2:	9.3	←
3:	10.2	↘
4:	10.6	↘
5:	10.4	↘
Serie	49.0	
Total	49.0	

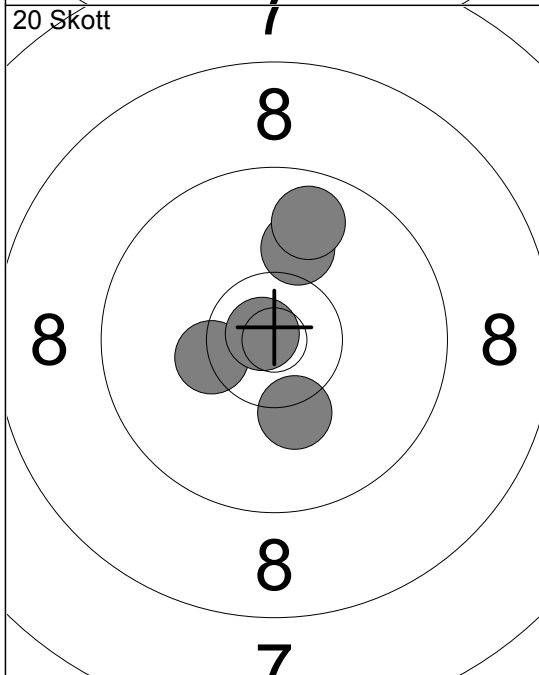

20 Skott

6:	10.2	↘
7:	10.3	↘
8:	10.8	↘
9:	10.1	↑
10:	9.8	↑
Serie	49.0	
Total	98.0	

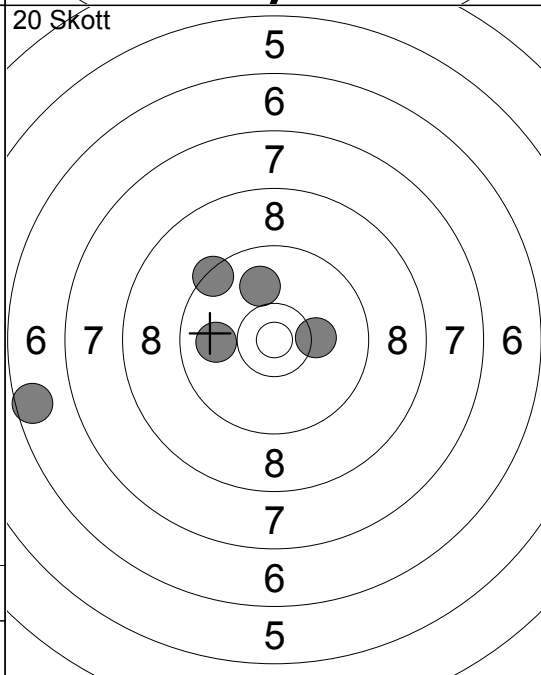

20 Skott

11:	6.6	←
12:	9.4	↖
13:	9.9	←
14:	10.2	→
15:	10.0	↑
Serie	44.0	
Total	142.0	

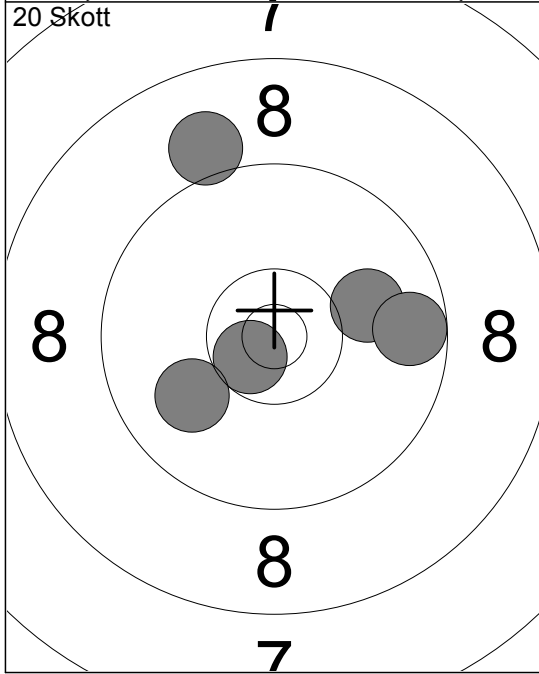

20 Skott

16:	10.6	↘
17:	10.0	→
18:	9.7	→
19:	9.0	↑
20:	10.0	↘
Serie	48.0	
Total	190.0	

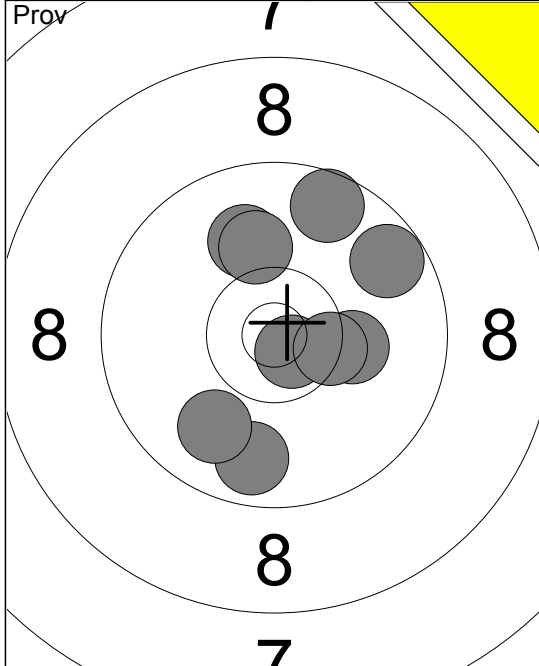

20 Skott

1:	9.7 ↗
2:	10.7x ↘
3:	10.2 →
4:	9.8 ↓
5:	9.6 ↗
6:	10.0 ↗
7:	9.9 ↘
8:	10.1 ↗
9:	10.4x →
Serie 86.0	
Total 0.0	

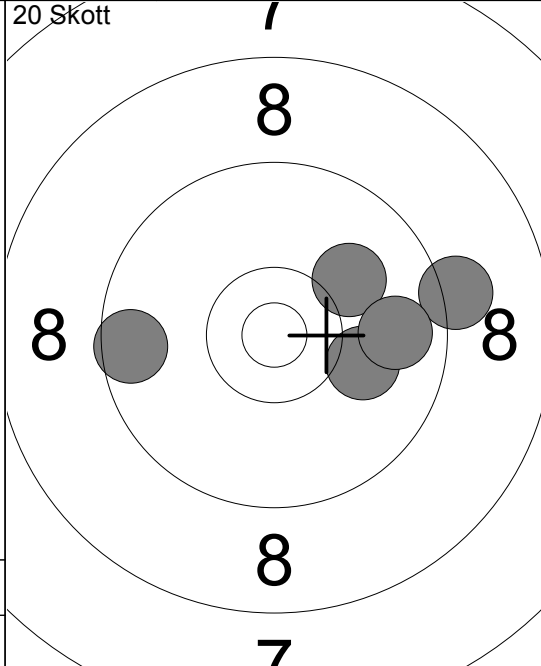

1:	10.1 →
2:	9.2 →
3:	9.6 ←
4:	10.1 ↗
5:	9.8 →
Serie 47.0	
Total 47.0	

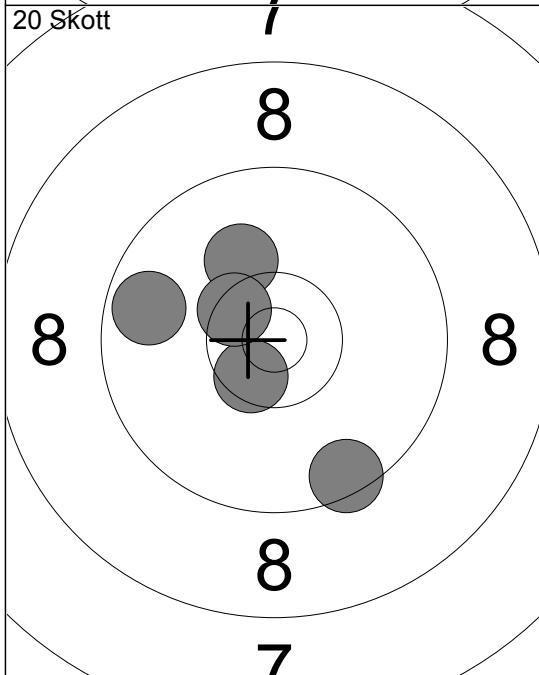

6:	9.7 ←
7:	10.5x ↘
8:	10.1 ↗
9:	10.5x ↘
10:	9.5 ↓
Serie 48.0	
Total 95.0	

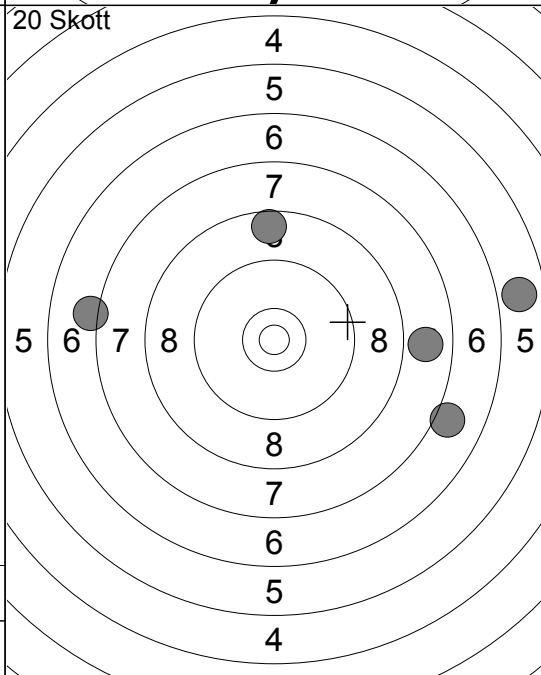

11:	7.8 →
12:	7.1 ←
13:	5.8 →
14:	8.6 ↑
15:	7.0 →
Serie 34.0	
Total 129.0	

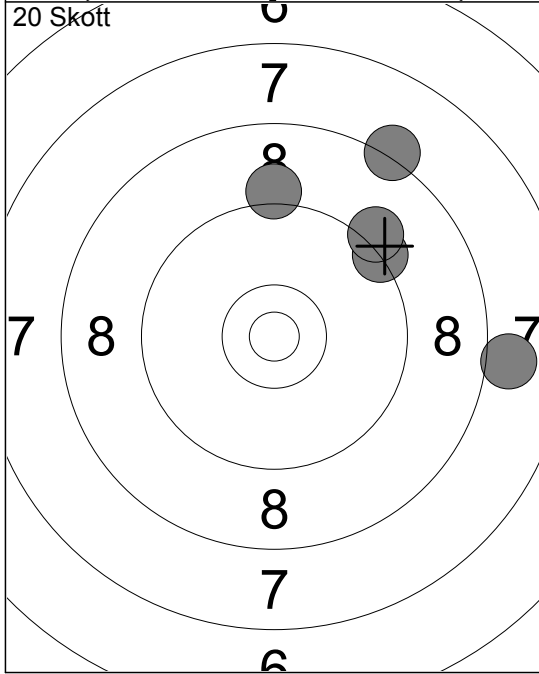

16:	8.0 →
17:	8.2 ↗
18:	9.3 ↗
19:	9.1 ↑
20:	9.2 ↗
Serie 43.0	
Total 172.0	

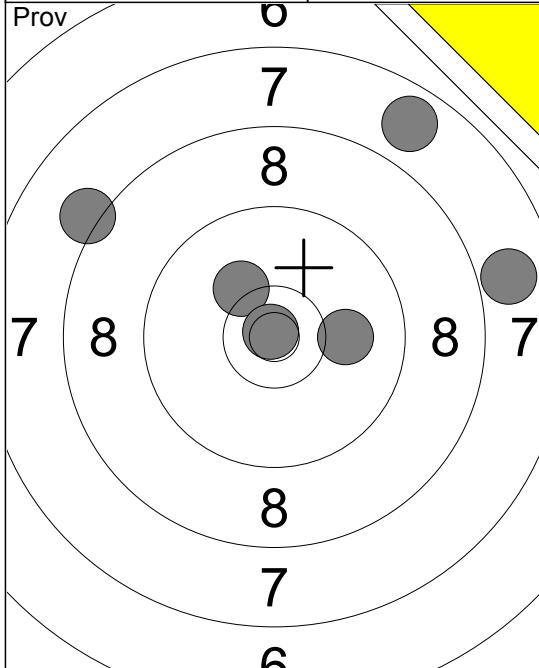

- 1: 7.9 →
- 2: 10.1 →
- 3: 10.2 ↖
- 4: 10.9 ↘
- 5: 7.8 ↗
- 6: 8.1 ↖

Serie 52.0
Total 0.0

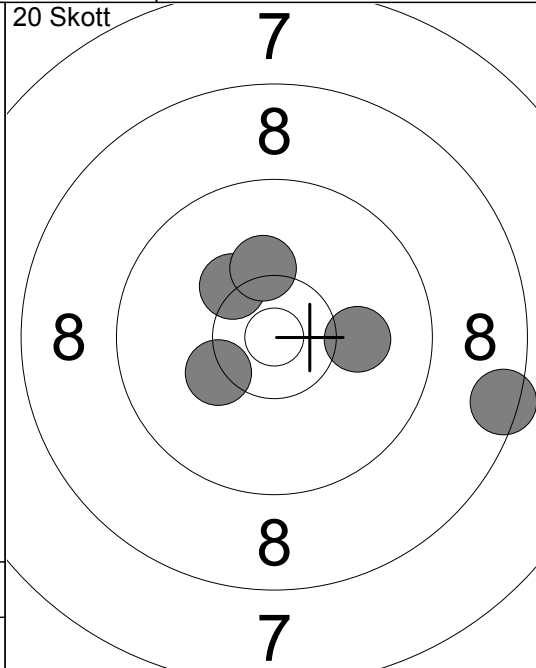

- 1: 10.3 ↙
- 2: 8.5 →
- 3: 10.1 →
- 4: 10.3 ↖
- 5: 10.2 ↑

Serie 48.0
Total 48.0

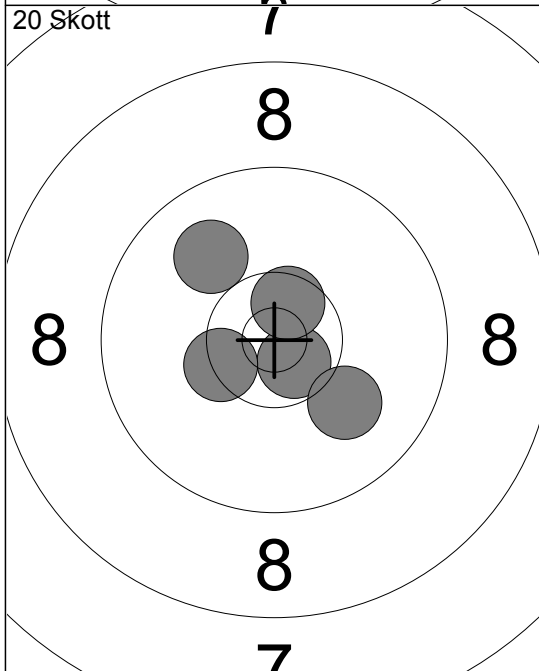

- 6: 10.7 ↘
- 7: 10.6 ↗
- 8: 10.0 ↖
- 9: 10.1 ↘
- 10: 10.4 ↘

Serie 50.0
Total 98.0

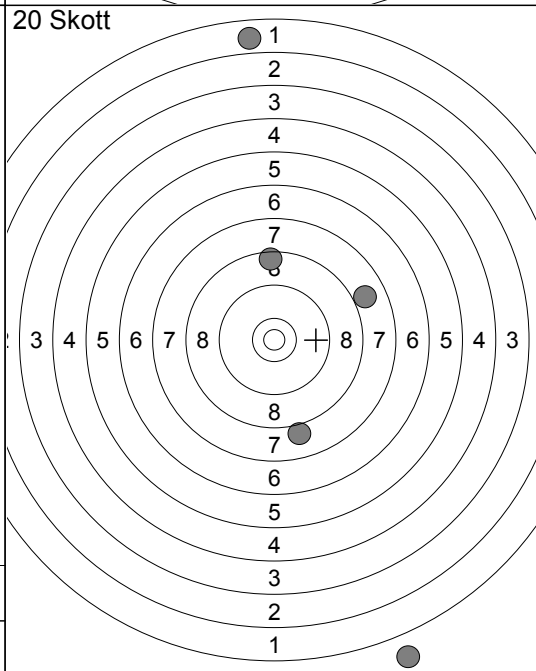

- 11: 0.0 ↓
- 12: 1.9 ↑
- 13: 8.0 ↓
- 14: 7.9 ↗
- 15: 8.5 ↑

Serie 24.0
Total 122.0

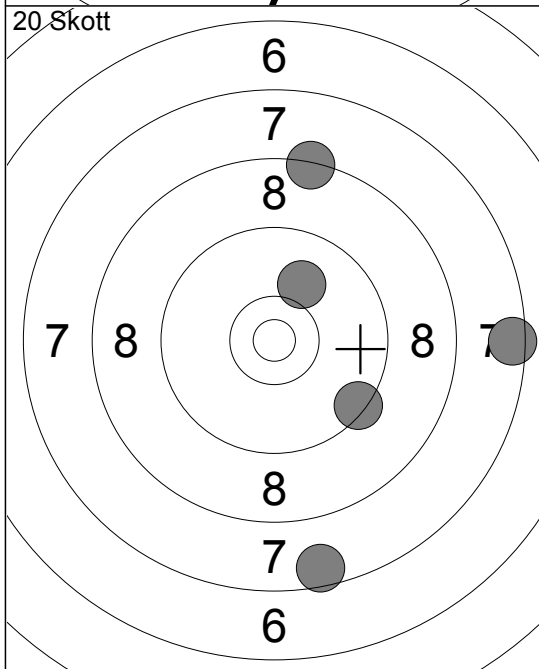

- 16: 8.3 ↑
- 17: 7.5 →
- 18: 9.4 ↘
- 19: 10.1 ↗
- 20: 7.6 ↓

Serie 41.0
Total 163.0

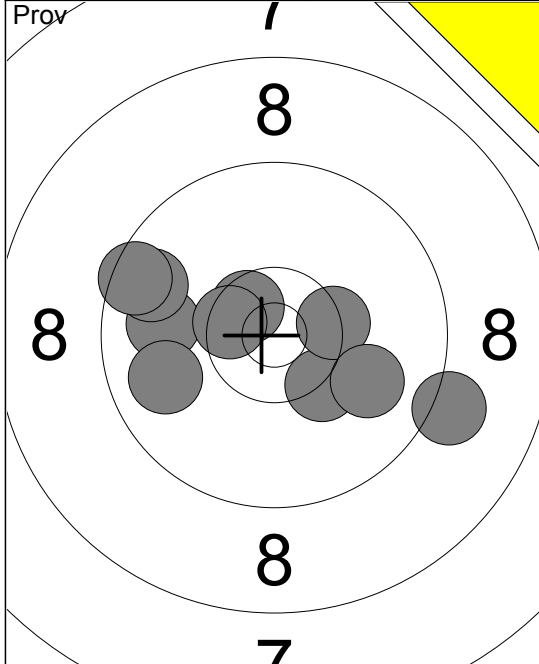

1:	9.9	←
2:	9.7	←
3:	9.5	←
4:	10.3	x↘
5:	10.6	x↘
6:	9.8	←
7:	10.4	x→
8:	10.0	↘
9:	10.5	x←
10:	9.1	↘
Serie	95.0	
Total	0.0	

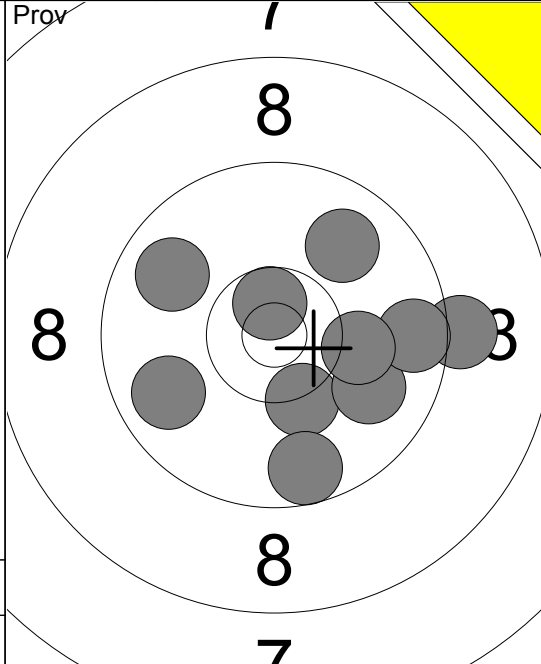

11:	9.8	↖
12:	9.9	↗
13:	10.3	↘
14:	9.6	↘
15:	10.6	x↗
16:	9.9	↘
17:	9.2	→
18:	9.6	→
19:	10.1	→
20:	9.8	←
Serie	93.0	
Total	0.0	

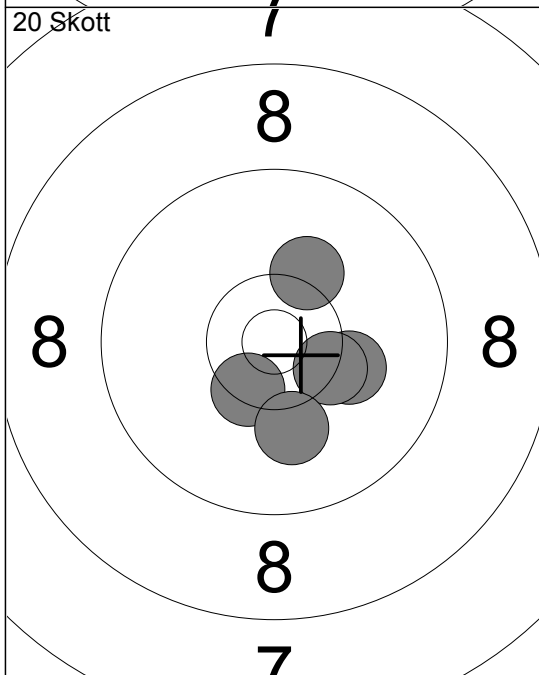

1:	10.4	x↘
2:	10.2	↘
3:	10.4	x↘
4:	10.1	↘
5:	10.2	↗
Serie	50.0	
Total	50.0	

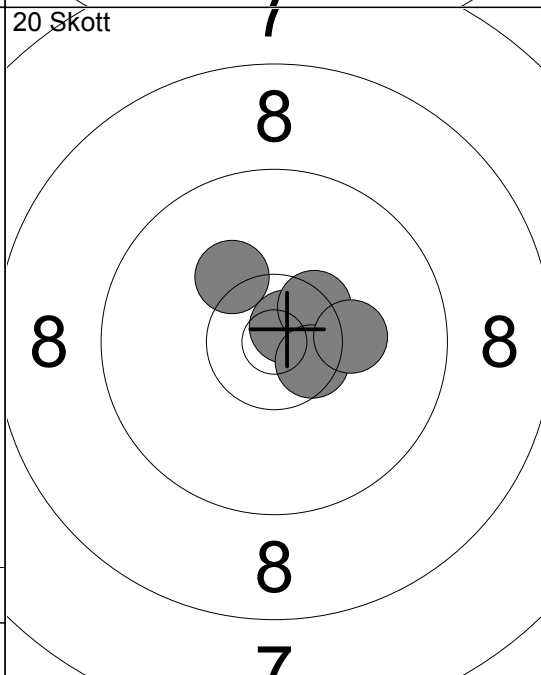

6:	10.2	↗
7:	10.8	x↗
8:	10.4	x↗
9:	10.5	x↘
10:	10.2	→
Serie	50.0	
Total	100.0	

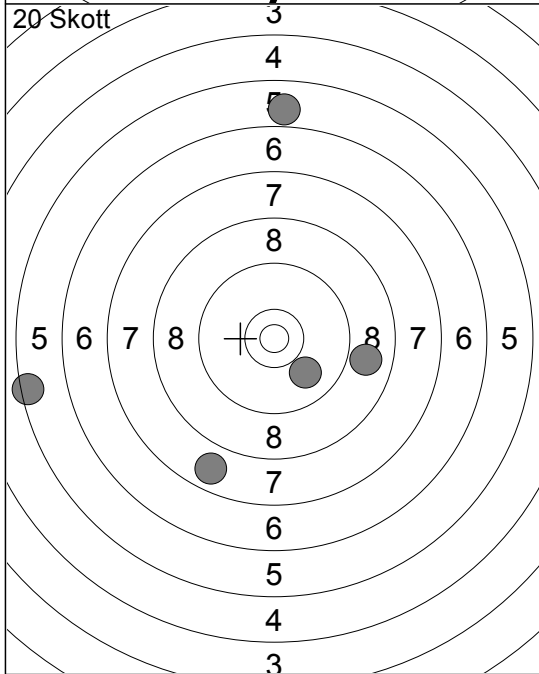

11:	8.9	→
12:	5.4	←
13:	9.9	↘
14:	7.8	↘
15:	5.9	↑
Serie	34.0	
Total	134.0	

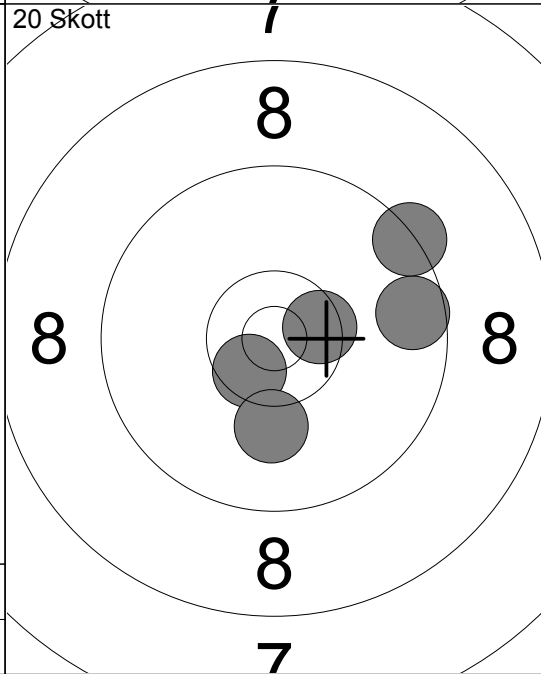

16:	10.6	x↘
17:	10.5	x→
18:	9.6	→
19:	10.1	↘
20:	9.4	↗
Serie	48.0	
Total	182.0	

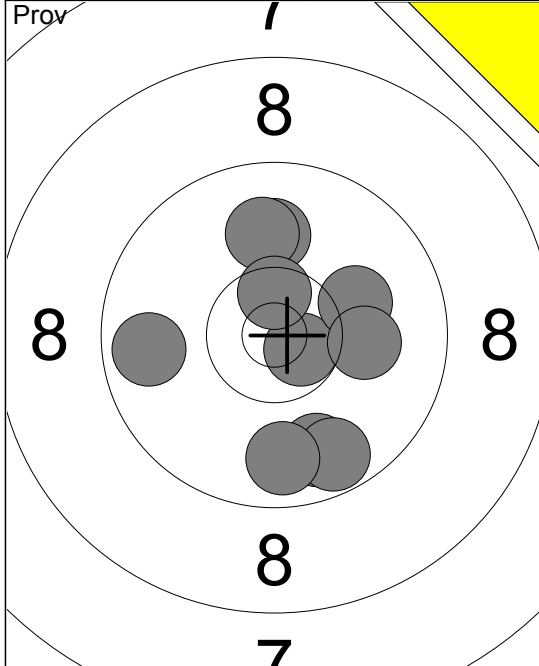

1:	10.0	↑
2:	9.8	↓
3:	10.0	↑
4:	10.7	x↘
5:	10.1	→
6:	9.7	↓
7:	9.7	←
8:	10.5	x↑
9:	10.1	→
10:	9.8	↓
Serie	96.0	
Total	0.0	

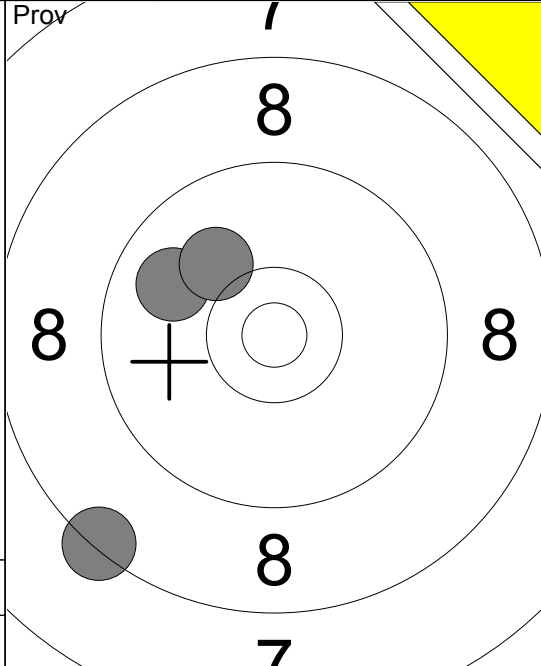

11:	9.9	↖
12:	8.4	↙
13:	10.1	↗
Serie	27.0	
Total	0.0	

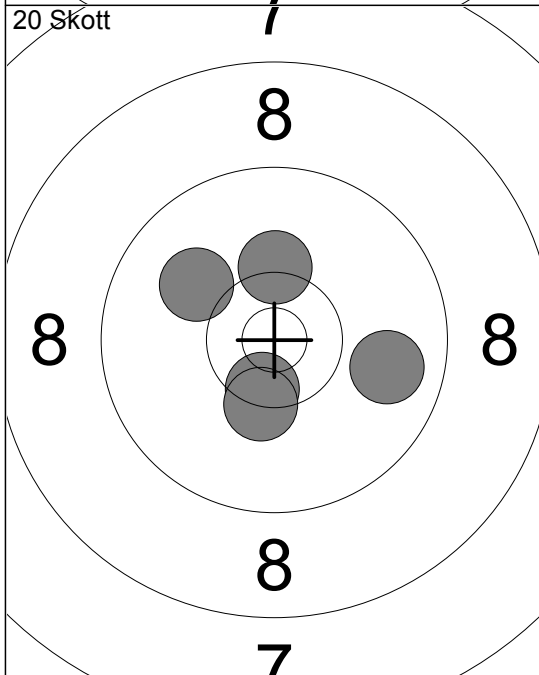

1:	10.3	↑
2:	10.5	x↓
3:	10.3	x↓
4:	10.0	↖
5:	9.8	→
Serie	49.0	
Total	49.0	

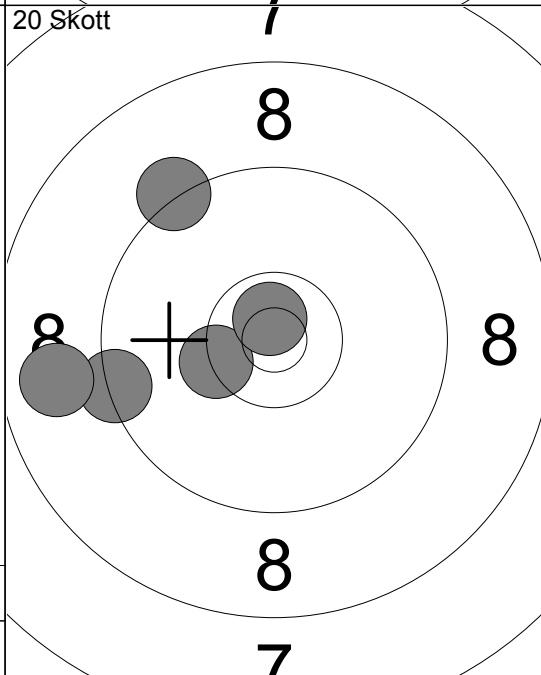

6:	9.4	←
7:	9.3	↗
8:	8.8	←
9:	10.4	x↖
10:	10.7	x↑
Serie	46.0	
Total	95.0	

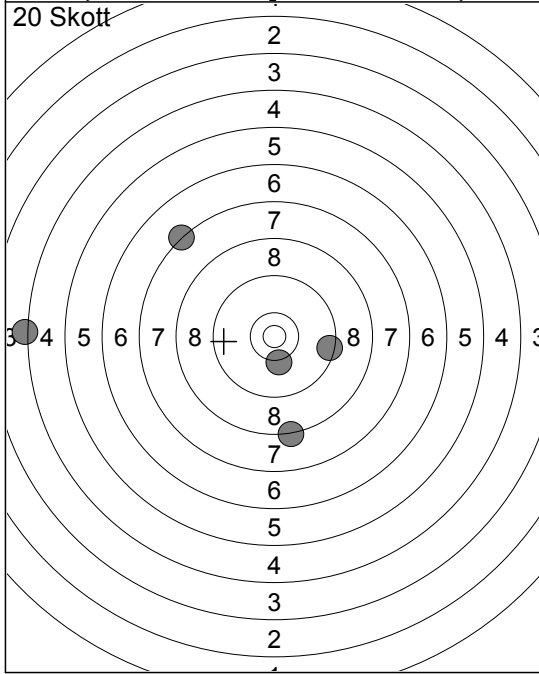

11:	4.2	←
12:	7.3	↗
13:	10.2	↓
14:	8.3	↓
15:	9.4	→
Serie	38.0	
Total	133.0	

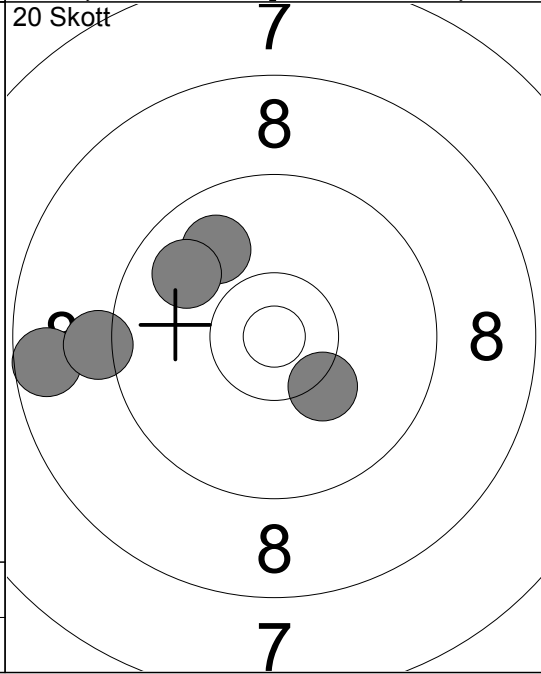

16:	8.6	←
17:	9.9	↗
18:	9.2	←
19:	9.9	↗
20:	10.2	x↓
Serie	45.0	
Total	178.0	

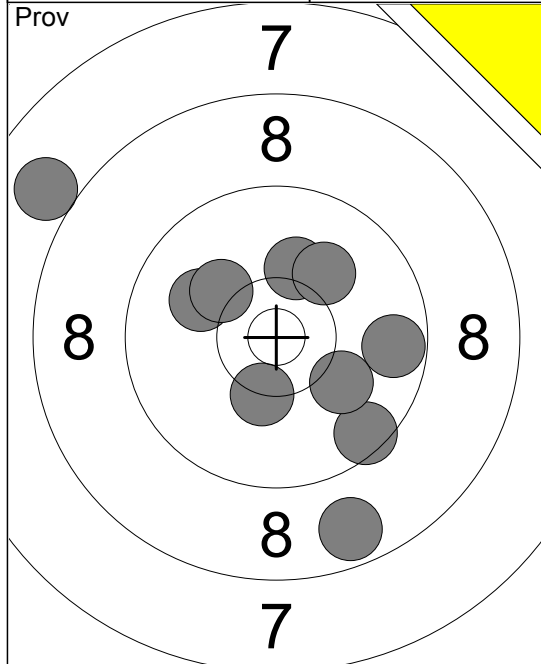

1:	8.7	↘
2:	9.5	↘
3:	10.2	↗
4:	10.1	↗
5:	9.7	→
6:	8.0	↖
7:	10.3	↘
8:	10.0	↖
9:	10.1	↘
10:	10.2	↖
Serie	94.0	
Total	0.0	

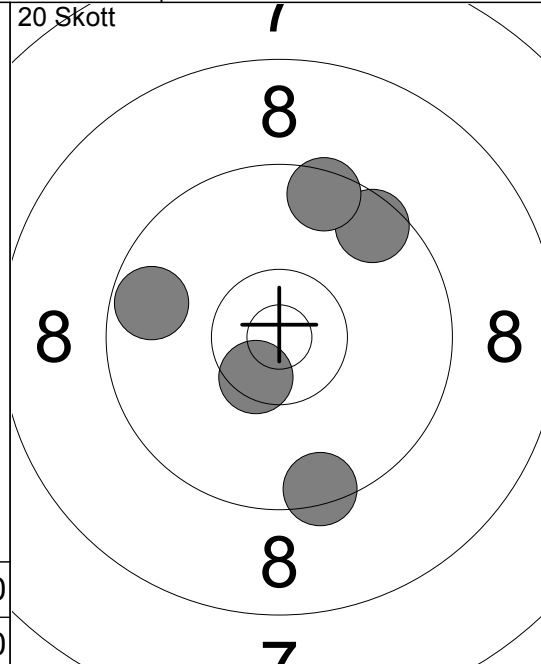

1:	9.6	↗
2:	9.5	↗
3:	9.4	↘
4:	9.7	↖
5:	10.5	↘
Serie	46.0	
Total	46.0	

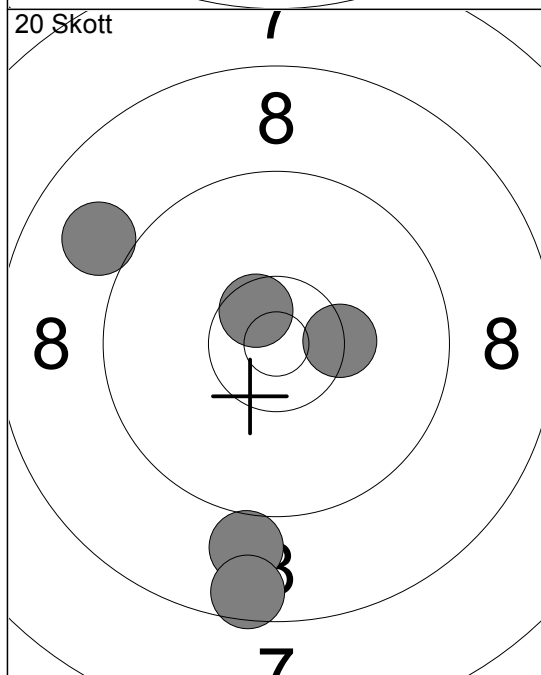

6:	9.0	↘
7:	8.6	↘
8:	10.3	↘
9:	9.0	↖
10:	10.6	↗
Serie	46.0	
Total	92.0	

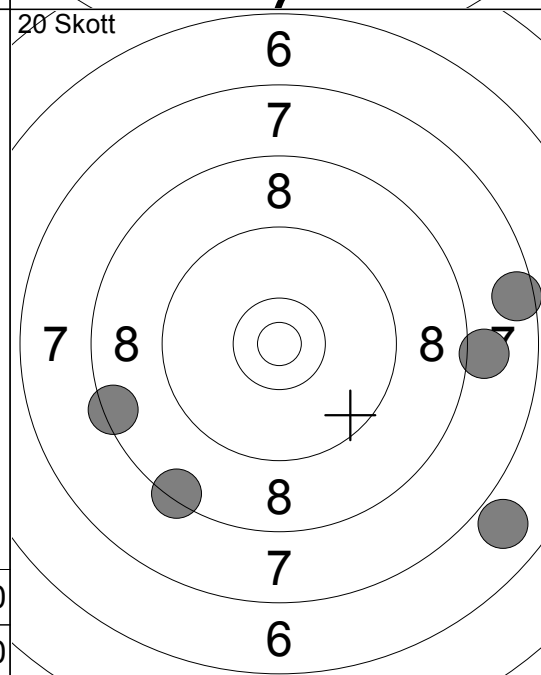

11:	8.4	↘
12:	6.9	↘
13:	8.4	↖
14:	8.1	→
15:	7.5	→
Serie	37.0	
Total	129.0	

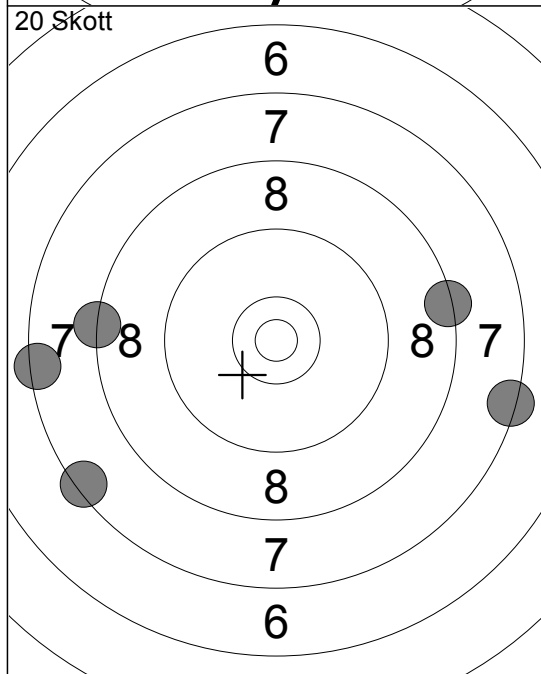

16:	8.4	→
17:	7.4	→
18:	7.4	↖
19:	8.3	↖
20:	7.4	↖
Serie	37.0	
Total	166.0	

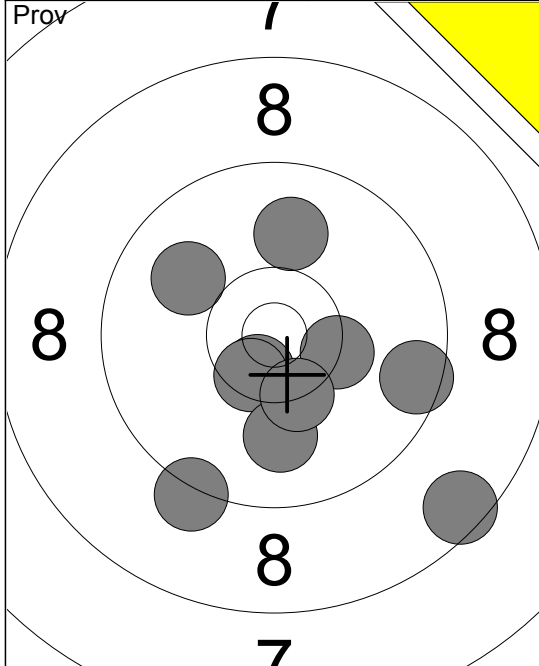

1:	10.0 ↖
2:	10.6x ↘
3:	9.5 →
4:	10.0 ↑
5:	8.5 ↘
6:	10.3x →
7:	10.5x ↘
8:	9.2 ↘
9:	10.0 ↓
10:	10.3x ↘
Serie	96.0
Total	0.0

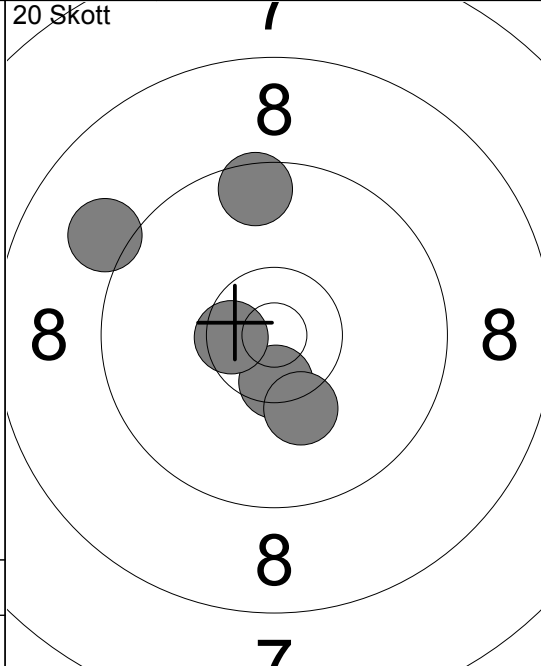

1:	10.5x ↓
2:	10.2 ↓
3:	9.1 ↖
4:	10.5x ↖
5:	9.5 ↑
Serie	48.0
Total	48.0

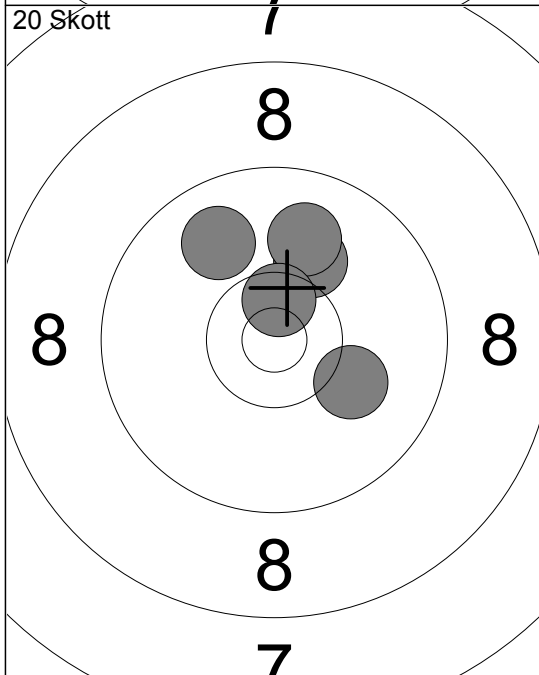

6:	10.1 ↑
7:	9.9 ↑
8:	10.1 →
9:	9.9 ↖
10:	10.6x ↑
Serie	48.0
Total	96.0

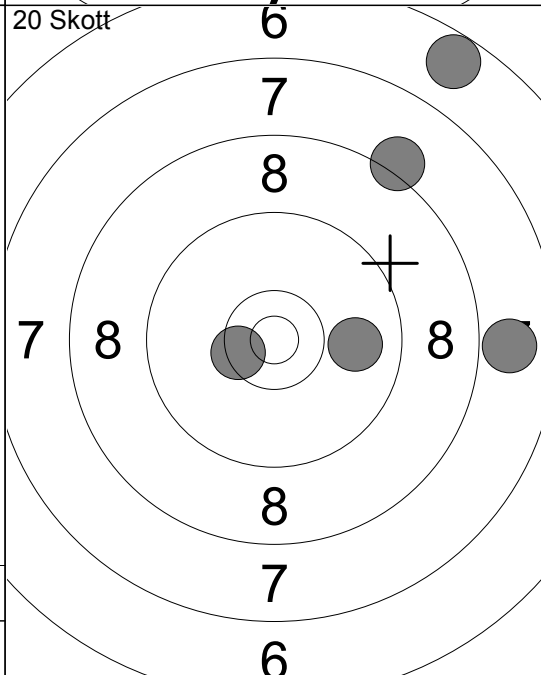

11:	8.2 ↗
12:	6.7 ↗
13:	7.9 →
14:	10.4x ↖
15:	9.9 →
Serie	40.0
Total	136.0

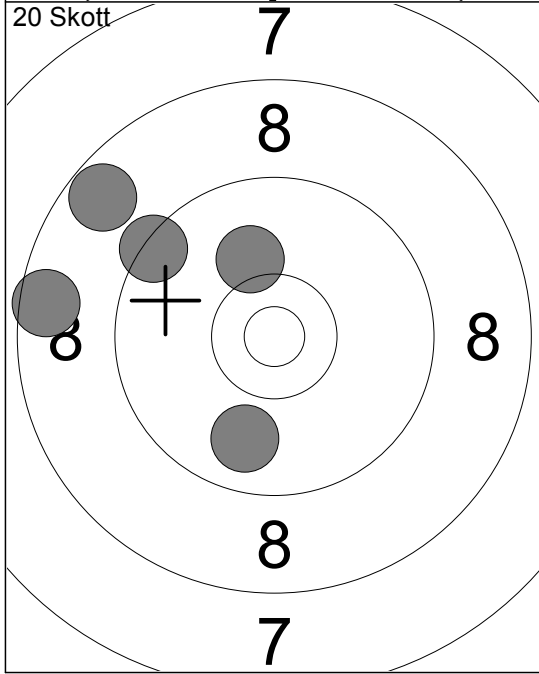

16:	9.9 ↓
17:	8.6 ←
18:	10.1 ↑
19:	9.4 ↖
20:	8.7 ↖
Serie	44.0
Total	180.0

Skjutlag 4 Tavla 5

Gustaf Björndahl

50m Kvistbro Jun-S Ör

12.07.2016 Tavelträffen Korthåll 2016 Ramselefors SKF

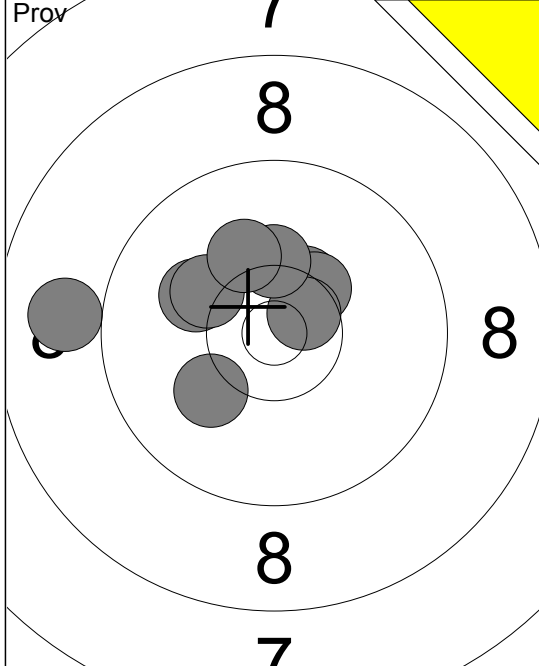

- 1: 10.1 ↖
- 2: 10.4 ↗
- 3: 10.2 ↖
- 4: 10.4 ↗
- 5: 10.6 ↗
- 6: 10.1 ↘
- 7: 10.3 ↑
- 8: 8.9 ←
- 9: 10.2 ↗

Serie 88.0
Total 0.0

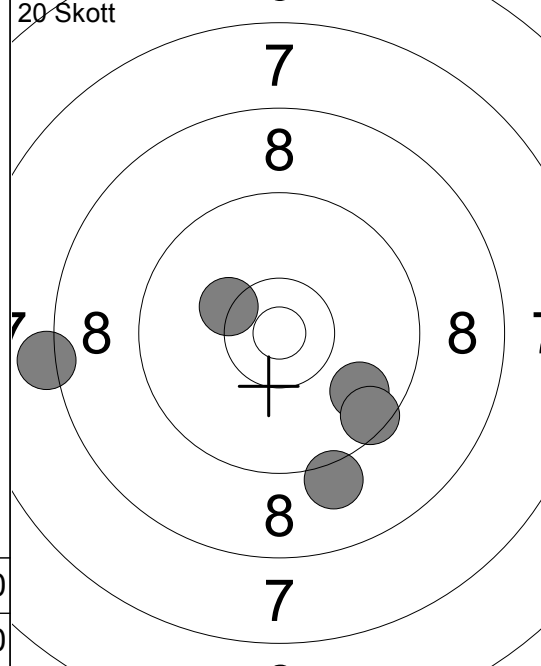

- 1: 9.8 ↘
- 2: 9.5 ↘
- 3: 10.3 ↖
- 4: 9.1 ↘
- 5: 8.2 ←

Serie 45.0
Total 45.0

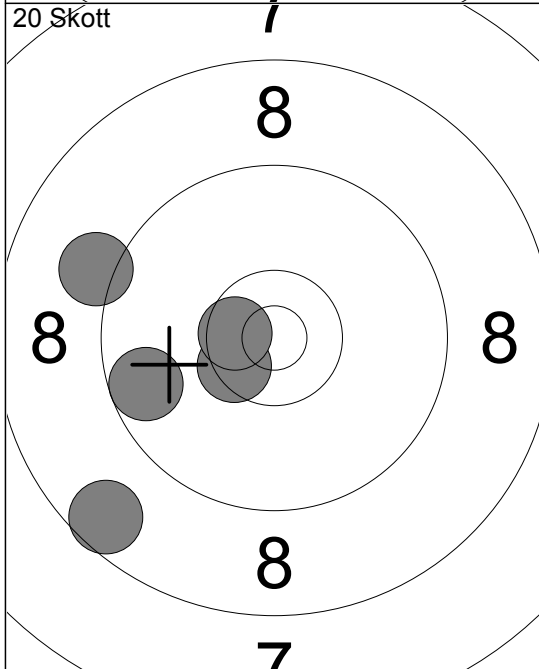

- 6: 10.5 ↘
- 7: 8.6 ↘
- 8: 9.7 ←
- 9: 10.6 ↘
- 10: 9.1 ←

Serie 46.0
Total 91.0

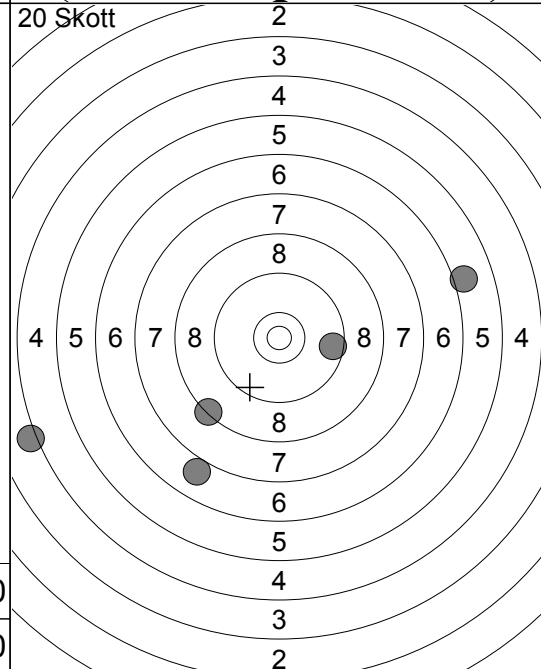

- 11: 4.2 ←
- 12: 8.3 ↘
- 13: 7.0 ↘
- 14: 9.6 →
- 15: 6.0 →

Serie 34.0
Total 125.0

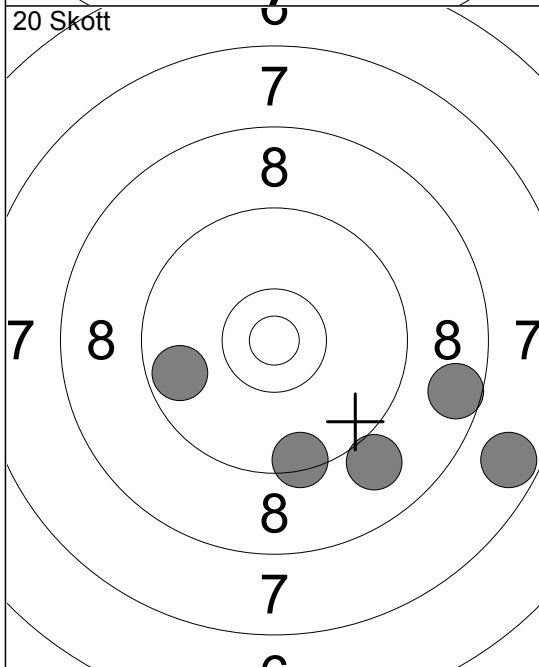

- 16: 8.6 →
- 17: 9.7 ←
- 18: 7.7 →
- 19: 9.0 ↘
- 20: 9.4 ↘

Serie 42.0
Total 167.0

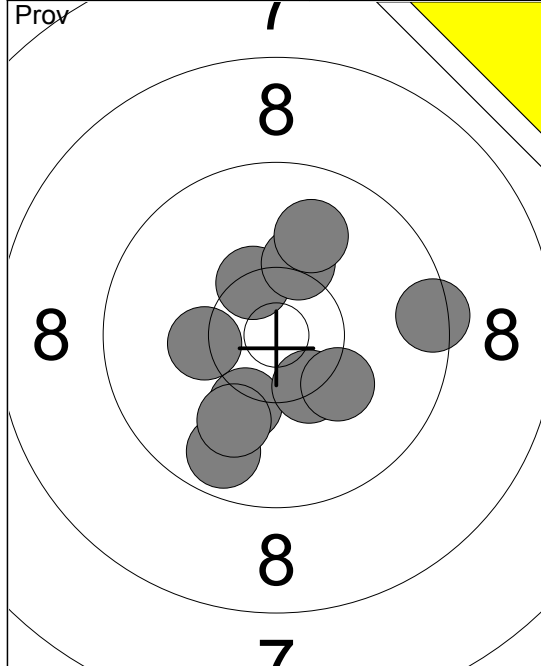

1:	9.7	↘
2:	10.2	↘
3:	10.4x	↘
4:	10.0	↘
5:	10.2	↘
6:	10.3	←
7:	9.4	→
8:	10.4x	↗
9:	10.2	↑
10:	9.9	↑
Serie		97.0
Total		0.0

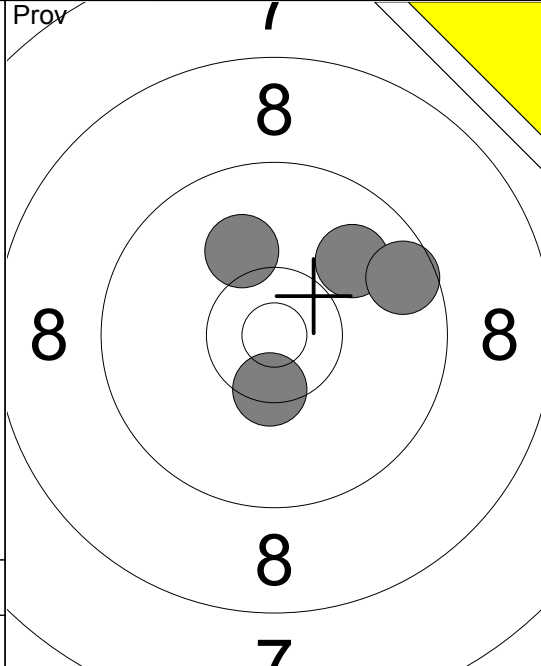

11:	10.4x	↘
12:	9.9	↗
13:	10.1	↖
14:	9.6	↗
Serie		38.0
Total		0.0

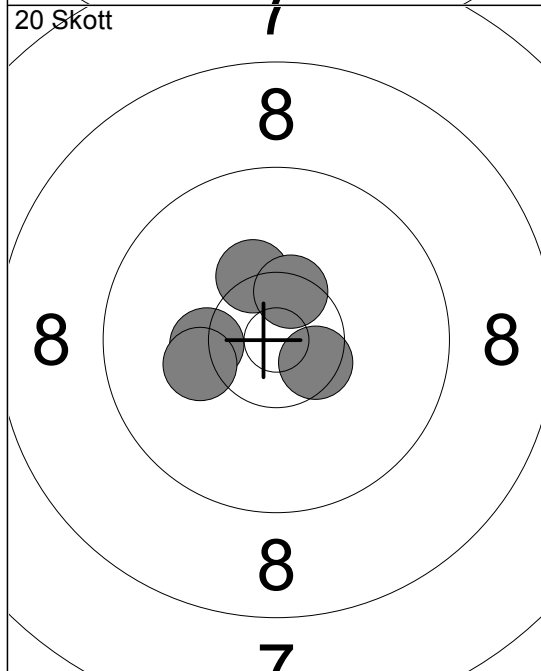

1:	10.3x	↗
2:	10.5x	↘
3:	10.3	←
4:	10.2	←
5:	10.5x	↗
Serie		50.0
Total		50.0

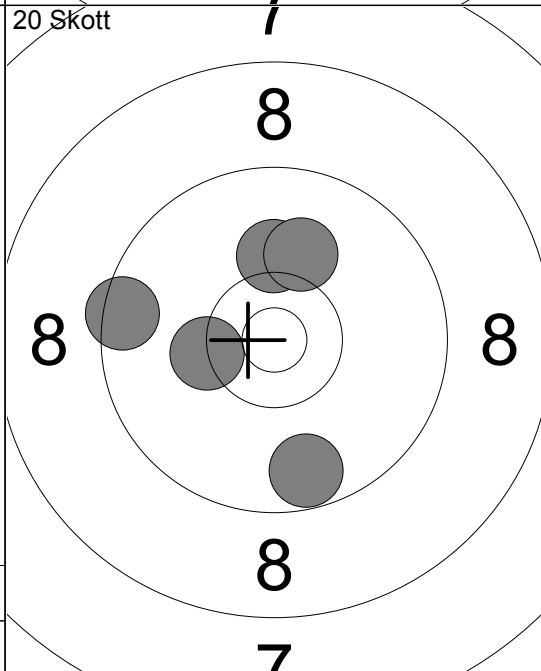

6:	9.5	←
7:	10.2	↑
8:	9.7	↘
9:	10.3x	←
10:	10.1	↑
Serie		48.0
Total		98.0

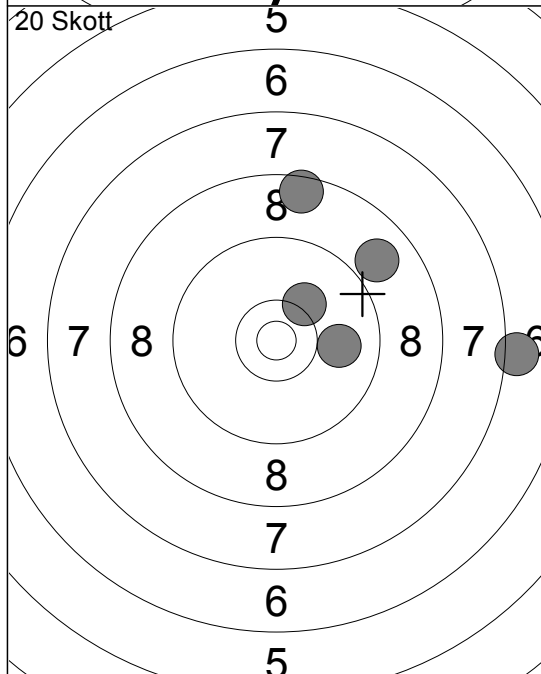

11:	9.9	→
12:	10.2	↗
13:	8.5	↑
14:	8.9	↗
15:	7.1	→
Serie		42.0
Total		140.0

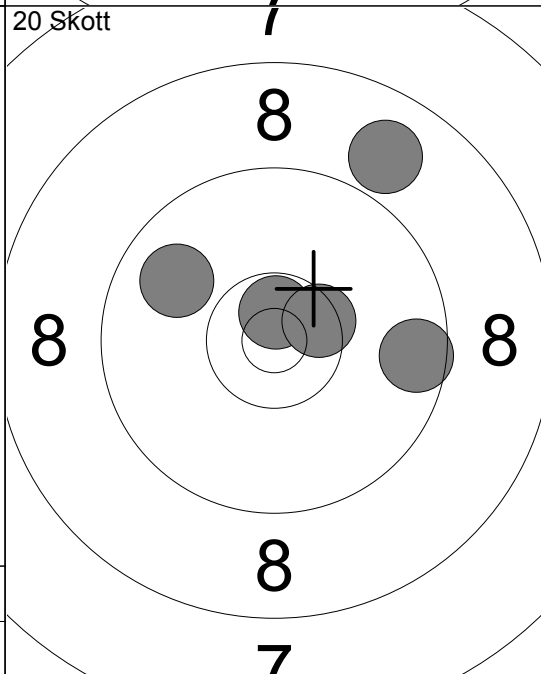

16:	8.9	↗
17:	9.9	↖
18:	10.7x	↗
19:	10.5x	↗
20:	9.6	→
Serie		46.0
Total		186.0

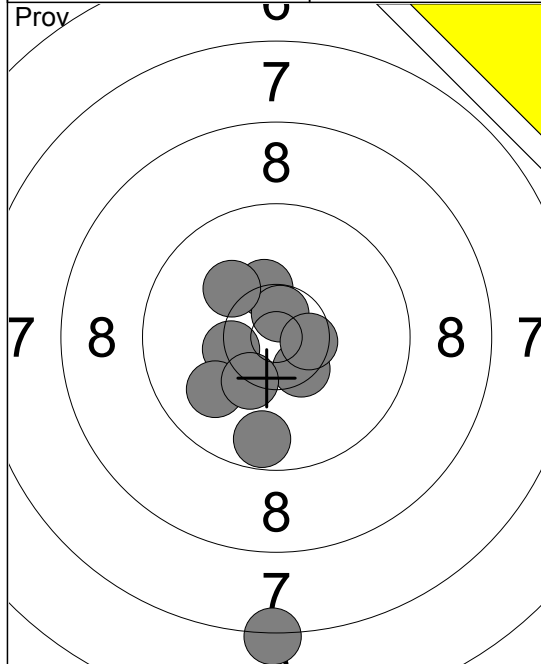

Prov

1:	7.3	↓
2:	10.3	↗
3:	10.4	✕
4:	10.5	↘
5:	10.7	↗
6:	9.7	↓
7:	10.0	↙
8:	10.3	↘
9:	10.1	↖
10:	10.5	→

Serie	96.0
Total	0.0

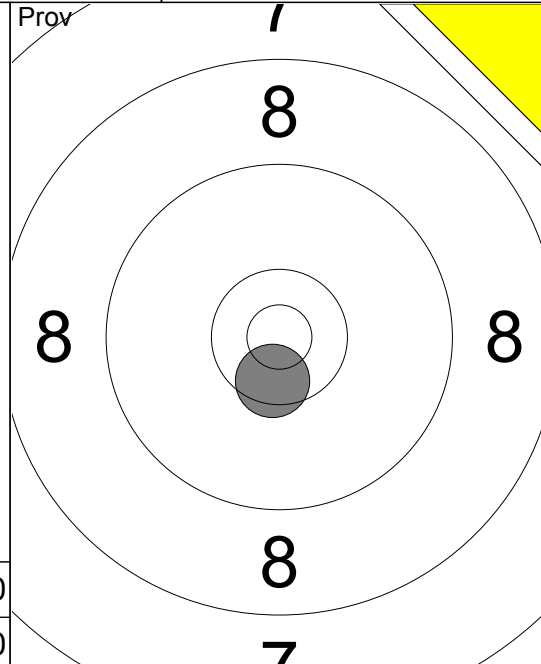

Prov

11:	10.5	↘
-----	------	---

Serie	10.0
Total	0.0

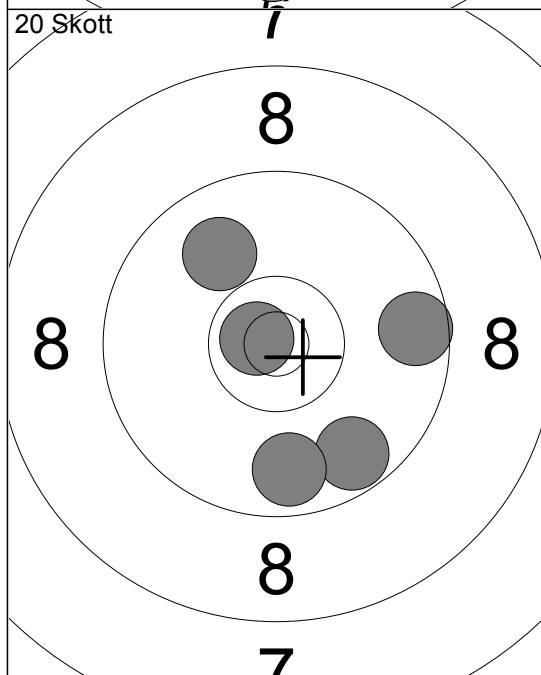

20 Skott

1:	10.8	✕
2:	9.7	↓
3:	9.7	↓
4:	9.9	↗
5:	9.6	→

Serie	46.0
Total	46.0

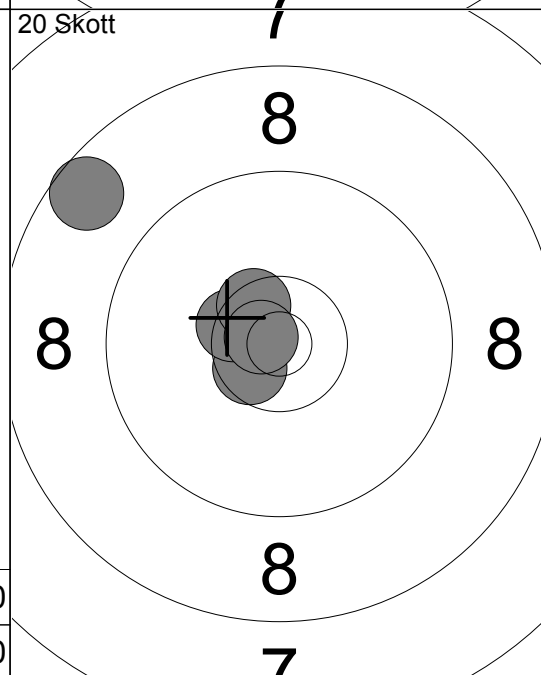

20 Skott

6:	8.6	↖
7:	10.6	✕
8:	10.5	✕
9:	10.5	↗
10:	10.8	✕

Serie	48.0
Total	94.0

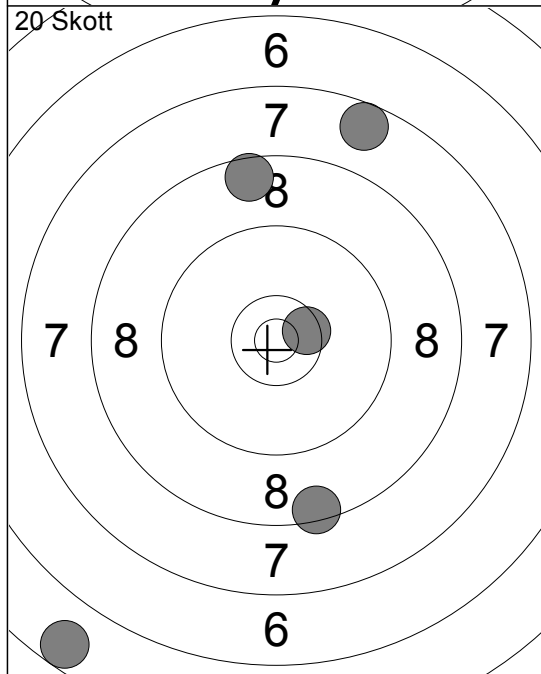

20 Skott

11:	8.6	↑
12:	7.6	↗
13:	8.5	↓
14:	5.6	↘
15:	10.5	→

Serie	38.0
Total	132.0

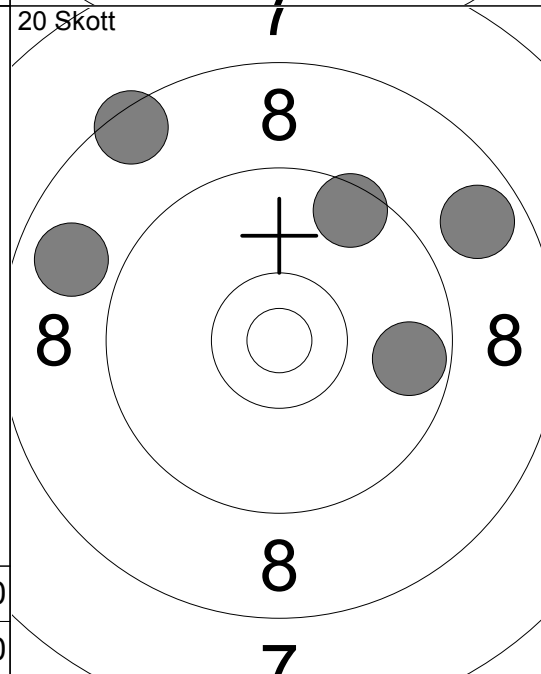

20 Skott

16:	8.8	↙
17:	9.7	→
18:	9.5	↗
19:	8.7	↗
20:	8.5	↖

Serie	42.0
Total	174.0

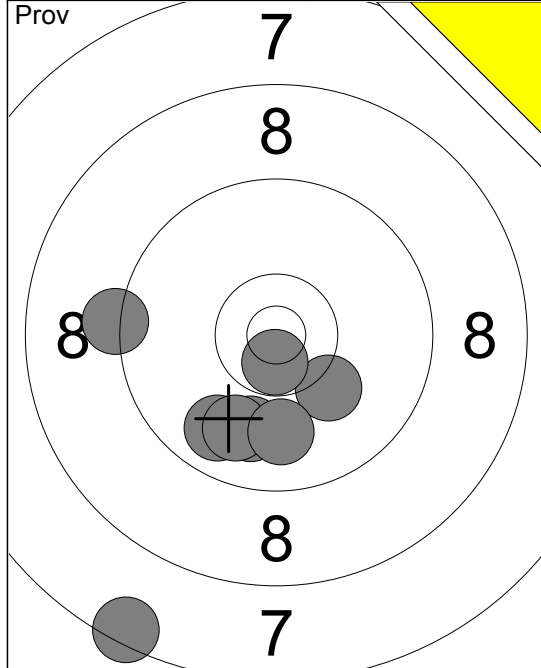

1:	9.8	↘
2:	7.5	↘
3:	9.9	↘
4:	10.2	↘
5:	9.9	↘
6:	9.2	←
7:	9.9	↘
8:	10.7x	↘
Serie		72.0
Total		0.0

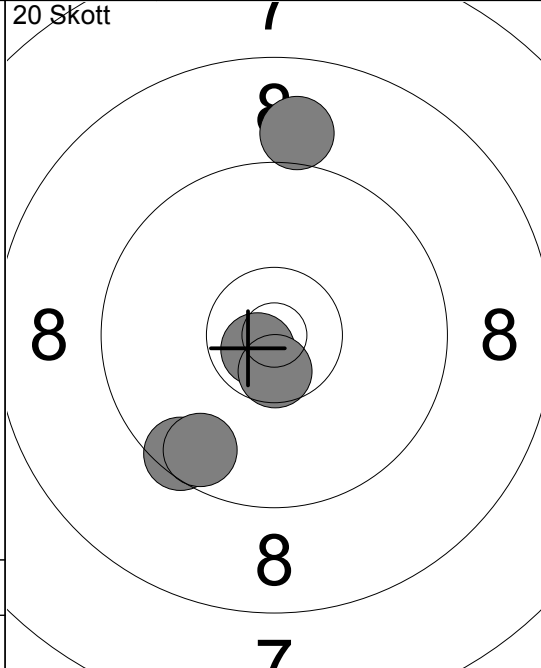

1:	10.7x	↘
2:	9.5	↘
3:	9.6	↘
4:	10.6x	↘
5:	9.0	↑
Serie		47.0
Total		47.0

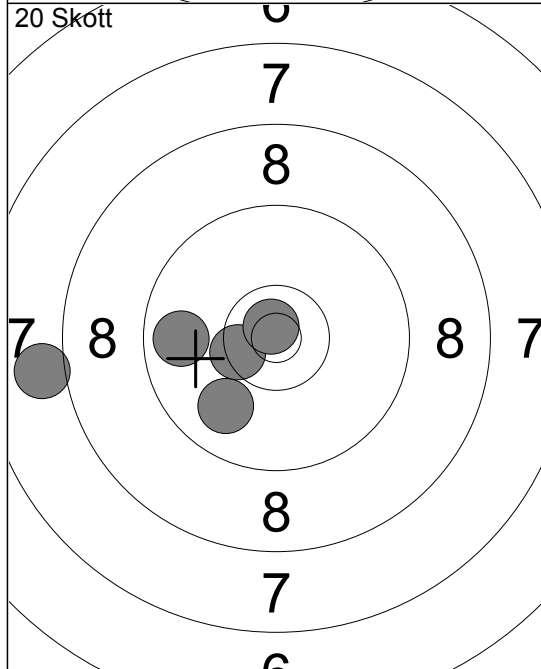

6:	9.9	↘
7:	8.0	←
8:	10.4x	↘
9:	10.8x	↘
10:	9.8	←
Serie		46.0
Total		93.0

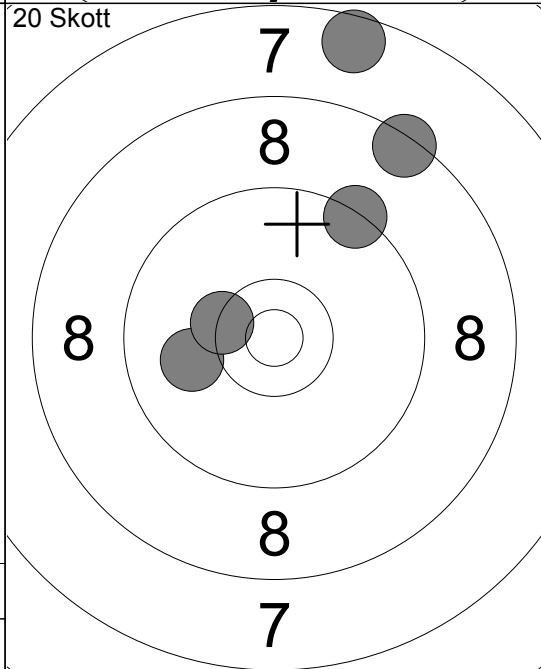

11:	8.4	↗
12:	9.4	↗
13:	10.0	←
14:	10.4x	↘
15:	7.6	↑
Serie		44.0
Total		137.0

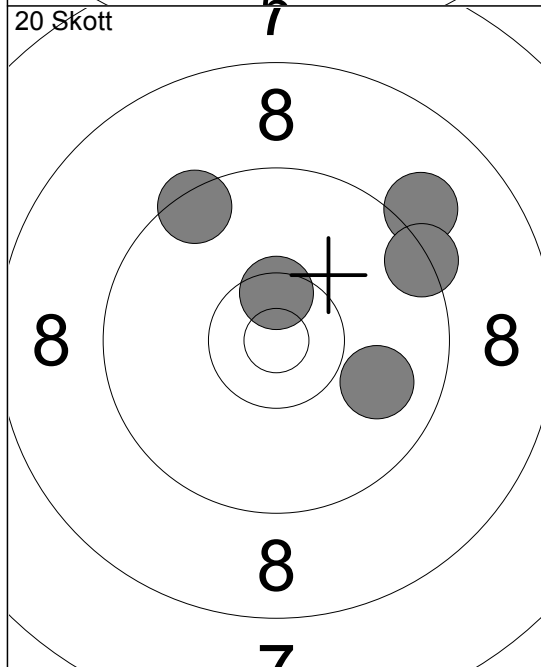

16:	9.9	→
17:	10.5x	↗
18:	9.5	↖
19:	9.1	↗
20:	9.4	↗
Serie		46.0
Total		183.0

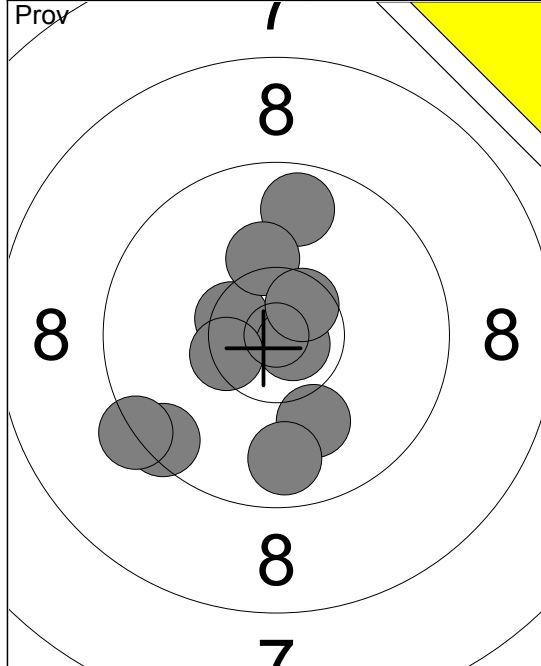

1:	10.5	↗
2:	9.7	↑
3:	10.2	↑
4:	10.8	↘
5:	10.4	↘
6:	10.1	↓
7:	10.6	↗
8:	9.8	↓
9:	9.5	↙
10:	9.3	↙
Serie		96.0
Total		0.0

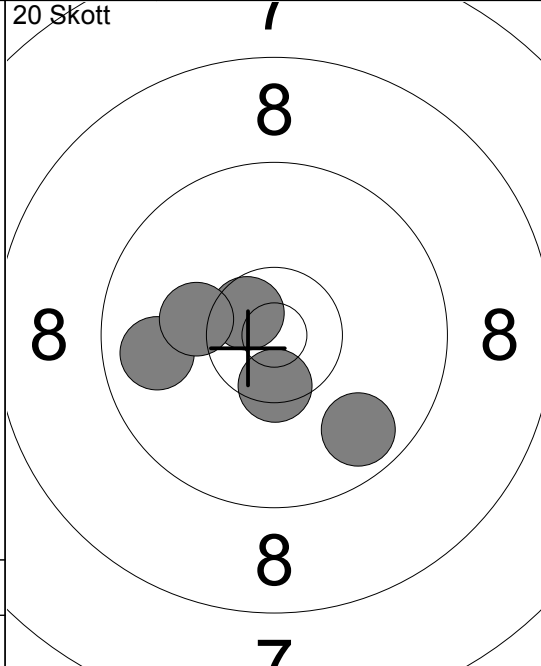

1:	10.5	↓
2:	9.7	↘
3:	10.6	↘
4:	9.8	←
5:	10.2	↙
Serie		48.0
Total		48.0

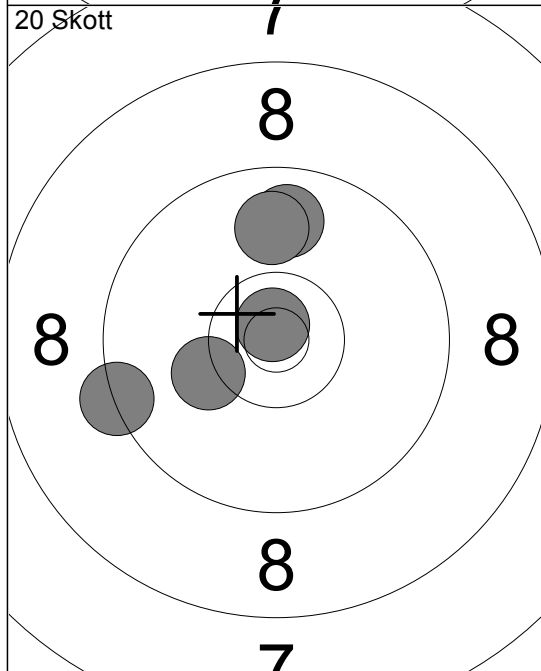

6:	9.3	←
7:	10.2	↙
8:	9.8	↑
9:	10.8	↗
10:	9.9	↑
Serie		47.0
Total		95.0

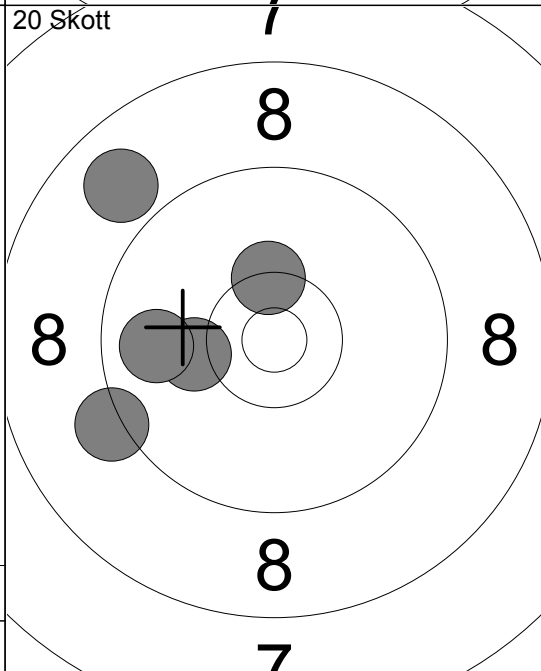

11:	10.4	↗
12:	8.9	↖
13:	10.2	↙
14:	9.8	←
15:	9.2	↙
Serie		46.0
Total		141.0

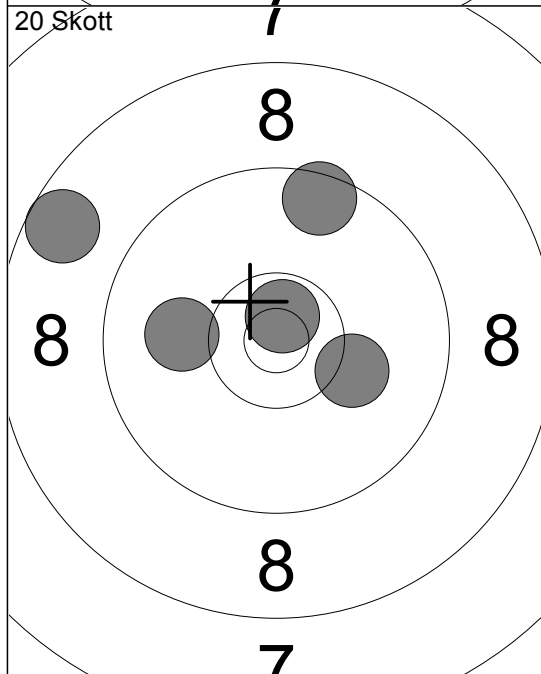

16:	9.5	↑
17:	8.6	↖
18:	10.1	←
19:	10.2	→
20:	10.7	↗
Serie		47.0
Total		188.0

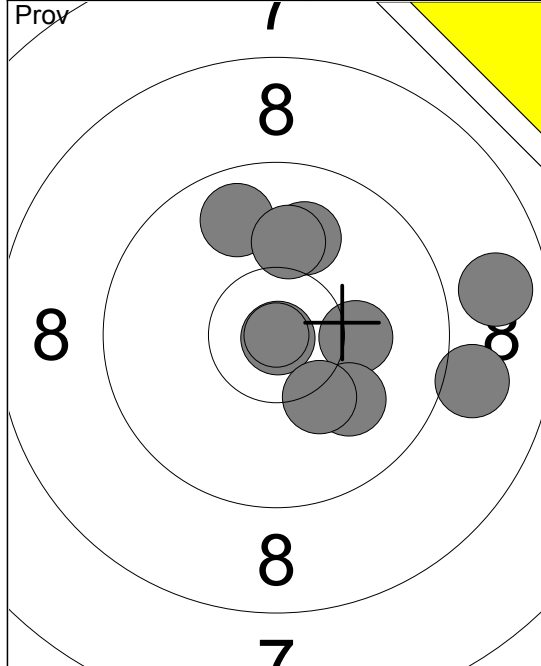

1:	10.0	↗
2:	9.8	↗
3:	10.2	→
4:	8.8	→
5:	10.1	↗
6:	10.0	↘
7:	9.0	→
8:	10.9	↘
9:	10.2	↘

Serie	86.0
Total	0.0

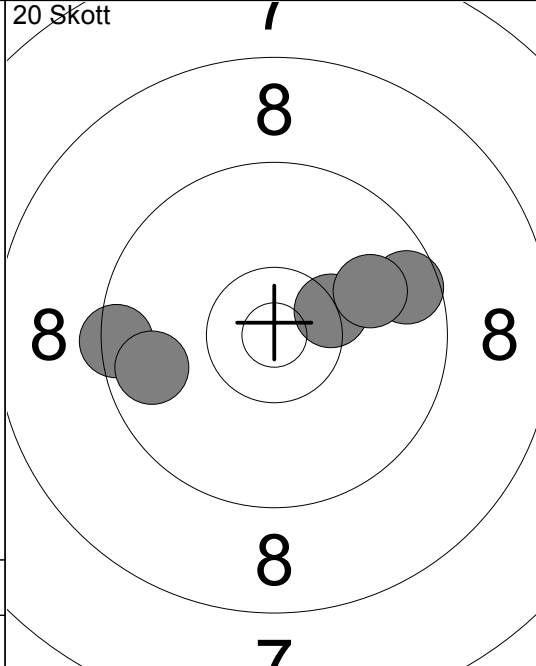

1:	9.6	→
2:	9.4	←
3:	10.4	↗
4:	9.7	←
5:	9.9	→

Serie	46.0
Total	46.0

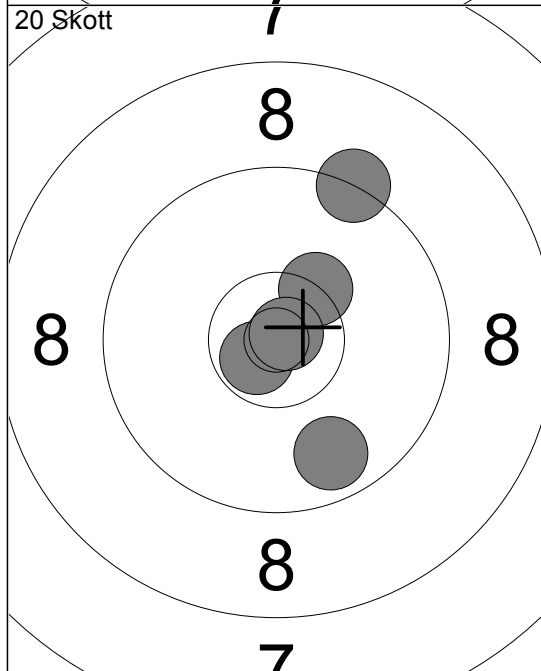

6:	9.3	↗
7:	9.8	↘
8:	10.7	↘
9:	10.3	↗
10:	10.8	↗

Serie	48.0
Total	94.0

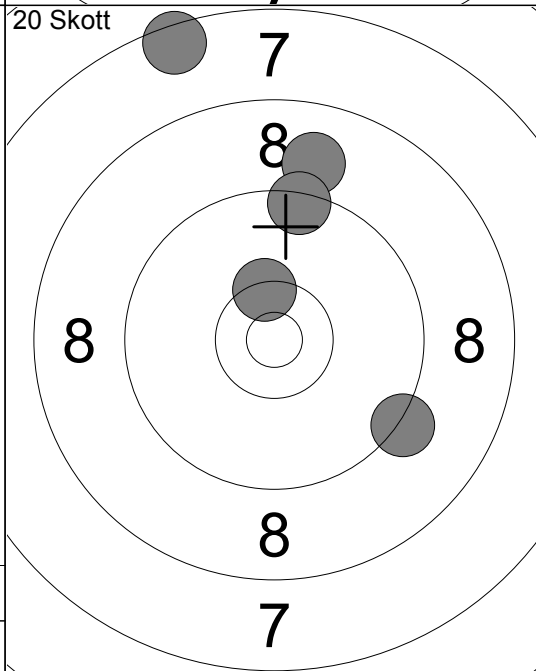

11:	10.4	↗
12:	9.3	↘
13:	7.5	↗
14:	9.0	↗
15:	9.4	↗

Serie	44.0
Total	138.0

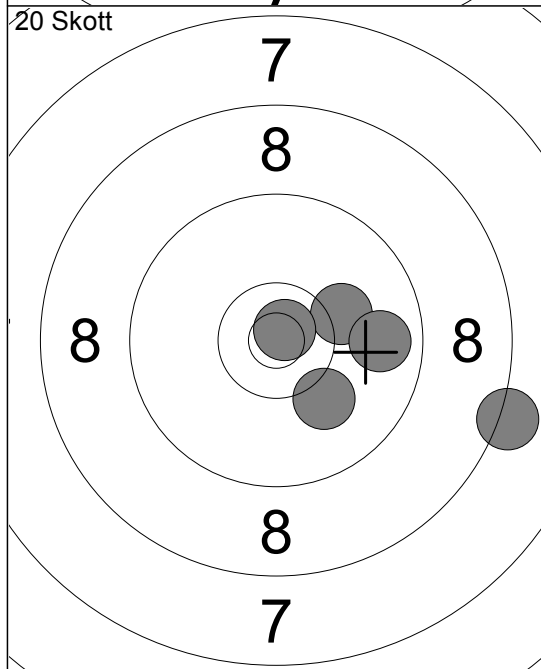

16:	10.1	↘
17:	8.2	→
18:	10.2	→
19:	9.8	→
20:	10.8	↗

Serie	47.0
Total	185.0

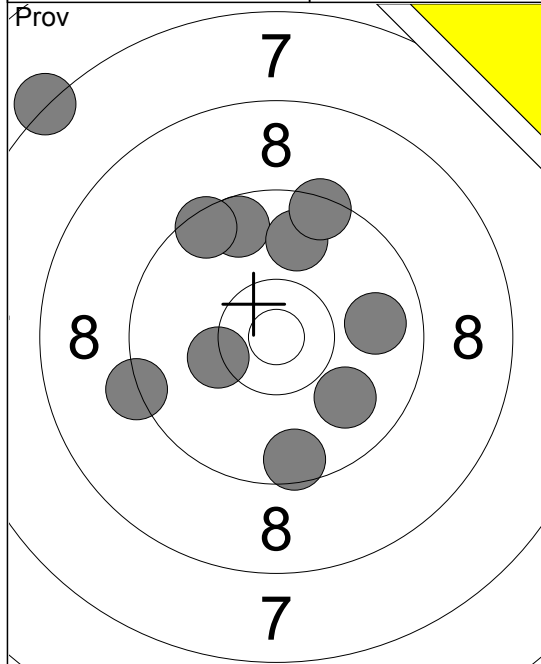

1:	9.3	←
2:	9.6	↓
3:	9.9	↘
4:	9.8	→
5:	9.6	↑
6:	9.5	↗
7:	7.3	↖
8:	9.8	↑
9:	9.4	↗
10:	10.3	←
Serie	89.0	
Total	0.0	

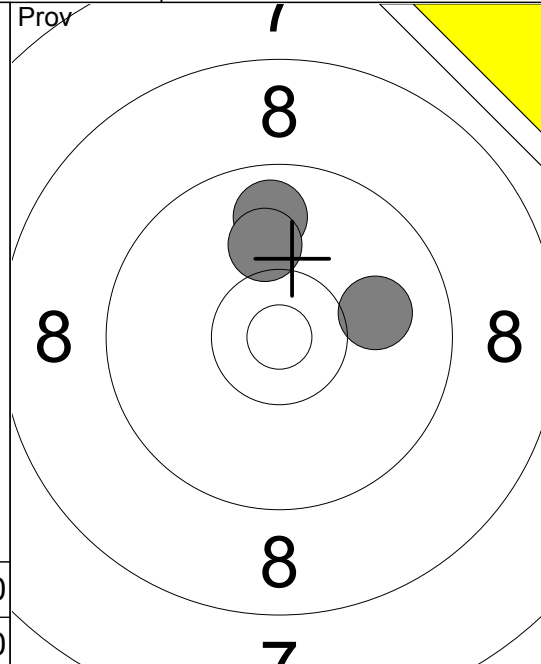

11:	9.8	↑
12:	10.1	↑
13:	10.0	→
Serie	29.0	
Total	0.0	

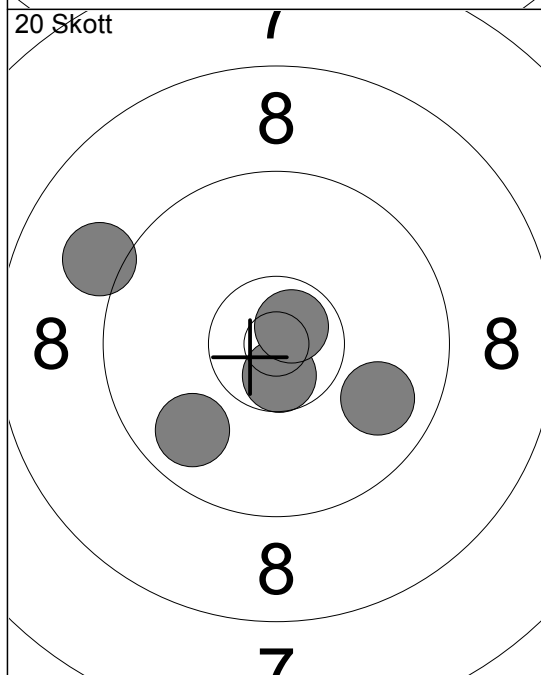

1:	10.6	↘
2:	9.1	←
3:	9.8	↘
4:	9.9	→
5:	10.7	↗
Serie	47.0	
Total	47.0	

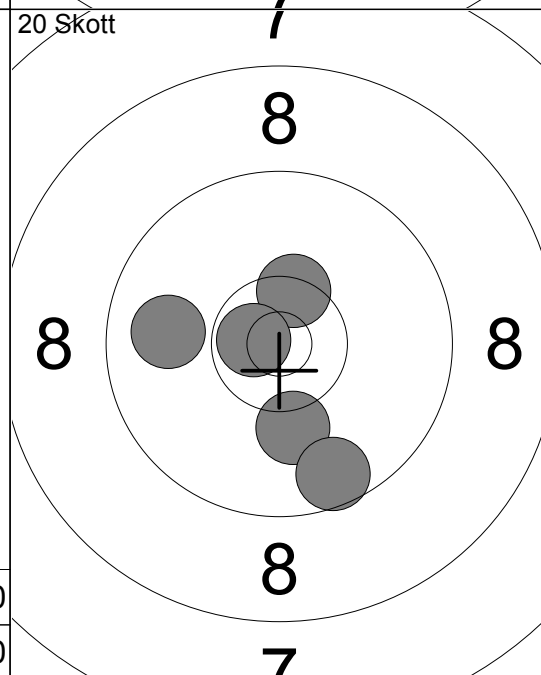

6:	10.1	↓
7:	10.4	↗
8:	9.6	↓
9:	10.7	↖
10:	9.9	←
Serie	48.0	
Total	95.0	

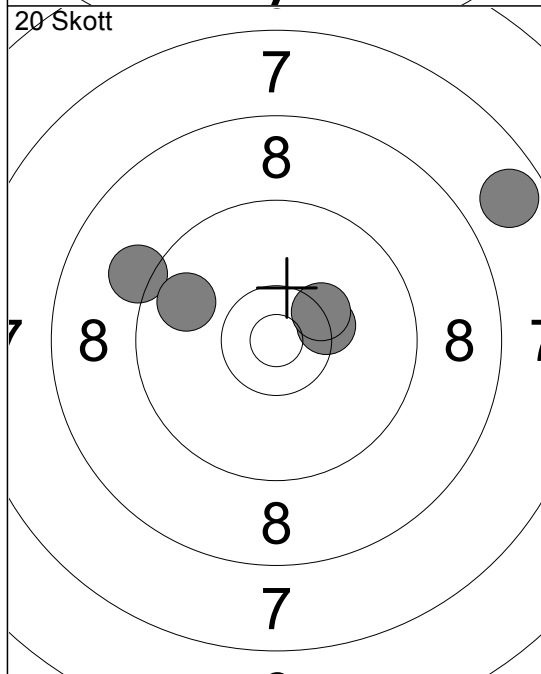

11:	7.7	↗
12:	9.2	←
13:	10.3	→
14:	10.3	↗
15:	9.8	←
Serie	45.0	
Total	140.0	

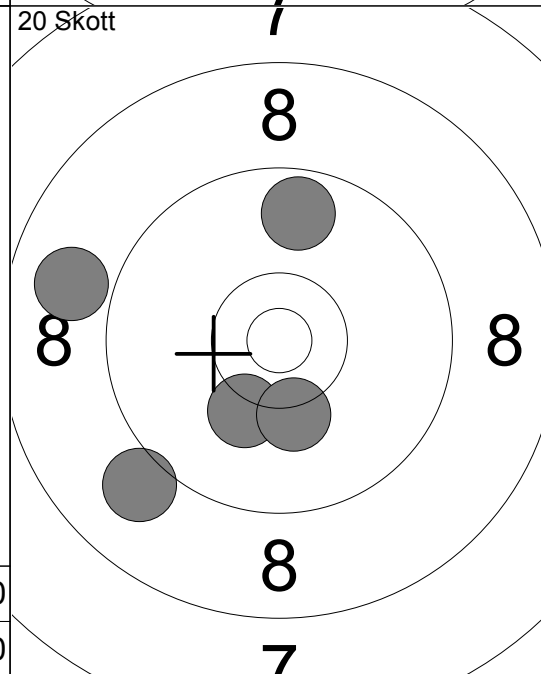

16:	10.2	↘
17:	10.2	↓
18:	9.0	↘
19:	8.9	←
20:	9.7	↑
Serie	46.0	
Total	186.0	

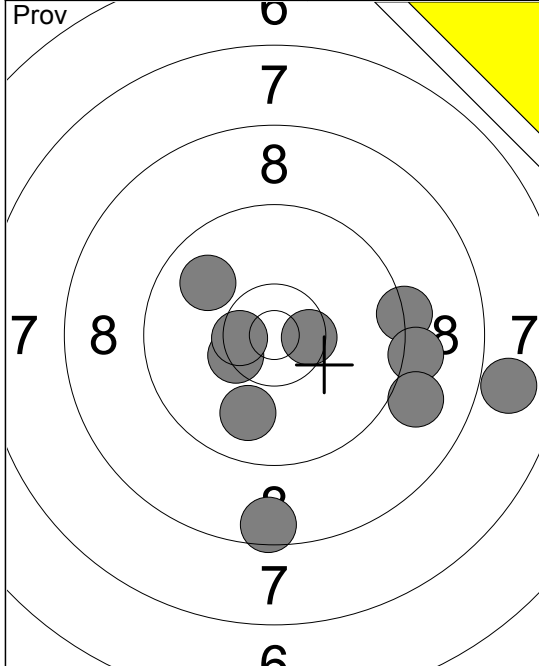

1:	8.6	↓
2:	10.4	✕
3:	9.9	↓
4:	9.3	→
5:	9.2	→
6:	9.0	↘
7:	9.9	↗
8:	7.9	→
9:	10.5	↘
10:	10.5	✕
Serie		90.0
Total		0.0

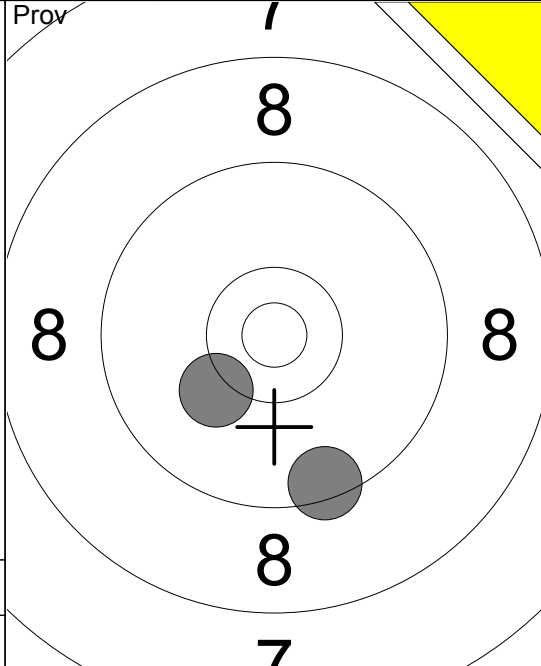

11:	9.5	↓
12:	10.2	↘
Serie		19.0
Total		0.0

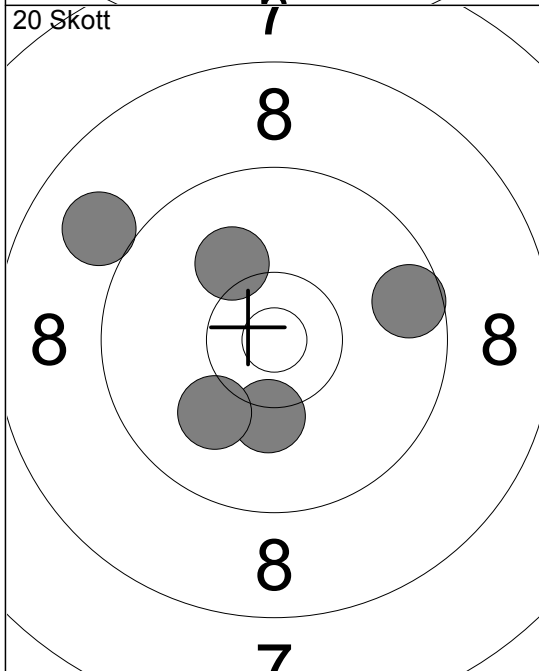

1:	10.2	↓
2:	9.6	→
3:	10.1	↘
4:	10.1	↗
5:	9.0	↖
Serie		48.0
Total		48.0

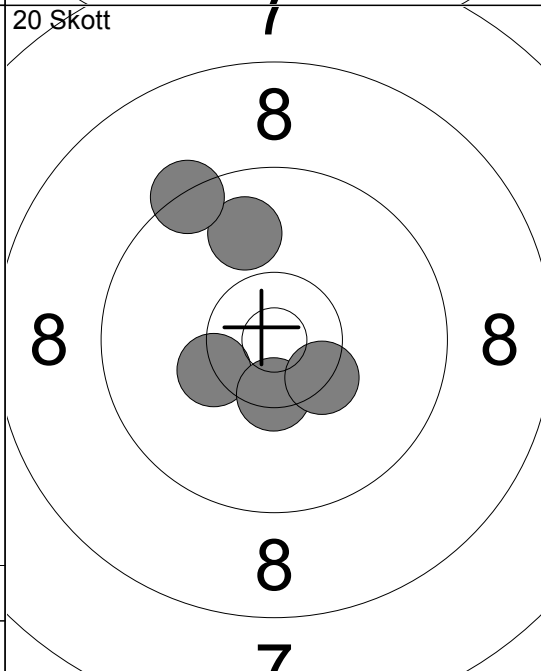

6:	9.9	↑
7:	10.3	✕
8:	9.4	↗
9:	10.4	↘
10:	10.4	✕
Serie		48.0
Total		96.0

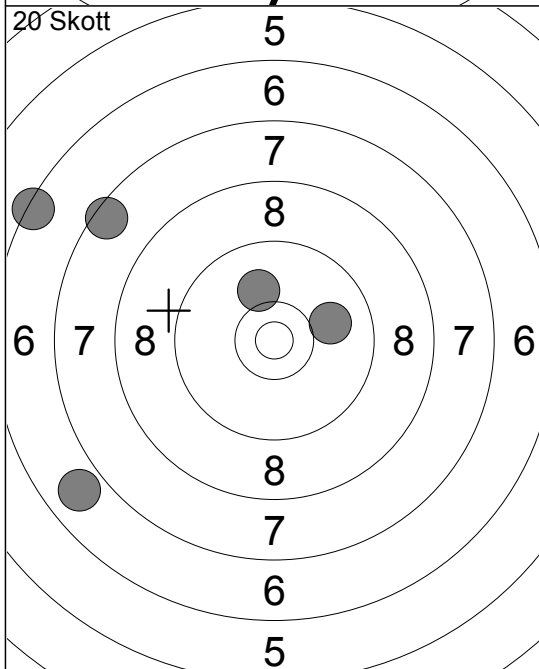

11:	6.9	↖
12:	10.1	↗
13:	6.4	↖
14:	7.5	↖
15:	10.0	→
Serie		39.0
Total		135.0

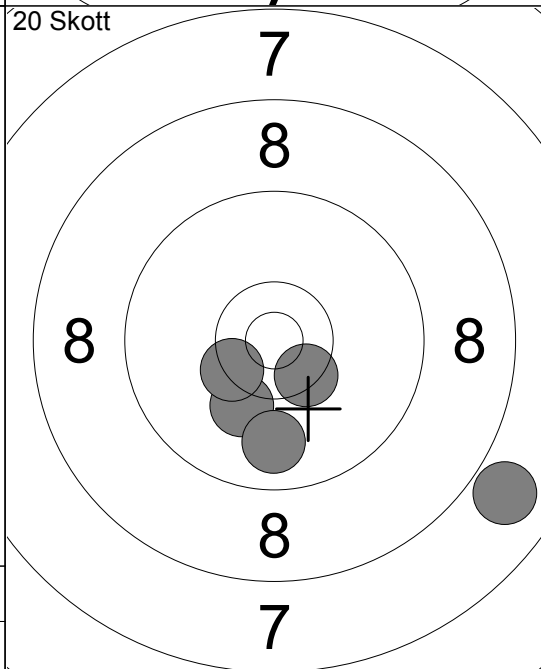

16:	10.2	↘
17:	10.4	✕
18:	7.9	↘
19:	10.4	✕
20:	9.8	↓
Serie		46.0
Total		181.0

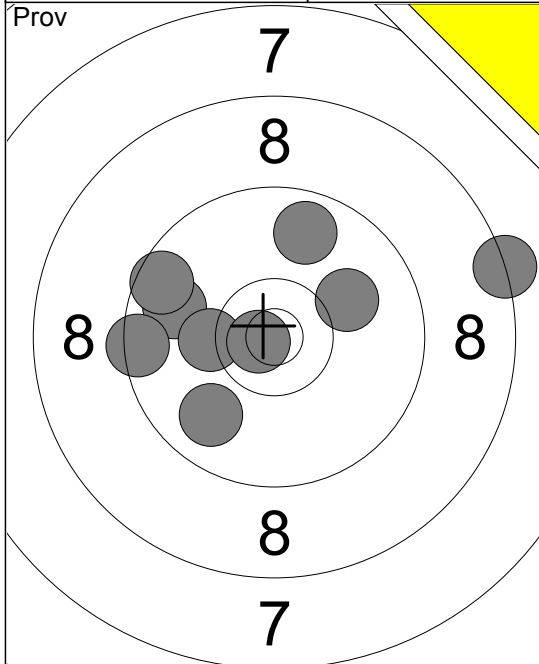

- 1: 9.8 ↙
- 2: 9.8 ←
- 3: 9.8 ↑
- 4: 10.2 ←
- 5: 8.3 →
- 6: 10.1 →
- 7: 9.4 ←
- 8: 10.8 ✕
- 9: 9.6 ↙

Serie 83.0
Total 0.0

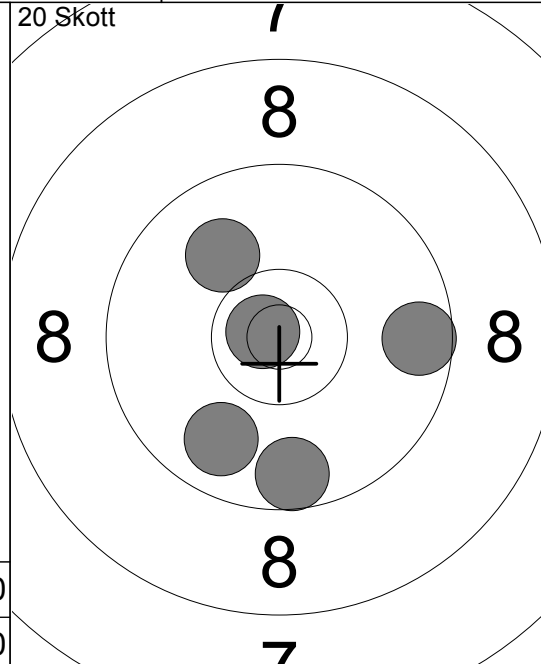

- 10: 10.8 ✕
- 11: 9.6 ↓
- 12: 9.6 →
- 13: 9.8 ↓
- 14: 10.0 ↗

Serie 47.0
Total 47.0

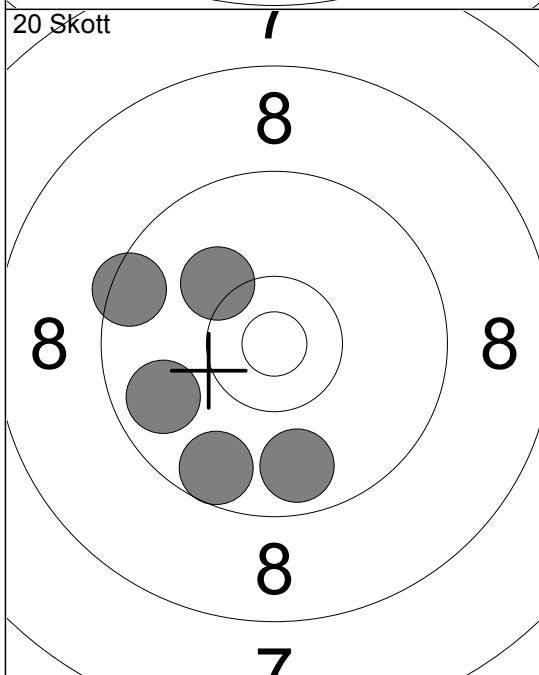

- 15: 9.8 ←
- 16: 9.6 ↓
- 17: 9.5 ←
- 18: 10.2 ↗
- 19: 9.8 ↓

Serie 46.0
Total 93.0

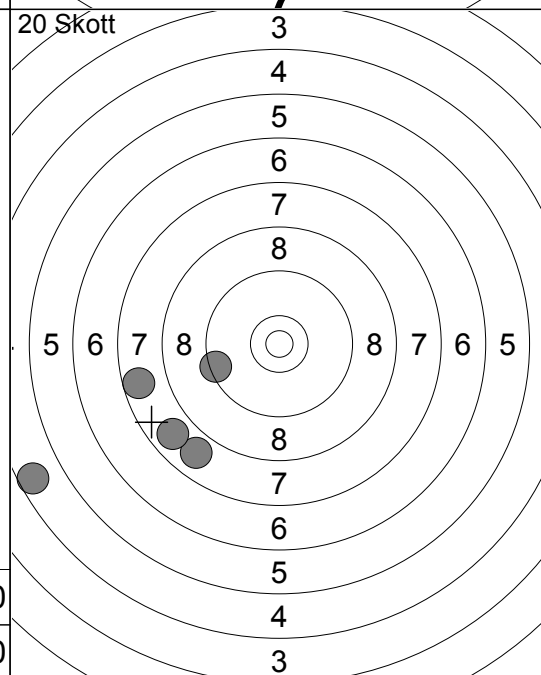

- 20: 7.9 ↓
- 21: 7.8 ↓
- 22: 4.6 ←
- 23: 7.6 ←
- 24: 9.4 ←

Serie 34.0
Total 127.0

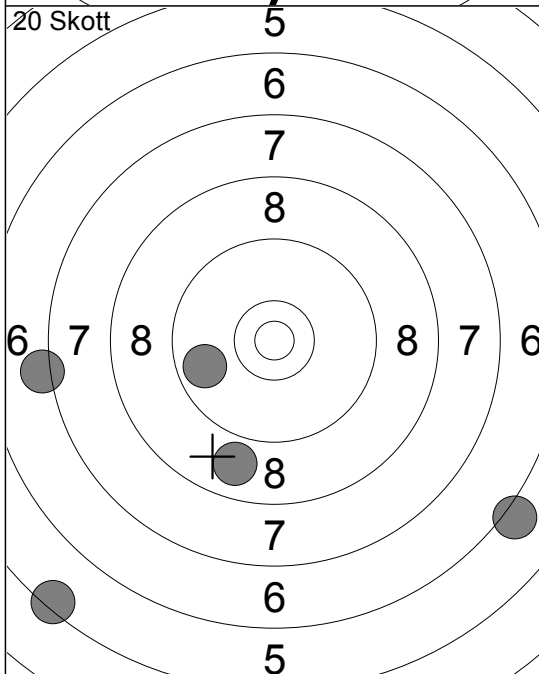

- 25: 8.9 ↓
- 26: 5.4 ↓
- 27: 7.2 ←
- 28: 9.8 ←
- 29: 6.1 ↘

Serie 35.0
Total 162.0

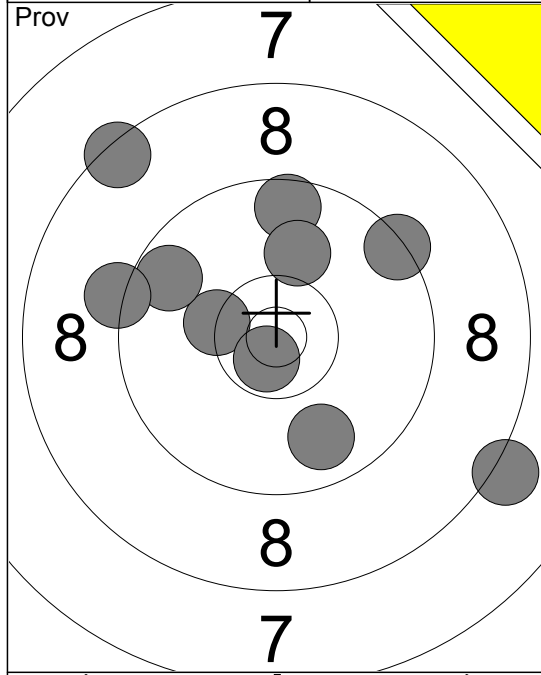

- 1: 10.3 ↘
- 2: 9.6 ↑
- 3: 8.4 ↗
- 4: 8.2 ↘
- 5: 10.7 ↘
- 6: 9.7 ↖
- 7: 9.2 ←
- 8: 10.0 ↑
- 9: 9.8 ↓
- 10: 9.4 ↗

Serie 91.0
Total 0.0

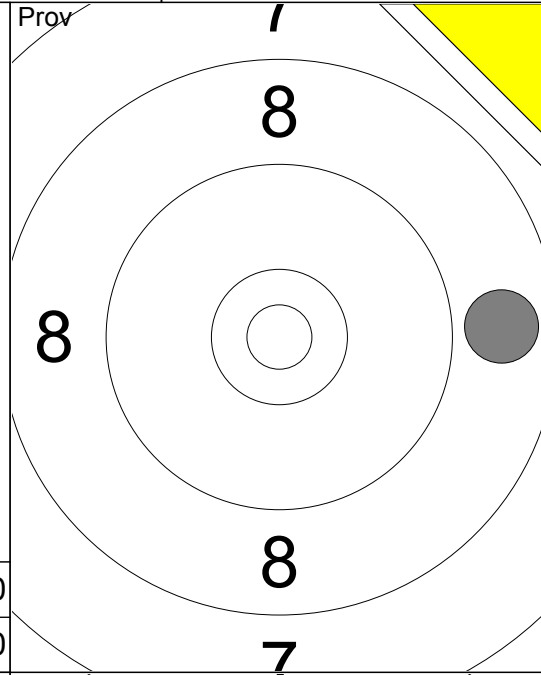

11: 8.8 →

Serie 8.0
Total 0.0

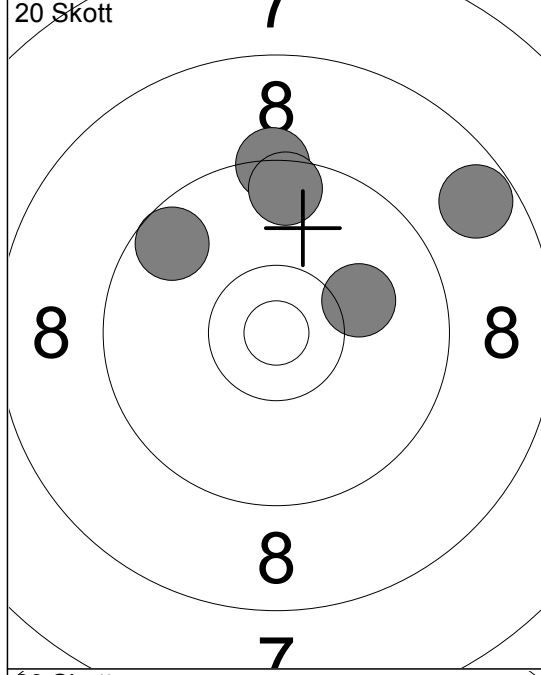

- 1: 8.7 ↗
- 2: 9.3 ↑
- 3: 10.1 →
- 4: 9.6 ↑
- 5: 9.6 ↖

Serie 45.0
Total 45.0

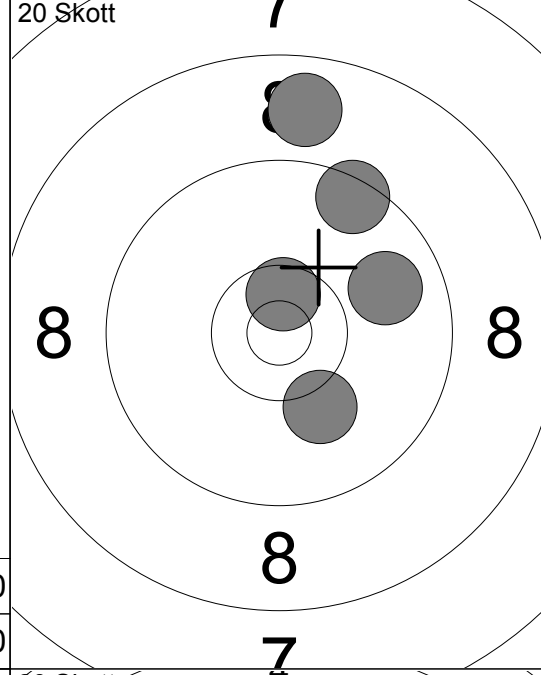

- 6: 9.5 ↗
- 7: 8.8 ↑
- 8: 10.1 ↘
- 9: 10.6x ↑
- 10: 9.9 →

Serie 46.0
Total 91.0

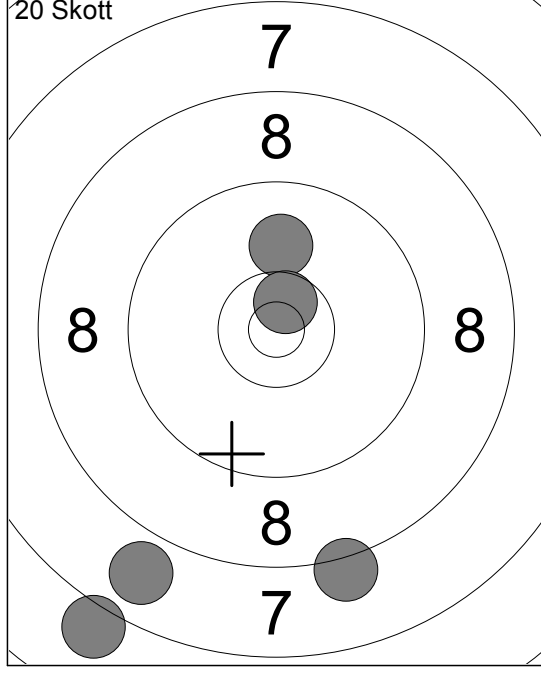

- 11: 10.0 ↑
- 12: 10.6x ↑
- 13: 7.1 ↘
- 14: 7.9 ↘
- 15: 8.2 ↓

Serie 42.0
Total 133.0

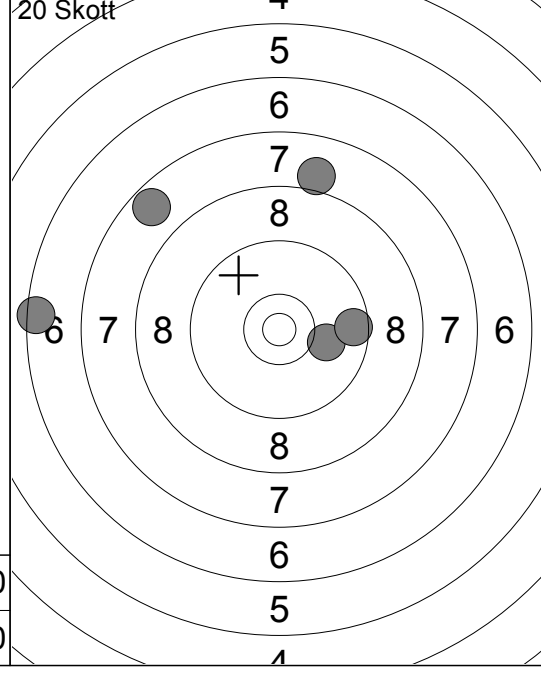

- 16: 6.5 ←
- 17: 8.0 ↑
- 18: 10.1 →
- 19: 9.6 →
- 20: 7.7 ↖

Serie 40.0
Total 173.0

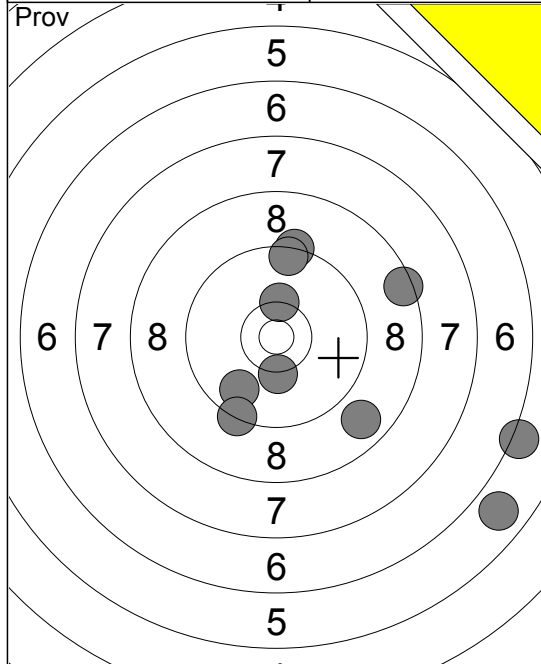

1:	5.8	↘
2:	6.2	↘
3:	8.8	↘
4:	8.5	↗
5:	9.8	↘
6:	10.3	↓
7:	10.3	↗
8:	9.3	↗
9:	9.3	↘
10:	9.5	↗
Serie	83.0	
Total	0.0	

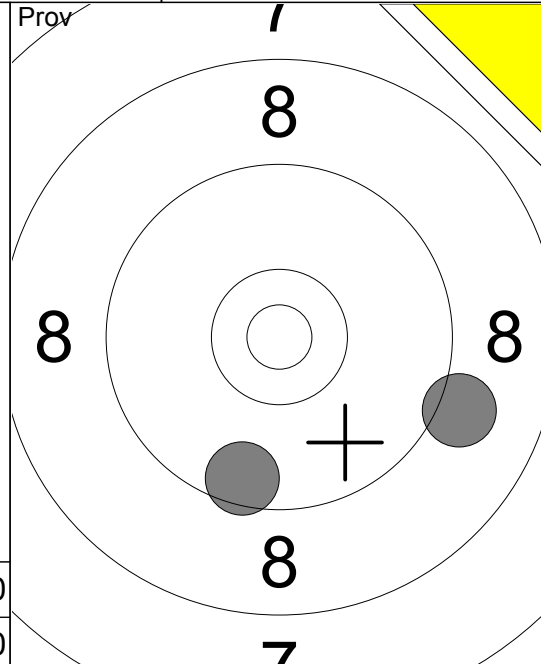

11:	9.6	↘
12:	9.1	↗
Serie	18.0	
Total	0.0	

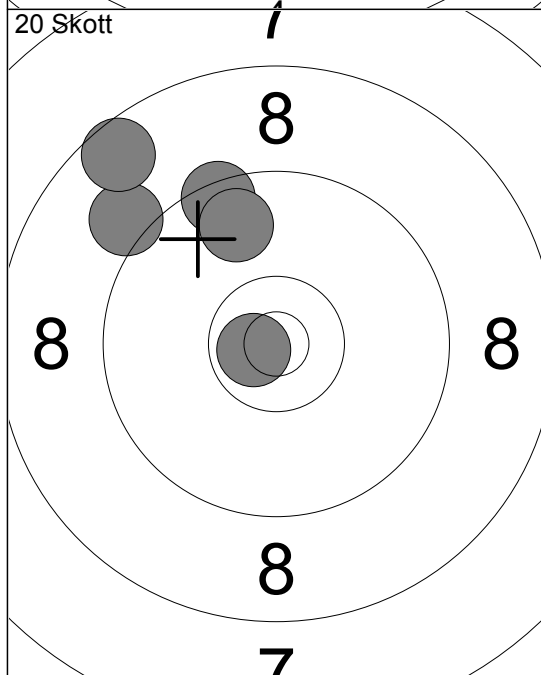

1:	9.5	↗
2:	9.1	↖
3:	9.8	↗
4:	10.7	↖
5:	8.6	↗
Serie	45.0	
Total	45.0	

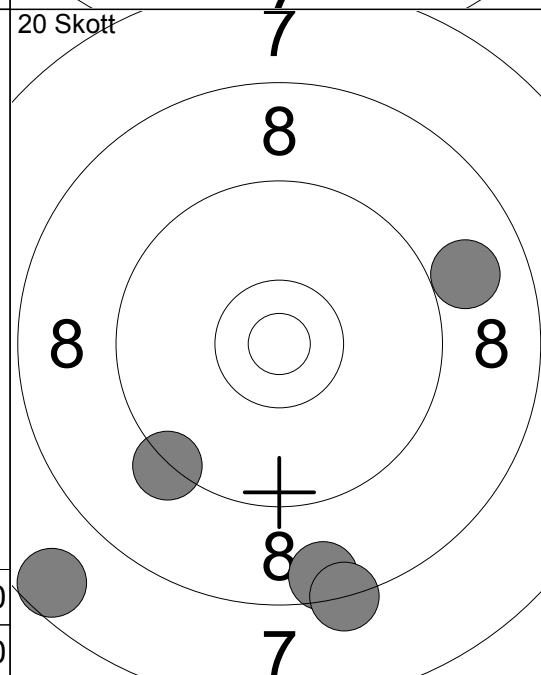

6:	8.6	↘
7:	9.3	↘
8:	7.6	↘
9:	8.9	↗
10:	8.3	↘
Serie	40.0	
Total	85.0	

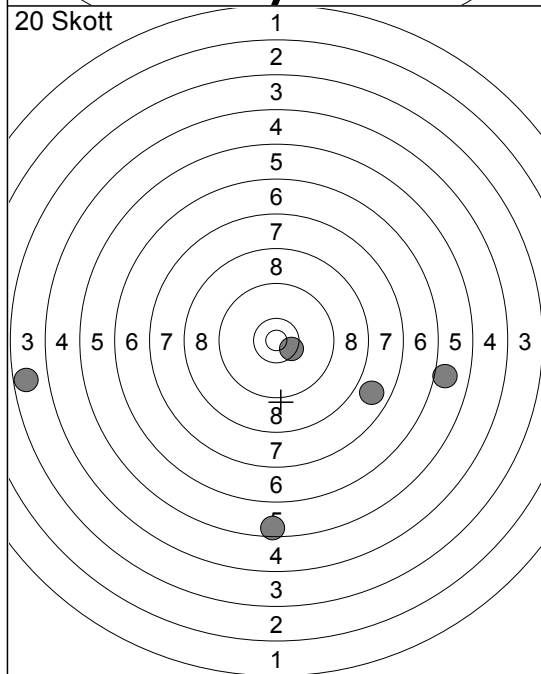

11:	3.7	↖
12:	7.8	↘
13:	10.5	↘
14:	5.6	↓
15:	6.0	↗
Serie	31.0	
Total	116.0	

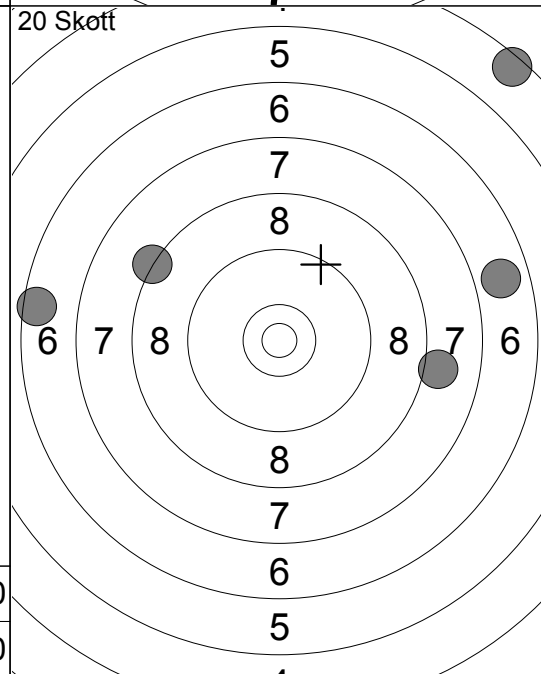

16:	8.3	↖
17:	6.5	↖
18:	8.0	↗
19:	6.8	↗
20:	4.5	↗
Serie	32.0	
Total	148.0	

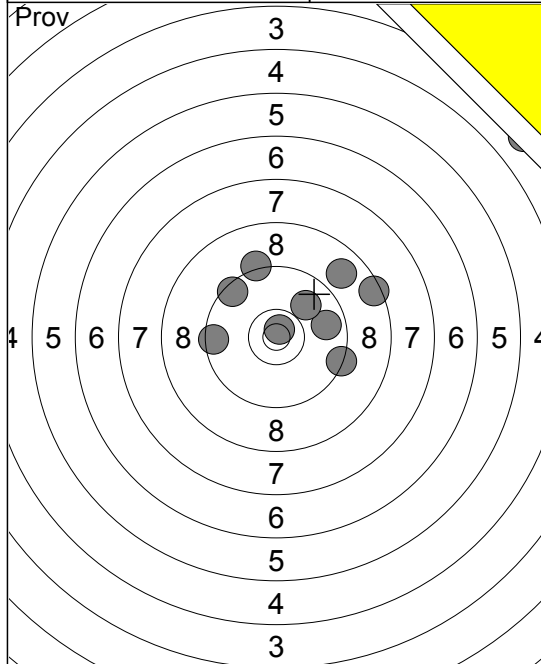

1:	3.6	↗
2:	8.5	→
3:	9.2	↖
4:	8.8	↗
5:	9.8	→
6:	10.0	↗
7:	9.5	←
8:	10.8	↗
9:	9.4	→
10:	9.5	↖
Serie	84.0	
Total	0.0	

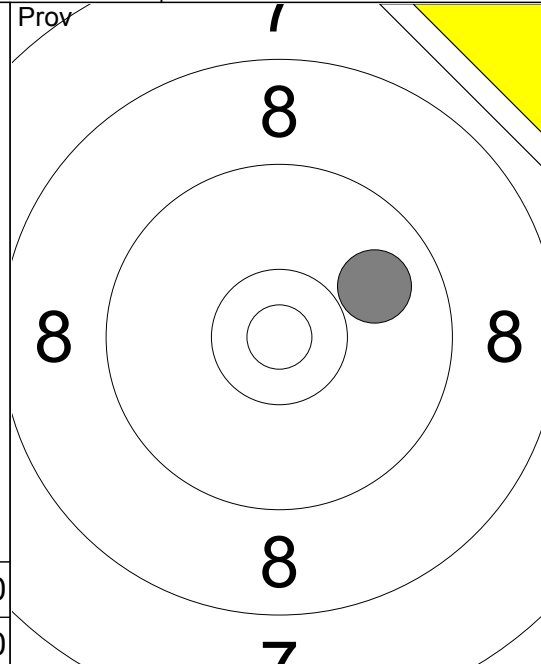

11:	9.9	↗
Serie	9.0	
Total	0.0	

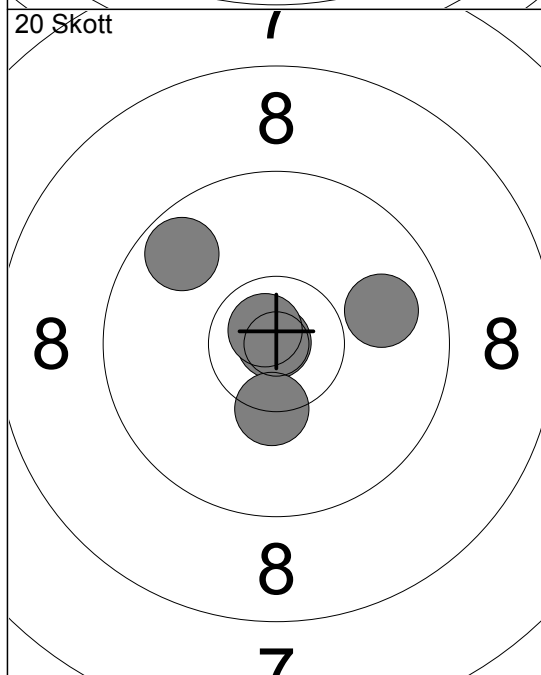

1:	9.9	→
2:	10.9	↘
3:	9.7	↖
4:	10.8	↘
5:	10.3	↘
Serie	48.0	
Total	48.0	

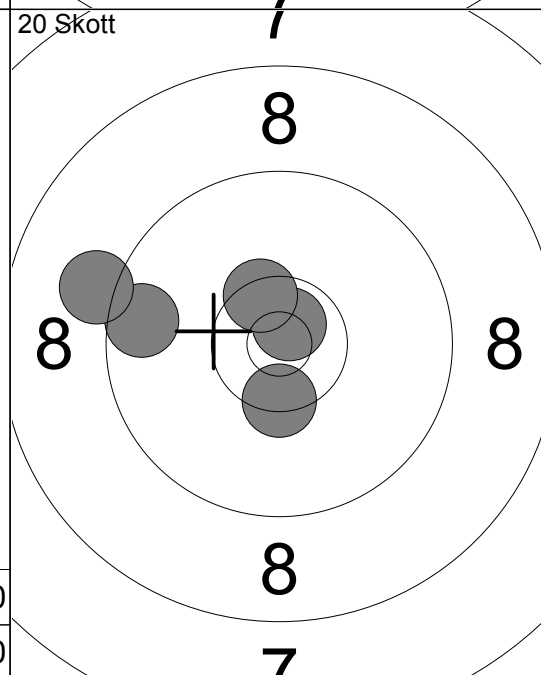

6:	10.7	↗
7:	10.5	↘
8:	9.6	←
9:	10.4	↘
10:	9.1	←
Serie	48.0	
Total	96.0	

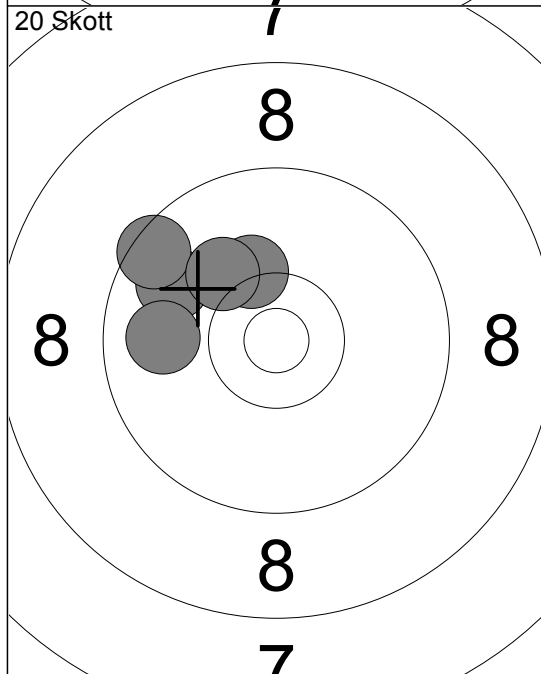

11:	10.3	↖
12:	9.8	↖
13:	9.5	↖
14:	9.9	←
15:	10.1	↖
Serie	47.0	
Total	143.0	

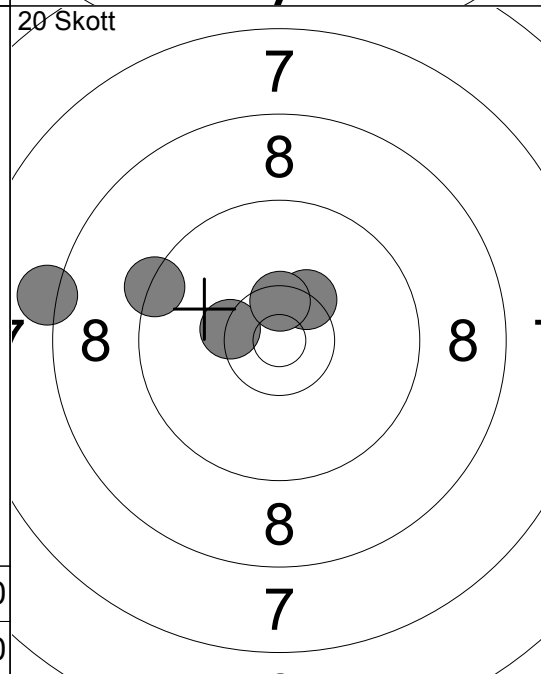

16:	10.4	↗
17:	9.4	↖
18:	10.4	↘
19:	10.5	↗
20:	8.2	←
Serie	47.0	
Total	190.0	

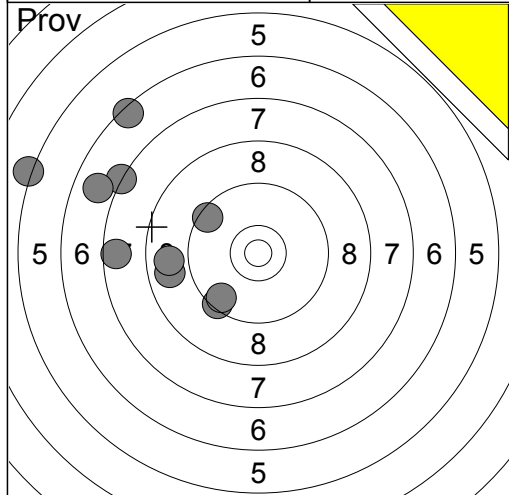

1:	7.3	↗
2:	6.4	↗
3:	5.2	↖
4:	7.6	↖
5:	6.9	↗
6:	8.8	↖
7:	8.8	↖
8:	9.4	↘
9:	9.6	↘
10:	9.5	↖
Serie	74.0	
Total	0.0	

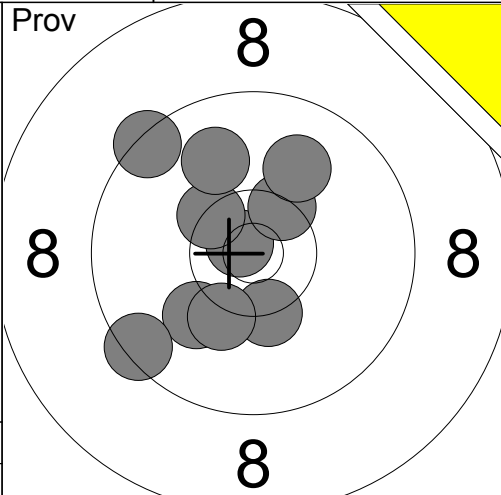

11:	10.8x	↗
12:	10.3x	↘
13:	10.4x	↗
14:	10.1	↘
15:	9.4	↘
16:	10.2	↘
17:	10.4x	↗
18:	9.4	↗
19:	10.0	↗
20:	9.9	↗
Serie	97.0	
Total	0.0	

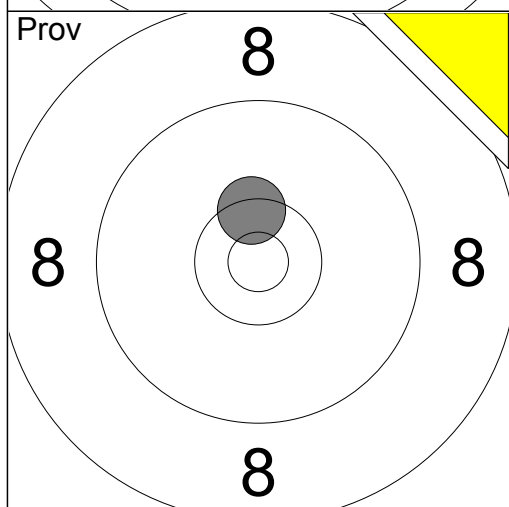

21:	10.4x	↑
Serie	10.0	
Total	0.0	

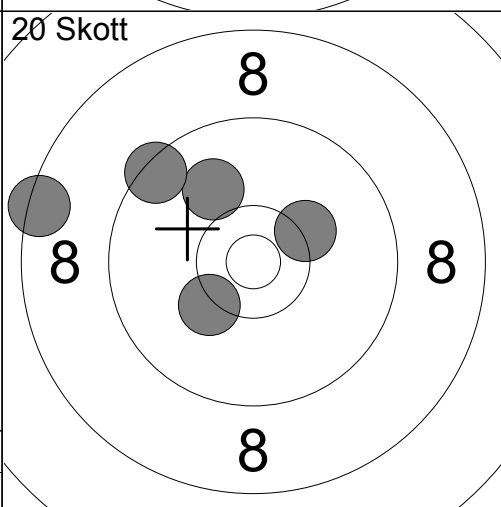

1:	10.3	↗
2:	8.4	↖
3:	10.0	↗
4:	9.4	↗
5:	10.2	↘
Serie	47.0	
Total	47.0	

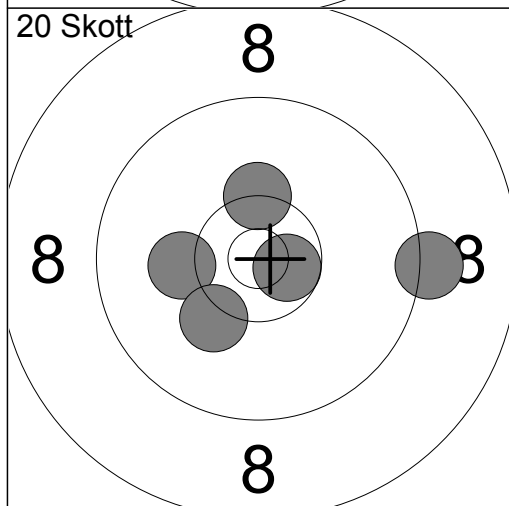

6:	10.3x	↑
7:	10.2	↖
8:	10.6x	➡
9:	9.2	➡
10:	10.2	↘
Serie	49.0	
Total	96.0	

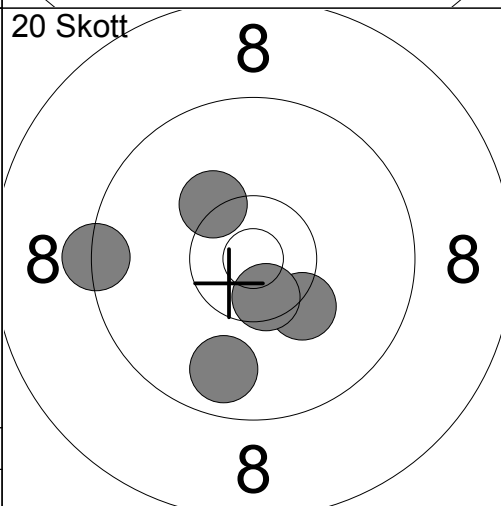

11:	9.8	↘
12:	9.3	↖
13:	10.3	↗
14:	10.3	↘
15:	10.5x	↘
Serie	48.0	
Total	144.0	

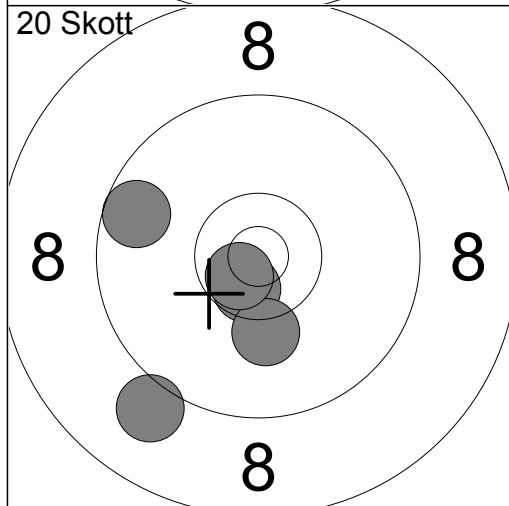

16:	10.6x	↘
17:	10.2	↘
18:	9.6	↖
19:	9.0	↘
20:	10.7x	↘
Serie	48.0	
Total	192.0	

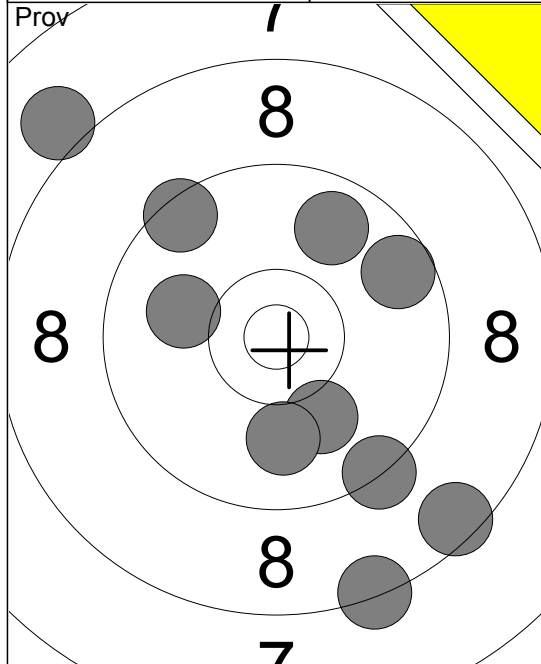

1:	8.0	↖
2:	9.6	→
3:	8.3	↙
4:	9.3	↙
5:	8.5	↙
6:	9.8	↗
7:	10.1	↙
8:	10.0	↖
9:	10.0	↓
10:	9.5	↖
Serie		90.0
Total		0.0

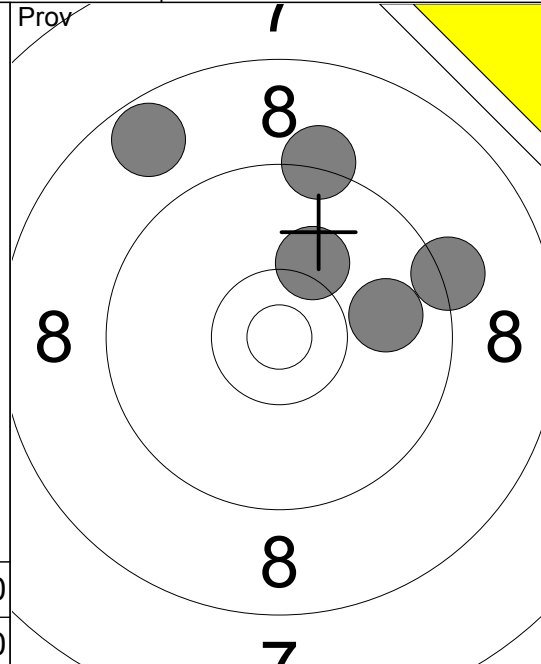

11:	8.7	↖
12:	9.2	→
13:	10.2	↗
14:	9.9	→
15:	9.2	↗
Serie		45.0
Total		0.0

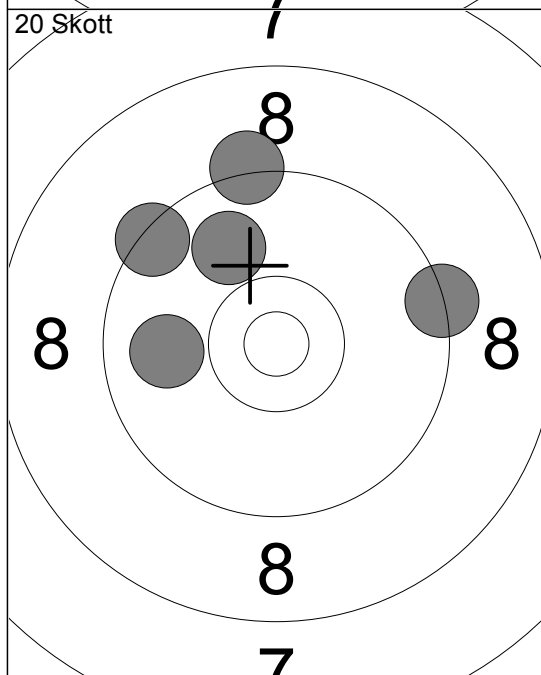

1:	9.4	↗
2:	9.3	→
3:	9.9	↖
4:	9.2	↗
5:	9.9	↗
Serie		45.0
Total		45.0

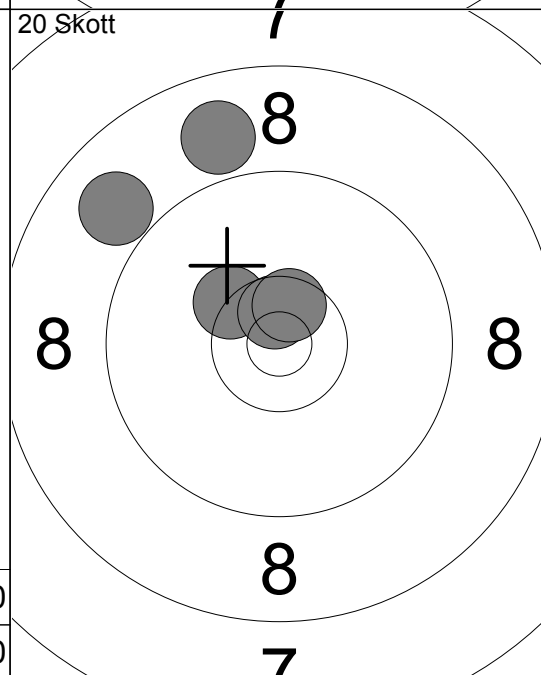

6:	10.3	↖
7:	10.6	↗
8:	8.9	↖
9:	8.9	↗
10:	10.6	↗
Serie		46.0
Total		91.0

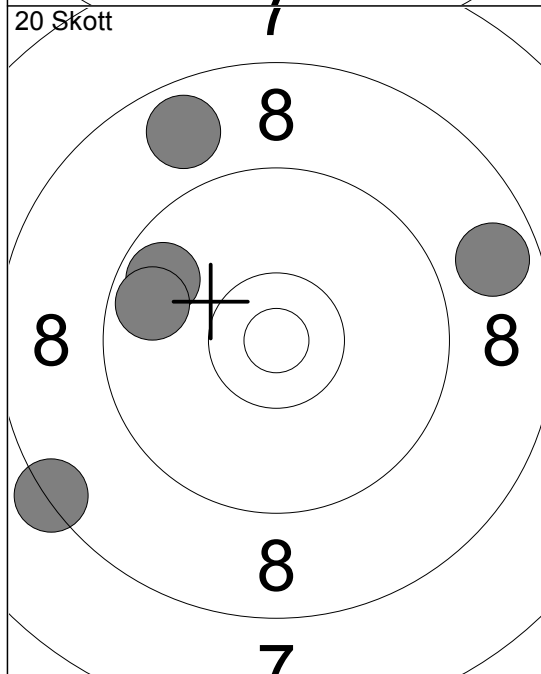

11:	8.3	↙
12:	9.7	↖
13:	8.7	→
14:	8.8	↗
15:	9.7	↖
Serie		42.0
Total		133.0

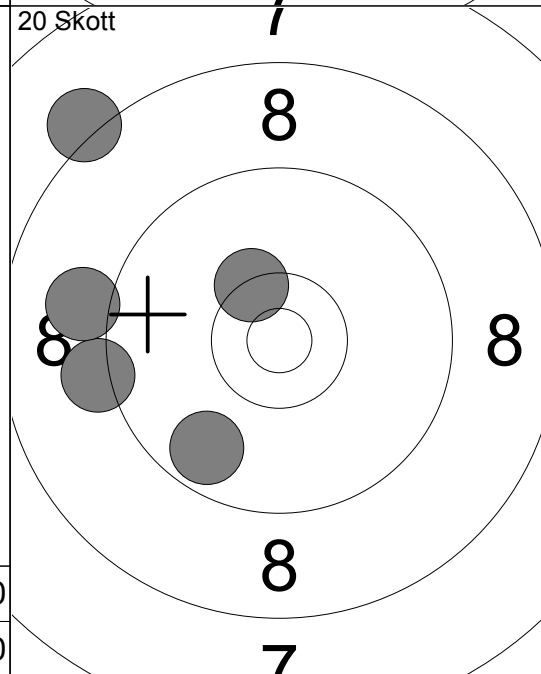

16:	10.4	↖
17:	8.2	↖
18:	9.2	↖
19:	9.7	↙
20:	9.0	↖
Serie		45.0
Total		178.0

<p>Prov</p> <p style="text-align: center;">6 7 8 8 8 7</p> <p style="text-align: center;">8 8 7</p> <p style="text-align: center;">8 7</p> <p style="text-align: right;">Serie 90.0 Total 0.0</p>	<p>1: 7.8 ←</p> <p>2: 8.6 ↙</p> <p>3: 10.7 ↗</p> <p>4: 10.1 ↗</p> <p>5: 9.2 ↗</p> <p>6: 9.2 ↖</p> <p>7: 10.4 ↗</p> <p>8: 9.3 ↗</p> <p>9: 8.9 ↗</p> <p>10: 10.4 ↘</p> <p style="text-align: right;">Serie 47.0 Total 0.0</p>	<p>Prov</p> <p style="text-align: center;">7 8 8 8 8 8</p> <p style="text-align: center;">8 8</p> <p style="text-align: center;">8 7</p> <p style="text-align: right;">11: 9.4 ↗ 12: 10.3 ↘ 13: 9.1 ↖ 14: 9.7 ↗ 15: 10.5 ↘</p> <p style="text-align: right;">Serie 47.0 Total 0.0</p>
<p>20 Skott</p> <p style="text-align: center;">8 8 8 8</p> <p style="text-align: center;">8 8</p> <p style="text-align: center;">8 7</p> <p style="text-align: right;">Serie 48.0 Total 48.0</p>	<p>1: 10.1 ←</p> <p>2: 9.5 ↗</p> <p>3: 10.6 ↘</p> <p>4: 9.5 ←</p> <p>5: 10.3 ↗</p> <p style="text-align: right;">Serie 50.0 Total 98.0</p>	<p>20 Skott</p> <p style="text-align: center;">8 8 8 8</p> <p style="text-align: center;">8 8</p> <p style="text-align: center;">8 7</p> <p style="text-align: right;">6: 10.0 ↗ 7: 10.1 ↖ 8: 10.1 ↘ 9: 10.0 ↘ 10: 10.8 ↘</p> <p style="text-align: right;">Serie 50.0 Total 98.0</p>
<p>20 Skott</p> <p style="text-align: center;">8 8 8 8</p> <p style="text-align: center;">8 8</p> <p style="text-align: center;">8 7</p> <p style="text-align: right;">Serie 48.0 Total 146.0</p>	<p>11: 9.9 ↗</p> <p>12: 10.2 →</p> <p>13: 9.9 ↗</p> <p>14: 10.5 ↘</p> <p>15: 10.7 ↘</p> <p style="text-align: right;">Serie 46.0 Total 192.0</p>	<p>20 Skott</p> <p style="text-align: center;">8 8 8 8</p> <p style="text-align: center;">8 8</p> <p style="text-align: center;">8 7</p> <p style="text-align: right;">16: 9.3 ↗ 17: 9.0 ↖ 18: 9.9 ← 19: 9.9 ↗ 20: 10.4 ↘</p> <p style="text-align: right;">Serie 46.0 Total 192.0</p>

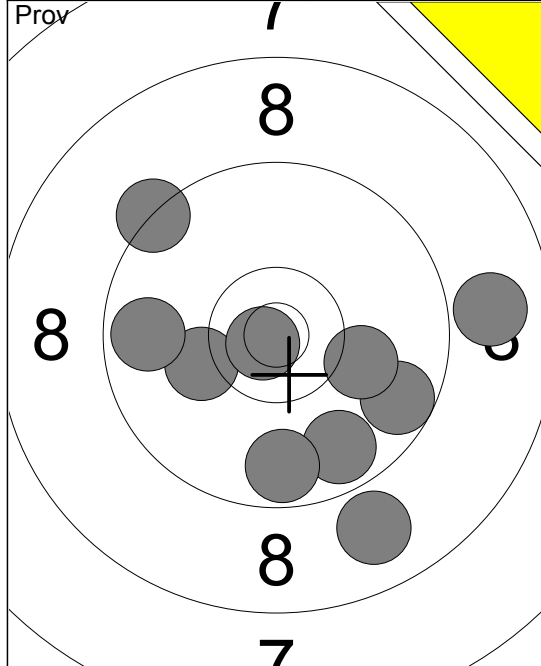

1:	10.2	↙
2:	9.7	→
3:	9.3	↗
4:	9.7	↖
5:	9.7	↘
6:	10.1	→
7:	8.9	→
8:	9.7	↘
9:	8.9	↘
10:	10.8	↘
Serie	91.0	
Total	0.0	

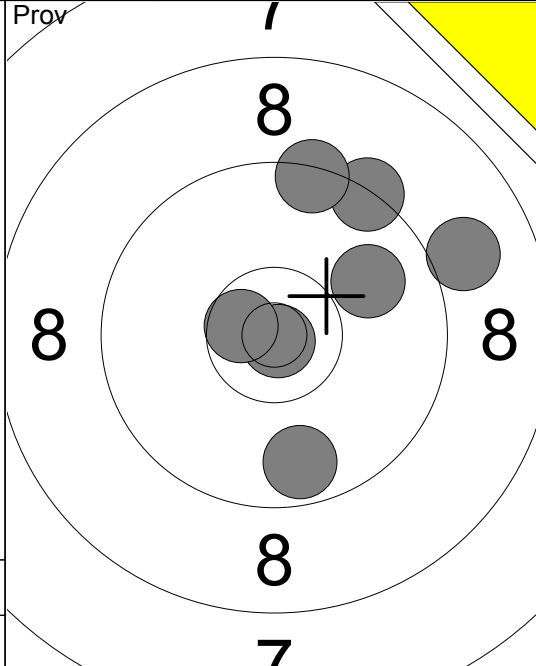

11:	10.9	↘
12:	9.9	↗
13:	9.3	↗
14:	9.0	↗
15:	9.4	↗
16:	10.6	↘
17:	9.7	↘
Serie	65.0	
Total	0.0	

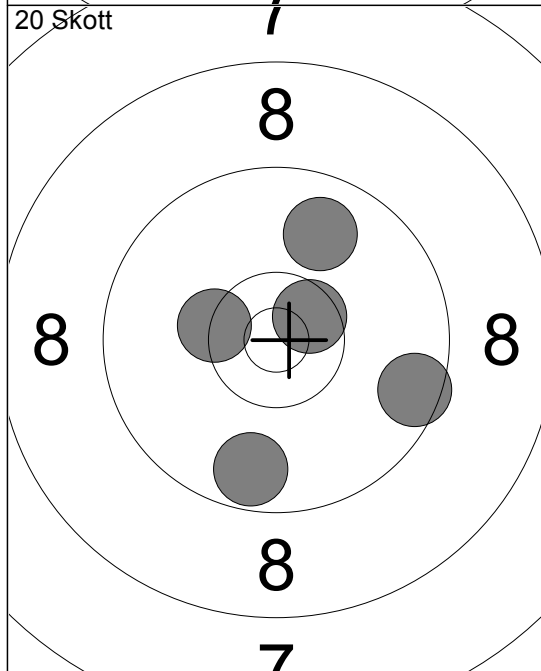

1:	10.6	↗
2:	9.9	↗
3:	9.5	→
4:	10.3	↘
5:	9.7	↘
Serie	47.0	
Total	47.0	

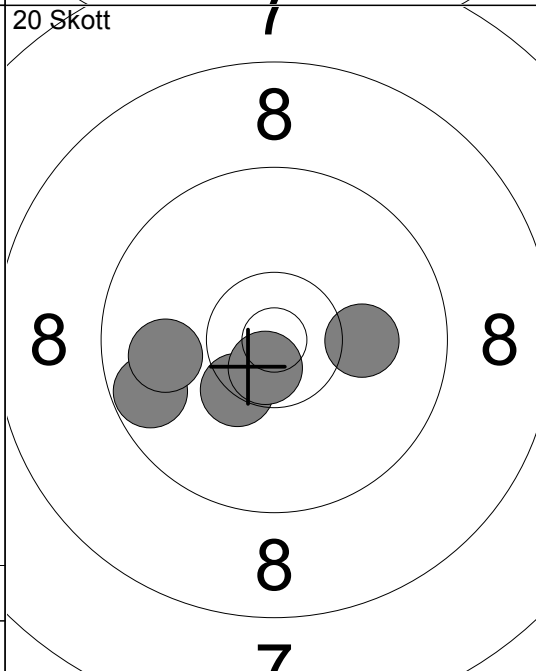

6:	10.4	↘
7:	9.7	↖
8:	9.9	↖
9:	10.7	↘
10:	10.1	→
Serie	48.0	
Total	95.0	

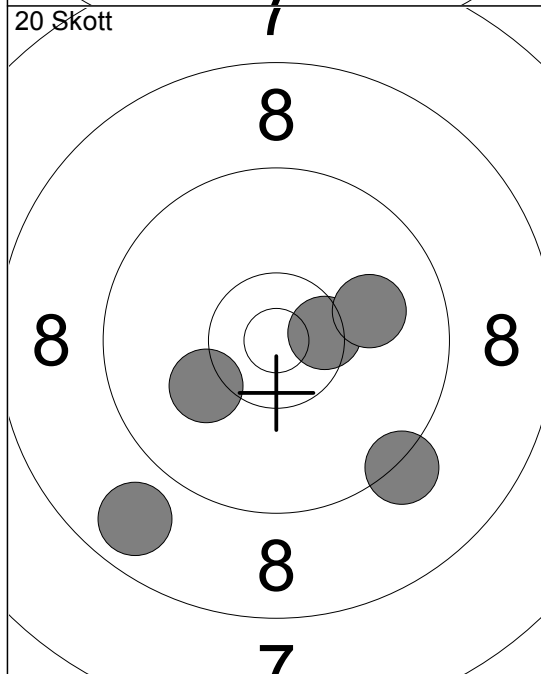

11:	10.5	↗
12:	10.0	→
13:	9.2	↘
14:	8.8	↘
15:	10.2	↙
Serie	47.0	
Total	142.0	

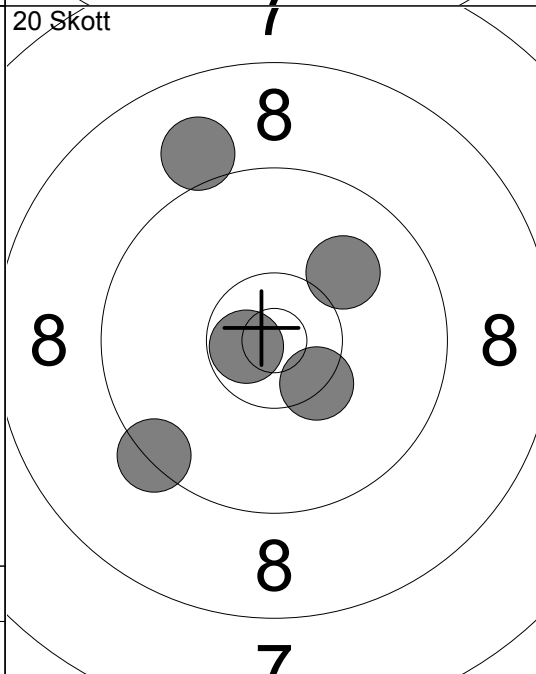

16:	10.4	↘
17:	10.7	↘
18:	9.4	↖
19:	9.0	↗
20:	10.0	↗
Serie	48.0	
Total	190.0	

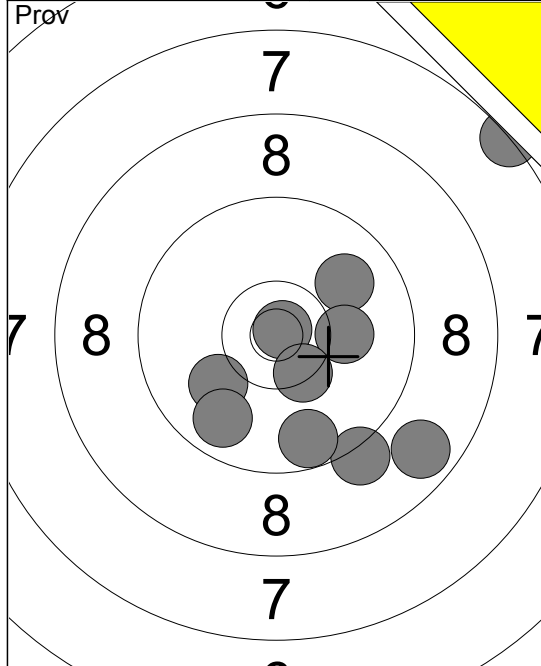

1:	7.3 ↗
2:	8.7 ↘
3:	9.2 ↘
4:	9.9 ↗
5:	9.7 ↘
6:	10.1 →
7:	10.9 ↗
8:	10.4 ✕
9:	10.0 ↘
10:	9.8 ↘
Serie	91.0
Total	0.0

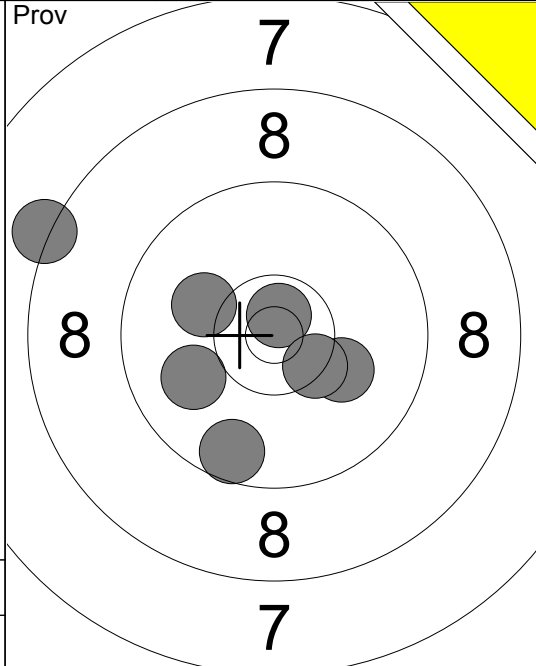

11:	10.7 ✕ ↗
12:	10.0 ↙
13:	10.1 ↘
14:	8.2 ↙
15:	10.1 ↙
16:	10.4 ✕ ↘
17:	9.6 ↘
Serie	67.0
Total	0.0

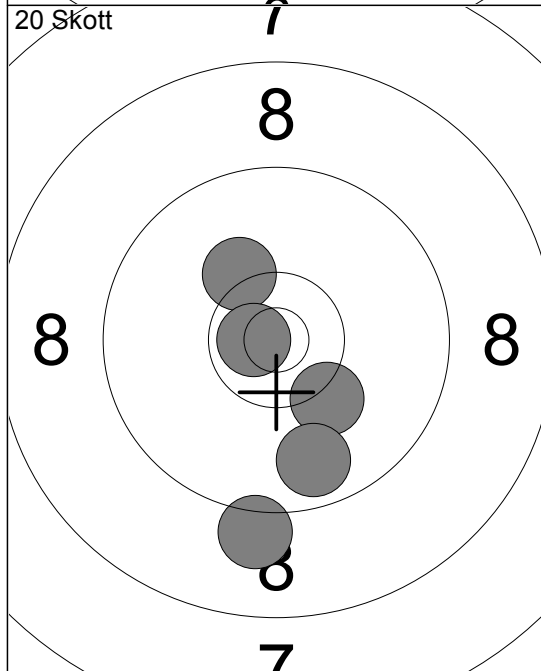

1:	10.2 ↗
2:	10.2 ↘
3:	9.7 ↘
4:	10.7 ✕ ←
5:	9.1 ↘
Serie	48.0
Total	48.0

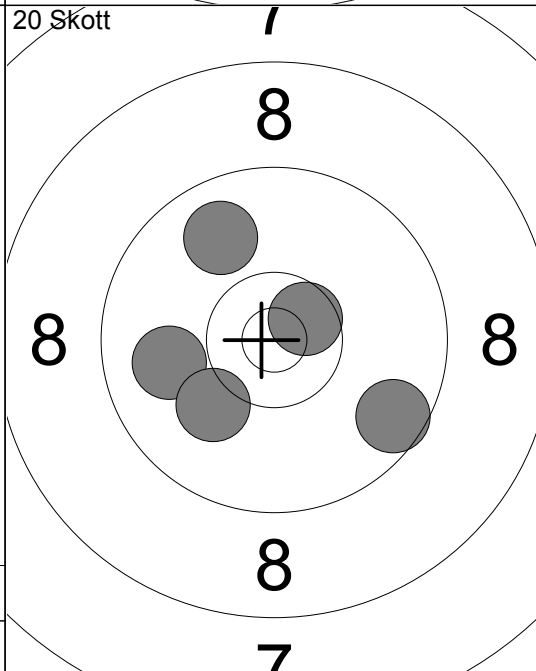

6:	9.9 ←
7:	10.1 ↘
8:	10.6 ✕ ↗
9:	9.6 ↘
10:	9.9 ↗
Serie	47.0
Total	95.0

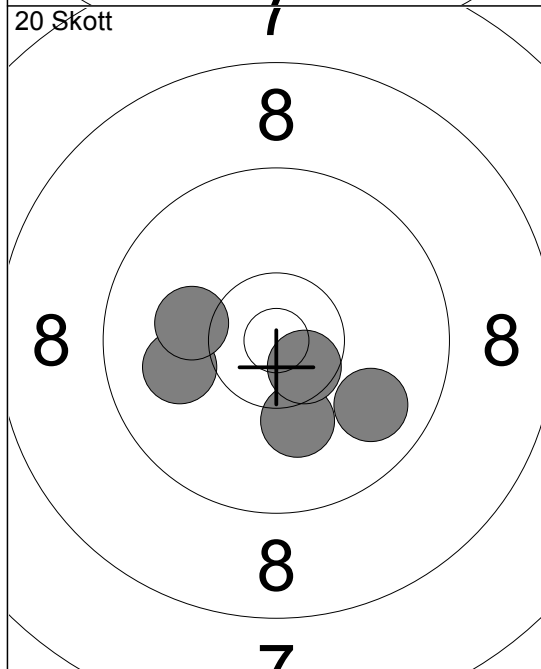

11:	10.0 ↙
12:	10.2 ↘
13:	10.1 ↙
14:	10.6 ✕ ↘
15:	9.9 ↘
Serie	49.0
Total	144.0

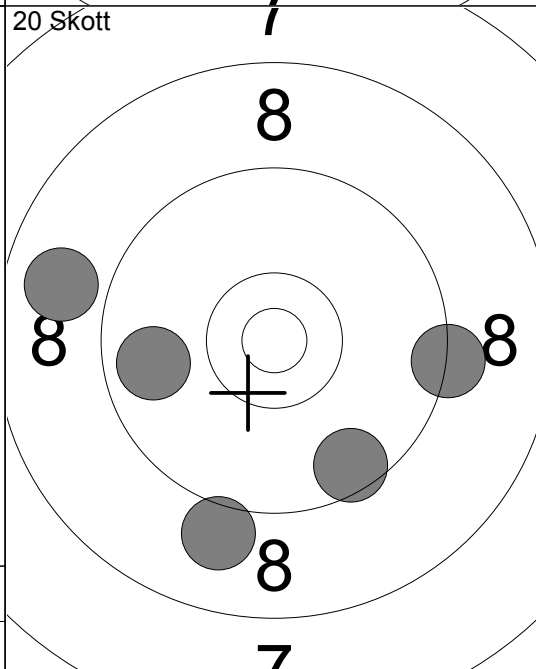

16:	9.0 ↘
17:	9.3 →
18:	9.6 ↘
19:	8.8 ↙
20:	9.8 ←
Serie	44.0
Total	188.0

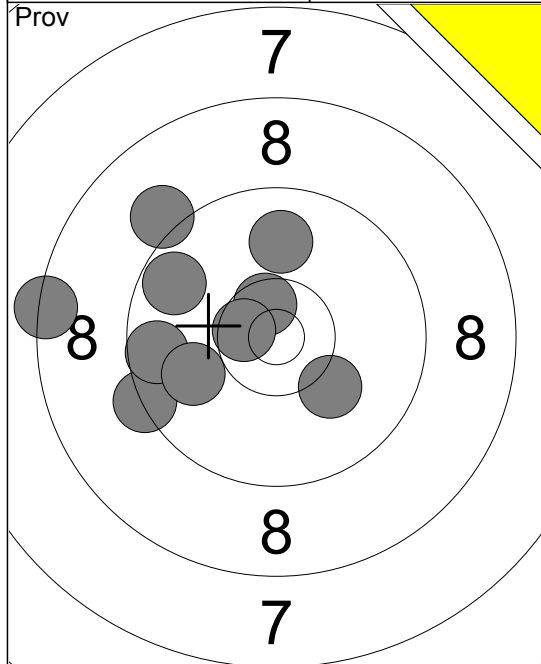

1:	9.3	↙
2:	10.1	↘
3:	8.4	←
4:	9.6	←
5:	9.9	↙
6:	9.9	↑
7:	10.6	↗
8:	9.7	↖
9:	10.6	↘
10:	9.1	↖
Serie		92.0
Total		0.0

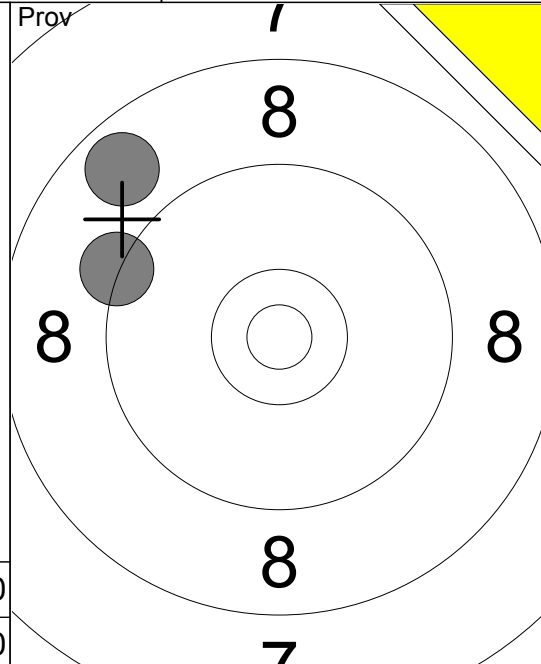

11:	9.3	↙
12:	8.8	↖
Serie		17.0
Total		0.0

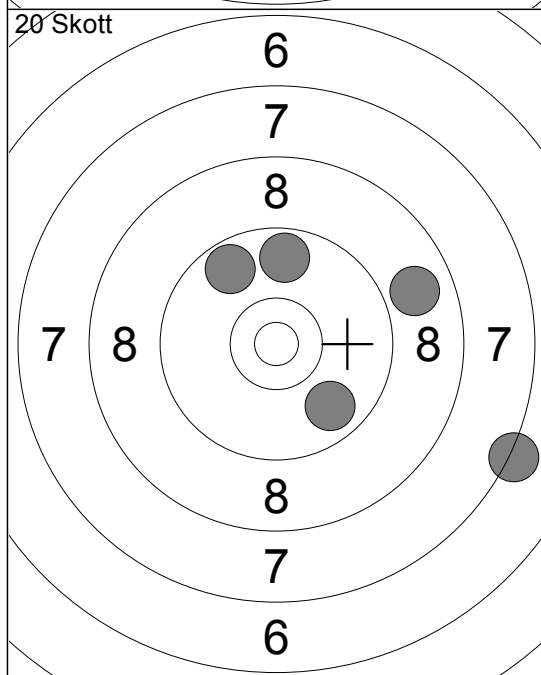

1:	9.8	↘
2:	7.2	↘
3:	8.9	→
4:	9.7	↑
5:	9.7	↖
Serie		42.0
Total		42.0

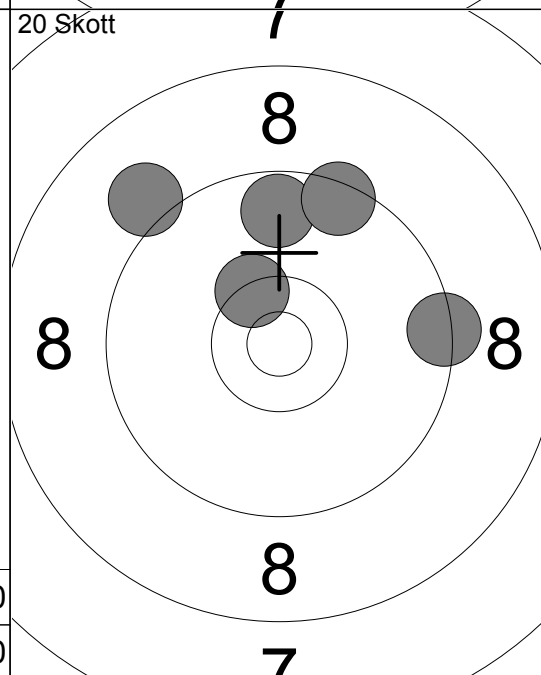

6:	9.7	↑
7:	10.4	↘
8:	9.5	↖
9:	9.1	↖
10:	9.4	→
Serie		46.0
Total		88.0

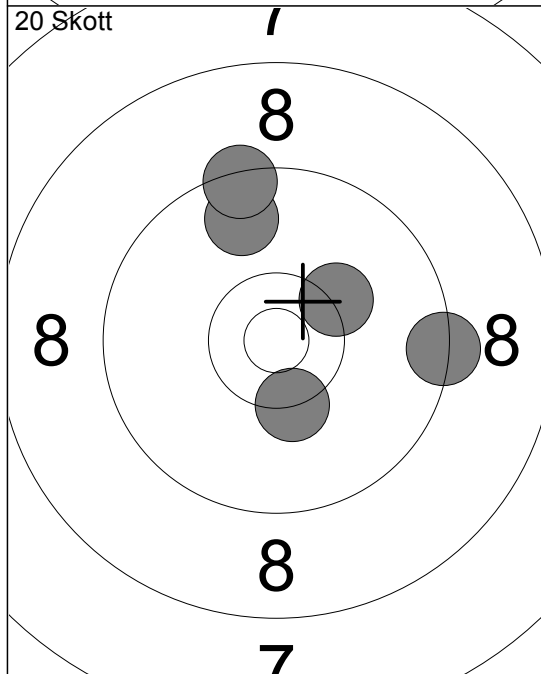

11:	10.3	↗
12:	9.7	↖
13:	10.3	↘
14:	9.4	↑
15:	9.4	→
Serie		47.0
Total		135.0

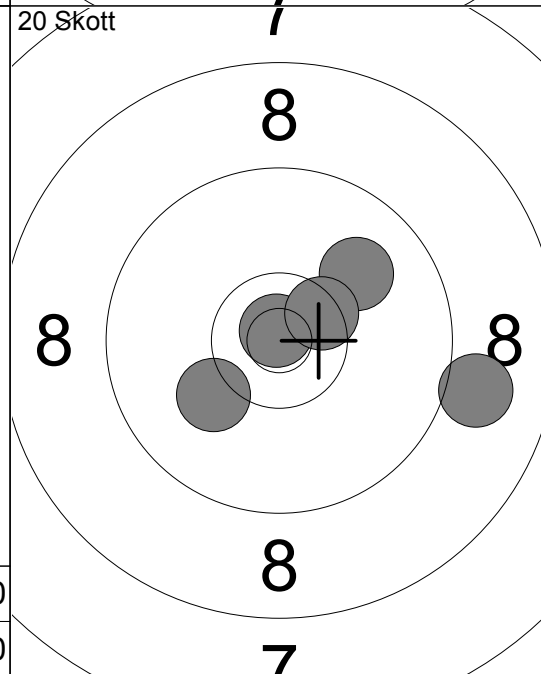

16:	9.0	→
17:	10.1	↙
18:	10.0	↗
19:	10.9	↘
20:	10.5	↘
Serie		49.0
Total		184.0