

1. Serie 5 Skott

1:	9.5	↑
2:	9.3	↓
3:	8.7	↓
4:	9.8	↑
5:	10.7x	↗
Serie	45.0	
Total	0.0	

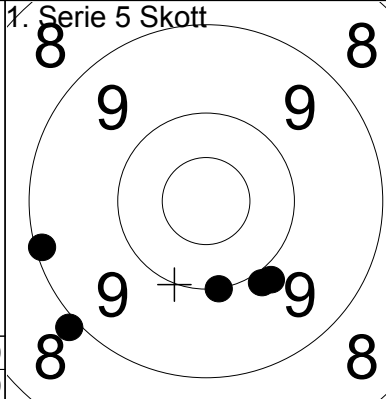

1. Serie 5 Skott

1:	9.1	←
2:	8.9	↙
3:	9.9	↓
4:	9.9	↓
5:	10.0	↓
Serie	45.0	
Total	45.0	

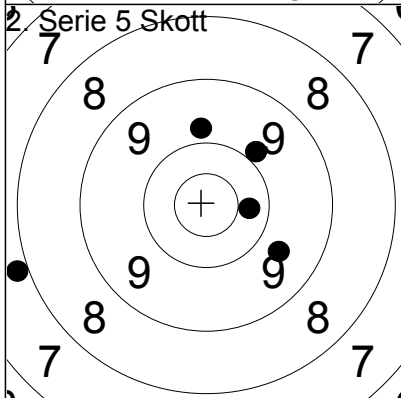

2. Serie 5 Skott

1:	7.9	←
2:	9.9	↗
3:	10.3	→
4:	9.8	↑
5:	9.7	↓
Serie	44.0	
Total	89.0	

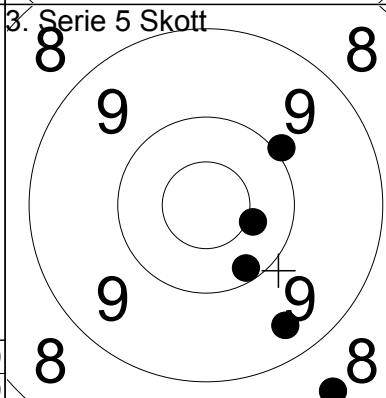

3. Serie 5 Skott

1:	10.2	↓
2:	8.5	↙
3:	9.4	↙
4:	10.4x	→
5:	10.0	↗
Serie	47.0	
Total	136.0	

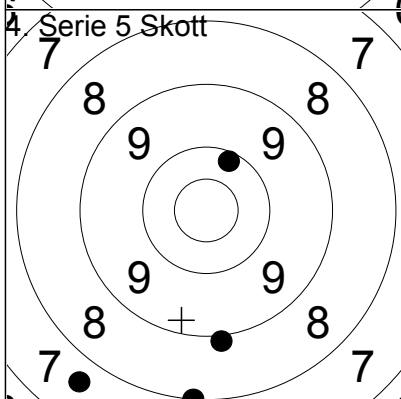

4. Serie 5 Skott

1:	8.9	↓
2:	8.0	↓
3:	10.2	↗
4:	0.0	
5:	7.6	↙
Serie	33.0	
Total	169.0	

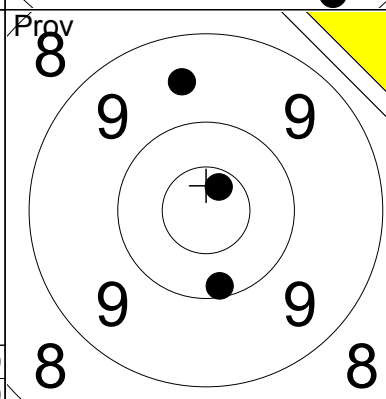

5. Serie 5 Skott

1:	9.6	↑
2:	10.1	↓
3:	10.7x	↗
Serie	29.0	
Total	169.0	

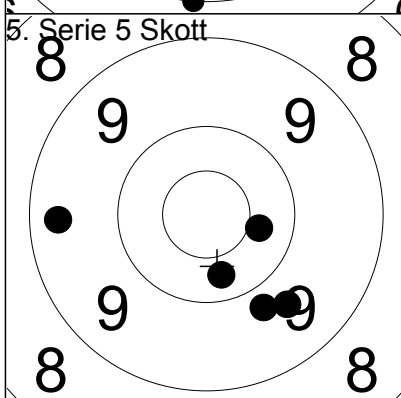

6. Serie 5 Skott

1:	9.4	←
2:	10.4	→
3:	9.8	↙
4:	10.3	↙
5:	9.7	↙
Serie	47.0	
Total	216.0	

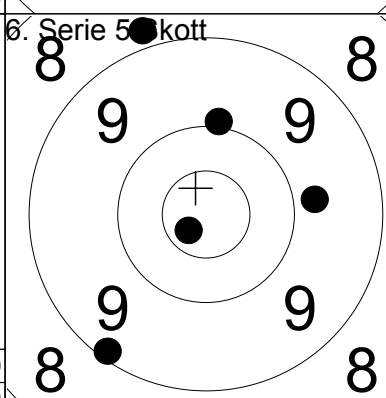

7. Serie 5 Skott

1:	8.8	↑
2:	9.1	↙
3:	10.7x	↙
4:	9.8	→
5:	10.0	↑
Serie	46.0	
Total	262.0	

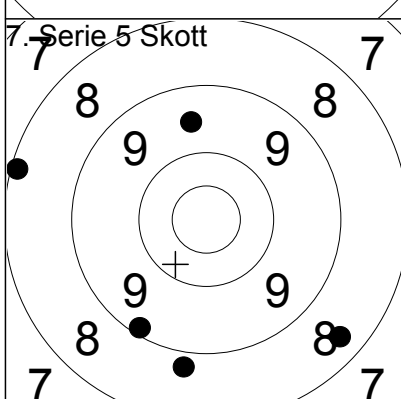

8. Serie 5 Skott

1:	9.6	↑
2:	8.1	←
3:	8.4	↙
4:	8.8	↙
5:	9.1	↙
Serie	42.0	
Total	304.0	

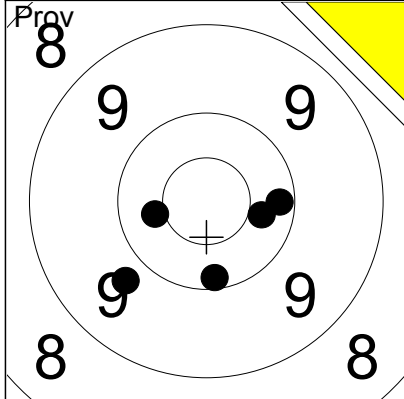

1:	10.1	↓
2:	10.4	→
3:	9.7	↙
4:	10.2	→
5:	10.4	←
Serie	49.0	
Total	0.0	

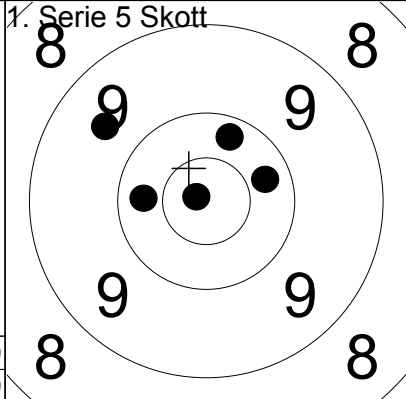

1:	10.8x	↖
2:	9.6	↗
3:	10.3	←
4:	10.3	→
5:	10.2	↑
Serie	49.0	
Total	49.0	

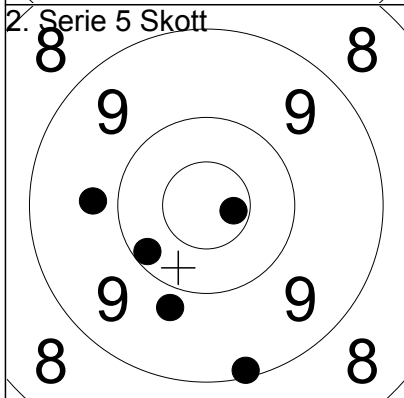

1:	10.7x	→
2:	10.2	↙
3:	9.7	←
4:	9.8	↘
5:	9.1	↓
Serie	47.0	
Total	96.0	

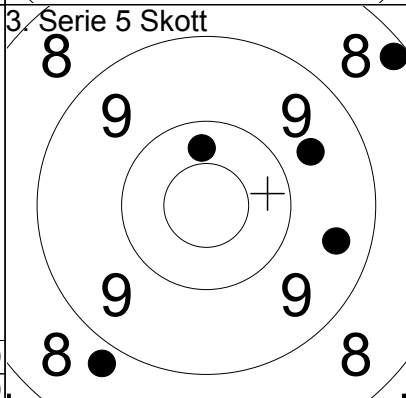

1:	8.2	↗
2:	9.6	→
3:	9.4	→
4:	10.3	↑
5:	8.8	↘
Serie	44.0	
Total	140.0	

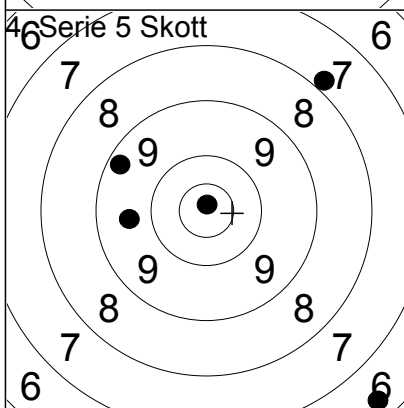

1:	9.3	↖
2:	10.9x	↑
3:	7.8	↗
4:	9.6	←
5:	6.4	↘
Serie	41.0	
Total	181.0	

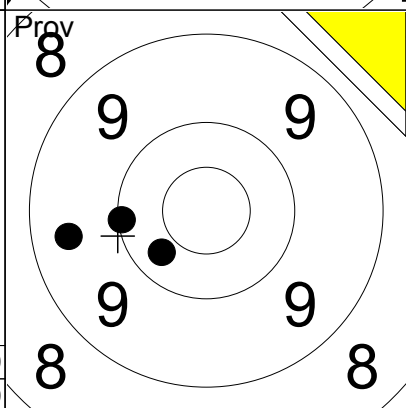

1:	10.1	←
2:	10.3	↙
3:	9.4	←
Serie	29.0	
Total	181.0	

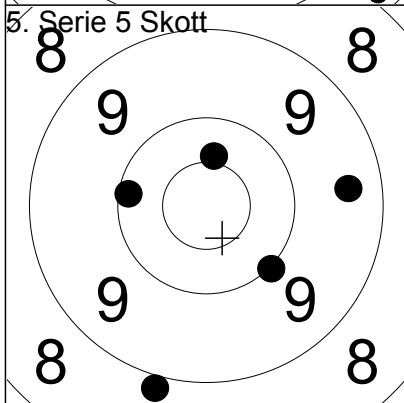

1:	10.1	←
2:	10.0	↘
3:	8.9	↘
4:	10.4x	↑
5:	9.4	→
Serie	47.0	
Total	228.0	

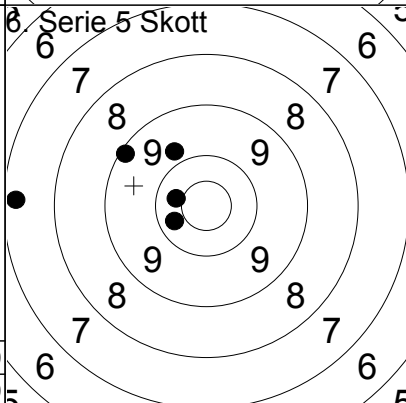

1:	9.1	↖
2:	10.3	←
3:	7.3	←
4:	10.4	←
5:	9.8	↗
Serie	45.0	
Total	273.0	

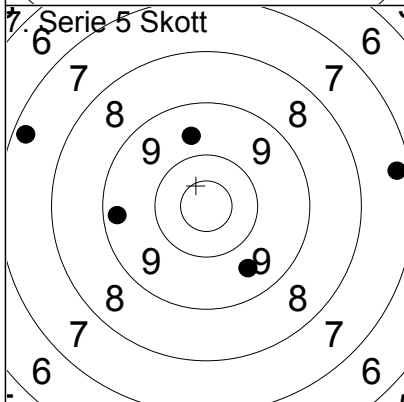

1:	7.3	←
2:	9.6	↑
3:	9.3	←
4:	7.3	→
5:	9.6	↘
Serie	41.0	
Total	314.0	

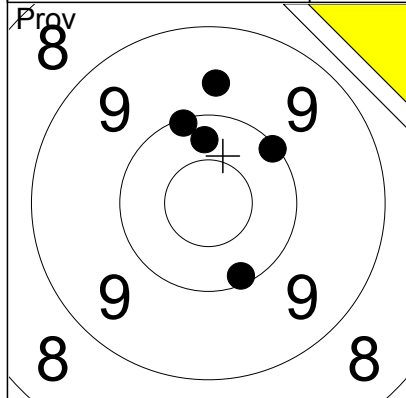

1:	9.7	↑
2:	10.1	↓
3:	10.3	↑
4:	10.1	↑
5:	10.1	↗
Serie		49.0
Total		0.0

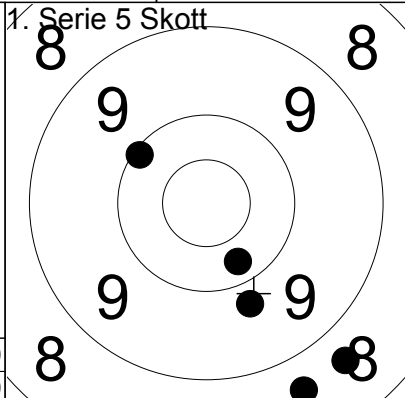

1:	10.1	↗
2:	10.3	↓
3:	9.8	↓
4:	8.7	↓
5:	8.6	↓
Serie		45.0
Total		45.0

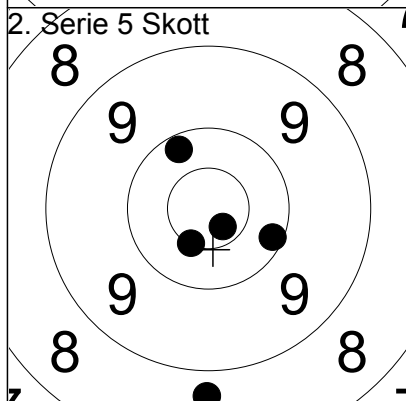

1:	10.5x	↓
2:	10.7x	↓
3:	10.2	↗
4:	10.1	↓
5:	8.7	↓
Serie		48.0
Total		93.0

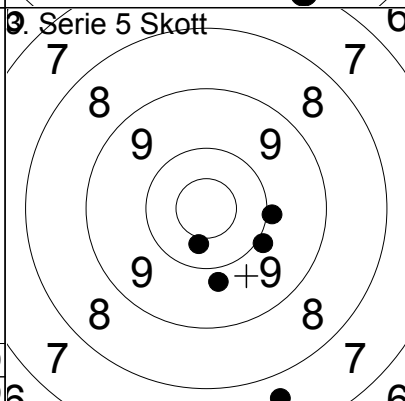

1:	9.9	↘
2:	9.9	→
3:	10.4	↓
4:	9.8	↓
5:	7.7	↓
Serie		44.0
Total		137.0

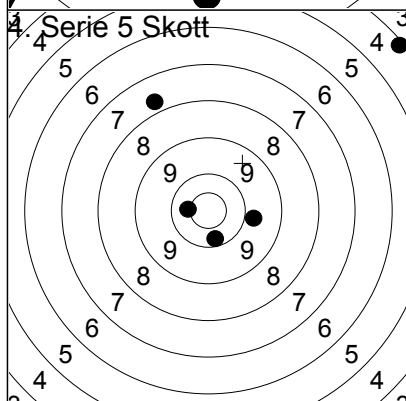

1:	10.4x	←
2:	9.8	→
3:	10.2	↓
4:	4.1	↗
5:	7.7	↗
Serie		40.0
Total		177.0

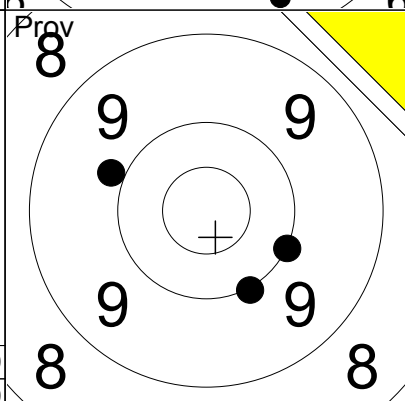

1:	9.9	↖
2:	10.0	↓
3:	10.0	↘
Serie		29.0
Total		177.0

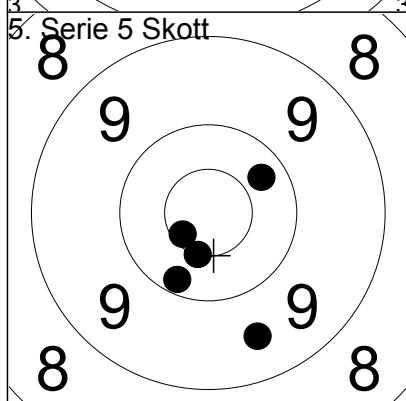

1:	10.5x	↓
2:	9.5	↓
3:	10.2	↓
4:	10.3	↗
5:	10.6x	↖
Serie		49.0
Total		226.0

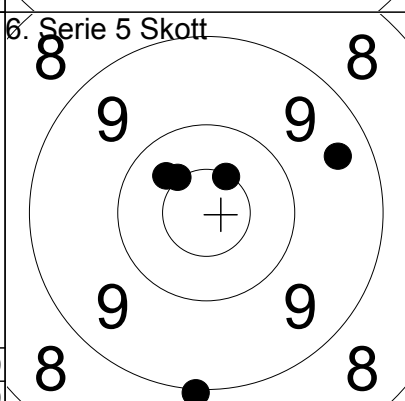

1:	10.5x	↗
2:	10.5x	↗
3:	9.0	↓
4:	9.4	↗
5:	10.4	↗
Serie		48.0
Total		274.0

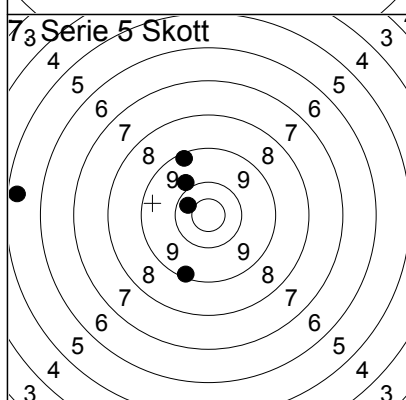

1:	10.3	↖
2:	9.1	↓
3:	9.2	↗
4:	5.3	←
5:	9.9	↗
Serie		42.0
Total		316.0

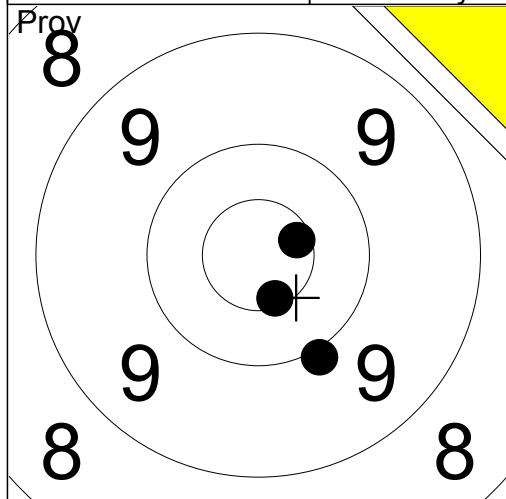

1: 10.6x ↘
2: 10.0 ↘
3: 10.6x →

Serie 30.0
Total 0.0

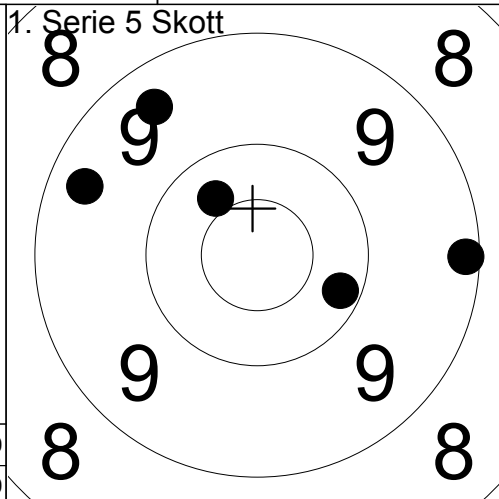

1: 9.4 ↗
2: 9.4 ↗
3: 10.4 ↗
4: 9.2 →
5: 10.2 ↘

Serie 47.0
Total 47.0

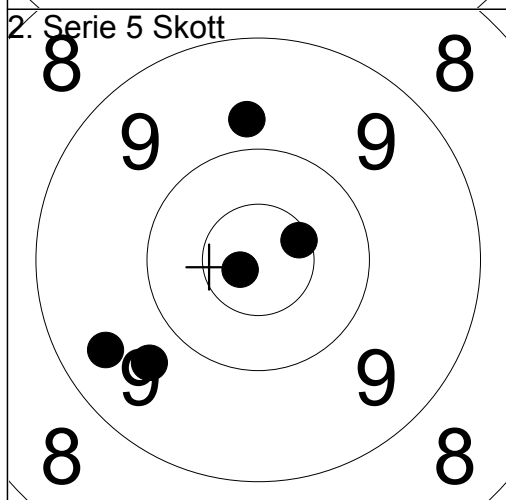

1: 9.7 ↙
2: 9.4 ↙
3: 10.6x →
4: 10.8x ↙
5: 9.8 ↑

Serie 47.0
Total 94.0

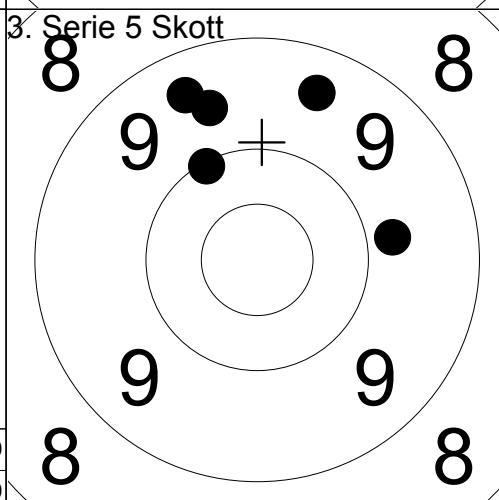

1: 9.8 →
2: 9.4 ↑
3: 9.4 ↑
4: 9.6 ↑
5: 10.1 ↗

Serie 46.0
Total 140.0

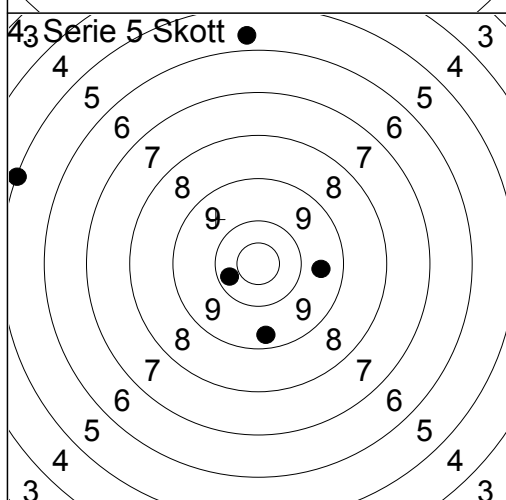

1: 9.4 ↘
2: 10.3 ↙
3: 9.6 →
4: 5.0 ↙
5: 5.7 ↑

Serie 38.0
Total 178.0

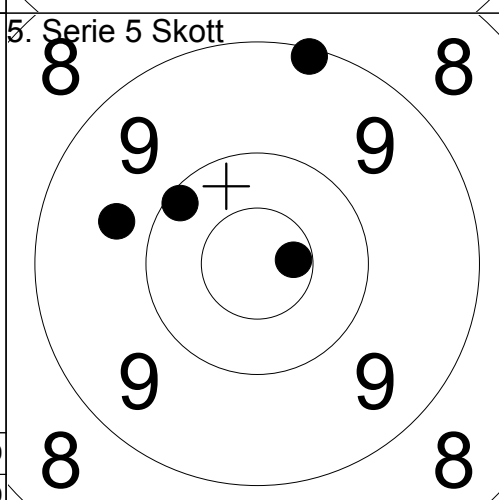

1: 9.7 ↙
2: 10.1 ↗
3: 9.1 ↑
4: 10.6x →
5: 0.0

Serie 38.0
Total 216.0

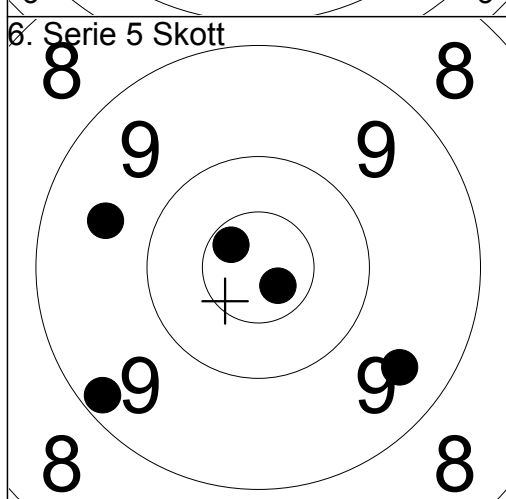

1: 9.2 ↙
2: 9.6 ↙
3: 10.7x ↗
4: 10.7x ↘
5: 9.5 ↘

Serie 47.0
Total 263.0

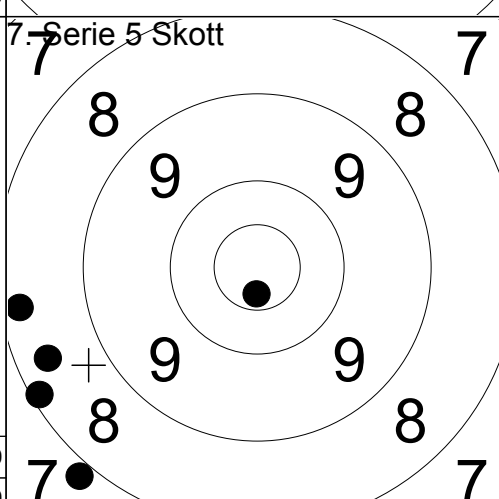

1: 8.4 ↙
2: 8.3 ↙
3: 10.7x ↘
4: 7.9 ↙
5: 8.1 ↙

Serie 41.0
Total 304.0

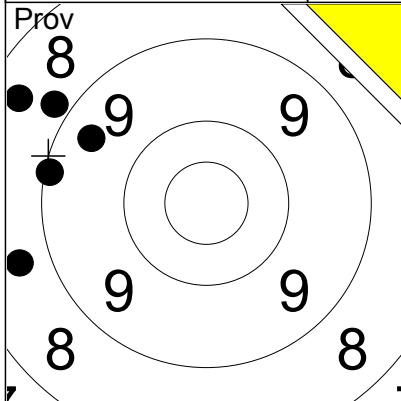

1:	8.8	↗
2:	9.4	↗
3:	8.4	↗
4:	9.1	↗
5:	8.6	←
Serie	42.0	
Total	0.0	

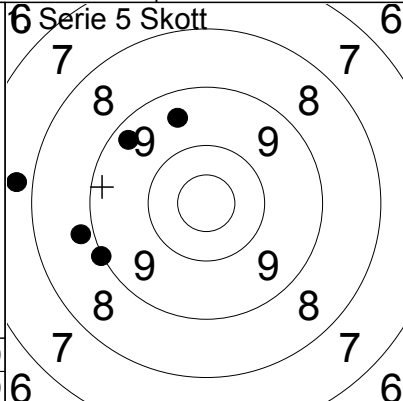

1:	9.5	↗
2:	9.3	↗
3:	8.8	←
4:	7.8	←
5:	9.0	←
Serie	42.0	
Total	42.0	

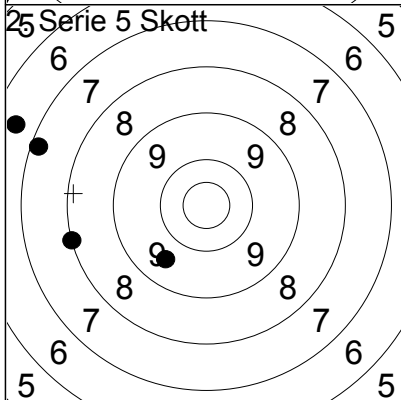

1:	9.6	↘
2:	7.2	↗
3:	6.6	↗
4:	8.0	←
5:	0.0	
Serie	30.0	
Total	72.0	

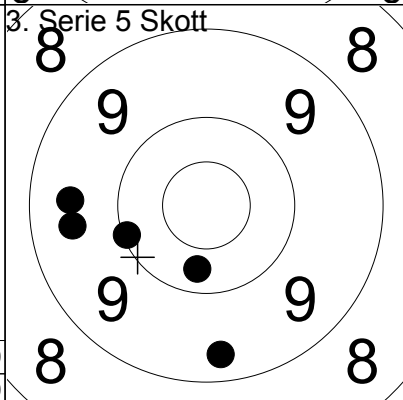

1:	10.3	↘
2:	9.5	←
3:	9.5	←
4:	10.1	←
5:	9.3	↘
Serie	47.0	
Total	119.0	

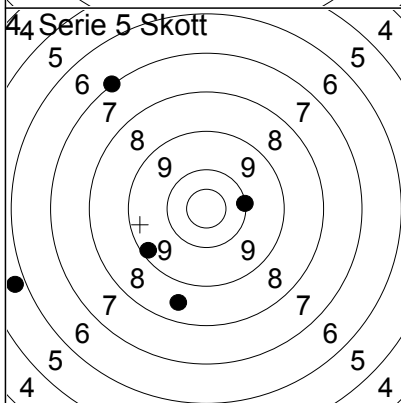

1:	7.0	↗
2:	8.5	↘
3:	10.0	→
4:	5.8	←
5:	9.2	↘
Serie	39.0	
Total	158.0	

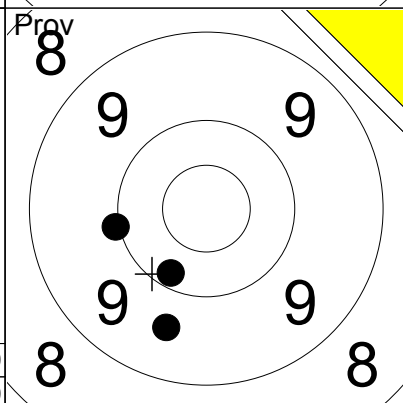

1:	10.2	↘
2:	9.6	↘
3:	10.0	←
Serie	29.0	
Total	158.0	

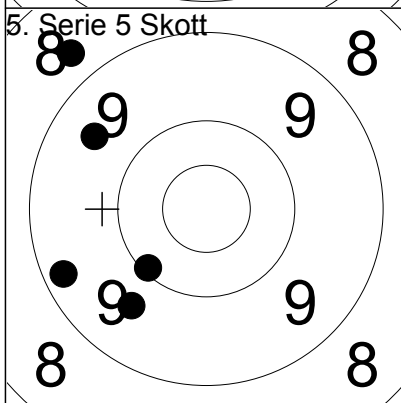

1:	9.3	←
2:	9.6	↘
3:	8.7	↗
4:	9.5	↗
5:	10.1	↘
Serie	45.0	
Total	203.0	

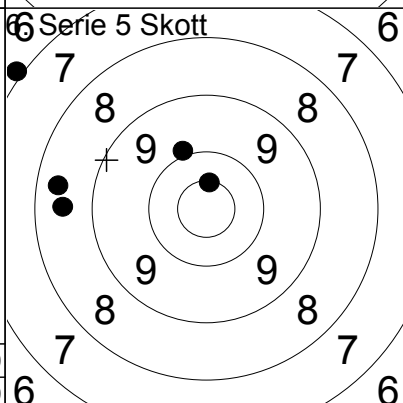

1:	9.9	↗
2:	8.4	←
3:	8.5	←
4:	6.9	↗
5:	10.5x	↗
Serie	41.0	
Total	244.0	

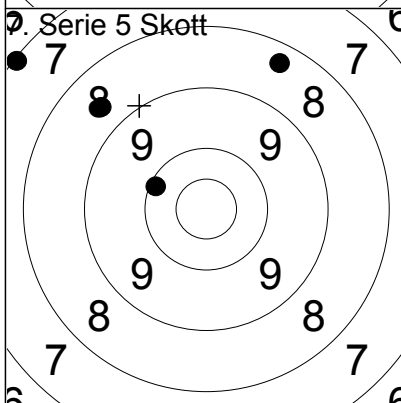

1:	7.1	↗
2:	10.1	↗
3:	0.0	
4:	8.4	↗
5:	8.6	↗
Serie	33.0	
Total	277.0	

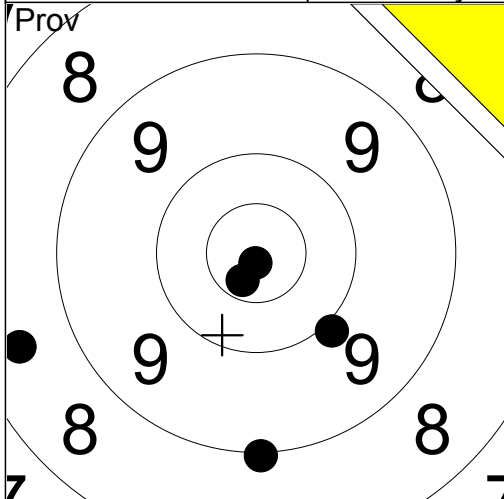

1:	9.0	↓
2:	9.9	↓
3:	10.9x	↓
4:	8.5	←
5:	10.7x	↓
Serie	46.0	
Total	0.0	

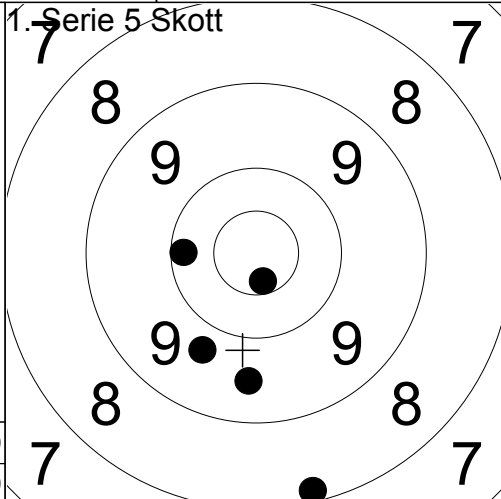

1:	10.2	←
2:	10.6x	↓
3:	8.2	↓
4:	9.5	↓
5:	9.7	↓
Serie	46.0	
Total	46.0	

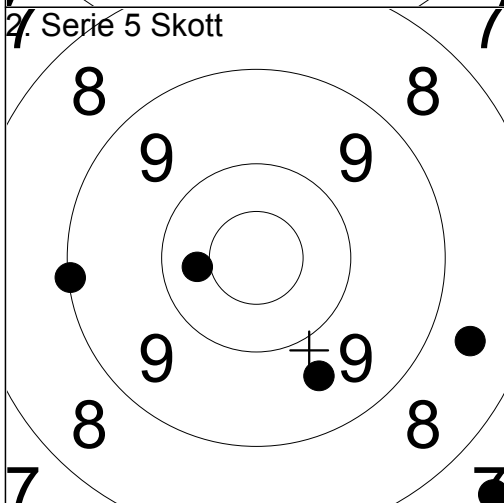

1:	10.4	←
2:	9.6	↓
3:	7.5	↓
4:	8.6	→
5:	9.1	←
Serie	43.0	
Total	89.0	

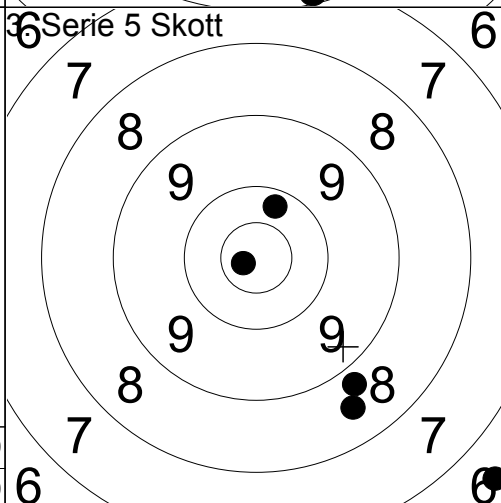

1:	10.8x	←
2:	8.8	↓
3:	10.2	↑
4:	8.5	↓
5:	6.5	↓
Serie	42.0	
Total	131.0	

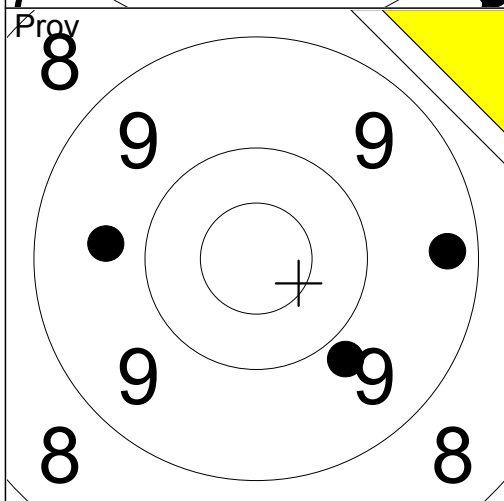

1:	9.8	↓
2:	9.7	←
3:	9.3	→
Serie	27.0	
Total	131.0	

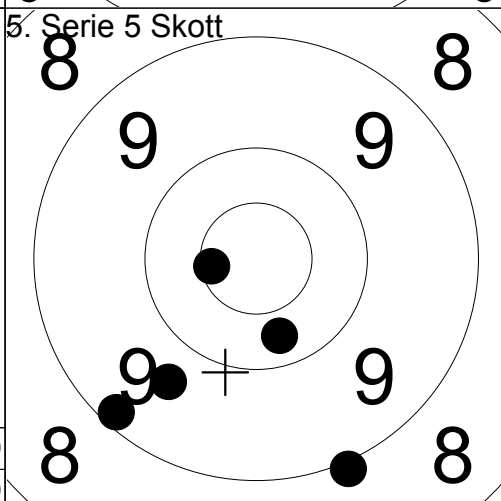

1:	9.0	↓
2:	10.6x	←
3:	10.3	↓
4:	9.7	↓
5:	9.2	↓
Serie	47.0	
Total	178.0	

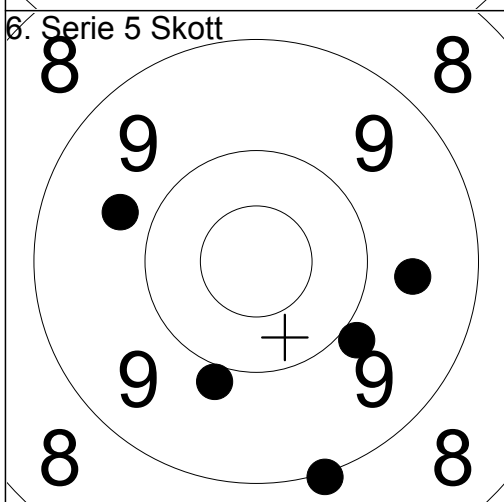

1:	9.7	↑
2:	9.6	→
3:	9.9	↓
4:	9.9	↓
5:	9.0	↓
Serie	45.0	
Total	223.0	

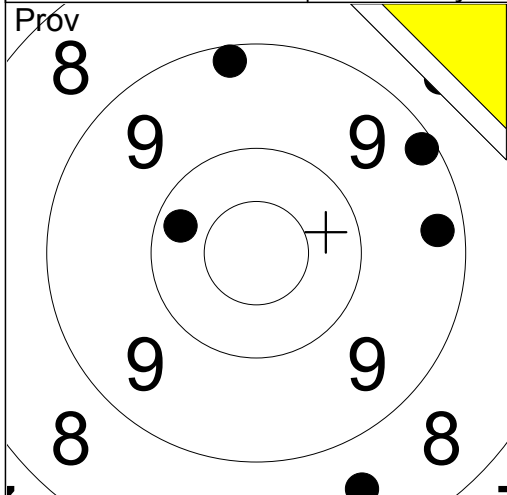

1:	8.6	↘
2:	10.2	↖
3:	9.3	→
4:	9.2	↗
5:	9.2	↑
Serie		45.0
Total		0.0

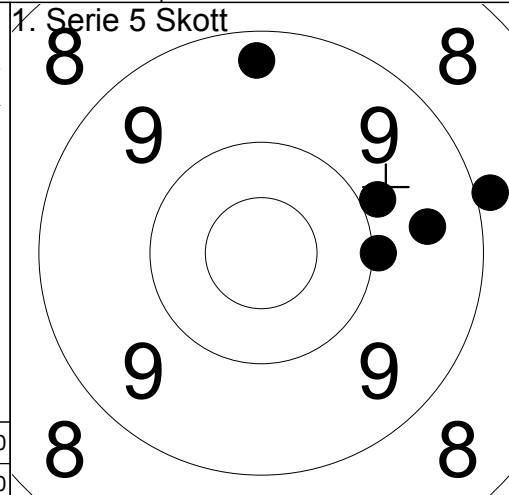

1:	9.5	→
2:	10.0	→
3:	8.9	→
4:	9.3	↑
5:	9.9	↗
Serie		45.0
Total		45.0

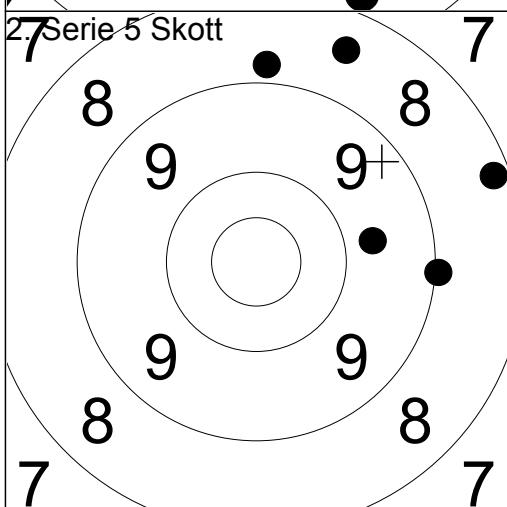

1:	8.8	↑
2:	9.7	→
3:	8.2	↗
4:	9.0	→
5:	8.5	↑
Serie		42.0
Total		87.0

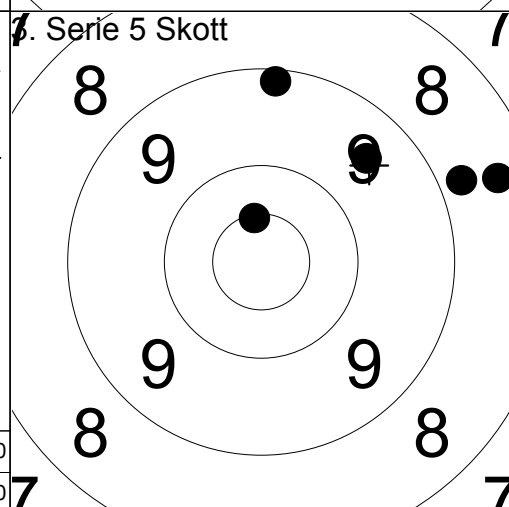

1:	9.2	↑
2:	10.5x	↑
3:	8.8	↗
4:	9.5	↗
5:	8.4	→
Serie		44.0
Total		131.0

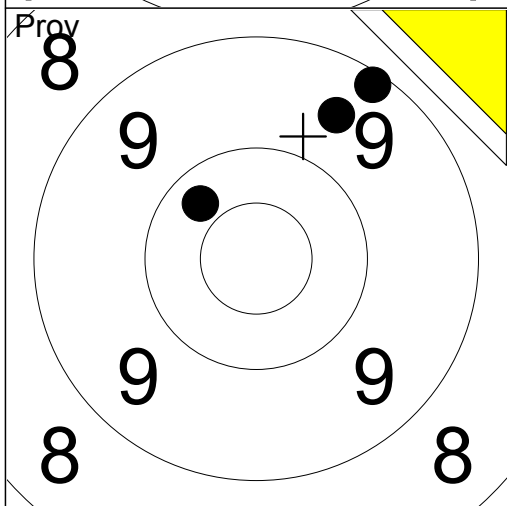

1:	10.3	↖
2:	9.5	↗
3:	9.2	↗
Serie		28.0
Total		131.0

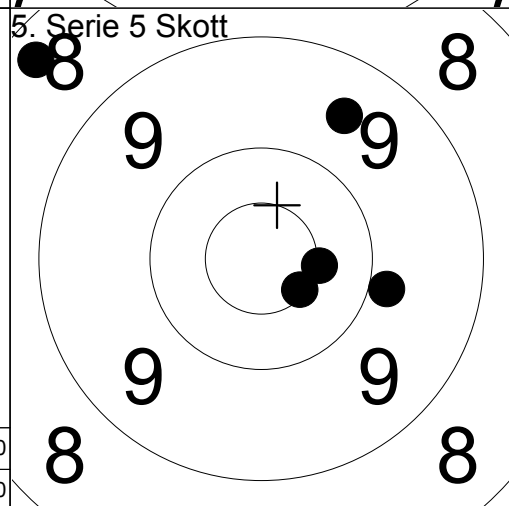

1:	8.3	↖
2:	9.5	↗
3:	10.5x	→
4:	10.5x	↘
5:	9.9	→
Serie		46.0
Total		177.0

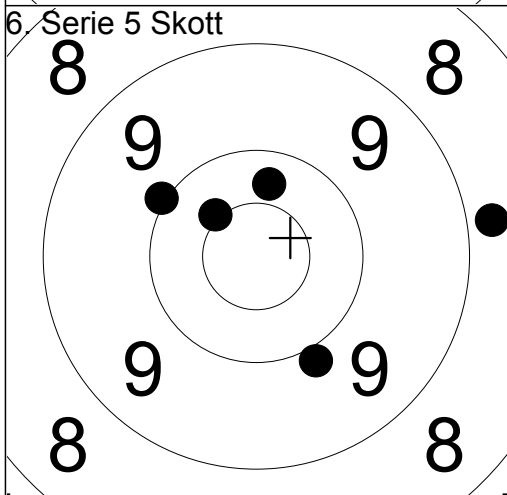

1:	8.8	→
2:	10.3	↑
3:	9.9	↘
4:	10.4x	↗
5:	10.0	↗
Serie		47.0
Total		224.0

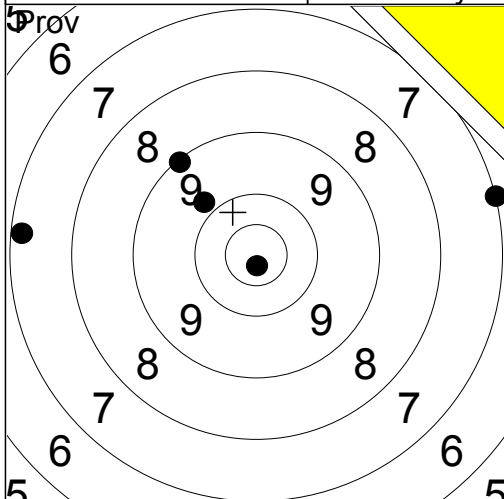

1:	7.2	←
2:	10.8x	↓
3:	9.1	↗
4:	9.8	↗
5:	7.0	→

Serie	42.0
Total	0.0

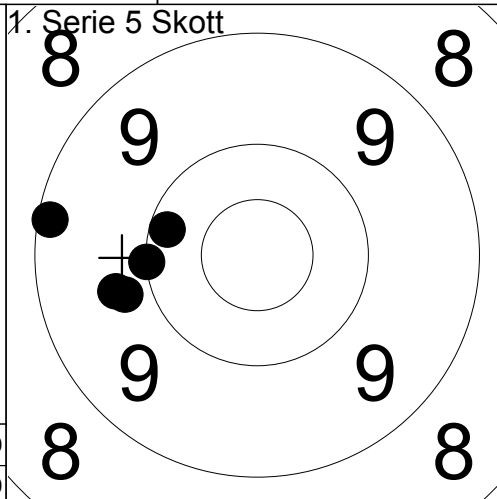

1:	9.1	←
2:	9.7	←
3:	9.8	←
4:	10.0	←
5:	10.2	←

Serie	47.0
Total	47.0

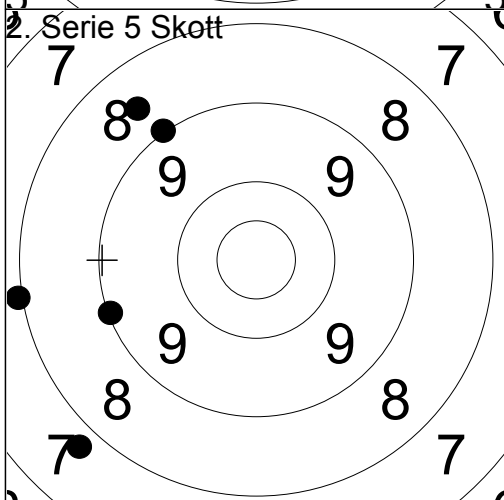

1:	8.6	↗
2:	9.0	↗
3:	9.1	←
4:	7.8	↙
5:	8.0	←

Serie	41.0
Total	88.0

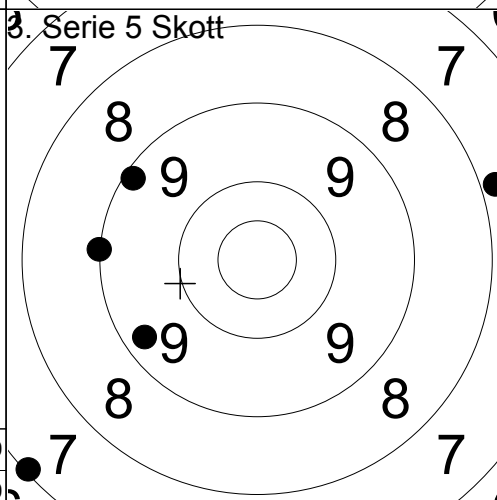

1:	7.8	→
2:	7.1	↙
3:	9.0	←
4:	9.3	↙
5:	9.1	↖

Serie	41.0
Total	129.0

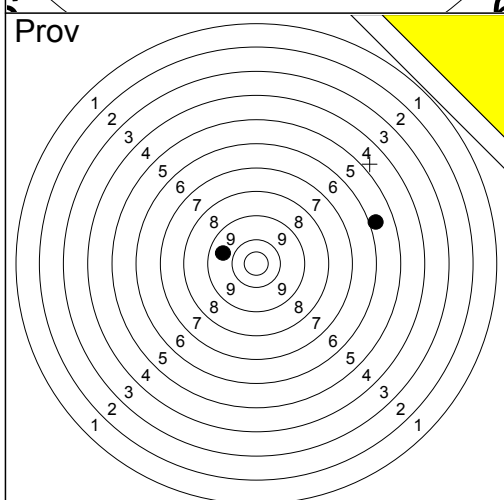

1:	9.6	←
2:	0.0	↗
3:	5.8	→

Serie	14.0
Total	129.0

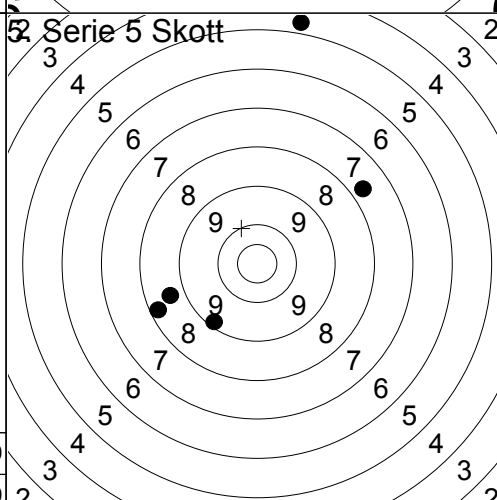

1:	4.7	↑
2:	7.7	↗
3:	8.7	←
4:	8.2	↙
5:	9.2	↙

Serie	36.0
Total	165.0

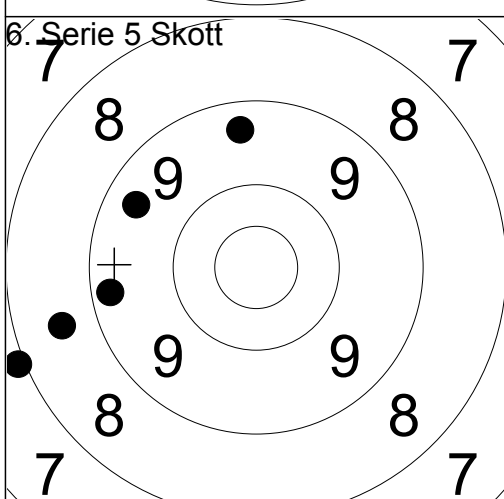

1:	8.0	←
2:	9.4	←
3:	8.6	←
4:	9.3	←
5:	9.4	↑

Serie	43.0
Total	208.0

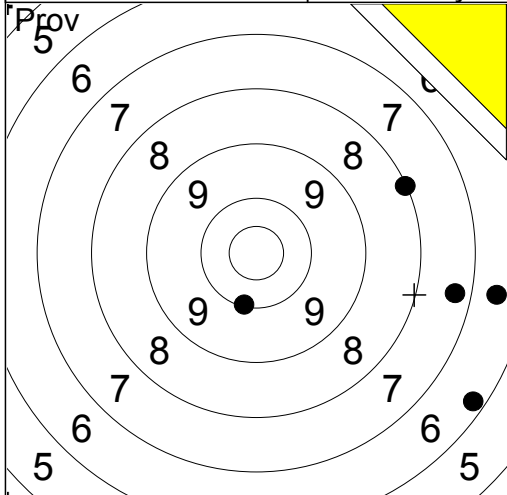

1:	6.6	→
2:	6.2	↘
3:	7.3	→
4:	8.1	→
5:	10.1	↓

Serie	37.0
Total	0.0

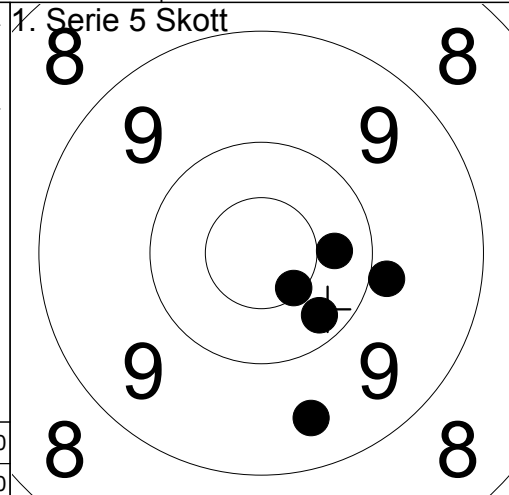

1:	10.2	↘
2:	9.9	→
3:	10.3	→
4:	10.6x	↘
5:	9.5	↘

Serie	48.0
Total	48.0

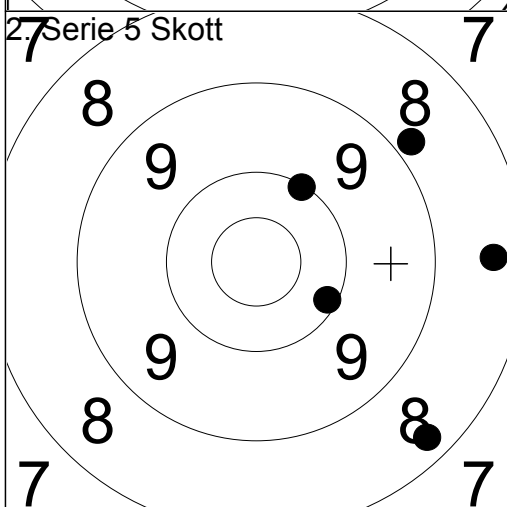

1:	10.0	↗
2:	10.1	↘
3:	8.8	↗
4:	8.3	↘
5:	8.4	→

Serie	44.0
Total	92.0

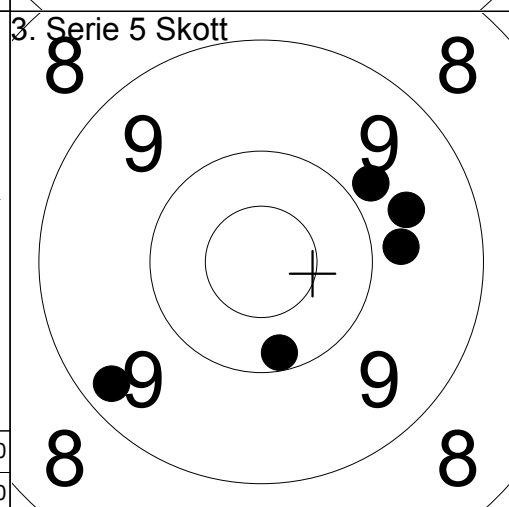

1:	9.8	→
2:	10.2	↓
3:	9.3	↙
4:	9.6	→
5:	9.8	↗

Serie	46.0
Total	138.0

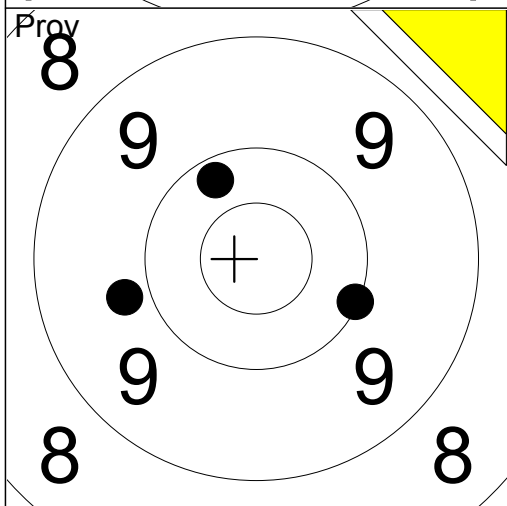

1:	9.8	←
2:	10.2	↗
3:	10.0	↘

Serie	29.0
Total	138.0

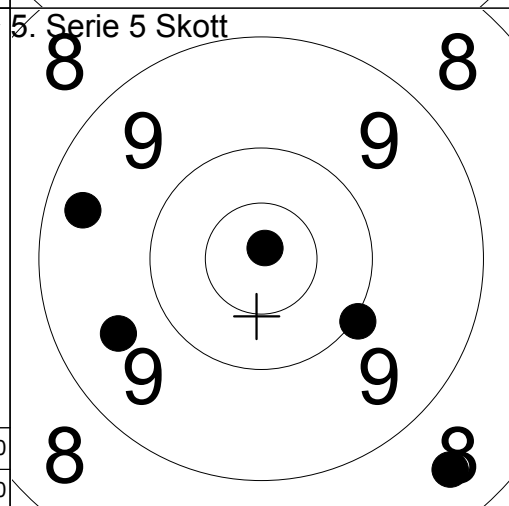

1:	8.5	↘
2:	10.0	↘
3:	9.4	←
4:	9.6	↙
5:	10.9x	↗

Serie	46.0
Total	184.0

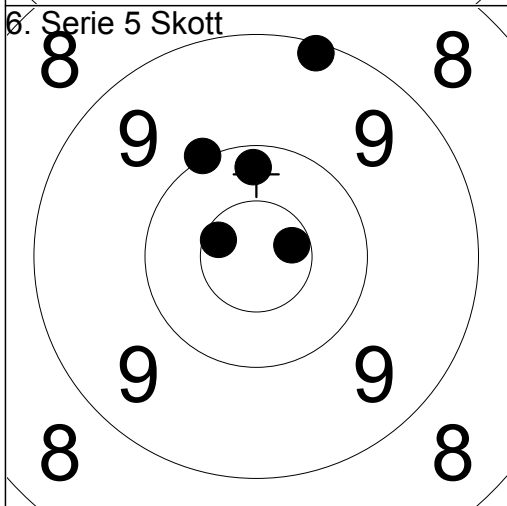

1:	10.2	↑
2:	10.6x	→
3:	9.1	↑
4:	10.6x	↙
5:	10.0	↗

Serie	49.0
Total	233.0