

1:	9.0	→
2:	8.6	↓
3:	10.5	x→
4:	10.0	→
5:	6.3	→
7:	9.3	→
8:	10.4	x→
9:	10.2	↓
10:	10.3	x↑
Serie	82.0	
Total	0.0	

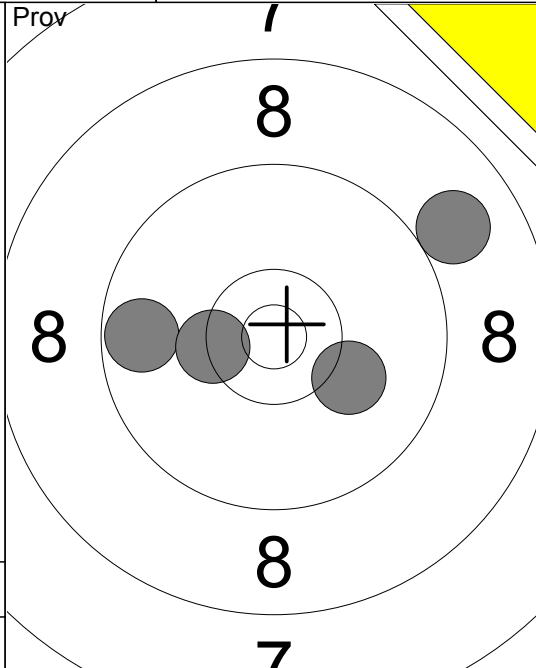

11:	10.1	↘
12:	9.7	←
13:	8.9	↗
14:	10.4	x←
Serie	37.0	
Total	0.0	

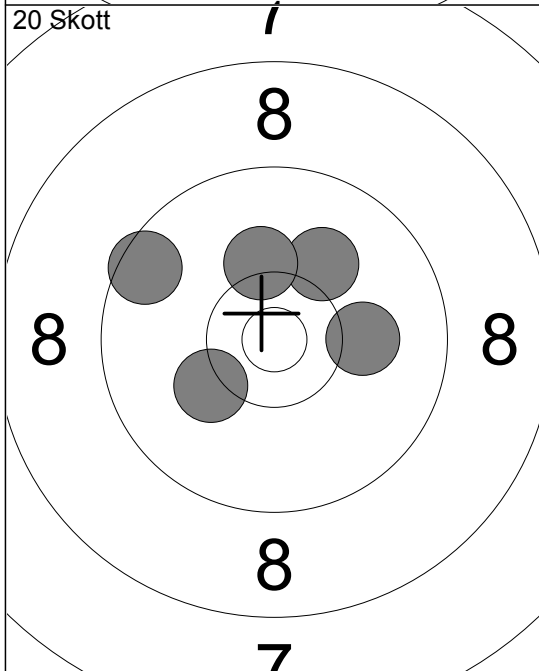

1:	9.5	←
2:	10.2	↙
3:	10.1	→
4:	10.1	↗
5:	10.2	↑
Serie	49.0	
Total	49.0	

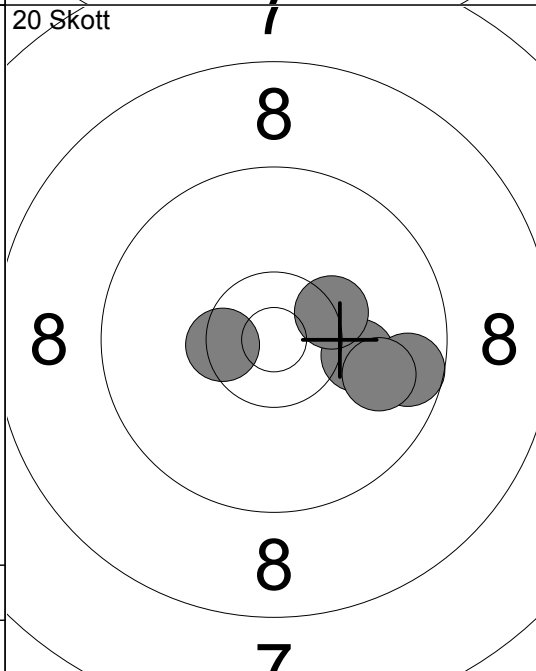

6:	10.1	→
7:	9.6	→
8:	9.9	→
9:	10.5	x←
10:	10.3	x↗
Serie	48.0	
Total	97.0	

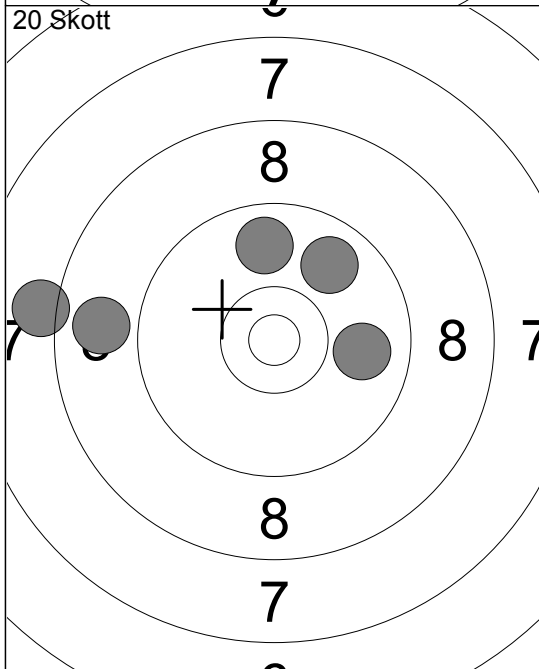

11:	8.9	←
12:	9.9	→
13:	9.8	↑
14:	9.8	↗
15:	8.1	←
Serie	43.0	
Total	140.0	

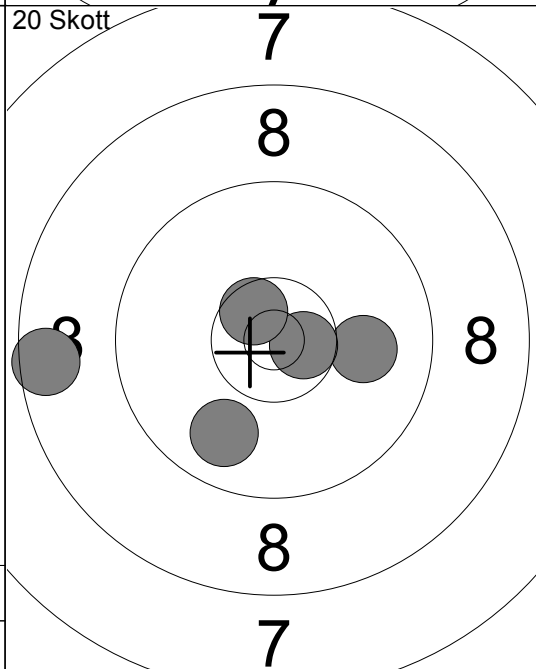

16:	9.9	↙
17:	10.0	→
18:	8.6	←
19:	10.6	x→
20:	10.6	x↘
Serie	47.0	
Total	187.0	

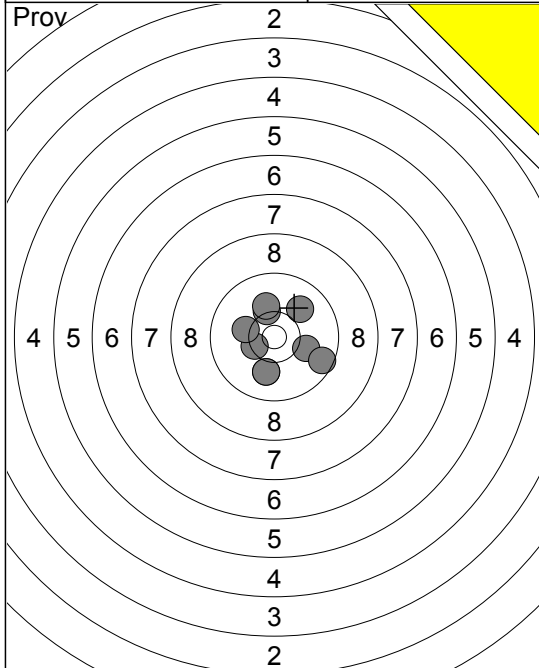

1:	1.6	↗
2:	10.0	↓
3:	10.0	↓
4:	10.3	↗
5:	10.4	✕
6:	10.2	↙
7:	10.1	→
8:	9.6	→
9:	10.0	↗
10:	10.1	↗
Serie	90.0	
Total	0.0	

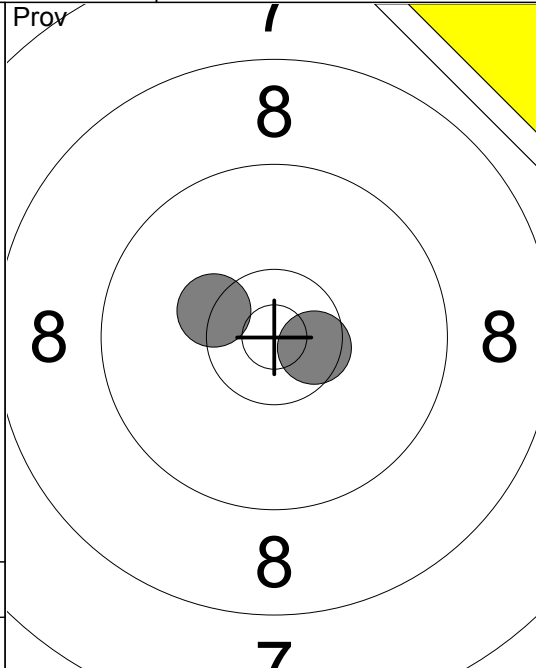

11:	10.6	✕→
12:	10.3	✕
Serie	20.0	
Total	0.0	

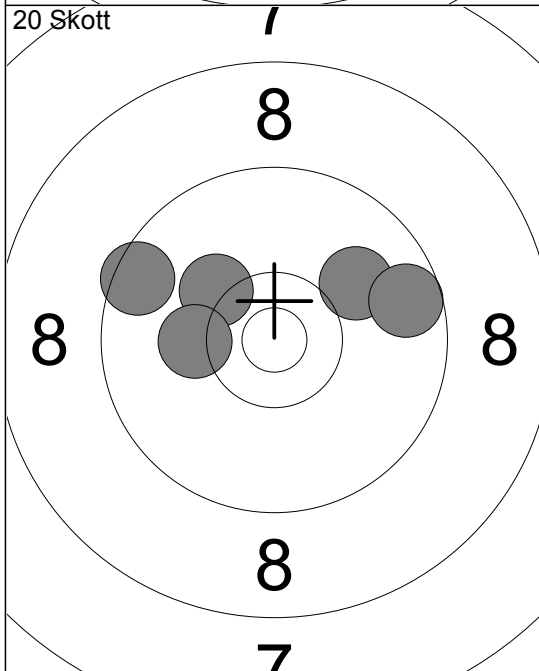

1:	10.0	↗
2:	10.2	↙
3:	9.5	↙
4:	9.6	→
5:	10.2	↙
Serie	48.0	
Total	48.0	

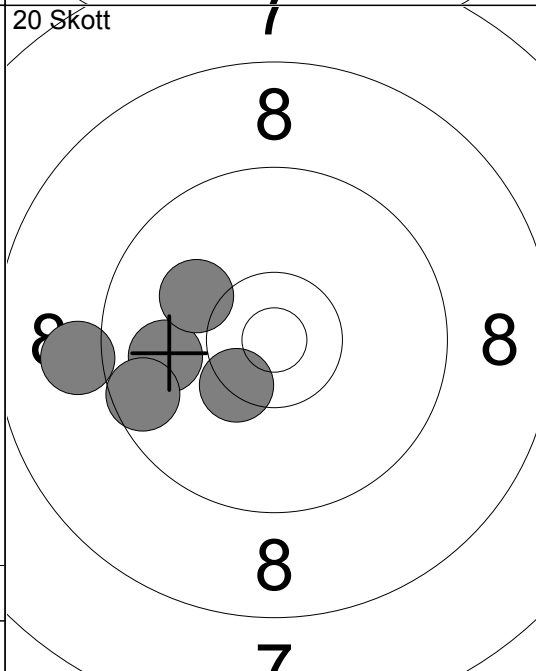

6:	10.4	✕↙
7:	9.9	↙
8:	9.6	↙
9:	9.1	↙
10:	10.1	↙
Serie	47.0	
Total	95.0	

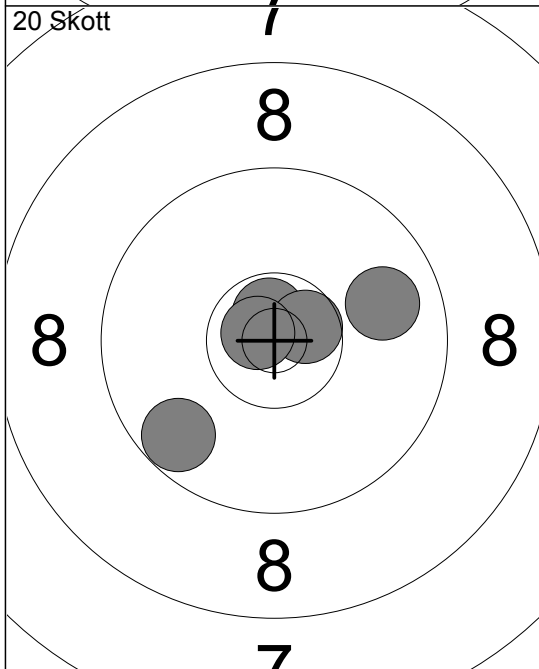

11:	9.9	→
12:	10.7	↗
13:	10.6	✕→
14:	10.8	✕
15:	9.7	↙
Serie	48.0	
Total	143.0	

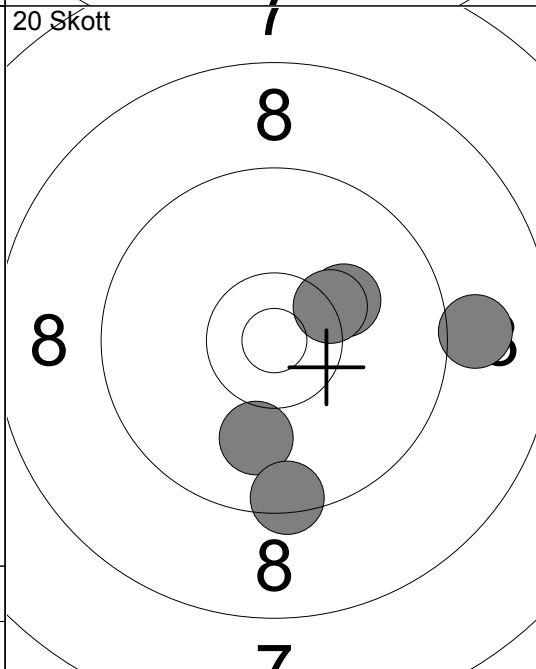

16:	10.0	↓
17:	10.2	↗
18:	9.0	→
19:	9.4	↓
20:	10.3	✕→
Serie	48.0	
Total	191.0	

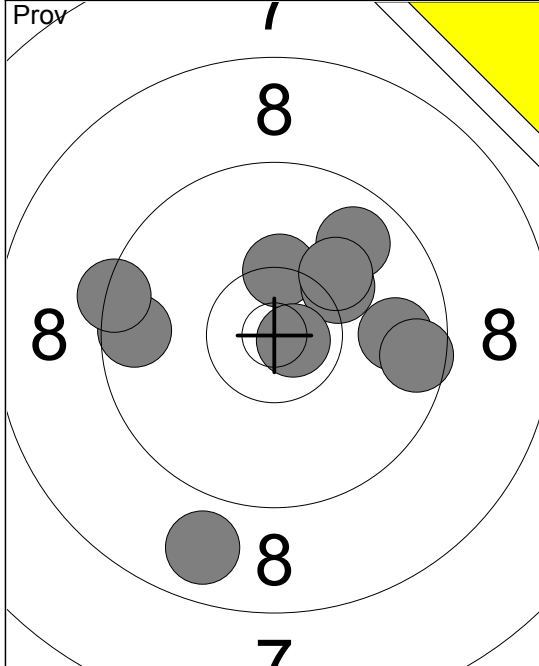

1:	9.6	←
2:	9.4	←
3:	10.3	↗
4:	9.8	→
5:	9.6	→
6:	8.8	↓
7:	10.2	↗
8:	9.8	↗
9:	10.1	↗
10:	10.8	↘
Serie		93.0
Total		0.0

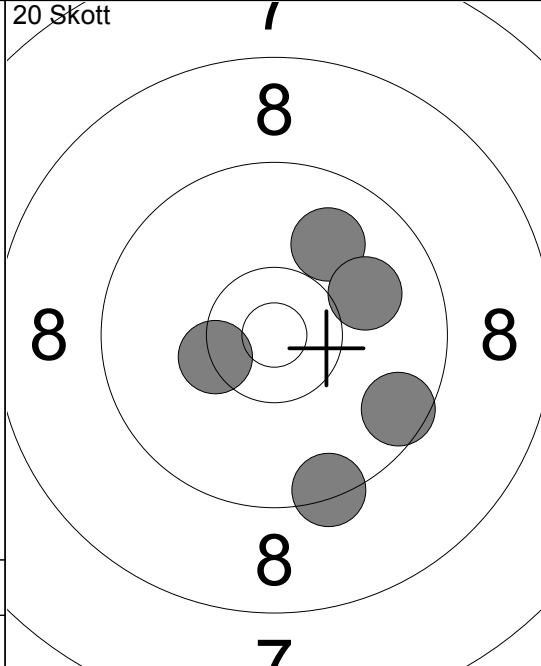

1:	9.9	↗
2:	10.0	↗
3:	10.4	↘
4:	9.4	↓
5:	9.6	↘
Serie		47.0
Total		47.0

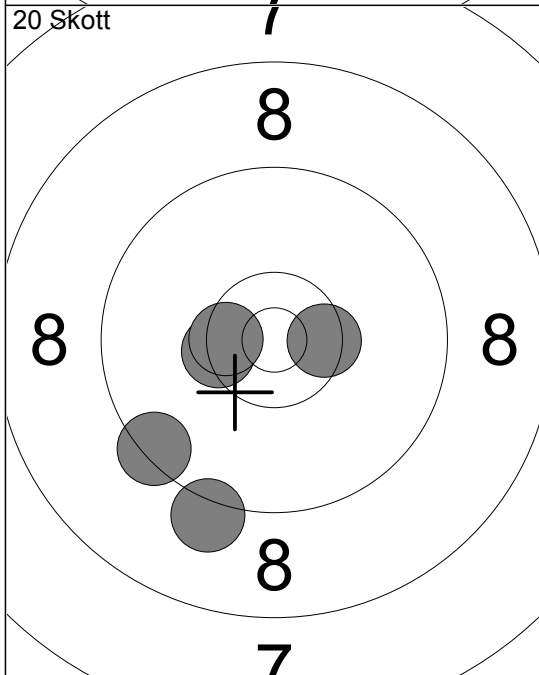

6:	10.5	↘
7:	10.4	↘
8:	10.5	↘
9:	9.2	↓
10:	9.4	↙
Serie		48.0
Total		95.0

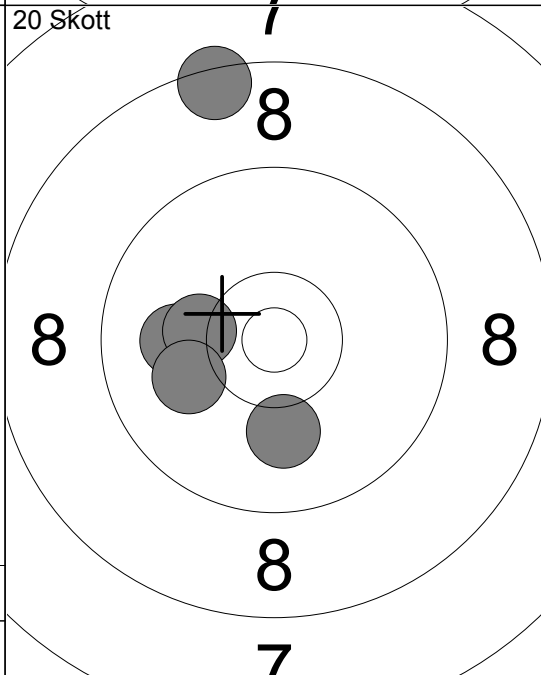

11:	10.0	←
12:	10.2	←
13:	10.1	←
14:	10.1	↓
15:	8.4	↑
Serie		48.0
Total		143.0

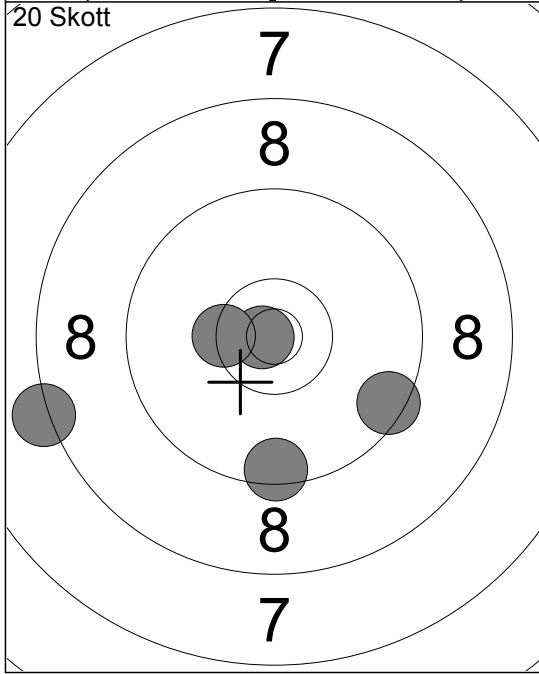

16:	10.8	←
17:	10.4	←
18:	9.5	↘
19:	9.5	↓
20:	8.2	←
Serie		46.0
Total		189.0

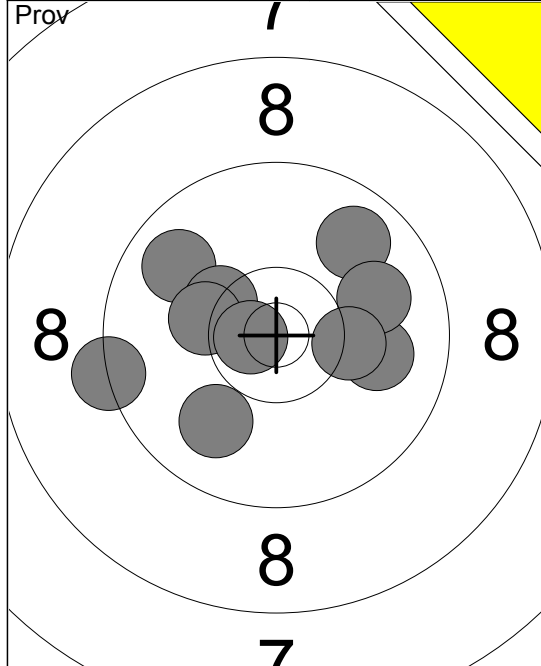

1:	9.3	←
2:	9.8	↖
3:	9.9	↙
4:	10.3	↘
5:	9.8	↗
6:	10.3	←
7:	10.0	→
8:	10.0	→
9:	10.3	→
10:	10.7	↘
Serie		96.0
Total		0.0

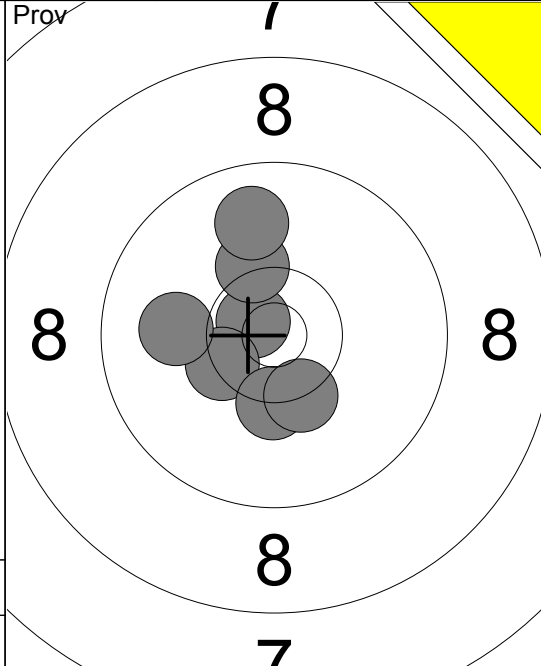

11:	10.7	↘
12:	10.4	↘
13:	10.3	↘
14:	10.3	↗
15:	10.3	↘
16:	9.9	↗
17:	10.0	←
Serie		69.0
Total		0.0

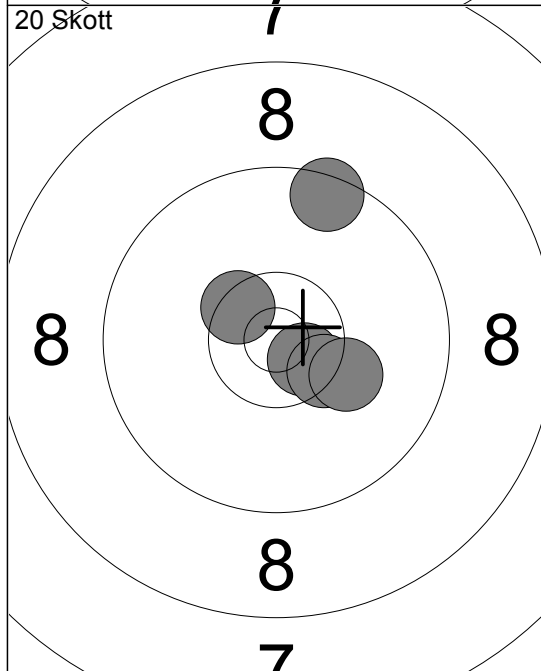

1:	9.5	↗
2:	10.6	↘
3:	10.4	↘
4:	10.5	↘
5:	10.2	↘
Serie		49.0
Total		49.0

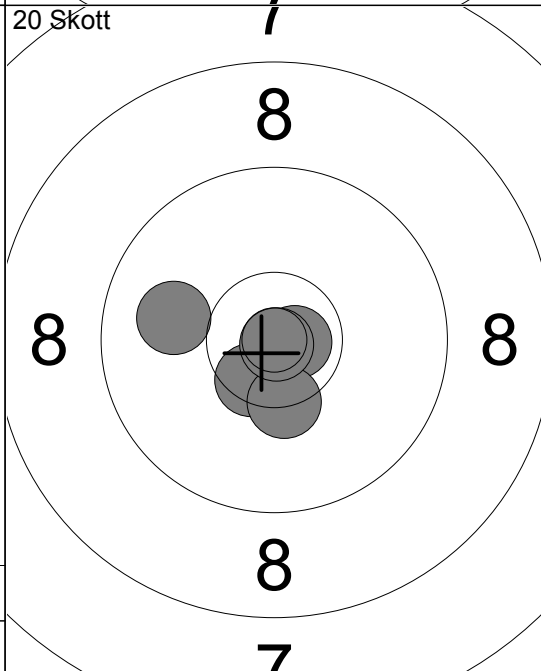

6:	10.5	↘
7:	10.8	→
8:	10.4	↘
9:	10.9	↘
10:	10.0	←
Serie		50.0
Total		99.0

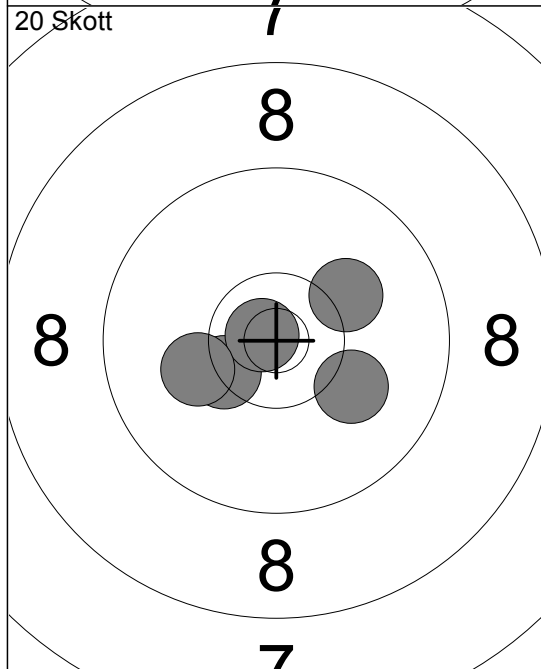

11:	10.1	↘
12:	10.4	↘
13:	10.2	↗
14:	10.8	↘
15:	10.2	←
Serie		50.0
Total		149.0

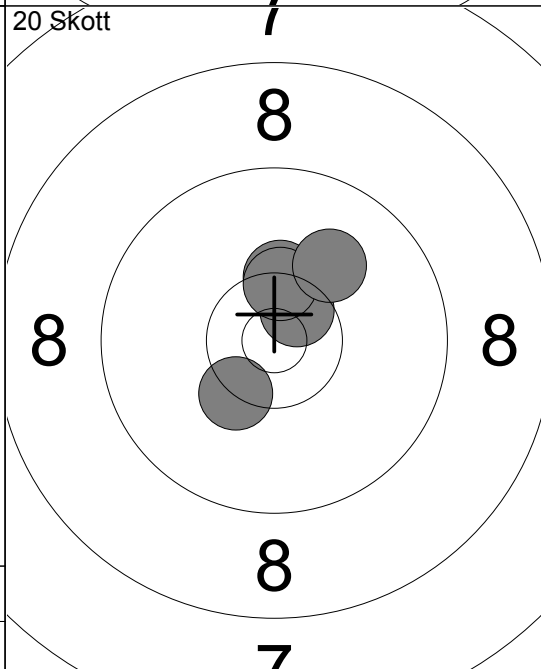

16:	10.6	↗
17:	10.3	↗
18:	10.3	↘
19:	10.4	↗
20:	10.1	↗
Serie		50.0
Total		199.0

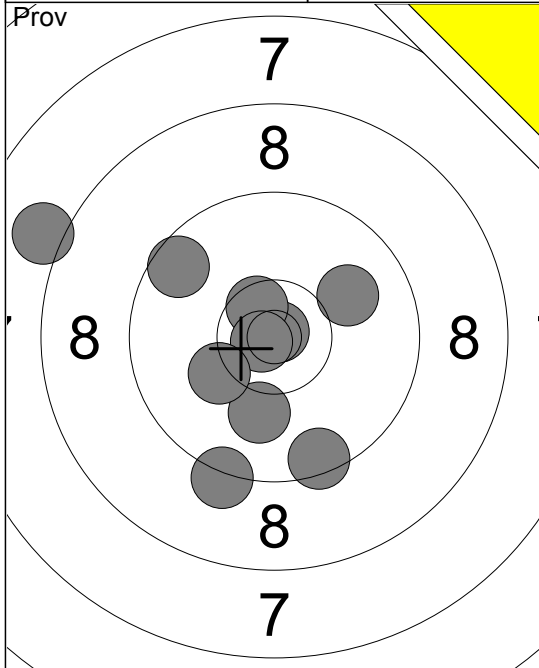

1:	8.1	↖
2:	10.0	↗
3:	9.5	↓
4:	9.2	↓
5:	10.9	↗
6:	9.6	↖
7:	10.6	↗
8:	10.8	✕
9:	10.1	↓
10:	10.2	↙
Serie	95.0	
Total	0.0	

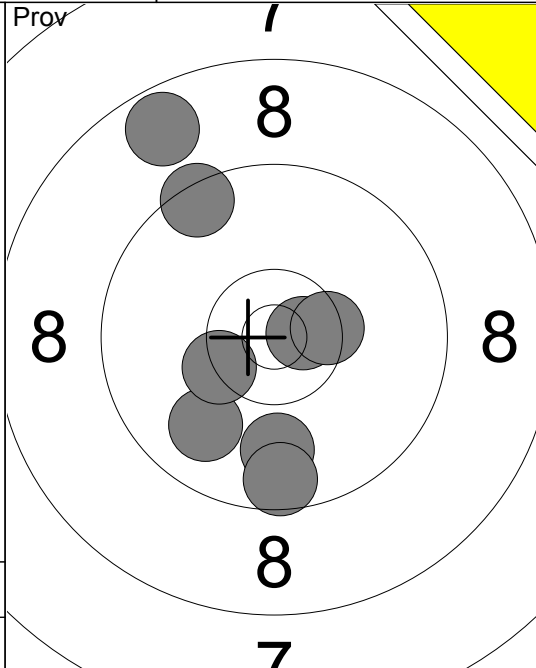

11:	8.7	↗
12:	9.9	↙
13:	9.9	↓
14:	10.3	✕
15:	9.6	↓
16:	9.5	↖
17:	10.7	↗
18:	10.4	↗
Serie	74.0	
Total	0.0	

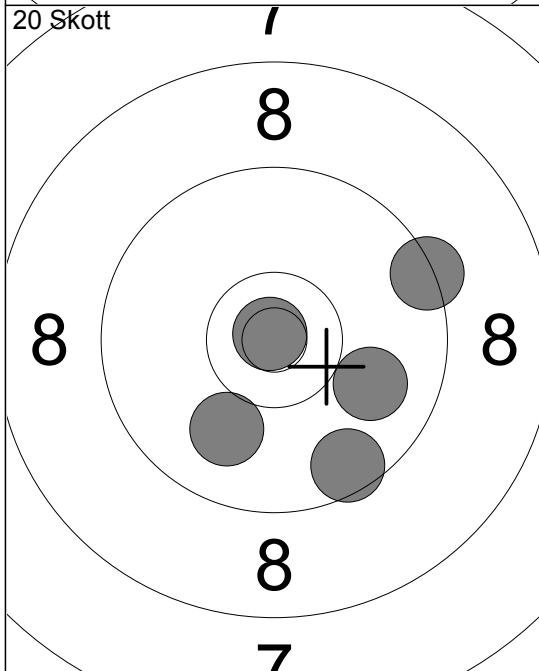

1:	9.4	↗
2:	9.6	↓
3:	9.9	↗
4:	10.9	↗
5:	10.0	↓
Serie	47.0	
Total	47.0	

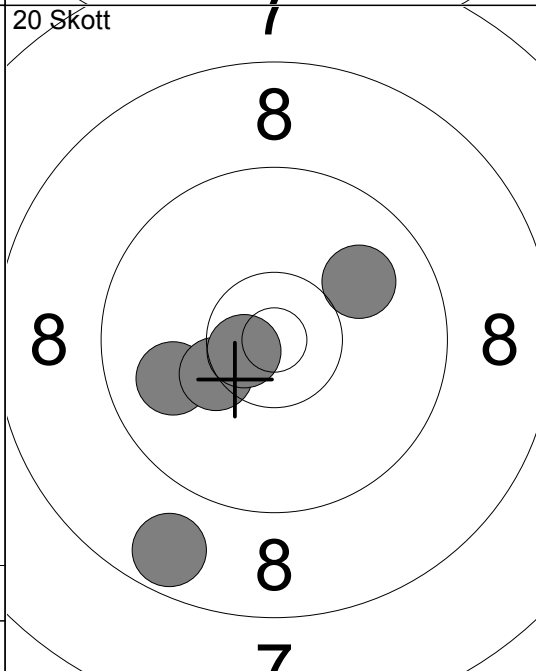

6:	8.7	↓
7:	9.9	↖
8:	10.0	↗
9:	10.3	✕
10:	10.6	✕
Serie	47.0	
Total	94.0	

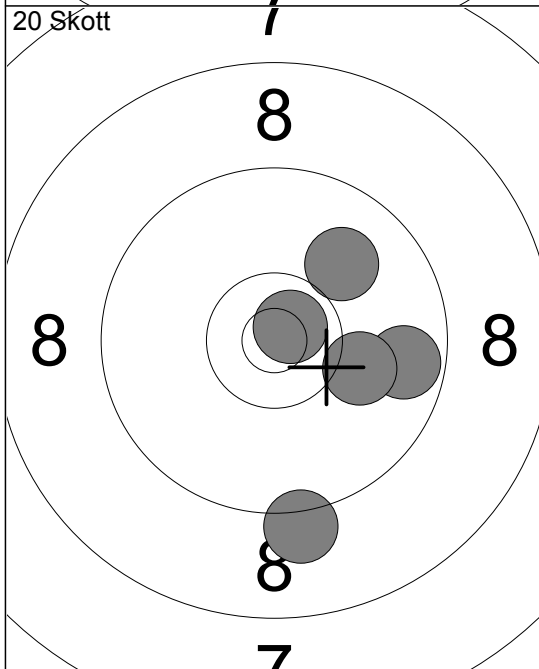

11:	9.7	↗
12:	10.0	↗
13:	10.8	↗
14:	9.2	↓
15:	10.1	↗
Serie	48.0	
Total	142.0	

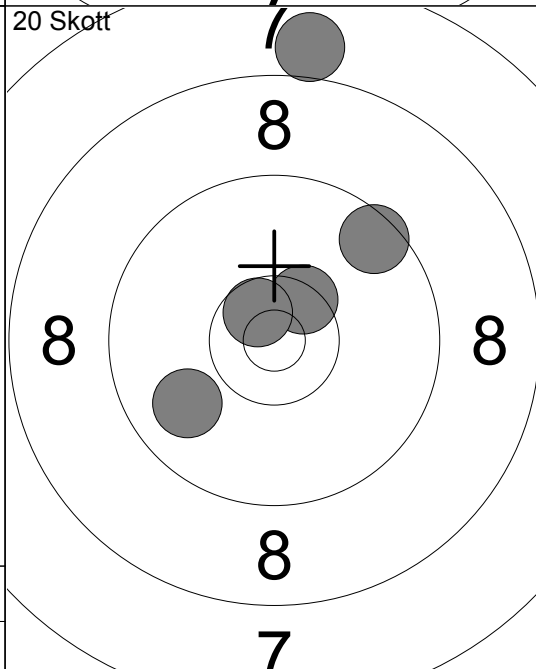

16:	8.0	↑
17:	10.5	↗
18:	9.5	↗
19:	10.6	✕
20:	9.9	↙
Serie	46.0	
Total	188.0	

Skjutlag 1 Tavla 6 **Wolfgang Voge**

50m Ramselefors Vet-L Vb

21.08.2016 FM korthåll 2016 Ramselefors SKF

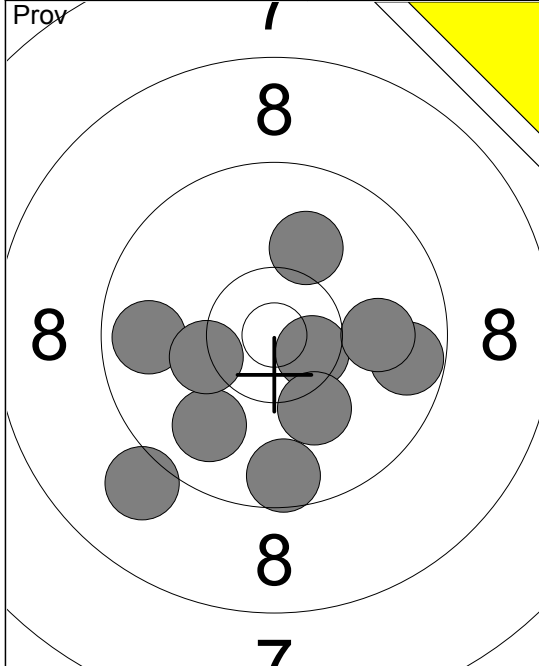

20 Skott

1:	10.6x	↘
2:	9.7	→
3:	9.1	↙
4:	10.1	↗
5:	9.9	↙
6:	10.0	→
7:	9.8	←
8:	9.6	↓
9:	10.2	↘
10:	10.3	↙
Serie	95.0	
Total	0.0	

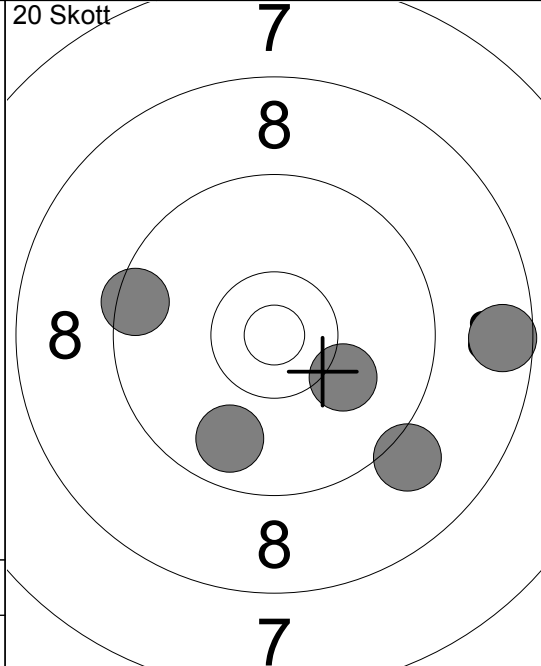

20 Skott

1:	9.5	←
2:	9.8	↙
3:	10.1	↘
4:	8.6	→
5:	9.1	↙
Serie	45.0	
Total	45.0	

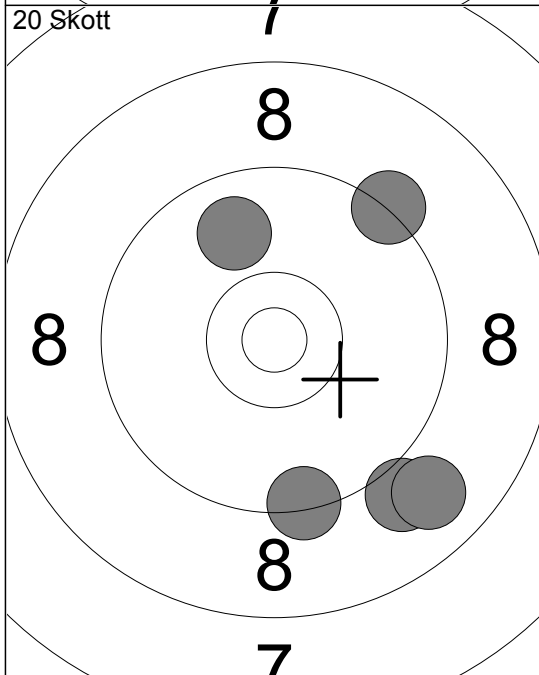

20 Skott

6:	9.4	↓
7:	9.0	↙
8:	9.3	↗
9:	8.9	↘
10:	9.9	↗
Serie	44.0	
Total	89.0	

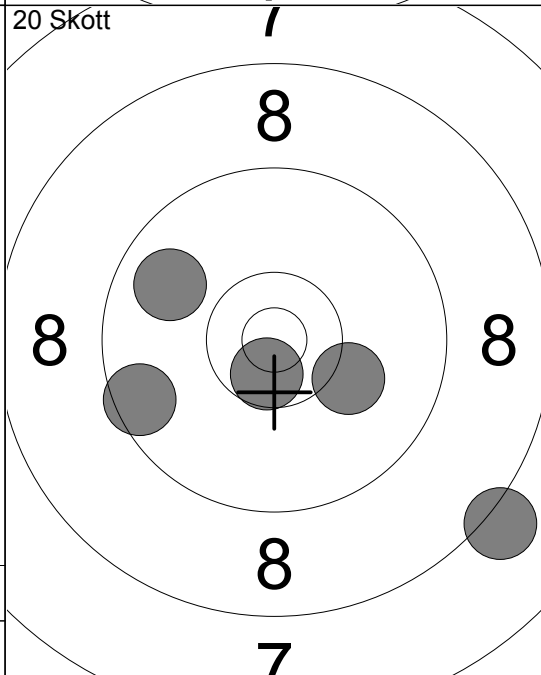

20 Skott

11:	10.2	↘
12:	9.8	←
13:	8.2	↘
14:	10.6x	↘
15:	9.5	←
Serie	46.0	
Total	135.0	

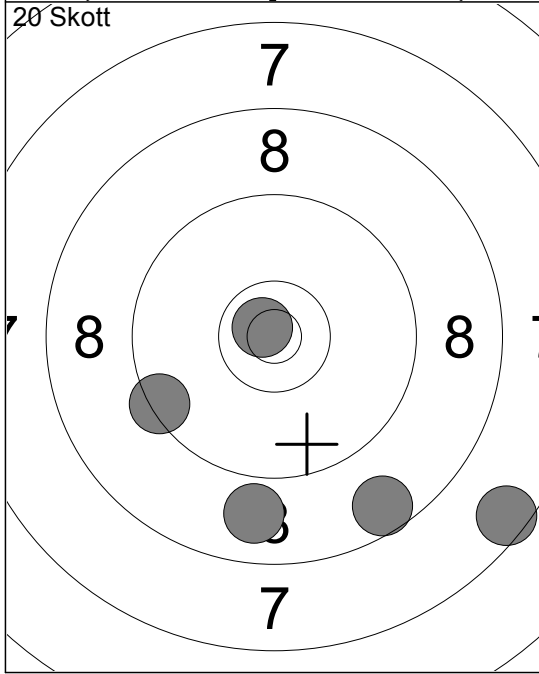

20 Skott

16:	7.5	↘
17:	8.9	↓
18:	10.8x	↘
19:	8.6	↘
20:	9.4	↙
Serie	42.0	
Total	177.0	

Skjutlag
1

Tavla
7

Lennart Westermark

50m

Drängsmark

Vet-L

Vb

21.08.2016

FM korthåll 2016

Ramselefors SKF

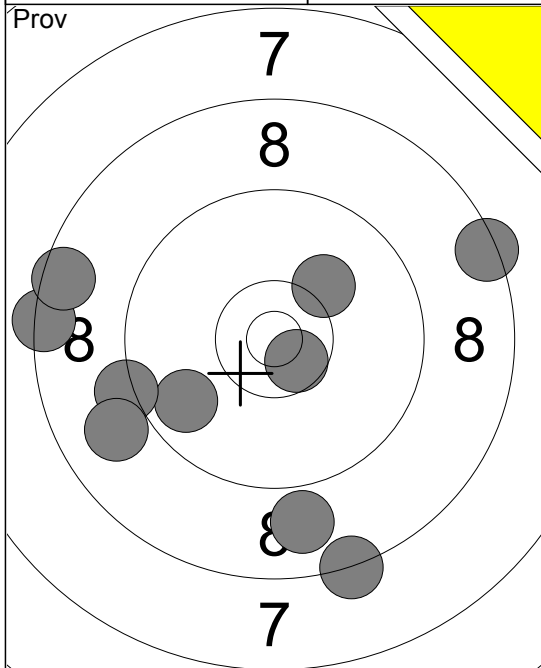

- 1: 8.4 →
- 2: 8.3 ↓
- 3: 8.4 ←
- 4: 9.8 ↙
- 5: 8.5 ←
- 6: 8.9 ↓
- 7: 9.2 ←
- 8: 10.6 ↘
- 9: 8.9 ↙
- 10: 10.2 ↗

Serie 86.0
Total 0.0

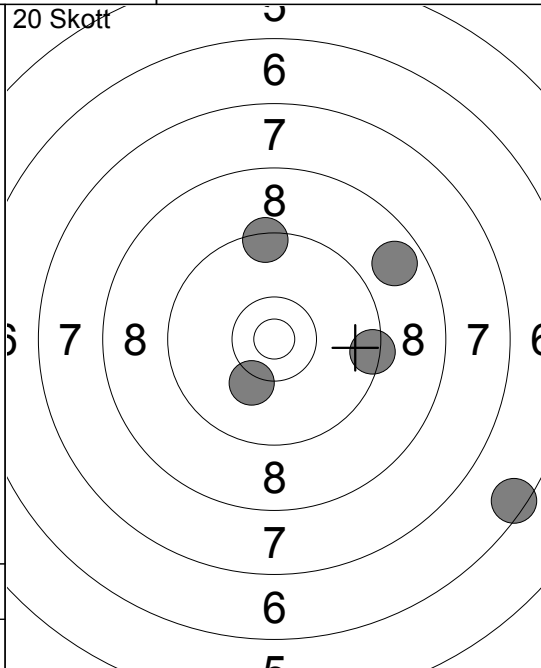

- 20 Skott
- 1: 6.5 ↘
- 2: 9.4 ↑
- 3: 8.8 ↗
- 4: 9.4 →
- 5: 10.2 ↘

Serie 42.0
Total 42.0

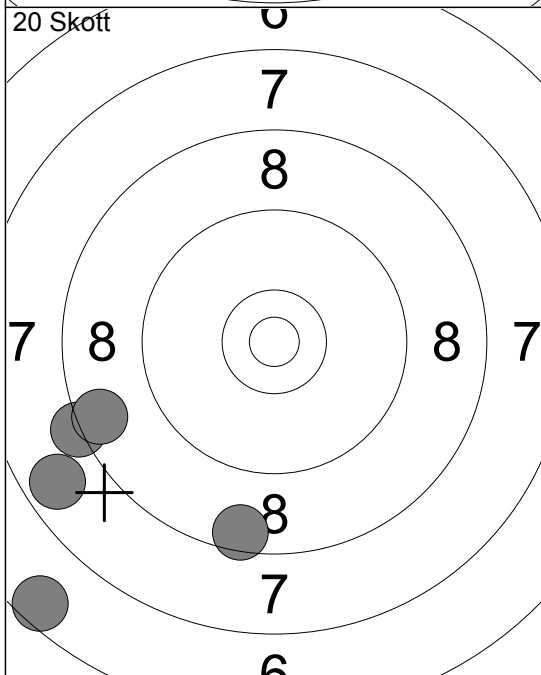

- 6: 6.6 ↙
- 7: 7.7 ↙
- 8: 8.3 ←
- 9: 8.6 ←
- 10: 8.5 ↓

Serie 37.0
Total 79.0

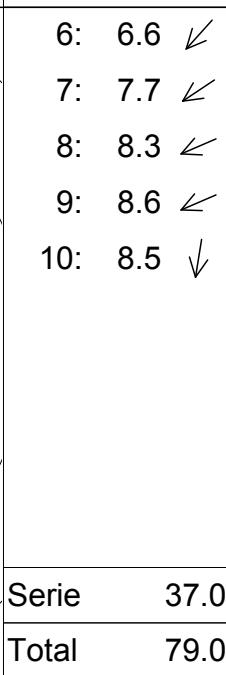

- 11: 8.1 ↙
- 12: 9.3 ↗
- 13: 10.2 ↘
- 14: 9.2 ↗
- 15: 9.0 ↙

Serie 45.0
Total 124.0

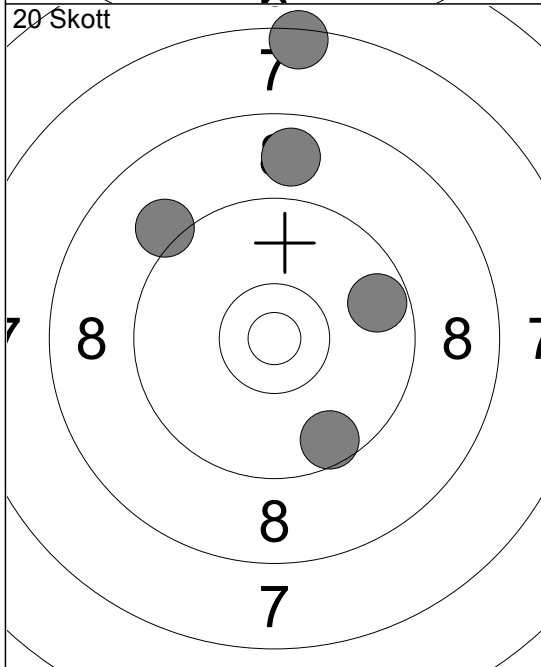

- 16: 7.4 ↑
- 17: 8.8 ↑
- 18: 9.7 →
- 19: 9.1 ↗
- 20: 9.6 ↓

Serie 42.0
Total 166.0

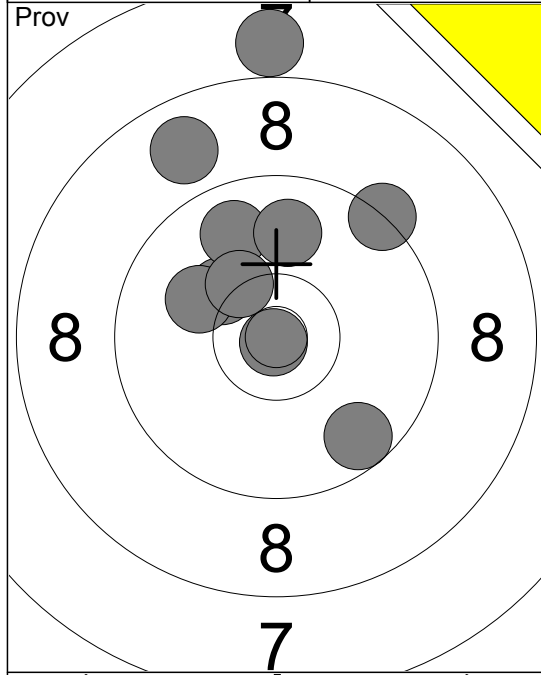

1:	10.2 ↖
2:	10.9 ✕
3:	9.8 ↗
4:	9.6 ↘
5:	8.0 ↗
6:	9.3 ↗
7:	10.1 ↖
8:	9.9 ↗
9:	10.3 ✕
10:	8.8 ↗
Serie 92.0	
Total 0.0	

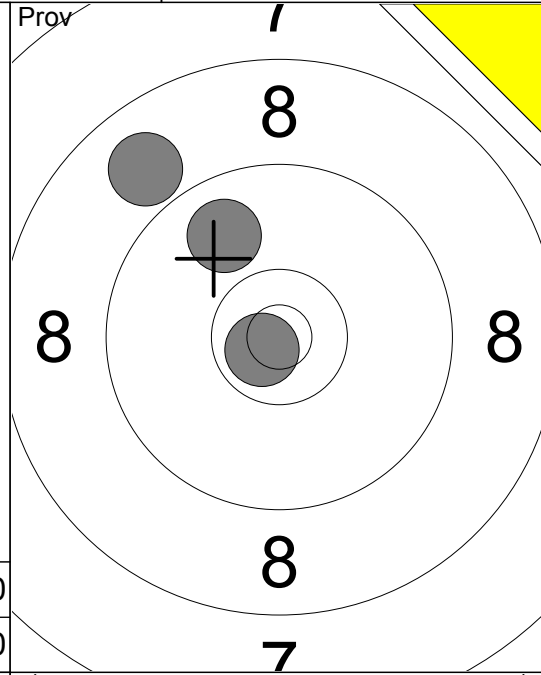

11:	10.7 ✕
12:	9.8 ↗
13:	8.9 ↗
Serie 27.0	
Total 0.0	

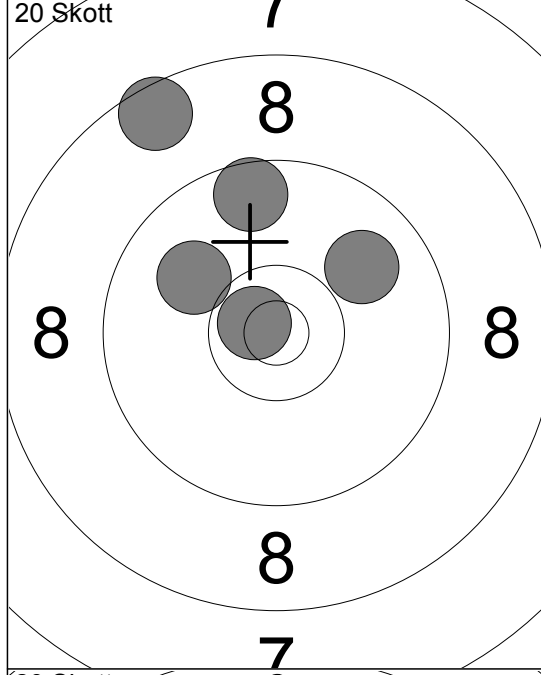

1:	10.7 ✕
2:	9.9 ↗
3:	10.0 ↖
4:	8.6 ↗
5:	9.6 ↗
Serie 46.0	
Total 46.0	

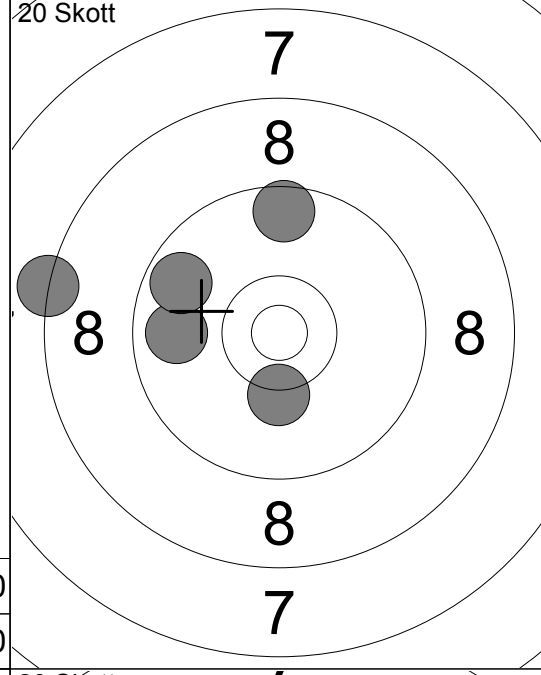

6:	9.8 ←
7:	8.3 ←
8:	10.3 ↓
9:	9.6 ↗
10:	9.7 ↖
Serie 45.0	
Total 91.0	

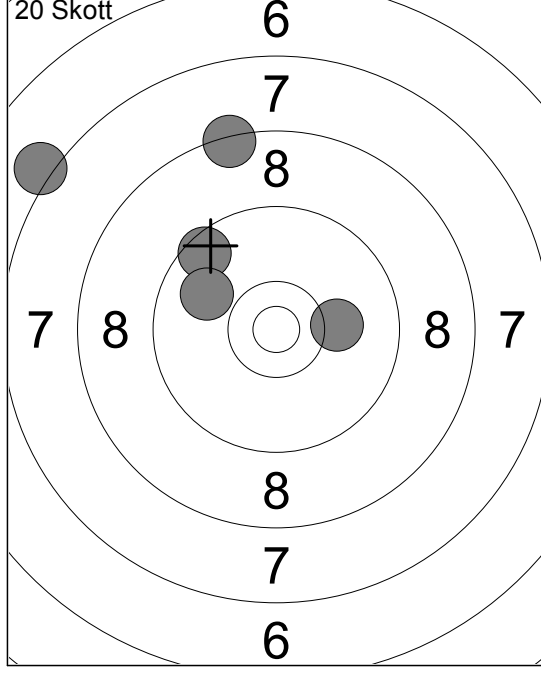

11:	9.6 ↖
12:	7.1 ↖
13:	10.1 →
14:	9.9 ↖
15:	8.4 ↗
Serie 43.0	
Total 134.0	

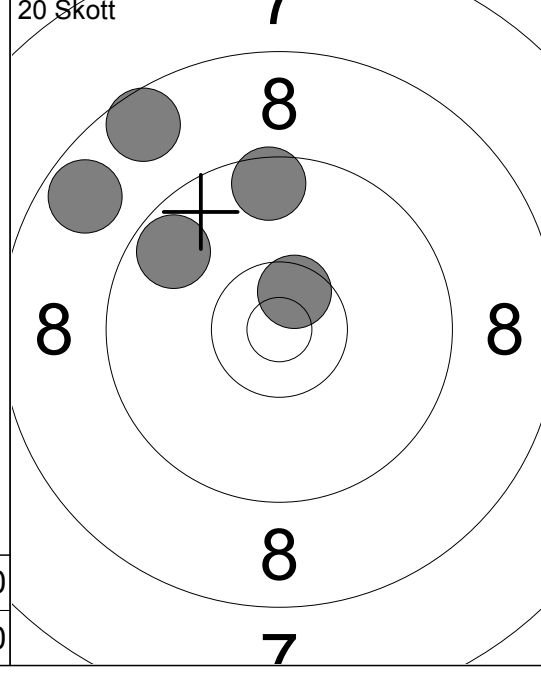

16:	8.7 ↖
17:	8.6 ↗
18:	10.6 ✕
19:	9.7 ↖
20:	9.6 ↗
Serie 44.0	
Total 178.0	

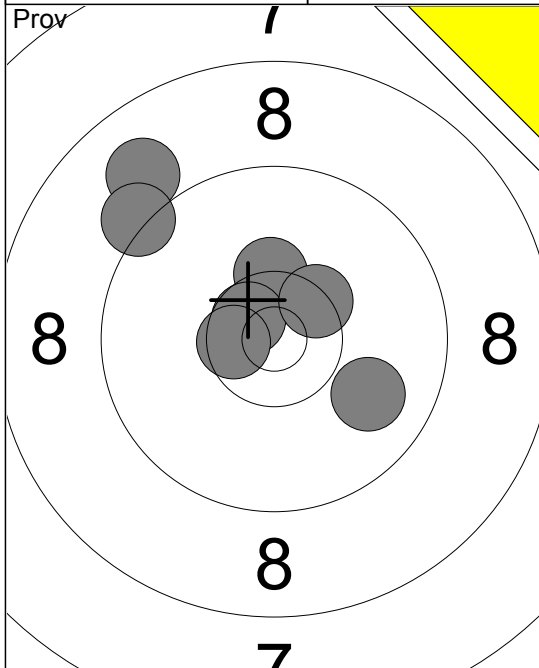

1:	10.3x↑
2:	10.6x↘
3:	9.9 ↘
4:	10.6x↘
5:	8.9 ↗
6:	9.2 ↗
7:	10.4x↗
Serie	66.0
Total	0.0

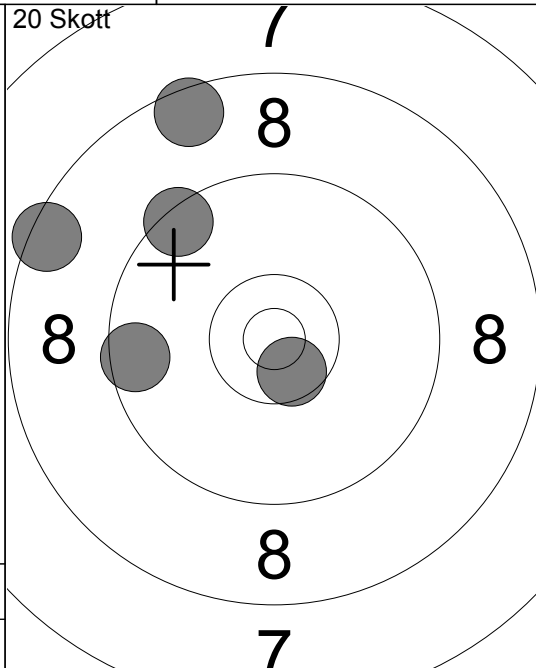

1:	10.6x↘
2:	8.5 ↖
3:	9.4 ↗
4:	9.6 ↖
5:	8.5 ↗
Serie	44.0
Total	44.0

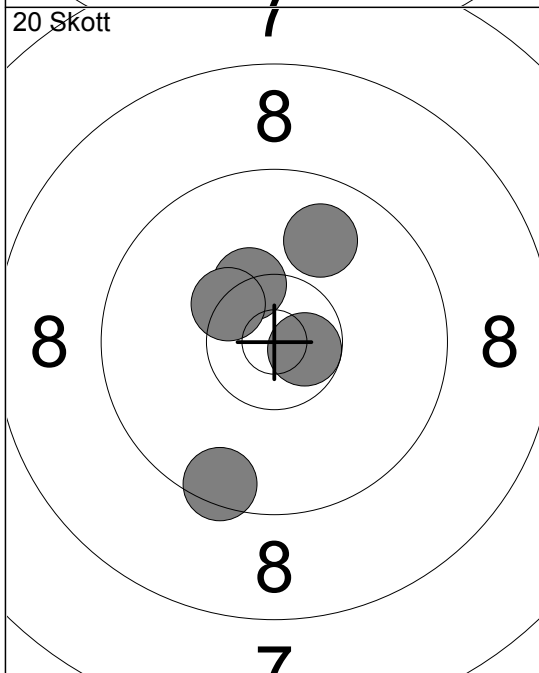

6:	10.4x↘
7:	9.5 ↘
8:	9.9 ↗
9:	10.4x↘
10:	10.7x➤
Serie	48.0
Total	92.0

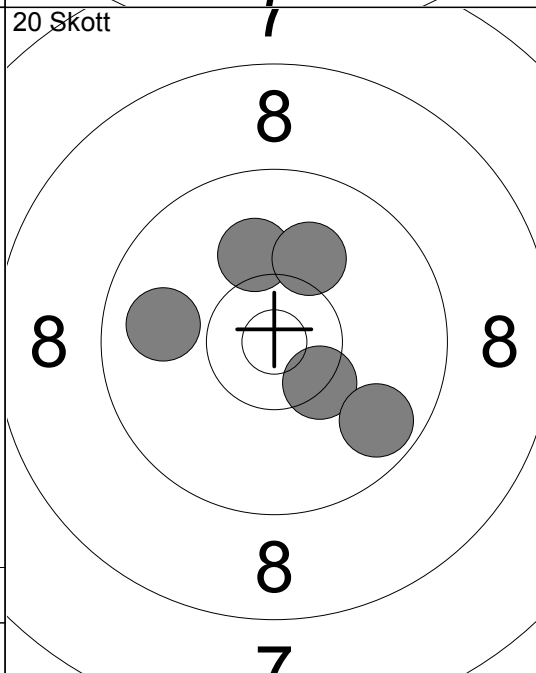

11:	10.1 ↗
12:	9.9 ↖
13:	10.4x↘
14:	9.7 ↘
15:	10.1 ↗
Serie	48.0
Total	140.0

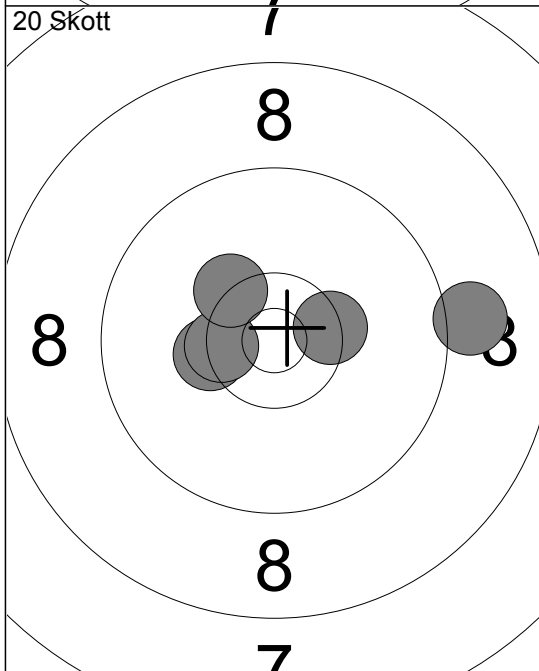

16:	9.1 →
17:	10.4x➤
18:	10.3x↘
19:	10.4x↘
20:	10.3x↘
Serie	49.0
Total	189.0

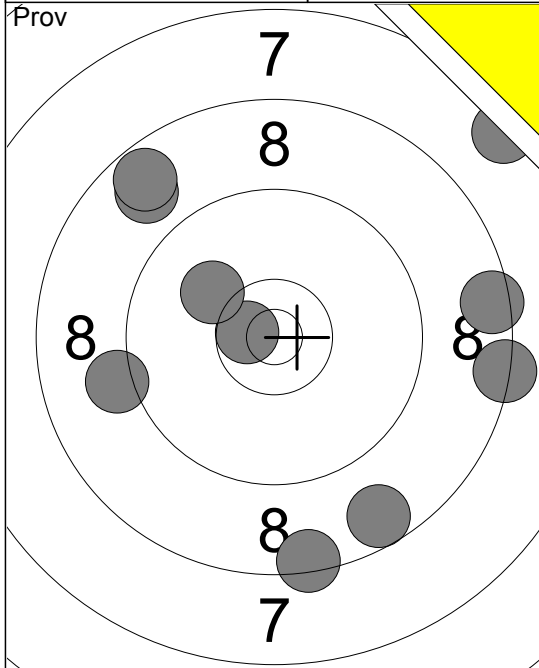

1:	8.4	↘
2:	8.4	→
3:	8.6	↘
4:	7.5	↗
5:	8.5	→
6:	10.6	✕
7:	10.1	↖
8:	8.8	↗
9:	8.7	↗
10:	9.1	←
Serie	84.0	
Total	0.0	

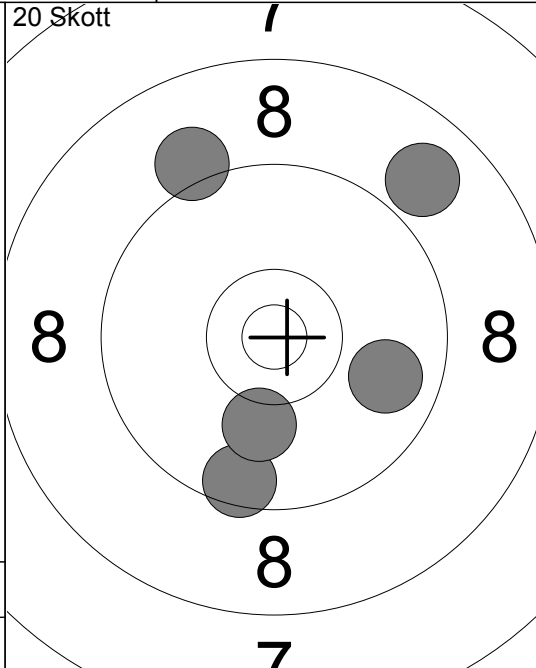

1:	8.9	↗
2:	9.8	→
3:	9.1	↗
4:	9.5	↘
5:	10.1	↘
Serie	45.0	
Total	45.0	

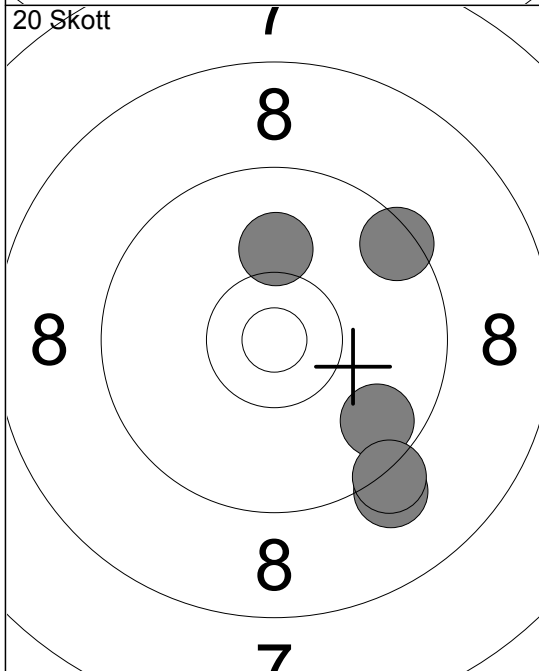

6:	9.1	↘
7:	9.7	↘
8:	10.1	↑
9:	9.2	↘
10:	9.5	↗
Serie	46.0	
Total	91.0	

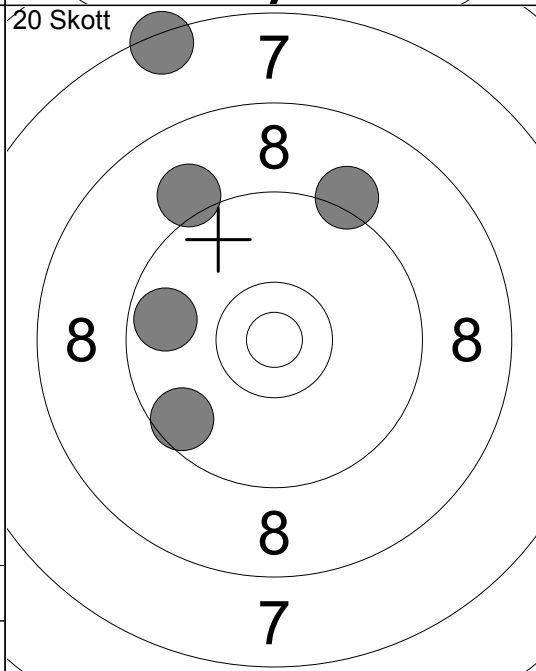

11:	9.2	↗
12:	7.4	↖
13:	9.1	↖
14:	9.6	↘
15:	9.7	←
Serie	43.0	
Total	134.0	

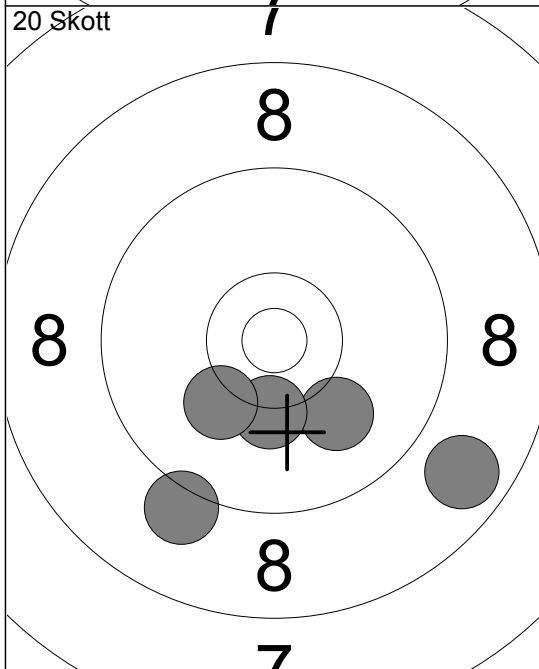

16:	9.1	↘
17:	10.0	↘
18:	10.3	↘
19:	10.2	↘
20:	8.8	↘
Serie	47.0	
Total	181.0	

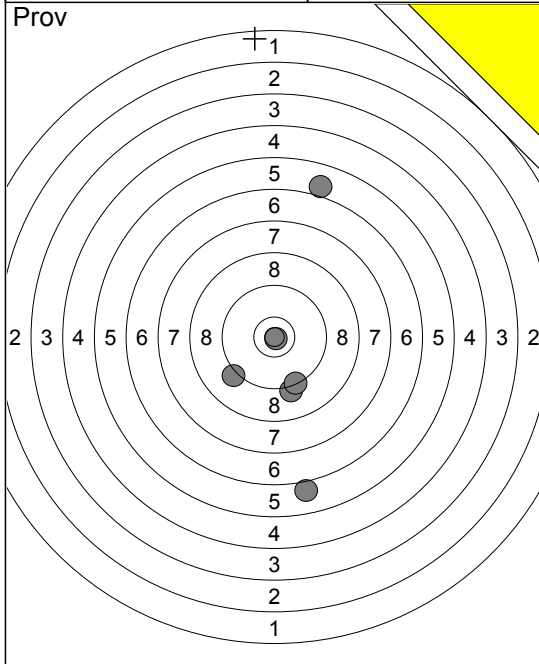

1:	0.0	↑
2:	0.0	↑
3:	0.0	↑
4:	0.0	↑
5:	6.0	↑
6:	6.0	↓
7:	10.9	↘
8:	9.2	↓
9:	9.2	↙
10:	9.4	↓
Serie	49.0	
Total	0.0	

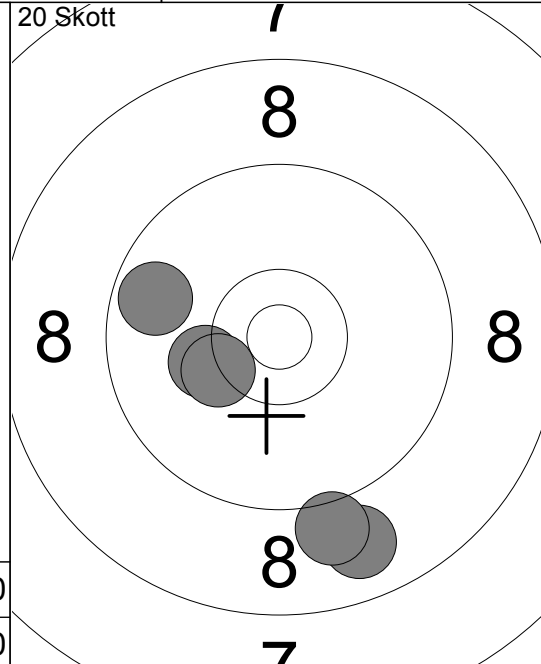

1:	10.2	↙
2:	8.9	↓
3:	10.3	↙
4:	9.1	↓
5:	9.7	↙
Serie	46.0	
Total	46.0	

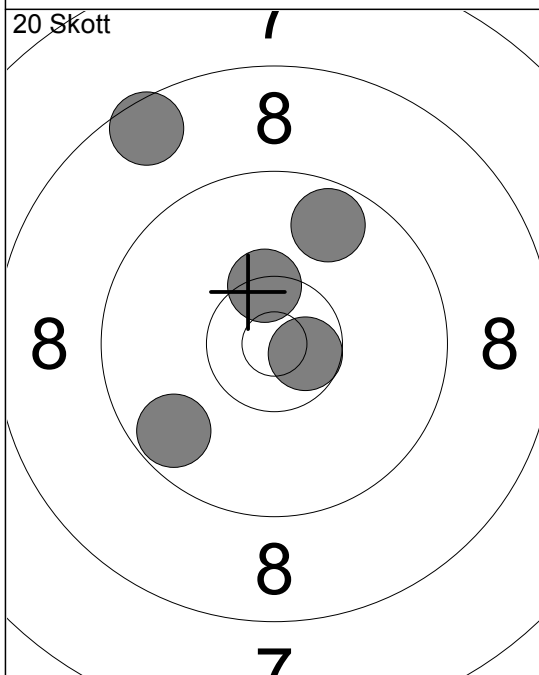

6:	10.4	↗
7:	9.7	↗
8:	10.6	↘
9:	8.6	↖
10:	9.7	↙
Serie	46.0	
Total	92.0	

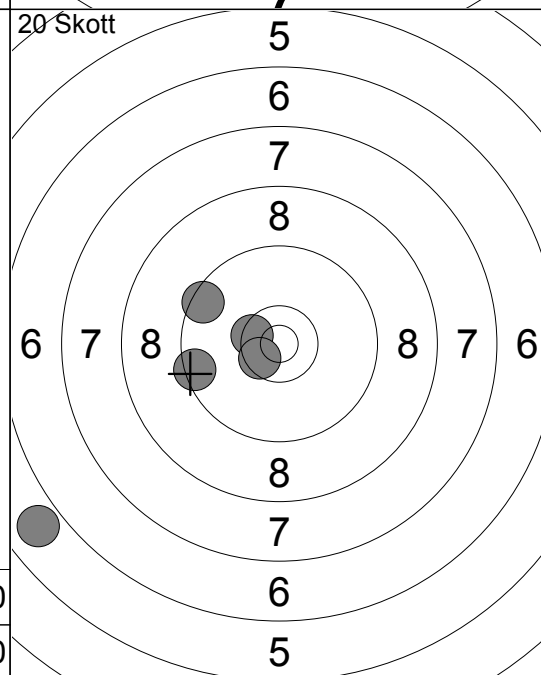

11:	5.9	↙
12:	9.5	↖
13:	10.5	↘
14:	10.5	↘
15:	9.5	↙
Serie	43.0	
Total	135.0	

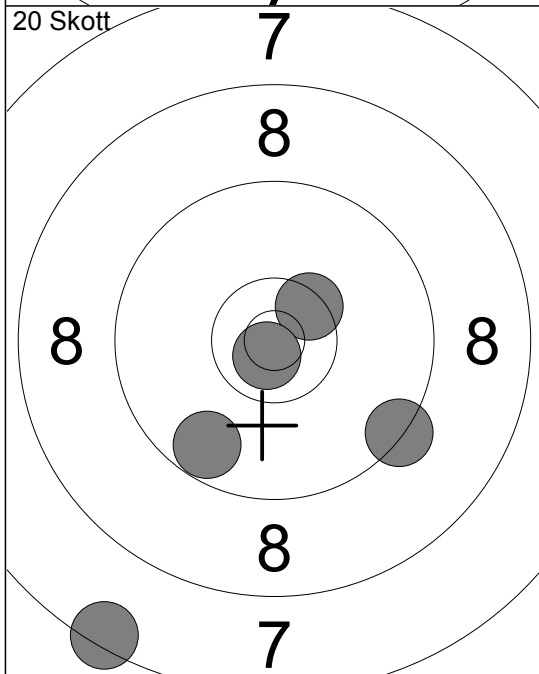

16:	9.7	↙
17:	9.3	↘
18:	7.4	↙
19:	10.5	↗
20:	10.8	↘
Serie	45.0	
Total	180.0	

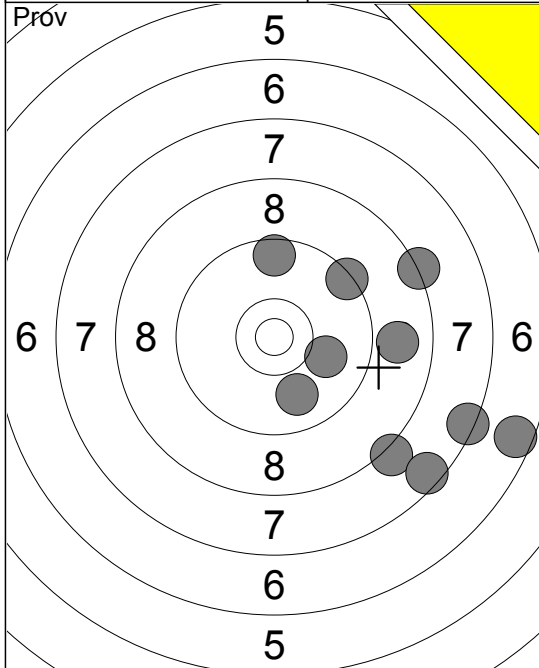

1:	9.4	↗
2:	8.3	→
3:	9.6	↑
4:	8.2	↘
5:	9.9	↘
6:	7.5	↘
7:	10.0	→
8:	8.9	→
9:	6.6	↘
10:	7.4	↘
Serie		81.0
Total		0.0

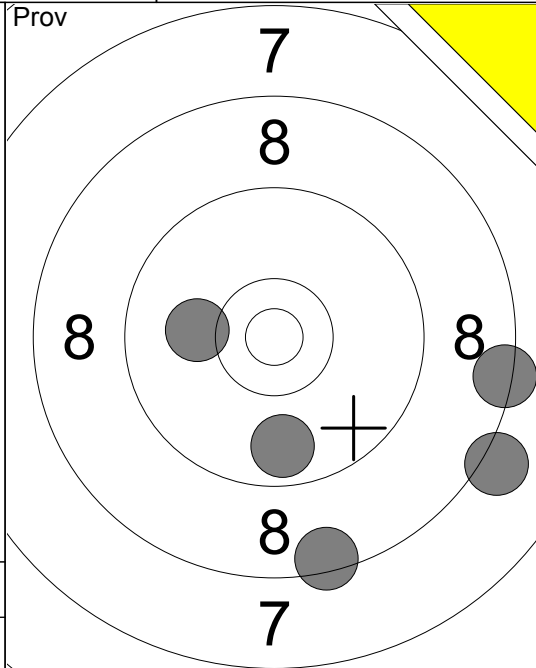

11:	8.1	↘
12:	8.4	↓
13:	10.1	←
14:	9.7	↓
15:	8.4	→
Serie		43.0
Total		0.0

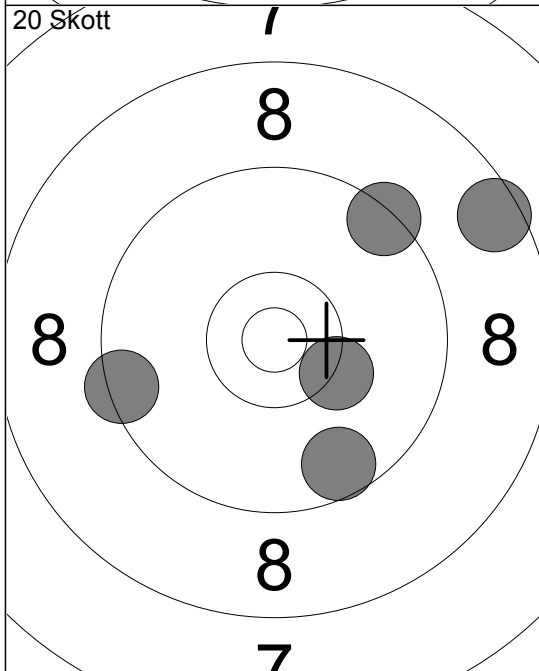

1:	9.6	↘
2:	9.4	←
3:	8.5	↗
4:	9.4	↗
5:	10.3	↘
Serie		45.0
Total		45.0

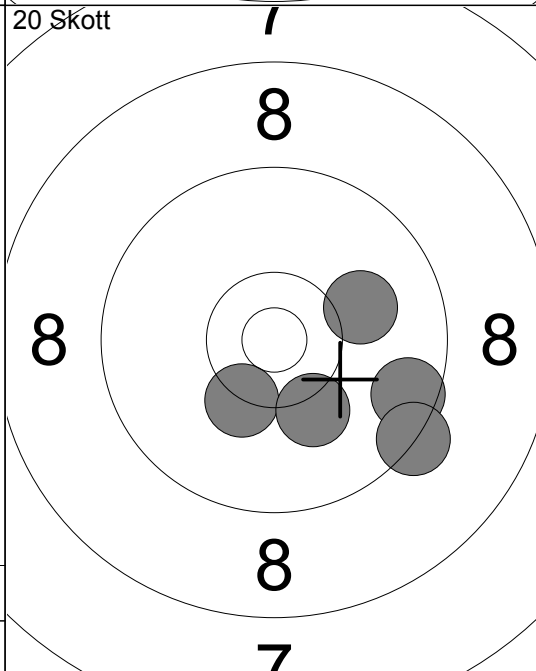

6:	10.3	↘
7:	10.2	↘
8:	9.6	→
9:	9.3	↘
10:	10.1	→
Serie		48.0
Total		93.0

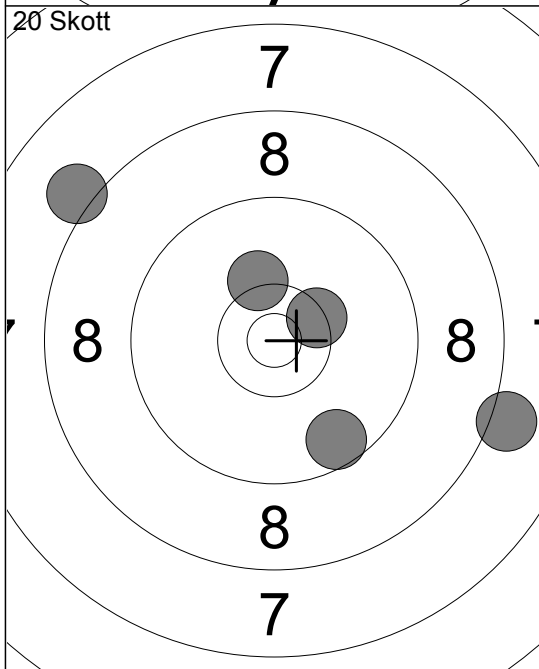

11:	9.6	↘
12:	8.1	→
13:	8.1	↖
14:	10.2	↖
15:	10.4	↗
Serie		45.0
Total		138.0

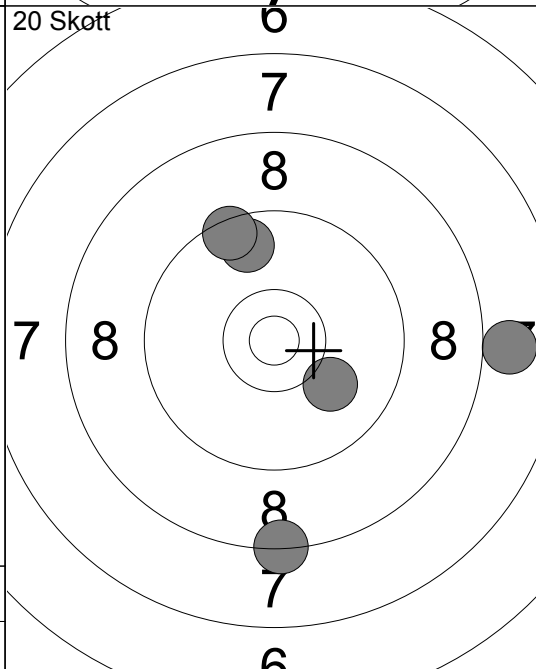

16:	9.7	↑
17:	8.3	↓
18:	8.0	→
19:	10.0	↘
20:	9.5	↖
Serie		44.0
Total		182.0

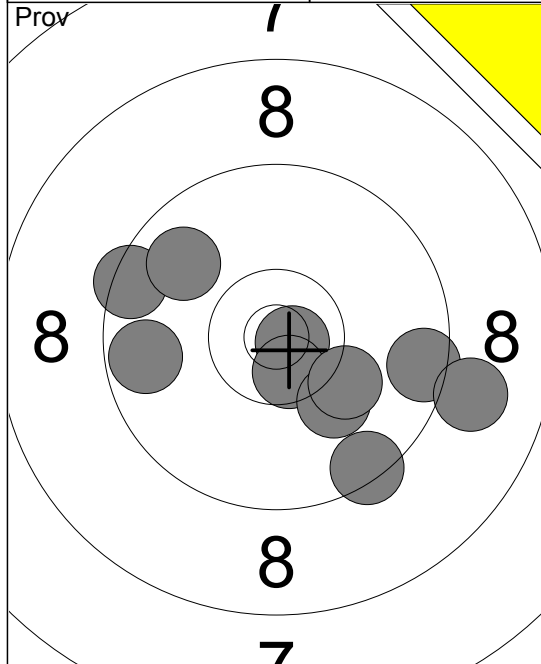

1:	9.5	→
2:	10.8x	→
3:	10.6x	↓
4:	9.5	↖
5:	9.4	↓
6:	10.1	↓
7:	10.2	↓
8:	9.8	↗
9:	9.0	→
10:	9.7	←
Serie	94.0	
Total	0.0	

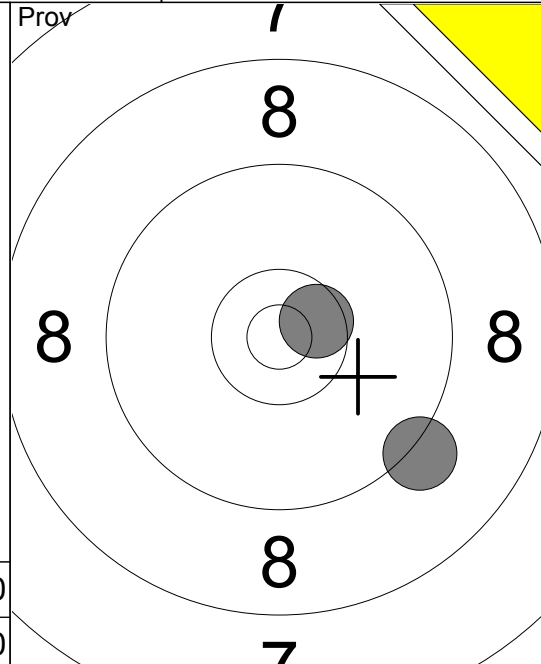

11:	9.2	↘
12:	10.6x	↗
Serie	19.0	
Total	0.0	

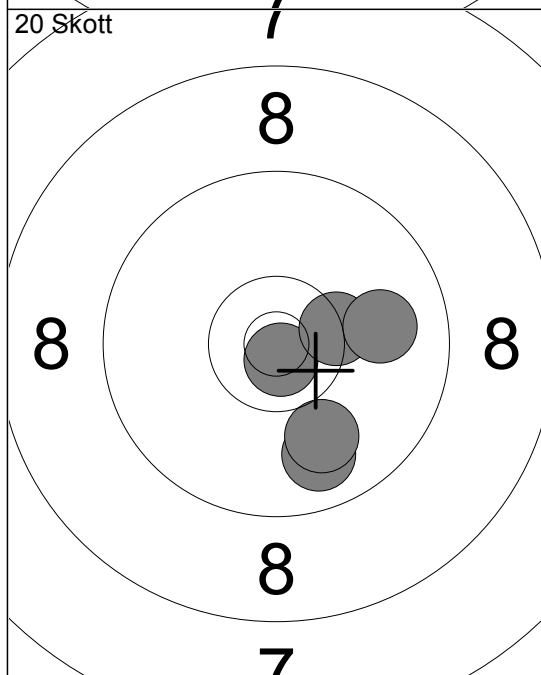

1:	9.8	↓
2:	10.8x	↓
3:	10.0	↓
4:	10.4x	↗
5:	9.9	→
Serie	48.0	
Total	48.0	

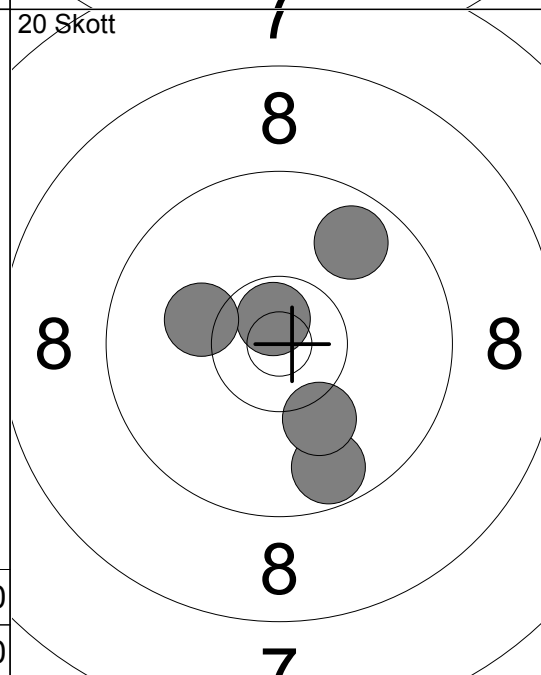

6:	9.7	↓
7:	10.7x	↗
8:	10.1	↓
9:	10.2	↖
10:	9.8	↗
Serie	48.0	
Total	96.0	

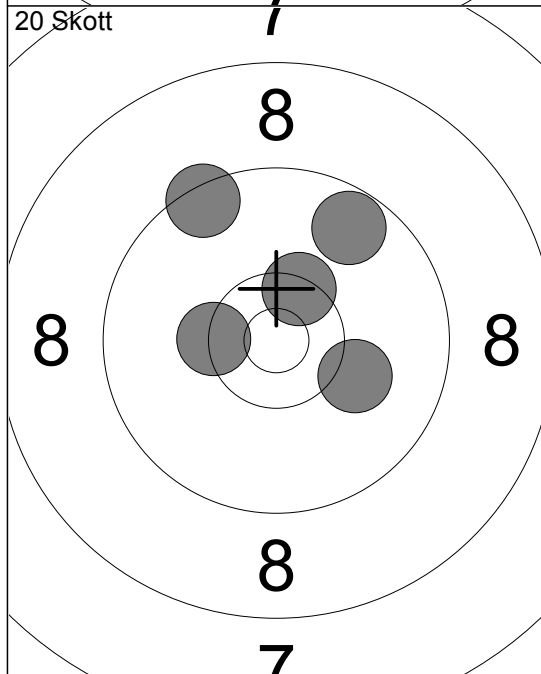

11:	10.4x	↗
12:	9.4	↖
13:	9.7	↗
14:	10.1	→
15:	10.4x	←
Serie	48.0	
Total	144.0	

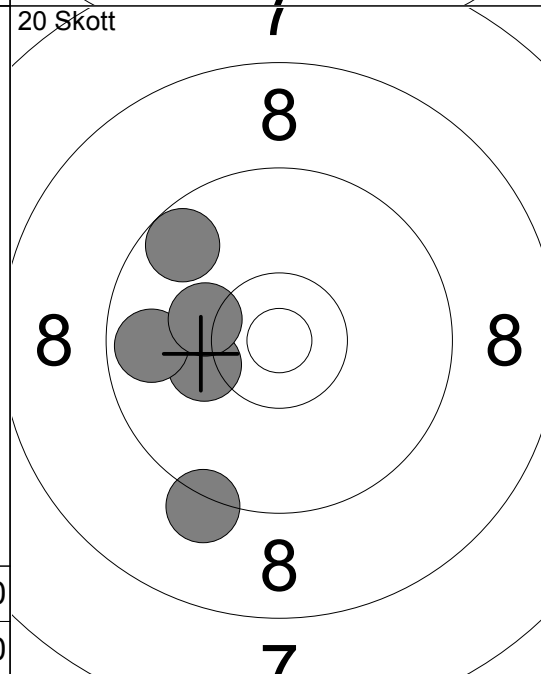

16:	10.2	↖
17:	9.2	↓
18:	9.7	←
19:	9.7	↖
20:	10.2	↖
Serie	47.0	
Total	191.0	

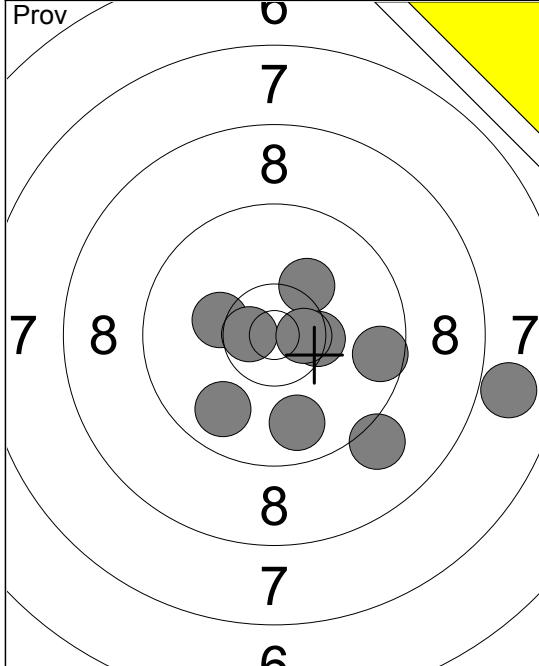

1:	9.1	↘
2:	10.2	↙
3:	10.6	↔
4:	10.2	↗
5:	9.6	→
6:	9.8	↘
7:	7.9	→
8:	9.8	↘
9:	10.4	→
10:	10.6	→
Serie		93.0
Total		0.0

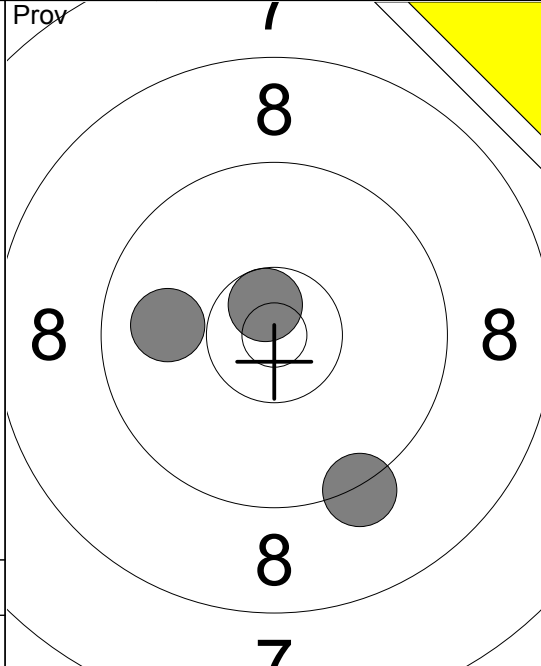

11:	9.9	↔
12:	9.3	↘
13:	10.6	↗
Serie		28.0
Total		0.0

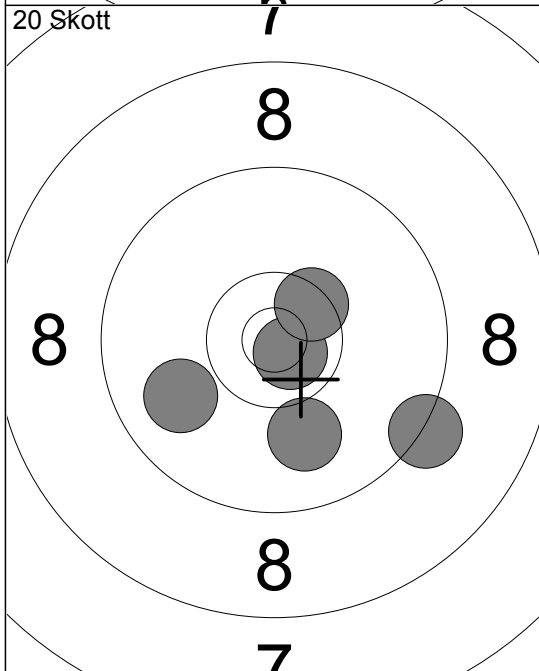

1:	10.8	↘
2:	10.5	↗
3:	9.3	↘
4:	10.0	↘
5:	9.9	↙
Serie		48.0
Total		48.0

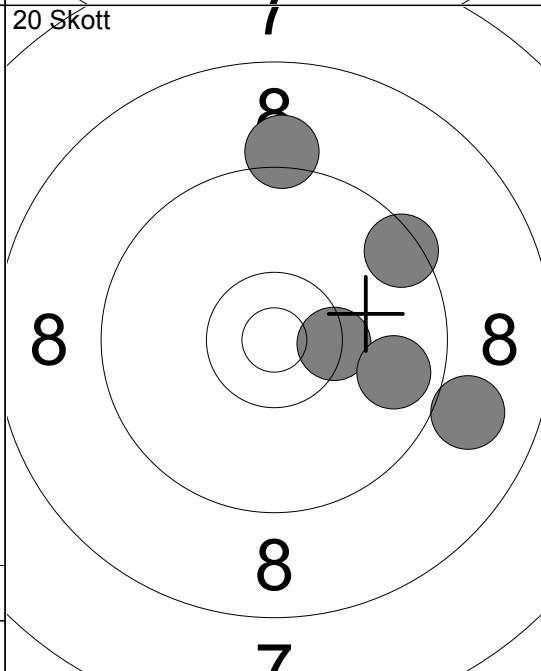

6:	9.5	↗
7:	9.0	→
8:	10.4	→
9:	9.2	↑
10:	9.8	→
Serie		46.0
Total		94.0

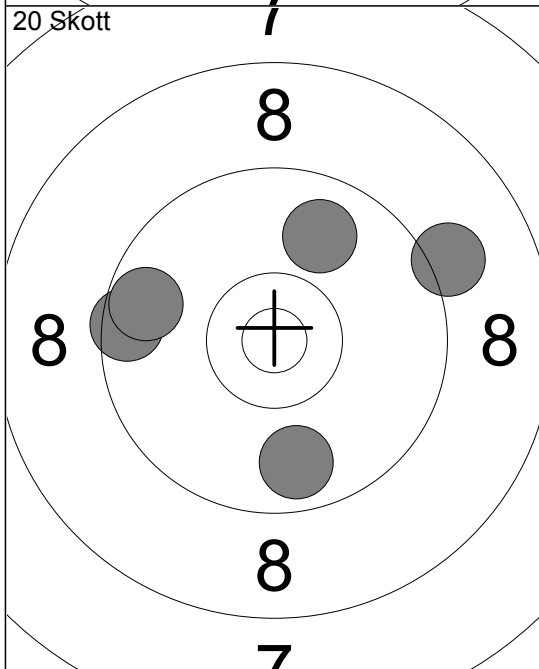

11:	9.9	↗
12:	9.1	→
13:	9.8	↘
14:	9.5	↔
15:	9.7	↔
Serie		45.0
Total		139.0

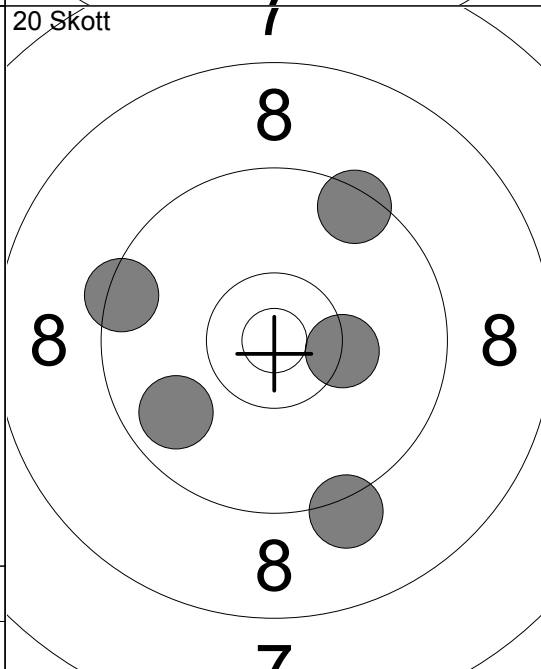

16:	9.8	↙
17:	9.4	↔
18:	9.5	↗
19:	9.2	↘
20:	10.3	→
Serie		46.0
Total		185.0

Skjutlag 1 Tavla 15 Agnes Ebbhagen

50m Ramselefors 11 Vb

21.08.2016 FM korthåll 2016 Ramselefors SKF

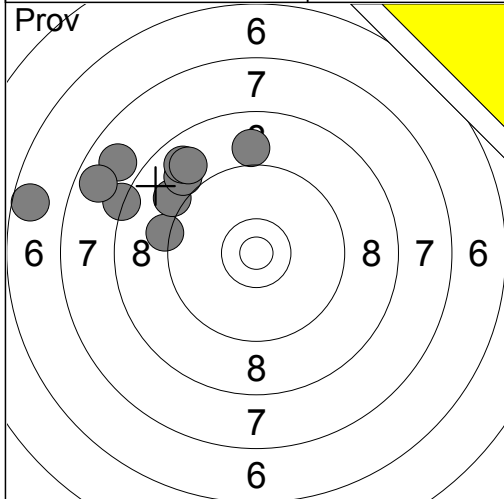

1:	9.0	↑
2:	7.9	↗
3:	9.2	←
4:	9.1	↗
5:	9.0	↗
6:	8.8	↗
7:	8.9	↗
8:	8.3	↗
9:	7.7	↗
10:	6.6	←

Serie	80.0
Total	0.0

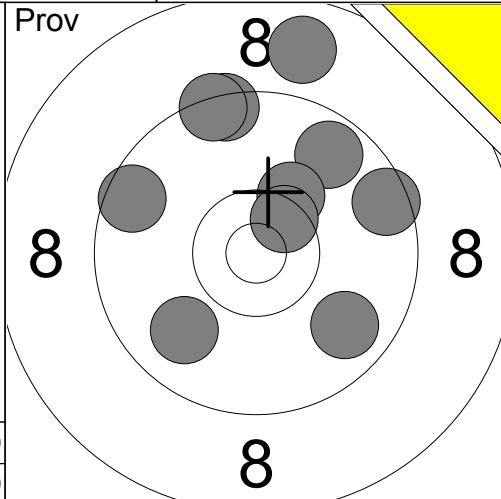

11:	8.8	↑
12:	9.6	↖
13:	9.4	↑
14:	9.8	↘
15:	9.4	↑
16:	9.5	→
17:	9.7	↗
18:	9.9	↙
19:	10.3	↗
20:	10.5x	↗

Serie	91.0
Total	0.0

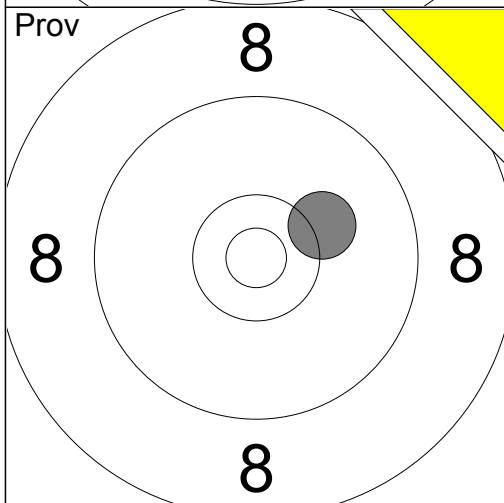

21:	10.2	↗
-----	------	---

Serie	10.0
Total	0.0

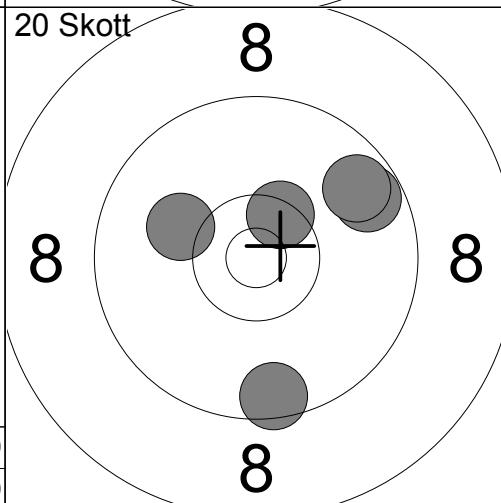

1:	10.4x	↗
2:	9.5	↘
3:	9.7	↗
4:	9.7	↗
5:	10.1	↖

Serie	47.0
Total	47.0

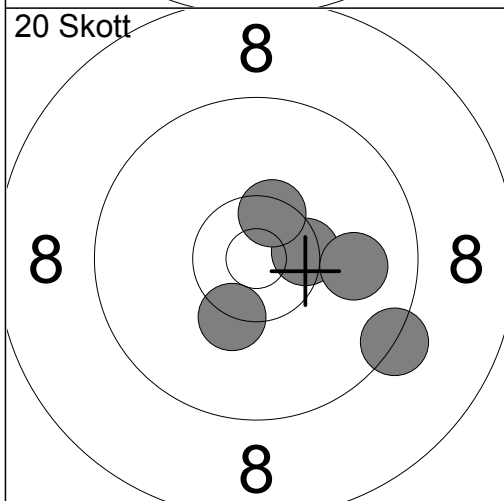

6:	10.3x	↘
7:	9.3	↘
8:	10.4x	→
9:	10.0	→
10:	10.5x	↗

Serie	49.0
Total	96.0

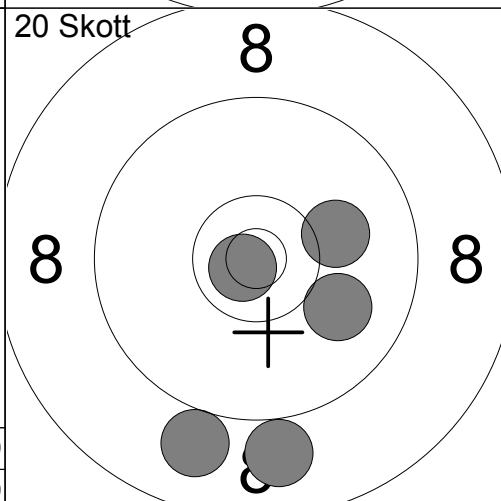

11:	9.0	↘
12:	10.1	→
13:	10.8x	↖
14:	10.0	↘
15:	9.0	↘

Serie	48.0
Total	144.0

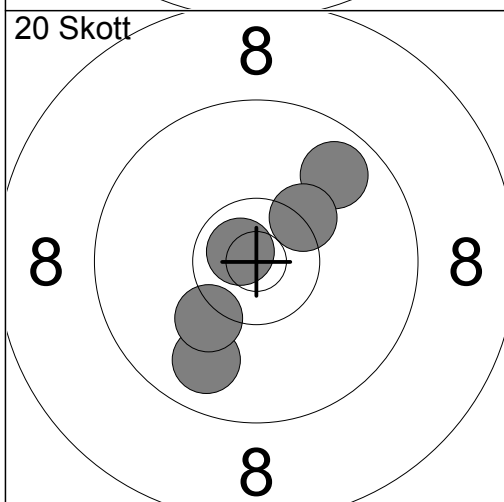

16:	9.8	↘
17:	9.8	↗
18:	10.3x	↗
19:	10.8x	↗
20:	10.2	↘

Serie	48.0
Total	192.0

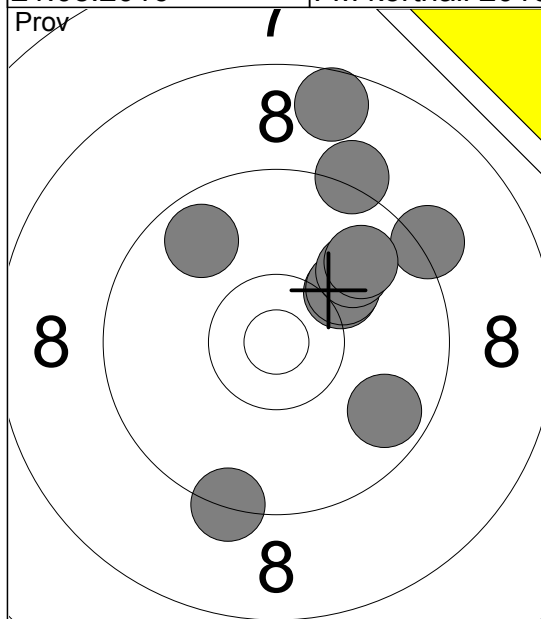

- 1: 8.6 ↑
- 2: 10.2 ↗
- 3: 9.2 ↑
- 4: 10.1 ↗
- 5: 9.2 ↗
- 6: 9.3 ↓
- 7: 9.7 ↖
- 8: 10.0 ↗
- 9: 9.7 ↘
- 10: 9.8 ↗

Serie 92.0
Total 0.0

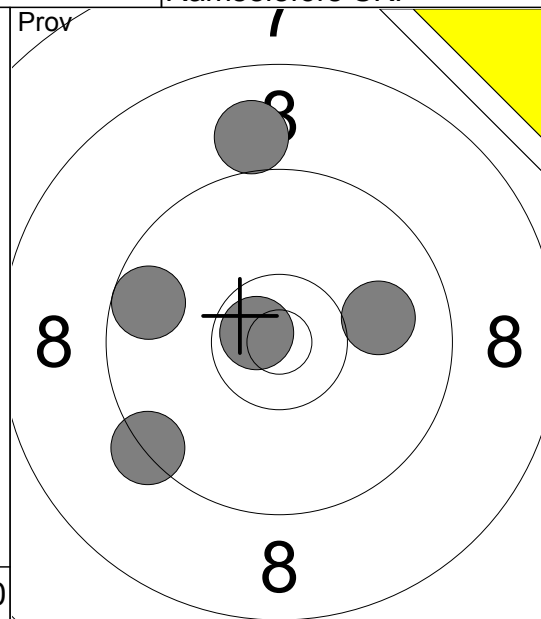

- 11: 10.0 →
- 12: 9.7 ←
- 13: 9.3 ↙
- 14: 9.0 ↑
- 15: 10.7 ✕

Serie 47.0
Total 0.0

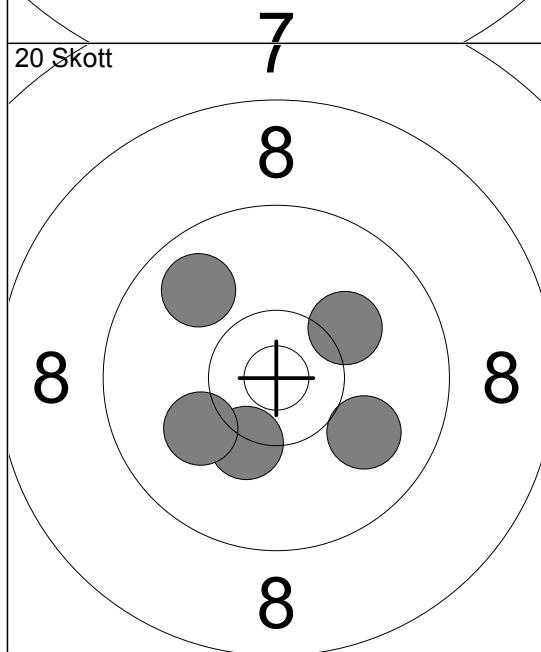

- 1: 10.1 ↗
- 2: 9.8 ↖
- 3: 10.3 ↓
- 4: 10.1 ↙
- 5: 10.0 ↘

Serie 49.0
Total 49.0

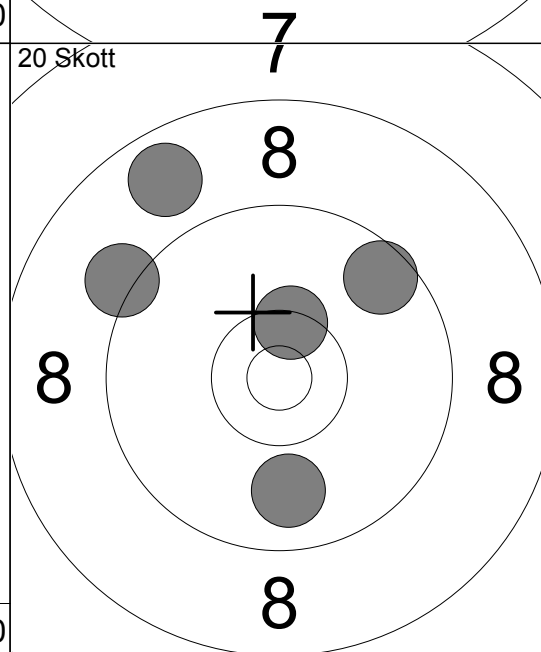

- 6: 10.4 ✕ ↗
- 7: 9.6 ↗
- 8: 9.2 ↖
- 9: 8.8 ↑
- 10: 9.9 ↓

Serie 45.0
Total 94.0

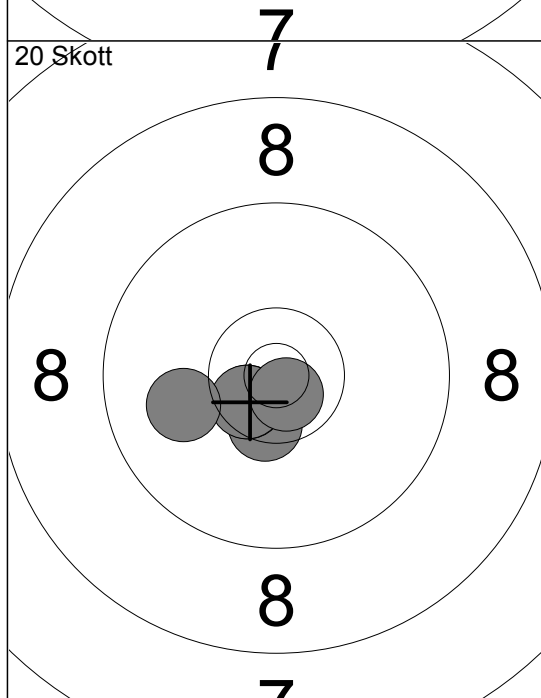

- 11: 10.5 ✕ ↓
- 12: 10.6 ✕ ↘
- 13: 10.6 ✕ ↘
- 14: 10.0 ↙
- 15: 10.7 ✕ ↘

Serie 50.0
Total 144.0

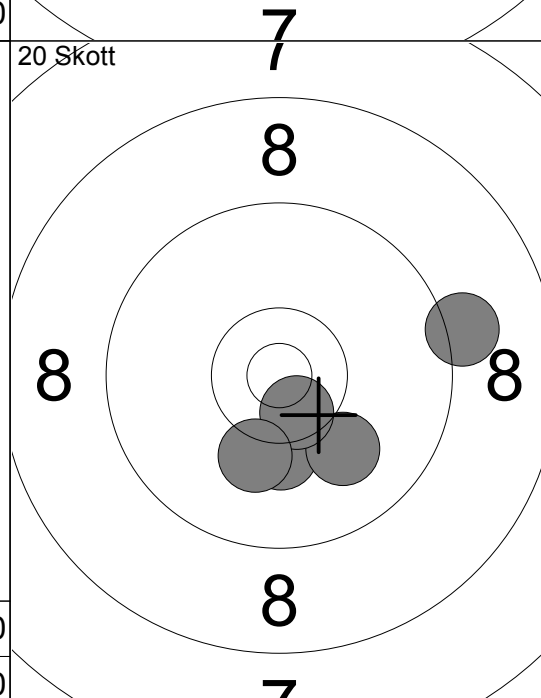

- 16: 10.2 ↓
- 17: 10.0 ↘
- 18: 10.6 ✕ ↘
- 19: 10.2 ↓
- 20: 9.2 →

Serie 49.0
Total 193.0

Skjutlag	Tavla	Stefan Thorin		Sen-L	Vb
1	17	50m	Umeå		
21.08.2016	FM korthåll 2016	Ramselefors SKF			
Prov	7	8	8	8	8
		1: 9.0 → 2: 10.6x↘ 3: 10.5x↘ 4: 10.4x↗ 5: 9.5 → 6: 10.5x↘ 7: 9.4 ↗ 8: 10.7x↔ 9: 10.6x↗	Prov	7	11: 10.3 ↗
		Serie 87.0		Serie 10.0	
		Total 0.0		Total 0.0	
20 Skott	7	8	8	8	8
		1: 8.7 ↖ 2: 9.6 ↗ 3: 10.0 ↘ 4: 9.6 ↗ 5: 10.1 ↑	20 Skott	7	6: 9.0 ↑ 7: 10.1 ↗ 8: 10.5x↘ 9: 10.3x↘ 10: 10.7x↘
		Serie 46.0		Serie 49.0	
		Total 46.0		Total 95.0	
20 Skott	7	8	8	8	8
		11: 10.4x↗ 12: 10.4x↗ 13: 10.2 ↗ 14: 9.5 → 15: 10.4x↘	20 Skott	7	16: 10.3x↘ 17: 10.2 ↗ 18: 10.1 ← 19: 9.7 ← 20: 10.1 ←
		Serie 49.0		Serie 49.0	
		Total 144.0		Total 193.0	

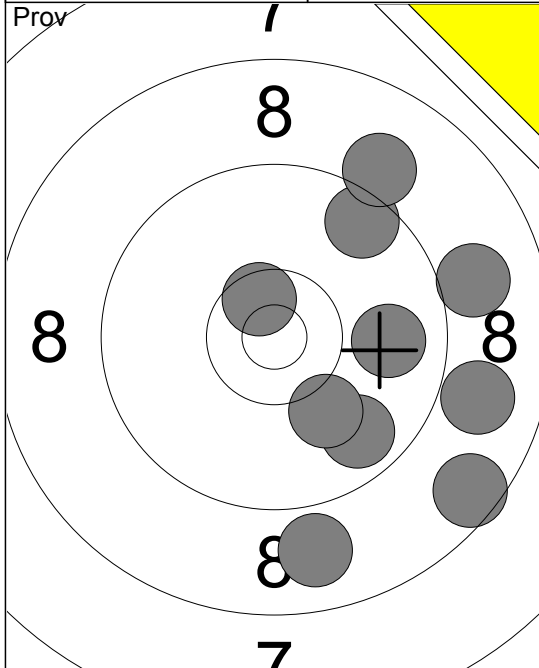

1:	8.9	→
2:	9.6	↗
3:	9.9	→
4:	9.1	↗
5:	10.6	↘
6:	8.9	↓
7:	8.6	↓
8:	9.7	↓
9:	9.0	→
10:	10.1	↓
Serie	89.0	
Total	0.0	

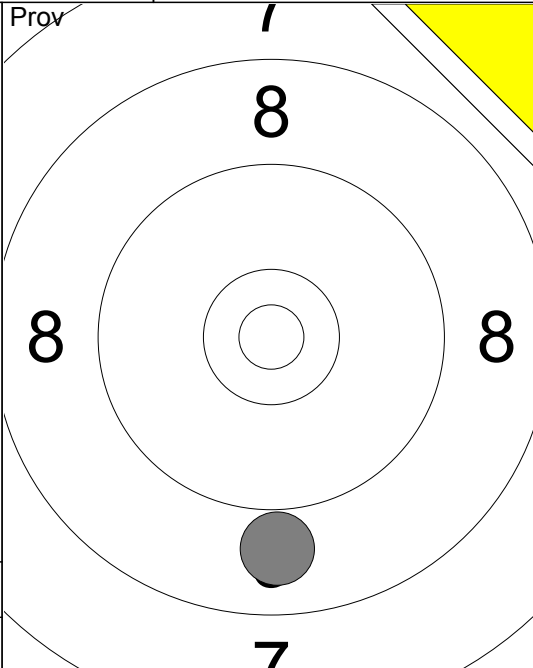

11:	8.9	↓
Serie	8.0	
Total	0.0	

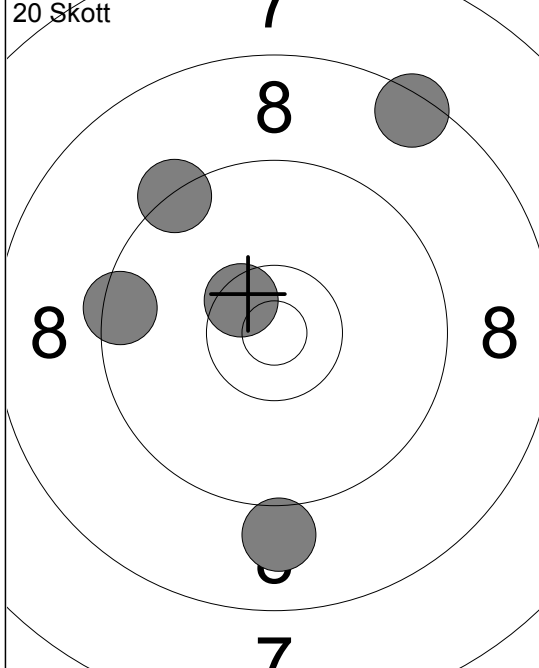

1:	9.0	↓
2:	9.3	↗
3:	10.5	↘
4:	8.5	↗
5:	9.5	←
Serie	45.0	
Total	45.0	

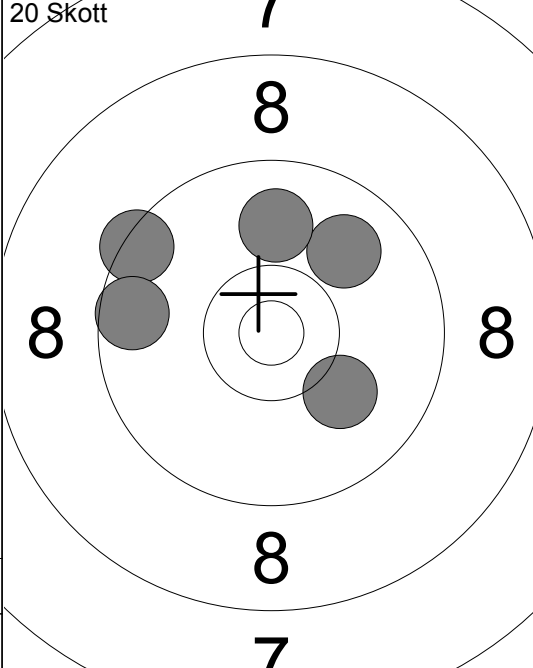

6:	9.9	↗
7:	9.9	↑
8:	9.4	↖
9:	9.6	←
10:	10.1	↘
Serie	46.0	
Total	91.0	

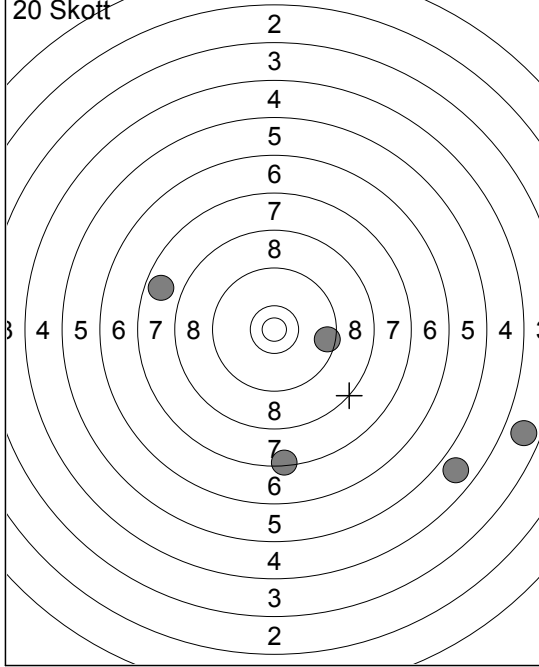

11:	7.7	←
12:	3.8	→
13:	9.5	→
14:	7.4	↓
15:	4.8	↘
Serie	30.0	
Total	121.0	

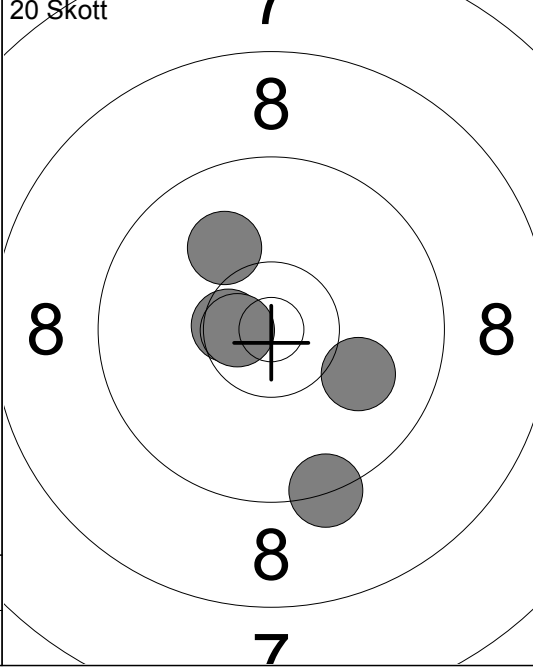

16:	9.3	↓
17:	10.0	↘
18:	10.5	↖
19:	10.6	↖
20:	10.1	↖
Serie	49.0	
Total	170.0	

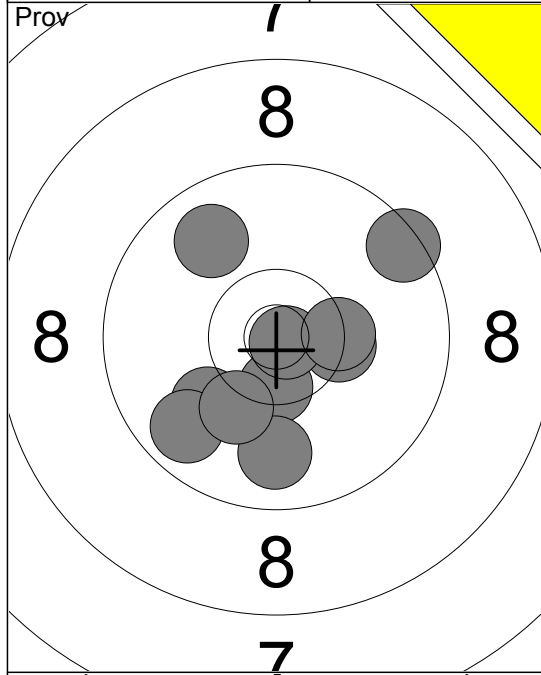

1:	10.0	↙
2:	10.3	x→
3:	10.5	x↓
4:	9.5	↗
5:	9.7	↙
6:	9.9	↓
7:	10.2	↙
8:	10.8	x↘
9:	10.4	x→
10:	9.8	↖
Serie	96.0	
Total	0.0	

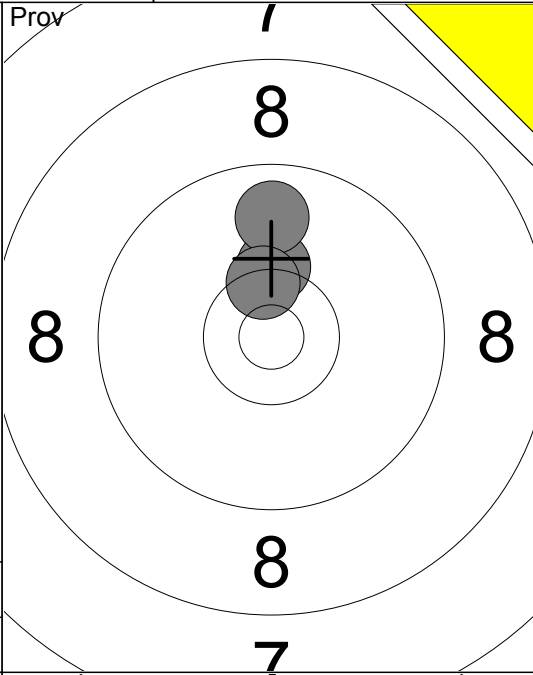

11:	10.3	↑
12:	9.8	↑
13:	10.4	x↑
Serie	29.0	
Total	0.0	

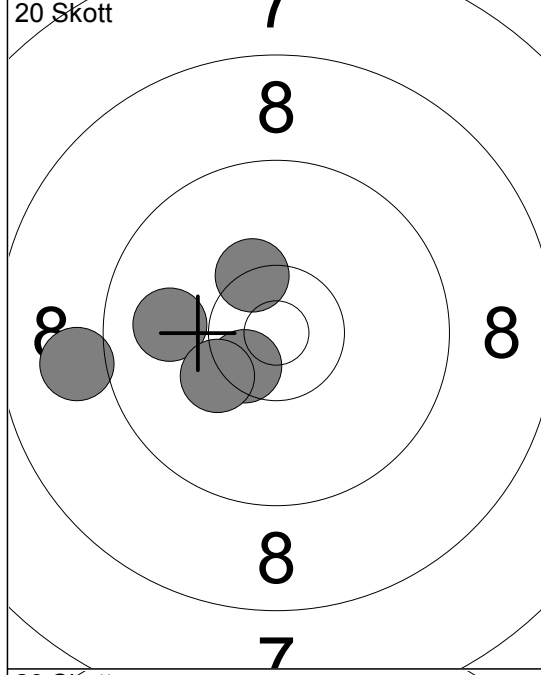

1:	9.0	←
2:	10.4	x↗
3:	9.9	←
4:	10.5	x↘
5:	10.3	↙
Serie	48.0	
Total	48.0	

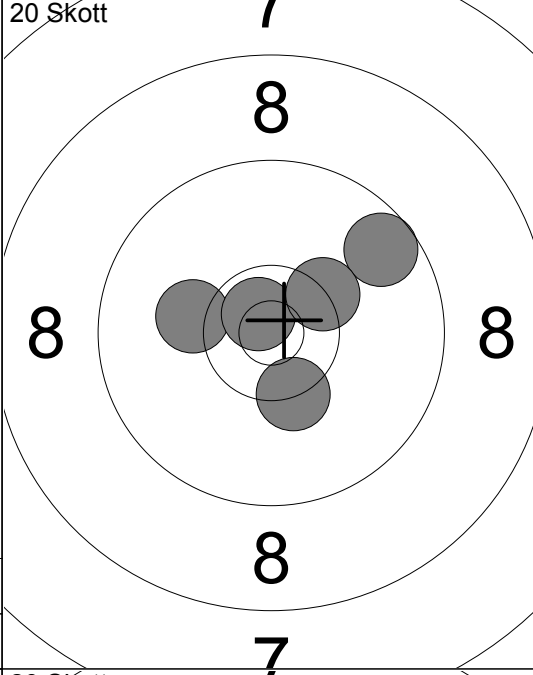

6:	10.2	↙
7:	10.3	x↓
8:	9.6	↗
9:	10.7	x↘
10:	10.3	x↗
Serie	49.0	
Total	97.0	

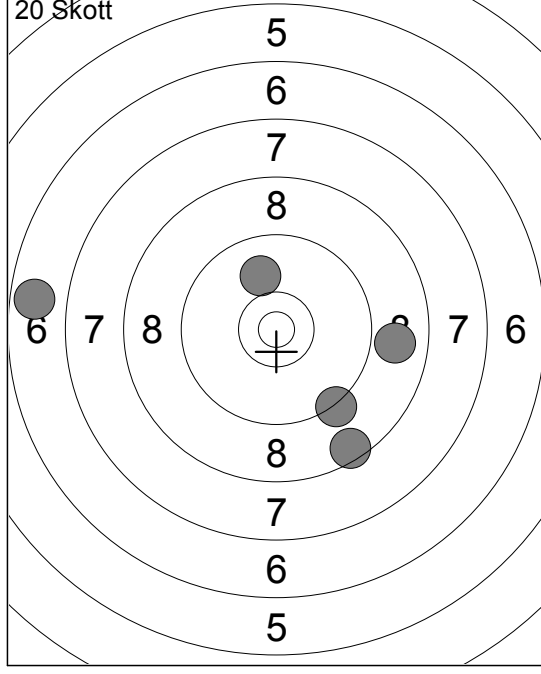

11:	8.9	→
12:	10.0	↑
13:	9.3	↘
14:	6.7	←
15:	8.5	↘
Serie	41.0	
Total	138.0	

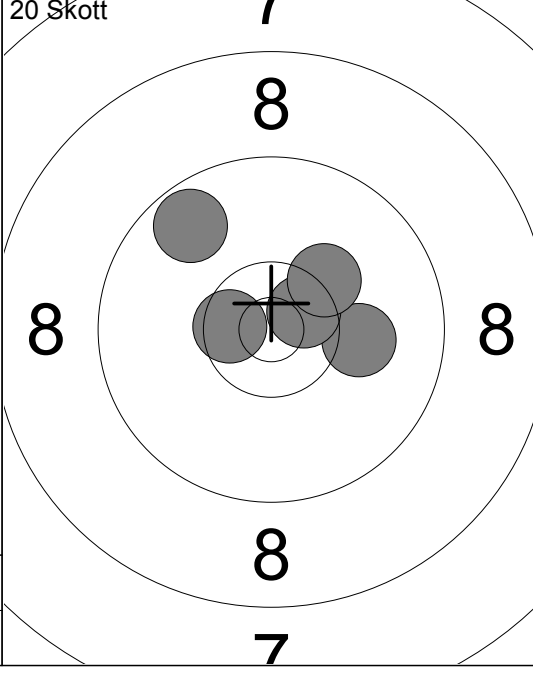

16:	10.6	x←
17:	10.1	→
18:	10.6	x↗
19:	10.3	↗
20:	9.7	↖
Serie	49.0	
Total	187.0	

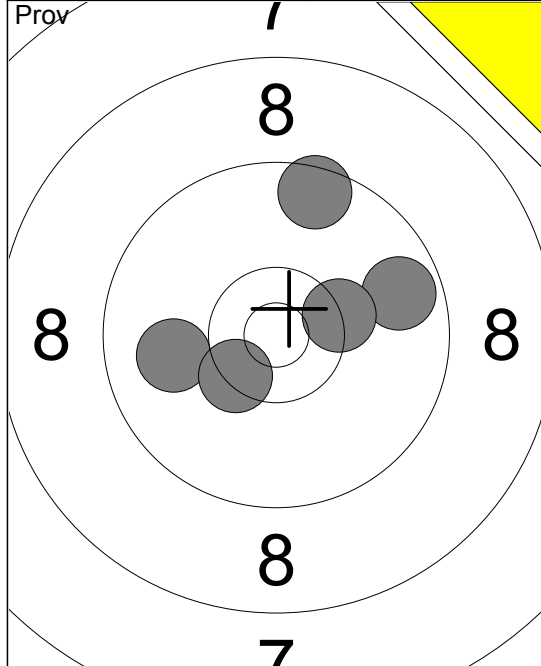

1:	9.7	→
2:	9.5	↑
3:	10.0	←
4:	10.4	↘
5:	10.3	↗
Serie	48.0	
Total	0.0	

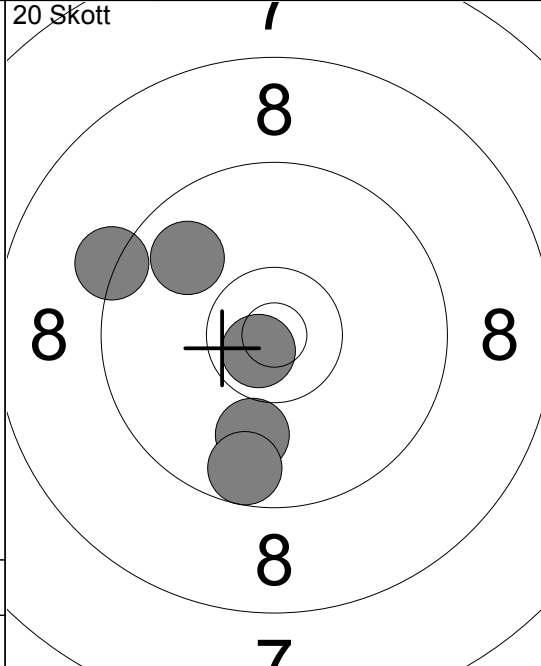

1:	9.8	↖
2:	10.0	↓
3:	10.7	↘
4:	9.3	↖
5:	9.7	↓
Serie	47.0	
Total	47.0	

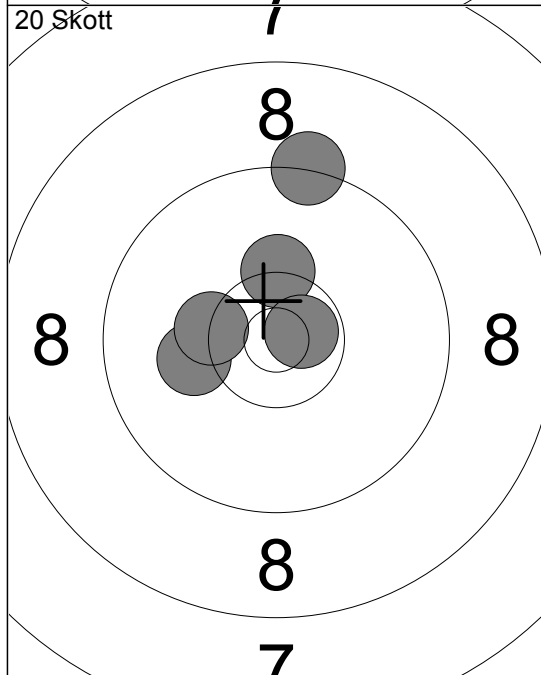

6:	10.3	↑
7:	10.1	←
8:	10.3	↘
9:	10.7	↗
10:	9.3	↑
Serie	49.0	
Total	96.0	

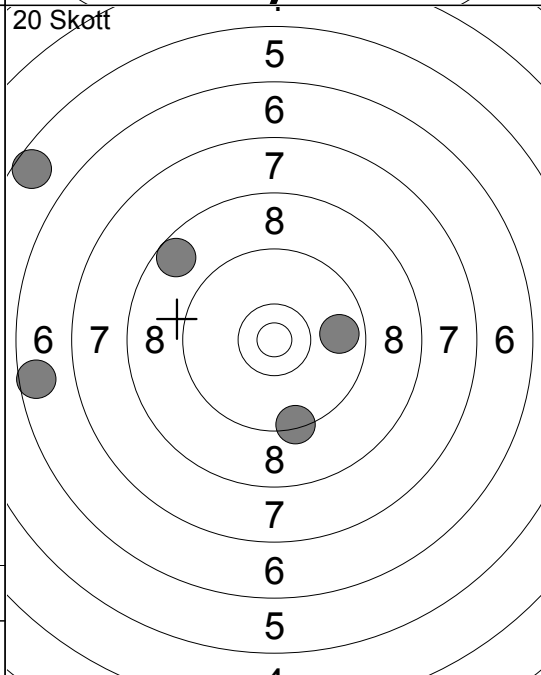

11:	9.8	→
12:	6.6	←
13:	5.6	↖
14:	8.6	↖
15:	9.4	↓
Serie	37.0	
Total	133.0	

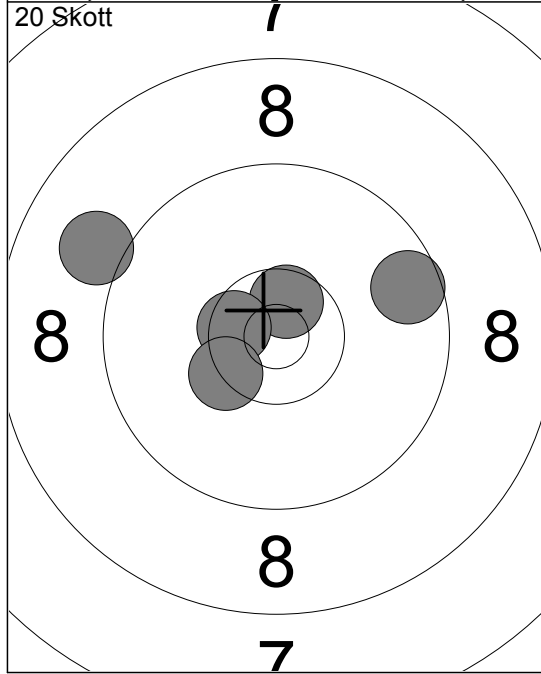

16:	9.6	→
17:	10.6	↗
18:	10.5	↘
19:	10.4	↘
20:	9.0	↖
Serie	48.0	
Total	181.0	

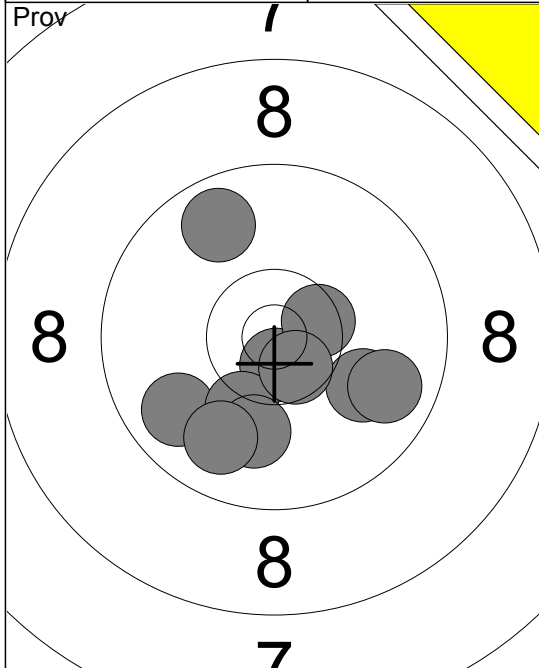

1: 9.8 ↙
2: 10.0 ↘
3: 9.8 →
4: 10.7x↓
5: 10.2 ↓
6: 10.5x→
7: 10.0 ↓
8: 10.6x↘
9: 9.9 ↓
10: 9.8 ↗

Serie 96.0
Total 0.0

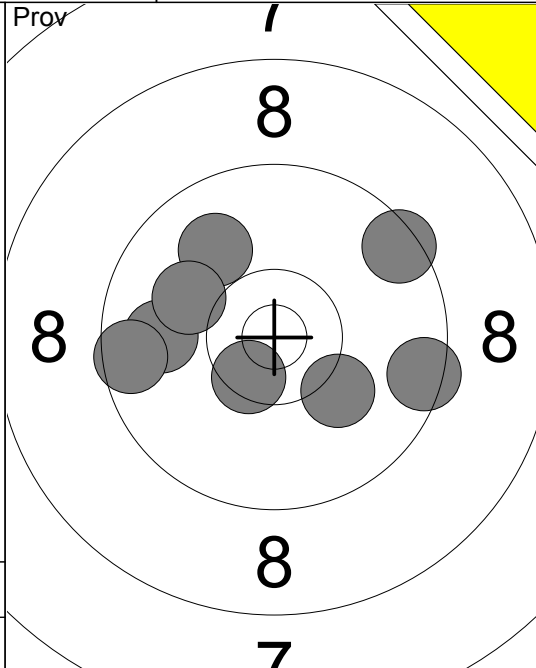

11: 9.5 →
12: 9.5 ↗
13: 9.9 ←
14: 9.9 ↗
15: 9.6 ←
16: 10.5x↓
17: 10.2 ↘
18: 10.1 ↖

Serie 75.0
Total 0.0

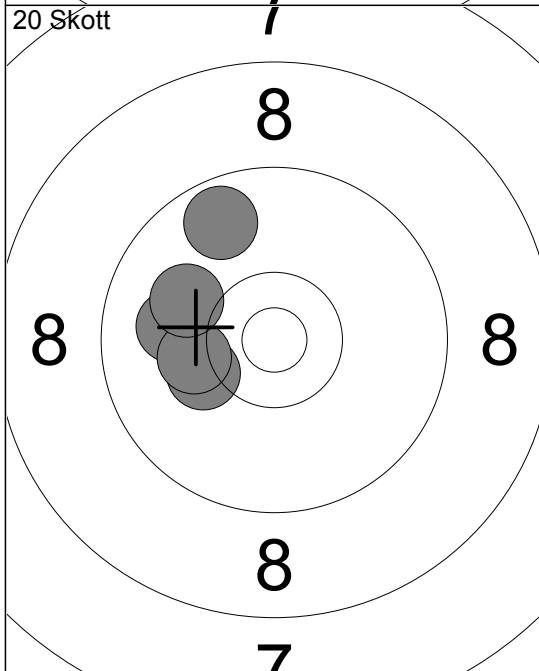

1: 10.0 ←
2: 10.2 ←
3: 10.2 ←
4: 9.7 ↗
5: 10.0 ↖

Serie 49.0
Total 49.0

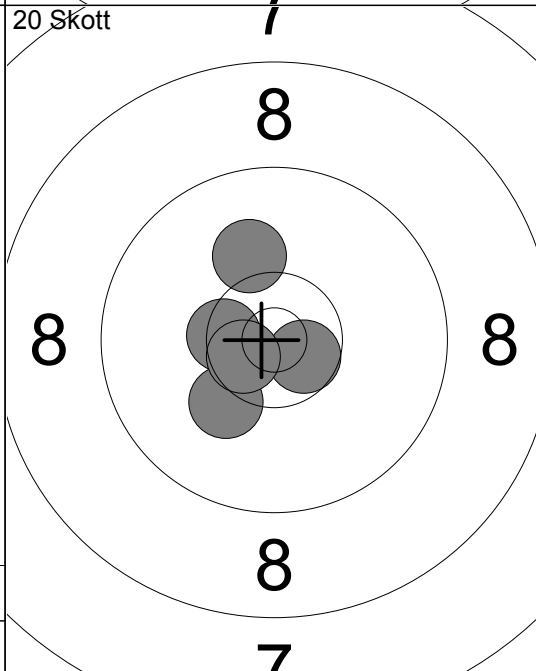

6: 10.5x↖
7: 10.6x↘
8: 10.1 ↗
9: 10.2 ↓
10: 10.6x↖

Serie 50.0
Total 99.0

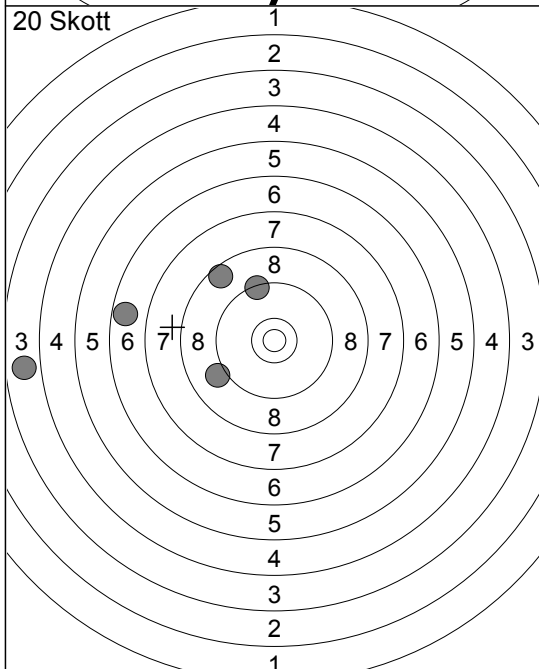

11: 8.6 ↖
12: 9.4 ↗
13: 3.8 ←
14: 6.7 ←
15: 9.1 ↖

Serie 35.0
Total 134.0

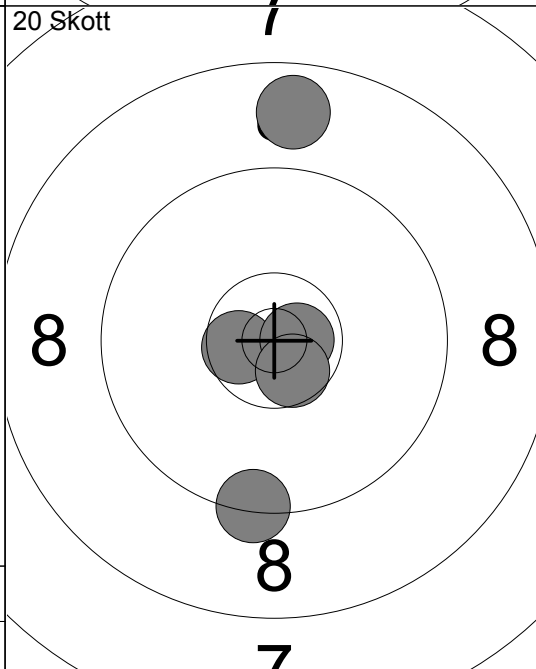

16: 10.6x↖
17: 10.7x→
18: 10.6x↘
19: 9.4 ↓
20: 8.8 ↗

Serie 47.0
Total 181.0

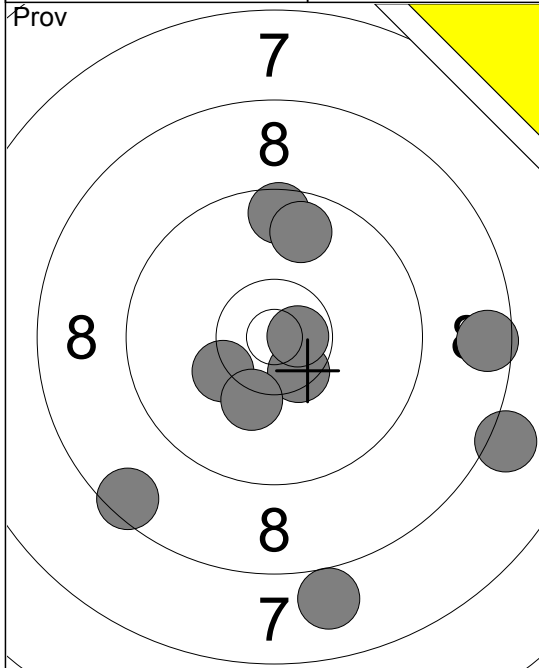

1:	9.6	↑
2:	9.7	↑
3:	10.5	↘
4:	10.3	↙
5:	8.6	→
6:	10.7	↘
7:	8.0	↓
8:	8.1	→
9:	10.2	↓
10:	8.5	↙
Serie	90.0	
Total	0.0	

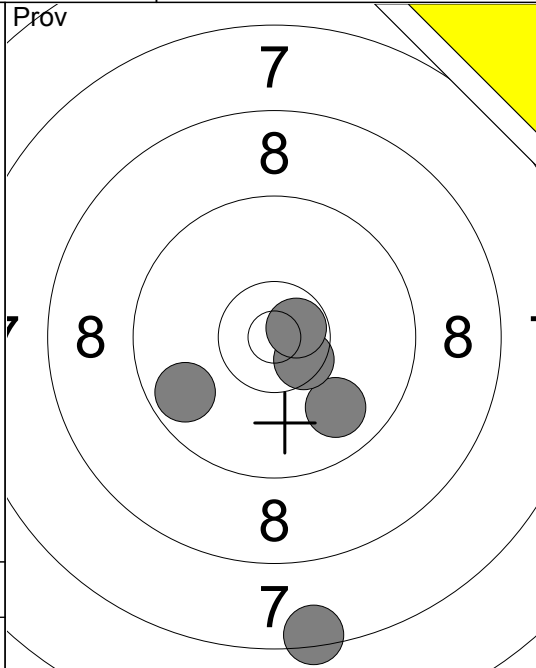

11:	7.4	↓
12:	9.9	↘
13:	10.5	↘
14:	9.7	↙
15:	10.7	↘
Serie	45.0	
Total	0.0	

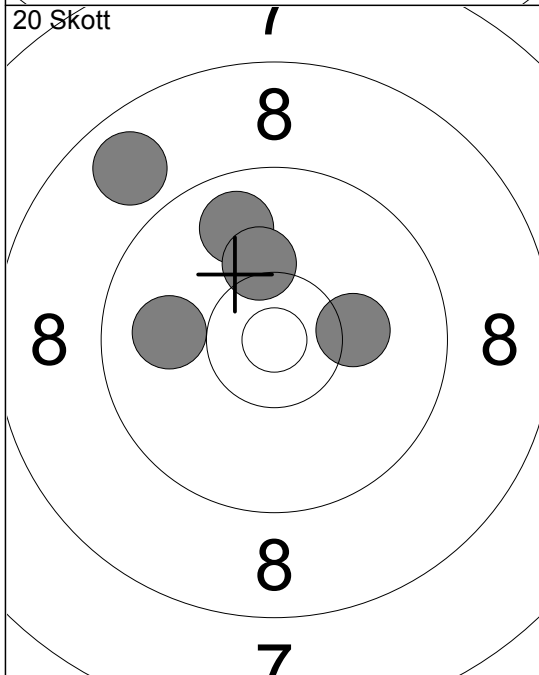

1:	8.8	↑
2:	9.8	↑
3:	10.2	→
4:	9.9	←
5:	10.2	↑
Serie	46.0	
Total	46.0	

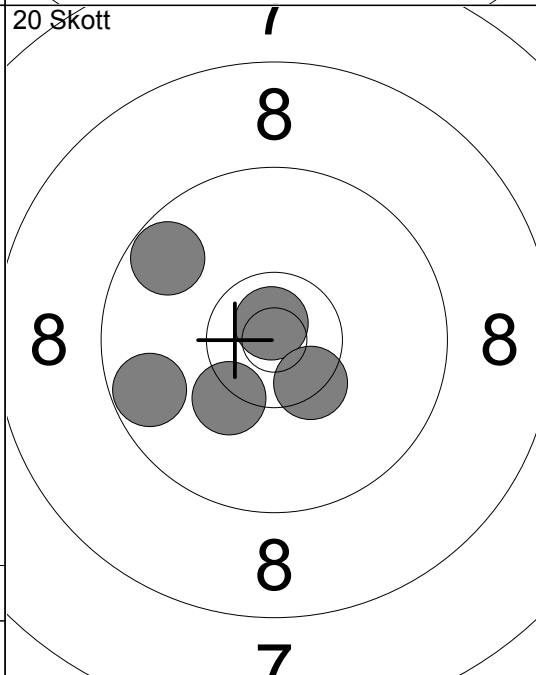

6:	10.8	↗
7:	10.2	↘
8:	10.4	↘
9:	9.7	↙
10:	9.7	←
Serie	48.0	
Total	94.0	

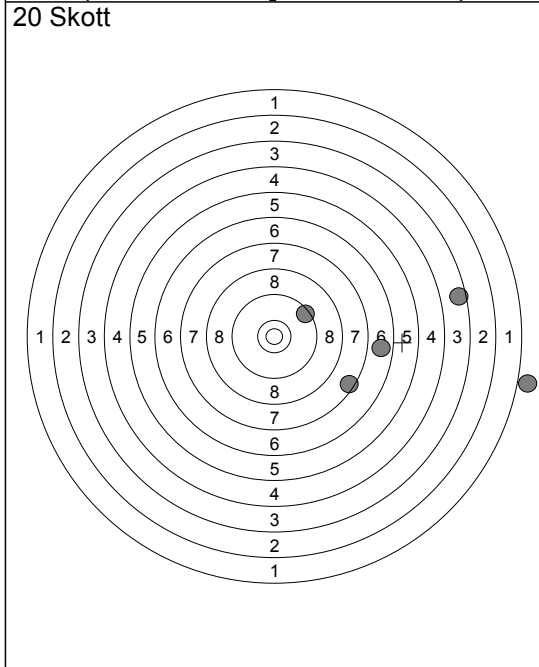

11:	7.5	↘
12:	0.0	→
13:	9.4	↗
14:	3.6	→
15:	6.8	→
Serie	25.0	
Total	119.0	

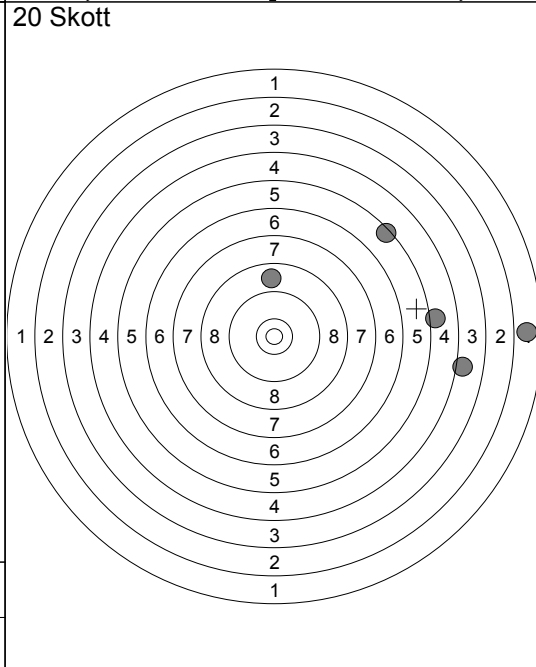

16:	8.9	↑
17:	5.1	→
18:	4.1	→
19:	1.8	→
20:	5.5	↗
Serie	23.0	
Total	142.0	

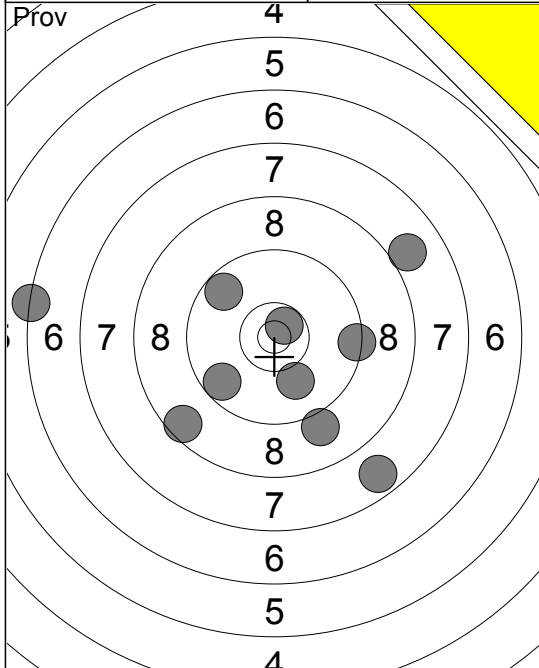

1:	9.0	↘
2:	10.0	↘
3:	9.4	→
4:	9.7	↗
5:	8.6	↘
6:	7.7	↘
7:	10.7	↗
8:	9.7	↘
9:	8.0	↗
10:	6.3	←
Serie		85.0
Total		0.0

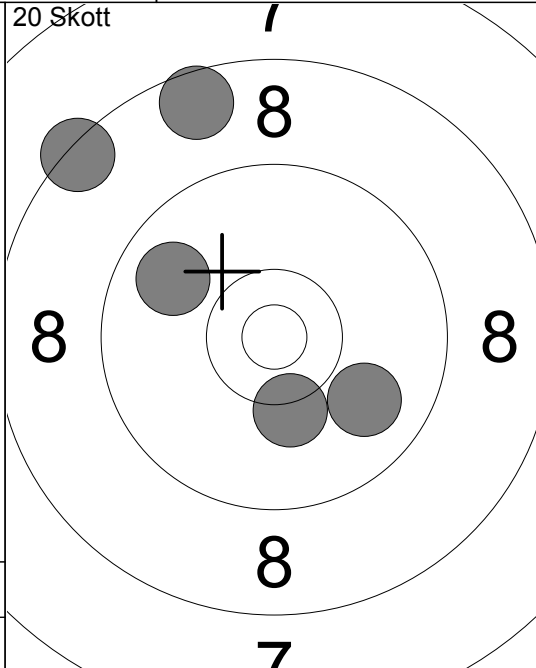

1:	8.4	↗
2:	9.9	↘
3:	8.6	↗
4:	10.2	↘
5:	9.8	↖
Serie		44.0
Total		44.0

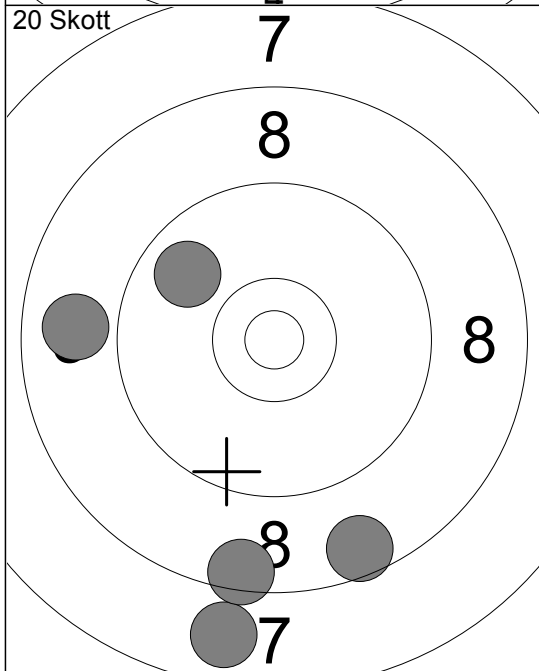

6:	9.8	↖
7:	8.6	↘
8:	7.8	↘
9:	8.5	↘
10:	8.9	←
Serie		40.0
Total		84.0

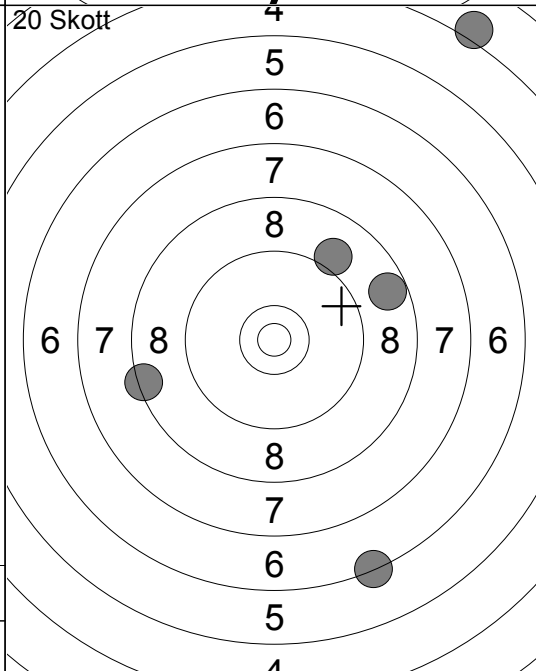

11:	8.4	←
12:	9.1	↗
13:	4.1	↗
14:	6.3	↘
15:	8.7	↗
Serie		35.0
Total		119.0

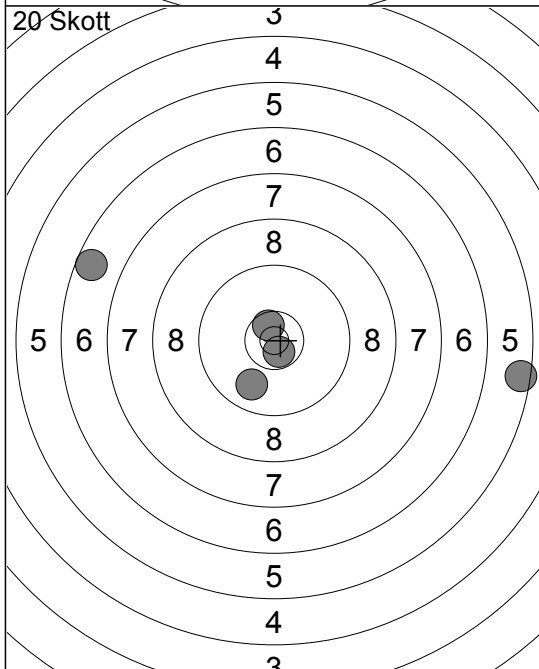

16:	6.6	←
17:	10.6	↗
18:	10.7	↘
19:	5.5	→
20:	9.9	↘
Serie		40.0
Total		159.0

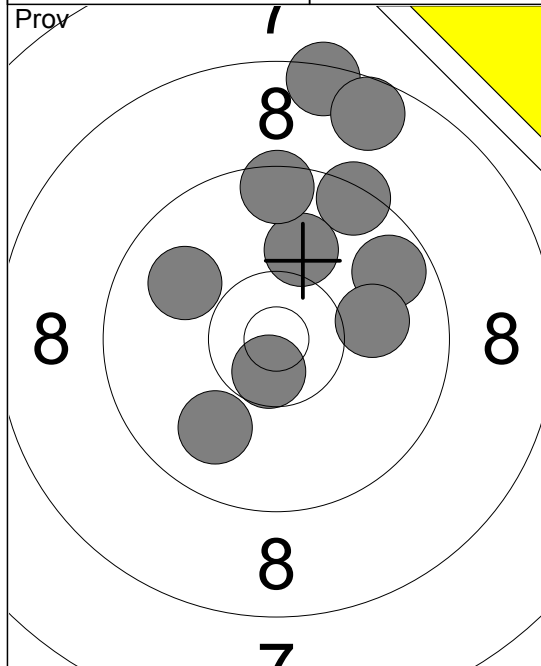

- 1: 10.6x ↘
- 2: 9.7 ↗
- 3: 9.9 ↖
- 4: 9.4 ↗
- 5: 8.4 ↑
- 6: 10.1 ↑
- 7: 9.9 ↘
- 8: 10.0 →
- 9: 8.6 ↑
- 10: 9.5 ↑

Serie 91.0
Total 0.0

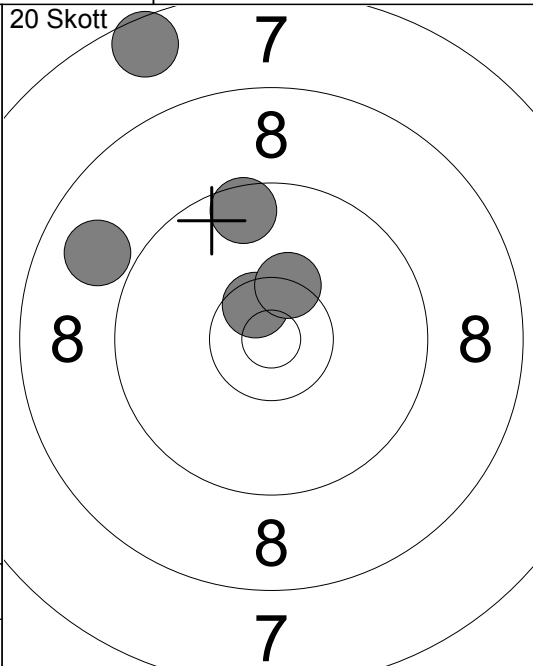

- 1: 8.9 ↖
- 2: 10.6x ↗
- 3: 7.6 ↗
- 4: 10.4x ↗
- 5: 9.6 ↑

Serie 44.0
Total 44.0

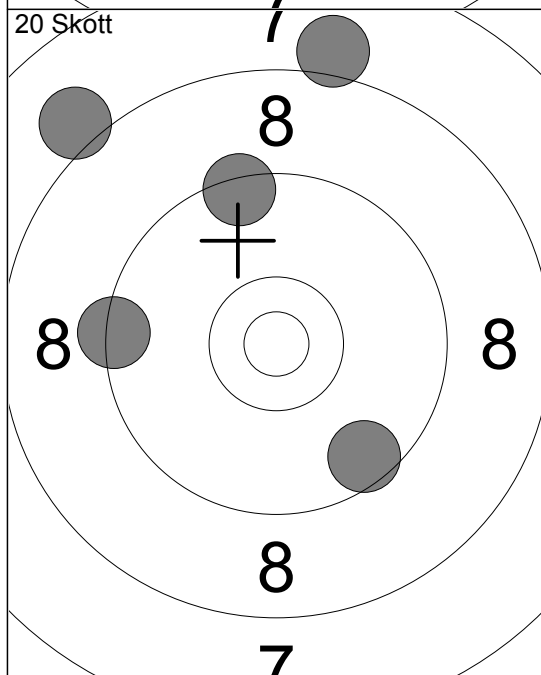

- 6: 8.1 ↗
- 7: 9.4 ↖
- 8: 9.6 ↘
- 9: 9.4 ↑
- 10: 8.1 ↑

Serie 43.0
Total 87.0

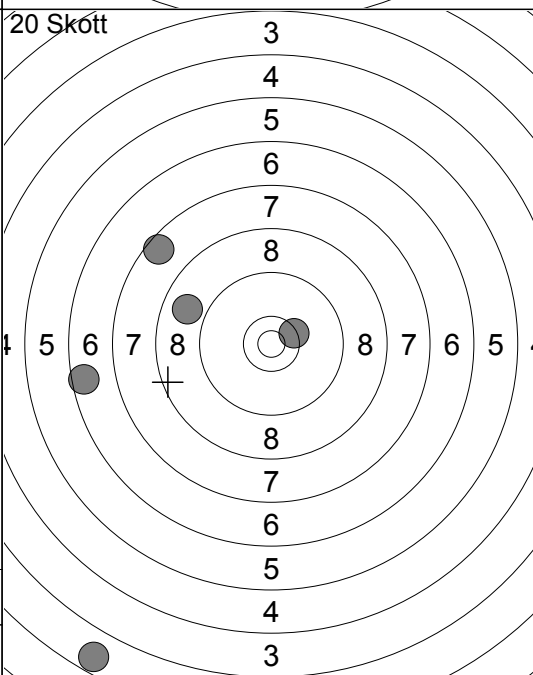

- 11: 2.7 ↘
- 12: 7.6 ↖
- 13: 8.9 ↖
- 14: 6.6 ↖
- 15: 10.4x ↗

Serie 33.0
Total 120.0

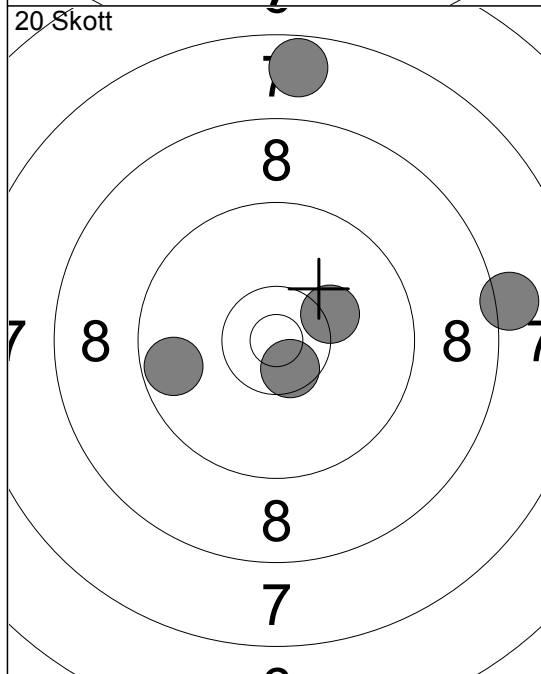

- 16: 8.1 →
- 17: 9.7 ↖
- 18: 10.6x ↘
- 19: 7.7 ↑
- 20: 10.2 ↗

Serie 44.0
Total 164.0

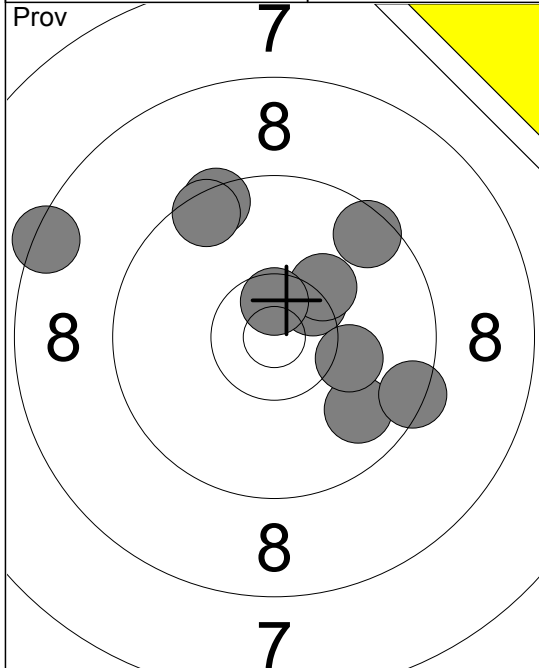

- 1: 9.4 ↗
- 2: 8.4 ↙
- 3: 10.4x ↗
- 4: 9.8 ↘
- 5: 9.5 ↗
- 6: 10.2 →
- 7: 10.2 ↗
- 8: 9.4 →
- 9: 10.6x ↑
- 10: 9.5 ↖

Serie 93.0
Total 0.0

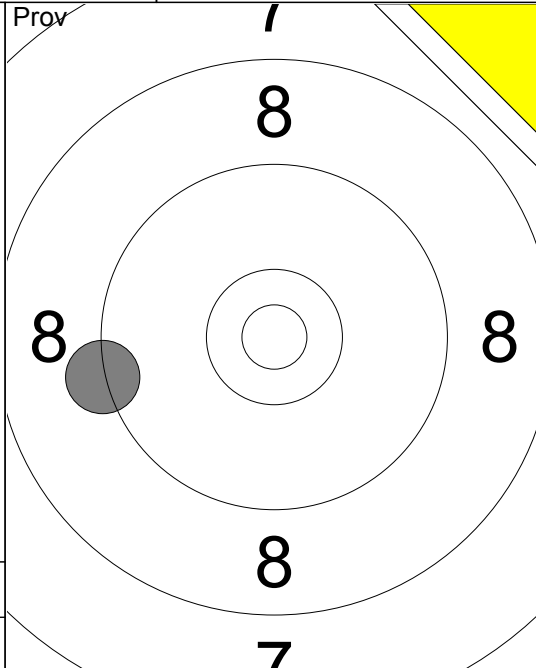

- 11: 9.3 ←

Serie 9.0
Total 0.0

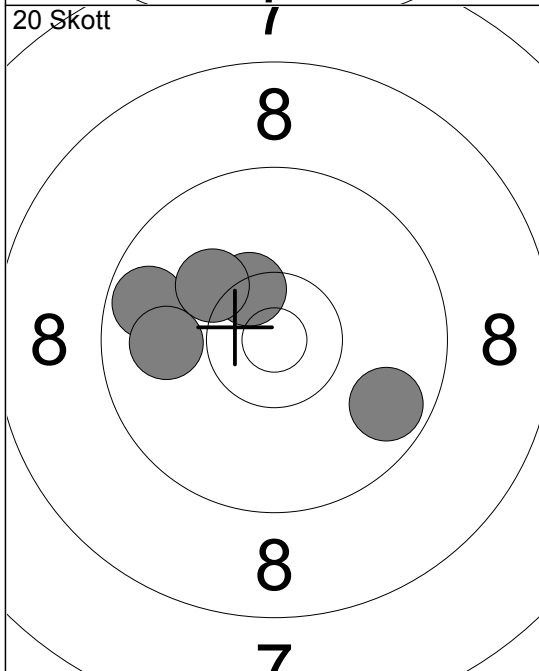

- 1: 9.7 ←
- 2: 9.9 ←
- 3: 10.4x ↗
- 4: 10.2 ↖
- 5: 9.7 ↘

Serie 47.0
Total 47.0

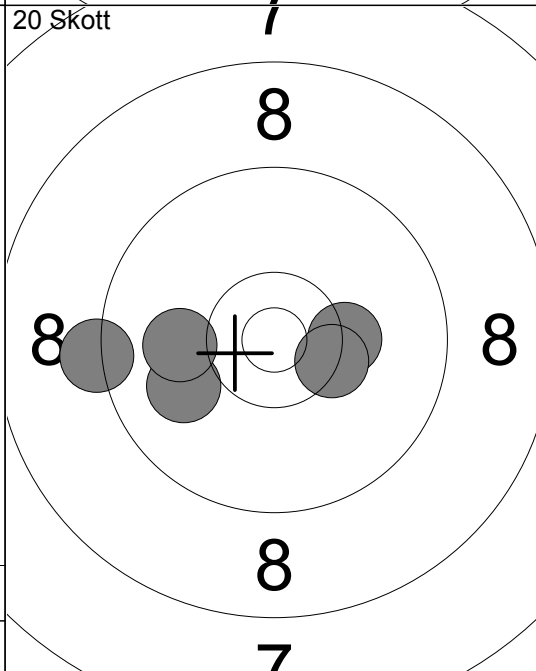

- 6: 10.0 ↙
- 7: 9.2 ←
- 8: 10.0 ↙
- 9: 10.3 →
- 10: 10.4x →

Serie 49.0
Total 96.0

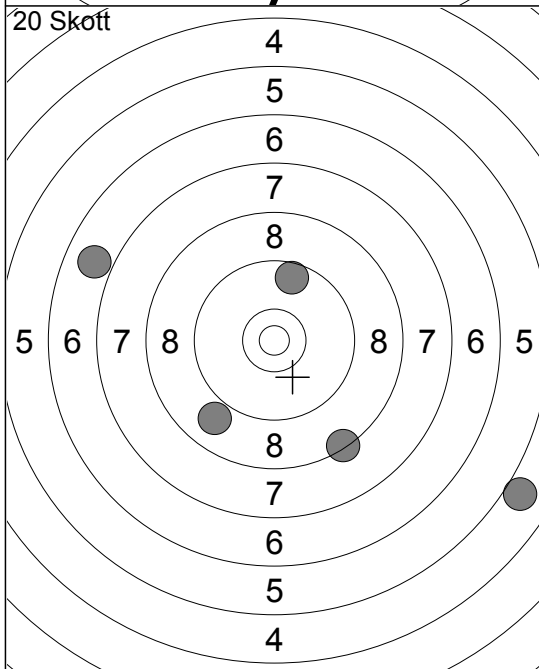

- 11: 9.6 ↑
- 12: 8.9 ↘
- 13: 5.0 ↘
- 14: 6.9 ↖
- 15: 8.4 ↘

Serie 36.0
Total 132.0

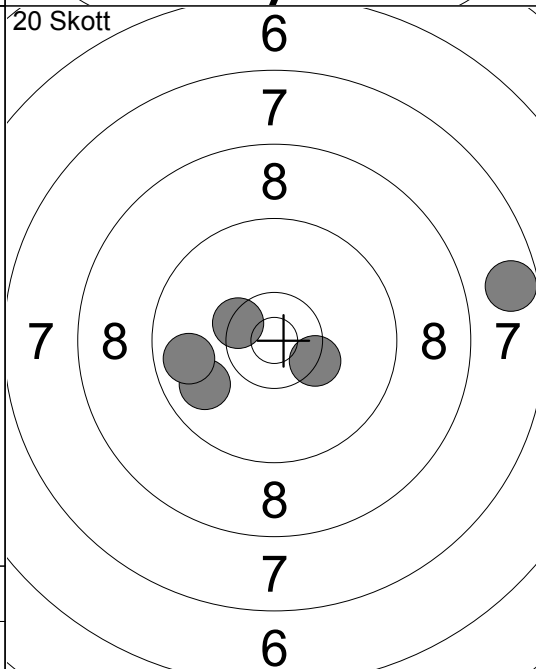

- 16: 10.3x →
- 17: 9.8 ↙
- 18: 9.8 ←
- 19: 10.4x ↖
- 20: 7.7 →

Serie 45.0
Total 177.0

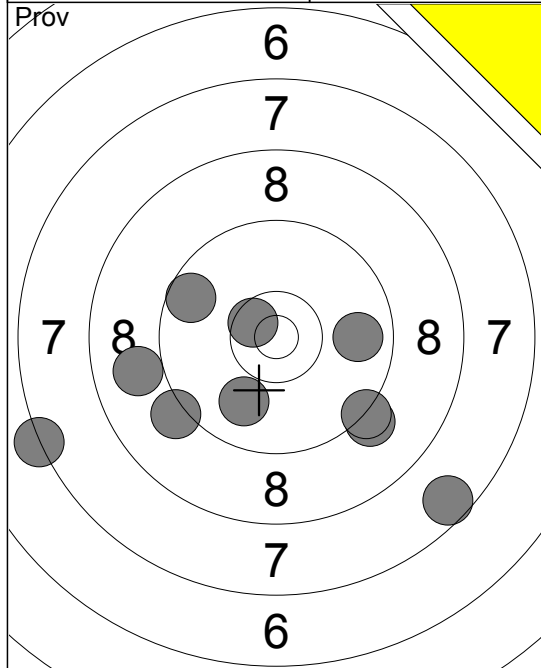

1:	7.3	←
2:	9.6	←
3:	10.6	↘
4:	9.2	↘
5:	9.9	↓
6:	9.8	→
7:	8.9	←
8:	9.3	↘
9:	9.2	←
10:	7.6	↘
Serie	86.0	
Total	0.0	

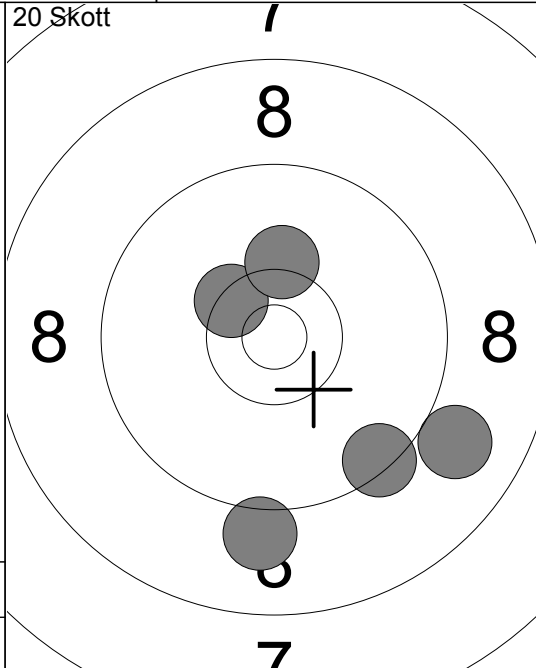

1:	9.1	↓
2:	9.4	↘
3:	9.0	↘
4:	10.4	↘
5:	10.2	↑
Serie	47.0	
Total	47.0	

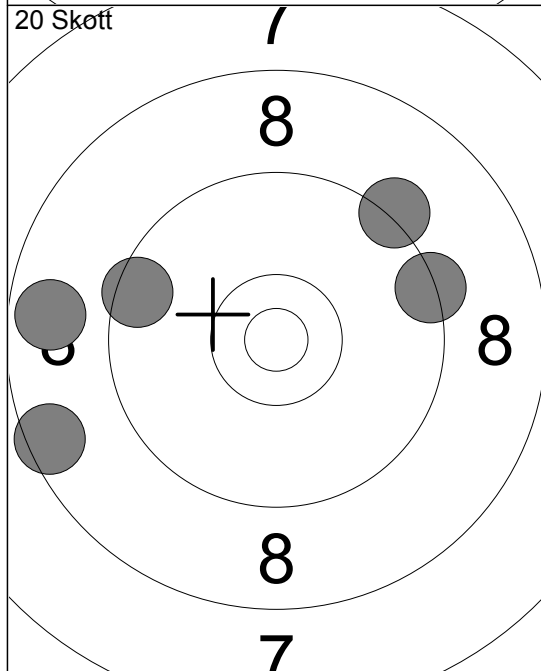

6:	9.4	→
7:	9.5	←
8:	8.7	←
9:	8.5	←
10:	9.2	↗
Serie	43.0	
Total	90.0	

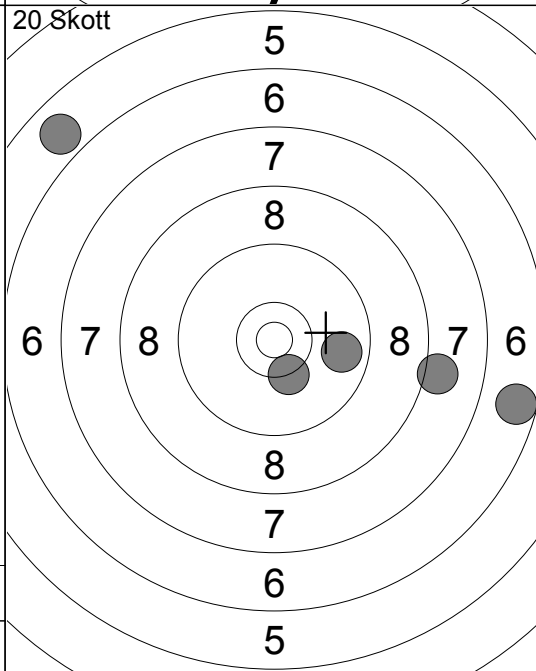

11:	5.9	↖
12:	6.7	→
13:	9.8	→
14:	10.3	↘
15:	8.1	→
Serie	38.0	
Total	128.0	

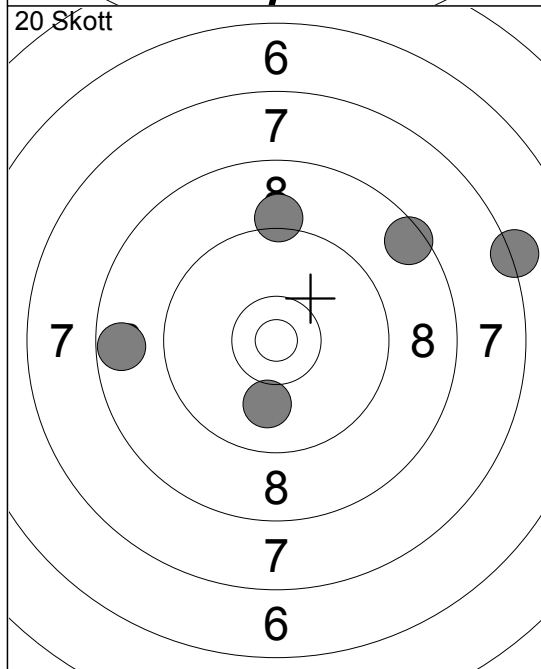

16:	8.5	↗
17:	7.2	→
18:	10.0	↓
19:	9.2	↑
20:	8.7	←
Serie	42.0	
Total	170.0	

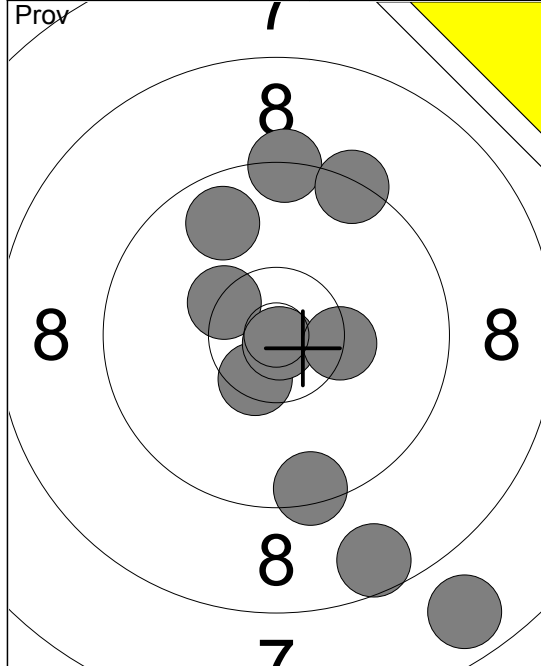

1:	9.3	↑
2:	9.4	↗
3:	9.8	↖
4:	10.5	x↘
5:	10.4	x↖
6:	10.9	x↘
7:	9.4	↓
8:	8.6	↓
9:	7.8	↓
10:	10.3	x→
Serie	91.0	
Total	0.0	

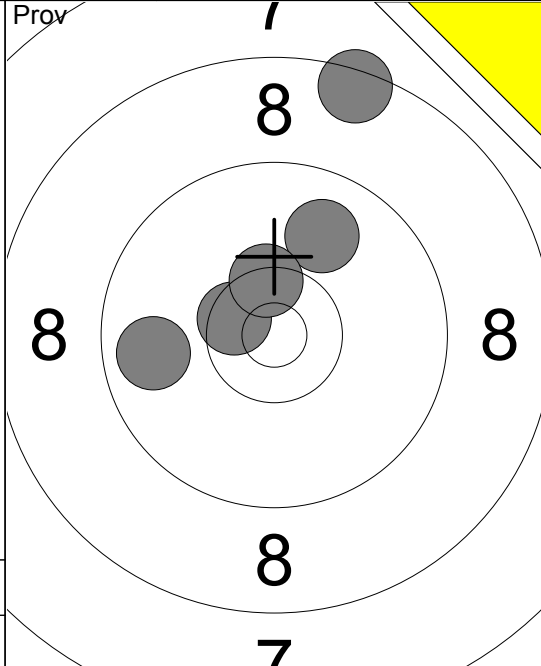

11:	10.5	x↖
12:	8.5	↗
13:	9.9	↗
14:	10.4	x↗
15:	9.8	←
Serie	46.0	
Total	0.0	

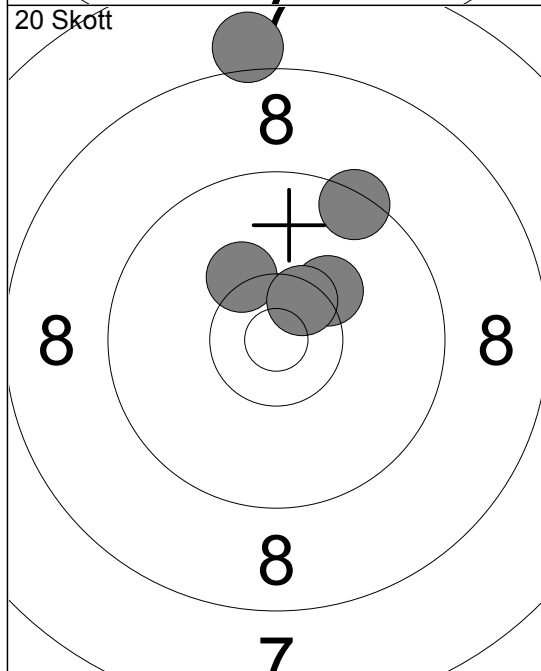

1:	9.4	↗
2:	10.3	↗
3:	8.1	↑
4:	10.2	↖
5:	10.5	x↗
Serie	47.0	
Total	47.0	

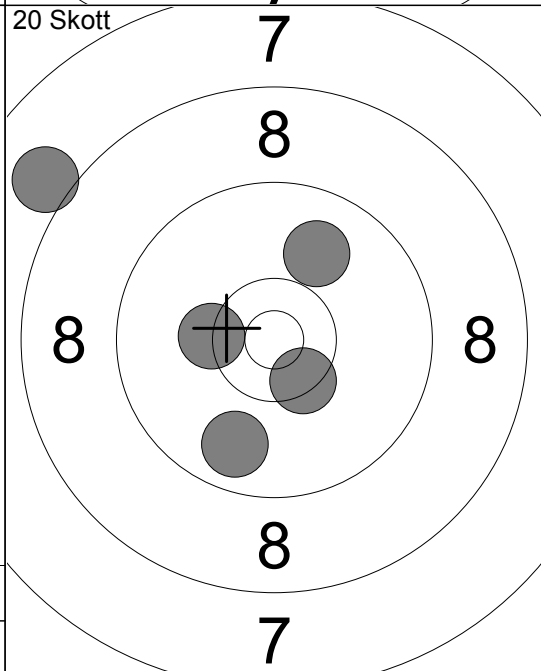

6:	8.0	↖
7:	10.3	x↖
8:	9.8	↓
9:	9.9	↗
10:	10.4	x↘
Serie	46.0	
Total	93.0	

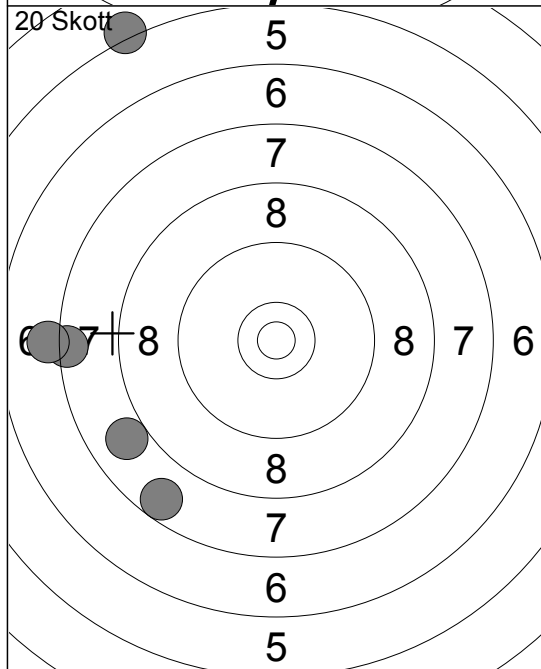

11:	7.4	←
12:	7.1	←
13:	7.7	↘
14:	5.2	↖
15:	7.9	↖
Serie	33.0	
Total	126.0	

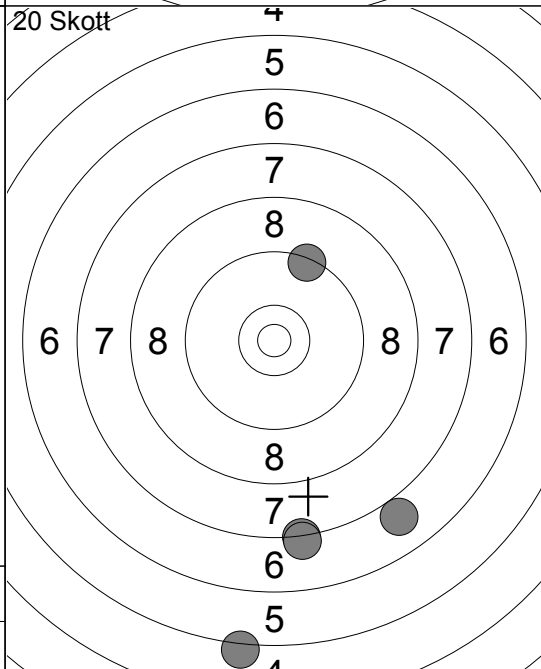

16:	7.0	↘
17:	5.2	↓
18:	7.3	↓
19:	9.4	↗
20:	7.2	↓
Serie	35.0	
Total	161.0	

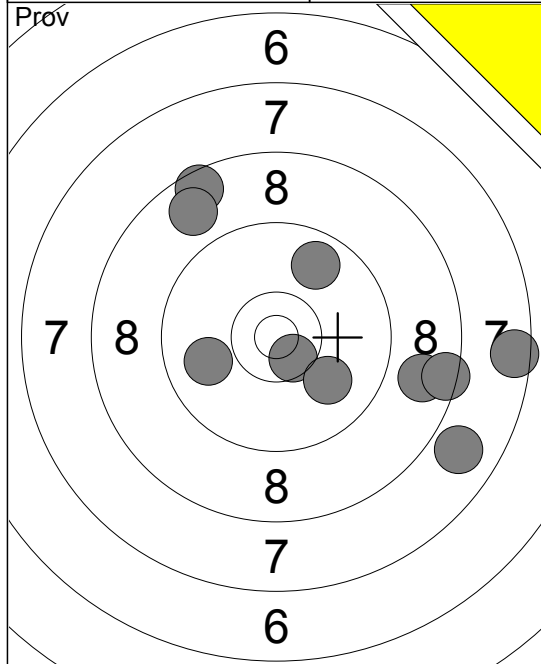

1:	8.6	↗
2:	9.8	↗
3:	7.5	→
4:	8.8	→
5:	8.5	→
6:	10.6	↘
7:	8.8	↗
8:	7.9	↘
9:	10.0	↘
10:	9.9	←
Serie	84.0	
Total	0.0	

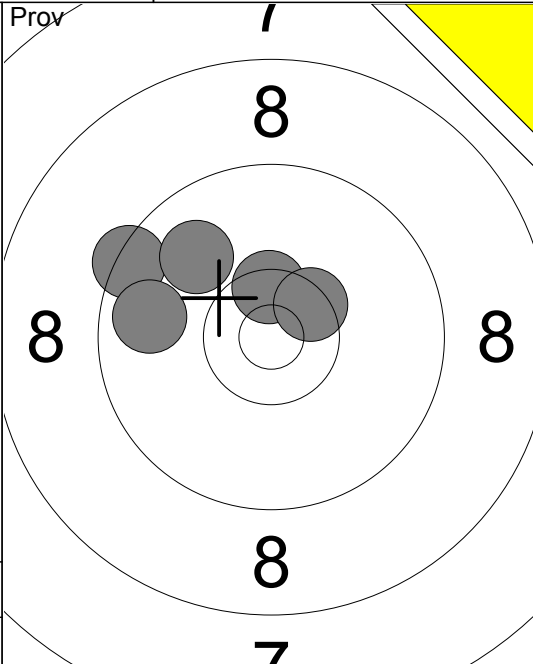

11:	9.4	↖
12:	9.8	←
13:	9.9	↗
14:	10.5	↗
15:	10.5	↗
Serie	47.0	
Total	0.0	

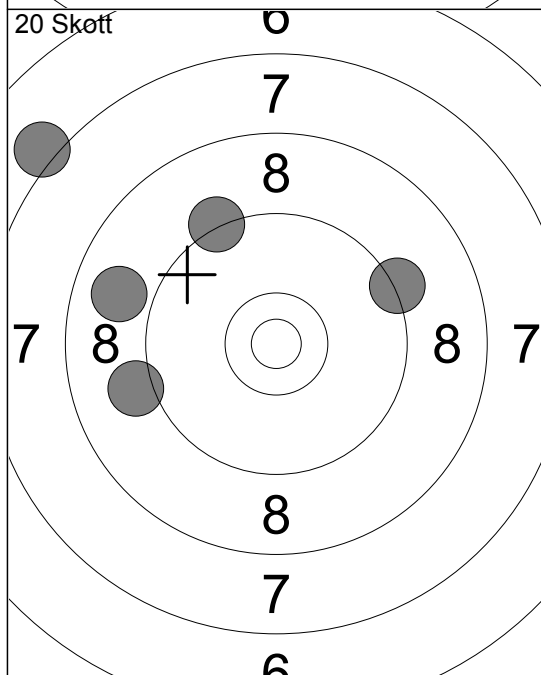

1:	9.3	→
2:	8.9	←
3:	9.3	↗
4:	7.1	↗
5:	9.1	←
Serie	42.0	
Total	42.0	

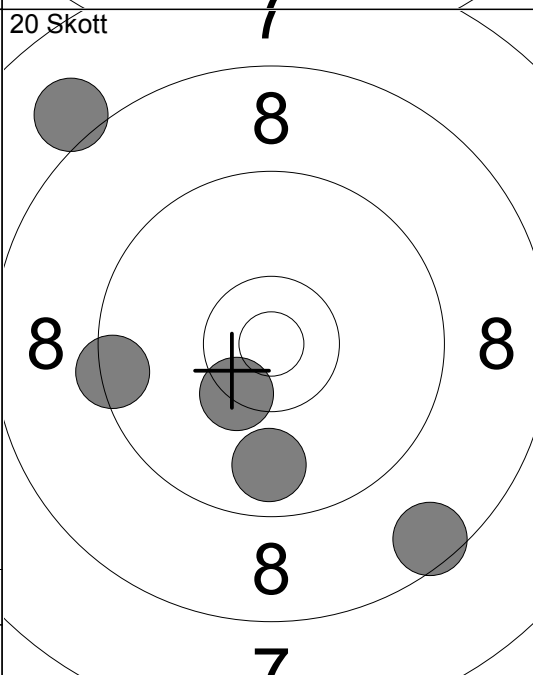

6:	8.6	↘
7:	9.4	←
8:	10.4	↘
9:	8.1	↖
10:	9.8	↓
Serie	44.0	
Total	86.0	

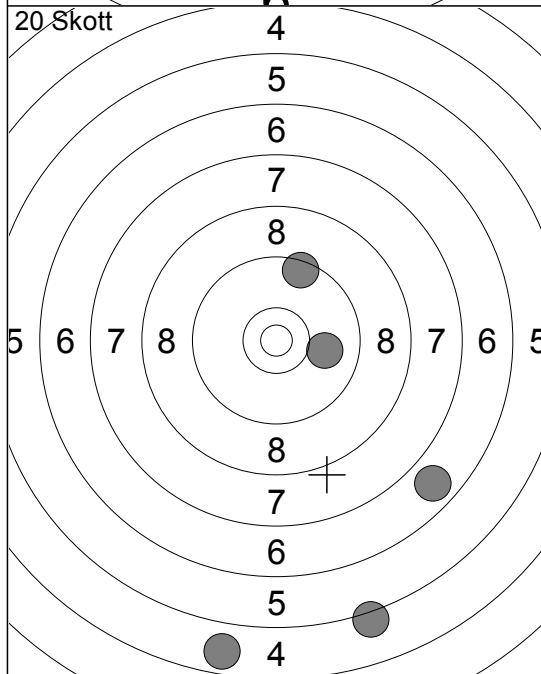

11:	6.8	↘
12:	4.8	↓
13:	9.5	↗
14:	10.0	→
15:	5.2	↓
Serie	34.0	
Total	120.0	

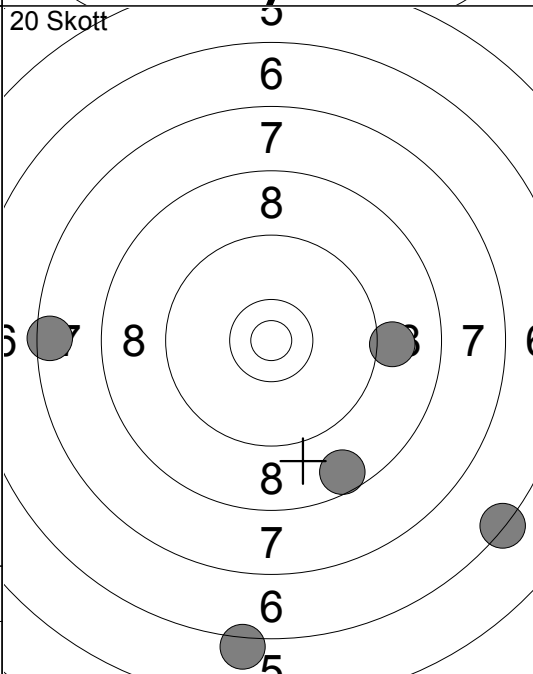

16:	8.6	↘
17:	6.2	↓
18:	6.3	↘
19:	9.1	→
20:	7.5	←
Serie	36.0	
Total	156.0	

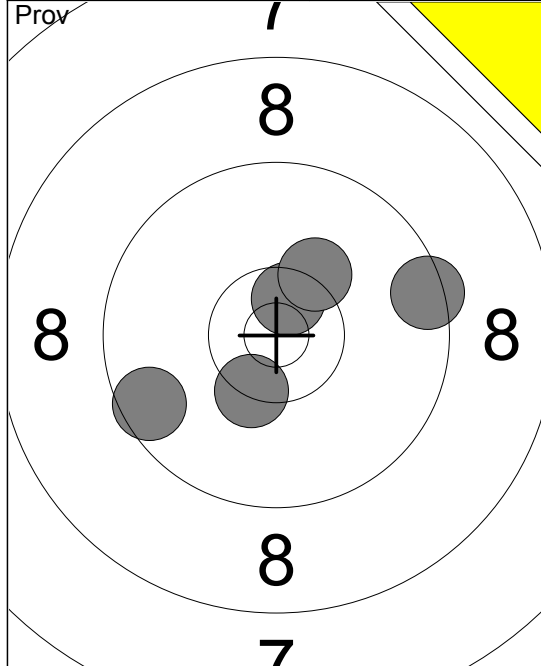

1:	10.4x ↘
2:	9.5 →
3:	10.6x ↗
4:	10.3 ↗
5:	9.6 ↙
Serie	48.0
Total	0.0

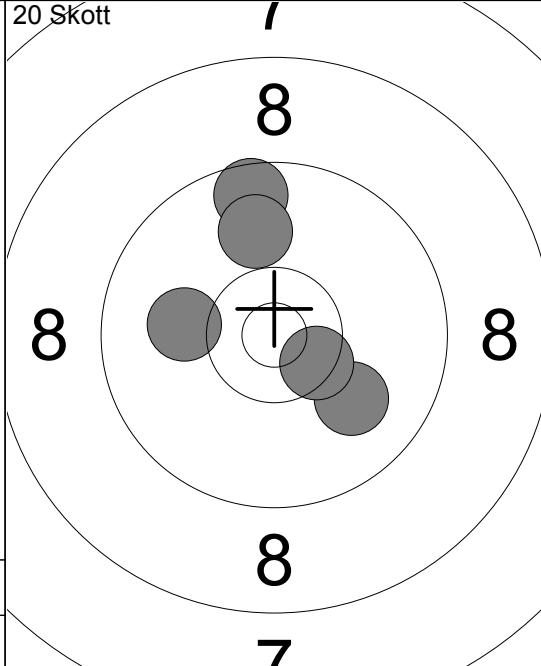

1:	9.6 ↑
2:	10.1 ←
3:	9.9 ↑
4:	10.0 ↘
5:	10.5x ↘
Serie	48.0
Total	48.0

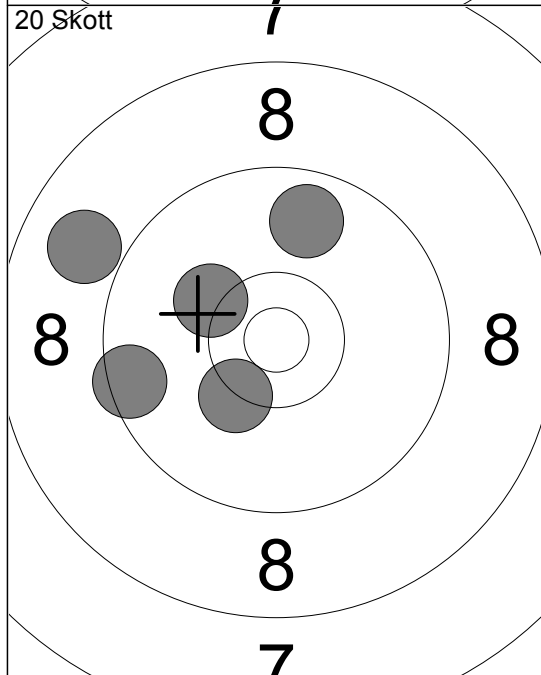

6:	9.8 ↑
7:	10.3x ↘
8:	8.9 ↙
9:	10.2 ↙
10:	9.5 ←
Serie	46.0
Total	94.0

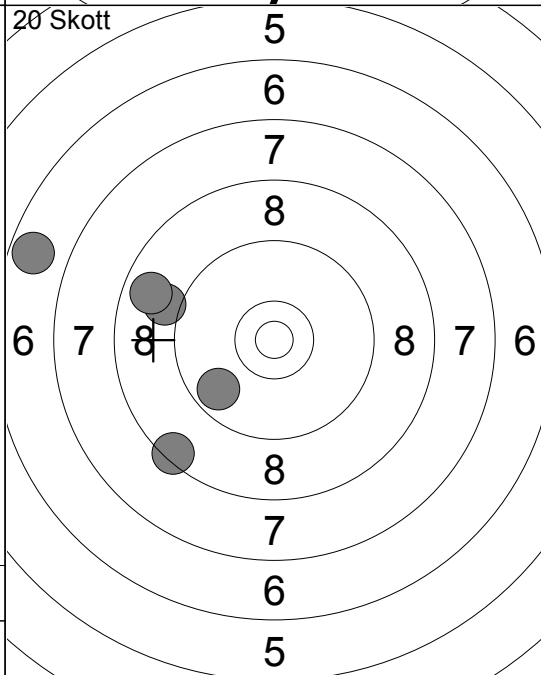

11:	9.0 ←
12:	9.7 ↘
13:	6.7 ←
14:	8.4 ↘
15:	8.8 ←
Serie	40.0
Total	134.0

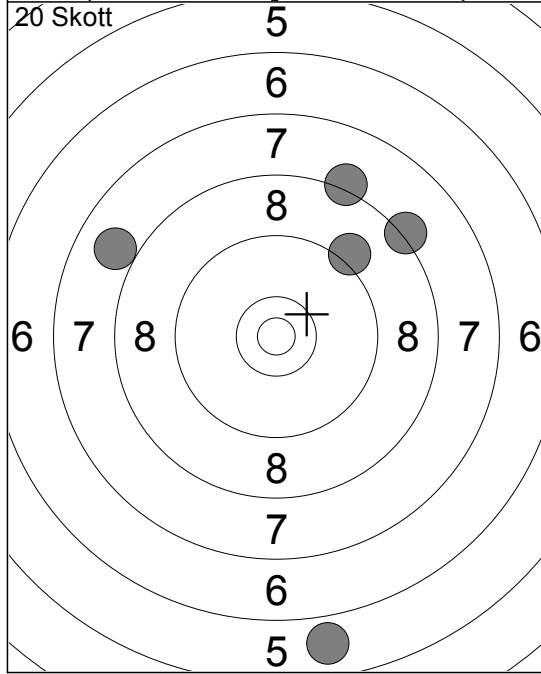

16:	8.2 ↗
17:	9.1 ↗
18:	8.2 ↗
19:	7.9 ↙
20:	5.9 ↓
Serie	37.0
Total	171.0