

Skjutlag	Tavla	Stefan Thorin		Sen-L	Vb		
1	1	50m	Umeå				
27.08.2016	Höstträffen 2016	Ramselefors SKF					
Prov	7	8	8	Prov	7		
	1: 8.3 ↗ 2: 9.5 → 3: 10.0 ↗ 4: 9.9 ↗ 5: 9.4 ↓ 6: 9.0 ← 7: 10.5 ✕ 8: 9.4 ↗ 9: 10.3 ↖ 10: 10.6 ✕ →		11: 9.5 ↘ 12: 10.2 ↓ 13: 9.1 ↘	Serie	93.0	Serie	28.0
	Total	0.0	Total	0.0			
20 Skott	7	8	8	20 Skott	7		
	1: 10.0 ↓ 2: 9.5 ↖ 3: 10.5 ✕ → 4: 10.4 ✕ ↓ 5: 9.1 ↗		6: 10.0 ↑ 7: 9.8 ↖ 8: 9.8 ↘ 9: 9.3 ← 10: 9.5 ↗	Serie	48.0	Serie	46.0
	Total	48.0	Total	94.0			
20 Skott	7	8	8	20 Skott	7		
	11: 10.1 ↖ 12: 8.7 → 13: 10.3 ↓ 14: 8.8 → 15: 10.3 ↗		16: 10.4 ✕ ← 17: 10.4 ✕ → 18: 9.6 ↓ 19: 10.4 ✕ ↗ 20: 8.9 ↖	Serie	46.0	Serie	47.0
	Total	140.0	Total	187.0			

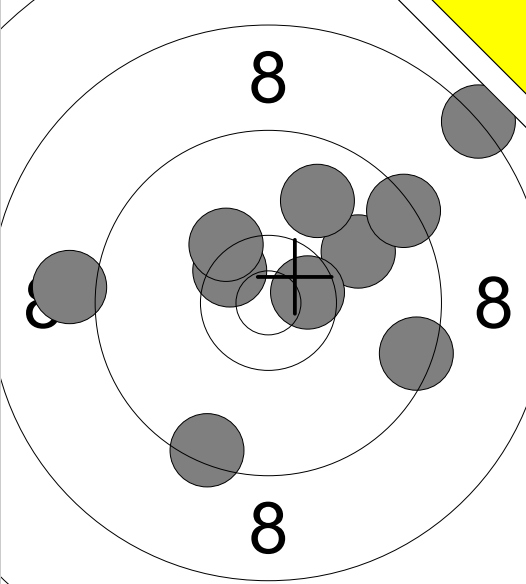

1:	9.6	↓
2:	10.3	↘
3:	10.3	→
4:	9.7	→
5:	9.2	↑
6:	10.0	↗
7:	10.5	↖
8:	9.7	→
9:	8.7	→
10:	10.1	↗
Serie	94.0	
Total	0.0	

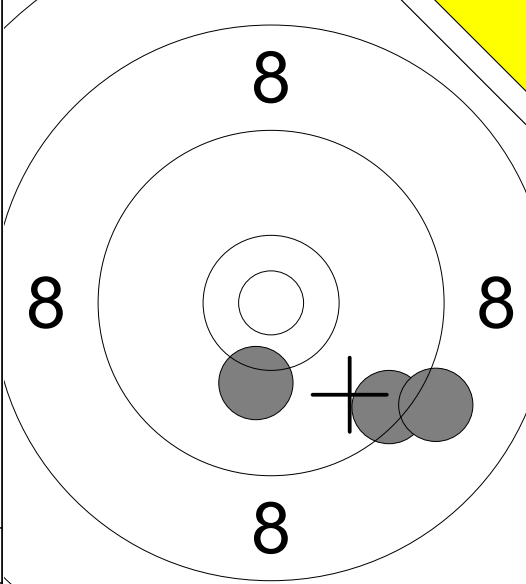
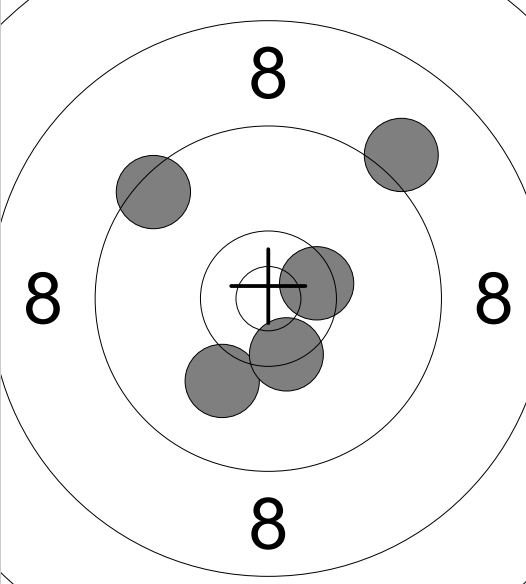
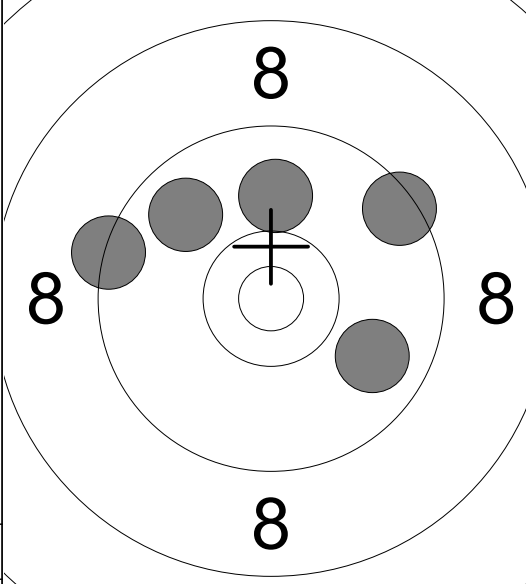
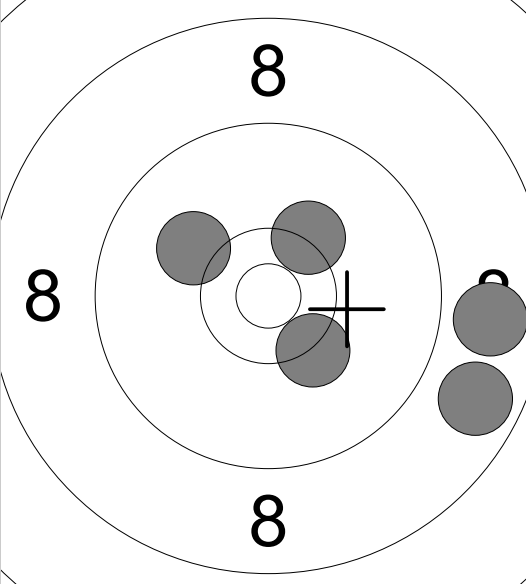
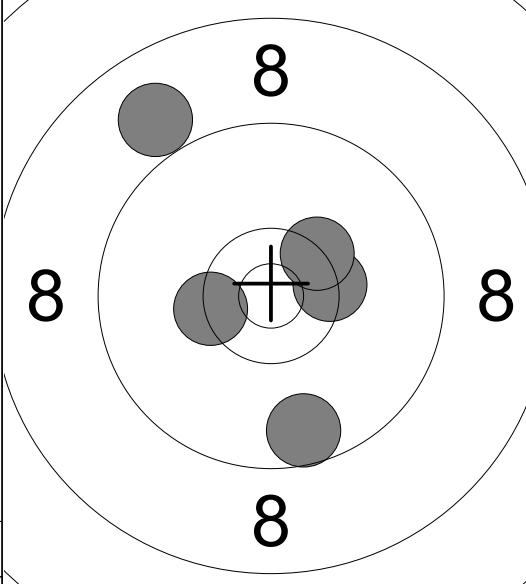
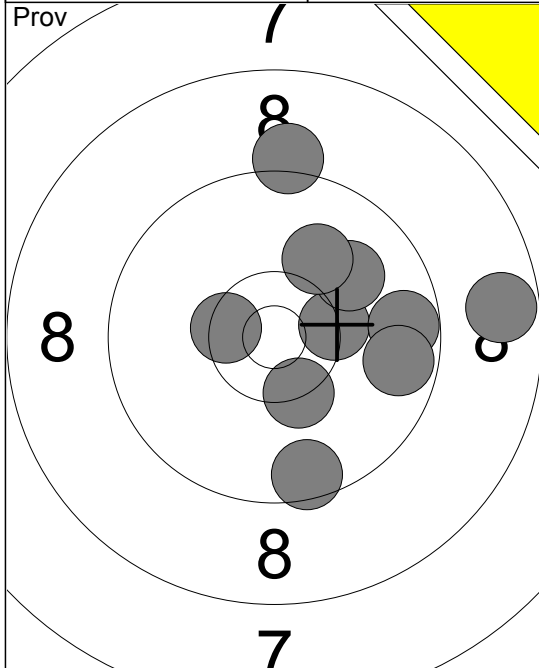
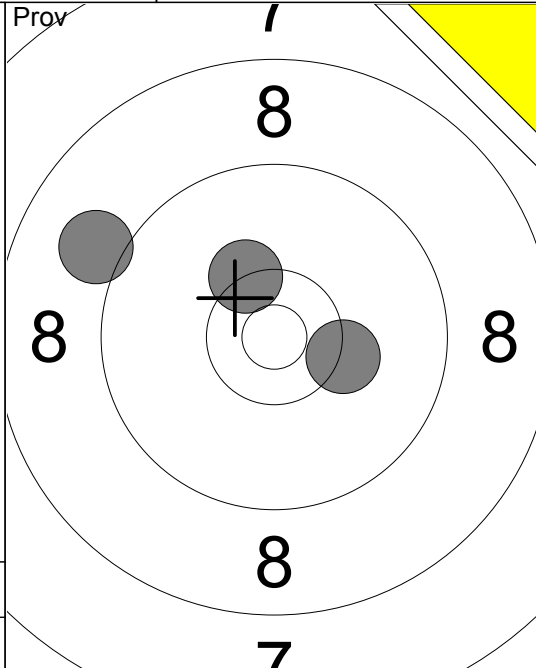

11:	9.0	↖
12:	10.3	→
13:	10.3	↘
Serie	29.0	
Total	0.0	

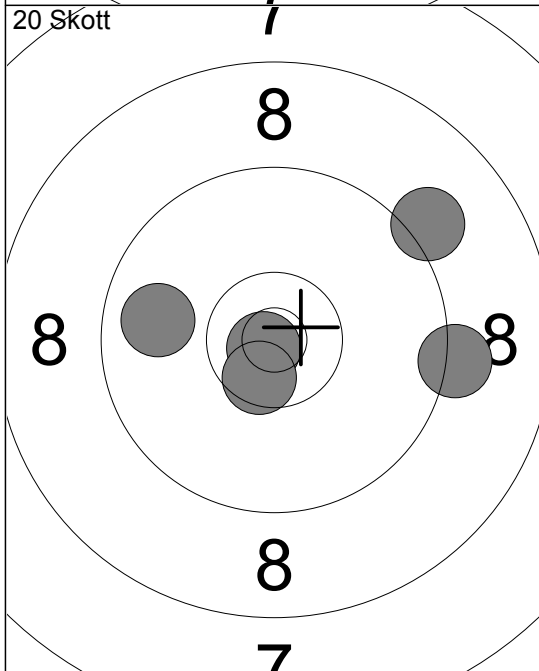

1:	9.1	↗
2:	9.2	→
3:	10.8	↘
4:	10.6	↘
5:	9.8	←
Serie	47.0	
Total	47.0	

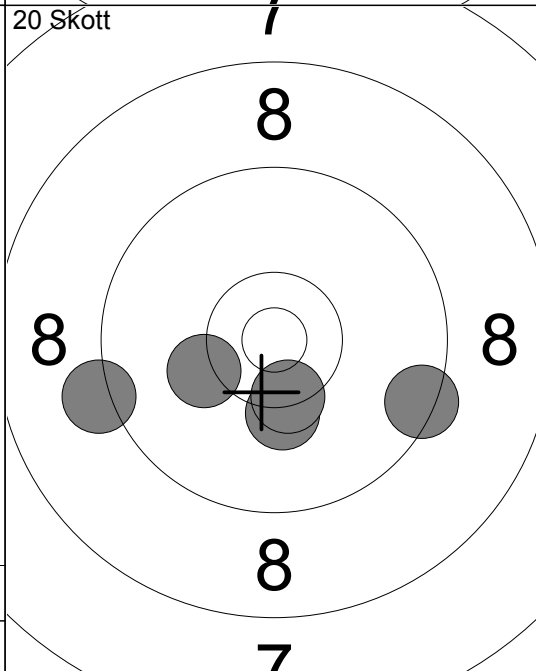

6:	9.2	←
7:	10.2	↖
8:	9.4	→
9:	10.2	↓
10:	10.4	↘
Serie	48.0	
Total	95.0	

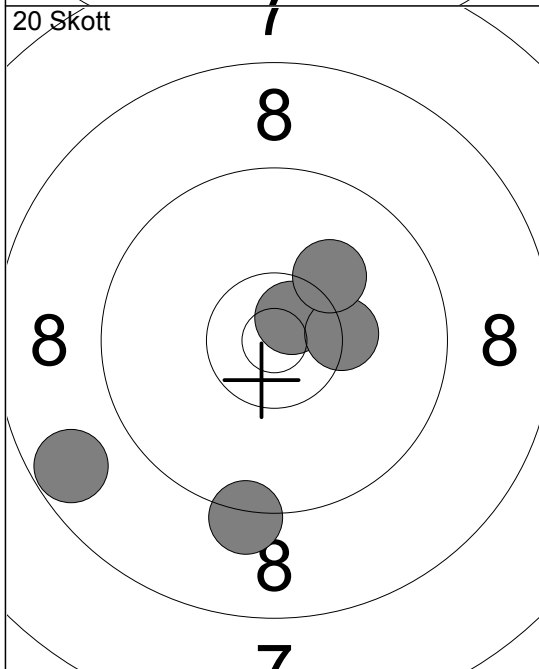

11:	10.7	↗
12:	10.3	→
13:	8.7	←
14:	10.1	↗
15:	9.2	↓
Serie	47.0	
Total	142.0	

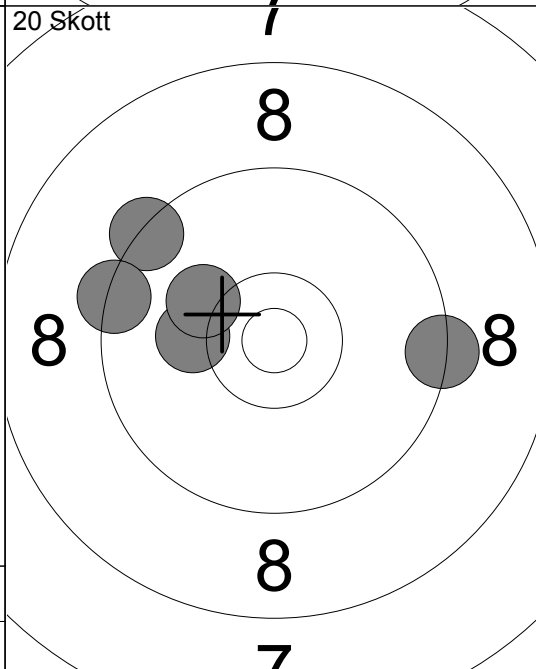

16:	9.4	↖
17:	10.2	↖
18:	10.2	↖
19:	9.4	←
20:	9.3	→
Serie	47.0	
Total	189.0	

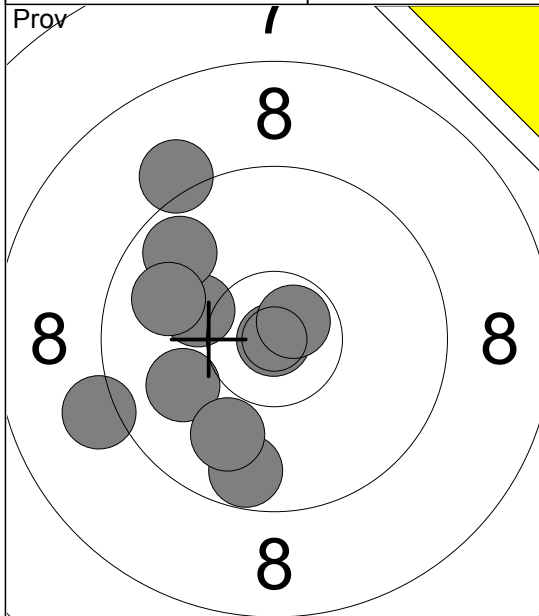

- 1: 9.1 ↖
- 2: 9.1 ←
- 3: 10.9x ↘
- 4: 9.7 ↓
- 5: 10.0 ↙
- 6: 9.9 ↓
- 7: 10.2 ↖
- 8: 10.7x ↗
- 9: 9.7 ↖
- 10: 9.9 ←

Serie 94.0

Total 0.0

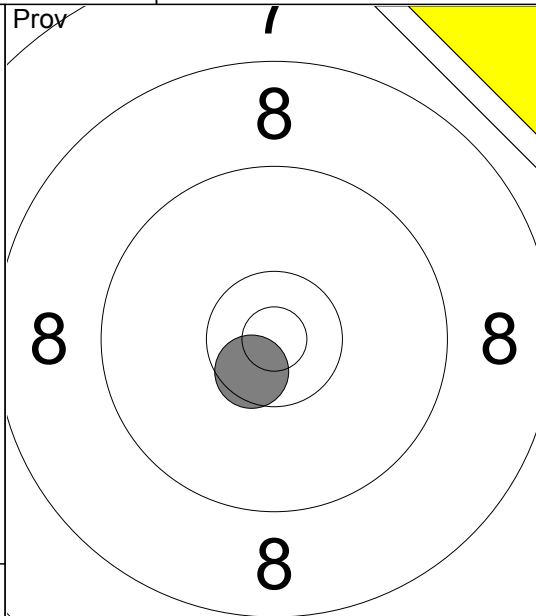

- 11: 10.6x ↘

Serie 10.0

Total 0.0

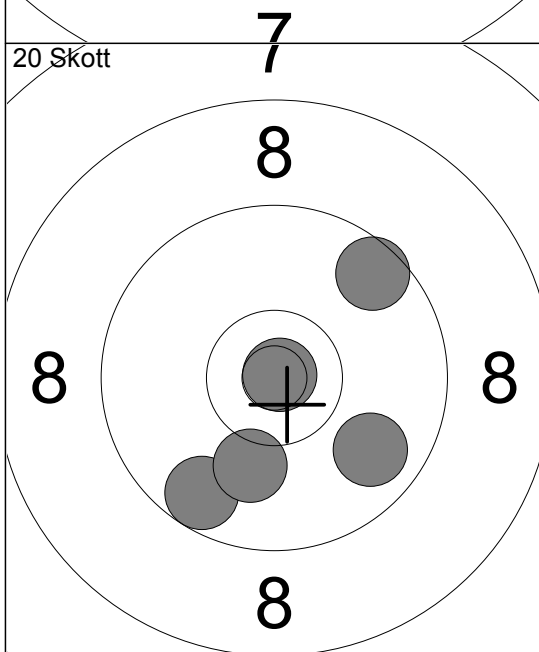

- 1: 10.9x ↗
- 2: 9.8 ↘
- 3: 9.6 ↗
- 4: 9.7 ↓
- 5: 10.1 ↓

Serie 47.0

Total 47.0

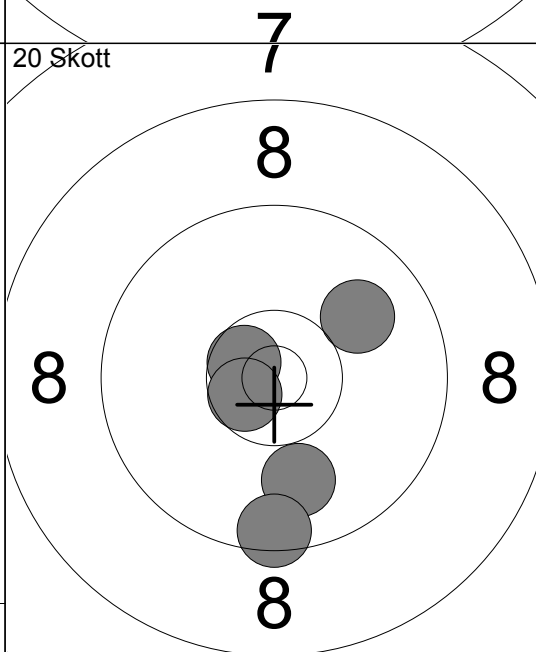

- 6: 10.0 ↗
- 7: 10.6x ↘
- 8: 10.6x ↘
- 9: 10.0 ↓
- 10: 9.5 ↓

Serie 49.0

Total 96.0

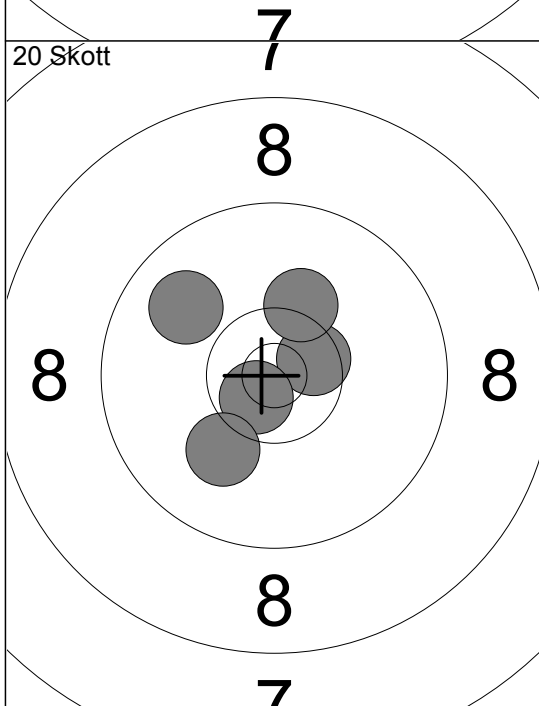

- 11: 10.5x ↗
- 12: 10.7x ↘
- 13: 10.1 ↓
- 14: 10.2 ↗
- 15: 9.9 ↖

Serie 49.0

Total 145.0

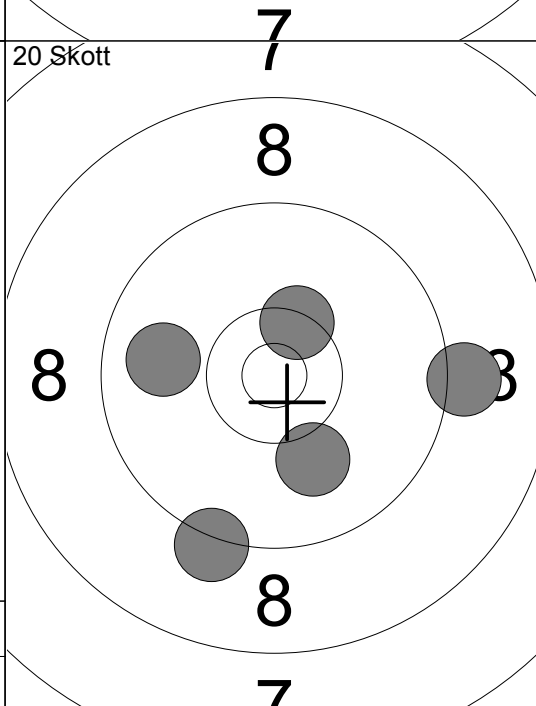

- 16: 9.1 →
- 17: 10.1 ↓
- 18: 10.4x ↗
- 19: 9.9 ←
- 20: 9.2 ↓

Serie 47.0

Total 192.0

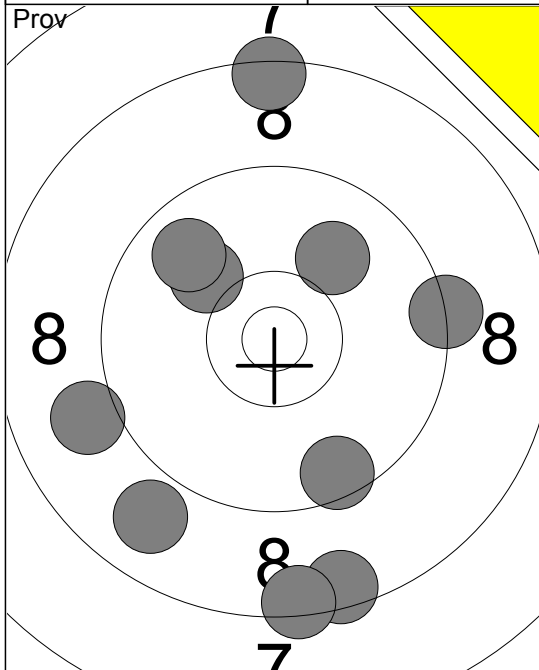

- 1: 8.5 ↓
- 2: 8.9 ↓
- 3: 9.3 →
- 4: 8.4 ↓
- 5: 9.5 ↓
- 6: 10.1 ↖
- 7: 8.4 ↑
- 8: 9.0 ←
- 9: 10.0 ↗
- 10: 9.8 ↖

Serie 88.0

Total 0.0

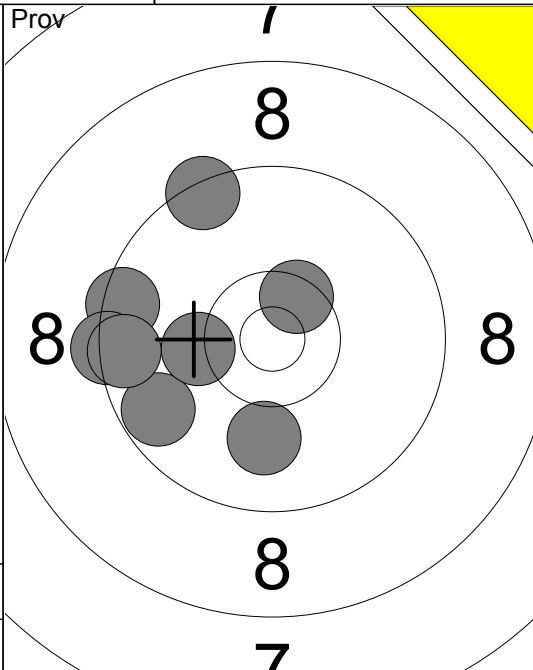

- 11: 9.7 ↙
- 12: 10.2 ←
- 13: 10.5x ↗
- 14: 10.0 ↓
- 15: 9.5 ←
- 16: 9.4 ←
- 17: 9.5 ←
- 18: 9.4 ↗

Serie 75.0

Total 0.0

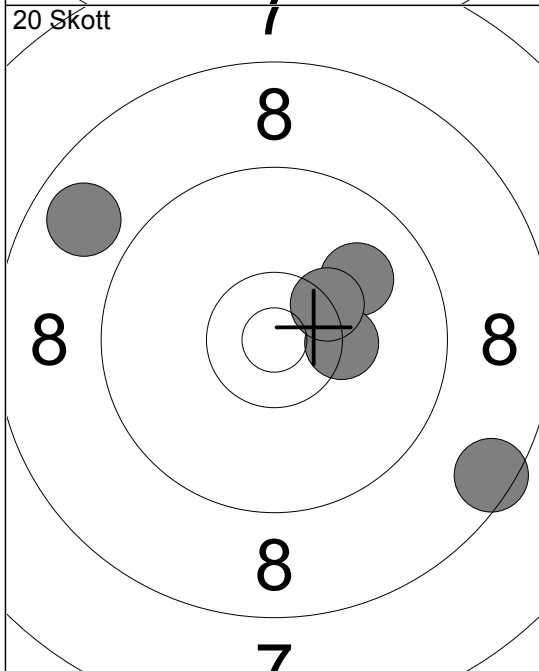

- 1: 8.8 ↖
- 2: 10.0 ↗
- 3: 10.3x →
- 4: 8.5 →
- 5: 10.3x ↗

Serie 46.0

Total 46.0

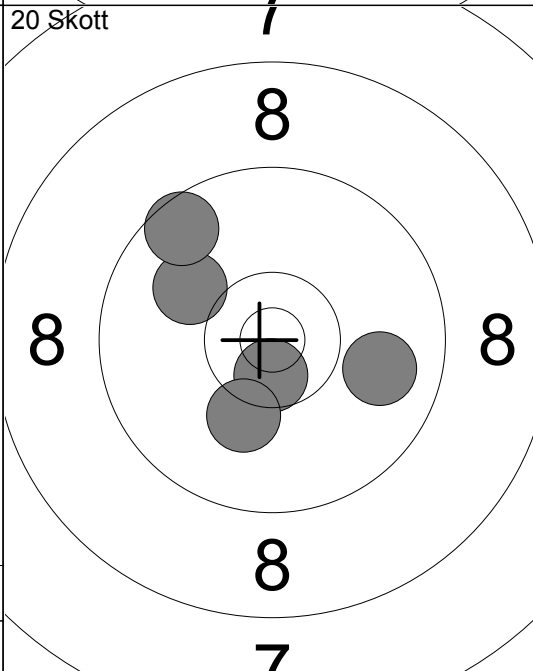

- 6: 9.9 →
- 7: 10.0 ↖
- 8: 10.6x ↓
- 9: 10.2 ↓
- 10: 9.6 ↖

Serie 48.0

Total 94.0

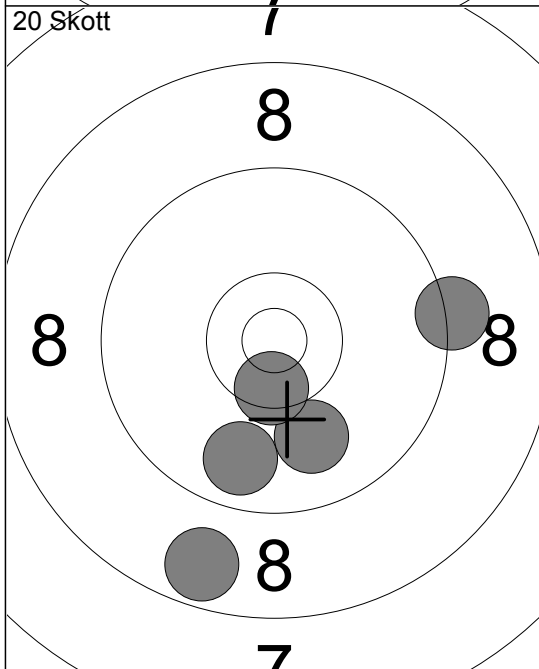

- 11: 9.8 ↓
- 12: 10.0 ↓
- 13: 8.7 ↓
- 14: 9.2 →
- 15: 10.5x ↓

Serie 46.0

Total 140.0

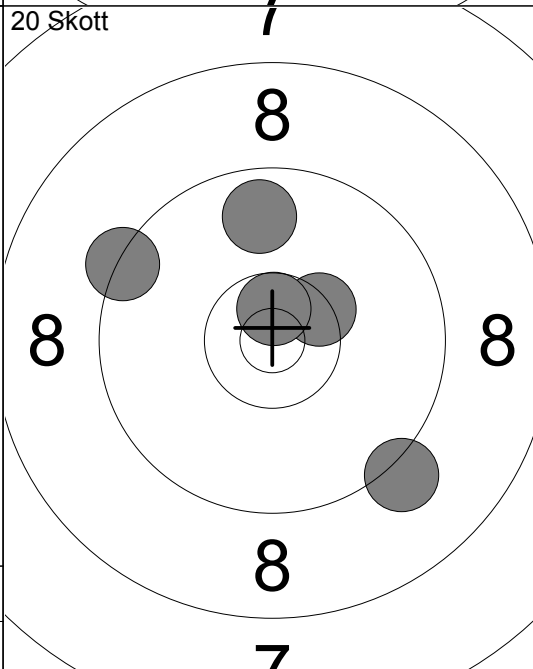

- 16: 9.8 ↑
- 17: 9.2 ↓
- 18: 10.4x ↗
- 19: 9.3 ↖
- 20: 10.6x ↗

Serie 47.0

Total 187.0

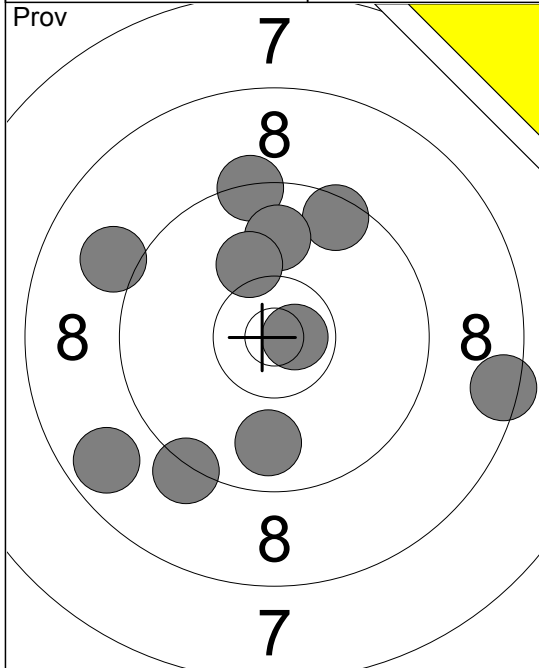

- 1: 9.3 ↑
- 2: 8.5 →
- 3: 9.5 ↗
- 4: 9.9 ↑
- 5: 9.0 ↖
- 6: 10.7x →
- 7: 8.7 ↙
- 8: 10.1 ↑
- 9: 9.2 ↘
- 10: 9.8 ↓

Serie 90.0
Total 0.0

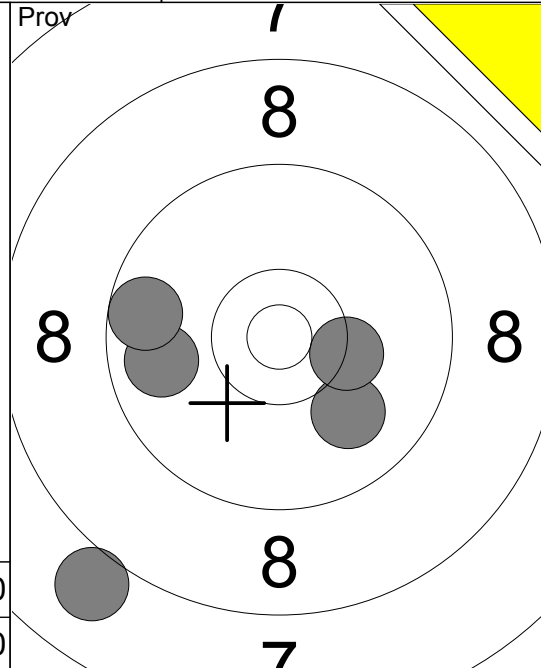

- 11: 10.0 ↘
- 12: 8.0 ↘
- 13: 9.8 ←
- 14: 9.7 ←
- 15: 10.3 →

Serie 46.0
Total 0.0

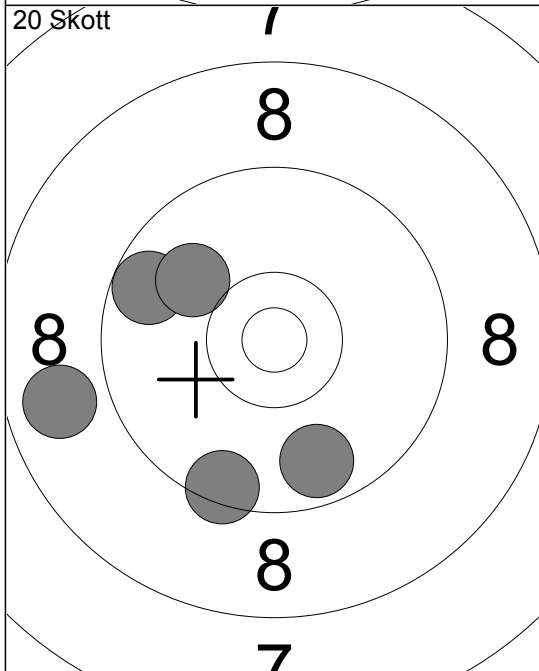

- 1: 9.7 ↓
- 2: 8.8 ←
- 3: 9.7 ↖
- 4: 10.0 ↖
- 5: 9.5 ↓

Serie 45.0
Total 45.0

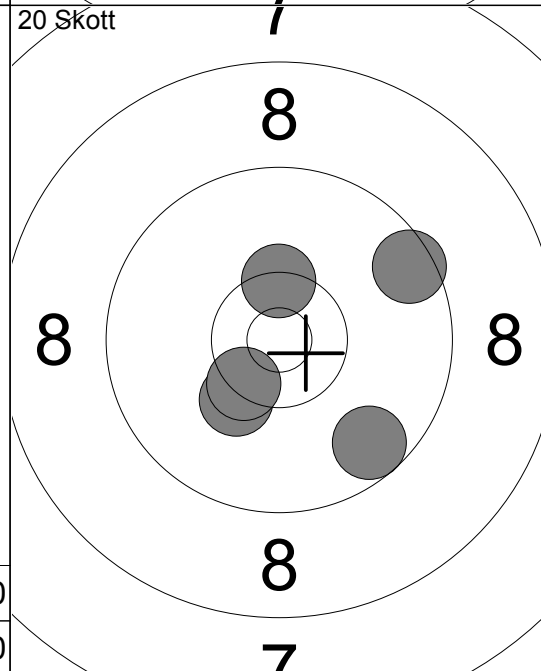

- 6: 10.2 ↘
- 7: 9.6 ↘
- 8: 9.5 ↗
- 9: 10.4x ↑
- 10: 10.4x ↘

Serie 48.0
Total 93.0

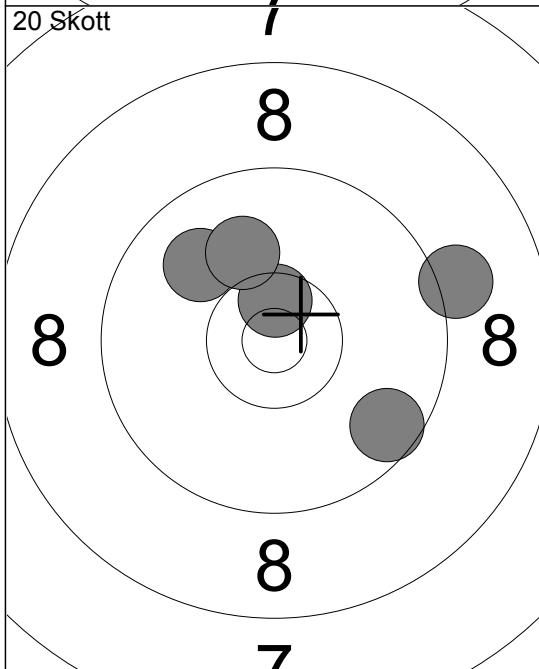

- 11: 10.6x ↑
- 12: 9.9 ↗
- 13: 9.6 ↘
- 14: 9.1 →
- 15: 10.1 ↑

Serie 47.0
Total 140.0

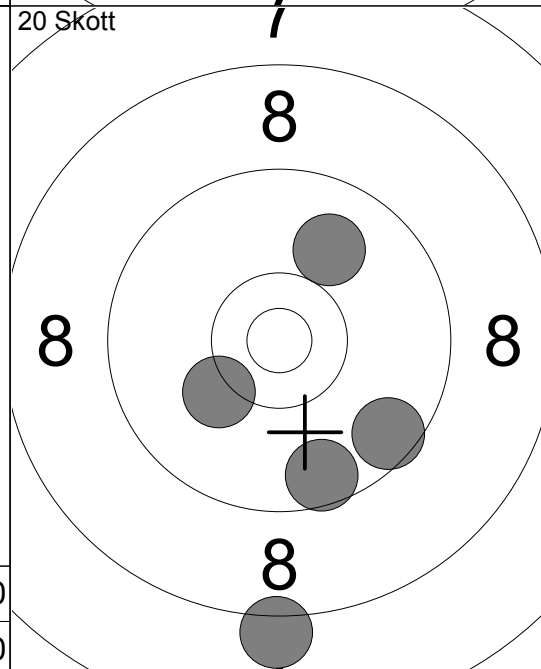

- 16: 10.2 ↘
- 17: 10.0 ↗
- 18: 8.1 ↓
- 19: 9.6 ↘
- 20: 9.6 ↓

Serie 46.0
Total 186.0

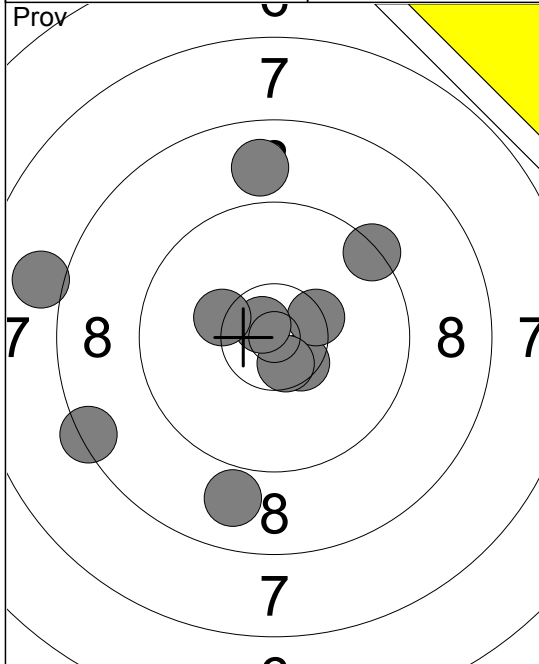

1:	8.0	←
2:	8.4	←
3:	10.5	↘
4:	10.4	↗
5:	8.9	↓
6:	9.4	↗
7:	10.6	↘
8:	8.9	↑
9:	10.7	↘
10:	10.3	←
Serie		91.0
Total		0.0

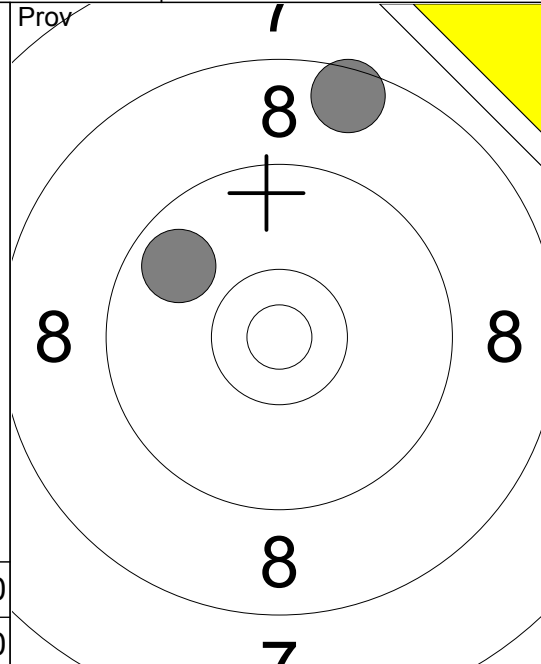

11:	9.8	↖
12:	8.6	↑
Serie		17.0
Total		0.0

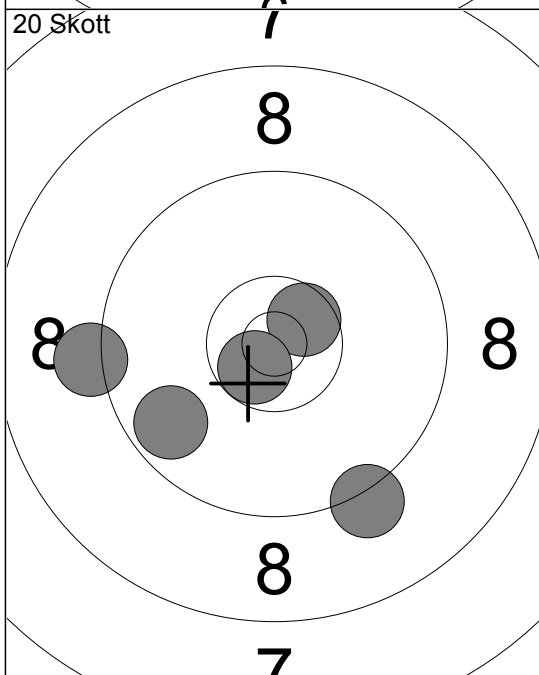

1:	10.6	↗
2:	9.2	←
3:	9.2	↓
4:	10.7	↘
5:	9.7	←
Serie		47.0
Total		47.0

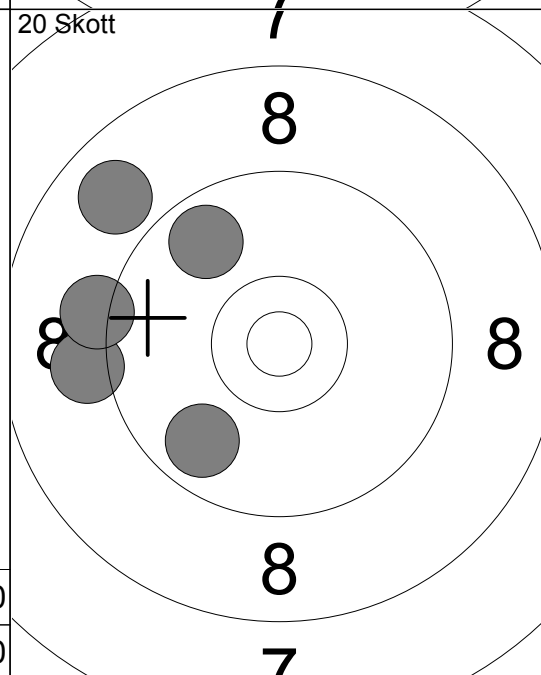

6:	9.1	←
7:	9.2	←
8:	9.8	↘
9:	9.8	↗
10:	8.9	↖
Serie		44.0
Total		91.0

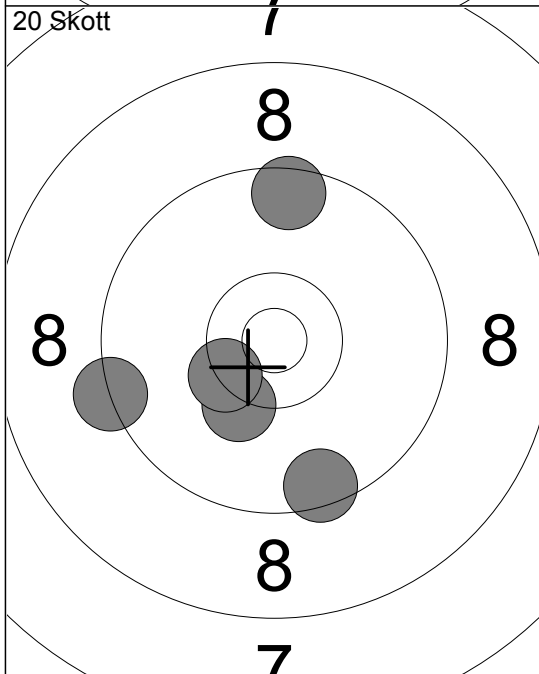

11:	9.5	↓
12:	10.2	↘
13:	9.3	←
14:	10.4	↘
15:	9.5	↑
Serie		47.0
Total		138.0

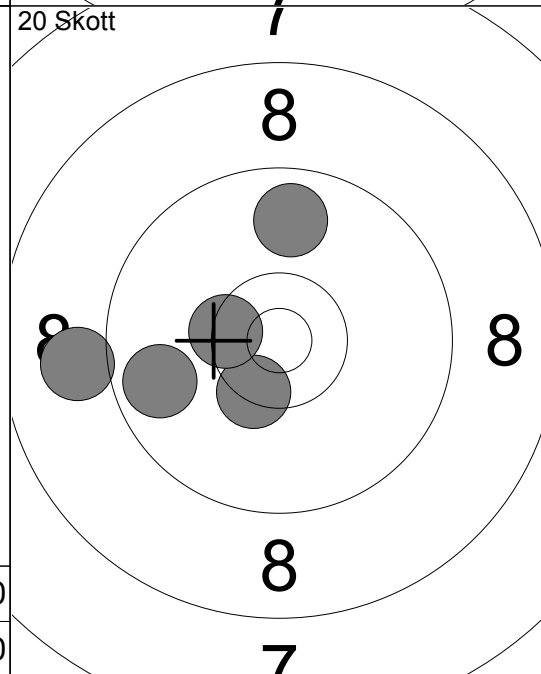

16:	9.8	←
17:	9.0	←
18:	10.4	↘
19:	10.4	↘
20:	9.8	↑
Serie		47.0
Total		185.0

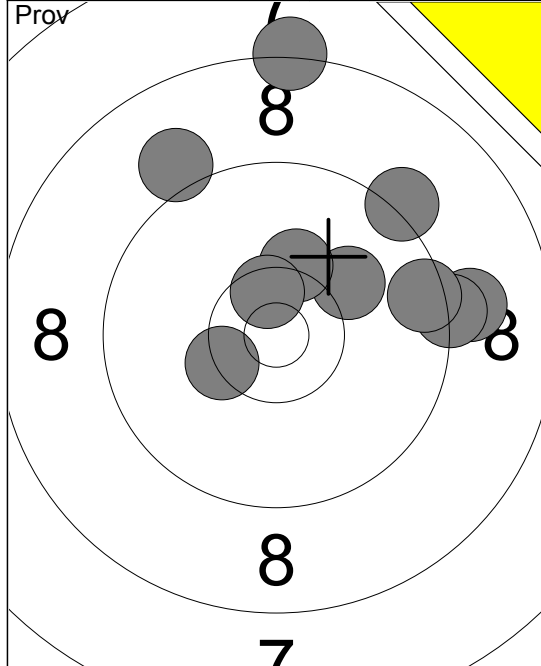

1:	10.1 ↗
2:	8.3 ↑
3:	9.1 →
4:	9.3 →
5:	9.1 ↖
6:	9.5 →
7:	10.3 ↑
8:	10.5x ↗
9:	9.2 ↗
10:	10.4x ↘
Serie	93.0
Total	0.0

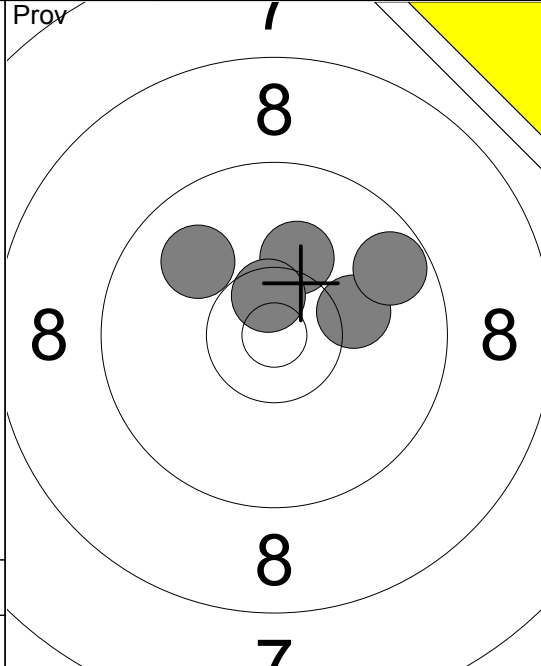

11:	10.2 ↗
12:	10.2 →
13:	9.7 ↗
14:	9.9 ↖
15:	10.6x ↗
Serie	48.0
Total	0.0

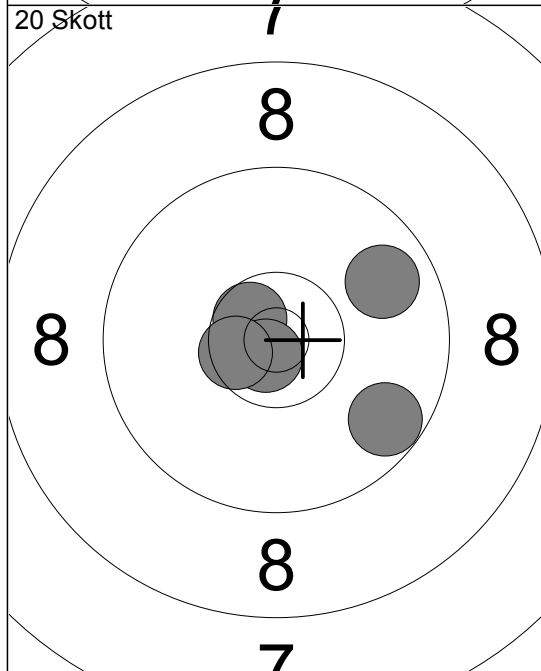

1:	9.8 ↗
2:	10.6x ↘
3:	10.8x ↘
4:	10.5x ↘
5:	9.7 ↘
Serie	48.0
Total	48.0

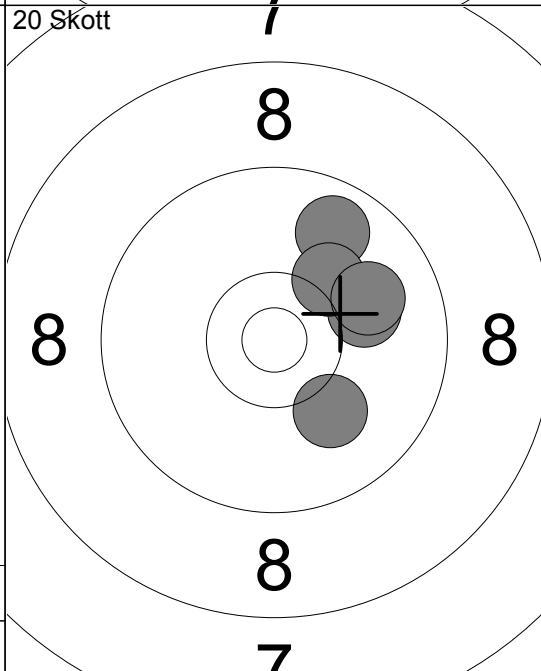

6:	10.0 →
7:	9.8 ↗
8:	10.1 ↘
9:	10.2 ↗
10:	10.0 →
Serie	49.0
Total	97.0

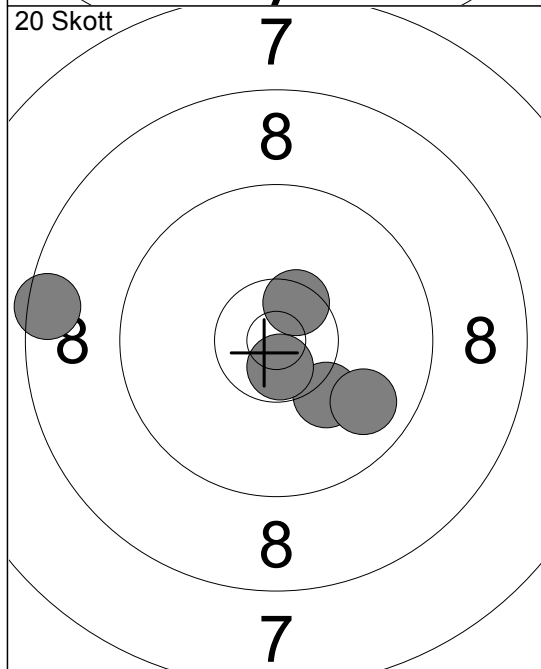

11:	8.5 ←
12:	10.5x ↗
13:	10.2 ↘
14:	9.8 ↘
15:	10.7x ↘
Serie	47.0
Total	144.0

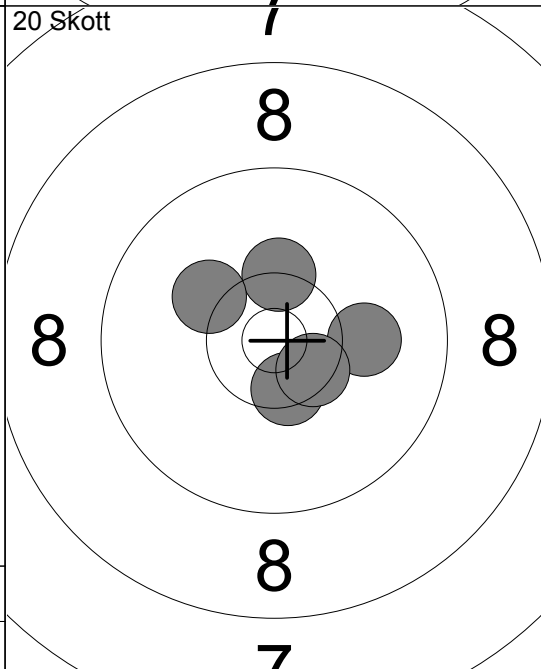

16:	10.1 →
17:	10.5x ↘
18:	10.3x ↗
19:	10.5x ↘
20:	10.2 ↖
Serie	50.0
Total	194.0

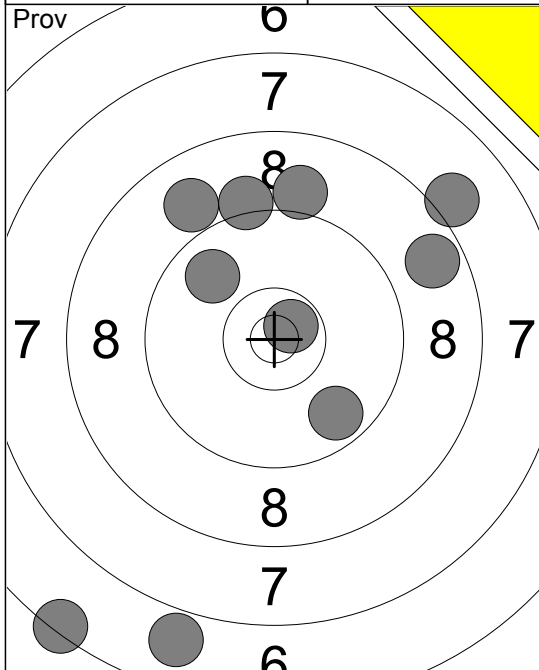

20 Skott

10 Shot Series Data:

1:	10.5	↘
2:	10.8	↘
3:	9.0	↙
4:	10.4	↘
5:	6.1	↖
Serie	45.0	
Total	45.0	

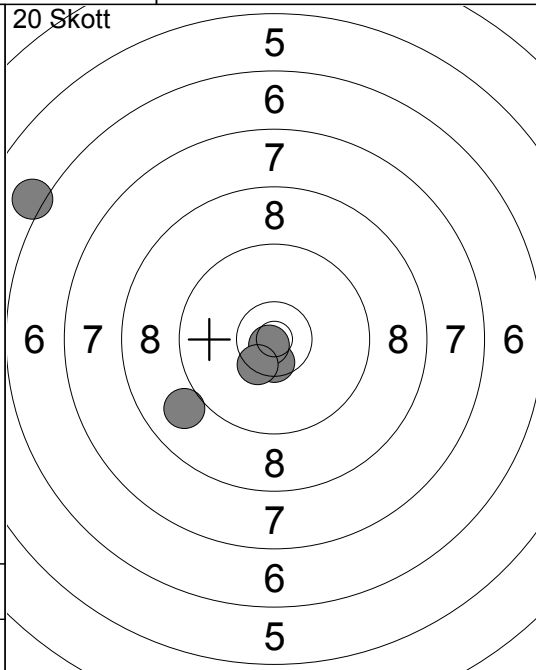

20 Skott

10 Shot Series Data:

11:	10.3	↗
12:	9.2	↖
13:	10.0	↖
14:	9.9	↑
15:	9.5	↖
Serie	47.0	
Total	140.0	

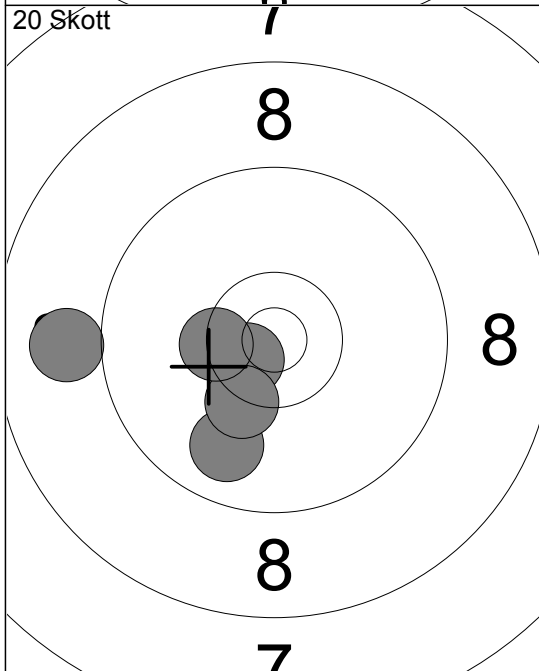

20 Skott

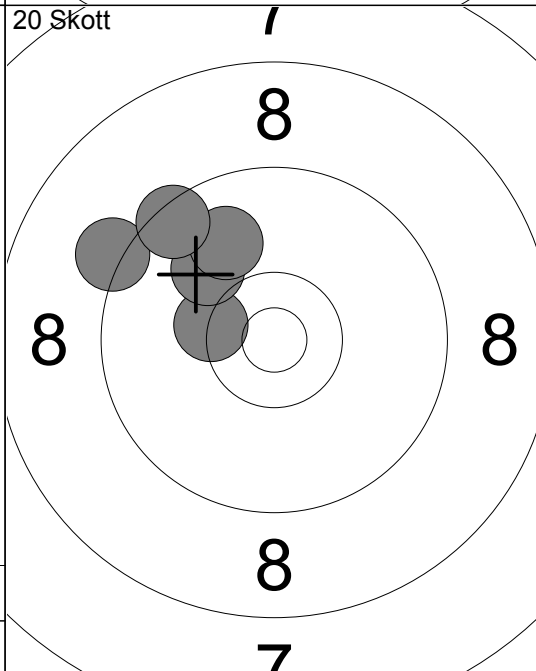

20 Skott

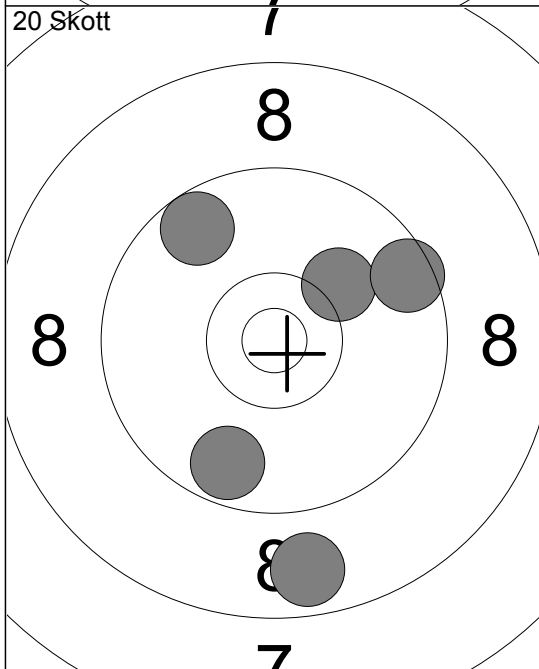

20 Skott

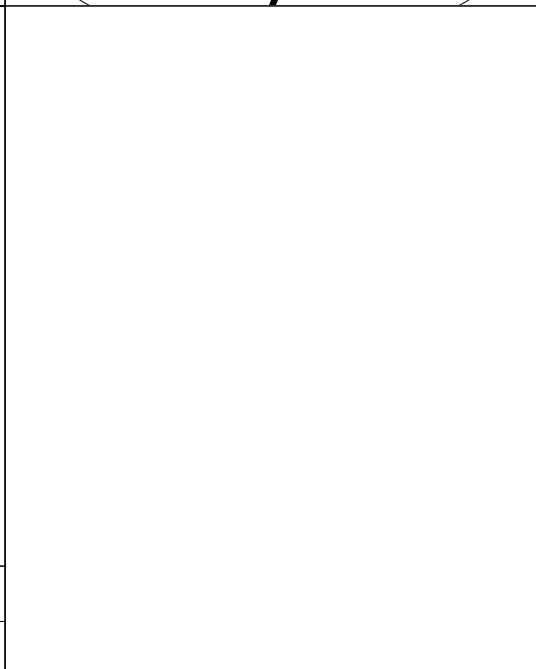

20 Skott

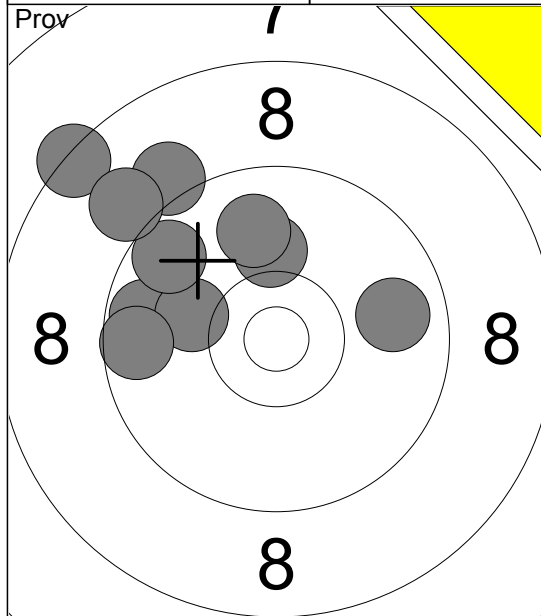

- 1: 9.1 ↗
- 2: 9.7 ←
- 3: 10.1 ↙
- 4: 9.7 ↗
- 5: 8.4 ↗
- 6: 9.8 →
- 7: 10.1 ↑
- 8: 9.0 ↗
- 9: 9.9 ↑
- 10: 9.6 ←

Serie 91.0

Total 0.0

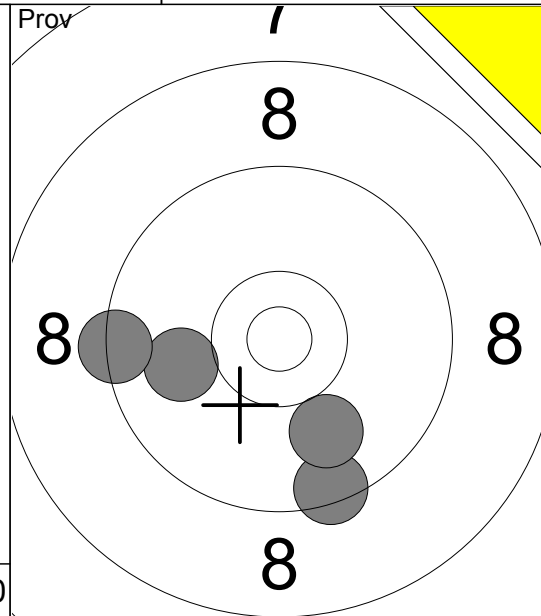

- 11: 9.4 ↓
- 12: 10.0 ↙
- 13: 10.0 ↓
- 14: 9.4 ←

Serie 38.0

Total 0.0

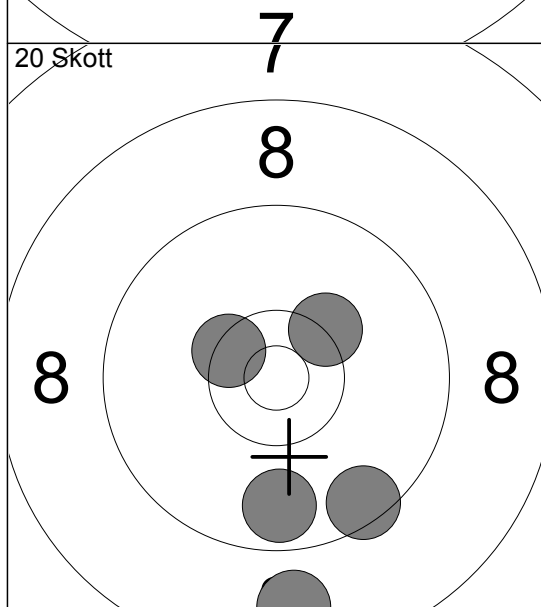

- 1: 10.3x ↗
- 2: 10.4x ↘
- 3: 8.8 ↓
- 4: 9.7 ↓
- 5: 9.5 ↓

Serie 46.0

Total 46.0

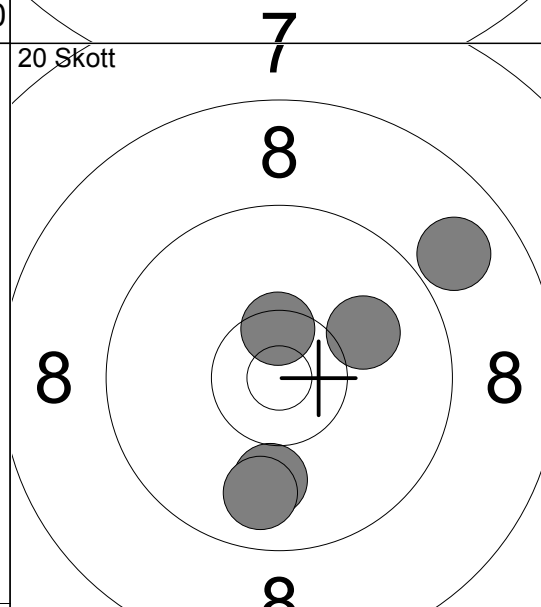

- 6: 10.0 ↗
- 7: 10.0 ↓
- 8: 8.9 ↗
- 9: 10.5x ↑
- 10: 9.8 ↓

Serie 47.0

Total 93.0

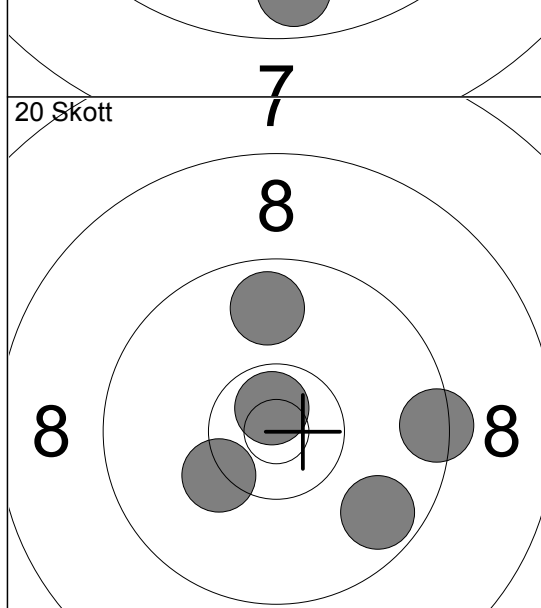

- 11: 10.7x ↑
- 12: 9.4 →
- 13: 9.8 ↑
- 14: 10.3 ↙
- 15: 9.7 ↘

Serie 47.0

Total 140.0

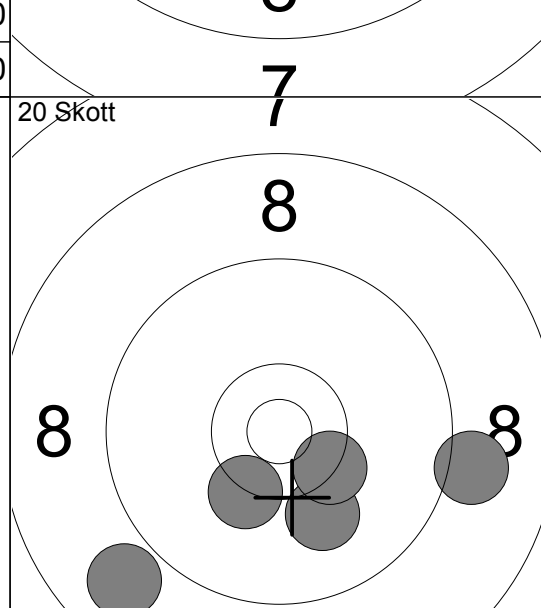

- 16: 10.1 ↓
- 17: 9.1 →
- 18: 8.9 ↙
- 19: 10.4x ↘
- 20: 10.3 ↓

Serie 47.0

Total 187.0

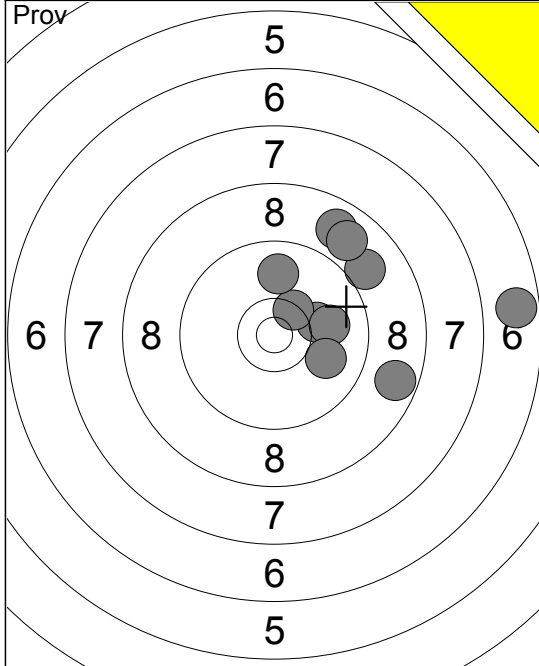

1:	8.7	→
2:	10.2	→
3:	6.7	→
4:	9.0	↗
5:	8.8	↗
6:	8.9	↗
7:	10.4	↗
8:	10.0	→
9:	9.9	↑
10:	10.0	→
Serie		88.0
Total		0.0

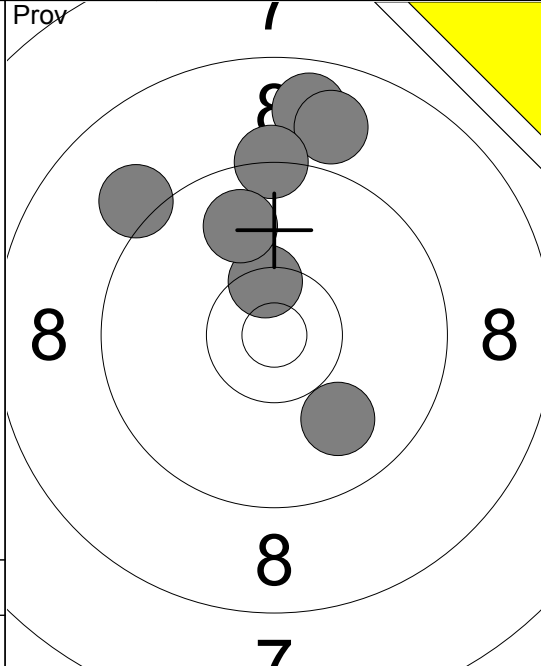

11:	10.4	↗
12:	9.9	↘
13:	8.8	↑
14:	8.9	↑
15:	9.3	↑
16:	9.9	↑
17:	9.1	↖
Serie		62.0
Total		0.0

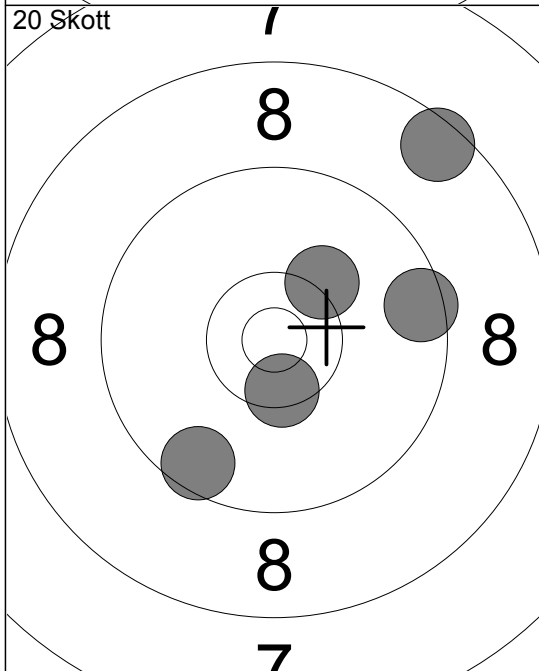

1:	10.2	↗
2:	8.5	↗
3:	9.6	↘
4:	9.5	→
5:	10.5	↘
Serie		46.0
Total		46.0

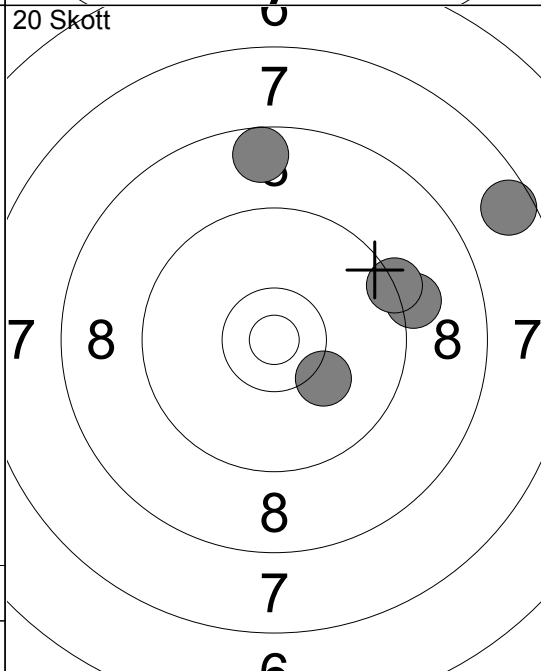

6:	9.2	→
7:	8.6	↑
8:	9.3	↗
9:	10.2	↘
10:	7.6	↗
Serie		43.0
Total		89.0

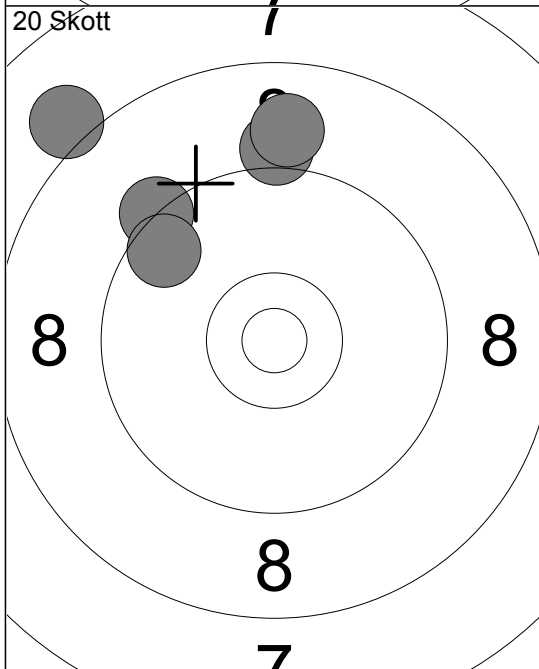

11:	9.1	↑
12:	9.3	↖
13:	8.1	↖
14:	9.6	↖
15:	8.9	↑
Serie		43.0
Total		132.0

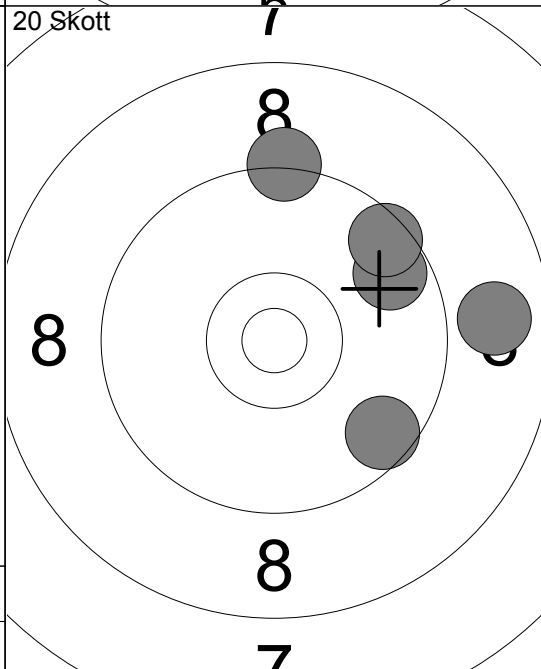

16:	9.7	↗
17:	8.8	→
18:	9.3	↑
19:	9.6	↘
20:	9.5	↗
Serie		44.0
Total		176.0

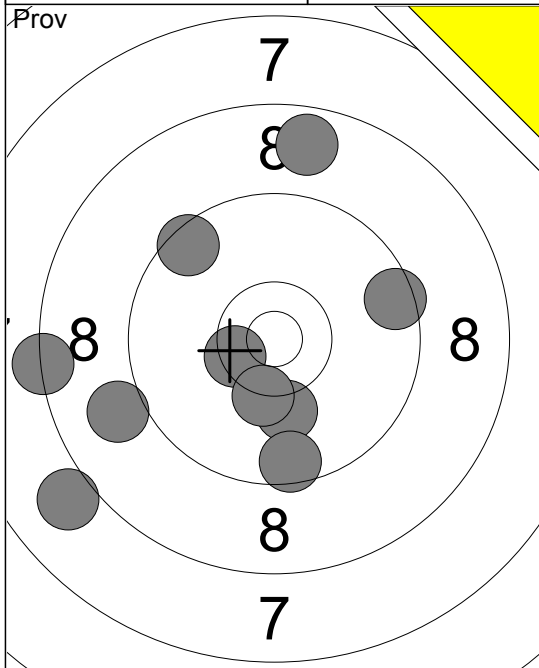

1:	8.7	↑
2:	8.0	↙
3:	9.5	→
4:	10.1	↓
5:	10.5	↘
6:	9.6	↓
7:	8.3	←
8:	9.0	←
9:	10.3	↙
10:	9.5	↖
Serie	90.0	
Total	0.0	

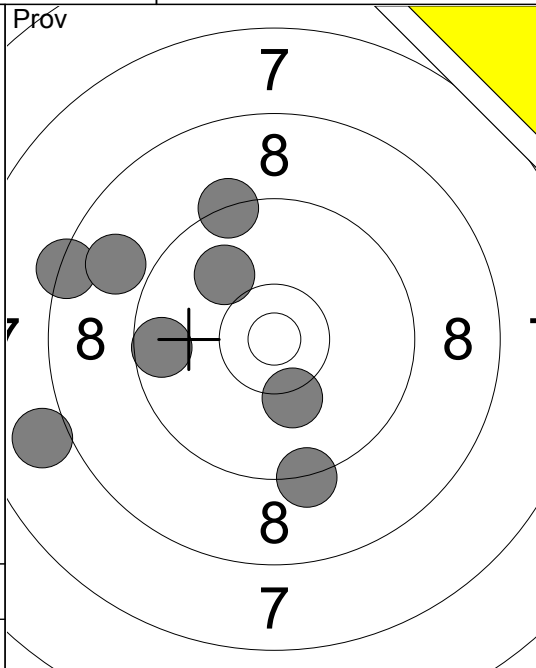

11:	8.0	↙
12:	10.0	↖
13:	8.4	←
14:	10.2	↓
15:	9.3	↑
16:	8.9	↖
17:	9.6	←
18:	9.3	↓
Serie	71.0	
Total	0.0	

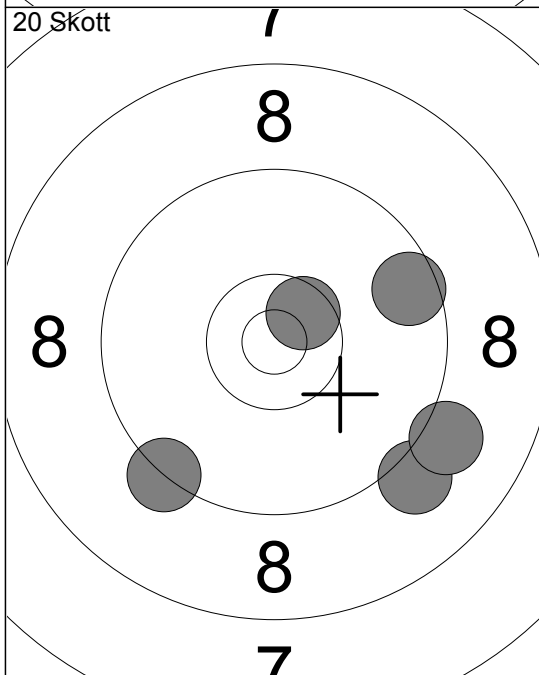

1:	10.6	↗
2:	9.6	→
3:	9.1	↓
4:	9.3	↙
5:	9.1	↘
Serie	46.0	
Total	46.0	

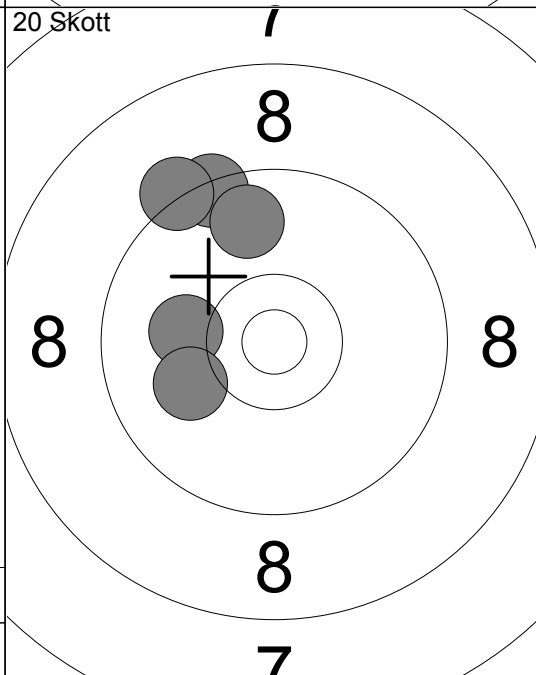

6:	10.1	←
7:	9.4	↑
8:	9.3	↖
9:	10.1	↙
10:	9.8	↑
Serie	47.0	
Total	93.0	

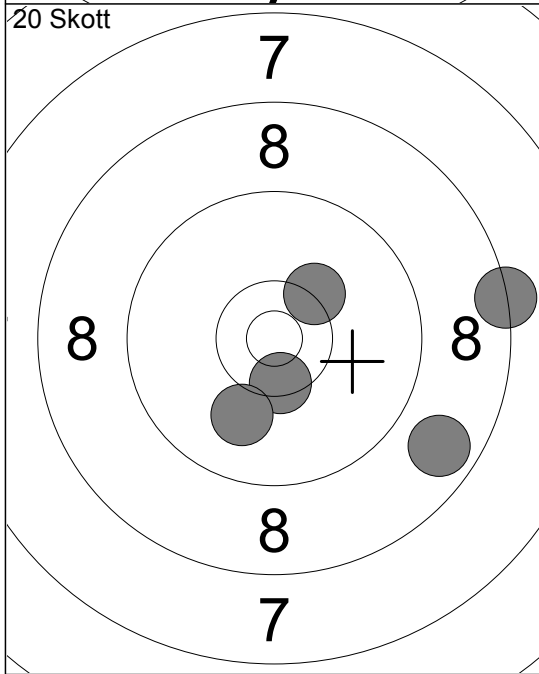

11:	10.3	↗
12:	10.4	↘
13:	8.8	↘
14:	8.3	→
15:	10.0	↓
Serie	46.0	
Total	139.0	

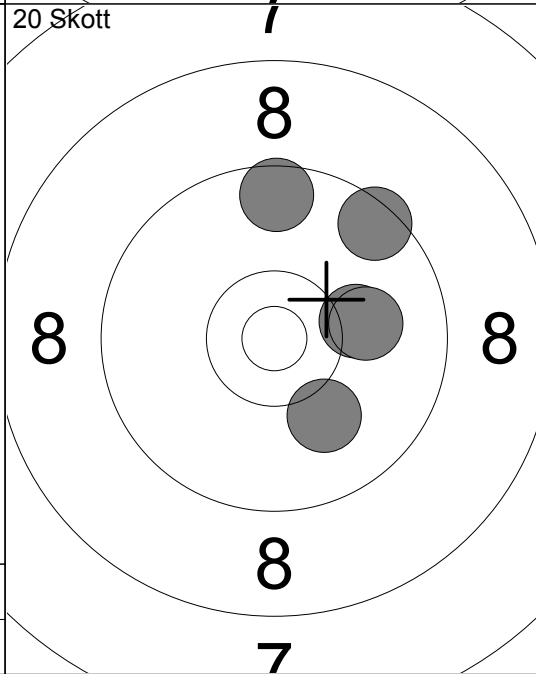

16:	10.1	↘
17:	10.2	→
18:	10.1	→
19:	9.5	↗
20:	9.6	↑
Serie	48.0	
Total	187.0	

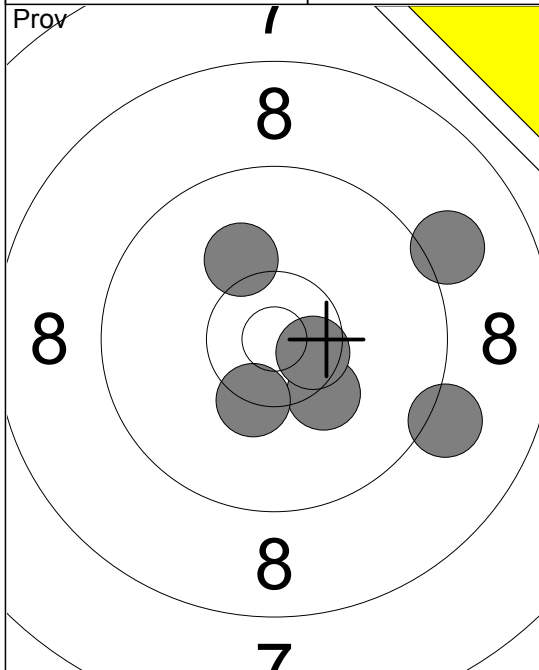

- 1: 10.2 ↘
- 2: 9.1 ↗
- 3: 10.3x ↘
- 4: 10.6x ↘
- 5: 9.1 ↘
- 6: 10.1 ↗

Serie 58.0

Total 0.0

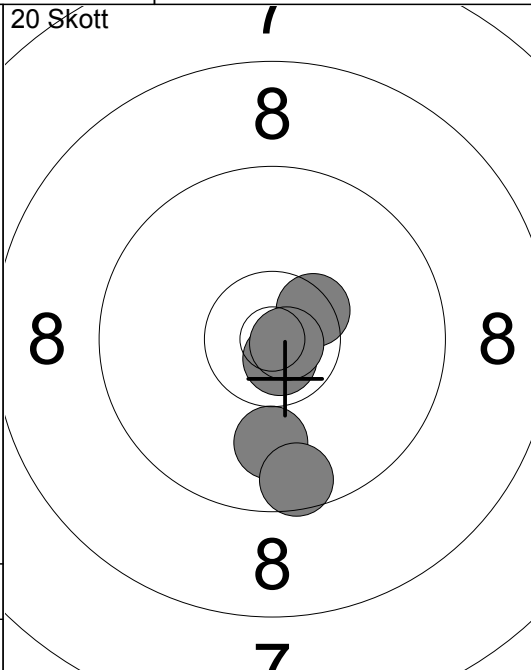

- 1: 10.8x ↘
- 2: 10.5x ↗
- 3: 10.8x ↘
- 4: 10.0 ↓
- 5: 9.6 ↓

Serie 49.0

Total 49.0

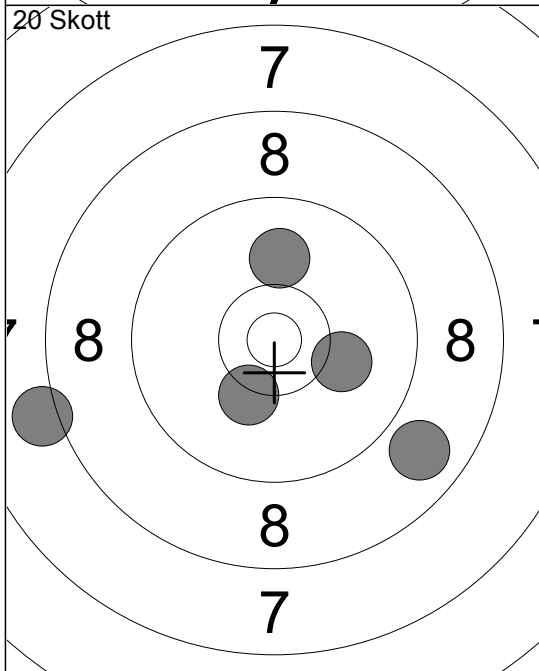

- 6: 10.1 ↗
- 7: 8.8 ↘
- 8: 10.2 ↘
- 9: 8.1 ←
- 10: 10.0 ↑

Serie 46.0

Total 95.0

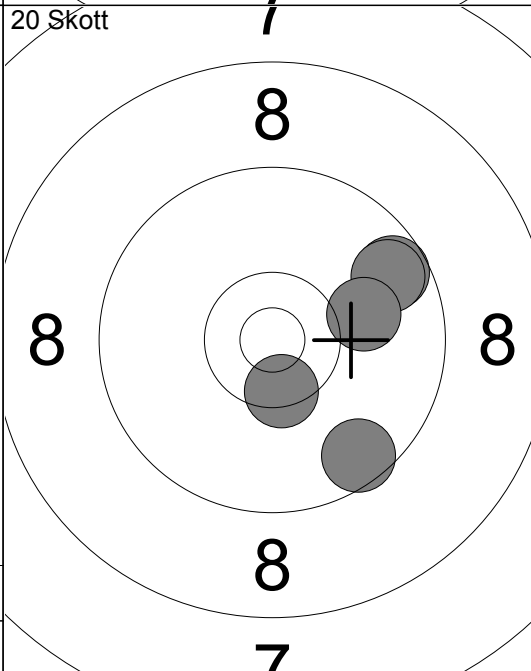

- 11: 9.6 ↘
- 12: 9.6 ↗
- 13: 9.7 ↗
- 14: 10.5x ↘
- 15: 10.0 →

Serie 47.0

Total 142.0

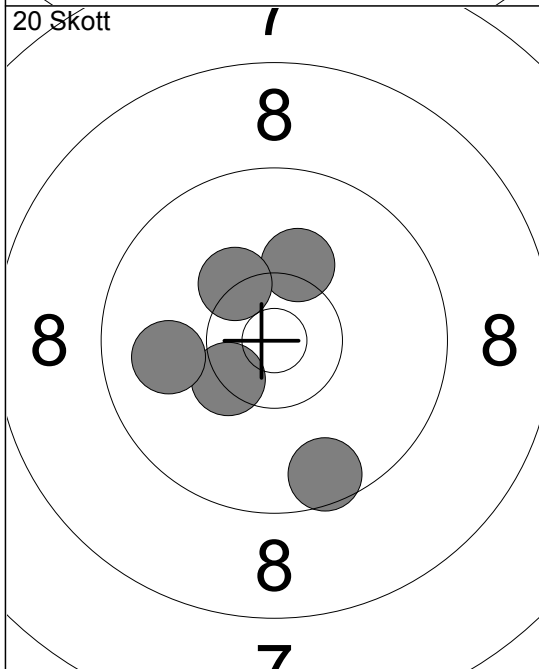

- 16: 10.4x ↘
- 17: 9.9 ←
- 18: 10.2 ↗
- 19: 9.6 ↘
- 20: 10.3x ↘

Serie 48.0

Total 190.0

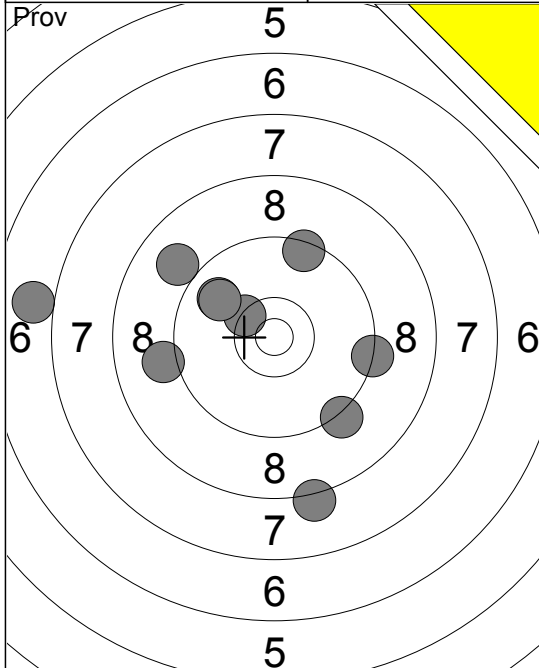

1:	9.0	↗
2:	9.2	↓
3:	9.1	←
4:	9.8	↗
5:	9.5	↗
6:	8.2	↓
7:	10.4	↘
8:	9.3	→
9:	9.9	↗
10:	7.0	←
Serie	88.0	
Total	0.0	

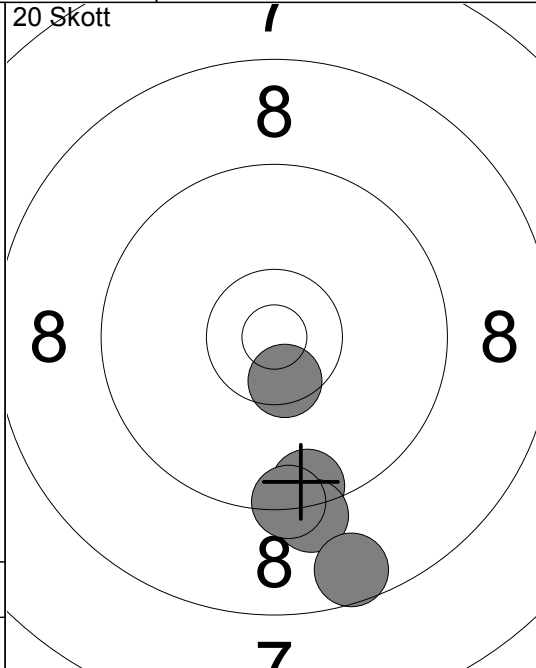

1:	9.5	↓
2:	9.2	↓
3:	10.5	↘
4:	8.6	↓
5:	9.4	↓
Serie	45.0	
Total	45.0	

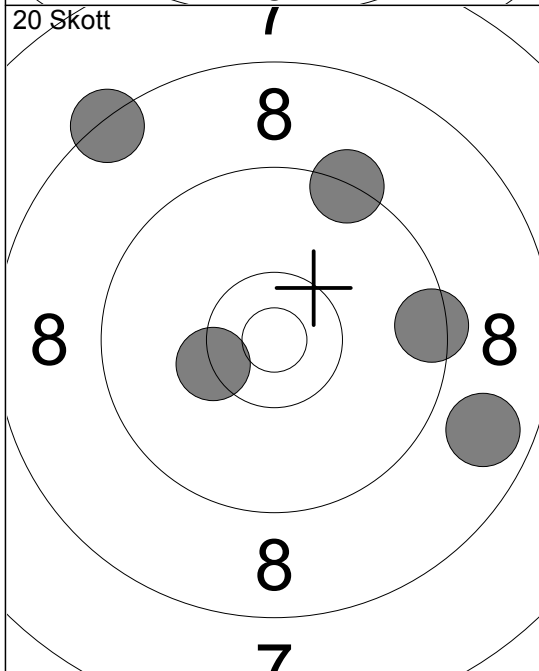

6:	8.4	↗
7:	10.3	↘
8:	9.3	↗
9:	9.4	→
10:	8.8	↘
Serie	44.0	
Total	89.0	

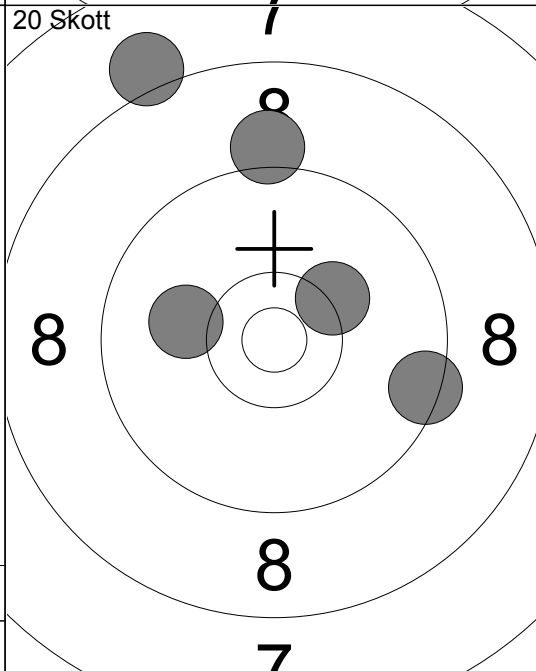

11:	8.1	↗
12:	9.1	↑
13:	9.4	→
14:	10.3	↗
15:	10.1	←
Serie	46.0	
Total	135.0	

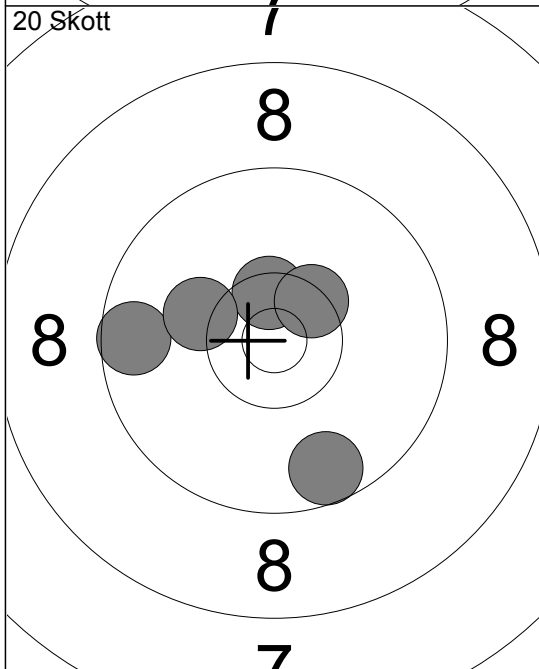

16:	9.6	←
17:	10.5	↗
18:	10.4	↘
19:	9.6	↓
20:	10.2	←
Serie	48.0	
Total	183.0	

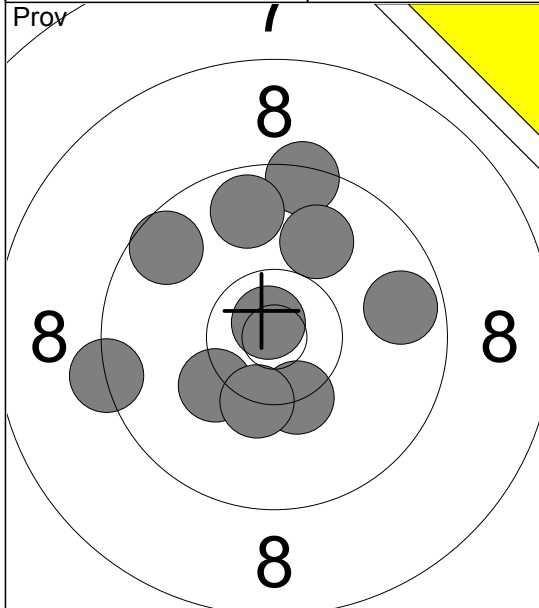

- 1: 9.7 →
- 2: 9.4 ↑
- 3: 10.2 ↙
- 4: 10.3x ↘
- 5: 10.3x ↘
- 6: 9.7 ↑
- 7: 10.8x ↗
- 8: 9.3 ←
- 9: 9.6 ↖
- 10: 10.0 ↗

Serie 95.0
Total 0.0

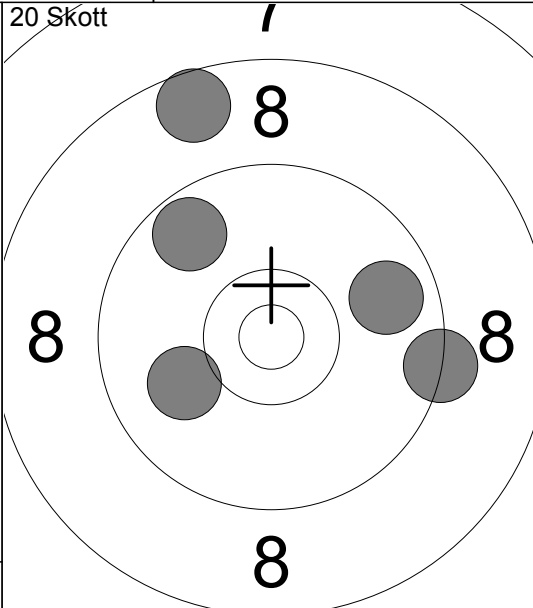

- 1: 10.0 ↙
- 2: 8.6 ↑
- 3: 9.3 →
- 4: 9.7 ↗
- 5: 9.8 →

Serie 45.0
Total 45.0

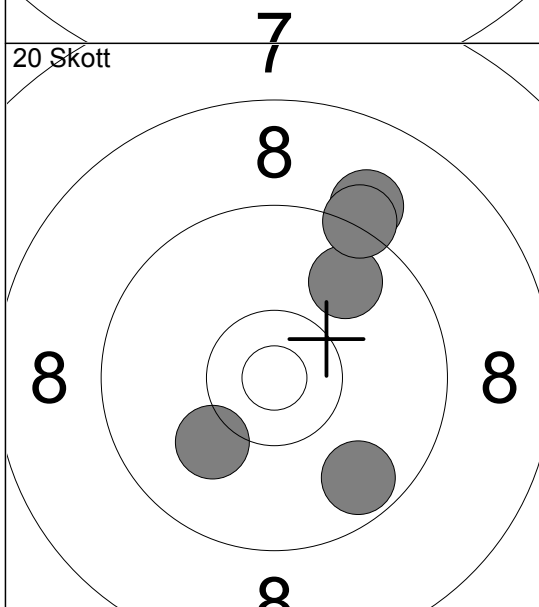

- 6: 10.1 ↙
- 7: 9.8 ↗
- 8: 9.1 ↗
- 9: 9.7 ↘
- 10: 9.3 ↗

Serie 46.0
Total 91.0

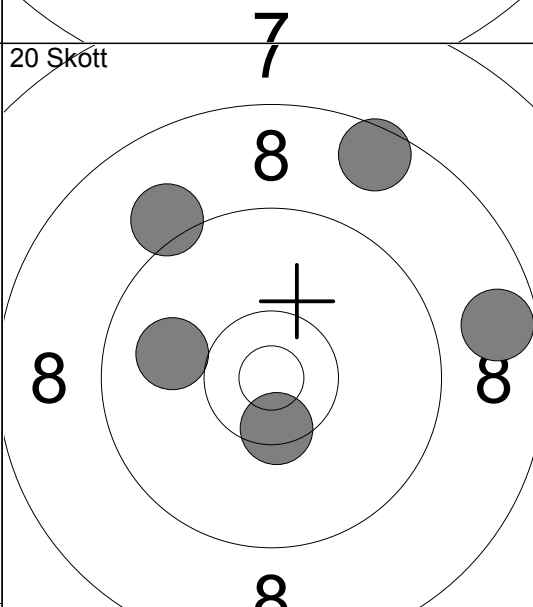

- 11: 10.5x ↘
- 12: 10.0 ↙
- 13: 8.6 ↑
- 14: 8.7 →
- 15: 9.1 ↖

Serie 45.0
Total 136.0

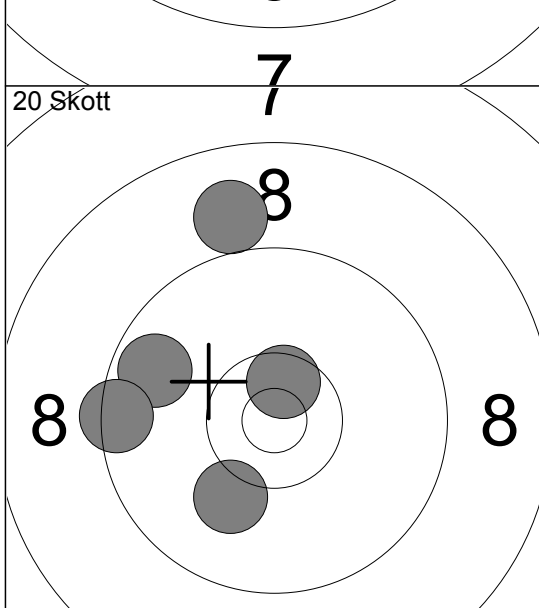

- 16: 9.7 ←
- 17: 10.1 ↘
- 18: 9.4 ←
- 19: 10.6x ↗
- 20: 9.0 ↑

Serie 47.0
Total 183.0

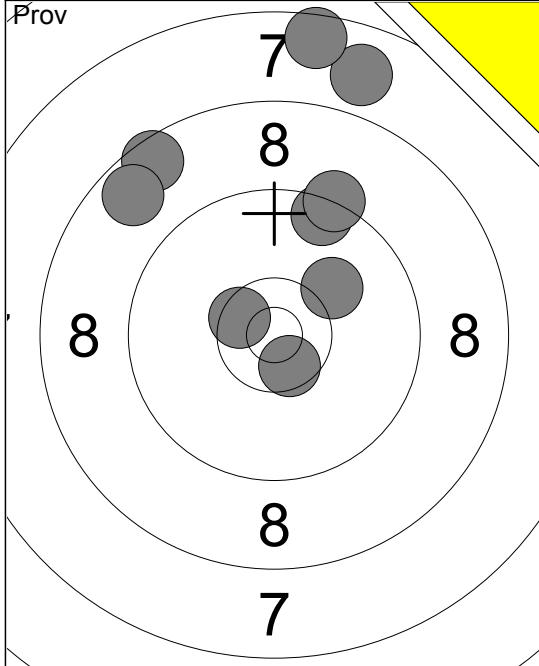

1:	10.1 ↗
2:	9.5 ↑
3:	9.3 ↑
4:	10.5 ✕
5:	8.6 ↖
6:	10.6 ✕
7:	8.7 ↖
8:	7.9 ↑
9:	7.6 ↑
Serie	78.0
Total	0.0

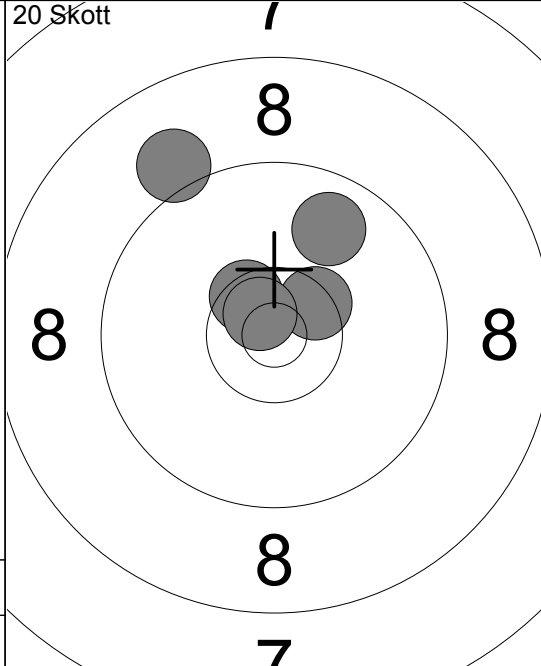

1:	10.5 ✕
2:	9.1 ↖
3:	10.5 ✕
4:	9.8 ↑
5:	10.7 ✕
Serie	48.0
Total	48.0

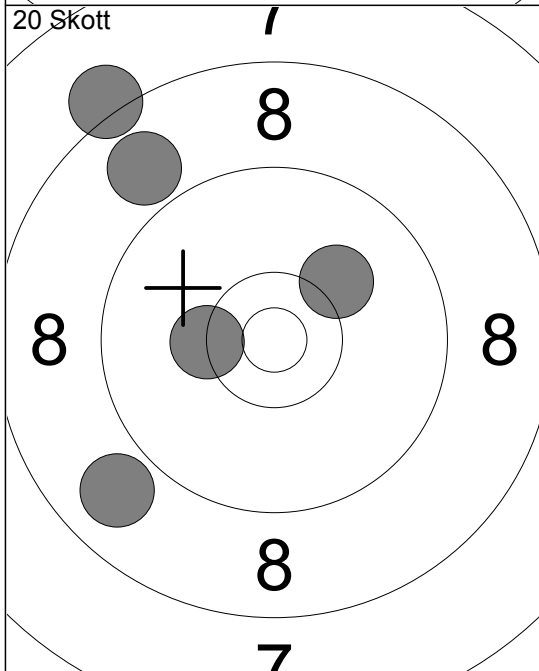

6:	10.3 ✕
7:	8.2 ↖
8:	8.9 ↙
9:	8.9 ↖
10:	10.1 ↗
Serie	44.0
Total	92.0

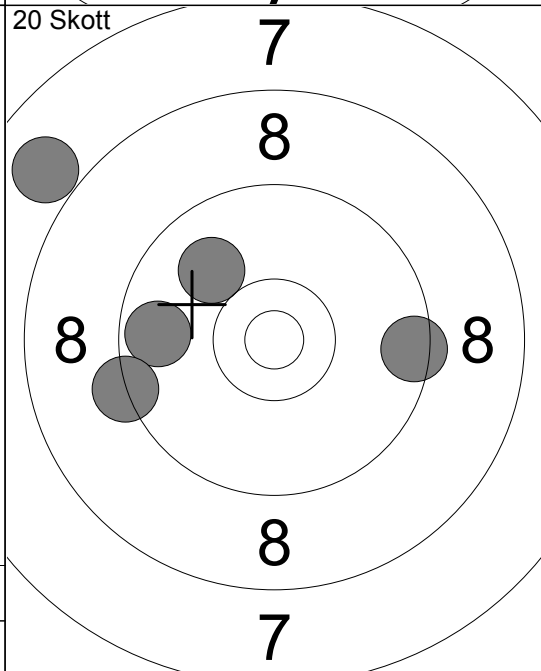

11:	9.7 ←
12:	9.3 ←
13:	9.5 →
14:	10.0 ↖
15:	7.9 ↖
Serie	44.0
Total	136.0

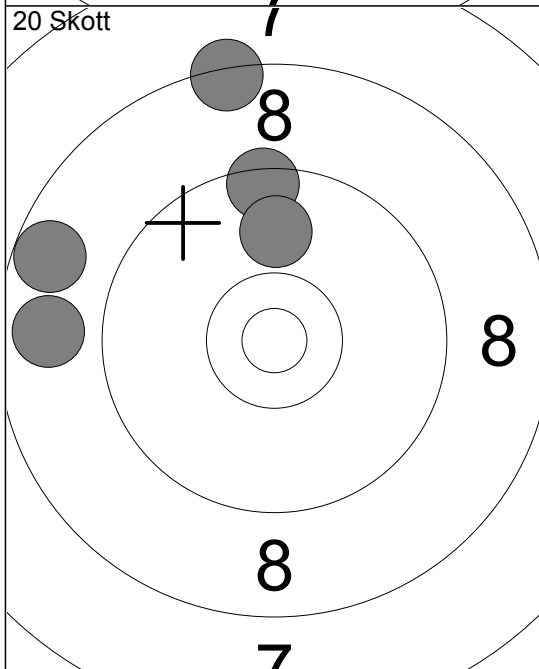

16:	9.4 ↑
17:	9.9 ↑
18:	8.4 ↑
19:	8.8 ←
20:	8.7 ↖
Serie	42.0
Total	178.0

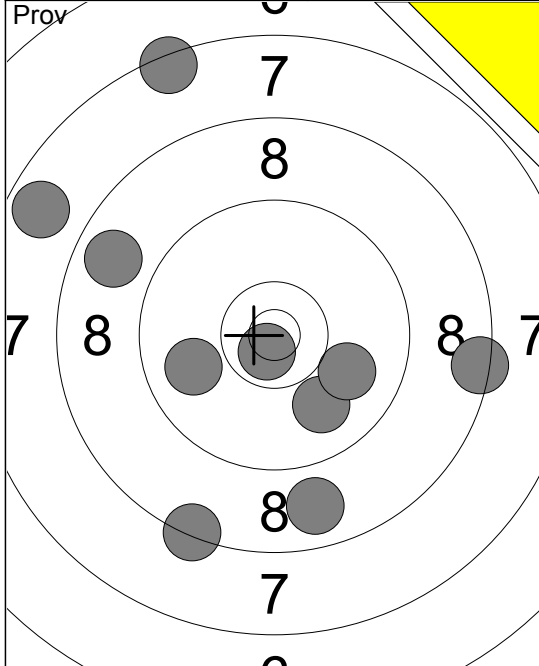

1: 7.4 ↗
 2: 8.8 ↓
 3: 10.7x ↘
 4: 9.9 ↓
 5: 8.4 ↓
 6: 9.9 ←
 7: 8.8 ↖
 8: 10.0 ↘
 9: 8.4 →
 10: 7.7 ↖

Serie 84.0
 Total 0.0

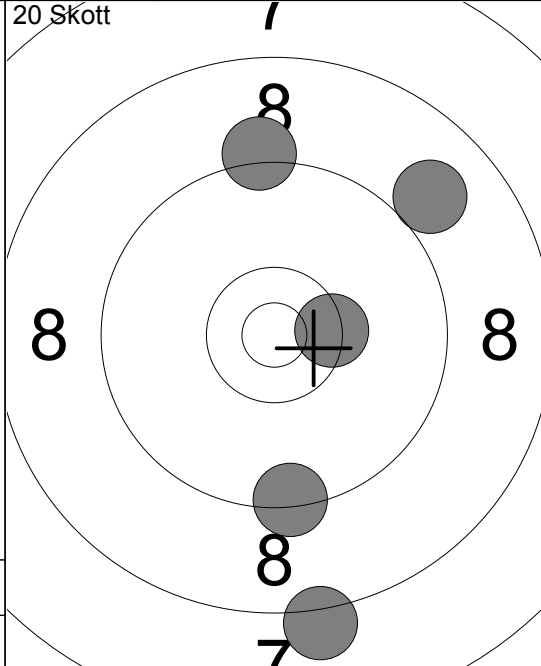

1: 9.0 ↗
 2: 8.2 ↓
 3: 9.4 ↓
 4: 9.2 ↑
 5: 10.4x →

Serie 45.0
 Total 45.0

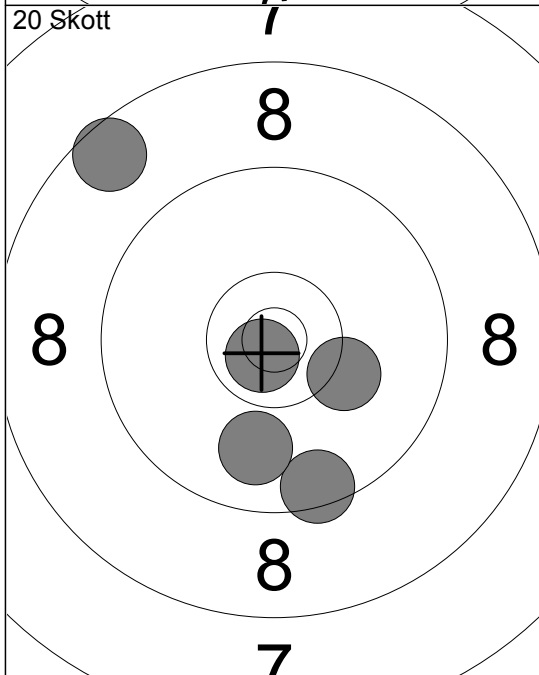

6: 8.6 ↗
 7: 9.5 ↓
 8: 10.2 ↘
 9: 9.9 ↓
 10: 10.8x ↘

Serie 46.0
 Total 91.0

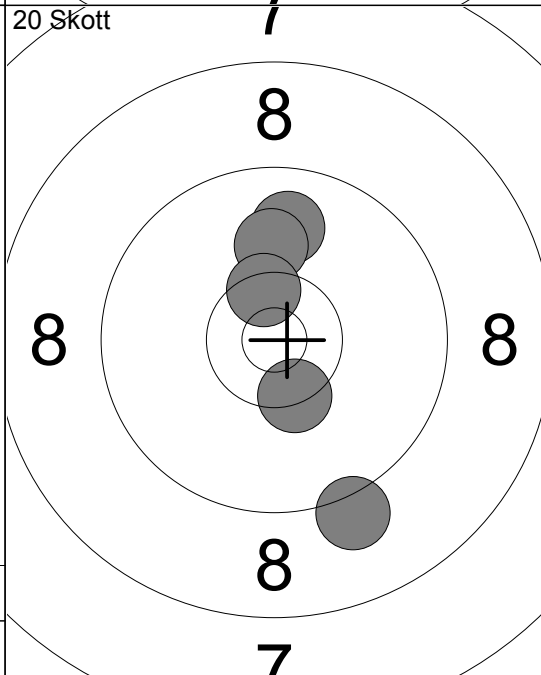

11: 9.9 ↑
 12: 10.0 ↑
 13: 9.1 ↓
 14: 10.5x ↗
 15: 10.4x ↘

Serie 48.0
 Total 139.0

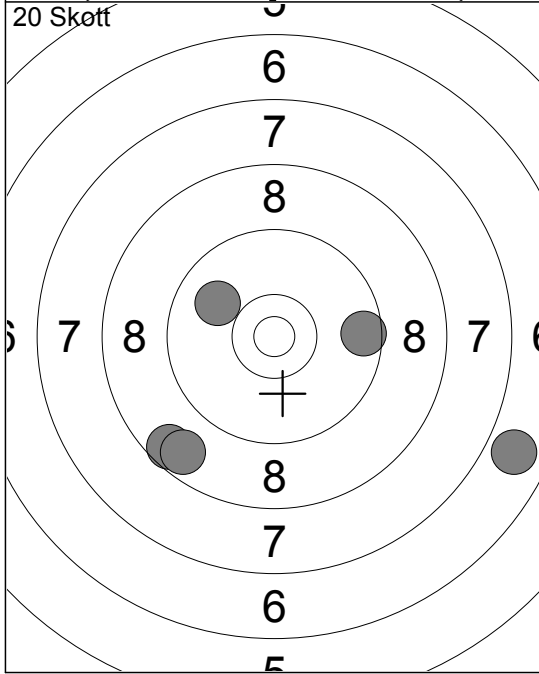

16: 8.6 ↘
 17: 8.7 ↘
 18: 9.9 ↖
 19: 9.6 →
 20: 6.9 ↘

Serie 40.0
 Total 179.0

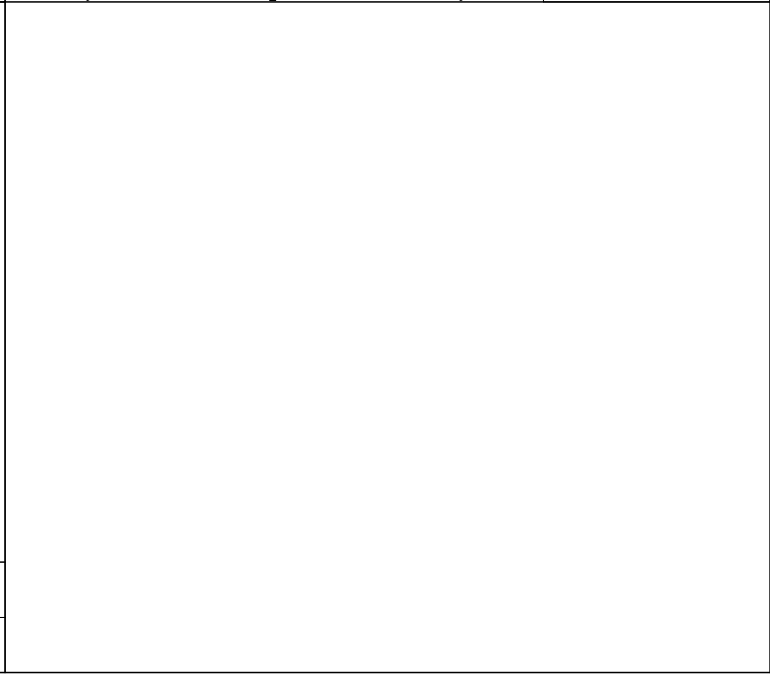

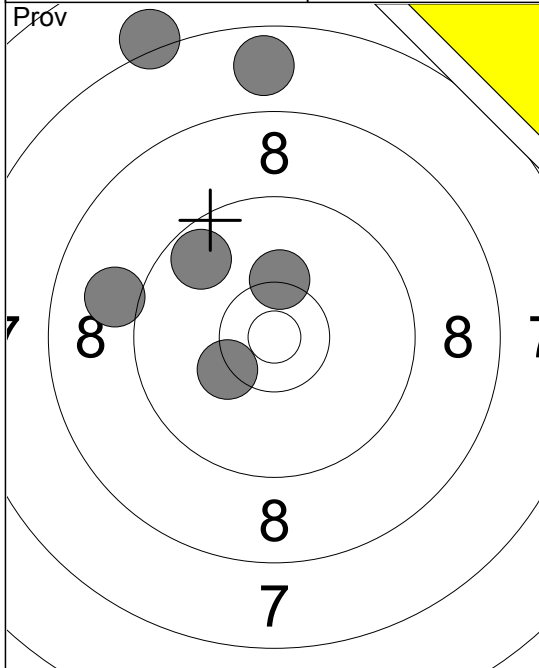

1: 7.2 ↖
 2: 7.8 ↑
 3: 9.7 ↖
 4: 10.3 ↙
 5: 10.3 ↑
 6: 9.0 ←

Serie	52.0
Total	0.0

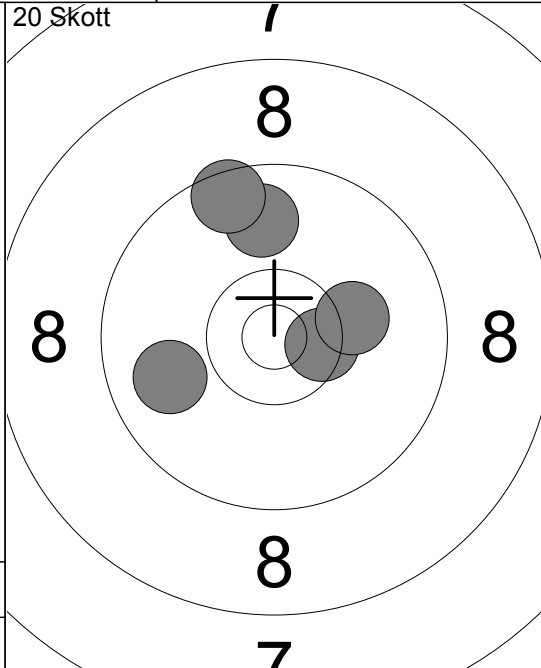

1: 10.5x➤
 2: 9.8 ↑
 3: 9.5 ↖
 4: 10.2➔
 5: 9.9 ←

Serie	47.0
Total	47.0

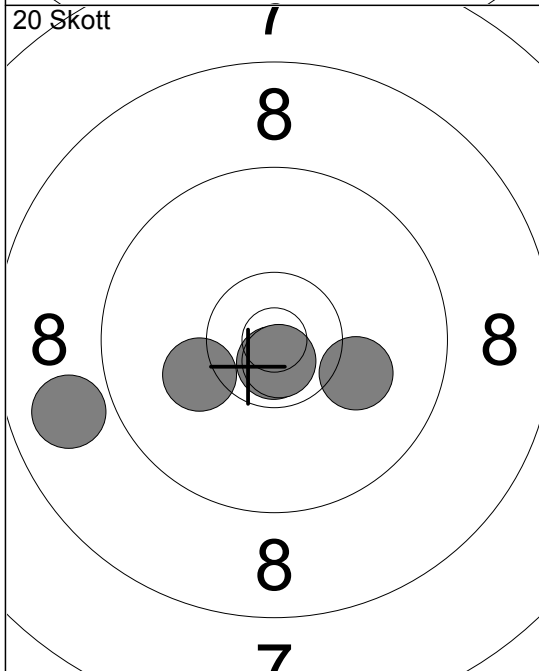

6: 10.7x↓
 7: 10.2↙
 8: 10.7x↓
 9: 10.1➔
 10: 8.9 ←

Serie	48.0
Total	95.0

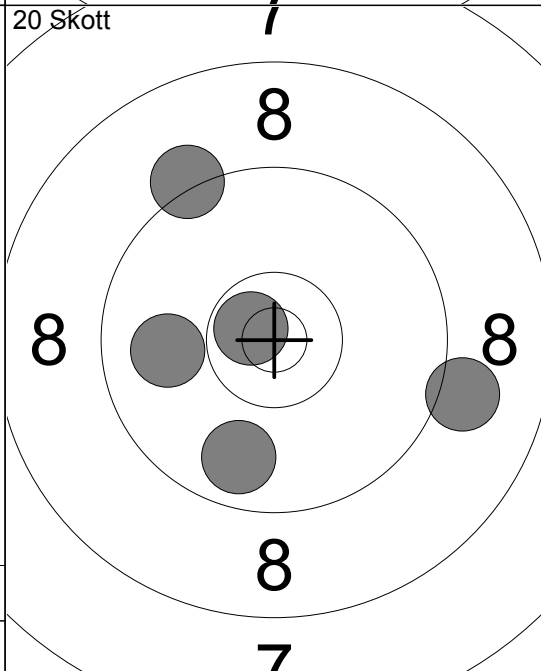

11: 9.8 ↓
 12: 9.2 ↖
 13: 9.9 ←
 14: 10.7x↘
 15: 9.1 ➔

Serie	46.0
Total	141.0

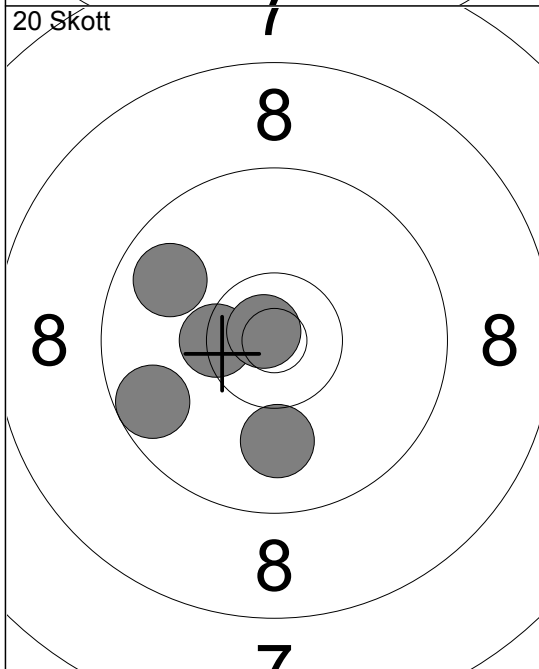

16: 10.0 ↓
 17: 10.4x←
 18: 9.8 ↖
 19: 9.6 ↙
 20: 10.8x↘

Serie	48.0
Total	189.0

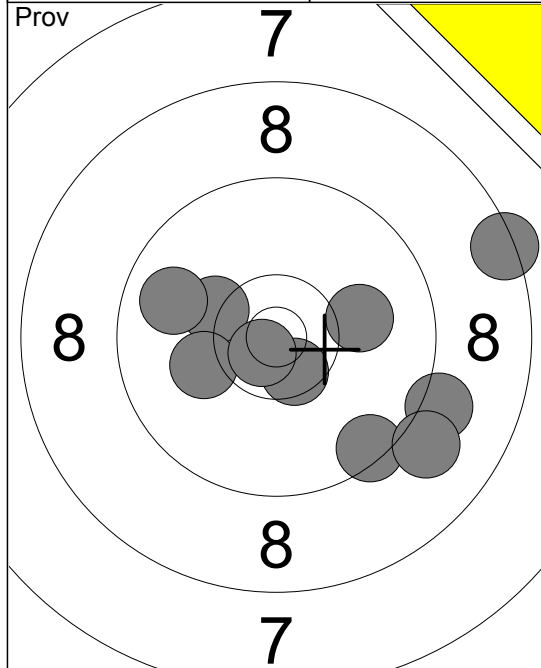

1:	8.4	➔
2:	10.3	↙
3:	10.1	↙
4:	9.1	➔
5:	10.5	↘
6:	10.1	➔
7:	9.8	↙
8:	9.4	↘
9:	10.7	↘
10:	9.0	↘
Serie	94.0	
Total	0.0	

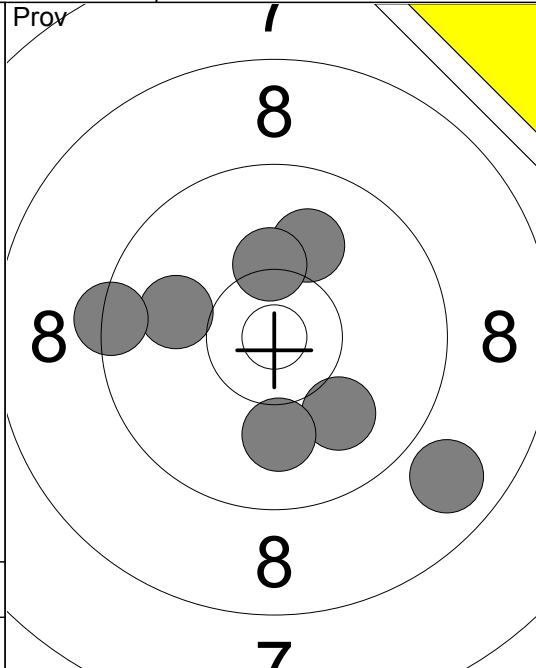

11:	10.0	↘
12:	10.0	↗
13:	10.0	↘
14:	8.8	↘
15:	10.0	↙
16:	10.3	↗
17:	9.4	↙
Serie	67.0	
Total	0.0	

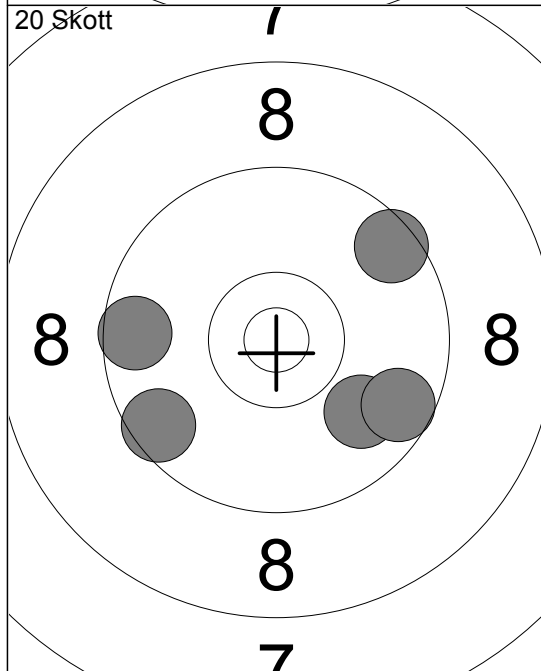

1:	9.9	↘
2:	9.6	↘
3:	9.5	↗
4:	9.6	↙
5:	9.6	↙
Serie	45.0	
Total	45.0	

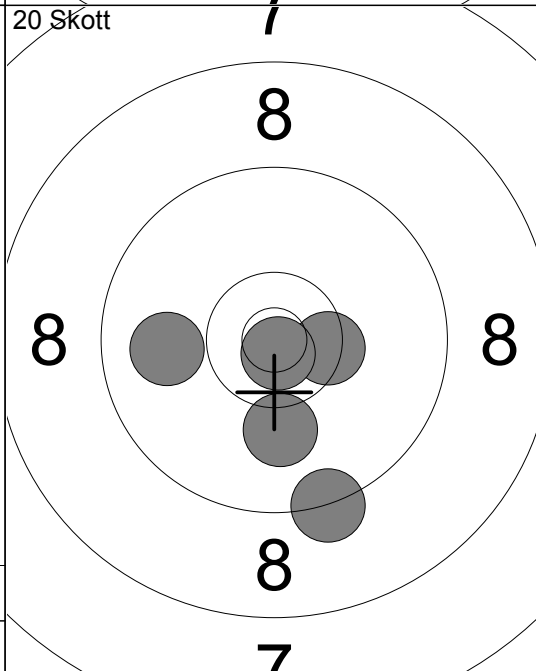

6:	9.3	↘
7:	10.1	↘
8:	10.4	➔
9:	9.9	↙
10:	10.8	↘
Serie	48.0	
Total	93.0	

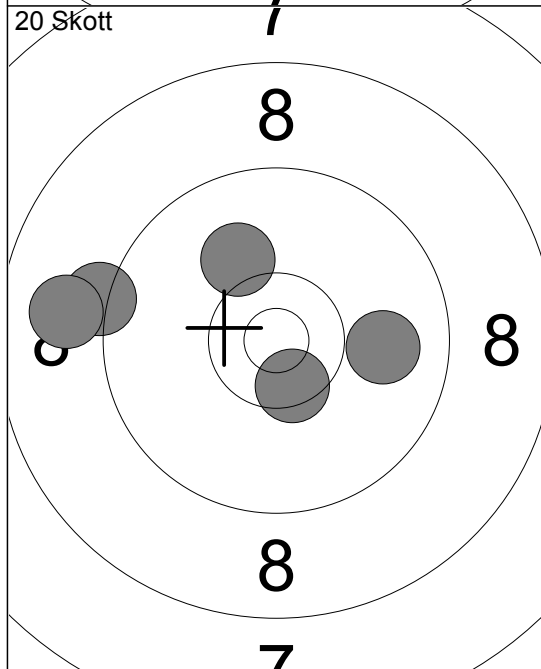

11:	9.2	↙
12:	8.9	↙
13:	10.5	↘
14:	9.9	➔
15:	10.1	↗
Serie	46.0	
Total	139.0	

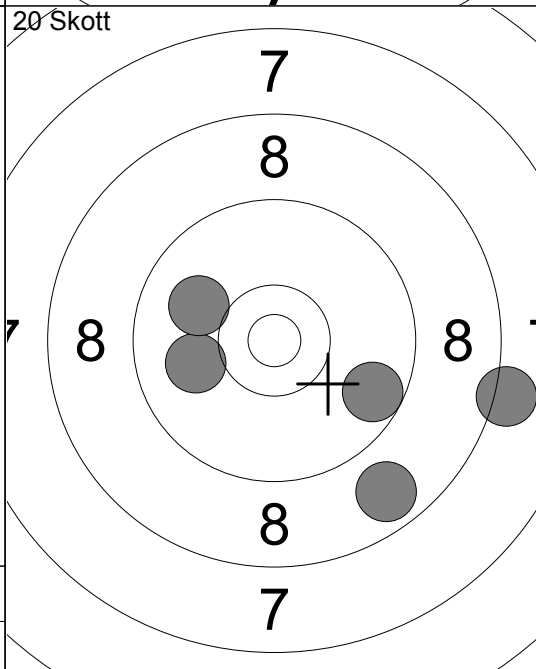

16:	10.0	↙
17:	10.0	↙
18:	8.8	↘
19:	8.2	➔
20:	9.7	↘
Serie	45.0	
Total	184.0	

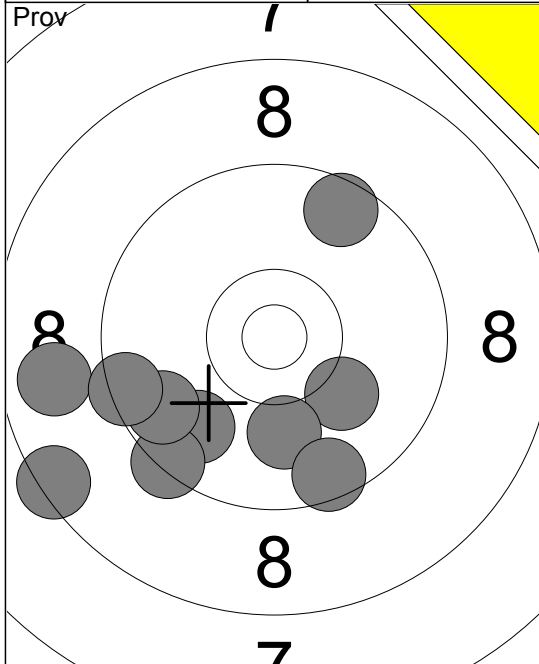

1:	10.1	↘
2:	8.4	↙
3:	9.8	↙
4:	8.8	←
5:	9.4	↙
6:	10.0	↓
7:	9.7	↙
8:	9.4	←
9:	9.5	↘
10:	9.6	↗
Serie		90.0
Total		0.0

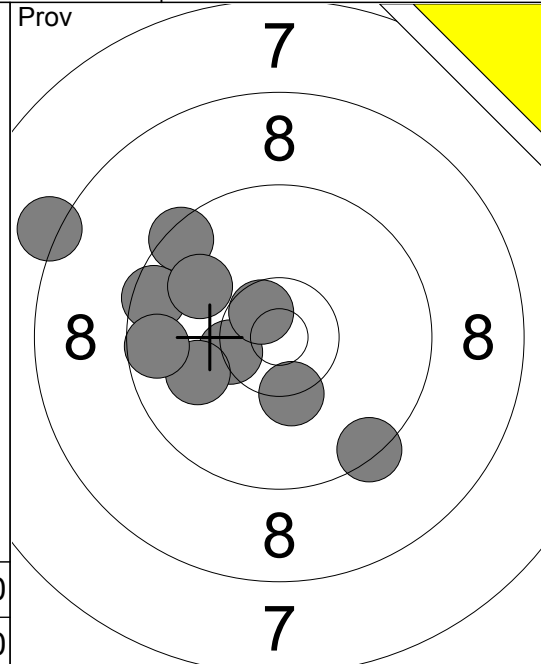

11:	9.4	↘
12:	10.4	↘
13:	9.5	←
14:	9.5	↗
15:	9.9	↙
16:	10.3	↘
17:	8.2	↙
18:	10.6	↘
19:	10.0	↙
20:	9.6	←
Serie		93.0
Total		0.0

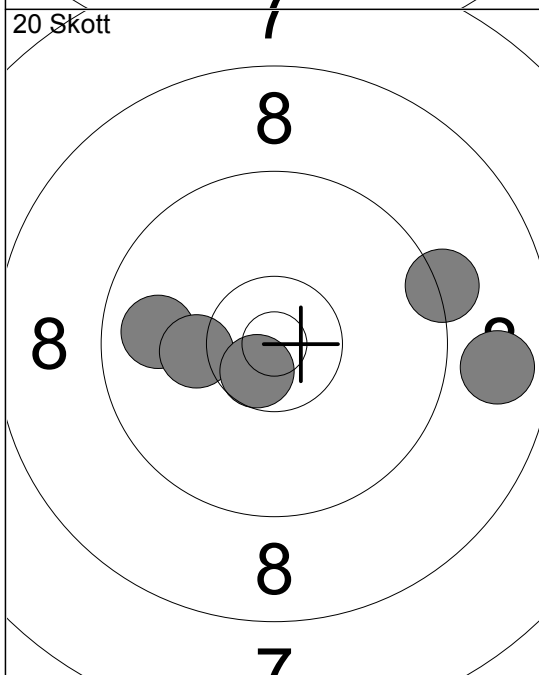

1:	8.8	→
2:	9.3	→
3:	9.8	←
4:	10.2	←
5:	10.6	↘
Serie		46.0
Total		46.0

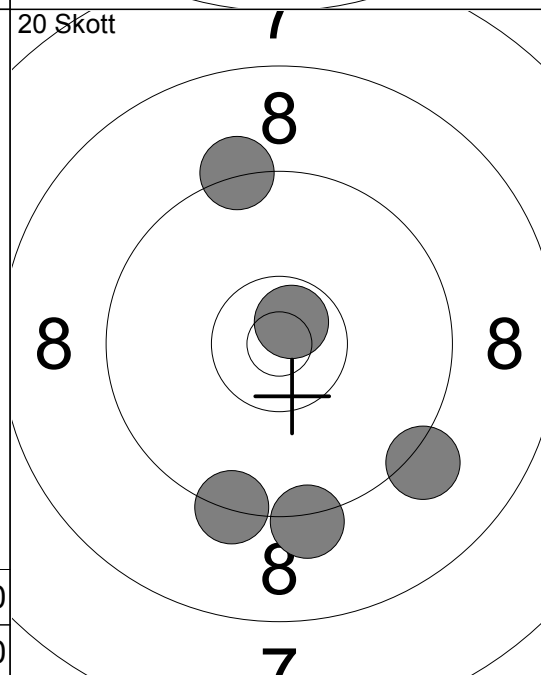

6:	9.2	↘
7:	9.2	↓
8:	9.3	↑
9:	9.3	↘
10:	10.7	↗
Serie		46.0
Total		92.0

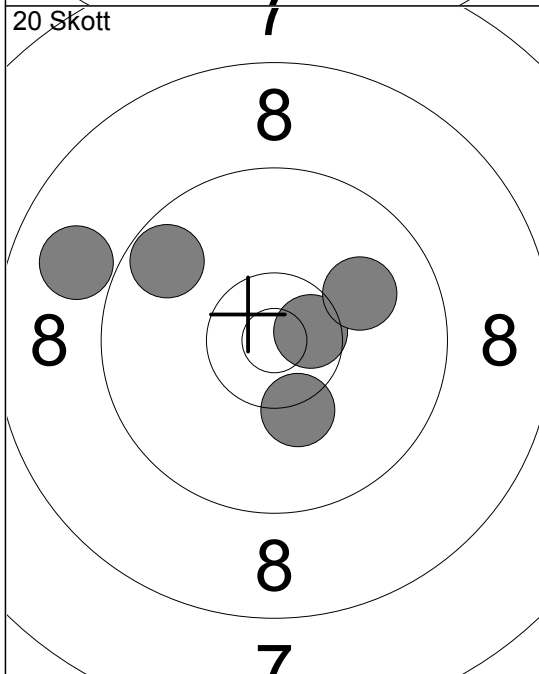

11:	9.7	↙
12:	8.9	←
13:	10.6	↗
14:	10.0	↗
15:	10.3	↓
Serie		47.0
Total		139.0

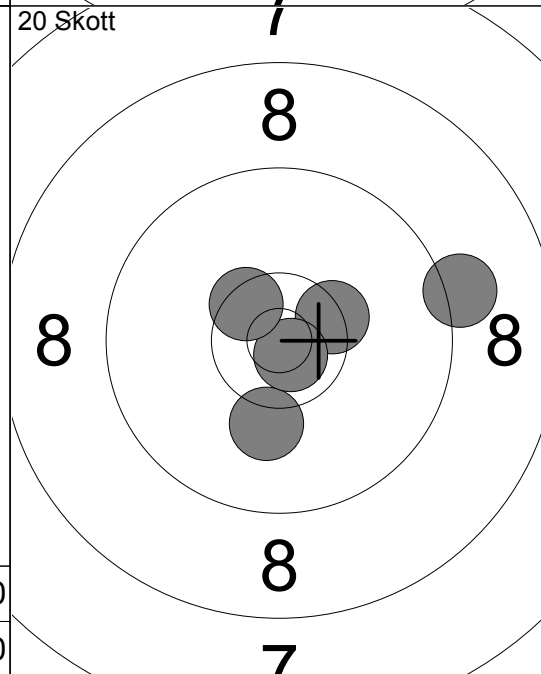

16:	10.4	↗
17:	10.1	↓
18:	10.8	↘
19:	10.5	↘
20:	9.2	→
Serie		49.0
Total		188.0

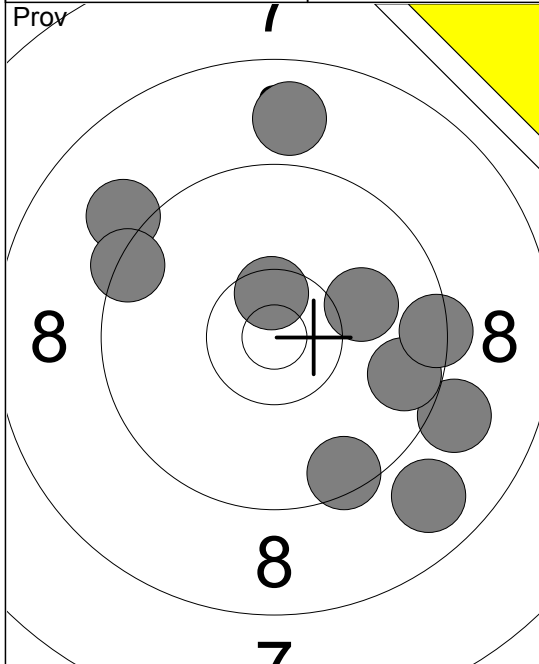

1:	8.9	↑
2:	9.1	↘
3:	9.5	↘
4:	8.8	↘
5:	9.1	↗
6:	9.7	↘
7:	10.1	→
8:	10.5	↗
9:	9.4	→
10:	9.4	↖
Serie		90.0
Total		0.0

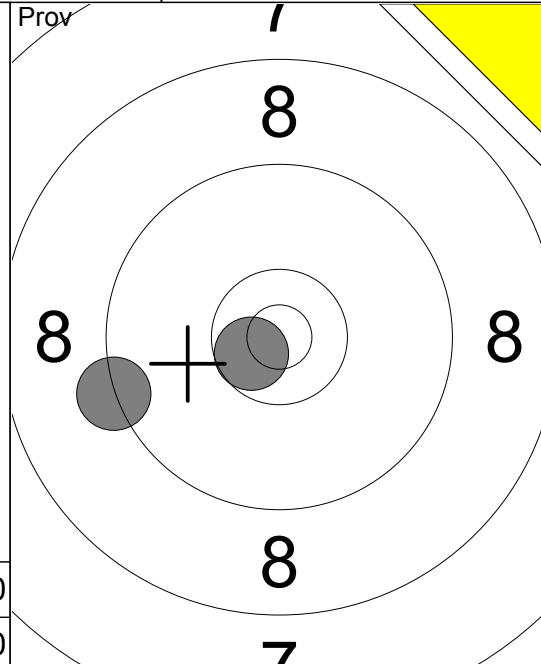

11:	10.6	↘
12:	9.3	↖
Serie		19.0
Total		0.0

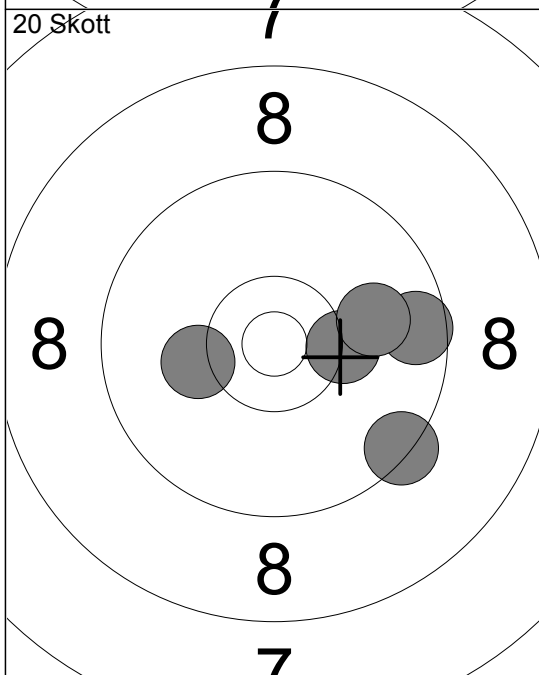

1:	9.6	→
2:	10.2	↖
3:	10.3	↗
4:	10.0	→
5:	9.4	↘
Serie		48.0
Total		48.0

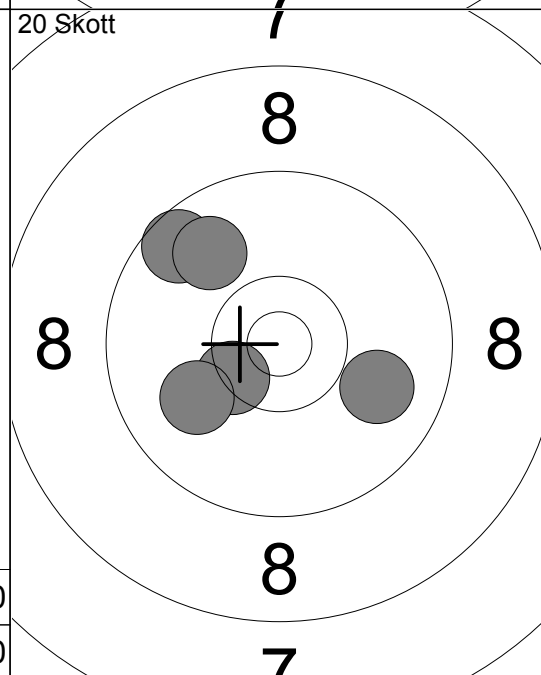

6:	9.6	↗
7:	9.9	↗
8:	9.9	↘
9:	10.4	↘
10:	10.0	↖
Serie		47.0
Total		95.0

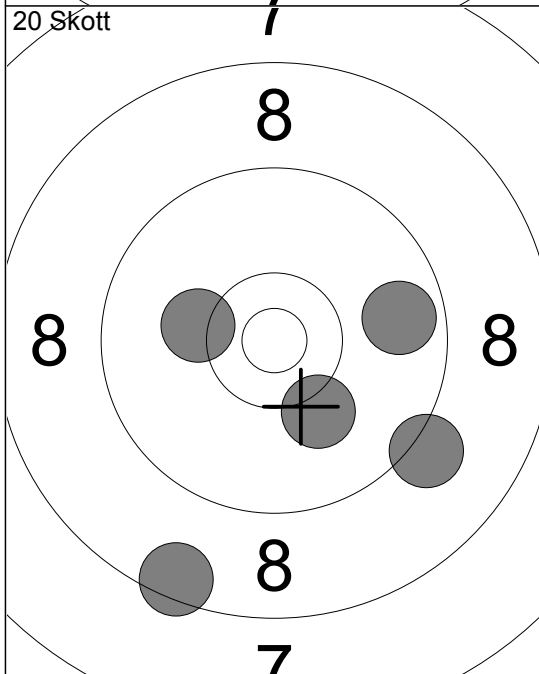

11:	9.7	→
12:	8.5	↘
13:	10.2	↖
14:	9.2	↘
15:	10.2	↘
Serie		46.0
Total		141.0

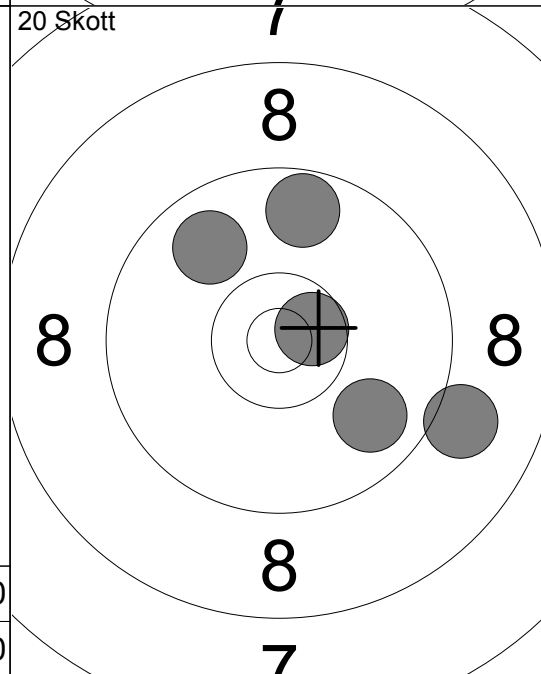

16:	9.8	↘
17:	9.7	↑
18:	9.1	↘
19:	10.6	↗
20:	9.8	↗
Serie		46.0
Total		187.0

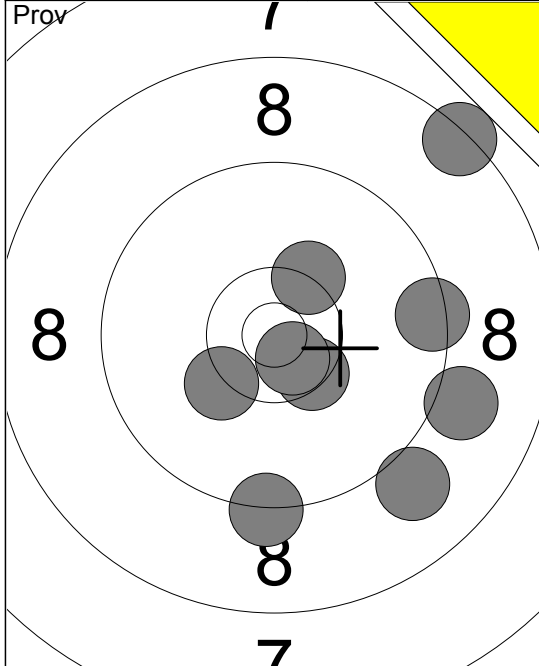

- 1: 8.4 ↗
- 2: 10.3x ↗
- 3: 10.4x ↘
- 5: 9.4 →
- 6: 9.3 ↓
- 7: 9.0 ↘
- 8: 9.1 →
- 9: 10.7x ↘
- 10: 10.3 ↙

Serie 84.0
Total 0.0

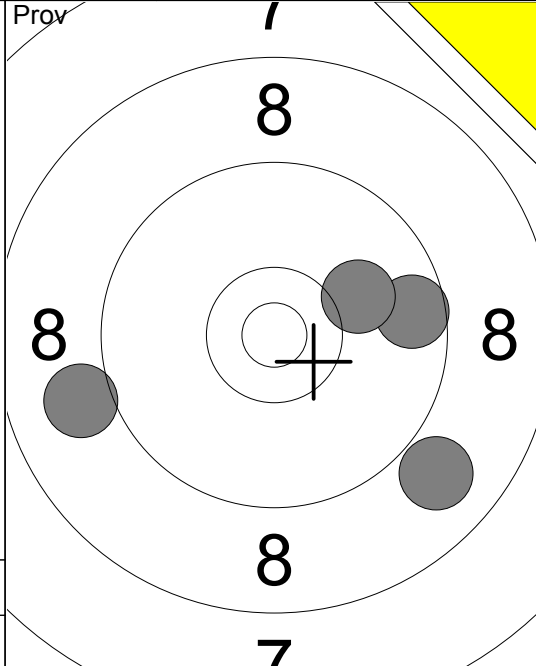

- 11: 8.9 ↘
- 12: 9.0 ←
- 13: 9.6 →
- 14: 10.1 ↗

Serie 36.0
Total 0.0

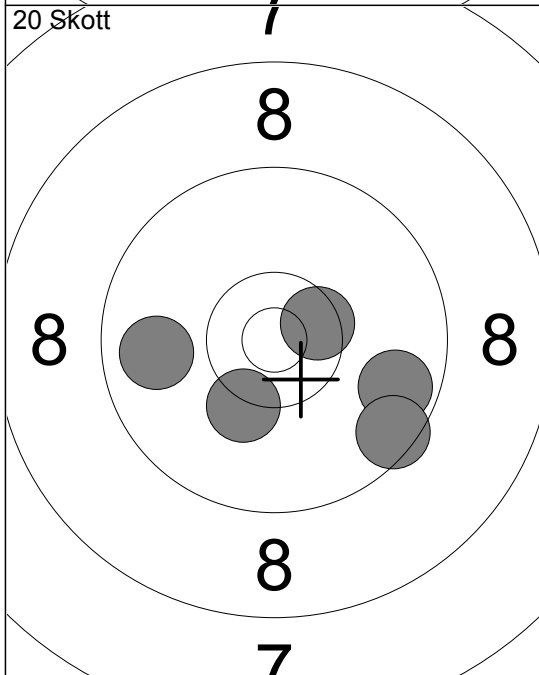

- 1: 9.7 →
- 2: 9.5 ↘
- 3: 9.8 ←
- 4: 10.3 ↓
- 5: 10.5x ↗

Serie 47.0
Total 47.0

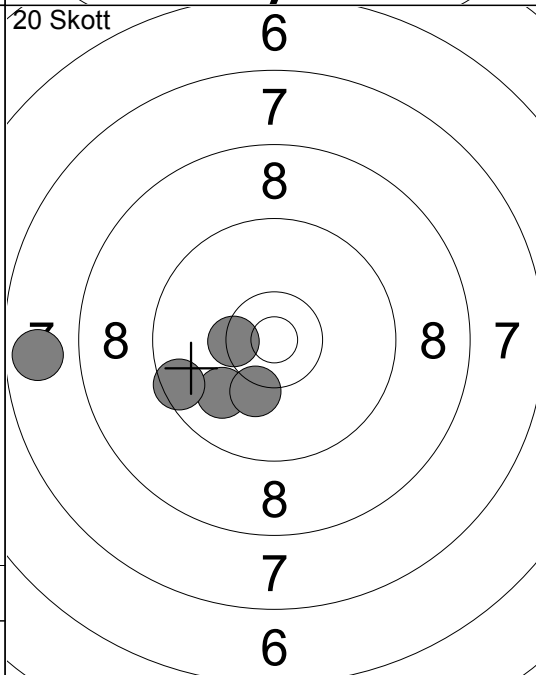

- 6: 10.0 ↙
- 7: 10.2 ↓
- 8: 10.4x ←
- 9: 9.5 ←
- 10: 7.7 ←

Serie 46.0
Total 93.0

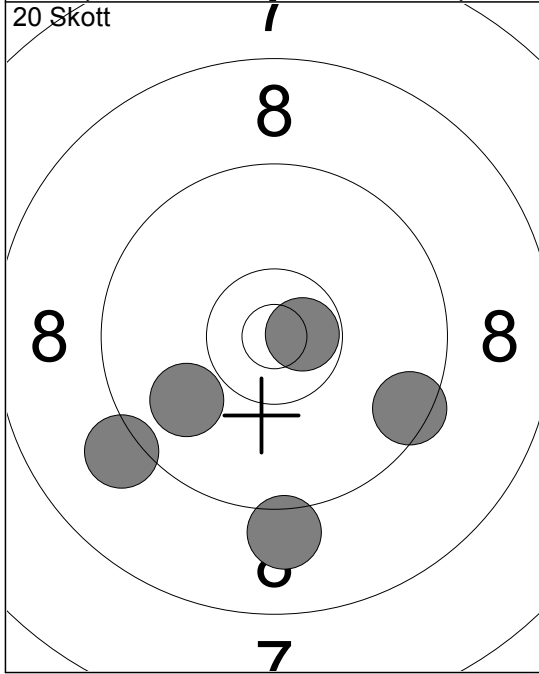

- 11: 9.1 ↙
- 12: 9.9 ↙
- 13: 10.7x ↗
- 14: 9.5 →
- 15: 9.1 ↓

Serie 46.0
Total 139.0

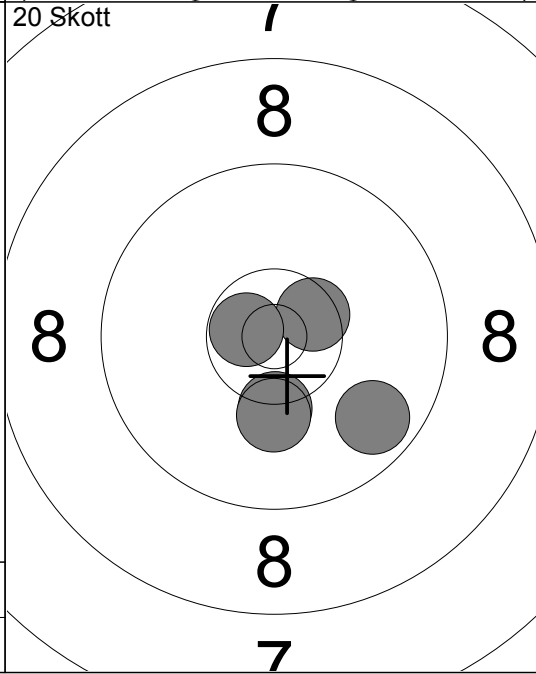

- 16: 10.5x ↗
- 17: 9.7 ↘
- 18: 10.7x ←
- 19: 10.3 ↓
- 20: 10.2 ↓

Serie 49.0
Total 188.0

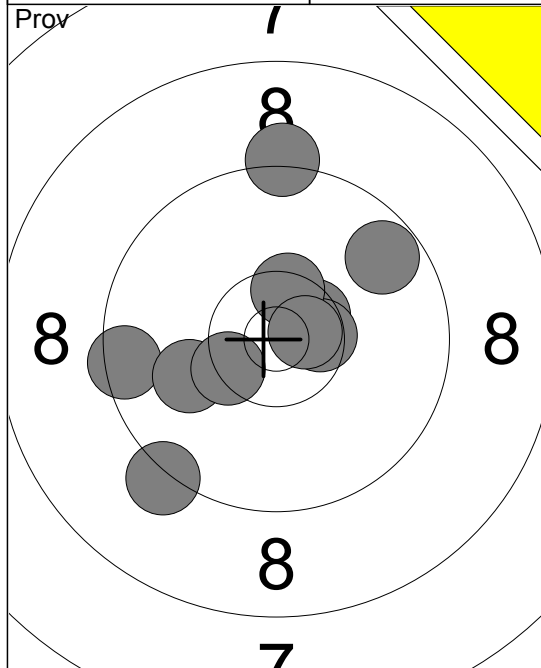

1:	10.5x ↗
2:	9.5 ←
3:	10.5x →
4:	9.2 ↑
5:	9.2 ↘
6:	10.5x ↗
7:	9.7 ↗
8:	10.7x →
9:	10.0 ↙
10:	10.4x ↘
Serie	96.0
Total	0.0

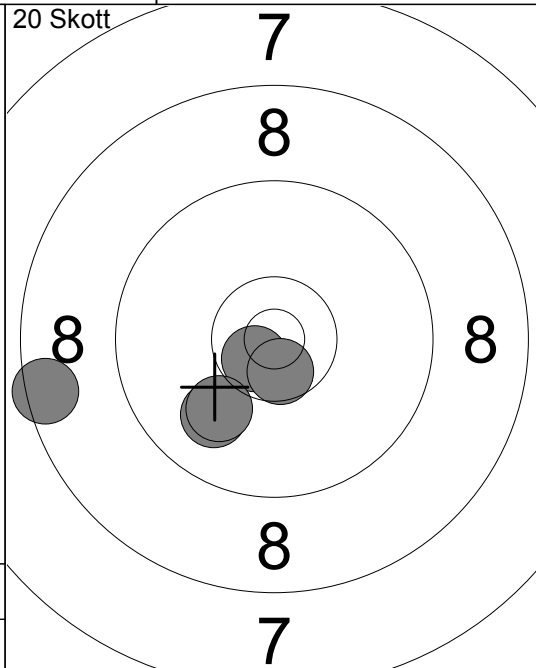

1:	9.9 ↘
2:	8.5 ←
3:	10.7x ↘
4:	10.0 ↘
5:	10.6x ↘
Serie	47.0
Total	47.0

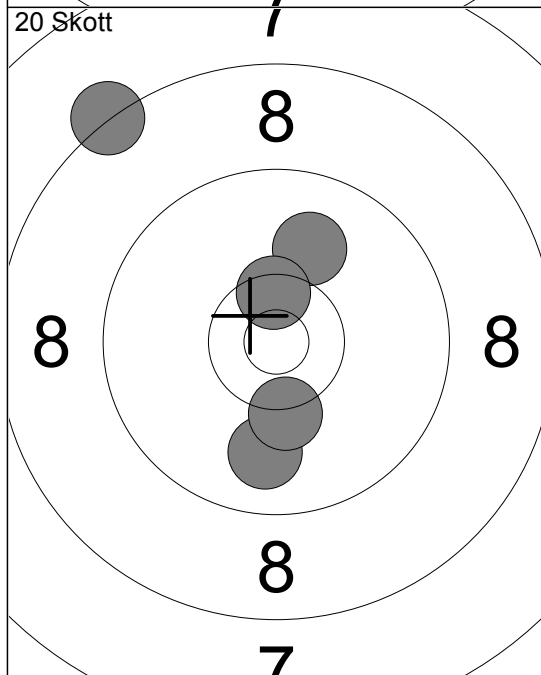

6:	8.3 ↖
7:	10.0 ↑
8:	10.5x ↗
9:	9.9 ↓
10:	10.3 ↓
Serie	47.0
Total	94.0

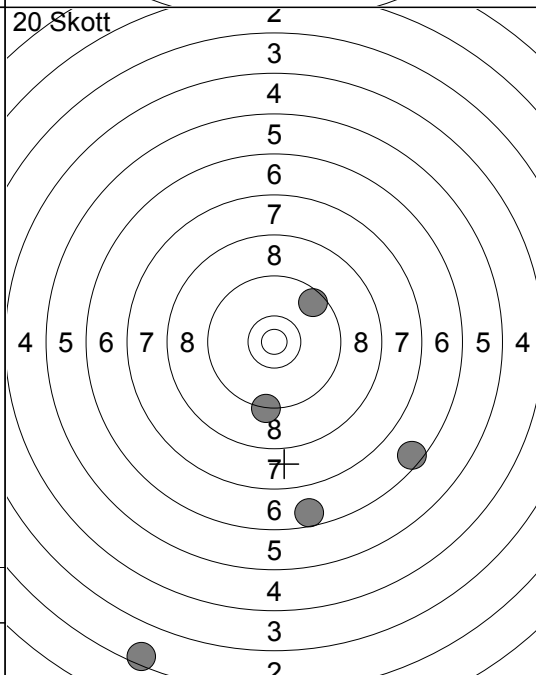

11:	6.5 ↘
12:	9.3 ↓
13:	6.6 ↓
14:	2.5 ↓
15:	9.6 ↗
Serie	32.0
Total	126.0

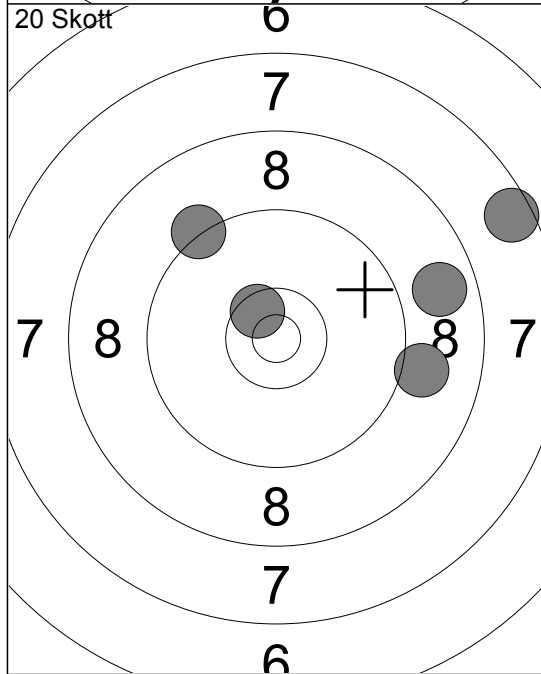

16:	8.8 →
17:	10.5x ↘
18:	7.6 ↗
19:	9.0 →
20:	9.3 ↖
Serie	43.0
Total	169.0

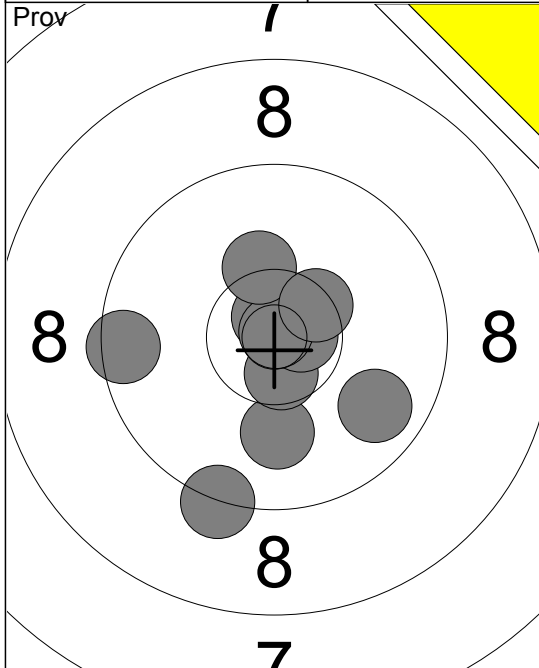

1:	9.3	↓
2:	10.0	↓
3:	10.6	x↓
4:	9.8	→
5:	9.5	←
6:	10.7	x→
7:	10.7	x↗
8:	10.9	x↗
9:	10.3	↑
10:	10.5	x↗
Serie	97.0	
Total	0.0	

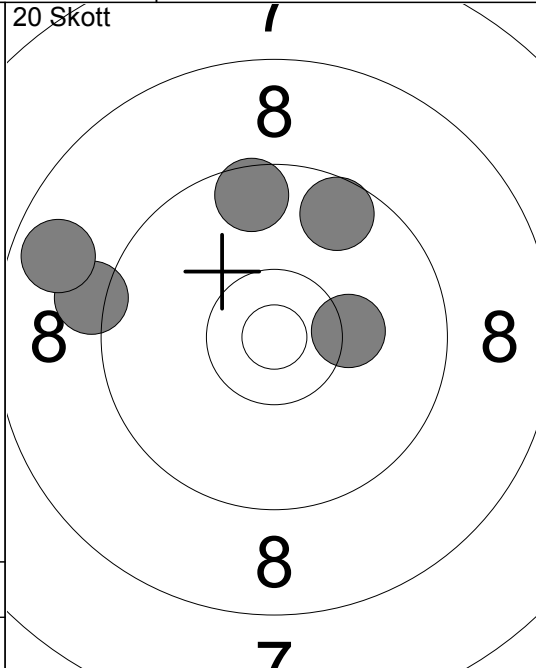

1:	9.2	←
2:	9.6	↗
3:	8.7	←
4:	10.2	→
5:	9.6	↑
Serie	45.0	
Total	45.0	

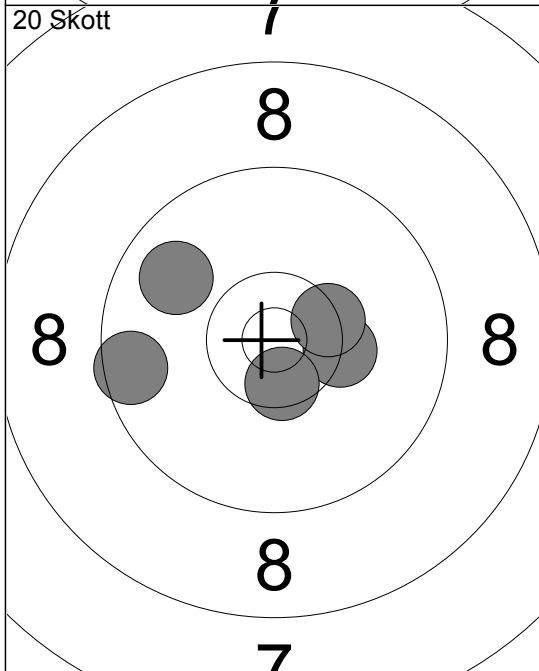

6:	10.3	x→
7:	9.8	←
8:	10.5	x↓
9:	10.4	x→
10:	9.6	←
Serie	48.0	
Total	93.0	

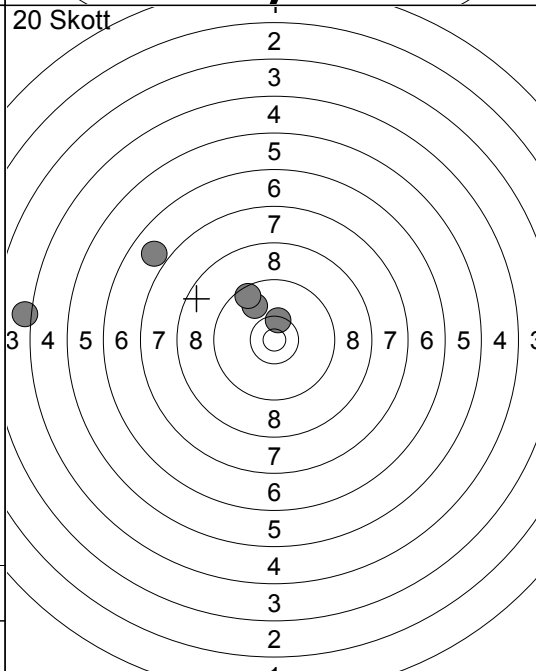

11:	9.9	↗
12:	4.1	←
13:	10.4	x↗
14:	9.6	↗
15:	6.9	↖
Serie	38.0	
Total	131.0	

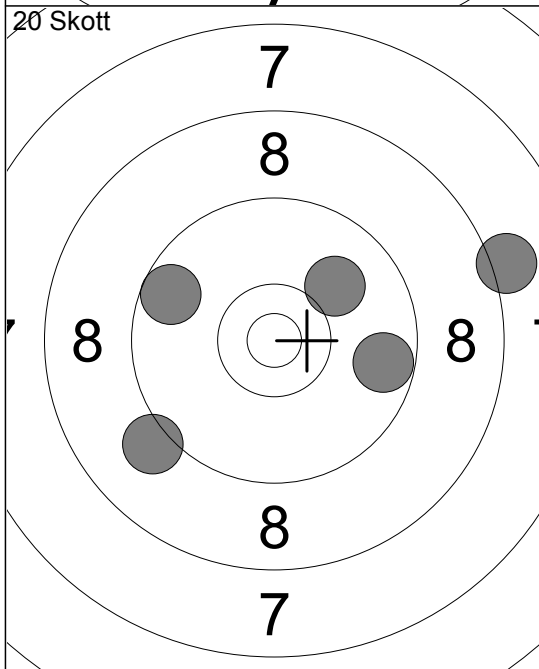

16:	8.1	→
17:	10.0	↗
18:	9.6	←
19:	9.1	↖
20:	9.7	→
Serie	45.0	
Total	176.0	

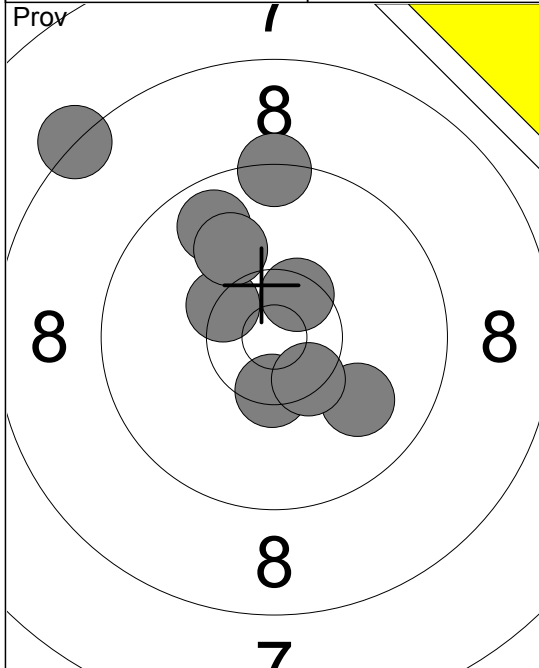

1:	8.3	↖
2:	10.0	↘
3:	10.4	↘
4:	9.4	↑
5:	10.4	↘
6:	9.7	↖
7:	10.0	↖
8:	10.5	↗
9:	10.4	↘
Serie	86.0	
Total	0.0	

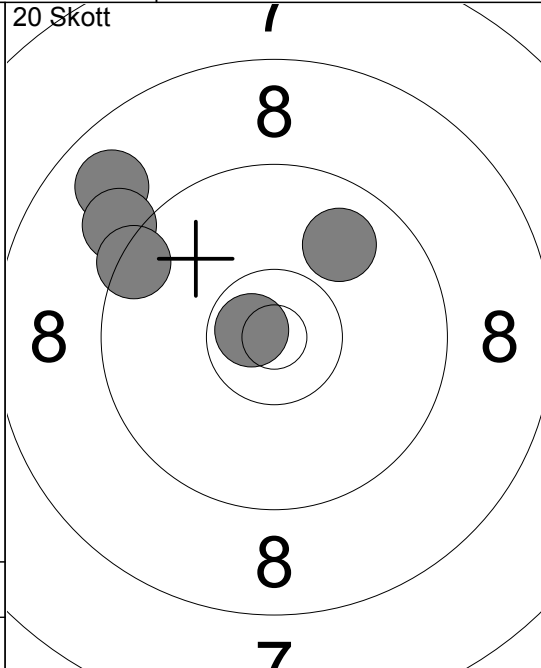

1:	8.8	↖
2:	9.1	↖
3:	10.7	↘
4:	9.9	↗
5:	9.4	↖
Serie	45.0	
Total	45.0	

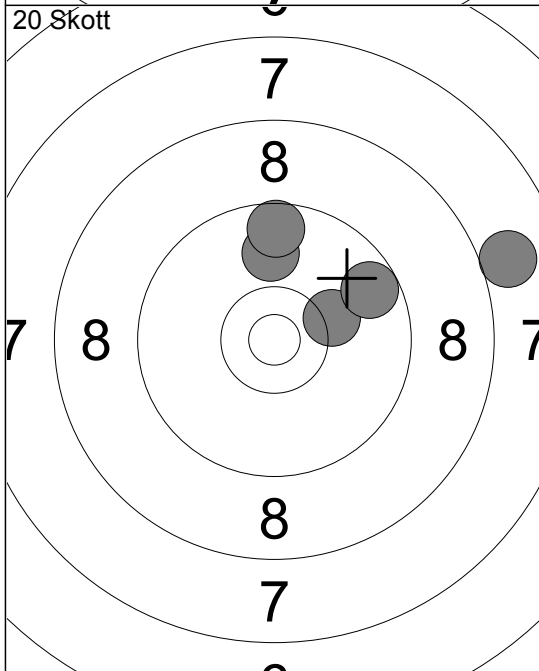

6:	10.2	→
7:	9.7	→
8:	9.9	↑
9:	9.6	↑
10:	8.0	→
Serie	45.0	
Total	90.0	

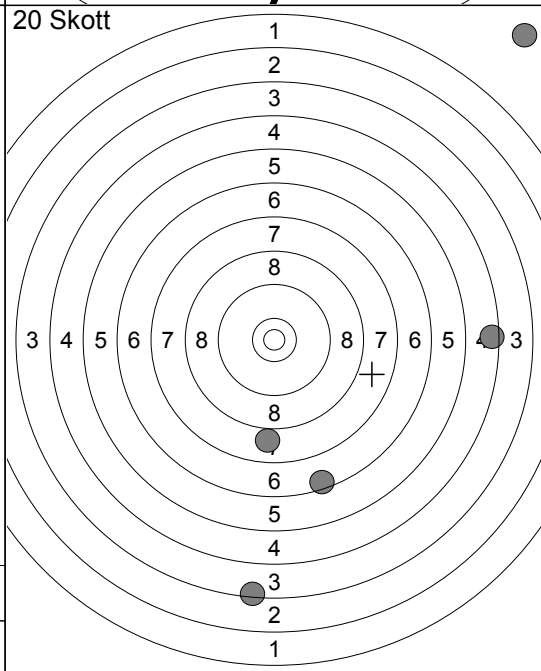

11:	0.0	↗
12:	3.4	↓
13:	6.5	↓
14:	8.0	↓
15:	4.5	→
Serie	21.0	
Total	111.0	

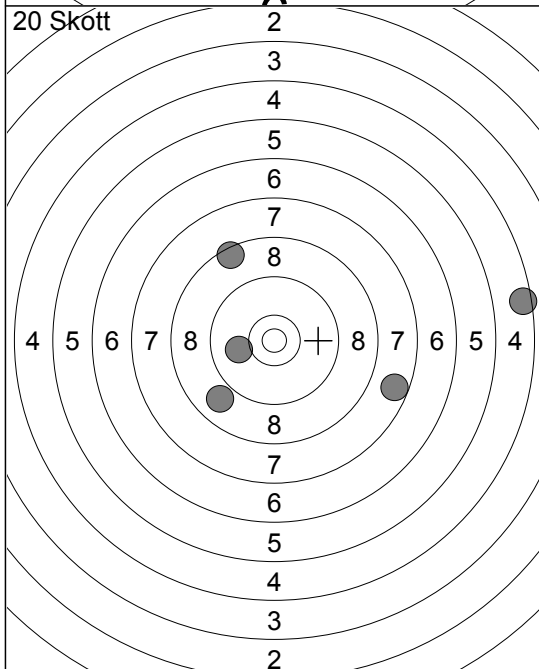

16:	10.0	←
17:	4.5	→
18:	8.9	↙
19:	8.5	↖
20:	7.7	↘
Serie	37.0	
Total	148.0	

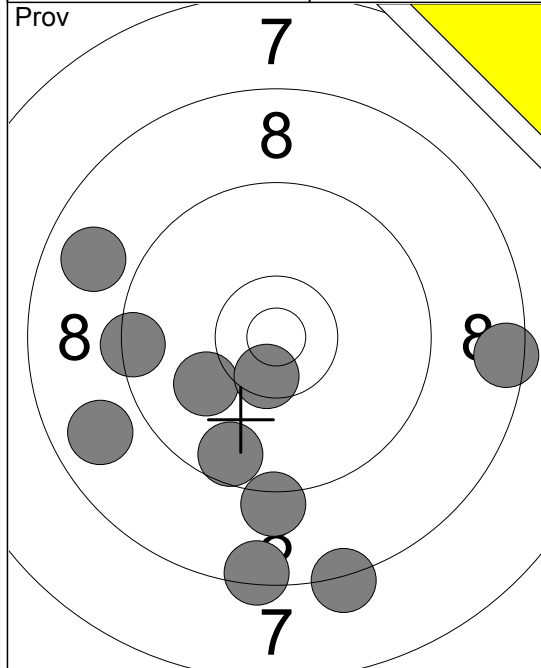

1:	8.3	↓
2:	9.2	↓
3:	8.8	↖
4:	8.5	→
5:	9.4	←
6:	8.4	↓
7:	8.8	↖
8:	9.6	↓
9:	10.1	↙
10:	10.5	↘
Serie	87.0	
Total	0.0	

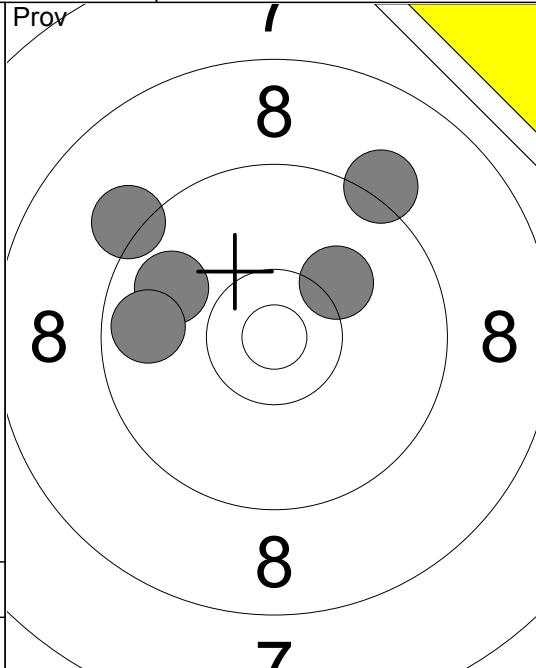

11:	9.2	↖
12:	9.9	↖
13:	9.2	↗
14:	10.2	↗
15:	9.7	←
Serie	46.0	
Total	0.0	

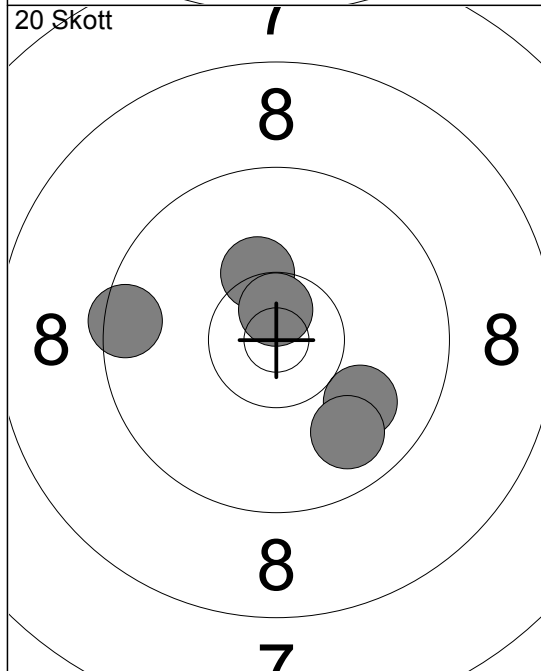

1:	9.5	←
2:	10.3	↗
3:	10.0	↘
4:	10.7	↗
5:	9.8	↓
Serie	48.0	
Total	48.0	

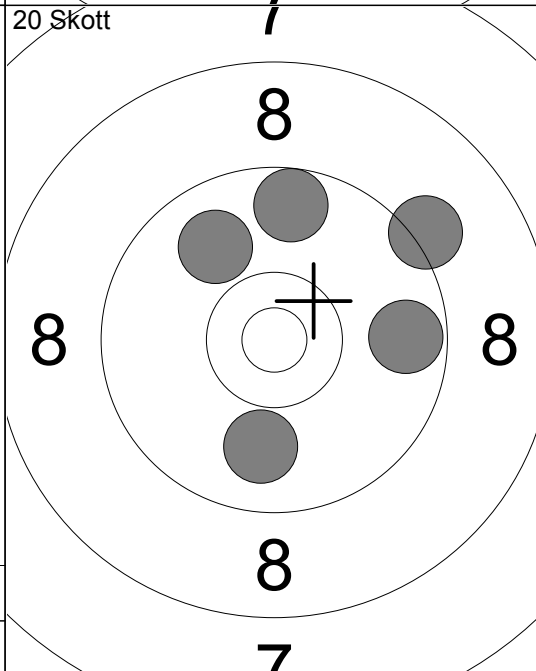

6:	9.7	↑
7:	9.2	↗
8:	9.9	↖
9:	9.9	↓
10:	9.7	→
Serie	45.0	
Total	93.0	

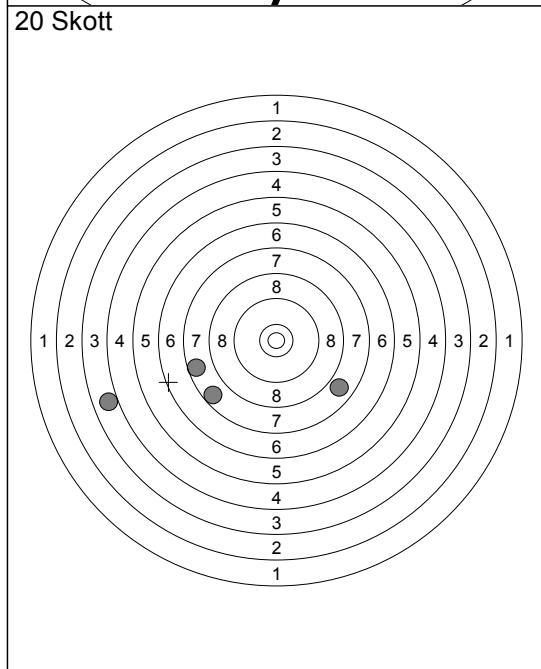

11:	7.6	←
12:	0.0	←
13:	7.7	↙
14:	3.9	←
15:	7.9	↘
Serie	24.0	
Total	117.0	

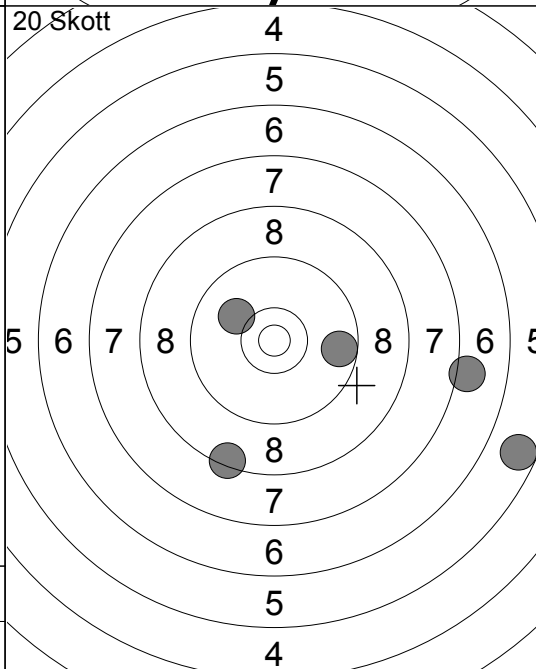

16:	8.4	↓
17:	7.1	→
18:	5.7	↘
19:	9.7	→
20:	10.1	↖
Serie	39.0	
Total	156.0	

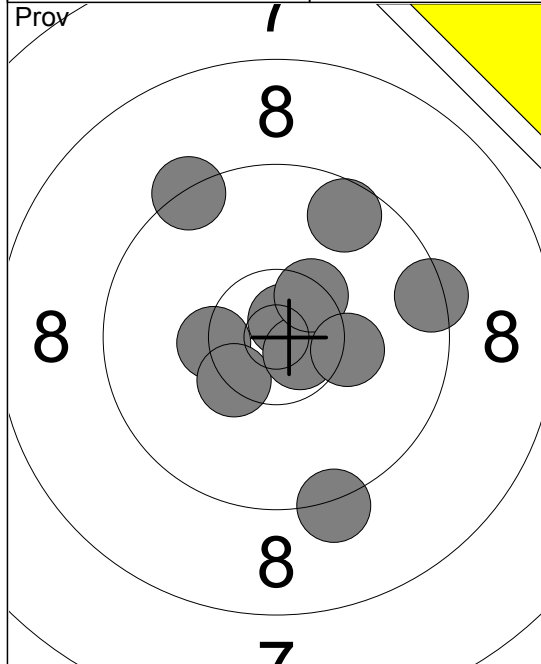

1:	9.3	↘
2:	9.3	↗
3:	10.3	↔
4:	10.4	↘
5:	10.8	↗
6:	9.4	→
7:	10.7	↘
8:	10.4	↗
9:	10.3	→
10:	9.6	↗
Serie	96.0	
Total	0.0	

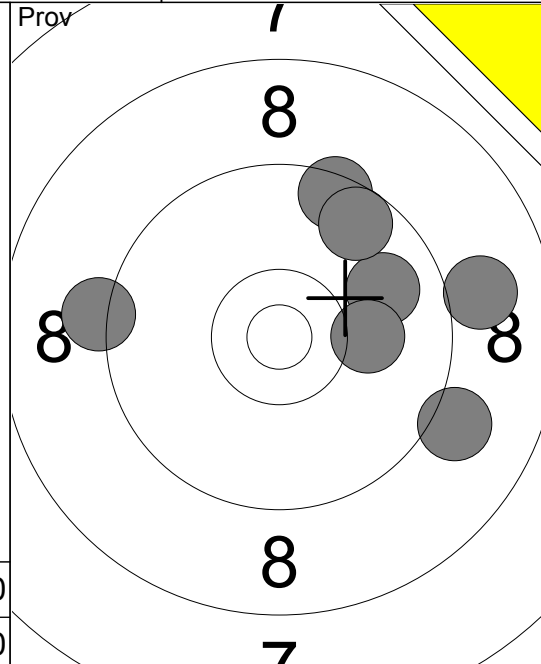

11:	9.2	←
12:	9.9	→
13:	9.5	↗
14:	9.6	↗
15:	9.0	→
16:	9.1	↘
17:	10.1	→
Serie	64.0	
Total	0.0	

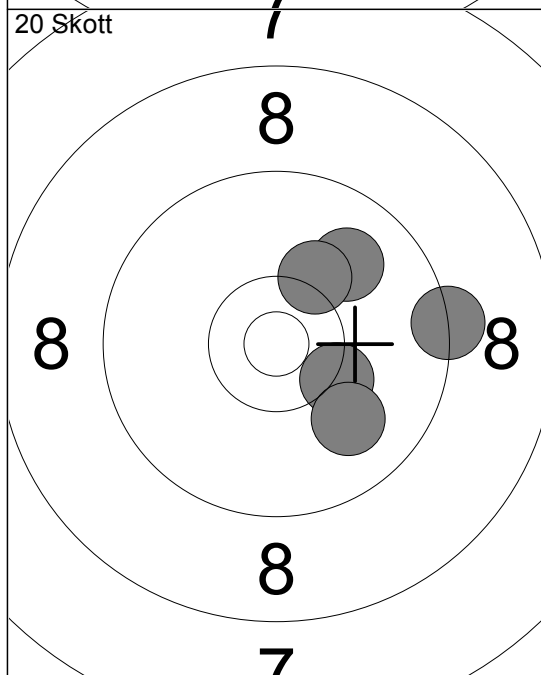

1:	9.3	→
2:	9.9	↗
3:	10.3	↘
4:	10.0	↘
5:	10.2	↗
Serie	48.0	
Total	48.0	

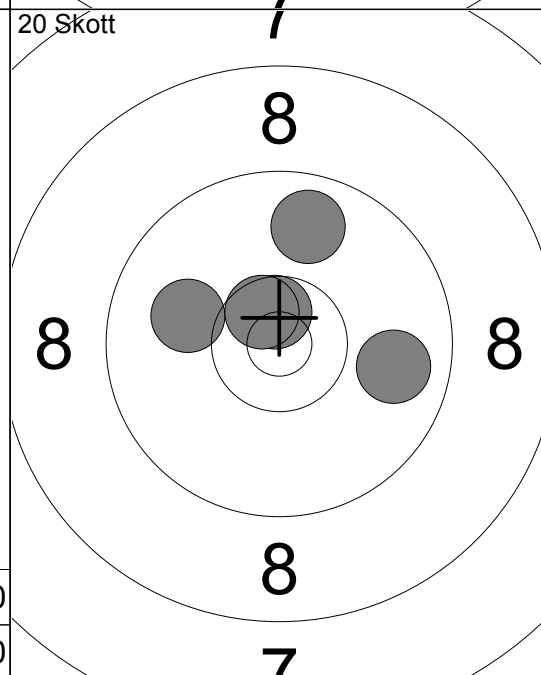

6:	10.0	←
7:	9.8	↗
8:	10.6	↗
9:	10.6	↘
10:	9.8	→
Serie	48.0	
Total	96.0	

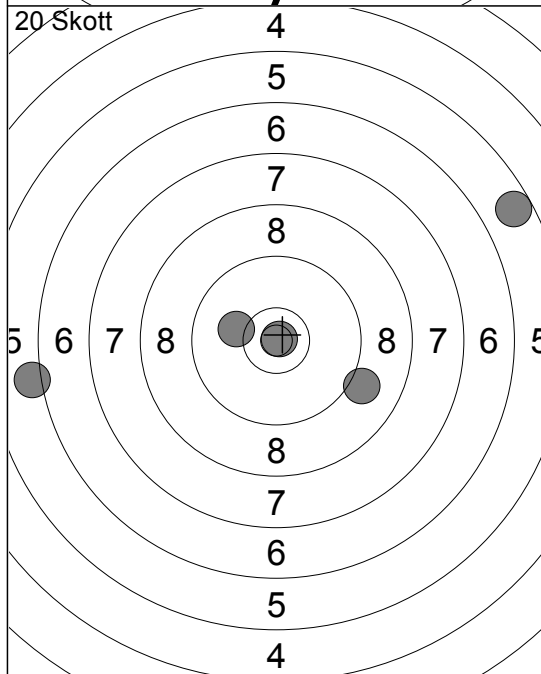

11:	9.1	↘
12:	10.1	←
13:	5.7	↗
14:	6.1	←
15:	10.9	↗
Serie	40.0	
Total	136.0	

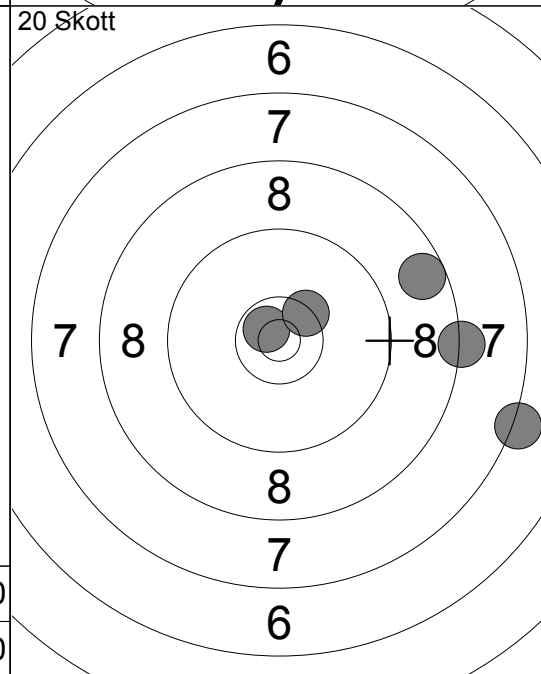

16:	8.3	→
17:	7.2	↘
18:	10.7	↘
19:	10.4	↗
20:	8.6	→
Serie	43.0	
Total	179.0	

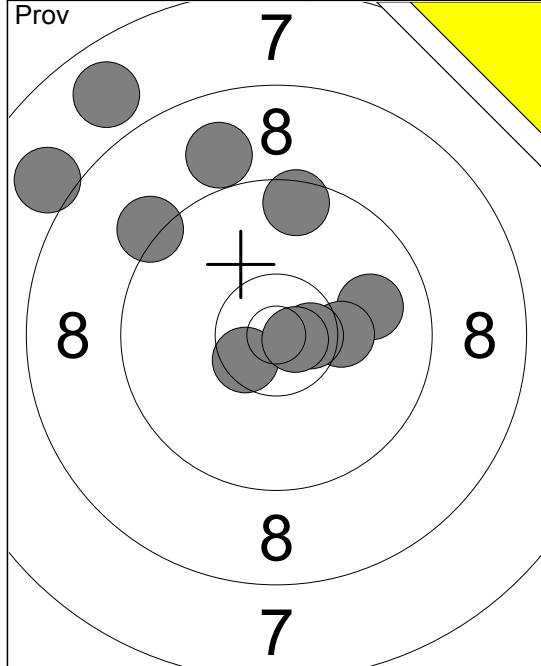

1:	9.9	→
2:	10.3	→
3:	10.5	↘
4:	9.0	↑
5:	7.8	↑
6:	8.0	↖
7:	10.6	→
8:	9.5	↑
9:	9.2	↖
10:	10.7	→
Serie		91.0
Total		0.0

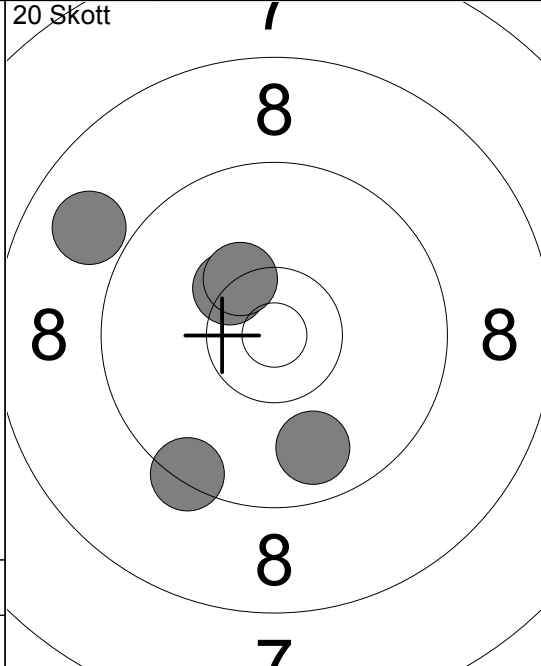

1:	9.4	↘
2:	9.8	↘
3:	10.3	↘
4:	8.9	↖
5:	10.3	↘
Serie		46.0
Total		46.0

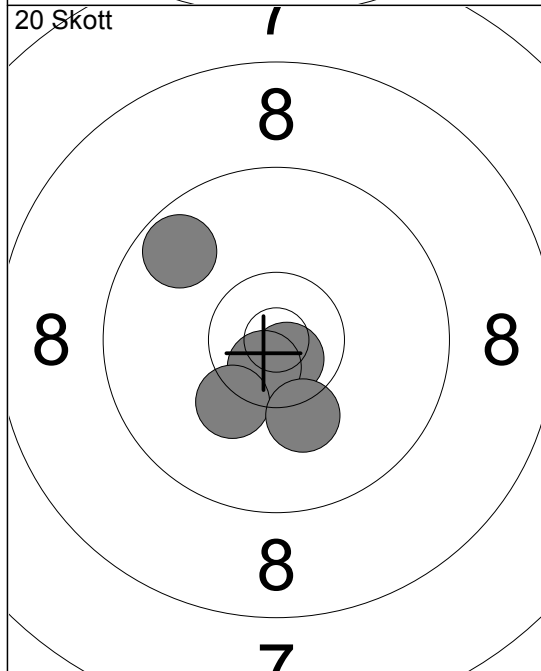

6:	10.7	↘
7:	9.7	↖
8:	10.7	↘
9:	10.2	↘
10:	10.2	↘
Serie		49.0
Total		95.0

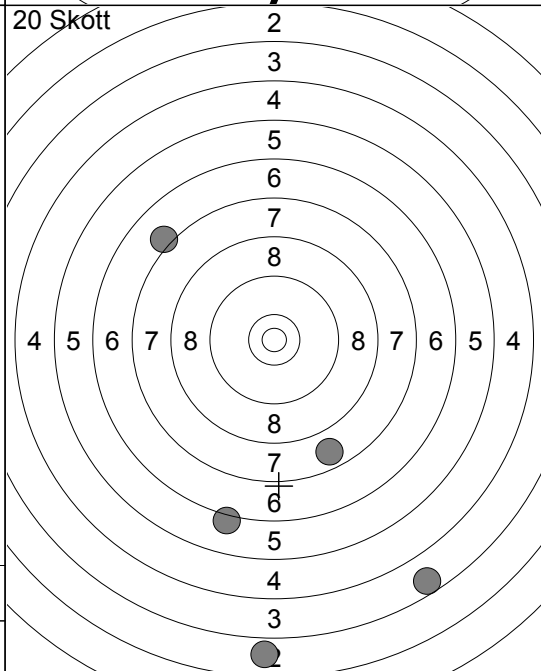

11:	6.1	↘
12:	7.1	↖
13:	2.9	↘
14:	3.6	↘
15:	7.8	↘
Serie		25.0
Total		120.0

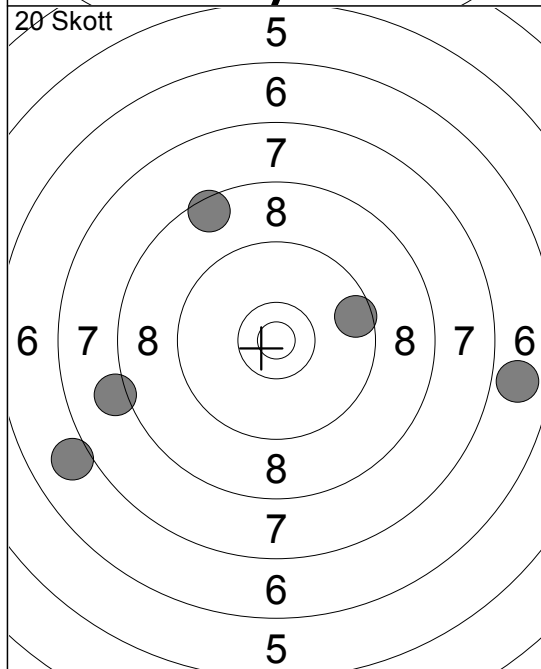

16:	6.9	→
17:	7.0	↖
18:	9.6	→
19:	8.1	↖
20:	8.5	↑
Serie		38.0
Total		158.0

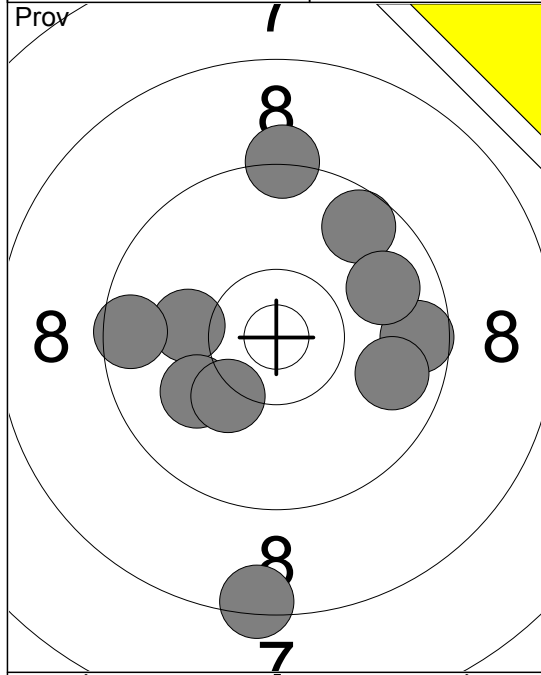

Prov

1:	9.6	→
2:	8.4	↓
3:	10.1	←
4:	9.6	←
5:	10.0	↙
6:	10.2	↘
7:	9.3	↑
8:	9.8	→
9:	9.6	↗
10:	9.8	→
Serie	92.0	
Total	0.0	

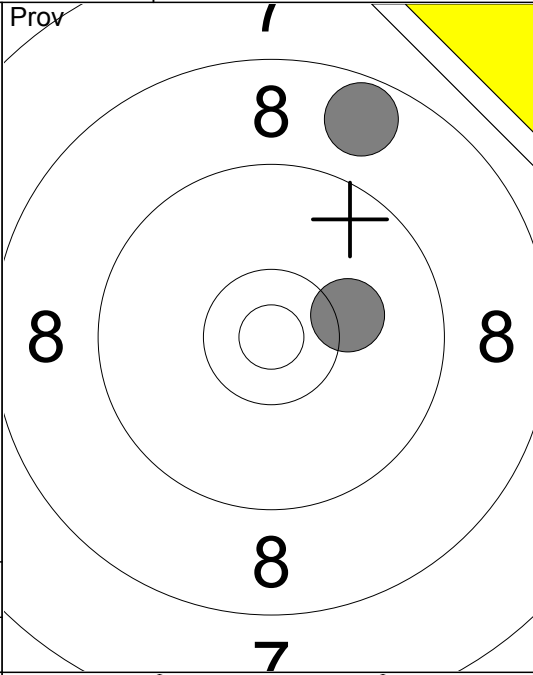

Prov

11:	10.2	→
12:	8.7	↗
Serie	18.0	
Total	0.0	

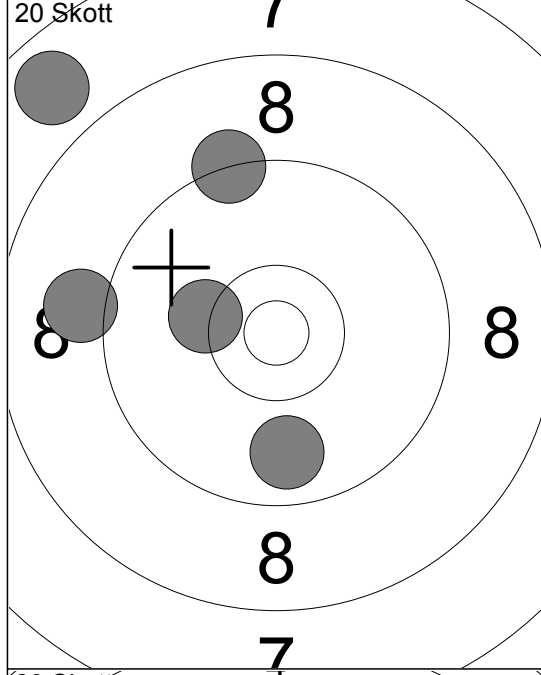

20 Skott

1:	9.1	←
2:	9.3	↑
3:	10.3	←
4:	7.8	↗
5:	9.8	↓
Serie	44.0	
Total	44.0	

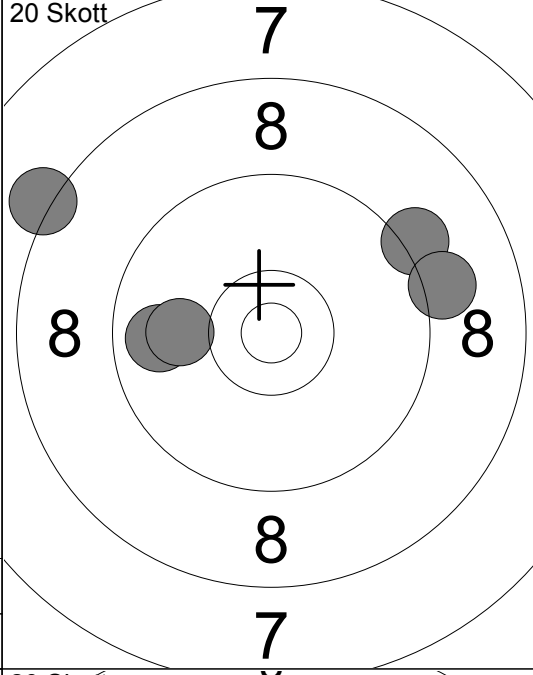

20 Skott

6:	9.8	←
7:	9.2	↗
8:	9.1	→
9:	10.0	←
10:	8.2	↖
Serie	45.0	
Total	89.0	

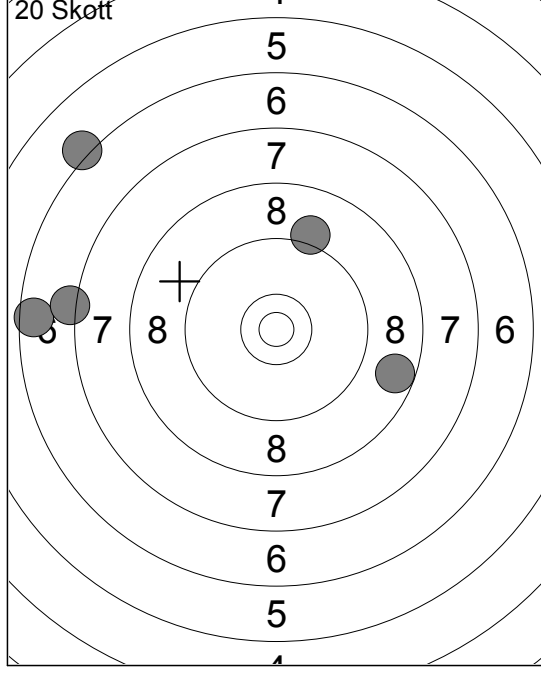

20 Skott

11:	9.1	↗
12:	6.5	←
13:	6.2	↗
14:	7.2	←
15:	8.7	→
Serie	36.0	
Total	125.0	

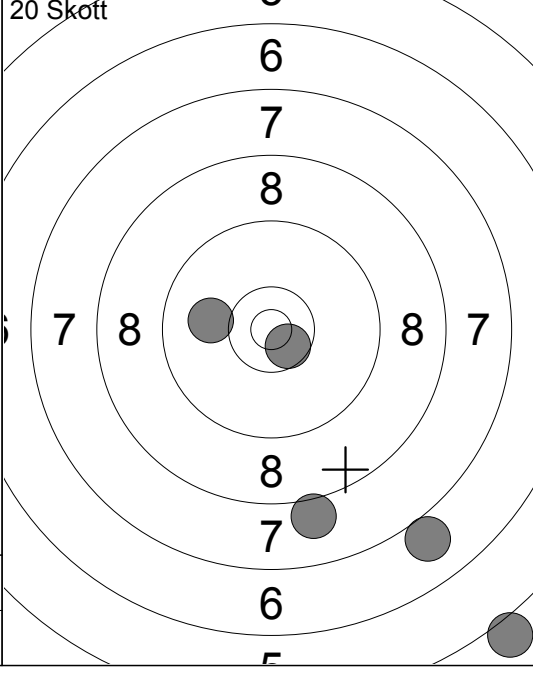

20 Skott

16:	10.0	←
17:	7.0	↓
18:	5.1	↓
19:	10.6	↘
20:	8.0	↓
Serie	40.0	
Total	165.0	

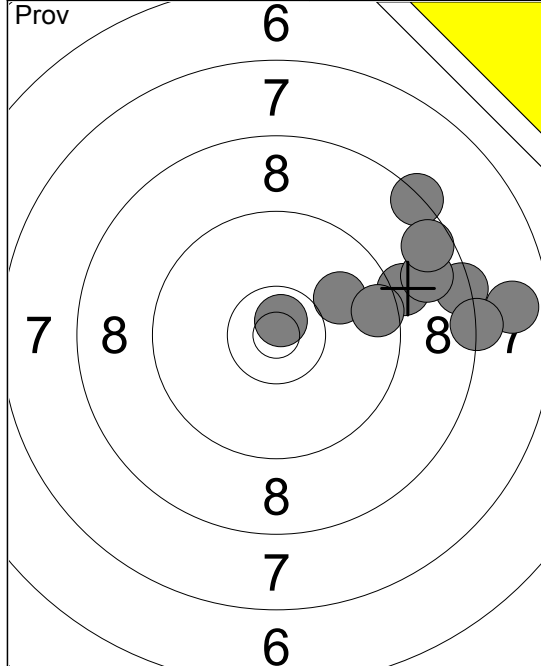

1:	10.0	↗
2:	8.4	↗
3:	7.8	→
4:	9.2	↗
5:	8.4	↗
6:	9.6	→
7:	8.8	↗
8:	10.8	↗
9:	8.6	↗
10:	8.3	→
Serie		85.0
Total		0.0

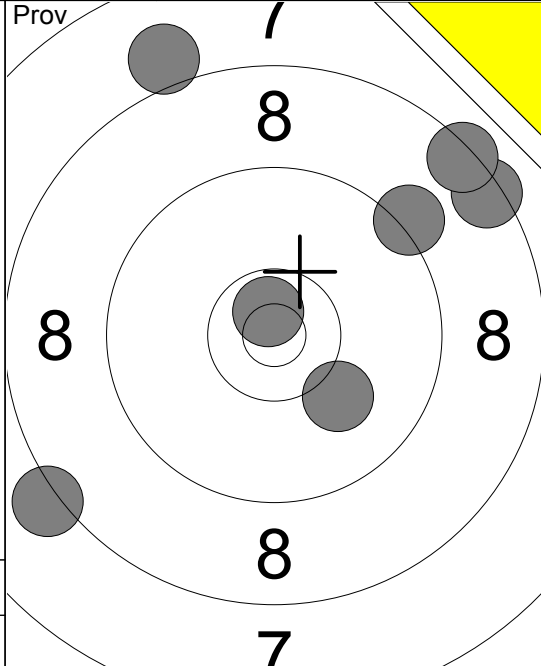

11:	9.2	↗
12:	8.4	↗
13:	8.4	↗
14:	8.0	↑
15:	8.2	↙
16:	10.1	↘
17:	10.7	↗
Serie		61.0
Total		0.0

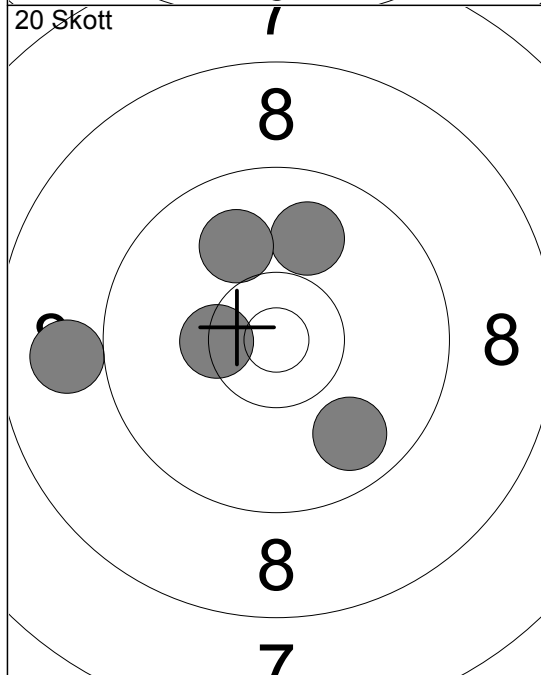

1:	9.9	↑
2:	9.8	↘
3:	8.9	←
4:	10.4	↔
5:	10.0	↗
Serie		46.0
Total		46.0

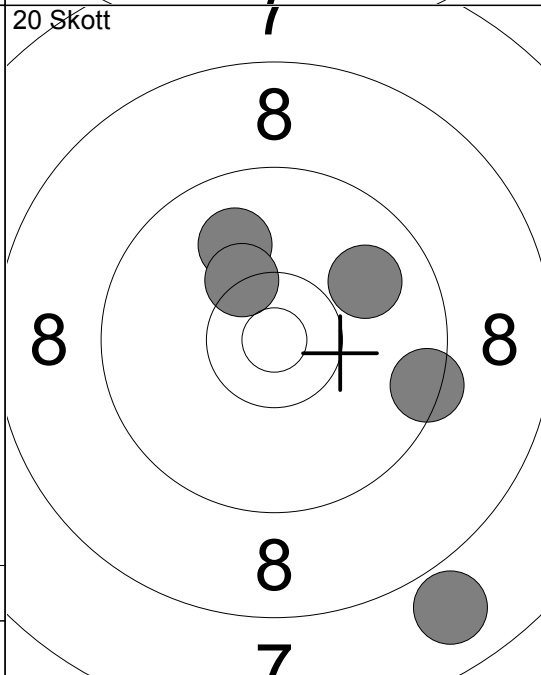

6:	7.9	↘
7:	9.9	↗
8:	9.4	→
9:	10.0	↗
10:	10.3	↗
Serie		45.0
Total		91.0

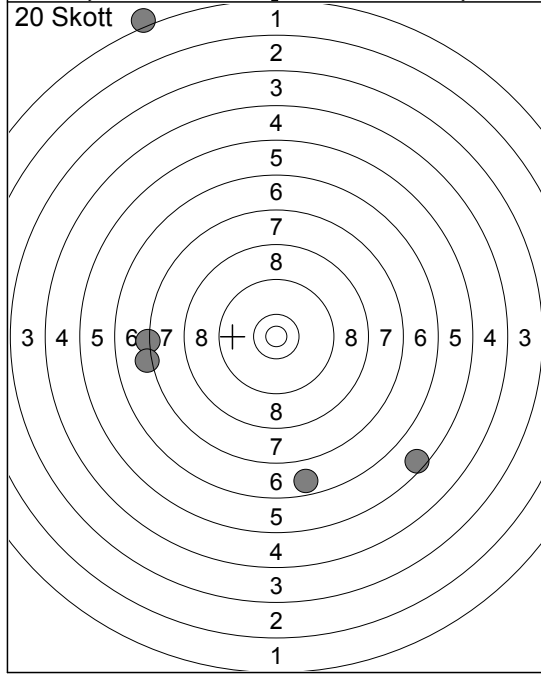

11:	6.7	↘
12:	5.5	↘
13:	1.1	↗
14:	7.3	←
15:	7.2	←
Serie		26.0
Total		117.0

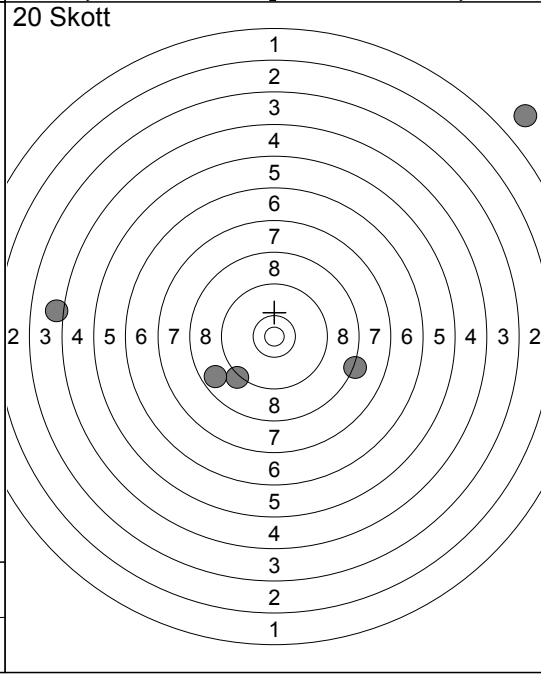

16:	9.2	↙
17:	8.2	→
18:	4.1	←
19:	0.0	↗
20:	8.7	↙
Serie		29.0
Total		146.0

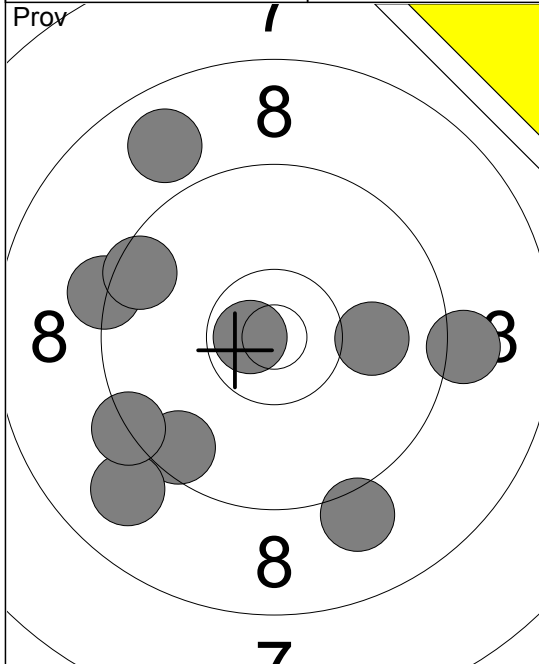

10 Shot Target Results:

1:	9.9	↙
2:	10.2	↙
3:	8.9	↗
4:	9.9	→
5:	10.4	✕
Serie	46.0	
Total	46.0	

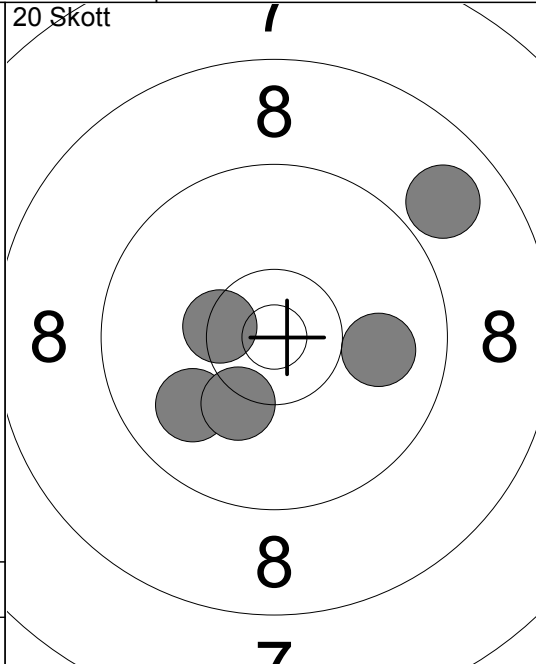

15 Shot Target Results:

11:	7.5	↘
12:	4.8	↘
13:	7.3	↗
14:	8.4	→
15:	9.7	↗
Serie	35.0	
Total	126.0	

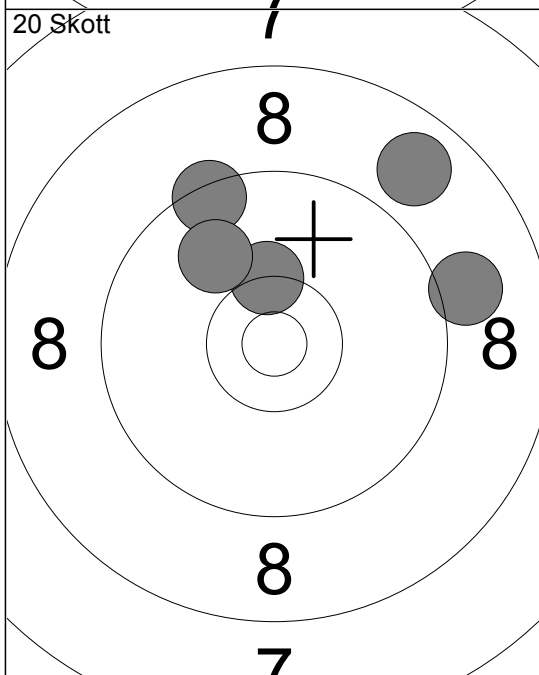

10 Shot Target Results:

16:	8.9	→
17:	8.8	↙
18:	9.1	↖
19:	10.3	↗
20:	9.1	↙
Serie	44.0	
Total	170.0	

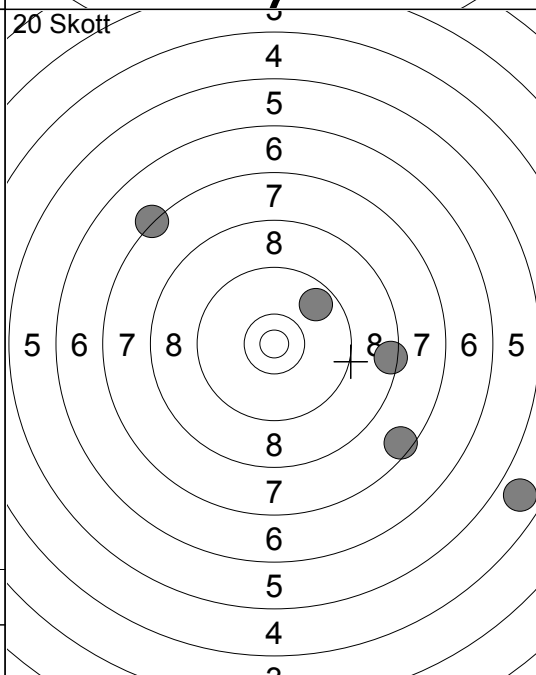

10 Shot Target Results:

16:	8.9	→
17:	8.8	↙
18:	9.1	↖
19:	10.3	↗
20:	9.1	↙
Serie	44.0	
Total	170.0	

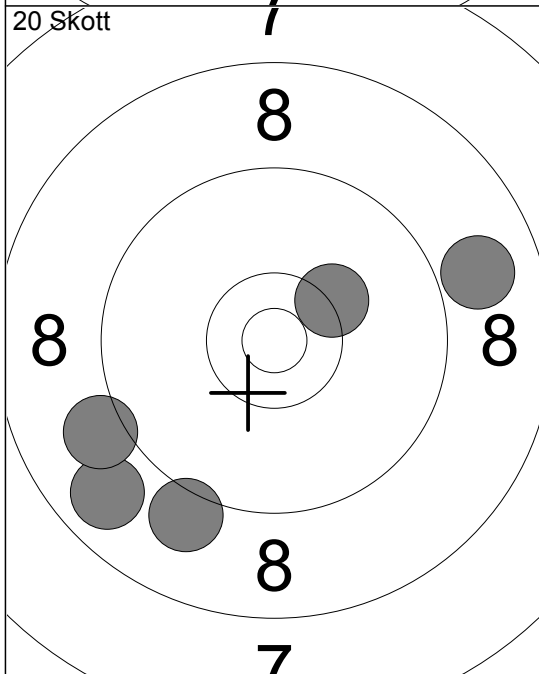

10 Shot Target Results:

16:	8.9	→
17:	8.8	↙
18:	9.1	↖
19:	10.3	↗
20:	9.1	↙
Serie	44.0	
Total	170.0	

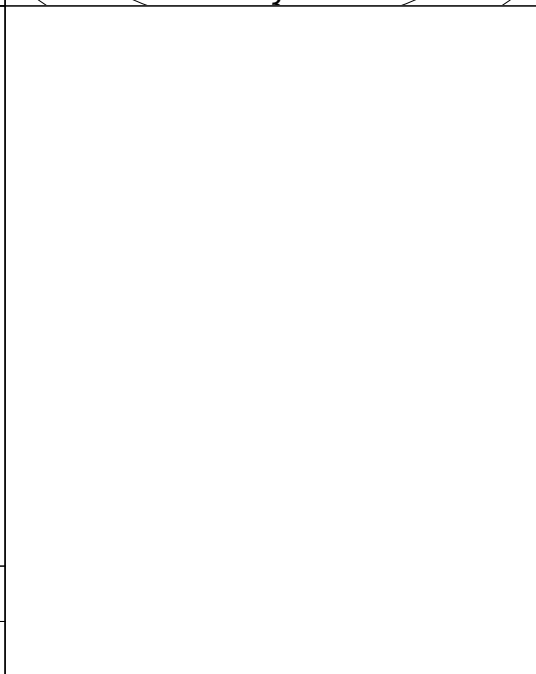

10 Shot Target Results:

16:	8.9	→
17:	8.8	↙
18:	9.1	↖
19:	10.3	↗
20:	9.1	↙
Serie	44.0	
Total	170.0	

Skjutlag
2

Tavla
18

Lennart Westermark

50m

Drängsmark

Vet-S Vb

27.08.2016

Höstträffen 2016

Ramselefors SKF

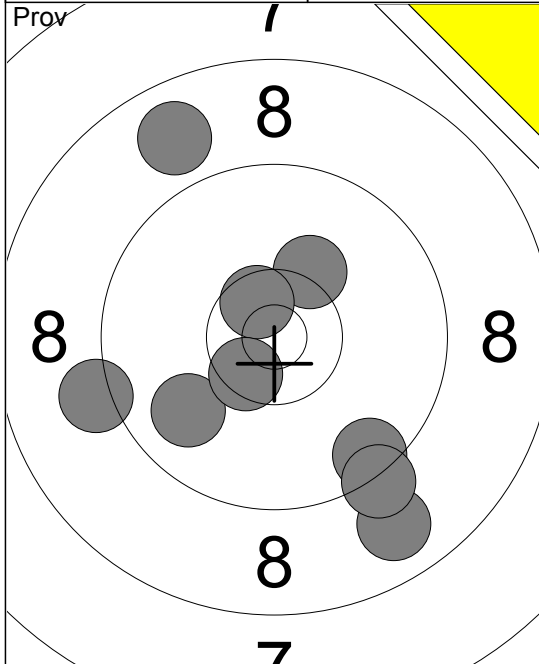

- 1: 8.8 ↗
- 2: 8.8 ↘
- 3: 10.2 ↗
- 4: 9.5 ↘
- 5: 9.9 ↙
- 6: 10.6x ↗
- 7: 9.2 ←
- 8: 9.3 ↘
- 9: 10.5x ↘

Serie 82.0

Total 0.0

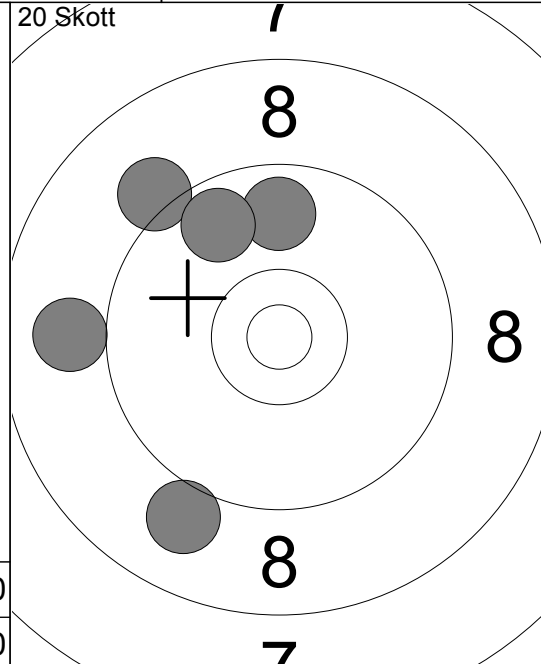

- 1: 9.1 ↗
- 2: 9.8 ↑
- 3: 9.0 ←
- 4: 9.0 ↘
- 5: 9.7 ↗

Serie 45.0

Total 45.0

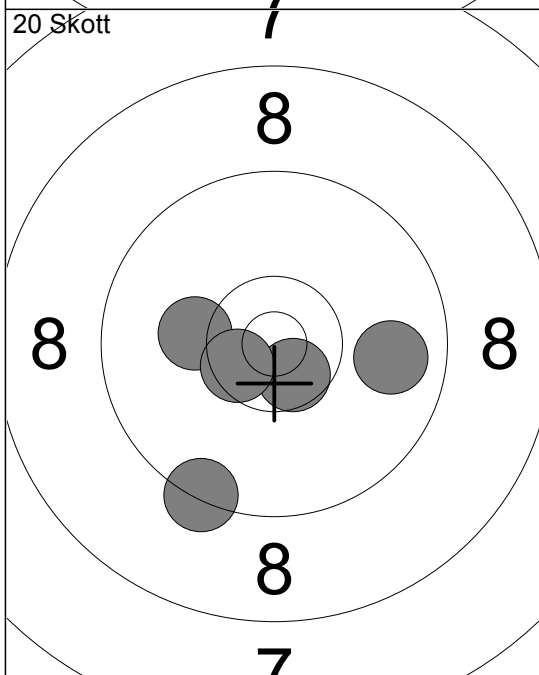

- 6: 9.4 ↘
- 7: 9.8 →
- 8: 10.6x ↘
- 9: 10.2 ←
- 10: 10.5x ↘

Serie 48.0

Total 93.0

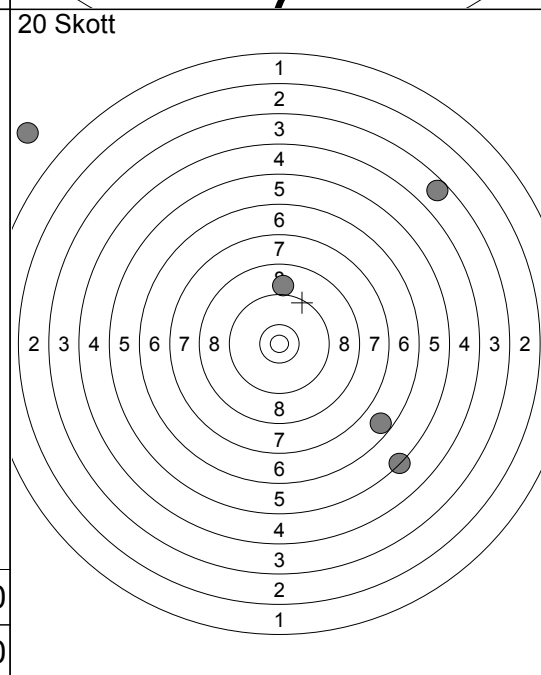

- 11: 9.0 ↑
- 12: 3.6 ↗
- 13: 6.7 ↘
- 14: 5.3 ↘
- 15: 0.0 ↗

Serie 23.0

Total 116.0

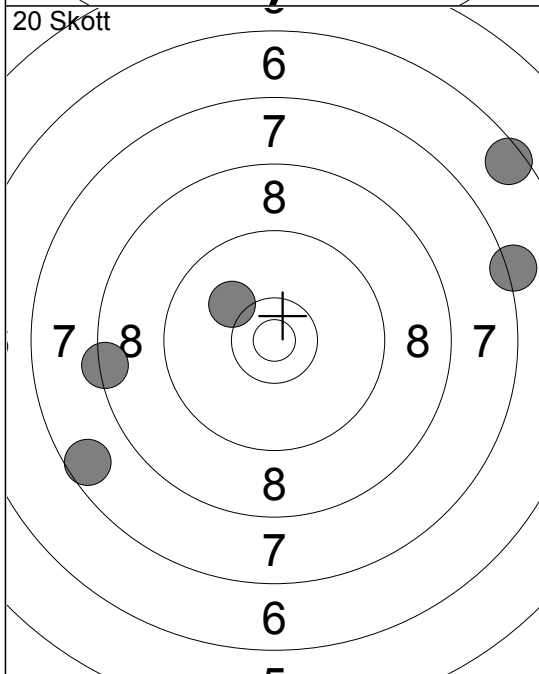

- 16: 8.4 ←
- 17: 10.1 ↗
- 18: 7.2 →
- 19: 7.6 ↙
- 20: 6.5 ↗

Serie 38.0

Total 154.0