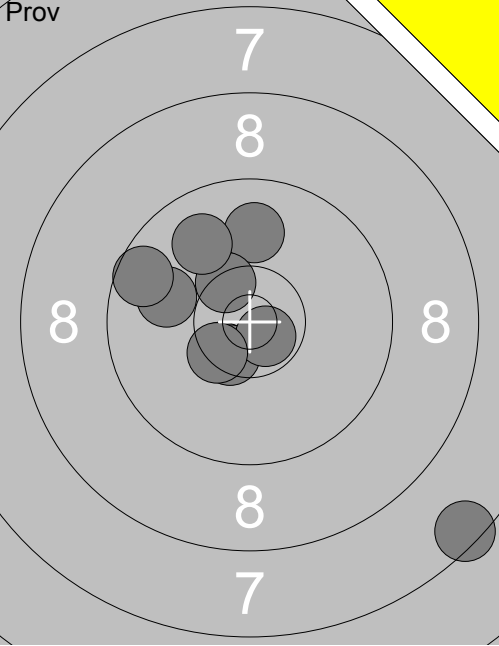
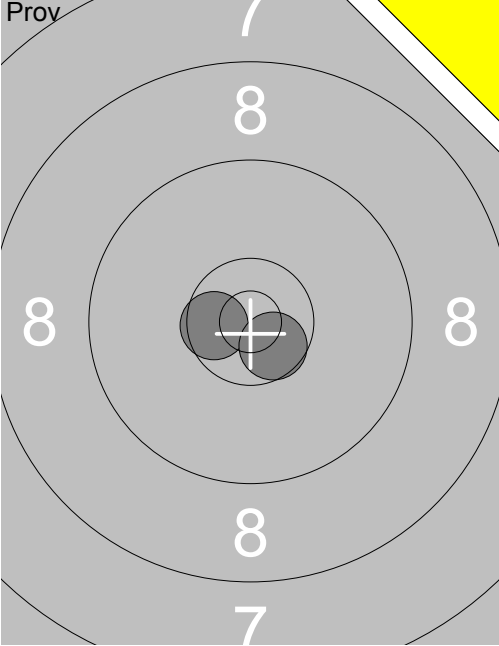
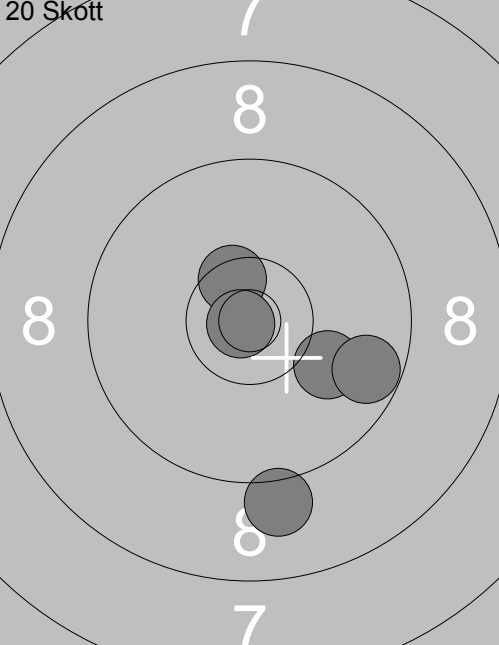
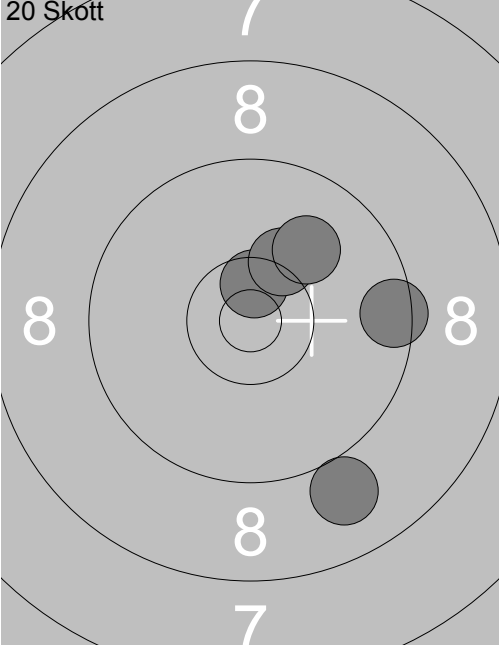
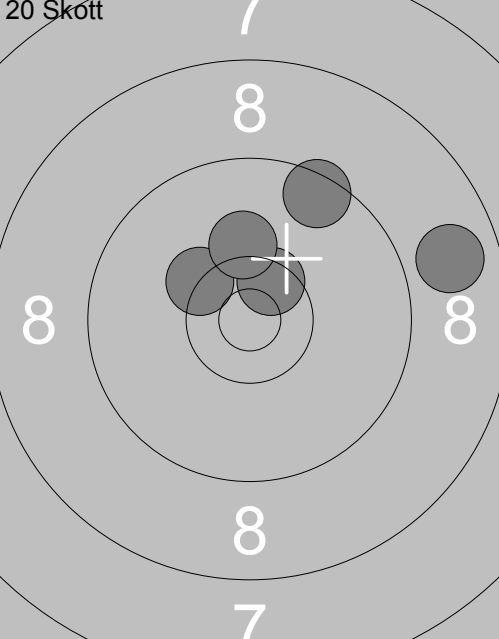
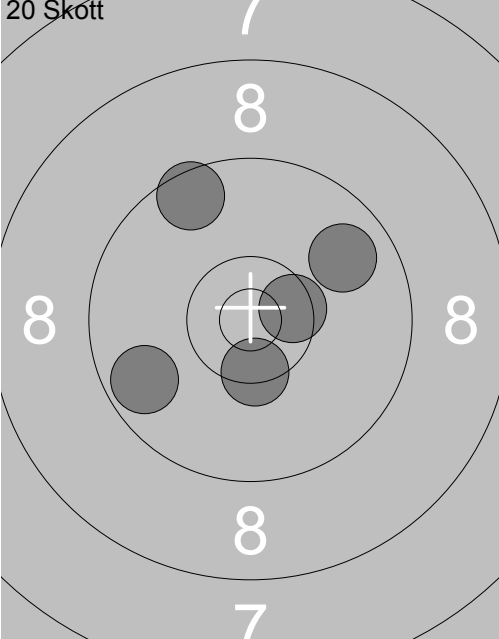
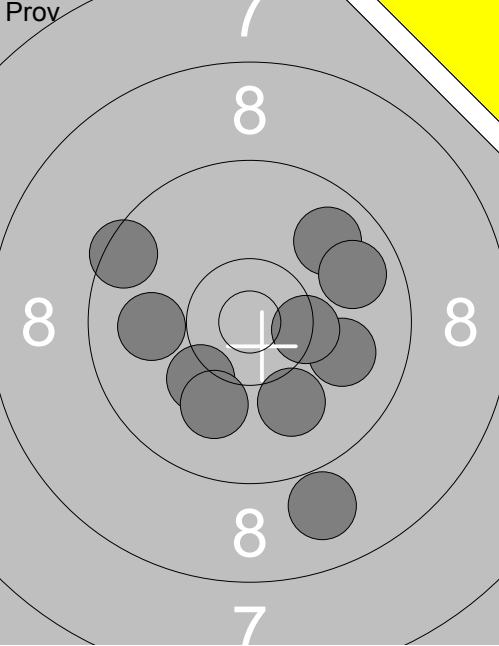
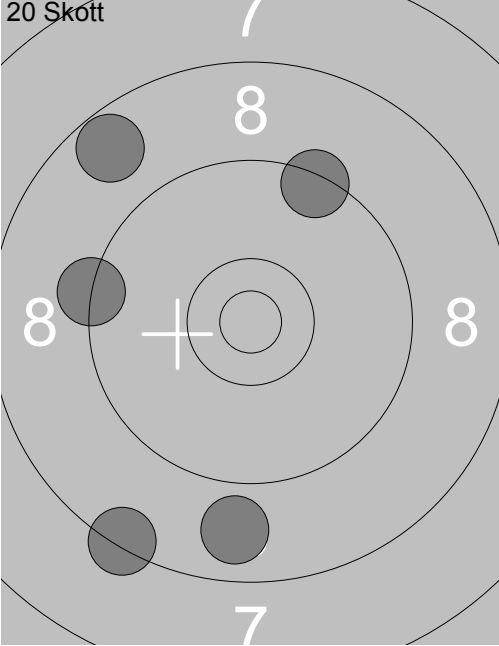
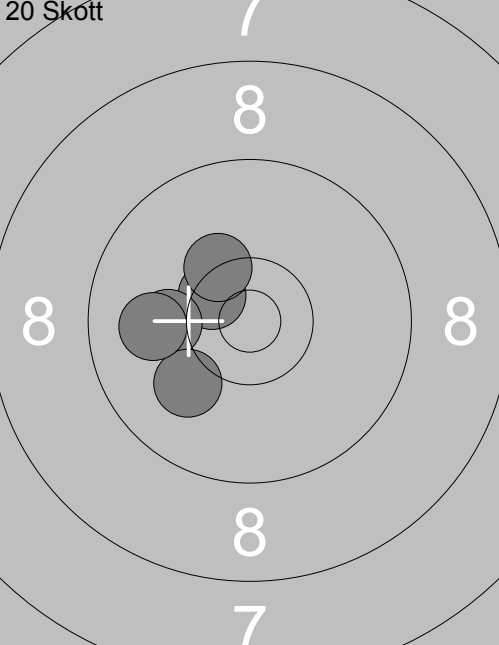
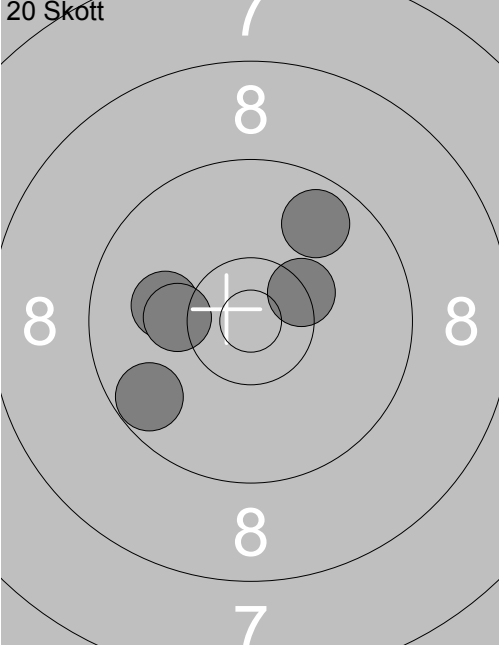
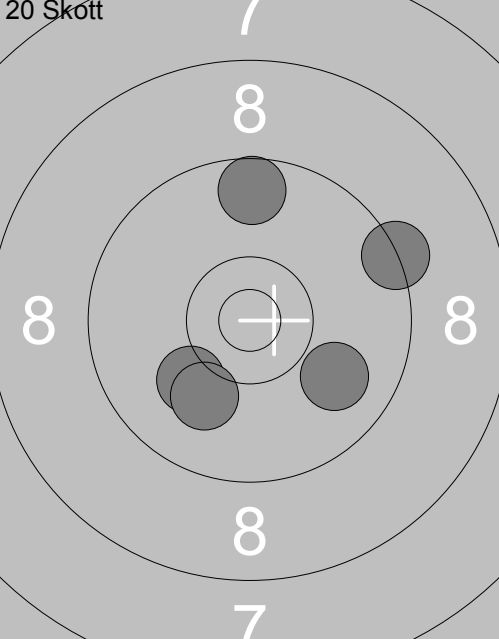
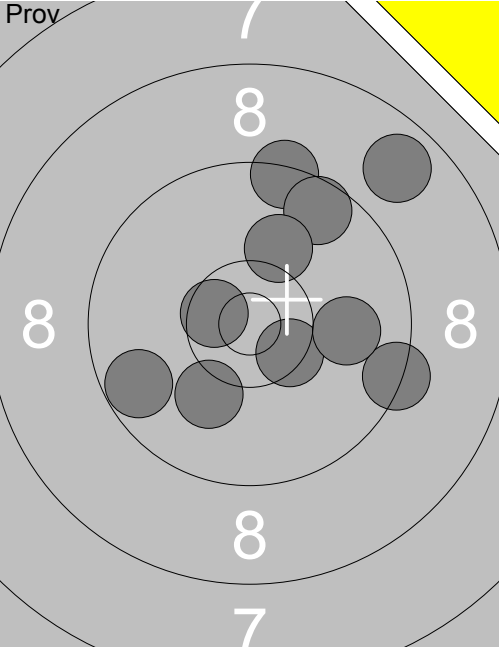
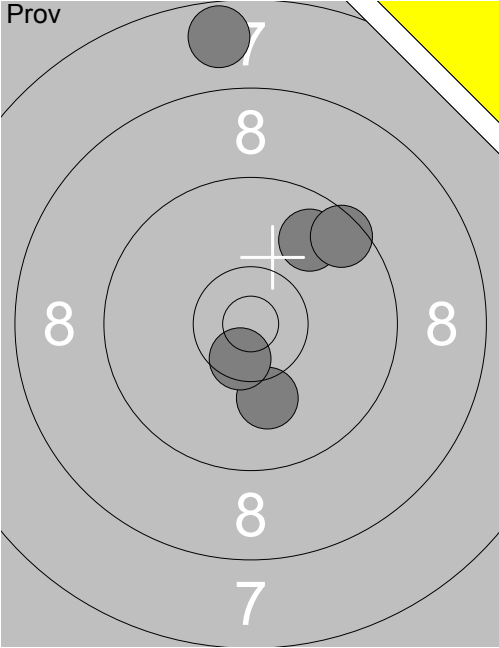
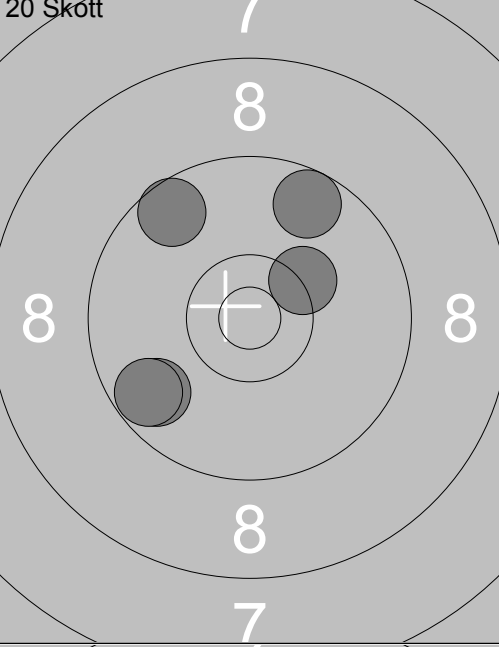
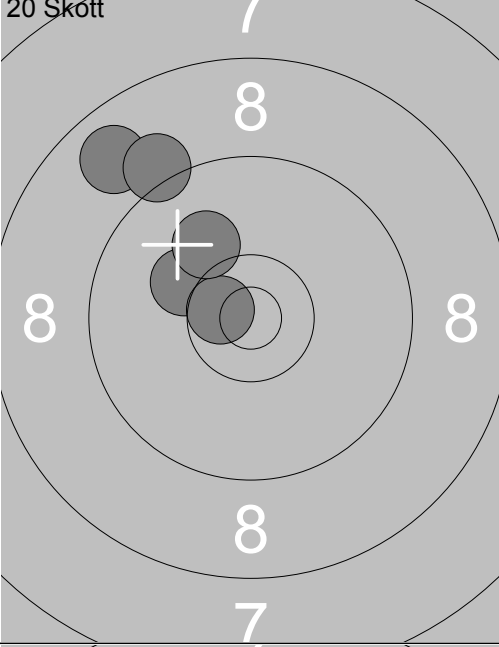
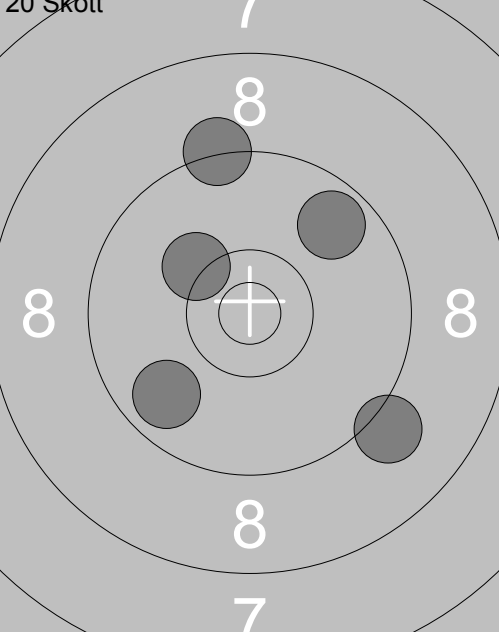
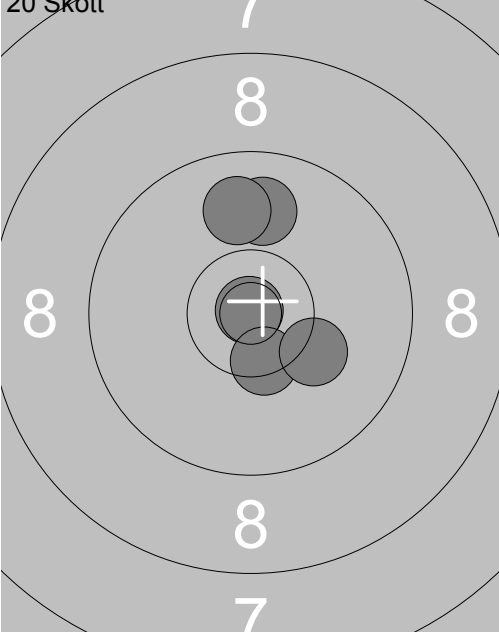
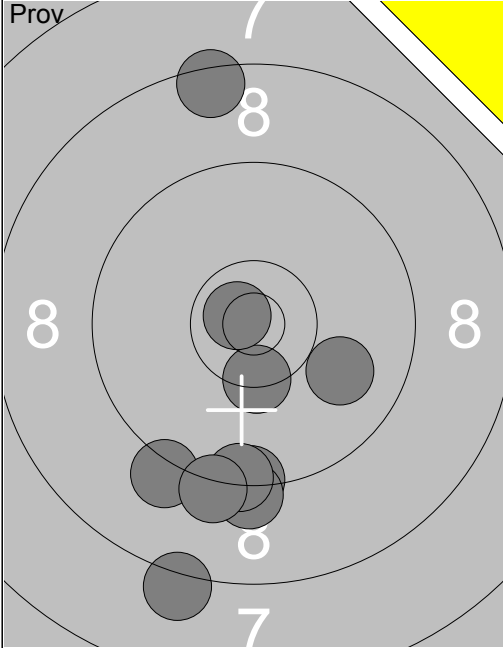
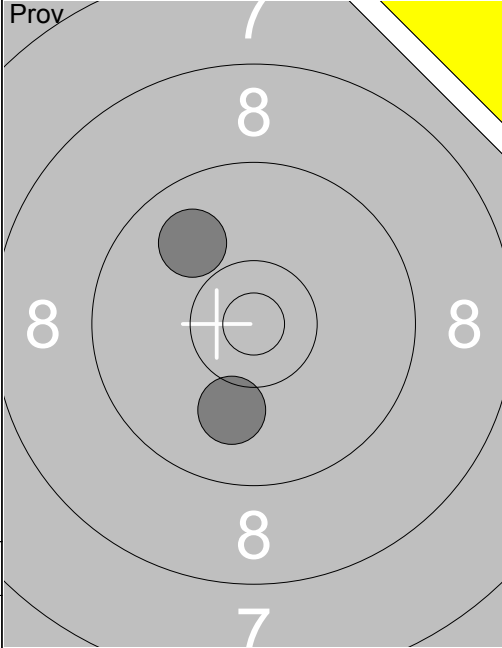
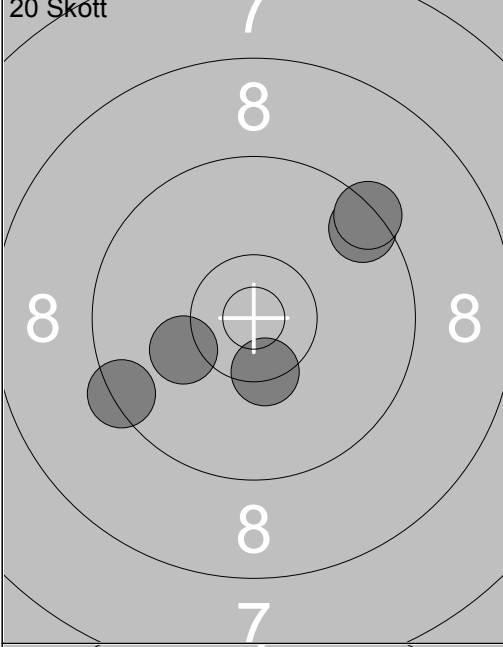
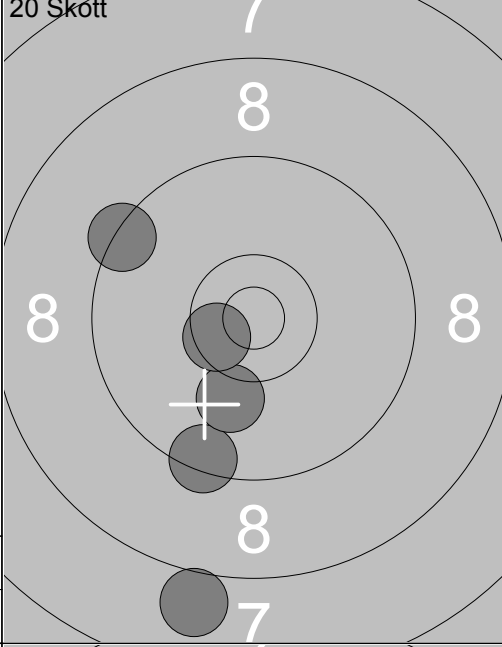
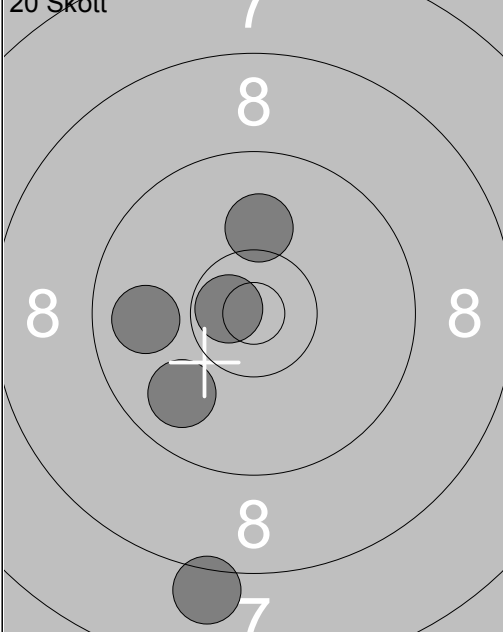
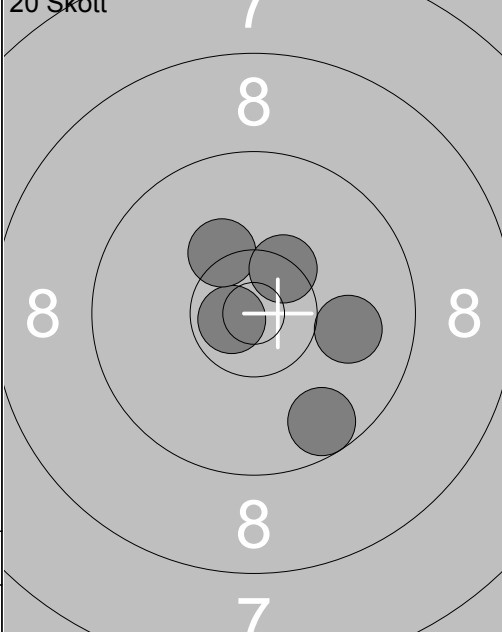

Skjuttag	Tavla	Agnes Ebbhagen			
1	1	Vindeln	Ramselefors	11	Vb
29.04.2017	Vindelnskottet 2017	Ramselefors SKF			
Prov		1: 9.9 ↑	Prov		11: 10.6x↖
		2: 10.5x↘			12: 10.6x↘
		3: 10.5x↘			
		4: 10.4x↖			
		5: 10.7x↘			
		6: 10.4x↘			
		7: 9.9 ↖			
		8: 9.9 ↗			
		9: 9.6 ↖			
		10: 7.5 ↘			
		Serie 93.0			Serie 20.0
		Total 0.0			Total 0.0
20 Skott		1: 10.5x↗	20 Skott		6: 9.0 ↘
		2: 10.0 ↘			7: 10.6x↗
		3: 10.8x↖			8: 9.5 →
		4: 9.7 ↘			9: 10.3 ↗
		5: 9.1 ↘			10: 10.0 ↗
		Serie 48.0			Serie 48.0
		Total 48.0			Total 96.0
20 Skott		11: 10.5x↗	20 Skott		16: 10.5x↗
		12: 10.3x↖			17: 9.8 ↗
		13: 8.8 →			18: 9.5 ↖
		14: 10.2 ↑			19: 9.7 ↖
		15: 9.5 ↗			20: 10.4x↘
		Serie 47.0			Serie 47.0
		Total 143.0			Total 190.0

Skjutlag	Tavla	Ellinor Henriksson			
1	2	Vindeln	Vännäs	11 Vb	
29.04.2017	Vindelnskottet 2017	Ramselefors SKF			
Prov		1: 10.2 ↙ 2: 10.0 ↓ 3: 10.0 → 4: 9.8 ↗ 5: 10.0 ↓ 6: 8.9 ↓ 7: 9.5 ↖ 8: 9.9 ← 9: 10.4x → 10: 9.8 ↗	20 Skott		1: 9.4 ↗ 2: 9.3 ← 3: 8.7 ↖ 4: 8.4 ↓ 5: 8.8 ↓
		Serie 94.0		Serie 42.0	
		Total 0.0		Total 42.0	
20 Skott		6: 10.5x ↘ 7: 10.1 ← 8: 10.3x ↘ 9: 10.1 ↓ 10: 10.0 ←	20 Skott		11: 9.7 ↙ 12: 10.1 ← 13: 10.4x ↗ 14: 9.8 ↗ 15: 10.2 ←
		Serie 50.0		Serie 48.0	
		Total 92.0		Total 140.0	
20 Skott		16: 10.1 ↙ 17: 9.6 ↑ 18: 9.9 → 19: 10.1 ↓ 20: 9.3 ↗			
		Serie 47.0			
		Total 187.0			

Skjutlag	Tavla	Hanna Augustsson			
1	3	Vindeln	Vännäs	13	Vb
29.04.2017		Vindelnskottet 2017		Ramselefors SKF	
Prov		1: 9.4 ↑		11: 7.7 ↑	
		2: 10.4x↘		12: 10.1 ↓	
		3: 9.6 ↗		13: 9.8 ↗	
		4: 8.8 ↗		14: 9.5 ↗	
		5: 9.4 ➡		15: 10.5x↓	
		6: 10.1 ↑			
		7: 10.0 →			
		8: 9.7 ↙			
		9: 10.6x↙			
		10: 10.1 ↓			
		Serie 94.0		Serie 45.0	
		Total 0.0		Total 0.0	
20 Skott		1: 9.7 ↙		6: 10.2 ↙	
		2: 10.3 ↗		7: 10.6x↙	
		3: 9.6 ↖		8: 8.8 ↖	
		4: 9.7 ↙		9: 9.1 ↗	
		5: 9.6 ↑		10: 10.1 ↖	
		Serie 46.0		Serie 47.0	
		Total 46.0		Total 93.0	
20 Skott		11: 9.3 ↑		16: 9.9 ↑	
		12: 10.2 ↖		17: 9.9 ↑	
		13: 9.8 ↙		18: 10.9x↙	
		14: 9.1 ➡		19: 10.4x↓	
		15: 9.7 ↗		20: 10.2 ➡	
		Serie 46.0		Serie 48.0	
		Total 139.0		Total 187.0	

Skjutlag 1	Tavla 4	Hanna Johansson					
Vindeln		Vännäs		Jun-L	Vb		
29.04.2017		Vindelnskottet 2017		Ramselefors SKF			
		1: 7.0 ↑ 2: 9.3 ↑ 3: 10.4x↖ 4: 10.7x→ 5: 9.0 ↘ 6: 9.7 → 7: 9.0 ↗ 8: 7.8 ↓ 9: 9.8 ↗ 10: 9.5 ↗ Serie 88.0 Total 0.0				1: 10.7x↘ 2: 9.7 ↑ 3: 8.9 ↘ 4: 9.5 ↘ 5: 10.6x↗ Serie 46.0 Total 46.0	
		6: 8.2 ↘ 7: 9.3 ↘ 8: 9.7 → 9: 9.9 ↑ 10: 8.9 ↓ Serie 43.0 Total 89.0				11: 10.3 ↓ 12: 9.5 ↙ 13: 8.4 ↓ 14: 10.2 ↖ 15: 7.7 ↓ Serie 44.0 Total 133.0	
		16: 8.4 ↓ 17: 10.0 ↙ 18: 10.4x↘ 19: 9.0 → 20: 10.2 ↗ Serie 47.0 Total 180.0					

Skjutlag	Tavla	Helena Dreyer Perkiömäki			
1	5	Vindeln	Umeå	13	Vb
29.04.2017	Vindelnskottet 2017	Ramselefors SKF			
	1: 10.4x↓		11: 10.0 ↓		
	2: 9.2 ↓		12: 9.9 ↖		
	3: 9.4 ↓				
	4: 8.2 ↓				
	5: 9.2 ↓				
	6: 10.0 →				
	7: 9.4 ↓				
	8: 10.8x↘				
	9: 8.5 ↑				
	10: 9.2 ↓				
	Serie 91.0		Serie 19.0		
	Total 0.0		Total 0.0		
	1: 9.5 ↗		6: 9.4 ↓		
	2: 9.4 ↗		7: 10.1 ↓		
	3: 9.4 ↙		8: 9.4 ↖		
	4: 10.4x↓		9: 8.0 ↓		
	5: 10.2↙		10: 10.5x↙		
	Serie 47.0		Serie 46.0		
	Total 47.0		Total 93.0		
	11: 9.9 ↓		16: 10.7x↘		
	12: 9.8 ←		17: 10.0 →		
	13: 10.1 ↑		18: 10.3 ↗		
	14: 10.7x↘		19: 10.4x↗		
	15: 8.1 ↓		20: 9.6 ↓		
	Serie 46.0		Serie 49.0		
	Total 139.0		Total 188.0		

Skjutlag	Tavla	Irma Karlsson			
1	6	Vindeln	Vännäs	11	Vb
29.04.2017		Vindelnskottet 2017		Ramselefors SKF	
	1: 8.4 ↙		11: 10.7x ↘		
	2: 6.5 ←		12: 9.5 ↑		
	3: 6.5 ←		13: 9.9 →		
	4: 8.4 ↙		14: 8.8 ↘		
	5: 7.7 ←				
	6: 9.9 →				
	7: 8.9 ←				
	8: 10.1 ↙				
	9: 10.3x ↘				
	10: 10.0 ←				
Serie	82.0	Serie	36.0		
Total	0.0	Total	0.0		
	1: 10.2 ↘		6: 8.2 ←		
	2: 10.2 ↗		7: 9.5 ↙		
	3: 10.3x ↘		8: 10.6x ↘		
	4: 10.1 ↓		9: 10.3x ↘		
	5: 10.3x ↘		10: 10.2 ←		
Serie	50.0	Serie	47.0		
Total	50.0	Total	97.0		
	11: 10.1 ←		16: 10.1 ↘		
	12: 10.2 →		17: 9.9 ↑		
	13: 9.5 ↗		18: 8.8 ↗		
	14: 9.4 ↓		19: 10.3 ↗		
	15: 9.4 ↗		20: 9.1 ↗		
Serie	47.0	Serie	46.0		
Total	144.0	Total	190.0		

<p>Prov</p>	<p>1: 6.5 ↓ 2: 9.6 ↗ 3: 9.2 ↗ 4: 9.7 ← 5: 10.2 ← 6: 9.7 ← 7: 9.6 → 8: 9.9 ↖ 9: 9.1 ↗ 10: 9.5 ↗</p> <p>Serie 88.0 Total 0.0</p>	<p>Prov</p>	<p>11: 9.6 ↖ 12: 9.2 → 13: 9.7 ↖ 14: 10.2 ← 15: 9.7 ↖ 16: 8.8 → 17: 9.4 ↗ 18: 9.3 ↗ 19: 9.4 ↗</p> <p>Serie 81.0 Total 0.0</p>
<p>20 Skott</p>	<p>1: 8.5 ↗ 2: 9.7 ↗ 3: 9.5 ↗ 4: 9.7 ↗ 5: 10.4x ↓</p> <p>Serie 45.0 Total 45.0</p>	<p>20 Skott</p>	<p>6: 10.1 ↖ 7: 10.4x ↗ 8: 10.5x ↓ 9: 10.0 ↓ 10: 10.1 ↓</p> <p>Serie 50.0 Total 95.0</p>
<p>20 Skott</p>	<p>11: 10.6x ↘ 12: 10.8x ↗ 13: 10.1 ↓ 14: 9.9 → 15: 9.6 ↗</p> <p>Serie 48.0 Total 143.0</p>	<p>20 Skott</p>	<p>16: 10.1 ↓ 17: 8.9 ↗ 18: 10.2 → 19: 9.9 → 20: 10.0 ↗</p> <p>Serie 47.0 Total 190.0</p>

Skjuttag	Tavla	Saga Ebbhagen			
1	8	Vindeln	Ramselefors	15	Vb
29.04.2017	Vindelnskottet 2017	Ramselefors SKF			
Prov		1: 6.2 ↑ 2: 8.4 ↓ 3: 10.5x ↗ 4: 9.6 ↘ 5: 10.0 ↓ 6: 9.3 ↓ 7: 8.7 ↓ 8: 9.4 ↑ 9: 9.6 ↖ 10: 9.4 ↘	Prov	11: 10.5x ↓ 12: 9.1 ←	
	Serie 87.0		Serie 19.0		
	Total 0.0		Total 0.0		
20 Skott		1: 8.4 ← 2: 9.1 ↓ 3: 9.6 ↓ 4: 9.6 ↑ 5: 10.1 ↖	20 Skott	6: 10.4x ↘ 7: 9.5 ↓ 8: 9.6 → 9: 9.3 ↗ 10: 9.7 ↖	
	Serie 45.0		Serie 46.0		
	Total 45.0		Total 91.0		
20 Skott		11: 10.5x ↗ 12: 10.1 ← 13: 10.1 ↑ 14: 10.4x ↘ 15: 10.3x ↘	20 Skott	16: 9.6 ↖ 17: 10.5x ↑ 18: 9.9 ↖ 19: 9.9 ↖ 20: 9.7 ↓	
	Serie 50.0		Serie 46.0		
	Total 141.0		Total 187.0		

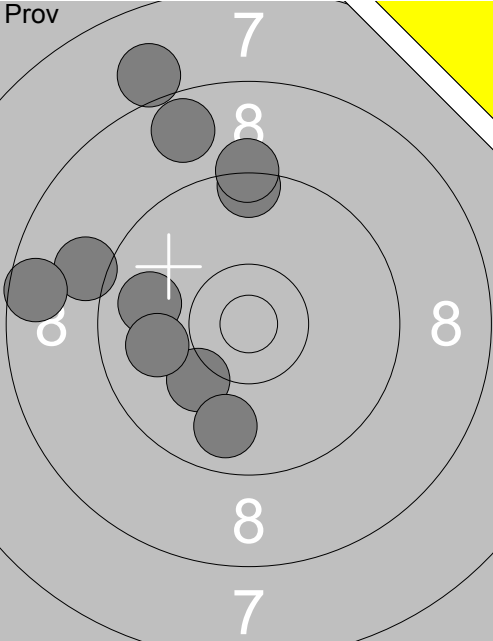
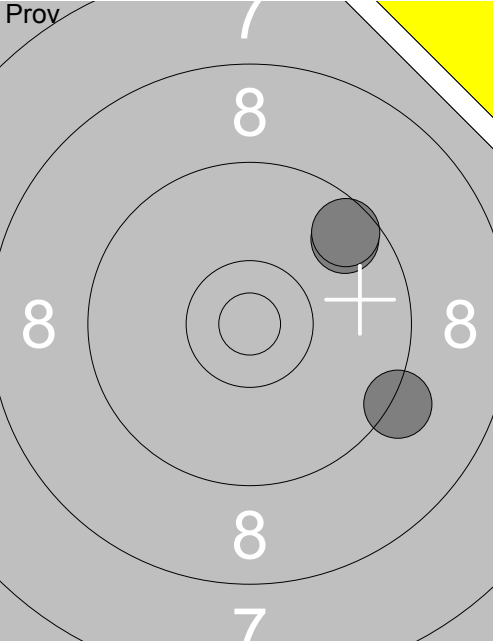
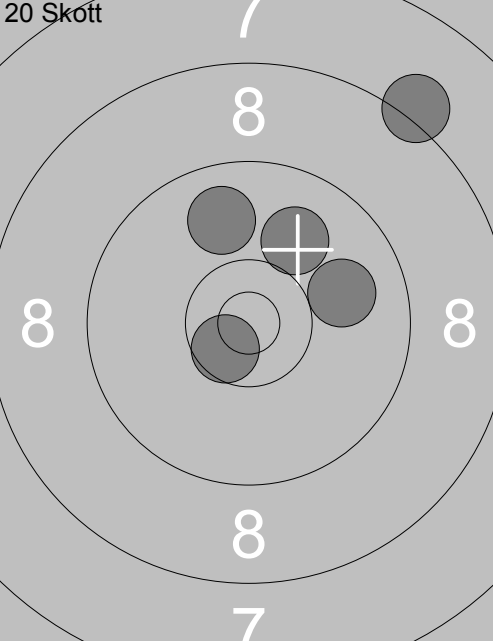
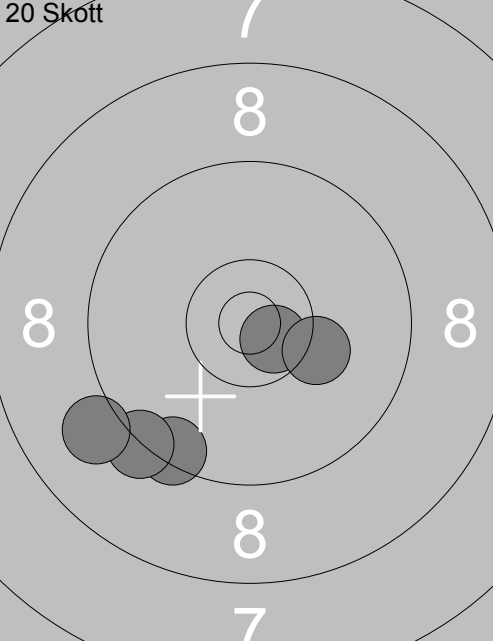
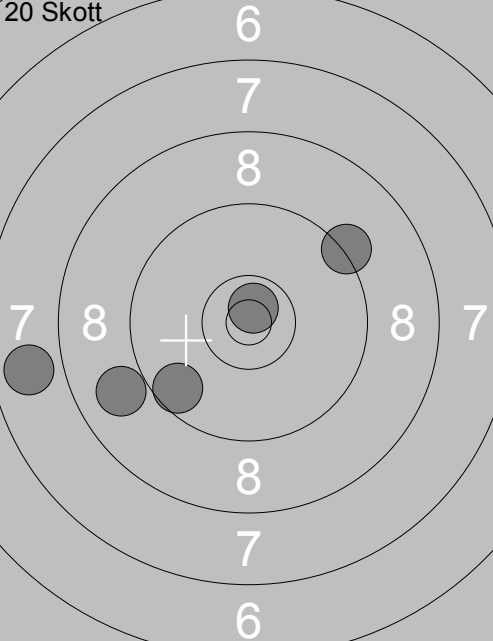
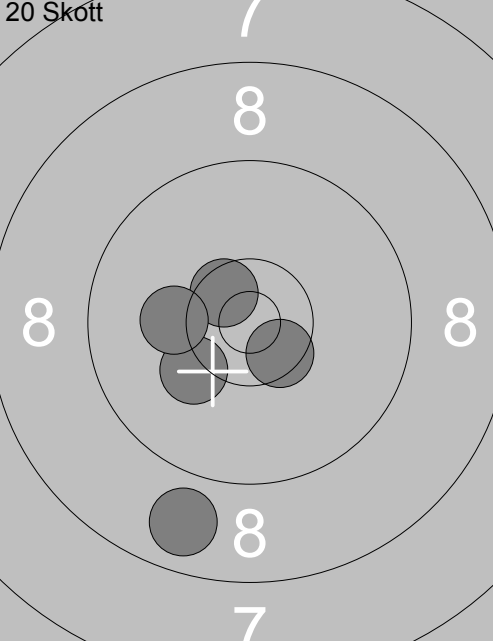
Skjuttag	Tavla	Bert-Ove Hægglund			
1	9	Vindeln	Ramselefors	Vet-L	Vb
29.04.2017		Vindelnskottet 2017		Ramselefors SKF	
Prov		1: 9.1 ← 2: 9.4 ↑ 3: 8.0 ↗ 4: 9.3 ↑ 5: 8.7 ↗ 6: 8.6 ← 7: 10.1 ↘ 8: 9.8 ← 9: 9.8 ↓ 10: 9.9 ←	Prov		11: 9.2 → 12: 9.6 ↗ 13: 9.6 ↗
		Serie 88.0		Serie 27.0	
		Total 0.0		Total 0.0	
20 Skott		1: 8.2 ↗ 2: 9.9 ↑ 3: 10.6x ↘ 4: 10.0 ↗ 5: 9.9 →	20 Skott		6: 10.7x ↘ 7: 9.4 ↓ 8: 9.3 ↓ 9: 10.2 → 10: 9.0 ←
		Serie 46.0		Serie 47.0	
		Total 46.0		Total 93.0	
20 Skott		11: 10.7x ↗ 12: 7.8 ← 13: 9.3 ↗ 14: 9.6 ↓ 15: 8.9 ←	20 Skott		16: 10.5x ↘ 17: 8.8 ↓ 18: 10.2 ↘ 19: 10.5x ↘ 20: 10.2 ←
		Serie 43.0		Serie 48.0	
		Total 136.0		Total 184.0	

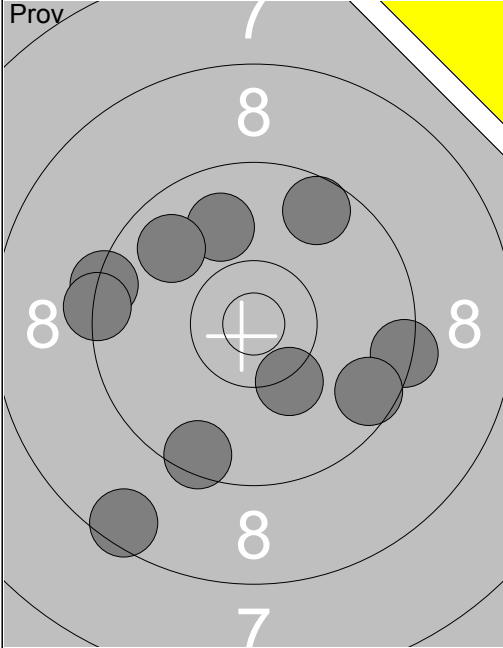
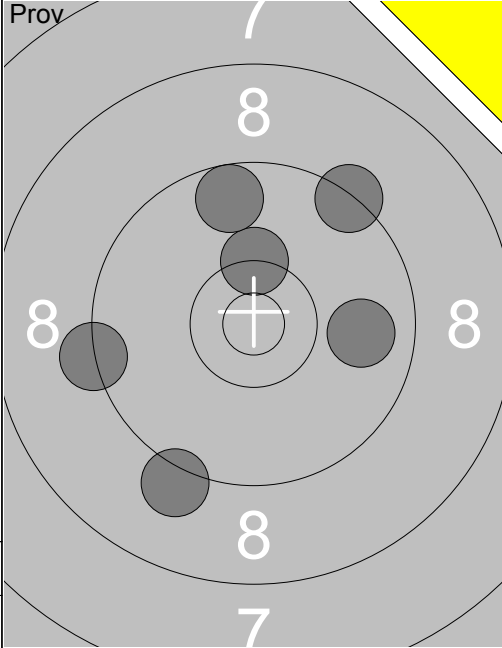
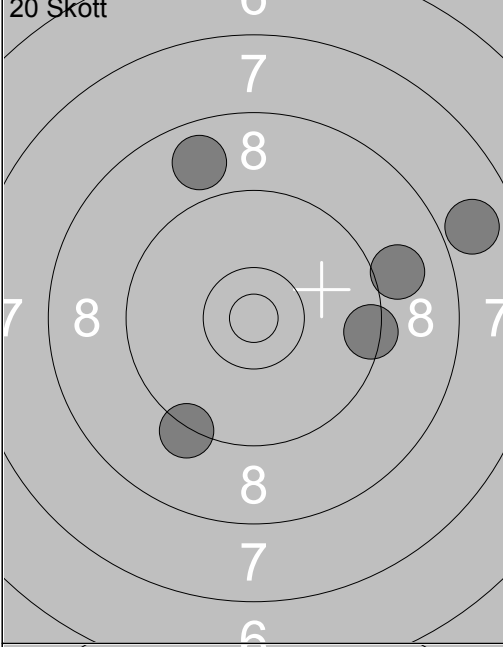
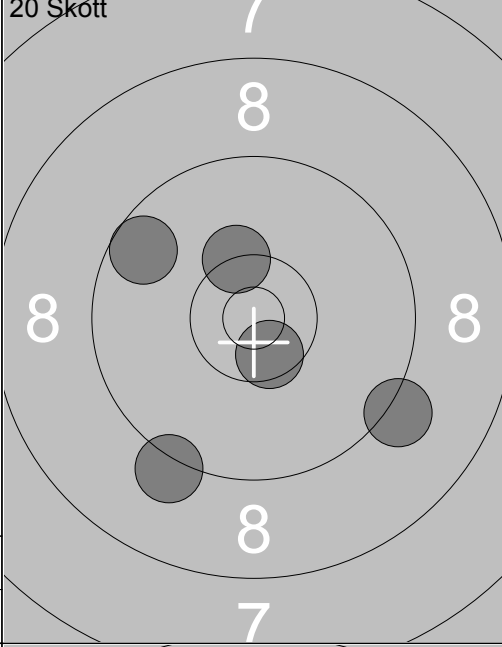
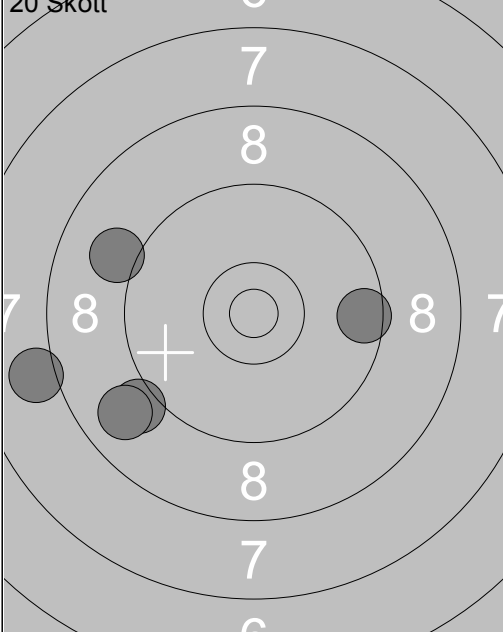
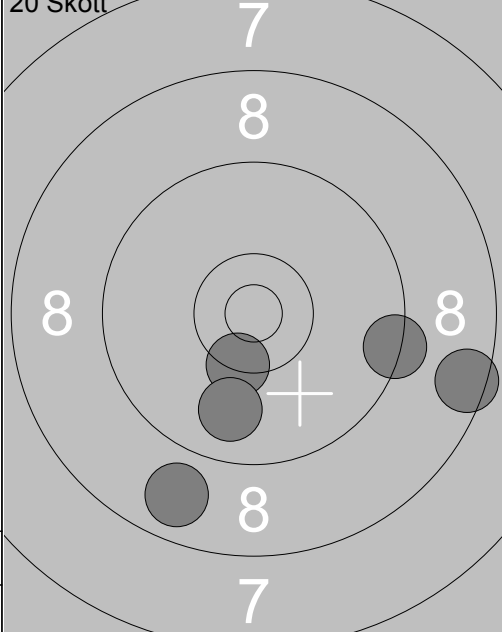
Skjuttag	Tavla	Mathias Fredriksson			
1	10	Vindeln		Ramselefors	Sen-L Vb
29.04.2017		Vindelnskottet 2017		Ramselefors SKF	
Prov		1: 9.4 ←	Prov		11: 10.3x↑
		2: 8.5 ↘			12: 9.9 →
		3: 9.9 ↑			13: 9.3 ↗
		4: 9.4 →			14: 9.1 ↘
		5: 9.3 ←			15: 9.3 ←
		6: 9.5 ↘			16: 9.7 ↑
		7: 9.6 ↗			
		8: 9.6 ↗			
		9: 9.8 ↖			
		10: 10.3 ↘			
		Serie 90.0			Serie 55.0
		Total 0.0			Total 0.0
20 Skott		1: 9.3 ↘	20 Skott		6: 9.2 ↘
		2: 9.4 →			7: 10.5x↘
		3: 7.9 →			8: 9.2 ↘
		4: 8.8 ↑			9: 10.3x↑
		5: 9.0 →			10: 9.6 ↖
		Serie 42.0			Serie 47.0
		Total 42.0			Total 89.0
20 Skott		11: 9.1 ↘	20 Skott		16: 9.4 →
		12: 8.1 ←			17: 10.4x↘
		13: 8.9 ↘			18: 8.5 →
		14: 9.1 ←			19: 8.8 ↘
		15: 9.5 →			20: 9.9 ↘
		Serie 43.0			Serie 44.0
		Total 132.0			Total 176.0

Skjutlag	Tavla	Mats Österlund					
1	11	Vindeln	Ramselefors	Sen-L	Vb		
29.04.2017	Vindelnskottet 2017	Ramselefors SKF					
	1: 9.4 ↙ 2: 7.5 ↙ 3: 7.7 ↗ 4: 9.9 ↑ 5: 10.2 ↓ 6: 10.6x ↘ 7: 9.1 ↘ 8: 10.2 ↙ 9: 9.4 ↘ 10: 10.1 ↘ Serie 90.0 Total 0.0		11: 8.9 ← 12: 8.3 ← Serie 16.0 Total 0.0				
					1: 10.3 ↓ 2: 9.5 ← 3: 9.9 ← 4: 10.1 ← 5: 10.6x ↗ Serie 48.0 Total 48.0		6: 8.4 ↑ 7: 7.8 ↘ 8: 8.3 → 9: 10.3 ↗ 10: 8.0 ↑ Serie 41.0 Total 89.0

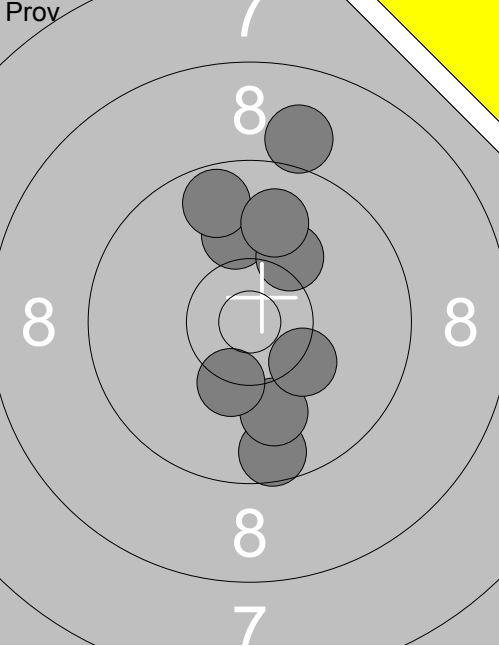
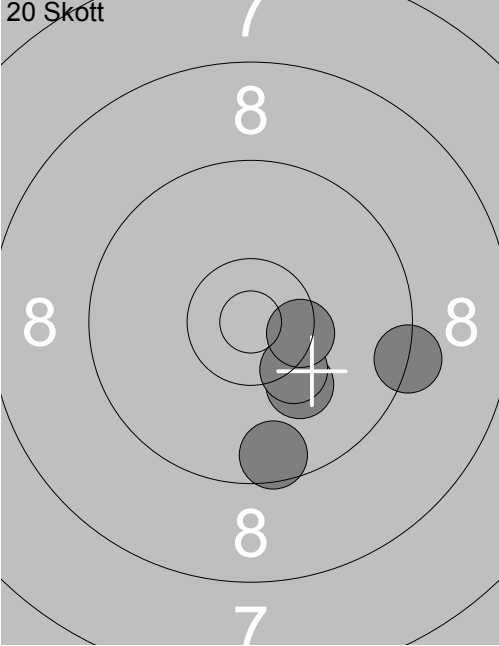
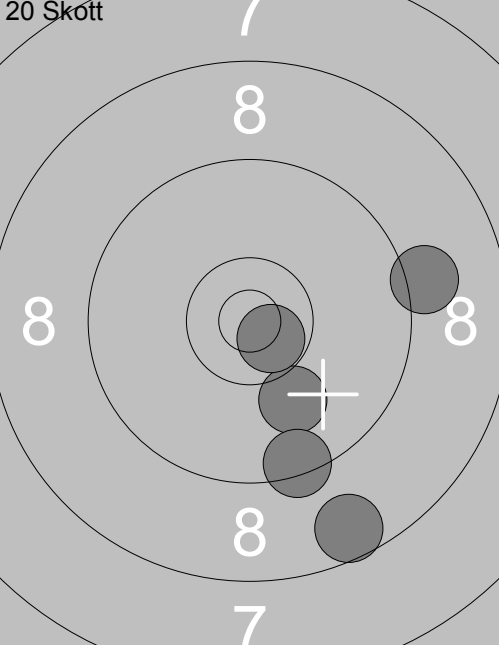
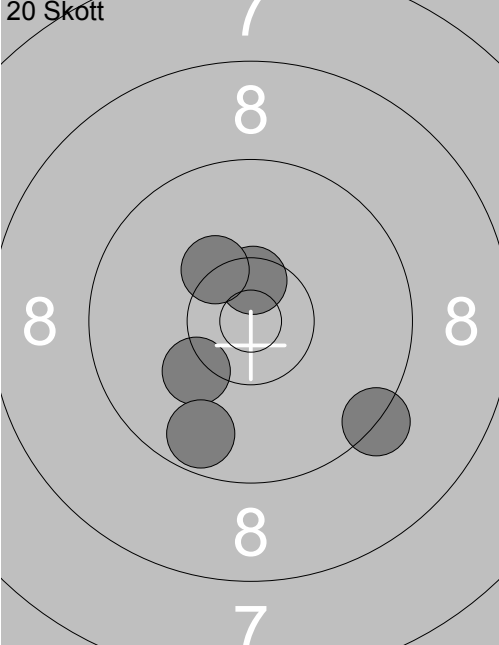
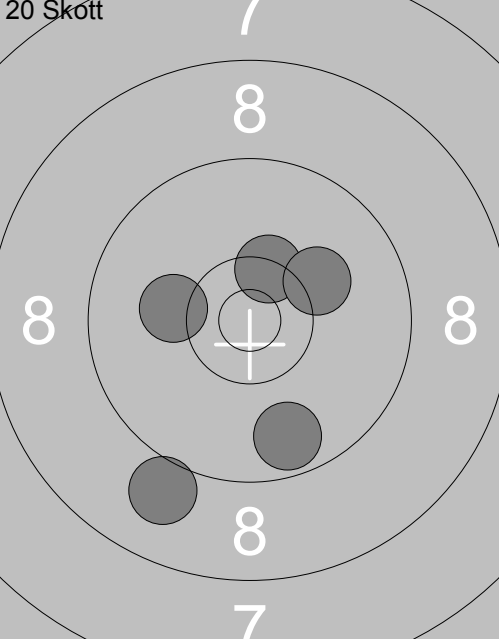
Skjutlag	Tavla	Ulf Enoksson			
1	12	Luleå		Vet-L	No
29.04.2017		Vindelnskottet 2017		Ramselefors SKF	
Prov		1: 9.0 ↗ 2: 9.6 ↓ 3: 10.0 ↓ 4: 10.1 ↑ 5: 10.2 ↗ 6: 10.3x↓ 7: 9.7 ↑ 8: 10.3 ↘ 9: 9.9 ↑	20 Skott		1: 9.3 → 2: 10.1 ↓ 3: 10.3x↘ 4: 10.4x→ 5: 9.6 ↓
		Serie 86.0		Serie 48.0	
		Total 0.0		Total 48.0	
20 Skott		6: 10.0 ↓ 7: 9.4 ↓ 8: 9.1 → 9: 8.6 ↓ 10: 10.7x↘	20 Skott		11: 10.2 ↙ 12: 10.5x↑ 13: 9.3 ↘ 14: 10.3x↘ 15: 9.7 ↓
		Serie 46.0		Serie 48.0	
		Total 94.0		Total 142.0	
20 Skott		16: 10.4x↗ 17: 10.2 ↗ 18: 9.0 ↓ 19: 10.2← 20: 9.7 ↓			
		Serie 48.0			
		Total 190.0			

Skjuttag	Tavla	Håkan Lidman		Vet-L	No
1	13				
Vindeln		Piteå			
29.04.2017		Vindelnskottet 2017		Ramselefors SKF	
Prov		1: 9.7 ↑ 2: 10.1 ↗ 3: 9.9 ↗ 4: 9.7 ↑ 5: 10.1 ← 6: 9.9 → 7: 10.5x ↗ 8: 9.8 ↖ 9: 10.1 → 10: 10.2 ↘	20 Skott		1: 10.2 ↘ 2: 10.0 ↘ 3: 10.2 ← 4: 9.5 → 5: 10.4x ↗
		Serie 95.0		Serie 49.0	
		Total 0.0		Total 49.0	
20 Skott		6: 10.3x ↘ 7: 10.4x ↗ 8: 10.3x ↘ 9: 9.7 ↑ 10: 9.9 ↘	20 Skott		11: 9.4 ↘ 12: 10.5x ↗ 13: 10.0 ↗ 14: 10.5x ↘ 15: 9.8 ↗
		Serie 48.0		Serie 48.0	
		Total 97.0		Total 145.0	
20 Skott		16: 9.6 ↑ 17: 10.0 ↗ 18: 10.1 → 19: 10.1 → 20: 9.9 ↘			
		Serie 48.0			
		Total 193.0			

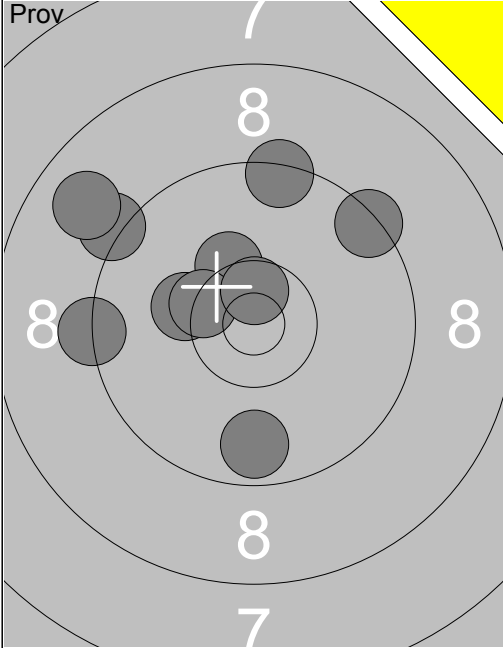
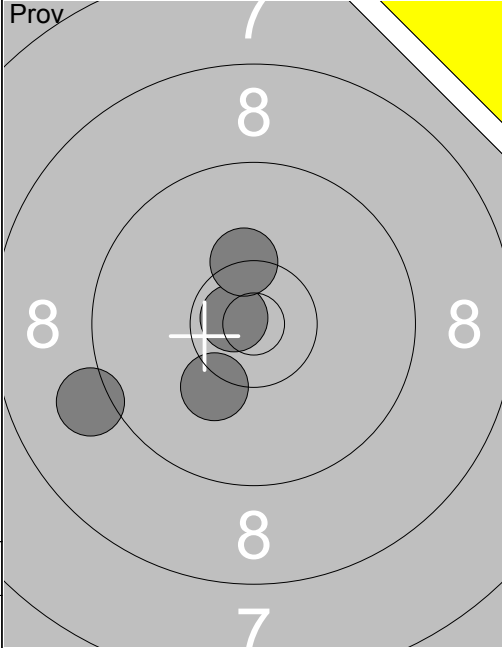
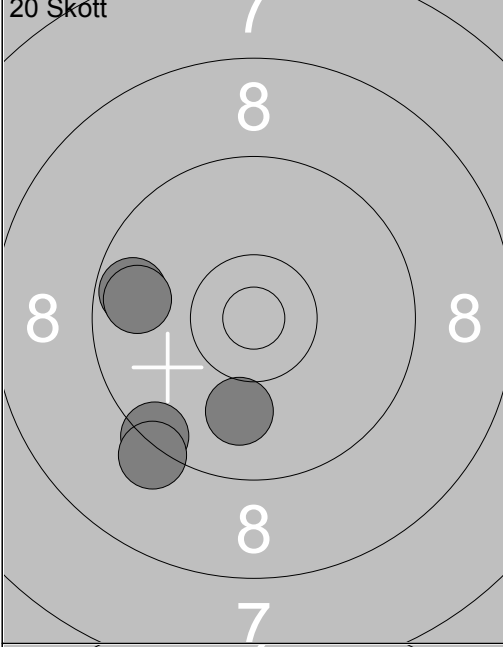
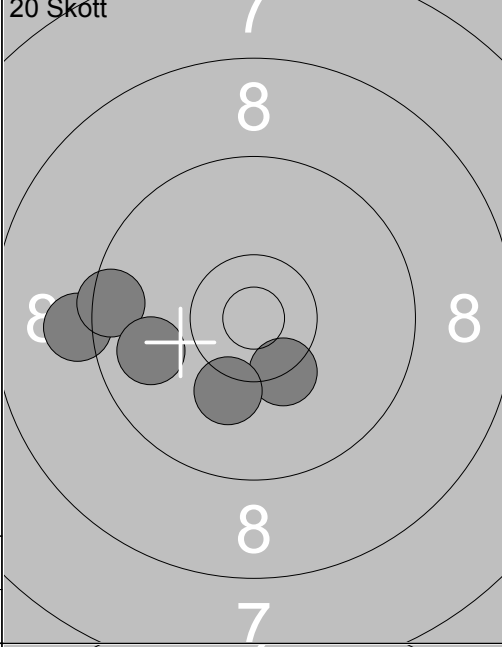
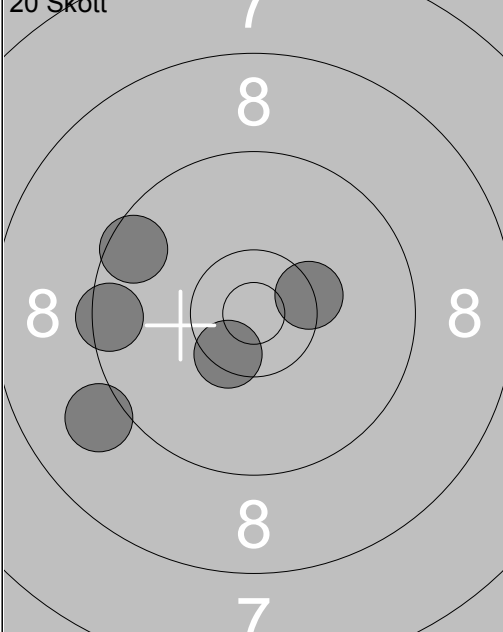
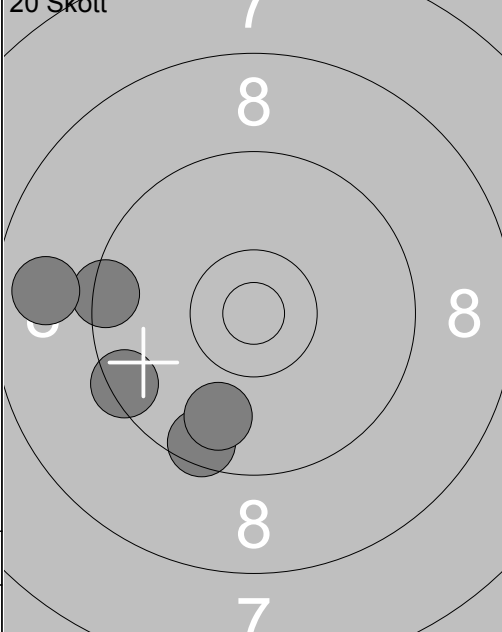
Skjuttag	Tavla	Niklas Johansson			
1	14	Vindeln	Ramselefors	Sen-L	Vb
29.04.2017	Vindelnskottet 2017	Ramselefors SKF			
Prov		1: 9.4 ↗ 2: 9.4 ↑ 3: 9.2 ↙ 4: 8.9 ↙ 5: 10.3x↗ 6: 10.2↙ 7: 10.4x↖ 8: 9.3 ← 9: 10.6x↑ 10: 9.7 ↓	Prov		11: 10.2 ↘ 12: 10.7x↖ 13: 9.1 ← 14: 10.3x↑
	Serie 93.0		Serie 39.0		
	Total 0.0		Total 0.0		
20 Skott		1: 10.0 ↓ 2: 9.7 ← 3: 9.4 ↘ 4: 9.2 ↘ 5: 9.8 ←	20 Skott		6: 9.2 ← 7: 9.5 ← 8: 9.8 ← 9: 10.3x↘ 10: 10.2 ↓
	Serie 46.0		Serie 47.0		
	Total 46.0		Total 93.0		
20 Skott		11: 9.6 ↙ 12: 10.4x➤ 13: 9.0 ↙ 14: 10.5x↘ 15: 9.5 ←	20 Skott		16: 9.5 ↓ 17: 9.8 ↓ 18: 9.4 ← 19: 9.5 ↙ 20: 8.8 ←
	Serie 47.0		Serie 44.0		
	Total 140.0		Total 184.0		

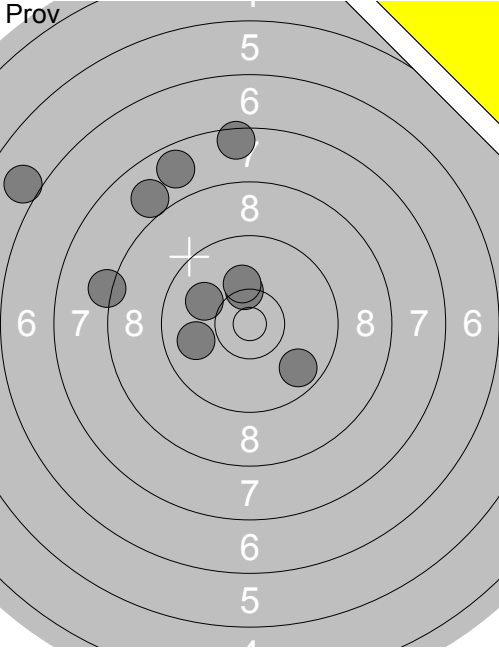
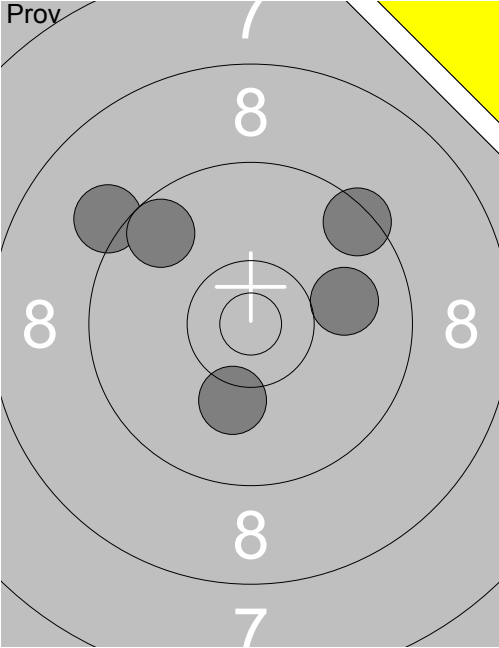
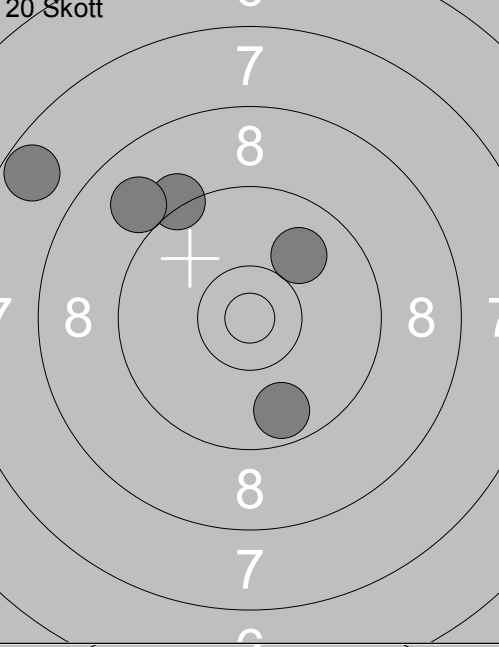
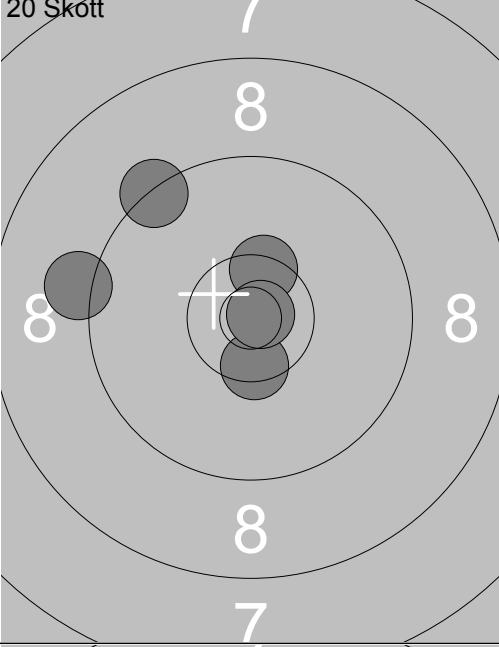
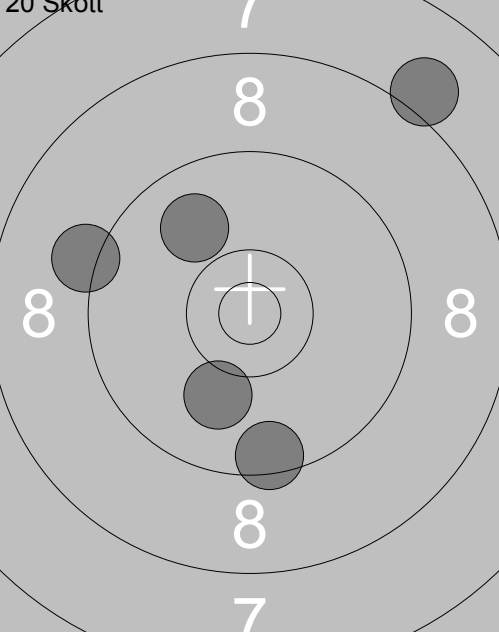
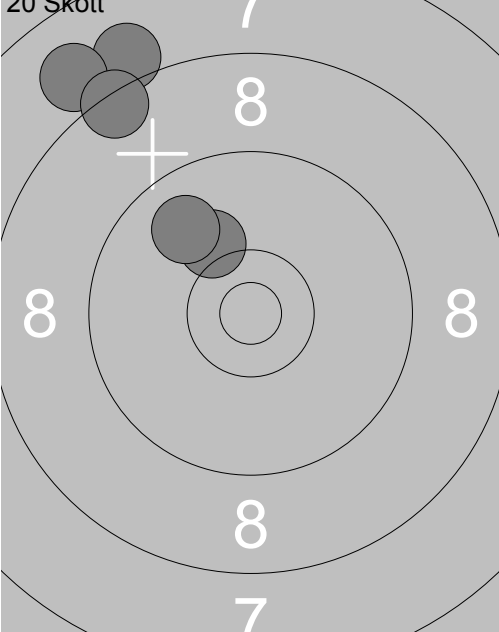
Skjuttag	Tavla	Ida Lundmark	
2	1		
Vindeln	Drängsmark	Sen-L	Vb
29.04.2017	Vindelnskottet 2017	Ramselefors SKF	
	1: 6.0 ↙		11: 9.4 ↗
	2: 7.7 ↗		12: 10.0 →
	3: 10.3x ↗		13: 9.1 ↙
	4: 7.5 ↑		14: 9.7 ↙
	5: 8.0 ↙		15: 10.1 ↓
	6: 10.0 ↙		
	7: 8.2 ←		
	8: 9.9 ←		
	9: 9.7 ↓		
	10: 10.2 ↑		
	Serie 84.0		Serie 47.0
	Total 0.0		Total 0.0
	1: 9.2 ↙		6: 10.4x ↗
	2: 9.7 ↓		7: 9.2 ←
	3: 10.0 ↗		8: 10.5x ↓
	4: 7.7 ↙		9: 9.3 ↙
	5: 9.0 ↙		10: 10.8x ↗
	Serie 44.0		Serie 48.0
	Total 44.0		Total 92.0
	11: 10.1 ↓		16: 10.1 ↙
	12: 9.9 ↙		17: 8.0 ↙
	13: 8.1 ↗		18: 9.9 ↙
	14: 9.5 ↓		19: 7.9 ↙
	15: 9.2 ←		20: 8.4 ↙
	Serie 45.0		Serie 42.0
	Total 137.0		Total 179.0

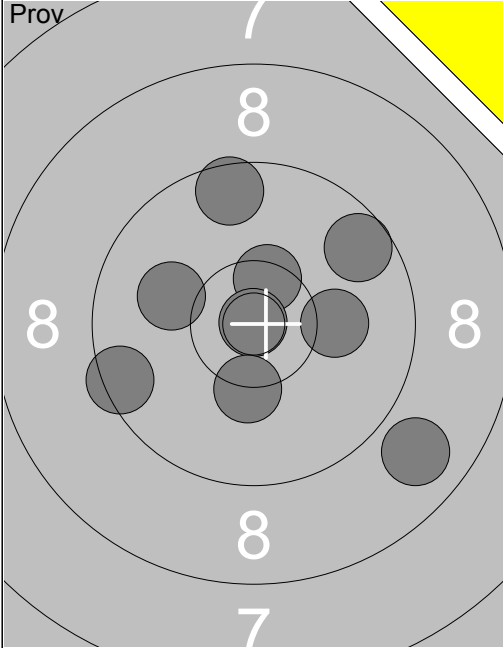
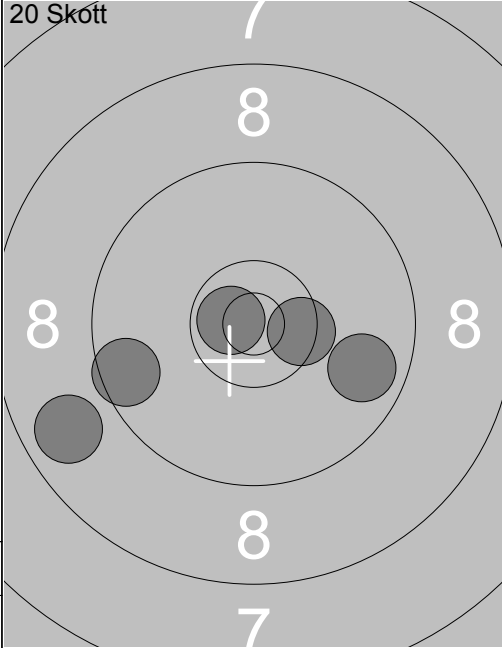
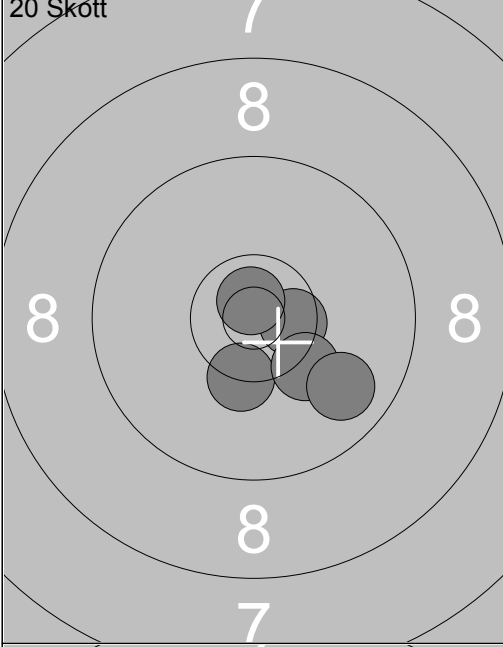
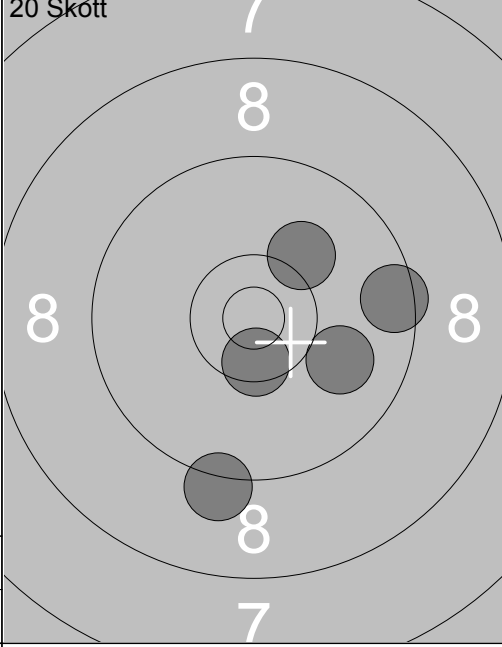
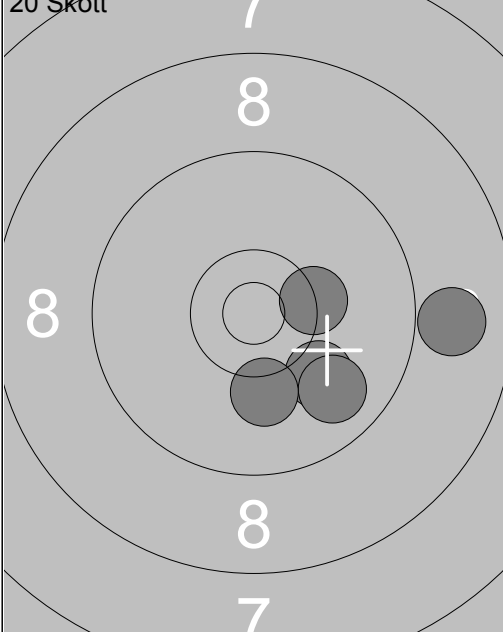
Skjuttag	Tavla	Johan Nilsson			
2	2	Vindeln	Ramselefors	Sen-L	Vb
29.04.2017		Vindelnskottet 2017	Ramselefors SKF		
Prov		1: 9.6 ↑ 2: 9.5 ← 3: 10.5x↑ 4: 9.6 ↗ 5: 10.1 → 6: 10.9x↑ 7: 10.3 ↓ 8: 8.8 ↘ 9: 10.1 ←	20 Skott		1: 8.8 ↙ 2: 9.8 → 3: 10.5x→ 4: 9.6 ← 5: 10.7x↖
		Serie 85.0		Serie 46.0	
		Total 0.0		Total 46.0	
20 Skott		6: 10.3x↓ 7: 10.5x→ 8: 10.2 ↘ 9: 10.8x↑ 10: 9.8 ↘	20 Skott		11: 10.5x↓ 12: 10.0 → 13: 10.1 ↗ 14: 9.5 → 15: 9.2 ↓
		Serie 49.0		Serie 48.0	
		Total 95.0		Total 143.0	
20 Skott		16: 8.9 → 17: 10.0 ↘ 18: 9.8 ↘ 19: 10.1 ↓ 20: 10.3x→			
		Serie 47.0			
		Total 190.0			

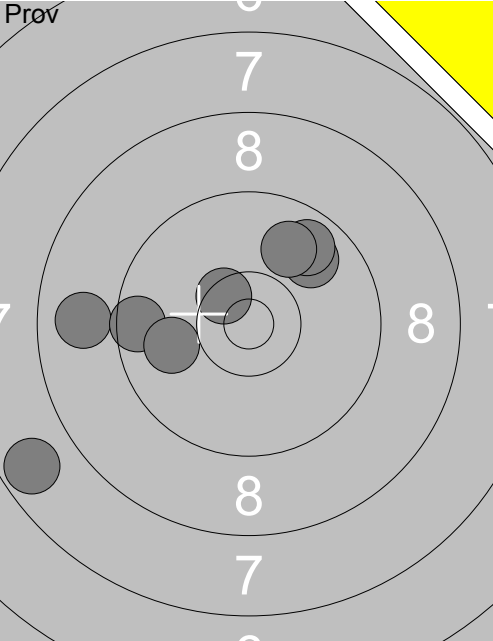
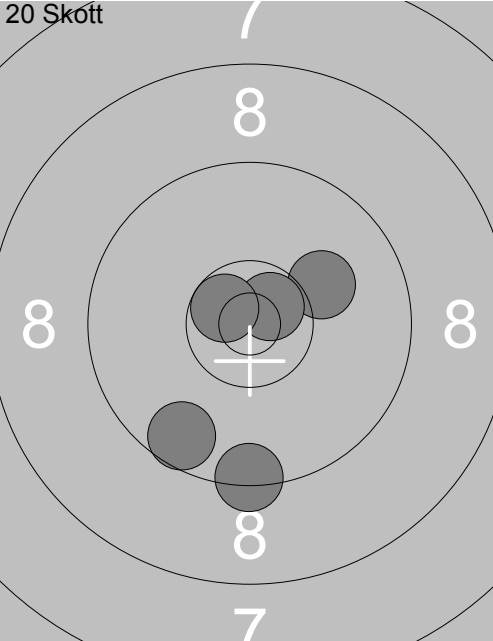
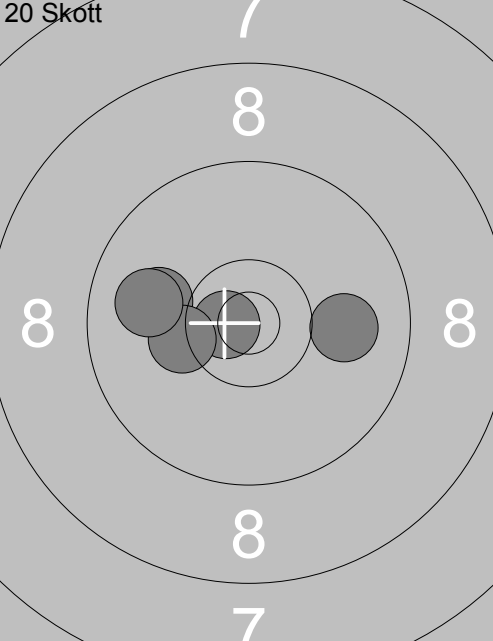
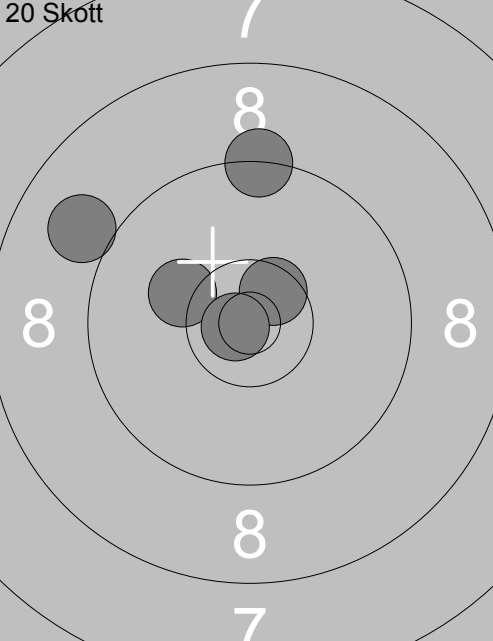
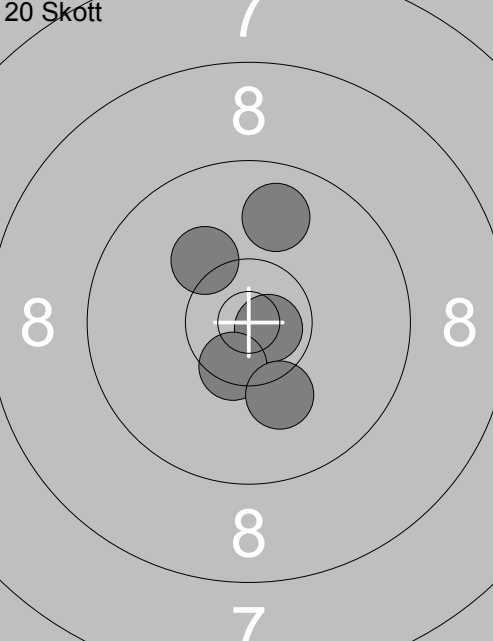
Skjuttag	Tavla	Lars Möllsten			
2	3	Vindeln	Umeå	Sen-L	Vb
29.04.2017		Vindelnskottet 2017	Ramselefors SKF		
Pröv 	1: 7.7 ↙ 2: 8.9 ← 3: 9.6 ← 4: 10.5x ↘ 5: 10.0 ← 6: 9.8 ↗ 7: 9.8 ↗ 8: 9.9 ↗	20 Skott 	1: 9.4 ↓ 2: 10.1 ↗ 3: 9.6 ↓ 4: 10.7x ↘ 5: 10.6x ↘	Serie 71.0 Total 0.0	Serie 48.0 Total 48.0
20 Skott 	6: 10.0 ← 7: 10.7x ↘ 8: 10.3 ← 9: 10.0 → 10: 9.9 ←	20 Skott 	11: 10.5x ↗ 12: 10.2 ↖ 13: 10.8x ↘ 14: 9.3 ↑ 15: 9.0 ↖	Serie 49.0 Total 97.0	Serie 48.0 Total 145.0
20 Skott 	16: 10.2 ↖ 17: 10.7x ↘ 18: 10.5x ↘ 19: 9.8 ↑ 20: 10.1 ↓			Serie 49.0 Total 194.0	

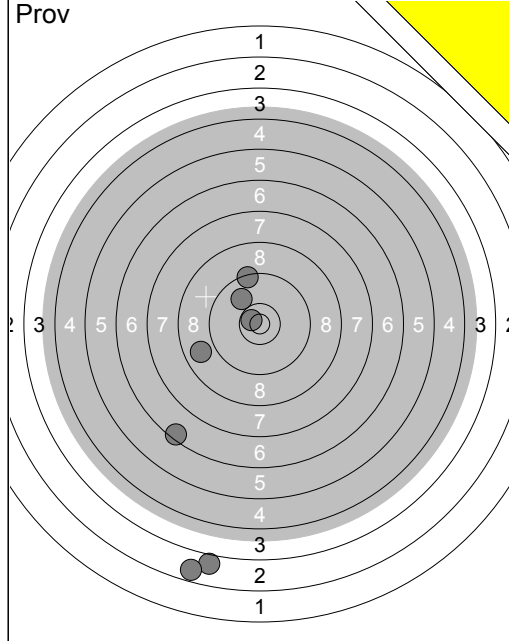

1:	0.0	↑
2:	0.0	↑
3:	3.0	↓
4:	2.7	↓
5:	6.4	↘
6:	8.8	←
7:	9.4	↑
8:	9.9	↖
9:	10.7	↘

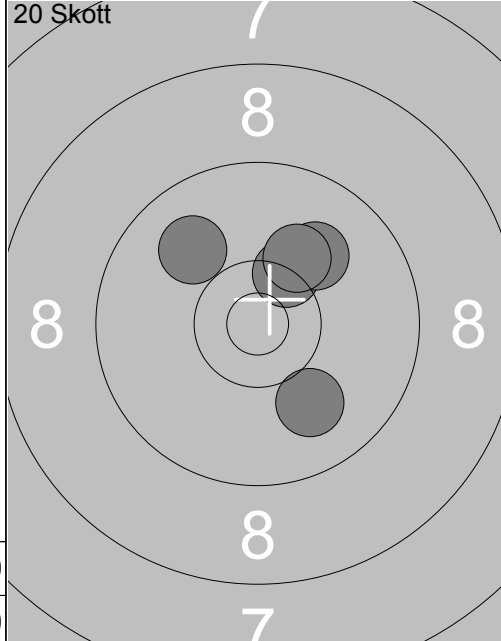

1:	9.9	↖
2:	10.4	↗
3:	10.0	↘
4:	10.0	↗
5:	10.2	↗

Serie	47.0
Total	0.0

Serie	49.0
Total	49.0

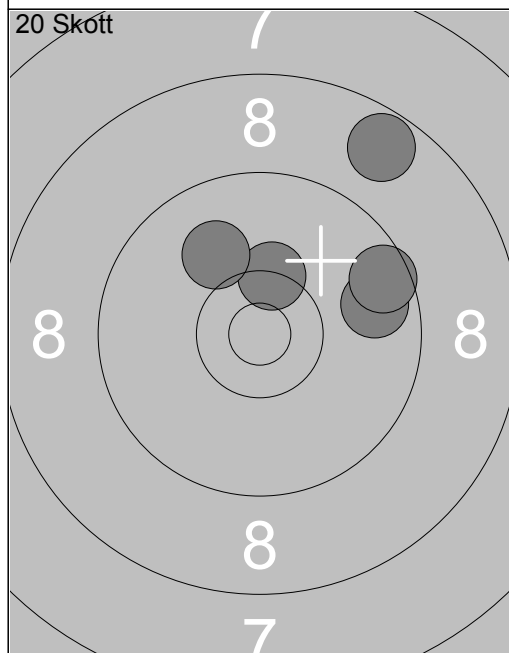

6:	8.7	↗
7:	10.3	↗
8:	9.7	→
9:	9.6	→
10:	10.0	↖

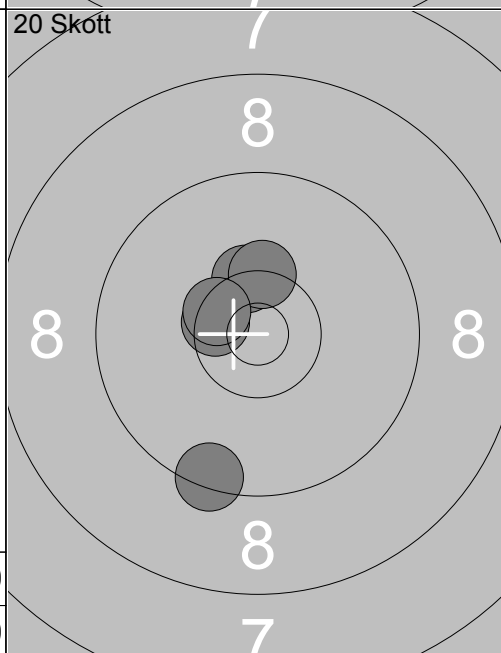

11:	10.4	↗
12:	9.4	↓
13:	10.5	↘
14:	10.3	↗
15:	10.5	↘

Serie	46.0
Total	95.0

Serie	49.0
Total	144.0

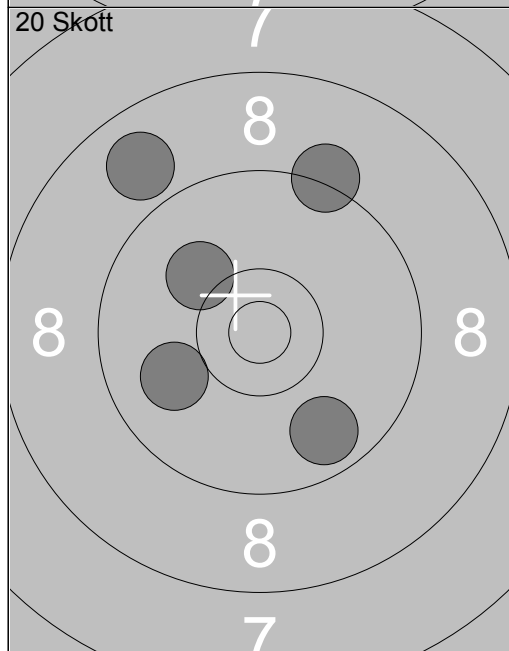

16:	9.2	↗
17:	10.0	←
18:	10.1	↖
19:	8.9	↖
20:	9.8	↘

Serie	46.0
Total	190.0

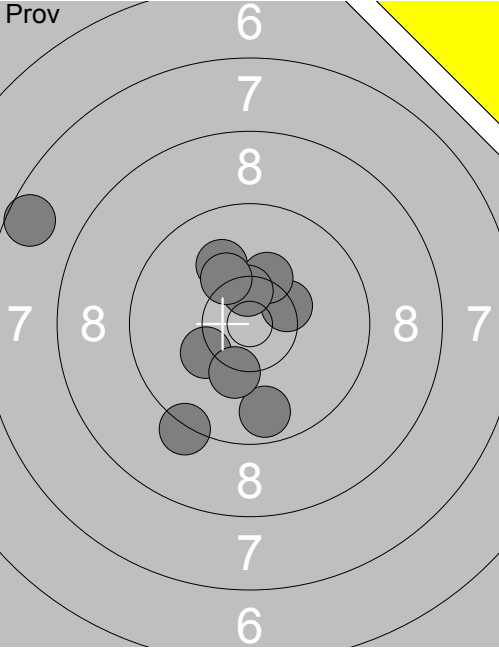
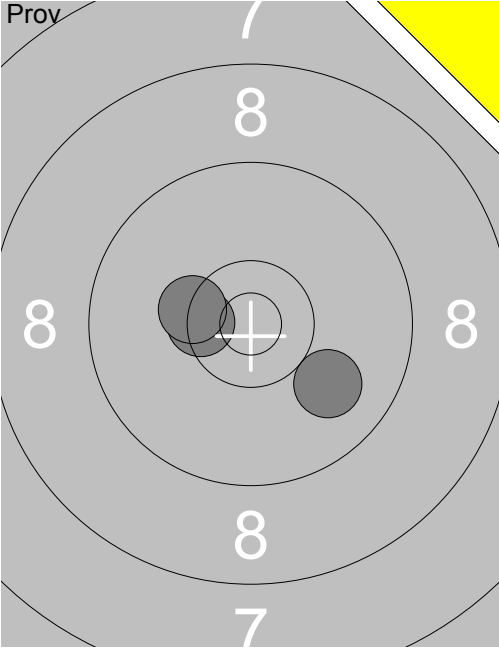
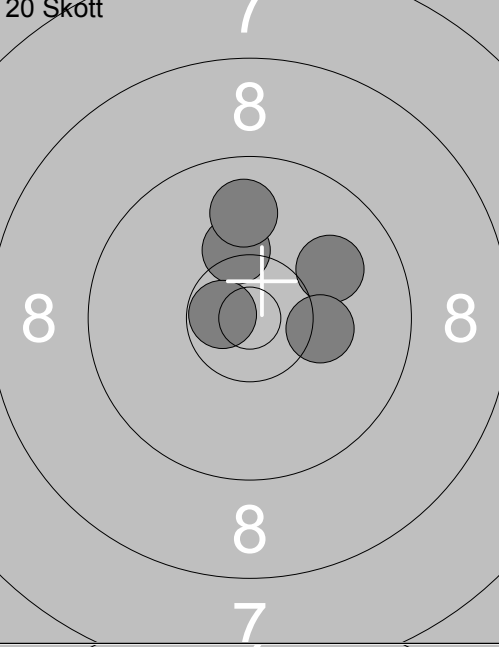
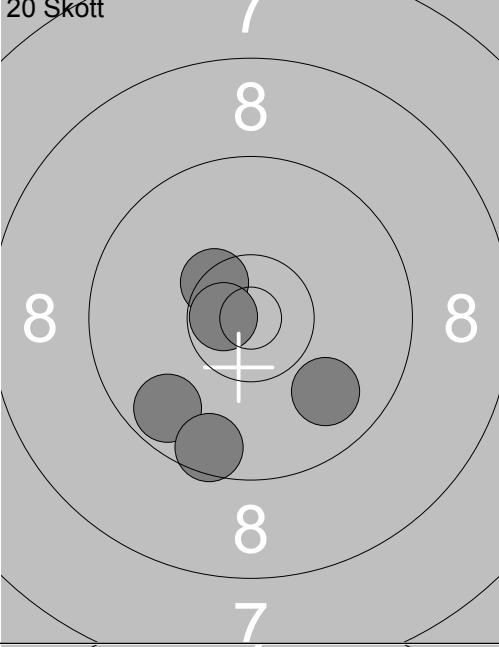
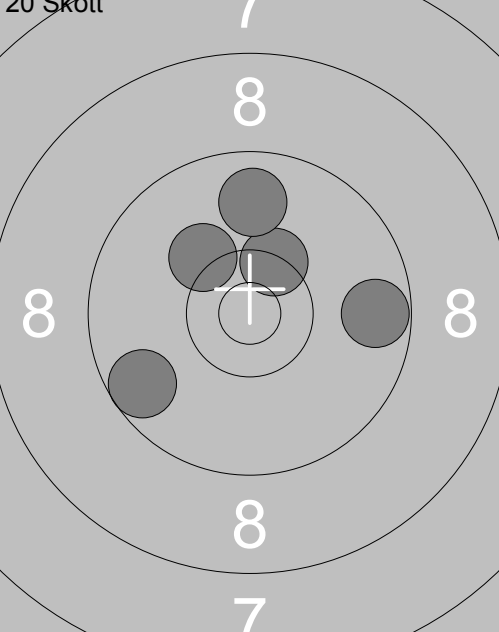
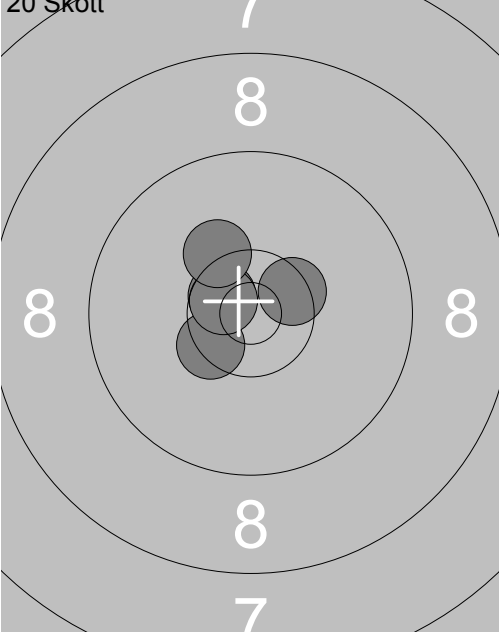
Skjuttag	Tavla	Marie Wingård				
2	5	Vindeln		Ramselefors	Sen-L	Vb
29.04.2017		Vindelnskottet 2017		Ramselefors SKF		
	Prov	1: 7.6 ↙		11: 10.0 ↘		
		2: 10.4x↗		12: 10.4x↖		
		3: 10.1 ↖		13: 10.3x↖		
		4: 10.2 ↙				
		5: 10.3 ↗				
		6: 10.5x↑				
		7: 9.3 ↘				
		8: 10.2 ↖				
		9: 9.7 ↘				
		10: 10.3 ↘				
		Serie 95.0		Serie 30.0		
		Total 0.0		Total 0.0		
	20 Skott	1: 10.2 ↑		6: 9.9 ↘		
		2: 10.7x↖		7: 10.4x↖		
		3: 10.0 ↗		8: 10.7x↖		
		4: 9.9 ↑		9: 9.7 ↘		
		5: 10.2 →		10: 9.6 ↘		
		Serie 49.0		Serie 47.0		
		Total 49.0		Total 96.0		
	20 Skott	11: 9.7 →		16: 10.6x↖		
		12: 10.2 ↖		17: 10.4x↖		
		13: 10.4x↑		18: 10.6x↖		
		14: 9.8 ↑		19: 10.3 ↖		
		15: 9.6 ↙		20: 10.5x↗		
		Serie 47.0		Serie 50.0		
		Total 143.0		Total 193.0		

<p>Prov</p>	<p>Prov</p>	<p>Serie 87.0</p> <p>Total 0.0</p>	<p>Serie 57.0</p> <p>Total 0.0</p>
<p>20 Skott</p>	<p>20 Skott</p>	<p>Serie 47.0</p> <p>Total 47.0</p>	<p>Serie 49.0</p> <p>Total 96.0</p>
<p>20 Skott</p>	<p>20 Skott</p>	<p>Serie 47.0</p> <p>Total 143.0</p>	<p>Serie 50.0</p> <p>Total 193.0</p>

Skjuttag	Tavla	Stefan Thorin				
2	8	Umeå		Sen-L	Vb	
29.04.2017		Vindelnskottet 2017		Ramselefors SKF		
Prov 	1: 8.4 ↗		20 Skott 	1: 9.1 ↖		
	2: 9.4 ↘			2: 9.2 ↖		
	3: 10.2 ↗			3: 10.0 ↘		
4: 9.1 ←		4: 10.6x ↘		4: 10.6x ↘		
5: 10.4x ↘		5: 10.5x ↗		5: 10.5x ↗		
6: 10.5x ↗		Serie 92.0		Serie 48.0		
7: 9.2 ←		Total 0.0		Total 48.0		
8: 9.9 ←						
9: 8.6 ↖						
10: 10.3x ↘						
20 Skott 	6: 9.5 ↖		20 Skott 	11: 9.6 ↗		
	7: 9.1 ↖			12: 9.4 ↖		
	8: 9.6 ↑			13: 10.9x ↘		
9: 10.8x ↘		14: 10.3x ↘		14: 10.3x ↘		
10: 9.5 ↖		Serie 46.0		Serie 47.0		
Serie 46.0		Total 94.0		Total 141.0		
Total 94.0						
20 Skott 	16: 9.1 ↖					
	17: 9.8 ↖					
	18: 9.6 ↘					
19: 10.3 ↗						
20: 8.3 ↖						
Serie 45.0						
Total 186.0						
Total 186.0						

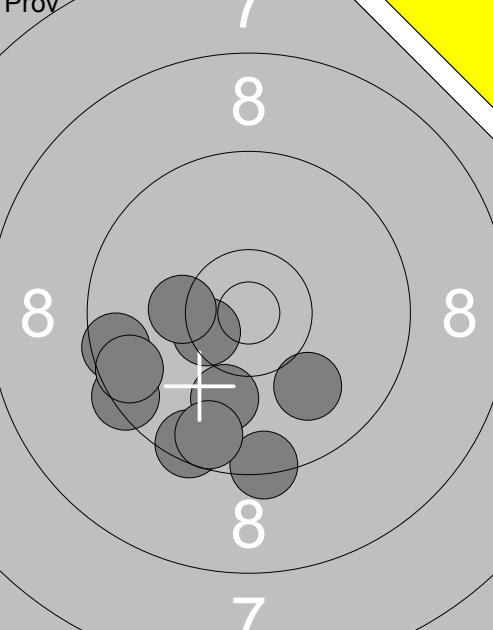
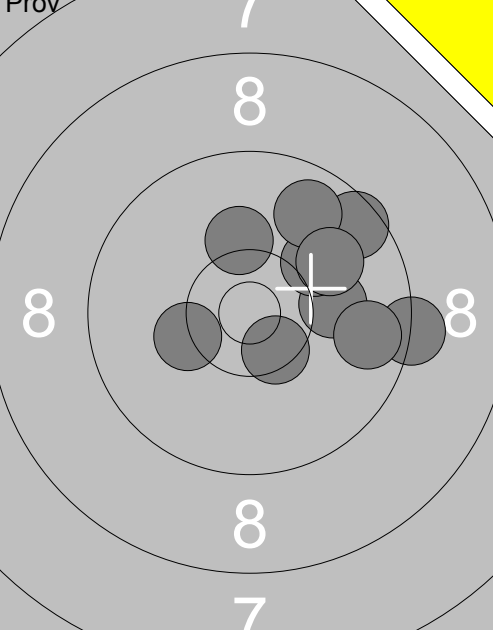
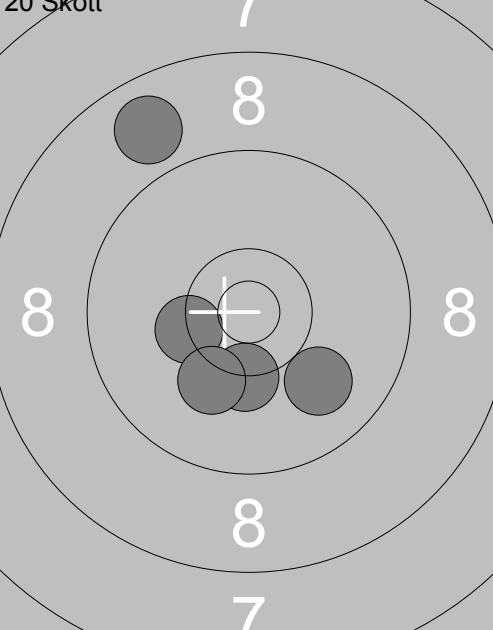
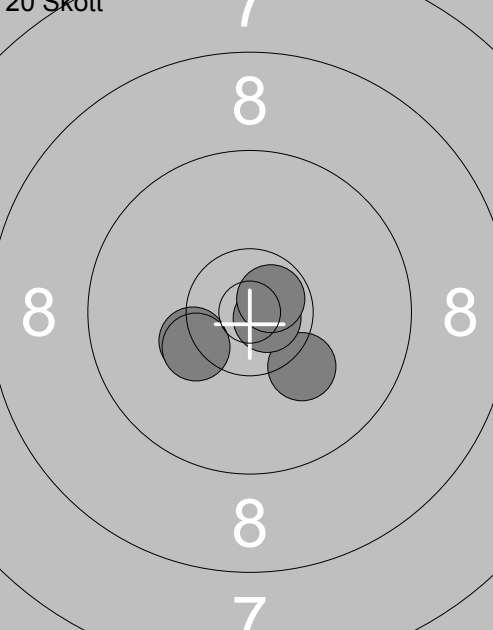
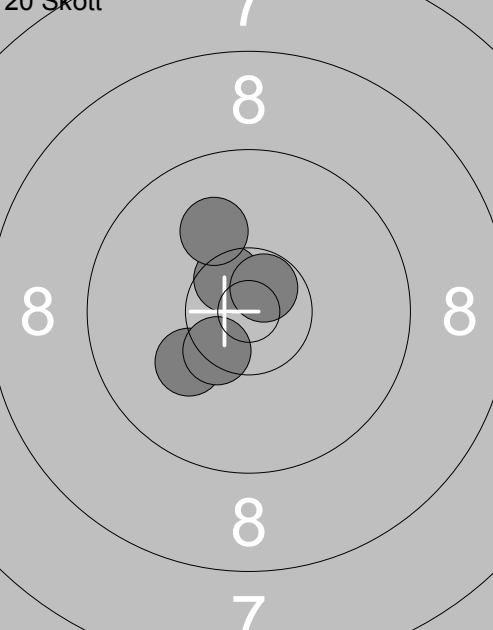
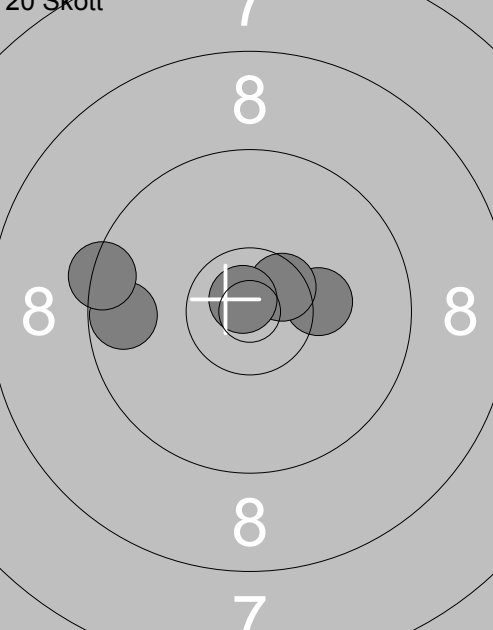
	<p>1: 9.4 ↙</p> <p>2: 10.5x↘</p> <p>3: 9.5 ↓</p> <p>4: 10.3↙</p> <p>5: 9.5 ←</p> <p>6: 10.0 ↓</p> <p>7: 9.4 ↓</p> <p>8: 9.6 ←</p> <p>9: 9.6 ↓</p> <p>10: 10.0 ↘</p> <hr/> <p>Serie 94.0</p> <hr/> <p>Total 0.0</p>		<p>11: 10.2 ↑</p> <p>12: 9.6 ↗</p> <p>13: 10.1 →</p> <p>14: 10.1 ↗</p> <p>15: 10.5x↘</p> <p>16: 9.3 →</p> <p>17: 9.7 →</p> <p>18: 9.8 ↗</p> <p>19: 10.3↙</p> <p>20: 10.0 ↗</p> <hr/> <p>Serie 96.0</p> <hr/> <p>Total 0.0</p>
<p>20 Skott</p> 	<p>1: 10.3 ↓</p> <p>2: 10.3x↙</p> <p>3: 10.2 ↓</p> <p>4: 8.8 ↗</p> <p>5: 10.0 ↘</p> <hr/> <p>Serie 48.0</p> <hr/> <p>Total 48.0</p>	<p>20 Skott</p> 	<p>6: 10.2 ↘</p> <p>7: 10.3x↙</p> <p>8: 10.3x↙</p> <p>9: 10.8x↘</p> <p>10: 10.7x↗</p> <hr/> <p>Serie 50.0</p> <hr/> <p>Total 98.0</p>
<p>20 Skott</p> 	<p>11: 10.2 ↙</p> <p>12: 10.6x↘</p> <p>13: 10.4x↙</p> <p>14: 10.1 ↗</p> <p>15: 10.7x↗</p> <hr/> <p>Serie 50.0</p> <hr/> <p>Total 148.0</p>	<p>20 Skott</p> 	<p>16: 10.2 →</p> <p>17: 10.5x↗</p> <p>18: 9.7 ←</p> <p>19: 9.4 ←</p> <p>20: 10.8x↘</p> <hr/> <p>Serie 48.0</p> <hr/> <p>Total 196.0</p>

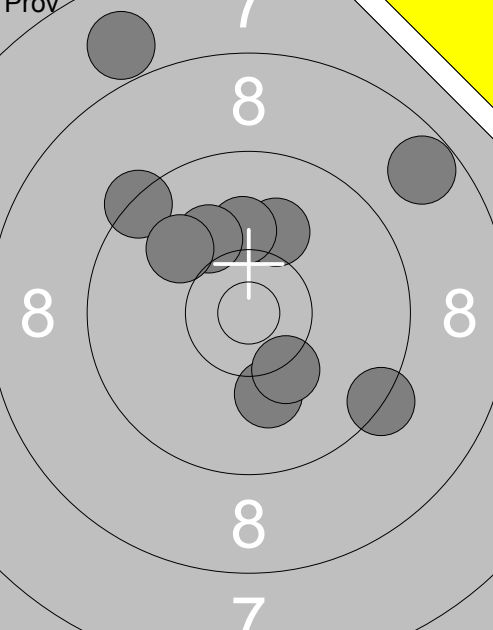
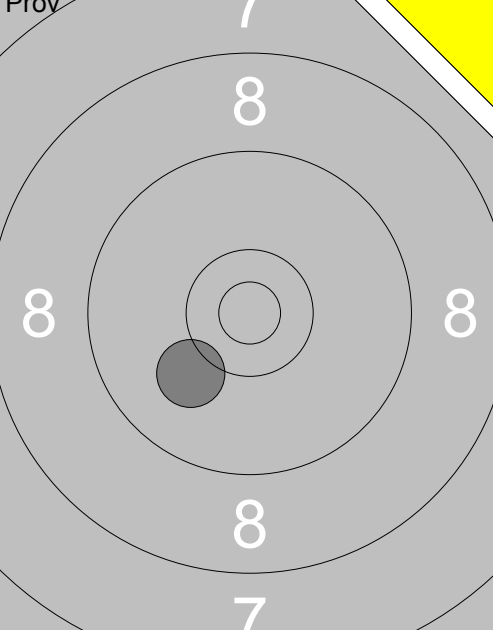
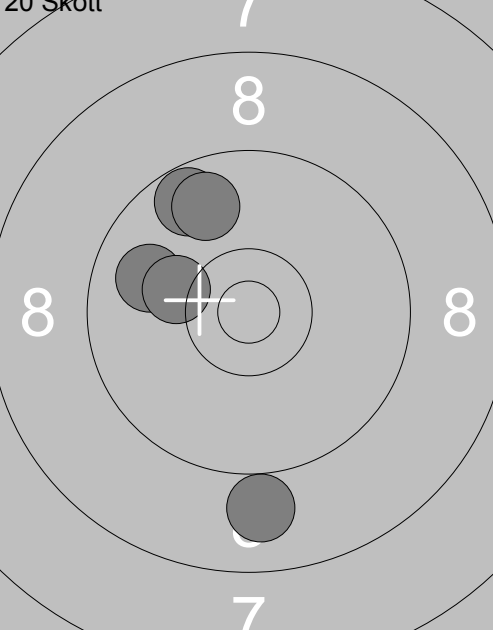
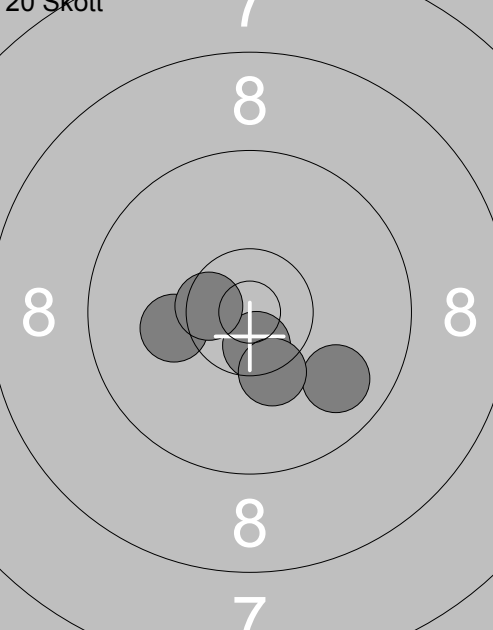
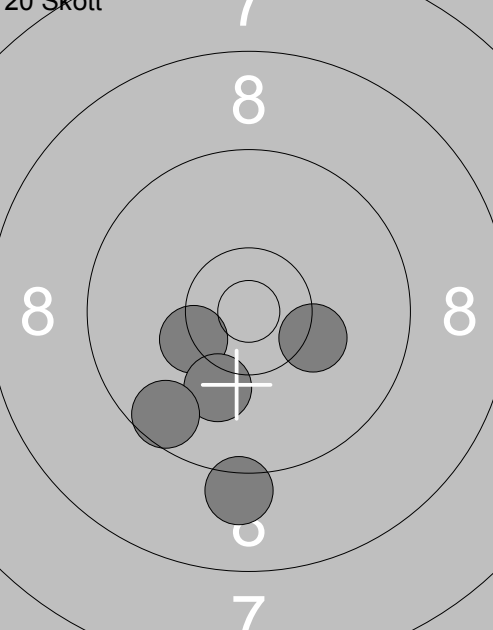
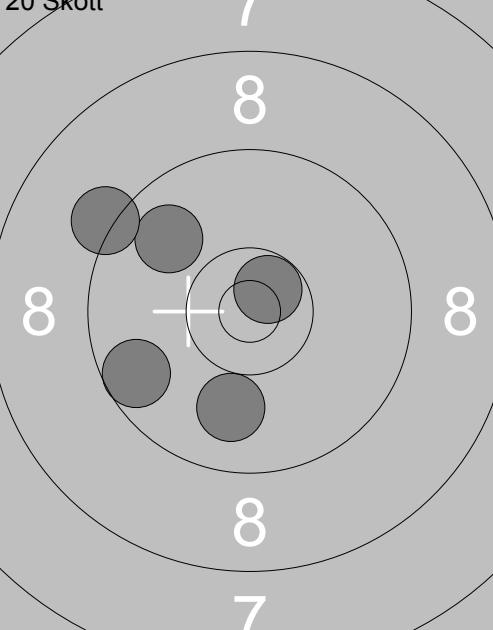
<div style="text-align: center;">Prov</div>  <div style="text-align: center;">7</div>	<div style="text-align: center;">1: 7.9 ↗</div> <div style="text-align: center;">2: 8.7 ↗</div> <div style="text-align: center;">3: 9.3 ↘</div> <div style="text-align: center;">4: 10.1 ↗</div> <div style="text-align: center;">5: 10.1 ↗</div> <div style="text-align: center;">6: 10.1 ↓</div> <div style="text-align: center;">7: 9.4 ↗</div> <div style="text-align: center;">8: 10.1 ↗</div> <div style="text-align: center;">9: 10.3 ↓</div> <div style="text-align: center;">10: 10.0 ↖</div> <div style="border-top: 1px solid black; text-align: center;">Serie 93.0</div> <div style="border-top: 1px solid black; text-align: center;">Total 0.0</div>	<div style="text-align: center;">Prov</div>  <div style="text-align: center;">7</div> <div style="text-align: right;">11: 10.1 ↘</div> <div style="border-top: 1px solid black; text-align: right;">Serie 10.0</div> <div style="border-top: 1px solid black; text-align: right;">Total 0.0</div>
<div style="text-align: center;">20 Skott</div>  <div style="text-align: center;">7</div>	<div style="text-align: center;">1: 9.9 ←</div> <div style="text-align: center;">2: 10.2 ←</div> <div style="text-align: center;">3: 9.7 ↗</div> <div style="text-align: center;">4: 9.8 ↗</div> <div style="text-align: center;">5: 9.0 ↓</div> <div style="border-top: 1px solid black; text-align: center;">Serie 46.0</div> <div style="border-top: 1px solid black; text-align: center;">Total 46.0</div>	<div style="text-align: center;">20 Skott</div>  <div style="text-align: center;">7</div> <div style="text-align: right;">6: 10.6x↓</div> <div style="text-align: right;">7: 9.8 ↘</div> <div style="text-align: right;">8: 10.2←</div> <div style="text-align: right;">9: 10.5x←</div> <div style="text-align: right;">10: 10.3x↓</div> <div style="border-top: 1px solid black; text-align: right;">Serie 49.0</div> <div style="border-top: 1px solid black; text-align: right;">Total 95.0</div>
<div style="text-align: center;">20 Skott</div>  <div style="text-align: center;">7</div>	<div style="text-align: center;">11: 10.3x←</div> <div style="text-align: center;">12: 10.1 ↓</div> <div style="text-align: center;">13: 9.1 ↓</div> <div style="text-align: center;">14: 10.2 ↘</div> <div style="text-align: center;">15: 9.6 ↘</div> <div style="border-top: 1px solid black; text-align: center;">Serie 48.0</div> <div style="border-top: 1px solid black; text-align: center;">Total 143.0</div>	<div style="text-align: center;">20 Skott</div>  <div style="text-align: center;">7</div> <div style="text-align: right;">16: 9.6 ↖</div> <div style="text-align: right;">17: 10.7x↗</div> <div style="text-align: right;">18: 9.8 ↖</div> <div style="text-align: right;">19: 9.2 ↖</div> <div style="text-align: right;">20: 10.0 ↓</div> <div style="border-top: 1px solid black; text-align: right;">Serie 47.0</div> <div style="border-top: 1px solid black; text-align: right;">Total 190.0</div>

	<p>20 Skott</p>	<p>1: 8.9 ↗</p> <p>2: 9.9 ↗</p> <p>3: 6.7 ←</p> <p>4: 7.4 ←</p> <p>5: 9.5 ↑</p> <p>6: 10.6x ↘</p> <p>7: 10.5x ↗</p> <p>8: 10.2 ↖</p> <p>9: 9.7 ↖</p> <p>10: 9.2 ↘</p> <p>Serie 87.0</p> <p>Total 0.0</p>	<p>1: 10.1 ↘</p> <p>2: 7.8 ←</p> <p>3: 10.8x ↘</p> <p>4: 10.2 ↓</p> <p>5: 9.2 ↘</p> <p>Serie 46.0</p> <p>Total 46.0</p>
--	-----------------	--	---

<p>20 Skott</p>	<p>20 Skott</p>	<p>6: 9.9 ↘</p> <p>7: 10.5x ↓</p> <p>8: 9.1 ←</p> <p>9: 10.4x ↓</p> <p>10: 10.2 ↓</p> <p>Serie 48.0</p> <p>Total 94.0</p>	<p>11: 8.2 ↘</p> <p>12: 9.6 ↘</p> <p>13: 9.2 ←</p> <p>14: 8.6 ↓</p> <p>15: 9.4 ←</p> <p>Serie 43.0</p> <p>Total 137.0</p>
-----------------	-----------------	---	---

<p>20 Skott</p>	<p>Serie 43.0</p> <p>Total 180.0</p>		
-----------------	--------------------------------------	--	--

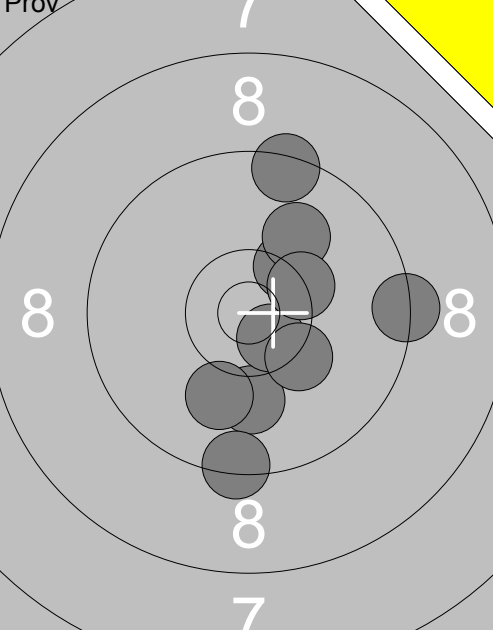
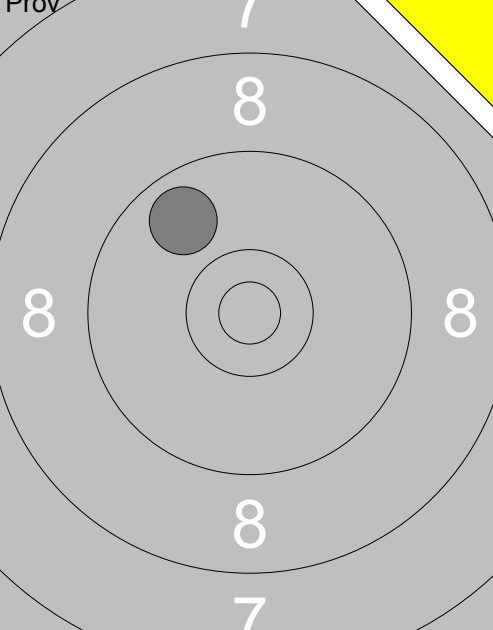
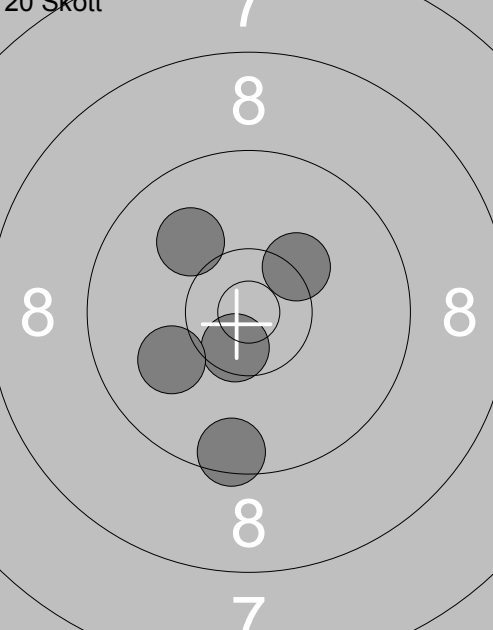
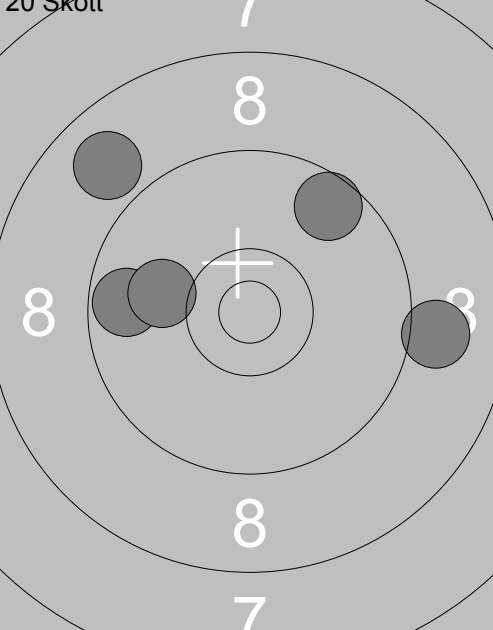
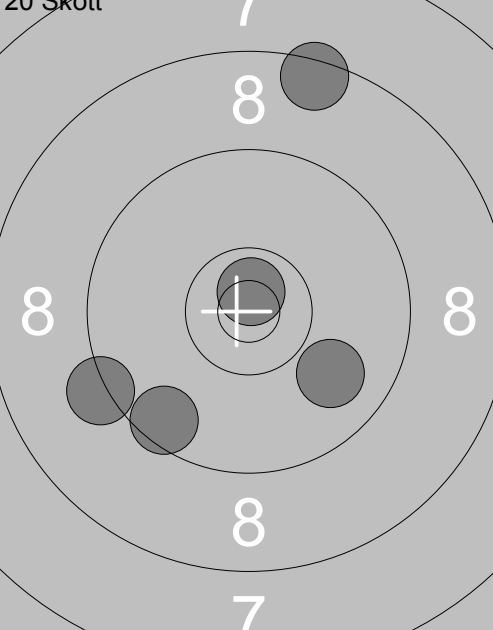
<div style="text-align: center;">Prov</div> 	<div style="text-align: center;">Prov</div> 	<div style="text-align: right;">11: 9.8 ↖</div>
<p>1: 9.4 ↗</p> <p>2: 9.3 →</p> <p>3: 10.1 ↓</p> <p>4: 10.6x↘</p> <p>5: 10.3 ↘</p> <p>6: 10.3x↗</p> <p>7: 10.0 ↗</p> <p>8: 10.1 ↓</p> <p>9: 10.4x↗</p> <p>10: 9.4 ↓</p>	<p>1: 10.6x↘</p> <p>2: 10.3 ↗</p> <p>3: 10.0 ↙</p> <p>4: 10.0 ↖</p> <p>5: 9.5 ↓</p>	<p>6: 8.9 ↖</p> <p>7: 9.7 ←</p> <p>8: 10.0 ←</p> <p>9: 9.0 →</p> <p>10: 9.6 ↗</p>
Serie 97.0	Serie 9.0	Serie 45.0
Total 0.0	Total 0.0	Total 94.0
<div style="text-align: center;">20 Skott</div> 	<div style="text-align: center;">20 Skott</div> 	<div style="text-align: center;">20 Skott</div> 
<p>1: 10.6x↘</p> <p>2: 10.3 ↗</p> <p>3: 10.0 ↙</p> <p>4: 10.0 ↖</p> <p>5: 9.5 ↓</p>	<p>11: 9.2 ↙</p> <p>12: 9.9 ↘</p> <p>13: 9.5 ↙</p> <p>14: 10.7x↗</p> <p>15: 8.5 ↗</p>	<p>16: 9.1 ↗</p> <p>17: 8.8 ↗</p> <p>18: 9.4 ↗</p> <p>19: 9.7 ↓</p> <p>20: 10.4x←</p>
Serie 49.0	Serie 45.0	Serie 45.0
Total 49.0	Total 94.0	Total 139.0
Serie 45.0	Serie 45.0	Serie 45.0
Total 139.0	Total 184.0	Total 184.0

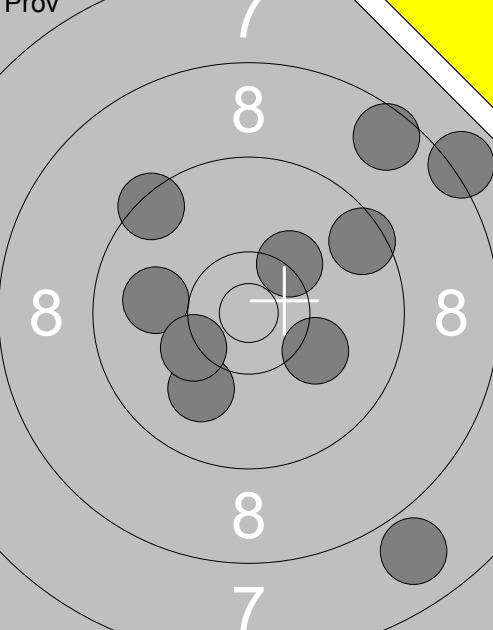
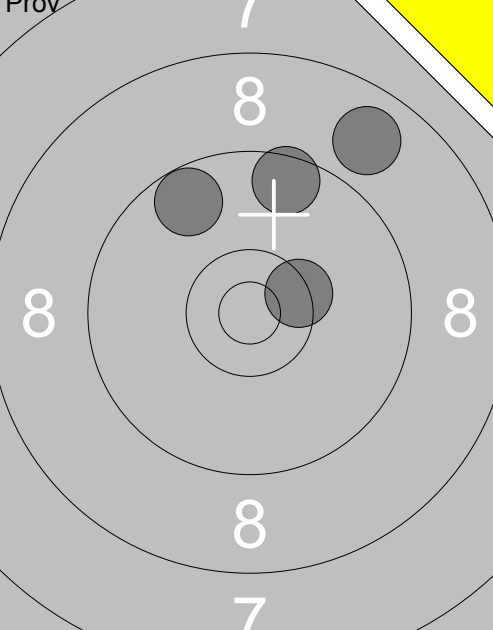
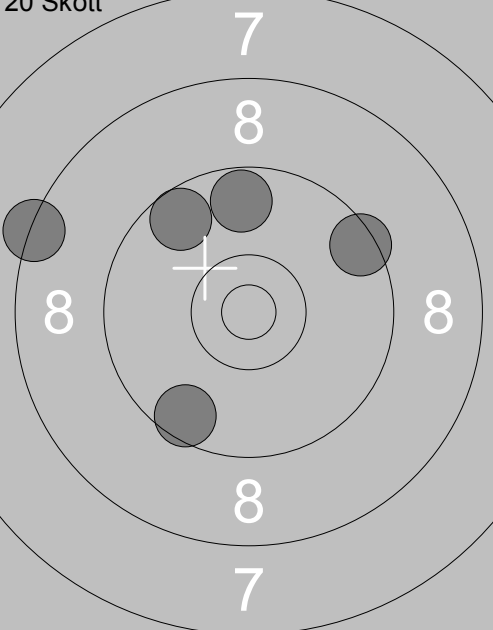
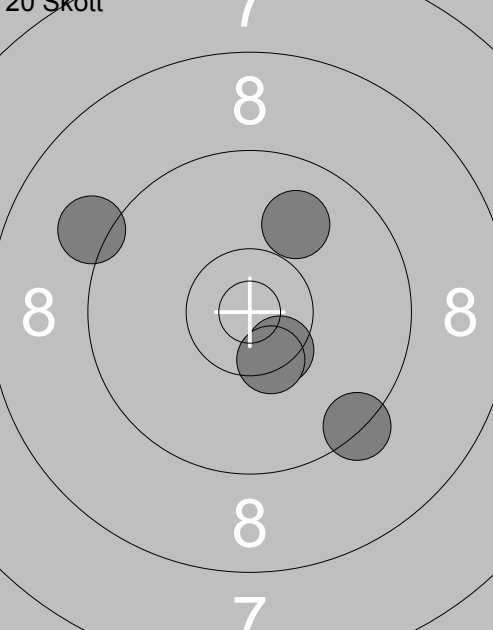
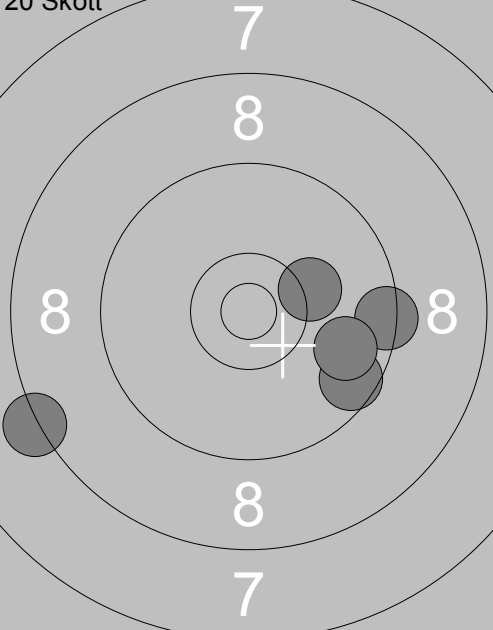
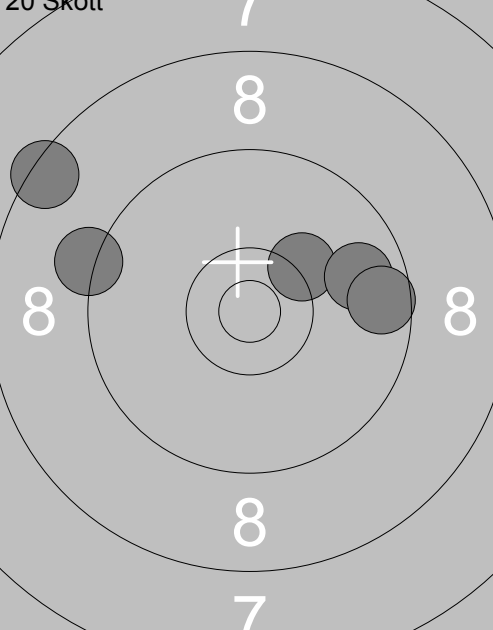
	<p>Prov</p> <p>1: 8.2 ↗ 2: 10.0 ↓ 3: 9.5 ↗ 4: 10.3 ↗ 5: 8.6 ↗ 6: 9.4 ↖ 7: 7.9 ↓ 8: 10.0 ← 9: 10.3 ↙ 10: 10.1 ↘</p> <p>Serie 91.0 Total 0.0</p>	 <p>Prov</p> <p>11: 8.8 ↗ 12: 10.4x↗ 13: 9.7 ↖ 14: 9.6 ↗</p> <p>Serie 36.0 Total 0.0</p>
<p>20 Skott</p> 	<p>1: 8.3 ← 2: 9.7 ↑ 3: 9.5 ↗ 4: 9.6 ↖ 5: 9.6 ↓</p> <p>Serie 44.0 Total 44.0</p>	<p>20 Skott</p>  <p>6: 10.5x↘ 7: 9.4 ↓ 8: 9.1 ← 9: 9.9 ↗ 10: 10.4x↘</p> <p>Serie 47.0 Total 91.0</p>
<p>20 Skott</p> 	<p>11: 8.3 ↙ 12: 9.4 → 13: 10.2↗ 14: 9.6 ↓ 15: 9.8 →</p> <p>Serie 45.0 Total 136.0</p>	<p>20 Skott</p>  <p>16: 8.4 ↖ 17: 10.3 ↗ 18: 9.8 → 19: 9.2 ← 20: 9.6 →</p> <p>Serie 45.0 Total 181.0</p>

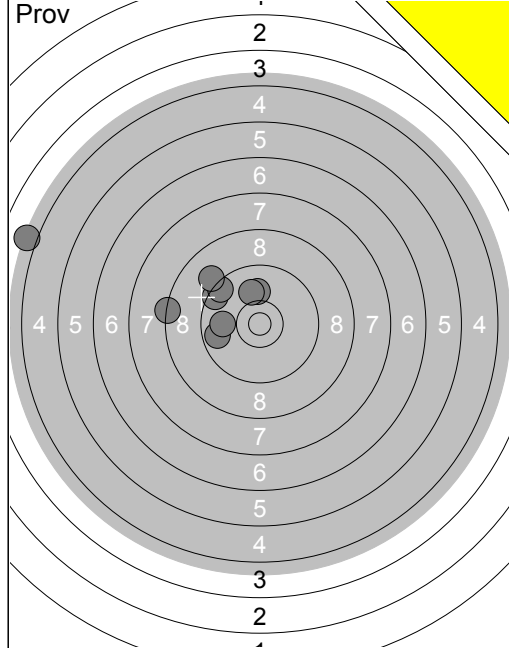

1:	4.0	←
2:	8.3	←
3:	9.5	↖
4:	9.7	←
5:	9.5	↖
6:	9.9	←
7:	10.0	↑
8:	9.1	↖
9:	10.0	↑
Serie		77.0
Total		0.0

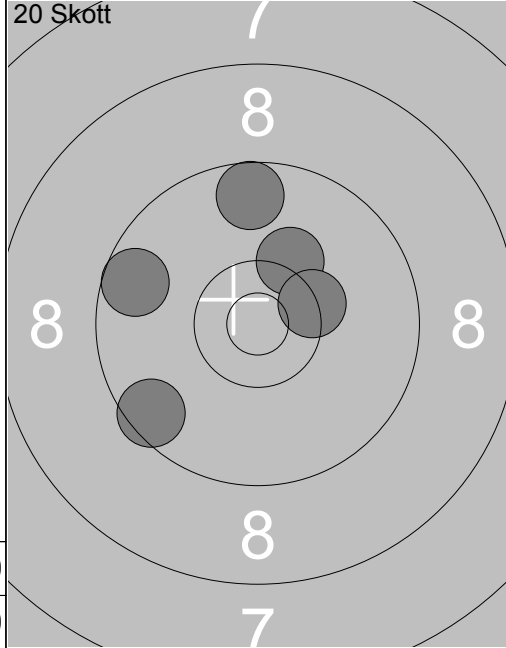

1:	9.6	←
2:	9.5	↙
3:	10.2	↗
4:	9.6	↑
5:	10.4x	↗
Serie		47.0
Total		47.0

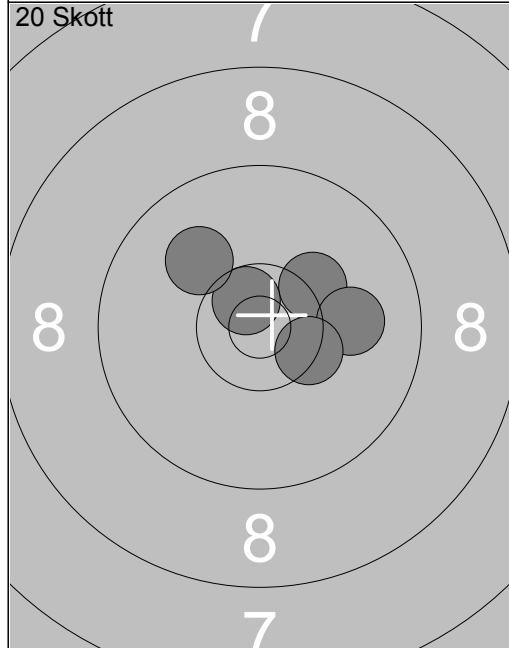

6:	10.3	↗
7:	10.0	→
8:	10.4x	↗
9:	10.7x	↗
10:	10.0	↖
Serie		50.0
Total		97.0

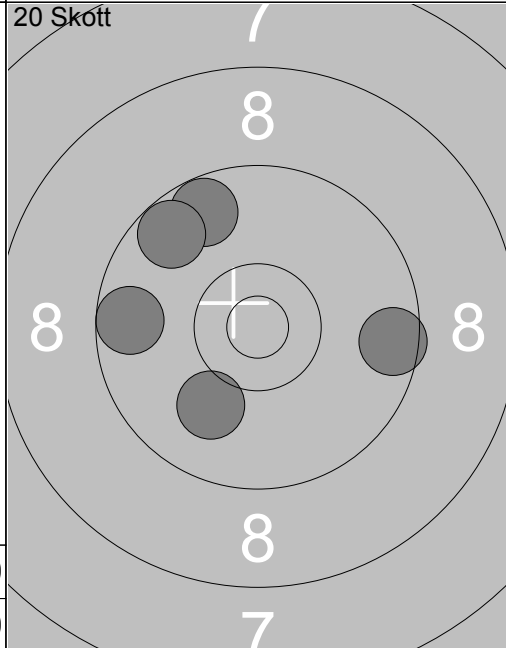

11:	9.7	↖
12:	9.7	↖
13:	9.6	←
14:	10.0	↙
15:	9.6	→
Serie		46.0
Total		143.0

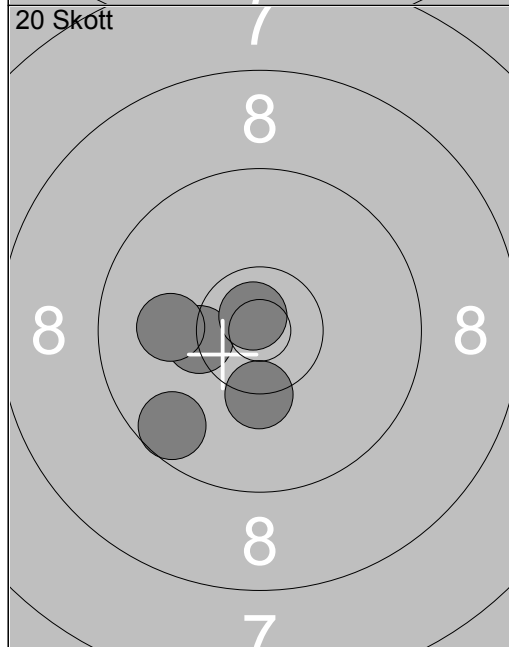

16:	10.3x	←
17:	10.3x	↓
18:	10.8x	↖
19:	9.6	↙
20:	10.0	←
Serie		49.0
Total		192.0

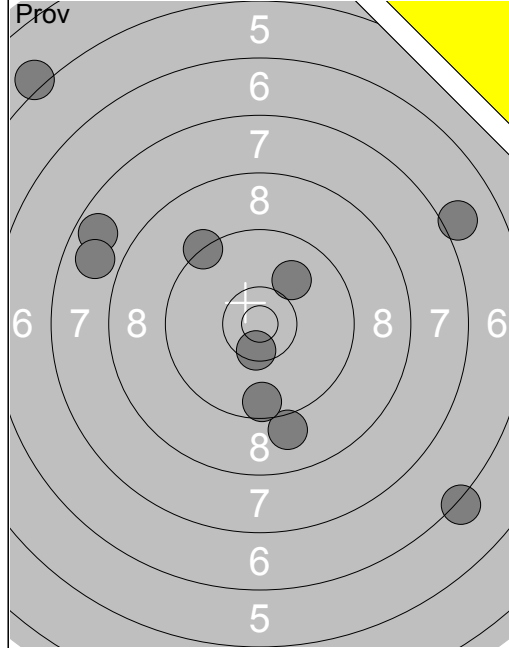

1:	5.1 ↖
2:	7.0 ↗
3:	10.0 ↗
4:	6.2 ↘
5:	7.7 ↖
6:	9.0 ↓
7:	7.8 ↖
8:	9.6 ↓
9:	9.3 ↖
10:	10.5x↓
Serie	79.0
Total	0.0

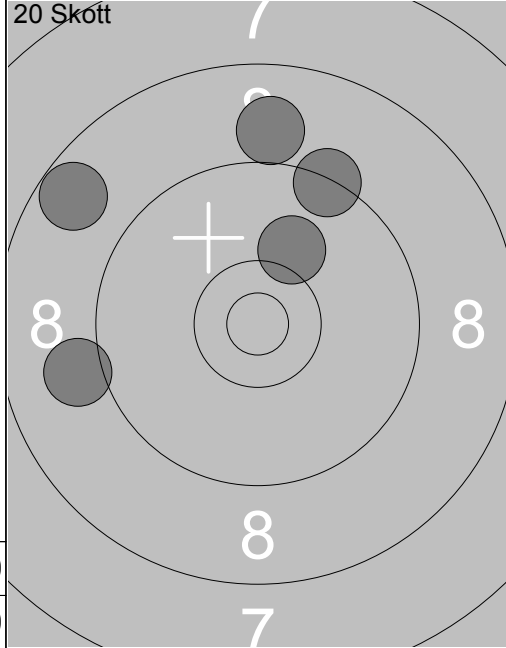

1:	9.0 ↑
2:	10.1 ↗
3:	9.3 ↗
4:	8.7 ↖
5:	9.0 ←
Serie	45.0
Total	45.0

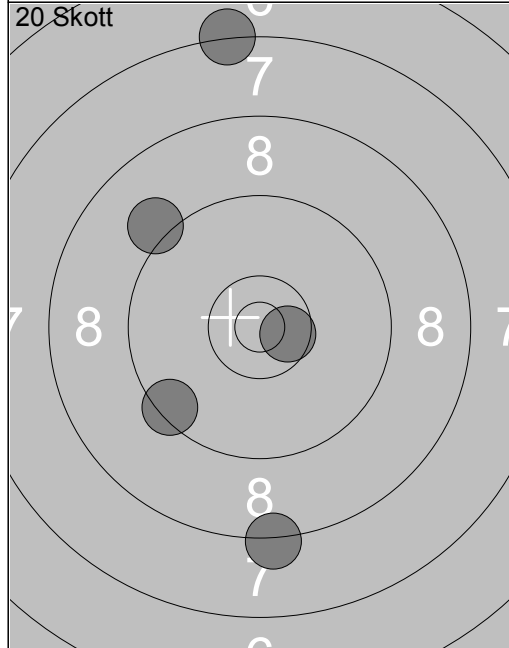

6:	9.4 ↖
7:	8.3 ↓
8:	9.1 ↖
9:	7.3 ↑
10:	10.6x➤
Serie	43.0
Total	88.0

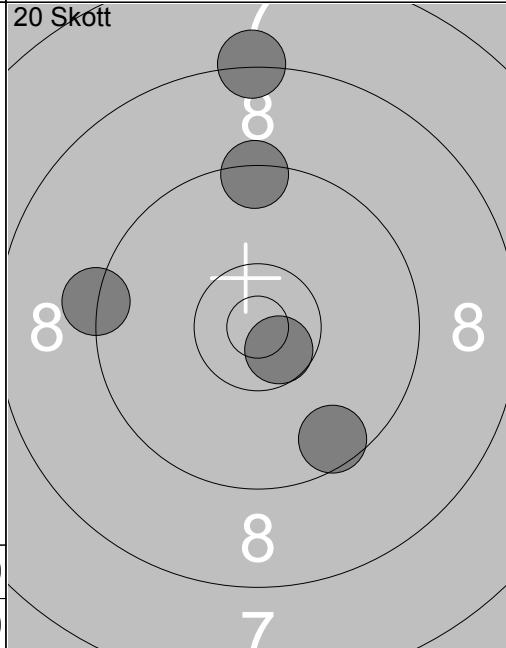

11:	8.3 ↑
12:	10.6x↘
13:	9.3 ←
14:	9.4 ↑
15:	9.6 ↘
Serie	45.0
Total	133.0

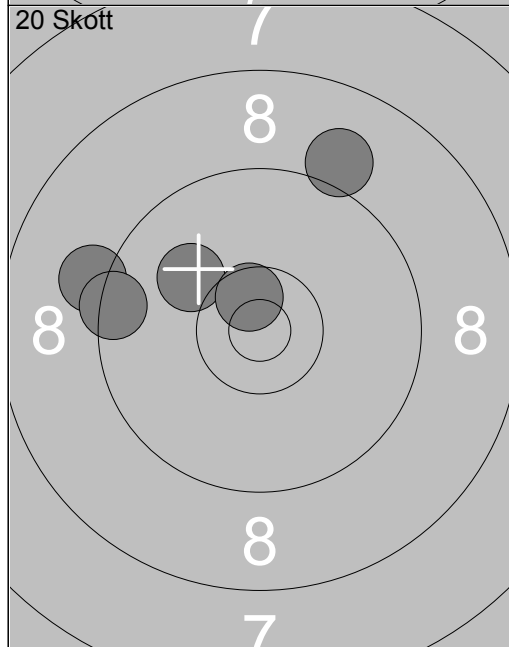

16:	9.2 ↖
17:	10.1 ↖
18:	9.4 ←
19:	10.6x↗
20:	9.1 ↗
Serie	47.0
Total	180.0

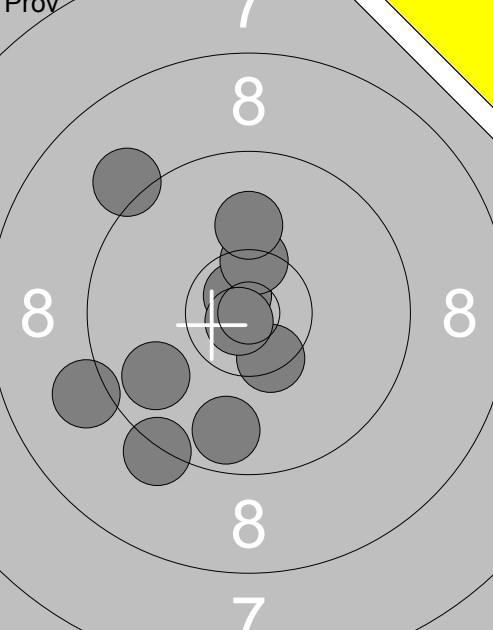
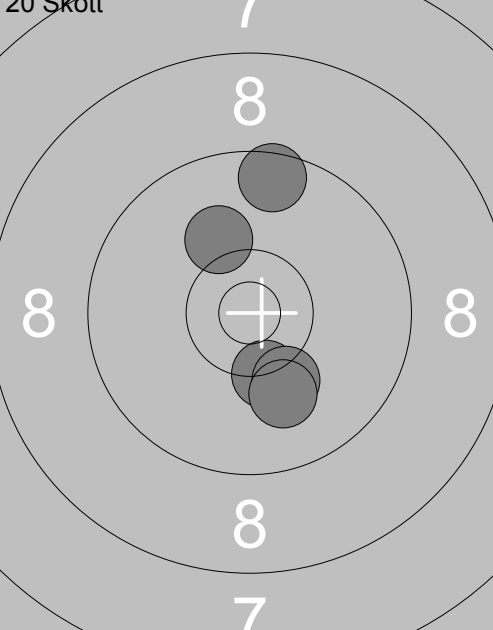
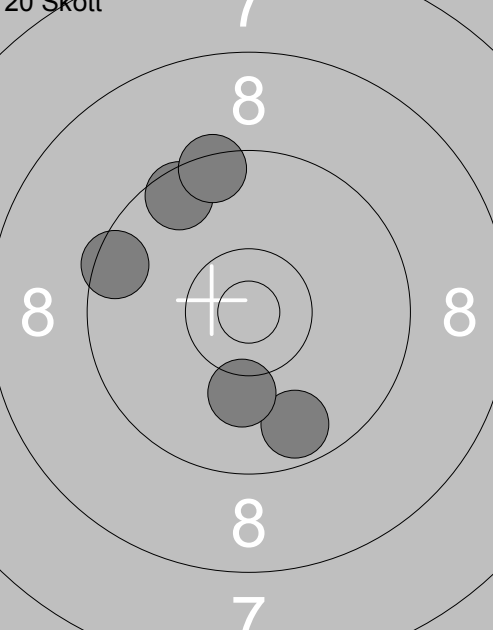
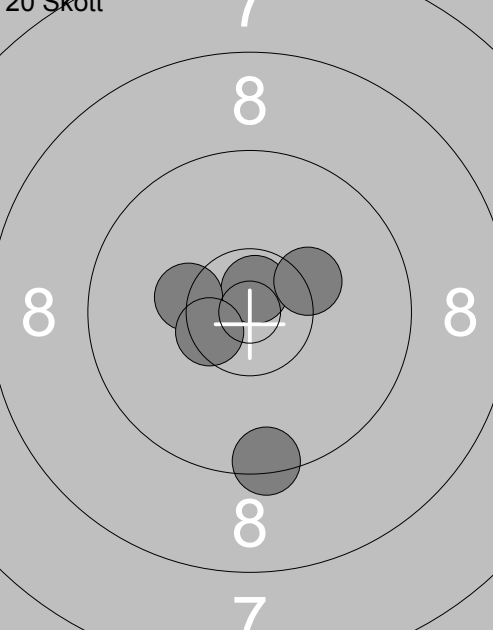
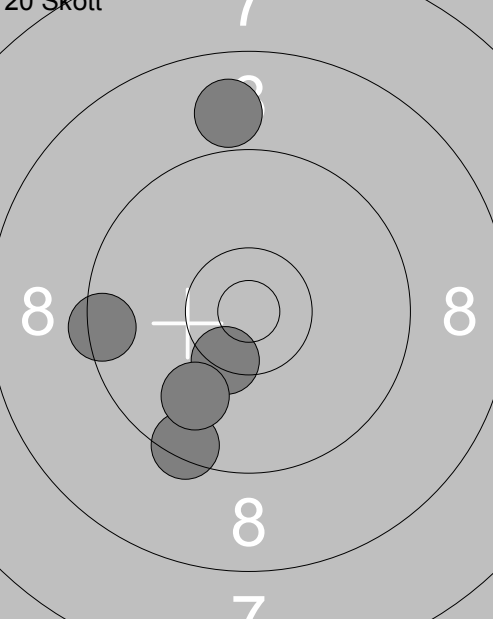
<div style="font-size: 0.8em; margin-bottom: 5px;">Prov</div> 	<div style="font-size: 0.8em; margin-bottom: 5px;">20 Skott</div> 	
1: 9.7 ↓ 2: 9.3 ↓ 3: 10.4x↓ 4: 9.1 ← 5: 10.7x↘ 6: 10.4x↑ 7: 9.8 ← 8: 10.8x↘ 9: 9.1 ↖ 10: 10.1 ↑	1: 10.3x↓ 2: 10.1 ↑ 3: 10.2 ↓ 4: 10.1 ↓ 5: 9.5 ↑	
Serie 95.0	Serie 49.0	
Total 0.0	Total 49.0	
<div style="font-size: 0.8em; margin-bottom: 5px;">20 Skott</div> 	<div style="font-size: 0.8em; margin-bottom: 5px;">20 Skott</div> 	
6: 9.5 ← 7: 9.6 ↗ 8: 9.4 ↑ 9: 9.7 ↓ 10: 10.1 ↓	11: 10.7x↑ 12: 10.3x↘ 13: 10.5x↘ 14: 9.4 ↓ 15: 10.3 ↗	
Serie 46.0	Serie 49.0	
Total 95.0	Total 144.0	
<div style="font-size: 0.8em; margin-bottom: 5px;">20 Skott</div> 		
16: 10.4x↓ 17: 9.4 ↓ 18: 8.9 ↑ 19: 9.9 ↓ 20: 9.4 ←		
Serie 45.0		
Total 189.0		

	<p>20 Skott</p> <p>1: 10.2 ↗</p> <p>2: 10.1 ↗</p> <p>3: 9.9 →</p> <p>4: 9.6 ←</p> <p>5: 8.5 ↘</p> <p>6: 10.7x ↘</p> <p>7: 10.4x ←</p> <p>8: 10.4x ↗</p> <p>9: 9.2 ↗</p> <p>10: 9.8 ↗</p>		<p>20 Skott</p> <p>1: 10.1 ↘</p> <p>2: 9.5 →</p> <p>3: 9.9 ↗</p> <p>4: 8.7 ↗</p> <p>5: 10.5x ←</p>
Serie 94.0	Serie 46.0	Serie 46.0	Serie 46.0
Total 0.0	Total 46.0	Total 46.0	Total 46.0

	<p>20 Skott</p> <p>6: 9.6 ↖</p> <p>7: 10.6x ↗</p> <p>8: 8.6 ↗</p> <p>9: 8.9 ←</p> <p>10: 8.7 ↗</p>		<p>20 Skott</p> <p>11: 5.1 ←</p> <p>12: 9.8 →</p> <p>13: 6.2 ←</p> <p>14: 7.7 ←</p> <p>15: 7.2 ↖</p>
Serie 43.0	Serie 34.0	Serie 34.0	Serie 34.0
Total 89.0	Total 123.0	Total 123.0	Total 123.0

	<p>20 Skott</p> <p>16: 9.4 ↖</p> <p>17: 7.1 ←</p> <p>18: 8.0 ↖</p> <p>19: 7.9 ←</p> <p>20: 9.9 ↗</p>		
Serie 40.0	Serie 40.0		
Total 163.0	Total 163.0		

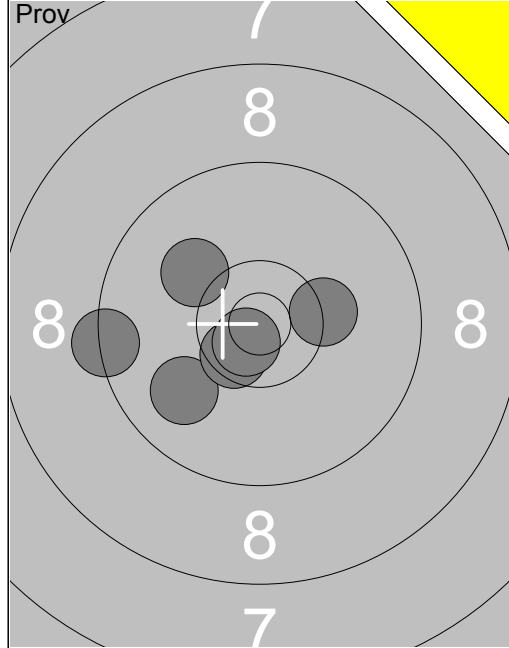

1:	10.1 ↖
2:	9.9 ↙
3:	10.5x ↘
4:	10.3x →
5:	10.7x ↘
6:	9.4 ←
Serie 58.0	
Total 0.0	

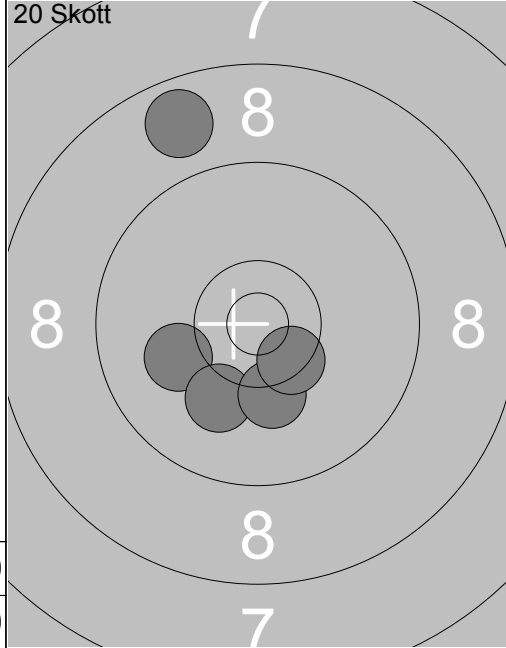

1:	10.1 ↖
2:	10.1 ↘
3:	10.2 ↘
4:	8.8 ↗
5:	10.5x ↘
Serie 48.0	
Total 48.0	

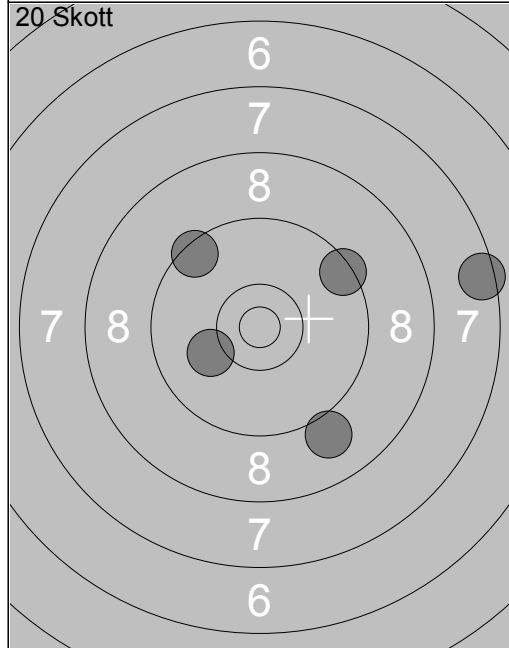

6:	9.4 ↗
7:	9.0 ↘
8:	10.1 ↖
9:	7.5 →
10:	9.5 ↖
Serie 44.0	
Total 92.0	

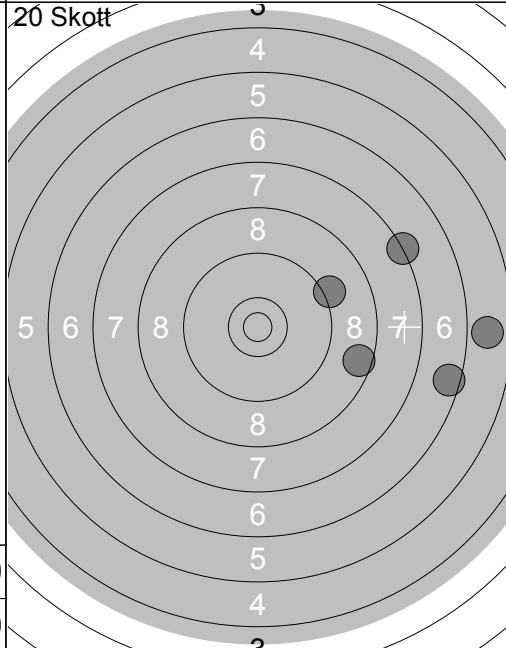

11:	7.3 ↗
12:	6.5 →
13:	9.2 ↗
14:	5.9 →
15:	8.6 →
Serie 35.0	
Total 127.0	

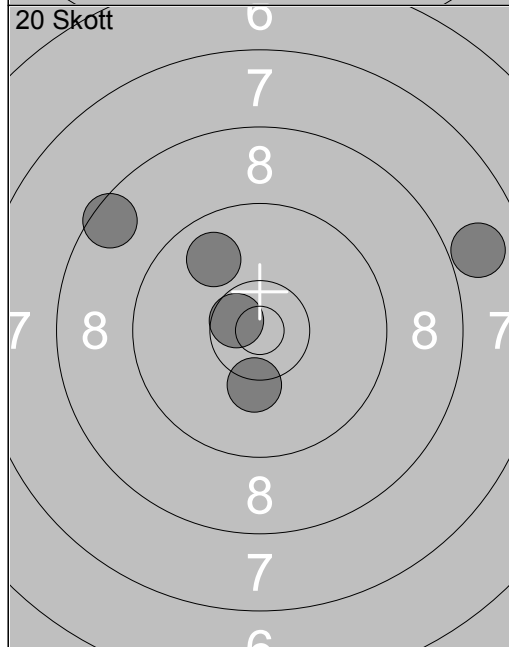

16:	7.9 →
17:	8.5 ↖
18:	10.2 ↘
19:	9.8 ↖
20:	10.6x ↘
Serie 44.0	
Total 171.0	

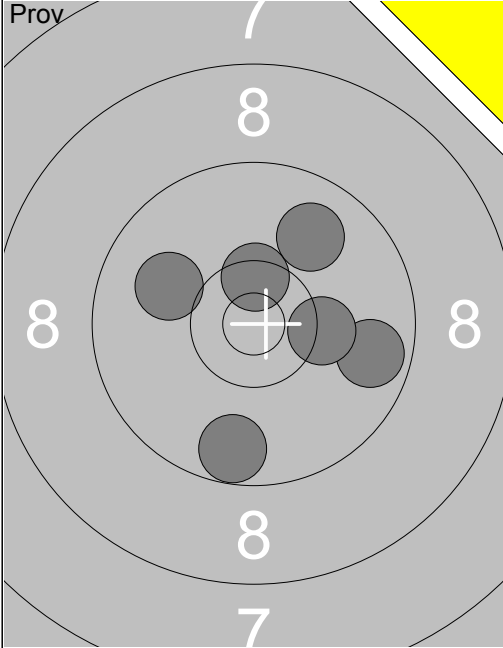
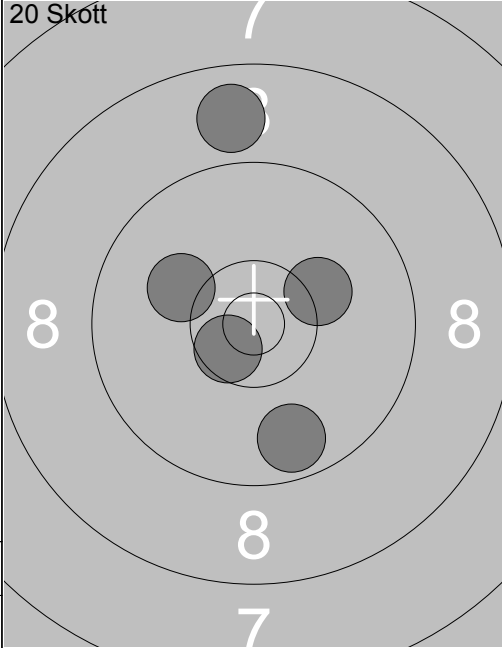
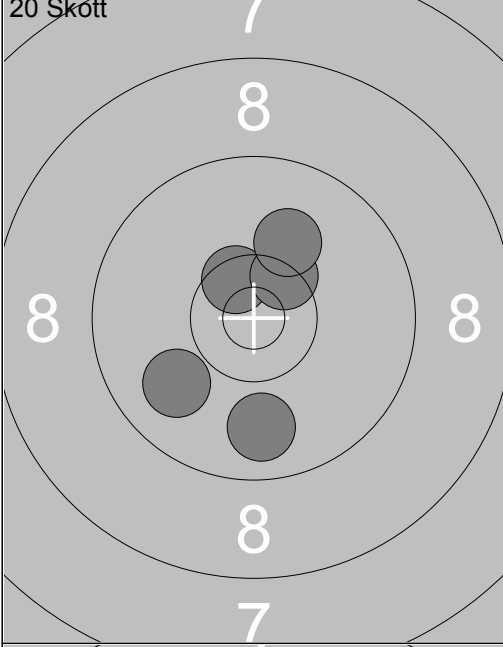
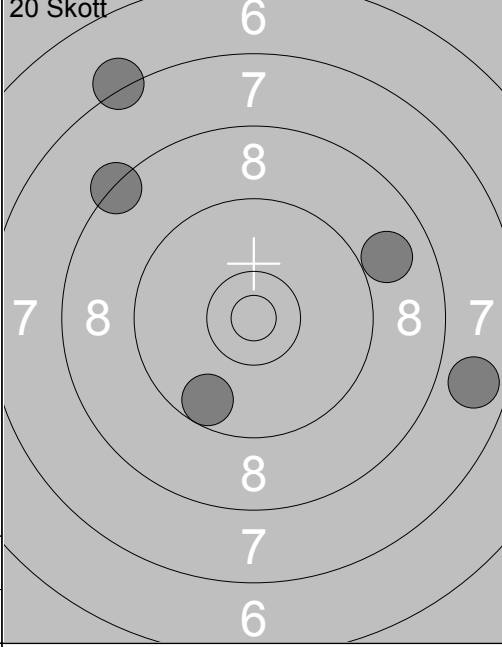
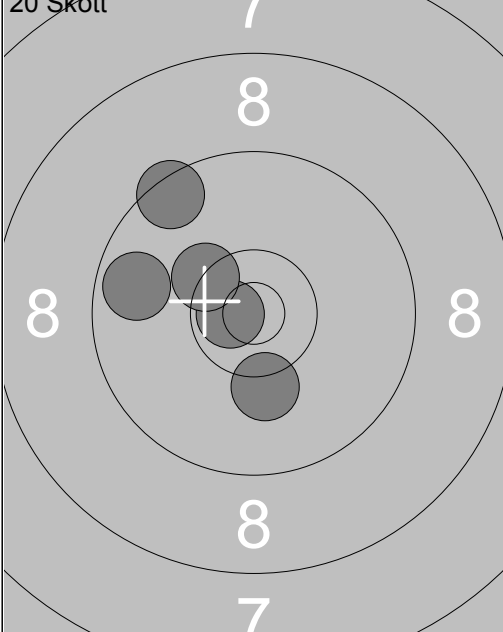
Skjuttag	Tavla	Lars Möllsten			
3	3	Vindeln	Umeå	Sen-S	Vb
29.04.2017		Vindelnskottet 2017		Ramselefors SKF	
Prov		1: 9.9 ↗	20 Skott		1: 8.8 ↑
		2: 10.0 ↙			2: 10.1 ↙
		3: 9.7 ↓			3: 10.2 ↗
		4: 10.5x↑			4: 10.6x↘
		5: 9.7 →			5: 9.7 ↓
		6: 10.3 →			
		Serie 57.0			Serie 47.0
		Total 0.0			Total 47.0
20 Skott		6: 9.8 ↓	20 Skott		11: 7.2 ↖
		7: 10.5x↘			12: 7.8 →
		8: 9.9 ↙			13: 8.9 ↗
		9: 10.4x↗			14: 9.7 ↓
		10: 10.1 ↗			15: 8.3 ↖
		Serie 48.0			Serie 39.0
		Total 95.0			Total 134.0
20 Skott		16: 9.7 ↙			
		17: 10.2 ↓			
		18: 9.5 ↖			
		19: 10.7x↙			
		20: 10.3x↙			
		Serie 48.0			
		Total 182.0			

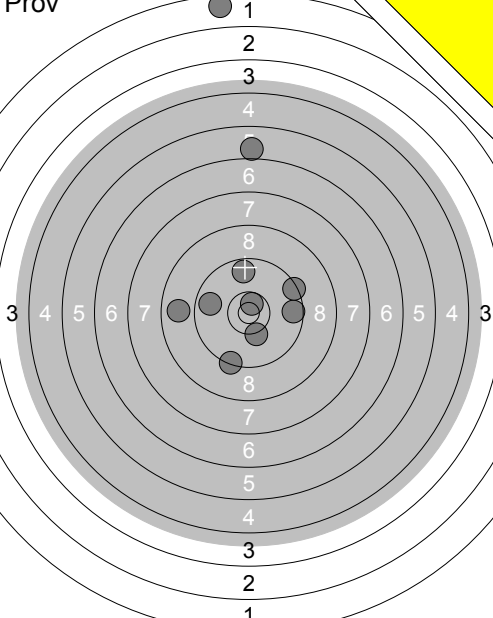
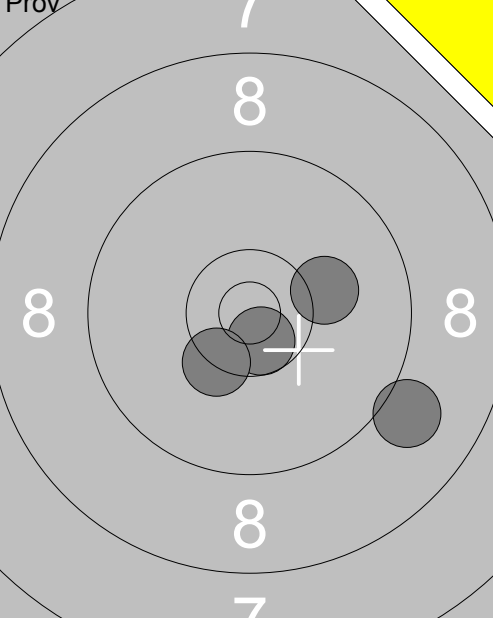
	<p>Prov</p> <p>1: 1.6 ↑</p> <p>2: 6.0 ↑</p> <p>3: 9.6 →</p> <p>4: 9.4 ↗</p> <p>5: 9.7 ↑</p> <p>6: 10.7x ↗</p> <p>7: 9.8 ←</p> <p>8: 9.3 ↓</p> <p>9: 8.8 ←</p> <p>10: 10.3 ↓</p>			<p>11: 9.0 ↘</p> <p>12: 10.6x ↘</p> <p>13: 10.3x ↘</p> <p>14: 10.2 →</p>
Serie 80.0		Serie 39.0		
Total 0.0		Total 0.0		

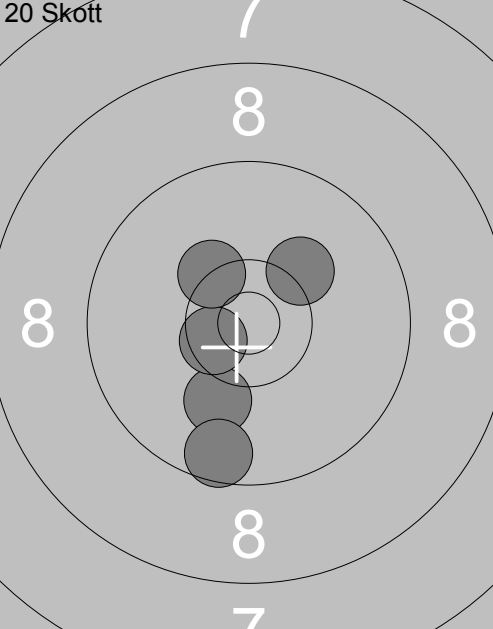
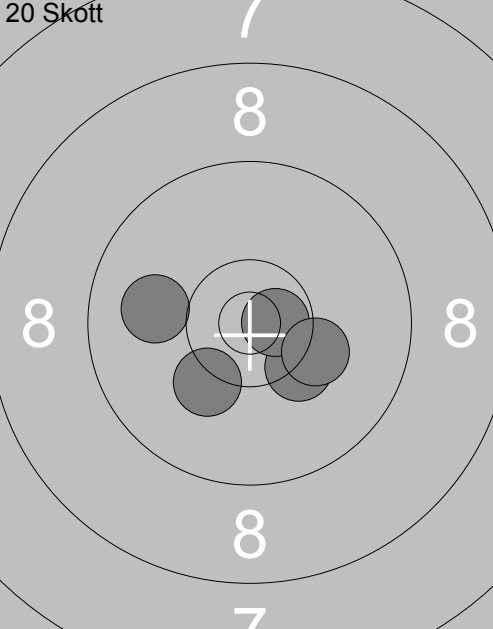
<p>20 Skott</p> 	<p>1: 10.1 ↓</p> <p>2: 10.5x ↘</p> <p>3: 9.6 ↓</p> <p>4: 10.2 ↗</p> <p>5: 10.3x ↘</p>	<p>20 Skott</p> 		<p>6: 10.0 ←</p> <p>7: 10.3 ↘</p> <p>8: 10.7x →</p> <p>9: 10.2 ↓</p> <p>10: 10.2 →</p>
Serie 49.0		Serie 50.0		
Total 49.0		Total 99.0		

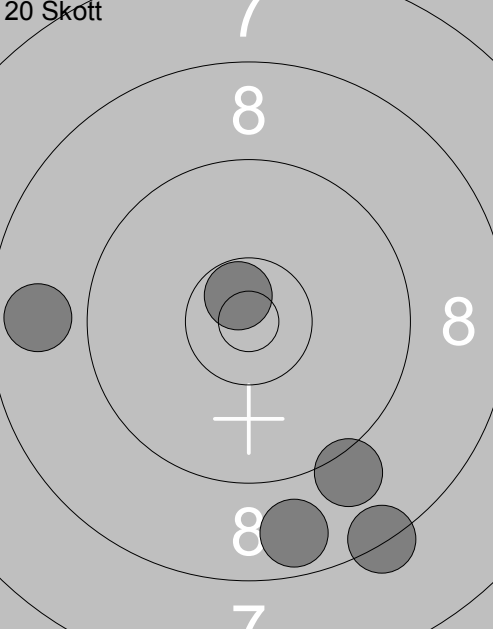
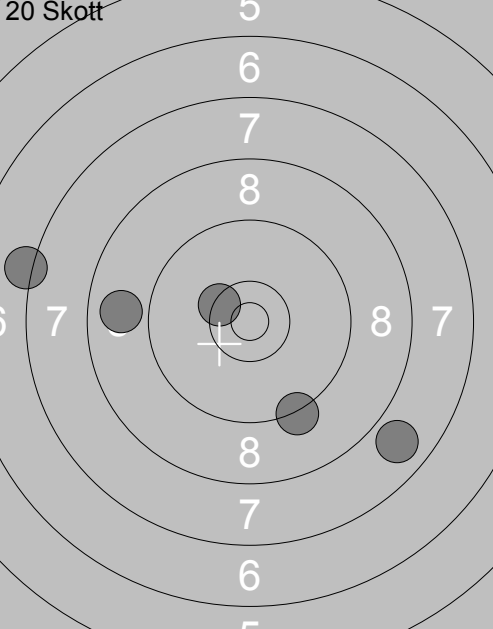
<p>20 Skott</p> 	<p>11: 9.1 ↓</p> <p>12: 10.7x ↗</p> <p>13: 8.7 ↓</p> <p>14: 8.8 ←</p> <p>15: 8.3 ↓</p>	<p>20 Skott</p> 		<p>16: 9.3 ↓</p> <p>17: 7.8 ↘</p> <p>18: 10.4x ↘</p> <p>19: 7.2 ←</p> <p>20: 8.8 ←</p>
Serie 43.0		Serie 41.0		
Total 142.0		Total 183.0		

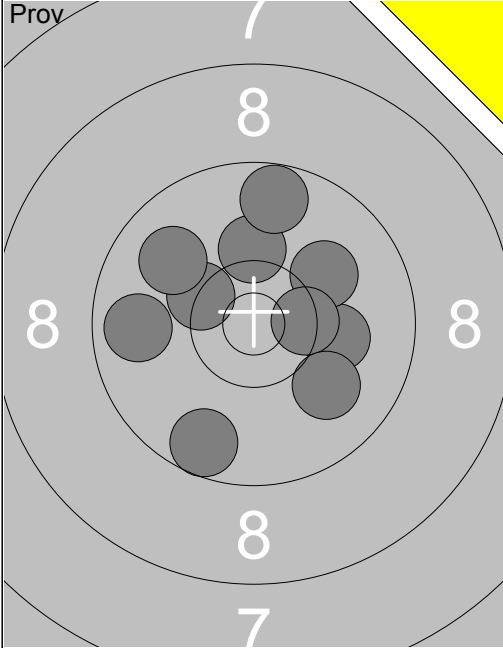
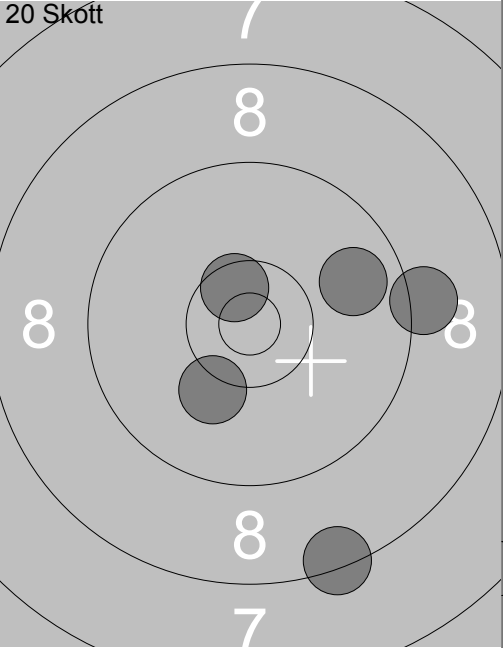
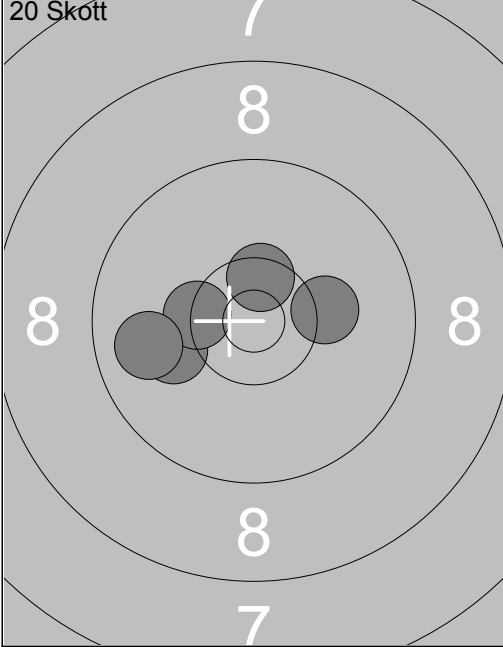
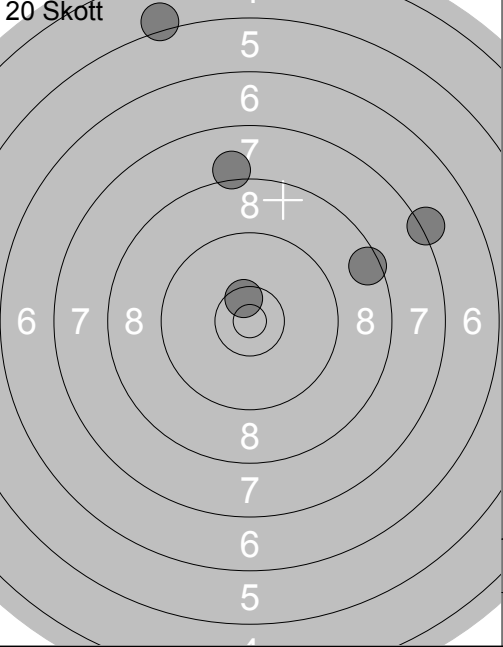
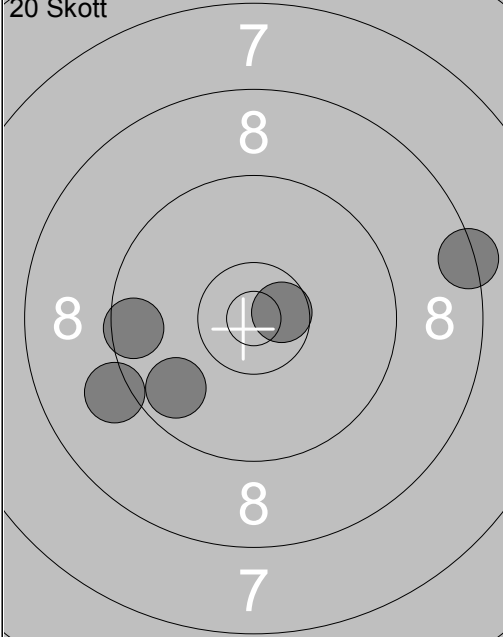
Skjuttag	Tavla	Marie Wingård			
3	5	Vindeln	Ramselefors	Sen-S	Vb
29.04.2017	Vindelnskottet 2017	Ramselefors SKF			
Prov		1: 10.1 → 2: 9.6 ↓ 3: 10.1 ↗ 4: 10.4x → 5: 10.3x ↘ 6: 10.0 ↘ 7: 10.2 ↑ 8: 9.8 ← 9: 9.7 ↑ 10: 9.9 ↖	20 Skott		1: 10.2 ↙ 2: 8.4 ↓ 3: 9.2 → 4: 9.8 ↗ 5: 10.5x ↘
		Serie 96.0		Serie 46.0	
		Total 0.0		Total 46.0	
20 Skott		6: 10.1 ← 7: 10.4x ↘ 8: 10.5x ↗ 9: 9.9 ← 10: 10.2 →	20 Skott		11: 7.2 ↗ 12: 5.1 ↑ 13: 8.1 ↑ 14: 10.5x ↘ 15: 8.5 ↗
		Serie 49.0		Serie 38.0	
		Total 95.0		Total 133.0	
20 Skott		16: 8.4 → 17: 9.6 ← 18: 10.6x → 19: 9.1 ← 20: 9.7 ↙			
		Serie 45.0			
		Total 178.0			

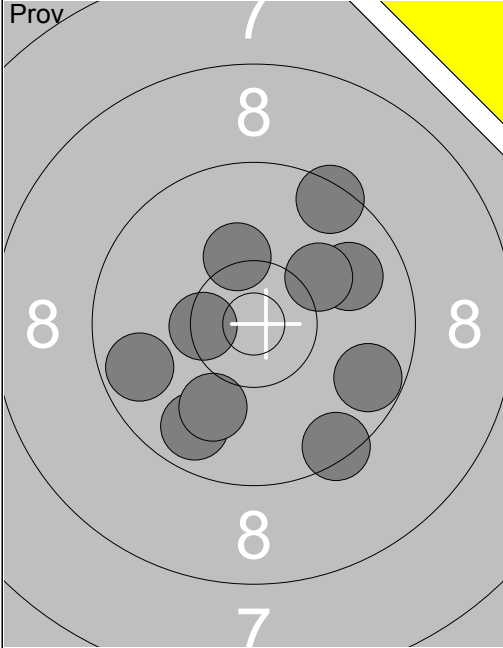
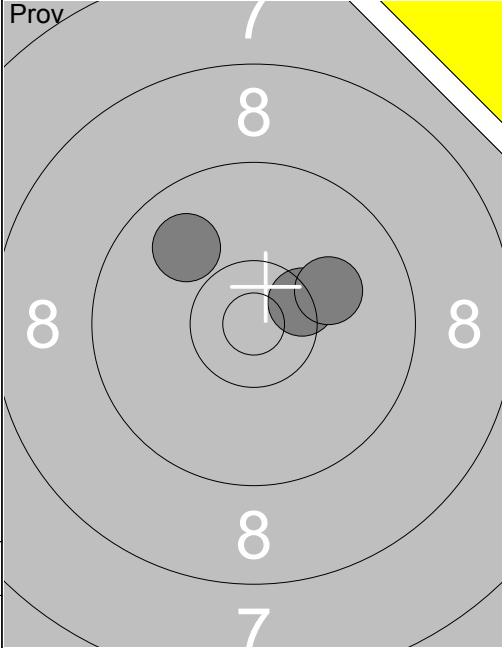
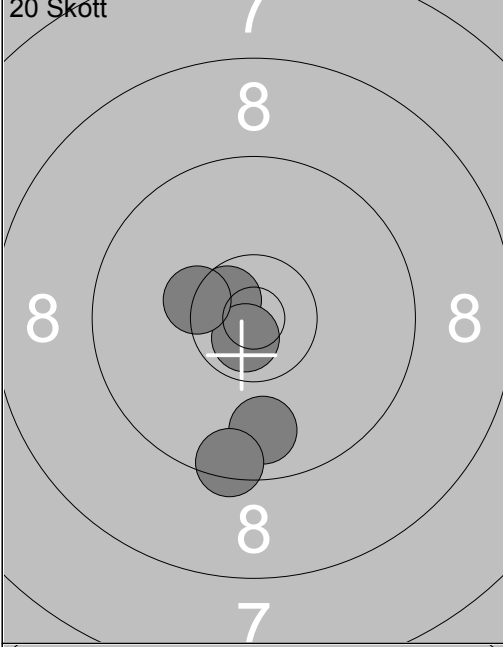
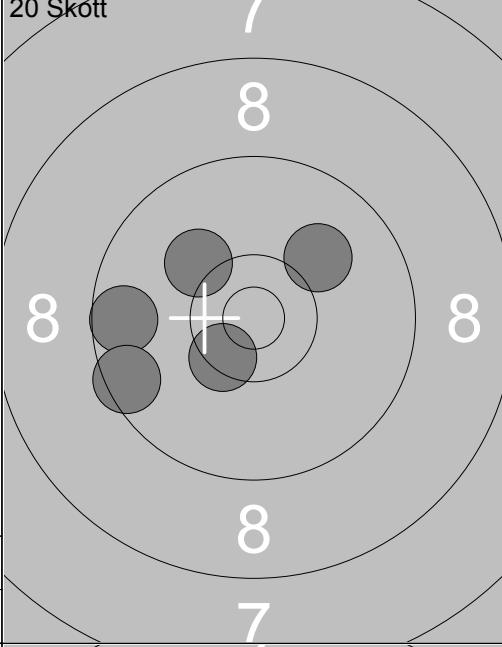
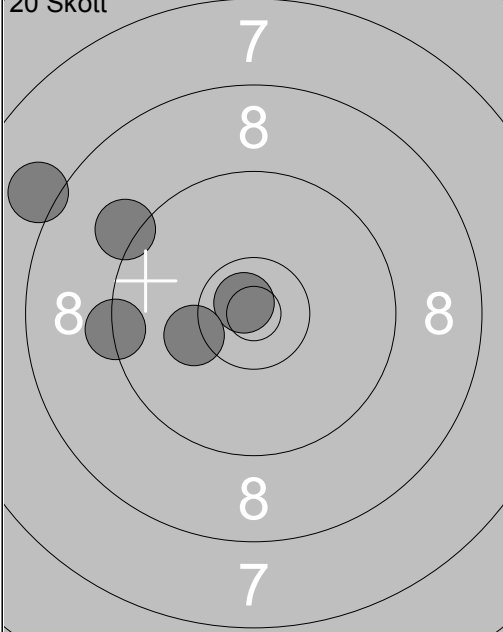
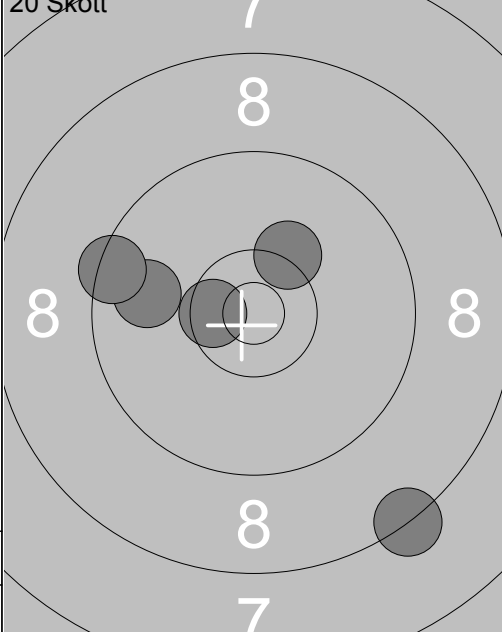
Skjuttag	Tavla	Marlene Forsell Forsman				
3	6	Vindeln		Ramselefors	Sen-S	Vb
29.04.2017		Vindelnskottet 2017		Ramselefors SKF		
Prov 	1: 9.7 ↘	Prov 	11: 10.4x↗			
	2: 9.7 ←		12: 10.1 ↗			
	3: 9.4 ↘		13: 9.9 ↖			
	4: 10.4x←					
	5: 9.7 ↘					
	6: 10.0 ↘					
	7: 9.5 ↗					
	8: 10.2 ↑					
	9: 9.9 ↗					
	10: 10.1 ↗					
	Serie 94.0		Serie 29.0			
	Total 0.0		Total 0.0			
20 Skott 	1: 10.6x↘	20 Skott 	6: 9.6 ←			
	2: 10.7x↘		7: 10.4x↘			
	3: 10.3x↘		8: 10.2 ↖			
	4: 9.8 ↓		9: 10.1 ↗			
	5: 9.5 ↓		10: 9.5 ←			
	Serie 48.0		Serie 48.0			
	Total 48.0		Total 96.0			
20 Skott 	11: 10.8x↘	20 Skott 	16: 8.3 ↘			
	12: 8.1 ↖		17: 10.5x←			
	13: 10.2←		18: 10.3 ↗			
	14: 9.3 ←		19: 9.8 ←			
	15: 9.2 ↖		20: 9.4 ←			
	Serie 46.0		Serie 46.0			
	Total 142.0		Total 188.0			

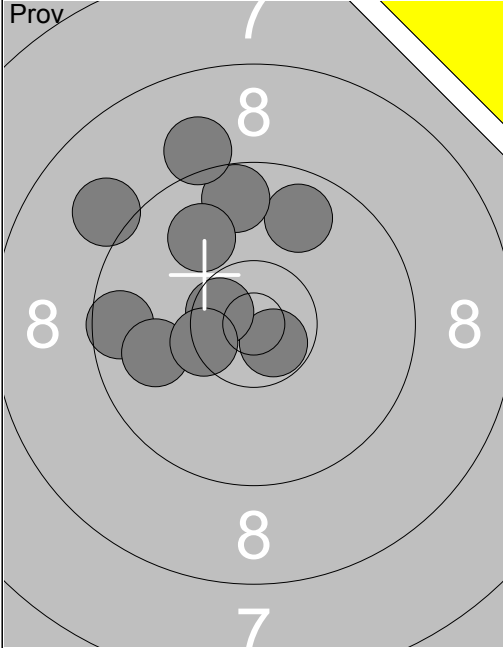
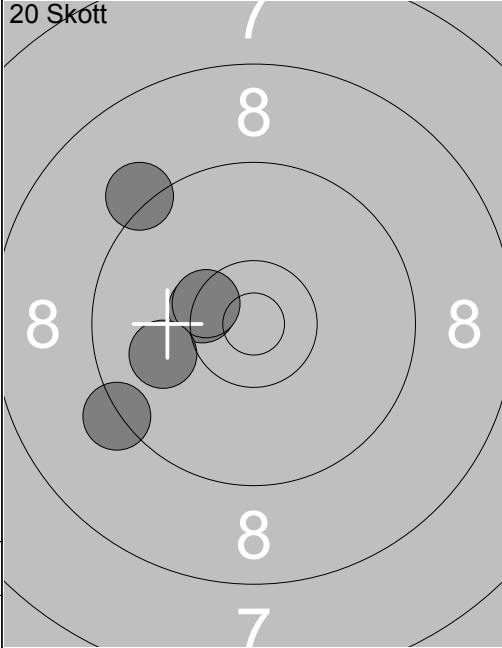
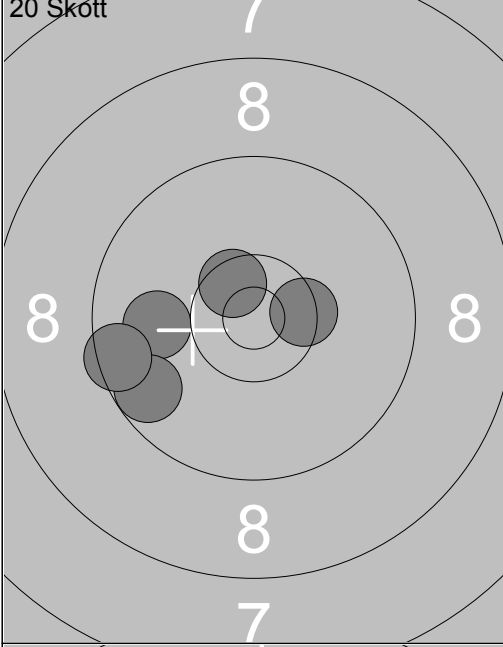
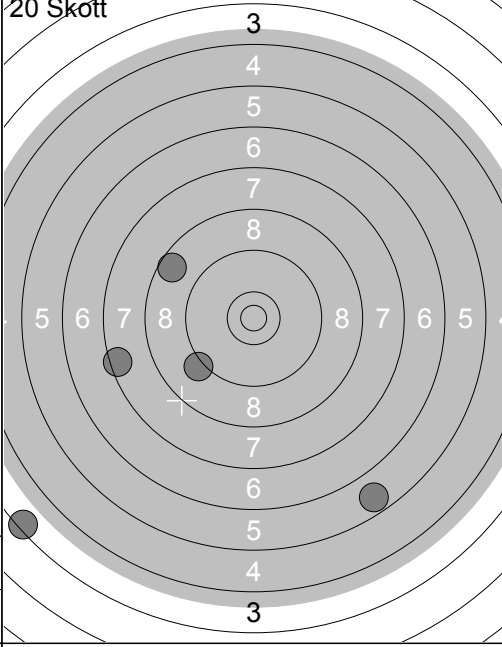
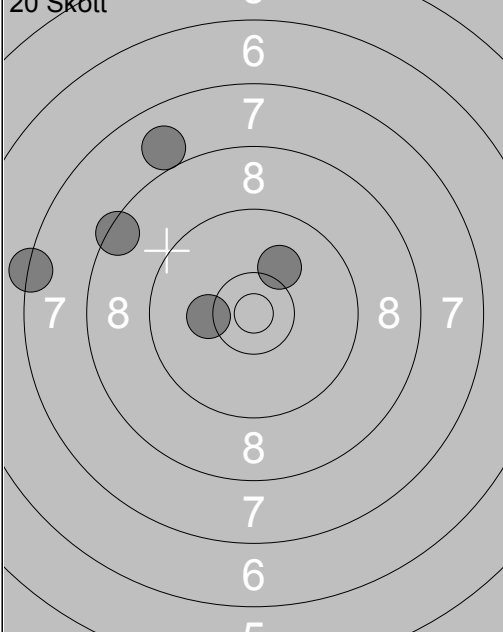
Skjuttag	Tavla	Stefan Thorin			
3	8	Vindeln	Umeå	Sen-S	Vb
29.04.2017		Vindelnskottet 2017		Ramselefors SKF	
Prov		1: 9.8 ↗ 2: 9.6 ← 3: 9.7 ↑ 4: 9.9 ← 5: 10.7x↘ 6: 10.6x↘ 7: 10.4x↘ 8: 9.9 ↗ 9: 9.1 ↑ 10: 9.1 ↘	20 Skott		1: 9.3 ↙ 2: 10.4x↘ 3: 9.2 ↗ 4: 10.4x↘ 5: 10.0 ←
		Serie 93.0		Serie 48.0	
		Total 0.0		Total 48.0	
20 Skott		6: 10.0 ← 7: 9.7 ↙ 8: 9.5 ← 9: 10.4x→ 10: 10.5x↘	20 Skott		11: 5.7 ↘ 12: 9.2 ↙ 13: 3.4 ↙ 14: 8.6 ↗ 15: 7.5 ←
		Serie 48.0		Serie 32.0	
		Total 96.0		Total 128.0	
20 Skott		16: 10.2 ← 17: 8.4 ↗ 18: 10.1 ↗ 19: 8.0 ↗ 20: 7.3 ←			
		Serie 43.0			
		Total 171.0			

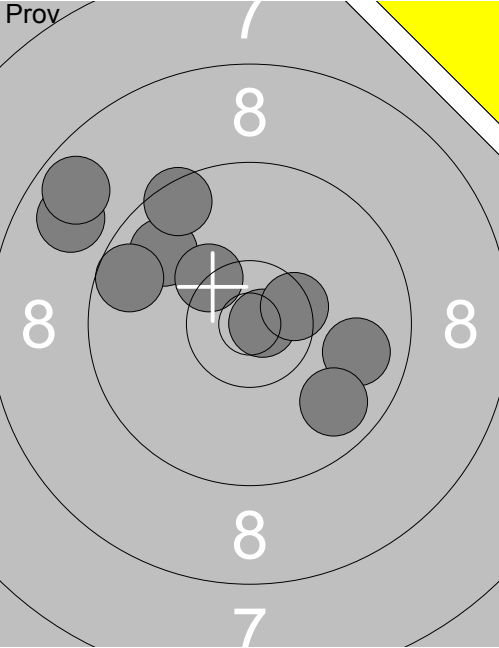
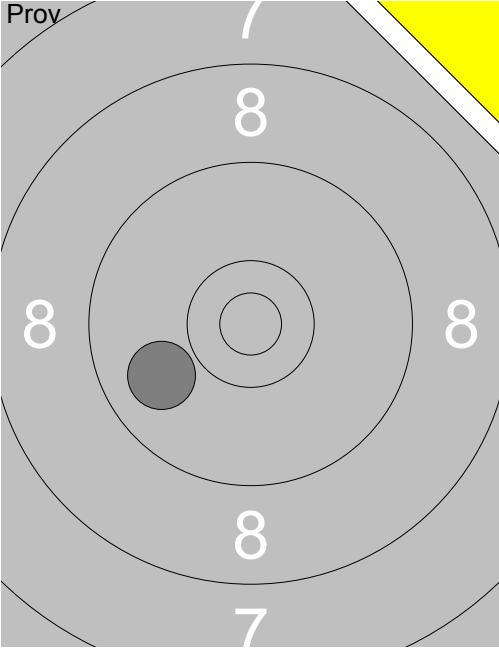
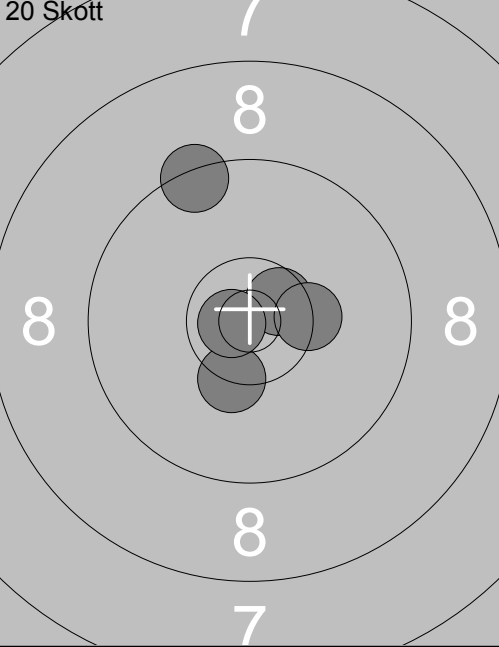
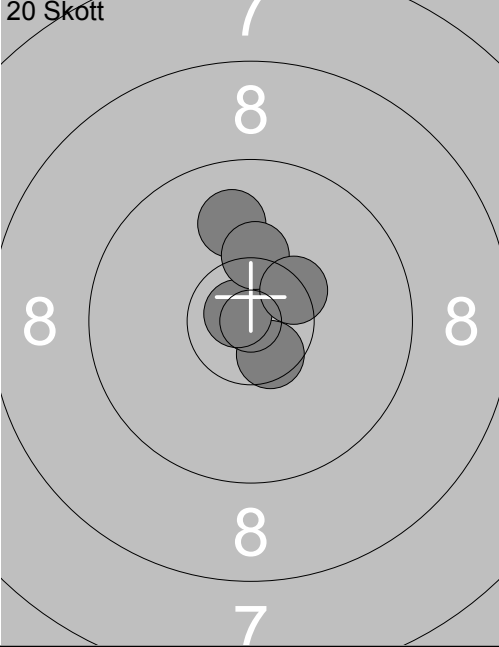
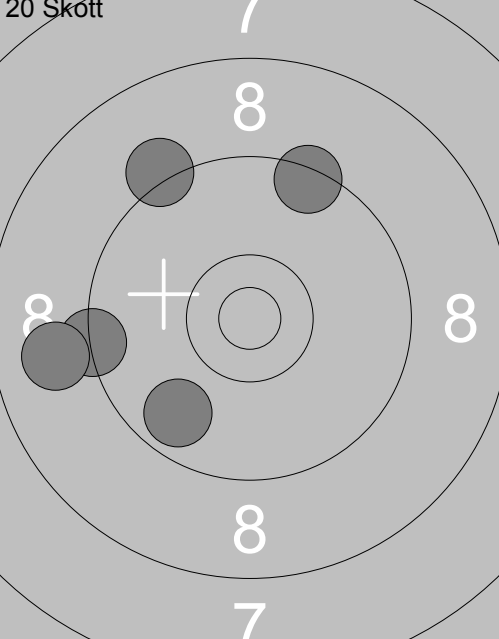
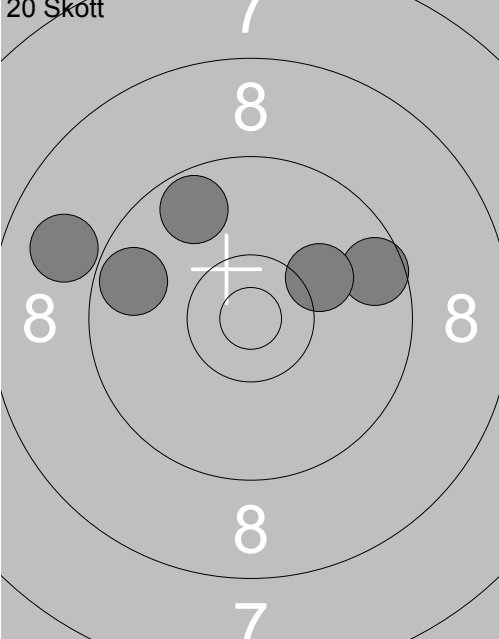
Skjuttag	Tavla	Casper Fredriksson			
3	9	Vindeln	Ramselefors	Jun-S	Vb
29.04.2017	Vindelnskottet 2017	Ramselefors SKF			
Prov		1: 9.8 ↖ 2: 8.8 ↖ 3: 9.8 → 4: 10.3x↗ 5: 8.7 ↖ 6: 9.5 ↖ 7: 10.8x→ 8: 9.6 ↖ 9: 10.5x→ 10: 9.8 ↘	Prov		11: 9.9 ↙
		Serie 91.0		Serie 9.0	
		Total 0.0		Total 0.0	
20 Skott		1: 9.4 ↖ 2: 10.3x↘ 3: 10.6x↗ 4: 10.4x→ 5: 10.8x←	20 Skott		6: 10.6x↘ 7: 10.8x↗ 8: 9.9 ↖ 9: 10.3 ↖ 10: 10.4x↗
		Serie 49.0		Serie 49.0	
		Total 49.0		Total 98.0	
20 Skott		11: 9.7 ↘ 12: 9.2 ↖ 13: 9.3 ← 14: 9.4 ↖ 15: 8.9 ←	20 Skott		16: 9.7 ↖ 17: 9.6 → 18: 10.1 ↗ 19: 8.9 ↖ 20: 9.7 ↖
		Serie 44.0		Serie 45.0	
		Total 142.0		Total 187.0	

Skjuttag	Tavla	Emma Eriksson				
3	10	Vindeln		Ramselefors	Jun-S	Vb
29.04.2017		Vindelnskottet 2017		Ramselefors SKF		
Prov		1: 7.5 ↘		11: 9.5 →		
		2: 5.9 ↘		12: 9.7 ↙		
		3: 9.1 →				
		4: 7.6 ↘				
		5: 8.2 ↘				
		6: 10.0 ↘				
		7: 10.0 ↘				
		8: 10.3x ↗				
		9: 9.5 →				
		10: 6.5 ↗				
		Serie 81.0		Serie 18.0		
		Total 0.0		Total 0.0		
20 Skott		1: 9.3 ↘		6: 9.8 →		
		2: 8.5 ↗		7: 8.9 ↓		
		3: 10.0 ↗		8: 10.3 ↖		
		4: 9.3 ↗		9: 9.6 ↖		
		5: 9.3 →		10: 9.0 ↗		
		Serie 45.0		Serie 45.0		
		Total 45.0		Total 90.0		
20 Skott		11: 8.9 ↖		16: 9.5 ↓		
		12: 8.9 ↘		17: 9.5 ←		
		13: 6.0 ↖		18: 7.6 ↖		
		14: 9.1 ↖		19: 9.7 ←		
		15: 8.0 ↖		20: 9.7 →		
		Serie 39.0		Serie 43.0		
		Total 129.0		Total 172.0		

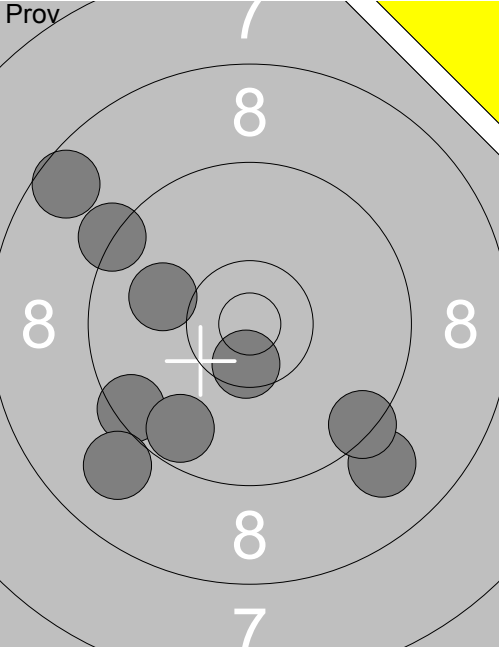
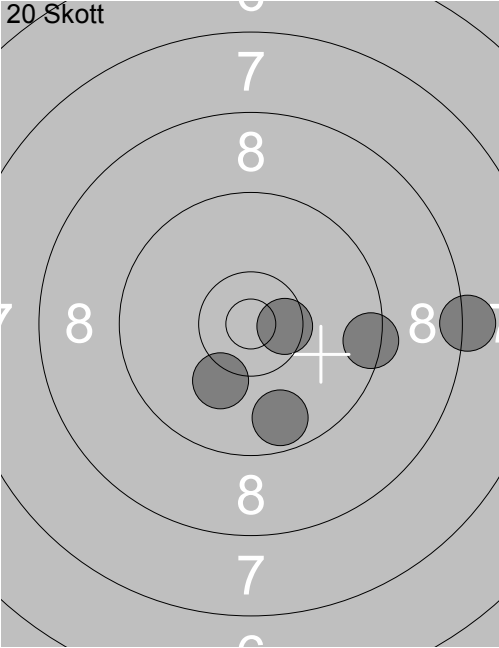
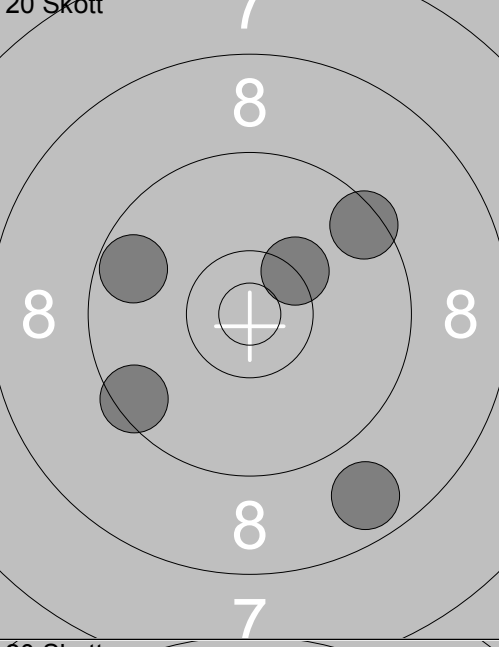
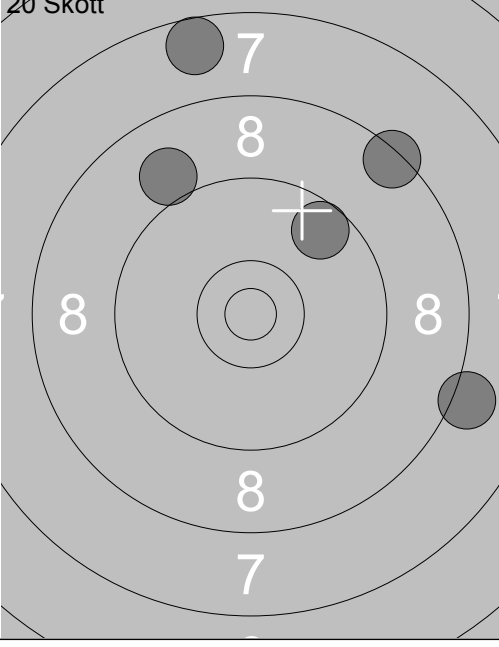
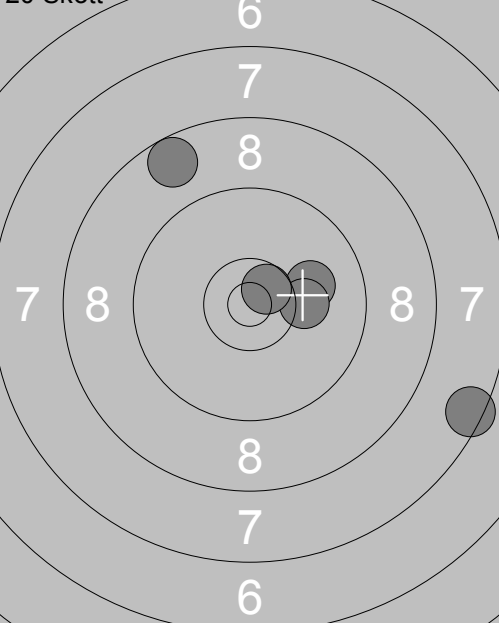
Skjuttag	Tavla	Emma Johansson			
3	11	Vindeln	Ramselefors	Jun-S	Vb
29.04.2017	Vindelnskottet 2017	Ramselefors SKF			
Prov		1: 9.5 ↙ 2: 9.7 ↙ 3: 10.5x↓ 4: 9.0 ↘ 5: 9.4 ↘	20 Skott		1: 10.2 ↘ 2: 9.7 ↘ 3: 8.2 → 4: 10.5x→ 5: 9.4 →
		Serie 82.0		Serie 46.0	
		Total 0.0		Total 46.0	
20 Skott		6: 9.7 ↙ 7: 9.5 ↙ 8: 10.3x↗ 9: 8.8 ↘ 10: 9.5 ↗	20 Skott		11: 9.0 ↖ 12: 8.4 ↗ 13: 8.1 → 14: 7.6 ↑ 15: 9.6 ↗
		Serie 45.0		Serie 41.0	
		Total 91.0		Total 132.0	
20 Skott		16: 7.5 → 17: 10.0 → 18: 8.7 ↖ 19: 10.2 → 20: 10.6x↗			
		Serie 45.0			
		Total 177.0			

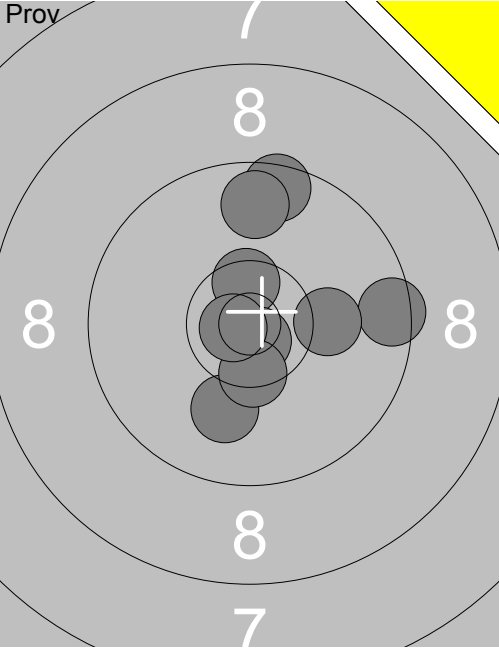
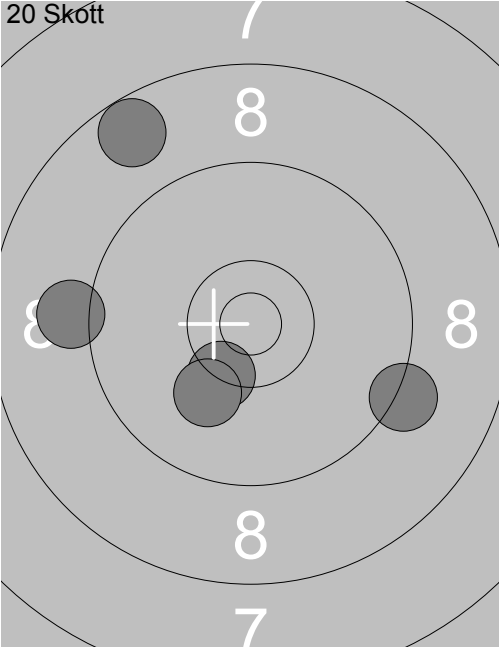
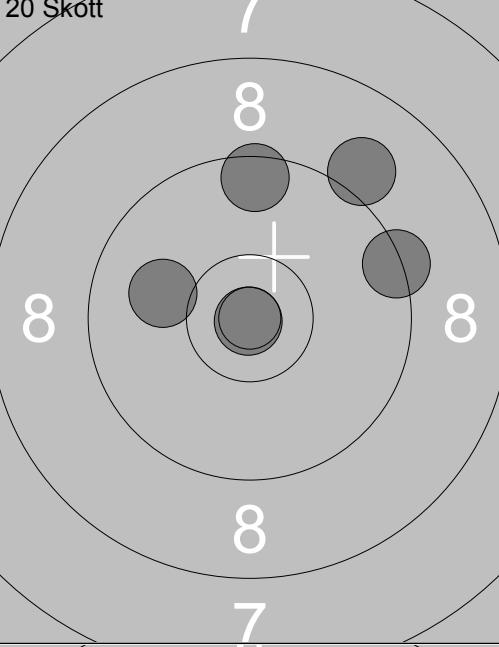
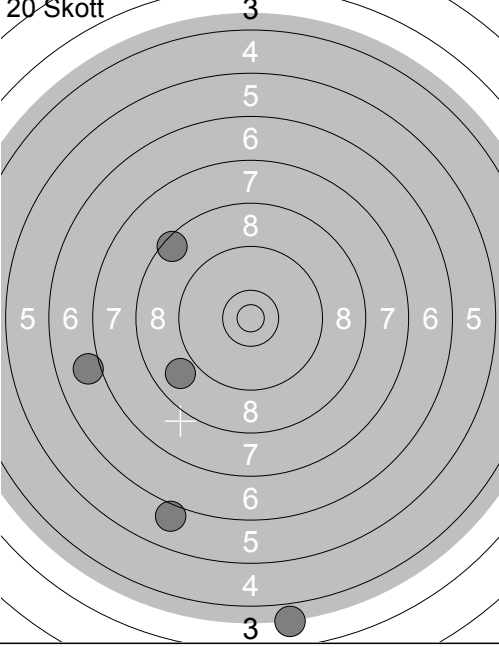
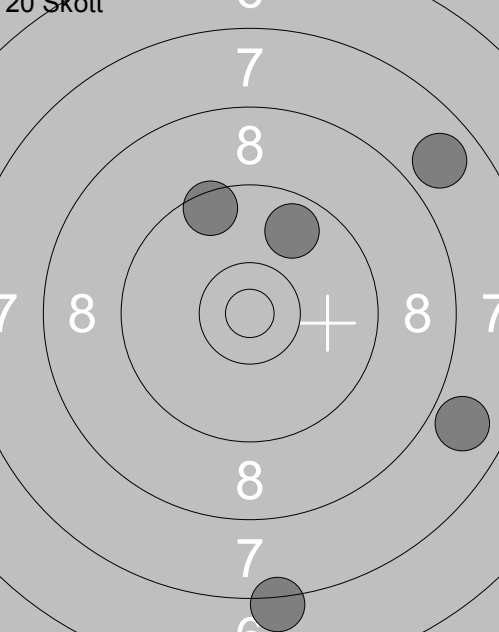
Skjuttag 3	Tavla 12	Maja Lindberg			
Vindeln	Ramselefors	Jun-S	Vb		
29.04.2017	Vindelnskottet 2017	Ramselefors SKF			
Prov		1: 10.0 ↓ 2: 10.5x↑ 3: 10.8x↓ 4: 10.4x↓ 5: 9.5 ↑ 6: 10.8x← 7: 9.5 → 8: 9.7 ↑ 9: 10.2→	20 Skött		1: 9.1 ← 2: 9.2 → 3: 8.7 ↖ 4: 10.3x↓ 5: 10.1 ↓
	Serie 87.0		Serie 46.0		
	Total 0.0		Total 46.0		
20 Skött		6: 9.4 → 7: 9.1 ↗ 8: 10.0← 9: 9.5 ↑ 10: 10.9x↓	20 Skött		11: 7.0 ← 12: 3.9 ↓ 13: 6.0 ↓ 14: 8.9 ← 15: 8.5 ↖
	Serie 47.0		Serie 32.0		
	Total 93.0		Total 125.0		
20 Skött		16: 7.9 → 17: 7.2 ↓ 18: 9.8 ↗ 19: 7.8 ↗ 20: 9.5 ↖			
	Serie 39.0				
	Total 164.0				

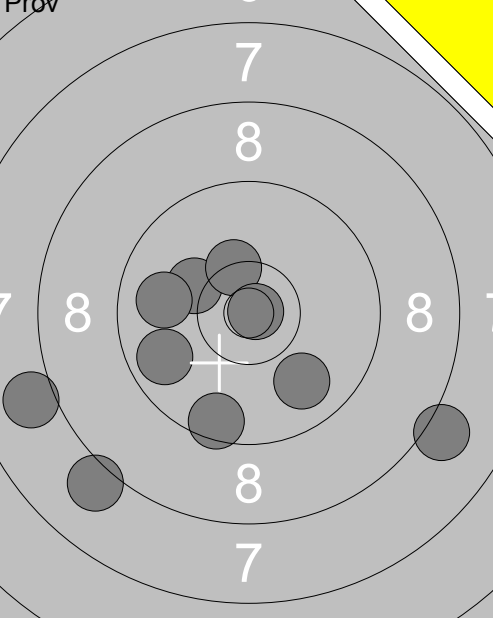
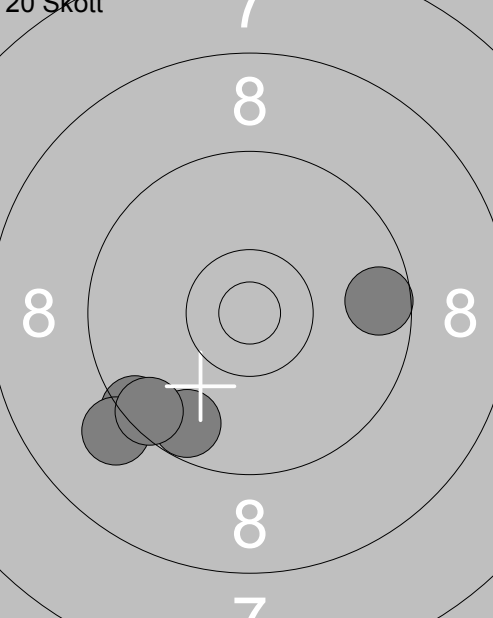
 <p>Prov</p>	<p>1: 8.1 ↘</p> <p>2: 8.0 ←</p> <p>3: 9.5 ↓</p> <p>4: 8.1 ↙</p> <p>5: 10.2 ↖</p>	<p>20 Skott</p> 	<p>1: 9.4 ↙</p> <p>2: 9.7 ↓</p> <p>3: 9.1 ↙</p> <p>4: 9.5 ↙</p> <p>5: 9.6 →</p>
Serie 90.0		Serie 45.0	
Total 0.0		Total 45.0	

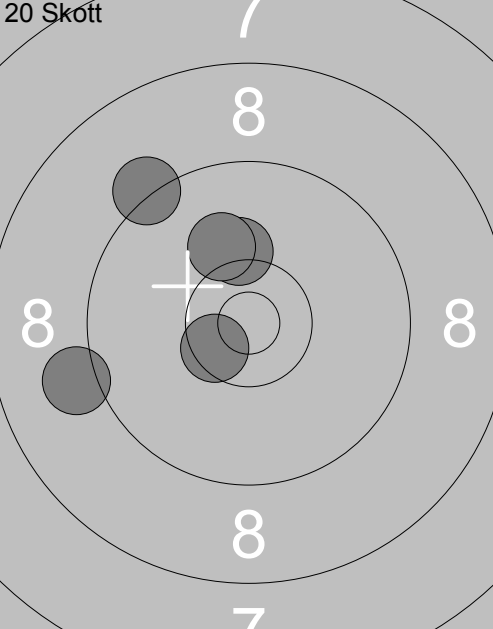
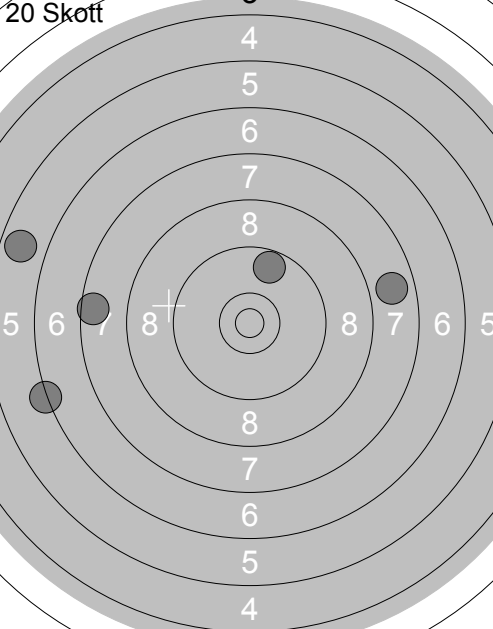
<p>20 Skott</p> 	<p>6: 10.5x ↘</p> <p>7: 10.2 ↑</p> <p>8: 9.1 ←</p> <p>9: 10.1 ↑</p> <p>10: 9.2 ↖</p>	<p>20 Skott</p> 	<p>11: 5.7 ←</p> <p>12: 7.8 →</p> <p>13: 9.7 ↑</p> <p>14: 7.6 ←</p> <p>15: 6.3 ←</p>
Serie 48.0		Serie 34.0	
Total 93.0		Total 127.0	

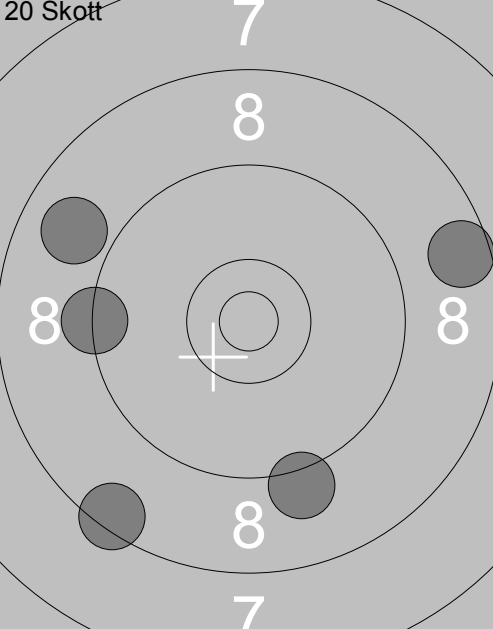
<p>20 Skott</p> 	<p>16: 9.3 ←</p> <p>17: 8.6 →</p> <p>18: 9.1 ↓</p> <p>19: 8.9 ↖</p> <p>20: 8.4 ↙</p>		
Serie 42.0			
Total 169.0			

	<p>20 Skott</p> <p>1: 9.8 ↓</p> <p>2: 8.5 ↓</p> <p>3: 9.4 ↘</p> <p>4: 10.0 ←</p> <p>5: 9.7 ↓</p> <p>6: 10.1 →</p> <p>7: 8.7 →</p> <p>8: 10.9x ←</p> <p>9: 10.6x ↗</p> <p>10: 10.5x ↘</p> <p>Serie 93.0</p> <p>Total 0.0</p>		<p>1: 10.2 ↖</p> <p>2: 9.8 ←</p> <p>3: 10.3 ↗</p> <p>4: 10.2 →</p> <p>5: 10.1 ↖</p> <p>Serie 49.0</p> <p>Total 49.0</p>
--	---	--	---

	<p>20 Skott</p> <p>6: 8.7 ←</p> <p>7: 10.2 ↓</p> <p>8: 10.3x ↘</p> <p>9: 9.7 →</p> <p>10: 10.1 →</p> <p>Serie 47.0</p> <p>Total 96.0</p>		<p>11: 6.7 ↓</p> <p>12: 0.0 ↖</p> <p>13: 4.9 →</p> <p>14: 10.3x ↗</p> <p>15: 10.3 ↓</p> <p>Serie 30.0</p> <p>Total 126.0</p>
--	--	--	--

	<p>20 Skott</p> <p>16: 10.3 ↓</p> <p>17: 9.4 →</p> <p>18: 10.8x ↗</p> <p>19: 9.7 ↗</p> <p>20: 9.1 ←</p> <p>Serie 47.0</p> <p>Total 173.0</p>		
--	--	--	--

		<p>11: 10.1 ↗</p> <p>Serie 10.0</p> <p>Total 0.0</p>
Serie 88.0		Serie 10.0
Total 0.0		Total 0.0

<p>20 Skott</p>	<p>20 Skott</p>	<p>6: 8.3 ↘</p> <p>7: 10.4x ↙</p> <p>8: 9.2 ↗</p> <p>9: 8.8 ↗</p> <p>10: 9.9 ↗</p> <p>Serie 44.0</p> <p>Total 44.0</p>
Serie 44.0		Serie 44.0
Total 44.0		Total 88.0

<p>20 Skott</p>	<p>20 Skott</p>	<p>16: 6.4 →</p> <p>17: 3.1 →</p> <p>18: 9.0 ↘</p> <p>19: 6.2 →</p> <p>20: 4.4 →</p> <p>Serie 26.0</p> <p>Total 114.0</p>
Serie 26.0		Serie 28.0
Total 114.0		Total 142.0

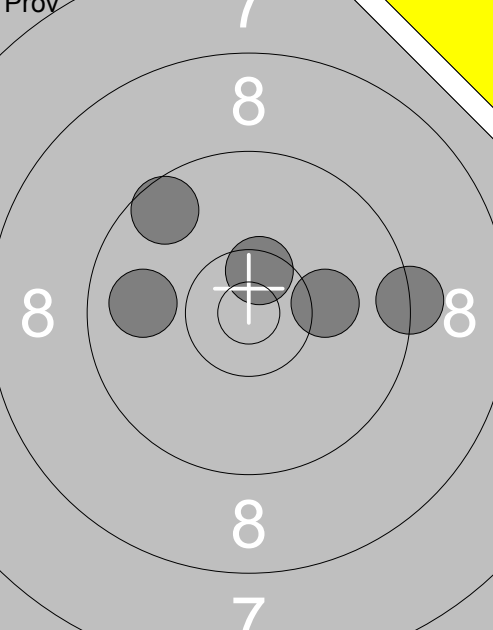
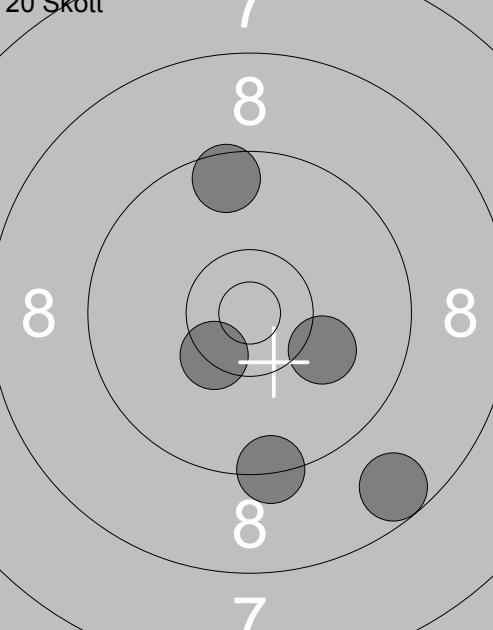
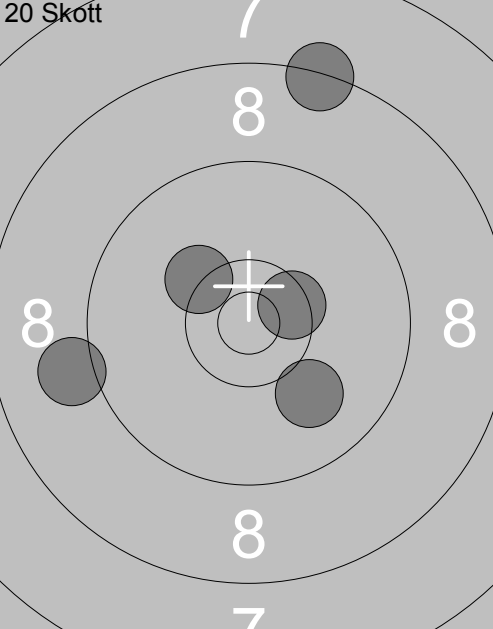
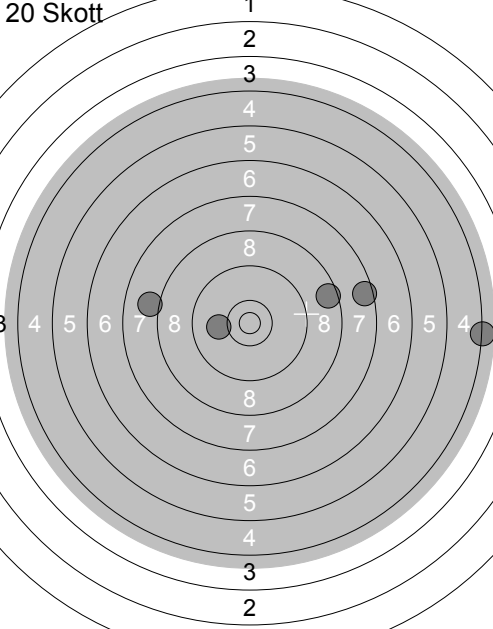
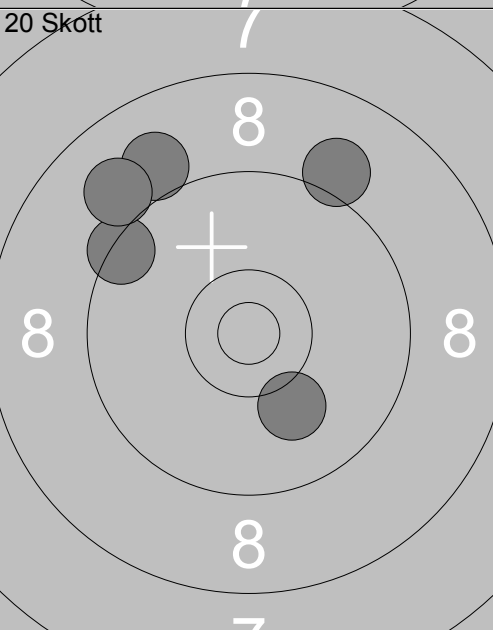
<div style="text-align: right; font-size: 10pt;">Prov</div>  <div style="text-align: center; font-size: 24pt; font-weight: bold;">7</div>	<div style="text-align: right; font-size: 10pt;">20 Skott</div>  <div style="text-align: center; font-size: 24pt; font-weight: bold;">7</div>	<table style="width:100%; border-collapse: collapse;"> <tr><td style="text-align: right;">1:</td><td>10.5x ↗</td><td style="text-align: right;">1:</td><td>8.7 ↘</td></tr> <tr><td style="text-align: right;">2:</td><td>9.3 →</td><td style="text-align: right;">2:</td><td>10.4x ↘</td></tr> <tr><td style="text-align: right;">3:</td><td>9.9 ←</td><td style="text-align: right;">3:</td><td>9.6 ↑</td></tr> <tr><td style="text-align: right;">4:</td><td>9.6 ↖</td><td style="text-align: right;">4:</td><td>9.3 ↓</td></tr> <tr><td style="text-align: right;">5:</td><td>10.2 →</td><td style="text-align: right;">5:</td><td>10.1 ↘</td></tr> <tr><td colspan="4" style="border-top: 1px solid black;">Serie 47.0</td></tr> <tr><td colspan="4" style="border-top: 1px solid black;">Total 0.0</td></tr> </table>	1:	10.5x ↗	1:	8.7 ↘	2:	9.3 →	2:	10.4x ↘	3:	9.9 ←	3:	9.6 ↑	4:	9.6 ↖	4:	9.3 ↓	5:	10.2 →	5:	10.1 ↘	Serie 47.0				Total 0.0			
1:	10.5x ↗	1:	8.7 ↘																											
2:	9.3 →	2:	10.4x ↘																											
3:	9.9 ←	3:	9.6 ↑																											
4:	9.6 ↖	4:	9.3 ↓																											
5:	10.2 →	5:	10.1 ↘																											
Serie 47.0																														
Total 0.0																														
<div style="text-align: right; font-size: 10pt;">20 Skott</div>  <div style="text-align: center; font-size: 24pt; font-weight: bold;">7</div>	<div style="text-align: right; font-size: 10pt;">20 Skott</div>  <div style="text-align: center; font-size: 24pt; font-weight: bold;">7</div>	<table style="width:100%; border-collapse: collapse;"> <tr><td style="text-align: right;">6:</td><td>10.3 ↖</td><td style="text-align: right;">11:</td><td>7.5 →</td></tr> <tr><td style="text-align: right;">7:</td><td>8.3 ↑</td><td style="text-align: right;">12:</td><td>10.1 ←</td></tr> <tr><td style="text-align: right;">8:</td><td>9.1 ←</td><td style="text-align: right;">13:</td><td>8.0 ←</td></tr> <tr><td style="text-align: right;">9:</td><td>10.5x ↗</td><td style="text-align: right;">14:</td><td>8.6 →</td></tr> <tr><td style="text-align: right;">10:</td><td>10.0 ↓</td><td style="text-align: right;">15:</td><td>4.3 →</td></tr> <tr><td colspan="4" style="border-top: 1px solid black;">Serie 47.0</td></tr> <tr><td colspan="4" style="border-top: 1px solid black;">Total 93.0</td></tr> </table>	6:	10.3 ↖	11:	7.5 →	7:	8.3 ↑	12:	10.1 ←	8:	9.1 ←	13:	8.0 ←	9:	10.5x ↗	14:	8.6 →	10:	10.0 ↓	15:	4.3 →	Serie 47.0				Total 93.0			
6:	10.3 ↖	11:	7.5 →																											
7:	8.3 ↑	12:	10.1 ←																											
8:	9.1 ←	13:	8.0 ←																											
9:	10.5x ↗	14:	8.6 →																											
10:	10.0 ↓	15:	4.3 →																											
Serie 47.0																														
Total 93.0																														
<div style="text-align: right; font-size: 10pt;">20 Skott</div>  <div style="text-align: center; font-size: 24pt; font-weight: bold;">7</div>	<table style="width:100%; border-collapse: collapse;"> <tr><td style="text-align: right;">16:</td><td>9.0 ↖</td></tr> <tr><td style="text-align: right;">17:</td><td>9.1 ↗</td></tr> <tr><td style="text-align: right;">18:</td><td>9.4 ↖</td></tr> <tr><td style="text-align: right;">19:</td><td>9.0 ↖</td></tr> <tr><td style="text-align: right;">20:</td><td>10.1 ↓</td></tr> <tr><td colspan="2" style="border-top: 1px solid black;">Serie 46.0</td></tr> <tr><td colspan="2" style="border-top: 1px solid black;">Total 176.0</td></tr> </table>		16:	9.0 ↖	17:	9.1 ↗	18:	9.4 ↖	19:	9.0 ↖	20:	10.1 ↓	Serie 46.0		Total 176.0															
16:	9.0 ↖																													
17:	9.1 ↗																													
18:	9.4 ↖																													
19:	9.0 ↖																													
20:	10.1 ↓																													
Serie 46.0																														
Total 176.0																														