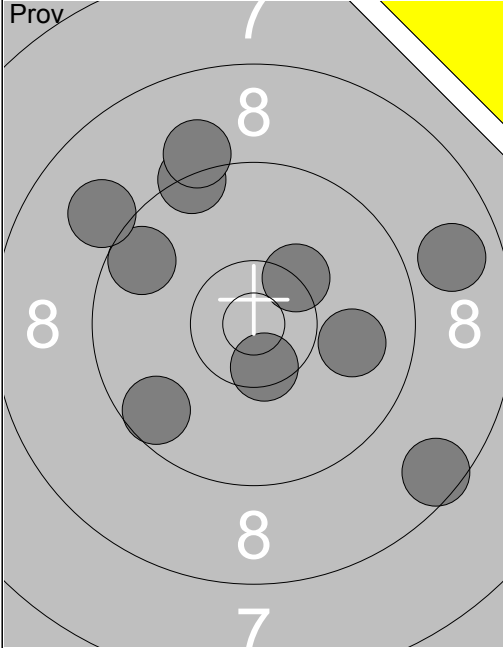
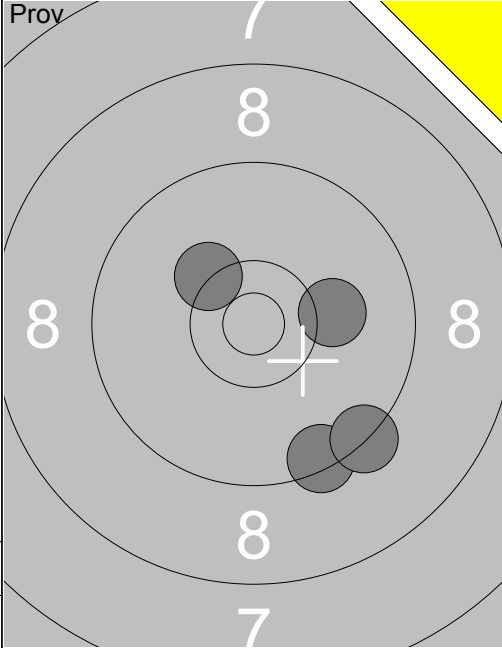
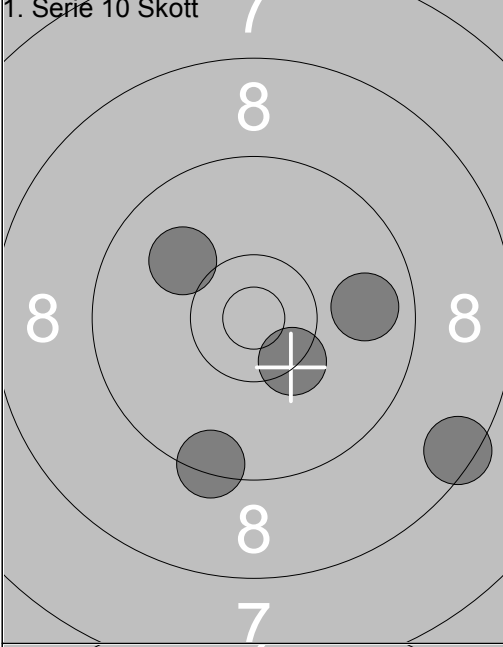
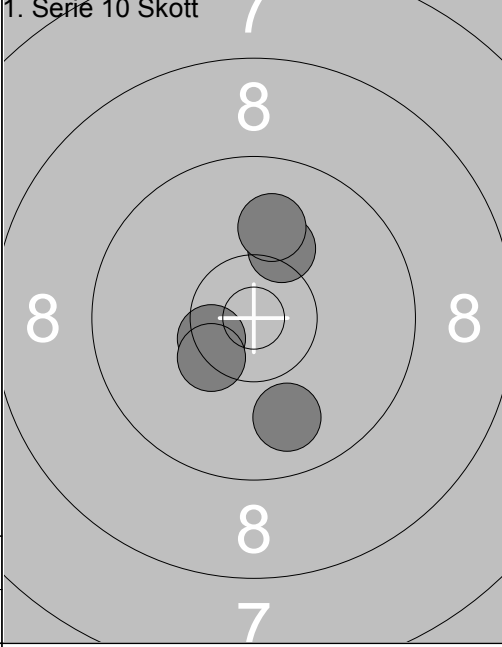
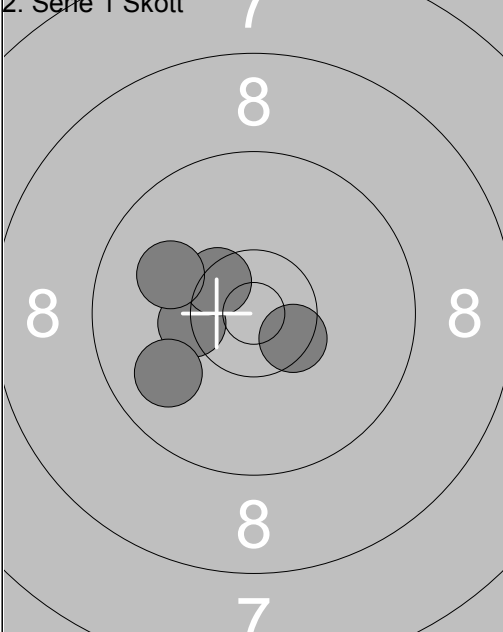

	<p>1: 7.0 ↘ 2: 9.4 ↓ 3: 9.4 ↓ 4: 10.3x⇒ 5: 8.1 ↓ 6: 8.5 → 7: 8.2 ↘ 8: 8.5 ↓ 9: 9.8 ↓ 10: 9.3 ↓</p> <p>Serie 85.0 Total 190.0</p>		<p>11: 9.5 ⇒ 12: 9.4 ⇒ 13: 10.5x↗ 14: 10.4x⇒ 15: 10.0 ↑ 16: 9.3 ↗ 17: 9.3 ↖ 18: 10.5x↖ 19: 8.7 ↓ 20: 9.4 →</p> <p>Serie 93.0 Total 190.0</p>
--	--	--	--

<p>1. Serie 10 Skott</p>	<p>1: 9.3 ↑ 2: 10.3 ↗ 3: 8.8 ↗ 4: 9.0 ↑ 5: 10.3x↖</p> <p>Serie 46.0 Total 236.0</p>	<p>1. Serie 10 Skott</p>	<p>6: 9.6 ↓ 7: 10.1↖ 8: 9.9 ↑ 9: 8.0 ↘ 10: 9.0 →</p> <p>Serie 45.0 Total 281.0</p>
--------------------------	---	--------------------------	--

<p>2. Serie 1 Skott</p>	<p>1: 8.6 ↑ 2: 10.3x↖ 3: 9.7 ↖ 4: 10.3x↖ 5: 9.5 ↑</p> <p>Serie 46.0 Total 327.0</p>		
-------------------------	---	--	--

Skjuttag <b>4</b>	Tavla <b>2</b>	<b>Emma Eriksson</b>			
Vindeln		Ramselefors		U	Vb
29.04.2017		Vindelnskottet 2017		Ramselefors SKF	
Prov		1: 9.3 ↗ 2: 9.1 ↗ 3: 9.6 ↖ 4: 9.0 ↖ 5: 9.9 → 6: 8.8 → 7: 10.5x↓ 8: 8.6 ↘ 9: 10.3x↗ 10: 9.6 ↙	Prov		11: 9.4 ↘ 12: 10.1 → 13: 10.3 ↗ 14: 9.3 ↘
		Serie 90.0		Serie 38.0	
		Total 190.0		Total 190.0	
1. Serie 10 Skott		1: 10.4x↘ 2: 8.5 ↘ 3: 9.8 → 4: 9.4 ↓ 5: 10.0 ↖	1. Serie 10 Skott		6: 9.9 ↘ 7: 10.2 ↗ 8: 10.5x↖ 9: 10.0 ↗ 10: 10.4x↖
		Serie 46.0		Serie 49.0	
		Total 236.0		Total 285.0	
2. Serie 1 Skott		1: 10.5x↘ 2: 10.3x↖ 3: 9.9 ↙ 4: 10.5x↗ 5: 10.0 ↖			
		Serie 49.0			
		Total 334.0			

	<p>1: 10.9x↘</p> <p>2: 10.6x↘</p> <p>3: 10.5x↘</p> <p>4: 10.7x↘</p> <p>5: 10.1↙</p> <p>6: 10.2↓</p> <p>7: 10.4x↗</p> <p>8: 9.0↓</p> <p>9: 10.3←</p> <p>10: 9.9↑</p>	
Serie 98.0		Serie 20.0
Total 190.0		Total 190.0

<p>1. Serie 10 Skott</p>	<p>1: 10.4x↘</p> <p>2: 10.4x↘</p> <p>3: 10.0↑</p> <p>4: 10.0↓</p> <p>5: 10.3x↘</p>	<p>1. Serie 10 Skott</p>
Serie 50.0		Serie 49.0
Total 240.0		Total 289.0

<p>2. Serie 1 Skott</p>	<p>1: 10.2↖</p> <p>2: 10.5x↘</p> <p>3: 9.5↗</p> <p>4: 10.2↓</p> <p>5: 10.0↓</p>	
Serie 49.0		
Total 338.0		

Skjuttag	Tavla	Irma Karlsson			
4	4	Vindeln	Vännäs	U	Vb
29.04.2017	Vindelnskottet 2017	Ramselefors SKF			
	1: 9.2 ↘ 2: 9.5 ↘ 3: 8.7 ↘ 4: 10.0 ↑ 5: 7.0 → 6: 7.2 → 7: 9.8 → 8: 8.4 → 9: 8.9 ↘ 10: 7.5 ↘ Serie 82.0 Total 190.0		11: 10.2 ↓ 12: 8.4 ↓ 13: 9.4 → 14: 10.1 ↓ 15: 7.2 ↓ 16: 8.5 ↓ 17: 9.2 → Serie 61.0 Total 190.0		
1. Serie 10 Skott 	1: 9.9 ↑ 2: 10.3x↑ 3: 10.4x↘ 4: 9.8 ↘ 5: 10.5x↑ Serie 48.0 Total 238.0	1. Serie 10 Skott 	6: 8.9 ↓ 7: 8.8 ↑ 8: 8.1 ↑ 9: 9.0 ← 10: 9.6 ↖ Serie 42.0 Total 280.0		
2. Serie 1 Skott 	1: 9.5 → 2: 9.0 ↓ 3: 9.3 ↓ 4: 10.0 ↑ 5: 9.8 → Serie 46.0 Total 326.0				

	<p>1: 9.7 ↖</p> <p>2: 9.7 →</p> <p>3: 9.9 ↓</p> <p>4: 9.2 ↓</p> <p>5: 10.3 →</p> <p>6: 9.7 →</p> <p>7: 9.7 ↗</p> <p>8: 10.5 ✕</p> <p>9: 9.6 ←</p> <p>10: 10.2 ←</p>	
Serie 93.0		11: 9.8 ↖
Total 188.0		Serie 9.0
		Total 188.0

<p>1. Serie 10 Skott</p>	<p>1: 9.8 →</p> <p>2: 9.8 ↘</p> <p>3: 10.1 ↑</p> <p>4: 9.9 ↖</p> <p>5: 10.1 ↙</p>	<p>1. Serie 10 Skott</p>
Serie 47.0		6: 10.3 ✕
Total 235.0		7: 9.9 ←
		8: 9.3 ↓
		9: 10.4 ✕ ↑
		10: 9.1 ↑
		Serie 47.0
		Total 282.0

<p>2. Serie 1 Skott</p>	<p>1: 10.2 ↖</p> <p>2: 9.9 ↓</p> <p>3: 10.7 ✕ ↓</p> <p>4: 9.2 ↗</p> <p>5: 9.2 ↑</p>	
Serie 47.0		
Total 329.0		

<p>Prov</p> 	<p>1: 9.9 ← 2: 9.1 ↓ 3: 10.4x↗ 4: 9.3 ↖ 5: 10.2 ← 6: 10.1 ↙ 7: 9.4 ↖ 8: 10.3x↘ 9: 9.8 ← 10: 9.7 ↙</p> <p>Serie 94.0 Total 187.0</p>	<p>Prov</p> 	<p>11: 10.0 ↗ 12: 10.0 ↖ 13: 9.6 ↙ 14: 7.5 ↙ 15: 9.9 ↘ 16: 10.4x↗</p> <p>Serie 55.0 Total 187.0</p>
--	---	--	---

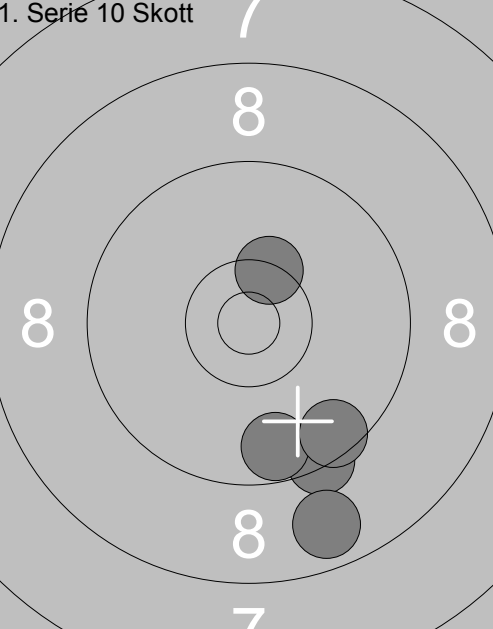
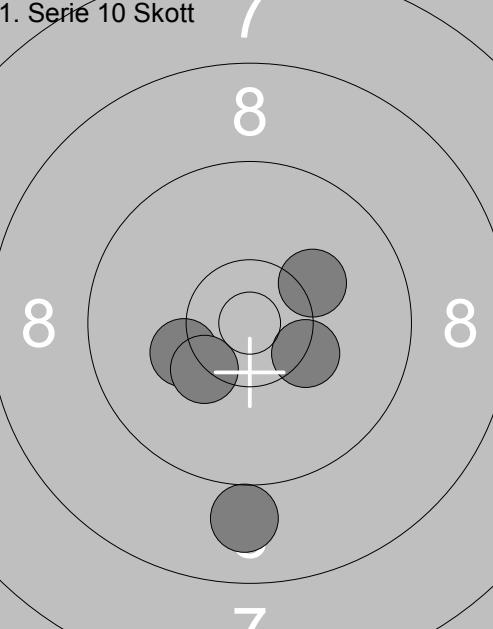
<p>1. Serie 10 Skott</p> 	<p>1: 9.4 ↓ 2: 8.7 ↓ 3: 9.7 ↓ 4: 9.5 ↓ 5: 10.4x↗</p> <p>Serie 45.0 Total 232.0</p>	<p>1. Serie 10 Skott</p> 	<p>6: 10.2 ← 7: 10.2 ↗ 8: 10.3x↘ 9: 10.3x↙ 10: 9.0 ↓</p> <p>Serie 49.0 Total 281.0</p>
--	--	--	--

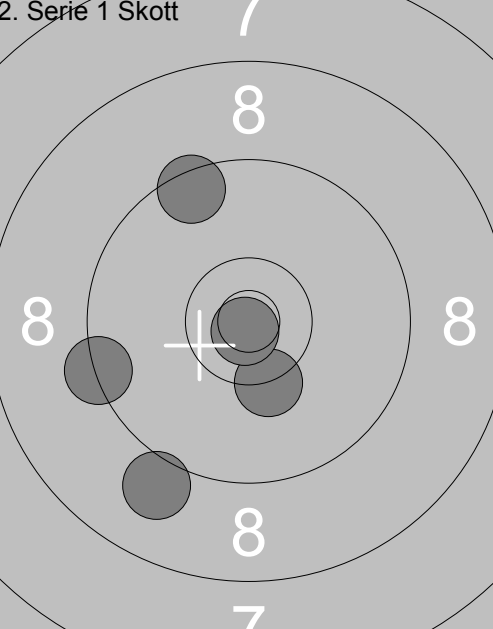
<p>2. Serie 1 Skott</p> 	<p>1: 9.3 ← 2: 9.5 ↖ 3: 10.3x↘ 4: 9.0 ↓ 5: 10.8x↘</p> <p>Serie 47.0 Total 328.0</p>		
--	---	--	--

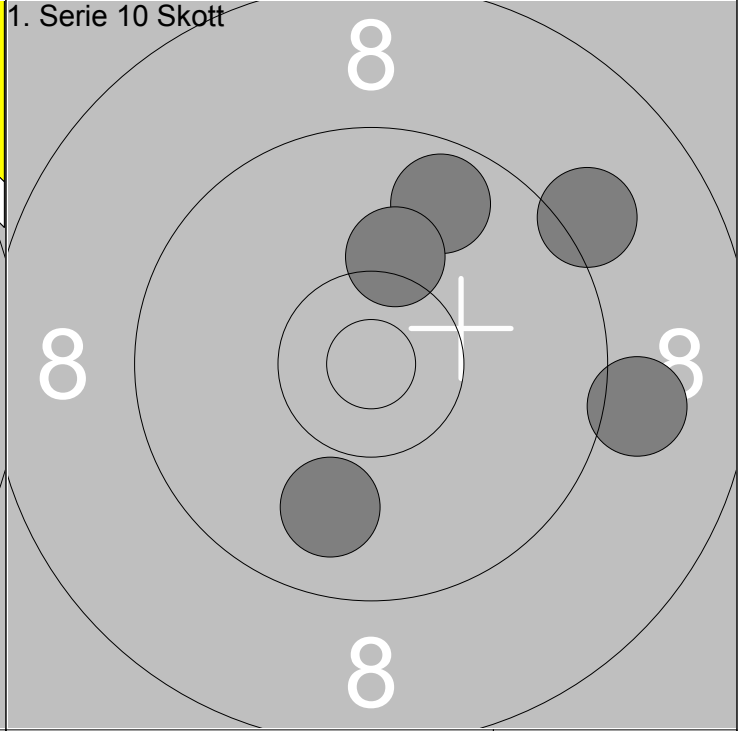
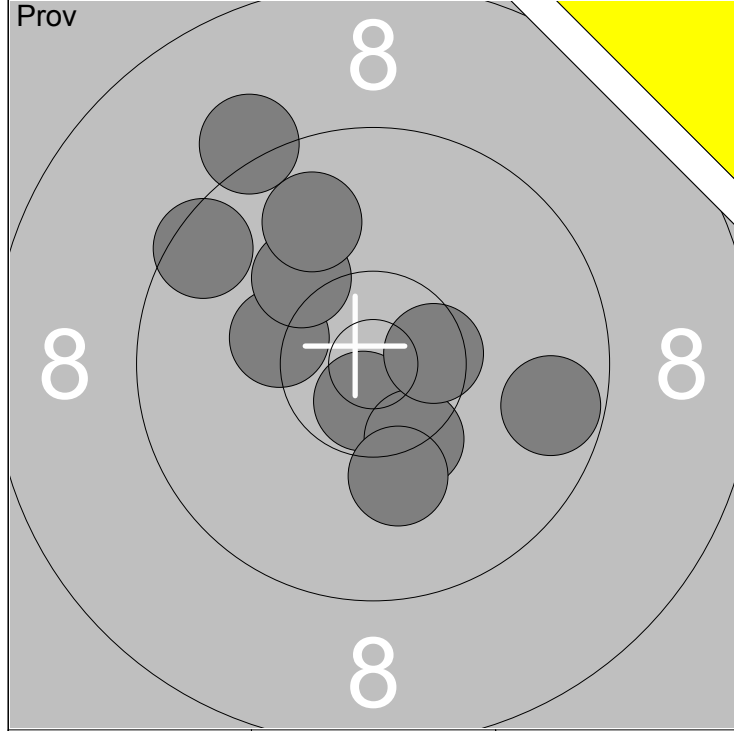

1: 9.7 →	6: 10.2 ↗
2: 10.7x ↓	7: 9.5 ↖
3: 10.4x ↓	8: 9.9 ↗
4: 10.3 ←	9: 9.2 ↗
5: 10.1 ↓	10: 10.5x →

Serie	96
Total	187

1: 9.7 ↗	2: 9.1 ↗
3: 9.9 ↓	4: 9.1 →
5: 10.2 ↗	

Serie	46
Total	233

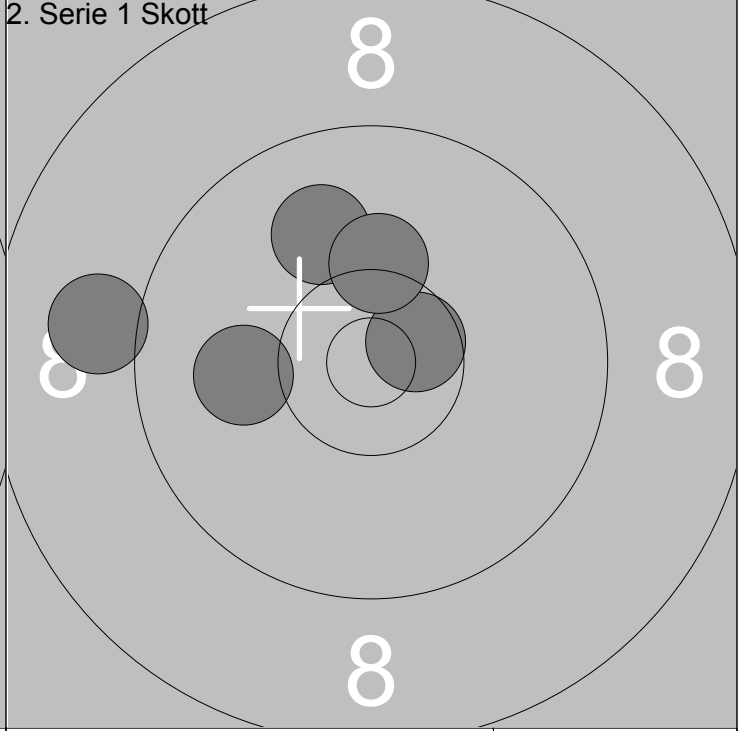
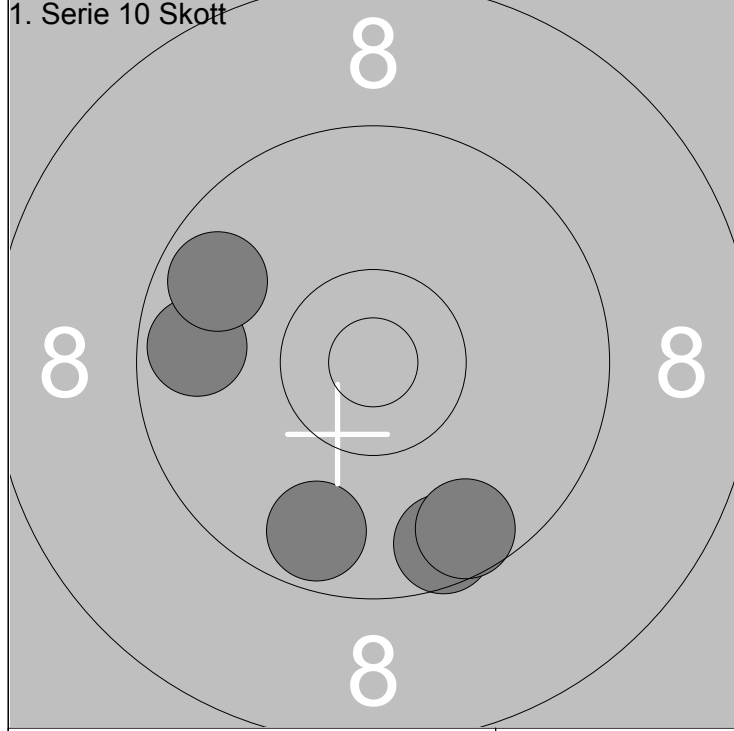

6: 9.7 ←	7: 9.7 ↓
8: 9.6 ↓	9: 9.7 ↗
10: 9.6 ↓	

Serie	45
Total	278

1: 10.0 ↗	2: 10.6x ↗
3: 9.0 ←	4: 10.3 ↗
5: 10.1 ←	

Serie	49
Total	327

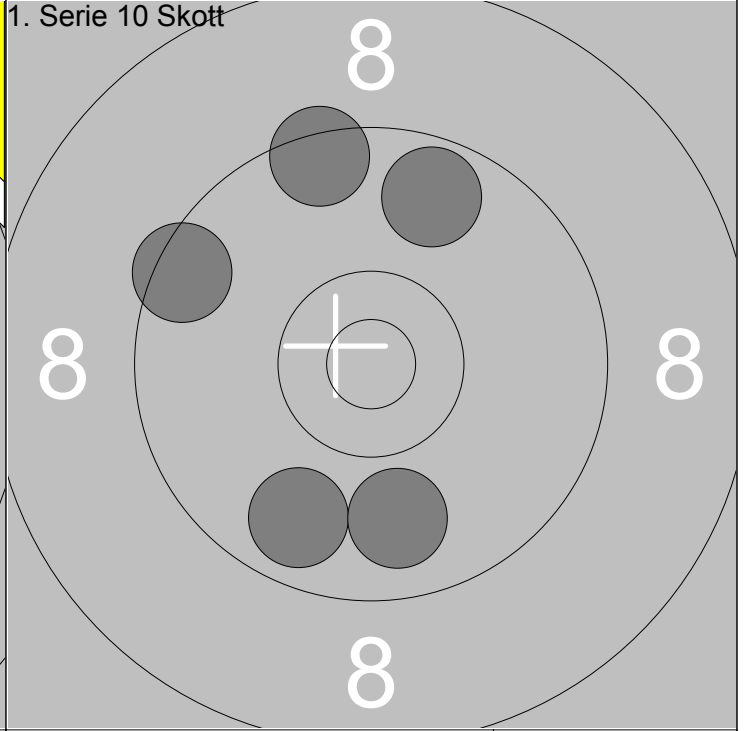
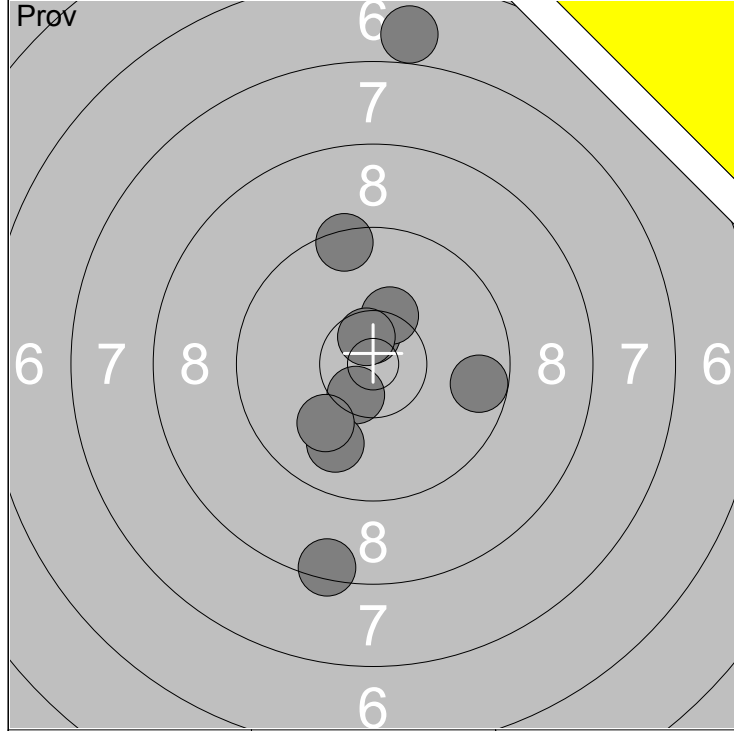

1: 9.4	↗	6: 10.3x	↗
2: 8.4	↘	7: 9.7	→
3: 10.6x	↗	8: 7.0	↗
4: 10.5x	↘	9: 10.0	↘
5: 9.9	↘	10: 10.6x	↗

Serie	92
Total	187

1: 9.5	↖
2: 9.7	↗
3: 9.5	↗
4: 9.8	↘
5: 9.9	↘

Serie	45
Total	232

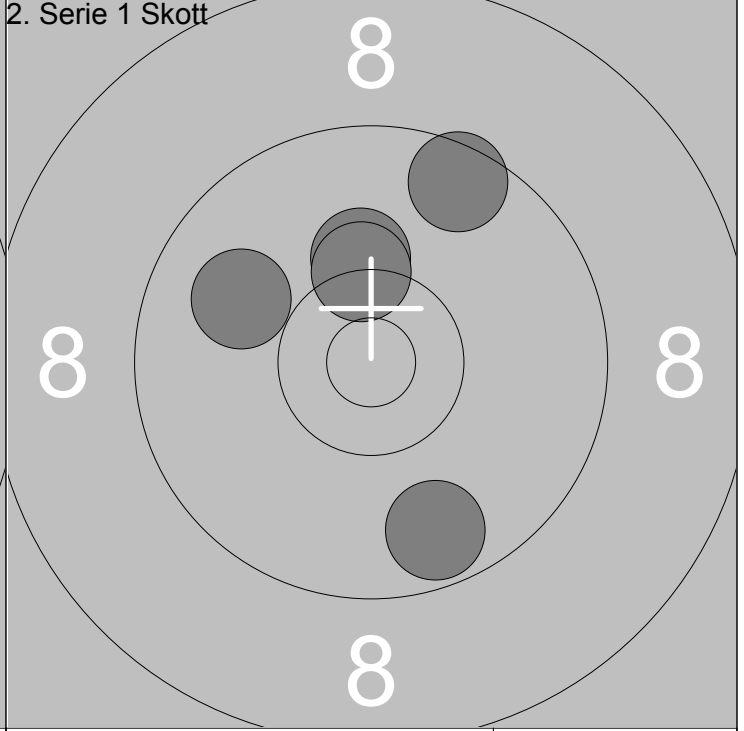
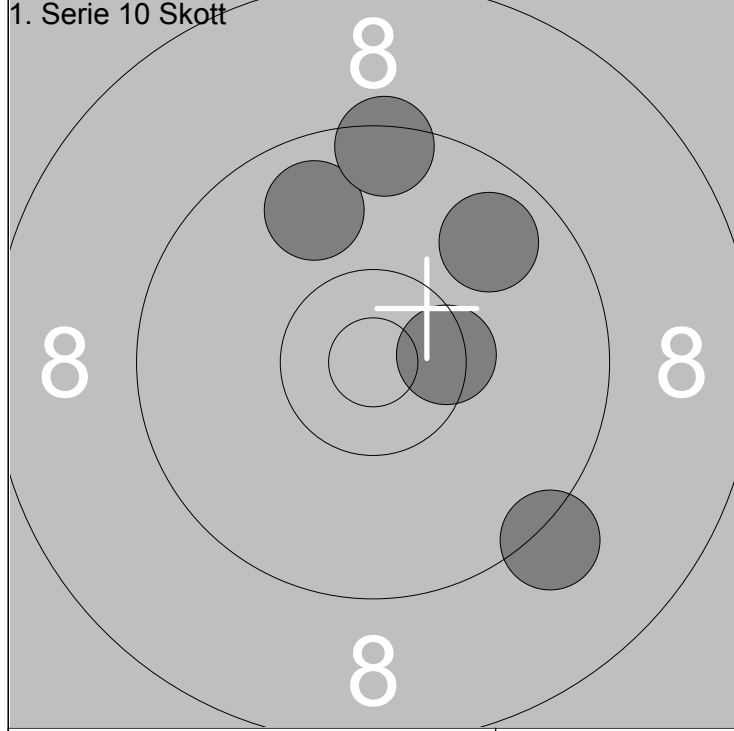

6: 9.8	↗
7: 9.4	↗
8: 10.4x	→
9: 9.2	↘
10: 9.8	↗

Serie	46
Total	278

1: 9.7	↘
2: 9.9	↖
3: 9.6	↗
4: 10.2	↗
5: 10.3x	↗

Serie	47
Total	325



Skjuttag <b>4</b>	Tavla <b>9</b>	
----------------------	-------------------	--

Vindeln		
---------	--	--

29.04.2017	Vindelnskottet 2017	Ramselefors SKF
------------	---------------------	-----------------

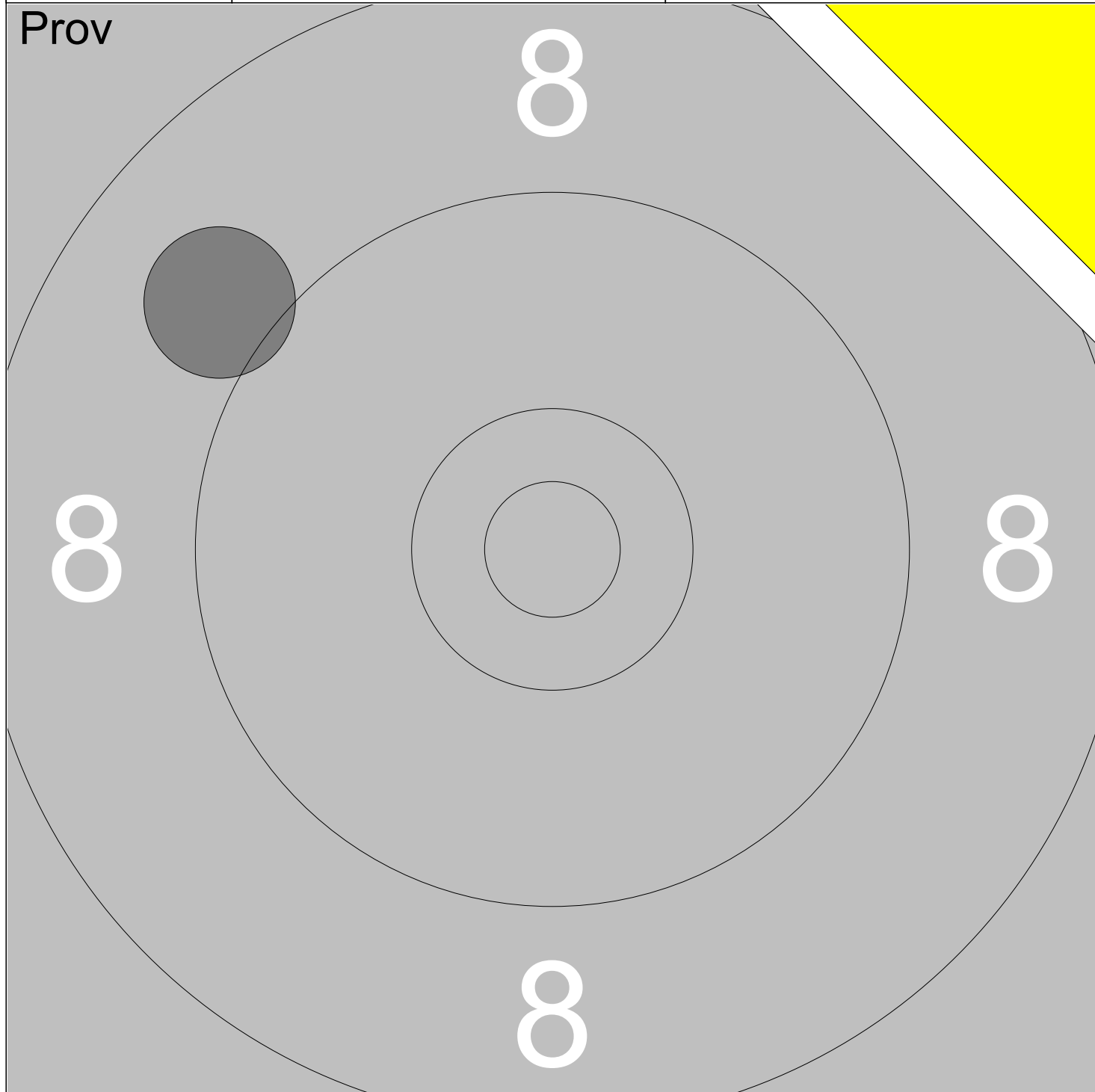

1:	9.0	↖
----	-----	---

Serie	9
-------	---

Total	0
-------	---

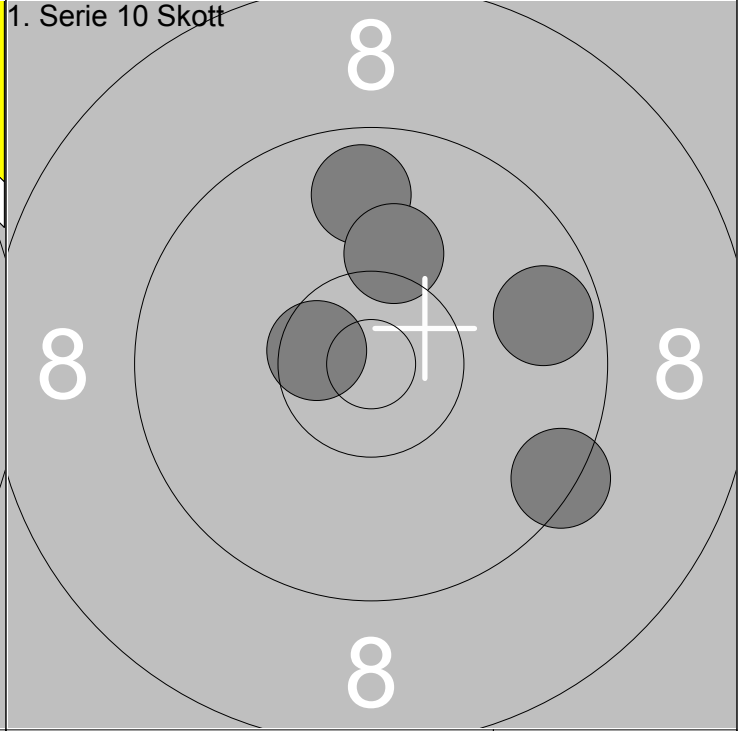
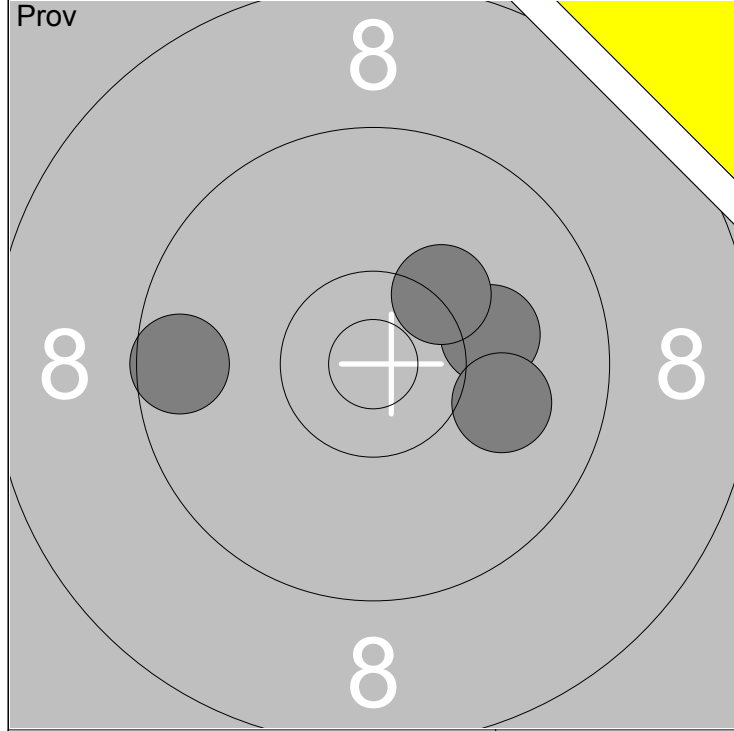

1:	10.1	→
2:	10.0	→
3:	10.3	↗
4:	9.6	←

Serie	39
Total	193

1:	9.8	↑
2:	10.6x	←
3:	9.7	→
4:	10.2	↑
5:	9.4	↘

Serie	47
Total	240

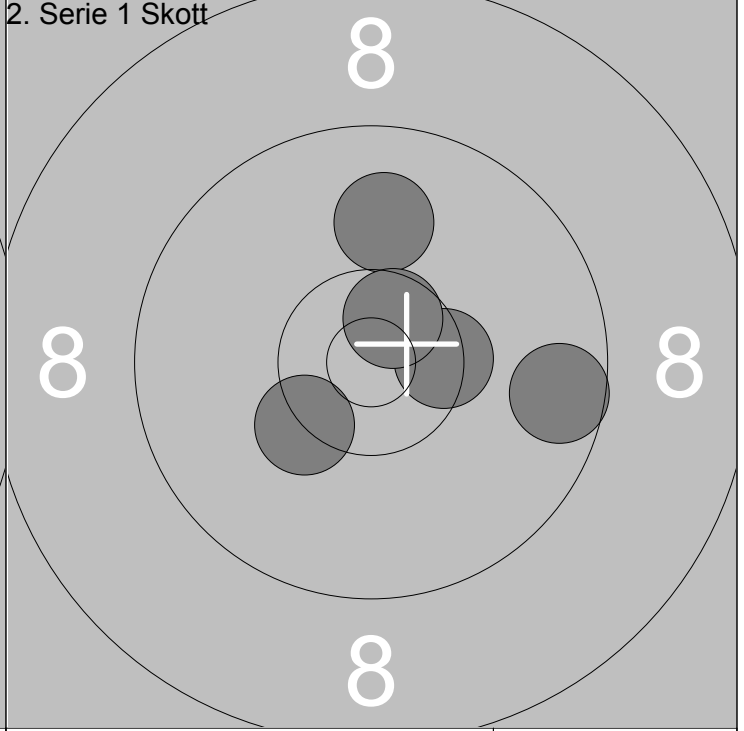
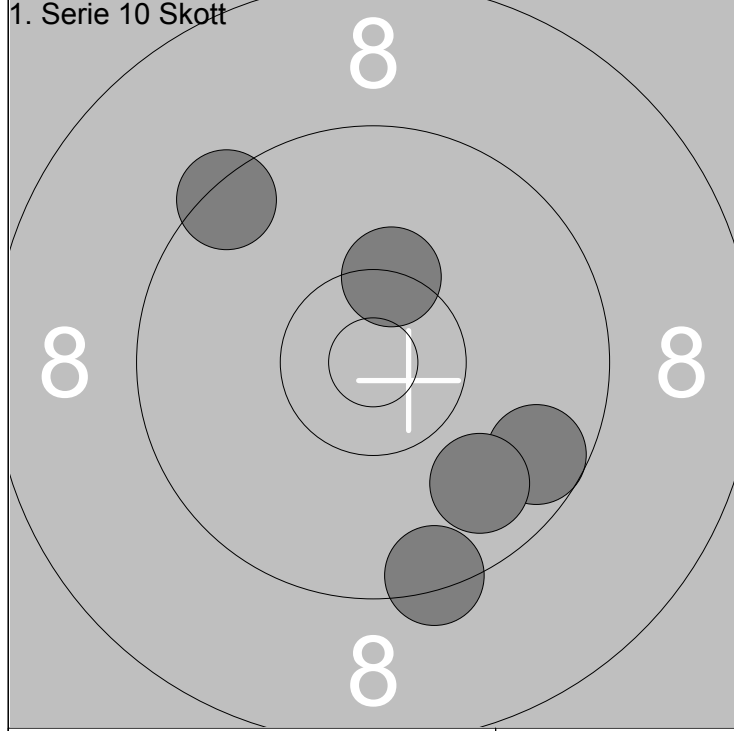

6:	9.4	↖
7:	10.3x	↑
8:	9.4	↓
9:	9.6	↘
10:	9.8	↘

Serie	46
Total	286

1:	10.3x	↖
2:	9.6	→
3:	10.0	↑
4:	10.4x	→
5:	10.6x	↑

Serie	49
Total	335

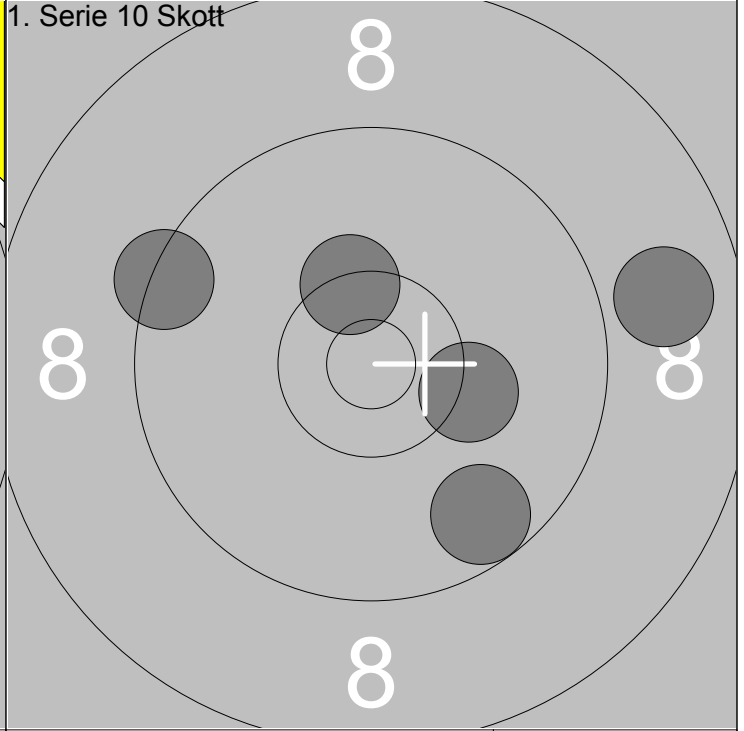
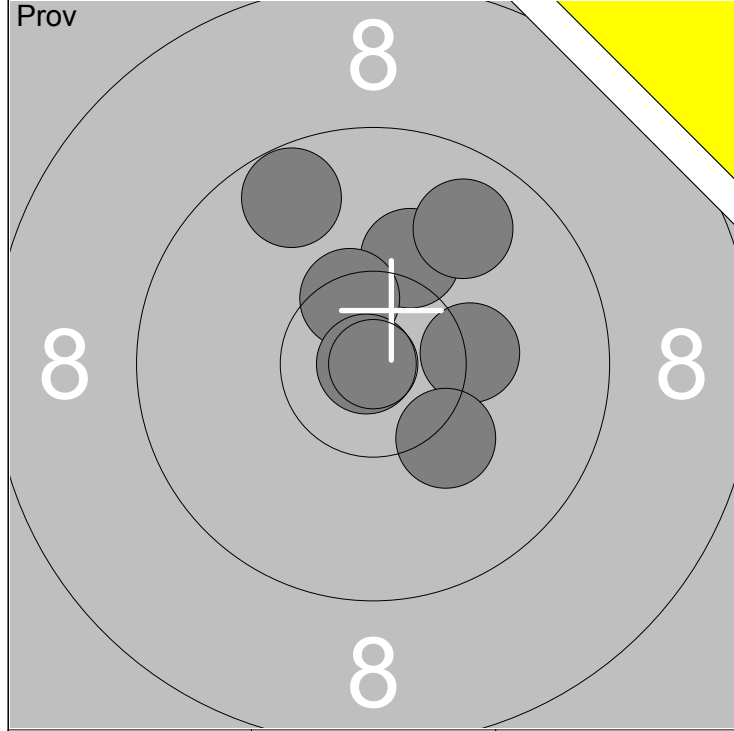

1: 9.7 ↖	6: 10.2 ↘	Serie	68
2: 10.2 ↗	7: 10.9x ←		
3: 9.8 ↗		Total	192
4: 10.3 →			
5: 10.5x ↗			

1: 8.9 →	Serie	46
2: 9.7 ↘		
3: 10.2 →	Total	238
4: 9.4 ↖		
5: 10.4x ↗		

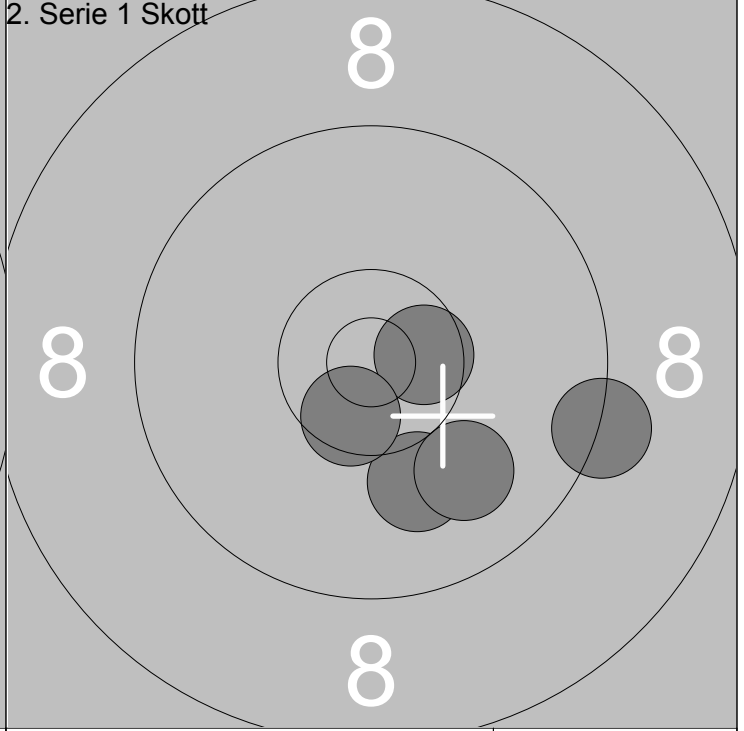
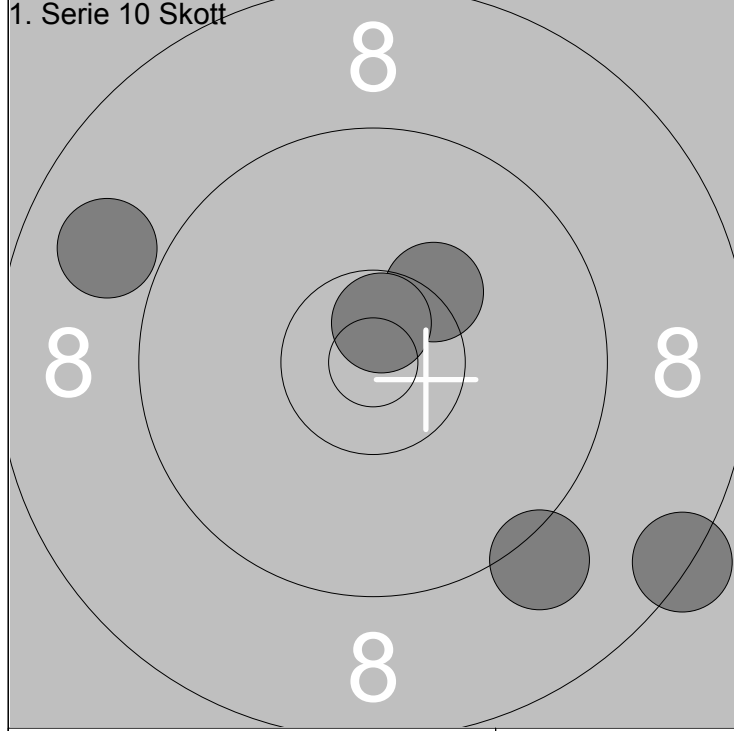

6: 10.3x ↗	Serie	45
7: 10.7x ↗		
8: 8.4 ↘	Total	283
9: 8.9 ↖		
10: 9.1 ↘		

1: 10.1 ↘	Serie	49
2: 9.3 →		
3: 10.0 ↘	Total	332
4: 10.6x →		
5: 10.5x ↘		

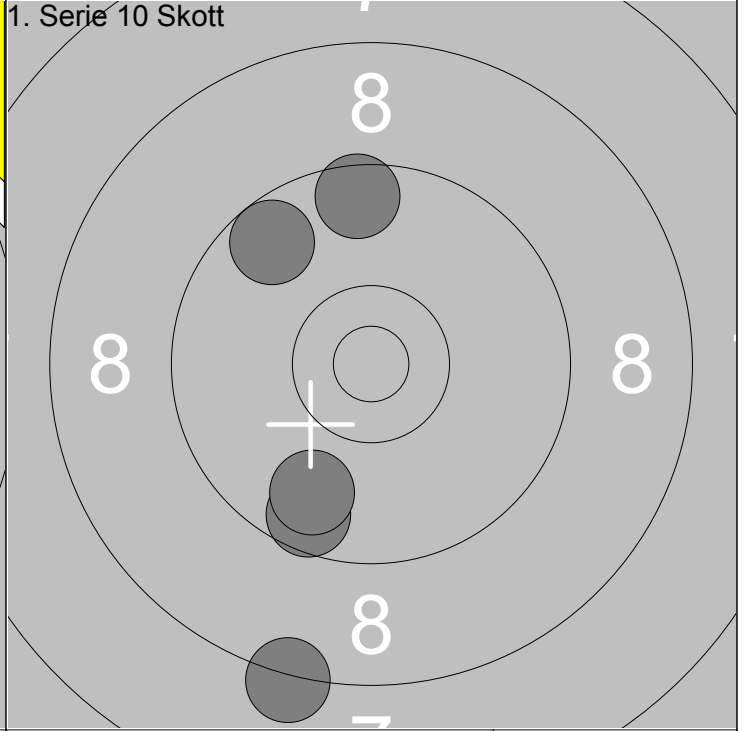
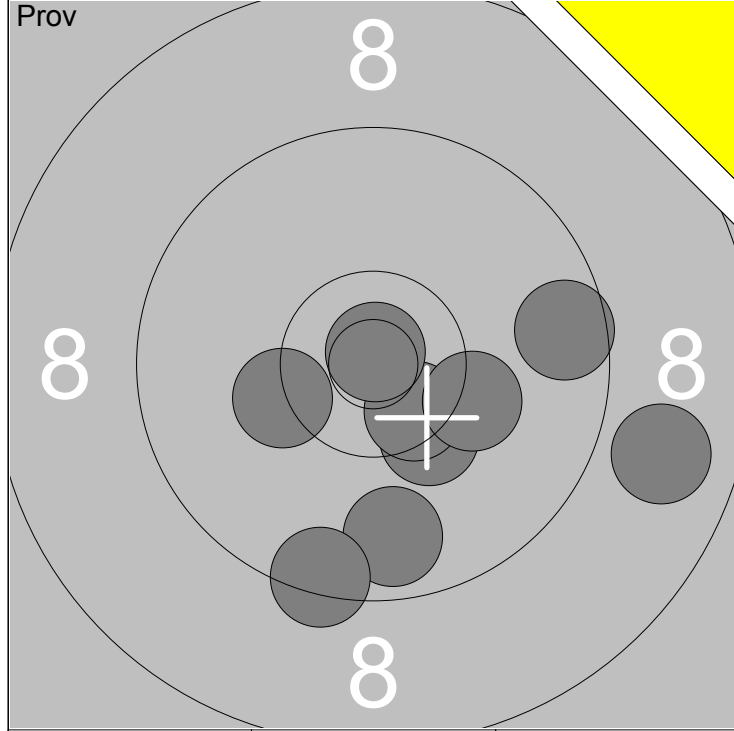

1: 9.7 ↓	6: 10.2 →	Serie	85
2: 10.3x ↓	7: 9.4 ↓		
3: 8.8 →	8: 10.3 ←	Total	190
4: 9.6 →	9: 10.9x ↑		
5: 10.5x ↓			

1: 9.6 ↑	Serie	44
2: 9.7 ↖		
3: 8.2 ↓	Total	234
4: 9.6 ↓		
5: 9.8 ↓		

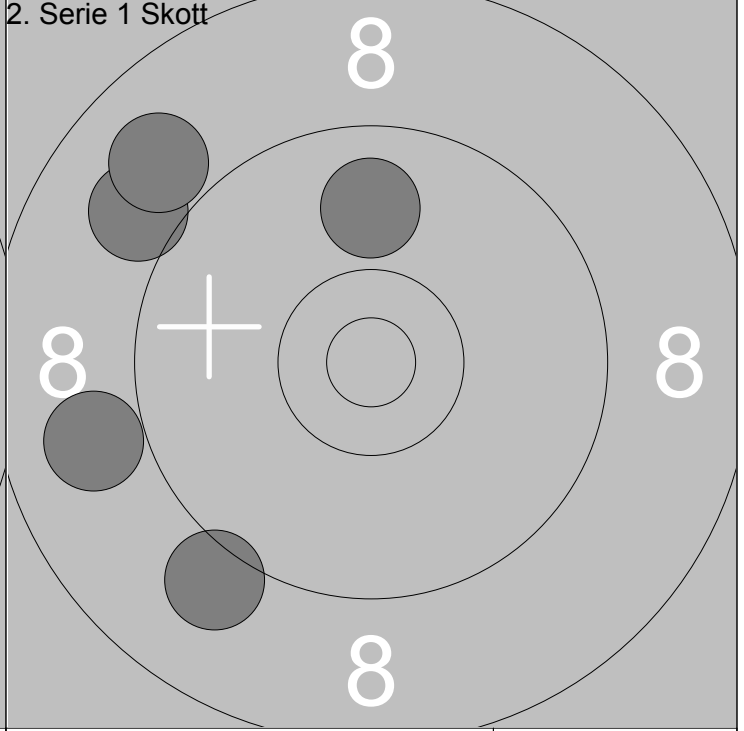
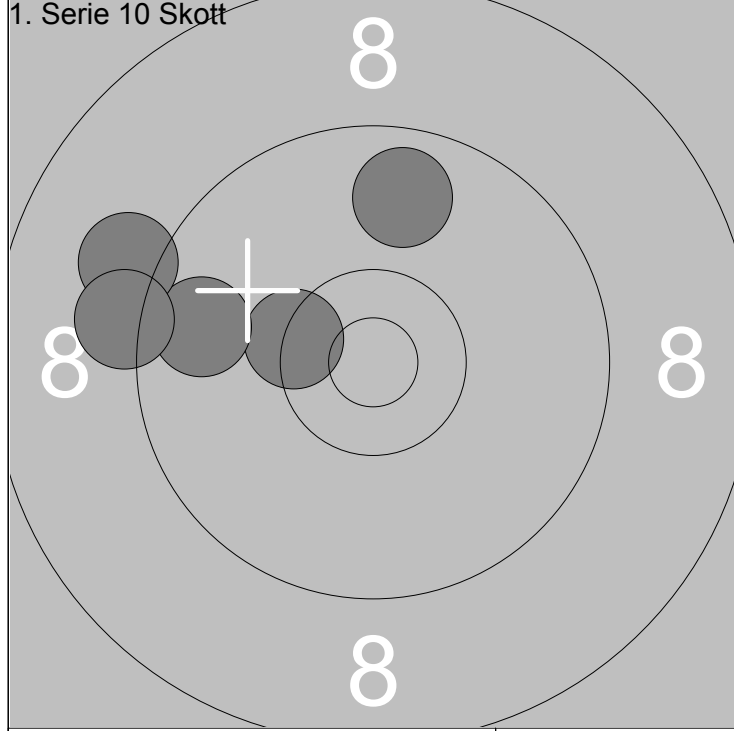

6: 10.4x ←	Serie	46
7: 9.7 ←		
8: 9.8 ↑	Total	280
9: 9.1 ↖		
10: 9.2 ←		

1: 9.0 ↖	Serie	43
2: 8.9 ↖		
3: 9.9 ↑	Total	323
4: 8.9 ←		
5: 9.1 ↙		

	<p>1: 8.0 ←</p> <p>2: 10.0 ↑</p> <p>3: 9.3 ↗</p> <p>4: 9.7 ←</p> <p>5: 9.5 ↖</p> <p>6: 9.1 ↗</p> <p>7: 10.0 ↑</p> <p>8: 9.6 ↘</p> <p>9: 10.3x↖</p> <p>10: 10.6x↓</p>		<p>11: 10.5x↗</p> <p>12: 10.5x↘</p> <p>13: 9.7 ↖</p> <p>14: 9.8 ←</p>
Serie 93.0		Serie 38.0	
Total 184.0		Total 184.0	

<p>1. Serie 10 Skott</p>	<p>1: 10.0 ↓</p> <p>2: 10.0 ↑</p> <p>3: 10.3 ↓</p> <p>4: 8.3 ←</p> <p>5: 10.7x↓</p>	<p>1. Serie 10 Skott</p>	<p>6: 10.1 ↖</p> <p>7: 8.9 ↖</p> <p>8: 10.1 ↗</p> <p>9: 9.9 ↗</p> <p>10: 9.2 ↑</p>
Serie 48.0		Serie 46.0	
Total 232.0		Total 278.0	

<p>2. Serie 1 Skott</p>	<p>1: 9.1 →</p> <p>2: 10.6x↑</p> <p>3: 10.5x↑</p> <p>4: 9.7 →</p> <p>5: 9.8 ↓</p>		
Serie 47.0			
Total 325.0			

Skjuttag	Tavla	Dan-Ivan Karlsson				
4	14	Vindeln		Ramselefors	Vet-L	Vb
29.04.2017		Vindelnskottet 2017		Ramselefors SKF		
Prov 	1: 9.4 ↙	Prov 	11: 10.0 ←			
	2: 8.8 ↗		12: 9.7 ←			
	3: 9.8 ↖					
	4: 10.6x ↘					
	5: 10.3x ↘					
	6: 10.6x ↘					
	7: 9.9 ←					
	8: 8.9 ↘					
	9: 9.5 →					
	10: 9.7 ↘					
	Serie 91.0		Serie 19.0			
	Total 181.0		Total 181.0			
1. Serie 10 Skott 	1: 10.2 ↘	1. Serie 10 Skott 	6: 10.5x ↗			
	2: 10.1 →		7: 10.0 ↗			
	3: 8.5 ↗		8: 8.9 ↘			
	4: 10.7x →		9: 10.1 ↘			
	5: 10.3 ↗		10: 9.7 ↗			
	Serie 48.0		Serie 47.0			
	Total 229.0		Total 276.0			
2. Serie 1 Skott 	1: 9.6 ←					
	2: 10.8x ↘					
	3: 10.1 ↗					
	4: 10.3 ←					
	5: 10.1 ↗					
	Serie 49.0					
	Total 325.0					

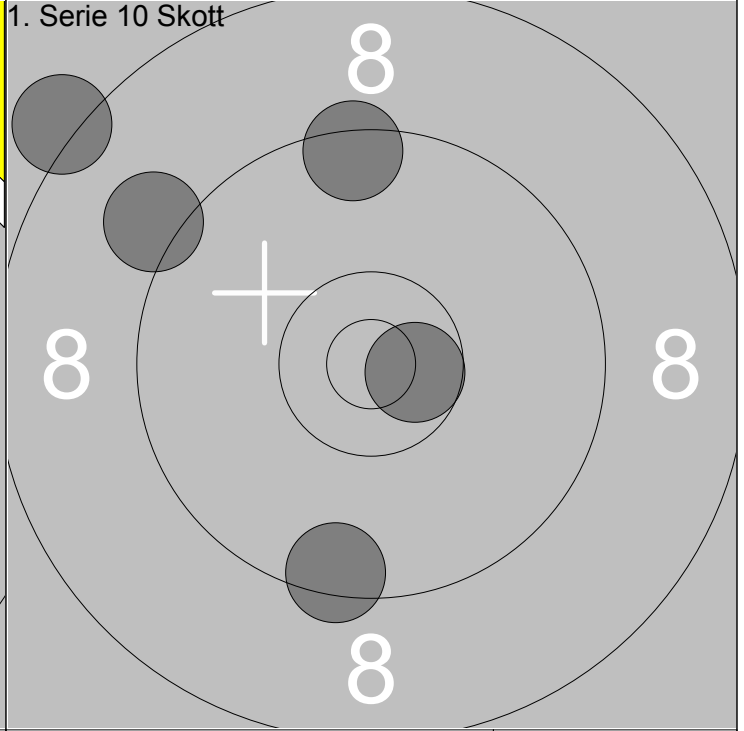
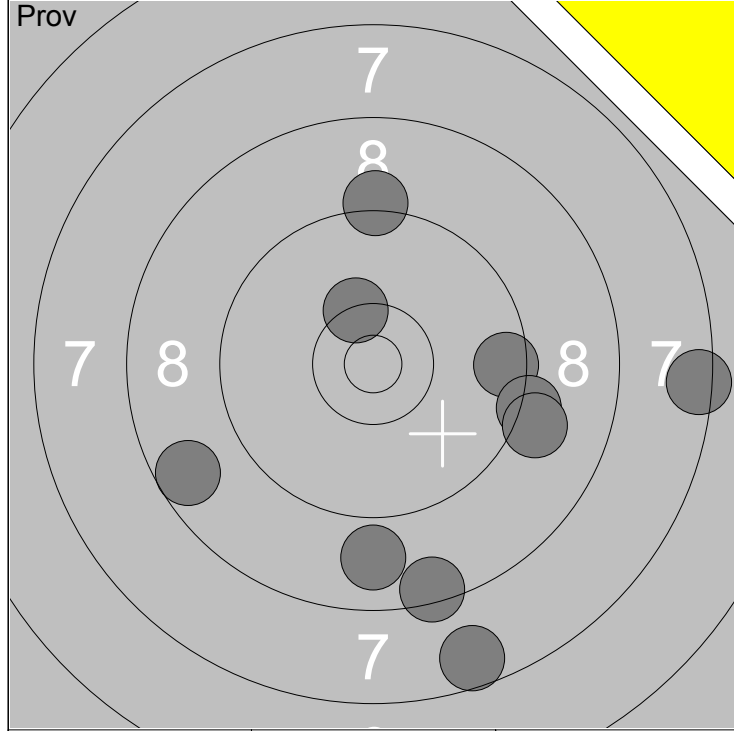

1: 7.4 →	6: 8.9 ↓		Serie	84
2: 9.5 →	7: 9.2 →			
3: 10.3x ↑	8: 9.1 →	Total	180	
4: 7.6 ↓	9: 8.4 ↓			
5: 9.2 ↑	10: 8.6 ↙			

1: 9.5 ↓		Serie	45
2: 8.2 ↗			
3: 9.1 ↗	Total	225	
4: 9.4 ↑			
5: 10.6x →			

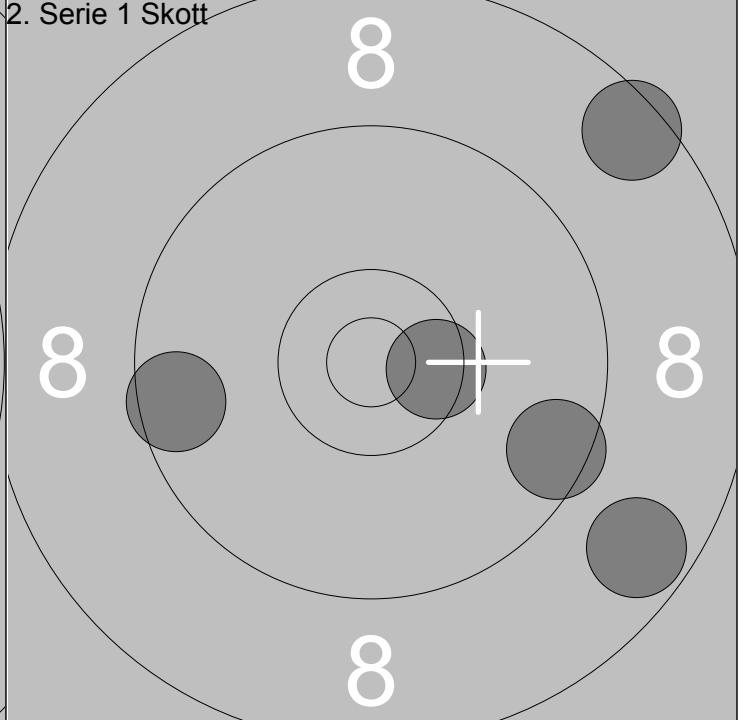
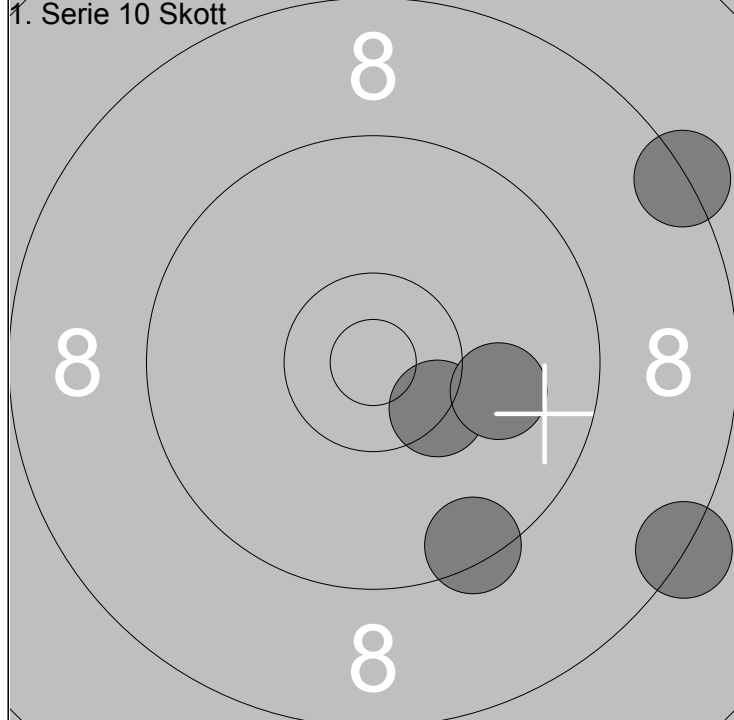

6: 8.3 ↘		Serie	45
7: 9.4 ↓			
8: 10.4x ↓	Total	270	
9: 10.0 →			
10: 8.3 ↗			

1: 8.7 ↘		Serie	44
2: 8.5 ↗			
3: 9.5 →	Total	314	
4: 9.6 ←			
5: 10.5x →			

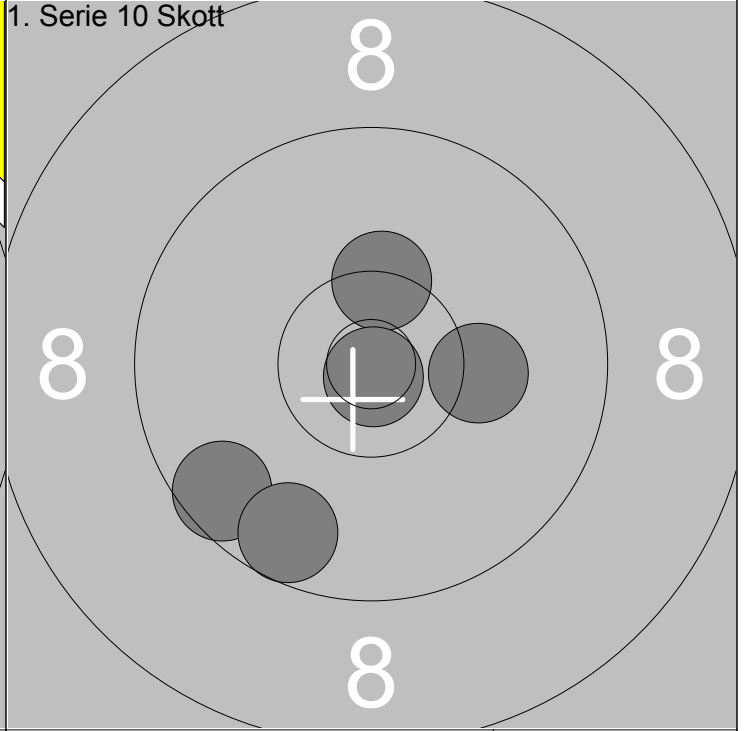
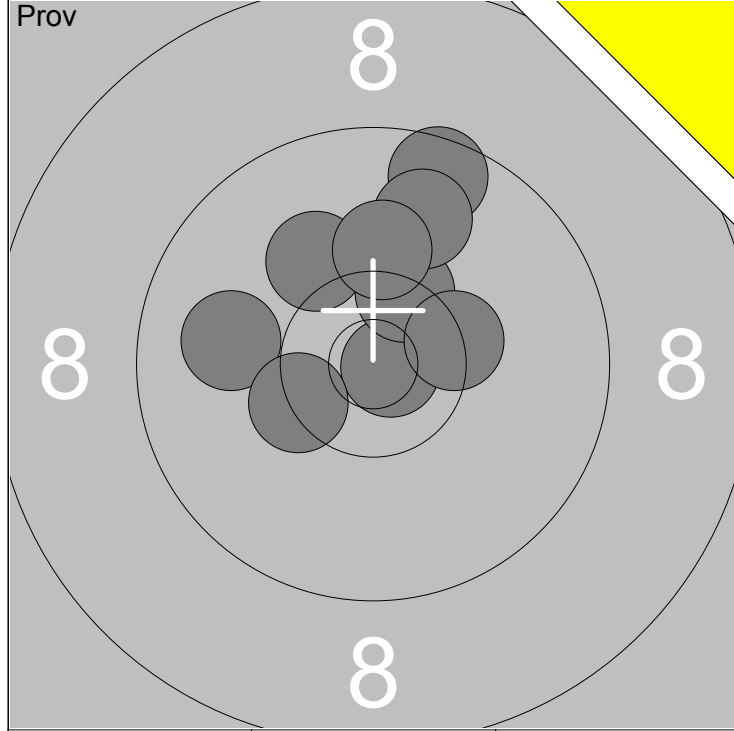

1: 9.6 ↗	6: 9.9 ↗		
2: 9.9 ←	7: 10.1 ↖		
3: 10.8x →	8: 10.2 ↑	Serie	87
4: 10.4x ↗	9: 10.4x ↖	Total	194
5: 10.4x →			

1: 9.6 ↖		
2: 10.4x ↑		
3: 9.6 ↘	Serie	48
4: 10.2 →	Total	242
5: 10.9x ↘		

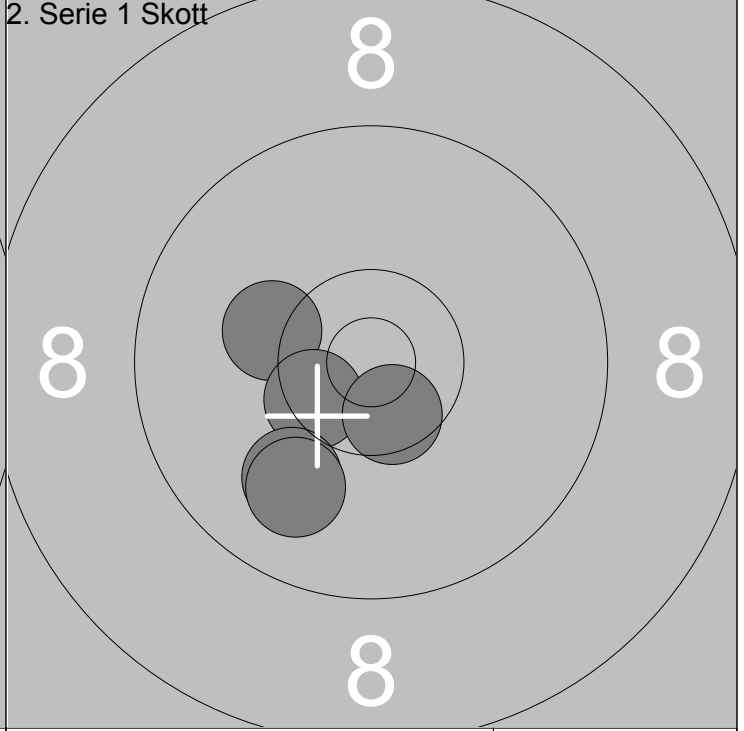
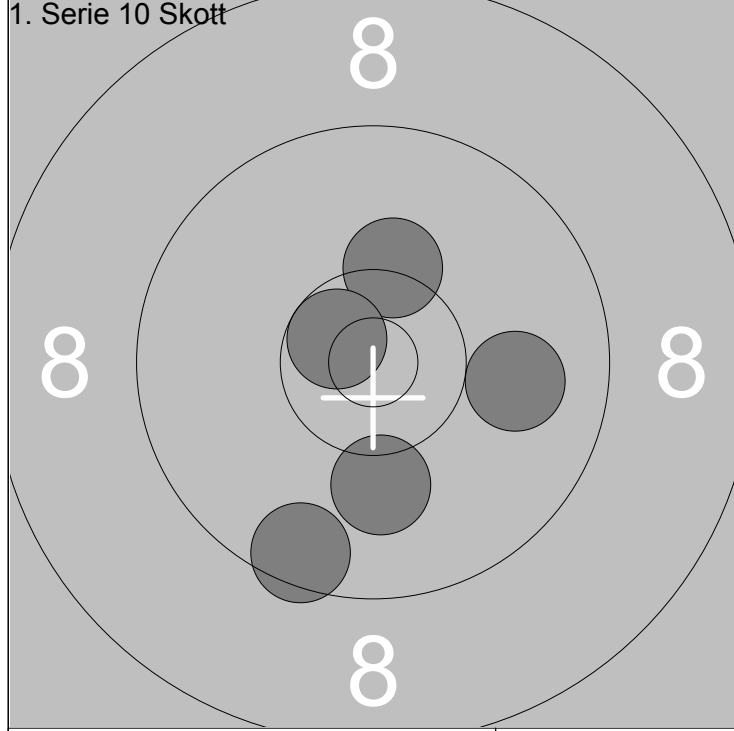

6: 10.3 ↗		
7: 9.5 ↘		
8: 10.7x ↖	Serie	49
9: 10.0 →	Total	291
10: 10.1 ↘		

1: 10.2 ↖		
2: 10.5x ↖		
3: 10.6x ↘	Serie	49
4: 10.0 ↘	Total	340
5: 9.9 ↘		



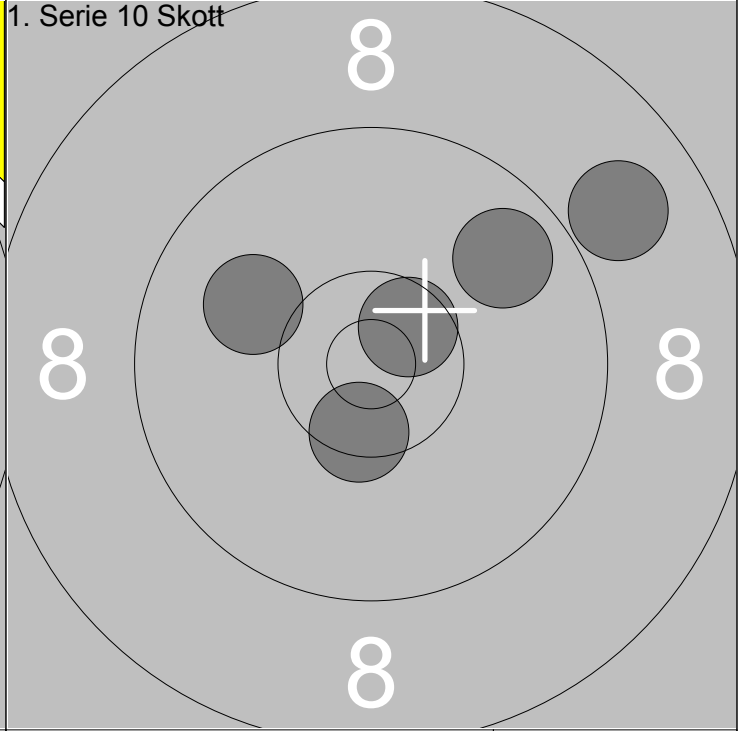
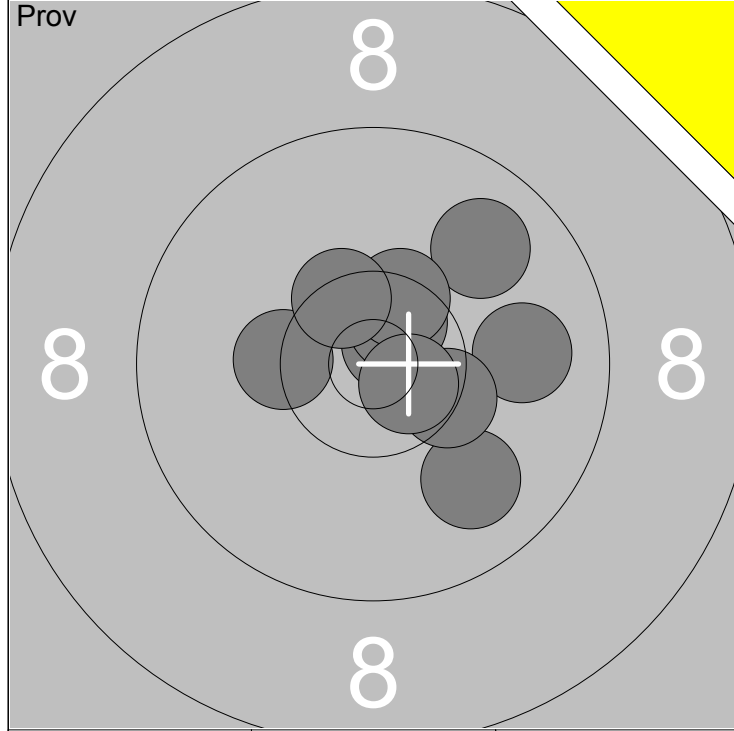

1: 10.8x ↗	6: 9.9 →	Serie 97
2: 10.6x ↗	7: 10.4x ➤	
3: 9.9 ↗	8: 10.7x ➤	Total 193
4: 10.5x ↗	9: 10.3x ←	
5: 9.9 ↘	10: 10.4x ↗	

1: 10.0 ↖	Serie 47
2: 10.5x ↓	
3: 10.6x ↗	Total 240
4: 9.8 ↗	
5: 8.9 ↗	

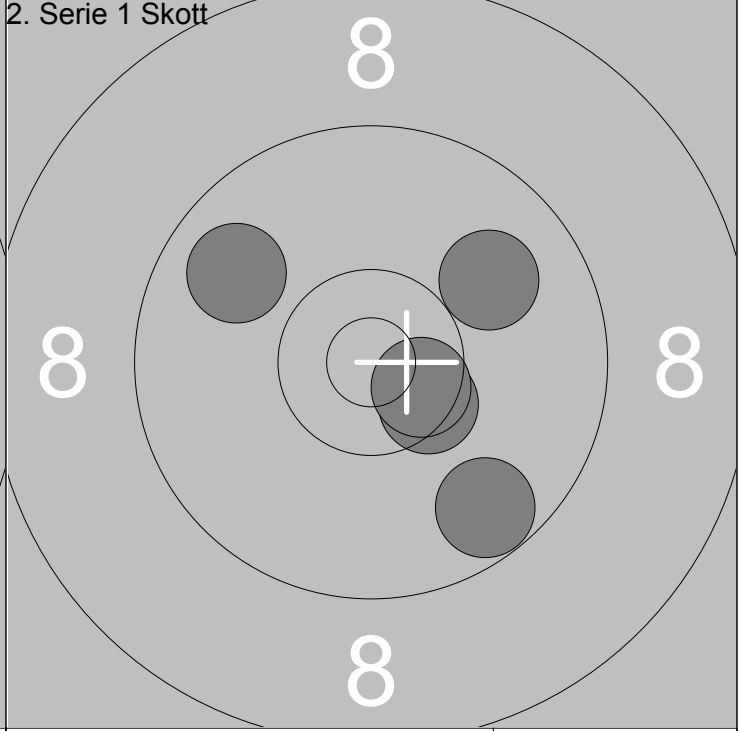
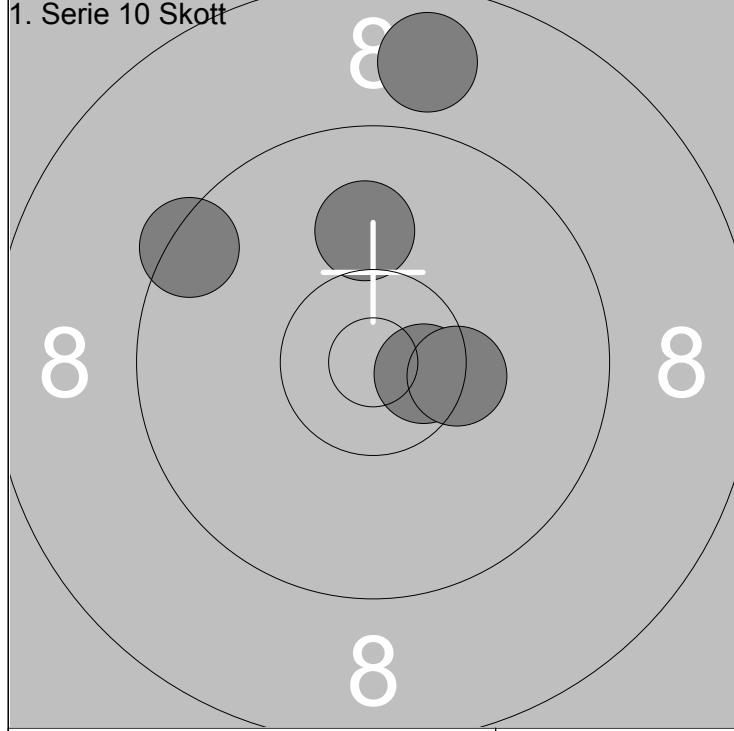

6: 10.6x ➤	Serie 47
7: 8.8 ↑	
8: 10.0 ↑	Total 287
9: 10.4x ➤	
10: 9.4 ↖	

1: 9.7 ↘	Serie 47
2: 9.8 ↗	
3: 9.9 ↗	Total 334
4: 10.5x ↘	
5: 10.6x ➤	

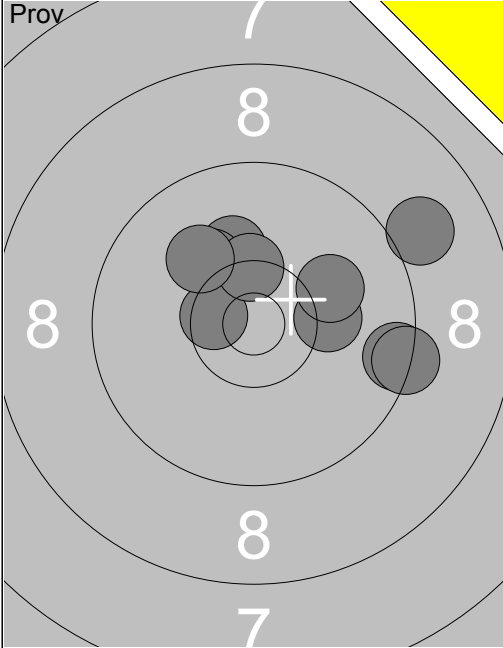
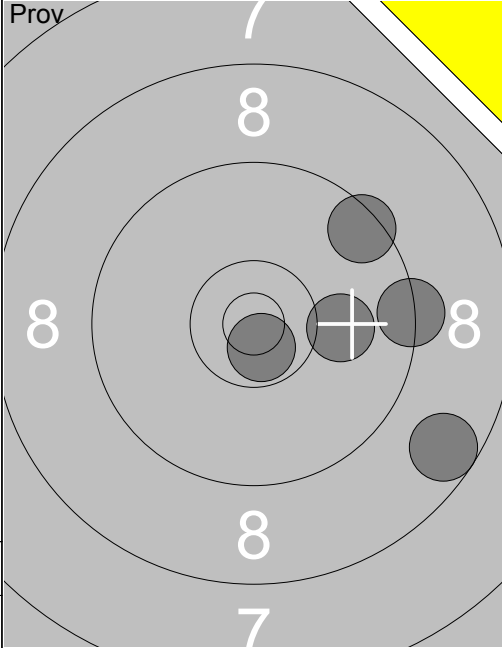
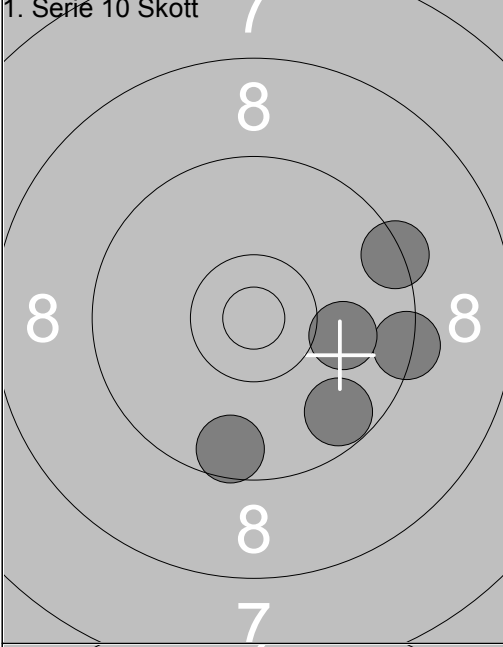
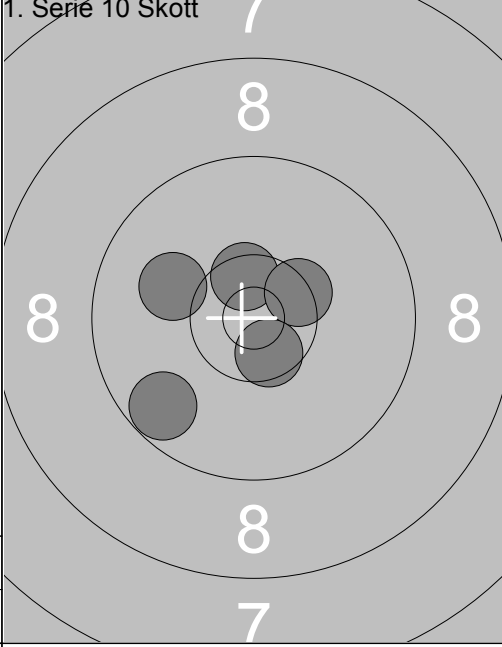
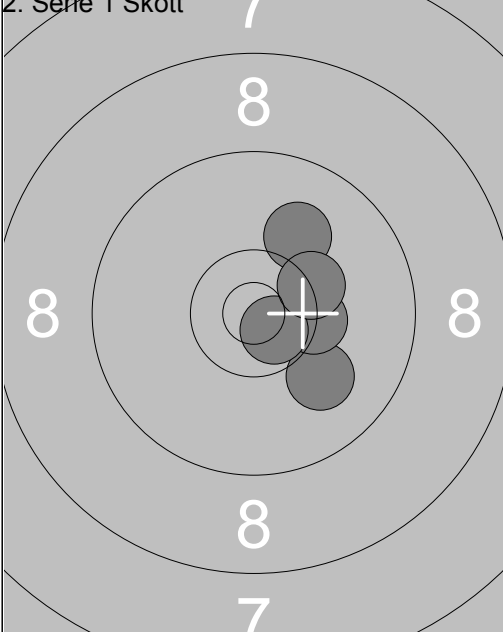
Skjuttag	Tavla	Marlene Forsell Forsman			
5	3	Vindelns	Ramselefors	Sen-L	Vb
29.04.2017	Vindelnskottet 2017	Ramselefors SKF			
Prov 	1: 9.5 →	Prov 	11: 9.5 ↗		
	2: 10.2 →		12: 10.7x ↘		
	3: 9.4 →		13: 10.1 →		
	4: 10.1 ↗		14: 8.6 ↘		
	5: 10.2 ↑		15: 9.3 →		
	6: 10.2 ↖				
	7: 10.5x ↙				
	8: 9.0 ↗				
	9: 10.4x ↑				
	10: 10.1 ↖				
	Serie 97.0		Serie 46.0		
	Total 193.0		Total 193.0		
1. Serie 10 Skott 	1: 9.4 ↗	1. Serie 10 Skott 	6: 10.1 ↖		
	2: 9.4 →		7: 10.5x ↑		
	3: 9.6 ↓		8: 9.7 ↘		
	4: 10.0 →		9: 10.4x ↗		
	5: 9.7 ↘		10: 10.6x ↘		
	Serie 46.0		Serie 49.0		
	Total 239.0		Total 288.0		
2. Serie 1 Skott 	1: 10.0 ↘				
	2: 10.0 ↗				
	3: 10.3x →				
	4: 10.7x ↘				
	5: 10.3x ↗				
	Serie 50.0				
	Total 338.0				

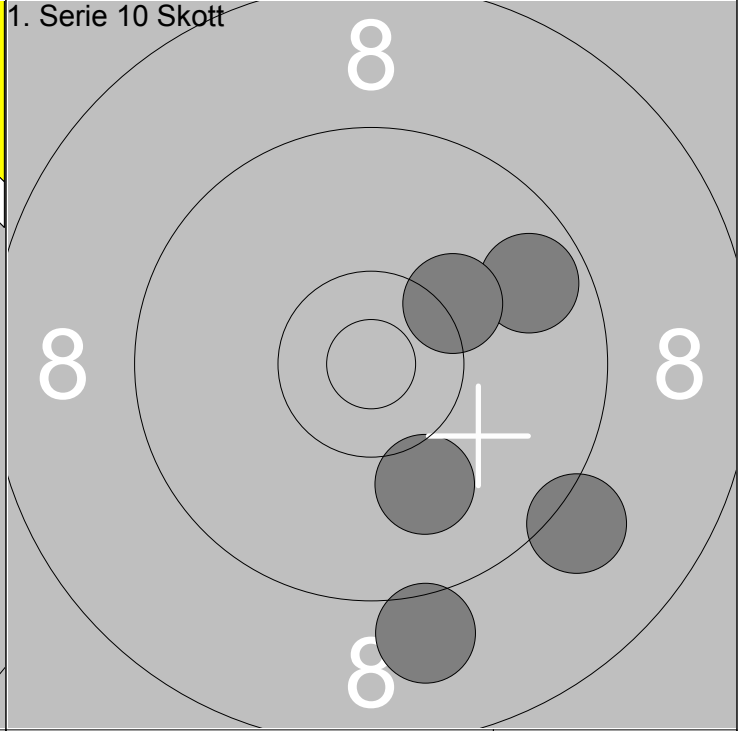
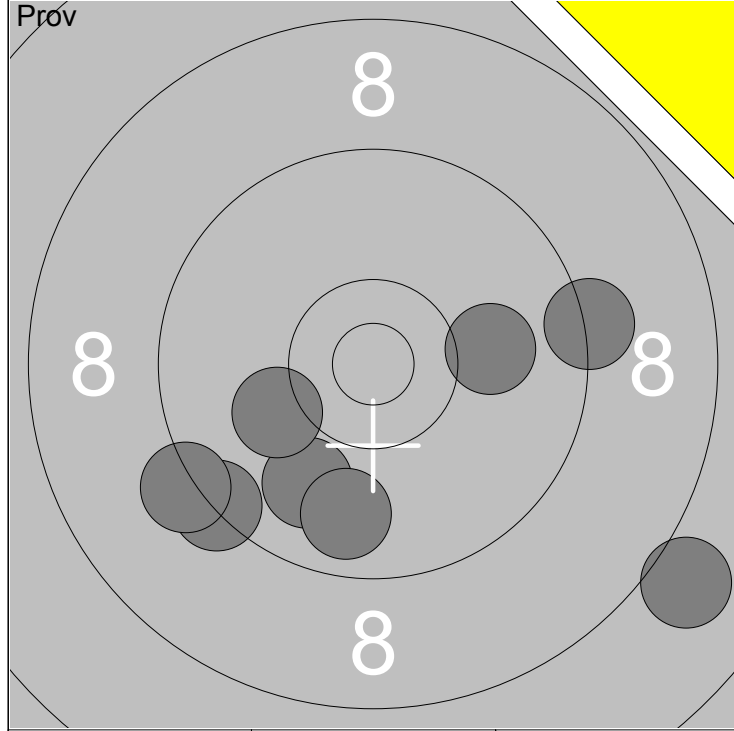

1: 9.3 ↙	6: 9.3 →	Serie	73
2: 9.9 ↓	7: 8.0 ↘		
3: 9.2 ↙	8: 10.0 →	Total	190
4: 9.8 ↓			
5: 10.1 ↙			

1: 9.1 ↘	Serie	47
2: 9.7 ↗		
3: 9.0 ↓	Total	237
4: 10.0 ↓		
5: 10.2 ↗		

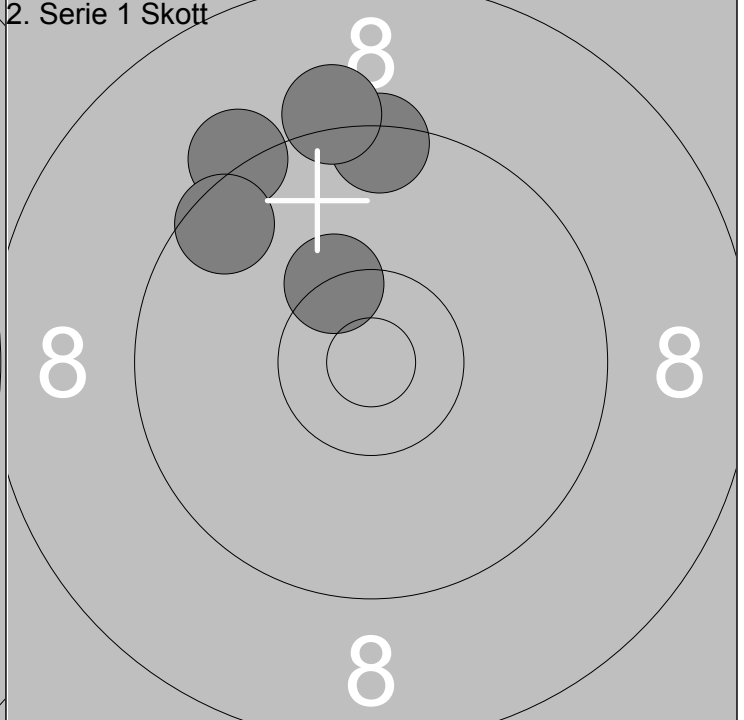
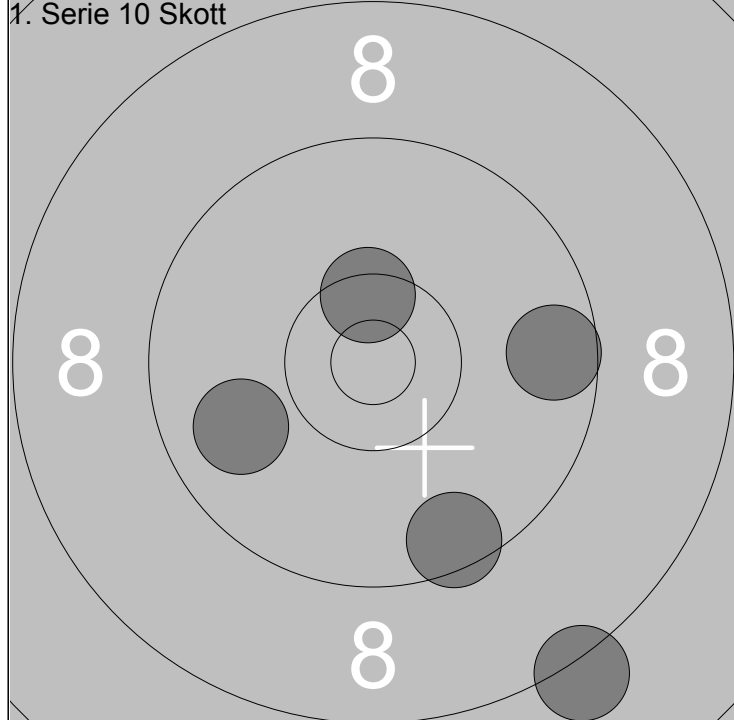

6: 9.6 →	Serie	45
7: 9.5 ↓		
8: 8.2 ↓	Total	282
9: 10.5x ↑		
10: 9.9 ↙		

1: 9.4 ↑	Serie	46
2: 9.3 ↗		
3: 9.5 ↖	Total	328
4: 10.3x ↖		
5: 9.2 ↑		

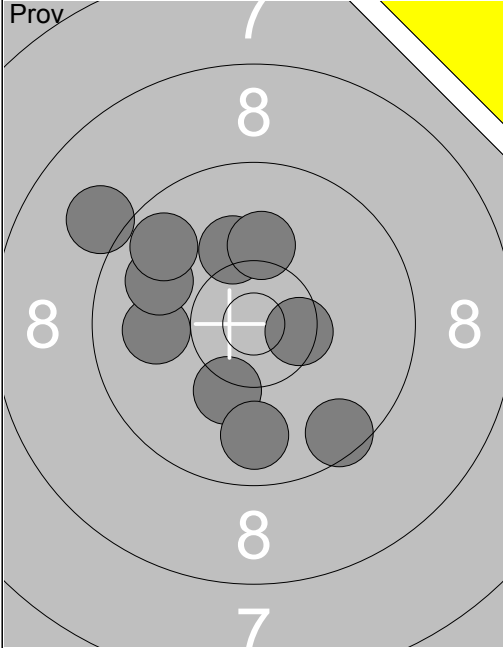
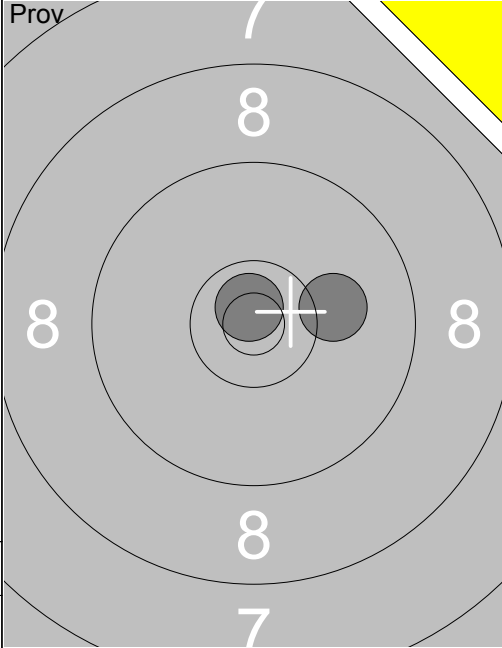
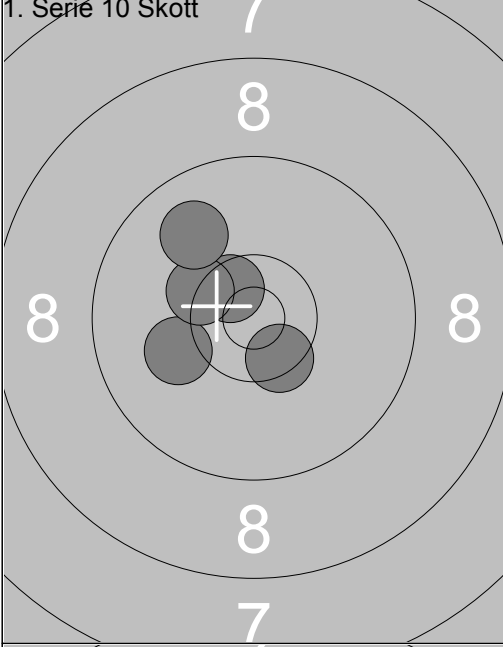
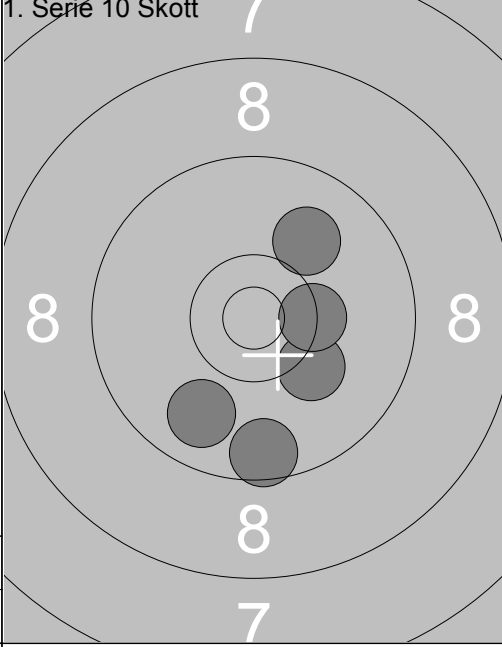
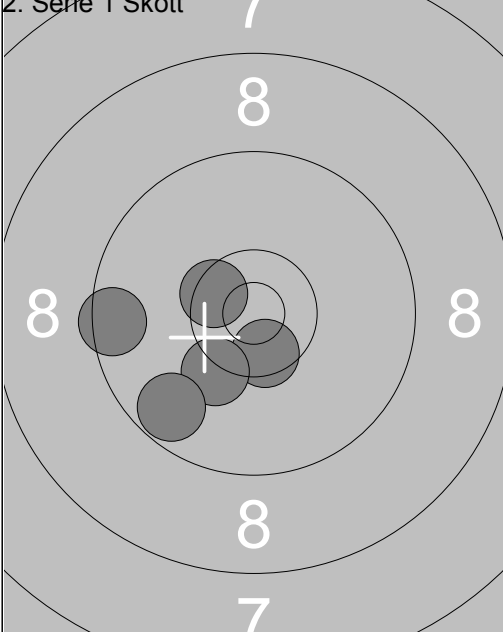
Skjuttag	Tavla	Maria Hägglund			
5	5	Vindeln	Ramselefors	Sen-L	Vb
29.04.2017	Vindelnskottet 2017	Ramselefors SKF			
Prov		1: 10.2 ↗ 2: 9.5 ↘ 3: 10.2 ↘ 4: 9.8 ↓ 5: 10.0 ← 6: 10.5x → 7: 9.9 ← 8: 9.7 ↗ 9: 9.1 ↗ 10: 10.1 ↑	Prov		11: 10.8x ↗ 12: 10.1 →
		Serie 95.0		Serie 20.0	
		Total 190.0		Total 190.0	
1. Serie 10 Skott		1: 10.5x ↘ 2: 10.1 ← 3: 10.6x ↗ 4: 10.3x ↗ 5: 9.9 ↗	1. Serie 10 Skott		6: 10.2 ↘ 7: 10.4x → 8: 9.6 ↓ 9: 9.8 ↘ 10: 10.0 ↗
		Serie 49.0		Serie 48.0	
		Total 239.0		Total 287.0	
2. Serie 1 Skott		1: 10.5x ↗ 2: 9.5 ← 3: 10.5x ↘ 4: 10.2 ↘ 5: 9.7 ↘			
		Serie 48.0			
		Total 335.0			

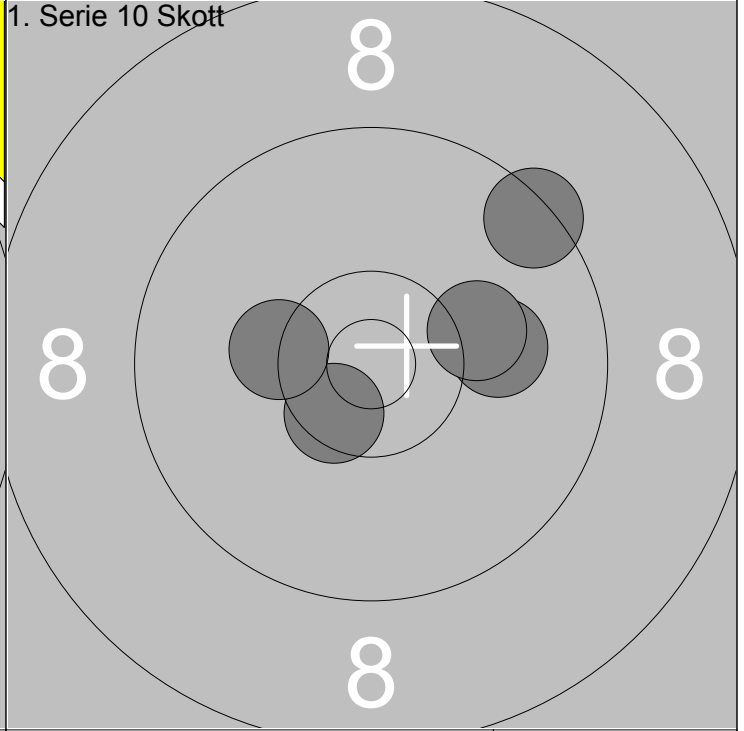
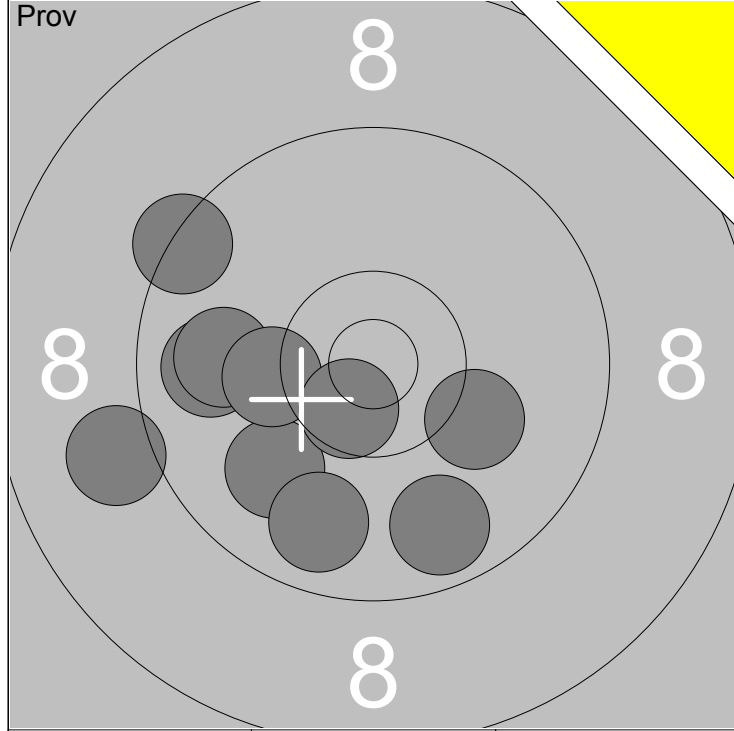

1: 9.8 ←	6: 10.2 ←
2: 9.0 ←	7: 10.6x ↓
3: 9.4 ↗	8: 9.8 ↓
4: 9.9 ←	9: 9.7 ↓
5: 10.0 ↘	10: 10.1 ↘

Serie	94
Total	189

1: 9.4 ↗	2: 10.5x ↓
3: 10.3x ←	4: 10.1 →
5: 10.2 →	

Serie	49
Total	238

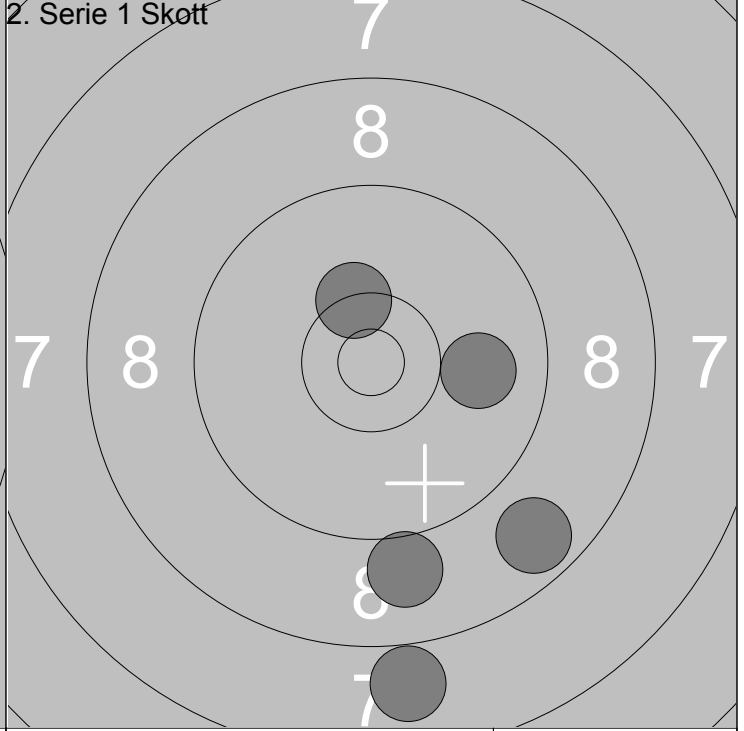
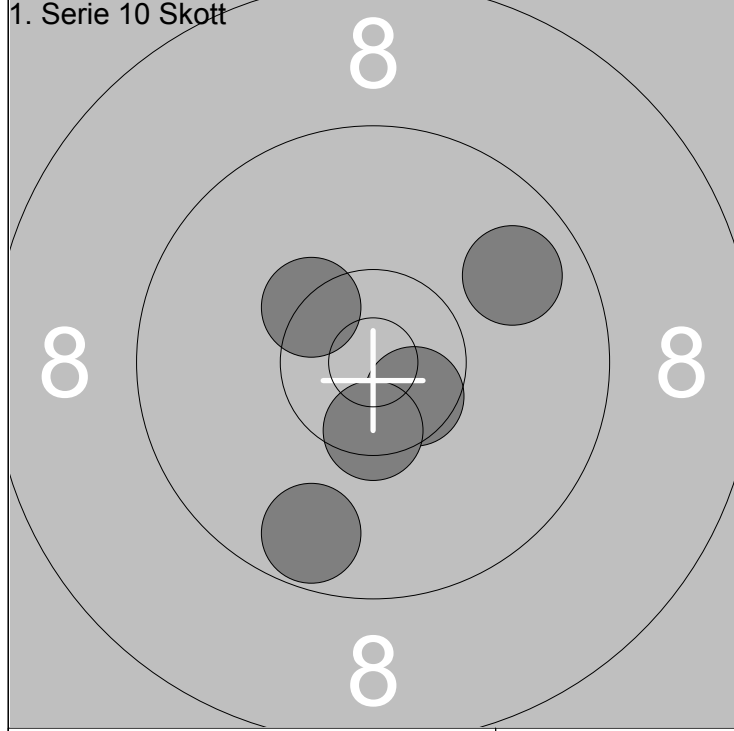

6: 9.8 ↗	7: 10.6x ↓
8: 10.4x ↗	9: 10.5x ↓
10: 9.7 ↓	

Serie	48
Total	286

1: 7.9 ↓	2: 9.0 ↓
3: 10.4x ↗	4: 8.7 ↓
5: 9.9 →	

Serie	43
Total	329

Skjuttag	Tavla	Stefan Thorin																		
5	7	Vindeln	Umeå	Sen-L	Vb															
29.04.2017	Vindelnskottet 2017	Ramselefors SKF																		
Prov		1: 8.5 →	2: 8.6 ↘	3: 9.7 ↘	4: 9.4 ↘	5: 9.5 →	6: 9.5 ↙	7: 9.8 →	8: 9.6 ↗	9: 9.2 ↖	10: 9.3 ←	Serie	88.0	Total	186.0					
Prov		11: 9.7 ↓	12: 10.0 ↙	13: 9.9 ↓	Serie	28.0	Total	186.0												
1. Serie 10 Skott		1: 9.6 ↓	2: 9.5 →	3: 9.5 ←	4: 10.0 ↓	5: 8.6 ↓	Serie	45.0	Total	231.0	1. Serie 10 Skott	6: 9.4 ↑	7: 10.4x ↘	8: 9.6 ↖	9: 9.6 ↓	10: 10.4x ↓	Serie	47.0	Total	278.0
2. Serie 1 Skott		1: 9.5 ←	2: 10.0 ↖	3: 9.1 ↗	4: 9.8 ↑	5: 9.5 ↓	Serie	46.0	Total	324.0										

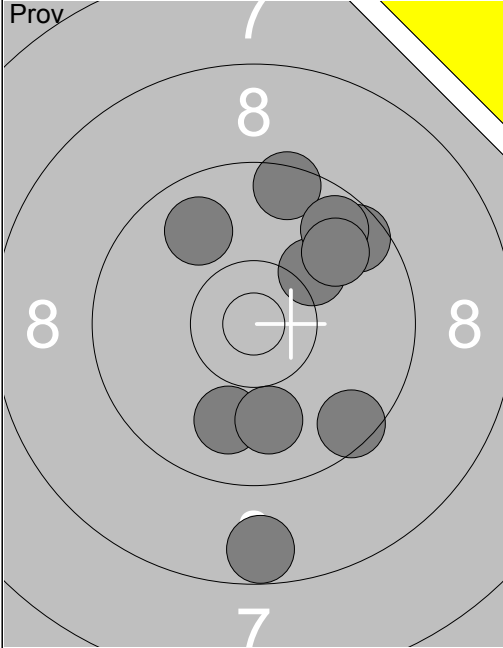
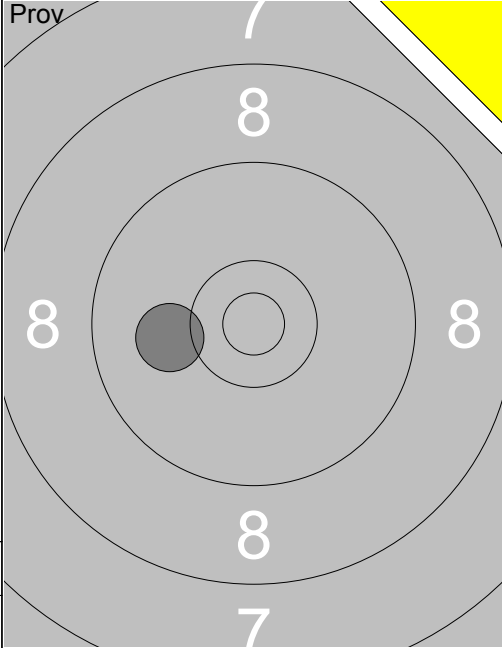
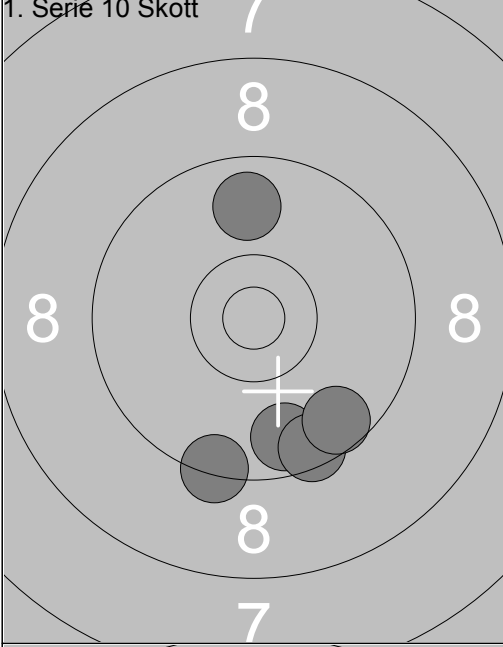
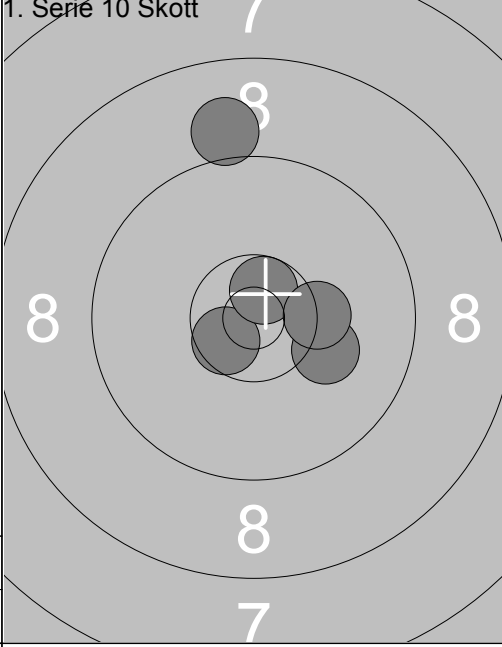
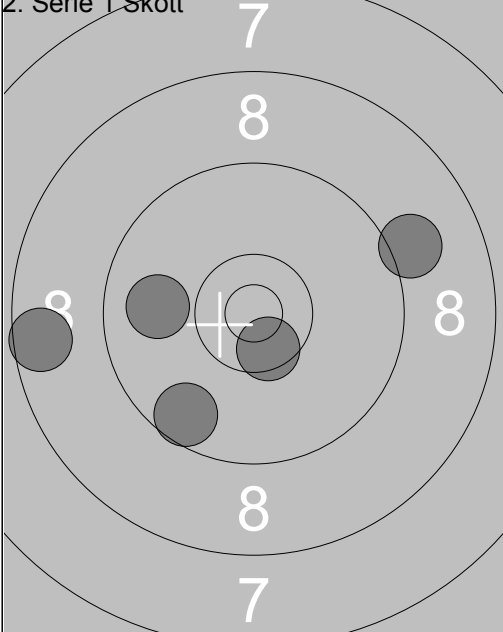
Skjuttag	Tavla	Niklas Johansson			
5	8	Vindeln		Ramselefors	Sen-L Vb
29.04.2017		Vindelnskottet 2017		Ramselefors SKF	
Prov 	1: 9.8 ↖	Prov 	11: 10.1 ←		
	2: 9.5 ↑				
	3: 9.9 ↓				
	4: 8.7 ↓				
	5: 10.0 ↓				
	6: 10.2 ↗				
	7: 9.6 ↗				
	8: 9.7 ↗				
	9: 9.8 ↗				
	10: 9.5 ↘				
	Serie 91.0		Serie 10.0		
	Total 184.0		Total 184.0		
1. Serie 10 Skott 	1: 9.7 ↓	1. Serie 10 Skott 	6: 9.0 ↑		
	2: 9.5 ↓		7: 10.6 ✕		
	3: 9.8 ↑		8: 10.6 ✕		
	4: 9.6 ↘		9: 10.1 ➤		
	5: 9.4 ↓		10: 10.3 ✕ ➤		
	Serie 45.0		Serie 49.0		
	Total 229.0		Total 278.0		
2. Serie 1 Skott 	1: 9.6 ↓				
	2: 10.5 ✕				
	3: 9.9 ←				
	4: 8.6 ←				
	5: 9.1 ➤				
	Serie 45.0				
	Total 323.0				

	<p>1: 8.9 ↑</p> <p>2: 9.3 ↑</p> <p>3: 10.0 ↙</p> <p>4: 10.1 ↓</p> <p>5: 9.6 ↙</p> <p>6: 9.6 ↗</p> <p>7: 9.0 ↙</p> <p>8: 8.6 ↗</p> <p>9: 8.8 ↙</p> <p>10: 9.1 ↑</p>	
Serie 89.0		Serie 18.0
Total 179.0		Total 179.0

<p>1. Serie 10 Skott</p>	<p>1: 7.3 ↗</p> <p>2: 10.3x↑</p> <p>3: 8.2 ↙</p> <p>4: 6.6 ↙</p> <p>5: 10.2 ↙</p>	
Serie 41.0		Serie 40.0
Total 220.0		Total 260.0

<p>2. Serie 1 Skott</p>	<p>1: 10.1 ↗</p> <p>2: 9.4 ↙</p> <p>3: 9.8 ↗</p> <p>4: 8.1 ↑</p> <p>5: 8.6 →</p>	
Serie 44.0		
Total 304.0		



	<p>Prov</p> <p>1: 9.5 ↑</p> <p>2: 7.3 ↑</p> <p>3: 10.1 ↓</p> <p>4: 8.6 ↖</p> <p>5: 8.6 ↙</p> <p>6: 7.6 ↙</p> <p>7: 9.5 ↖</p> <p>8: 9.2 ↑</p> <p>9: 9.0 ↘</p> <p>10: 9.2 ←</p> <p>Serie 85.0</p> <p>Total 176.0</p>	<p>Prov</p> <p>11: 9.3 ↓</p> <p>12: 7.6 ↖</p> <p>13: 9.6 ↓</p> <p>14: 9.9 ←</p> <p>15: 8.9 ↗</p> <p>16: 10.0 →</p> <p>17: 10.2 ↗</p> <p>18: 9.7 ↓</p> <p>19: 9.6 ↓</p> <p>Serie 80.0</p> <p>Total 176.0</p>
--	--	---

<p>1. Serie 10 Skott</p> <p>Serie 46.0</p> <p>Total 222.0</p>	<p>1: 9.1 ↘</p> <p>2: 9.0 ↑</p> <p>3: 9.6 ↗</p> <p>4: 9.0 →</p> <p>5: 10.8x ↗</p> <p>Serie 46.0</p> <p>Total 222.0</p>	<p>1. Serie 10 Skott</p> <p>Serie 47.0</p> <p>Total 269.0</p> <p>6: 10.0 ↑</p> <p>7: 8.1 →</p> <p>8: 9.5 ↑</p> <p>9: 10.8x ↘</p> <p>10: 10.2 ←</p> <p>Serie 47.0</p> <p>Total 269.0</p>
---	--	---

<p>2. Serie 1 Skott</p> <p>Serie 46.0</p> <p>Total 315.0</p>	<p>1: 9.6 ↓</p> <p>2: 9.5 →</p> <p>3: 9.3 ↖</p> <p>4: 10.0 ↓</p> <p>5: 9.3 ↗</p> <p>Serie 46.0</p> <p>Total 315.0</p>	
--	---	--

Skjutlag	Tavla	Mats Österlund				
5	11	Vindeln		Ramselefors	Sen-L	Vb
29.04.2017		Vindelnskottet 2017		Ramselefors SKF		
	1: 10.3✕		11: 9.3 ↑			
	2: 10.5✕		12: 8.7 ↑			
	3: 10.4✕					
	4: 10.9✕					
	5: 9.7 →					
	6: 9.7 ↗					
	7: 8.8 ↗					
	8: 8.9 ↑					
	9: 9.4 ↗					
	10: 10.0↙					
	Serie 93.0		Serie 17.0			
	Total 172.0		Total 172.0			
1. Serie 10 Skott 	1: 9.1 ↗	1. Serie 10 Skott 	6: 9.5 ↖			
	2: 9.1 ↑		7: 9.8 ↓			
	3: 8.7 ↘		8: 8.7 ↖			
	4: 10.3✕		9: 7.2 ↓			
	5: 9.8 ↑		10: 10.3✕			
	Serie 45.0		Serie 43.0			
	Total 217.0		Total 260.0			
3. Serie 1 Skott 	1: 9.8 ↙					
	2: 8.9 ↙					
	3: 6.7 ↖					
	4: 7.6 ↙					
	Serie 30.0					
	Total 290.0					

	1: 9.8 ↓ 2: 9.5 → 3: 10.0 ↗ 4: 10.3x↘ 5: 10.3 → 6: 10.2 ↙ 7: 10.2 ← 8: 9.1 ↙ 9: 10.4x↗ 10: 9.9 ↗		11: 10.4x↘ 12: 10.0 ↑ 13: 9.9 ↗ 14: 10.1 ← 15: 10.6x↗ 16: 9.8 ↑ 17: 9.1 ↙ 18: 9.9 ↙ 19: 10.1 ↙ 20: 10.5x↘
	Serie 96.0		Serie 96.0
	Total 196.0		Total 196.0

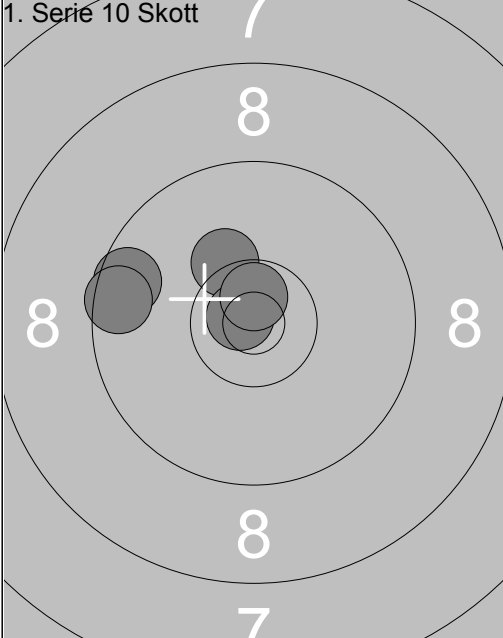
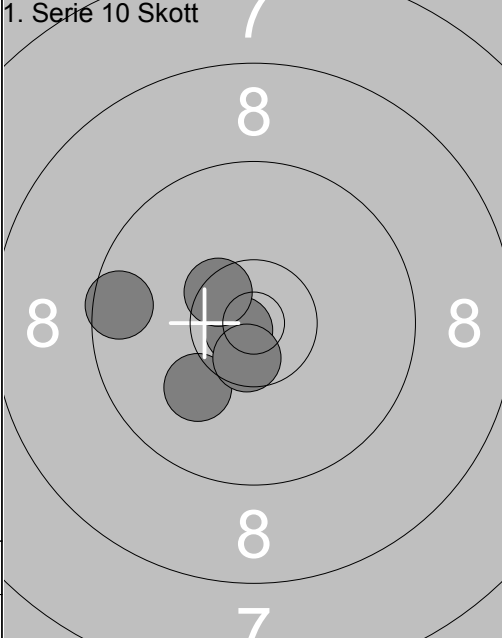
1. Serie 10 Skott 	1: 9.6 ← 2: 10.3 ↗ 3: 10.8x↘ 4: 9.6 ← 5: 10.7x↗	1. Serie 10 Skott 	6: 10.8x↙ 7: 10.1 ↙ 8: 9.6 ← 9: 10.5x↘ 10: 10.6x↘
	Serie 48.0		Serie 49.0
	Total 244.0		Total 293.0

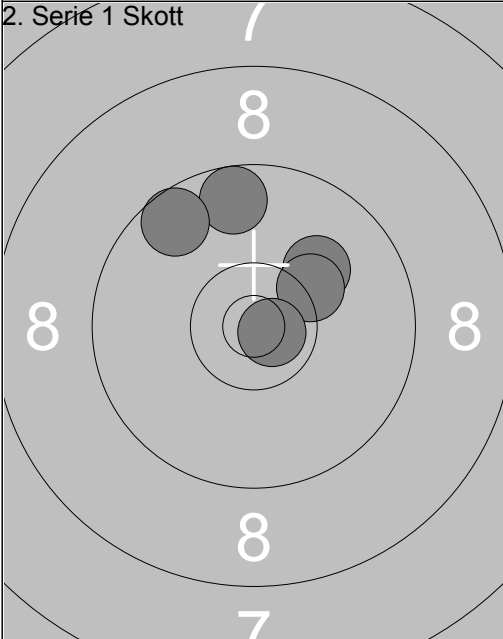
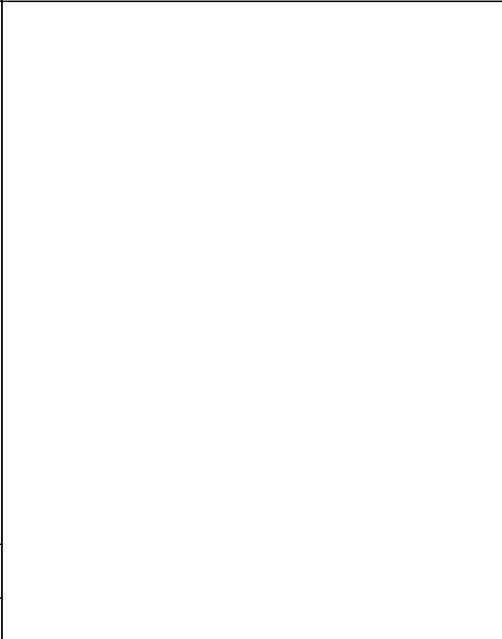
2. Serie 1 Skott 	1: 9.6 ↑ 2: 10.1 ↗ 3: 10.3 ↗ 4: 9.6 ↙ 5: 10.8x↘	
	Serie 48.0	
	Total 341.0	

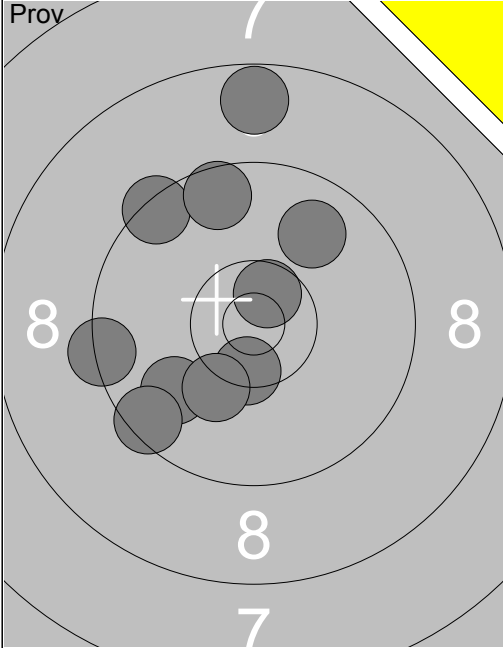
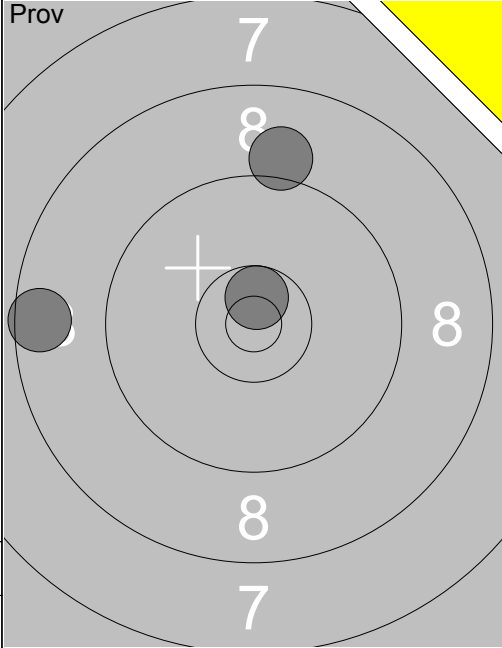
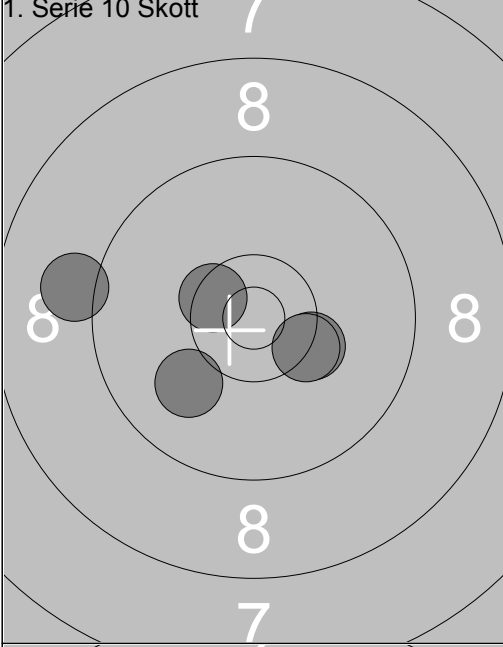
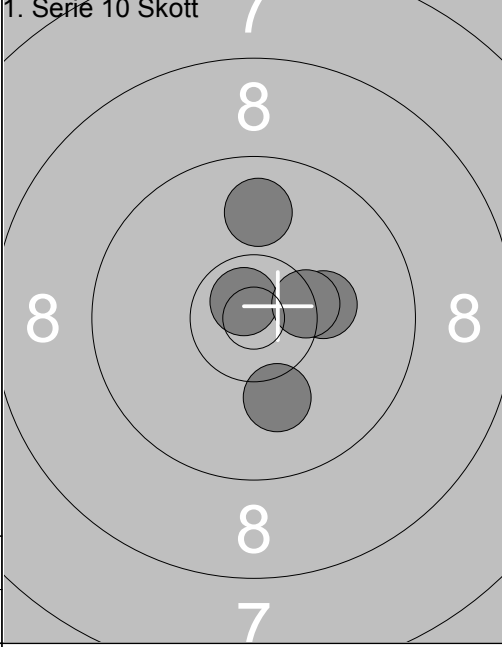
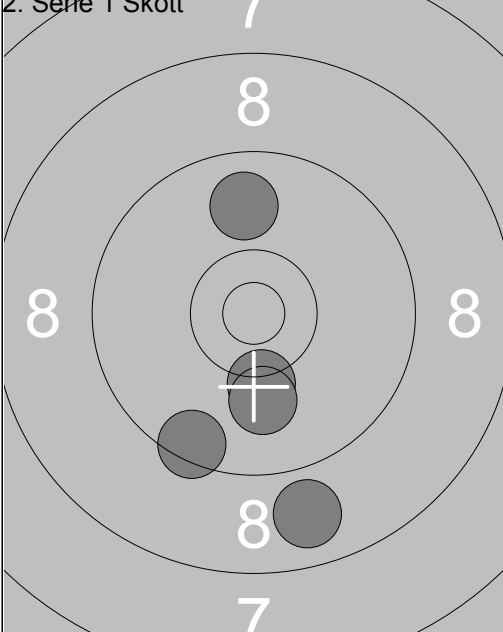
Skjuttag	Tavla	Maja Lindberg			
5	14	Vindeln	Ramselefors	Jun-L	Vb
29.04.2017	Vindelnskottet 2017	Ramselefors SKF			
Prov		1: 9.4 ↖ 2: 8.7 ↑ 3: 9.6 ↑ 4: 9.4 ← 5: 10.5x↓ 6: 10.6x↗ 7: 9.9 ↙ 8: 9.9 ↗ 9: 9.5 ↙ 10: 10.2 ↓	Prov		11: 8.6 ← 12: 9.1 ↑ 13: 10.7x↗
		Serie 92.0		Serie 27.0	
		Total 184.0		Total 184.0	
1. Serie 10 Skott		1: 10.0 ↙ 2: 9.1 ← 3: 10.3x↘ 4: 10.5x↘ 5: 10.3x↘	1. Serie 10 Skott		6: 10.8x↘ 7: 10.1 ↓ 8: 10.2 → 9: 10.4x↘ 10: 9.9 ↑
		Serie 49.0		Serie 49.0	
		Total 233.0		Total 282.0	
2. Serie 1 Skott		1: 8.8 ↓ 2: 9.5 ↓ 3: 10.2 ↓ 4: 10.1 ↓ 5: 9.9 ↑			
		Serie 46.0			
		Total 328.0			

	<p>1: 6.4 →</p> <p>2: 9.6 ↘</p> <p>3: 7.5 →</p> <p>4: 9.9 →</p> <p>5: 10.0 →</p> <p>6: 9.1 ↑</p> <p>7: 9.9 →</p> <p>8: 9.9 ←</p> <p>9: 9.8 ↑</p> <p>10: 9.7 ↘</p>		<p>11: 9.0 ↓</p> <p>12: 9.7 ←</p>
Serie 86.0		Serie 18.0	
Total 180.0		Total 180.0	

<p>1. Serie 10 Skott</p>	<p>1: 9.1 ↑</p> <p>2: 9.6 ←</p> <p>3: 9.8 ←</p> <p>4: 9.8 ↘</p> <p>5: 9.9 ↘</p>	<p>1. Serie 10 Skott</p>	<p>6: 9.3 ↓</p> <p>7: 9.9 ↓</p> <p>8: 9.5 ←</p> <p>9: 9.8 →</p> <p>10: 10.1 ↘</p>
Serie 45.0		Serie 46.0	
Total 225.0		Total 271.0	

<p>2. Serie 1 Skott</p>	<p>1: 9.9 →</p> <p>2: 9.4 ↑</p> <p>3: 9.5 ←</p> <p>4: 9.7 ↘</p> <p>5: 8.6 ↑</p>		
Serie 44.0			
Total 315.0			

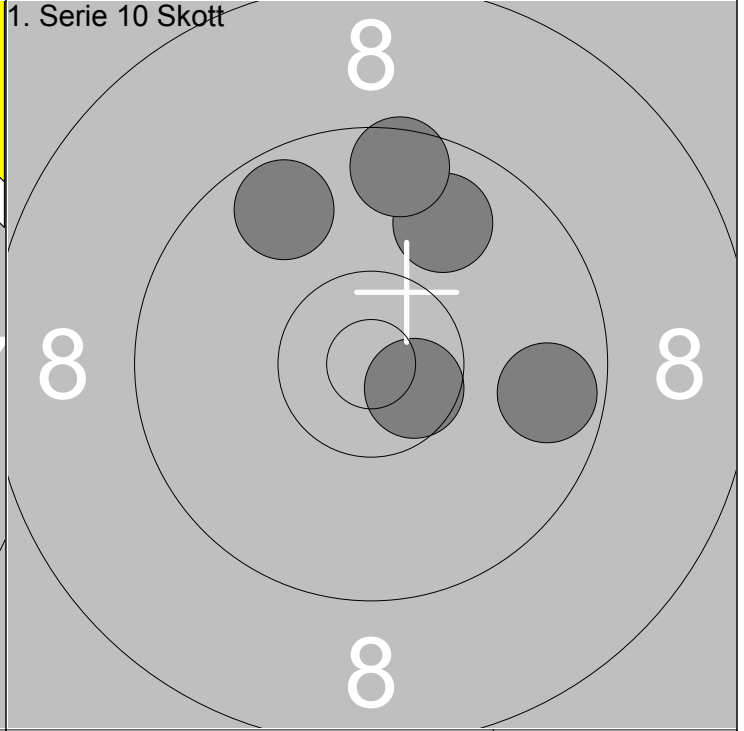
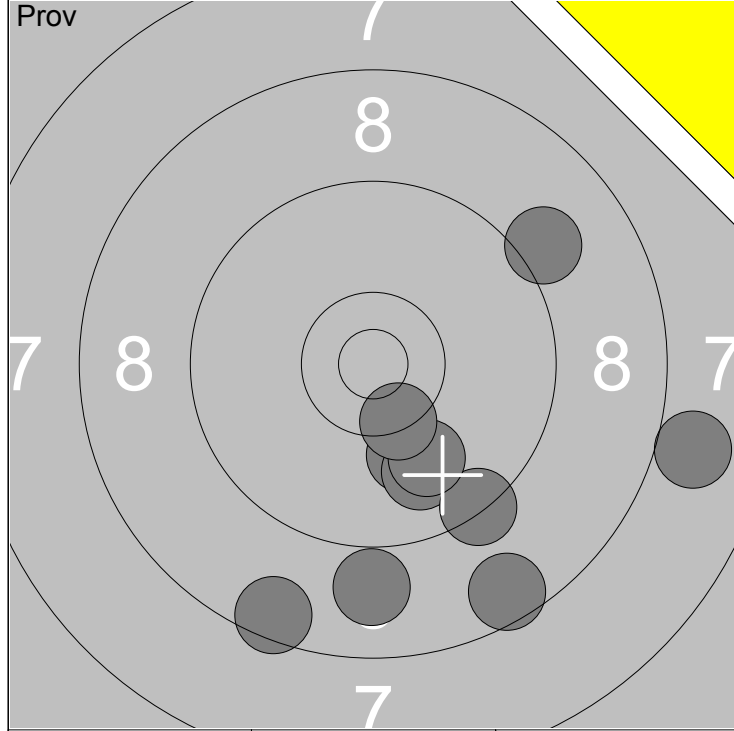

1: 10.1 ↓	6: 10.0 ↓	Serie	89
2: 8.5 ↓	7: 8.0 →		
3: 9.9 ↓	8: 8.9 ↓	Total	180
4: 8.6 ↓	9: 9.1 ↗		
5: 9.4 ↓	10: 10.4x ↓		

1: 9.8 ↗	Serie	46
2: 10.6x →		
3: 9.6 ↑	Total	226
4: 9.7 →		
5: 9.7 ↗		

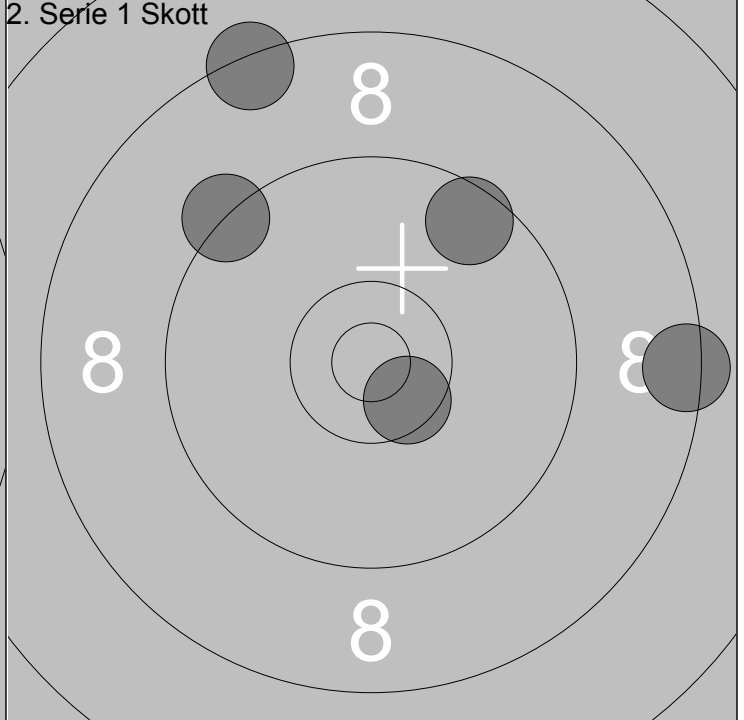
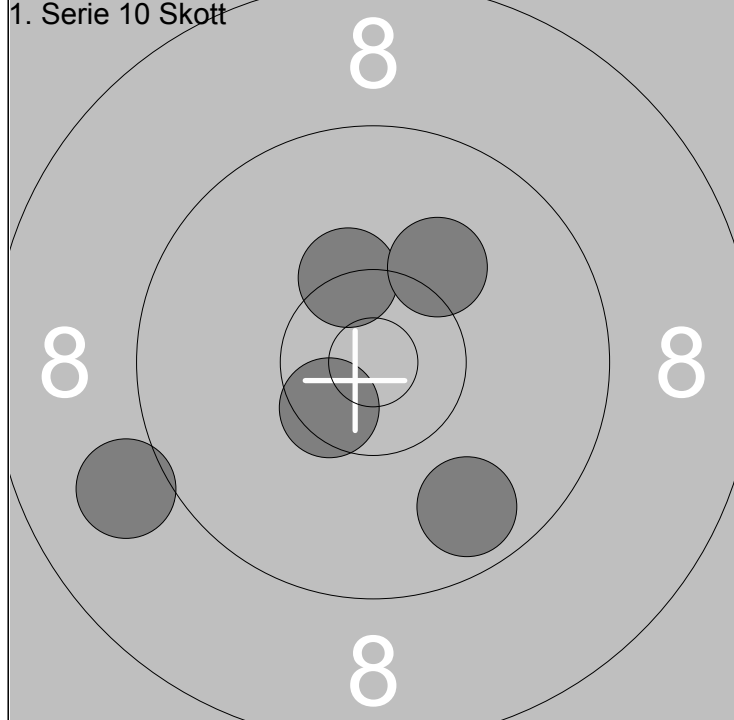

6: 9.8 ↓	Serie	48
7: 10.5x ↙		
8: 10.3x ↗	Total	274
9: 10.1 ↗		
10: 9.0 ↙		

1: 8.4 →	Serie	44
2: 9.6 ↗		
3: 9.3 ↗	Total	318
4: 8.4 ↗		
5: 10.5x ↓		

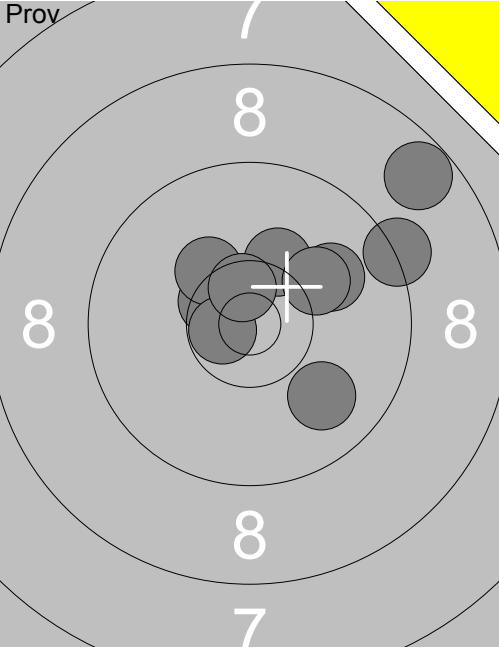
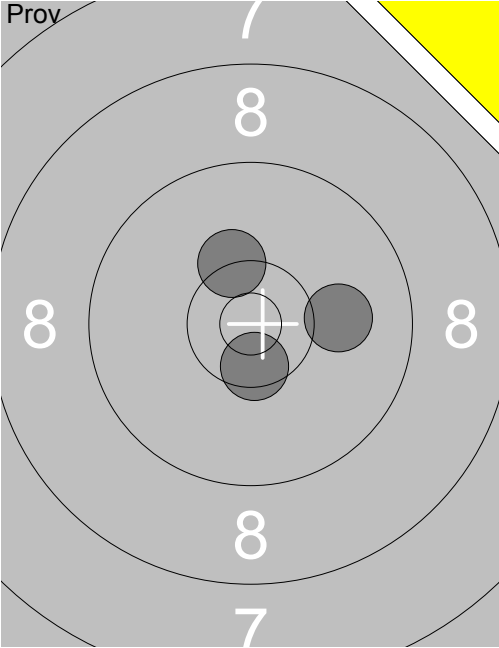
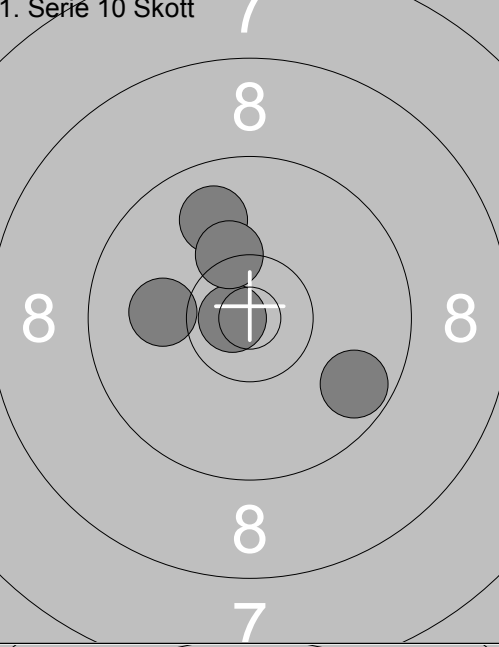
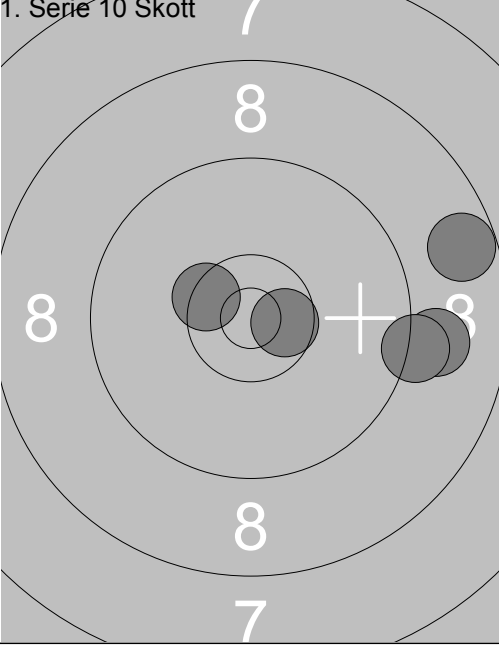
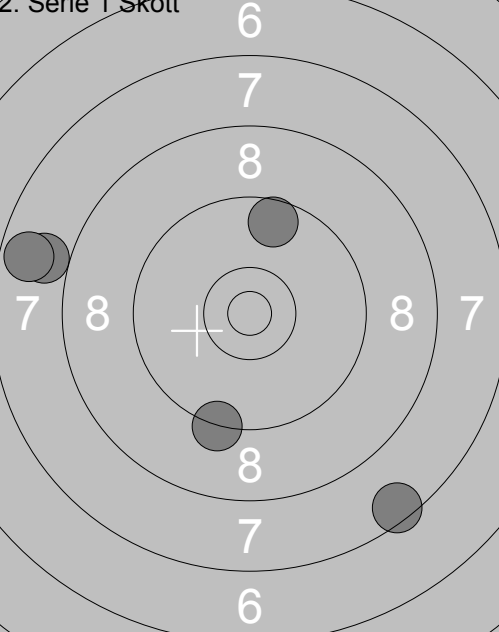
Skjuttag	Tavla	Marlene Forsell Forsman			
6	1	Vindeln	Ramselefors	Sen-S	Vb
29.04.2017	Vindelnskottet 2017	Ramselefors SKF			
Prov 	1: 10.5x↗	Prov 	11: 10.3x↖		
	2: 10.0↗		12: 10.5x↓		
	3: 10.3↗		13: 10.1→		
	4: 8.7↗				
	5: 9.3↗				
	6: 10.3↖				
	7: 10.7x↖				
	8: 10.1↗				
	9: 10.6x↗				
	10: 9.9↘				
	Serie 96.0		Serie 30.0		
	Total 188.0		Total 188.0		
1. Serie 10 Skott 	1: 9.7↘	1. Serie 10 Skott 	6: 9.0→		
	2: 10.8x↖		7: 10.4x↖		
	3: 9.9↗		8: 10.6x→		
	4: 10.3↗		9: 8.7↗		
	5: 10.1↖		10: 9.2→		
	Serie 48.0		Serie 46.0		
	Total 236.0		Total 282.0		
2. Serie 1 Skott 	1: 7.9↖				
	2: 7.5↘				
	3: 9.3↓				
	4: 9.6↗				
	5: 7.7↖				
	Serie 39.0				
	Total 321.0				

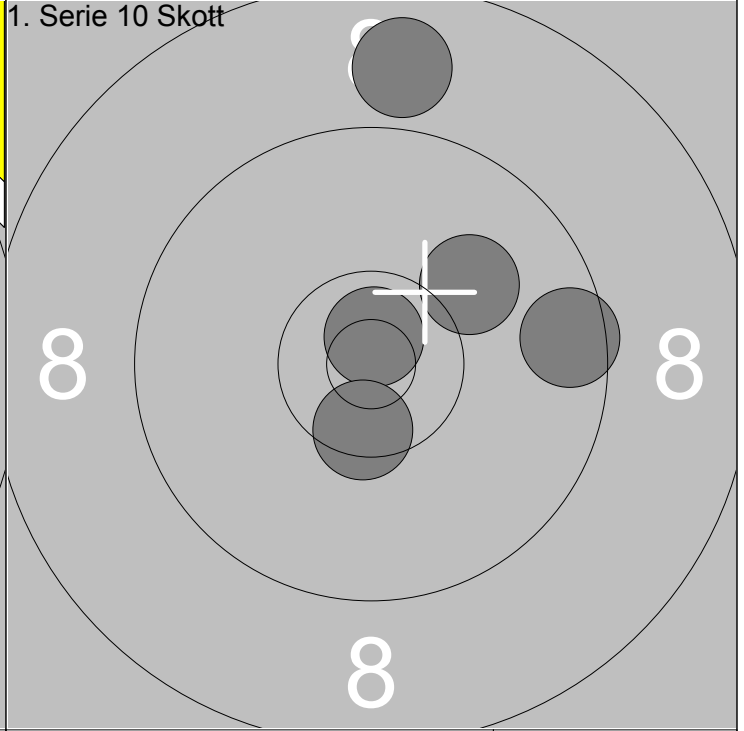
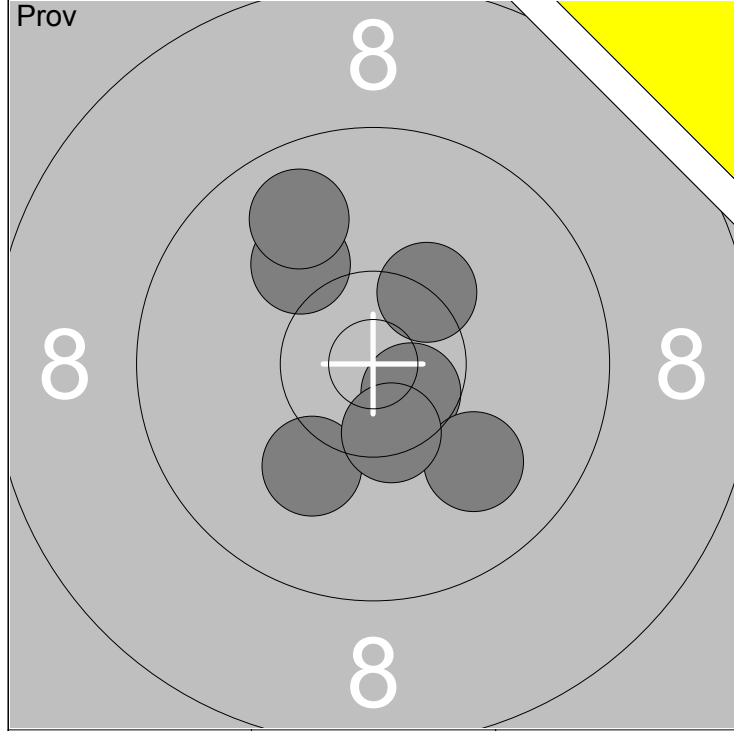

1: 10.1 ↖
2: 10.3x ↗
3: 10.1 ↙
4: 9.8 ↗
5: 10.6x ↘

6: 10.0 ↘
7: 10.5x ↙

Serie	69
Total	182

1: 10.1 ↗
2: 10.8x ↑
3: 10.5x ↓
4: 9.5 →
5: 8.9 ↑

Serie	47
Total	229

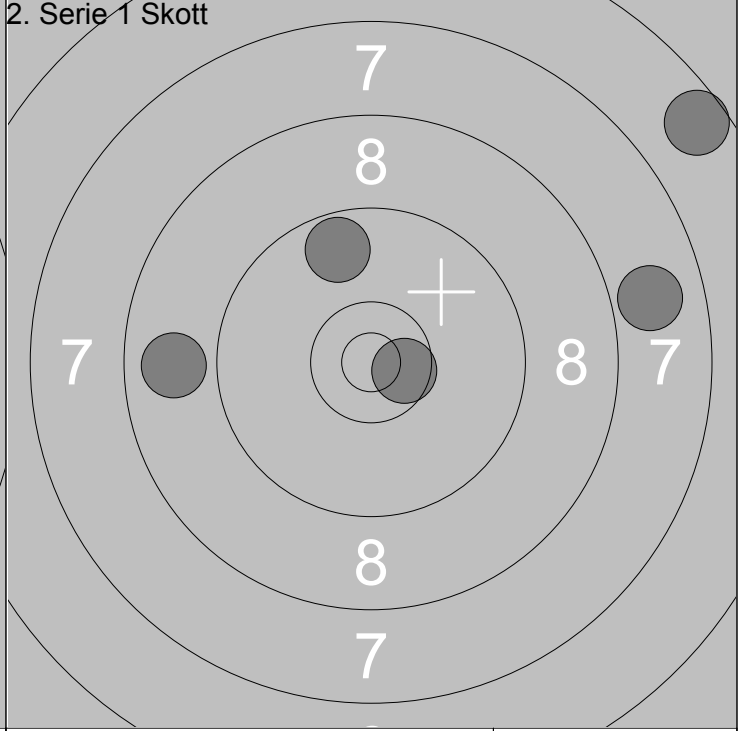
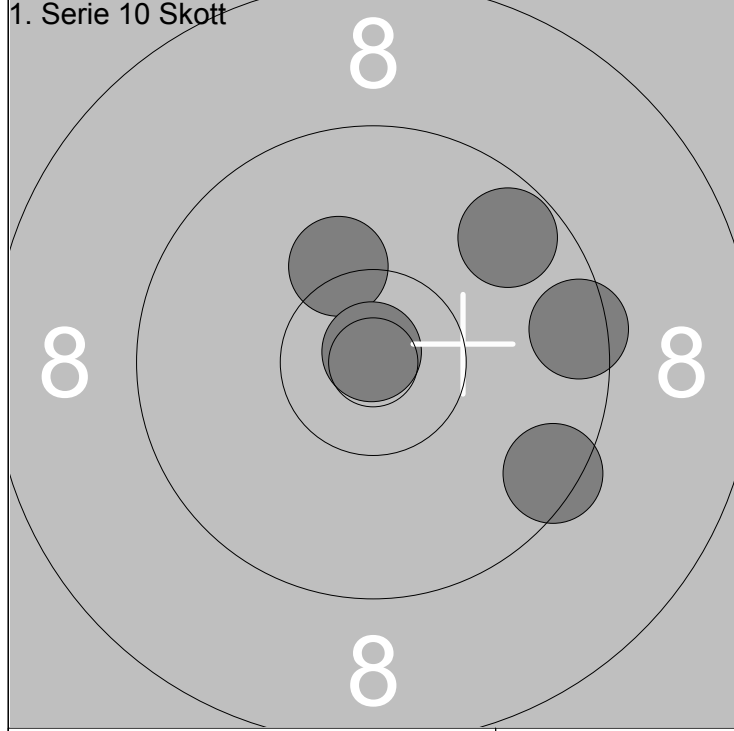

6: 9.5 ↘
7: 10.2 ↗
8: 9.5 →
9: 10.9x ↑
10: 9.7 ↗

Serie	47
Total	276

1: 9.7 ↗
2: 6.6 ↗
3: 8.8 ←
4: 7.9 →
5: 10.6x →

Serie	40
Total	316



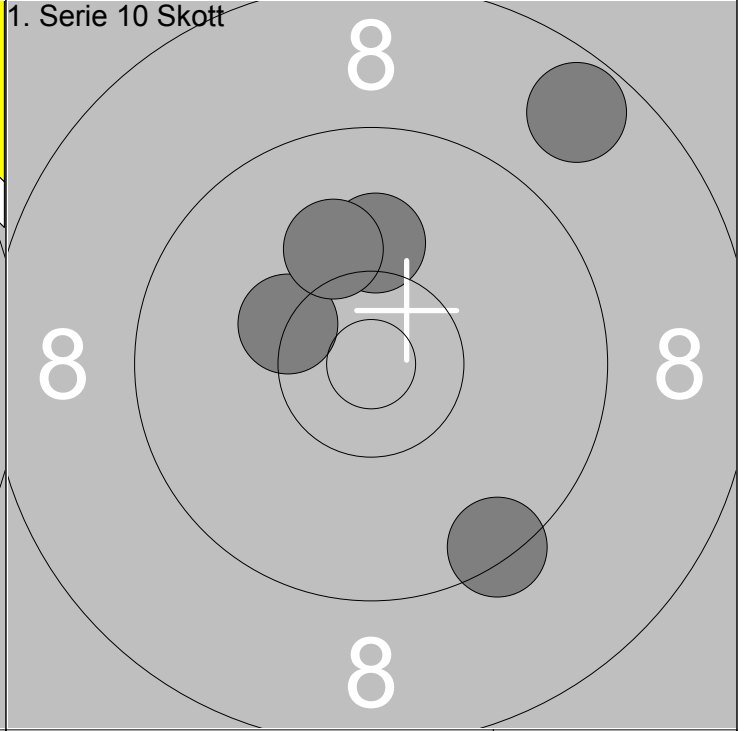
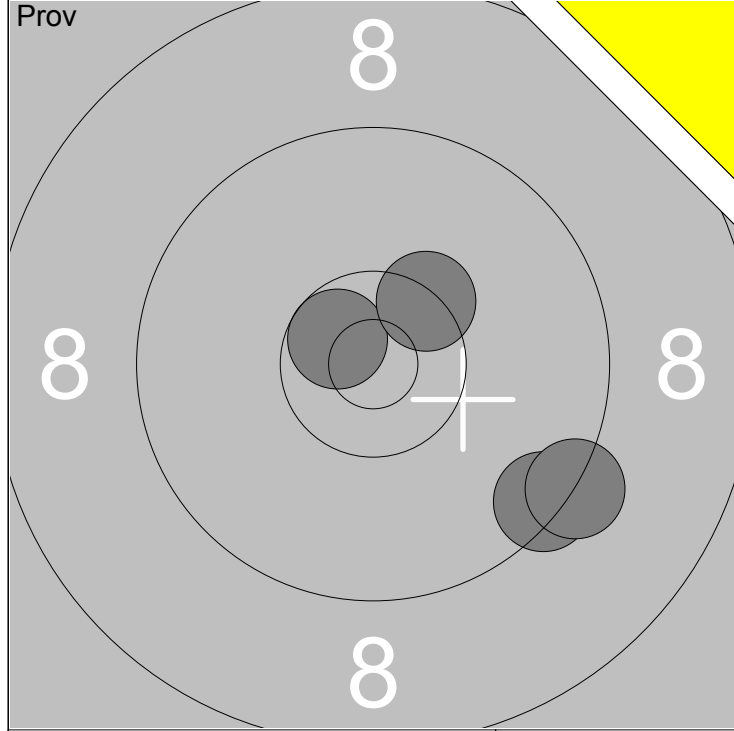

1:	9.4	↘
2:	9.3	↘
3:	10.6x	↗
4:	10.4x	↗

Serie	38
Total	176

1:	8.7	↗
2:	9.4	↘
3:	10.1	↑
4:	10.3x	↖
5:	10.1	↑

Serie	47
Total	223

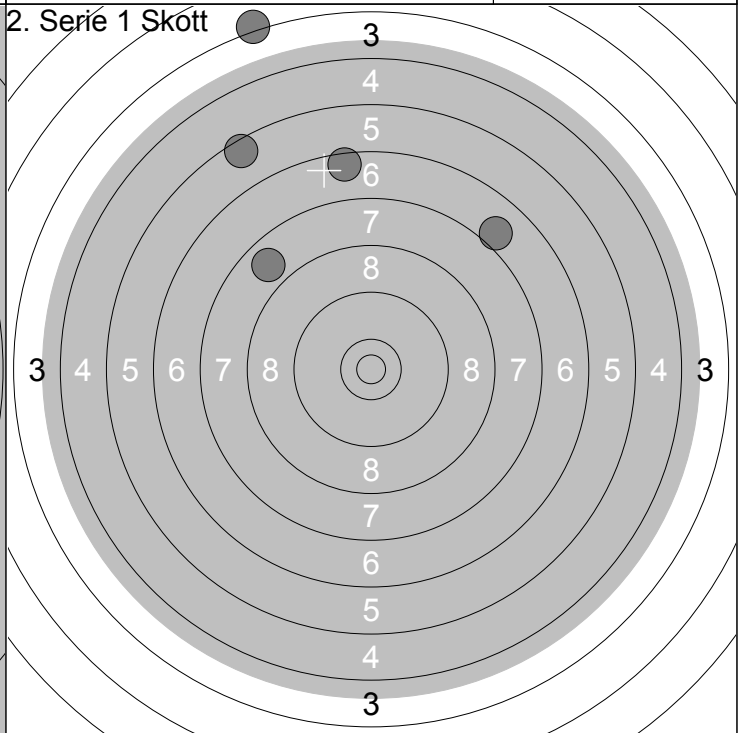
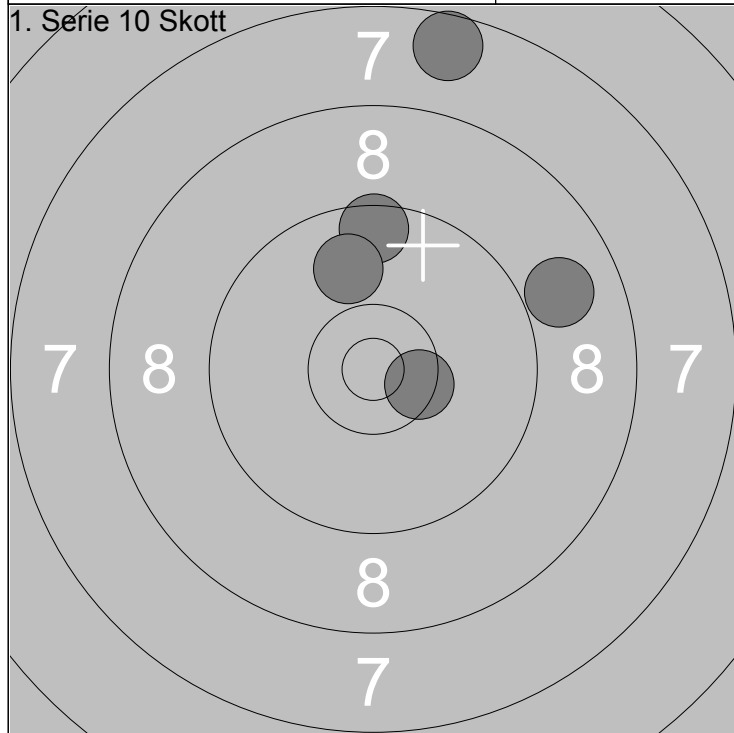

6:	10.5x	→
7:	7.6	↑
8:	9.5	↑
9:	9.9	↑
10:	8.9	↗

Serie	43
Total	266

1:	5.5	↖
2:	7.8	↖
3:	6.5	↑
4:	7.0	↗
5:	3.2	↑

Serie	28
Total	294

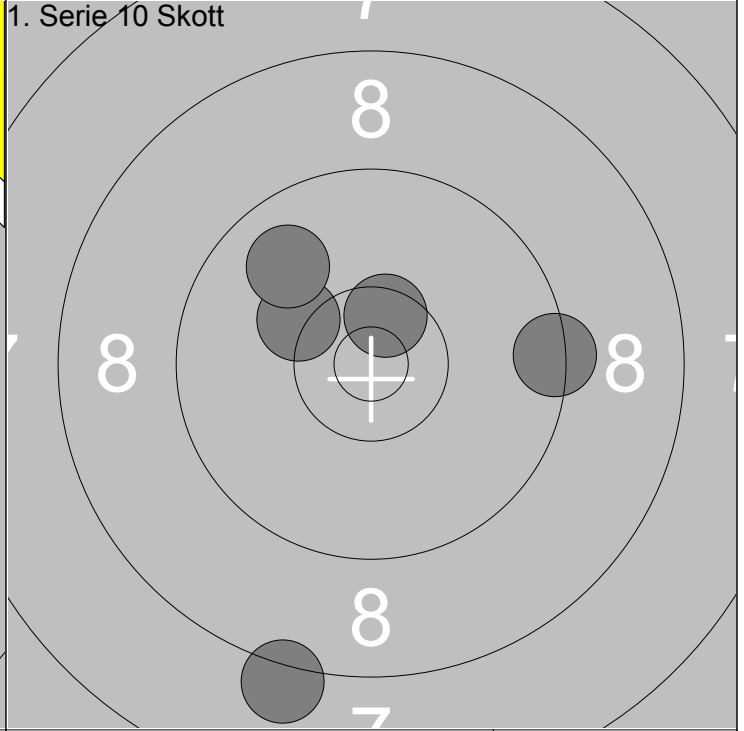
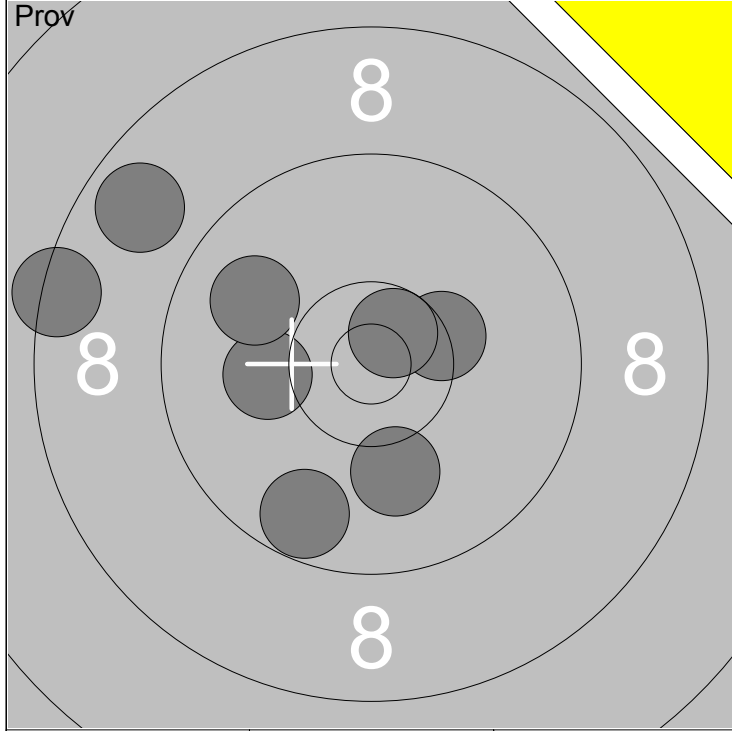

1: 8.8 ↖	6: 10.1 ↓	Serie	74
2: 8.4 ←	7: 9.9 ↖		
3: 10.4x →	8: 10.7x ↗	Total	171
4: 9.7 ↓			
5: 10.1 ←			

1: 9.4 →	Serie	46
2: 10.2 ↖		
3: 9.9 ↖	Total	217
4: 8.2 ↓		
5: 10.5x ↗		

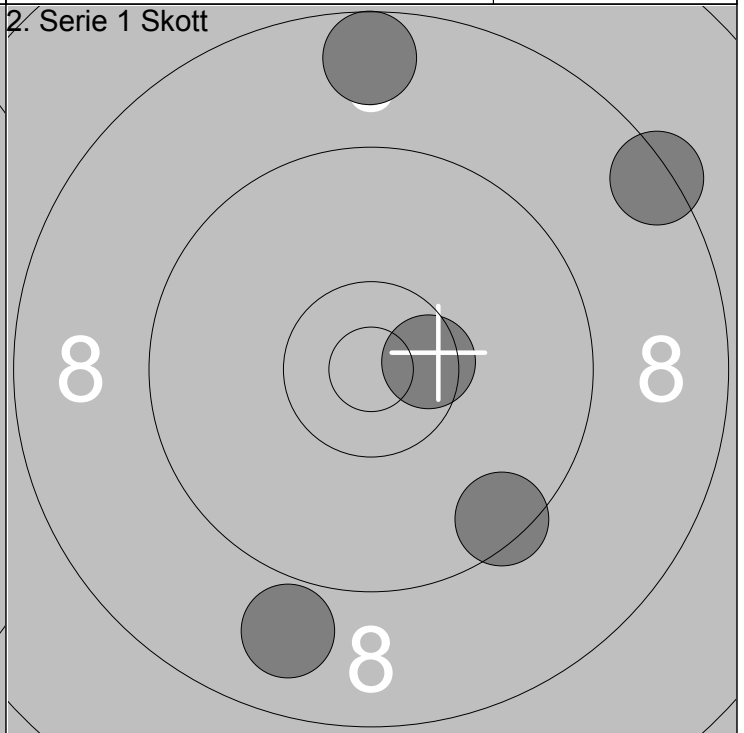
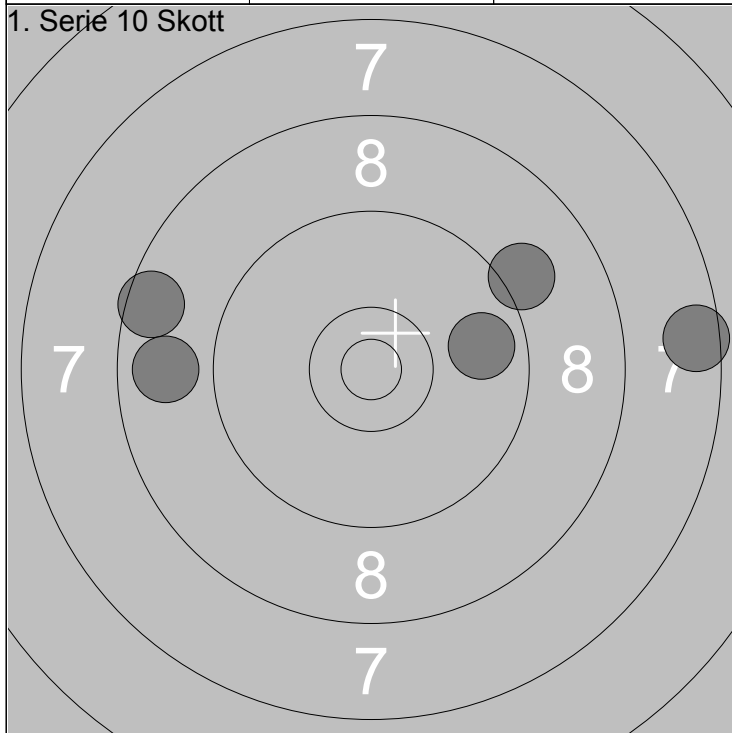

6: 7.5 →	Serie	41
7: 9.8 →		
8: 9.1 ↗	Total	258
9: 8.6 ←		
10: 8.8 ←		

1: 8.9 ↓	Serie	43
2: 8.6 ↑		
3: 8.4 ↗	Total	301
4: 10.5x →		
5: 9.5 ↓		

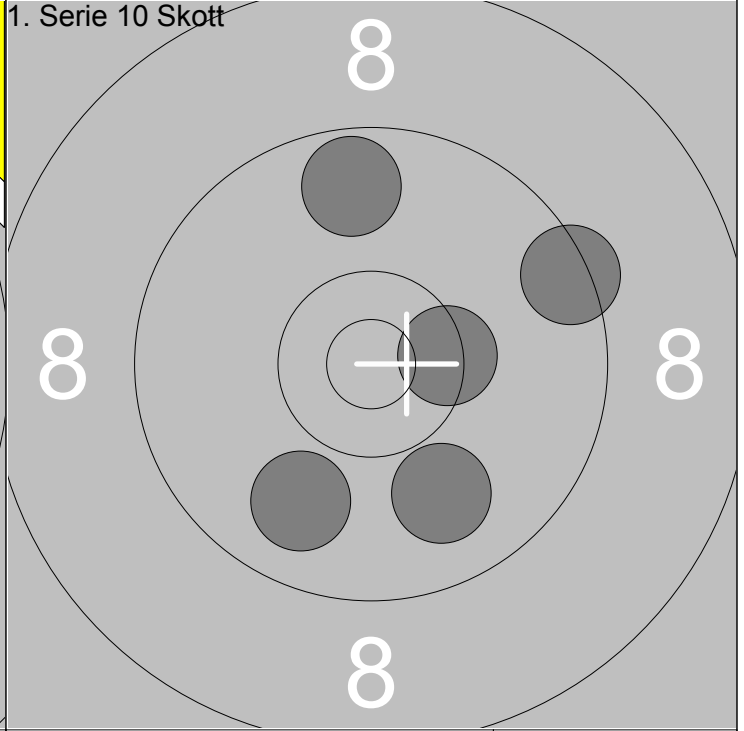
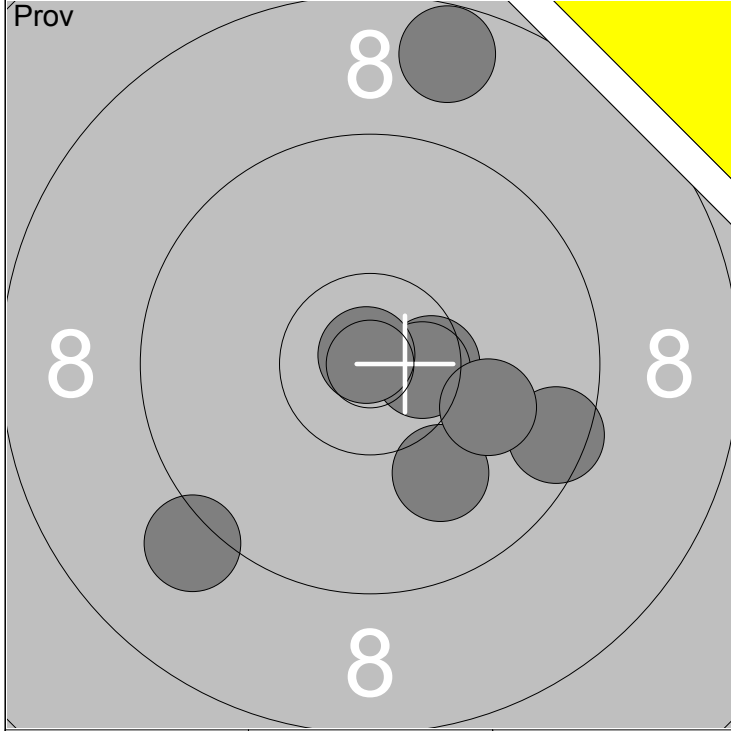

1: 9.5 →	6: 10.0 →	Serie	76
2: 10.5x →	7: 10.9x ↗		
3: 8.7 ↗	8: 9.1 ↘	Total	171
4: 10.0 ↘			
5: 10.6x →			

1: 9.4 ↗	Serie	46
2: 9.9 ↘		
3: 10.4x →	Total	217
4: 9.9 ↘		
5: 9.7 ↗		

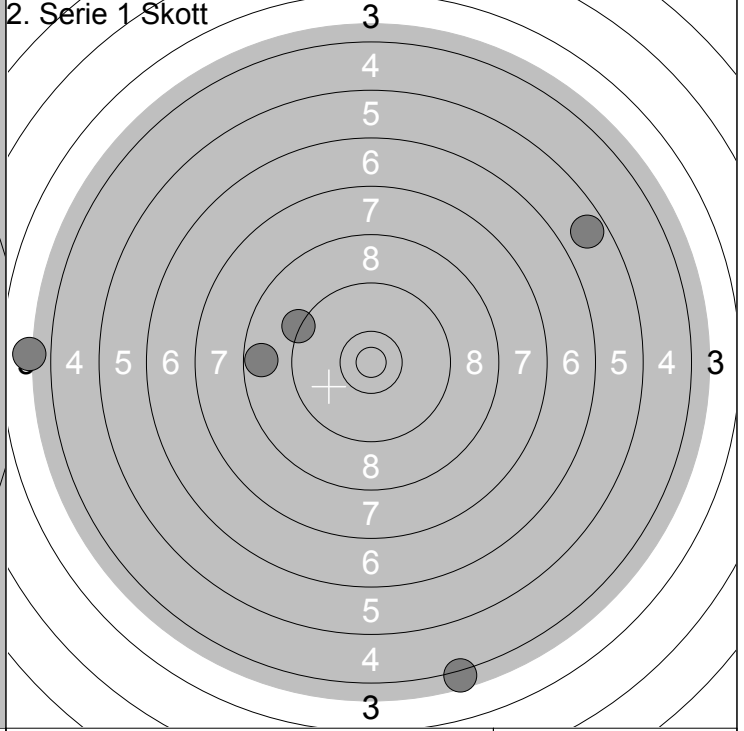
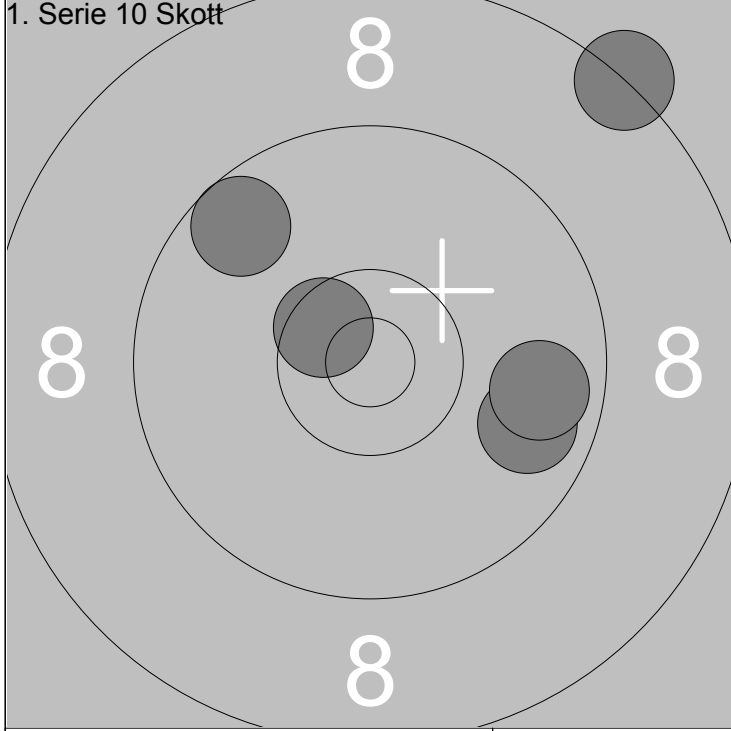

6: 9.8 →	Serie	45
7: 8.3 ↗		
8: 9.8 →	Total	262
9: 10.5x ↗		
10: 9.6 ↗		

1: 5.7 ↗	Serie	29
2: 3.9 ←		
3: 9.3 ↗	Total	291
4: 4.2 ↘		
5: 8.7 ←		

Skjuttag	Tavla	Ida Lundmark					
6	8	Vindeln		Drängsmark	Sen-S	Vb	
29.04.2017		Vindelnskottet 2017		Ramselefors SKF			
Prov						11: 7.4 ← 12: 9.3 ← 13: 8.6 ↗ 14: 7.2 ↖	
		1: 7.0 ↖ 2: 8.0 ↖ 3: 9.4 ↑ 4: 6.8 ↖ 5: 6.7 ↖ 6: 9.9 ← 7: 8.1 ← 8: 8.8 ↑ 9: 7.9 ↖ 10: 8.9 ↖					
		Serie 76.0		Serie 31.0			
		Total 163.0		Total 163.0			
1. Serie 10 Skott						6: 7.0 ↖ 7: 8.3 ↑ 8: 10.1 ↘ 9: 8.7 ↑ 10: 10.5x↗	
		1: 8.8 ↑ 2: 8.9 ↑ 3: 9.9 ↓ 4: 10.3x↖ 5: 8.6 ↓					
		Serie 43.0		Serie 43.0			
		Total 206.0		Total 249.0			
2. Serie 1 Skott							
		1: 6.3 ↖ 2: 9.4 ↓ 3: 6.7 ↘ 4: 4.8 ↖ 5: 6.1 ↘					
		Serie 31.0					
		Total 280.0					

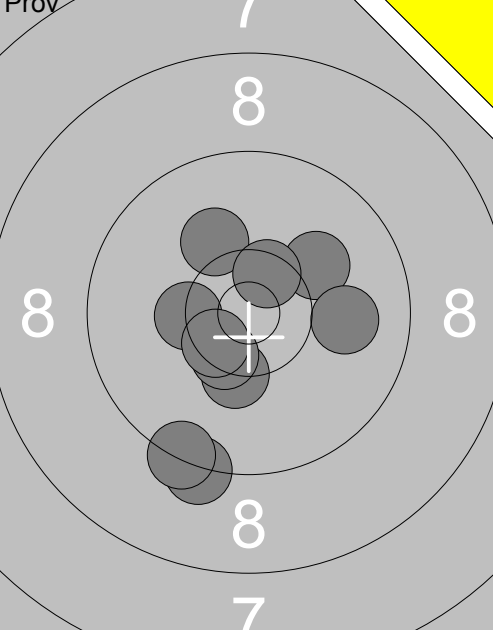
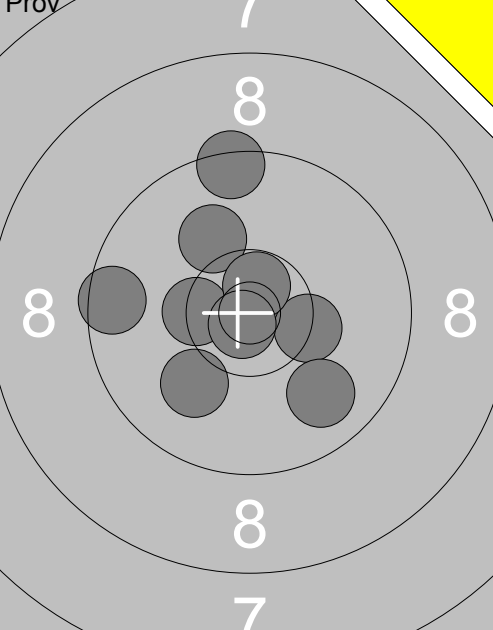
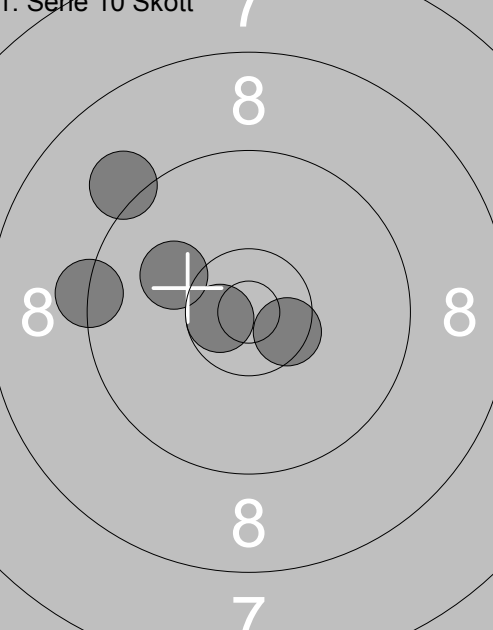
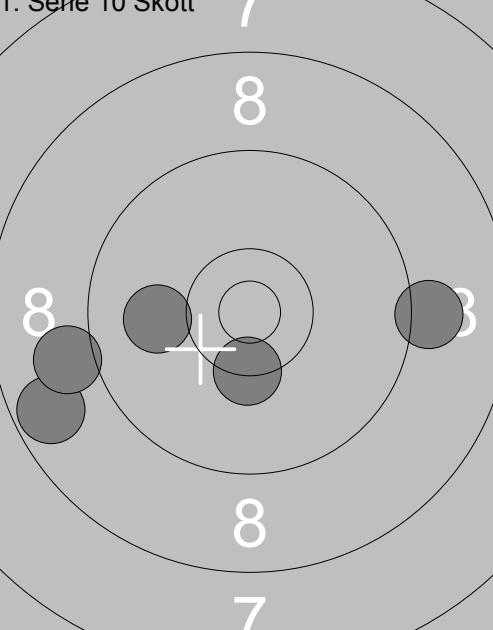
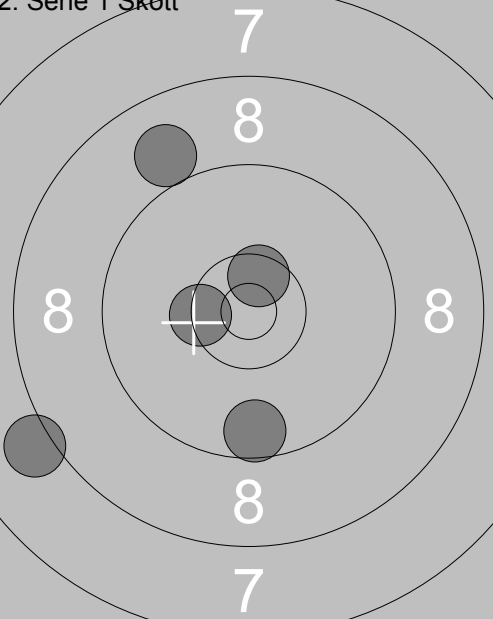
 <p style="font-size: small; margin-top: 5px;">Prov</p>	<p>1: 9.3 ↓</p> <p>2: 10.1 ↗</p> <p>3: 10.0 →</p> <p>4: 10.3 ✕</p> <p>5: 10.3 ✕ ↓</p> <p>6: 9.3 ↓</p> <p>7: 10.5 ✕ ↓</p> <p>8: 10.1 ↖</p> <p>9: 10.5 ✕ ↓</p> <p>10: 10.5 ✕ ↗</p> <table border="1" style="width:100%; border-collapse: collapse; margin-top: 5px;"> <tr><td style="text-align: right;">Serie</td><td style="text-align: left;">98.0</td></tr> <tr><td style="text-align: right;">Total</td><td style="text-align: left;">187.0</td></tr> </table>	Serie	98.0	Total	187.0	 <p style="font-size: small; margin-top: 5px;">Prov</p>	<p>11: 9.5 ←</p> <p>12: 10.3 ✕ →</p> <p>13: 10.4 ✕ ←</p> <p>14: 10.1 ↖</p> <p>15: 9.4 ↑</p> <p>16: 9.9 ↓</p> <p>17: 10.7 ✕ ↗</p> <p>18: 10.0 ↓</p> <p>19: 10.8 ✕ ↓</p> <table border="1" style="width:100%; border-collapse: collapse; margin-top: 5px;"> <tr><td style="text-align: right;">Serie</td><td style="text-align: left;">87.0</td></tr> <tr><td style="text-align: right;">Total</td><td style="text-align: left;">187.0</td></tr> </table>	Serie	87.0	Total	187.0
Serie	98.0										
Total	187.0										
Serie	87.0										
Total	187.0										
<p>1. Serie 10 Skott</p> 	<p>1: 10.7 ✕ ←</p> <p>2: 9.3 ←</p> <p>3: 10.5 ✕ →</p> <p>4: 10.1 ↖</p> <p>5: 9.1 ↖</p> <table border="1" style="width:100%; border-collapse: collapse; margin-top: 5px;"> <tr><td style="text-align: right;">Serie</td><td style="text-align: left;">48.0</td></tr> <tr><td style="text-align: right;">Total</td><td style="text-align: left;">235.0</td></tr> </table>	Serie	48.0	Total	235.0	<p>1. Serie 10 Skott</p> 	<p>6: 10.0 ←</p> <p>7: 9.1 →</p> <p>8: 10.3 ✕ ↓</p> <p>9: 8.7 ←</p> <p>10: 9.0 ←</p> <table border="1" style="width:100%; border-collapse: collapse; margin-top: 5px;"> <tr><td style="text-align: right;">Serie</td><td style="text-align: left;">46.0</td></tr> <tr><td style="text-align: right;">Total</td><td style="text-align: left;">281.0</td></tr> </table>	Serie	46.0	Total	281.0
Serie	48.0										
Total	235.0										
Serie	46.0										
Total	281.0										
<p>2. Serie 1 Skott</p> 	<p>1: 9.6 ↓</p> <p>2: 8.1 ↖</p> <p>3: 9.0 ↖</p> <p>4: 10.4 ✕ ←</p> <p>5: 10.5 ✕ ↗</p> <table border="1" style="width:100%; border-collapse: collapse; margin-top: 5px;"> <tr><td style="text-align: right;">Serie</td><td style="text-align: left;">46.0</td></tr> <tr><td style="text-align: right;">Total</td><td style="text-align: left;">327.0</td></tr> </table>	Serie	46.0	Total	327.0						
Serie	46.0										
Total	327.0										

	<p>1: 9.0 →</p> <p>2: 10.0 ←</p> <p>3: 8.9 →</p> <p>4: 8.7 ↓</p> <p>5: 9.6 ↖</p> <p>6: 9.5 →</p> <p>7: 8.9 ↑</p> <p>8: 9.1 ↑</p> <p>9: 9.6 ↓</p> <p>10: 9.7 ↓</p>	<p style="text-align: right;">11: 10.0 ←</p>
7	7	7
Serie 88.0		Serie 10.0
Total 177.0		Total 177.0

<p>1. Serie 10 Skott</p>	<p>1: 10.6 ↘</p> <p>2: 10.5 ↗</p> <p>3: 10.2 →</p> <p>4: 9.6 ↑</p> <p>5: 10.3 ↓</p>	<p>1. Serie 10 Skott</p>
7	7	7
Serie 49.0		Serie 37.0
Total 226.0		Total 263.0

<p>2. Serie 1 Skott</p>	<p>1: 7.4 ↑</p> <p>2: 7.1 ↑</p> <p>3: 7.8 ↑</p> <p>4: 8.2 ↗</p> <p>5: 7.1 ↗</p>	
7		
Serie 36.0		
Total 299.0		

Skjuttag	Tavla	Emma Eriksson			
6	11	Vindeln	Ramselefors	Jun-S	Vb
29.04.2017	Vindelnskottet 2017	Ramselefors SKF			
Pröv 	1: 6.3 ↘ 2: 10.0 ↓ 3: 8.5 ↘ 4: 9.3 ↘ 5: 8.4 ↓ 6: 8.1 ↘ 7: 9.5 → 8: 10.4x ↘ 9: 10.5x ↗ 10: 8.8 ↗	Pröv 	11: 8.4 ↗ 12: 8.8 ↗		
	Serie 86.0		Serie 16.0		
	Total 172.0		Total 172.0		
1. Serie 10 Skott 	1: 10.0 ↘ 2: 8.9 ↗ 3: 10.5x ↗ 4: 10.4x ↗ 5: 10.1 ↗	1. Serie 10 Skott 	6: 9.2 ← 7: 9.7 ← 8: 9.1 → 9: 7.9 → 10: 9.1 ↗		
	Serie 48.0		Serie 43.0		
	Total 220.0		Total 263.0		
2. Serie 1 Skott 	1: 6.9 ← 2: 6.3 ↘ 3: 7.3 ↘ 4: 8.7 ↗ 5: 8.4 ↗				
	Serie 35.0				
	Total 298.0				

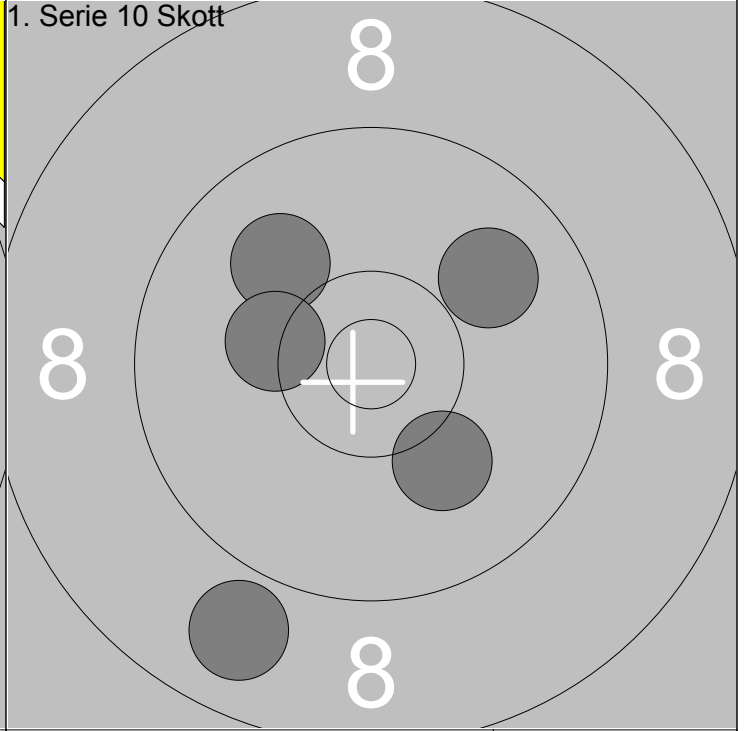
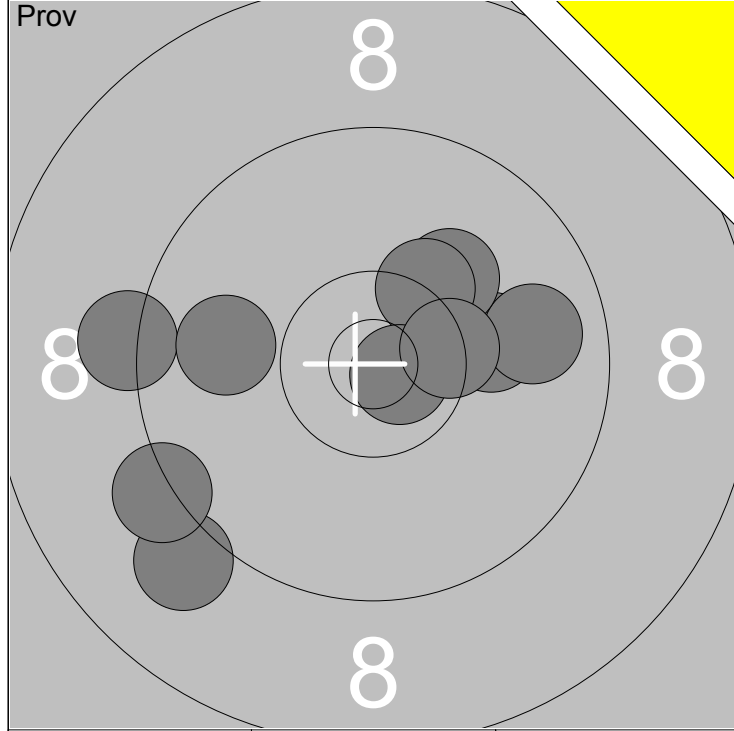

1: 9.2 ←	6: 10.3x ↗	Serie	95
2: 10.1 →	7: 10.7x →		
3: 9.0 ↙	8: 10.4x →	Total	164
4: 9.8 →	9: 9.2 ←		
5: 10.1 ↗	10: 9.9 ←		

1: 10.1 ↘	Serie	47
2: 10.0 ↗		
3: 9.9 ↗	Total	211
4: 8.9 ↙		
5: 10.3 ←		

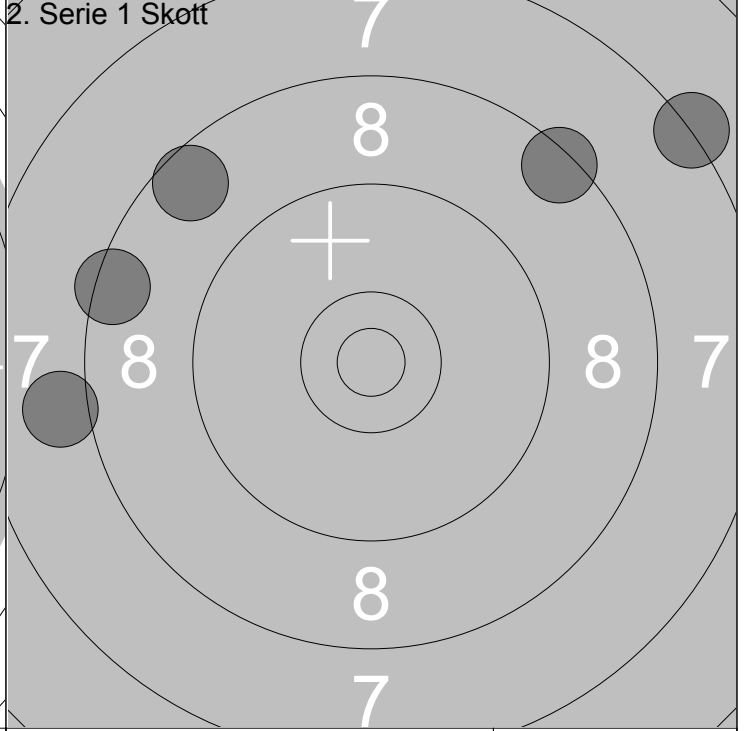
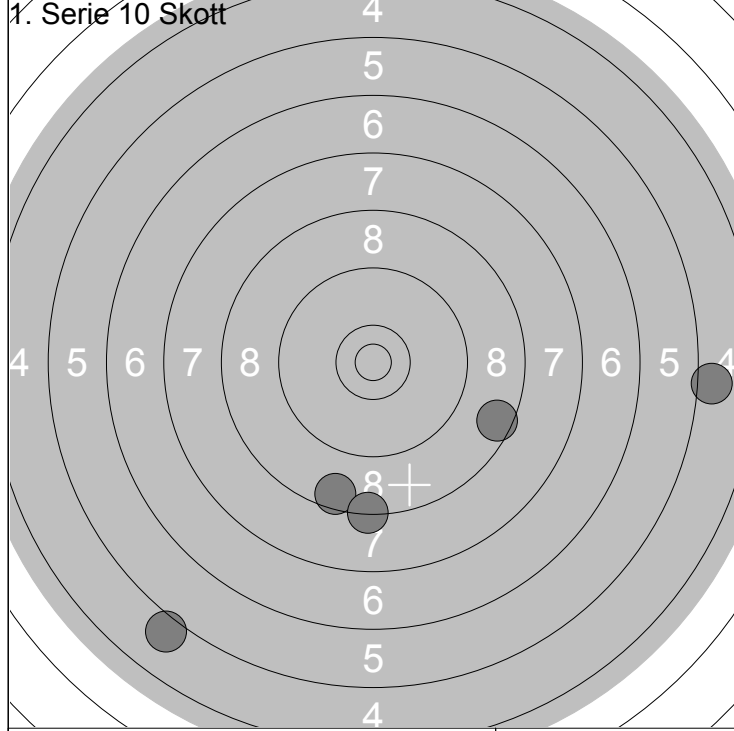

6: 8.6 →	Serie	34
7: 8.6 ↓		
8: 8.3 ↓	Total	245
9: 5.0 ↙		
10: 5.0 →		

1: 8.0 ←	Serie	39
2: 8.5 ←		
3: 8.6 ↗	Total	284
4: 8.4 ↗		
5: 7.3 ↗		



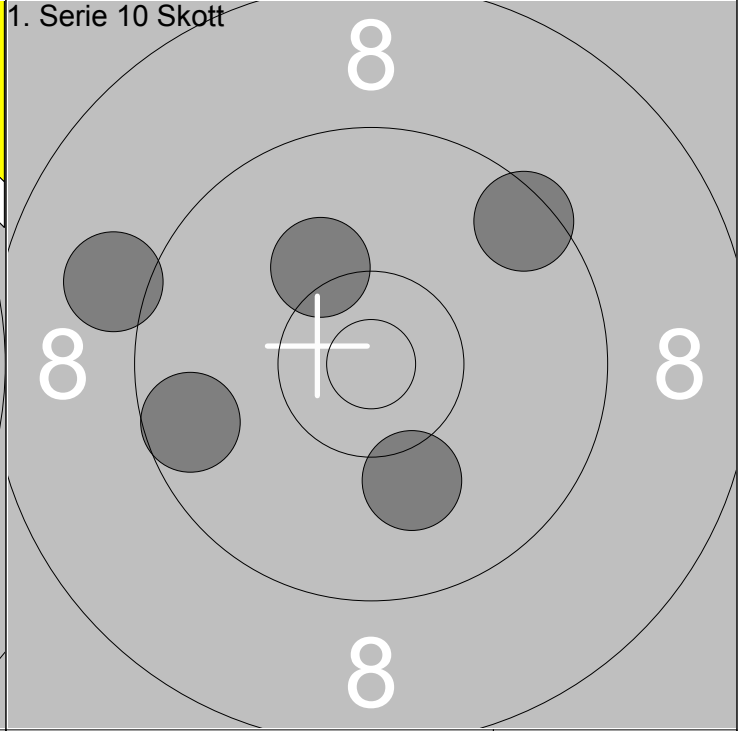
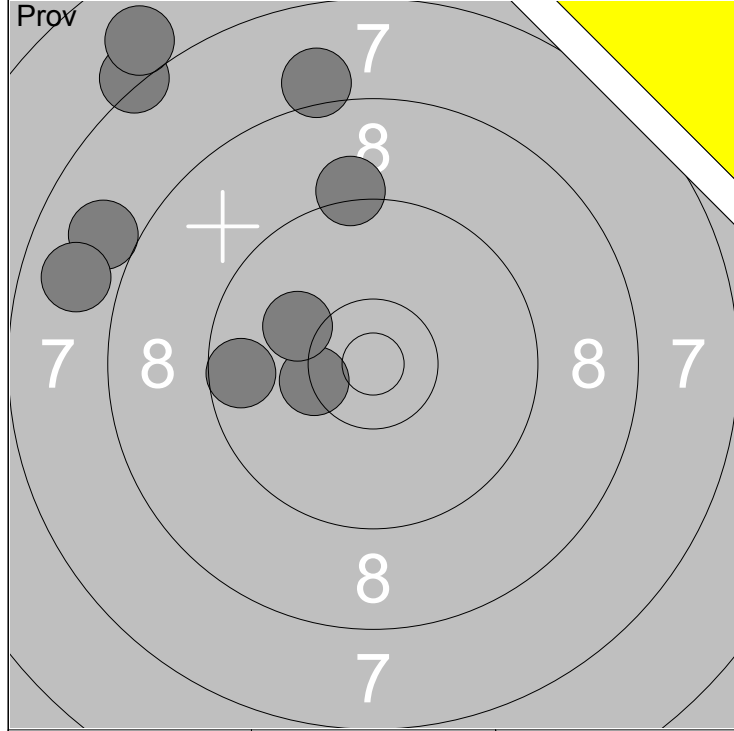

1: 9.2 ↑	6: 7.0 ↘	Serie	75
2: 8.0 ↖	7: 9.6 ←		
3: 7.9 ↖	8: 10.3x ←	Total	173
4: 8.1 ↑	9: 10.1 ↖		
5: 7.2 ↗			

1: 9.5 ↗	Serie	47
2: 10.2 ↗		
3: 9.6 ←	Total	220
4: 9.1 ←		
5: 10.1 ↓		

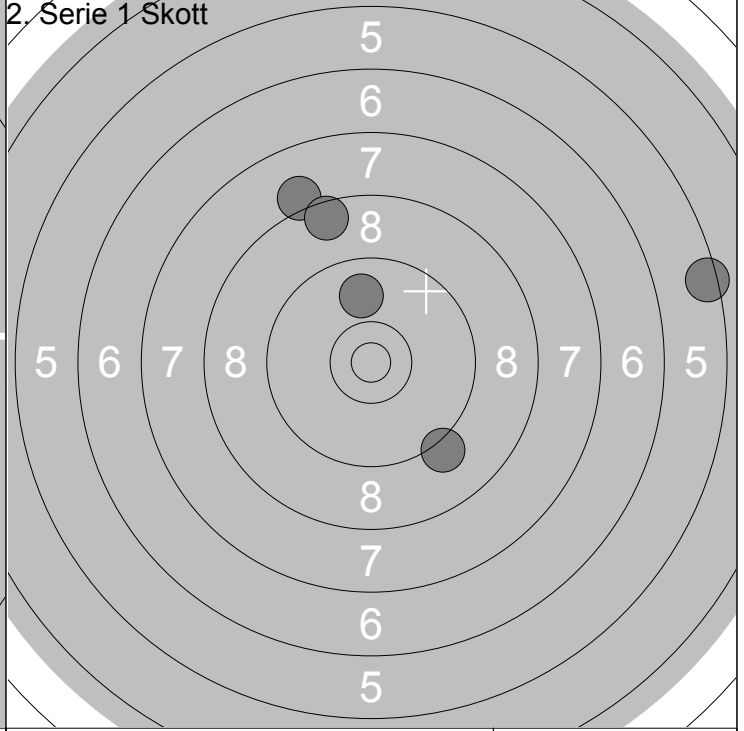
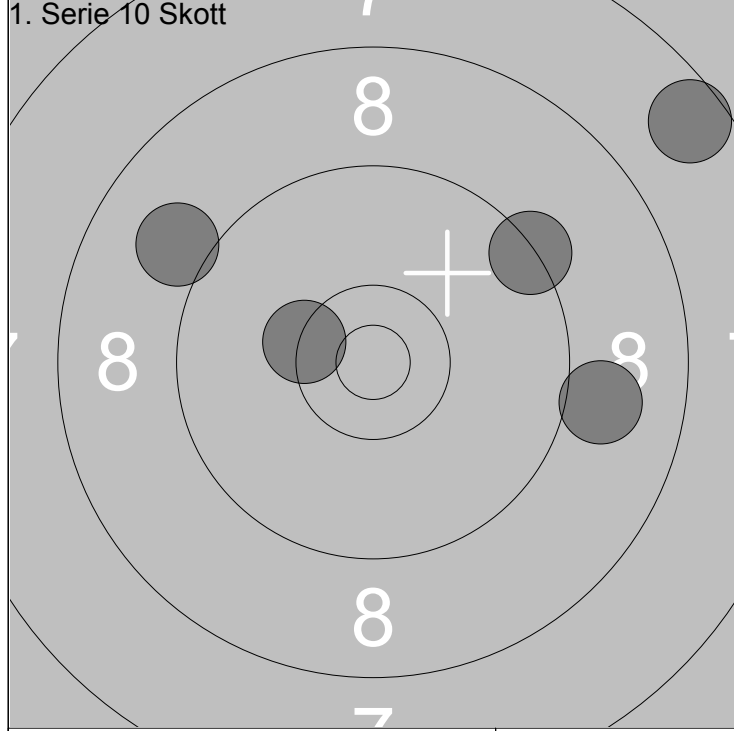

6: 9.0 →	Serie	44
7: 9.0 ↖		
8: 9.3 ↗	Total	264
9: 10.3x ↖		
10: 7.6 ↗		

1: 8.1 ↗	Serie	39
2: 9.2 ↓		
3: 9.9 ↑	Total	303
4: 8.6 ↑		
5: 5.5 →		

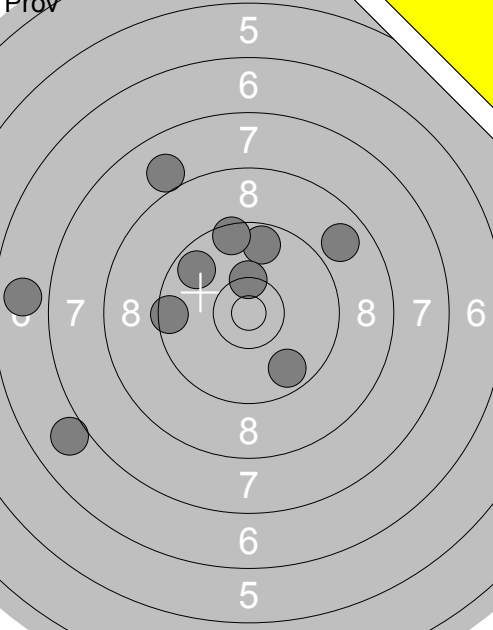
	<p>1: 7.0 ↙</p> <p>2: 8.8 ↗</p> <p>3: 9.7 ↘</p> <p>4: 9.5 ←</p> <p>5: 6.8 ←</p> <p>6: 9.7 ↑</p> <p>7: 8.0 ↗</p> <p>8: 9.5 ↑</p> <p>9: 9.7 ↖</p> <p>10: 10.3x↑</p>		<p>11: 10.1 ↑</p>
Serie 84.0		Serie 10.0	
Total 169.0		Total 169.0	

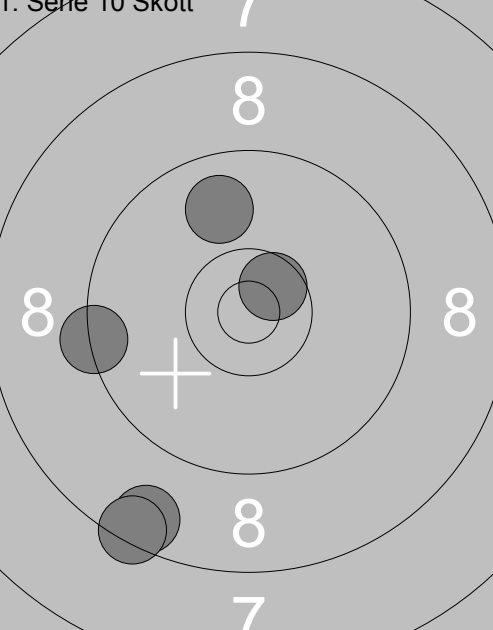
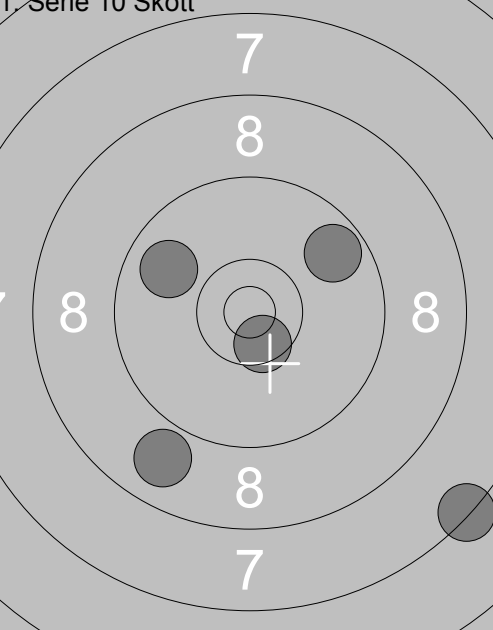
<p>1. Serie 10 Skott</p> 	<p>1: 8.6 ↘</p> <p>2: 8.4 ↘</p> <p>3: 9.9 ↑</p> <p>4: 9.3 ←</p> <p>5: 10.6x↗</p>	<p>1. Serie 10 Skott</p> 	<p>6: 10.5x↘</p> <p>7: 7.3 ↘</p> <p>8: 8.9 ↘</p> <p>9: 9.8 ↖</p> <p>10: 9.7 ↗</p>
Serie 44.0		Serie 43.0	
Total 213.0		Total 256.0	

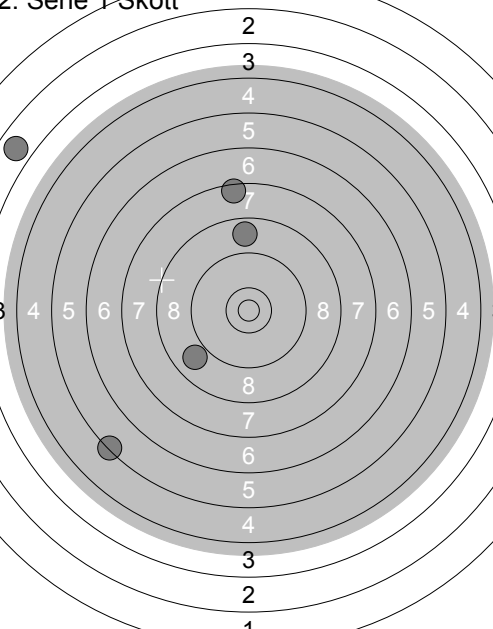
<p>2. Serie 1 Skott</p> 	<p>1: 8.8 ↑</p> <p>2: 2.8 ↖</p> <p>3: 5.3 ↘</p> <p>4: 7.5 ↑</p> <p>5: 8.9 ↘</p>		
Serie 30.0			
Total 286.0			

	<p>1: 7.6 →</p> <p>2: 6.1 ↘</p> <p>3: 9.1 ↓</p> <p>4: 9.5 ↓</p> <p>5: 10.5x →</p> <p>6: 8.0 →</p> <p>7: 10.3 ↗</p> <p>8: 8.1 ↗</p> <p>9: 7.4 ↑</p> <p>10: 9.0 ↑</p>	
Serie 83.0		Serie 9.0
Total 142.0		Total 142.0

<p>1. Serie 10 Skott</p>	<p>1: 6.5 ↗</p> <p>2: 0.0</p> <p>3: 8.4 ↘</p> <p>4: 9.1 ↗</p> <p>5: 8.4 ↗</p>	<p>1. Serie 10 Skott</p>
Serie 31.0		Serie 31.0
Total 173.0		Total 204.0

<p>2. Serie 1 Skott</p>	<p>1: 3.2 ↗</p> <p>2: 0.0 ↘</p> <p>3: 0.0 ←</p> <p>4: 7.8 ↗</p> <p>5: 4.5 ←</p>	
Serie 14.0		
Total 218.0		