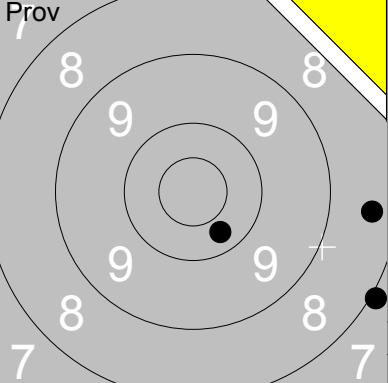
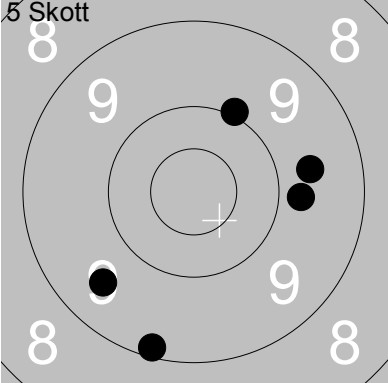
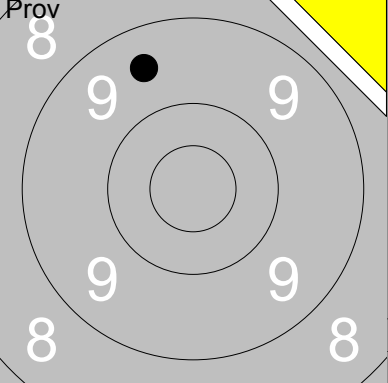
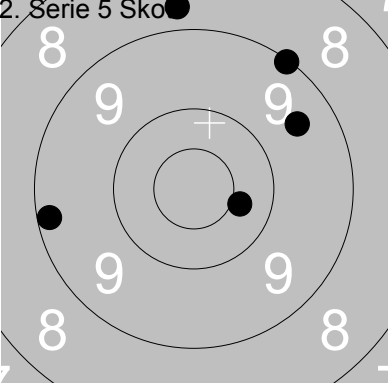
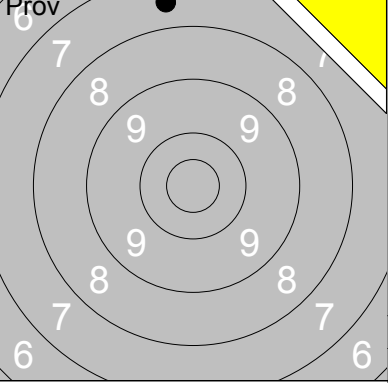
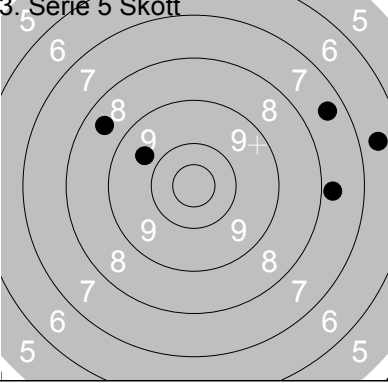
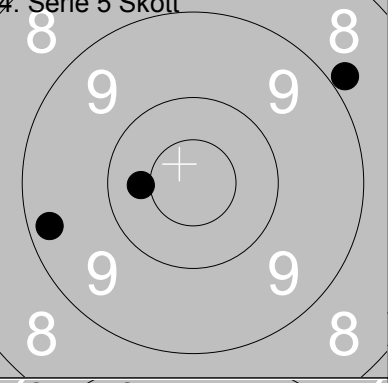
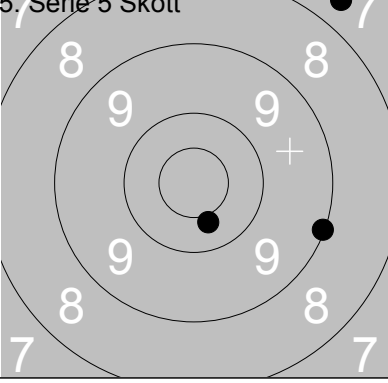
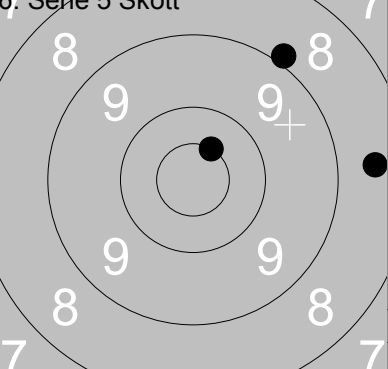
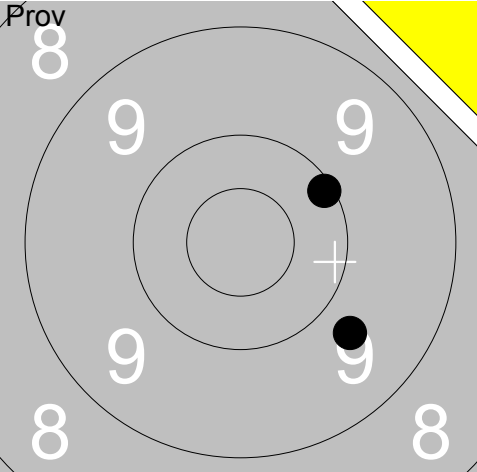
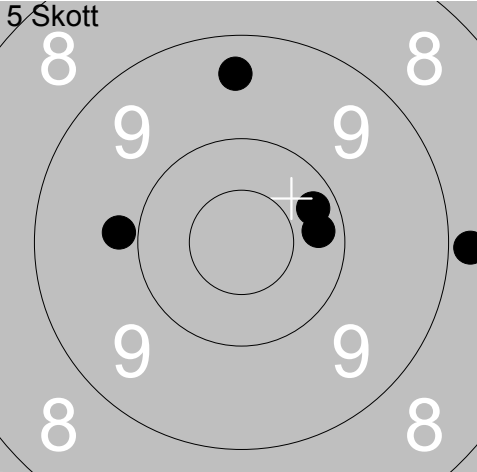
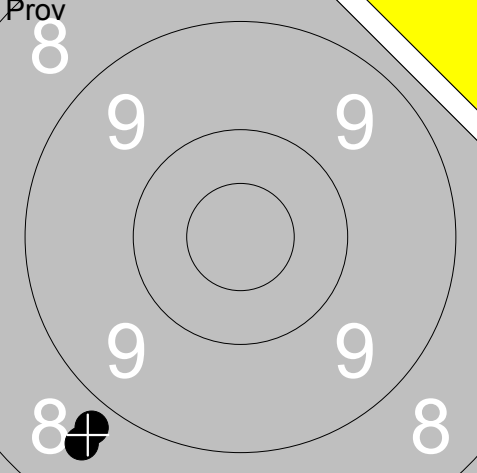
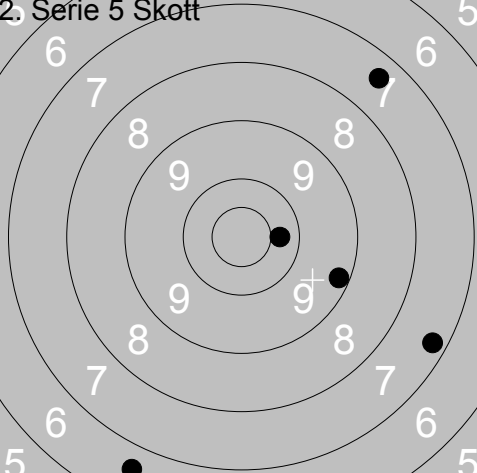
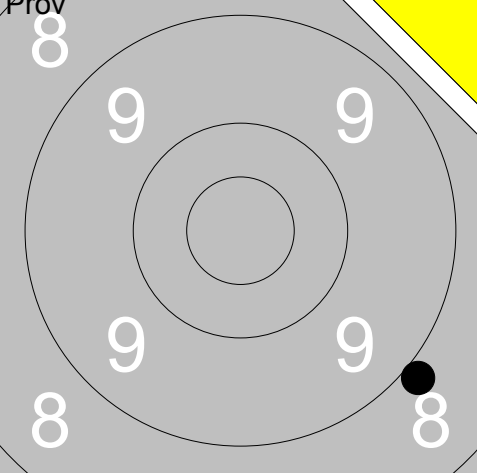
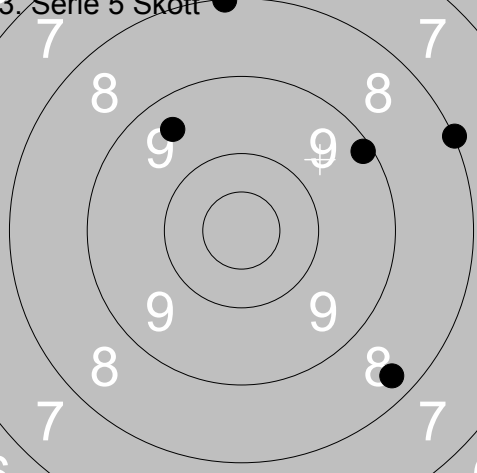
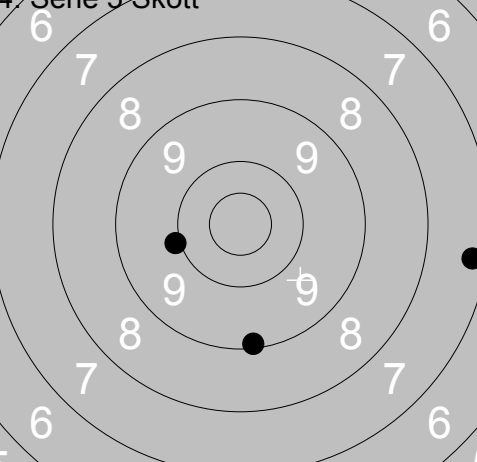

Skjuttag	Tavla	Kvistbro	
1	2		
Vindeln		Emil B, Björn J, Martin N	
09.07.2017		Tavelträffen Lagtävling 2017	
		Ramselefors SKF	
	1: 8.0 → 2: 8.4 → 3: 10.3 ↓	5 Skott 	1: 9.5 ↙ 2: 9.8 → 3: 9.6 → 4: 10.0 ↗ 5: 9.1 ↓
Serie 26.0	Total 0.0	Serie 46.0	Total 46.0
	1: 9.5 ↗	2. Serie 5 Skott 	1: 8.7 ↑ 2: 9.1 ↗ 3: 9.5 ↗ 4: 10.4 → 5: 9.2 ←
Serie 9.0	Total 46.0	Serie 45.0	Total 91.0
	1: 7.5 ↑	3. Serie 5 Skott 	1: 7.8 → 2: 7.4 ↗ 3: 8.5 ↗ 4: 6.6 → 5: 9.7 ↗
Serie 7.0	Total 91.0	Serie 37.0	Total 128.0
4. Serie 5 Skott 	1: 10.4 ← 2: 9.3 ← 3: 8.9 ↗	5. Serie 5 Skott 	1: 9.0 → 2: 10.4 ↓ 3: 7.6 ↗
Serie 27.0	Total 155.0	Serie 26.0	Total 181.0
6. Serie 5 Skott 	1: 8.5 → 2: 8.9 ↗ 3: 10.5x ↗		
Serie 26.0	Total 207.0		

Skjuttag	Tavla	Ramselefors Rookies	
1	4		
Vindeln	Saga, Casper, Maja		Lag
09.07.2017	Tavelträffen Lagtävling 2017		Ramselefors SKF
Prov 	1: 9.7 ↘ 2: 10.1 →	5 Skott 	1: 8.8 → 2: 9.4 ↑ 3: 10.2 → 4: 10.3 → 5: 9.8 ←
	Serie 19.0		Serie 46.0
	Total 0.0		Total 46.0
Prov 	1: 8.6 ↙ 2: 8.8 ↙	2. Serie 5 Skott 	1: 7.3 → 2: 9.2 → 3: 6.6 ↘ 4: 7.4 ↗ 5: 10.3 →
	Serie 16.0		Serie 39.0
	Total 46.0		Total 85.0
Prov 	1: 8.9 ↘	3. Serie 5 Skott 	1: 8.0 ↑ 2: 9.4 ↗ 3: 9.1 ↗ 4: 8.3 ↘ 5: 8.0 →
	Serie 8.0		Serie 42.0
	Total 85.0		Total 127.0
4. Serie 5 Skott 	1: 10.0 ← 2: 9.1 ↓ 3: 7.3 →		
	Serie 26.0		
	Total 153.0		

<p>Prov</p>	<p>1: 9.7 ↑</p> <p>2: 9.6 ↗</p>	<p>5 Skott</p>	<p>1: 9.4 ↓</p> <p>2: 10.5x →</p> <p>3: 10.0 ↑</p> <p>4: 10.7x ↓</p> <p>5: 10.0 ↓</p>
Serie 18.0		Serie 49.0	
Total 0.0		Total 49.0	

<p>Prov</p>	<p>1: 9.6 ↓</p> <p>2: 8.8 ←</p> <p>3: 9.5 →</p>	<p>2. Serie 5 Skott</p>	<p>1: 10.5x ↘</p> <p>2: 9.7 ←</p> <p>3: 10.6x ←</p> <p>4: 9.8 ↑</p> <p>5: 9.6 ↖</p>
Serie 26.0		Serie 47.0	
Total 49.0		Total 96.0	

<p>3. Serie 5 Skott</p>	<p>1: 10.0 ↑</p> <p>2: 4.3 ←</p> <p>3: 8.0 ↑</p> <p>4: 8.9 ↗</p> <p>5: 8.9 ↖</p>	<p>4. Serie 5 Skott</p>	<p>1: 10.0 →</p> <p>2: 9.2 ↓</p> <p>3: 3.1 ↗</p>
Serie 38.0		Serie 22.0	
Total 134.0		Total 156.0	

<p>5. Serie 5 Skott</p>	<p>1: 10.0 ↖</p> <p>2: 9.3 →</p> <p>3: 2.5 →</p>		
Serie 21.0			
Total 177.0			

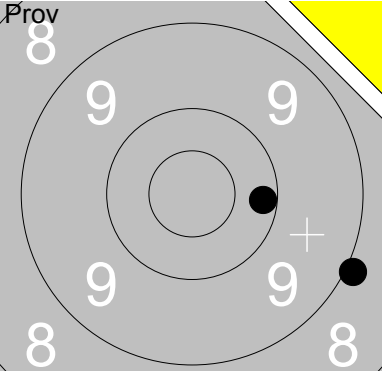
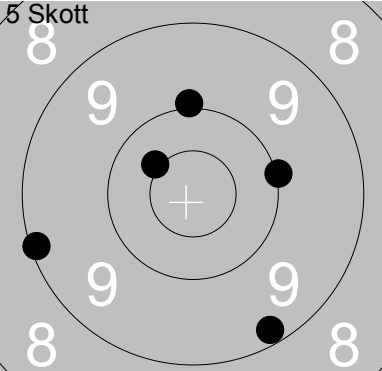
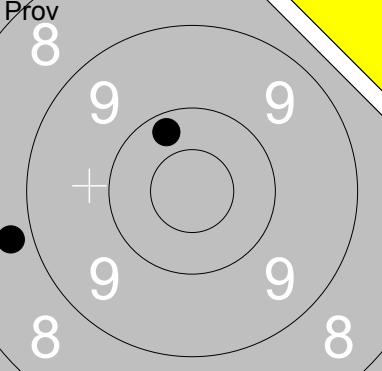
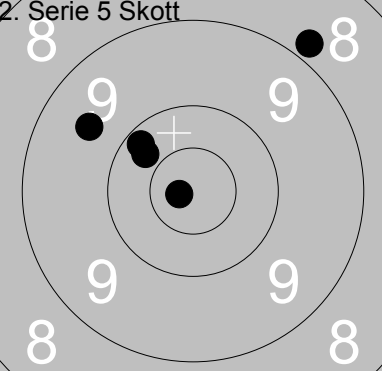
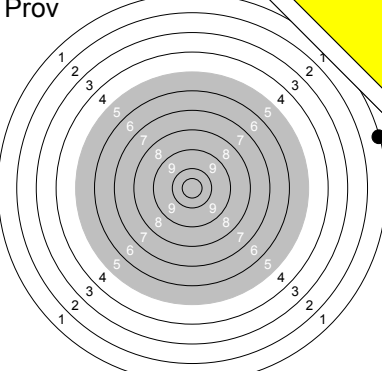
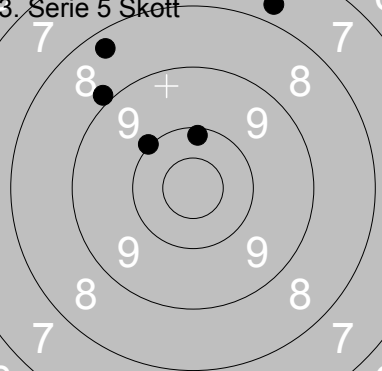
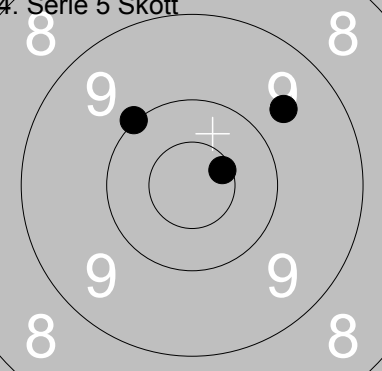
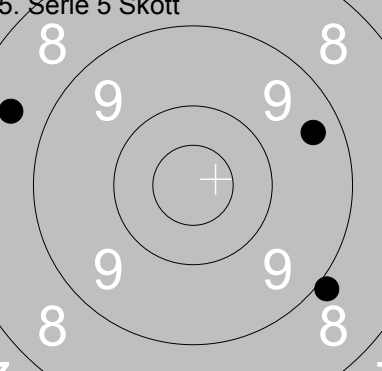
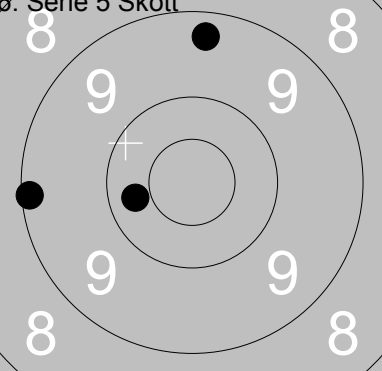
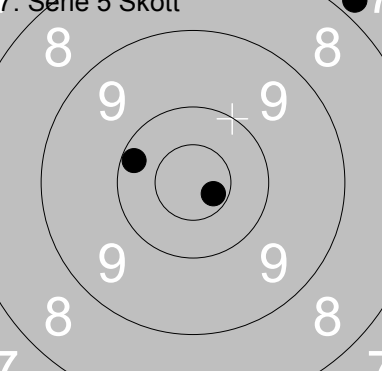
Skjutlag	Tavla	Skåningarna		Vindeln	Henrik, Ingemar, Johny	Lag	
1	8			09.07.2017	Tavelträffen Lagtävling 2017	Ramselefors SKF	
Prov		1: 8.9 → 2: 10.2 →		5 Skott		1: 10.0 ↑ 2: 9.2 ↓ 3: 10.0 → 4: 9.1 ← 5: 10.4x ↖	
		Serie 18.0 Total 0.0				Serie 48.0 Total 48.0	
Prov		1: 10.2 ↖ 2: 8.8 ←		2. Serie 5 Skott		1: 10.2 ↖ 2: 9.6 ↖ 3: 8.8 ↗ 4: 10.8x ← 5: 10.3 ↖	
		Serie 18.0 Total 48.0				Serie 47.0 Total 95.0	
Prov		1: 1.1 →		3. Serie 5 Skott		1: 7.7 ↖ 2: 8.9 ↖ 3: 10.0 ↖ 4: 10.1 ↑ 5: 8.3 ↖	
		Serie 1.0 Total 95.0				Serie 43.0 Total 138.0	
4. Serie 5 Skott		1: 10.6x → 2: 10.0 ↖ 3: 9.6 ↗		5. Serie 5 Skott		1: 8.6 ← 2: 8.9 ↓ 3: 9.4 →	
		Serie 29.0 Total 167.0				Serie 25.0 Total 192.0	
6. Serie 5 Skott		1: 9.3 ↑ 2: 10.3 ← 3: 9.1 ←		7. Serie 5 Skott		1: 10.2 ← 2: 10.7x ↓ 3: 7.8 ↗	
		Serie 28.0 Total 220.0				Serie 27.0 Total 247.0	

Skjutlag	Tavla	F 21	
Vindeln	Urban, Henry, Peter		Lag
09.07.2017	Tavelträffen Lagtävling 2017	Ramselefors SKF	
Prov		1: 9.0 ↓ 2: 10.0 ↓	5 Skott
		1: 8.7 ↘ 2: 8.6 ↘ 3: 9.9 ↙ 4: 8.4 ↖ 5: 9.7 ↑	
	Serie 19.0 Total 0.0	Serie 42.0 Total 42.0	
Prov		1: 10.3 ↗ 2: 8.0 ↖	2. Serie 5 Skott
		1: 9.7 ↑ 2: 10.6 ↘ 3: 7.4 ↖ 4: 9.1 ← 5: 9.3 ↖	
	Serie 18.0 Total 42.0	Serie 44.0 Total 86.0	
Prov		1: 9.9 ↓	3. Serie 5 Skott
		1: 8.0 ↖ 2: 10.2 ↑ 3: 7.1 ↗ 4: 7.7 ↘ 5: 8.0 ↓	
	Serie 9.0 Total 86.0	Serie 40.0 Total 126.0	

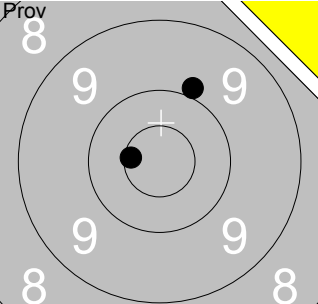
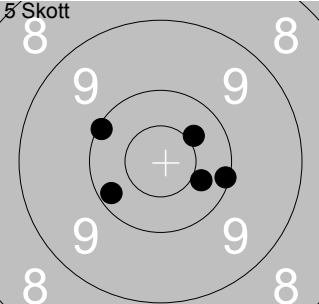
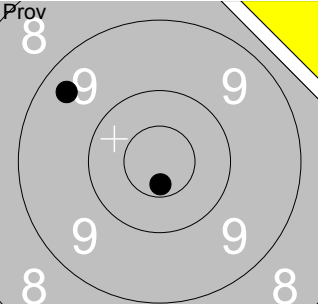
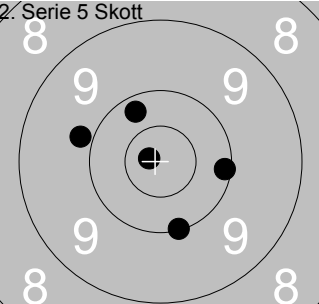
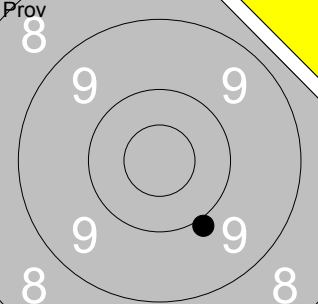
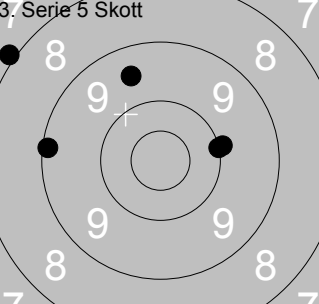
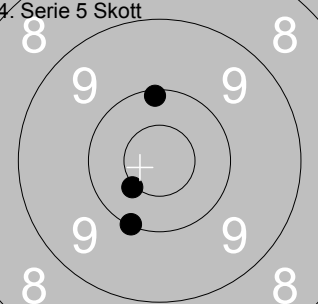
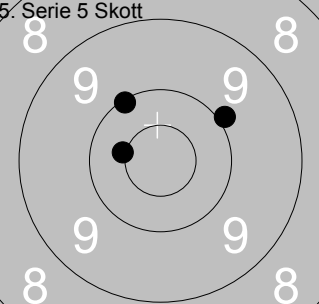
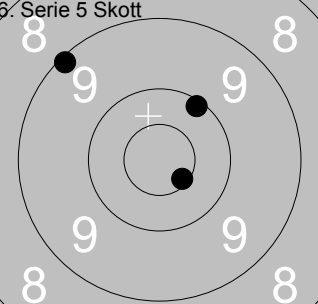
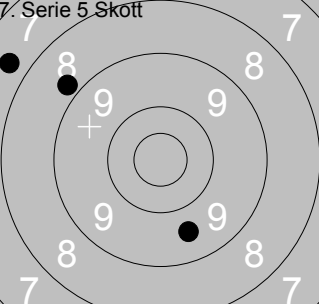
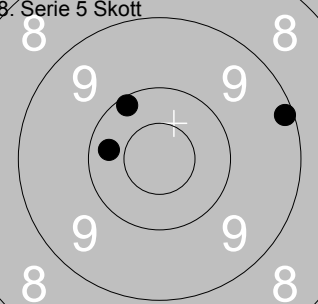
Skjutlag	Tavla	Tioetta				
1	12					
Vindeln		Elise, Markus, Hans			Lag	
09.07.2017		Tavelträffen Lagtävling 2017		Ramselefors SKF		
Prov 	1: 10.6x 2: 9.9	← ↑	Skott 	1: 10.4 2: 10.1 3: 10.1 4: 10.2 5: 10.4	↗ → ↗ ↖ ↘	
Serie 19.0		Total 0.0		Serie 50.0		
Total 0.0				Total 50.0		
Prov 	1: 10.6x 2: 9.4	↓ ↖	2. Serie 5 Skott 	1: 10.0 2: 10.8x 3: 10.1 4: 10.2 5: 9.8	↓ ↖ → ↗ ↖	
Serie 19.0		Total 50.0		Serie 49.0		
Total 50.0				Total 99.0		
Prov 	1: 9.9	↓	3. Serie 5 Skott 	1: 7.9 2: 10.0 3: 9.5 4: 10.0 5: 9.1	↗ → ↗ → ↖	
Serie 9.0		Total 99.0		Serie 45.0		
Total 99.0				Total 144.0		
4. Serie 5 Skott 	1: 10.5x 2: 10.0 3: 10.1	↘ ↓ ↑	5. Serie 5 Skott 	1: 10.4x 2: 10.1 3: 9.9	← ↗ ↗	
Serie 30.0		Total 174.0		Serie 29.0		
Total 174.0				Total 203.0		
6. Serie 5 Skott 	1: 10.1 2: 10.6x 3: 9.1	↗ ↓ ↗	7. Serie 5 Skott 	1: 9.6 2: 8.8 3: 7.7	↓ ↗ ↗	
Serie 29.0		Total 232.0		Serie 24.0		
Total 232.0				Total 256.0		
8. Serie 5 Skott 	1: 10.3 2: 10.1 3: 9.2	← ↖ →				
Serie 29.0		Total 285.0				
Total 285.0						

Skjuttag	Tavla	Kalix-S3	
1	14	Kristian, J-O, Roger	Lag
09.07.2017	Tavelträffen Lagtävling 2017	Ramselefors SKF	
Prov 	1: 8.1 ↗ 2: 8.8 ↗	5 Skott 	1: 9.4 ↗ 2: 8.7 ↘ 3: 8.1 ↘ 4: 9.4 ↗ 5: 10.3 ↘
	Serie 16.0		Serie 44.0
	Total 0.0		Total 44.0
Prov 	1: 9.5 ↑ 2: 8.0 ↖	2. Serie 5 Skott 	1: 8.1 ↑ 2: 9.2 ↖ 3: 10.0 ↗ 4: 10.5 ✗ 5: 8.8 ↗
	Serie 17.0		Serie 45.0
	Total 44.0		Total 89.0
Prov 	1: 7.7 ↑	3. Serie 5 Skott 	1: 2.2 ↑ 2: 9.5 → 3: 7.1 ↑ 4: 4.0 ↑ 5: 9.3 ↗
	Serie 7.0		Serie 31.0
	Total 89.0		Total 120.0

Skjutlag	Tavla	Loos		Vindeln	Johnny, Daniel, Fanny	Lag	
1	16			09.07.2017	Tavelträffen Lagtävling 2017	Ramselefors SKF	
Provs 	1: 10.5x ↙ 2: 10.9x ↙	Skotts 	1: 10.3 ↖ 2: 9.4 ↗ 3: 10.4 ↘ 4: 9.4 ↘ 5: 9.6 ↘	Serie	20.0	Serie	47.0
	Total	0.0	Total	47.0		Total	47.0
Provs 	1: 9.7 ↖ 2: 9.8 ↖	2. Serie 5 Skott 	1: 10.3 ↗ 2: 10.8x ↗ 3: 10.5x ↘ 4: 10.5x ↖ 5: 10.2 →	Serie	18.0	Serie	50.0
	Total	47.0	Total	97.0		Total	97.0
Provs 	1: 8.7 ↖	3. Serie 5 Skott 	1: 10.4x ↗ 2: 9.8 ↗ 3: 7.8 ↗ 4: 9.0 ↗ 5: 9.3 ↘	Serie	8.0	Serie	44.0
	Total	97.0	Total	141.0		Total	141.0
4. Serie 5 Skott 	1: 10.6x ↖ 2: 10.4 ↘ 3: 9.7 ↘	5. Serie 5 Skott 	1: 9.1 ↗ 2: 10.8x ↗ 3: 9.8 ↗	Serie	29.0	Serie	28.0
	Total	170.0	Total	198.0		Total	198.0
6. Serie 5 Skott 	1: 8.8 ↗ 2: 10.4x ↘ 3: 10.7x ↘	7. Serie 5 Skott 	1: 10.5x ↘ 2: 10.8x ↘ 3: 10.8x ↗	Serie	28.0	Serie	30.0
	Total	226.0	Total	256.0		Total	256.0
8. Serie 5 Skott 	1: 10.3 ↘ 2: 7.7 ↖ 3: 9.8 ↗			Serie	26.0		
	Total	282.0					

Prov 	1: 8.8 ↘ 2: 10.4 ↙ Serie 18.0 Total 0.0	5 Skott 	1: 10.4x ↘ 2: 9.3 ↙ 3: 10.5x ← 4: 9.6 ↘ 5: 9.9 ↙ Serie 47.0 Total 47.0
-----------------	--	--------------------	--

Prov 	1: 9.6 ↗ 2: 10.1 ↗ Serie 19.0 Total 47.0	24 Serie 5 Skott 	1: 9.3 ↘ 2: 6.1 ↘ 3: 8.9 ← 4: 6.9 ↘ 5: 8.0 → Serie 37.0 Total 84.0
-----------------	---	-----------------------------	--

Prov 	1: 10.3 → Serie 10.0 Total 84.0	3. Serie 5 Skott 	1: 9.2 ↗ 2: 9.2 → 3: 8.7 ↘ 4: 10.4 ← 5: 9.9 ↗ Serie 45.0 Total 129.0
-----------------	---------------------------------------	-----------------------------	--

4. Serie 5 Skott 	1: 10.6x ← 2: 7.7 ↘ 3: 8.1 ↘ Serie 25.0 Total 154.0	5. Serie 5 Skott 	1: 9.2 ← 2: 6.7 ↘ 3: 10.1 ↗ Serie 25.0 Total 179.0
-----------------------------	---	-----------------------------	--

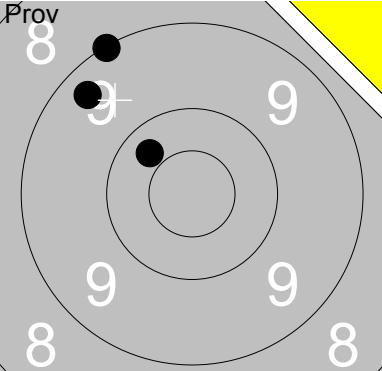
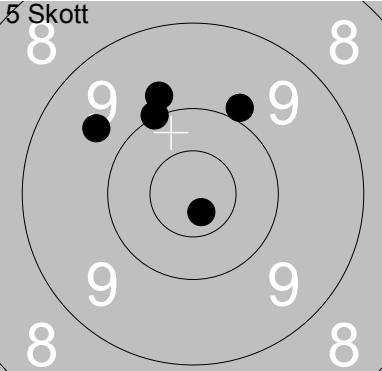
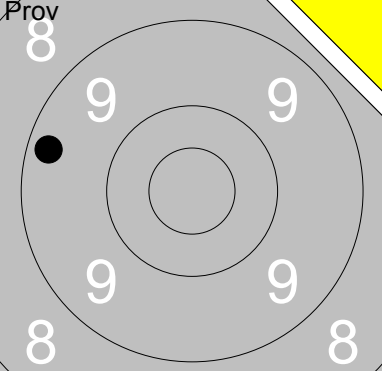
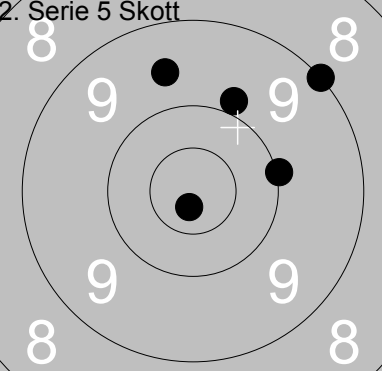
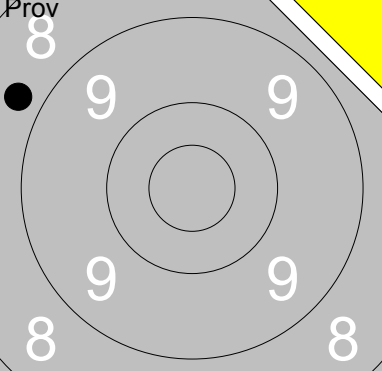
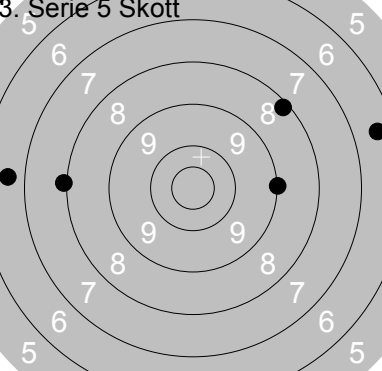
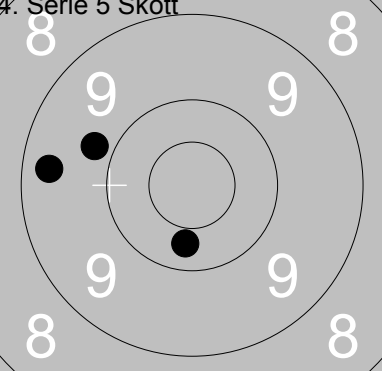
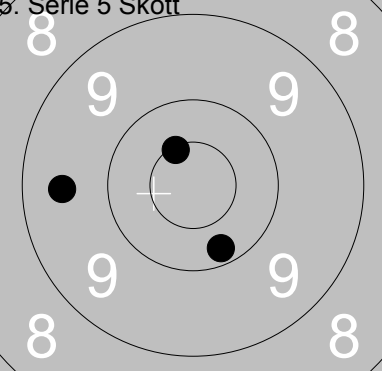
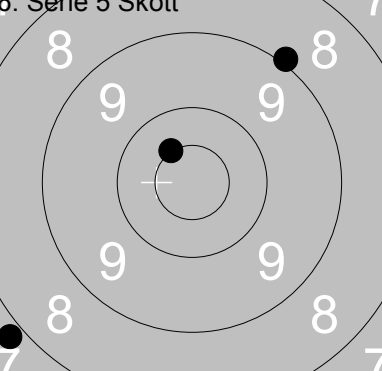
Skjutlag 1	Tavla 20	Lapua	
Vindeln	Helena, Lars-Göran, Bengt		Lag
09.07.2017	Tavelträffen Lagtävling 2017		Ramselefors SKF
Prov 	1: 9.4 ↗ 2: 9.1 ↗ 3: 10.3 ↗	5 Skott 	1: 10.7x ↓ 2: 9.8 ↗ 3: 9.9 ↗ 4: 10.0 ↗ 5: 9.7 ↖
	Serie 28.0		Serie 47.0
	Total 0.0		Total 47.0
Prov 	1: 9.3 ←	2. Serie 5 Skott 	1: 9.6 ↑ 2: 10.0 → 3: 9.0 ↗ 4: 9.9 ↗ 5: 10.8x ↓
	Serie 9.0		Serie 47.0
	Total 47.0		Total 94.0
Prov 	1: 8.7 ↖	3. Serie 5 Skott 	1: 6.6 ← 2: 6.4 → 3: 8.2 ↗ 4: 9.0 → 5: 8.0 ←
	Serie 8.0		Serie 37.0
	Total 94.0		Total 131.0
4. Serie 5 Skott 	1: 10.3 ↓ 2: 9.3 ← 3: 9.8 ↖	5. Serie 5 Skott 	1: 10.2 ↓ 2: 10.5x ↗ 3: 9.5 ←
	Serie 28.0		Serie 29.0
	Total 159.0		Total 188.0
6. Serie 5 Skott 	1: 10.5x ↗ 2: 9.0 ↗ 3: 7.8 ↖		
	Serie 26.0		
	Total 214.0		

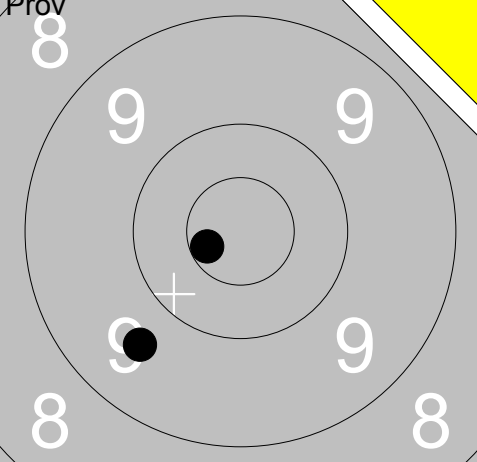
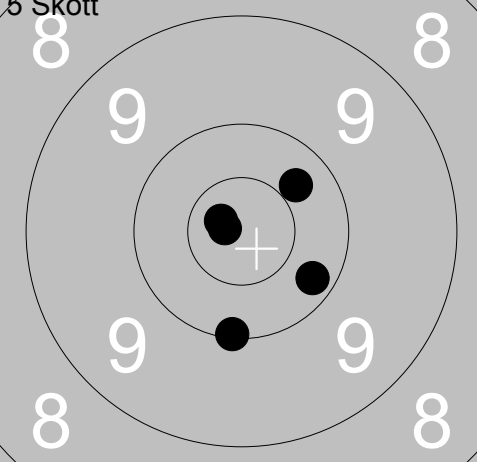
<p>Prov</p> 	<p>1: 10.6x ↙ 2: 9.6 ↘</p> <p>Serie 19.0 Total 0.0</p>	<p>5 Skott</p> 	<p>1: 10.3 ↗ 2: 10.2 ↘ 3: 10.8x ↗ 4: 10.8x ↖ 5: 10.1 ↓</p> <p>Serie 50.0 Total 50.0</p>
--	--	---	---

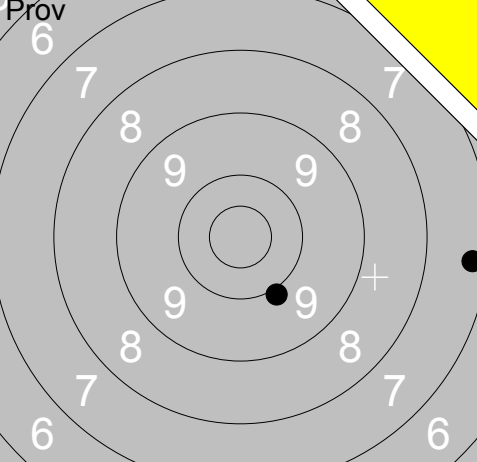
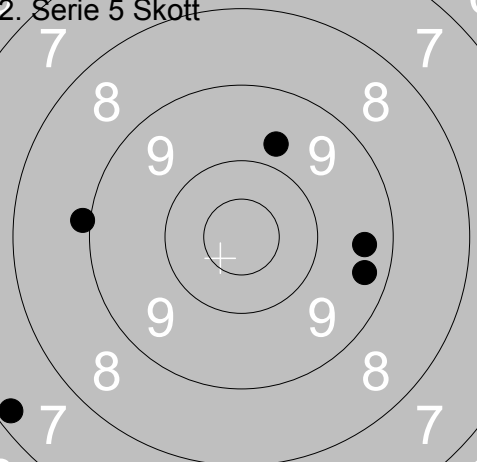
<p>Prov</p> 	<p>1: 7.3 → 2: 9.9 ↘</p> <p>Serie 16.0 Total 50.0</p>	<p>2. Serie 5 Skott</p> 	<p>1: 8.9 ← 2: 9.7 ↑ 3: 9.3 → 4: 7.2 ↘ 5: 9.4 →</p> <p>Serie 42.0 Total 92.0</p>
---	---	---	--

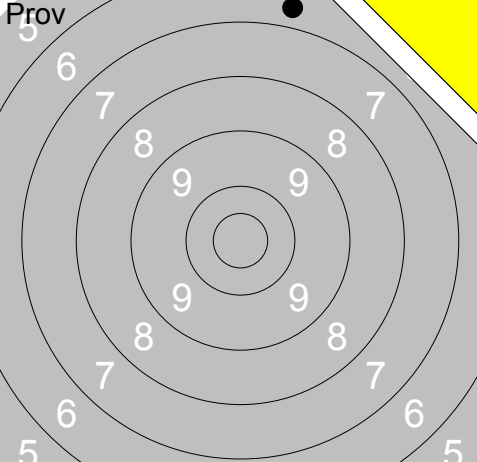
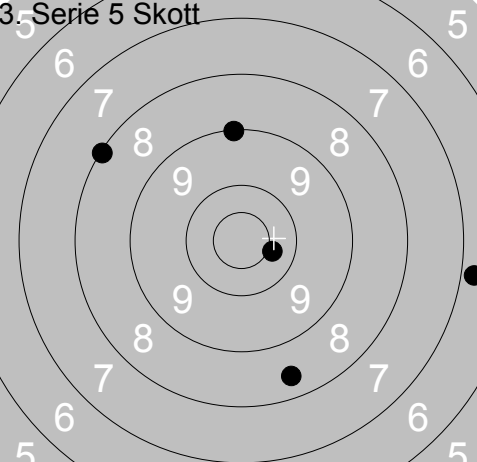
<p>Prov</p> 	<p>1: 6.7 ↑</p> <p>Serie 6.0 Total 92.0</p>	<p>3. Serie 5 Skott</p> 	<p>1: 10.4 → 2: 8.1 ↗ 3: 9.0 ↑ 4: 8.4 ↘ 5: 6.8 →</p> <p>Serie 41.0 Total 133.0</p>
--	---	--	--

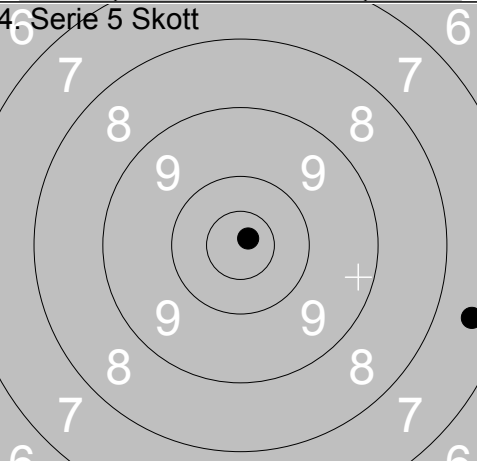
<p>4. Serie 5 Skott</p> 	<p>1: 10.8x ↗ 2: 7.5 →</p> <p>Serie 17.0 Total 150.0</p>		
--	--	--	--

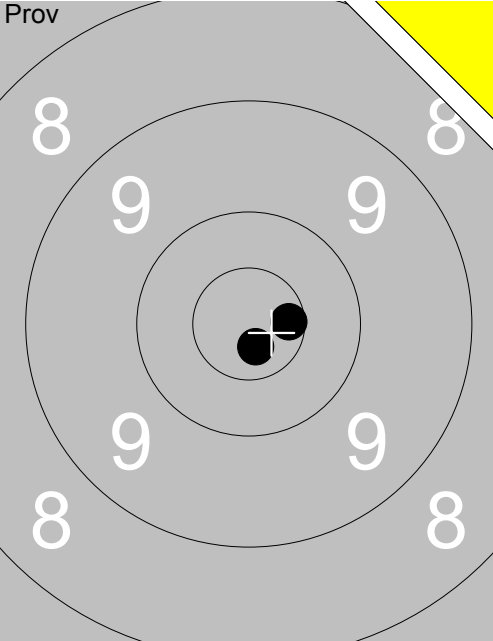
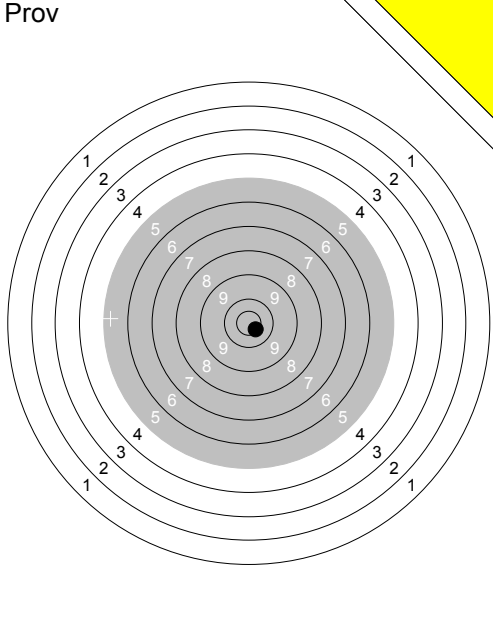
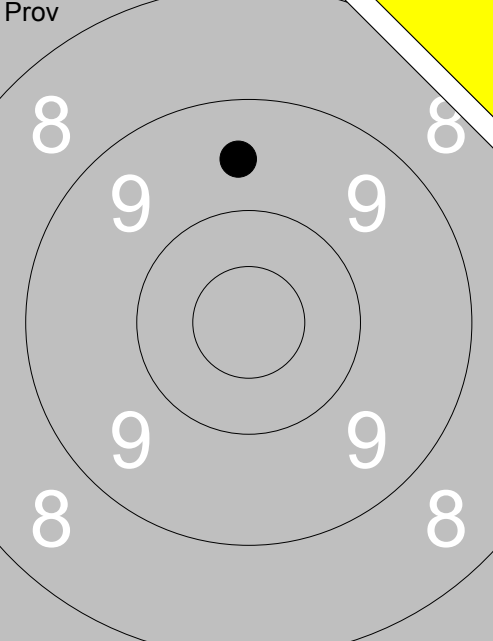
Skjutlag	Tavla	Ale	
Vindeln	Emil, Elina, Donald		Lag
09.07.2017	Tavelträffen Lagtävling 2017		Ramselefors SKF
Prov		1: 10.6x ➤ 2: 10.8x ↘	1: 10.1 ↘ 2: 9.3 ➤ 3: 9.4 ➤ 4: 10.5x ↘ 5: 9.8 ➤
	Serie 20.0 Total 0.0	5 Skott	Serie 47.0 Total 47.0
Prov		1: 10.6x ↘ 2: 0.0 ←	1: 7.8 ↖ 2: 8.7 ↑ 3: 0.0 ← 4: 10.2 ↖ 5: 2.3 ←
	Serie 10.0 Total 47.0	2. Serie 5 Skott	Serie 27.0 Total 74.0
Prov		1: 9.6 ↑	1: 8.5 ↘ 2: 9.6 ← 3: 9.3 ← 4: 7.4 ↖ 5: 7.1 ↑
	Serie 9.0 Total 74.0	3. Serie 5 Skott	Serie 40.0 Total 114.0