

Skjutlag	Tavla	Jennifer Gustafsson	
1	11	Ramselefors	Vb
03.02.2018	Skyttiadens Regionsfinal 2018	Ramselefors SKF	13
Prov		1: 7.4 → 2: 8.2 → 3: 8.9 → 4: 9.3 → 5: 10.2x ↗ 6: 10.1 ↗ 7: 10.4x → 8: 10.4x → 9: 10.4x → 10: 10.2x ↗	11: 10.4x → 12: 10.8x ↓ 13: 10.7x ↓ 14: 10.7x ↖ 15: 10.6x ↑ 16: 10.8x ↗
	Serie 95.5	Serie 64.0	
	Total 0.0	Total 0.0	
40 Skott		1: 10.4x → 2: 10.6x ↗ 3: 10.6x ↖ 4: 10.1 ↑ 5: 10.5x ↗ 6: 10.3x ↓ 7: 10.4x ↓ 8: 10.7x ↑ 9: 10.4x → 10: 10.5x →	11: 9.9 → 12: 10.2x → 13: 10.6x ↓ 14: 10.3x → 15: 10.7x → 16: 10.8x ← 17: 10.3x → 18: 10.5x ↑ 19: 10.7x ↖ 20: 10.1 ↓
	Serie 104.5	Serie 104.1	
	Total 104.5	Total 208.6	
40 Skott		21: 10.2x ↓ 22: 10.3x → 23: 10.6x ↓ 24: 10.0 → 25: 10.2x → 26: 10.4x ↘ 27: 10.8x ↖ 28: 10.5x ↓ 29: 10.4x → 30: 10.6x ←	31: 10.6x ← 32: 10.3x ↘ 33: 10.4x ↘ 34: 10.6x ↓ 35: 10.4x → 36: 10.5x ↓ 37: 10.5x ↑ 38: 10.5x → 39: 10.3x ↘ 40: 10.5x ↑
	Serie 104.0	Serie 104.6	
	Total 312.6	Total 417.2	

Skjutlag	Tavla	Erika Augustsson	
1	12	Ramselefors	Vännäs
03.02.2018	Skyttiadens Regionsfinal 2018	13	Vb
03.02.2018	Skyttiadens Regionsfinal 2018	Ramselefors SKF	
<b>Prov</b> 	1: 9.3 ↘ 2: 8.9 ↘ 3: 10.1 ↘ 4: 10.3x → 5: 9.8 ↓ 6: 9.9 ↓ 7: 10.1 ← 8: 10.4x ← 9: 10.5x → 10: 10.9x → Serie 100.2 Total 0.0	<b>Prov</b> 	11: 10.5x ↑ 12: 10.1 ↑ 13: 10.3x → 14: 10.5x ↑ 15: 10.4x → 16: 10.6x ← Serie 62.4 Total 0.0
<b>40 Skott</b> 	1: 10.9x ↘ 2: 10.8x ↘ 3: 9.7 ↓ 4: 10.9x ← 5: 10.7x ← 6: 10.5x ↑ 7: 10.7x → 8: 10.7x → 9: 10.6x ↗ 10: 10.4x ↗ Serie 105.9 Total 105.9	<b>40 Skott</b> 	11: 10.1 ↑ 12: 10.6x ↘ 13: 10.4x ↗ 14: 10.6x ↗ 15: 10.9x ← 16: 10.2x ↑ 17: 10.7x → 18: 10.6x → 19: 10.6x ↓ 20: 10.4x ↗ Serie 105.1 Total 211.0
<b>40 Skott</b> 	21: 10.3x ↓ 22: 10.4x ↘ 23: 10.3x ↗ 24: 10.6x ← 25: 10.7x → 26: 10.6x ↑ 27: 10.6x ↘ 28: 10.7x ↘ 29: 10.3x ↗ 30: 10.4x ↗ Serie 104.9 Total 315.9	<b>40 Skott</b> 	31: 10.6x ← 32: 10.7x ← 33: 10.9x ← 34: 10.6x ← 35: 10.5x ↘ 36: 10.7x ↑ 37: 10.5x ↑ 38: 10.7x ← 39: 10.6x ↓ 40: 10.5x → Serie 106.3 Total 422.2

Skjutlag	Tavla	Alva Persson	
1	13	Ramselefors	Kyrkås
03.02.2018	Skyttiadens Regionsfinal 2018	13	Jä
03.02.2018	Skyttiadens Regionsfinal 2018	Ramselefors SKF	
Prov		1: 10.2x ↗ 2: 9.9 → 3: 10.5x ↓ 4: 10.7x ↓ 5: 10.1 ↓ 6: 10.6x ← 7: 10.6x → 8: 10.3x ← 9: 10.4x ↓ 10: 10.6x ↓	11: 10.5x ↗ 12: 10.5x ↓ 13: 10.6x ↓ 14: 10.3x ↓ 15: 10.5x ↓ 16: 10.8x ↓
		Serie 103.9	Serie 63.2
		Total 0.0	Total 0.0
40 Skott		1: 10.3x ↖ 2: 10.3x → 3: 10.4x ↗ 4: 10.5x ← 5: 10.8x ↗ 6: 10.5x ↓ 7: 10.6x ↑ 8: 10.6x ↑ 9: 10.4x ↓ 10: 10.1 →	11: 9.8 ↓ 12: 10.4x → 13: 10.9x ← 14: 10.4x ↖ 15: 10.1 ↗ 16: 9.9 ↑ 17: 10.5x ↓ 18: 10.1 → 19: 10.6x ↖ 20: 10.3x →
		Serie 104.5	Serie 103.0
		Total 104.5	Total 207.5
40 Skott		21: 10.5x ← 22: 10.5x ↖ 23: 10.4x → 24: 10.5x ↓ 25: 10.7x ↑ 26: 10.7x ↓ 27: 10.9x ↗ 28: 10.3x ↖ 29: 9.8 ↓ 30: 10.1 ↙	31: 10.6x → 32: 10.4x ↓ 33: 10.2x ↓ 34: 10.0 ↗ 35: 10.2x ← 36: 10.4x ↗ 37: 10.4x ↗ 38: 10.2x → 39: 9.8 → 40: 10.8x →
		Serie 104.4	Serie 103.0
		Total 311.9	Total 414.9

Skjutlag	Tavla	Hanna Augustsson	
1	14	Ramselefors	Vännäs
03.02.2018	Skyttiadens Regionsfinal 2018	13	Vb
03.02.2018	Skyttiadens Regionsfinal 2018	Ramselefors SKF	
Prov		1: 10.2x ↗ 2: 10.0 ↗ 3: 10.4x ↖ 4: 10.4x ↘ 5: 10.3x ↘ 6: 9.7 ← 7: 10.0 ← 8: 10.2x ↘ 9: 10.2x → 10: 10.7x ↙	11: 10.4x ↗ 12: 10.7x ↖ 13: 10.1 ↓ 14: 10.4x ↙ 15: 10.6x ↓ 16: 10.3x ↓ 17: 10.4x ↓ 18: 10.4x ↗ 19: 10.7x ↖
	Serie 102.1	Serie 94.0	
	Total 0.0	Total 0.0	
40 Skott		1: 10.5x ↗ 2: 10.3x ↙ 3: 10.2x ↗ 4: 10.3x ↘ 5: 10.8x ↗ 6: 10.1 ↓ 7: 10.4x ↙ 8: 10.5x ↘ 9: 10.2x ↗ 10: 10.8x ↗	11: 10.0 ↖ 12: 10.5x ↓ 13: 10.4x ↓ 14: 10.6x ↓ 15: 10.0 ↗ 16: 10.2x ↗ 17: 10.2x ↗ 18: 9.8 → 19: 9.6 ↓ 20: 10.6x ↓
	Serie 104.1	Serie 101.9	
	Total 104.1	Total 206.0	
40 Skott		21: 10.8x ↗ 22: 10.8x ↙ 23: 10.7x ↓ 24: 10.7x ↖ 25: 10.5x → 26: 10.8x ↗ 27: 10.5x ↙ 28: 10.6x ↗ 29: 10.5x ↘ 30: 10.2x ↙	31: 10.5x → 32: 10.2x ↘ 33: 9.9 ↙ 34: 10.8x ↖ 35: 10.0 ↓ 36: 10.2x ↙ 37: 10.2x → 38: 10.8x ↗ 39: 10.2x → 40: 10.1 ↖
	Serie 106.1	Serie 102.9	
	Total 312.1	Total 415.0	

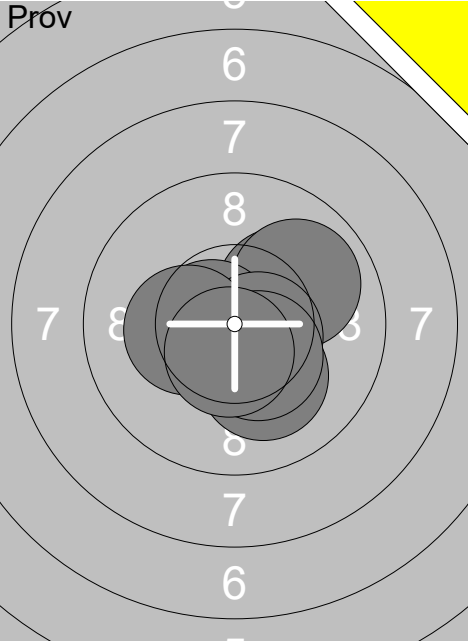
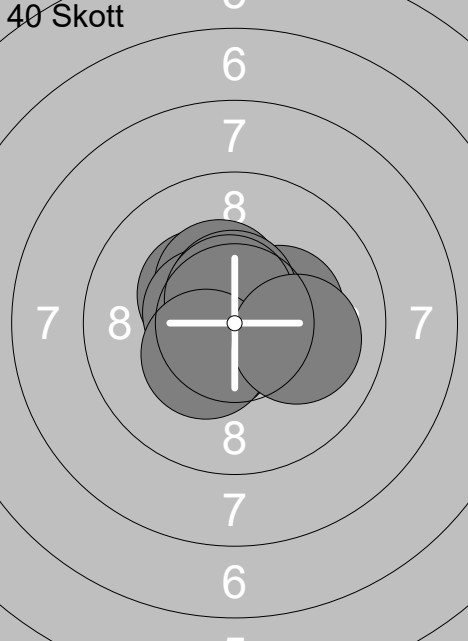
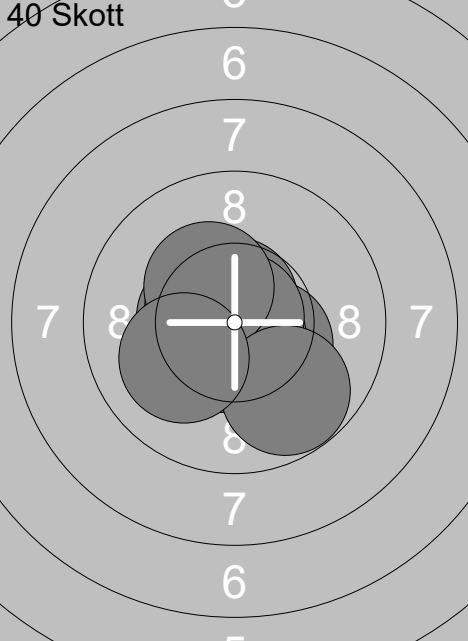
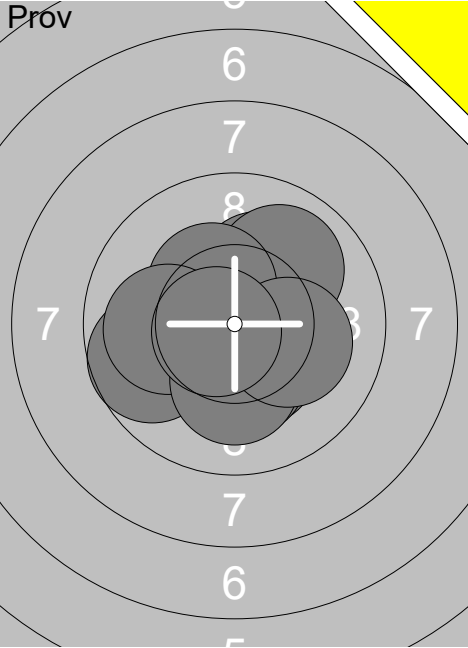
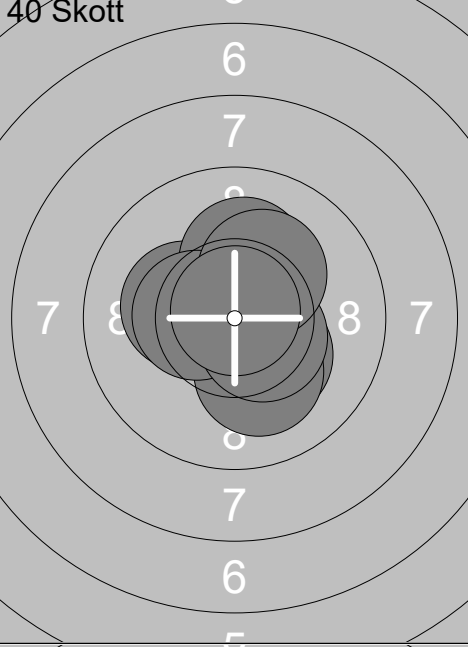
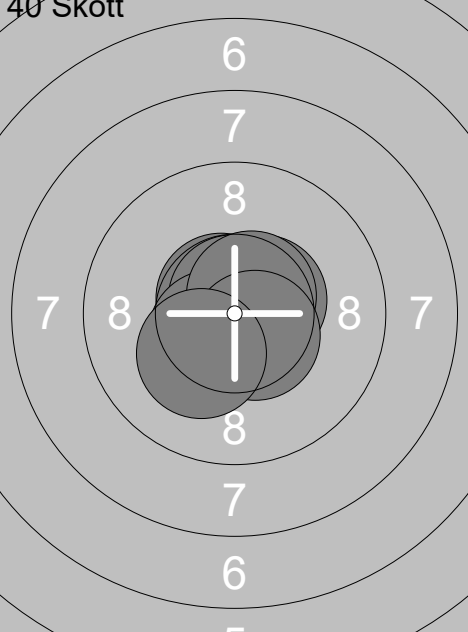
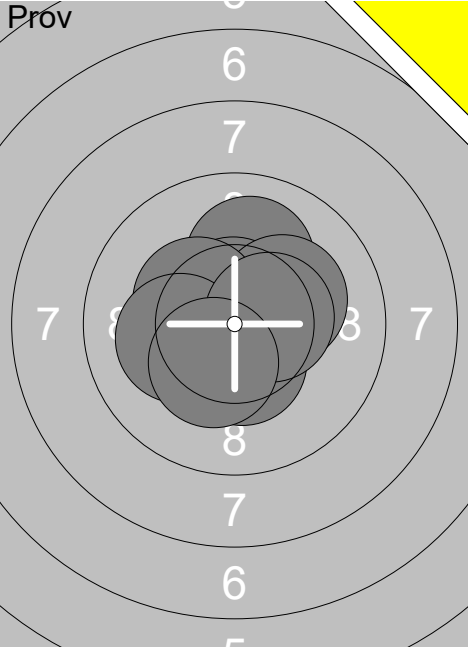
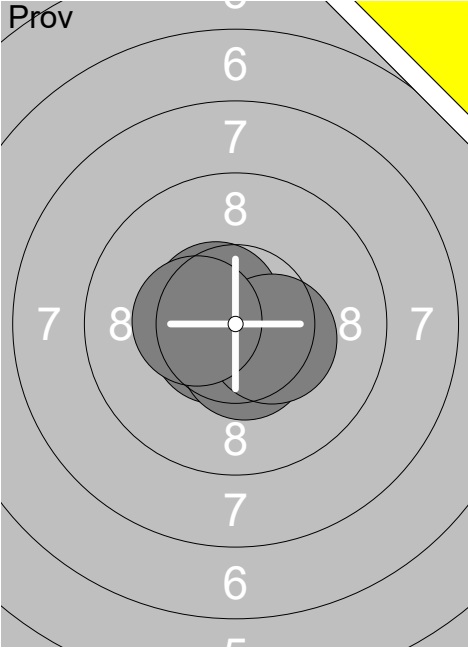
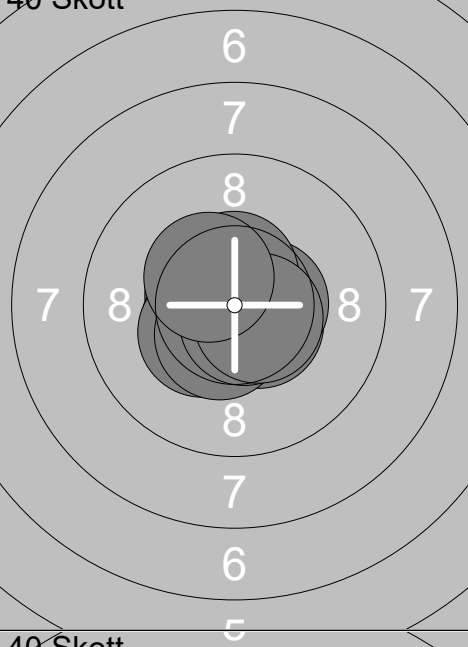
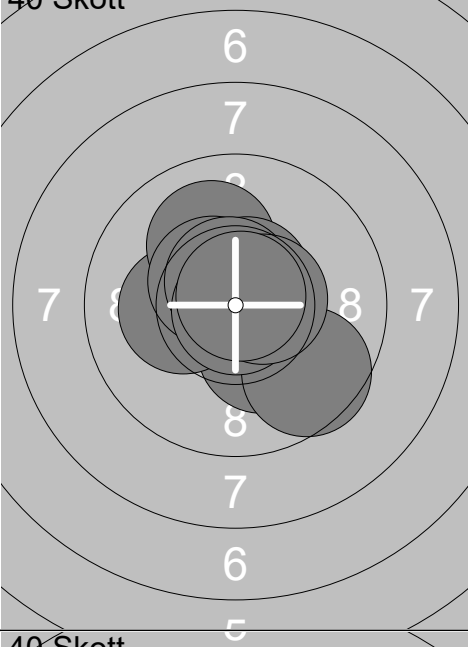
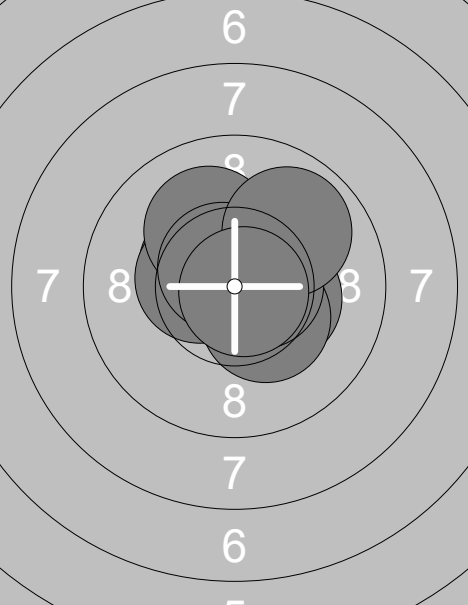
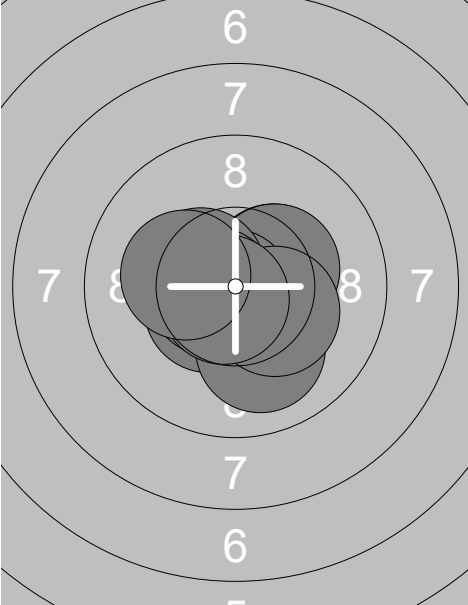

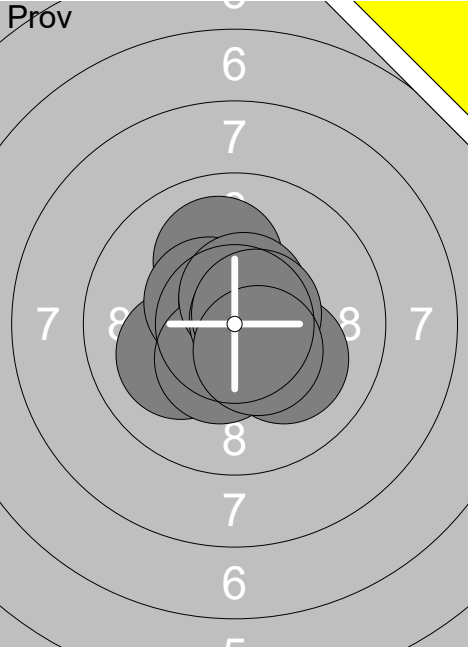
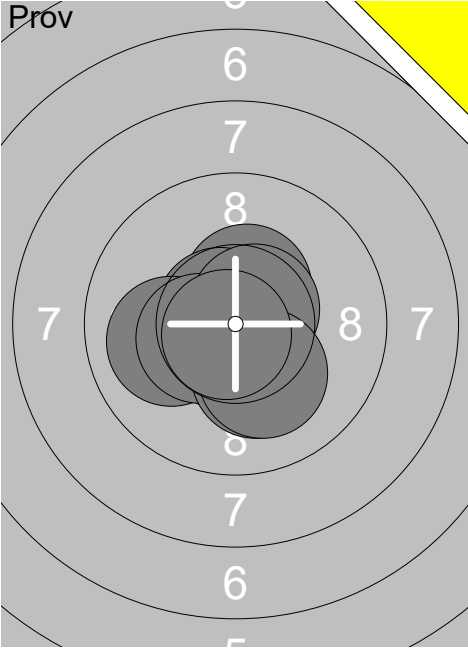
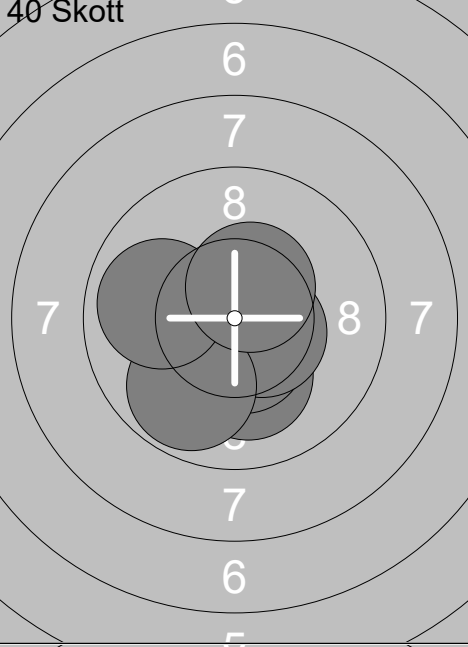
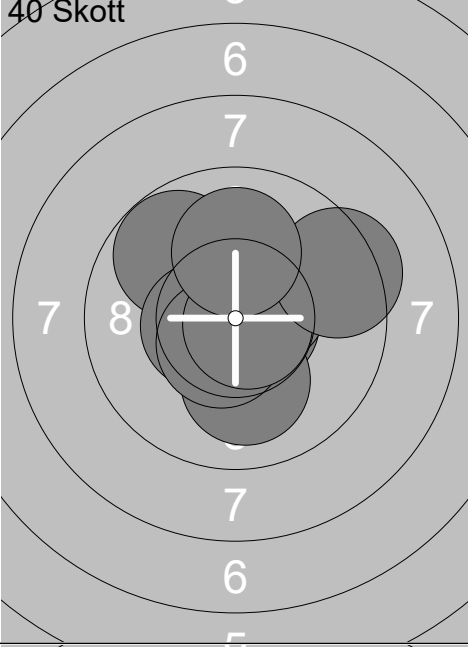
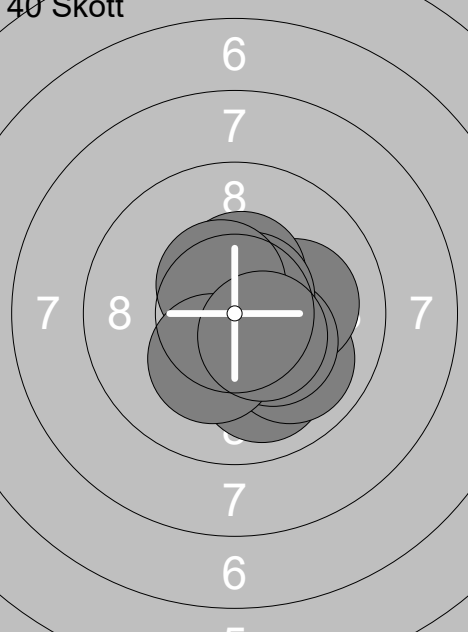
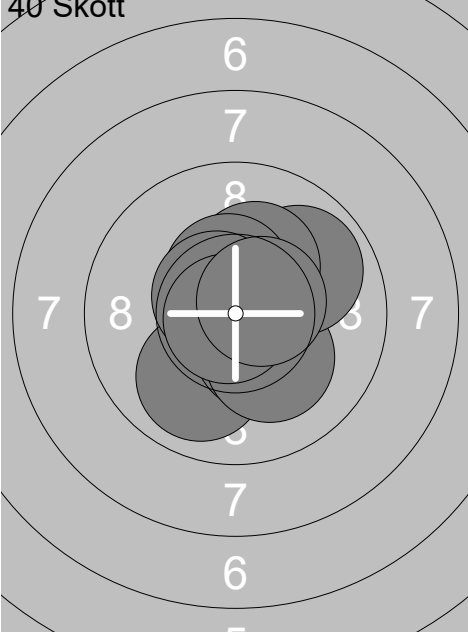
Skjutlag	Tavla	Beatrice Andersson			
1	15	Ramselefors	Ramselefors	13	Vb
03.02.2018		Skyttiadens Regionsfinal 2018		Ramselefors SKF	
Prov 	1: 10.5x ↗	Prov 	11: 10.6x ↙		
	2: 10.0 ↑		12: 10.6x ↖		
	3: 10.6x ↑		13: 10.5x ↓		
	4: 10.8x ←		14: 10.4x →		
	5: 10.4x ↓		15: 10.4x ←		
	6: 10.2x ↗				
	7: 10.4x ↖				
	8: 10.2x ←				
	9: 10.5x →				
	10: 10.3x ↓				
	Serie 103.9		Serie 52.5		
	Total 0.0		Total 0.0		
40 Skott 	1: 10.6x ←	40 Skott 	11: 10.2x ↓		
	2: 10.4x ↙		12: 10.2x ←		
	3: 10.4x ↙		13: 9.6 ↓		
	4: 10.5x ↘		14: 10.1 ↑		
	5: 10.5x ↓		15: 10.6x ↗		
	6: 10.5x →		16: 10.5x ↖		
	7: 10.6x ↑		17: 10.6x ↑		
	8: 10.7x ↓		18: 10.9x ↓		
	9: 10.6x ↘		19: 10.6x →		
	10: 10.4x ↖		20: 10.8x ↗		
	Serie 105.2		Serie 104.1		
	Total 105.2		Total 209.3		
40 Skott 	21: 10.4x ↖	40 Skott 	31: 10.4x →		
	22: 10.5x ←		32: 10.4x →		
	23: 10.1 ↑		33: 10.5x ↙		
	24: 10.3x →		34: 10.8x ↙		
	25: 10.8x ↗		35: 10.0 ↓		
	26: 10.3x ↓		36: 10.4x ↖		
	27: 10.6x →		37: 10.6x ←		
	28: 10.6x ↖		38: 10.3x ↘		
	29: 9.9 ↗		39: 10.7x ↙		
	30: 10.8x ↘		40: 10.2x ←		
	Serie 104.3		Serie 104.3		
	Total 313.6		Total 417.9		

Skjuttag	Tavla	Chris Johansson		
1	17	Ramselefors	Hammerdal	13
03.02.2018	Skyttiadens Regionsfinal 2018	Ramselefors SKF		
Prov 	1: 10.0 ↑	Prov 	11: 10.6x ↓	
	2: 10.1 ↙		12: 10.4x ↑	
	3: 10.5x ↘		13: 10.7x ↖	
	4: 10.6x ↑		14: 10.0 ←	
	5: 10.1 ↘		15: 10.4x ↙	
	6: 10.4x ↓		16: 10.2x ↓	
	7: 10.6x ↑		17: 10.6x ↗	
	8: 10.7x →		18: 10.2x ↓	
	9: 10.6x ↗		19: 10.8x ↙	
	10: 10.5x ↘			
	Serie 104.1		Serie 93.9	
	Total 0.0		Total 0.0	
40 Skott 	1: 10.7x ↙	40 Skott 	11: 9.8 ↖	
	2: 10.1 ↓		12: 10.9x ↙	
	3: 10.5x ↓		13: 10.7x →	
	4: 10.8x ↙		14: 10.5x ↗	
	5: 10.8x ↘		15: 10.1 ↓	
	6: 10.5x ↙		16: 10.5x ↙	
	7: 10.5x →		17: 10.6x ↓	
	8: 9.8 ↓		18: 10.8x →	
	9: 9.9 ←		19: 9.4 ↗	
	10: 10.5x ↑		20: 10.0 ↑	
	Serie 104.1		Serie 103.3	
	Total 104.1		Total 207.4	
40 Skott 	21: 10.0 ↓	40 Skott 	31: 10.0 ↓	
	22: 10.0 ↘		32: 10.4x ↘	
	23: 10.6x →		33: 10.2x ↘	
	24: 10.1 →		34: 9.9 ↗	
	25: 10.4x ↑		35: 10.4x ↑	
	26: 10.3x →		36: 10.2x ↑	
	27: 10.6x ↗		37: 10.5x ↑	
	28: 10.5x ↖		38: 10.6x ↖	
	29: 10.2x ↓		39: 10.8x ↙	
	30: 10.4x ↘		40: 10.6x ↗	
	Serie 103.1		Serie 103.6	
	Total 310.5		Total 414.1	

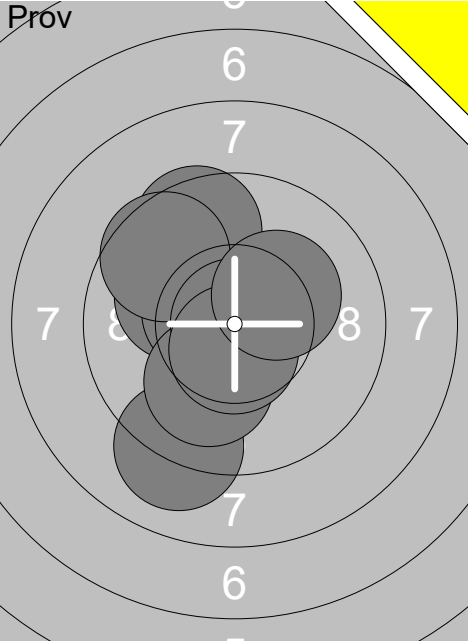
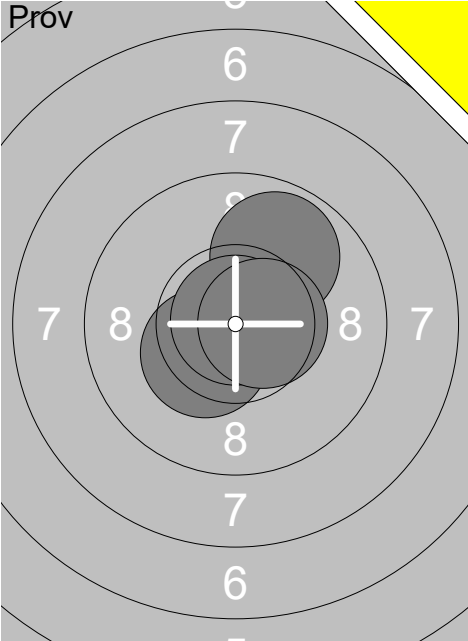
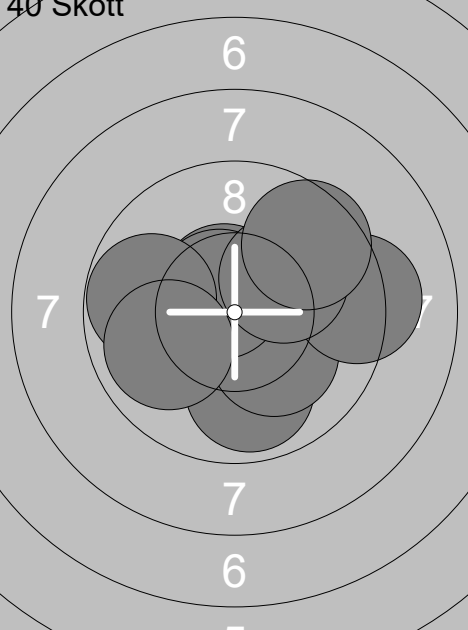
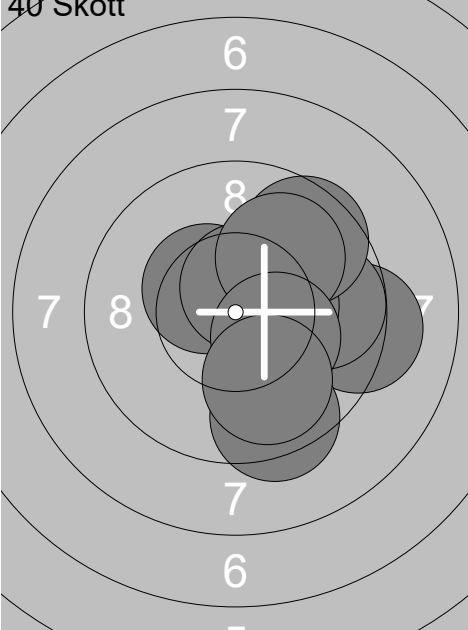
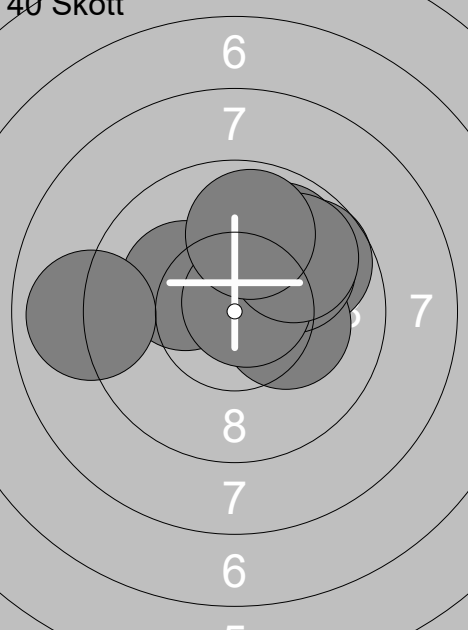
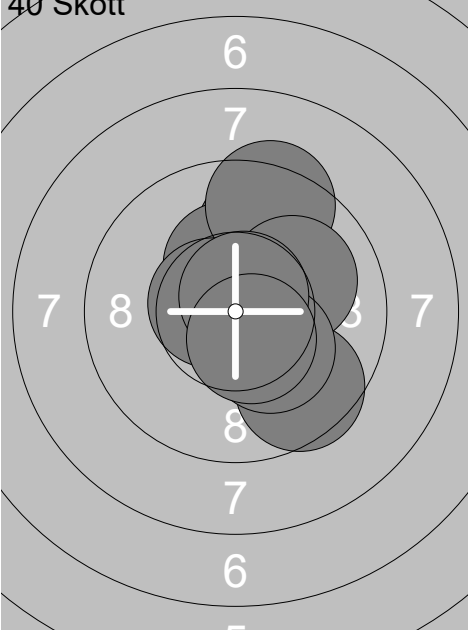
Skjutlag	Tavla	Emelie Andersson		
1	18	Ramselefors	Hammerdal	13
03.02.2018		Skyttiadens Regionsfinal 2018		Ramselefors SKF
Prov 	1: 9.7 ←	Prov 	11: 10.4x ↗	
	2: 10.6x ↘		12: 10.6x ←	
	3: 9.0 ←		13: 10.6x ↗	
	4: 9.1 ←		14: 10.4x →	
	5: 10.6x ←		15: 10.1 ↘	
	6: 10.0 ↗		16: 10.0 ↗	
	7: 10.2x ↗		17: 10.8x →	
	8: 10.3x ↘			
	9: 10.4x ↘			
	10: 10.7x ↗			
	Serie 100.6		Serie 72.9	
	Total 0.0		Total 0.0	
40 Skott 	1: 10.8x ↘	40 Skott 	11: 10.2x ↘	
	2: 10.5x →		12: 10.7x ↘	
	3: 10.4x ↗		13: 10.7x ↗	
	4: 10.5x →		14: 10.9x →	
	5: 10.3x →		15: 10.6x →	
	6: 9.7 ↘		16: 10.5x ↗	
	7: 10.7x ↗		17: 10.5x →	
	8: 10.0 ←		18: 10.6x ↘	
	9: 10.4x ↗		19: 9.9 ↗	
	10: 9.9 ↗		20: 10.1 ↗	
	Serie 103.2		Serie 104.7	
	Total 103.2		Total 207.9	
40 Skott 	21: 10.7x →	40 Skott 	31: 10.6x ←	
	22: 9.7 ↗		32: 9.6 →	
	23: 9.6 ↗		33: 10.7x ↘	
	24: 10.4x ↗		34: 10.1 ↗	
	25: 9.6 ↗		35: 10.8x ↘	
	26: 10.2x ↗		36: 10.5x ↗	
	27: 10.5x →		37: 10.1 ↗	
	28: 10.3x ←		38: 10.1 ↗	
	29: 10.2x →		39: 10.6x →	
	30: 10.3x →		40: 10.3x ↗	
	Serie 101.5		Serie 103.4	
	Total 309.4		Total 412.8	

Skjutlag	Tavla	Ebba Wikström	
1	19	Ramselefors	Fältjägarna
03.02.2018	Skyttiadens Regionsfinal 2018	13	Jä
03.02.2018	Skyttiadens Regionsfinal 2018	Ramselefors SKF	
Prov 	1: 9.1 ↘ 2: 10.7x ↗ 3: 9.6 ↗ 4: 10.1 ↖ 5: 10.5x ↖ 6: 9.6 ↗ 7: 10.1 ↘ 8: 10.9x ↗ 9: 10.6x ↘ 10: 10.2x ↗	Prov 	11: 10.4x ↘ 12: 9.9 ↗ 13: 10.9x ↗ 14: 10.6x →
Serie 101.4	Total 0.0	Serie 41.8	Total 0.0
40 Skott 	1: 10.6x ↘ 2: 9.9 ↘ 3: 10.2x ↘ 4: 9.2 → 5: 10.6x ↗ 6: 10.6x ↖ 7: 10.1 ↗ 8: 9.6 ↗ 9: 9.8 ← 10: 9.9 ←	40 Skott 	11: 9.2 → 12: 9.4 ↘ 13: 9.8 → 14: 10.4x → 15: 10.4x ↖ 16: 10.6x ↗ 17: 9.6 ↗ 18: 10.0 ↗ 19: 10.3x ↘ 20: 9.9 ↘
Serie 100.5	Total 100.5	Serie 99.6	Total 200.1
40 Skott 	21: 9.9 ↗ 22: 10.6x ↗ 23: 9.7 ↗ 24: 10.2x ↖ 25: 10.2x → 26: 10.0 ↗ 27: 10.7x ↗ 28: 9.8 ↗ 29: 9.9 ↗ 30: 8.9 ←	40 Skott 	31: 9.6 ↘ 32: 9.8 ↗ 33: 10.3x ↗ 34: 9.4 ↗ 35: 10.8x ↗ 36: 10.0 ↗ 37: 10.6x ↖ 38: 10.2x ↘ 39: 10.7x ↗ 40: 10.5x ↘
Serie 99.9	Total 300.0	Serie 101.9	Total 401.9

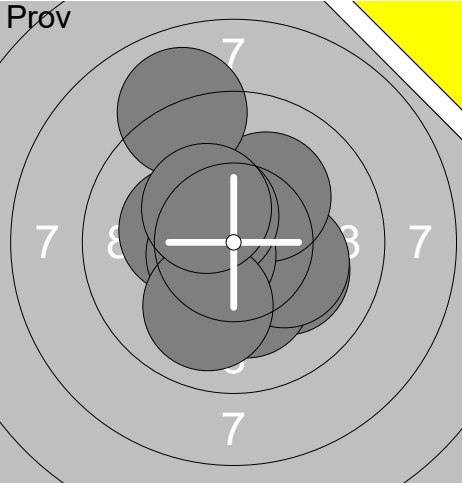
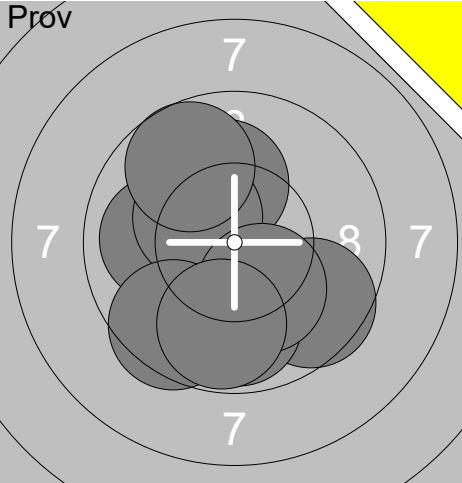

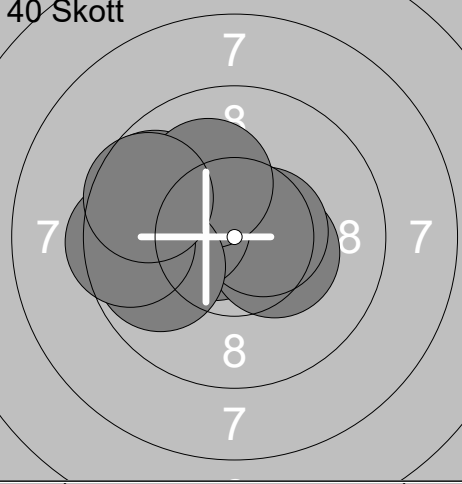
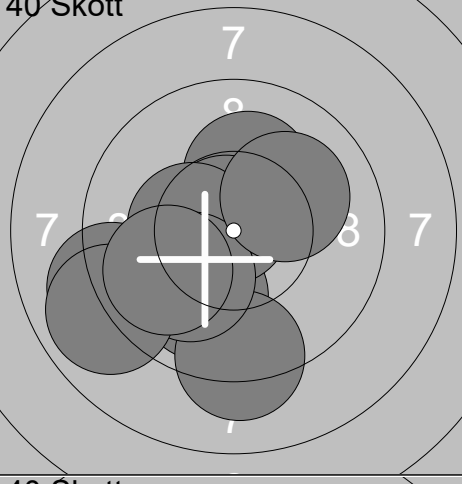
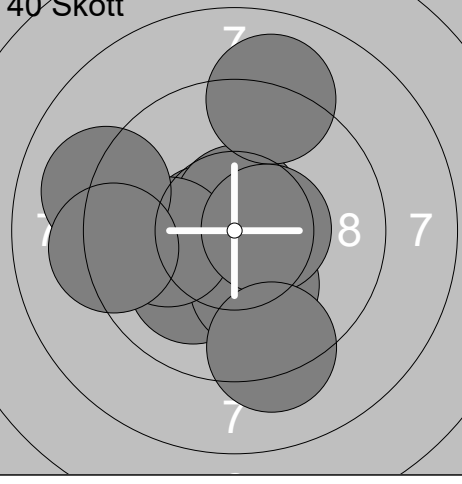
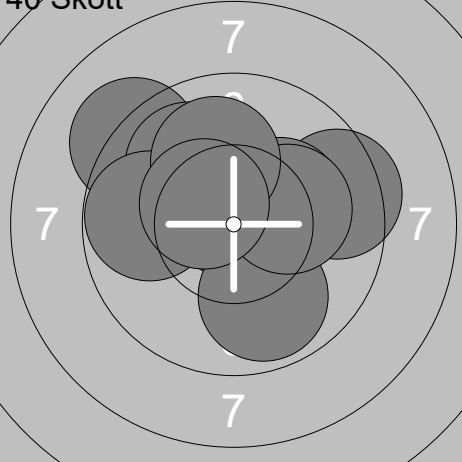
Skjutlag <b>1</b>	Tavla <b>20</b>	<b>Zigge Rinzén</b>	
Ramselefors	Aspås	13	Jä
03.02.2018	Skyttiadens Regionsfinal 2018	Ramselefors SKF	
<b>Prov</b> 	1: 10.1 ↘ 2: 10.2x ↓ 3: 10.2x ← 4: 10.2x → 5: 10.2x ↗ 6: 9.0 ↗ 7: 10.6x ← 8: 10.5x ↗ 9: 10.0 ↓ 10: 10.3x ↗ Serie 101.3 Total 0.0	<b>Prov</b> 	11: 10.1 ↘ 12: 10.0 ← 13: 9.6 ↘ 14: 10.1 ↗ 15: 10.3x ↗ 16: 9.5 ↘ 17: 9.7 ↗ 18: 9.9 ↓ 19: 10.2x ↓ 20: 9.8 ↓ Serie 99.2 Total 0.0
<b>Prov</b> 	21: 10.3x ↓ 22: 10.4x ↓ Serie 20.7 Total 0.0	<b>40 Skott</b> 	1: 10.0 ← 2: 10.7x ← 3: 10.4x → 4: 9.7 ↗ 5: 10.5x → 6: 10.2x ← 7: 10.1 ↗ 8: 9.8 ← 9: 9.5 ← 10: 9.6 ↗ Serie 100.5 Total 100.5
<b>40 Skott</b> 	11: 10.0 ↓ 12: 9.2 ↓ 13: 10.2x ↑ 14: 10.8x ↗ 15: 10.4x ← 16: 10.1 ↓ 17: 9.1 ← 18: 8.9 ← 19: 9.9 ← 20: 10.1 ↗ Serie 98.7 Total 199.2	<b>40 Skott</b> 	21: 10.6x ← 22: 10.1 ↓ 23: 10.7x ↑ 24: 10.2x ↓ 25: 10.0 ← 26: 9.1 ↑ 27: 10.5x → 28: 9.3 ↓ 29: 9.1 ← 30: 9.3 ← Serie 98.9 Total 298.1
<b>40 Skott</b> 	31: 9.2 ↗ 32: 10.0 ↗ 33: 9.8 ← 34: 9.5 → 35: 10.8x ↑ 36: 10.2x → 37: 9.9 ↓ 38: 10.2x → 39: 10.0 ↑ 40: 10.4x ↗ Serie 100.0 Total 398.1		

Skjuttlag	Tavla	Elis Eliasson	
1	21	Piteå	No
03.02.2018	Skyttiadens Regionsfinal 2018	Ramselefors SKF	
Prov			
	Serie 102.1	Serie 52.3	
	Total 0.0	Total 0.0	
40 Skott			
	Serie 102.7	Serie 102.1	
	Total 102.7	Total 204.8	
40 Skott			
	Serie 103.6	Serie 102.7	
	Total 308.4	Total 411.1	

Skjutlag	Tavla	Pontus Holmlund		
1	22	Ramselefors	Gideå	13 Vn
03.02.2018	Skyttiadens Regionsfinal 2018	Ramselefors SKF		
<b>Prov</b> 	1: 10.5x → 2: 10.1 ↑ 3: 10.1 ↖ 4: 10.1 ↙ 5: 10.0 ↗ 6: 9.9 ↓ 7: 10.2x ↓ 8: 9.3 ↖ 9: 10.5x → 10: 10.9x ↑	<b>Prov</b> 	11: 10.5x ↓ 12: 9.9 ↑ 13: 10.7x → 14: 10.5x ← 15: 10.4x ↑	
	Serie 101.6		Serie 52.0	
	Total 0.0		Total 0.0	
<b>40 Skott</b> 	1: 10.1 ↓ 2: 10.3x → 3: 10.1 ↓ 4: 9.7 ← 5: 10.2x ↑ 6: 9.4 ← 7: 10.5x ↑ 8: 9.5 → 9: 10.3x ↑ 10: 10.7x ↙	<b>40 Skott</b> 	11: 9.6 ↙ 12: 10.5x ↓ 13: 10.5x ↓ 14: 9.8 ↖ 15: 10.6x ← 16: 10.3x ↖ 17: 9.7 ← 18: 10.5x ↓ 19: 10.6x ↗ 20: 10.4x ↗	
	Serie 100.8		Serie 102.5	
	Total 100.8		Total 203.3	
<b>40 Skott</b> 	21: 9.5 ← 22: 9.5 ↓ 23: 10.1 ↓ 24: 10.7x ← 25: 8.9 → 26: 10.4x ↓ 27: 9.8 ↙ 28: 10.0 → 29: 10.1 ↓ 30: 9.8 ↙	<b>40 Skott</b> 	31: 8.7 ↓ 32: 9.9 ↙ 33: 9.9 ↓ 34: 10.2x → 35: 9.1 ↙ 36: 10.5x ← 37: 10.3x ← 38: 10.5x ← 39: 9.9 ↓ 40: 10.5x ↓	
	Serie 98.8		Serie 99.5	
	Total 302.1		Total 401.6	

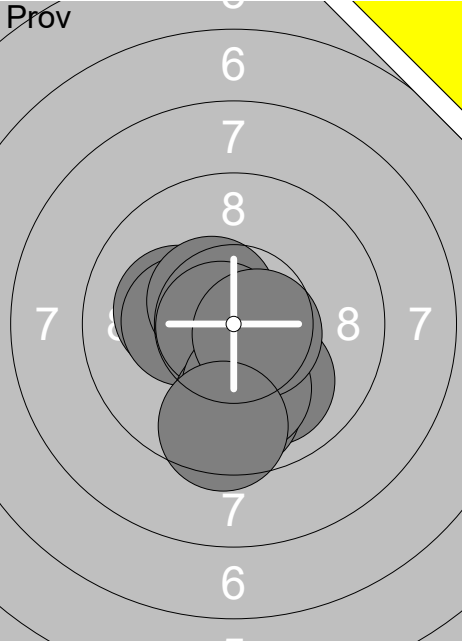
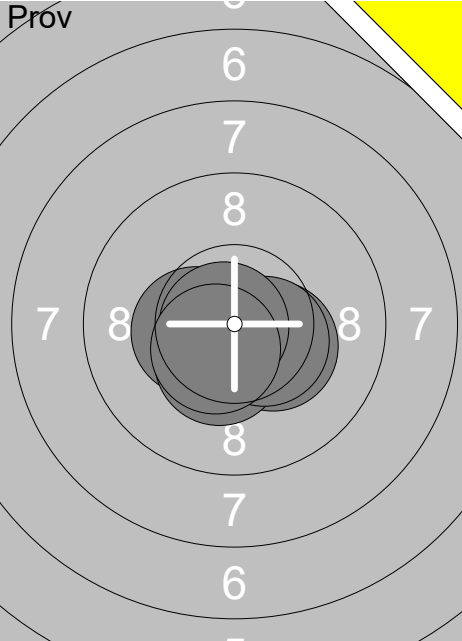
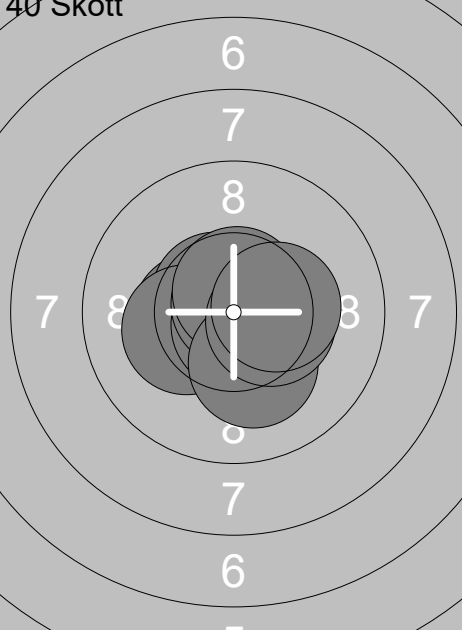
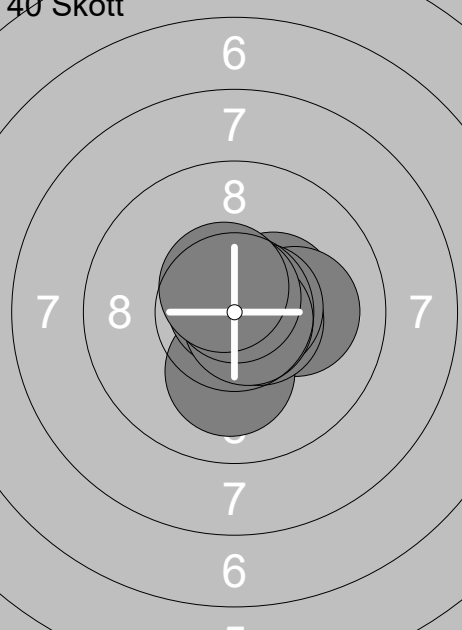
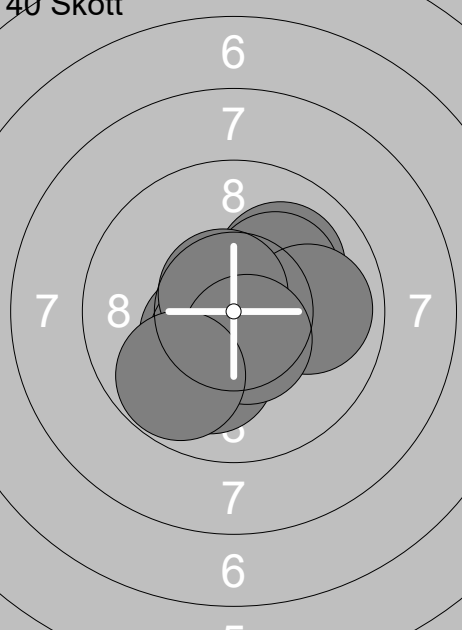
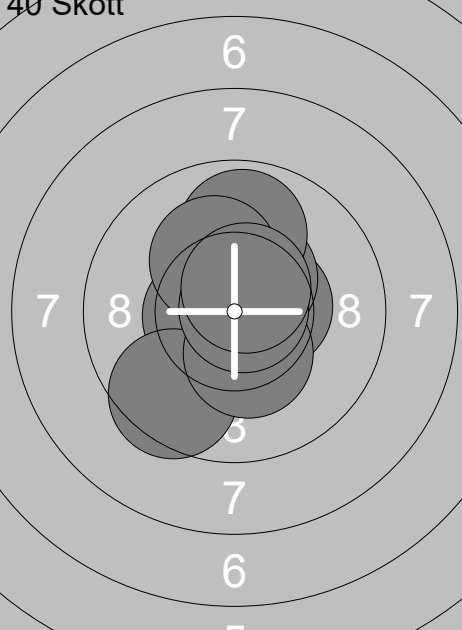
Skjutlag	Tavla	Mattis Hemå			
1	25	Ramselefors	Fältjägarna	15	Jä
03.02.2018		Skyttiadens Regionsfinal 2018		Ramselefors SKF	
Prov		1: 10.2x ← 2: 10.9x ↙ 3: 10.3x ← 4: 10.5x ↗ 5: 10.0 ↓ 6: 10.8x ← 7: 9.8 ↓ 8: 10.0 ↓ 9: 10.6x → 10: 9.5 ↓	Prov		11: 10.4x ← 12: 10.3x ↘ 13: 10.4x ↓ 14: 10.5x ↘ 15: 10.8x ← 16: 10.5x ↓
		Serie 102.6		Serie 62.9	
		Total 0.0		Total 0.0	
40 Skott		1: 10.4x ← 2: 10.6x ↗ 3: 10.3x ← 4: 10.8x ↓ 5: 10.8x → 6: 10.8x ↑ 7: 10.7x ↑ 8: 10.2x ↓ 9: 10.4x → 10: 10.4x →	40 Skott		11: 10.8x → 12: 10.4x → 13: 10.1 → 14: 10.1 ↓ 15: 10.8x ↑ 16: 10.6x → 17: 10.6x → 18: 10.7x ↘ 19: 10.7x ↑ 20: 10.6x ↗
		Serie 105.4		Serie 105.4	
		Total 105.4		Total 210.8	
40 Skott		21: 10.6x ↓ 22: 10.4x ↙ 23: 10.1 ↗ 24: 10.2x ↗ 25: 9.9 → 26: 10.5x ↙ 27: 10.1 ↓ 28: 10.7x ↗ 29: 10.5x ↓ 30: 9.8 ↓	40 Skott		31: 10.6x ← 32: 10.6x ↑ 33: 9.5 ↓ 34: 10.5x → 35: 10.4x ↑ 36: 9.9 ↑ 37: 10.3x ↓ 38: 10.2x ↗ 39: 10.8x → 40: 10.6x ↑
		Serie 102.8		Serie 103.4	
		Total 313.6		Total 417.0	

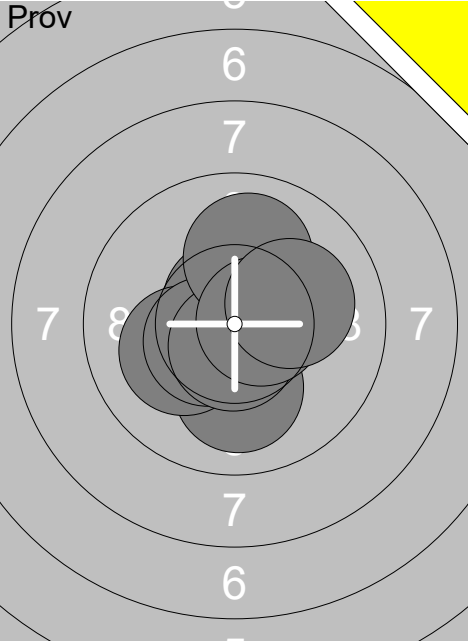
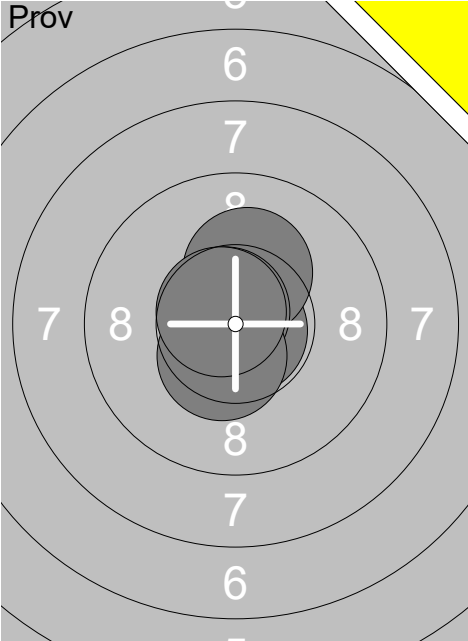
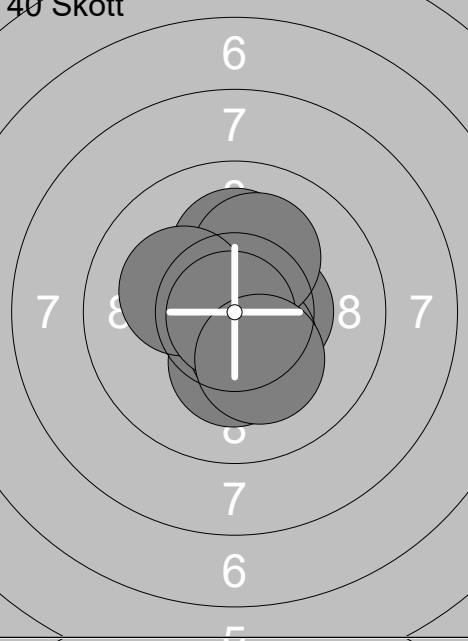
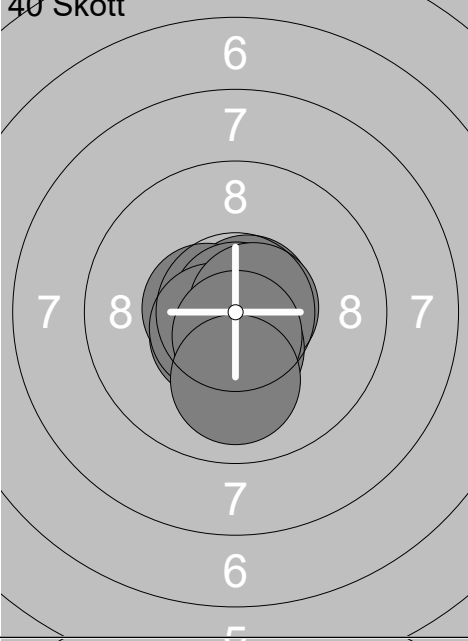
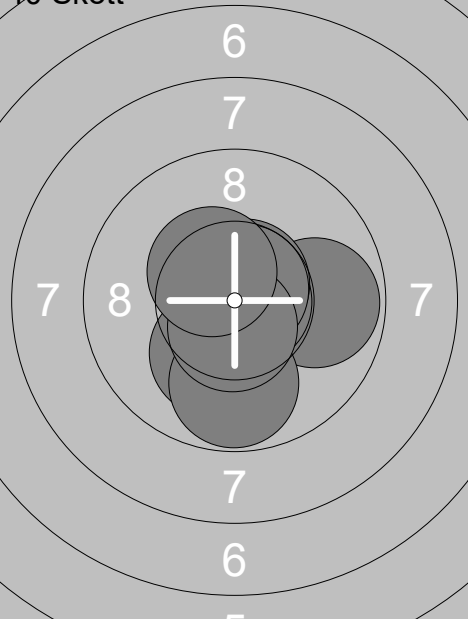
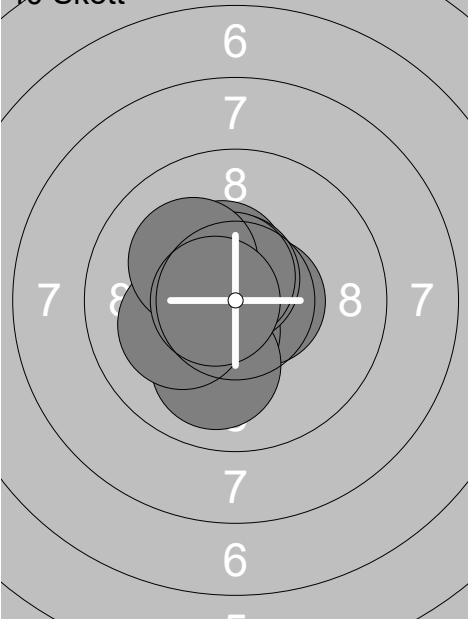
Skjuttag	Tavla	Petter Hemå			
1	27	Ramselefors	Fältjägarna	15	Jä
03.02.2018		Skyttiadens Regionsfinal 2018		Ramselefors SKF	
Prov 	1: 10.8x ↘	Prov 	11: 10.8x ↘		
	2: 10.6x ↑		12: 10.2x ↑		
	3: 10.1 ↓		13: 10.7x ↖		
	4: 10.7x ↑		14: 10.5x ↘		
	5: 10.2x ↙		15: 10.7x ↖		
	6: 10.5x ↙			Serie	52.9
	7: 10.6x ↓			Total	0.0
	8: 10.0 ↑				
	9: 10.6x →				
	10: 10.1 →				
40 Skott 	1: 10.1 ↑	40 Skott 	11: 10.5x ↙		
	2: 10.6x →		12: 10.7x ↗		
	3: 10.8x ↘		13: 10.8x ↙		
	4: 10.5x →		14: 10.6x ↙		
	5: 10.3x ↓		15: 10.9x ↑		
	6: 10.4x ↘		16: 10.6x ↙		
	7: 10.1 ↑		17: 10.7x →		
	8: 10.2x ↙		18: 10.4x ↓		
	9: 10.9x ↙		19: 10.6x ↓		
	10: 10.2x ↘		20: 10.0 ↓		
	Serie	104.1	Serie	105.8	
	Total	104.1	Total	209.9	
40 Skott 	21: 10.8x ↘	40 Skott 	31: 10.6x ↘		
	22: 10.2x ↘		32: 10.6x →		
	23: 10.6x ↘		33: 10.4x ↘		
	24: 9.8 →		34: 10.4x ↑		
	25: 10.8x →		35: 10.6x ↑		
	26: 9.8 ↓		36: 10.6x ↑		
	27: 10.7x ↗		37: 10.0 ↓		
	28: 10.8x ↗		38: 10.1 ↙		
	29: 10.6x ↓		39: 10.2x ↖		
	30: 10.4x ↖		40: 10.7x ↙		
	Serie	104.5	Serie	104.2	
	Total	314.4	Total	418.6	

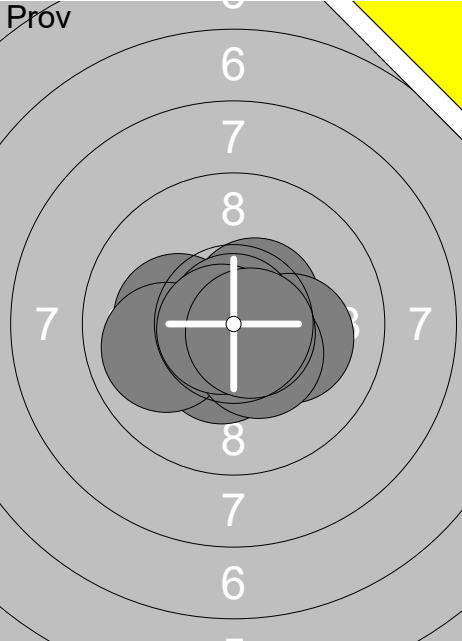
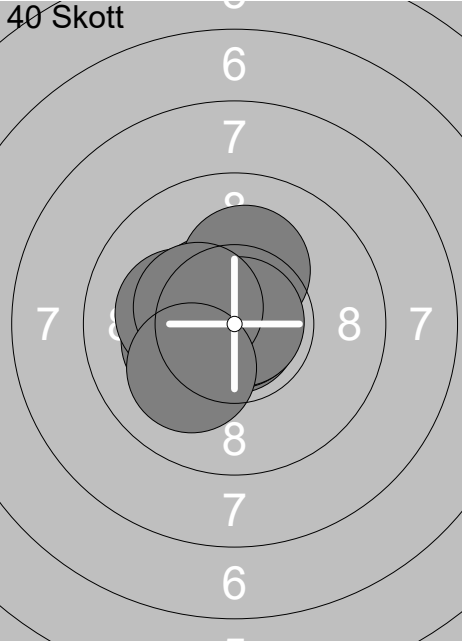
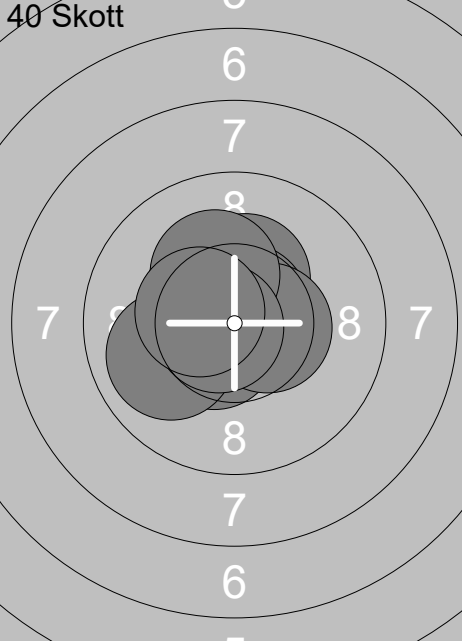
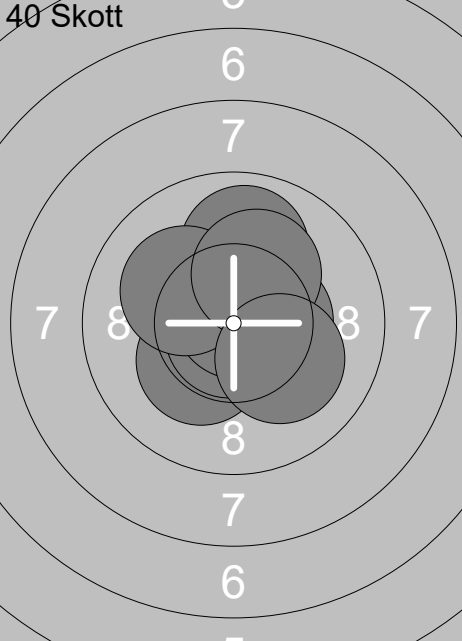
Skjutlag <b>1</b>	Tavla <b>28</b>	<b>Cassandra Sjödin</b>	
Ramselefors	Hammerdal	15	Jä
03.02.2018	Skyttiadens Regionsfinal 2018	Ramselefors SKF	
Prov		40 Skott 	
	1: 10.5x ↗ 2: 10.2x → 3: 10.4x ↓ 4: 10.8x ↓ 5: 10.2x ← 6: 10.0 ← 7: 10.4x ↘ 8: 10.9x ↑ 9: 10.8x ← 10: 10.7x → Serie 104.9 Total 0.0	1: 10.3x ← 2: 10.9x ↓ 3: 10.5x ↖ 4: 10.2x ↑ 5: 10.2x ← 6: 10.9x → 7: 10.2x ← 8: 10.9x ↗ 9: 10.4x ↖ 10: 10.1 ↘ Serie 104.6 Total 104.6	21: 10.4x ↖ 22: 10.4x ↑ 23: 10.5x ↘ 24: 10.3x ↑ 25: 10.7x ↗ 26: 10.5x → 27: 10.0 ← 28: 10.2x ↖ 29: 10.7x ← 30: 10.4x ← Serie 104.1 Total 313.0
40 Skott		11: 10.3x ↘ 12: 10.8x → 13: 10.5x → 14: 9.9 ↑ 15: 10.8x ↘ 16: 10.8x ↓ 17: 10.8x ↑ 18: 10.1 ↖ 19: 10.2x ↑ 20: 10.1 ↘ Serie 104.3 Total 208.9	31: 10.8x ↘ 32: 10.5x ↗ 33: 9.8 ← 34: 10.0 ↘ 35: 10.5x → 36: 10.6x ↘ 37: 10.4x ↖ 38: 10.2x ↗ 39: 10.6x → 40: 10.6x ↑ Serie 104.0 Total 417.0

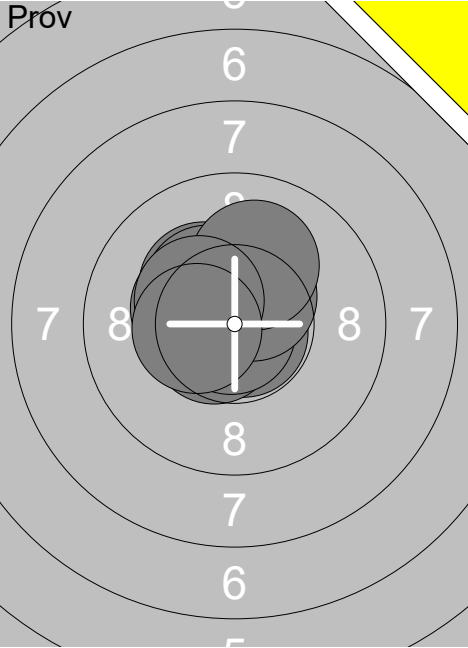
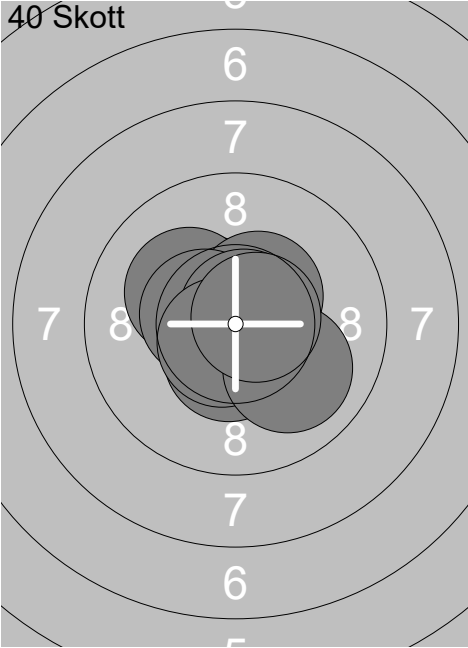
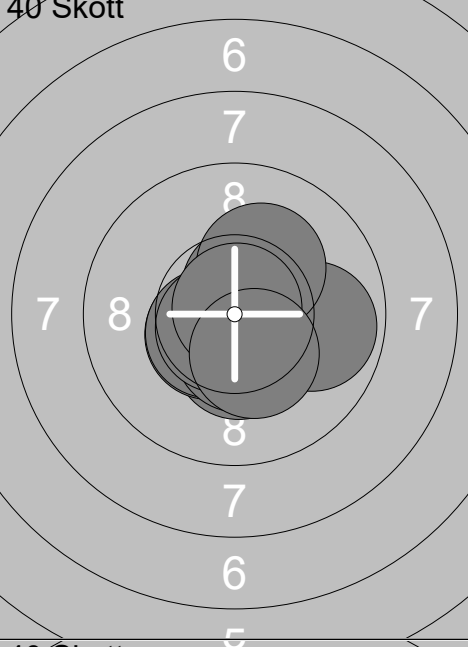
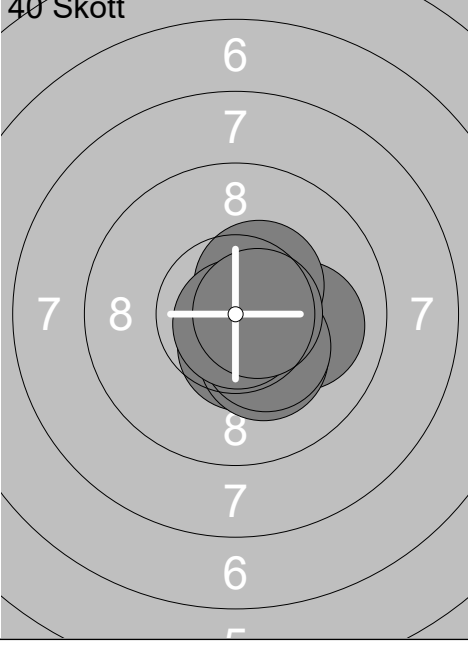
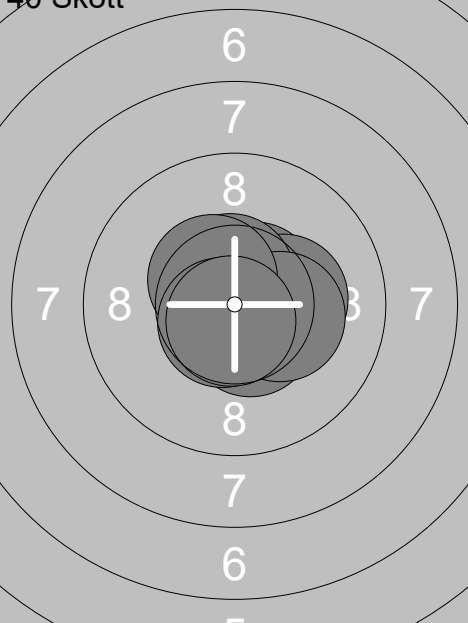
Skjutlag <b>1</b>	Tavla <b>29</b>	<b>Anton Landin</b>		
Ramselefors	Fältjägarna	15	Jä	
03.02.2018	Skyttiadens Regionsfinal 2018	Ramselefors SKF		
Prov	40 Skott	40 Skott	40 Skott	
	1: 10.8x ↘ 2: 10.6x ↙ 3: 10.9x ↘ 4: 10.5x ↗ 5: 10.3x ↖ 6: 10.4x ↖ 7: 10.3x ↖ 8: 10.1 ↗ 9: 10.4x ↖ 10: 10.4x ←		1: 10.7x ↗ 2: 10.5x ↖ 3: 10.2x ↖ 4: 10.4x ↗ 5: 10.5x ↖ 6: 10.5x ↓ 7: 10.8x ↗ 8: 10.6x ↘ 9: 10.0 ↘ 10: 10.7x →	
	Serie 104.7		Serie 104.9	
	Total 0.0		Total 104.9	
40 Skott	40 Skott	40 Skott	40 Skott	
	11: 10.6x ↗ 12: 9.9 → 13: 10.4x ↓ 14: 10.5x ↙ 15: 10.5x ↙ 16: 10.5x ↓ 17: 10.7x ↙ 18: 10.2x ↗ 19: 10.9x ↗ 20: 10.3x ↘		21: 10.5x ↓ 22: 10.6x → 23: 10.7x → 24: 10.4x ↘ 25: 10.0 → 26: 10.4x ↗ 27: 10.3x ↓ 28: 10.3x ↘ 29: 10.8x ↓ 30: 10.6x →	
	Serie 104.5		Serie 104.6	
	Total 209.4		Total 314.0	
40 Skott	40 Skott			
	31: 10.6x ↗ 32: 10.3x → 33: 10.5x ↘ 34: 10.7x ↗ 35: 10.6x ↗ 36: 10.8x ↙ 37: 10.3x → 38: 10.5x ↖ 39: 10.6x ↘ 40: 10.7x ↓			
	Serie 105.6			
	Total 419.6			

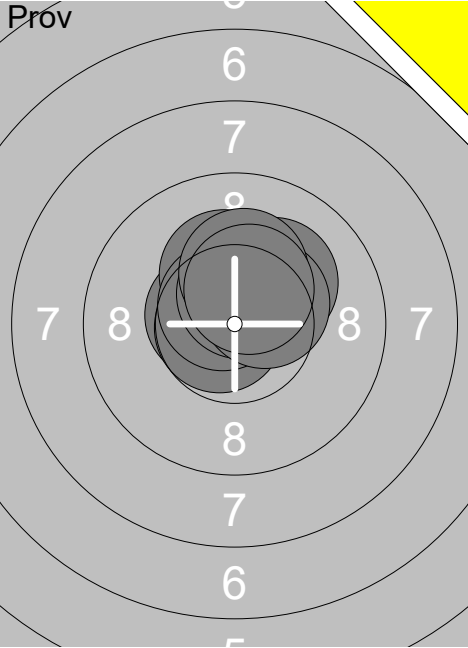
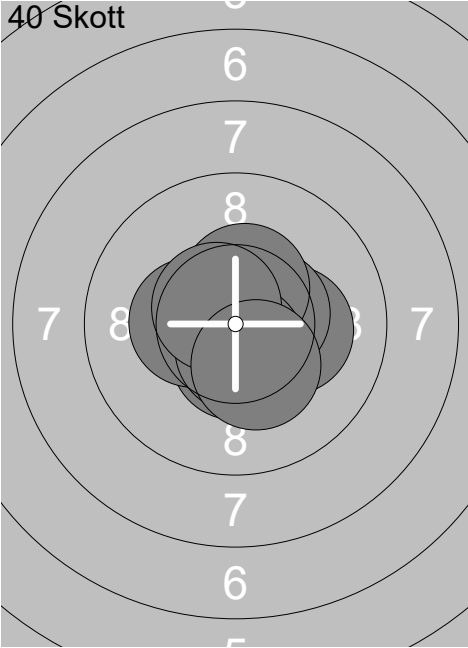
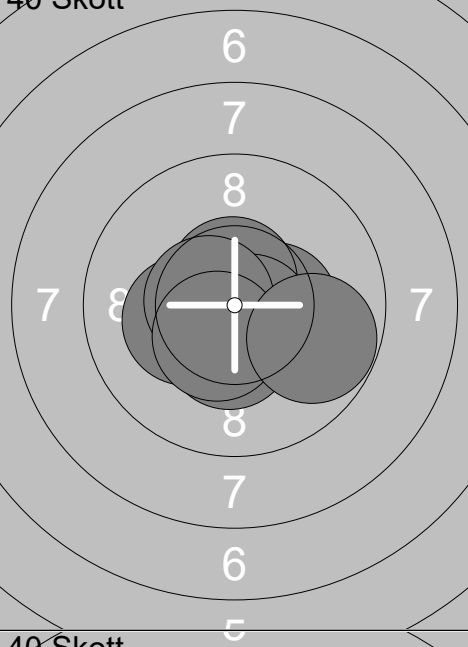
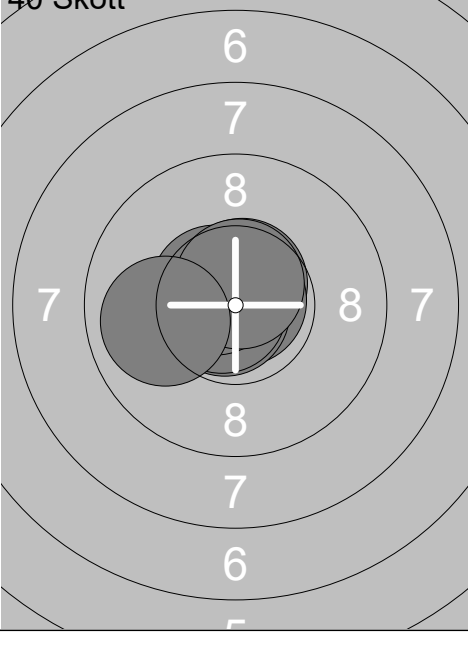
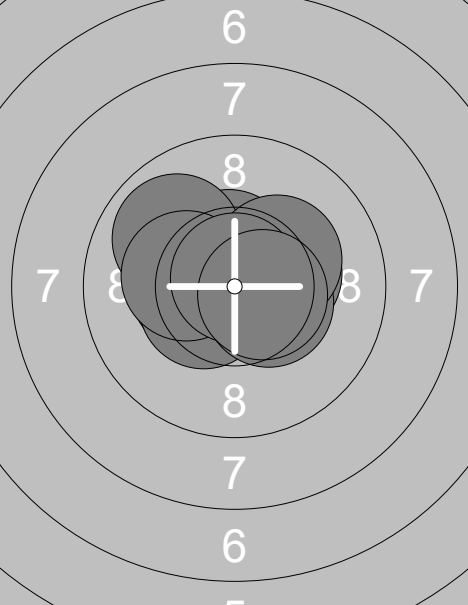
Skjutlag <b>1</b>	Tavla <b>30</b>	<b>Sofi Jonsson</b>		
Ramselefors	Ramselefors	15	Vb	
03.02.2018	Skyttiadens Regionsfinal 2018	Ramselefors SKF		
Prov		40 Skott		
	1: 10.6x ← 2: 10.3x ↑ 3: 10.7x ← 4: 10.2x ↗ 5: 10.7x ↘ 6: 10.5x ↗ 7: 10.5x ↑ 8: 10.4x ↗ 9: 10.2x ↑ 10: 10.4x ↗ Serie 104.5 Total 0.0		1: 10.5x ← 2: 10.5x ↓ 3: 10.6x → 4: 10.2x → 5: 10.5x → 6: 10.4x ↑ 7: 10.4x ← 8: 10.6x ↓ 9: 10.6x ↘ 10: 10.3x ↓ Serie 104.6 Total 104.6	
40 Skott		40 Skott		
	11: 10.9x ← 12: 10.7x ← 13: 10.4x ↓ 14: 10.4x → 15: 10.3x ← 16: 10.6x ↑ 17: 10.7x ↘ 18: 10.6x ← 19: 10.5x ↓ 20: 9.8 → Serie 104.9 Total 209.5		21: 10.8x ← 22: 10.7x ↗ 23: 10.6x ↑ 24: 10.8x ↑ 25: 10.8x ↗ 26: 10.8x ← 27: 10.8x ← 28: 10.6x ↘ 29: 10.7x ↑ 30: 9.9 ← Serie 106.5 Total 316.0	
40 Skott				
	31: 10.4x ← 32: 10.3x → 33: 10.5x ← 34: 10.5x ↑ 35: 10.4x → 36: 9.9 ↘ 37: 10.3x ← 38: 10.3x ↗ 39: 10.8x ↑ 40: 10.6x → Serie 104.0 Total 420.0			

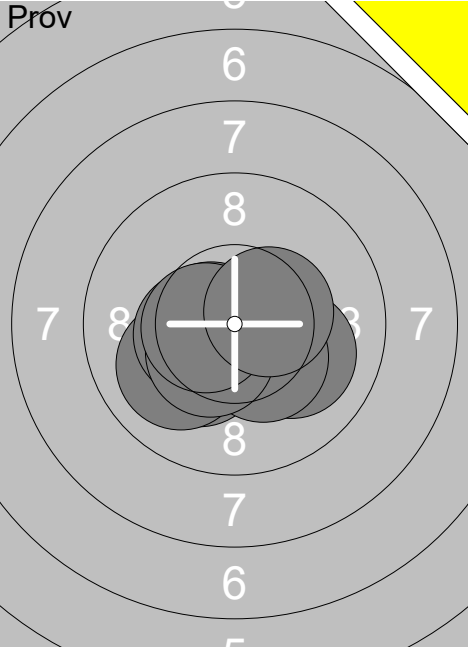
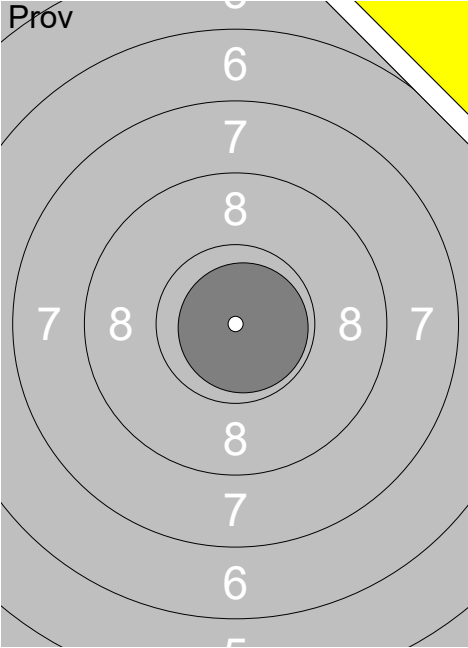
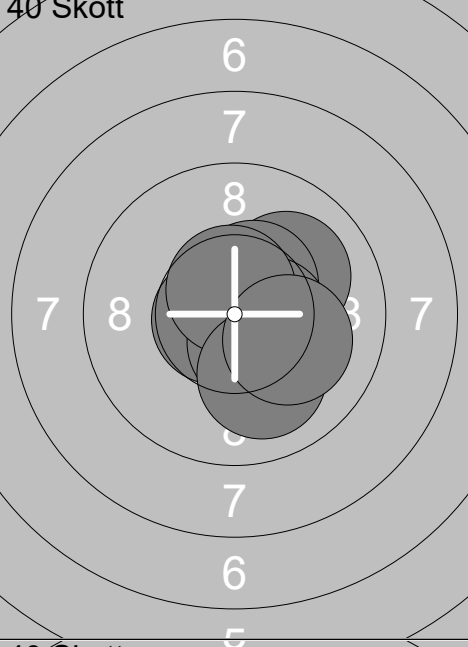
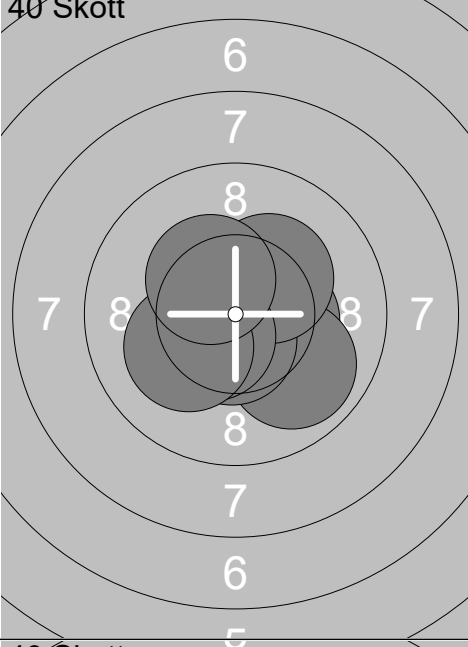
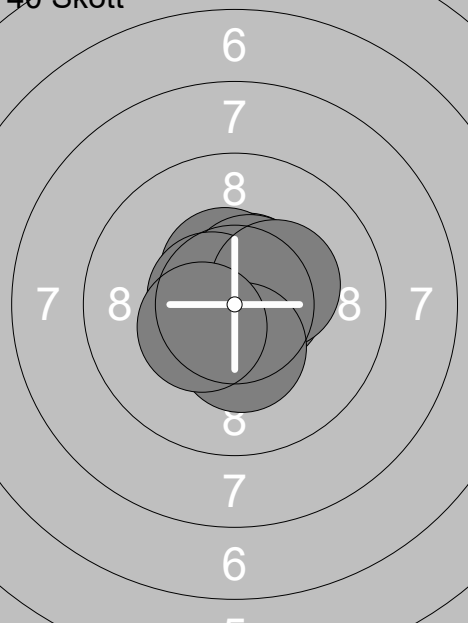
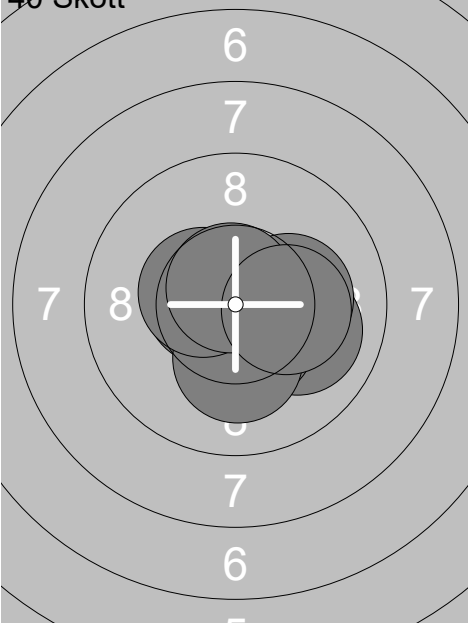

Skjutlag	Tavla	Anna Grönlund	
1	31	Piteå	No
Ramselefors		15	
03.02.2018	Skyttiadens Regionsfinal 2018	Ramselefors SKF	
Prov		Prov	
	1: 10.1 ➤ 2: 10.6x ↙ 3: 10.2x ↙ 4: 10.6x ← 5: 10.3x ↘ 6: 10.0 ↙ 7: 10.4x ← 8: 10.4x ↙ 9: 10.5x ← 10: 10.5x ➔		11: 10.8x ➤
	Serie 103.6		Serie 10.8
	Total 0.0		Total 0.0
40 Skott		40 Skott	
	1: 10.1 ➔ 2: 10.8x ➔ 3: 10.7x ← 4: 10.6x ↑ 5: 10.5x ↘ 6: 10.5x ↗ 7: 10.5x ➔ 8: 10.6x ↑ 9: 10.0 ↘ 10: 10.1 ➔		11: 10.7x ↓ 12: 10.4x ➔ 13: 10.7x ↙ 14: 10.6x ➔ 15: 9.9 ↘ 16: 10.6x ↓ 17: 10.3x ↗ 18: 10.5x ↙ 19: 10.2x ↙ 20: 10.4x ↘
	Serie 104.4		Serie 104.3
	Total 104.4		Total 208.7
40 Skott		40 Skott	
	21: 10.5x ↗ 22: 10.8x ↘ 23: 10.5x ↘ 24: 10.6x ➔ 25: 10.5x ↗ 26: 10.5x ↗ 27: 10.6x ← 28: 10.3x ➔ 29: 10.3x ↘ 30: 10.4x ↙		31: 10.0 ➔ 32: 10.2x ➔ 33: 10.6x ← 34: 10.5x ↘ 35: 10.7x ↘ 36: 10.9x ↑ 37: 10.2x ↓ 38: 10.5x ← 39: 10.7x ↑ 40: 10.2x ➔
	Serie 105.0		Serie 104.5
	Total 313.7		Total 418.2

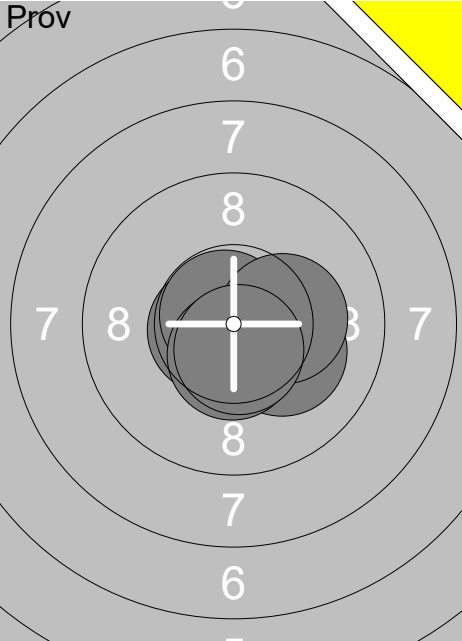
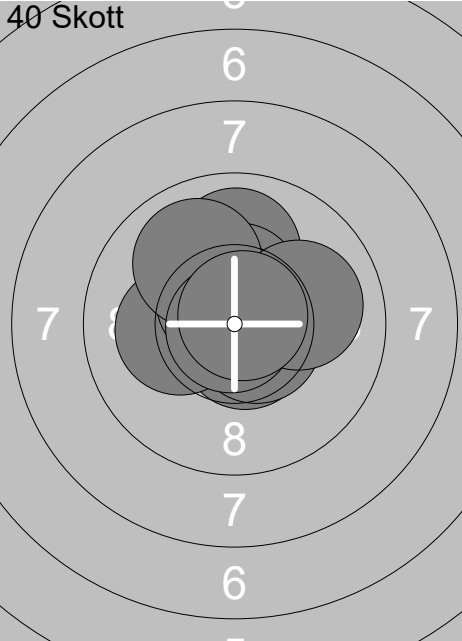
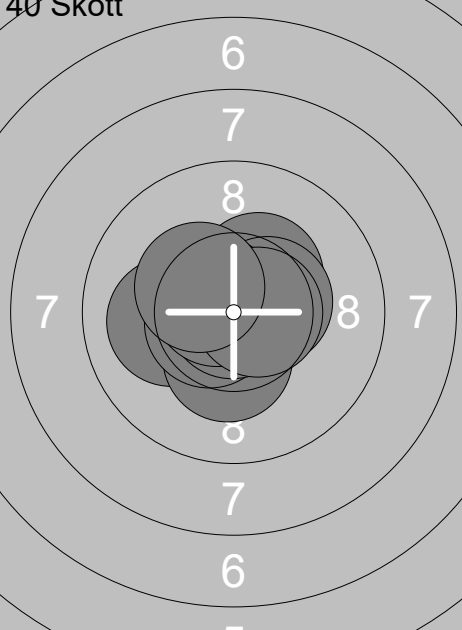
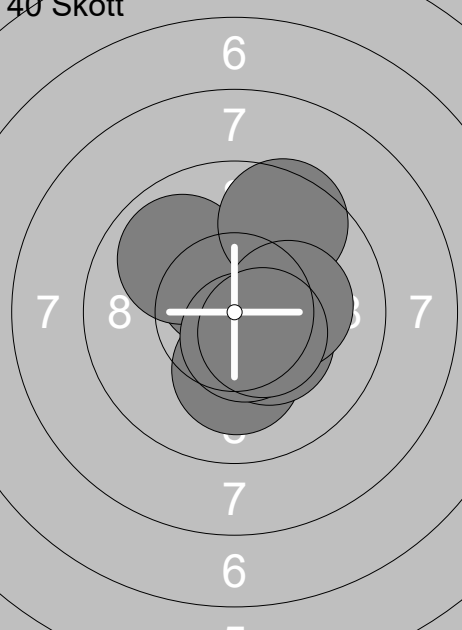
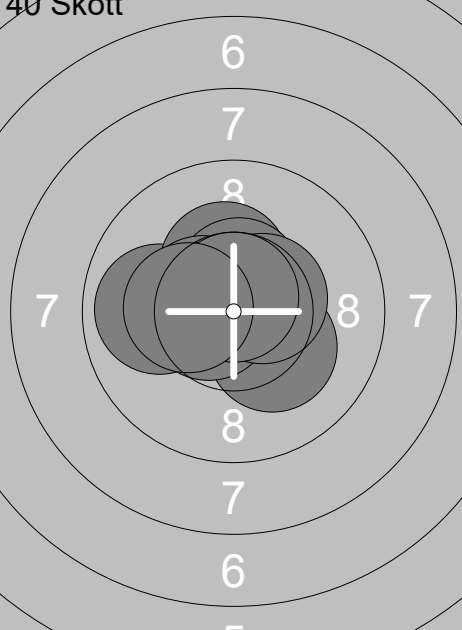
Skjuttag	Tavla	Saga Ebbhagen		
1	32	Ramselefors	15	Vb
03.02.2018	Skyttiadens Regionsfinal 2018	Ramselefors SKF		
Prov 	1: 10.6x ←	40 Skott 	1: 10.6x ↘	
	2: 10.8x ↗		2: 10.0 ↑	
	3: 10.2x ↘		3: 10.6x ↘	
	4: 10.3x →		4: 10.4x ↑	
	5: 10.5x ↓		5: 10.2x ←	
	6: 10.6x ↓		6: 10.6x ↗	
			7: 10.0 ↗	
			8: 10.0 →	
			9: 10.9x ↙	
			10: 10.8x ↗	
	Serie 63.0		Serie 104.1	
	Total 0.0		Total 104.1	
40 Skott 	11: 10.9x ↙	40 Skott 	21: 10.5x ↘	
	12: 10.1 ←		22: 10.7x ↗	
	13: 10.3x ↓		23: 10.5x ↗	
	14: 10.6x ←		24: 9.9 ↗	
	15: 10.4x ↗		25: 9.5 ↗	
	16: 10.9x ↙		26: 10.2x ↓	
	17: 10.5x →		27: 10.3x ↘	
	18: 10.7x ↗		28: 10.2x →	
	19: 10.6x →		29: 10.6x ↓	
	20: 10.4x ↗		30: 10.5x ↘	
	Serie 105.4		Serie 102.9	
	Total 209.5		Total 312.4	
40 Skott 	31: 10.2x ↘			
	32: 9.9 ←			
	33: 10.3x ↑			
	34: 10.5x ↑			
	35: 10.5x ←			
	36: 10.6x ←			
	37: 10.6x ←			
	38: 10.5x →			
	39: 10.7x ↑			
	40: 10.3x ←			
	Serie 104.1			
	Total 416.5			

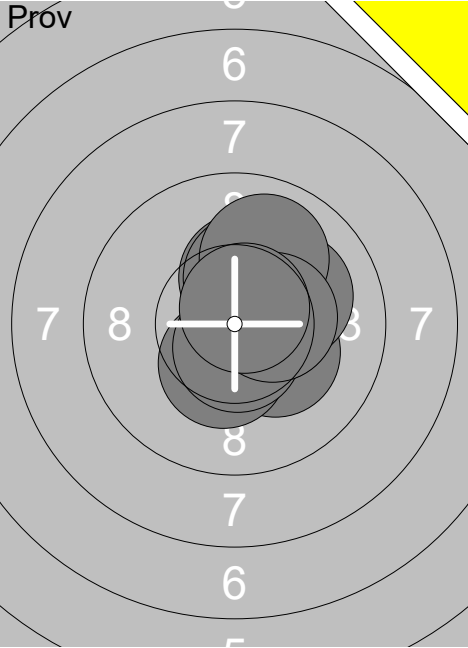
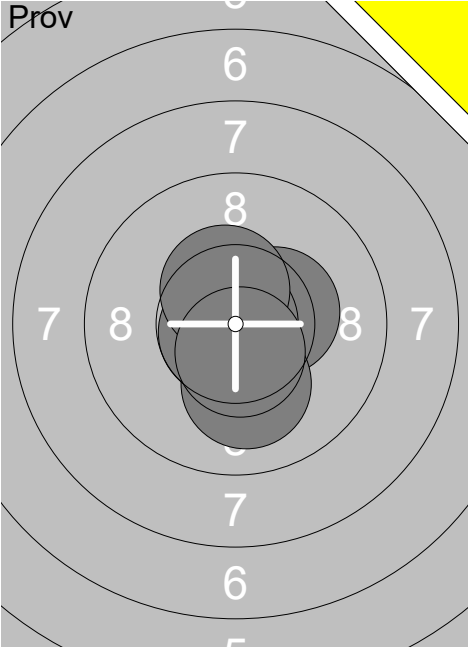
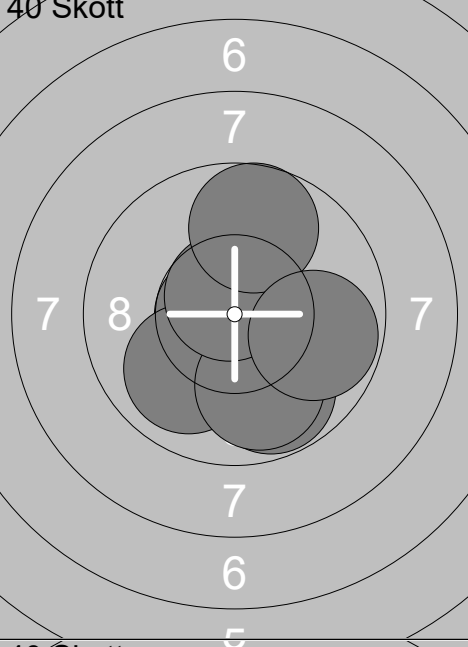
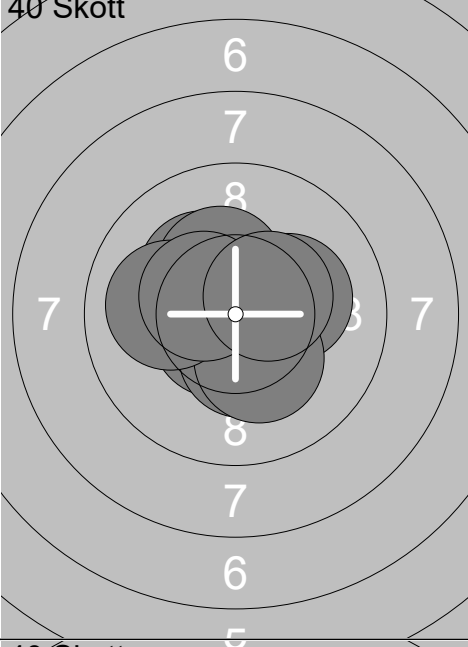
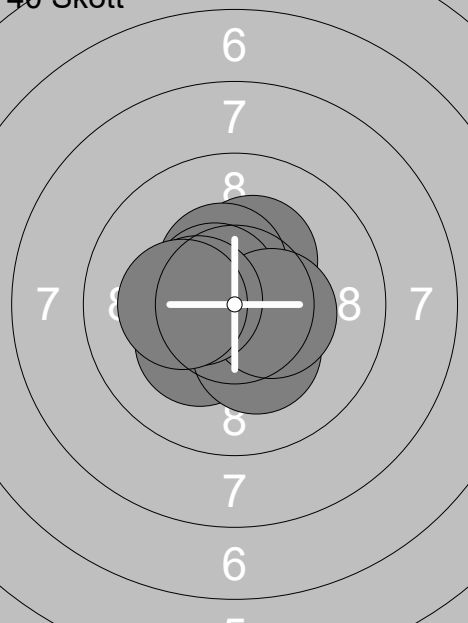
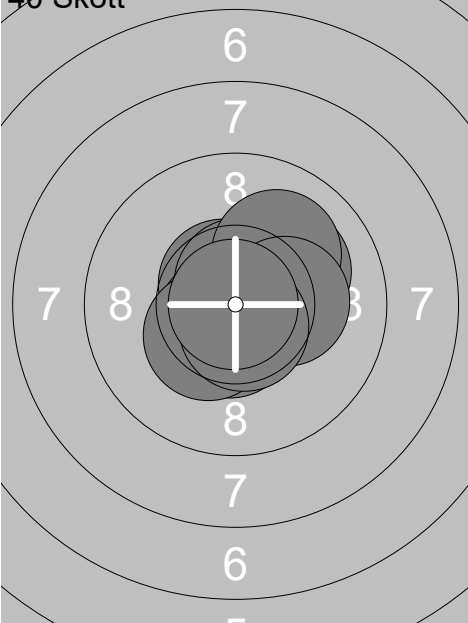
Skjutlag	Tavla	Fluk Jonsson	
1	33	Ramselefors	Vb
Ramselefors	Ramselefors	15	
03.02.2018	Skyttiadens Regionsfinal 2018	Ramselefors SKF	
Prov		Prov	
	1: 10.3x ↘ 2: 10.4x ↓ 3: 10.3x ↑ 4: 10.4x → 5: 10.1 ↗ 6: 10.6x ↓ 7: 10.3x ↑ 8: 10.0 ↗ 9: 10.4x → 10: 10.7x ↗		11: 10.4x → 12: 10.9x ↖ 13: 10.1 ↓ 14: 10.7x ↙ 15: 10.5x ↑ 16: 10.6x ↓
Serie 103.5	Serie 63.2	Total 0.0	Total 0.0
40 Skott		40 Skott	
	1: 10.6x ↓ 2: 10.6x ↓ 3: 9.8 ↓ 4: 10.7x ← 5: 10.7x ↓ 6: 10.0 ↙ 7: 9.9 ↓ 8: 10.7x ↑ 9: 9.7 ↑ 10: 9.8 →		11: 10.6x ↙ 12: 10.5x ↓ 13: 10.2x ↖ 14: 10.3x ↑ 15: 10.2x → 16: 10.4x ↓ 17: 10.3x ↓ 18: 10.0 ← 19: 10.4x ↖ 20: 10.4x ↗
Serie 102.5	Serie 103.3	Total 102.5	Total 205.8
40 Skott		40 Skott	
	21: 10.6x ← 22: 10.8x ↑ 23: 10.3x ↑ 24: 10.4x ↑ 25: 10.2x ↙ 26: 10.6x ↖ 27: 10.3x ↓ 28: 10.4x → 29: 10.4x ← 30: 10.2x ←		31: 10.6x ↖ 32: 10.7x ↑ 33: 10.1 ↗ 34: 10.1 ↗ 35: 10.7x ↙ 36: 10.5x ↓ 37: 10.3x → 38: 10.4x ↙ 39: 10.6x ↓ 40: 10.9x ←
Serie 104.2	Serie 104.9	Total 310.0	Total 414.9

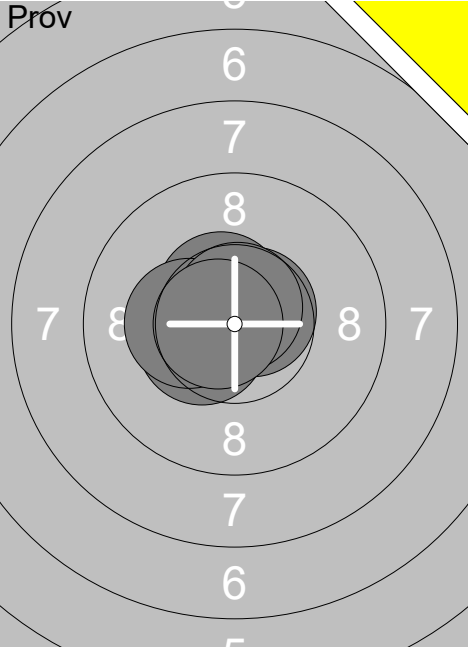
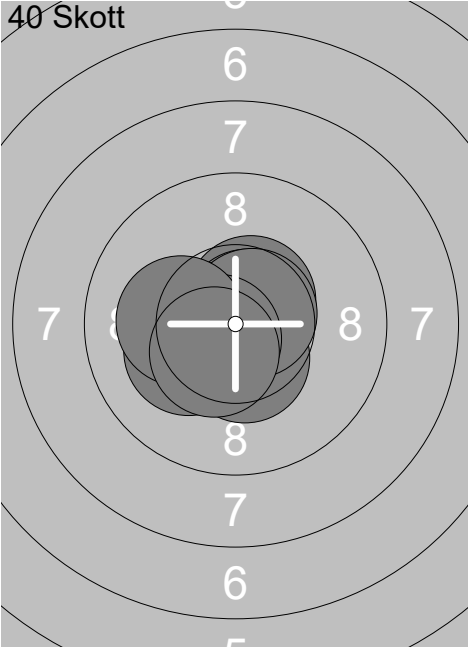
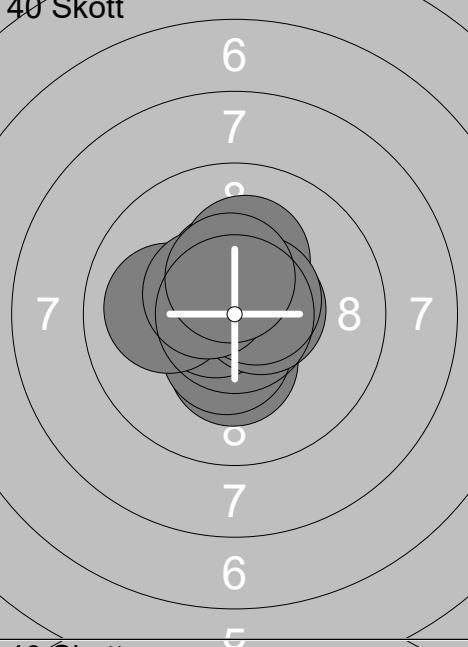
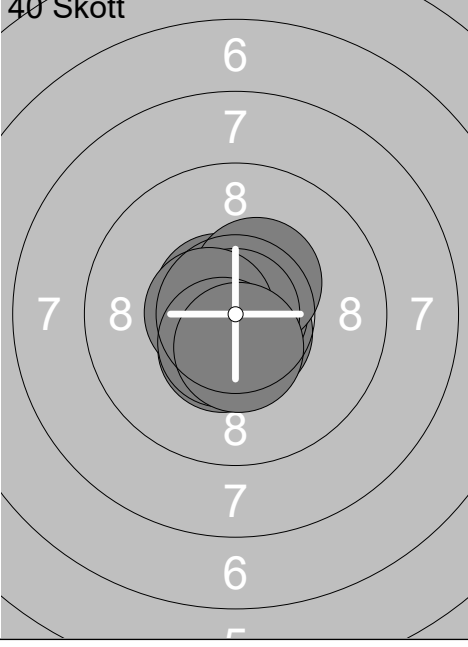
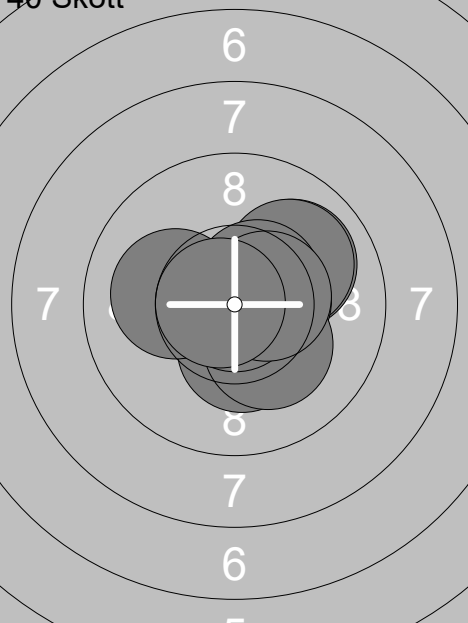
Skjutlag <b>1</b>	Tavla <b>34</b>	<b>Martin Blombäck</b>		
Ramselefors	Piteå	15	No	
03.02.2018	Skyttiadens Regionsfinal 2018	Ramselefors SKF		
Prov	1: 10.4x ↙ 2: 10.7x ↗ 3: 10.5x ↖ 4: 10.3x ← 5: 10.7x ↑ 6: 10.7x ←	40 Skott	1: 10.6x ↗ 2: 10.7x ↗ 3: 10.7x ← 4: 10.8x ← 5: 10.5x ↓ 6: 10.7x ↗ 7: 10.6x ↙ 8: 10.2x ← 9: 10.2x ← 10: 10.5x ↙	
	Serie 63.3		Serie 105.5	
	Total 0.0		Total 105.5	
40 Skott	11: 10.3x ↓ 12: 10.4x ↓ 13: 10.4x ↑ 14: 10.2x ↑ 15: 10.7x ← 16: 10.6x → 17: 10.0 ← 18: 10.6x ↗ 19: 10.5x ↖ 20: 10.4x ↑	40 Skott	21: 10.5x ↓ 22: 10.5x ↓ 23: 10.6x ↓ 24: 10.6x ↖ 25: 10.8x → 26: 10.4x ↗ 27: 10.9x ↖ 28: 10.6x ← 29: 10.5x ↓ 30: 10.5x ↓	
	Serie 104.1		Serie 105.9	
	Total 209.6		Total 315.5	
40 Skott	31: 10.0 ↗ 32: 10.0 ↗ 33: 10.3x ↓ 34: 10.5x → 35: 10.5x ↗ 36: 10.1 ← 37: 10.2x ↓ 38: 10.9x ↓ 39: 10.5x → 40: 10.7x ←			
	Serie 103.7			
	Total 419.2			

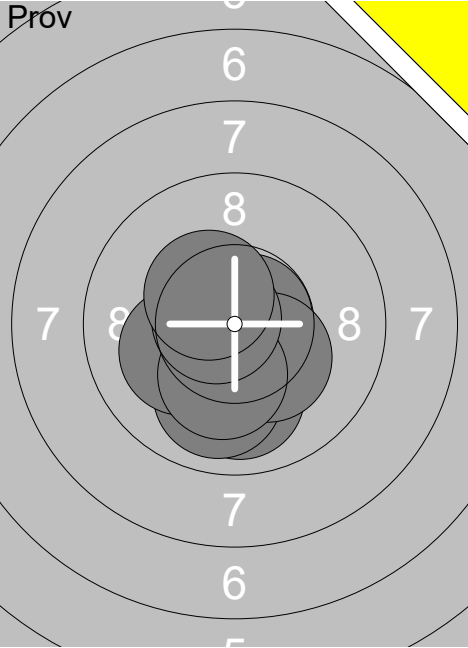
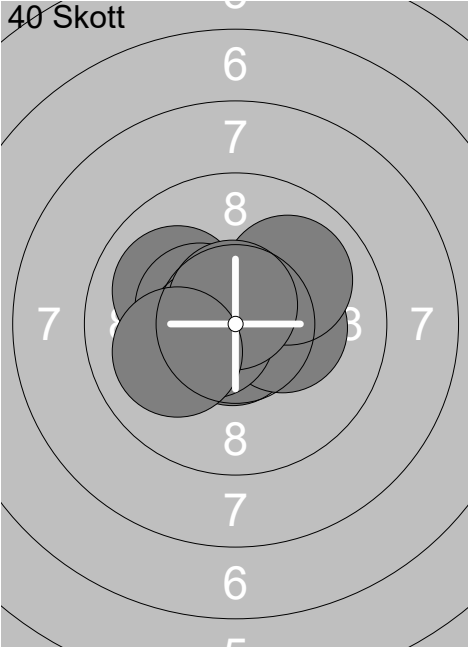
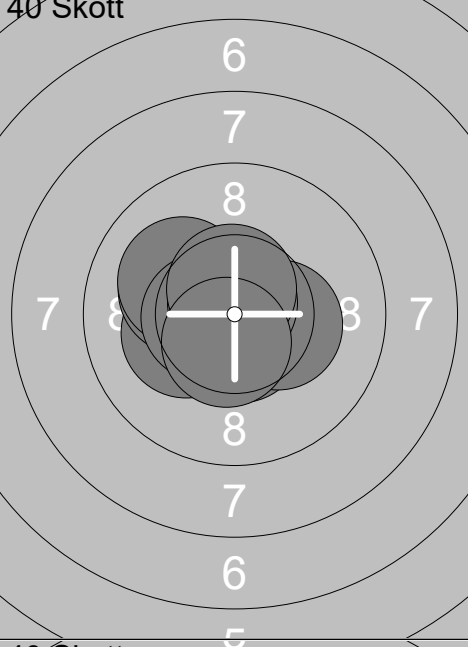
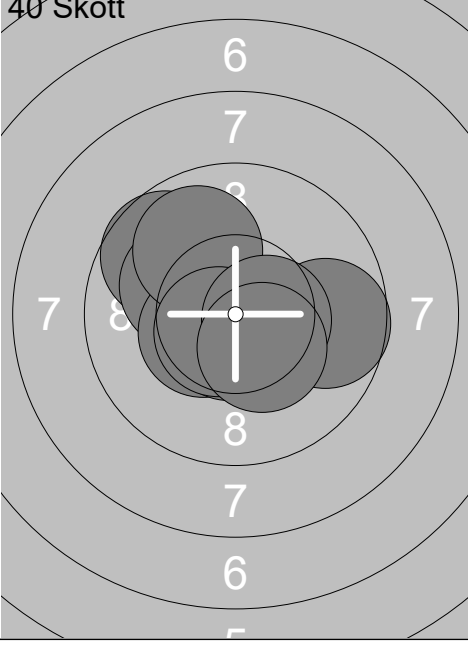
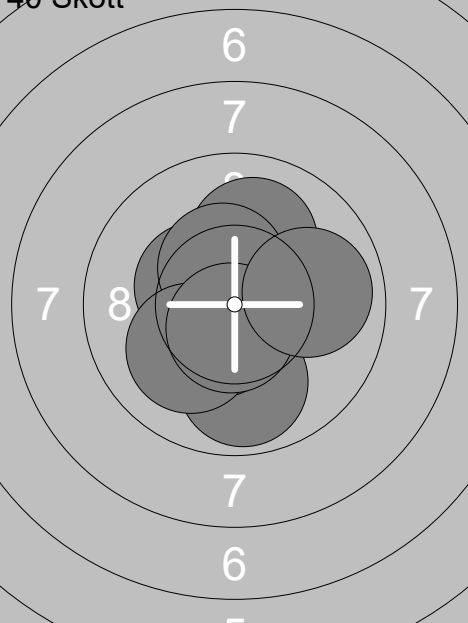

Skjutlag	Tavla	Fabian Grindborg			
1	35	Ramselefors	Fältjägarna	15	Jä
03.02.2018		Skyttiadens Regionsfinal 2018		Ramselefors SKF	
Prov		1: 10.6x ↗ 2: 10.8x ➡ 3: 9.9 ← 4: 9.8 ↘ 5: 10.3x ↙ 6: 10.4x ↖ 7: 10.7x ↖ 8: 10.6x ↘ 9: 10.4x ↗ 10: 10.4x ➡ Serie 103.9 Total 0.0	Prov		11: 10.2x ↙ 12: 10.3x ↑ 13: 10.3x ↙ 14: 10.1 ↖ 15: 10.2x ↖ 16: 10.4x ➡ 17: 10.8x ↘ 18: 10.5x ↖ 19: 10.6x ↑ 20: 10.3x ↙ Serie 103.7 Total 0.0
40 Skott		1: 10.6x ↗ 2: 10.4x ↖ 3: 10.6x ↗ 4: 10.4x ↙ 5: 10.5x ➡ 6: 10.5x ↙ 7: 10.5x ➡ 8: 10.5x ↘ 9: 10.9x ↘ 10: 10.5x ↙ Serie 105.4 Total 105.4	40 Skott		11: 10.8x ↗ 12: 10.5x ➡ 13: 10.7x ↑ 14: 10.7x ↘ 15: 10.8x ↙ 16: 10.3x ↖ 17: 10.4x ↘ 18: 10.7x ↙ 19: 10.6x ↖ 20: 10.5x ↑ Serie 106.0 Total 211.4
40 Skott		21: 10.9x ↘ 22: 10.6x ↙ 23: 10.4x ↖ 24: 10.2x ↙ 25: 10.7x ↘ 26: 10.5x ➡ 27: 10.8x ➡ 28: 10.5x ↑ 29: 10.4x ↙ 30: 10.5x ↙ Serie 105.5 Total 316.9	40 Skott		31: 10.5x ↘ 32: 9.9 ← 33: 10.5x ↘ 34: 10.4x ↘ 35: 10.5x ↖ 36: 10.6x ↙ 37: 10.5x ➡ 38: 10.9x ↘ 39: 10.6x ↑ 40: 10.6x ↖ Serie 105.0 Total 421.9

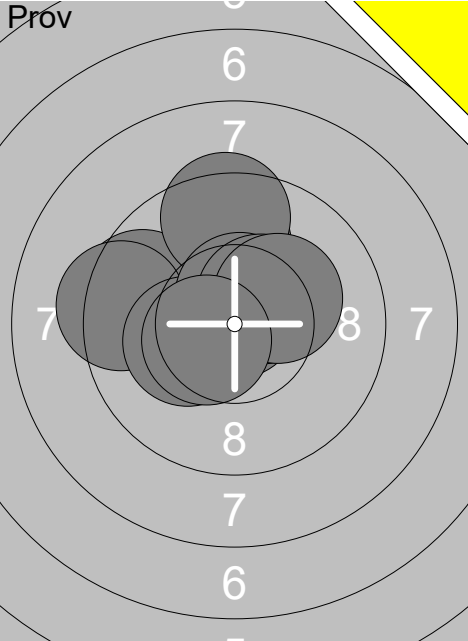
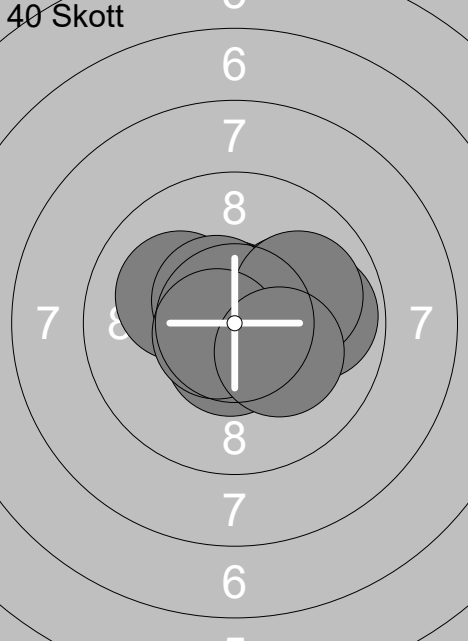
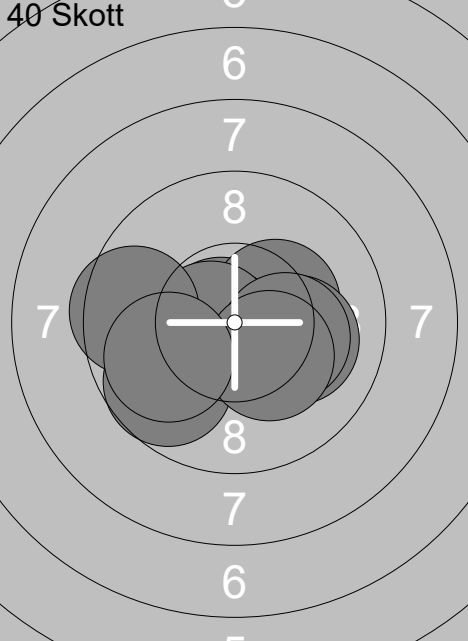
Skjutlag <b>1</b>	Tavla <b>36</b>	<b>Hanna Larsson</b>		
Ramselefors	Boden	15	No	
03.02.2018	Skyttiadens Regionsfinal 2018	Ramselefors SKF		
Prov		40 Skott		
	1: 10.0 ↓ 2: 10.8x → 3: 10.0 ↓ 4: 10.2x ↙ 5: 10.3x ↘ 6: 10.2x ↓ 7: 10.7x ↙ 8: 10.4x ↖		1: 10.7x ↓ 2: 10.2x ↙ 3: 10.7x ↙ 4: 10.3x → 5: 10.0 ↖ 6: 10.4x ↙ 7: 10.6x ↙ 8: 10.0 ↗ 9: 10.7x ↑ 10: 10.0 ↙	
	Serie 82.6		Serie 103.6	
	Total 0.0		Total 103.6	
40 Skott		40 Skott		
	11: 10.2x ↙ 12: 10.2x ↙ 13: 10.8x ↓ 14: 10.1 ↖ 15: 10.6x ↓ 16: 10.5x ↙ 17: 10.3x → 18: 10.8x ↑ 19: 10.6x ↑ 20: 10.6x ↓		21: 9.7 ↖ 22: 10.1 ↖ 23: 10.8x ↙ 24: 10.4x ↙ 25: 9.9 ↖ 26: 9.7 → 27: 10.6x ↓ 28: 10.6x ↙ 29: 10.5x → 30: 10.4x ↘	
	Serie 104.7		Serie 102.7	
	Total 208.3		Total 311.0	
40 Skott				
	31: 10.5x ↖ 32: 10.1 ↑ 33: 10.7x ↑ 34: 9.9 ↓ 35: 10.5x ↘ 36: 10.4x ↙ 37: 10.4x ↖ 38: 10.1 ↙ 39: 10.6x ↓ 40: 9.9 →			
	Serie 103.1			
	Total 414.1			

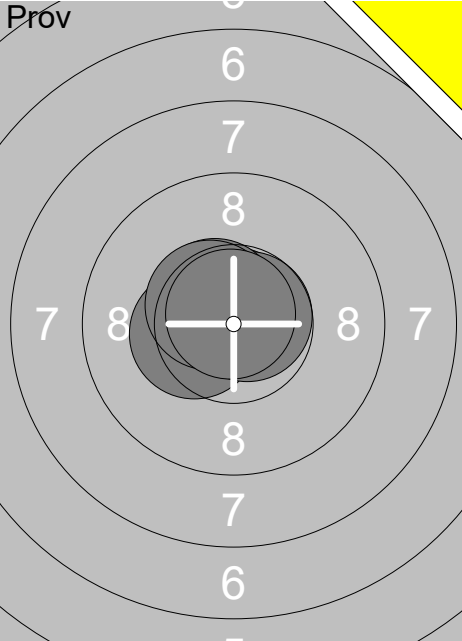
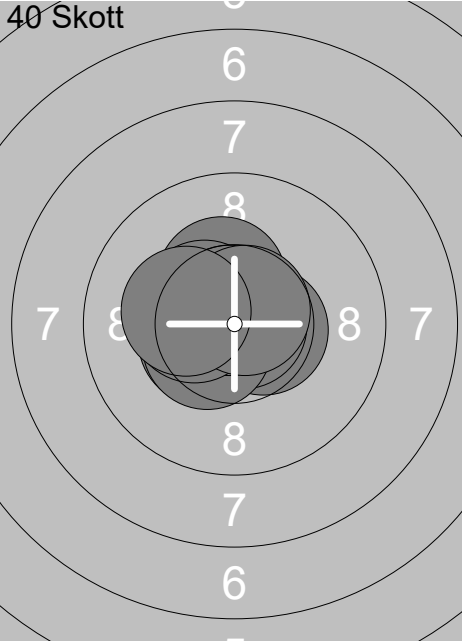
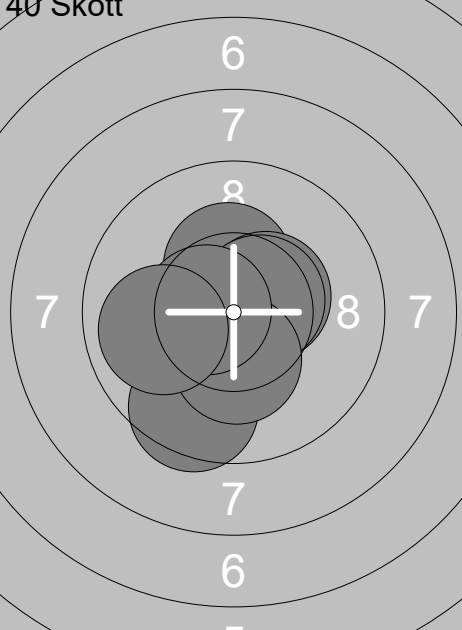
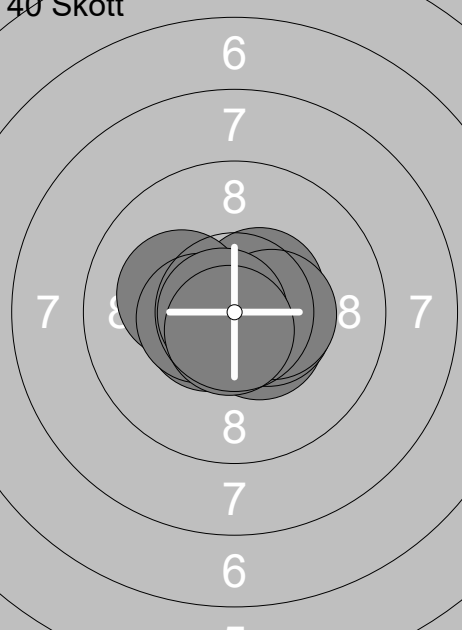
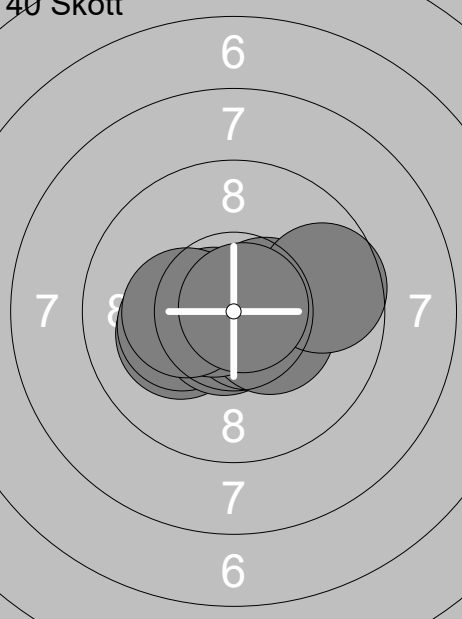
Skjutlag	Tavla	Emma Eriksson		
1	37	Ramselefors	15	Vb
03.02.2018	Skyttiadens Regionsfinal 2018	Ramselefors SKF		
Prov		1: 9.8 ↑ 2: 9.6 ← 3: 9.4 ← 4: 9.5 ↑ 5: 10.3x← 6: 10.8x ↑ 7: 10.6x ↑ 8: 10.4x ↗ 9: 10.3x ↗ 10: 10.5x↙	Prov	11: 10.8x ↘
		Serie 101.2		Serie 10.8
		Total 0.0		Total 0.0
40 Skott		1: 10.7x ↑ 2: 10.1 → 3: 10.9x ↖ 4: 10.1 ← 5: 9.9 → 6: 10.5x ↖ 7: 10.0 → 8: 10.6x ↓ 9: 10.7x↙ 10: 10.2x ↘	40 Skott	11: 9.7 ↘ 12: 10.0 → 13: 10.3x→ 14: 10.8x← 15: 10.8x↖ 16: 9.6 ← 17: 10.6x ↓ 18: 10.4x← 19: 9.9 ↑ 20: 10.4x→
		Serie 103.7		Serie 102.5
		Total 103.7		Total 206.2
40 Skott		21: 10.8x← 22: 9.7 ↙ 23: 10.3x→ 24: 10.7x↙ 25: 10.6x← 26: 10.1 → 27: 10.2x→ 28: 10.3x ↘ 29: 9.5 ← 30: 9.9 ↙	40 Skott	31: 10.2x← 32: 10.8x← 33: 10.1 ← 34: 10.6x← 35: 9.9 ↙ 36: 10.2x→ 37: 10.7x→ 38: 10.6x↙ 39: 10.5x← 40: 10.7x→
		Serie 102.1		Serie 104.3
		Total 308.3		Total 412.6

Skjutlag <b>2</b>	Tavla <b>11</b>	<b>Olle Grindborg</b>	
Ramselefors	Fältjägarna	11	Jä
03.02.2018	Skyttiadens Regionsfinal 2018	Ramselefors SKF	
	1: 10.4x ← 2: 10.8x ↑ 3: 10.7x ↗ 4: 10.6x ↖ 5: 10.5x ↖ 6: 10.8x ↑ Serie 63.8 Total 0.0		1: 10.5x → 2: 10.3x ↑ 3: 10.8x → 4: 10.5x ↙ 5: 10.5x ↖ 6: 10.5x ↙ 7: 10.8x ↑ 8: 10.4x ← 9: 10.7x ↗ 10: 10.3x ← Serie 105.3 Total 105.3
	11: 10.7x ↗ 12: 10.9x → 13: 9.5 ↓ 14: 10.8x ↖ 15: 10.3x ↑ 16: 10.4x ↗ 17: 10.5x ↗ 18: 10.3x ↓ 19: 10.6x ← 20: 9.9 ← Serie 103.9 Total 209.2		21: 10.5x ↗ 22: 10.7x ← 23: 10.2x ← 24: 10.5x ↘ 25: 10.6x ↙ 26: 10.5x → 27: 10.5x ← 28: 10.4x → 29: 10.8x ← 30: 10.7x ↓ Serie 105.4 Total 314.6
	31: 10.2x ↙ 32: 10.2x ← 33: 10.7x ↓ 34: 10.7x ↘ 35: 10.5x → 36: 10.4x ↘ 37: 10.7x ← 38: 10.3x ← 39: 9.7 → 40: 10.8x → Serie 104.2 Total 418.8		

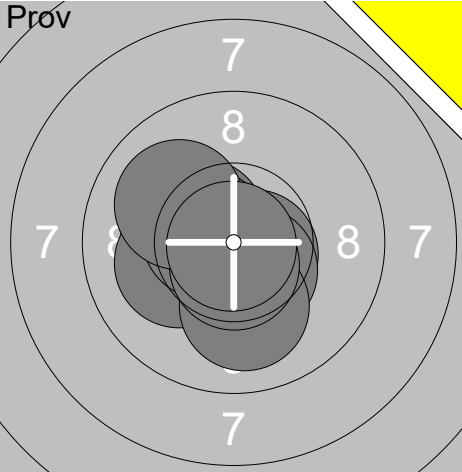

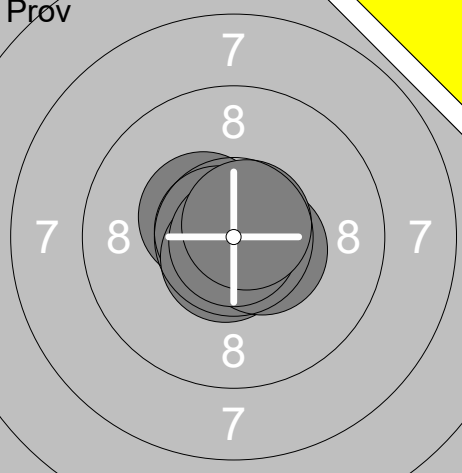
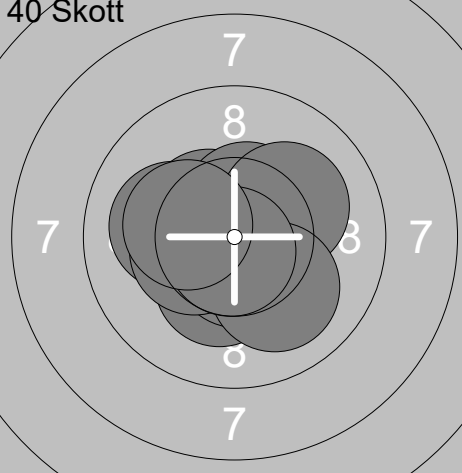
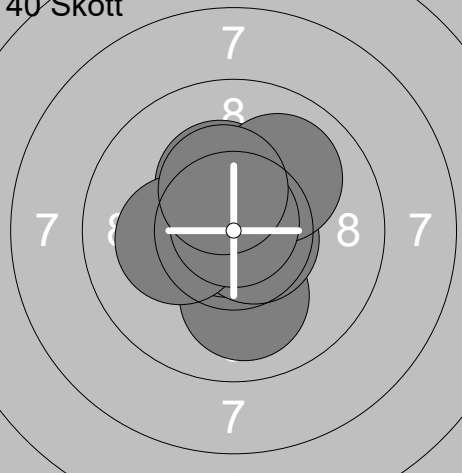
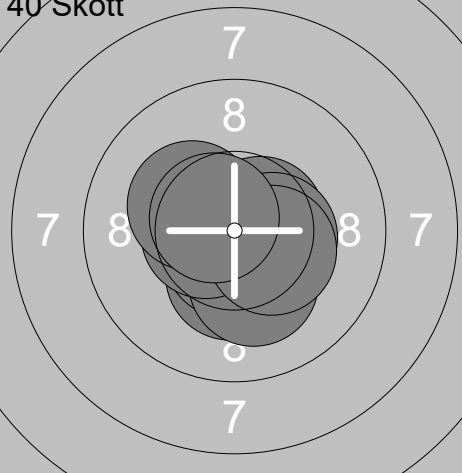
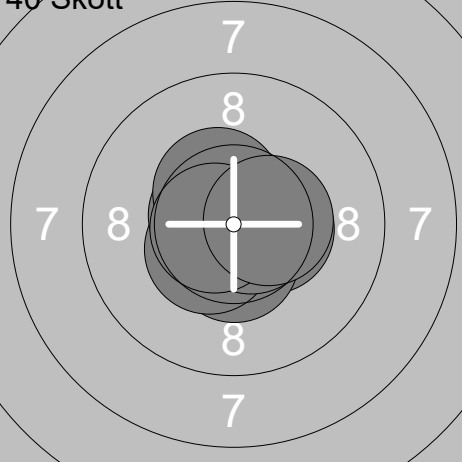
Skjuttag <b>2</b>	Tavla <b>12</b>	<b>Agnes Ebbhagen</b>	
Ramselefors	Ramselefors	11	Vb
03.02.2018	Skyttiadens Regionsfinal 2018	Ramselefors SKF	
<b>Prøv</b> 	1: 10.1 ↗ 2: 10.1 ← 3: 10.4x ↗ 4: 10.6x ↗ 5: 10.6x ↘ 6: 10.5x ↘ 7: 10.1 ↓ 8: 10.6x ↓ 9: 10.0 ↗ 10: 10.9x ↓ Serie 103.9 Total 0.0	<b>Prøv</b> 	11: 10.4x ↗ 12: 10.3x ← 13: 10.4x ↓ 14: 10.2x ↘ 15: 10.6x ↗ 16: 10.3x ↗ 17: 10.7x ↗ 18: 10.1 → 19: 10.5x → 20: 10.7x ↗ Serie 104.2 Total 0.0
<b>Prøv</b> 	21: 10.4x ↗ 22: 10.7x ↗ 23: 10.6x ↓ 24: 10.5x ↘ 25: 10.9x ↓ 26: 10.7x ↗ Serie 63.8 Total 0.0	<b>40 Skott</b> 	1: 10.5x ↗ 2: 10.5x ↗ 3: 10.3x ↓ 4: 10.1 ← 5: 10.6x ↓ 6: 10.4x ← 7: 10.1 ↗ 8: 10.1 ↓ 9: 10.7x ↓ 10: 10.3x ← Serie 103.6 Total 103.6
<b>40 Skott</b> 	11: 10.0 ↓ 12: 10.3x ↗ 13: 10.9x ← 14: 10.6x → 15: 10.4x ↗ 16: 10.5x ← 17: 10.2x ← 18: 10.0 ↗ 19: 10.8x ↗ 20: 10.4x ↗ Serie 104.1 Total 207.7	<b>40 Skott</b> 	21: 10.6x → 22: 10.3x ↓ 23: 10.6x → 24: 10.6x ↓ 25: 10.2x ↓ 26: 10.5x ← 27: 10.4x → 28: 10.4x ↘ 29: 10.3x ↗ 30: 10.6x ↗ Serie 104.5 Total 312.2
<b>40 Skott</b> 	31: 10.7x ↓ 32: 10.8x ← 33: 10.4x → 34: 10.5x ↓ 35: 10.5x ↘ 36: 10.6x ↗ 37: 10.7x → 38: 10.5x ↗ 39: 10.7x ← 40: 10.5x → Serie 105.9 Total 418.1		

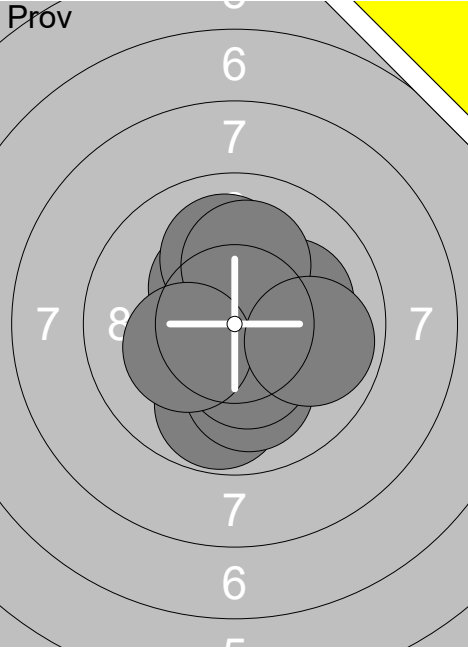
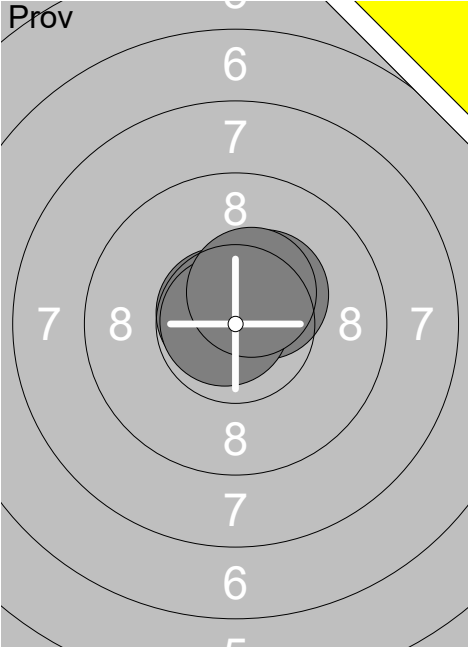
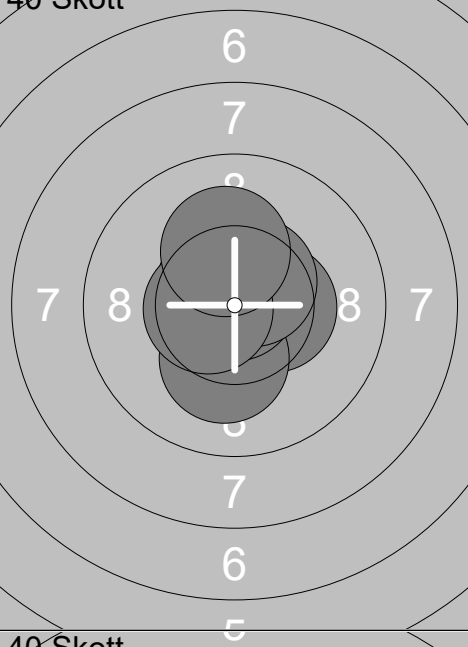
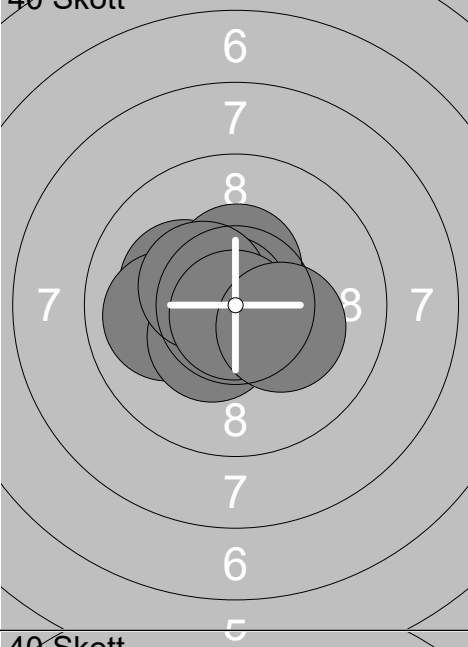
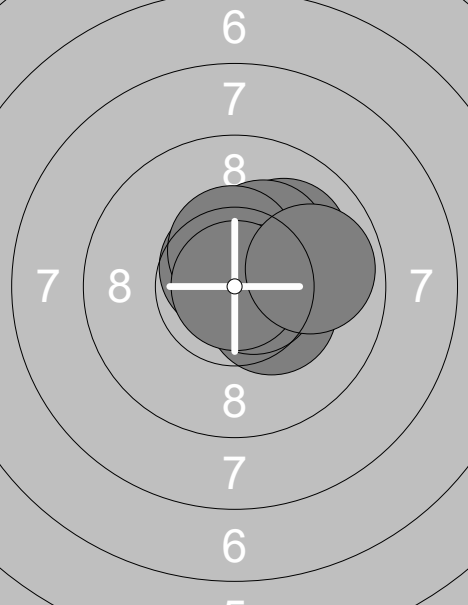
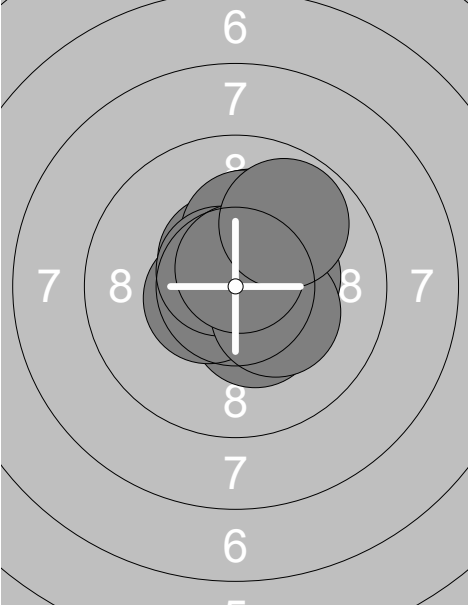
Skjutlag	Tavla	Ebba Lundstedt	
2	13	Ramselefors	Vb
Ramselefors	Ramselefors	11	
03.02.2018	Skyttiadens Regionsfinal 2018	Ramselefors SKF	
Prov		Prov	
	1: 9.8 ↓ 2: 10.3x ↘ 3: 10.1 ↓ 4: 10.4x ↓ 5: 10.1 → 6: 10.4x ↗ 7: 10.0 ↑ 8: 10.1 ↑ 9: 10.2x ↙ 10: 9.9 →		11: 10.4x ↗ 12: 10.7x ↖ 13: 10.8x ↙ 14: 10.5x ↗
Serie	101.3	Serie	42.4
Total	0.0	Total	0.0
40 Skott		40 Skott	
	1: 10.6x ↖ 2: 10.7x ↗ 3: 10.5x ↑ 4: 10.8x ↙ 5: 10.4x → 6: 10.2x ↓ 7: 10.8x ↑ 8: 10.5x ↗ 9: 10.6x ↙ 10: 10.2x ↑		11: 10.2x ↙ 12: 10.0 ← 13: 10.4x ↙ 14: 10.8x ↗ 15: 10.7x ↗ 16: 10.4x ↑ 17: 10.8x ↖ 18: 10.4x ↖ 19: 10.8x ↓ 20: 10.3x →
Serie	105.3	Serie	104.8
Total	105.3	Total	210.1
40 Skott		40 Skott	
	21: 10.9x ↗ 22: 10.8x ↑ 23: 10.0 ↗ 24: 10.6x ↖ 25: 10.2x ↗ 26: 10.5x ↑ 27: 10.3x ↘ 28: 10.7x → 29: 10.9x → 30: 9.9 →		31: 10.5x ↖ 32: 10.2x ↑ 33: 10.2x ↑ 34: 10.4x → 35: 10.4x ↓ 36: 10.5x ↙ 37: 10.7x ↖ 38: 10.3x → 39: 10.7x ↑ 40: 9.8 ↗
Serie	104.8	Serie	103.7
Total	314.9	Total	418.6

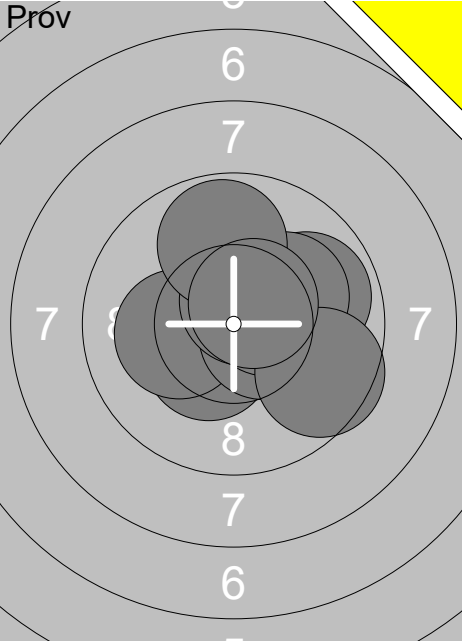
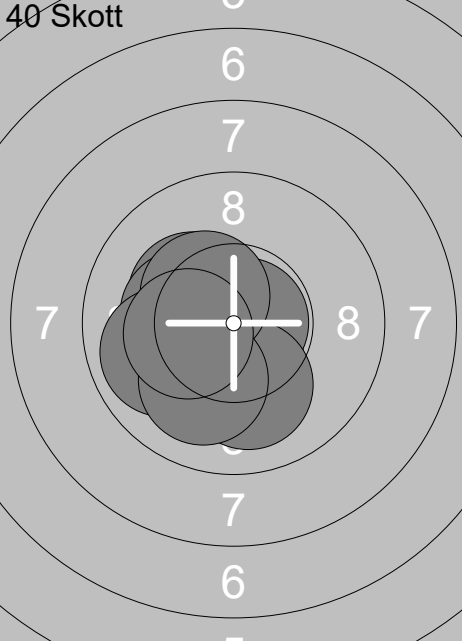
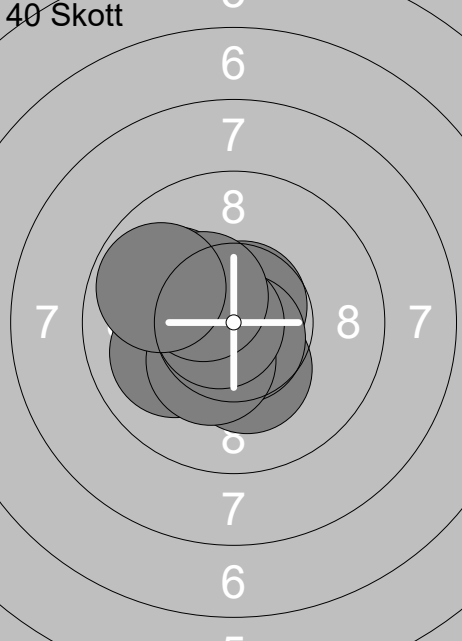

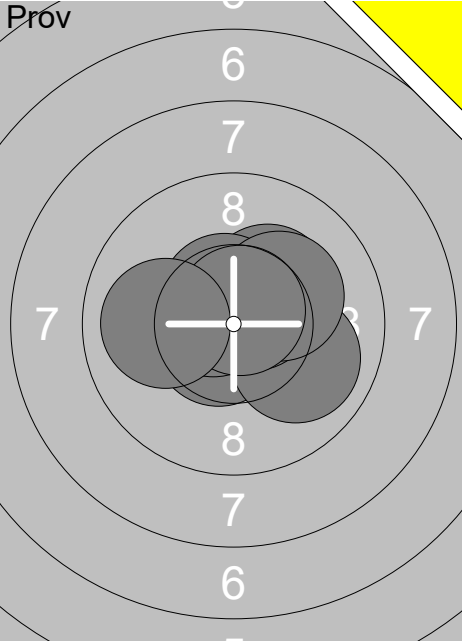
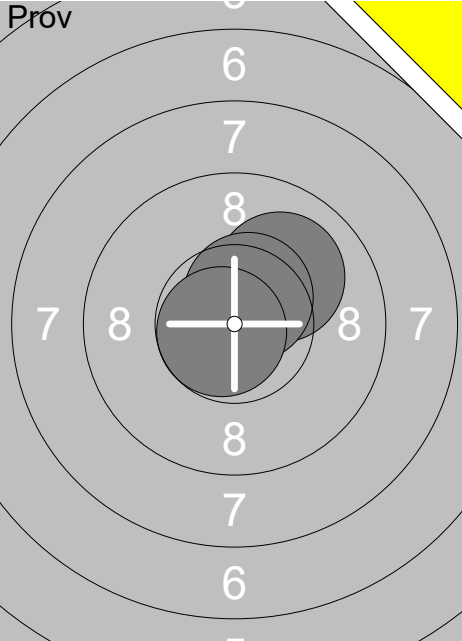
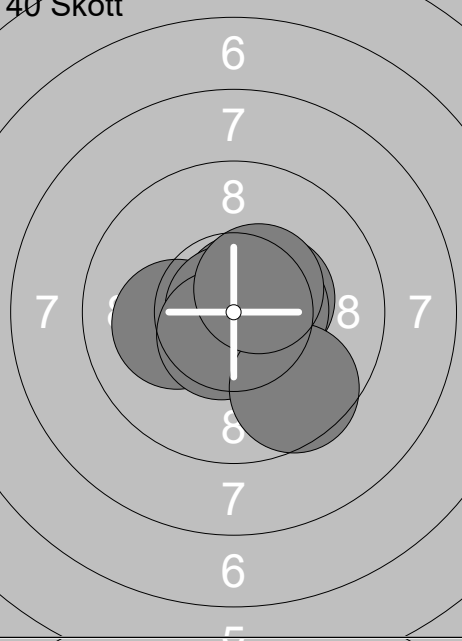
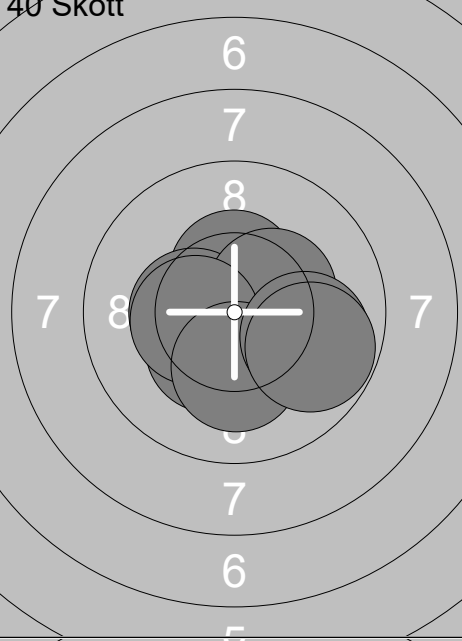
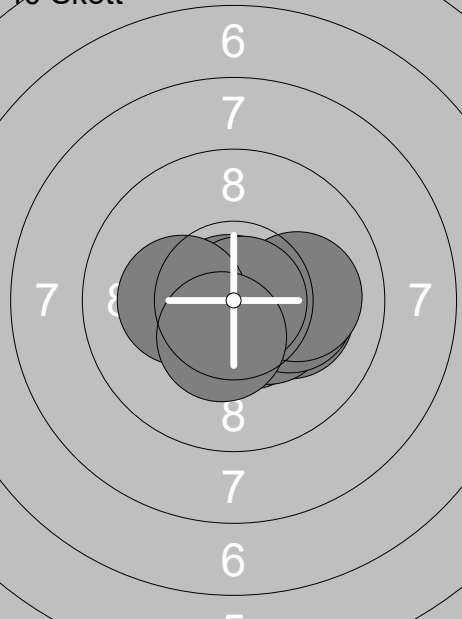
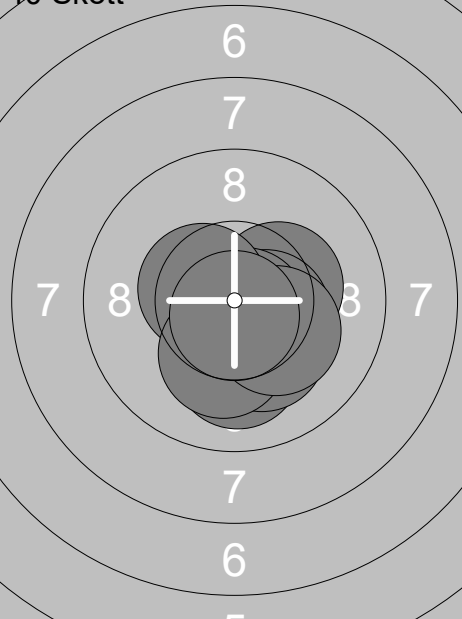
Skjutlag	Tavla	Sofia Öhman		
2	14	Ramselefors	Gällivare	11 No
03.02.2018		Skyttiadens Regionsfinal 2018	Ramselefors SKF	
Prov		1: 10.4x ↘ 2: 10.2x ← 3: 10.5x → 4: 10.4x → 5: 9.9 → 6: 10.2x → 7: 9.6 ↘ 8: 10.6x ↗ 9: 9.8 ↑ 10: 10.6x ↗ Serie 102.2 Total 0.0	Prov	11: 10.4x ↑ 12: 10.7x ↗ Serie 21.1 Total 0.0
40 Skott		1: 10.3x ↖ 2: 10.7x ← 3: 10.5x ↓ 4: 10.3x ← 5: 10.8x → 6: 10.1 ↓ 7: 10.4x ↗ 8: 9.9 ← 9: 10.1 ↓ 10: 10.3x ← Serie 103.4 Total 103.4	40 Skott	11: 10.6x ↑ 12: 10.5x ↗ 13: 10.5x ← 14: 10.3x ← 15: 10.6x ↘ 16: 9.2 ↓ 17: 10.7x ↑ 18: 9.9 ← 19: 10.1 ← 20: 10.5x ↘ Serie 102.9 Total 206.3
40 Skott		21: 10.0 ← 22: 10.3x ↓ 23: 10.7x ← 24: 10.0 ← 25: 10.7x ↗ 26: 10.7x ↓ 27: 10.3x ↘ 28: 10.8x ← 29: 10.4x ↗ 30: 9.8 ← Serie 103.7 Total 310.0	40 Skott	31: 10.9x ↓ 32: 10.6x ← 33: 10.7x ↓ 34: 10.6x ↓ 35: 10.8x ↗ 36: 10.8x ↘ 37: 9.9 → 38: 10.8x ↗ 39: 10.7x ← 40: 10.2x ↑ Serie 106.0 Total 416.0

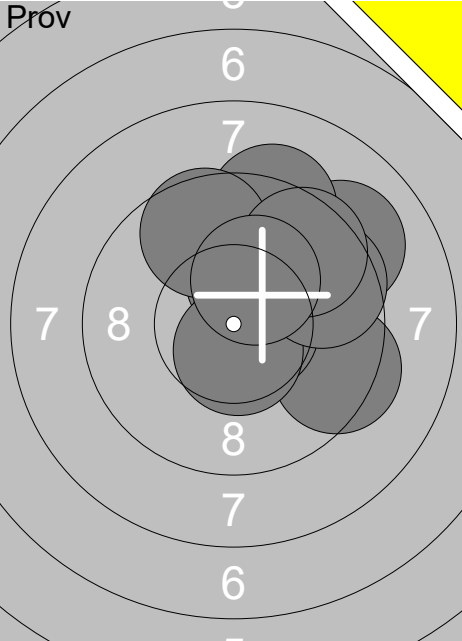
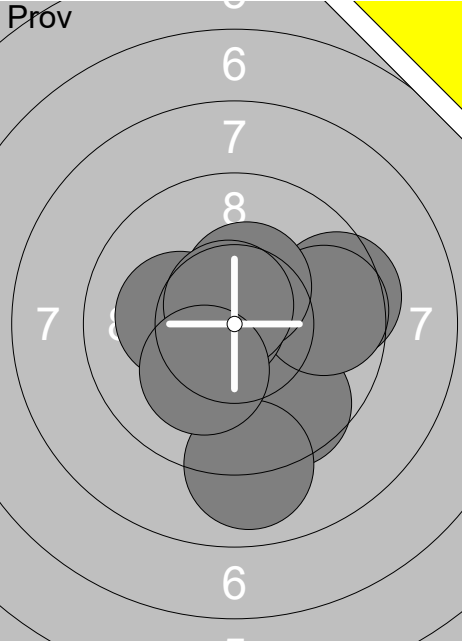
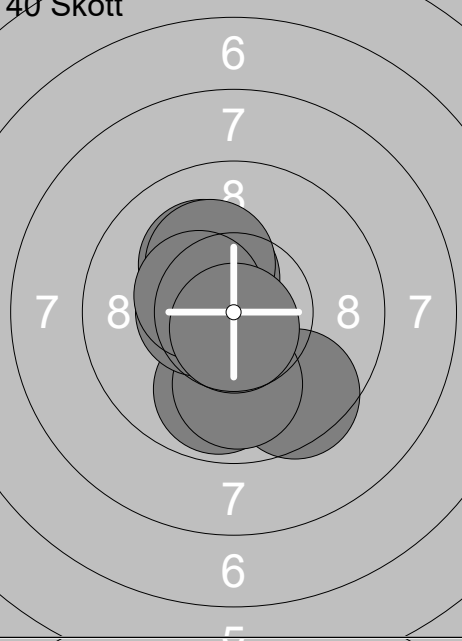
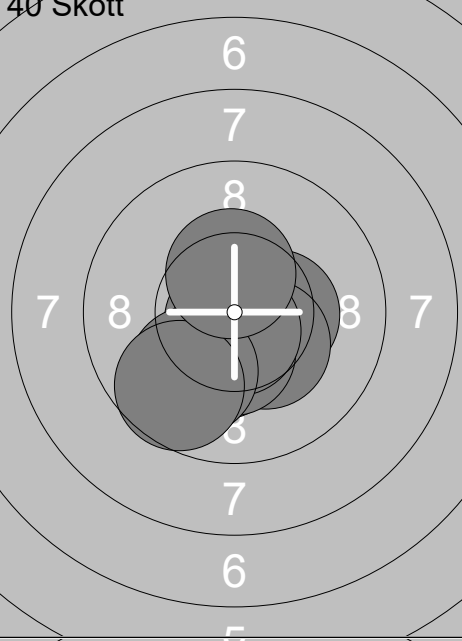
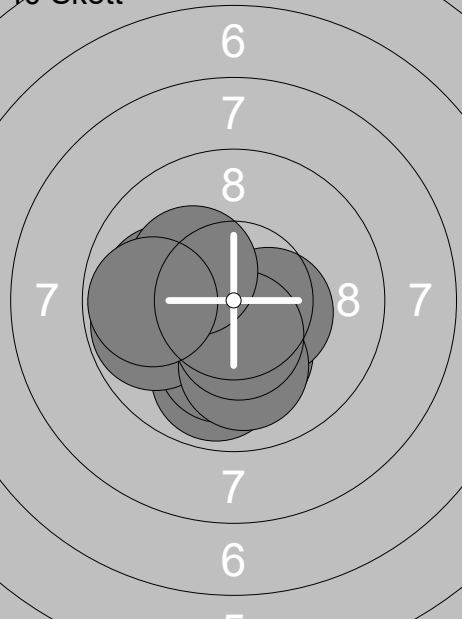
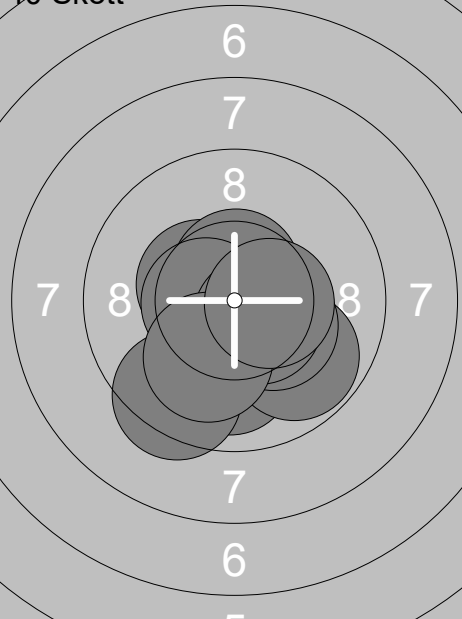
Skjutlag	Tavla	Elvina Bohman		
2	15	Ramselefors	Gideå	11 Vn
03.02.2018		Skyttiadens Regionsfinal 2018		Ramselefors SKF
Prov 	1: 10.8x ←	Prov 	11: 10.0 ↗	
	2: 10.6x ↘		12: 10.5x ↗	
	3: 10.0 →		13: 10.7x ↙	
	4: 10.3x ↗			
	5: 10.6x ↖			
	6: 10.6x ↗			
	7: 10.6x ↗			
	8: 10.2x ↗			
	9: 10.7x ↗			
	10: 10.0 ←			
	Serie 104.4		Serie 31.2	
	Total 0.0		Total 0.0	
40 Skott 	1: 10.7x ↗	40 Skott 	11: 10.4x ↘	
	2: 10.7x ↘		12: 10.4x ↑	
	3: 10.5x ↘		13: 10.7x ↘	
	4: 10.4x →		14: 10.4x ←	
	5: 10.5x →		15: 10.4x ↘	
	6: 10.1 ←		16: 10.4x ↗	
	7: 10.9x ↖		17: 10.4x ←	
	8: 10.6x ↘		18: 10.2x ↓	
	9: 9.6 ↘		19: 9.9 →	
	10: 10.5x ↗		20: 9.8 →	
	Serie 104.5		Serie 103.0	
	Total 104.5		Total 207.5	
40 Skott 	21: 10.6x ↘	40 Skott 	31: 10.1 ↓	
	22: 10.2x →		32: 10.3x →	
	23: 10.9x ↖		33: 10.2x ↘	
	24: 10.4x ↘		34: 10.5x →	
	25: 10.2x →		35: 10.7x ↘	
	26: 10.1 →		36: 10.7x ↘	
	27: 10.6x ↘		37: 10.5x ↖	
	28: 10.8x →		38: 10.2x ↓	
	29: 10.2x ←		39: 10.2x ↘	
	30: 10.4x ↘		40: 10.7x ↓	
	Serie 104.4		Serie 104.1	
	Total 311.9		Total 416.0	

Skjutlag	Tavla	Johanna Lööw		
2	16	Ramselefors	Hammerdal	11
03.02.2018		Skyttiadens Regionsfinal 2018		Ramselefors SKF
<b>Prov</b> 	1: 9.1 ↗ 2: 9.3 ↑ 3: 10.3x ↑ 4: 9.4 → 5: 10.7x → 6: 10.6x ↓ 7: 9.6 → 8: 9.6 ↑ 9: 9.6 ↗ 10: 10.3x ↑ Serie 98.5 Total 0.0	<b>Prov</b> 	11: 9.6 ↓ 12: 9.5 → 13: 9.7 → 14: 10.4x ↑ 15: 10.7x ← 16: 9.0 ↓ 17: 10.2x ← 18: 10.7x ↑ 19: 10.2x ↓ Serie 90.0 Total 0.0	
<b>40 Skott</b> 	1: 9.9 ↓ 2: 10.6x ← 3: 9.5 ↓ 4: 10.0 ↓ 5: 10.2x ↗ 6: 10.5x ← 7: 10.4x ↗ 8: 10.2x ↗ 9: 10.4x ← 10: 10.7x ↓ Serie 102.4 Total 102.4	<b>40 Skott</b> 	11: 10.8x ↓ 12: 10.4x → 13: 10.3x ↓ 14: 10.5x ↓ 15: 10.3x ↘ 16: 10.4x ↓ 17: 10.7x ↓ 18: 9.9 ↓ 19: 9.7 ↓ 20: 10.4x ↑ Serie 103.4 Total 205.8	
<b>40 Skott</b> 	21: 9.9 ↓ 22: 10.1 ↓ 23: 10.2x ↓ 24: 10.0 ← 25: 10.4x → 26: 9.8 ← 27: 10.0 ↓ 28: 10.5x ↓ 29: 10.3x ↗ 30: 9.8 ← Serie 101.0 Total 306.8	<b>40 Skott</b> 	31: 10.4x ← 32: 10.0 ↓ 33: 10.6x ↑ 34: 10.6x ← 35: 9.8 ↘ 36: 10.3x ↘ 37: 10.5x ↘ 38: 9.4 ↓ 39: 10.1 ↓ 40: 10.5x → Serie 102.2 Total 409.0	

Skjutlag	Tavla	Leon Brink		
2	17	Ramselefors	Kyrkås	11
03.02.2018		Skyttiadens Regionsfinal 2018		Ramselefors SKF
Prov 	1: 9.8 ← 2: 9.9 ↑ 3: 10.3x ↖ 4: 10.4x → 5: 10.1 ↗ 6: 10.0 ↓ 7: 9.9 ↙ 8: 10.1 ↗ 9: 9.3 ← 10: 10.1 ↖	Prov 	11: 9.5 ← 12: 10.3x ↖ 13: 10.1 ↓ 14: 10.3x ↗ 15: 10.6x ↖	
	Serie 99.9		Serie 50.8	
	Total 0.0		Total 0.0	
40 Skott 	1: 10.7x ↓ 2: 10.4x → 3: 10.8x ↙ 4: 10.5x ↗ 5: 10.4x → 6: 10.0 ↑ 7: 10.6x ↑ 8: 10.6x ↓ 9: 9.9 → 10: 10.5x ↑	40 Skott 	11: 9.8 ↑ 12: 10.7x ↙ 13: 10.5x ↓ 14: 10.2x ↘ 15: 9.9 ↑ 16: 9.6 ↗ 17: 10.6x ↓ 18: 10.0 ↖ 19: 10.2x ↙ 20: 10.2x ↙	
	Serie 104.4		Serie 101.7	
	Total 104.4		Total 206.1	
40 Skott 	21: 10.5x ↗ 22: 10.5x → 23: 10.2x ↓ 24: 9.8 ↑ 25: 10.1 ↘ 26: 10.6x ↘ 27: 10.8x ↑ 28: 10.7x → 29: 10.3x ↓ 30: 9.7 ↗	40 Skott 	31: 10.4x ↘ 32: 5.9 ↓ 33: 10.6x ↑ 34: 10.0 ↓ 35: 10.7x ↖ 36: 10.3x → 37: 10.0 ↗ 38: 9.9 → 39: 9.8 ↓ 40: 10.3x ↖	
	Serie 103.2		Serie 97.9	
	Total 309.3		Total 407.2	

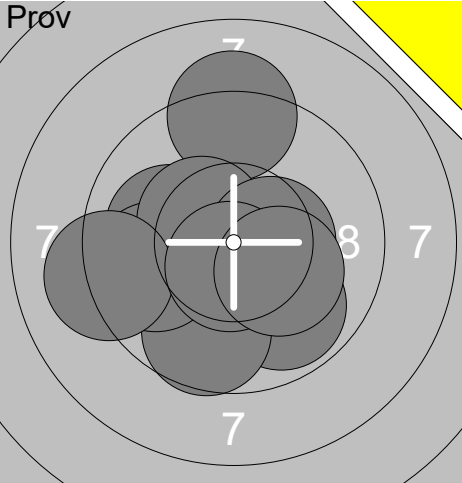
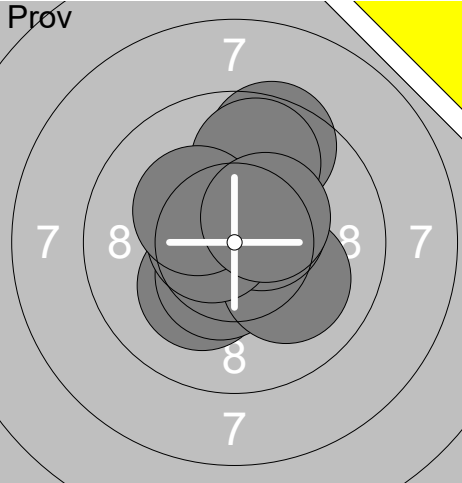
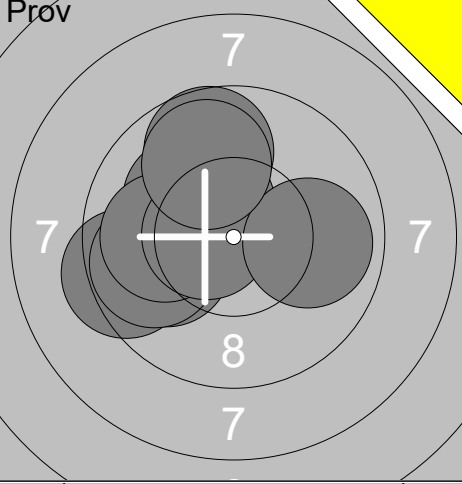
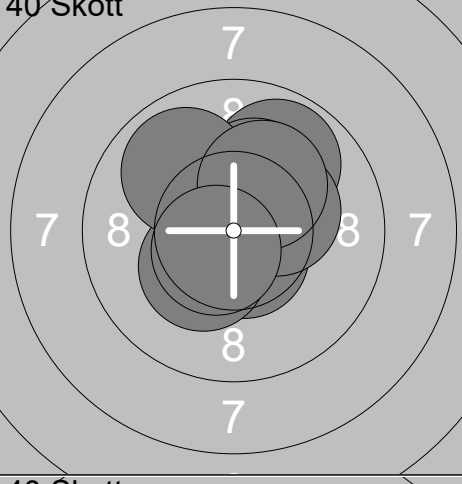
Skjutlag	Tavla	Erika Georgsson	
2	18	Bjurholm-Balsjö	11 Vb
03.02.2018	Skyttiadens Regionsfinal 2018	Ramselefors SKF	
Prov		Prov	
	Serie 103.9		Serie 83.4
	Total 0.0		Total 0.0
40 Skott		40 Skott	
	Serie 103.1		Serie 103.3
	Total 103.1		Total 206.4
40 Skott		40 Skott	
	Serie 103.1		Serie 102.5
	Total 309.5		Total 412.0

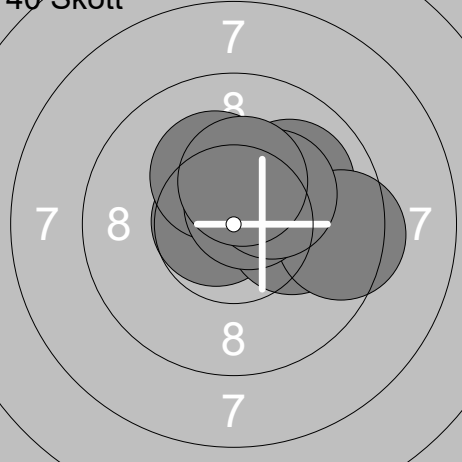

Skjutlag	Tavla	Maria Olofsson		
2	19	Ramselefors	Aspås	11 Jä
03.02.2018	Skyttiadens Regionsfinal 2018	Ramselefors SKF		
<b>Prov</b> 	1: 10.1 ← 2: 9.9 ↘ 3: 9.2 ↑ 4: 9.7 ↘ 5: 9.8 ← 6: 10.4x ↗ 7: 9.2 ← 8: 10.4x → 9: 10.6x ↘ 10: 10.2x ↘	<b>Prov</b> 	11: 10.2x ↙ 12: 10.5x ↘ 13: 9.5 ↑ 14: 9.8 ↑ 15: 10.6x ↗ 16: 10.1 ↘ 17: 10.5x ↗ 18: 10.6x ← 19: 10.3x ↗ 20: 10.4x ↗	
Serie 99.5	Total 0.0	Serie 102.5	Total 0.0	
<b>Prov</b> 	21: 9.4 ← 22: 10.0 ← 23: 10.1 ↗ 24: 10.4x ↗ 25: 9.8 ← 26: 9.7 ↑ 27: 10.0 ← 28: 10.6x ← 29: 9.9 → 30: 9.9 ↑	<b>Prov</b> 	31: 9.7 ← 32: 10.6x ↑ 33: 10.5x ←	
Serie 99.8	Total 0.0	Serie 30.8	Total 0.0	
<b>40 Skott</b> 	1: 10.6x ↘ 2: 9.9 ↑ 3: 10.6x ↗ 4: 10.2x ↑ 5: 10.3x ↘ 6: 10.5x ↗ 7: 10.3x → 8: 9.9 ↗ 9: 10.2x ↑ 10: 10.6x ↘	<b>40 Skott</b> 	11: 10.8x ↘ 12: 10.2x ↗ 13: 10.1 ↗ 14: 9.9 ↑ 15: 10.8x ↗ 16: 10.1 ↑ 17: 10.2x ↗ 18: 10.7x → 19: 10.0 ↗ 20: 10.4x ↗	
Serie 103.1	Total 103.1	Serie 103.2	Total 206.3	
<b>40 Skott</b> 	21: 10.7x ← 22: 10.5x ↗ 23: 10.1 → 24: 10.2x ↗ 25: 10.0 ↗ 26: 10.1 → 27: 9.4 → 28: 10.6x ↗ 29: 10.3x ↗ 30: 10.3x ↑	<b>40 Skott</b> 	31: 10.6x → 32: 10.8x ↘ 33: 10.4x ↗ 34: 10.2x ↗ 35: 10.6x ↘ 36: 10.0 ↑ 37: 9.8 ↗ 38: 10.4x ↘ 39: 10.5x ↘ 40: 9.4 ↑	
Serie 102.2	Total 308.5	Serie 102.7	Total 411.2	

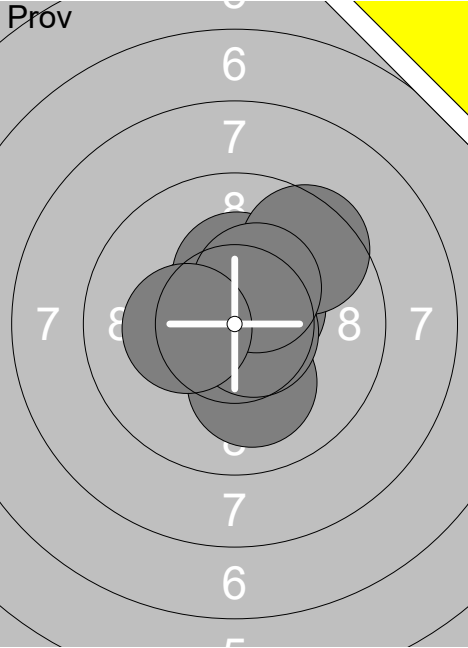
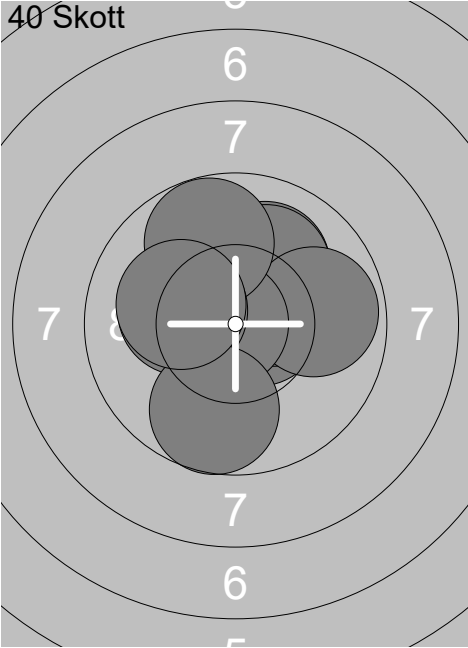
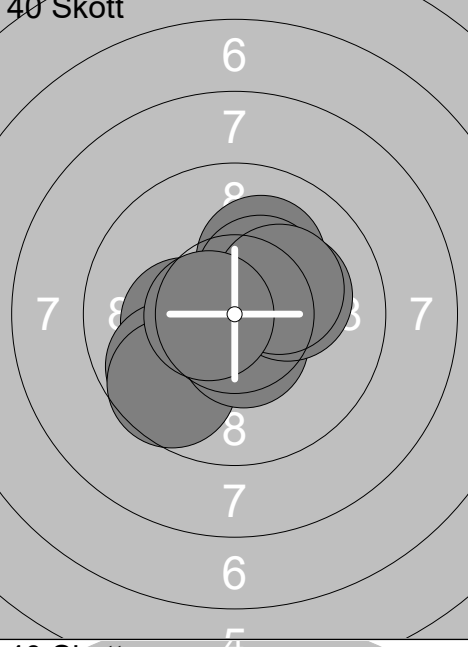
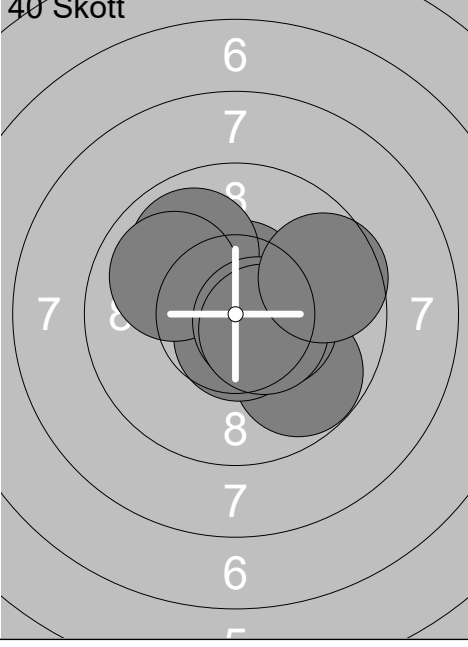
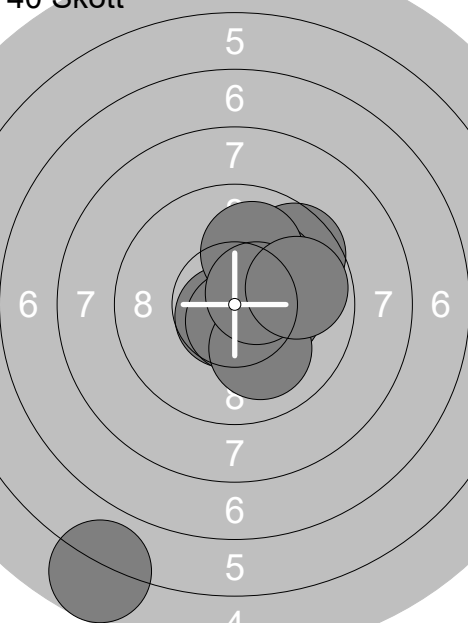

Skjutlag <b>2</b>	Tavla <b>20</b>	<b>Anders Eliasson</b>		
Ramselefors		Aspås	11	Jä
03.02.2018		Skyttiadens Regionsfinal 2018		Ramselefors SKF
<b>Prov</b> 	1: 9.0 ↗ 2: 9.5 ↗ 3: 10.7x ↙ 4: 10.7x ↑ 5: 9.6 ↗ 6: 9.9 ← 7: 10.2x ↙ 8: 10.7x ↗ 9: 9.7 ↑ 10: 9.0 ↑ Serie 99.0 Total 0.0	<b>Prov</b> 	11: 10.4x ↗ 12: 10.5x ↗ 13: 9.5 ↗ 14: 10.2x ↗ 15: 10.4x ↙ 16: 10.6x ↑ 17: 10.4x ← 18: 10.5x ← 19: 9.6 ↗ 20: 10.0 ↑ Serie 102.1 Total 0.0	
<b>Prov</b> 	21: 9.8 ← 22: 10.5x → 23: 10.0 ↑ 24: 10.4x → 25: 10.1 ↓ Serie 50.8 Total 0.0	<b>40 Skott</b> 	1: 10.1 ↑ 2: 10.7x ↓ 3: 10.4x ← 4: 10.3x ↓ 5: 10.0 ↙ 6: 10.8x ↑ 7: 9.7 ↗ 8: 10.1 ↗ 9: 10.5x ↓ 10: 10.6x ← Serie 103.2 Total 103.2	
<b>40 Skott</b> 	11: 10.1 ↑ 12: 10.6x ↓ 13: 10.1 ↙ 14: 10.5x ↑ 15: 10.5x ↗ 16: 10.1 ↗ 17: 9.7 ← 18: 10.4x ↙ 19: 10.1 ↙ 20: 10.5x ↗ Serie 102.6 Total 205.8	<b>40 Skott</b> 	21: 10.3x ↑ 22: 10.1 → 23: 10.2x ↙ 24: 10.5x ↑ 25: 10.1 ← 26: 10.0 ← 27: 10.2x ↗ 28: 10.1 ↙ 29: 10.0 ↑ 30: 10.0 → Serie 101.5 Total 307.3	
<b>40 Skott</b> 	31: 10.7x ↙ 32: 10.7x ↗ 33: 10.5x ↓ 34: 10.6x ↙ 35: 9.9 ↗ 36: 9.9 ↗ 37: 10.1 ↗ 38: 10.4x ↙ 39: 9.7 → 40: 9.7 ↗ Serie 102.2 Total 409.5			

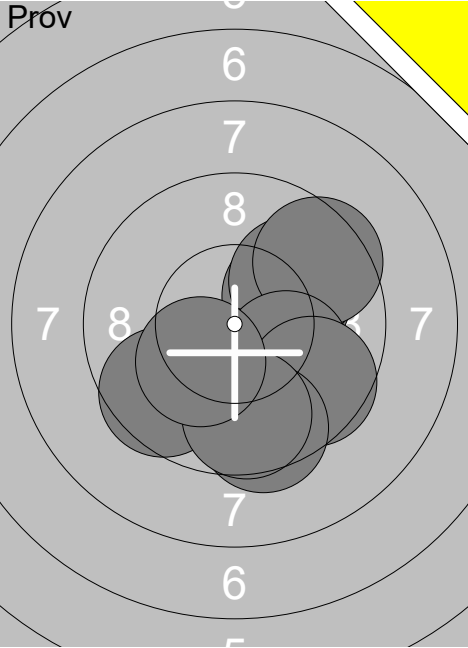
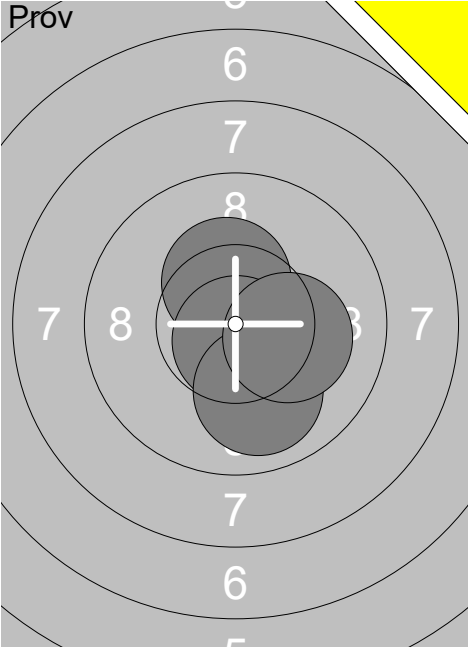
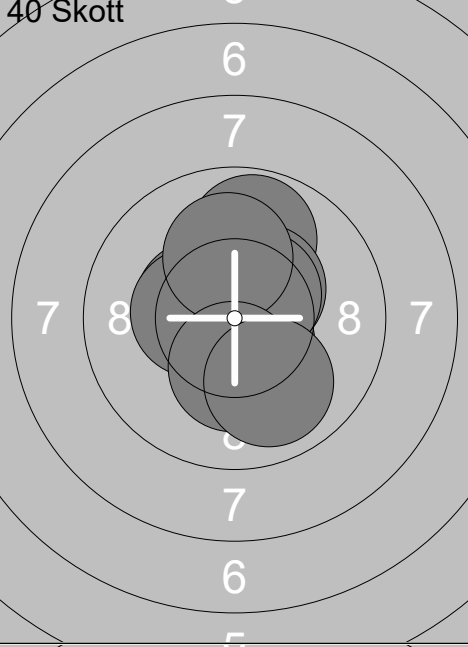
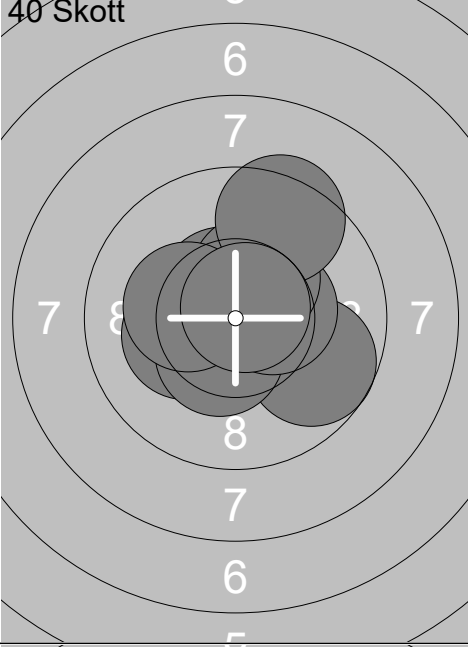
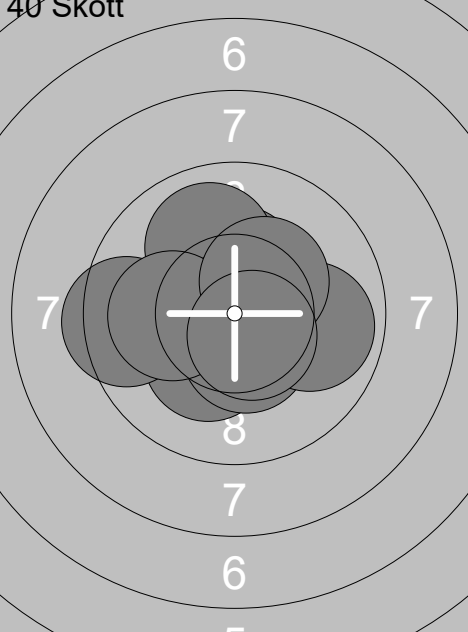
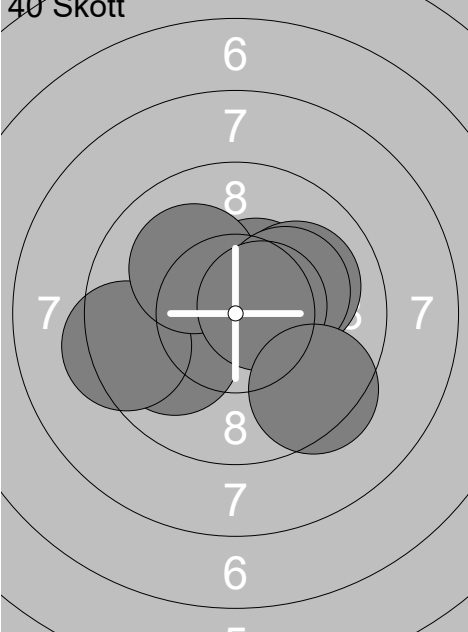
Skjutlag <b>2</b>	Tavla <b>21</b>	<b>Vilda Stridsson</b>	
Ramselefors	Gällivare	11	No
03.02.2018	Skyttiadens Regionsfinal 2018	Ramselefors SKF	
	1: 10.5x ↗ 2: 10.6x ← 3: 10.1 ↓ 4: 10.7x ↑ 5: 10.7x → 6: 10.3x ↑ 7: 9.5 ↗ 8: 10.4x ↗ 9: 10.3x ← Serie 93.1 Total 0.0		1: 10.6x → 2: 10.1 ↑ 3: 10.3x ↗ 4: 10.1 ↑ 5: 9.9 → 6: 10.8x ← 7: 9.8 ↑ 8: 10.2x ← 9: 9.7 ↓ 10: 10.1 ← Serie 101.6 Total 101.6
	11: 10.3x ← 12: 10.5x ↘ 13: 9.8 ↙ 14: 9.7 ↙ 15: 10.1 ↑ 16: 10.4x ↗ 17: 10.5x ↓ 18: 10.2x → 19: 10.2x ↗ 20: 10.6x ← Serie 102.3 Total 203.9		21: 9.8 ↘ 22: 10.6x ↗ 23: 10.5x ↑ 24: 10.6x ↓ 25: 9.9 ↗ 26: 9.9 ← 27: 10.4x → 28: 10.6x → 29: 10.5x ↘ 30: 9.6 → Serie 102.4 Total 306.3
	31: 9.6 ↗ 32: 10.7x ↘ 33: 10.1 ↗ 34: 10.0 ↑ 35: 10.3x → 36: 10.7x ↓ 37: 10.1 ↓ 38: 10.5x ↗ 39: 5.7 ↓ 40: 9.8 → Serie 97.5 Total 403.8		

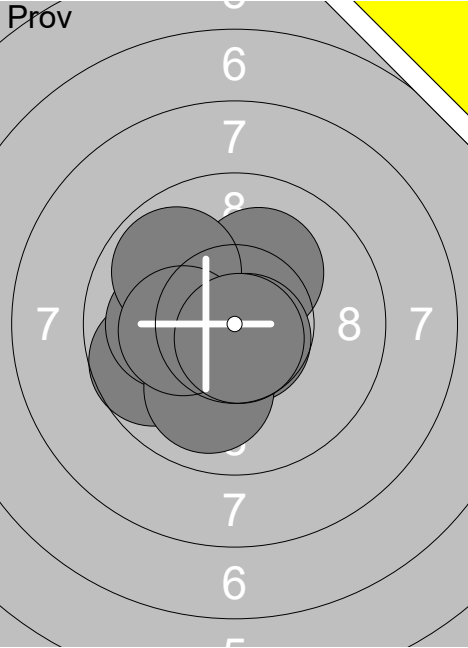
Skjutlag	Tavla	Ida Wärme	
2	22	Ramselefors	Boden
03.02.2018	Skyttiadens Regionsfinal 2018	11	No
03.02.2018	Skyttiadens Regionsfinal 2018	Ramselefors SKF	
Prov		Prov	
	1: 10.1 ↗ 2: 9.9 ↗ 3: 9.5 ↗ 4: 10.3x ↓ 5: 10.1 ↘ 6: 9.6 ↘ 7: 9.6 ↙ 8: 9.5 ↓ 9: 9.7 ↓ 10: 10.2x ↙		11: 10.4x ↗ 12: 10.7x ↓ 13: 10.0 ↓ 14: 10.2x →
Serie	98.5	Serie	41.3
Total	0.0	Total	0.0
40 Skott		40 Skott	
	1: 10.6x ↓ 2: 10.5x ↗ 3: 10.4x ↙ 4: 9.8 ↗ 5: 10.4x ↙ 6: 10.4x ↗ 7: 10.5x ↗ 8: 10.1 ↗ 9: 10.3x ↓ 10: 9.9 ↓		11: 9.7 ↘ 12: 10.6x ↗ 13: 10.6x ↗ 14: 10.2x ↙ 15: 10.4x ↓ 16: 10.4x → 17: 10.3x ↗ 18: 9.5 ↗ 19: 10.3x ↙ 20: 10.8x ↗
Serie	102.9	Serie	102.8
Total	102.9	Total	205.7
40 Skott		40 Skott	
	21: 10.2x ↓ 22: 10.4x ↓ 23: 9.4 ← 24: 10.4x ↗ 25: 10.0 ↗ 26: 10.9x → 27: 10.1 ← 28: 9.9 → 29: 10.4x ↗ 30: 10.6x ↓		31: 10.5x ↙ 32: 10.4x ↗ 33: 10.4x ↗ 34: 10.0 ↙ 35: 10.0 ↗ 36: 9.4 ← 37: 10.1 ↗ 38: 10.2x → 39: 10.6x → 40: 9.4 ↓
Serie	102.3	Serie	101.0
Total	308.0	Total	409.0

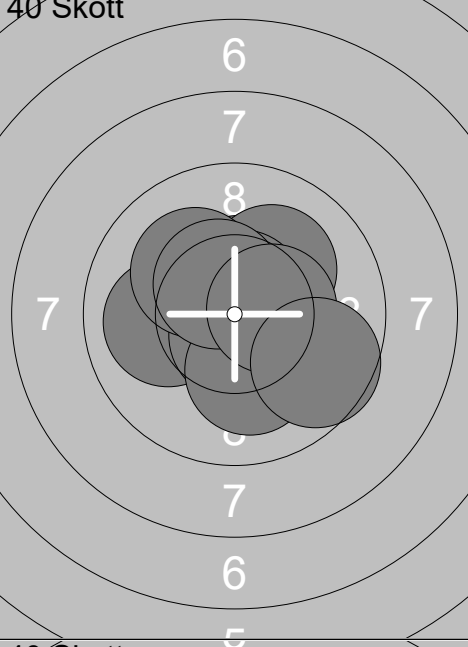
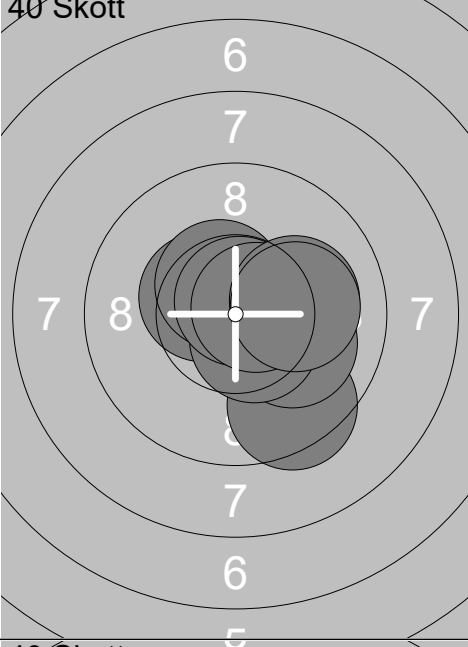
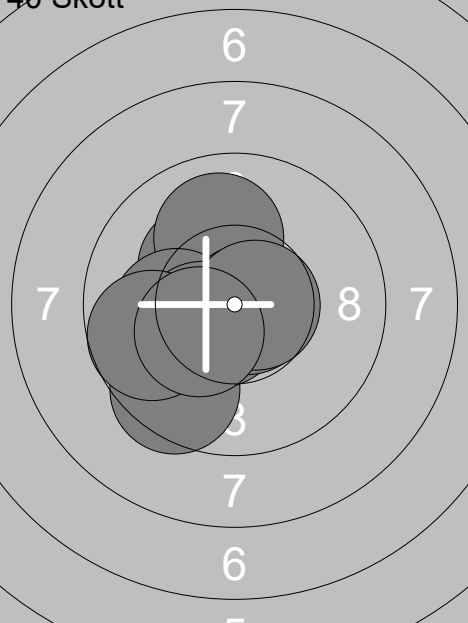
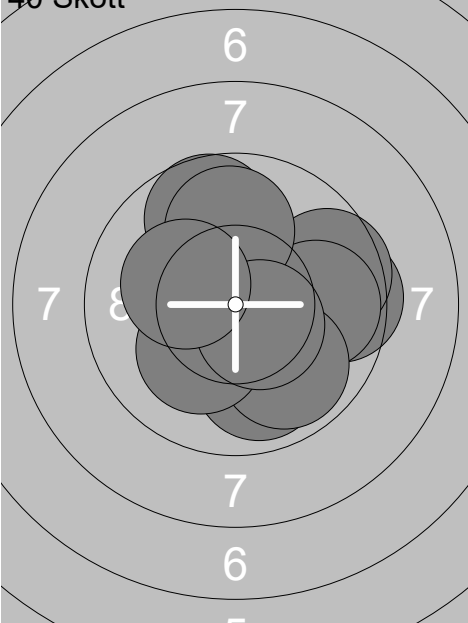
Skjutlag	Tavla	Gabriel Rönndahl		
2	24	Ramselefors	Ramselefors	11 Vb
03.02.2018	Skyttiadens Regionsfinal 2018	Ramselefors SKF		
Prov		1: 10.3x ↙	Prov	11: 10.5x ↗
		2: 10.3x ↙		12: 10.5x ↓
		3: 10.2x ↗		13: 10.6x →
		4: 9.7 ↙		14: 10.7x →
		5: 10.1 ↙		15: 10.5x ↗
		6: 9.9 ↗		
		7: 10.7x ↘		
		8: 10.0 ↓		
		9: 10.2x ↙		
		10: 10.7x ↓		
		Serie 102.1		Serie 52.8
		Total 0.0		Total 0.0
40 Skott		1: 10.5x ↗	40 Skott	11: 10.6x →
		2: 10.1 ↗		12: 9.5 ↓
		3: 10.0 ↙		13: 10.4x ↙
		4: 10.7x ↓		14: 10.1 ↗
		5: 10.7x ↗		15: 10.5x ↗
		6: 10.1 ↓		16: 10.5x ↘
		7: 10.2x ↗		17: 10.8x ↗
		8: 10.5x ↗		18: 10.7x →
		9: 10.4x →		19: 10.1 →
		10: 9.6 ↘		20: 10.1 →
		Serie 102.8		Serie 103.3
		Total 102.8		Total 206.1
40 Skott		21: 10.3x ↗	40 Skott	31: 9.9 ↓
		22: 10.0 ↗		32: 9.5 →
		23: 9.5 ↓		33: 9.6 →
		24: 10.6x ↙		34: 9.7 ↗
		25: 10.1 ↙		35: 9.8 →
		26: 10.8x →		36: 9.9 ↓
		27: 10.4x ↙		37: 10.2x ↙
		28: 10.7x →		38: 9.9 ↗
		29: 9.7 ↙		39: 10.5x ↘
		30: 10.3x ↙		40: 10.2x ↙
		Serie 102.4		Serie 99.2
		Total 308.5		Total 407.7

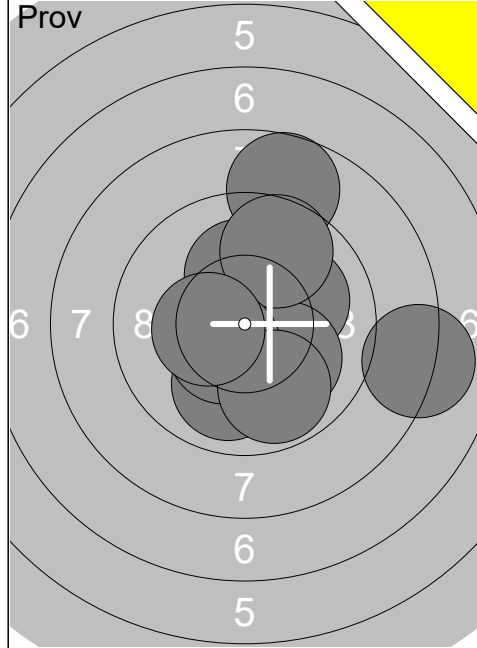

1:	10.2x ↑
2:	10.1 →
3:	8.7 ↑
4:	10.1 ↘
5:	8.1 →
6:	10.0 ↓
7:	9.7 ↑
8:	10.5x ↙
9:	9.8 ↓
10:	10.4x ←
Serie	97.6
Total	0.0

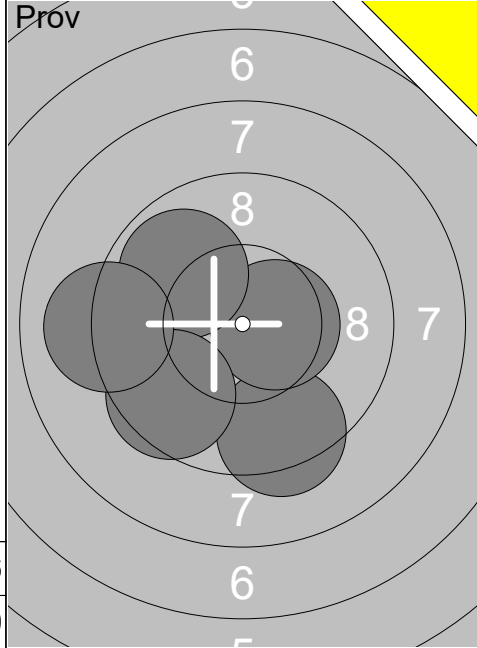

11:	9.4 ↓
12:	10.5x →
13:	9.9 ↗
14:	9.6 ↙
15:	9.1 ←
Serie	48.5
Total	0.0

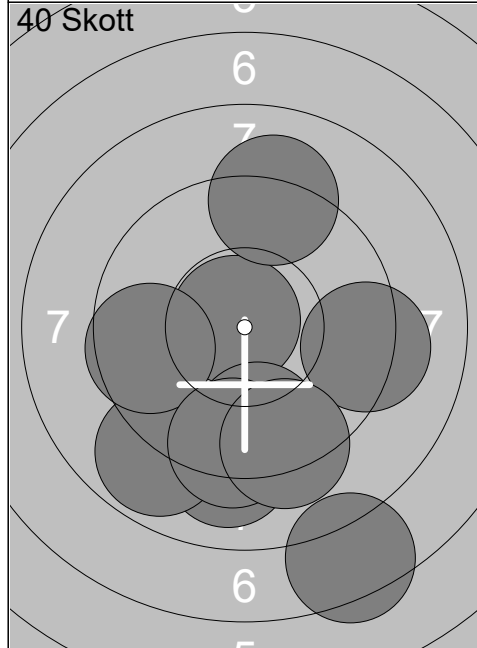

1:	9.3 →
2:	10.8x ↗
3:	9.1 ↓
4:	8.9 ↙
5:	9.6 ←
6:	9.1 ↑
7:	9.6 ↓
8:	7.4 ↙
9:	9.3 ↓
10:	9.2 ↓
Serie	92.3
Total	92.3

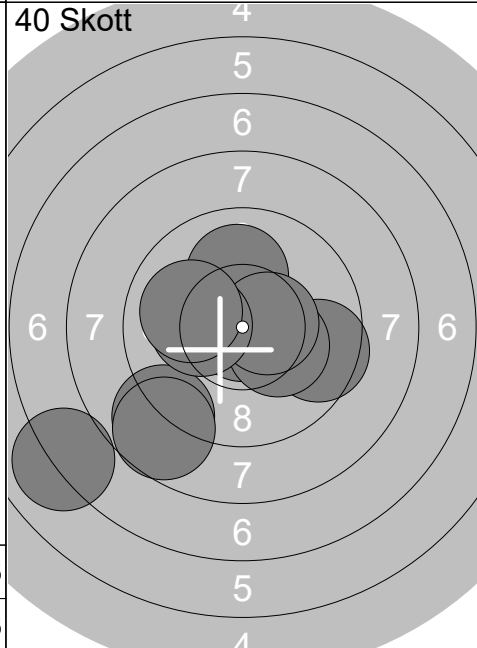

11:	7.0 ↙
12:	10.9x ↓
13:	10.0 ↑
14:	8.9 ↙
15:	9.6 →
16:	8.7 ↙
17:	10.3x →
18:	10.5x →
19:	10.2x ←
20:	10.0 ←
Serie	96.1
Total	188.4

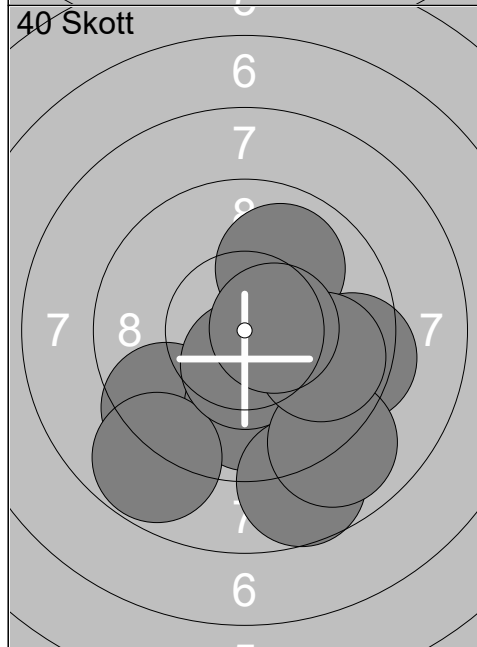

21:	9.4 ↙
22:	10.0 ↗
23:	9.9 ↓
24:	8.8 ↙
25:	10.5x ↓
26:	9.4 →
27:	8.7 ↙
28:	9.0 ↙
29:	9.8 →
30:	10.5x →
Serie	96.0
Total	284.4

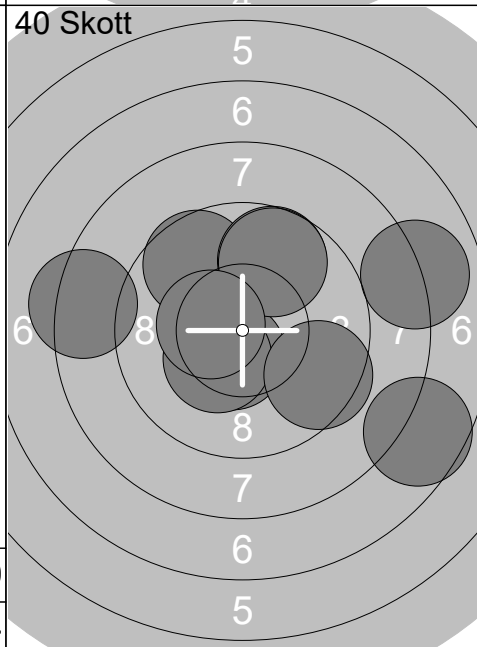

31:	10.5x ↓
32:	8.0 →
33:	9.6 ↗
34:	9.7 ↑
35:	9.7 ↑
36:	8.3 ←
37:	10.3x ↙
38:	10.4x ←
39:	7.6 ↘
40:	9.5 ↘
Serie	93.6
Total	378.0

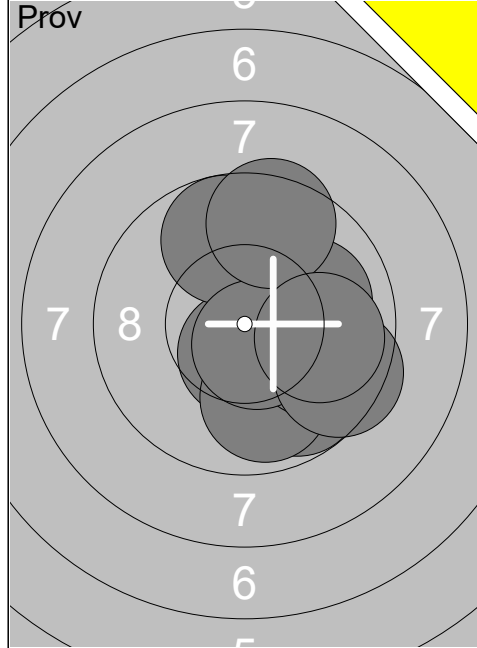

1:	10.0	→
2:	10.5x	↓
3:	9.8	↘
4:	9.9	↓
5:	9.9	→
6:	9.8	↑
7:	10.6x	↓
8:	9.5	↘
9:	9.5	↑
10:	9.9	→
Serie		99.4
Total		0.0

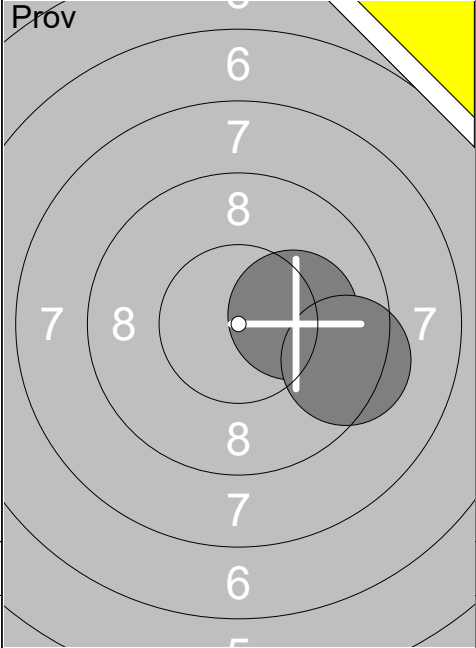

11:	10.2x	→
12:	9.4	→
Serie		19.6
Total		0.0

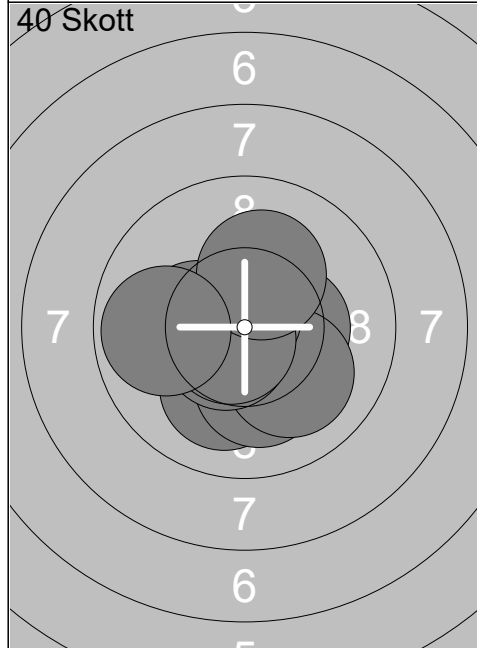

1:	10.1	↓
2:	10.4x	→
3:	10.2x	↓
4:	10.1	↘
5:	10.6x	↙
6:	10.7x	↗
7:	10.3x	←
8:	10.7x	↙
9:	10.2x	↑
10:	9.9	←
Serie		103.2
Total		103.2

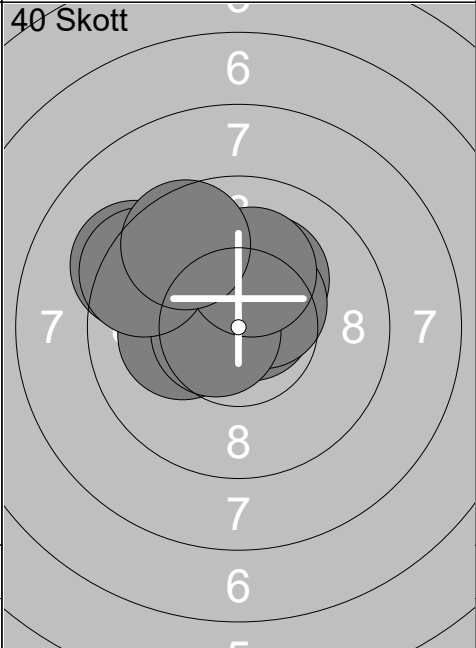

11:	10.7x	↗
12:	10.2x	↗
13:	10.7x	↑
14:	10.2x	←
15:	10.5x	↗
16:	9.3	↖
17:	10.6x	←
18:	10.2x	↑
19:	9.4	↖
20:	9.6	↗
Serie		101.4
Total		204.6

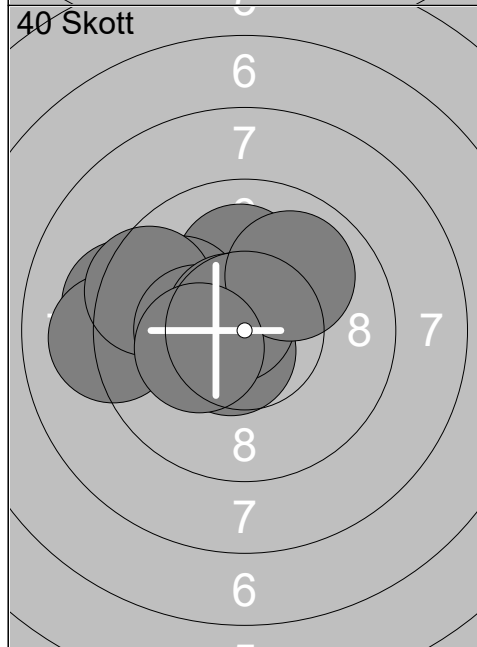

21:	10.1	↑
22:	9.3	←
23:	9.1	←
24:	10.0	↖
25:	9.5	↖
26:	10.6x	↙
27:	10.3x	←
28:	10.7x	↖
29:	10.0	↗
30:	10.3x	←
Serie		99.9
Total		304.5

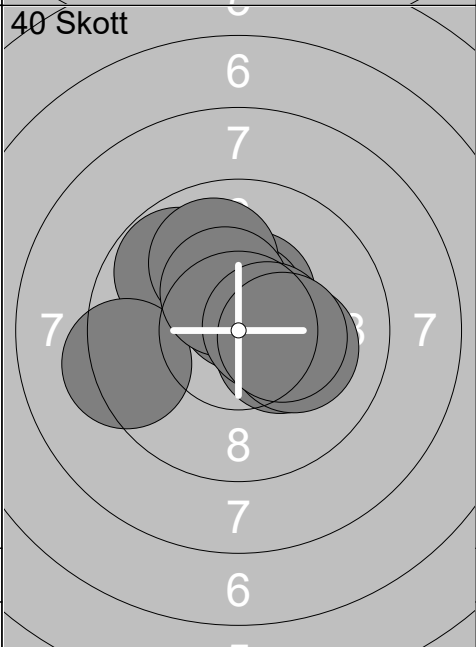

31:	9.8	↖
32:	9.3	←
33:	10.3x	→
34:	10.4x	↑
35:	10.1	→
36:	10.6x	↑
37:	10.0	↑
38:	10.4x	↗
39:	10.6x	→
40:	10.3x	→
Serie		101.8
Total		406.3

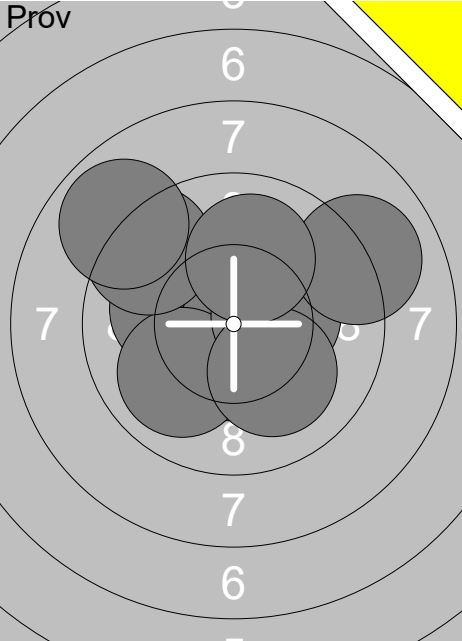
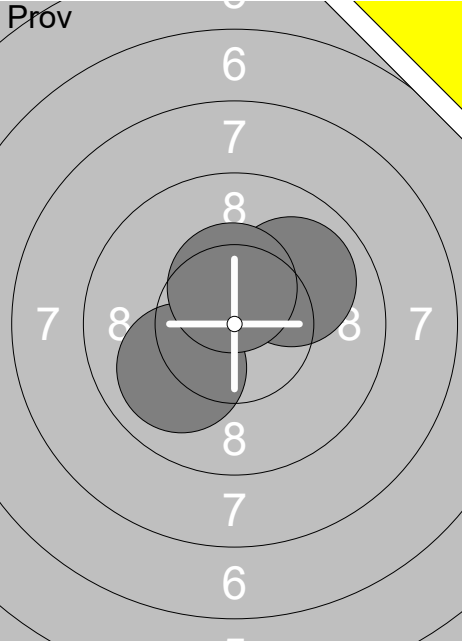
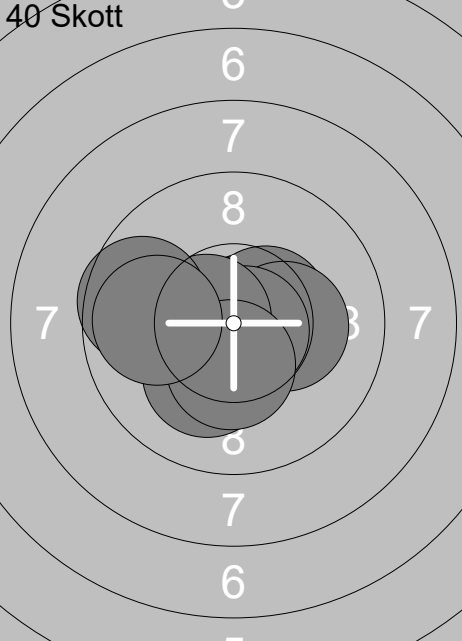
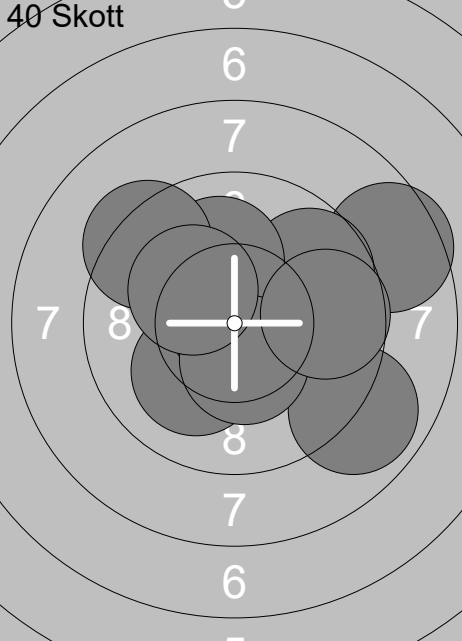
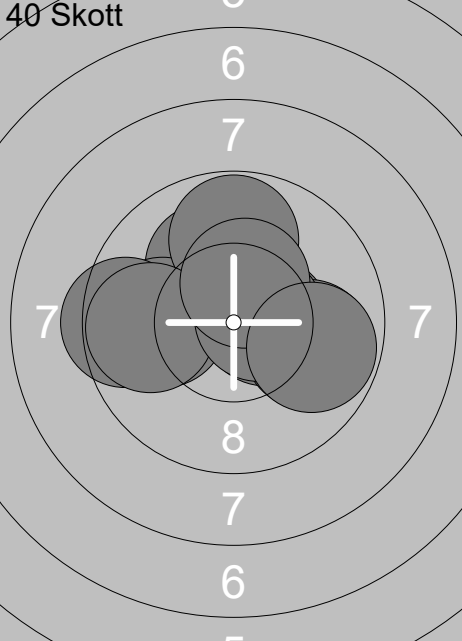
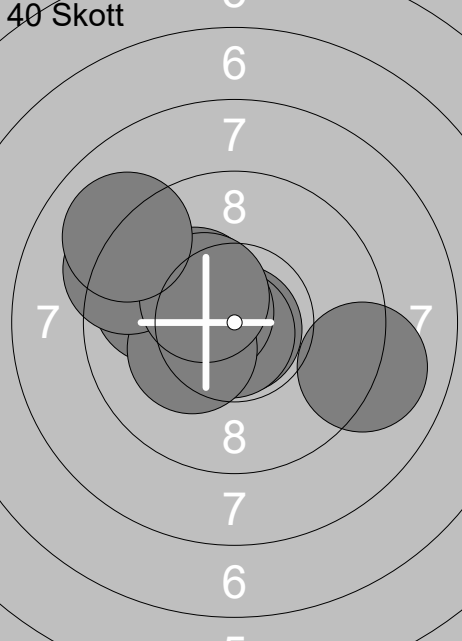
Skjutlag	Tavla	Nicolle Nygren		
3	1	Ramselefors	Umeå	
03.02.2018	Skyttiadens Regionsfinal 2018	13S	Vb	
03.02.2018	Skyttiadens Regionsfinal 2018	Ramselefors SKF		
Prov		1: 10.1 ← 2: 10.5x ↓ 3: 10.8x → 4: 10.0 ↙ 5: 9.4 ↖ 6: 10.3x → 7: 8.9 ↖ 8: 9.0 → 9: 10.1 ↓ 10: 10.0 ↑ Serie 99.1 Total 0.0		11: 10.0 ↗ 12: 10.0 ↙ 13: 10.4x ↑ Serie 30.4 Total 0.0
40 Skott		1: 10.7x → 2: 10.5x → 3: 10.2x ↓ 4: 10.3x → 5: 10.8x ↘ 6: 10.5x ← 7: 10.6x ← 8: 10.4x ↓ 9: 9.6 ← 10: 9.9 ← Serie 103.5 Total 103.5		11: 10.1 ↙ 12: 8.9 ↘ 13: 8.6 → 14: 10.9x ↖ 15: 9.7 → 16: 10.1 ↑ 17: 9.3 ↖ 18: 10.4x ↓ 19: 9.7 → 20: 10.2x ↖ Serie 97.9 Total 201.4
40 Skott		21: 10.5x → 22: 10.1 ↑ 23: 10.0 ← 24: 9.9 → 25: 9.4 ← 26: 9.8 ↑ 27: 9.8 ← 28: 10.6x → 29: 10.4x ↑ 30: 9.8 → Serie 100.3 Total 301.7		31: 10.9x ↓ 32: 9.1 → 33: 9.8 ← 34: 10.8x ↓ 35: 10.6x ← 36: 10.3x ↖ 37: 10.3x ← 38: 9.3 ↖ 39: 10.4x ↖ 40: 9.0 ↖ Serie 100.5 Total 402.2

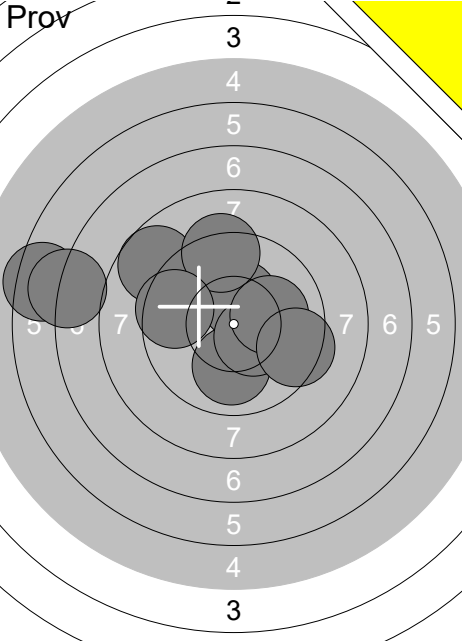
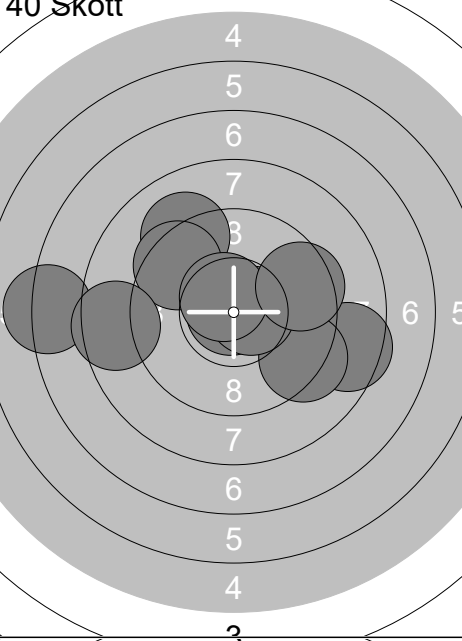
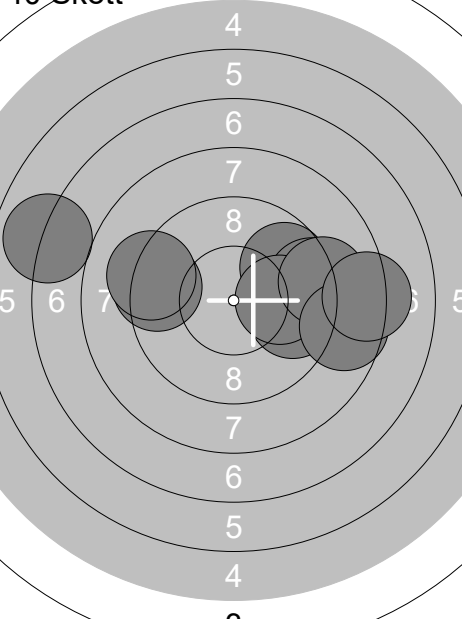
Skjuttlag	Tavla	Petter Asplund	
3	2	Ramselefors	Boden
03.02.2018		Skyttiadens Regionsfinal 2018	Ramselefors SKF
Prov		1: 6.4 ← 2: 8.7 ↖ 3: 10.0 ↓ 4: 10.4x ↑ 5: 9.3 ↑ 6: 9.6 ← 7: 10.4x ↘ 8: 10.1 → 9: 7.0 ← 10: 9.4 →	11: 10.0 ↑ 12: 9.0 → 13: 10.6x ↖
		Serie 91.3	Serie 29.6
		Total 0.0	Total 0.0
40 Skott		1: 9.1 ↖ 2: 7.2 ← 3: 10.9x ↖ 4: 8.5 → 5: 9.5 ↗ 6: 9.3 ↘ 7: 10.6x → 8: 10.6x ↗ 9: 8.5 ← 10: 9.5 →	11: 9.6 ↗ 12: 6.7 → 13: 7.3 → 14: 8.1 ← 15: 10.4x → 16: 9.9 ↗ 17: 10.2x → 18: 10.2x ← 19: 8.8 ↘ 20: 9.8 ←
		Serie 93.7	Serie 91.0
		Total 93.7	Total 184.7
40 Skott		21: 9.7 ↗ 22: 9.3 → 23: 9.7 → 24: 7.0 ← 25: 10.0 → 26: 9.4 ← 27: 9.2 ← 28: 9.1 → 29: 8.6 → 30: 8.2 →	31: 9.5 ↖ 32: 8.0 ↘ 33: 9.3 ↓ 34: 10.8x ↗ 35: 10.2x ← 36: 8.5 ↓ 37: 10.2x ↗ 38: 9.8 → 39: 8.4 ↘ 40: 10.4x ↘
		Serie 90.2	Serie 95.1
		Total 274.9	Total 370.0

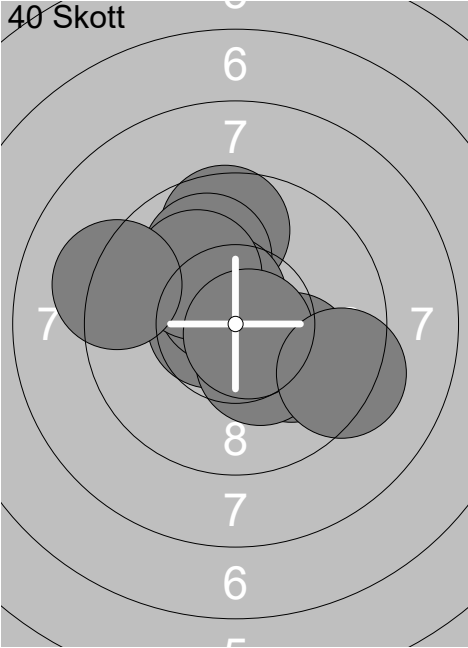
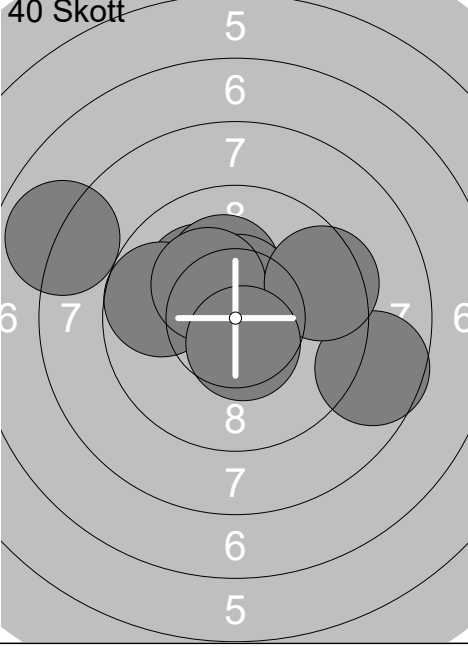
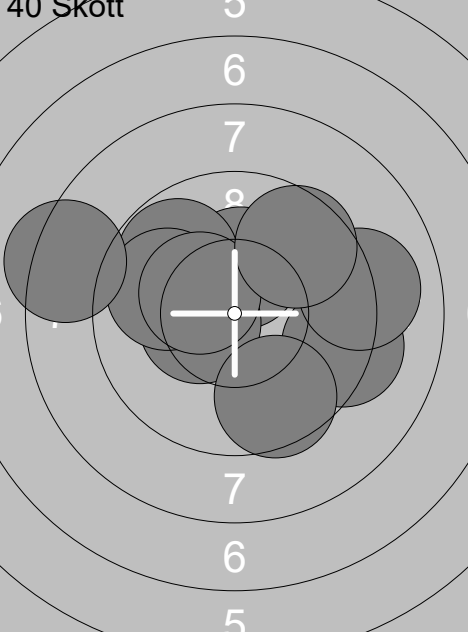

Skjutlag	Tavla	Helena Dreyer Perkiömäki		
3	3	Ramselefors	Umeå	13S Vb
03.02.2018		Skyttiadens Regionsfinal 2018	Ramselefors SKF	
	1: 10.8x ↙		1: 10.1 ↘	
	2: 10.1 ↑		2: 10.6x ←	
	3: 9.4 →		3: 9.6 ↑	
	4: 10.6x →		4: 10.0 ↑	
	5: 10.2x ↘		5: 10.3x ↘	
	6: 10.0 ↑		6: 10.6x ↗	
	7: 10.0 ↘		7: 10.1 ↗	
			8: 9.2 ←	
			9: 10.7x ↘	
			10: 9.3 ↘	
	Serie 71.1		Serie 100.5	
	Total 0.0		Total 100.5	
	11: 10.4x →		21: 8.7 ↘	
	12: 9.8 ↗		22: 10.1 ↗	
	13: 8.5 →		23: 10.2x ↑	
	14: 8.6 →		24: 10.8x ↗	
	15: 7.4 →		25: 9.7 ←	
	16: 10.6x ←		26: 10.5x ↑	
	17: 8.0 ←		27: 10.3x ↖	
	18: 10.0 ↗		28: 7.9 ←	
	19: 10.1 ←		29: 9.5 →	
	20: 9.8 ↗		30: 10.5x ↘	
	Serie 93.2		Serie 98.2	
	Total 193.7		Total 291.9	
	31: 10.3x ↑			
	32: 10.4x ←			
	33: 9.3 →			
	34: 9.6 ↘			
	35: 9.8 ↗			
	36: 9.9 ←			
	37: 8.3 ←			
	38: 9.1 →			
	39: 10.4x ↖			
	40: 9.6 ↗			
	Serie 96.7			
	Total 388.6			

Skjutlag <b>3</b>	Tavla <b>4</b>	<b>Jennifer Gustafsson</b>	
Ramselefors	Ramselefors	13S	Vb
03.02.2018	Skyttiadens Regionsfinal 2018	Ramselefors SKF	
Prov		1: 9.8 ↑ 2: 7.8 ↗ 3: 7.0 ↗ 4: 8.2 ↑ 5: 7.3 → 6: 9.4 ↑ 7: 8.1 → 8: 7.7 → 9: 9.7 ↑ 10: 8.7 ↗	11: 9.2 → 12: 9.1 ↗ 13: 7.8 → 14: 7.8 ↖ 15: 7.1 ↖ 16: 8.2 ↗ 17: 8.7 ↖ 18: 10.1 ↑ 19: 7.3 → 20: 10.0 ↑
	Serie 83.7 Total 0.0	Serie 85.3 Total 0.0	
Prov		40 Skott	1: 10.3x → 2: 9.3 → 3: 10.5x → 4: 8.8 ↗ 5: 7.5 ← 6: 9.5 ↖ 7: 10.7x ↑ 8: 10.4x ↖ 9: 9.7 ↗ 10: 10.0 ↖
	Serie 10.1 Total 0.0	Serie 96.7 Total 96.7	
40 Skott		40 Skott	21: 10.0 ← 22: 7.1 ↖ 23: 9.4 ↓ 24: 10.2x ↗ 25: 6.1 ← 26: 9.9 → 27: 9.1 ↖ 28: 10.6x → 29: 8.8 → 30: 10.4x →
	Serie 92.5 Total 189.2	Serie 91.6 Total 280.8	
40 Skott			
	31: 8.3 ↑ 32: 9.3 → 33: 9.7 ↑ 34: 10.1 → 35: 9.1 ↗ 36: 10.0 ↑ 37: 10.4x ↑ 38: 10.3x → 39: 9.4 → 40: 9.2 →		
	Serie 95.8 Total 376.6		

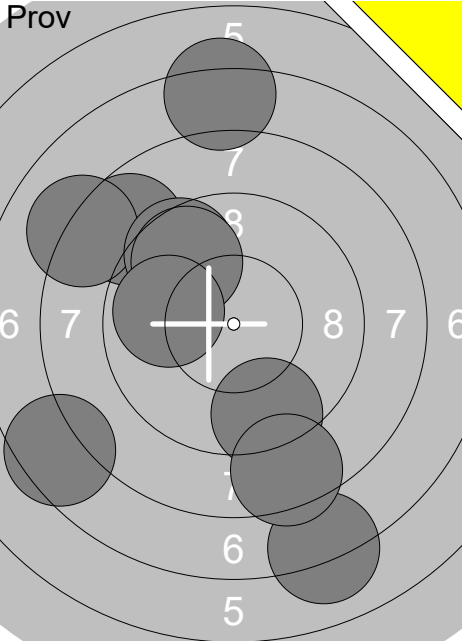
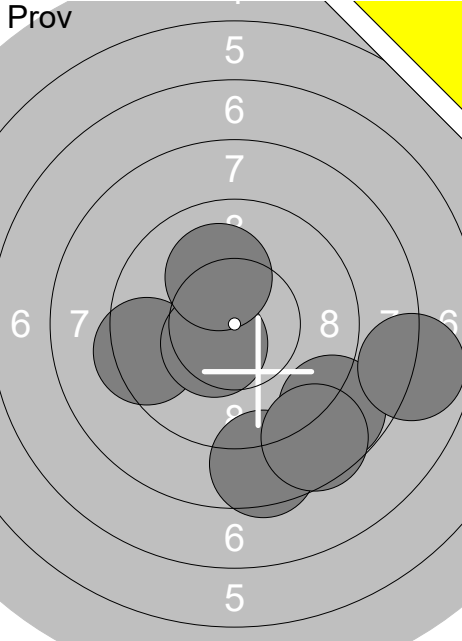
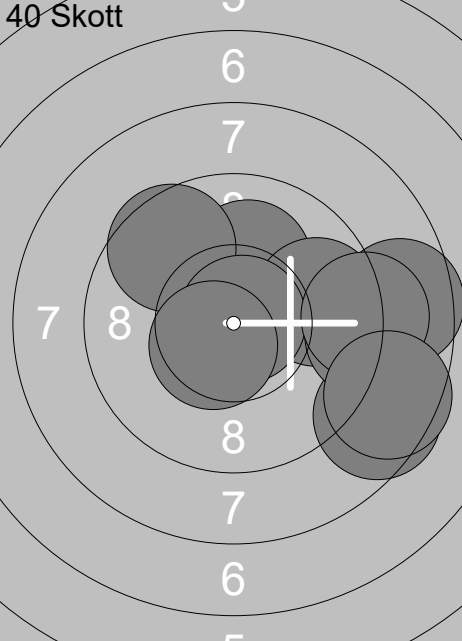
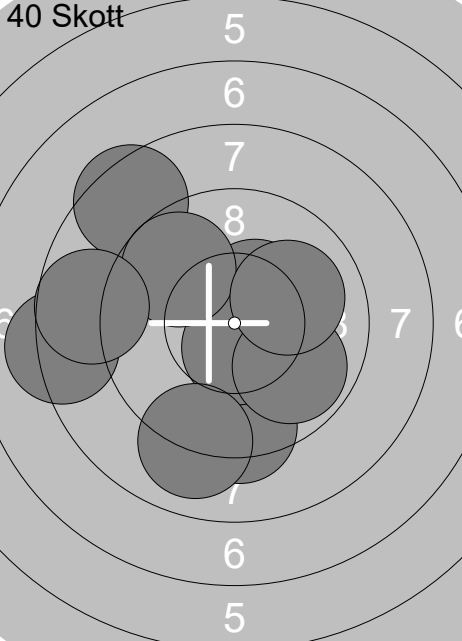
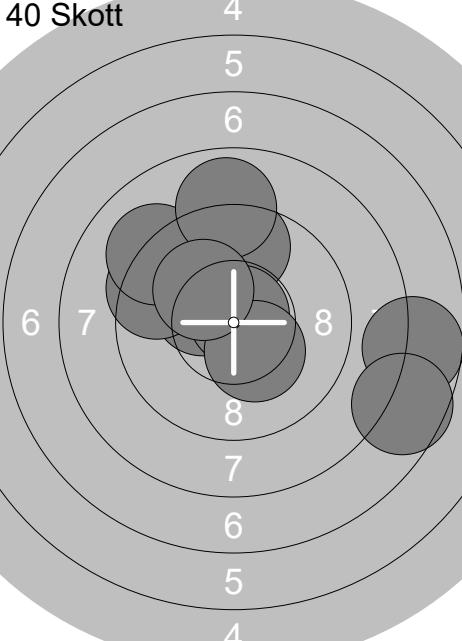
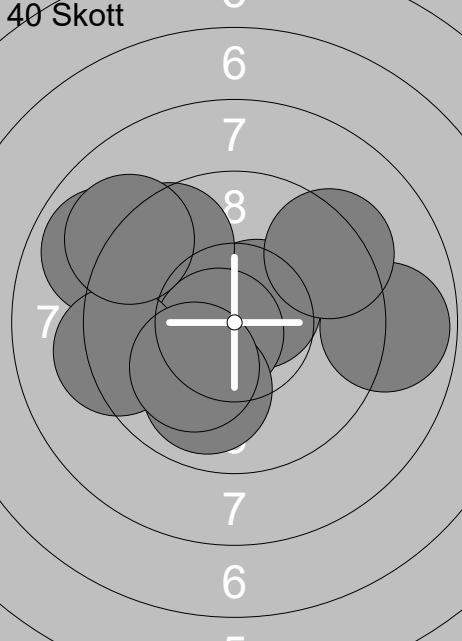
Skjutlag	Tavla	Hanna Augustsson		
3	5	Ramselefors	Vännäs	13S Vb
03.02.2018	Skyttiadens Regionsfinal 2018	Ramselefors SKF		
	1: 7.3 ↑		11: 9.4 ←	
	2: 8.7 ↗		12: 8.6 ↓	
	3: 8.1 ↗		13: 10.5x ↙	
	4: 9.5 ↗		14: 8.8 ↘	
	5: 9.7 ↗		15: 8.6 ↓	
	6: 9.4 ↓		16: 7.9 →	
	7: 7.1 ↓		17: 10.1 ↑	
	8: 9.9 ←			
	9: 8.5 ↓			
	10: 7.5 ↙			
Serie	85.7	Serie	63.9	
Total	0.0	Total	0.0	
	1: 10.1 ↑		11: 8.5 ↖	
	2: 9.6 ↗		12: 9.3 ↓	
	3: 8.6 ↘		13: 10.4x ↗	
	4: 9.7 →		14: 10.6x ↓	
	5: 9.0 →		15: 8.2 ←	
	6: 10.8x →		16: 9.0 ↓	
	7: 8.6 →		17: 9.7 ↗	
	8: 9.1 →		18: 9.9 ↘	
	9: 10.5x ↙		19: 10.0 ↗	
	10: 8.6 ↘		20: 8.7 ←	
Serie	94.6	Serie	94.3	
Total	94.6	Total	188.9	
	21: 9.6 ↑		31: 8.9 ←	
	22: 7.7 →		32: 10.6x ↗	
	23: 7.6 ↘		33: 9.6 ↖	
	24: 10.3x ↖		34: 10.7x ↙	
	25: 9.5 ←		35: 9.9 ↓	
	26: 10.8x ↗		36: 9.3 ←	
	27: 10.3x ↓		37: 9.1 ↖	
	28: 9.1 ↗		38: 8.9 →	
	29: 8.9 ↑		39: 9.3 ↗	
	30: 10.2x ↖		40: 10.1 ↙	
Serie	94.0	Serie	96.4	
Total	282.9	Total	379.3	

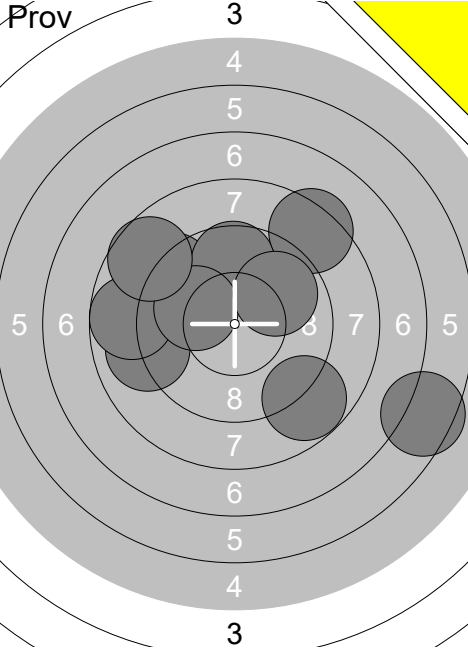
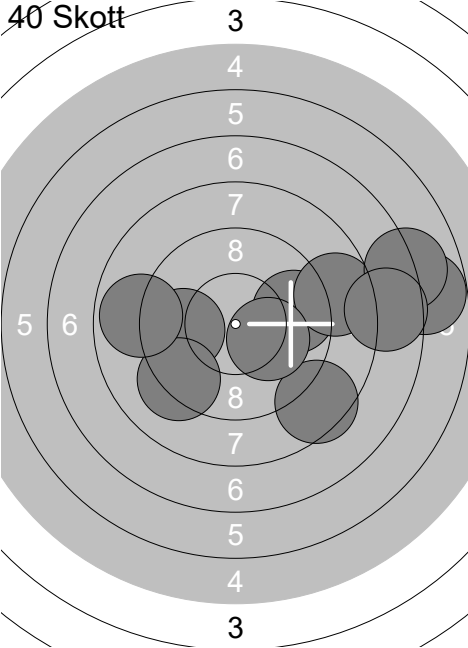
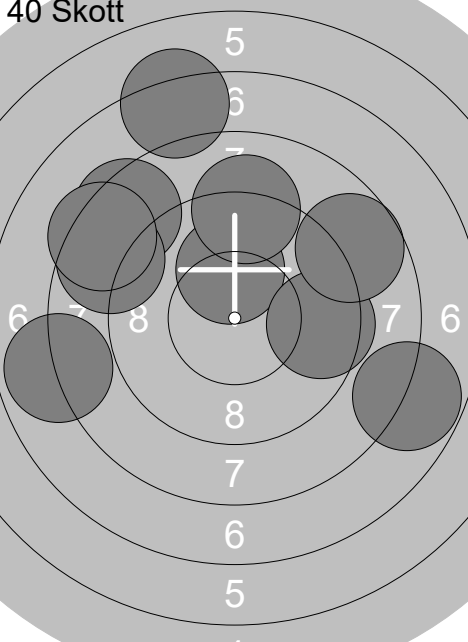
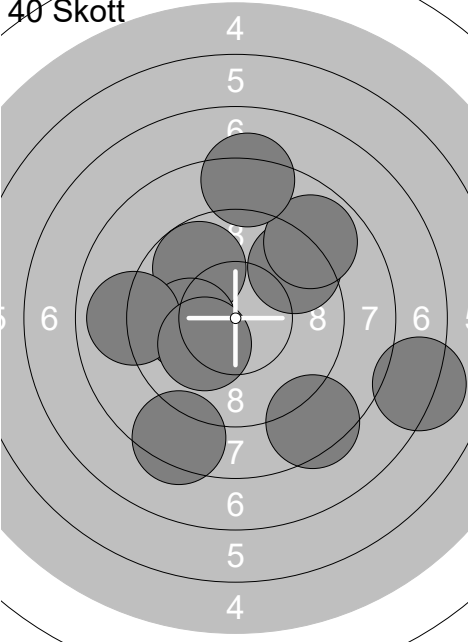
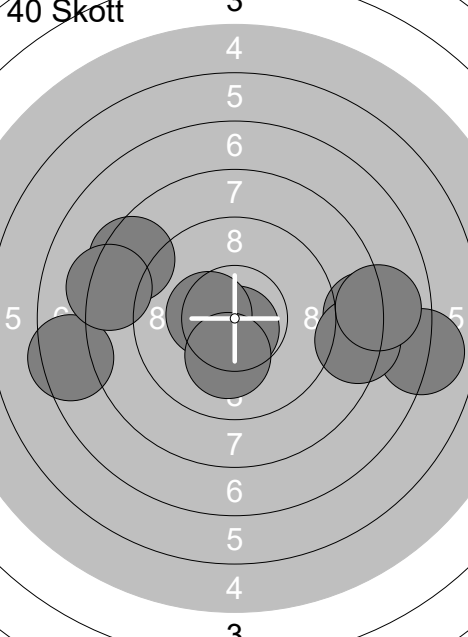
Skjutlag <b>3</b>	Tavla <b>6</b>	<b>Joel Bergqvist</b>	
Ramselefors	Umeå	13S	Vb
03.02.2018	Skyttiadens Regionsfinal 2018	Ramselefors SKF	
Prov		40 Skott	
	1: 8.8 ↘ 2: 9.2 ↖ 3: 9.0 ← 4: 9.7 ↑ 5: 8.4 ↗ 6: 8.8 ← 7: 10.1 ← 8: 6.5 ↘ 9: 8.7 ↖ 10: 9.9 ↗		1: 6.8 → 2: 9.7 → 3: 8.5 ↘ 4: 9.8 ← 5: 8.7 → 6: 9.2 ↘ 7: 10.2x → 8: 7.1 → 9: 8.9 ← 10: 7.7 →
	Serie 89.1		Serie 86.6
	Total 0.0		Total 86.6
40 Skott		40 Skott	
	11: 8.4 ↖ 12: 10.1 ↑ 13: 8.7 ← 14: 7.8 ↘ 15: 8.4 ↖ 16: 9.5 → 17: 8.7 ↗ 18: 7.9 ← 19: 9.1 ↑ 20: 7.2 ↑		21: 9.4 ↗ 22: 8.9 ↗ 23: 9.8 ↖ 24: 8.5 ↘ 25: 10.1 ← 26: 7.2 → 27: 8.3 ↑ 28: 8.4 ↘ 29: 9.0 ← 30: 10.2x ↘
	Serie 85.8		Serie 89.8
	Total 172.4		Total 262.2
40 Skott			
	31: 7.0 → 32: 8.5 ↖ 33: 10.7x ↓ 34: 8.2 → 35: 8.3 → 36: 10.4x ← 37: 7.5 ← 38: 8.0 → 39: 8.3 ← 40: 10.2x ↓		
	Serie 87.1		
	Total 349.3		

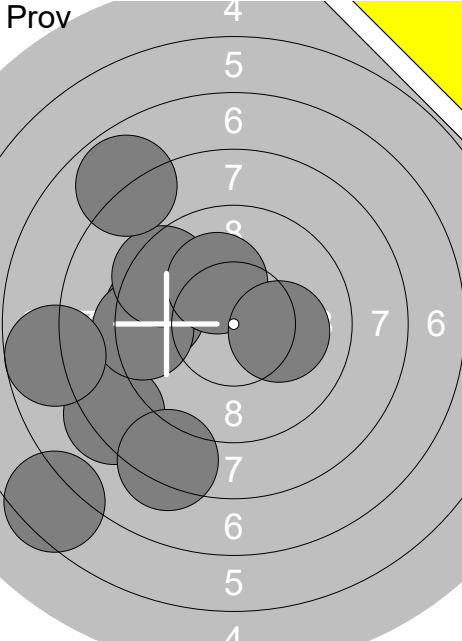
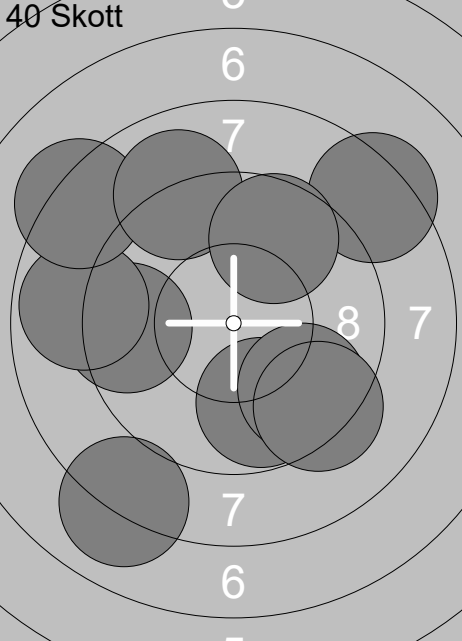
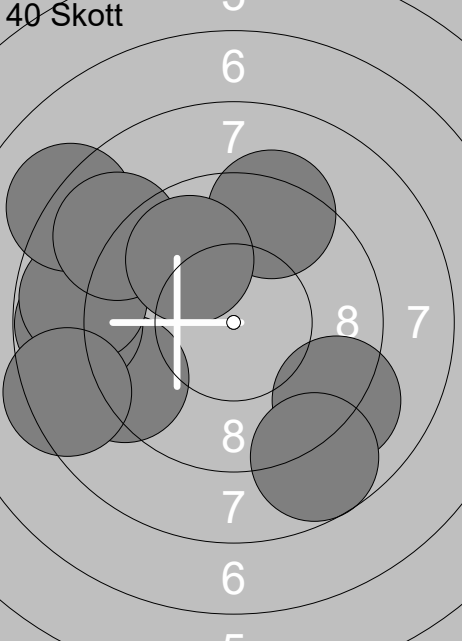
Skjutlag	Tavla	Nadja Kurkkio	
3	7	Ramselefors	Gällivare
03.02.2018		Skyttiadens Regionsfinal 2018	Ramselefors SKF
Prov		1: 8.3 ↙ 2: 9.5 ← 3: 6.5 ↘ 4: 9.3 ← 5: 9.4 ↗ 6: 7.9 ↗ 7: 7.7 ← 8: 10.2x ↗ 9: 8.3 ↘ 10: 10.1 →	11: 10.4x →
		Serie 87.2	Serie 10.4
		Total 0.0	Total 0.0
40 Skott		1: 9.8 ↘ 2: 9.5 ← 3: 9.6 ↘ 4: 9.3 ↘ 5: 8.0 ↘ 6: 8.3 ↗ 7: 8.9 ← 8: 8.2 ↗ 9: 9.0 ↗ 10: 9.7 ↗	11: 10.8x ↓ 12: 8.4 ← 13: 9.2 ↘ 14: 7.1 ← 15: 7.7 ↗ 16: 6.8 ← 17: 9.4 ← 18: 9.1 ← 19: 8.7 ↗ 20: 9.9 ↘
		Serie 90.3	Serie 87.1
		Total 90.3	Total 177.4
40 Skott		21: 9.2 ↙ 22: 8.8 ← 23: 8.8 ← 24: 9.1 ↘ 25: 8.1 ↗ 26: 8.9 ↗ 27: 8.4 ← 28: 8.7 ↘ 29: 9.3 ↗ 30: 9.9 ↗	31: 7.7 ↘ 32: 9.5 ← 33: 8.7 → 34: 8.4 ↘ 35: 9.0 ↘ 36: 9.8 ↘ 37: 10.1 ↘ 38: 10.3x → 39: 9.6 ↗ 40: 8.6 ↘
		Serie 89.2	Serie 91.7
		Total 266.6	Total 358.3

Skjutlag	Tavla	William Wallin	
3	8	Ramselefors	Aspås
03.02.2018		Skyttiadens Regionsfinal 2018	Ramselefors SKF
Prov		1: 10.0 ↓ 2: 9.1 ↓ 3: 9.2 ↓ 4: 9.1 ↓ 5: 10.8x ↖ 6: 7.4 ↓ 7: 9.7 → 8: 9.2 ↓ 9: 9.8 ↓ 10: 7.5 ←	11: 9.8 ↓ 12: 9.6 → 13: 10.0 ← 14: 8.8 → 15: 10.2x ↓ 16: 8.6 → 17: 9.8 ↖ 18: 9.6 ← 19: 10.1 ↘ 20: 8.2 →
		Serie 91.8	Serie 94.7
		Total 0.0	Total 0.0
40 Skott		1: 8.7 ↖ 2: 9.0 ← 3: 9.0 → 4: 10.5x ↖ 5: 10.6x → 6: 8.9 ↖ 7: 10.5x ↗ 8: 10.0 ← 9: 10.3x ← 10: 8.3 ←	11: 7.8 ↖ 12: 7.8 ↖ 13: 8.4 ← 14: 9.9 ↖ 15: 3.7 ↓ 16: 10.4x ↖ 17: 10.0 → 18: 9.2 ↖ 19: 8.3 ↗ 20: 9.8 ↓
		Serie 95.8	Serie 85.3
		Total 95.8	Total 181.1
40 Skott		21: 8.7 → 22: 7.3 ↗ 23: 9.5 ↓ 24: 10.1 ↗ 25: 9.1 ↗ 26: 10.0 ↗ 27: 9.7 ↓ 28: 8.4 ↖ 29: 7.7 ↖ 30: 10.3x →	31: 9.8 ↗ 32: 8.1 → 33: 8.6 ↖ 34: 10.1 ↓ 35: 10.1 ← 36: 6.9 ↖ 37: 9.6 ↖ 38: 10.1 → 39: 9.8 ↓ 40: 8.9 →
		Serie 90.8	Serie 92.0
		Total 271.9	Total 363.9

Skjuttag	Tavla	Einar Kurkkio	
3	9	Ramselefors	Gällivare
03.02.2018		Skyttiadens Regionsfinal 2018	Ramselefors SKF
Prov		1: 2.7 ← 2: 9.8 → 3: 9.7 ↗ 4: 10.1 ↗ 5: 10.3x ↓ 6: 7.6 ← 7: 8.8 ← 8: 7.2 ← 9: 10.2x ↖ 10: 7.2 ← Serie 83.6 Total 0.0	11: 5.3 → 12: 10.0 → 13: 10.3x ↑ 14: 9.0 ← 15: 8.4 ← 16: 8.9 → 17: 9.9 ↑ 18: 10.0 ← 19: 8.4 ← 20: 7.3 ← Serie 87.4 Total 162.0
40 Skott		1: 9.0 ← 2: 5.1 ↓ 3: 9.8 ↓ 4: 8.0 ← 5: 7.6 ← 6: 5.4 → 7: 9.0 ↗ 8: 7.1 ← 9: 7.3 ↓ 10: 6.3 ← Serie 74.6 Total 74.6	11: 5.2 → 12: 10.0 → 13: 10.3x ↑ 14: 9.0 ← 15: 8.4 ← 16: 8.9 → 17: 9.9 ↑ 18: 10.0 ← 19: 8.4 ← 20: 7.3 ← Serie 87.4 Total 162.0
40 Skott		21: 6.5 ← 22: 10.6x ↓ 23: 9.7 → 24: 10.5x → 25: 8.5 ← 26: 8.2 ← 27: 9.4 ← 28: 7.6 ← 29: 7.5 ↑ 30: 10.6x ↓ Serie 89.1 Total 251.1	31: 8.4 ↙ 32: 10.0 ↗ 33: 7.8 ↙ 34: 8.1 ↓ 35: 7.9 ← 36: 8.3 ← 37: 9.2 → 38: 9.5 ↑ 39: 8.1 ← 40: 6.8 ↘ Serie 84.1 Total 335.2

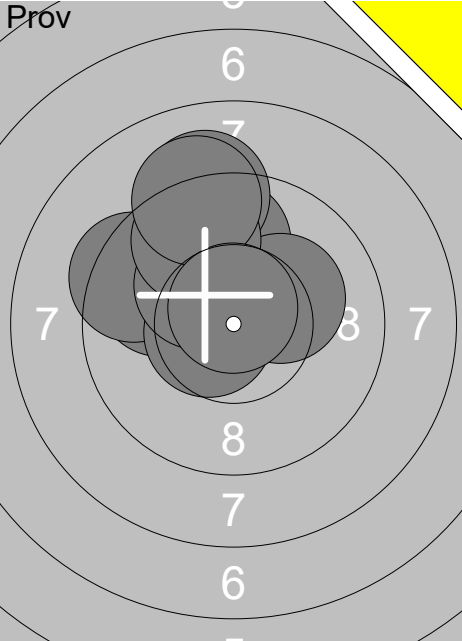
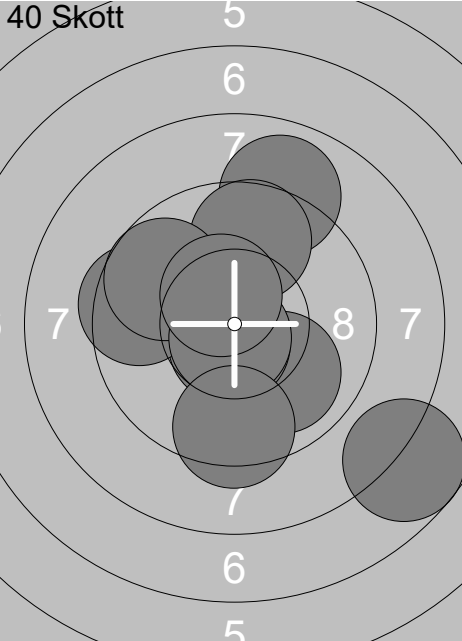
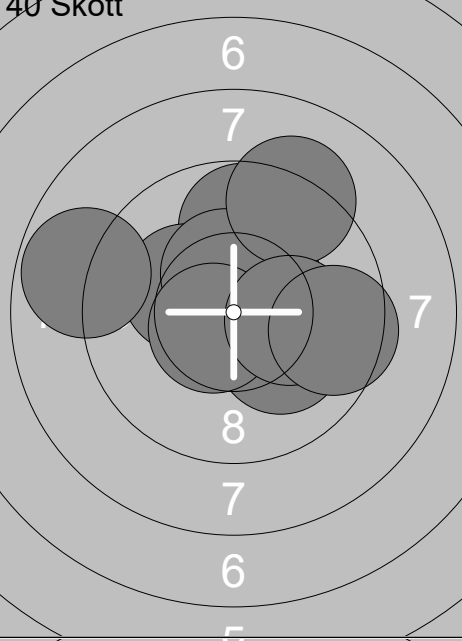
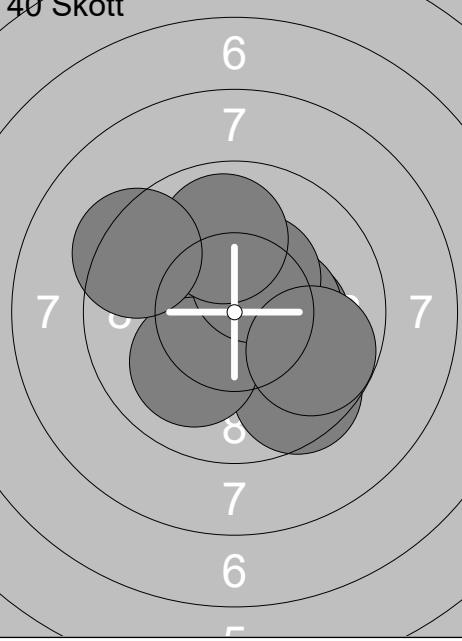
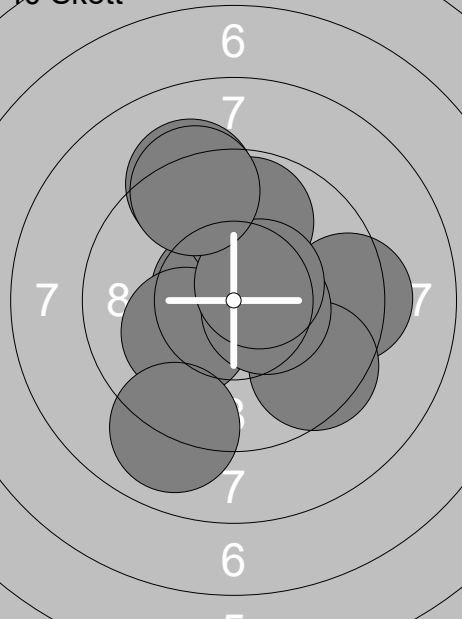
Skjuttag	Tavla	Carl Bergling		
3	11	Ramselefors	Umeå	15S Vb
03.02.2018		Skyttiadens Regionsfinal 2018	Ramselefors SKF	
	1: 9.8 ↙		1: 9.0 ↗	
	2: 9.4 ↙		2: 10.0 ↘	
	3: 10.6x↙		3: 10.7x↘	
	4: 9.8 ↑		4: 7.7 ↘	
	5: 9.1 ↑		5: 9.5 ↙	
	6: 10.2x↖		6: 9.7 ↑	
	7: 10.2x↗		7: 9.7 ↙	
	8: 9.7 ↗		8: 10.7x↘	
	9: 9.2 ↑		9: 10.5x↖	
	10: 10.7x↑		10: 9.4 ↓	
	Serie 98.7		Serie 96.9	
	Total 0.0		Total 96.9	
	11: 9.8 ↑		21: 9.6 ↘	
	12: 10.5x↗		22: 10.5x↗	
	13: 10.2x↙		23: 10.2x→	
	14: 8.8 ↙		24: 10.7x↙	
	15: 10.1 ↘		25: 10.3x→	
	16: 10.4x↑		26: 10.1 ↘	
	17: 9.2 ↗		27: 10.4x↗	
	18: 10.6x↙		28: 9.9 ↑	
	19: 10.2x→		29: 9.4 ↙	
	20: 9.5 →		30: 9.8 ↘	
	Serie 99.3		Serie 100.9	
	Total 196.2		Total 297.1	
	31: 10.7x↙			
	32: 10.1 ↙			
	33: 9.0 ↘			
	34: 9.4 →			
	35: 9.5 ↘			
	36: 10.5x→			
	37: 9.2 ↑			
	38: 9.8 ↑			
	39: 10.5x↗			
	40: 9.3 ↑			
	Serie 98.0			
	Total 395.1			

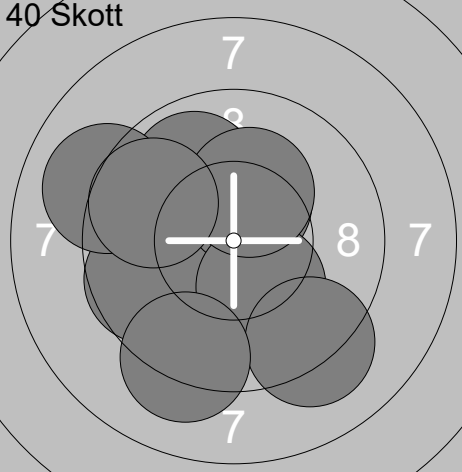
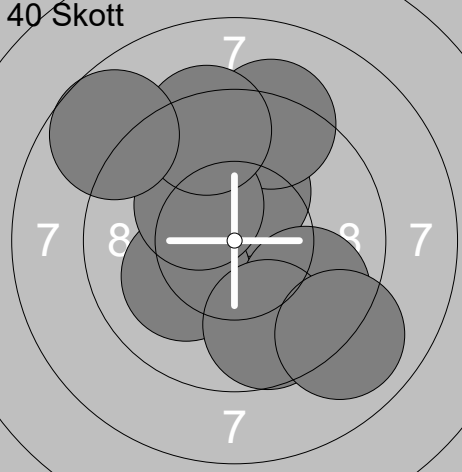

Skjutlag	Tavla	Erika Bergqvist		
3	12	Umeå	15S	Vb
03.02.2018	Skyttiadens Regionsfinal 2018	Ramselefors SKF		
Prov 	1: 10.2x ↘	Prov 	11: 9.5 ↘	
	2: 9.1 ←		12: 10.2x ↘	
	3: 10.2x ↙			
	4: 10.6x ↙			
	5: 10.2x ↙			
	6: 10.1 ↗			
	7: 10.1 ↖			
	8: 9.2 ←			
	9: 9.8 ↗			
	10: 9.3 ←			
	Serie 98.8		Serie 19.7	
	Total 0.0		Total 0.0	
40 Skott 	1: 9.2 ←	40 Skott 	11: 10.3x ↙	
	2: 9.2 ↘		12: 9.8 →	
	3: 10.5x →		13: 10.3x ↙	
	4: 10.7x →		14: 10.7x ↘	
	5: 9.3 ↘		15: 9.2 ↘	
	6: 10.7x ↙		16: 10.2x ↗	
	7: 10.0 ↗		17: 9.5 ↘	
	8: 10.3x →		18: 9.7 ↘	
	9: 9.1 ↗		19: 10.6x ↗	
	10: 8.6 →		20: 9.7 ↘	
	Serie 97.6		Serie 100.0	
	Total 97.6		Total 197.6	
40 Skott 	21: 10.1 ↘	40 Skott 	31: 9.7 ↘	
	22: 10.1 →		32: 9.1 →	
	23: 9.9 ←		33: 9.4 ↘	
	24: 10.0 ↘		34: 9.9 ↘	
	25: 10.3x ↙		35: 9.0 ←	
	26: 9.6 ↘		36: 10.3x →	
	27: 10.6x ↙		37: 10.4x ↑	
	28: 10.1 ←		38: 10.4x ↗	
	29: 10.1 ↘		39: 10.3x ↘	
	30: 7.6 →		40: 8.7 ↘	
	Serie 98.4		Serie 97.2	
	Total 296.0		Total 393.2	

 <p>Prov</p>	<table border="1" style="width:100%; border-collapse: collapse;"> <tr><td>1:</td><td>10.3x</td><td>↖</td></tr> <tr><td>2:</td><td>10.0</td><td>↑</td></tr> <tr><td>3:</td><td>10.4x</td><td>↖</td></tr> <tr><td>4:</td><td>10.0</td><td>↖</td></tr> <tr><td>5:</td><td>8.8</td><td>→</td></tr> <tr><td>6:</td><td>8.3</td><td>↖</td></tr> <tr><td>7:</td><td>9.2</td><td>↖</td></tr> <tr><td>8:</td><td>9.2</td><td>↖</td></tr> <tr><td>9:</td><td>8.1</td><td>→</td></tr> <tr><td>10:</td><td>10.3x</td><td>↑</td></tr> <tr><td colspan="2">Serie</td><td>94.6</td></tr> <tr><td colspan="2">Total</td><td>0.0</td></tr> </table>	1:	10.3x	↖	2:	10.0	↑	3:	10.4x	↖	4:	10.0	↖	5:	8.8	→	6:	8.3	↖	7:	9.2	↖	8:	9.2	↖	9:	8.1	→	10:	10.3x	↑	Serie		94.6	Total		0.0	 <p>Prov</p>	<table border="1" style="width:100%; border-collapse: collapse;"> <tr><td>11:</td><td>10.4x</td><td>↖</td></tr> <tr><td>12:</td><td>8.4</td><td>↘</td></tr> <tr><td>13:</td><td>9.9</td><td>↖</td></tr> <tr><td>14:</td><td>6.3</td><td>↘</td></tr> <tr><td>15:</td><td>8.2</td><td>↖</td></tr> <tr><td>16:</td><td>9.2</td><td>↖</td></tr> <tr><td>17:</td><td>10.1</td><td>↖</td></tr> <tr><td>18:</td><td>9.7</td><td>↘</td></tr> <tr><td>19:</td><td>9.6</td><td>↘</td></tr> <tr><td>20:</td><td>9.4</td><td>↘</td></tr> <tr><td colspan="2">Serie</td><td>91.2</td></tr> <tr><td colspan="2">Total</td><td>0.0</td></tr> </table>	11:	10.4x	↖	12:	8.4	↘	13:	9.9	↖	14:	6.3	↘	15:	8.2	↖	16:	9.2	↖	17:	10.1	↖	18:	9.7	↘	19:	9.6	↘	20:	9.4	↘	Serie		91.2	Total		0.0
1:	10.3x	↖																																																																									
2:	10.0	↑																																																																									
3:	10.4x	↖																																																																									
4:	10.0	↖																																																																									
5:	8.8	→																																																																									
6:	8.3	↖																																																																									
7:	9.2	↖																																																																									
8:	9.2	↖																																																																									
9:	8.1	→																																																																									
10:	10.3x	↑																																																																									
Serie		94.6																																																																									
Total		0.0																																																																									
11:	10.4x	↖																																																																									
12:	8.4	↘																																																																									
13:	9.9	↖																																																																									
14:	6.3	↘																																																																									
15:	8.2	↖																																																																									
16:	9.2	↖																																																																									
17:	10.1	↖																																																																									
18:	9.7	↘																																																																									
19:	9.6	↘																																																																									
20:	9.4	↘																																																																									
Serie		91.2																																																																									
Total		0.0																																																																									
 <p>Prov</p>	<table border="1" style="width:100%; border-collapse: collapse;"> <tr><td>21:</td><td>9.5</td><td>→</td></tr> <tr><td>22:</td><td>8.6</td><td>↘</td></tr> <tr><td>23:</td><td>10.2x</td><td>↘</td></tr> <tr><td>24:</td><td>10.4x</td><td>↘</td></tr> <tr><td>25:</td><td>10.4x</td><td>→</td></tr> <tr><td colspan="2">Serie</td><td>49.1</td></tr> <tr><td colspan="2">Total</td><td>0.0</td></tr> </table>	21:	9.5	→	22:	8.6	↘	23:	10.2x	↘	24:	10.4x	↘	25:	10.4x	→	Serie		49.1	Total		0.0	 <p>40 Skott</p>	<table border="1" style="width:100%; border-collapse: collapse;"> <tr><td>1:</td><td>9.0</td><td>↘</td></tr> <tr><td>2:</td><td>9.0</td><td>↖</td></tr> <tr><td>3:</td><td>10.4x</td><td>←</td></tr> <tr><td>4:</td><td>10.4x</td><td>↑</td></tr> <tr><td>5:</td><td>10.0</td><td>↖</td></tr> <tr><td>6:</td><td>10.3x</td><td>↖</td></tr> <tr><td>7:</td><td>8.2</td><td>←</td></tr> <tr><td>8:</td><td>9.7</td><td>↖</td></tr> <tr><td>9:</td><td>9.0</td><td>↖</td></tr> <tr><td>10:</td><td>9.7</td><td>←</td></tr> <tr><td colspan="2">Serie</td><td>95.7</td></tr> <tr><td colspan="2">Total</td><td>95.7</td></tr> </table>	1:	9.0	↘	2:	9.0	↖	3:	10.4x	←	4:	10.4x	↑	5:	10.0	↖	6:	10.3x	↖	7:	8.2	←	8:	9.7	↖	9:	9.0	↖	10:	9.7	←	Serie		95.7	Total		95.7															
21:	9.5	→																																																																									
22:	8.6	↘																																																																									
23:	10.2x	↘																																																																									
24:	10.4x	↘																																																																									
25:	10.4x	→																																																																									
Serie		49.1																																																																									
Total		0.0																																																																									
1:	9.0	↘																																																																									
2:	9.0	↖																																																																									
3:	10.4x	←																																																																									
4:	10.4x	↑																																																																									
5:	10.0	↖																																																																									
6:	10.3x	↖																																																																									
7:	8.2	←																																																																									
8:	9.7	↖																																																																									
9:	9.0	↖																																																																									
10:	9.7	←																																																																									
Serie		95.7																																																																									
Total		95.7																																																																									
 <p>40 Skott</p>	<table border="1" style="width:100%; border-collapse: collapse;"> <tr><td>11:</td><td>10.3x</td><td>←</td></tr> <tr><td>12:</td><td>9.7</td><td>←</td></tr> <tr><td>13:</td><td>10.4x</td><td>↖</td></tr> <tr><td>14:</td><td>10.2x</td><td>↘</td></tr> <tr><td>15:</td><td>9.9</td><td>↖</td></tr> <tr><td>16:</td><td>9.1</td><td>↖</td></tr> <tr><td>17:</td><td>10.2x</td><td>↖</td></tr> <tr><td>18:</td><td>9.2</td><td>↘</td></tr> <tr><td>19:</td><td>9.2</td><td>↘</td></tr> <tr><td>20:</td><td>9.7</td><td>↖</td></tr> <tr><td colspan="2">Serie</td><td>97.9</td></tr> <tr><td colspan="2">Total</td><td>193.6</td></tr> </table>	11:	10.3x	←	12:	9.7	←	13:	10.4x	↖	14:	10.2x	↘	15:	9.9	↖	16:	9.1	↖	17:	10.2x	↖	18:	9.2	↘	19:	9.2	↘	20:	9.7	↖	Serie		97.9	Total		193.6	 <p>40 Skott</p>	<table border="1" style="width:100%; border-collapse: collapse;"> <tr><td>21:</td><td>10.5x</td><td>↖</td></tr> <tr><td>22:</td><td>10.2x</td><td>↖</td></tr> <tr><td>23:</td><td>10.1</td><td>←</td></tr> <tr><td>24:</td><td>9.2</td><td>↖</td></tr> <tr><td>25:</td><td>10.3x</td><td>↖</td></tr> <tr><td>26:</td><td>9.4</td><td>↖</td></tr> <tr><td>27:</td><td>9.7</td><td>↘</td></tr> <tr><td>28:</td><td>8.7</td><td>↖</td></tr> <tr><td>29:</td><td>9.7</td><td>↘</td></tr> <tr><td>30:</td><td>9.0</td><td>↘</td></tr> <tr><td colspan="2">Serie</td><td>96.8</td></tr> <tr><td colspan="2">Total</td><td>290.4</td></tr> </table>	21:	10.5x	↖	22:	10.2x	↖	23:	10.1	←	24:	9.2	↖	25:	10.3x	↖	26:	9.4	↖	27:	9.7	↘	28:	8.7	↖	29:	9.7	↘	30:	9.0	↘	Serie		96.8	Total		290.4
11:	10.3x	←																																																																									
12:	9.7	←																																																																									
13:	10.4x	↖																																																																									
14:	10.2x	↘																																																																									
15:	9.9	↖																																																																									
16:	9.1	↖																																																																									
17:	10.2x	↖																																																																									
18:	9.2	↘																																																																									
19:	9.2	↘																																																																									
20:	9.7	↖																																																																									
Serie		97.9																																																																									
Total		193.6																																																																									
21:	10.5x	↖																																																																									
22:	10.2x	↖																																																																									
23:	10.1	←																																																																									
24:	9.2	↖																																																																									
25:	10.3x	↖																																																																									
26:	9.4	↖																																																																									
27:	9.7	↘																																																																									
28:	8.7	↖																																																																									
29:	9.7	↘																																																																									
30:	9.0	↘																																																																									
Serie		96.8																																																																									
Total		290.4																																																																									
 <p>40 Skott</p>	<table border="1" style="width:100%; border-collapse: collapse;"> <tr><td>31:</td><td>8.0</td><td>↖</td></tr> <tr><td>32:</td><td>8.0</td><td>↖</td></tr> <tr><td>33:</td><td>8.3</td><td>↖</td></tr> <tr><td>34:</td><td>10.1</td><td>↘</td></tr> <tr><td>35:</td><td>10.2x</td><td>↘</td></tr> <tr><td>36:</td><td>9.0</td><td>←</td></tr> <tr><td>37:</td><td>10.2x</td><td>↖</td></tr> <tr><td>38:</td><td>9.4</td><td>↘</td></tr> <tr><td>39:</td><td>9.2</td><td>↘</td></tr> <tr><td>40:</td><td>8.6</td><td>↘</td></tr> <tr><td colspan="2">Serie</td><td>91.0</td></tr> <tr><td colspan="2">Total</td><td>381.4</td></tr> </table>	31:	8.0	↖	32:	8.0	↖	33:	8.3	↖	34:	10.1	↘	35:	10.2x	↘	36:	9.0	←	37:	10.2x	↖	38:	9.4	↘	39:	9.2	↘	40:	8.6	↘	Serie		91.0	Total		381.4																																						
31:	8.0	↖																																																																									
32:	8.0	↖																																																																									
33:	8.3	↖																																																																									
34:	10.1	↘																																																																									
35:	10.2x	↘																																																																									
36:	9.0	←																																																																									
37:	10.2x	↖																																																																									
38:	9.4	↘																																																																									
39:	9.2	↘																																																																									
40:	8.6	↘																																																																									
Serie		91.0																																																																									
Total		381.4																																																																									

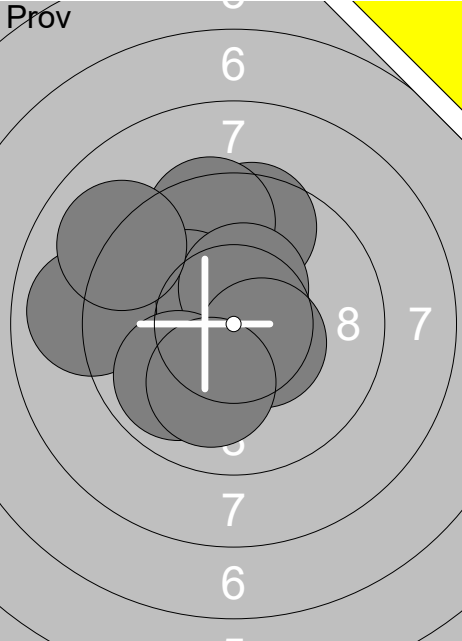
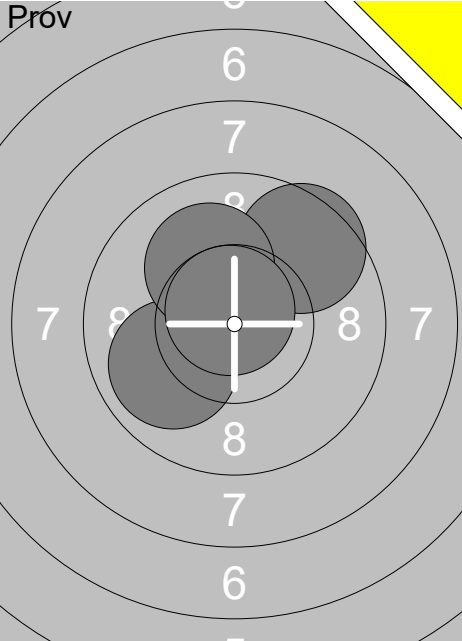
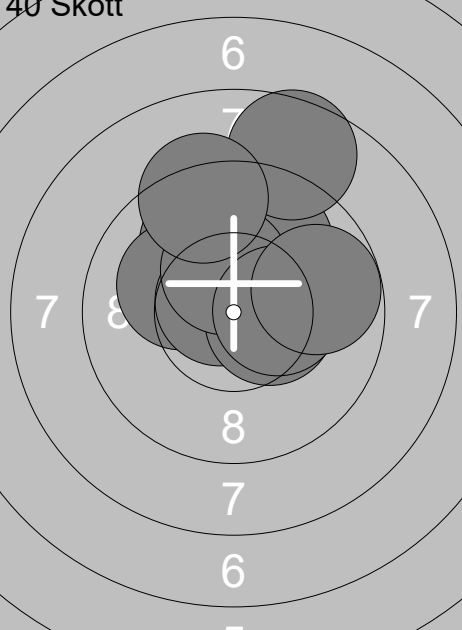
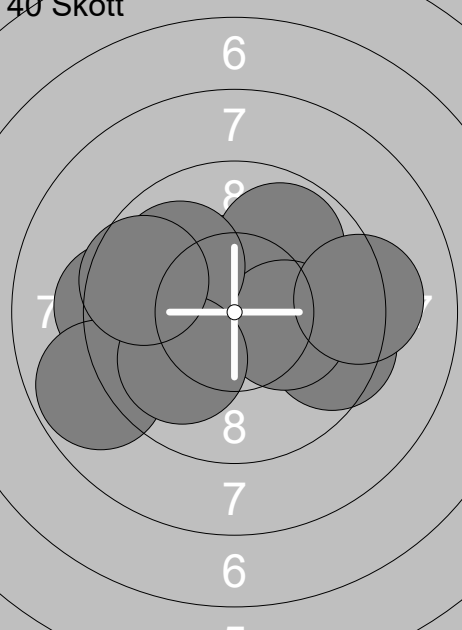
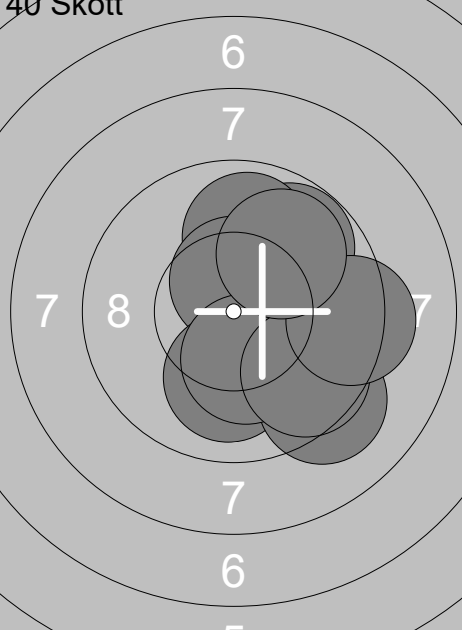
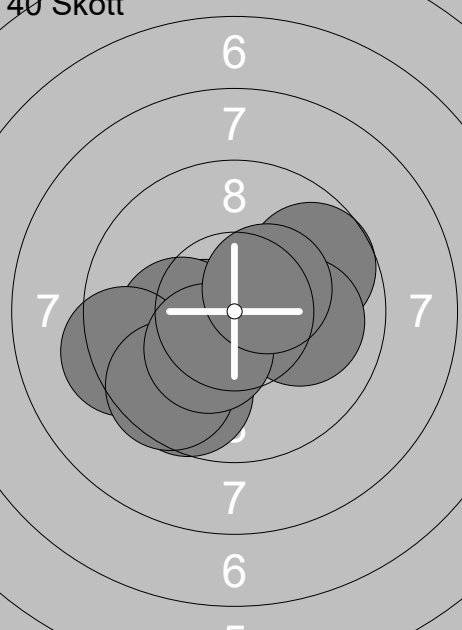
Skjutlag	Tavla	Miranda Karlsson	
3	14	Ramselefors	Gällivare
03.02.2018	Skyttiadens Regionsfinal 2018	15S	No
03.02.2018	Skyttiadens Regionsfinal 2018	Ramselefors SKF	
Prov		Prov	
	1: 10.6x ↓ 2: 9.6 ↑ 3: 9.5 ↑ 4: 10.2x ↖ 5: 9.0 ← 6: 10.4x ↑ 7: 9.1 ↖ 8: 9.9 ↘ 9: 10.5x ↘ 10: 10.1 ↓		11: 9.9 ↙ 12: 9.5 ↗ 13: 10.1 ↖ 14: 10.7x ↑
	Serie 98.9		Serie 40.2
	Total 0.0		Total 0.0
40 Skott		40 Skott	
	1: 9.9 ↖ 2: 9.9 ↗ 3: 10.1 ↖ 4: 10.7x ↖ 5: 10.4x → 6: 10.3x ↑ 7: 10.3x → 8: 8.6 ↑ 9: 9.8 → 10: 9.3 ↑		11: 9.5 → 12: 9.3 ← 13: 10.5x ↑ 14: 9.9 ↗ 15: 10.2x → 16: 8.8 ← 17: 10.0 ↖ 18: 9.2 → 19: 10.0 ↘ 20: 9.6 ←
	Serie 99.3		Serie 97.0
	Total 99.3		Total 196.3
40 Skott		40 Skott	
	21: 9.8 ↗ 22: 9.9 ↑ 23: 10.5x ↑ 24: 9.7 → 25: 10.0 ↓ 26: 9.2 ↘ 27: 10.3x ↓ 28: 9.6 ↘ 29: 9.3 → 30: 9.9 ↗		31: 9.7 ↓ 32: 9.7 ↗ 33: 10.4x → 34: 10.5x ↖ 35: 10.2x ← 36: 9.3 ← 37: 10.0 → 38: 9.6 ↘ 39: 10.3x ↘ 40: 10.4x ↗
	Serie 98.2		Serie 100.1
	Total 294.5		Total 394.6

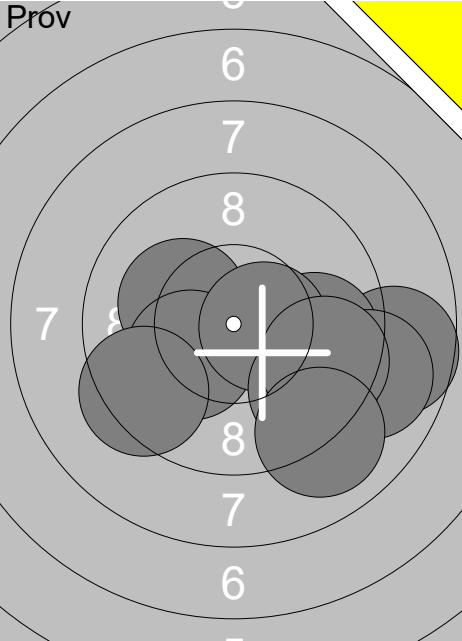
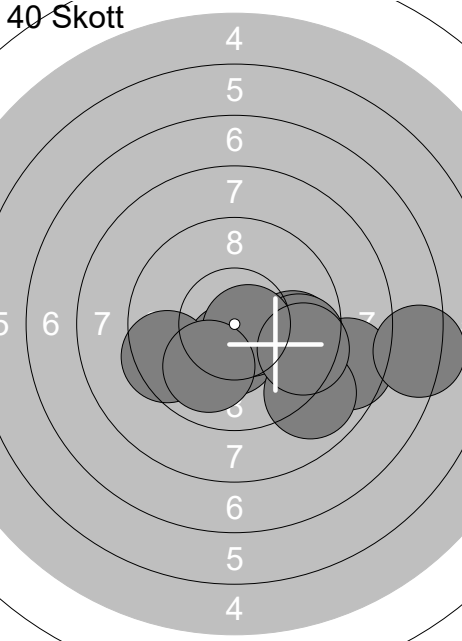
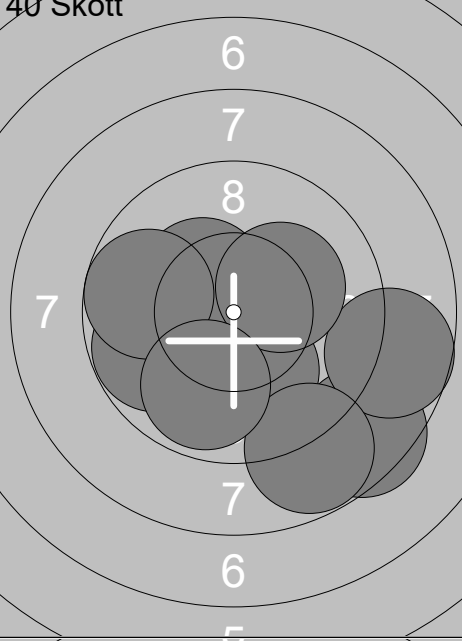
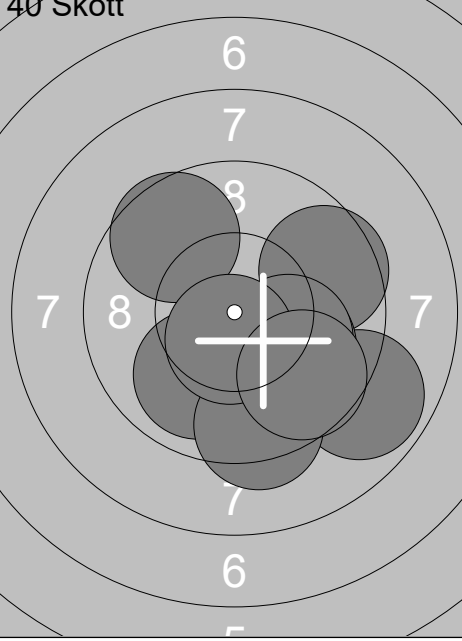
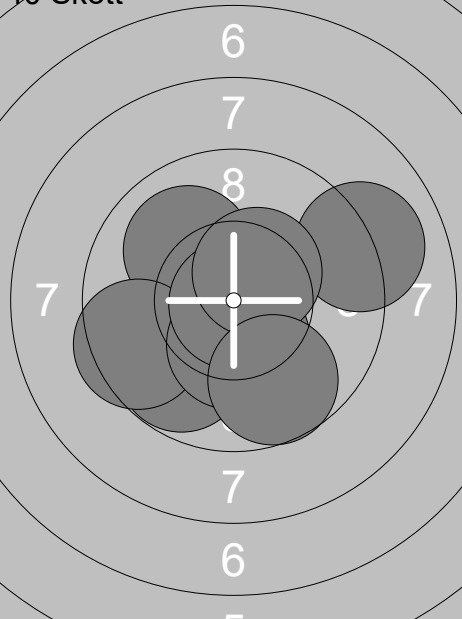
Skjutlag	Tavla	Vincent Stridsson		
3	15	Ramselefors	Gällivare	15S No
03.02.2018		Skyttiadens Regionsfinal 2018	Ramselefors SKF	
Prov 	1: 8.7 →	40 Skott 	1: 9.8 →	
	2: 10.2x ↙		2: 10.5x ↓	
	3: 9.8 →		3: 9.5 ↙	
	4: 10.2x ↙		4: 8.6 →	
	5: 10.5x →		5: 9.6 →	
	6: 9.4 ↙		6: 8.9 ↓	
	7: 9.0 →		7: 10.7x ↘	
	8: 9.5 ↓		8: 9.5 →	
	9: 9.6 →		9: 7.3 →	
	10: 9.0 ↓		10: 10.0 ↓	
	Serie 95.9		Serie 94.4	
	Total 0.0		Total 94.4	
40 Skott 	11: 9.8 ↙	40 Skott 	21: 9.9 ↓	
	12: 8.5 ↓		22: 9.6 ↗	
	13: 10.3x ↙		23: 9.6 →	
	14: 10.1 ↓		24: 10.0 ↓	
	15: 10.4x ↗		25: 8.9 ↓	
	16: 8.7 →		26: 9.3 ↓	
	17: 8.8 ↓		27: 10.0 ↘	
	18: 10.2x →		28: 10.1 ↘	
	19: 9.7 ↙		29: 10.6x ↓	
	20: 9.9 ↓		30: 9.7 ↓	
	Serie 96.4		Serie 97.7	
	Total 190.8		Total 288.5	
40 Skott 	31: 10.4x ↓			
	32: 9.8 ↙			
	33: 10.4x ↓			
	34: 10.0 ↗			
	35: 9.5 ↙			
	36: 10.3x ↓			
	37: 9.0 →			
	38: 10.9x ↓			
	39: 10.4x ↗			
	40: 9.7 ↓			
	Serie 100.4			
	Total 388.9			

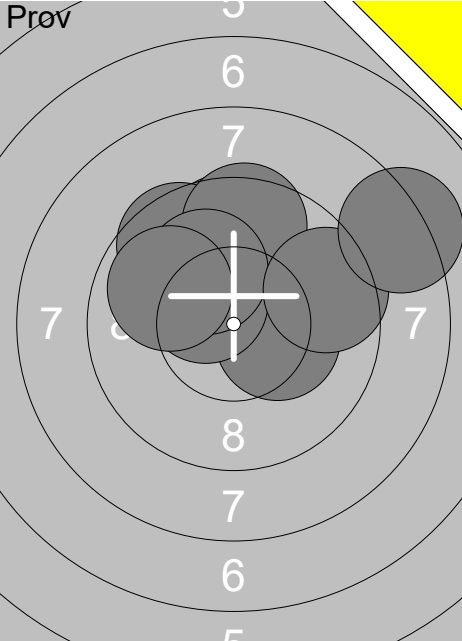
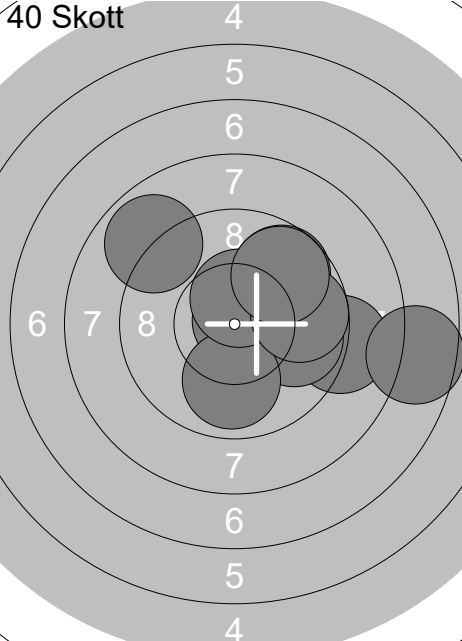
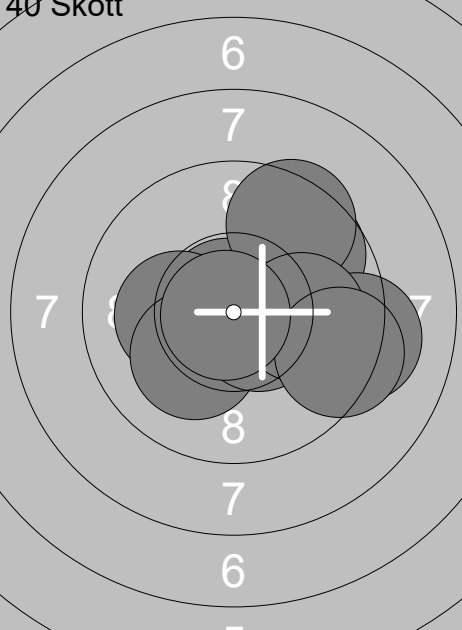
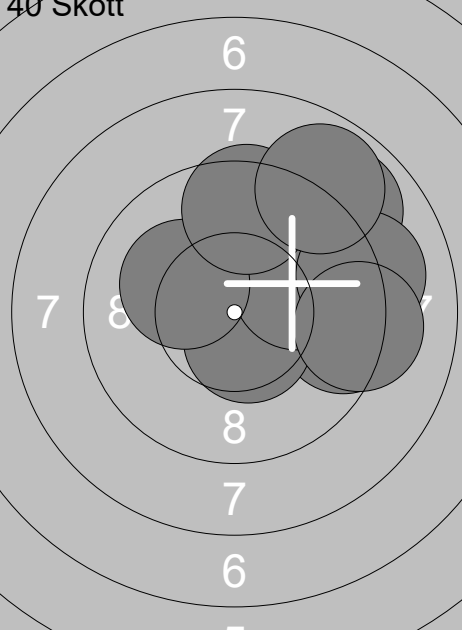
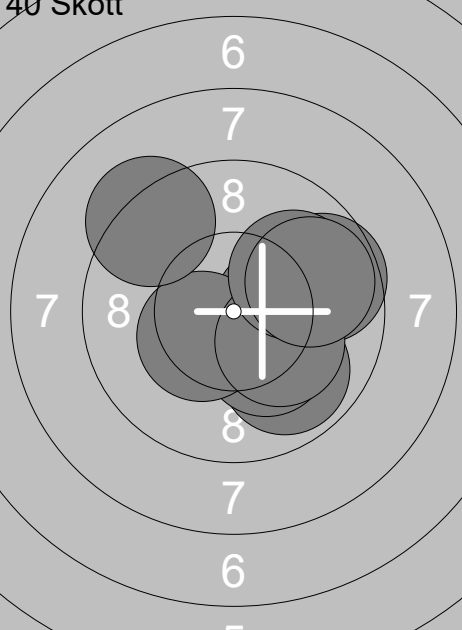
Skjutlag <b>3</b>	Tavla <b>16</b>	<b>Jonas Olofsson</b>	
Ramselefors	Aspås	15S	Jä
03.02.2018	Skyttiadens Regionsfinal 2018	Ramselefors SKF	
	1: 9.7 ↑ 2: 10.3x ↑ 3: 10.3x → 4: 10.4x ↖ 5: 9.6 ↖ 6: 9.5 ↑ 7: 10.1 ↖ 8: 9.9 ↖ 9: 9.5 → 10: 8.2 ↗ Serie 97.5 Total 0.0		1: 10.8x ↗ 2: 9.0 → 3: 8.9 ↖ 4: 9.8 → 5: 9.7 ↗ 6: 9.9 ↓ 7: 10.5x ↑ 8: 9.7 → 9: 9.7 ↗ 10: 7.6 → Serie 95.6 Total 95.6
	11: 10.8x ↖ 12: 9.7 ↗ 13: 10.2x ← 14: 10.2x ↙ 15: 9.5 ↗ 16: 9.2 → 17: 10.6x → 18: 10.0 → 19: 9.4 → 20: 10.8x ← Serie 100.4 Total 196.0		21: 9.4 → 22: 10.8x ↗ 23: 10.5x ↘ 24: 8.9 ↗ 25: 10.0 → 26: 9.1 → 27: 10.2x ↖ 28: 9.5 ↑ 29: 8.9 ↗ 30: 9.2 → Serie 96.5 Total 292.5
	31: 10.3x → 32: 9.6 → 33: 9.9 ↘ 34: 10.3x ↘ 35: 10.2x ↘ 36: 10.4x ↙ 37: 10.2x ↘ 38: 10.0 ↗ 39: 9.2 ↖ 40: 9.8 → Serie 99.9 Total 392.4		

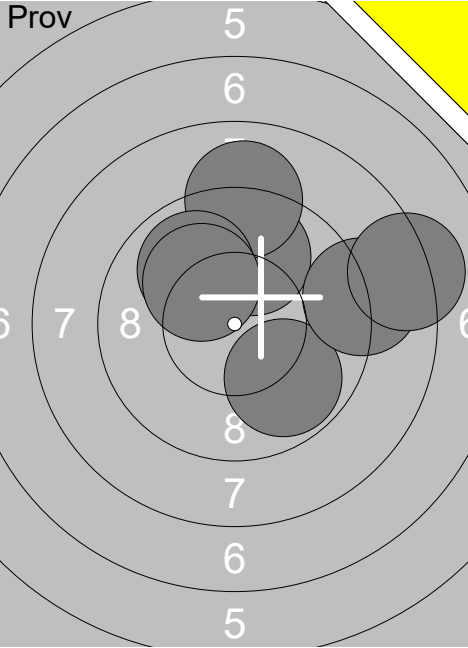
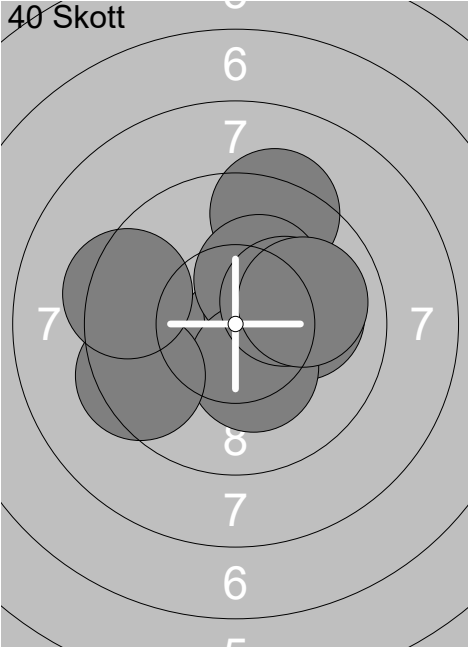
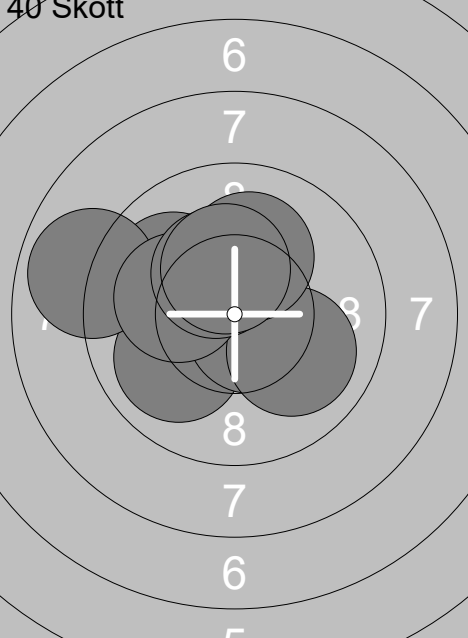
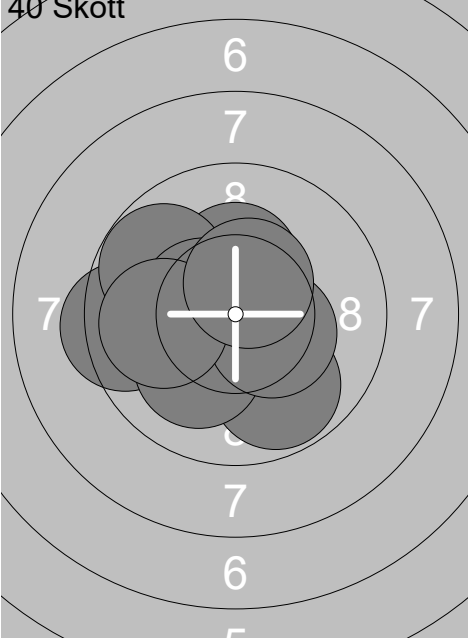
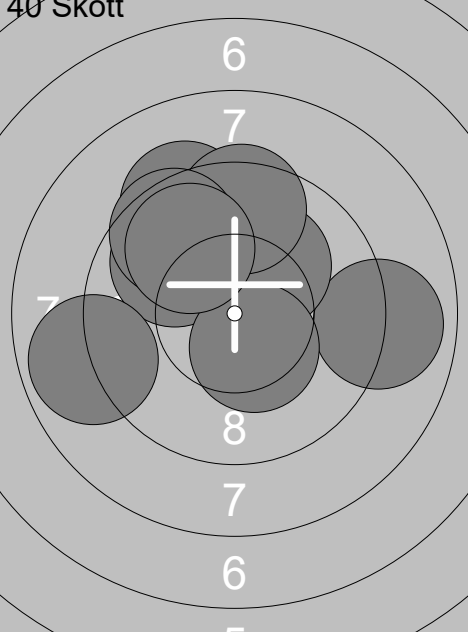
Skjutlag <b>3</b>	Tavla <b>17</b>	<b>Klara Olsson</b>	
Ramselefors	Hammerdal	15S	Jä
03.02.2018	Skyttiadens Regionsfinal 2018	Ramselefors SKF	
Prov		40 Skott	
	1: 9.8 ↘ 2: 9.9 ↑ 3: 9.0 ↑ 4: 9.0 → 5: 9.9 ↗ 6: 10.1 ↗ 7: 8.2 →		1: 10.7x ↘ 2: 9.3 ↑ 3: 10.4x → 4: 10.0 → 5: 10.3x ↗ 6: 10.3x ↘ 7: 10.2x → 8: 9.4 ← 9: 10.0 → 10: 9.4 ←
	Serie 65.9		Serie 100.0
	Total 0.0		Total 100.0
40 Skott		40 Skott	
	11: 10.0 ← 12: 10.0 ↙ 13: 10.5x ↑ 14: 10.6x ↘ 15: 10.0 ↘ 16: 8.9 ← 17: 10.1 ← 18: 10.3x ↗ 19: 10.1 ↑ 20: 10.3x ↗		21: 9.4 ← 22: 10.3x ↑ 23: 10.7x ← 24: 9.8 ↘ 25: 9.8 ↖ 26: 10.5x ← 27: 10.1 ↘ 28: 10.4x → 29: 9.9 ← 30: 10.5x ↗
	Serie 100.8		Serie 101.4
	Total 200.8		Total 302.2
40 Skott			
	31: 9.3 ↗ 32: 8.9 → 33: 9.8 ↑ 34: 9.9 ↖ 35: 8.9 ← 36: 10.1 ↗ 37: 9.5 ↑ 38: 9.6 ↗ 39: 10.4x ↘ 40: 9.9 ↖		
	Serie 96.3		
	Total 398.5		

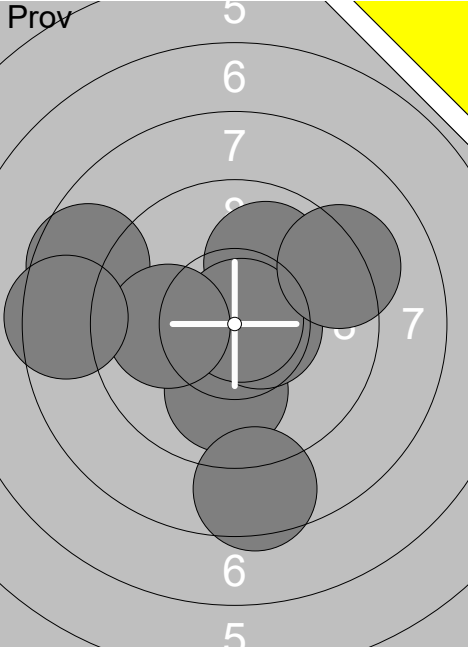
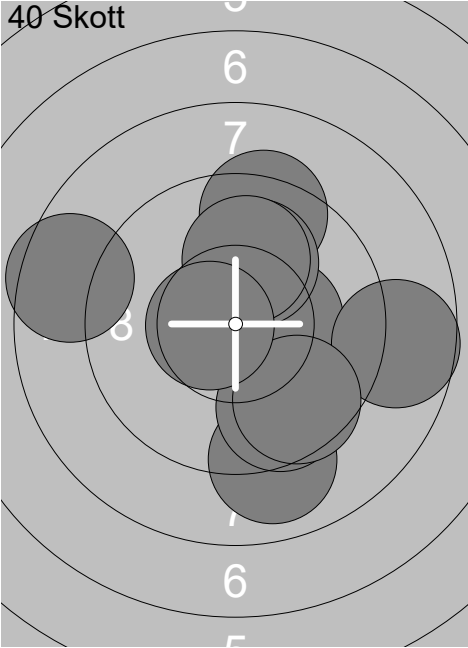
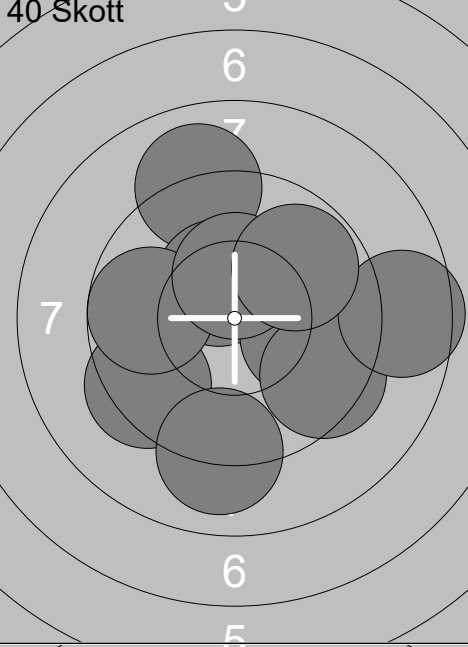
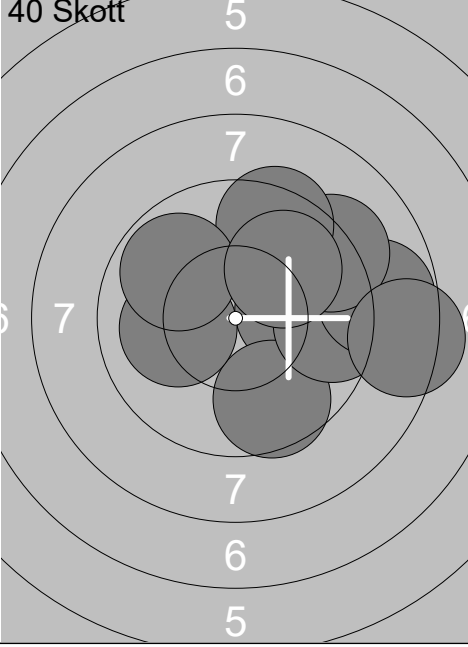
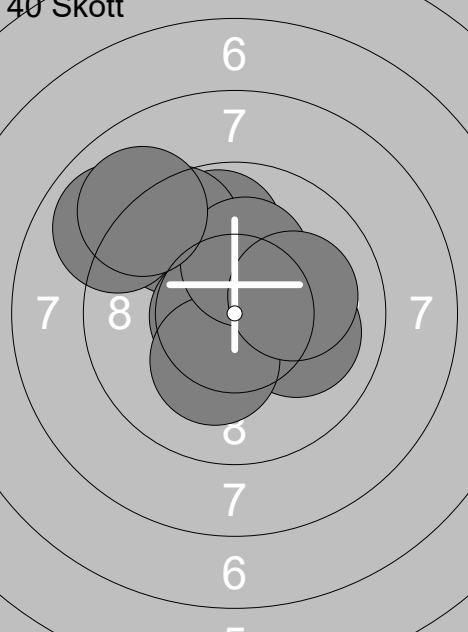
Skjutlag	Tavla	Elin Elnnerud			
3	18	Ramselefors	Fältjägarna	15S	Jä
03.02.2018		Skyttiadens Regionsfinal 2018		Ramselefors SKF	
	1: 10.0 ↓		1: 9.0 ↓		
	2: 10.6x →		2: 9.4 ↑		
	3: 8.5 ↓		3: 10.3x →		
	4: 10.0 ↑		4: 8.7 →		
	5: 10.8x ↗		5: 10.1 ↑		
	6: 8.7 ←		6: 8.5 ←		
	7: 10.0 ←		7: 9.6 ↓		
	8: 8.5 ←		8: 10.0 ↑		
	9: 9.2 ↗		9: 9.6 ↓		
			10: 10.6x ←		
	Serie 86.3		Serie 95.8		
	Total 0.0		Total 95.8		
	11: 9.0 ↑		21: 10.1 →		
	12: 10.4x ↗		22: 9.6 ↓		
	13: 9.4 ←		23: 9.5 →		
	14: 9.7 ←		24: 8.8 →		
	15: 9.9 →		25: 9.2 ↗		
	16: 9.0 ↓		26: 10.1 ←		
	17: 9.5 ↘		27: 9.4 ↑		
	18: 8.6 →		28: 9.8 ↖		
	19: 10.3x ↑		29: 8.3 →		
	20: 9.8 ↗		30: 9.9 ↗		
	Serie 95.6		Serie 94.7		
	Total 191.4		Total 286.1		
	31: 10.5x ↑				
	32: 9.8 ↑				
	33: 9.5 ↖				
	34: 10.7x ←				
	35: 10.1 →				
	36: 10.2x ↓				
	37: 10.2x ↑				
	38: 8.9 ↖				
	39: 10.1 →				
	40: 9.0 ↖				
	Serie 99.0				
	Total 385.1				

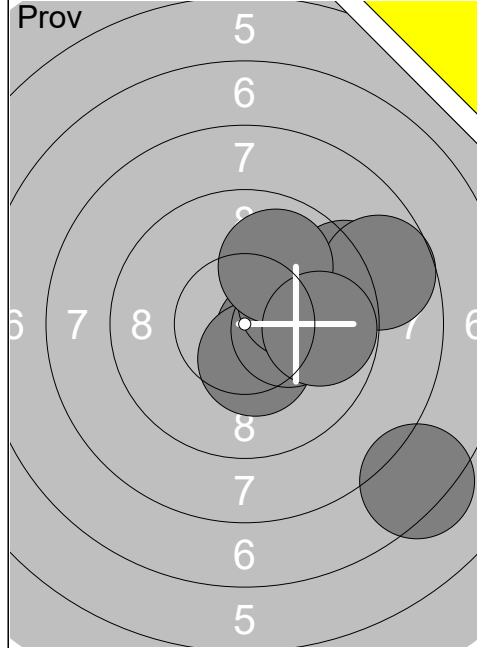

1:	9.2	➔
2:	10.5x	➔
3:	10.4x	⬇
4:	10.3x	➔
5:	7.3	⬇
6:	10.0	➔
7:	10.1	➔
8:	8.7	➔
9:	9.9	⬆
10:	9.8	➔
Serie		96.2
Total		0.0

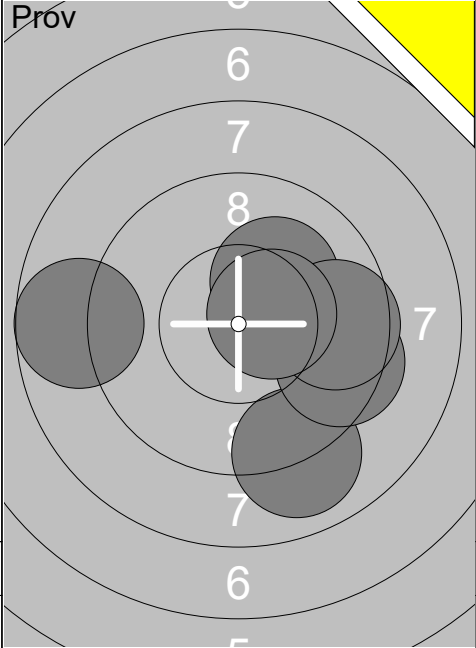

11:	9.0	⬇
12:	9.4	➔
13:	8.7	⬅
14:	10.2x	⬆
15:	9.6	➔
16:	10.5x	➔
Serie		57.4
Total		0.0

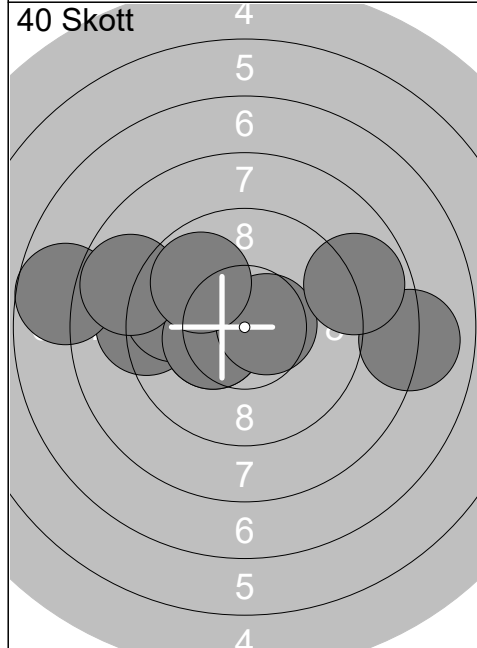

1:	10.3x	⬅
2:	9.2	⬅
3:	9.7	⬅
4:	8.0	➔
5:	10.4x	⬅
6:	7.7	⬅
7:	8.8	⬅
8:	10.6x	➔
9:	8.9	➔
10:	9.8	⬆
Serie		93.4
Total		93.4

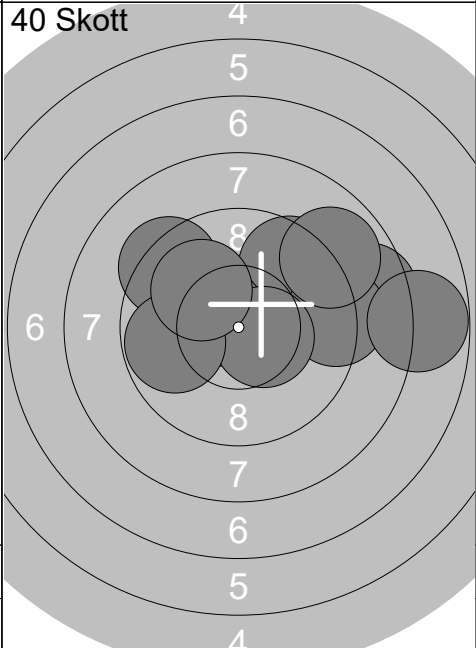

11:	9.6	⬆
12:	8.6	➔
13:	9.2	➔
14:	8.9	⬆
15:	10.5x	⬅
16:	10.5x	➔
17:	7.8	➔
18:	9.3	⬆
19:	9.8	⬅
20:	10.0	⬆
Serie		94.2
Total		187.6

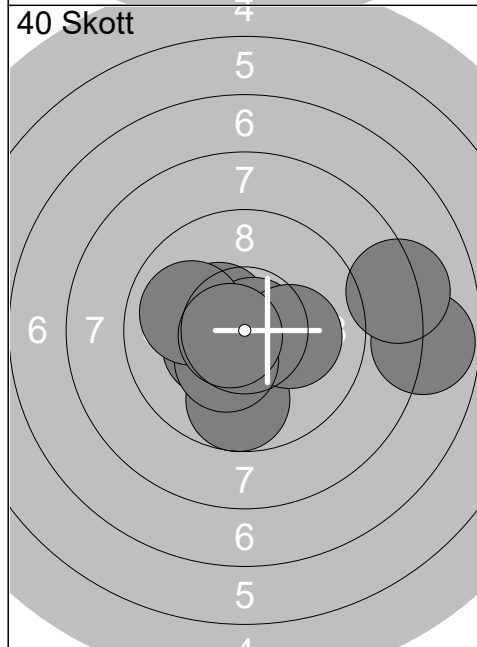

21:	10.4x	⬅
22:	10.8x	➔
23:	9.8	⬇
24:	10.2x	➔
25:	10.4x	⬅
26:	7.8	➔
27:	10.4x	⬇
28:	8.2	➔
29:	10.0	⬅
30:	10.7x	⬅
Serie		98.7
Total		286.3

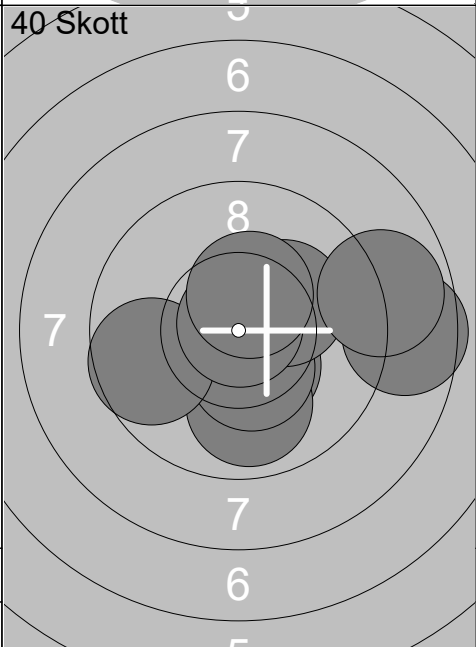

31:	10.4x	⬇
32:	9.9	⬇
33:	10.8x	➔
34:	10.4x	⬇
35:	9.6	⬅
36:	8.6	➔
37:	10.2x	⬆
38:	10.9x	⬆
39:	8.9	➔
40:	10.4x	⬆
Serie		100.1
Total		386.4

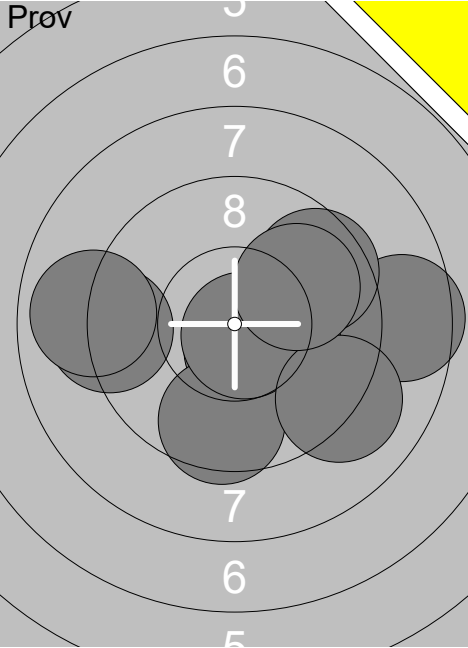
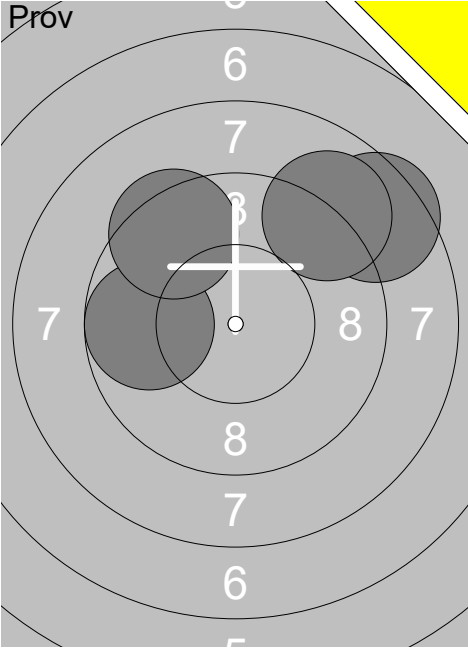
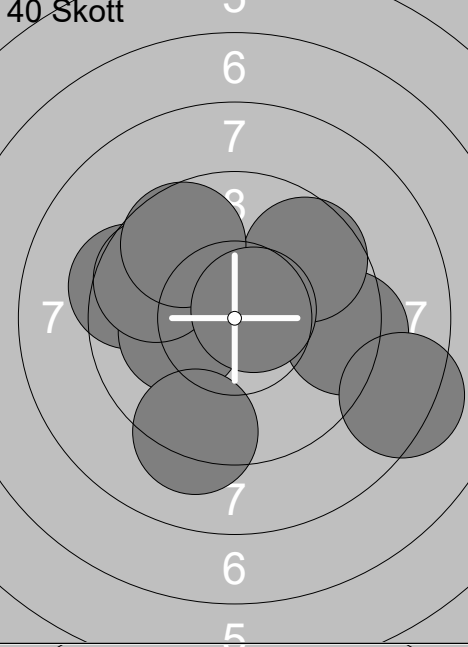
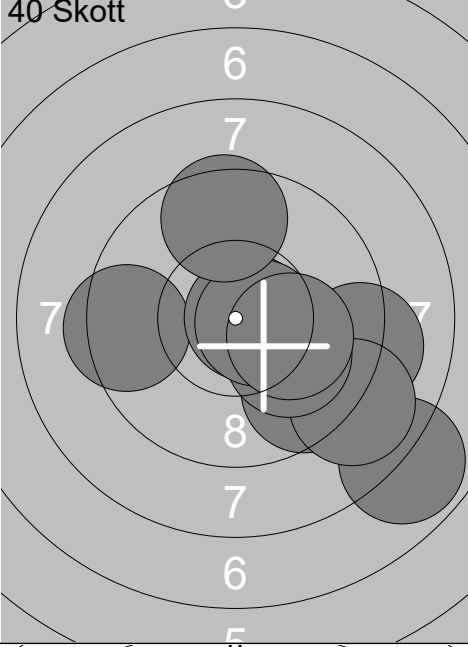
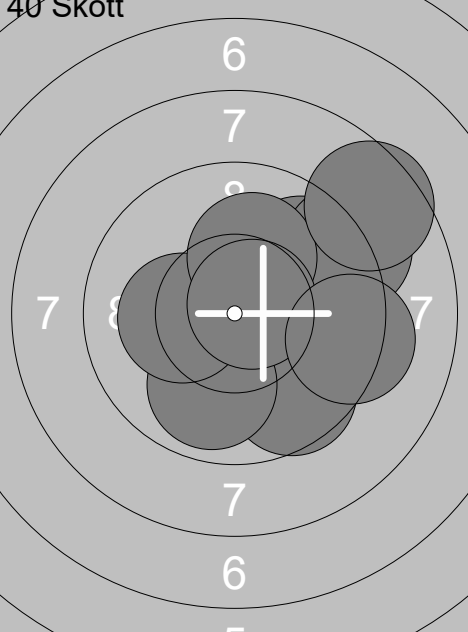
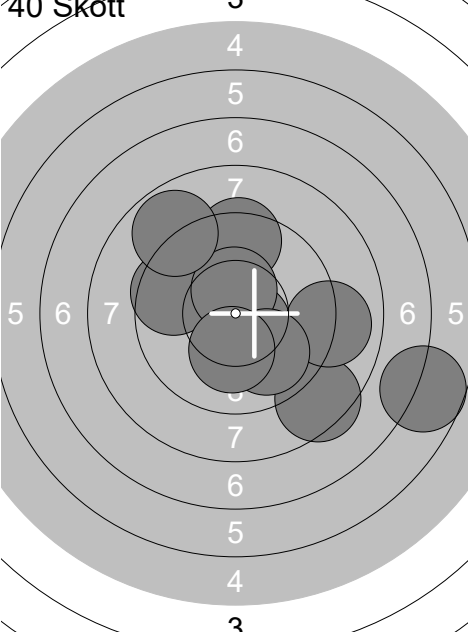

Skjuttag	Tavla	Elsa Krigsman	
3	20		
Ramselefors	Gällivare	15S	No
03.02.2018	Skyttiadens Regionsfinal 2018	Ramselefors SKF	
Prov 	1: 9.7 →	Prov 	11: 8.5 ↗
	2: 8.6 →		12: 9.0 ↗
	3: 9.6 ↗		13: 9.8 ←
	4: 10.6x ↓		14: 9.4 ↗
	5: 9.2 ←		
	6: 9.6 ↓		
	7: 10.7x ↓		
	8: 8.9 ←		
	9: 9.1 ↓		
	10: 9.9 ↗		
	Serie 95.9		Serie 36.7
	Total 0.0		Total 0.0
40 Skott 	1: 9.3 →	40 Skott 	11: 9.1 →
	2: 10.7x ↑		12: 7.9 ↓
	3: 9.4 ←		13: 9.4 ←
	4: 10.2x ←		14: 9.6 ↓
	5: 9.7 ←		15: 8.9 ↓
	6: 8.3 →		16: 10.8x →
	7: 9.6 ↗		17: 10.1 ↓
	8: 9.7 ↗		18: 10.6x →
	9: 10.7x →		19: 9.5 ↑
	10: 9.2 ↓		20: 10.1 →
	Serie 96.8		Serie 96.0
	Total 96.8		Total 192.8
40 Skott 	21: 9.8 ↗	40 Skott 	31: 6.7 →
	22: 10.6x ↗		32: 8.5 ↓
	23: 9.6 ↓		33: 9.6 ←
	24: 9.9 ↓		34: 10.6x ↓
	25: 9.1 ↗		35: 9.4 ↑
	26: 10.2x ←		36: 10.5x ↑
	27: 10.1 ↑		37: 9.0 →
	28: 10.7x →		38: 9.9 ↓
	29: 8.6 ↗		39: 10.2x ↓
	30: 9.3 →		40: 8.9 ↗
	Serie 97.9		Serie 93.3
	Total 290.7		Total 384.0

Skjuttlag	Tavla	Isak Börjesson	
3	21	Ramselefors	Gideå
03.02.2018	Skyttiadens Regionsfinal 2018	15S	Vn
03.02.2018	Skyttiadens Regionsfinal 2018	Ramselefors SKF	
<b>Prov</b> 	1: 10.5x → 2: 7.6 ↘ 3: 9.1 → 4: 9.3 ↘ 5: 9.3 → 6: 9.3 ↗ 7: 10.0 ↓ 8: 9.9 ↓ 9: 10.9x ↘ 10: 9.5 ←	<b>Prov</b> 	11: 8.0 → 12: 10.6x ↖
	Serie 95.4		Serie 18.6
	Total 0.0		Total 0.0
<b>40 Skott</b> 	1: 9.9 ← 2: 9.4 ↖ 3: 10.6x ↘ 4: 8.8 ← 5: 10.1 ↘ 6: 10.1 ← 7: 10.7x ↗ 8: 9.5 ↗ 9: 9.8 → 10: 10.9x ←	<b>40 Skott</b> 	11: 10.1 → 12: 9.0 → 13: 9.3 ↘ 14: 9.6 ↘ 15: 8.3 ← 16: 9.0 ↓ 17: 8.0 ← 18: 9.3 ← 19: 9.3 → 20: 10.7x ↗
	Serie 99.8		Serie 92.6
	Total 99.8		Total 192.4
<b>40 Skott</b> 	21: 10.0 ← 22: 10.2x ↖ 23: 8.8 ← 24: 9.9 ↗ 25: 9.5 ↗ 26: 10.0 ← 27: 10.3x ↓ 28: 9.9 ↗ 29: 9.2 ↓ 30: 10.8x ↗	<b>40 Skott</b> 	31: 9.9 ↘ 32: 8.4 ↗ 33: 9.5 → 34: 8.7 ← 35: 9.7 → 36: 9.0 ← 37: 9.2 ↖ 38: 10.3x ↖ 39: 9.0 ↓ 40: 7.9 →
	Serie 98.6		Serie 91.6
	Total 291.0		Total 382.6

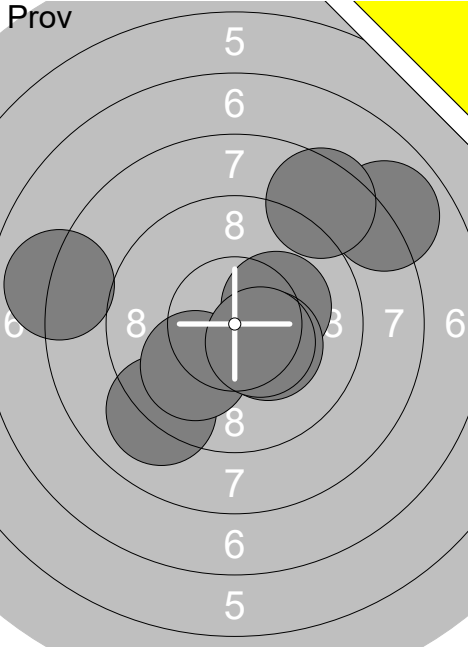
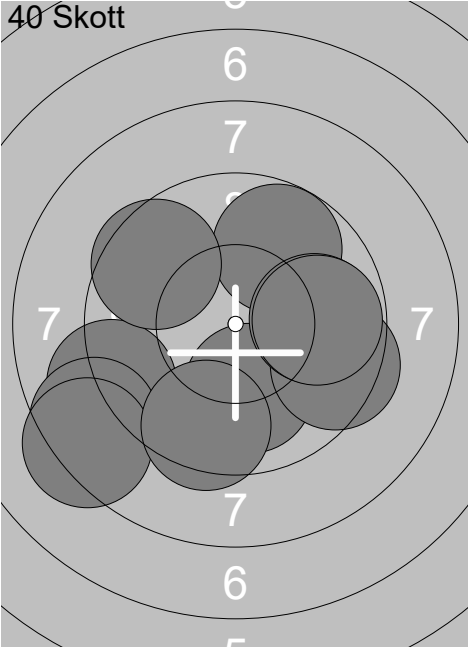
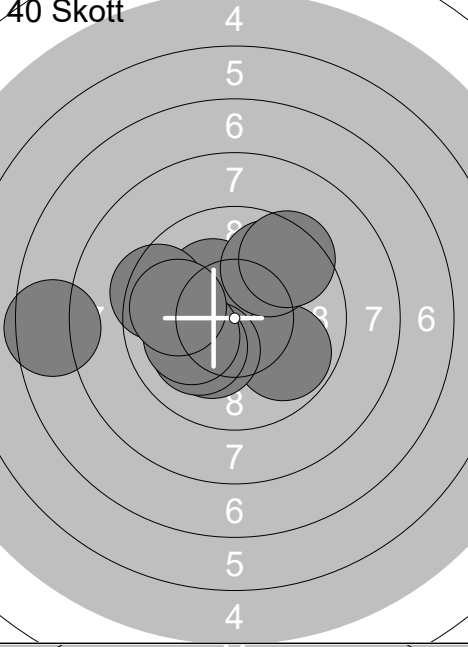
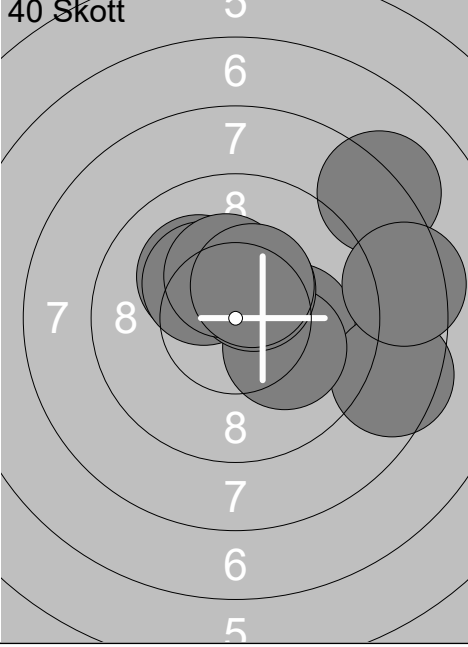
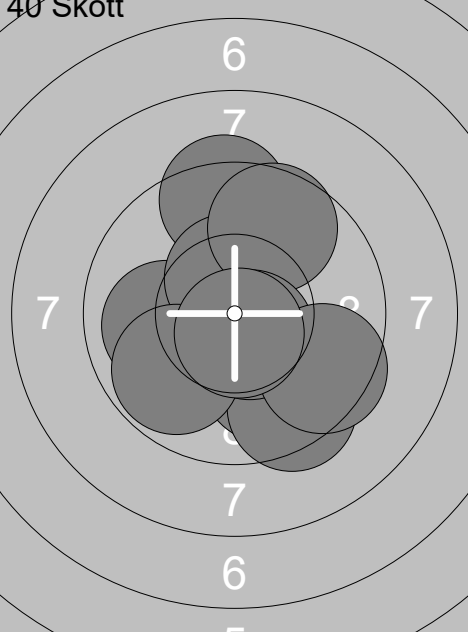
Skjutlag	Tavla	Sofi Jonsson			
3	22	Ramselefors	Ramselefors	15S	Vb
03.02.2018		Skyttiadens Regionsfinal 2018	Ramselefors SKF		
Prov 	1: 7.9 ↗	40 Skott 	1: 10.0 ↓		
	2: 8.0 ←		2: 9.8 ↗		
	3: 10.2x →		3: 9.5 →		
	4: 8.5 ↗		4: 9.9 →		
	5: 10.3x ↘		5: 9.0 ←		
	6: 9.1 ↓		6: 8.6 ←		
	7: 10.0 ↓		7: 8.3 ←		
	8: 10.4x ↘		8: 9.8 →		
			9: 9.6 ↖		
			10: 9.5 ↓		
	Serie 74.4		Serie 94.0		
	Total 0.0		Total 94.0		
40 Skott 	11: 10.2x ↖	40 Skott 	21: 8.2 ↗		
	12: 7.5 ←		22: 10.1 →		
	13: 9.8 ↘		23: 10.1 ↗		
	14: 9.8 ↗		24: 8.5 →		
	15: 10.2x ↓		25: 8.4 →		
	16: 9.5 ↗		26: 10.1 ↘		
	17: 10.1 ←		27: 10.3x ↖		
	18: 10.1 ←		28: 10.5x ↗		
	19: 9.4 ←		29: 10.3x ↑		
	20: 9.9 ←		30: 10.4x ↗		
	Serie 96.5		Serie 96.9		
	Total 190.5		Total 287.4		
40 Skott 	31: 9.4 ↑				
	32: 10.0 ←				
	33: 10.5x ↑				
	34: 10.0 ↓				
	35: 9.4 ↓				
	36: 9.7 ↗				
	37: 10.6x ↘				
	38: 9.8 ←				
	39: 9.5 ↘				
	40: 10.7x ↓				
	Serie 99.6				
	Total 387.0				

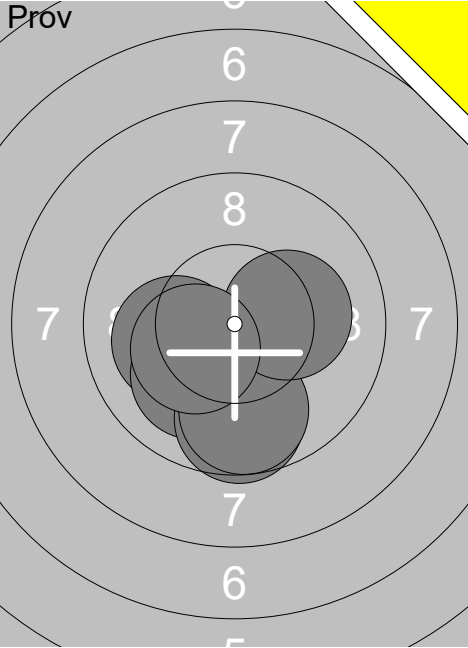
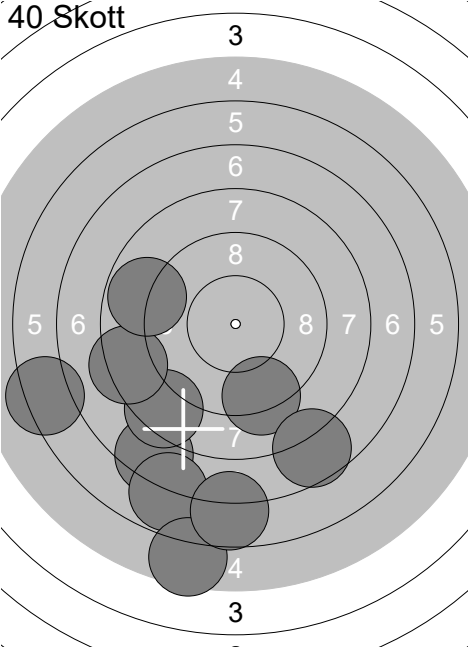
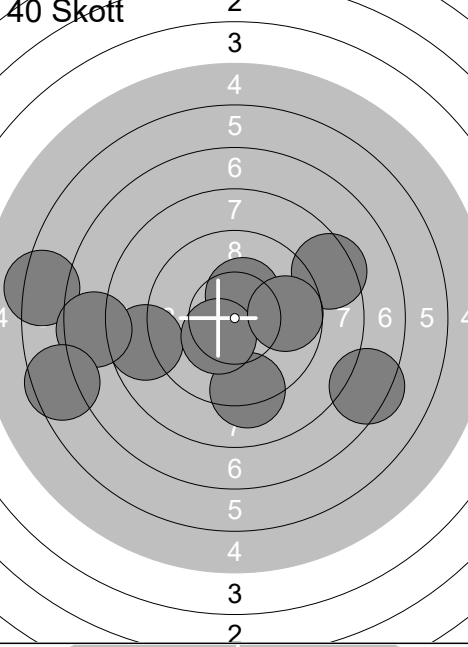
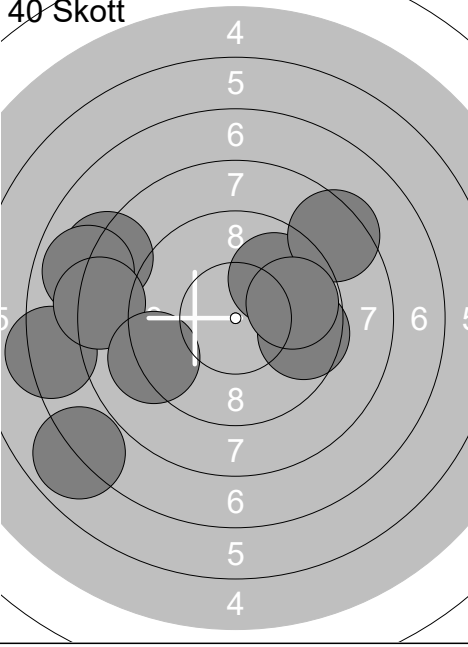
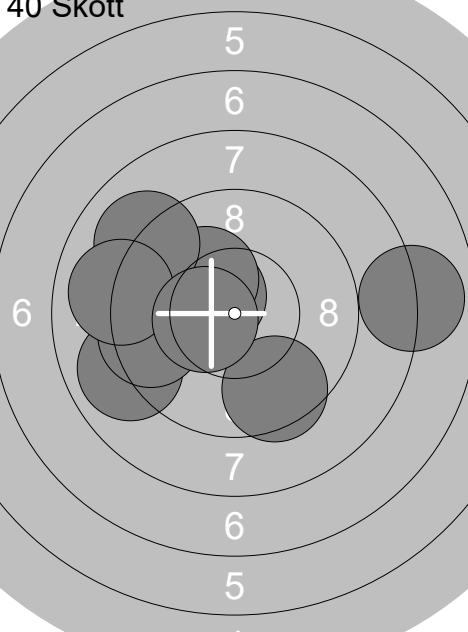
Skjutlag	Tavla	Hampus Wärme		
3	23	Ramselefors	Boden	15S No
03.02.2018		Skyttiadens Regionsfinal 2018	Ramselefors SKF	
	1: 10.1 ←		1: 9.2 ↓	
	2: 10.1 ↙		2: 7.4 ↙	
	3: 9.6 ↓		3: 6.3 ←	
	4: 9.8 ↓		4: 7.6 ↘	
	5: 10.2x →		5: 8.4 ↙	
	6: 10.3x ↙		6: 6.8 ↓	
	<b>Serie 60.1</b>		<b>Serie 75.0</b>	
	<b>Total 0.0</b>		<b>Total 75.0</b>	
	11: 6.3 ←		21: 8.2 ←	
	12: 8.7 ←		22: 9.9 ↗	
	13: 10.4x ↗		23: 8.4 ↗	
	14: 7.6 ←		24: 7.9 ←	
	15: 9.2 ↓		25: 6.9 ↙	
	16: 7.4 →		26: 7.3 ←	
	17: 8.4 ↗		27: 8.3 ←	
	18: 10.4x ↙		28: 9.6 →	
	19: 9.7 →		29: 9.2 ←	
	20: 6.5 ←		30: 9.8 →	
	<b>Serie 84.6</b>		<b>Serie 85.5</b>	
	<b>Total 159.6</b>		<b>Total 245.1</b>	
	31: 9.0 ←			
	32: 10.5x ↖			
	33: 10.2x ↗			
	34: 9.6 ←			
	35: 9.5 ↓			
	36: 9.1 ↗			
	37: 9.5 ←			
	38: 7.9 →			
	39: 9.0 ←			
	40: 10.4x ←			
	<b>Serie 94.7</b>			
	<b>Total 339.8</b>			

Skjutlag	Tavla	Anna Grönlund		
3	24	Ramselefors	Piteå	15S No
03.02.2018	Skyttiadens Regionsfinal 2018	Ramselefors SKF		
	1: 8.1 ↙ 2: 8.5 ↘ 3: 9.0 → 4: 6.6 ↖ 5: 9.4 ↗ 6: 8.3 ↗ 7: 8.1 ↖ 8: 6.9 ↖ 9: 7.9 ↖ 10: 9.3 → Serie 82.1 Total 0.0		11: 10.2x ↖ Serie 10.2 Total 0.0	
	1: 8.5 → 2: 7.2 ↗ 3: 9.9 → 4: 9.7 → 5: 9.3 → 6: 8.2 ↗ 7: 7.0 → 8: 7.7 ↖ 9: 7.2 ↖ 10: 8.1 → Serie 82.8 Total 82.8		11: 9.2 → 12: 7.9 → 13: 9.0 ↖ 14: 8.8 ↗ 15: 10.6x ↗ 16: 9.3 → 17: 9.6 ↖ 18: 9.1 ↘ 19: 9.4 ↖ 20: 8.9 ↖ Serie 91.8 Total 174.6	
	21: 10.3x ↘ 22: 10.3x → 23: 9.2 ↖ 24: 9.2 ↖ 25: 10.2x ↘ 26: 10.1 ↘ 27: 9.2 → 28: 8.7 ↗ 29: 9.4 → 30: 9.6 ↖ Serie 96.2 Total 270.8		31: 10.2x ↘ 32: 7.8 ↖ 33: 8.6 → 34: 10.6x ↘ 35: 10.1 ↘ 36: 10.3x ↘ 37: 8.7 → 38: 10.0 ↘ 39: 7.7 → 40: 10.3x ↗ Serie 94.3 Total 365.1	

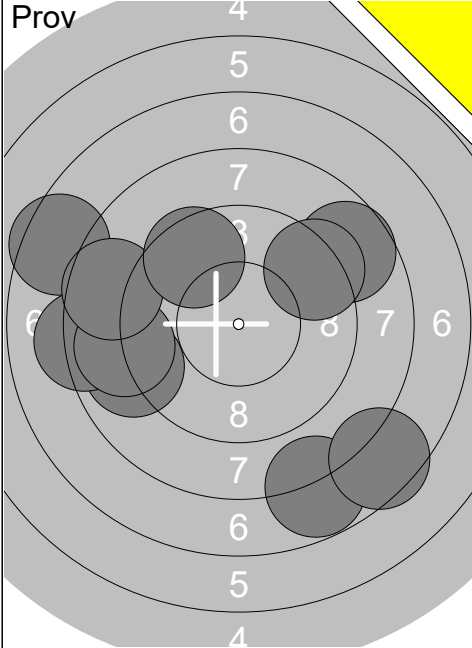
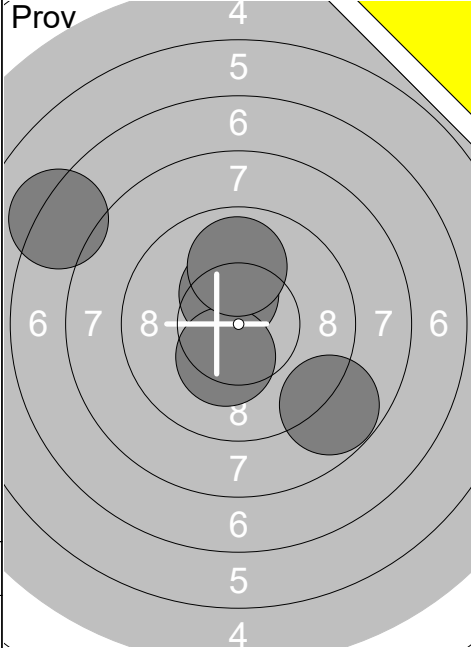
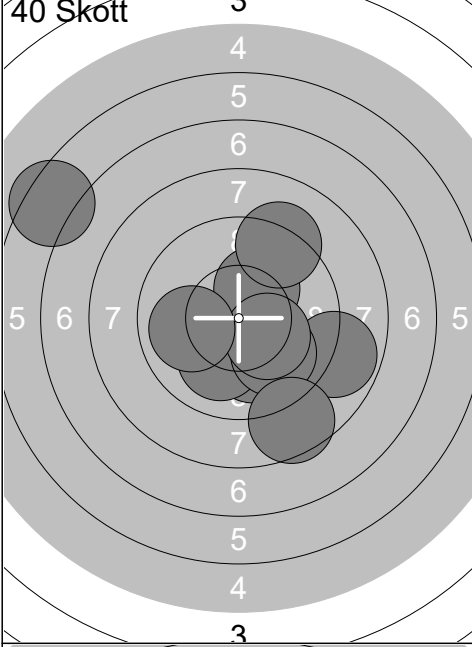
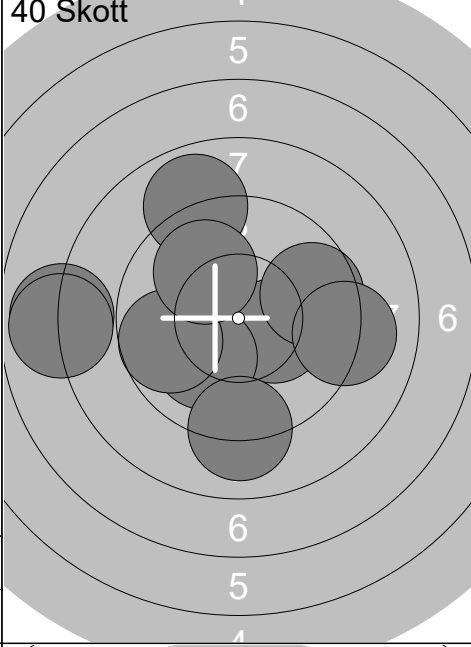
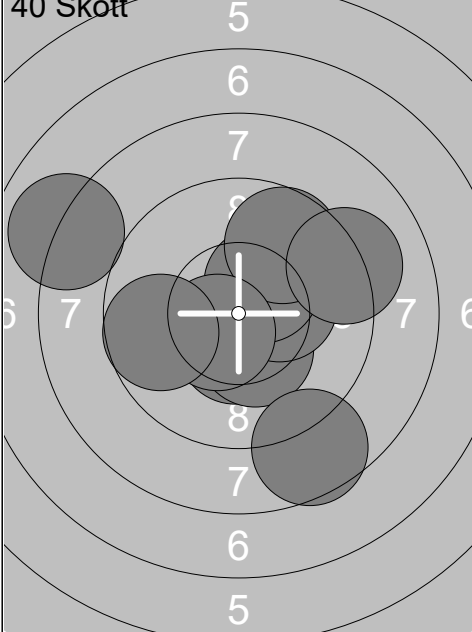
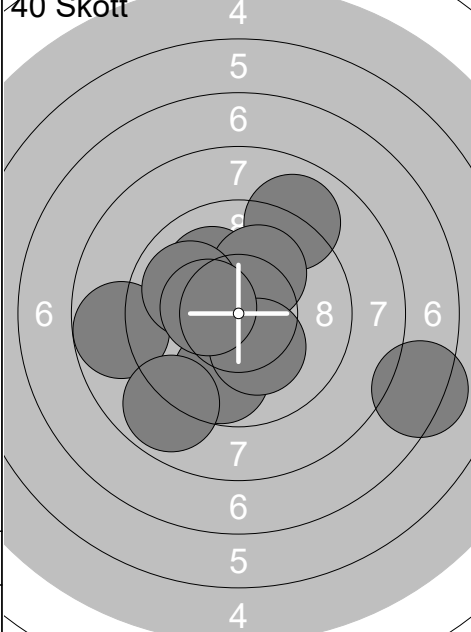
Skjuttlag	Tavla	Petter Hemå	
3	25	Ramselefors	Fältjägarna
03.02.2018		Skyttiadens Regionsfinal 2018	
Prov		Ramselefors SKF	
	1: 7.8 ↘ 2: 8.9 ← 3: 8.2 ← 4: 7.5 ↘ 5: 7.5 ← 6: 8.7 ↗ 7: 8.9 ← 8: 8.6 ← 9: 9.3 ↗ 10: 9.5 ↗ Serie 84.9 Total 0.0		11: 7.2 ↖ 12: 10.4x ↗ 13: 10.3x ↘ 14: 8.8 ↘ 15: 9.9 ↗ Serie 46.6 Total 0.0
	1: 10.2x ↗ 2: 10.0 ↘ 3: 9.2 ↗ 4: 10.0 ↘ 5: 8.8 → 6: 9.9 ↘ 7: 10.2x ↘ 8: 8.6 ↘ 9: 10.0 ← 10: 6.4 ↖ Serie 93.3 Total 93.3		11: 8.9 ↗ 12: 7.9 ← 13: 10.3x → 14: 10.1 ↘ 15: 9.6 → 16: 9.7 ← 17: 10.0 ↗ 18: 9.1 → 19: 7.9 ← 20: 9.1 ↘ Serie 92.6 Total 185.9
	21: 10.4x ↘ 22: 8.0 ← 23: 10.3x ↘ 24: 10.3x → 25: 10.4x ↗ 26: 9.7 ↗ 27: 10.5x ↖ 28: 9.2 ↗ 29: 8.6 ↘ 30: 9.7 ← Serie 97.1 Total 283.0		31: 7.3 → 32: 9.8 ↘ 33: 10.1 ↗ 34: 9.0 ↗ 35: 10.1 ↗ 36: 10.2x ↘ 37: 8.8 ← 38: 8.9 ↘ 39: 9.9 ← 40: 10.4x ← Serie 94.5 Total 377.5

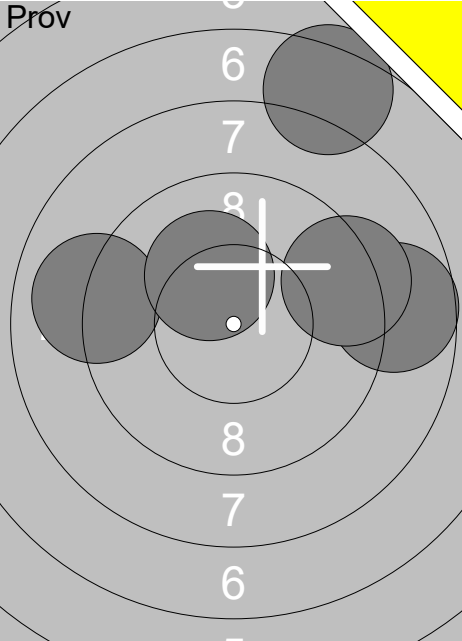
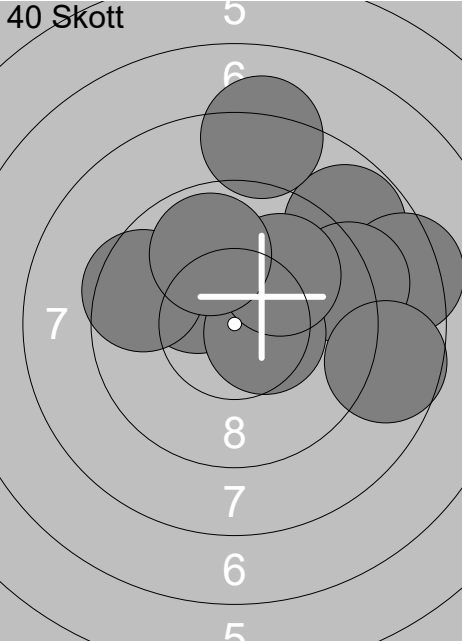
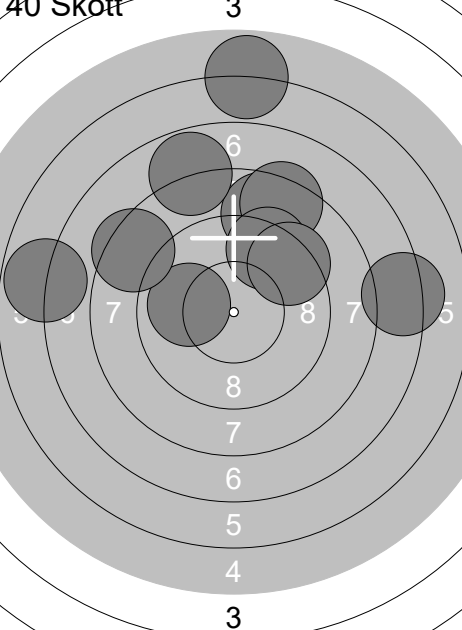
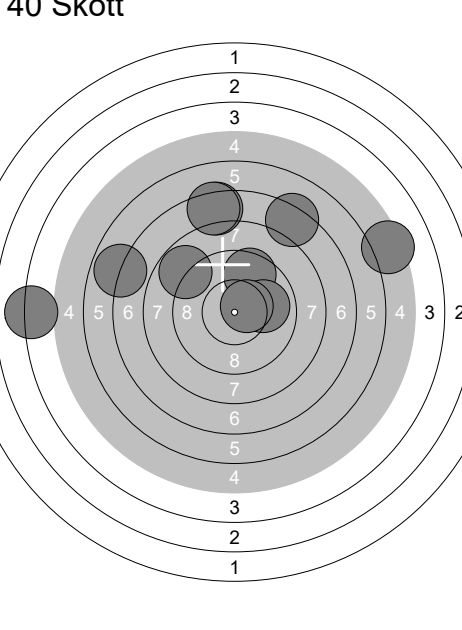
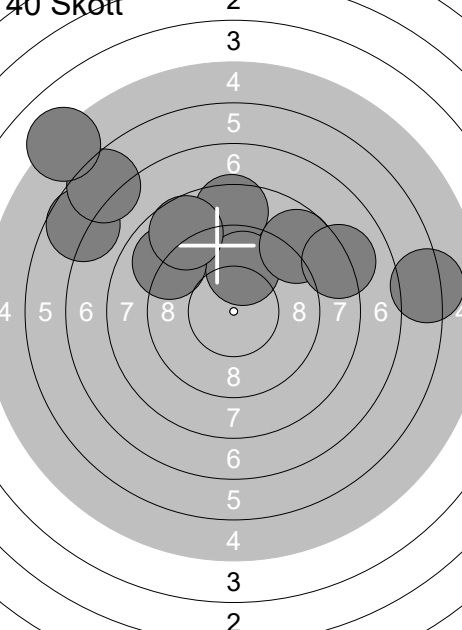
Skjutlag <b>3</b>	Tavla <b>26</b>	<b>John Karlsson</b>	
Ramselefors	Fältjägarna	15S	Jä
03.02.2018	Skyttiadens Regionsfinal 2018	Ramselefors SKF	
<b>Prov</b> 	1: 9.0 ← 2: 7.4 ↑ 3: 8.7 → 4: 10.2x ↖ 5: 9.3 →  <b>Serie 44.6</b> <b>Total 0.0</b>	<b>40 Skott</b> 	1: 8.8 ↗ 2: 8.4 → 3: 10.2x ↖ 4: 9.2 → 5: 8.7 → 6: 10.5x → 7: 8.2 ↑ 8: 10.0 ↗ 9: 9.5 ← 10: 9.9 ↑  <b>Serie 93.4</b> <b>Total 93.4</b>
<b>40 Skott</b> 	11: 10.0 ← 12: 8.7 ↑ 13: 8.4 ↖ 14: 8.4 ↑ 15: 7.3 → 16: 9.4 ↑ 17: 6.8 ← 18: 9.4 ↗ 19: 5.9 ↑ 20: 7.8 ↑  <b>Serie 82.1</b> <b>Total 175.5</b>	<b>40 Skott</b> 	21: 6.9 ← 22: 9.6 ↑ 23: 7.4 ↑ 24: 5.3 → 25: 4.1 ← 26: 7.4 ↑ 27: 10.0 → 28: 7.3 ↗ 29: 10.5x ↗ 30: 8.8 ↖  <b>Serie 77.3</b> <b>Total 252.8</b>
<b>40 Skott</b> 	31: 8.5 ↑ 32: 9.9 ↑ 33: 8.7 ↗ 34: 9.0 ↖ 35: 6.7 ↖ 36: 6.2 → 37: 6.5 ↗ 38: 8.7 ↗ 39: 8.1 → 40: 5.1 ↖  <b>Serie 77.4</b> <b>Total 330.2</b>		

<p>Prov</p>	<p>1: 8.6 →</p> <p>2: 9.3 →</p> <p>3: 6.6 ←</p> <p>4: 8.4 ↑</p> <p>5: 9.0 ↑</p> <p>6: 8.9 ↓</p> <p>7: 7.6 ↓</p> <p>8: 10.4x ↗</p> <p>9: 6.7 →</p> <p>10: 9.2 ↖</p>	<p>Prov</p>	<p>11: 8.5 ↑</p> <p>12: 10.6x →</p>
<b>Serie 84.7</b>		<b>Serie 19.1</b>	
<b>Total 0.0</b>		<b>Total 0.0</b>	

<p>40 Skott</p>	<p>1: 7.7 ↖</p> <p>2: 10.3x ↘</p> <p>3: 4.3 →</p> <p>4: 10.0 ↑</p> <p>5: 7.4 ←</p> <p>6: 10.1 ↑</p> <p>7: 9.5 ↓</p> <p>8: 9.6 ↘</p> <p>9: 7.9 ↑</p> <p>10: 8.8 ↓</p>	<p>40 Skott</p>	<p>11: 8.7 ↘</p> <p>12: 9.7 ↓</p> <p>13: 8.3 ↑</p> <p>14: 7.4 ↖</p> <p>15: 8.1 ←</p> <p>16: 7.7 ↓</p> <p>17: 9.8 ←</p> <p>18: 7.6 →</p> <p>19: 6.4 ←</p> <p>20: 4.1 →</p>
<b>Serie 85.6</b>		<b>Serie 77.8</b>	
<b>Total 85.6</b>		<b>Total 163.4</b>	

<p>40 Skott</p>	<p>21: 6.7 →</p> <p>22: 5.9 →</p> <p>23: 9.0 ↘</p> <p>24: 8.2 ↗</p> <p>25: 9.1 ↑</p> <p>26: 10.2x ↓</p> <p>27: 8.3 →</p> <p>28: 10.3x →</p> <p>29: 9.7 ↓</p> <p>30: 8.1 ↖</p>	<p>40 Skott</p>	<p>31: 10.0 ←</p> <p>32: 7.6 →</p> <p>33: 9.4 ←</p> <p>34: 8.6 ↖</p> <p>35: 6.0 ←</p> <p>36: 7.9 →</p> <p>37: 8.2 →</p> <p>38: 8.6 ↗</p> <p>39: 10.1 ↓</p> <p>40: 7.7 →</p>
<b>Serie 85.5</b>		<b>Serie 84.1</b>	
<b>Total 248.9</b>		<b>Total 333.0</b>	

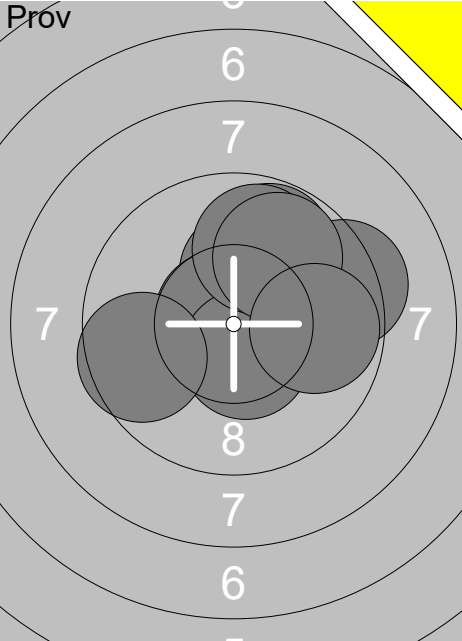
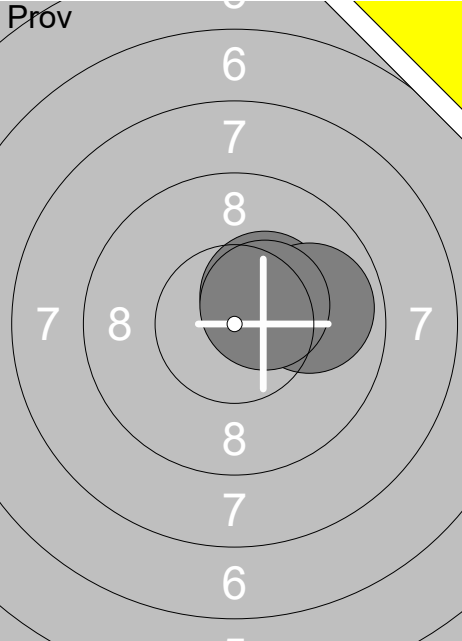
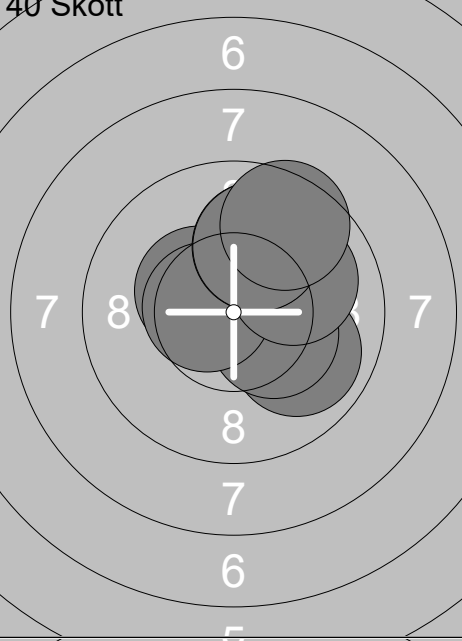
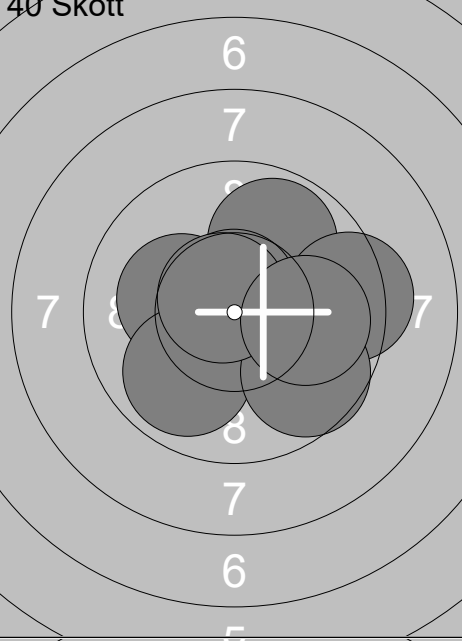
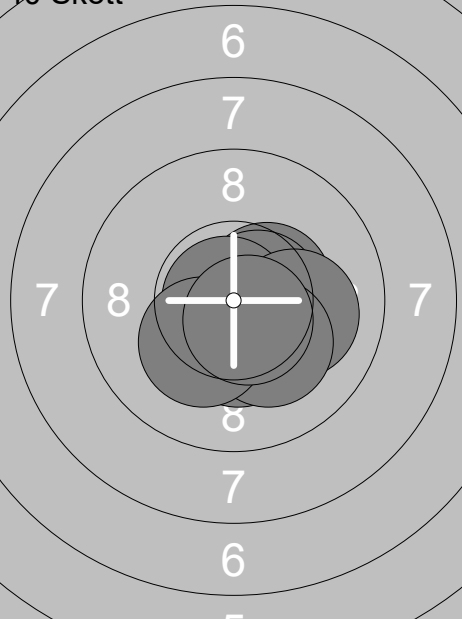
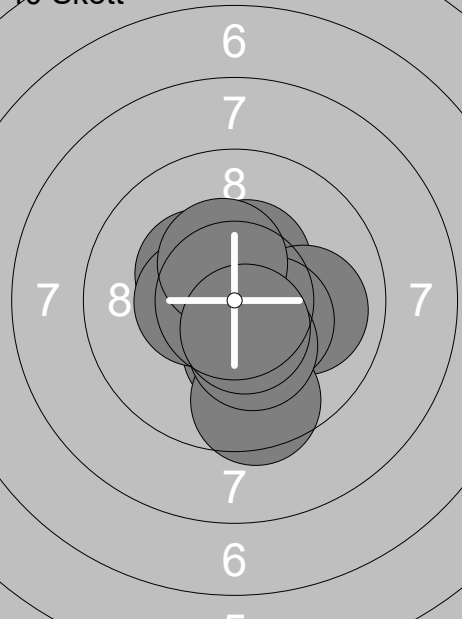

Skjutlag	Tavla	Anna Mårtensson			
3	29	Ramselefors	Kyrkås	17 Jä	
03.02.2018	Skyttiadens Regionsfinal 2018	Ramselefors SKF			
Prov		1: 10.6x ↑ 2: 10.2x ↑ 3: 10.7x ↖ 4: 9.3 → 5: 10.5x ↓ 6: 9.8 ↑ 7: 9.6 ← 8: 9.9 ↑ 9: 9.8 ↑ 10: 9.8 →	Prov	 11: 10.4x ↗ 12: 9.9 → 13: 10.5x ↗	
	Serie	100.2		Serie	30.8
	Total	0.0		Total	0.0
40 Skott		1: 10.7x ↑ 2: 9.9 → 3: 10.4x ↖ 4: 10.8x ↑ 5: 10.3x → 6: 10.6x ↖ 7: 10.0 → 8: 10.0 ↑ 9: 10.0 ↑ 10: 9.6 ↑	40 Skott	 11: 9.9 → 12: 9.9 ↑ 13: 10.2x ↖ 14: 10.3x → 15: 10.7x ↑ 16: 9.3 → 17: 9.9 ↓ 18: 9.7 ↓ 19: 10.7x ↖ 20: 10.0 →	
	Serie	102.3		Serie	100.6
	Total	102.3		Total	202.9
40 Skott		21: 10.6x ↓ 22: 10.8x ↓ 23: 10.5x → 24: 10.6x → 25: 10.9x ← 26: 10.4x ↓ 27: 10.1 → 28: 10.2x ↓ 29: 10.2x ↓ 30: 10.6x ↓	40 Skott	 31: 10.4x ↑ 32: 10.0 → 33: 10.2x ↓ 34: 10.4x → 35: 10.3x ↖ 36: 10.5x ← 37: 10.4x ↑ 38: 9.5 ↓ 39: 10.3x ↓ 40: 10.5x ↓	
	Serie	104.9		Serie	102.5
	Total	307.8		Total	410.3

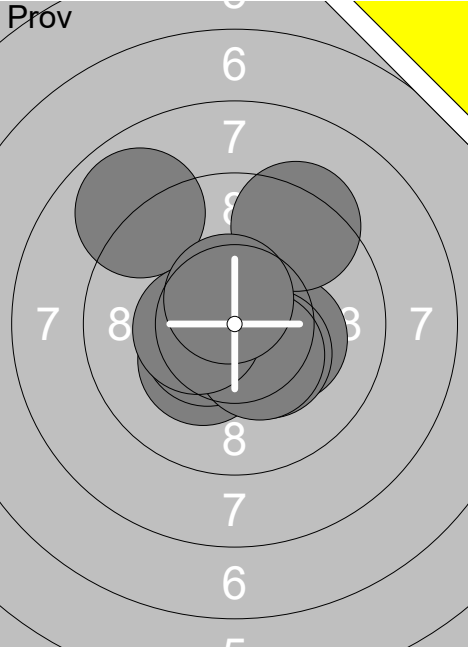
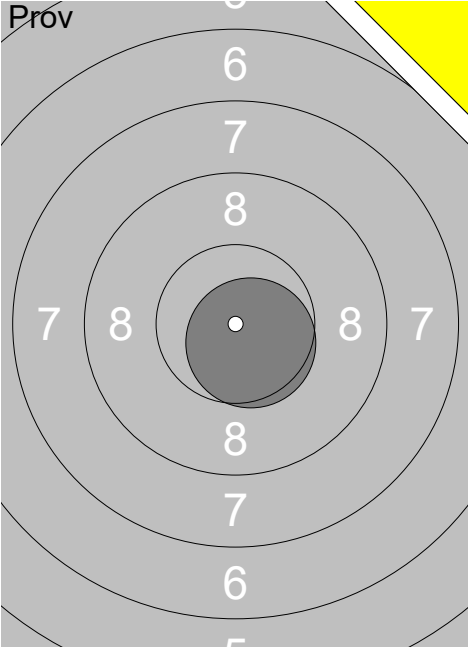
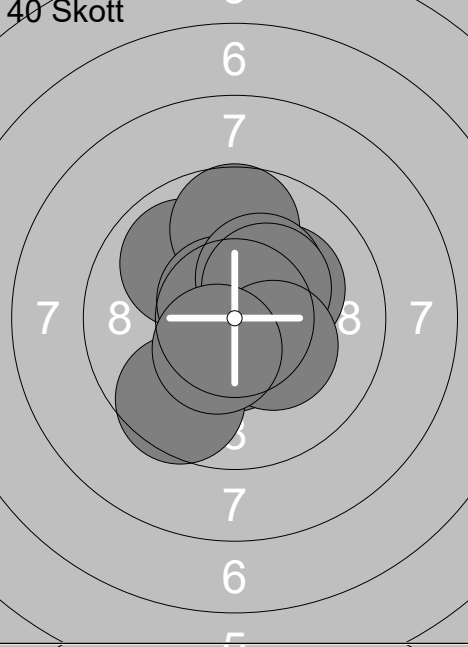
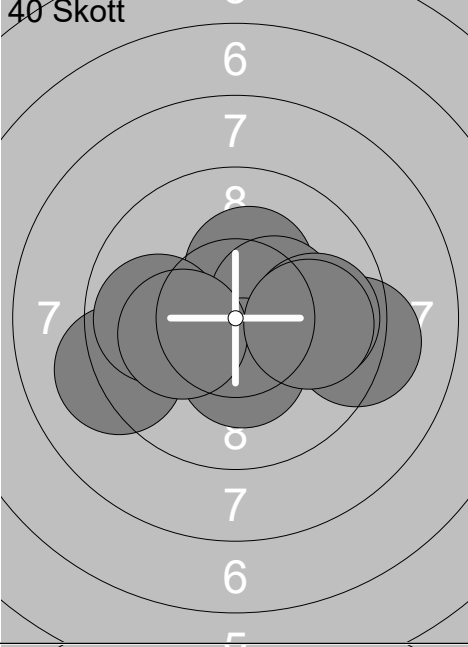
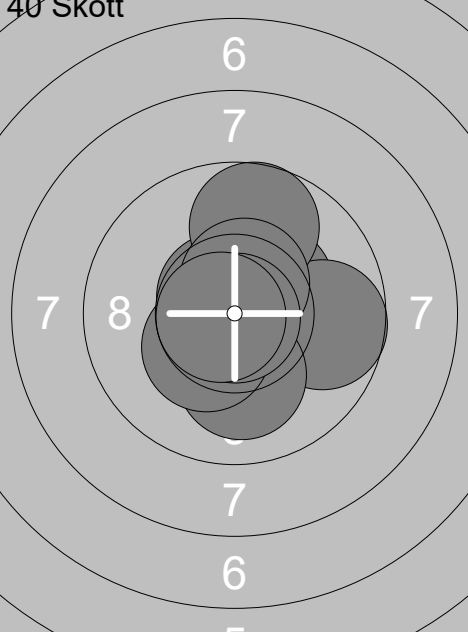
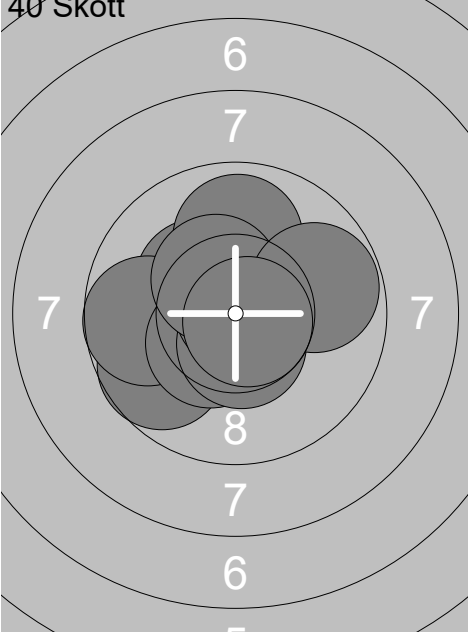
Skjutlag	Tavla	Hanna Lundin		
3	30	Umeå	17	Vb
03.02.2018	Skyttiadens Regionsfinal 2018	Ramselefors SKF		
	1: 10.3x → 2: 10.3x ↘ 3: 8.9 ↗ 4: 10.3x ↙ 5: 10.8x ← 6: 10.5x ↙ 7: 10.4x ↘ 8: 10.4x ← 9: 9.3 ↗ 10: 10.6x ↑		11: 10.6x ↘	
	Serie 101.8		Serie 10.6	
	Total 0.0		Total 0.0	
	1: 10.5x ↓ 2: 10.2x ↗ 3: 9.9 ↖ 4: 9.7 ↑ 5: 10.6x ↖ 6: 10.3x ↗ 7: 10.3x ↗ 8: 10.3x ↘ 9: 9.6 ↓ 10: 10.5x ↘		11: 10.7x ↗ 12: 10.3x ↑ 13: 9.2 ← 14: 9.2 → 15: 9.9 ← 16: 10.4x → 17: 10.3x ↓ 18: 10.2x ← 19: 9.8 → 20: 9.9 →	
	Serie 101.9		Serie 99.9	
	Total 101.9		Total 201.8	
	21: 10.5x ↓ 22: 10.7x ↖ 23: 10.4x ↗ 24: 9.7 → 25: 9.7 ↑ 26: 10.5x ↑ 27: 10.1 ↓ 28: 10.4x ↙ 29: 10.9x ↓ 30: 10.8x ←		31: 9.7 ↙ 32: 10.3x ↖ 33: 9.7 ← 34: 10.4x ↙ 35: 10.5x ↓ 36: 10.8x ↗ 37: 9.9 ↑ 38: 10.4x ↖ 39: 9.8 → 40: 10.7x ↘	
	Serie 103.7		Serie 102.2	
	Total 305.5		Total 407.7	

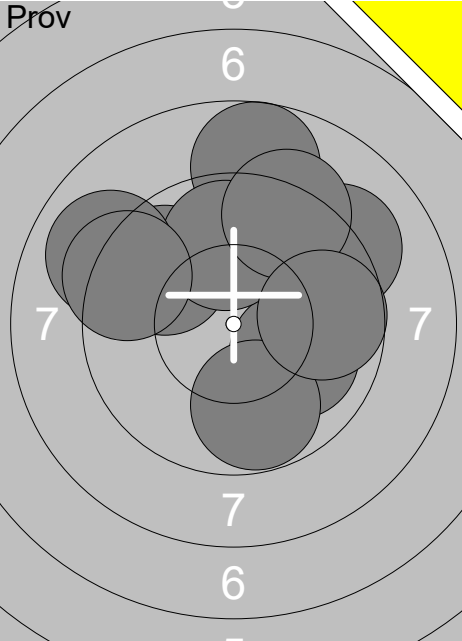
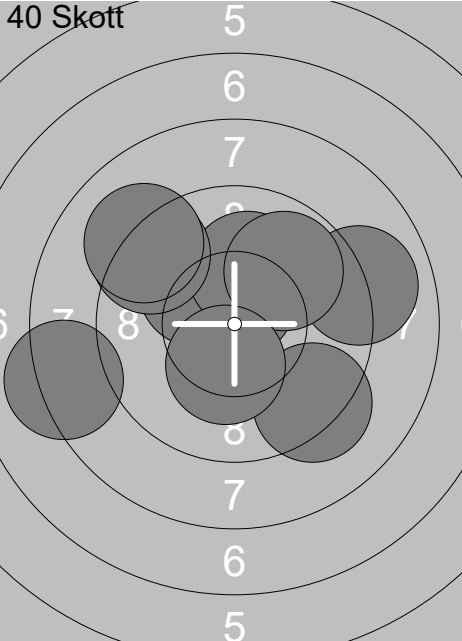
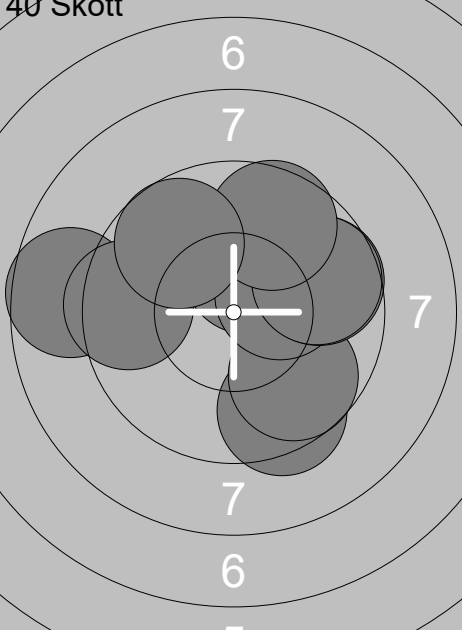
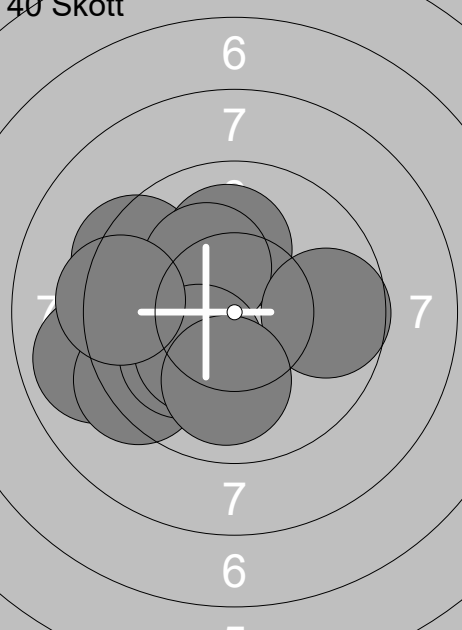
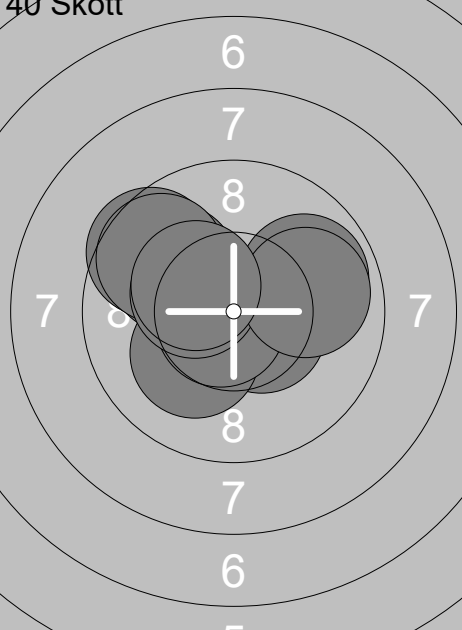
Skjutlag <b>3</b>	Tavla <b>32</b>	<b>Hugo Nyberg</b>	
Ramselefors	Drängsmark	17	Vb
03.02.2018	Skyttiadens Regionsfinal 2018	Ramselefors SKF	
<b>Prov</b> 	1: 10.0 ↘ 2: 8.7 ↑ 3: 9.7 ↖ 4: 9.9 ↑ 5: 9.0 ↖ 6: 9.2 ↗ 7: 9.3 ↑ 8: 9.3 ↖ 9: 9.8 ↓ 10: 9.7 → <b>Serie 94.6</b> <b>Total 0.0</b>	<b>40 Skott</b> 	1: 10.6x ↑ 2: 10.2x ↖ 3: 10.1 ↑ 4: 9.3 ↖ 5: 9.1 ↖ 6: 9.0 → 7: 9.9 ↗ 8: 9.3 ↘ 9: 8.2 ← 10: 10.3x ↓ <b>Serie 96.0</b> <b>Total 96.0</b>
<b>40 Skott</b> 	11: 9.4 ↓ 12: 9.7 ↓ 13: 10.3x ↑ 14: 10.3x → 15: 9.7 → 16: 8.7 ← 17: 9.5 ← 18: 9.7 → 19: 9.6 ↑ 20: 9.7 ↖ <b>Serie 96.6</b> <b>Total 192.6</b>	<b>40 Skott</b> 	21: 9.4 ↖ 22: 8.9 ← 23: 10.1 ↑ 24: 10.2x ↖ 25: 9.3 ↖ 26: 10.0 ↖ 27: 10.2x ↖ 28: 9.7 → 29: 10.0 ↓ 30: 9.4 ← <b>Serie 97.2</b> <b>Total 289.8</b>
<b>40 Skott</b> 	31: 10.5x ↘ 32: 10.2x ↖ 33: 9.5 ↖ 34: 9.9 ↖ 35: 9.7 ↖ 36: 10.7x ↖ 37: 9.9 → 38: 10.4x ↖ 39: 9.9 → 40: 10.3x ↖ <b>Serie 101.0</b> <b>Total 390.8</b>		

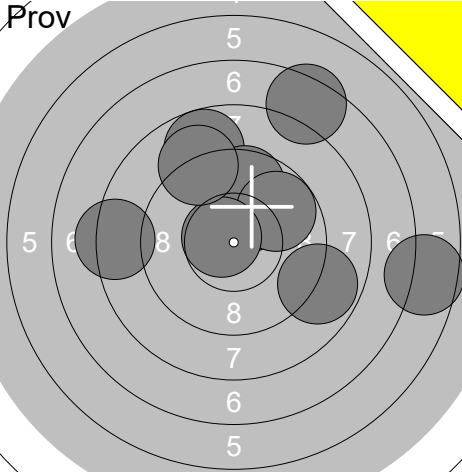
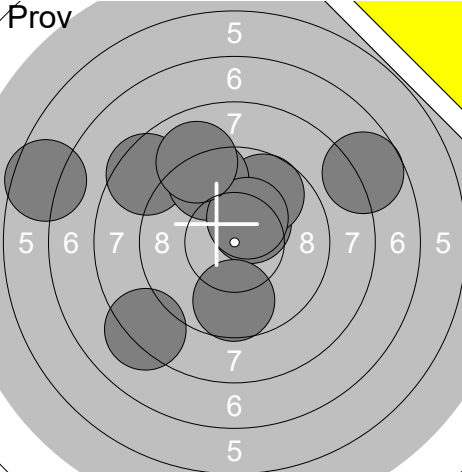
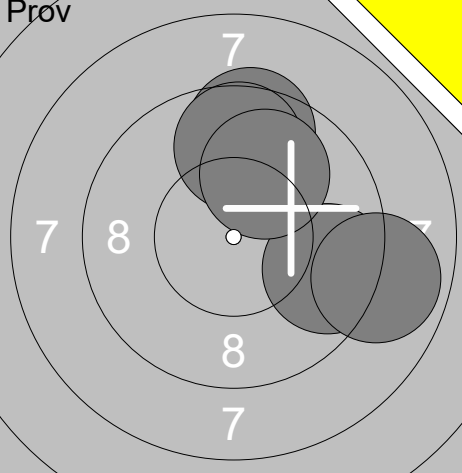
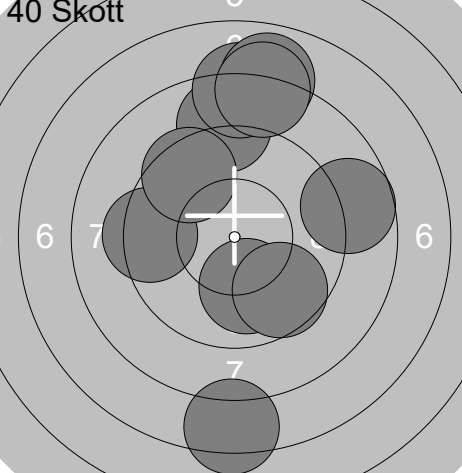
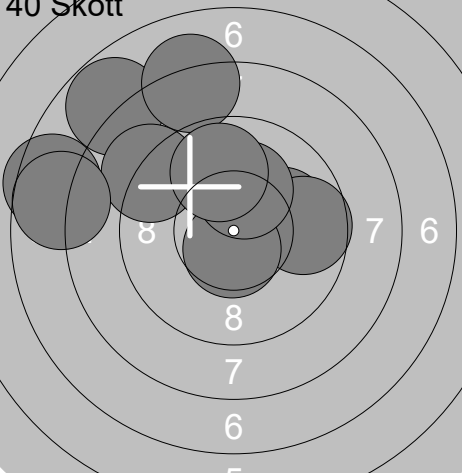
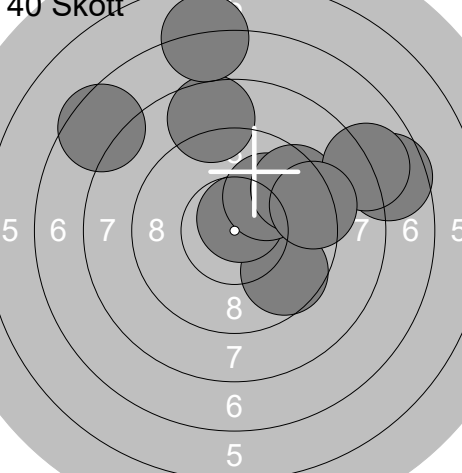
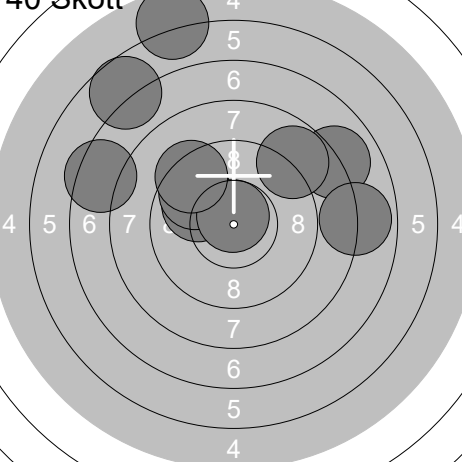
Skjutlag	Tavla		
<b>3</b>	<b>33</b>	<b>André Engström</b>	
Ramselefors	Piteå	17	No
03.02.2018	Skyttiadens Regionsfinal 2018	Ramselefors SKF	
<b>Prov</b> 	1: 10.2x ↗ 2: 8.8 ↗ 3: 6.6 → 4: 7.4 ↗ 5: 9.7 ↗ 6: 8.8 ↘ 7: 9.8 ↗ 8: 10.7x ↖ 9: 9.0 ↗ 10: 8.3 ← Serie 89.3 Total 0.0	<b>Prov</b> 	11: 8.5 ↖ 12: 10.4x ↗ 13: 9.7 ↗ 14: 7.7 ↗ 15: 9.4 ↗ 16: 6.6 ↖ 17: 10.3x ↗ 18: 9.0 ↗ 19: 8.2 ↖ 20: 9.7 ↓ Serie 89.5 Total 0.0
<b>Prov</b> 	21: 9.6 → 22: 9.5 ↗ 23: 9.7 ↗ 24: 8.9 → 25: 10.0 ↗ Serie 47.7 Total 0.0	<b>40 Skott</b> 	1: 8.8 ↗ 2: 7.4 ↓ 3: 9.3 ← 4: 8.2 ↗ 5: 10.0 ↓ 6: 8.7 → 7: 9.6 ↘ 8: 7.9 ↗ 9: 8.1 ↗ 10: 9.5 ↖ Serie 87.5 Total 87.5
<b>40 Skott</b> 	11: 7.8 ↖ 12: 10.0 → 13: 9.1 ↖ 14: 9.7 → 15: 10.6x ↓ 16: 8.1 ↗ 17: 7.5 ← 18: 10.2x ↗ 19: 7.7 ← 20: 9.9 ↗ Serie 90.6 Total 178.1	<b>40 Skott</b> 	21: 9.6 ↘ 22: 7.5 ↖ 23: 10.7x ↗ 24: 10.0 ↗ 25: 8.6 ↗ 26: 7.0 ↗ 27: 7.6 → 28: 9.5 ↗ 29: 8.0 → 30: 9.3 → Serie 87.8 Total 265.9
<b>40 Skott</b> 	31: 9.9 ↖ 32: 8.0 ↗ 33: 9.7 ↗ 34: 8.8 ↗ 35: 7.9 → 36: 7.4 ↖ 37: 10.7x ↗ 38: 6.7 ↗ 39: 9.4 ↗ 40: 5.7 ↗ Serie 84.2 Total 350.1		

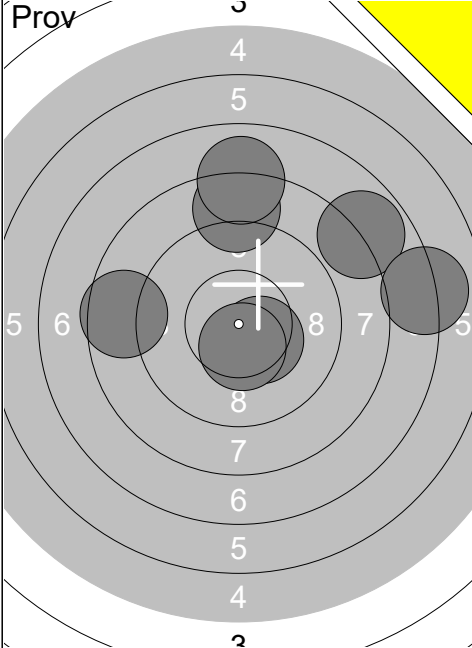
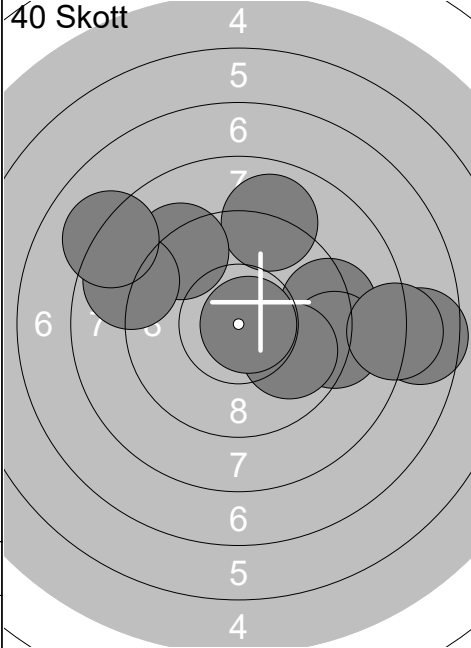
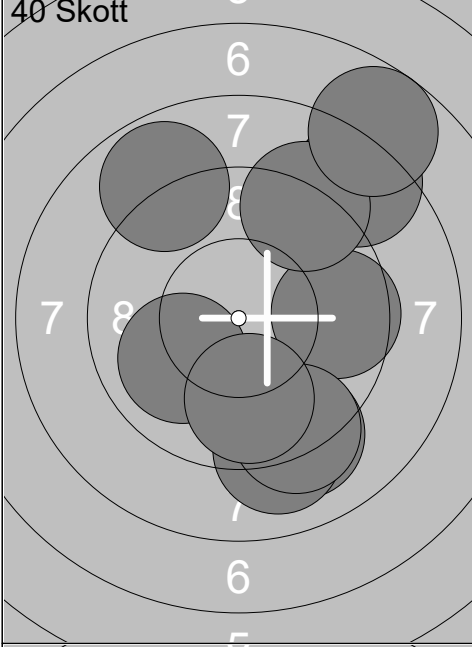
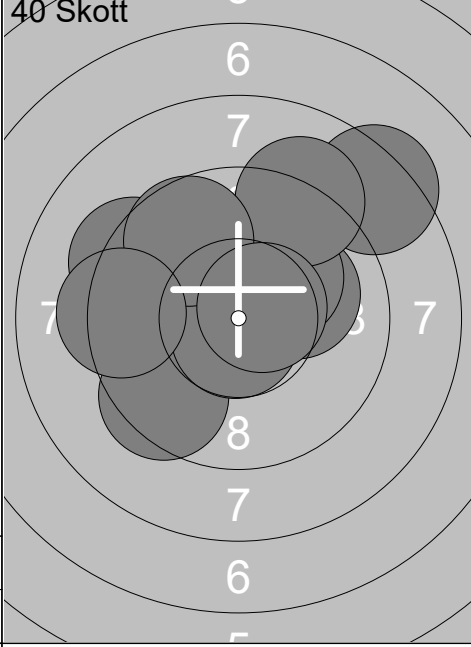
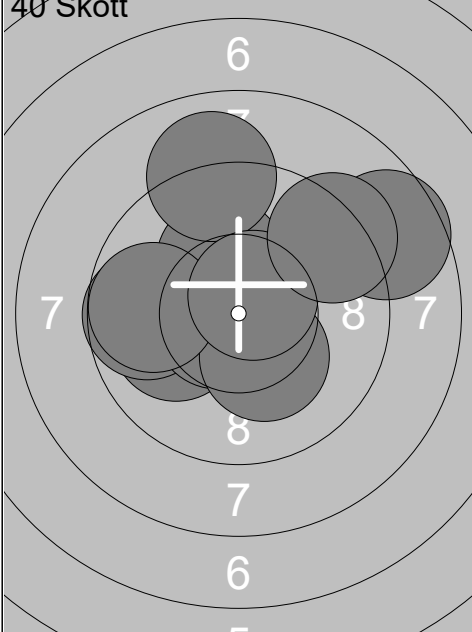
Skjutlag <b>3</b>	Tavla <b>34</b>	<b>Albin Landin</b>	
Ramselefors	Fältjägarna	17	Jä
03.02.2018	Skyttiadens Regionsfinal 2018	Ramselefors SKF	
Prov		40 Skott	
	1: 8.6 ↑ 2: 7.9 ↗ 3: 10.4x ↘ 4: 10.5x ↓ 5: 8.0 ↑ 6: 7.1 → 7: 8.6 ←		1: 7.6 → 2: 9.3 → 3: 9.0 ↑ 4: 9.1 → 5: 9.9 ↘ 6: 9.2 ↗ 7: 8.8 ← 8: 10.8x → 9: 8.0 → 10: 8.1 ↖
	Serie 61.1		Serie 89.8
	Total 0.0		Total 89.8
40 Skott		40 Skott	
	11: 9.1 ↓ 12: 9.6 → 13: 8.9 ↗ 14: 8.4 ↗ 15: 9.1 ↗ 16: 10.0 ← 17: 9.1 ↓ 18: 7.7 ↗ 19: 9.2 ↓ 20: 9.8 ↓		21: 9.5 ↙ 22: 8.4 ↗ 23: 10.1 ↗ 24: 10.7x ↓ 25: 9.3 ↖ 26: 10.2x ↗ 27: 9.1 ↗ 28: 9.7 ↗ 29: 9.3 ← 30: 10.6x →
	Serie 90.9		Serie 96.9
	Total 180.7		Total 277.6
40 Skott			
	31: 10.2x ↑ 32: 10.0 ← 33: 9.7 ← 34: 10.6x ↙ 35: 10.3x ↓ 36: 9.0 ↑ 37: 9.8 ← 38: 8.6 ↗ 39: 10.6x ↗ 40: 9.3 ↗		
	Serie 98.1		
	Total 375.7		

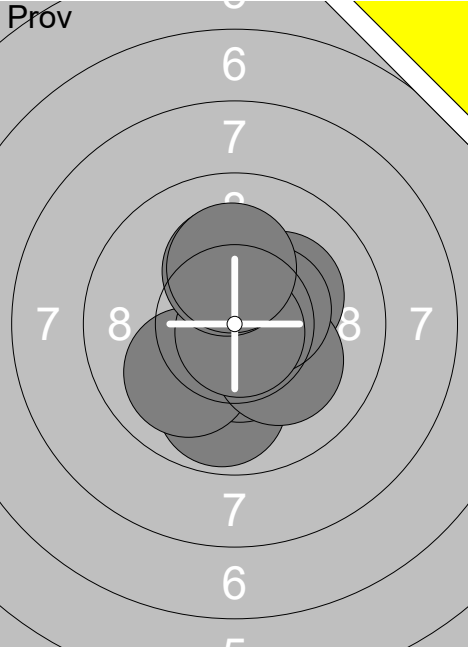
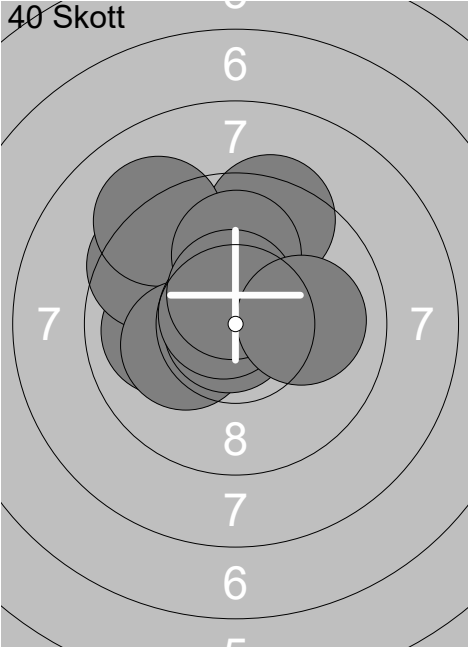
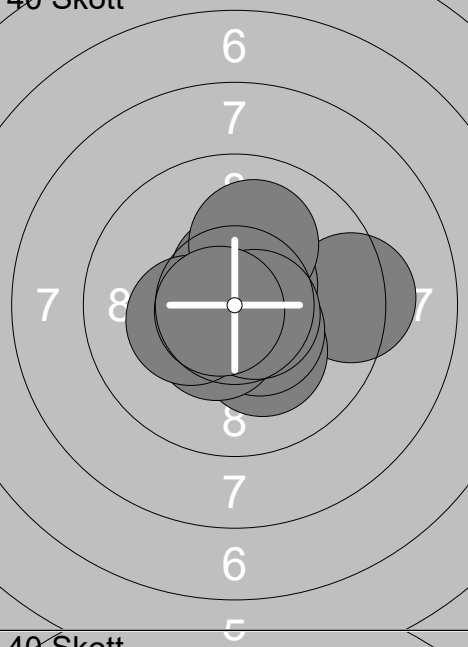
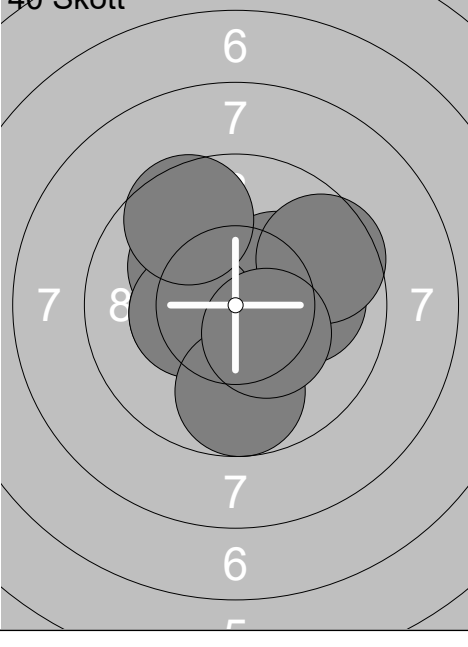
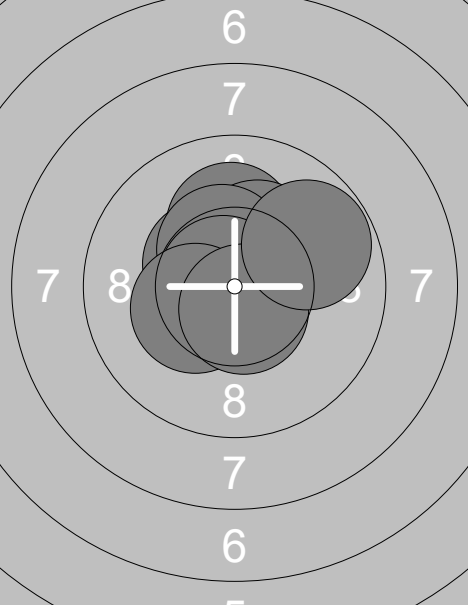
Skjutlag <b>3</b>	Tavla <b>36</b>	<b>Saul Johansson</b>		
Ramselefors	Ramselefors	21	Vb	
03.02.2018	Skyttiadens Regionsfinal 2018	Ramselefors SKF		
Prov		40 Skott		
	1: 9.9 ↓ 2: 10.5x ↓ 3: 10.2x ↗ 4: 10.0 ↙ 5: 10.2x ↘ 6: 10.5x ↗ 7: 10.8x ↓ 8: 10.2x ↑ 9: 10.2x ↑		1: 10.0 ← 2: 9.4 ↑ 3: 9.5 ↖ 4: 9.2 ↗ 5: 10.2x ← 6: 10.0 ↑ 7: 10.8x ↙ 8: 10.7x ↖ 9: 10.5x ↑ 10: 10.0 →	
	Serie 92.5		Serie 100.3	
	Total 0.0		Total 100.3	
40 Skott		40 Skott		
	11: 9.3 → 12: 10.6x ↑ 13: 10.2x ↓ 14: 10.4x ↘ 15: 10.6x ↗ 16: 10.5x ↓ 17: 10.3x ← 18: 10.1 ↑ 19: 10.6x ↘ 20: 10.7x ←		21: 10.2x ↓ 22: 10.4x ← 23: 10.1 ↖ 24: 10.0 → 25: 10.3x ↗ 26: 10.4x ← 27: 9.6 ↗ 28: 9.8 ↓ 29: 10.4x ↘ 30: 9.6 ↖	
	Serie 103.3		Serie 100.8	
	Total 203.6		Total 304.4	
40 Skott				
	31: 10.5x ↖ 32: 10.1 ↑ 33: 10.3x ↗ 34: 10.6x ↖ 35: 10.4x ↑ 36: 10.8x ← 37: 10.8x ↖ 38: 10.3x ← 39: 10.6x ↓ 40: 9.8 ↗			
	Serie 104.2			
	Total 408.6			

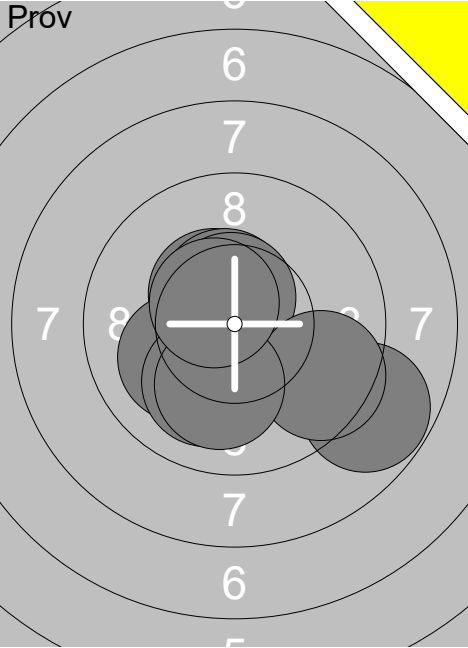
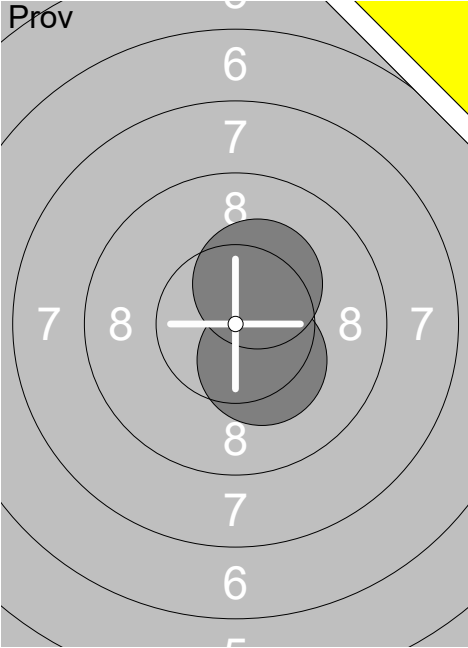
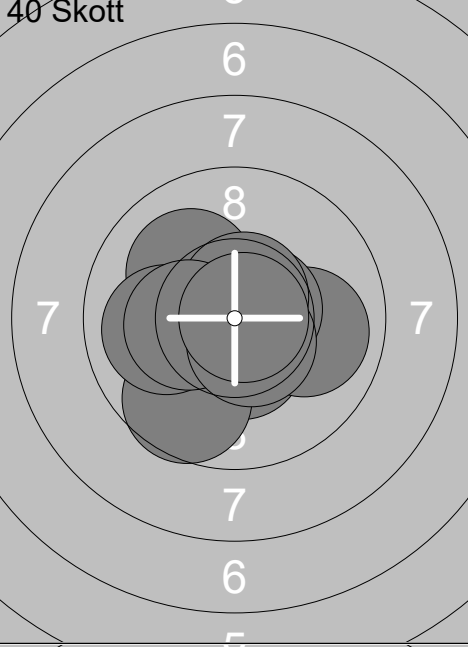
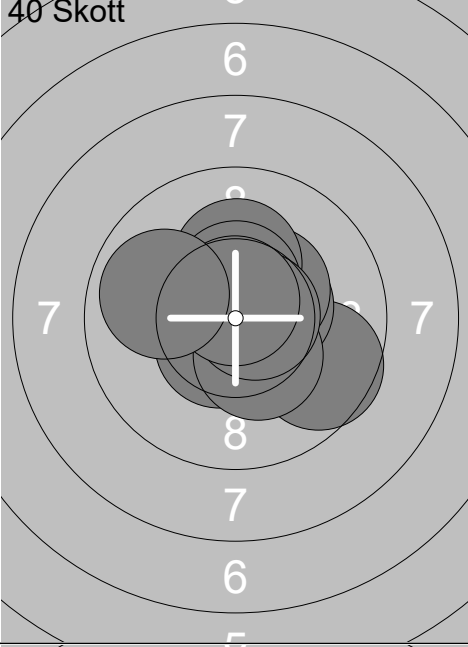
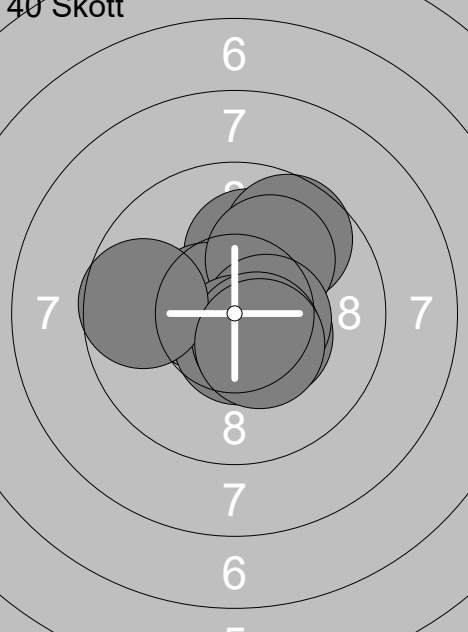
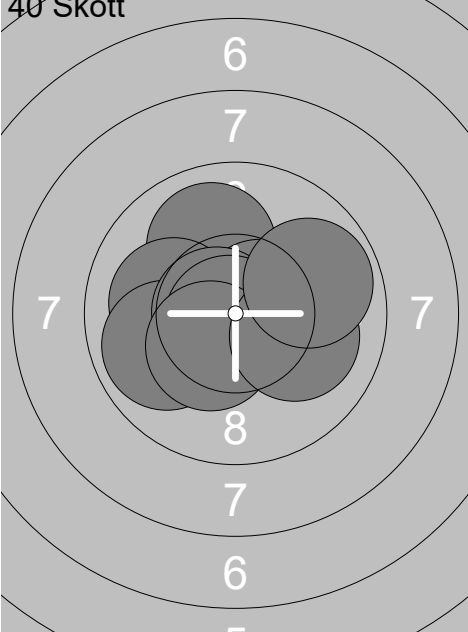
Skjutlag	Tavla	Emma Fjällström	
3	37	Ramselefors	Gällivare
03.02.2018	Skyttiadens Regionsfinal 2018	21	No
03.02.2018	Skyttiadens Regionsfinal 2018	Ramselefors SKF	
Prov 	1: 10.4x ↗ 2: 10.5x ↑ 3: 10.1 ← 4: 10.7x ↗ 5: 10.6x ↑ 6: 8.8 → 7: 9.6 → 8: 10.1 ↓ 9: 10.1 ↓ 10: 10.5x ↗ Serie 101.4 Total 0.0	Prov 	11: 10.3x ↘ 12: 10.3x ↑ Serie 20.6 Total 0.0
40 Skott 	1: 10.4x ↓ 2: 10.1 ↗ 3: 10.0 → 4: 9.7 ↓ 5: 10.6x → 6: 10.6x ↑ 7: 10.0 ← 8: 10.3x ← 9: 10.6x ↘ 10: 10.8x → Serie 103.1 Total 103.1	40 Skott 	11: 9.6 → 12: 10.5x ↘ 13: 10.5x → 14: 10.4x ↗ 15: 10.2x ↑ 16: 10.4x ↘ 17: 10.5x ↑ 18: 10.7x → 19: 10.7x ↑ 20: 9.9 ← Serie 103.4 Total 206.5
40 Skott 	21: 10.1 ↑ 22: 9.7 ↗ 23: 10.6x ← 24: 10.1 ↗ 25: 10.4x ↘ 26: 10.5x → 27: 10.6x ↓ 28: 10.5x ↘ 29: 9.7 ← 30: 10.4x ↘ Serie 102.6 Total 309.1	40 Skott 	31: 10.0 ↑ 32: 10.1 ← 33: 10.2x → 34: 10.6x → 35: 9.9 ← 36: 10.7x ← 37: 10.8x ↘ 38: 10.4x ↘ 39: 10.1 → 40: 9.9 → Serie 102.7 Total 411.8

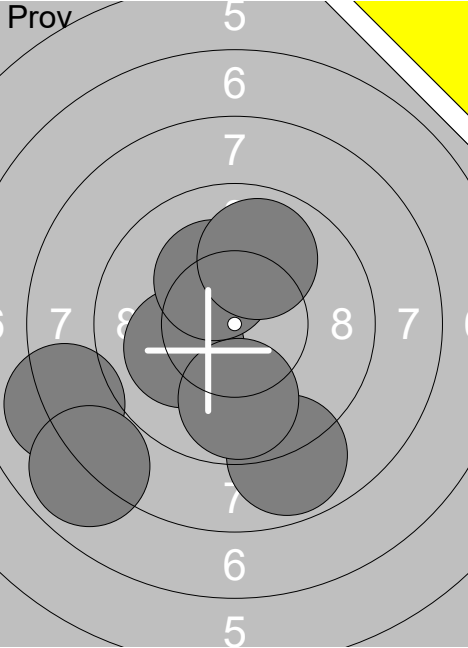
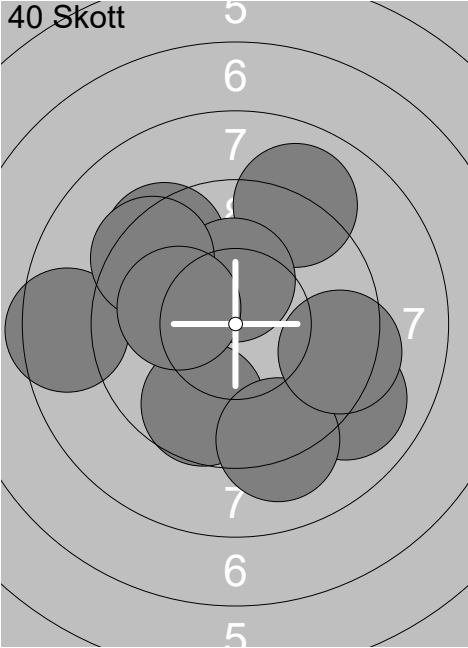
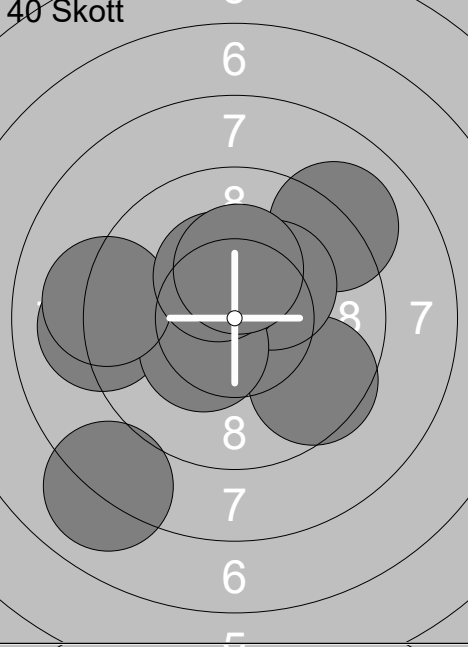
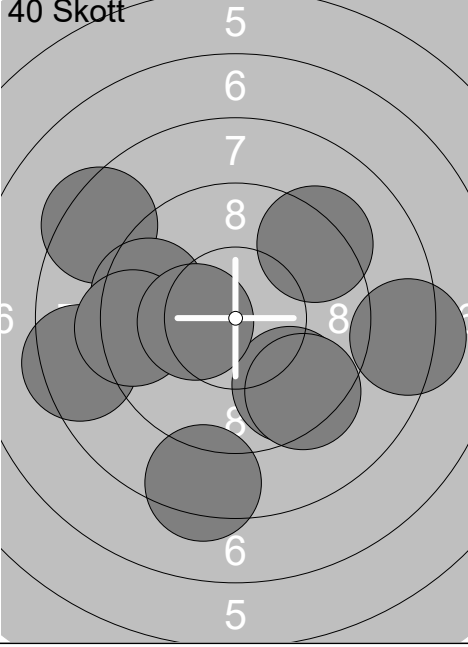
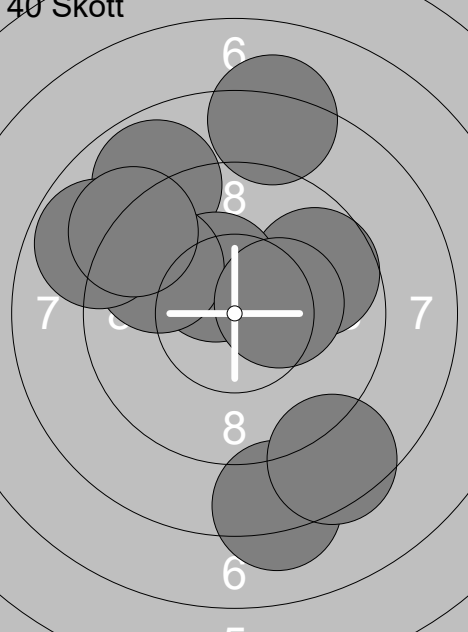
Skjuttlag	Tavla	Emma Andersson		
3	39	Ramselefors	Kubikenborg	21 Vn
03.02.2018	Skyttiadens Regionsfinal 2018	Ramselefors SKF		
	1: 10.1 ↙		1: 9.4 ↗	
	2: 8.1 ↙		2: 9.0 ↗	
	3: 7.9 ↙		3: 10.3x ↑	
	4: 8.8 ↓		4: 9.7 ↓	
	5: 9.8 ↓		5: 9.0 ↘	
	6: 10.2x ↗		6: 9.2 ↓	
	7: 9.9 ↗		7: 8.5 ←	
			8: 9.4 ↗	
			9: 9.4 →	
			10: 10.1 ←	
	Serie 64.8		Serie 94.0	
	Total 0.0		Total 94.0	
	11: 9.1 ↗		21: 8.3 ↓	
	12: 9.6 ↘		22: 9.6 ↓	
	13: 8.0 ↓		23: 8.4 ↖	
	14: 10.3x ↗		24: 9.3 ↗	
	15: 9.1 ←		25: 9.4 ↘	
	16: 10.4x ↗		26: 8.3 →	
	17: 10.4x ↙		27: 9.6 ←	
	18: 9.2 ←		28: 8.4 ←	
	19: 10.3x ↗		29: 9.4 ←	
	20: 10.3x ↑		30: 10.3x ←	
	Serie 96.7		Serie 91.0	
	Total 190.7		Total 281.7	
	31: 9.7 ↗			
	32: 8.9 ↗			
	33: 10.4x ↗			
	34: 9.7 ↖			
	35: 8.2 ↓			
	36: 8.2 ↑			
	37: 10.3x →			
	38: 8.8 ↖			
	39: 8.5 ↓			
	40: 9.1 ↖			
	Serie 91.8			
	Total 373.5			

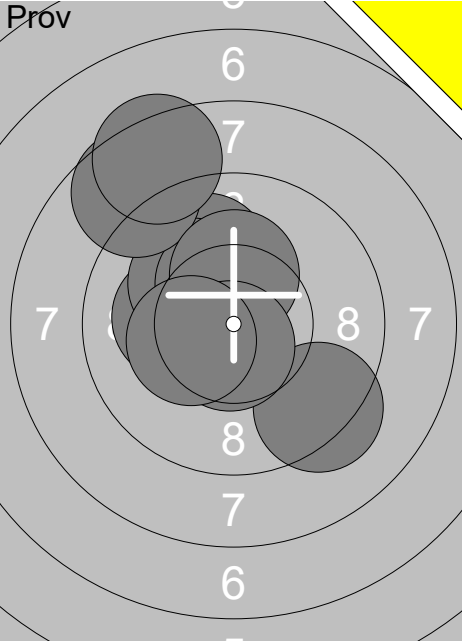
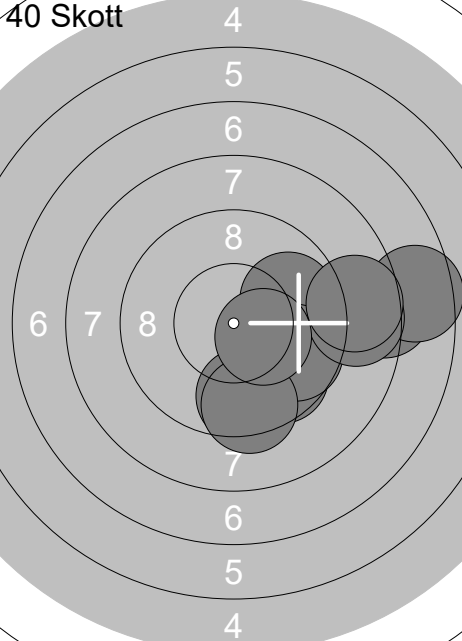
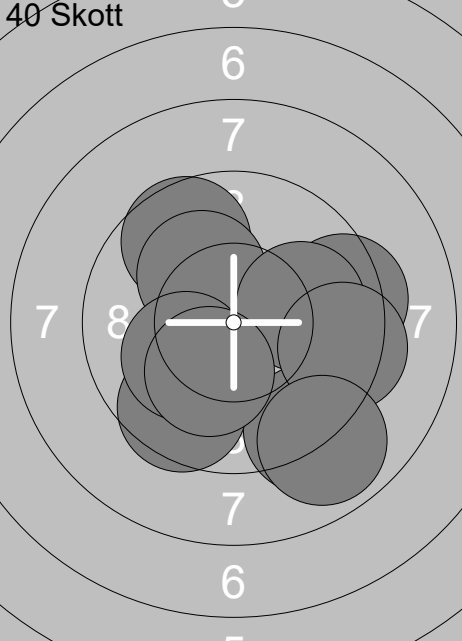

Skjuttlag <b>3</b>	Tavla <b>40</b>	<b>Klas Jonsson</b>		
Ramselefors	Aspås	21	Jä	
03.02.2018	Skyttiadens Regionsfinal 2018	Ramselefors SKF		
Prov		1: 10.0 ↗ 2: 10.2x ← 3: 10.1 ↗ 4: 10.4x ↗ 5: 8.7 ↗ 6: 8.4 ↗ 7: 10.3x ↑ 8: 9.3 ↘ 9: 10.6x ↓ 10: 10.3x ←	40 Skott	1: 10.5x ↘ 2: 10.6x ← 3: 9.7 ↘ 4: 9.3 ← 5: 9.4 ↘ 6: 9.4 ← 7: 10.5x ↘ 8: 10.1 ↓ 9: 8.5 ↘ 10: 10.2x ↗
	Serie 98.3		Serie 98.2	
	Total 0.0		Total 98.2	
40 Skott		11: 9.6 ↓ 12: 9.9 → 13: 8.2 → 14: 9.7 ↘ 15: 9.7 ↘ 16: 7.6 → 17: 9.4 ↓ 18: 8.7 → 19: 8.7 → 20: 10.4x →	40 Skott	21: 9.3 ↗ 22: 10.8x ↘ 23: 9.5 ↗ 24: 10.0 ↑ 25: 9.3 → 26: 10.6x ↓ 27: 9.9 ← 28: 9.6 → 29: 9.3 ↘ 30: 9.5 ↓
	Serie 91.9		Serie 97.8	
	Total 190.1		Total 287.9	
40 Skott		31: 9.1 ↓ 32: 9.6 ↗ 33: 10.2x ↗ 34: 9.4 → 35: 9.6 ↘ 36: 10.1 ← 37: 10.0 → 38: 10.2x ↓ 39: 9.4 → 40: 8.9 ↓		
	Serie 96.5			
	Total 384.4			