

Prov 	1: 9.2 ← 2: 8.7 ↗ 3: 9.6 ← 4: 9.7 ↖ 5: 10.2 ← 6: 10.4x ↓ 7: 10.2 ↖ 8: 10.5x ↖ 9: 10.6x ↗ 10: 8.6 ↑ Serie 93 Total 0	Prov 	11: 9.7 ← 12: 9.2 ↑ 13: 10.6x ↓ 14: 9.0 ↑ 15: 10.0 ↑ 16: 10.3 ↖ Serie 57 Total 0
20 Skott 	1: 10.7x ↓ 2: 10.3 ↖ 3: 10.5x ↖ 4: 9.9 ↓ 5: 10.1 ← Serie 49 Total 49	20 Skott 	6: 10.7x ↑ 7: 9.8 ↖ 8: 9.5 ← 9: 9.9 ↓ 10: 10.3x ↑ Serie 47 Total 96
20 Skott 	11: 10.3x → 12: 10.4x ↑ 13: 9.7 ↗ 14: 9.7 ↓ 15: 10.3x ↖ Serie 48 Total 144	20 Skott 	16: 10.3 ← 17: 10.7x ↑ 18: 10.5x ↘ 19: 10.0 → 20: 9.8 ↖ Serie 49 Total 193

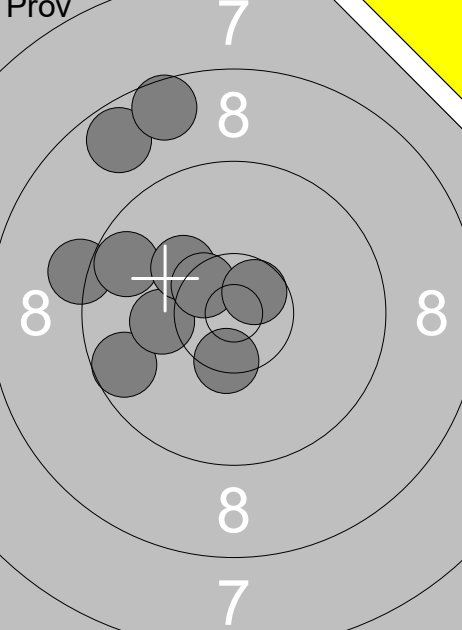

1:	8.8	↙
2:	7.8	←
3:	10.2	←
4:	10.3x	↙
5:	10.3x	↘
6:	9.8	←
7:	10.1	↙
8:	9.7	←
9:	7.7	←
10:	8.8	↙
Serie		88
Total		0

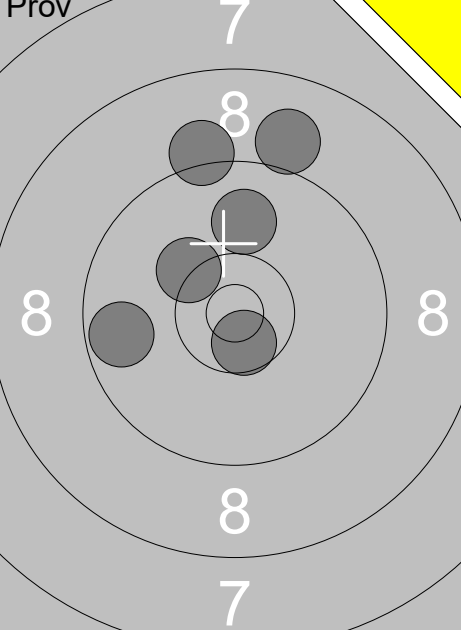
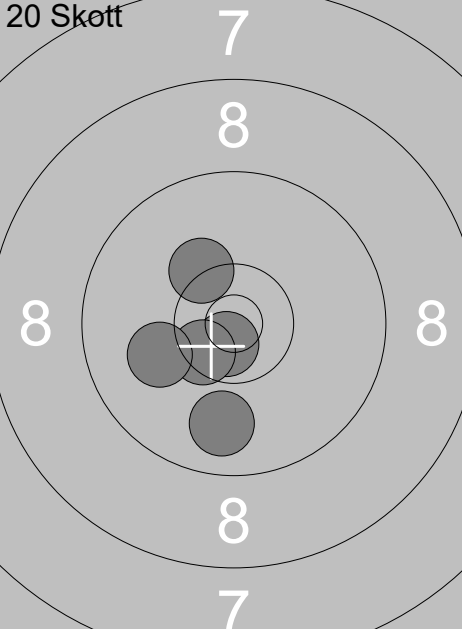
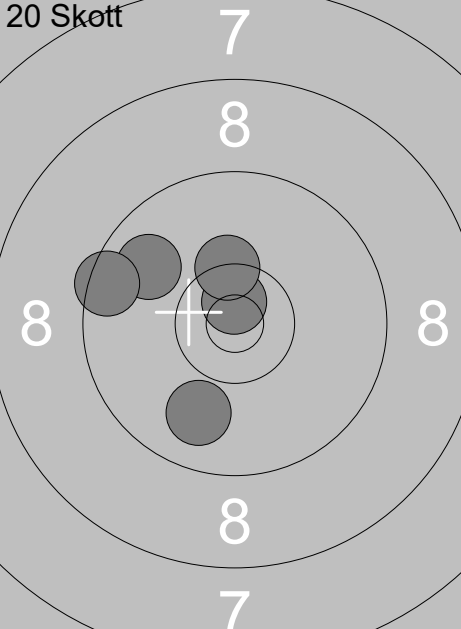
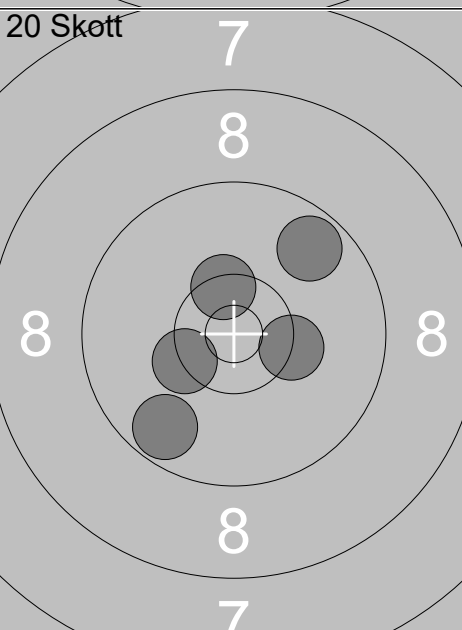
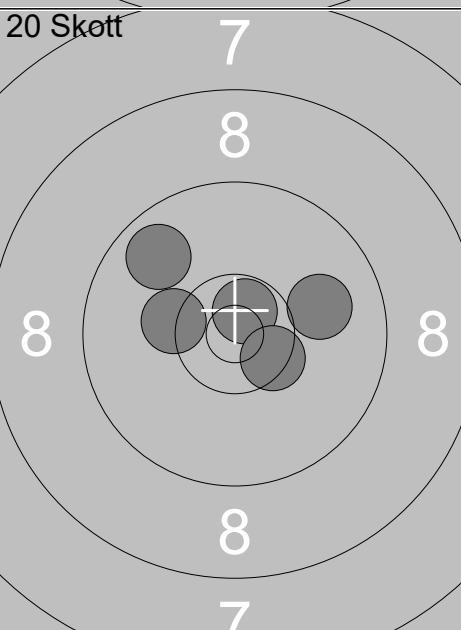
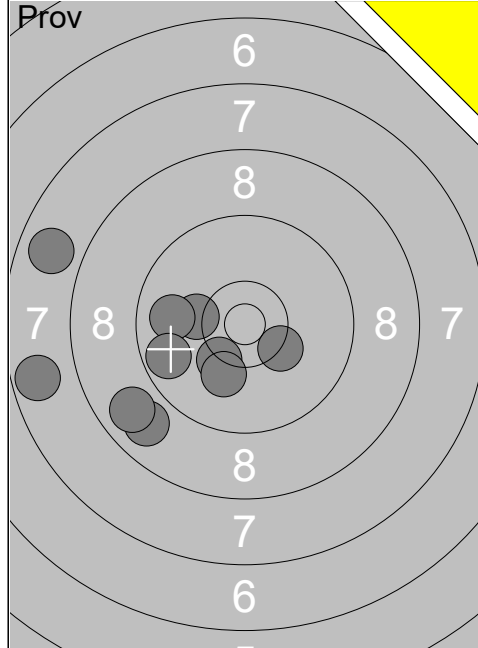
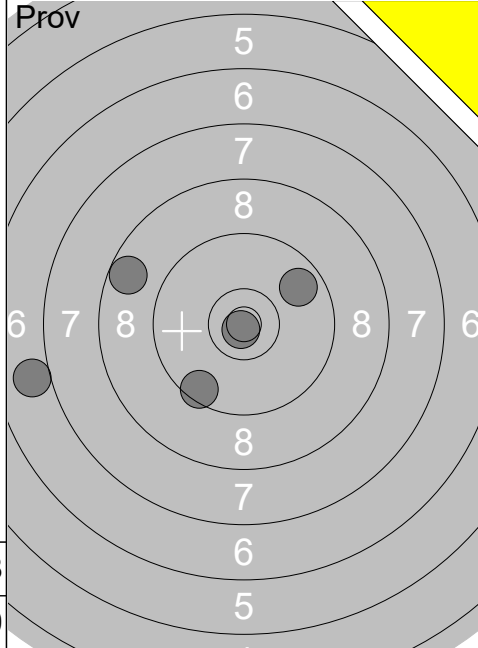

11:	9.7	↗
12:	7.0	←
13:	10.8x	↙
14:	8.7	←
15:	9.5	↙
Serie		43
Total		0

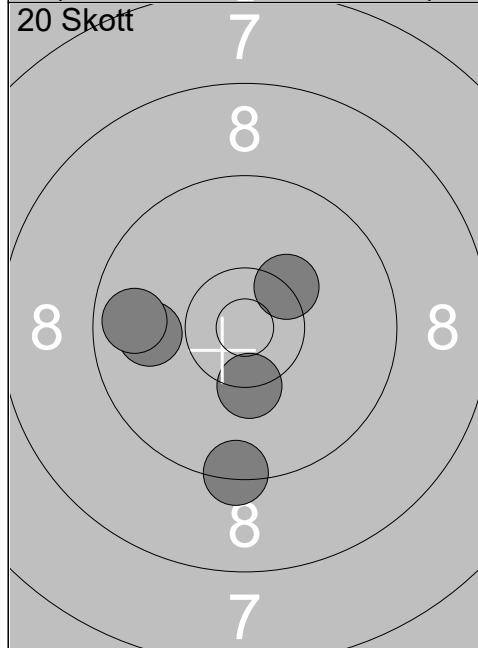

1:	9.9	←
2:	9.4	↓
3:	10.3x	↓
4:	10.3x	↗
5:	9.8	←
Serie		47
Total		47

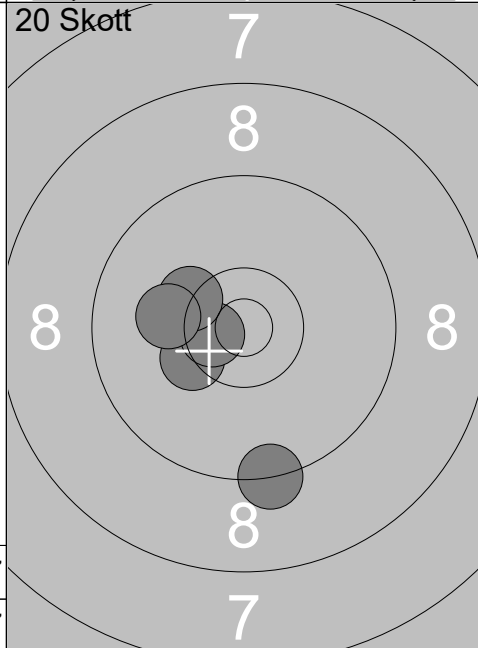

6:	10.3x	↙
7:	10.6x	↙
8:	10.3x	↙
9:	10.1	←
10:	9.3	↓
Serie		49
Total		96

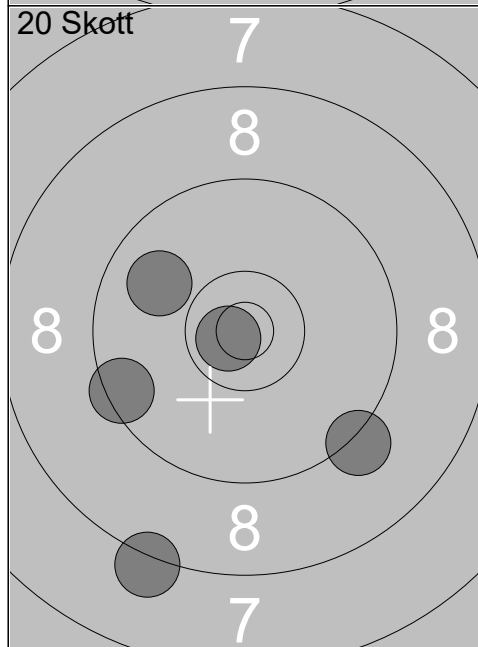

11:	9.9	↙
12:	10.8x	↙
13:	9.2	↘
14:	9.5	←
15:	8.2	↘
Serie		45
Total		141

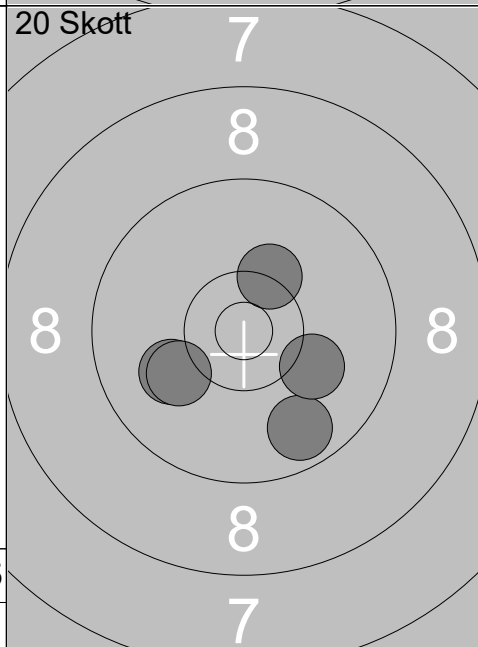

16:	9.7	↘
17:	10.1	↘
18:	10.0	←
19:	10.1	←
20:	10.3x	↗
Serie		49
Total		190

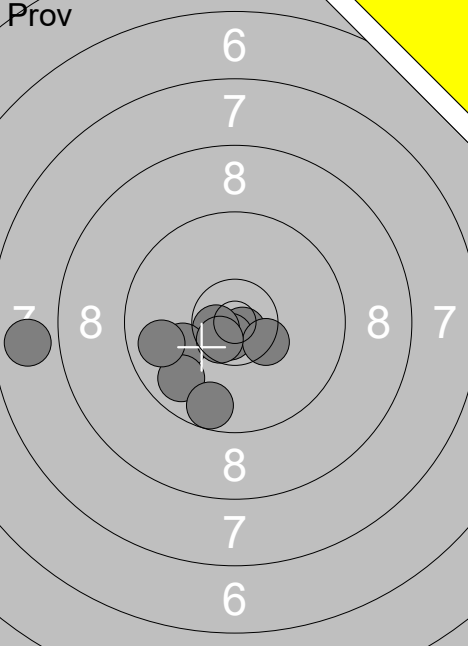
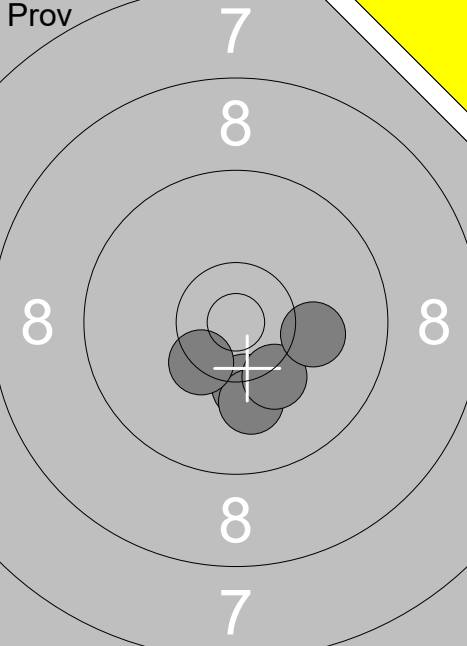
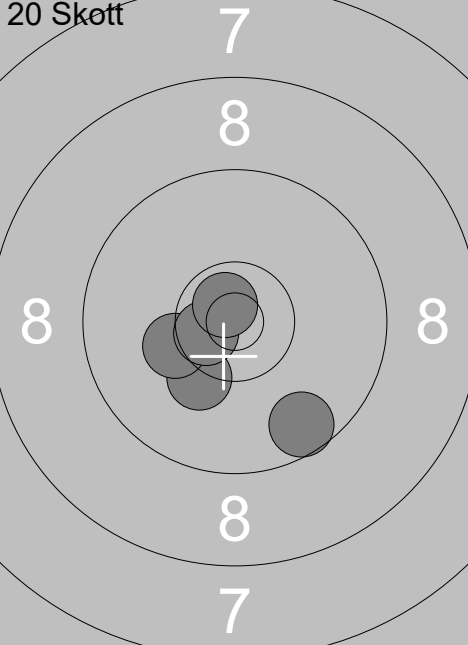
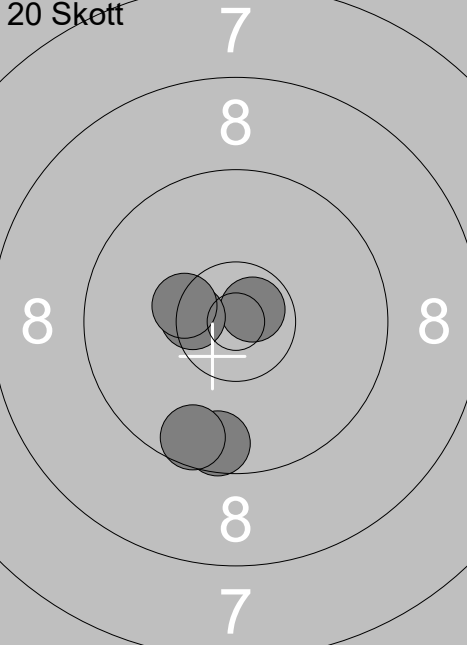
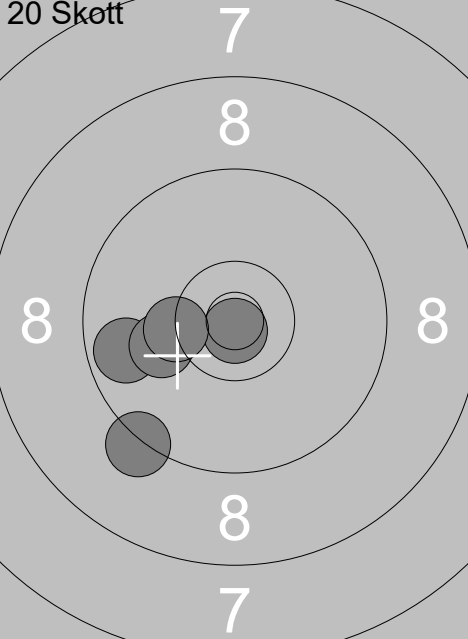
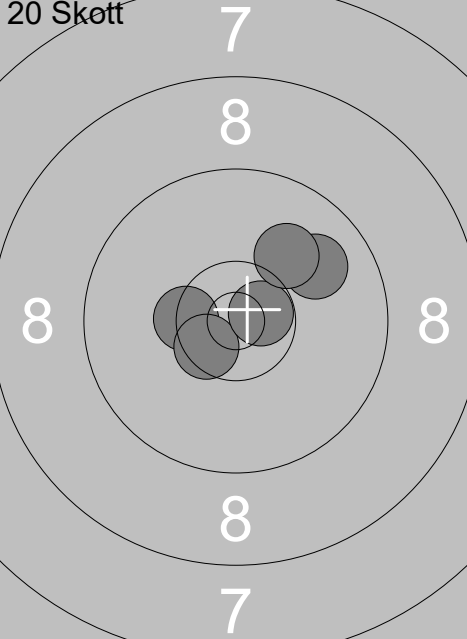
Skjutlag	Tavla	Casper Fredriksson			
1	3	Ramselefors	Ramselefors	Jun-L	Vb
28.04.2018	Vindelnskottet 2018	Ramselefors SKF			
Prov		1: 7.8 ←	Prov		11: 10.2 ↓
		2: 10.8x ↘			12: 10.1 ↓
		3: 10.7x ↓			13: 10.4x ↙
		4: 10.7x ←			14: 10.2 ↓
		5: 10.1 ←			15: 10.1 →
		6: 9.8 ↙			
		7: 10.4x ↘			
		8: 10.6x ↘			
		9: 9.8 ←			
		10: 9.7 ↓			
		Serie 94			Serie 50
		Total 0			Total 0
20 Skott		1: 10.2 ↓	20 Skott		6: 9.6 ↓
		2: 9.6 ↓			7: 10.7x ↗
		3: 10.2 ←			8: 10.5x ←
		4: 10.6x ←			9: 10.4x ←
		5: 10.7x ↗			10: 9.6 ↓
		Serie 49			Serie 48
		Total 49			Total 97
20 Skott		11: 9.7 ←	20 Skott		16: 10.4x ←
		12: 10.8x ↓			17: 10.5x ↙
		13: 10.1 ←			18: 10.7x →
		14: 9.2 ↓			19: 9.9 ↗
		15: 10.3x ←			20: 10.1 ↗
		Serie 48			Serie 49
		Total 145			Total 194

Skjuttlag	Tavla	Anna Grönlund		
1	4	Ramselefors	Piteå	15 No
28.04.2018	Vindelnskottet 2018	Ramselefors SKF		
Prov 	1: 8.4 → 2: 8.9 ↓ 3: 9.9 → 4: 10.5x ↓ 5: 10.3 ↓ 6: 9.2 ← 7: 9.4 ← 8: 9.8 → 9: 9.3 ↗ 10: 10.9x ↓	Prov 	11: 8.8 ↗	
	Serie 91		Serie 8	
	Total 0		Total 0	
20 Skott 	1: 10.6x ↓ 2: 10.2 → 3: 9.4 ↗ 4: 10.2 ↗ 5: 9.4 →	20 Skott 	6: 9.9 ↓ 7: 10.4x ↓ 8: 10.5x → 9: 10.6x ← 10: 10.1 ←	
	Serie 48		Serie 49	
	Total 48		Total 97	
20 Skott 	11: 8.7 → 12: 10.1 ← 13: 10.1 ↓ 14: 10.5x ↑ 15: 9.9 ↓	20 Skott 	16: 10.4x ↓ 17: 10.2 ← 18: 9.2 ↓ 19: 9.2 → 20: 10.2 ←	
	Serie 47		Serie 48	
	Total 144		Total 192	

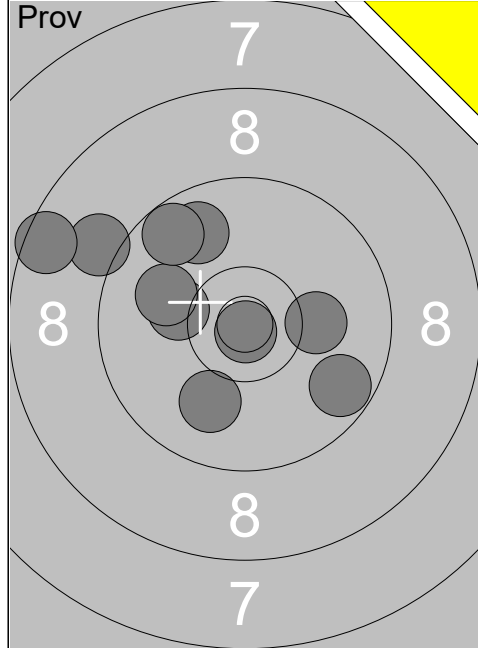

1:	9.1	↖
2:	8.5	↖
3:	10.1	→
4:	10.2	↖
5:	9.7	↘
6:	10.9x	↓
7:	10.0	↓
8:	10.0	↖
9:	9.8	↗
10:	9.7	↗
Serie		94
Total		0

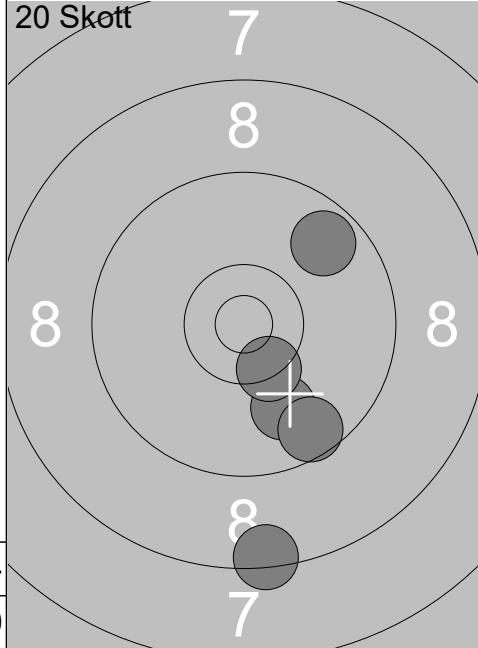

1:	8.4	↓
2:	10.0	↓
3:	9.7	↗
4:	10.4x	↘
5:	9.6	↘
Serie		46
Total		46

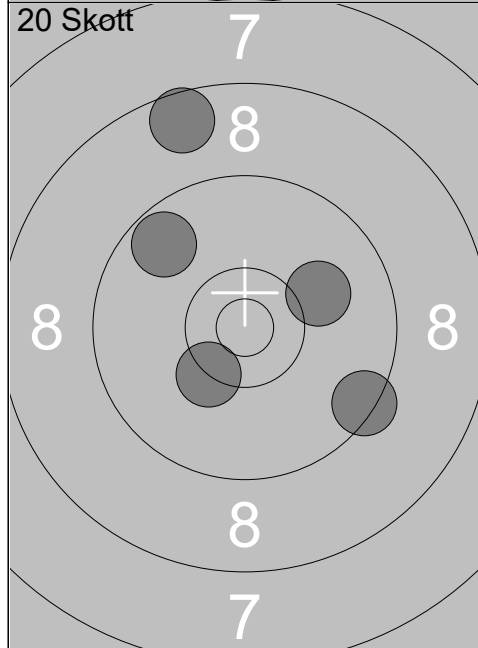

6:	10.1	↗
7:	9.7	↗
8:	8.6	↗
9:	9.4	↘
10:	10.3x	↘
Serie		46
Total		92

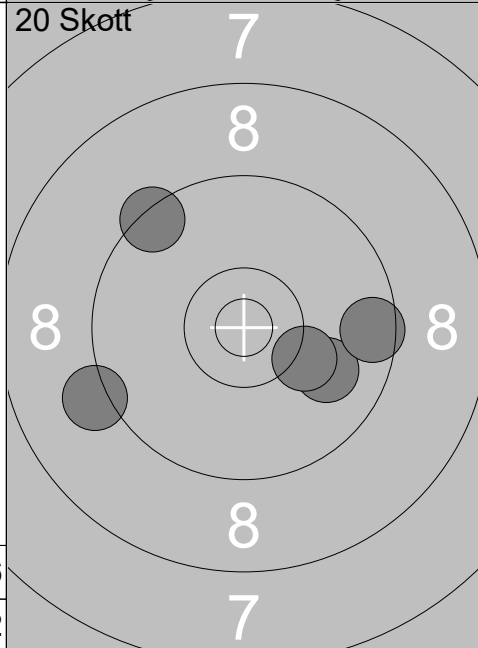

11:	9.9	↘
12:	9.6	→
13:	10.2	↘
14:	9.2	↖
15:	9.4	↗
Serie		46
Total		138

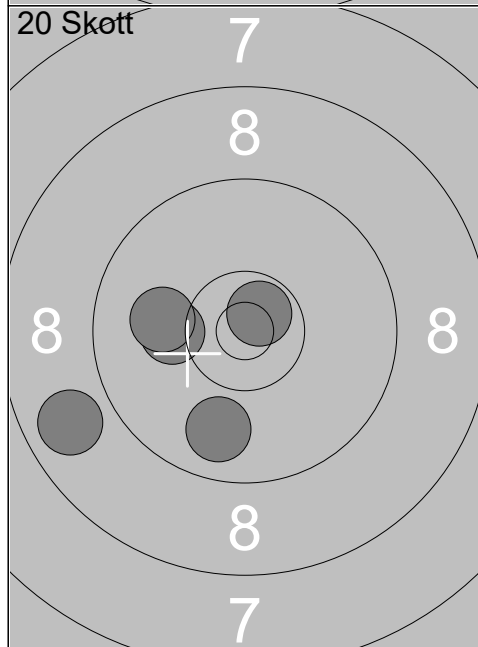

16:	9.8	↓
17:	10.2	↖
18:	8.8	↖
19:	10.7x	↗
20:	10.0	↖
Serie		47
Total		185

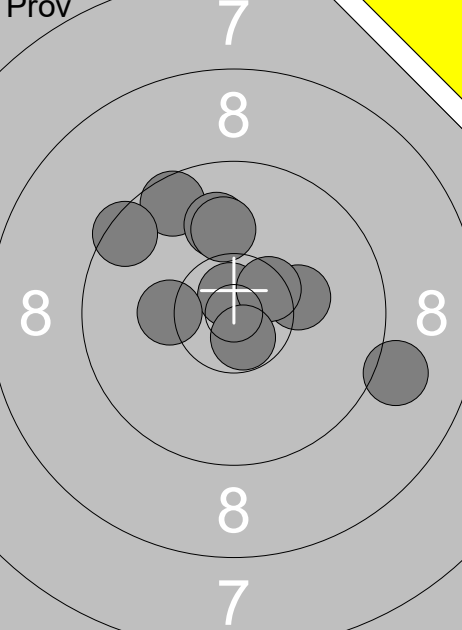
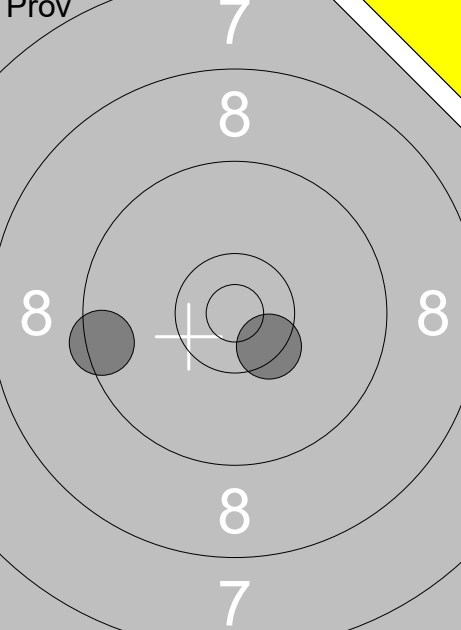
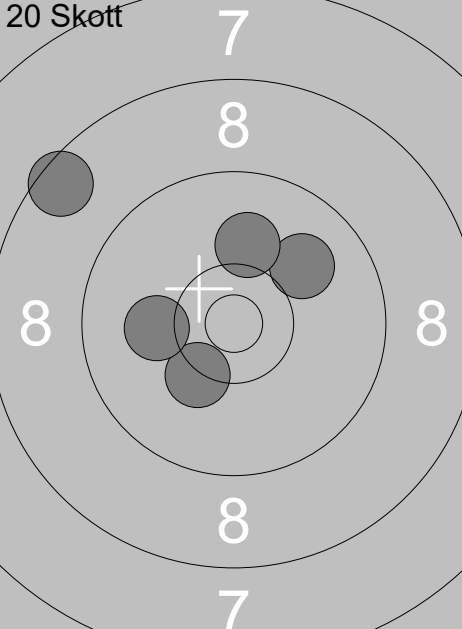
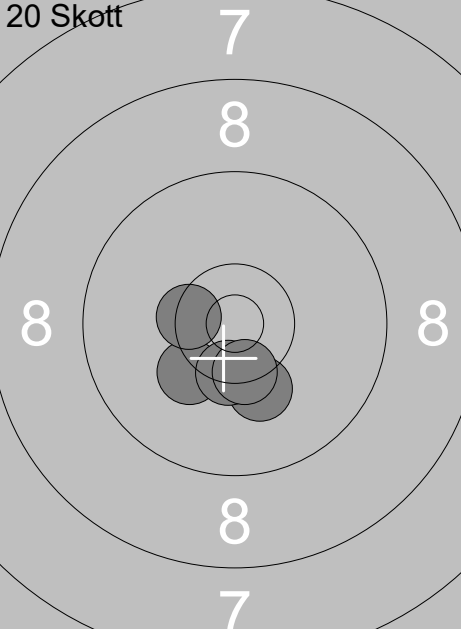
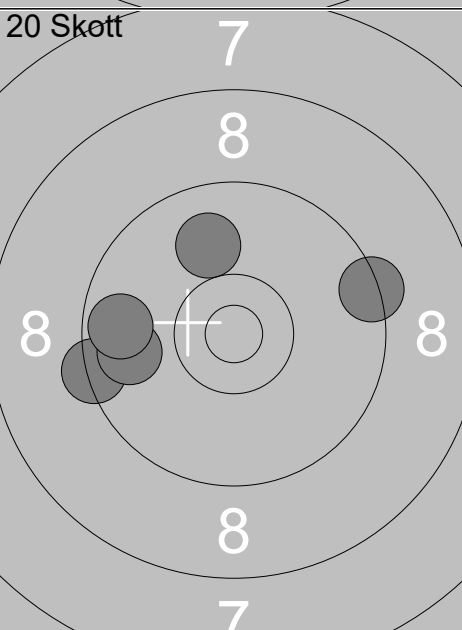
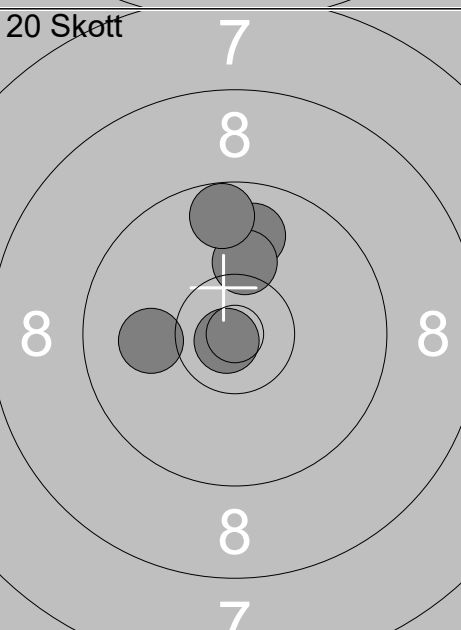
Prov 	1: 9.6 ↗ 2: 9.1 → 3: 10.7x ↑ 4: 10.0 ↑ 5: 10.3 ← 6: 10.2 → 7: 10.5x ↗ 8: 10.7x ↓ 9: 10.0 ↑ 10: 9.5 ↖ <hr/> Serie 97 Total 0	Prov 	11: 10.4x ↘ 12: 9.5 ← <hr/> Serie 19 Total 0
20 Skott 	1: 10.0 ↗ 2: 8.5 ↖ 3: 10.3 ↘ 4: 10.1 ← 5: 10.1 ↑ <hr/> Serie 48 Total 48	20 Skott 	6: 10.2 ↙ 7: 10.2 ↓ 8: 10.4x ↓ 9: 10.4x ← 10: 10.4x ↓ <hr/> Serie 50 Total 98
20 Skott 	11: 9.4 ← 12: 9.4 → 13: 10.0 ↑ 14: 9.8 ← 15: 9.7 ← <hr/> Serie 46 Total 144	20 Skott 	16: 9.9 ↑ 17: 10.0 ← 18: 10.2 ↑ 19: 9.7 ↑ 20: 10.8x ↙ <hr/> Serie 48 Total 192

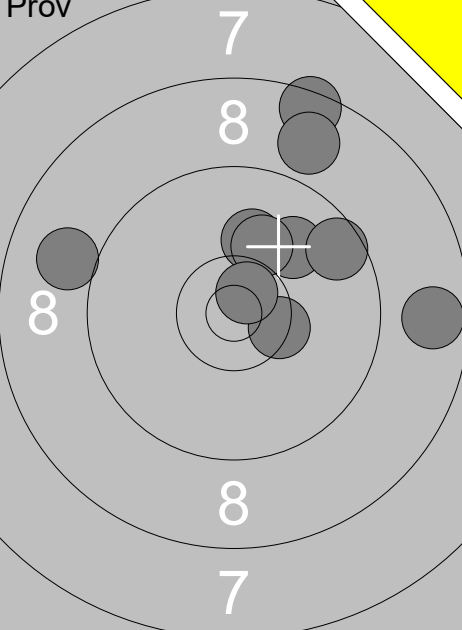
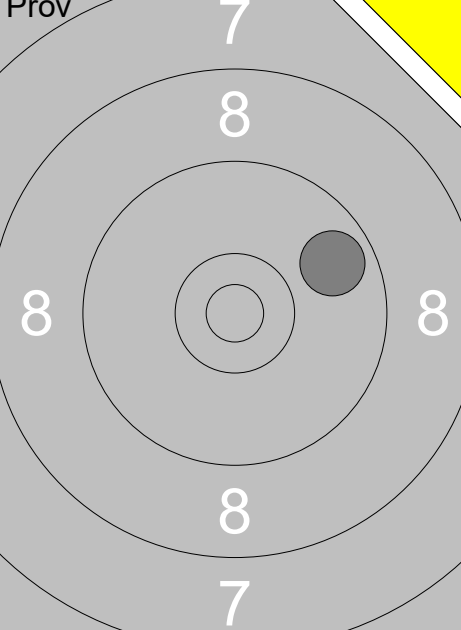
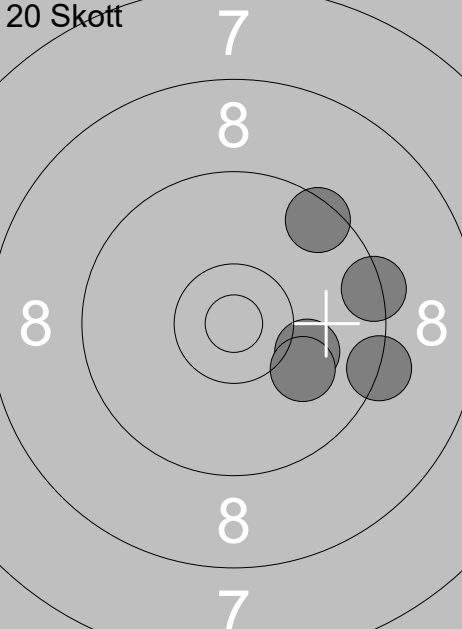
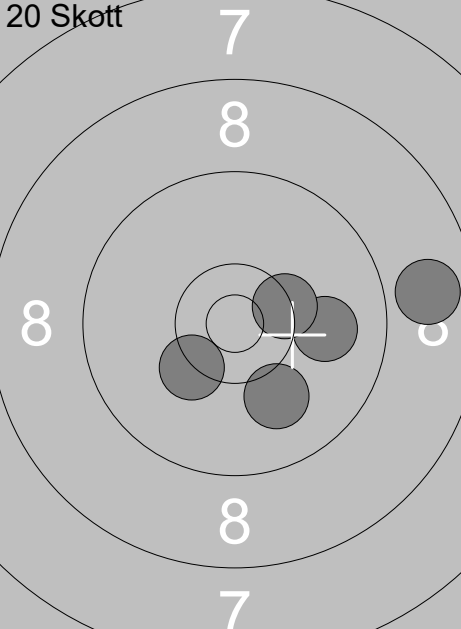
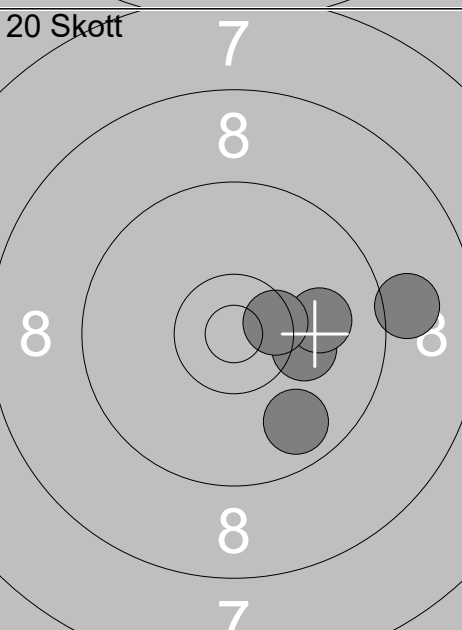
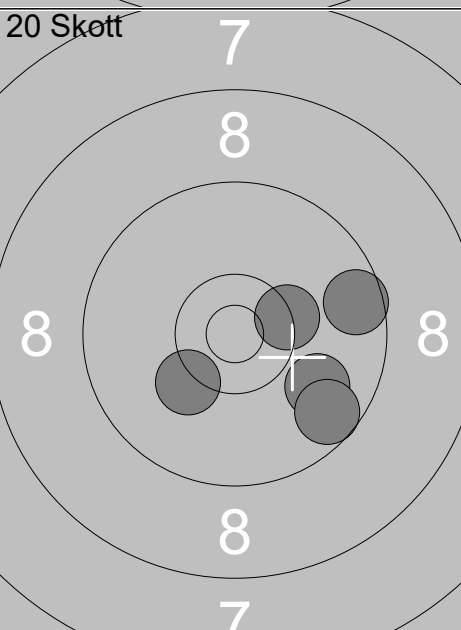
Prov 	1: 9.0 ← 2: 8.5 ↑ 3: 10.1 ↑ 4: 8.7 → 5: 10.4x → 6: 10.0 ↗ 7: 8.9 ↑ 8: 10.1 ↑ 9: 9.6 ↗ 10: 10.7x ↗ Serie 92 Total 0	Prov 	11: 9.8 ↗ Serie 9 Total 0
20 Skott 	1: 10.1 → 2: 10.1 ↘ 3: 9.5 ↗ 4: 9.3 → 5: 9.4 → Serie 47 Total 47	20 Skott 	6: 10.3 ↙ 7: 10.0 → 8: 10.4x → 9: 8.8 → 10: 10.0 ↘ Serie 48 Total 95
20 Skott 	11: 9.8 ↘ 12: 10.2 → 13: 10.0 → 14: 9.0 → 15: 10.5x → Serie 48 Total 143	20 Skott 	16: 9.9 ↘ 17: 9.6 ↘ 18: 9.6 → 19: 10.2 ↙ 20: 10.4x → Serie 47 Total 190

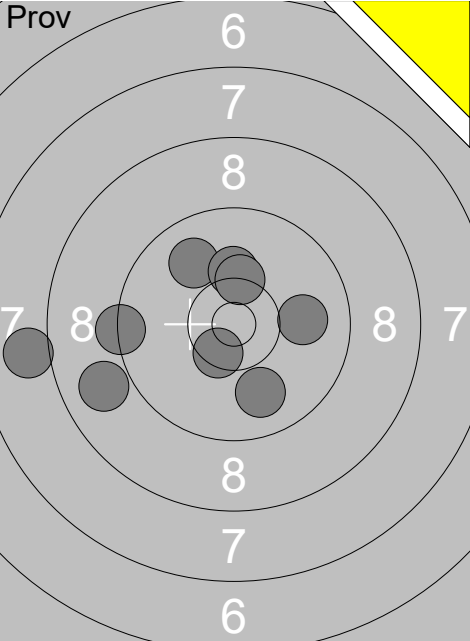
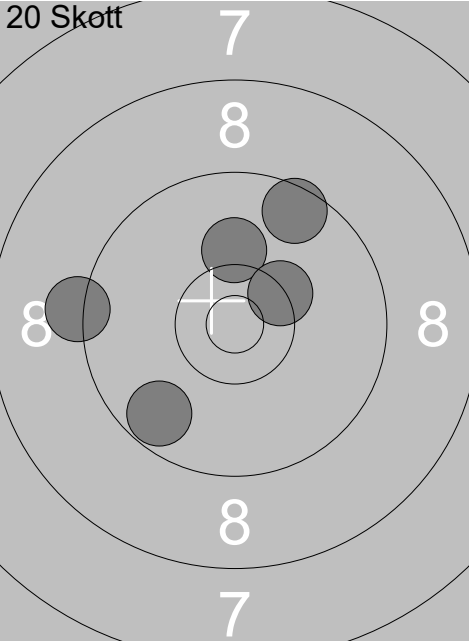
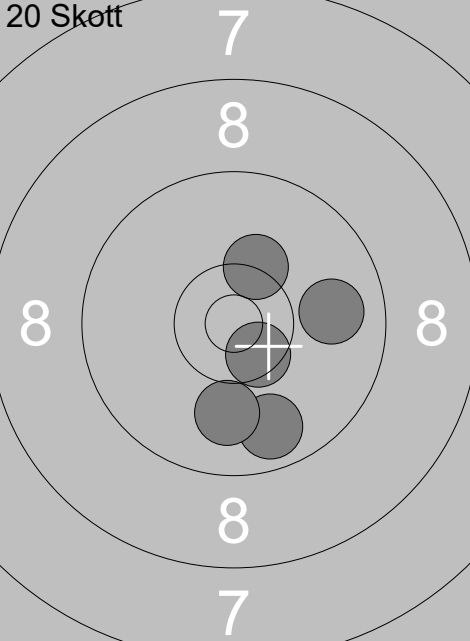
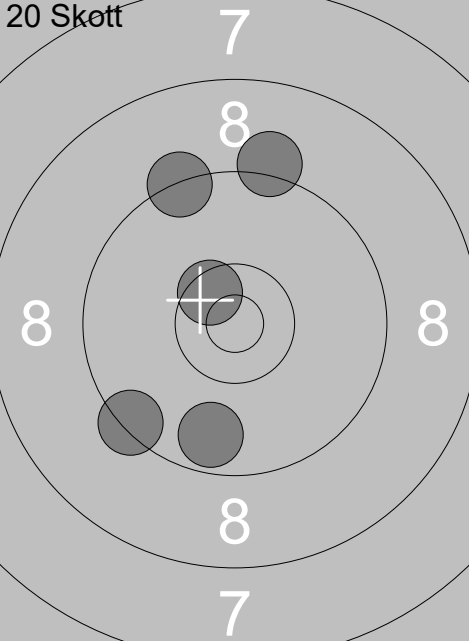
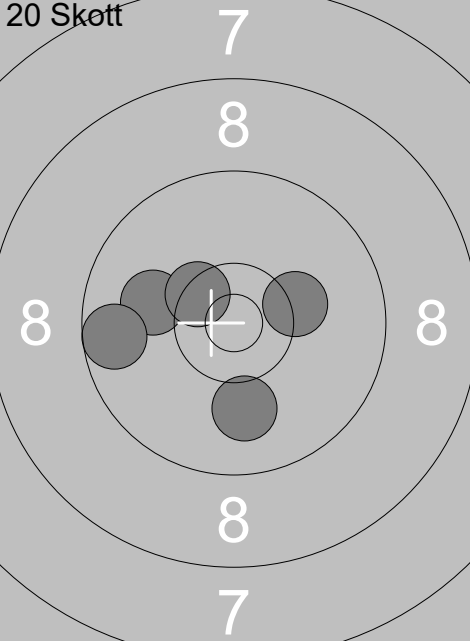
Skjutlag 1	Tavla 8	Lars Möllsten			
Ramselefors		Umeå		Sen-L	Vb
28.04.2018		Vindelnskottet 2018		Ramselefors SKF	
Prov 	1: 8.9 ←	20 Skott 	1: 9.2 ←		
	2: 8.0 ←		2: 10.1 ↑		
	3: 9.3 ←		3: 9.6 ↗		
	4: 9.9 ↗		4: 9.7 ↘		
	5: 9.9 ↓		5: 10.4x ↗		
	6: 10.2 ↑				
	7: 10.0 →				
	8: 10.3x ↑				
	9: 10.5x ↘				
	Serie 83		Serie 47		
	Total 0		Total 47		
20 Skott 	6: 9.8 ↓	20 Skott 	11: 10.5x ↖		
	7: 10.0 ↓		12: 9.3 ↑		
	8: 10.3x ↗		13: 9.2 ↑		
	9: 9.9 →		14: 9.4 ↙		
	10: 10.5x ↘		15: 9.7 ↓		
	Serie 48		Serie 46		
	Total 95		Total 141		
20 Skott 	16: 10.3 →				
	17: 10.0 ←				
	18: 9.6 ←				
	19: 10.4x ↖				
	20: 10.0 ↓				
	Serie 49				
	Total 190				

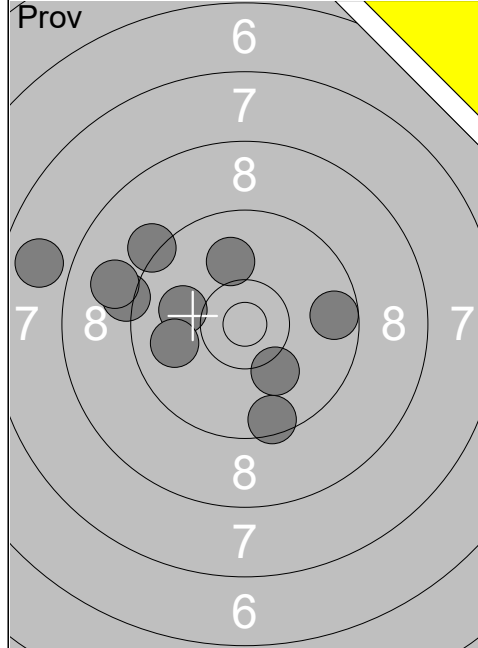

1:	7.8	↖
2:	9.5	↓
3:	9.2	↗
4:	10.0	↖
5:	9.2	↖
6:	10.0	↑
7:	9.0	↖
8:	9.9	↖
9:	9.6	→
10:	10.1	↓
Serie		91
Total		0

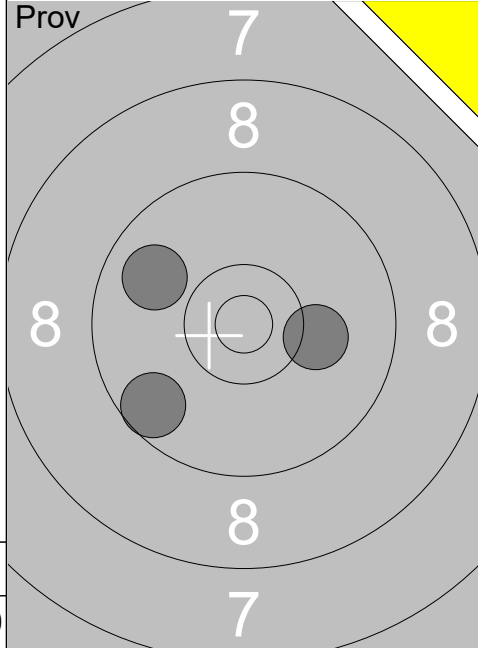

11:	9.9	↖
12:	9.6	↙
13:	10.2	→
Serie		28
Total		0

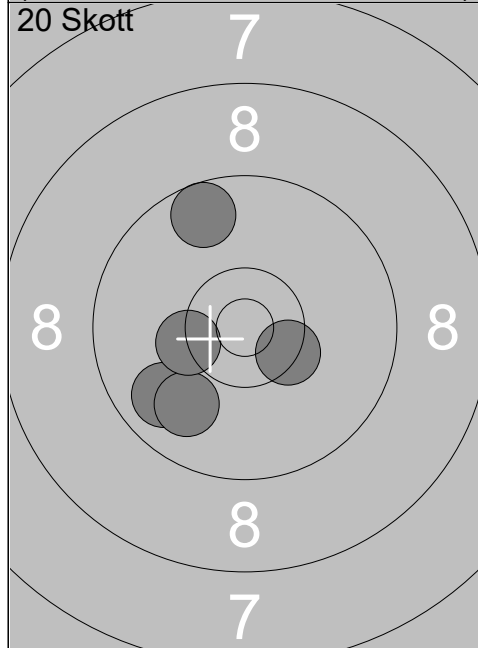

1:	9.8	↖
2:	10.4x	→
3:	9.9	↙
4:	10.3x	↖
5:	9.6	↑
Serie		47
Total		47

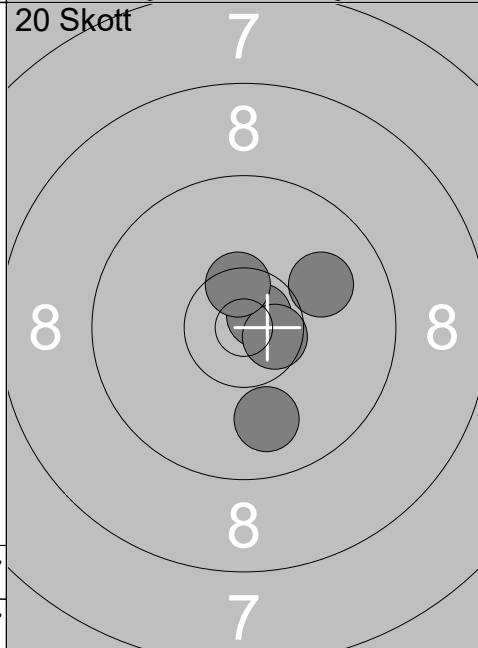

6:	9.9	↓
7:	10.7x	↗
8:	10.6x	→
9:	10.0	↗
10:	10.5x	↑
Serie		49
Total		96

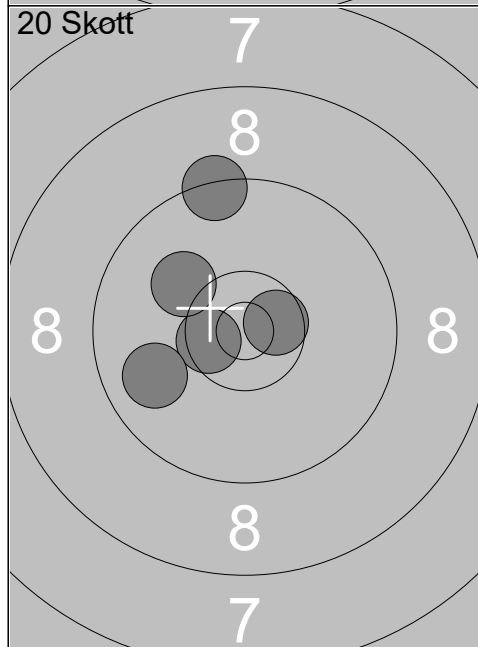

11:	10.6x	→
12:	10.5x	↖
13:	10.1	↖
14:	9.9	↖
15:	9.4	↑
Serie		48
Total		144

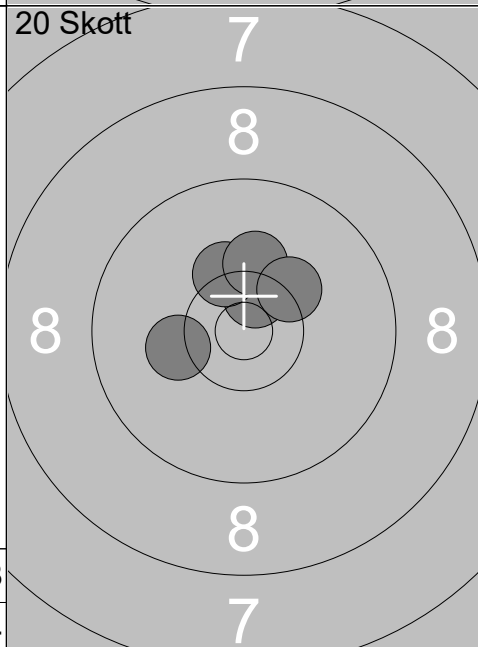

16:	10.5x	↑
17:	10.3x	↖
18:	10.2	↑
19:	10.3	↗
20:	10.2	↖
Serie		50
Total		194

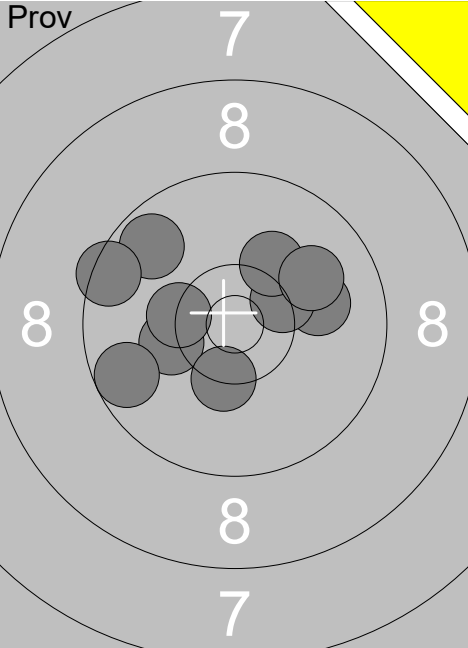
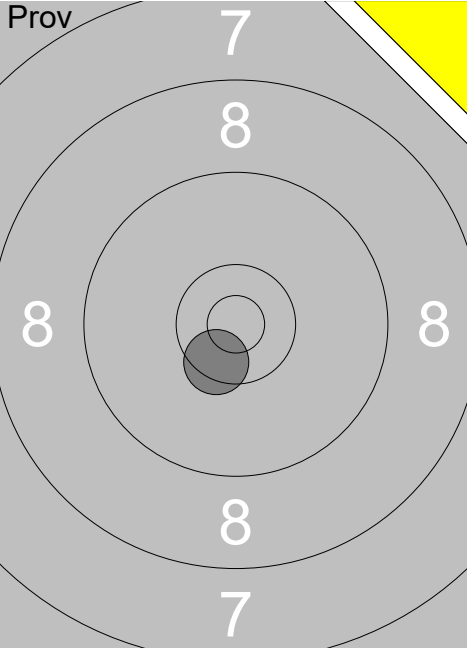
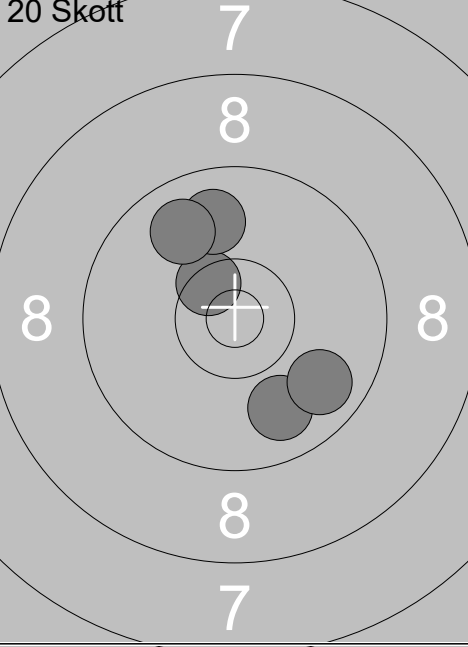
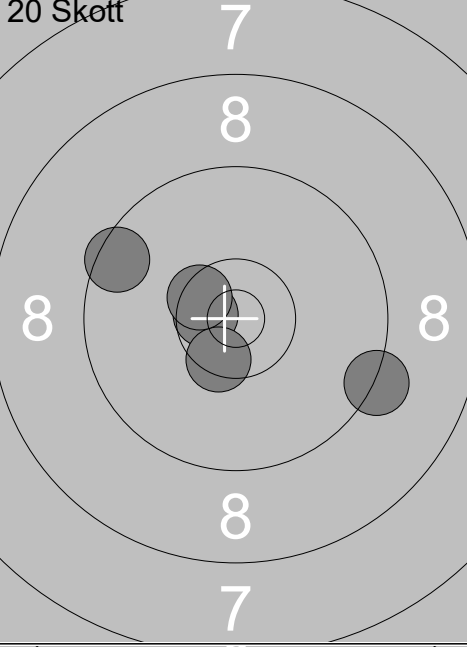
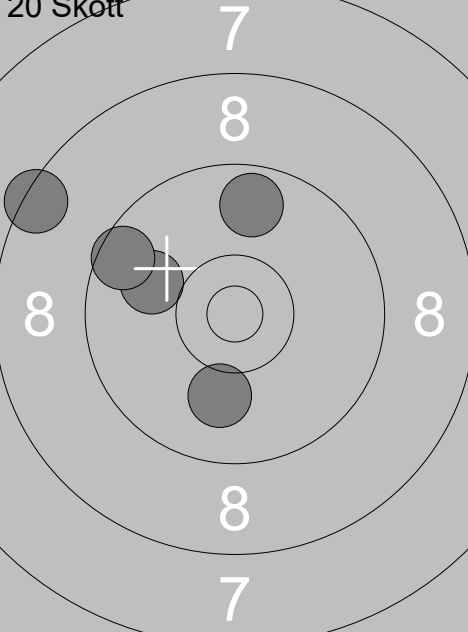
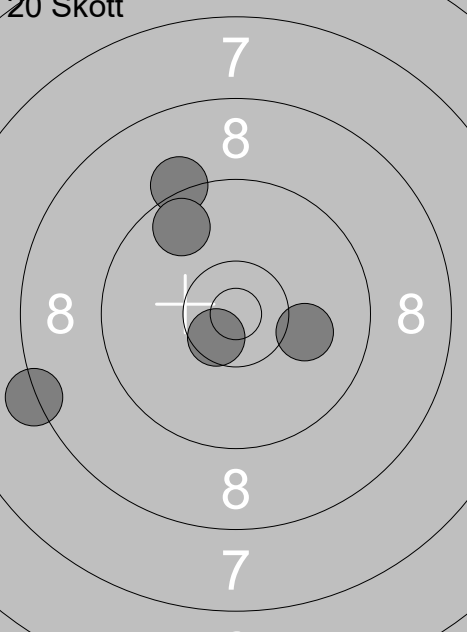
Skjutlag	Tavla	Stefan Thorin			
1	11	Umeå	Sen-L	Vb	
28.04.2018	Vindelnskottet 2018	Ramselefors SKF			
Prov	7	1: 10.2 ←	Prov	7	11: 10.5x ↘
	8	2: 9.7 ←		8	
	8	3: 10.0 →		8	
	8	4: 10.4x ↗		8	
	8	5: 10.3x ↓		8	
	8	6: 10.3x ←		8	
	8	7: 9.7 ↖		8	
	8	8: 10.2 ↗		8	
	8	9: 9.5 ←		8	
	8	10: 10.0 ↗		8	
	7	Serie 97		7	Serie 10
	7	Total 0		7	Total 0
20 Skott	7	1: 10.5x ↗	20 Skott	7	6: 10.6x ←
	8	2: 9.9 ↑		8	7: 10.5x ↓
	8	3: 9.9 ↓		8	8: 9.5 ↖
	8	4: 9.8 ↗		8	9: 10.5x ↖
	8	5: 9.8 ↓		8	10: 9.3 →
	8	Serie 46		8	Serie 48
	7	Total 46		7	Total 94
20 Skott	7	11: 10.0 ←	20 Skott	7	16: 10.1 →
	8	12: 8.4 ←		8	17: 9.2 ↗
	8	13: 9.7 ↑		8	18: 9.7 ↗
	8	14: 9.6 ←		8	19: 8.3 ←
	8	15: 10.0 ↓		8	20: 10.6x ↘
	8	Serie 46		8	Serie 46
	7	Total 140		7	Total 186

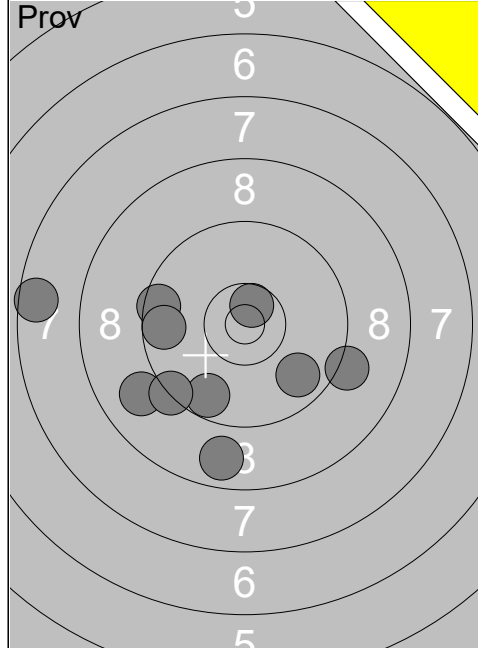

1:	8.8	↓
2:	8.9	↙
3:	7.6	←
4:	9.7	↓
5:	9.3	↙
6:	10.6x	↗
7:	9.8	↘
8:	9.5	←
9:	9.7	←
10:	9.2	↘
Serie		87
Total		0

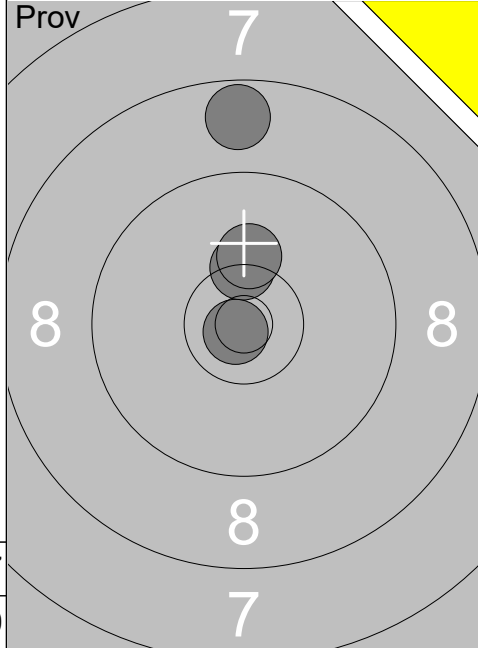

11:	10.3x	↑
12:	8.7	↑
13:	10.8x	↙
14:	10.2	↑
Serie		38
Total		0

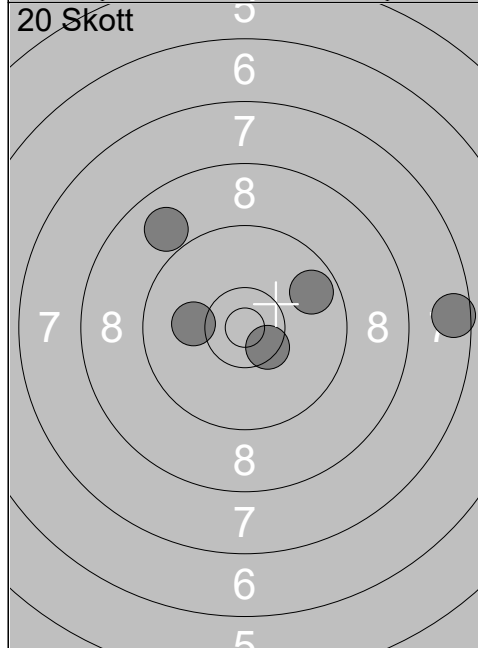

1:	9.7	↗
2:	7.6	→
3:	10.1	←
4:	10.5x	↘
5:	8.9	↗
Serie		44
Total		44

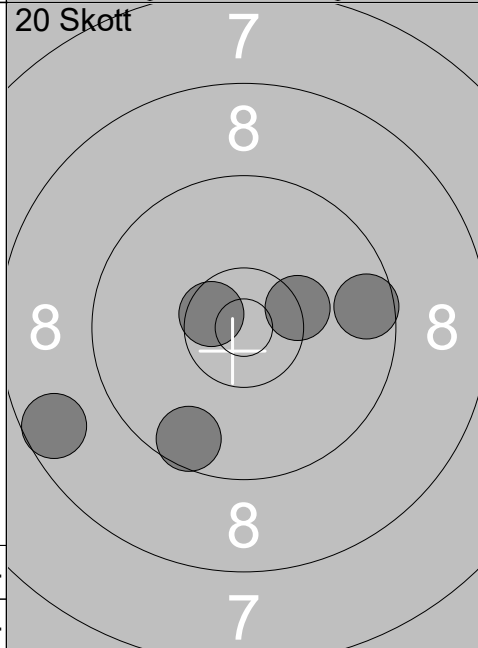

6:	9.6	→
7:	8.6	↙
8:	9.6	↓
9:	10.3x	↗
10:	10.6x	↙
Serie		46
Total		90

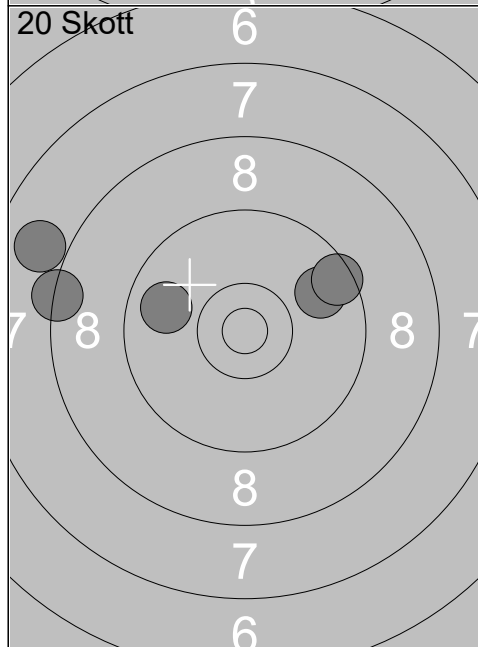

11:	9.8	↗
12:	9.5	↗
13:	9.8	←
14:	8.3	←
15:	7.9	←
Serie		42
Total		132

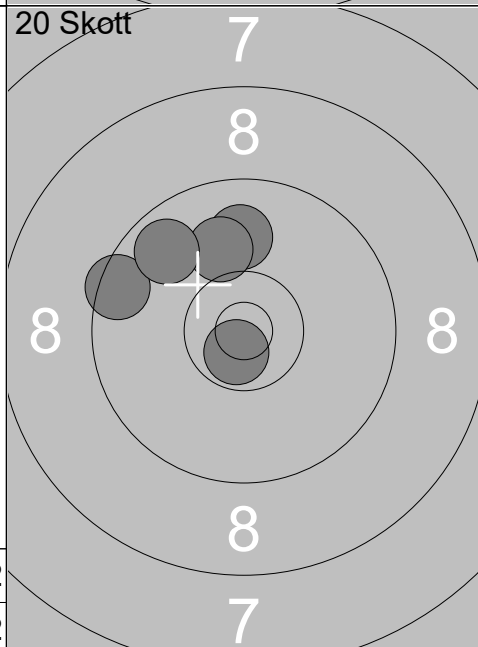

16:	10.7x	↘
17:	9.9	↑
18:	10.0	↑
19:	9.5	↙
20:	9.8	↙
Serie		47
Total		179

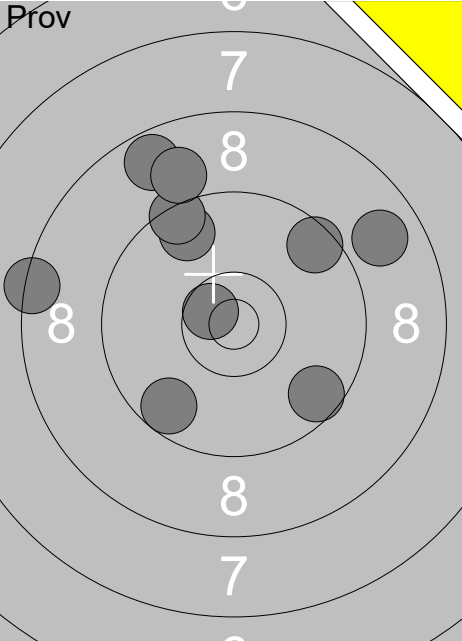
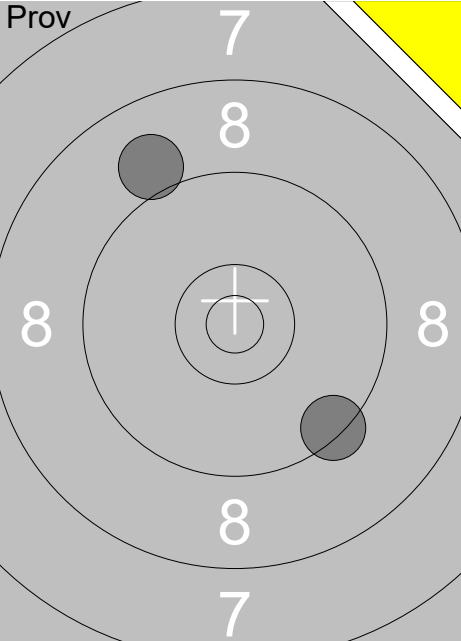
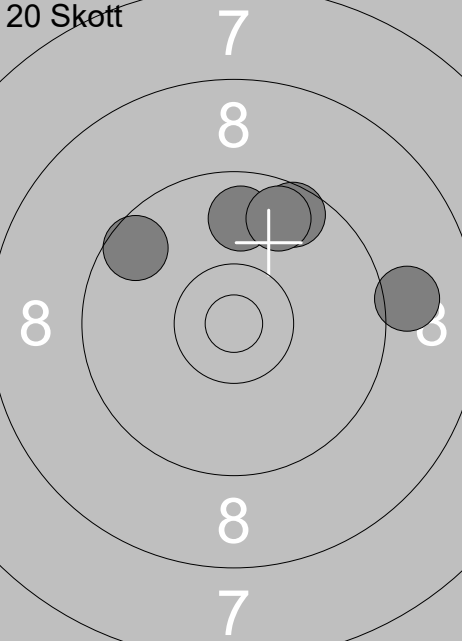
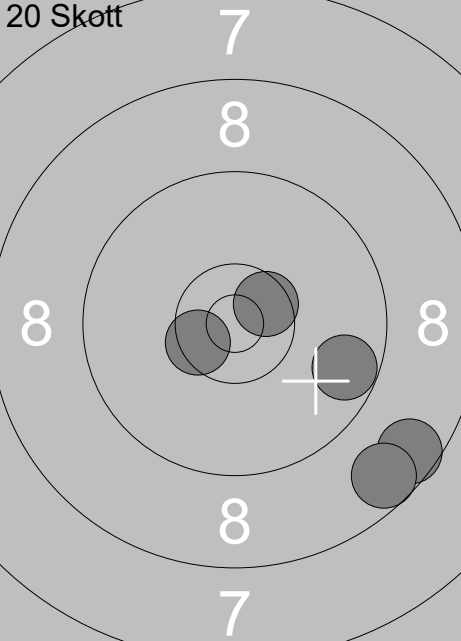
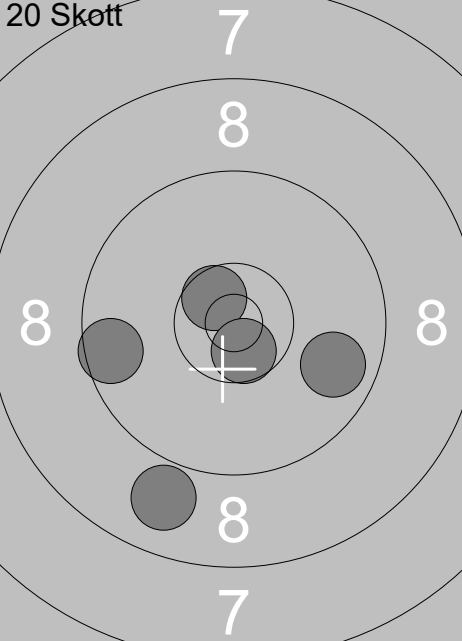
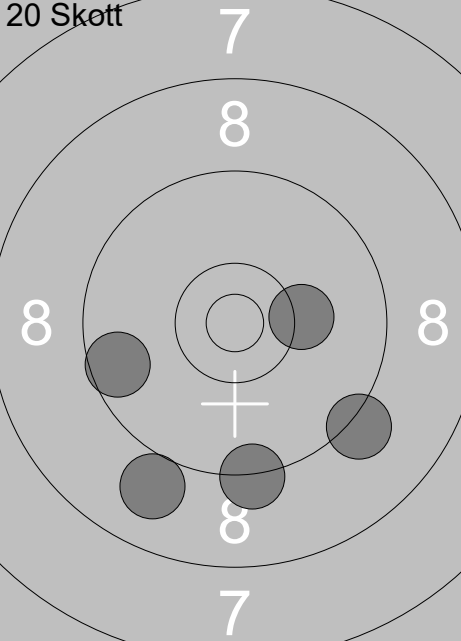
Skjutlag	Tavla	Dan-Ivan Karlsson			
1	13	Ramselefors	Ramselefors	Vet-L	Vb
28.04.2018	Vindelnskottet 2018	Ramselefors SKF			
Prov 	1: 8.4 ←	Prov 	11: 9.0 ↗		
	2: 8.7 ↗		12: 9.4 ↘		
	3: 9.7 ↗				
	4: 8.8 ↗				
	5: 10.6x ↖				
	6: 9.6 ↘				
	7: 9.6 ↘				
	8: 9.4 ↗				
	9: 9.5 ↗				
	10: 9.0 ↗				
	Serie 88		Serie 18		
	Total 0		Total 0		
20 Skott 	1: 9.1 →	20 Skott 	6: 10.6x ↗		
	2: 9.6 ↗		7: 9.7 →		
	3: 9.8 ↑		8: 8.6 ↘		
	4: 9.7 ↗		9: 8.6 ↘		
	5: 9.6 ↖		10: 10.5x ↖		
	Serie 45		Serie 45		
	Total 45		Total 90		
20 Skott 	11: 9.6 ←	20 Skott 	16: 10.2 →		
	12: 10.6x ↖		17: 9.6 ←		
	13: 8.9 ↘		18: 9.0 ↘		
	14: 9.8 →		19: 9.2 ↘		
	15: 10.6x ↘		20: 9.3 ↓		
	Serie 46		Serie 46		
	Total 136		Total 182		

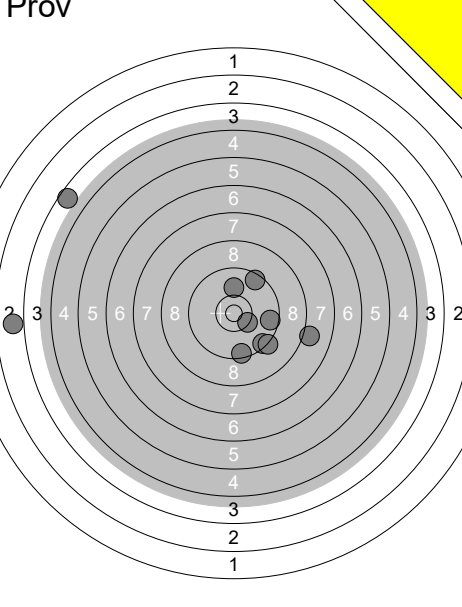
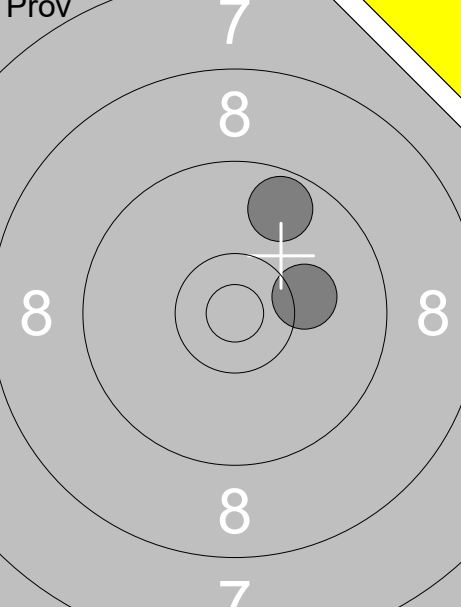
<p>Prov</p> 	<p>1: 3.6 ↗</p> <p>2: 2.9 ←</p> <p>3: 10.0 ↑</p> <p>4: 9.4 ↘</p> <p>5: 10.4x ↘</p> <p>6: 9.6 →</p> <p>7: 9.5 ↗</p> <p>8: 9.5 ↓</p> <p>9: 9.3 ↘</p> <p>10: 8.1 →</p>	<p>Prov</p> 	<p>11: 10.2 →</p> <p>12: 9.7 ↗</p>
Serie 78		Serie 19	
Total 0		Total 0	

<p>20 Skott</p> 	<p>1: 10.3 ←</p> <p>2: 9.2 ←</p> <p>3: 10.0 →</p> <p>4: 10.3x ↗</p> <p>5: 10.3x ↘</p>	<p>20 Skott</p> 	<p>6: 10.2 ↗</p> <p>7: 10.4x →</p> <p>8: 10.5x →</p> <p>9: 9.4 ↗</p> <p>10: 10.4x ↘</p>
Serie 49		Serie 49	
Total 49		Total 98	

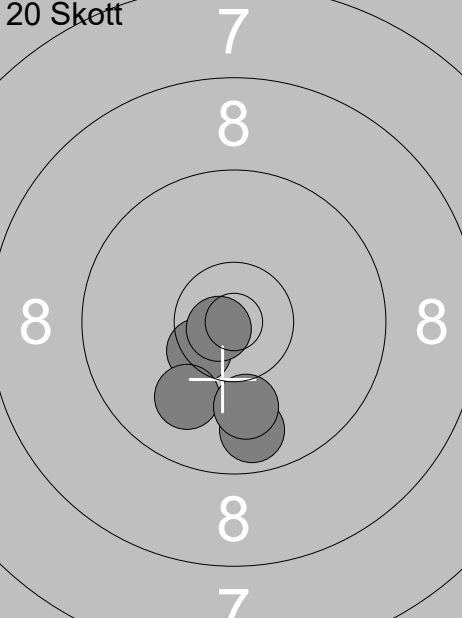
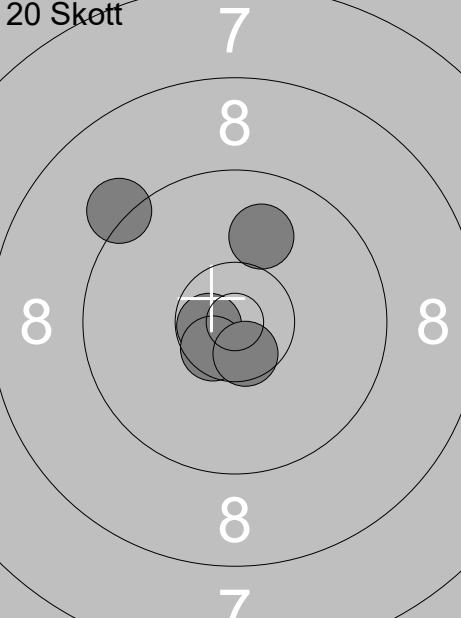
<p>20 Skott</p> 	<p>11: 9.8 ↓</p> <p>12: 10.5x ↙</p> <p>13: 10.0 ↓</p> <p>14: 10.8x ↙</p> <p>15: 10.0 ↓</p>	<p>20 Skott</p> 	<p>16: 10.7x ←</p> <p>17: 9.2 ↖</p> <p>18: 10.6x ↙</p> <p>19: 10.0 ↗</p> <p>20: 10.6x ↘</p>
Serie 49		Serie 49	
Total 147		Total 196	

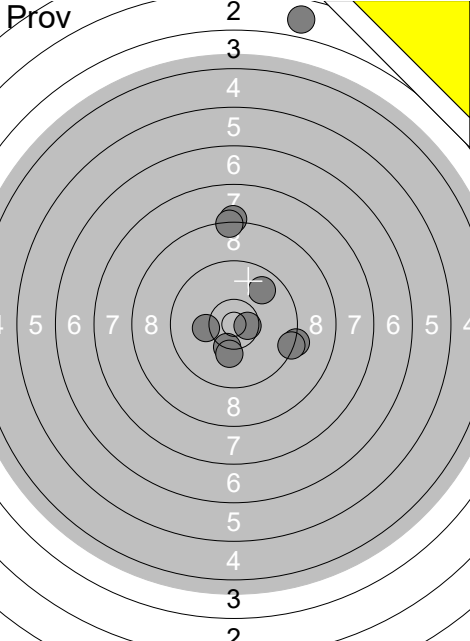
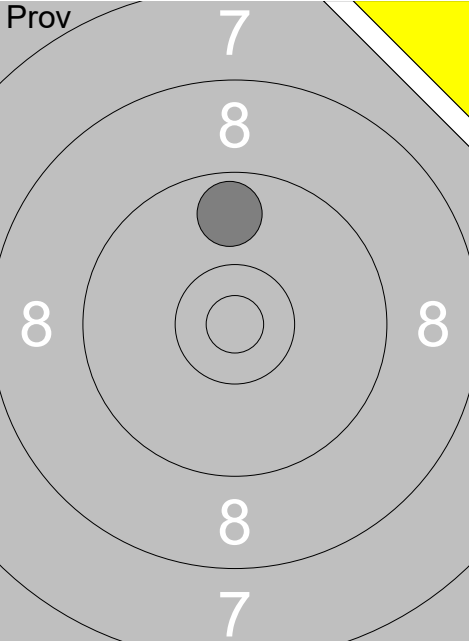
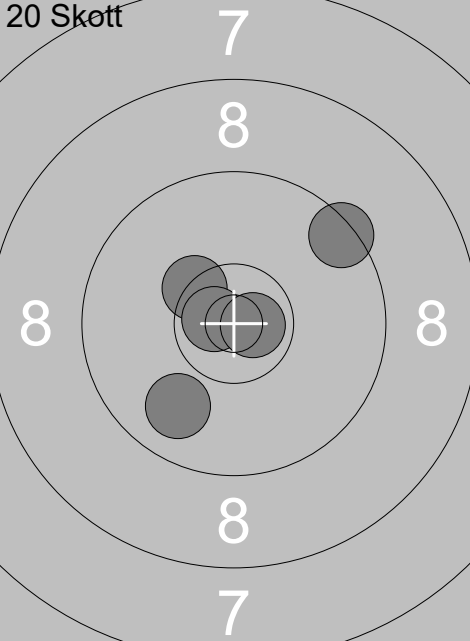
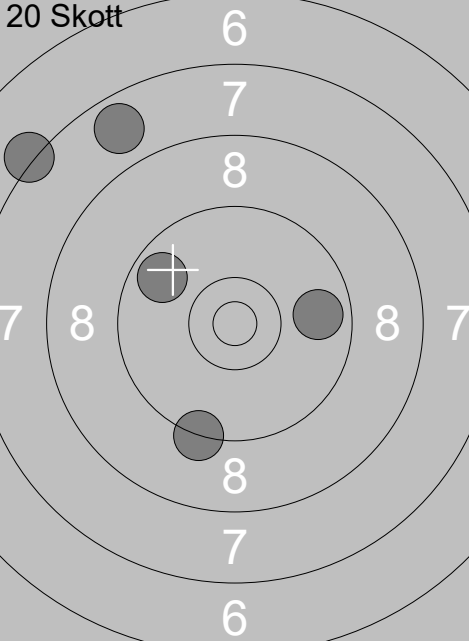
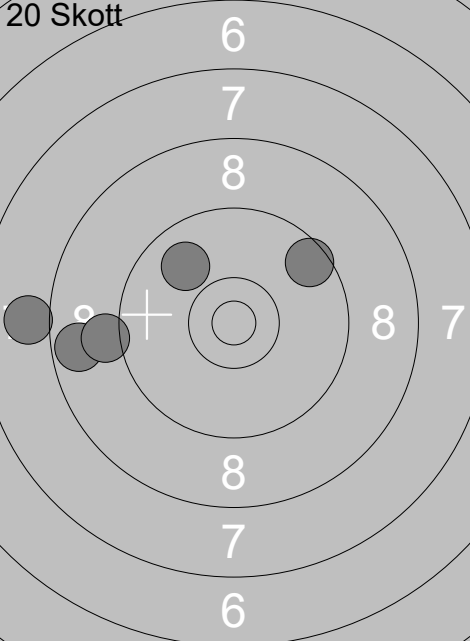
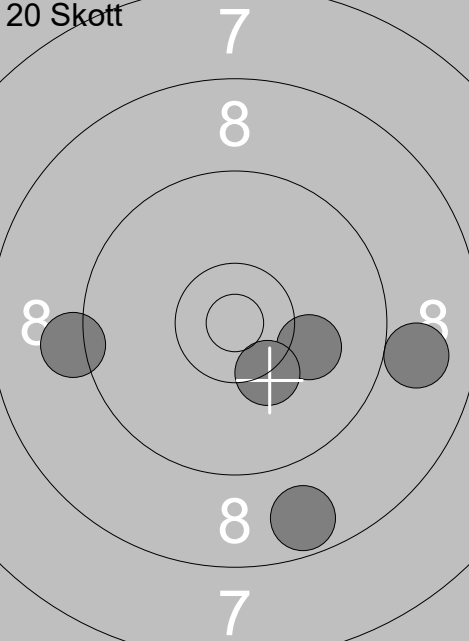
Skjutlag	Tavla	Mats Österlund	
1	16	Ramselefors	Sen-L Vb
28.04.2018	Vindelnskottet 2018	Ramselefors SKF	
Prov 	1: 2.8 ↑ 2: 8.2 ↑ 3: 8.3 ↑ 4: 9.8 ↗ 5: 10.3x ↓ 6: 9.3 → 7: 10.6x → 8: 10.2 ← 9: 10.2 ↓ 10: 9.4 → Serie 85 Total 0	Prov 	11: 9.7 ↑ Serie 9 Total 0
20 Skott 	1: 9.4 ↗ 2: 10.4x ↖ 3: 10.7x ← 4: 9.9 ↓ 5: 10.7x → Serie 48 Total 48	20 Skott 	6: 9.7 ↖ 7: 9.3 ↓ 8: 7.8 ↗ 9: 9.8 → 10: 7.2 ↖ Serie 41 Total 89
20 Skott 	11: 8.0 ← 12: 8.7 ← 13: 9.1 ← 14: 9.6 ↗ 15: 9.9 ↖ Serie 43 Total 132	20 Skott 	16: 10.1 → 17: 9.2 ← 18: 8.7 ↓ 19: 8.9 → 20: 10.3x ↓ Serie 45 Total 177

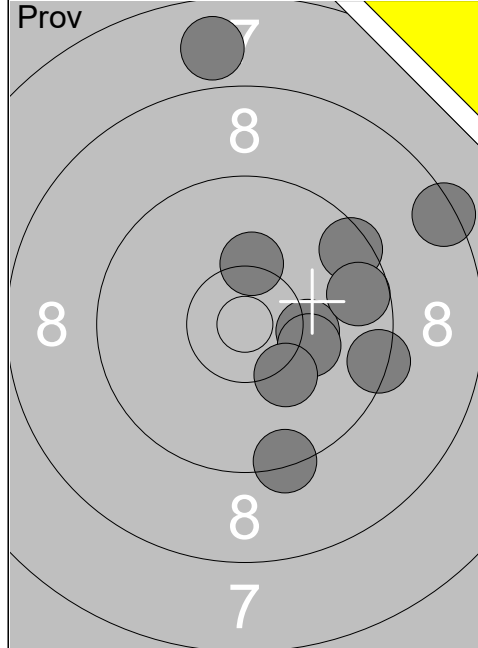

1:	10.2	→
2:	9.5	↗
3:	9.4	→
4:	8.4	↗
5:	10.2	→
6:	9.6	→
7:	7.8	↑
8:	9.4	↓
9:	10.3	↑
10:	10.2	↘
Serie		91
Total		0

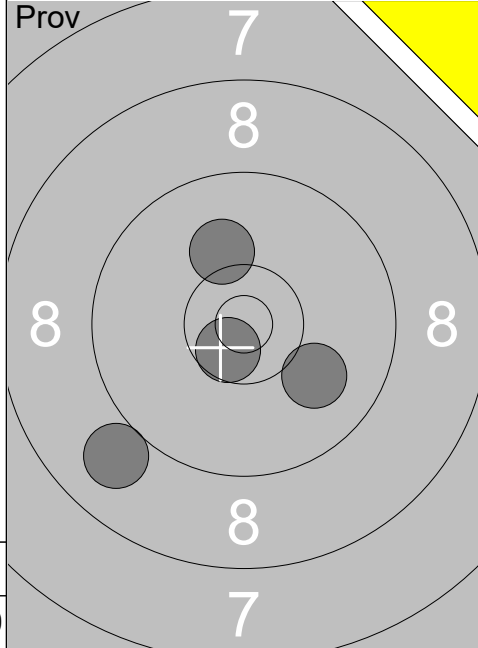

11:	10.6x	↘
12:	10.1	↑
13:	9.0	↘
14:	10.0	↘
Serie		39
Total		0

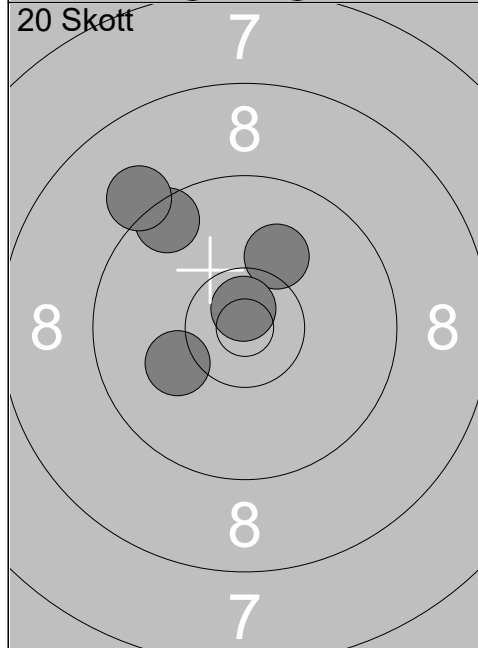

1:	9.5	↗
2:	9.1	↗
3:	10.1	↗
4:	10.7x	↑
5:	10.1	←
Serie		48
Total		48

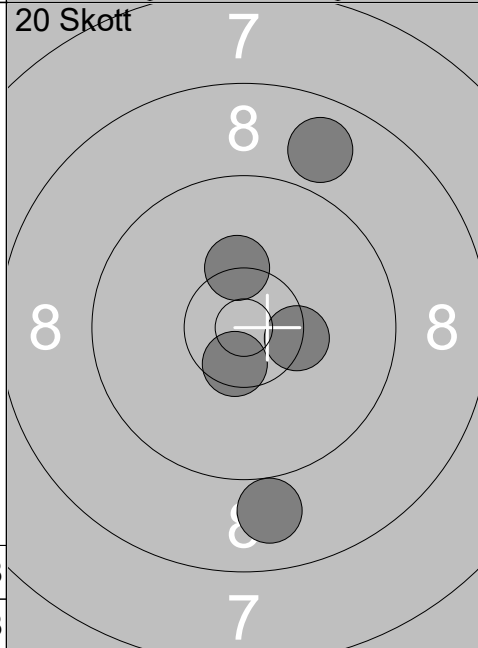

6:	10.4x	→
7:	10.3x	↑
8:	8.9	↗
9:	8.9	↓
10:	10.5x	↘
Serie		46
Total		94

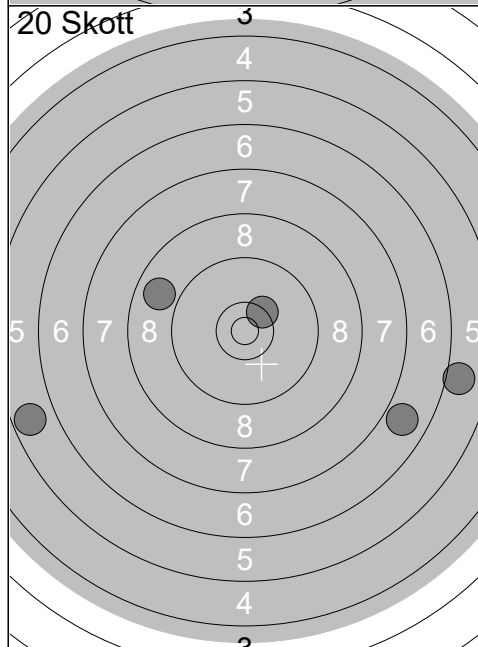

11:	6.0	→
12:	6.9	↘
13:	5.7	←
14:	10.4x	↗
15:	8.8	←
Serie		35
Total		129

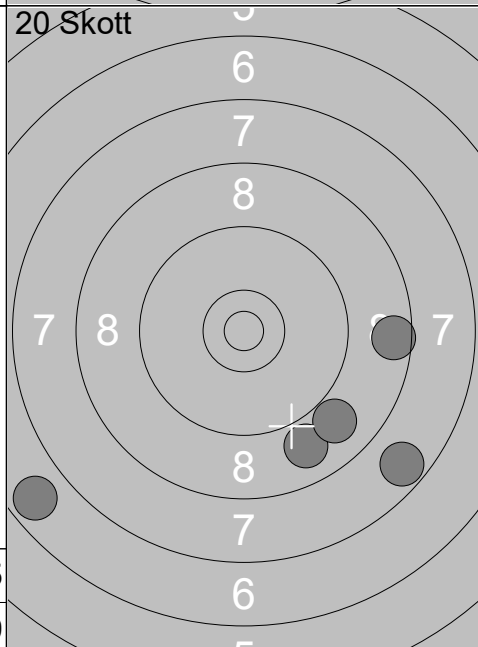

16:	6.7	↘
17:	8.9	↘
18:	8.9	↘
19:	7.7	↘
20:	8.6	→
Serie		37
Total		166

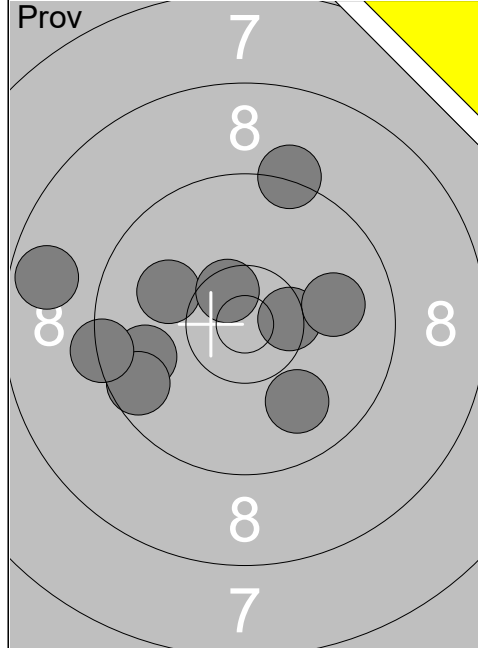

1:	10.0	←
2:	8.7	←
3:	9.8	←
4:	9.6	←
5:	9.3	↑
6:	10.5x	→
7:	9.9	↓
8:	10.5x	↗
9:	9.4	←
10:	10.0	→
Serie		93
Total		0

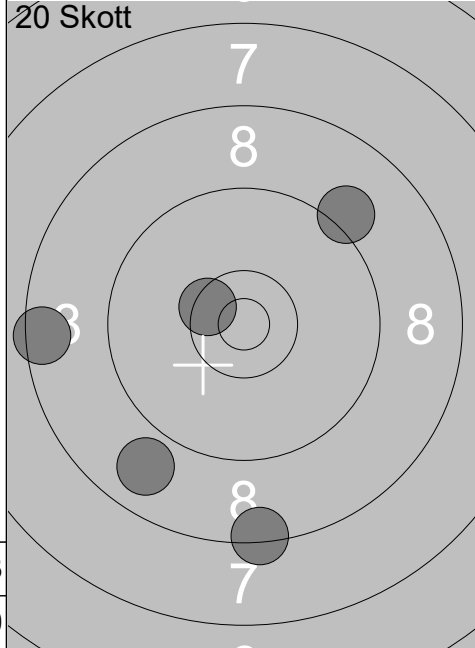

1:	8.5	←
2:	8.9	↘
3:	8.4	↓
4:	9.1	↗
5:	10.5x	↖
Serie		43
Total		43

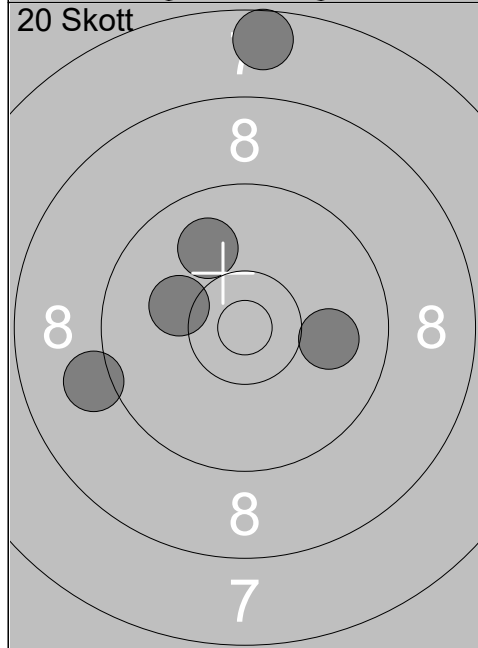

6:	9.9	↗
7:	10.0	→
8:	9.1	←
9:	10.2	←
10:	7.6	↑
Serie		45
Total		88

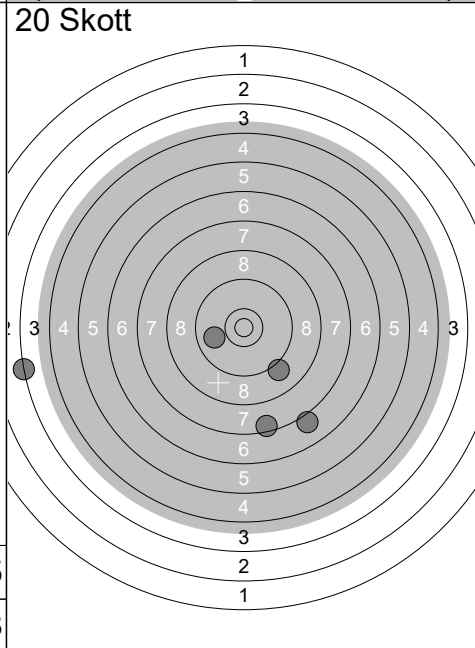

11:	9.9	←
12:	7.5	↓
13:	7.0	↘
14:	3.3	←
15:	9.1	↘
Serie		35
Total		123

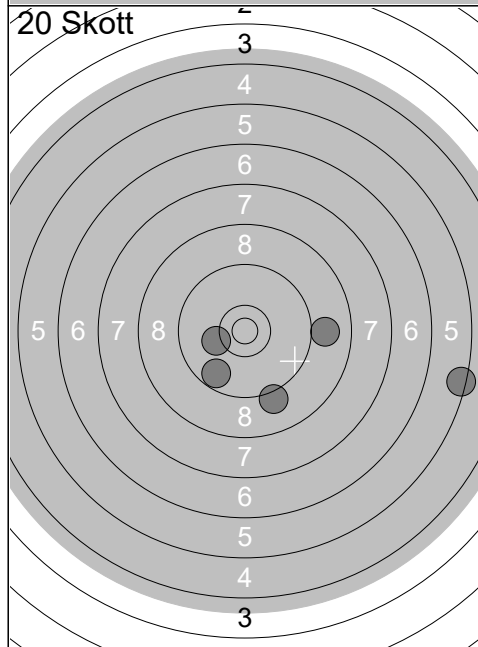

16:	9.0	→
17:	9.1	↘
18:	10.2	←
19:	5.4	→
20:	9.7	↘
Serie		42
Total		165

Skjutlag	Tavla	Casper Fredriksson			
2	3	Ramselefors	Ramselefors	Jun-S	Vb
28.04.2018	Vindelnskottet 2018	Ramselefors SKF			
Prov		1: 10.0 ↘ 2: 10.1 ↙ 3: 10.5x ↗ 4: 10.2 ↖ 5: 9.6 ↘ 6: 10.6x ↗ 7: 9.7 ↖ 8: 10.4x ↗ 9: 10.0 ↖ 10: 10.4x ↘	Prov		11: 10.3 ↖ 12: 10.3 ↘ 13: 10.0 ↗ 14: 10.6x ↘
	Serie 98		Serie 40		
	Total 0		Total 0		
20 Skott		1: 9.5 ↗ 2: 10.0 ↘ 3: 10.4x ↖ 4: 10.5x ↗ 5: 10.4x →	20 Skott		6: 10.1 ↖ 7: 10.5x ↘ 8: 10.5x ↘ 9: 10.4x ↘ 10: 10.2 ↘
	Serie 49		Serie 50		
	Total 49		Total 99		
20 Skott		11: 8.6 ↘ 12: 9.0 ↗ 13: 8.9 ↖ 14: 9.4 ↖ 15: 10.5x ↘	20 Skott		16: 10.5x ↖ 17: 10.0 ↖ 18: 10.0 ↖ 19: 9.3 ↖ 20: 9.3 ↖
	Serie 44		Serie 48		
	Total 143		Total 191		

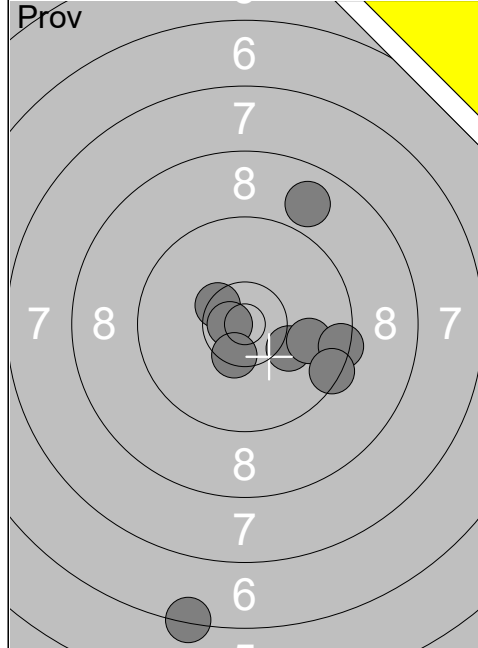

1:	10.4x ↖
2:	6.3 ↓
3:	10.7x ←
4:	10.2 ↘
5:	9.9 →
6:	8.9 ↗
7:	9.4 →
8:	9.4 ↘
9:	10.4x ↓
Serie 81	
Total 0	

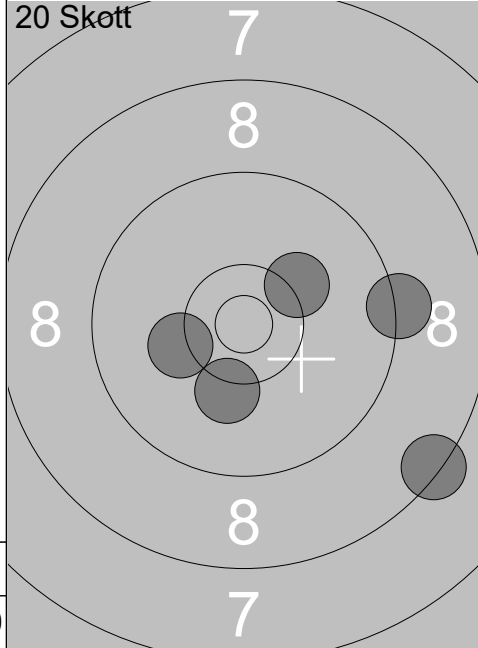

1:	10.2 ←
2:	10.2 ↗
3:	10.2 ↓
4:	8.4 ↘
5:	9.3 →
Serie 47	
Total 47	

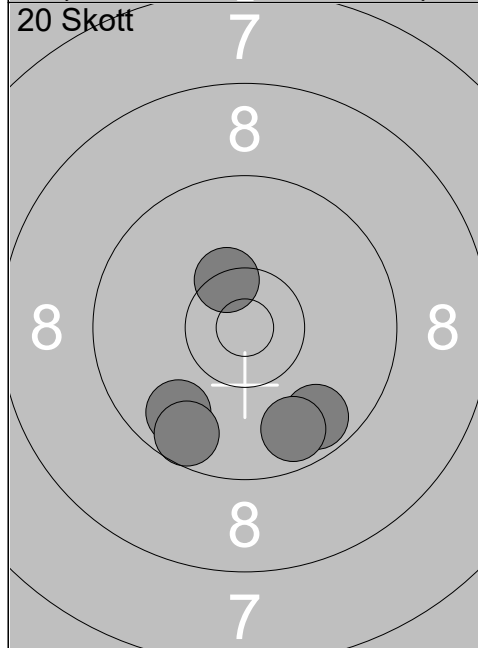

6:	9.7 ↘
7:	9.7 ↓
8:	9.8 ↘
9:	10.4x ↗
10:	9.6 ↓
Serie 46	
Total 93	

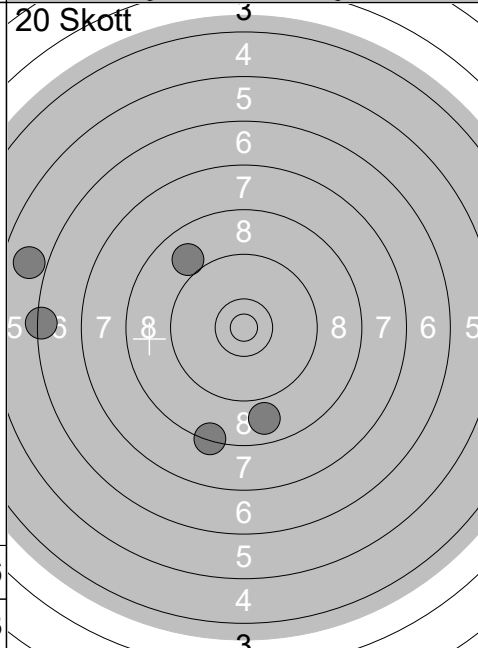

11:	8.3 ↓
12:	5.9 ←
13:	8.8 ↓
14:	9.0 ↗
15:	6.4 ←
Serie 36	
Total 129	

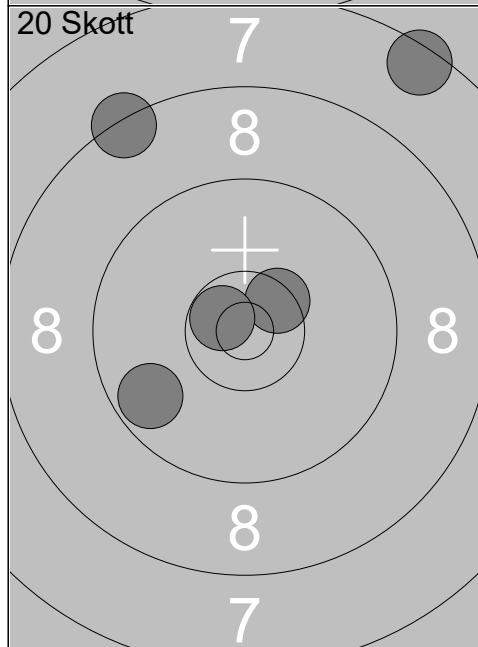

16:	8.4 ↗
17:	7.5 ↗
18:	10.5x ↗
19:	9.7 ←
20:	10.7x ↖
Serie 44	
Total 173	

<p>Prov</p>	<p>1: 10.4x →</p> <p>2: 9.6 →</p> <p>3: 9.2 ↙</p> <p>4: 9.4 ↓</p> <p>5: 9.3 ←</p> <p>6: 9.1 ↙</p> <p>7: 9.1 ←</p> <p>8: 9.3 ↓</p> <p>9: 8.7 ←</p> <p>10: 9.3 ←</p> <p>Serie 90</p> <p>Total 0</p>	<p>20 Skott</p> <p>1: 10.2 ↖</p> <p>2: 8.9 ↙</p> <p>3: 9.9 ↙</p> <p>4: 8.9 ↙</p> <p>5: 8.9 ←</p> <p>Serie 43</p> <p>Total 43</p>
-------------	---	--

<p>20 Skott</p>	<p>6: 9.2 →</p> <p>7: 10.2 ↗</p> <p>8: 8.8 ←</p> <p>9: 10.4x ↙</p> <p>10: 9.9 ↓</p> <p>Serie 46</p> <p>Total 89</p>	<p>20 Skott</p> <p>11: 6.6 ↑</p> <p>12: 9.1 ↗</p> <p>13: 7.7 ↙</p> <p>14: 7.4 ↙</p> <p>15: 8.1 ←</p> <p>Serie 37</p> <p>Total 126</p>
-----------------	---	---

<p>20 Skott</p>	<p>16: 6.8 ↙</p> <p>17: 7.4 ←</p> <p>18: 9.0 ↙</p> <p>19: 8.2 →</p> <p>20: 9.9 ↓</p> <p>Serie 39</p> <p>Total 165</p>	
-----------------	---	--

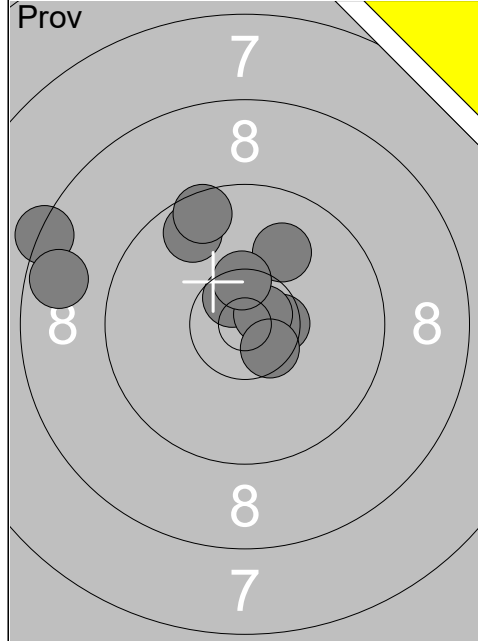

1:	10.0	↗
2:	10.5x	→
3:	9.7	↖
4:	8.4	↖
5:	8.7	←
6:	10.6x	↖
7:	10.7x	↗
8:	10.4x	↑
9:	10.5x	↘
10:	9.6	↑
Serie		94
Total		0

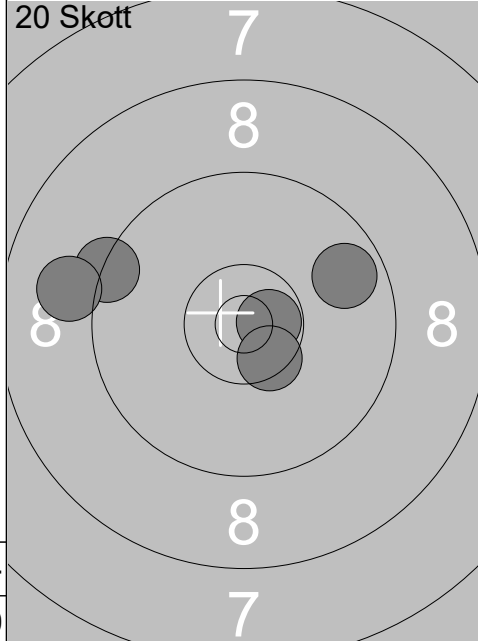

1:	9.7	↗
2:	9.3	↖
3:	10.7x	→
4:	10.5x	↘
5:	9.0	←
Serie		47
Total		47

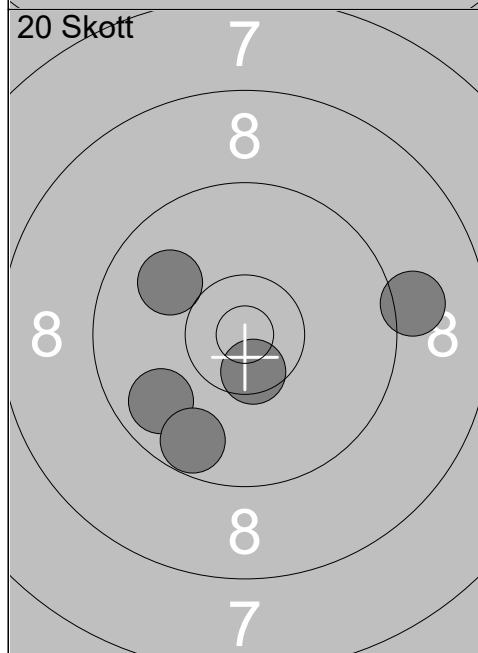

6:	10.5x	↘
7:	9.8	↖
8:	9.7	↘
9:	9.1	→
10:	10.0	↖
Serie		47
Total		94

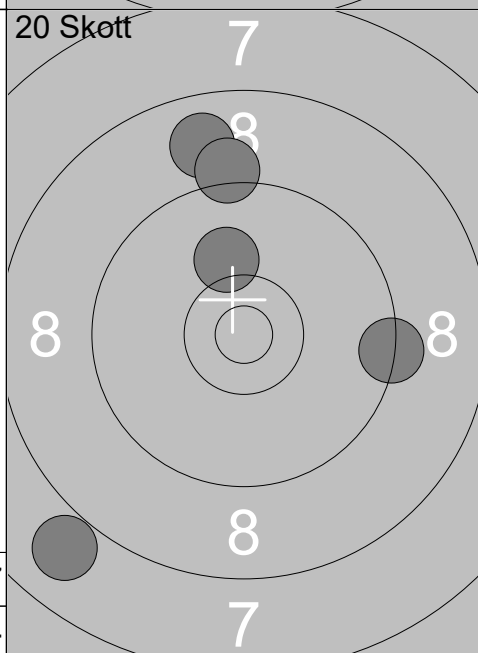

11:	8.9	↑
12:	9.3	→
13:	7.9	↘
14:	9.2	↑
15:	10.1	↑
Serie		43
Total		137

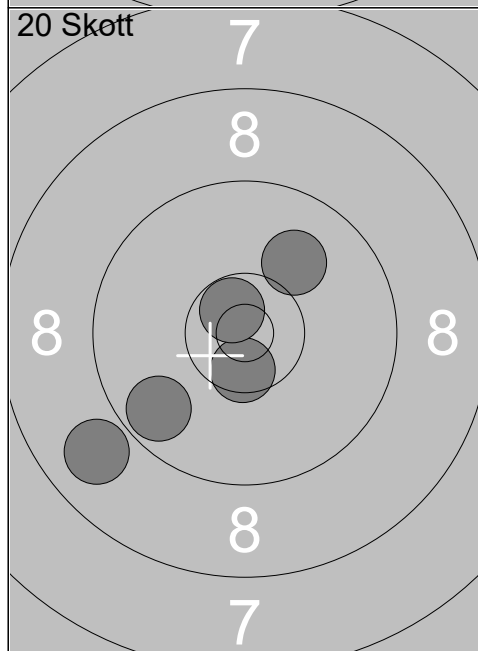

16:	10.5x	↘
17:	10.7x	↖
18:	9.7	↖
19:	10.0	↗
20:	8.9	↖
Serie		47
Total		184

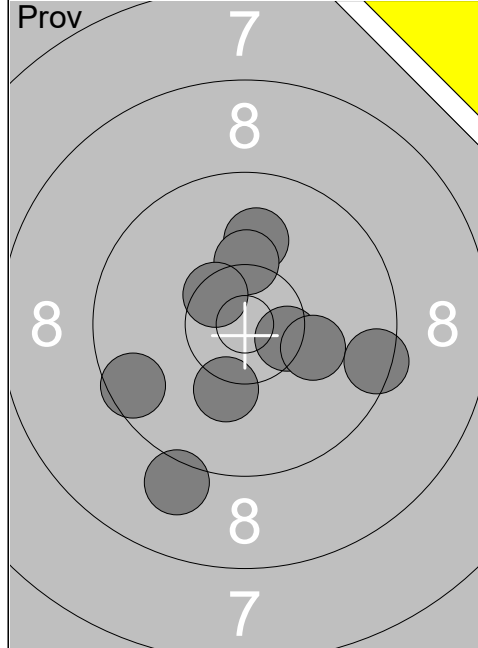

- 1: 9.1 ↘
- 2: 10.0 ↑
- 3: 10.5x ➔
- 4: 10.2 ➔
- 5: 9.6 ↙
- 6: 10.3 ↑
- 7: 9.5 ➔
- 8: 10.2 ↘
- 9: 10.5x ↙

Serie 87
Total 0

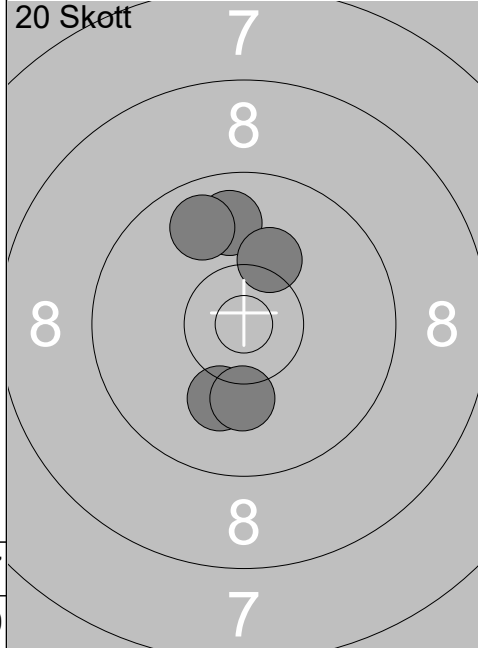

- 1: 9.8 ↑
- 2: 10.1 ↘
- 3: 10.2 ↗
- 4: 10.1 ↘
- 5: 9.8 ↗

Serie 48
Total 48

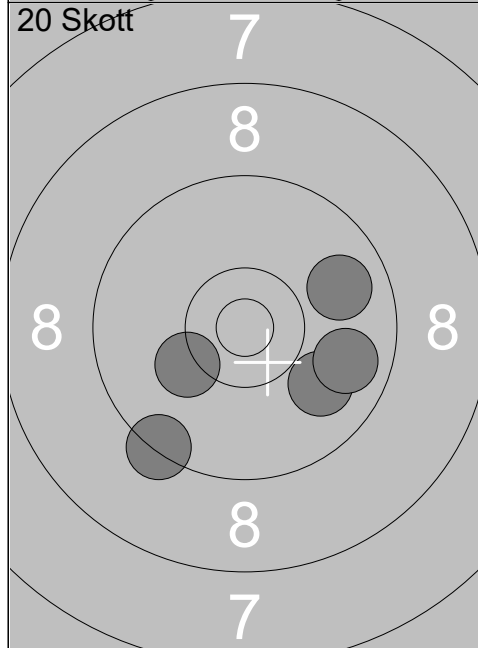

- 6: 10.2 ↙
- 7: 9.4 ↘
- 8: 9.9 ↘
- 9: 9.8 ➔
- 10: 9.8 ➔

Serie 46
Total 94

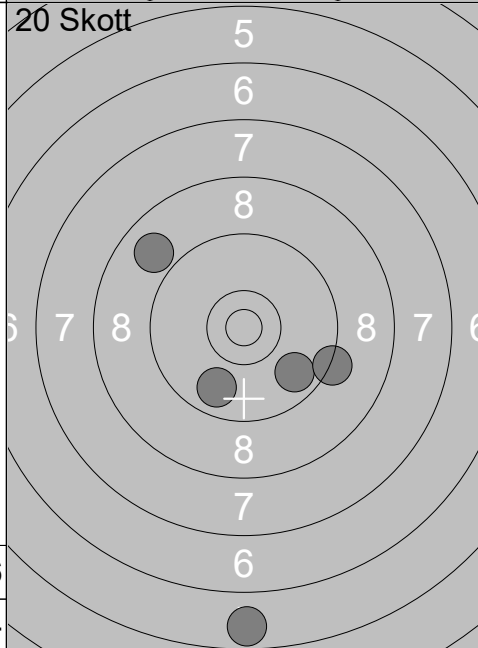

- 11: 9.8 ↘
- 12: 8.9 ↗
- 13: 5.7 ↘
- 14: 9.8 ↘
- 15: 9.3 ➔

Serie 40
Total 134

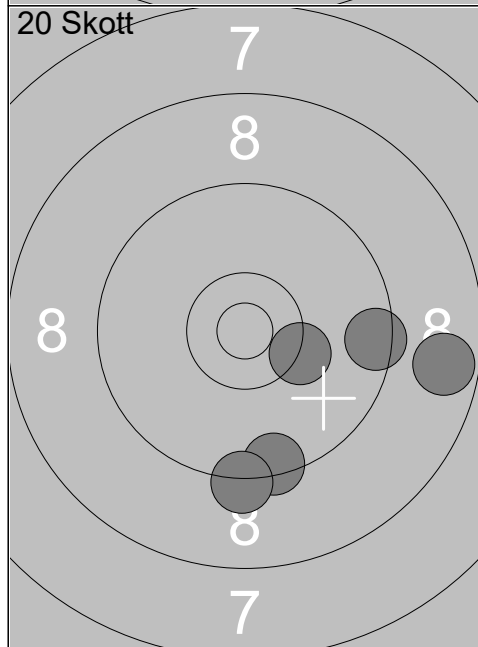

- 16: 9.4 ↘
- 17: 8.7 ➔
- 18: 10.3 ➔
- 19: 9.3 ↘
- 20: 9.5 ➔

Serie 45
Total 179

Skjutlag	Tavla	Lars Möllsten			
2	8	Ramselefors	Umeå	Sen-S	
28.04.2018	Vindelnskottet 2018	Ramselefors SKF			
Prov		1: 10.1 ↖ 2: 10.2 ← 3: 9.9 ← 4: 10.3 ↗ 5: 10.1 ↗ 6: 10.2 ↖ 7: 10.5x ↑	20 Skott		1: 10.2 ↘ 2: 10.5x ↓ 3: 10.5x ↓ 4: 10.2 ↑ 5: 10.2 ↘
	Serie 69			Serie 50	
	Total 0			Total 50	
20 Skott		6: 10.0 ↖ 7: 10.3x ↗ 8: 10.2 ← 9: 10.2 → 10: 10.3 ↑	20 Skott		11: 8.2 ← 12: 8.8 ↑ 13: 7.2 ↓ 14: 10.2 ↓ 15: 7.8 ↑
	Serie 50			Serie 40	
	Total 100			Total 140	
20 Skott		16: 10.7x ↗ 17: 10.4x ← 18: 10.9x ↓ 19: 9.5 → 20: 10.4x ↖			
	Serie 49				
	Total 189				

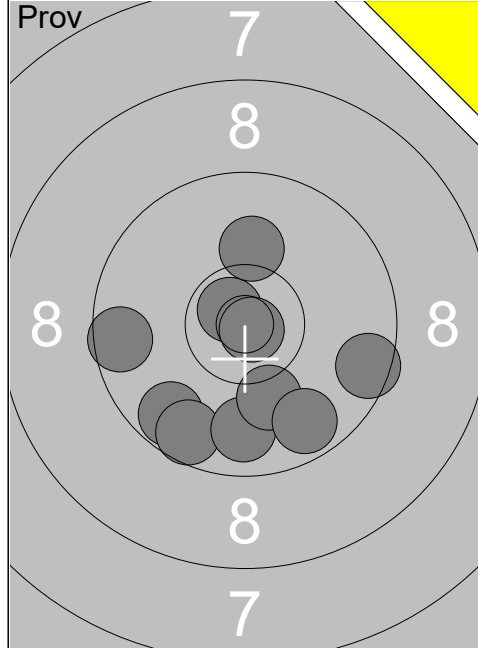

- 1: 9.7 ↙
- 2: 9.6 ↓
- 3: 9.8 ↓
- 4: 9.5 →
- 5: 10.7x ↖
- 6: 10.9x ↘
- 7: 10.1 ↑
- 8: 10.1 ↓
- 9: 9.6 ←
- 10: 9.7 ↘

Serie 94
Total 0

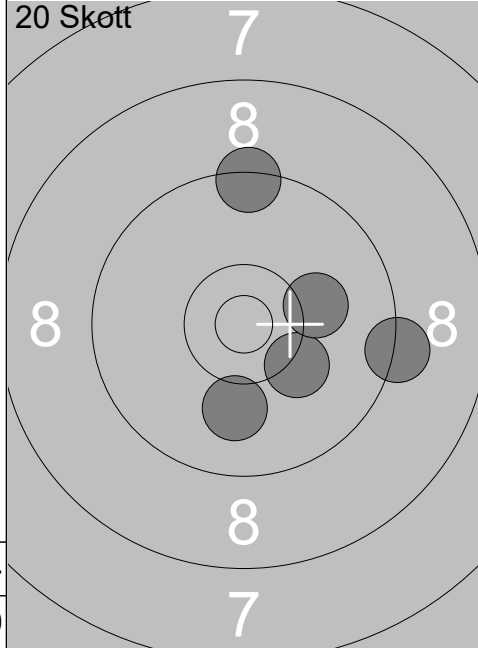

- 1: 10.2 ↘
- 2: 9.4 ↑
- 3: 10.0 ↓
- 4: 9.3 →
- 5: 10.1 →

Serie 48
Total 48

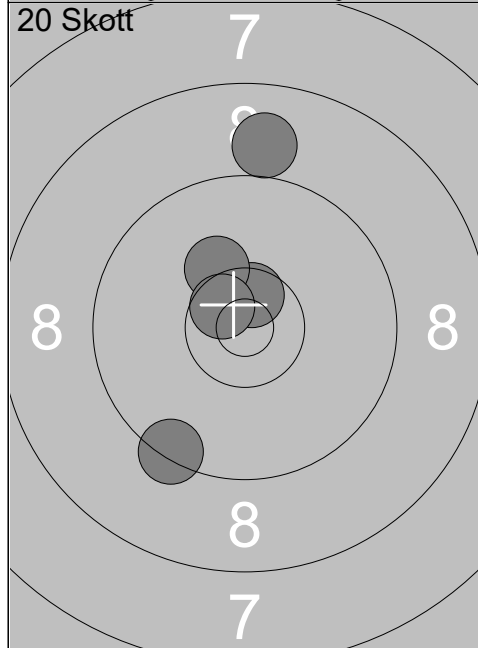

- 6: 10.6x ↑
- 7: 9.0 ↑
- 8: 10.2 ↗
- 9: 10.6x ↖
- 10: 9.4 ↘

Serie 48
Total 96

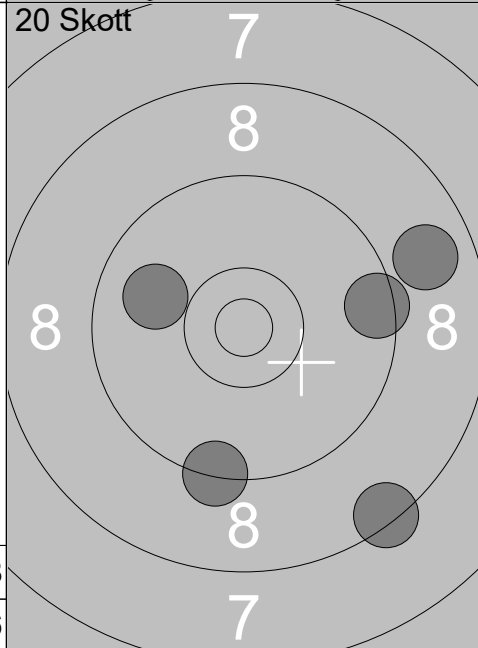

- 11: 9.9 ←
- 12: 9.5 →
- 13: 8.8 ↗
- 14: 9.3 ↓
- 15: 8.4 ↘

Serie 43
Total 139

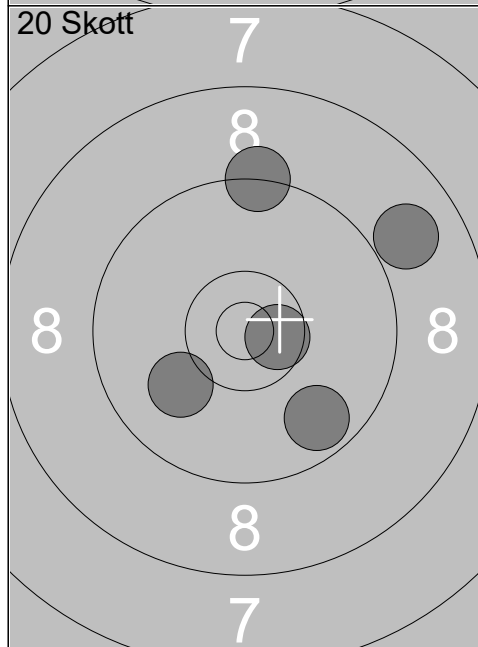

- 16: 8.9 ↗
- 17: 10.0 ↙
- 18: 9.3 ↑
- 19: 9.7 ↘
- 20: 10.6x →

Serie 46
Total 185

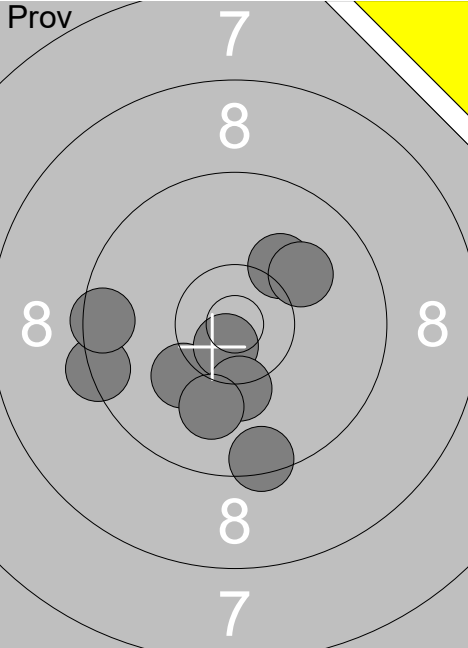
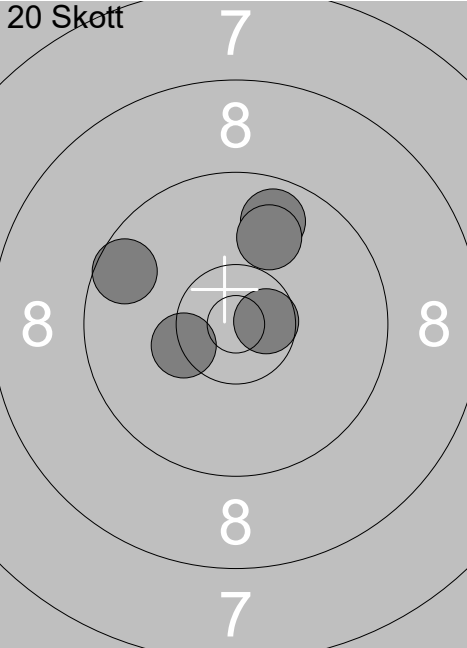
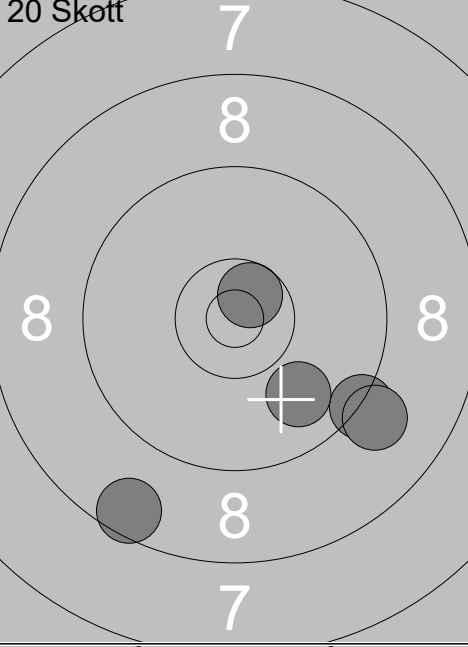
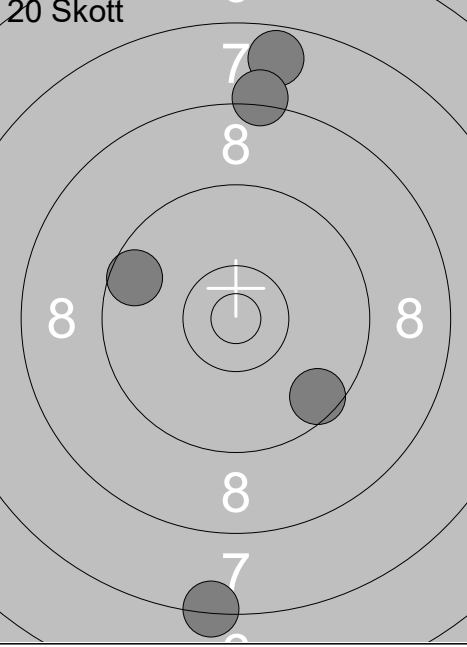
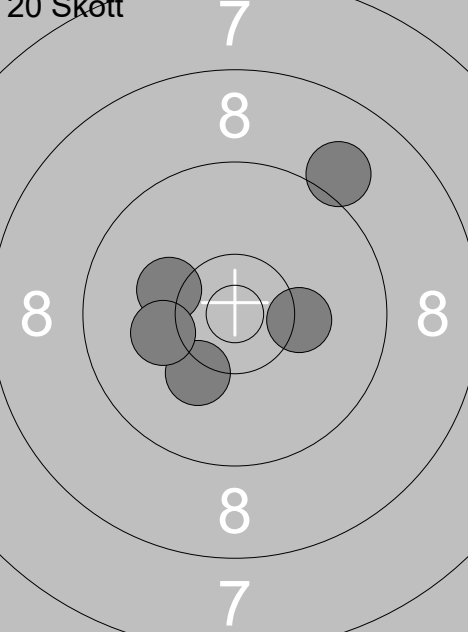
Skjutlag 2	Tavla 11	Stefan Thorin	
Ramselefors	Umeå	Sen-S	Vb
28.04.2018	Vindelnskottet 2018	Ramselefors SKF	
Prov 	1: 10.1 ↗ 2: 10.2 ↘ 3: 10.7x ↘ 4: 9.4 ← 5: 9.5 ← 6: 10.3 ↓ 7: 10.0 ↓ 8: 10.1 ↗ 9: 9.5 ↓	20 Skott 	1: 9.6 ↖ 2: 9.8 ↗ 3: 10.3x ↖ 4: 9.9 ↗ 5: 10.6x →
	Serie 87		Serie 47
	Total 0		Total 47
20 Skott 	6: 9.3 ↘ 7: 10.6x ↗ 8: 9.9 ↘ 9: 8.6 ↘ 10: 9.1 ↘	20 Skott 	11: 7.7 ↗ 12: 9.6 ↘ 13: 8.2 ↗ 14: 7.4 ↘ 15: 9.6 ↖
	Serie 45		Serie 40
	Total 92		Total 132
20 Skott 	16: 10.3 → 17: 10.2 ↘ 18: 10.2 ← 19: 10.1 ← 20: 9.1 ↗		
	Serie 49		
	Total 181		

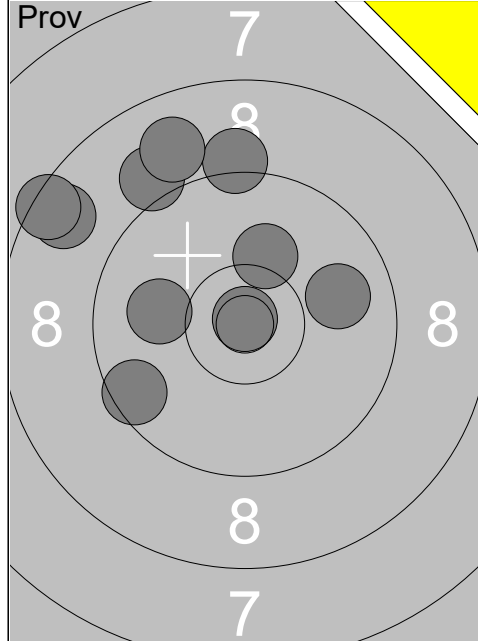

1:	8.7	↖
2:	10.0	←
3:	8.5	↖
4:	10.2	↑
5:	9.5	↙
6:	9.9	→
7:	9.2	↑
8:	9.1	↖
9:	8.9	↖
10:	10.9x	↑
Serie		90
Total		0

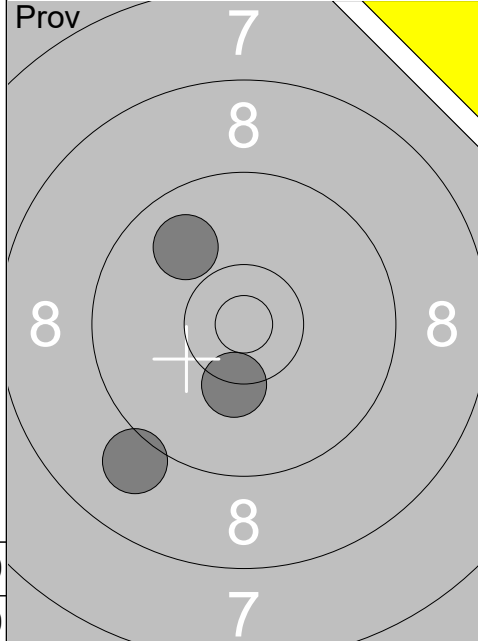

11:	9.1	↙
12:	9.9	↖
13:	10.3x	↓
Serie		28
Total		0

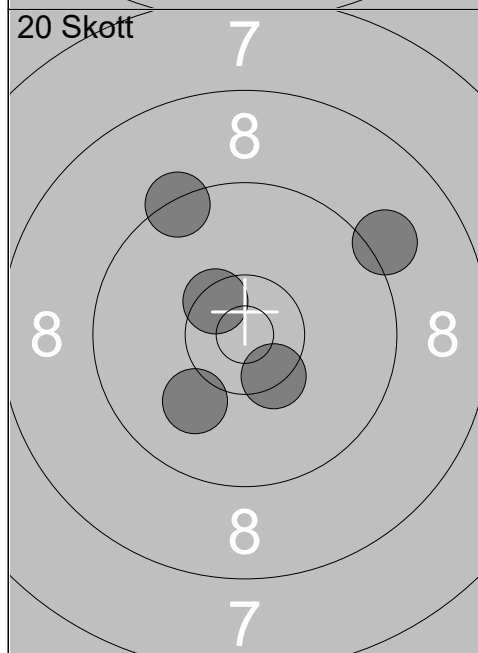

1:	10.0	↙
2:	10.4x	↘
3:	10.5x	↖
4:	9.4	↖
5:	9.1	↗
Serie		48
Total		48

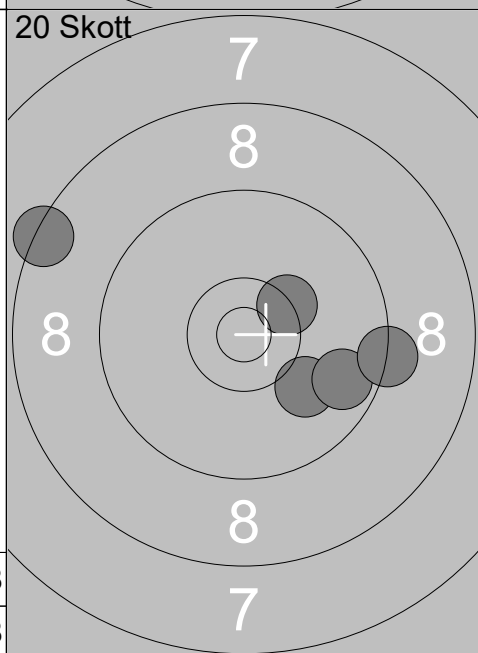

6:	10.0	↘
7:	9.7	↘
8:	10.4x	↗
9:	9.3	→
10:	8.4	↖
Serie		46
Total		94

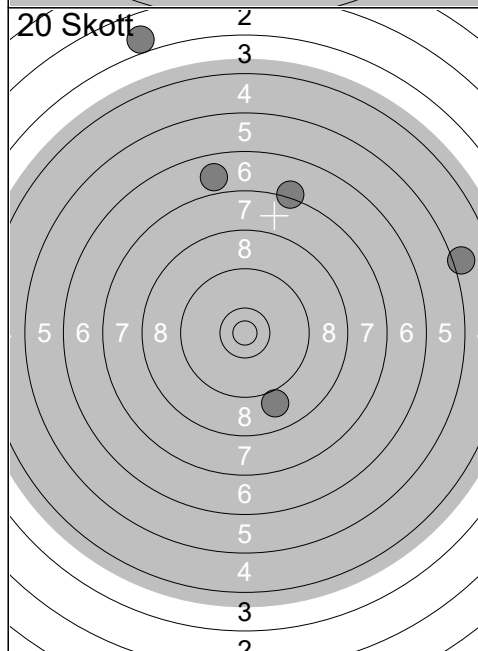

11:	6.9	↑
12:	5.1	→
13:	7.2	↑
14:	9.0	↘
15:	3.0	↖
Serie		30
Total		124

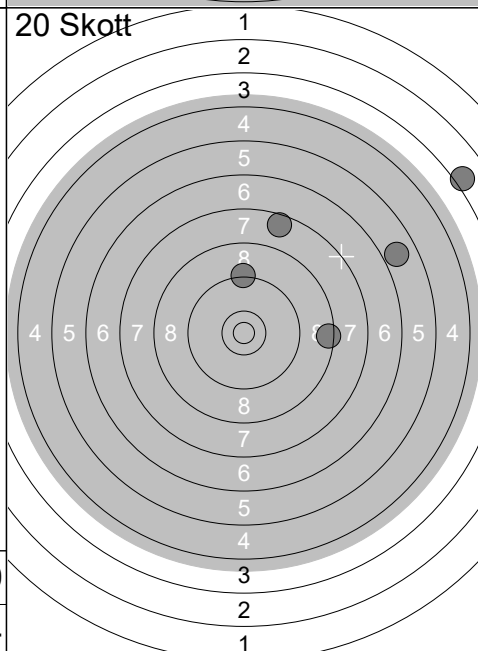

16:	3.1	↗
17:	8.4	→
18:	9.3	↑
19:	7.6	↑
20:	5.9	↗
Serie		32
Total		156

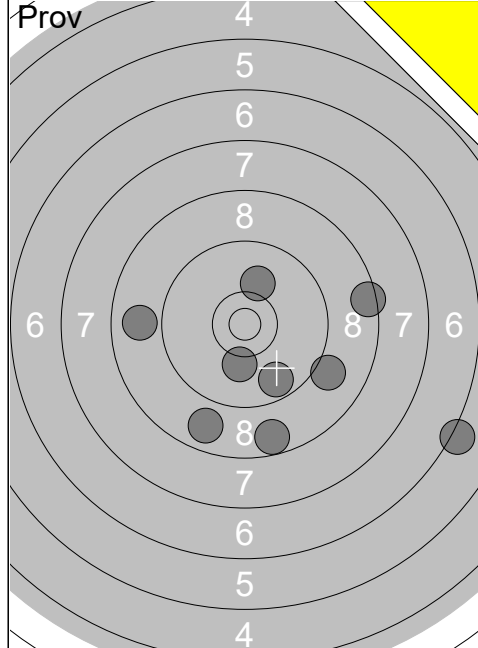

1:	9.0	↘
2:	10.1	↓
3:	8.5	→
4:	9.7	↓
5:	8.8	↓
6:	6.2	↘
7:	8.9	←
8:	10.1	↑
9:	8.6	↓
Serie		76
Total		0

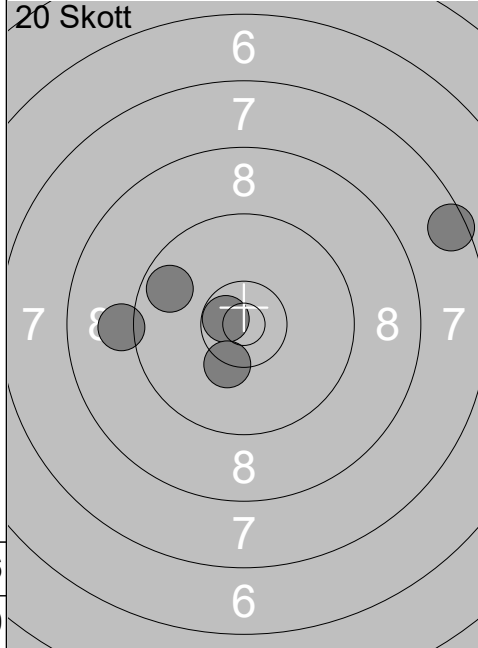

1:	10.7x	↙
2:	7.5	↗
3:	10.3x	↓
4:	9.7	↖
5:	9.1	←
Serie		45
Total		45

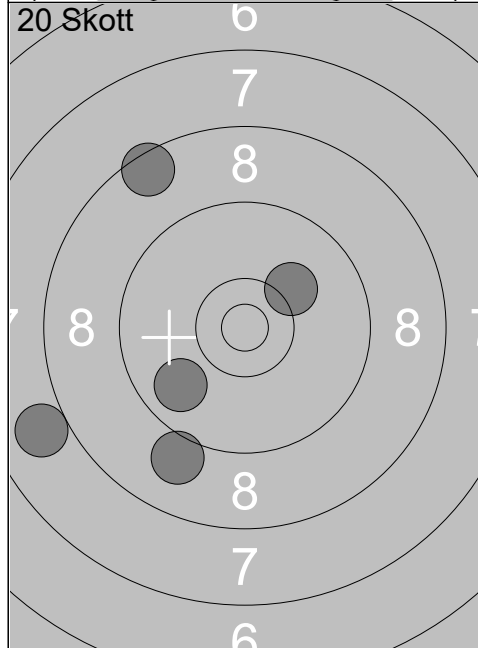

6:	8.5	↖
7:	10.2	↗
8:	7.9	↖
9:	9.8	↖
10:	9.0	↓
Serie		43
Total		88

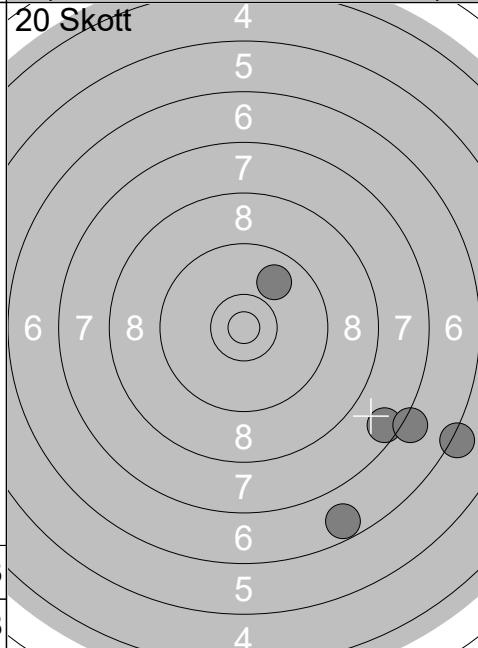

11:	9.9	↗
12:	6.7	↓
13:	7.6	↘
14:	6.2	↘
15:	7.1	↘
Serie		35
Total		123

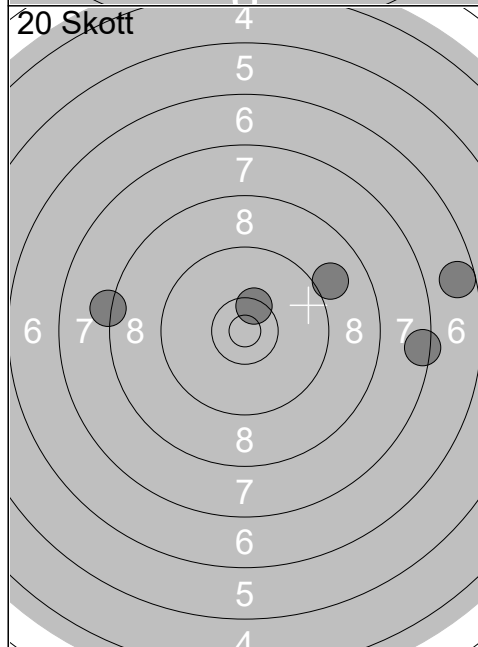

16:	6.7	→
17:	7.4	→
18:	9.0	↗
19:	8.2	←
20:	10.4x	↗
Serie		40
Total		163

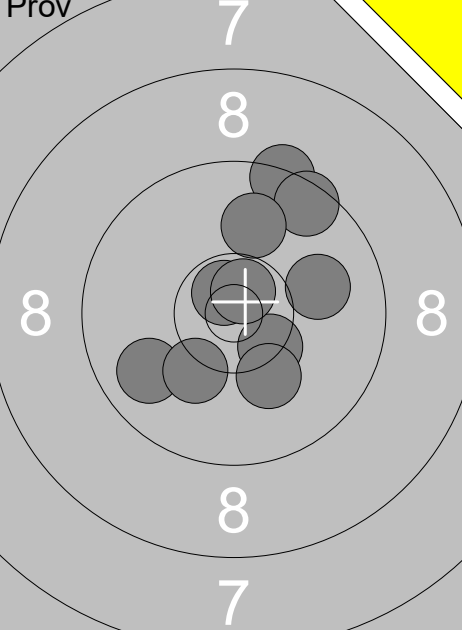
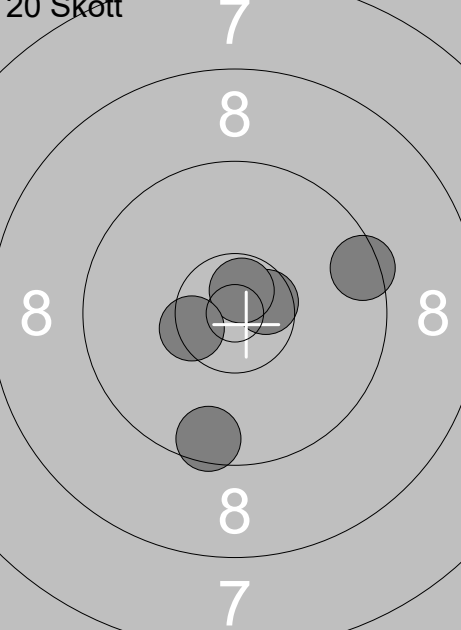
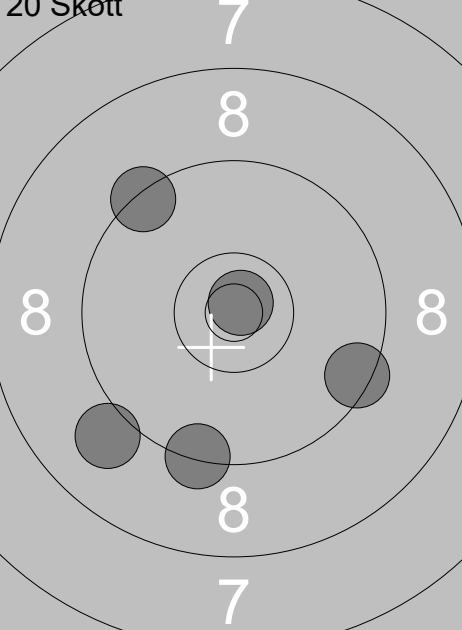
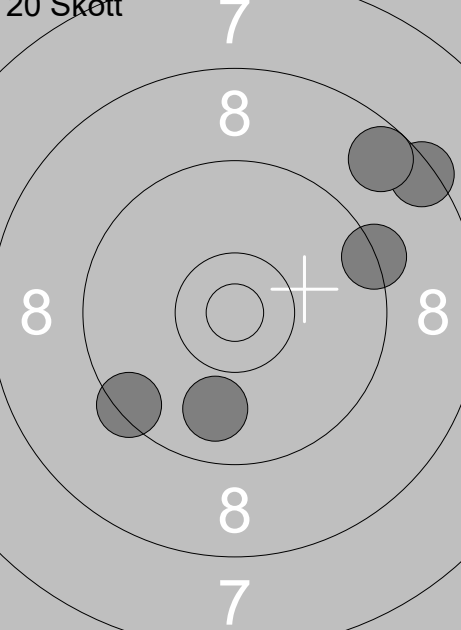
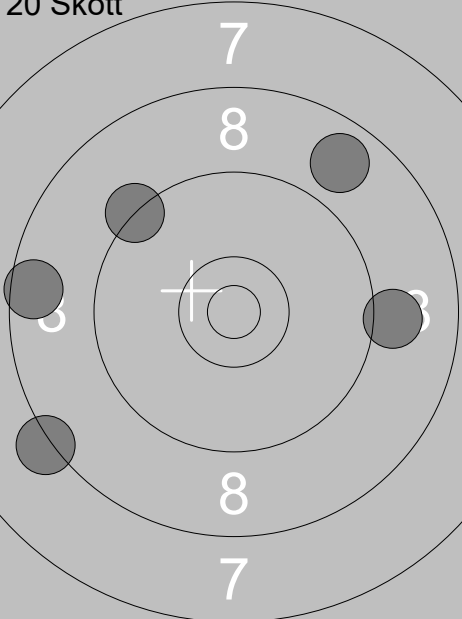
Prov 	1: 9.4 ↗ 2: 9.8 ↙ 3: 10.4x ↘ 4: 10.2 ↘ 5: 10.7x ↗ 6: 9.5 ↗ 7: 10.2 ↘ 8: 10.7x ↗ 9: 10.0 → 10: 10.0 ↑ Serie 97 Total 0	20 Skott  1: 9.5 → 2: 10.6x → 3: 9.6 ↓ 4: 10.7x ↗ 5: 10.5x ← Serie 48 Total 48
20 Skott 	6: 9.4 ↘ 7: 9.5 → 8: 10.8x ↗ 9: 9.0 ↙ 10: 9.3 ↓ Serie 46 Total 94	20 Skott  11: 9.4 ↙ 12: 9.9 ↓ 13: 8.4 ↗ 14: 9.3 → 15: 8.7 ↗ Serie 43 Total 137
20 Skott 	16: 8.2 ↙ 17: 9.1 → 18: 8.6 ← 19: 8.8 ↗ 20: 9.3 ↘ Serie 42 Total 179	

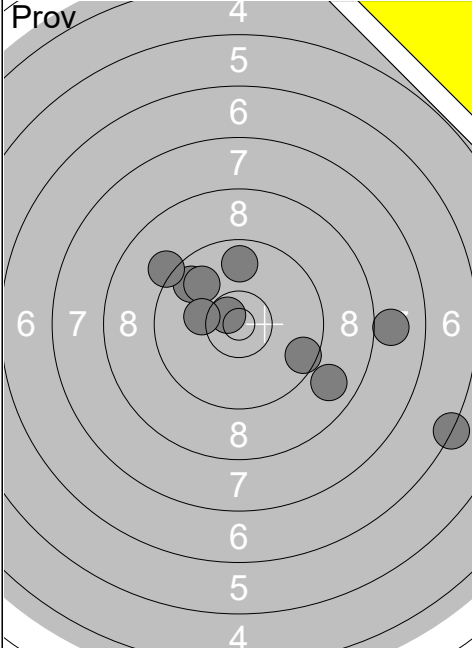
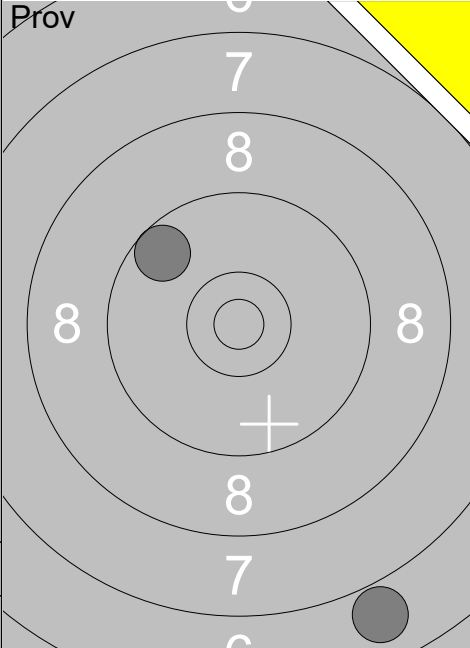
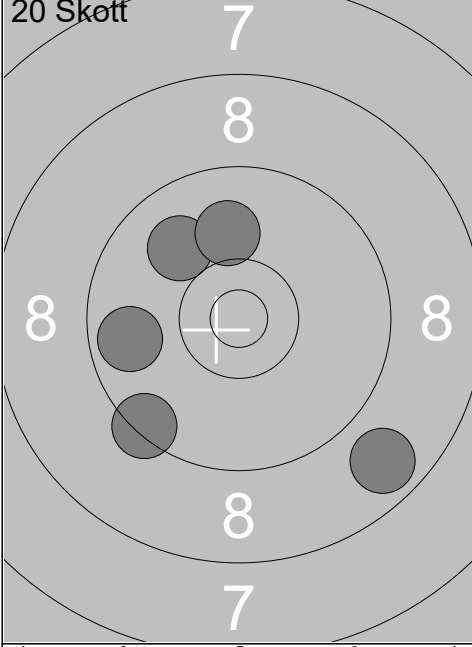
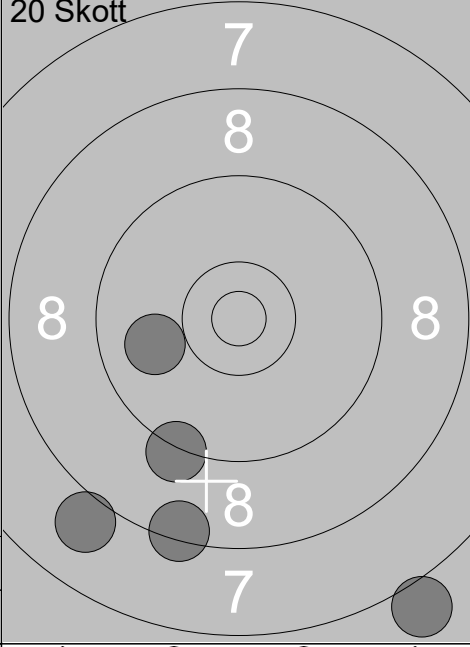
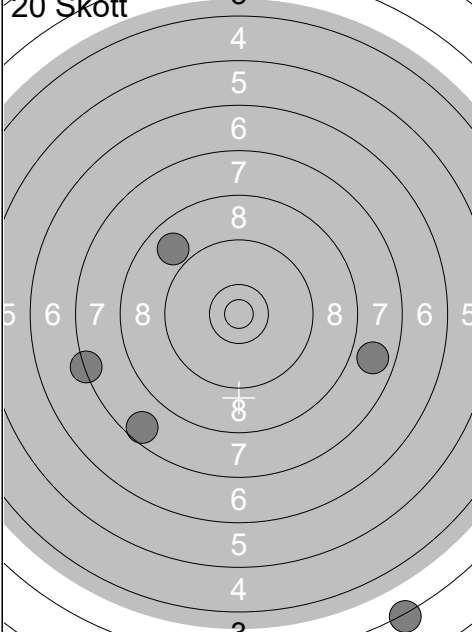
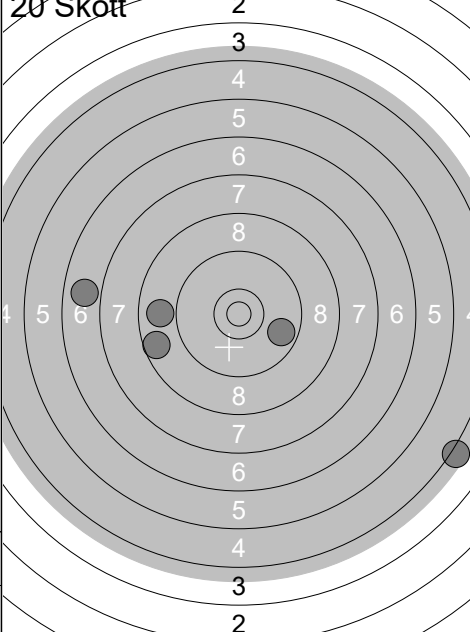
Skjuttlag	Tavla	Mats Österlund			
2	16	Ramselefors	Ramselefors	Sen-S	Vb
28.04.2018	Vindelnskottet 2018	Ramselefors SKF			
	1: 6.3 ↘		11: 6.9 ↘		
	2: 9.6 ↘		12: 9.6 ↗		
	3: 9.7 ↗				
	4: 9.2 ↗				
	5: 9.9 ↗				
	6: 8.9 ↘				
	7: 8.0 →				
	8: 9.8 ↑				
	9: 10.7x ↗				
	10: 10.2 ←				
Serie	87	Serie	15		
Total	0	Total	0		
	1: 10.0 ↗		6: 7.0 ↘		
	2: 9.7 ←		7: 9.3 ↘		
	3: 9.4 ↘		8: 8.0 ↘		
	4: 8.8 ↘		9: 9.9 ←		
	5: 10.0 ↑		10: 8.4 ↘		
Serie	46	Serie	41		
Total	46	Total	87		
	11: 8.9 ↗		16: 4.2 ↘		
	12: 7.8 →		17: 8.9 ←		
	13: 7.3 ←		18: 8.6 ←		
	14: 3.2 ↘		19: 6.9 ←		
	15: 7.6 ↘		20: 9.7 →		
Serie	32	Serie	35		
Total	119	Total	154		

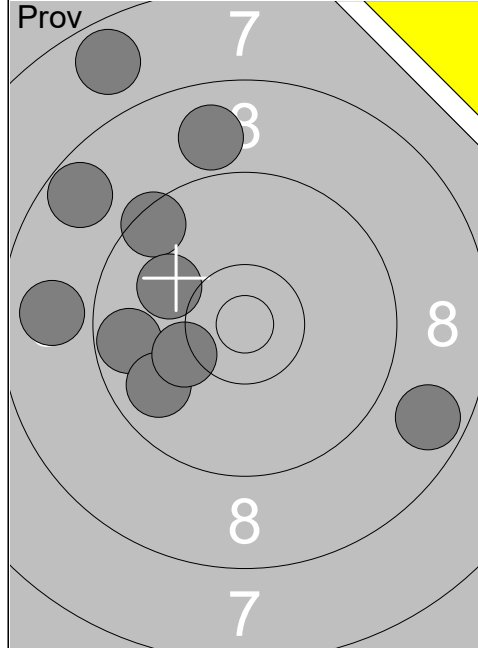

1:	9.7	←
2:	9.8	↙
3:	8.7	↗
4:	8.9	←
5:	7.7	↗
6:	9.5	↗
7:	8.9	↑
8:	10.0	↖
9:	8.7	↘
10:	10.2	↖
Serie		86
Total		0

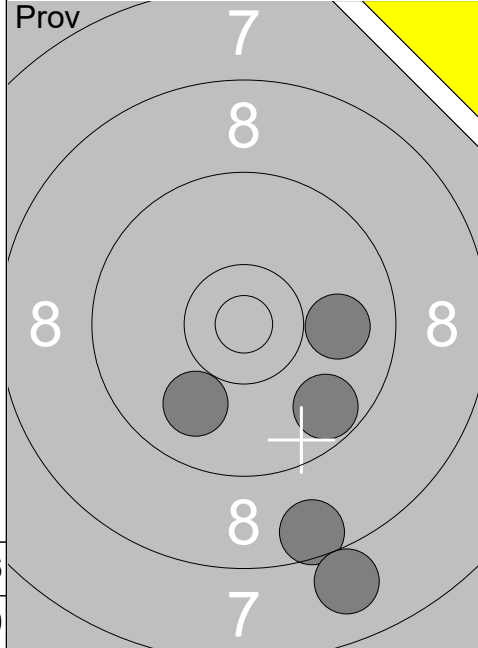

11:	9.9	↘
12:	9.7	↘
13:	8.6	↘
14:	9.9	→
15:	7.9	↘
Serie		42
Total		0

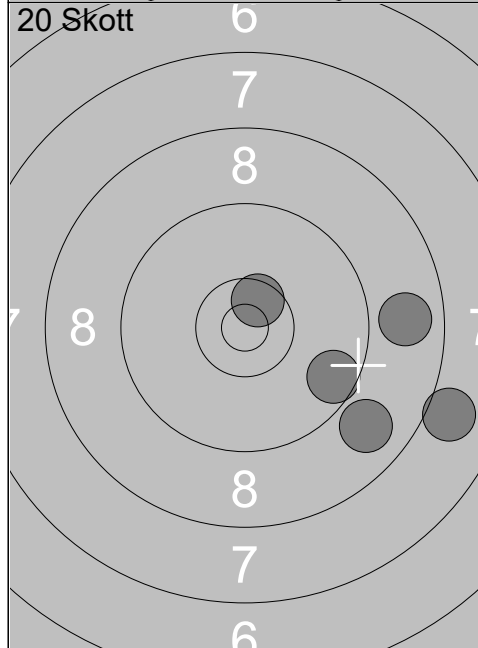

1:	8.9	↘
2:	10.6x	↗
3:	8.0	↘
4:	9.6	↘
5:	8.8	→
Serie		43
Total		43

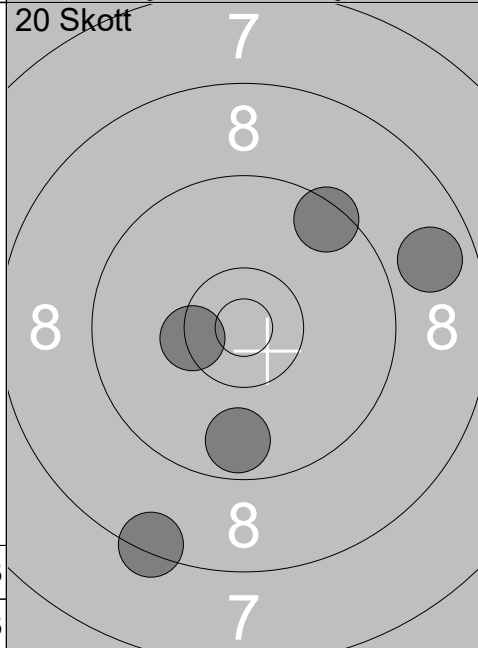

6:	8.4	↘
7:	9.7	↘
8:	10.4x	↖
9:	9.5	↗
10:	8.8	→
Serie		44
Total		87

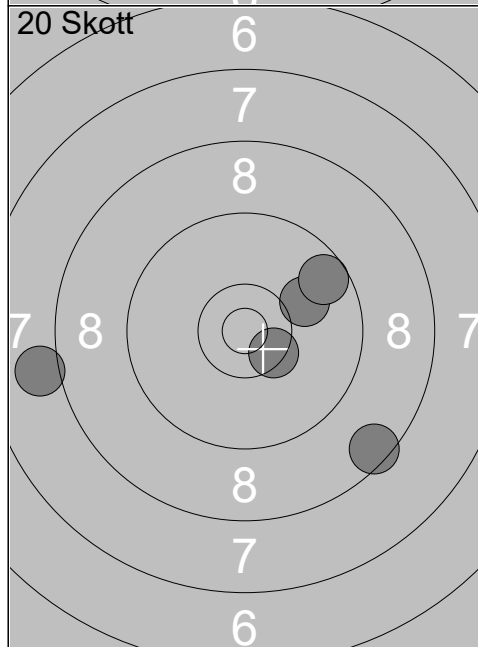

11:	10.0	↗
12:	10.5x	↘
13:	8.0	←
14:	8.5	↘
15:	9.6	↗
Serie		45
Total		132

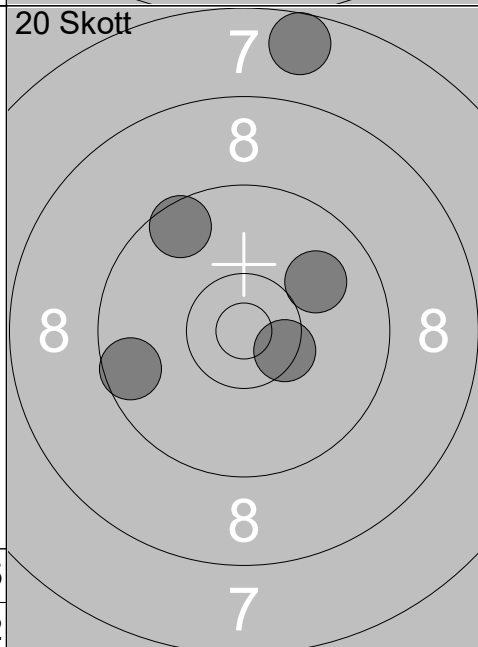

16:	9.6	↖
17:	9.6	←
18:	10.0	↗
19:	7.6	↑
20:	10.4x	↘
Serie		45
Total		177

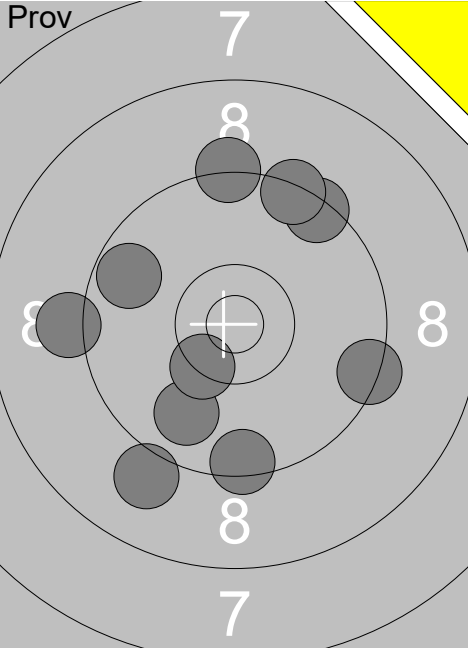
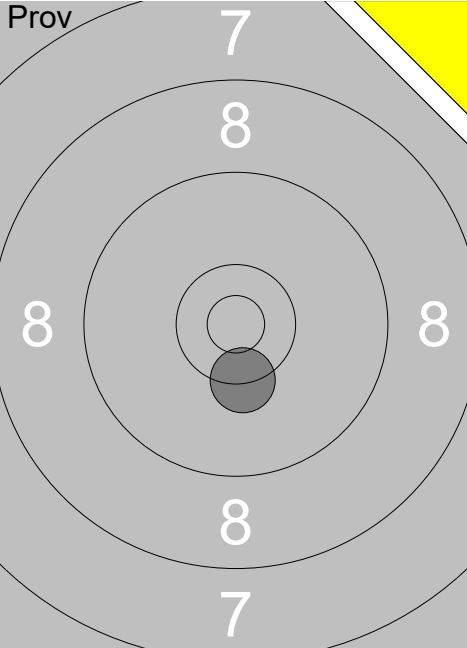
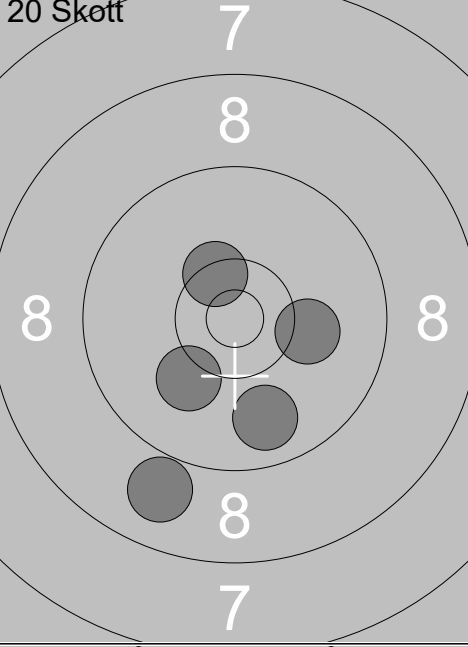
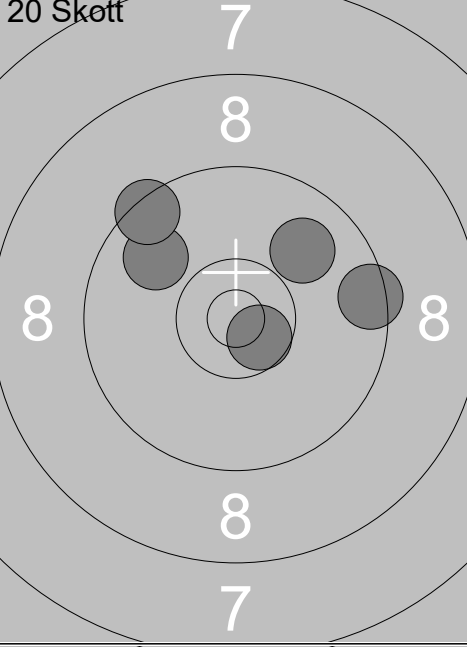
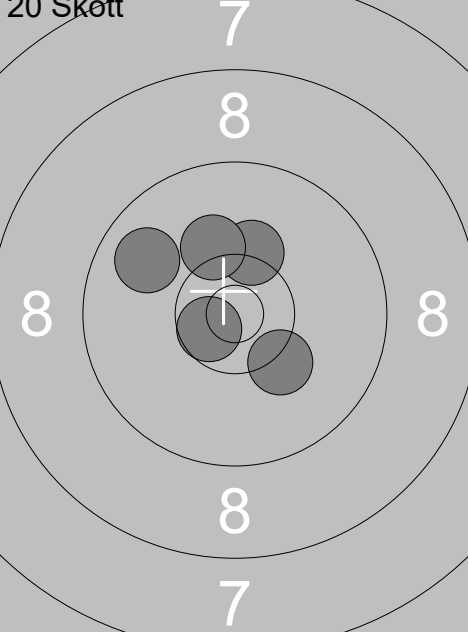
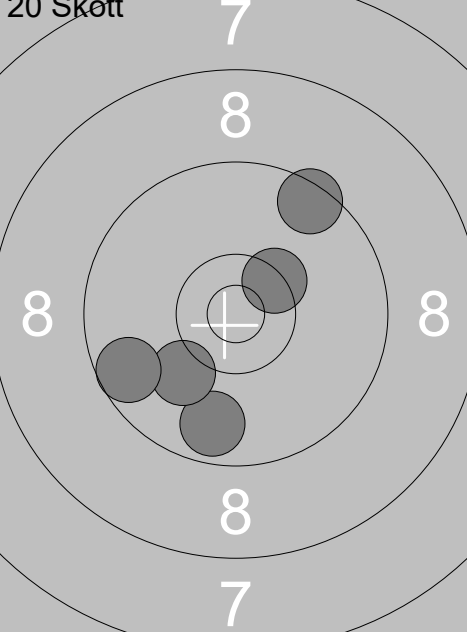
Skjutlag	Tavla	Beatrice Andersson			
3	3	Ramselefors	Ramselefors	15	Vb
28.04.2018	Vindelnskottet 2018	Ramselefors SKF			
Prov		1: 9.9 ↘ 2: 9.1 ← 3: 9.4 ↗ 4: 9.4 ↗ 5: 9.4 → 6: 9.7 ↖ 7: 9.3 ↑ 8: 9.0 ↘ 9: 10.4x ↘ 10: 9.5 ↓	Prov		11: 10.3x ↘
		Serie 91		Serie 10	
		Total 0		Total 0	
20 Skott		1: 9.8 ↘ 2: 10.1 ↘ 3: 10.2 → 4: 10.4x ↗ 5: 8.9 ↘	20 Skott		6: 9.9 ↗ 7: 9.5 → 8: 9.9 ↖ 9: 9.4 ↗ 10: 10.6x ↘
		Serie 47		Serie 46	
		Total 47		Total 93	
20 Skott		11: 10.3 ↑ 12: 10.6x ↖ 13: 10.2 ↘ 14: 10.2 ↑ 15: 9.8 ↖	20 Skott		16: 10.4x ↗ 17: 9.5 ↗ 18: 9.7 ↘ 19: 10.1 ↘ 20: 9.6 ↖
		Serie 49		Serie 47	
		Total 142		Total 189	

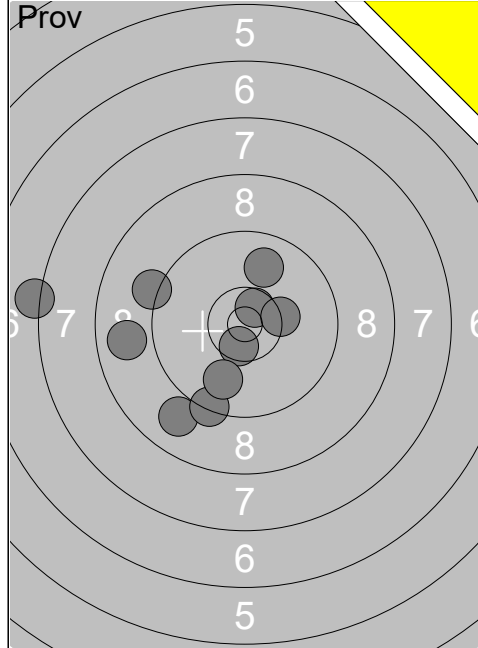

1:	10.5x ↓
2:	8.9 ↓
3:	9.2 ←
4:	8.8 ←
5:	10.6x ↗
6:	10.3x →
7:	9.4 ↓
8:	9.9 ↓
9:	9.9 ↗
10:	7.2 ←
Serie	89
Total	0

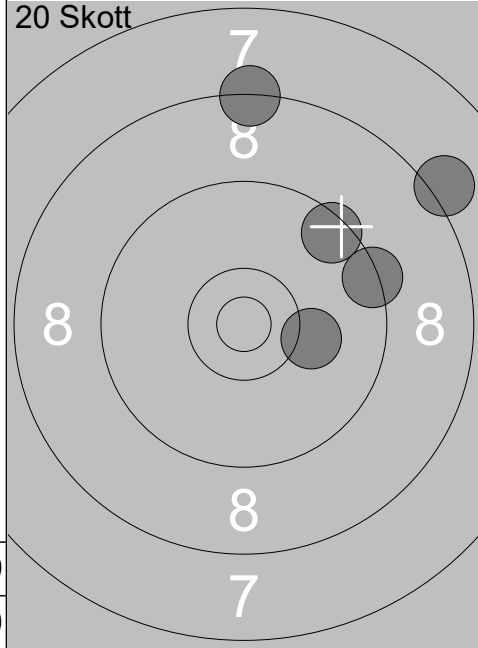

1:	8.1 ↗
2:	8.3 ↑
3:	9.5 ↗
4:	9.4 →
5:	10.2 →
Serie	44
Total	44

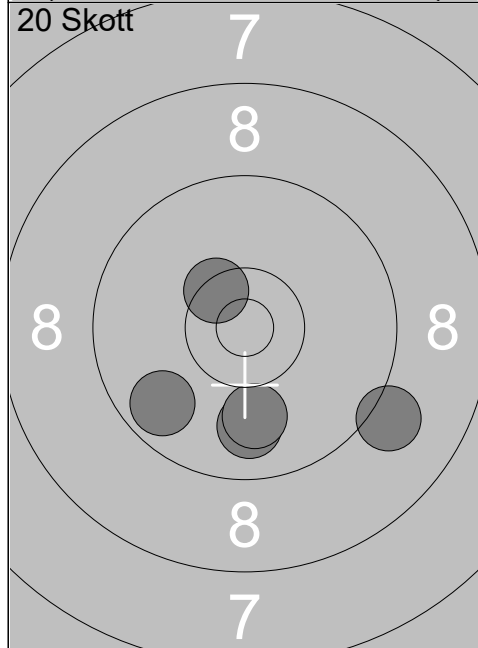

6:	10.4x ↘
7:	9.9 ↓
8:	9.1 →
9:	10.0 ↓
10:	9.7 ↙
Serie	47
Total	91

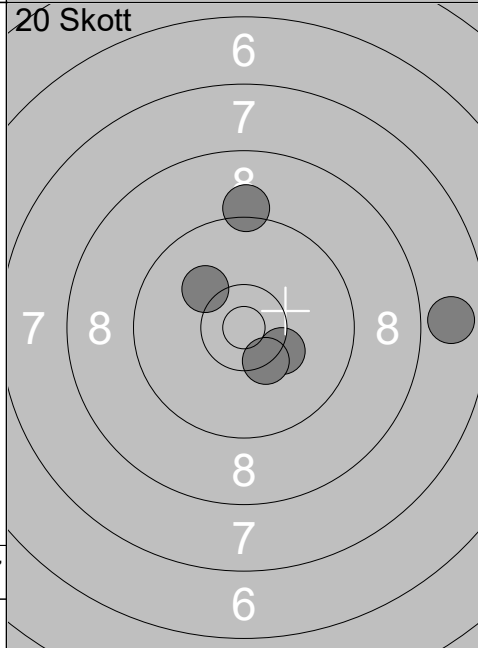

11:	10.3 ↘
12:	10.3x ↘
13:	10.1 ↗
14:	7.8 →
15:	9.2 ↑
Serie	46
Total	137

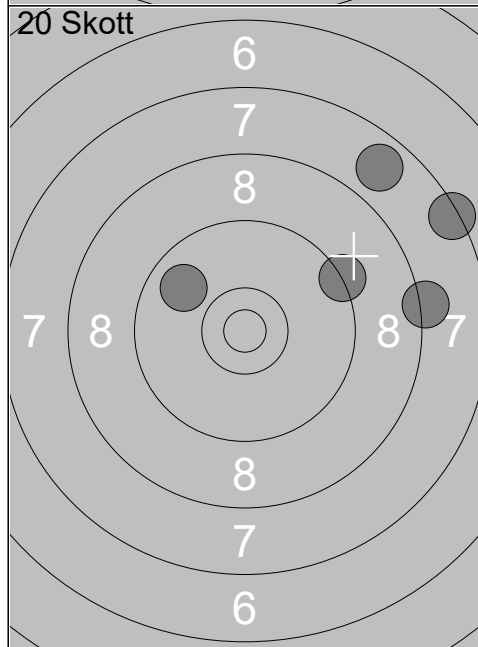

16:	7.8 ↗
17:	7.4 ↗
18:	8.2 →
19:	9.8 ↖
20:	9.3 ↗
Serie	40
Total	177

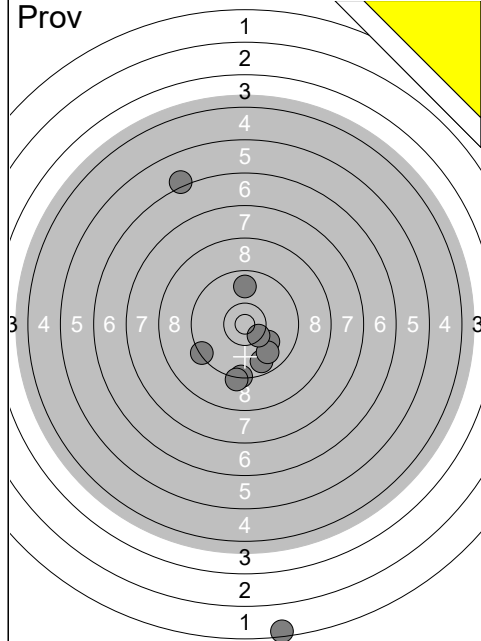

1:	1.5	↓
2:	6.2	↗
3:	9.3	↓
4:	9.7	↓
5:	10.1	↘
6:	9.3	↙
7:	9.8	↑
8:	9.8	↓
9:	10.4x	↘
10:	9.2	↓
Serie	81	
Total	0	

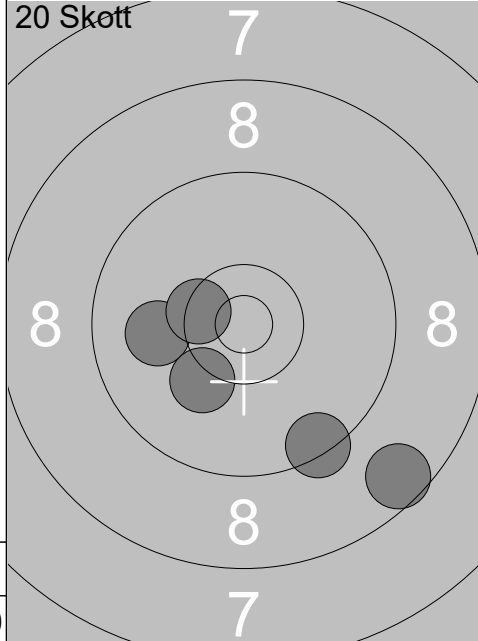

1:	8.6	↘
2:	10.0	←
3:	10.4x	↙
4:	9.4	↓
5:	10.2	↘
Serie	47	
Total	47	

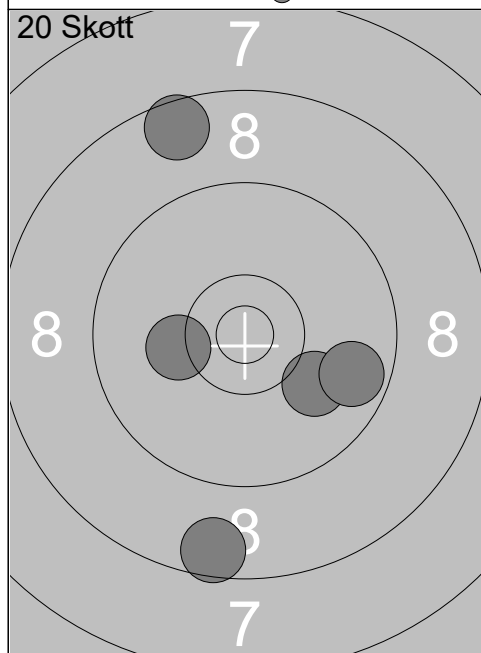

6:	10.0	↘
7:	9.7	→
8:	8.6	↑
9:	8.6	↓
10:	10.2	←
Serie	45	
Total	92	

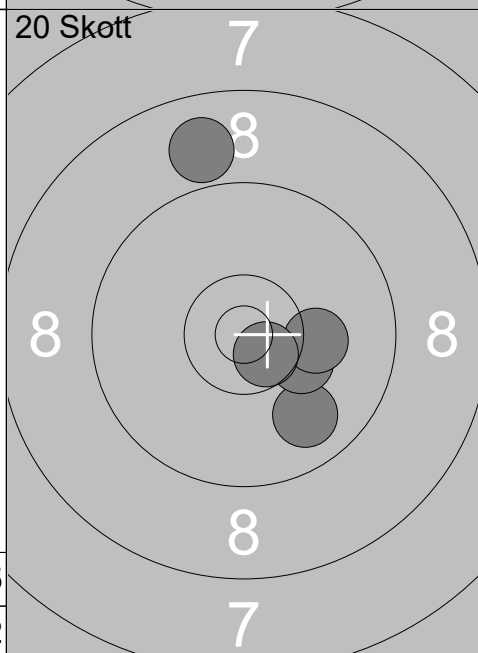

11:	9.9	↘
12:	10.3	→
13:	8.9	↑
14:	10.2	→
15:	10.6x	↘
Serie	47	
Total	139	

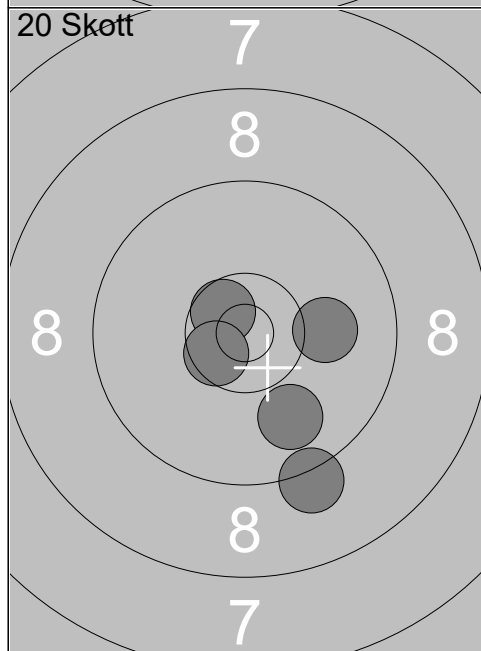

16:	9.2	↓
17:	10.1	→
18:	10.6x	↗
19:	10.6x	↙
20:	9.9	↘
Serie	48	
Total	187	

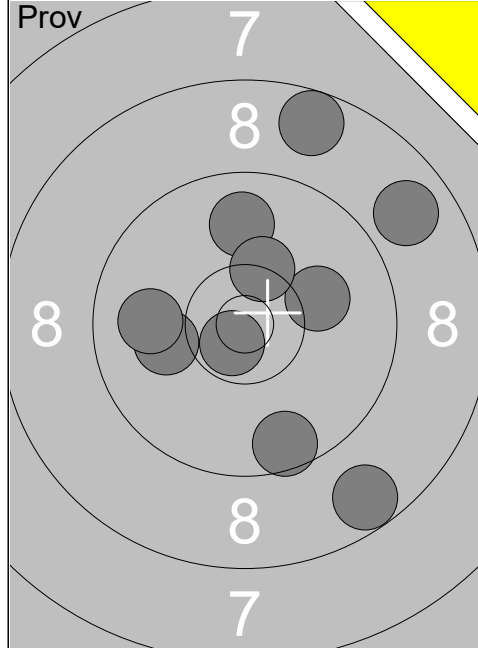

1:	8.6	↗
2:	10.1	→
3:	8.8	↗
4:	8.7	↘
5:	9.6	↘
6:	10.1	←
7:	10.7x	↘
8:	9.9	←
9:	9.9	↑
10:	10.3x	↗
Serie		91
Total		0

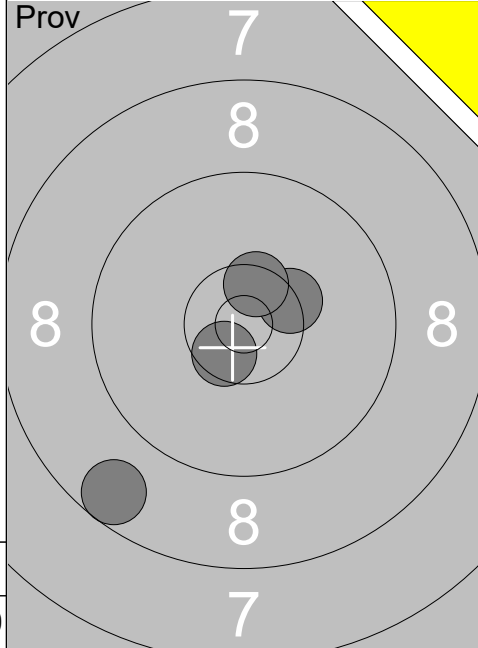

11:	10.6x	↘
12:	8.7	↘
13:	10.4x	↗
14:	10.5x	↗
Serie		38
Total		0

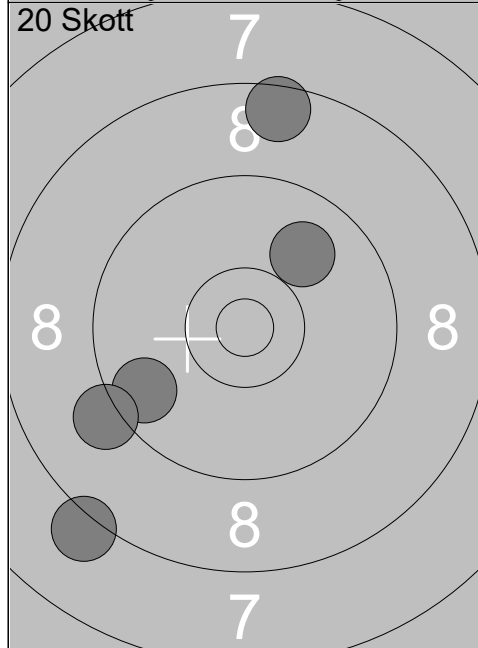

1:	9.7	↖
2:	8.1	↘
3:	9.9	↗
4:	8.5	↑
5:	9.2	↖
Serie		43
Total		43

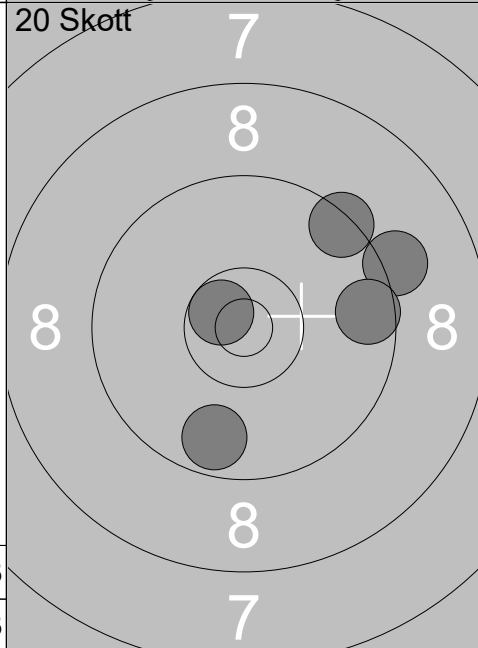

6:	9.4	↗
7:	9.2	↗
8:	9.6	→
9:	9.7	↘
10:	10.7x	↖
Serie		46
Total		89

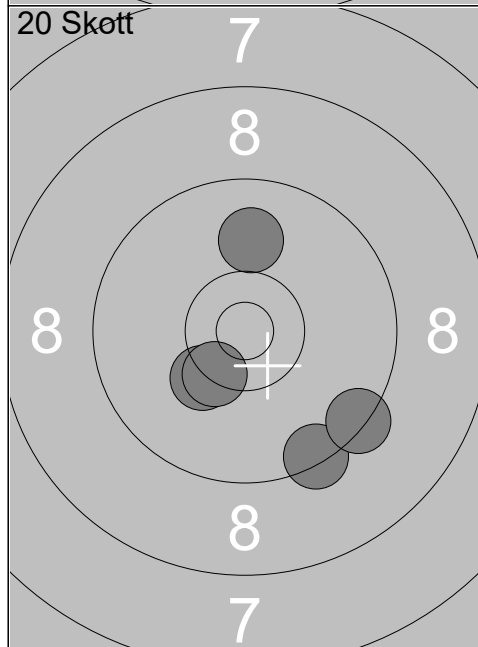

11:	10.3	↘
12:	10.4x	↘
13:	10.0	↑
14:	9.4	↘
15:	9.4	↘
Serie		48
Total		137

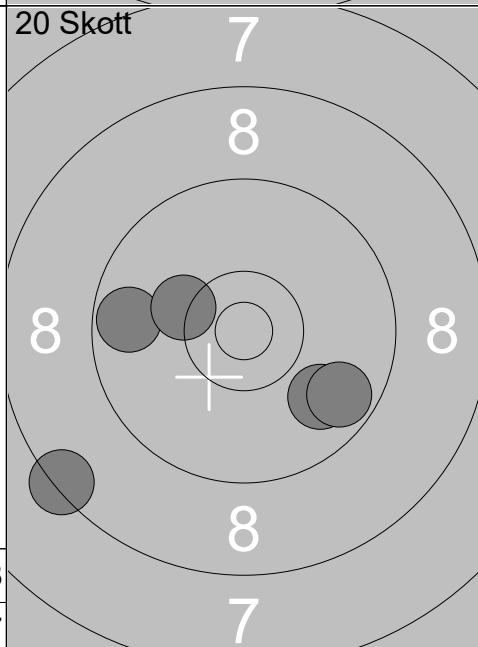

16:	9.9	↘
17:	8.4	↖
18:	9.7	↘
19:	9.7	←
20:	10.2	↖
Serie		45
Total		182

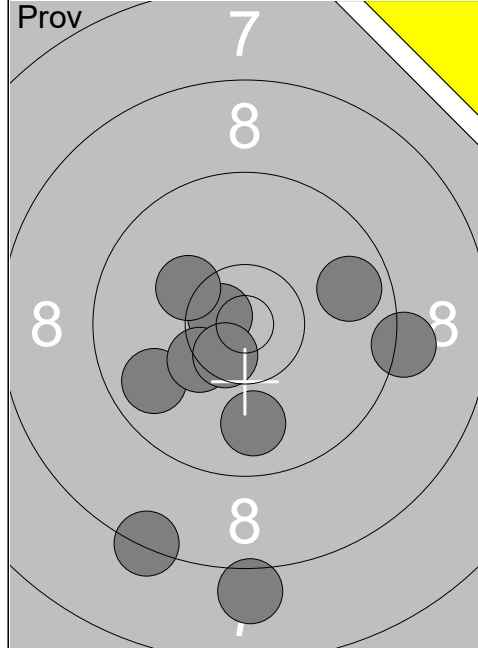

1:	10.7x	↙
2:	8.3	↓
3:	8.0	↓
4:	9.9	↓
5:	9.2	→
6:	9.8	→
7:	9.8	↙
8:	10.3x	↙
9:	10.2	↙
10:	10.5x	↙
Serie		92
Total		0

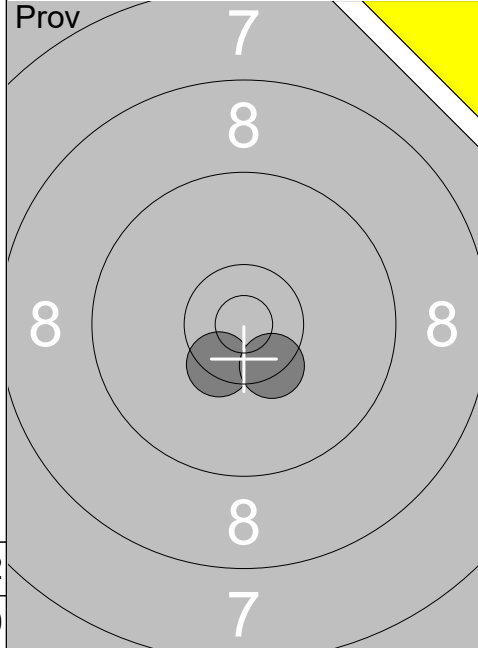

11:	10.4x	↙
12:	10.4x	↘
Serie		20
Total		0

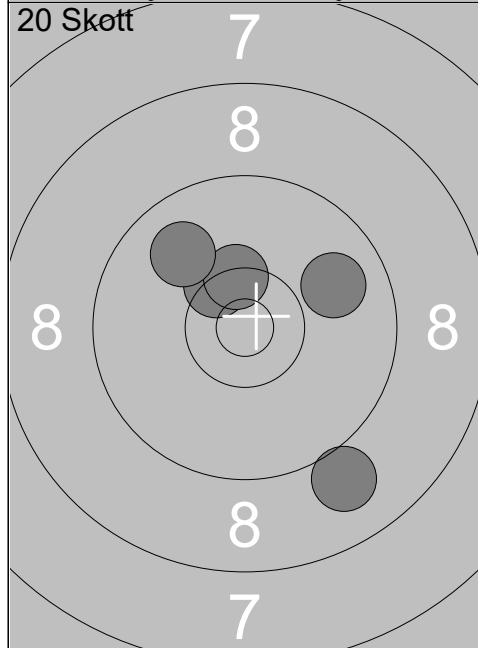

1:	10.4x	↖
2:	10.4x	↑
3:	9.0	↓
4:	9.9	→
5:	9.9	↖
Serie		47
Total		47

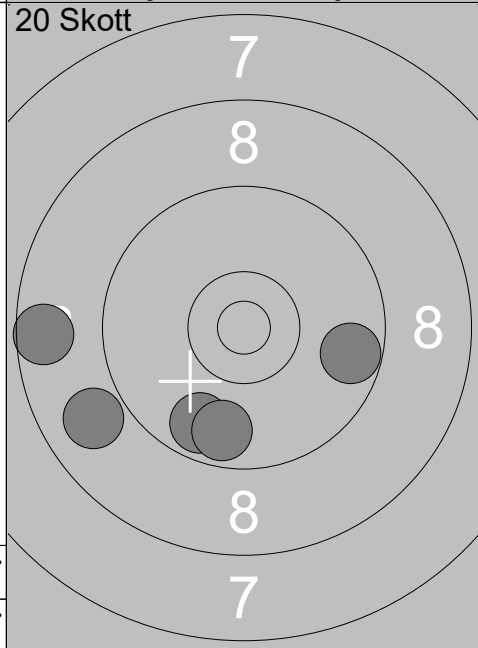

6:	9.7	↘
7:	8.6	←
8:	8.9	↙
9:	9.7	↓
10:	9.7	→
Serie		43
Total		90

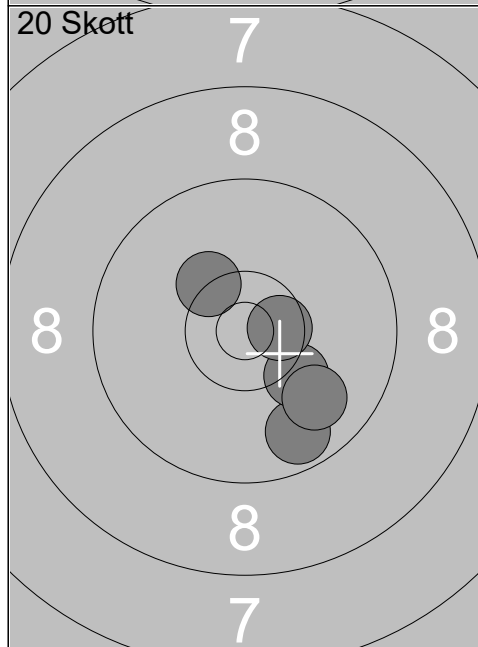

11:	10.3x	↖
12:	9.7	↓
13:	10.2	↘
14:	9.9	↓
15:	10.6x	→
Serie		48
Total		138

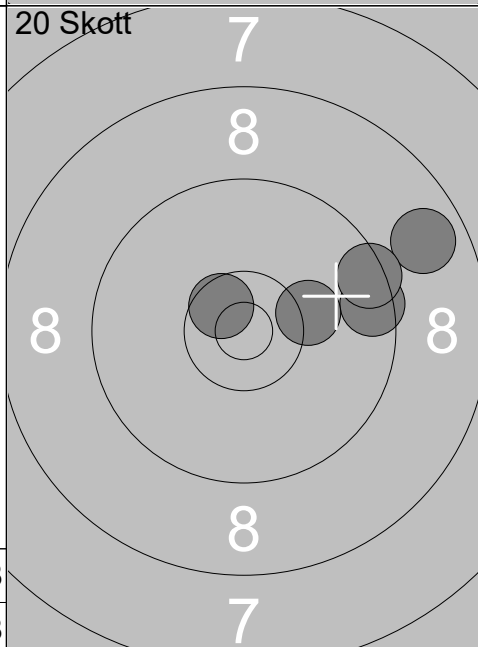

16:	9.5	→
17:	8.8	↗
18:	9.5	↗
19:	10.6x	↖
20:	10.2	→
Serie		46
Total		184

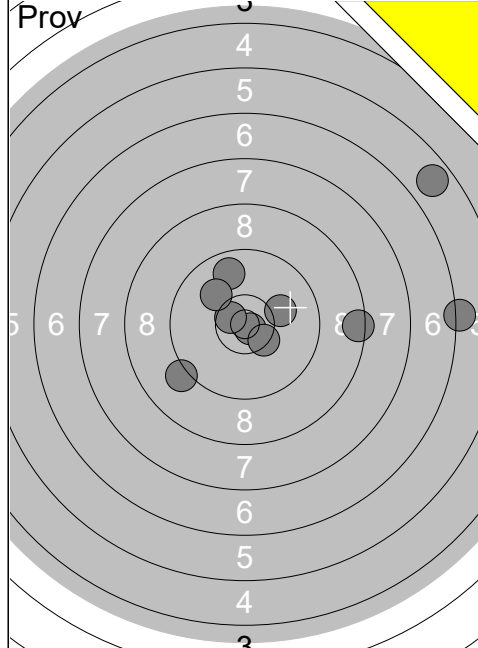

1: 5.7 ↗
2: 6.2 →
3: 8.4 →
4: 9.8 ↑
5: 10.8x ↘
6: 10.6x ↙
7: 10.0 ↗
8: 10.1 →
9: 9.1 ↙
10: 10.4x ↘
Serie 87
Total 0

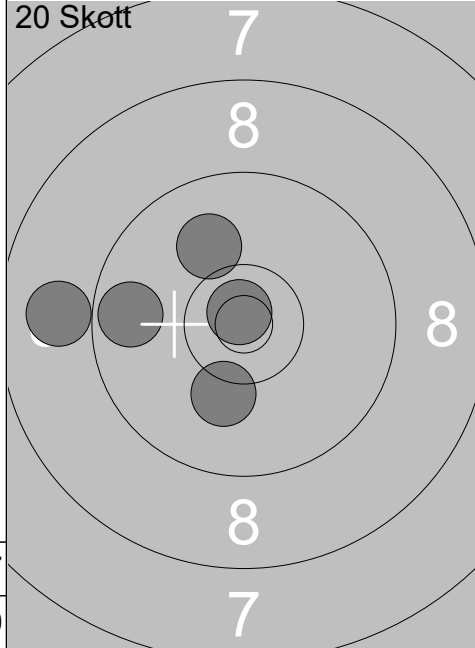

1: 9.7 ←
2: 8.9 ←
3: 10.8x ↗
4: 10.2 ↓
5: 10.0 ↗
Serie 47
Total 47

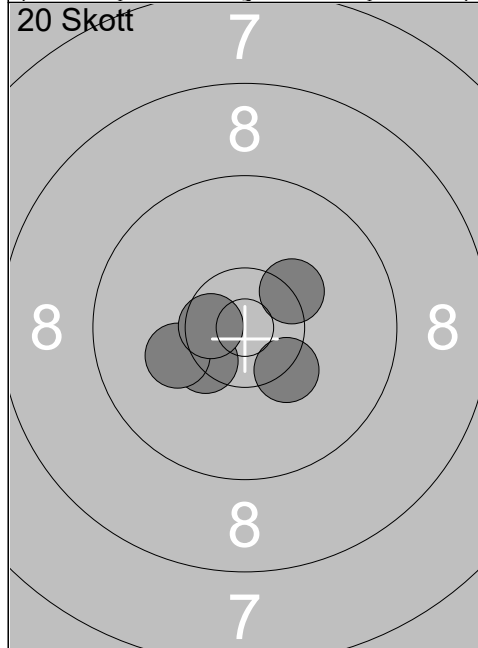

6: 10.4x ↙
7: 10.3x ↗
8: 10.3x ↘
9: 10.2 ←
10: 10.6x ↙
Serie 50
Total 97

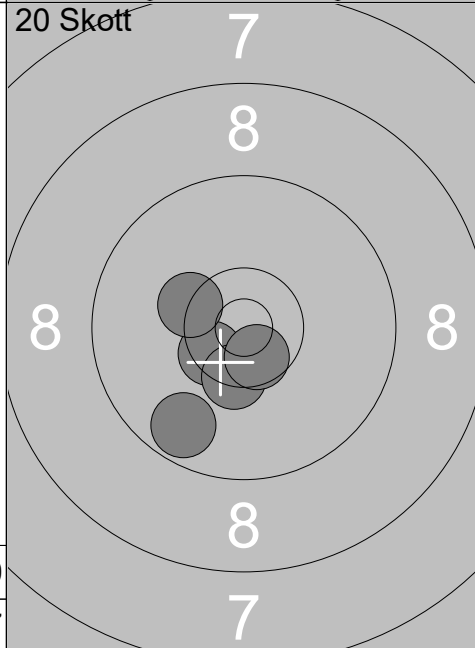

11: 9.7 ↓
12: 10.5x ↙
13: 10.4x ↓
14: 10.3x ↙
15: 10.6x ↘
Serie 49
Total 146

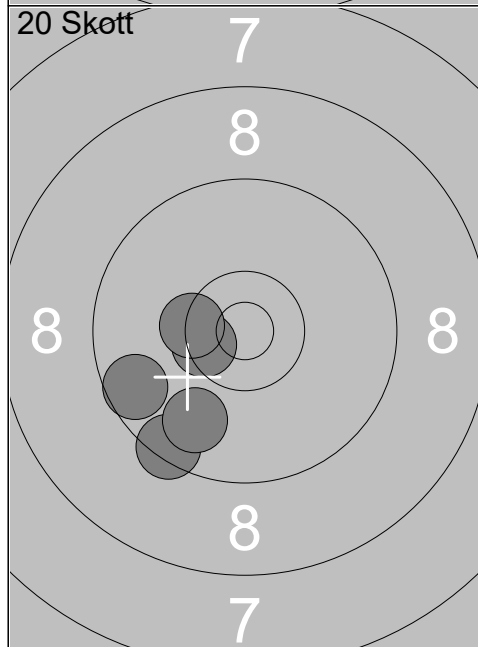

16: 9.4 ↓
17: 9.8 ↓
18: 10.5x ↙
19: 10.4x ↙
20: 9.6 ←
Serie 47
Total 193

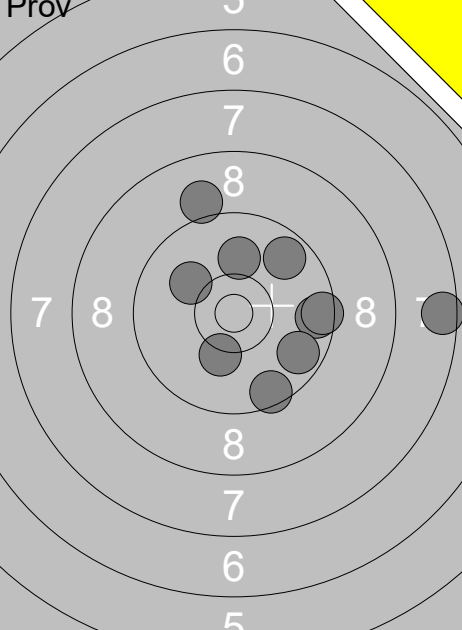
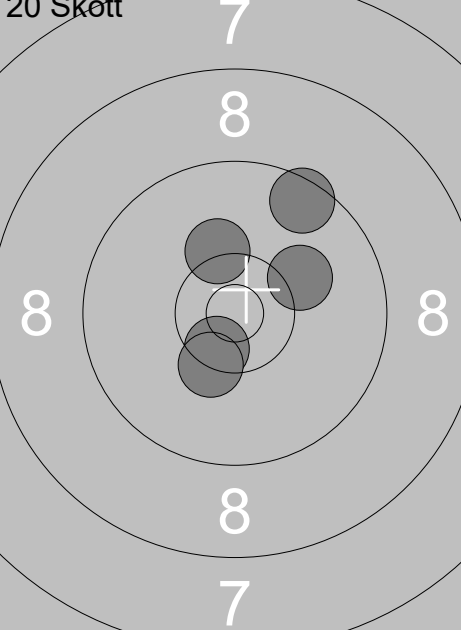
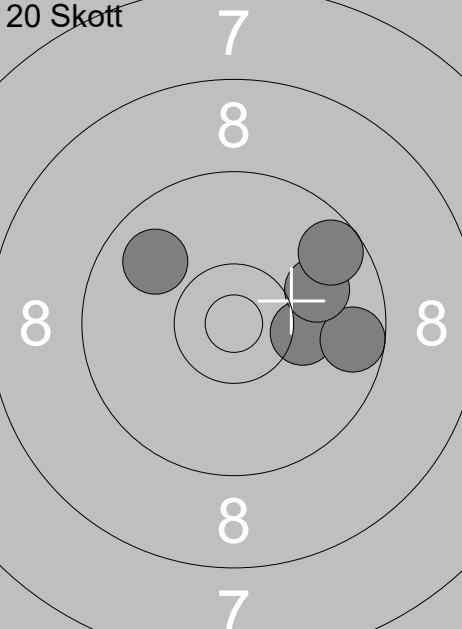
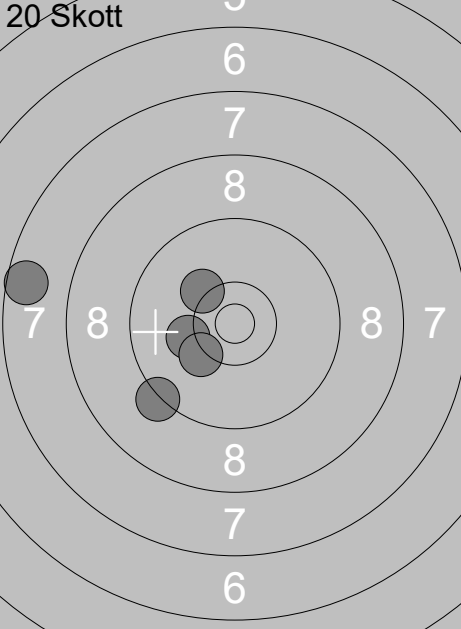
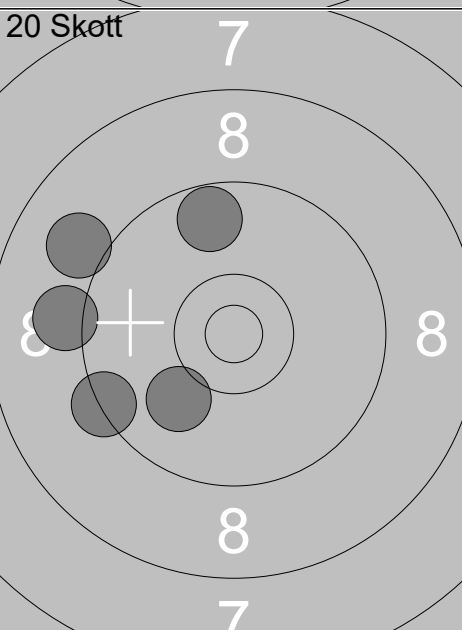
 <p>Prov</p>	<p>1: 10.0 ↑</p> <p>2: 9.6 →</p> <p>3: 10.2 ↓</p> <p>4: 9.5 ↓</p> <p>5: 7.5 →</p> <p>6: 9.5 →</p> <p>7: 9.7 ↘</p> <p>8: 9.7 ↗</p> <p>9: 10.1 ↖</p> <p>10: 9.0 ↑</p> <p>Serie 91</p> <p>Total 0</p>	 <p>20 Skott</p>	<p>1: 10.5x ↙</p> <p>2: 10.3 ↑</p> <p>3: 10.3x ↙</p> <p>4: 10.1 ↗</p> <p>5: 9.5 ↗</p> <p>Serie 49</p> <p>Total 49</p>
 <p>20 Skott</p>	<p>6: 9.9 ↖</p> <p>7: 10.2 →</p> <p>8: 9.6 →</p> <p>9: 10.0 →</p> <p>10: 9.6 ↗</p> <p>Serie 47</p> <p>Total 96</p>	 <p>20 Skott</p>	<p>11: 7.6 ←</p> <p>12: 9.3 ↙</p> <p>13: 10.2 ↖</p> <p>14: 10.2 ←</p> <p>15: 10.2 ↙</p> <p>Serie 46</p> <p>Total 142</p>
 <p>20 Skott</p>	<p>16: 9.3 ↙</p> <p>17: 9.0 ↖</p> <p>18: 9.1 ←</p> <p>19: 9.7 ↑</p> <p>20: 10.0 ↙</p> <p>Serie 46</p> <p>Total 188</p>		

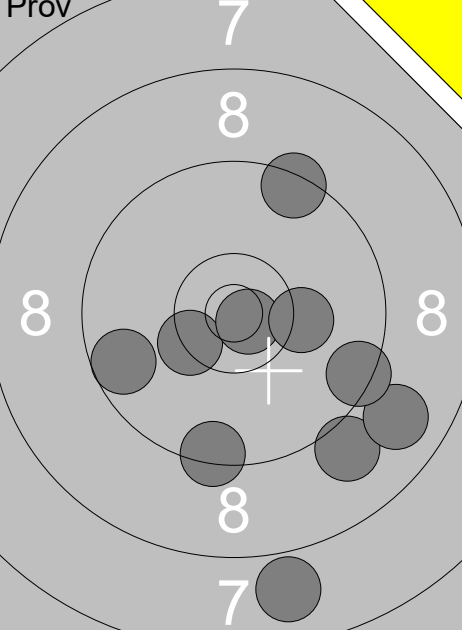
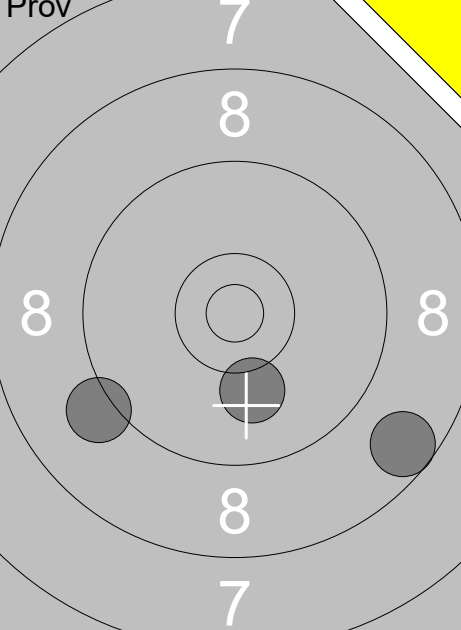
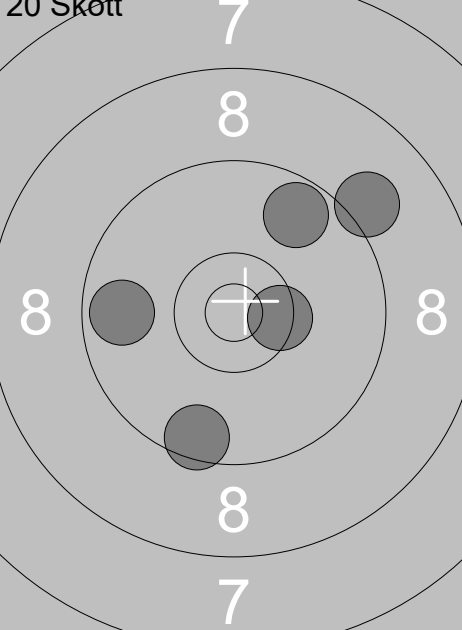
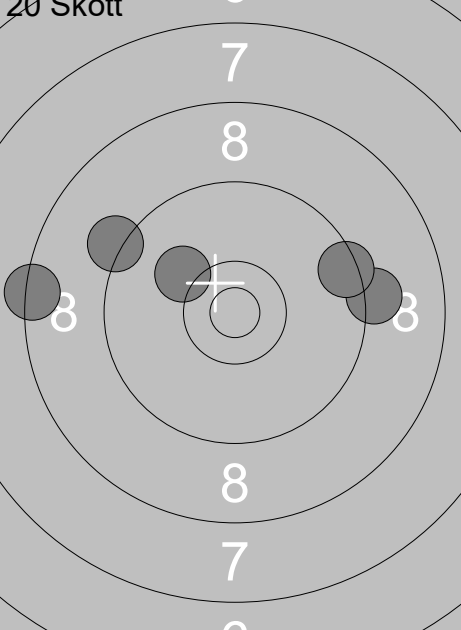
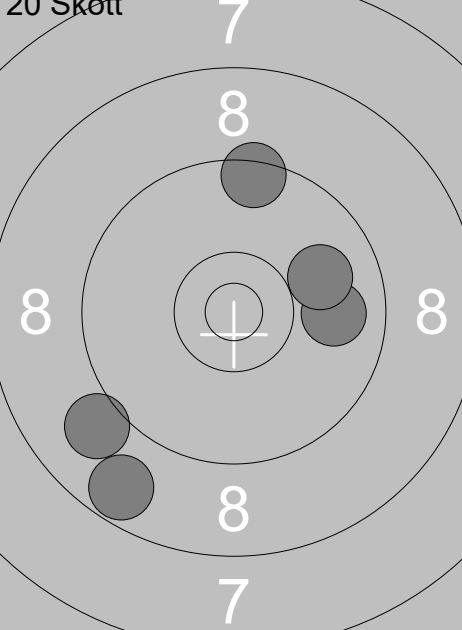
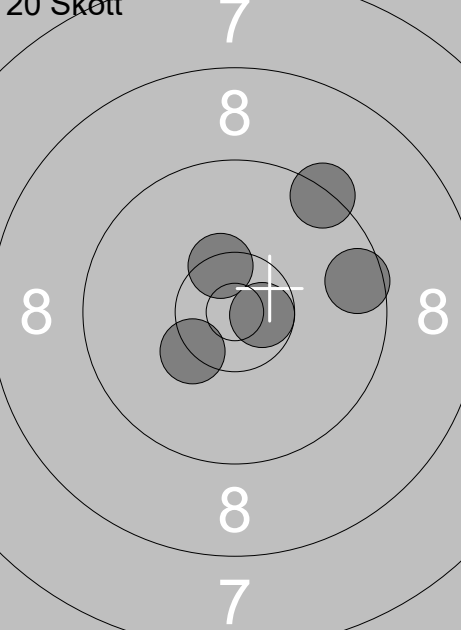
Prov 	1: 9.4 ↗ 2: 10.4x ↙ 3: 9.6 ← 4: 10.8x ↘ 5: 9.0 ↓ 6: 7.9 ↓ 7: 9.4 ↓ 8: 8.9 ↘ 9: 9.4 ↘ 10: 10.2 → <hr/> Serie 90 Total 0	Prov 	11: 8.6 ↘ 12: 9.1 ↙ 13: 10.1 ↓ <hr/> Serie 27 Total 0
20 Skott 	1: 9.7 ↗ 2: 9.7 ← 3: 9.5 ↓ 4: 10.4x → 5: 9.1 ↗ <hr/> Serie 46 Total 46	20 Skott 	6: 9.2 → 7: 9.4 → 8: 9.2 ← 9: 10.1 ↖ 10: 8.4 ← <hr/> Serie 45 Total 91
20 Skott 	11: 9.9 → 12: 9.9 → 13: 9.0 ↙ 14: 8.7 ↙ 15: 9.4 ↑ <hr/> Serie 44 Total 135	20 Skott 	16: 10.3x ↙ 17: 10.4x ↗ 18: 9.4 ↗ 19: 9.6 → 20: 10.7x → <hr/> Serie 48 Total 183