

1:	8.9	↙
2:	8.4	←
3:	10.3	↘
4:	10.1	↗
5:	10.0	↖
Serie		46
Total		0

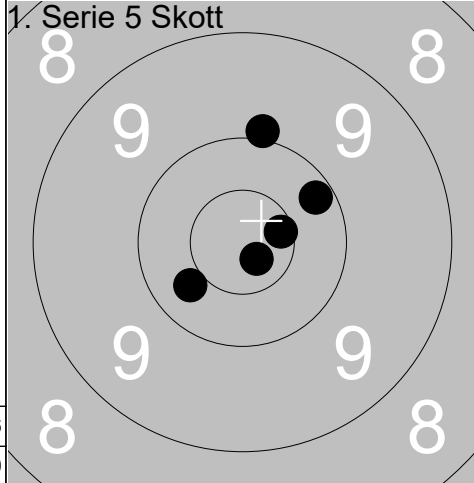

1:	10.2	↗
2:	9.9	↑
3:	10.4	↘
4:	10.8x	↘
5:	10.6x	→
Serie		49
Total		49

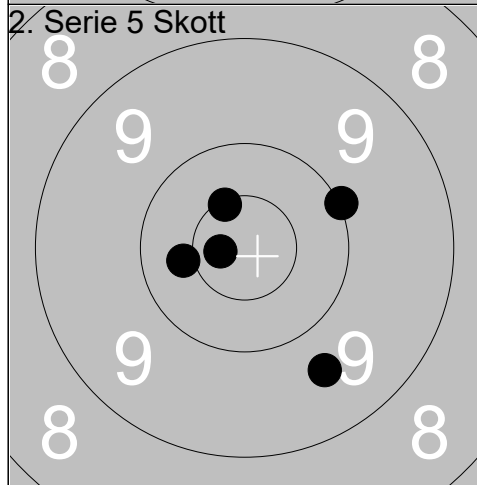

1:	10.0	↗
2:	10.4	←
3:	10.7x	←
4:	10.5x	↗
5:	9.6	↘
Serie		49
Total		98

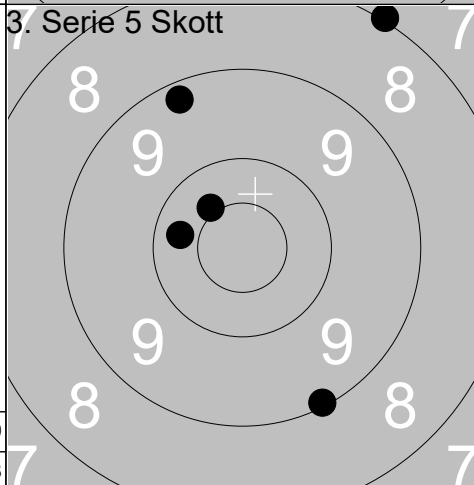

1:	9.1	↘
2:	10.4x	↗
3:	8.0	↗
4:	10.3	←
5:	9.2	↗
Serie		46
Total		144

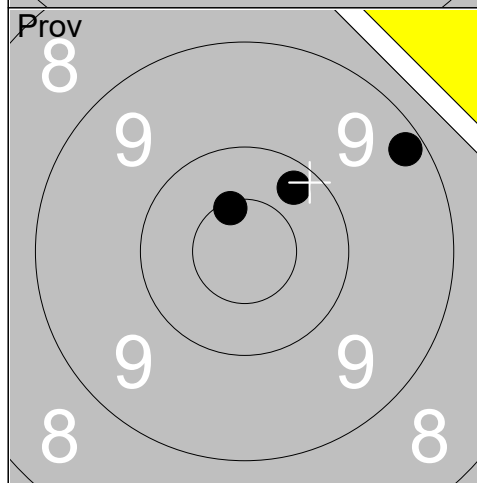

1:	10.5x	↗
2:	9.2	↗
3:	10.2	↗
Serie		29
Total		144

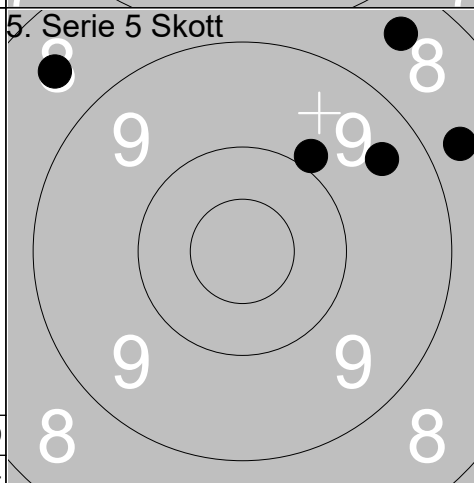

1:	9.9	↗
2:	8.5	↗
3:	8.7	↗
4:	9.4	↗
5:	8.5	↖
Serie		42
Total		186

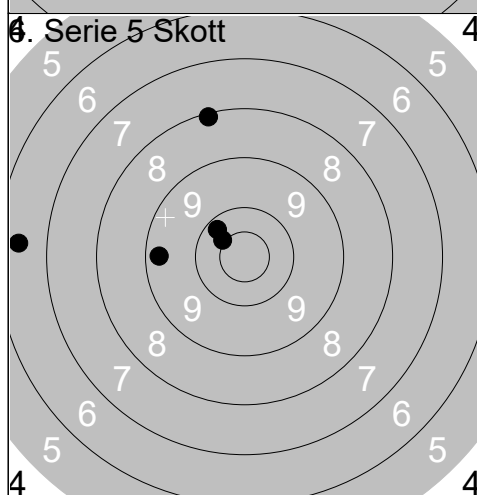

1:	10.4x	↗
2:	6.5	←
3:	9.3	←
4:	10.2	↗
5:	8.1	↗
Serie		43
Total		229

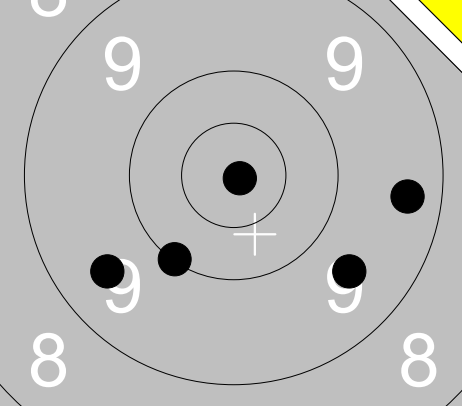
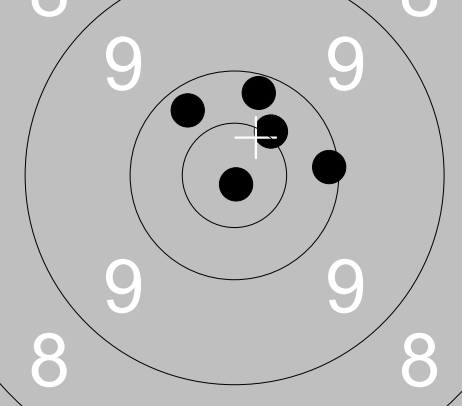
<b>Prov</b> 	1: 9.6 ↘ 2: 9.4 → 3: 10.9x ↘ 4: 10.0 ↓ 5: 9.5 ↙ <hr/> Serie 47 Total 0	<b>1. Serie 5 Skott</b> 	1: 10.9x ↓ 2: 10.2 ↗ 3: 10.1 → 4: 10.4x ↗ 5: 10.2 ↑ <hr/> Serie 50 Total 50
---	--	---	---

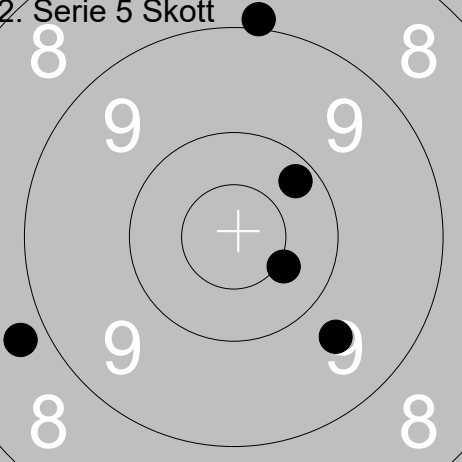
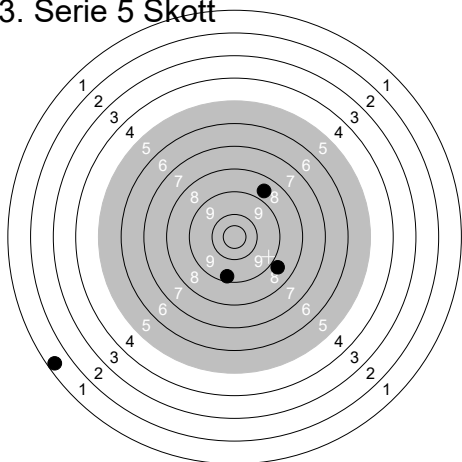
<b>2. Serie 5 Skott</b> 	1: 10.2 ↗ 2: 8.8 ← 3: 9.7 ↘ 4: 8.9 ↑ 5: 10.4x ↘ <hr/> Serie 45 Total 95	<b>3. Serie 5 Skott</b> 	1: 8.6 ↗ 2: 1.3 ← 3: 9.3 ↓ 4: 0.0 → 5: 8.7 ↘ <hr/> Serie 26 Total 121
--	---	--	---

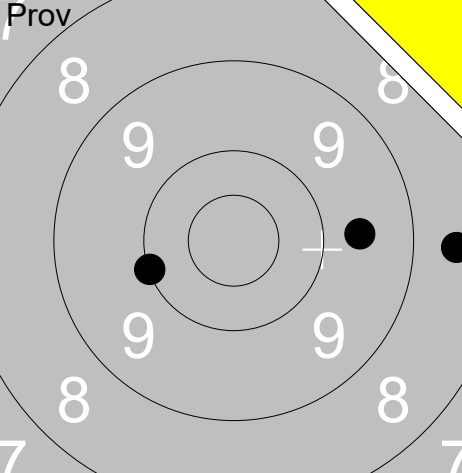
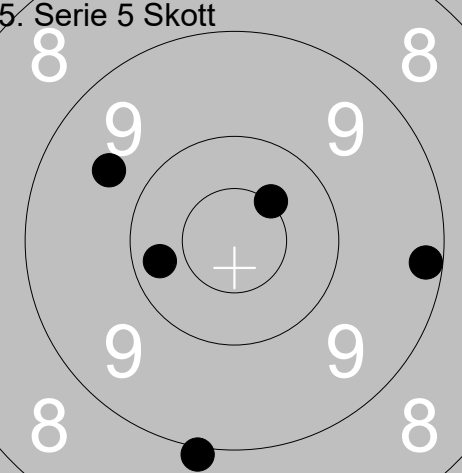
<b>Prov</b> 	1: 10.0 ← 2: 9.6 → 3: 8.6 → <hr/> Serie 27 Total 121	<b>5. Serie 5 Skott</b> 	1: 9.0 ↓ 2: 10.3 ← 3: 9.7 ↗ 4: 10.5x ↗ 5: 9.2 → <hr/> Serie 47 Total 168
---	--	---	--

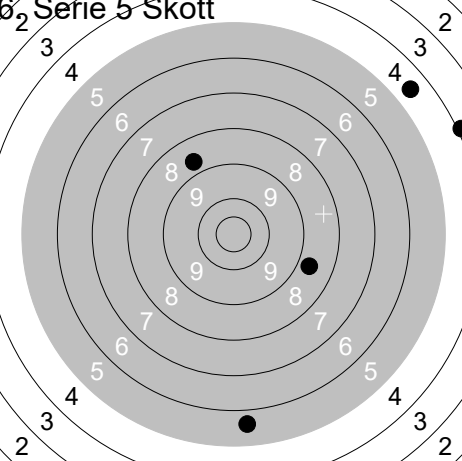
<b>6. Serie 5 Skott</b> 	1: 8.7 ↗ 2: 8.7 → 3: 5.6 ↓ 4: 3.9 → 5: 4.5 ↗ <hr/> Serie 28 Total 196		
---	---	--	--

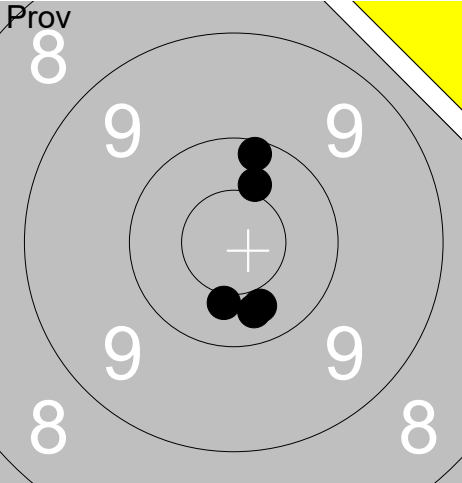
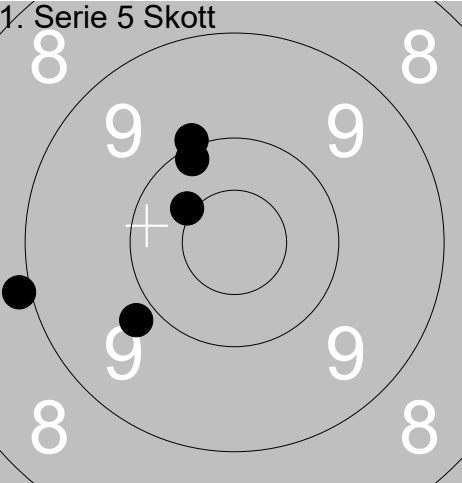
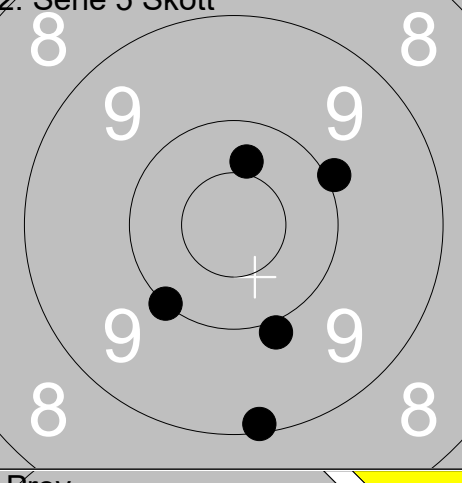
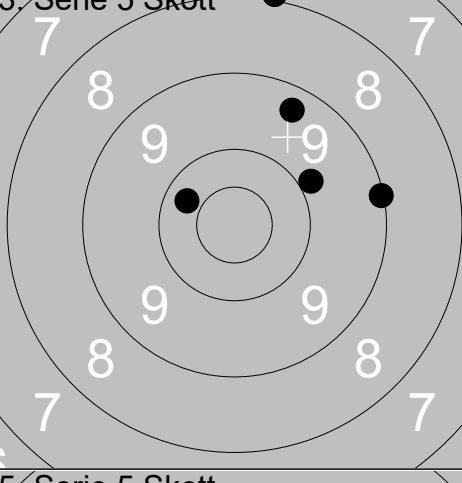
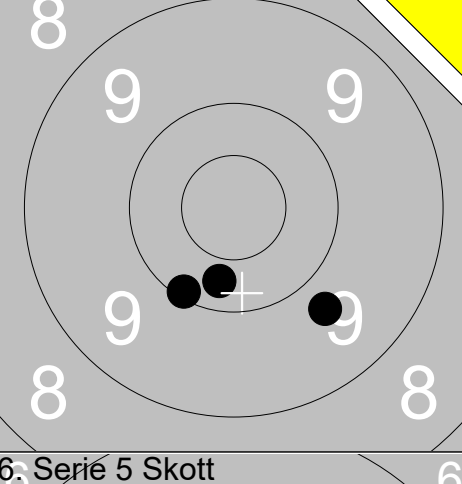
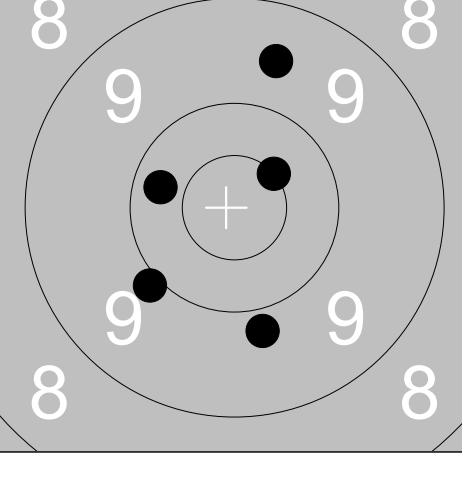
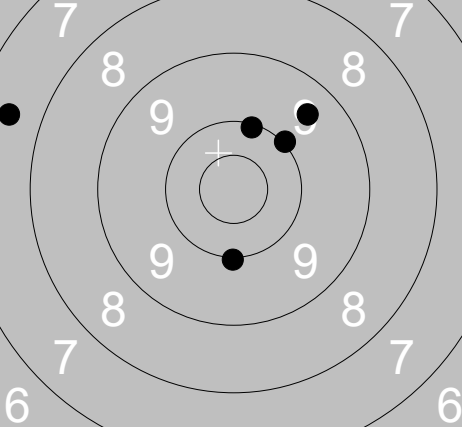
Skjutlag <b>1</b>	Tavla <b>3</b>	<b>Henry Lindström</b>			
Ramselefors		I 19 / A 9		Vet	
No					
07.07.2018		Björskottet 2018		Ramselefors SKF	
Prov		1: 10.3 ↓ 2: 10.4 ↑ 3: 10.1 ↑ 4: 10.4 ↓ 5: 10.3 ↓	1. Serie 5 Skott		1: 10.4x ↖ 2: 9.8 ↙ 3: 8.9 ← 4: 10.1 ↑ 5: 10.0 ↑
	Serie 50	Total 0		Serie 47	Total 47
2. Serie 5 Skott		1: 10.0 ↙ 2: 10.0 → 3: 10.4 ↑ 4: 9.9 ↓ 5: 9.1 ↓	3. Serie 5 Skott		1: 9.9 ↗ 2: 10.3 ↖ 3: 9.3 ↑ 4: 7.9 ↑ 5: 9.1 →
	Serie 48	Total 95		Serie 44	Total 139
Prov		1: 9.7 ↘ 2: 10.3 ↓ 3: 10.1 ↙	5. Serie 5 Skott		1: 9.6 ↑ 2: 10.3 ↖ 3: 10.5x ↗ 4: 9.9 ↙ 5: 9.8 ↓
	Serie 29	Total 139		Serie 47	Total 186
6. Serie 5 Skott		1: 9.5 ↗ 2: 10.1 ↑ 3: 10.0 ↗ 4: 7.5 ← 5: 10.0 ↓			
	Serie 46	Total 232			

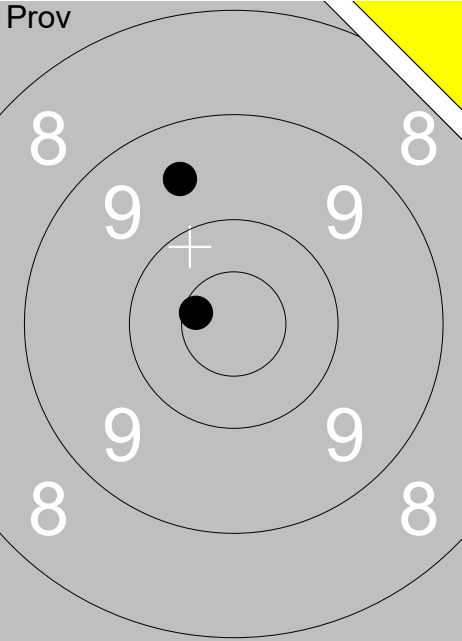
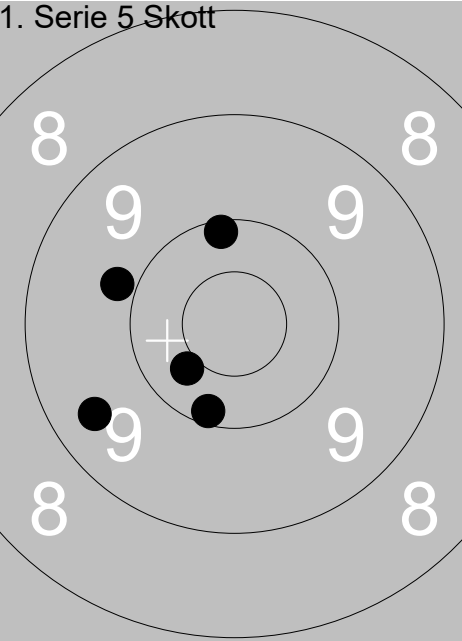
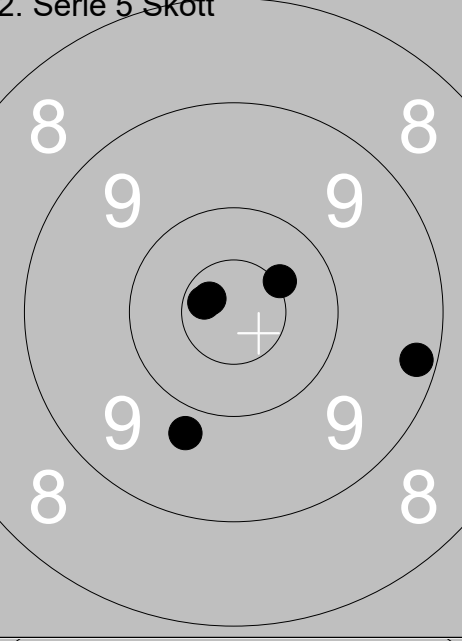
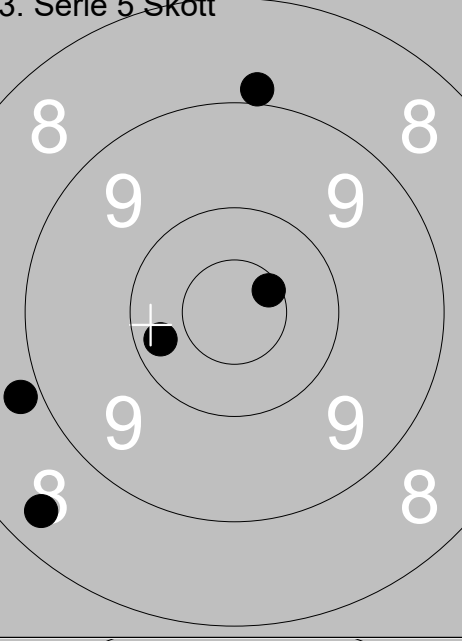
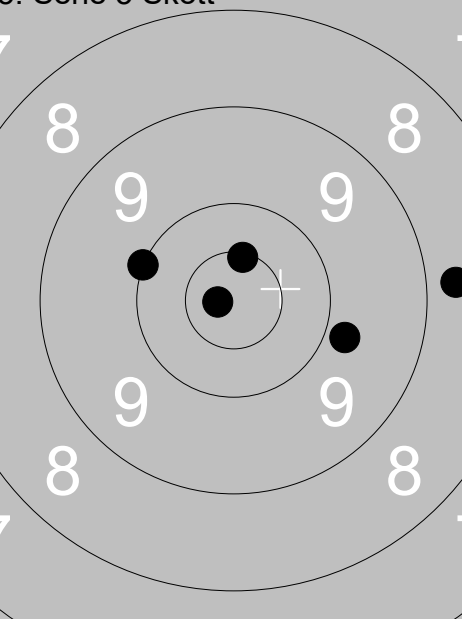
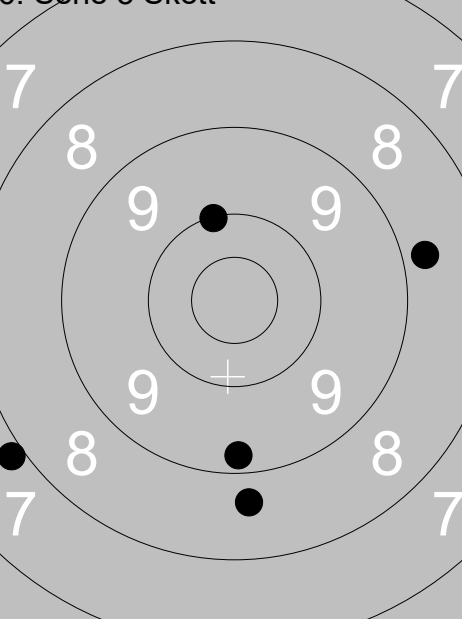
Skjutlag	Tavla	Dan-Ivan Karlsson			
1	4	Ramselefors	Ramselefors	Vet	Vb
07.07.2018	Björskottet 2018	Ramselefors SKF			
Prov 	1: 9.6 ↗ 2: 10.6x↙	1. Serie 5 Skott 	1: 10.1 ↗ 2: 9.4 ↙ 3: 10.1 ↓ 4: 9.8 ↙ 5: 10.4 ↙		
	Serie 19 Total 0		Serie 48 Total 48		
2. Serie 5 Skott 	1: 10.7x↙ 2: 10.5x↗ 3: 9.2 → 4: 9.8 ↓ 5: 10.7x↙	3. Serie 5 Skott 	1: 8.9 ↗ 2: 8.8 ↙ 3: 10.3 ↙ 4: 10.6x↗ 5: 8.4 ↙		
	Serie 48 Total 96		Serie 44 Total 140		
5. Serie 5 Skott 	1: 10.0 ↙ 2: 10.8x↙ 3: 8.7 → 4: 9.8 → 5: 10.5x↗	6. Serie 5 Skott 	1: 10.0 ↗ 2: 8.8 → 3: 9.2 ↓ 4: 7.9 ↙ 5: 8.7 ↓		
	Serie 47 Total 187		Serie 42 Total 229		

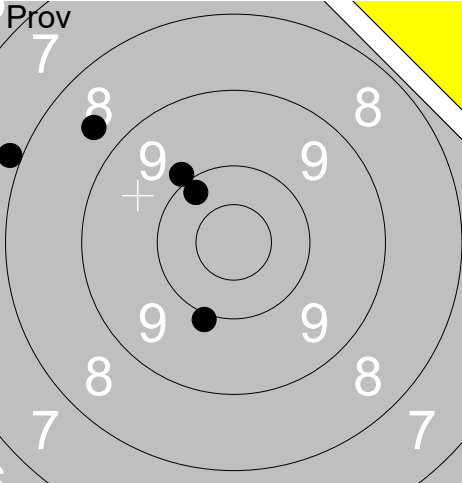
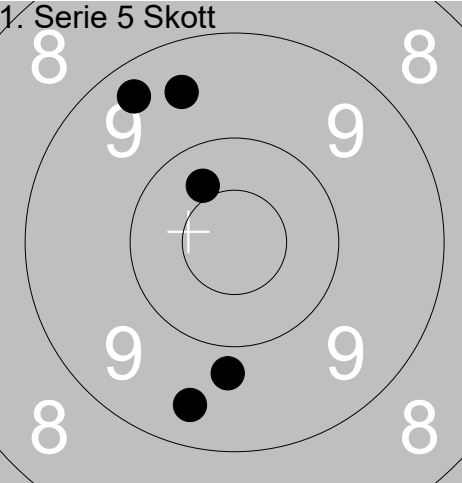
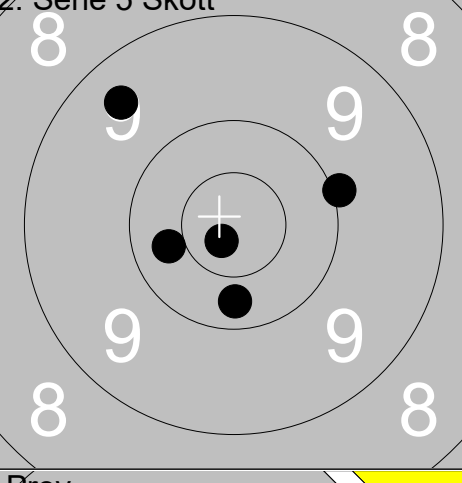
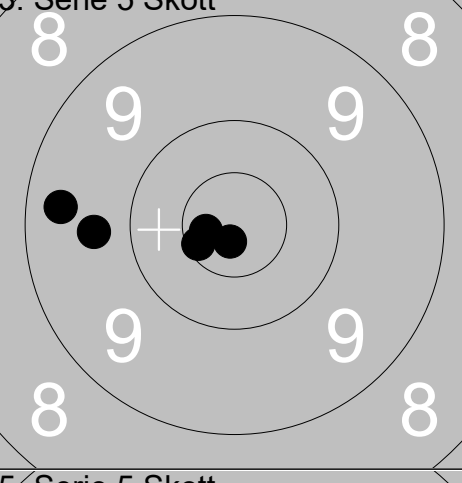
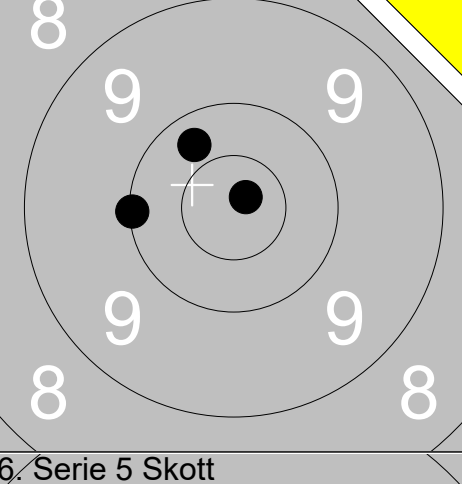
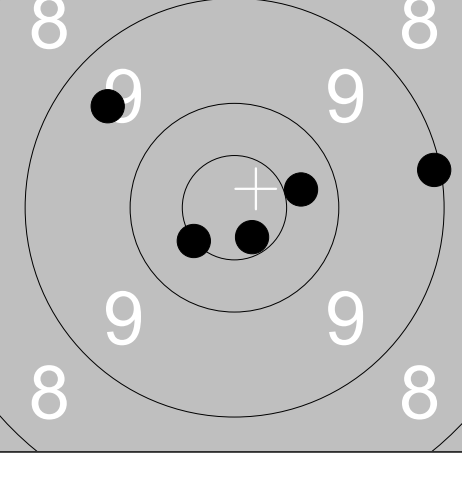
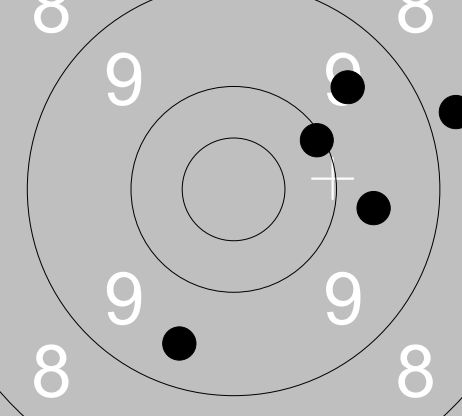
Skjutlag <b>1</b>	Tavla <b>5</b>	<b>Håkan Lidman</b>					
Ramselefors		Piteå		Vet	No		
07.07.2018		Björkskottet 2018		Ramselefors SKF			
<b>Prov</b> 	1: 9.9 ↗ 2: 7.9 ↗ 3: 8.6 ↗ 4: 10.2 ↗ 5: 9.9 ↓	<b>1. Serie 5 Skott</b> 	1: 9.8 ↓ 2: 9.4 ↓ 3: 10.4 ↗ 4: 9.5 ↗ 5: 9.3 ↗	Serie 43 Total 0		Serie 46 Total 46	
<b>2. Serie 5 Skott</b> 	1: 10.8x ↓ 2: 10.0 → 3: 9.4 ↗ 4: 10.3 ← 5: 10.3 ↓	<b>3. Serie 5 Skott</b> 	1: 10.8x ↓ 2: 9.7 ← 3: 9.4 ← 4: 10.6x ← 5: 10.7x ←	Serie 49 Total 95		Serie 48 Total 143	
<b>Prov</b> 	1: 10.1 ← 2: 10.3 ↗ 3: 10.8x ↗	<b>5. Serie 5 Skott</b> 	1: 9.1 → 2: 10.6x ↓ 3: 9.5 ↗ 4: 10.3 → 5: 10.5x ↓	Serie 30 Total 143		Serie 48 Total 191	
<b>6. Serie 5 Skott</b> 	1: 8.8 → 2: 9.4 ↓ 3: 9.5 ↗ 4: 10.1 ↗ 5: 9.7 →					Serie 45 Total 236	

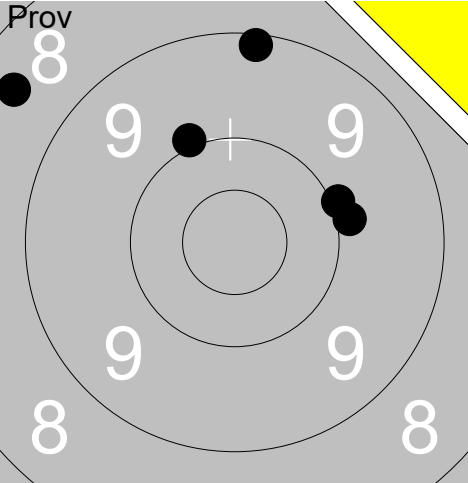
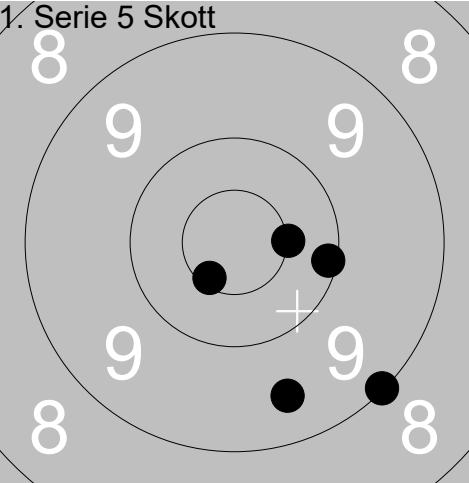
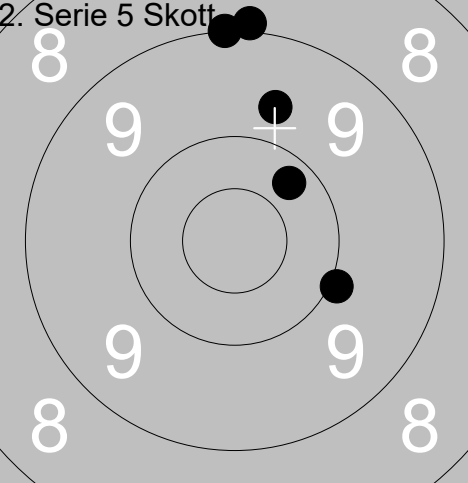
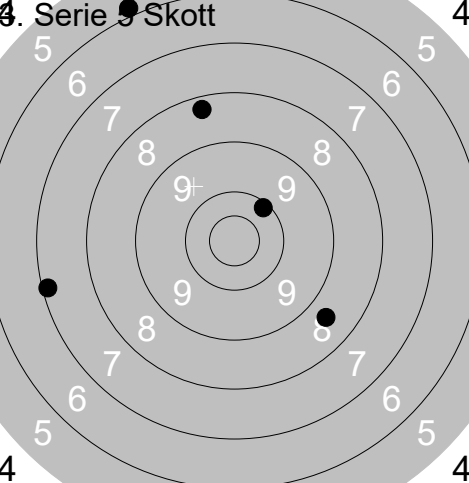
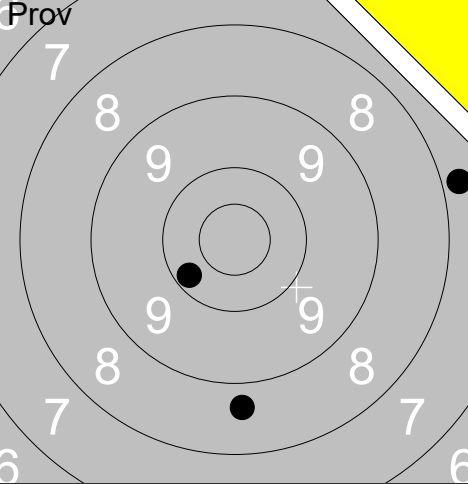
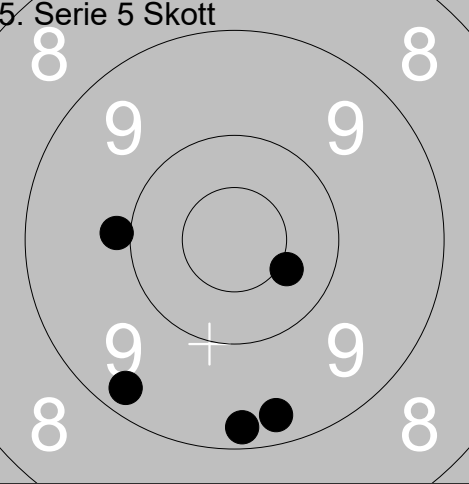
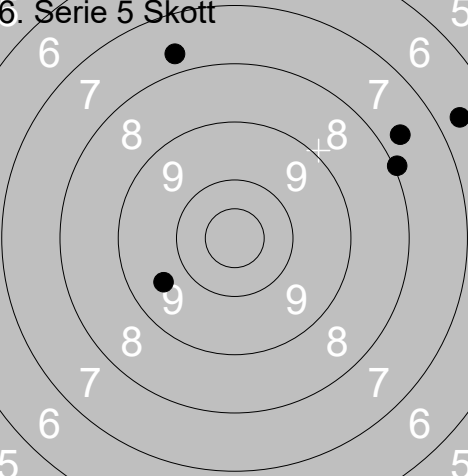
Skjutlag <b>1</b>	Tavla <b>6</b>	<b>Jan-Erik Karlsson</b>			
Ramselefors		Ramselefors		Vet	Vb
07.07.2018		Björskottet 2018		Ramselefors SKF	
Prov 	1: 9.1 ↑ 2: 9.9 → 3: 8.5 ↗ 4: 10.0 → 5: 10.0 ↗ Serie 46 Total 0	1. Serie 5 Skott 	1: 10.6x ↙ 2: 9.0 ↘ 3: 10.5x → 4: 9.5 ↘ 5: 10.1 → Serie 48 Total 48		
2. Serie 5 Skott 	1: 10.2 ↗ 2: 9.7 ↑ 3: 10.0 → 4: 8.9 ↑ 5: 9.0 ↑ Serie 46 Total 94	3. Serie 5 Skott 	1: 7.1 ← 2: 8.3 ↑ 3: 8.6 ↘ 4: 5.9 ↑ 5: 10.1 ↗ Serie 38 Total 132		
Prov 	1: 7.8 → 2: 10.2 ↙ 3: 8.7 ↓ Serie 25 Total 132	4. Serie 5 Skott 	1: 10.4x → 2: 9.3 ↙ 3: 9.9 ← 4: 9.3 ↘ 5: 9.2 ↓ Serie 46 Total 178		
6. Serie 5 Skott 	1: 6.6 → 2: 7.7 ↗ 3: 8.0 → 4: 9.6 ↙ 5: 7.7 ↑ Serie 37 Total 215				

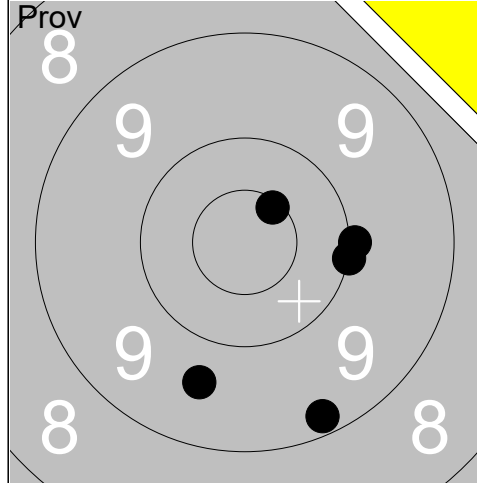

1:	9.2	↘
2:	9.6	↘
3:	10.0	→
4:	10.6x	↗
5:	10.0	→
Serie		48
Total		0

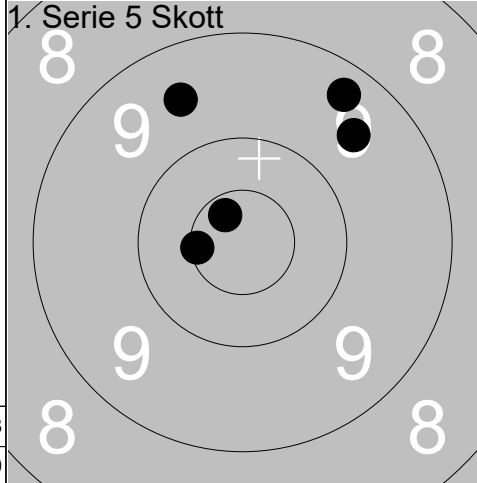

1:	10.7x	↗
2:	9.5	↗
3:	9.3	↗
4:	9.6	↗
5:	10.5x	←
Serie		47
Total		47

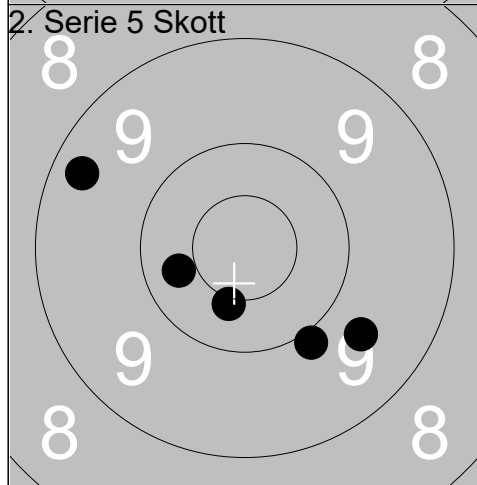

1:	9.9	↘
2:	9.6	↘
3:	10.3	←
4:	9.3	↗
5:	10.4x	↘
Serie		47
Total		94

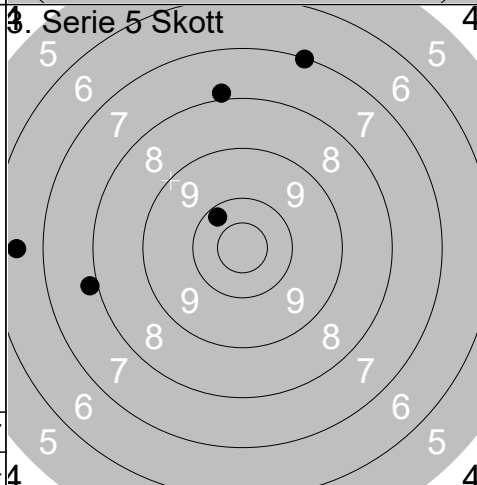

1:	7.0	↑
2:	10.2	↖
3:	7.9	↑
4:	6.5	←
5:	7.9	←
Serie		37
Total		131

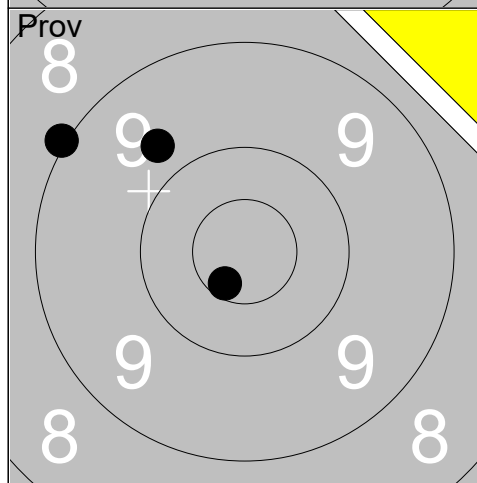

1:	10.6x	↘
2:	9.7	↗
3:	9.0	↗
Serie		28
Total		131

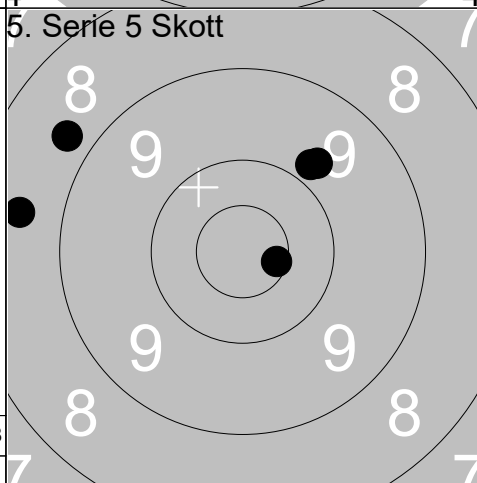

1:	8.7	↖
2:	9.8	↗
3:	9.8	↗
4:	10.6x	→
5:	8.6	←
Serie		44
Total		175

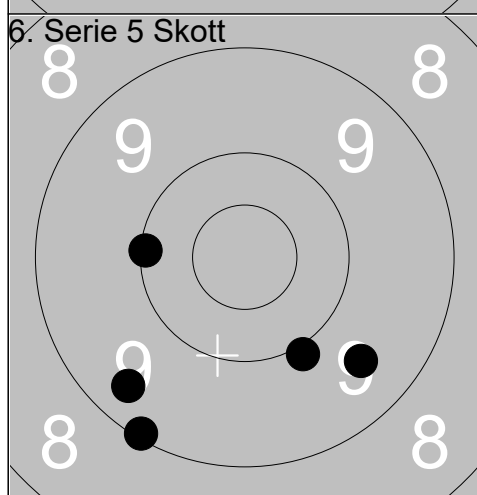

1:	9.9	↘
2:	9.5	↘
3:	9.4	↘
4:	10.1	←
5:	9.1	↘
Serie		46
Total		221

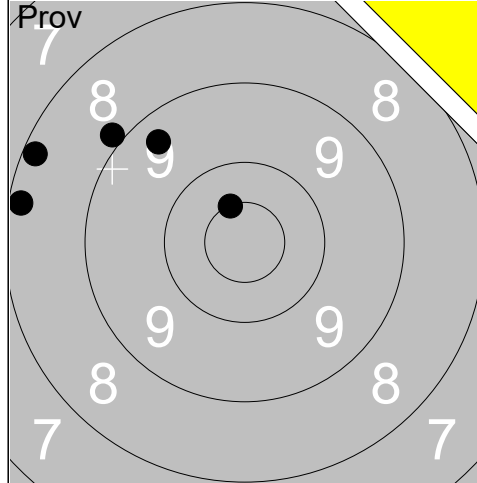

1:	8.2	↖
2:	8.2	↖
3:	10.5x	↗
4:	8.9	↗
5:	9.4	↗
Serie		43
Total		0

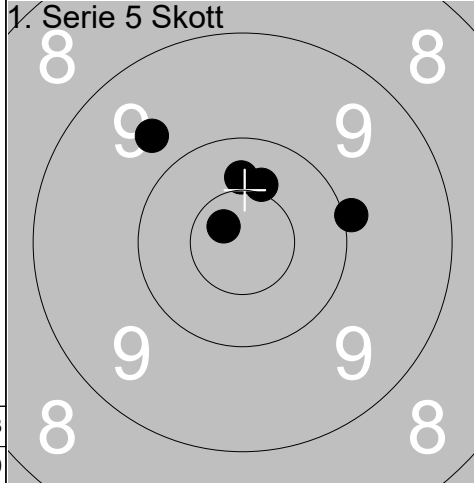

1:	10.0	→
2:	10.7x	↖
3:	9.7	↗
4:	10.4	↗
5:	10.4	↗
Serie		49
Total		49

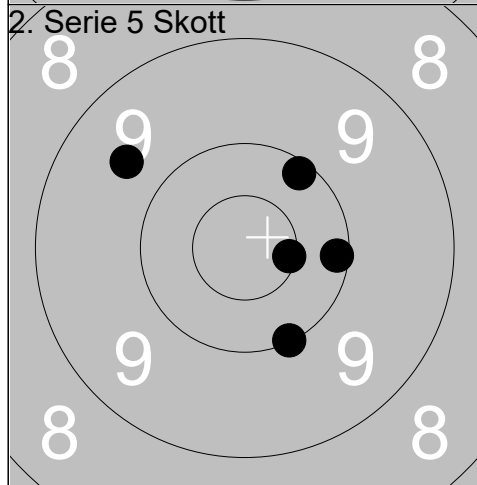

1:	10.1	↗
2:	10.6x	→
3:	10.1	→
4:	9.6	↗
5:	10.0	↘
Serie		49
Total		98

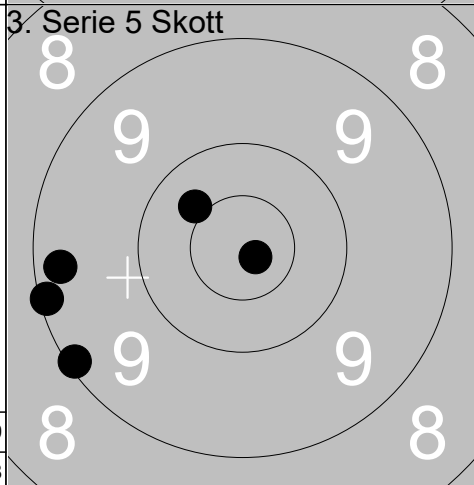

1:	9.3	←
2:	9.1	↖
3:	10.8x	↘
4:	10.4	↗
5:	9.1	←
Serie		47
Total		145

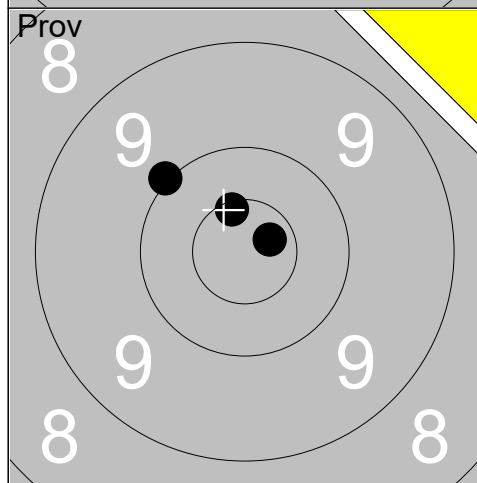

1:	10.6x	↗
2:	10.0	↗
3:	10.7x	↗
Serie		30
Total		145

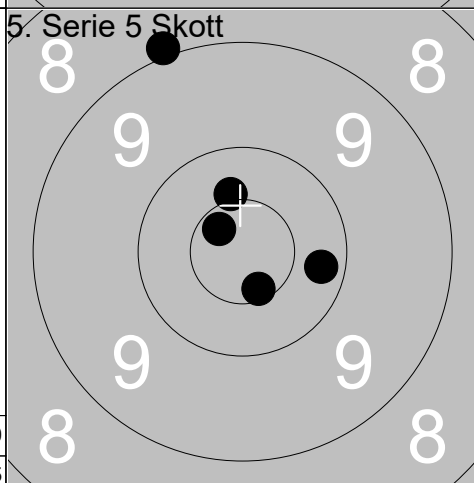

1:	10.4x	↗
2:	10.7x	↗
3:	10.6x	↘
4:	10.2	→
5:	8.9	↗
Serie		48
Total		193

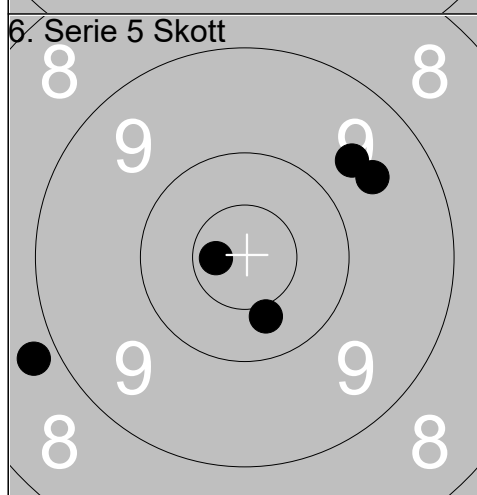

1:	10.7x	←
2:	10.4	↘
3:	9.7	↗
4:	8.8	↖
5:	9.6	↗
Serie		46
Total		239



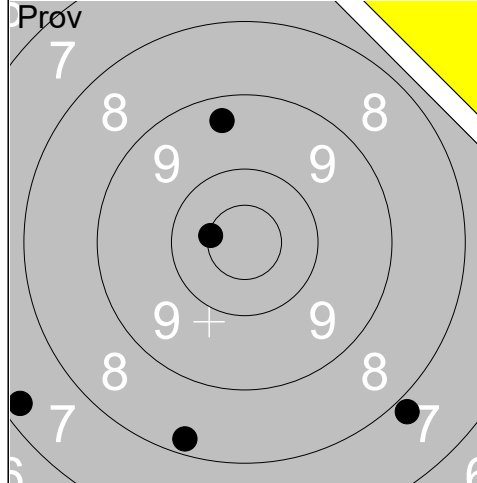

1:	7.3	↙
2:	8.2	↓
3:	10.5x	←
4:	9.3	↑
5:	7.8	↘
Serie		41
Total		0

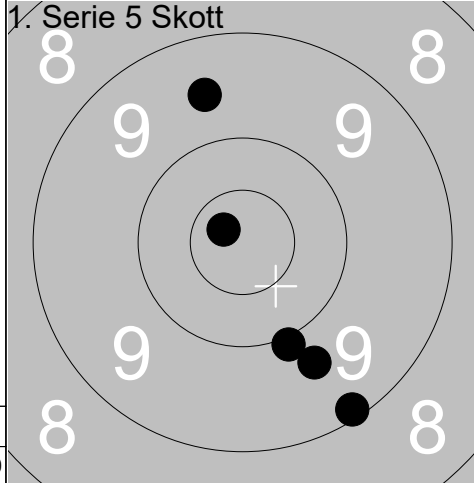

1:	9.7	↘
2:	10.0	↘
3:	9.1	↘
4:	9.6	↑
5:	10.7x	↗
Serie		47
Total		47

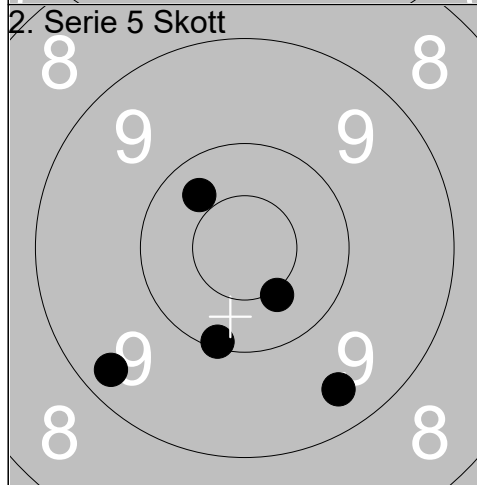

1:	10.4x	↘
2:	9.4	↘
3:	10.1	↘
4:	9.3	↙
5:	10.3	↗
Serie		48
Total		95

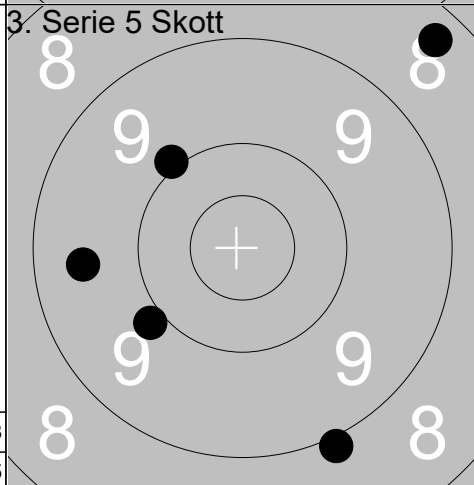

1:	8.3	↗
2:	9.9	↙
3:	8.9	↘
4:	9.5	←
5:	10.0	↗
Serie		44
Total		139

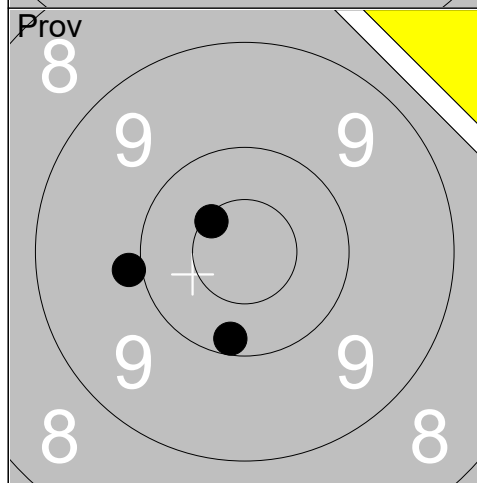

1:	10.6x	↗
2:	9.9	←
3:	10.2	↓
Serie		29
Total		139

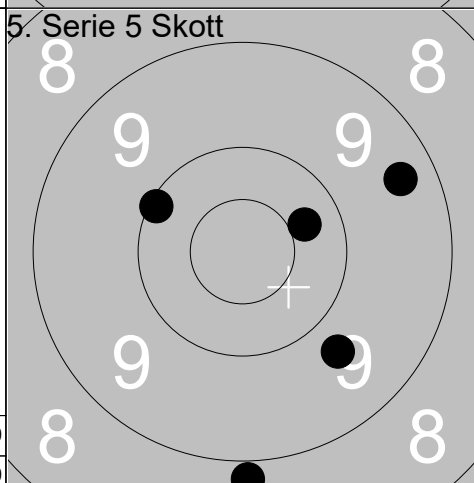

1:	9.7	↘
2:	9.4	↗
3:	10.4	↗
4:	8.9	↓
5:	10.1	↖
Serie		46
Total		185

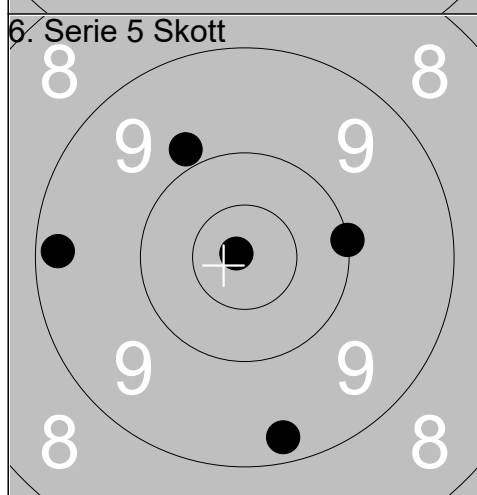

1:	9.2	←
2:	9.3	↓
3:	10.9x	↗
4:	9.9	↗
5:	10.0	→
Serie		47
Total		232

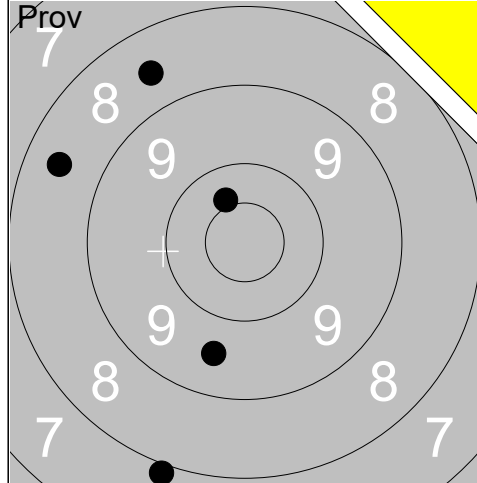

1:	8.5	↖
2:	8.6	↗
3:	10.4	↗
4:	9.6	↘
5:	7.9	↘

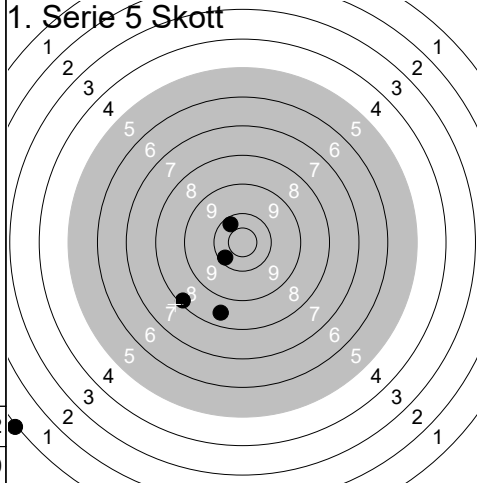

1:	1.0	↖
2:	10.2	↗
3:	10.2	↘
4:	8.5	↘
5:	8.2	↘

Serie	42
Total	0

Serie	37
Total	37

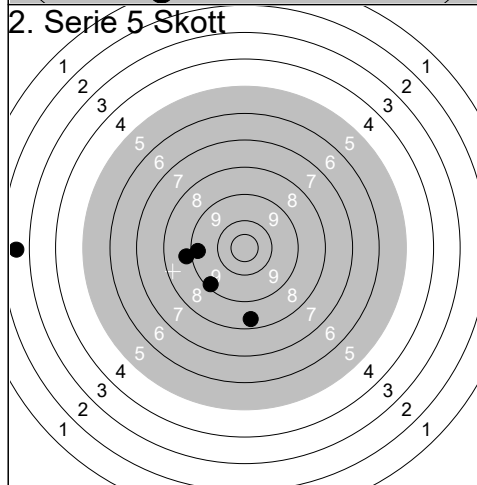

1:	8.4	↓
2:	9.3	←
3:	8.8	←
4:	2.6	←
5:	9.2	↙

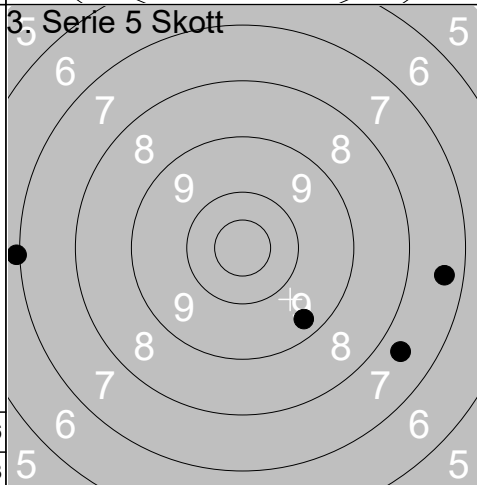

1:	7.4	→
2:	7.6	↘
3:	7.0	←
4:	9.3	↘
5:	0.0	

Serie	36
Total	73

Serie	30
Total	103

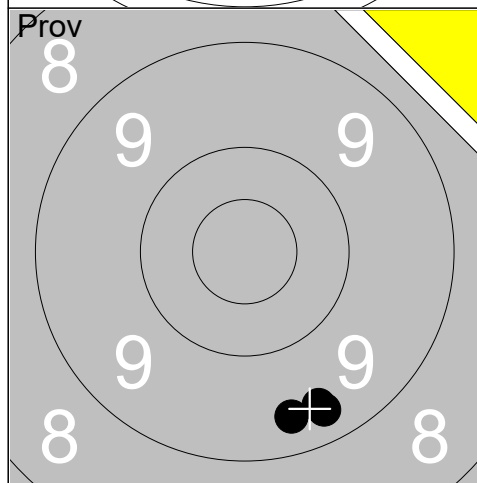

1:	9.4	↘
2:	9.4	↘
3:	9.3	↘

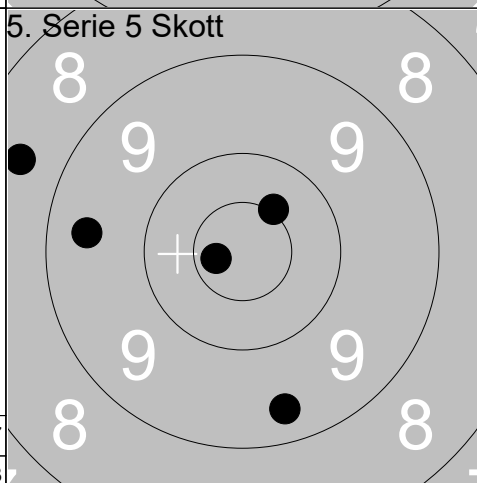

1:	10.7x	←
2:	9.4	←
3:	10.5x	↗
4:	8.6	←
5:	9.4	↘

Serie	27
Total	103

Serie	46
Total	149

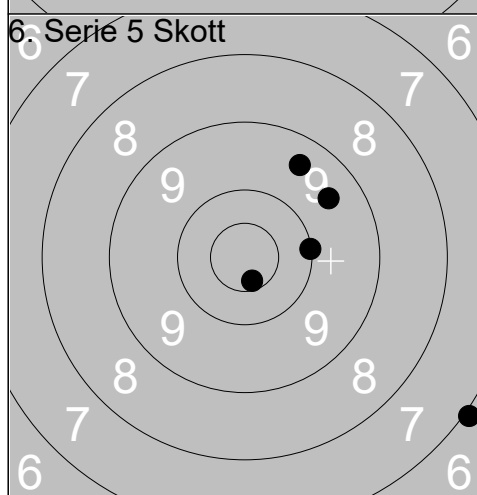

1:	9.4	↗
2:	10.6x	↘
3:	9.5	↗
4:	10.0	→
5:	7.0	↘

Serie	45
Total	194

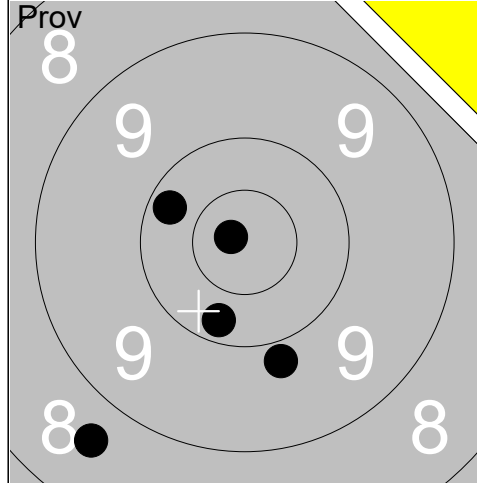

1:	9.8	↘
2:	8.6	↘
3:	10.8x	↗
4:	10.2	↗
5:	10.2	↘

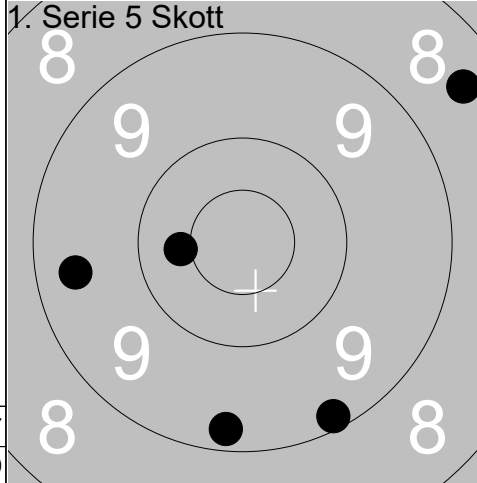

1:	8.4	↗
2:	9.4	↖
3:	9.2	↘
4:	9.2	↘
5:	10.4	↖

Serie	47
Total	0

Serie	45
Total	45

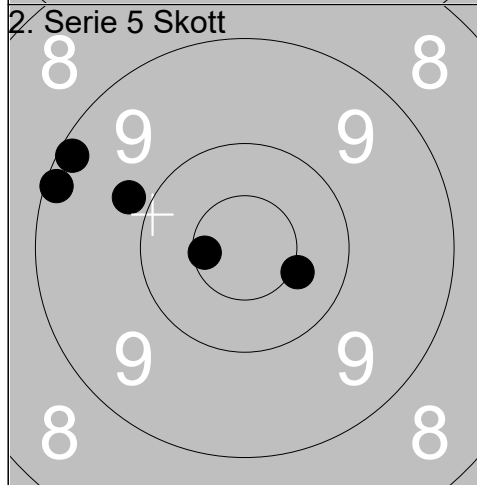

1:	9.8	↖
2:	10.4x	↗
3:	9.1	↖
4:	9.2	↗
5:	10.6x	↖

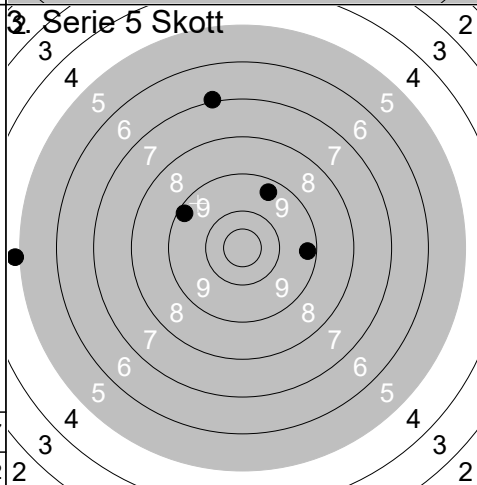

1:	7.0	↗
2:	9.4	↗
3:	9.2	↖
4:	4.9	↖
5:	9.3	↗

Serie	47
Total	92

Serie	38
Total	130

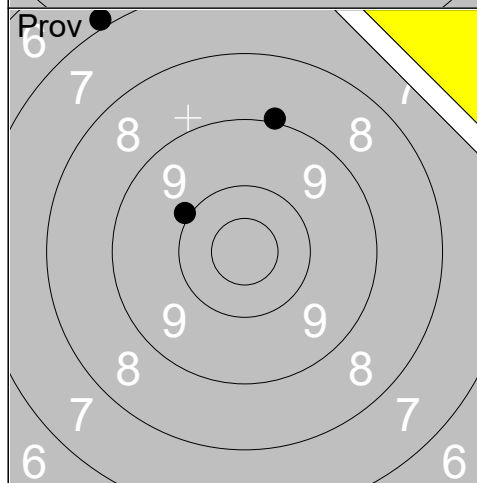

1:	9.0	↗
2:	6.9	↗
3:	9.9	↗

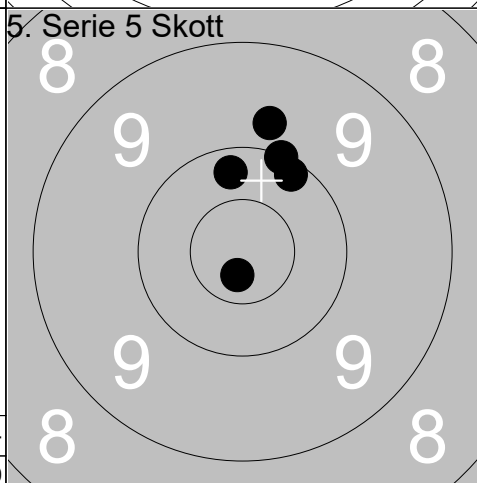

1:	9.8	↗
2:	10.1	↗
3:	10.0	↗
4:	10.7x	↘
5:	10.2	↗

Serie	24
Total	130

Serie	49
Total	179

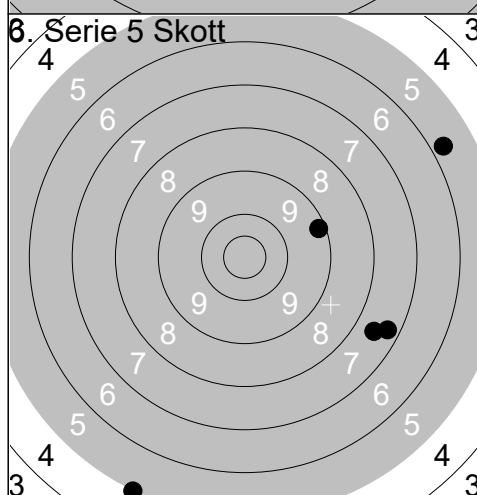

1:	9.2	↗
2:	7.3	↘
3:	7.6	↘
4:	5.0	↘
5:	5.7	↗

Serie	33
Total	212

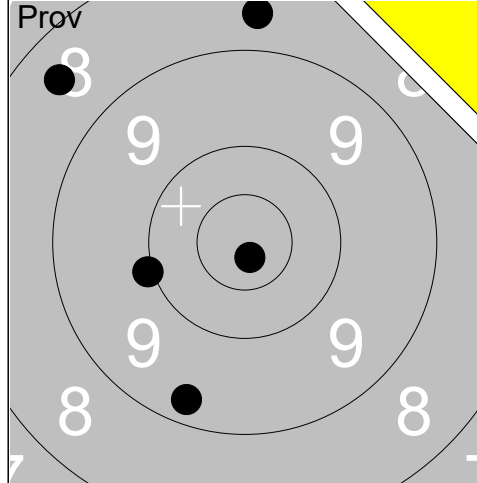

1:	8.6	↑
2:	9.3	↓
3:	10.0	←
4:	10.8x	↓
5:	8.5	↑
Serie		45
Total		0

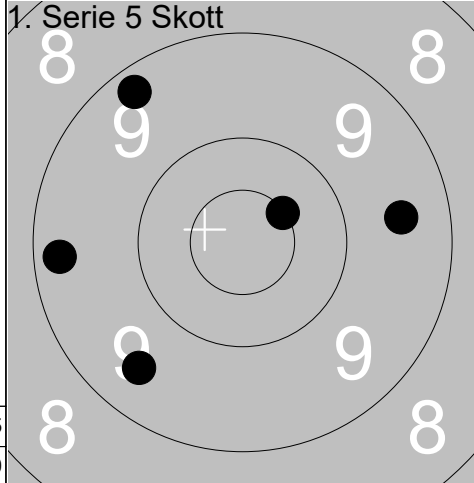

1:	9.3	←
2:	9.3	↖
3:	9.5	→
4:	9.5	↓
5:	10.5x	↗
Serie		46
Total		46

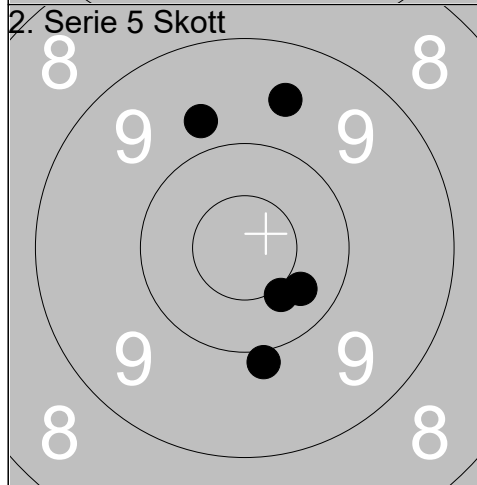

1:	10.3	↘
2:	9.9	↓
3:	10.4x	↘
4:	9.6	↑
5:	9.7	↑
Serie		47
Total		93

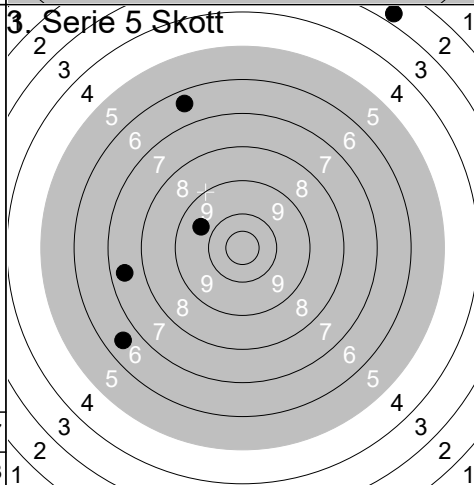

1:	7.5	←
2:	9.7	↖
3:	6.6	↙
4:	6.4	↑
5:	2.8	↗
Serie		30
Total		123

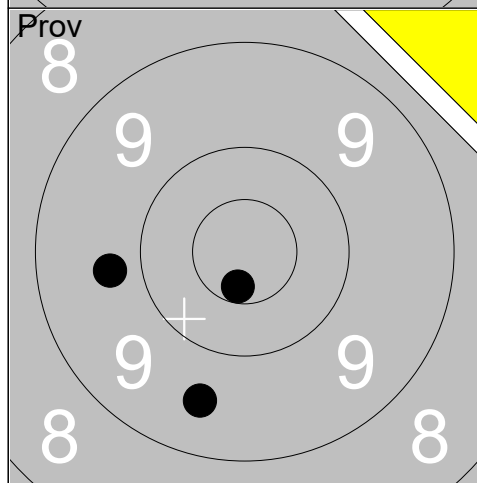

1:	10.6x	↓
2:	9.5	↓
3:	9.7	←
Serie		28
Total		123

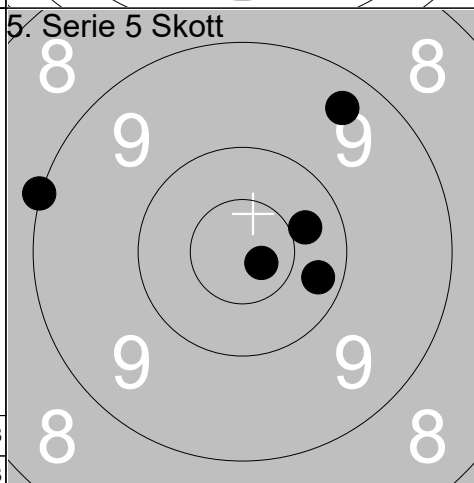

1:	9.4	↗
2:	10.4	→
3:	10.8x	↘
4:	10.2	→
5:	9.0	←
Serie		48
Total		171

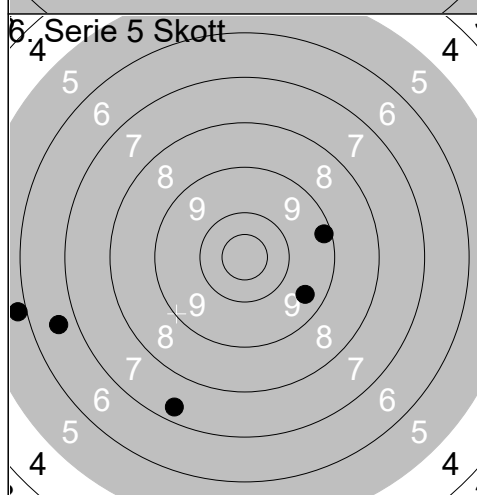

1:	6.6	←
2:	9.2	→
3:	9.5	↘
4:	7.4	↓
5:	5.8	←
Serie		36
Total		207

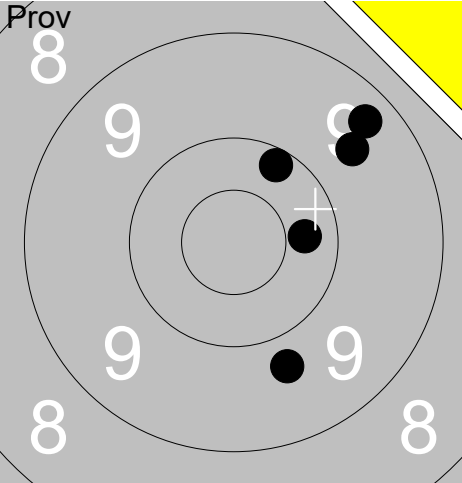
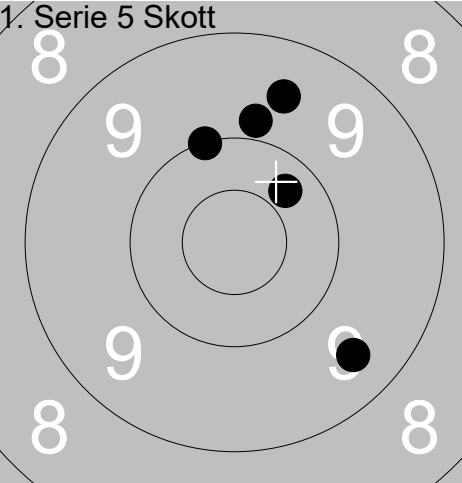
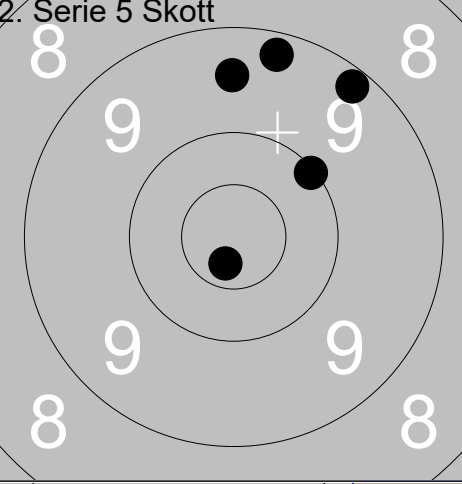
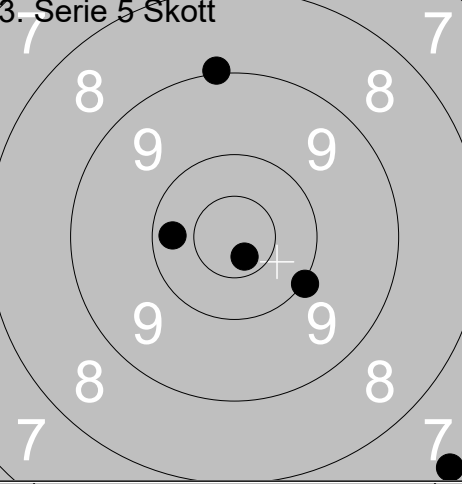
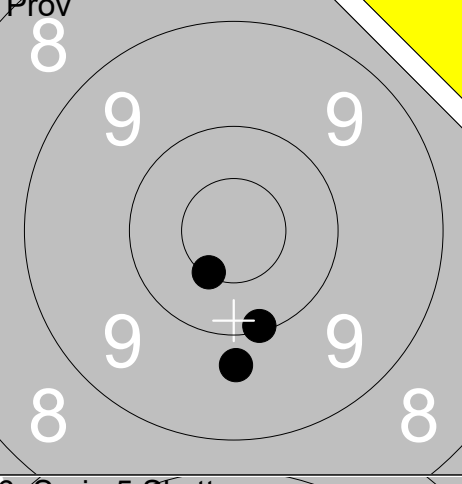
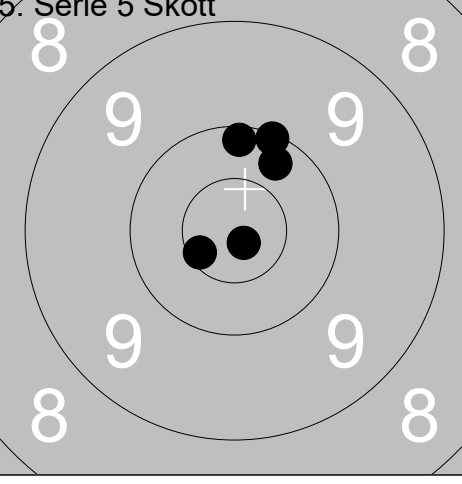
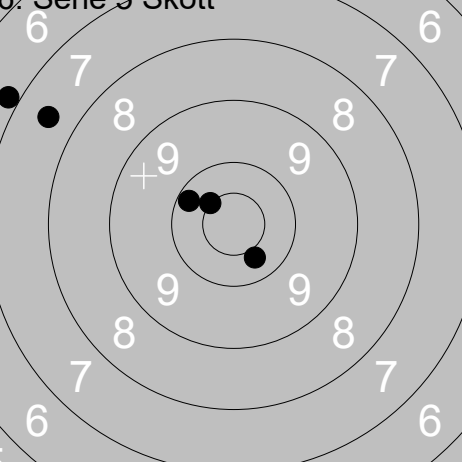
Skjutlag <b>1</b>	Tavla <b>17</b>	<b>Samuel Jos</b>	
Ramselefors		Bromma-Solna	Jun St
07.07.2018		Björskottet 2018	Ramselefors SKF
<b>Prov</b> 	1: 9.6 ↗ 2: 10.2 ↑ 3: 10.3 → 4: 9.3 ↗ 5: 9.7 ↓	<b>1. Serie 5 Skott</b> 	1: 9.8 ↑ 2: 10.0 ↑ 3: 9.6 ↑ 4: 10.3 ↗ 5: 9.5 ↓
	Serie 47 Total 0		Serie 47 Total 47
<b>2. Serie 5 Skott</b> 	1: 9.2 ↑ 2: 9.5 ↑ 3: 10.7x ↓ 4: 10.1 ↗ 5: 9.2 ↗	<b>3. Serie 5 Skott</b> 	1: 10.0 ↘ 2: 10.3 ← 3: 10.7x ↓ 4: 9.0 ↑ 5: 7.2 ↘
	Serie 47 Total 94		Serie 46 Total 140
<b>Prov</b> 	1: 10.1 ↓ 2: 10.5x ↓ 3: 9.7 ↓	<b>5. Serie 5 Skott</b> 	1: 10.3 ↗ 2: 10.1 ↑ 3: 10.1 ↑ 4: 10.8x ↘ 5: 10.6x ←
	Serie 29 Total 140		Serie 50 Total 190
<b>6. Serie 5 Skott</b> 	1: 6.8 ↗ 2: 10.5x ↗ 3: 10.2 ↗ 4: 10.4 ↓ 5: 7.6 ↗		
	Serie 43 Total 233		

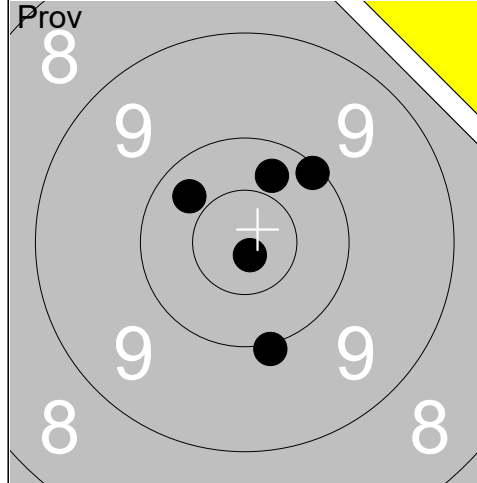

1:	10.1	↗
2:	10.3	↖
3:	10.0	↘
4:	10.8x	↘
5:	10.3	↗
Serie		50
Total		0

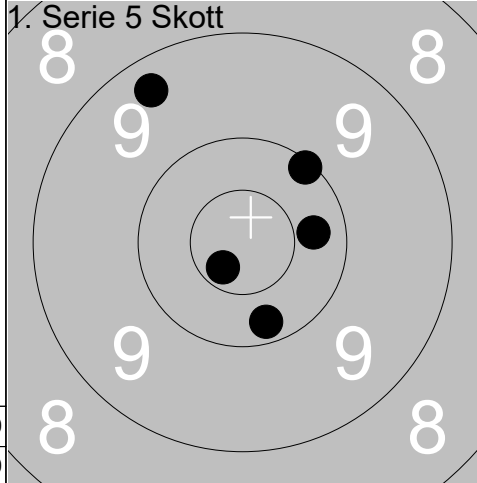

1:	10.2	↘
2:	10.1	↗
3:	10.3	→
4:	9.3	↖
5:	10.7x	↙
Serie		49
Total		49

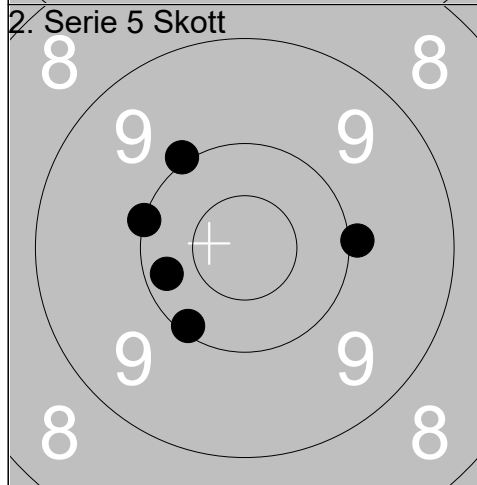

1:	10.0	→
2:	10.2	←
3:	10.1	↘
4:	10.0	↗
5:	10.0	↗
Serie		50
Total		99

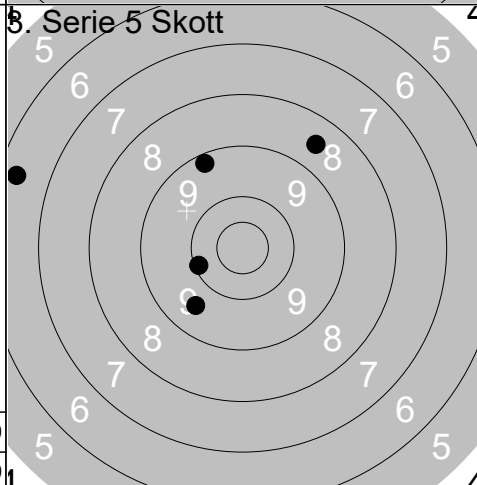

1:	10.1	←
2:	9.2	↖
3:	6.4	←
4:	8.5	↗
5:	9.6	↘
Serie		42
Total		141

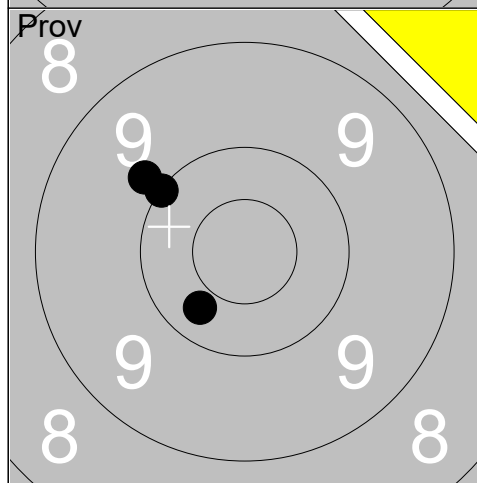

1:	9.8	↗
2:	10.3	↘
3:	10.0	↗
Serie		29
Total		141

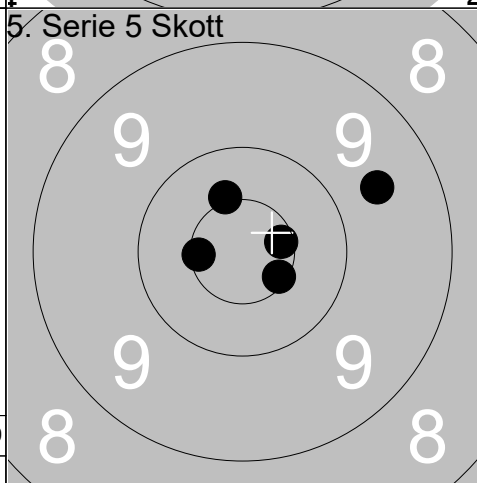

1:	9.6	↗
2:	10.6x	→
3:	10.6x	↘
4:	10.4x	↗
5:	10.6x	←
Serie		49
Total		190

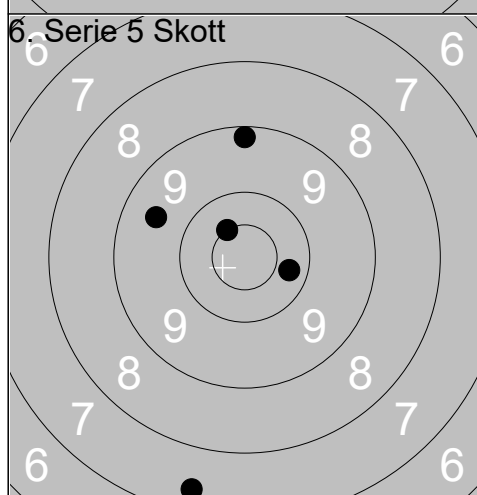

1:	10.5x	↗
2:	9.5	↖
3:	10.3	→
4:	9.2	↑
5:	7.4	↘
Serie		45
Total		235

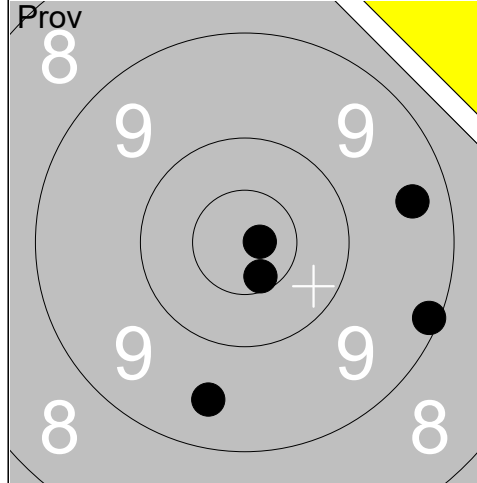

1:	9.1	→
2:	9.5	↓
3:	9.4	→
4:	10.6x	↓
5:	10.8x	→
Serie		47
Total		0

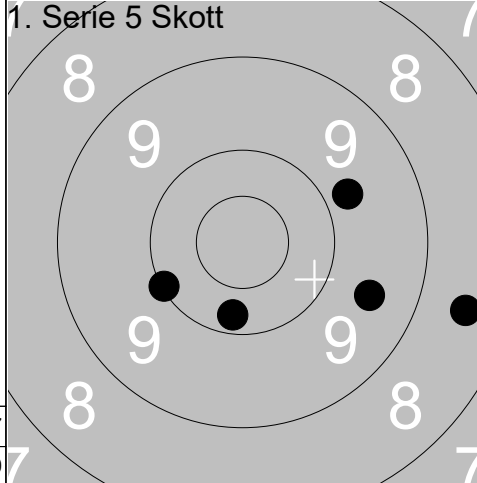

1:	9.5	→
2:	8.5	→
3:	10.0	←
4:	10.2	↓
5:	9.8	→
Serie		46
Total		46

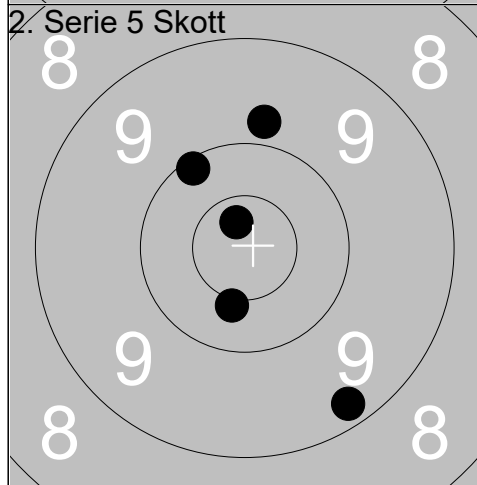

1:	9.2	↓
2:	10.4x	↓
3:	10.7x	↑
4:	9.8	↑
5:	10.1	↑
Serie		48
Total		94

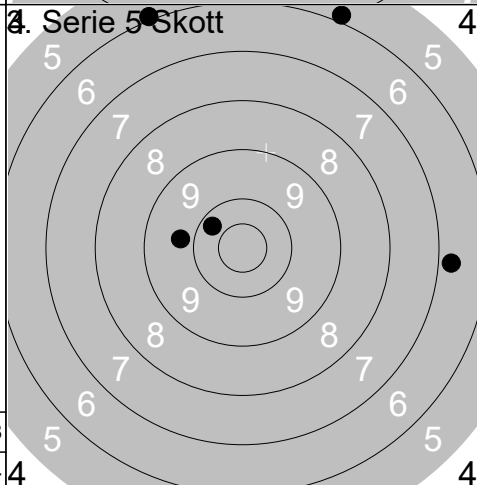

1:	5.9	↑
2:	9.7	←
3:	10.2	↑
4:	5.9	↑
5:	6.8	→
Serie		35
Total		129

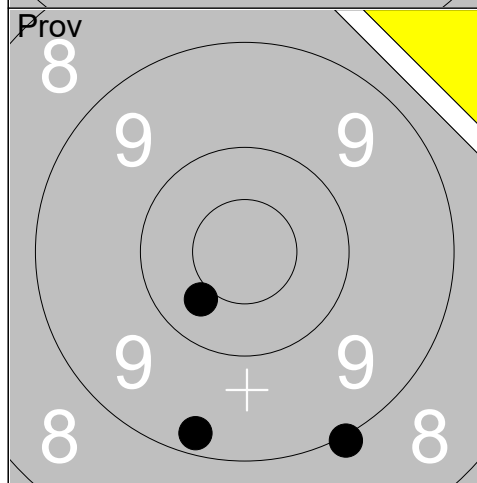

1:	10.4	←
2:	9.0	↓
3:	9.2	↓
Serie		28
Total		129

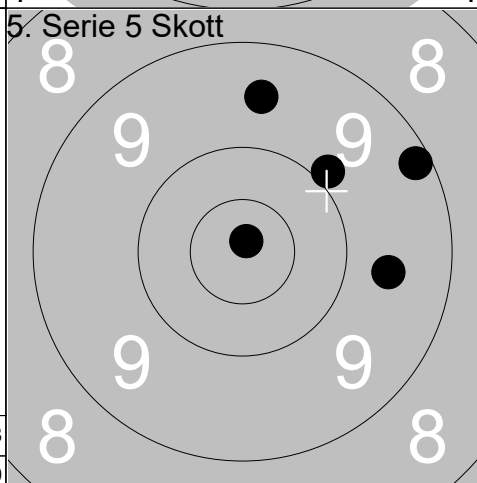

1:	9.6	→
2:	9.9	↗
3:	9.2	↗
4:	9.5	↑
5:	10.9x	↑
Serie		46
Total		175

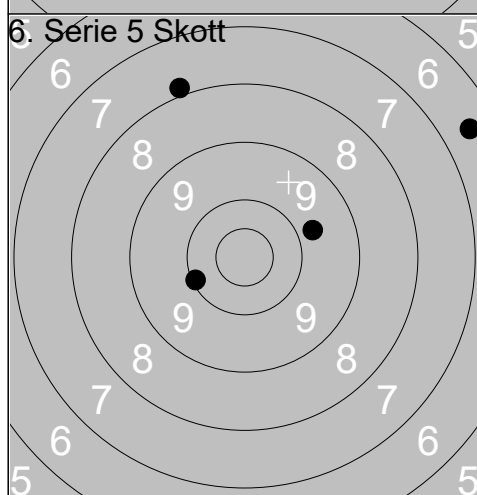

1:	6.5	↗
2:	10.1	←
3:	0.0	
4:	9.8	↗
5:	7.9	↑
Serie		32
Total		207

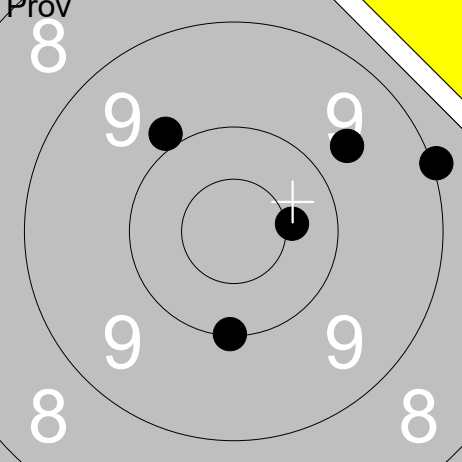
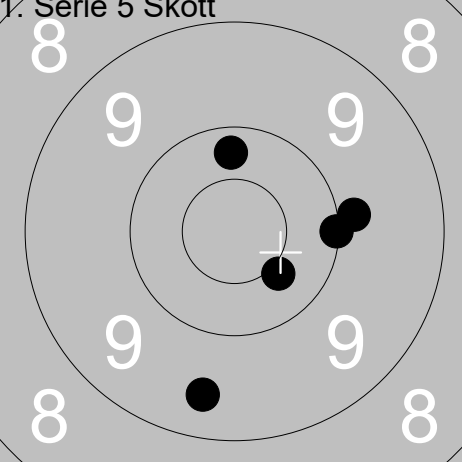
<b>Prov</b> 	<table border="1" style="width:100%; border-collapse: collapse;"> <tr><td>1:</td><td>9.7</td><td>↗</td></tr> <tr><td>2:</td><td>10.4x</td><td>→</td></tr> <tr><td>3:</td><td>9.9</td><td>↗</td></tr> <tr><td>4:</td><td>9.0</td><td>→</td></tr> <tr><td>5:</td><td>10.0</td><td>↓</td></tr> <tr><td colspan="2">Serie</td><td>47</td></tr> <tr><td colspan="2">Total</td><td>0</td></tr> </table>	1:	9.7	↗	2:	10.4x	→	3:	9.9	↗	4:	9.0	→	5:	10.0	↓	Serie		47	Total		0	<b>1. Serie 5 Skott</b>  <table border="1" style="width:100%; border-collapse: collapse;"> <tr><td>1:</td><td>9.4</td><td>↓</td></tr> <tr><td>2:</td><td>10.3</td><td>↑</td></tr> <tr><td>3:</td><td>10.4</td><td>↘</td></tr> <tr><td>4:</td><td>9.9</td><td>→</td></tr> <tr><td>5:</td><td>10.0</td><td>→</td></tr> <tr><td colspan="2">Serie</td><td>48</td></tr> <tr><td colspan="2">Total</td><td>48</td></tr> </table>	1:	9.4	↓	2:	10.3	↑	3:	10.4	↘	4:	9.9	→	5:	10.0	→	Serie		48	Total		48
1:	9.7	↗																																										
2:	10.4x	→																																										
3:	9.9	↗																																										
4:	9.0	→																																										
5:	10.0	↓																																										
Serie		47																																										
Total		0																																										
1:	9.4	↓																																										
2:	10.3	↑																																										
3:	10.4	↘																																										
4:	9.9	→																																										
5:	10.0	→																																										
Serie		48																																										
Total		48																																										

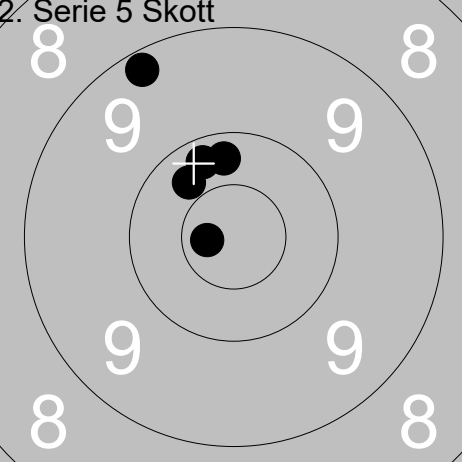
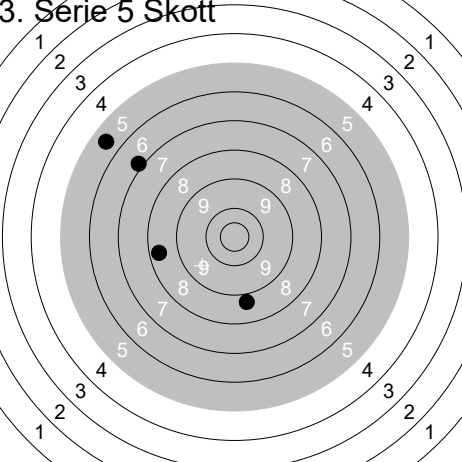
<b>2. Serie 5 Skott</b> 	<table border="1" style="width:100%; border-collapse: collapse;"> <tr><td>1:</td><td>10.3</td><td>↗</td></tr> <tr><td>2:</td><td>9.2</td><td>↗</td></tr> <tr><td>3:</td><td>10.7x</td><td>←</td></tr> <tr><td>4:</td><td>10.2</td><td>↗</td></tr> <tr><td>5:</td><td>10.2</td><td>↑</td></tr> <tr><td colspan="2">Serie</td><td>49</td></tr> <tr><td colspan="2">Total</td><td>97</td></tr> </table>	1:	10.3	↗	2:	9.2	↗	3:	10.7x	←	4:	10.2	↗	5:	10.2	↑	Serie		49	Total		97	<b>3. Serie 5 Skott</b>  <table border="1" style="width:100%; border-collapse: collapse;"> <tr><td>1:</td><td>5.5</td><td>↗</td></tr> <tr><td>2:</td><td>8.4</td><td>←</td></tr> <tr><td>3:</td><td>6.9</td><td>↗</td></tr> <tr><td>4:</td><td>8.8</td><td>↓</td></tr> <tr><td>5:</td><td>1.9</td><td>↓</td></tr> <tr><td colspan="2">Serie</td><td>28</td></tr> <tr><td colspan="2">Total</td><td>125</td></tr> </table>	1:	5.5	↗	2:	8.4	←	3:	6.9	↗	4:	8.8	↓	5:	1.9	↓	Serie		28	Total		125
1:	10.3	↗																																										
2:	9.2	↗																																										
3:	10.7x	←																																										
4:	10.2	↗																																										
5:	10.2	↑																																										
Serie		49																																										
Total		97																																										
1:	5.5	↗																																										
2:	8.4	←																																										
3:	6.9	↗																																										
4:	8.8	↓																																										
5:	1.9	↓																																										
Serie		28																																										
Total		125																																										

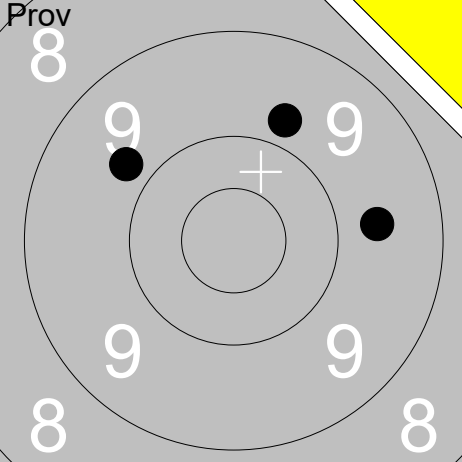
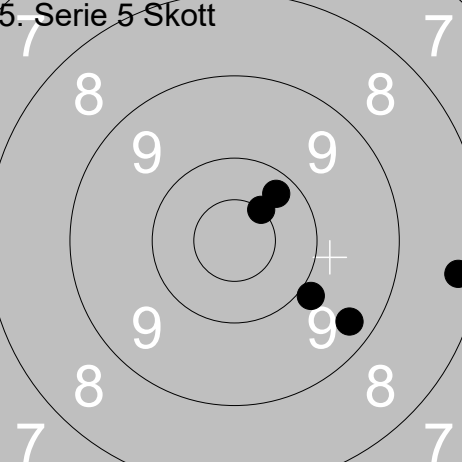
<b>Prov</b> 	<table border="1" style="width:100%; border-collapse: collapse;"> <tr><td>1:</td><td>9.8</td><td>↖</td></tr> <tr><td>2:</td><td>9.8</td><td>↑</td></tr> <tr><td>3:</td><td>9.6</td><td>→</td></tr> <tr><td colspan="2">Serie</td><td>27</td></tr> <tr><td colspan="2">Total</td><td>125</td></tr> </table>	1:	9.8	↖	2:	9.8	↑	3:	9.6	→	Serie		27	Total		125	<b>5. Serie 5 Skott</b>  <table border="1" style="width:100%; border-collapse: collapse;"> <tr><td>1:</td><td>10.5x</td><td>↗</td></tr> <tr><td>2:</td><td>10.2</td><td>↗</td></tr> <tr><td>3:</td><td>8.3</td><td>→</td></tr> <tr><td>4:</td><td>9.9</td><td>↘</td></tr> <tr><td>5:</td><td>9.3</td><td>↘</td></tr> <tr><td colspan="2">Serie</td><td>46</td></tr> <tr><td colspan="2">Total</td><td>171</td></tr> </table>	1:	10.5x	↗	2:	10.2	↗	3:	8.3	→	4:	9.9	↘	5:	9.3	↘	Serie		46	Total		171
1:	9.8	↖																																				
2:	9.8	↑																																				
3:	9.6	→																																				
Serie		27																																				
Total		125																																				
1:	10.5x	↗																																				
2:	10.2	↗																																				
3:	8.3	→																																				
4:	9.9	↘																																				
5:	9.3	↘																																				
Serie		46																																				
Total		171																																				

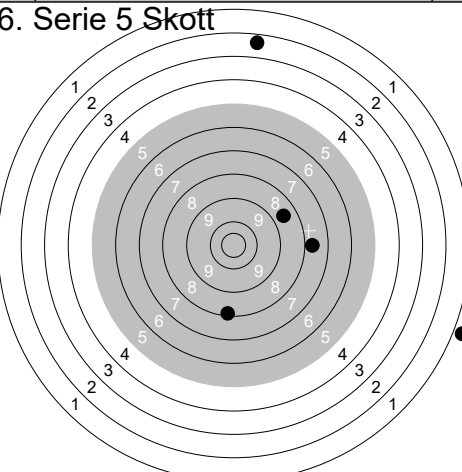
<b>6. Serie 5 Skott</b> 	<table border="1" style="width:100%; border-collapse: collapse;"> <tr><td>1:</td><td>8.6</td><td>↗</td></tr> <tr><td>2:</td><td>8.2</td><td>↓</td></tr> <tr><td>3:</td><td>7.7</td><td>→</td></tr> <tr><td>4:</td><td>2.4</td><td>↑</td></tr> <tr><td>5:</td><td>0.0</td><td>⇒</td></tr> <tr><td colspan="2">Serie</td><td>25</td></tr> <tr><td colspan="2">Total</td><td>196</td></tr> </table>	1:	8.6	↗	2:	8.2	↓	3:	7.7	→	4:	2.4	↑	5:	0.0	⇒	Serie		25	Total		196	
1:	8.6	↗																					
2:	8.2	↓																					
3:	7.7	→																					
4:	2.4	↑																					
5:	0.0	⇒																					
Serie		25																					
Total		196																					



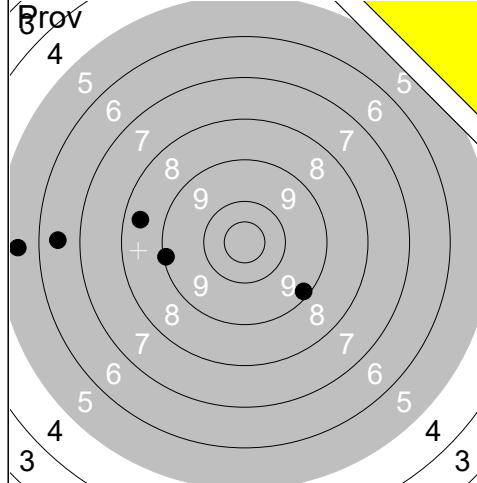

1:	6.5	←
2:	5.5	←
3:	9.1	←
4:	8.4	←
5:	9.2	↓
Serie		37
Total		0

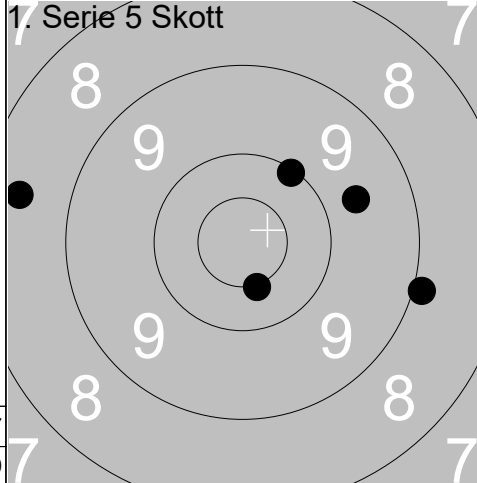

1:	9.7	→
2:	8.5	←
3:	8.9	→
4:	10.1	↗
5:	10.5x	↓
Serie		45
Total		45

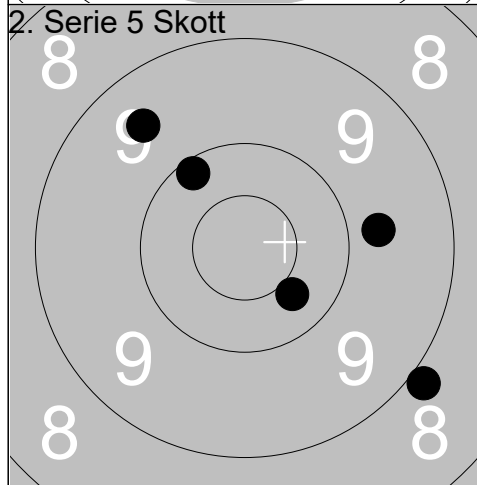

1:	9.7	→
2:	10.1	↗
3:	9.5	↗
4:	10.4	↓
5:	8.9	↓
Serie		46
Total		91

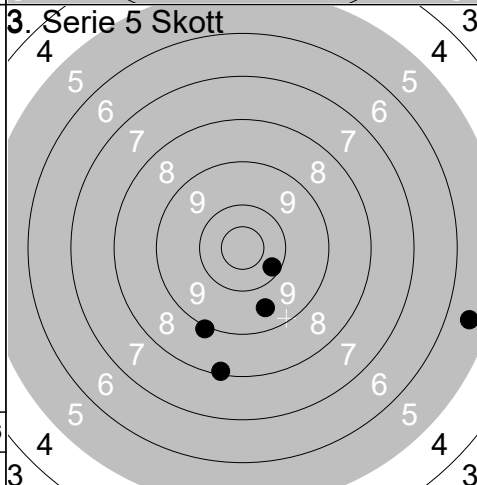

1:	10.2	↘
2:	9.5	↓
3:	8.9	↓
4:	8.1	↓
5:	5.5	→
Serie		40
Total		131

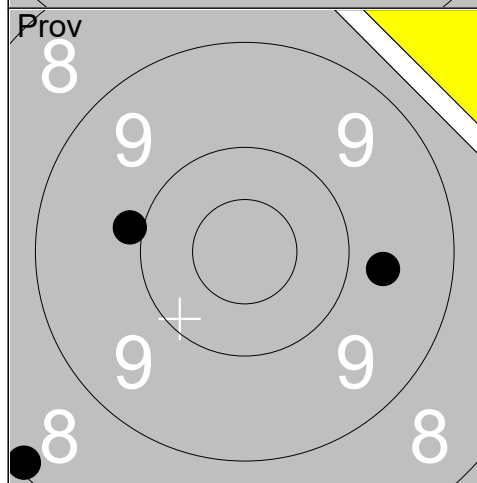

1:	9.7	→
2:	8.1	←
3:	9.9	←
Serie		26
Total		131

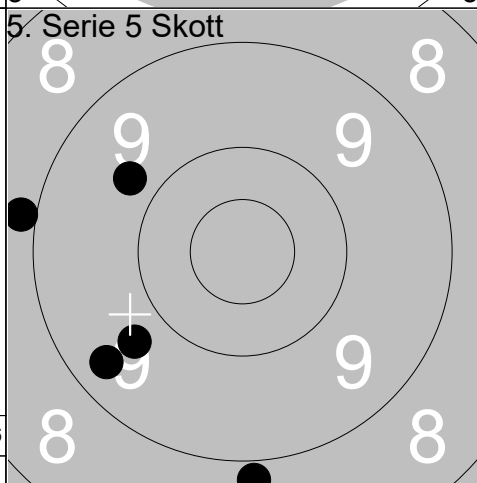

1:	9.4	←
2:	9.7	←
3:	8.9	←
4:	8.8	↓
5:	9.7	↖
Serie		43
Total		174

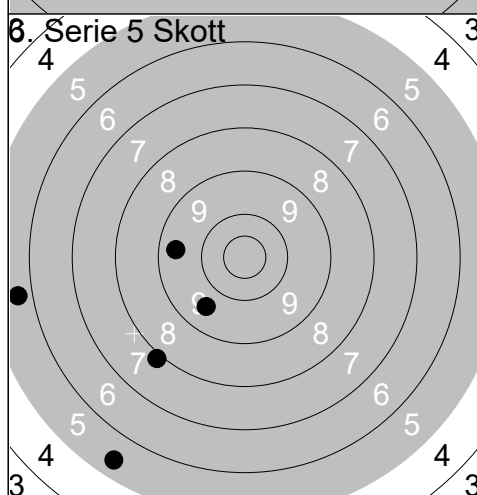

1:	9.6	↓
2:	9.4	←
3:	5.4	↓
4:	7.9	↓
5:	5.7	←
Serie		35
Total		209

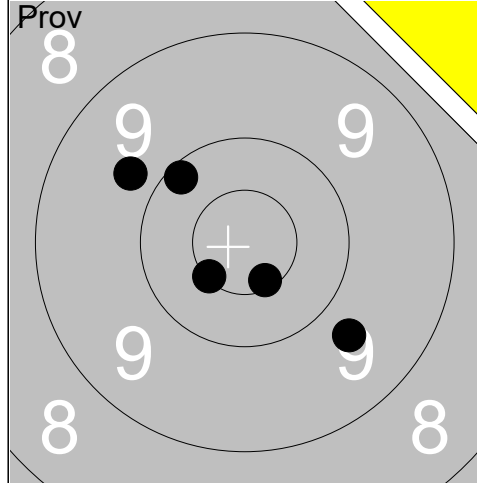

1:	10.1	↗
2:	10.6x	↘
3:	10.5x	↘
4:	9.7	↘
5:	9.8	↗
Serie		48
Total		0

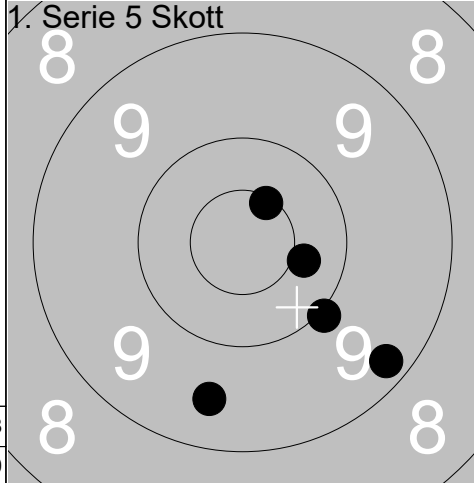

1:	10.5x	↗
2:	9.5	↘
3:	9.2	↘
4:	10.0	↘
5:	10.4	↘
Serie		48
Total		48

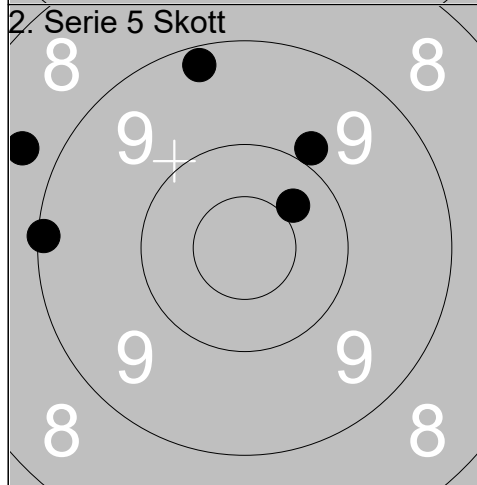

1:	9.1	←
2:	9.2	↑
3:	8.7	←
4:	9.9	↗
5:	10.4	↗
Serie		45
Total		93

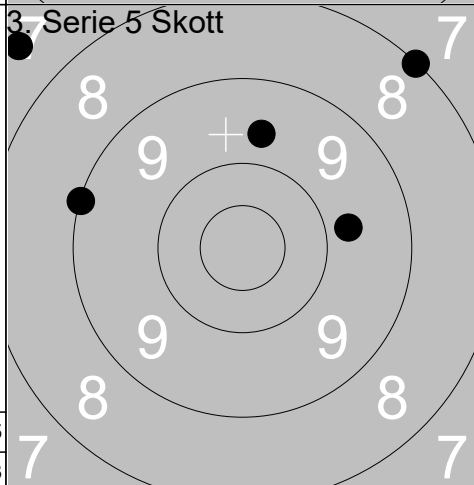

1:	9.8	→
2:	9.7	↑
3:	9.0	←
4:	7.5	↖
5:	8.0	↗
Serie		42
Total		135

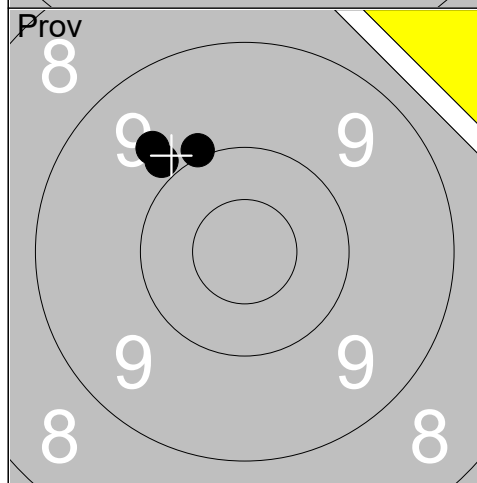

1:	10.0	↗
2:	9.7	↗
3:	9.9	↗
Serie		28
Total		135

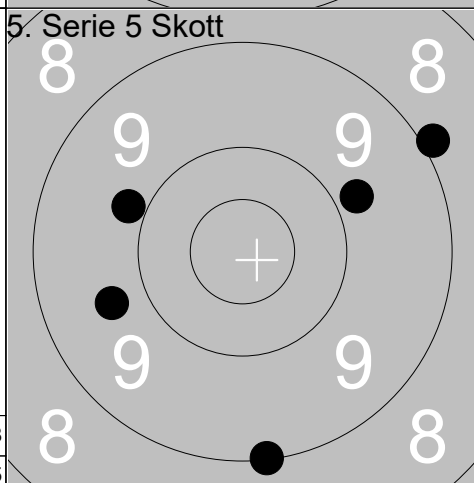

1:	9.0	↘
2:	9.8	↗
3:	8.9	↗
4:	9.7	←
5:	9.9	←
Serie		44
Total		179

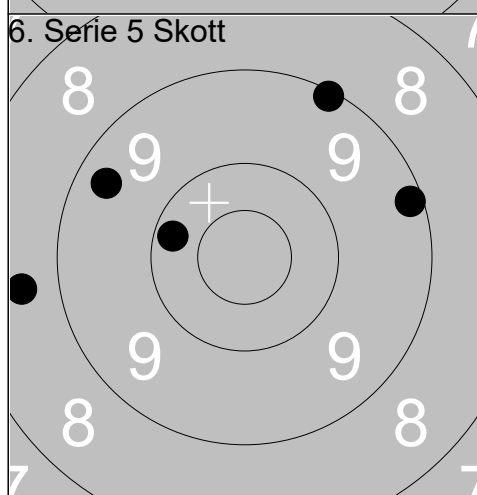

1:	10.2	←
2:	9.2	→
3:	9.4	↗
4:	8.6	←
5:	9.1	↗
Serie		45
Total		224

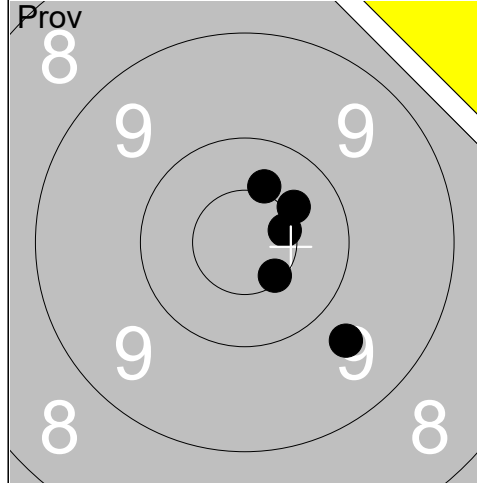

1:	9.7	↘
2:	10.6x	→
3:	10.6x	↘
4:	10.4x	↗
5:	10.4x	↑
Serie		49
Total		0

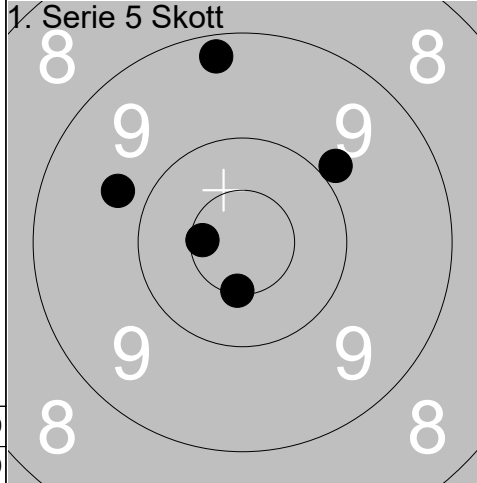

1:	10.5x	↓
2:	9.7	↖
3:	9.2	↑
4:	10.6x	←
5:	9.9	↗
Serie		47
Total		47

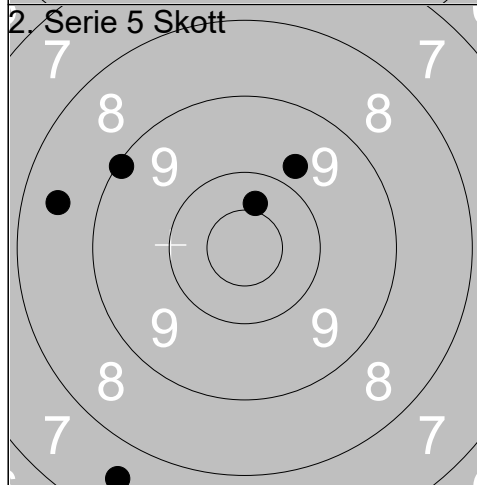

1:	7.6	↘
2:	9.1	↗
3:	8.5	←
4:	9.8	↗
5:	10.4	↑
Serie		43
Total		90

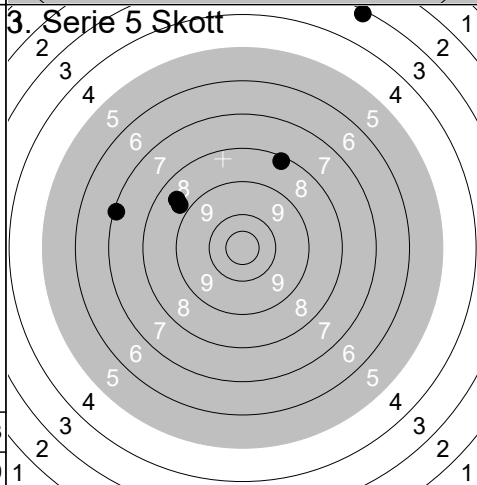

1:	8.8	↖
2:	8.6	↖
3:	8.2	↑
4:	7.1	←
5:	3.1	↑
Serie		34
Total		124

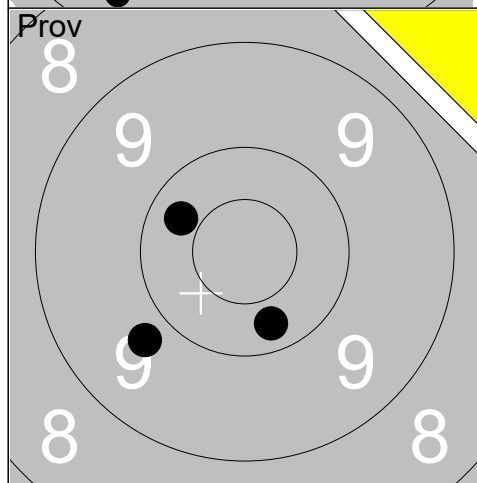

1:	9.8	↖
2:	10.3	↖
3:	10.3	↓
Serie		29
Total		124

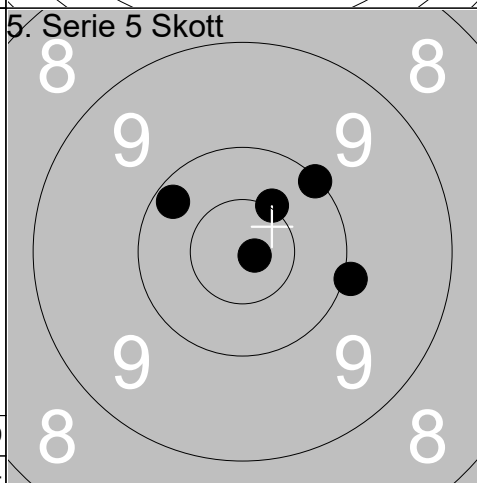

1:	10.8x	→
2:	10.5x	↗
3:	10.1	↗
4:	10.0	→
5:	10.2	↖
Serie		50
Total		174

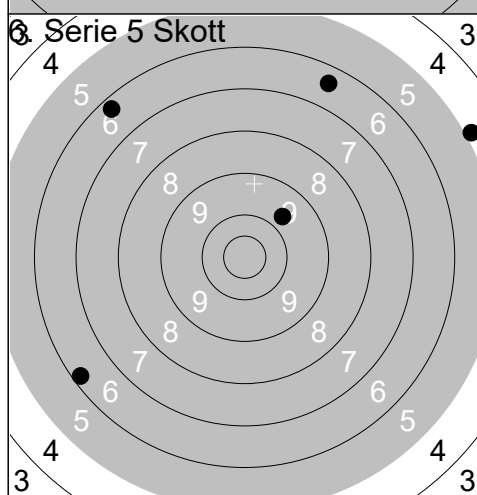

1:	9.7	↗
2:	4.9	↗
3:	6.3	↗
4:	6.4	↗
5:	6.2	↖
Serie		31
Total		205

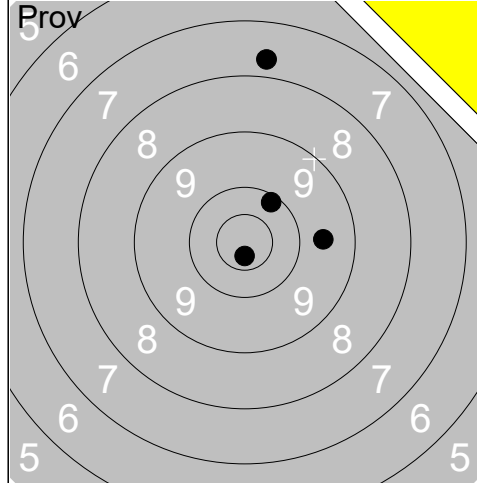

1:	5.5	↗
2:	7.7	↑
3:	9.6	→
4:	10.1	↗
5:	10.7x	↓
Serie	41	
Total	0	

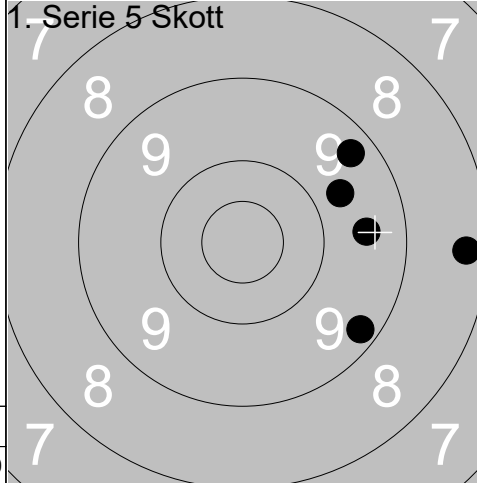

1:	9.3	↗
2:	8.3	→
3:	9.7	↗
4:	9.5	→
5:	9.2	↘
Serie	44	
Total	44	

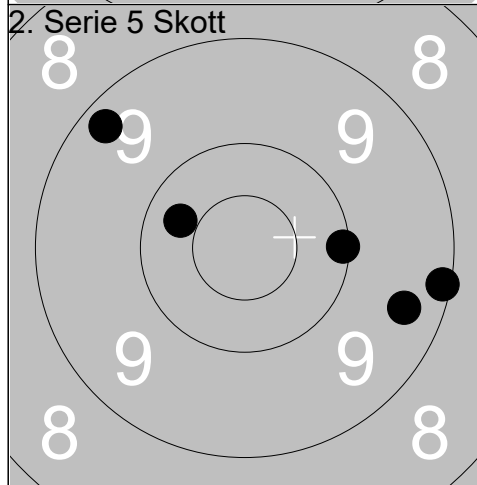

1:	10.1	→
2:	10.3	↗
3:	9.3	↗
4:	9.4	↘
5:	9.1	→
Serie	47	
Total	91	

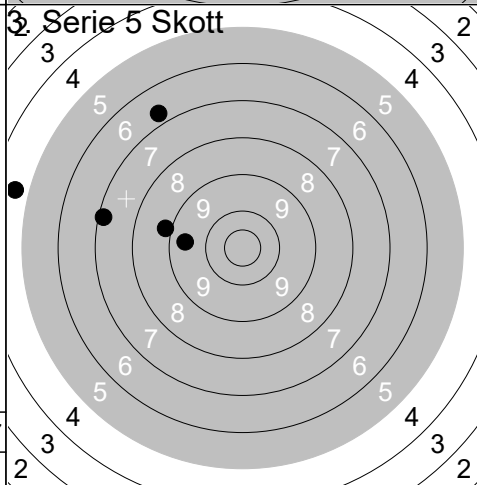

1:	8.9	←
2:	9.5	←
3:	7.2	←
4:	6.7	↗
5:	4.7	←
Serie	34	
Total	125	

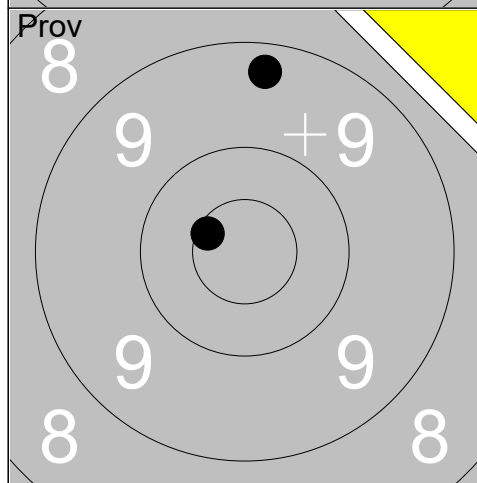

1:	10.6x	←
2:	8.6	↗
3:	9.3	↑
Serie	27	
Total	125	

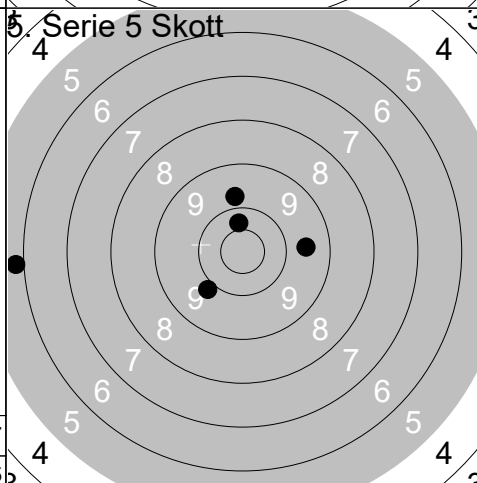

1:	10.3	↑
2:	9.6	→
3:	9.8	↑
4:	5.9	←
5:	9.8	↘
Serie	42	
Total	167	

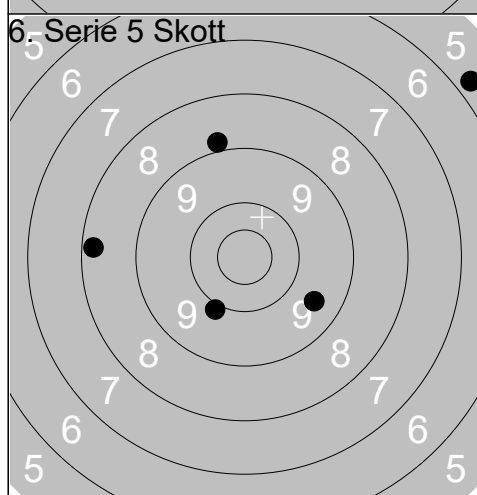

1:	9.9	↘
2:	9.5	↘
3:	8.2	←
4:	5.8	↗
5:	8.9	↑
Serie	39	
Total	206	

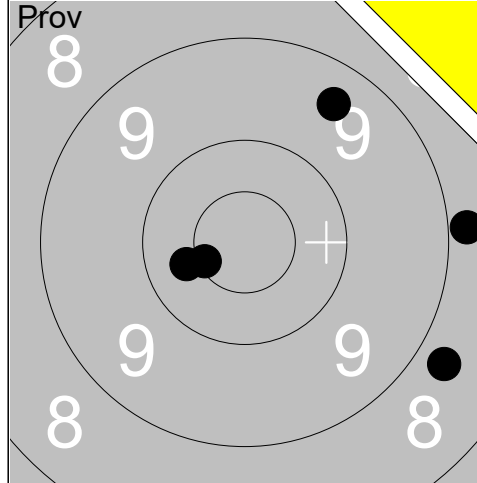

1. Serie 5 Skott		
1:	10.2	↘
2:	9.2	↖
3:	8.1	↖
4:	9.7	↖
5:	9.0	↖
Serie		45
Total		45

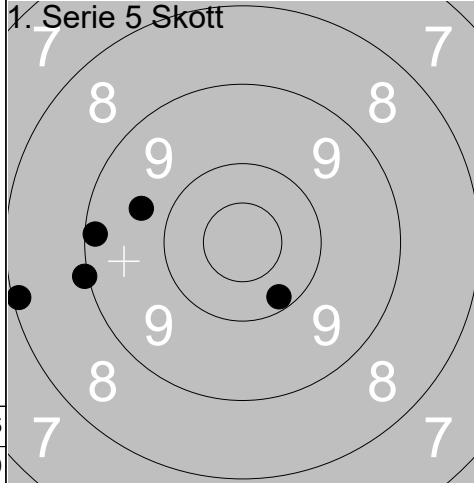

3. Serie 5 Skott		
1:	10.0	↘
2:	9.3	→
3:	7.9	↘
4:	10.9x	↘
5:	8.0	↘
Serie		44
Total		132

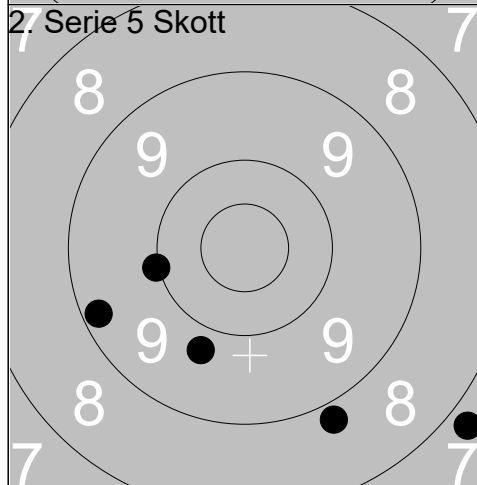

5. Serie 5 Skott		
1:	8.6	→
2:	9.6	↑
3:	10.5x	↖
4:	9.7	↘
5:	9.5	↘
Serie		45
Total		177

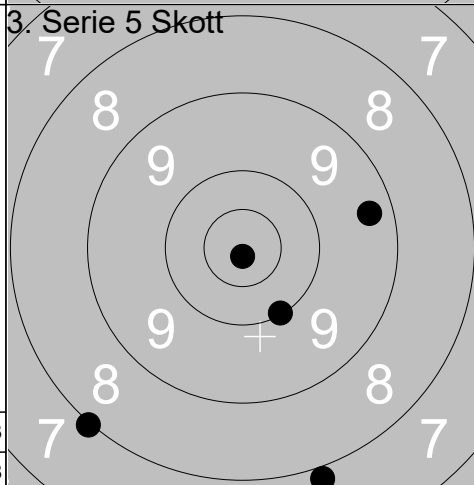

6. Serie 5 Skott		
1:	8.8	↖
2:	9.9	↘
3:	10.4	↘
4:	9.7	↖
5:	9.8	↗
Serie		45
Total		222

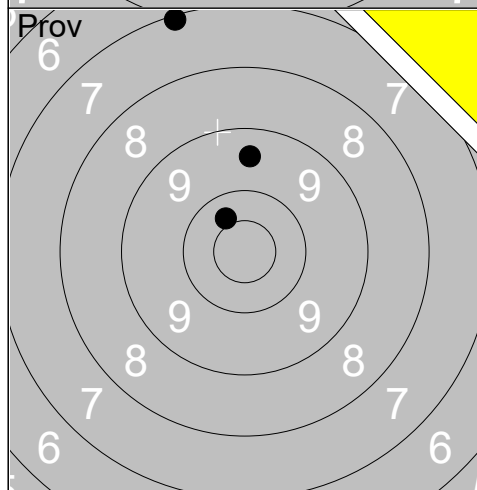

6. Serie 5 Skott		
1:	8.8	↖
2:	9.9	↘
3:	10.4	↘
4:	9.7	↖
5:	9.8	↗
Serie		45
Total		222

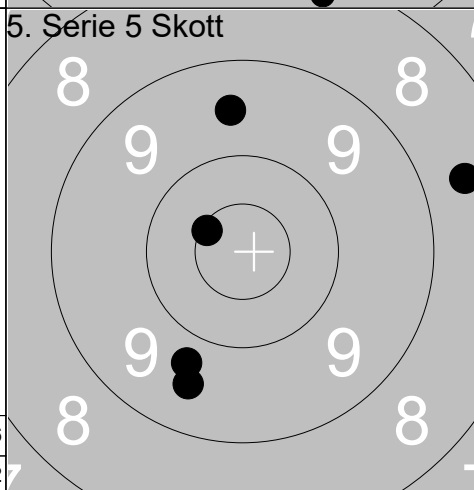

6. Serie 5 Skott		
1:	8.8	↖
2:	9.9	↘
3:	10.4	↘
4:	9.7	↖
5:	9.8	↗
Serie		45
Total		222

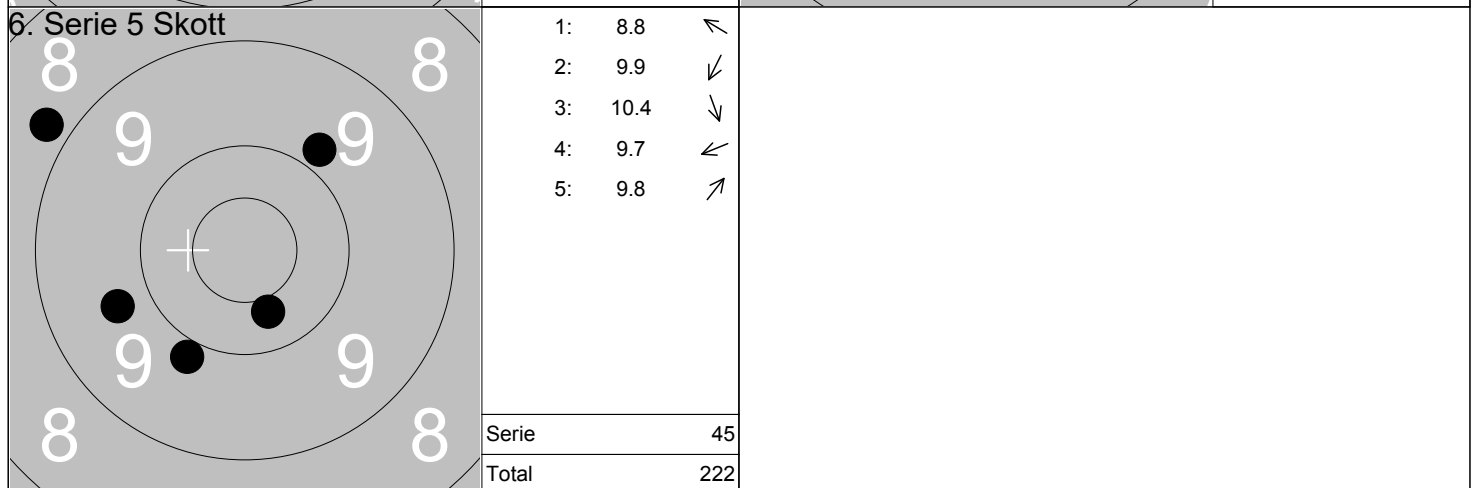

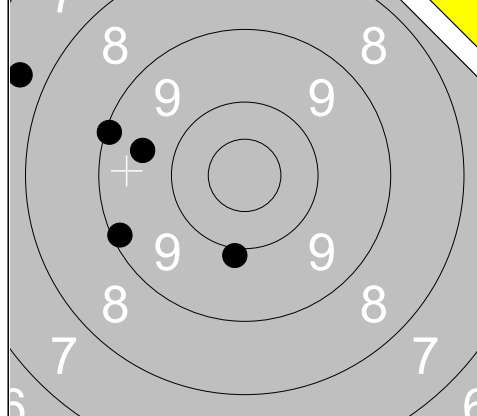

1:	7.7	↖
2:	9.1	↖
3:	9.6	↖
4:	9.1	↖
5:	9.9	↓
Serie		43
Total		0

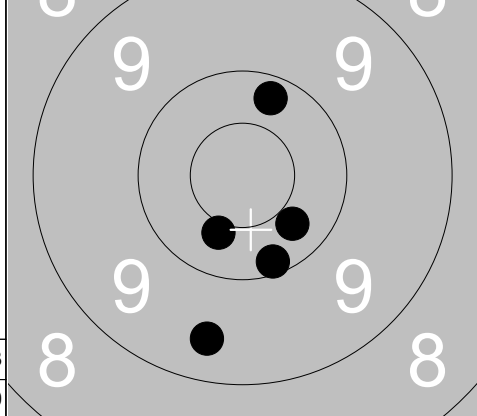

1:	10.3	↘
2:	10.4	↓
3:	9.4	↓
4:	10.1	↓
5:	10.2	↑
Serie		49
Total		49

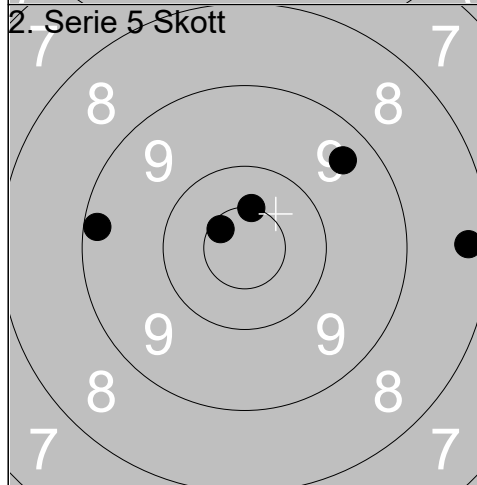

1:	9.4	↗
2:	9.2	↖
3:	10.6x	↖
4:	8.3	→
5:	10.5x	↑
Serie		46
Total		95

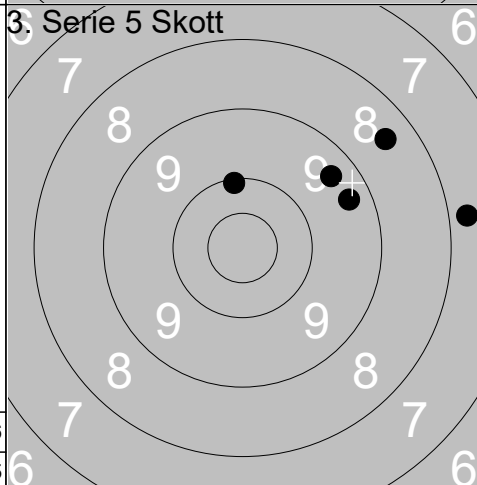

1:	9.3	↗
2:	7.8	→
3:	9.4	↗
4:	8.4	↗
5:	10.1	↑
Serie		43
Total		138

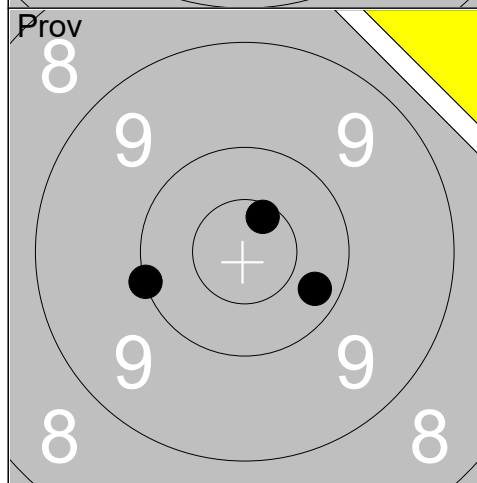

1:	10.2	↘
2:	10.6x	↑
3:	10.0	↖
Serie		30
Total		138

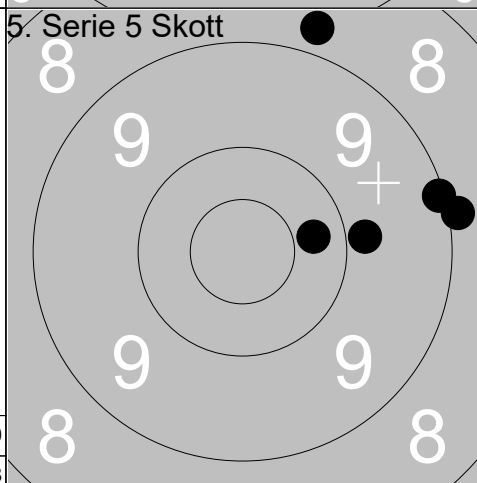

1:	10.3	→
2:	9.1	→
3:	8.8	↑
4:	9.9	→
5:	8.9	→
Serie		44
Total		182

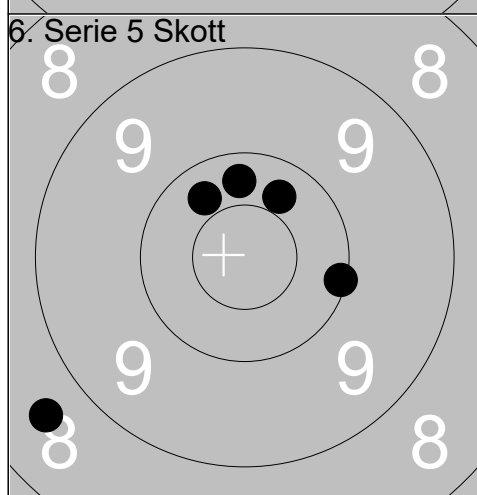

1:	8.6	↖
2:	10.1	→
3:	10.3	↗
4:	10.3	↑
5:	10.3	↖
Serie		48
Total		230

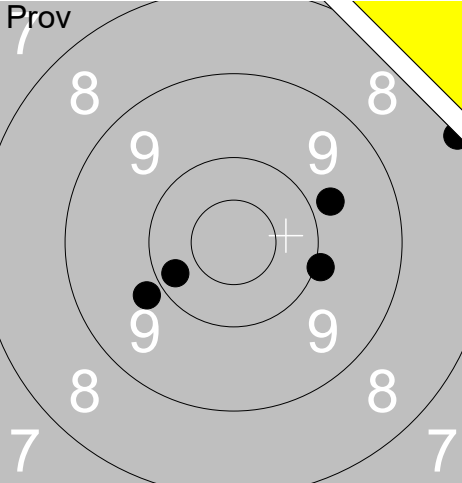
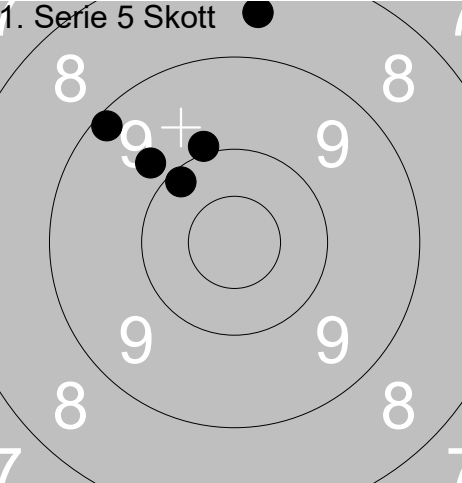
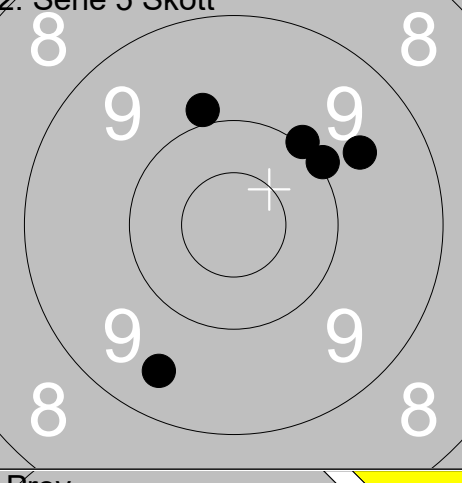
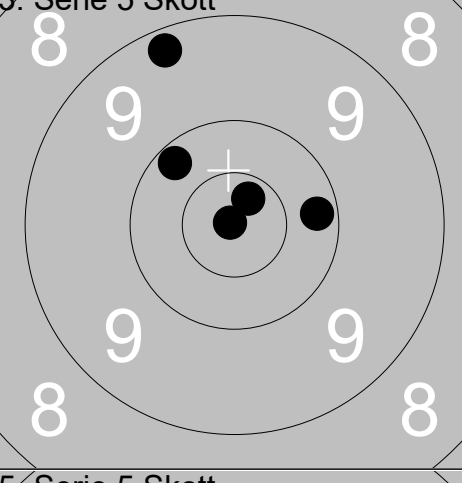
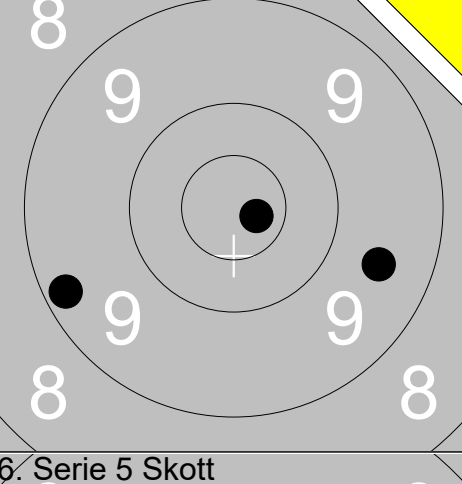
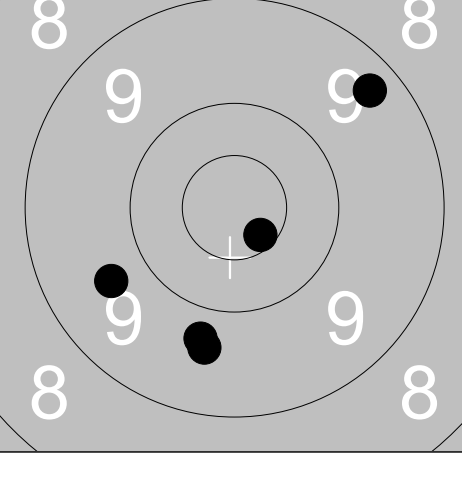
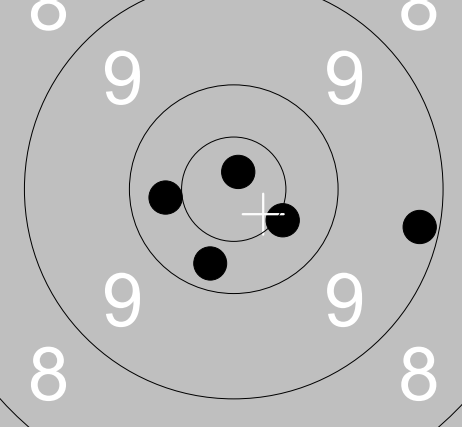
Skjutlag	Tavla	Anna Grönlund			
2	3	Ramselefors	Piteå	Ligg	No
07.07.2018	Björskottet 2018	Ramselefors SKF			
<b>Prov</b> 	1: 8.1 → 2: 9.8 → 3: 9.8 ← 4: 10.0 → 5: 10.2 ←	<b>1. Serie 5 Skott</b> 	1: 9.2 ↖ 2: 9.9 ↑ 3: 10.1 ↖ 4: 9.8 ↖ 5: 8.5 ↑		
	Serie 46 Total 0		Serie 45 Total 45		
<b>2. Serie 5 Skott</b> 	1: 9.5 ↓ 2: 9.9 ↑ 3: 10.0 → 4: 10.0 ↗ 5: 9.6 →	<b>3. Serie 5 Skott</b> 	1: 10.9x ← 2: 10.2 ↖ 3: 10.7x ↗ 4: 9.2 ↑ 5: 10.2 →		
	Serie 47 Total 92		Serie 49 Total 141		
<b>Prov</b> 	1: 10.7x → 2: 9.2 ← 3: 9.5 →	<b>5. Serie 5 Skott</b> 	1: 10.6x ↘ 2: 9.7 ↓ 3: 9.3 ↗ 4: 9.7 ← 5: 9.7 ↓		
	Serie 28 Total 141		Serie 46 Total 187		
<b>6. Serie 5 Skott</b> 	1: 10.8x ↑ 2: 10.3 ↓ 3: 10.3 ← 4: 10.4x ↘ 5: 9.2 →				
	Serie 49 Total 236				

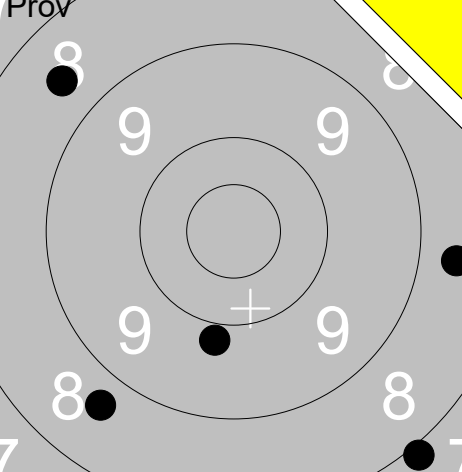
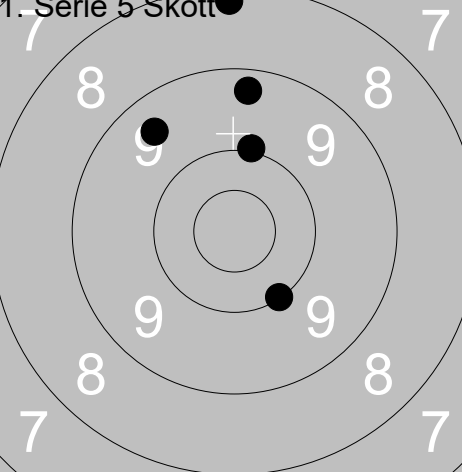
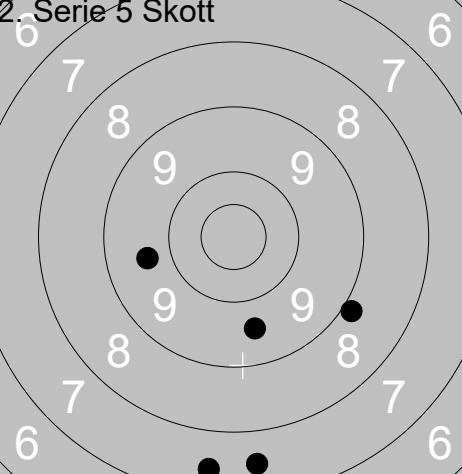
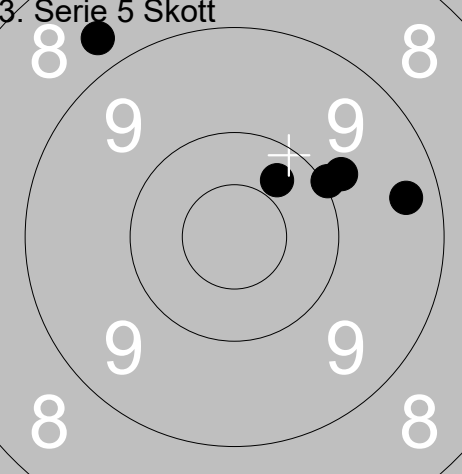
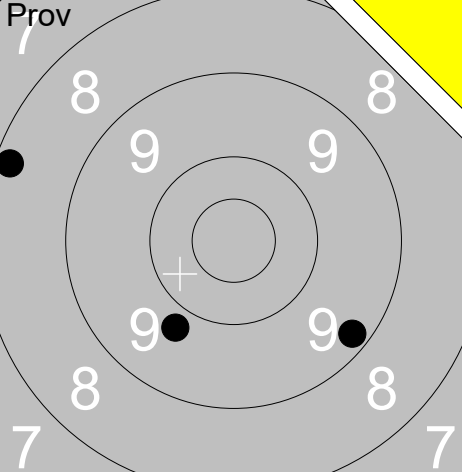
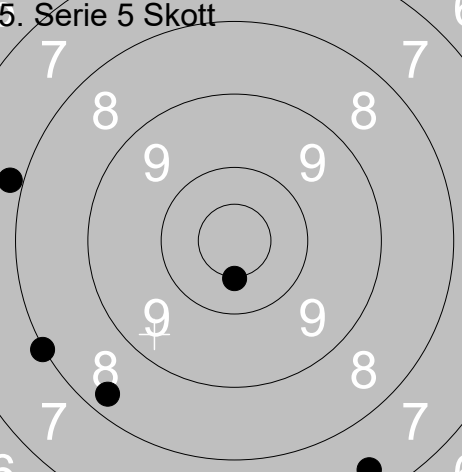
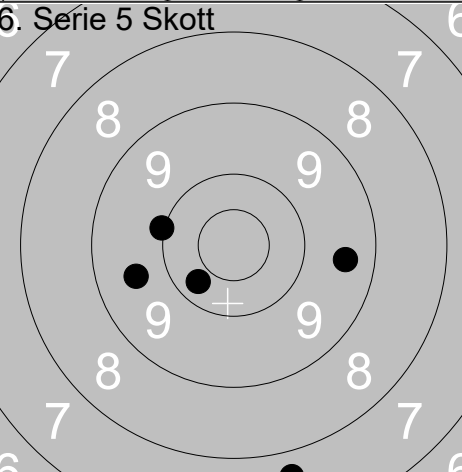
<p><b>Prov</b></p>  <p style="text-align: right;">Serie 40 Total 0</p>	<p>1: 7.9 ↘ 2: 8.6 → 3: 8.6 ↗ 4: 9.9 ↓ 5: 8.7 ↘</p>	<p><b>1. Serie 5 Skott</b></p>  <p style="text-align: right;">Serie 46 Total 46</p>	<p>1: 9.3 ↑ 2: 8.2 ↑ 3: 9.5 ↖ 4: 10.0 ↓ 5: 10.0 ↑</p>
<p><b>2. Serie 5 Skott</b></p>  <p style="text-align: right;">Serie 40 Total 86</p>	<p>1: 7.5 ↓ 2: 7.4 ↓ 3: 9.7 ← 4: 9.6 ↓ 5: 8.9 ↘</p>	<p><b>3. Serie 5 Skott</b></p>  <p style="text-align: right;">Serie 46 Total 132</p>	<p>1: 10.0 ↗ 2: 9.4 → 3: 10.3 ↗ 4: 9.8 ↗ 5: 8.7 ↖</p>
<p><b>Prov</b></p>  <p style="text-align: right;">Serie 26 Total 132</p>	<p>1: 9.8 ↘ 2: 8.2 ↖ 3: 9.2 ↘</p>	<p><b>5. Serie 5 Skott</b></p>  <p style="text-align: right;">Serie 40 Total 172</p>	<p>1: 10.5x ↓ 2: 7.9 ← 3: 8.3 ↘ 4: 7.4 ↓ 5: 8.0 ↖</p>
<p><b>6. Serie 5 Skott</b></p>  <p style="text-align: right;">Serie 45 Total 217</p>	<p>1: 10.0 ← 2: 10.3 ↘ 3: 9.6 ← 4: 9.4 → 5: 7.7 ↓</p>		



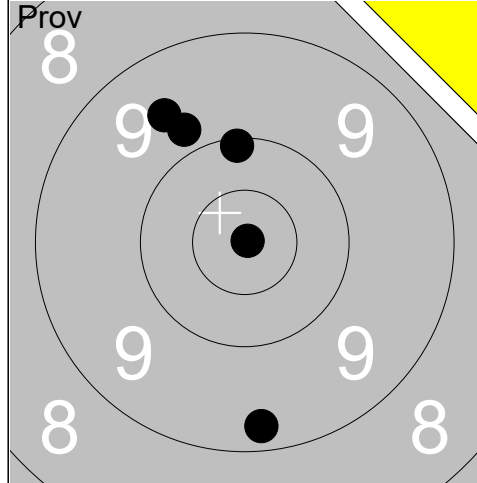

1:	10.9x	↗
2:	9.6	↖
3:	9.3	↓
4:	10.1	↑
5:	9.8	↗
Serie		47
Total		0

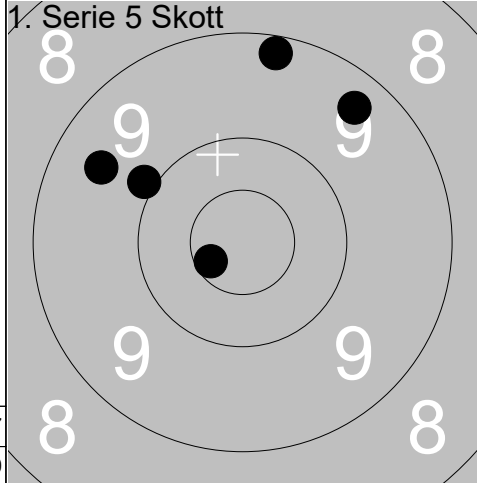

1:	9.4	↗
2:	9.9	↖
3:	10.6x	↙
4:	9.5	↖
5:	9.2	↑
Serie		46
Total		46

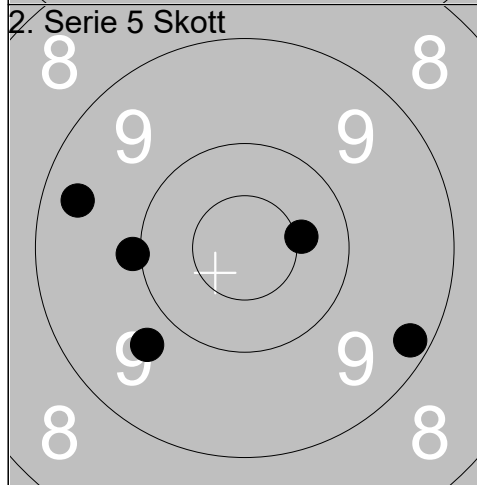

1:	9.2	↘
2:	10.0	←
3:	9.4	↖
4:	9.7	↙
5:	10.4x	→
Serie		47
Total		93

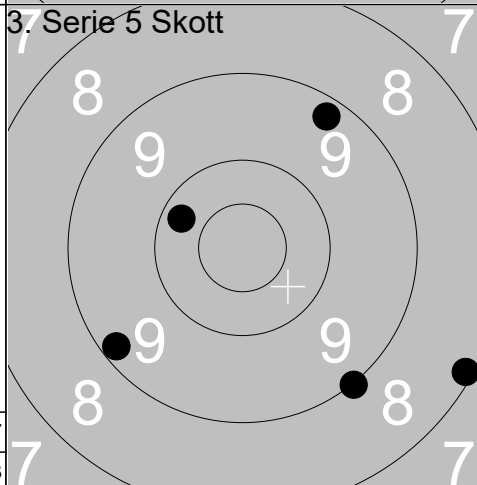

1:	9.0	↘
2:	8.1	↘
3:	9.2	↗
4:	10.2	↖
5:	9.2	↙
Serie		45
Total		138

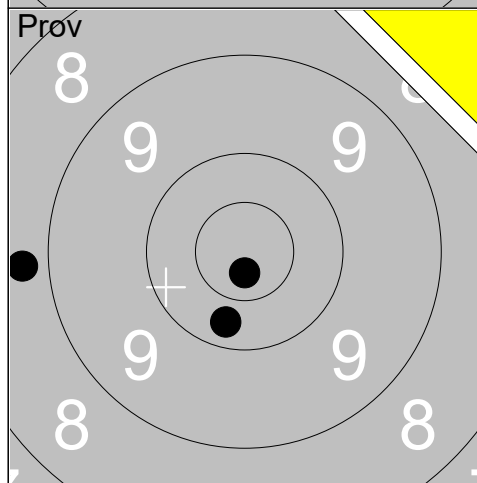

1:	8.8	←
2:	10.3	↓
3:	10.7x	↓
Serie		28
Total		138

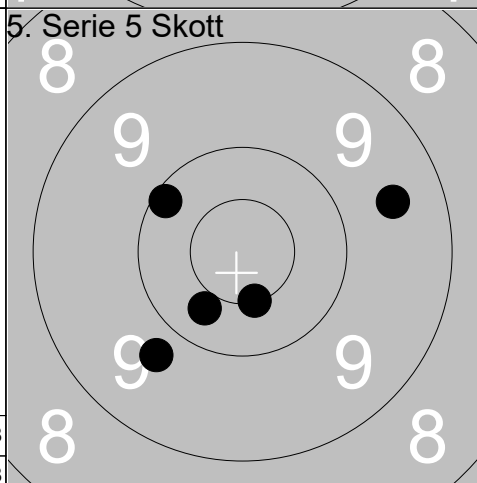

1:	9.7	↙
2:	10.1	↖
3:	10.4	↙
4:	10.5x	↓
5:	9.5	→
Serie		48
Total		186

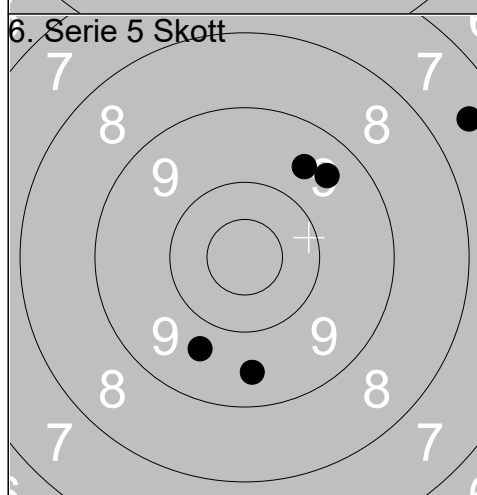

1:	9.5	↓
2:	7.5	↗
3:	9.7	↙
4:	9.5	↗
5:	9.6	↗
Serie		43
Total		229

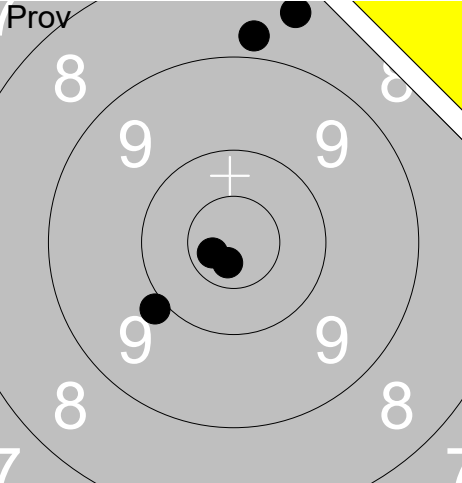
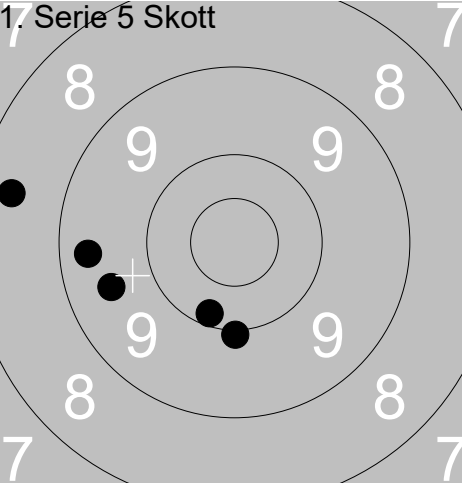
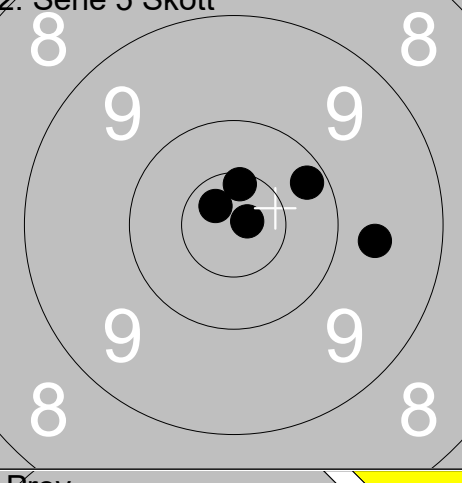
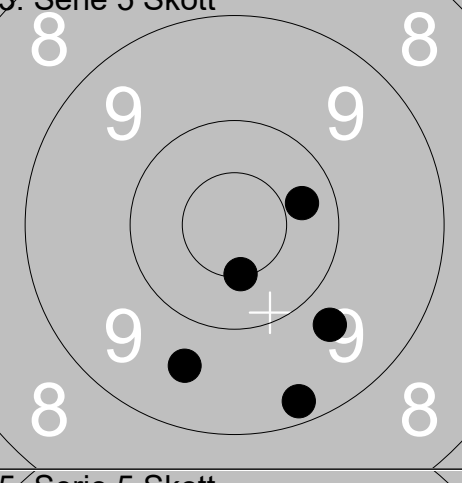
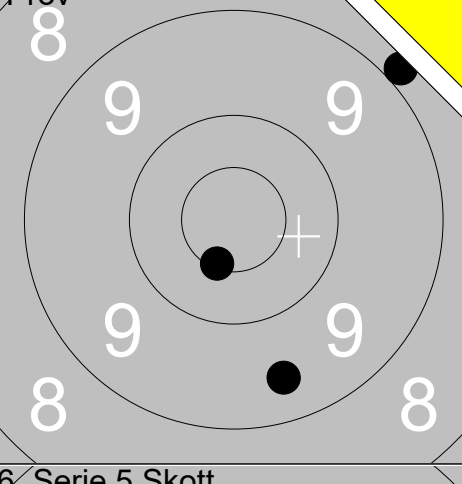
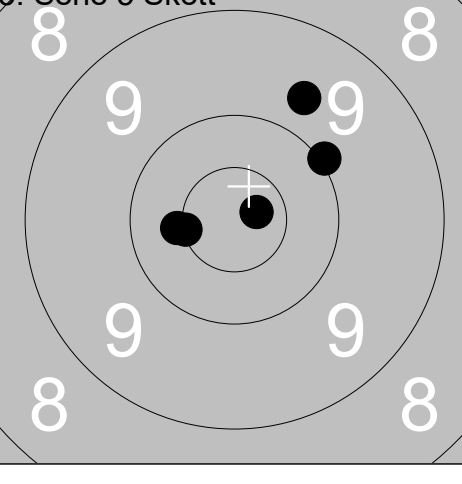
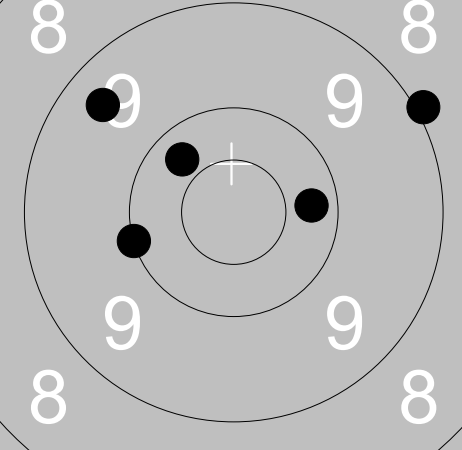
Skjuttag	Tavla	Elise Solum Bakken			
2	6	Ramselefors	Nordre Skage	Ligg	Norge
07.07.2018	Björskottet 2018	Ramselefors SKF			
<b>Prov</b> 	1: 8.5 ↑ 2: 8.8 ↑ 3: 10.7x ↓ 4: 10.7x ← 5: 9.9 ↙	<b>1. Serie 5 Skott</b> 	1: 10.0 ↓ 2: 8.4 ← 3: 10.2 ↓ 4: 9.4 ← 5: 9.5 ←		
	Serie 45 Total 0		Serie 46 Total 46		
<b>2. Serie 5 Skott</b> 	1: 10.2 → 2: 10.6x ↑ 3: 9.7 → 4: 10.8x → 5: 10.7x ↖	<b>3. Serie 5 Skott</b> 	1: 10.5x ↓ 2: 10.3 → 3: 9.7 ↘ 4: 9.6 ↓ 5: 9.2 ↓		
	Serie 49 Total 95		Serie 47 Total 142		
<b>Prov</b> 	1: 10.5x ↓ 2: 9.4 ↓ 3: 8.9 ↗	<b>5. Serie 5 Skott</b> 	1: 10.0 ↗ 2: 10.7x → 3: 9.7 ↑ 4: 10.5x ← 5: 10.4x ←		
	Serie 27 Total 142		Serie 49 Total 191		
<b>6. Serie 5 Skott</b> 	1: 9.4 ↖ 2: 10.3 → 3: 10.0 ← 4: 10.3 ↗ 5: 9.0 ↗				
	Serie 48 Total 239				

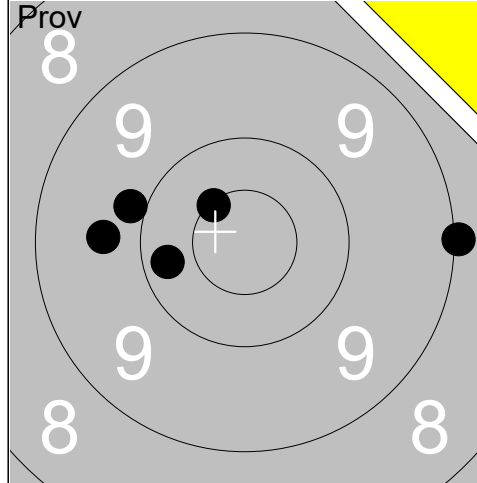

1:	10.2	←
2:	9.0	→
3:	10.5x	↗
4:	9.7	←
5:	9.9	↖
Serie		47
Total		0

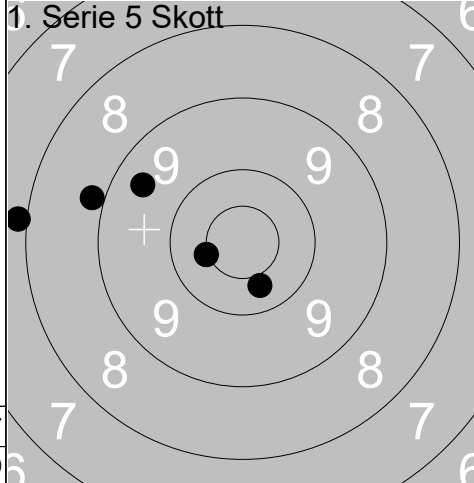

1:	10.4	↓
2:	9.4	↖
3:	7.9	←
4:	8.9	←
5:	10.5x	←
Serie		44
Total		44

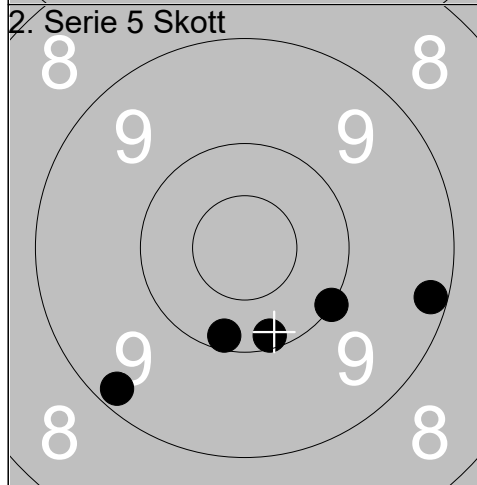

1:	10.1	↓
2:	10.0	↓
3:	10.2	↓
4:	9.2	→
5:	9.2	↙
Serie		48
Total		92

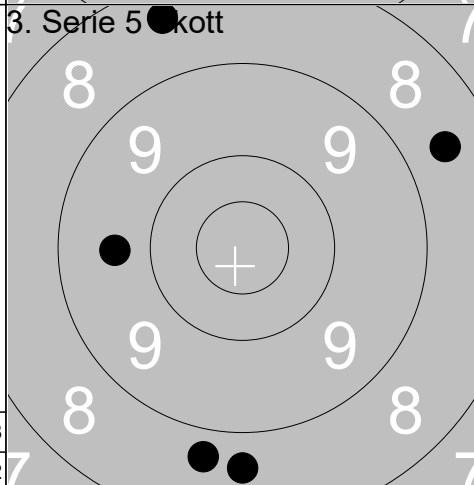

1:	8.7	↓
2:	8.6	↓
3:	8.4	↖
4:	9.6	←
5:	8.6	↗
Serie		41
Total		133

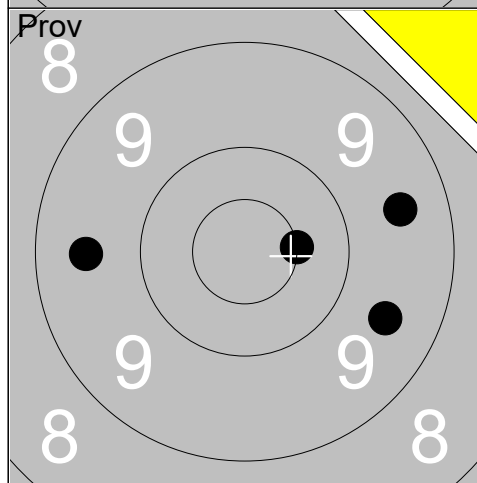

1:	10.5x	→
2:	9.5	←
3:	9.5	→
4:	9.5	→
Serie		37
Total		133

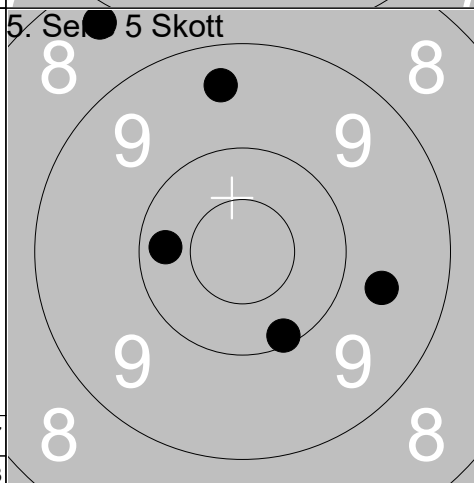

1:	10.3	←
2:	9.6	→
3:	10.1	↓
4:	9.4	↖
5:	8.4	↗
Serie		46
Total		179

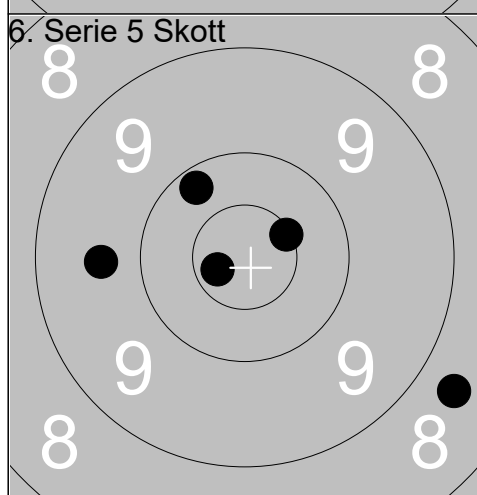

1:	10.7x	←
2:	9.7	←
3:	10.5x	↗
4:	10.2	↗
5:	8.7	↓
Serie		47
Total		226

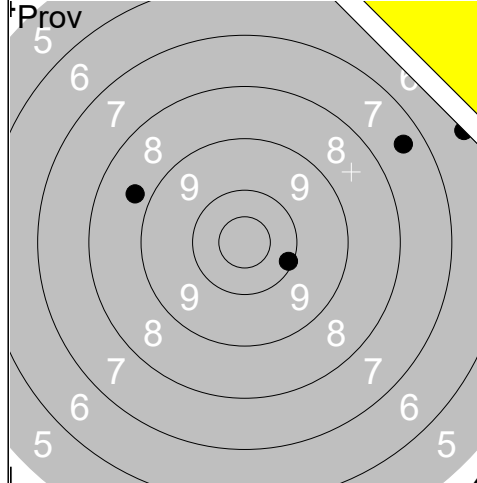

1:	6.1	↗
2:	6.3	↗
3:	8.7	↖
4:	10.1	↘
5:	7.4	↗
Serie		37
Total		0

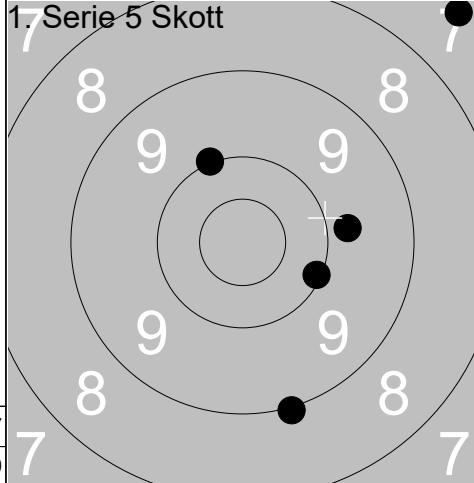

1:	10.1	↘
2:	9.8	→
3:	10.0	↖
4:	9.0	↘
5:	7.3	↗
Serie		45
Total		45

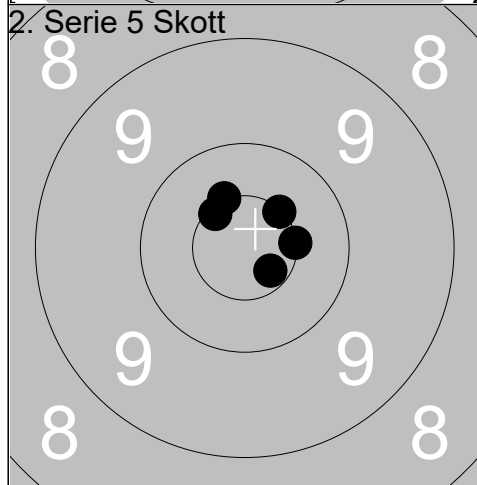

1:	10.6x	↖
2:	10.5x	↗
3:	10.5x	→
4:	10.7x	↘
5:	10.5x	↖
Serie		50
Total		95

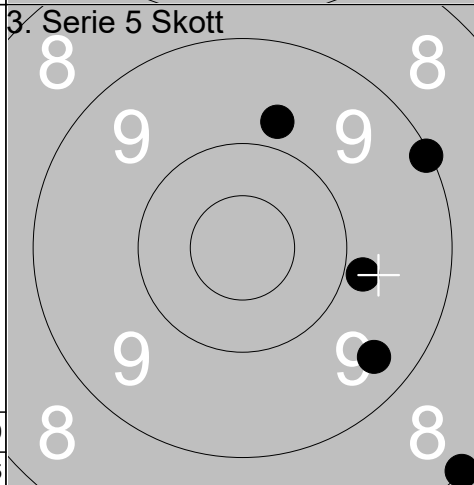

1:	9.1	↗
2:	9.9	↘
3:	8.0	↘
4:	9.4	↘
5:	9.8	↖
Serie		44
Total		139

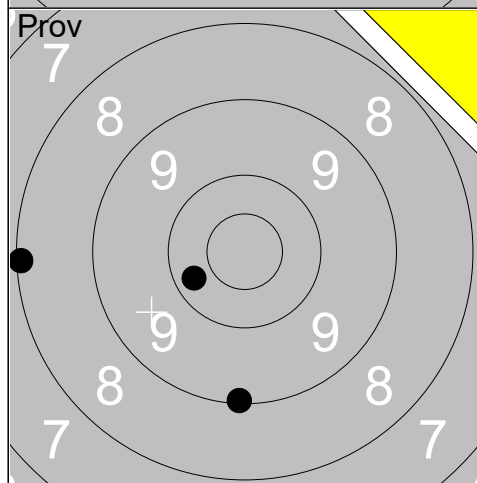

1:	8.1	←
2:	9.1	↓
3:	10.3	←
Serie		27
Total		139

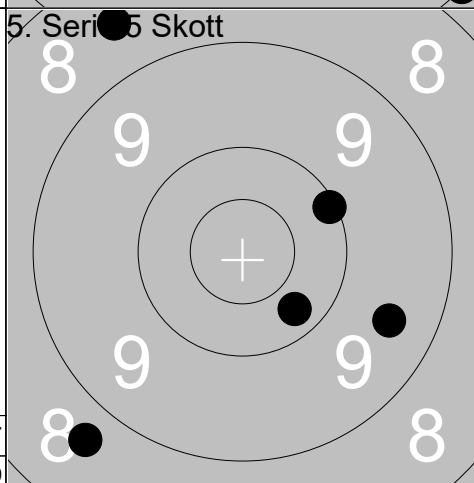

1:	10.3	↘
2:	9.5	↘
3:	8.5	↖
4:	10.1	↗
5:	8.7	↘
Serie		45
Total		184

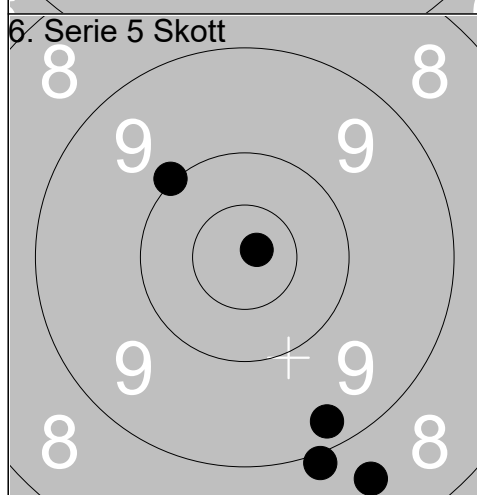

1:	10.0	↖
2:	8.9	↘
3:	9.3	↘
4:	8.6	↘
5:	10.8x	↗
Serie		45
Total		229

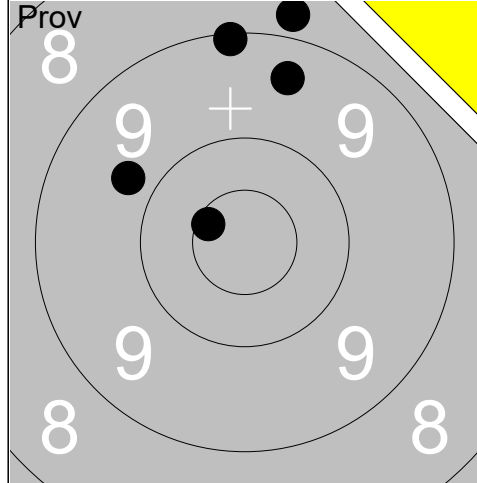

1:	9.8	↖
2:	9.1	↑
3:	8.8	↑
4:	10.6x	↖
5:	9.4	↑
Serie		45
Total		0

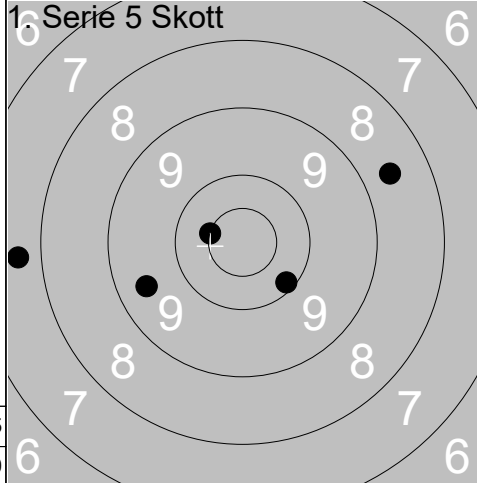

1:	8.6	↗
2:	9.5	↖
3:	10.1	↘
4:	7.7	↖
5:	10.5x	↖
Serie		44
Total		44

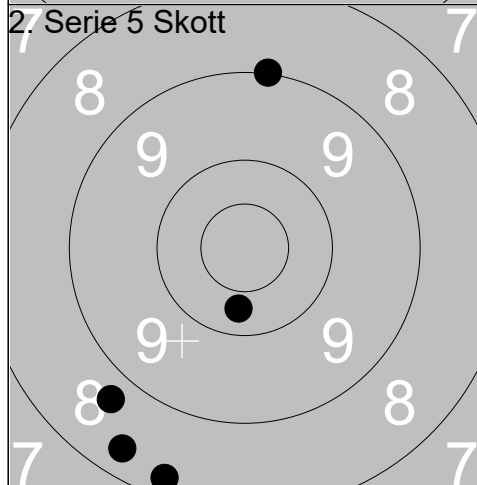

1:	8.4	↘
2:	10.3	↘
3:	8.3	↘
4:	8.7	↘
5:	9.0	↑
Serie		43
Total		87

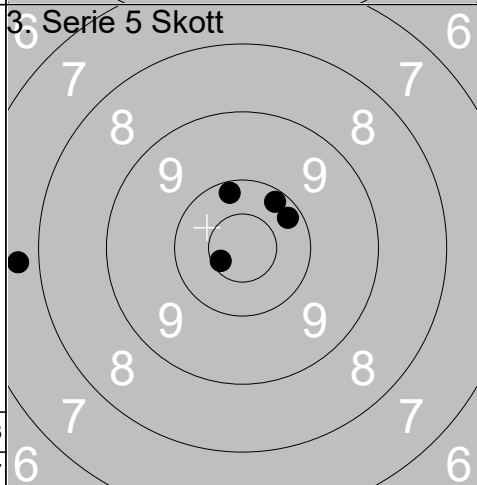

1:	7.7	↖
2:	10.2	↗
3:	10.6x	↖
4:	10.2	↗
5:	10.2	↑
Serie		47
Total		134

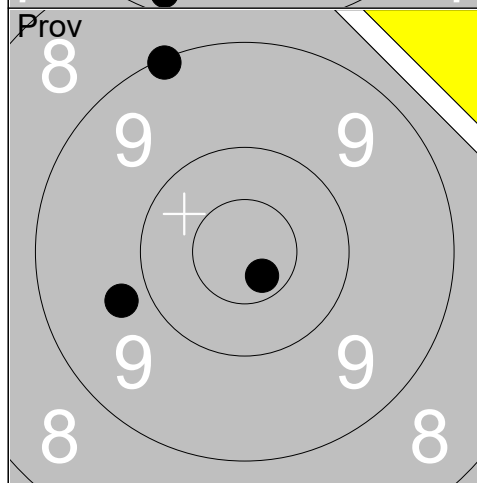

1:	9.1	↗
2:	9.8	↖
3:	10.7x	↘
Serie		28
Total		134

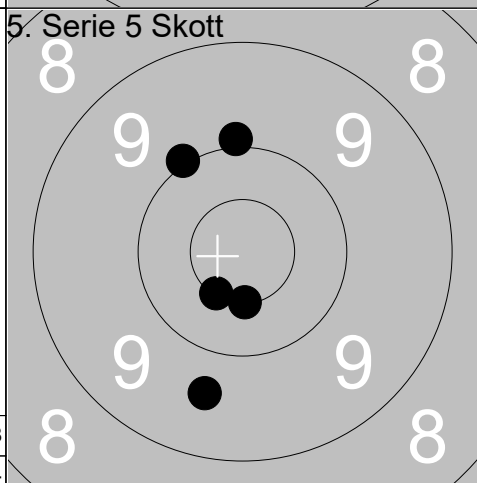

1:	10.0	↖
2:	10.5x	↘
3:	10.5x	↖
4:	9.6	↘
5:	10.0	↑
Serie		49
Total		183

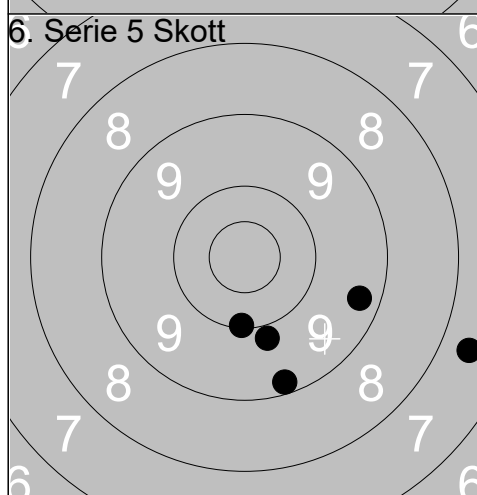

1:	7.6	↗
2:	9.9	↘
3:	10.1	↘
4:	9.2	↘
5:	9.3	↗
Serie		44
Total		227

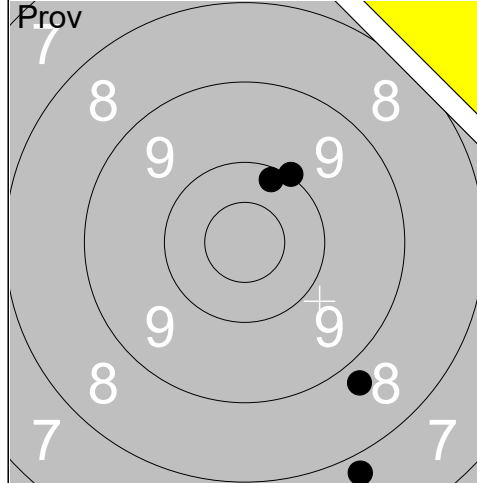

1:	7.8	↘
2:	8.8	↘
3:	10.0	↗
4:	10.2	↗
Serie		35
Total		0

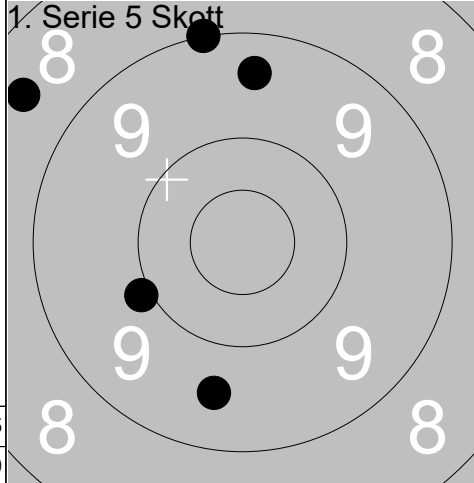

1:	9.0	↑
2:	9.4	↑
3:	8.5	↖
4:	9.6	↘
5:	9.9	↙
Serie		44
Total		44

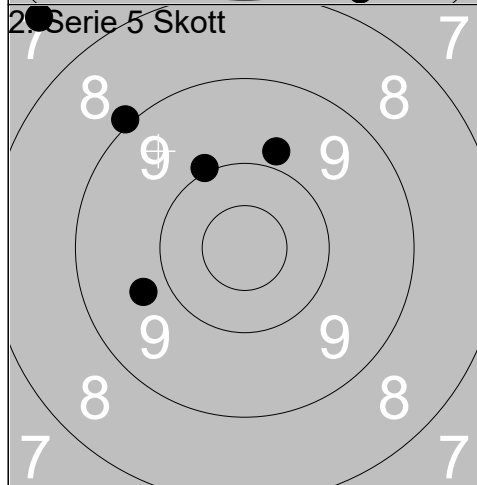

1:	9.7	↖
2:	7.4	↗
3:	10.0	↗
4:	9.0	↗
5:	9.8	↗
Serie		44
Total		88

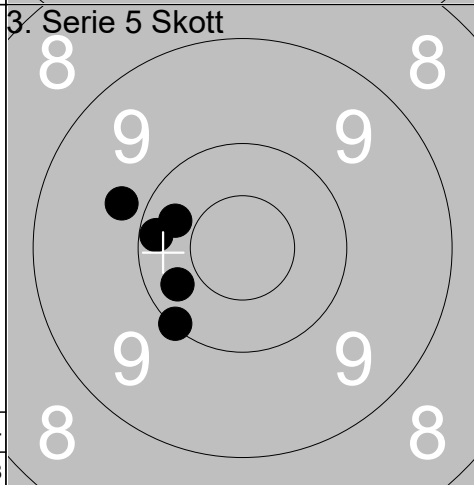

1:	9.8	↖
2:	10.3	↖
3:	10.3	↖
4:	10.2	↖
5:	10.1	↙
Serie		49
Total		137

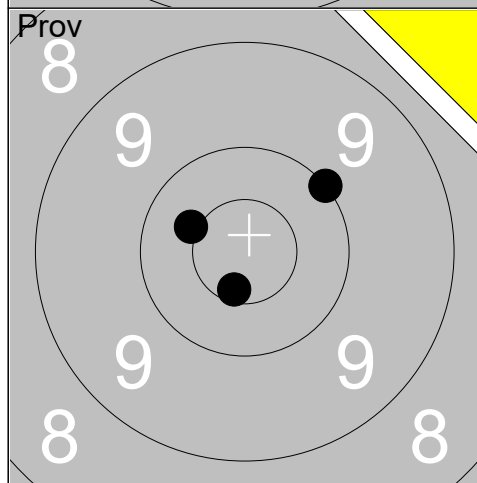

1:	10.0	↗
2:	10.4x	↖
3:	10.6x	↘
Serie		30
Total		137

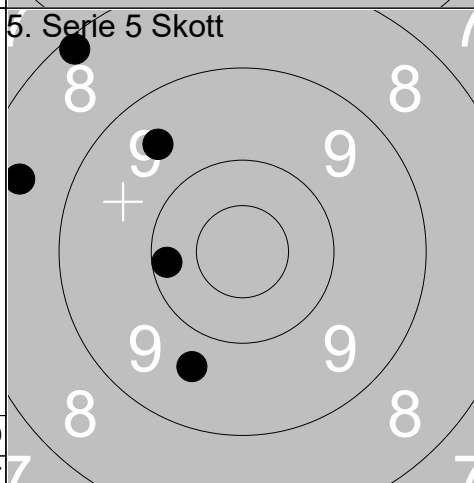

1:	8.5	↖
2:	9.5	↗
3:	10.2	↖
4:	8.2	↗
5:	9.7	↘
Serie		44
Total		181

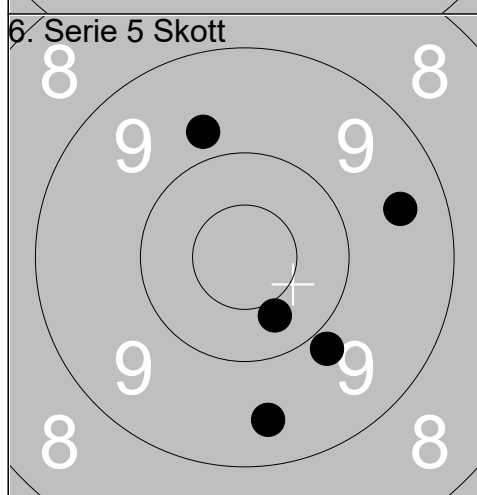

1:	9.8	↗
2:	9.9	↘
3:	10.4	↘
4:	9.5	→
5:	9.5	↘
Serie		46
Total		227

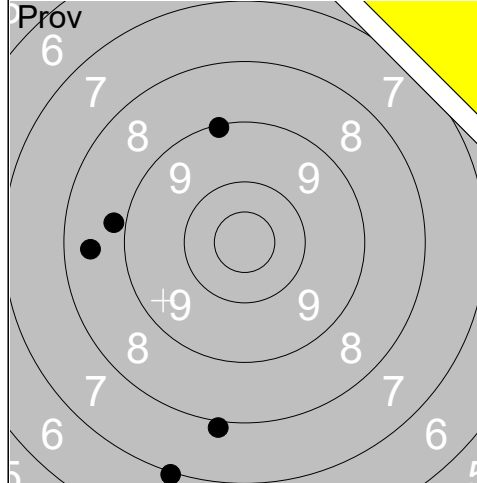

1:	7.0	↘
2:	7.9	↘
3:	9.1	↗
4:	8.5	←
5:	8.8	←
Serie		39
Total		0

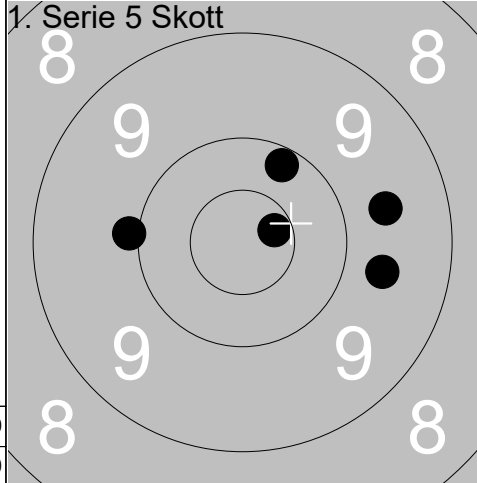

1:	9.6	→
2:	10.6x	→
3:	10.2	↗
4:	9.9	←
5:	9.7	→
Serie		47
Total		47

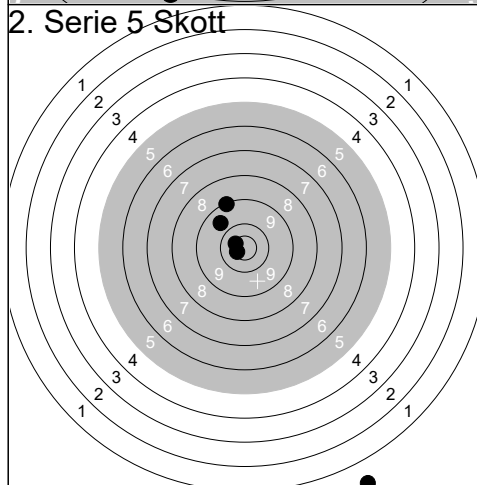

1:	9.6	↗
2:	0.0	↘
3:	10.6x	←
4:	9.1	↗
5:	10.6x	↖
Serie		38
Total		85

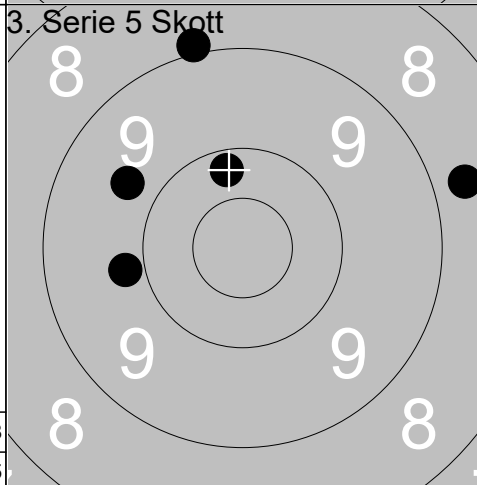

1:	9.8	←
2:	10.2	↗
3:	8.9	↗
4:	9.7	↖
5:	8.7	→
Serie		44
Total		129

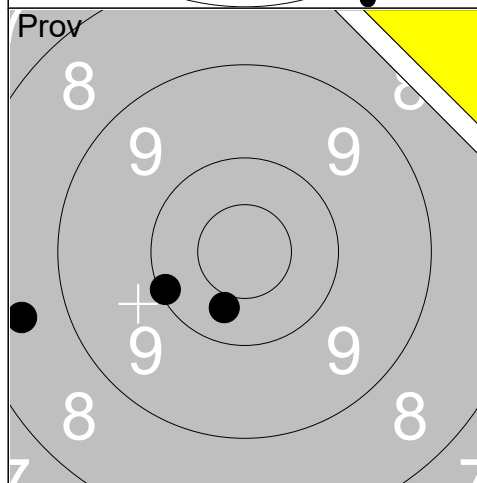

1:	10.1	←
2:	8.5	←
3:	10.4	↘
Serie		28
Total		129

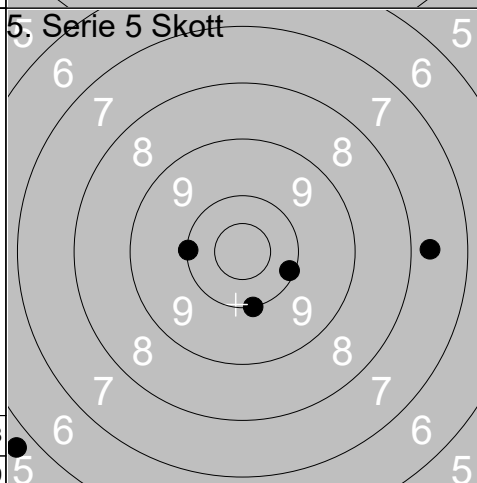

1:	5.7	↖
2:	10.1	←
3:	10.0	↘
4:	10.1	→
5:	7.7	→
Serie		42
Total		171

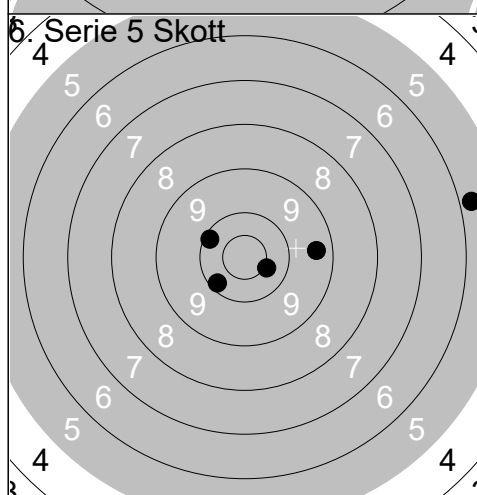

1:	10.1	↗
2:	10.4x	↘
3:	9.4	→
4:	10.2	↖
5:	5.8	→
Serie		44
Total		215

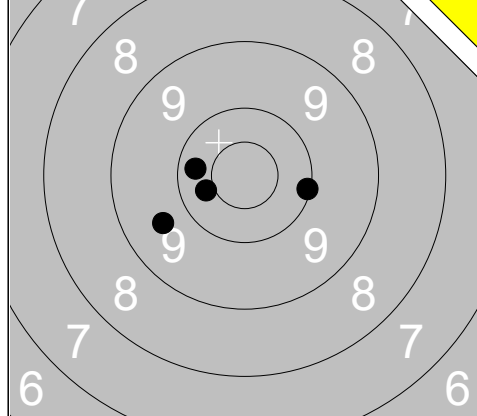

1:	9.6	↙
2:	10.3	←
3:	10.1	→
4:	7.6	↑
5:	10.4	←
Serie		46
Total		0

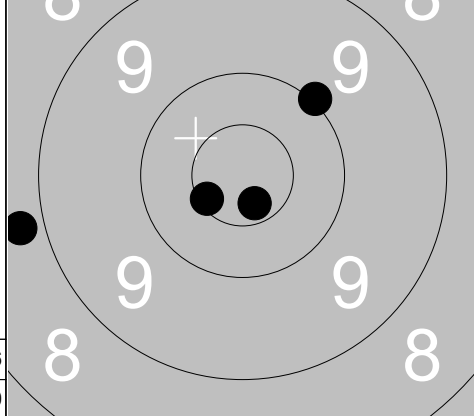

1:	10.0	↗
2:	8.8	↑
3:	10.7x	↓
4:	10.6x	↙
5:	8.8	←
Serie		46
Total		46

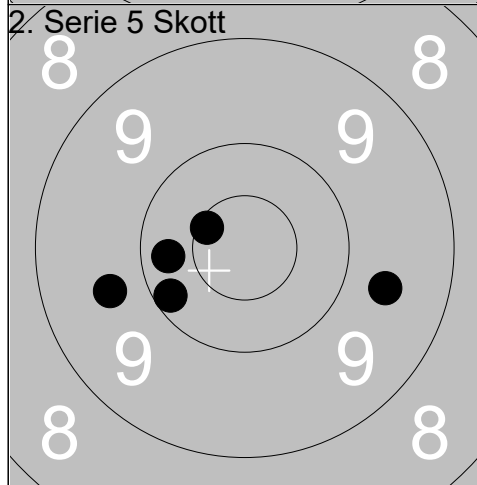

1:	10.6x	↙
2:	9.7	←
3:	9.6	→
4:	10.2	↙
5:	10.3	←
Serie		48
Total		94

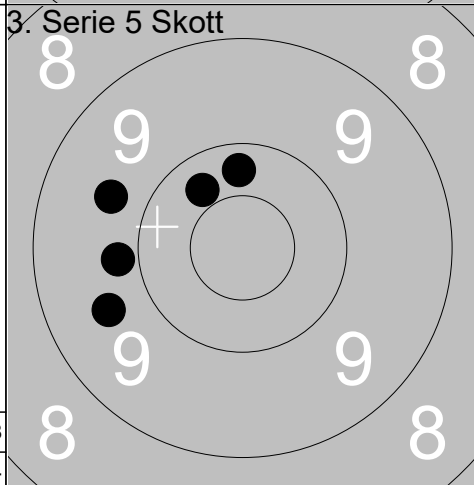

1:	9.6	←
2:	9.8	←
3:	10.3	↑
4:	10.3	↗
5:	9.7	↙
Serie		47
Total		141

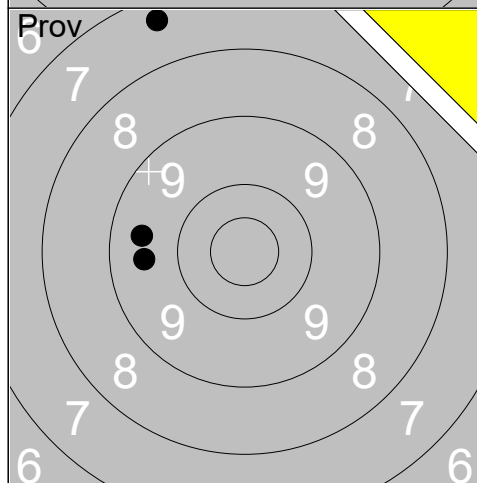

1:	9.5	←
2:	7.4	↑
3:	9.5	←
Serie		25
Total		141

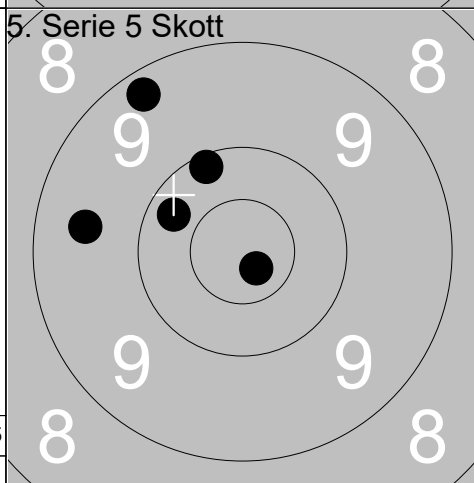

1:	9.3	↗
2:	10.1	↗
3:	9.5	←
4:	10.3	↗
5:	10.8x	↘
Serie		48
Total		189

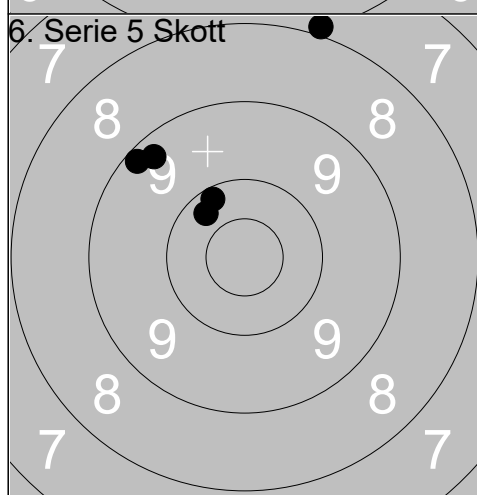

1:	10.2	↗
2:	9.2	↗
3:	7.9	↑
4:	9.3	↗
5:	10.3	↗
Serie		45
Total		234



<p>Prov</p>	<table style="width:100%; border-collapse: collapse;"> <tr><td>1:</td><td>10.1</td><td>←</td></tr> <tr><td>2:</td><td>9.8</td><td>↓</td></tr> <tr><td>3:</td><td>10.4</td><td>↓</td></tr> <tr><td>4:</td><td>9.9</td><td>↗</td></tr> <tr><td>5:</td><td>9.7</td><td>↓</td></tr> <tr><td colspan="2">Serie</td><td>47</td></tr> <tr><td colspan="2">Total</td><td>0</td></tr> </table>	1:	10.1	←	2:	9.8	↓	3:	10.4	↓	4:	9.9	↗	5:	9.7	↓	Serie		47	Total		0	<p>1. Serie 5 Skott</p> <table style="width:100%; border-collapse: collapse;"> <tr><td>1:</td><td>9.1</td><td>↑</td></tr> <tr><td>2:</td><td>9.8</td><td>↓</td></tr> <tr><td>3:</td><td>10.1</td><td>↓</td></tr> <tr><td>4:</td><td>8.6</td><td>↓</td></tr> <tr><td>5:</td><td>9.4</td><td>→</td></tr> <tr><td colspan="2">Serie</td><td>45</td></tr> <tr><td colspan="2">Total</td><td>45</td></tr> </table>	1:	9.1	↑	2:	9.8	↓	3:	10.1	↓	4:	8.6	↓	5:	9.4	→	Serie		45	Total		45
1:	10.1	←																																										
2:	9.8	↓																																										
3:	10.4	↓																																										
4:	9.9	↗																																										
5:	9.7	↓																																										
Serie		47																																										
Total		0																																										
1:	9.1	↑																																										
2:	9.8	↓																																										
3:	10.1	↓																																										
4:	8.6	↓																																										
5:	9.4	→																																										
Serie		45																																										
Total		45																																										
<p>2. Serie 5 Skott</p>	<table style="width:100%; border-collapse: collapse;"> <tr><td>1:</td><td>9.4</td><td>←</td></tr> <tr><td>2:</td><td>10.3</td><td>↘</td></tr> <tr><td>3:</td><td>10.6x</td><td>↓</td></tr> <tr><td>4:</td><td>9.3</td><td>↓</td></tr> <tr><td>5:</td><td>8.9</td><td>↙</td></tr> <tr><td colspan="2">Serie</td><td>46</td></tr> <tr><td colspan="2">Total</td><td>91</td></tr> </table>	1:	9.4	←	2:	10.3	↘	3:	10.6x	↓	4:	9.3	↓	5:	8.9	↙	Serie		46	Total		91	<p>3. Serie 5 Skott</p> <table style="width:100%; border-collapse: collapse;"> <tr><td>1:</td><td>10.0</td><td>↗</td></tr> <tr><td>2:</td><td>10.5x</td><td>→</td></tr> <tr><td>3:</td><td>9.9</td><td>→</td></tr> <tr><td>4:</td><td>9.3</td><td>↗</td></tr> <tr><td>5:</td><td>10.6x</td><td>↑</td></tr> <tr><td colspan="2">Serie</td><td>48</td></tr> <tr><td colspan="2">Total</td><td>139</td></tr> </table>	1:	10.0	↗	2:	10.5x	→	3:	9.9	→	4:	9.3	↗	5:	10.6x	↑	Serie		48	Total		139
1:	9.4	←																																										
2:	10.3	↘																																										
3:	10.6x	↓																																										
4:	9.3	↓																																										
5:	8.9	↙																																										
Serie		46																																										
Total		91																																										
1:	10.0	↗																																										
2:	10.5x	→																																										
3:	9.9	→																																										
4:	9.3	↗																																										
5:	10.6x	↑																																										
Serie		48																																										
Total		139																																										
<p>Prov</p>	<table style="width:100%; border-collapse: collapse;"> <tr><td>1:</td><td>9.0</td><td>↗</td></tr> <tr><td>2:</td><td>10.5x</td><td>→</td></tr> <tr><td>3:</td><td>8.8</td><td>↓</td></tr> <tr><td colspan="2">Serie</td><td>27</td></tr> <tr><td colspan="2">Total</td><td>139</td></tr> </table>	1:	9.0	↗	2:	10.5x	→	3:	8.8	↓	Serie		27	Total		139	<p>5. Serie 5 Skott</p> <table style="width:100%; border-collapse: collapse;"> <tr><td>1:</td><td>9.3</td><td>↗</td></tr> <tr><td>2:</td><td>10.3</td><td>↘</td></tr> <tr><td>3:</td><td>8.9</td><td>↓</td></tr> <tr><td>4:</td><td>8.7</td><td>↓</td></tr> <tr><td>5:</td><td>10.1</td><td>↗</td></tr> <tr><td colspan="2">Serie</td><td>45</td></tr> <tr><td colspan="2">Total</td><td>184</td></tr> </table>	1:	9.3	↗	2:	10.3	↘	3:	8.9	↓	4:	8.7	↓	5:	10.1	↗	Serie		45	Total		184						
1:	9.0	↗																																										
2:	10.5x	→																																										
3:	8.8	↓																																										
Serie		27																																										
Total		139																																										
1:	9.3	↗																																										
2:	10.3	↘																																										
3:	8.9	↓																																										
4:	8.7	↓																																										
5:	10.1	↗																																										
Serie		45																																										
Total		184																																										
<p>6. Serie 5 Skott</p>	<table style="width:100%; border-collapse: collapse;"> <tr><td>1:</td><td>10.4x</td><td>←</td></tr> <tr><td>2:</td><td>9.4</td><td>↓</td></tr> <tr><td>3:</td><td>10.3</td><td>→</td></tr> <tr><td>4:</td><td>8.2</td><td>↓</td></tr> <tr><td>5:</td><td>8.8</td><td>↓</td></tr> <tr><td colspan="2">Serie</td><td>45</td></tr> <tr><td colspan="2">Total</td><td>229</td></tr> </table>	1:	10.4x	←	2:	9.4	↓	3:	10.3	→	4:	8.2	↓	5:	8.8	↓	Serie		45	Total		229																						
1:	10.4x	←																																										
2:	9.4	↓																																										
3:	10.3	→																																										
4:	8.2	↓																																										
5:	8.8	↓																																										
Serie		45																																										
Total		229																																										

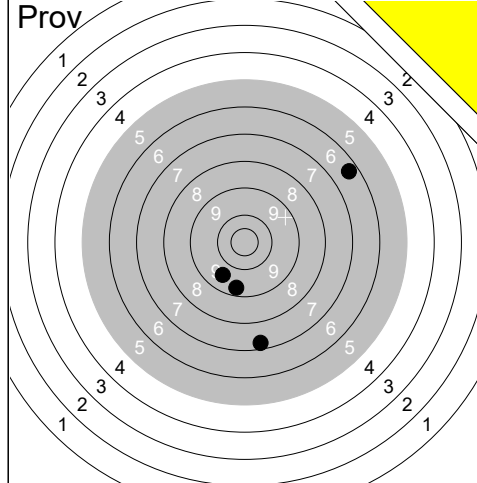

1:	6.4	↗
2:	1.4	↑
3:	7.3	↓
4:	9.6	↓
5:	9.3	↓

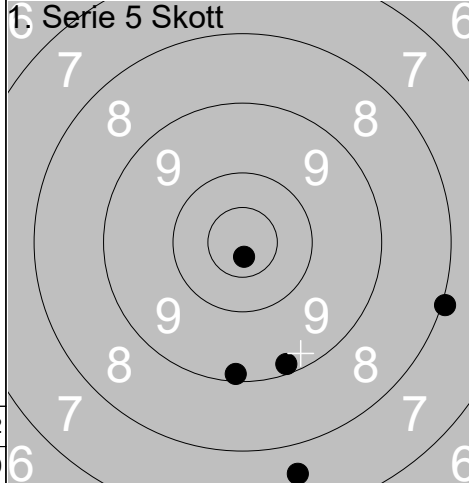

1:	8.0	→
2:	7.6	↓
3:	9.1	↓
4:	10.8x	↓
5:	9.2	↓

Serie	32
Total	0

Serie	43
Total	43

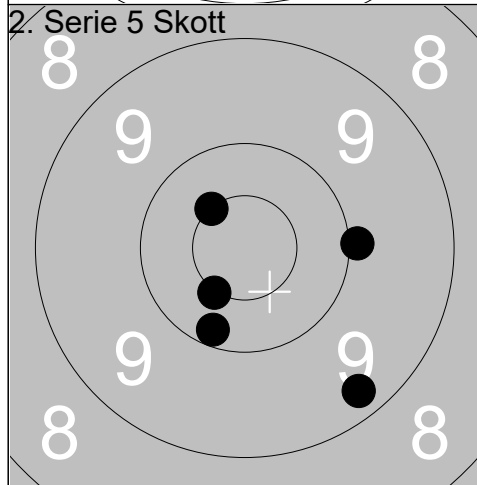

1:	10.2	↓
2:	9.3	↓
3:	10.5x	↓
4:	10.5x	↗
5:	10.0	→

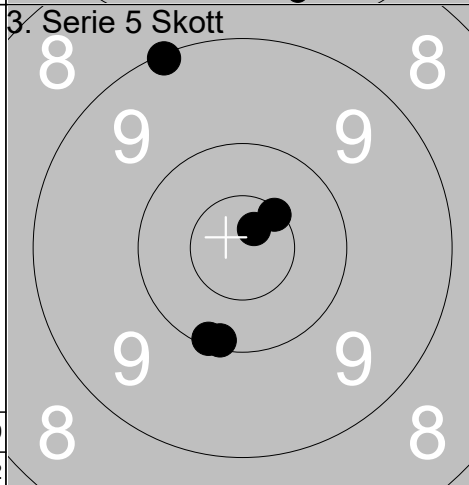

1:	10.5x	↗
2:	10.8x	↗
3:	10.1	↓
4:	10.1	↓
5:	9.1	↗

Serie	49
Total	92

Serie	49
Total	141

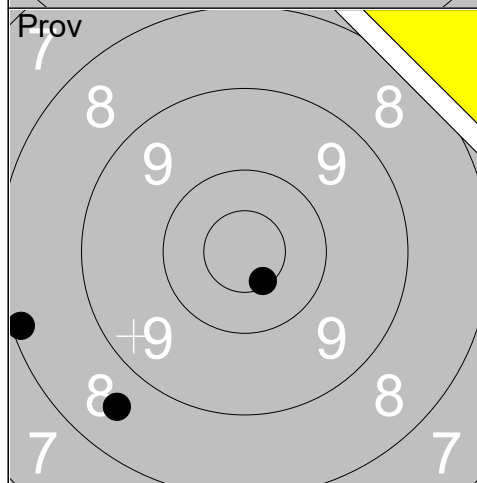

1:	10.6x	↓
2:	8.6	↓
3:	8.1	←

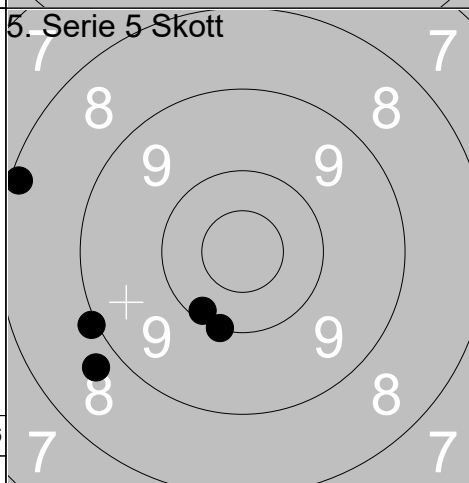

1:	10.1	↓
2:	8.7	←
3:	8.1	←
4:	9.0	←
5:	10.0	↓

Serie	26
Total	141

Serie	45
Total	186

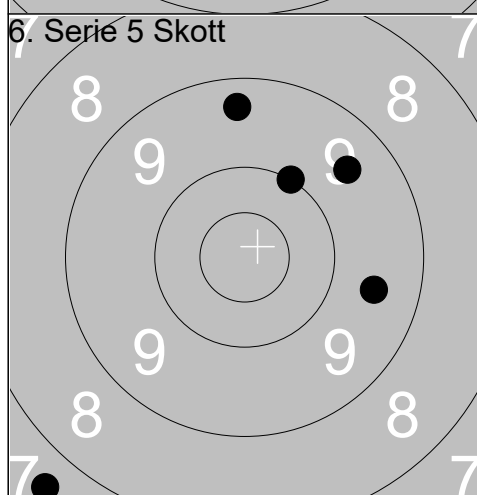

1:	9.3	↑
2:	9.5	↗
3:	10.0	↗
4:	9.5	→
5:	7.6	↓

Serie	44
Total	230

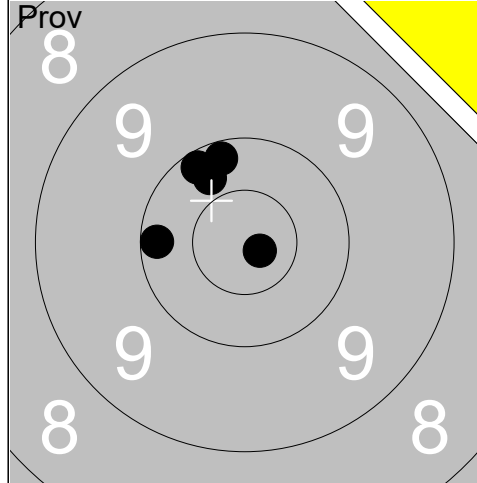

1:	10.3	↗
2:	10.2	←
3:	10.2	↗
4:	10.2	↗
5:	10.8x	↘
Serie		50
Total		0

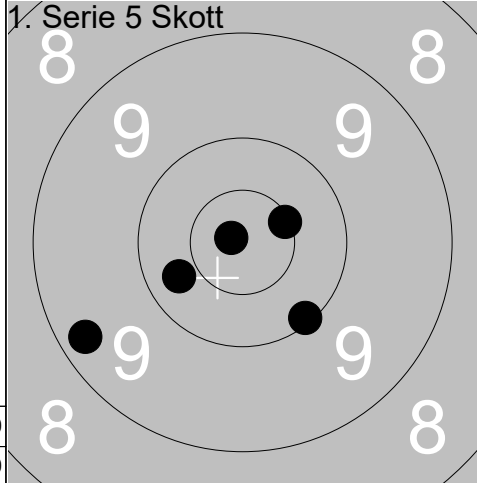

1:	10.5x	↗
2:	10.1	↘
3:	10.3	←
4:	9.3	←
5:	10.8x	←
Serie		49
Total		49

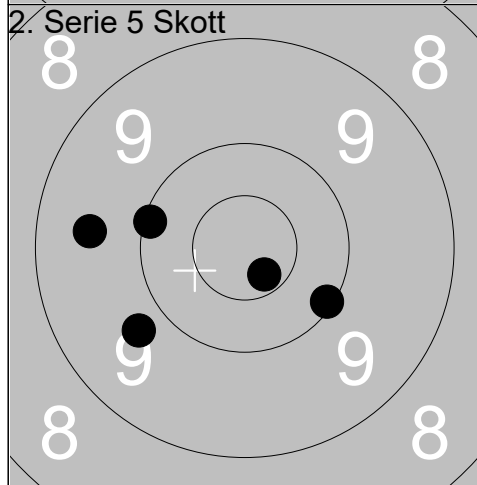

1:	10.7x	↘
2:	9.7	←
3:	10.1	←
4:	10.1	↘
5:	9.5	←
Serie		48
Total		97

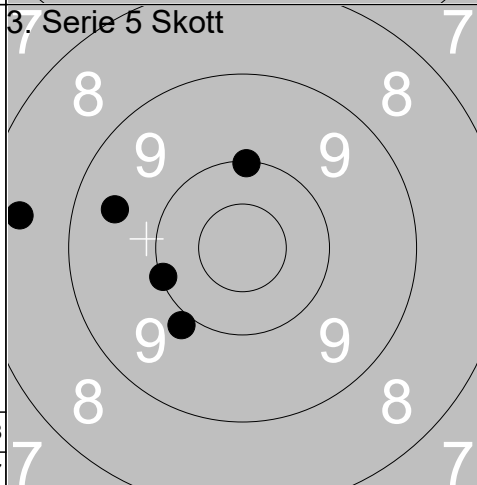

1:	10.1	↑
2:	8.4	←
3:	9.9	↘
4:	10.1	←
5:	9.5	←
Serie		46
Total		143

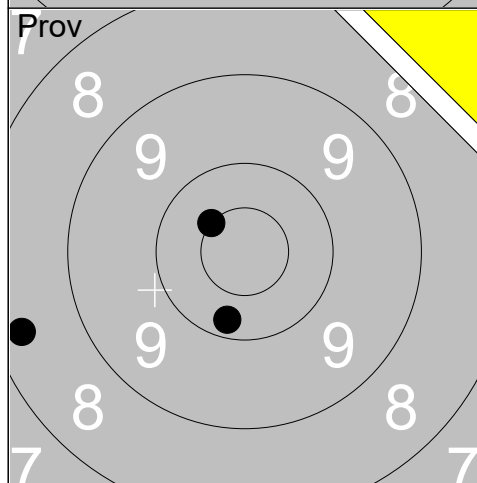

1:	8.3	←
2:	10.2	↘
3:	10.5x	↗
Serie		28
Total		143

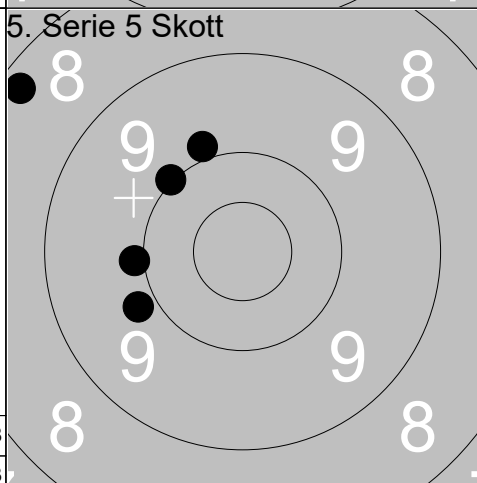

1:	8.2	↖
2:	10.0	↗
3:	9.9	↗
4:	9.9	←
5:	9.8	←
Serie		45
Total		188

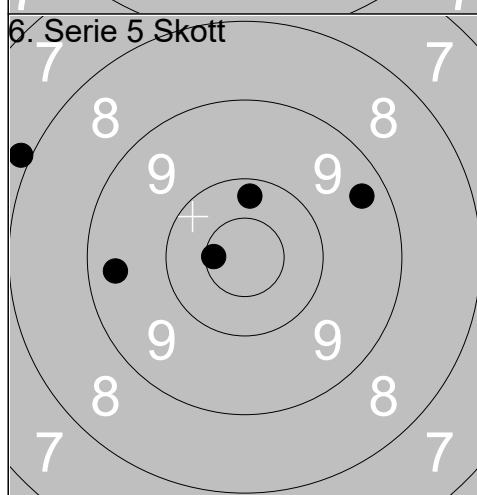

1:	7.9	←
2:	10.2	↑
3:	9.4	←
4:	10.6x	←
5:	9.3	↗
Serie		45
Total		233

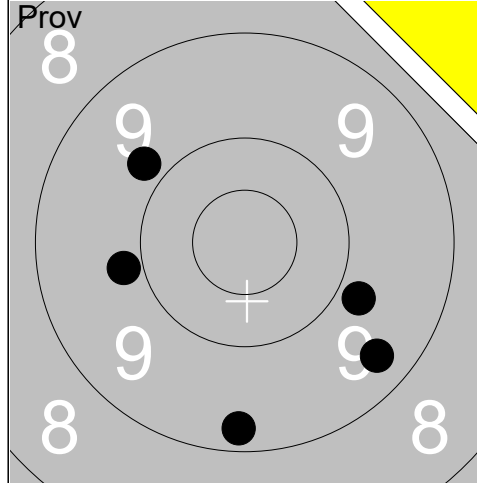

1:	9.8	↘
2:	9.8	↗
3:	9.9	←
4:	9.4	↙
5:	9.3	↓
Serie		45
Total		0

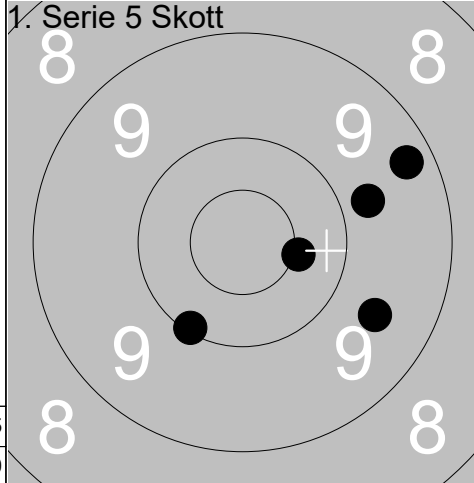

1:	9.3	↗
2:	9.6	↘
3:	10.4x	→
4:	10.1	↙
5:	9.8	→
Serie		47
Total		47

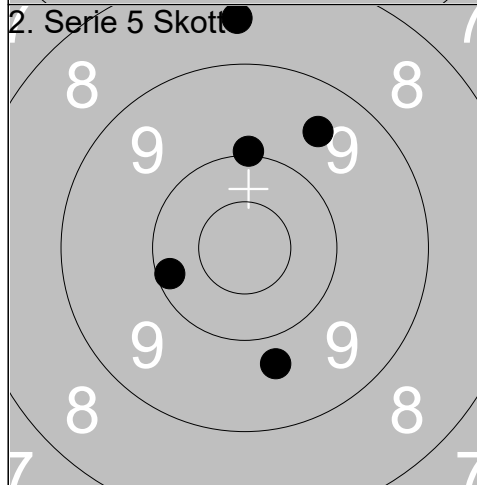

1:	8.5	↑
2:	10.2	←
3:	9.7	↙
4:	9.5	↗
5:	10.0	↑
Serie		46
Total		93

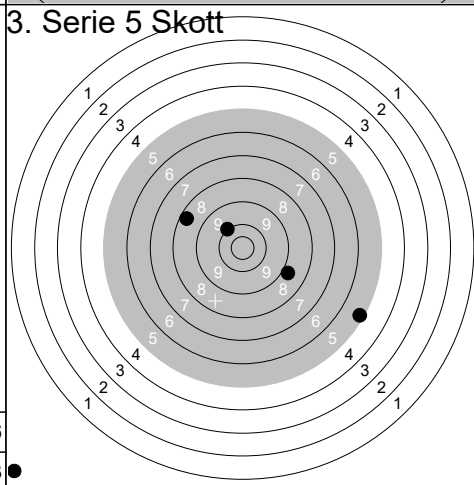

1:	8.3	↖
2:	8.8	↘
3:	10.0	↗
4:	5.2	↙
5:	0.0	↘
Serie		31
Total		124

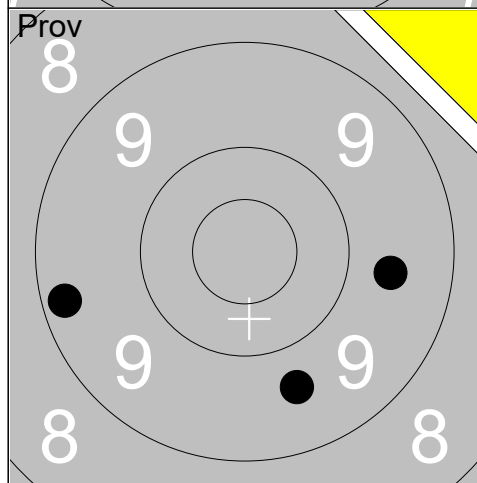

1:	9.3	←
2:	9.6	↙
3:	9.6	→
Serie		27
Total		124

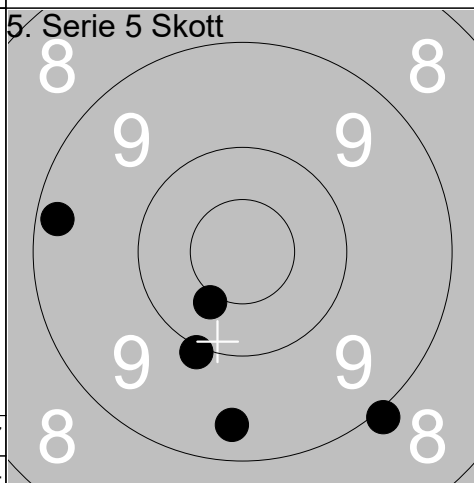

1:	9.2	←
2:	9.4	↓
3:	10.4x	↙
4:	10.0	↙
5:	9.0	↙
Serie		47
Total		171

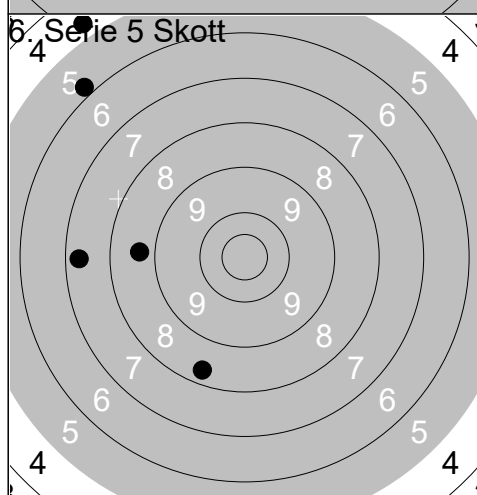

1:	7.3	←
2:	8.7	←
3:	8.3	↙
4:	4.7	↗
5:	5.8	↗
Serie		32
Total		203

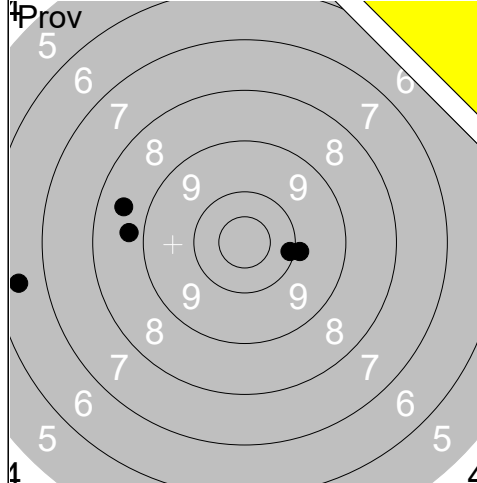

1:	8.7	←
2:	8.5	←
3:	6.5	←
4:	9.9	→
5:	10.1	→
Serie		41
Total		0

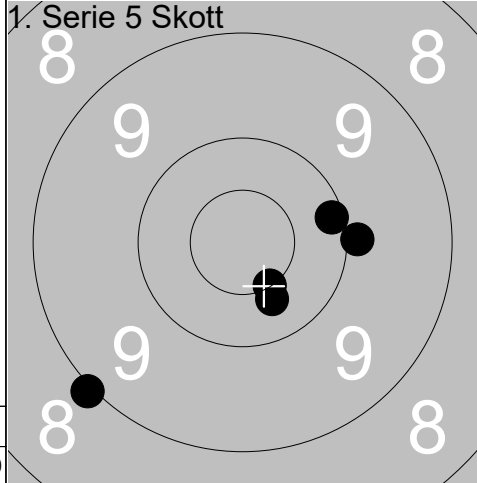

1:	9.9	→
2:	10.1	→
3:	9.0	↙
4:	10.5x	↘
5:	10.4	↘
Serie		48
Total		48

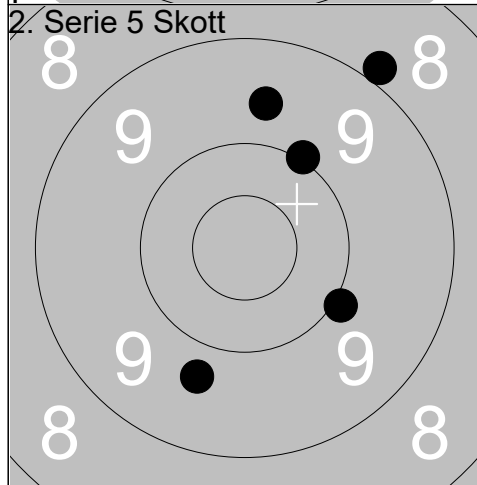

1:	9.6	↑
2:	10.0	→
3:	9.7	↘
4:	10.0	↗
5:	8.9	↗
Serie		46
Total		94

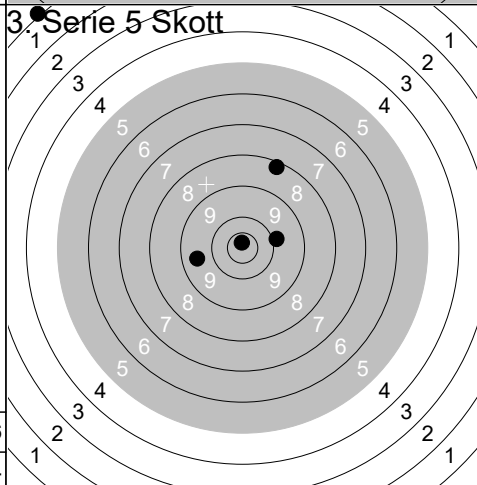

1:	10.8x	↑
2:	9.9	→
3:	9.5	←
4:	8.2	↑
5:	1.0	↖
Serie		37
Total		131

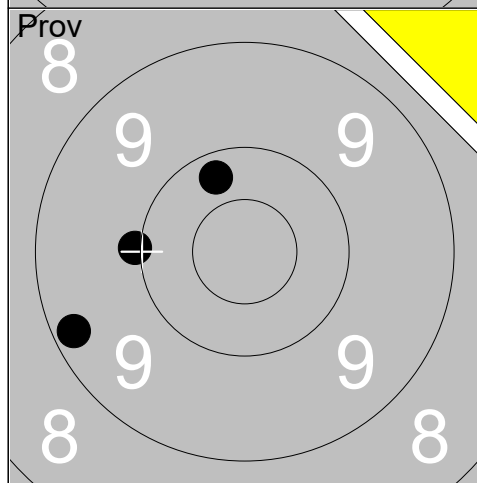

1:	9.2	←
2:	10.2	↑
3:	10.0	←
Serie		29
Total		131

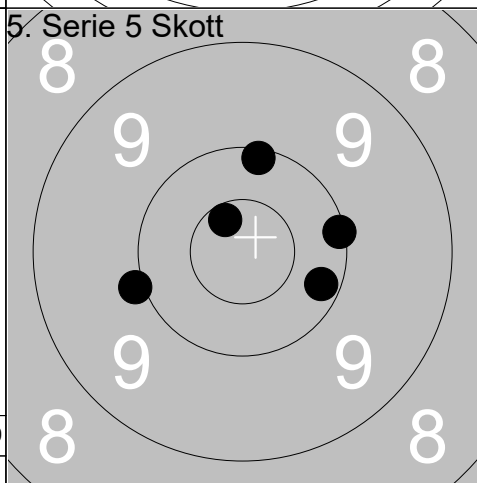

1:	10.1	↑
2:	10.2	→
3:	10.1	→
4:	10.6x	↗
5:	10.0	←
Serie		50
Total		181

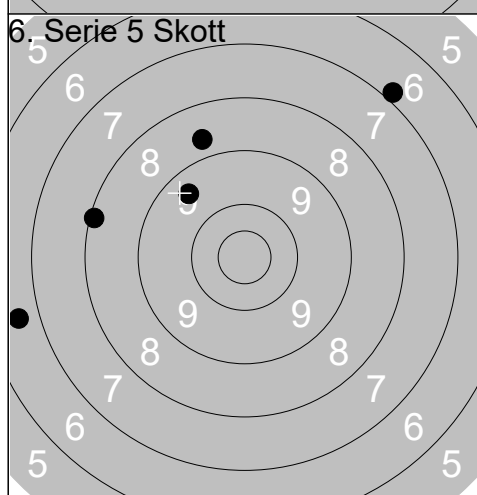

1:	8.1	←
2:	9.4	↗
3:	6.9	↗
4:	8.7	↗
5:	6.6	←
Serie		37
Total		218

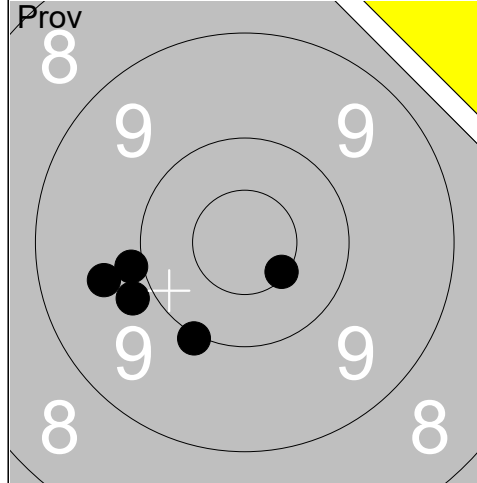

1:	9.8	↙
2:	9.9	←
3:	9.6	←
4:	10.5x	↘
5:	10.0	↘
Serie		47
Total		0

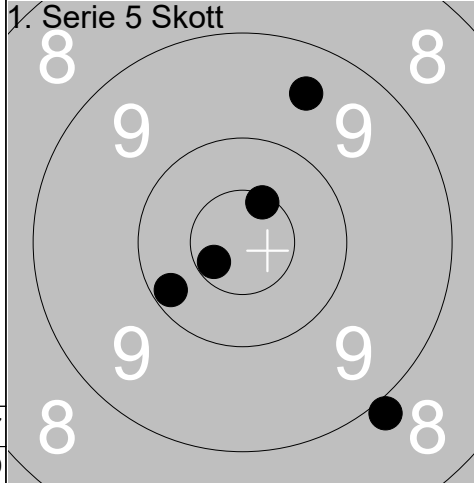

1:	9.5	↗
2:	8.9	↘
3:	10.2	↙
4:	10.6x	↙
5:	10.6x	↗
Serie		47
Total		47

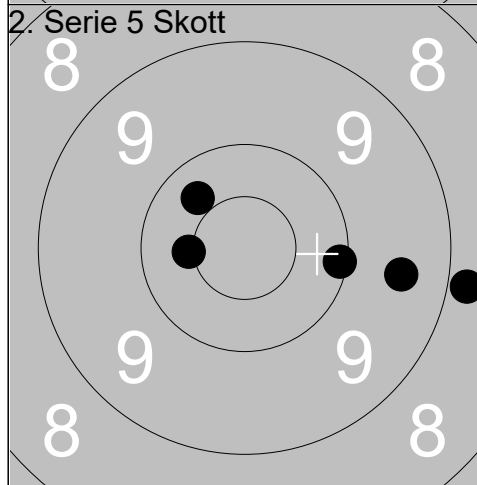

1:	10.3	↗
2:	10.1	→
3:	10.4x	←
4:	9.5	→
5:	8.9	→
Serie		47
Total		94

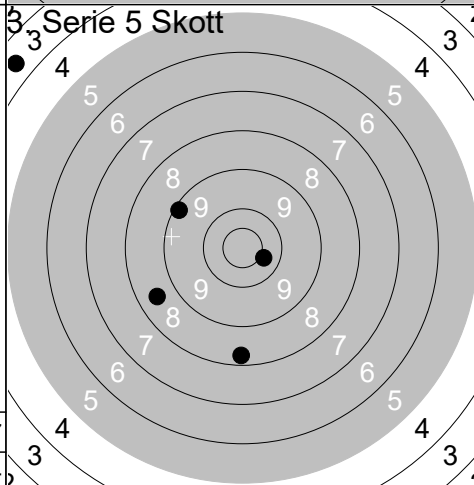

1:	8.5	↙
2:	10.4	→
3:	8.3	↓
4:	3.6	↗
5:	9.1	↗
Serie		38
Total		132

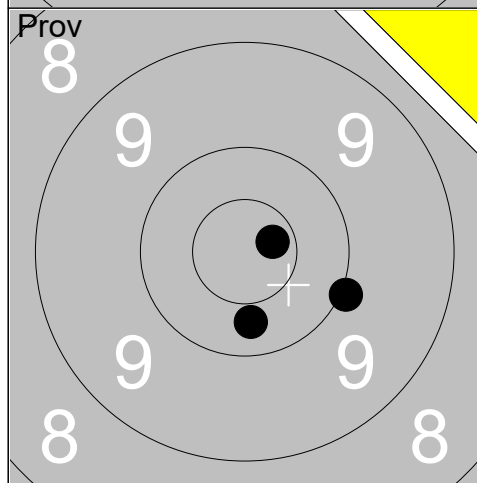

1:	10.0	→
2:	10.7x	→
3:	10.3	↓
Serie		30
Total		132

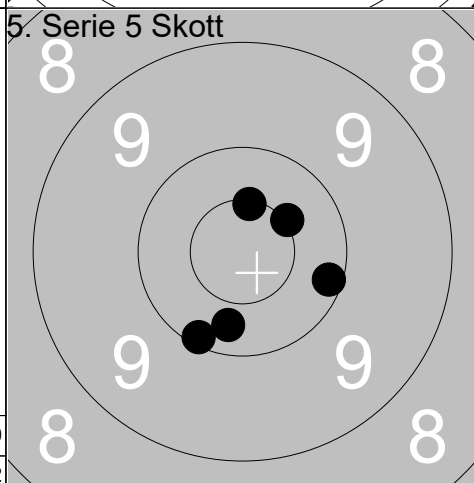

1:	10.5x	↑
2:	10.1	→
3:	10.3	↓
4:	10.5x	↗
5:	10.1	↘
Serie		50
Total		182

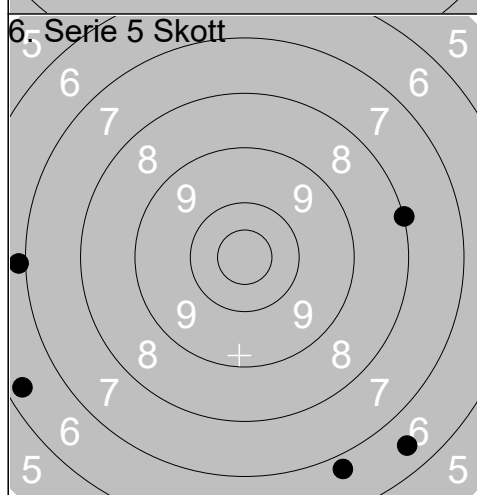

1:	6.9	←
2:	8.0	→
3:	6.3	↙
4:	6.5	↘
5:	6.8	↘
Serie		32
Total		214

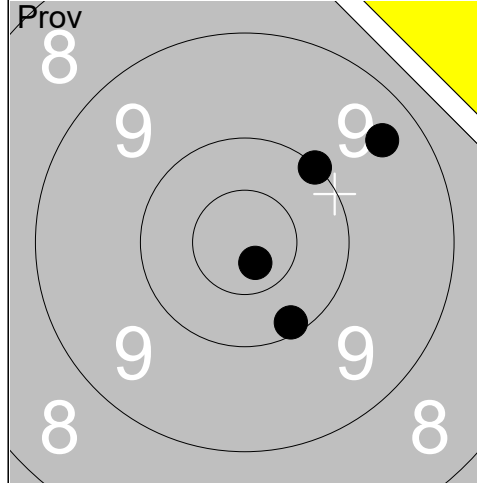

1:	8.6	↗
2:	10.0	↗
3:	9.4	↗
4:	10.1	↘
5:	10.7x	↘
Serie		47
Total		0

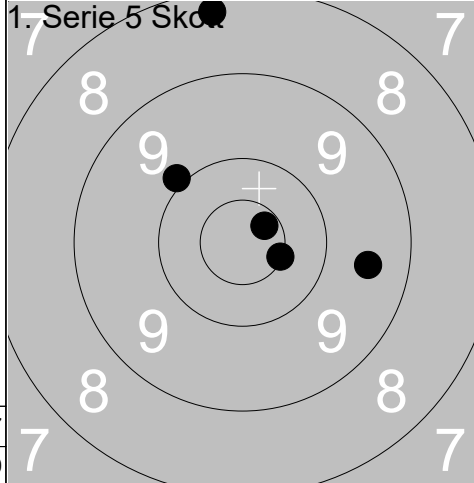

1:	8.3	↑
2:	10.6x	↗
3:	9.9	↗
4:	9.5	→
5:	10.5x	↘
Serie		46
Total		46

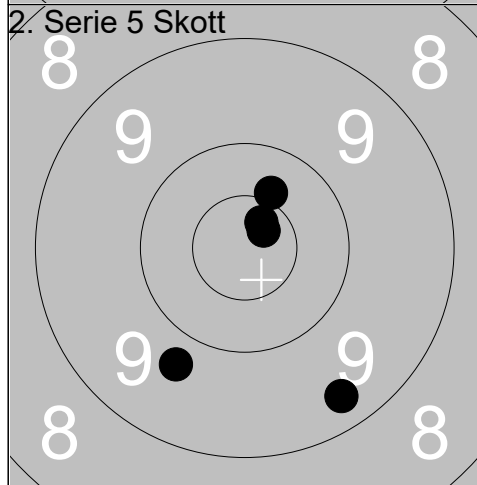

1:	10.7x	↗
2:	10.7x	↗
3:	10.4	↗
4:	9.3	↘
5:	9.7	↘
Serie		48
Total		94

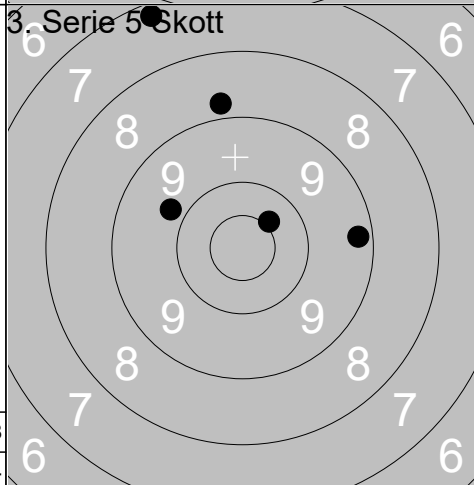

1:	9.8	↖
2:	10.4x	↗
3:	8.8	↑
4:	9.3	→
5:	7.2	↑
Serie		43
Total		137

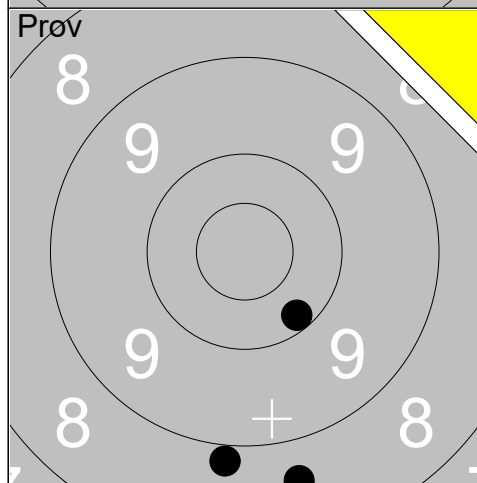

1:	10.2	↘
2:	8.9	↘
3:	8.6	↘
Serie		26
Total		137

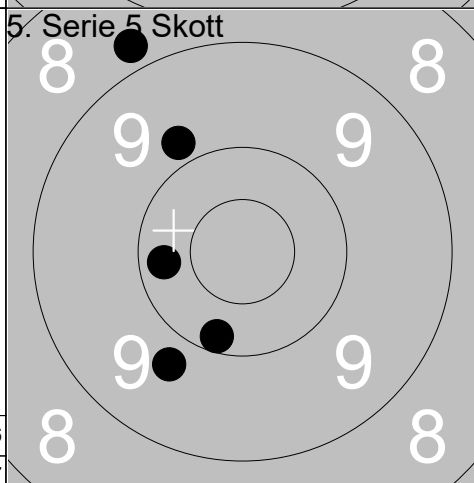

1:	9.7	↘
2:	9.8	↗
3:	8.8	↗
4:	10.3	↖
5:	10.2	↘
Serie		46
Total		183

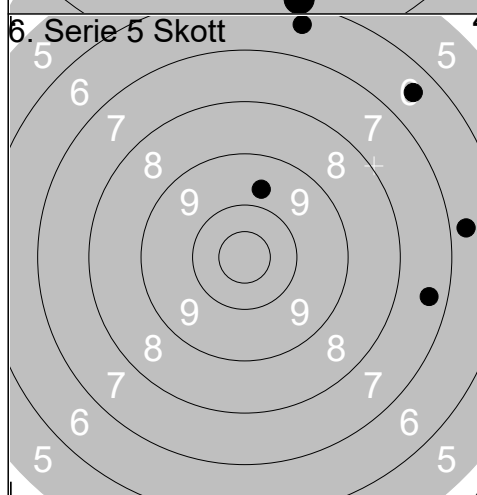

1:	9.7	↑
2:	6.5	↗
3:	6.7	→
4:	7.4	→
5:	6.4	↑
Serie		34
Total		217

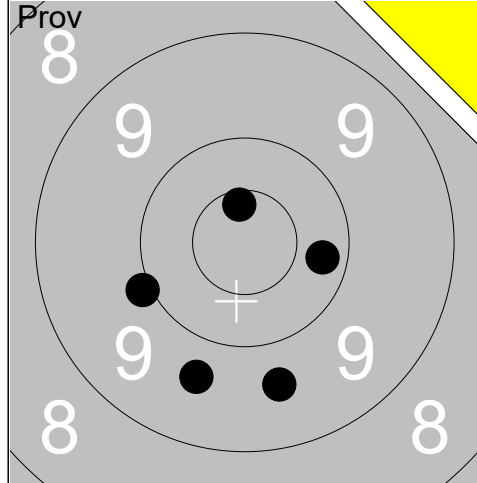

1:	9.6	↘
2:	10.6x	↑
3:	9.7	↘
4:	10.0	↙
5:	10.2	→
Serie		48
Total		0

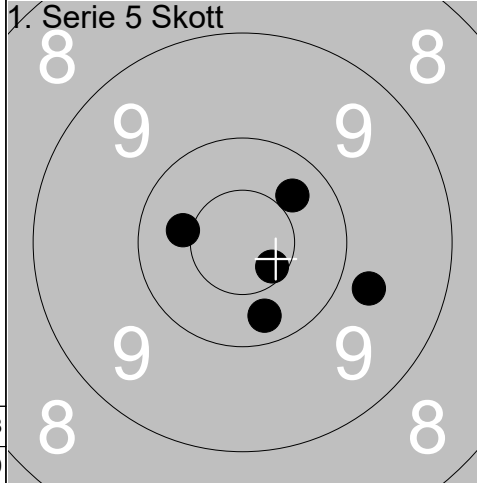

1:	9.7	→
2:	10.6x	↘
3:	10.3	↗
4:	10.4	↙
5:	10.3	↘
Serie		49
Total		49

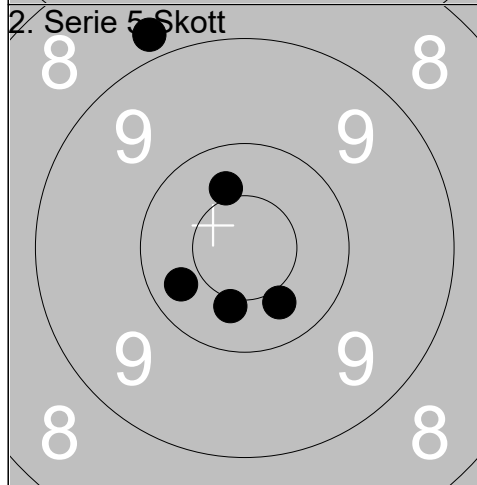

1:	8.8	↗
2:	10.4x	↘
3:	10.4	↗
4:	10.3	↙
5:	10.4	↘
Serie		48
Total		97

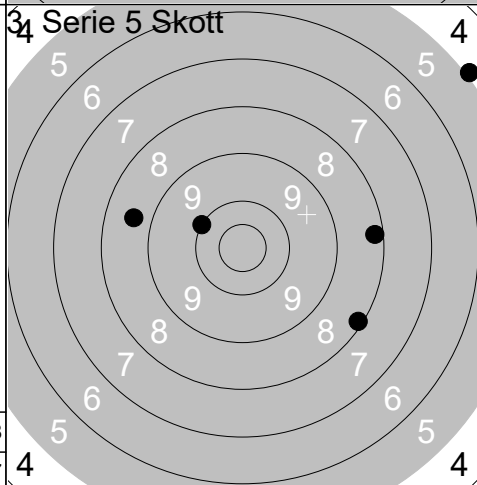

1:	5.0	↗
2:	8.1	↘
3:	8.2	→
4:	10.0	↗
5:	8.6	↖
Serie		39
Total		136

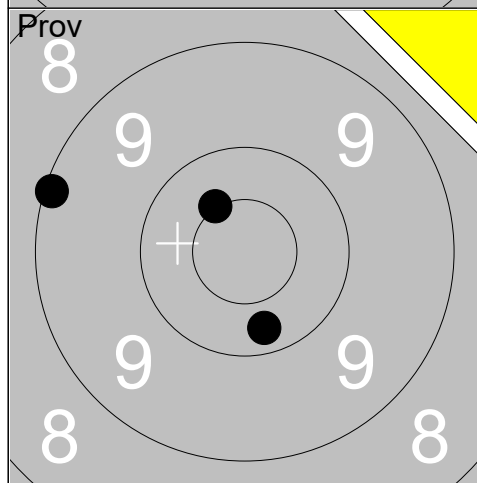

1:	9.1	↙
2:	10.5x	↗
3:	10.2	↘
Serie		29
Total		136

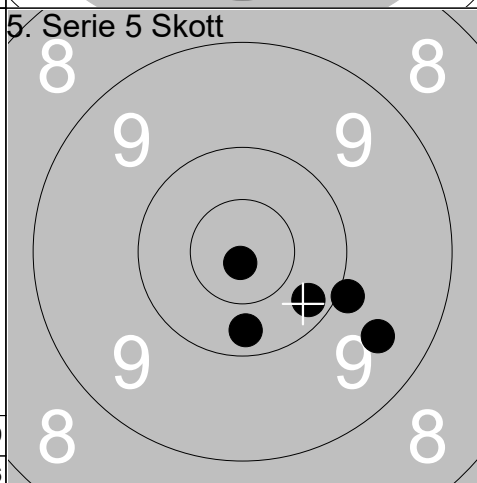

1:	9.5	↘
2:	10.3	↘
3:	10.2	↘
4:	10.8x	↘
5:	9.9	↘
Serie		48
Total		184

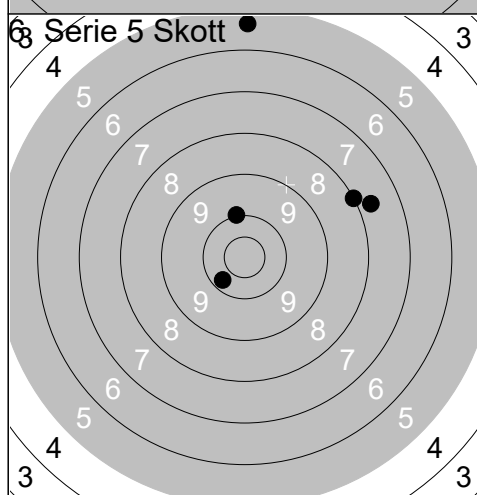

1:	10.0	↑
2:	8.0	↗
3:	10.2	↘
4:	5.4	↑
5:	7.7	↗
Serie		40
Total		224



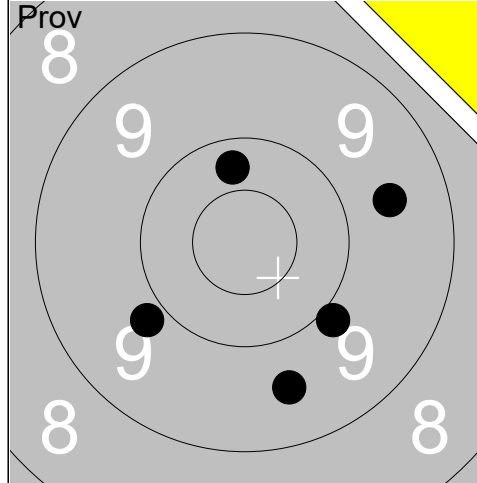

1:	9.9	↘
2:	9.6	→
3:	9.6	↘
4:	9.8	↙
5:	10.3	↑
Serie		46
Total		0

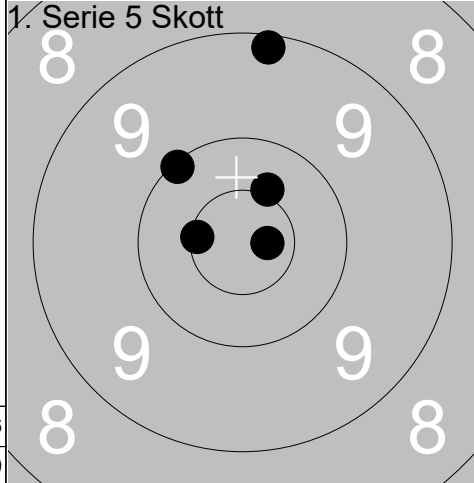

1:	10.5x	←
2:	10.4x	↗
3:	9.2	↑
4:	10.7x	→
5:	10.1	↖
Serie		49
Total		49

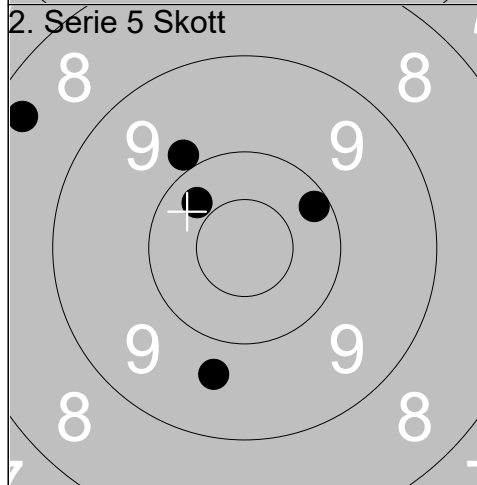

1:	10.2	↗
2:	10.3	↗
3:	8.3	↗
4:	9.7	↘
5:	9.9	↗
Serie		46
Total		95

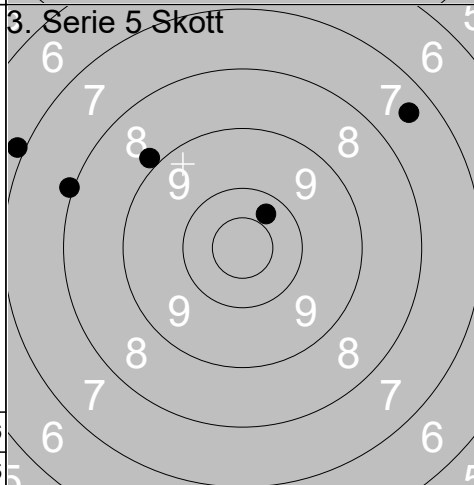

1:	10.3	↗
2:	7.4	↗
3:	8.0	↖
4:	6.9	↖
5:	8.9	↗
Serie		39
Total		134

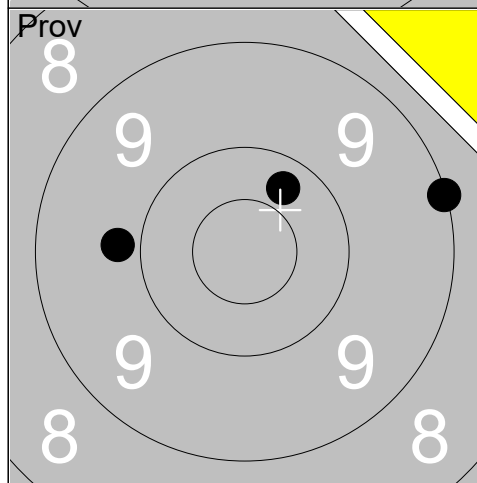

1:	9.0	→
2:	9.8	←
3:	10.3	↑
Serie		28
Total		134

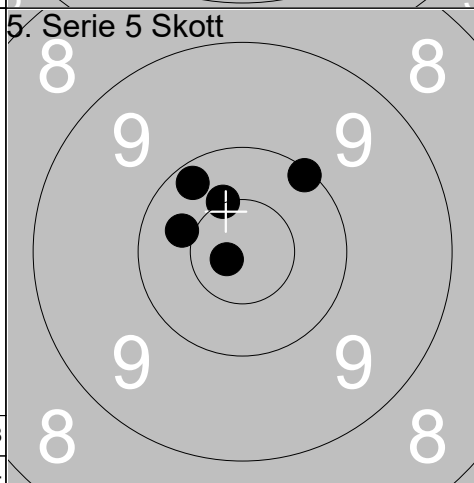

1:	10.1	↗
2:	10.8x	←
3:	10.2	↗
4:	10.5x	↗
5:	10.4	↖
Serie		50
Total		184

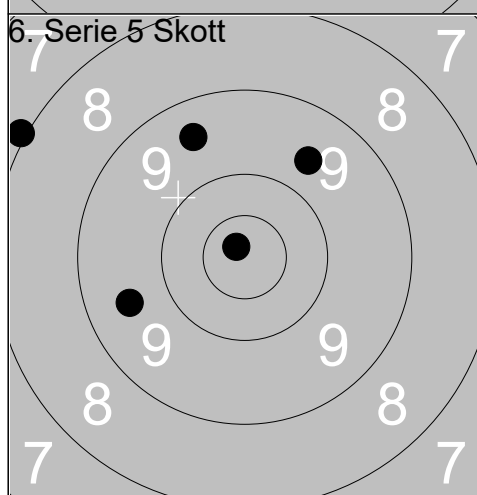

1:	8.0	↗
2:	9.5	↗
3:	9.6	↗
4:	9.6	↖
5:	10.8x	↗
Serie		45
Total		229

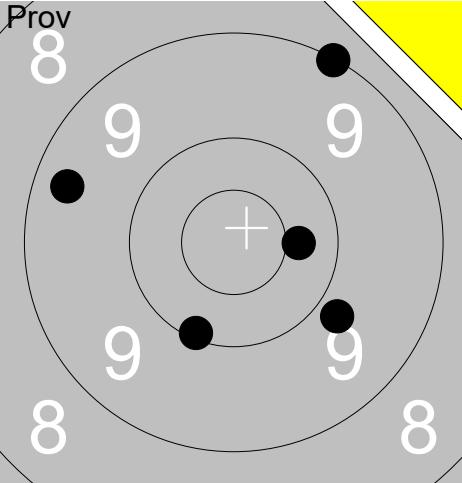
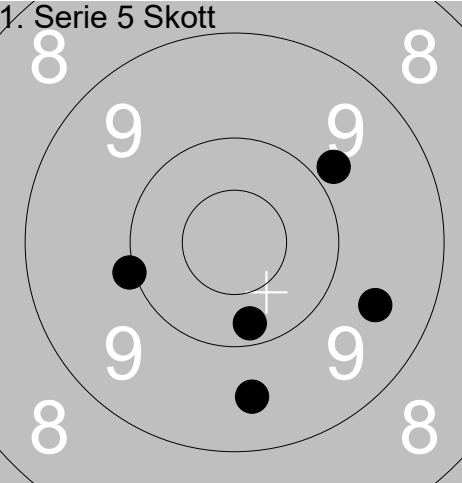
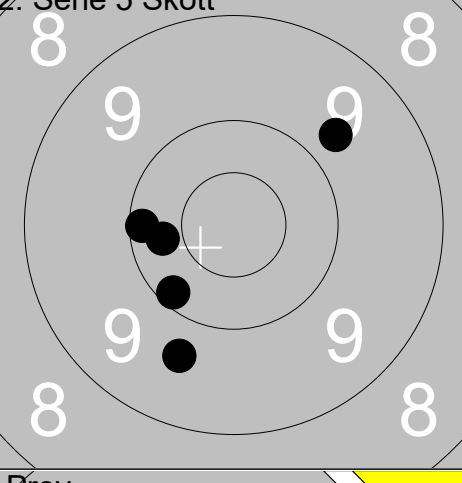
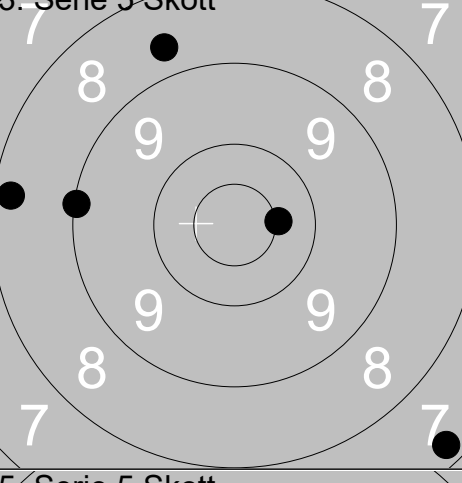
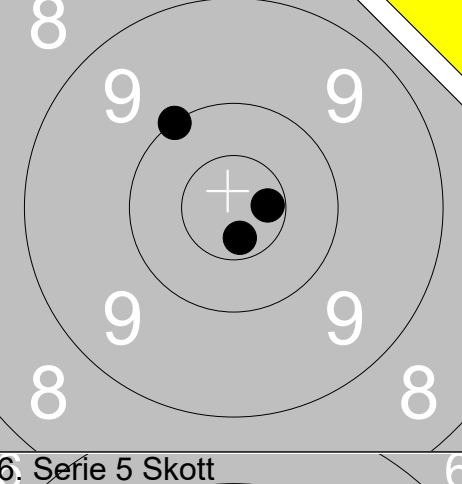
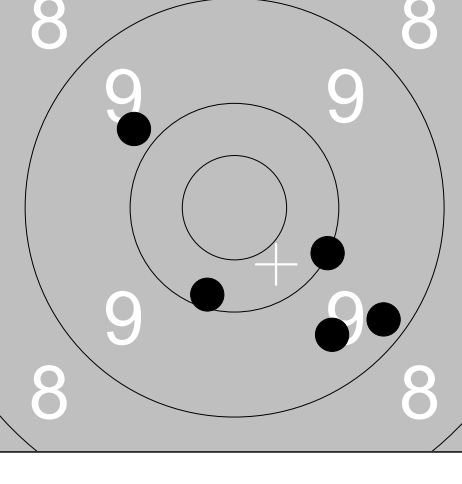
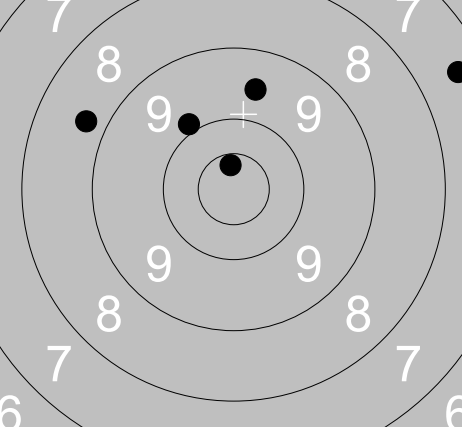
Skjutlag	Tavla	Linda Gustavsson		
3	3	Ramselefors	Umeå	Sen/Vet S/Vb
07.07.2018	Björskottet 2018	Ramselefors SKF		
<b>Prov</b> 	1: 10.4 → 2: 9.0 ↗ 3: 9.4 ↗ 4: 10.1 ↓ 5: 9.8 ↘	<b>1. Serie 5 Skott</b> 	1: 10.2 ↓ 2: 9.5 ↓ 3: 9.6 ↗ 4: 9.8 ↗ 5: 10.0 ←	
	Serie 47 Total 0		Serie 47 Total 47	
<b>2. Serie 5 Skott</b> 	1: 9.7 ↗ 2: 10.1 ← 3: 10.3 ← 4: 10.1 ↓ 5: 9.7 ↓	<b>3. Serie 5 Skott</b> 	1: 10.4x → 2: 9.1 ← 3: 8.2 ← 4: 7.3 ↓ 5: 8.7 ↗	
	Serie 48 Total 95		Serie 42 Total 137	
<b>Prov</b> 	1: 10.0 ↗ 2: 10.7x ↓ 3: 10.7x →	<b>5. Serie 5 Skott</b> 	1: 9.8 ↗ 2: 10.1 ↓ 3: 9.5 ↓ 4: 9.3 ↓ 5: 10.0 ↓	
	Serie 30 Total 137		Serie 47 Total 184	
<b>6. Serie 5 Skott</b> 	1: 9.6 ↗ 2: 10.6x ↗ 3: 8.7 ← 4: 9.9 ↗ 5: 7.4 ↗			
	Serie 43 Total 227			

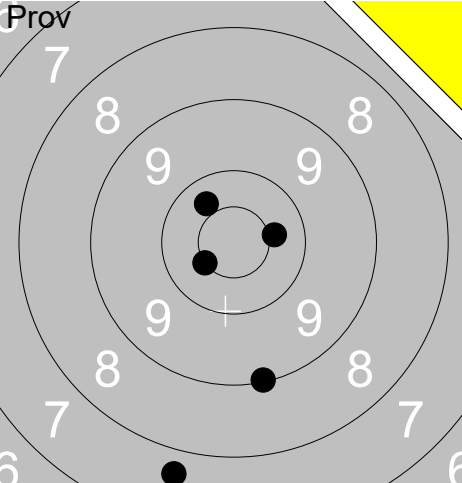
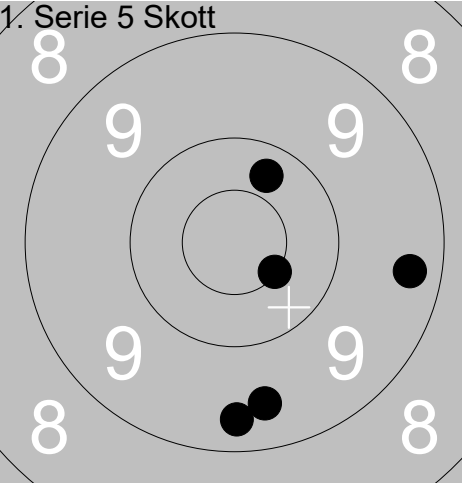
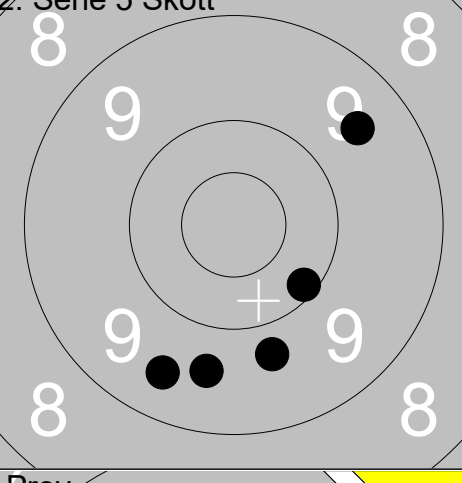
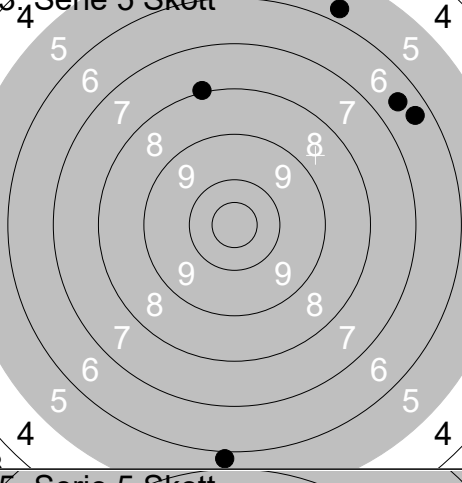
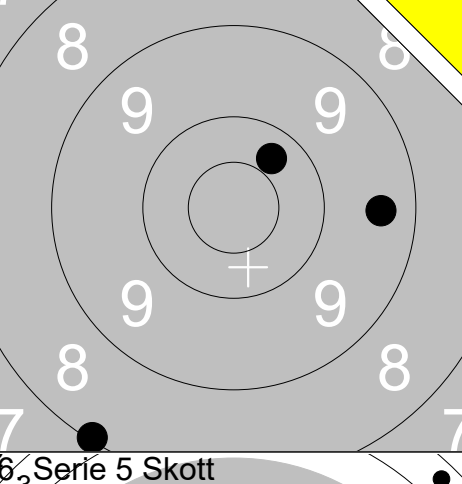
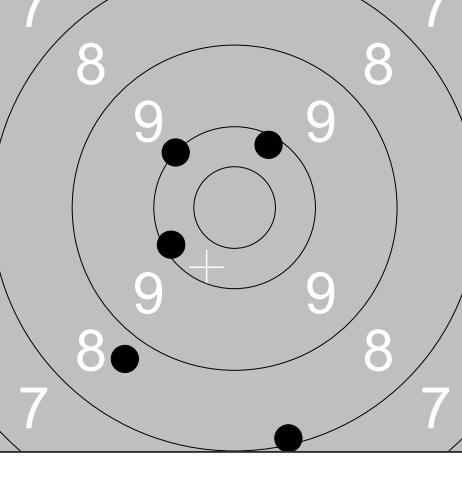
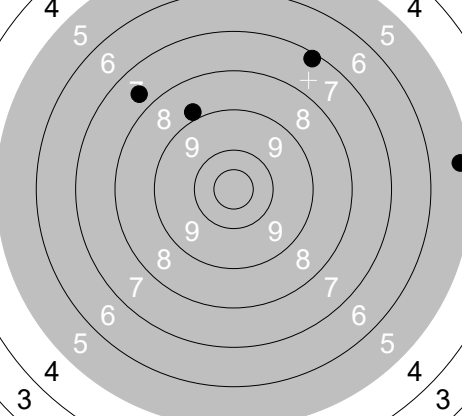
Skjutlag <b>3</b>	Tavla <b>4</b>	<b>Mathias Fredriksson</b>			
Ramselefors		Ramselefors		Sen/Vet S	Vb
07.07.2018		Björskottet 2018		Ramselefors SKF	
<b>Prov</b> 	1: 9.1 ↘ 2: 10.3 ↗ 3: 10.5x ↙ 4: 10.4x → 5: 7.7 ↘ Serie 46 Total 0	<b>1. Serie 5 Skott</b> 	1: 10.5x ↘ 2: 9.3 ↘ 3: 9.5 ↘ 4: 10.3 ↗ 5: 9.3 → Serie 47 Total 47		
<b>2. Serie 5 Skott</b> 	1: 9.5 ↗ 2: 9.5 ↘ 3: 9.7 ↘ 4: 10.1 ↘ 5: 9.6 ↘ Serie 46 Total 93	<b>3. Serie 5 Skott</b> 	1: 6.4 ↗ 2: 6.5 ↗ 3: 5.9 ↘ 4: 5.7 ↗ 5: 8.0 ↗ Serie 30 Total 123		
<b>Prov</b> 	1: 10.3 ↗ 2: 9.4 → 3: 8.1 ↘ Serie 27 Total 123	<b>5. Serie 5 Skott</b> 	1: 10.0 ↖ 2: 8.7 ↘ 3: 10.1 ↖ 4: 10.1 ↗ 5: 8.1 ↘ Serie 46 Total 169		
<b>6. Serie 5 Skott</b> 	1: 7.6 ↖ 2: 5.2 → 3: 7.2 ↗ 4: 3.4 ↗ 5: 8.8 ↗ Serie 30 Total 199				

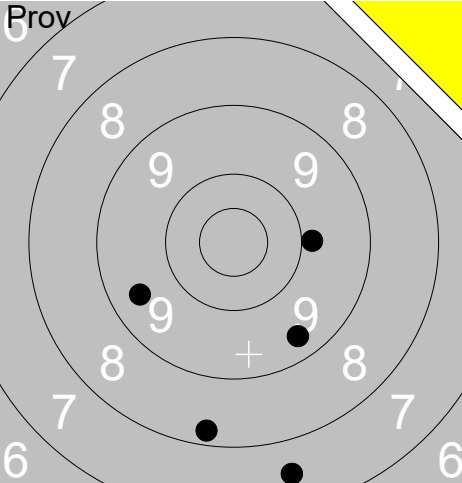
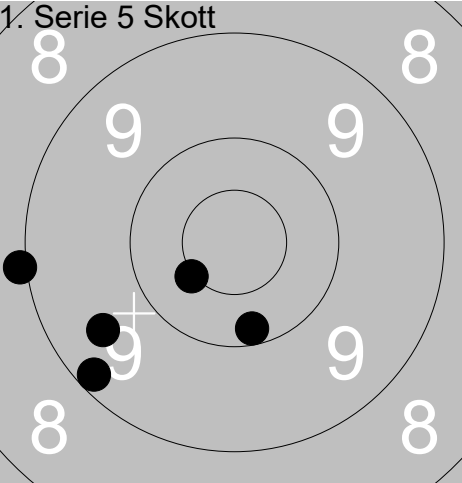
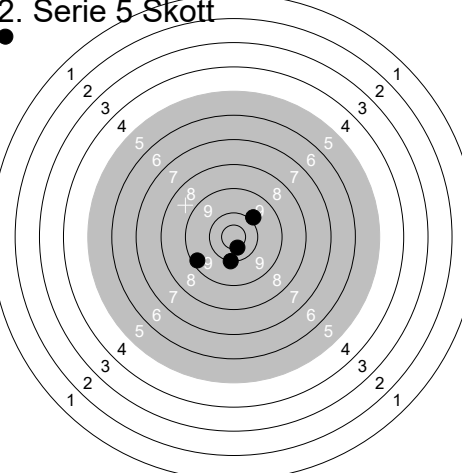
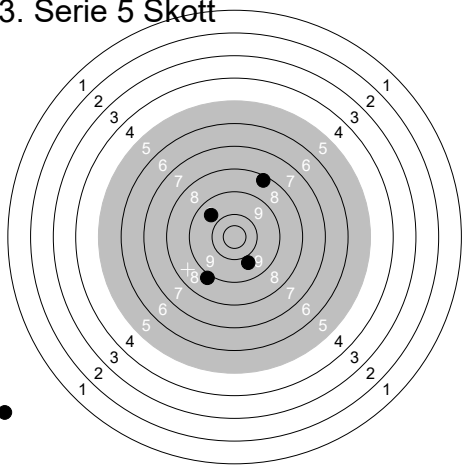
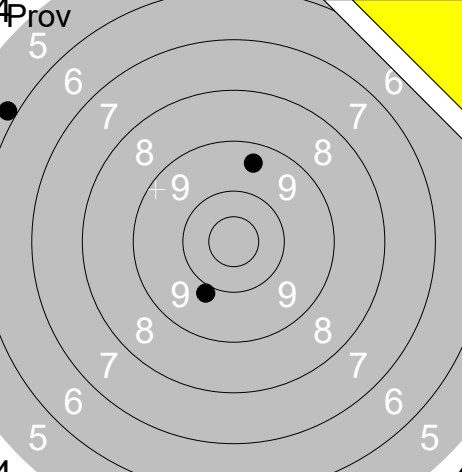
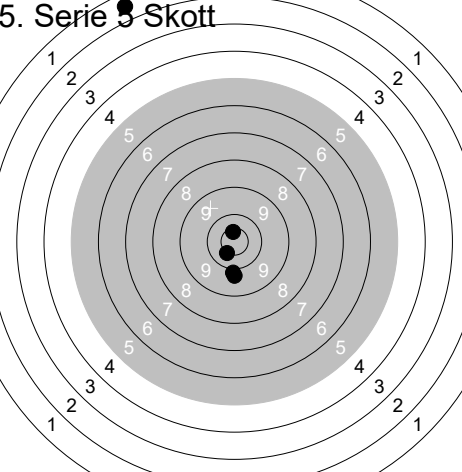
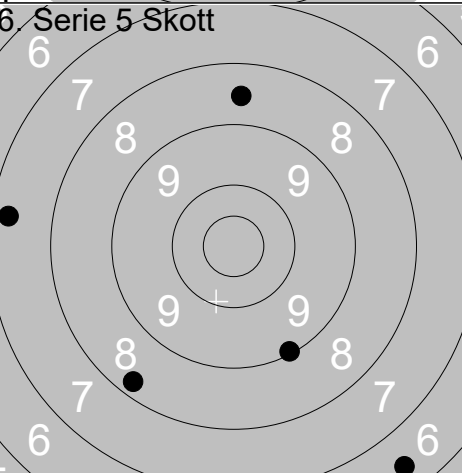
Skjutlag <b>3</b>	Tavla <b>5</b>	<b>Elina Johansson</b>	
Ramselefors	Ale	Sen/Vet S	No
07.07.2018	Björkskottet 2018	Ramselefors SKF	
<b>Prov</b> 	1: 9.9 → 2: 7.5 ↓ 3: 8.3 ↓ 4: 9.5 ↙ 5: 9.4 ↓ Serie 42 Total 0	<b>1. Serie 5 Skott</b> 	1: 10.5x ↙ 2: 9.5 ↙ 3: 9.2 ↙ 4: 10.2 ↓ 5: 9.0 ← Serie 47 Total 47
<b>2. Serie 5 Skott</b> 	1: 10.5x ↓ 2: 9.3 ↙ 3: 9.9 ↗ 4: 0.0 ↗ 5: 10.0 ↓ Serie 38 Total 85	<b>3. Serie 5 Skott</b> 	1: 8.2 ↗ 2: 8.9 ↙ 3: 9.7 ↙ 4: 9.6 ↗ 5: 0.0 ↙ Serie 34 Total 119
<b>4. Prov</b> 	1: 5.8 ↙ 2: 9.4 ↗ 3: 9.9 ↙ Serie 23 Total 119	<b>5. Serie 5 Skott</b> 	1: 10.6x ↗ 2: 10.5x ↙ 3: 1.5 ↗ 4: 9.9 ↓ 5: 9.8 ↓ Serie 39 Total 158
<b>6. Serie 5 Skott</b> 	1: 6.5 ↓ 2: 9.1 ↓ 3: 8.3 ↙ 4: 8.6 ↗ 5: 7.3 ← Serie 38 Total 196		

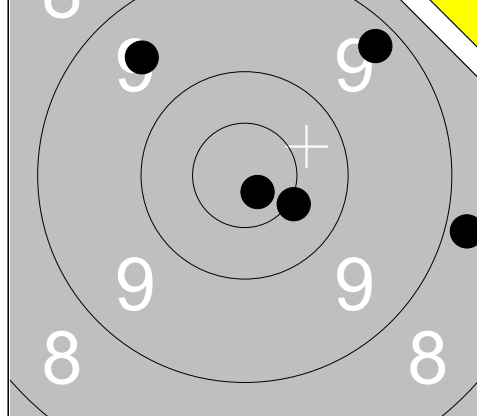

1:	8.8	→
2:	9.3	↗
3:	10.8x	↘
4:	10.4x	↘
5:	9.5	↗
Serie		46
Total		0

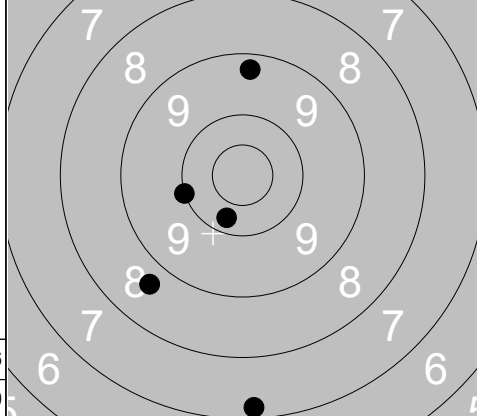

1:	9.3	↑
2:	10.0	←
3:	8.7	↘
4:	10.3	↘
5:	7.2	↓
Serie		44
Total		44

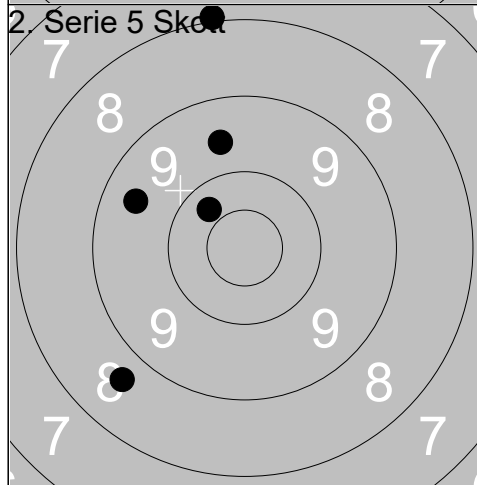

1:	8.0	↑
2:	9.6	↑
3:	9.5	←
4:	10.3	↗
5:	8.7	↘
Serie		44
Total		88

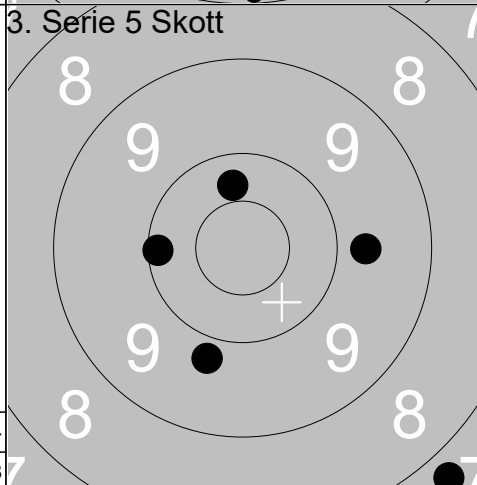

1:	10.3	↑
2:	9.8	↓
3:	9.7	→
4:	7.8	↘
5:	10.1	←
Serie		45
Total		133

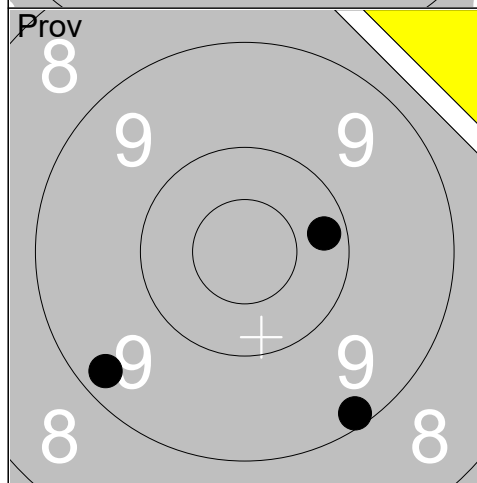

1:	9.2	↘
2:	10.2	→
3:	9.3	↘
Serie		28
Total		133

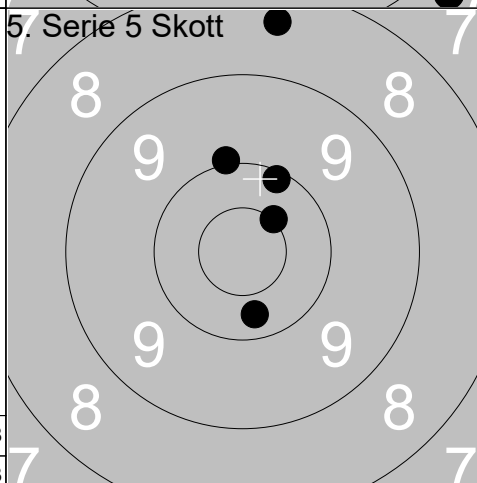

1:	8.4	↑
2:	10.5x	↗
3:	10.0	↑
4:	10.3	↓
5:	10.1	↑
Serie		48
Total		181

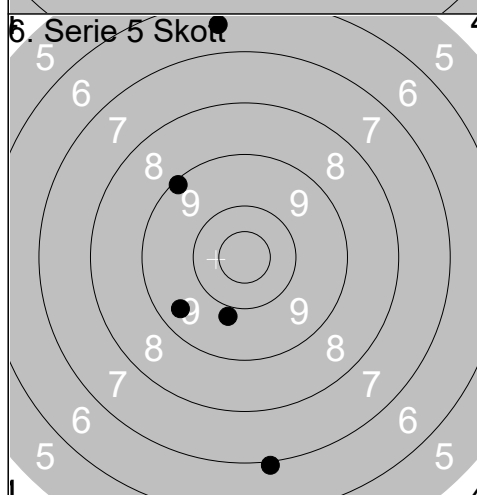

1:	6.5	↑
2:	6.9	↓
3:	9.8	↘
4:	9.1	↗
5:	9.4	↘
Serie		39
Total		220

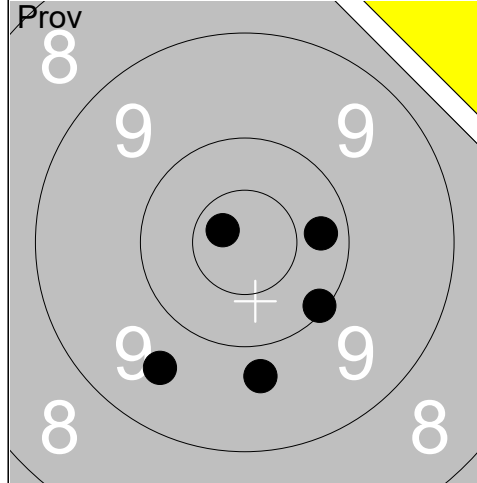

1:	10.7x	↖
2:	9.7	↓
3:	10.1	↘
4:	10.3	→
5:	9.6	↙
Serie		48
Total		0

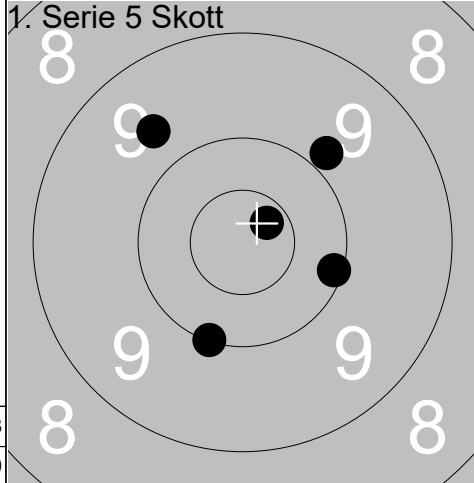

1:	9.7	↖
2:	10.1	→
3:	9.9	↗
4:	10.7x	↗
5:	10.0	↓
Serie		48
Total		48

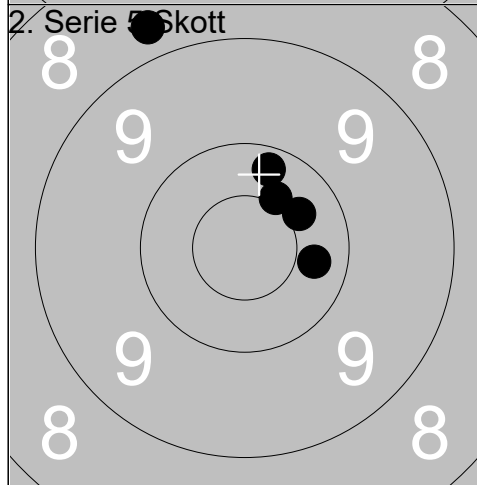

1:	10.3	→
2:	10.4x	↗
3:	10.4	↗
4:	8.7	↗
5:	10.2	↑
Serie		48
Total		96

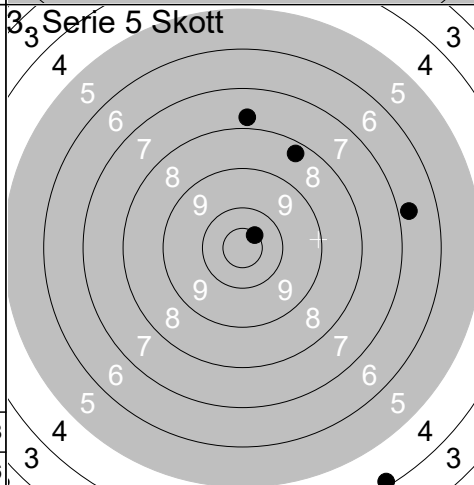

1:	7.7	↑
2:	10.5x	↗
3:	6.8	→
4:	8.3	↗
5:	4.1	↘
Serie		35
Total		131

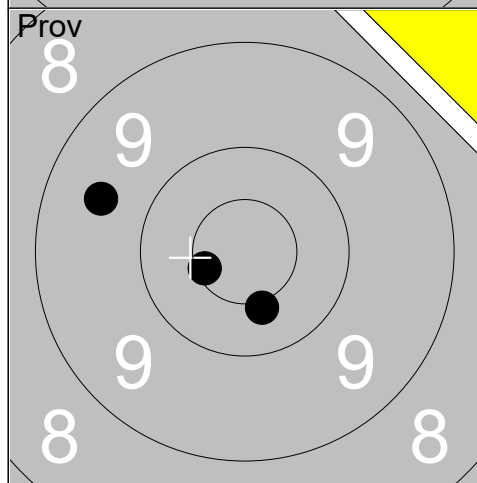

1:	10.4x	↓
2:	10.6x	←
3:	9.6	←
Serie		29
Total		131

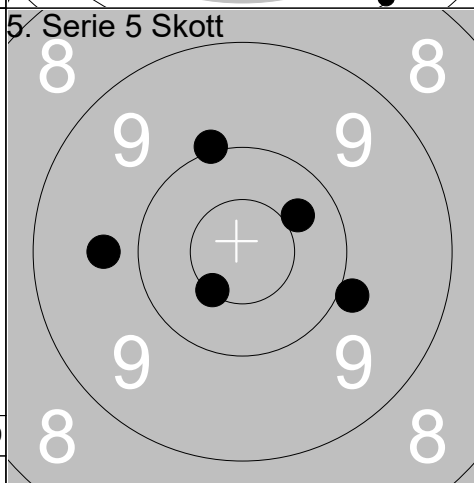

1:	9.7	←
2:	10.4	↗
3:	10.0	↑
4:	9.9	→
5:	10.5x	↙
Serie		48
Total		179

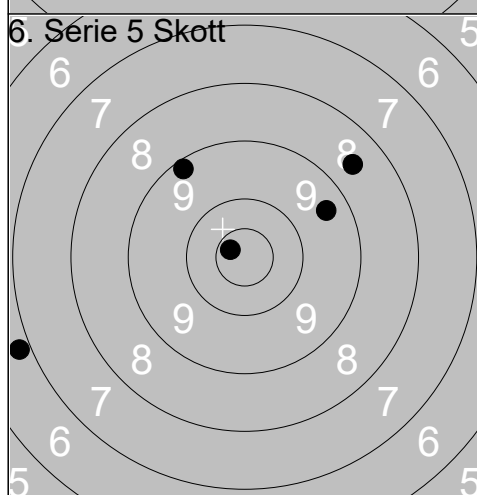

1:	9.2	↖
2:	8.6	↗
3:	9.4	↗
4:	10.7x	↖
5:	6.8	←
Serie		42
Total		221

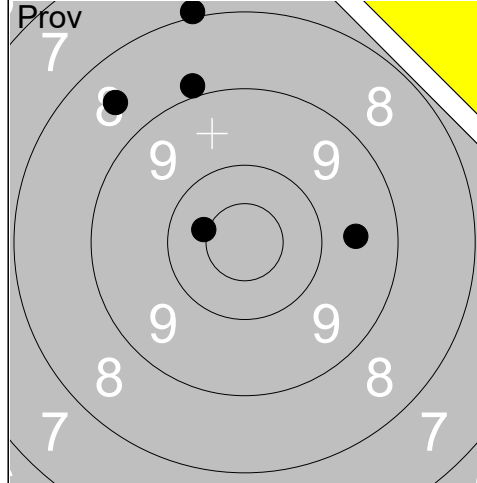

1:	7.9	↗
2:	8.9	↗
3:	8.6	↗
4:	10.4x	↖
5:	9.6	→
Serie		42
Total		0

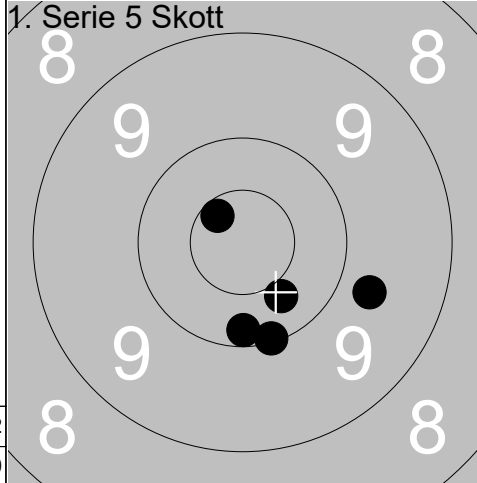

1:	10.6x	↗
2:	9.7	→
3:	10.1	↘
4:	10.2	↘
5:	10.4	↘
Serie		49
Total		49

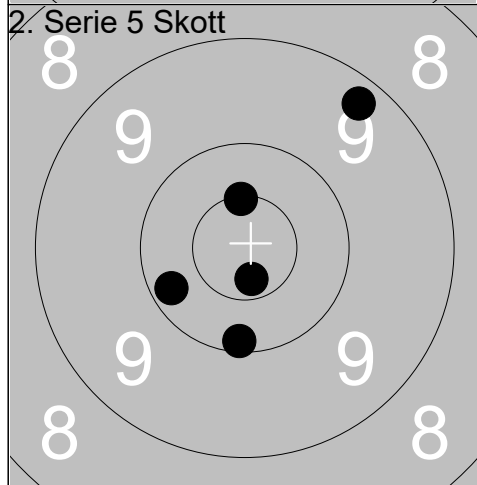

1:	9.3	↗
2:	10.5x	↑
3:	10.7x	↘
4:	10.1	↘
5:	10.2	↖
Serie		49
Total		98

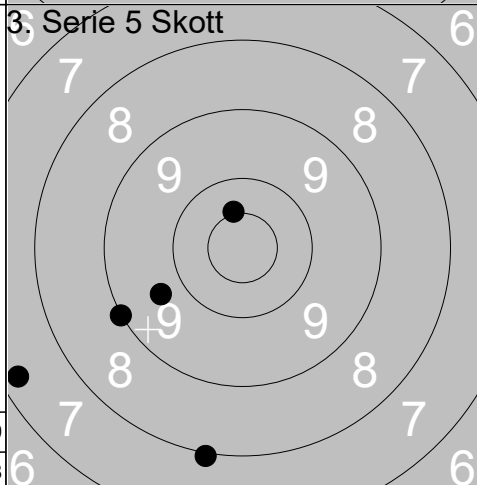

1:	9.0	↖
2:	10.4x	↑
3:	7.3	↖
4:	8.0	↘
5:	9.7	↖
Serie		43
Total		141

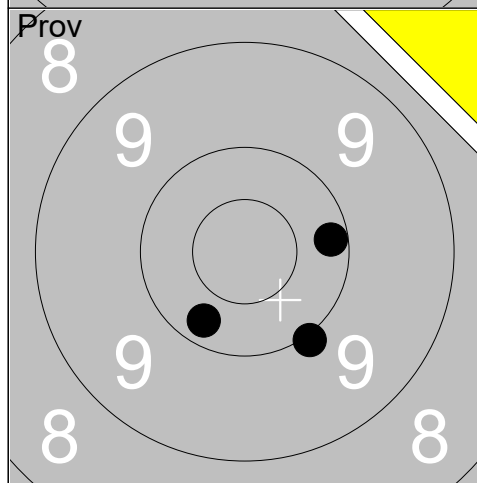

1:	10.0	↘
2:	10.2	↘
3:	10.2	→
Serie		30
Total		141

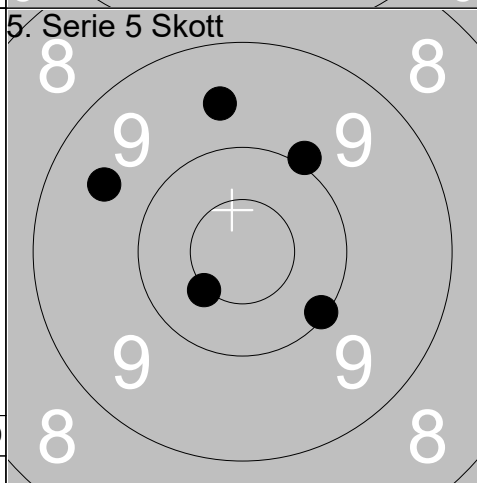

1:	9.6	↑
2:	10.5x	↖
3:	10.1	↘
4:	10.0	↗
5:	9.6	↖
Serie		48
Total		189

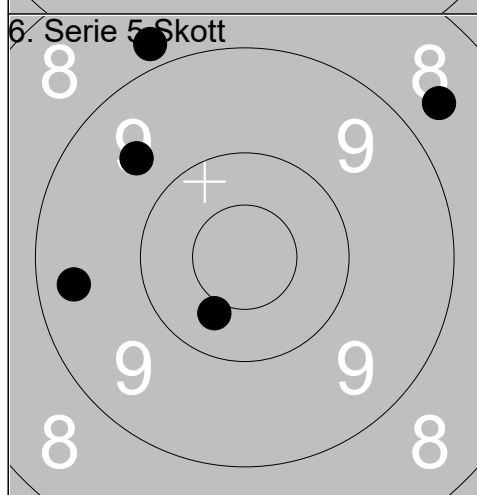

1:	10.4	↘
2:	8.8	↗
3:	8.7	↗
4:	9.4	↖
5:	9.6	↗
Serie		44
Total		233

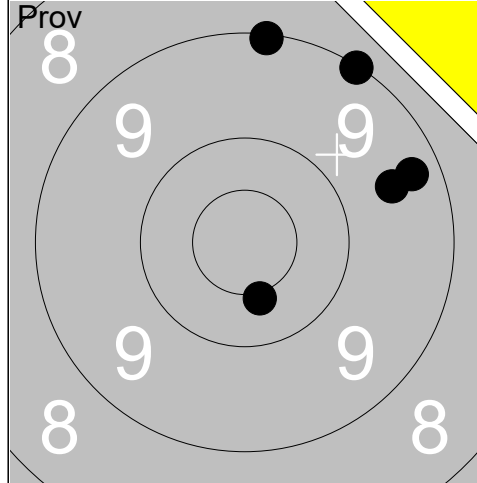

1:	9.5	→
2:	9.0	↗
3:	9.1	↑
4:	9.3	→
5:	10.4x	↓
Serie		46
Total		0

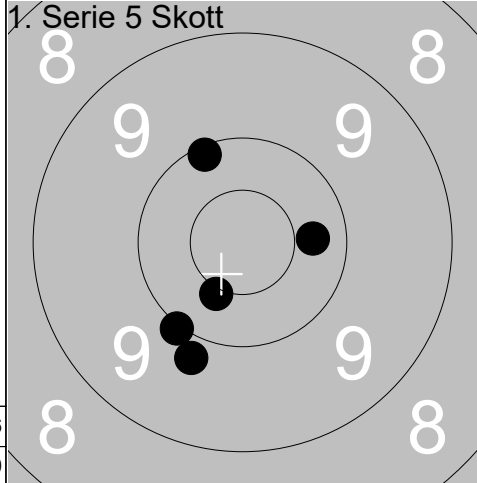

1:	10.4x	↓
2:	10.1	↗
3:	10.0	↓
4:	10.3	→
5:	9.8	↓
Serie		49
Total		49

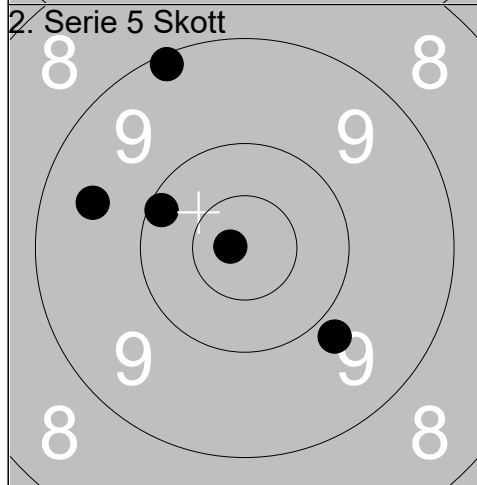

1:	10.8x	←
2:	9.8	↘
3:	10.1	↗
4:	9.1	↗
5:	9.5	←
Serie		47
Total		96

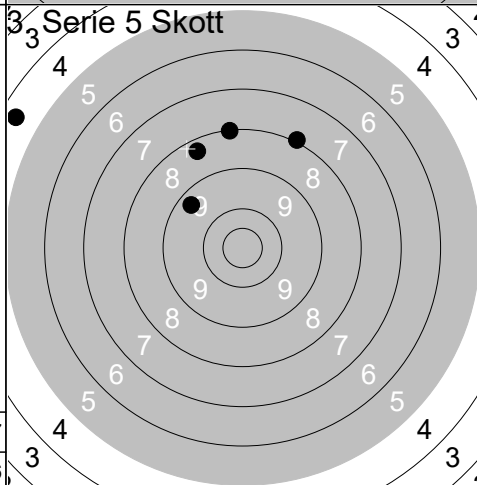

1:	8.0	↗
2:	8.3	↗
3:	9.3	↗
4:	4.4	↗
5:	8.0	↑
Serie		37
Total		133

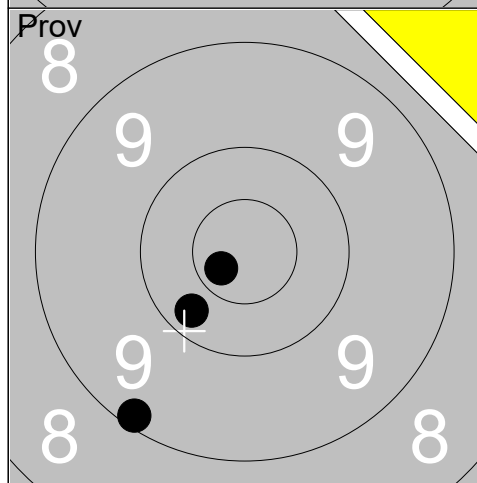

1:	9.1	↘
2:	10.3	↘
3:	10.7x	↘
Serie		29
Total		133

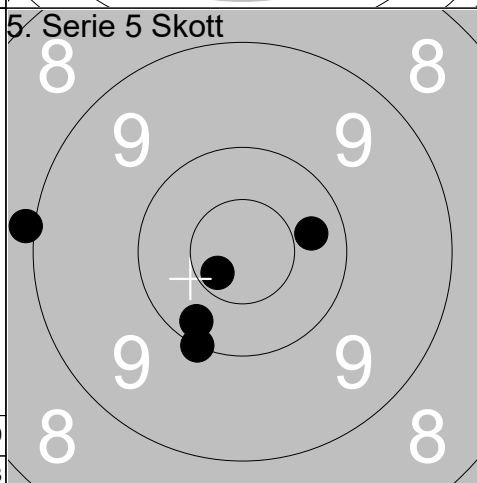

1:	10.3	→
2:	8.9	←
3:	10.2	↘
4:	10.0	↘
5:	10.7x	↘
Serie		48
Total		181

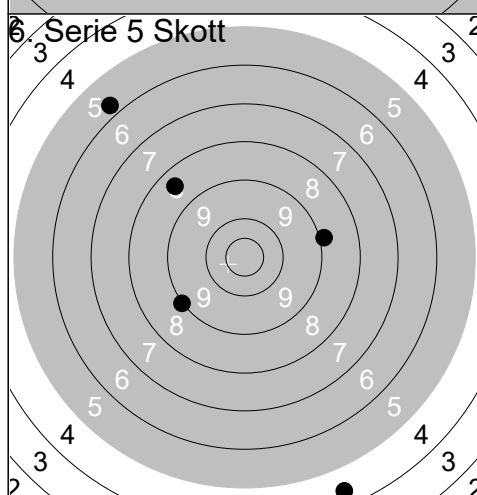

1:	5.8	↗
2:	8.9	→
3:	8.4	↗
4:	9.0	↘
5:	4.4	↘
Serie		34
Total		215



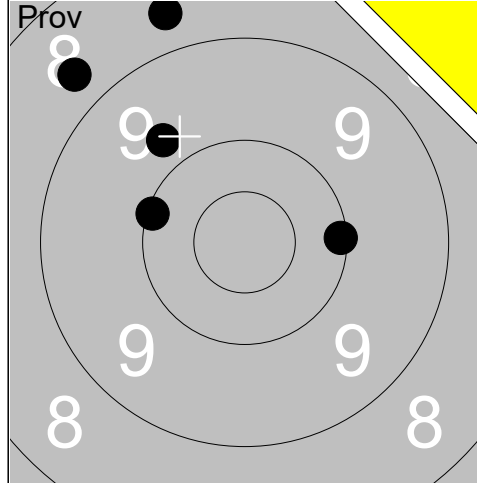

1:	8.7	↗
2:	8.7	↗
3:	9.8	↗
4:	10.1	↗
5:	10.1	→
Serie		45
Total		0

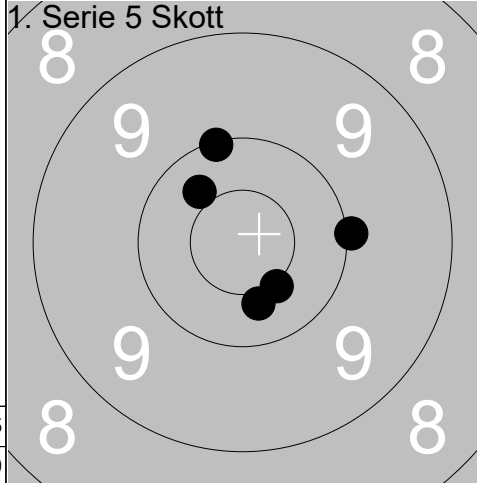

1:	10.0	→
2:	10.4	↗
3:	10.5x	↘
4:	10.1	↗
5:	10.4	↘
Serie		50
Total		50

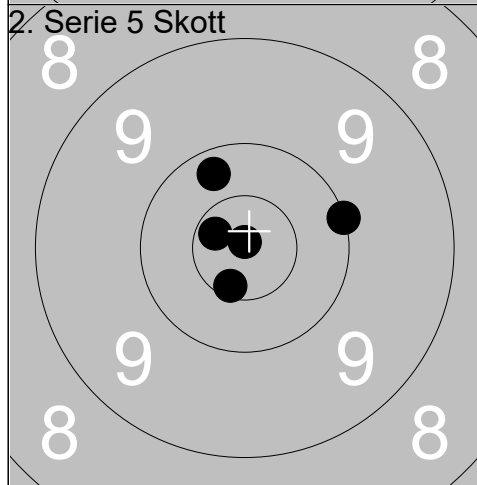

1:	10.0	→
2:	10.7x	↗
3:	10.6x	↘
4:	10.2	↗
5:	10.9x	↑
Serie		50
Total		100

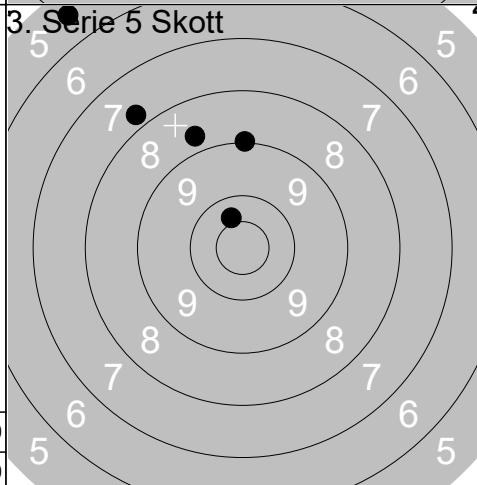

1:	9.0	↑
2:	8.7	↗
3:	7.8	↗
4:	10.4	↗
5:	5.5	↗
Serie		39
Total		139

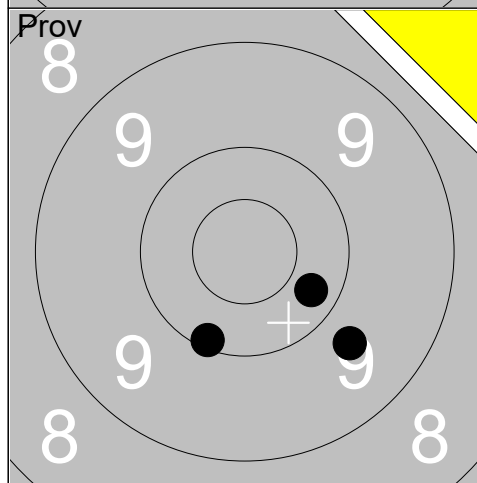

1:	10.3	↘
2:	9.7	↘
3:	10.1	↘
Serie		29
Total		139

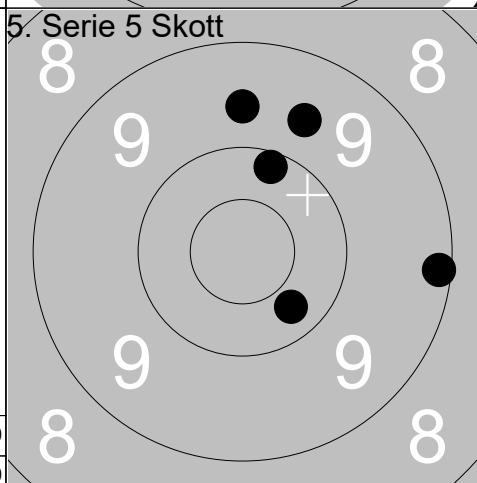

1:	10.2	↑
2:	10.3	↘
3:	9.1	→
4:	9.6	↗
5:	9.6	↑
Serie		47
Total		186

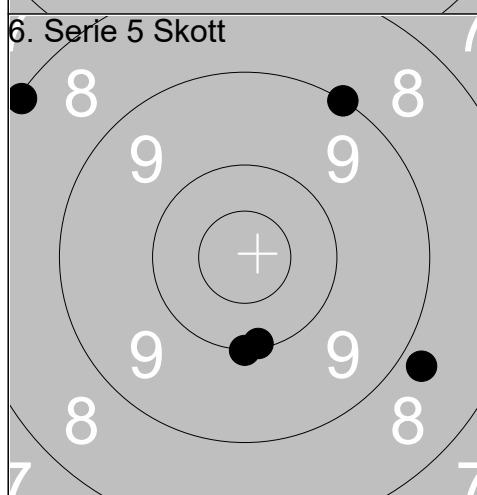

1:	9.0	↗
2:	10.0	↘
3:	10.1	↘
4:	8.8	↘
5:	8.1	↗
Serie		45
Total		231

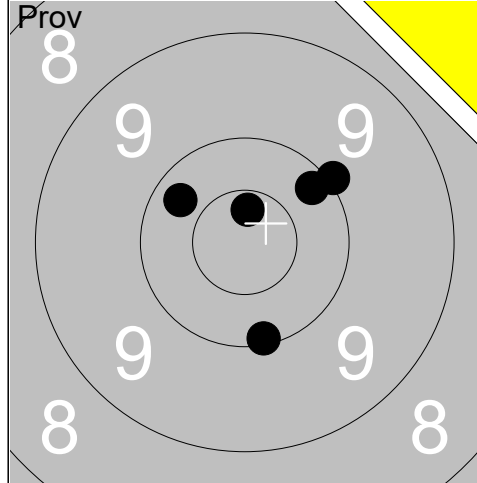

1:	10.1	↓
2:	10.3	↖
3:	10.7x	↑
4:	10.2	↗
5:	10.0	↗
Serie		50
Total		0

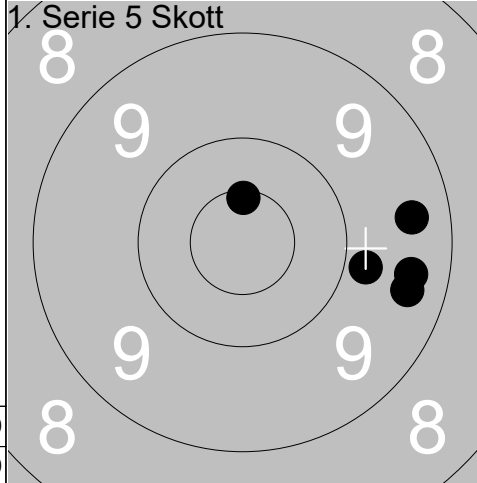

1:	9.4	→
2:	9.8	→
3:	9.4	→
4:	9.4	→
5:	10.6x	↑
Serie		46
Total		46

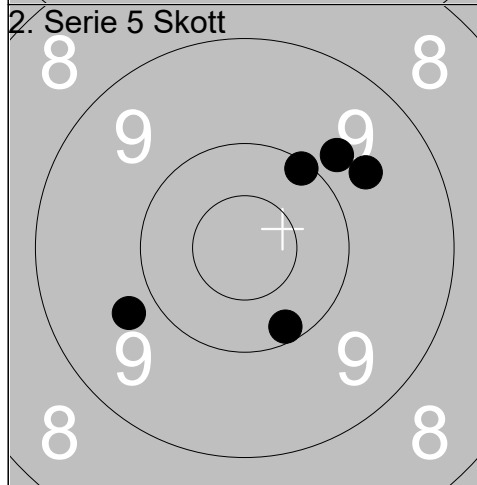

1:	9.8	↖
2:	10.1	↗
3:	9.7	↗
4:	9.8	↗
5:	10.2	↓
Serie		47
Total		93

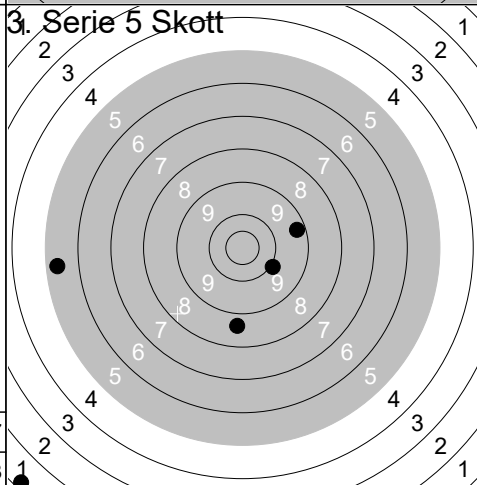

1:	9.9	↘
2:	8.6	↓
3:	9.3	→
4:	5.4	←
5:	1.2	↙
Serie		32
Total		125

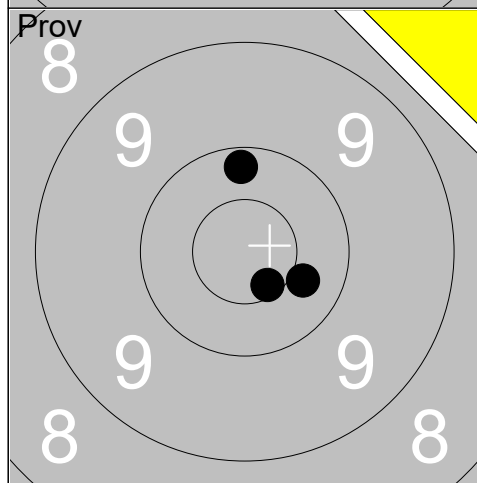

1:	10.4	↘
2:	10.6x	↓
3:	10.2	↑
Serie		30
Total		125

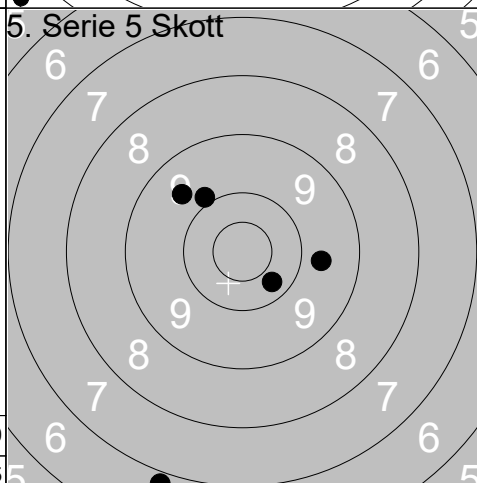

1:	9.7	→
2:	10.3	↘
3:	9.6	↗
4:	9.9	↗
5:	6.8	↓
Serie		43
Total		168

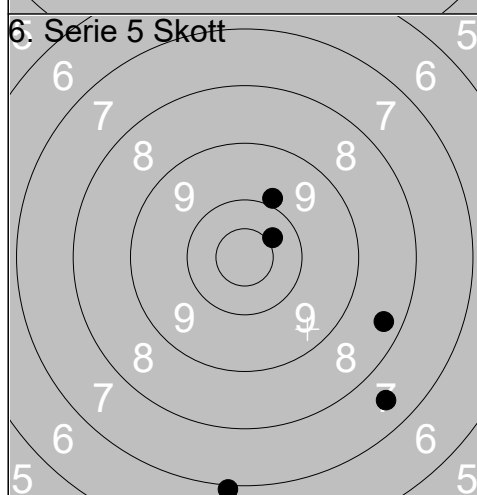

1:	7.5	↘
2:	9.9	↗
3:	8.3	→
4:	10.4	↗
5:	7.0	↓
Serie		41
Total		209

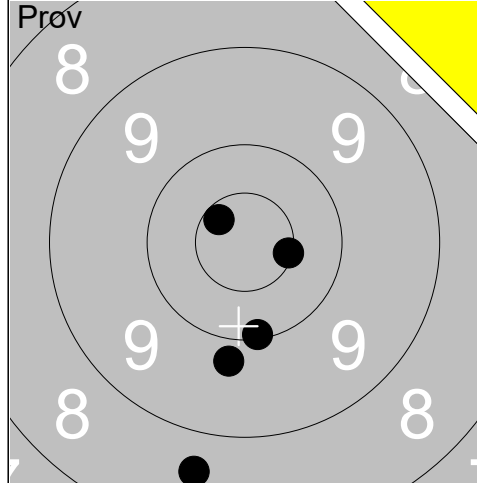

1:	8.6	↘
2:	10.1	↘
3:	9.8	↘
4:	10.5x	→
5:	10.6x	↗
Serie		47
Total		0

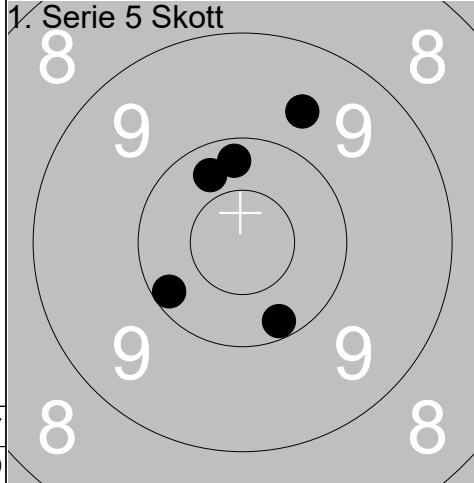

1:	9.7	↗
2:	10.2	↑
3:	10.3	↗
4:	10.2	↘
5:	10.2	↙
Serie		49
Total		49

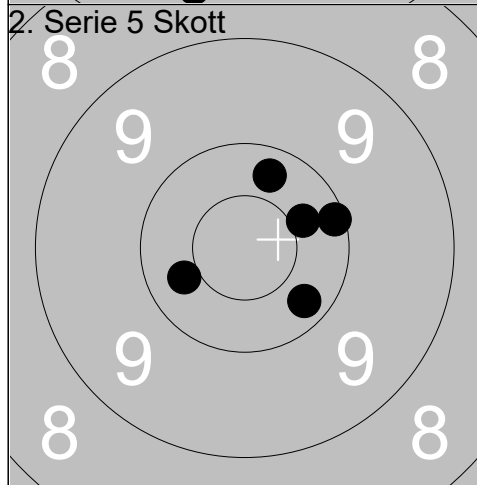

1:	10.3	↑
2:	10.4	↗
3:	10.2	↘
4:	10.1	→
5:	10.4	↙
Serie		50
Total		99

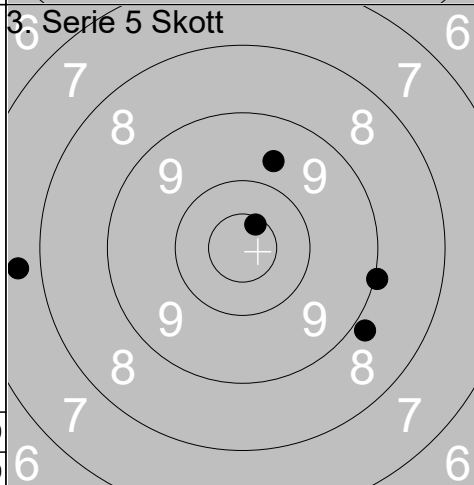

1:	8.8	↘
2:	7.7	←
3:	10.6x	↗
4:	9.7	↑
5:	9.0	→
Serie		43
Total		142

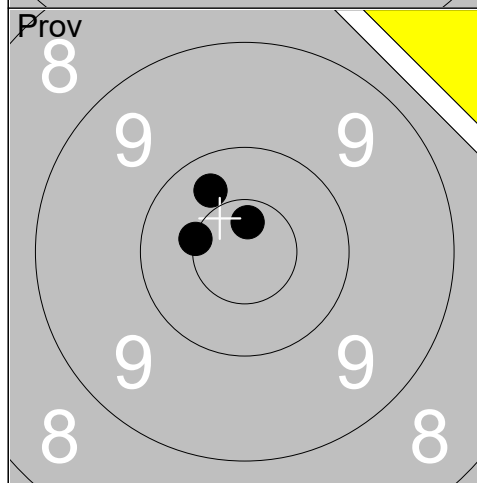

1:	10.7x	↑
2:	10.5x	←
3:	10.3	↗
Serie		30
Total		142

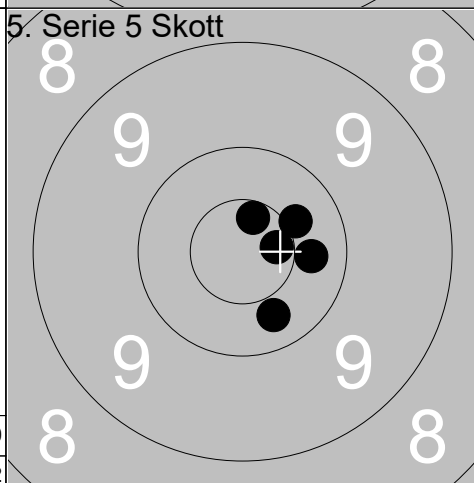

1:	10.4	↗
2:	10.6x	→
3:	10.3	→
4:	10.6x	↑
5:	10.3	↘
Serie		50
Total		192

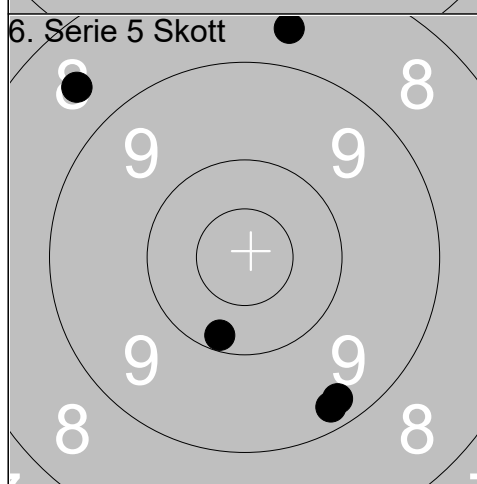

1:	10.2	↘
2:	9.3	↘
3:	9.3	↘
4:	8.6	↗
5:	8.6	↑
Serie		44
Total		236

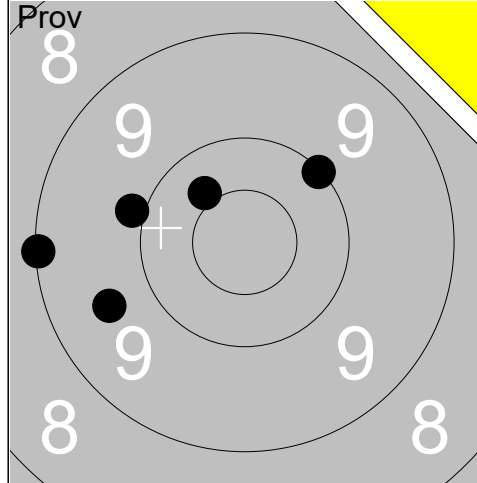

1:	10.0	↗
2:	9.9	↖
3:	10.4	↗
4:	9.1	↖
5:	9.6	↖
Serie		47
Total		0

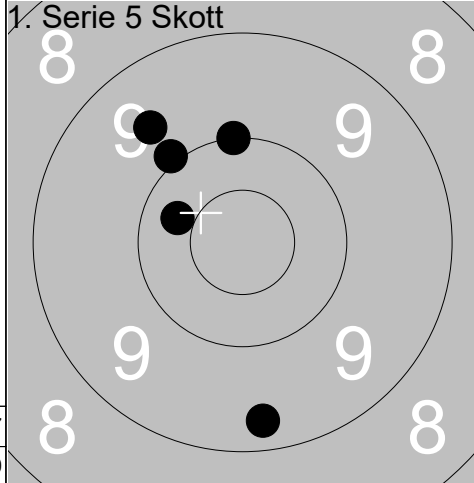

1:	9.6	↗
2:	10.0	↗
3:	10.0	↑
4:	9.3	↓
5:	10.3	↖
Serie		48
Total		48

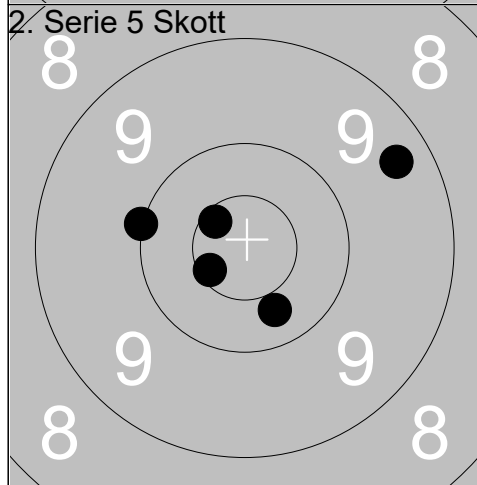

1:	9.4	↗
2:	10.6x	↗
3:	10.3	↓
4:	10.0	↖
5:	10.6x	↖
Serie		49
Total		97

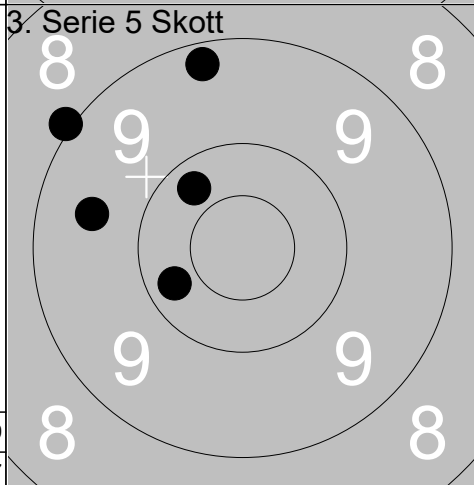

1:	10.3	↗
2:	9.2	↑
3:	9.0	↗
4:	9.6	↖
5:	10.3	↖
Serie		47
Total		144

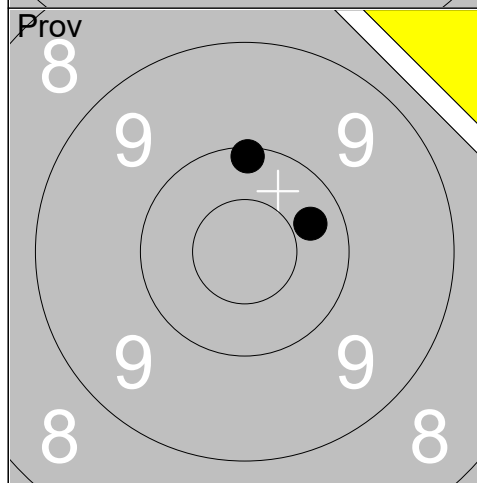

1:	10.3	↗
2:	10.1	↑
Serie		20
Total		144

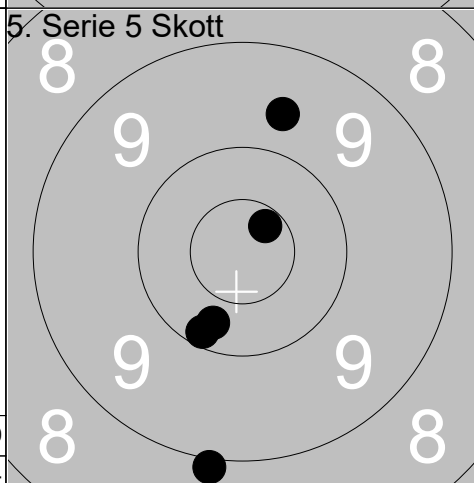

1:	9.7	↑
2:	10.6x	↗
3:	10.3	↓
4:	8.9	↓
5:	10.2	↓
Serie		47
Total		191

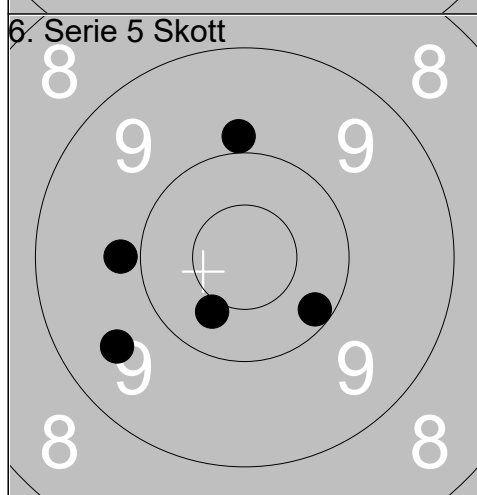

1:	10.4	↓
2:	10.2	↘
3:	9.5	↖
4:	9.9	↑
5:	9.8	↖
Serie		47
Total		238

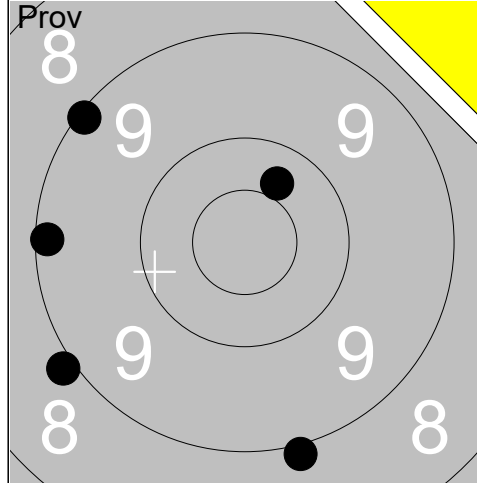

1:	9.1	↖
2:	9.1	←
3:	8.9	↙
4:	8.9	↓
5:	10.4	↗
Serie		44
Total		0

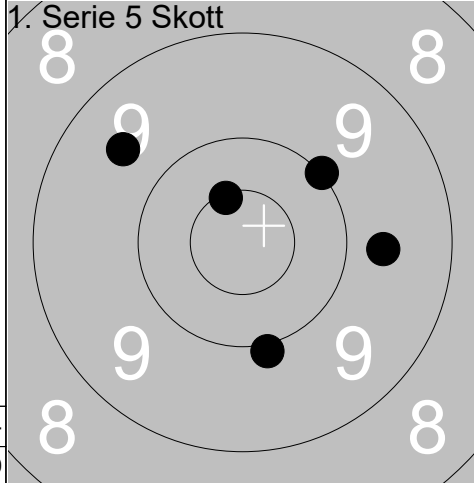

1:	10.0	↗
2:	10.5x	↗
3:	9.6	↗
4:	9.7	→
5:	10.0	↓
Serie		48
Total		48

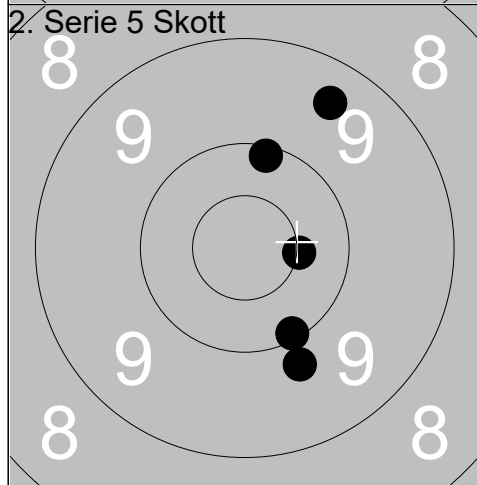

1:	10.5x	→
2:	9.8	↓
3:	10.1	↗
4:	9.4	↗
5:	10.1	↓
Serie		48
Total		96

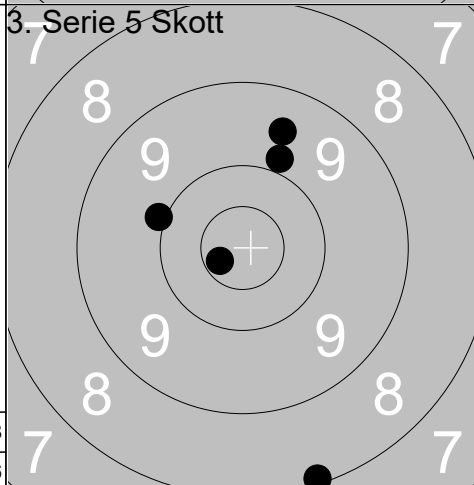

1:	9.9	↗
2:	10.0	↖
3:	10.7x	↖
4:	8.1	↓
5:	9.5	↗
Serie		46
Total		142

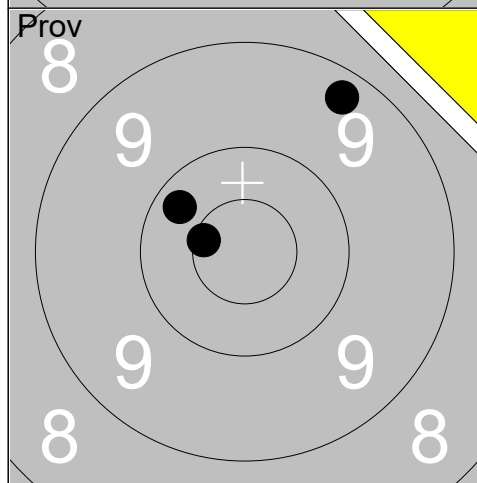

1:	9.3	↗
2:	10.3	↗
3:	10.6x	↖
Serie		29
Total		142

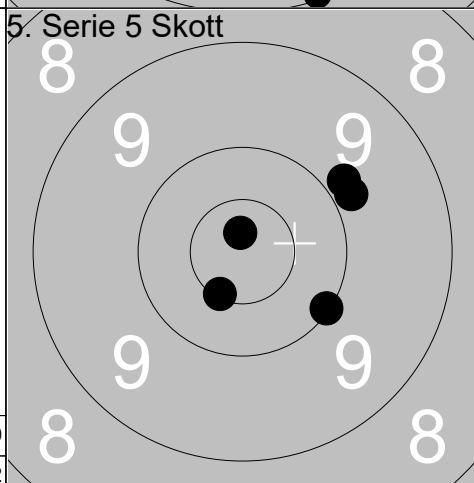

1:	9.9	↗
2:	9.9	↗
3:	10.1	↘
4:	10.5x	↓
5:	10.8x	↗
Serie		48
Total		190

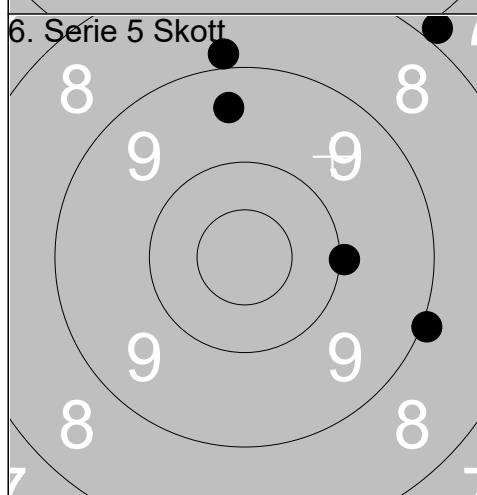

1:	9.4	↑
2:	9.0	→
3:	10.0	→
4:	8.9	↑
5:	7.9	↗
Serie		43
Total		233

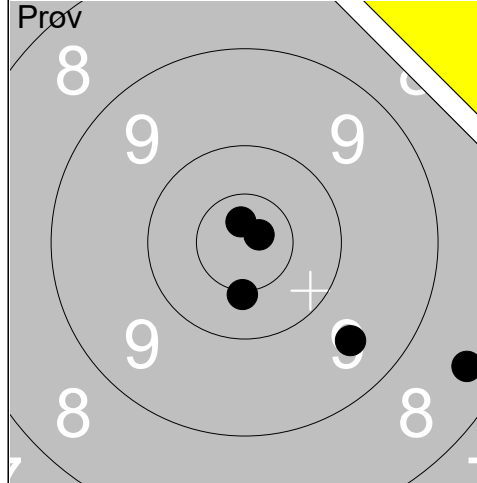

1:	8.4	↘
2:	10.7x	↑
3:	9.5	↘
4:	10.8x	↗
5:	10.5x	↓
Serie		47
Total		0

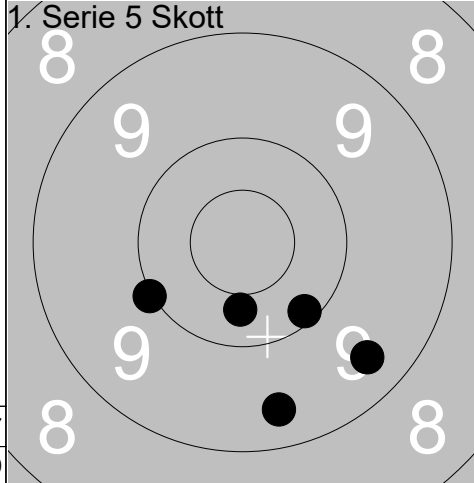

1:	10.0	↙
2:	10.4	↓
3:	9.4	↓
4:	10.1	↘
5:	9.4	↘
Serie		48
Total		48



1:	9.1	↑
2:	9.7	↗
3:	9.7	↘
4:	10.2	↓
5:	9.2	↘
Serie		46
Total		94

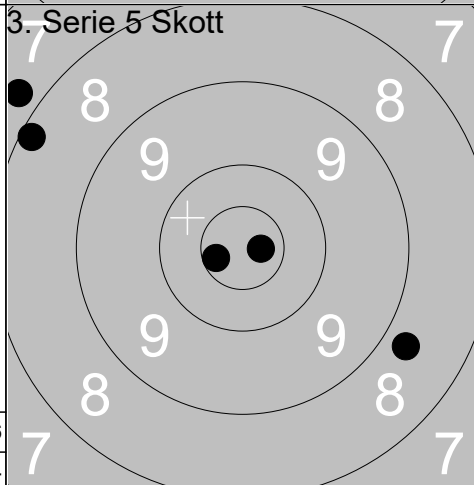

1:	10.6x	↙
2:	8.7	↘
3:	10.7x	→
4:	7.8	↗
5:	8.2	↗
Serie		43
Total		137

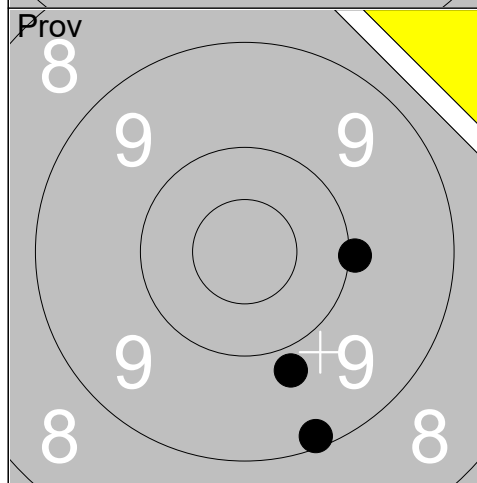

1:	10.0	→
2:	9.8	↓
3:	9.1	↓
Serie		28
Total		137

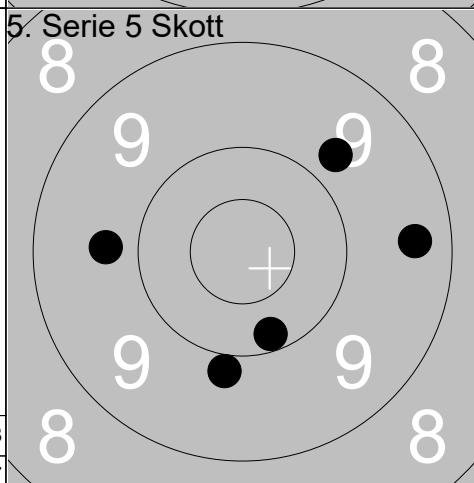

1:	9.4	→
2:	9.9	↓
3:	9.7	↗
4:	10.2	↓
5:	9.7	↙
Serie		46
Total		183

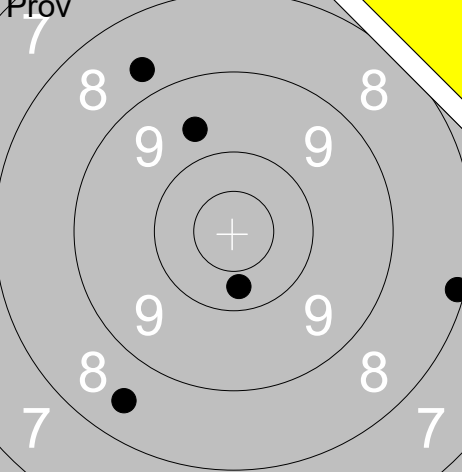
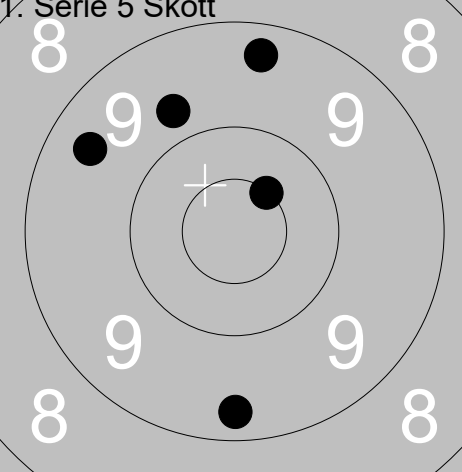
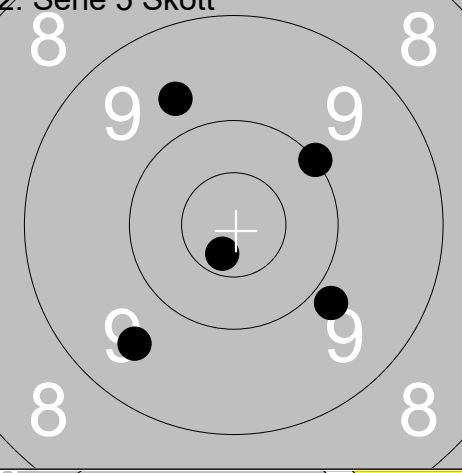
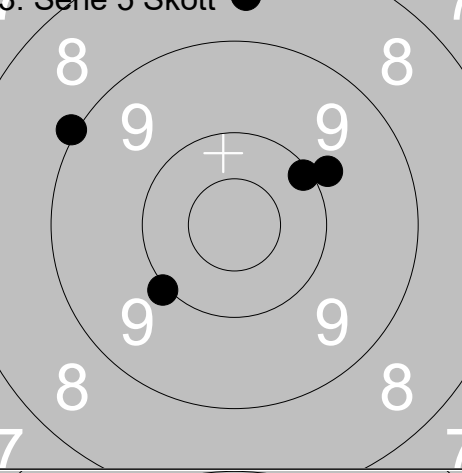
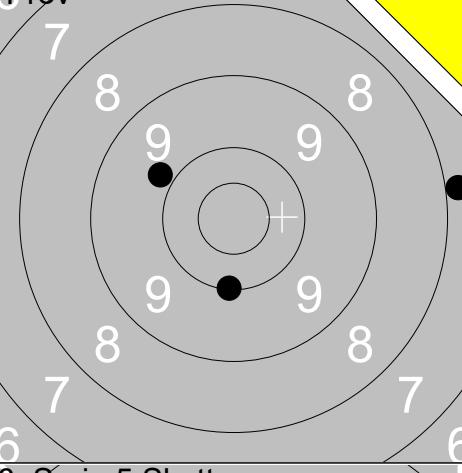
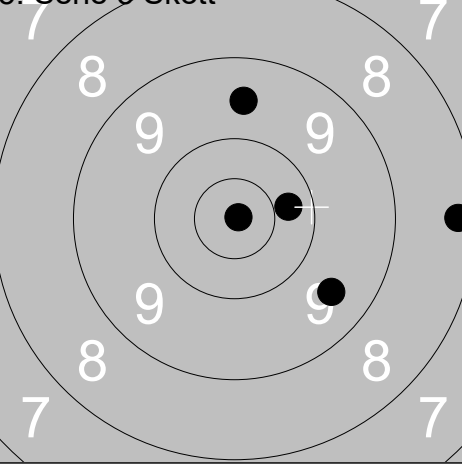
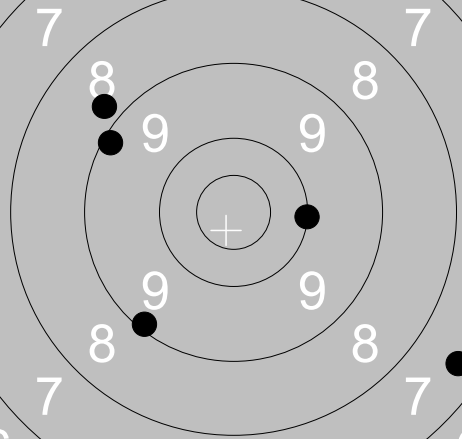

1:	8.3	→
2:	7.5	↗
3:	10.1	↙
4:	8.5	↑
5:	10.0	↓
Serie		43
Total		226

<b>Prov</b> 	1: 8.1 → 2: 8.7 ↗ 3: 9.7 ↗ 4: 10.3 ↓ 5: 8.5 ↓ <hr/> Serie 43 Total 0	<b>1. Serie 5 Skott</b> 	1: 9.3 ↓ 2: 9.7 ↗ 3: 9.4 ↖ 4: 10.5x ↗ 5: 9.3 ↑ <hr/> Serie 46 Total 46
<b>2. Serie 5 Skott</b> 	1: 10.7x ↓ 2: 9.6 ↓ 3: 10.0 ↗ 4: 9.7 ↗ 5: 9.8 ↓ <hr/> Serie 47 Total 93	<b>3. Serie 5 Skott</b> 	1: 10.1 ↗ 2: 9.9 ↗ 3: 9.0 ↖ 4: 8.5 ↑ 5: 10.0 ↓ <hr/> Serie 46 Total 139
<b>Prov</b> 	1: 7.9 → 2: 9.8 ↗ 3: 10.0 ↓ <hr/> Serie 26 Total 139	<b>5. Serie 5 Skott</b> 	1: 10.3 → 2: 9.6 ↑ 3: 8.2 → 4: 9.5 ↓ 5: 10.9x → <hr/> Serie 46 Total 185
<b>6. Serie 5 Skott</b> 	1: 9.1 ↓ 2: 7.4 ↓ 3: 10.0 → 4: 9.1 ↗ 5: 8.8 ↗ <hr/> Serie 43 Total 228		

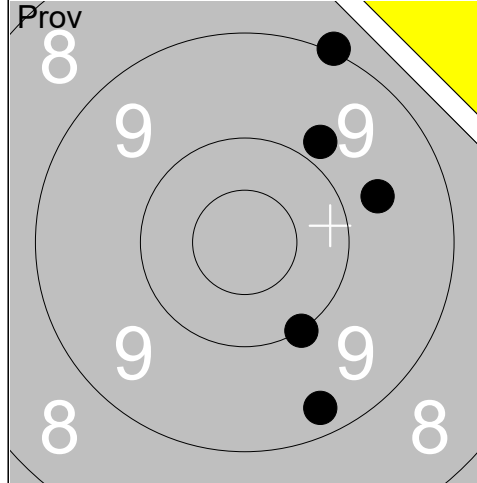

1:	9.3	↘
2:	10.0	↘
3:	9.0	↗
4:	9.8	↗
5:	9.7	→
Serie		46
Total		0

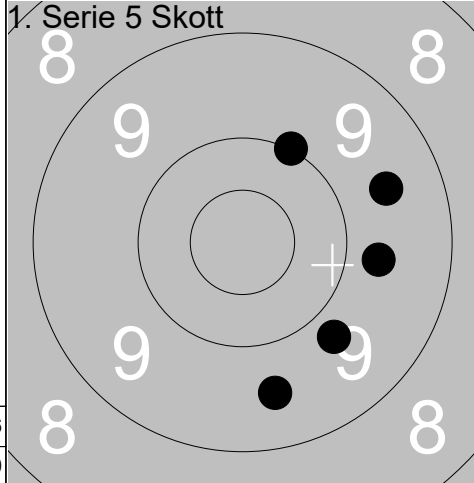

1:	9.6	↘
2:	9.8	↘
3:	10.0	↗
4:	9.7	→
5:	9.6	→
Serie		46
Total		46

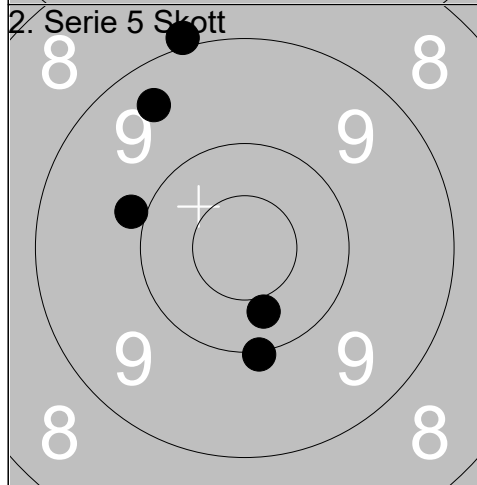

1:	9.4	↗
2:	10.4	↘
3:	8.9	↗
4:	10.0	↘
5:	9.9	↖
Serie		46
Total		92

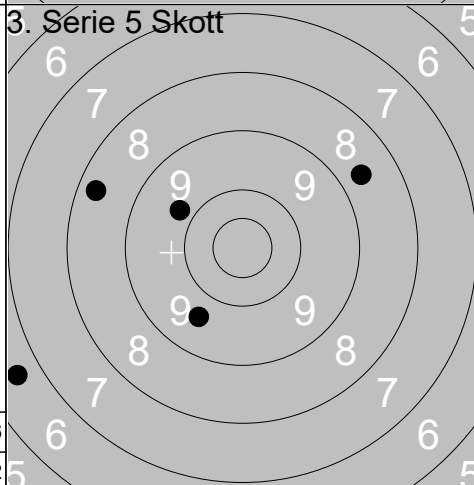

1:	8.6	↗
2:	9.8	↖
3:	8.3	↖
4:	6.6	↙
5:	9.6	↘
Serie		40
Total		132

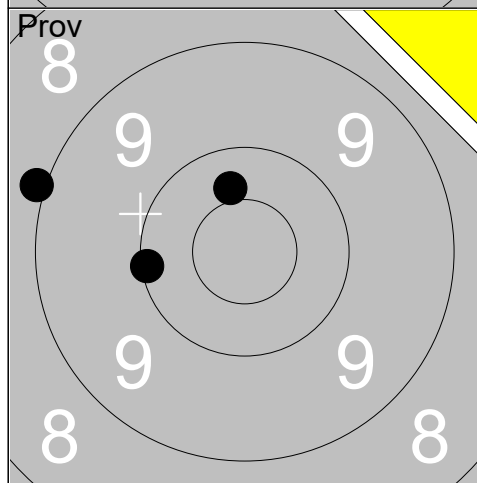

1:	10.1	↖
2:	8.9	↖
3:	10.4	↗
Serie		28
Total		132

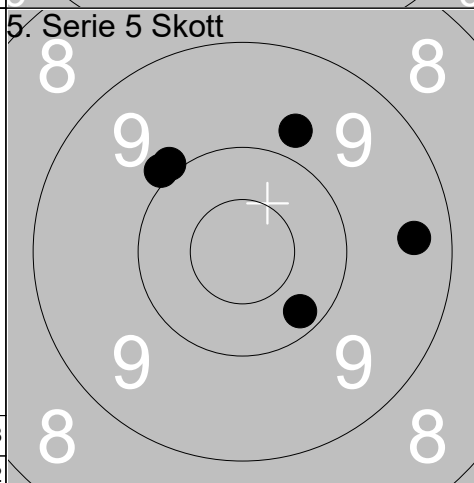

1:	9.9	↗
2:	10.2	↘
3:	9.4	→
4:	9.8	↗
5:	9.9	↗
Serie		46
Total		178

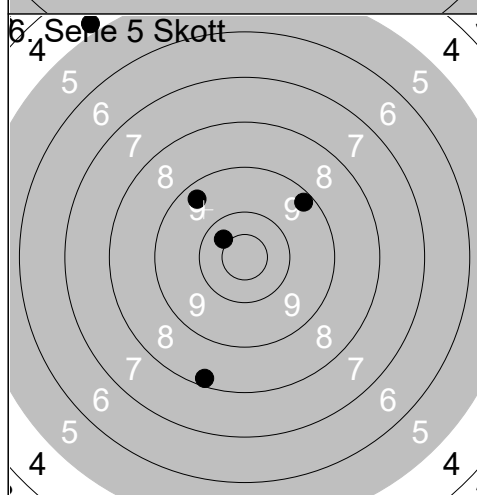

1:	4.8	↗
2:	10.4	↗
3:	9.4	↗
4:	9.2	↗
5:	8.2	↘
Serie		40
Total		218



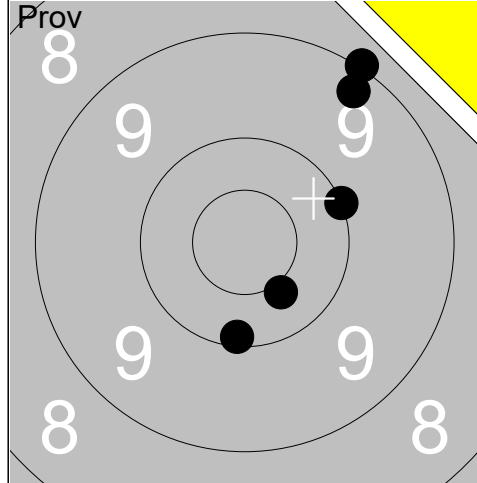

1:	10.0	→
2:	10.1	↓
3:	9.2	↗
4:	10.4	↓
5:	9.0	↗
Serie		48
Total		0

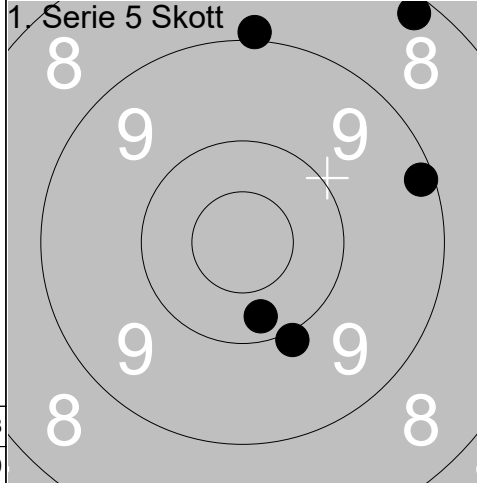

1:	8.2	↗
2:	8.9	↑
3:	9.9	↓
4:	10.2	↓
5:	9.2	→
Serie		44
Total		44

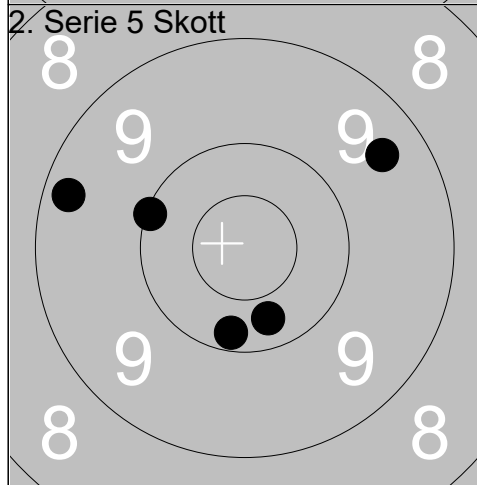

1:	10.3	↓
2:	9.4	↗
3:	10.2	↓
4:	10.1	↖
5:	9.3	↖
Serie		48
Total		92

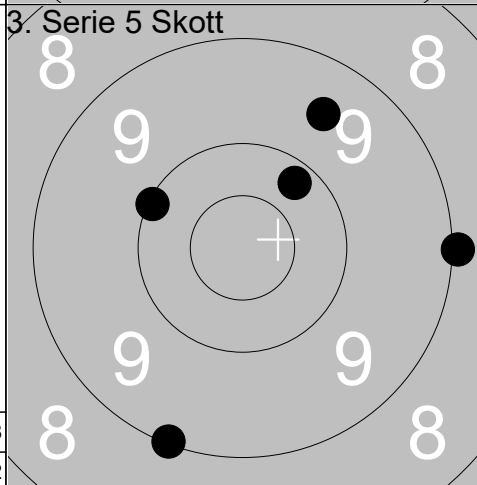

1:	9.5	↗
2:	10.2	↗
3:	10.1	↖
4:	9.0	↓
5:	9.0	→
Serie		47
Total		139

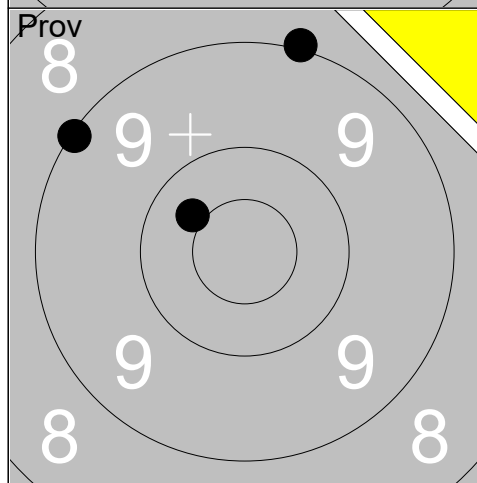

1:	9.0	↑
2:	9.1	↗
3:	10.4	↗
Serie		28
Total		139

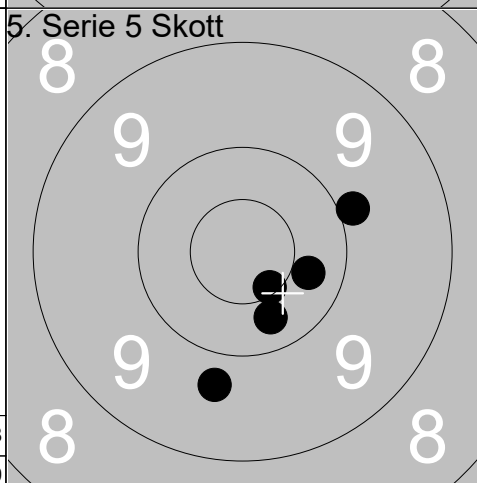

1:	10.6x	↓
2:	9.7	↓
3:	10.3	→
4:	9.9	→
5:	10.3	↓
Serie		48
Total		187

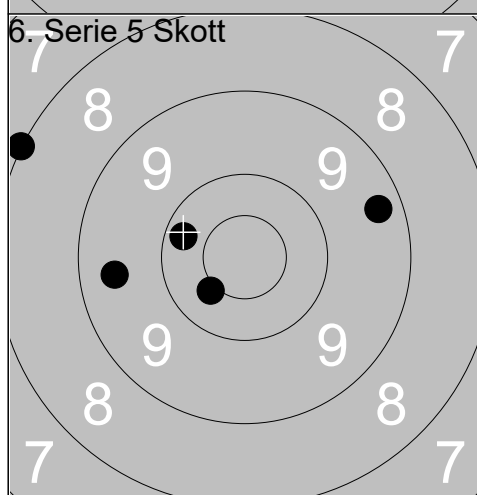

1:	10.2	↖
2:	9.3	→
3:	10.4x	↖
4:	9.4	↖
5:	8.0	↖
Serie		46
Total		233