

1: 8.2 →
2: 9.8 →
3: 9.5 ↗
4: 9.9 ↗
5: 10.7x ↗

Serie	45
Total	192

1: 9.8 ←
2: 10.3x ↗
3: 10.3 ↓
4: 10.5x ↓
5: 8.8 →

Serie	47
Total	239

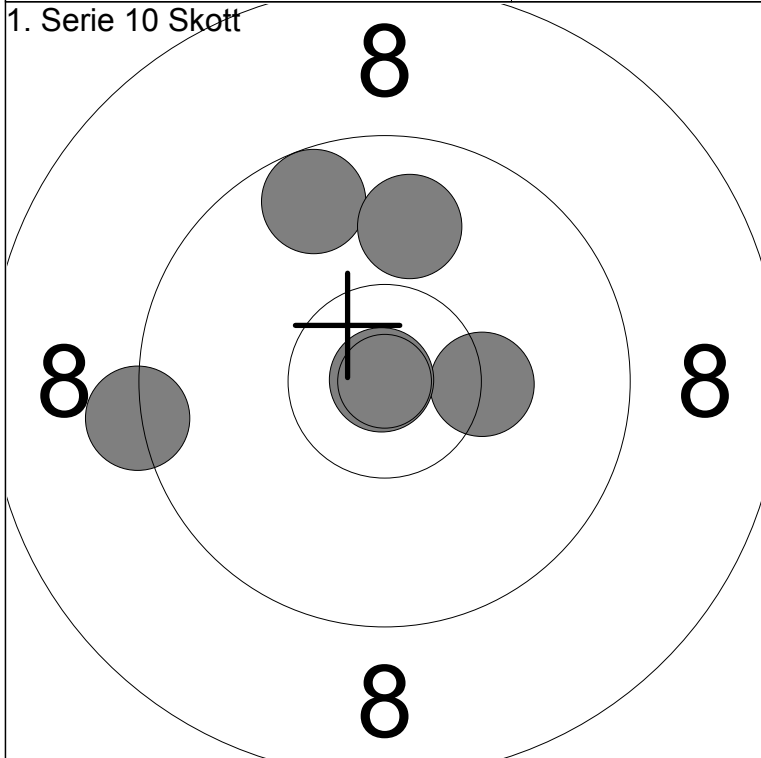

6: 9.3 ←
7: 10.3x →
8: 10.9x ↗
9: 9.7 ↗
10: 9.9 ↗

Serie	47
Total	286

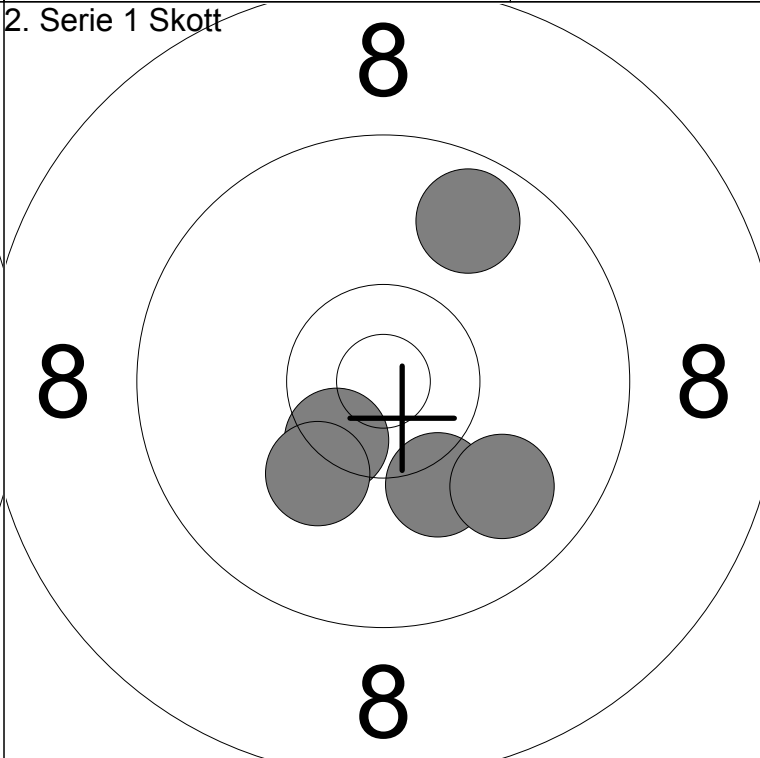

1: 10.2 ↓
2: 10.4x ↓
3: 9.7 ↗
4: 9.9 ↓
5: 10.2 ↓

Serie	48
Total	334

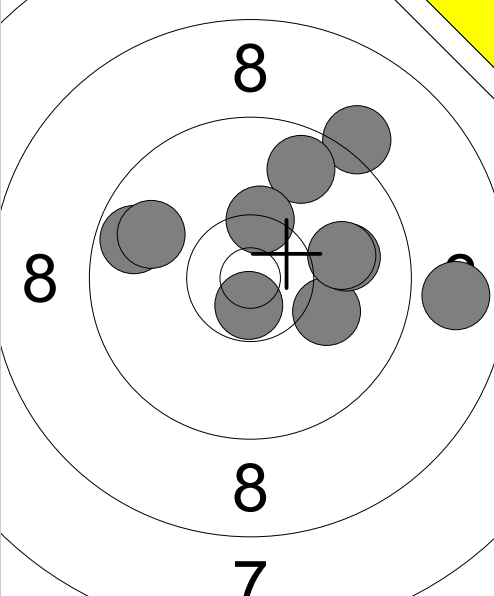
 <p style="text-align: center; font-size: 2em;">7</p>	<p>1: 9.2 ↗</p> <p>2: 8.8 →</p> <p>3: 10.1 →</p> <p>4: 9.7 ↗</p> <p>5: 9.7 ←</p> <p>6: 9.9 →</p> <p>7: 10.3x ↗</p> <p>8: 10.0 →</p> <p>9: 9.8 ←</p> <p>10: 10.7x ↓</p>	 <p style="text-align: center; font-size: 2em;">7</p>	<p>11: 10.0 ←</p>
Serie 93		Serie 10	
Total 192		Total 192	

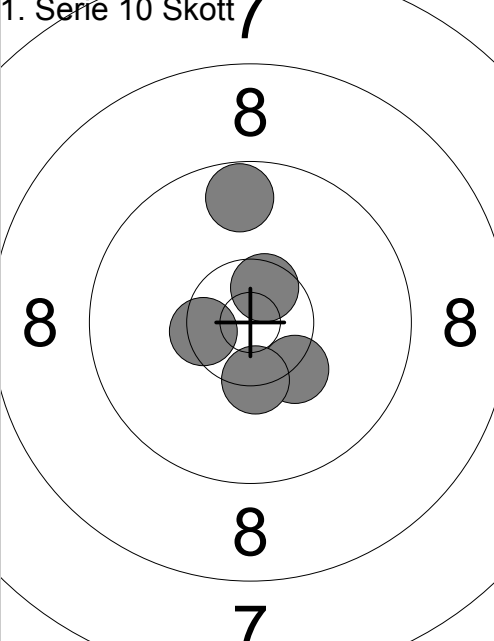
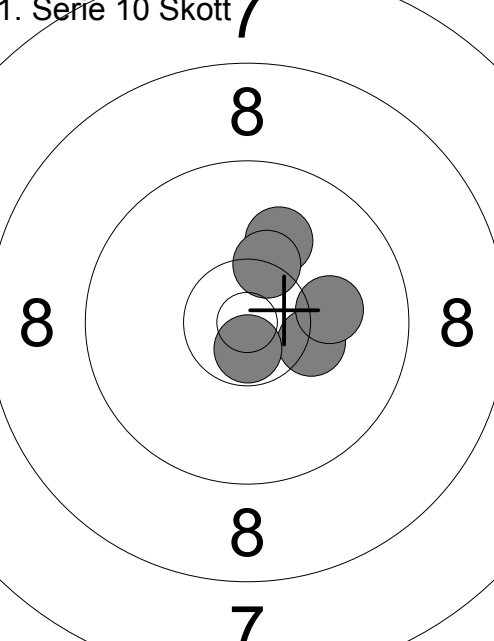
<p>1. Serie 10 Skott</p>  <p style="text-align: center; font-size: 2em;">7</p>	<p>1: 9.7 ↗</p> <p>2: 10.3x ↓</p> <p>3: 10.5x ←</p> <p>4: 10.6x ↗</p> <p>5: 10.4x ↓</p>	 <p style="text-align: center; font-size: 2em;">7</p>	<p>6: 10.3 →</p> <p>7: 10.1 ↗</p> <p>8: 10.3x ↗</p> <p>9: 10.1 →</p> <p>10: 10.7x ↓</p>
Serie 49		Serie 50	
Total 241		Total 291	

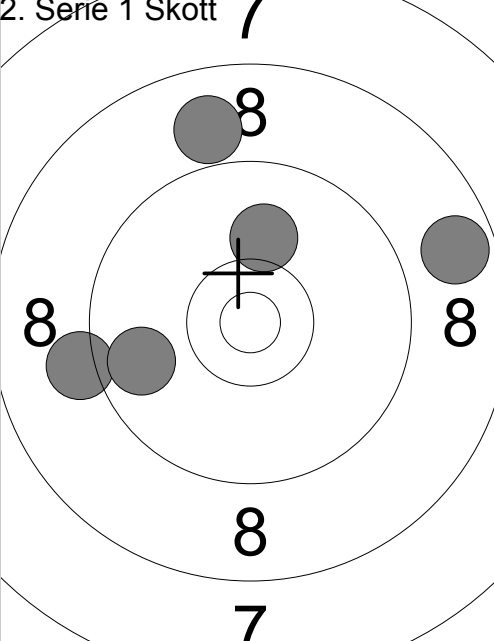
<p>2. Serie 1 Skott</p>  <p style="text-align: center; font-size: 2em;">7</p>	<p>1: 9.2 ←</p> <p>2: 9.8 ←</p> <p>3: 8.9 ↗</p> <p>4: 8.7 →</p> <p>5: 10.1 ↗</p>		
Serie 44			
Total 335			

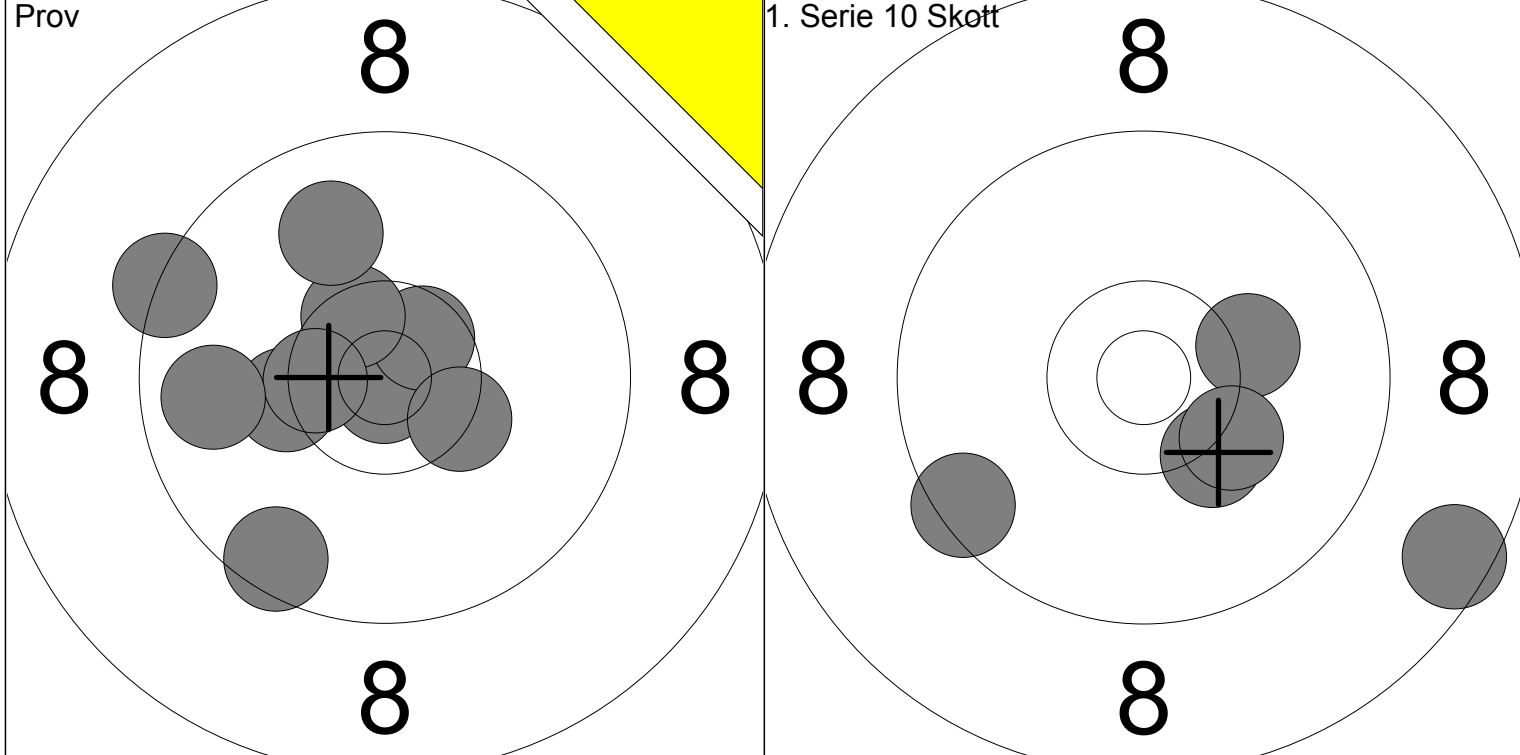

1: 10.9x ↓	6: 10.5x ←			1: 9.5 ↙			
2: 10.3 ←	7: 9.9 ↗	Serie	96	2: 10.3 ↓	Serie	47	
3: 10.6x ↗	8: 9.8 ←			3: 10.2 →			
4: 10.5x ↗	9: 9.3 ↙	Total	189	4: 8.5 ↓	Total	236	
5: 10.4x ↘	10: 9.5 ↘			5: 10.2 ↓			

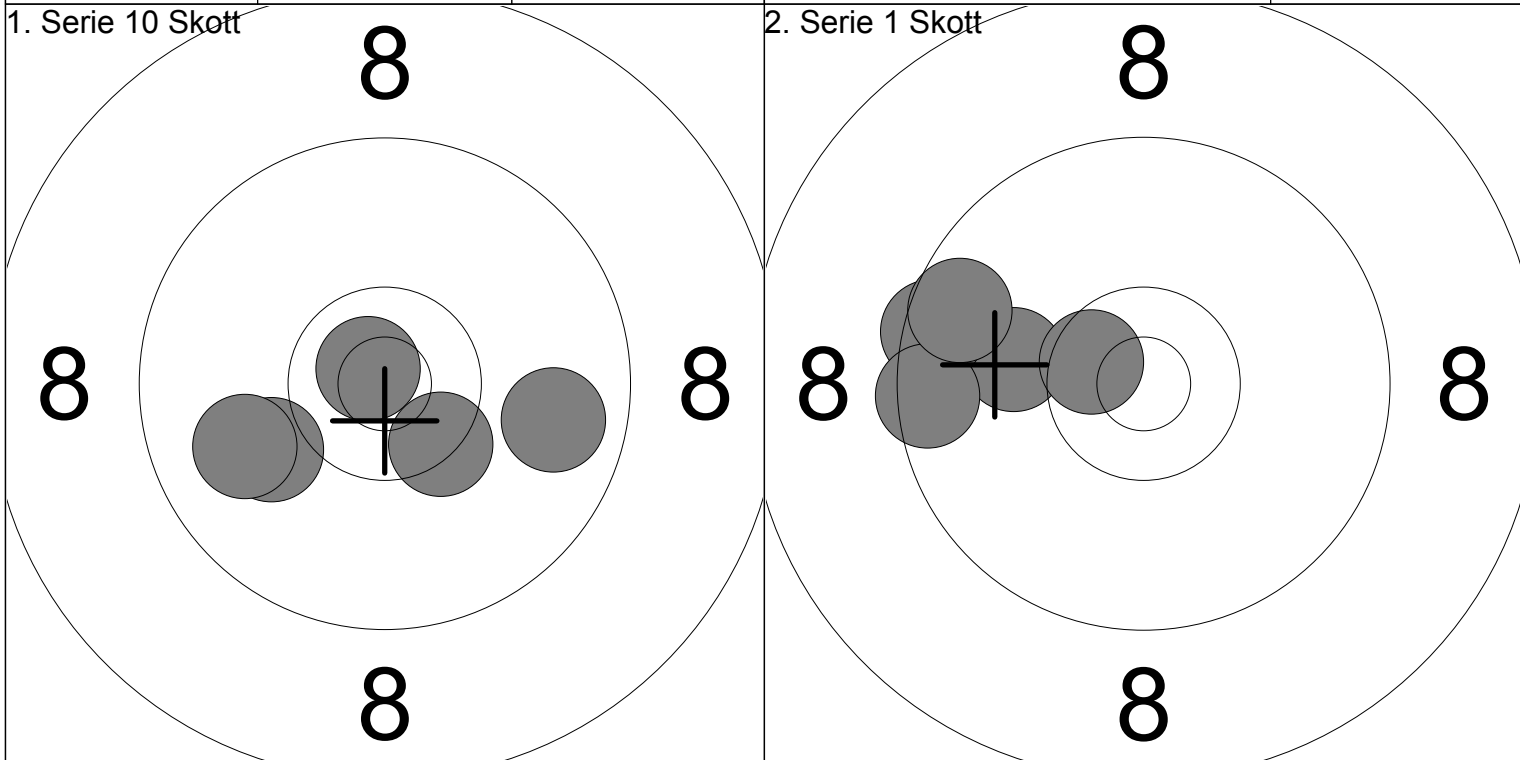

6: 9.8 →				1: 10.1 ←			
7: 10.8x ↗		Serie	48	2: 9.5 ←	Serie	47	
8: 10.1 ←				3: 9.5 ←			
9: 9.9 ←		Total	284	4: 10.6x ↗	Total	331	
10: 10.4x ↓				5: 9.6 ↙			

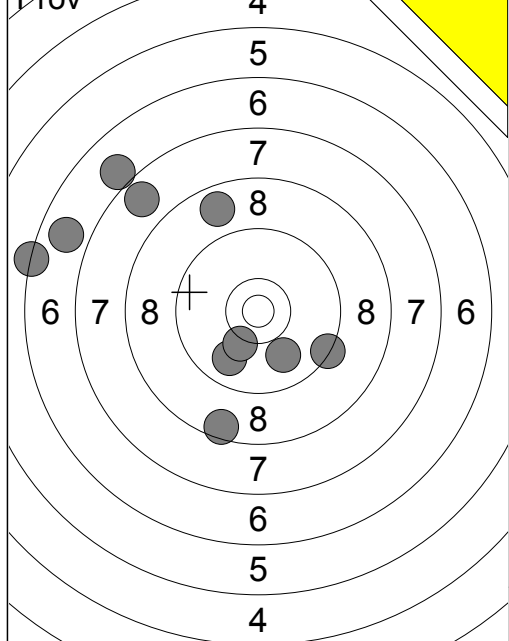

1:	9.3	↘
2:	8.5	↓
3:	9.9	↘
4:	8.8	↗
5:	9.9	↘
6:	10.2	↓
7:	6.8	↖
8:	7.0	↗
9:	6.3	↖
10:	7.7	↗
Serie		79
Total		179

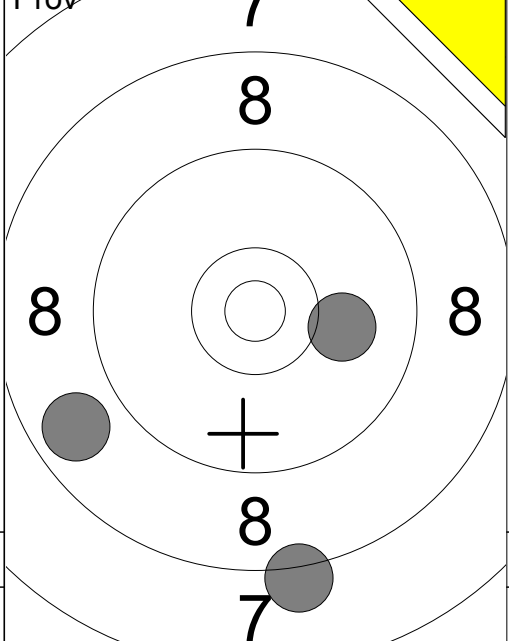

11:	8.8	↖
12:	8.2	↓
13:	10.0	→
Serie		26
Total		179

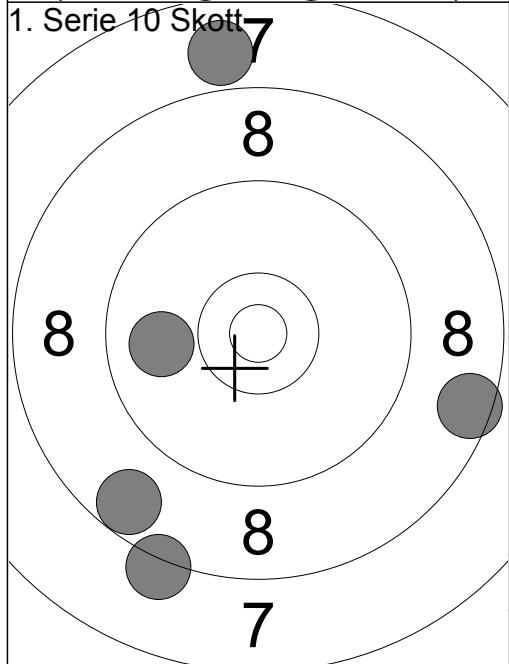

1:	7.9	↑
2:	8.2	↓
3:	9.9	↖
4:	8.5	→
5:	8.7	↘
Serie		40
Total		219

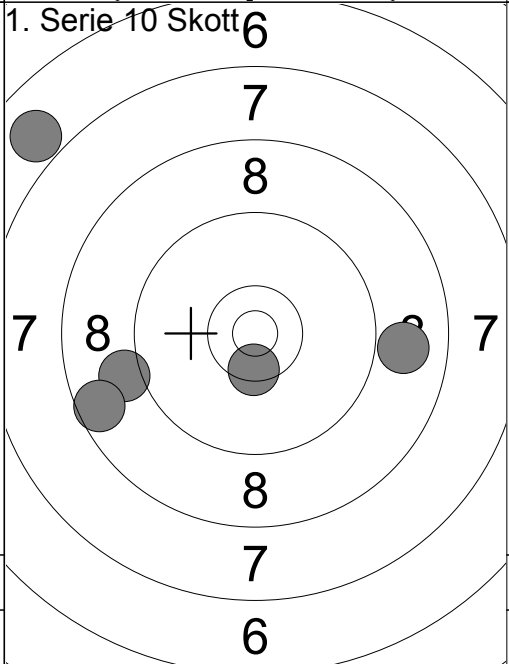

6:	8.9	→
7:	10.4x	↓
8:	6.9	↗
9:	9.1	↖
10:	8.6	↖
Serie		41
Total		260

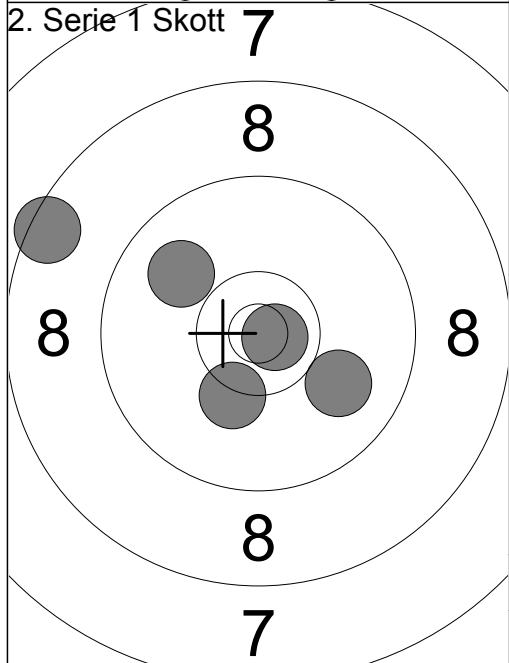

1:	10.0	↘
2:	8.5	↗
3:	10.2	↓
4:	10.8x	→
5:	9.9	↗
Serie		47
Total		307

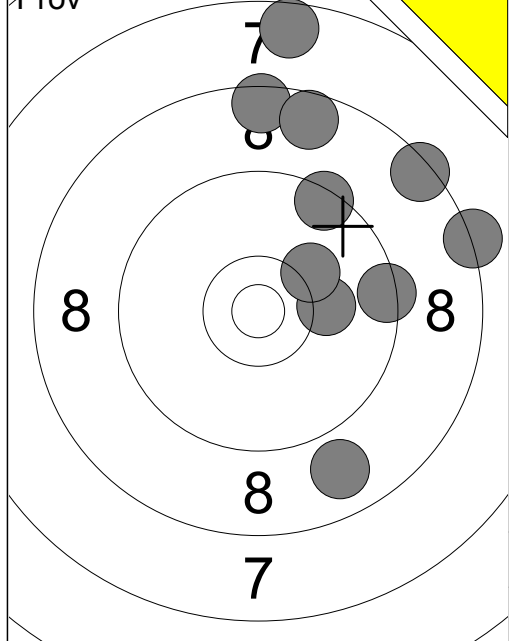

1:	10.1	→
2:	8.9	↘
3:	8.5	↑
4:	10.2	↗
5:	8.3	→
6:	8.4	↗
7:	7.6	↑
8:	9.4	↗
9:	8.6	↑
10:	9.4	→
Serie		85
Total		177

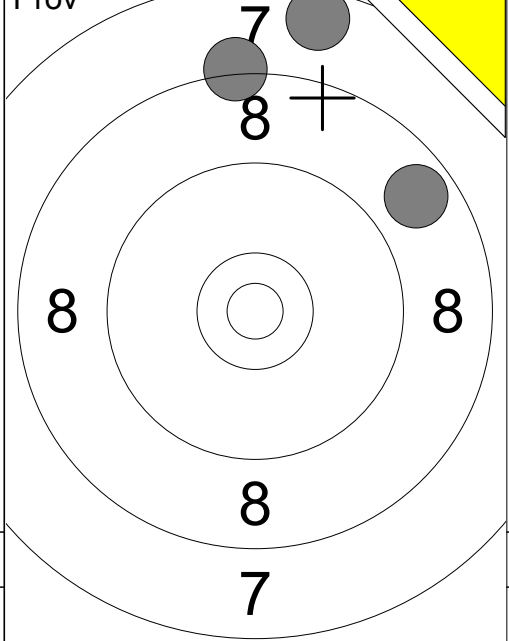

11:	7.6	↑
12:	8.7	↗
13:	8.2	↑
Serie		23
Total		177

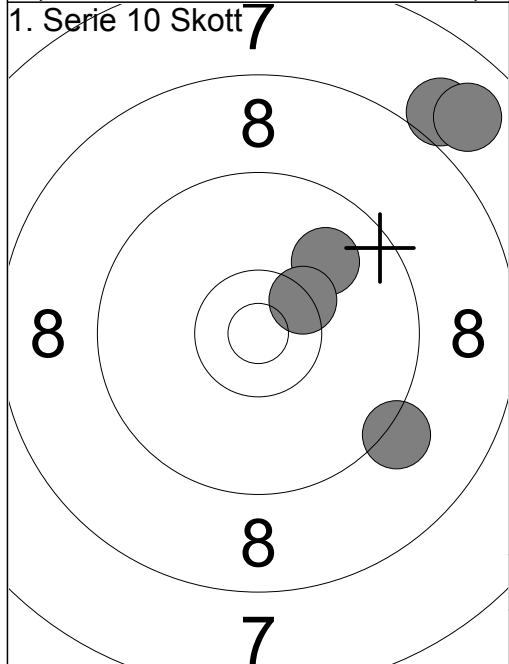

1:	8.0	↗
2:	9.2	↘
3:	9.9	↗
4:	10.4x	↗
5:	7.9	↗
Serie		43
Total		220

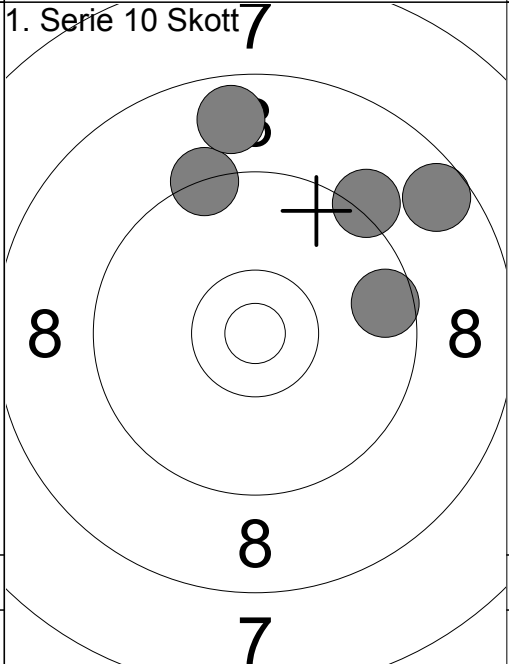

6:	9.2	↗
7:	9.3	↑
8:	9.6	→
9:	8.6	↗
10:	8.7	↑
Serie		43
Total		263

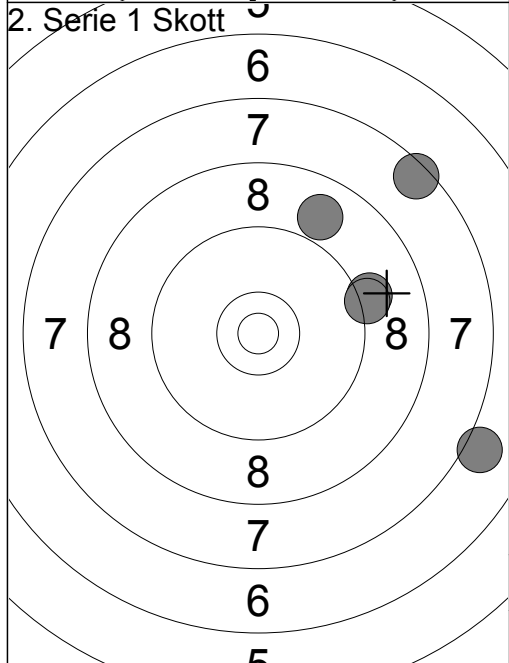

1:	9.1	→
2:	7.1	↘
3:	8.9	↗
4:	9.2	→
5:	7.5	↗
Serie		40
Total		303

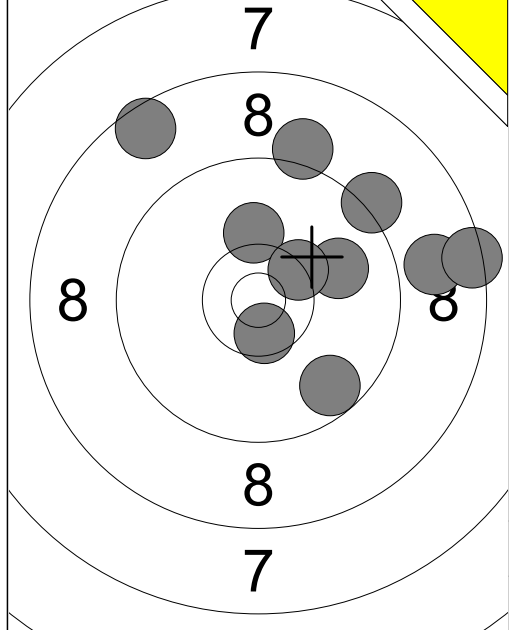

1:	10.2	↑
2:	10.6x	↓
3:	8.6	↖
4:	10.0	→
5:	8.9	→
6:	8.4	→
7:	9.1	↑
8:	10.4x	↗
9:	9.2	↗
10:	9.7	↓
Serie		91
Total		172

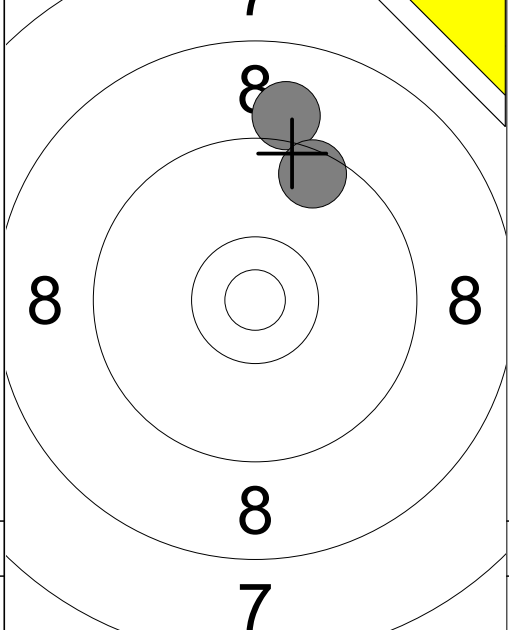

11:	9.0	↑
12:	9.5	↑
Serie		18
Total		172

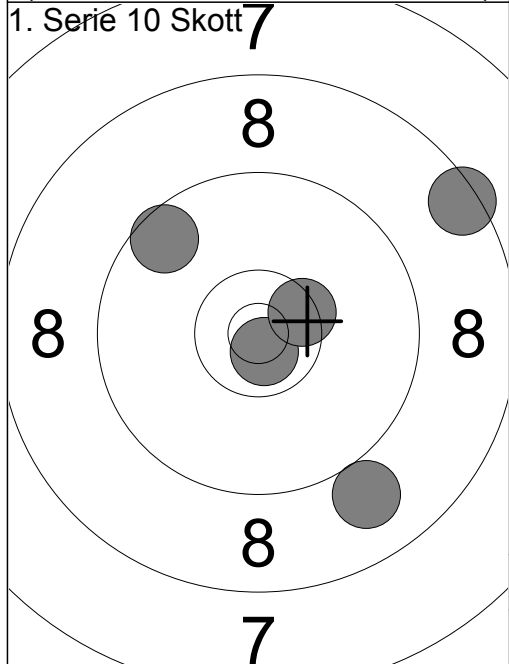

1:	8.5	↗
2:	9.0	↓
3:	10.8x	↓
4:	9.6	↖
5:	10.5x	↗
Serie		46
Total		218

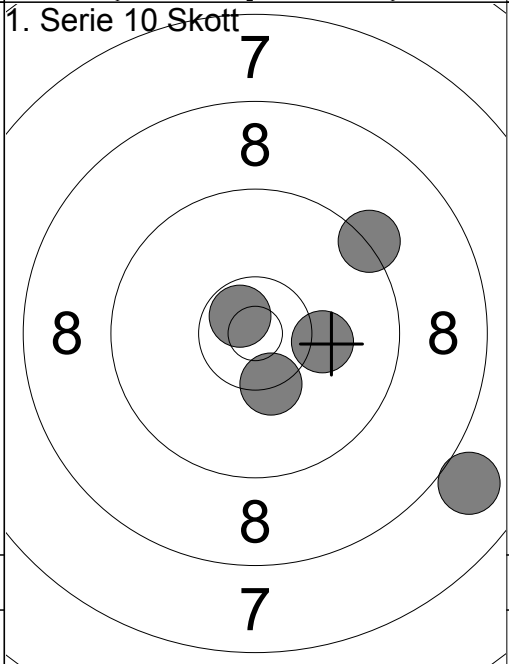

6:	8.0	↓
7:	10.7x	↖
8:	10.3x	↓
9:	9.3	↗
10:	10.2	→
Serie		47
Total		265

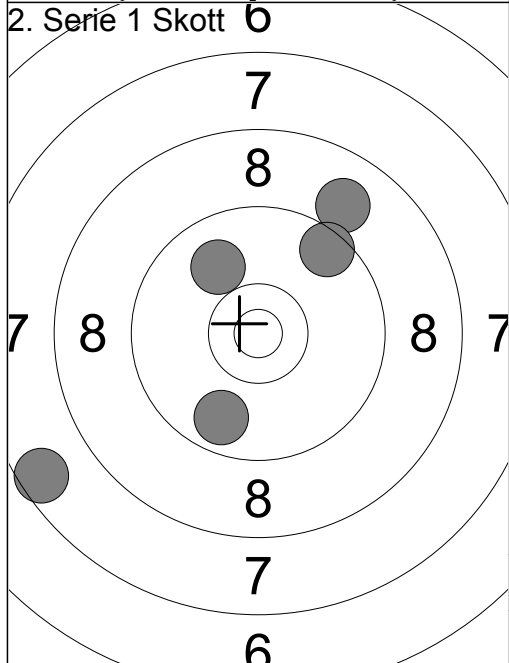

1:	7.6	↙
2:	9.0	↗
3:	9.9	↖
4:	9.5	↗
5:	9.8	↓
Serie		43
Total		308

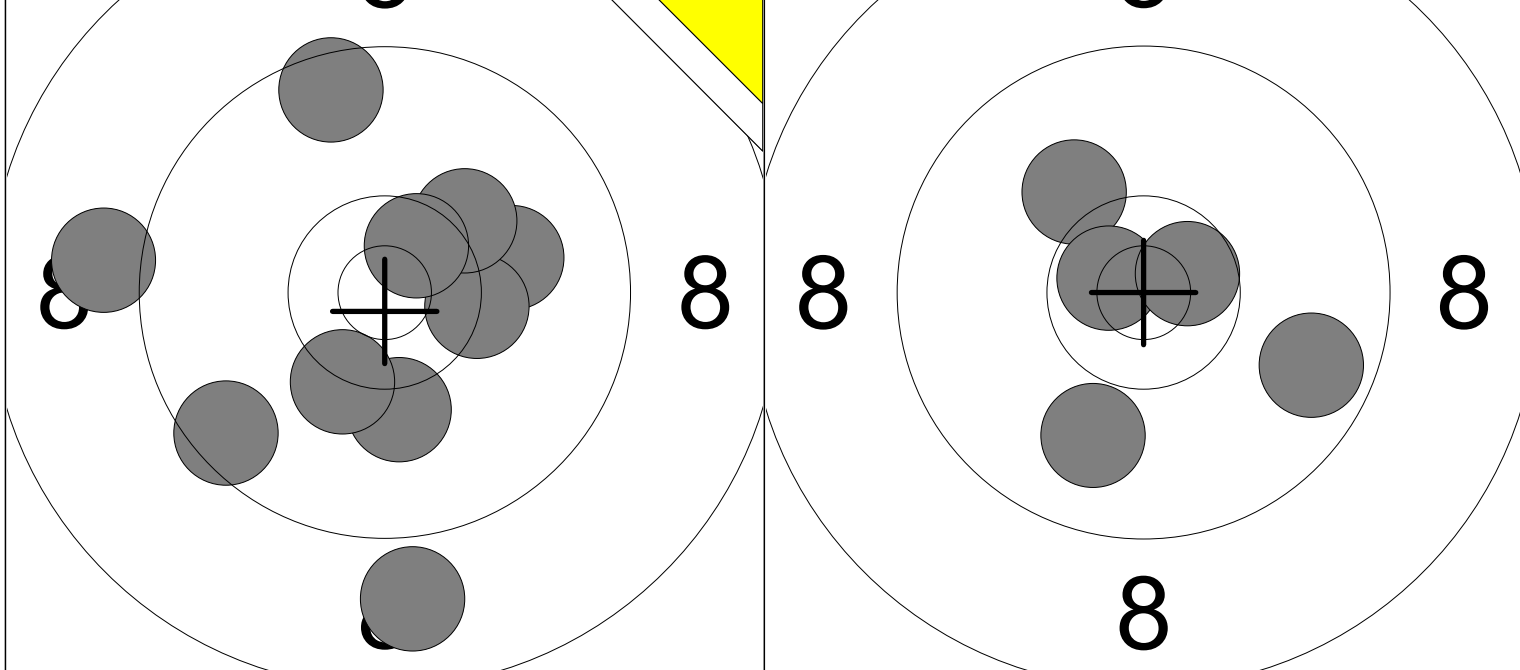

1: 10.2 ↓	6: 9.0 ←			1: 10.1 ↗			
2: 10.1 →	7: 8.9 ↓	Serie	95	2: 10.7x ↖		Serie	48
3: 10.3x →	8: 9.5 ↑			3: 9.7 →			
4: 10.2 ↗	9: 10.6x ↗	Total	194	4: 10.6x →		Total	242
5: 10.3x ↓	10: 9.5 ↙			5: 9.9 ↓			

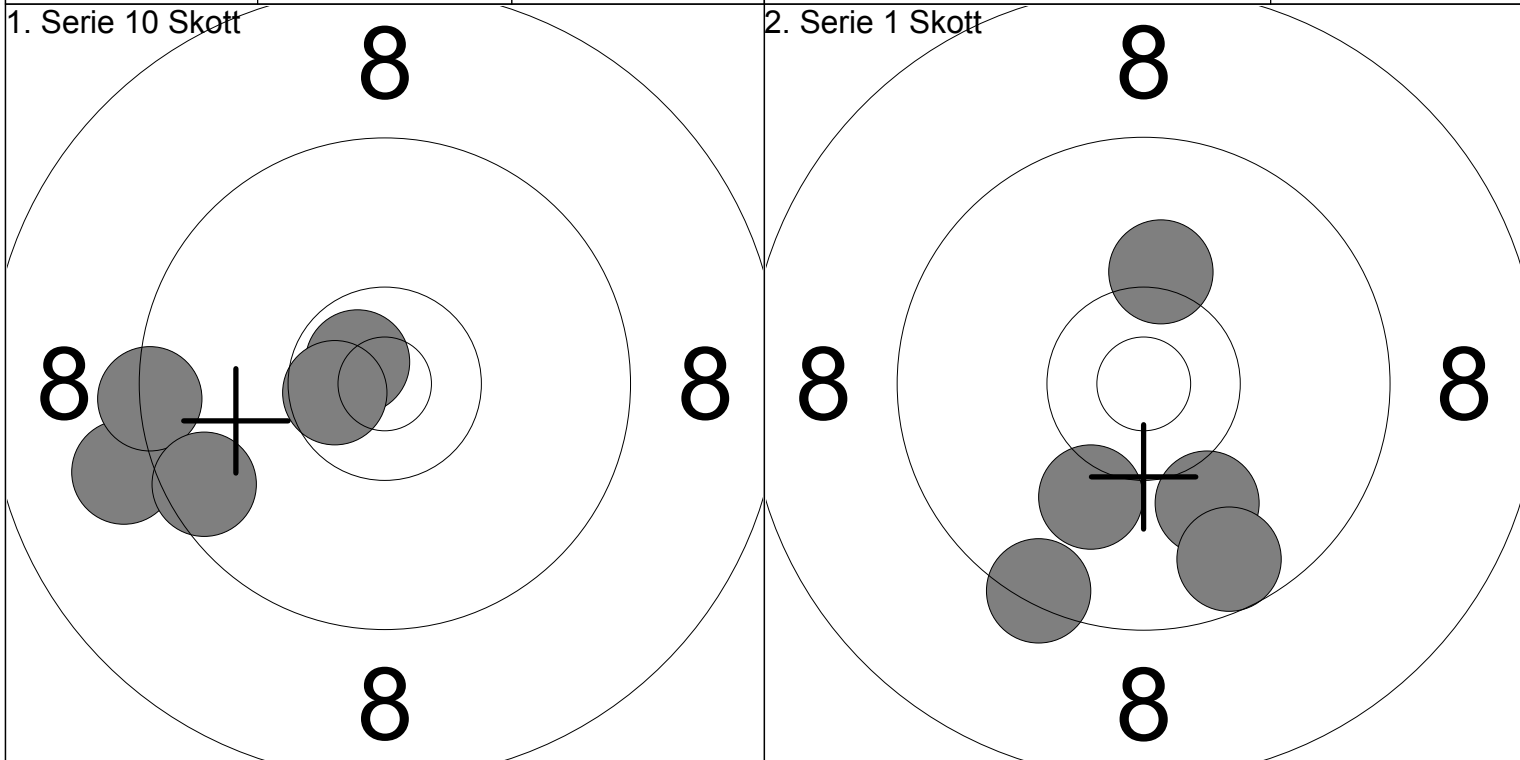

6: 9.1 ←	1: 9.4 ↓			2: 10.1 ↓			
7: 10.7x ↗	2: 10.1 ↓	Serie	47	3: 10.0 ↓		Serie	48
8: 9.4 ←	3: 10.0 ↓			4: 9.6 ↓			
9: 10.6x ←	4: 9.6 ↓	Total	289	5: 10.2 ↑		Total	337
10: 9.6 ↙	5: 10.2 ↑						

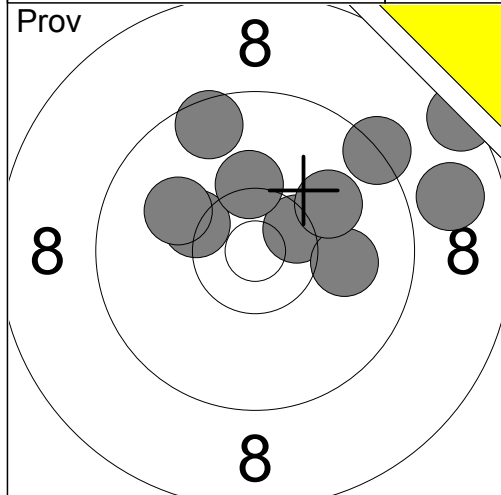

1:	10.3	↖
2:	10.5x	↗
3:	9.6	↗
4:	8.4	↗
5:	9.3	↗
6:	8.9	→
7:	10.0	→
8:	10.1	↗
9:	10.1	↖
10:	10.3	↑
Serie		94
Total		191

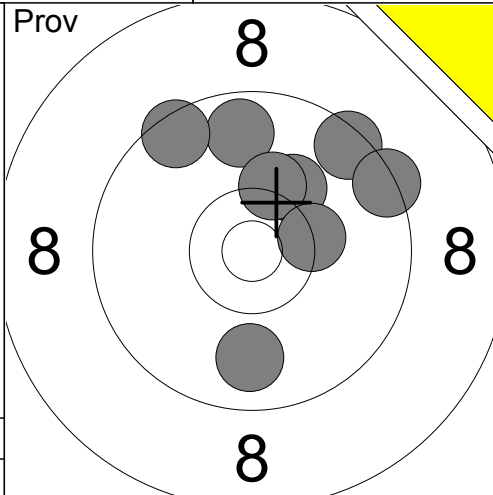

11:	9.7	↑
12:	9.5	↖
13:	10.2	↗
14:	10.2	↑
15:	9.5	↗
16:	10.3x	→
17:	9.4	↗
18:	9.8	↓
Serie		75
Total		191

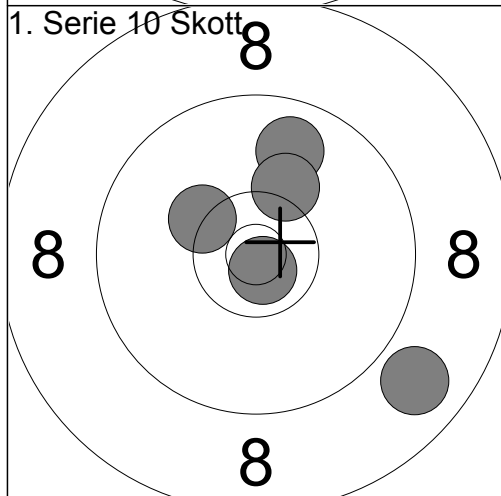

1:	8.9	↘
2:	10.3x	↖
3:	9.8	↗
4:	10.2	↗
5:	10.8x	↘
Serie		47
Total		238

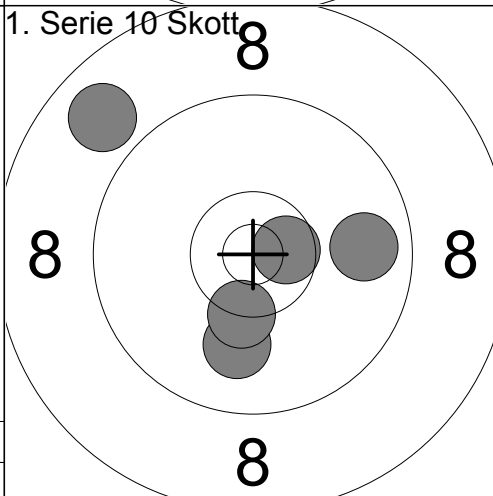

6:	10.0	↓
7:	10.6x	→
8:	9.8	→
9:	10.3x	↘
10:	8.8	↖
Serie		47
Total		285

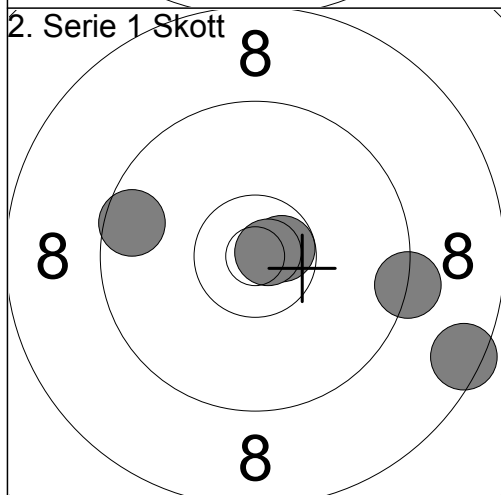

1:	9.6	↖
2:	8.5	↘
3:	9.3	→
4:	10.7x	→
5:	10.8x	→
Serie		46
Total		331

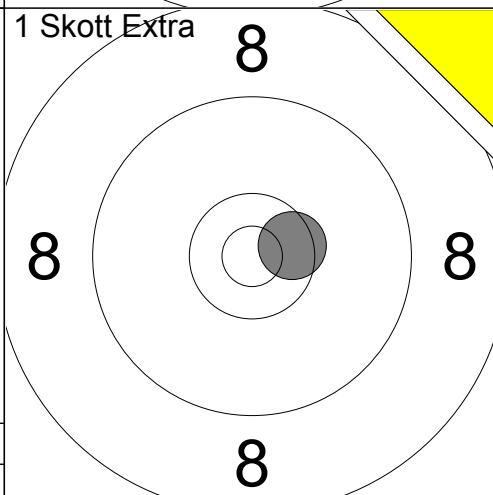

1:	10.5x	→
Serie		10
Total		331

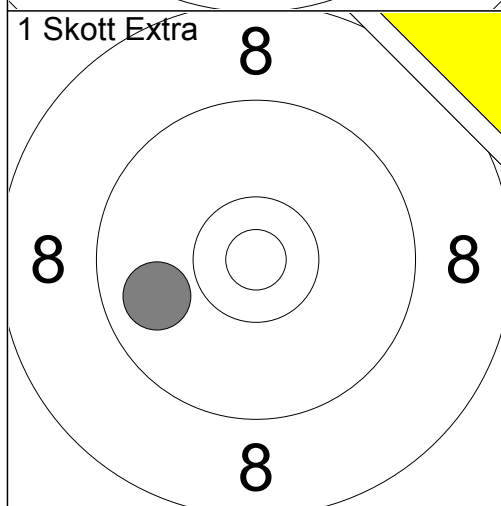

1:	9.9	↖
Serie		9
Total		331



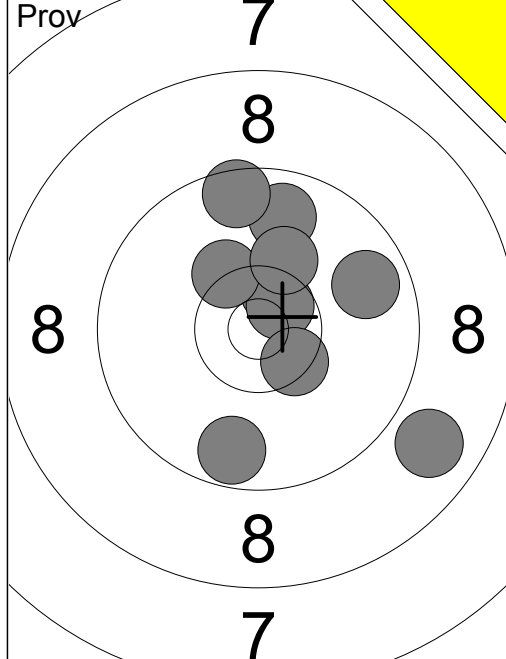

1:	8.9	↘
2:	10.5x	↗
3:	10.6x	↗
4:	9.8	↑
5:	9.7	↓
6:	10.5x	↘
7:	10.3x	↖
8:	10.2	↑
9:	9.8	→
10:	9.5	↑

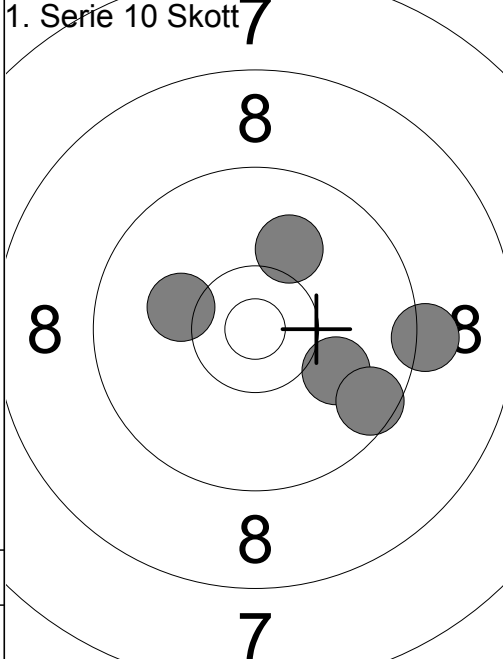

1:	10.0	↘
2:	10.2	←
3:	9.6	↘
4:	10.1	↑
5:	9.2	→

Serie	94
Total	189

Serie	48
Total	237

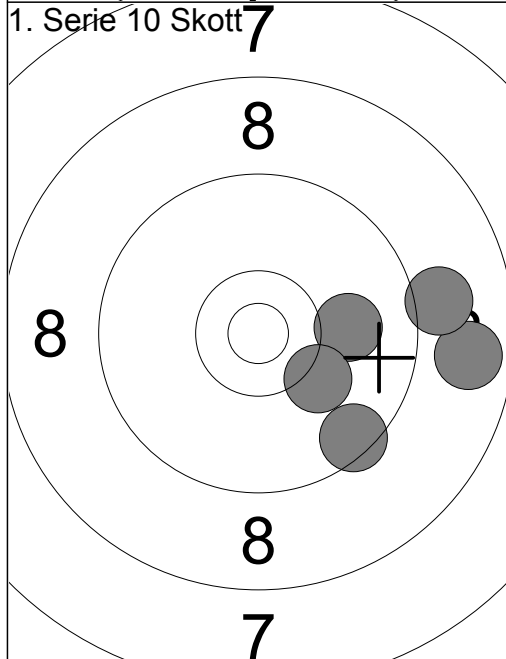

6:	10.0	→
7:	10.2	↘
8:	8.8	→
9:	9.1	→
10:	9.5	↘

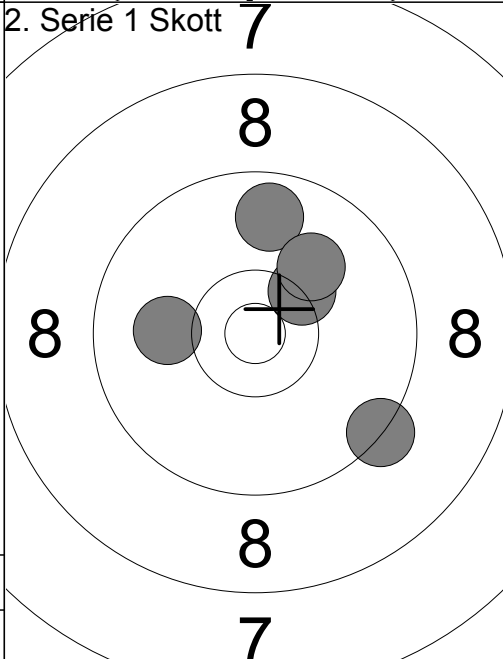

1:	10.1	←
2:	10.3x	↗
3:	9.7	↑
4:	9.3	↘
5:	10.1	↗

Serie	46
Total	283

Serie	48
Total	331

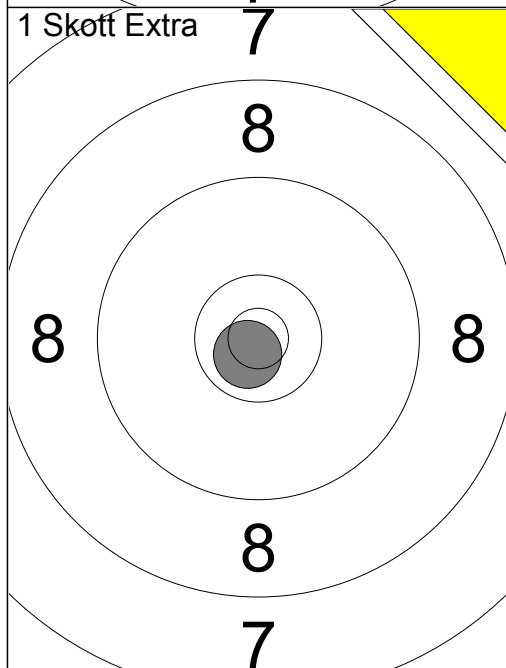

1:	10.8x	↘
----	-------	---

Serie	10
Total	331

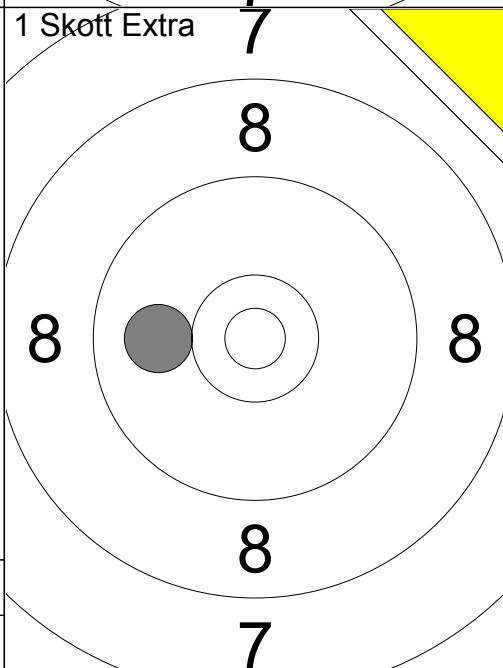

1:	10.0	←
----	------	---

Serie	10
Total	331

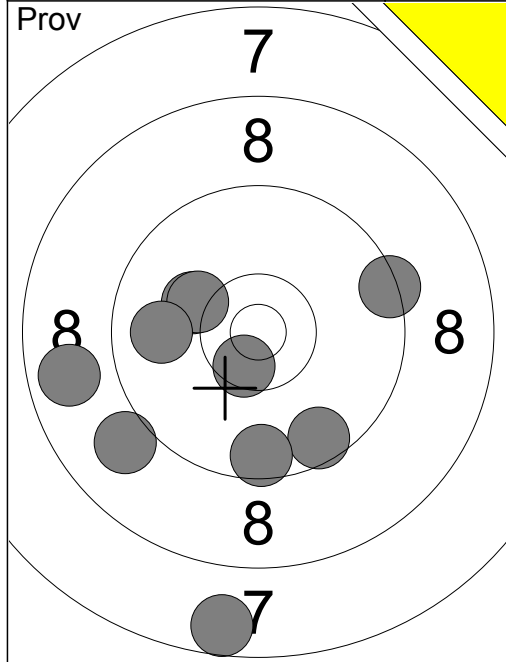

1: 7.6 ↓
2: 8.8 ←
3: 9.0 ↙
4: 10.5x ↓
5: 9.6 ↓
6: 10.1 ↖
7: 10.2 ↖
8: 9.4 →
9: 9.9 ←
10: 9.6 ↓
Serie 90
Total 189

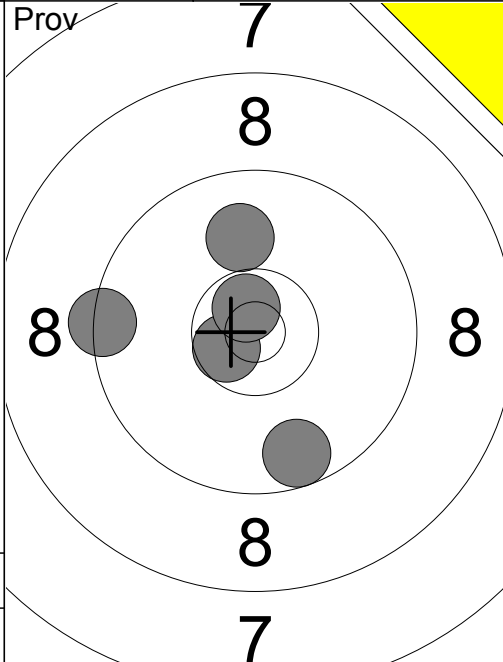

11: 10.6x ↙
12: 9.4 ←
13: 10.0 ↑
14: 10.7x ↗
15: 9.6 ↓
Serie 48
Total 189

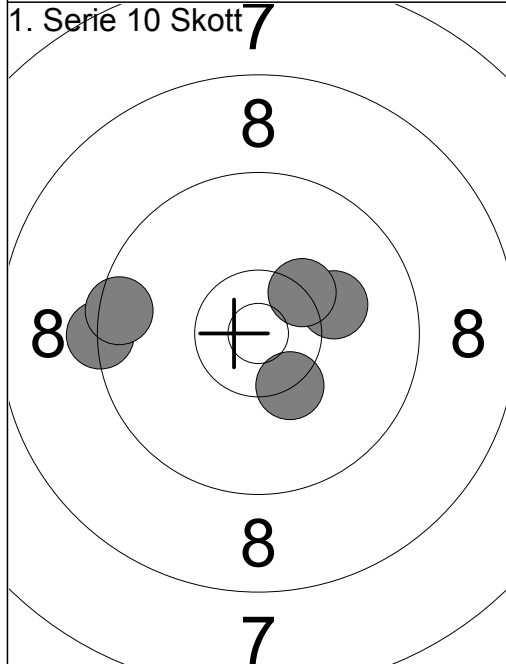

1: 9.3 ←
2: 9.5 ←
3: 10.1 →
4: 10.3x ↓
5: 10.3x ↗
Serie 48
Total 237

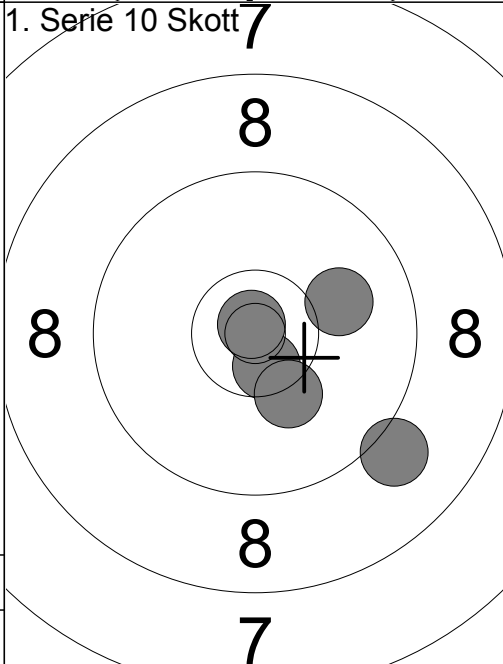

6: 10.6x ↓
7: 9.1 ↓
8: 10.0 →
9: 10.2 ↓
10: 10.9x ↗
Serie 49
Total 286

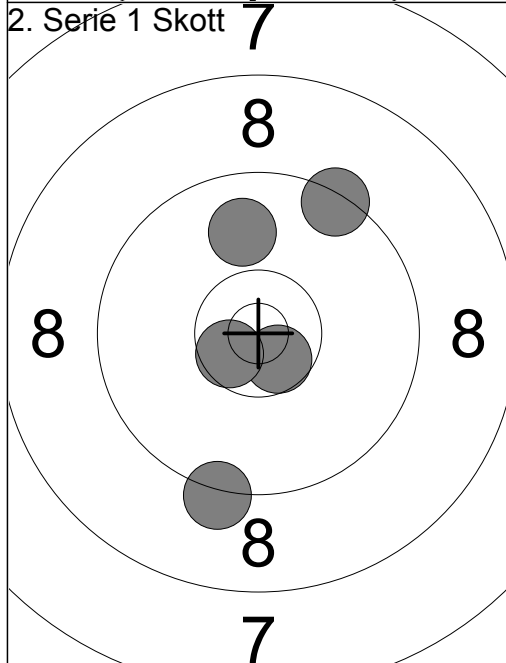

1: 9.2 ↓
2: 10.6x ↓
3: 10.6x ↙
4: 9.4 ↗
5: 9.9 ↑
Serie 47
Total 333

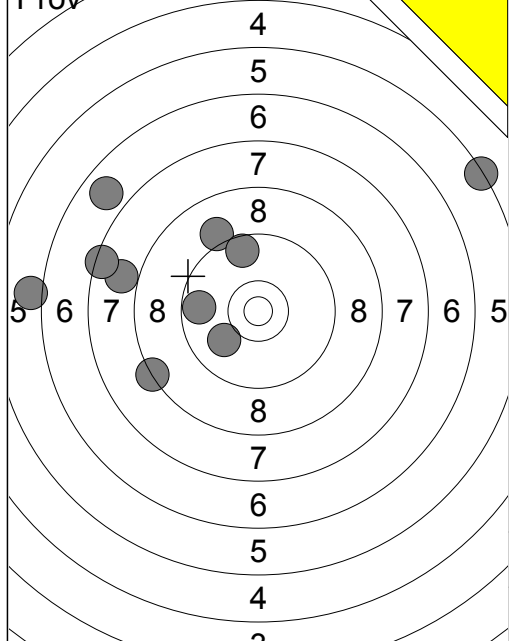

1:	6.1	←
2:	7.9	←
3:	9.1	↑
4:	6.8	↖
5:	7.4	←
6:	9.7	←
7:	8.3	↙
8:	5.3	↗
9:	10.0	↙
10:	9.6	↑
Serie		76
Total		183

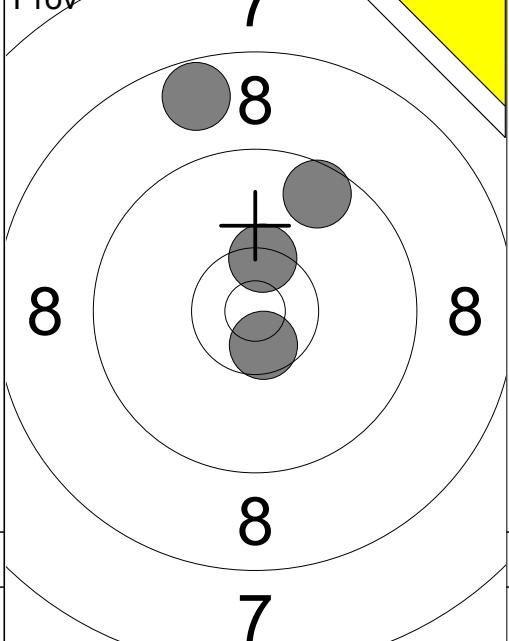

11:	8.7	↑
12:	10.4x	↑
13:	9.6	↗
14:	10.6x	↘
Serie		37
Total		183

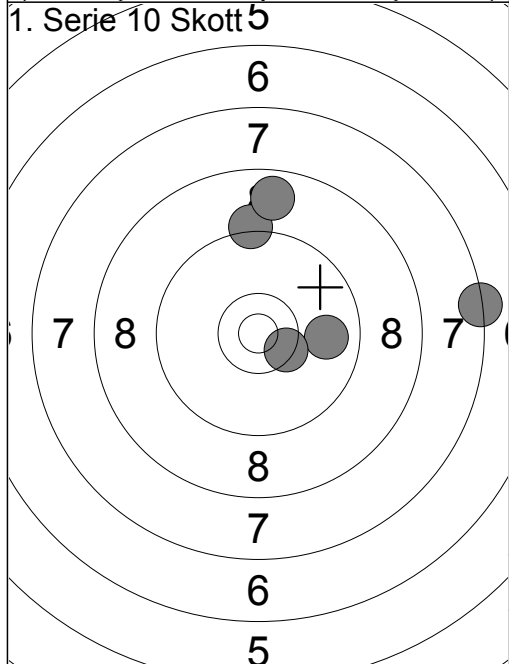

1:	9.2	↑
2:	7.3	→
3:	9.9	→
4:	8.7	↑
5:	10.4x	↘
Serie		43
Total		226

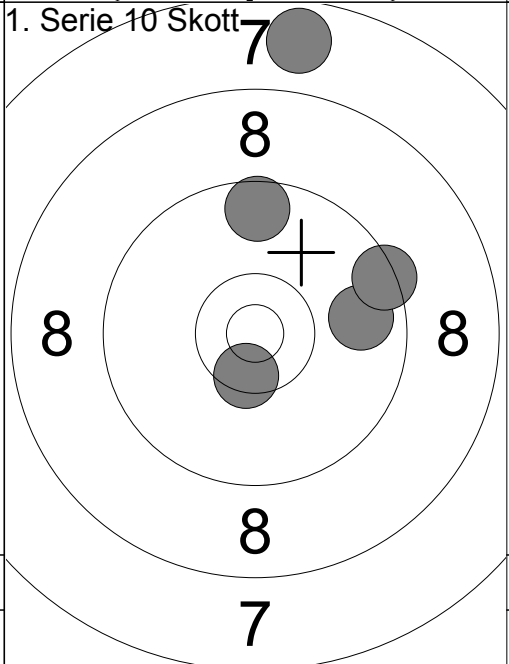

6:	10.5x	↘
7:	9.6	↑
8:	9.8	→
9:	7.7	↑
10:	9.4	↗
Serie		44
Total		270

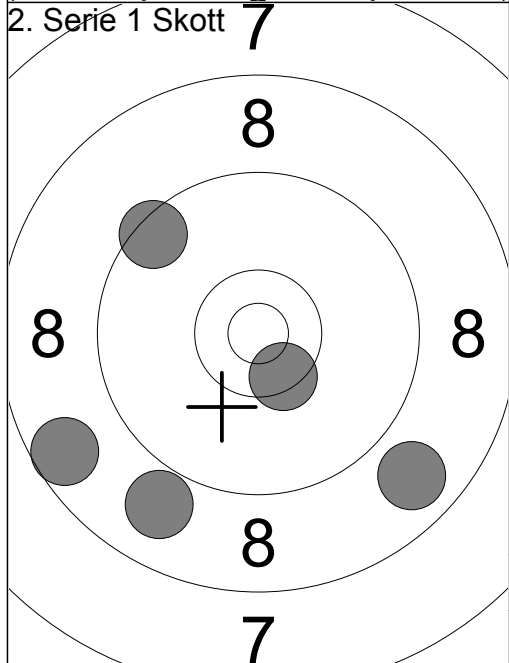

1:	8.9	↙
2:	9.5	↖
3:	8.8	↘
4:	10.4x	↘
5:	8.6	↙
Serie		43
Total		313

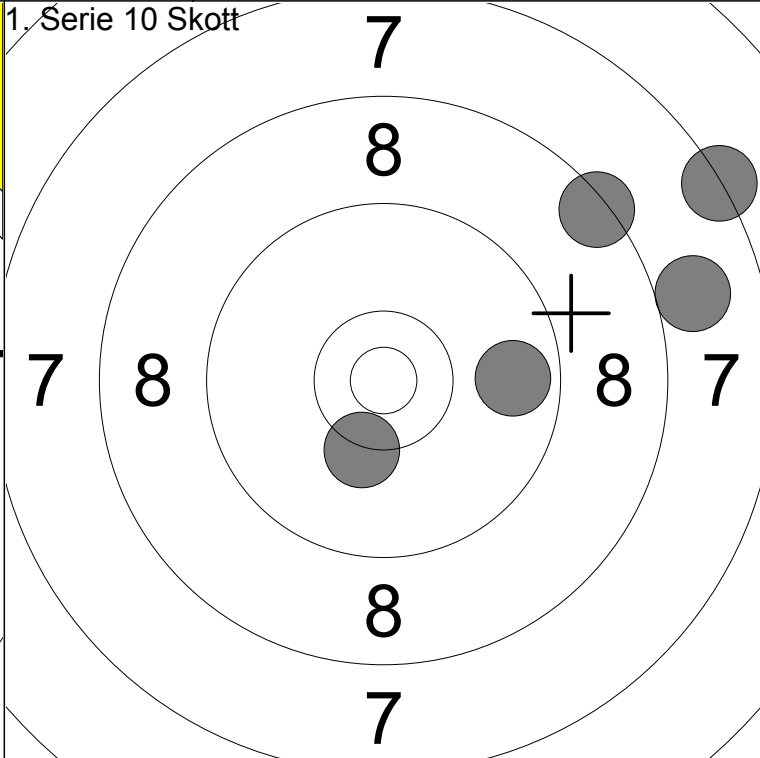
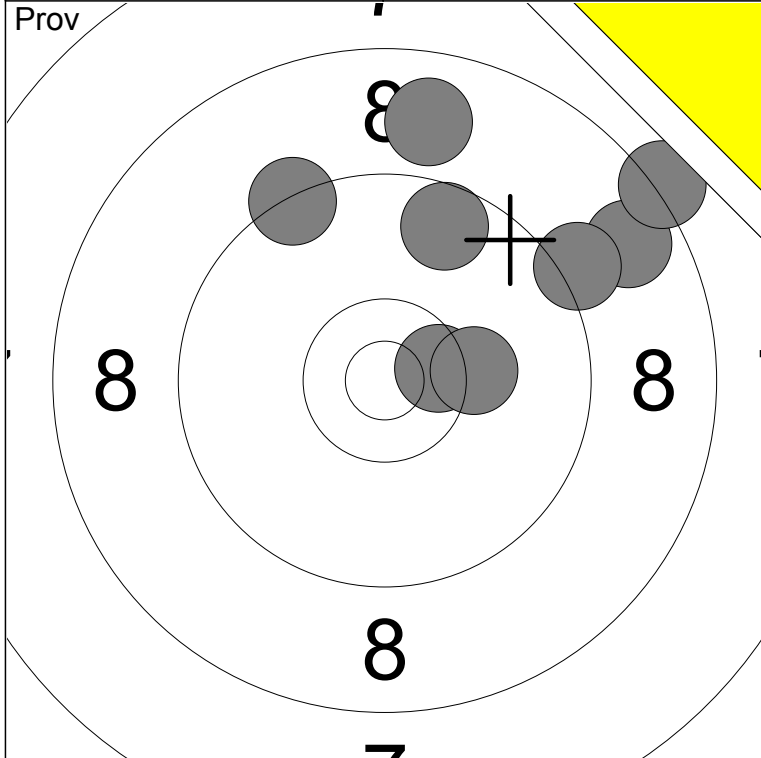

1: 9.3 ↖	6: 9.6 ↗	Serie	78
2: 10.5x →	7: 8.9 ↗		
3: 8.7 ↗	8: 8.2 ↗	Total	169
4: 7.5 ↗	9: 9.2 ↗		
5: 10.2 →			

1: 10.3 ↓	Serie	42
2: 8.4 ↗		
3: 8.0 →	Total	211
4: 7.3 ↗		
5: 9.7 →		

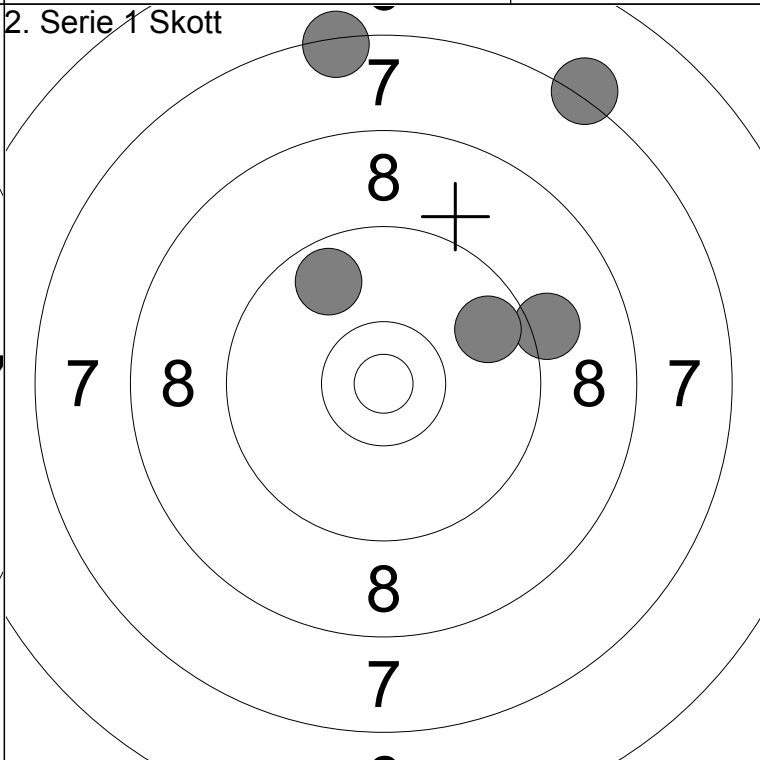
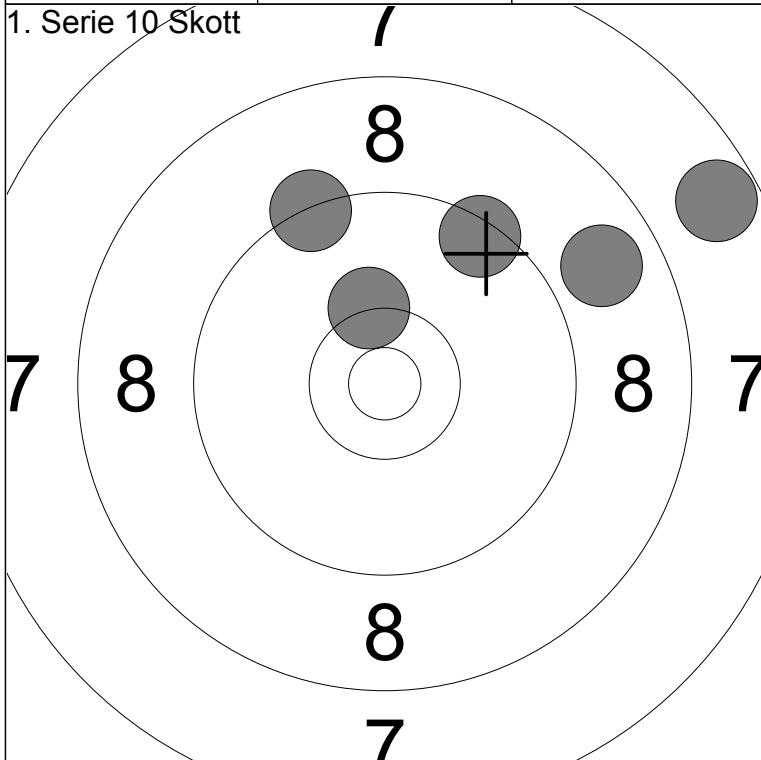

6: 9.4 ↗	Serie	43
7: 7.7 ↗		
8: 8.8 ↗	Total	254
9: 9.3 ↗		
10: 10.3 ↗		

1: 9.7 ↖	Serie	41
2: 9.1 →		
3: 7.4 ↗	Total	295
4: 9.7 ↗		
5: 7.2 ↗		

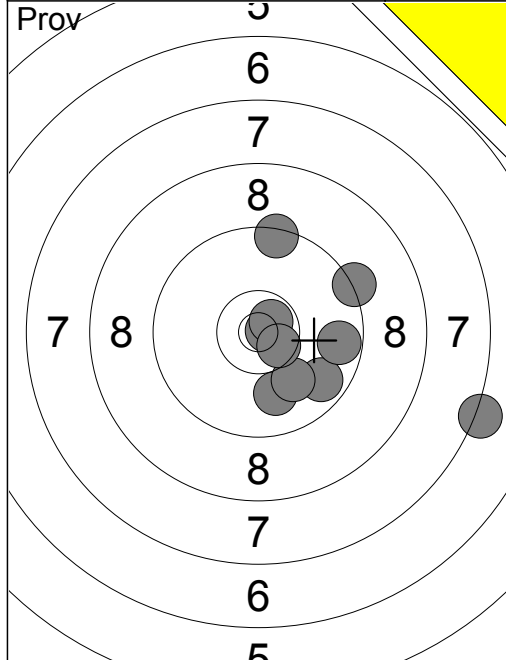

1:	7.2	↘
2:	10.8x	→
3:	10.7x	↗
4:	9.7	↘
5:	9.9	↓
6:	9.3	↗
7:	9.7	→
8:	10.0	↘
9:	9.4	↑
10:	10.6x	↘
Serie		92
Total		199

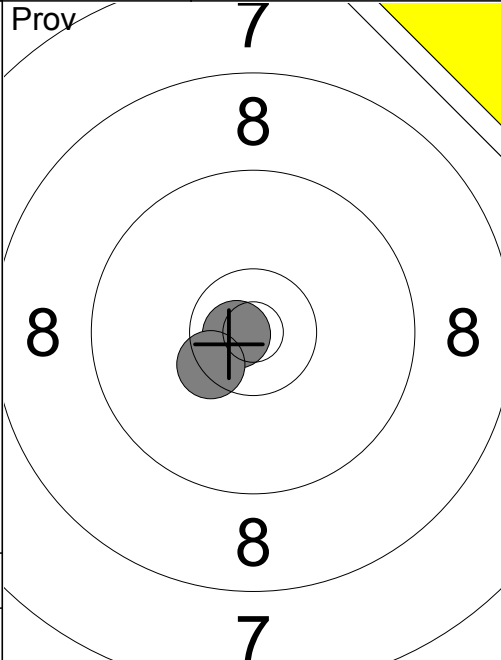

11:	10.8x	↙
12:	10.4x	↙
Serie		20
Total		199

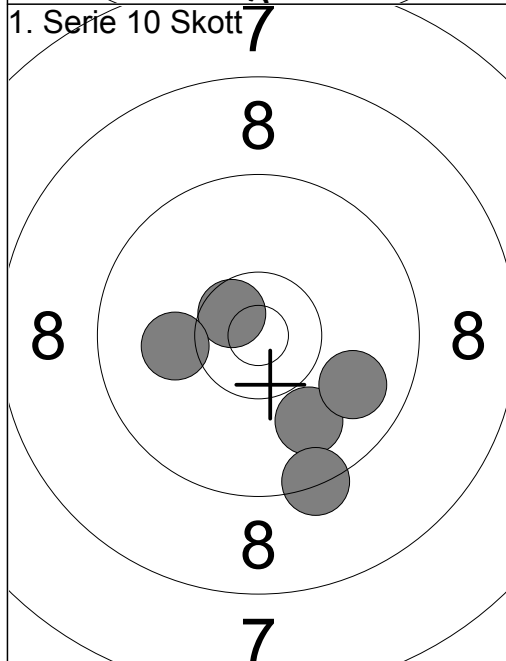

1:	10.6x	↖
2:	9.9	↘
3:	10.1	←
4:	9.9	↘
5:	9.3	↘
Serie		47
Total		246

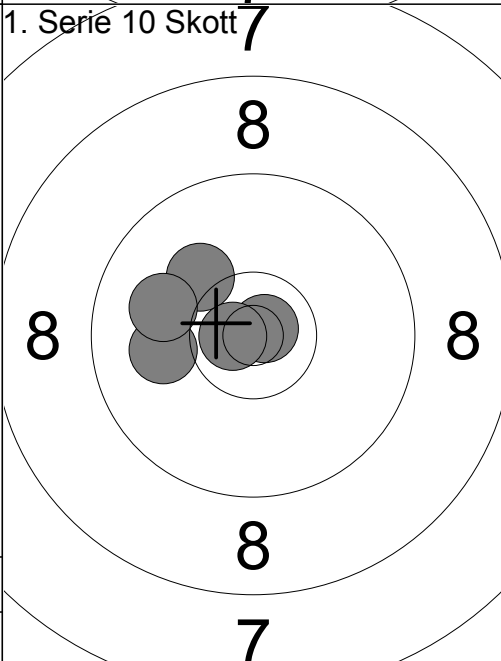

6:	10.1	↖
7:	10.8x	↗
8:	10.7x	←
9:	10.0	←
10:	10.0	←
Serie		50
Total		296

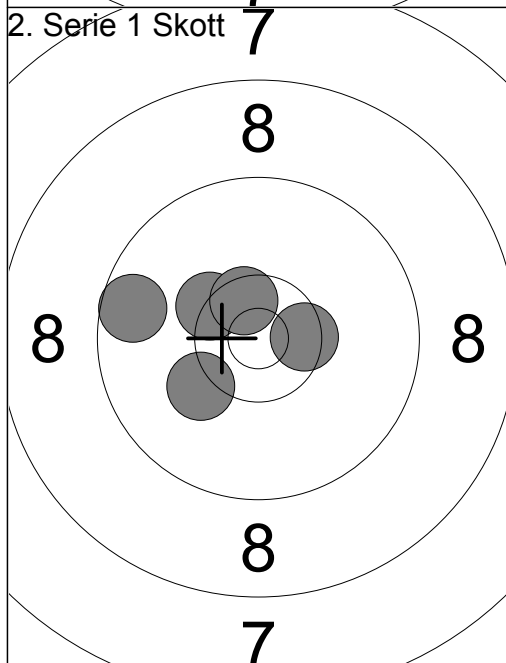

1:	10.4x	↖
2:	9.6	←
3:	10.2	↙
4:	10.5x	→
5:	10.5x	↖
Serie		49
Total		345

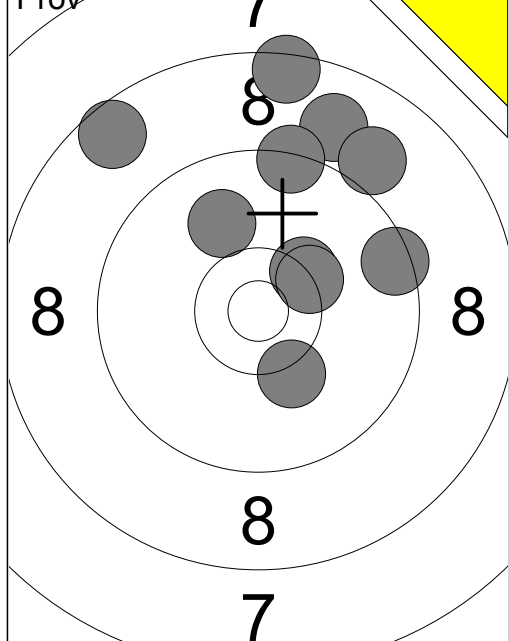

- 1: 10.2 ↘
- 2: 10.3x ↗
- 3: 8.9 ↗
- 4: 9.0 ↗
- 5: 8.5 ↑
- 6: 8.6 ↖
- 7: 10.0 ↖
- 8: 9.5 →
- 9: 9.4 ↑
- 10: 10.3x ↗

Serie 91  
Total 193

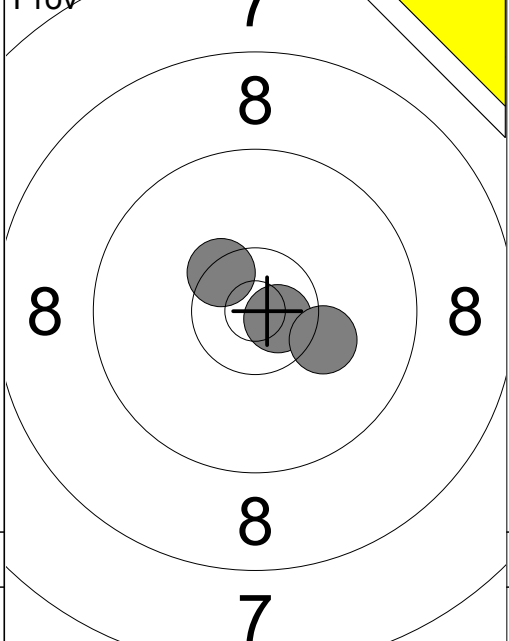

- 11: 10.7x →
- 12: 10.4x ↖
- 13: 10.2 →

Serie 30  
Total 193

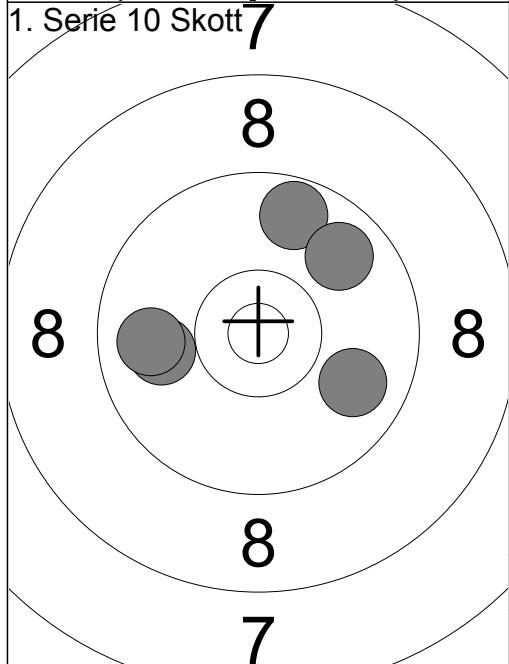

- 1: 9.7 ↑
- 2: 9.9 ←
- 3: 9.8 ←
- 4: 9.9 →
- 5: 9.8 ↗

Serie 45  
Total 238

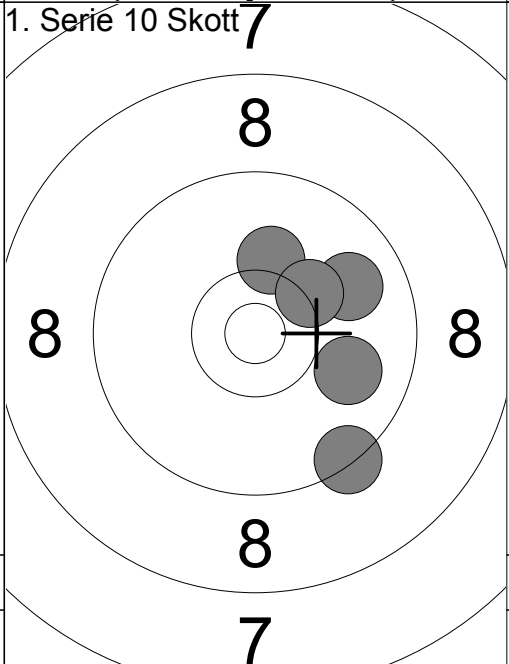

- 6: 9.3 ↘
- 7: 9.9 ↗
- 8: 9.9 →
- 9: 10.2 ↑
- 10: 10.3 ↗

Serie 47  
Total 285

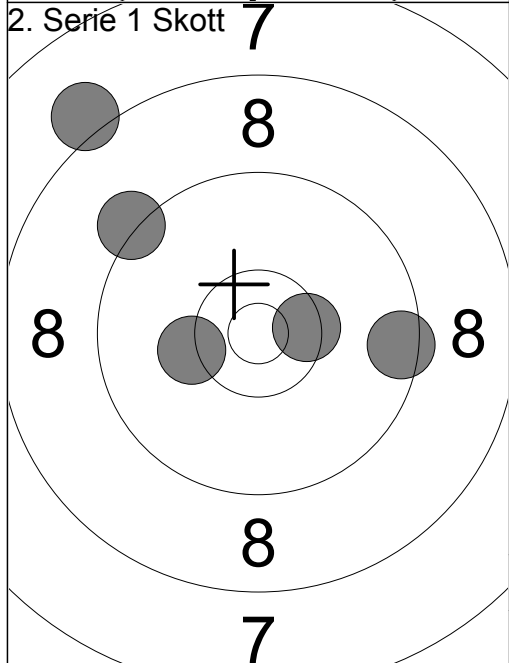

- 1: 9.5 →
- 2: 10.4x →
- 3: 9.2 ↖
- 4: 10.2 ←
- 5: 8.1 ↖

Serie 46  
Total 331

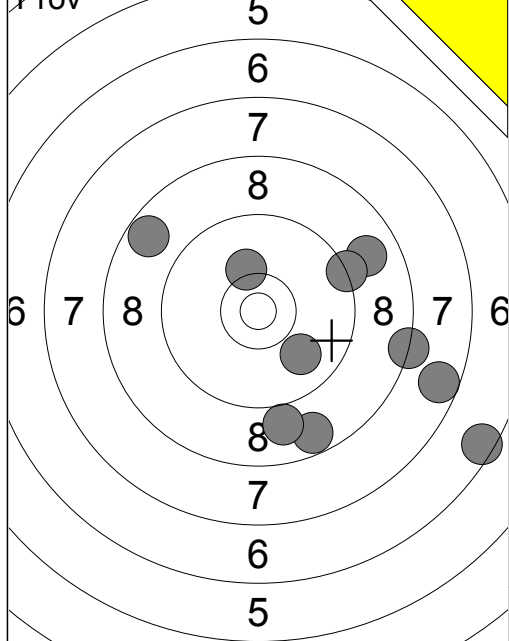

1:	8.7	↘
2:	7.6	→
3:	9.0	↘
4:	8.3	→
5:	8.9	→
6:	9.3	→
7:	9.9	↘
8:	6.5	↘
9:	8.7	↗
10:	10.2	↑
Serie		82
Total		173

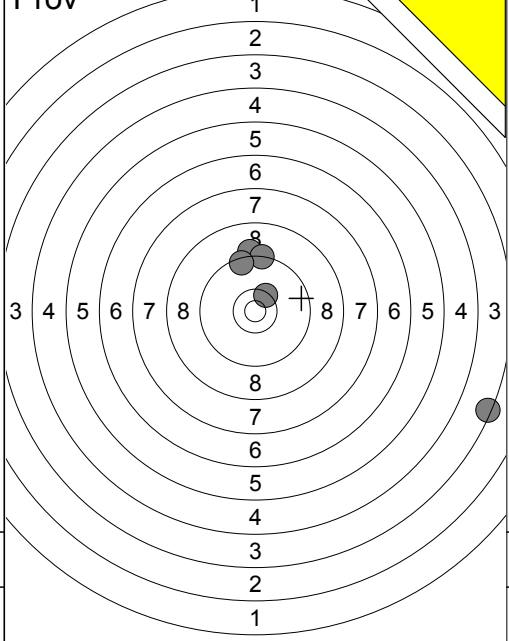

11:	3.4	↘
12:	9.2	↑
13:	9.3	↑
14:	10.4x	↗
15:	9.5	↑
Serie		40
Total		173

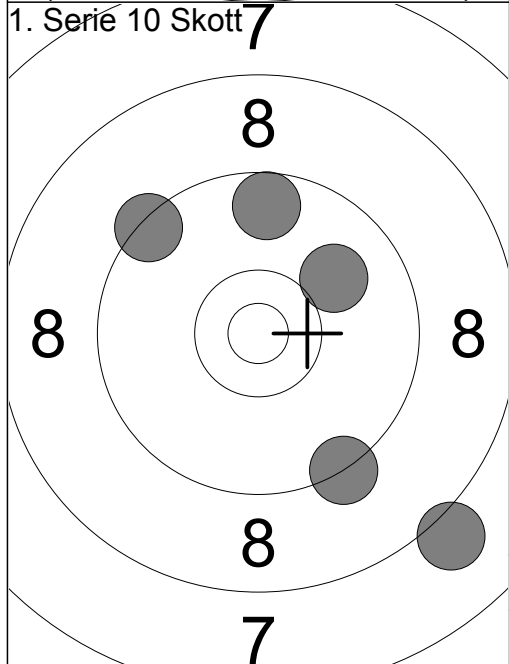

1:	9.6	↑
2:	9.4	↗
3:	9.3	↘
4:	10.0	↗
5:	8.1	↘
Serie		45
Total		218

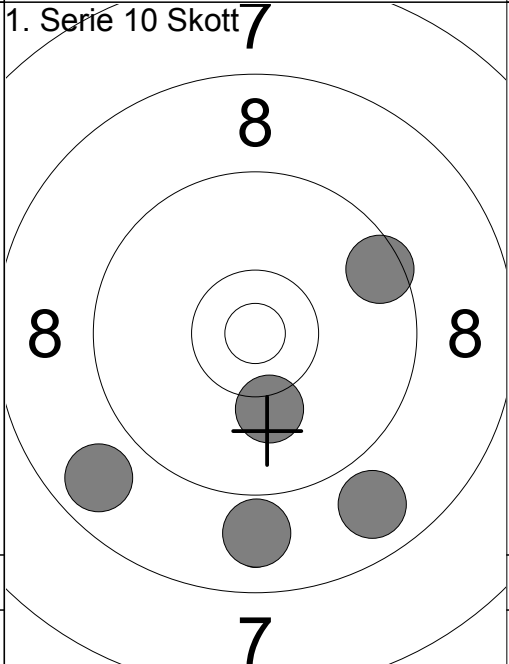

6:	8.8	↘
7:	9.5	↗
8:	10.2	↘
9:	8.8	↙
10:	8.9	↘
Serie		43
Total		261

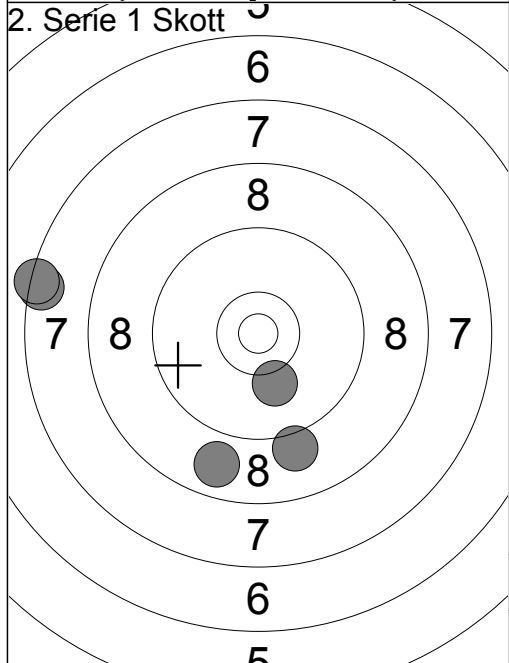

1:	8.8	↘
2:	10.1	↘
3:	9.1	↘
4:	7.5	←
5:	7.4	←
Serie		41
Total		302

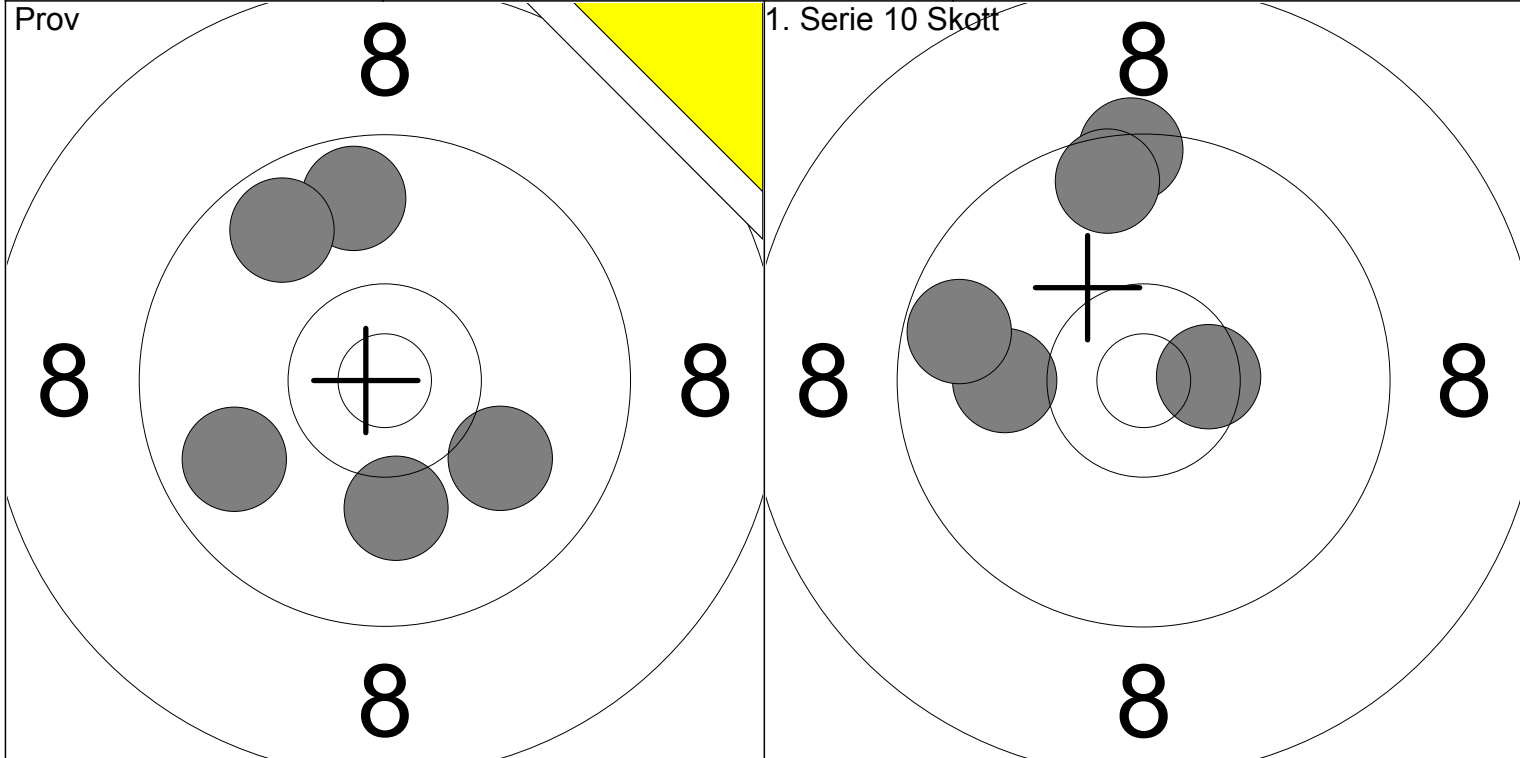

1:	9.7	↑
2:	10.1	↓
3:	10.0	↘
4:	9.8	←
5:	9.7	↖

Serie	47
Total	181

1:	10.0	←
2:	10.5x	→
3:	9.4	↑
4:	9.7	←
5:	9.6	↑

Serie	47
Total	228

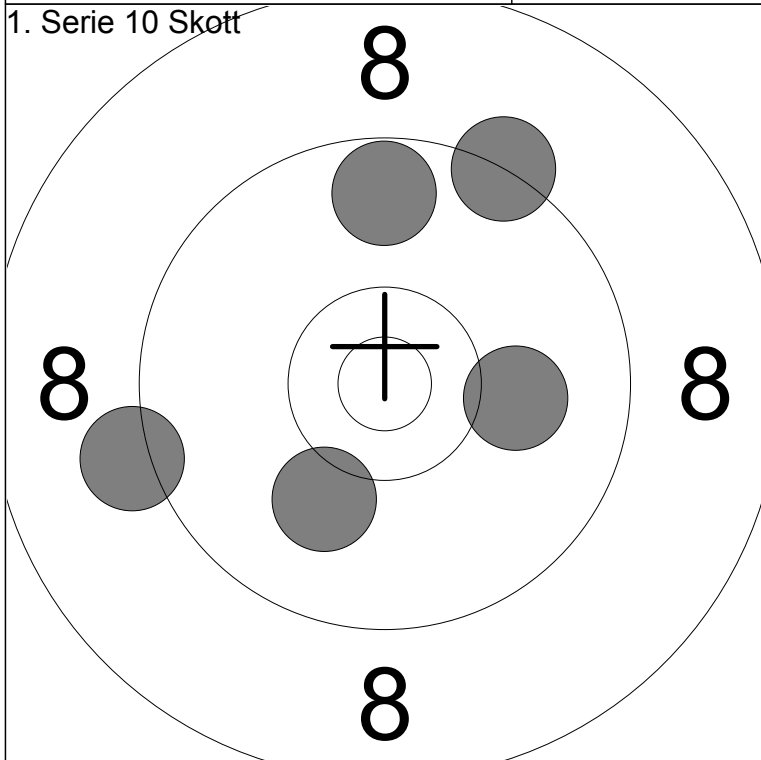

6:	10.1	↙
7:	9.7	↑
8:	9.3	↗
9:	9.2	←
10:	10.1	→

Serie	47
Total	275

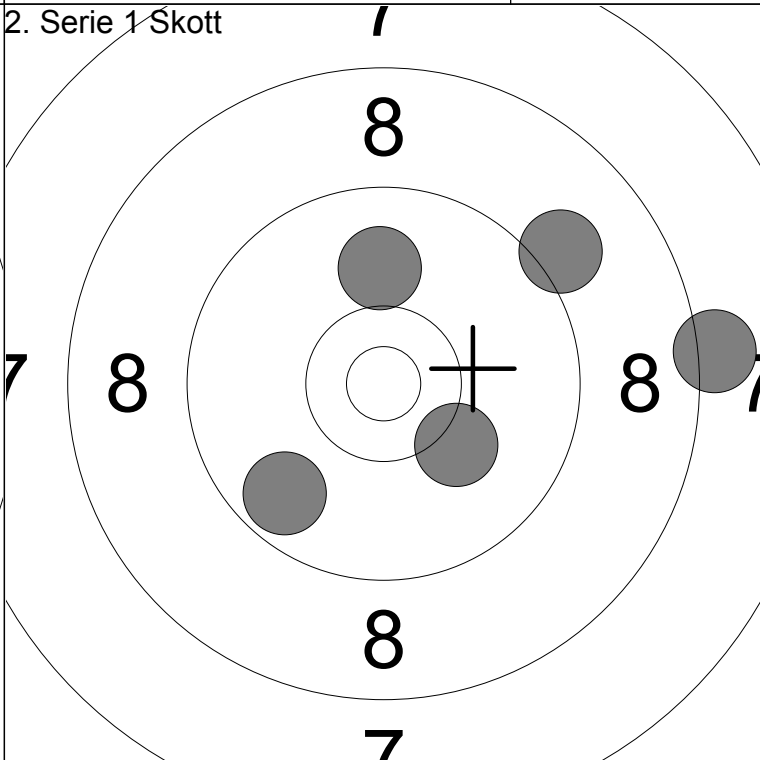

1:	10.0	↑
2:	9.1	↗
3:	9.7	↙
4:	10.2	↘
5:	8.2	→

Serie	46
Total	321



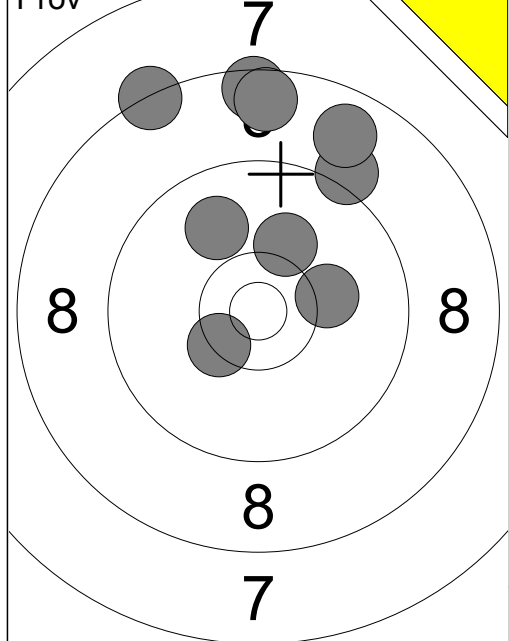

1:	10.2	→
2:	10.4x	↙
3:	9.1	↗
4:	8.5	↑
5:	7.1	↗
6:	8.8	↗
7:	10.2	↗
8:	8.6	↑
9:	8.3	↖
10:	9.9	↖
Serie		87
Total		171

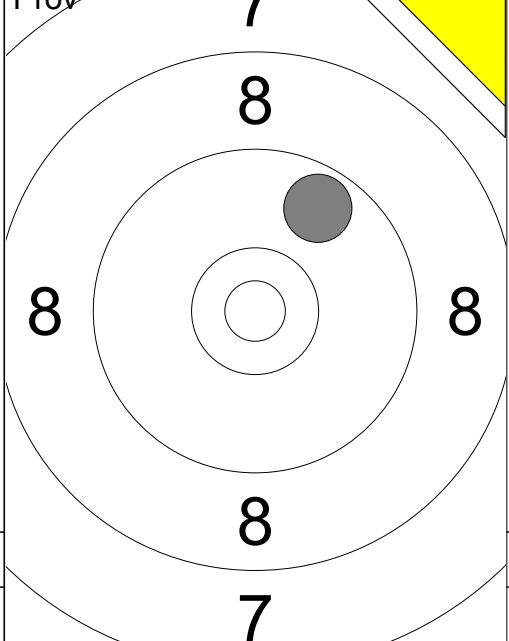

11:	9.7	↗
Serie		9
Total		171

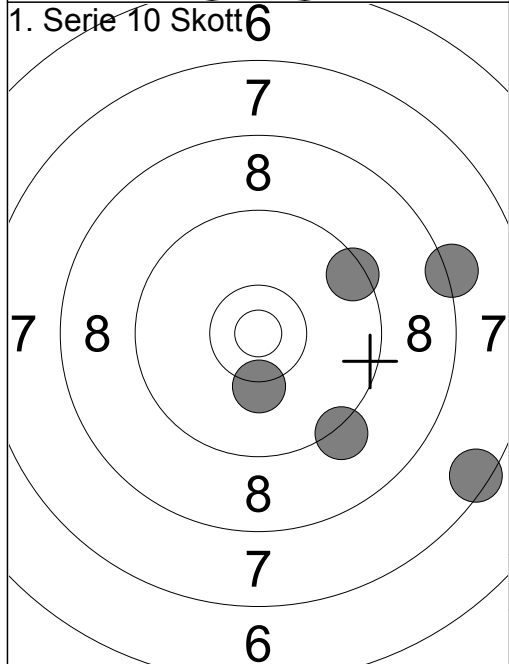

1:	7.5	↘
2:	8.2	→
3:	10.2	↓
4:	9.2	↘
5:	9.5	↗
Serie		43
Total		214

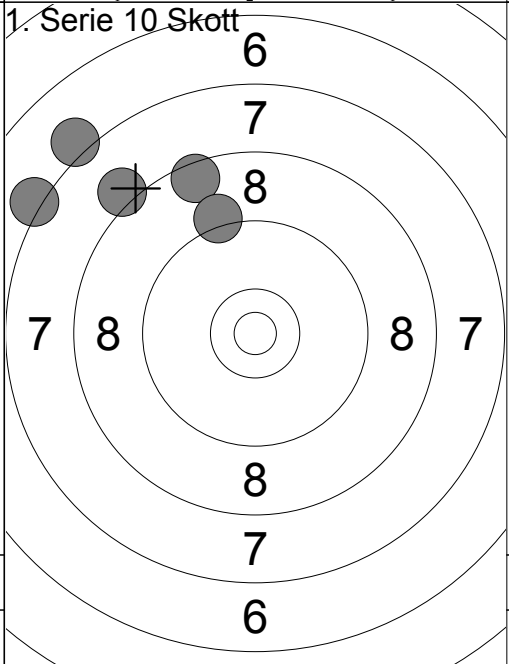

6:	8.5	↗
7:	7.2	↘
8:	9.2	↗
9:	8.1	↗
10:	7.1	↖
Serie		39
Total		253

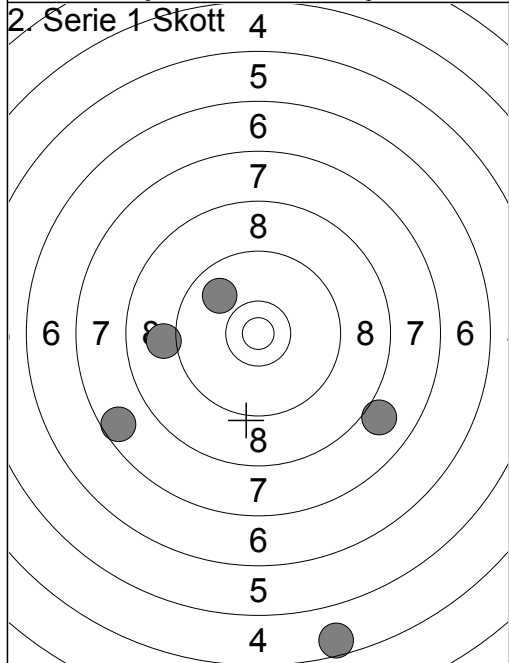

1:	8.0	↘
2:	4.6	↓
3:	9.0	←
4:	9.9	↗
5:	7.6	↙
Serie		37
Total		290

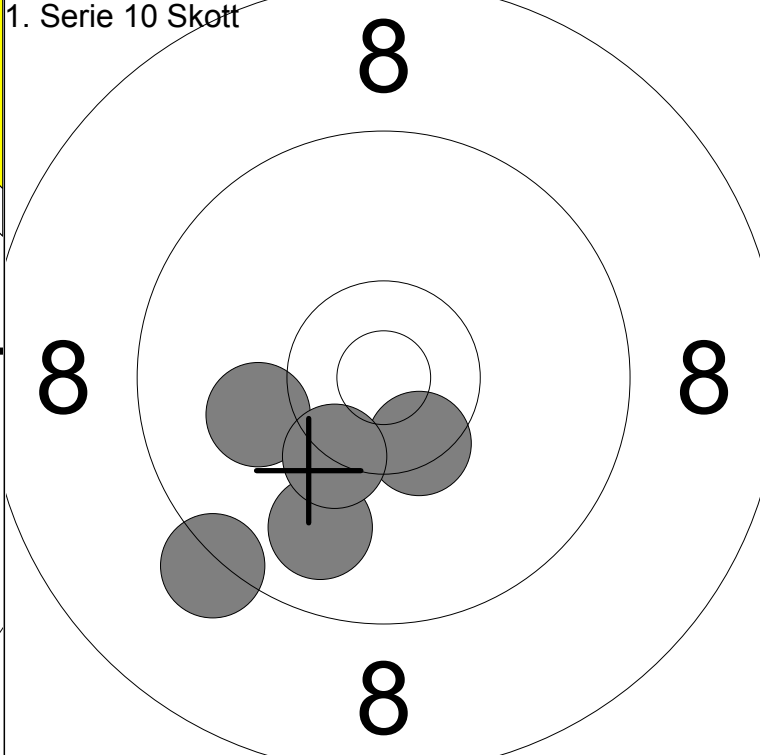
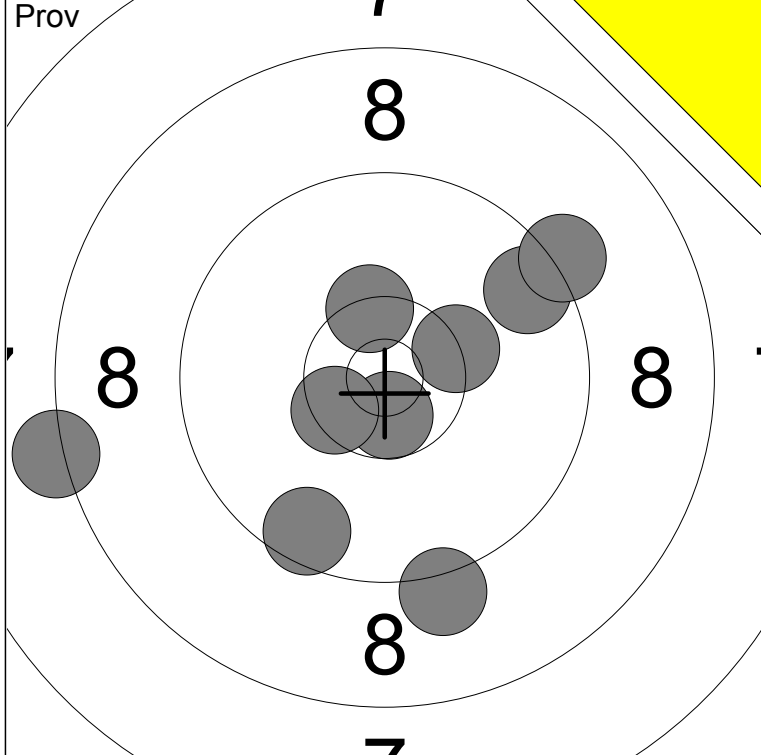

1: 9.6 ↗	6: 8.2 ←	Serie	84
2: 10.4x ↑	7: 9.6 ↘		
3: 9.2 ↗	8: 10.5x ←	Total	171
4: 10.6x ↓	9: 9.2 ↓		
5: 10.3x →			

1: 9.2 ↙	Serie	48
2: 9.9 ↘		
3: 10.4x ↘	Total	219
4: 10.1 ←		
5: 10.3x ↘		

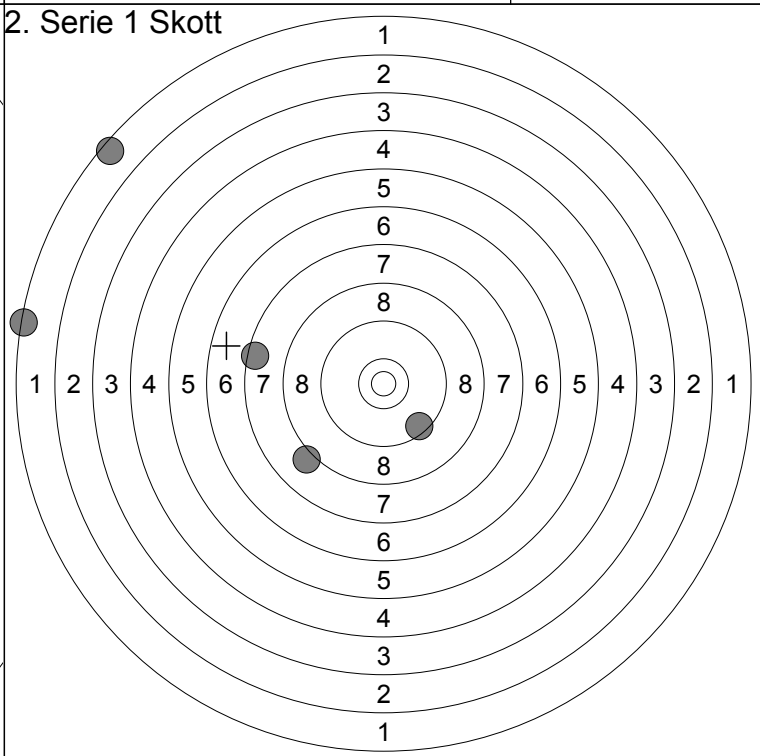
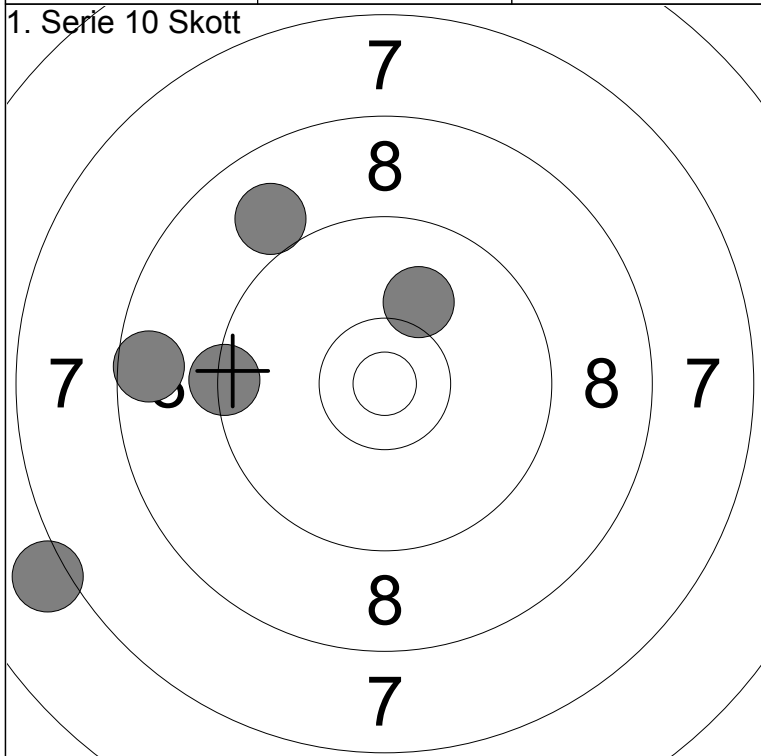

6: 7.1 ←	Serie	43
7: 9.0 ↗		
8: 10.1 ↗	Total	262
9: 9.4 ←		
10: 8.6 ←		

1: 9.5 ↘	Serie	26
2: 1.5 ↗		
3: 8.1 ↙	Total	288
4: 1.4 ←		
5: 7.5 ←		

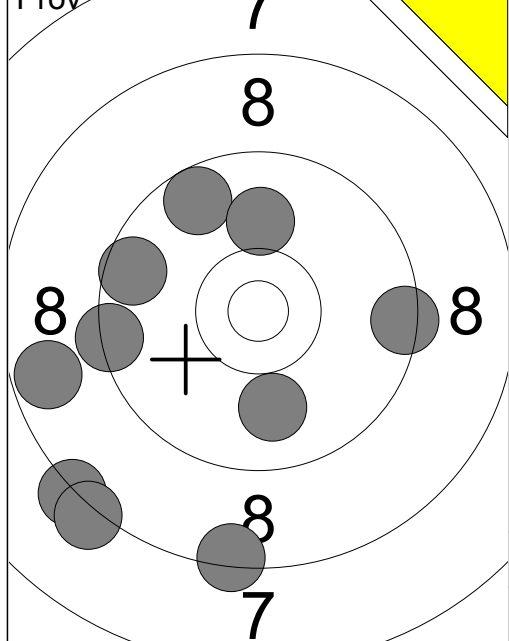

1:	9.4	←
2:	8.3	↙
3:	9.7	↗
4:	8.4	↓
5:	9.4	→
6:	9.6	←
7:	10.0	↓
8:	10.0	↑
9:	8.2	↙
10:	8.7	←
Serie		88
Total		170

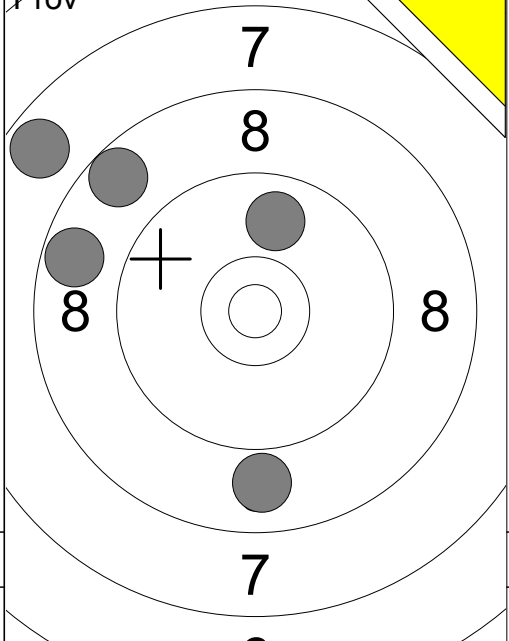

11:	8.7	↗
12:	8.7	←
13:	9.9	↑
14:	7.7	↙
15:	8.9	↓
Serie		40
Total		170

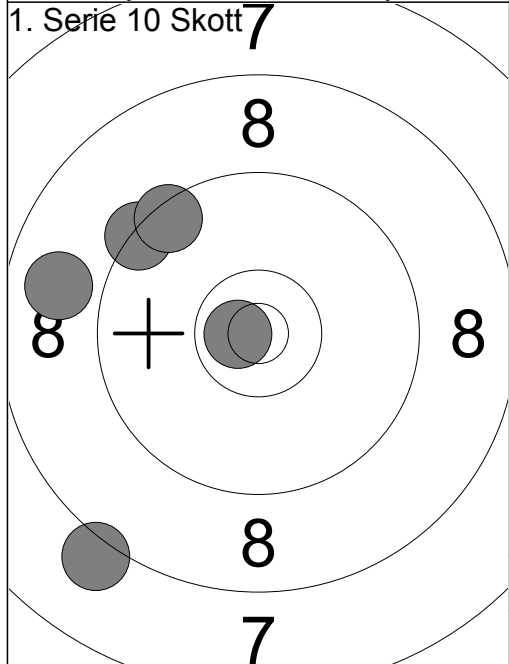

1:	8.9	←
2:	8.1	↙
3:	10.7x	←
4:	9.4	↗
5:	9.5	↗
Serie		44
Total		214

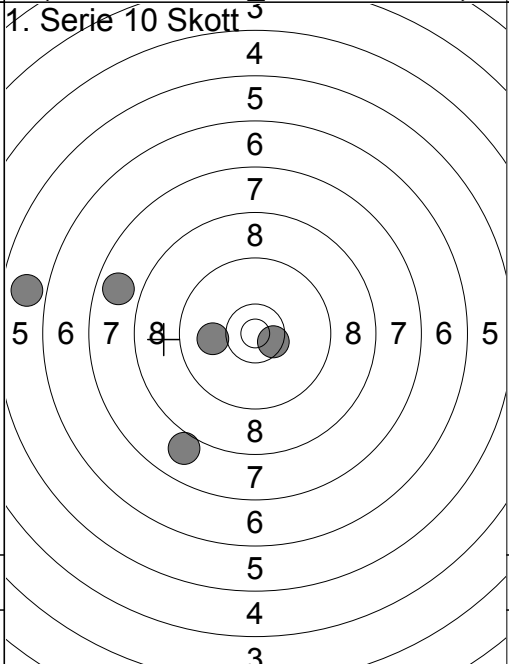

6:	10.0	←
7:	8.0	↙
8:	10.5x	↘
9:	7.8	←
10:	5.8	←
Serie		40
Total		254

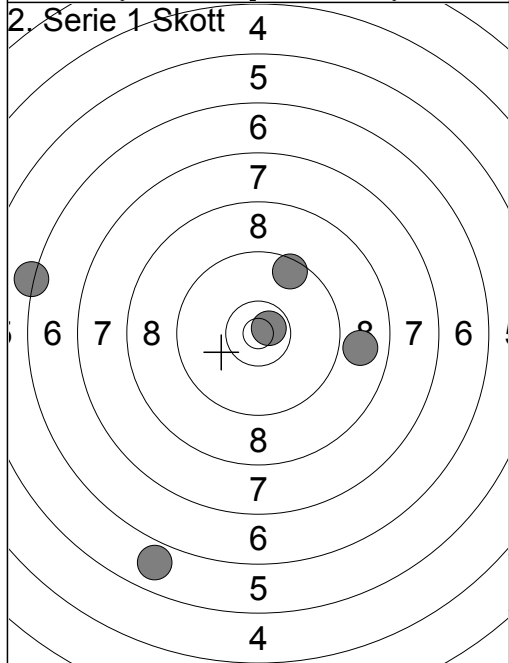

1:	6.2	←
2:	5.9	↙
3:	9.5	↗
4:	8.9	→
5:	10.7x	↗
Serie		38
Total		292

<p>Prov</p>	<p>1: 9.4 ↑                  2: 10.1 ↖                  3: 10.0 ↗                  4: 9.5 ↗                  5: 9.9 ↖                  6: 10.3x ↑                  7: 10.5x ↓                  8: 9.9 ↓                  9: 10.9x ↖                  10: 10.1 ↓</p>	<p>Prov</p> <p style="text-align: right;">11: 10.4x ↗</p>								
<table border="1" style="width:100%; border-collapse: collapse;"> <tr><td style="width:50%;">Serie</td><td style="width:50%; text-align: right;">96</td></tr> <tr><td>Total</td><td style="text-align: right;">181</td></tr> </table>	Serie	96	Total	181		<table border="1" style="width:100%; border-collapse: collapse;"> <tr><td style="width:50%;">Serie</td><td style="width:50%; text-align: right;">10</td></tr> <tr><td>Total</td><td style="text-align: right;">181</td></tr> </table>	Serie	10	Total	181
Serie	96									
Total	181									
Serie	10									
Total	181									

<p>1. Serie 10 Skott</p>	<p>1: 8.8 ←                  2: 9.2 ←                  3: 10.9x ↓                  4: 10.6x ↖                  5: 10.7x ↓</p>	<p>1. Serie 10 Skott</p>								
<table border="1" style="width:100%; border-collapse: collapse;"> <tr><td style="width:50%;">Serie</td><td style="width:50%; text-align: right;">47</td></tr> <tr><td>Total</td><td style="text-align: right;">228</td></tr> </table>	Serie	47	Total	228		<table border="1" style="width:100%; border-collapse: collapse;"> <tr><td style="width:50%;">Serie</td><td style="width:50%; text-align: right;">42</td></tr> <tr><td>Total</td><td style="text-align: right;">270</td></tr> </table>	Serie	42	Total	270
Serie	47									
Total	228									
Serie	42									
Total	270									

<p>2. Serie 1 Skott</p>	<p>1: 10.4x ↖                  2: 10.4x ↗                  3: 8.8 ↓                  4: 10.1 ↘                  5: 9.3 ↘</p>					
<table border="1" style="width:100%; border-collapse: collapse;"> <tr><td style="width:50%;">Serie</td><td style="width:50%; text-align: right;">47</td></tr> <tr><td>Total</td><td style="text-align: right;">317</td></tr> </table>	Serie	47	Total	317		
Serie	47					
Total	317					

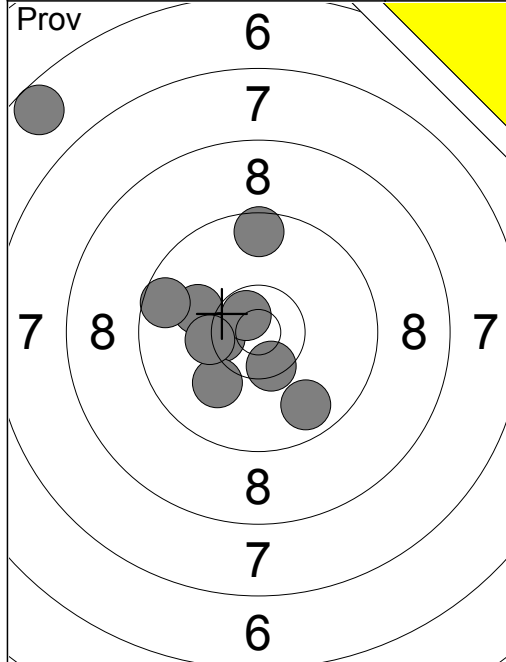

1:	6.6	↖
2:	10.1	↖
3:	9.6	↖
4:	10.4x	↖
5:	9.8	↘
6:	10.7x	↗
7:	10.4x	↘
8:	10.0	↘
9:	9.6	↑
10:	10.3	↖

Serie	93
Total	177

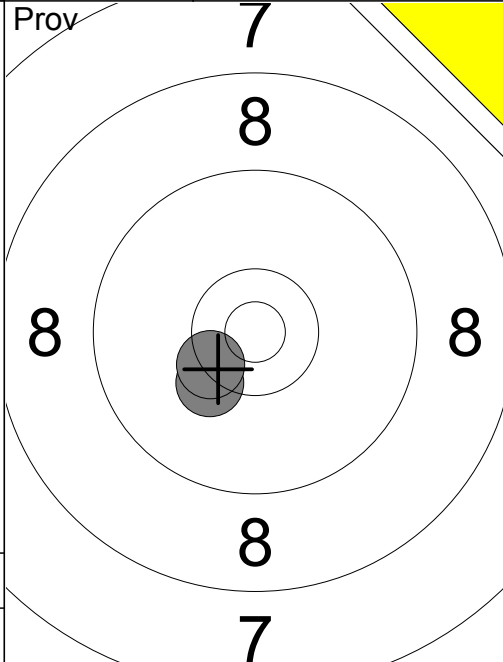

11:	10.3	↘
12:	10.4x	↘

Serie	20
Total	177

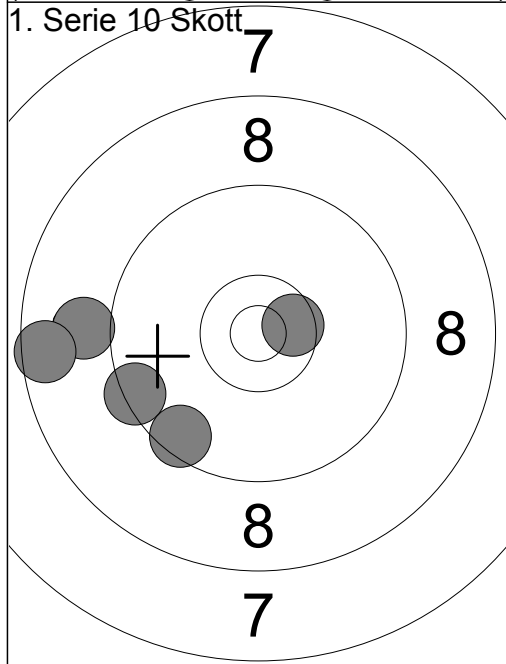

1:	9.0	↖
2:	8.6	↖
3:	10.6x	→
4:	9.4	↖
5:	9.5	↘

Serie	45
Total	222

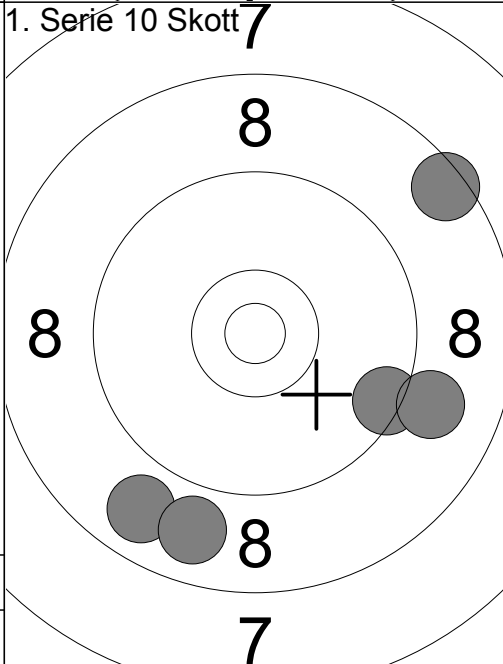

6:	9.4	→
7:	8.8	↘
8:	8.5	↗
9:	9.0	→
10:	8.8	↘

Serie	42
Total	264

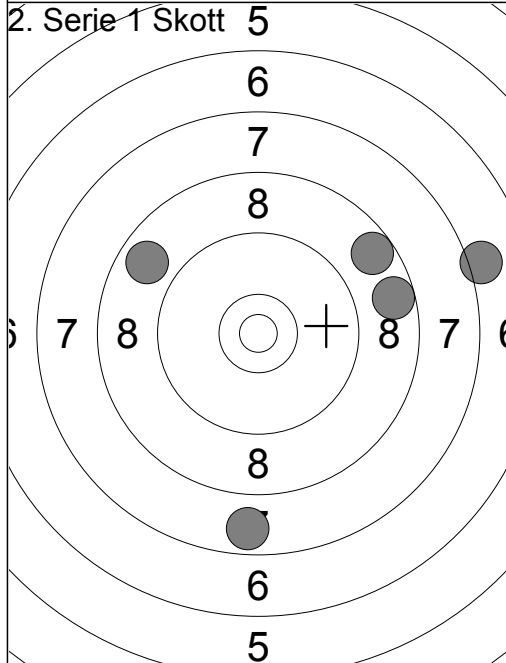

1:	8.8	↖
2:	8.7	↗
3:	7.7	↓
4:	7.1	→
5:	8.6	→

Serie	38
Total	302

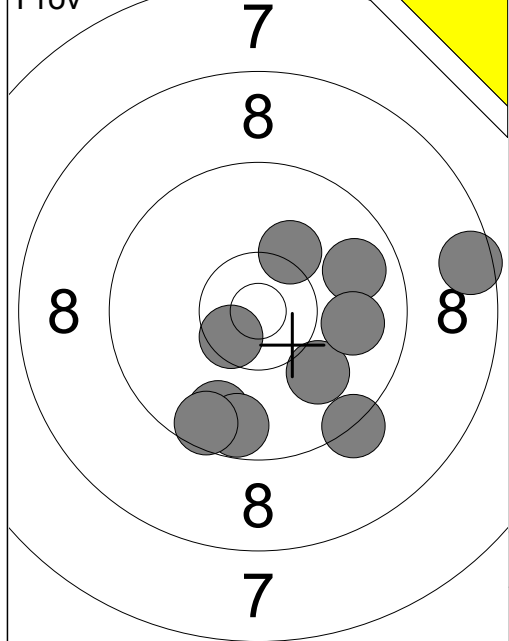

1:	9.7	↓
2:	10.5x	↙
3:	9.8	→
4:	8.5	→
5:	9.7	↓
6:	10.0	↓
7:	9.3	↓
8:	9.9	→
9:	10.2	↗
10:	9.6	↓
Serie		92
Total		177

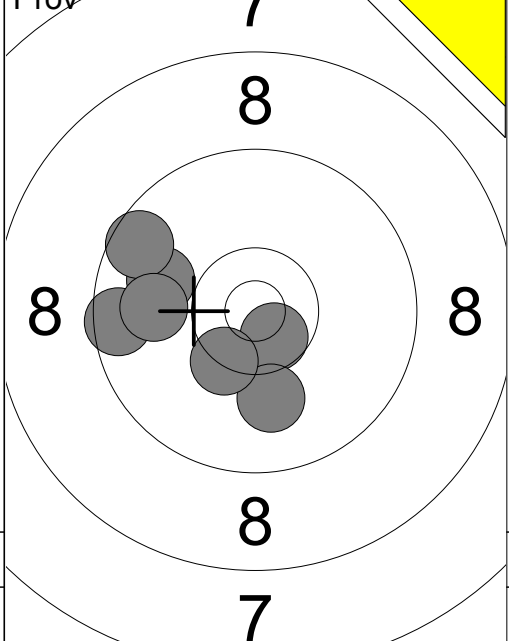

11:	9.9	←
12:	9.6	↖
13:	9.5	←
14:	9.9	←
15:	10.6x	↘
16:	10.0	↓
17:	10.4x	↙
Serie		66
Total		177

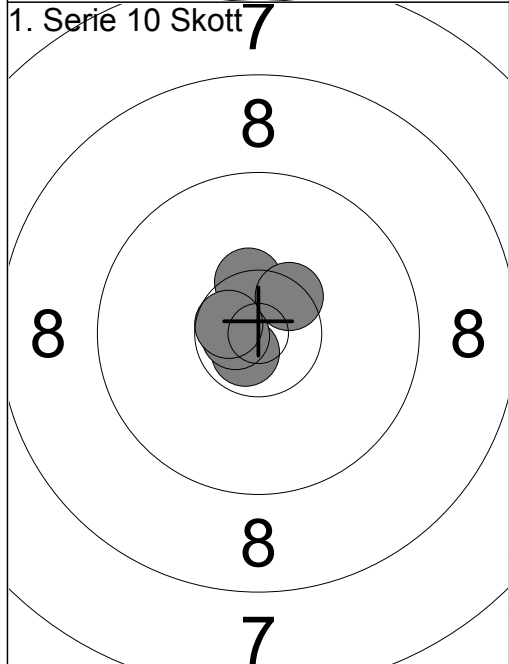

1:	10.7x	↘
2:	10.4x	↗
3:	10.5x	↗
4:	10.7x	←
5:	10.6x	←
Serie		50
Total		227

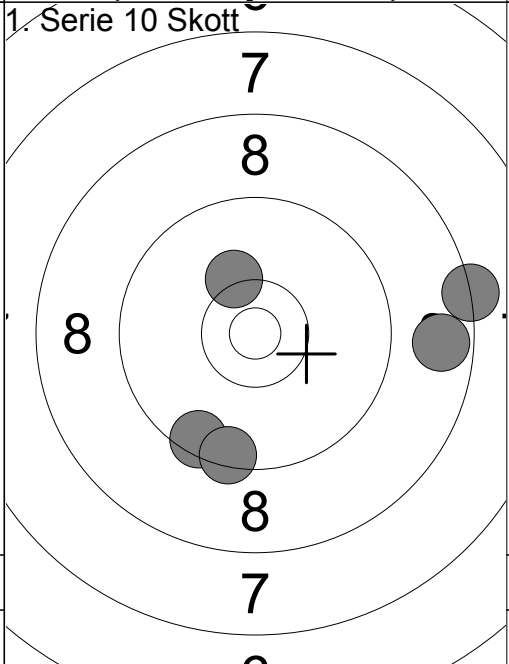

6:	10.2	↗
7:	8.7	→
8:	9.5	↓
9:	9.4	↓
10:	8.3	→
Serie		44
Total		271

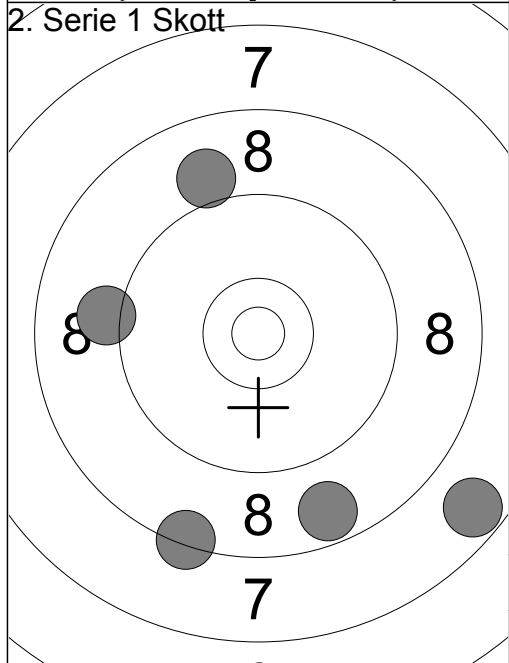

1:	9.1	←
2:	8.7	↓
3:	7.7	↘
4:	9.0	↗
5:	8.4	↓
Serie		41
Total		312

<p>Prov</p>	<p>1: 8.8 →                  2: 9.1 →                  3: 9.2 →                  4: 9.5 ↘                  5: 10.5x →                  6: 9.5 →                  7: 10.0 ↗                  8: 8.7 →                  9: 9.5 ←                  10: 9.6 ↑</p>	<p>Prov</p>
Serie 90		11: 9.3 ←
Total 170		Serie 9
		Total 170

<p>1. Serie 10 Skott</p>	<p>1: 9.7 ←                  2: 9.1 →                  3: 8.2 ↗                  4: 9.0 ←                  5: 10.6x ↗</p>	<p>1. Serie 10 Skott</p>
Serie 45		6: 9.7 ↗
Total 215		7: 8.1 ↗
		8: 9.4 ↗
		9: 8.1 ↗
		10: 10.4x ↗
		Serie 44
		Total 259

<p>2. Serie 1 Skott</p>	<p>1: 6.4 ↖                  2: 6.4 ↑                  3: 7.3 ←                  4: 8.9 →                  5: 8.7 ↑</p>	
Serie 35		
Total 294		

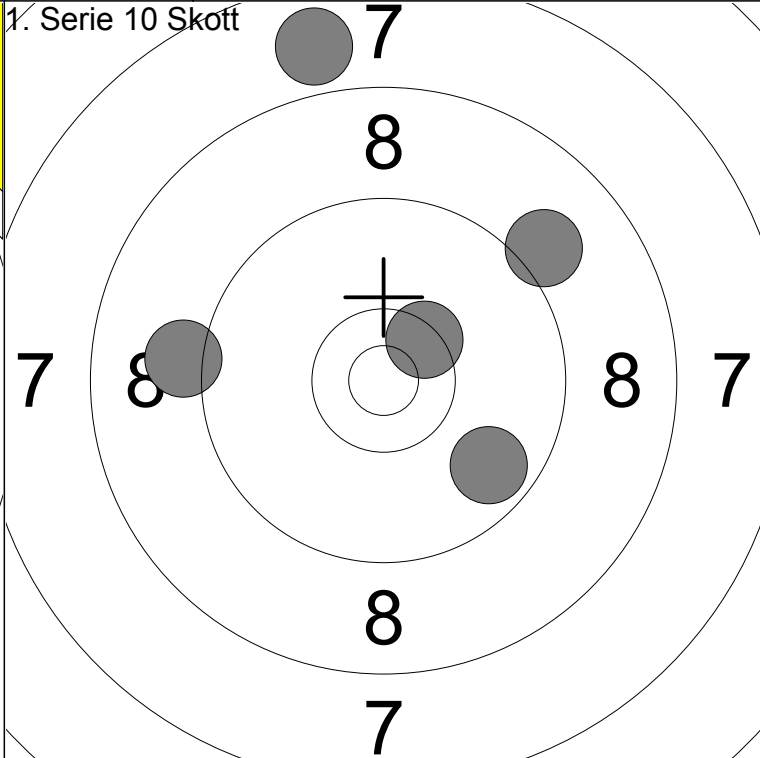
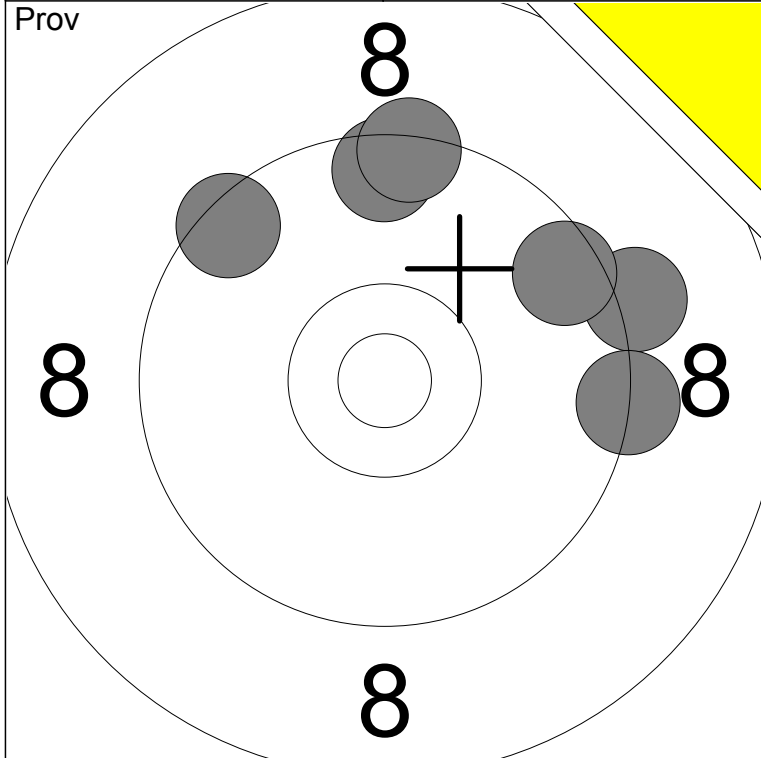

1: 9.2 →	6: 9.5 ↖	Serie	54
2: 9.5 ↑		Total	147
3: 9.3 →			
4: 9.4 ↑			
5: 9.5 ↗			

1: 9.1 ←	Serie	44
2: 10.4x ↗	Total	191
3: 9.1 ↗		
4: 9.7 ↘		
5: 7.9 ↑		

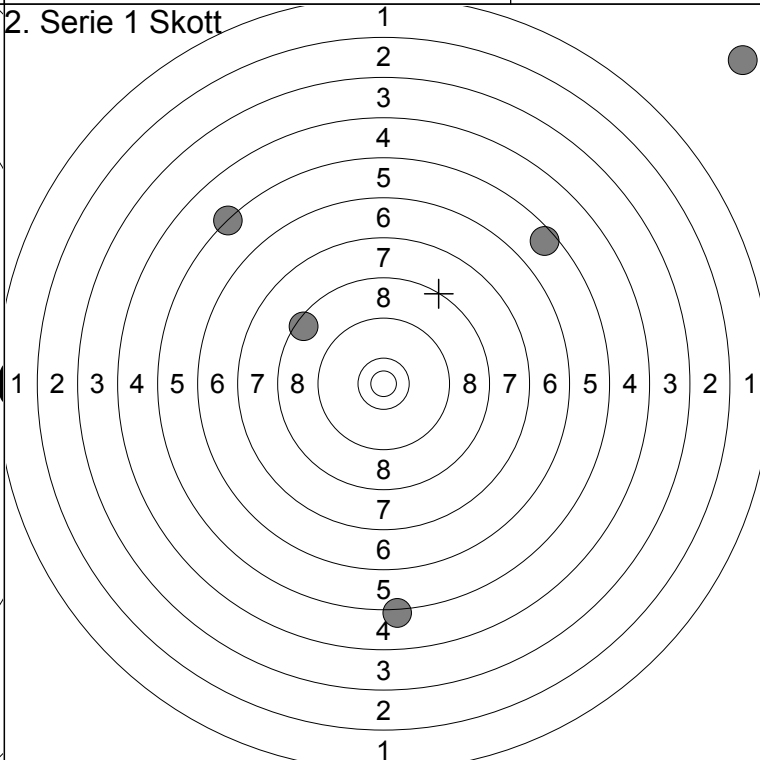
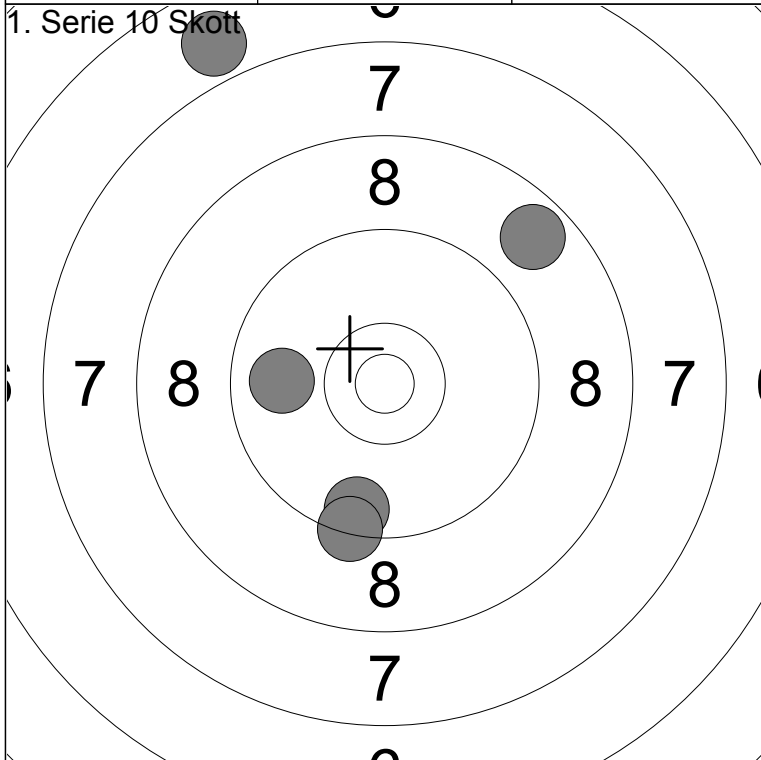

6: 6.9 ↖	Serie	41
7: 9.9 ←	Total	232
8: 9.6 ↓		
9: 9.4 ↓		
10: 8.7 ↗		

1: 0.0 ↗	Serie	23
2: 5.6 ↗	Total	255
3: 5.3 ↗		
4: 5.2 ↓		
5: 8.5 ↖		



Skjutlag  
**4**

Tavla  
**22**

Ramselefors

01.09.2018

Höstträffen 2018

Ramselefors SKF

**Prov**

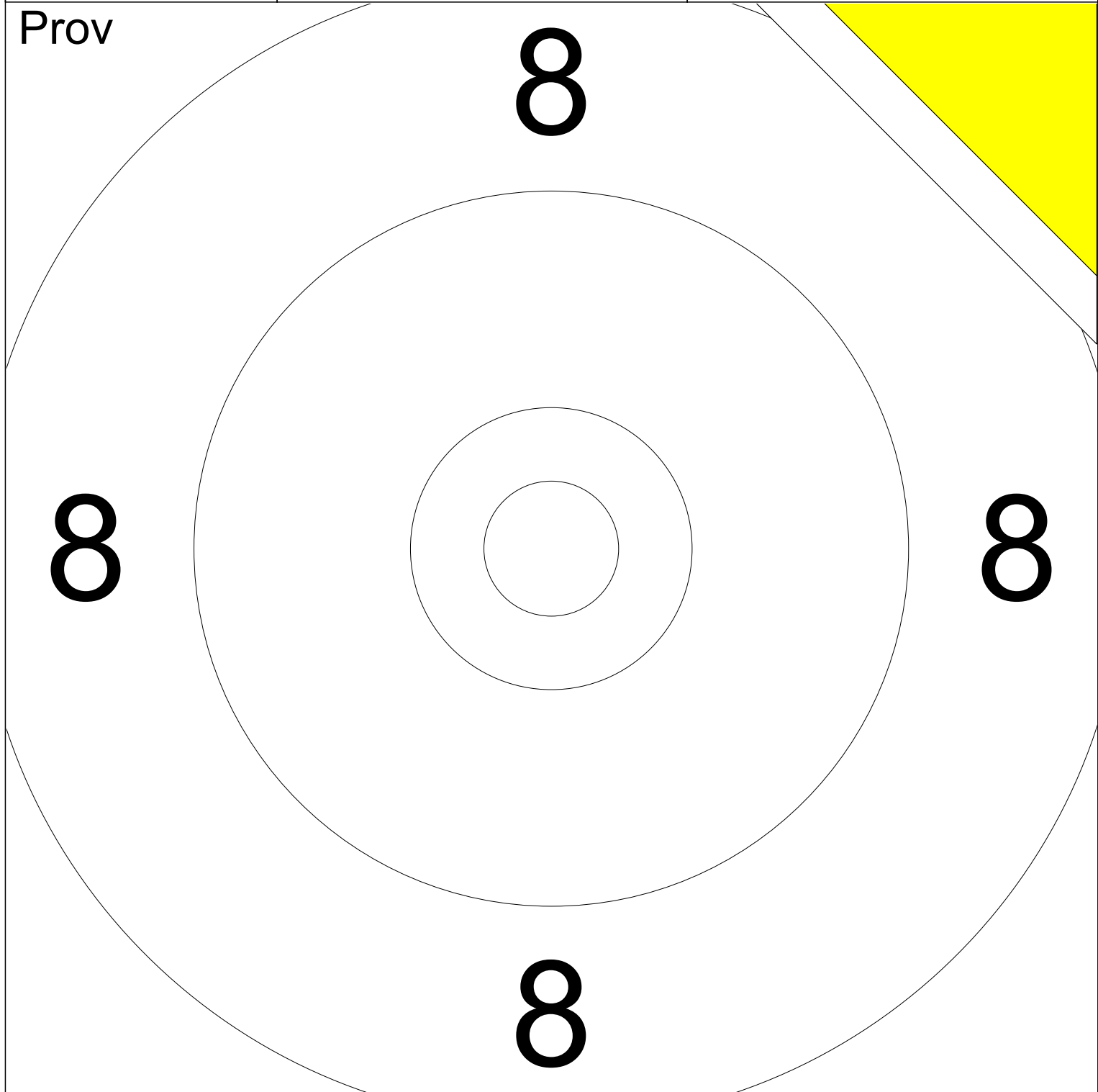

Serie 0

Total 0

Prov 	1: 8.6 ↖ 2: 9.3 ↗ 3: 9.5 → 4: 9.0 ↘ 5: 9.0 → 6: 9.4 ↗ 7: 10.1 ↘ 8: 10.3 ↗ 9: 10.0 → 10: 10.2 ↘	Prov 	11: 9.8 ↖ 12: 10.1 ↘ 13: 10.5x →
Serie 93 Total 190		Serie 29 Total 190	

1. Serie 10 Skott 	1: 10.3x ↓ 2: 9.8 ↗ 3: 9.9 ↗ 4: 8.5 ↗ 5: 10.3x ↗	1. Serie 10 Skott 	6: 10.0 → 7: 10.6x → 8: 9.7 ↗ 9: 10.7x ↗ 10: 10.9x ↓
Serie 46 Total 236		Serie 49 Total 285	

2. Serie 1 Skott 	1: 9.2 ↘ 2: 10.7x ← 3: 10.1 → 4: 10.2 ↗ 5: 10.1 ↘		
Serie 49 Total 334			