

1:	9.8	←
2:	10.0	↗
3:	10.7x	↗
4:	9.5	↖
5:	10.2x	↑

Serie	50.2
Total	445.2



1:	10.2x	↑
2:	10.1	↗
3:	10.4x	↗
4:	10.6x	↗
5:	9.4	↘

Serie	50.7
Total	495.9

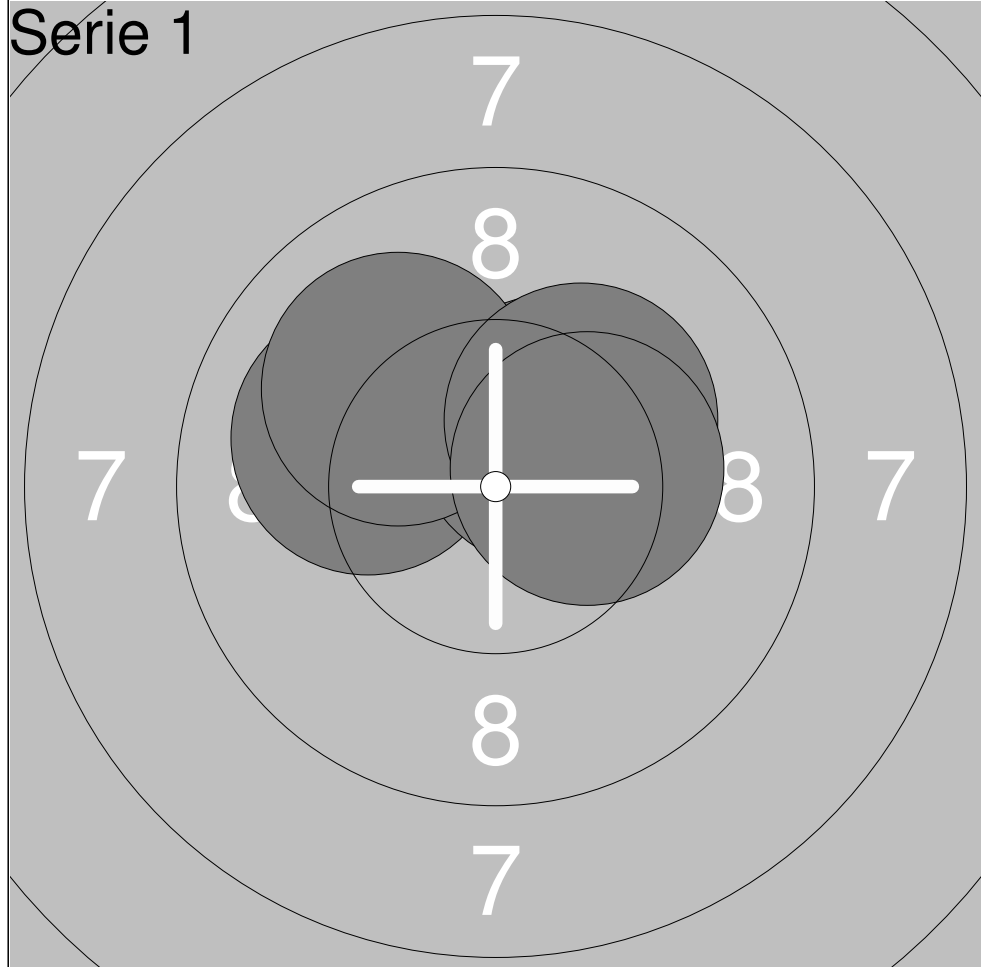

1:	10.0	↖
2:	10.4x	↗
3:	10.0	↖
4:	10.2x	↗
5:	10.3x	→

Serie	50.9
Total	445.9



1:	10.4x	→
2:	10.4x	↗
3:	9.8	→
4:	10.0	↗
5:	10.7x	→

Serie	51.3
Total	497.2

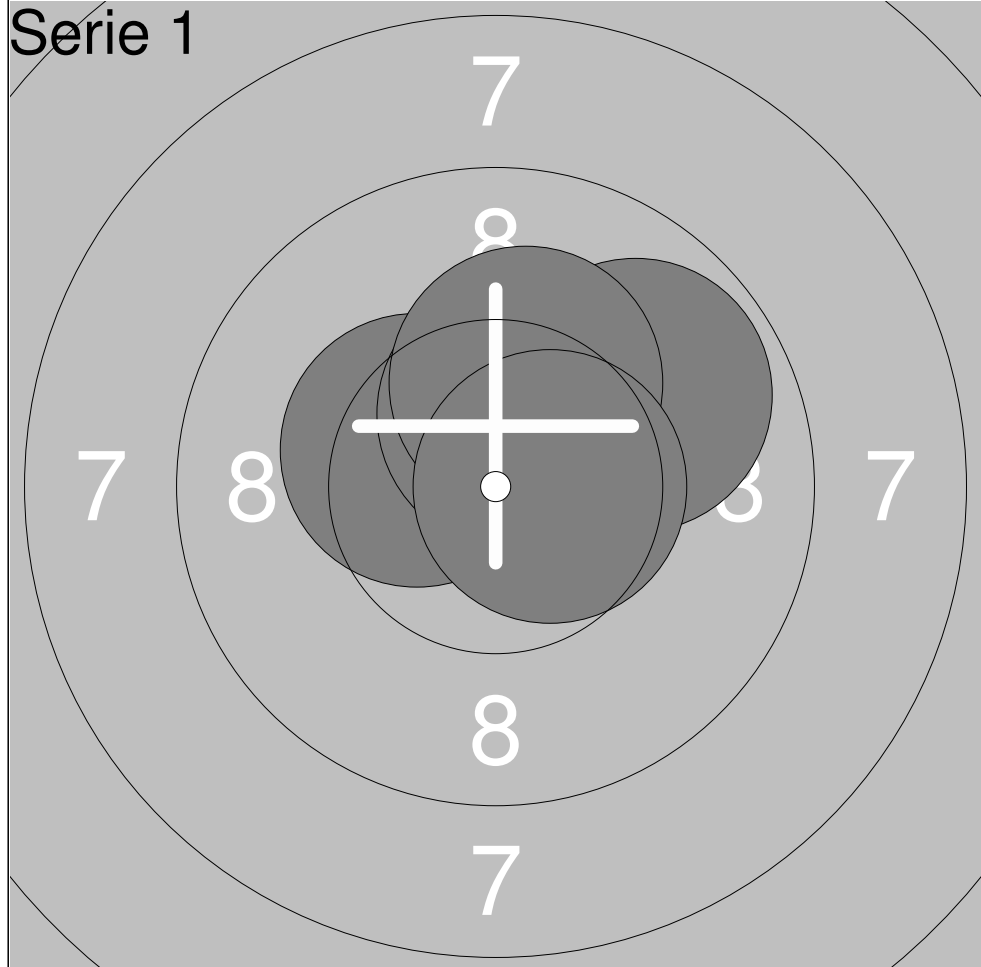

1:	10.4x	↖
2:	9.8	↗
3:	10.4x	↑
4:	10.2x	↑
5:	10.6x	→

Serie	51.4
Total	444.4



1:	9.6	←
2:	9.8	↑
3:	9.6	↖
4:	10.8x	↗
5:	10.7x	→

Serie	50.5
Total	494.9

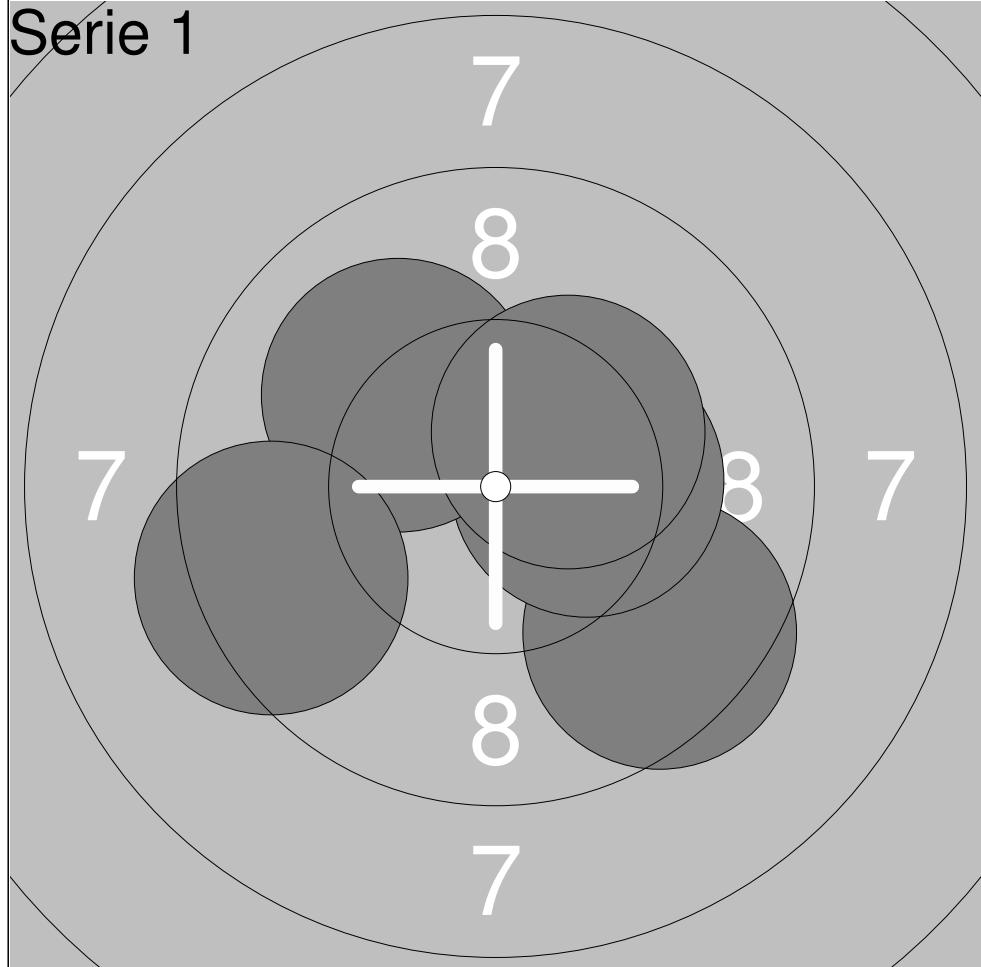

1:	9.5	↘
2:	10.3x	→
3:	10.0	↖
4:	10.3x	↗
5:	9.3	↙

Serie	49.4
Total	442.4



1:	10.5x	↗
2:	10.2x	↘
3:	9.2	↓
4:	9.9	↙
5:	8.7	↖

Serie	48.5
Total	490.9

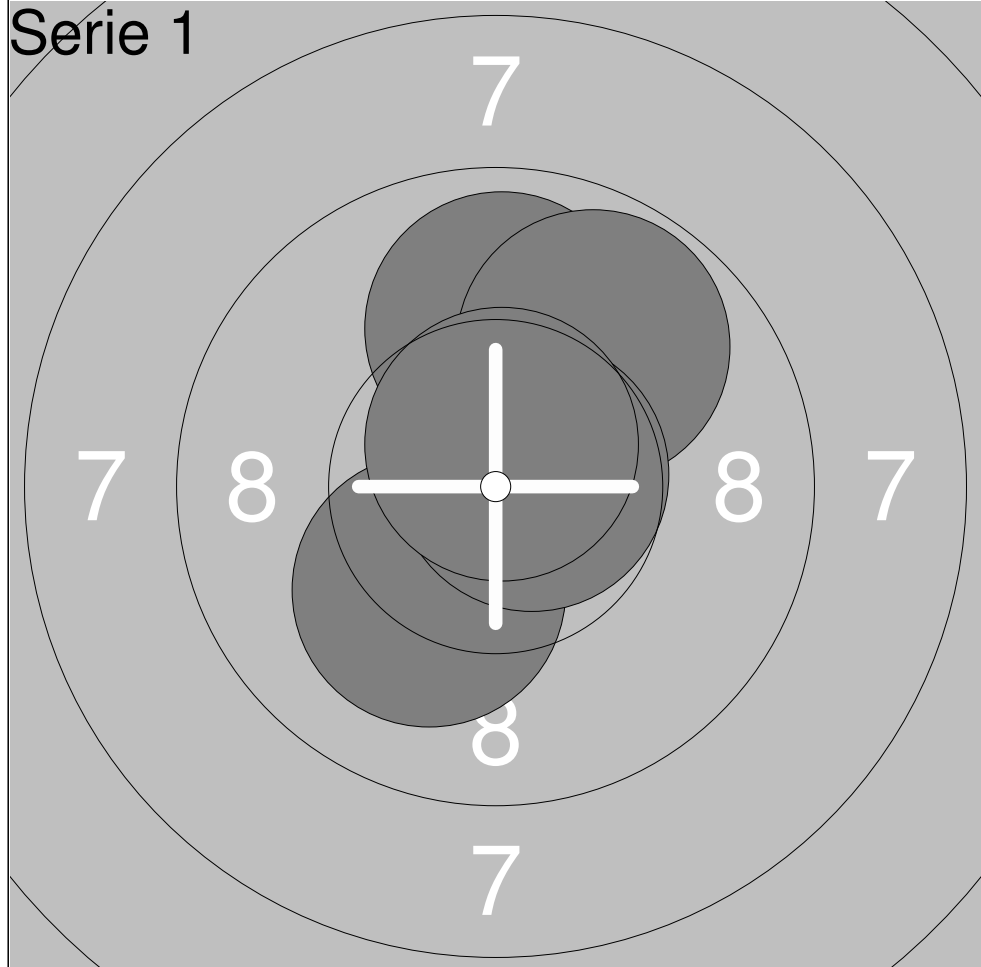

1:	9.9	↑
2:	9.8	↗
3:	10.1	↘
4:	10.7x	→
5:	10.6x	↑

Serie	51.1
Total	442.1



1:	10.1	↓
2:	10.6x	↗
3:	10.4x	←
4:	10.3x	↗
5:	10.7x	→

Serie	52.1
Total	494.2



1:	9.7	↗
2:	10.1	↘
3:	9.8	↑
4:	10.5x	↑
5:	10.2x	↑

Serie	50.3
Total	441.3

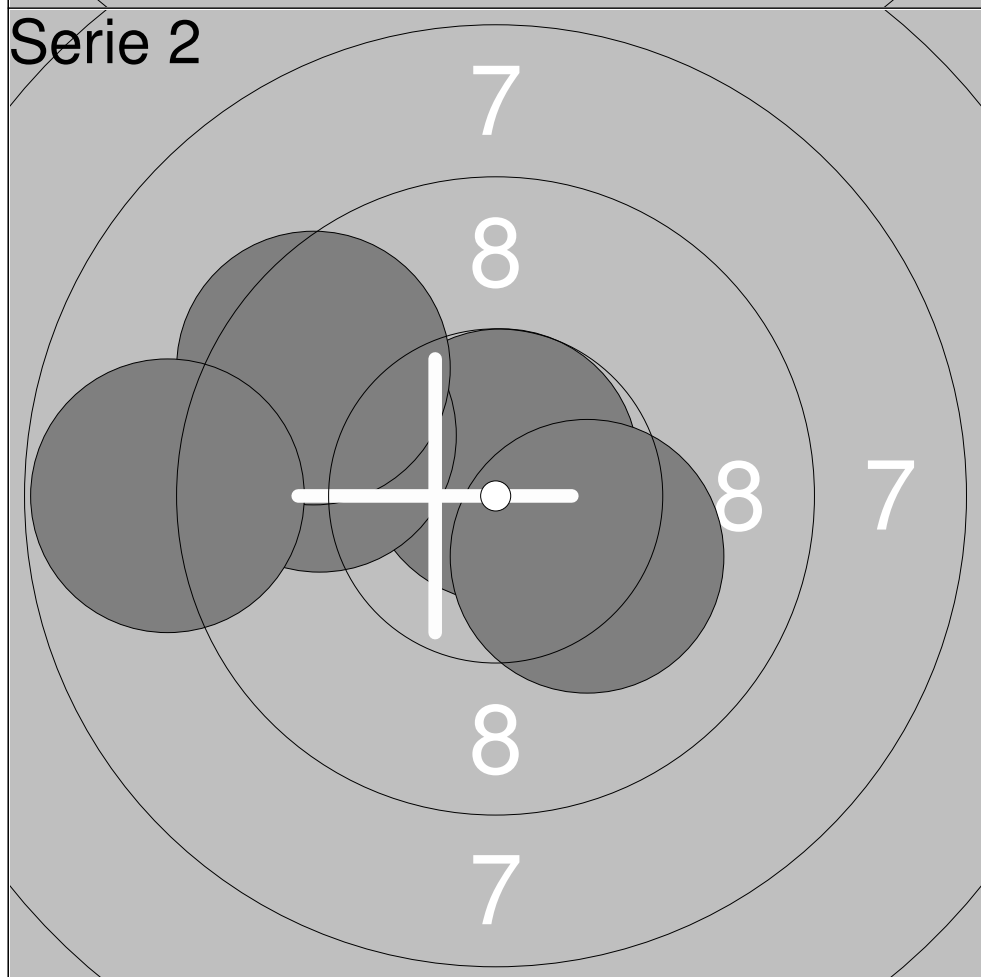

1:	10.7x	↑
2:	9.7	↖
3:	10.2x	↘
4:	9.5	↗
5:	8.8	←

Serie	48.9
Total	490.2

Skjutlag <b>1</b>	Tavla <b>8</b>	<b>Oscar, Wässman</b>
----------------------	-------------------	-----------------------

Final stående	Björksta Ungdomsskytteförening	JSM
---------------	--------------------------------	-----

03.11.2018	SM luftgevär 2018	Öckerö Skytteförening
------------	-------------------	-----------------------



1:	9.7	↗
2:	10.1	↗
3:	10.7x	↑
4:	10.5x	↗
5:	10.6x	→
<b>Serie</b>		<b>51.6</b>
<b>Total</b>		<b>442.6</b>



1:	10.0	↗
2:	9.8	↖
3:	10.3x	↖
4:	10.2x	↖
5:	10.6x	↗
<b>Serie</b>		<b>50.9</b>
<b>Total</b>		<b>493.5</b>

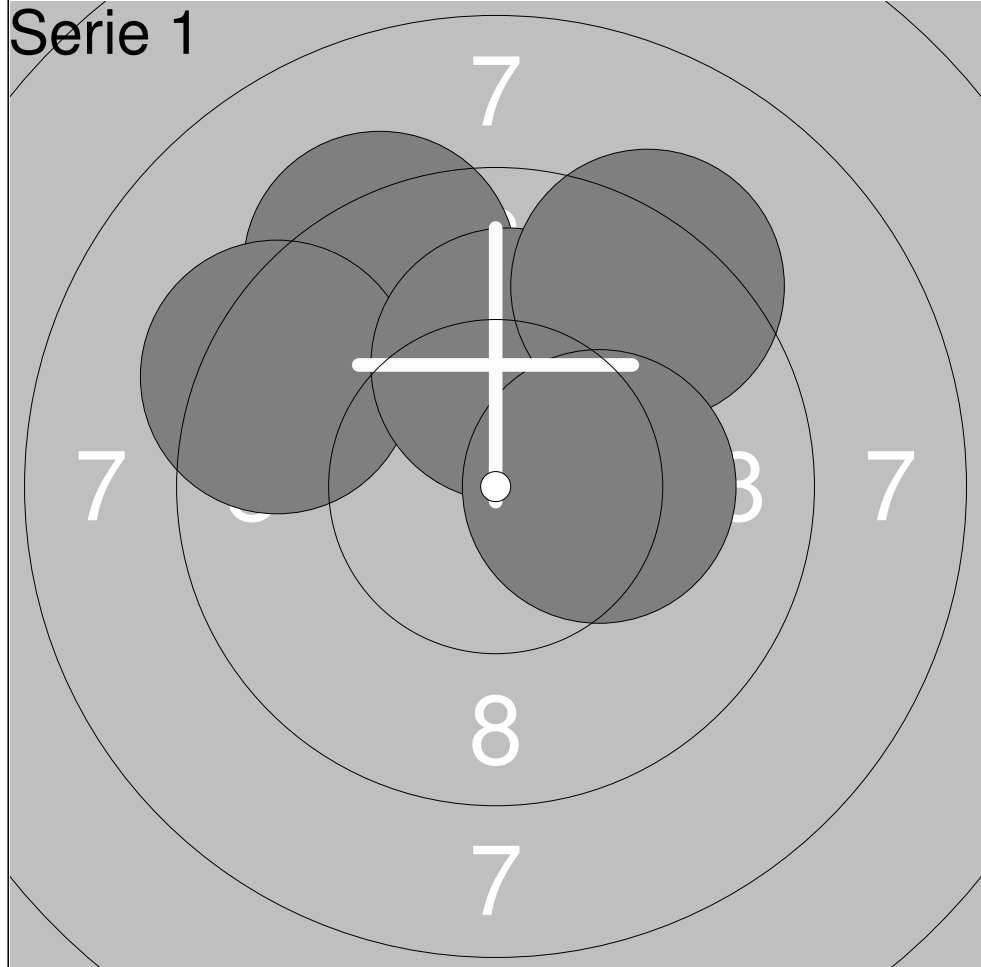

1:	9.3	↖
2:	9.3	↖
3:	10.1	↑
4:	9.3	↗
5:	10.3x	→
<b>Serie</b>		<b>48.3</b>
<b>Total</b>		<b>438.3</b>



1:	10.6x	↑
2:	10.3x	↖
3:	10.1	←
4:	10.0	→
5:	10.9x	→
<b>Serie</b>		<b>51.9</b>
<b>Total</b>		<b>490.2</b>



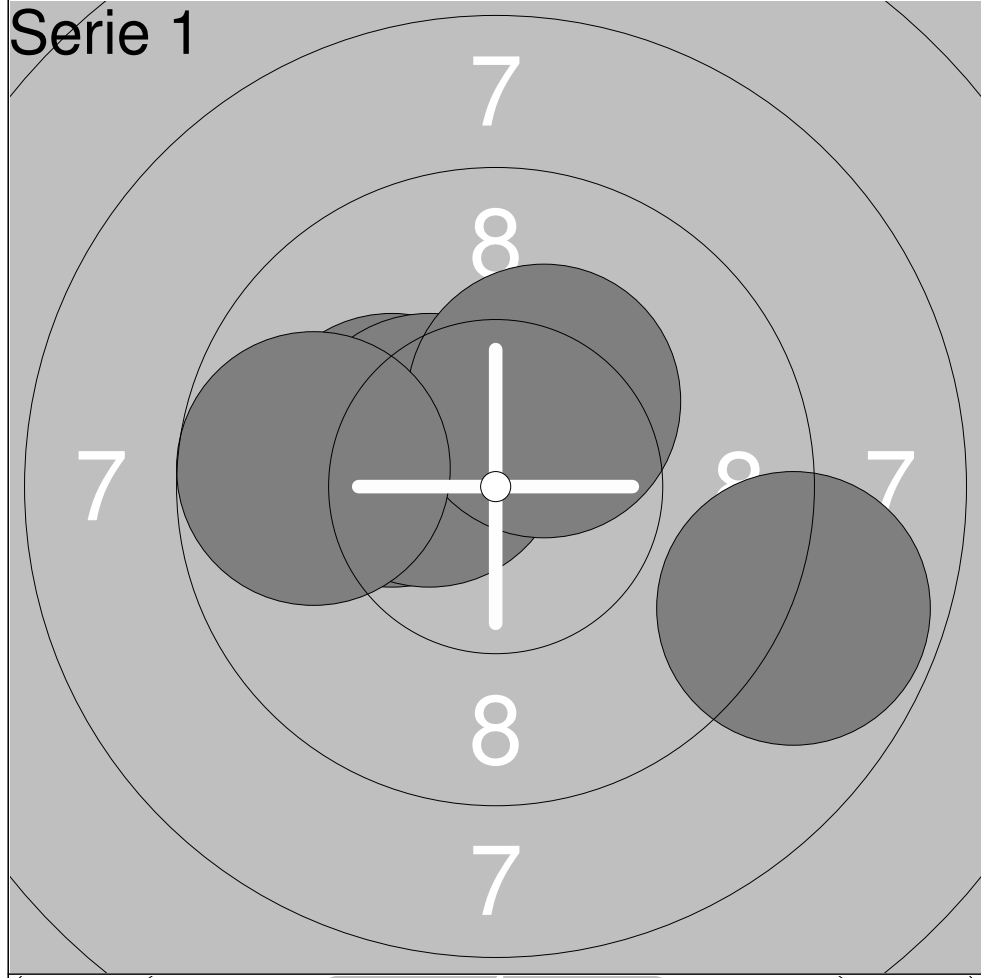

1:	10.2x	←
2:	10.4x	↖
3:	10.3x	↗
4:	9.7	←
5:	8.8	↘

Serie	49.4
Total	439.4



1:	8.5	→
2:	10.6x	↗
3:	10.8x	→
4:	9.5	↘
5:	9.8	↗

Serie	49.2
Total	488.6

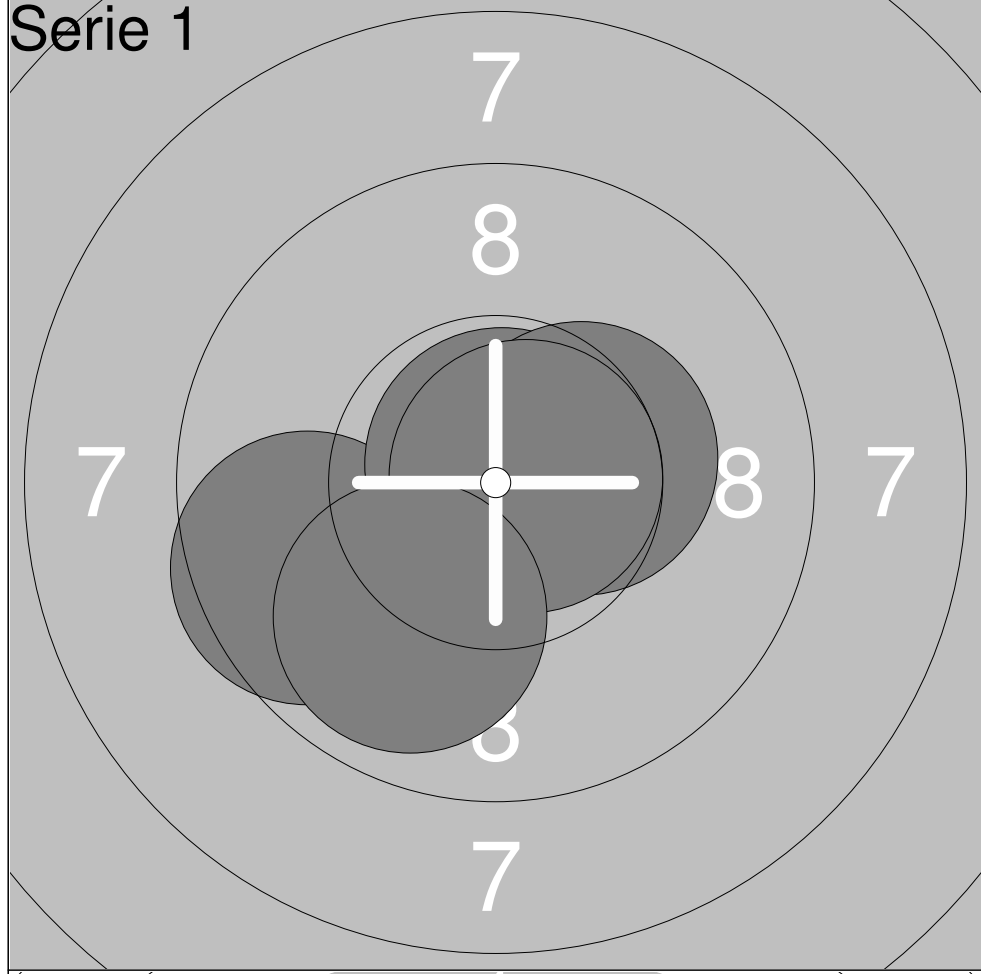

1:	9.6	↙
2:	10.8x	↗
3:	10.3x	→
4:	10.7x	→
5:	9.9	↘

Serie	51.3
Total	441.3

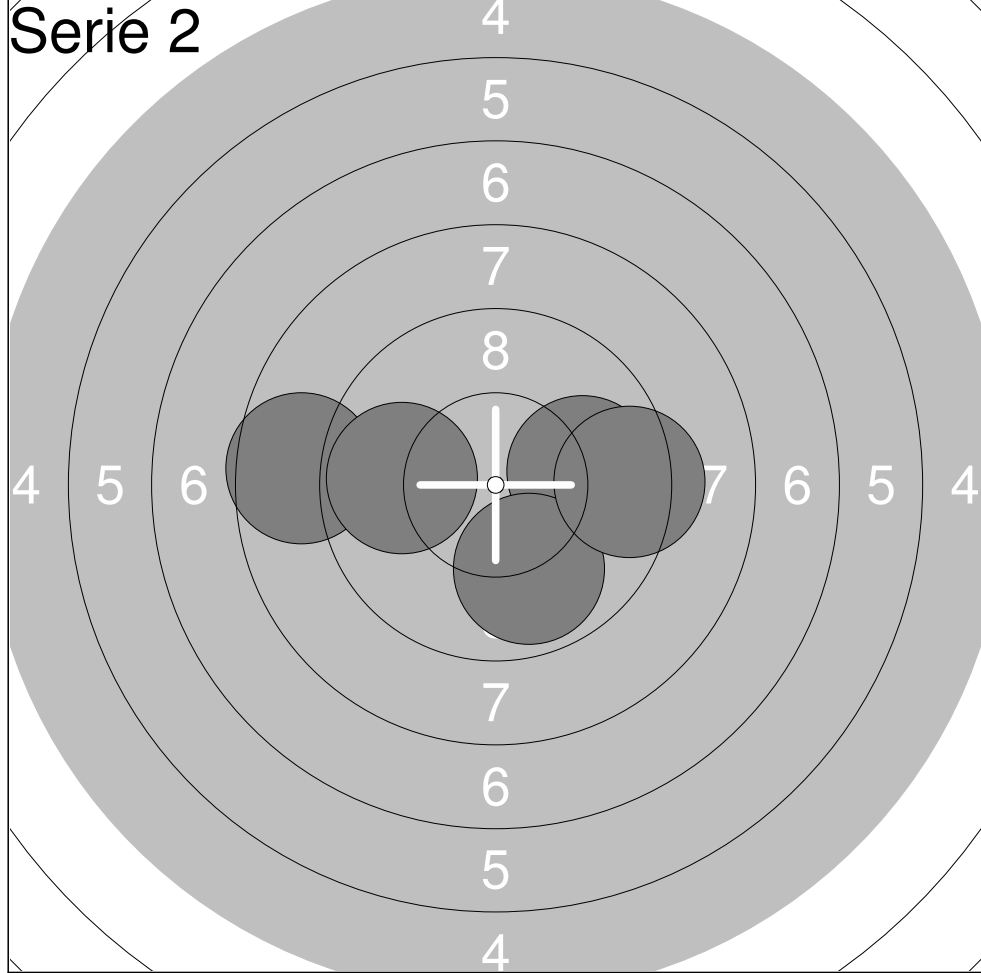

1:	8.6	↙
2:	9.8	↙
3:	9.9	→
4:	9.8	↘
5:	9.3	→

Serie	47.4
Total	488.7

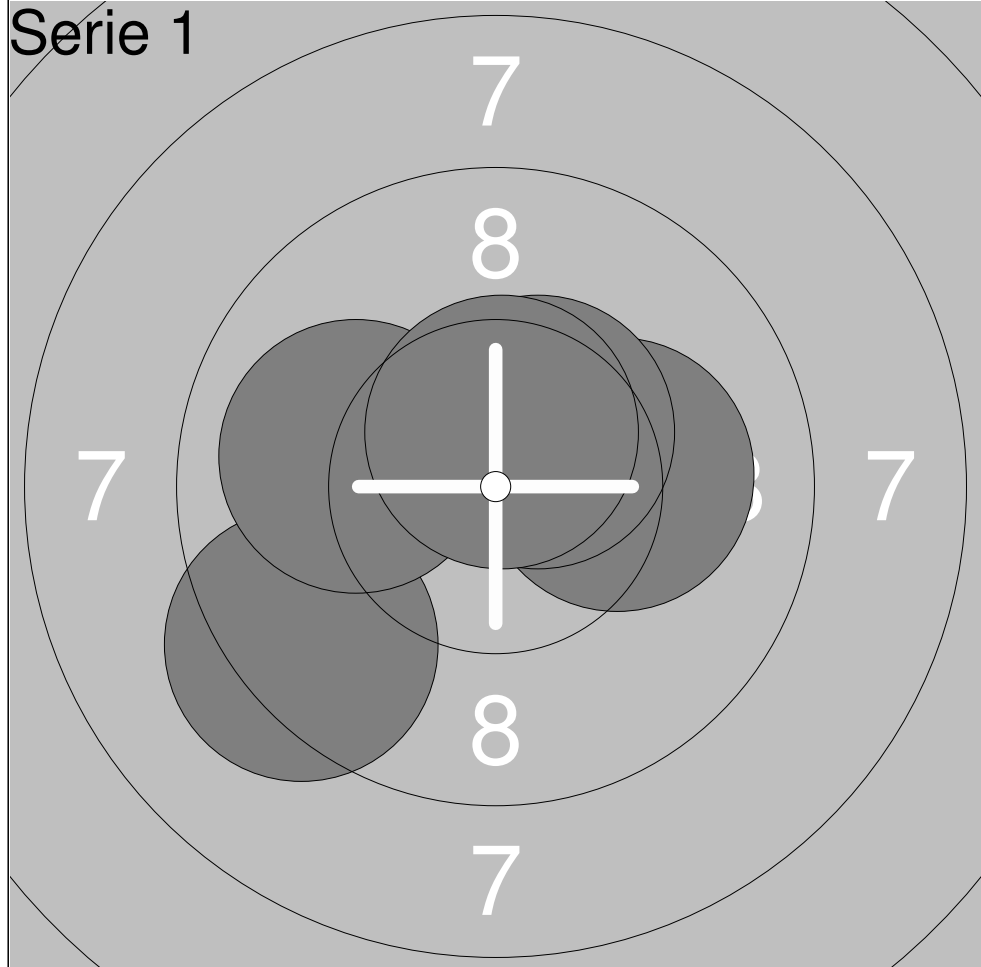

1:	10.1	→
2:	9.3	↙
3:	10.4x	↗
4:	10.0	↖
5:	10.6x	↑
Serie		50.4
Total		437.4



1:	9.8	↓
2:	9.0	↙
3:	10.2x	↖
4:	9.9	↗
5:	10.0	↗
Serie		48.9
Total		486.3

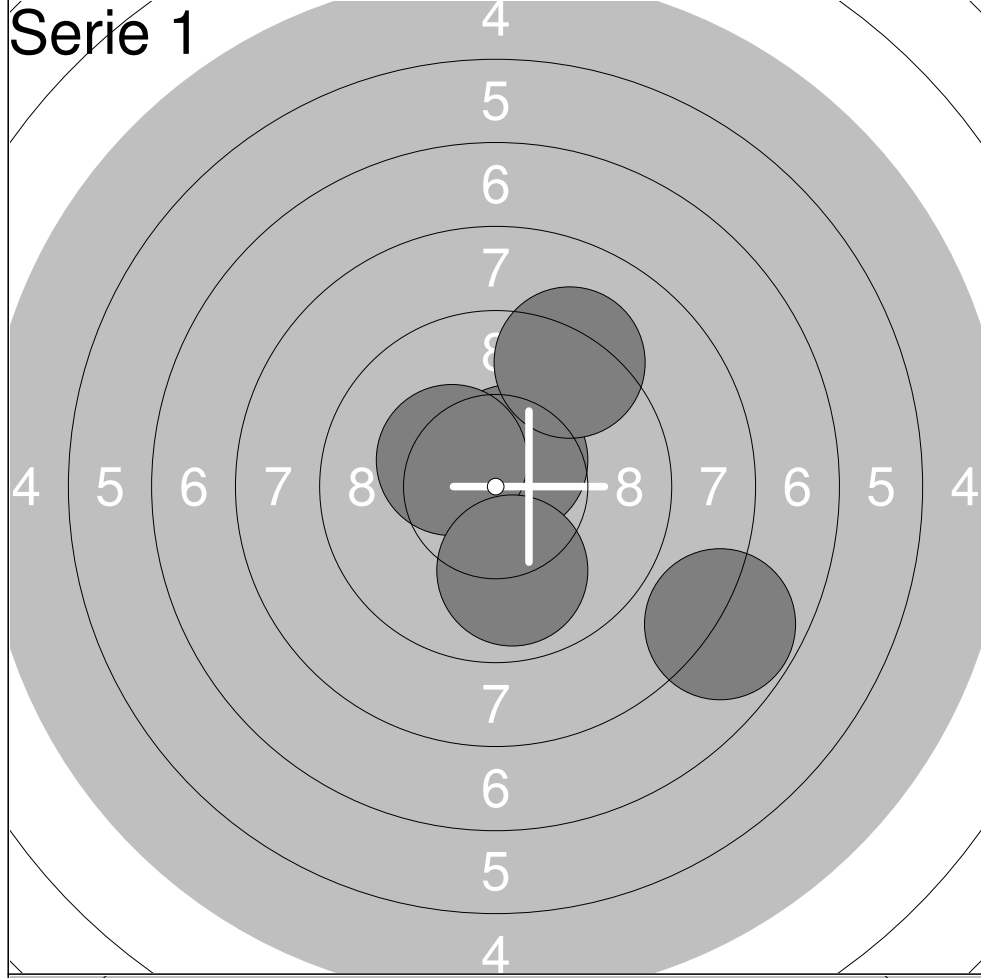

1:	10.5x	↗
2:	7.8	↘
3:	10.3x	↖
4:	9.9	↙
5:	9.2	↗

Serie	47.7
Total	431.7

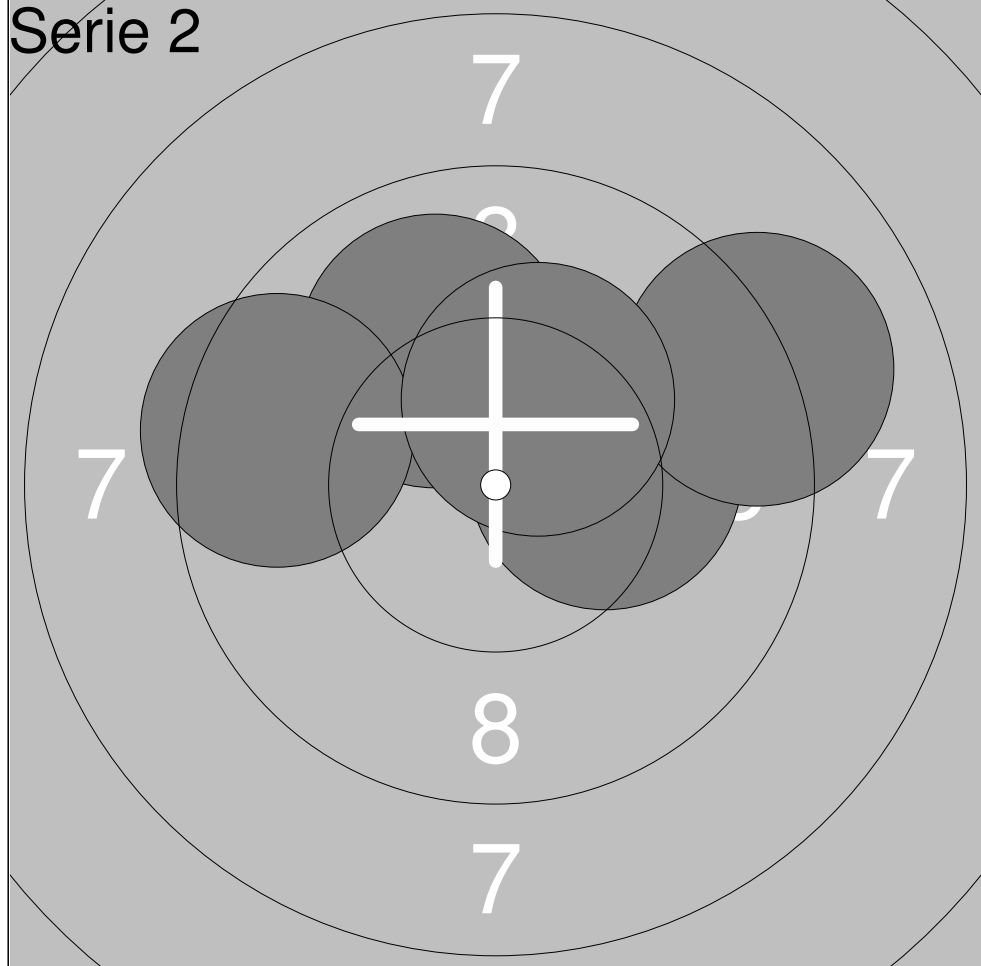

1:	10.2x	→
2:	10.0	↖
3:	9.0	↗
4:	9.4	↖
5:	10.3x	↗

Serie	48.9
Total	480.6

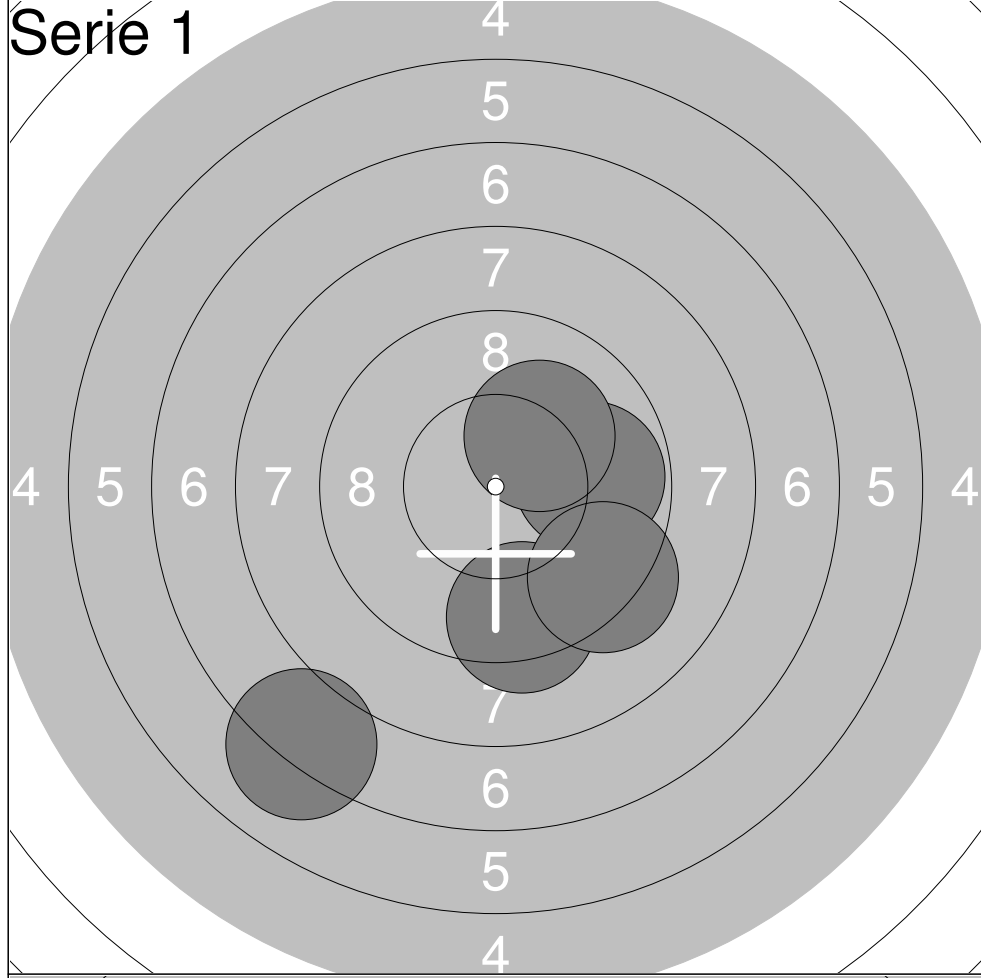

1:	9.8	→
2:	9.3	↓
3:	7.1	↙
4:	10.1	↗
5:	9.2	↘

Serie	45.5
Total	428.5

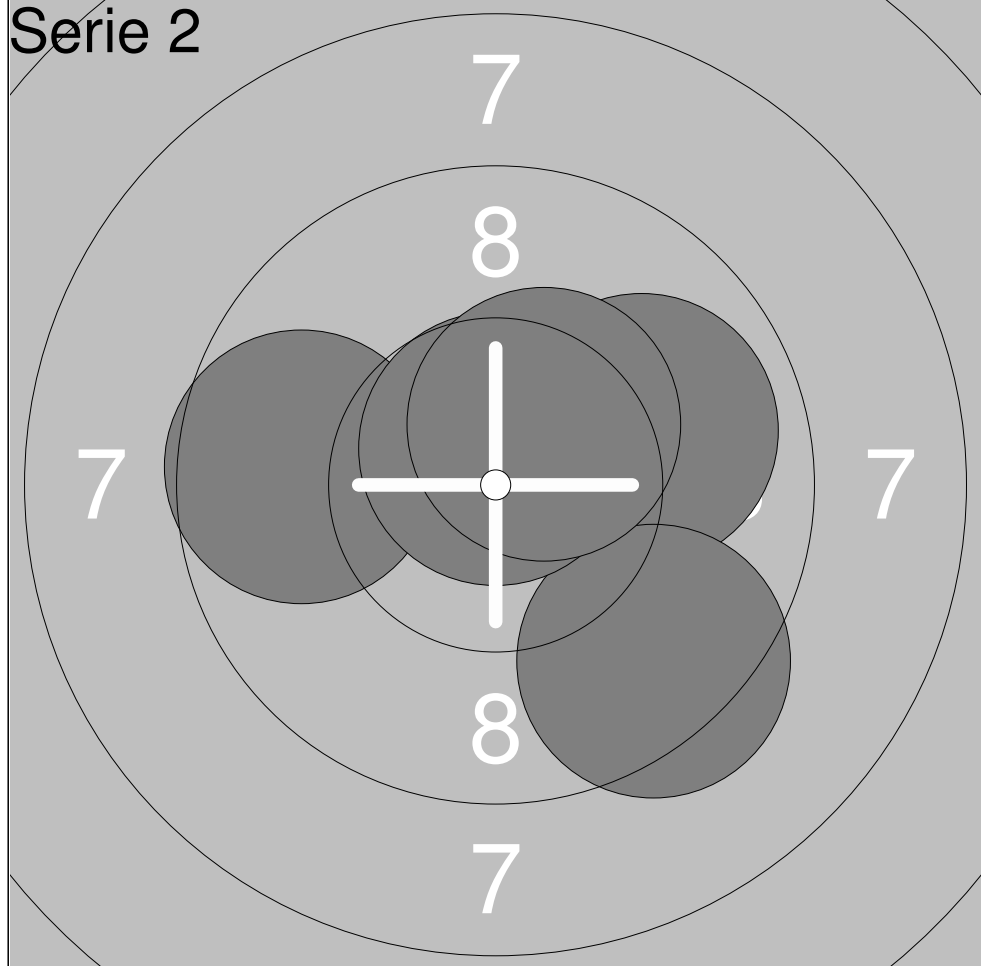

1:	9.9	↗
2:	9.7	←
3:	9.4	↘
4:	10.7x	↑
5:	10.4x	↗

Serie	50.1
Total	478.6

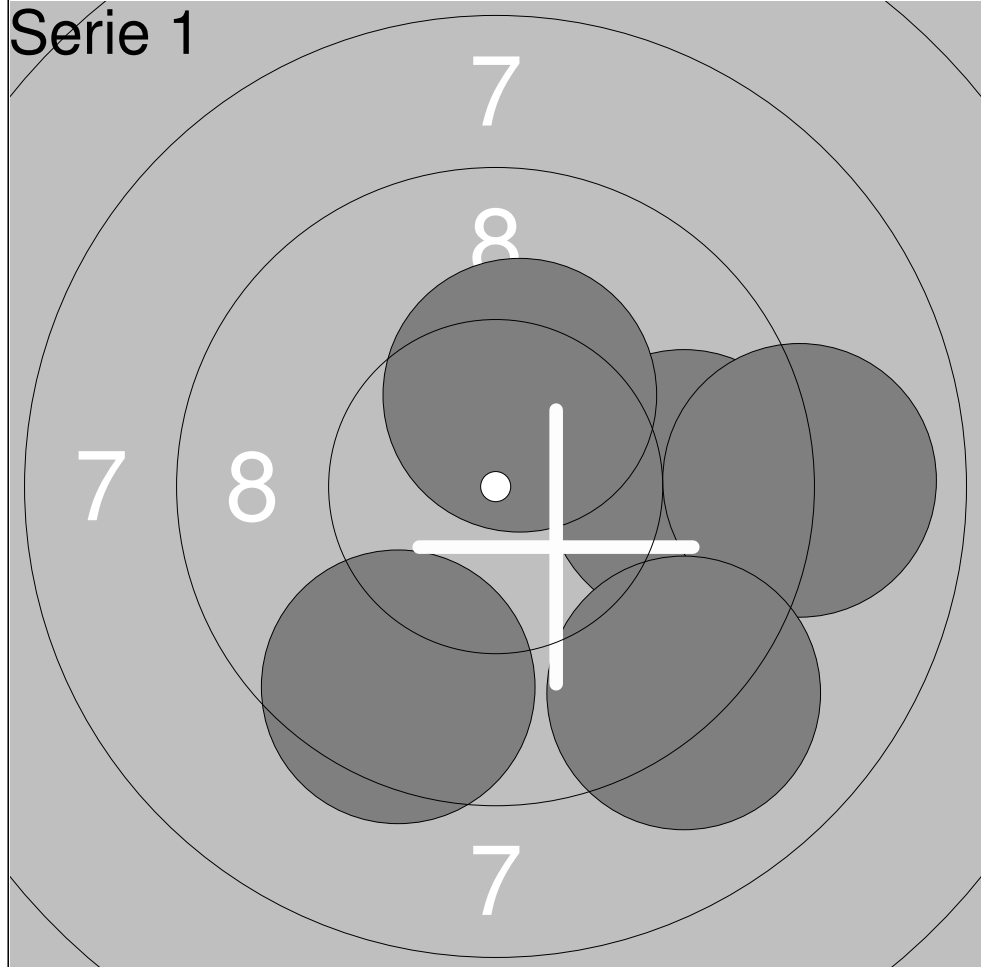

1:	9.5	↙
2:	9.7	→
3:	8.9	→
4:	10.3x	↑
5:	9.1	↘
<b>Serie</b>		<b>47.5</b>
<b>Total</b>		<b>426.5</b>



1:	10.5x	↗
2:	10.5x	↗
3:	10.0	↙
4:	8.5	↙
5:	10.0	↙
<b>Serie</b>		<b>49.5</b>
<b>Total</b>		<b>476.0</b>

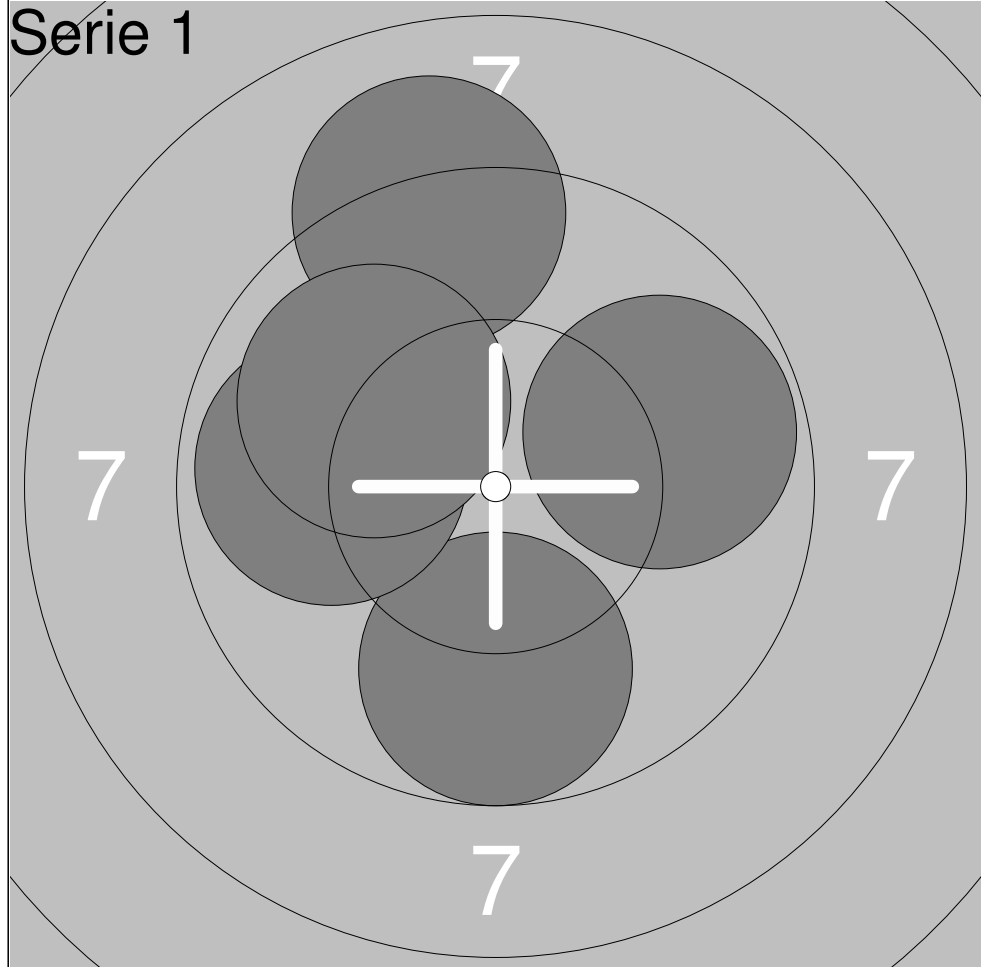

1:	9.1	↑
2:	9.8	→
3:	9.8	↓
4:	9.8	←
5:	9.9	↗
<b>Serie</b>		<b>48.4</b>
<b>Total</b>		<b>425.4</b>

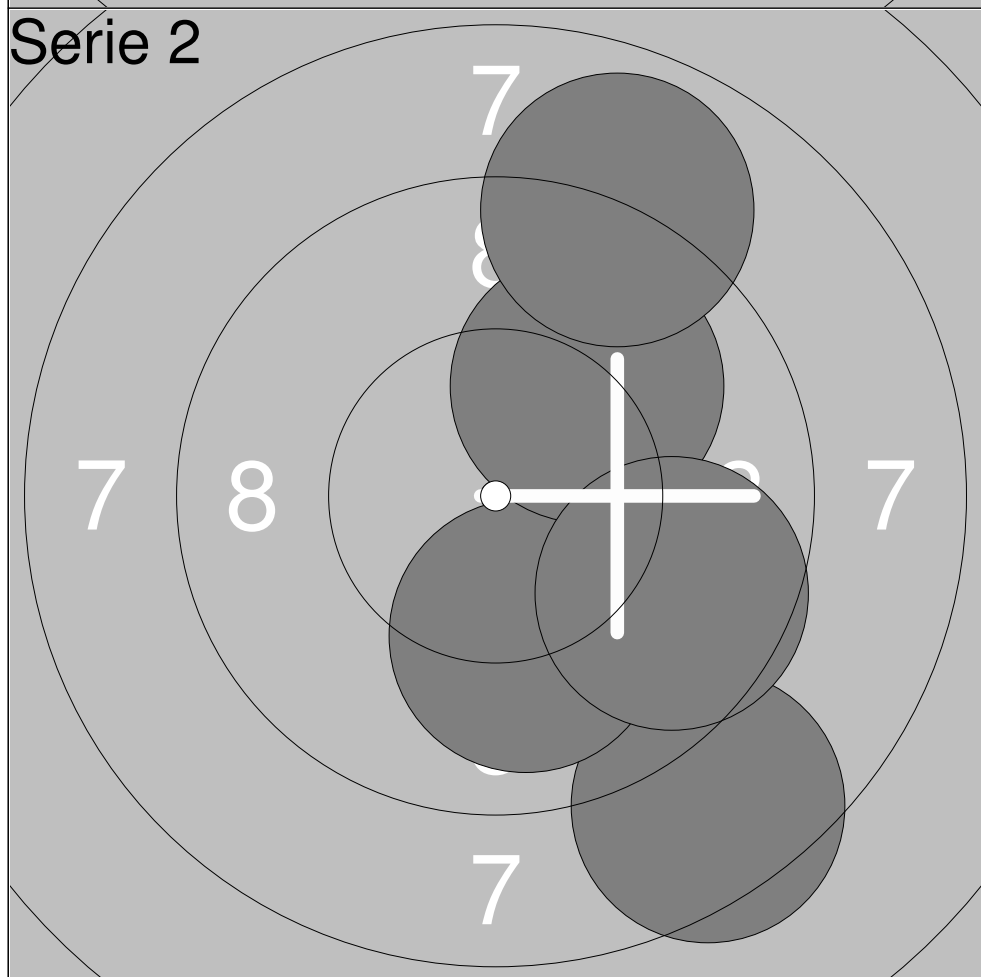

1:	8.4	↘
2:	10.0	↓
3:	10.0	↗
4:	8.9	↗
5:	9.6	↘
<b>Serie</b>		<b>46.9</b>
<b>Total</b>		<b>472.3</b>

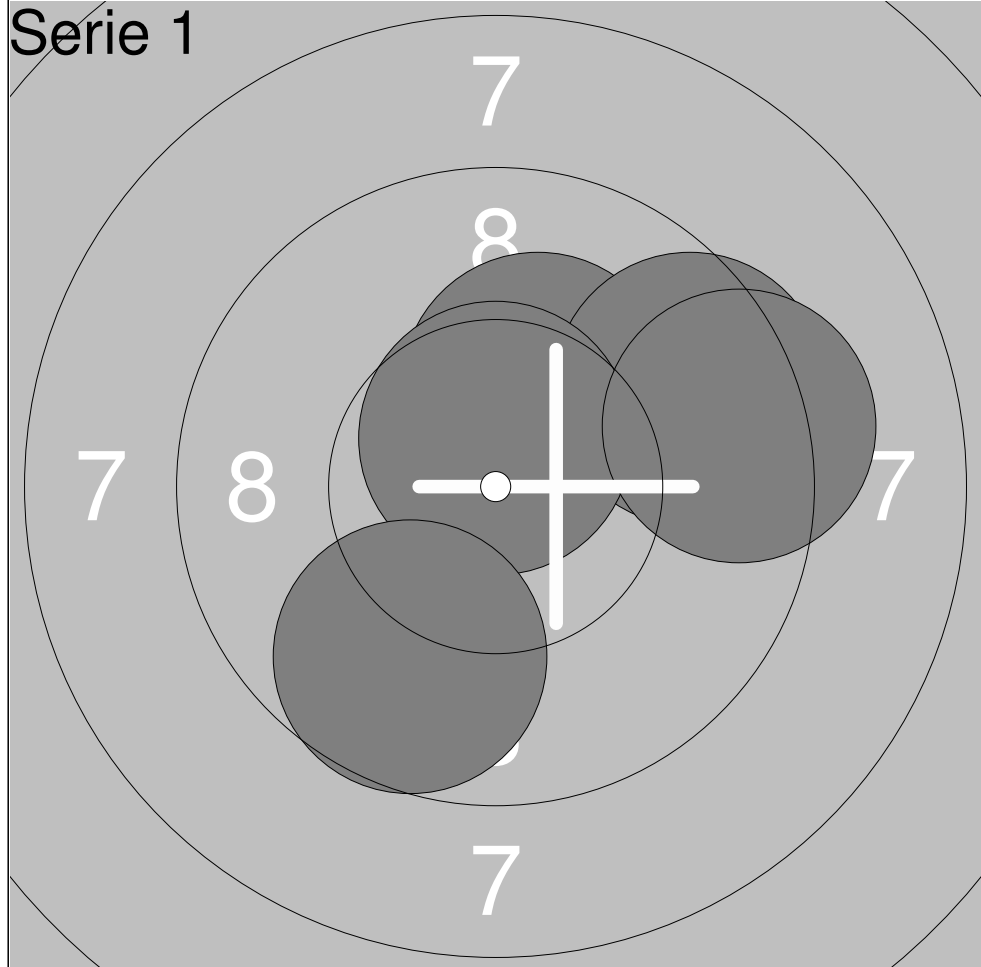

1:	10.2x	↗
2:	9.5	↘
3:	10.6x	↑
4:	9.7	↙
5:	9.3	↘
<b>Serie</b>		<b>49.3</b>
<b>Total</b>		<b>425.3</b>



1:	10.3x	→
2:	10.6x	↗
3:	10.3x	↖
4:	10.8x	↗
5:	10.5x	↓
<b>Serie</b>		<b>52.5</b>
<b>Total</b>		<b>477.8</b>



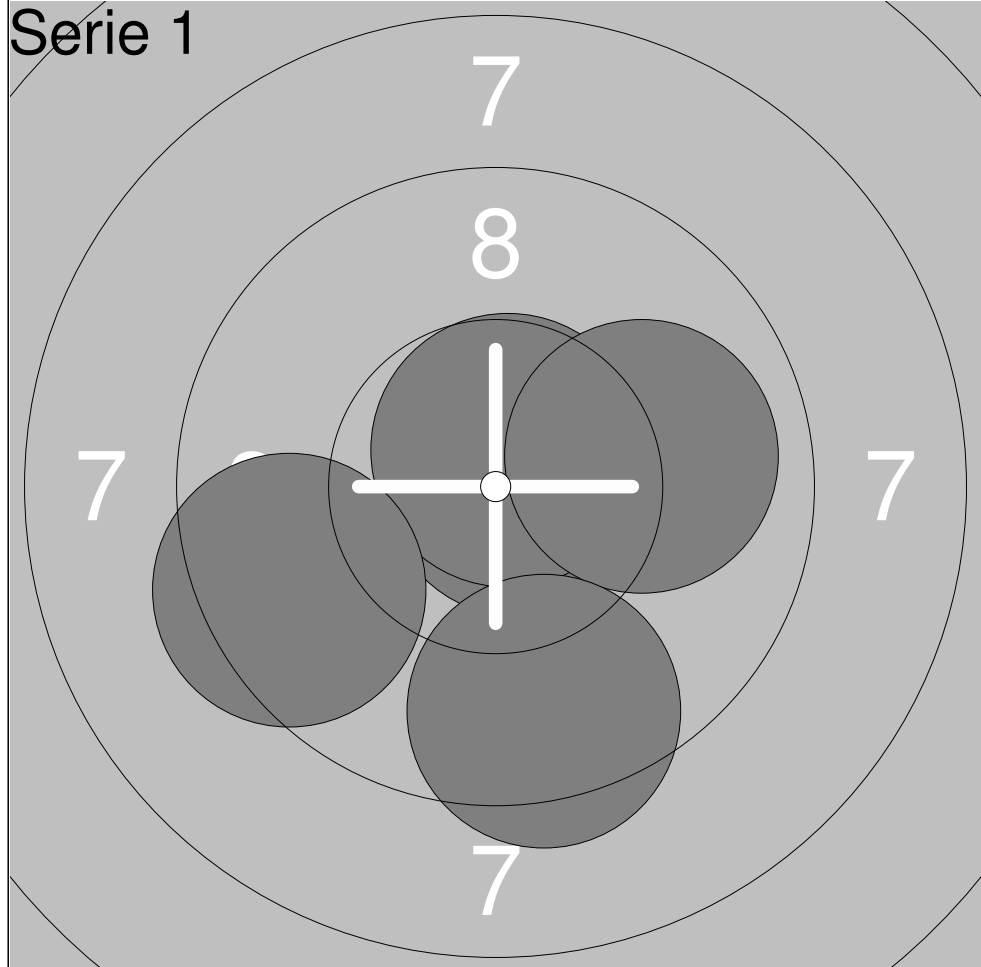

1:	10.7x	→
2:	10.7x	↑
3:	9.4	↙
4:	10.0	→
5:	9.4	↓
Serie		50.2
Total		426.2

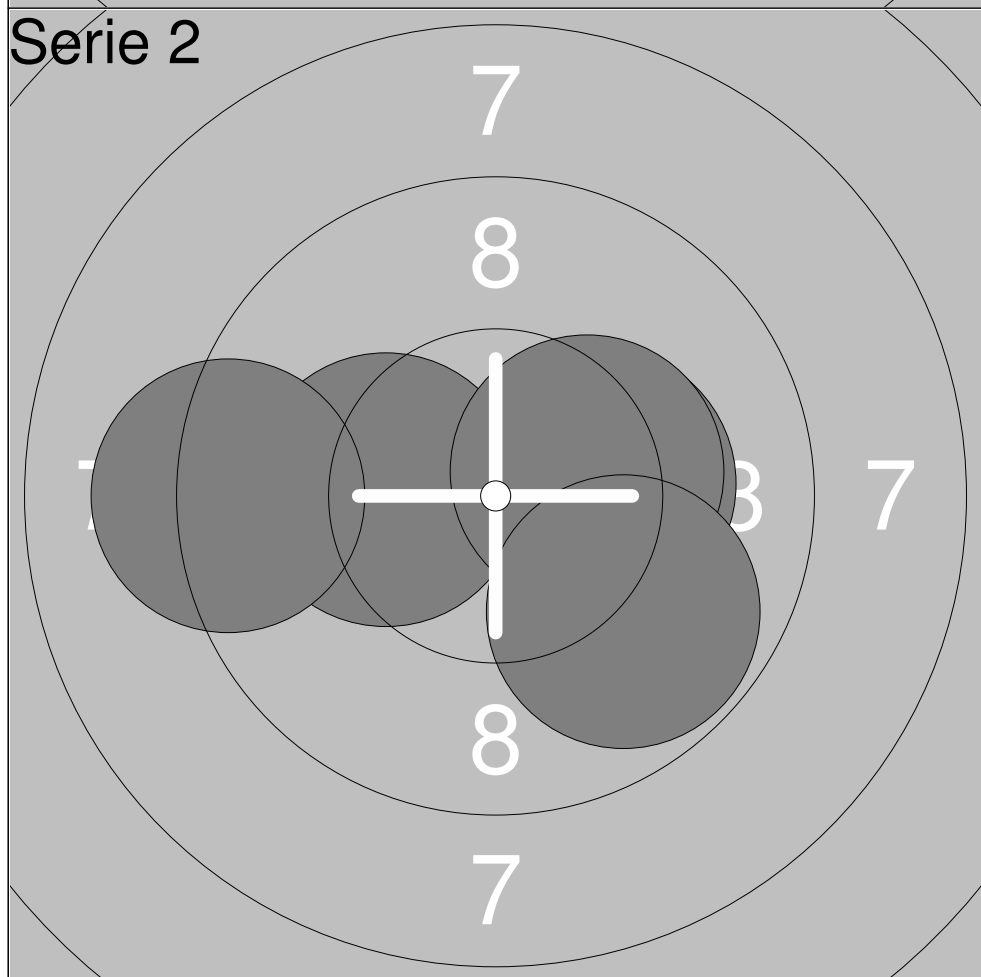

1:	10.3x	→
2:	10.2x	↙
3:	10.3x	→
4:	9.8	↘
5:	9.2	↙
Serie		49.8
Total		476.0

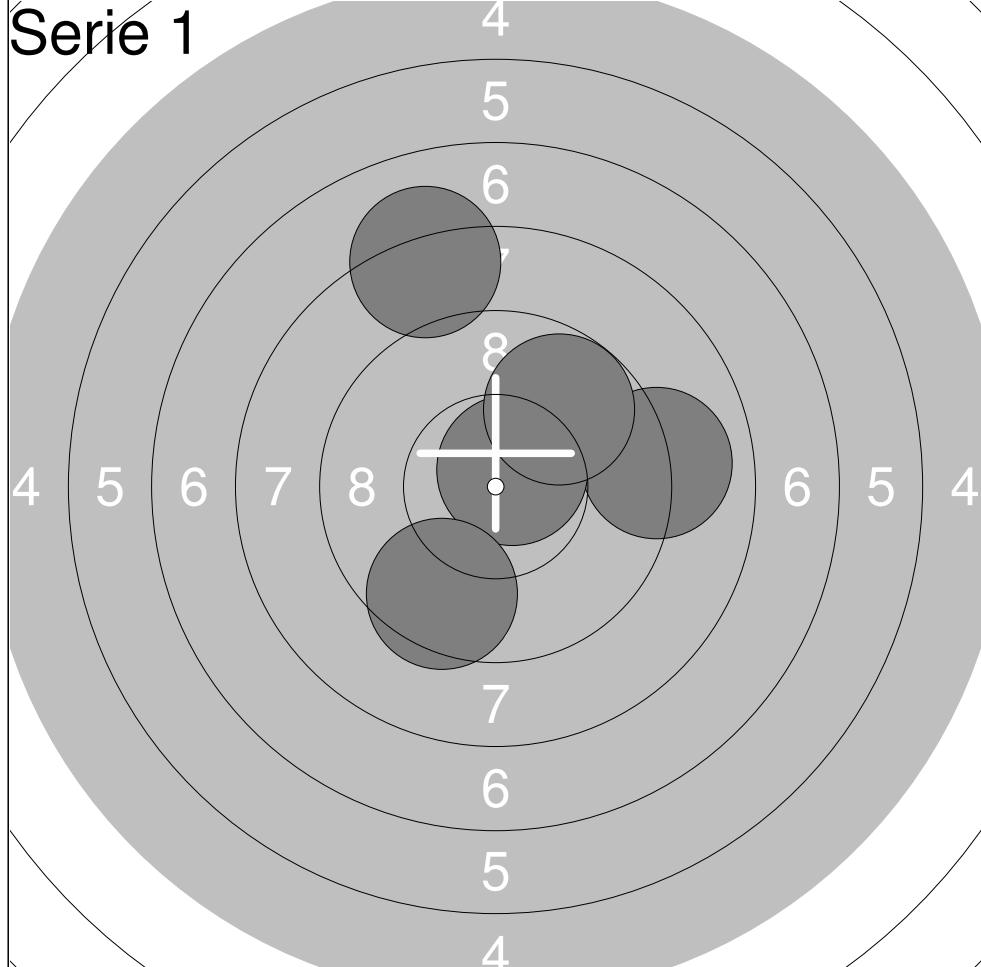

1:	9.0	→
2:	10.7x	↗
3:	8.1	↖
4:	9.5	↘
5:	9.7	↗

Serie	47.0
Total	422.0

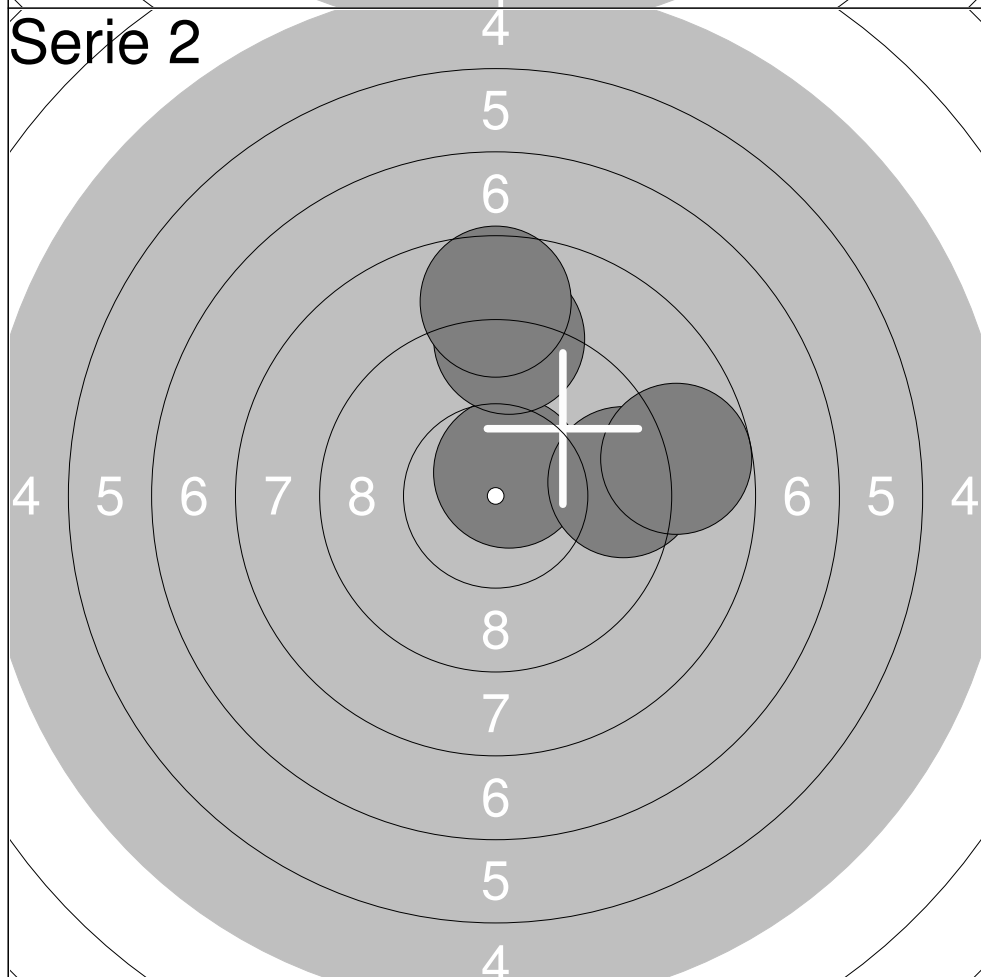

1:	10.6x	↗
2:	9.4	→
3:	8.7	→
4:	9.0	↑
5:	8.6	↑

Serie	46.3
Total	468.3

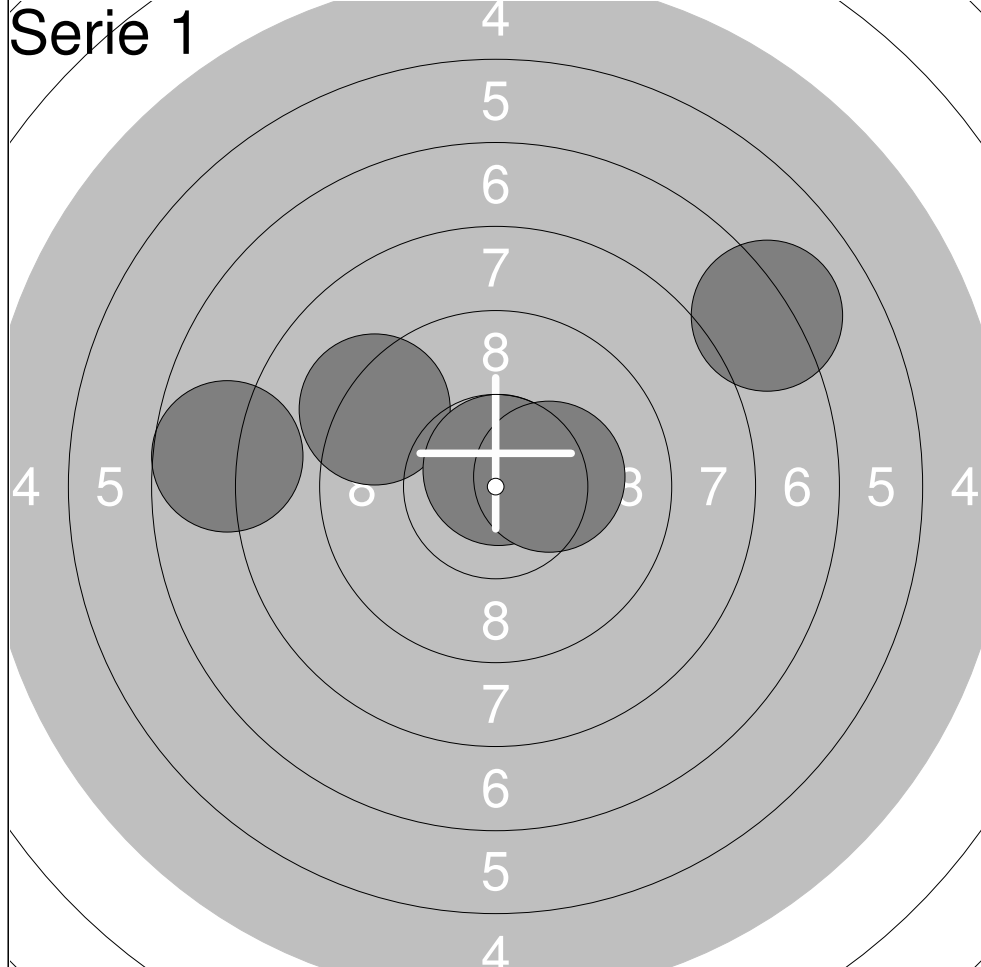

1:	9.2	↖
2:	7.7	←
3:	10.7x	↑
4:	10.3x	→
5:	7.1	↗

Serie	45.0
Total	420.0



1:	8.9	↗
2:	10.7x	↑
3:	10.5x	←
4:	7.3	↗
5:	10.6x	↑

Serie	48.0
Total	468.0

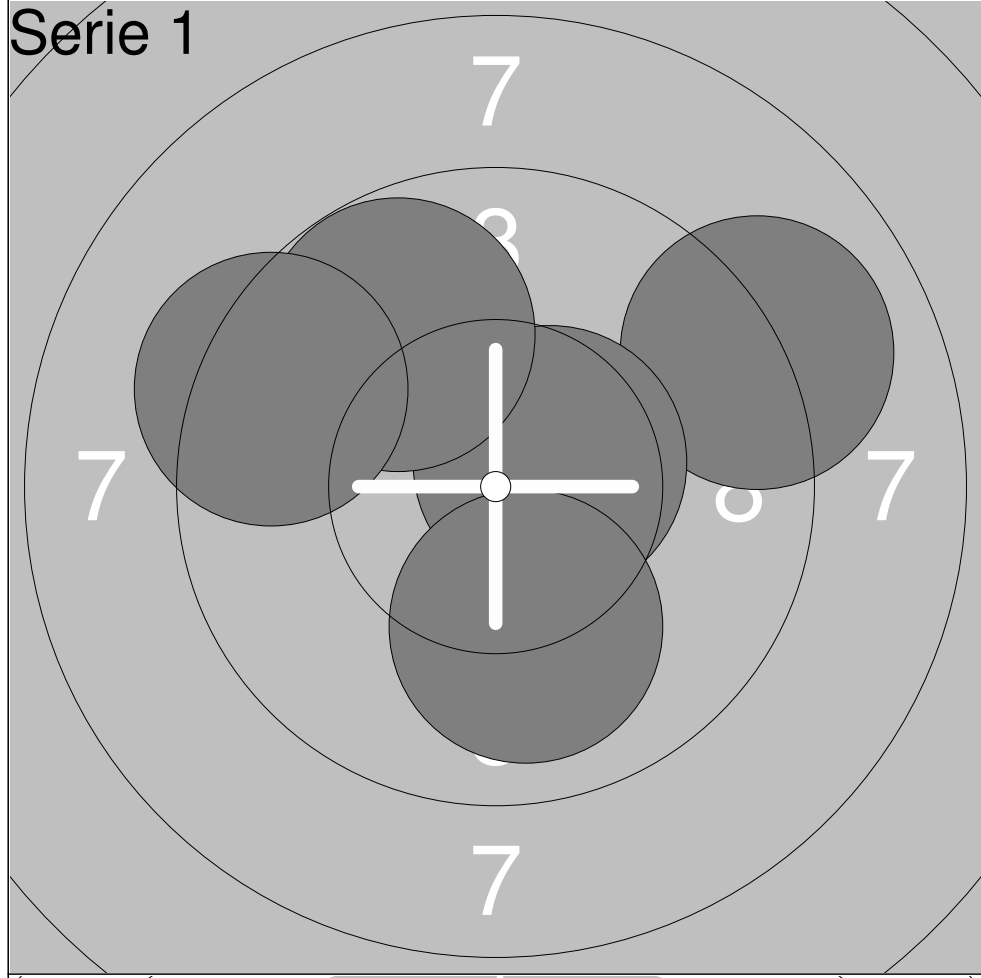

1:	9.0	↗
2:	10.5x	↗
3:	9.7	↖
4:	9.3	↖
5:	10.0	↓

Serie	48.5
Total	421.5



1:	9.7	↘
2:	7.7	↗
3:	10.4x	↗
4:	10.1	↘
5:	10.4x	↓

Serie	48.3
Total	469.8



1:	10.2x	→
2:	10.3x	↘
3:	10.2x	→
4:	10.0	↙
5:	10.7x	↑
<b>Serie</b>		<b>51.4</b>
<b>Total</b>		<b>450.4</b>



1:	9.9	↙
2:	9.8	↙
3:	10.1	↗
4:	9.6	↗
5:	10.5x	↙
<b>Serie</b>		<b>49.9</b>
<b>Total</b>		<b>500.3</b>



1:	10.3x	→
2:	10.1	↙
3:	10.1	↑
4:	10.8x	↗
5:	10.3x	↑

Serie	51.6
Total	447.6



1:	9.1	↗
2:	9.8	↑
3:	10.5x	←
4:	10.4x	↓
5:	10.6x	↑

Serie	50.4
Total	498.0



1:	10.7x	↗
2:	10.2x	↖
3:	9.4	↖
4:	10.7x	↗
5:	10.6x	↗
<b>Serie</b>		<b>51.6</b>
<b>Total</b>		<b>446.6</b>

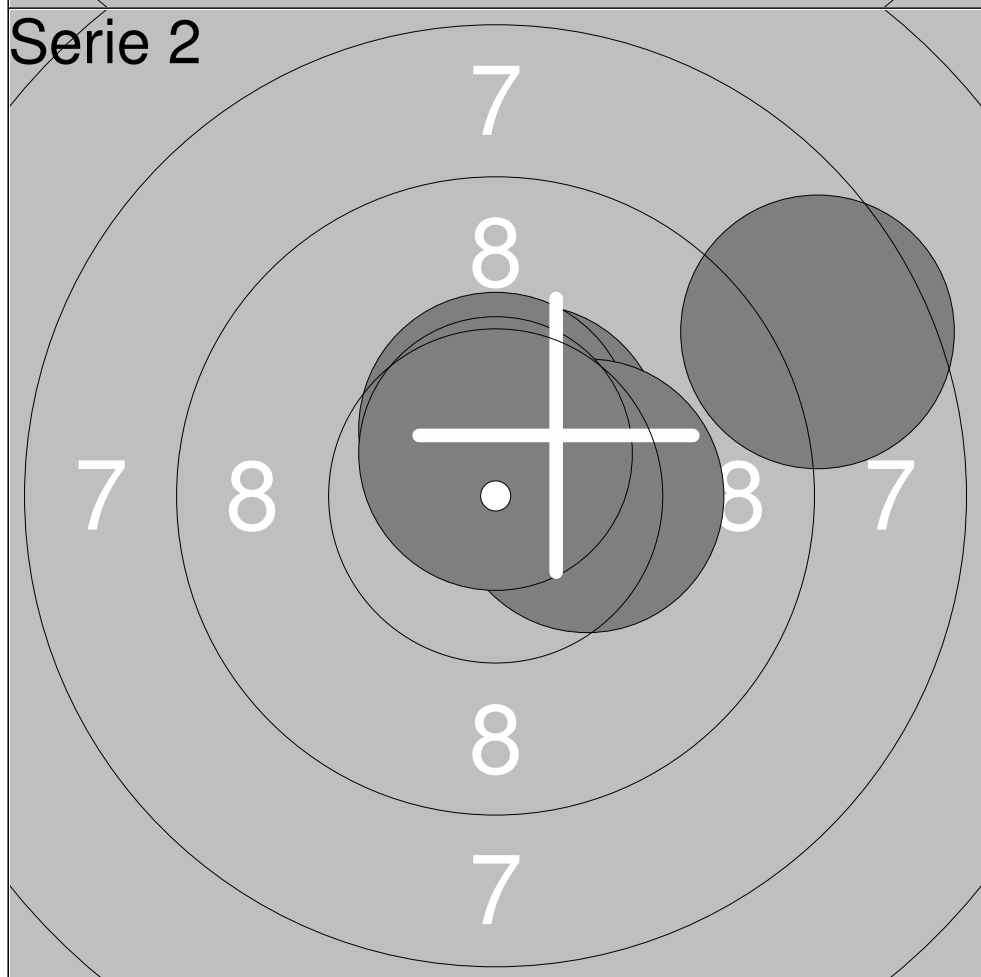

1:	10.5x	↗
2:	10.5x	↑
3:	10.3x	→
4:	8.5	↗
5:	10.6x	↑
<b>Serie</b>		<b>50.4</b>
<b>Total</b>		<b>497.0</b>

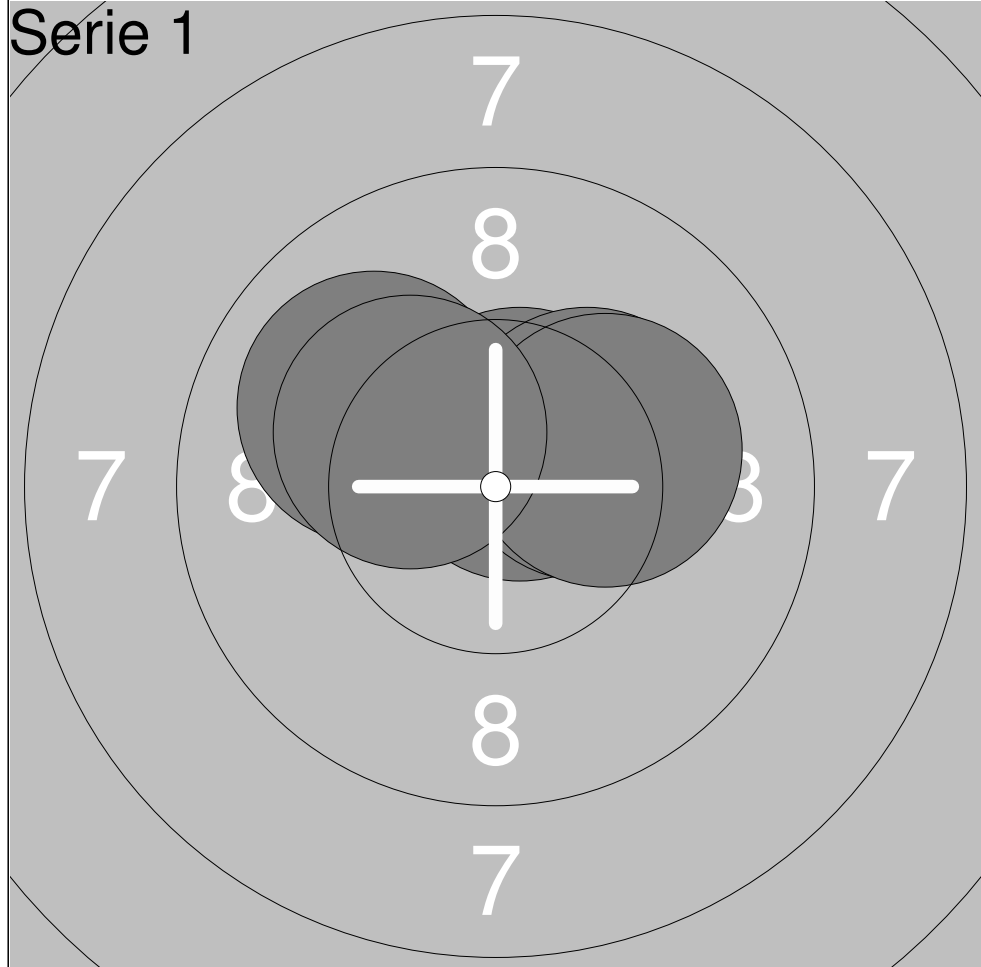

1:	10.6x	↗
2:	10.3x	→
3:	10.2x	→
4:	10.0	↖
5:	10.3x	↖
<b>Serie</b>		<b>51.4</b>
<b>Total</b>		<b>446.4</b>

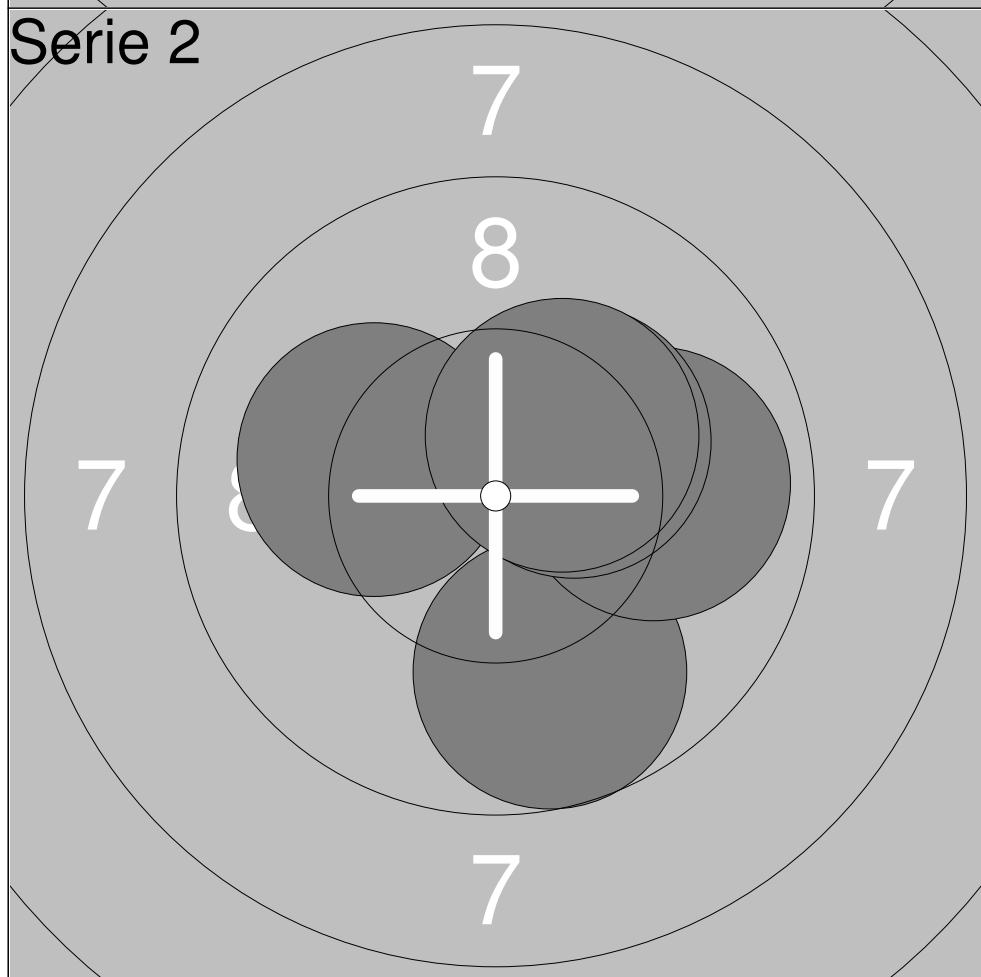

1:	9.7	↘
2:	9.9	→
3:	10.1	↖
4:	10.3x	↗
5:	10.3x	↗
<b>Serie</b>		<b>50.3</b>
<b>Total</b>		<b>496.7</b>





1:	10.5x	↗
2:	9.9	↖
3:	10.6x	↗
4:	10.3x	↗
5:	10.3x	→
<b>Serie</b>		<b>51.6</b>
<b>Total</b>		<b>446.6</b>



1:	10.3x	↗
2:	10.4x	↗
3:	10.2x	↗
4:	9.9	↗
5:	9.6	↖
<b>Serie</b>		<b>50.4</b>
<b>Total</b>		<b>497.0</b>

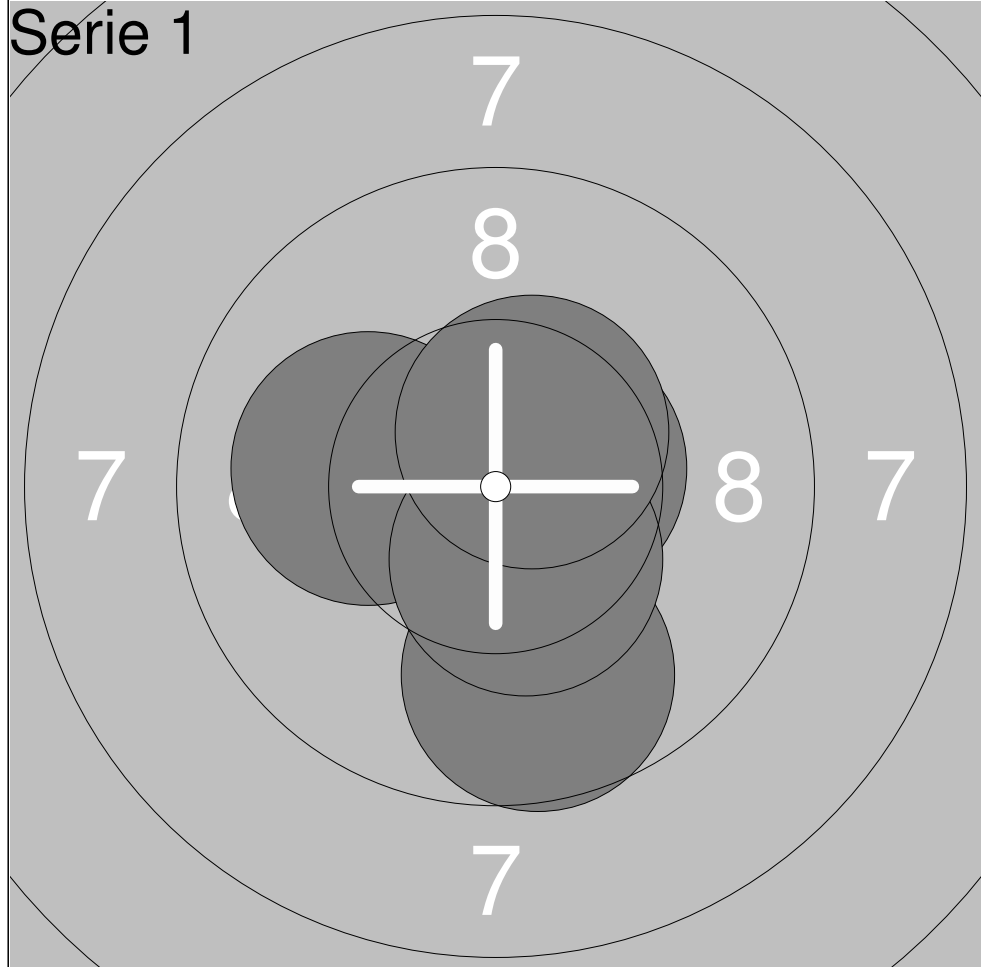

1:	10.6x	→
2:	9.7	↓
3:	10.1	←
4:	10.4x	↓
5:	10.5x	↗

Serie	51.3
Total	444.3

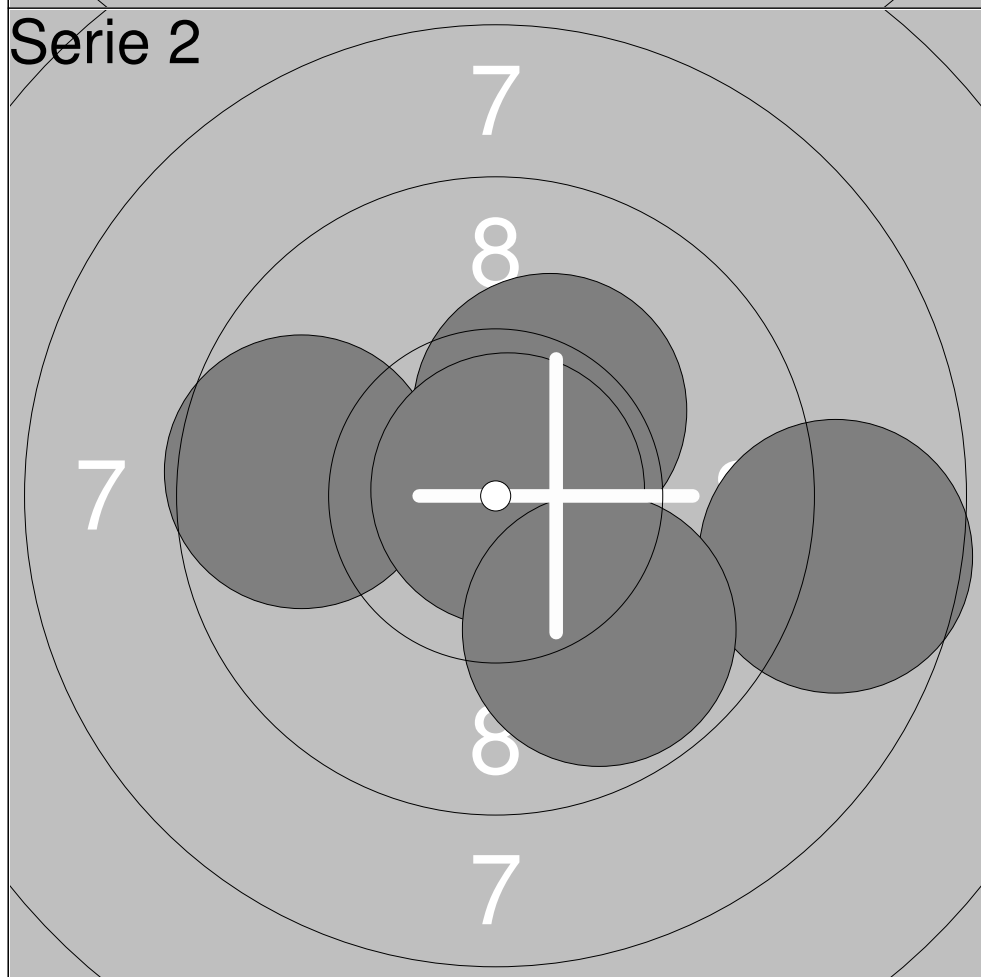

1:	10.2x	↗
2:	8.7	→
3:	9.6	←
4:	10.8x	↗
5:	9.8	↓

Serie	49.1
Total	493.4

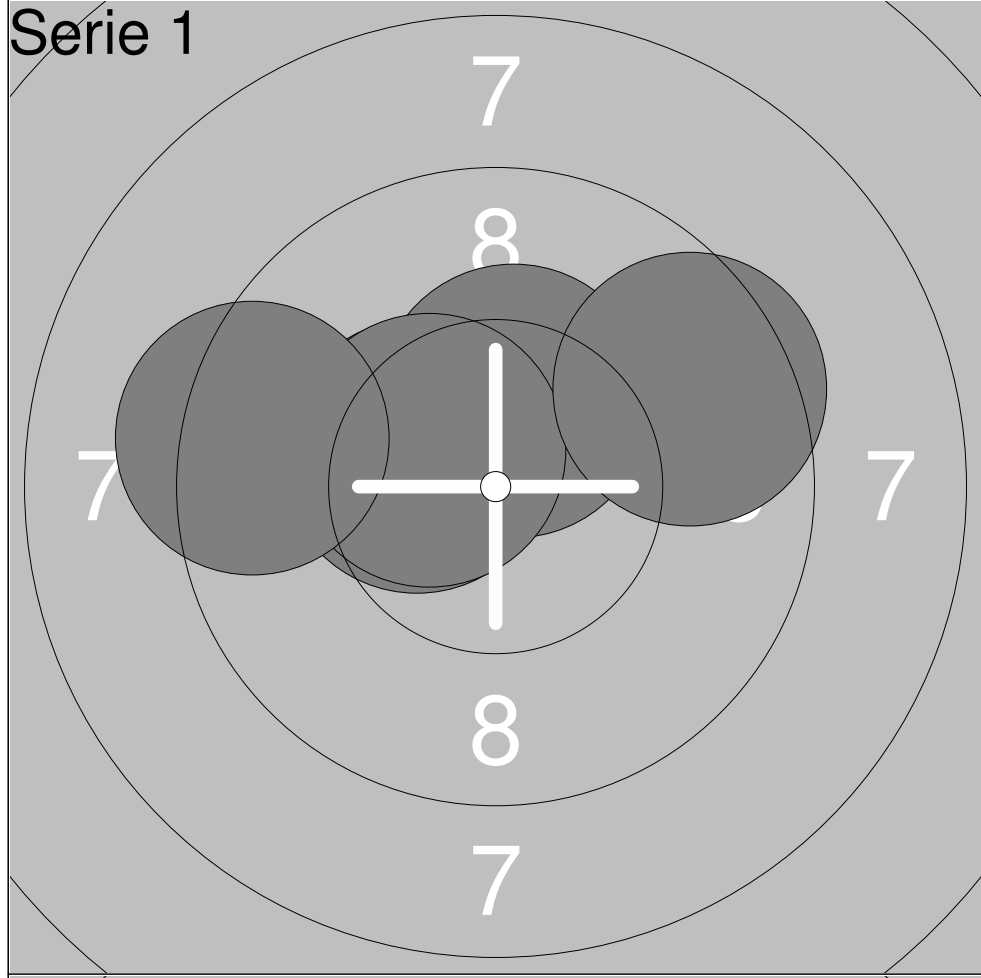

1:	10.4x	↗
2:	10.4x	↖
3:	10.4x	↖
4:	9.3	↖
5:	9.5	↗
<b>Serie</b>		<b>50.0</b>
<b>Total</b>		<b>443.0</b>

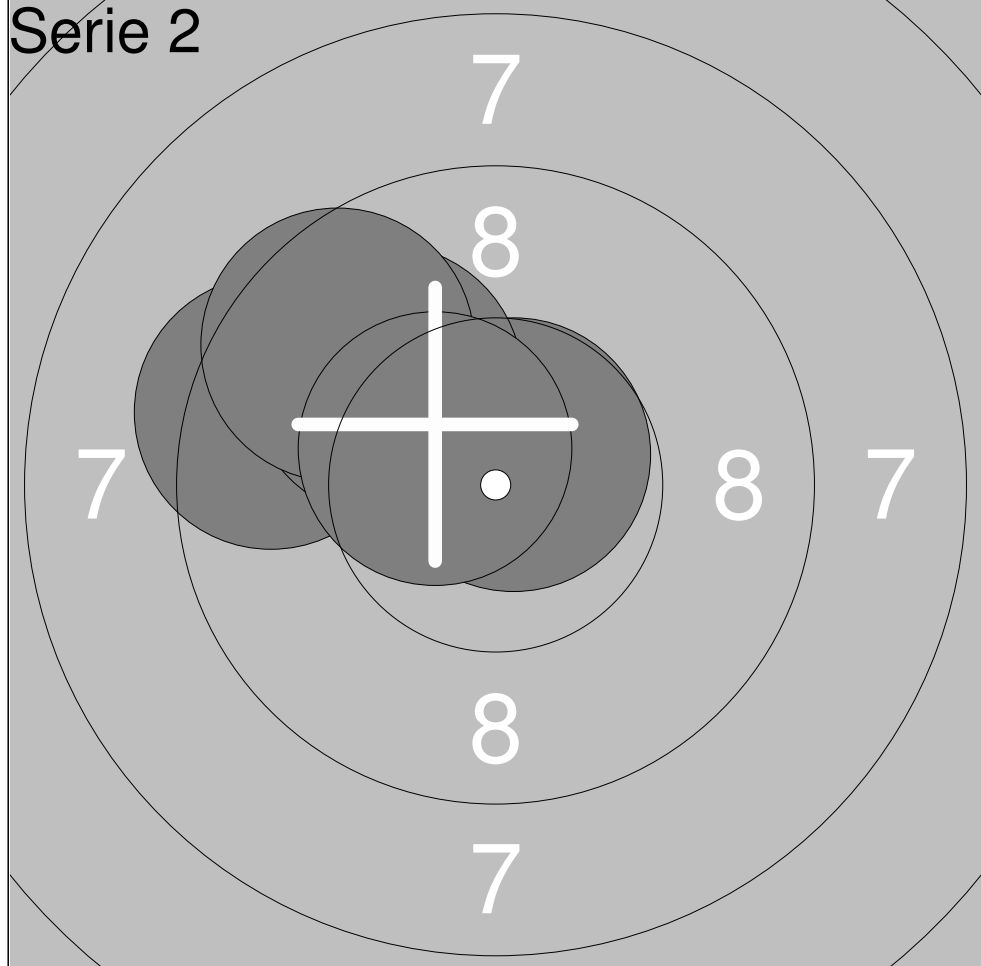

1:	10.7x	↗
2:	9.4	↖
3:	9.9	↗
4:	9.6	↗
5:	10.5x	↖
<b>Serie</b>		<b>50.1</b>
<b>Total</b>		<b>493.1</b>

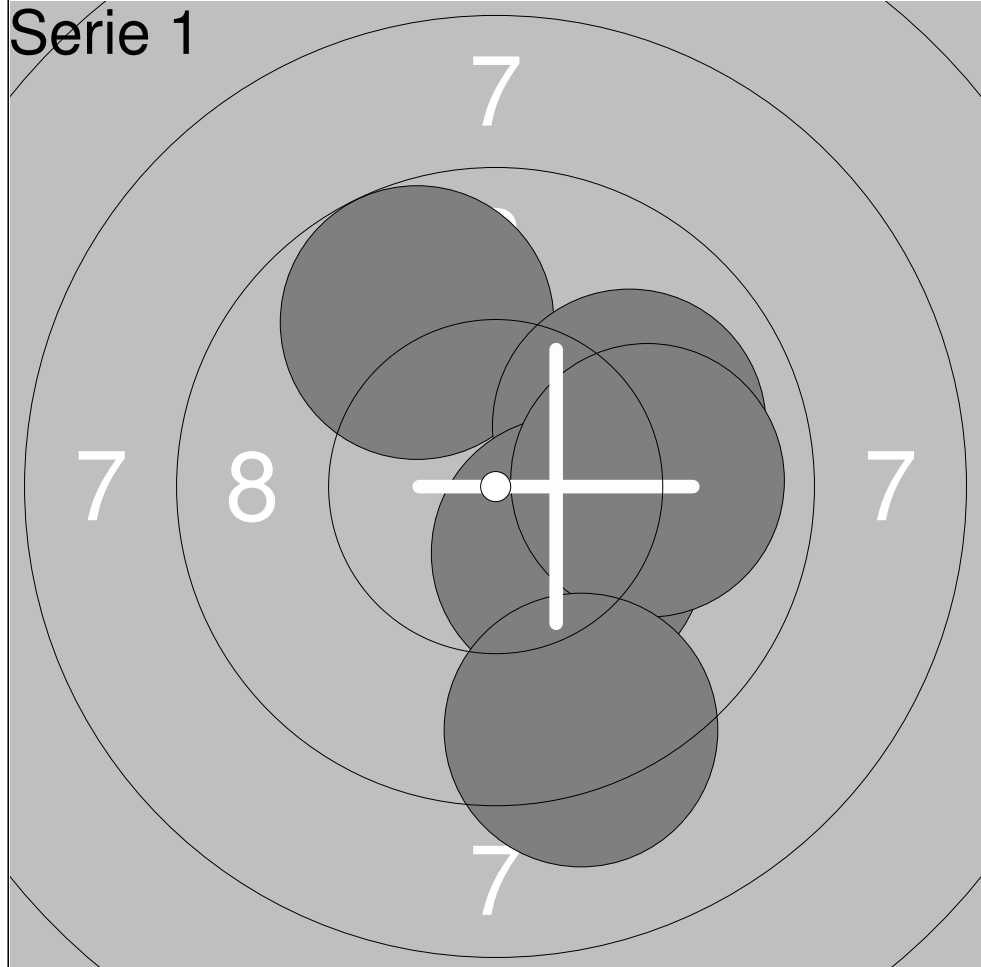

1:	9.7	↖
2:	9.9	↗
3:	10.3x	↘
4:	9.9	→
5:	9.2	↙
Serie		49.0
Total		441.0



1:	10.7x	↑
2:	10.3x	↓
3:	9.7	↖
4:	10.1	↘
5:	10.5x	↑
Serie		51.3
Total		492.3

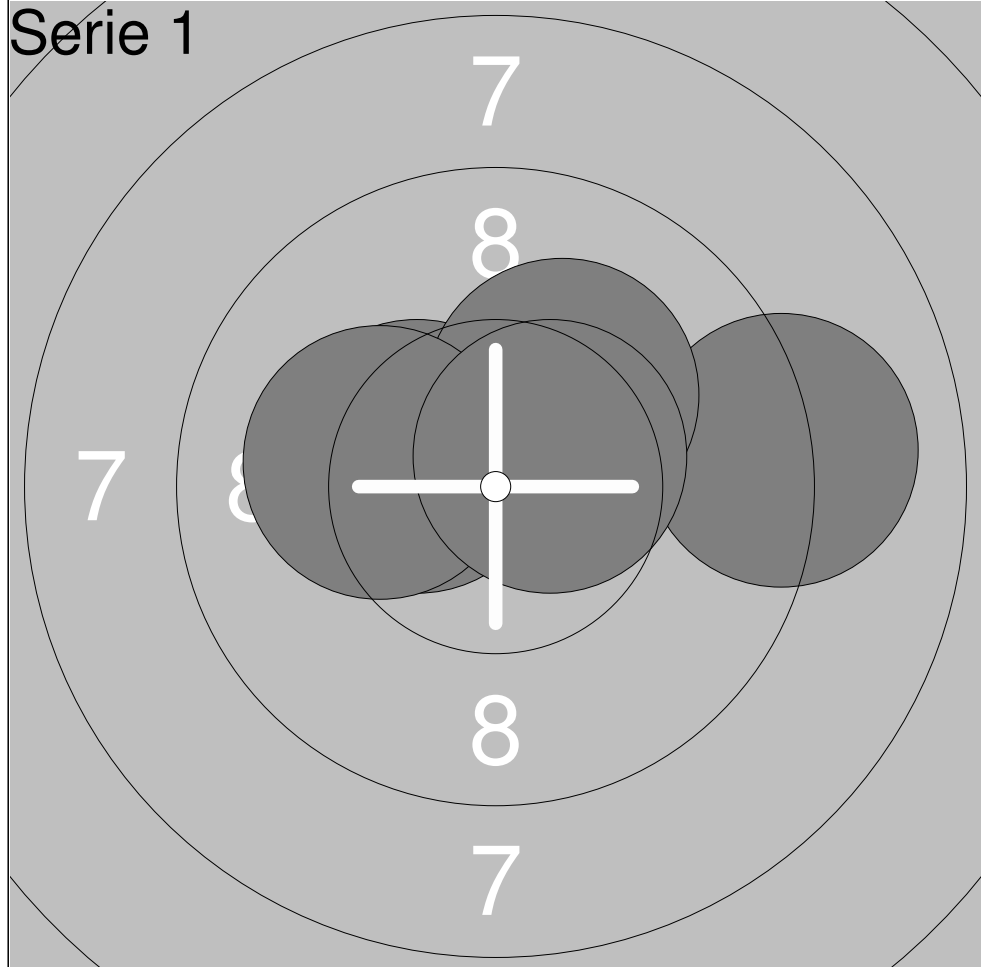

1:	10.4x	↖
2:	9.0	→
3:	10.2x	↗
4:	10.1	↖
5:	10.5x	↗

Serie	50.2
Total	442.2



1:	10.4x	↗
2:	10.1	↖
3:	9.0	↘
4:	10.7x	↗
5:	10.7x	↗

Serie	50.9
Total	493.1

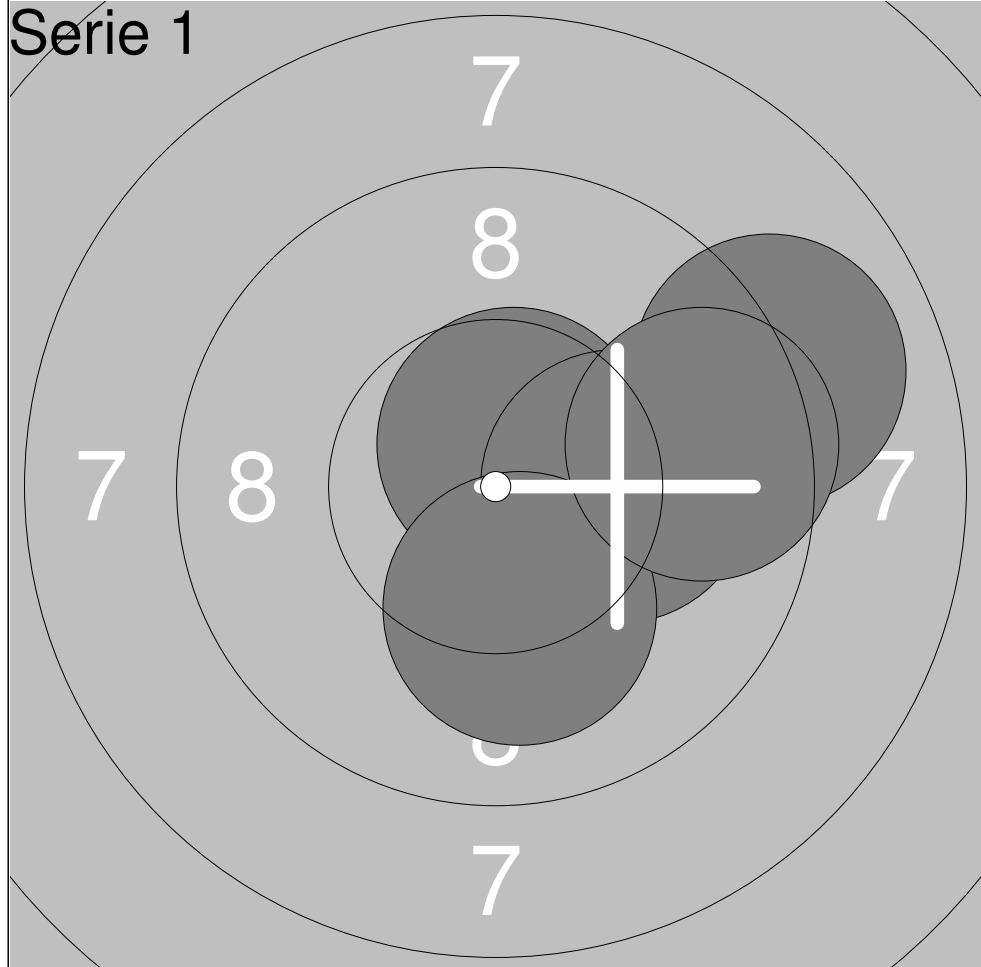

1:	9.0	→
2:	10.6x	↗
3:	10.1	→
4:	10.1	↘
5:	9.6	→
<b>Serie</b>		<b>49.4</b>
<b>Total</b>		<b>441.4</b>



1:	9.3	→
2:	10.3x	→
3:	10.0	↖
4:	10.8x	↗
5:	9.7	↗
<b>Serie</b>		<b>50.1</b>
<b>Total</b>		<b>491.5</b>