

Skjutlag 1	Tavla 1	Jacob Nilsson	
S		Umeå Skf	
07.04.2019		Startskottet 2019	
Prov		Umeå skytteallians	
	1: 7.3 → 2: 8.5 ↓ 3: 8.2 → 4: 9.8 → 5: 9.7 ← 6: 10.3 ↓ 7: 10.3x ↓ 8: 9.3 ↓ 9: 9.9 ↓ 10: 10.7x ↓ Serie 89.0 Total 0.0		11: 9.9 ↓ 12: 10.1 ↗ 13: 9.6 ↓ 14: 8.8 ↓ 15: 10.4x ← 16: 9.9 → 17: 9.7 ↓ 18: 10.2 ← 19: 8.6 ↓ 20: 8.0 ↓ Serie 90.0 Total 0.0
	21: 10.6x ↓ 22: 8.0 ↓ 23: 9.4 ↗ 24: 10.6x ↗ 25: 10.8x ← Serie 47.0 Total 0.0		1: 10.6x ↓ 2: 9.2 → 3: 9.8 ↑ 4: 9.3 → 5: 9.5 ← 6: 9.2 ↓ 7: 10.5x ← 8: 9.2 ↑ 9: 9.6 → 10: 10.1 ↑ Serie 93.0 Total 93.0
	11: 10.7x ↓ 12: 8.9 ↓ 13: 9.6 ↑ 14: 10.3x ↓ 15: 10.7x ↗ 16: 10.1 ↗ 17: 10.0 ↗ 18: 9.6 ↗ 19: 9.7 ↗ 20: 9.5 ← Serie 94.0 Total 187.0		21: 9.8 ↓ 22: 10.1 ↑ 23: 10.3 ↓ 24: 10.2 ↗ 25: 9.9 → 26: 10.5x ↗ 27: 10.1 → 28: 9.6 ↓ 29: 10.4x ↓ 30: 9.9 ↙ Serie 96.0 Total 283.0
	31: 9.6 ↗ 32: 10.3 ↗ 33: 10.8x ↓ 34: 10.1 ↓ 35: 10.1 ↓ 36: 10.2 ↓ 37: 9.9 ↓ 38: 9.6 ↗ 39: 10.2 ↗ 40: 10.1 ↗ Serie 97.0 Total 380.0		41: 8.9 ↗ 42: 9.3 ↗ 43: 9.0 → 44: 10.3x ↗ 45: 10.1 ↗ 46: 10.4x ↓ 47: 9.7 ↗ 48: 9.8 ↑ 49: 9.7 ↓ 50: 10.4x ↙ Serie 93.0 Total 473.0
	51: 10.2 ↓ 52: 9.1 ← 53: 10.6x ↗ 54: 10.2 ↓ 55: 9.7 ← 56: 10.0 ↓ 57: 9.4 ↓ 58: 10.2 ↓ 59: 9.6 ← 60: 10.6x ← Serie 96.0 Total 569.0		1: 7.6 ↓ 2: 5.5 ↑ 3: 9.7 → 4: 5.1 → 5: 2.3 ↑ 6: 6.5 ← 7: 9.4 ↑ 8: 6.4 ← 9: 5.8 → 10: 6.2 ← Serie 60.0 Total 569.0

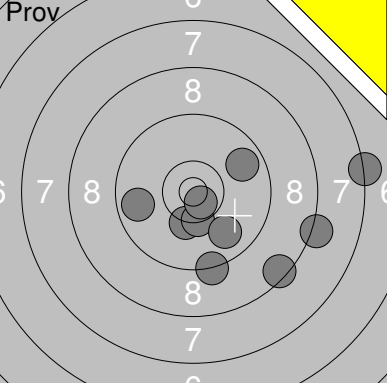

11: 9.6 ↗
 12: 1.6 ↘
 13: 8.5 ←

Serie 18.0
 Total 569.0

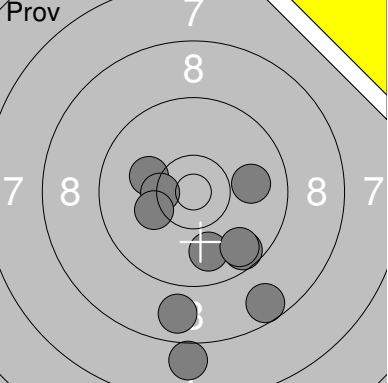
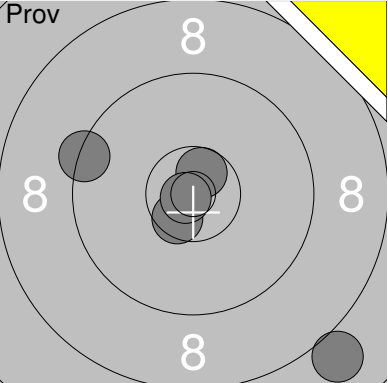
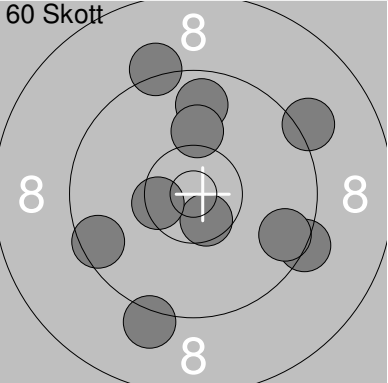
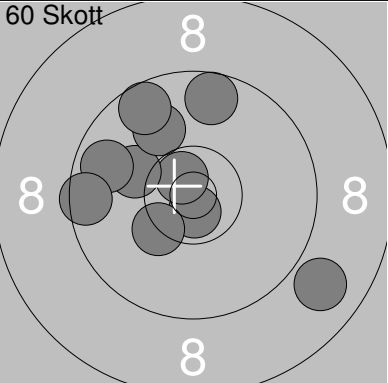
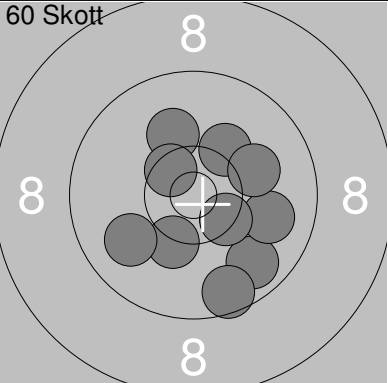
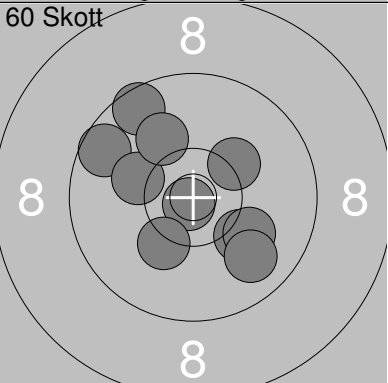
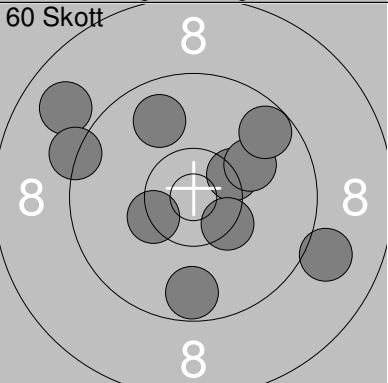
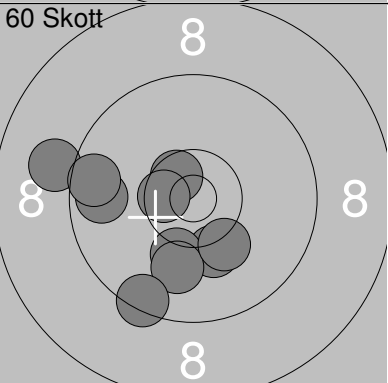
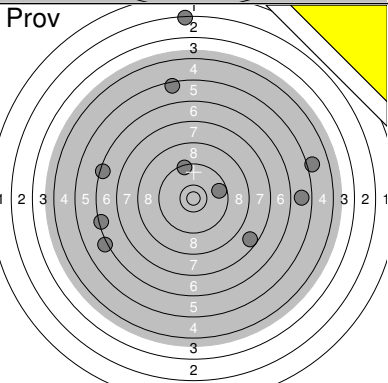
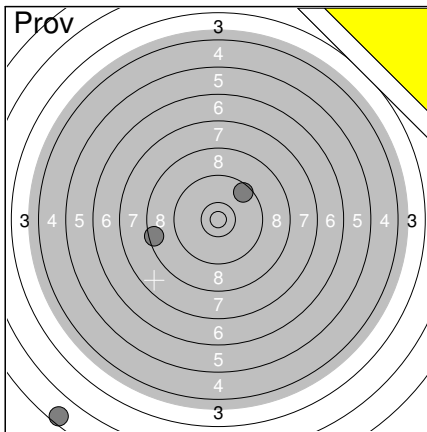
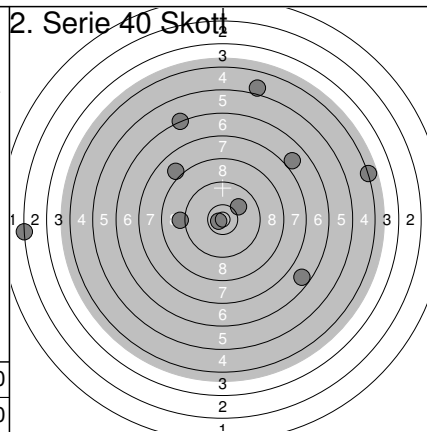

1: 5.0 ↗
 2: 8.0 ↗
 3: 6.3 ↗
 4: 6.7 ↘
 5: 7.0 ↗
 6: 2.3 ←
 7: 9.1 ←
 8: 10.8x ←
 9: 4.3 →
 10: 10.0 ↗

Serie 67.0
 Total 636.0

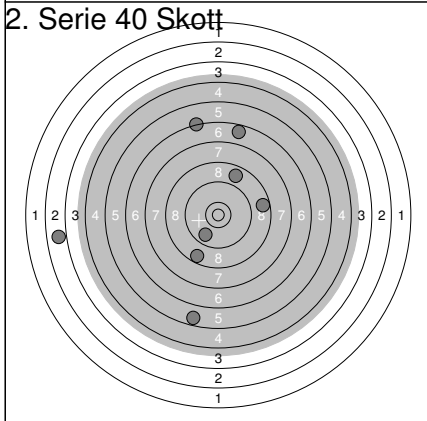

11: 6.7 ↑
 12: 8.7 →
 13: 6.3 ↑
 14: 0.0 ←
 15: 0.0 →
 16: 5.7 ↓
 17: 8.8 ↑
 18: 8.6 ↓
 19: 9.8 ↓
 20: 2.9 ←

Serie 52.0
 Total 688.0

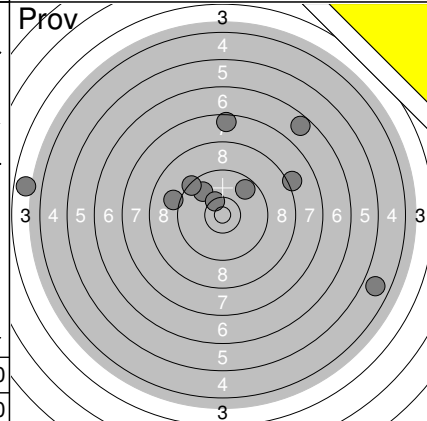

1: 3.7 ←
 2: 9.8 ↗
 3: 8.2 →
 4: 9.1 ←
 5: 9.4 ↗
 6: 6.7 ↗
 7: 9.7 ↗
 8: 7.6 ↑
 9: 10.4x ↗
 10: 4.8 →

Serie 74.0
 Total 688.0

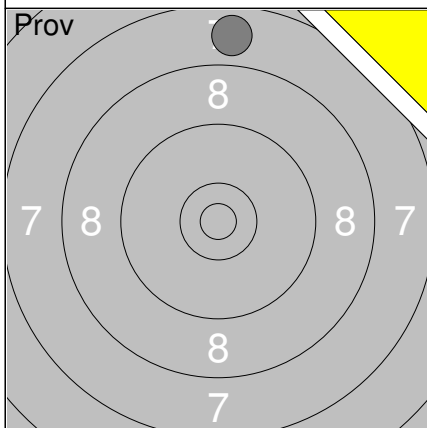

11: 7.8 ↑

Serie 7.0
 Total 688.0

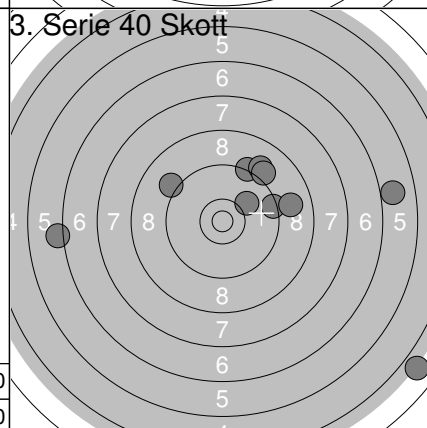

1: 5.9 →
 2: 10.1 ↗
 3: 9.4 →
 4: 8.9 →
 5: 9.1 ↗
 6: 9.3 ↑
 7: 6.2 ←
 8: 9.0 ↗
 9: 9.1 ↗
 10: 3.9 ↘

Serie 77.0
 Total 765.0

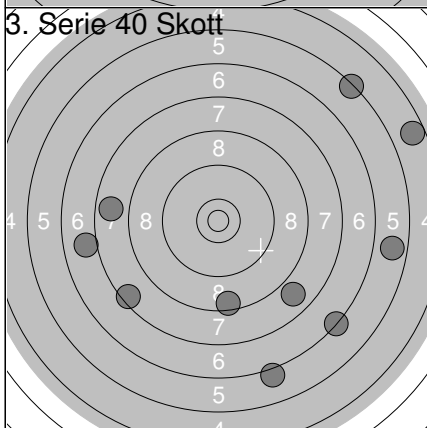

11: 8.5 ↓
 12: 7.0 ←
 13: 5.7 →
 14: 6.3 ↘
 15: 6.1 ↓
 16: 7.8 ←
 17: 4.7 →
 18: 7.9 ↘
 19: 5.4 ↗
 20: 7.5 ↘

Serie 62.0
 Total 827.0

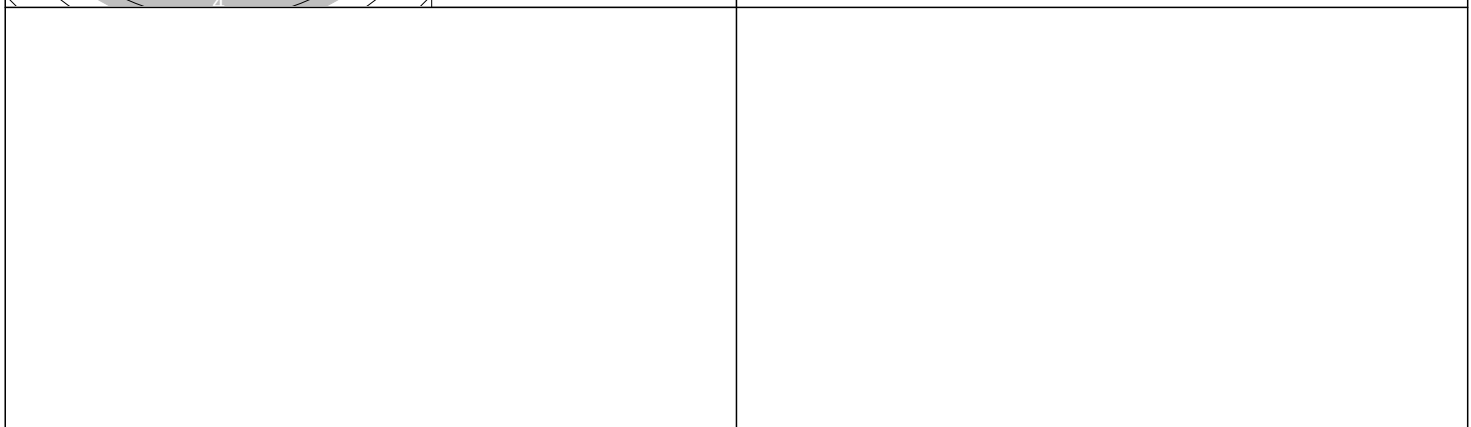

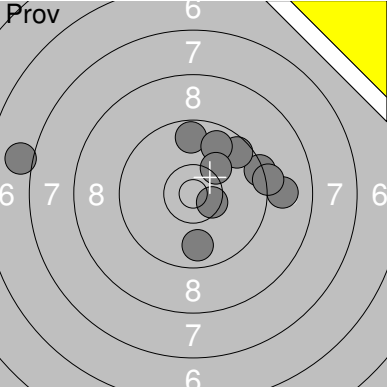
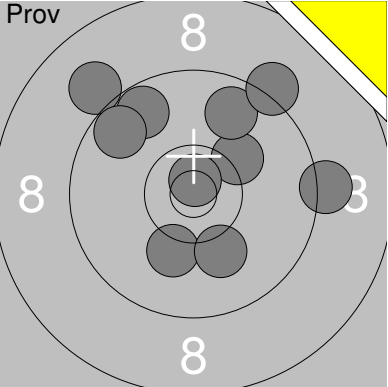
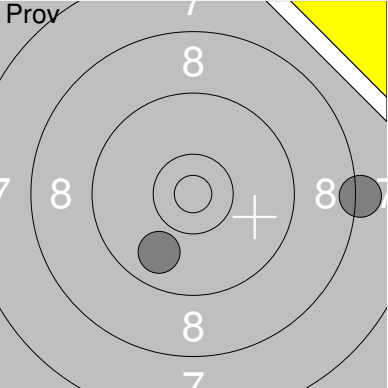
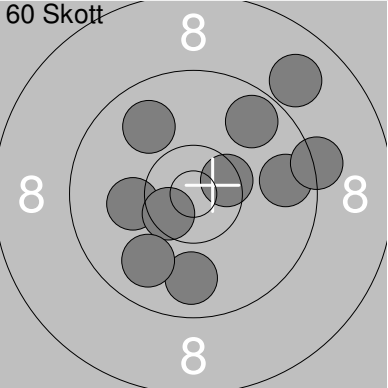
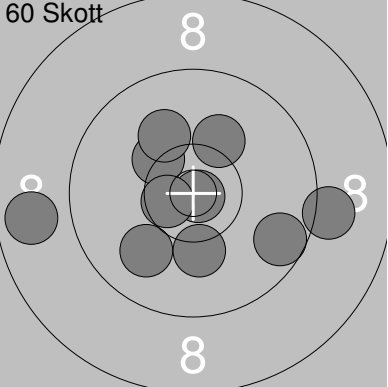
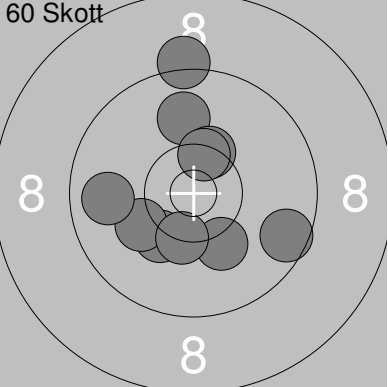
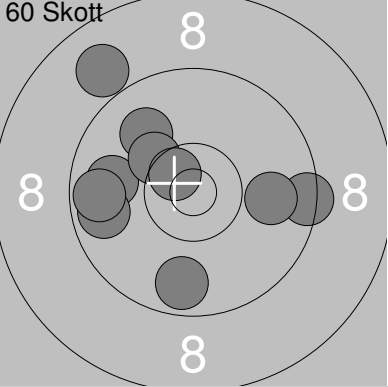
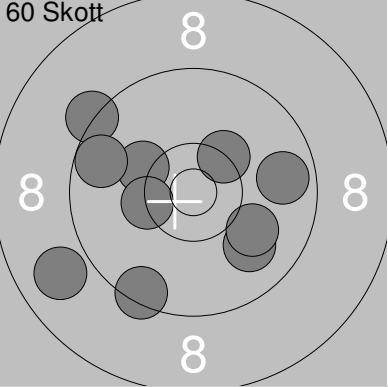
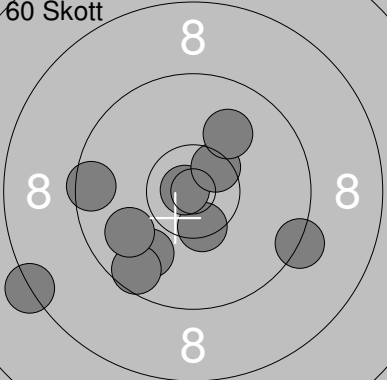
Skjutlag 1	Tavla 4	Edvin Strömberg	
S		Vännäs Skf	
07.04.2019		Startskottet 2019	
Umeå skytteallians			
	1: 7.0 ← 2: 9.0 → 3: 9.8 ↓ 4: 10.5x → 5: 9.7 ↑ 6: 9.4 → 7: 9.2 → 8: 9.6 ↗ 9: 9.8 ↗ 10: 10.2 ↗ Serie 90.0 Total 0.0		11: 10.2 ↗ 12: 10.1 ↓ 13: 9.8 ↗ 14: 9.2 ↗ 15: 10.1 ↓ 16: 10.8x ↑ 17: 9.0 ↗ 18: 9.7 ↗ 19: 9.2 → 20: 9.7 ↖ Serie 94.0 Total 0.0
	21: 9.9 ↓ 22: 8.2 → Serie 17.0 Total 0.0		1: 8.9 ↗ 2: 9.7 ↗ 3: 9.7 → 4: 10.1 ← 5: 9.9 ↗ 6: 10.5x ← 7: 9.8 ↓ 8: 9.3 → 9: 10.5x → 10: 9.9 ↓ Serie 92.0 Total 92.0
	11: 9.1 → 12: 10.3x ↗ 13: 10.9x → 14: 10.0 ↖ 15: 10.2 ↗ 16: 9.6 → 17: 10.2 ↓ 18: 10.6x ← 19: 10.1 ↗ 20: 8.8 ← Serie 96.0 Total 188.0		21: 10.2 ↓ 22: 9.2 ↑ 23: 10.0 ↑ 24: 10.4x ↗ 25: 10.4x ↗ 26: 10.1 ← 27: 10.2 ↓ 28: 9.8 ← 29: 9.6 → 30: 10.3x ↓ Serie 97.0 Total 285.0
	31: 9.9 ← 32: 8.9 ↗ 33: 9.4 → 34: 9.9 → 35: 9.7 ← 36: 10.0 ↗ 37: 9.7 ↓ 38: 10.3 ↗ 39: 9.7 ← 40: 10.6x ↗ Serie 92.0 Total 377.0		41: 8.9 ← 42: 9.3 ↖ 43: 9.9 ↓ 44: 10.0 ↓ 45: 9.7 → 46: 10.2 ↖ 47: 10.3x ↗ 48: 9.7 ← 49: 9.4 ↓ 50: 10.3x ← Serie 93.0 Total 470.0
	51: 9.5 ← 52: 9.9 ↓ 53: 8.3 ← 54: 9.6 ↓ 55: 10.4x ↓ 56: 9.3 → 57: 10.8x ← 58: 10.5x ↗ 59: 10.0 ↗ 60: 9.9 ← Serie 93.0 Total 563.0		

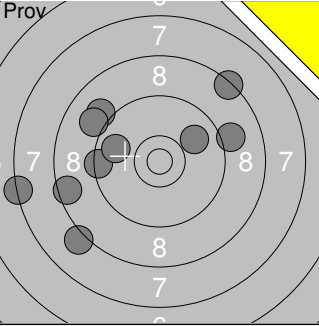
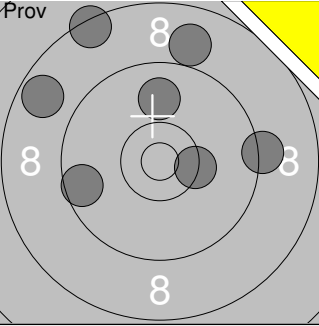
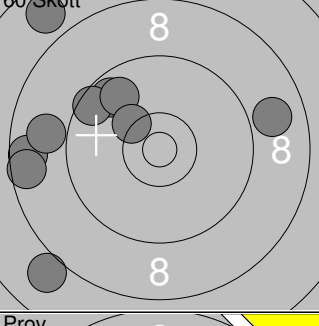
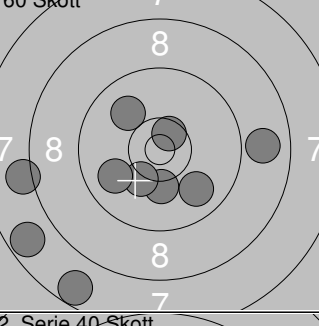
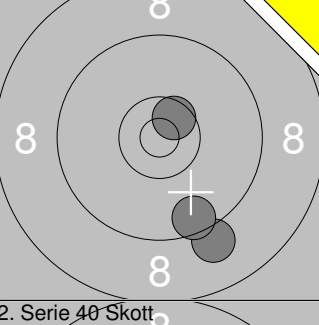
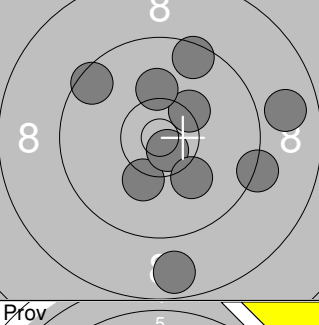
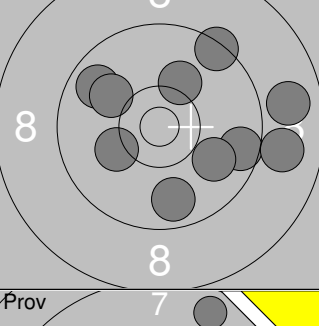
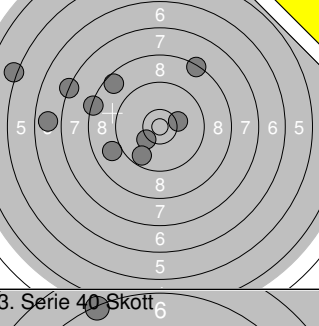
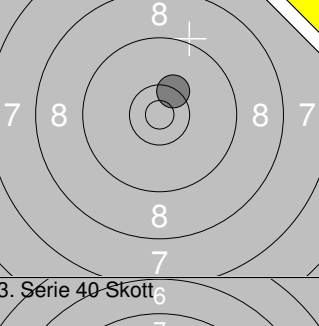
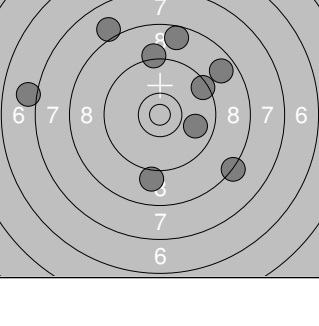
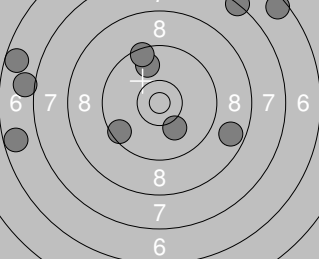
Skjutlag	Tavla	Mats Österlund																																																																								
1	5																																																																									
S	Ramselefors Skf																																																																									
07.04.2019	Startskottet 2019	Umeå skytteallians																																																																								
Prov	 <table border="1"> <tr><td>1:</td><td>9.1</td><td>→</td></tr> <tr><td>2:</td><td>9.0</td><td>↗</td></tr> <tr><td>3:</td><td>9.4</td><td>←</td></tr> <tr><td>4:</td><td>7.3</td><td>←</td></tr> <tr><td>5:</td><td>8.5</td><td>←</td></tr> <tr><td>6:</td><td>9.0</td><td>↗</td></tr> <tr><td>7:</td><td>8.4</td><td>↗</td></tr> <tr><td>8:</td><td>8.1</td><td>↖</td></tr> <tr><td>9:</td><td>9.8</td><td>←</td></tr> <tr><td>10:</td><td>9.9</td><td>↗</td></tr> <tr><td>Serie</td><td>85.0</td><td></td></tr> <tr><td>Total</td><td>0.0</td><td></td></tr> </table>	1:	9.1	→	2:	9.0	↗	3:	9.4	←	4:	7.3	←	5:	8.5	←	6:	9.0	↗	7:	8.4	↗	8:	8.1	↖	9:	9.8	←	10:	9.9	↗	Serie	85.0		Total	0.0		 <table border="1"> <tr><td>11:</td><td>9.9</td><td>↑</td></tr> <tr><td>12:</td><td>9.2</td><td>→</td></tr> <tr><td>13:</td><td>8.7</td><td>↗</td></tr> <tr><td>14:</td><td>8.4</td><td>↗</td></tr> <tr><td>15:</td><td>8.9</td><td>↑</td></tr> <tr><td>16:</td><td>9.6</td><td>←</td></tr> <tr><td>17:</td><td>10.4x</td><td>→</td></tr> <tr><td>Serie</td><td>61.0</td><td></td></tr> <tr><td>Total</td><td>0.0</td><td></td></tr> </table>	11:	9.9	↑	12:	9.2	→	13:	8.7	↗	14:	8.4	↗	15:	8.9	↑	16:	9.6	←	17:	10.4x	→	Serie	61.0		Total	0.0										
1:	9.1	→																																																																								
2:	9.0	↗																																																																								
3:	9.4	←																																																																								
4:	7.3	←																																																																								
5:	8.5	←																																																																								
6:	9.0	↗																																																																								
7:	8.4	↗																																																																								
8:	8.1	↖																																																																								
9:	9.8	←																																																																								
10:	9.9	↗																																																																								
Serie	85.0																																																																									
Total	0.0																																																																									
11:	9.9	↑																																																																								
12:	9.2	→																																																																								
13:	8.7	↗																																																																								
14:	8.4	↗																																																																								
15:	8.9	↑																																																																								
16:	9.6	←																																																																								
17:	10.4x	→																																																																								
Serie	61.0																																																																									
Total	0.0																																																																									
60 Skott	 <table border="1"> <tr><td>1:</td><td>8.6</td><td>←</td></tr> <tr><td>2:</td><td>8.9</td><td>←</td></tr> <tr><td>3:</td><td>8.9</td><td>→</td></tr> <tr><td>4:</td><td>9.7</td><td>↗</td></tr> <tr><td>5:</td><td>7.8</td><td>↗</td></tr> <tr><td>6:</td><td>8.6</td><td>←</td></tr> <tr><td>7:</td><td>9.5</td><td>↗</td></tr> <tr><td>8:</td><td>9.8</td><td>↗</td></tr> <tr><td>9:</td><td>8.0</td><td>↘</td></tr> <tr><td>10:</td><td>10.3</td><td>↗</td></tr> <tr><td>Serie</td><td>84.0</td><td></td></tr> <tr><td>Total</td><td>84.0</td><td></td></tr> </table>	1:	8.6	←	2:	8.9	←	3:	8.9	→	4:	9.7	↗	5:	7.8	↗	6:	8.6	←	7:	9.5	↗	8:	9.8	↗	9:	8.0	↘	10:	10.3	↗	Serie	84.0		Total	84.0		 <table border="1"> <tr><td>11:</td><td>7.7</td><td>↘</td></tr> <tr><td>12:</td><td>8.9</td><td>→</td></tr> <tr><td>13:</td><td>10.6x</td><td>↗</td></tr> <tr><td>14:</td><td>10.2</td><td>↘</td></tr> <tr><td>15:</td><td>10.0</td><td>↗</td></tr> <tr><td>16:</td><td>8.1</td><td>←</td></tr> <tr><td>17:</td><td>10.2</td><td>↘</td></tr> <tr><td>18:</td><td>9.9</td><td>←</td></tr> <tr><td>19:</td><td>9.9</td><td>↘</td></tr> <tr><td>20:</td><td>7.7</td><td>↘</td></tr> <tr><td>Serie</td><td>88.0</td><td></td></tr> <tr><td>Total</td><td>172.0</td><td></td></tr> </table>	11:	7.7	↘	12:	8.9	→	13:	10.6x	↗	14:	10.2	↘	15:	10.0	↗	16:	8.1	←	17:	10.2	↘	18:	9.9	←	19:	9.9	↘	20:	7.7	↘	Serie	88.0		Total	172.0	
1:	8.6	←																																																																								
2:	8.9	←																																																																								
3:	8.9	→																																																																								
4:	9.7	↗																																																																								
5:	7.8	↗																																																																								
6:	8.6	←																																																																								
7:	9.5	↗																																																																								
8:	9.8	↗																																																																								
9:	8.0	↘																																																																								
10:	10.3	↗																																																																								
Serie	84.0																																																																									
Total	84.0																																																																									
11:	7.7	↘																																																																								
12:	8.9	→																																																																								
13:	10.6x	↗																																																																								
14:	10.2	↘																																																																								
15:	10.0	↗																																																																								
16:	8.1	←																																																																								
17:	10.2	↘																																																																								
18:	9.9	←																																																																								
19:	9.9	↘																																																																								
20:	7.7	↘																																																																								
Serie	88.0																																																																									
Total	172.0																																																																									
Prov	 <table border="1"> <tr><td>1:</td><td>9.1</td><td>↘</td></tr> <tr><td>2:</td><td>9.5</td><td>↘</td></tr> <tr><td>3:</td><td>10.6x</td><td>↗</td></tr> <tr><td>Serie</td><td>28.0</td><td></td></tr> <tr><td>Total</td><td>172.0</td><td></td></tr> </table>	1:	9.1	↘	2:	9.5	↘	3:	10.6x	↗	Serie	28.0		Total	172.0		 <table border="1"> <tr><td>1:</td><td>10.2</td><td>↘</td></tr> <tr><td>2:</td><td>8.8</td><td>→</td></tr> <tr><td>3:</td><td>9.5</td><td>↗</td></tr> <tr><td>4:</td><td>10.7x</td><td>↘</td></tr> <tr><td>5:</td><td>10.3x</td><td>↗</td></tr> <tr><td>6:</td><td>9.5</td><td>↗</td></tr> <tr><td>7:</td><td>10.1</td><td>↘</td></tr> <tr><td>8:</td><td>10.2</td><td>↑</td></tr> <tr><td>9:</td><td>9.3</td><td>↘</td></tr> <tr><td>10:</td><td>8.7</td><td>↘</td></tr> <tr><td>Serie</td><td>93.0</td><td></td></tr> <tr><td>Total</td><td>265.0</td><td></td></tr> </table>	1:	10.2	↘	2:	8.8	→	3:	9.5	↗	4:	10.7x	↘	5:	10.3x	↗	6:	9.5	↗	7:	10.1	↘	8:	10.2	↑	9:	9.3	↘	10:	8.7	↘	Serie	93.0		Total	265.0																						
1:	9.1	↘																																																																								
2:	9.5	↘																																																																								
3:	10.6x	↗																																																																								
Serie	28.0																																																																									
Total	172.0																																																																									
1:	10.2	↘																																																																								
2:	8.8	→																																																																								
3:	9.5	↗																																																																								
4:	10.7x	↘																																																																								
5:	10.3x	↗																																																																								
6:	9.5	↗																																																																								
7:	10.1	↘																																																																								
8:	10.2	↑																																																																								
9:	9.3	↘																																																																								
10:	8.7	↘																																																																								
Serie	93.0																																																																									
Total	265.0																																																																									
2. Serie 40 Skott	 <table border="1"> <tr><td>11:</td><td>10.2</td><td>↗</td></tr> <tr><td>12:</td><td>9.6</td><td>→</td></tr> <tr><td>13:</td><td>8.9</td><td>→</td></tr> <tr><td>14:</td><td>10.2</td><td>←</td></tr> <tr><td>15:</td><td>8.9</td><td>→</td></tr> <tr><td>16:</td><td>9.8</td><td>↗</td></tr> <tr><td>17:</td><td>9.8</td><td>↘</td></tr> <tr><td>18:</td><td>10.0</td><td>↗</td></tr> <tr><td>19:</td><td>9.9</td><td>↘</td></tr> <tr><td>20:</td><td>9.4</td><td>↗</td></tr> <tr><td>Serie</td><td>91.0</td><td></td></tr> <tr><td>Total</td><td>356.0</td><td></td></tr> </table>	11:	10.2	↗	12:	9.6	→	13:	8.9	→	14:	10.2	←	15:	8.9	→	16:	9.8	↗	17:	9.8	↘	18:	10.0	↗	19:	9.9	↘	20:	9.4	↗	Serie	91.0		Total	356.0		 <table border="1"> <tr><td>1:</td><td>8.4</td><td>↗</td></tr> <tr><td>2:</td><td>10.2</td><td>↘</td></tr> <tr><td>3:</td><td>8.4</td><td>↗</td></tr> <tr><td>4:</td><td>10.2</td><td>→</td></tr> <tr><td>5:</td><td>5.2</td><td>↗</td></tr> <tr><td>6:</td><td>9.0</td><td>←</td></tr> <tr><td>7:</td><td>6.8</td><td>←</td></tr> <tr><td>8:</td><td>7.3</td><td>↗</td></tr> <tr><td>9:</td><td>8.6</td><td>↗</td></tr> <tr><td>10:</td><td>9.7</td><td>↘</td></tr> <tr><td>Serie</td><td>80.0</td><td></td></tr> <tr><td>Total</td><td>356.0</td><td></td></tr> </table>	1:	8.4	↗	2:	10.2	↘	3:	8.4	↗	4:	10.2	→	5:	5.2	↗	6:	9.0	←	7:	6.8	←	8:	7.3	↗	9:	8.6	↗	10:	9.7	↘	Serie	80.0		Total	356.0	
11:	10.2	↗																																																																								
12:	9.6	→																																																																								
13:	8.9	→																																																																								
14:	10.2	←																																																																								
15:	8.9	→																																																																								
16:	9.8	↗																																																																								
17:	9.8	↘																																																																								
18:	10.0	↗																																																																								
19:	9.9	↘																																																																								
20:	9.4	↗																																																																								
Serie	91.0																																																																									
Total	356.0																																																																									
1:	8.4	↗																																																																								
2:	10.2	↘																																																																								
3:	8.4	↗																																																																								
4:	10.2	→																																																																								
5:	5.2	↗																																																																								
6:	9.0	←																																																																								
7:	6.8	←																																																																								
8:	7.3	↗																																																																								
9:	8.6	↗																																																																								
10:	9.7	↘																																																																								
Serie	80.0																																																																									
Total	356.0																																																																									
Prov	 <table border="1"> <tr><td>11:</td><td>7.8</td><td>↗</td></tr> <tr><td>12:</td><td>10.4x</td><td>↗</td></tr> <tr><td>Serie</td><td>17.0</td><td></td></tr> <tr><td>Total</td><td>356.0</td><td></td></tr> </table>	11:	7.8	↗	12:	10.4x	↗	Serie	17.0		Total	356.0		 <table border="1"> <tr><td>1:</td><td>8.6</td><td>↑</td></tr> <tr><td>2:</td><td>9.4</td><td>↗</td></tr> <tr><td>3:</td><td>7.1</td><td>←</td></tr> <tr><td>4:</td><td>8.0</td><td>↗</td></tr> <tr><td>5:</td><td>9.0</td><td>↘</td></tr> <tr><td>6:</td><td>8.3</td><td>↘</td></tr> <tr><td>7:</td><td>9.2</td><td>↑</td></tr> <tr><td>8:</td><td>9.9</td><td>→</td></tr> <tr><td>9:</td><td>8.7</td><td>↗</td></tr> <tr><td>10:</td><td>6.4</td><td>↗</td></tr> <tr><td>Serie</td><td>81.0</td><td></td></tr> <tr><td>Total</td><td>437.0</td><td></td></tr> </table>	1:	8.6	↑	2:	9.4	↗	3:	7.1	←	4:	8.0	↗	5:	9.0	↘	6:	8.3	↘	7:	9.2	↑	8:	9.9	→	9:	8.7	↗	10:	6.4	↗	Serie	81.0		Total	437.0																									
11:	7.8	↗																																																																								
12:	10.4x	↗																																																																								
Serie	17.0																																																																									
Total	356.0																																																																									
1:	8.6	↑																																																																								
2:	9.4	↗																																																																								
3:	7.1	←																																																																								
4:	8.0	↗																																																																								
5:	9.0	↘																																																																								
6:	8.3	↘																																																																								
7:	9.2	↑																																																																								
8:	9.9	→																																																																								
9:	8.7	↗																																																																								
10:	6.4	↗																																																																								
Serie	81.0																																																																									
Total	437.0																																																																									
3. Serie 40 Skott	 <table border="1"> <tr><td>11:</td><td>7.3</td><td>↗</td></tr> <tr><td>12:</td><td>9.8</td><td>↗</td></tr> <tr><td>13:</td><td>9.5</td><td>↘</td></tr> <tr><td>14:</td><td>8.7</td><td>→</td></tr> <tr><td>15:</td><td>9.5</td><td>↗</td></tr> <tr><td>16:</td><td>7.0</td><td>←</td></tr> <tr><td>17:</td><td>6.6</td><td>↗</td></tr> <tr><td>18:</td><td>6.6</td><td>←</td></tr> <tr><td>19:</td><td>10.1</td><td>↘</td></tr> <tr><td>20:</td><td>6.7</td><td>←</td></tr> <tr><td>Serie</td><td>77.0</td><td></td></tr> <tr><td>Total</td><td>514.0</td><td></td></tr> </table>	11:	7.3	↗	12:	9.8	↗	13:	9.5	↘	14:	8.7	→	15:	9.5	↗	16:	7.0	←	17:	6.6	↗	18:	6.6	←	19:	10.1	↘	20:	6.7	←	Serie	77.0		Total	514.0																																						
11:	7.3	↗																																																																								
12:	9.8	↗																																																																								
13:	9.5	↘																																																																								
14:	8.7	→																																																																								
15:	9.5	↗																																																																								
16:	7.0	←																																																																								
17:	6.6	↗																																																																								
18:	6.6	←																																																																								
19:	10.1	↘																																																																								
20:	6.7	←																																																																								
Serie	77.0																																																																									
Total	514.0																																																																									

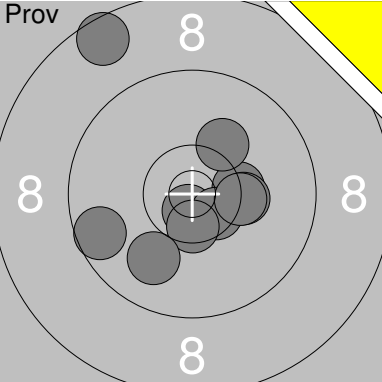
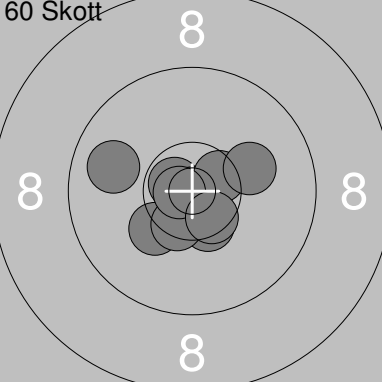
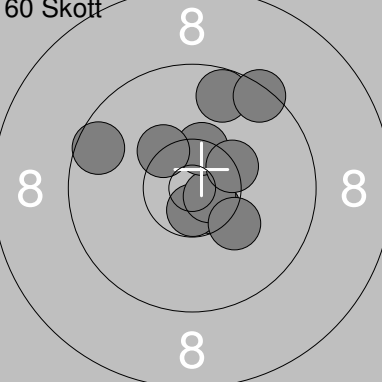
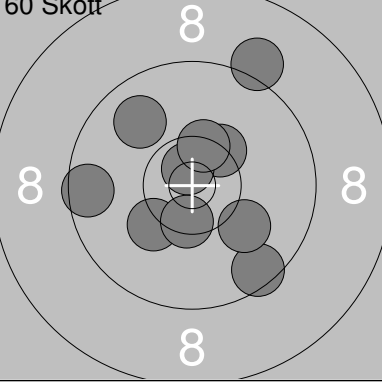
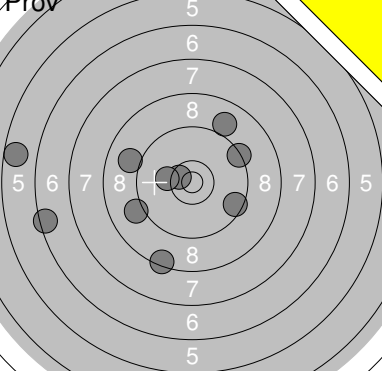
Skjutlag	Tavla	Marlene Forsell Forsman	
1	8		
S	Ramselefors Skf		
07.04.2019	Startskottet 2019	Umeå skytteallians	
Prov		1: 8.6 ↗ 2: 10.3x → 3: 9.6 ← 4: 10.7x ↓ 5: 10.5x ↘ 6: 10.2 ↗ 7: 10.5x ↓ 8: 10.3 → 9: 10.3x → 10: 10.0 ↓	11: 10.5x ← 12: 9.9 ← 13: 10.6x ↘ 14: 9.8 ↙ 15: 10.3 ↙ 16: 10.3 ↓ 17: 9.8 ↓ 18: 10.4x →
	Serie 97.0 Total 0.0		Serie 77.0 Total 0.0
60 Skott		1: 10.7x ↙ 2: 10.2 ↘ 3: 10.4x ↘ 4: 10.9x ↓ 5: 10.5x ↓ 6: 10.5x → 7: 10.1 → 8: 10.8x ← 9: 9.9 ← 10: 10.5x ↓	11: 10.4x → 12: 9.6 ↗ 13: 10.1 ↓ 14: 10.7x → 15: 10.7x ↓ 16: 10.4x → 17: 9.5 ↗ 18: 9.6 → 19: 10.4x ← 20: 10.6x ↙
	Serie 99.0 Total 99.0		Serie 97.0 Total 196.0
60 Skott		21: 10.6x ↘ 22: 9.6 ← 23: 10.7x ↓ 24: 10.7x → 25: 9.7 ↗ 26: 10.4x ↗ 27: 10.3x → 28: 9.4 ↗ 29: 10.2 ↘ 30: 10.3x ↗	31: 10.6x ↑ 32: 10.5x ↗ 33: 10.8x ← 34: 9.6 ↙ 35: 9.5 ↘ 36: 10.0 ↗ 37: 9.8 ↑ 38: 10.2 ↗ 39: 10.2 ↙ 40: 9.7 ↗
	Serie 97.0 Total 293.0		Serie 96.0 Total 389.0
60 Skott		41: 9.5 ↘ 42: 10.4x ↗ 43: 10.1 ↘ 44: 9.1 ↗ 45: 9.6 ← 46: 10.2 ↙ 47: 10.7x ↗ 48: 9.9 ↗ 49: 10.5x ↓ 50: 10.4x ↗	51: 9.1 ↓ 52: 10.2 → 53: 10.7x → 54: 9.0 ↓ 55: 9.6 ↙ 56: 9.4 ↑ 57: 10.0 ↓ 58: 10.4x ↓ 59: 10.0 ↙ 60: 10.4x ↗
	Serie 96.0 Total 485.0		Serie 96.0 Total 581.0
Prov		1: 9.0 ← 2: 6.5 ← 3: 9.0 ↗ 4: 9.5 → 5: 5.7 ← 6: 9.1 ← 7: 10.6x ← 8: 9.3 → 9: 8.4 ↓ 10: 10.2 ←	11: 7.1 ↓ 12: 10.5x ↓ 13: 8.6 ↗ 14: 8.2 ↗ 15: 8.3 ← 16: 9.6 ↘ 17: 9.9 → 18: 8.3 ↗ 19: 9.0 ↑ 20: 8.8 →
	Serie 84.0 Total 581.0		Serie 84.0 Total 581.0

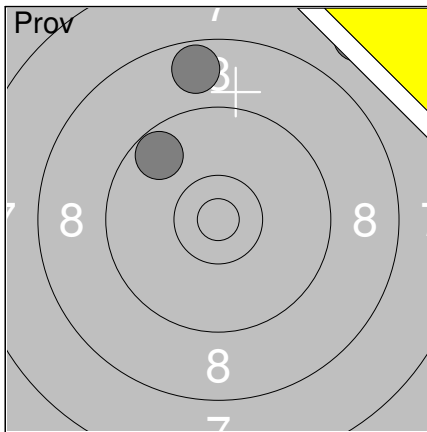

21:	7.6	↗
22:	9.7	↗
23:	8.7	↑

Serie	24.0
Total	581.0

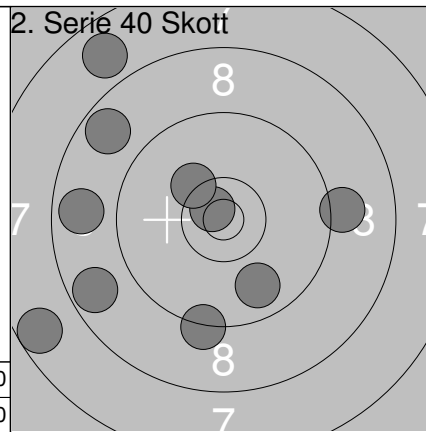

1:	9.3	↓
2:	8.8	←
3:	10.7x	↗
4:	7.7	←
5:	9.1	→
6:	9.8	↓
7:	7.8	↗
8:	8.7	↗
9:	10.2	↗
10:	8.7	←

Serie	85.0
Total	666.0

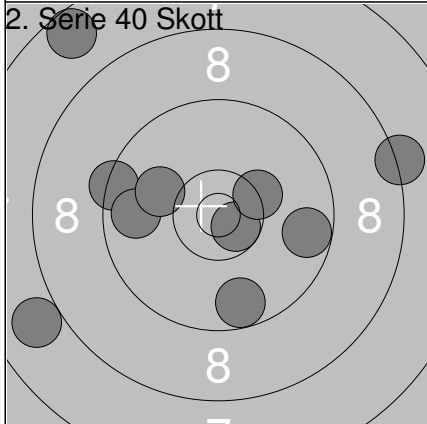

11:	9.7	→
12:	7.6	↗
13:	9.4	←
14:	7.9	←
15:	9.7	↓
16:	10.7x	↓
17:	9.8	←
18:	8.3	→
19:	10.1	↗
20:	10.3x	→

Serie	88.0
Total	754.0

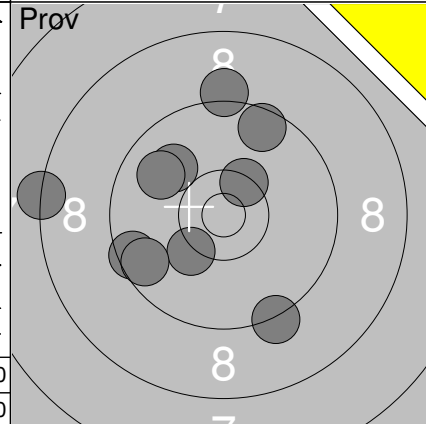

1:	8.3	←
2:	9.5	←
3:	10.2	↙
4:	9.6	↗
5:	9.2	↑
6:	9.6	←
7:	10.0	↗
8:	9.9	↗
9:	9.3	↓
10:	10.4x	↗

Serie	92.0
Total	754.0

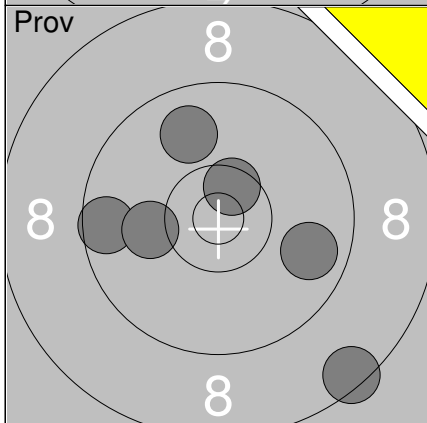

11:	9.6	←
12:	8.5	↓
13:	9.9	↗
14:	10.1	←
15:	9.8	→
16:	10.5x	↑

Serie	55.0
Total	754.0

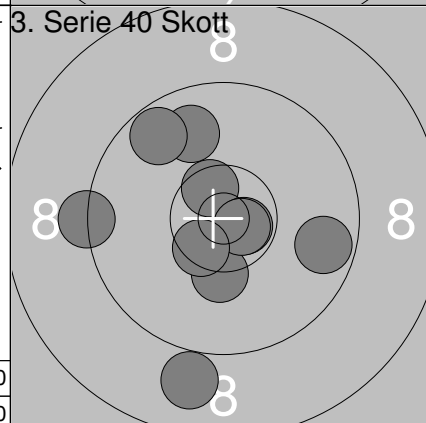

1:	9.7	→
2:	10.5x	↗
3:	9.8	↗
4:	10.3	↓
5:	10.7x	→
6:	10.7x	→
7:	9.3	←
8:	8.9	↓
9:	10.5x	↙
10:	9.7	↗

Serie	94.0
Total	848.0

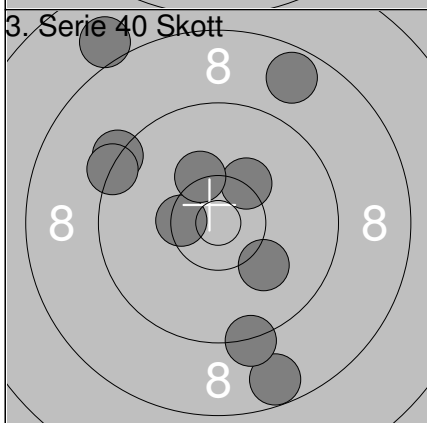

11:	8.7	↗
12:	8.0	↗
13:	10.3	↗
14:	8.7	↓
15:	9.3	↗
16:	9.3	↗
17:	10.4x	←
18:	9.3	↓
19:	10.3	↗
20:	10.1	↓

Serie	91.0
Total	939.0

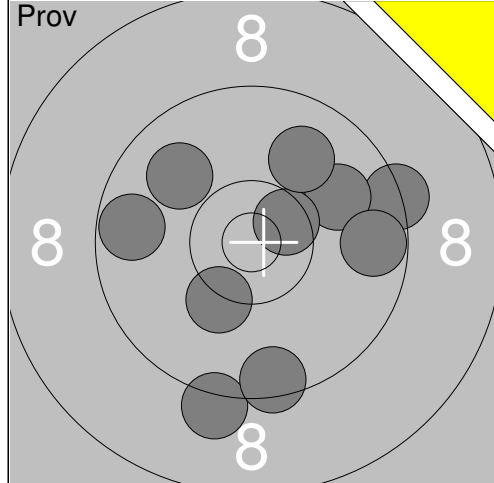

1:	9.4	→
2:	9.2	↓
3:	9.5	↓
4:	9.9	→
5:	10.5x	→
6:	9.9	↗
7:	9.7	←
8:	10.3	↓
9:	9.7	→
10:	9.9	↗

Serie	92.0
Total	0.0

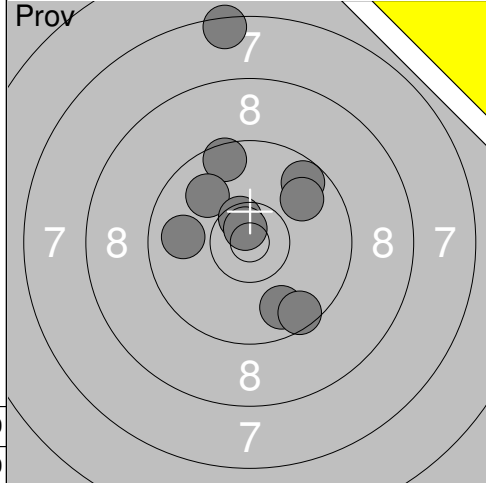

11:	9.7	↗
12:	9.8	↓
13:	9.9	←
14:	9.6	↗
15:	9.9	↗
16:	9.6	↓
17:	7.4	↗
18:	9.9	↗
19:	10.5x	↗
20:	10.7x	↗

Serie	90.0
Total	0.0

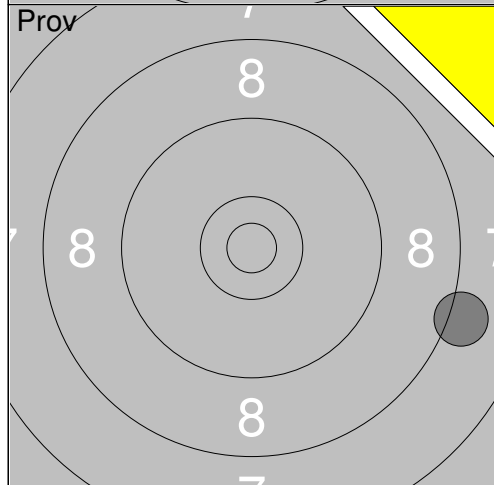

21:	8.1	→
-----	-----	---

Serie	8.0
Total	0.0

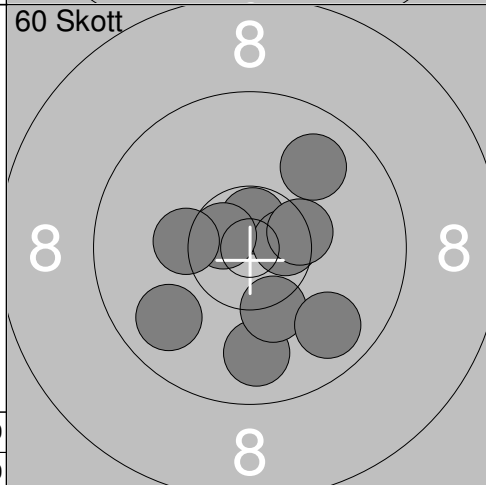

1:	10.7x	↗
2:	10.6x	→
3:	9.8	↓
4:	10.6x	↗
5:	10.3	←
6:	10.4x	→
7:	10.3	↓
8:	9.9	↗
9:	9.8	↓
10:	9.8	↙

Serie	96.0
Total	96.0

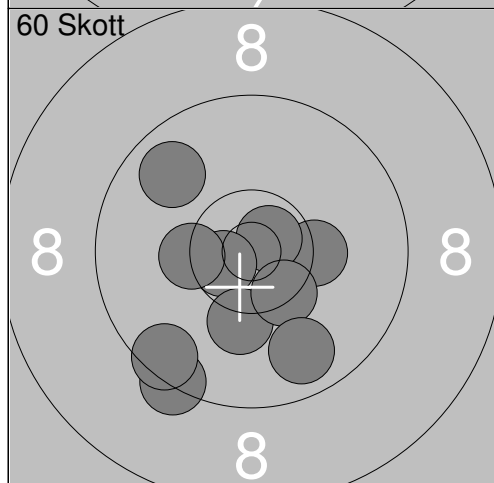

11:	9.8	↗
12:	9.3	↓
13:	9.5	↓
14:	10.3x	→
15:	10.7x	↗
16:	10.6x	←
17:	10.2	↓
18:	10.4x	↓
19:	10.3x	←
20:	9.8	↓

Serie	96.0
Total	192.0

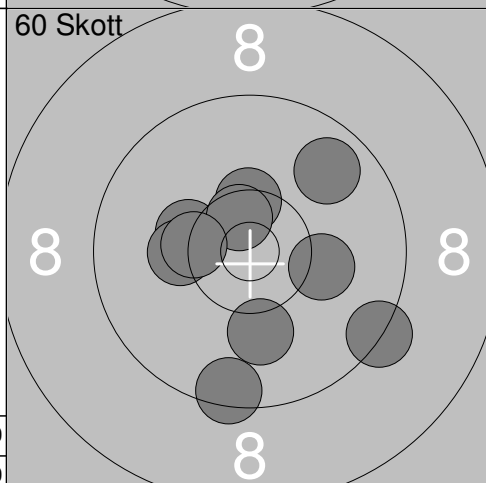

21:	9.8	↗
22:	10.4x	↗
23:	10.1	↓
24:	9.3	↓
25:	10.2	→
26:	9.5	↓
27:	10.3	←
28:	10.6x	↗
29:	10.2	←
30:	10.4x	←

Serie	97.0
Total	289.0

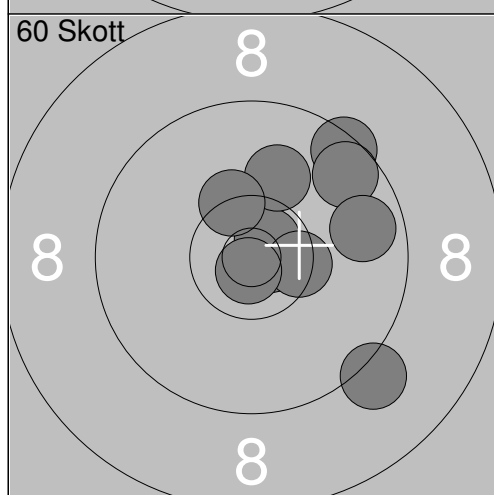

31:	10.8x	→
32:	10.7x	↗
33:	10.1	↗
34:	9.5	↗
35:	9.6	↗
36:	9.2	↓
37:	10.4x	→
38:	10.8x	↓
39:	10.3x	↗
40:	9.7	→

Serie	96.0
Total	385.0

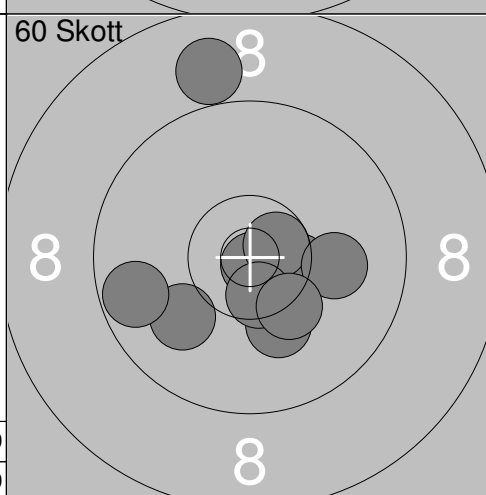

41:	10.9x	↓
42:	10.4x	→
43:	10.6x	→
44:	10.2	↓
45:	10.1	→
46:	10.5x	↓
47:	10.0	↙
48:	10.3	↓
49:	8.9	↗
50:	9.7	←

Serie	97.0
Total	482.0

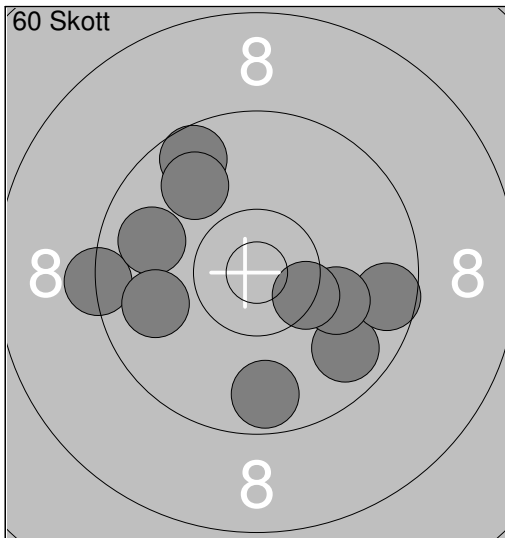

51:	9.3	←
52:	9.8	↘
53:	9.6	→
54:	10.1	→
55:	9.7	↘
56:	9.6	↗
57:	9.8	↗
58:	9.9	↗
59:	10.4x	↘
60:	9.9	←
Serie		92.0
Total		574.0

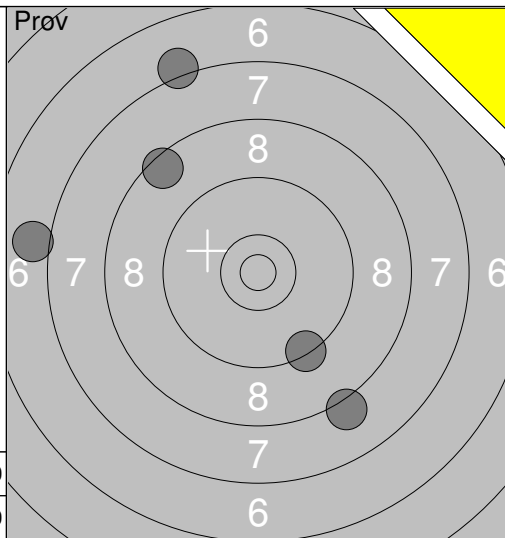

1:	9.4	↘
2:	7.2	↗
3:	7.0	←
4:	8.1	↘
5:	8.5	↗
Serie		39.0
Total		574.0

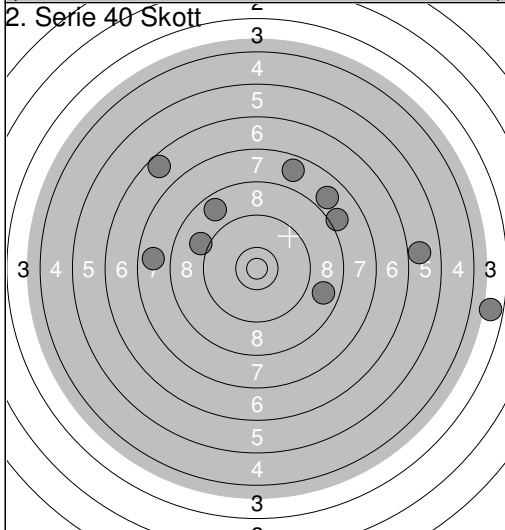

1:	8.8	→
2:	3.7	→
3:	7.7	↗
4:	9.1	↗
5:	6.0	→
6:	7.8	←
7:	6.6	↗
8:	7.9	↗
9:	8.7	↗
10:	8.1	↗
Serie		69.0
Total		643.0

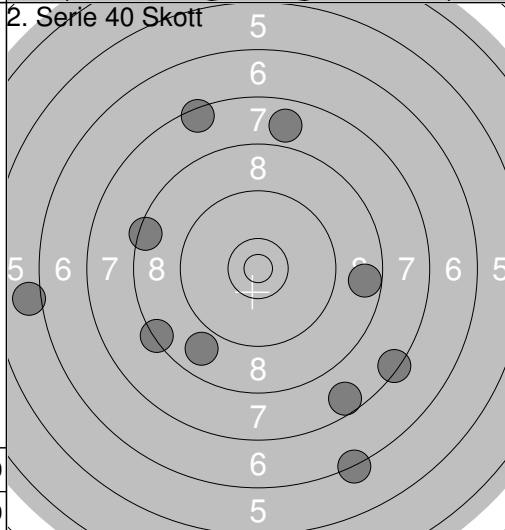

11:	7.5	↗
12:	6.3	↘
13:	7.4	↘
14:	7.6	↘
15:	7.9	↗
16:	8.7	→
17:	8.4	↖
18:	8.4	↖
19:	8.9	↘
20:	6.0	←
Serie		72.0
Total		715.0

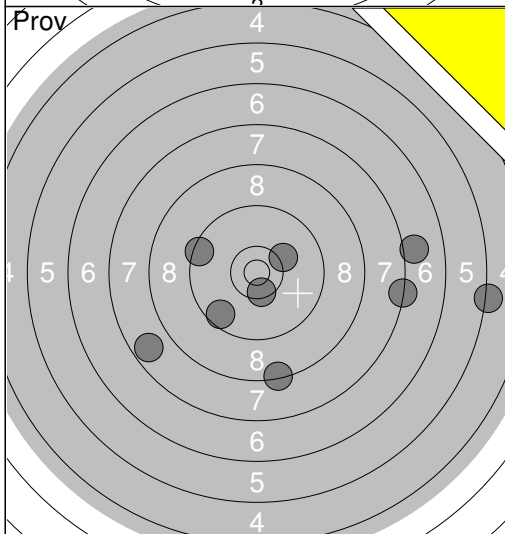

1:	7.7	↖
2:	9.6	↖
3:	8.3	↘
4:	7.3	→
5:	7.0	→
6:	5.2	→
7:	10.5x	↘
8:	10.2	↗
9:	9.4	↖
Serie		72.0
Total		715.0

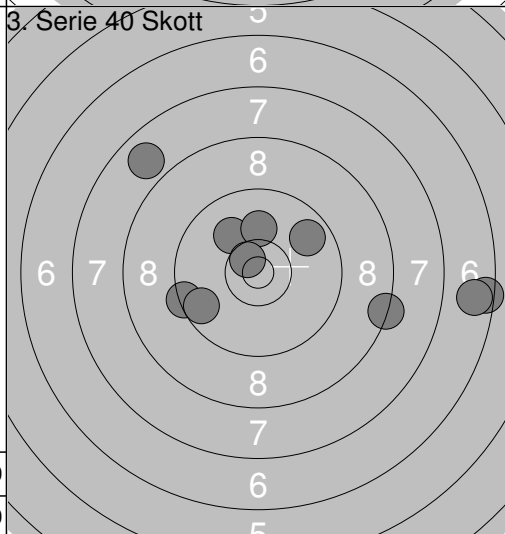

1:	9.4	←
2:	8.3	→
3:	10.0	↗
4:	6.5	→
5:	7.9	↗
6:	9.7	↖
7:	9.8	↗
8:	10.1	↑
9:	10.6x	↗
10:	6.7	→
Serie		84.0
Total		799.0

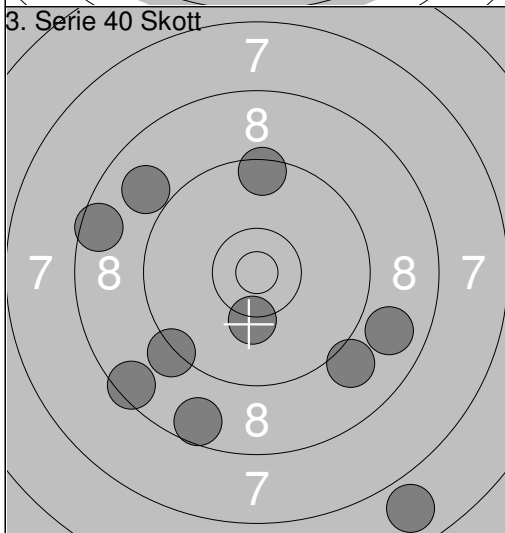

11:	10.3	↘
12:	8.5	↖
13:	8.9	↗
14:	8.8	↘
15:	9.0	↘
16:	8.6	↖
17:	6.9	↘
18:	9.2	↖
19:	9.5	↑
20:	8.6	↘
Serie		83.0
Total		882.0

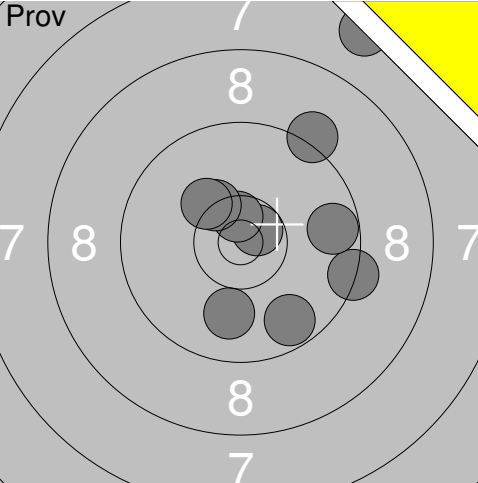
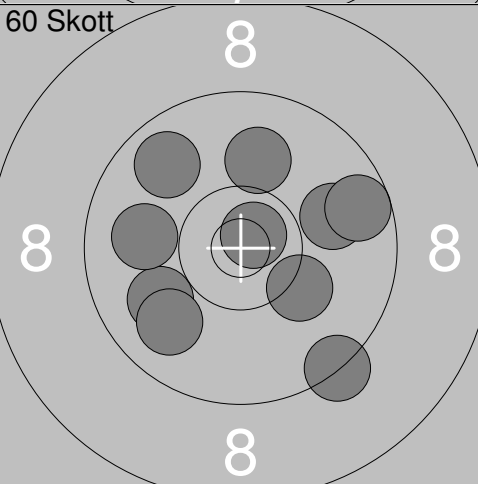
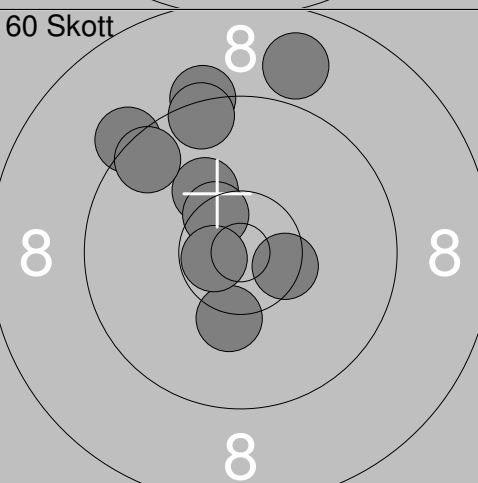
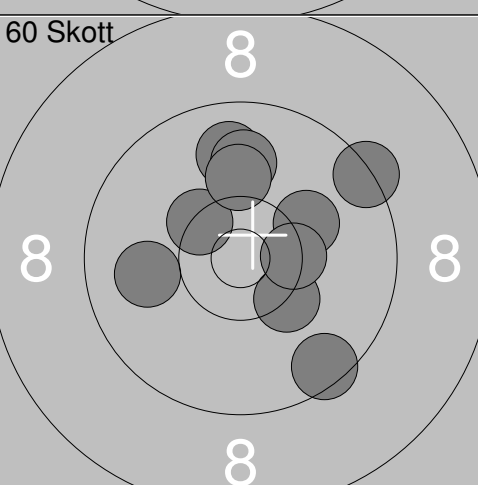
Skjutlag	Tavla	Hanna Johansson	
S	Vännäs Skf		
07.04.2019	Startskottet 2019	Umeå skytteallians	
Prov		1: 7.6 ↗ 2: 9.3 → 3: 9.7 ↘ 4: 9.2 ↗ 5: 10.7x ↗ 6: 10.0 ↘ 7: 10.6x ↗ 8: 10.3x ↗ 9: 10.2 ↗ 10: 9.7 → Serie 93.0 Total 0.0	11: 9.7 ← 12: 9.3 ↑ 13: 9.7 ↘ 14: 9.1 ↗ 15: 10.0 ↘ Serie 46.0 Total 0.0
60 Skott		1: 9.9 ← 2: 9.9 ← 3: 10.8x ↗ 4: 9.9 ↘ 5: 10.2 ↘ 6: 9.3 ↘ 7: 9.8 ↗ 8: 9.9 → 9: 9.6 → 10: 10.0 ↑ Serie 93.0 Total 93.0	11: 9.7 ↘ 12: 9.4 ↑ 13: 9.8 ↑ 14: 10.1 ↘ 15: 10.2 → 16: 9.8 ↘ 17: 10.2 ↘ 18: 9.3 ↗ 19: 9.7 ← 20: 10.2 ↗ Serie 94.0 Total 187.0
60 Skott		21: 9.3 ↗ 22: 10.2 ↗ 23: 10.5x → 24: 9.3 ↗ 25: 10.5x ↗ 26: 9.5 ↗ 27: 8.9 ↗ 28: 10.2 ↘ 29: 9.6 ↗ 30: 10.7x ← Serie 94.0 Total 281.0	31: 10.5x ↗ 32: 10.9x ↘ 33: 10.6x ↗ 34: 10.1 ↘ 35: 9.0 ↗ 36: 10.1 ← 37: 10.5x ↗ 38: 10.2 ↘ 39: 10.5x ↗ 40: 9.9 ↗ Serie 98.0 Total 379.0
60 Skott		41: 10.0 ← 42: 9.5 ↘ 43: 9.4 ↗ 44: 10.2 ↗ 45: 9.8 ↑ 46: 10.3x ↘ 47: 10.4x ↗ 48: 9.9 ↑ 49: 10.1 ↑ 50: 10.4x → Serie 96.0 Total 475.0	51: 9.1 → 52: 10.0 ↗ 53: 10.7x ↘ 54: 9.8 → 55: 10.5x ↗ 56: 9.8 ↘ 57: 10.5x → 58: 10.4x ↗ 59: 10.2 ↘ 60: 9.7 ↘ Serie 96.0 Total 571.0

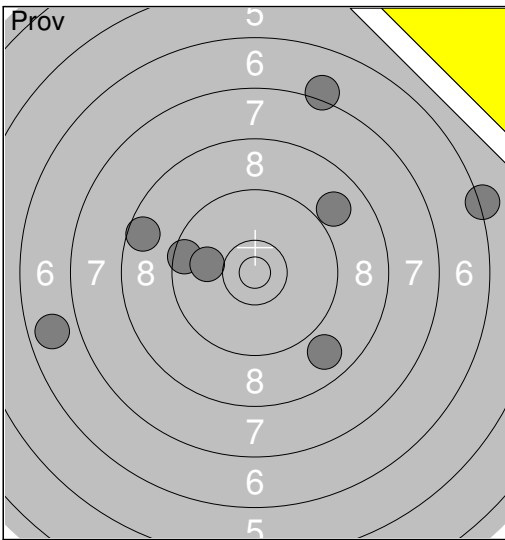

1:	8.6	←
2:	6.8	←
3:	8.9	↘
4:	8.9	↗
5:	7.1	↗
6:	9.5	←
7:	10.0	←
8:	6.2	→
Serie		62.0
Total		571.0

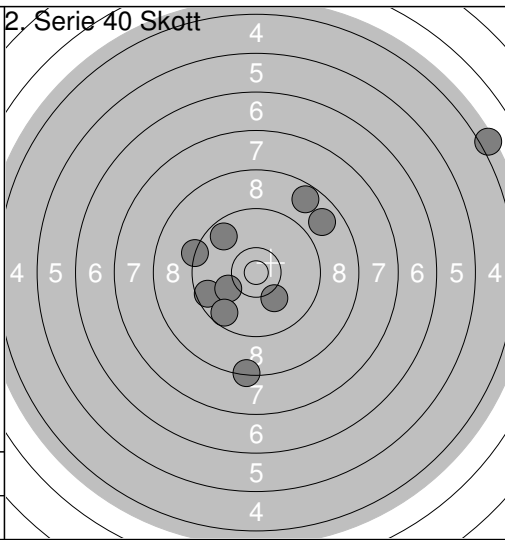

1:	10.1	↘
2:	9.3	←
3:	8.8	↗
4:	9.7	↗
5:	4.1	↗
6:	9.6	←
7:	8.4	↓
8:	10.1	←
9:	8.7	↗
10:	9.6	↘
Serie		84.0
Total		655.0

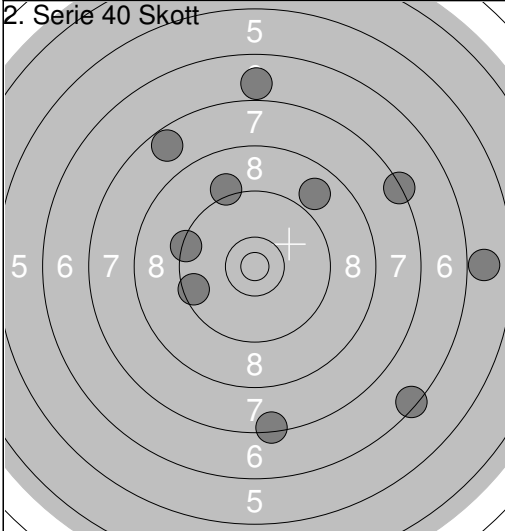

11:	9.4	←
12:	5.9	→
13:	8.9	↗
14:	9.1	↗
15:	7.4	↓
16:	6.9	↑
17:	7.3	↗
18:	7.7	↗
19:	6.4	↘
20:	9.5	←
Serie		73.0
Total		728.0

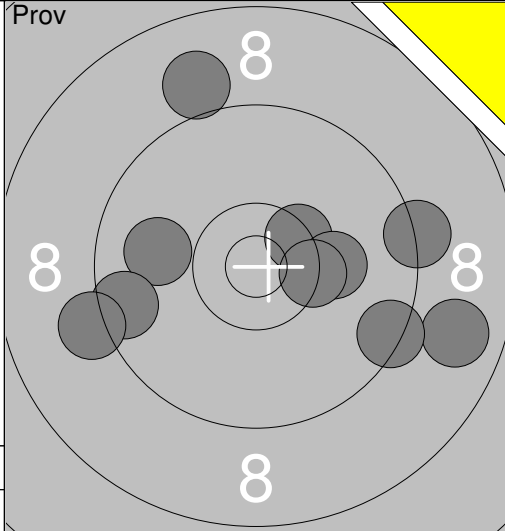

1:	10.4x	↗
2:	9.9	←
3:	10.2	→
4:	9.0	↑
5:	9.3	→
6:	8.8	→
7:	9.4	↘
8:	9.6	←
9:	9.2	←
10:	10.4x	→
Serie		92.0
Total		728.0

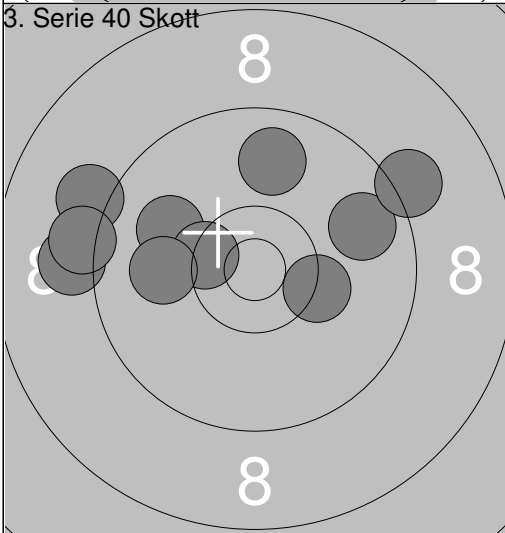

1:	9.8	→
2:	10.0	←
3:	10.3x	→
4:	9.1	←
5:	10.4x	←
6:	9.1	↗
7:	9.8	↑
8:	9.2	↗
9:	10.0	←
10:	9.2	←
Serie		94.0
Total		822.0

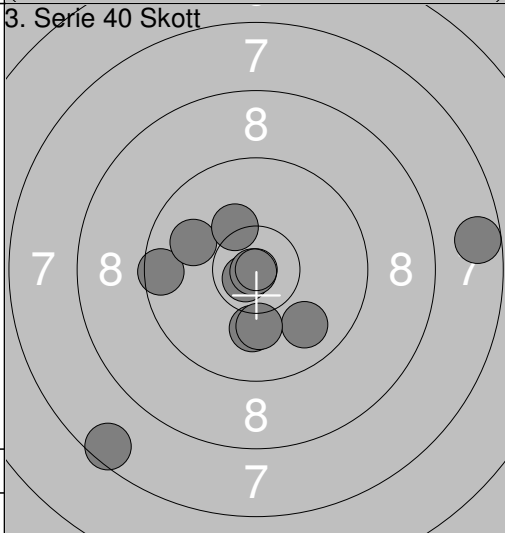

11:	10.7x	↘
12:	9.9	↘
13:	9.5	←
14:	9.9	←
15:	7.6	→
16:	10.1	↓
17:	7.5	↘
18:	10.9x	↘
19:	10.1	↓
20:	10.2	↗
Serie		91.0
Total		913.0

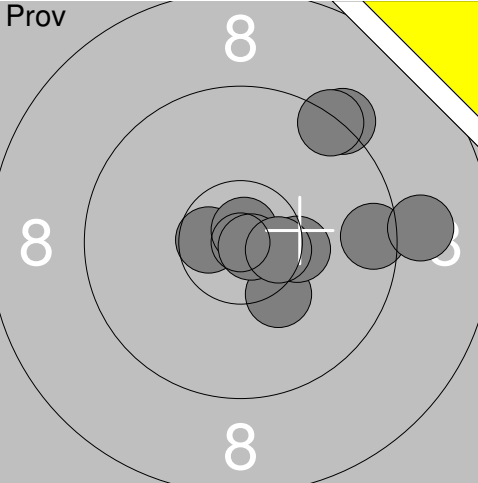
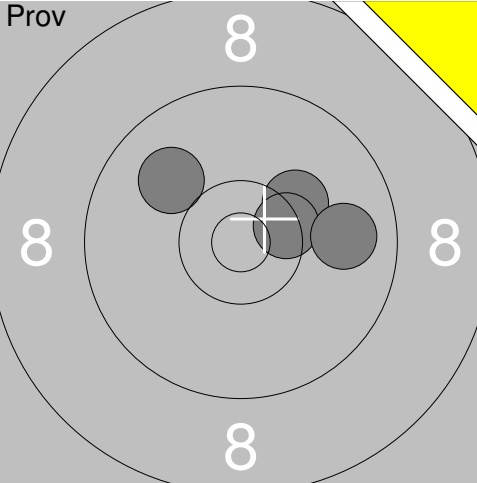
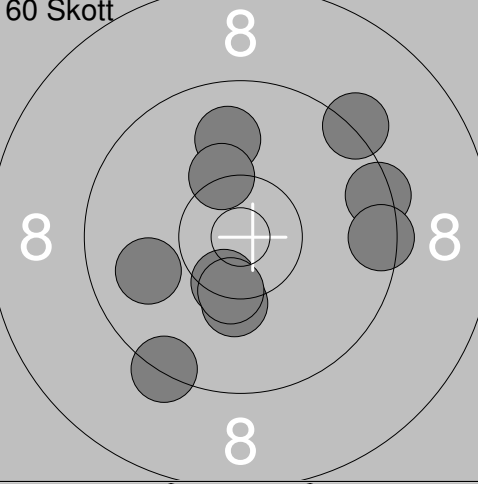
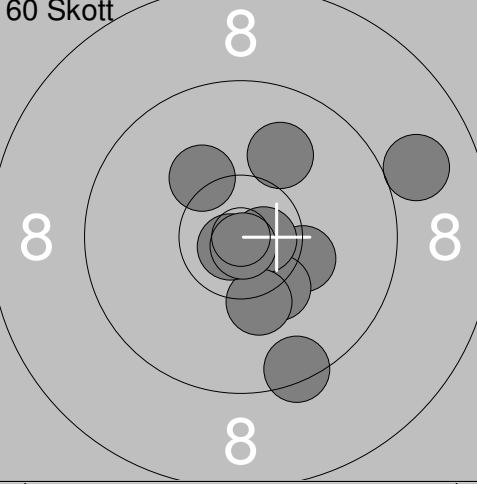
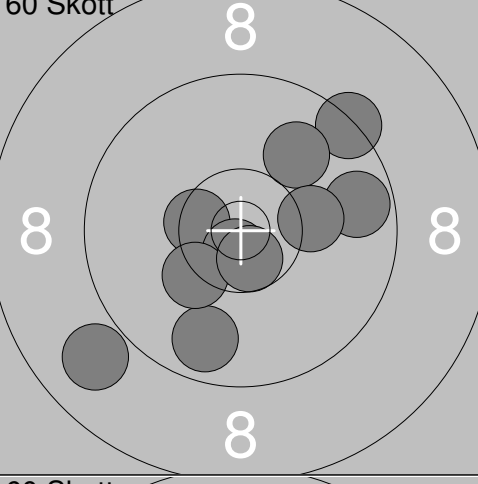
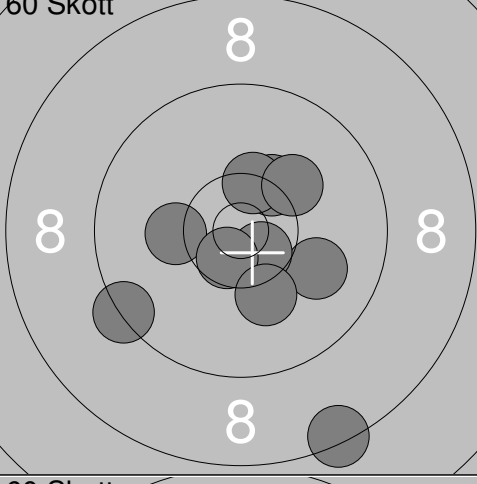
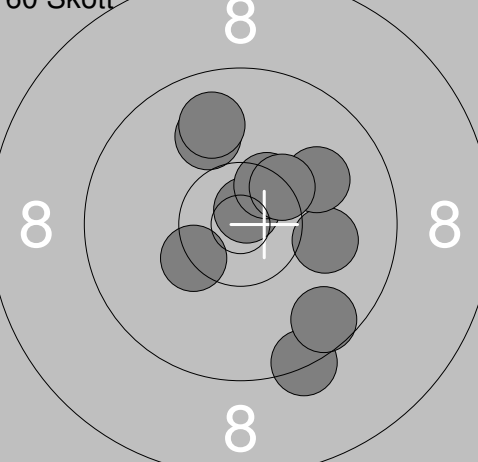
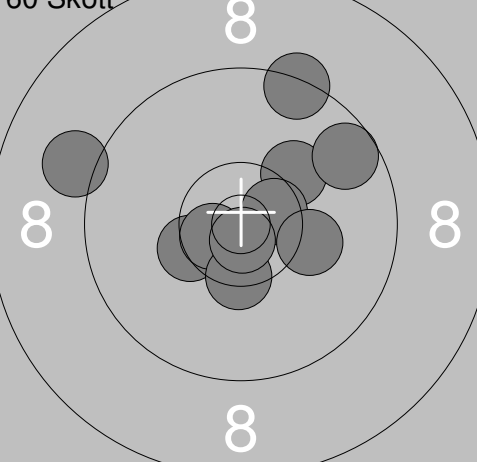
Skjutlag 1	Tavla 13	Lars Möllsten			
S		Umeå Skf			
07.04.2019		Startskottet 2019	Umeå skytteallians		
Prov		1: 10.6x ← 2: 9.3 ↗ 3: 10.8x ↑ 4: 10.3 ↓ 5: 9.4 ↗ 6: 10.8x ↘ 7: 10.3x → 8: 10.5x → 9: 9.5 → 10: 9.0 → Serie 96.0 Total 0.0	Prov		11: 10.2 ↗ 12: 10.4x → 13: 9.9 → 14: 10.0 ↖ Serie 39.0 Total 0.0
60 Skott		1: 9.3 ↗ 2: 9.9 ↑ 3: 9.4 → 4: 10.2 ↓ 5: 10.3 ↑ 6: 9.9 ← 7: 9.5 → 8: 9.3 ↓ 9: 10.4x ↓ 10: 10.4x ↓ Serie 94.0 Total 94.0	60 Skott		11: 9.0 → 12: 9.4 ↓ 13: 10.3 → 14: 10.3 ↓ 15: 10.7x → 16: 10.2 ↓ 17: 10.8x ← 18: 10.2 ↗ 19: 10.9x ↓ 20: 10.0 ↗ Serie 98.0 Total 192.0
60 Skott		21: 9.7 → 22: 10.5x ← 23: 9.7 ↓ 24: 9.4 ↗ 25: 8.9 ← 26: 10.7x ↓ 27: 10.3 ← 28: 10.6x ↓ 29: 10.0 ↗ 30: 10.2 → Serie 95.0 Total 287.0	60 Skott		31: 10.0 → 32: 10.2 ← 33: 10.3x ↗ 34: 10.4x ↑ 35: 10.6x ↓ 36: 8.4 ↓ 37: 9.3 ← 38: 10.6x ↓ 39: 10.2 ↓ 40: 10.2 ↗ Serie 97.0 Total 384.0
60 Skott		41: 10.8x ↑ 42: 10.0 ↗ 43: 10.5x ↗ 44: 10.0 → 45: 10.3x ← 46: 9.9 ↑ 47: 10.0 → 48: 10.4x ↗ 49: 9.3 ↓ 50: 9.6 ↓ Serie 97.0 Total 481.0	60 Skott		51: 10.4x ← 52: 10.6x ← 53: 10.4x ↓ 54: 10.2 ↗ 55: 10.6x → 56: 9.6 ↗ 57: 9.1 ← 58: 9.4 ↑ 59: 10.8x ↓ 60: 10.2 → Serie 97.0 Total 578.0

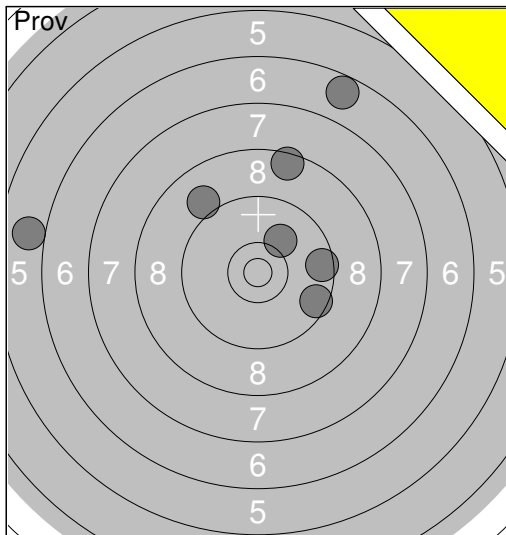

1:	8.5	↗
2:	9.6	→
3:	6.7	↗
4:	10.1	↗
5:	5.9	←
6:	9.6	↘
7:	9.0	↗
Serie		56.0
Total		578.0

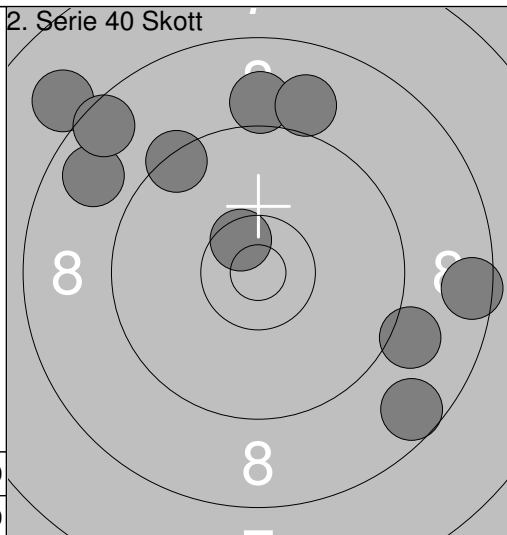

1:	8.0	↗
2:	9.4	↗
3:	10.5x	↗
4:	8.8	↗
5:	8.6	↘
6:	9.0	↑
7:	8.6	↗
8:	9.1	↘
9:	8.5	→
10:	9.0	↑
Serie		86.0
Total		664.0

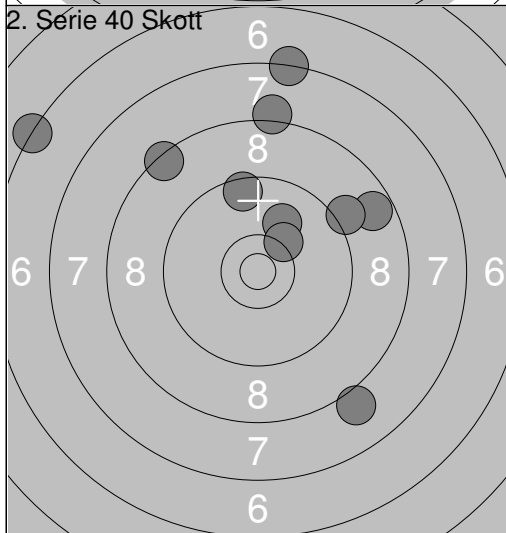

11:	8.2	↑
12:	9.5	↑
13:	8.7	→
14:	10.0	↗
15:	10.3	↗
16:	9.1	↗
17:	7.3	↑
18:	6.3	↖
19:	8.0	↘
20:	8.4	↗
Serie		83.0
Total		747.0

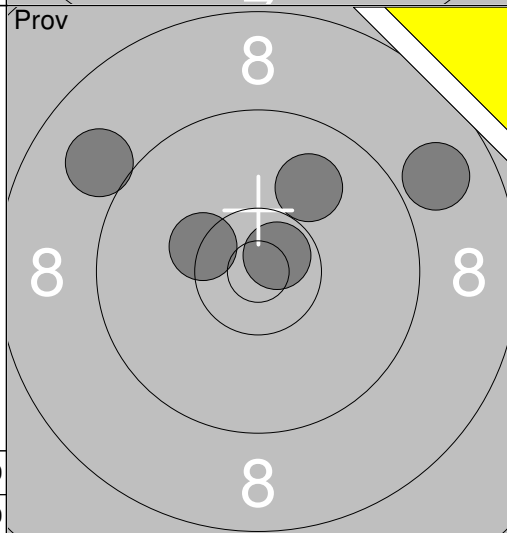

1:	10.3x	↖
2:	9.9	↗
3:	9.0	↖
4:	8.9	→
5:	10.7x	↗
Serie		46.0
Total		747.0

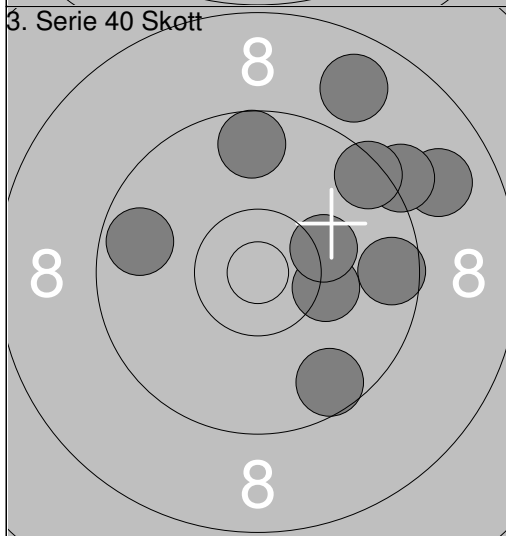

1:	8.9	→
2:	9.6	→
3:	9.6	↘
4:	9.2	↗
5:	9.5	↗
6:	9.6	↑
7:	10.2	→
8:	10.2	→
9:	8.8	↗
10:	9.7	←
Serie		90.0
Total		837.0

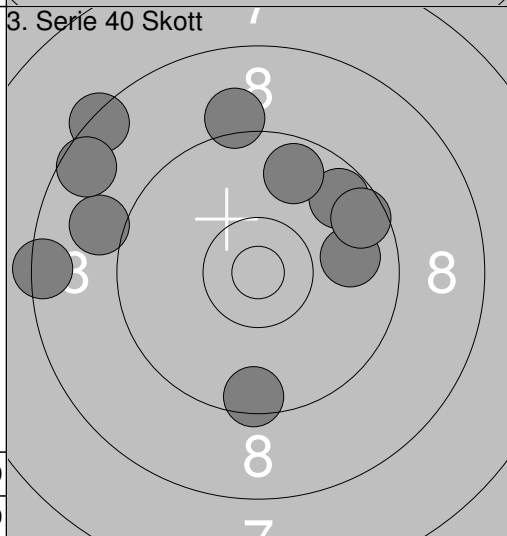

11:	9.9	→
12:	9.7	↗
13:	9.6	↗
14:	8.4	←
15:	8.4	↖
16:	9.7	↑
17:	9.1	↑
18:	9.0	←
19:	8.6	↖
20:	9.5	↓
Serie		87.0
Total		924.0

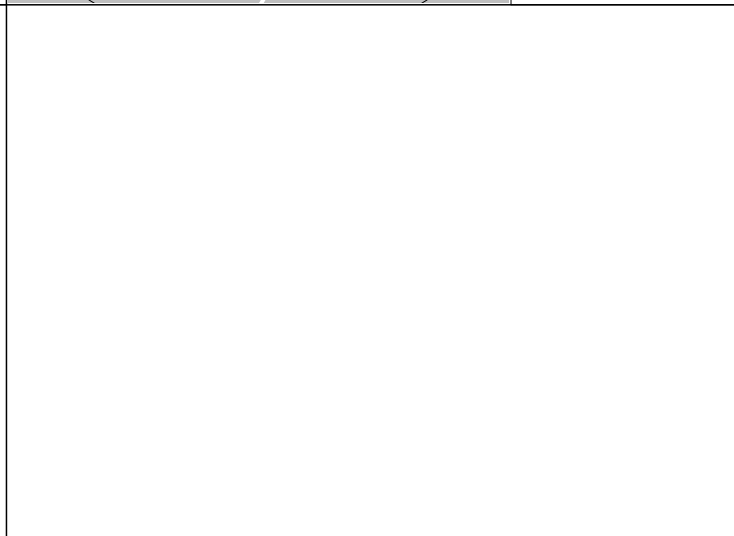
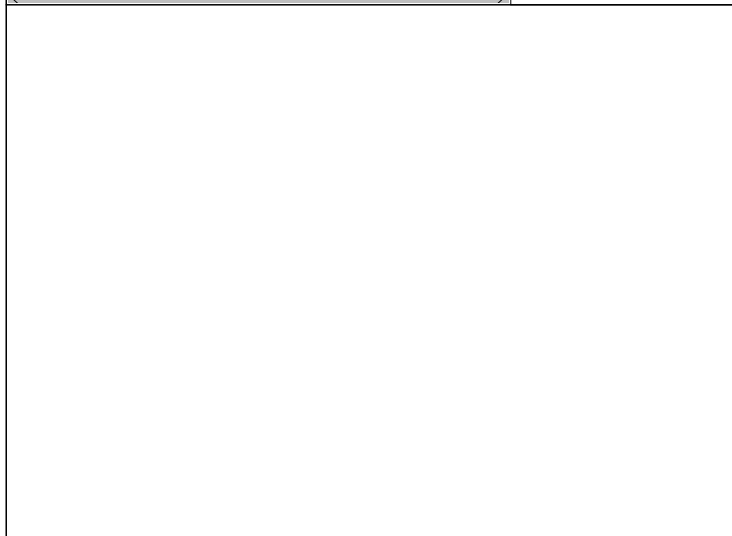

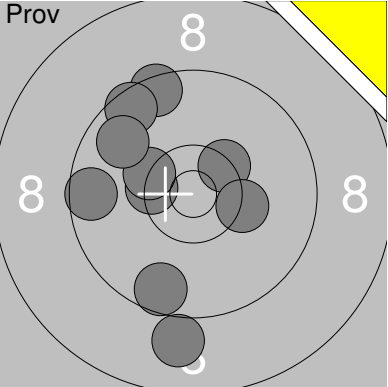
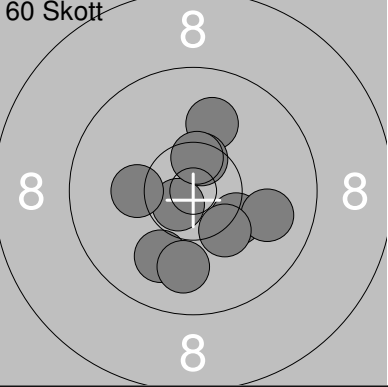
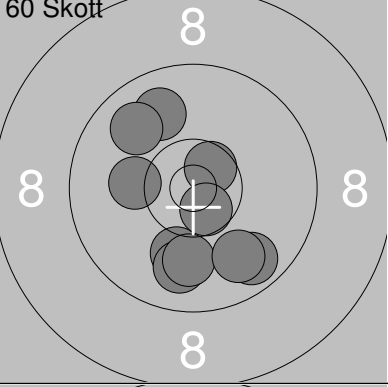
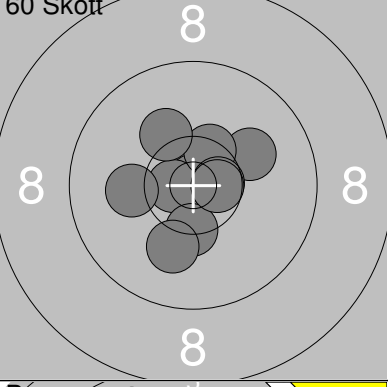
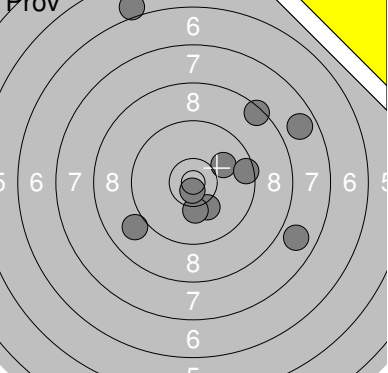
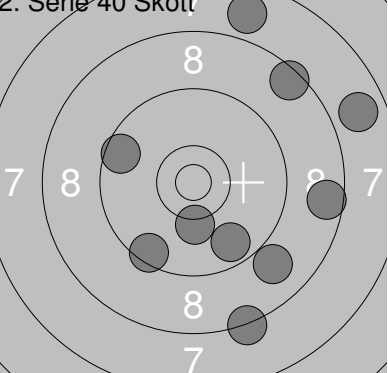
Skjuttag	Tavla	Casper Fredriksson	
S		Ramselefors Skf	
07.04.2019		Startskottet 2019	Umeå skytteallians
Prov		1: 10.4x ↗ 2: 9.0 ↓ 3: 9.6 ↓ 4: 9.6 ← 5: 10.4x ← 6: 9.5 ↗ 7: 10.3x ↗ 8: 10.3 → 9: 9.5 ↗ 10: 9.8 ↗ Serie 94.0 Total 0.0	11: 10.9x ← 12: 10.3 → 13: 10.8x ↗ 14: 9.9 ← 15: 10.6x ↓ 16: 10.1 ↗ 17: 10.5x ↑ 18: 10.4x ↓ 19: 9.5 → 20: 9.8 ↓ Serie 97.0 Total 0.0
60 Skott		1: 10.0 ↑ 2: 10.7x ← 3: 10.2 ← 4: 10.0 ↓ 5: 10.3 ↓ 6: 9.9 ↓ 7: 9.9 → 8: 10.5x ↑ 9: 10.3 ↓ 10: 10.5x ↑ Serie 98.0 Total 98.0	11: 9.9 ← 12: 10.4x → 13: 10.2 ↑ 14: 9.9 ↓ 15: 9.5 ↑ 16: 10.5x ↗ 17: 10.0 ↗ 18: 10.0 ↓ 19: 10.4x ← 20: 9.7 → Serie 96.0 Total 194.0
60 Skott		21: 9.9 ↑ 22: 10.6x ↗ 23: 10.1 ↓ 24: 10.2 ← 25: 9.7 ↓ 26: 9.9 ↓ 27: 9.9 ↗ 28: 10.0 ↓ 29: 9.9 ↓ 30: 10.6x ↓ Serie 95.0 Total 289.0	31: 10.7x ↓ 32: 9.4 ↓ 33: 10.1 ↗ 34: 10.6x ↓ 35: 9.1 ↓ 36: 10.3x ← 37: 10.5x ↓ 38: 10.6x ↗ 39: 10.4x ← 40: 9.7 ↗ Serie 97.0 Total 386.0
60 Skott		41: 10.9x ↑ 42: 10.7x ← 43: 10.4x ↓ 44: 10.1 ↗ 45: 10.1 ↓ 46: 10.4x ↑ 47: 10.6x → 48: 10.1 ← 49: 10.6x → 50: 10.2 ↗ Serie 100.0 Total 486.0	51: 10.6x → 52: 10.8x ← 53: 10.3x → 54: 10.6x ↓ 55: 10.2 ↓ 56: 10.8x ↗ 57: 10.8x ↓ 58: 10.5x ↓ 59: 9.8 → 60: 10.6x ↗ Serie 99.0 Total 585.0
Prov		1: 9.0 ← 2: 6.0 ↑ 3: 10.0 → 4: 8.5 ↗ 5: 7.8 ↗ 6: 10.2 ↓ 7: 10.2 ↓ 8: 10.7x ↓ 9: 9.5 → 10: 7.9 ↓ Serie 86.0 Total 585.0	2. Serie 40 Skott  1: 8.5 ↗ 2: 9.5 ↓ 3: 8.6 → 4: 8.3 ↓ 5: 7.8 ↑ 6: 9.6 ← 7: 10.2 ↓ 8: 8.9 ↓ 9: 7.8 → 10: 9.7 ↓ Serie 83.0 Total 668.0

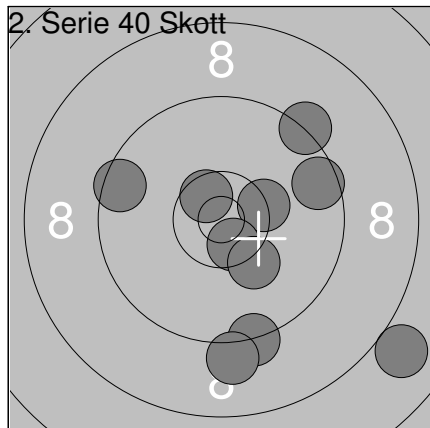

11:	10.4x	→
12:	8.0	↘
13:	9.6	→
14:	9.5	←
15:	9.3	↗
16:	10.6x	↘
17:	9.3	↘
18:	10.6x	↗
19:	10.2	↘
20:	9.1	↓
Serie		93.0
Total		761.0

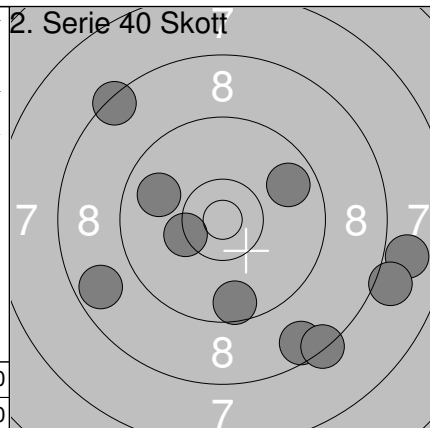

21:	8.6	↘
22:	10.3x	←
23:	7.9	→
24:	8.1	→
25:	8.4	↗
26:	9.6	↓
27:	9.8	↖
28:	8.4	↘
29:	8.7	←
30:	9.8	↗
Serie		84.0
Total		845.0

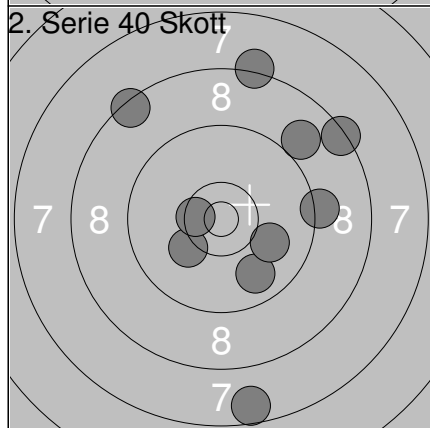

31:	7.6	↓
32:	10.2	←
33:	9.0	↗
34:	9.2	→
35:	8.4	↗
36:	9.8	↘
37:	8.2	↑
38:	8.4	↗
39:	10.5x	←
40:	10.0	↘
Serie		88.0
Total		933.0

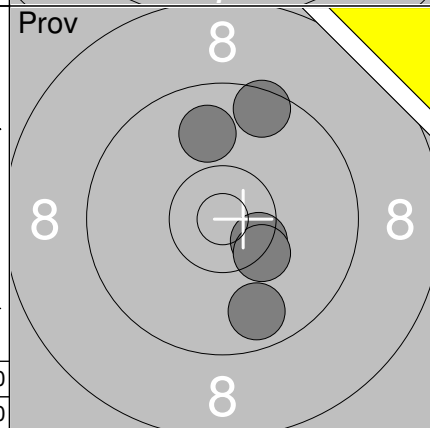

1:	9.8	↓
2:	10.4x	→
3:	9.5	↑
4:	10.3x	↘
5:	9.9	↑
Serie		47.0
Total		933.0

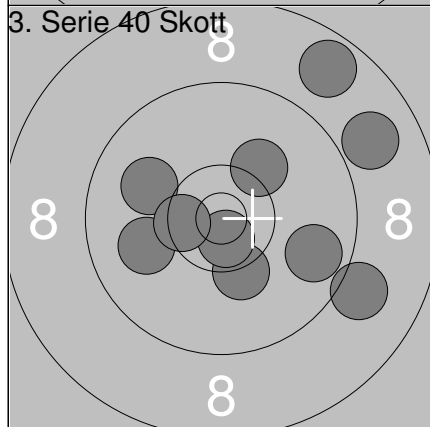

1:	8.9	↗
2:	10.3	↘
3:	10.0	↖
4:	8.7	↗
5:	10.7x	↘
6:	9.1	↘
7:	10.0	←
8:	10.5x	←
9:	9.8	→
10:	10.2	↗
Serie		94.0
Total		1027.0

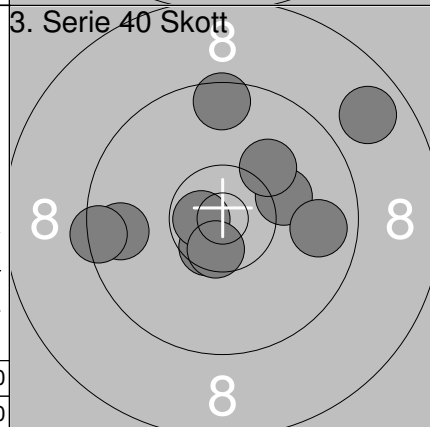

11:	10.2	→
12:	9.7	←
13:	9.8	→
14:	10.6x	↘
15:	9.4	←
16:	10.1	↗
17:	8.8	↗
18:	9.5	↑
19:	10.7x	←
20:	10.6x	↓
Serie		94.0
Total		1121.0

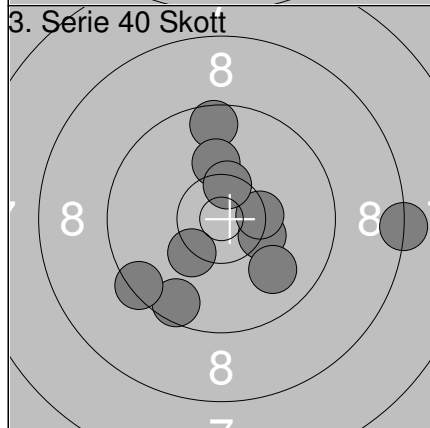

21:	9.6	↑
22:	10.3x	→
23:	10.3x	↘
24:	10.1	↑
25:	9.6	↘
26:	9.9	↘
27:	10.4x	→
28:	9.4	←
29:	8.3	→
30:	10.4x	↑
Serie		94.0
Total		1215.0

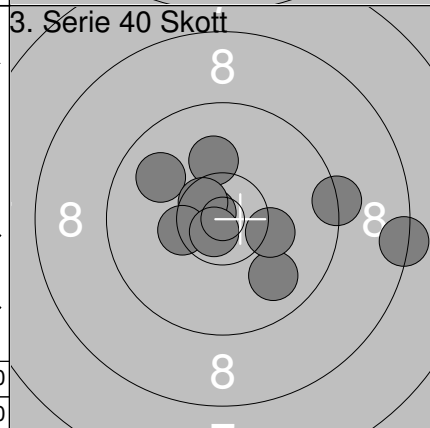

31:	9.9	↘
32:	10.1	↑
33:	10.3	→
34:	9.9	↗
35:	9.3	→
36:	10.8x	↖
37:	10.6x	↗
38:	8.4	→
39:	10.4x	←
40:	10.7x	↘
Serie		95.0
Total		1310.0

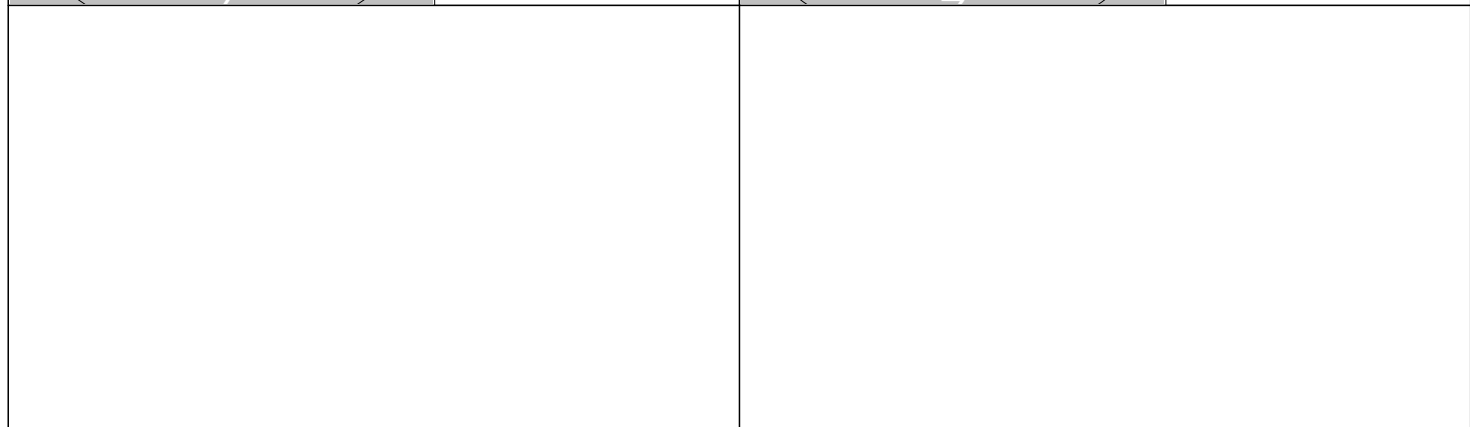

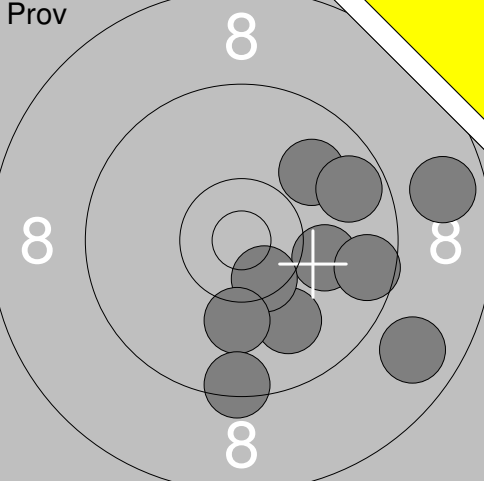
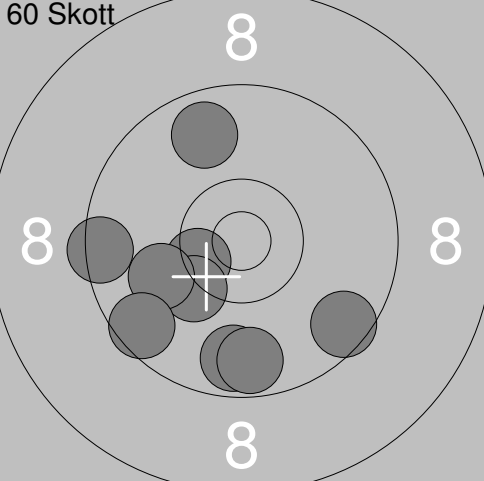
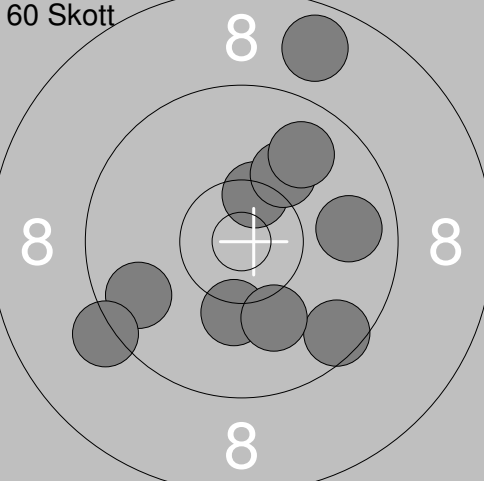
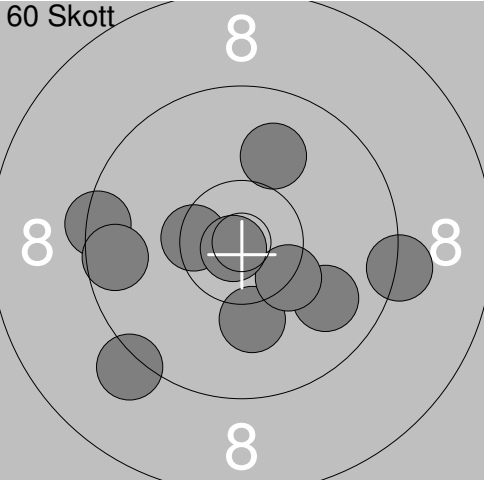
Skjutlag	Tavla	Stefan Thorin	
2	1		
S	Umeå Skf		
07.04.2019	Startskottet 2019	Umeå skytteallians	
Prov		1: 10.1 → 2: 8.8 ↘ 3: 8.8 → 4: 9.9 ↗ 5: 10.0 ↘ 6: 9.7 ↗ 7: 9.6 → 8: 10.5x ↘ 9: 10.1 ↓ 10: 9.4 ↓	11: 10.7x ↖ 12: 10.4x ↗ 13: 10.0 ↓ 14: 9.7 → 15: 10.5x ↘ 16: 9.6 → 17: 9.6 ↓
	Serie 92.0 Total 0.0		Serie 67.0 Total 0.0
60 Skott		1: 10.2 ← 2: 9.5 ← 3: 9.7 ↓ 4: 10.4x ← 5: 9.7 ↓ 6: 10.2 ← 7: 10.0 ← 8: 9.6 ↘ 9: 9.6 ↘ 10: 9.8 ↗	11: 9.7 ↖ 12: 9.9 ↘ 13: 9.5 ↘ 14: 8.6 → 15: 9.0 ↘ 16: 8.9 ↓ 17: 10.0 ↓ 18: 10.5x ← 19: 10.3x ↘ 20: 9.6 ←
	Serie 94.0 Total 94.0		Serie 91.0 Total 185.0
60 Skott		21: 9.7 ← 22: 9.2 ← 23: 8.8 ↗ 24: 9.6 ↘ 25: 10.2 ↓ 26: 10.4x ↗ 27: 10.1 ↓ 28: 10.1 ↗ 29: 9.8 ↗ 30: 9.8 →	31: 10.4x ↘ 32: 9.9 ↗ 33: 9.2 ↓ 34: 10.7x ← 35: 10.0 ↓ 36: 9.7 → 37: 10.5x ↗ 38: 10.1 ← 39: 9.9 ↓ 40: 10.3 ↗
	Serie 93.0 Total 278.0		Serie 96.0 Total 374.0
60 Skott		41: 10.4x ← 42: 9.9 ↘ 43: 10.1 ↓ 44: 9.3 → 45: 10.3x ↘ 46: 9.4 ← 47: 9.2 ↘ 48: 10.0 ↗ 49: 9.6 ← 50: 10.8x ↘	51: 10.0 ↘ 52: 10.5x ↘ 53: 10.2 ← 54: 10.6x ↘ 55: 9.7 ← 56: 9.7 ↖ 57: 10.1 ↗ 58: 10.2 ↗ 59: 9.9 ↗ 60: 10.7x ↗
	Serie 95.0 Total 469.0		Serie 97.0 Total 566.0

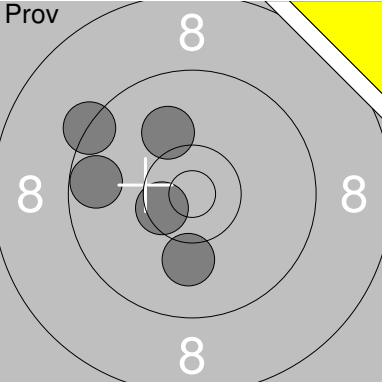
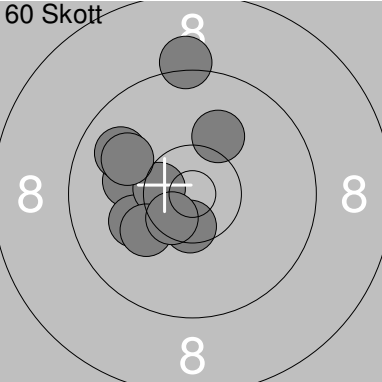
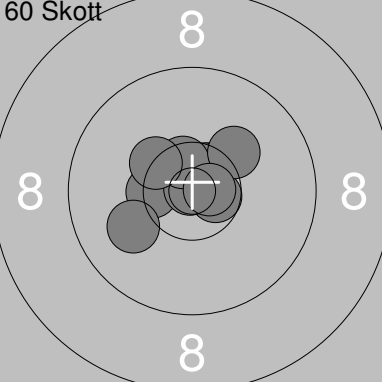
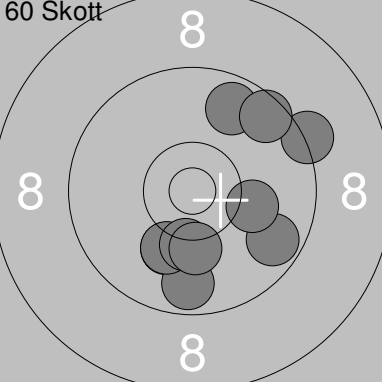
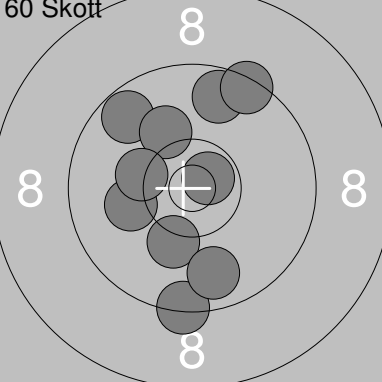
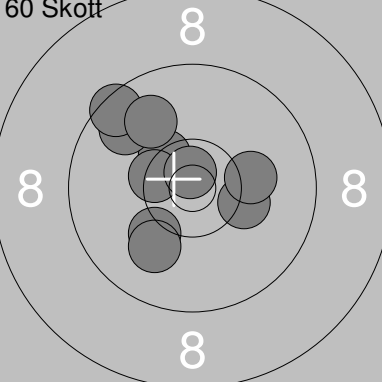
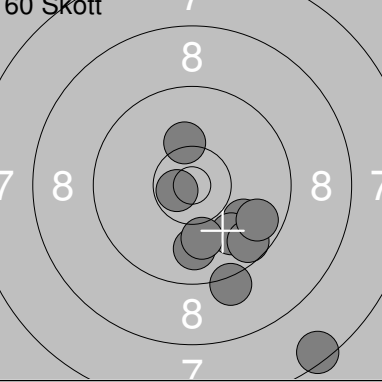
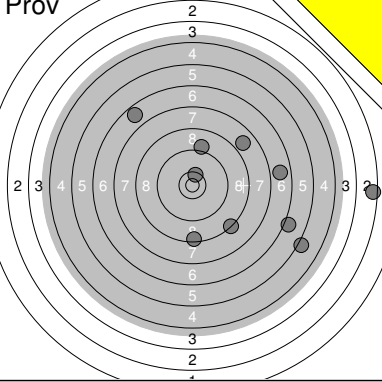
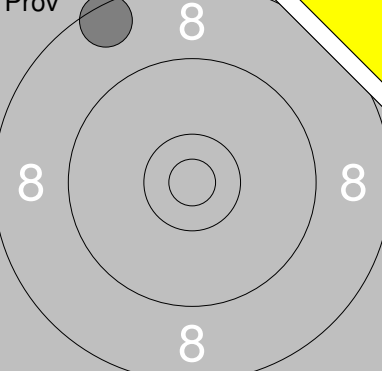
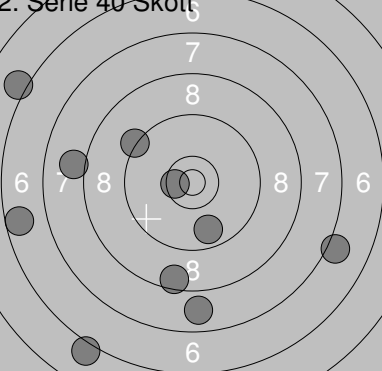
Skjuttag	Tavla	Jennifer Gustavsson	
2	4		
S	Ramselefors Skf		
07.04.2019	Startskottet 2019	Umeå skytteallians	
Prov	 1: 9.7 ← 2: 9.3 ↗ 3: 10.1 ↓ 4: 10.5x ← 5: 10.1 ↗ Serie 48.0 Total 0.0	60 Skott	 1: 10.1 ← 2: 10.1 ↗ 3: 10.1 ← 4: 9.2 ↑ 5: 10.5x ↓ 6: 10.5x ← 7: 9.9 ↗ 8: 10.2 ↓ 9: 10.5x ↓ 10: 10.0 ↗ Serie 98.0 Total 98.0
60 Skott	 11: 10.4x ← 12: 10.6x ↗ 13: 10.6x → 14: 10.6x ↗ 15: 10.9x ↗ 16: 10.5x ↗ 17: 10.3x ↗ 18: 10.2 ↗ 19: 10.0 ← 20: 10.7x → Serie 100.0 Total 198.0	60 Skott	 21: 9.7 ↗ 22: 9.7 → 23: 10.1 → 24: 10.1 ↓ 25: 9.7 ↓ 26: 10.1 ↓ 27: 10.2 ↓ 28: 9.3 → 29: 10.2 ↓ 30: 9.6 ↗ Serie 95.0 Total 293.0
60 Skott	 31: 9.7 ↗ 32: 9.7 ↗ 33: 10.7x → 34: 10.2 ↓ 35: 10.1 ← 36: 9.4 ↓ 37: 10.1 ↗ 38: 9.4 ↗ 39: 9.8 ↓ 40: 10.3 ← Serie 95.0 Total 388.0	60 Skott	 41: 10.2 ↓ 42: 10.0 ↓ 43: 10.4x ↗ 44: 10.4x ← 45: 9.8 ↗ 46: 9.5 ↗ 47: 9.9 ↗ 48: 10.7x ↑ 49: 10.2 → 50: 10.2 → Serie 97.0 Total 485.0
60 Skott	 51: 9.2 ↓ 52: 9.9 ↓ 53: 9.9 ↓ 54: 7.5 ↓ 55: 10.7x ← 56: 9.9 ↓ 57: 10.1 ↓ 58: 9.6 ↓ 59: 9.7 ↓ 60: 10.2 ↑ Serie 91.0 Total 576.0	Prov	 1: 6.7 ↗ 2: 5.2 → 3: 2.5 → 4: 10.4x ↑ 5: 8.3 ↓ 6: 9.1 ↑ 7: 7.9 ↗ 8: 6.1 → 9: 6.8 → 10: 8.5 ↓ Serie 67.0 Total 576.0
Prov	 11: 8.5 ↗ Serie 8.0 Total 576.0	2. Serie 40 Skott	 1: 7.1 → 2: 10.5x ← 3: 6.1 ↓ 4: 9.7 ↓ 5: 6.6 ← 6: 8.5 ↓ 7: 8.0 ← 8: 9.3 ↗ 9: 7.8 ↓ 10: 6.1 ↗ Serie 76.0 Total 652.0

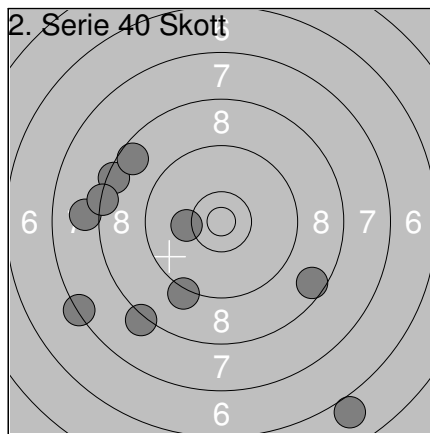

11:	8.0	←
12:	9.2	↙
13:	8.2	↙
14:	8.6	↙
15:	6.0	↙
16:	7.3	←
17:	10.2	←
18:	8.4	↗
19:	8.3	←
20:	8.6	↗
Serie		80.0
Total		732.0

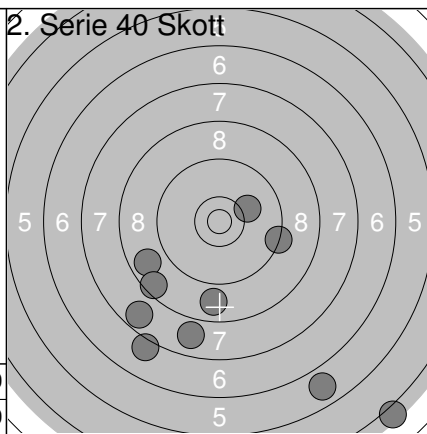

21:	8.8	↙
22:	7.1	↙
23:	7.9	↙
24:	9.3	→
25:	8.5	↙
26:	8.8	↓
27:	5.8	↙
28:	10.1	→
29:	7.7	↙
30:	4.1	↙
Serie		73.0
Total		805.0

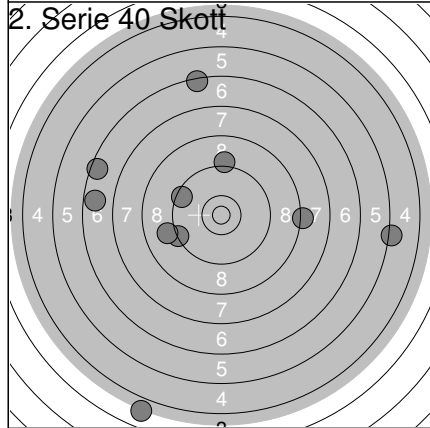

31:	5.2	→
32:	6.4	↑
33:	8.2	→
34:	6.5	↖
35:	3.9	↓
36:	9.3	←
37:	6.7	←
38:	9.1	←
39:	9.5	↖
40:	9.2	↑
Serie		70.0
Total		875.0

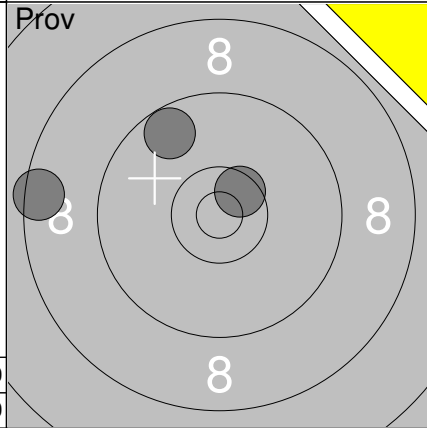

1:	8.5	←
2:	9.7	↗
3:	10.5x	↗
Serie		27.0
Total		875.0

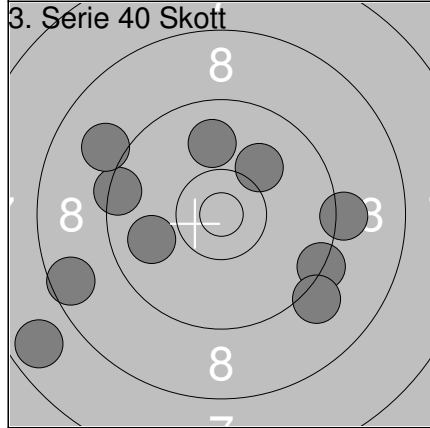

1:	9.9	←
2:	9.4	←
3:	9.3	↙
4:	9.2	→
5:	9.0	↗
6:	7.7	↙
7:	9.1	↙
8:	8.6	←
9:	10.1	↗
10:	9.9	↑
Serie		88.0
Total		963.0

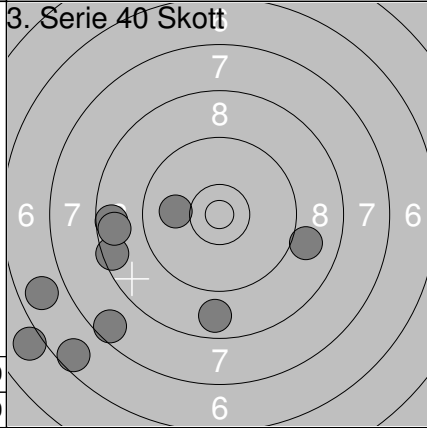

11:	6.8	←
12:	9.0	→
13:	8.5	←
14:	7.6	↙
15:	8.8	↓
16:	6.0	↙
17:	6.6	↙
18:	10.0	←
19:	8.6	←
20:	8.7	←
Serie		76.0
Total		1039.0

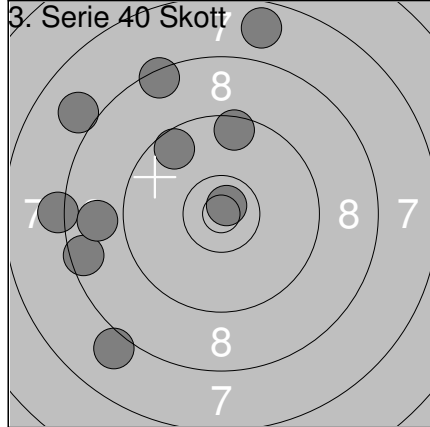

21:	8.2	←
22:	8.5	←
23:	9.6	↗
24:	8.9	←
25:	7.8	↑
26:	8.0	↙
27:	9.5	↑
28:	8.4	↗
29:	8.0	↗
30:	10.8x	↗
Serie		83.0
Total		1122.0

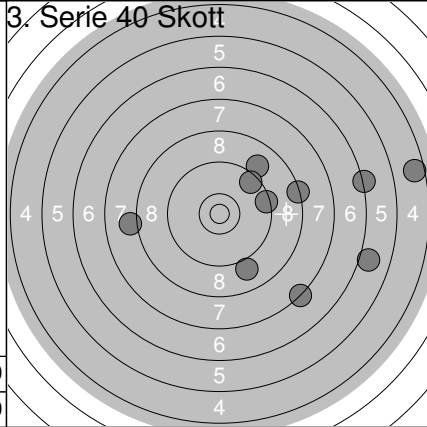

31:	9.0	↗
32:	9.4	→
33:	6.3	→
34:	9.5	↗
35:	7.3	↙
36:	9.0	↙
37:	8.1	←
38:	8.4	→
39:	6.0	→
40:	4.6	→
Serie		75.0
Total		1197.0

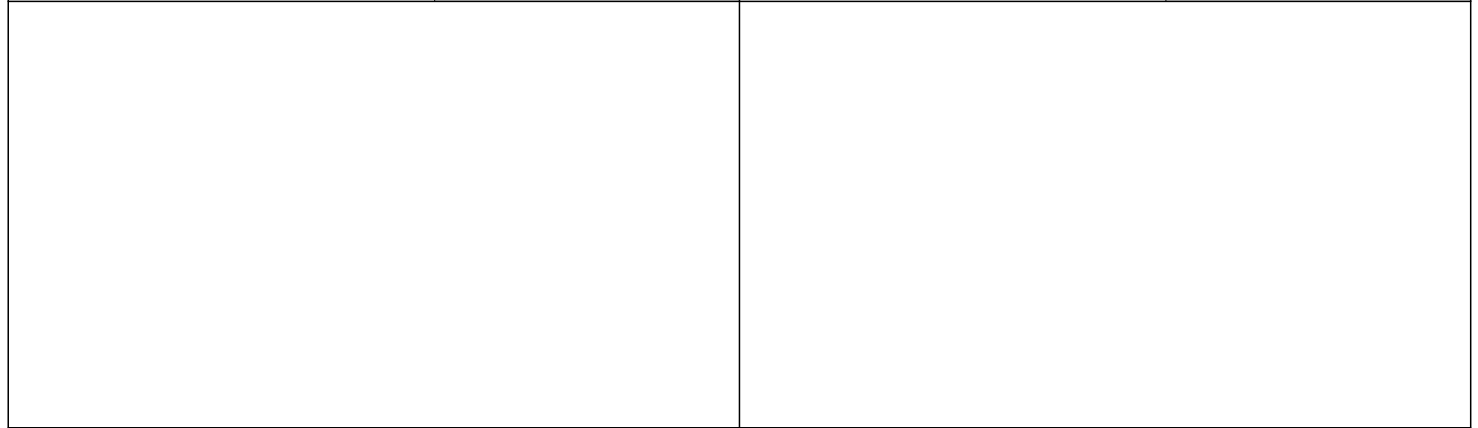

<p>Prov</p>	<table border="1" style="width:100%; border-collapse: collapse;"> <tr><td>1:</td><td>9.4</td><td>↘</td></tr> <tr><td>2:</td><td>6.7</td><td>↙</td></tr> <tr><td>3:</td><td>8.6</td><td>←</td></tr> <tr><td>4:</td><td>8.7</td><td>↗</td></tr> <tr><td>5:</td><td>8.4</td><td>↗</td></tr> <tr><td>6:</td><td>9.5</td><td>↘</td></tr> <tr><td>7:</td><td>8.6</td><td>↙</td></tr> <tr><td>8:</td><td>9.8</td><td>↙</td></tr> <tr><td>9:</td><td>9.6</td><td>↙</td></tr> <tr><td>10:</td><td>9.3</td><td>↘</td></tr> <tr><td colspan="2">Serie</td><td style="text-align: right;">83.0</td></tr> <tr><td colspan="2">Total</td><td style="text-align: right;">0.0</td></tr> </table>	1:	9.4	↘	2:	6.7	↙	3:	8.6	←	4:	8.7	↗	5:	8.4	↗	6:	9.5	↘	7:	8.6	↙	8:	9.8	↙	9:	9.6	↙	10:	9.3	↘	Serie		83.0	Total		0.0	<p>Prov</p>	<table border="1" style="width:100%; border-collapse: collapse;"> <tr><td>11:</td><td>10.0</td><td>↘</td></tr> <tr><td>12:</td><td>9.7</td><td>←</td></tr> <tr><td>13:</td><td>10.5x</td><td>↙</td></tr> <tr><td>14:</td><td>10.8x</td><td>↙</td></tr> <tr><td>15:</td><td>10.4x</td><td>↑</td></tr> <tr><td>16:</td><td>8.7</td><td>←</td></tr> <tr><td>17:</td><td>9.4</td><td>↗</td></tr> <tr><td>18:</td><td>8.9</td><td>↑</td></tr> <tr><td>19:</td><td>9.2</td><td>↘</td></tr> <tr><td>20:</td><td>10.7x</td><td>←</td></tr> <tr><td colspan="2">Serie</td><td style="text-align: right;">93.0</td></tr> <tr><td colspan="2">Total</td><td style="text-align: right;">0.0</td></tr> </table>	11:	10.0	↘	12:	9.7	←	13:	10.5x	↙	14:	10.8x	↙	15:	10.4x	↑	16:	8.7	←	17:	9.4	↗	18:	8.9	↑	19:	9.2	↘	20:	10.7x	←	Serie		93.0	Total		0.0
1:	9.4	↘																																																																									
2:	6.7	↙																																																																									
3:	8.6	←																																																																									
4:	8.7	↗																																																																									
5:	8.4	↗																																																																									
6:	9.5	↘																																																																									
7:	8.6	↙																																																																									
8:	9.8	↙																																																																									
9:	9.6	↙																																																																									
10:	9.3	↘																																																																									
Serie		83.0																																																																									
Total		0.0																																																																									
11:	10.0	↘																																																																									
12:	9.7	←																																																																									
13:	10.5x	↙																																																																									
14:	10.8x	↙																																																																									
15:	10.4x	↑																																																																									
16:	8.7	←																																																																									
17:	9.4	↗																																																																									
18:	8.9	↑																																																																									
19:	9.2	↘																																																																									
20:	10.7x	←																																																																									
Serie		93.0																																																																									
Total		0.0																																																																									
<p>Prov</p>	<table border="1" style="width:100%; border-collapse: collapse;"> <tr><td>21:</td><td>9.0</td><td>↑</td></tr> <tr><td>22:</td><td>9.5</td><td>←</td></tr> <tr><td>23:</td><td>10.0</td><td>←</td></tr> <tr><td>24:</td><td>10.2</td><td>↙</td></tr> <tr><td>25:</td><td>9.3</td><td>↗</td></tr> <tr><td>26:</td><td>10.7x</td><td>↙</td></tr> <tr><td>27:</td><td>9.4</td><td>↗</td></tr> <tr><td>28:</td><td>7.9</td><td>↗</td></tr> <tr><td>29:</td><td>9.4</td><td>→</td></tr> <tr><td>30:</td><td>10.2</td><td>↗</td></tr> <tr><td colspan="2">Serie</td><td style="text-align: right;">92.0</td></tr> <tr><td colspan="2">Total</td><td style="text-align: right;">0.0</td></tr> </table>	21:	9.0	↑	22:	9.5	←	23:	10.0	←	24:	10.2	↙	25:	9.3	↗	26:	10.7x	↙	27:	9.4	↗	28:	7.9	↗	29:	9.4	→	30:	10.2	↗	Serie		92.0	Total		0.0	<p>60 Skott</p>	<table border="1" style="width:100%; border-collapse: collapse;"> <tr><td>1:</td><td>10.5x</td><td>←</td></tr> <tr><td>2:</td><td>8.7</td><td>↗</td></tr> <tr><td>3:</td><td>8.1</td><td>↗</td></tr> <tr><td>4:</td><td>8.1</td><td>↗</td></tr> <tr><td>5:</td><td>10.1</td><td>↙</td></tr> <tr><td>6:</td><td>10.7x</td><td>↗</td></tr> <tr><td>7:</td><td>10.1</td><td>↙</td></tr> <tr><td>8:</td><td>10.8x</td><td>↙</td></tr> <tr><td>9:</td><td>9.0</td><td>↗</td></tr> <tr><td>10:</td><td>10.2</td><td>↑</td></tr> <tr><td colspan="2">Serie</td><td style="text-align: right;">93.0</td></tr> <tr><td colspan="2">Total</td><td style="text-align: right;">93.0</td></tr> </table>	1:	10.5x	←	2:	8.7	↗	3:	8.1	↗	4:	8.1	↗	5:	10.1	↙	6:	10.7x	↗	7:	10.1	↙	8:	10.8x	↙	9:	9.0	↗	10:	10.2	↑	Serie		93.0	Total		93.0
21:	9.0	↑																																																																									
22:	9.5	←																																																																									
23:	10.0	←																																																																									
24:	10.2	↙																																																																									
25:	9.3	↗																																																																									
26:	10.7x	↙																																																																									
27:	9.4	↗																																																																									
28:	7.9	↗																																																																									
29:	9.4	→																																																																									
30:	10.2	↗																																																																									
Serie		92.0																																																																									
Total		0.0																																																																									
1:	10.5x	←																																																																									
2:	8.7	↗																																																																									
3:	8.1	↗																																																																									
4:	8.1	↗																																																																									
5:	10.1	↙																																																																									
6:	10.7x	↗																																																																									
7:	10.1	↙																																																																									
8:	10.8x	↙																																																																									
9:	9.0	↗																																																																									
10:	10.2	↑																																																																									
Serie		93.0																																																																									
Total		93.0																																																																									
<p>60 Skott</p>	<table border="1" style="width:100%; border-collapse: collapse;"> <tr><td>11:</td><td>9.4</td><td>↗</td></tr> <tr><td>12:</td><td>10.3x</td><td>→</td></tr> <tr><td>13:</td><td>10.0</td><td>↙</td></tr> <tr><td>14:</td><td>9.2</td><td>↑</td></tr> <tr><td>15:</td><td>8.1</td><td>↘</td></tr> <tr><td>16:</td><td>9.2</td><td>↗</td></tr> <tr><td>17:</td><td>9.9</td><td>↑</td></tr> <tr><td>18:</td><td>9.4</td><td>↙</td></tr> <tr><td>19:</td><td>9.8</td><td>↗</td></tr> <tr><td>20:</td><td>7.4</td><td>↙</td></tr> <tr><td colspan="2">Serie</td><td style="text-align: right;">89.0</td></tr> <tr><td colspan="2">Total</td><td style="text-align: right;">182.0</td></tr> </table>	11:	9.4	↗	12:	10.3x	→	13:	10.0	↙	14:	9.2	↑	15:	8.1	↘	16:	9.2	↗	17:	9.9	↑	18:	9.4	↙	19:	9.8	↗	20:	7.4	↙	Serie		89.0	Total		182.0	<p>60 Skott</p>	<table border="1" style="width:100%; border-collapse: collapse;"> <tr><td>21:</td><td>9.1</td><td>↗</td></tr> <tr><td>22:</td><td>9.7</td><td>↑</td></tr> <tr><td>23:</td><td>9.8</td><td>→</td></tr> <tr><td>24:</td><td>10.1</td><td>↙</td></tr> <tr><td>25:</td><td>10.1</td><td>↙</td></tr> <tr><td>26:</td><td>9.1</td><td>↑</td></tr> <tr><td>27:</td><td>7.3</td><td>↘</td></tr> <tr><td>28:</td><td>10.2</td><td>←</td></tr> <tr><td>29:</td><td>10.2</td><td>↙</td></tr> <tr><td>30:</td><td>9.2</td><td>→</td></tr> <tr><td colspan="2">Serie</td><td style="text-align: right;">92.0</td></tr> <tr><td colspan="2">Total</td><td style="text-align: right;">274.0</td></tr> </table>	21:	9.1	↗	22:	9.7	↑	23:	9.8	→	24:	10.1	↙	25:	10.1	↙	26:	9.1	↑	27:	7.3	↘	28:	10.2	←	29:	10.2	↙	30:	9.2	→	Serie		92.0	Total		274.0
11:	9.4	↗																																																																									
12:	10.3x	→																																																																									
13:	10.0	↙																																																																									
14:	9.2	↑																																																																									
15:	8.1	↘																																																																									
16:	9.2	↗																																																																									
17:	9.9	↑																																																																									
18:	9.4	↙																																																																									
19:	9.8	↗																																																																									
20:	7.4	↙																																																																									
Serie		89.0																																																																									
Total		182.0																																																																									
21:	9.1	↗																																																																									
22:	9.7	↑																																																																									
23:	9.8	→																																																																									
24:	10.1	↙																																																																									
25:	10.1	↙																																																																									
26:	9.1	↑																																																																									
27:	7.3	↘																																																																									
28:	10.2	←																																																																									
29:	10.2	↙																																																																									
30:	9.2	→																																																																									
Serie		92.0																																																																									
Total		274.0																																																																									
<p>60 Skott</p>	<table border="1" style="width:100%; border-collapse: collapse;"> <tr><td>31:</td><td>9.3</td><td>←</td></tr> <tr><td>32:</td><td>10.2</td><td>↙</td></tr> <tr><td>33:</td><td>9.1</td><td>→</td></tr> <tr><td>34:</td><td>10.2</td><td>↗</td></tr> <tr><td>35:</td><td>7.7</td><td>↗</td></tr> <tr><td>36:</td><td>8.8</td><td>↙</td></tr> <tr><td>37:</td><td>9.9</td><td>↗</td></tr> <tr><td>38:</td><td>10.5x</td><td>↑</td></tr> <tr><td>39:</td><td>7.8</td><td>↑</td></tr> <tr><td>40:</td><td>9.7</td><td>↗</td></tr> <tr><td colspan="2">Serie</td><td style="text-align: right;">88.0</td></tr> <tr><td colspan="2">Total</td><td style="text-align: right;">362.0</td></tr> </table>	31:	9.3	←	32:	10.2	↙	33:	9.1	→	34:	10.2	↗	35:	7.7	↗	36:	8.8	↙	37:	9.9	↗	38:	10.5x	↑	39:	7.8	↑	40:	9.7	↗	Serie		88.0	Total		362.0																																						
31:	9.3	←																																																																									
32:	10.2	↙																																																																									
33:	9.1	→																																																																									
34:	10.2	↗																																																																									
35:	7.7	↗																																																																									
36:	8.8	↙																																																																									
37:	9.9	↗																																																																									
38:	10.5x	↑																																																																									
39:	7.8	↑																																																																									
40:	9.7	↗																																																																									
Serie		88.0																																																																									
Total		362.0																																																																									

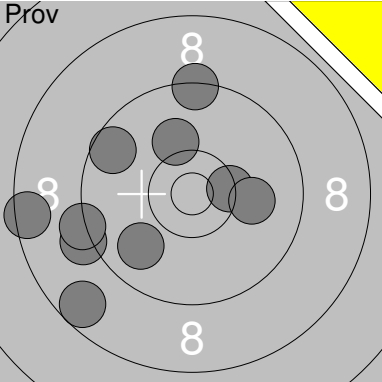
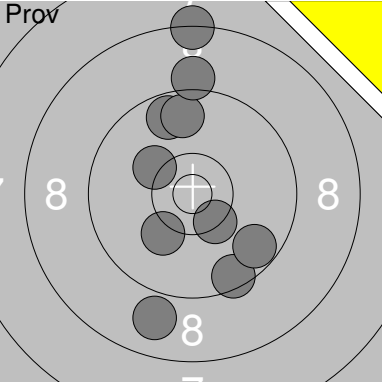
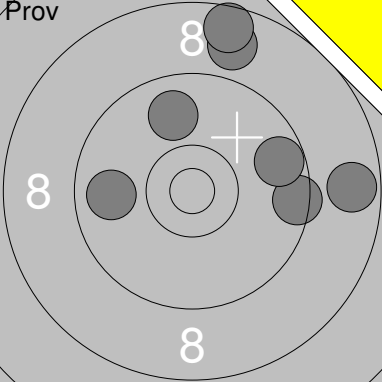
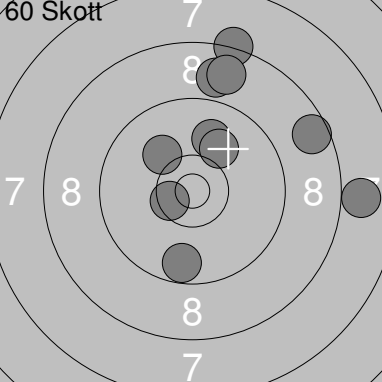
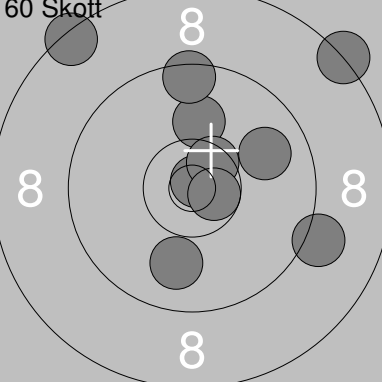
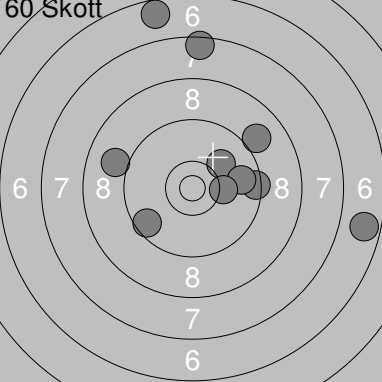
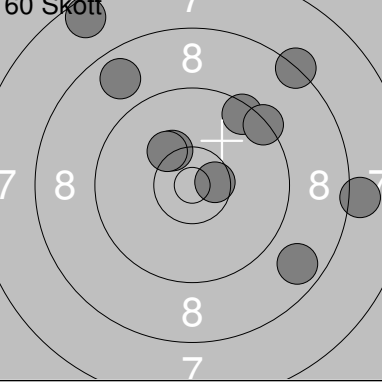
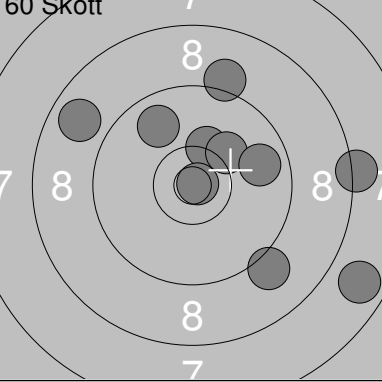
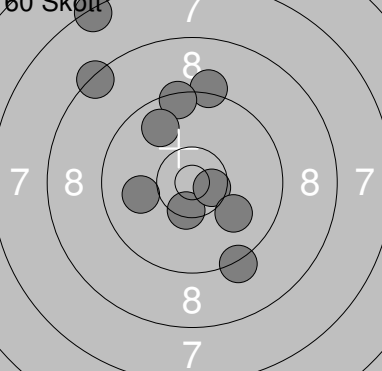
Skjuttag 2	Tavla 8	Beatrice Andersson	
S		Ramselefors Skf	
07.04.2019		Startskottet 2019	
Umeå skytteallians			
Prov 	1: 9.4 ↑ 2: 8.6 ↓ 3: 8.5 ← 4: 9.2 ← 5: 9.6 ↗ 6: 10.4x → 7: 10.1 ↑ 8: 9.9 ↓ 9: 10.1 → 10: 9.2 ←	Prov 	11: 9.7 ↑ 12: 8.9 ↓ 13: 9.5 ↓ 14: 9.7 ↑ 15: 8.3 ↑ 16: 10.4x ↓ 17: 9.7 ↓ 18: 10.2 ↗ 19: 10.2 ↓ 20: 9.1 ↑
Serie 91.0		Serie 91.0	
Total 0.0		Total 0.0	
Prov 	21: 8.7 → 22: 9.9 ↑ 23: 9.5 → 24: 8.8 ↑ 25: 9.8 ← 26: 8.6 ↑ 27: 9.7 →	60 Skott 	1: 10.0 ↑ 2: 8.9 ↑ 3: 8.6 → 4: 8.3 ↑ 5: 10.5x ← 6: 9.7 ↓ 7: 10.1 ↗ 8: 10.1 ↑ 9: 8.0 → 10: 8.8 ↑
Serie 60.0		Serie 89.0	
Total 0.0		Total 89.0	
60 Skott 	11: 8.3 ↗ 12: 10.1 ↑ 13: 10.8x ↗ 14: 10.5x ↗ 15: 9.1 → 16: 8.4 ↗ 17: 9.5 ↑ 18: 9.9 ↗ 19: 10.6x → 20: 9.9 ↓	60 Skott 	21: 9.0 ↗ 22: 9.0 ← 23: 6.7 → 24: 9.4 → 25: 10.0 ↗ 26: 6.7 ↑ 27: 9.6 ↙ 28: 9.8 → 29: 7.5 ↑ 30: 10.2 →
Serie 92.0		Serie 84.0	
Total 181.0		Total 265.0	
60 Skott 	31: 8.1 → 32: 8.3 ↗ 33: 8.8 ↗ 34: 9.5 ↗ 35: 9.4 ↗ 36: 10.3 ↗ 37: 8.7 ↙ 38: 10.2 ↗ 39: 10.6x → 40: 7.6 ↗	60 Skott 	41: 8.8 ↙ 42: 10.3 ↑ 43: 9.8 ↗ 44: 7.8 → 45: 10.2 ↗ 46: 9.1 ↑ 47: 9.1 ↓ 48: 10.9x → 49: 8.2 → 50: 9.8 →
Serie 87.0		Serie 89.0	
Total 352.0		Total 441.0	
60 Skott 	51: 8.4 ↗ 52: 9.2 ↑ 53: 9.2 ↓ 54: 10.0 ← 55: 7.4 ↗ 56: 9.4 ↑ 57: 10.4x ↓ 58: 9.8 ↗ 59: 10.6x → 60: 10.0 ↓		
Serie 91.0			
Total 532.0			

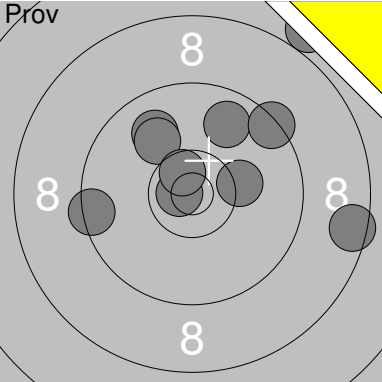
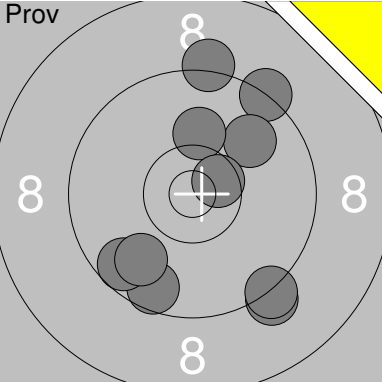
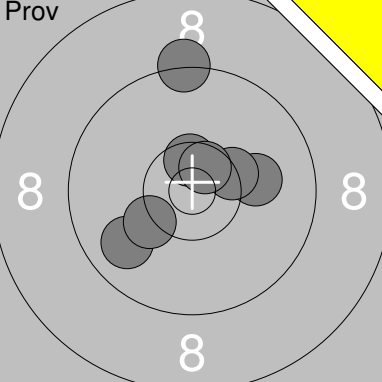
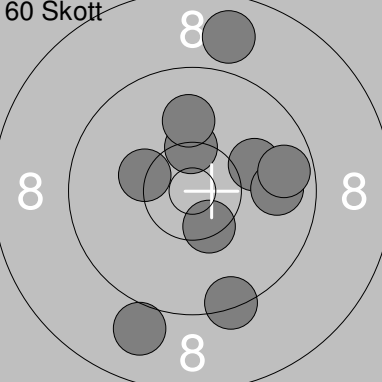
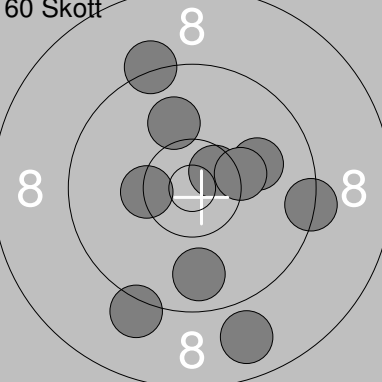
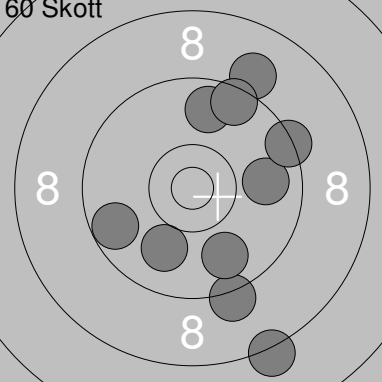
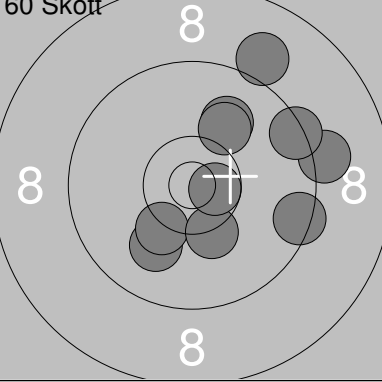
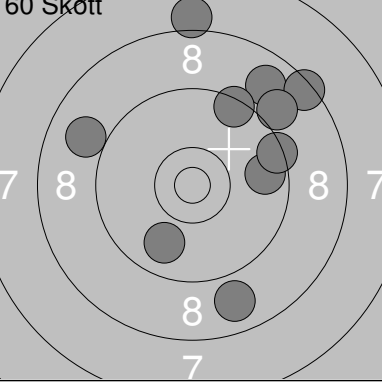
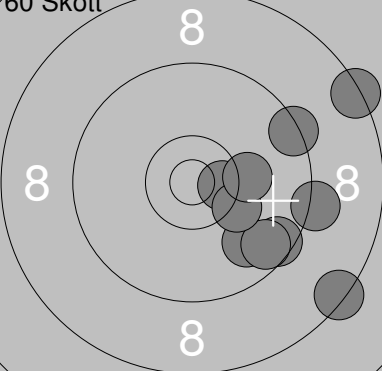
Skjuttlag 2	Tavla 10	Hanna Augustsson	
S		Vännäs Skf	
07.04.2019		Startskottet 2019	Umeå skytteallians
Prov 	1: 9.8 ↑ 2: 8.0 ↑ 3: 10.8x ← 4: 9.9 ↑ 5: 8.5 → 6: 10.0 ↑ 7: 9.4 ↑ 8: 10.2 → 9: 9.4 ← 10: 10.6x ↑ Serie 92.0 Total 0.0	Prov 	11: 9.2 ↑ 12: 9.3 ↑ 13: 9.2 ↓ 14: 9.9 ↑ 15: 10.1 ↑ 16: 9.6 ↓ 17: 9.6 ↓ 18: 9.8 ↓ 19: 10.6x → 20: 9.3 ↓ Serie 92.0 Total 0.0
Prov 	21: 10.5x ↑ 22: 9.8 ↓ 23: 10.1 → 24: 10.3 ← 25: 10.4x → 26: 9.3 ↑ 27: 10.6x ↑ Serie 68.0 Total 0.0	60 Skott 	1: 10.4x ↓ 2: 10.1 → 3: 8.8 ↑ 4: 10.4x ↑ 5: 10.3 ← 6: 9.8 → 7: 9.7 → 8: 9.0 ↓ 9: 10.0 ↑ 10: 9.4 ↓ Serie 94.0 Total 94.0
60 Skott 	11: 9.8 ↓ 12: 8.8 ↓ 13: 10.6x → 14: 10.0 → 15: 10.3x ← 16: 9.4 → 17: 10.1 ↑ 18: 9.2 ↓ 19: 9.3 ↑ 20: 10.3 → Serie 94.0 Total 188.0	60 Skott 	21: 8.2 ↓ 22: 9.2 ↓ 23: 9.7 ← 24: 9.9 → 25: 10.0 ↓ 26: 9.1 ↑ 27: 9.8 ↓ 28: 9.4 → 29: 9.7 ↑ 30: 9.5 ↑ Serie 90.0 Total 278.0
60 Skott 	31: 9.1 → 32: 10.0 ↓ 33: 9.0 ↑ 34: 9.4 → 35: 10.2 ↓ 36: 10.0 ↑ 37: 9.5 → 38: 10.3 ↓ 39: 10.6x → 40: 10.1 ↑ Serie 96.0 Total 374.0	60 Skott 	41: 8.1 ↑ 42: 8.8 ↑ 43: 9.7 → 44: 9.4 ↑ 45: 9.9 ↓ 46: 8.9 ← 47: 8.4 → 48: 9.0 → 49: 8.9 ↓ 50: 9.4 → Serie 85.0 Total 459.0
60 Skott 	51: 8.4 → 52: 8.4 ↓ 53: 9.8 ↓ 54: 9.5 ↓ 55: 10.5x → 56: 9.4 → 57: 9.6 ↓ 58: 10.2 ↓ 59: 9.2 → 60: 10.2 → Serie 91.0 Total 550.0		

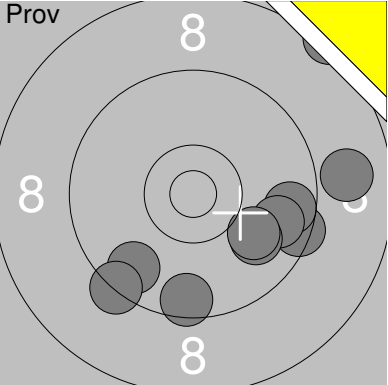
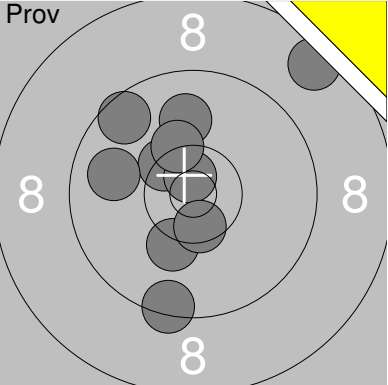
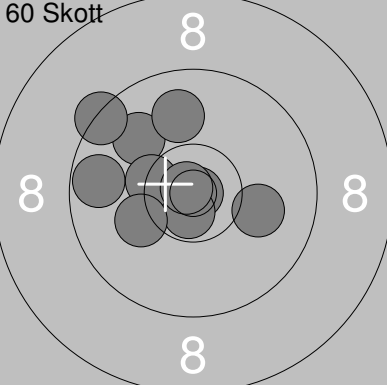
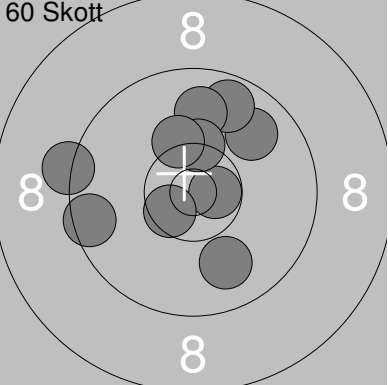
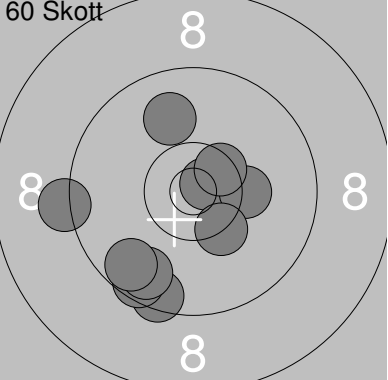
Skjuttag	Tavla	Maja Lindberg		
S		Ramselefors Skf		
07.04.2019		Startskottet 2019	Umeå skytteallians	
Prov		1: 8.2 ↗ 2: 9.5 → 3: 8.9 → 4: 9.7 → 5: 9.8 → 6: 9.7 ↘ 7: 9.3 ↘ 8: 9.9 ↘ 9: 9.5 ↓ 10: 10.0 ↓ Serie 89.0 Total 0.0	11: 10.3 ↓ 12: 8.7 → 13: 9.4 ↓ 14: 9.7 ↓ 15: 8.3 ↓ 16: 9.5 ↓ 17: 9.6 ↓ 18: 10.1 ↗ 19: 10.2 ↗ 20: 10.2 ↓ Serie 92.0 Total 0.0	
Prov		21: 10.4x ↗ 22: 10.2 ↓ 23: 10.7x ↑ 24: 9.9 ← 25: 8.6 ↗ 26: 10.5x ↓ 27: 10.0 ↑ 28: 9.4 ↓ 29: 9.6 ↗ 30: 10.3 ↑ Serie 95.0 Total 0.0	60 Skott	1: 10.1 ↗ 2: 10.4x → 3: 10.4x ↗ 4: 10.2 ↑ 5: 10.4x ← 6: 10.2 ↖ 7: 9.7 ↑ 8: 10.5x ↑ 9: 10.6x ← 10: 10.6x ↖ Serie 99.0 Total 99.0
60 Skott		11: 9.7 ← 12: 10.9x → 13: 9.9 ↗ 14: 9.4 ↗ 15: 10.4x ← 16: 9.9 ↑ 17: 10.1 → 18: 10.7x ↓ 19: 10.8x ↗ 20: 10.2 ↖ Serie 96.0 Total 195.0	60 Skott	21: 9.8 ↑ 22: 9.6 ↑ 23: 10.5x ↓ 24: 10.0 → 25: 9.8 ↑ 26: 10.2 ↗ 27: 9.3 → 28: 10.2 ↗ 29: 10.5x → 30: 9.2 ↑ Serie 95.0 Total 290.0
60 Skott		31: 9.9 ↗ 32: 9.3 ← 33: 10.7x → 34: 9.7 ↑ 35: 9.9 ↑ 36: 9.5 ← 37: 10.3x ↑ 38: 10.5x ↖ 39: 9.9 ↓ 40: 10.2 ↑ Serie 94.0 Total 384.0	60 Skott	41: 10.7x ↓ 42: 10.6x ↓ 43: 10.2 → 44: 10.2 → 45: 10.2 ↑ 46: 9.4 ← 47: 10.5x ↖ 48: 10.3 ↓ 49: 10.4x → 50: 10.3x ↘ Serie 99.0 Total 483.0
60 Skott		51: 9.5 ↓ 52: 10.8x → 53: 9.9 ↑ 54: 9.2 ← 55: 10.3 → 56: 9.6 ↓ 57: 10.3x ↓ 58: 9.7 ↓ 59: 9.7 ↖ 60: 10.5x ↗ Serie 94.0 Total 577.0		

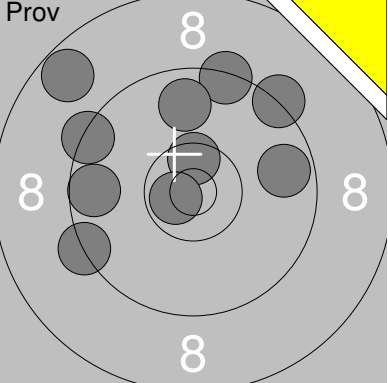
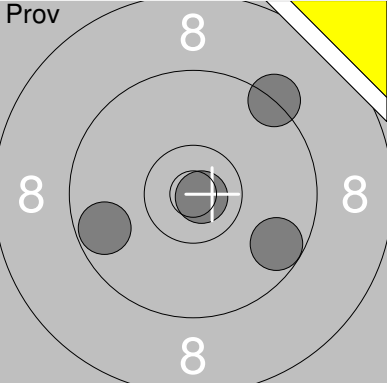
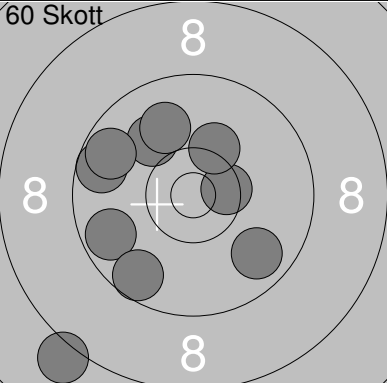
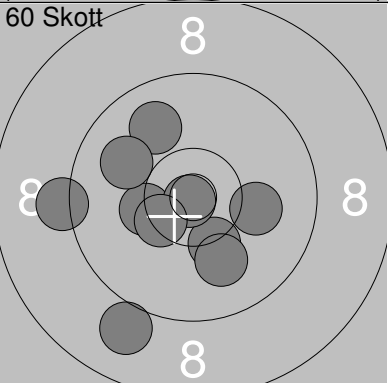
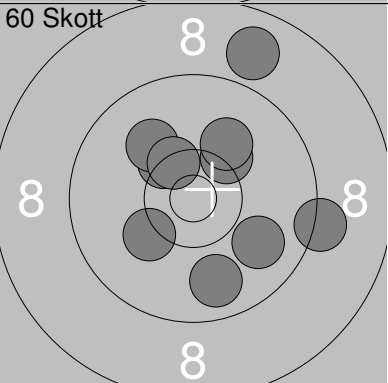
Skjuttlag	Tavla	Emma Eriksson	
2	13		
S	Ramselefors Skf		
07.04.2019	Startskottet 2019	Umeå skytteallians	
Prov		1: 9.3 ↗ 2: 9.4 ↑ 3: 10.5x ↑ 4: 9.8 ↑ 5: 10.7x ← 6: 9.7 → 7: 8.7 ↗ 8: 9.4 ↗ 9: 9.6 ← 10: 9.3 ←	11: 10.4x → 12: 10.5x ↑ 13: 10.6x ↑ 14: 9.9 ← 15: 9.7 ↓ 16: 10.3 ↗ 17: 9.7 ↑ 18: 10.6x ↗ 19: 10.2 ← 20: 9.6 ↗
	Serie 91.0 Total 0.0	Serie 96.0 Total 0.0	
Prov		21: 9.7 → 22: 10.8x → 23: 9.7 ← 24: 9.3 ↗	60 Skott
	Serie 37.0 Total 0.0	Serie 91.0 Total 91.0	1: 9.9 ← 2: 10.0 ← 3: 10.5x → 4: 10.7x ← 5: 10.1 ↑ 6: 7.8 ← 7: 9.0 ← 8: 9.3 ↑ 9: 8.9 ← 10: 9.8 ↓
60 Skott		11: 10.5x → 12: 10.0 ↗ 13: 9.7 ← 14: 10.0 ↗ 15: 9.8 ↓ 16: 9.6 ← 17: 10.2 ↗ 18: 9.7 ↗ 19: 9.6 ↓ 20: 8.1 ↓	60 Skott
	Serie 93.0 Total 184.0	Serie 97.0 Total 281.0	21: 10.3x ↘ 22: 10.0 ← 23: 9.7 ↘ 24: 9.6 ↘ 25: 10.3 → 26: 10.2 ↑ 27: 9.9 → 28: 10.0 → 29: 10.2 → 30: 10.3x ↗
60 Skott		31: 10.3x ← 32: 9.2 ← 33: 9.9 ↗ 34: 10.3 ↓ 35: 10.1 → 36: 9.0 ↓ 37: 10.0 ↓ 38: 10.9x ↘ 39: 10.0 ↘ 40: 10.4x ↘	60 Skott
	Serie 97.0 Total 378.0	Serie 94.0 Total 472.0	41: 10.4x ← 42: 10.2 → 43: 10.2 ↓ 44: 10.5x ← 45: 9.2 ↓ 46: 9.7 ↓ 47: 10.1 ↗ 48: 9.2 ↓ 49: 9.7 ← 50: 8.6 ↓
60 Skott		51: 10.2 ← 52: 10.2 ↗ 53: 10.3x ↗ 54: 8.9 ↗ 55: 9.2 → 56: 9.8 ↓ 57: 10.1 ↗ 58: 10.4x ↗ 59: 10.1 ↗ 60: 9.9 ↓	
	Serie 95.0 Total 567.0		

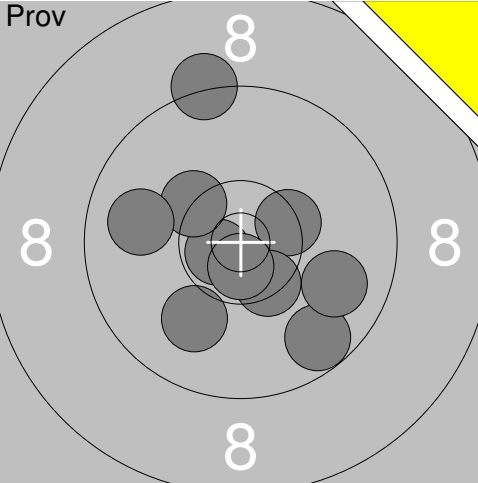
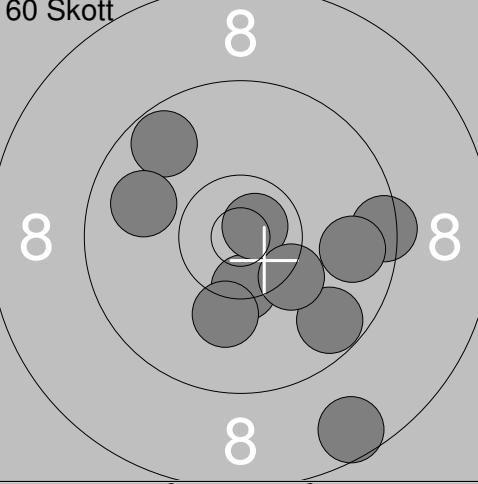
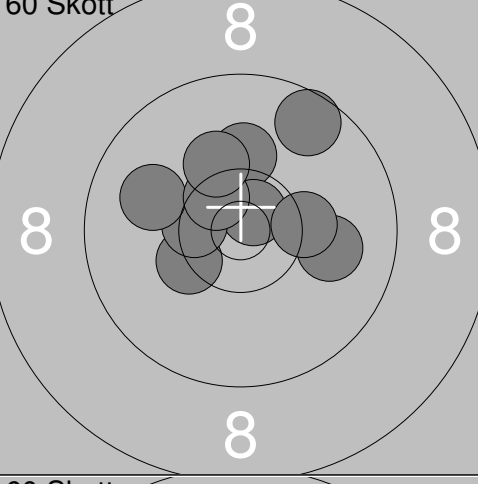
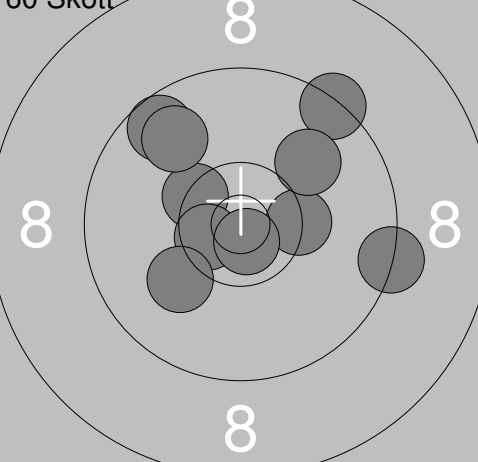
Skjuttlag	Tavla	Niklas Johansson	
2	15		
S	Ramselefors Skf		
07.04.2019	Startskottet 2019	Umeå skytteallians	
Prov		1: 9.3 ↗ 2: 10.7x ↖ 3: 9.7 ↘ 4: 9.9 ↘ 5: 10.4x → 6: 10.0 ↖ 7: 10.3x ↗ 8: 10.4x ↘ 9: 9.9 ← 10: 10.7x ↓	11: 10.6x ↘ 12: 10.8x ↘ 13: 10.4x ↑
	Serie	96.0	Serie 30.0
	Total	0.0	Total 0.0
60 Skott		1: 9.7 ↘ 2: 10.4x ↘ 3: 9.7 ↗ 4: 10.8x → 5: 10.3 ↘ 6: 9.4 → 7: 8.6 ↘ 8: 10.1 ↘ 9: 9.8 → 10: 9.9 ↗	11: 10.0 ↓ 12: 10.4x ↘ 13: 10.5x ↘ 14: 9.4 ↗ 15: 10.3 ↘ 16: 9.7 ↖ 17: 10.0 ↓ 18: 10.2 ↗ 19: 10.1 ↘ 20: 9.3 ↖
	Serie	93.0	Serie 97.0
	Total	93.0	Total 190.0
60 Skott		21: 10.3x ↖ 22: 10.2 ↑ 23: 10.7x ↗ 24: 9.6 ↗ 25: 10.5x ↖ 26: 10.0 → 27: 10.3 → 28: 10.0 ↖ 29: 10.5x ↗ 30: 10.2 ↗	31: 10.7x ↗ 32: 10.5x ↖ 33: 10.5x ↖ 34: 9.8 ↗ 35: 10.2 → 36: 10.3 ↖ 37: 9.1 ↑ 38: 10.3x ↗ 39: 10.5x ↖ 40: 10.2 →
	Serie	99.0	Serie 98.0
	Total	289.0	Total 387.0
60 Skott		41: 9.3 → 42: 10.3x → 43: 9.4 ↗ 44: 10.0 ↗ 45: 9.6 ↗ 46: 10.4x ↗ 47: 9.8 ↗ 48: 10.6x ↖ 49: 10.8x ↘ 50: 10.1 ↖	51: 10.3x ↖ 52: 10.2 ↖ 53: 9.6 ↑ 54: 9.5 ↑ 55: 10.0 → 56: 10.1 ↗ 57: 10.4x ↘ 58: 9.3 ↗ 59: 10.5x → 60: 10.1 ↗
	Serie	96.0	Serie 97.0
	Total	483.0	Total 580.0