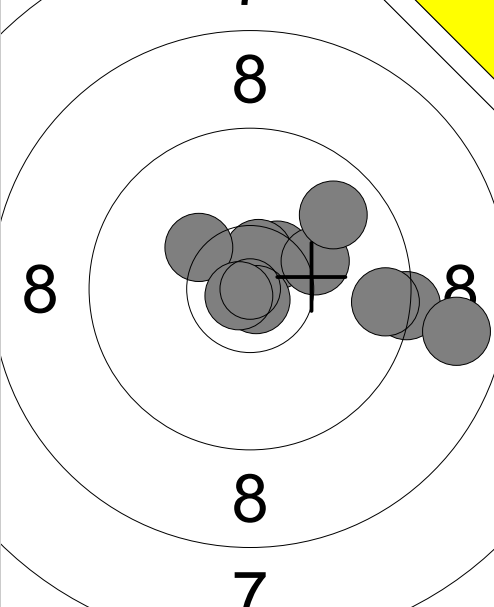
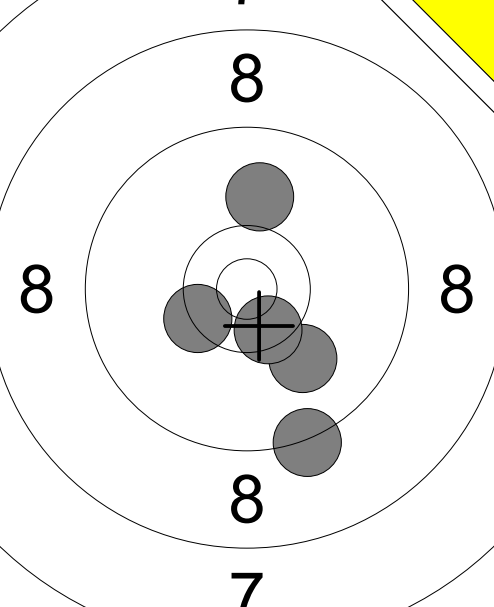
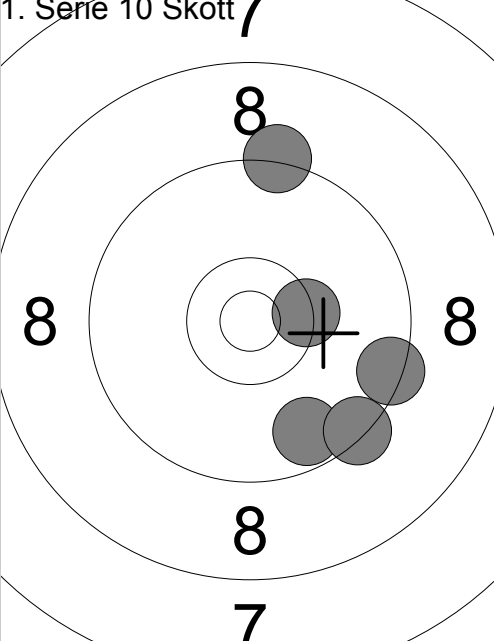
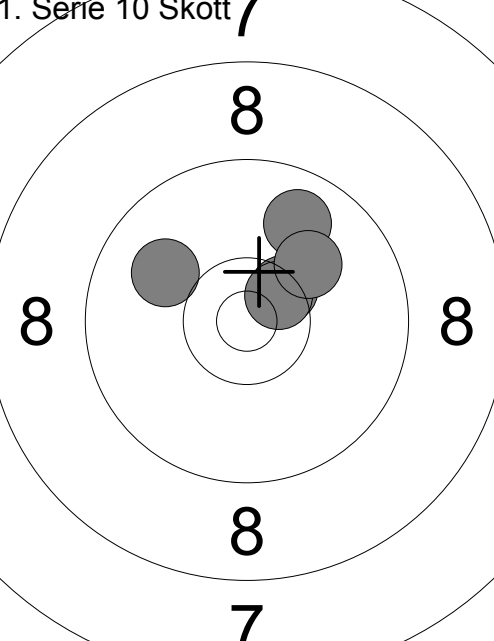
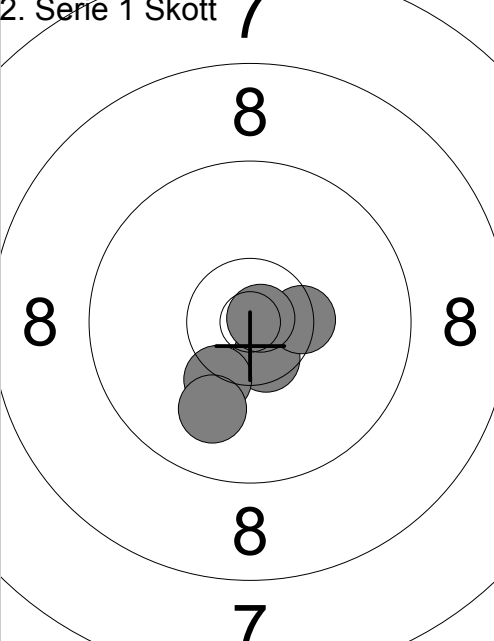
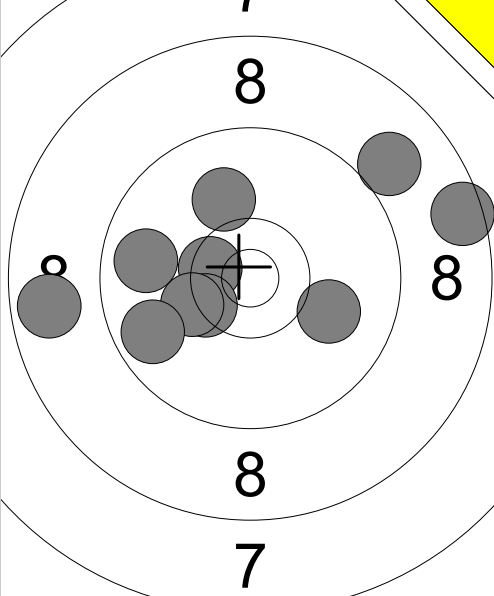
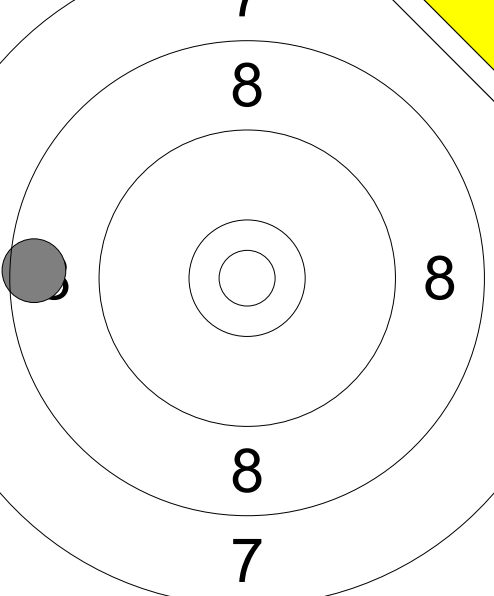
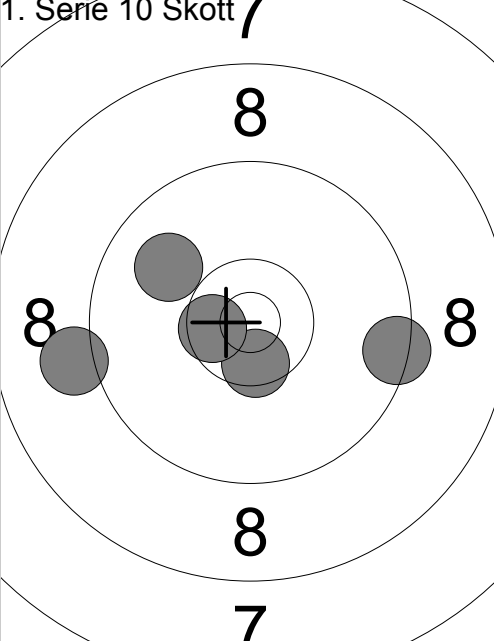
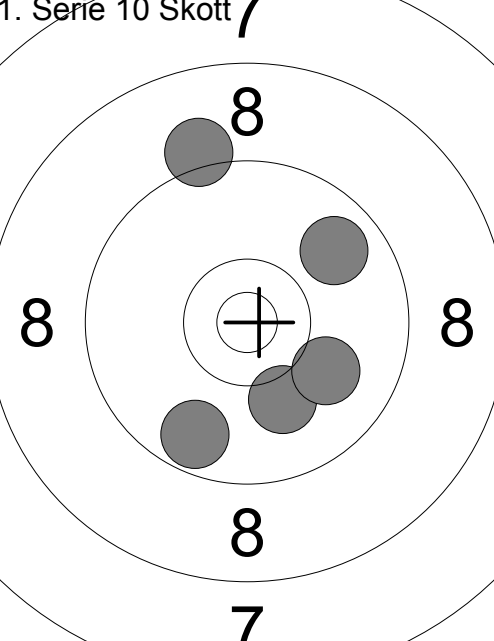

Prov 	1: 10.5x ↗ 2: 10.6x ↑ 3: 9.3 → 4: 10.8x ↓ 5: 8.8 → 6: 10.3 ↗ 7: 10.2 → 8: 9.6 → 9: 10.8x ↙ 10: 9.8 ↗ Serie 95 Total 193	Prov 	11: 10.4x ↙ 12: 10.0 ↓ 13: 10.0 ↑ 14: 10.5x ↓ 15: 9.3 ↓ Serie 49 Total 193
--	--	--	--

1. Serie 10 Skott 	1: 10.4x → 2: 9.7 ↓ 3: 9.4 → 4: 9.4 ↓ 5: 9.3 ↑ Serie 46 Total 239	1. Serie 10 Skott 	6: 10.5x ↗ 7: 10.5x ↗ 8: 9.8 ↑ 9: 10.1 ↗ 10: 10.0 ↙ Serie 49 Total 288
--	---	--	--

2. Serie 1 Skott 	1: 10.5x ↓ 2: 10.3 ↓ 3: 10.0 ↓ 4: 10.4x → 5: 10.8x → Serie 50 Total 338		
--	---	--	--

<p>Prov</p> 	<p>1: 8.7 ←                  2: 9.0 ↗                  3: 10.5x↙                  4: 10.4x↙                  5: 10.0 →                  6: 10.0 ↑                  7: 10.3 ←                  8: 8.5 →                  9: 9.8 ←                  10: 9.7 ↙</p>	<p>Prov</p> 
7 8 8 8 7	7 8 8 8 7	11: 8.6 ←
Serie 93	Serie 8	Total 192
Total 192	Total 192	

<p>1. Serie 10 Skott</p> 	<p>1: 9.4 →                  2: 9.9 ↙                  3: 10.5x↓                  4: 10.6x↙                  5: 9.1 ←</p>	<p>1. Serie 10 Skott</p> 
8 8 8 7	8 8 8 7	6: 9.8 ↗ 7: 9.1 ↑ 8: 9.7 ↙ 9: 10.1 ↙ 10: 10.0 ↘
Serie 47	Serie 47	Total 286
Total 239	Total 286	

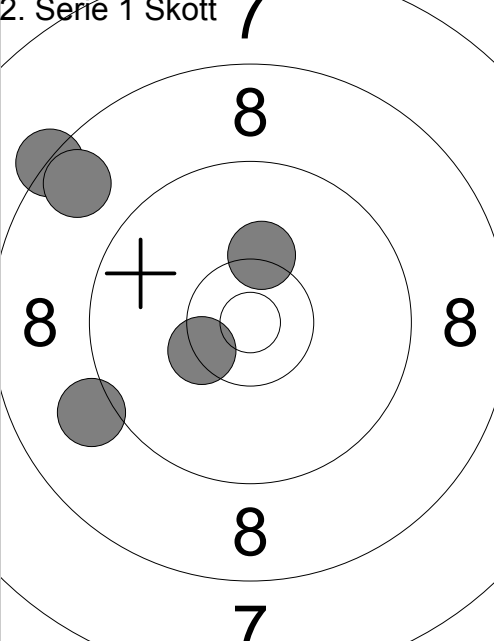
<p>2. Serie 1 Skott</p> 	<p>1: 8.3 ↙                  2: 10.4x↙                  3: 9.1 ←                  4: 10.3 ↑                  5: 8.7 ↙</p>	
8 8 7		
Serie 45		
Total 331		

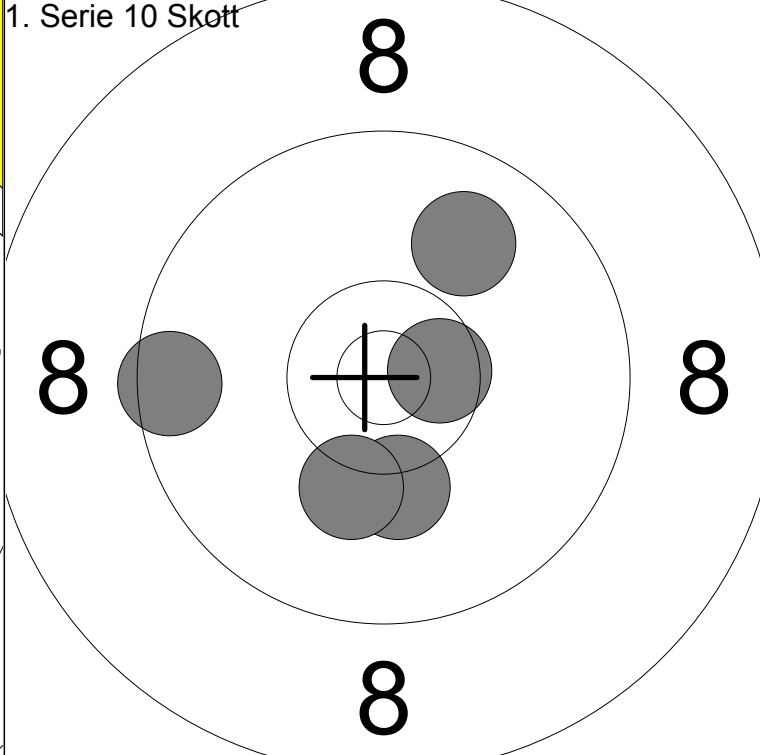
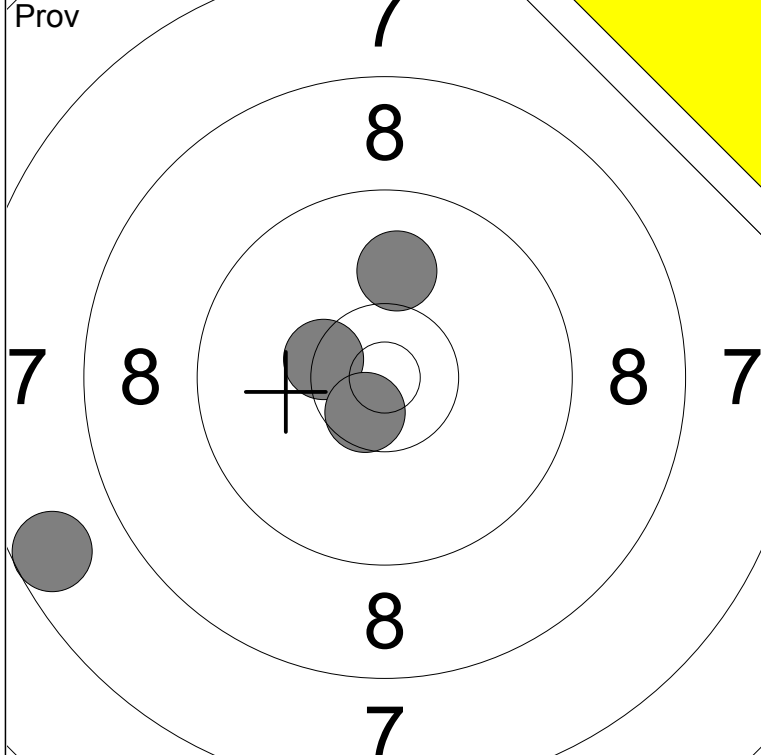

1: 7.6 ↙		
2: 10.4x ↙	Serie	37
3: 10.0 ↑	Total	192
4: 10.6x ↘		

1: 10.2 ↓		
2: 9.5 ←	Serie	48
3: 10.2 ↓	Total	240
4: 10.6x →		
5: 9.9 ↗		

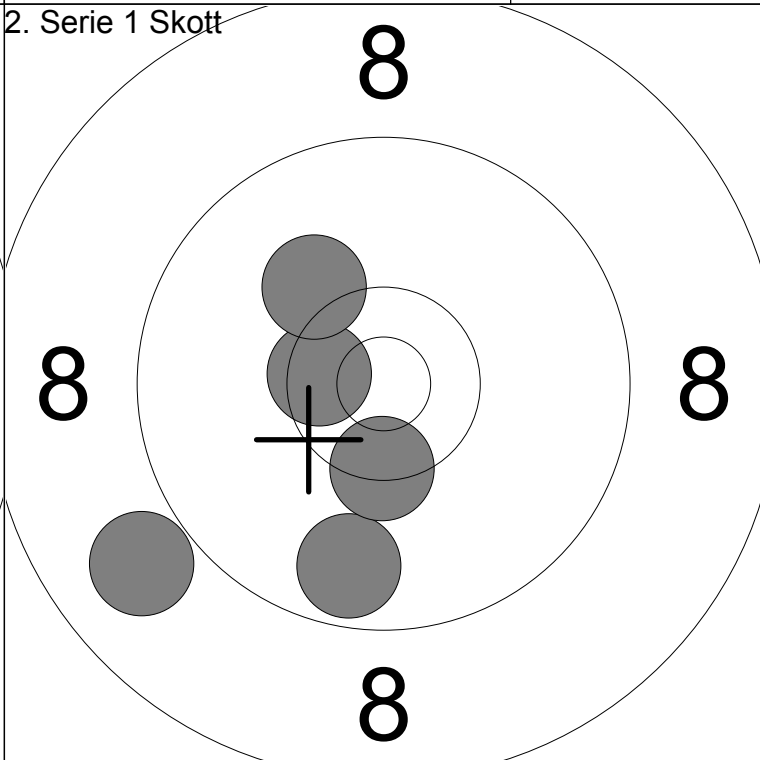
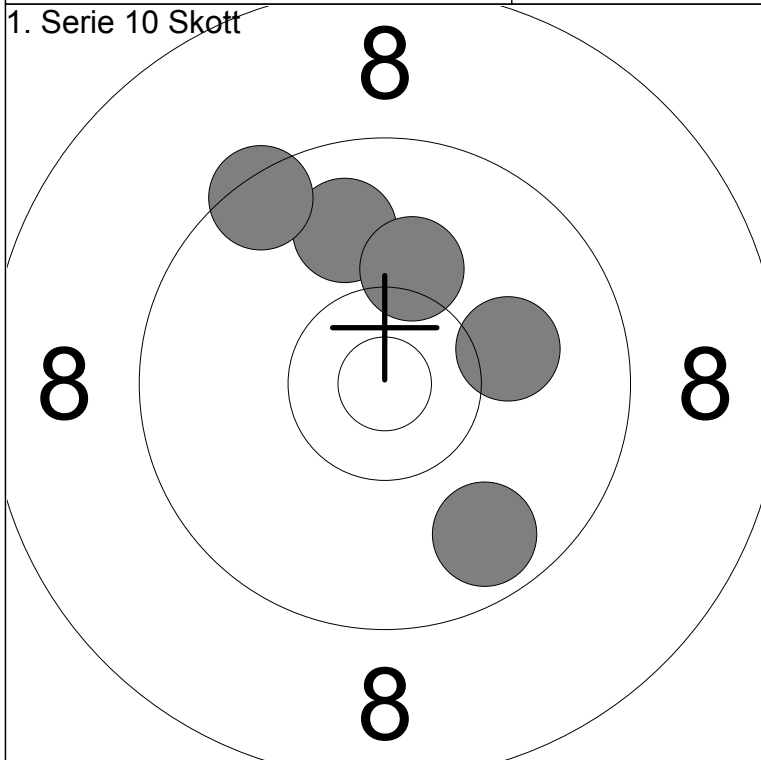

6: 10.1 →		
7: 9.7 ↘	Serie	47
8: 9.9 ↑	Total	287
9: 10.2 ↑		
10: 9.4 ↗		

1: 9.7 ↓		
2: 10.4x ↓	Serie	47
3: 10.5x ←	Total	334
4: 8.9 ↙		
5: 10.2 ↗		

Prov 	1: 9.4 ↓ 2: 10.4x ↓ 3: 9.4 ↓ 4: 9.7 ← 5: 10.5x ↓ 6: 9.7 ← 7: 9.9 ↓ 8: 10.7x ↑ 9: 9.7 ↖ 10: 10.0 ↓ Serie 94 Total 189	Prov 	11: 9.2 → 12: 10.5x ↑ 13: 10.0 ↗ 14: 10.3 ↓ 15: 10.1 → 16: 10.5x ↑ Serie 59 Total 189
----------	---	----------	--

1. Serie 10 Skott 	1: 9.3 → 2: 10.8x ↓ 3: 10.3x ↓ 4: 9.1 → 5: 9.4 ↓ Serie 47 Total 236	1. Serie 10 Skott 	6: 10.1 → 7: 8.8 ↓ 8: 10.4x ↓ 9: 9.9 ↗ 10: 10.3 ↓ Serie 47 Total 283
-----------------------	---	-----------------------	--

2. Serie 1 Skott 	1: 9.9 ↓ 2: 9.7 ↗ 3: 10.4x ↖ 4: 9.9 ↓ 5: 10.8x → Serie 47 Total 330		
----------------------	---	--	--

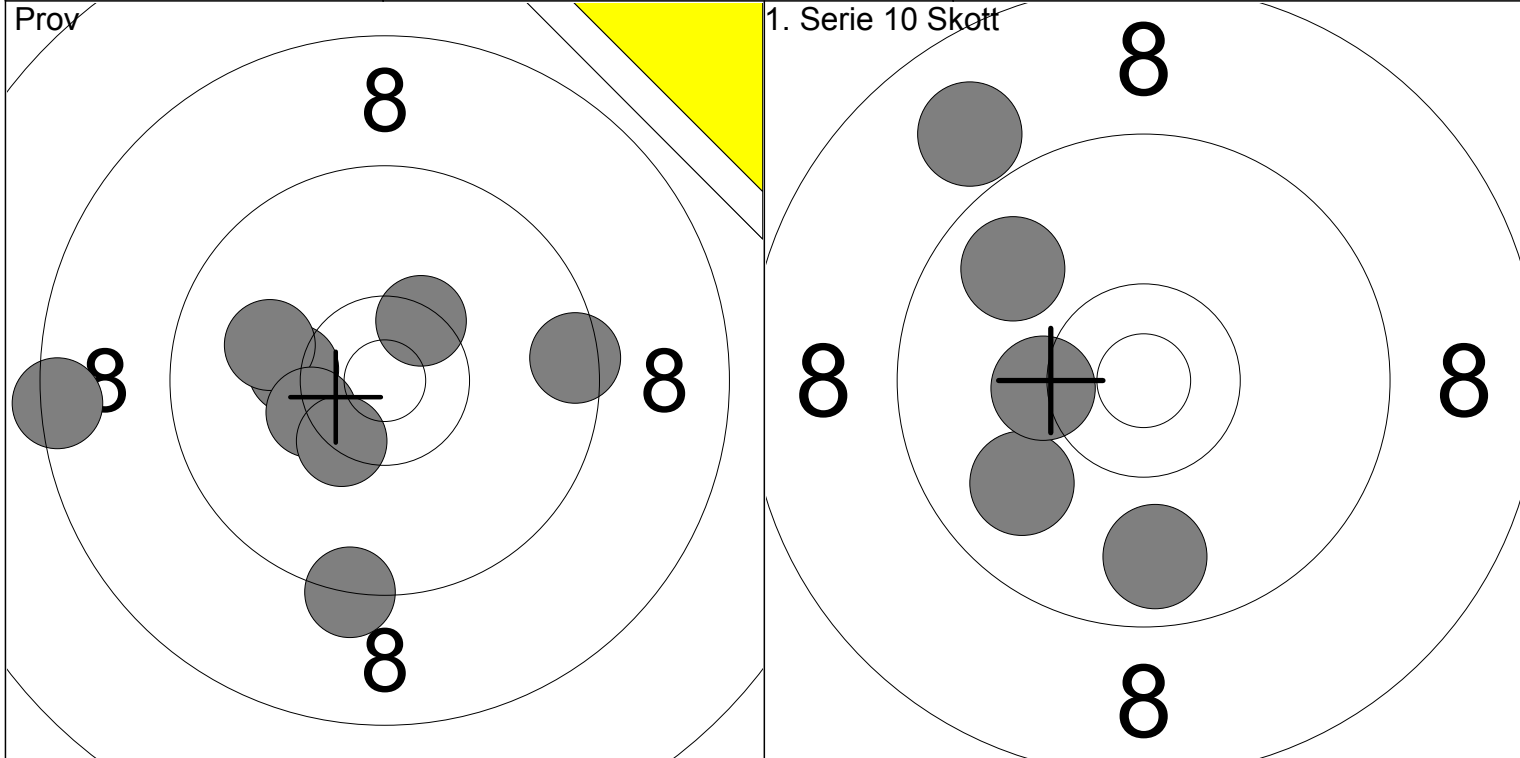

1: 10.2 ←	6: 9.3 ↓	Serie	76	1: 9.9 ↙	Serie	45
2: 10.0 ←	7: 10.4x ↘			2: 9.8 ↓		
3: 10.4x ↗	8: 9.5 →	Total	173	3: 10.3 ←	Total	218
4: 10.3x ←				4: 8.9 ↗		
5: 8.4 ←				5: 9.8 ↗		

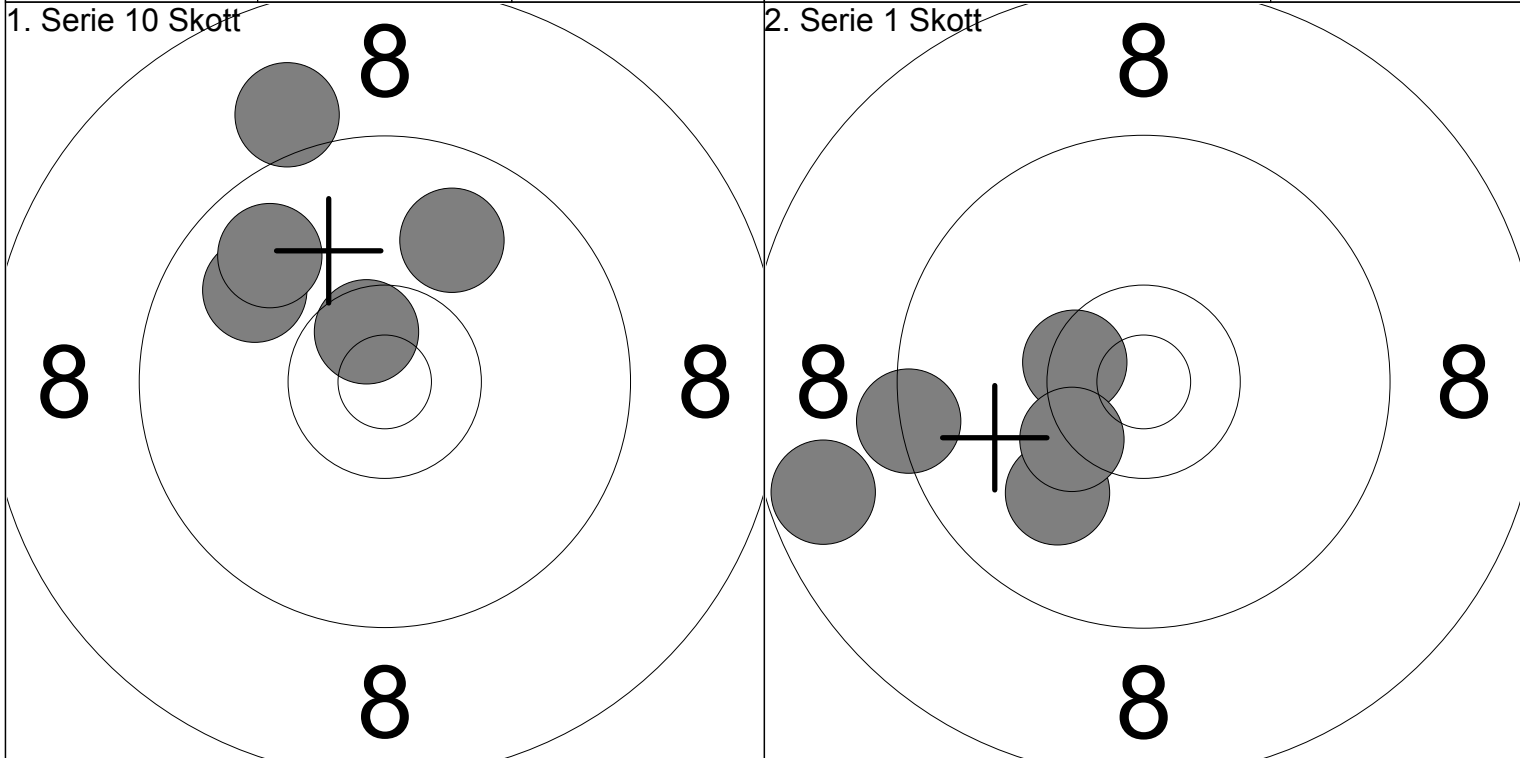

6: 9.0 ↗	Serie	46	1: 10.5x ←	Serie	47
7: 9.9 ↗			2: 8.7 ←		
8: 10.6x ↗	Total	264	3: 10.0 ↘	Total	311
9: 9.9 ↗			4: 10.3x ←		
10: 9.8 ↗			5: 9.4 ←		

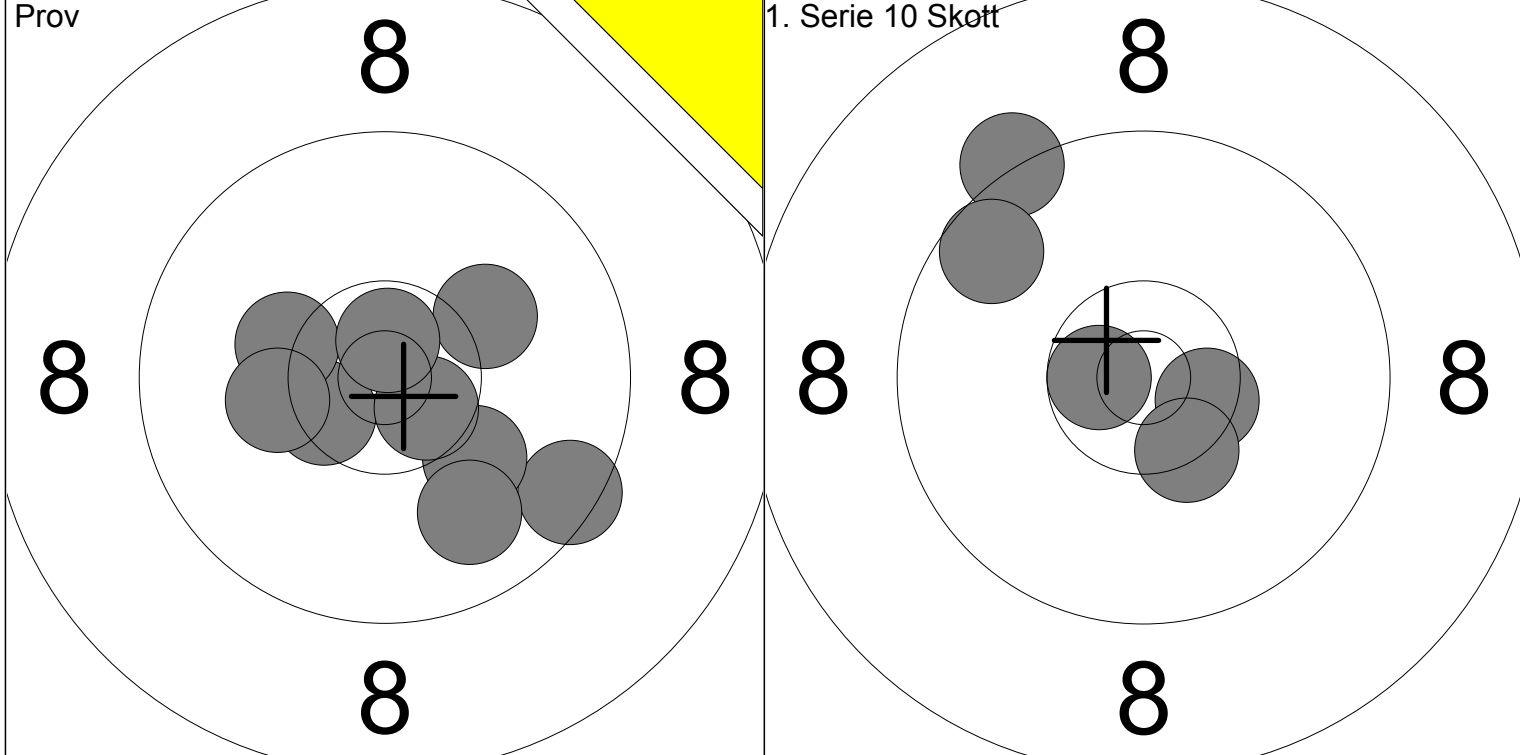

1: 10.5x ↙	6: 10.2 ↗			1: 9.3 ↗		
2: 9.5 ↘	7: 9.9 ↘	Serie	88	2: 10.5x ↘	Serie	
3: 10.1 ↘	8: 10.6x ↘	Total 193		3: 10.7x ←	Total 241	
4: 10.3 ↗	9: 10.7x ↑			4: 9.6 ↗		
5: 10.2 ←				5: 10.4x ↘		

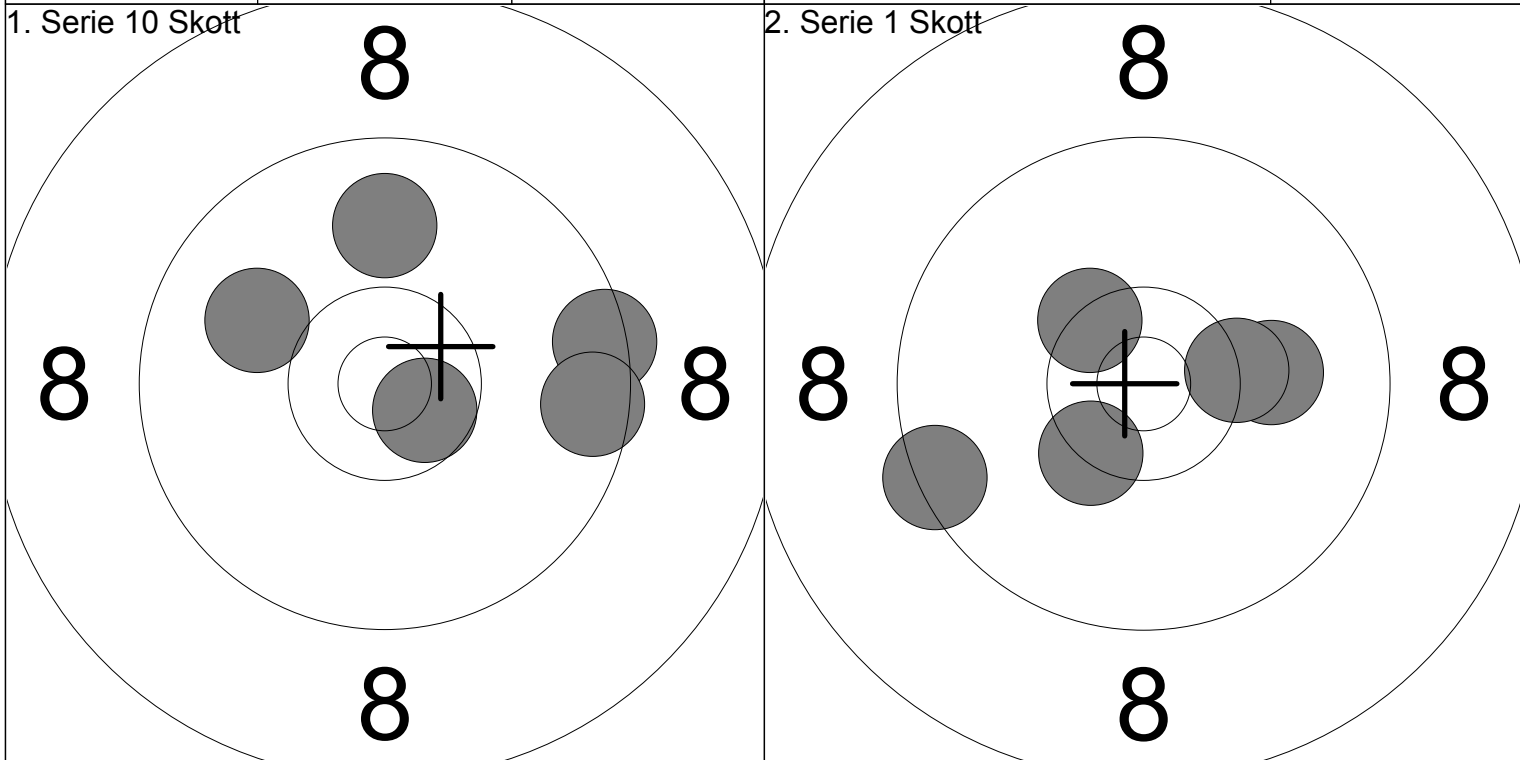

6: 10.6x ↘				1: 10.4x ↗		
7: 9.4 →		Serie	47	2: 10.4x ↘	Serie	
8: 9.5 →		Total 288		3: 9.4 ←	Total 337	
9: 9.9 ↑				4: 10.1 →		
10: 10.0 ↖				5: 10.3x →		

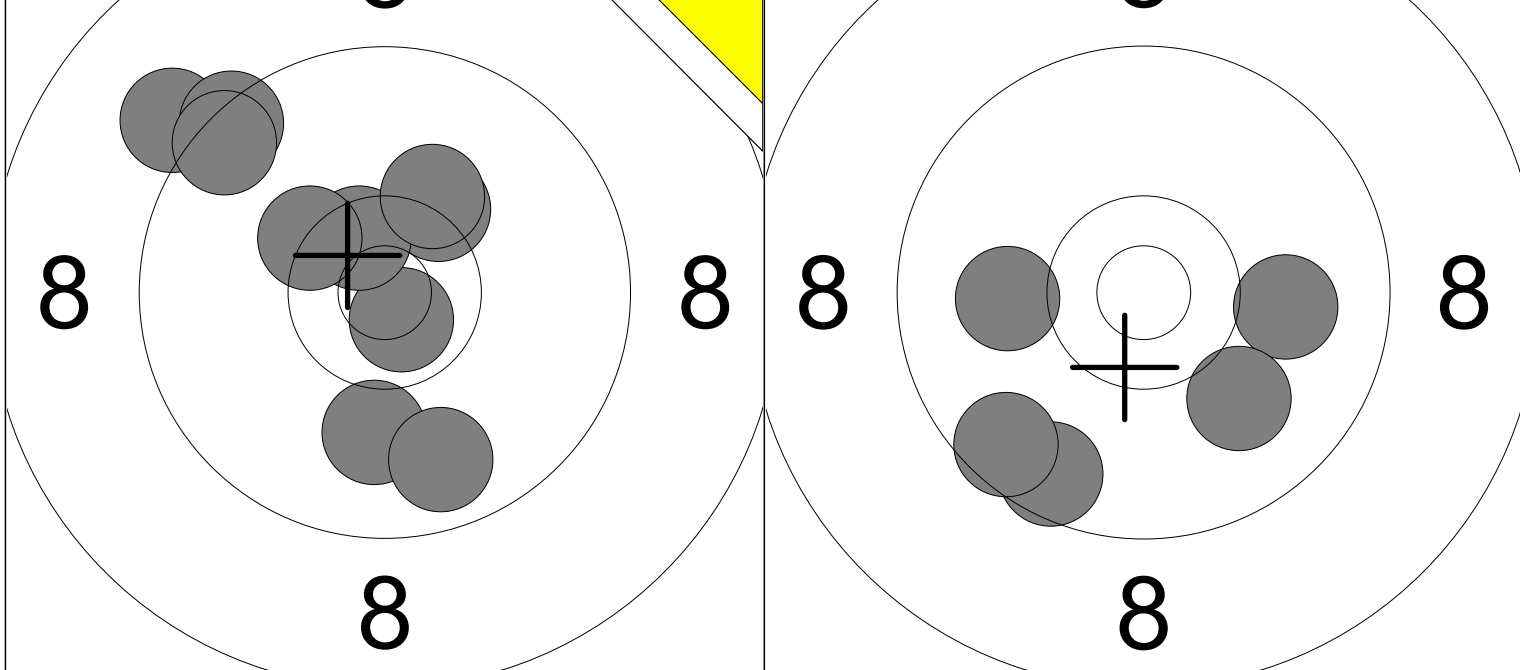

1: 10.0 ↓	6: 10.5x ↗		1: 10.0 →	
2: 10.7x ↓	7: 9.4 ↗	Serie	2: 9.6 ↓	48
3: 9.8 ↓	8: 10.2 ↗	96	3: 10.0 ↓	
4: 9.1 ↗	9: 9.5 ↗	Total	4: 10.0 ←	240
5: 10.3 ↗	10: 10.3x ↗	192	5: 9.6 ↓	

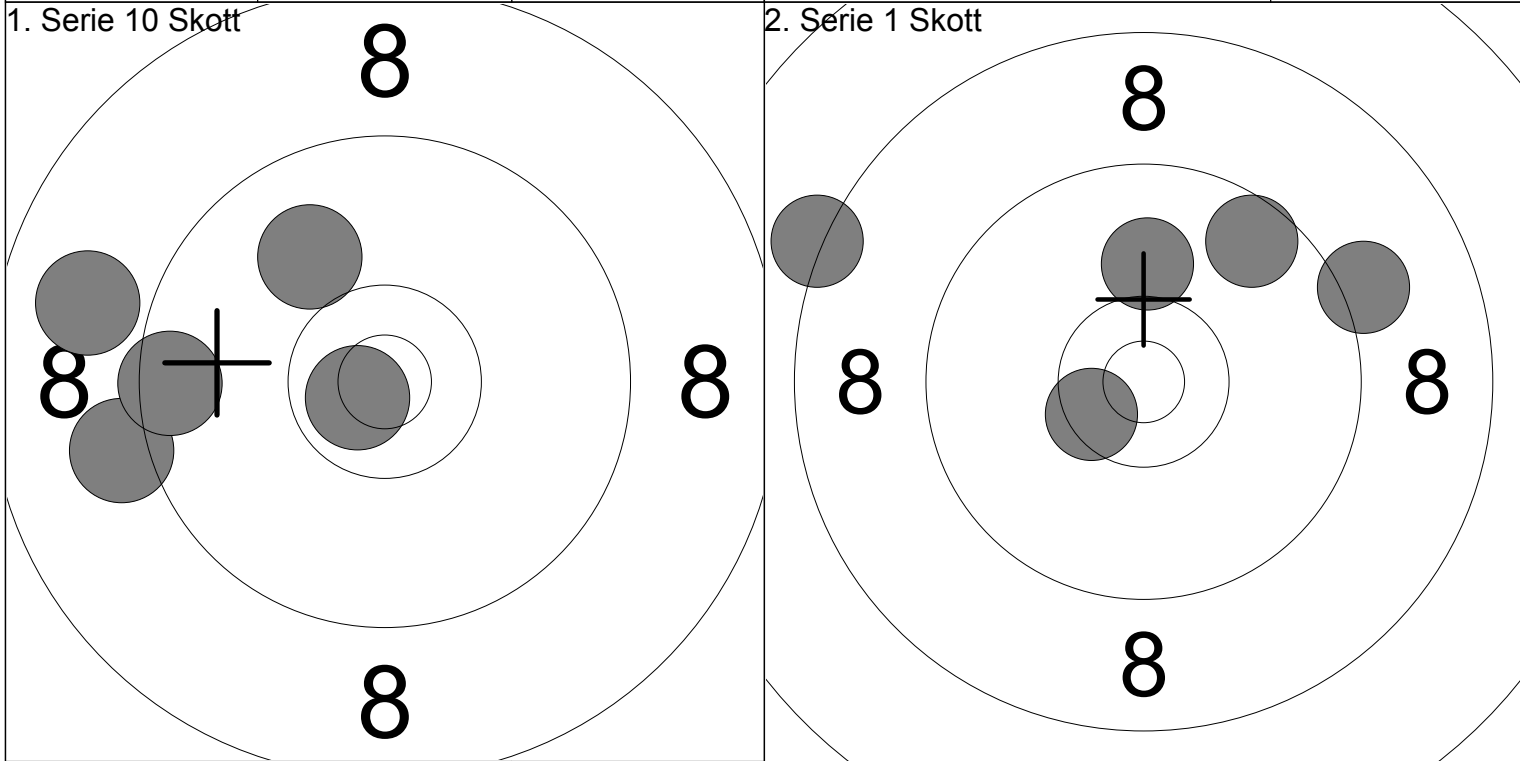

6: 10.7x ←	1: 9.1 ↗		2: 8.3 ←	
7: 9.1 ←	2: 8.3 ←	Serie	3: 10.1 ↑	46
8: 8.9 ←	3: 10.1 ↑	46	4: 10.5x ←	
9: 10.0 ↗	4: 10.5x ←	Total	5: 9.6 ↗	332
10: 9.5 ←	5: 9.6 ↗	286		

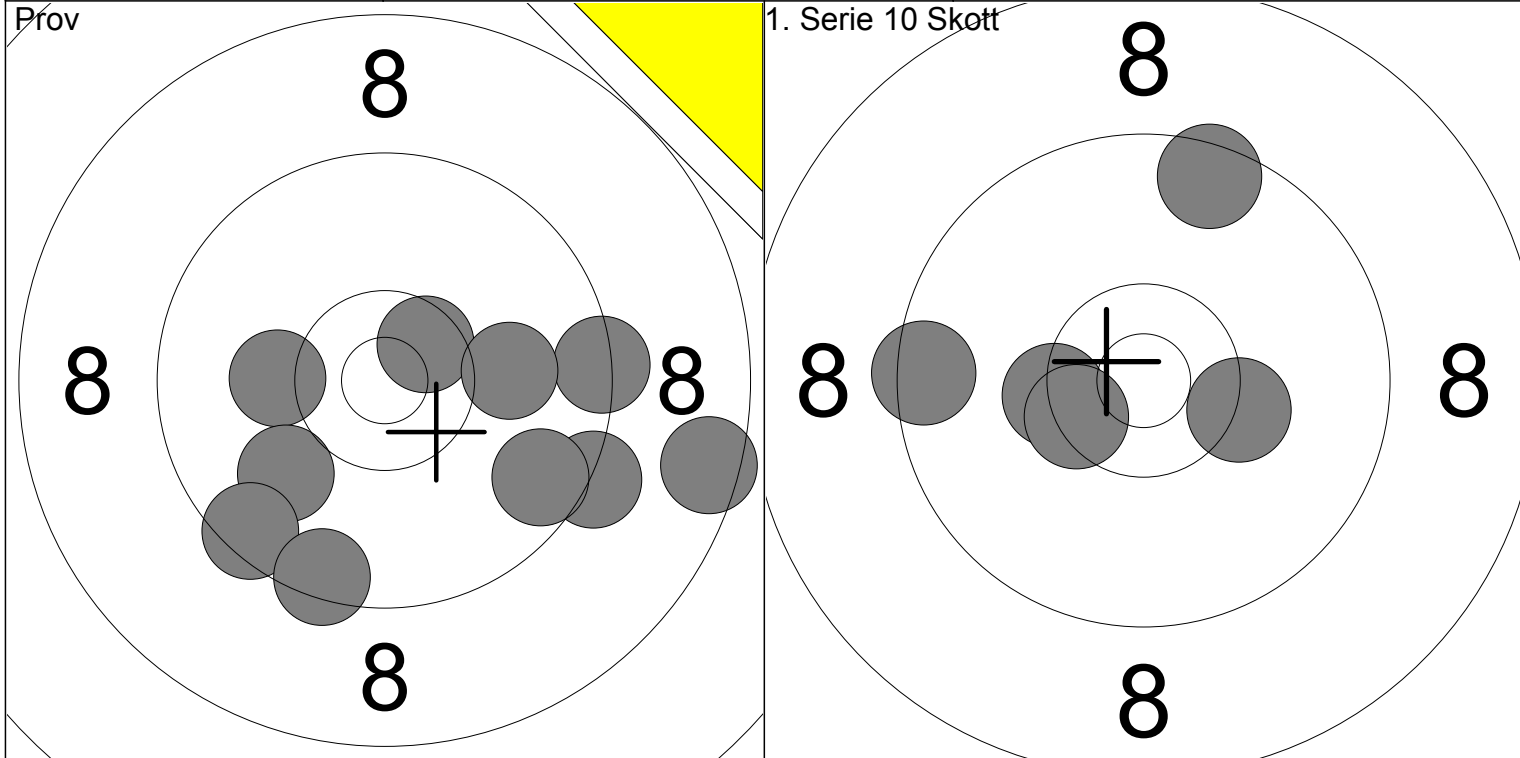

1: 9.4 →	6: 10.0 ↙	Serie	93	1: 10.3x ←	Serie	48	
2: 9.3 →	7: 9.6 →			2: 10.4x ←			
3: 10.6x ↗	8: 10.0 →	Total	191	3: 9.5 ↗	Total	239	
4: 8.5 →	9: 9.5 ↙			4: 9.5 ←			
5: 10.2 ←	10: 9.5 ↘					5: 10.3 →	

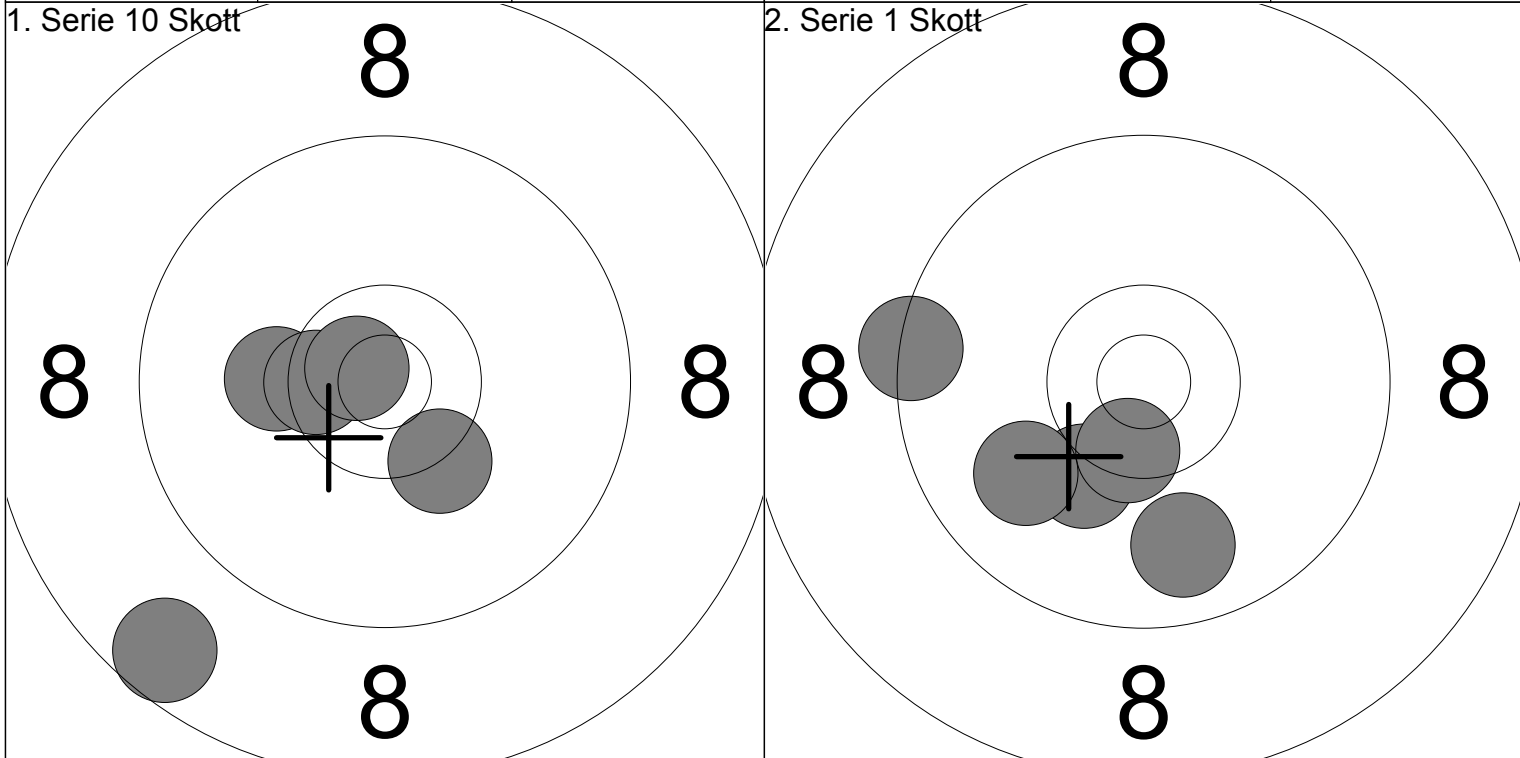

6: 10.3x ↘	Serie	48	1: 9.8 ↓	Serie	47	
7: 10.2 ←			2: 10.2 ↙			
8: 10.5x ←	Total	287	3: 10.5x ↓	Total	334	
9: 8.6 ↙			4: 9.9 ←			
10: 10.7x ↖					5: 9.4 ←	



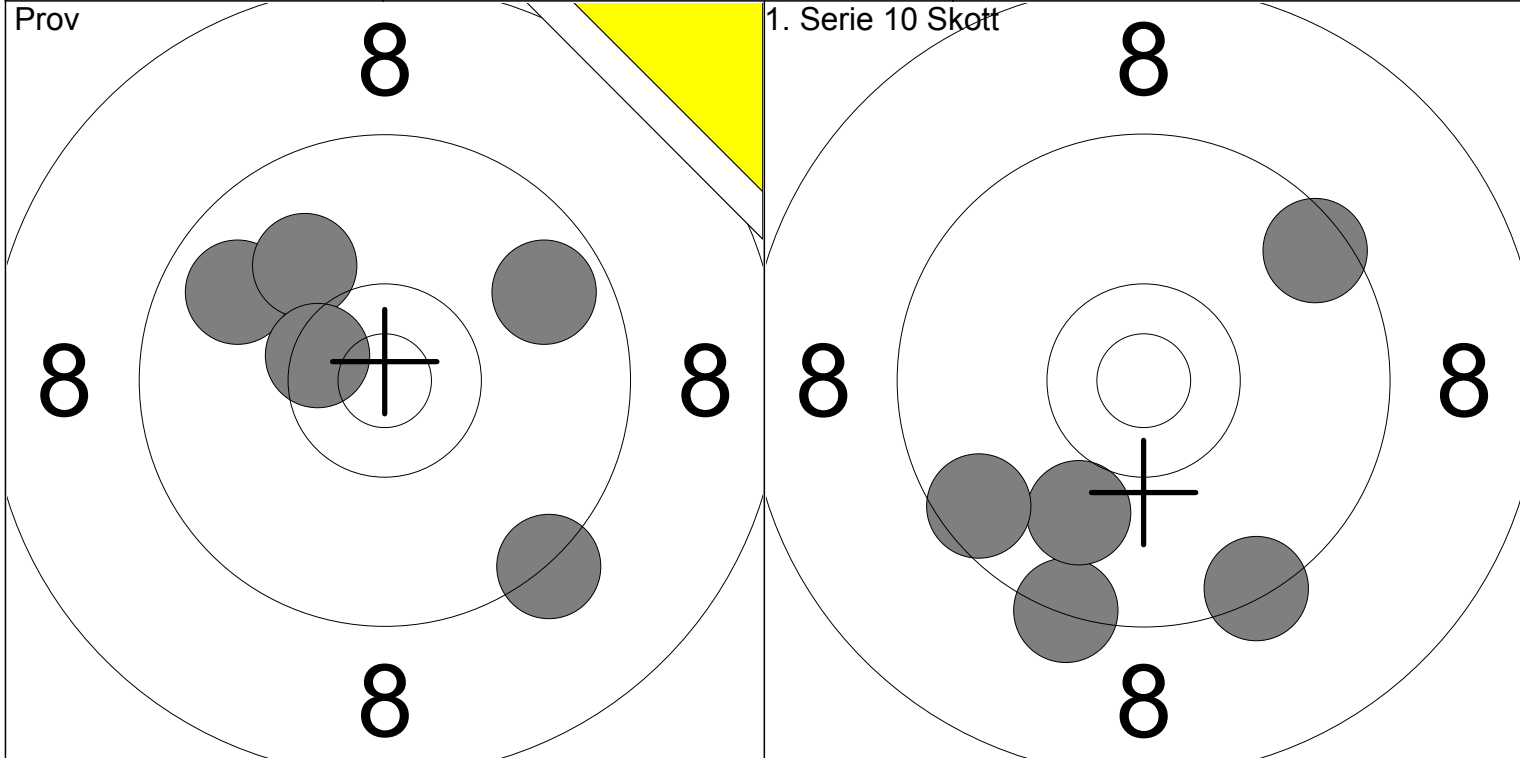

1: 9.7	↗
2: 9.3	↘
3: 9.8	↗
4: 10.0	↗
5: 10.5x	↖

Serie	47
Total	190

1: 9.5	↗
2: 9.3	↘
3: 10.0	↘
4: 9.6	↖
5: 9.4	↘

Serie	46
Total	236

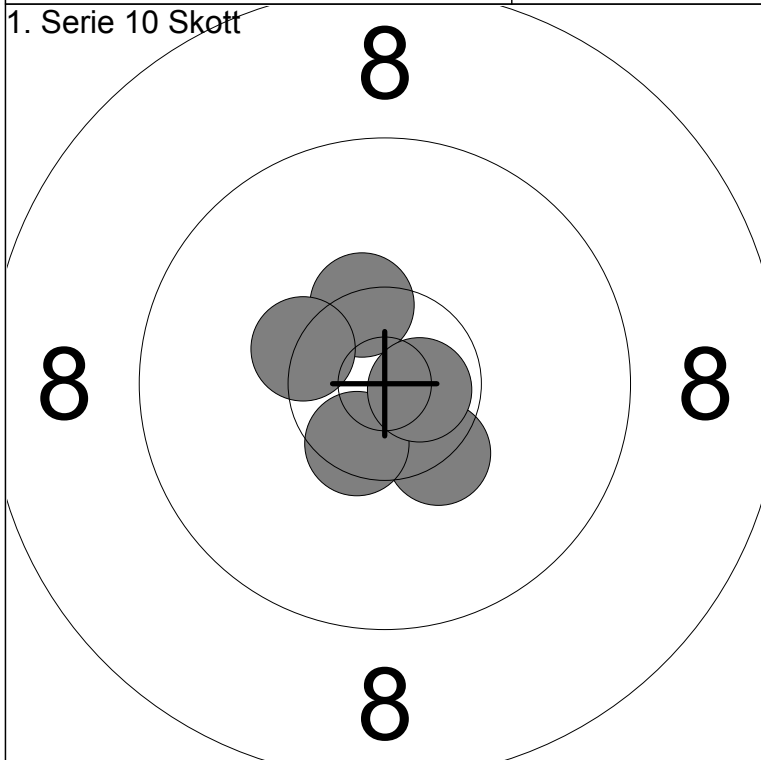

6: 10.4x	↗
7: 10.4x	↘
8: 10.5x	↘
9: 10.7x	↘
10: 10.4x	↖

Serie	50
Total	286

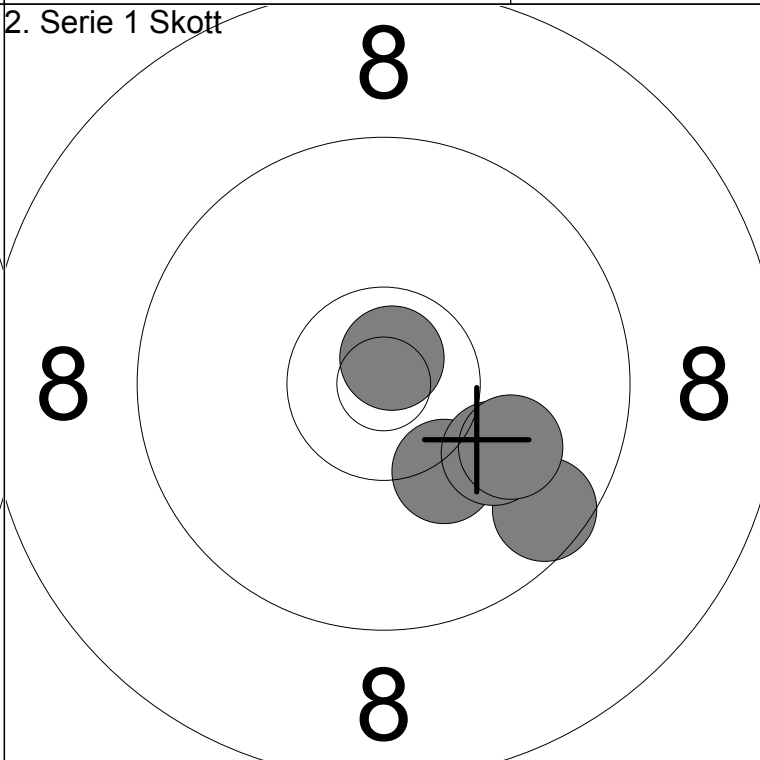

1: 9.6	↘
2: 10.2	↘
3: 10.8x	↗
4: 10.1	↘
5: 10.0	↘

Serie	49
Total	335

<p>Prov</p>	<p>1: 10.3 ↑                  2: 9.7 ←                  3: 10.5x →                  4: 10.0 ←                  5: 10.6x ←                  6: 10.1 ↓                  7: 10.6x ↓                  8: 10.1 ←                  9: 10.1 ←                  10: 10.6x ↑</p>	<p>Prov</p>
Serie 89		Serie 20
Total 188		Total 188

<p>1. Serie 10 Skott</p>	<p>1: 10.1 ←                  2: 8.9 ←                  3: 9.5 ↙                  4: 10.3 →                  5: 10.6x ←</p>	<p>1. Serie 10 Skott</p>
Serie 47		Serie 48
Total 235		Total 283

<p>2. Serie 1 Skott</p>	<p>1: 9.0 ↙                  2: 10.5x ↓                  3: 10.2 ←                  4: 10.3 ↓                  5: 10.3x ←</p>	
Serie 49		
Total 332		

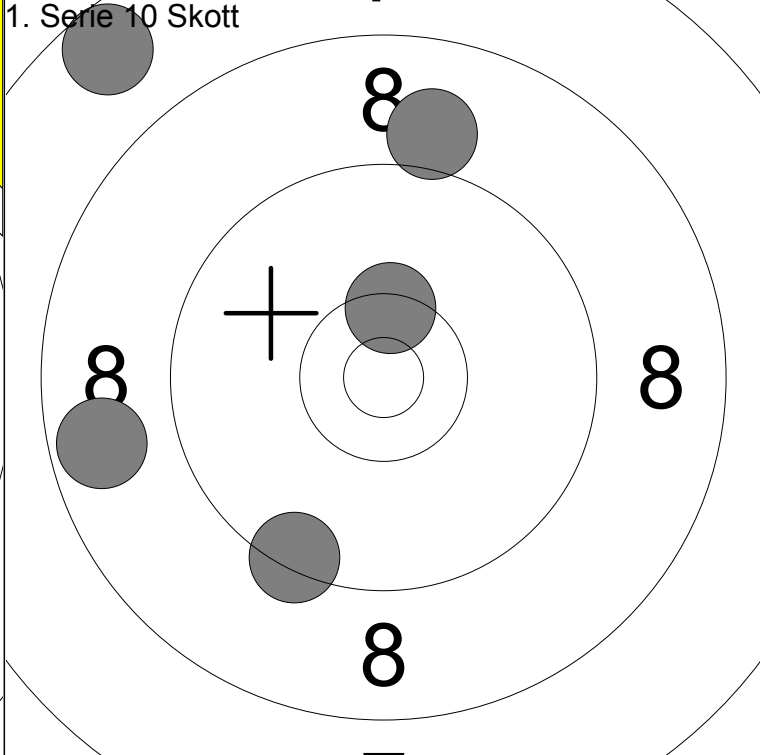
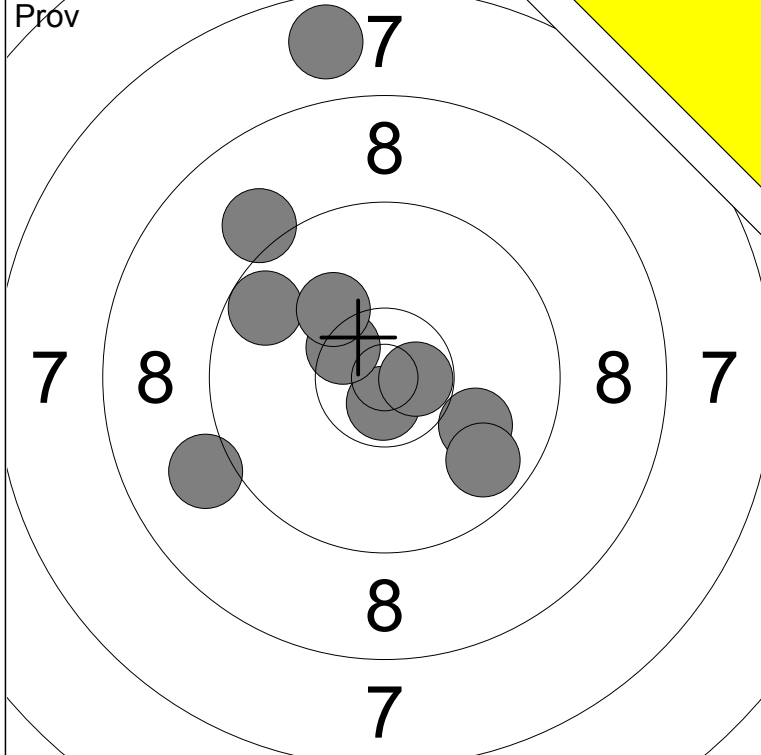

1: 10.0 ↘	6: 10.7x →	Serie	93
2: 7.7 ↑	7: 9.7 ↗		
3: 9.1 ↙	8: 9.1 ↗	Total	188
4: 9.7 ↘	9: 10.5x ↗		
5: 10.7x ↓	10: 10.1 ↗		

1: 10.4x ↑	Serie	43
2: 8.7 ←		
3: 7.6 ↗	Total	231
4: 9.0 ↑		
5: 9.4 ↓		

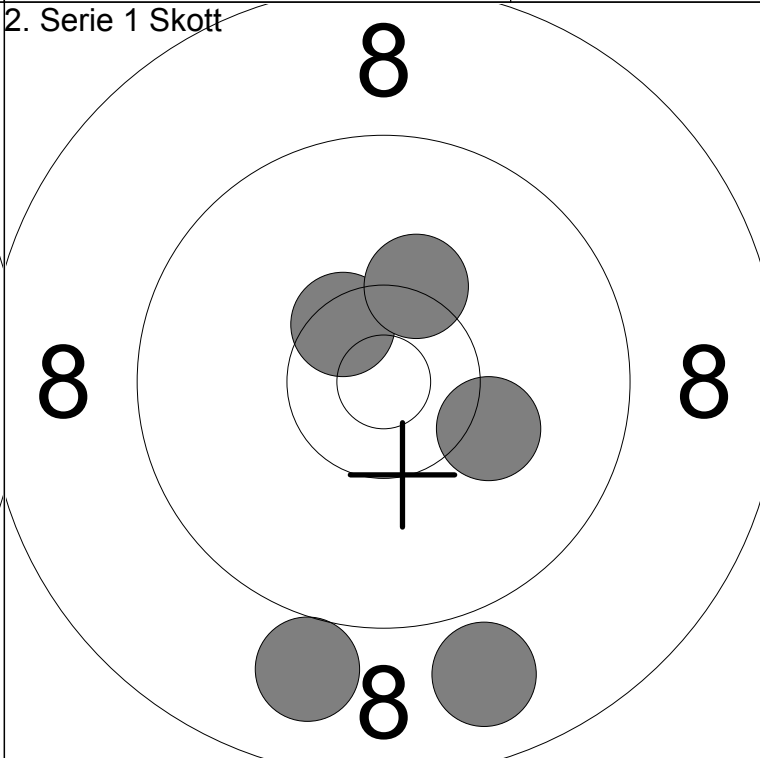
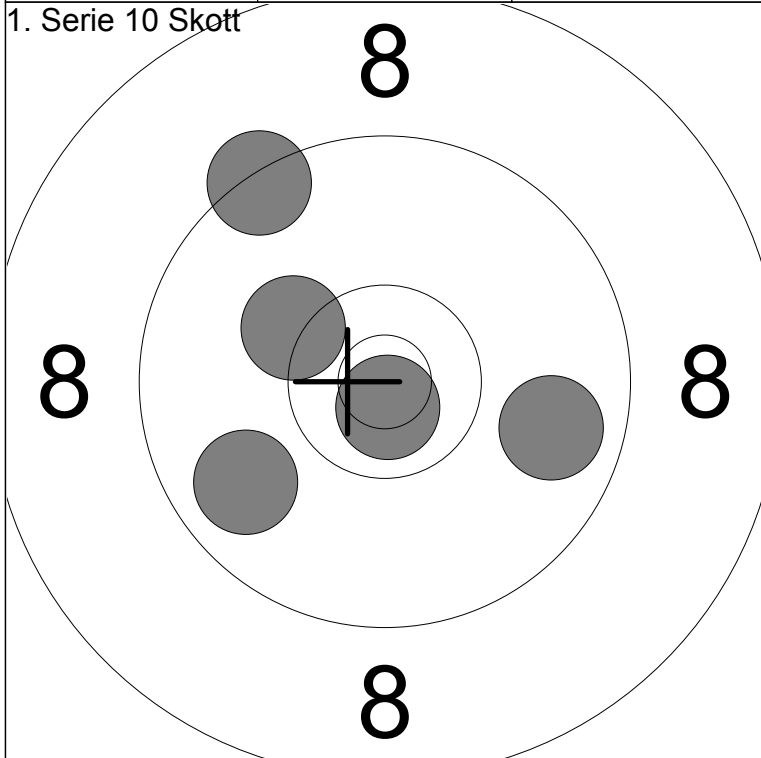

6: 9.4 ↗	Serie	47
7: 9.8 ↙		
8: 9.8 ↘	Total	278
9: 10.8x ↓		
10: 10.2 ↗		

1: 9.0 ↓	Serie	47
2: 10.5x ↗		
3: 8.9 ↓	Total	325
4: 10.2 ↘		
5: 10.3 ↑		

<p>Pröv</p>	<p>1: 8.3 →                  2: 8.3 ↘                  3: 10.0 →                  4: 10.5x ↙                  5: 10.8x ↑                  6: 9.5 →                  7: 10.4x ↘                  8: 9.7 ↙                  9: 9.7 ↓                  10: 10.9x ↘</p> <p>Serie 93 Total 186</p>	<p>Pröv</p>	<p>11: 10.7x ↘</p> <p>Serie 10 Total 186</p>
-------------	---	-------------	--

<p>1. Serie 10 Skott</p>	<p>1: 10.3x ↘                  2: 10.5x ↙                  3: 10.4x ↗                  4: 10.6x →                  5: 9.7 ↖</p> <p>Serie 49 Total 235</p>	<p>1. Serie 10 Skott</p>	<p>6: 9.7 ↑                  7: 10.4x ↙                  8: 10.9x ↑                  9: 8.5 ←                  10: 10.5x ↗</p> <p>Serie 47 Total 282</p>
--------------------------	---	--------------------------	--

<p>2. Serie 1 Skott</p>	<p>1: 10.6x ↙                  2: 10.3x ↘                  3: 10.6x ↑                  4: 9.6 ↓                  5: 10.4x →</p> <p>Serie 49 Total 331</p>		
-------------------------	---	--	--

<p>Prov</p>	<p>1: 9.8 ↗                  2: 9.9 →                  3: 9.0 ←                  4: 9.8 ↑                  5: 8.8 ←                  6: 10.1 ↗                  7: 10.0 ↗                  8: 8.7 ←                  9: 9.1 ←                  10: 9.6 ↗</p>	<p>Prov</p>
Serie 90		Serie 18
Total 185		Total 185

<p>1. Serie 10 Skott</p>	<p>1: 9.0 ←                  2: 10.0 ←                  3: 10.2 ↗                  4: 8.3 ↗                  5: 9.2 ↗</p>	<p>1. Serie 10 Skott</p>
Serie 46		Serie 45
Total 231		Total 276

<p>2. Serie 1 Skott</p>	<p>1: 9.8 ↑                  2: 10.7x ←                  3: 10.6x →                  4: 9.3 ↘                  5: 10.7x ↗</p>	
Serie 48		
Total 324		

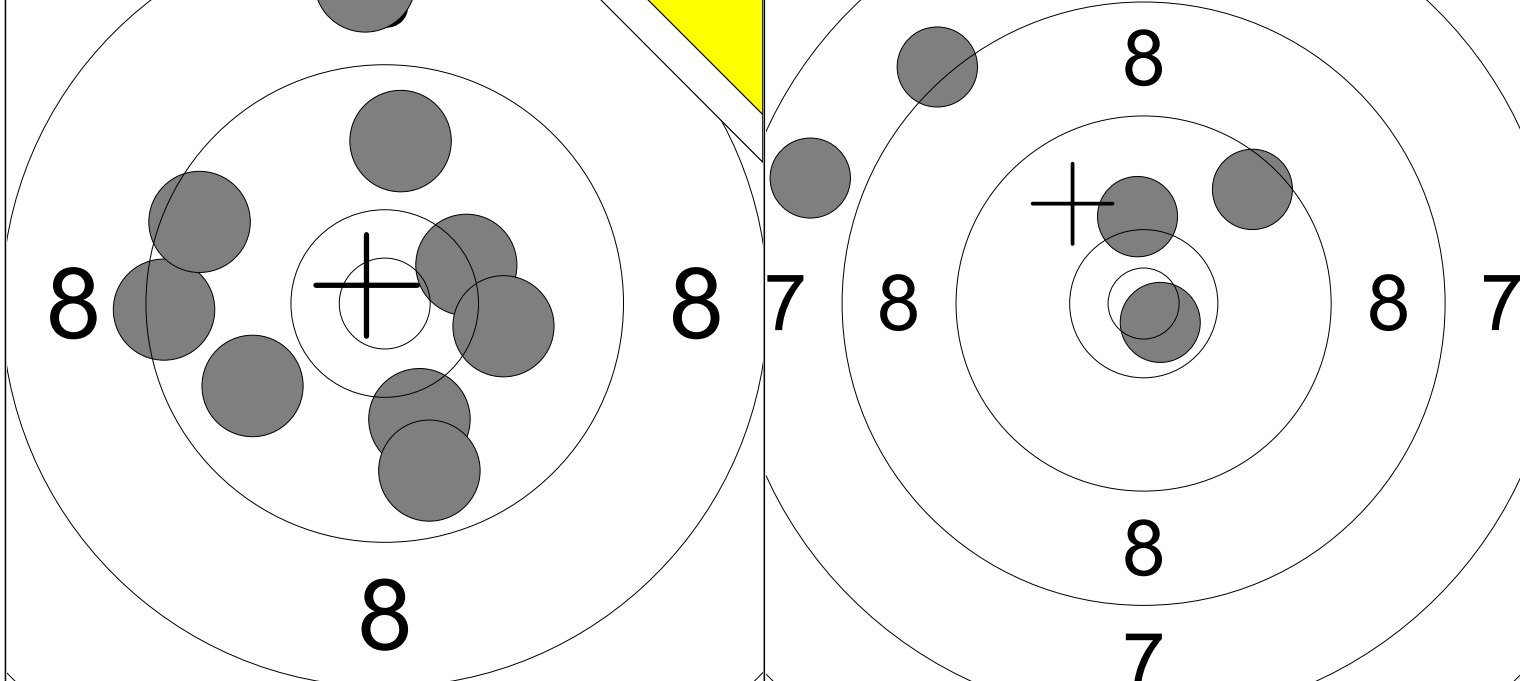

1: 9.9 ↙	6: 10.1 →			1: 8.2 ↗			
2: 10.3x ↗	7: 9.8 ↑	Serie	83	2: 9.6 ↗	Serie	44	Total
3: 8.7 ↑	9: 9.8 ↓			3: 10.2 ↑			
4: 10.1 ↓	10: 9.5 ↖	Total		165	Total		209
5: 9.4 ←				4: 7.8 ↖			
				5: 10.7x ↘			

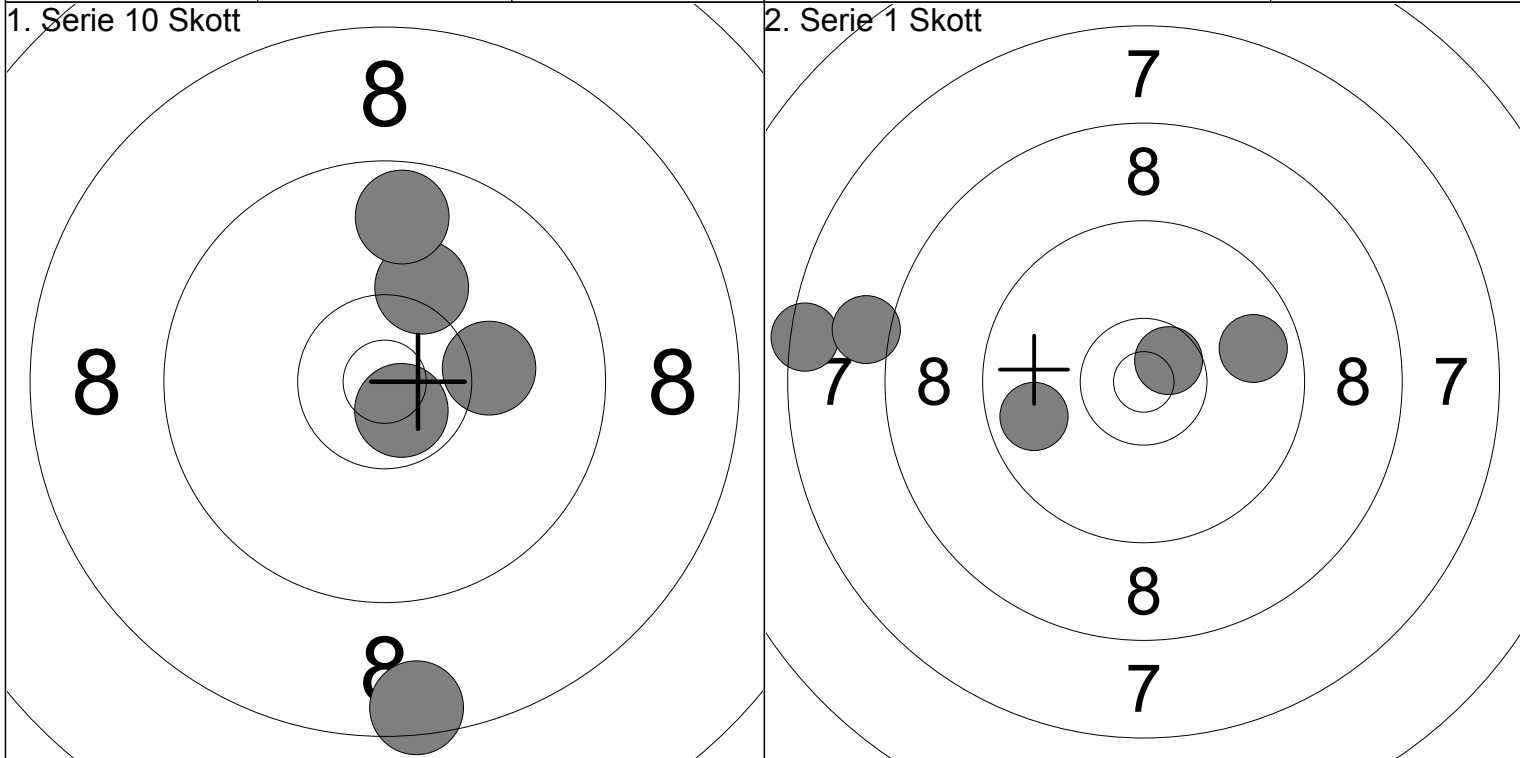

6: 10.2 ↑				1: 7.4 ←			
7: 10.7x ↓		Serie	47	2: 8.1 ←	Serie	43	Total
8: 10.2 →				3: 10.6x ↗			
9: 8.5 ↓		Total		256	Total		299
10: 9.7 ↑				4: 9.8 ←			
				5: 9.8 →			

<p>Prov</p>	<p>1: 7.3 ↘                  2: 9.3 ↘                  3: 9.2 →                  4: 10.3x ↗                  5: 10.0 ↗                  6: 8.8 ↗                  7: 10.0 →                  8: 10.4x →                  9: 9.9 ↑                  10: 9.5 ↖</p> <p>Serie 91 Total 183</p>	<p>Prov</p>	<p>11: 8.0 ↑                  12: 10.1 ↖                  13: 9.5 ↑                  14: 10.3x ↖                  15: 9.4 ↑                  16: 10.5x ↖</p> <p>Serie 56 Total 183</p>
-------------	--	-------------	--

<p>1. Serie 10 Skott 7</p>	<p>1: 9.1 ↘                  2: 10.0 →                  3: 9.7 ↘                  4: 10.3x ↑                  5: 9.9 →</p> <p>Serie 47 Total 230</p>	<p>1. Serie 10 Skott 7</p>	<p>6: 10.8x ↑                  7: 10.0 ↘                  8: 9.1 ↖                  9: 9.9 ↗                  10: 9.8 ↗</p> <p>Serie 47 Total 277</p>
----------------------------	--	----------------------------	---

<p>2. Serie 1 Skott 7</p>	<p>1: 10.3 ↗                  2: 8.8 ↑                  3: 10.3x ↓                  4: 9.6 ↗                  5: 9.5 ←</p> <p>Serie 46 Total 323</p>		
---------------------------	--	--	--

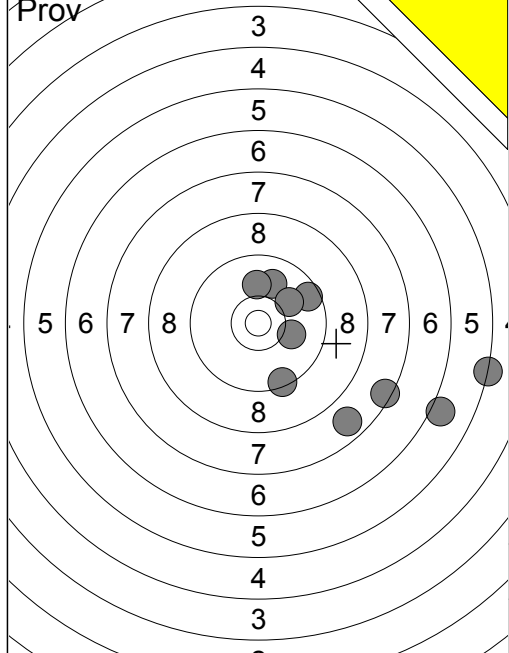

1:	9.6	→
2:	7.8	↘
3:	9.9	↑
4:	5.3	→
5:	7.5	↘
6:	9.4	↘
7:	10.1	→
8:	6.1	→
9:	10.0	→
10:	10.0	↑
Serie		82
Total		164

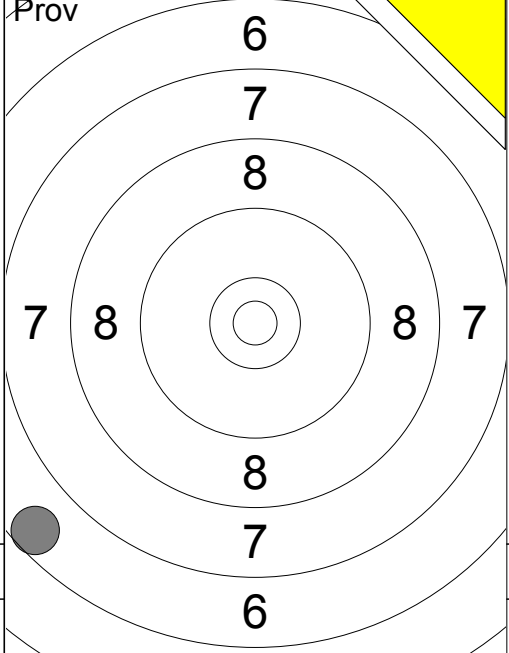

11:	6.6	↙
6:	8.7	←
7:	9.3	↗
8:	8.4	↘
9:	10.0	↗
10:	10.1	→
Serie		6
Total		164

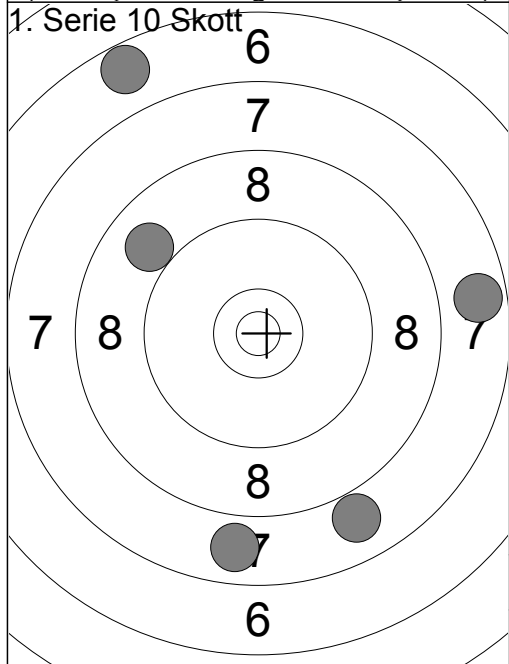

1:	7.8	↘
2:	8.9	↗
3:	7.9	↘
4:	6.7	↗
5:	7.7	→
Serie		35
Total		199

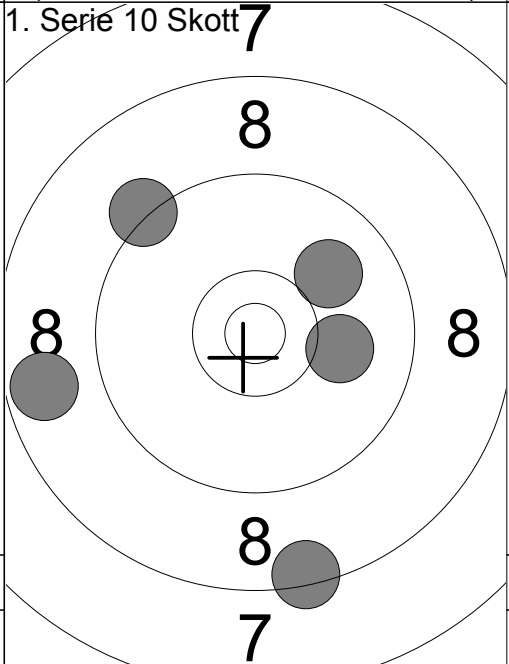

6:	8.7	←
7:	9.3	↗
8:	8.4	↘
9:	10.0	↗
10:	10.1	→
Serie		45
Total		244

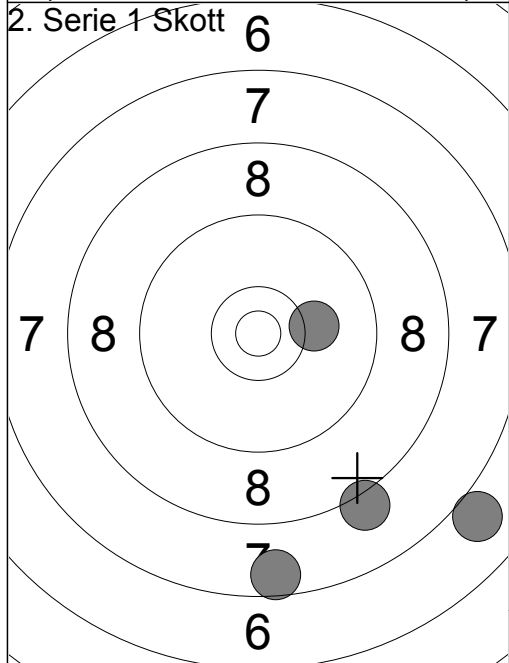

1:	7.6	↘
2:	10.2	→
3:	0.0	
4:	7.0	↘
5:	8.1	↘
Serie		32
Total		276



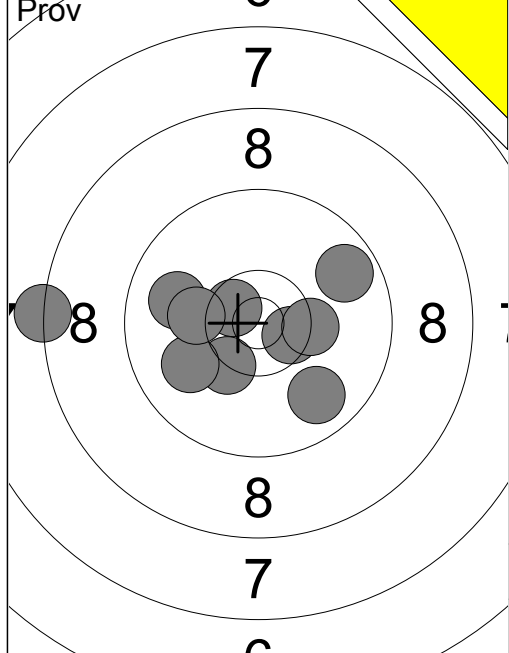

- 1: 9.8 ↘
- 2: 10.5x →
- 3: 9.9 ←
- 4: 10.6x ↙
- 5: 8.3 ←
- 6: 10.3x ↘
- 7: 9.7 →
- 8: 10.3x →
- 9: 10.0 ←
- 10: 10.2 ←

Serie 95  
Total 190

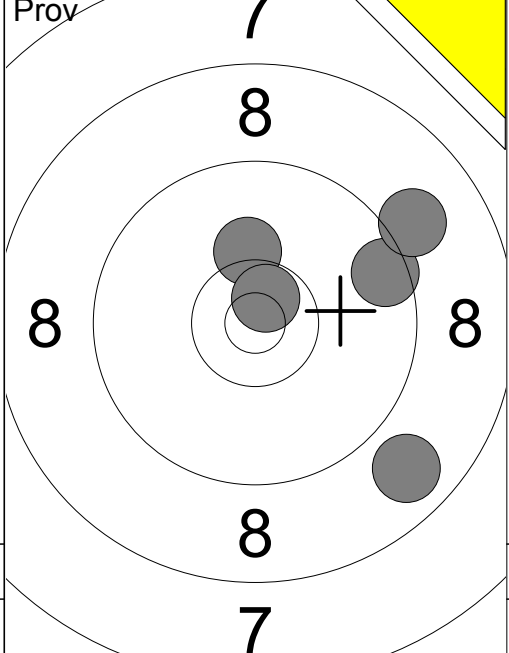

- 11: 10.2 ↑
- 12: 9.5 →
- 13: 9.0 ↗
- 14: 8.8 ↘
- 15: 10.7x ↑

Serie 46  
Total 190

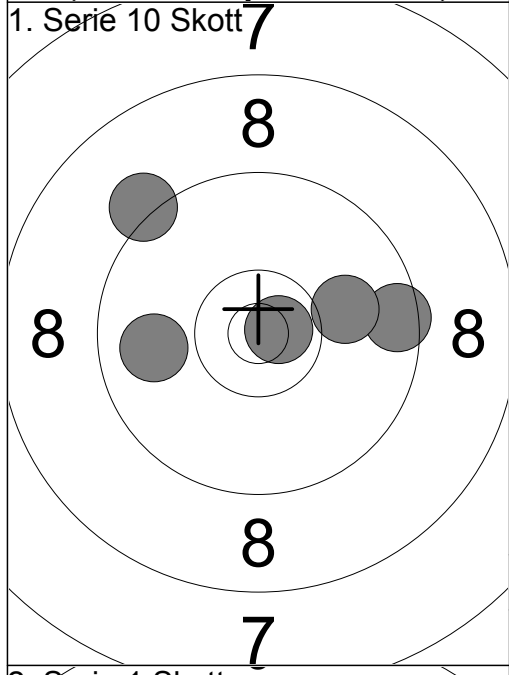

- 1: 9.2 ↙
- 2: 10.7x →
- 3: 9.9 ←
- 4: 9.5 →
- 5: 10.0 →

Serie 47  
Total 237

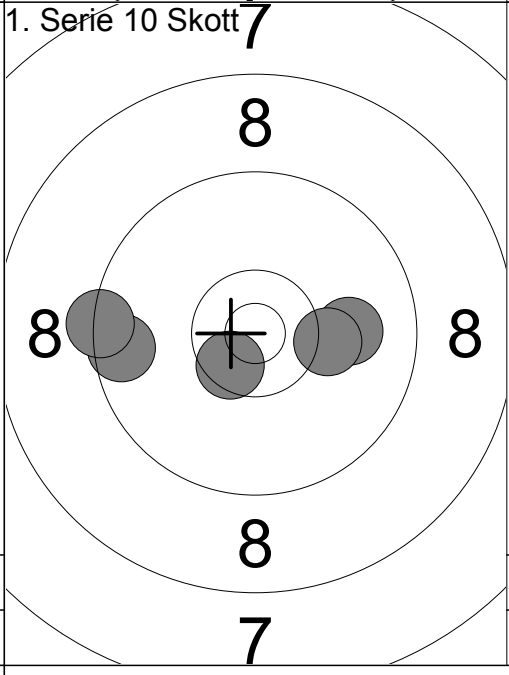

- 6: 10.0 →
- 7: 9.6 ←
- 8: 10.2 →
- 9: 9.4 ←
- 10: 10.5x ↘

Serie 48  
Total 285

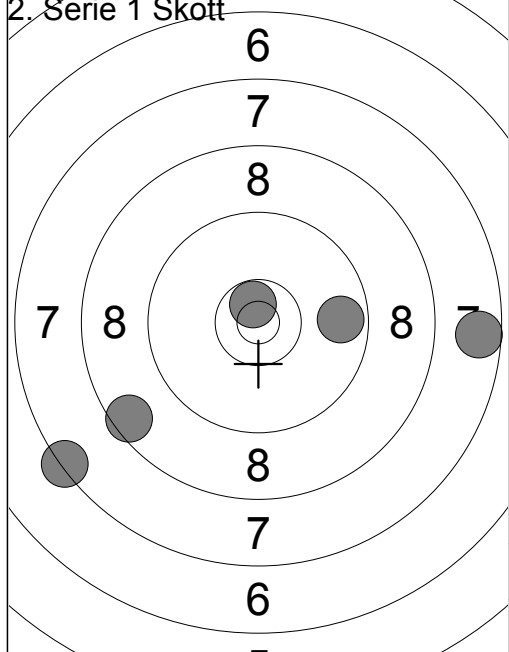

- 1: 7.6 →
- 2: 8.5 ↘
- 3: 9.7 →
- 4: 10.7x ↑
- 5: 7.4 ↘

Serie 41  
Total 326

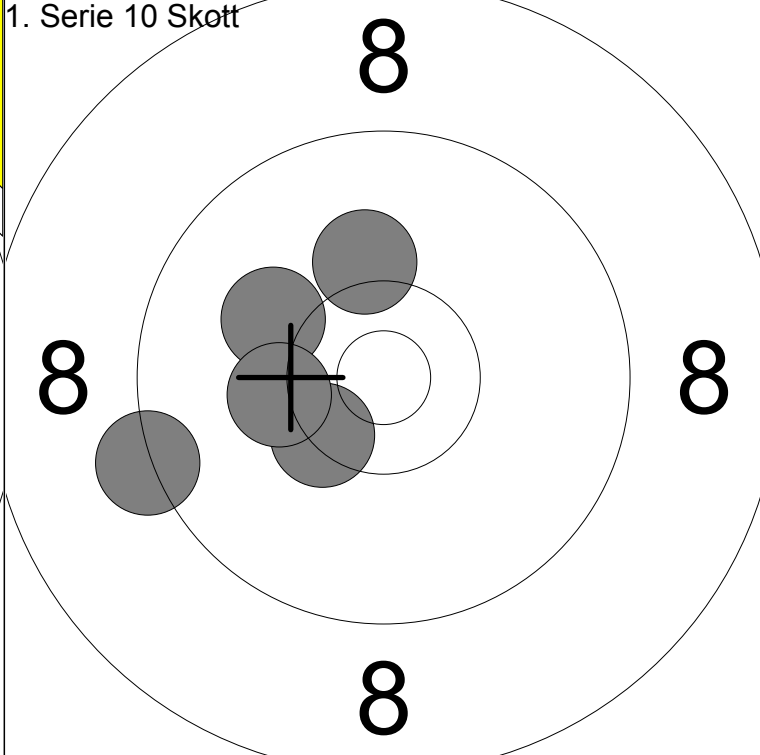
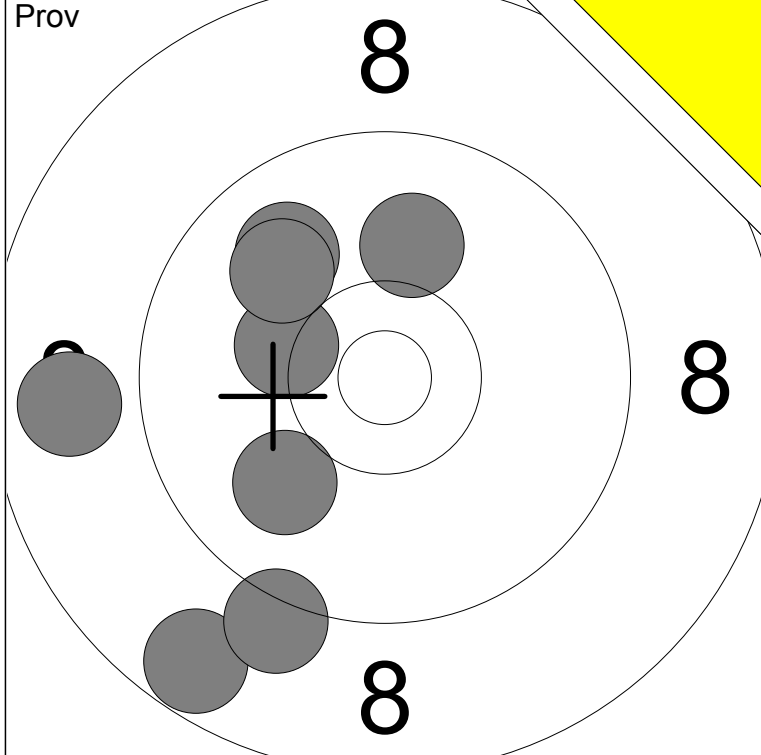

1: 8.7 ↘	7: 10.0 ↑	Serie	74
2: 10.0 ↘	8: 8.8 ←		
4: 10.3 ←	9: 10.0 ↗	Total	182
5: 9.9 ↗			
6: 9.2 ↘			

1: 10.2 ↑	Serie	49
2: 10.4x ↘		
3: 10.1 ↘	Total	231
4: 10.2 ←		
5: 9.3 ←		

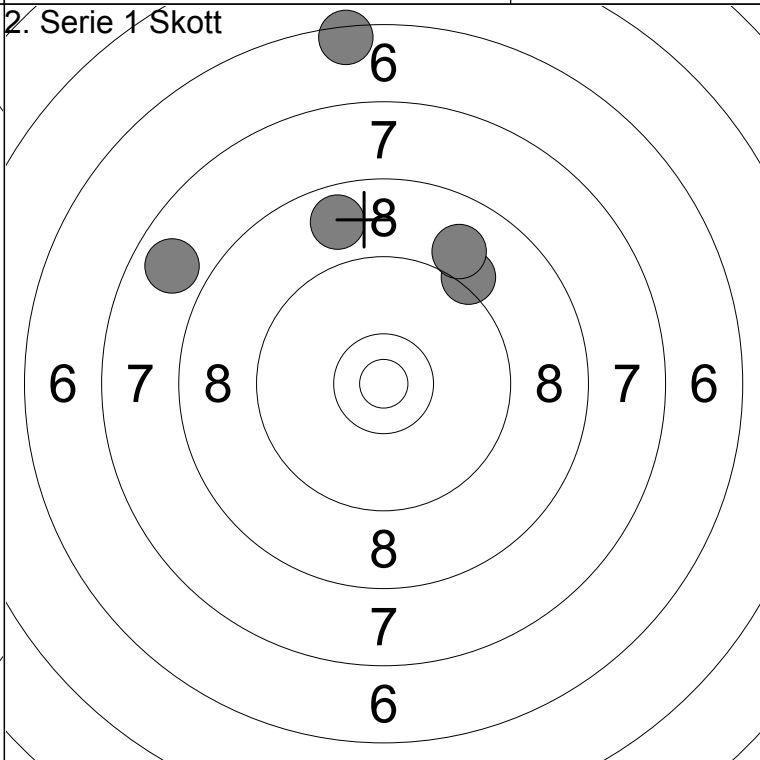
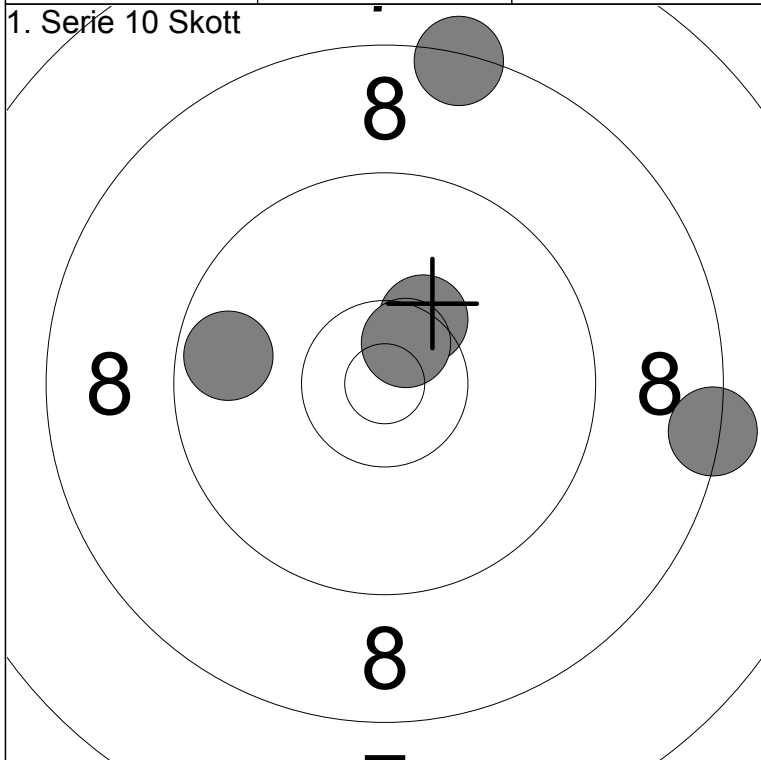

6: 10.4x ↗	Serie	45
7: 8.4 ↑		
8: 8.4 →	Total	276
9: 10.6x ↗		
10: 9.7 ←		

1: 6.4 ↑	Serie	39
2: 9.2 ↗		
3: 9.0 ↗	Total	315
4: 8.8 ↑		
5: 7.8 ←		

Prov 	1: 9.0 → 2: 10.6x ↑ 3: 8.9 ↗ 4: 8.8 ↓ 5: 9.7 ↗ 6: 10.1 ← 7: 9.6 ← 8: 10.5x → 9: 9.3 ↘ 10: 9.5 →	Prov 
Serie 91		Serie 18
Total 181		Total 181

1. Serie 10 Skott 	1: 10.1 ↑ 2: 10.3x ↗ 3: 8.8 ← 4: 9.2 → 5: 9.7 ←	1. Serie 10 Skott 
Serie 46		Serie 43
Total 227		Total 270

2. Serie 1 Skott 	1: 8.3 ← 2: 10.4x ↓ 3: 9.6 ↗ 4: 10.5x ↘ 5: 5.4 →	
Serie 42		
Total 312		

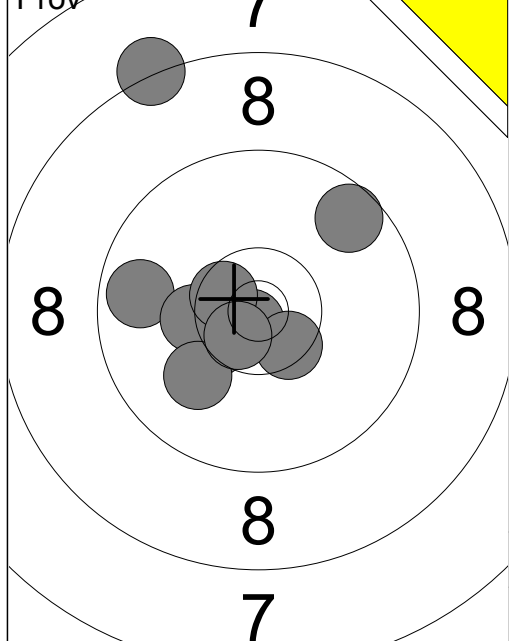

1:	9.6	↗
2:	9.7	←
3:	10.8x	↘
4:	10.4x	↘
5:	10.3	←
6:	10.0	↘
7:	10.6x	↖
8:	8.3	↗
9:	10.5x	↘
10:	10.6x	↘
Serie		96
Total		179

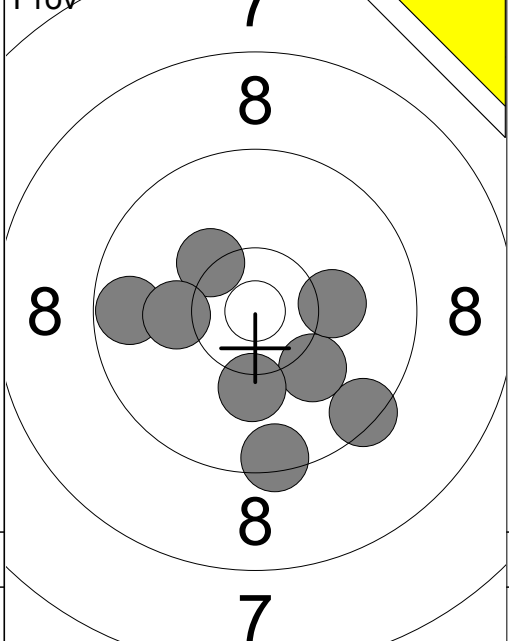

11:	10.3	↗
12:	9.7	←
13:	9.4	↘
14:	10.1	↘
15:	10.2	→
16:	10.1	←
17:	10.2	↓
18:	9.4	↓
Serie		77
Total		179

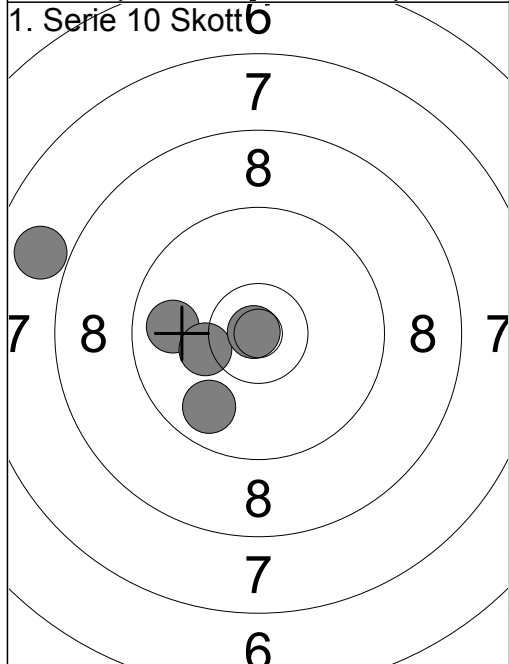

1. Serie 10 Skott		
1:	9.8	←
2:	10.2	←
3:	10.9x	↖
4:	7.9	←
5:	9.8	↘
Serie		45
Total		224

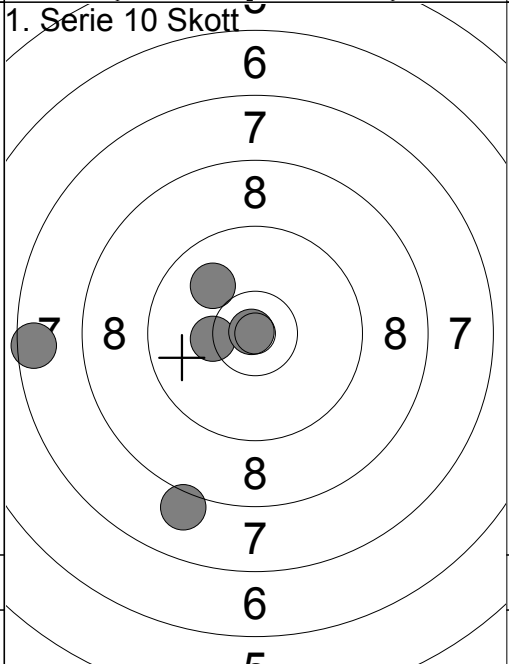

1. Serie 10 Skott		
6:	10.0	↗
7:	10.3x	↖
8:	8.1	↘
9:	7.5	←
10:	10.9x	↖
Serie		45
Total		269

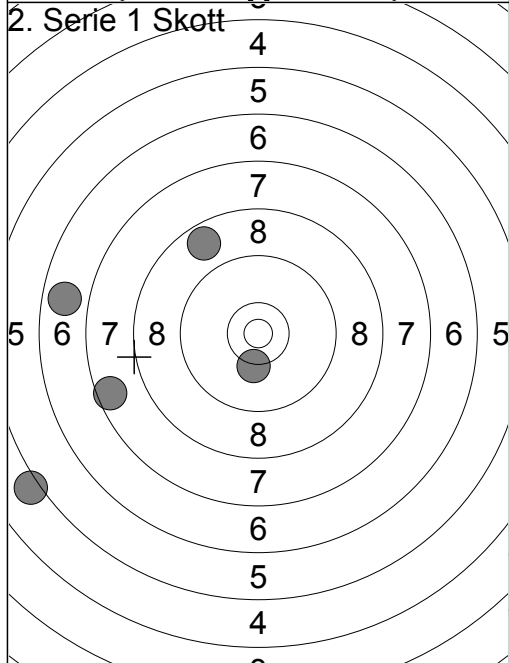

2. Serie 1 Skott		
1:	8.7	↗
2:	10.3	↘
3:	7.6	←
4:	5.1	↘
5:	6.8	←
Serie		36
Total		305

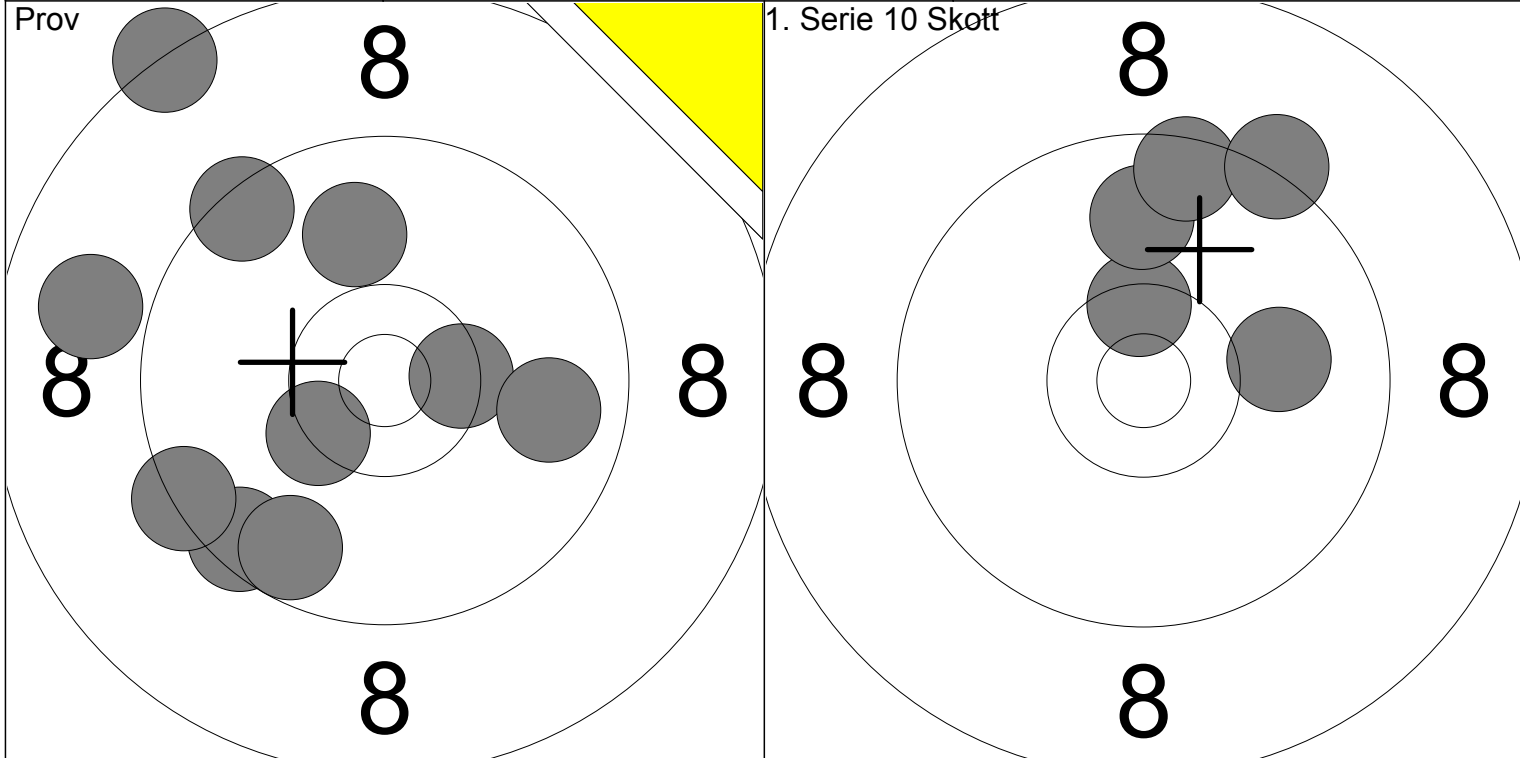

1: 9.5 ↙	6: 8.3 ↗			1: 10.4x ↑			
2: 9.7 ↘	7: 10.4x →	Serie	90	2: 10.0 →	Serie	47	
3: 9.9 ↑	8: 9.4 ↗		Total	173		3: 9.9 ↑	Total
4: 8.9 ←	9: 10.4x ↙				4: 9.5 ↑		
5: 9.4 ↙	10: 9.8 →			5: 9.3 ↗			

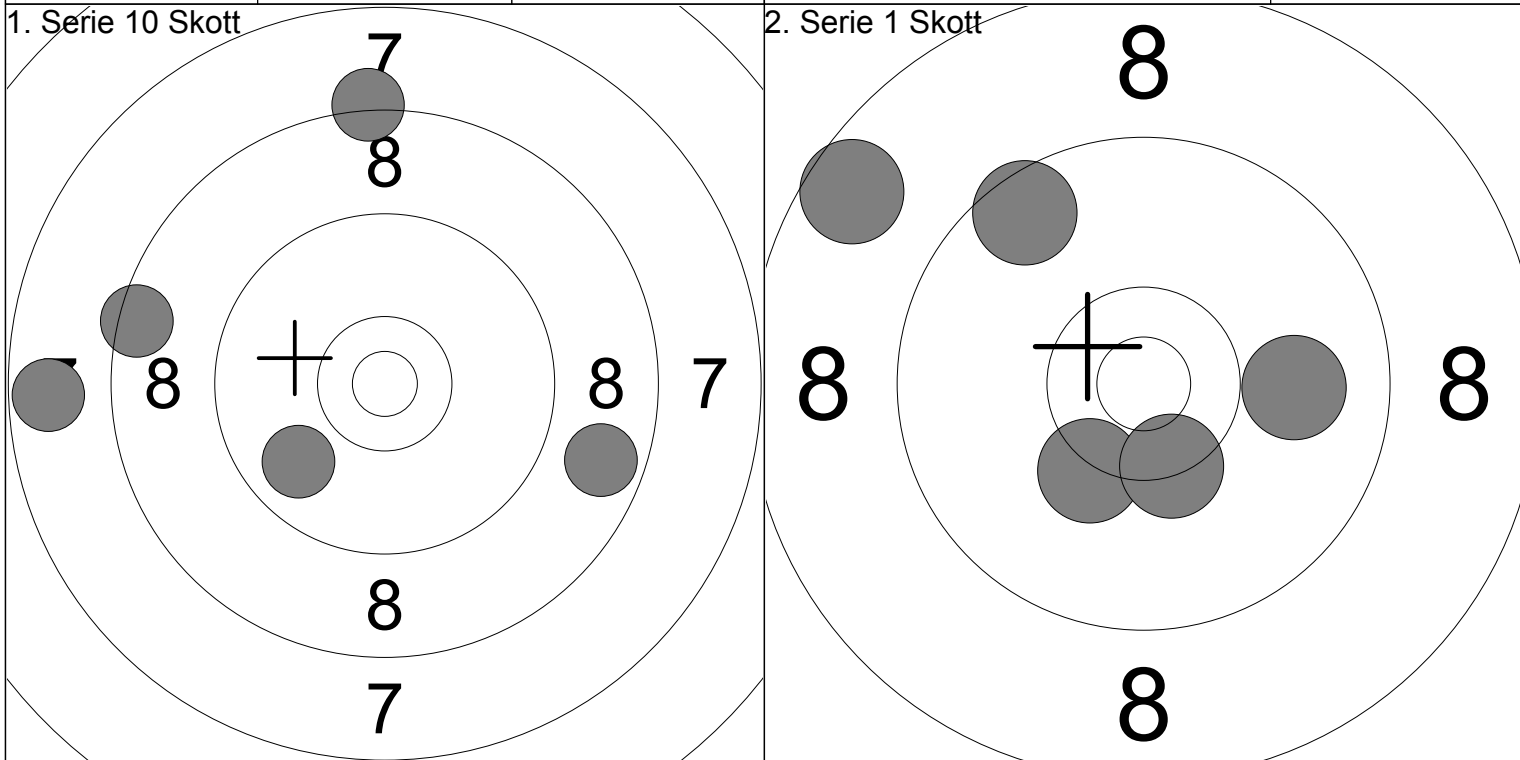

6: 8.7 →				1: 9.6 ↗			
7: 8.2 ↑		Serie	40	2: 9.9 →	Serie	46	
8: 9.8 ↙			Total	260		3: 10.3 ↘	Total
9: 8.5 ←					4: 10.4x ↘		
10: 7.7 ←				5: 8.6 ↗			

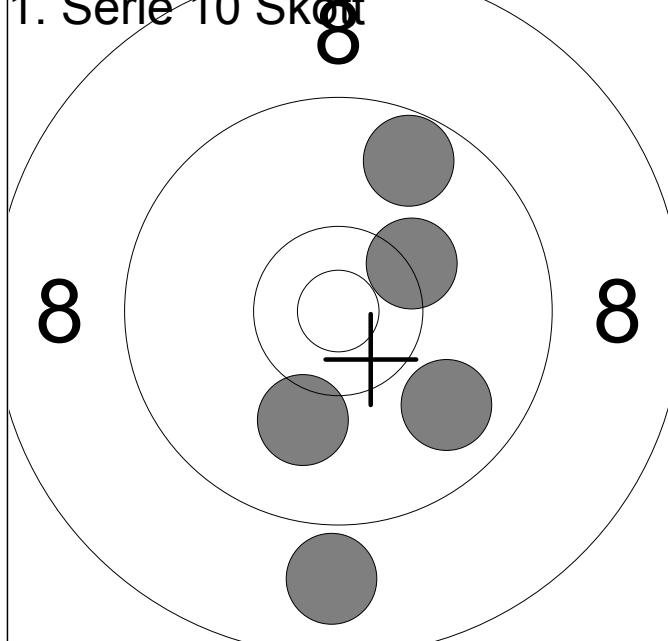

1:	9.7	↗
2:	10.1	↘
3:	8.9	↘
4:	9.8	↘
5:	10.3	↗
<b>Serie</b>		<b>46</b>
<b>Total</b>		<b>205</b>

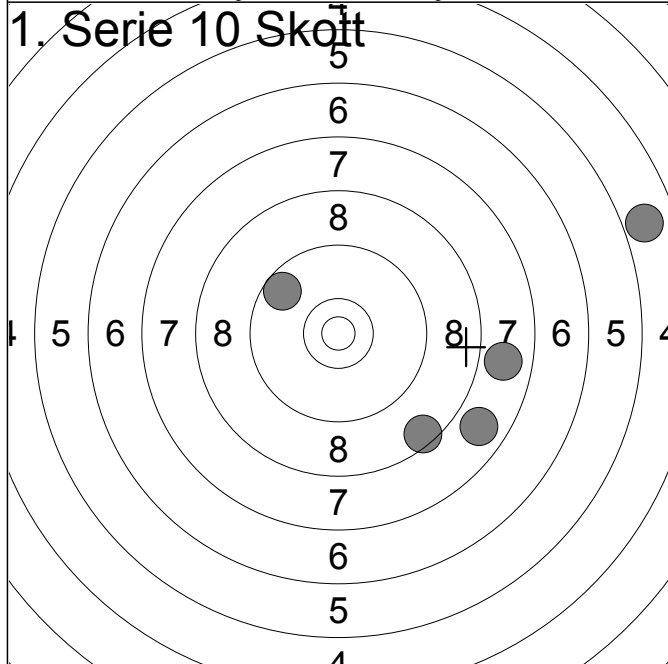

6:	8.5	↘
7:	7.8	↘
8:	4.9	→
9:	7.8	→
10:	9.6	↗
<b>Serie</b>		<b>35</b>
<b>Total</b>		<b>240</b>

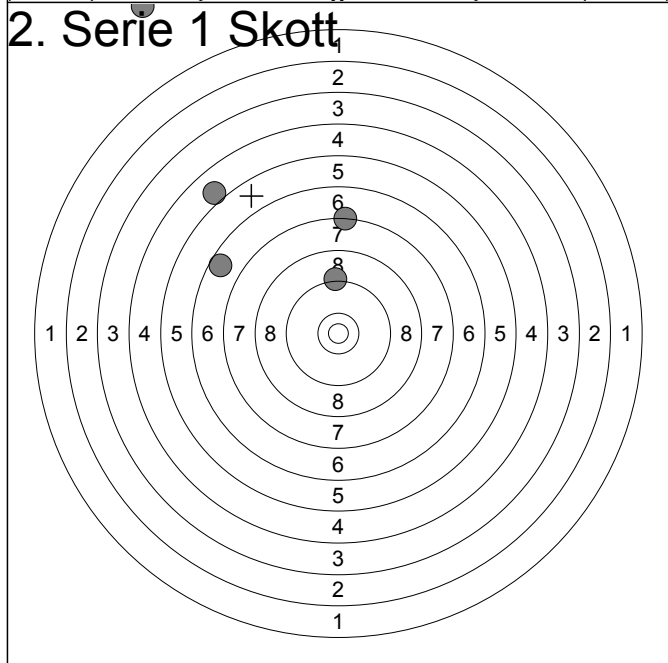

1:	0.0	↗
2:	9.2	↑
3:	6.6	↖
4:	7.3	↑
5:	5.0	↗
<b>Serie</b>		<b>27</b>
<b>Total</b>		<b>267</b>

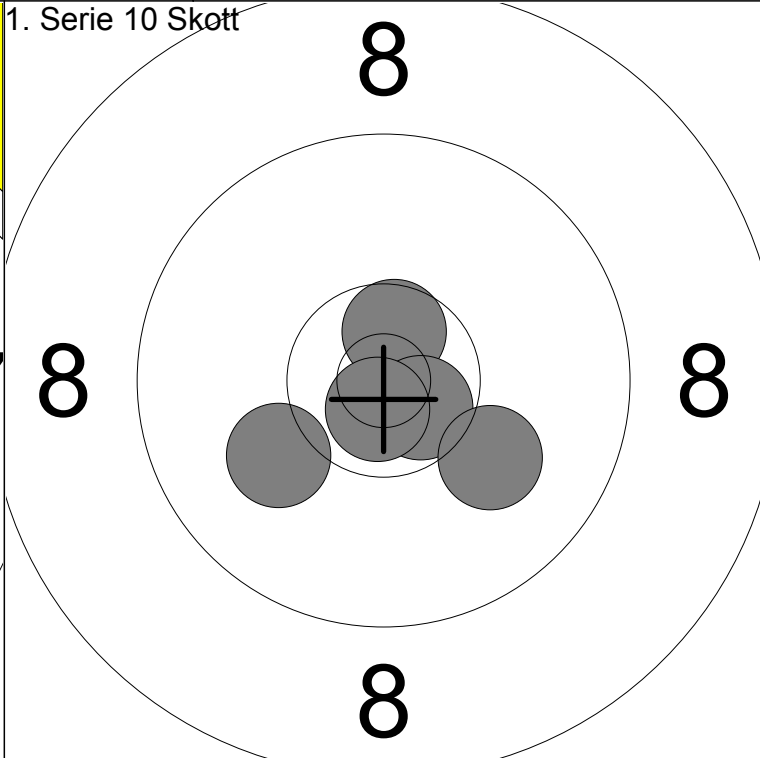
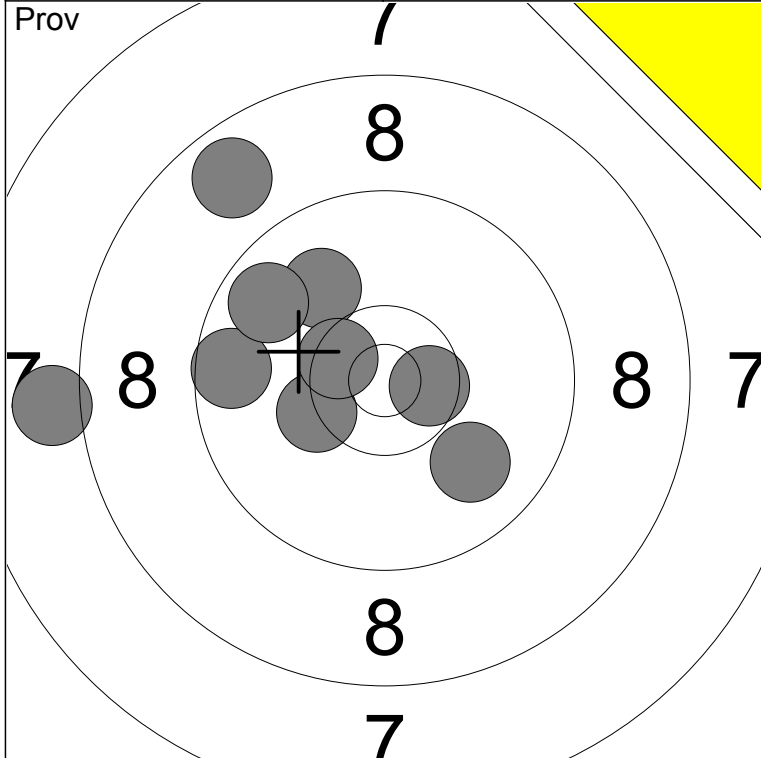

1: 8.1 ←	6: 10.3x ←	Serie	83
2: 10.0 ↗	7: 9.9 ↘		
3: 8.7 ↗	8: 10.5x ↗	Total	185
4: 10.6x →	9: 9.7 ↗		
5: 9.6 ←			

1: 10.6x ↑	Serie	50
2: 10.6x ↘		
3: 10.1 ↘	Total	235
4: 10.1 ←		
5: 10.8x ↓		

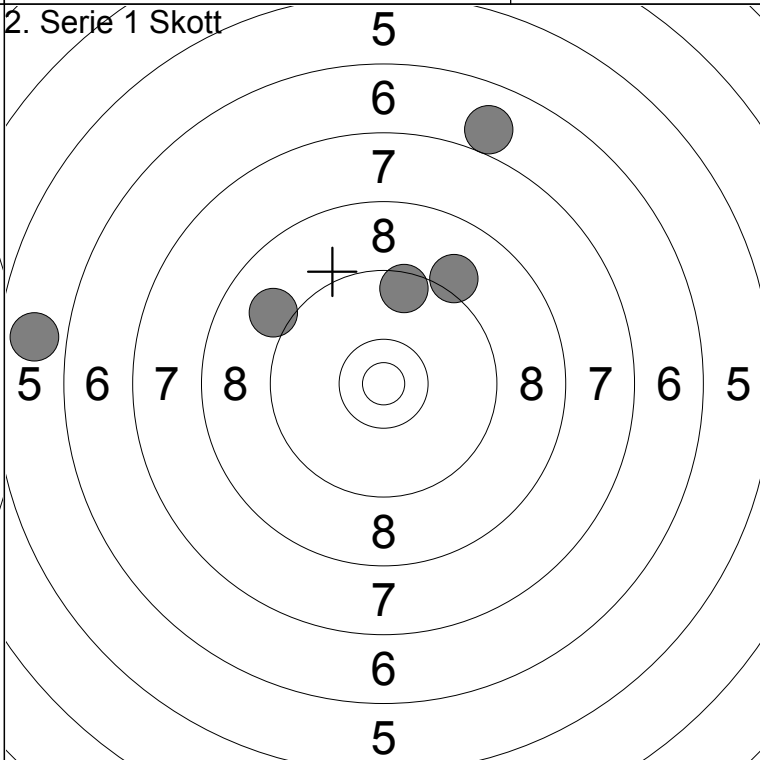
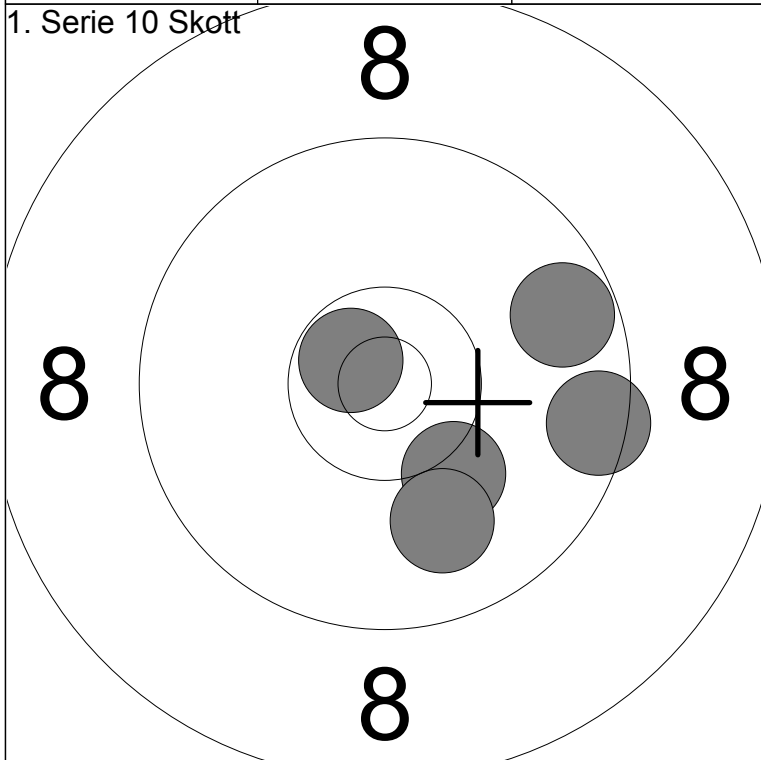

6: 9.7 →	Serie	48
7: 10.7x ↗		
8: 10.2 ↘	Total	283
9: 9.5 →		
10: 10.0 ↓		

1: 5.8 ←	Serie	39
2: 9.1 ↗		
3: 7.0 ↗	Total	322
4: 9.0 ↖		
5: 9.5 ↑		

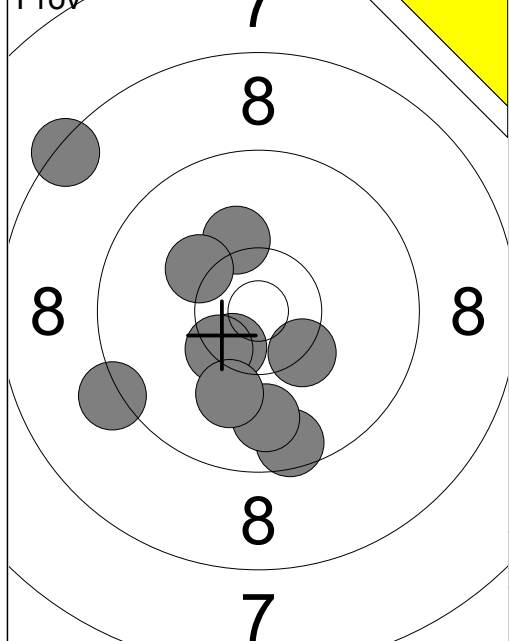

1:	9.6	↓
2:	10.5x	↙
3:	10.2	↑
4:	9.2	↙
5:	8.4	↖
6:	10.4x	↙
7:	10.2	↖
8:	9.9	↓
9:	10.3x	↘
10:	10.1	↓
Serie		95
Total		184

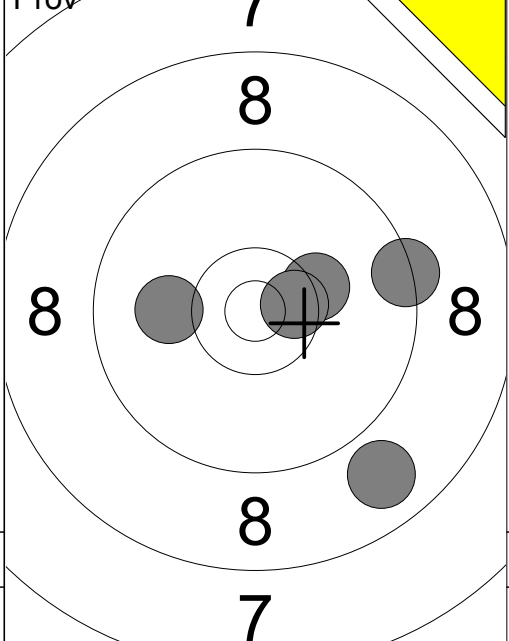

11:	10.1	←
12:	9.4	→
13:	10.3	→
14:	8.8	↓
15:	10.5x	→
Serie		47
Total		184

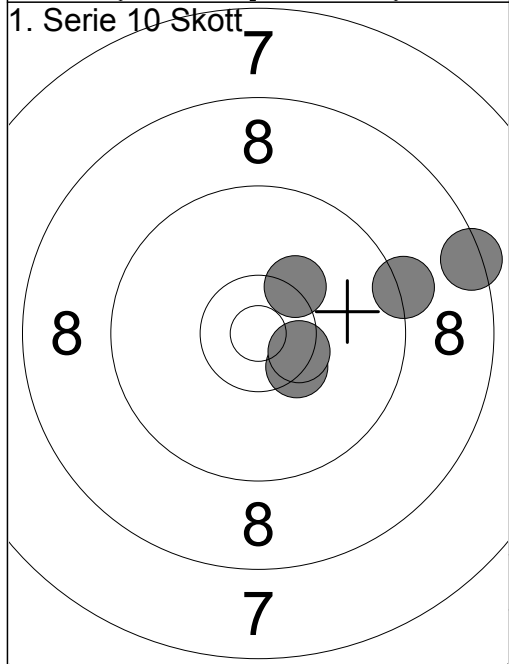

1:	10.3	↗
2:	10.4x	↘
3:	10.4x	→
4:	8.4	→
5:	9.2	→
Serie		47
Total		231

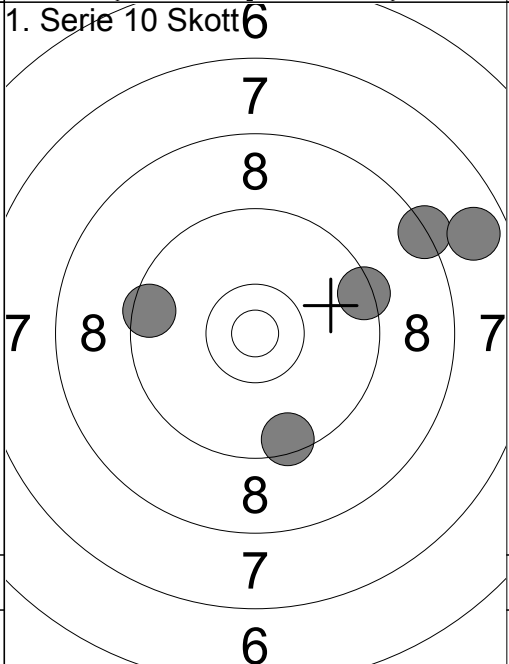

6:	9.5	↓
7:	9.5	←
8:	9.4	→
9:	8.3	↗
10:	7.8	→
Serie		42
Total		273

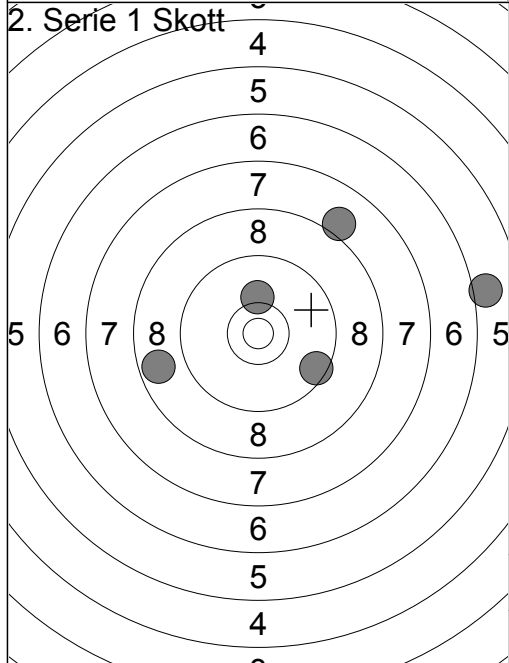

1:	8.1	↗
2:	6.0	→
3:	9.5	↘
4:	8.7	←
5:	10.2	↑
Serie		41
Total		314



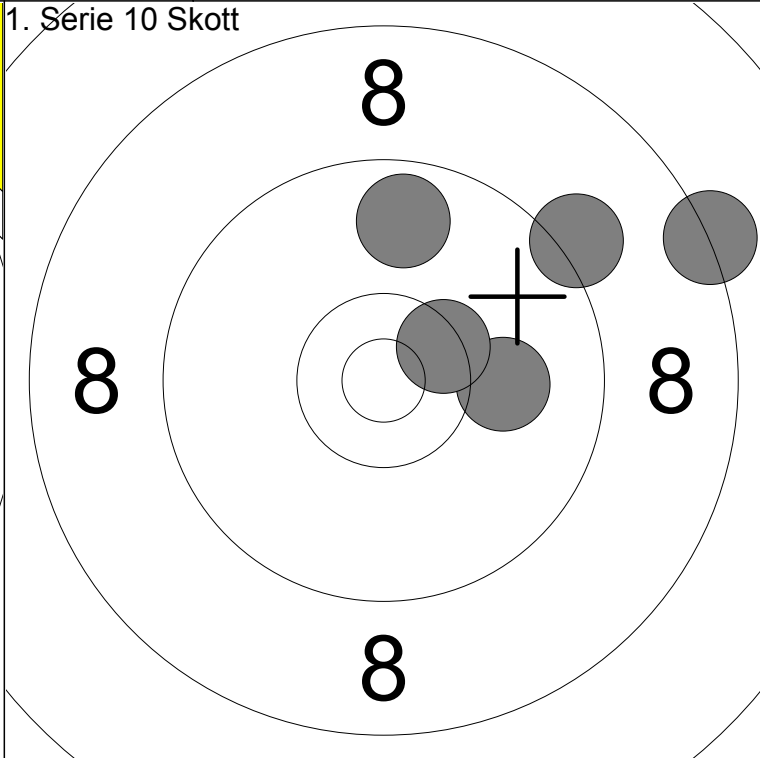
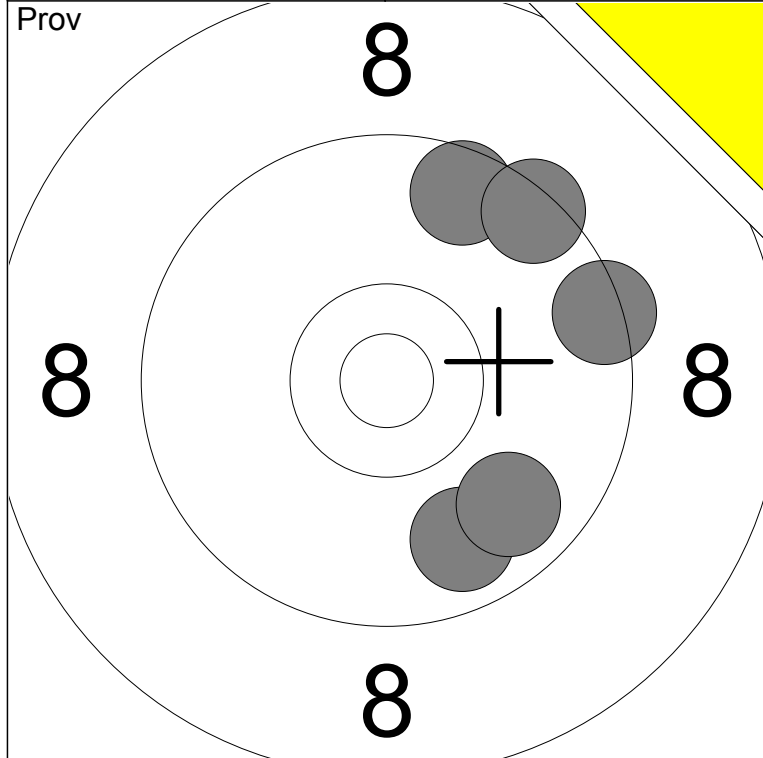

1:	9.4	→
2:	9.6	↑
3:	9.8	↓
4:	9.8	↓
5:	9.4	↗

Serie	45
Total	183

1:	9.8	↑
2:	10.1	→
3:	8.3	→
4:	10.4x	↗
5:	9.2	↗

Serie	46
Total	229

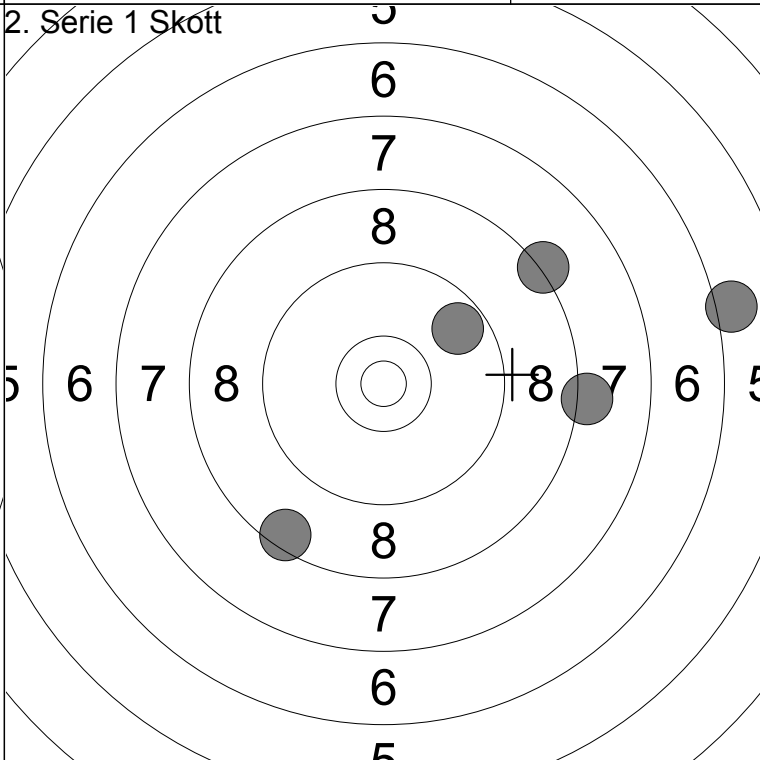
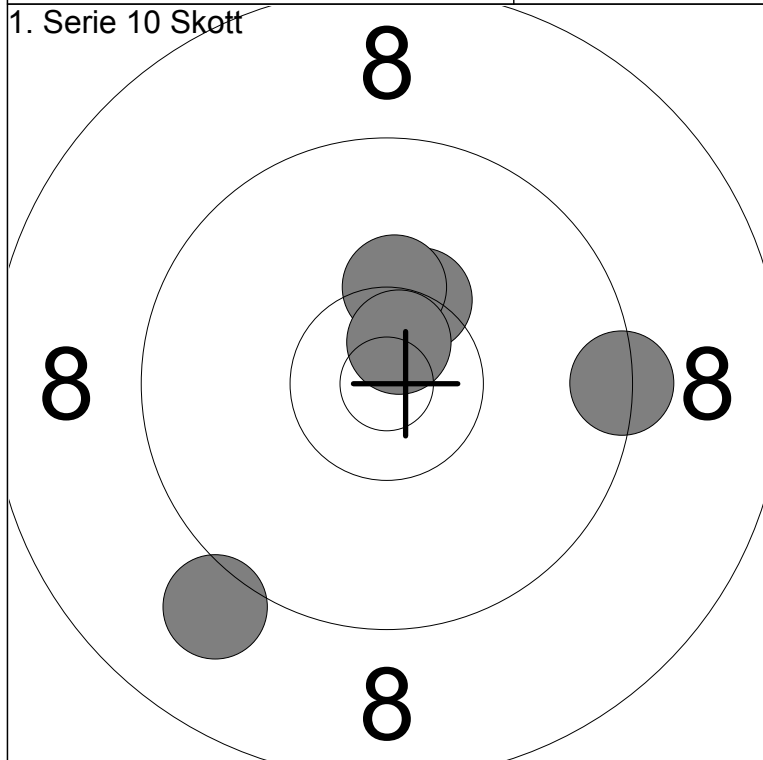

6:	10.3x	↑
7:	9.1	↙
8:	9.4	→
9:	10.3x	↑
10:	10.7x	↑

Serie	48
Total	277

1:	8.5	↙
2:	9.7	↗
3:	8.3	↗
4:	6.1	→
5:	8.2	→

Serie	39
Total	316

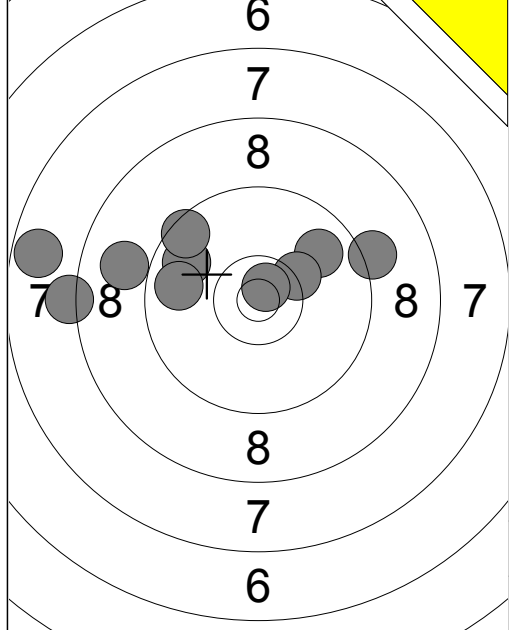

1:	9.8	↖
2:	9.8	←
3:	7.7	←
4:	8.2	←
5:	8.9	←
6:	9.5	↗
7:	9.2	→
8:	9.8	↗
9:	10.3x	↗
10:	10.7x	↗
Serie		88
Total		182

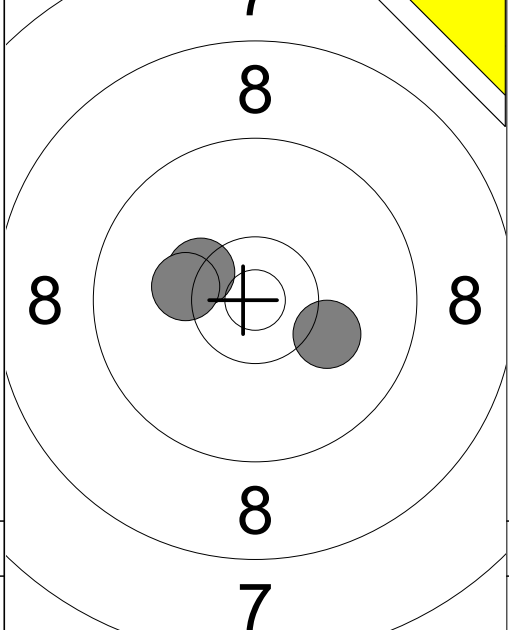

11:	10.3x	↖
12:	10.2	←
13:	10.1	↘
Serie		30
Total		182

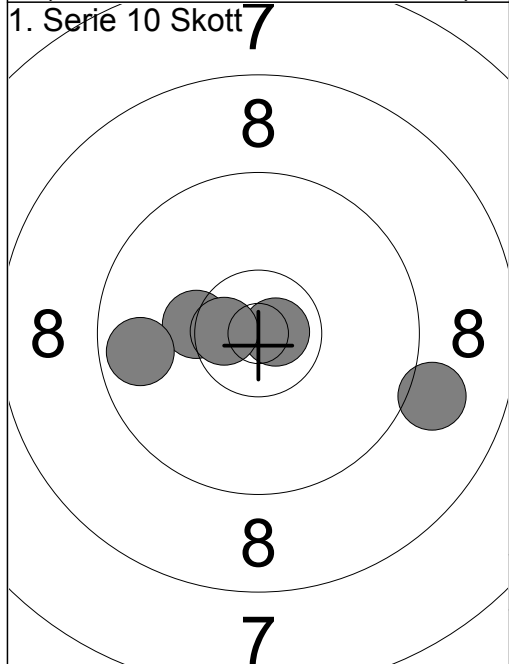

1:	10.3x	←
2:	10.8x	→
3:	9.1	→
4:	10.6x	←
5:	9.7	←
Serie		48
Total		230

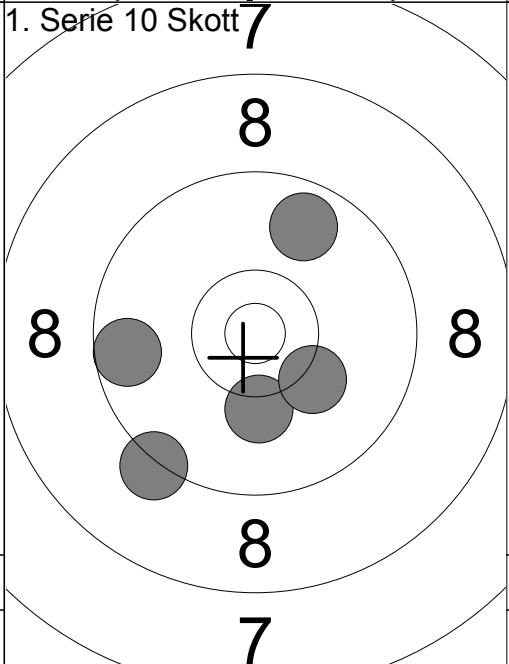

6:	9.2	↘
7:	10.2	↓
8:	9.8	↗
9:	9.6	←
10:	10.2	↘
Serie		47
Total		277

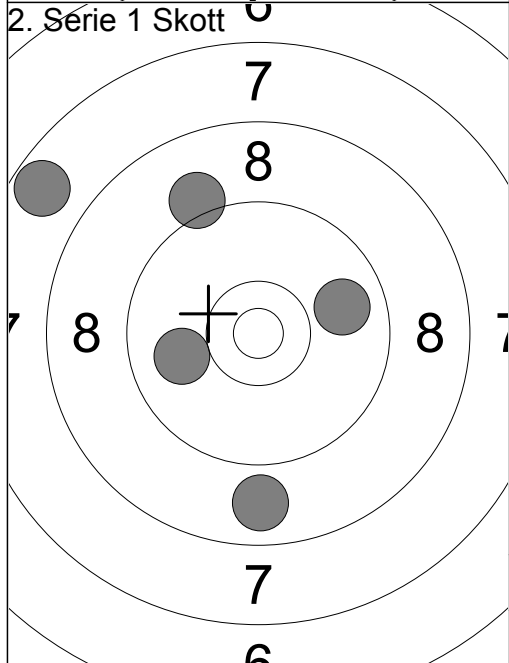

1:	8.8	↓
2:	7.7	↖
3:	9.8	→
4:	9.1	↗
5:	10.0	←
Serie		43
Total		320

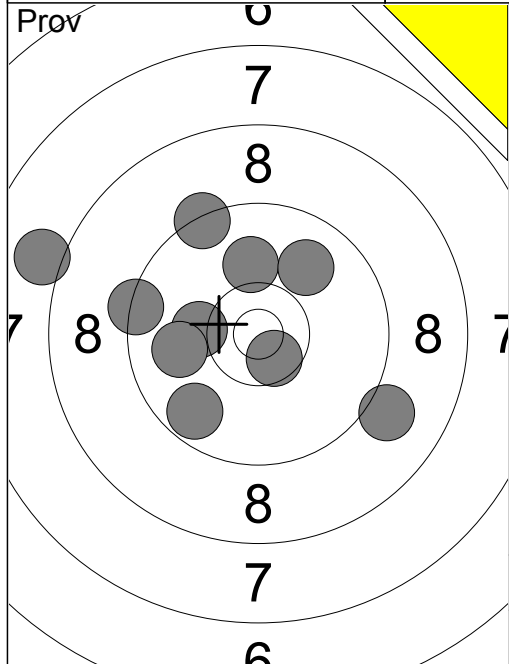

1:	10.6x ↘
2:	10.1 ↑
3:	9.4 ←
4:	9.4 ↗
5:	10.2 ←
6:	8.0 ←
7:	9.9 ↗
8:	9.7 ↘
9:	9.9 ←
10:	9.0 ↘
<b>Serie 92</b>	
<b>Total 178</b>	

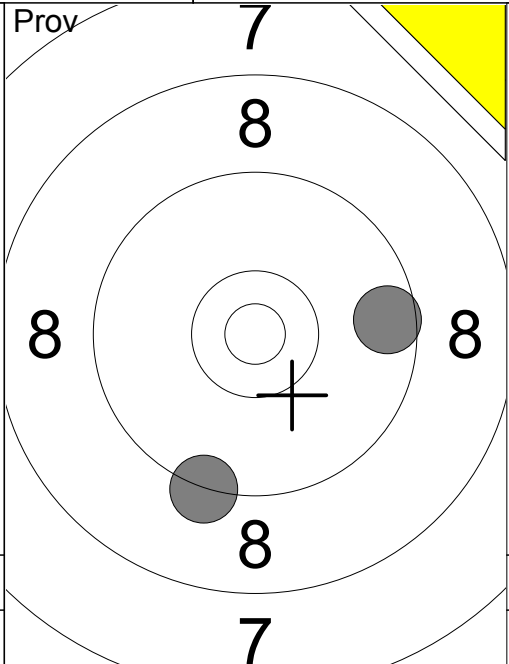

11:	9.6 →
12:	9.3 ↘
<b>Serie 18</b>	
<b>Total 178</b>	

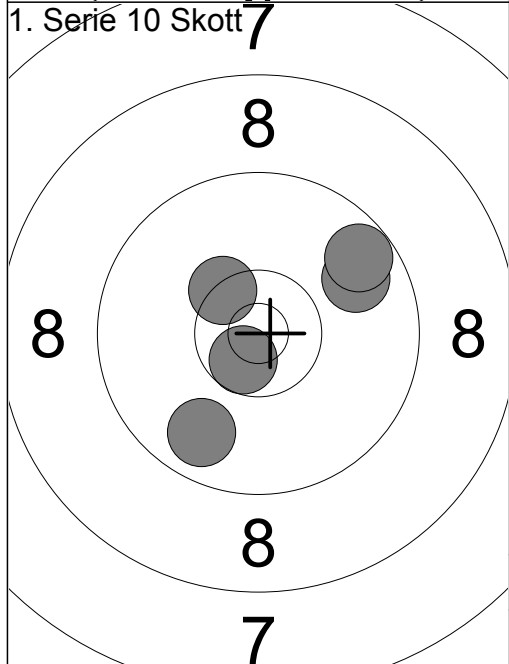

1:	10.6x ↘
2:	9.8 ↘
3:	10.4x ↖
4:	9.8 ↗
5:	9.7 ↗
<b>Serie 47</b>	
<b>Total 225</b>	

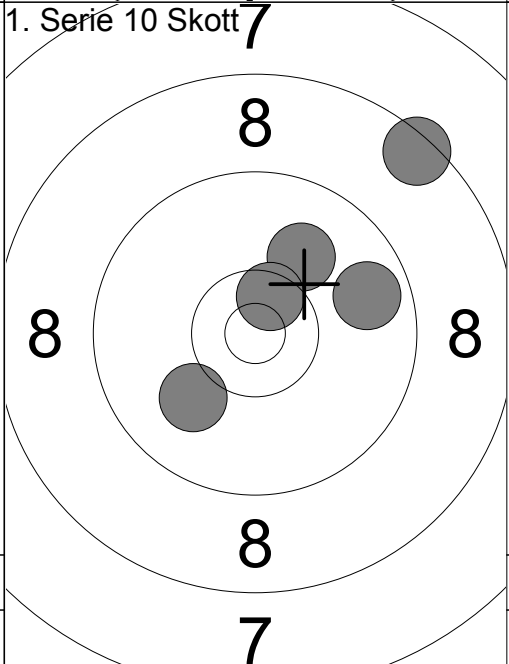

6:	10.0 ↗
7:	9.7 →
8:	10.5x ↗
9:	10.0 ↘
10:	8.5 ↗
<b>Serie 47</b>	
<b>Total 272</b>	

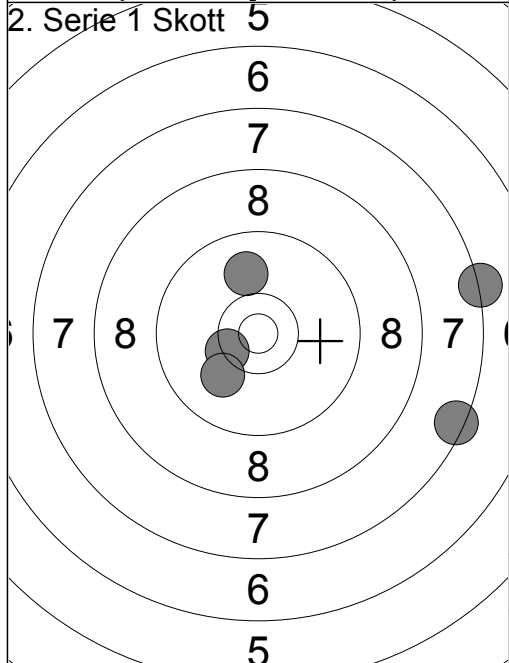

1:	10.0 ↑
2:	7.4 →
3:	7.3 →
4:	10.4x ↙
5:	10.1 ↘
<b>Serie 44</b>	
<b>Total 316</b>	

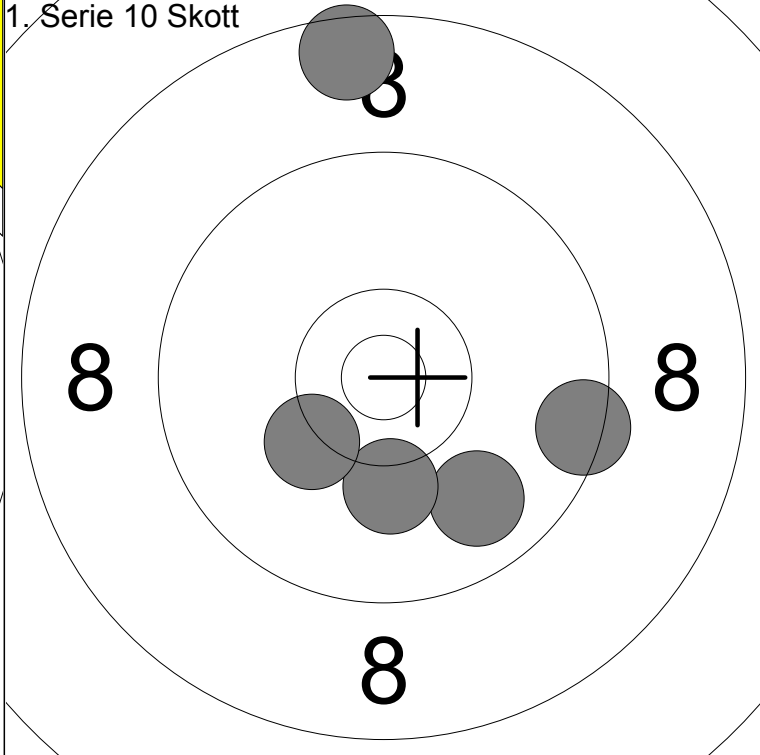
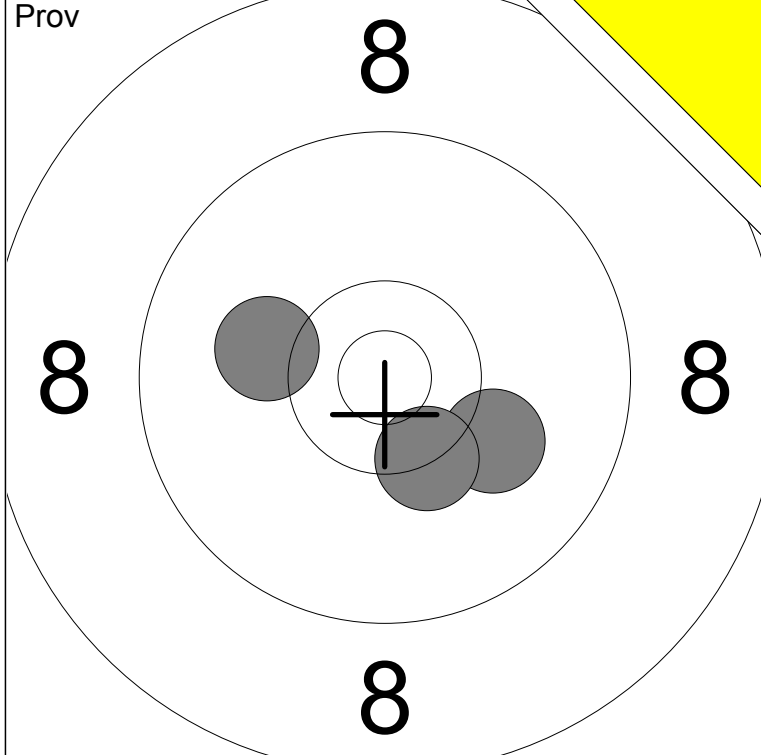

1: 10.1 ↘	
2: 10.1 ←	
3: 10.3x ↙	
Serie	30
Total	172

1: 9.8 ↘	
2: 9.4 →	
3: 8.6 ↑	
4: 10.2 ↓	
5: 10.2 ↙	
Serie	46
Total	218

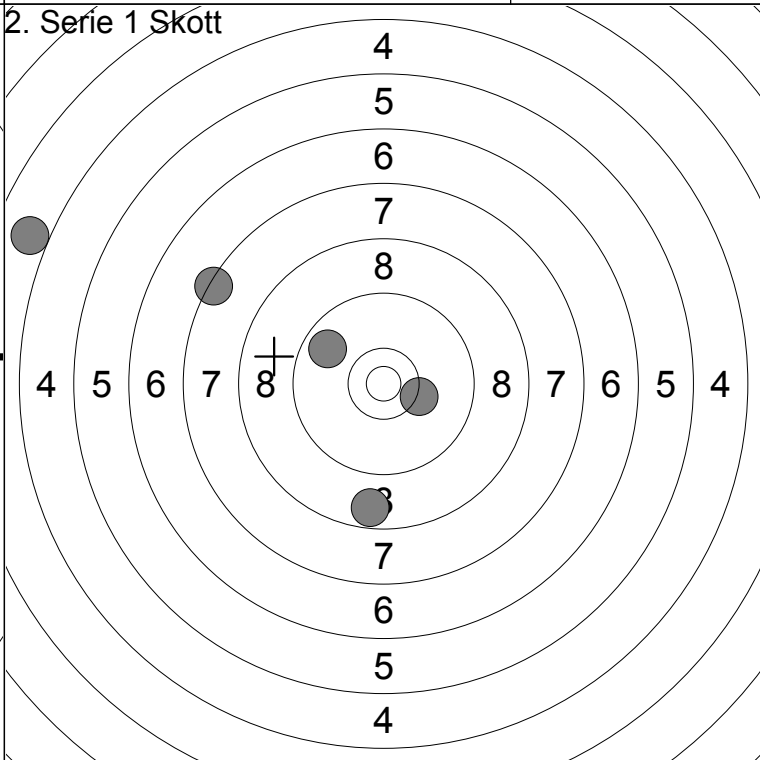
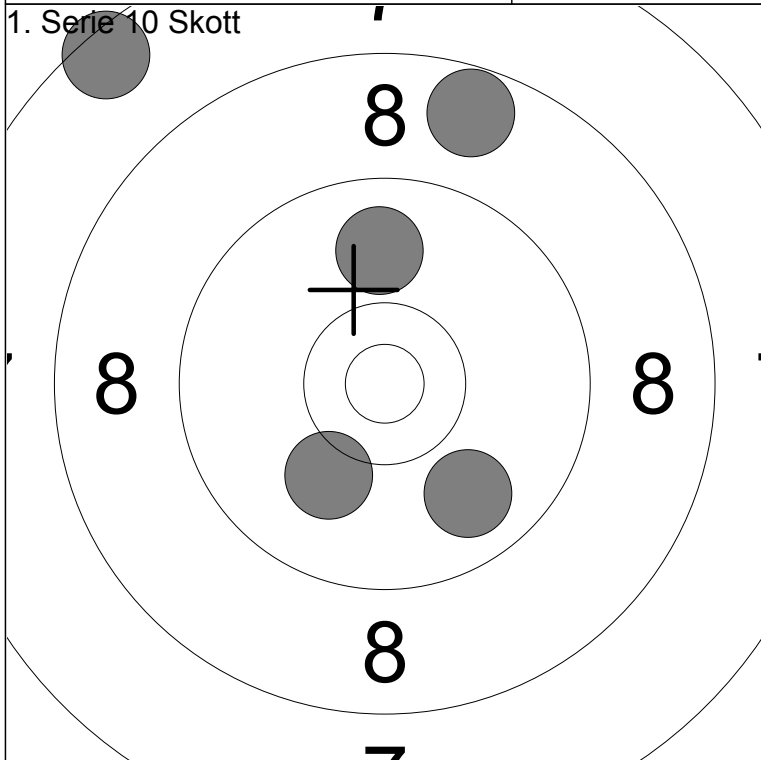

6: 10.1 ↙	
7: 7.5 ↗	
8: 9.8 ↙	
9: 9.9 ↑	
10: 8.7 ↗	
Serie	43
Total	261

1: 8.7 ↓	
2: 10.3 →	
3: 7.4 ↗	
4: 9.7 ↗	
5: 3.9 ↗	
Serie	37
Total	298

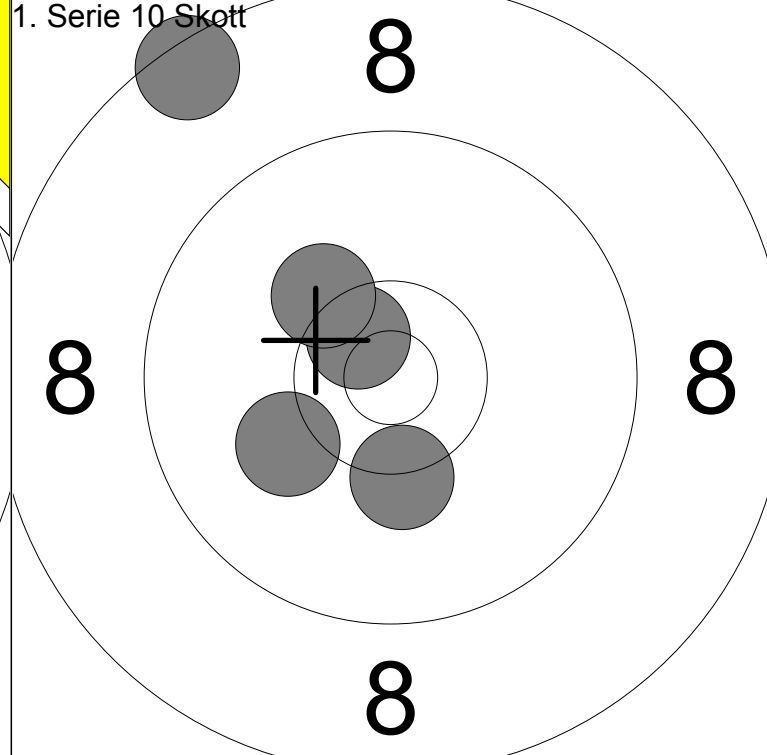
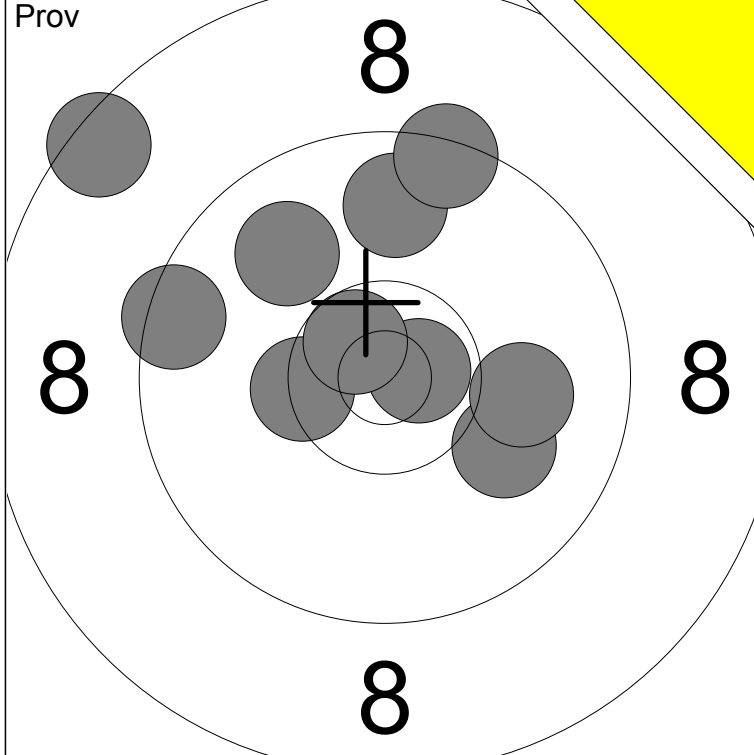

1: 8.5 ↗	6: 9.9 ↗	Serie	94
2: 9.8 ↑	7: 10.6x ↗		
3: 9.4 ↑	8: 10.0 ↘	Total	162
4: 10.4x ←	9: 10.0 →		
5: 10.7x →	10: 9.5 ←		

1: 8.5 ↗	Serie	48
2: 10.1 ↙		
3: 10.3 ↘	Total	210
4: 10.6x ↗		
5: 10.2 ↗		

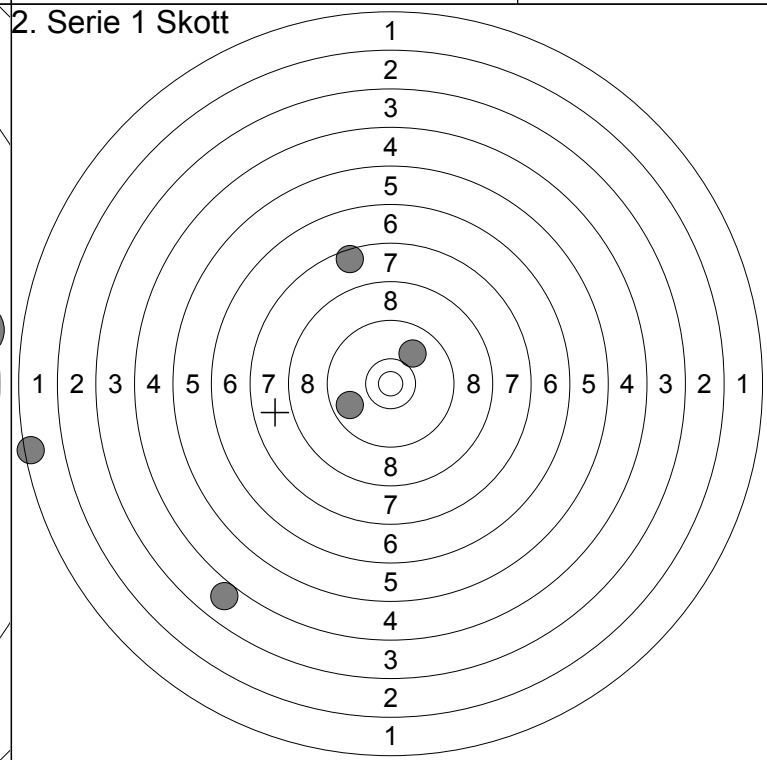
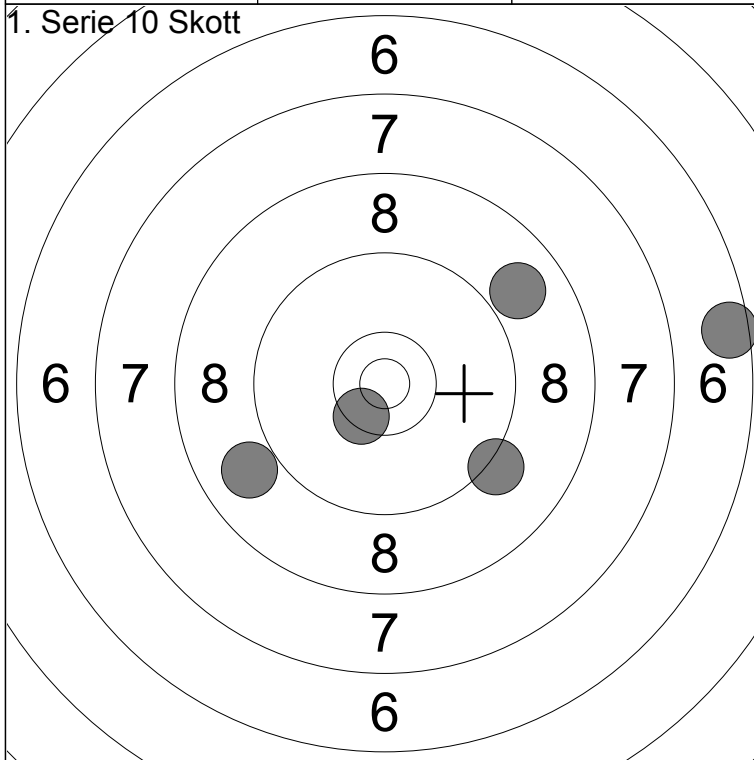

6: 6.5 →	Serie	41
7: 9.2 ↘		
8: 10.4x ↘	Total	251
9: 8.9 ↙		
10: 8.9 ↗		

1: 9.8 ↙	Serie	30
2: 10.0 ↗		
3: 3.9 ↙	Total	281
4: 7.6 ↗		
5: 1.5 ←		

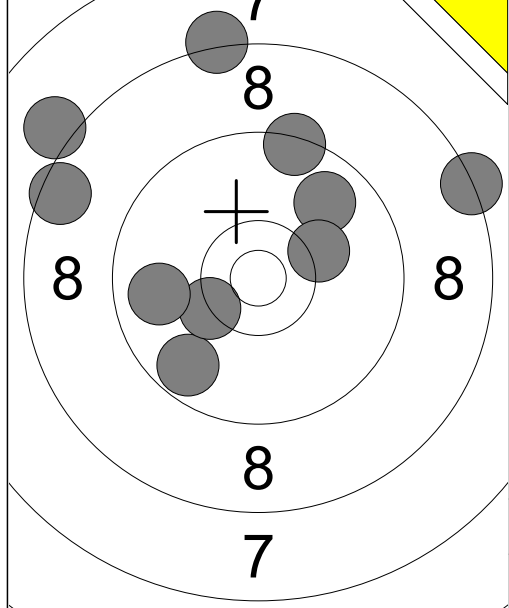

1:	9.7	↙
2:	10.3x	↙
3:	8.1	↖
4:	8.5	↖
5:	9.8	←
6:	8.2	↑
7:	9.8	↗
8:	10.2	→
9:	8.3	→
10:	9.4	↑
Serie		88
Total		156

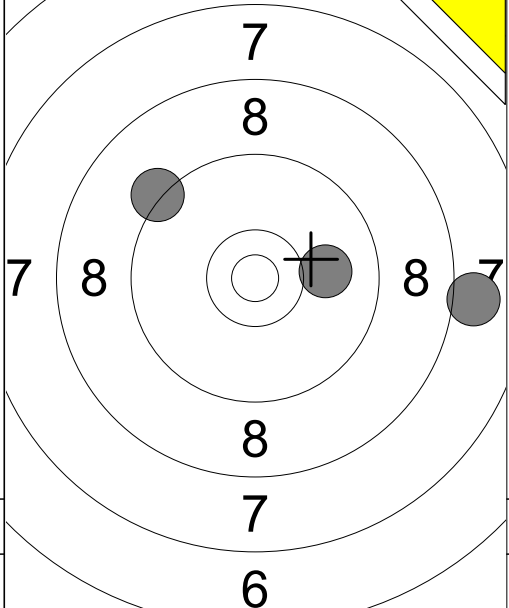

11:	8.0	→
12:	10.0	→
13:	9.2	↗
Serie		27
Total		156

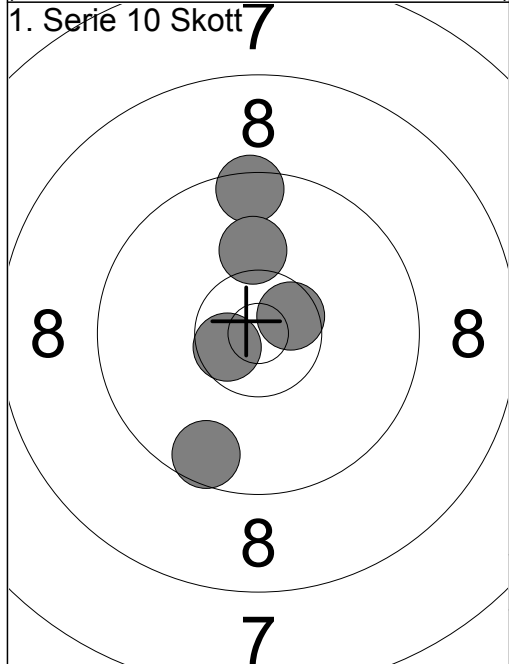

1:	9.5	↑
2:	10.1	↑
3:	10.6x	↙
4:	10.6x	→
5:	9.6	↓
Serie		48
Total		204

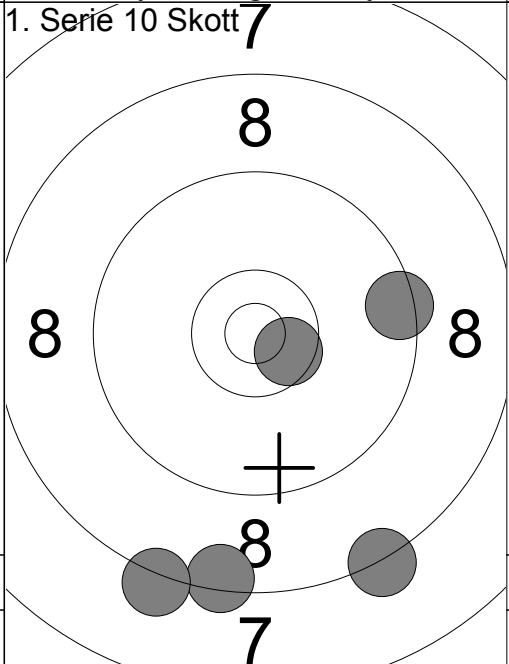

6:	9.5	→
7:	8.3	↓
8:	10.6x	↘
9:	8.4	↓
10:	8.2	↓
Serie		43
Total		247

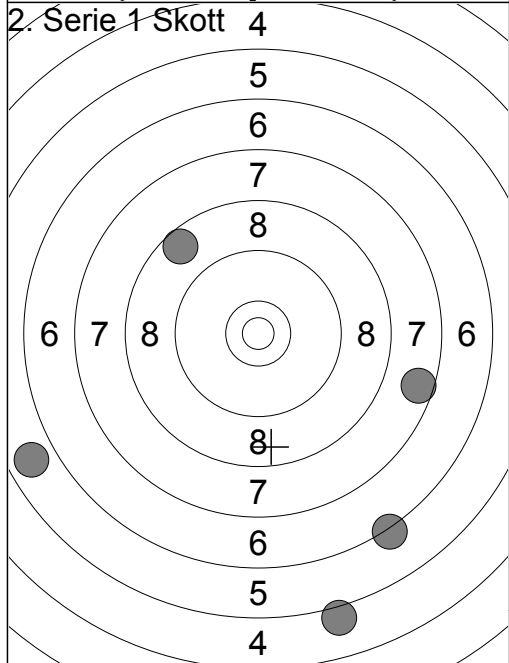

1:	6.2	↘
2:	8.6	↗
3:	7.6	→
4:	5.8	↙
5:	5.1	↓
Serie		31
Total		278

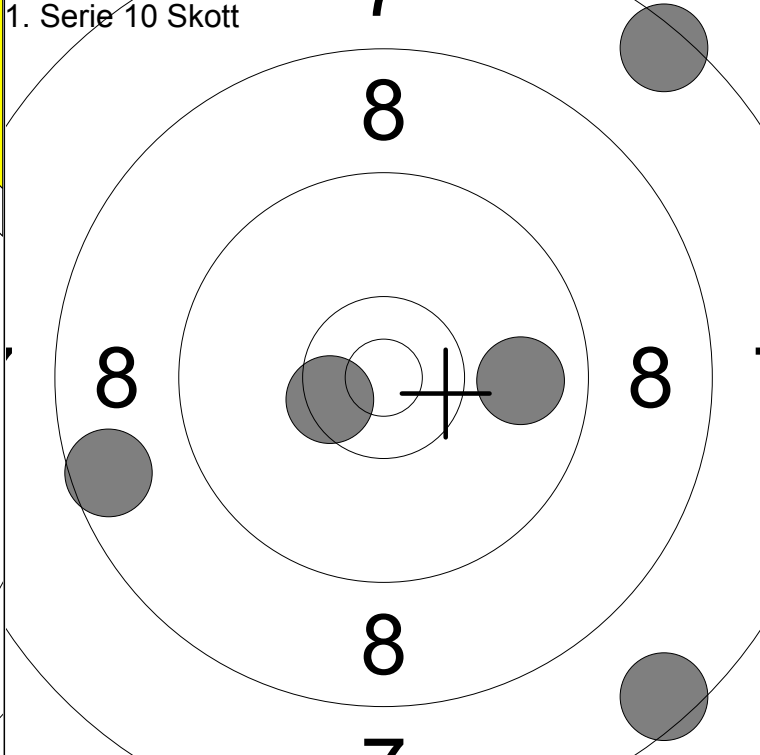
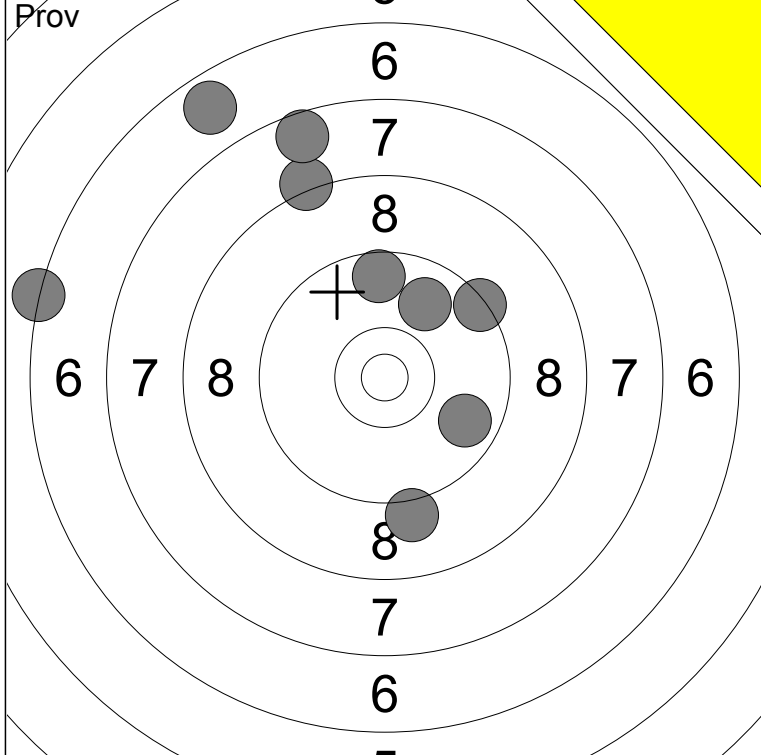

1: 9.1 ↓	6: 9.6 ↑	Serie 72
2: 9.9 ↗	7: 9.8 →	
3: 8.2 ↗	8: 6.7 ↗	Total 142
4: 6.3 ←	9: 9.4 ↗	
5: 7.6 ↗		

1: 10.5x ←	Serie 41
2: 7.5 ↓	
3: 7.5 ↗	Total 183
4: 8.6 ←	
5: 9.9 →	

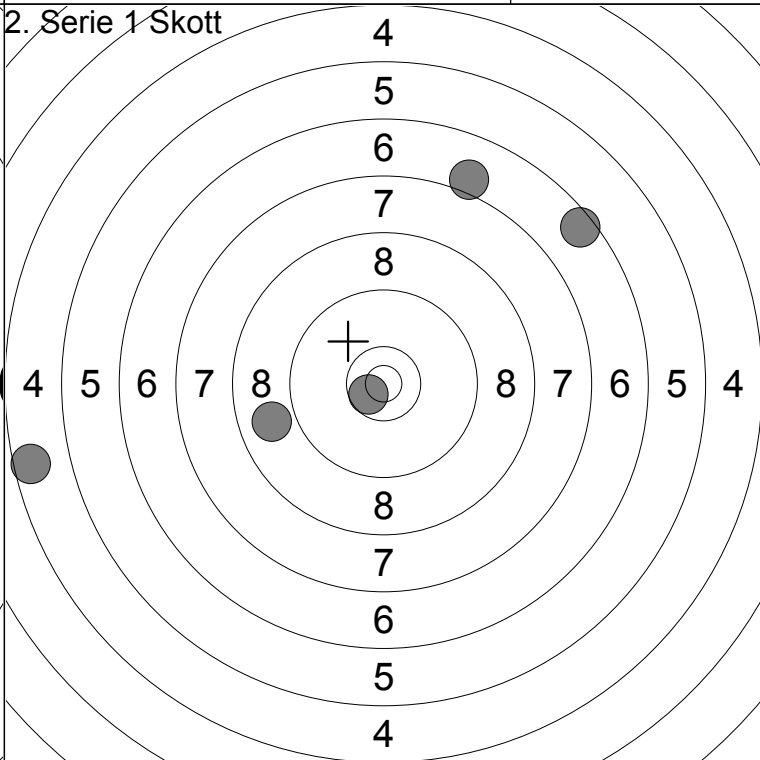
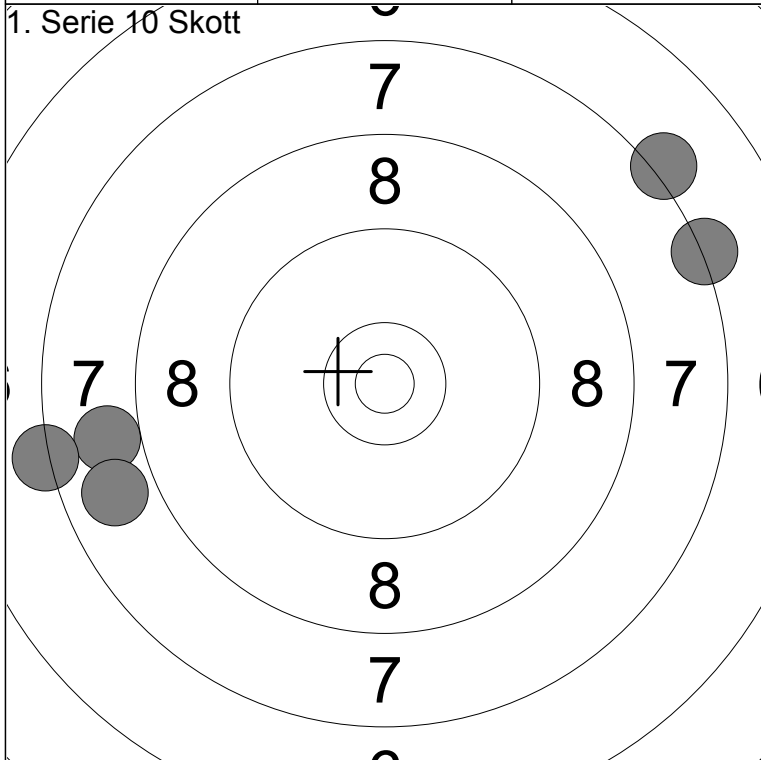

6: 7.3 →	Serie 35
7: 7.9 ←	
8: 7.3 ←	Total 218
9: 7.2 ↗	
10: 7.9 ←	

1: 6.5 ↗	Serie 35
2: 8.9 ←	
3: 10.6x ←	Total 253
4: 7.1 ↗	
5: 4.6 ←	

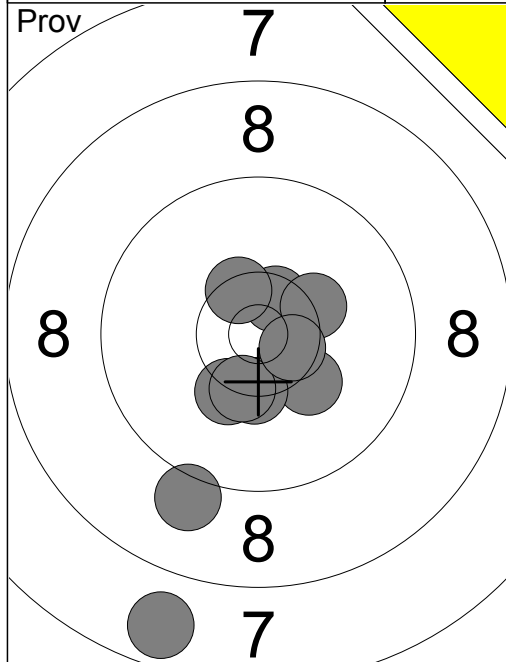

1:	7.7	↓
2:	9.1	↓
3:	10.2	↘
4:	10.5x	↗
5:	10.3x	→
6:	10.3	↓
7:	10.5x	↗
8:	10.4x	↓
9:	10.4x	↓
10:	10.6x	→
Serie	96	
Total	193	

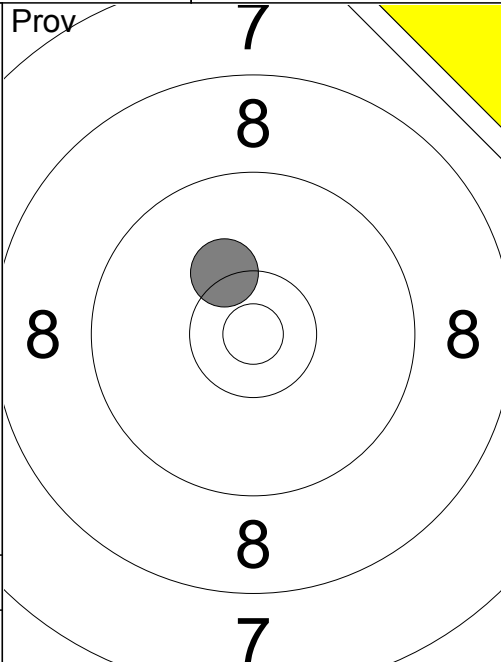

11:	10.3	↗
Serie	10	
Total	193	

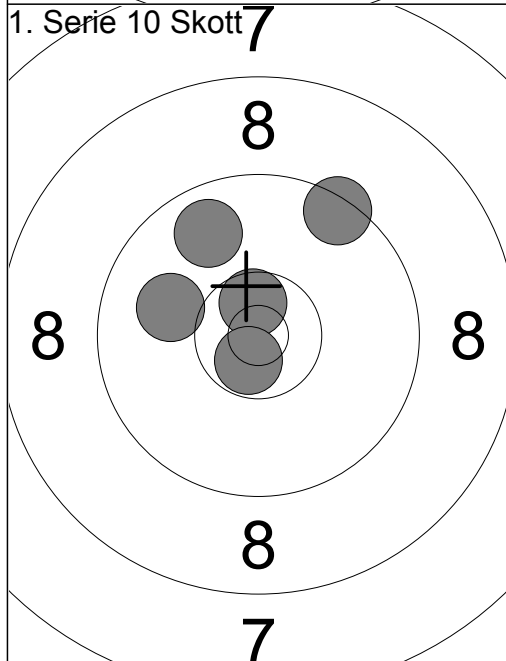

1:	10.6x	↑
2:	10.0	←
3:	10.7x	↓
4:	9.8	↗
5:	9.4	↗
Serie	48	
Total	241	

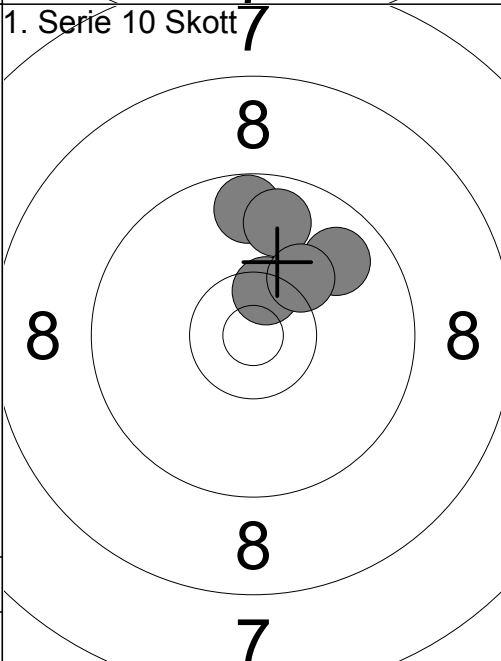

6:	9.7	↑
7:	10.5x	↗
8:	9.8	↗
9:	9.8	↑
10:	10.2	↗
Serie	47	
Total	288	

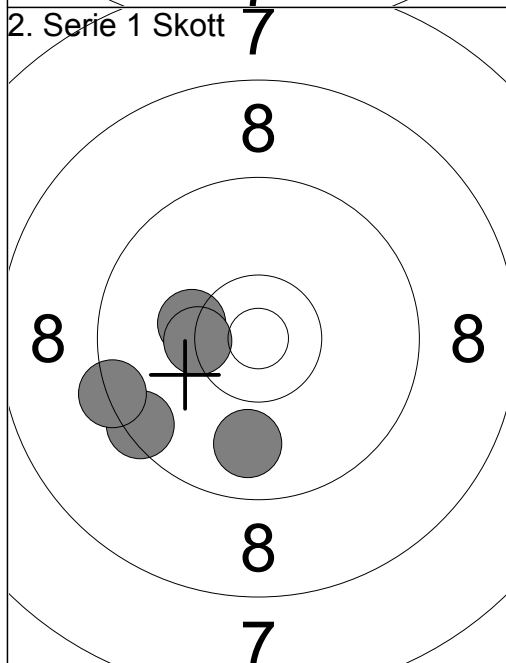

1:	9.9	↓
2:	10.3	←
3:	10.3x	←
4:	9.5	↘
5:	9.4	←
Serie	47	
Total	335	