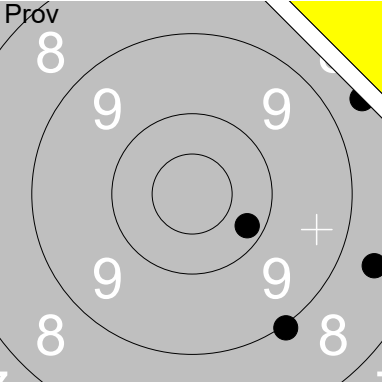
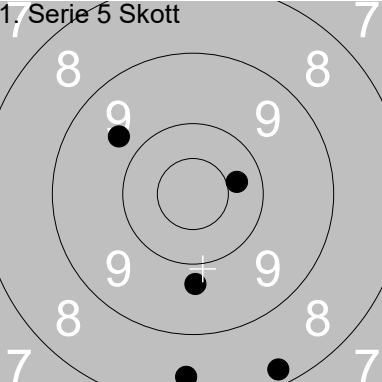
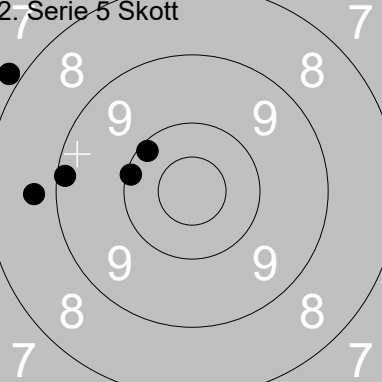
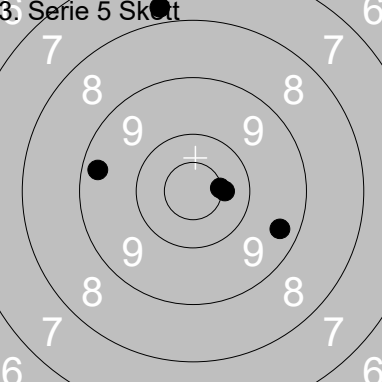
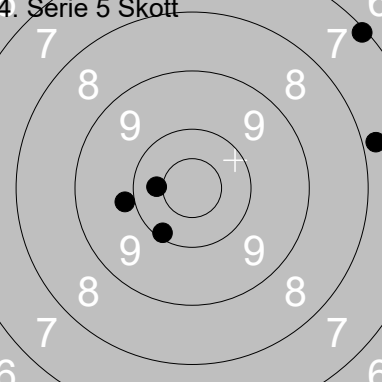
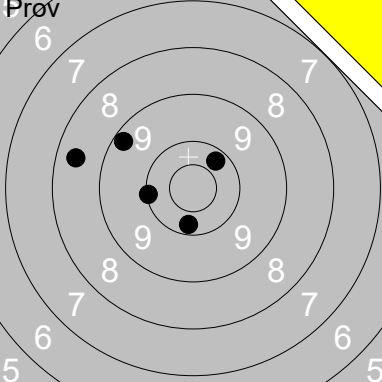
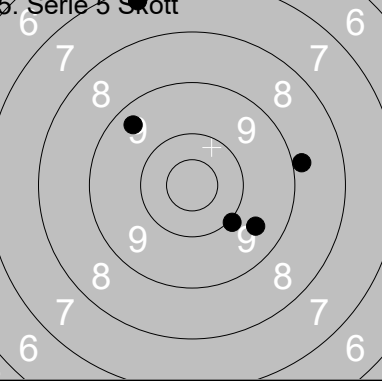
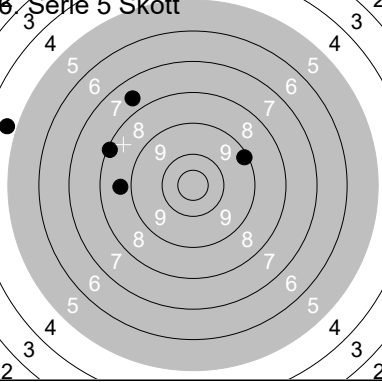
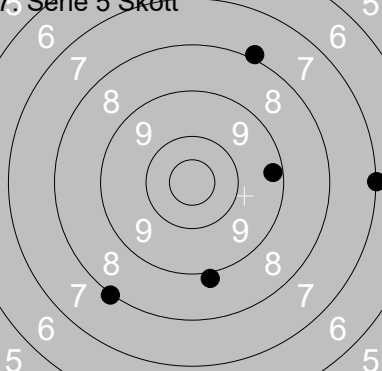

Skjutlag	Tavla	Anders Petersson	
1	1	Ramselefors	Älmhult
12.07.2021	Tavelträffen 2021	Ramselefors SKF	
	1: 10.1 ↖ 2: 9.4 ↖ 3: 10.1 ↑ 4: 10.3 ↓ 5: 10.3 ↓		1: 10.6x ↖ 2: 10.1 ↗ 3: 10.2 ↑ 4: 9.9 ↖ 5: 10.2 ↗
	Serie 49		Serie 49
	Total 0		Total 49
	1: 9.7 ↗ 2: 9.9 ↓ 3: 10.2 → 4: 10.5x ↓ 5: 9.6 ↓		1: 10.5x ↓ 2: 9.5 ← 3: 10.1 ↑ 4: 10.3 ← 5: 10.6x ↑
	Serie 47		Serie 49
	Total 96		Total 145
	1: 9.5 ↑ 2: 10.9x ← 3: 10.7x ↑ 4: 10.6x ↗ 5: 10.0 ←		1: 10.1 → 2: 10.3 ↑ 3: 10.2 ← 4: 10.0 ← 5: 8.9 ↗ 6: 10.0 ↗
	Serie 49		Serie 58
	Total 194		Total 194
	1: 10.4x ↗ 2: 10.7x ↓ 3: 10.1 → 4: 9.4 ↓ 5: 10.2 ↖		1: 9.5 ↗ 2: 9.6 ↗ 3: 10.0 ↑ 4: 8.7 ← 5: 8.0 ←
	Serie 49		Serie 44
	Total 243		Total 287
	1: 8.4 ↑ 2: 9.3 → 3: 6.5 ↓ 4: 7.1 → 5: 8.1 →		
	Serie 38		
	Total 325		

Skjutlag	Tavla	Anna Eklöf	
1	2		
Ramselefors	Storfors	A	Vä
12.07.2021	Tavelträffen 2021	Ramselefors SKF	
	1: 10.7x ↘ 2: 10.3 ↙ 3: 10.1 ↙ 4: 9.9 ↗ 5: 9.3 ←		1: 10.3 ↗ 2: 9.5 ↓ 3: 10.6x ↓ 4: 10.5x ↓ 5: 9.8 ↙
	Serie 48		Serie 48
	Total 0		Total 48
	1: 9.7 ↙ 2: 10.4 ↓ 3: 10.3 ↗ 4: 10.4x → 5: 9.5 ↘		1: 9.8 ↗ 2: 10.3 ↓ 3: 9.6 ↓ 4: 9.5 ← 5: 9.4 ↙
	Serie 48		Serie 46
	Total 96		Total 142
	1: 9.8 ↑ 2: 9.3 → 3: 9.3 ↗ 4: 10.3 → 5: 10.6x ↘		1: 10.6x ↓ 2: 10.1 ↓ 3: 10.5x ↙ 4: 10.6x → 5: 10.0 → 6: 10.2 →
	Serie 47		Serie 60
	Total 189		Total 189
	1: 9.3 → 2: 10.8x ↗ 3: 8.4 ↗ 4: 10.0 ↗ 5: 10.5x ↓		1: 10.2 → 2: 8.8 ↑ 3: 8.4 → 4: 8.6 ↘ 5: 8.8 ↗
	Serie 47		Serie 42
	Total 236		Total 278
	1: 7.5 ↑ 2: 7.7 → 3: 7.3 ↗ 4: 9.0 → 5: 7.0 ↗		
	Serie 37		
	Total 315		

Skjutlag	Tavla	Beatrice Andersson			
1	3	Ramselefors		B	Vb
12.07.2021		Tavelträffen 2021		Ramselefors SKF	
	1: 8.6 → 2: 8.6 → 3: 10.2 ↘ 4: 9.0 ↓		1: 8.4 ↓ 2: 9.8 ↓ 3: 10.4 → 4: 9.7 ↗ 5: 8.3 ↓		
	Serie 35 Total 0		Serie 44 Total 44		
	1: 9.1 ← 2: 10.1 ← 3: 10.1 ↗ 4: 8.7 ← 5: 7.8 ↗		1: 9.4 → 2: 7.7 ↑ 3: 10.5x → 4: 9.3 ← 5: 10.4x →		
	Serie 44 Total 88		Serie 45 Total 133		
	1: 10.4 ← 2: 7.1 ↗ 3: 7.8 → 4: 9.9 ← 5: 10.1 ↓		1: 10.2 ↓ 2: 8.4 ← 3: 10.3 ↗ 4: 10.1 ← 5: 9.2 ↖ 6: 6.2 ↗		
	Serie 43 Total 176		Serie 53 Total 176		
	1: 8.8 → 2: 10.0 ↓ 3: 7.3 ↗ 4: 9.6 ↓ 5: 9.4 ↗		1: 4.7 ← 2: 8.1 ↖ 3: 9.1 ↗ 4: 8.7 ← 5: 7.6 ↗		
	Serie 43 Total 219		Serie 36 Total 255		
	1: 7.9 ↗ 2: 8.0 ↓ 3: 7.0 → 4: 8.9 ↓ 5: 9.3 →				
	Serie 39 Total 294				

Skjutlag	Tavla	Olle Gabrielsson	
1	4	Ramselefors	Rommehed
12.07.2021	Tavelträffen 2021	Ramselefors SKF	
Prov 	1: 9.9 → 2: 10.1 ↓ 3: 9.6 ↙ 4: 10.8x ↗ 5: 10.3 ↓	1. Serie 5 Skott 	1: 10.3 ↑ 2: 10.2 ↓ 3: 10.5x ← 4: 9.9 ↓ 5: 9.8 ↙
Serie	48	Serie	48
Total	0	Total	48
2. Serie 5 Skott 	1: 9.4 ↗ 2: 9.8 ↘ 3: 10.6x ↗ 4: 10.8x ↗ 5: 10.3 ↗	3. Serie 5 Skott 	1: 10.4 ← 2: 10.4x ↓ 3: 9.9 ← 4: 10.0 ↗ 5: 10.1 ←
Serie	48	Serie	49
Total	96	Total	145
4. Serie 5 Skott 	1: 10.7x → 2: 10.7x → 3: 10.0 ↗ 4: 10.6x ↓ 5: 10.5x ↑	Prov 	1: 10.4x ↗ 2: 10.9x ↗ 3: 10.4 ↓ 4: 10.0 → 5: 10.8x ↓ 6: 8.7 ↓
Serie	50	Serie	58
Total	195	Total	195
5. Serie 5 Skott 	1: 10.4 → 2: 10.1 ↓ 3: 9.9 ↓ 4: 9.8 ↓ 5: 10.4 ↓	6. Serie 5 Skott 	1: 10.2 ↑ 2: 8.6 ↖ 3: 10.0 ↑ 4: 10.2 ← 5: 9.9 ↓
Serie	48	Serie	47
Total	243	Total	290
7. Serie 5 Skott 	1: 9.9 ↑ 2: 7.2 ↑ 3: 7.3 ↓ 4: 8.5 ↗ 5: 10.7x ↓		
Serie	41		
Total	331		

Skjutlag	Tavla	Björn Johansson	
1	5	Ramselefors	Kvistbro
12.07.2021	Tavelträffen 2021	Ramselefors SKF	
Prov 	1: 9.4 ↗ 2: 10.0 ↗ 3: 10.0 ↗ 4: 10.3 ↗ 5: 9.4 ↓	1. Serie 5 Skott 	1: 10.2 ↓ 2: 9.9 ↙ 3: 10.5x ↖ 4: 9.7 ↗ 5: 10.3 ↓
Serie 48	Total 0	Serie 48	Total 48
2. Serie 5 Skott 	1: 10.2 ↓ 2: 10.0 → 3: 10.0 → 4: 10.7x ↖ 5: 10.4x ↙	3. Serie 5 Skott 	1: 10.6x ↗ 2: 9.6 ↗ 3: 9.4 ↗ 4: 9.3 ↗ 5: 9.7 ↗
Serie 50	Total 98	Serie 46	Total 144
4. Serie 5 Skott 	1: 10.5x ↗ 2: 10.0 → 3: 10.2 ↗ 4: 10.7x ↓ 5: 10.5x ↓	Prov 	1: 9.0 ↓ 2: 9.9 ↓ 3: 9.6 ↓ 4: 10.4 ↓ 5: 7.0 → 6: 9.6 ↓
Serie 50	Total 194	Serie 53	Total 194
5. Serie 5 Skott 	1: 9.8 ↗ 2: 10.0 ↗ 3: 9.6 ← 4: 10.9x ← 5: 9.9 ↗	6. Serie 5 Skott 	1: 10.7x ↗ 2: 10.7x ↖ 3: 10.2 → 4: 10.1 ← 5: 10.1 ↓
Serie 47	Total 241	Serie 50	Total 291
7. Serie 5 Skott 	1: 8.4 ↗ 2: 9.4 ↗ 3: 7.7 ↖ 4: 8.7 → 5: 10.6x ↗		
Serie 42	Total 333		

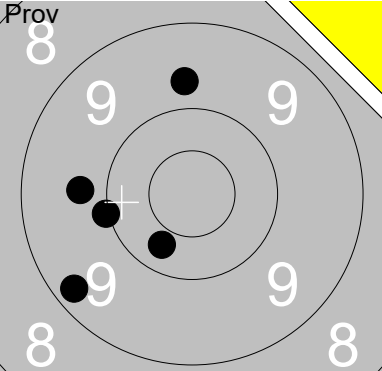
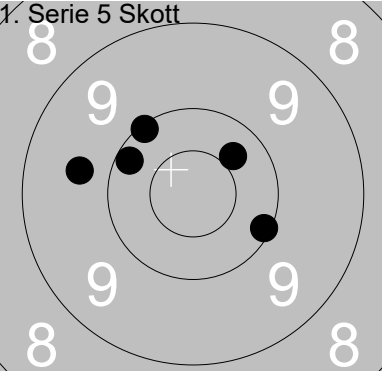
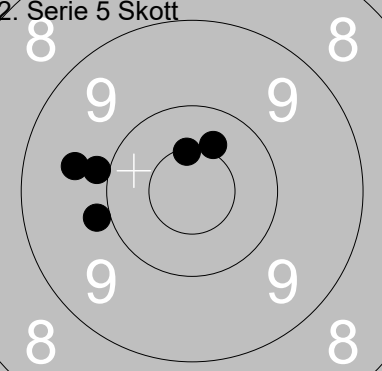
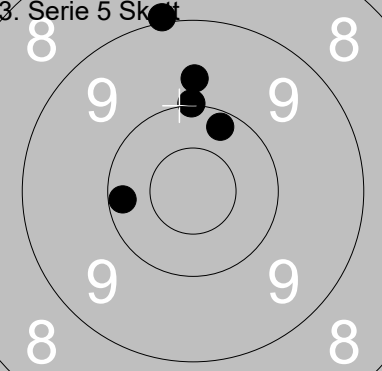
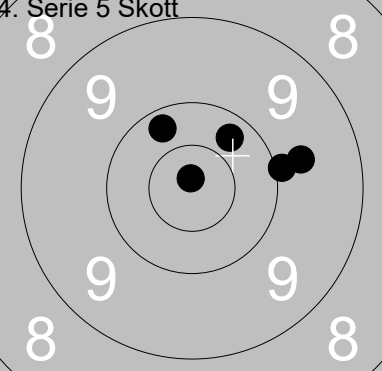
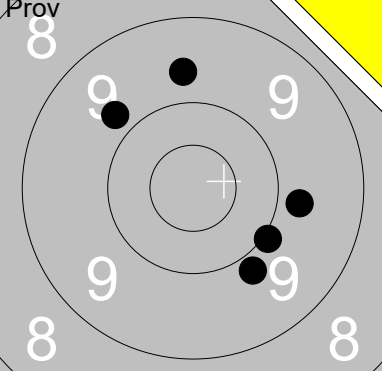
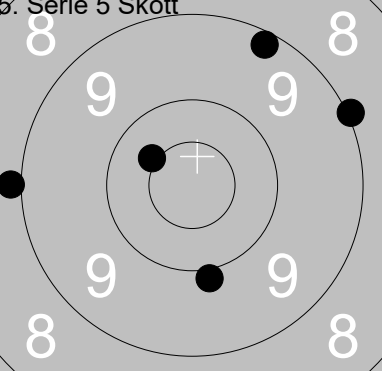
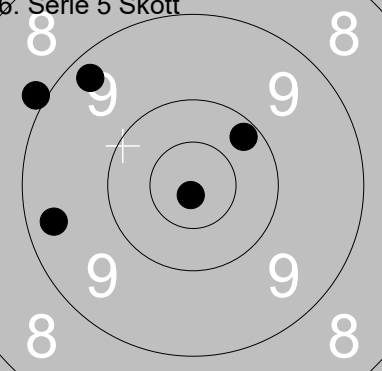
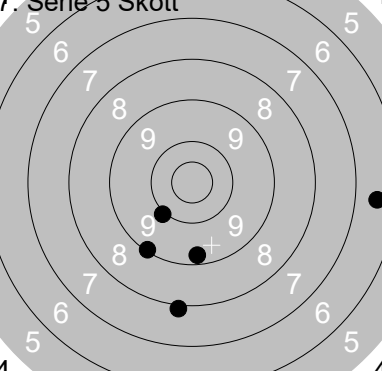
Skjutlag	Tavla	Bo Allansson	
1	6	Ramselefors	Stenungsund
12.07.2021	Tavelträffen 2021	B	Vs
		Ramselefors SKF	
	1: 10.3 ↘ 2: 9.7 ← 3: 9.3 ↘ 4: 9.7 ↑ 5: 10.0 ←	1. Serie 5 Skott 	1: 10.4 ↗ 2: 10.2 ↖ 3: 10.1 ↘ 4: 9.7 ← 5: 10.1 ↗
Serie 47	Total 0	Serie 49	Total 49
2. Serie 5 Skott 	1: 9.9 ← 2: 10.5x ↑ 3: 10.4 ↑ 4: 9.6 ← 5: 9.9 ←	3. Serie 5 Skott 	1: 10.0 ↑ 2: 10.2 ↑ 3: 9.0 ↑ 4: 9.7 ↑ 5: 10.2 ←
Serie 47	Total 96	Serie 48	Total 144
4. Serie 5 Skott 	1: 9.9 → 2: 10.3 ↗ 3: 10.2 ↗ 4: 10.8x ↑ 5: 9.7 →	Prov 	1: 9.7 ↑ 2: 10.0 ↘ 3: 9.8 → 4: 9.8 ↘ 5: 9.8 ↗
Serie 48	Total 192	Serie 46	Total 192
5. Serie 5 Skott 	1: 9.0 → 2: 9.2 ↑ 3: 9.9 ↓ 4: 8.9 ← 5: 10.4x ↖	6. Serie 5 Skott 	1: 9.3 ↖ 2: 9.3 ← 3: 8.9 ↖ 4: 10.8x ↓ 5: 10.2 ↗
Serie 45	Total 237	Serie 46	Total 283
7. Serie 5 Skott 	1: 6.5 → 2: 10.0 ↘ 3: 9.1 ↘ 4: 9.3 ↓ 5: 7.9 ↓		
Serie 41	Total 324		

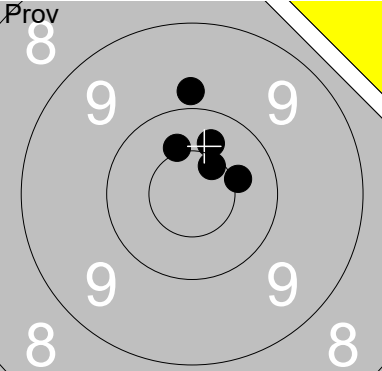
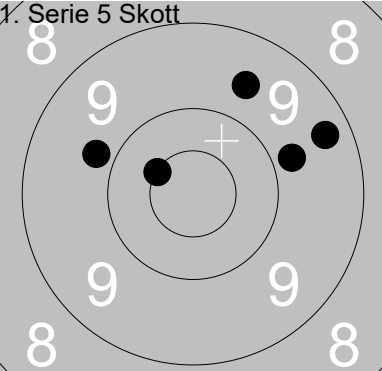
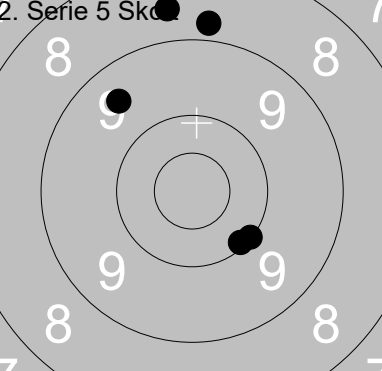
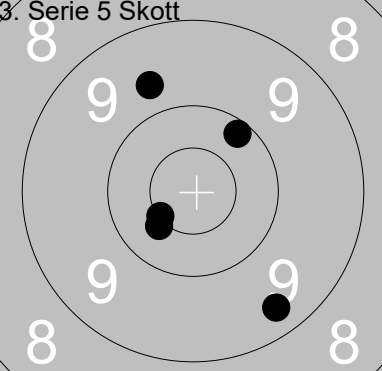
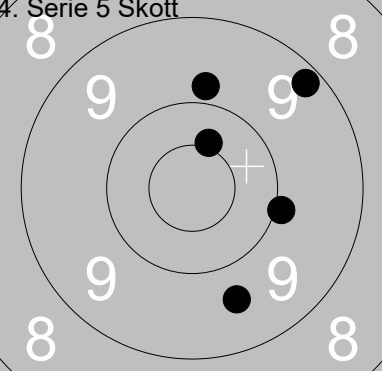
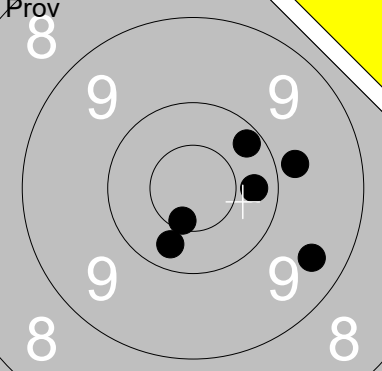
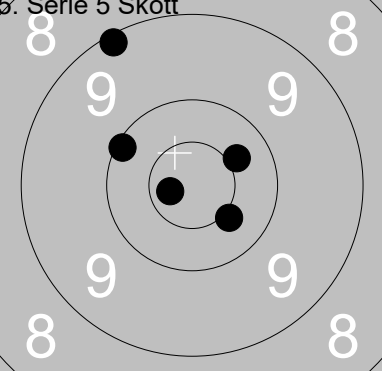
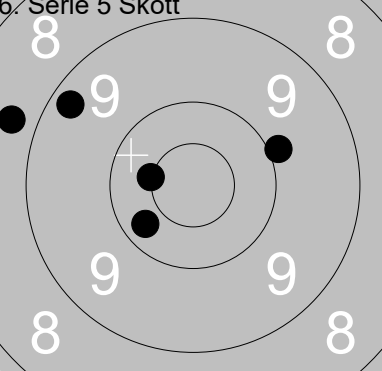
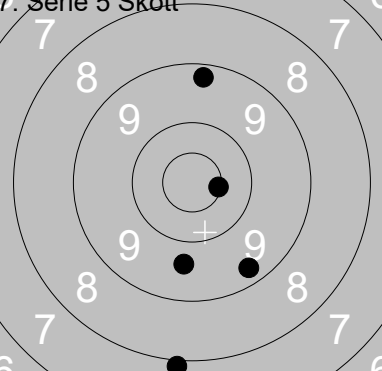
Skjutlag	Tavla	Casper Fredriksson			
1	7	Ramselefors	Ramselefors	A	Vb
12.07.2021	Tavelträffen 2021	Ramselefors SKF			
Prov 	1: 9.8 ↑ 2: 10.4 ↑ 3: 10.4x → 4: 10.6x ↑ 5: 10.4x ↑ Serie 49 Total 0	1. Serie 5 Skott 	1: 9.6 ↑ 2: 9.3 → 3: 9.8 ← 4: 10.5x ← 5: 9.8 → Serie 46 Total 46		
2. Serie 5 Skott 	1: 9.5 ↑ 2: 10.0 ↓ 3: 8.8 ↑ 4: 8.6 ↑ 5: 10.1 ↓ Serie 45 Total 91	3. Serie 5 Skott 	1: 9.7 ↑ 2: 9.4 ↓ 3: 10.2 ↑ 4: 10.5x ← 5: 10.4x ← Serie 48 Total 139		
4. Serie 5 Skott 	1: 9.8 ↑ 2: 10.4x ↑ 3: 9.2 ↑ 4: 10.0 → 5: 9.6 ↓ Serie 47 Total 186	Prov 	1: 9.8 → 2: 10.2 ↑ 3: 10.3 ↓ 4: 10.6x ↓ 5: 9.4 → 6: 10.3 → Serie 58 Total 186		
5. Serie 5 Skott 	1: 10.4 → 2: 10.7x ← 3: 9.1 ↑ 4: 10.1 ↑ 5: 10.4x ↓ Serie 49 Total 235	6. Serie 5 Skott 	1: 10.5x ← 2: 9.9 → 3: 9.3 ← 4: 8.7 ← 5: 10.3 ← Serie 46 Total 281		
7. Serie 5 Skott 	1: 7.9 ↓ 2: 9.3 ↑ 3: 9.7 ↓ 4: 9.3 ↓ 5: 10.5x → Serie 44 Total 325				

Skjutlag	Tavla	Daniel Wallberg			
1	8	Ramselefors	Loos	A	Gä
12.07.2021	Tavelträffen 2021	Ramselefors SKF			
Prov 	1: 9.0 ↙ 2: 9.3 ← 3: 8.9 ↓ 4: 10.7x ↑ 5: 10.3 ↓	1. Serie 5 Skott 	1: 9.1 ↓ 2: 9.7 ↑ 3: 10.4 → 4: 10.1 ↓ 5: 10.0 ←		
Serie 46		Serie 48			
Total 0		Total 48			
2. Serie 5 Skott 	1: 10.3 ↗ 2: 10.1 ↓ 3: 10.0 → 4: 10.4 ↗ 5: 9.9 ↗	3. Serie 5 Skott 	1: 10.5x ↖ 2: 10.4x → 3: 10.1 ↓ 4: 9.3 ↗ 5: 9.7 ←		
Serie 49		Serie 48			
Total 97		Total 145			
4. Serie 5 Skott 	1: 10.1 ↓ 2: 10.6x ← 3: 10.8x ↖ 4: 10.2 ↗ 5: 9.9 ↓	Prov 	1: 10.2 ← 2: 8.6 ↓ 3: 10.4 ↑ 4: 10.3 ↑ 5: 9.4 → 6: 10.0 →		
Serie 49		Serie 57			
Total 194		Total 194			
5. Serie 5 Skott 	1: 10.4x ↗ 2: 10.4x ↑ 3: 10.5x ↑ 4: 10.5x ↑ 5: 10.2 ↓	6. Serie 5 Skott 	1: 9.1 ↖ 2: 10.0 ↑ 3: 7.6 ↖ 4: 9.7 ↑ 5: 9.4 ↓		
Serie 50		Serie 44			
Total 244		Total 288			
7. Serie 5 Skott 	1: 8.0 → 2: 7.6 ↖ 3: 10.2 ↖ 4: 9.1 ← 5: 10.1 →				
Serie 44					
Total 332					

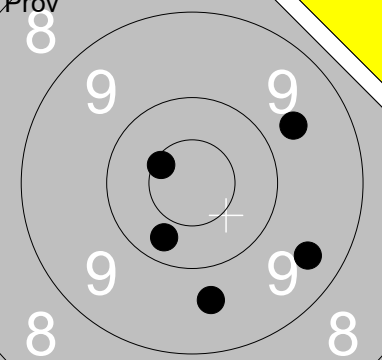
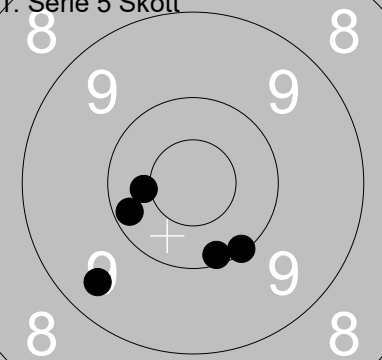
 <p>Prov</p>	<p>1: 9.7 ↗ 2: 9.4 ↘ 3: 9.6 ↓ 4: 10.3 ↓ 5: 10.6x ↖</p>	 <p>1. Serie 5 Skott</p>	<p>1: 10.1 ↓ 2: 10.1 ↓ 3: 9.4 ↙ 4: 10.2 ← 5: 10.4x ←</p>
Serie 47	Total 0	Serie 49	Total 49

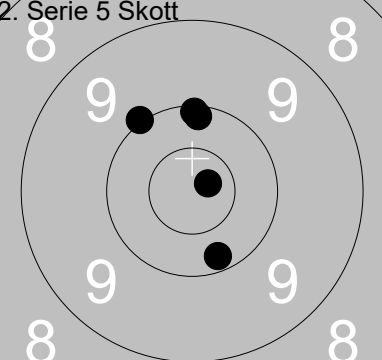
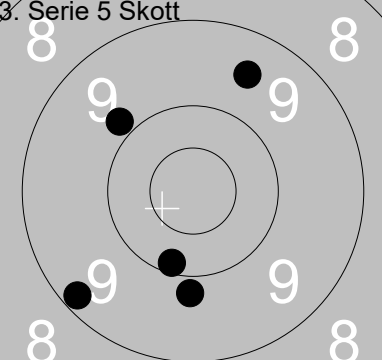
 <p>2. Serie 5 Skott</p>	<p>1: 10.1 ↑ 2: 10.2 ↓ 3: 10.8x ↗ 4: 10.0 ↖ 5: 10.1 ↑</p>	 <p>3. Serie 5 Skott</p>	<p>1: 9.5 ↑ 2: 9.8 ↖ 3: 9.8 ↓ 4: 9.2 ↙ 5: 10.1 ↓</p>
Serie 50	Total 99	Serie 46	Total 145

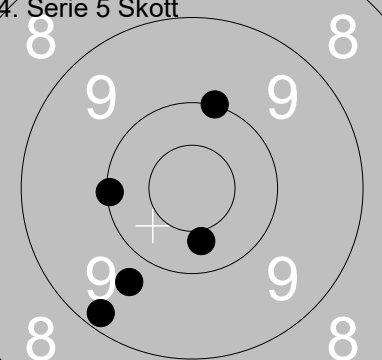
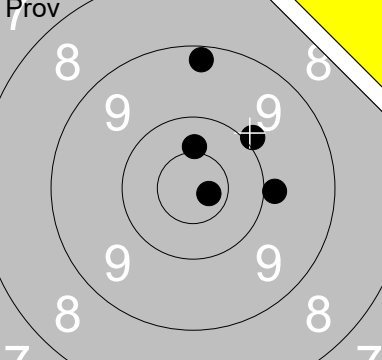
 <p>4. Serie 5 Skott</p>	<p>1: 10.0 ↑ 2: 10.4 ↓ 3: 9.2 ↓ 4: 10.1 ← 5: 9.7 ↙</p>	 <p>7. Serie 5 Skott</p>	<p>1: 10.4 ↑ 2: 9.9 → 3: 9.9 ↗ 4: 10.7x → 5: 7.9 ↗ 6: 9.2 ↑</p>
Serie 48	Total 193	Serie 54	Total 193

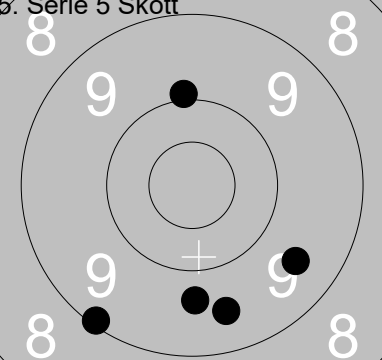
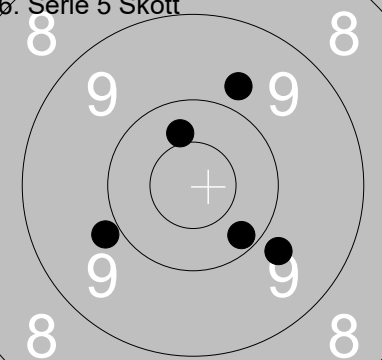
 <p>5. Serie 5 Skott</p>	<p>1: 10.0 ↑ 2: 9.5 ↓ 3: 9.1 ↓ 4: 9.7 ↓ 5: 9.5 ↘</p>	 <p>6. Serie 5 Skott</p>	<p>1: 9.9 ↙ 2: 10.2 ↓ 3: 9.8 ↘ 4: 9.8 ↑ 5: 10.4 ↑</p>
Serie 46	Total 239	Serie 47	Total 286

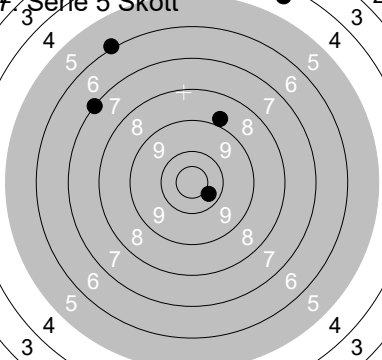
 <p>7. Serie 5 Skott</p>	<p>1: 5.9 ↖ 2: 8.8 ↑ 3: 4.4 ↑ 4: 7.0 ↖ 5: 10.4 ↓</p>		
Serie 34	Total 320		

Skjutlag	Tavla	Hanna Johansson		
1	10	Ramselefors	Umeå	B Vb
12.07.2021	Tavelträffen 2021	Ramselefors SKF		
	1: 8.3 ↗ 2: 9.5 ← 3: 10.5x ↗ 4: 9.9 ← 5: 9.9 ←		1: 9.9 ↗ 2: 9.2 ↗ 3: 10.3 ↗ 4: 10.4 ↓ 5: 10.1 ↓	
Serie	45	Serie	48	
Total	0	Total	48	
	1: 10.7x ↗ 2: 9.5 ↓ 3: 9.9 ↗ 4: 10.2 ↗ 5: 10.3 ←		1: 10.1 ← 2: 10.2 ↓ 3: 9.6 ↓ 4: 9.4 ↗ 5: 10.8x ↓	
Serie	48	Serie	48	
Total	96	Total	144	
	1: 9.5 → 2: 9.7 → 3: 10.4 ← 4: 9.2 ← 5: 10.0 ↑		1: 10.0 → 2: 9.2 → 3: 9.1 → 4: 10.7x ↓ 5: 6.8 → 6: 10.3 →	
Serie	47	Serie	54	
Total	191	Total	191	
	1: 9.8 ← 2: 10.3 ↗ 3: 10.1 ← 4: 8.3 ↓ 5: 9.8 ↓		1: 8.6 ↗ 2: 10.5x ↗ 3: 7.6 → 4: 10.6x ↓ 5: 9.9 →	
Serie	46	Serie	44	
Total	237	Total	281	
	1: 9.0 → 2: 8.1 ↗ 3: 7.4 ↗ 4: 8.6 ↗ 5: 10.1 ↗			
Serie	42			
Total	323			

Skjutlag	Tavla	Johan Nilsson			
1	11	Ramselefors	Ramselefors	B	Vb
12.07.2021	Tavelträffen 2021	Ramselefors SKF			
	1: 10.0 ↘ 2: 10.7x ← 3: 10.0 ← 4: 7.7 ↗ 5: 9.2 ↘ Serie 46 Total 0		1: 9.0 ↗ 2: 9.4 ← 3: 9.4 ↗ 4: 9.9 ↗ 5: 10.3 ↘ Serie 46 Total 46		
	1: 9.0 ← 2: 10.0 ↘ 3: 8.8 ↘ 4: 9.4 ↑ 5: 9.0 ↓ Serie 45 Total 91		1: 9.7 ← 2: 10.6x → 3: 10.1 ↘ 4: 8.8 ↗ 5: 9.2 ← Serie 46 Total 137		
	1: 9.2 ↓ 2: 9.9 ↓ 3: 10.2 → 4: 10.0 ↗ 5: 9.6 ← Serie 47 Total 184		1: 9.9 ↓ 2: 10.5x ↘ 3: 9.6 ↘ 4: 8.8 ↘ 5: 8.8 ↑ 6: 8.9 → Serie 52 Total 184		
	1: 10.2 ↑ 2: 9.0 ↑ 3: 10.1 ↑ 4: 10.2 → 5: 10.2 ← Serie 49 Total 233		1: 9.6 ↑ 2: 10.0 ↗ 3: 8.7 → 4: 9.1 ↗ 5: 8.7 ↑ Serie 44 Total 277		
	1: 7.7 → 2: 8.7 ↗ 3: 6.5 → 4: 8.1 ↑ 5: 7.9 ↑ Serie 36 Total 313				

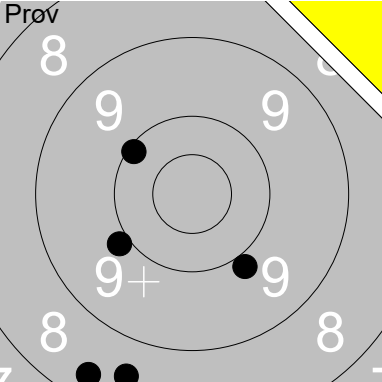
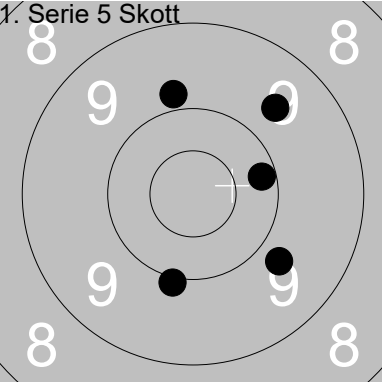
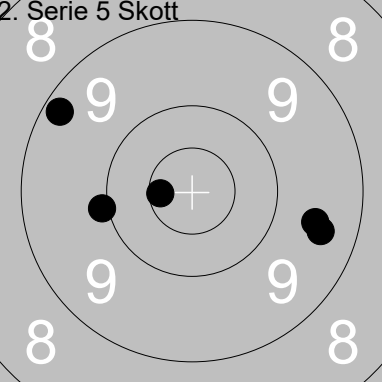
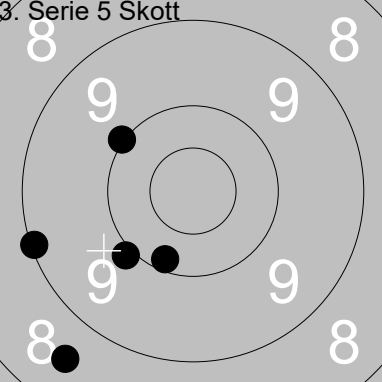
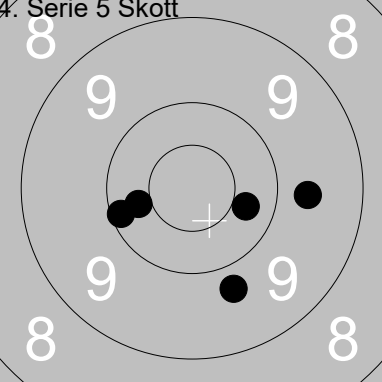
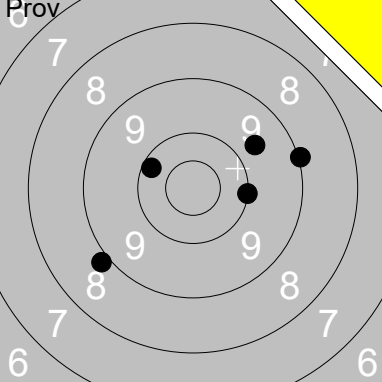
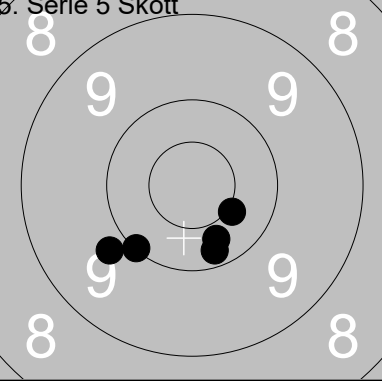
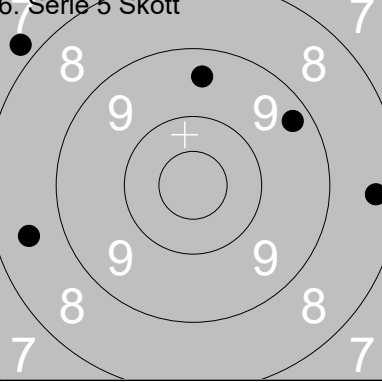
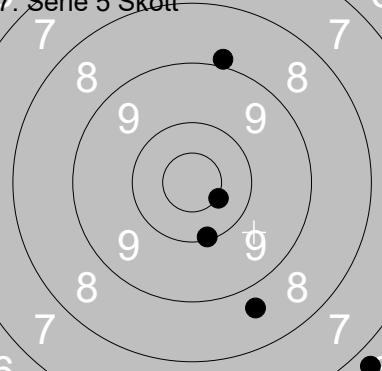
Skjutlag	Tavla	Kasper Svensson					
1	12	Ramselefors	Eggvena-Brättensby	A	Vg		
12.07.2021	Tavelträffen 2021	Ramselefors SKF					
Prov 	1: 8.6 ↘ 2: 8.4 ↘ 3: 9.9 ↘ 4: 9.9 ↖ 5: 10.1 ↗	1. Serie 5 Skott 	1: 9.8 ↘ 2: 10.0 ↘ 3: 9.8 ↑ 4: 9.6 ↗ 5: 10.2 →	Serie	44	Serie	47
	Total	0	Total	47			47
2. Serie 5 Skott 	1: 9.5 → 2: 9.5 → 3: 10.6x ← 4: 9.2 ↗ 5: 10.0 ←	3. Serie 5 Skott 	1: 10.0 ↖ 2: 8.6 ↘ 3: 9.1 ← 4: 10.2 ↘ 5: 9.9 ↘	Serie	47	Serie	46
	Total	94	Total	140			140
4. Serie 5 Skott 	1: 9.7 → 2: 9.8 ↘ 3: 10.3 → 4: 10.1 ← 5: 10.3 ←	Prov 	1: 8.9 ↘ 2: 10.2 ↖ 3: 9.0 → 4: 10.0 → 5: 7.1 ↗ 6: 9.7 ↗	Serie	48	Serie	53
	Total	188	Total	188			188
5. Serie 5 Skott 	1: 10.3 ↘ 2: 10.0 ↘ 3: 9.8 ↘ 4: 10.2 ↘ 5: 10.4x ↘	6. Serie 5 Skott 	1: 8.4 → 2: 9.3 ↗ 3: 7.8 ↖ 4: 8.5 ← 5: 9.4 ↑	Serie	49	Serie	41
	Total	237	Total	278			278
7. Serie 5 Skott 	1: 8.9 ↑ 2: 8.7 ↘ 3: 6.7 ↘ 4: 10.5x ↘ 5: 10.1 ↘			Serie	42		
	Total	320		Total	320		

Skjutlag	Tavla	Linda Bergman	
1	13	Ramselefors	Ununge
12.07.2021	Tavelträffen 2021	Ramselefors SKF	
Prov 	1: 10.3 ↗ 2: 9.7 ↑ 3: 10.0 → 4: 10.1 ↗ 5: 10.3 ↓	1. Serie 5 Skott 	1: 9.1 → 2: 10.2 ↗ 3: 10.0 ← 4: 10.4 ← 5: 9.0 ←
Serie 49		Serie 48	
Total 0		Total 48	
2. Serie 5 Skott 	1: 10.5x ↗ 2: 9.7 → 3: 10.5x ↓ 4: 9.6 ↓ 5: 9.8 ←	3. Serie 5 Skott 	1: 10.7x ↓ 2: 10.4x ← 3: 10.1 ← 4: 10.1 ↓ 5: 9.8 ↓
Serie 47		Serie 49	
Total 95		Total 144	
4. Serie 5 Skott 	1: 9.1 ↗ 2: 9.5 ← 3: 10.1 ← 4: 10.0 ← 5: 10.0 →	Prov 	1: 9.8 ↗ 2: 10.7x ← 3: 9.7 ↓ 4: 9.7 → 5: 10.5x ↗ 6: 9.8 ↓
Serie 48		Serie 56	
Total 192		Total 192	
5. Serie 5 Skott 	1: 10.1 → 2: 10.4 ↗ 3: 10.7x ↗ 4: 9.2 ← 5: 10.3 ↓	6. Serie 5 Skott 	1: 10.9x ↓ 2: 9.8 ↗ 3: 8.3 ← 4: 7.8 ↑ 5: 8.9 ←
Serie 49		Serie 42	
Total 241		Total 283	
7. Serie 5 Skott 	1: 6.7 ↑ 2: 7.5 ← 3: 5.8 ↗ 4: 10.3 ← 5: 6.3 ←		
Serie 34			
Total 317			

Skjutlag	Tavla	Marlene Forsell Forsman		
1	14	Ramselefors	Ramselefors	B Vb
12.07.2021	Tavelträffen 2021	Ramselefors SKF		
Prov 	1: 9.8 ↗ 2: 10.2 ↗ 3: 10.4x ↗ 4: 10.6x ↘ 5: 10.5x →	1. Serie 5 Skott 	1: 9.6 ← 2: 10.1 ↑ 3: 10.7x ↗ 4: 9.5 ← 5: 10.4 ↘	
Serie	49	Serie	48	
Total	0	Total	48	
2. Serie 5 Skott 	1: 9.8 ↗ 2: 9.8 ↗ 3: 10.7x ↑ 4: 10.0 ↗ 5: 10.5x ↘	3. Serie 5 Skott 	1: 8.4 ↗ 2: 10.3 ↗ 3: 9.7 ↗ 4: 10.5x ↗ 5: 10.1 ←	
Serie	48	Serie	47	
Total	96	Total	143	
4. Serie 5 Skott 	1: 10.1 ↑ 2: 10.0 ↘ 3: 10.7x ↗ 4: 10.6x ↘ 5: 10.8x ↗	Prov 	1: 10.3 ↘ 2: 9.1 → 3: 9.5 ↘ 4: 9.9 ↘ 5: 10.3 ↘ 6: 8.4 ↘	
Serie	50	Serie	55	
Total	193	Total	193	
5. Serie 5 Skott 	1: 10.8x ↘ 2: 10.3 ↘ 3: 10.3 ← 4: 10.6x ← 5: 10.1 ↘	6. Serie 5 Skott 	1: 9.1 → 2: 10.0 ↘ 3: 9.2 ↘ 4: 9.1 ↘ 5: 8.1 ←	
Serie	50	Serie	45	
Total	243	Total	288	
7. Serie 5 Skott 	1: 6.3 ← 2: 7.5 ↗ 3: 8.7 ↗ 4: 8.9 → 5: 10.8x ↑			
Serie	39			
Total	327			

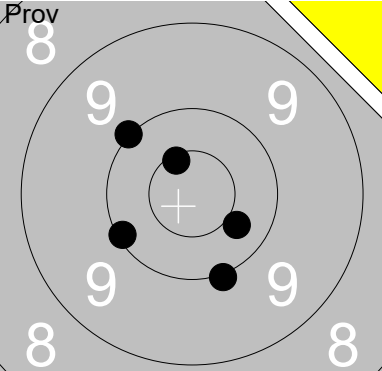
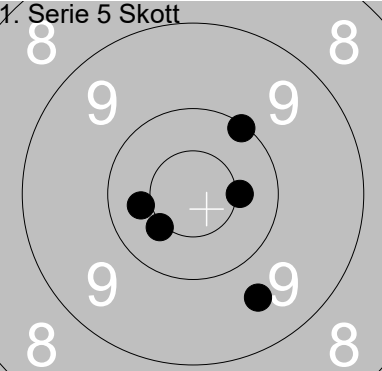
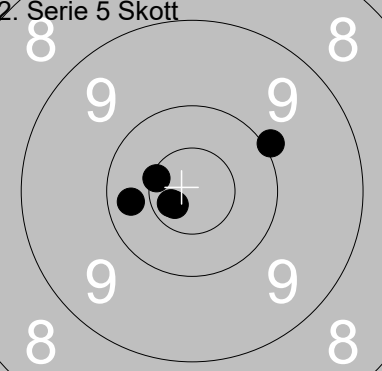
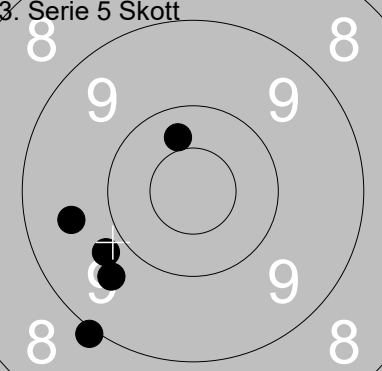
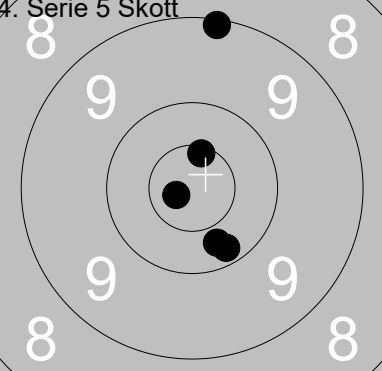
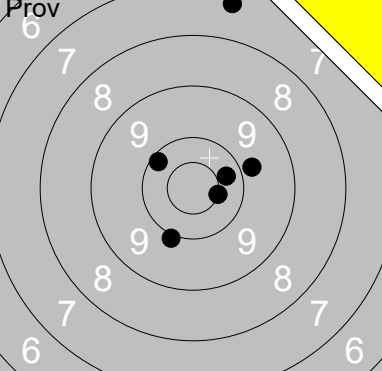
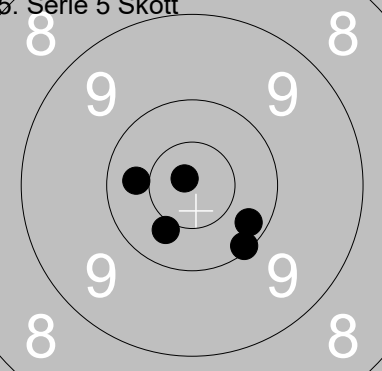
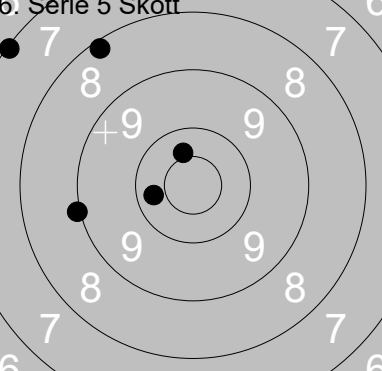
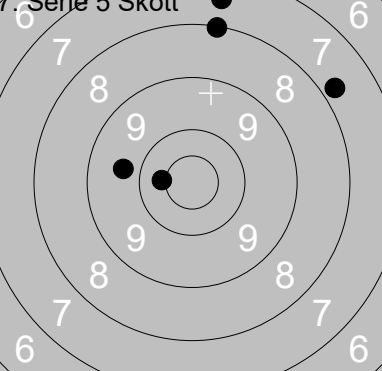
Skjutlag	Tavla	Martin Nilsson	
1	15	Ramselefors	Kvistbro
12.07.2021	Tavelträffen 2021	Ramselefors SKF	
	1: 10.0 ↖ 2: 10.1 ← 3: 10.0 ↓ 4: 10.6x ↑ 5: 10.4 ↓		1: 10.1 ↗ 2: 10.4x → 3: 10.4x ↓ 4: 10.4 ← 5: 9.6 ↓
Serie 50	Total 0	Serie 49	Total 49
	1: 10.3 ← 2: 10.0 → 3: 10.7x ← 4: 10.7x ↓ 5: 10.5x ←		1: 10.3 ↑ 2: 9.0 ↓ 3: 9.6 ← 4: 9.8 ↓ 5: 9.7 ↓
Serie 50	Total 99	Serie 46	Total 145
	1: 9.1 ↑ 2: 10.6x ↑ 3: 10.8x ← 4: 10.2 ↓ 5: 10.3 ↓		1: 9.8 → 2: 10.2 ↖ 3: 10.0 ↓ 4: 10.3 → 5: 7.3 ↑ 6: 10.5x →
Serie 49	Total 194	Serie 56	Total 194
	1: 10.3 ← 2: 10.1 ↓ 3: 10.4 ↓ 4: 10.2 ↓ 5: 10.8x ↑		1: 10.4 ↑ 2: 7.1 ↖ 3: 10.3 ← 4: 8.2 ↖ 5: 9.0 ←
Serie 50	Total 244	Serie 44	Total 288
	1: 10.4x ← 2: 8.1 ↑ 3: 7.5 ↑ 4: 7.8 → 5: 9.7 ←		
Serie 41	Total 329		

Skjutlag	Tavla	Mats Österlund	
1	16	Ramselefors	B Vb
12.07.2021	Tavelträffen 2021	Ramselefors SKF	
	1: 9.6 ↘ 2: 9.5 ↘ 3: 10.1 ↗ 4: 10.4 ↗ 5: 10.4 ↗	1. Serie 5 Skott 	1: 10.3 ↓ 2: 9.1 ↓ 3: 10.5x ↗ 4: 9.4 ↗ 5: 9.6 ↓
Serie 48	Total 0	Serie 47	Total 47
	1: 9.5 ↑ 2: 10.2 ↗ 3: 10.3 ↗ 4: 9.9 ↗ 5: 10.2 ↗	3. Serie 5 Skott 	1: 9.6 ↗ 2: 8.5 ↗ 3: 8.1 ↗ 4: 8.0 ↗ 5: 7.6 ↓
Serie 48	Total 95	Serie 40	Total 135
	1: 10.6x ← 2: 9.1 ↑ 3: 9.7 ↗ 4: 9.7 ← 5: 9.9 ↓		1: 9.6 ↗ 2: 10.7x ↓ 3: 9.1 ↓ 4: 10.1 ↓ 5: 8.3 → 6: 7.4 →
Serie 46	Total 181	Serie 53	Total 181
	1: 9.9 ↑ 2: 10.5x ↗ 3: 10.4x ↘ 4: 10.1 ← 5: 10.8x ←		1: 9.4 ↗ 2: 10.0 → 3: 10.7x ↗ 4: 9.4 → 5: 5.3 ↑
Serie 49	Total 230	Serie 43	Total 273
	1: 8.9 ↑ 2: 7.3 ← 3: 9.6 → 4: 6.8 ↓ 5: 8.0 ↗		
Serie 38	Total 311		

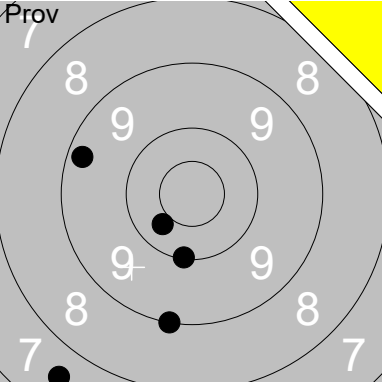
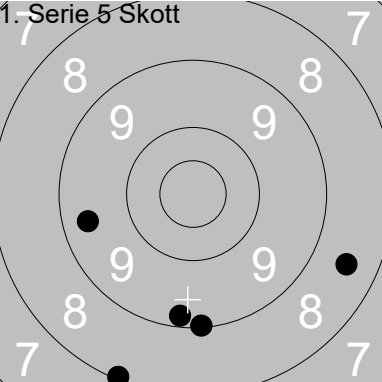
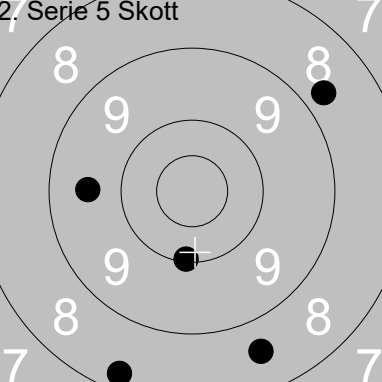
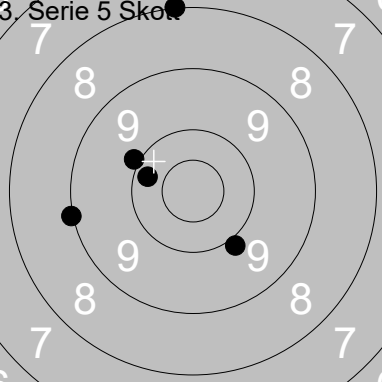
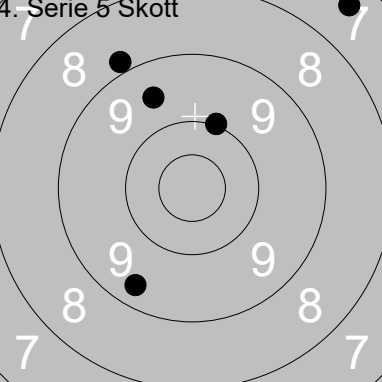
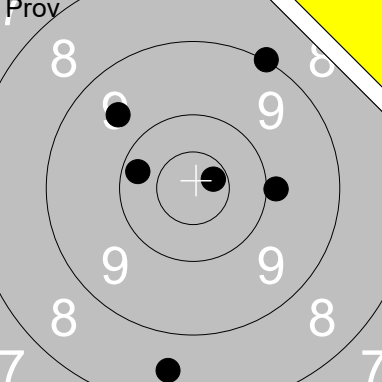
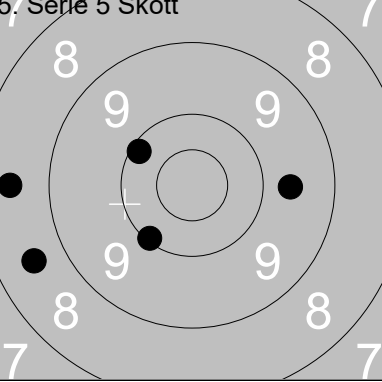
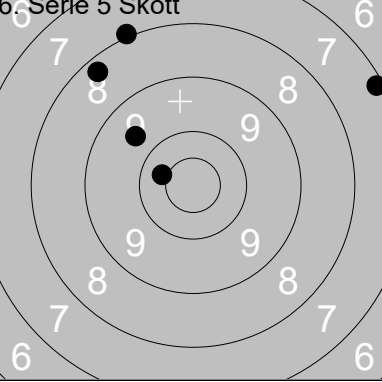
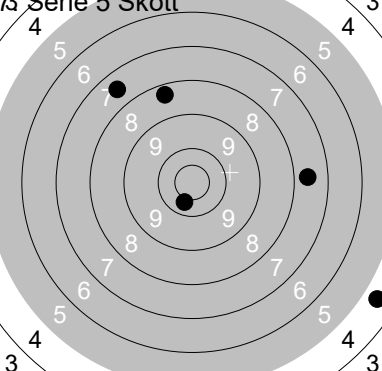
Skjutlag	Tavla	André Engström	
1	17		
Ramselefors	Piteå	B	No
12.07.2021	Tavelträffen 2021	Ramselefors SKF	
	1: 10.3 ↘ 2: 7.6 ↘ 3: 9.3 ← 4: 10.0 ↓ 5: 9.0 ↓		1: 8.5 → 2: 9.2 ↓ 3: 9.1 ↓ 4: 9.4 ← 5: 8.1 ↓
Serie 45	Total 0	Serie 43	Total 43
	1: 8.6 ↓ 2: 9.6 ← 3: 8.7 ↗ 4: 10.1 ↓ 5: 8.3 ↓		1: 9.0 ← 2: 9.9 ↗ 3: 10.2 ← 4: 8.0 ↑ 5: 9.9 ↓
Serie 43	Total 86	Serie 45	Total 131
	1: 8.9 ↗ 2: 9.5 ↗ 3: 10.0 ↑ 4: 9.3 ↓ 5: 7.4 ↗		1: 8.5 ↓ 2: 10.7x ↗ 3: 9.9 → 4: 10.2 ← 5: 9.6 ↗ 6: 9.0 ↗
Serie 43	Total 174	Serie 55	Total 174
	1: 10.1 ↗ 2: 8.6 ← 3: 8.5 ← 4: 9.7 → 5: 10.1 ↓		1: 7.1 ↗ 2: 9.6 ↗ 3: 10.4 ← 4: 8.0 ↗ 5: 8.3 ↗
Serie 45	Total 219	Serie 42	Total 261
	1: 4.6 → 2: 10.4 ↓ 3: 8.3 ↗ 4: 7.5 ↗ 5: 7.6 →		
Serie 36	Total 297		

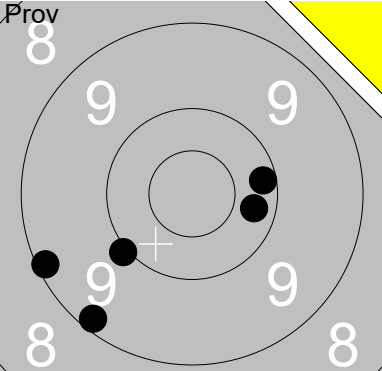
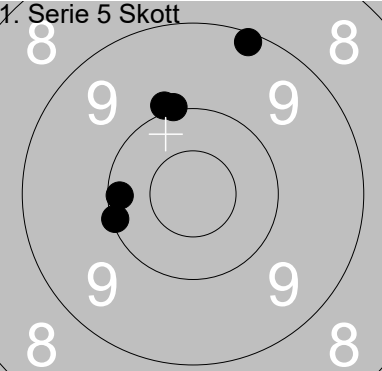
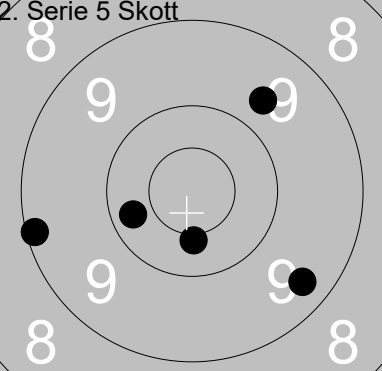
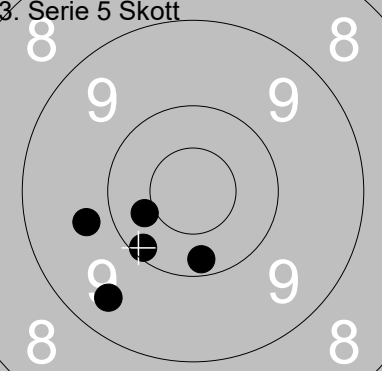
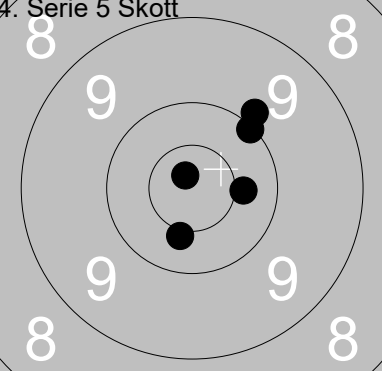
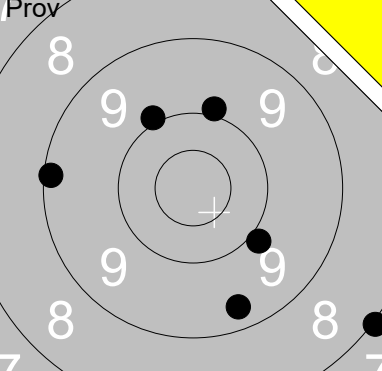
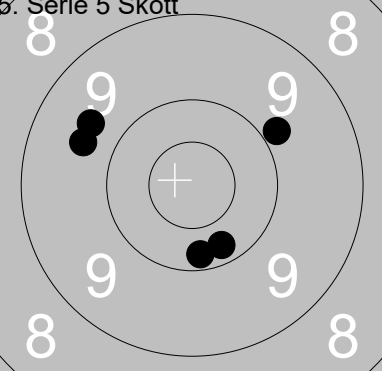
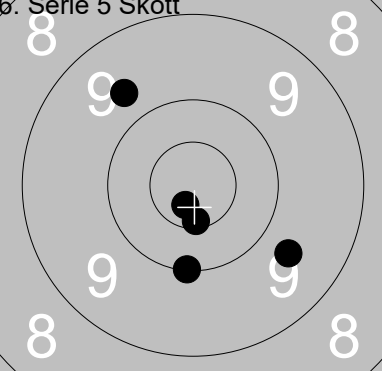
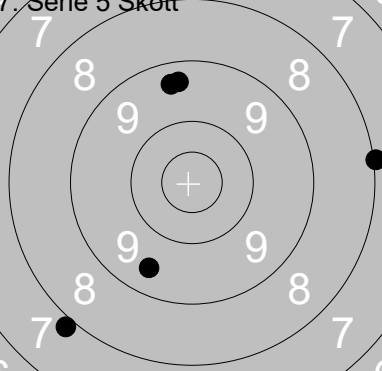
Skjutlag	Tavla	Bengt Jansson	
1	19	Ramselefors	Söderala
12.07.2021	Tavelträffen 2021	Ramselefors SKF	
Prov 	1: 9.1 ← 2: 9.2 ↓ 3: 10.3 → 4: 10.0 ↓ 5: 10.2 →	1. Serie 5 Skott 	1: 9.9 ↑ 2: 9.1 ↑ 3: 10.2 ← 4: 10.0 ↑ 5: 10.1 ←
Serie 48	Total 0	Serie 48	Total 48
2. Serie 5 Skott 	1: 9.4 → 2: 9.7 ↗ 3: 10.4x ↓ 4: 10.3 ← 5: 9.1 ←	3. Serie 5 Skott 	1: 9.4 ↓ 2: 9.7 ← 3: 10.4 ← 4: 10.1 ↓ 5: 10.2 ↓
Serie 47	Total 95	Serie 48	Total 143
4. Serie 5 Skott 	1: 10.4 → 2: 10.8x ↑ 3: 9.9 ↗ 4: 10.1 ↗ 5: 10.4x ↓	Prov 	1: 9.3 ↓ 2: 9.9 ↑ 3: 10.0 ↗ 4: 9.9 ↓ 5: 8.0 ↓ 6: 9.1 ←
Serie 49	Total 192	Serie 54	Total 192
5. Serie 5 Skott 	1: 10.2 ↓ 2: 9.6 ↖ 3: 9.7 ↖ 4: 9.9 ↗ 5: 10.2 ↓	6. Serie 5 Skott 	1: 10.0 ↓ 2: 10.7x ↓ 3: 9.7 ↘ 4: 10.6x ↓ 5: 9.7 ↗
Serie 47	Total 239	Serie 48	Total 287
7. Serie 5 Skott 	1: 9.4 ↑ 2: 8.0 → 3: 7.9 ↓ 4: 9.5 ↓ 5: 9.4 ↑		
Serie 42	Total 329		

Skjutlag	Tavla	Clas Bernhardsson			
1	21	Ramselefors	Mönsterås	A	Sm
12.07.2021	Tavelträffen 2021	Ramselefors SKF			
	1: 9.5 ↗ 2: 10.7x ↓ 3: 9.5 ↑ 4: 9.6 ← 5: 10.3 →	1. Serie 5 Skott 	1: 10.2 ↖ 2: 9.6 ↓ 3: 9.7 ↙ 4: 9.6 ↘ 5: 10.0 ↑	Serie	47
Total		Total		47	
	1: 9.1 → 2: 10.3 → 3: 10.5x ↓ 4: 10.3 ↓ 5: 10.2 →	3. Serie 5 Skott 	1: 9.6 ↖ 2: 10.1 ← 3: 10.3 ↙ 4: 9.4 ↗ 5: 9.8 ←	Serie	49
Total		Total		96	
				47	
				143	
	1: 9.8 ↓ 2: 10.1 ↗ 3: 10.2 ↓ 4: 9.7 ↑ 5: 10.2 ↑		1: 9.8 → 2: 10.2 ↙ 3: 10.4 ↗ 4: 10.4 ↑ 5: 7.8 → 6: 10.5x ↖	Serie	48
Total		Total		191	
				56	
				191	
	1: 10.1 ↖ 2: 10.8x ↖ 3: 10.5x ↓ 4: 9.8 → 5: 9.6 ↑	6. Serie 5 Skott 	1: 8.5 ← 2: 10.0 ↗ 3: 8.5 ↗ 4: 7.8 → 5: 9.8 ↑	Serie	48
Total		Total		239	
				42	
				281	
	1: 6.8 ↑ 2: 9.2 ↑ 3: 7.8 ↓ 4: 9.7 ↑ 5: 7.9 ↗				
Total		Total		319	
				38	
				319	

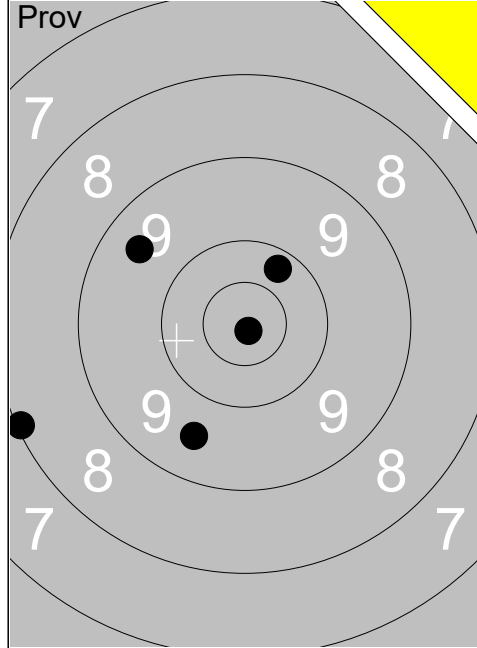

1:	8.1	↙
2:	10.2	↗
3:	10.9x	↘
4:	9.5	↖
5:	9.6	↘
Serie		46
Total		0

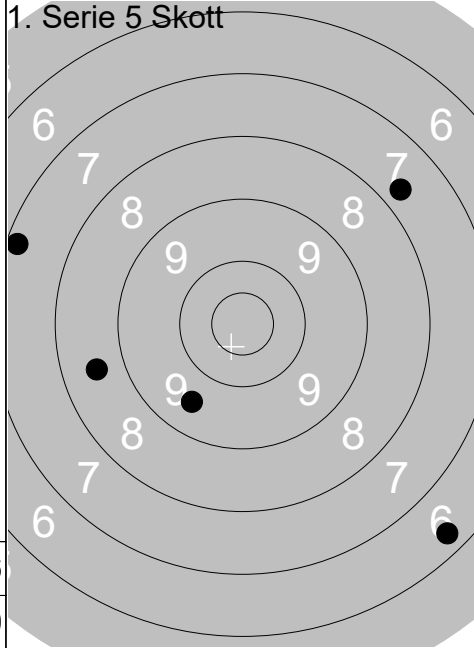

1:	7.7	↗
2:	6.3	↘
3:	8.6	↖
4:	9.6	↘
5:	7.2	↖
Serie		37
Total		37

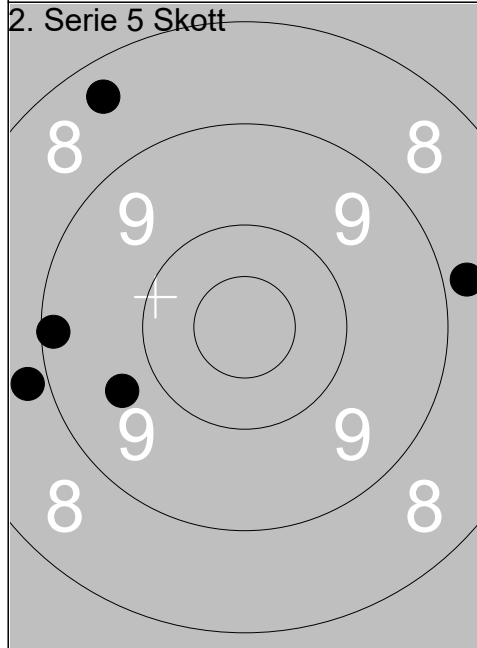

1:	8.8	→
2:	8.4	↗
3:	9.1	↖
4:	9.7	↖
5:	8.8	↖
Serie		42
Total		79

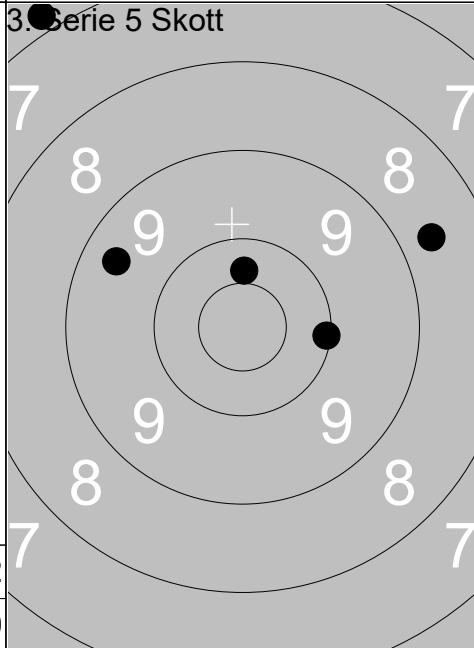

1:	8.7	↗
2:	9.4	↖
3:	10.4	↑
4:	6.8	↗
5:	10.1	→
Serie		43
Total		122

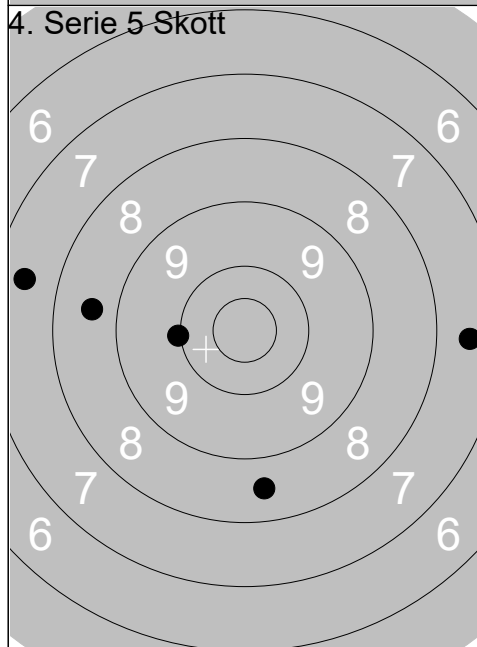

1:	8.6	↘
2:	10.0	↖
3:	7.5	→
4:	8.6	↖
5:	7.5	↖
Serie		40
Total		162

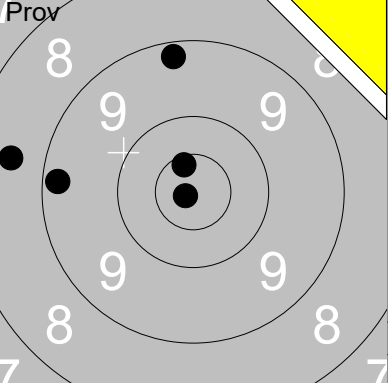
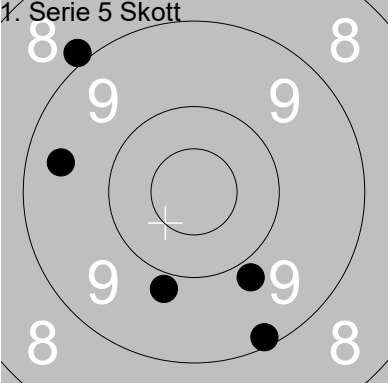
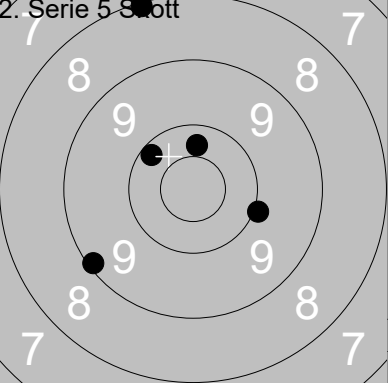
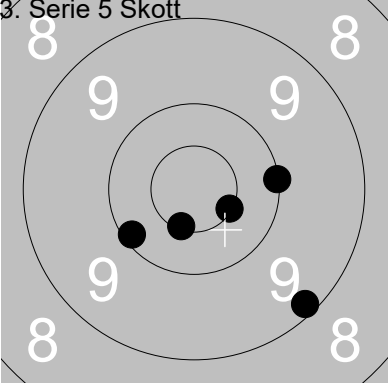
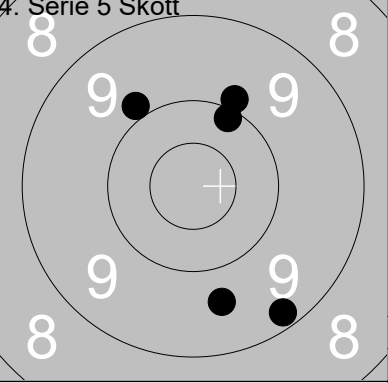
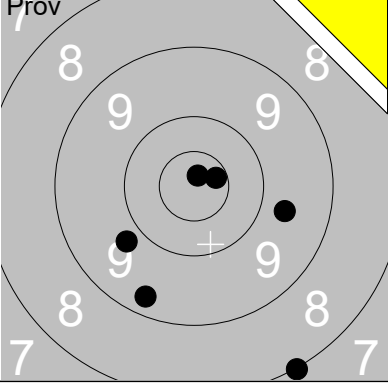
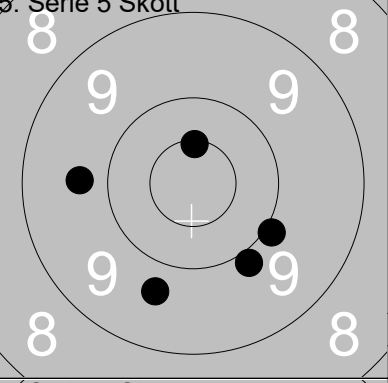
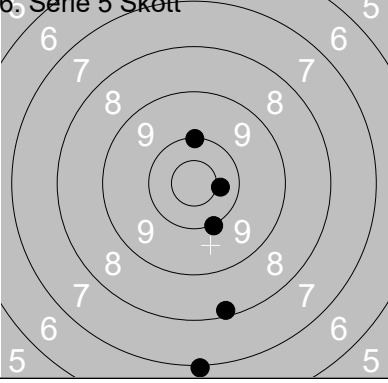
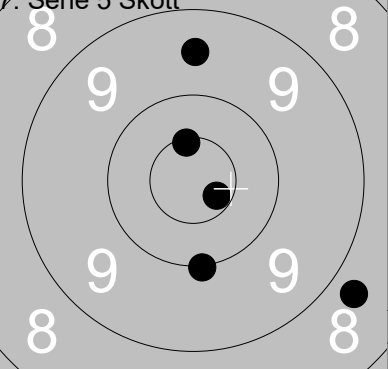
Skjutlag	Tavla	Bo Forsberg		D	Vn
1	23	Ramselefors	Moälven-Modo		
12.07.2021	Tavelträffen 2021	Ramselefors SKF			
Prov		1. Serie 5 Skott			
	1: 9.2 ← 2: 9.2 ↑ 3: 8.6 ← 4: 10.6x ↑ 5: 10.8x ←		1: 9.8 ↓ 2: 9.8 ↓ 3: 9.4 ← 4: 9.1 ↓ 5: 8.9 ↗		
	Serie 46 Total 0		Serie 44 Total 44		
2. Serie 5 Skott		3. Serie 5 Skott			
	1: 8.1 ↑ 2: 10.3 ↑ 3: 9.1 ← 4: 10.2 ↗ 5: 10.0 →		1: 10.5x ↓ 2: 10.1 ← 3: 10.0 → 4: 9.2 ↓ 5: 10.5x ↓		
	Serie 47 Total 91		Serie 49 Total 140		
4. Serie 5 Skott		Prov			
	1: 10.1 ↑ 2: 9.6 ↓ 3: 9.9 ↗ 4: 9.9 ↑ 5: 9.2 ↓		1: 9.8 ↙ 2: 9.7 → 3: 10.6x → 4: 10.8x ↑ 5: 9.3 ↓ 6: 8.0 ↓		
	Serie 46 Total 186		Serie 55 Total 186		
5. Serie 5 Skott		6. Serie 5 Skott			
	1: 9.7 ← 2: 9.9 → 3: 10.5x ↑ 4: 9.7 ↓ 5: 9.9 ↓		1: 7.0 ↓ 2: 8.2 ↓ 3: 10.4 → 4: 10.0 ↑ 5: 10.0 ↓		
	Serie 46 Total 232		Serie 45 Total 277		
7. Serie 5 Skott					
	1: 10.5x ↑ 2: 8.7 ↘ 3: 10.6x ↘ 4: 9.5 ↑ 5: 10.0 ↓				
	Serie 47 Total 324				

Skjutlag	Tavla	Rebecka Andersson					
2	1	Loos		B	Gä		
12.07.2021	Tavelträffen 2021	Ramselefors SKF					
Prov 	1: 8.8 ↗ 2: 10.2 ← 3: 9.8 ↗ 4: 9.7 ← 5: 10.1 ↗	1. Serie 5 Skott 	1: 10.5x ↓ 2: 9.9 ← 3: 9.7 ↗ 4: 10.4 ↗ 5: 10.3 ←	Serie	46	Serie	48
Total		0		Total		48	
2. Serie 5 Skott 	1: 10.7x ↘ 2: 9.9 ↓ 3: 10.1 ↗ 4: 10.2 ↓ 5: 10.6x ↘	3. Serie 5 Skott 	1: 10.1 ↗ 2: 10.0 ↗ 3: 10.2 ↓ 4: 10.6x ← 5: 10.2 ↓	Serie	49	Serie	50
Total		97		Total		147	
4. Serie 5 Skott 	1: 9.8 ← 2: 9.6 ↗ 3: 9.6 ↓ 4: 10.4x ← 5: 9.9 ↘	Prov 	1: 9.6 ↗ 2: 9.9 ↓ 3: 10.6x → 4: 9.2 → 5: 10.7x ← 6: 9.6 ↗	Serie	46	Serie	56
Total		193		Total		193	
5. Serie 5 Skott 	1: 10.1 ↓ 2: 8.7 ↓ 3: 9.4 ↗ 4: 10.3 ← 5: 10.0 ↓	6. Serie 5 Skott 	1: 7.3 ↑ 2: 10.1 ↗ 3: 10.1 ↓ 4: 10.0 ↓ 5: 10.5x ↗	Serie	47	Serie	47
Total		240		Total		287	
7. Serie 5 Skott 	1: 8.0 → 2: 6.8 ↑ 3: 10.0 → 4: 6.5 → 5: 7.3 →						
Total		324					

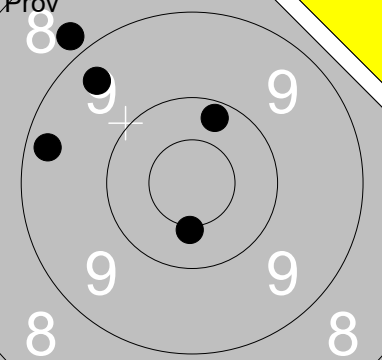
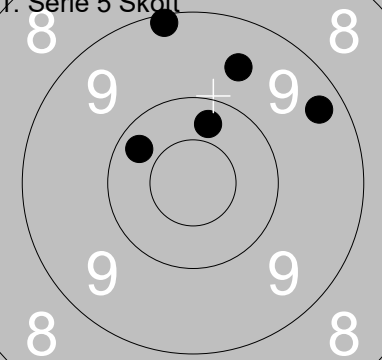
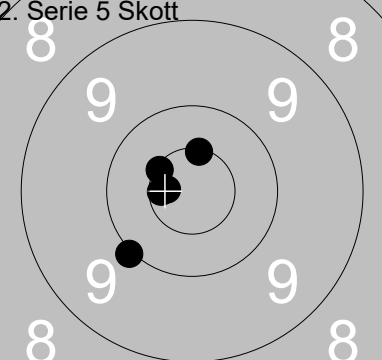
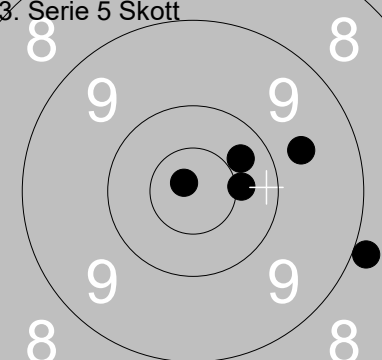
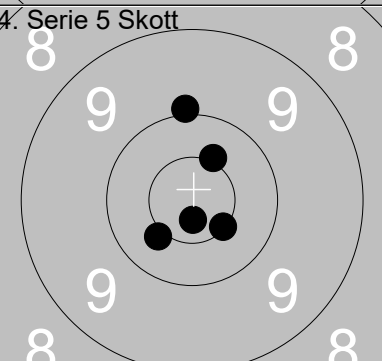
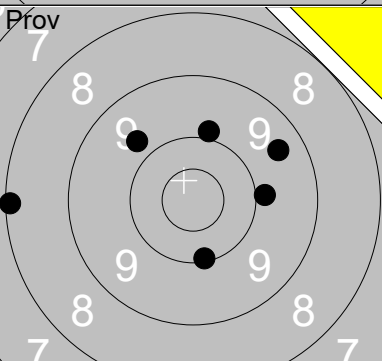
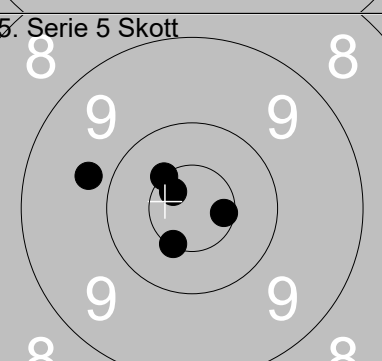
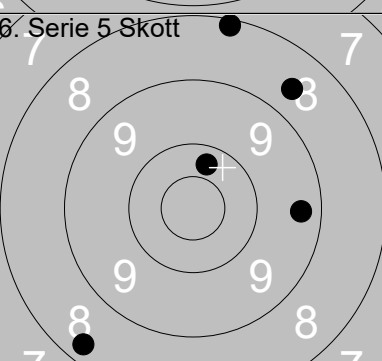
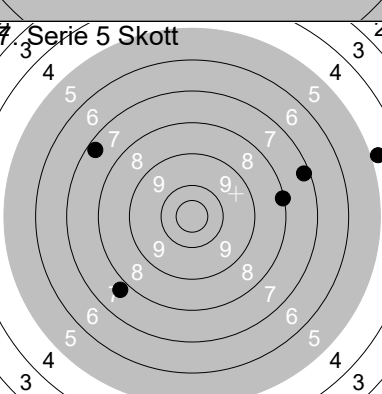
	<table border="1" style="width:100%; border-collapse: collapse;"> <tr><td>1:</td><td>10.4x</td><td>↓</td></tr> <tr><td>2:</td><td>8.8</td><td>↗</td></tr> <tr><td>3:</td><td>10.2</td><td>↑</td></tr> <tr><td>4:</td><td>9.4</td><td>↗</td></tr> <tr><td>5:</td><td>9.3</td><td>←</td></tr> <tr><td colspan="2">Serie</td><td>46</td></tr> <tr><td colspan="2">Total</td><td>0</td></tr> </table>	1:	10.4x	↓	2:	8.8	↗	3:	10.2	↑	4:	9.4	↗	5:	9.3	←	Serie		46	Total		0		<table border="1" style="width:100%; border-collapse: collapse;"> <tr><td>1:</td><td>10.3</td><td>↖</td></tr> <tr><td>2:</td><td>9.3</td><td>↗</td></tr> <tr><td>3:</td><td>9.6</td><td>↑</td></tr> <tr><td>4:</td><td>10.3</td><td>↑</td></tr> <tr><td>5:</td><td>9.1</td><td>↑</td></tr> <tr><td colspan="2">Serie</td><td>47</td></tr> <tr><td colspan="2">Total</td><td>47</td></tr> </table>	1:	10.3	↖	2:	9.3	↗	3:	9.6	↑	4:	10.3	↑	5:	9.1	↑	Serie		47	Total		47			
1:	10.4x	↓																																														
2:	8.8	↗																																														
3:	10.2	↑																																														
4:	9.4	↗																																														
5:	9.3	←																																														
Serie		46																																														
Total		0																																														
1:	10.3	↖																																														
2:	9.3	↗																																														
3:	9.6	↑																																														
4:	10.3	↑																																														
5:	9.1	↑																																														
Serie		47																																														
Total		47																																														
	<table border="1" style="width:100%; border-collapse: collapse;"> <tr><td>1:</td><td>10.5x</td><td>↖</td></tr> <tr><td>2:</td><td>10.6x</td><td>←</td></tr> <tr><td>3:</td><td>10.5x</td><td>↑</td></tr> <tr><td>4:</td><td>10.0</td><td>↘</td></tr> <tr><td>5:</td><td>10.7x</td><td>←</td></tr> <tr><td colspan="2">Serie</td><td>50</td></tr> <tr><td colspan="2">Total</td><td>97</td></tr> </table>	1:	10.5x	↖	2:	10.6x	←	3:	10.5x	↑	4:	10.0	↘	5:	10.7x	←	Serie		50	Total		97		<table border="1" style="width:100%; border-collapse: collapse;"> <tr><td>1:</td><td>10.4x</td><td>→</td></tr> <tr><td>2:</td><td>10.3</td><td>↗</td></tr> <tr><td>3:</td><td>9.7</td><td>↗</td></tr> <tr><td>4:</td><td>10.8x</td><td>↖</td></tr> <tr><td>5:</td><td>8.9</td><td>→</td></tr> <tr><td colspan="2">Serie</td><td>47</td></tr> <tr><td colspan="2">Total</td><td>144</td></tr> </table>	1:	10.4x	→	2:	10.3	↗	3:	9.7	↗	4:	10.8x	↖	5:	8.9	→	Serie		47	Total		144			
1:	10.5x	↖																																														
2:	10.6x	←																																														
3:	10.5x	↑																																														
4:	10.0	↘																																														
5:	10.7x	←																																														
Serie		50																																														
Total		97																																														
1:	10.4x	→																																														
2:	10.3	↗																																														
3:	9.7	↗																																														
4:	10.8x	↖																																														
5:	8.9	→																																														
Serie		47																																														
Total		144																																														
	<table border="1" style="width:100%; border-collapse: collapse;"> <tr><td>1:</td><td>10.4x</td><td>↑</td></tr> <tr><td>2:</td><td>10.0</td><td>↑</td></tr> <tr><td>3:</td><td>10.4x</td><td>↘</td></tr> <tr><td>4:</td><td>10.5x</td><td>↘</td></tr> <tr><td>5:</td><td>10.7x</td><td>↓</td></tr> <tr><td colspan="2">Serie</td><td>50</td></tr> <tr><td colspan="2">Total</td><td>194</td></tr> </table>	1:	10.4x	↑	2:	10.0	↑	3:	10.4x	↘	4:	10.5x	↘	5:	10.7x	↓	Serie		50	Total		194		<table border="1" style="width:100%; border-collapse: collapse;"> <tr><td>1:</td><td>9.7</td><td>↖</td></tr> <tr><td>2:</td><td>9.9</td><td>→</td></tr> <tr><td>3:</td><td>10.1</td><td>↓</td></tr> <tr><td>4:</td><td>9.9</td><td>↑</td></tr> <tr><td>5:</td><td>9.4</td><td>↗</td></tr> <tr><td>6:</td><td>8.1</td><td>←</td></tr> <tr><td colspan="2">Serie</td><td>54</td></tr> <tr><td colspan="2">Total</td><td>194</td></tr> </table>	1:	9.7	↖	2:	9.9	→	3:	10.1	↓	4:	9.9	↑	5:	9.4	↗	6:	8.1	←	Serie		54	Total		194
1:	10.4x	↑																																														
2:	10.0	↑																																														
3:	10.4x	↘																																														
4:	10.5x	↘																																														
5:	10.7x	↓																																														
Serie		50																																														
Total		194																																														
1:	9.7	↖																																														
2:	9.9	→																																														
3:	10.1	↓																																														
4:	9.9	↑																																														
5:	9.4	↗																																														
6:	8.1	←																																														
Serie		54																																														
Total		194																																														
	<table border="1" style="width:100%; border-collapse: collapse;"> <tr><td>1:</td><td>10.5x</td><td>↘</td></tr> <tr><td>2:</td><td>10.5x</td><td>↗</td></tr> <tr><td>3:</td><td>10.7x</td><td>↗</td></tr> <tr><td>4:</td><td>9.8</td><td>←</td></tr> <tr><td>5:</td><td>10.6x</td><td>→</td></tr> <tr><td colspan="2">Serie</td><td>49</td></tr> <tr><td colspan="2">Total</td><td>243</td></tr> </table>	1:	10.5x	↘	2:	10.5x	↗	3:	10.7x	↗	4:	9.8	←	5:	10.6x	→	Serie		49	Total		243		<table border="1" style="width:100%; border-collapse: collapse;"> <tr><td>1:</td><td>8.3</td><td>↘</td></tr> <tr><td>2:</td><td>8.1</td><td>↑</td></tr> <tr><td>3:</td><td>9.3</td><td>→</td></tr> <tr><td>4:</td><td>8.6</td><td>↗</td></tr> <tr><td>5:</td><td>10.3</td><td>↑</td></tr> <tr><td colspan="2">Serie</td><td>43</td></tr> <tr><td colspan="2">Total</td><td>286</td></tr> </table>	1:	8.3	↘	2:	8.1	↑	3:	9.3	→	4:	8.6	↗	5:	10.3	↑	Serie		43	Total		286			
1:	10.5x	↘																																														
2:	10.5x	↗																																														
3:	10.7x	↗																																														
4:	9.8	←																																														
5:	10.6x	→																																														
Serie		49																																														
Total		243																																														
1:	8.3	↘																																														
2:	8.1	↑																																														
3:	9.3	→																																														
4:	8.6	↗																																														
5:	10.3	↑																																														
Serie		43																																														
Total		286																																														
	<table border="1" style="width:100%; border-collapse: collapse;"> <tr><td>1:</td><td>7.3</td><td>↖</td></tr> <tr><td>2:</td><td>7.8</td><td>↘</td></tr> <tr><td>3:</td><td>8.1</td><td>→</td></tr> <tr><td>4:</td><td>7.2</td><td>→</td></tr> <tr><td>5:</td><td>4.8</td><td>→</td></tr> <tr><td colspan="2">Serie</td><td>33</td></tr> <tr><td colspan="2">Total</td><td>319</td></tr> </table>	1:	7.3	↖	2:	7.8	↘	3:	8.1	→	4:	7.2	→	5:	4.8	→	Serie		33	Total		319																										
1:	7.3	↖																																														
2:	7.8	↘																																														
3:	8.1	→																																														
4:	7.2	→																																														
5:	4.8	→																																														
Serie		33																																														
Total		319																																														

Skjutlag	Tavla	Stefan Lundqvist	
2	3		
Ramselefors	Ununge	A	St
12.07.2021	Tavelträffen 2021	Ramselefors SKF	
	1: 10.8x → 2: 9.9 ↗ 3: 9.7 ↑ 4: 9.4 ← 5: 10.5x →		1: 9.6 ↑ 2: 10.2 ↑ 3: 9.9 ↖ 4: 9.6 ← 5: 10.4 ↓
	Serie 47		Serie 47
	Total 0		Total 47
	1: 10.4 → 2: 10.1 → 3: 9.9 ← 4: 9.6 ↘ 5: 9.2 ↘		1: 9.7 ↘ 2: 10.5x ↑ 3: 10.7x ↑ 4: 10.7x ↓ 5: 10.4 ↖
	Serie 47		Serie 49
	Total 94		Total 143
	1: 9.6 ↓ 2: 10.1 ↓ 3: 10.3 ↑ 4: 10.2 ↗ 5: 10.7x ↓		1: 10.0 ↗ 2: 10.2 ↑ 3: 10.5x ↓ 4: 10.2 ↖ 5: 8.3 ↑ 6: 9.9 ↗
	Serie 49		Serie 57
	Total 192		Total 192
	1: 10.4 ↓ 2: 10.4 ← 3: 10.4x ↑ 4: 10.1 ← 5: 10.2 ↖		1: 9.8 ↖ 2: 9.1 ← 3: 9.7 ↑ 4: 9.3 ↓ 5: 8.2 →
	Serie 50		Serie 44
	Total 242		Total 286
	1: 8.6 → 2: 7.9 ↑ 3: 9.8 ↑ 4: 10.1 → 5: 7.1 ↘		
	Serie 41		
	Total 327		

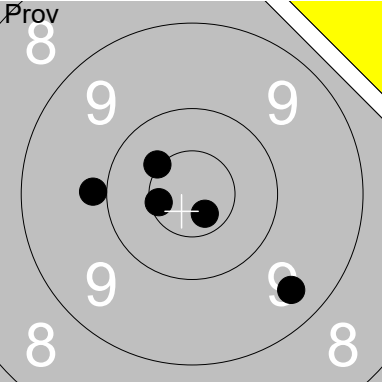
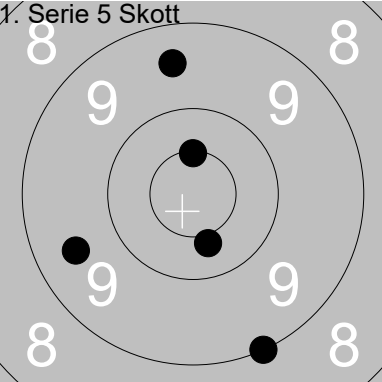
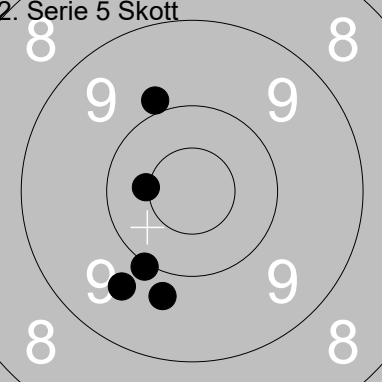
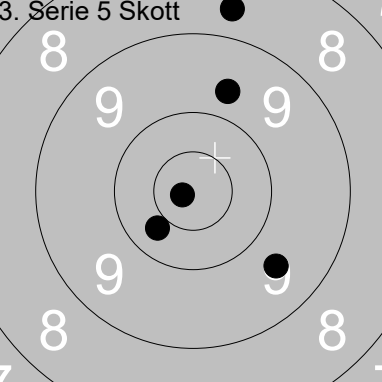
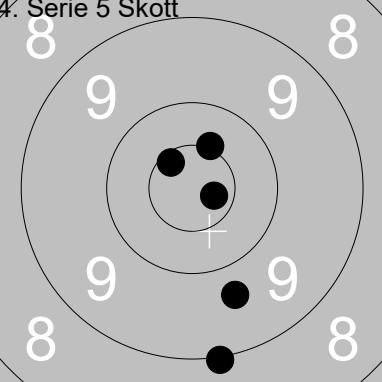
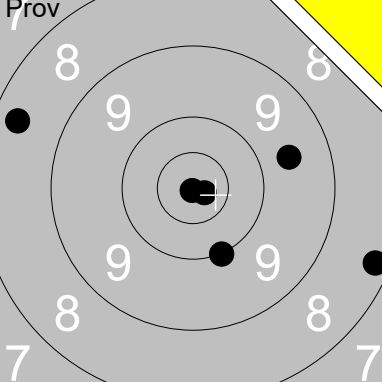
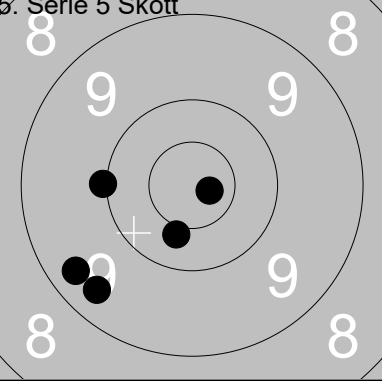
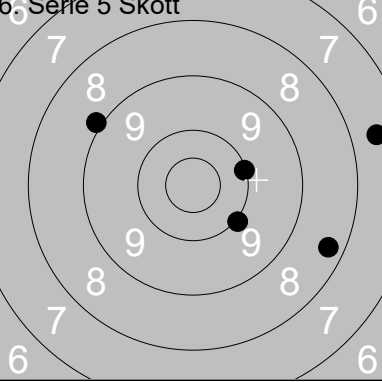
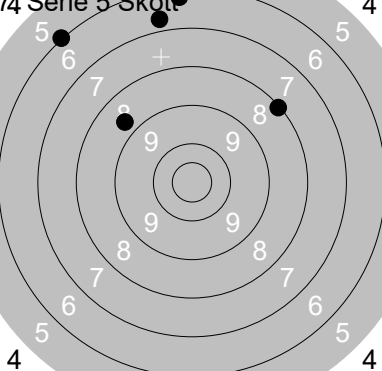
Skjutlag	Tavla	Sven Fäldt	
2	4	Ramselefors	Storfors
12.07.2021	Tavelträffen 2021	Ramselefors SKF	
	1: 10.5x ↗ 2: 9.4 ↘ 3: 10.7x ↘ 4: 10.6x ← 5: 9.9 ←		1: 9.5 ↑ 2: 10.4 ↓ 3: 9.0 ↓ 4: 10.5x ↑ 5: 9.5 ←
	Serie 48		Serie 47
	Total 0		Total 47
	1: 9.9 ↑ 2: 9.6 ↓ 3: 10.4x ← 4: 10.0 ↓ 5: 9.8 ↓		1: 8.7 ↑ 2: 9.7 ↑ 3: 10.3 ↓ 4: 10.8x ← 5: 9.6 ↓
	Serie 47		Serie 46
	Total 94		Total 140
	1: 10.7x → 2: 9.0 ↓ 3: 10.5x ↑ 4: 9.7 ↓ 5: 10.6x ↗		1: 10.9x ↓ 2: 9.6 → 3: 10.8x → 4: 10.0 ↓ 5: 8.4 ← 6: 8.2 →
	Serie 48		Serie 55
	Total 188		Total 188
	1: 9.3 ← 2: 10.0 ← 3: 9.4 ↓ 4: 10.4 ↓ 5: 10.8x →		1: 8.9 ↖ 2: 7.6 → 3: 10.0 → 4: 10.0 ↓ 5: 8.3 →
	Serie 48		Serie 43
	Total 236		Total 279
	1: 6.7 ↑ 2: 8.7 ↗ 3: 6.2 ↑ 4: 6.0 ↗ 5: 8.1 ↗		
	Serie 34		
	Total 313		

Skjutlag	Tavla	Mattias Eriksson		
2	5	Ramselefors	D	Vb
12.07.2021	Tavelträffen 2021	Ramselefors SKF		
Prov 	1: 7.4 ↗ 2: 7.2 ↗ 3: 10.2 ↓ 4: 10.0 ← 5: 8.8 ←	1. Serie 5 Skott 	1: 10.0 ↑ 2: 9.2 ↓ 3: 9.9 ← 4: 9.8 ↑ 5: 10.4x ↓	
Serie 42	Total 0	Serie 47	Total 47	
2. Serie 5 Skott 	1: 8.7 ↓ 2: 10.5x ↓ 3: 10.0 ↓ 4: 9.6 ↗ 5: 9.7 ↓	3. Serie 5 Skott 	1: 10.1 ← 2: 9.8 ← 3: 9.9 ↗ 4: 9.8 ↓ 5: 8.1 ↓	
Serie 46	Total 93	Serie 45	Total 138	
4. Serie 5 Skott 	1: 9.3 ↗ 2: 10.5x ↗ 3: 9.2 → 4: 9.4 ↓ 5: 10.2 ↗	Prov 	1: 9.5 → 2: 10.1 ↓ 3: 8.8 →	
Serie 47	Total 185	Serie 27	Total 185	
5. Serie 5 Skott 	1: 9.8 ↑ 2: 9.3 ↓ 3: 10.3 ← 4: 9.6 ← 5: 9.9 ↓	6. Serie 5 Skott 	1: 8.6 → 2: 9.0 ↓ 3: 10.4x ↓ 4: 9.9 → 5: 8.1 ↗	
Serie 46	Total 231	Serie 44	Total 275	
7. Serie 5 Skott 	1: 9.6 ↗ 2: 9.2 → 3: 10.1 → 4: 9.4 ↓ 5: 8.6 ↓			
Serie 45	Total 320			

Skjutlag	Tavla	Mattias Näslund			
2	6	Ramselefors	Ramselefors	D	Vb
12.07.2021	Tavelträffen 2021	Ramselefors SKF			
Prov 	1: 7.8 ↗ 2: 8.9 ↓ 3: 9.6 ↓ 4: 10.0 ↙ 5: 10.1 ↗	1. Serie 5 Skott 	1: 9.0 ↗ 2: 9.5 ← 3: 9.8 ← 4: 10.3 ↑ 5: 10.7x ↓		
Serie 44		Serie 47			
Total 0		Total 47			
2. Serie 5 Skott 	1: 10.0 ← 2: 10.4x ↗ 3: 9.3 ↗ 4: 9.9 ↓ 5: 9.8 ←	3. Serie 5 Skott 	1: 10.2 ↑ 2: 10.0 ↓ 3: 9.9 ↑ 4: 9.7 ↓ 5: 9.6 ↗		
Serie 47		Serie 47			
Total 94		Total 141			
4. Serie 5 Skott 	1: 9.9 ← 2: 7.9 ↑ 3: 8.9 ↑ 4: 9.4 ↓ 5: 10.6x ↗	Prov 	1: 10.1 ↘ 2: 9.3 ↘ 3: 8.1 → 4: 9.5 ↘ 5: 9.3 ↘ 6: 9.4 →		
Serie 43		Serie 54			
Total 184		Total 184			
5. Serie 5 Skott 	1: 9.4 ↑ 2: 9.3 ↓ 3: 9.8 ← 4: 9.5 ← 5: 10.2 ↗	6. Serie 5 Skott 	1: 9.4 ← 2: 10.5x → 3: 9.4 ↗ 4: 10.1 ↑ 5: 9.4 ↗		
Serie 46		Serie 47			
Total 230		Total 277			
7. Serie 5 Skott 	1: 10.5x ↗ 2: 9.0 ↑ 3: 8.8 ↗ 4: 10.7x ↓ 5: 10.7x ↓				
Serie 47					
Total 324					

Skjutlag	Tavla	Marie Wingård		
2	7	Ramselefors	D	Vb
12.07.2021	Tavelträffen 2021	Ramselefors SKF		
Prov 	1: 7.5 ↗ 2: 9.3 ↑ 3: 9.0 ← 4: 8.8 ↖ 5: 10.4 ↓	1. Serie 5 Skott 	1: 9.5 ↗ 2: 10.4x ↗ 3: 10.1 ↗ 4: 10.4x ↓ 5: 10.6x ↓	
Serie 43		Serie 49		
Total 0		Total 49		
2. Serie 5 Skott 	1: 9.7 ↗ 2: 9.6 ← 3: 9.4 ↓ 4: 10.8x ← 5: 9.5 ↓	3. Serie 5 Skott 	1: 10.8x ↓ 2: 10.4 ↓ 3: 10.3 ↓ 4: 9.8 ↓ 5: 10.6x ↗	
Serie 46		Serie 49		
Total 95		Total 144		
4. Serie 5 Skott 	1: 10.1 → 2: 10.2 ↗ 3: 9.1 ↗ 4: 10.3 ← 5: 10.2 ←	Prov 	1: 9.4 ↗ 2: 9.3 → 3: 9.4 → 4: 8.8 ↓ 5: 10.6x ↓ 6: 9.8 ↓	
Serie 49		Serie 54		
Total 193		Total 193		
5. Serie 5 Skott 	1: 10.7x ↑ 2: 9.6 ← 3: 8.0 ↓ 4: 8.3 ↓ 5: 10.0 →	6. Serie 5 Skott 	1: 9.6 → 2: 10.5x ↓ 3: 9.4 ↓ 4: 10.0 ↗ 5: 10.9x ↓	
Serie 45		Serie 48		
Total 238		Total 286		
7. Serie 5 Skott 	1: 10.1 → 2: 8.6 → 3: 9.7 ↓ 4: 9.7 → 5: 10.1 ←			
Serie 46				
Total 332				

Skjutlag	Tavla	Maja Lindberg	
2	8		
Ramselefors	Ramselefors	D	Vb
12.07.2021	Tavelträffen 2021	Ramselefors SKF	
	1: 9.7 ← 2: 10.2 ↙ 3: 9.2 ↗ 4: 8.9 ↙ 5: 8.9 ↙	1. Serie 5 Skott 	1: 9.0 ↗ 2: 9.1 ← 3: 9.6 ↙ 4: 10.1 ← 5: 10.0 ↓
Serie	44	Serie	47
Total	0	Total	47
2. Serie 5 Skott 	1: 10.7x ↗ 2: 10.0 ↗ 3: 9.1 ← 4: 10.6x ↓ 5: 8.5 ↙	3. Serie 5 Skott 	1: 10.2 ↗ 2: 9.6 → 3: 10.1 ↗ 4: 10.3 ↓ 5: 10.1 ↓
Serie	47	Serie	49
Total	94	Total	143
4. Serie 5 Skott 	1: 9.0 ↗ 2: 10.2 → 3: 10.9x ↗ 4: 9.4 → 5: 9.0 ↓	Prov 	1: 9.6 → 2: 8.9 ↓ 3: 8.8 ↓ 4: 8.7 ↓
Serie	47	Serie	33
Total	190	Total	190
5. Serie 5 Skott 	1: 9.7 ↗ 2: 9.2 ↙ 3: 9.7 ↙ 4: 10.6x ↙ 5: 10.0 ↗	6. Serie 5 Skott 	1: 9.6 ↗ 2: 8.2 → 3: 8.8 → 4: 9.0 ↗ 5: 9.0 →
Serie	47	Serie	43
Total	237	Total	280
7. Serie 5 Skott 	1: 10.5x ← 2: 10.0 ↗ 3: 9.4 ↗ 4: 10.0 → 5: 10.4 ←		
Serie	49		
Total	329		

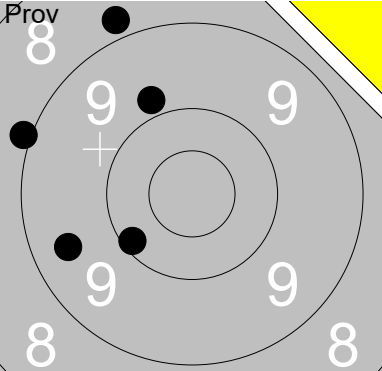
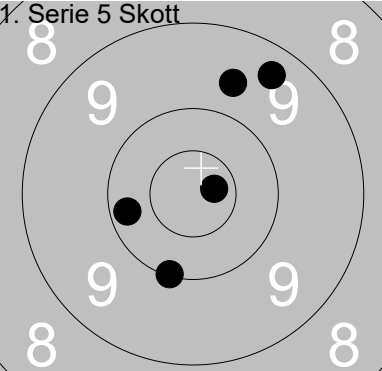
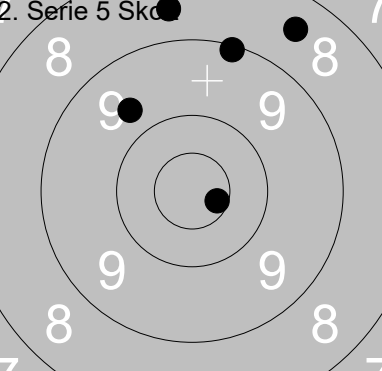
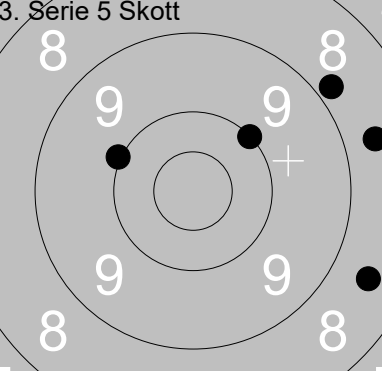
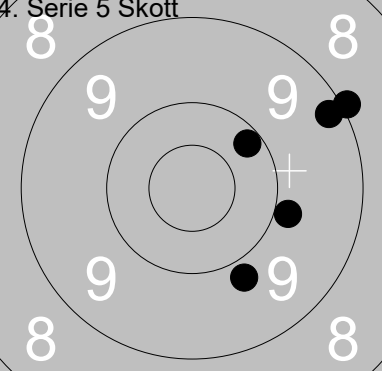
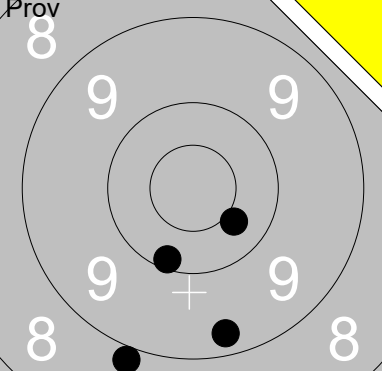
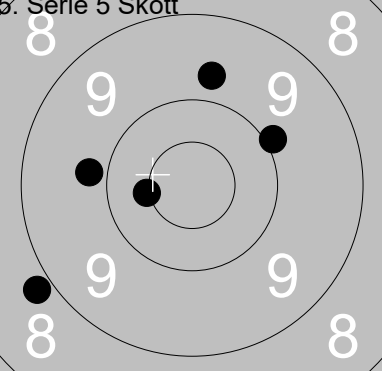
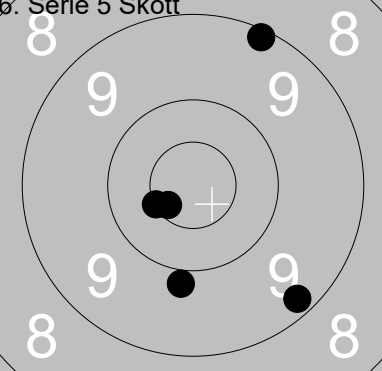
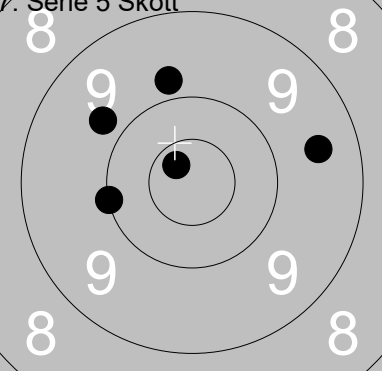
Skjutlag	Tavla	Mathias Fredriksson					
2	9	Ramselefors	Ramselefors	D	Vb		
12.07.2021	Tavelträffen 2021	Ramselefors SKF					
Prov 	1: 9.8 ↗ 2: 8.8 ↗ 3: 9.5 ← 4: 10.1 ↙ 5: 8.9 ←	1. Serie 5 Skott 	1: 9.4 ↗ 2: 9.7 ↗ 3: 10.0 ↓ 4: 10.2 ← 5: 10.7x →	Serie	44	Serie	48
	Total	0	Total	48			48
2. Serie 5 Skott 	1: 9.7 ↗ 2: 8.5 ↗ 3: 8.6 ↑ 4: 9.1 ↑ 5: 10.6x →	3. Serie 5 Skott 	1: 8.6 → 2: 8.6 → 3: 8.8 ↗ 4: 10.0 ← 5: 10.0 ↗	Serie	44	Serie	44
	Total	92	Total	136			136
4. Serie 5 Skott 	1: 9.8 ↓ 2: 9.9 → 3: 10.2 ↗ 4: 9.0 ↗ 5: 9.2 ↗	Prov 	1: 10.1 ↓ 2: 9.3 ↓ 3: 10.4 ↘ 4: 8.9 ↓	Serie	46	Serie	37
	Total	182	Total	182			182
5. Serie 5 Skott 	1: 10.5x ← 2: 9.7 ↑ 3: 9.9 ↗ 4: 9.8 ← 5: 8.8 ←	6. Serie 5 Skott 	1: 10.6x ← 2: 9.2 ↘ 3: 9.9 ↓ 4: 9.1 ↑ 5: 10.5x ←	Serie	45	Serie	47
	Total	227	Total	274			274
7. Serie 5 Skott 	1: 9.5 → 2: 9.8 ↑ 3: 9.8 ↗ 4: 10.0 ← 5: 10.7x ↗			Serie	47		
	Total	321					

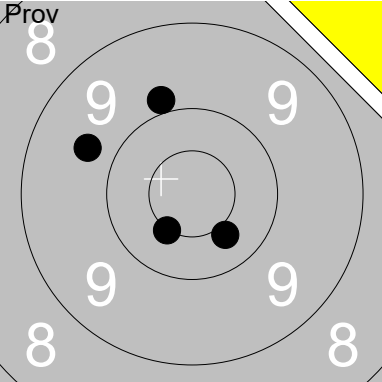
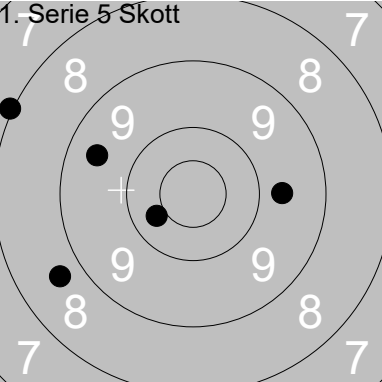
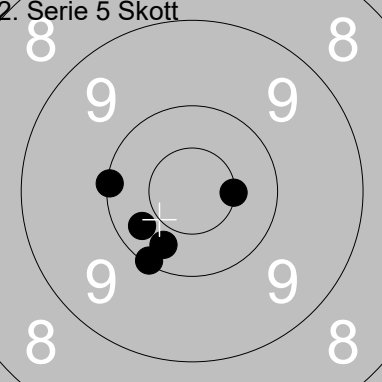
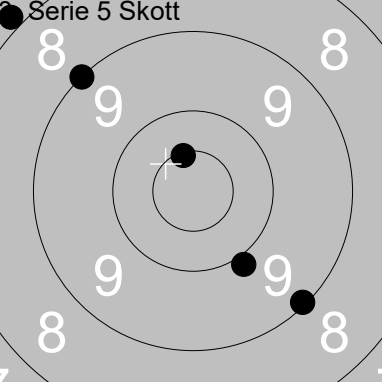
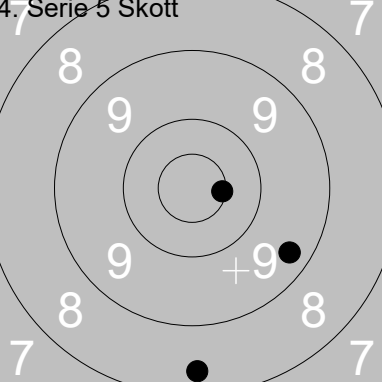
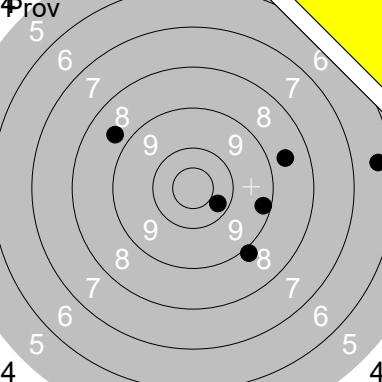
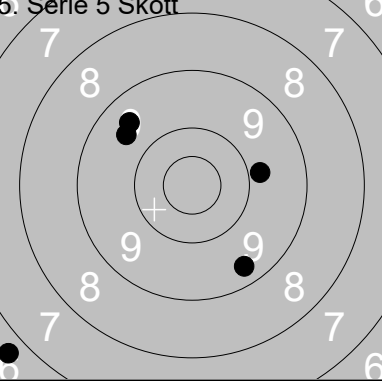
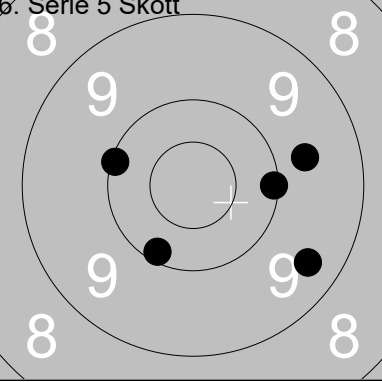
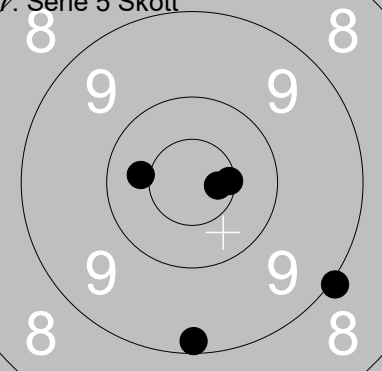
Ramselefors	Ramselefors	D	Vb
12.07.2021	Tavelträffen 2021	Ramselefors SKF	
	1: 9.7 ↖ 2: 9.9 ↗ 3: 10.5x ↘ 4: 10.4 ↙		1: 8.0 ↖ 2: 8.7 ↘ 3: 9.5 ↗ 4: 9.7 → 5: 10.4 ↙
	Serie 38		Serie 44
	Total 0		Total 44
	1: 10.1 ↘ 2: 10.1 ← 3: 10.3 ↘ 4: 10.5x → 5: 10.3 ↘		1: 9.0 ↗ 2: 9.1 ↘ 3: 7.9 ↗ 4: 10.5x ↗ 5: 9.9 ↘
	Serie 50		Serie 44
	Total 94		Total 138
	1: 10.5x → 2: 8.4 ↘ 3: 9.3 ↘		1: 8.9 ↘ 2: 9.2 → 3: 10.3 ↘ 4: 8.7 ↗ 5: 6.4 → 6: 8.6 →
	Serie 27		Serie 49
	Total 165		Total 165
	1: 9.5 ↗ 2: 9.4 ↘ 3: 9.6 ↗ 4: 9.8 → 5: 6.7 ↙		1: 10.1 → 2: 10.1 ↖ 3: 9.4 ↘ 4: 9.7 → 5: 10.1 ↘
	Serie 42		Serie 48
	Total 207		Total 255
	1: 10.7x → 2: 9.2 ↘ 3: 9.0 ↘ 4: 10.4 ← 5: 10.5x →		
	Serie 48		
	Total 303		

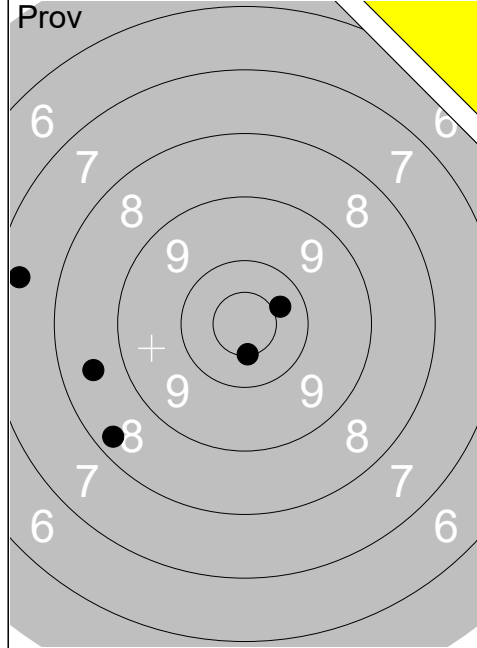

Serie	43
Total	0

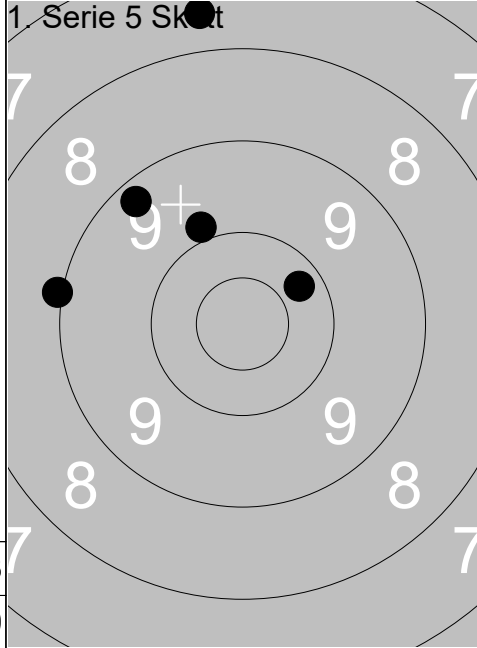

Serie	44
Total	44

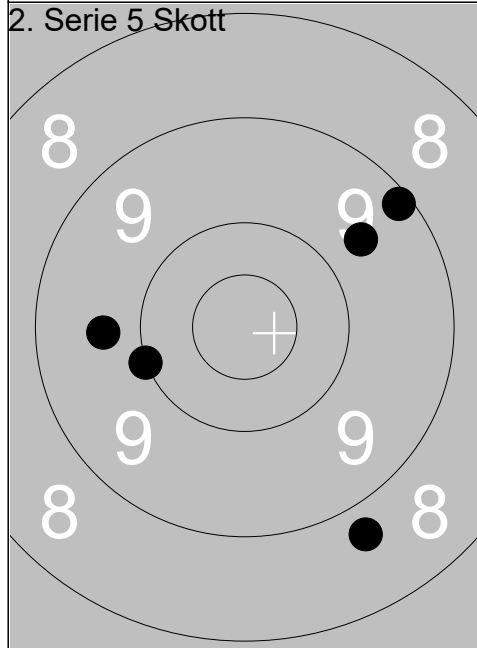

Serie	45
Total	89

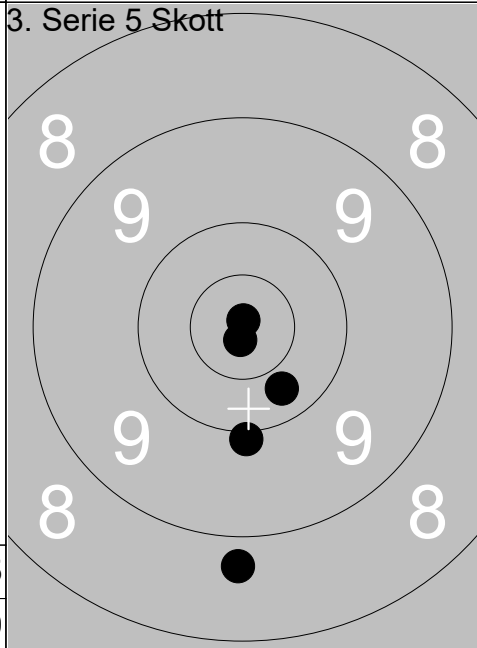

Serie	48
Total	137

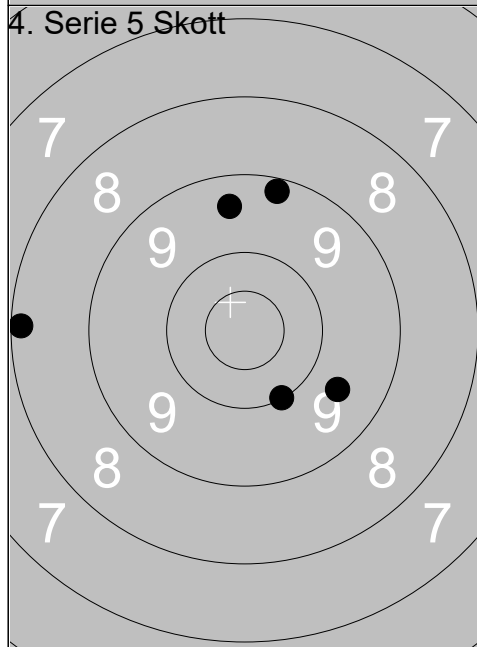

Serie	45
Total	182

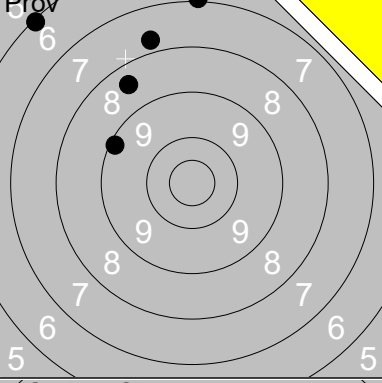
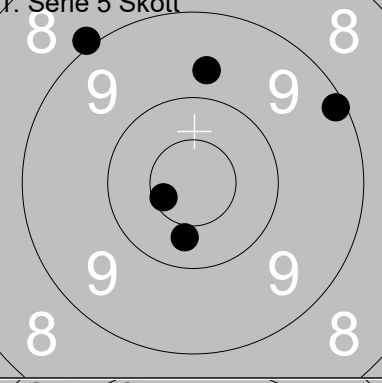
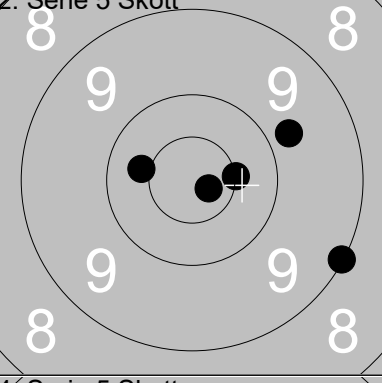
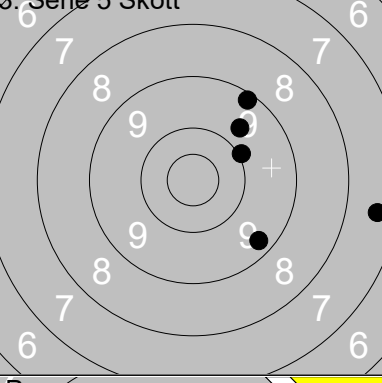
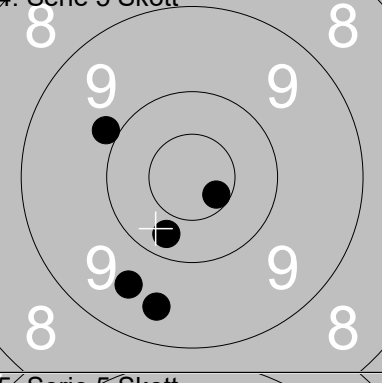
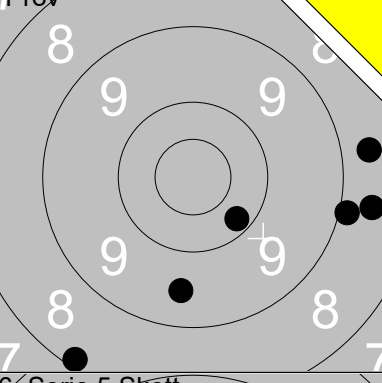
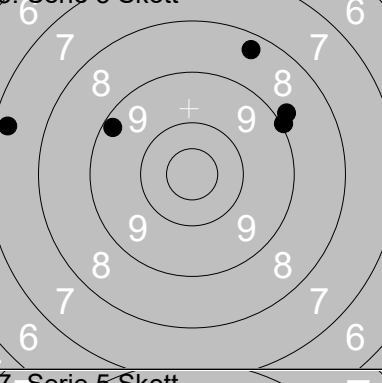
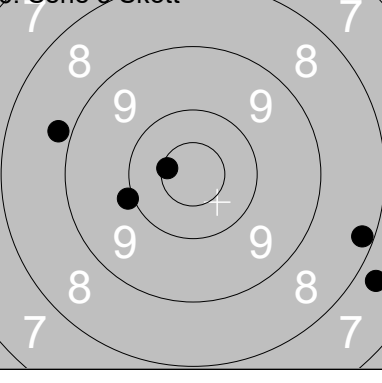
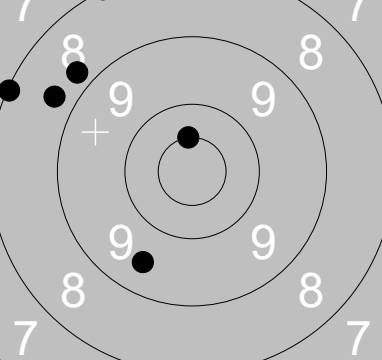
	<table border="1" style="width:100%; border-collapse: collapse;"> <tr><td>1:</td><td>9.1</td><td>↖</td></tr> <tr><td>2:</td><td>8.4</td><td>↗</td></tr> <tr><td>3:</td><td>6.1</td><td>↗</td></tr> <tr><td>4:</td><td>7.7</td><td>↗</td></tr> <tr><td>5:</td><td>7.0</td><td>↑</td></tr> <tr><td colspan="2">Serie</td><td>37</td></tr> <tr><td colspan="2">Total</td><td>0</td></tr> </table>	1:	9.1	↖	2:	8.4	↗	3:	6.1	↗	4:	7.7	↗	5:	7.0	↑	Serie		37	Total		0		<table border="1" style="width:100%; border-collapse: collapse;"> <tr><td>1:</td><td>10.4</td><td>↓</td></tr> <tr><td>2:</td><td>9.0</td><td>↖</td></tr> <tr><td>3:</td><td>10.6x</td><td>↖</td></tr> <tr><td>4:</td><td>9.7</td><td>↑</td></tr> <tr><td>5:</td><td>9.1</td><td>↗</td></tr> <tr><td colspan="2">Serie</td><td>47</td></tr> <tr><td colspan="2">Total</td><td>47</td></tr> </table>	1:	10.4	↓	2:	9.0	↖	3:	10.6x	↖	4:	9.7	↑	5:	9.1	↗	Serie		47	Total		47			
1:	9.1	↖																																														
2:	8.4	↗																																														
3:	6.1	↗																																														
4:	7.7	↗																																														
5:	7.0	↑																																														
Serie		37																																														
Total		0																																														
1:	10.4	↓																																														
2:	9.0	↖																																														
3:	10.6x	↖																																														
4:	9.7	↑																																														
5:	9.1	↗																																														
Serie		47																																														
Total		47																																														
	<table border="1" style="width:100%; border-collapse: collapse;"> <tr><td>1:</td><td>9.1</td><td>↗</td></tr> <tr><td>2:</td><td>10.4</td><td>↖</td></tr> <tr><td>3:</td><td>10.5x</td><td>→</td></tr> <tr><td>4:</td><td>10.7x</td><td>↗</td></tr> <tr><td>5:</td><td>9.8</td><td>↗</td></tr> <tr><td colspan="2">Serie</td><td>48</td></tr> <tr><td colspan="2">Total</td><td>95</td></tr> </table>	1:	9.1	↗	2:	10.4	↖	3:	10.5x	→	4:	10.7x	↗	5:	9.8	↗	Serie		48	Total		95		<table border="1" style="width:100%; border-collapse: collapse;"> <tr><td>1:</td><td>10.0</td><td>↗</td></tr> <tr><td>2:</td><td>7.4</td><td>→</td></tr> <tr><td>3:</td><td>9.7</td><td>↗</td></tr> <tr><td>4:</td><td>9.2</td><td>↗</td></tr> <tr><td>5:</td><td>9.3</td><td>↘</td></tr> <tr><td colspan="2">Serie</td><td>44</td></tr> <tr><td colspan="2">Total</td><td>139</td></tr> </table>	1:	10.0	↗	2:	7.4	→	3:	9.7	↗	4:	9.2	↗	5:	9.3	↘	Serie		44	Total		139			
1:	9.1	↗																																														
2:	10.4	↖																																														
3:	10.5x	→																																														
4:	10.7x	↗																																														
5:	9.8	↗																																														
Serie		48																																														
Total		95																																														
1:	10.0	↗																																														
2:	7.4	→																																														
3:	9.7	↗																																														
4:	9.2	↗																																														
5:	9.3	↘																																														
Serie		44																																														
Total		139																																														
	<table border="1" style="width:100%; border-collapse: collapse;"> <tr><td>1:</td><td>10.3</td><td>↓</td></tr> <tr><td>2:</td><td>9.6</td><td>↓</td></tr> <tr><td>3:</td><td>9.5</td><td>↓</td></tr> <tr><td>4:</td><td>10.6x</td><td>↘</td></tr> <tr><td>5:</td><td>9.9</td><td>↖</td></tr> <tr><td colspan="2">Serie</td><td>47</td></tr> <tr><td colspan="2">Total</td><td>186</td></tr> </table>	1:	10.3	↓	2:	9.6	↓	3:	9.5	↓	4:	10.6x	↘	5:	9.9	↖	Serie		47	Total		186		<table border="1" style="width:100%; border-collapse: collapse;"> <tr><td>1:</td><td>9.5</td><td>↓</td></tr> <tr><td>2:</td><td>8.6</td><td>→</td></tr> <tr><td>3:</td><td>8.9</td><td>→</td></tr> <tr><td>4:</td><td>8.1</td><td>↘</td></tr> <tr><td>5:</td><td>10.2</td><td>↘</td></tr> <tr><td>6:</td><td>8.7</td><td>→</td></tr> <tr><td colspan="2">Serie</td><td>51</td></tr> <tr><td colspan="2">Total</td><td>186</td></tr> </table>	1:	9.5	↓	2:	8.6	→	3:	8.9	→	4:	8.1	↘	5:	10.2	↘	6:	8.7	→	Serie		51	Total		186
1:	10.3	↓																																														
2:	9.6	↓																																														
3:	9.5	↓																																														
4:	10.6x	↘																																														
5:	9.9	↖																																														
Serie		47																																														
Total		186																																														
1:	9.5	↓																																														
2:	8.6	→																																														
3:	8.9	→																																														
4:	8.1	↘																																														
5:	10.2	↘																																														
6:	8.7	→																																														
Serie		51																																														
Total		186																																														
	<table border="1" style="width:100%; border-collapse: collapse;"> <tr><td>1:</td><td>9.2</td><td>↖</td></tr> <tr><td>2:</td><td>7.3</td><td>↖</td></tr> <tr><td>3:</td><td>8.3</td><td>↑</td></tr> <tr><td>4:</td><td>8.8</td><td>↗</td></tr> <tr><td>5:</td><td>9.0</td><td>↗</td></tr> <tr><td colspan="2">Serie</td><td>41</td></tr> <tr><td colspan="2">Total</td><td>227</td></tr> </table>	1:	9.2	↖	2:	7.3	↖	3:	8.3	↑	4:	8.8	↗	5:	9.0	↗	Serie		41	Total		227		<table border="1" style="width:100%; border-collapse: collapse;"> <tr><td>1:</td><td>7.7</td><td>↗</td></tr> <tr><td>2:</td><td>8.2</td><td>→</td></tr> <tr><td>3:</td><td>9.9</td><td>↖</td></tr> <tr><td>4:</td><td>10.6x</td><td>↖</td></tr> <tr><td>5:</td><td>8.8</td><td>↖</td></tr> <tr><td colspan="2">Serie</td><td>42</td></tr> <tr><td colspan="2">Total</td><td>269</td></tr> </table>	1:	7.7	↗	2:	8.2	→	3:	9.9	↖	4:	10.6x	↖	5:	8.8	↖	Serie		42	Total		269			
1:	9.2	↖																																														
2:	7.3	↖																																														
3:	8.3	↑																																														
4:	8.8	↗																																														
5:	9.0	↗																																														
Serie		41																																														
Total		227																																														
1:	7.7	↗																																														
2:	8.2	→																																														
3:	9.9	↖																																														
4:	10.6x	↖																																														
5:	8.8	↖																																														
Serie		42																																														
Total		269																																														
	<table border="1" style="width:100%; border-collapse: collapse;"> <tr><td>1:</td><td>8.1</td><td>↖</td></tr> <tr><td>2:</td><td>8.7</td><td>↖</td></tr> <tr><td>3:</td><td>9.5</td><td>↘</td></tr> <tr><td>4:</td><td>10.5x</td><td>↑</td></tr> <tr><td>5:</td><td>8.8</td><td>↖</td></tr> <tr><td colspan="2">Serie</td><td>43</td></tr> <tr><td colspan="2">Total</td><td>312</td></tr> </table>	1:	8.1	↖	2:	8.7	↖	3:	9.5	↘	4:	10.5x	↑	5:	8.8	↖	Serie		43	Total		312																										
1:	8.1	↖																																														
2:	8.7	↖																																														
3:	9.5	↘																																														
4:	10.5x	↑																																														
5:	8.8	↖																																														
Serie		43																																														
Total		312																																														

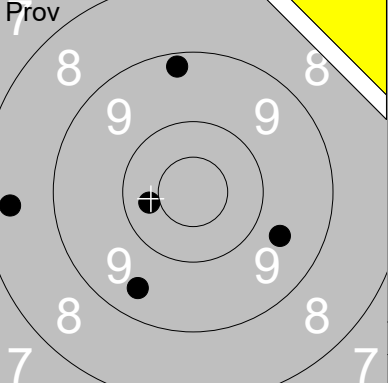
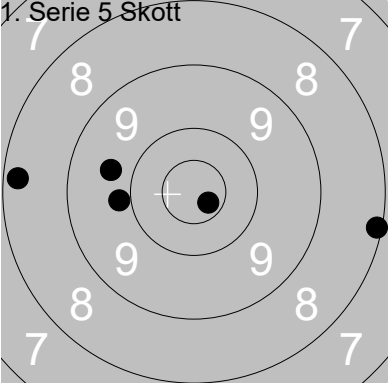
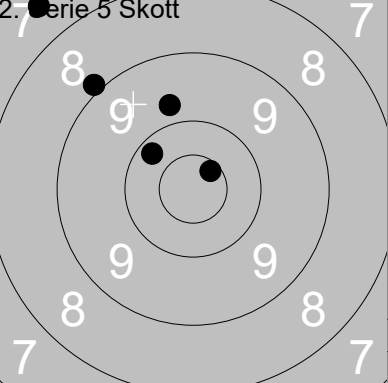
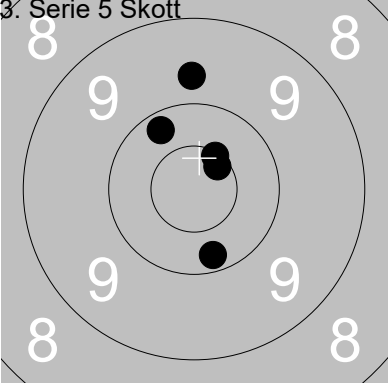
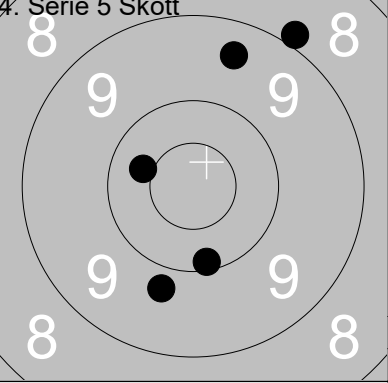
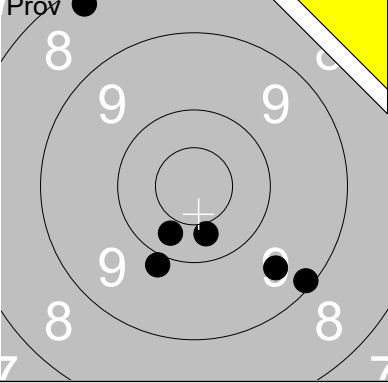
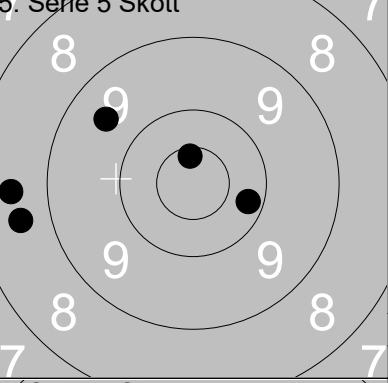
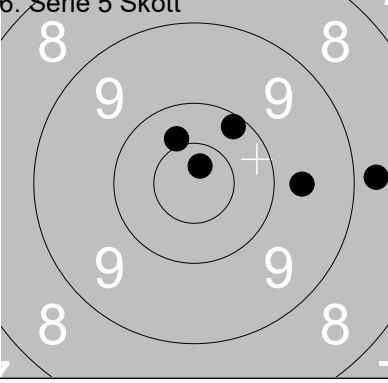
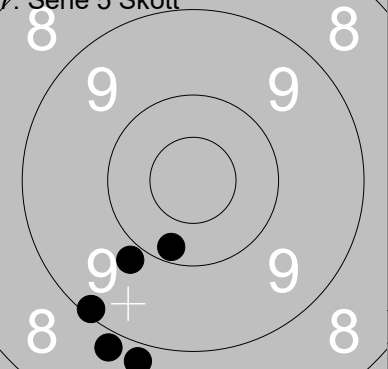
Skjutlag	Tavla	Jörgen Åström	
2	13	Ramselefors	Brattby
12.07.2021	Tavelträffen 2021	Ramselefors SKF	
	1: 9.6 → 2: 9.5 ↓ 3: 10.4 ← 4: 9.2 ↑ 5: 8.4 ←	1. Serie 5 Skott 	1: 9.8 ← 2: 8.3 ← 3: 9.7 ← 4: 10.7x ↓ 5: 8.1 →
Serie 45	Total 0	Serie 44	Total 44
2. Serie 5 Skott 	1: 9.8 ↑ 2: 7.5 ↗ 3: 8.9 ↗ 4: 10.6x ↗ 5: 10.2 ↗	3. Serie 5 Skott 	1: 10.2 ↗ 2: 9.7 ↑ 3: 10.2 ↓ 4: 10.6x ↗ 5: 10.5x ↗
Serie 44	Total 88	Serie 49	Total 137
4. Serie 5 Skott 	1: 8.9 ↗ 2: 10.4 ← 3: 10.1 ↓ 4: 9.8 ↓ 5: 9.4 ↑	Prov 	1: 8.3 ↗ 2: 9.9 ↓ 3: 10.3 ↓ 4: 10.4 ↓ 5: 9.5 ↓ 6: 9.1 ↓
Serie 46	Total 183	Serie 55	Total 183
5. Serie 5 Skott 	1: 9.5 ↗ 2: 8.5 ← 3: 8.6 ← 4: 10.6x ↑ 5: 10.2 →	6. Serie 5 Skott 	1: 10.2 ↗ 2: 9.7 → 3: 10.7x ↑ 4: 8.8 → 5: 10.4 ↗
Serie 45	Total 228	Serie 47	Total 275
7. Serie 5 Skott 	1: 9.1 ↓ 2: 9.9 ↓ 3: 10.2 ↓ 4: 8.8 ↓ 5: 8.8 ↓		
Serie 44	Total 319		

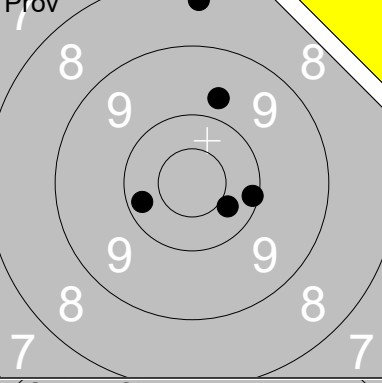
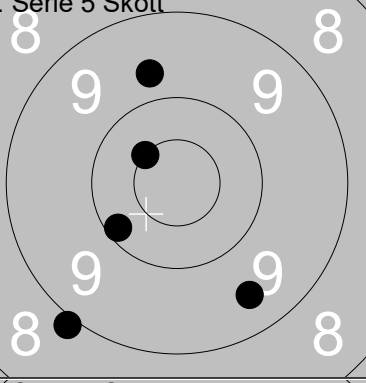
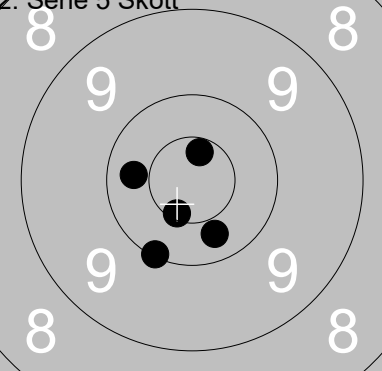
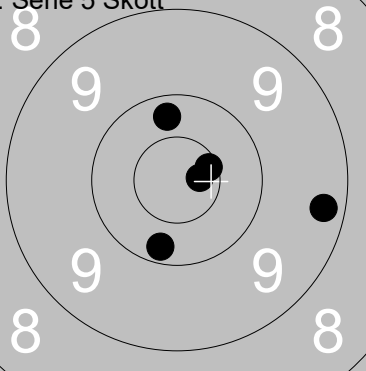
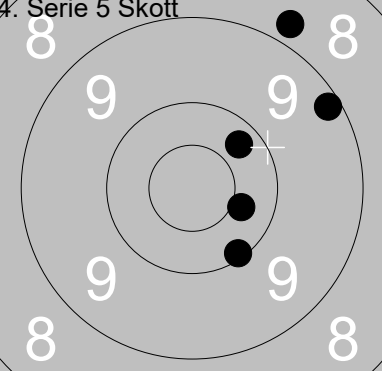
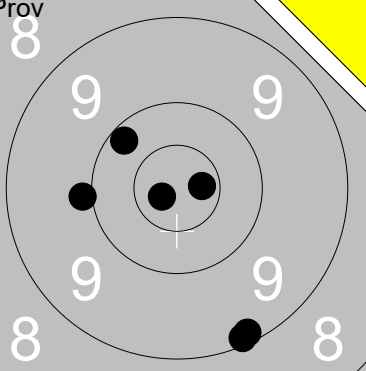
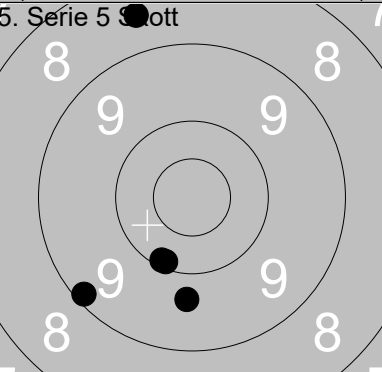
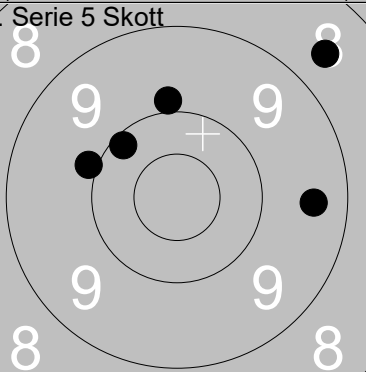
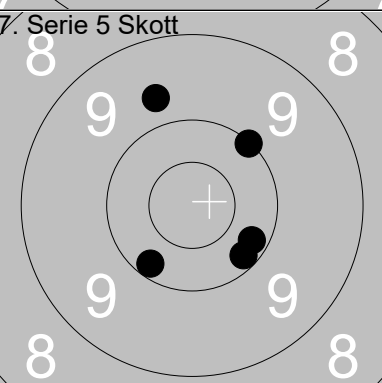
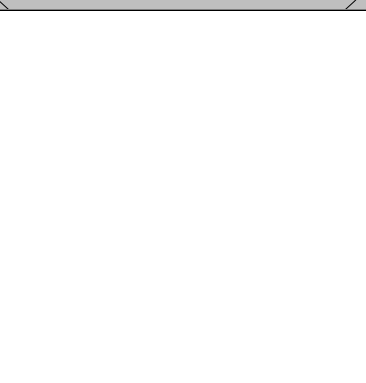
Prov 	1. Serie 5 Skott 	<table style="width:100%; border-collapse: collapse;"> <tr> <td style="width:50%;">1: 8.4 ↑</td> <td style="width:50%;">1: 9.7 ↑</td> </tr> <tr> <td>2: 9.7 ↑</td> <td>2: 8.9 ↓</td> </tr> <tr> <td>3: 10.1 →</td> <td>3: 10.1 ↙</td> </tr> <tr> <td>4: 10.2 ←</td> <td>4: 10.5x ↗</td> </tr> <tr> <td>5: 10.4 ↓</td> <td>5: 9.5 ↓</td> </tr> <tr> <td style="border-top: 1px solid black;">Serie 47</td> <td style="border-top: 1px solid black;">Serie 46</td> </tr> <tr> <td style="border-top: 1px solid black;">Total 0</td> <td style="border-top: 1px solid black;">Total 46</td> </tr> </table>	1: 8.4 ↑	1: 9.7 ↑	2: 9.7 ↑	2: 8.9 ↓	3: 10.1 →	3: 10.1 ↙	4: 10.2 ←	4: 10.5x ↗	5: 10.4 ↓	5: 9.5 ↓	Serie 47	Serie 46	Total 0	Total 46		
1: 8.4 ↑	1: 9.7 ↑																	
2: 9.7 ↑	2: 8.9 ↓																	
3: 10.1 →	3: 10.1 ↙																	
4: 10.2 ←	4: 10.5x ↗																	
5: 10.4 ↓	5: 9.5 ↓																	
Serie 47	Serie 46																	
Total 0	Total 46																	
2. Serie 5 Skott 	3. Serie 5 Skott 	<table style="width:100%; border-collapse: collapse;"> <tr> <td style="width:50%;">1: 10.6x ↑</td> <td style="width:50%;">1: 10.3 ↑</td> </tr> <tr> <td>2: 10.3 ←</td> <td>2: 10.2 ↓</td> </tr> <tr> <td>3: 10.3 ↓</td> <td>3: 10.7x →</td> </tr> <tr> <td>4: 10.6x ↓</td> <td>4: 9.3 →</td> </tr> <tr> <td>5: 10.1 ↓</td> <td>5: 10.6x →</td> </tr> <tr> <td style="border-top: 1px solid black;">Serie 50</td> <td style="border-top: 1px solid black;">Serie 49</td> </tr> <tr> <td style="border-top: 1px solid black;">Total 96</td> <td style="border-top: 1px solid black;">Total 145</td> </tr> </table>	1: 10.6x ↑	1: 10.3 ↑	2: 10.3 ←	2: 10.2 ↓	3: 10.3 ↓	3: 10.7x →	4: 10.6x ↓	4: 9.3 →	5: 10.1 ↓	5: 10.6x →	Serie 50	Serie 49	Total 96	Total 145		
1: 10.6x ↑	1: 10.3 ↑																	
2: 10.3 ←	2: 10.2 ↓																	
3: 10.3 ↓	3: 10.7x →																	
4: 10.6x ↓	4: 9.3 →																	
5: 10.1 ↓	5: 10.6x →																	
Serie 50	Serie 49																	
Total 96	Total 145																	
4. Serie 5 Skott 	Prov 	<table style="width:100%; border-collapse: collapse;"> <tr> <td style="width:50%;">1: 8.8 ↑</td> <td style="width:50%;">1: 9.1 ↓</td> </tr> <tr> <td>2: 9.2 ↗</td> <td>2: 9.2 ↓</td> </tr> <tr> <td>3: 10.1 ↓</td> <td>3: 10.2 ↗</td> </tr> <tr> <td>4: 10.3 ↗</td> <td>4: 10.8x ←</td> </tr> <tr> <td>5: 10.4 →</td> <td>5: 9.9 ←</td> </tr> <tr> <td>6: 10.7x →</td> <td>6: 10.7x →</td> </tr> <tr> <td style="border-top: 1px solid black;">Serie 47</td> <td style="border-top: 1px solid black;">Serie 57</td> </tr> <tr> <td style="border-top: 1px solid black;">Total 192</td> <td style="border-top: 1px solid black;">Total 192</td> </tr> </table>	1: 8.8 ↑	1: 9.1 ↓	2: 9.2 ↗	2: 9.2 ↓	3: 10.1 ↓	3: 10.2 ↗	4: 10.3 ↗	4: 10.8x ←	5: 10.4 →	5: 9.9 ←	6: 10.7x →	6: 10.7x →	Serie 47	Serie 57	Total 192	Total 192
1: 8.8 ↑	1: 9.1 ↓																	
2: 9.2 ↗	2: 9.2 ↓																	
3: 10.1 ↓	3: 10.2 ↗																	
4: 10.3 ↗	4: 10.8x ←																	
5: 10.4 →	5: 9.9 ←																	
6: 10.7x →	6: 10.7x →																	
Serie 47	Serie 57																	
Total 192	Total 192																	
5. Serie 5 Skott 	6. Serie 5 Skott 	<table style="width:100%; border-collapse: collapse;"> <tr> <td style="width:50%;">1: 8.5 ↑</td> <td style="width:50%;">1: 8.6 ↗</td> </tr> <tr> <td>2: 9.1 ↙</td> <td>2: 9.4 →</td> </tr> <tr> <td>3: 10.1 ↓</td> <td>3: 9.9 ↑</td> </tr> <tr> <td>4: 10.1 ↓</td> <td>4: 10.1 ↗</td> </tr> <tr> <td>5: 9.7 ↓</td> <td>5: 9.9 ←</td> </tr> <tr> <td style="border-top: 1px solid black;">Serie 46</td> <td style="border-top: 1px solid black;">Serie 45</td> </tr> <tr> <td style="border-top: 1px solid black;">Total 238</td> <td style="border-top: 1px solid black;">Total 283</td> </tr> </table>	1: 8.5 ↑	1: 8.6 ↗	2: 9.1 ↙	2: 9.4 →	3: 10.1 ↓	3: 9.9 ↑	4: 10.1 ↓	4: 10.1 ↗	5: 9.7 ↓	5: 9.9 ←	Serie 46	Serie 45	Total 238	Total 283		
1: 8.5 ↑	1: 8.6 ↗																	
2: 9.1 ↙	2: 9.4 →																	
3: 10.1 ↓	3: 9.9 ↑																	
4: 10.1 ↓	4: 10.1 ↗																	
5: 9.7 ↓	5: 9.9 ←																	
Serie 46	Serie 45																	
Total 238	Total 283																	
7. Serie 5 Skott 	(Empty target area) 	<table style="width:100%; border-collapse: collapse;"> <tr> <td style="width:50%;">1: 10.0 ↗</td> <td></td> </tr> <tr> <td>2: 9.7 ↑</td> <td></td> </tr> <tr> <td>3: 10.2 →</td> <td></td> </tr> <tr> <td>4: 10.2 ↓</td> <td></td> </tr> <tr> <td>5: 10.2 ↓</td> <td></td> </tr> <tr> <td style="border-top: 1px solid black;">Serie 49</td> <td></td> </tr> <tr> <td style="border-top: 1px solid black;">Total 332</td> <td></td> </tr> </table>	1: 10.0 ↗		2: 9.7 ↑		3: 10.2 →		4: 10.2 ↓		5: 10.2 ↓		Serie 49		Total 332			
1: 10.0 ↗																		
2: 9.7 ↑																		
3: 10.2 →																		
4: 10.2 ↓																		
5: 10.2 ↓																		
Serie 49																		
Total 332																		

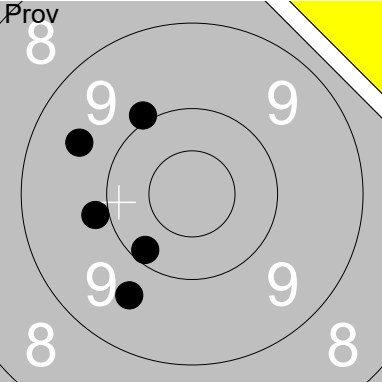
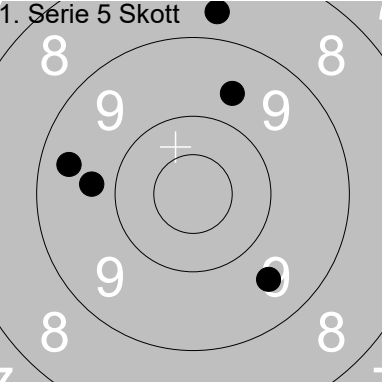
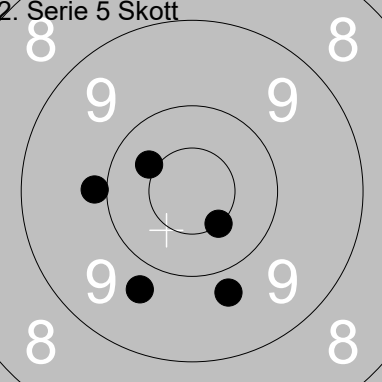
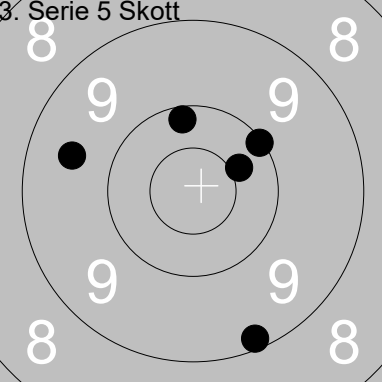
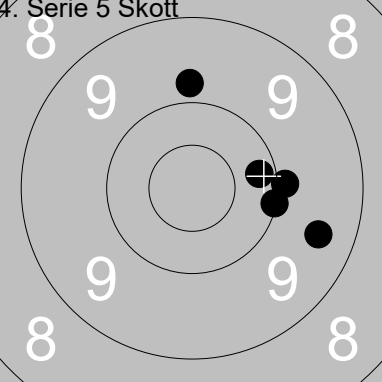
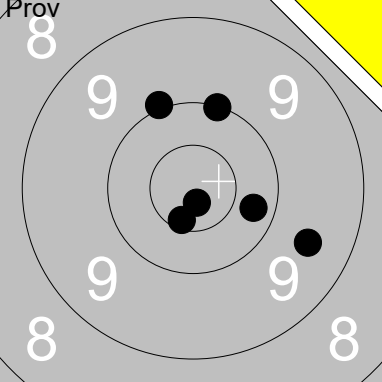
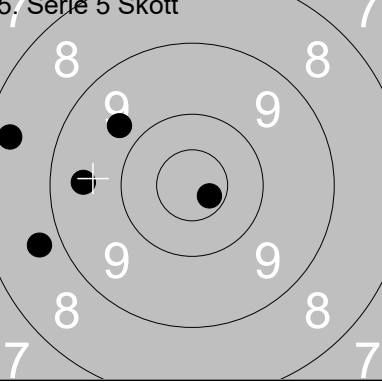
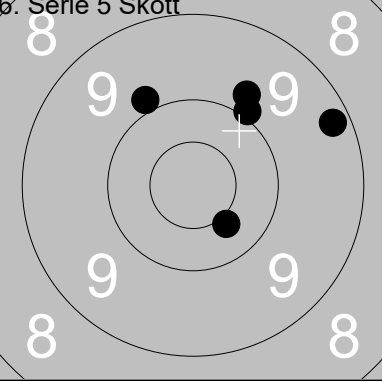
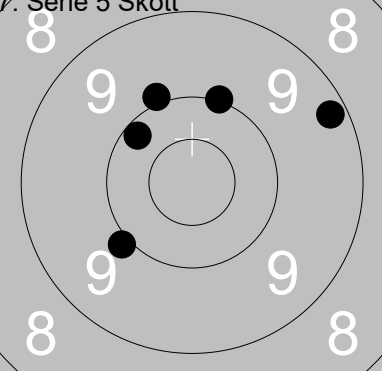
Skjutlag	Tavla	Stefan Thorin		
2	15	Umeå	D	Vb
12.07.2021	Tavelträffen 2021	Ramselefors SKF		
Prov 	1: 9.6 ↖ 2: 9.9 ↗ 3: 9.9 ↖ 4: 9.6 ↘ 5: 10.2 ↘	1. Serie 5 Skott 	1: 8.7 ↑ 2: 9.4 ↖ 3: 9.7 ↖ 4: 9.6 ↘ 5: 9.6 ↑	
Serie 46	Total 0	Serie 44	Total 44	
2. Serie 5 Skott 	1: 10.4 ↖ 2: 9.7 ↘ 3: 9.9 ↖ 4: 10.5x ↘ 5: 9.8 ↘	3. Serie 5 Skott 	1: 9.6 ↖ 2: 10.1 ↗ 3: 10.4 ↗ 4: 10.2 ↑ 5: 9.2 ↘	
Serie 47	Total 91	Serie 48	Total 139	
4. Serie 5 Skott 	1: 9.8 ↑ 2: 10.2 → 3: 9.9 → 4: 9.5 → 5: 10.0 →	Prov 	1: 10.3 → 2: 10.8x ↘ 3: 10.0 ↑ 4: 10.6x ↘ 5: 10.0 ↑ 6: 9.5 →	
Serie 47	Total 186	Serie 59	Total 186	
5. Serie 5 Skott 	1: 9.7 ↖ 2: 8.7 ↖ 3: 8.4 ↖ 4: 9.5 ↖ 5: 10.7x ↘	6. Serie 5 Skott 	1: 10.0 ↗ 2: 9.2 ↗ 3: 9.9 ↗ 4: 9.8 ↗ 5: 10.4 ↘	
Serie 44	Total 230	Serie 47	Total 277	
7. Serie 5 Skott 	1: 10.0 ↑ 2: 9.9 ↑ 3: 9.2 → 4: 10.2 ↖ 5: 9.9 ↖			
Serie 47	Total 324			

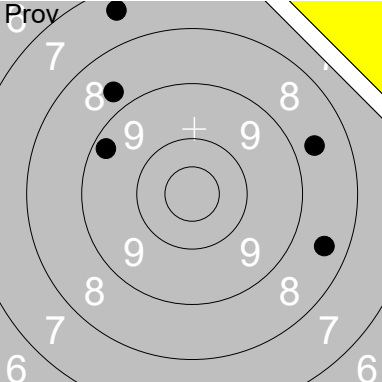
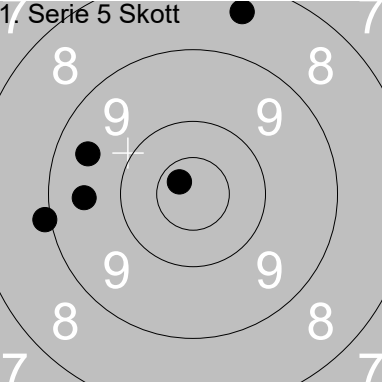
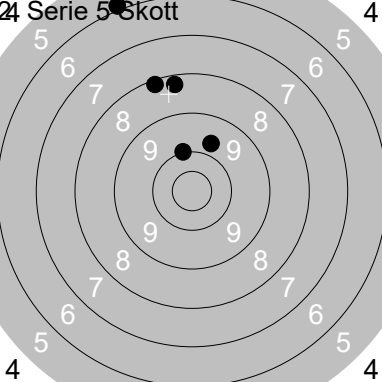
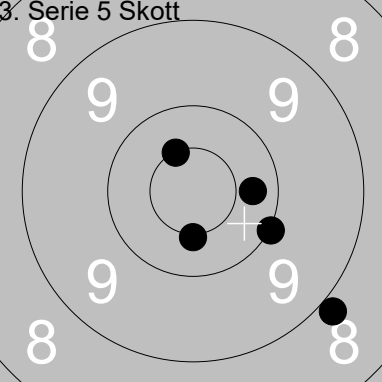
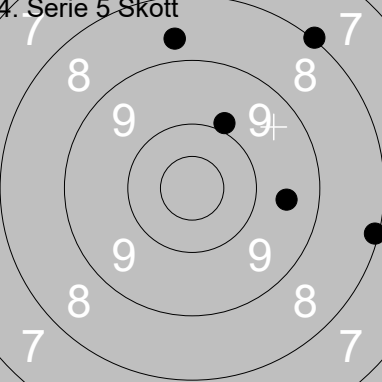
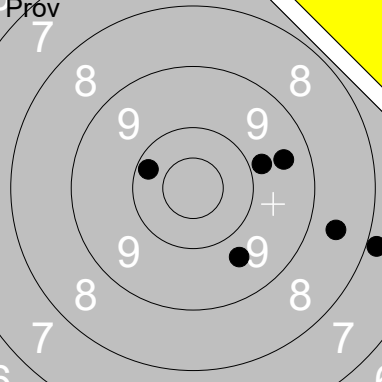
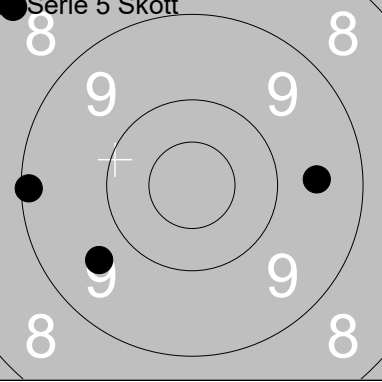
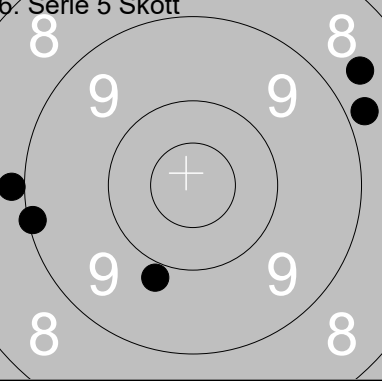
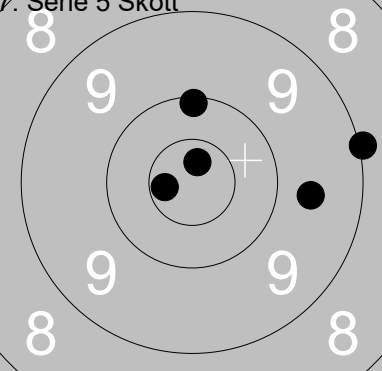
Skjutlag	Tavla	Mikael Svensson	
2	17		
Ramselefors	Eggvena-Brättensby	D	Vg
12.07.2021	Tavelträffen 2021	Ramselefors SKF	
	1: 8.5 → 2: 8.6 → 3: 9.3 ↖ 4: 8.7 ↗ 5: 7.4 ↗		1: 8.4 ↑ 2: 9.5 ↖ 3: 9.0 ↖ 4: 10.7x ↗ 5: 9.5 ↖
Serie 40	Total 0	Serie 45	Total 45
	1: 10.0 ↑ 2: 9.7 ↑ 3: 8.1 ↑ 4: 5.9 ↗ 5: 8.3 ↑		1: 8.9 ↘ 2: 10.5x ↗ 3: 10.3 → 4: 10.5x ↓ 5: 10.0 ↘
Serie 40	Total 85	Serie 48	Total 133
	1: 8.1 → 2: 9.9 ↑ 3: 8.0 ↗ 4: 8.7 ↑ 5: 9.5 →		1: 7.9 → 2: 8.6 → 3: 9.8 → 4: 9.7 ↘ 5: 10.2 ↖ 6: 9.5 →
Serie 42	Total 175	Serie 52	Total 175
	1: 9.6 ↖ 2: 9.1 ↖ 3: 8.1 ↗ 4: 9.6 → 5: 0.0		1: 8.6 ↗ 2: 8.8 ↗ 3: 8.9 ↖ 4: 9.1 ↖ 5: 9.8 ↓
Serie 35	Total 210	Serie 42	Total 252
	1: 10.7x ↑ 2: 9.6 → 3: 10.7x ↖ 4: 9.0 → 5: 10.1 ↑		
Serie 48	Total 300		

Skjutlag	Tavla	Ellen Jansson			
2	19	Ramselefors	Söderala	U	Gä
12.07.2021	Tavelträffen 2021	Ramselefors SKF			
	1: 9.8 ↑ 2: 10.3 ← 3: 10.0 → 4: 8.1 ↑ 5: 9.8 ←		1: 9.3 ← 2: 10.1 ↗ 3: 8.0 ↗ 4: 9.8 ← 5: 10.2 →	Serie	46
Total		Total		46	
	1: 10.1 ↓ 2: 9.4 ↗ 3: 9.7 ↗ 4: 9.4 ↑ 5: 10.8x ↓		1: 9.9 → 2: 10.2 ↓ 3: 10.2 ↗ 4: 10.0 → 5: 10.1 →	Serie	47
Total		Total		49	
93		142			
	1: 9.3 → 2: 8.6 → 3: 10.2 → 4: 9.9 ↗ 5: 10.2 →		1: 9.1 → 2: 10.2 ↓ 3: 10.5x → 4: 9.9 ↑ 5: 9.7 → 6: 10.5x ↗	Serie	46
Total		Total		57	
188		188			
	1: 8.8 ↗ 2: 8.6 ↓ 3: 10.3 ↓ 4: 10.6x ↓ 5: 10.3 ↗		1: 9.4 ↓ 2: 9.5 → 3: 10.6x ↗ 4: 10.3 ↓ 5: 10.1 ←	Serie	46
Total		Total		48	
234		282			
	1: 9.8 ← 2: 9.1 ↗ 3: 10.7x ↓ 4: 9.4 ↓ 5: 10.3 ↓				
Total		Total		47	
329					

Skjutlag	Tavla	Liam Bernhardsson	
2	21		
Ramselefors	Mönsterås	U	Sm
12.07.2021	Tavelträffen 2021	Ramselefors SKF	
	1: 10.5x ↓ 2: 10.2 ↓ 3: 8.9 ← 4: 8.9 ← 5: 9.7 ←		1: 10.0 ← 2: 10.1 ↑ 3: 9.7 ↑ 4: 10.8x ↖ 5: 10.0 ↑
	Serie 45		Serie 49
	Total 0		Total 49
	1: 10.2 → 2: 10.3 ↓ 3: 10.0 → 4: 10.2 ↗ 5: 9.8 ↗		1: 10.2 → 2: 9.8 → 3: 10.0 ↖ 4: 9.5 ↓ 5: 9.7 ←
	Serie 49		Serie 47
	Total 98		Total 145
	1: 10.0 ← 2: 9.9 ← 3: 10.3 ← 4: 10.8x ↘ 5: 10.2 ↓		1: 9.8 ↗ 2: 9.7 ↘ 3: 8.8 ↓ 4: 9.2 ↓ 5: 10.6x → 6: 10.3 ↓
	Serie 49		Serie 55
	Total 194		Total 194
	1: 10.0 ↙ 2: 10.7x ↑ 3: 10.5x ← 4: 10.3 ← 5: 10.6x ↗		1: 9.6 ↓ 2: 10.0 ↓ 3: 9.9 ↓ 4: 10.7x ← 5: 10.1 ↓
	Serie 50		Serie 48
	Total 244		Total 292
	1: 10.5x ↗ 2: 10.6x ↑ 3: 10.2 ↑ 4: 10.0 ↓ 5: 10.3 ↓		
	Serie 50		
	Total 342		

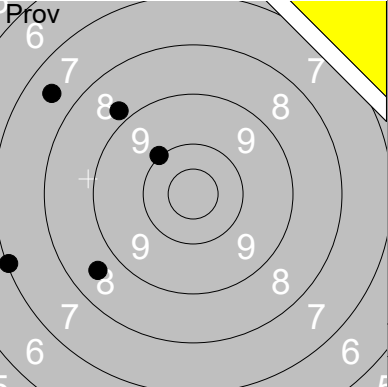
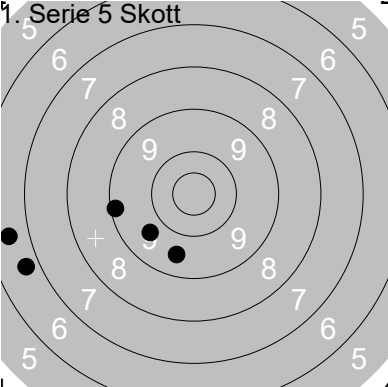
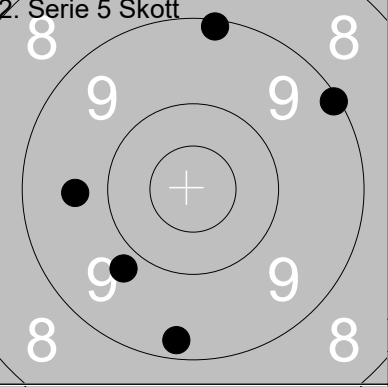
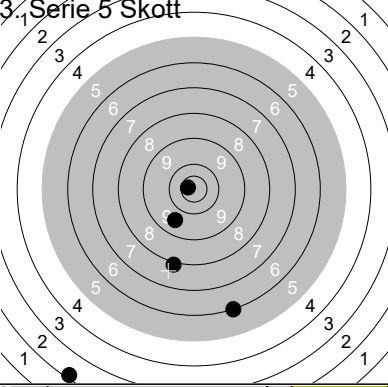
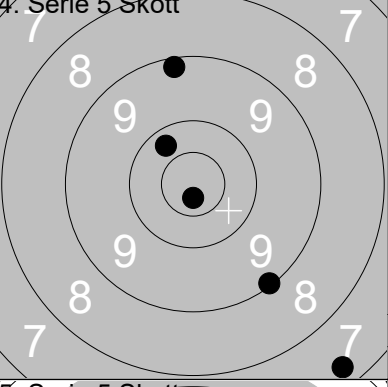
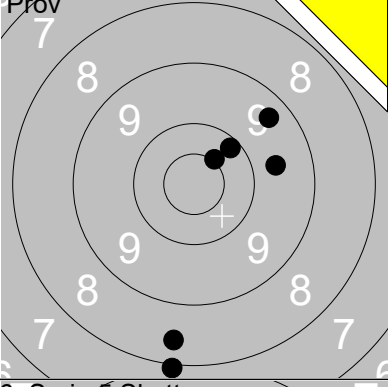
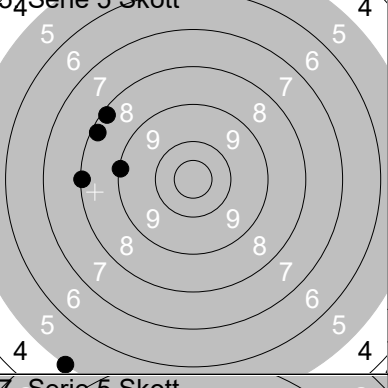
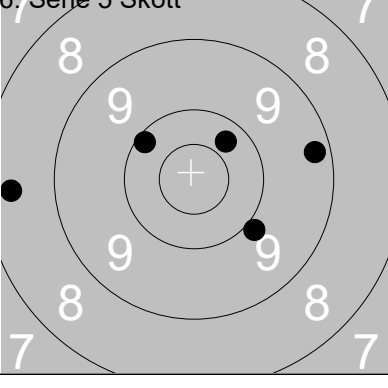
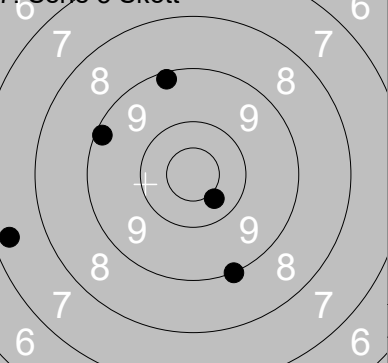
Skjutlag	Tavla	Edwin Frant		U	Vn
2	23	Ramselefors	Moälven-Modo		
12.07.2021	Tavelträffen 2021	Ramselefors SKF			
Prov 	1: 7.5 ↗ 2: 10.0 ↗ 3: 8.8 ↗ 4: 7.1 ← 5: 8.6 ↙ Serie 40 Total 0	1. Serie 5 Skott 	1: 9.1 ← 2: 6.6 ← 3: 9.6 ↙ 4: 6.7 ← 5: 9.5 ↓ Serie 39 Total 39		
2. Serie 5 Skott 	1: 9.3 ↓ 2: 9.1 → 3: 9.7 ← 4: 9.8 ↙ 5: 9.1 ↑ Serie 45 Total 84	3. Serie 5 Skott 	1: 9.6 ↓ 2: 2.2 ↙ 3: 7.9 ↓ 4: 6.0 ↓ 5: 10.7x ← Serie 34 Total 118		
4. Serie 5 Skott 	1: 9.1 ↘ 2: 9.2 ↑ 3: 7.3 ↘ 4: 10.8x ↘ 5: 10.3 ↗ Serie 45 Total 163	Prov 	1: 9.4 ↗ 2: 10.2 ↗ 3: 10.5x ↗ 4: 9.7 → 5: 8.4 ↓ 6: 8.0 ↓ Serie 54 Total 163		
5. Serie 5 Skott 	1: 5.0 ↘ 2: 8.1 ← 3: 8.2 ↗ 4: 8.2 ↗ 5: 9.1 ← Serie 38 Total 201	6. Serie 5 Skott 	1: 9.9 ↘ 2: 8.4 ← 3: 9.3 → 4: 10.3 ↗ 5: 10.1 ↖ Serie 46 Total 247		
7. Serie 5 Skott 	1: 9.0 ↓ 2: 7.3 ← 3: 10.4 ↘ 4: 9.2 ↗ 5: 9.2 ↗ Serie 44 Total 291				

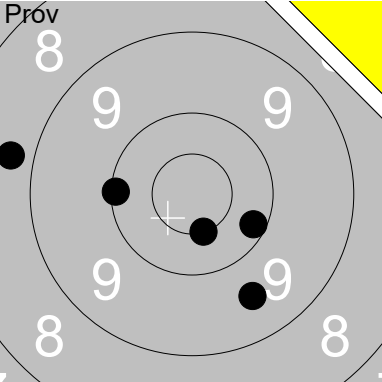
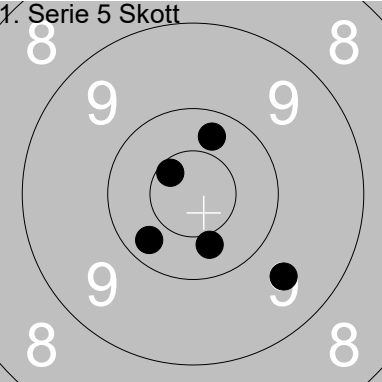
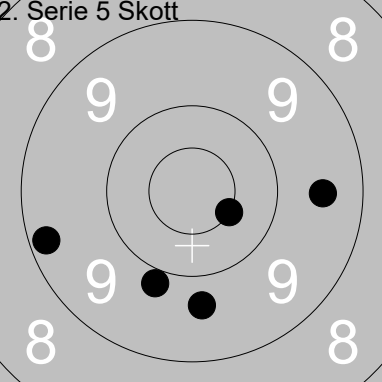
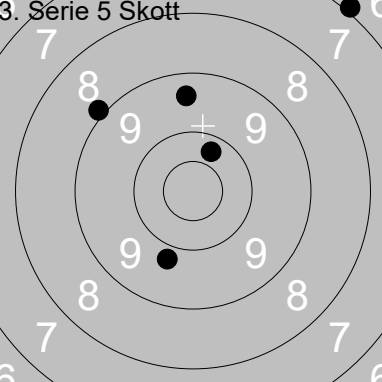
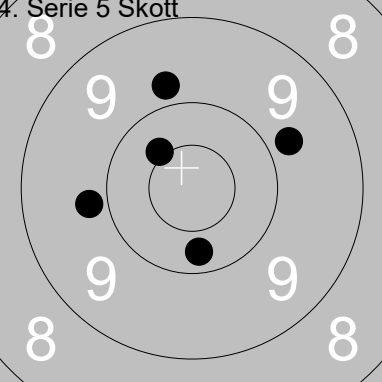
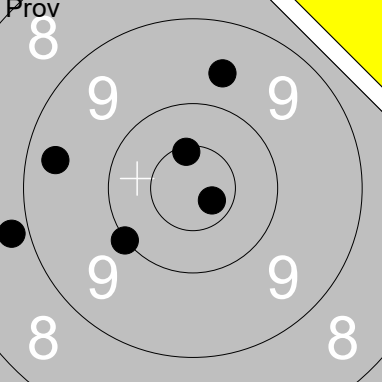
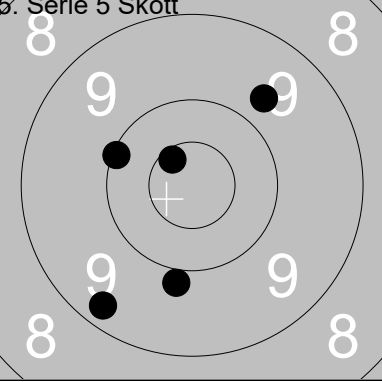
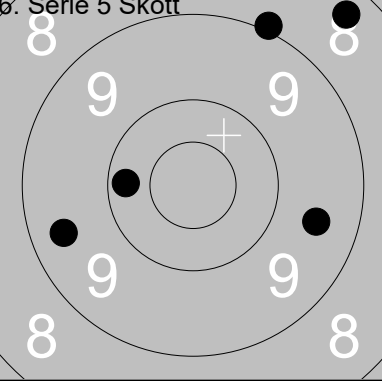
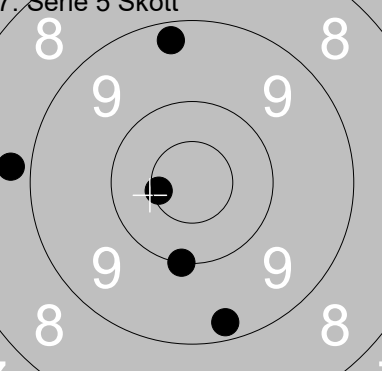
Skjutlag	Tavla	Dan-Ivan Karlsson			
3	1	Ramselefors	Ramselefors	C	Vb
12.07.2021	Tavelträffen 2021	Ramselefors SKF			
Pröv 	1: 8.7 ← 2: 9.6 ↓ 3: 10.1 ← 4: 10.5x ↓ 5: 10.2 →	1. Serie 5 Skott 	1: 10.6x ↖ 2: 10.4 ↓ 3: 10.3 ↑ 4: 10.3 ↙ 5: 9.6 ↓		
	Serie 47		Serie 49		
	Total 0		Total 49		
2. Serie 5 Skott 	1: 9.2 ← 2: 9.7 ↓ 3: 10.5x → 4: 9.9 ↓ 5: 9.5 →	3. Serie 5 Skott 	1: 10.3 ↑ 2: 6.9 ↗ 3: 9.4 ↑ 4: 8.9 ↖ 5: 9.8 ↓		
	Serie 46		Serie 42		
	Total 95		Total 137		
4. Serie 5 Skott 	1: 10.4x ↖ 2: 9.8 → 3: 10.3 ↓ 4: 9.8 ↑ 5: 9.8 ←	Pröv 	1: 8.8 ← 2: 10.0 ↙ 3: 9.4 ← 4: 10.7x → 5: 9.6 ↑ 6: 10.5x ↑		
	Serie 47		Serie 56		
	Total 184		Total 184		
5. Serie 5 Skott 	1: 9.3 ↙ 2: 9.7 ↗ 3: 10.1 ← 4: 9.9 ↓ 5: 10.6x ↖	6. Serie 5 Skott 	1: 8.4 ↗ 2: 9.0 ↑ 3: 9.4 ← 4: 9.5 → 5: 10.2 ←		
	Serie 47		Serie 45		
	Total 231		Total 276		
7. Serie 5 Skott 	1: 9.3 ↑ 2: 10.0 ↓ 3: 8.8 ← 4: 10.6x ← 5: 9.3 ↓				
	Serie 46				
	Total 322				

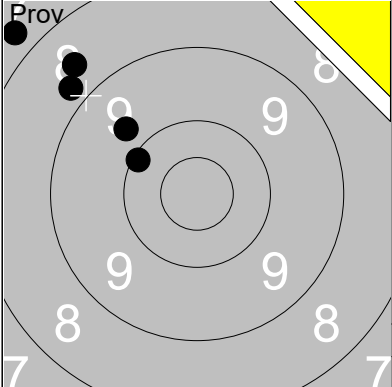
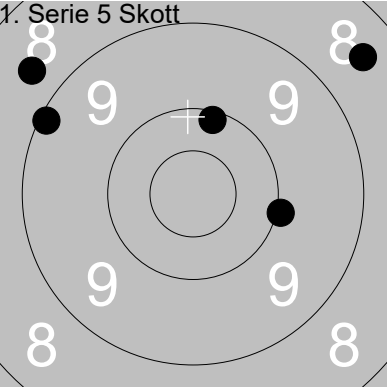
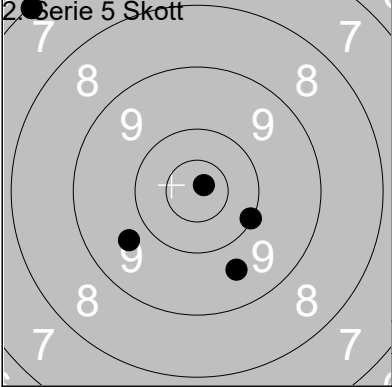
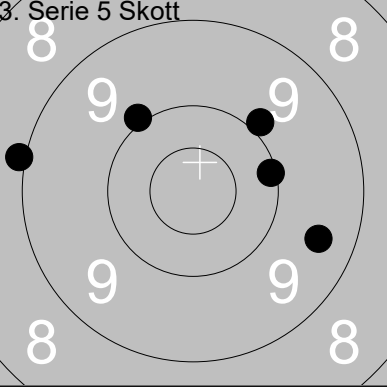
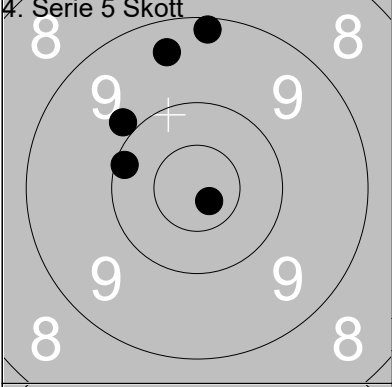
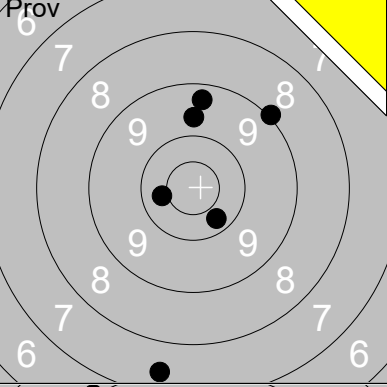
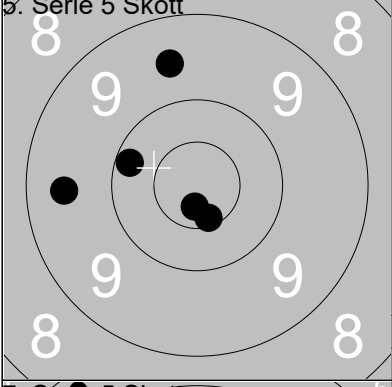
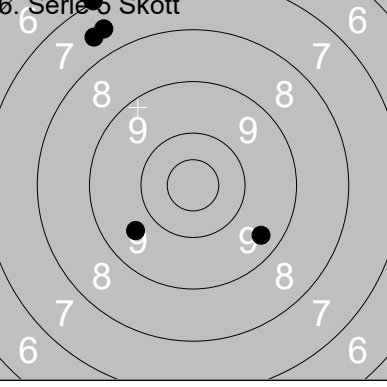
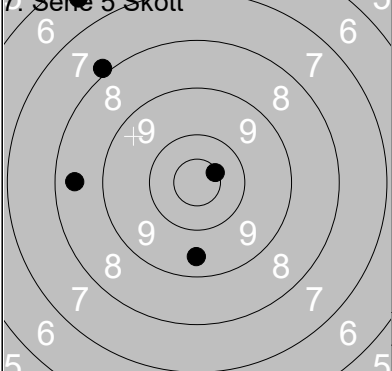
Skjutlag	Tavla	Jan-Erik Karlsson			
3	2	Ramselefors	Ramselefors	C	Vb
12.07.2021	Tavelträffen 2021	Ramselefors SKF			
	1: 10.1 ↗ 2: 7.7 ↗ 3: 8.6 ↗ 4: 8.8 ↗ 5: 9.7 ↗	1. Serie 5 Skott 	1: 8.5 ↗ 2: 10.0 → 3: 8.7 ↗ 4: 10.1 ↑ 5: 9.1 ↖		
Serie 42	Total 0	Serie 45	Total 45		
2. Serie 5 Skott 	1: 7.1 ↗ 2: 9.7 ↖ 3: 10.8x ↗ 4: 9.6 ↘ 5: 10.1 ↘	3. Serie 5 Skott 	1: 9.9 ↗ 2: 9.0 ← 3: 9.5 → 4: 10.1 → 5: 10.0 ↗		
Serie 45	Total 90	Serie 47	Total 137		
4. Serie 5 Skott 	1: 9.2 ↑ 2: 10.1 ← 3: 10.8x ↘ 4: 9.9 ↗ 5: 9.4 ↑	Prov 	1: 9.3 ↑ 2: 10.3 ↘ 3: 9.0 ↗ 4: 9.7 ↑ 5: 7.4 ↓ 6: 10.4 ←		
Serie 47	Total 184	Serie 54	Total 184		
5. Serie 5 Skott 	1: 10.2 ↖ 2: 10.6x ↘ 3: 10.7x ↘ 4: 9.6 ↑ 5: 9.5 ←	6. Serie 5 Skott 	1: 7.0 ↗ 2: 9.4 ↘ 3: 9.6 ↖ 4: 7.6 ↗ 5: 7.6 ↗		
Serie 48	Total 232	Serie 39	Total 271		
7. Serie 5 Skott 	1: 6.4 ↗ 2: 9.5 ↓ 3: 10.6x ↗ 4: 8.4 ← 5: 7.9 ↗				
Serie 40	Total 311				

Skjutlag	Tavla	Simon Ness	
3	4		
Ramselefors	Arvika	C	Vä
12.07.2021	Tavelträffen 2021	Ramselefors SKF	
Prov 	1: 8.2 ↙ 2: 10.4 ↙ 3: 9.7 ↓ 4: 10.2 ↗ 5: 9.4 ↙ Serie 46 Total 0	1. Serie 5 Skott 	1: 10.5x ↗ 2: 9.9 ↑ 3: 10.8x ↙ 4: 10.0 → 5: 10.0 ↓ Serie 49 Total 49
2. Serie 5 Skott 	1: 10.7x ↑ 2: 10.6x ↑ 3: 9.2 ↗ 4: 9.3 ↑ 5: 9.3 → Serie 47 Total 96	3. Serie 5 Skott 	1: 9.2 ↙ 2: 10.5x → 3: 9.5 ↗ 4: 10.9x ↙ 5: 10.6x → Serie 48 Total 144
4. Serie 5 Skott 	1: 8.3 → 2: 10.1 ↗ 3: 9.4 ↑ 4: 10.2 ↙ 5: 9.3 ↙ Serie 46 Total 190	Prov 	1: 8.4 ↘ 2: 9.7 → 3: 9.4 ↗ 4: 8.3 ↑ 5: 9.2 ↑ 6: 9.8 ↙ Serie 52 Total 190
5. Serie 5 Skott 	1: 10.4x → 2: 9.0 → 3: 10.1 ↑ 4: 10.6x ↑ 5: 8.5 ↗ Serie 47 Total 237	6. Serie 5 Skott 	1: 9.4 ↑ 2: 7.4 → 3: 9.0 → 4: 9.3 ↙ 5: 9.4 ↑ Serie 43 Total 280
7. Serie 5 Skott 	1: 7.3 → 2: 10.5x ↓ 3: 8.3 ↗ 4: 9.6 ↗ 5: 8.7 ↙ Serie 42 Total 322		

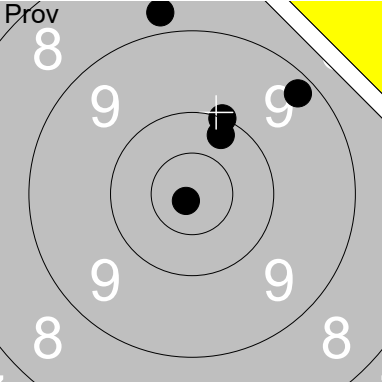
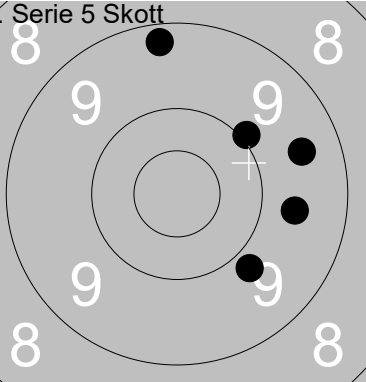
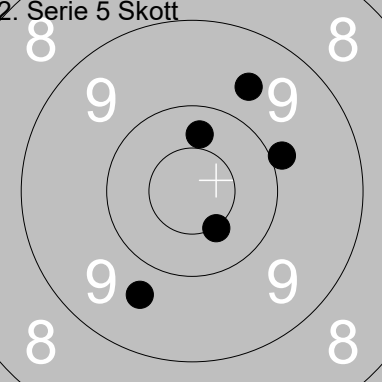
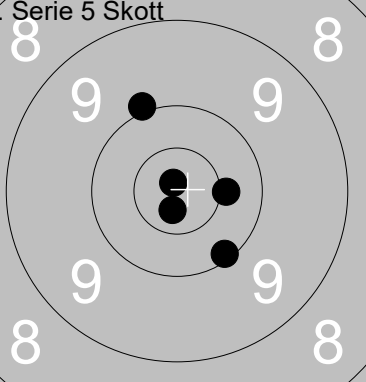
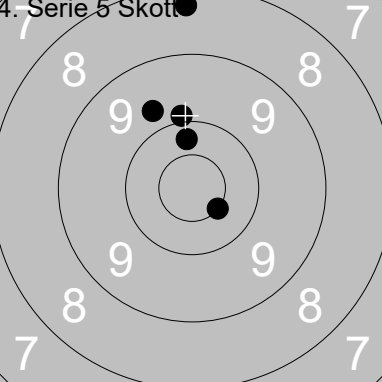
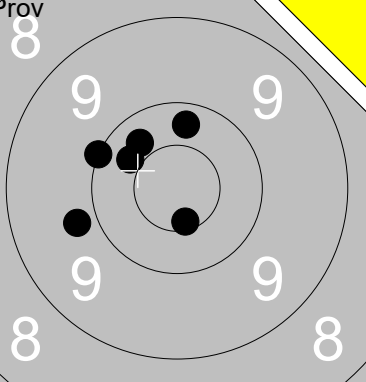
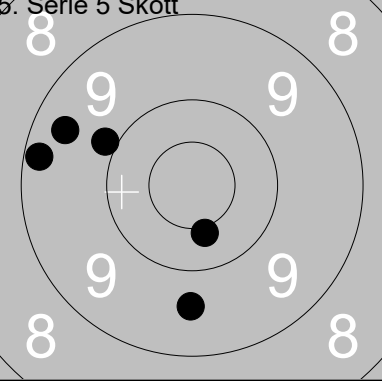
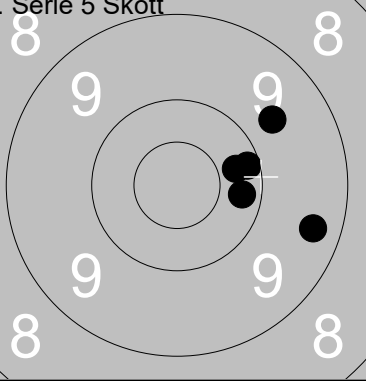
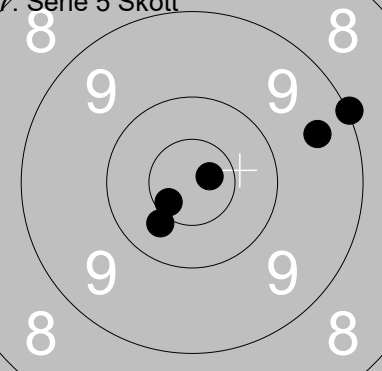
Skjutlag	Tavla	Håkan Lidman		
3	6	Ramselefors	Piteå	C No
12.07.2021	Tavelträffen 2021	Ramselefors SKF		
Prov 	1: 8.8 ↑ 2: 9.2 ↗ 3: 10.8x ↘ 4: 10.0 ↑ 5: 10.2 ↑	1. Serie 5 Skott 	1: 9.6 → 2: 9.5 → 3: 9.8 ↘ 4: 9.2 ↑ 5: 10.0 ↗	
Serie 47	Total 0	Serie 46	Total 46	
2. Serie 5 Skott 	1: 9.7 ↘ 2: 10.3 ↑ 3: 9.9 → 4: 9.6 ↗ 5: 10.5x ↘	3. Serie 5 Skott 	1: 10.7x ↘ 2: 10.0 ↗ 3: 10.9x ↗ 4: 10.1 ↘ 5: 10.4x →	
Serie 47	Total 93	Serie 50	Total 143	
4. Serie 5 Skott 	1: 10.5x ↘ 2: 9.7 ↗ 3: 8.3 ↑ 4: 10.3 ↑ 5: 9.9 ↑	Prov 	1: 10.6x ↘ 2: 10.4 ↖ 3: 10.3 ↑ 4: 9.8 ↖ 5: 10.0 ↖ 6: 10.3 ↗	
Serie 46	Total 189	Serie 59	Total 189	
5. Serie 5 Skott 	1: 10.4x ↘ 2: 9.9 ↖ 3: 9.2 ↖ 4: 9.4 ↖ 5: 9.6 ↘	6. Serie 5 Skott 	1: 9.4 → 2: 10.3 → 3: 10.2 → 4: 10.2 → 5: 9.7 ↗	
Serie 46	Total 235	Serie 48	Total 283	
7. Serie 5 Skott 	1: 9.5 → 2: 10.8x → 3: 10.4 ↘ 4: 10.6x ↘ 5: 9.0 →			
Serie 48	Total 331			

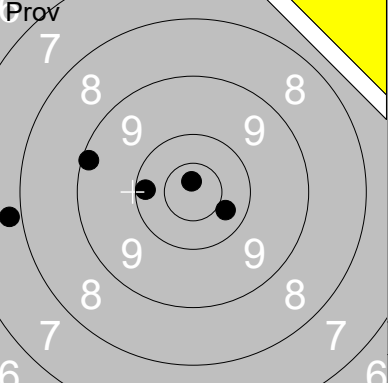
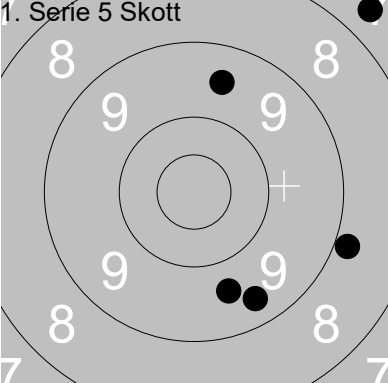
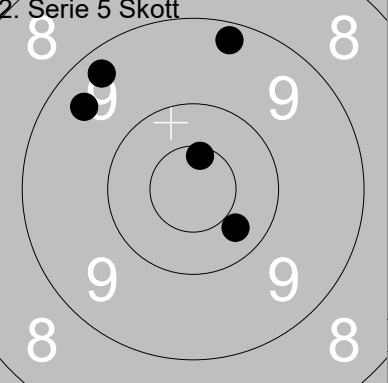
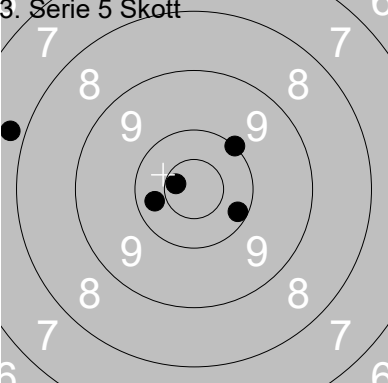
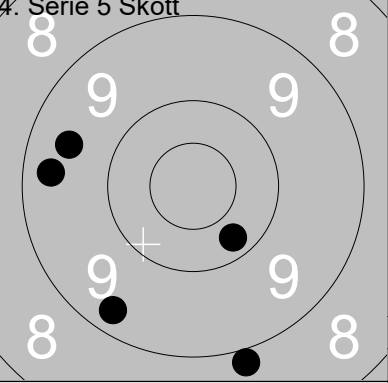
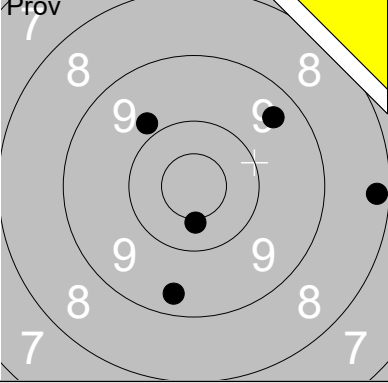
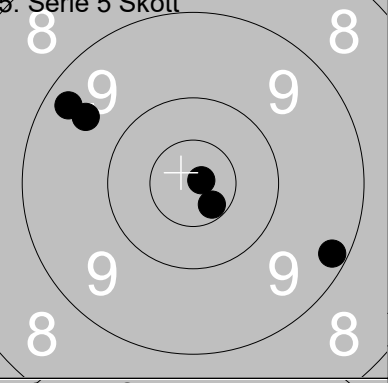
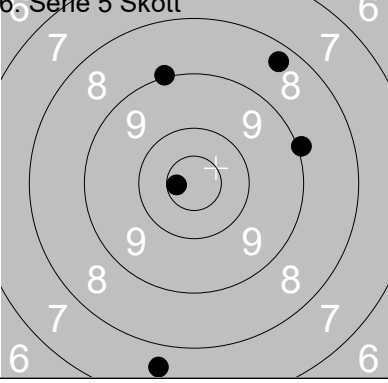
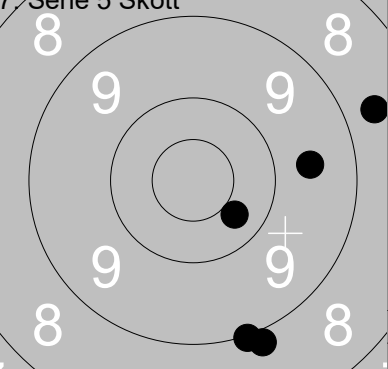
Skjutlag	Tavla	Berndt Steffen	
3	8	Ramselefors	Frötuna
12.07.2021	Tavelträffen 2021	Ramselefors SKF	
	1: 7.8 ← 2: 9.1 ← 3: 10.2 ← 4: 10.4 ↘ 5: 10.8x ↑	1. Serie 5 Skott 	1: 9.4 ↓ 2: 9.6 ↓ 3: 8.8 → 4: 7.6 ↗ 5: 9.5 ↑
Serie 46	Total 0	Serie 42	Total 42
2. Serie 5 Skott 	1: 9.2 ↑ 2: 9.4 ↗ 3: 10.6x ↑ 4: 9.3 ↗ 5: 10.3 ↓	3. Serie 5 Skott 	1: 10.3 ← 2: 10.2 ↘ 3: 10.7x ← 4: 7.8 ← 5: 10.0 ↗
Serie 47	Total 89	Serie 47	Total 136
4. Serie 5 Skott 	1: 9.5 ← 2: 9.4 ← 3: 10.2 ↓ 4: 9.3 ↓ 5: 8.9 ↓	Prov 	1: 9.8 ↗ 2: 10.4x ↓ 3: 9.4 ↓ 4: 9.4 ↗ 5: 8.2 → 6: 7.4 ↗
Serie 45	Total 181	Serie 52	Total 181
5. Serie 5 Skott 	1: 10.6x ↓ 2: 9.6 ↗ 3: 9.3 ↗ 4: 9.2 ↘ 5: 10.9x →	6. Serie 5 Skott 	1: 9.0 → 2: 8.3 ↗ 3: 9.0 ↑ 4: 7.6 ↓ 5: 10.7x ←
Serie 47	Total 228	Serie 43	Total 271
7. Serie 5 Skott 	1: 10.3 ↓ 2: 8.7 → 3: 9.6 → 4: 8.9 ↓ 5: 9.0 ↓		
Serie 44	Total 315		

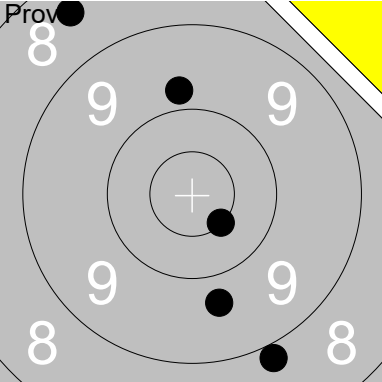
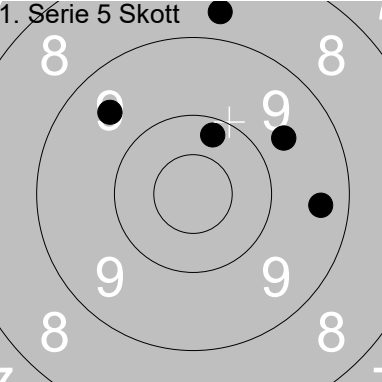
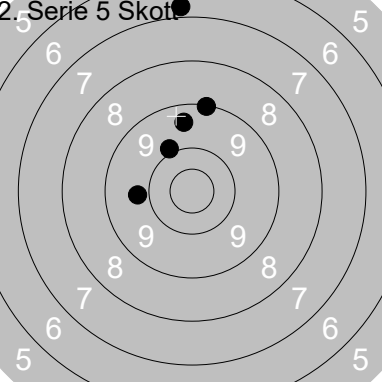
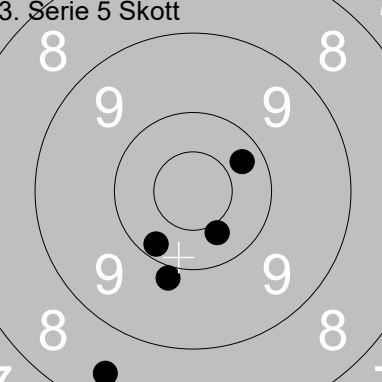
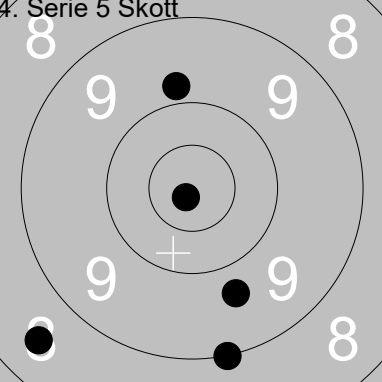
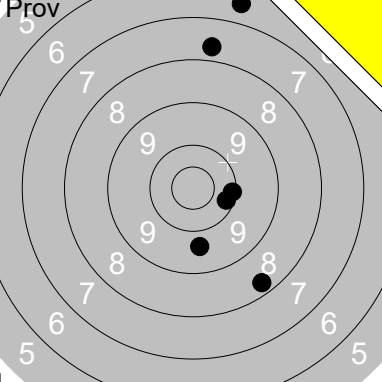
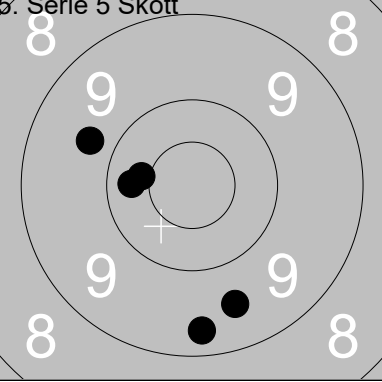
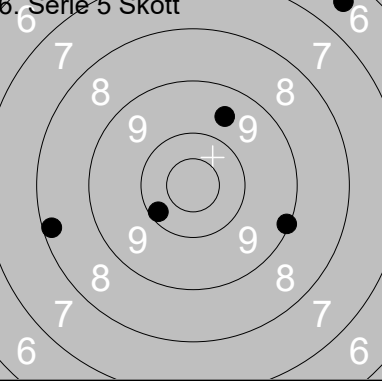
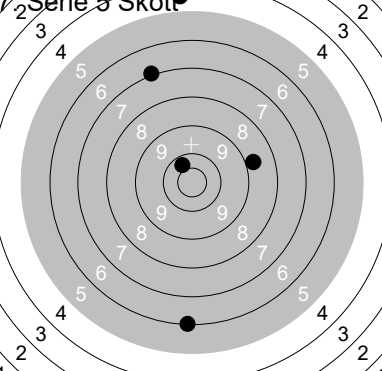
Skjutlag	Tavla	Torsten Karlsson					
3	10	Ramselefors	Vrenaorten	C	Sö		
12.07.2021	Tavelträffen 2021	Ramselefors SKF					
	1: 9.8 ↑ 2: 8.4 ↗ 3: 9.7 ↓ 4: 8.9 ↓ 5: 10.5x ↓		1: 9.7 ↗ 2: 9.5 ↖ 3: 8.7 ↑ 4: 9.4 → 5: 10.2 ↑	Serie	44	Serie	45
	Total	0	Total	45			45
	1: 9.1 ↑ 2: 9.9 ↗ 3: 6.8 ↑ 4: 9.4 ↑ 5: 9.8 ←		1: 10.2 ↓ 2: 8.5 ↓ 3: 10.3 ↗ 4: 9.9 ↓ 5: 10.4 ↓	Serie	42	Serie	47
	Total	87	Total	134			134
	1: 9.8 ↑ 2: 8.5 ↖ 3: 9.7 ↓ 4: 9.0 ↓ 5: 10.8x ↖		1: 8.3 ↓ 2: 10.2 → 3: 10.1 → 4: 9.7 ↓ 5: 7.7 ↑ 6: 6.6 ↑	Serie	45	Serie	50
	Total	179	Total	179			179
	1: 10.3 ← 2: 9.6 ↓ 3: 9.3 ↓ 4: 10.4 ← 5: 9.7 ←		1: 10.2 ↖ 2: 8.2 ← 3: 6.5 ↗ 4: 9.1 → 5: 9.6 ↗	Serie	47	Serie	42
	Total	226	Total	268			268
	1: 6.1 ↓ 2: 4.5 ↑ 3: 6.9 ↗ 4: 10.3 ↗ 5: 8.8 →			Serie	34		
	Total	302					

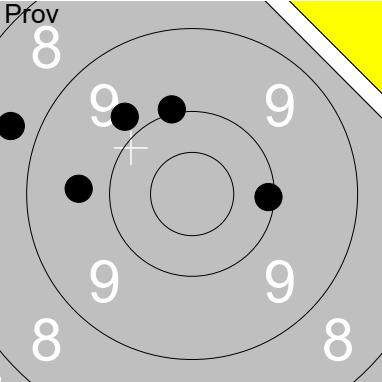
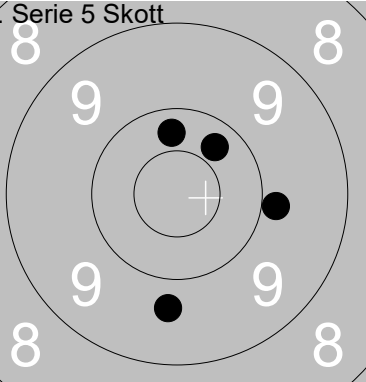
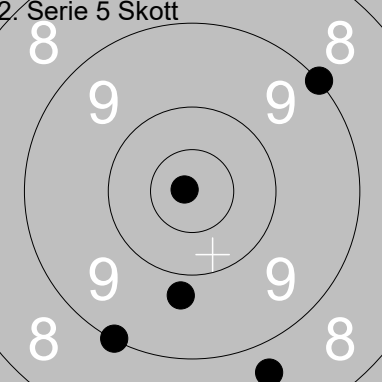
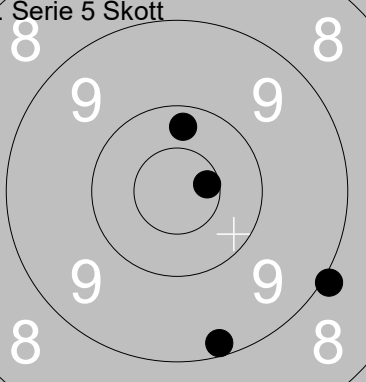
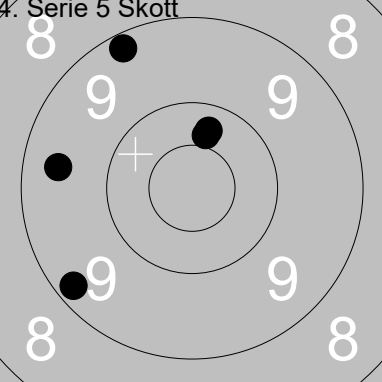
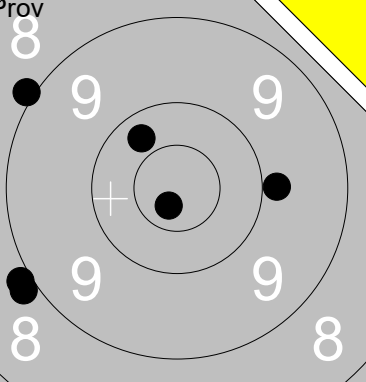
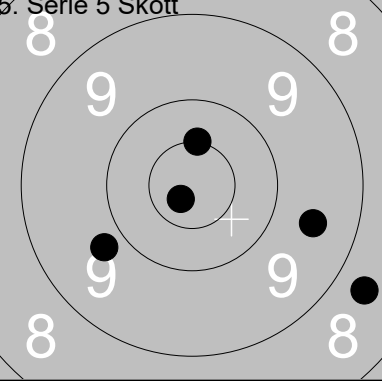
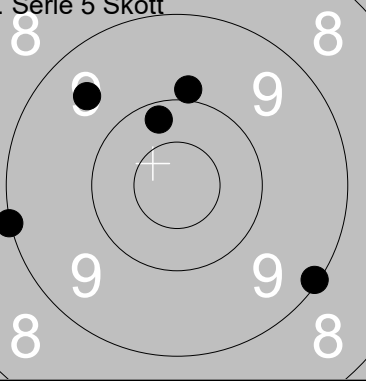
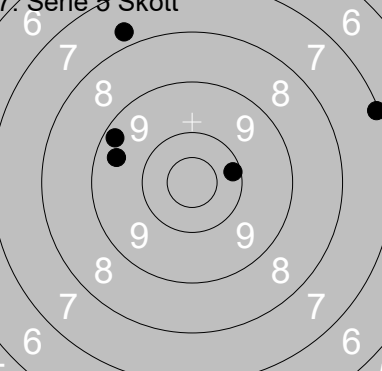
Skjutlag	Tavla	Torbjörn Karlsson	
3	11	Ramselefors	Vrenaorten
12.07.2021	Tavelträffen 2021	Ramselefors SKF	
Prov 	1: 9.7 ← 2: 10.0 ↑ 3: 10.1 → 4: 8.7 ← 5: 9.8 ↗ Serie 46 Total 0	1. Serie 5 Skott 	1: 9.9 → 2: 9.7 ↓ 3: 10.3 ↗ 4: 10.3 ↑ 5: 0.0 Serie 38 Total 38
2. Serie 5 Skott 	1: 9.0 ↗ 2: 9.0 ↓ 3: 10.9x ← 4: 9.8 ↓ 5: 8.7 ↓ Serie 45 Total 83	3. Serie 5 Skott 	1: 9.0 ↘ 2: 10.3 ↑ 3: 10.6x → 4: 9.2 ↓ 5: 0.0 Serie 38 Total 121
4. Serie 5 Skott 	1: 10.3 ↑ 2: 9.2 ↙ 3: 10.4 ↑ 4: 9.2 ↑ 5: 9.4 ← Serie 47 Total 168	Prov 	1: 10.7x ↓ 2: 8.9 ↖ 3: 10.3 ↗ 4: 8.9 ↙ 5: 8.9 ↙ 6: 9.9 → Serie 53 Total 168
5. Serie 5 Skott 	1: 9.8 ↙ 2: 10.8x ↓ 3: 8.7 → 4: 10.5x ↑ 5: 9.5 → Serie 46 Total 214	6. Serie 5 Skott 	1: 9.0 ← 2: 9.9 ↑ 3: 9.1 ↘ 4: 9.6 ↖ 5: 10.2 ↑ Serie 46 Total 260
7. Serie 5 Skott 	1: 7.7 ↖ 2: 7.1 → 3: 9.4 ← 4: 10.2 → 5: 9.2 ↖ Serie 42 Total 302		

Skjutlag	Tavla	Donald Johansson		
3	13	Ramselefors	Ale	C No
12.07.2021	Tavelträffen 2021	Ramselefors SKF		
Prov 	1: 8.7 ↖ 2: 9.9 ↗ 3: 9.7 ↗ 4: 9.3 → 5: 9.7 →	1. Serie 5 Skott 	1: 10.3 ↓ 2: 9.4 ↓ 3: 10.7x ↑ 4: 10.6x ← 5: 10.8x →	
	Serie 44		Serie 49	
	Total 0		Total 49	
2. Serie 5 Skott 	1: 9.4 ↗ 2: 10.5x ↑ 3: 10.7x ↑ 4: 10.1 ↑ 5: 9.9 ↗	3. Serie 5 Skott 	1: 8.7 ↗ 2: 10.8x ↗ 3: 10.5x ← 4: 10.2 ← 5: 10.0 ↗	
	Serie 48		Serie 48	
	Total 97		Total 145	
4. Serie 5 Skott 	1: 8.2 → 2: 8.5 → 3: 8.5 ← 4: 10.5x ↗ 5: 9.6 ↗	Prov 	1: 9.6 ↑ 2: 9.3 ← 3: 10.4 ↑ 4: 9.8 ↓ 5: 7.9 ← 6: 10.4 ↑	
	Serie 43		Serie 54	
	Total 188		Total 188	
5. Serie 5 Skott 	1: 10.5x ↑ 2: 9.7 ← 3: 9.8 ↓ 4: 8.9 ← 5: 10.1 ←	6. Serie 5 Skott 	1: 9.1 → 2: 9.7 ↑ 3: 10.6x ↓ 4: 8.1 ← 5: 9.1 ↓	
	Serie 46		Serie 45	
	Total 234		Total 279	
7. Serie 5 Skott 	1: 9.8 → 2: 10.6x ↑ 3: 9.6 → 4: 10.3 ↓ 5: 10.3 ↖			
	Serie 48			
	Total 327			

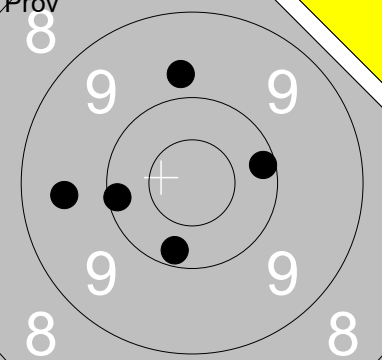
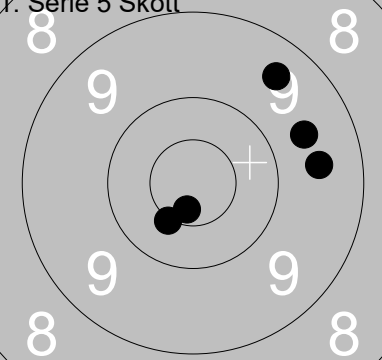
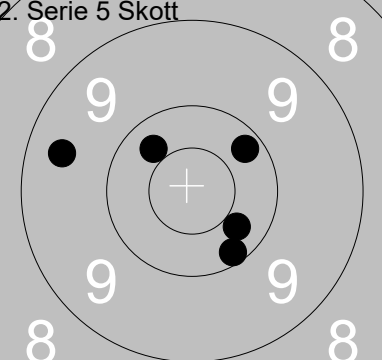
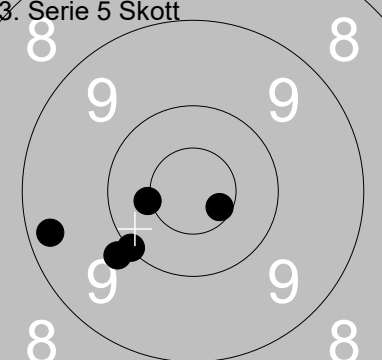
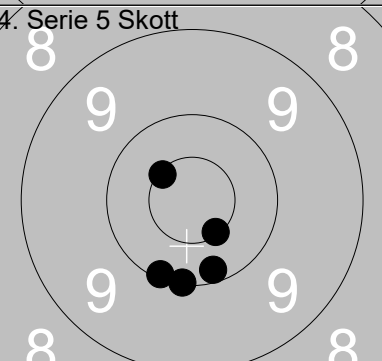
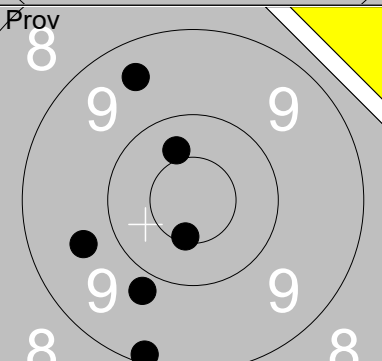
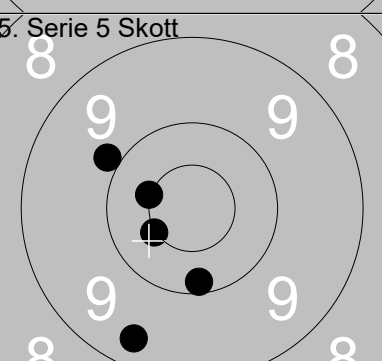
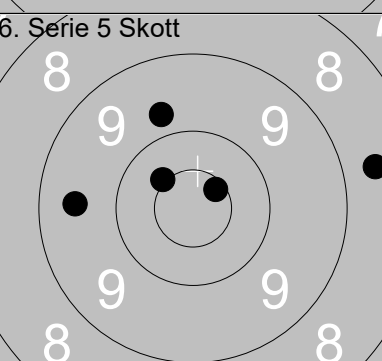
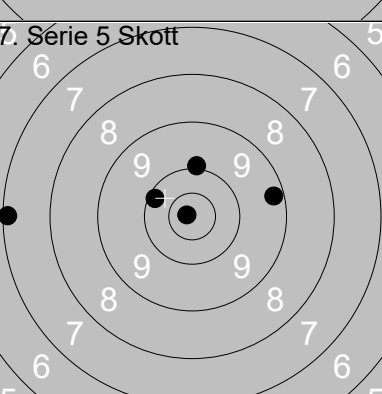
Prov 	1. Serie 5 Skott 	<table style="width:100%; border-collapse: collapse;"> <tr> <td style="width:50%;">1: 9.8 ↑</td> <td style="width:50%;">1: 9.4 ↗</td> </tr> <tr> <td>2: 10.2 →</td> <td>2: 9.5 →</td> </tr> <tr> <td>3: 9.5 ←</td> <td>3: 9.6 →</td> </tr> <tr> <td>4: 10.2 ↓</td> <td>4: 10.5x ↓</td> </tr> <tr> <td>5: 10.1 ←</td> <td>5: 10.7x ↓</td> </tr> <tr> <td style="border-top: 1px solid black;">Serie 48</td> <td style="border-top: 1px solid black;">Serie 47</td> </tr> <tr> <td style="border-top: 1px solid black;">Total 0</td> <td style="border-top: 1px solid black;">Total 47</td> </tr> </table>	1: 9.8 ↑	1: 9.4 ↗	2: 10.2 →	2: 9.5 →	3: 9.5 ←	3: 9.6 →	4: 10.2 ↓	4: 10.5x ↓	5: 10.1 ←	5: 10.7x ↓	Serie 48	Serie 47	Total 0	Total 47
1: 9.8 ↑	1: 9.4 ↗															
2: 10.2 →	2: 9.5 →															
3: 9.5 ←	3: 9.6 →															
4: 10.2 ↓	4: 10.5x ↓															
5: 10.1 ←	5: 10.7x ↓															
Serie 48	Serie 47															
Total 0	Total 47															
2. Serie 5 Skott 	3. Serie 5 Skott 	<table style="width:100%; border-collapse: collapse;"> <tr> <td style="width:50%;">1: 10.3 ↗</td> <td style="width:50%;">1: 9.9 ↙</td> </tr> <tr> <td>2: 10.2 ↗</td> <td>2: 10.6x ↘</td> </tr> <tr> <td>3: 10.3 ↓</td> <td>3: 10.4x ←</td> </tr> <tr> <td>4: 10.2 ↓</td> <td>4: 9.3 ←</td> </tr> <tr> <td>5: 9.4 ↑</td> <td>5: 10.0 ↙</td> </tr> <tr> <td style="border-top: 1px solid black;">Serie 49</td> <td style="border-top: 1px solid black;">Serie 48</td> </tr> <tr> <td style="border-top: 1px solid black;">Total 96</td> <td style="border-top: 1px solid black;">Total 144</td> </tr> </table>	1: 10.3 ↗	1: 9.9 ↙	2: 10.2 ↗	2: 10.6x ↘	3: 10.3 ↓	3: 10.4x ←	4: 10.2 ↓	4: 9.3 ←	5: 9.4 ↑	5: 10.0 ↙	Serie 49	Serie 48	Total 96	Total 144
1: 10.3 ↗	1: 9.9 ↙															
2: 10.2 ↗	2: 10.6x ↘															
3: 10.3 ↓	3: 10.4x ←															
4: 10.2 ↓	4: 9.3 ←															
5: 9.4 ↑	5: 10.0 ↙															
Serie 49	Serie 48															
Total 96	Total 144															
4. Serie 5 Skott 	Prov 	<table style="width:100%; border-collapse: collapse;"> <tr> <td style="width:50%;">1: 10.1 ↓</td> <td style="width:50%;">1: 9.7 ←</td> </tr> <tr> <td>2: 10.0 ↓</td> <td>2: 10.6x ↓</td> </tr> <tr> <td>3: 10.5x ↓</td> <td>3: 9.4 ↗</td> </tr> <tr> <td>4: 10.5x ↗</td> <td>4: 9.8 ↓</td> </tr> <tr> <td>5: 10.2 ↓</td> <td>5: 10.4 ↗</td> </tr> <tr> <td style="border-top: 1px solid black;">Serie 50</td> <td style="border-top: 1px solid black;">Serie 56</td> </tr> <tr> <td style="border-top: 1px solid black;">Total 194</td> <td style="border-top: 1px solid black;">Total 194</td> </tr> </table>	1: 10.1 ↓	1: 9.7 ←	2: 10.0 ↓	2: 10.6x ↓	3: 10.5x ↓	3: 9.4 ↗	4: 10.5x ↗	4: 9.8 ↓	5: 10.2 ↓	5: 10.4 ↗	Serie 50	Serie 56	Total 194	Total 194
1: 10.1 ↓	1: 9.7 ←															
2: 10.0 ↓	2: 10.6x ↓															
3: 10.5x ↓	3: 9.4 ↗															
4: 10.5x ↗	4: 9.8 ↓															
5: 10.2 ↓	5: 10.4 ↗															
Serie 50	Serie 56															
Total 194	Total 194															
5. Serie 5 Skott 	6. Serie 5 Skott 	<table style="width:100%; border-collapse: collapse;"> <tr> <td style="width:50%;">1: 10.5x ←</td> <td style="width:50%;">1: 9.7 ↗</td> </tr> <tr> <td>2: 10.2 ↓</td> <td>2: 8.6 →</td> </tr> <tr> <td>3: 10.5x ←</td> <td>3: 10.4x ↗</td> </tr> <tr> <td>4: 9.9 ↗</td> <td>4: 9.5 ←</td> </tr> <tr> <td>5: 9.4 ↓</td> <td>5: 10.6x ↗</td> </tr> <tr> <td style="border-top: 1px solid black;">Serie 48</td> <td style="border-top: 1px solid black;">Serie 46</td> </tr> <tr> <td style="border-top: 1px solid black;">Total 242</td> <td style="border-top: 1px solid black;">Total 288</td> </tr> </table>	1: 10.5x ←	1: 9.7 ↗	2: 10.2 ↓	2: 8.6 →	3: 10.5x ←	3: 10.4x ↗	4: 9.9 ↗	4: 9.5 ←	5: 9.4 ↓	5: 10.6x ↗	Serie 48	Serie 46	Total 242	Total 288
1: 10.5x ←	1: 9.7 ↗															
2: 10.2 ↓	2: 8.6 →															
3: 10.5x ←	3: 10.4x ↗															
4: 9.9 ↗	4: 9.5 ←															
5: 9.4 ↓	5: 10.6x ↗															
Serie 48	Serie 46															
Total 242	Total 288															
7. Serie 5 Skott 	<table style="width:100%; border-collapse: collapse;"> <tr> <td style="width:50%;">1: 9.2 →</td> <td style="width:50%;"></td> </tr> <tr> <td>2: 10.0 ↑</td> <td></td> </tr> <tr> <td>3: 10.2 ↗</td> <td></td> </tr> <tr> <td>4: 10.8x ↗</td> <td></td> </tr> <tr> <td>5: 7.1 ←</td> <td></td> </tr> <tr> <td style="border-top: 1px solid black;">Serie 46</td> <td></td> </tr> <tr> <td style="border-top: 1px solid black;">Total 334</td> <td></td> </tr> </table>		1: 9.2 →		2: 10.0 ↑		3: 10.2 ↗		4: 10.8x ↗		5: 7.1 ←		Serie 46		Total 334	
1: 9.2 →																
2: 10.0 ↑																
3: 10.2 ↗																
4: 10.8x ↗																
5: 7.1 ←																
Serie 46																
Total 334																

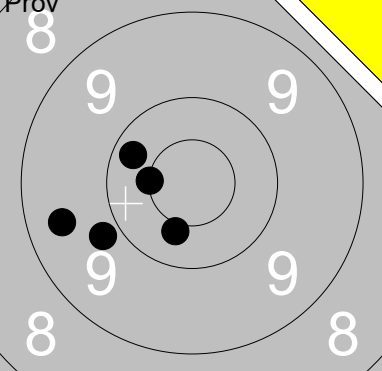
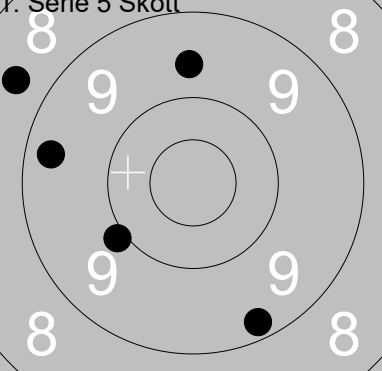
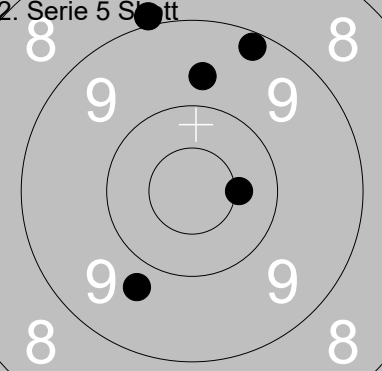
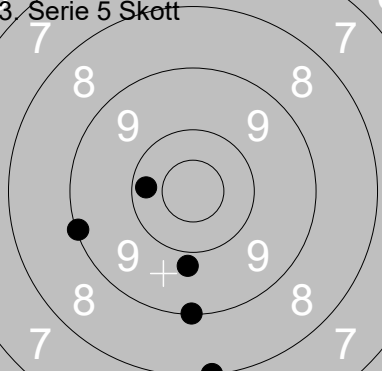
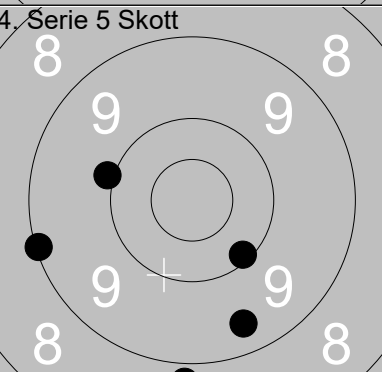
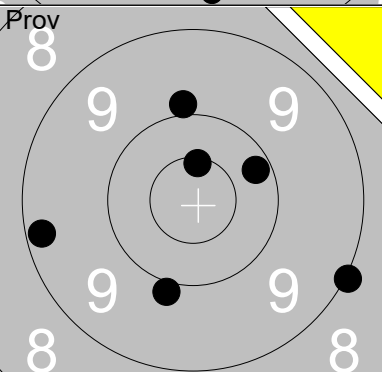
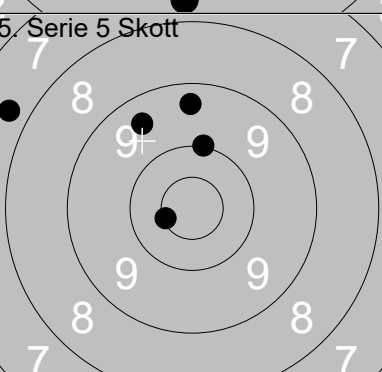
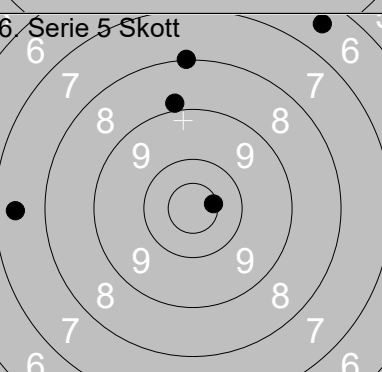
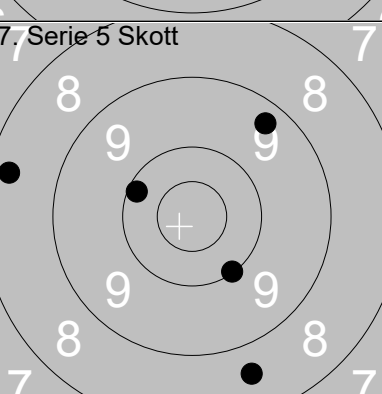
Prov 	1: 9.8 ← 2: 10.5x ← 3: 10.4 ↓ 4: 9.4 ← 5: 10.2 ↖ <hr/> Serie 48 Total 0	1. Serie 5 Skott 	1: 9.3 ← 2: 9.6 ↑ 3: 9.9 ↖ 4: 8.6 ↖ 5: 9.2 ↓ <hr/> Serie 44 Total 44
2. Serie 5 Skott 	1: 10.4x → 2: 9.7 ↑ 3: 8.9 ↑ 4: 9.2 ↑ 5: 9.7 ↓ <hr/> Serie 45 Total 89	3. Serie 5 Skott 	1: 9.0 ↓ 2: 10.2 ← 3: 9.1 ← 4: 9.8 ↓ 5: 8.0 ↓ <hr/> Serie 45 Total 134
4. Serie 5 Skott 	1: 9.4 ↓ 2: 9.9 ← 3: 10.1 ↓ 4: 8.8 ↓ 5: 9.1 ← <hr/> Serie 45 Total 179	Prov 	1: 9.9 ↓ 2: 10.5x ↑ 3: 10.2 → 4: 9.0 → 5: 9.9 ↑ 6: 9.2 ← <hr/> Serie 56 Total 179
5. Serie 5 Skott 	1: 9.4 ↑ 2: 9.4 ↖ 3: 10.5x ← 4: 10.0 ↑ 5: 7.7 ↖ <hr/> Serie 45 Total 224	6. Serie 5 Skott 	1: 6.5 ↗ 2: 8.9 ↑ 3: 8.0 ↑ 4: 10.6x → 5: 7.4 ← <hr/> Serie 39 Total 263
7. Serie 5 Skott 	1: 8.3 ← 2: 10.1 ↖ 3: 10.0 ↓ 4: 9.3 ↗ 5: 8.6 ↓ <hr/> Serie 45 Total 308		

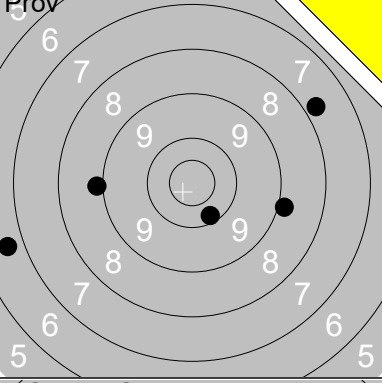
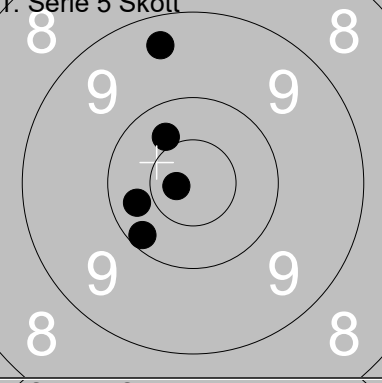
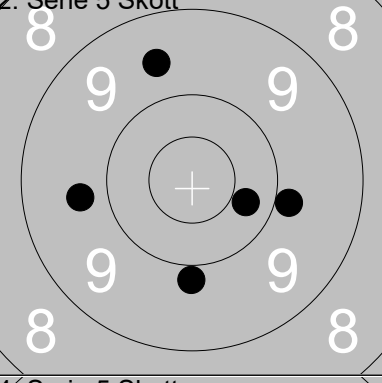
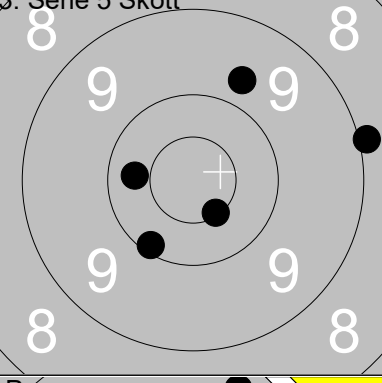
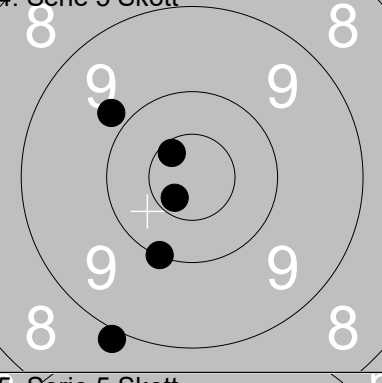
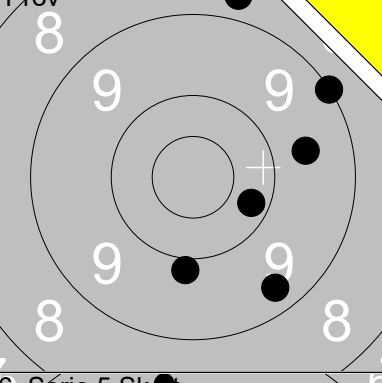
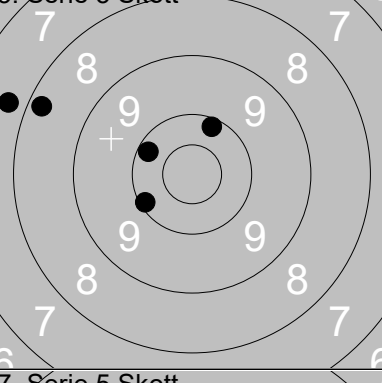
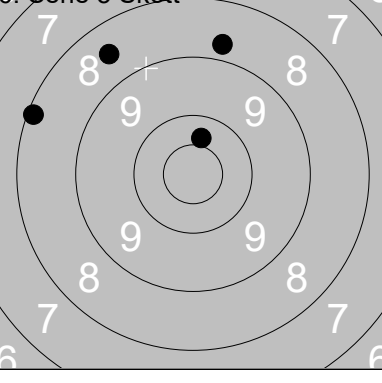
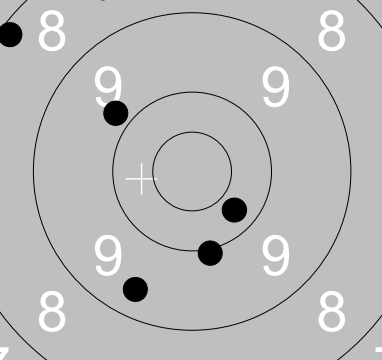
	<p>1: 6.7 ←</p> <p>2: 7.8 →</p> <p>3: 10.2 ↓</p> <p>4: 8.9 →</p> <p>5: 8.9 ←</p>		<p>1: 9.4 ↑</p> <p>2: 10.3 ←</p> <p>3: 10.2 ↓</p> <p>4: 10.8x ←</p> <p>5: 10.4 ↗</p>								
<table border="1" style="width:100%; border-collapse: collapse;"> <tr><td style="width:50%;">Serie</td><td style="width:50%; text-align: right;">39</td></tr> <tr><td>Total</td><td style="text-align: right;">0</td></tr> </table>	Serie	39	Total	0		<table border="1" style="width:100%; border-collapse: collapse;"> <tr><td style="width:50%;">Serie</td><td style="width:50%; text-align: right;">49</td></tr> <tr><td>Total</td><td style="text-align: right;">49</td></tr> </table>	Serie	49	Total	49	
Serie	39										
Total	0										
Serie	49										
Total	49										
<p>2. Serie 5 Skott</p> 	<p>1: 9.7 ←</p> <p>2: 10.3 ↓</p> <p>3: 9.9 ↓</p> <p>4: 9.6 ↑</p> <p>5: 9.9 →</p>	<p>3. Serie 5 Skott</p> 	<p>1: 8.9 →</p> <p>2: 9.7 ↗</p> <p>3: 10.3 ←</p> <p>4: 10.1 ↓</p> <p>5: 10.5x ↓</p>								
<table border="1" style="width:100%; border-collapse: collapse;"> <tr><td style="width:50%;">Serie</td><td style="width:50%; text-align: right;">46</td></tr> <tr><td>Total</td><td style="text-align: right;">95</td></tr> </table>	Serie	46	Total	95		<table border="1" style="width:100%; border-collapse: collapse;"> <tr><td style="width:50%;">Serie</td><td style="width:50%; text-align: right;">47</td></tr> <tr><td>Total</td><td style="text-align: right;">142</td></tr> </table>	Serie	47	Total	142	
Serie	46										
Total	95										
Serie	47										
Total	142										
<p>4. Serie 5 Skott</p> 	<p>1: 9.8 ↗</p> <p>2: 10.6x ↗</p> <p>3: 10.0 ↓</p> <p>4: 8.9 ↓</p> <p>5: 10.7x ↓</p>	<p>Prov</p> 	<p>1: 9.9 ↓</p> <p>2: 10.2 →</p> <p>3: 9.0 ↗</p> <p>4: 9.3 ↓</p> <p>5: 8.7 ↑</p> <p>6: 9.6 →</p>								
<table border="1" style="width:100%; border-collapse: collapse;"> <tr><td style="width:50%;">Serie</td><td style="width:50%; text-align: right;">47</td></tr> <tr><td>Total</td><td style="text-align: right;">189</td></tr> </table>	Serie	47	Total	189		<table border="1" style="width:100%; border-collapse: collapse;"> <tr><td style="width:50%;">Serie</td><td style="width:50%; text-align: right;">54</td></tr> <tr><td>Total</td><td style="text-align: right;">189</td></tr> </table>	Serie	54	Total	189	
Serie	47										
Total	189										
Serie	54										
Total	189										
<p>5. Serie 5 Skott</p> 	<p>1: 7.7 ←</p> <p>2: 8.3 ↗</p> <p>3: 10.1 ↗</p> <p>4: 10.2 ↗</p> <p>5: 10.1 ←</p>	<p>6. Serie 5 Skott</p> 	<p>1: 7.9 ↑</p> <p>2: 10.4 ↑</p> <p>3: 8.5 ↗</p> <p>4: 8.8 ↑</p> <p>5: 8.1 ←</p>								
<table border="1" style="width:100%; border-collapse: collapse;"> <tr><td style="width:50%;">Serie</td><td style="width:50%; text-align: right;">45</td></tr> <tr><td>Total</td><td style="text-align: right;">234</td></tr> </table>	Serie	45	Total	234		<table border="1" style="width:100%; border-collapse: collapse;"> <tr><td style="width:50%;">Serie</td><td style="width:50%; text-align: right;">41</td></tr> <tr><td>Total</td><td style="text-align: right;">275</td></tr> </table>	Serie	41	Total	275	
Serie	45										
Total	234										
Serie	41										
Total	275										
<p>7. Serie 5 Skott</p> 	<p>1: 9.4 ↓</p> <p>2: 8.2 ↗</p> <p>3: 9.8 ↗</p> <p>4: 10.0 ↓</p> <p>5: 10.3 ↓</p>										
<table border="1" style="width:100%; border-collapse: collapse;"> <tr><td style="width:50%;">Serie</td><td style="width:50%; text-align: right;">46</td></tr> <tr><td>Total</td><td style="text-align: right;">321</td></tr> </table>	Serie	46	Total	321							
Serie	46										
Total	321										

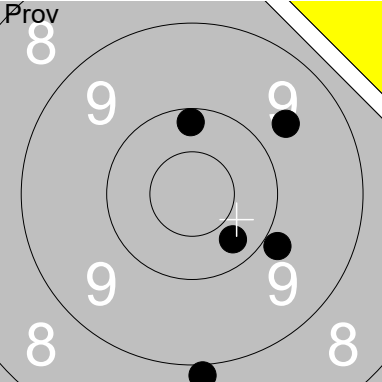
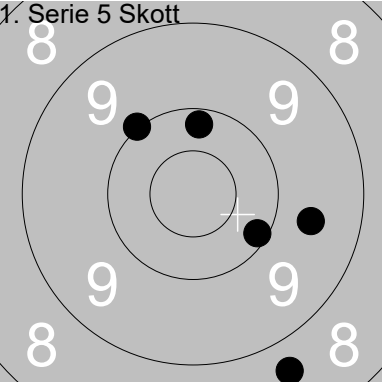
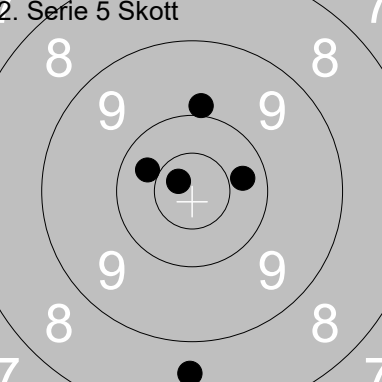
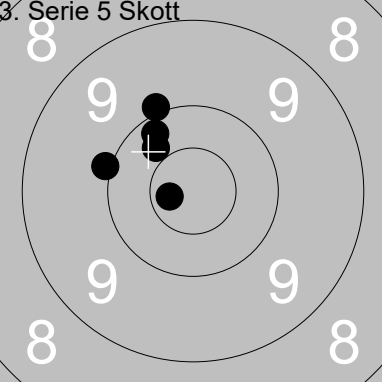
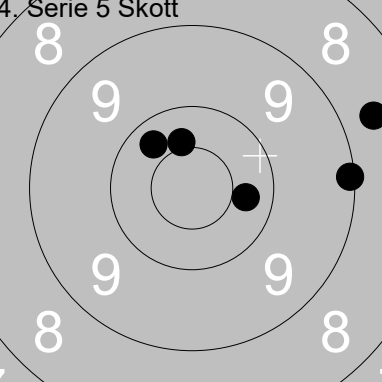
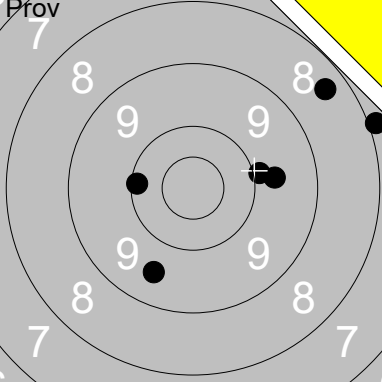
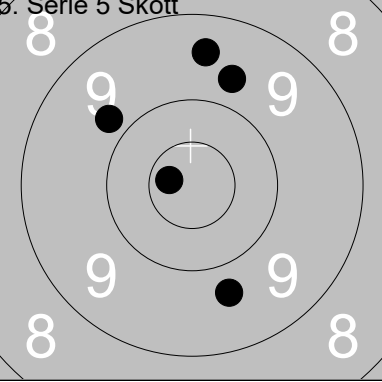
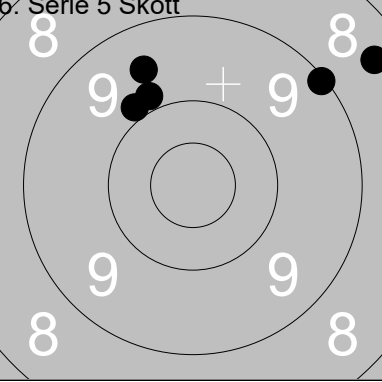
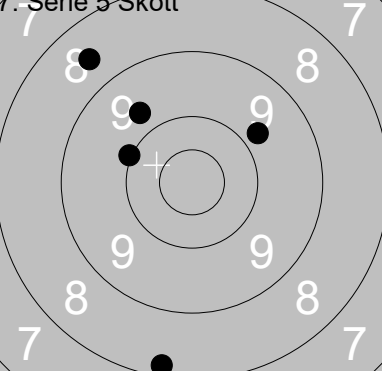
Skjutlag	Tavla	Jan Wallerström				
3	19	Ununge		C	St	
12.07.2021		Tavelträffen 2021		Ramselefors SKF		
	1: 8.9	↓	1. Serie 5 Skott		1: 10.0	↖
	2: 9.9	↘			2: 9.6	→
	3: 10.3	↘			3: 8.7	↓
	4: 9.7	↗			4: 10.2	↑
	5: 10.2	↑			5: 10.1	↘
	Serie	46			Serie	47
	Total	0			Total	47
	1: 10.7x	↗	2. Serie 5 Skott		1: 10.7x	←
	2: 8.6	↓			2: 10.2	↗
	3: 9.9	↑			3: 10.3	↗
	4: 10.3	→			4: 10.0	↗
	5: 10.3	↖			5: 10.0	↖
	Serie	47			Serie	50
	Total	94			Total	144
	1: 10.3	↗	4. Serie 5 Skott		1: 8.4	↗
	2: 8.6	→			2: 9.7	→
	3: 10.3	→			3: 7.9	→
	4: 10.4x	↑			4: 9.9	→
	5: 9.1	→			5: 10.1	←
	Serie	47			Serie	52
	Total	191			Total	191
	1: 10.7x	←	5. Serie 5 Skott		1: 9.9	↖
	2: 9.5	↑			2: 8.4	↗
	3: 9.7	↑			3: 9.1	↗
	4: 9.7	↓			4: 9.9	↖
	5: 9.8	↖			5: 9.5	↖
	Serie	46			Serie	44
	Total	237			Total	281
	1: 9.8	↗	7. Serie 5 Skott			
	2: 9.7	↖				
	3: 8.2	↓				
	4: 8.6	↖				
	5: 10.0	↖				
	Serie	44				
	Total	325				

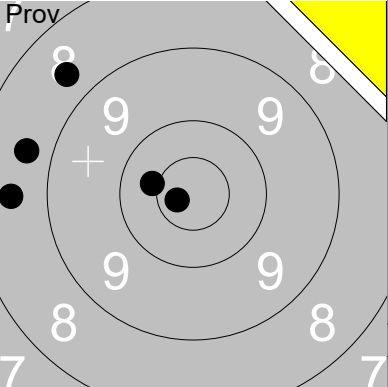
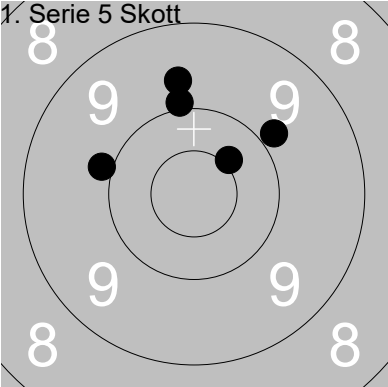
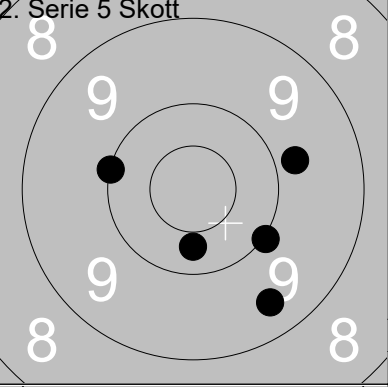
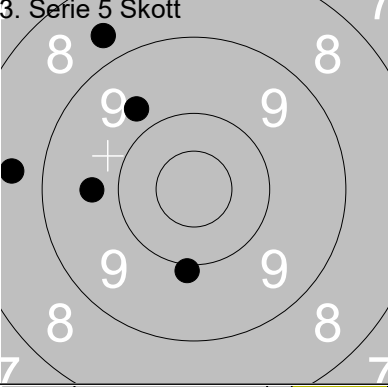
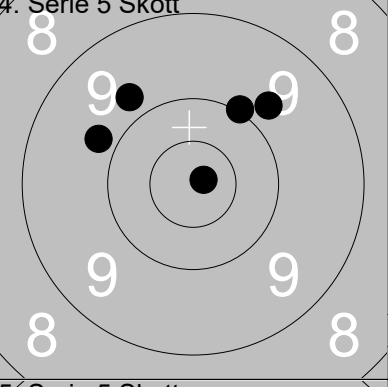
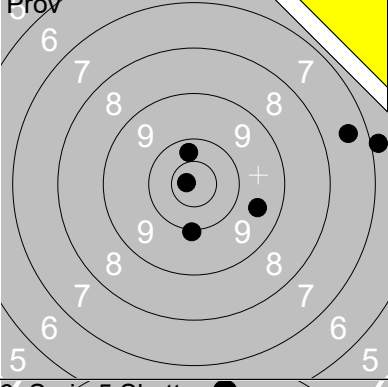
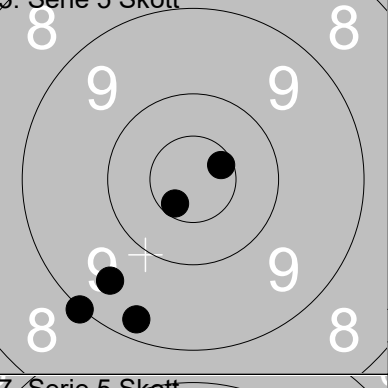
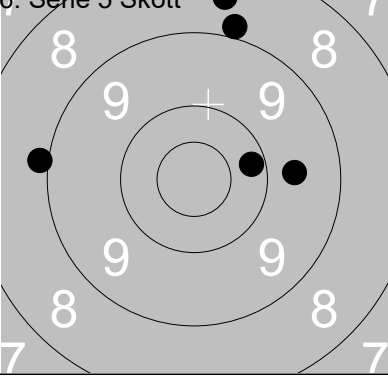
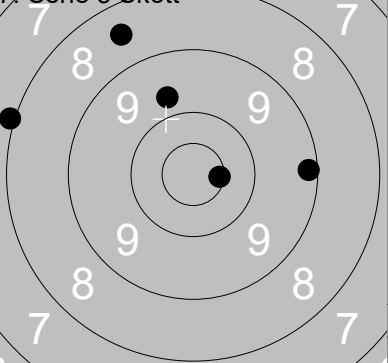
Skjutlag	Tavla	Jan-Erik Fäldt			
3	21	Ramselefors	Storfors	C	Vä
12.07.2021	Tavelträffen 2021	Ramselefors SKF			
Prov 	1: 8.7 ↗ 2: 8.5 ← 3: 8.7 ← 4: 10.7x ← 5: 10.4x ← Serie 44 Total 0	1. Serie 5 Skott 	1: 10.0 ↑ 2: 10.4x ↗ 3: 9.9 ← 4: 9.7 ↑ 5: 9.9 ↗ Serie 47 Total 47		
2. Serie 5 Skott 	1: 10.0 ↘ 2: 9.8 → 3: 10.0 ← 4: 10.3 ↓ 5: 9.4 ↓ Serie 48 Total 95	3. Serie 5 Skott 	1: 8.6 ← 2: 8.7 ↗ 3: 9.9 ↓ 4: 9.7 ↗ 5: 9.7 ← Serie 43 Total 138		
4. Serie 5 Skott 	1: 10.0 ↗ 2: 9.8 ↗ 3: 10.8x → 4: 9.8 ← 5: 9.8 ↗ Serie 47 Total 185	Prov 	1: 10.3 ↑ 2: 9.5 → 3: 10.8x ← 4: 10.0 ↓ 5: 7.4 → 6: 6.9 → Serie 52 Total 185		
5. Serie 5 Skott 	1: 10.6x → 2: 9.5 ↓ 3: 9.3 ↓ 4: 9.0 ↓ 5: 10.6x ↓ Serie 47 Total 232	6. Serie 5 Skott 	1: 8.9 ↑ 2: 8.5 ↑ 3: 10.2 → 4: 9.7 → 5: 8.9 ← Serie 43 Total 275		
7. Serie 5 Skott 	1: 8.0 ← 2: 10.6x → 3: 8.5 ↗ 4: 9.7 ↗ 5: 9.2 → Serie 44 Total 319				

Skjutlag

3

Tavla

23

Ramselefors

12.07.2021

Tavelträffen 2021

Ramselefors SKF

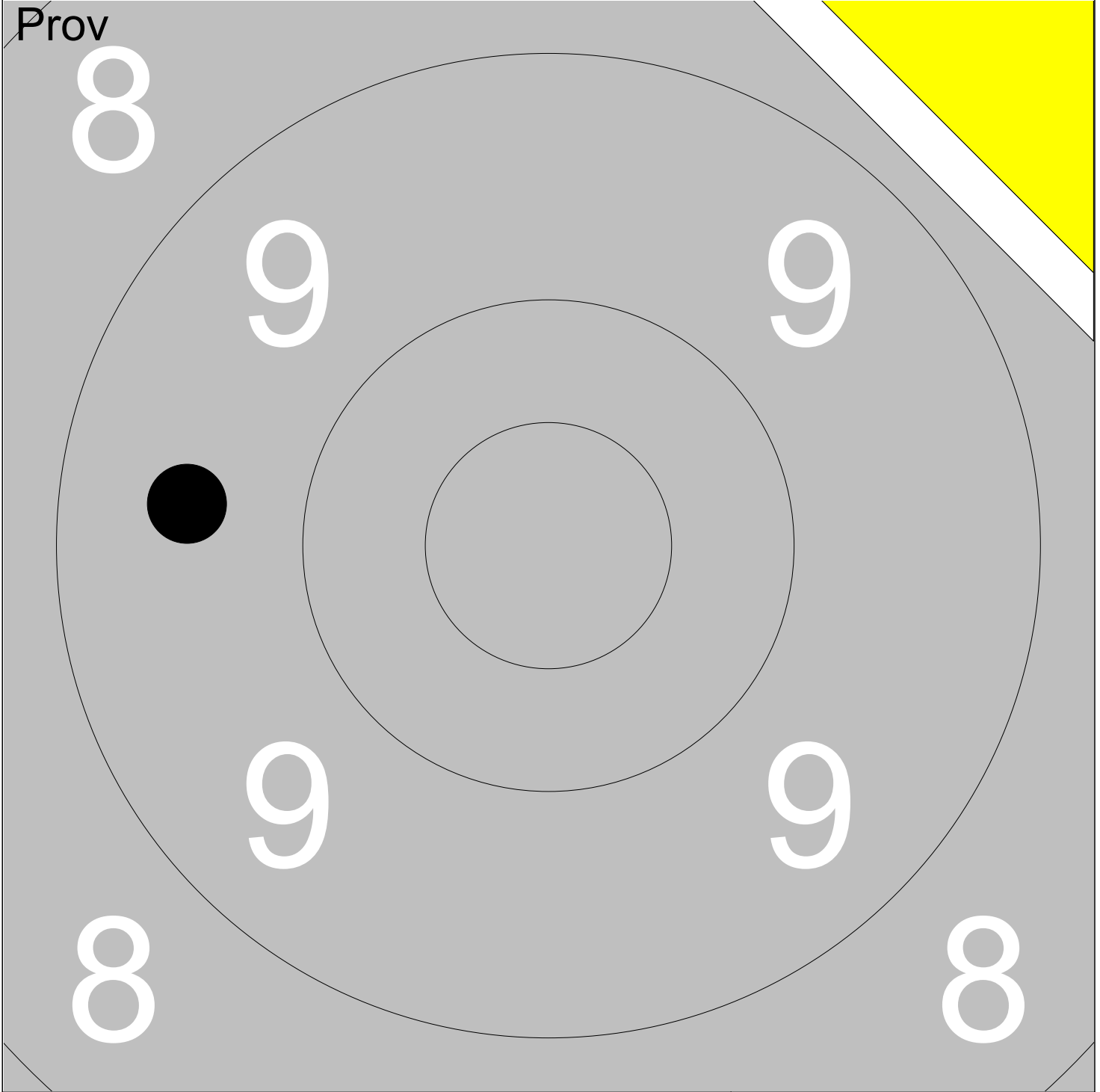

1:

9.6



Serie

9

Total

0

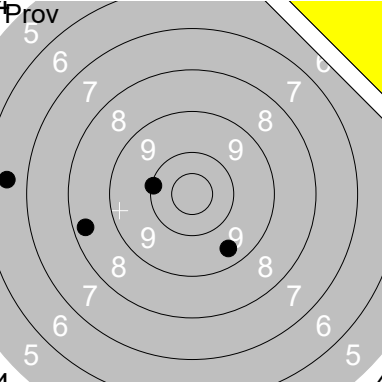
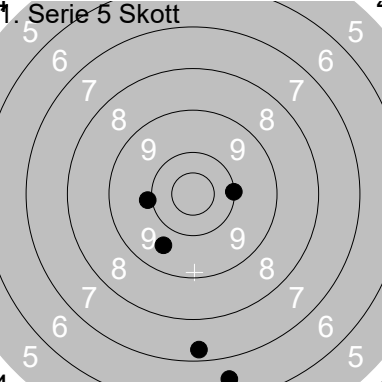
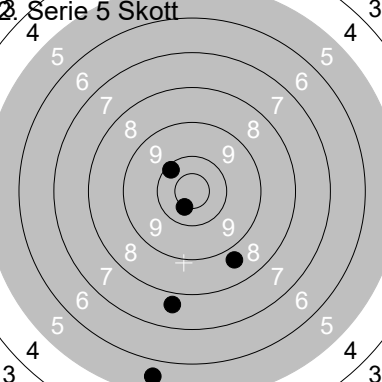
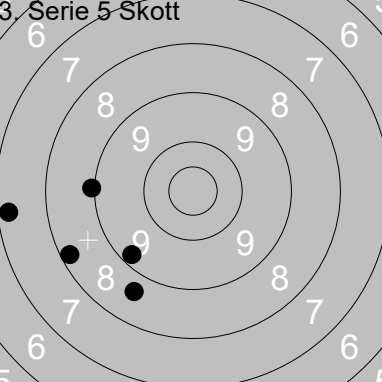
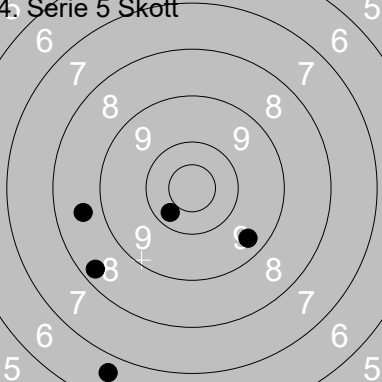
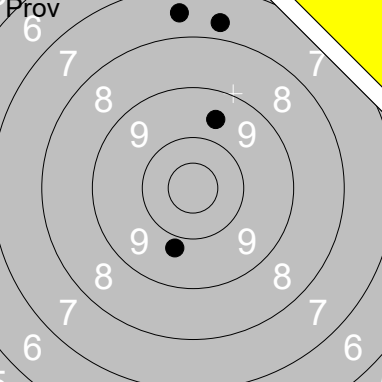
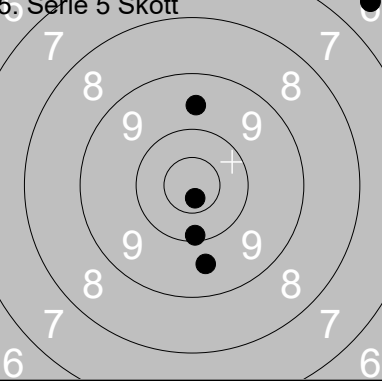
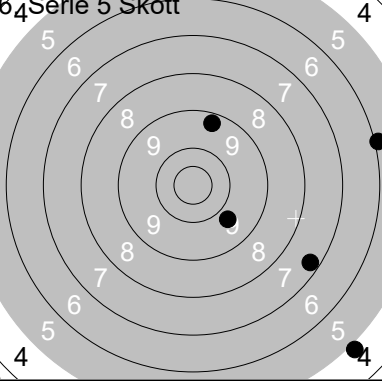
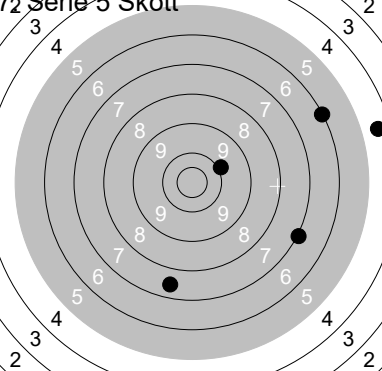
Ramselefors	Ramselefors	C	Vb																																
12.07.2021	Tavelträffen 2021	Ramselefors SKF																																	
	<table style="width:100%; border-collapse: collapse;"> <tr><td>1: 6.5</td><td style="text-align: right;">←</td></tr> <tr><td>2: 9.4</td><td style="text-align: right;">↘</td></tr> <tr><td>3: 8.3</td><td style="text-align: right;">←</td></tr> <tr><td>4: 10.1</td><td style="text-align: right;">←</td></tr> <tr><td colspan="2"><hr/></td></tr> <tr><td>Serie</td><td style="text-align: right;">33</td></tr> <tr><td>Total</td><td style="text-align: right;">0</td></tr> </table>	1: 6.5	←	2: 9.4	↘	3: 8.3	←	4: 10.1	←	<hr/>		Serie	33	Total	0		<table style="width:100%; border-collapse: collapse;"> <tr><td>1: 10.0</td><td style="text-align: right;">→</td></tr> <tr><td>2: 7.3</td><td style="text-align: right;">↓</td></tr> <tr><td>3: 9.6</td><td style="text-align: right;">↘</td></tr> <tr><td>4: 9.9</td><td style="text-align: right;">←</td></tr> <tr><td>5: 6.5</td><td style="text-align: right;">↓</td></tr> <tr><td colspan="2"><hr/></td></tr> <tr><td>Serie</td><td style="text-align: right;">41</td></tr> <tr><td>Total</td><td style="text-align: right;">41</td></tr> </table>	1: 10.0	→	2: 7.3	↓	3: 9.6	↘	4: 9.9	←	5: 6.5	↓	<hr/>		Serie	41	Total	41		
1: 6.5	←																																		
2: 9.4	↘																																		
3: 8.3	←																																		
4: 10.1	←																																		
<hr/>																																			
Serie	33																																		
Total	0																																		
1: 10.0	→																																		
2: 7.3	↓																																		
3: 9.6	↘																																		
4: 9.9	←																																		
5: 6.5	↓																																		
<hr/>																																			
Serie	41																																		
Total	41																																		
	<table style="width:100%; border-collapse: collapse;"> <tr><td>1: 10.5x</td><td style="text-align: right;">↓</td></tr> <tr><td>2: 5.5</td><td style="text-align: right;">↓</td></tr> <tr><td>3: 10.1</td><td style="text-align: right;">↗</td></tr> <tr><td>4: 7.7</td><td style="text-align: right;">↓</td></tr> <tr><td>5: 8.7</td><td style="text-align: right;">↓</td></tr> <tr><td colspan="2"><hr/></td></tr> <tr><td>Serie</td><td style="text-align: right;">40</td></tr> <tr><td>Total</td><td style="text-align: right;">81</td></tr> </table>	1: 10.5x	↓	2: 5.5	↓	3: 10.1	↗	4: 7.7	↓	5: 8.7	↓	<hr/>		Serie	40	Total	81		<table style="width:100%; border-collapse: collapse;"> <tr><td>1: 9.2</td><td style="text-align: right;">↘</td></tr> <tr><td>2: 8.2</td><td style="text-align: right;">←</td></tr> <tr><td>3: 9.0</td><td style="text-align: right;">←</td></tr> <tr><td>4: 7.3</td><td style="text-align: right;">←</td></tr> <tr><td>5: 8.7</td><td style="text-align: right;">↘</td></tr> <tr><td colspan="2"><hr/></td></tr> <tr><td>Serie</td><td style="text-align: right;">41</td></tr> <tr><td>Total</td><td style="text-align: right;">122</td></tr> </table>	1: 9.2	↘	2: 8.2	←	3: 9.0	←	4: 7.3	←	5: 8.7	↘	<hr/>		Serie	41	Total	122
1: 10.5x	↓																																		
2: 5.5	↓																																		
3: 10.1	↗																																		
4: 7.7	↓																																		
5: 8.7	↓																																		
<hr/>																																			
Serie	40																																		
Total	81																																		
1: 9.2	↘																																		
2: 8.2	←																																		
3: 9.0	←																																		
4: 7.3	←																																		
5: 8.7	↘																																		
<hr/>																																			
Serie	41																																		
Total	122																																		
	<table style="width:100%; border-collapse: collapse;"> <tr><td>1: 8.3</td><td style="text-align: right;">↘</td></tr> <tr><td>2: 10.3</td><td style="text-align: right;">↘</td></tr> <tr><td>3: 6.6</td><td style="text-align: right;">↘</td></tr> <tr><td>4: 9.4</td><td style="text-align: right;">↘</td></tr> <tr><td>5: 8.6</td><td style="text-align: right;">←</td></tr> <tr><td colspan="2"><hr/></td></tr> <tr><td>Serie</td><td style="text-align: right;">41</td></tr> <tr><td>Total</td><td style="text-align: right;">163</td></tr> </table>	1: 8.3	↘	2: 10.3	↘	3: 6.6	↘	4: 9.4	↘	5: 8.6	←	<hr/>		Serie	41	Total	163		<table style="width:100%; border-collapse: collapse;"> <tr><td>1: 9.6</td><td style="text-align: right;">↑</td></tr> <tr><td>2: 7.5</td><td style="text-align: right;">↑</td></tr> <tr><td>3: 7.7</td><td style="text-align: right;">↑</td></tr> <tr><td>4: 9.8</td><td style="text-align: right;">↓</td></tr> <tr><td>5: 6.6</td><td style="text-align: right;">↗</td></tr> <tr><td colspan="2"><hr/></td></tr> <tr><td>Serie</td><td style="text-align: right;">38</td></tr> <tr><td>Total</td><td style="text-align: right;">163</td></tr> </table>	1: 9.6	↑	2: 7.5	↑	3: 7.7	↑	4: 9.8	↓	5: 6.6	↗	<hr/>		Serie	38	Total	163
1: 8.3	↘																																		
2: 10.3	↘																																		
3: 6.6	↘																																		
4: 9.4	↘																																		
5: 8.6	←																																		
<hr/>																																			
Serie	41																																		
Total	163																																		
1: 9.6	↑																																		
2: 7.5	↑																																		
3: 7.7	↑																																		
4: 9.8	↓																																		
5: 6.6	↗																																		
<hr/>																																			
Serie	38																																		
Total	163																																		
	<table style="width:100%; border-collapse: collapse;"> <tr><td>1: 10.1</td><td style="text-align: right;">↓</td></tr> <tr><td>2: 9.6</td><td style="text-align: right;">↓</td></tr> <tr><td>3: 9.6</td><td style="text-align: right;">↑</td></tr> <tr><td>4: 10.7x</td><td style="text-align: right;">↓</td></tr> <tr><td>5: 6.5</td><td style="text-align: right;">↗</td></tr> <tr><td colspan="2"><hr/></td></tr> <tr><td>Serie</td><td style="text-align: right;">44</td></tr> <tr><td>Total</td><td style="text-align: right;">207</td></tr> </table>	1: 10.1	↓	2: 9.6	↓	3: 9.6	↑	4: 10.7x	↓	5: 6.5	↗	<hr/>		Serie	44	Total	207		<table style="width:100%; border-collapse: collapse;"> <tr><td>1: 5.9</td><td style="text-align: right;">→</td></tr> <tr><td>2: 4.9</td><td style="text-align: right;">↘</td></tr> <tr><td>3: 9.7</td><td style="text-align: right;">↘</td></tr> <tr><td>4: 7.3</td><td style="text-align: right;">↘</td></tr> <tr><td>5: 9.3</td><td style="text-align: right;">↑</td></tr> <tr><td colspan="2"><hr/></td></tr> <tr><td>Serie</td><td style="text-align: right;">34</td></tr> <tr><td>Total</td><td style="text-align: right;">241</td></tr> </table>	1: 5.9	→	2: 4.9	↘	3: 9.7	↘	4: 7.3	↘	5: 9.3	↑	<hr/>		Serie	34	Total	241
1: 10.1	↓																																		
2: 9.6	↓																																		
3: 9.6	↑																																		
4: 10.7x	↓																																		
5: 6.5	↗																																		
<hr/>																																			
Serie	44																																		
Total	207																																		
1: 5.9	→																																		
2: 4.9	↘																																		
3: 9.7	↘																																		
4: 7.3	↘																																		
5: 9.3	↑																																		
<hr/>																																			
Serie	34																																		
Total	241																																		
	<table style="width:100%; border-collapse: collapse;"> <tr><td>1: 9.9</td><td style="text-align: right;">↗</td></tr> <tr><td>2: 4.5</td><td style="text-align: right;">→</td></tr> <tr><td>3: 7.0</td><td style="text-align: right;">→</td></tr> <tr><td>4: 6.0</td><td style="text-align: right;">→</td></tr> <tr><td>5: 7.5</td><td style="text-align: right;">↓</td></tr> <tr><td colspan="2"><hr/></td></tr> <tr><td>Serie</td><td style="text-align: right;">33</td></tr> <tr><td>Total</td><td style="text-align: right;">274</td></tr> </table>	1: 9.9	↗	2: 4.5	→	3: 7.0	→	4: 6.0	→	5: 7.5	↓	<hr/>		Serie	33	Total	274																		
1: 9.9	↗																																		
2: 4.5	→																																		
3: 7.0	→																																		
4: 6.0	→																																		
5: 7.5	↓																																		
<hr/>																																			
Serie	33																																		
Total	274																																		