

Prov 	1: 9.6 ← 2: 8.3 ↗ 3: 8.4 ↗ 4: 9.2 ↗ 5: 10.5x ↘ 6: 9.4 ↘ 7: 10.4x ↗ 8: 10.6x → 9: 9.4 → 10: 8.5 → Serie 90 Total 195	Prov 	11: 9.6 → Serie 9 Total 195
----------	--	----------	-----------------------------------

1. Serie 10 Skott 	1: 10.5x ↗ 2: 9.8 ↘ 3: 10.2 ↘ 4: 10.2 ↘ 5: 10.0 ← Serie 49 Total 244	1. Serie 10 Skott 	6: 10.4x ← 7: 10.3x ← 8: 10.4x → 9: 10.3x → 10: 10.1 ↘ Serie 50 Total 294
-----------------------	--	-----------------------	---

2. Serie 1 Skott 	1: 10.2 ↘ 2: 9.2 → 3: 10.6x → 4: 9.9 ↘ 5: 9.9 → Serie 47 Total 341		
----------------------	--	--	--

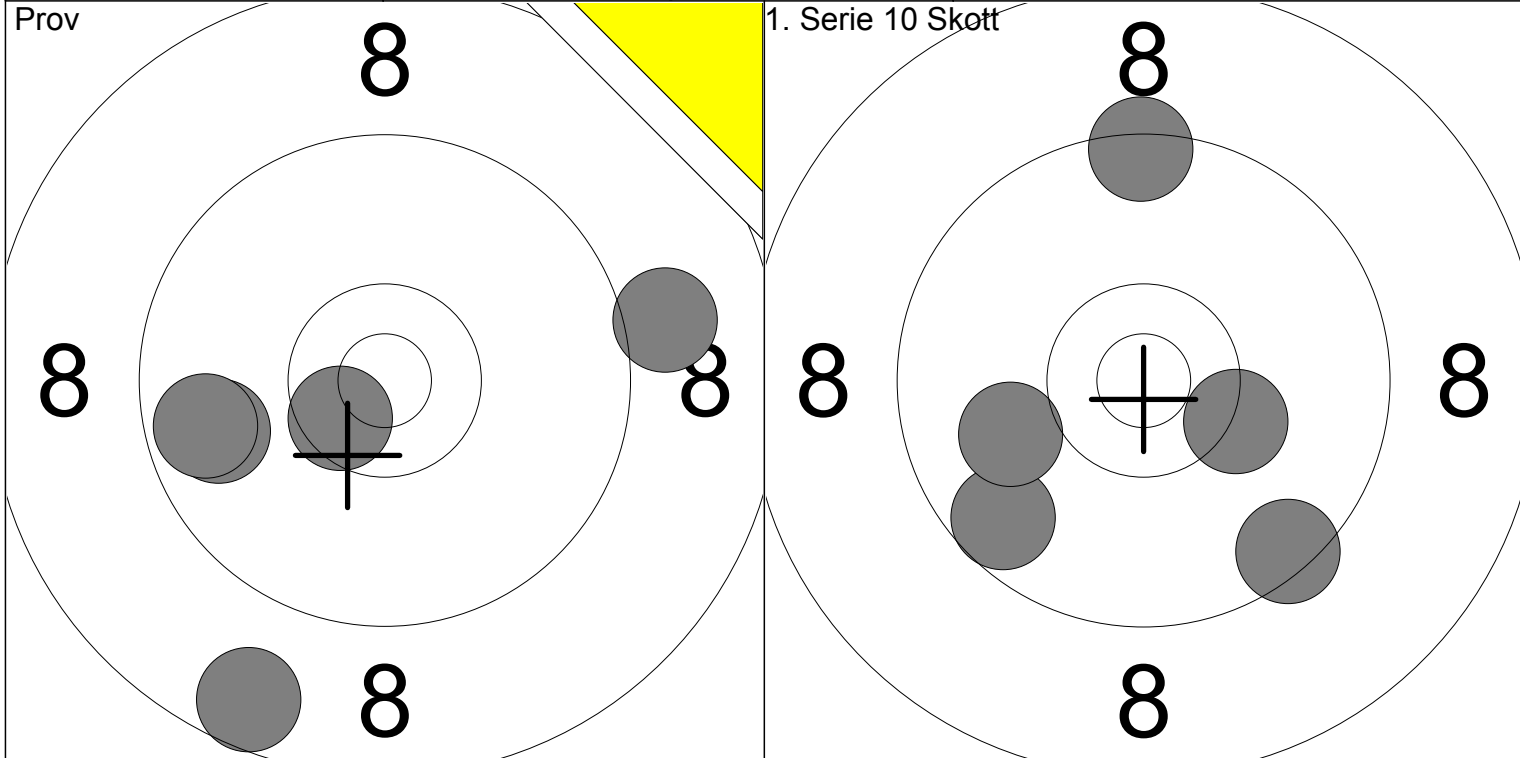

1: 8.6 ↓
2: 9.8 ←
3: 10.6x ↙
4: 9.0 →
5: 9.7 ←

Serie	45
Total	189

1: 9.4 ↑
2: 9.5 ↓
3: 10.3 →
4: 9.6 ↙
5: 10.0 ←

Serie	47
Total	236

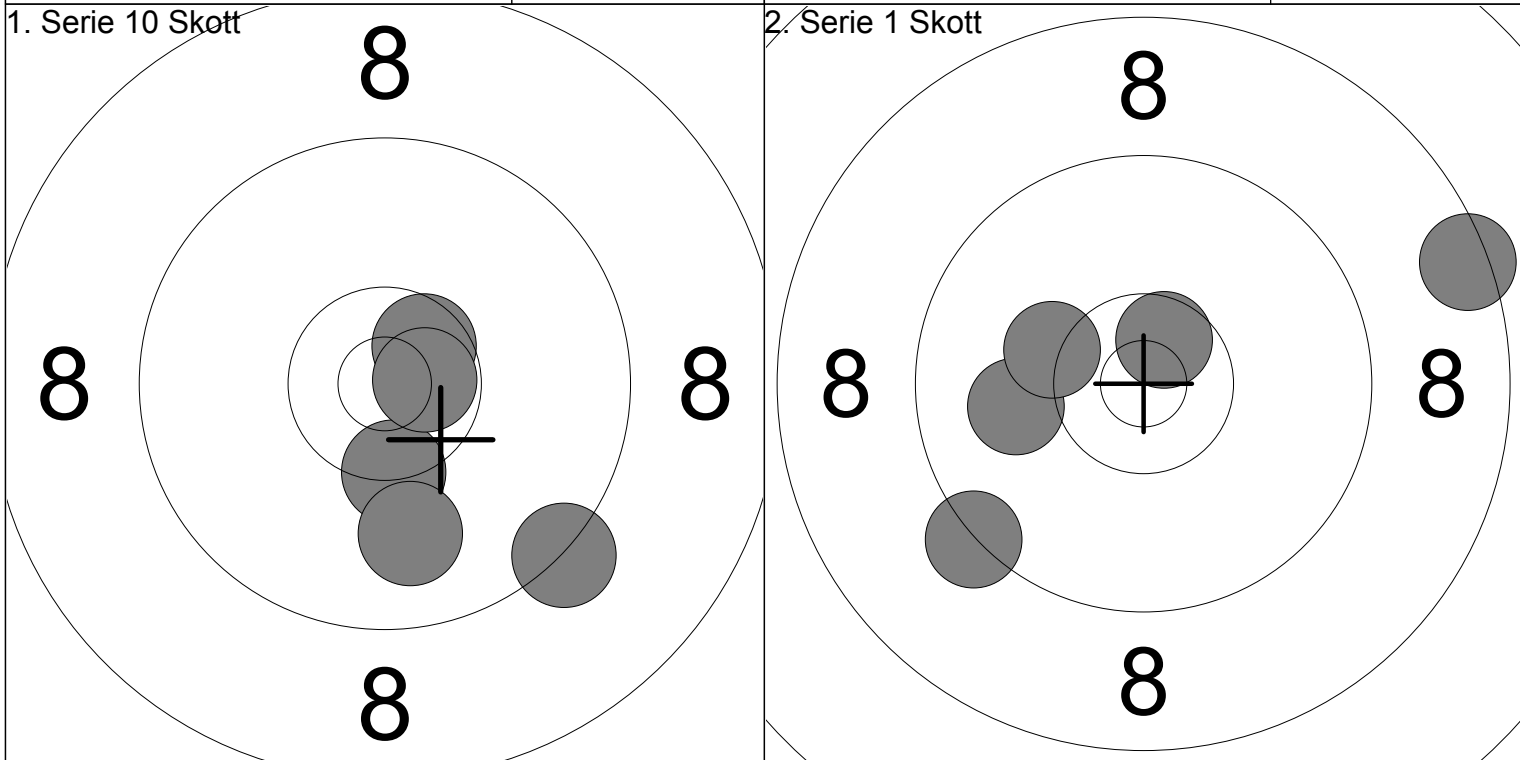

6: 10.4x ↓
7: 9.9 ↓
8: 10.6x ↗
9: 10.7x →
10: 9.3 ↓

Serie	48
Total	284

1: 10.0 ←
2: 9.3 ↙
3: 10.2 ←
4: 8.4 →
5: 10.6x ↗

Serie	47
Total	331

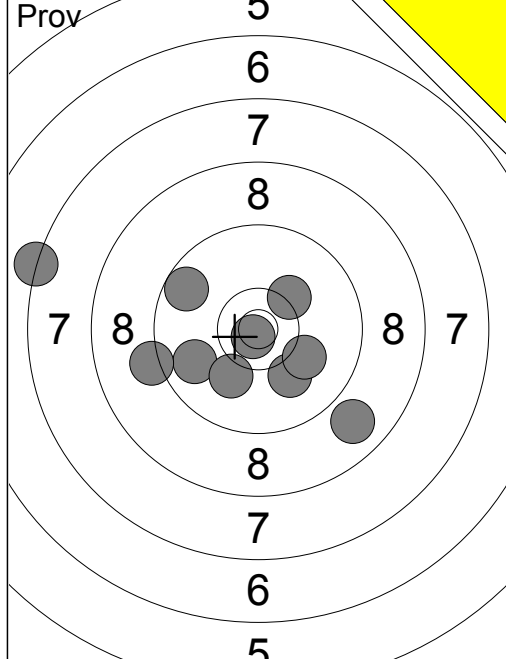

1:	9.8	↙
2:	9.6	↖
3:	10.2	↗
4:	8.9	↘
5:	10.1	↘
6:	10.8x	↘
7:	10.1	↘
8:	7.3	↖
9:	10.1	↘
10:	9.2	↖

Serie	92
Total	189

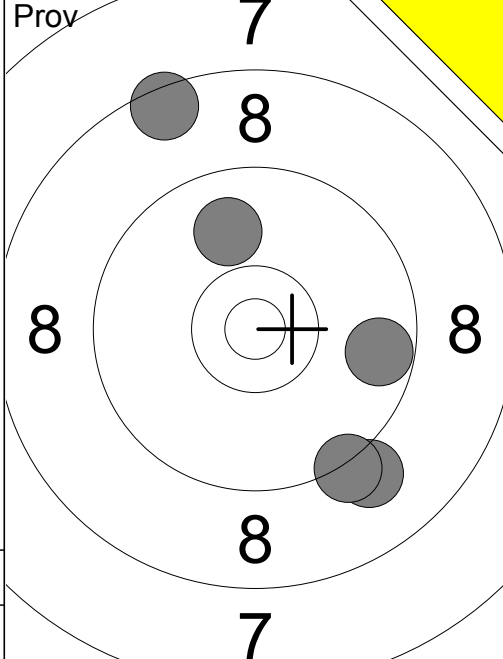

11:	9.1	↘
12:	8.5	↗
13:	9.2	↘
14:	9.9	↗
15:	9.7	→

Serie	44
Total	189

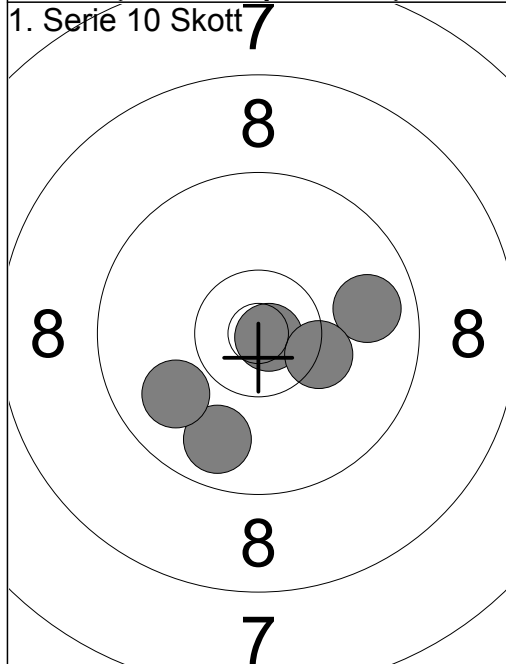

1:	9.8	↘
2:	10.8x	→
3:	9.8	→
4:	9.9	↖
5:	10.3x	→

Serie	47
Total	236

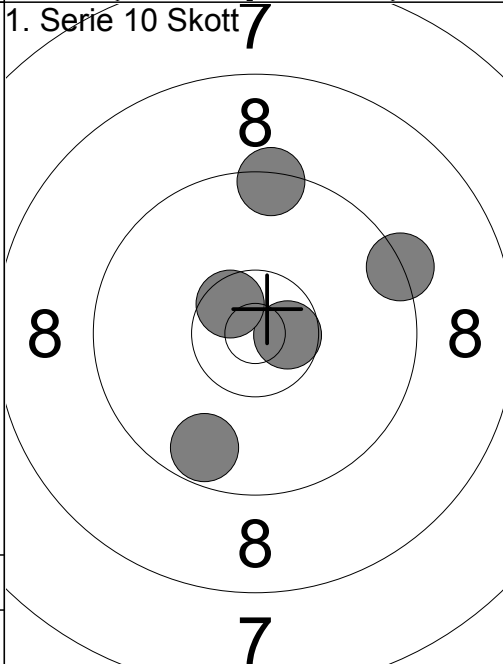

6:	9.4	↑
7:	10.6x	→
8:	9.3	↗
9:	10.6x	↖
10:	9.7	↘

Serie	47
Total	283

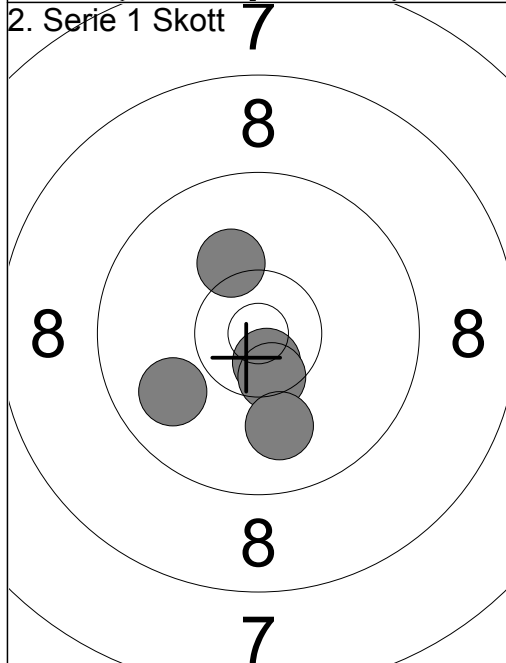

1:	10.2	↗
2:	10.6x	↘
3:	10.5x	↘
4:	10.0	↘
5:	9.9	↖

Serie	49
Total	332

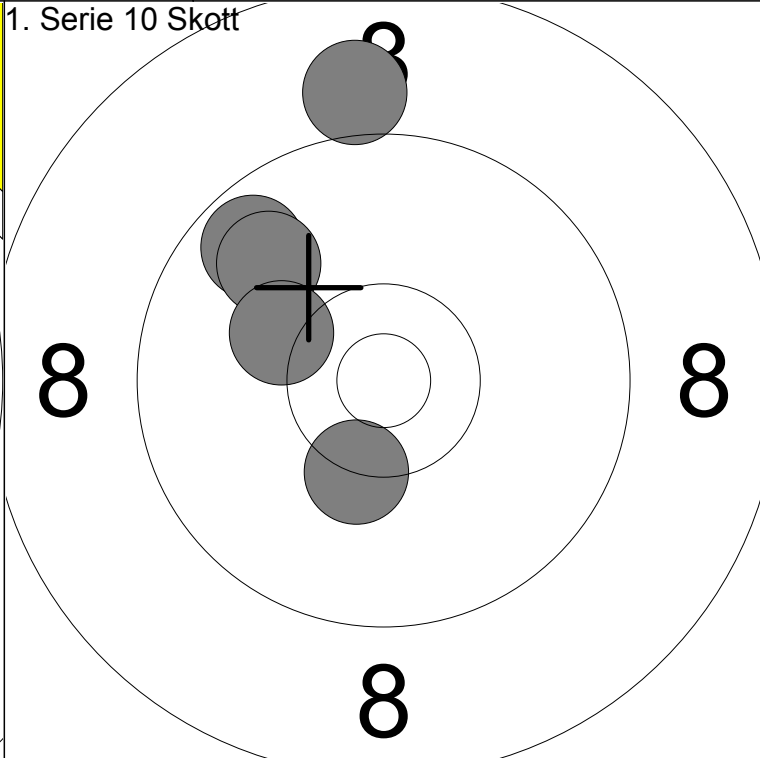
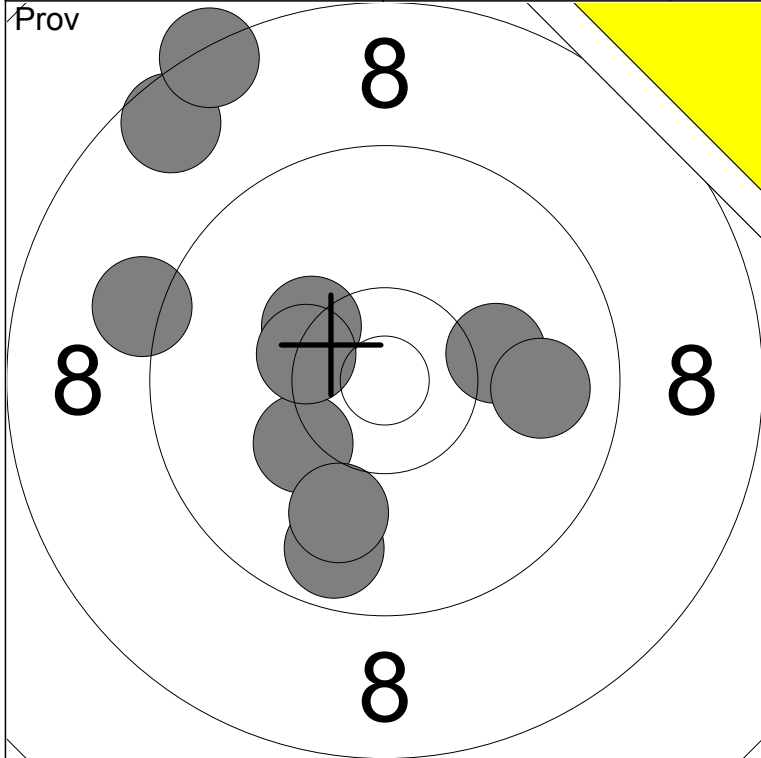

1: 10.2 →	6: 9.7 ↓	Serie	93
2: 8.6 ↗	7: 9.9 →		
3: 9.2 ↖	8: 10.0 ↓	Total	185
4: 8.4 ↗	9: 10.3x ↗		
5: 10.2 ↙	10: 10.4x ←		

1: 9.7 ↗	Serie	47
2: 9.0 ↑		
3: 10.3x ↓	Total	232
4: 9.8 ↗		
5: 10.2 ↗		

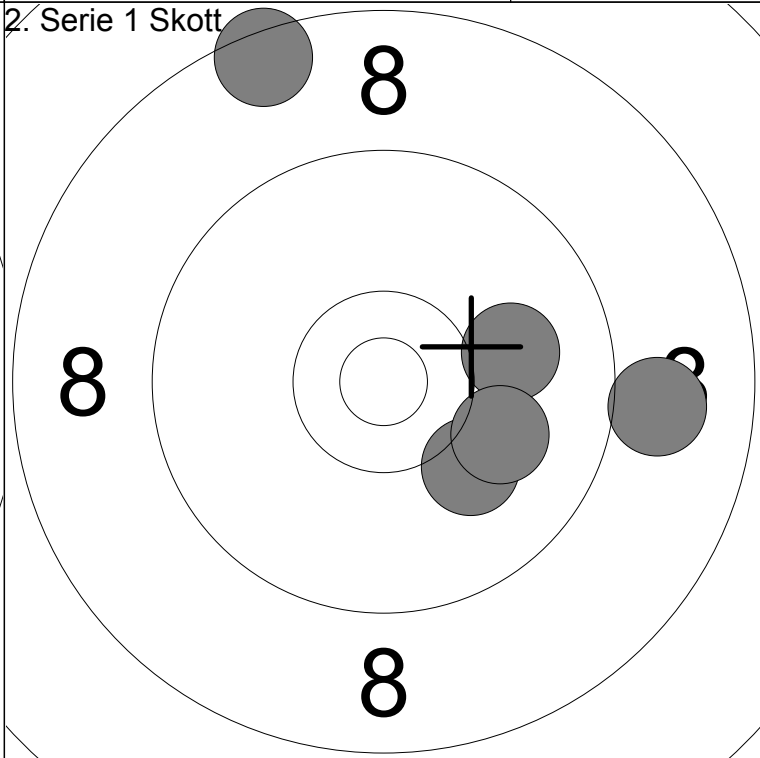
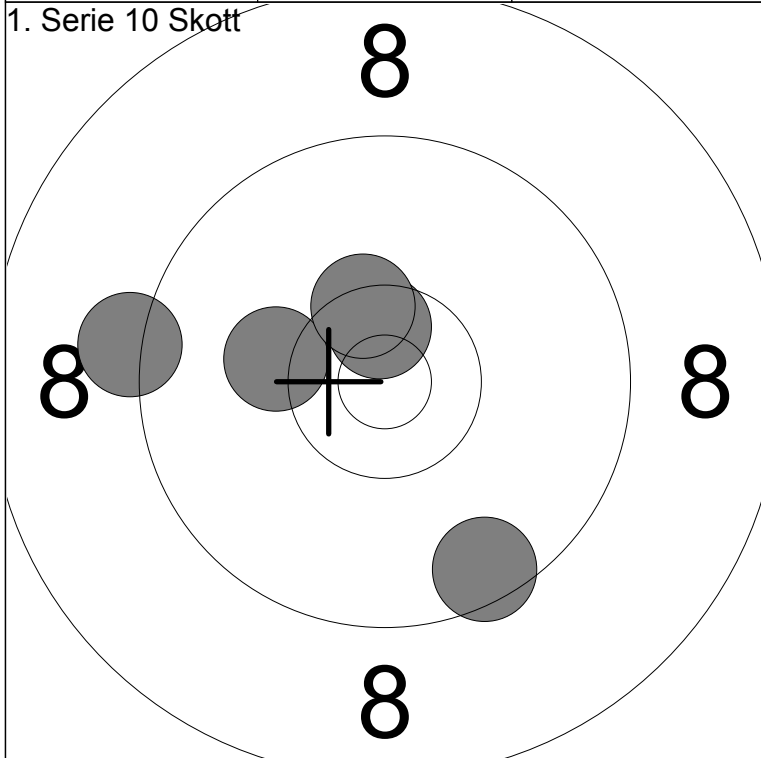

6: 9.5 ↓	Serie	48
7: 10.2 ←		
8: 10.6x ↑	Total	280
9: 9.2 ←		
10: 10.4x ↑		

1: 8.5 ↗	Serie	47
2: 10.0 →		
3: 9.0 →	Total	327
4: 10.1 ↓		
5: 10.0 ↓		

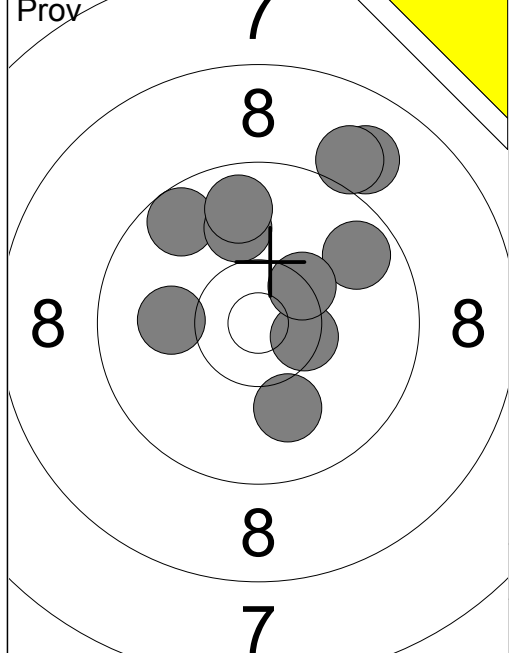

- 1: 9.6 ↖
- 2: 8.9 ↗
- 3: 10.0 ↑
- 4: 10.5x →
- 5: 10.0 ↓
- 6: 9.0 ↗
- 7: 9.8 ↑
- 8: 9.7 ↗
- 9: 10.4x ↗
- 10: 10.1 ←

Serie **94**
Total **195**

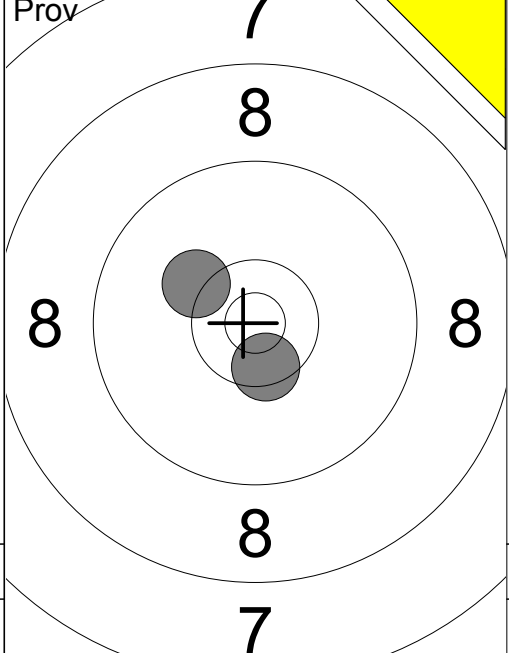

- 11: 10.5x ↓
- 12: 10.2 ↖

Serie **20**
Total **195**

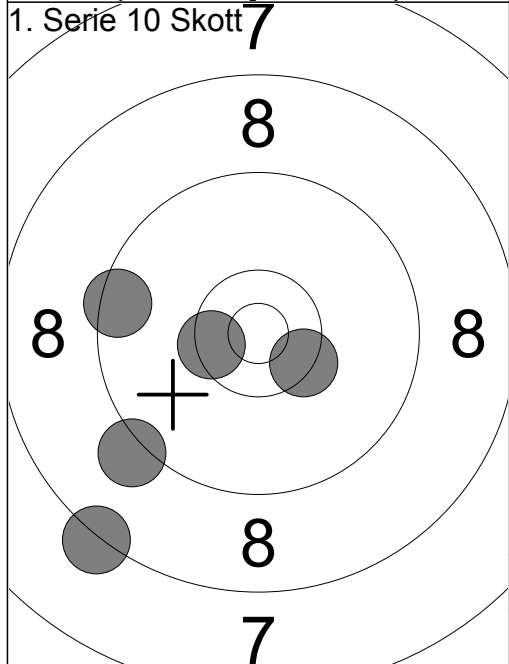

- 1: 10.4x →
- 2: 10.5x ←
- 3: 9.5 ←
- 4: 9.2 ↙
- 5: 8.3 ↙

Serie **46**
Total **241**

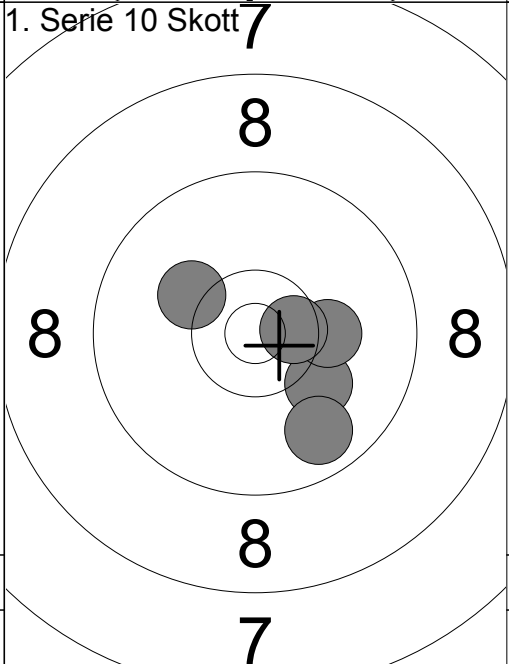

- 6: 10.1 ↘
- 7: 10.2 →
- 8: 10.2 ↖
- 9: 10.6x →
- 10: 9.8 ↘

Serie **49**
Total **290**

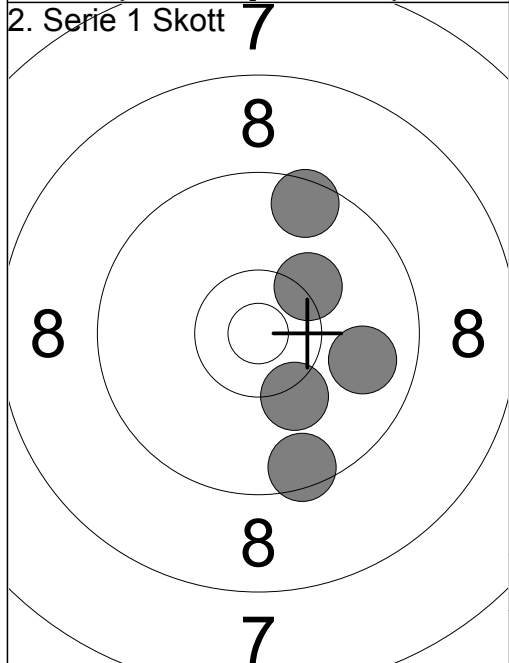

- 1: 9.5 ↓
- 2: 9.5 ↑
- 3: 10.2 ↓
- 4: 10.2 ↗
- 5: 9.8 →

Serie **47**
Total **337**

<p>Prov 7</p>	<p>1: 9.4 ↑ 2: 9.8 ↑ 3: 9.8 ↑ 4: 9.7 ↙ 5: 10.7x → 6: 9.4 → 7: 9.7 → 8: 9.2 ↘ 9: 9.8 ↓ 10: 10.3x ↑</p>	<p>Prov 7</p>	<p>11: 10.7x ↗ 12: 10.7x →</p>
8	Serie 92	8	Serie 20
8	Total 192	8	Total 192

<p>1. Serie 10 Skott 7</p>	<p>1: 9.2 ↙ 2: 9.5 ↗ 3: 9.6 ↗ 4: 10.2 ↓ 5: 10.8x ↓</p>	<p>1. Serie 10 Skott 7</p>	<p>6: 9.8 ↓ 7: 9.5 ↙ 8: 10.6x ↑ 9: 10.3x ↓ 10: 10.5x ↖</p>
8	Serie 47	8	Serie 48
8	Total 239	8	Total 287

<p>2. Serie 1 Skott 7</p>	<p>1: 10.4x ↙ 2: 10.4x ↓ 3: 9.2 ↙ 4: 10.5x ↓ 5: 9.9 ↓</p>		
8	Serie 48		
8	Total 335		

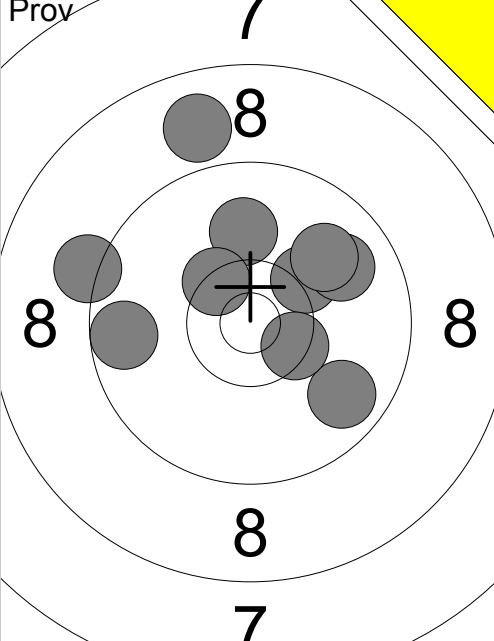
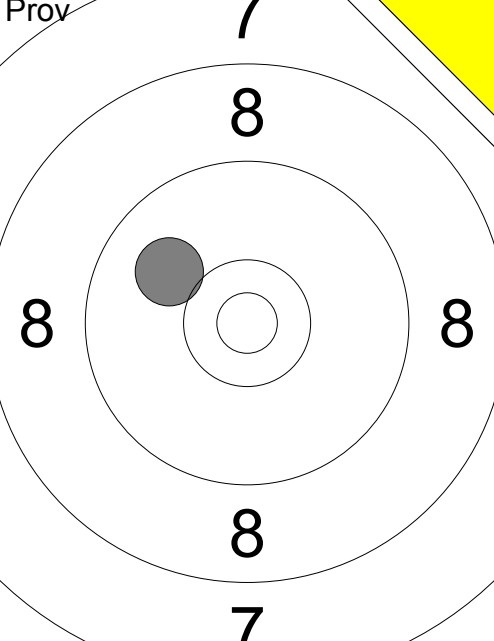
<p>Prov</p>  <p style="text-align: center; font-size: 2em;">7</p>	<p>1: 9.2 ←</p> <p>2: 8.9 ↑</p> <p>3: 10.2 ↗</p> <p>4: 9.9 ↗</p> <p>5: 10.0 ↑</p> <p>6: 9.9 ↗</p> <p>7: 9.8 ↘</p> <p>8: 9.7 ←</p> <p>9: 10.4x ↗</p> <p>10: 10.4x ↘</p>	<p>Prov</p>  <p style="text-align: center; font-size: 2em;">7</p> <p style="text-align: right;">11: 10.0 ↗</p>	
Serie	93	Serie	10
Total	187	Total	187

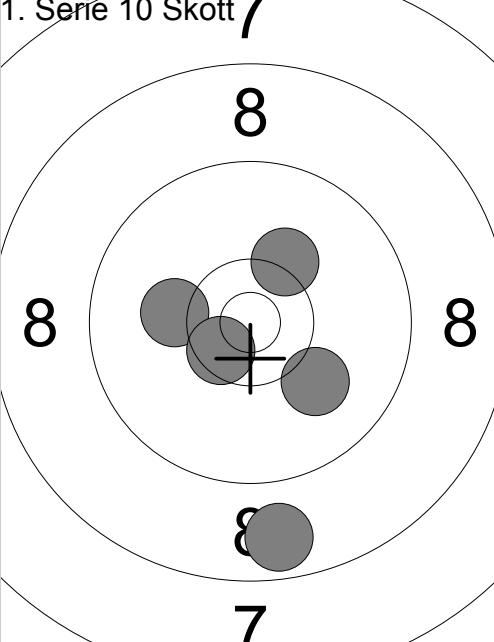
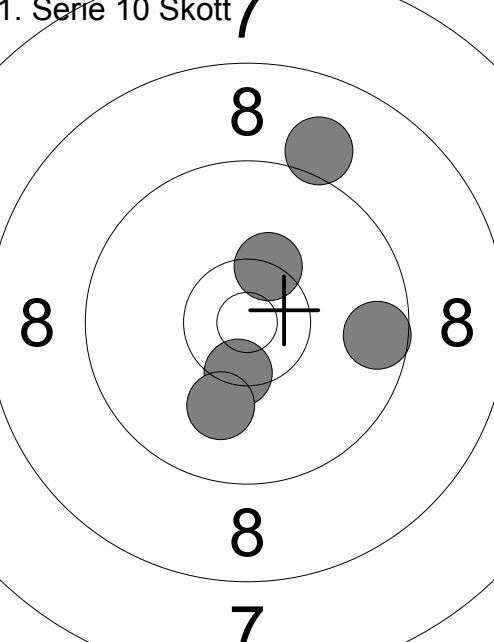
<p>1. Serie 10 Skott</p>  <p style="text-align: center; font-size: 2em;">7</p>	<p>1: 10.2 ←</p> <p>2: 10.2 ↗</p> <p>3: 10.5x ↘</p> <p>4: 8.7 ↓</p> <p>5: 10.1 ↘</p>	<p>1. Serie 10 Skott</p>  <p style="text-align: center; font-size: 2em;">7</p>	
Serie	48	Serie	48
Total	235	Total	283

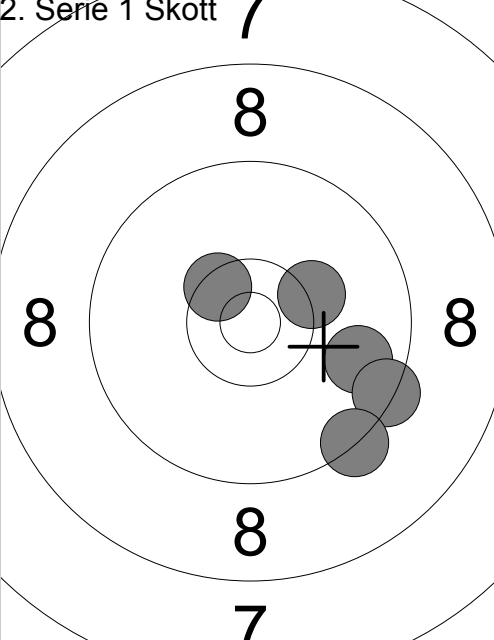
<p>2. Serie 1 Skott</p>  <p style="text-align: center; font-size: 2em;">7</p>	<p>1: 9.8 →</p> <p>2: 9.4 →</p> <p>3: 10.5x ↗</p> <p>4: 10.3 →</p> <p>5: 9.3 ↘</p>	
Serie	47	
Total	330	

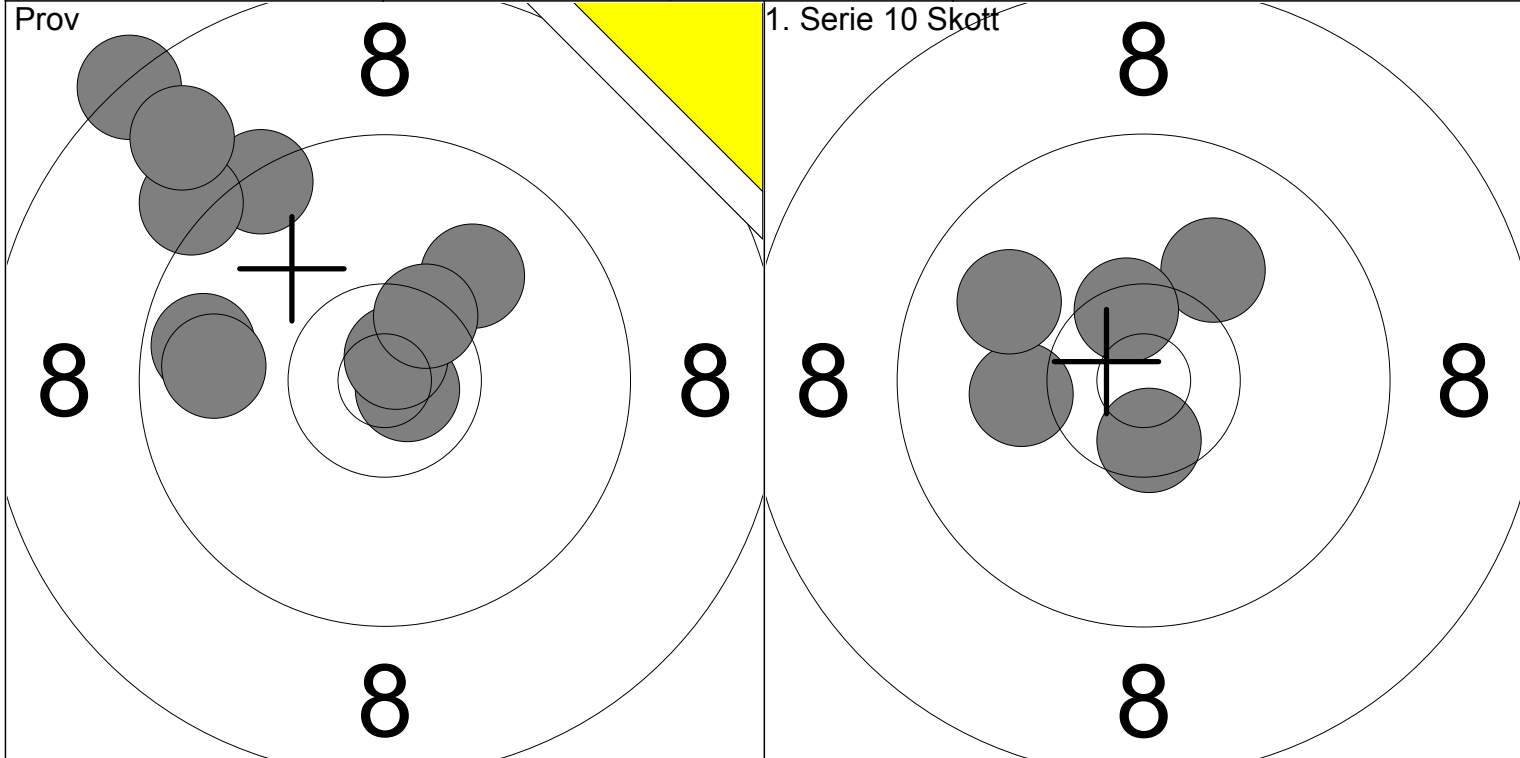

1: 8.3 ↗	6: 9.2 ↖		1: 10.1 ↗		
2: 10.8x →	7: 10.8x ↗	Serie 92	2: 10.5x ↗		Serie 49
3: 9.7 ←	8: 10.0 ↗		3: 10.1 ←		
4: 9.4 ↗	9: 10.4x ↗	Total 187	4: 10.5x ↓		Total 236
5: 9.8 ←	10: 8.8 ↖		5: 9.9 ↖		

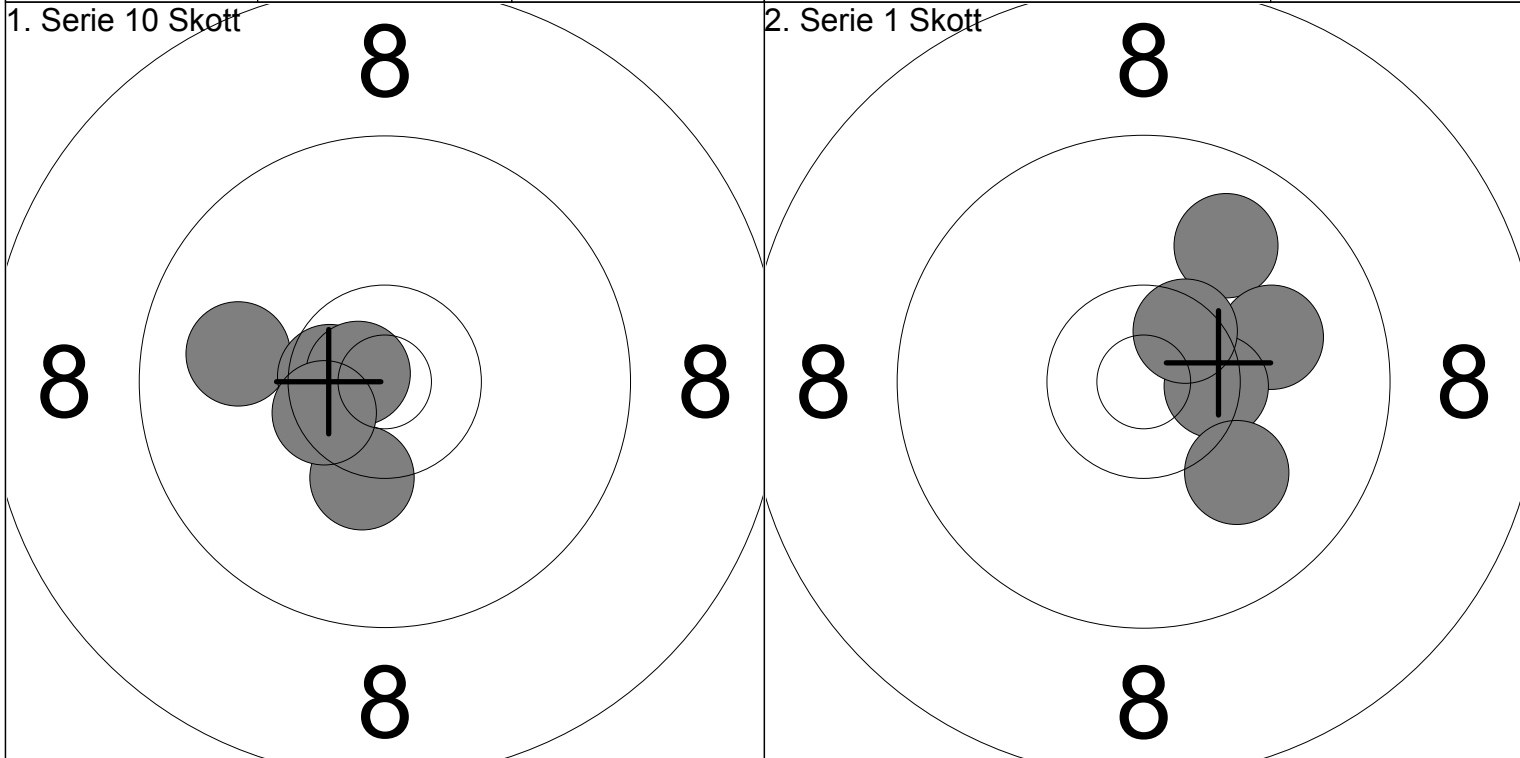

6: 9.9 ←			1: 9.9 ↗		
7: 10.6x ←		Serie 49	2: 10.0 →		Serie 49
8: 10.8x ←			3: 10.5x →		
9: 10.3x ↓		Total 285	4: 10.1 ↓		Total 334
10: 10.5x ←			5: 10.5x ↗		

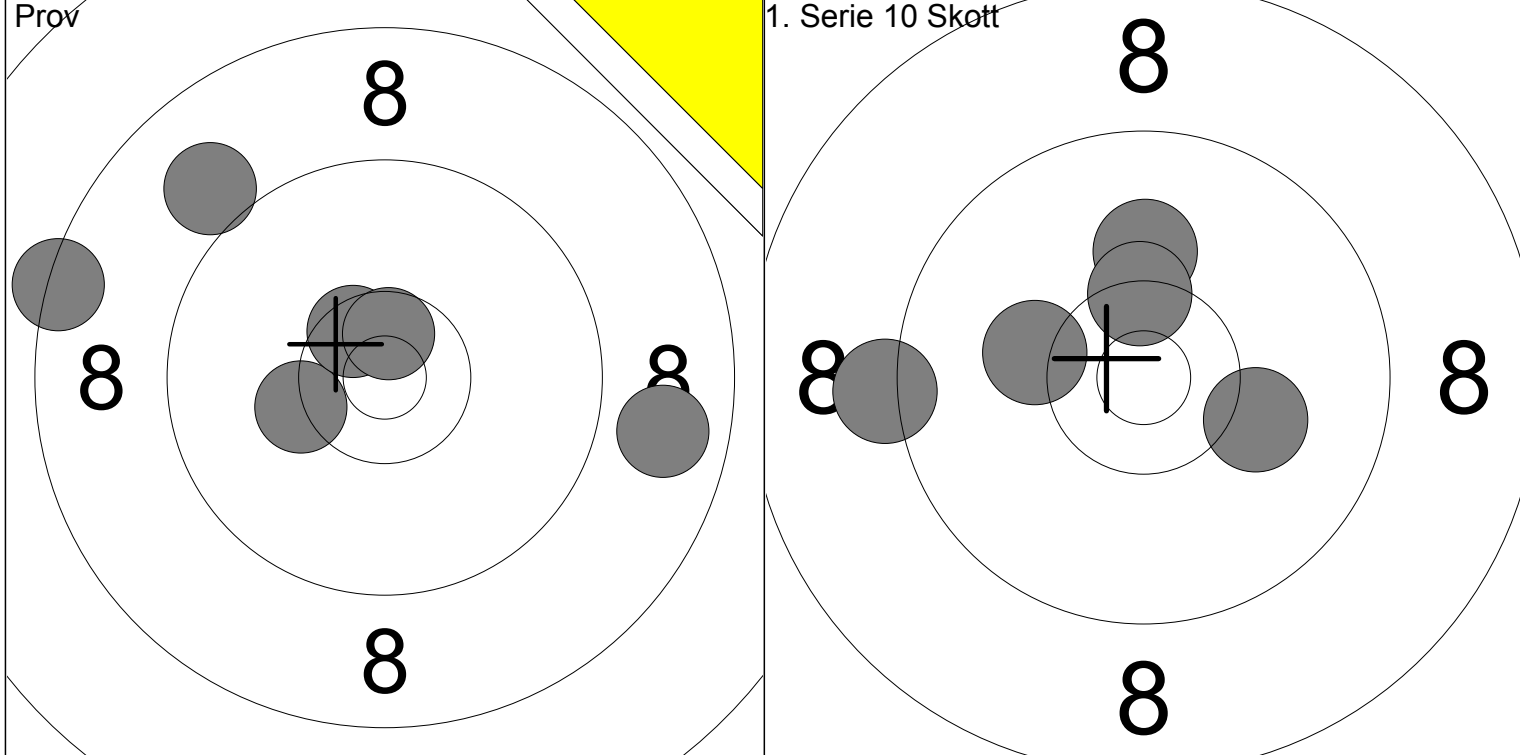

1: 9.0 ↗	6: 10.6x ↑			1: 10.2 ←	
2: 10.3 ←		Serie	55	2: 10.1 ↑	Serie
3: 8.8 →		Total	183	3: 9.2 ←	Total
4: 8.4 ←				4: 10.4x ↑	232
5: 10.5x ↗				5: 10.2 →	

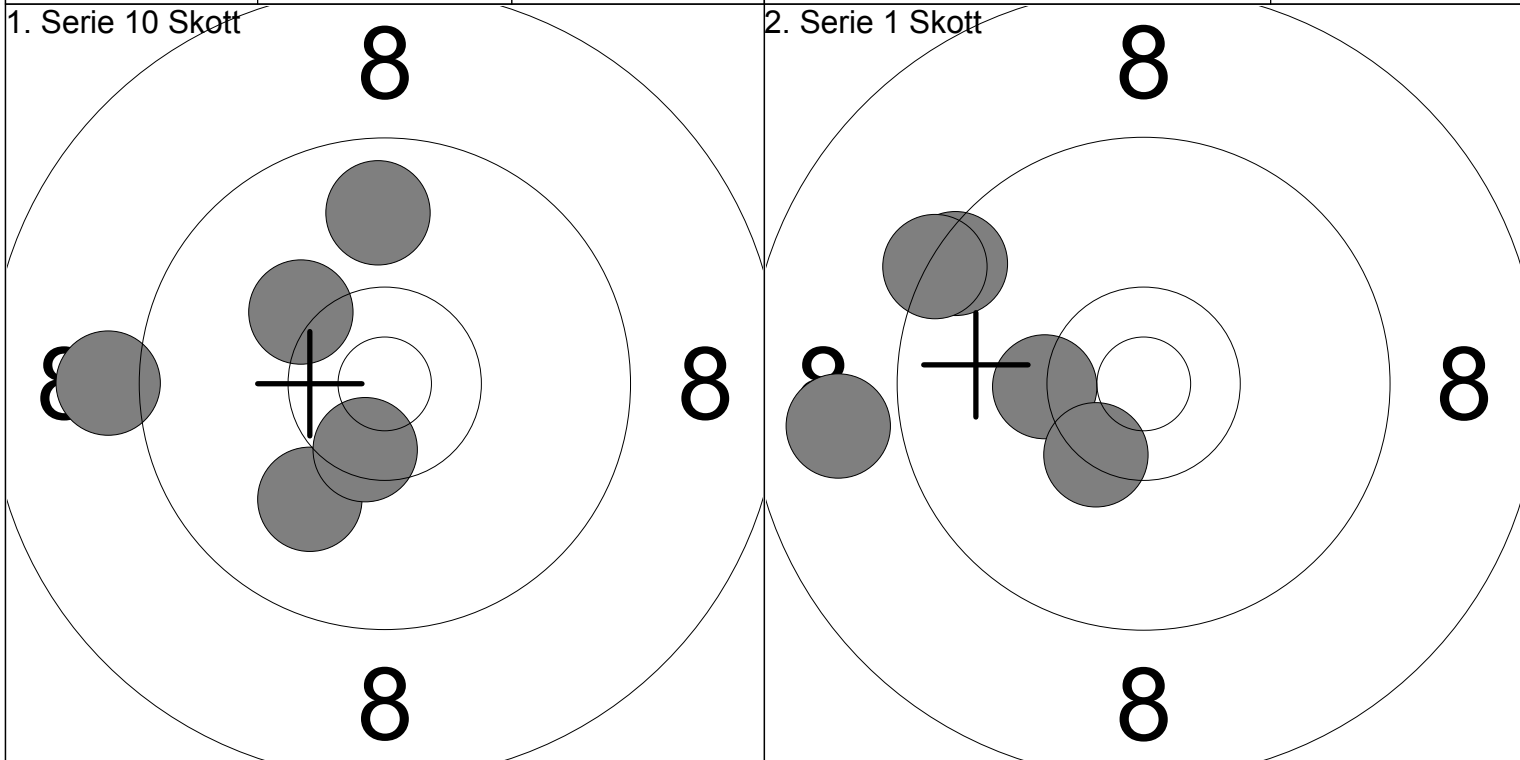

6: 9.8 ↑				1: 9.5 ↘	
7: 9.1 ←		Serie	48	2: 8.9 ←	Serie
8: 10.0 ↘		Total	280	3: 10.3x ←	Total
9: 10.2 ↗				4: 9.3 ↗	326
10: 10.5x ↓				5: 10.4x ↘	

Prov 	1: 9.3 ← 2: 8.9 ← 3: 9.0 ↑ 4: 9.7 ← 5: 10.4x ↓ 6: 9.3 ↑ 7: 8.3 ← 8: 10.0 ↑ 9: 9.7 ↑ 10: 10.5x ↗ Serie 91 Total 170	Prov 	11: 10.7x ← Serie 10 Total 170
----------	---	----------	--------------------------------------

1. Serie 10 Skott 7 	1: 9.6 → 2: 10.8x ← 3: 9.1 ↑ 4: 9.3 ↑ 5: 9.1 ← Serie 46 Total 216	1. Serie 10 Skott 7 	6: 10.0 ← 7: 9.0 ↑ 8: 9.8 ↓ 9: 9.6 ↓ 10: 8.7 ↗ Serie 45 Total 261
-------------------------	---	-------------------------	---

2. Serie 1 Skott 7 	1: 9.7 → 2: 10.1 → 3: 10.3 ↗ 4: 8.9 ↓ 5: 10.2 ↗ Serie 47 Total 308		
------------------------	--	--	--

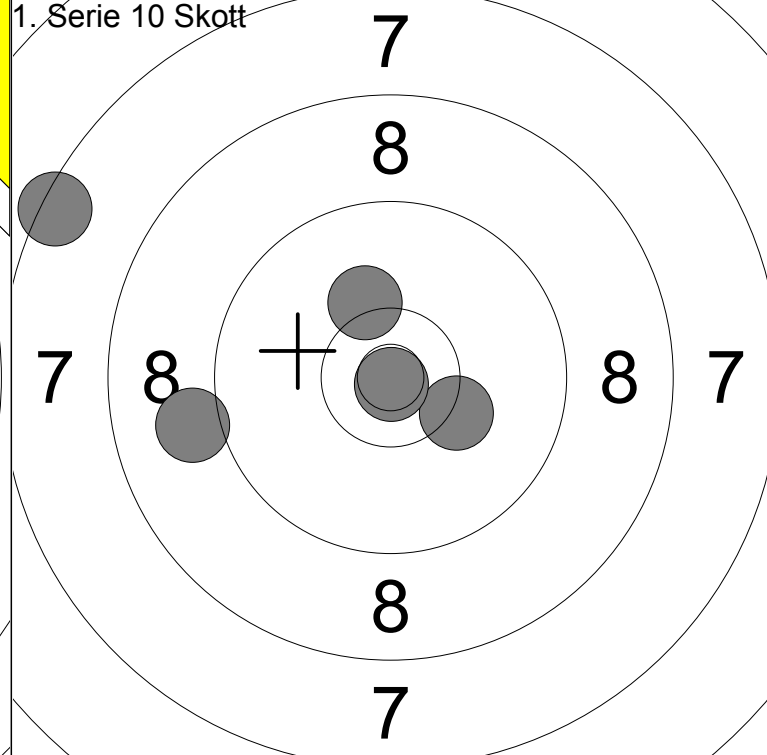
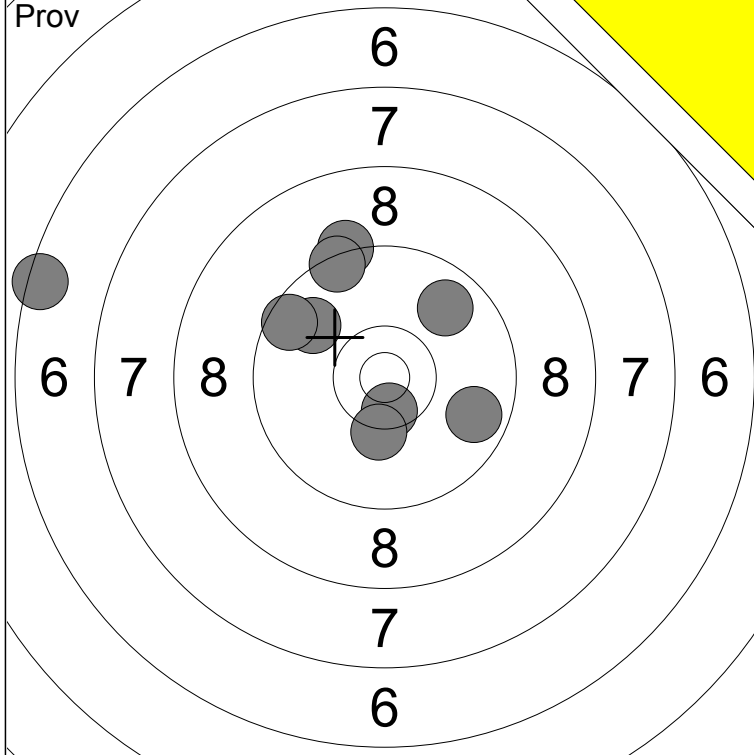

1: 10.5x ↓	6: 9.8 ↗	Serie	80
2: 6.5 ←	7: 9.7 →		
3: 9.3 ↗	8: 10.3 ↓	Total	162
4: 9.8 ↗	9: 9.6 ↖		
5: 9.4 ↗			

1: 9.0 ←	Serie	46
2: 10.2 →		
3: 10.9x ↓	Total	208
4: 10.2 ↗		
5: 7.4 ↖		

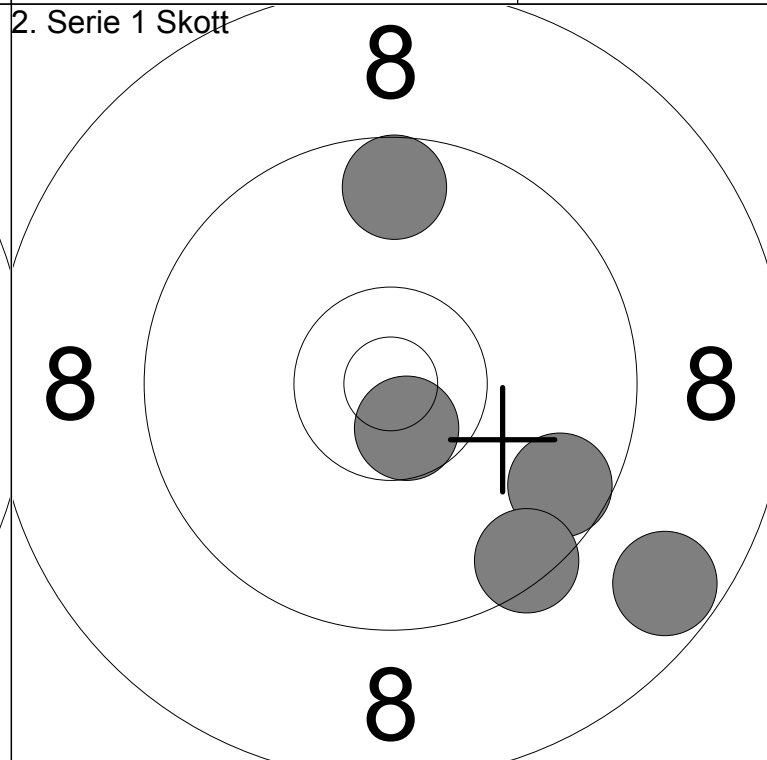
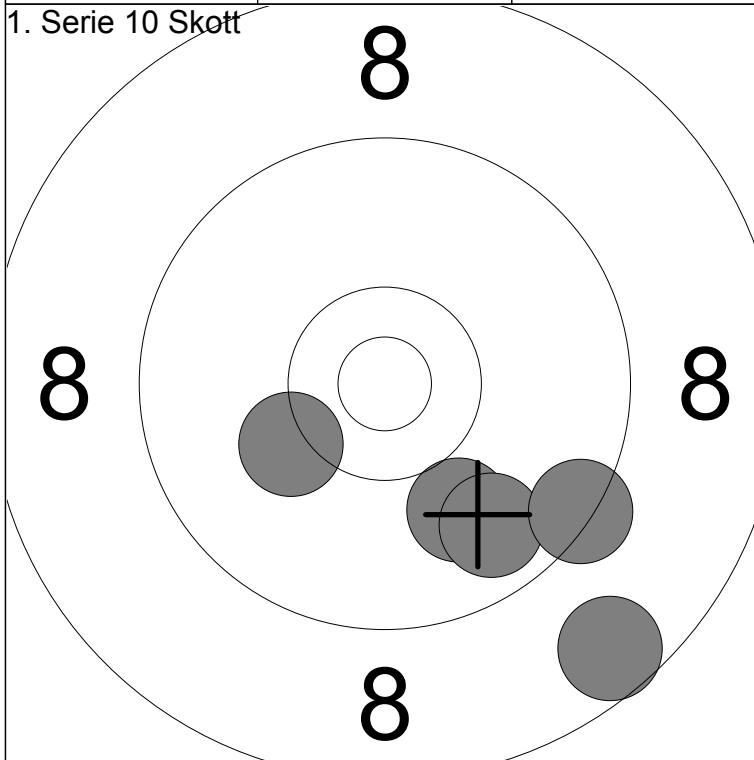

6: 10.0 ↘	Serie	46
7: 9.8 ↘		
8: 10.2 ←	Total	254
9: 9.4 ↘		
10: 8.6 ↘		

1: 8.7 ↘	Serie	45
2: 10.6x ↘		
3: 9.6 ↗	Total	299
4: 9.6 ↘		
5: 9.5 ↘		

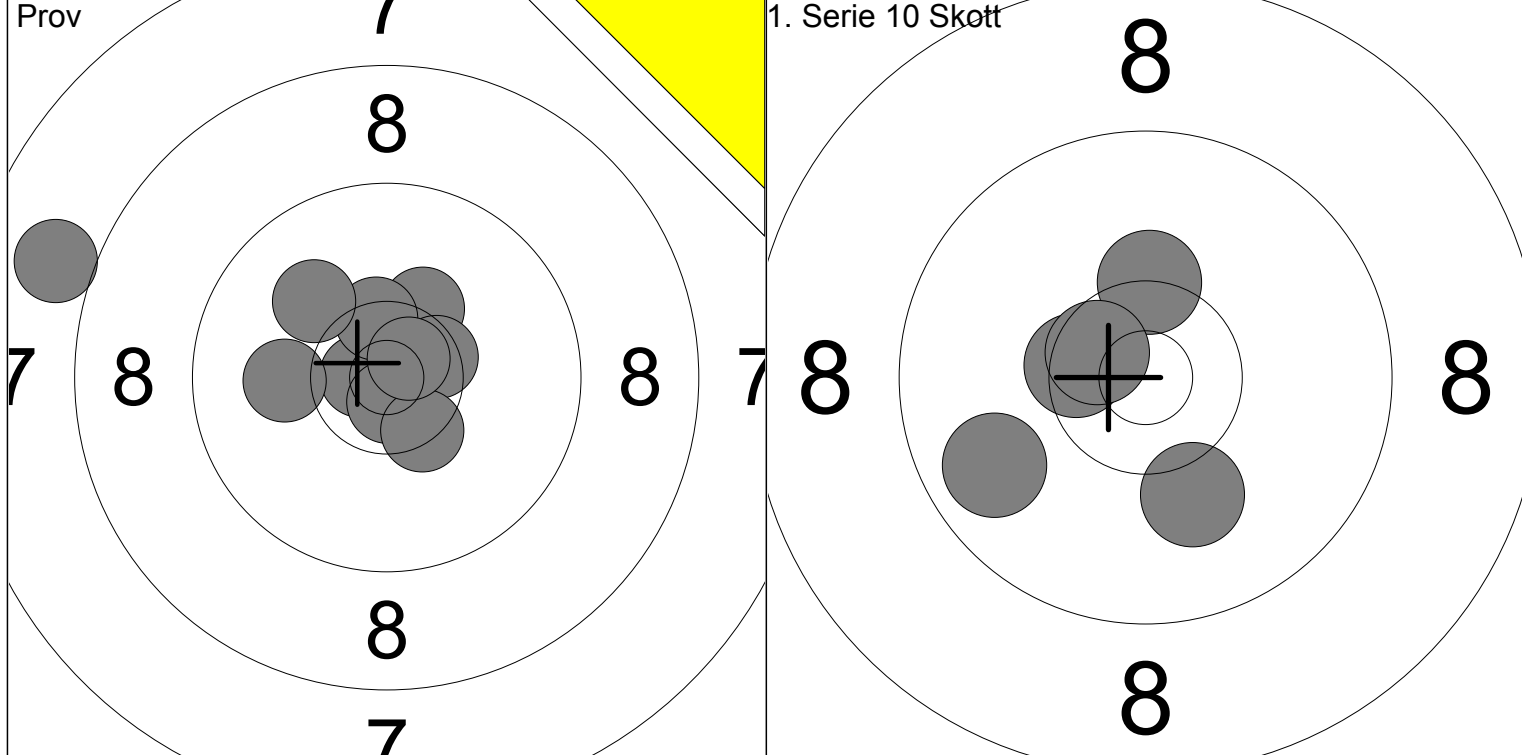

1: 10.3x ↗	6: 10.4x ↗	Serie	98	1: 10.1 ↓	Serie	49
2: 10.7x ←	7: 10.1 ←			2: 9.8 ←		
3: 10.7x ↓	8: 8.0 ←	Total	187	3: 10.5x ←	Total	236
4: 10.5x →	9: 10.7x ↗			4: 10.3x ↗		
5: 10.4x ↓	10: 10.1 ↖					5: 10.6x ←

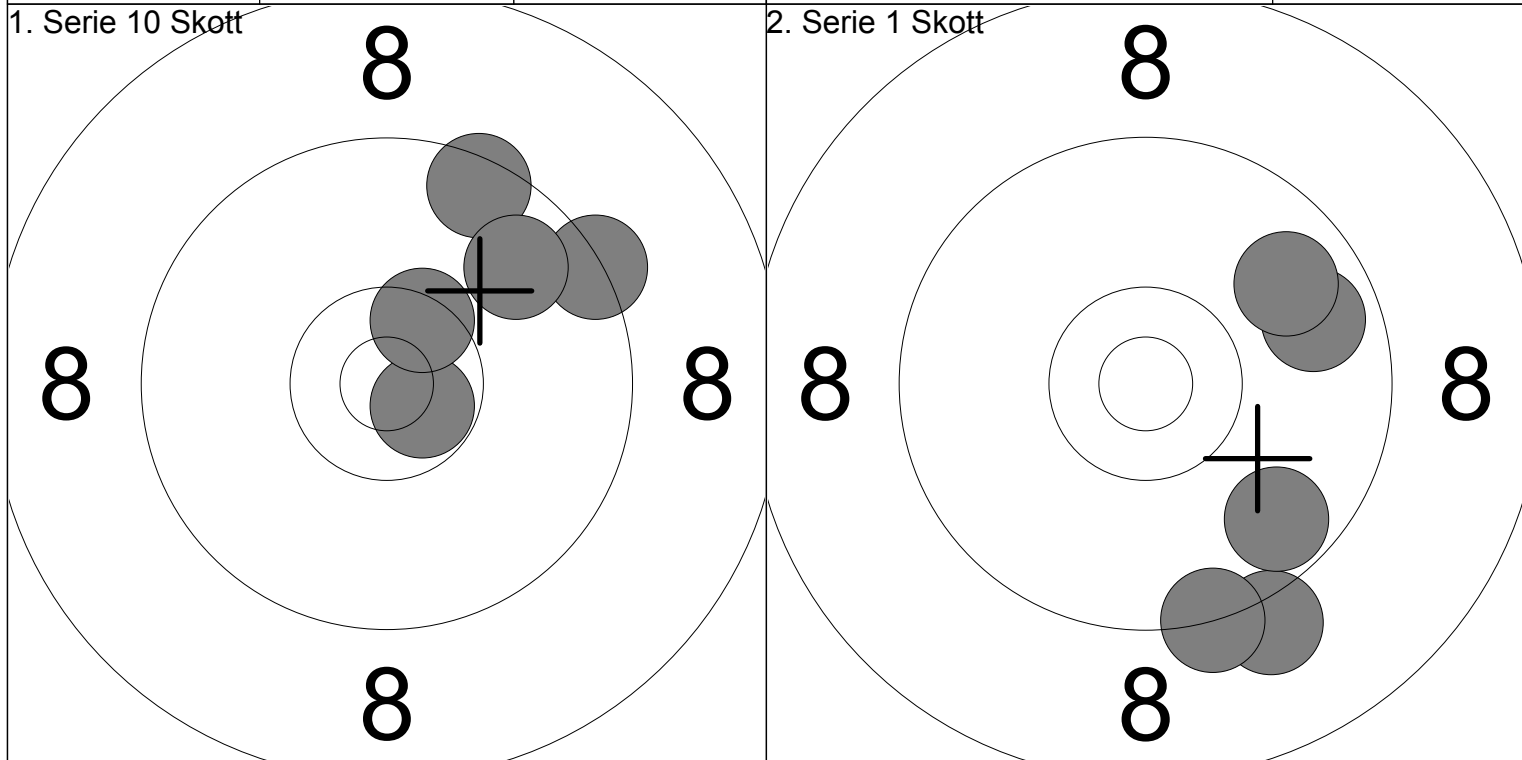

6: 9.3 →	Serie	47	1: 9.1 ↓	Serie	45
7: 10.7x ↘			2: 9.7 ↓		
8: 9.5 ↗	Total	283	3: 9.7 →	Total	328
9: 9.8 ↗			4: 9.8 ↗		
10: 10.5x ↗					5: 9.3 ↓

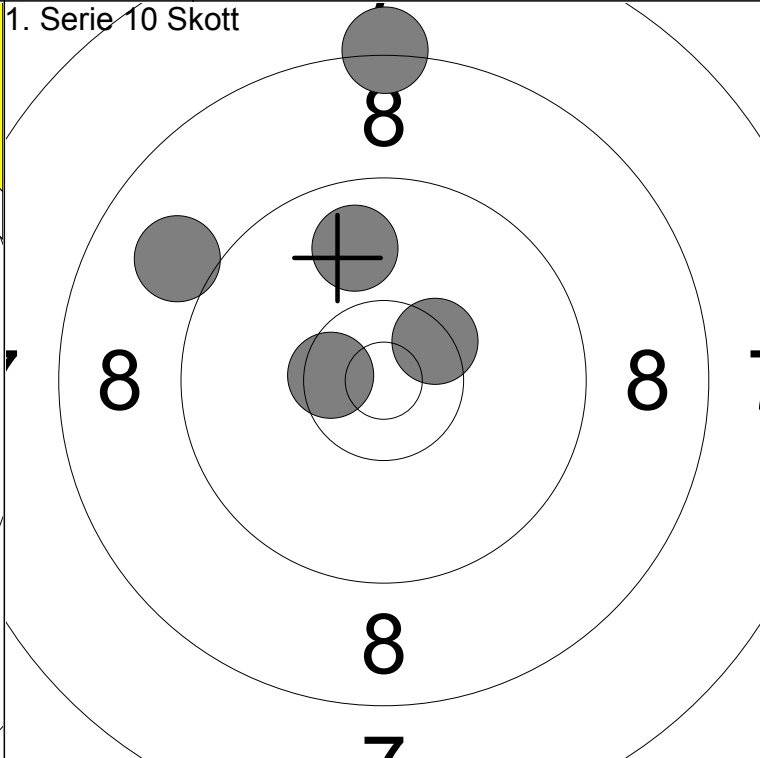
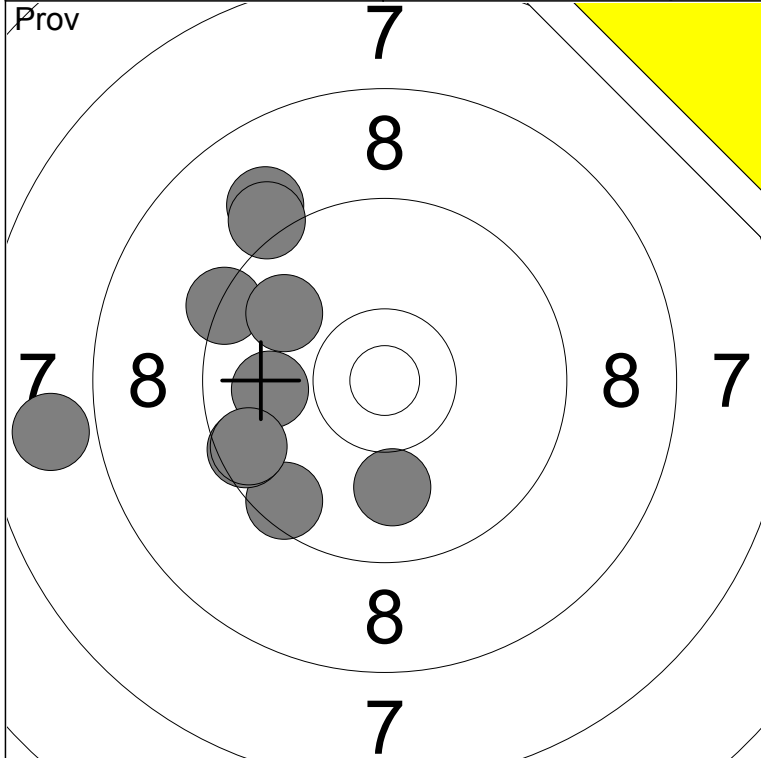

1: 9.9 ←	6: 9.9 ↗	Serie	89
2: 9.3 ↖	7: 9.0 ↗		
3: 9.5 ↘	8: 9.5 ←	Total	179
4: 10.0 ↓	9: 9.6 ←		
5: 7.9 ←	10: 9.1 ↗		

1: 10.5x ←	Serie	46
2: 10.4x ↗		
3: 9.0 ↖	Total	225
4: 9.8 ↑		
5: 8.3 ↑		

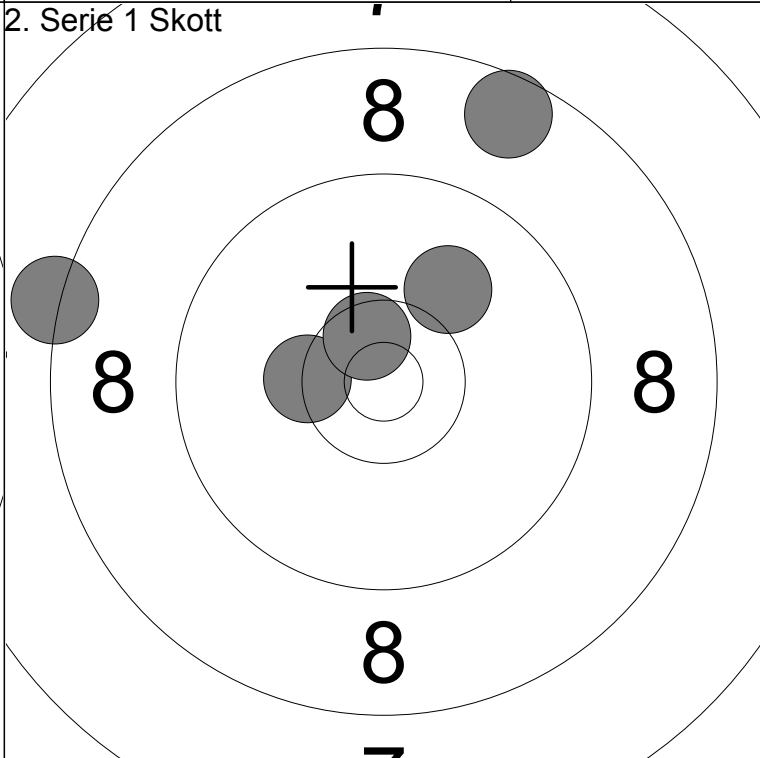
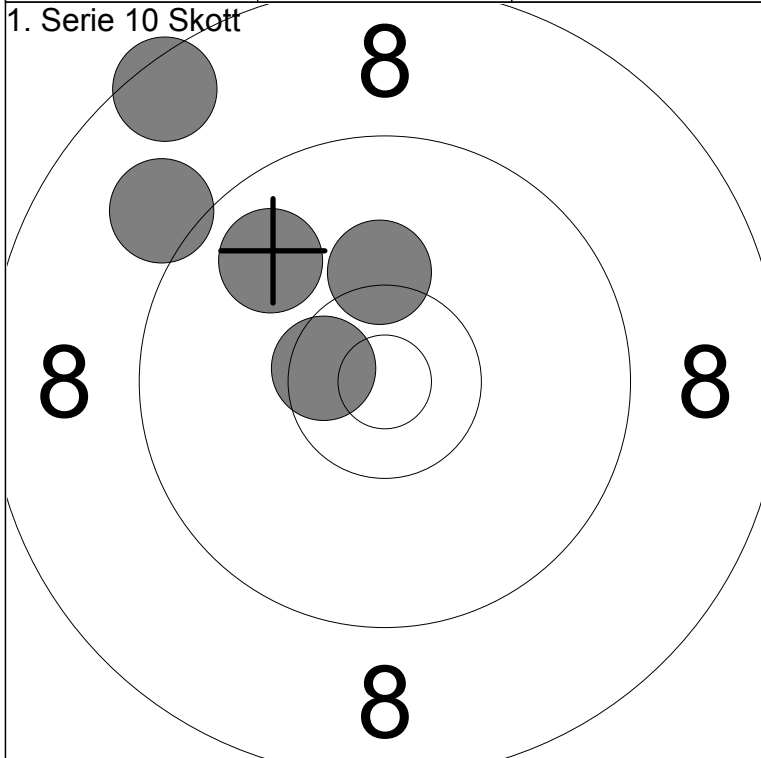

6: 9.8 ↗	Serie	46
7: 10.5x ←		
8: 10.2 ↑	Total	271
9: 9.1 ↗		
10: 8.5 ↗		

1: 8.3 ←	Serie	46
2: 10.3x ←		
3: 10.6x ↗	Total	317
4: 8.6 ↗		
5: 10.1 ↗		

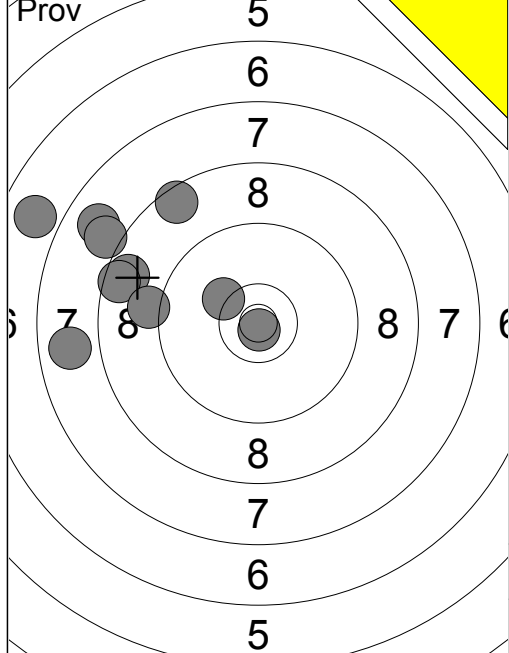

1:	7.8	←
2:	8.7	←
3:	8.5	↗
4:	10.3	↗
5:	7.9	↗
6:	10.8x	↓
7:	6.9	↗
8:	8.6	←
9:	9.1	←
10:	8.1	↗
Serie		81
Total		177

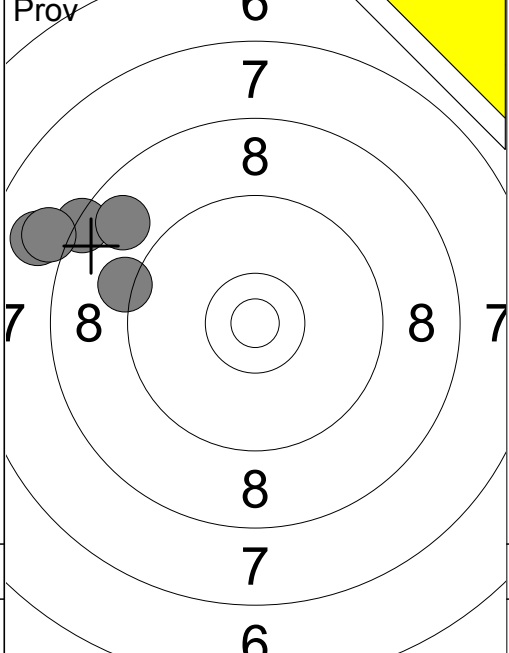

11:	8.4	↖
12:	8.8	↖
13:	9.2	←
14:	7.9	←
15:	8.0	↖
Serie		40
Total		177

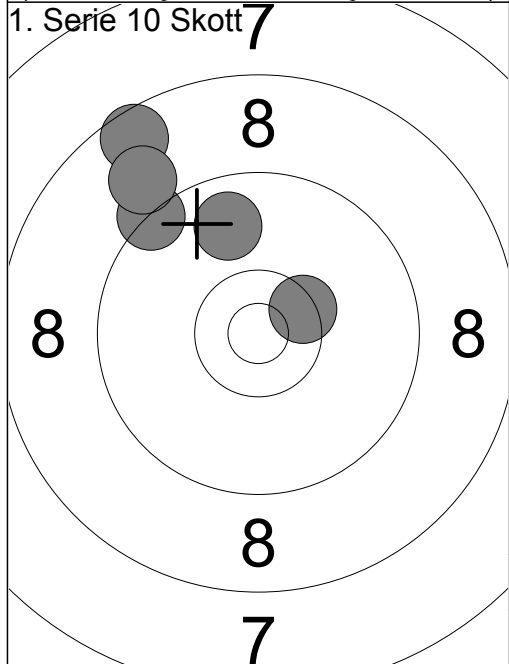

1:	10.4x	↗
2:	9.8	↗
3:	9.3	↗
4:	8.6	↗
5:	9.0	↗
Serie		45
Total		222

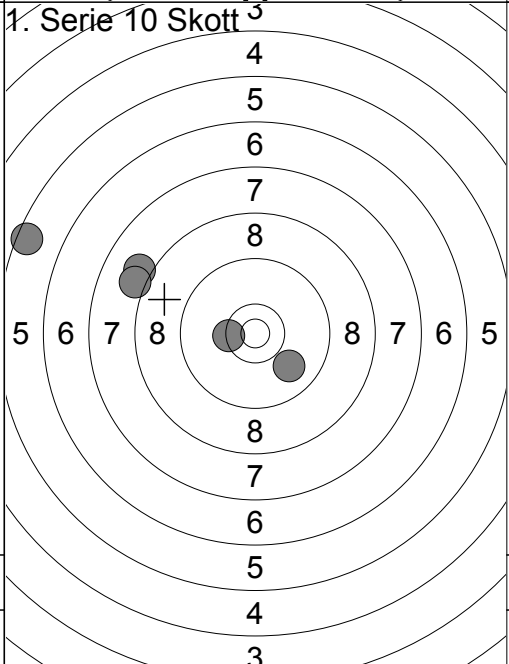

6:	8.0	↖
7:	8.1	↖
8:	10.4x	←
9:	9.9	↘
10:	5.5	↖
Serie		40
Total		262

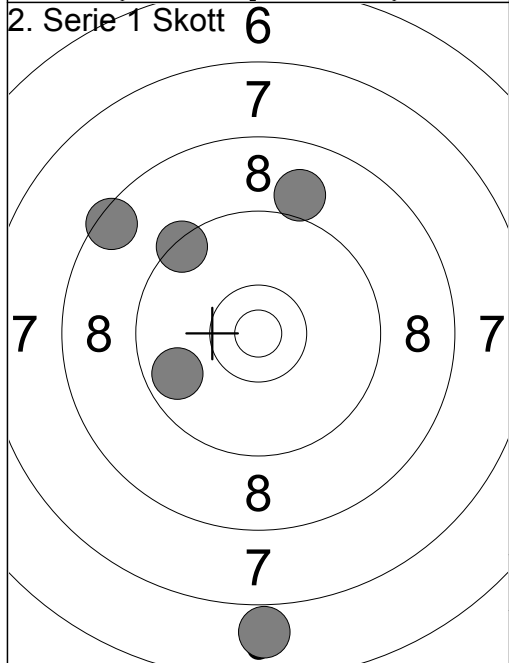

1:	6.9	↓
2:	9.4	↗
3:	9.0	↗
4:	8.5	↗
5:	9.7	↖
Serie		41
Total		303

Prov 	1: 10.2 ← 2: 7.9 ← 3: 9.0 ↙ 4: 10.3 ← 5: 8.0 ↙ 6: 10.2 ↗ 7: 10.2 ← 8: 9.0 ↗ 9: 9.7 ↙ 10: 9.0 ↘	Prov 	11: 8.0 ↓ 12: 9.9 ← 13: 9.6 →
Serie	91	Serie	26
Total	173	Total	173

1. Serie 10 Skott 	1: 10.0 ↓ 2: 9.1 ↗ 3: 9.3 → 4: 9.1 ↗ 5: 9.6 ↖	1. Serie 10 Skott 	6: 10.7x ← 7: 10.3 ↓ 8: 9.7 ← 9: 10.3x ↗ 10: 10.5x ↗
Serie	46	Serie	49
Total	219	Total	268

2. Serie 1 Skott 	1: 10.5x ↑ 2: 9.9 ↓ 3: 10.0 ↑ 4: 10.4x ↗ 5: 8.4 ↓		
Serie	47		
Total	315		

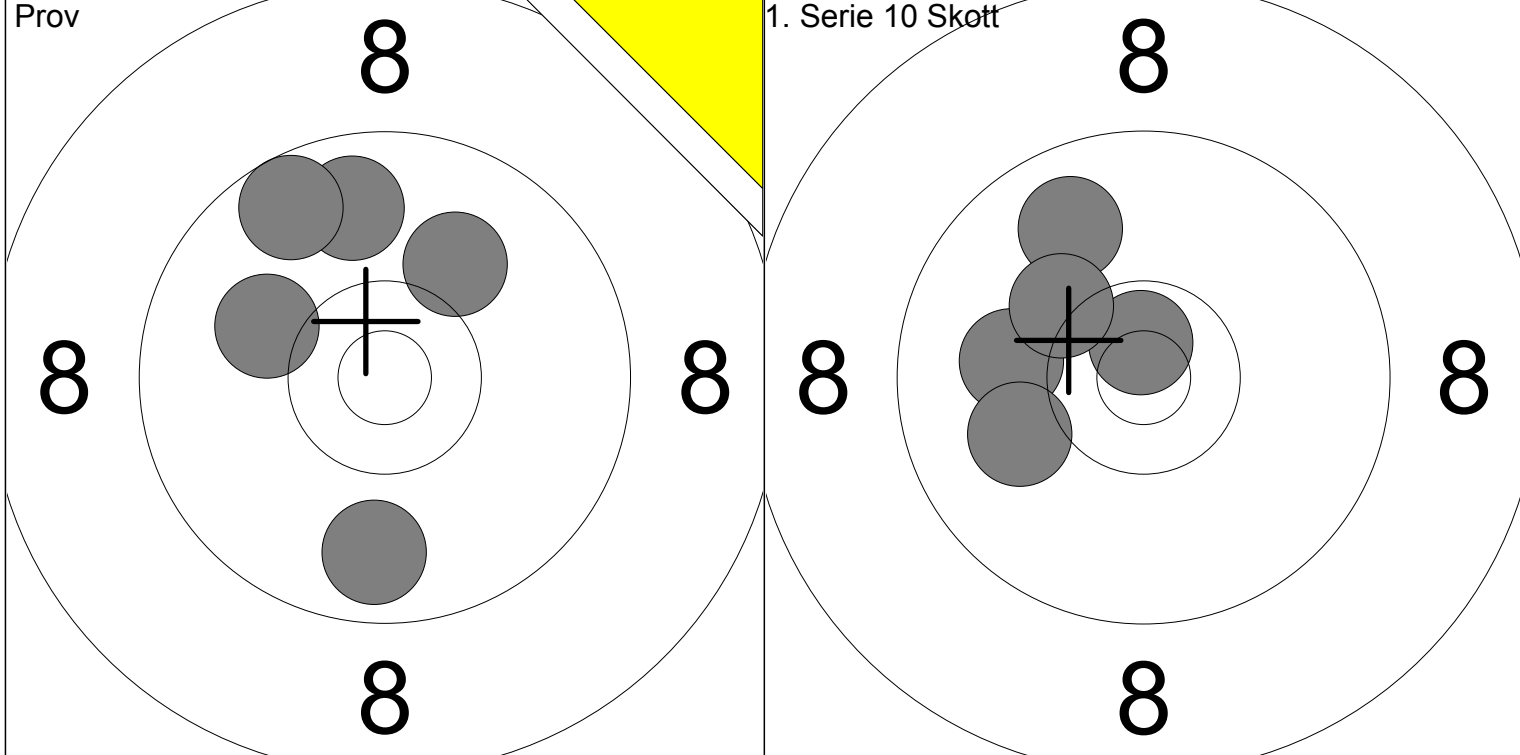

1:	9.8	↑
2:	10.1	↗
3:	10.1	↖
4:	9.6	↗
5:	9.8	↓

Serie	47
Total	195

1:	10.1	←
2:	10.7x	↑
3:	9.8	↗
4:	10.2	↗
5:	10.0	↖

Serie	49
Total	244

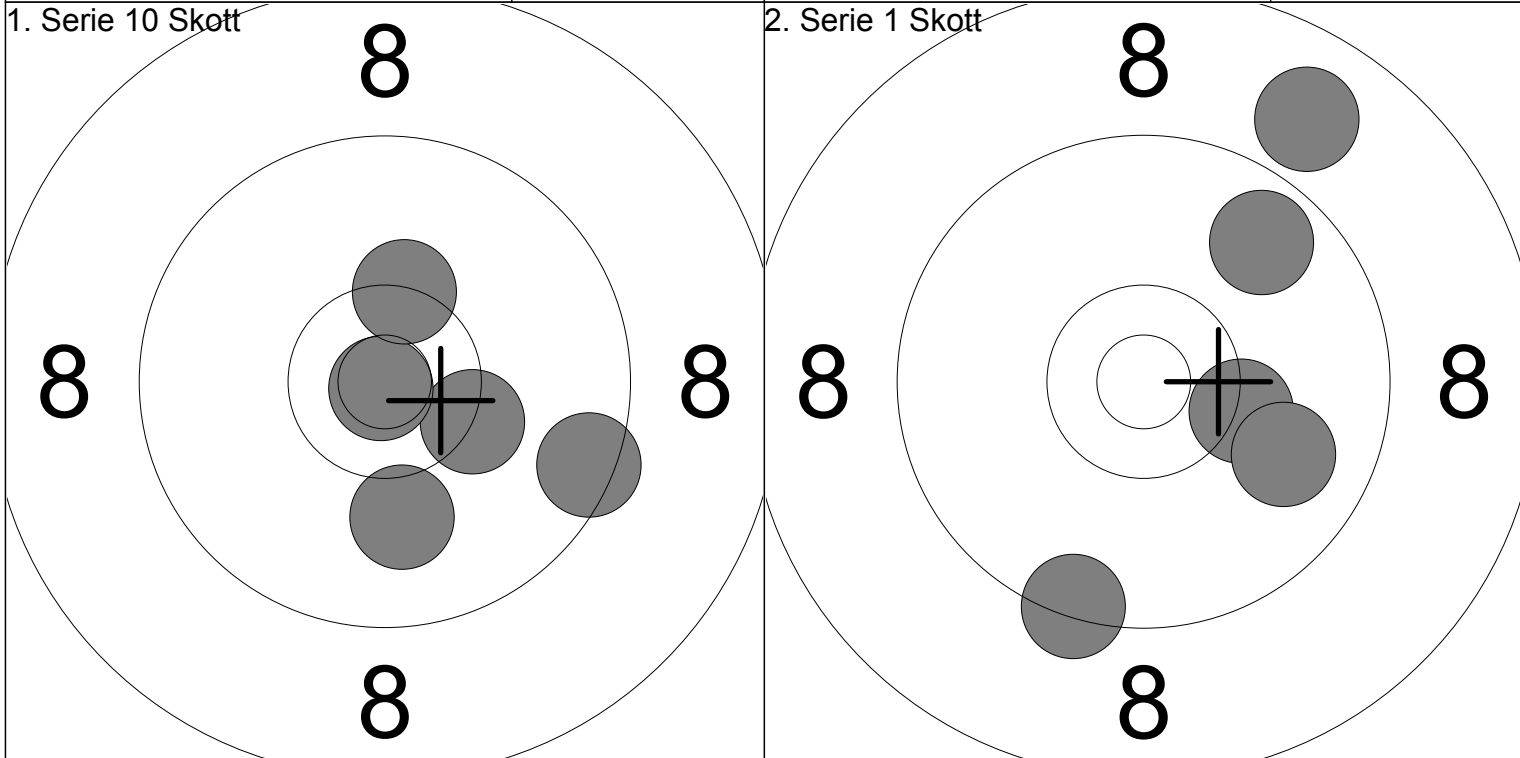

6:	10.0	↓
7:	10.3x	→
8:	10.9x	↙
9:	10.3x	↑
10:	9.5	→

Serie	49
Total	293

1:	10.3	→
2:	8.9	↗
3:	9.7	↗
4:	9.9	→
5:	9.4	↓

Serie	45
Total	338

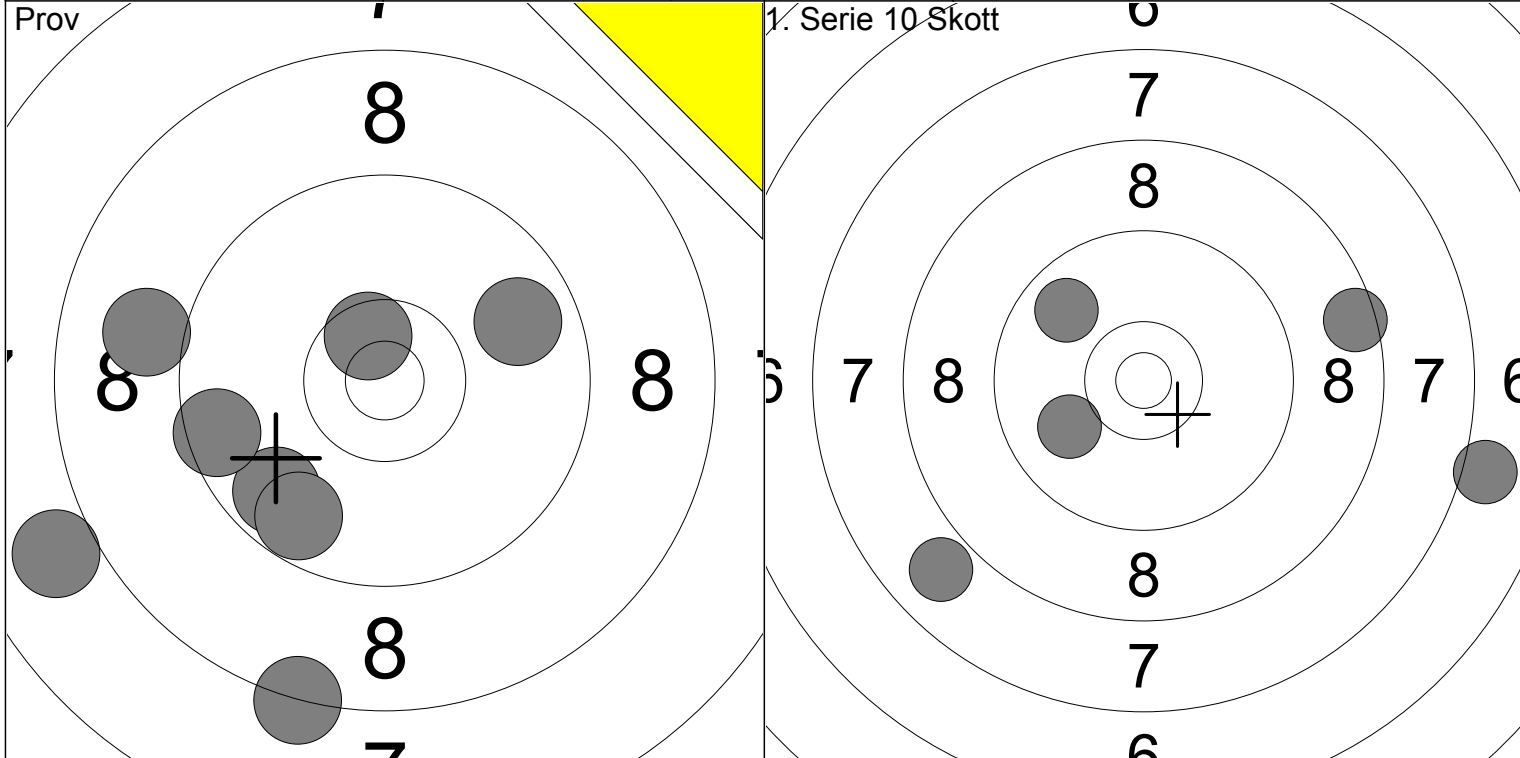

1: 9.7 ↙	6: 8.3 ↓		1: 7.9 ↙		
2: 8.0 ←	7: 9.0 ←	Serie	2: 10.0 ←		Serie
3: 9.8 →	8: 10.6x ↑	71	3: 9.8 ↗		41
4: 9.5 ←		Total	4: 7.0 →		Total
5: 9.7 ↓		183	5: 8.5 →		224

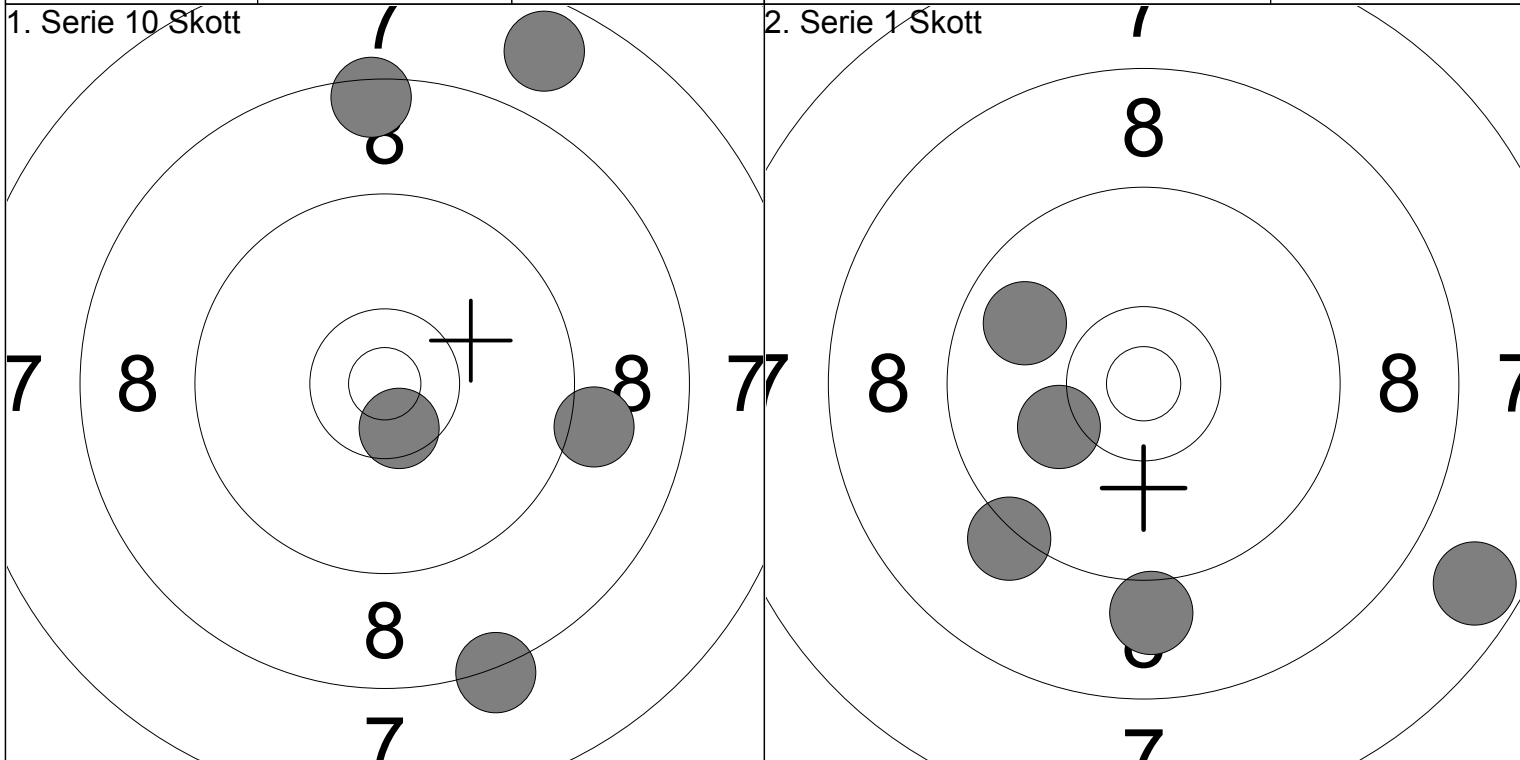

6: 8.3 ↓	1: 7.7 →		2: 9.0 ↓		
7: 10.5x ↓	2: 9.0 ↓	Serie	3: 9.8 ↖		Serie
8: 9.1 →	3: 9.8 ↖	42	4: 9.2 ↙		44
9: 7.7 ↗	4: 9.2 ↙	Total	5: 10.2 ←		Total
10: 8.5 ↑	5: 10.2 ←	266			310

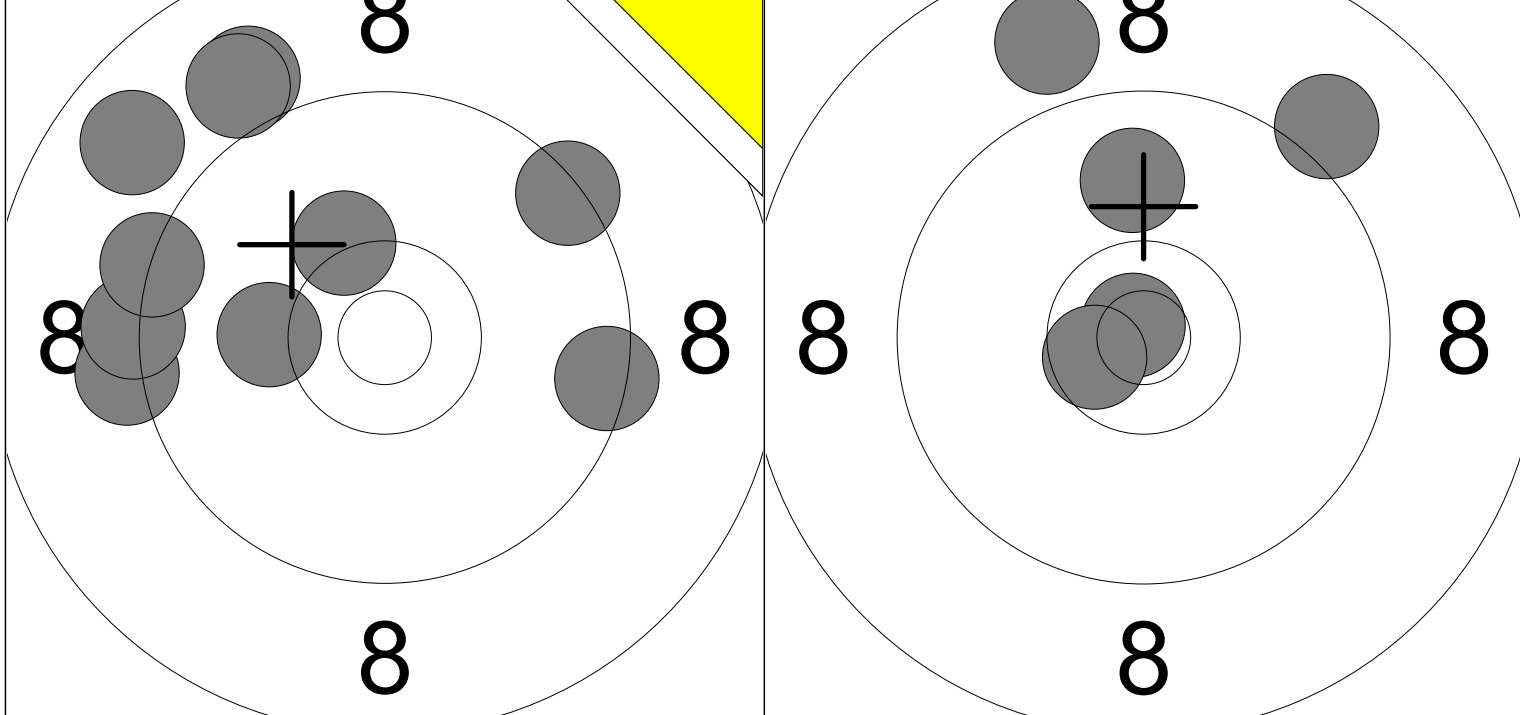

1: 9.2 ←	6: 9.4 ↗		Serie	91		1: 10.8x ↖		Serie	46
2: 9.0 ↗	7: 9.3 ←		Total	181		2: 10.6x ←		3: 9.9 ↑	Total
3: 10.2 ←	8: 9.0 ↗					4: 9.1 ↗			
4: 8.8 ↗	9: 9.3 ←					5: 8.9 ↑			
5: 10.3 ↗	10: 9.4 →								

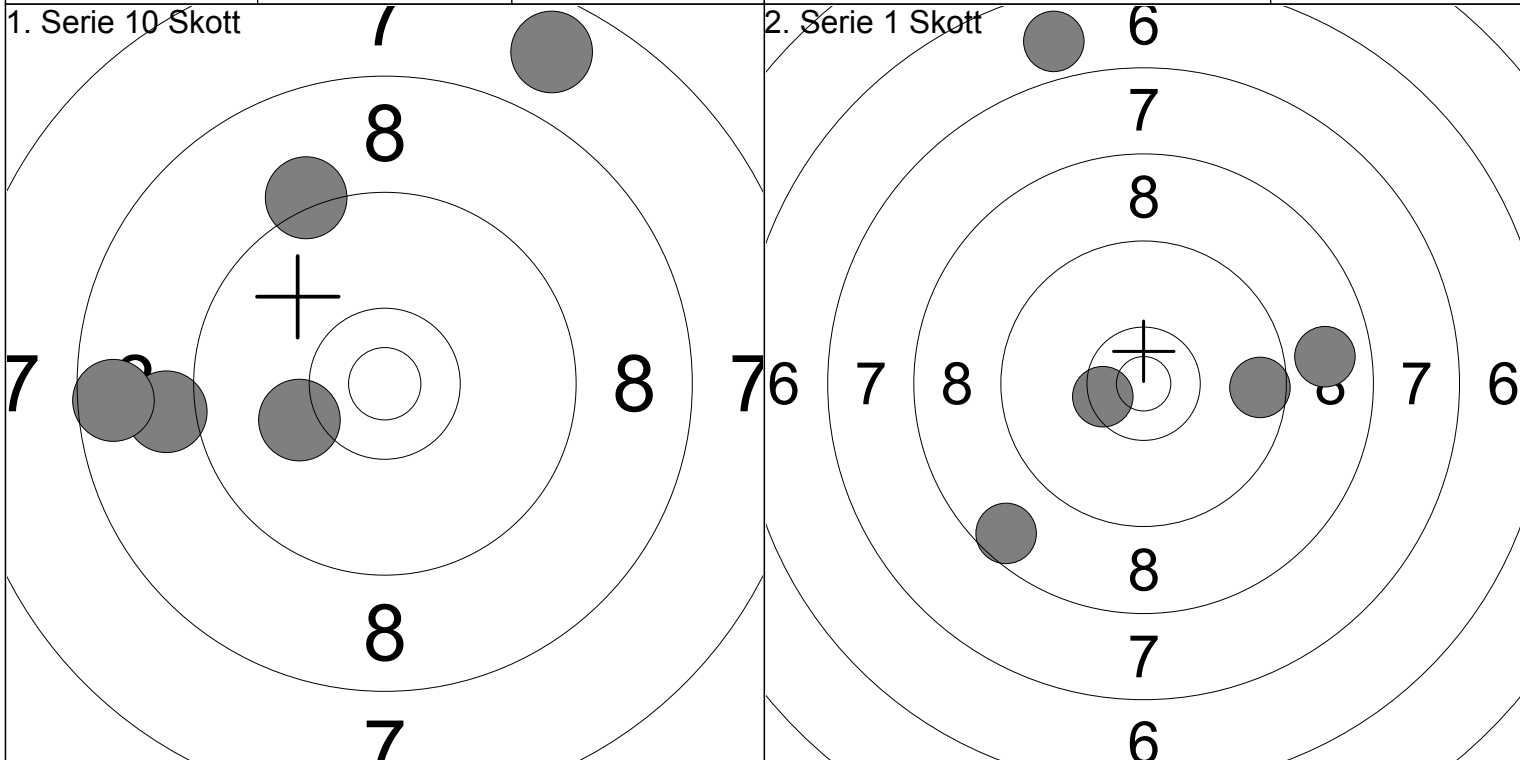

6: 7.7 ↗	7: 9.2 ↗		Serie	43		1: 10.5x ←		Serie	41
8: 10.2 ←	9: 9.1 ←		Total	270		2: 8.6 ↙		3: 8.8 →	Total
10: 8.6 ←						4: 6.9 ↑			
						5: 9.6 →			

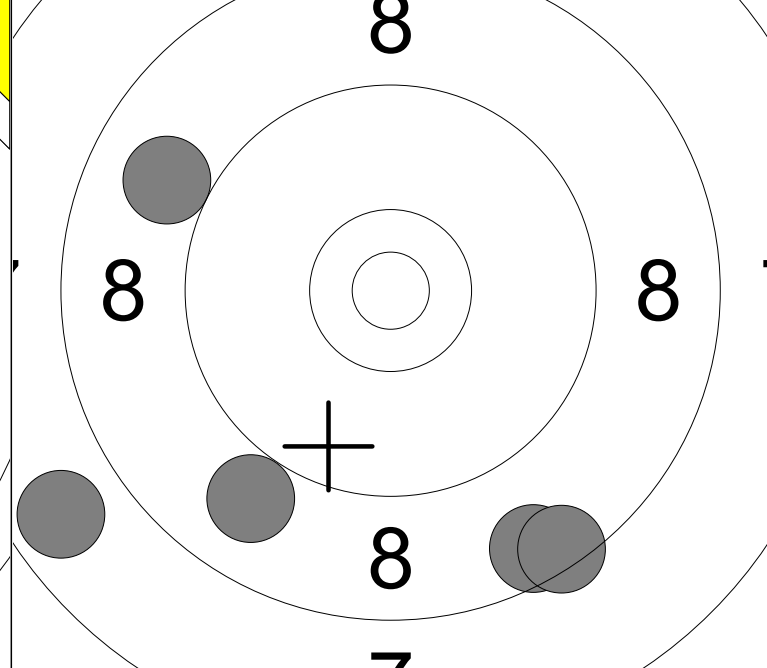
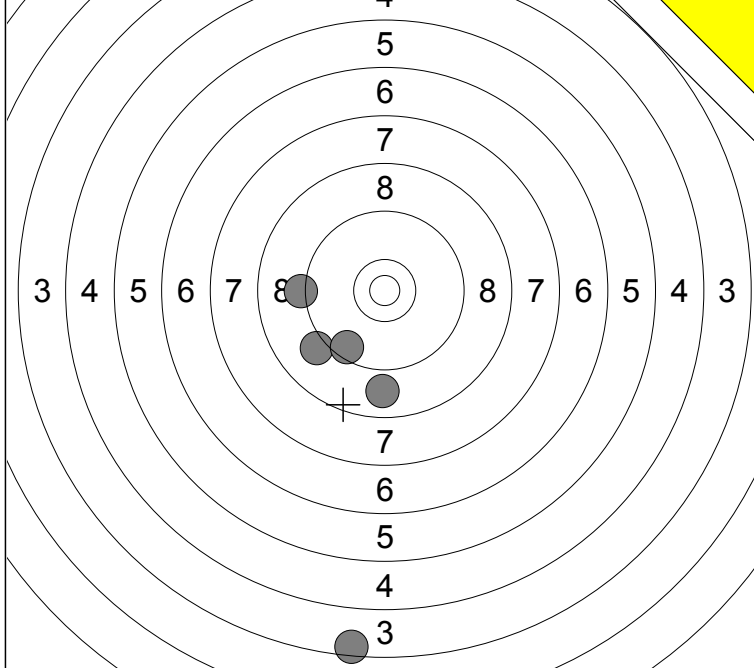

1:	3.5	↓
2:	9.2	←
3:	9.1	↙
4:	8.9	↓
5:	9.5	↘

Serie	38
Total	157

1:	7.8	↙
2:	8.6	↓
3:	8.9	↘
4:	8.9	↖
5:	8.5	↓

Serie	39
Total	196

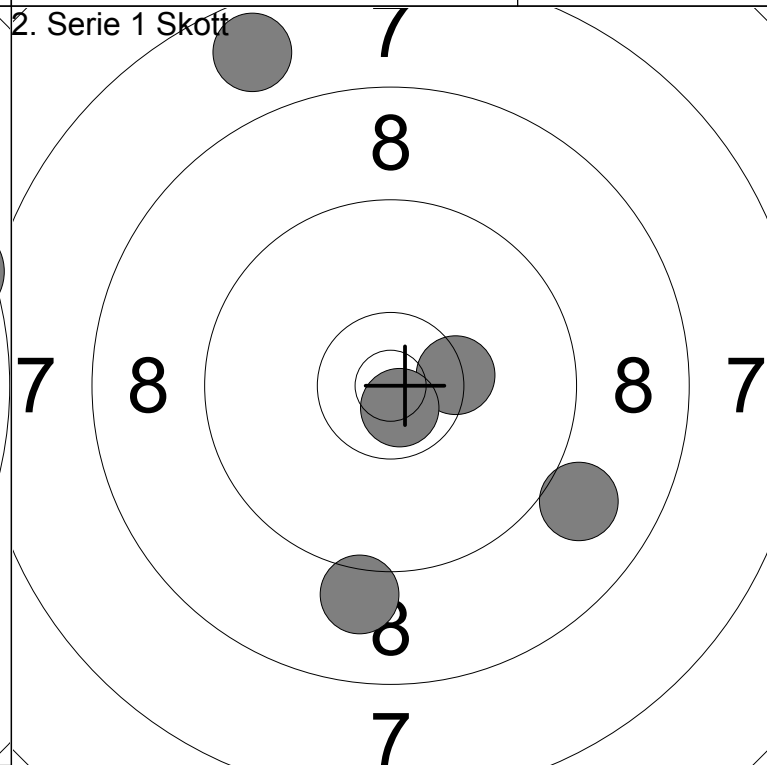
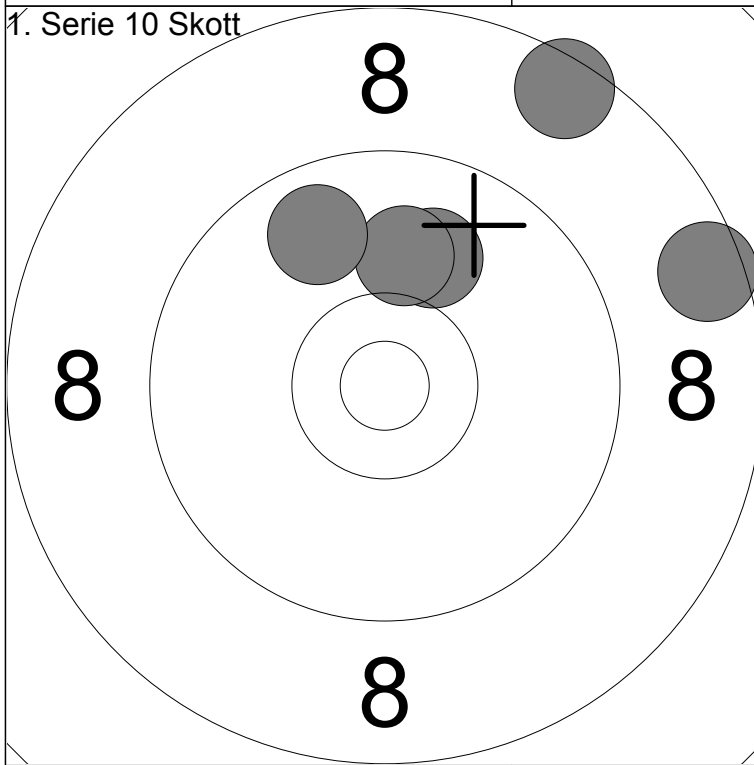

6:	10.0	↗
7:	10.0	↑
8:	8.5	→
9:	8.5	↗
10:	9.8	↖

Serie	45
Total	241

1:	9.0	↘
2:	9.1	↓
3:	10.4x	→
4:	7.7	↖
5:	10.7x	↓

Serie	45
Total	286