

1: 10.0 ↓	6: 10.3x ↑			1: 9.2 ←			
2: 9.3 →	7: 10.0 ↗	Serie	98	2: 9.8 ←	Serie	48	Total
3: 10.3x ↓	8: 9.8 ↗		Total	191		3: 10.8x ↗	
4: 10.0 →	9: 10.0 →				4: 10.7x ↗		
5: 10.5x ↓	10: 10.1 ←			5: 10.3x ↓			

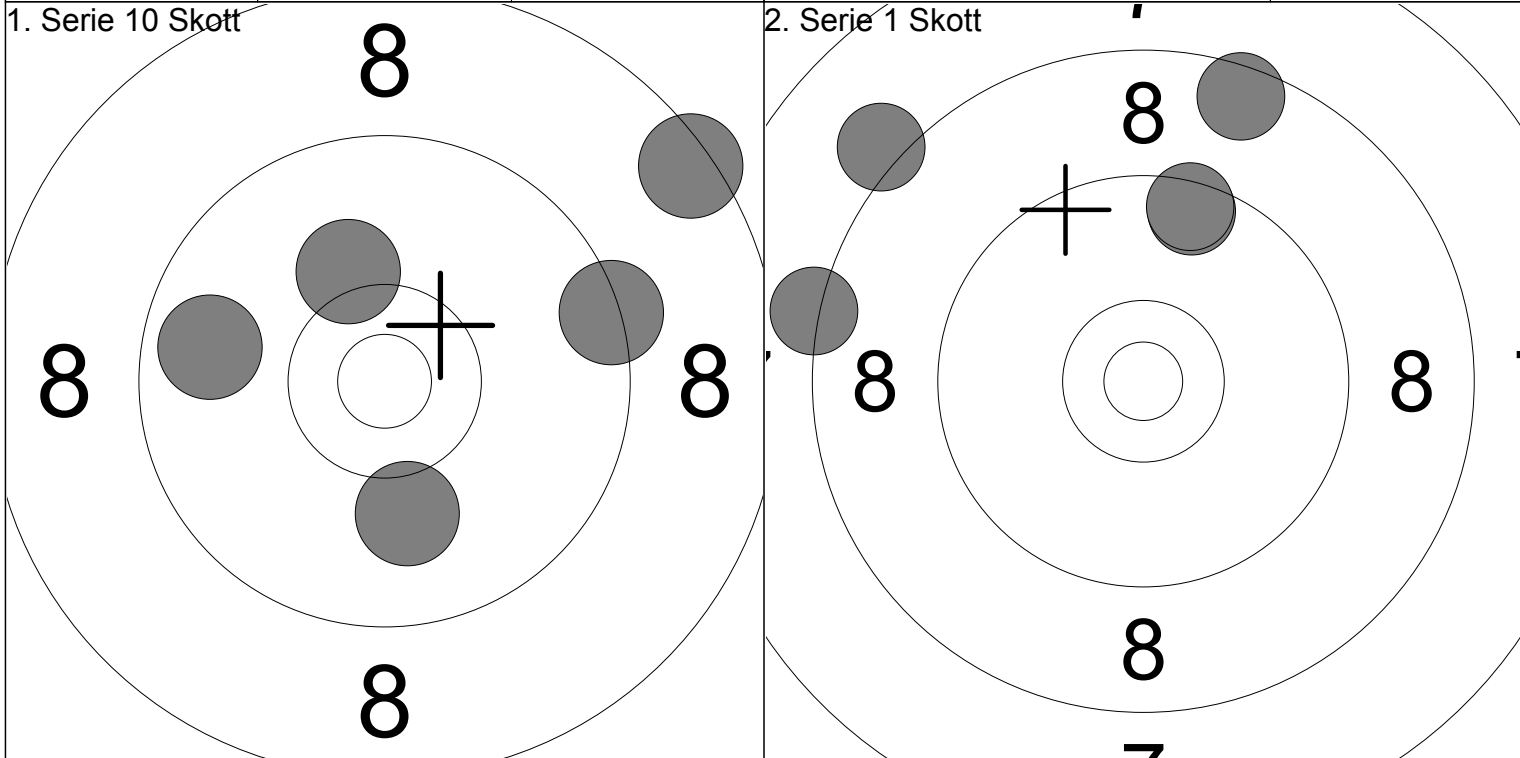

6: 10.1 ↓				1: 9.5 ↑			
7: 10.2 ↑		Serie	46	2: 8.5 ↑	Serie	42	Total
8: 8.4 ↗			Total	285		3: 8.3 ←	
9: 9.4 →					4: 9.5 ↑		
10: 9.8 ←				5: 8.1 ←			

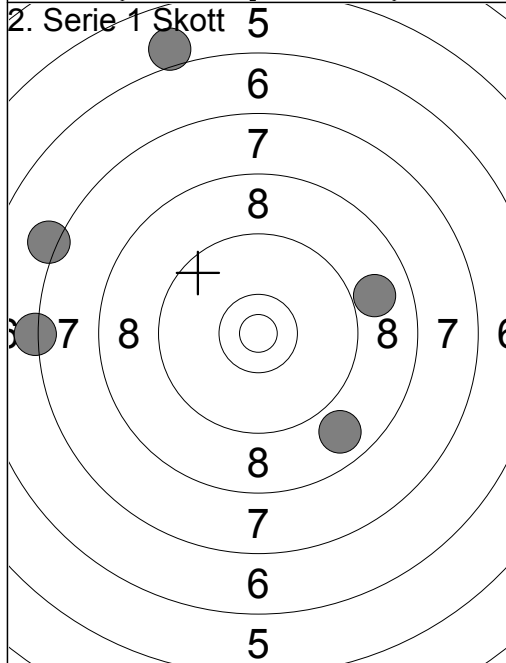
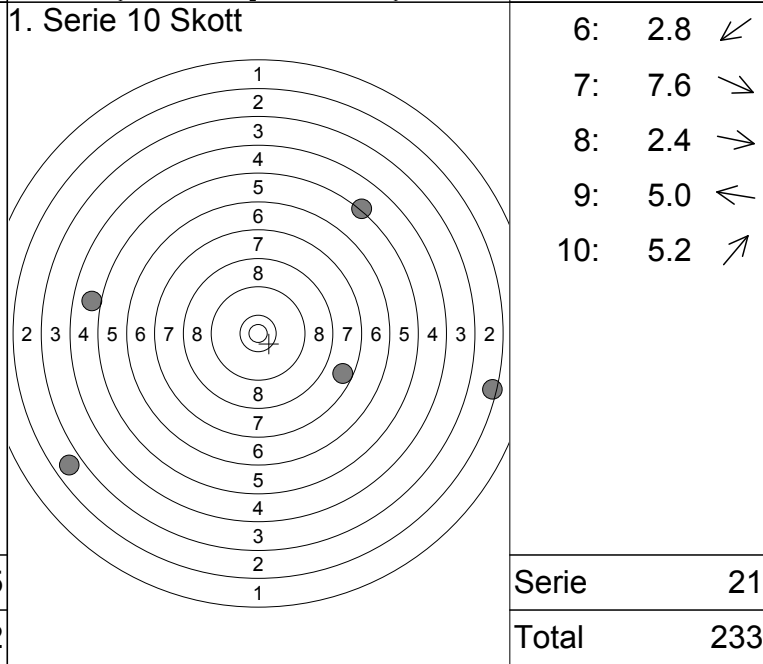
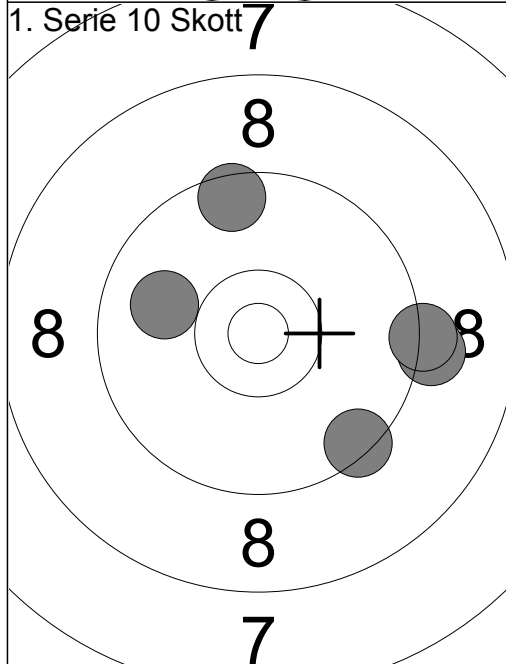
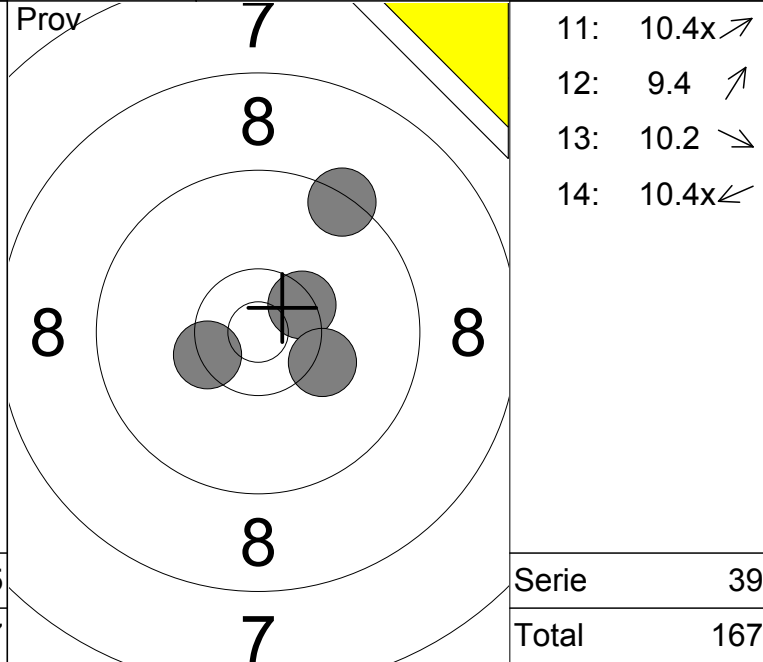
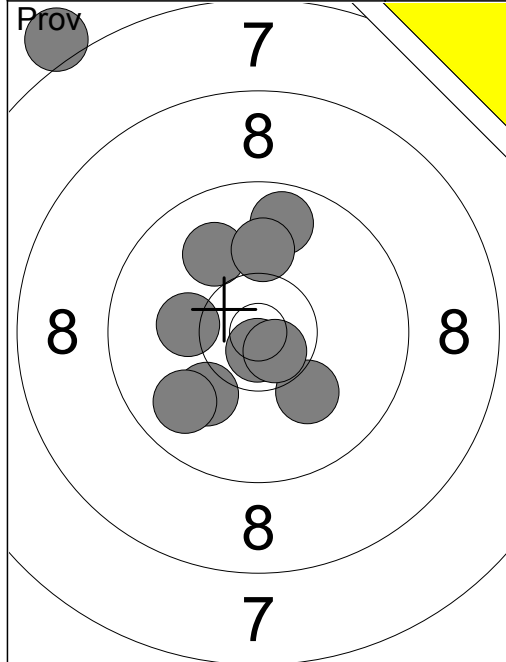

Skjutlag
4

Tavla
5

Marlene Forsell Forsman

Ramselefors

Ramselefors

Vb

15.08.2021

Förbundsmästerskap KH 2021

Ramselefors SKF

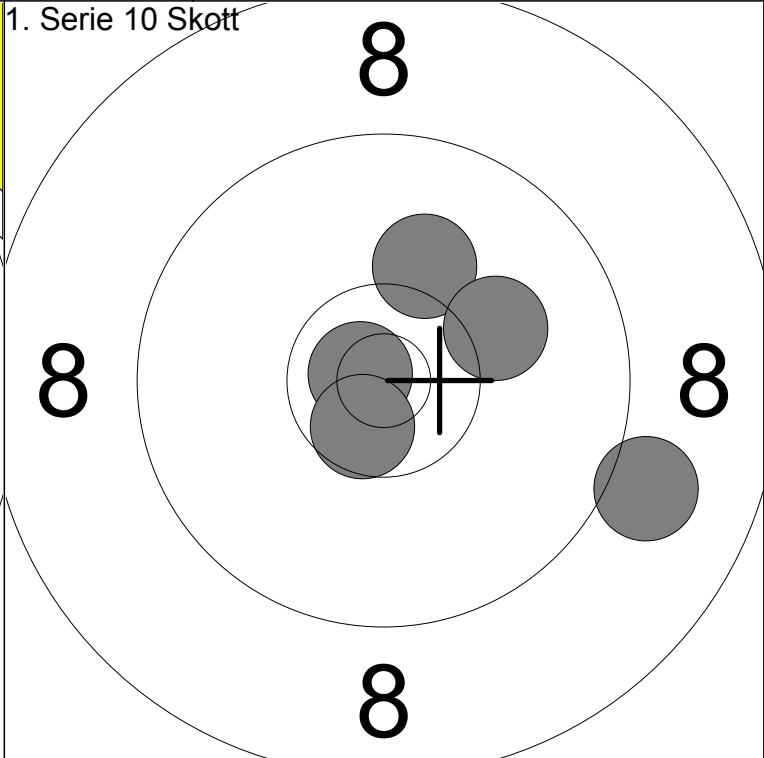
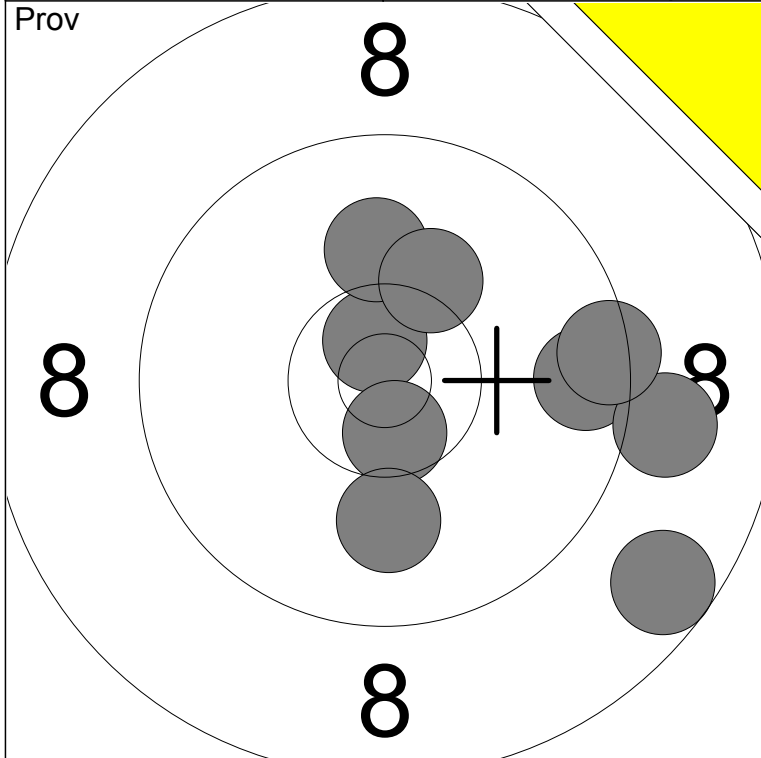

1: 8.6 ↘	6: 10.0 ↓
2: 10.7x ↗	7: 9.6 →
3: 10.1 ↗	8: 9.0 →
4: 10.2 ↗	9: 9.4 →
5: 10.6x ↓	

Serie	85
Total	188

1: 10.8x ←	
2: 10.1 ↗	
3: 10.6x ↓	
4: 10.1 ↗	
5: 9.1 ↘	

Serie	49
Total	237

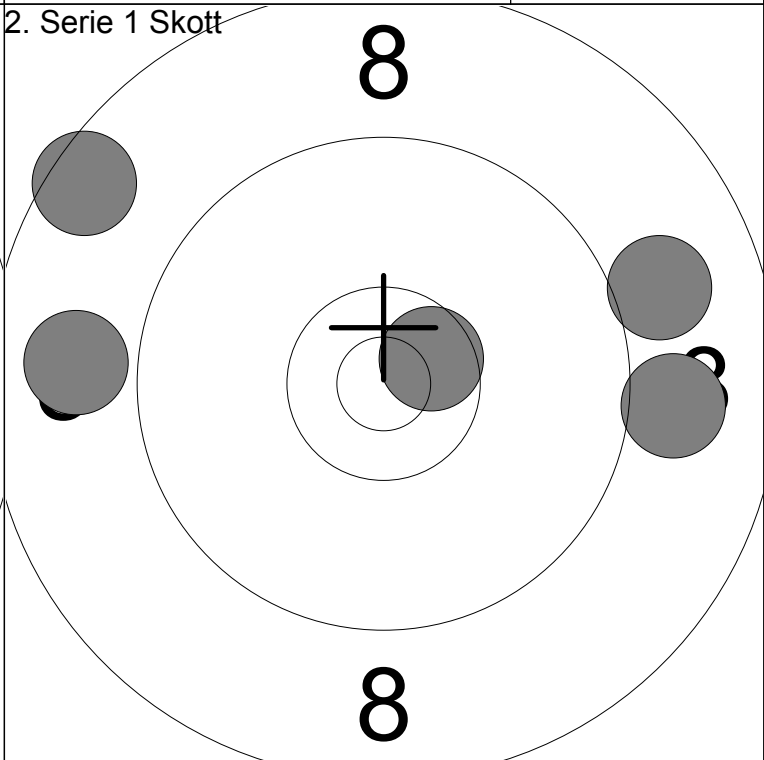
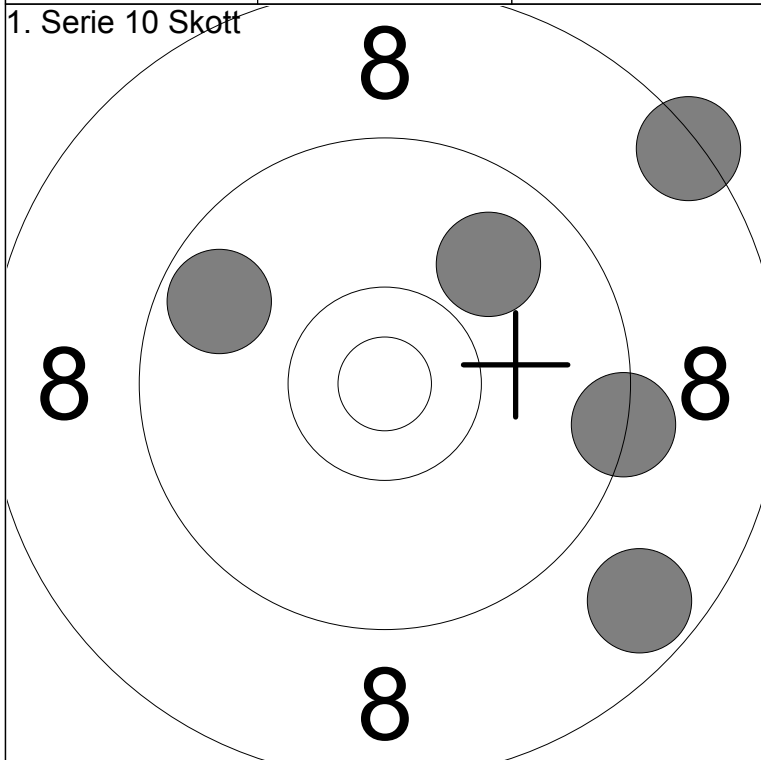

6: 9.3 →	
7: 8.7 ↓	
8: 8.4 ↗	
9: 9.7 ↖	
10: 9.9 ↗	

Serie	43
Total	280

1: 9.0 →	
2: 10.6x ↗	
3: 9.0 →	
4: 8.9 ←	
5: 8.5 ↖	

Serie	44
Total	324

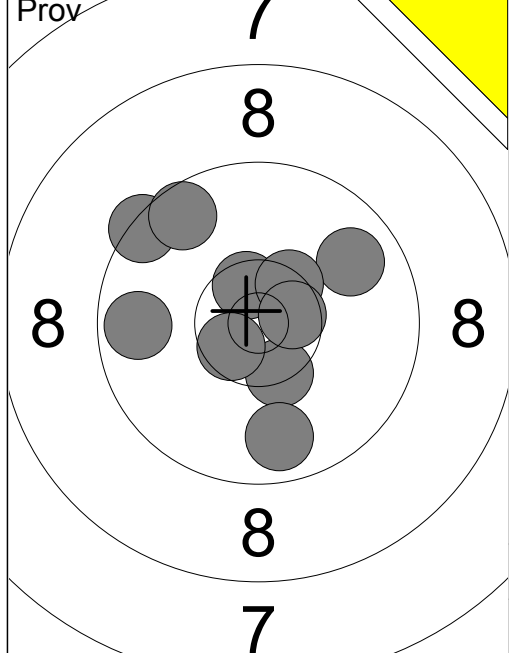

- 1: 9.8 ↗
- 2: 10.4x ↓
- 3: 9.8 ↓
- 4: 9.4 ↖
- 5: 9.6 ↗
- 6: 10.5x ↗
- 7: 9.7 ←
- 8: 10.4x ↗
- 9: 10.6x →
- 10: 10.6x ↙

Serie 95
Total 184

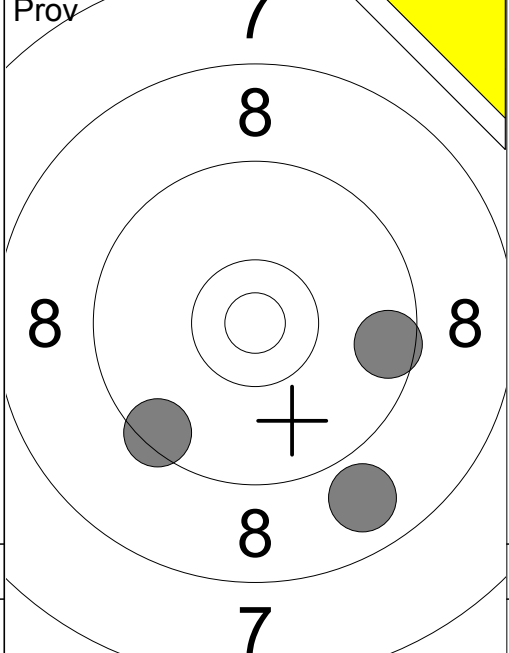

- 11: 9.4 ↙
- 12: 8.9 ↓
- 13: 9.6 →

Serie 26
Total 184

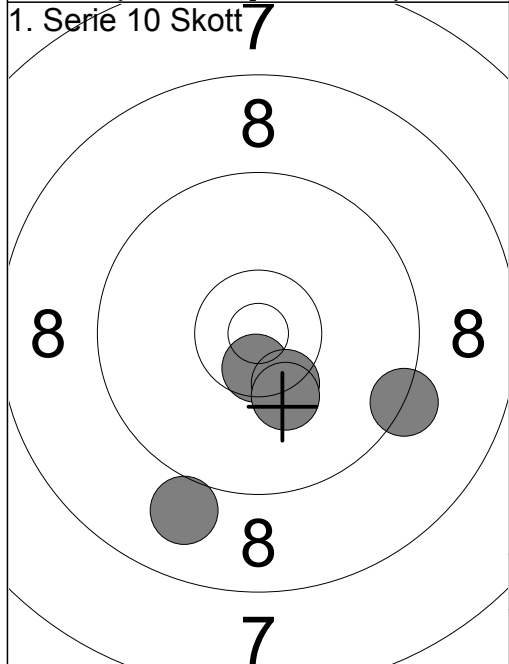

- 1: 9.3 →
- 2: 10.6x ↓
- 3: 9.0 ↓
- 4: 10.4x ↓
- 5: 10.2 ↓

Serie 48
Total 232

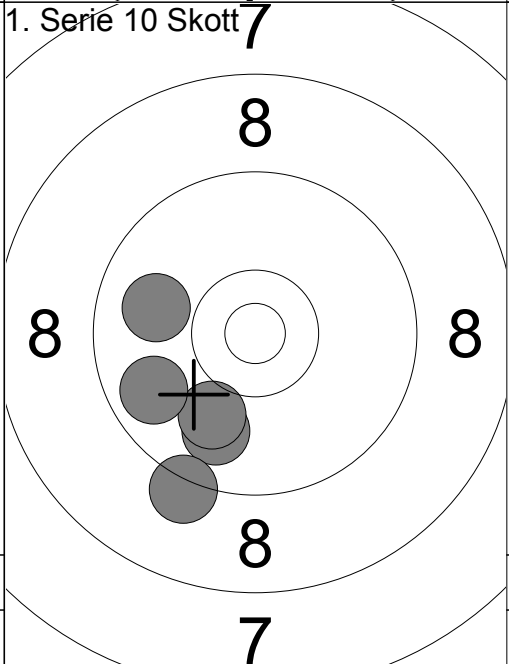

- 6: 9.9 ↓
- 7: 9.2 ↓
- 8: 10.0 ↓
- 9: 9.9 ←
- 10: 9.8 ↙

Serie 46
Total 278

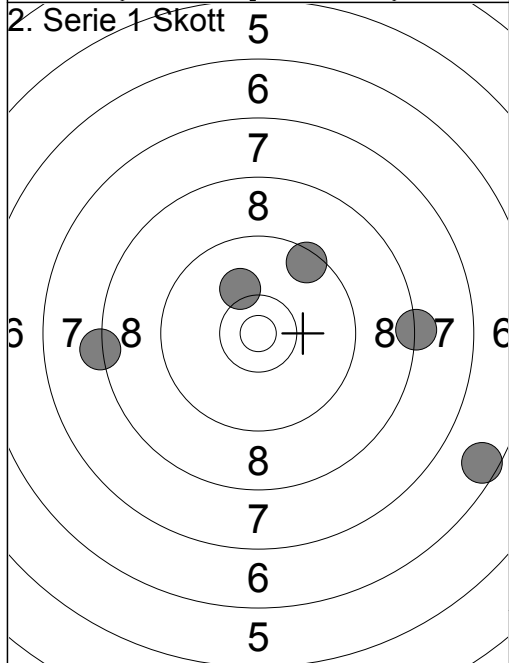

- 1: 8.3 →
- 2: 6.6 ↘
- 3: 10.1 ↗
- 4: 8.3 ←
- 5: 9.5 ↗

Serie 41
Total 319

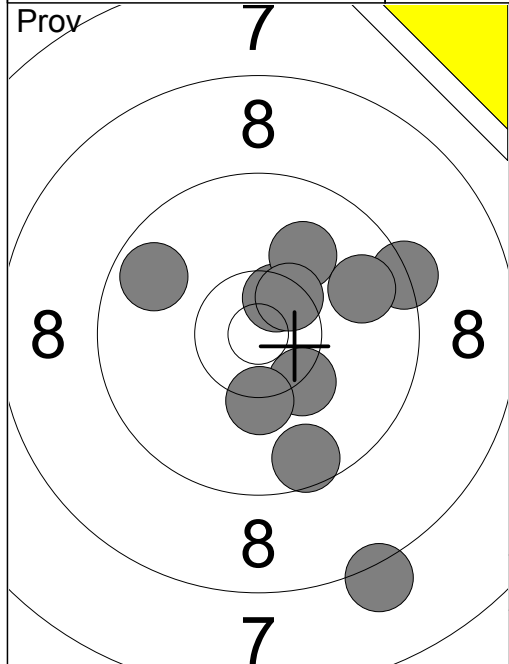

1:	10.5x ↗
2:	9.6 ↓
3:	9.3 →
4:	10.0 ↗
5:	8.2 ↓
6:	9.8 →
7:	9.7 ↖
8:	10.3x ↘
9:	10.3 ↓
10:	10.5x ↗

Serie	94
Total	178

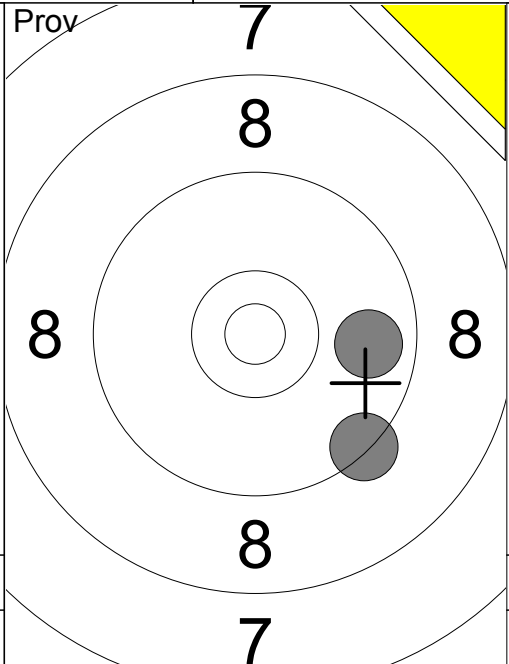

11:	9.4 ↓
12:	9.8 →

Serie	18
Total	178

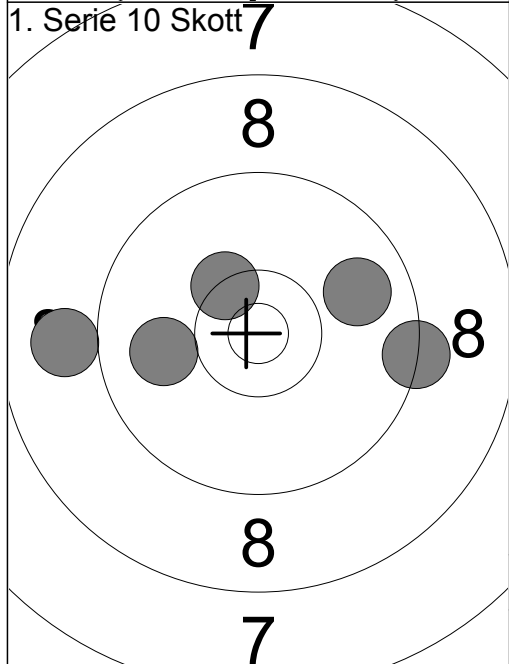

1:	10.0 ←
2:	10.4x ↗
3:	9.3 →
4:	9.0 ←
5:	9.9 →

Serie	47
Total	225

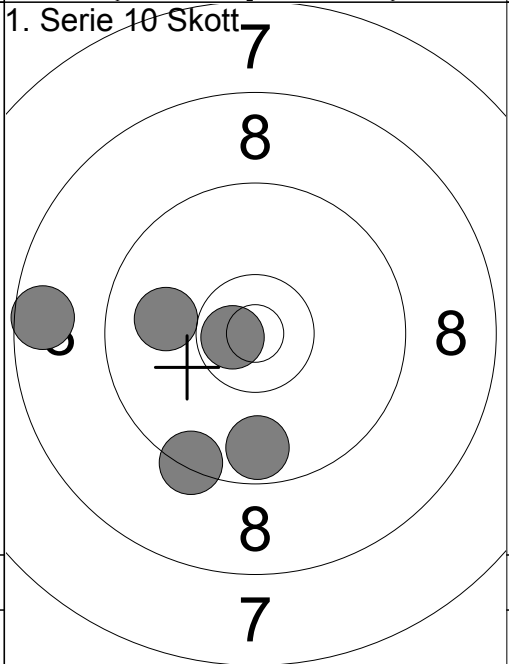

6:	9.4 ↓
7:	8.6 ←
8:	10.0 ←
9:	10.7x ←
10:	9.7 ↓

Serie	46
Total	271

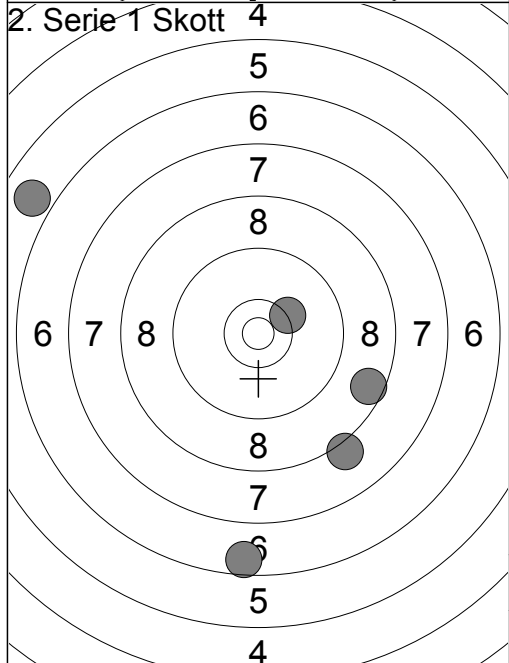

1:	6.6 ↓
2:	8.6 →
3:	10.3 ↗
4:	5.9 ↗
5:	8.1 ↓

Serie	37
Total	308

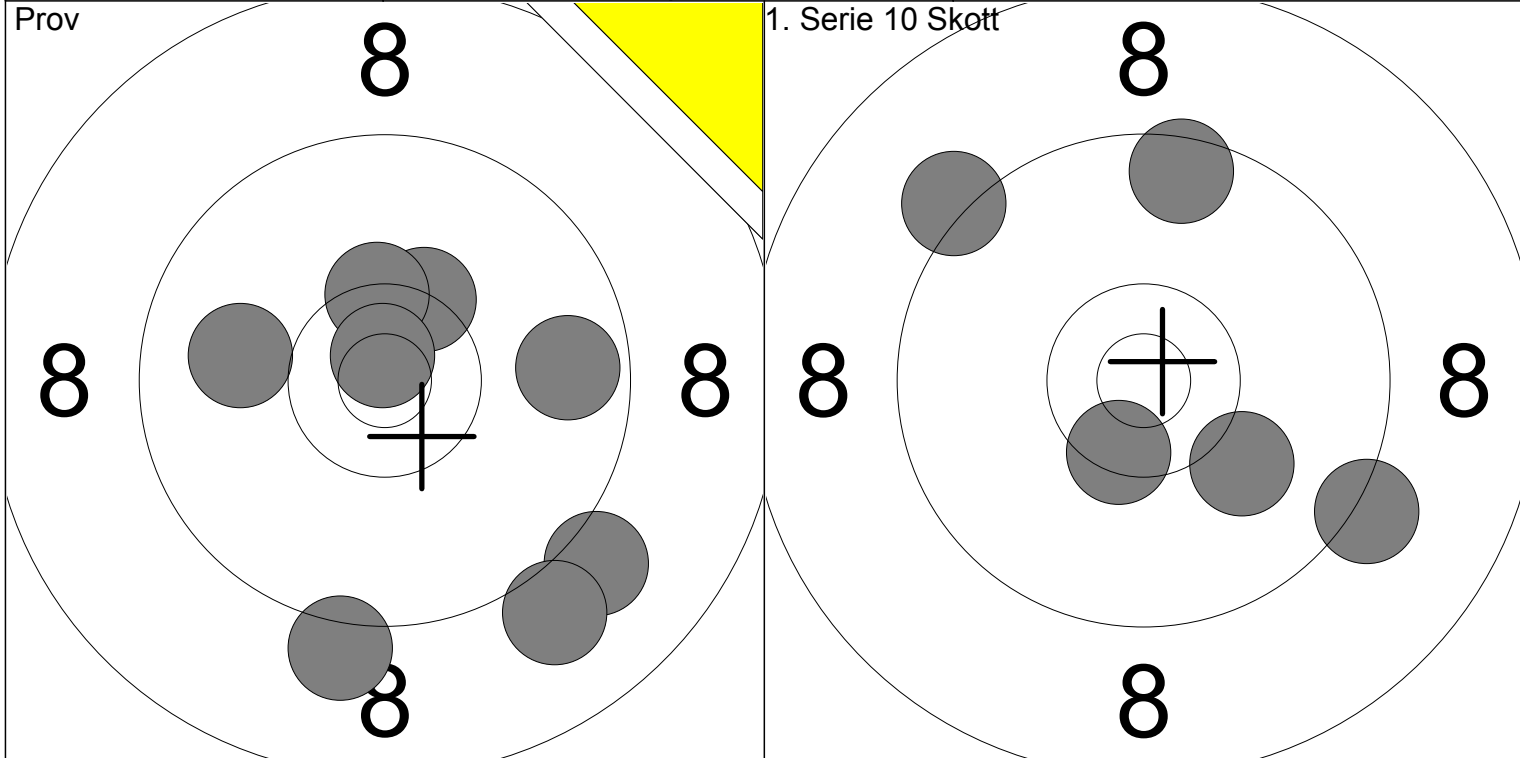

1: 10.0 ←	6: 9.1 ↘			1: 9.2 ↗			
2: 10.3x ↗	7: 9.0 ↘	Serie	76	2: 10.1 ↘	Serie	47	Total
3: 10.4x ↑	8: 9.7 →			3: 9.5 ↑			
4: 10.8x ↑		Total	173	4: 10.4x ↘			
5: 9.1 ↓				5: 9.2 ↘			

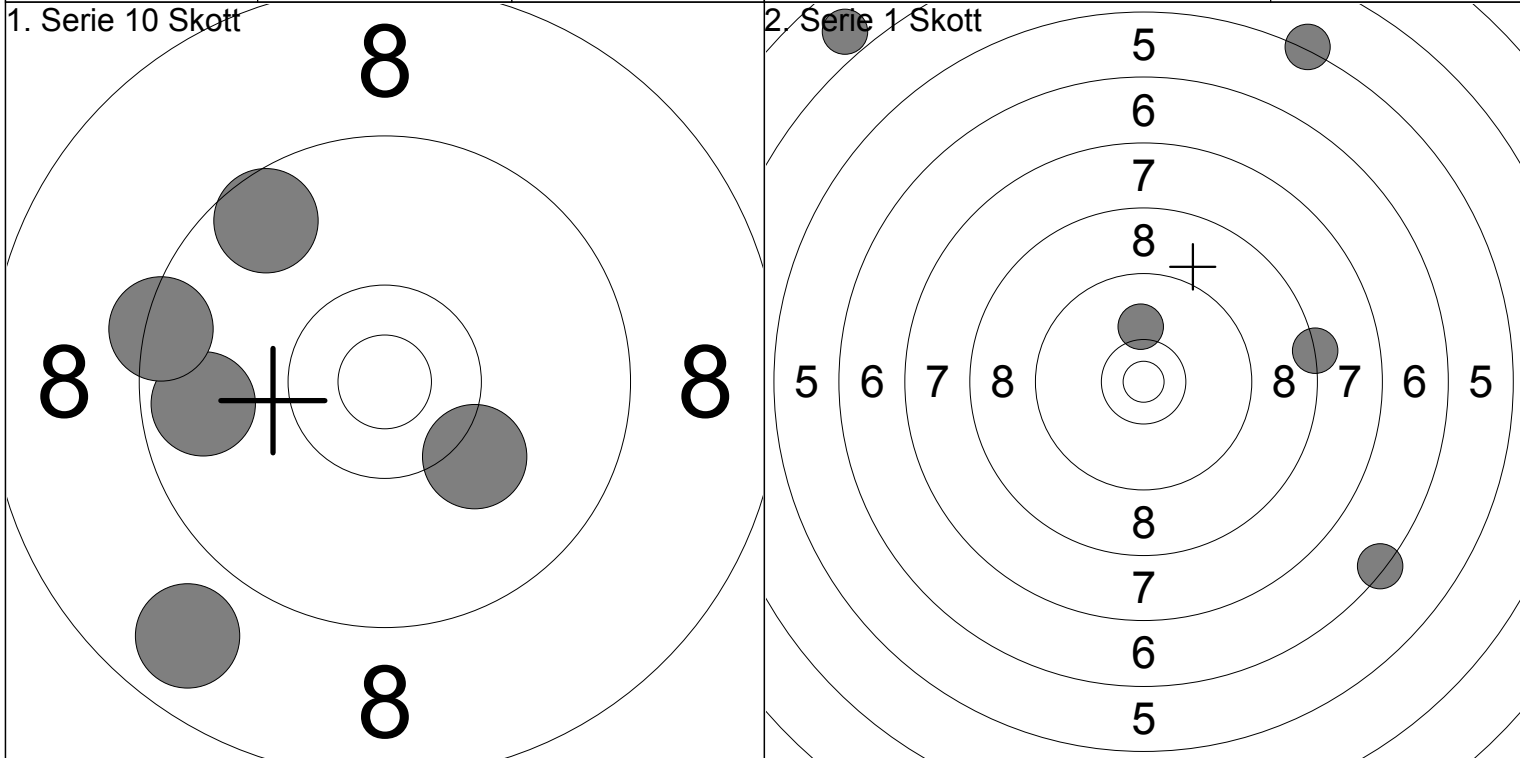

6: 9.7 ←				1: 3.9 ↗			
7: 8.8 ↘		Serie	45	2: 6.4 ↘	Serie	32	Total
8: 9.6 ↗				3: 5.3 ↗			
9: 10.2 ↘		Total	265	4: 8.3 →			
10: 9.4 ←				5: 10.1 ↑			

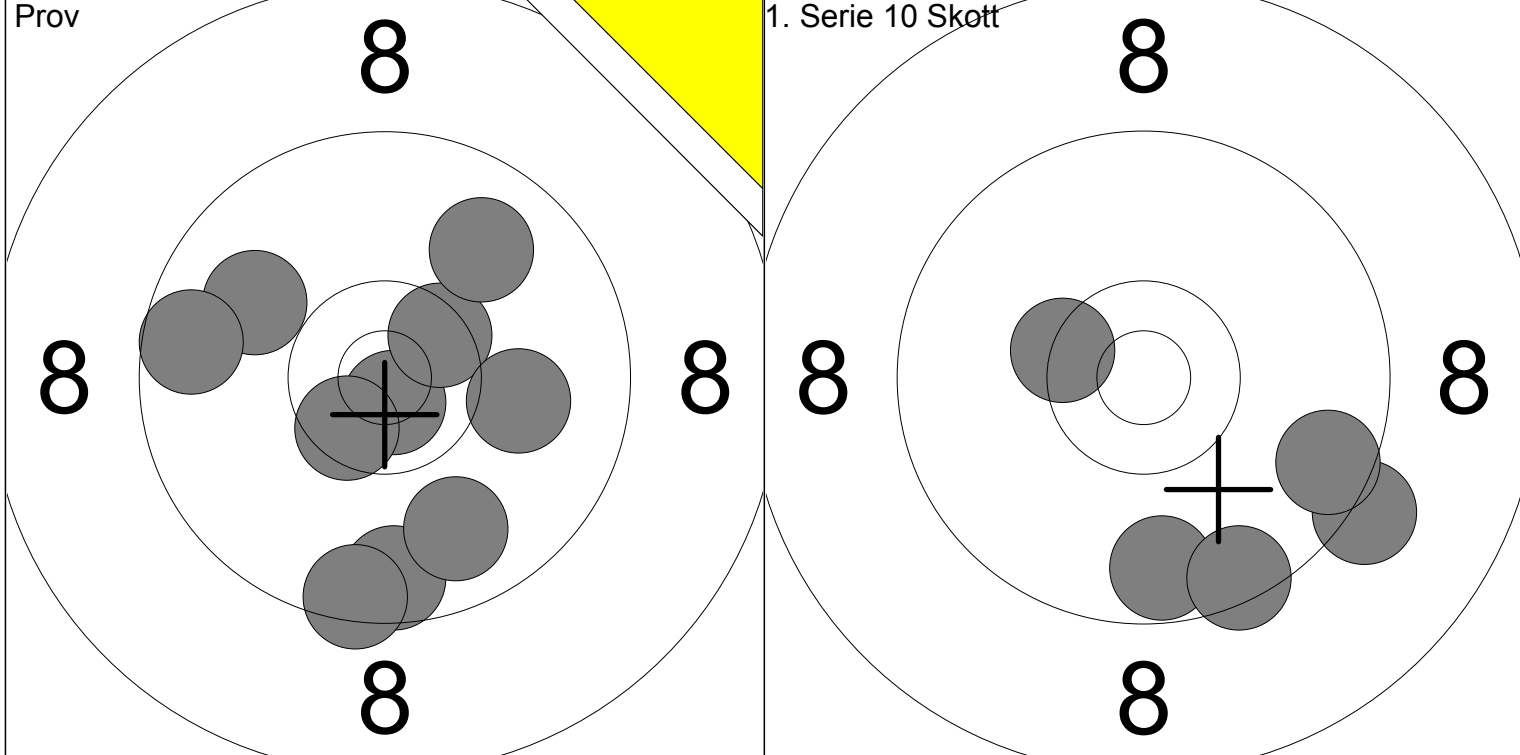

1: 9.9 ↖	6: 10.5x ↗		1: 10.4x ←		
2: 9.6 ←	7: 9.9 ↗	Serie 94	2: 9.7 ↓		Serie 46
3: 9.6 ↓	8: 10.5x ↘		3: 9.2 ↘		
4: 10.8x ↓	9: 9.8 ↓	Total 173	4: 9.5 ↓		Total 219
5: 9.5 ↓	10: 10.0 →		5: 9.6 ↘		

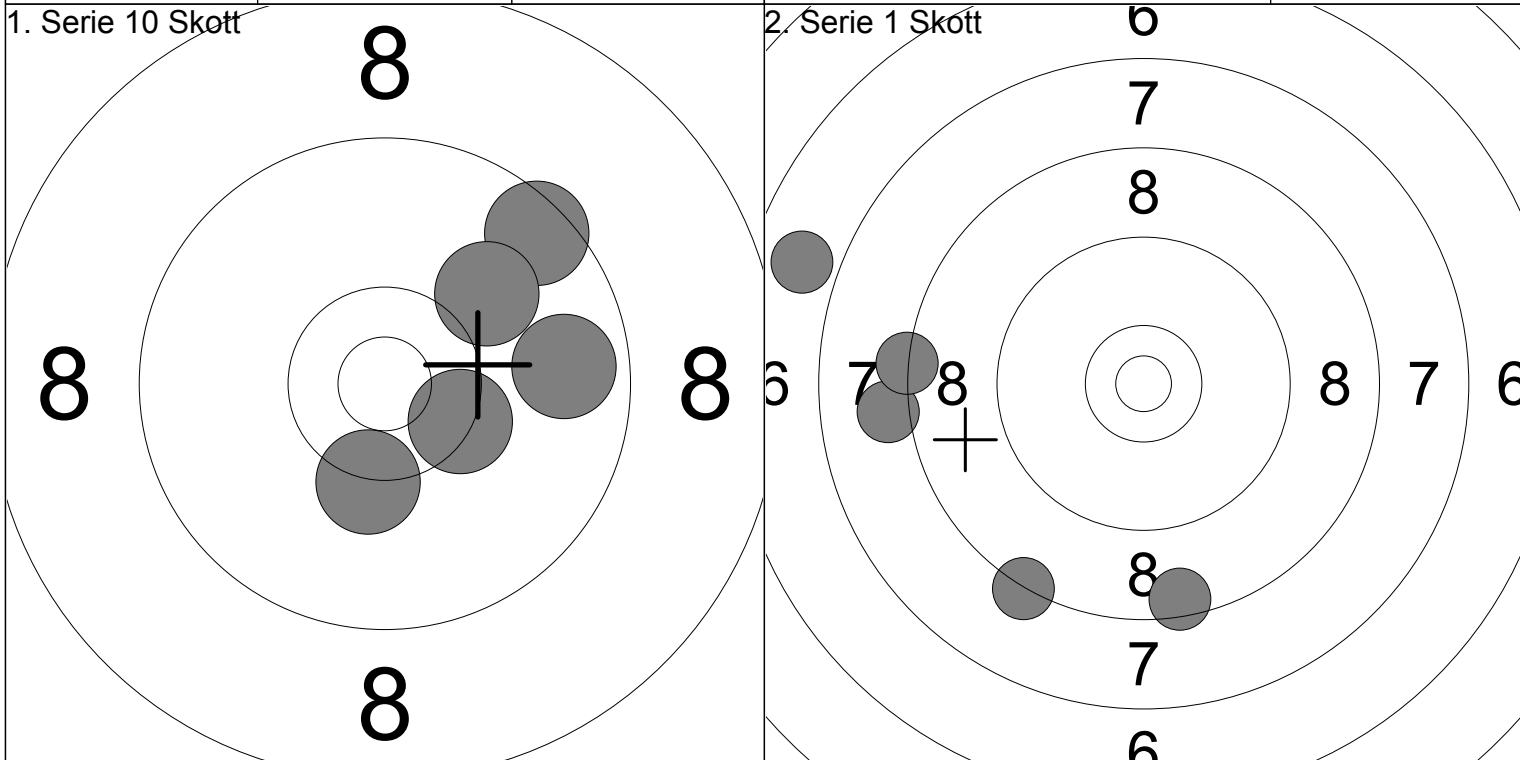

6: 9.7 →			1: 8.1 ←		
7: 10.4x →		Serie 48	2: 8.3 ↘		Serie 38
8: 9.5 ↗			3: 8.3 ←		
9: 10.3 ↓		Total 267	4: 6.9 ↖		Total 305
10: 10.0 ↗			5: 8.5 ↓		

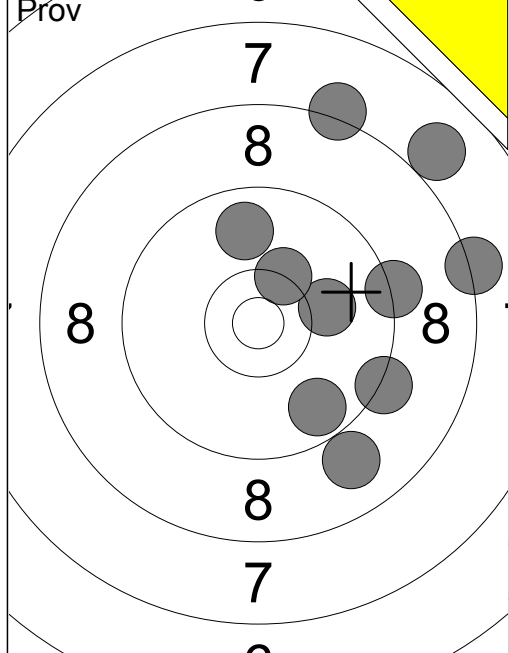

1:	9.2	↘
2:	9.3	→
3:	7.9	↗
4:	8.2	↑
5:	9.8	↑
6:	9.7	↘
7:	8.9	↘
8:	10.1	→
9:	8.2	→
10:	10.3x	↗

Serie	87
Total	153

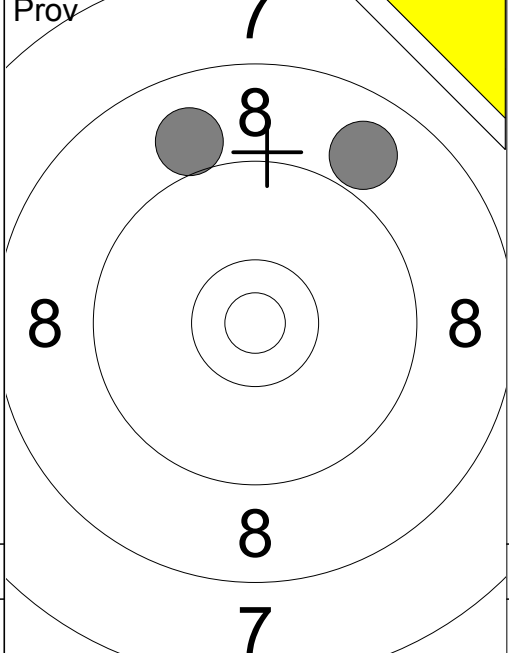

11:	8.9	↗
12:	9.0	↑

Serie	17
Total	153

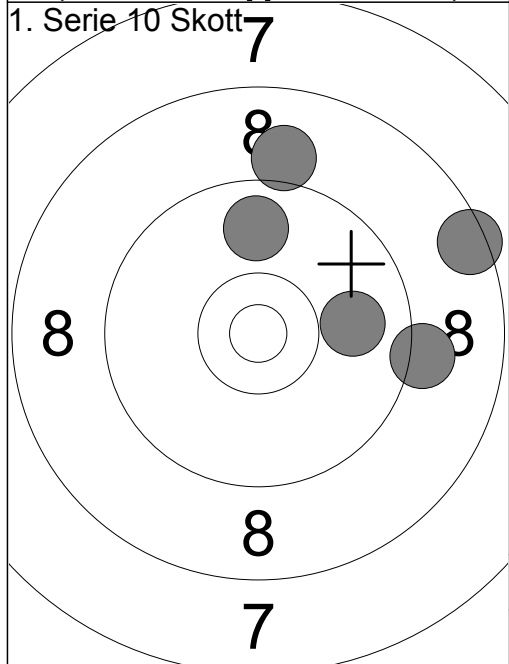

1:	9.0	↑
2:	8.5	→
3:	9.8	↑
4:	9.2	→
5:	9.9	→

Serie	44
Total	197

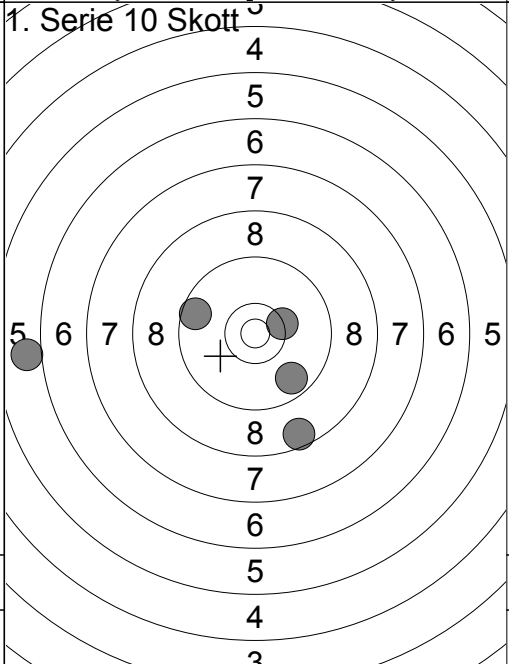

6:	9.7	↘
7:	8.6	↘
8:	6.0	←
9:	9.6	←
10:	10.3x	→

Serie	42
Total	239

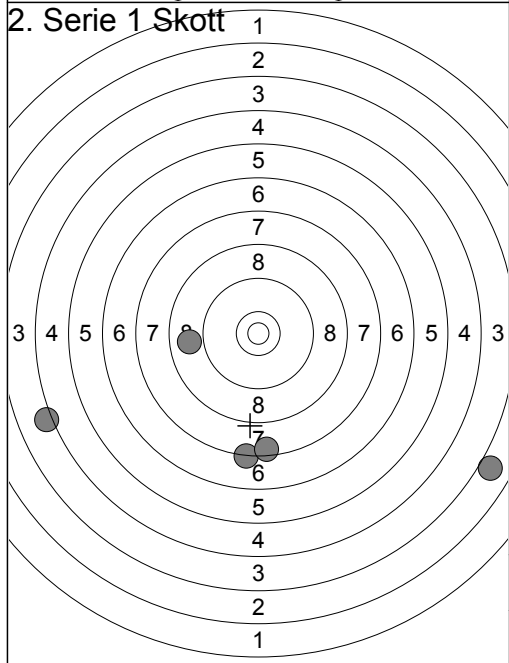

1:	7.3	↓
2:	8.9	←
3:	3.0	↘
4:	4.1	←
5:	7.5	↓

Serie	29
Total	268

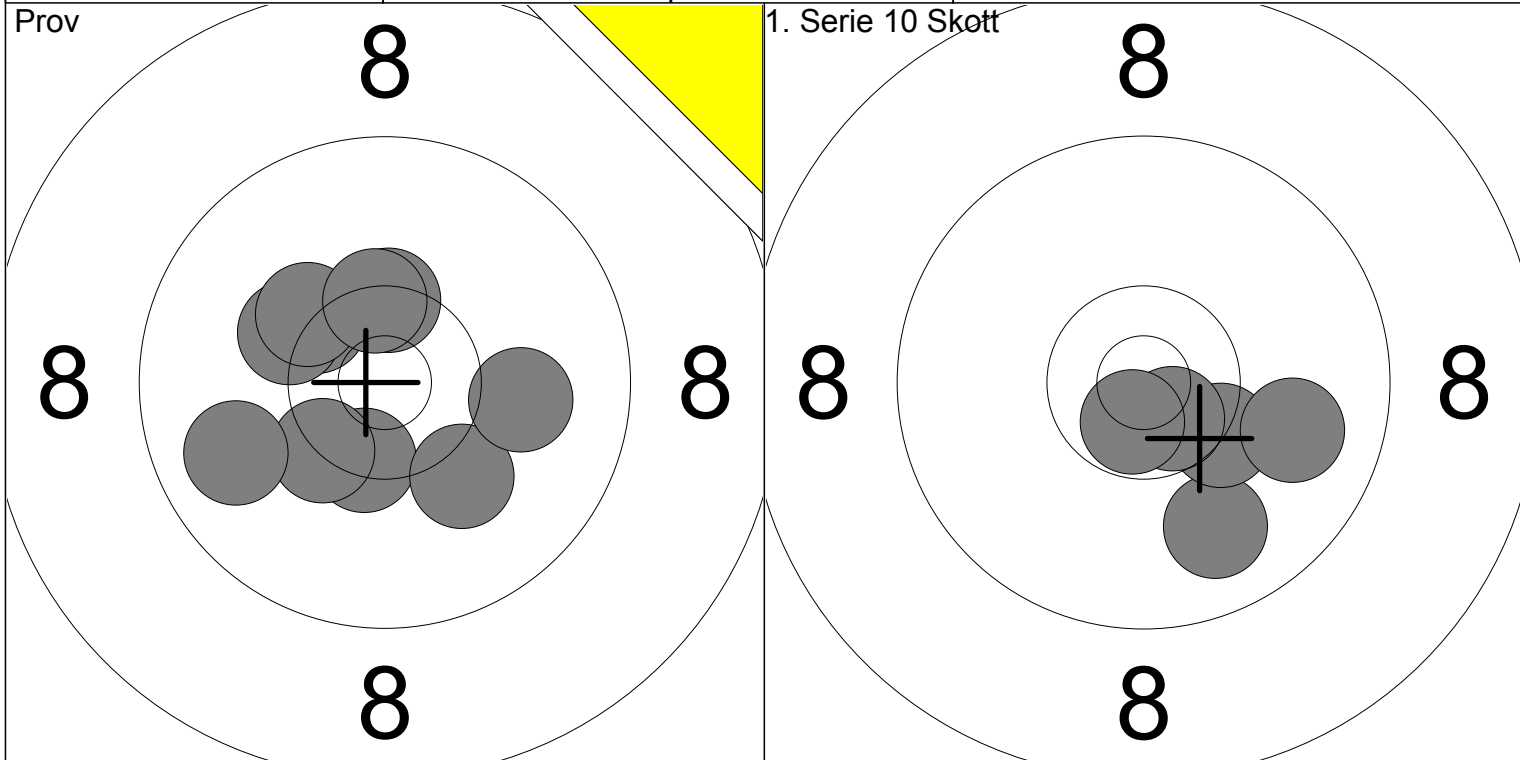

1: 10.4x ↓	6: 10.4x ↑			1: 9.9 ↓			
2: 10.3x ↗	7: 10.0 →	Serie	99	2: 10.3x ↓		Serie	48
3: 10.2 ↗	8: 10.4x ↑	Total	184	3: 10.6x ↓		Total	232
4: 10.3 ↗	9: 10.3x ↓			4: 9.9 ↓			
5: 10.1 ↓	10: 9.8 ←			5: 10.7x ↓			

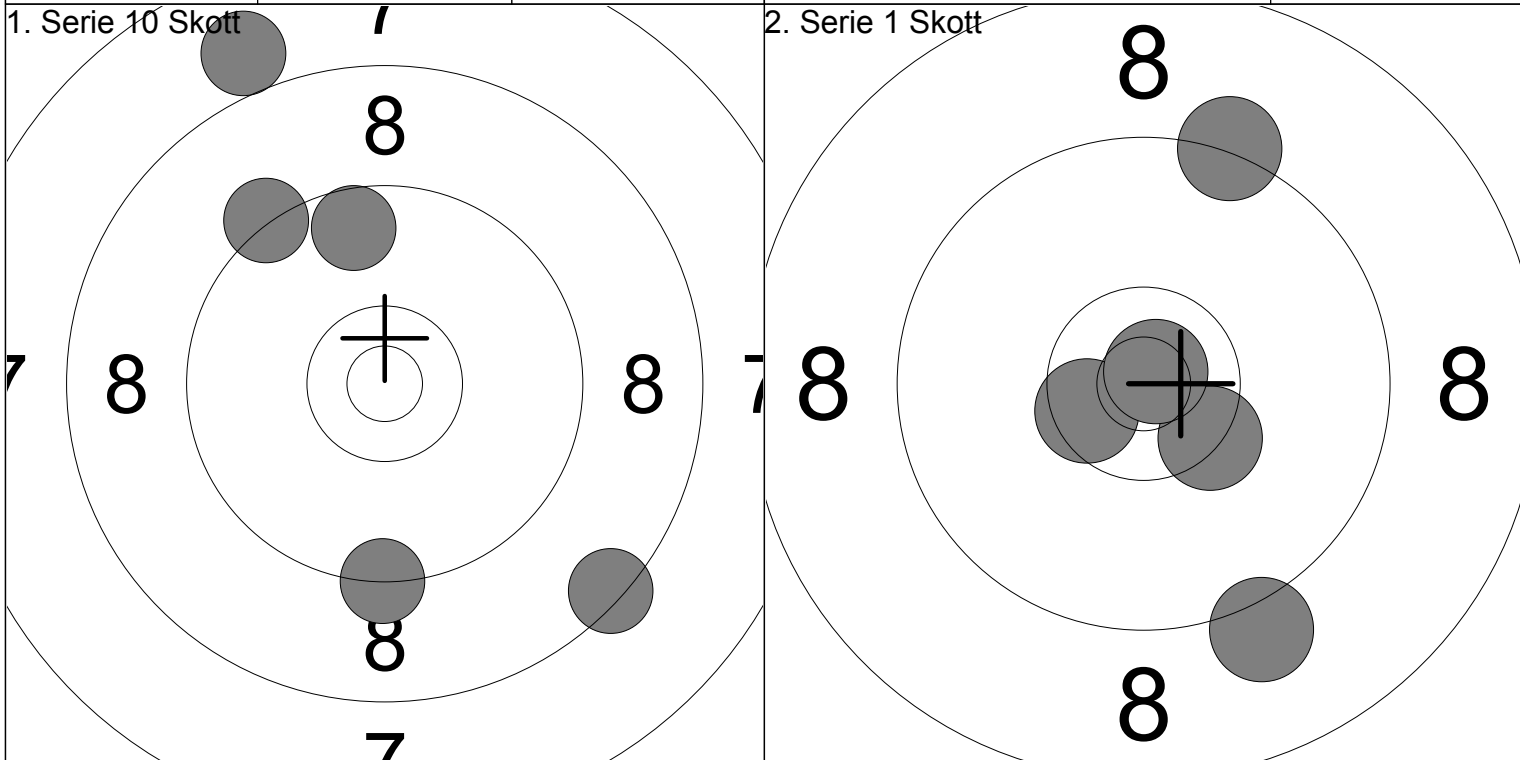

6: 8.4 ↓				1: 10.4x ↓			
7: 9.3 ↗		Serie	43	2: 10.5x ←		Serie	48
8: 9.6 ↗		Total	275	3: 9.3 ↑		Total	323
9: 8.0 ↗				4: 10.8x ↗			
10: 9.3 ↓				5: 9.1 ↓			

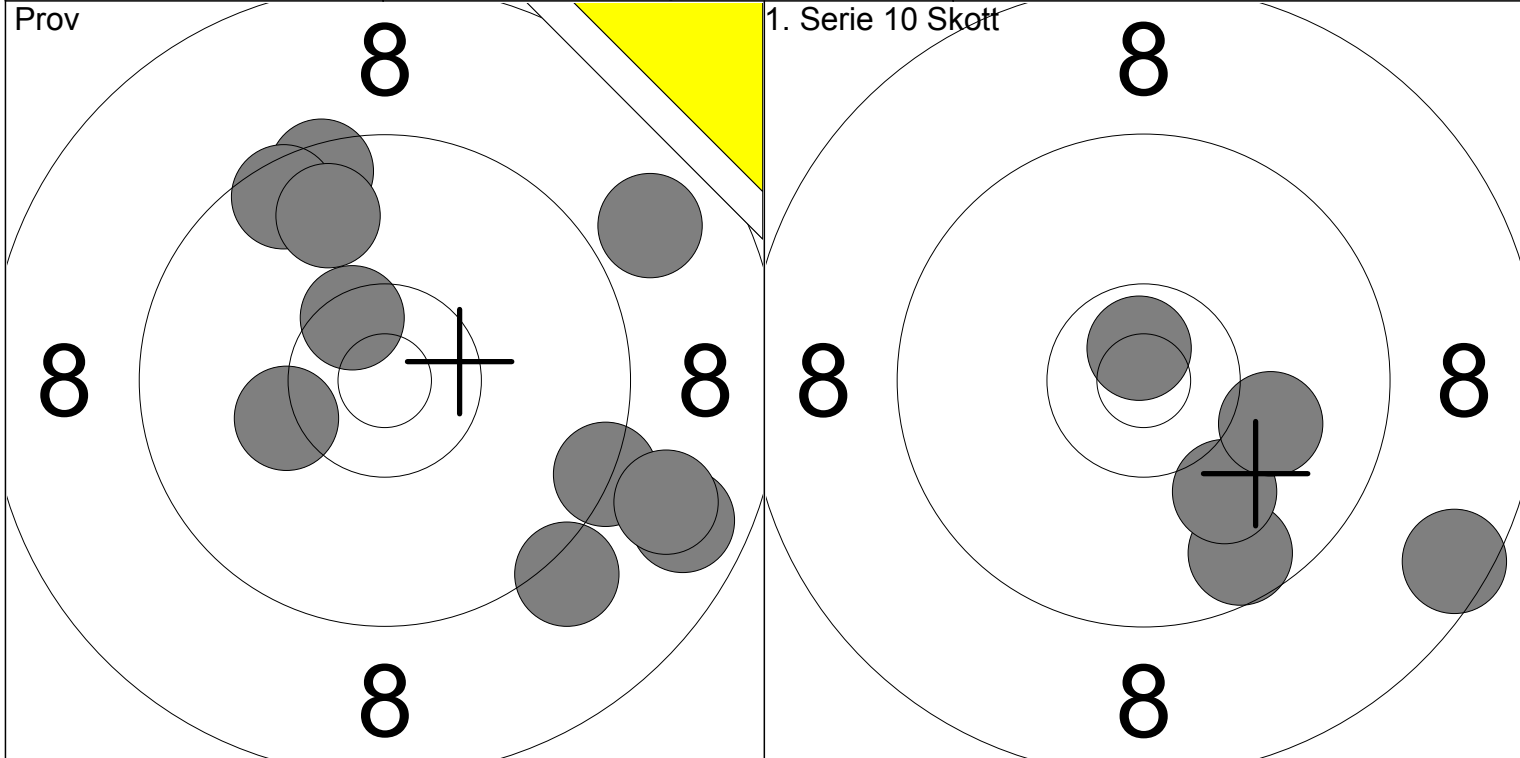

1: 10.5x ↗	6: 10.2 ←			1: 10.7x ↑			
2: 8.9 ↗	7: 9.5 ↗	Serie	89	2: 9.6 ↘	Serie	47	Total
3: 9.3 ↘	8: 9.5 ↗			3: 10.0 ↘			
4: 9.2 ↘	9: 9.8 ↗	Total	183	4: 10.0 ↘	Total	230	Total
5: 8.7 ↘	10: 8.9 ↘			5: 8.5 ↘			

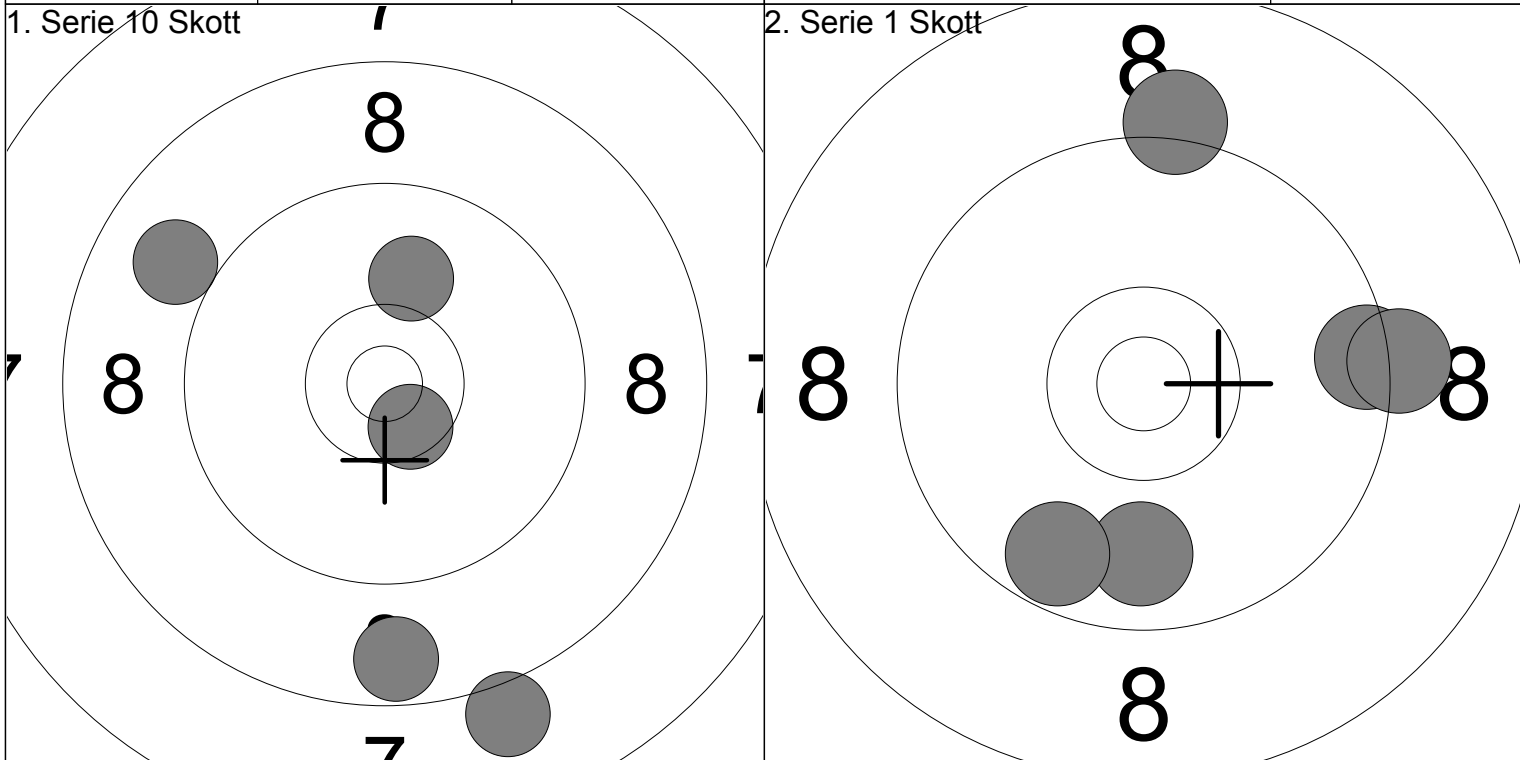

6: 10.5x ↘				1: 9.2 ↑			
7: 10.1 ↑	8: 8.7 ↘	Serie	45	2: 9.8 ↘	Serie	45	Total
9: 9.0 ↗	10: 8.1 ↘			3: 9.7 ↘			
		Total	275	4: 9.4 →	Total	320	Total
				5: 9.2 →			

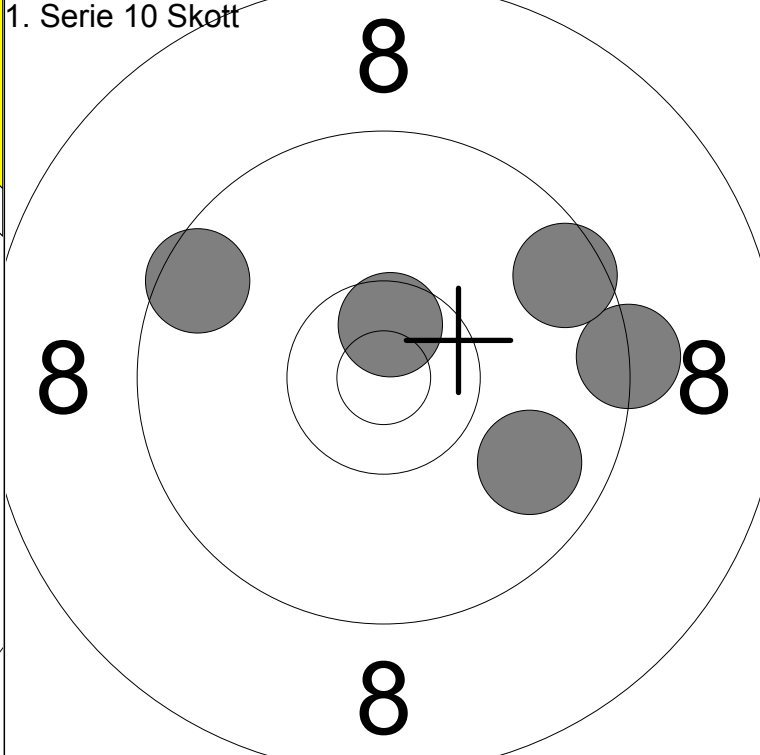
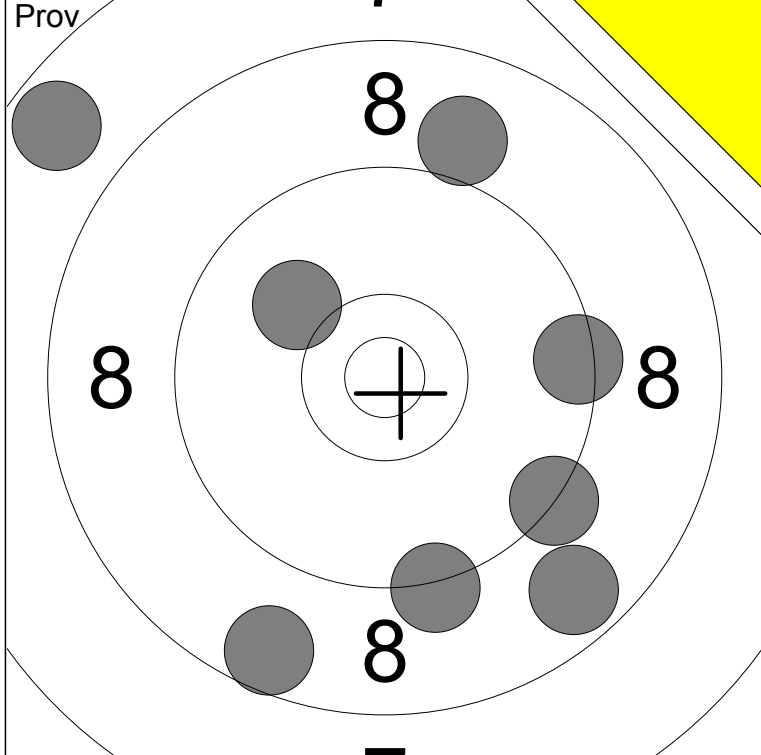

1: 7.7 ↗	6: 9.3 ↘	Serie	69
2: 9.0 ↑	7: 8.7 ↘		
3: 10.1 ↗	8: 9.3 ↘	Total	178
4: 8.6 ↘			
5: 9.4 →			

1: 9.5 ↖	Serie	46
2: 10.6x ↑		
3: 9.3 →	Total	224
4: 9.6 ↗		
5: 9.8 ↘		

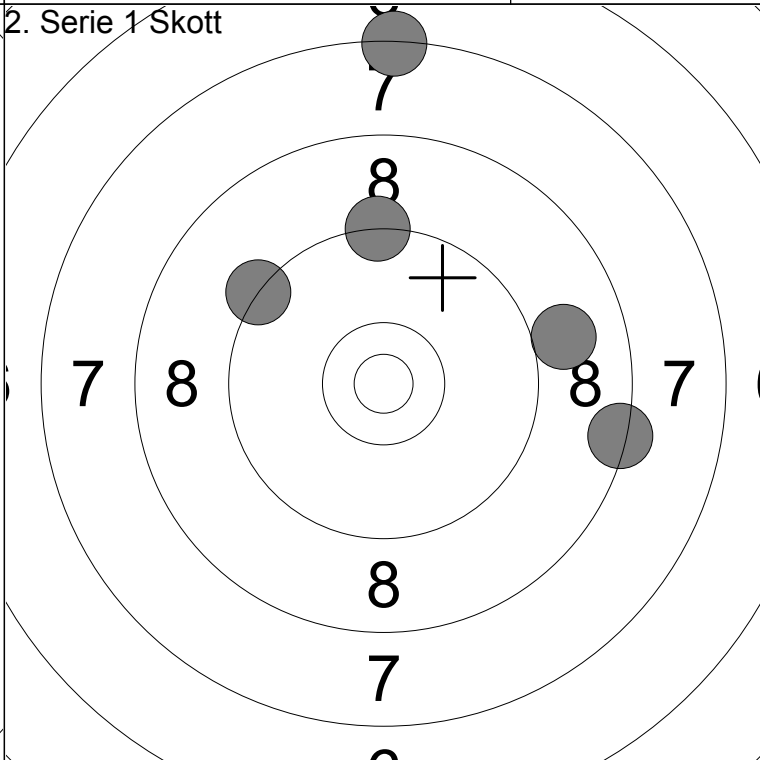
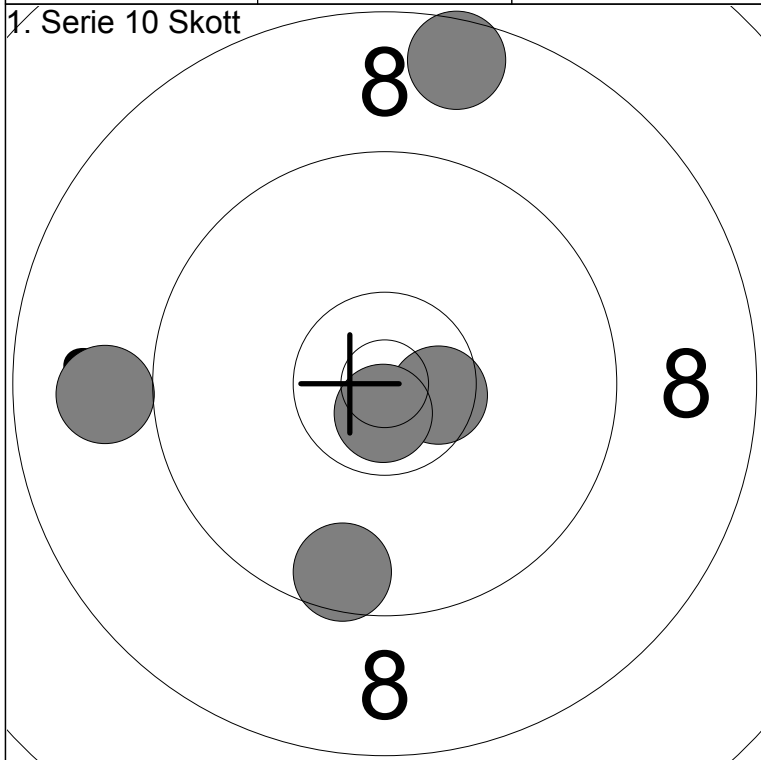

6: 10.6x →	Serie	46
7: 8.6 ↑		
8: 10.7x ↓	Total	270
9: 9.6 ↓		
10: 9.0 ←		

1: 9.0 →	Serie	42
2: 9.3 ↗		
3: 9.3 ↑	Total	312
4: 8.4 →		
5: 7.3 ↑		

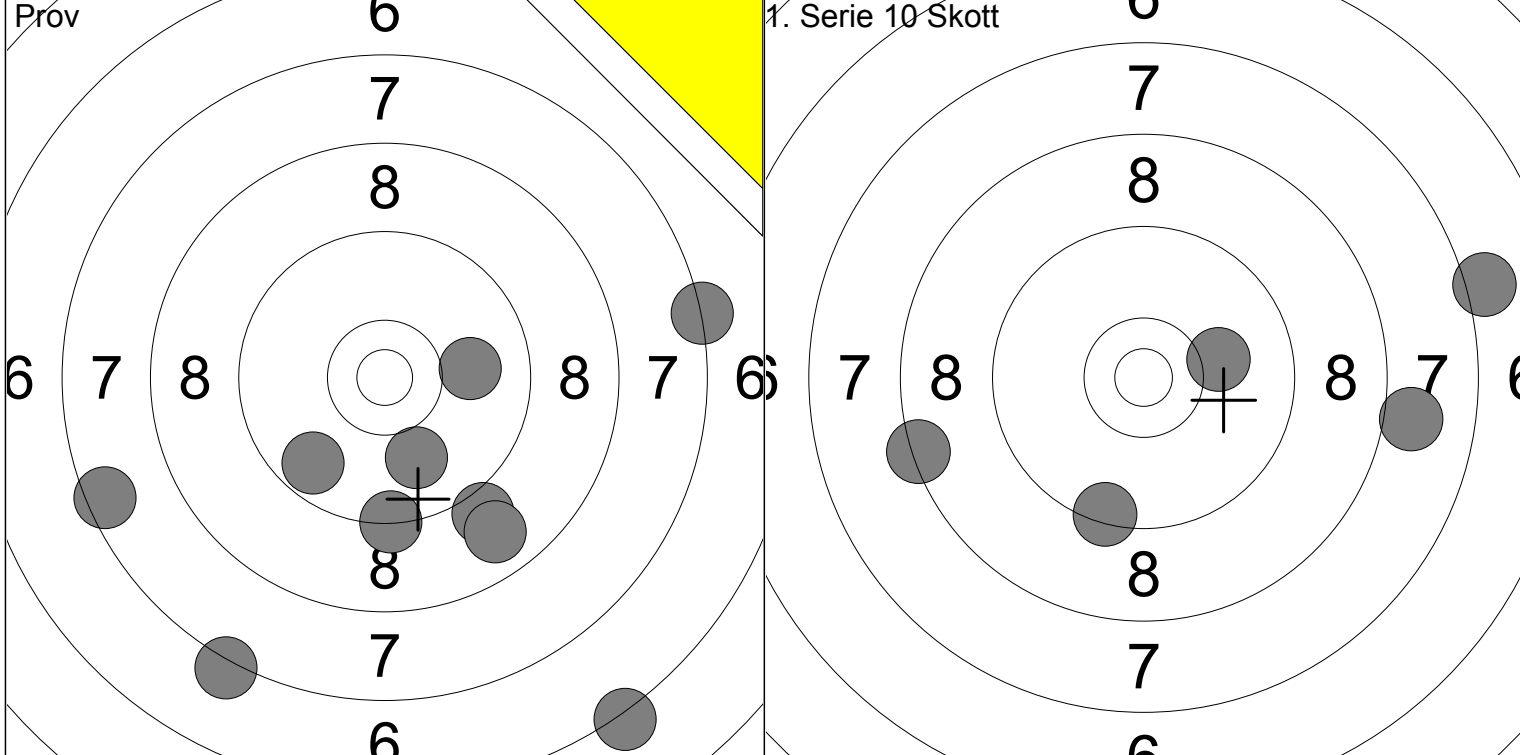

1: 9.3 ↓	6: 9.0 ↓	Serie	82	1: 8.4 ←	Serie	42
2: 7.5 ←	7: 10.0 →			2: 7.1 →		
3: 7.2 ↓	8: 10.0 ↓	Total	132	3: 9.4 ↓	Total	174
4: 6.2 ↓	9: 9.7 ↓			4: 8.0 →		
5: 7.3 →	10: 8.8 ↓			5: 10.1 →		

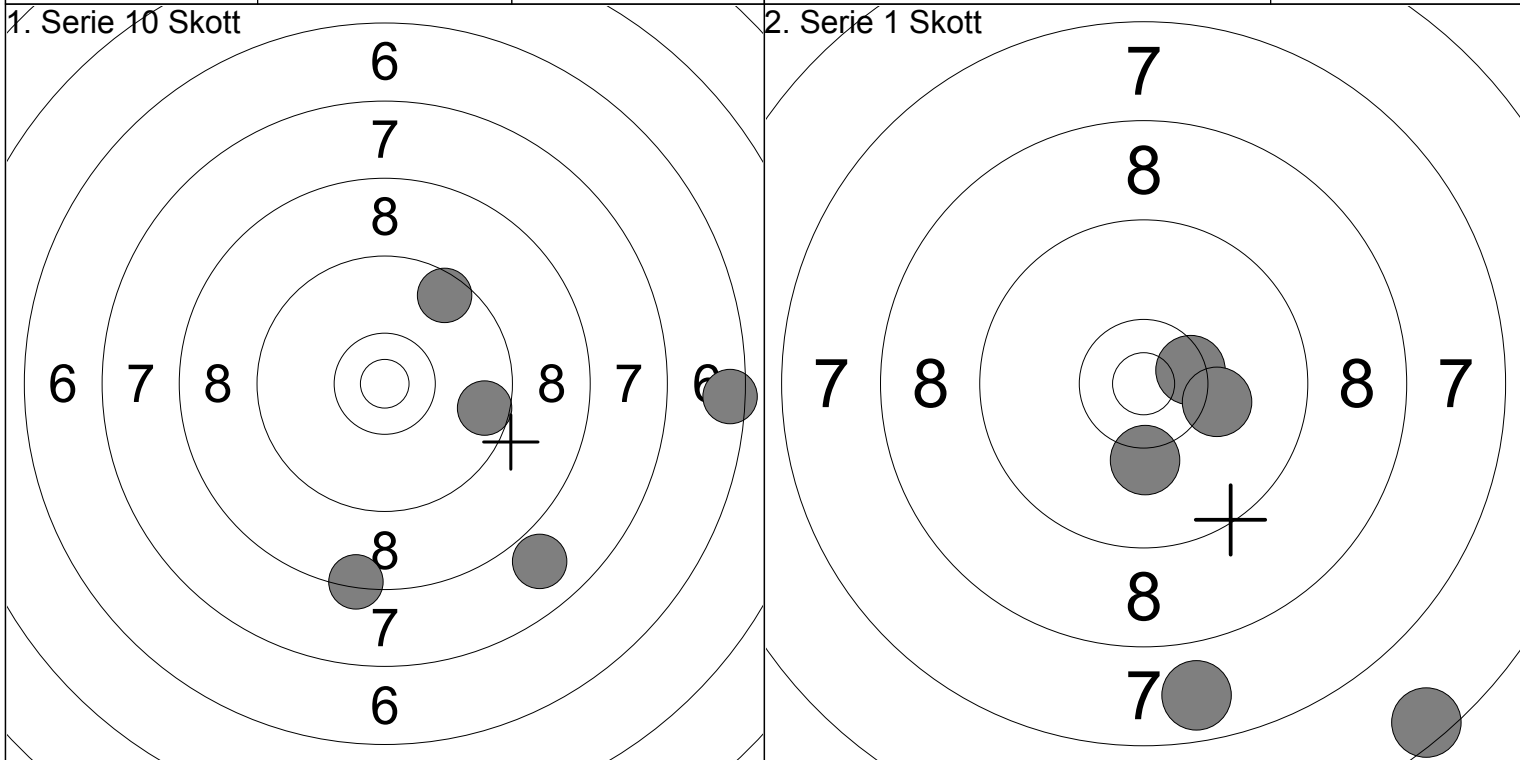

6: 9.6 →	Serie	39	1: 10.2 ↓	Serie	43
7: 7.9 ↓			2: 7.8 ↓		
8: 6.5 →	Total	213	3: 10.5x →	Total	256
9: 9.6 ↗			4: 10.2 →		
10: 8.4 ↓			5: 6.5 ↓		