

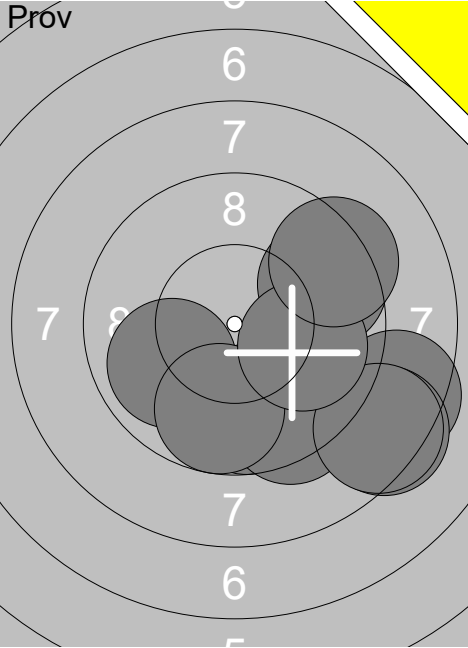
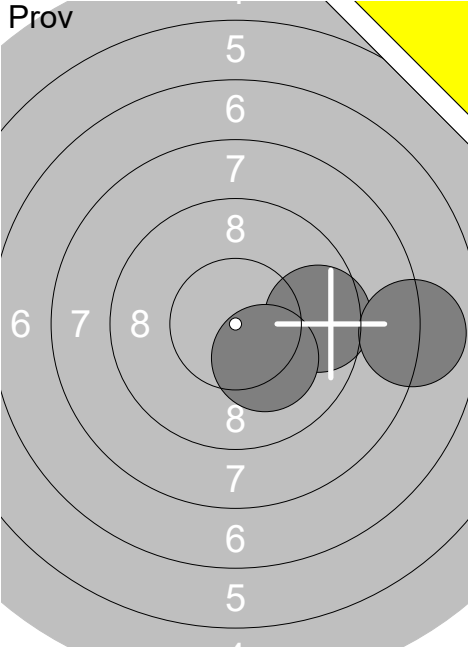
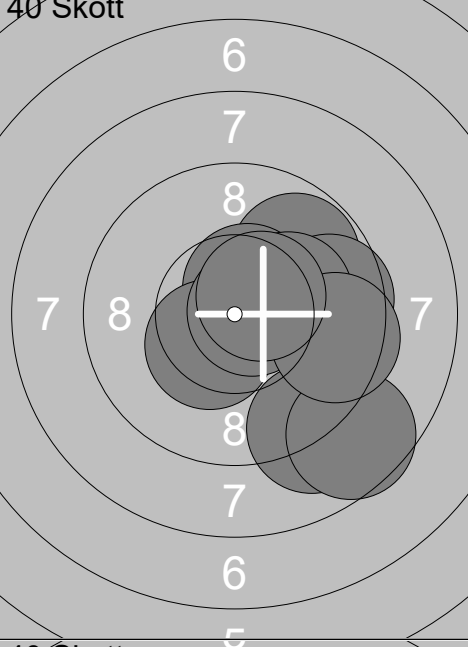
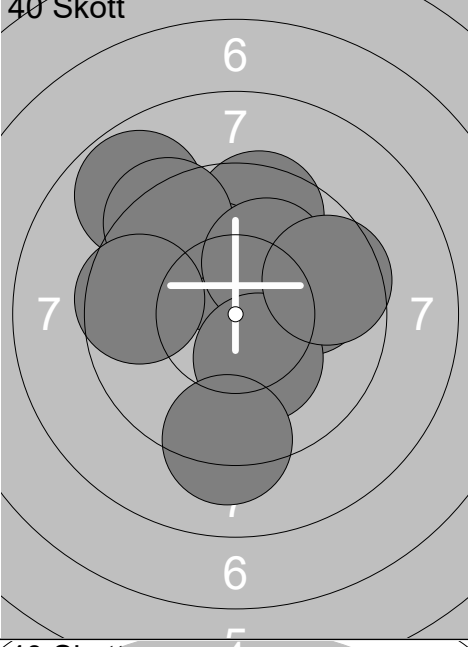
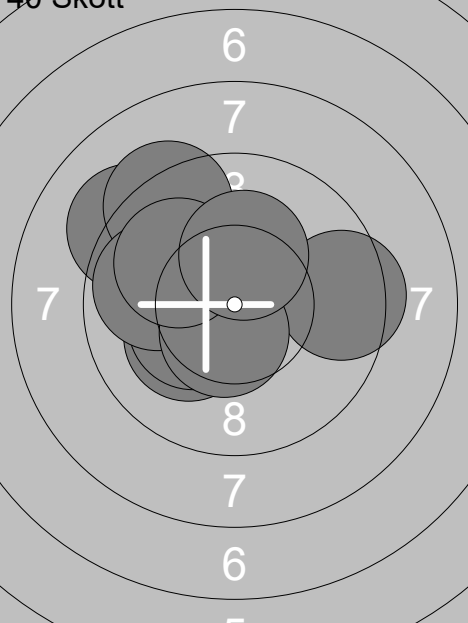
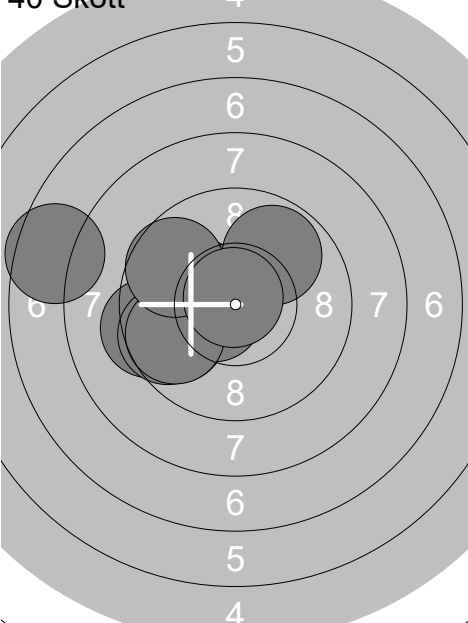
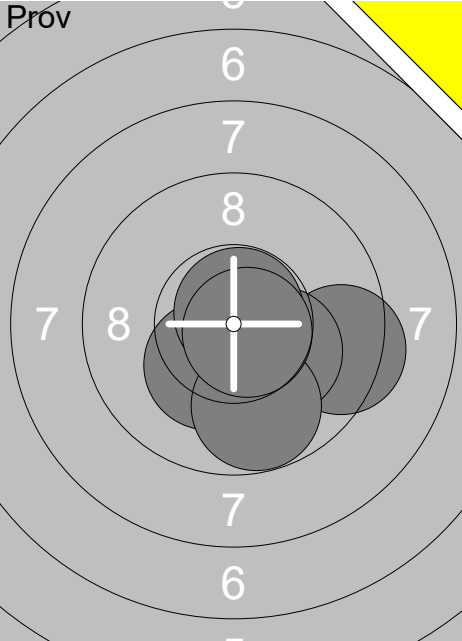
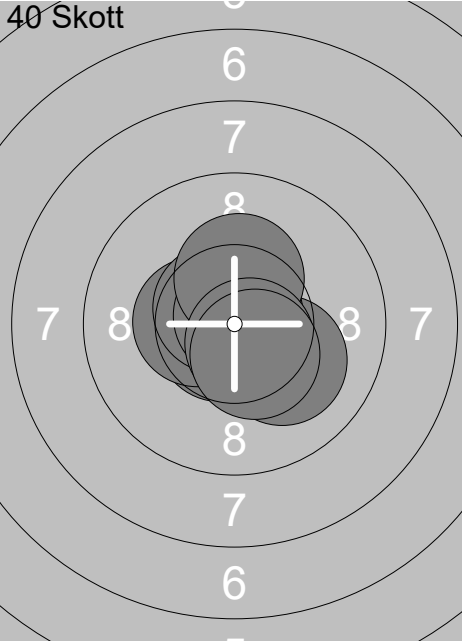
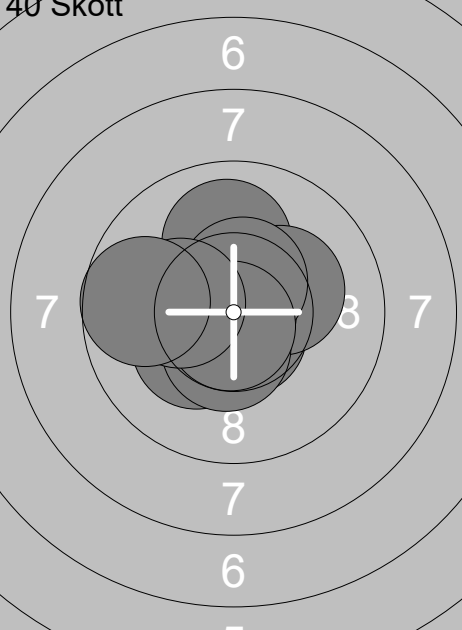
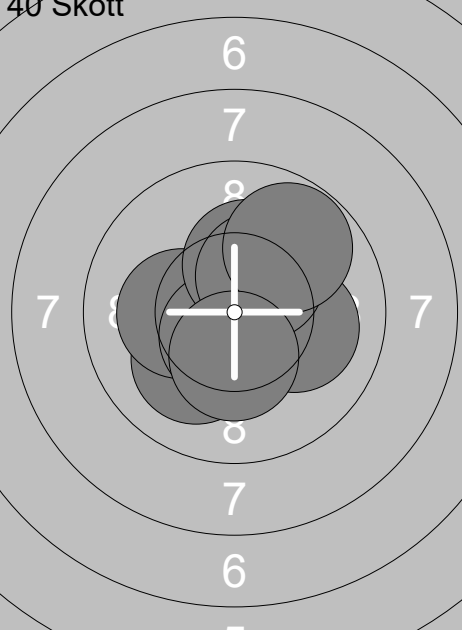
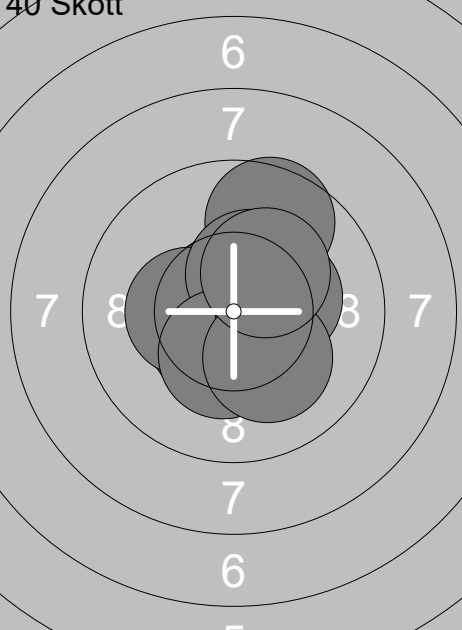
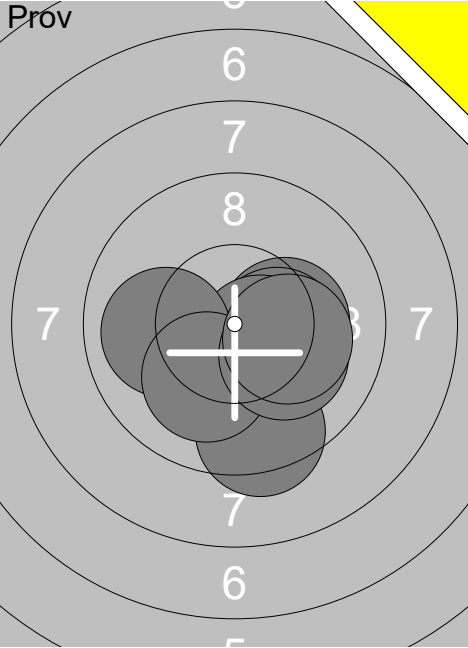
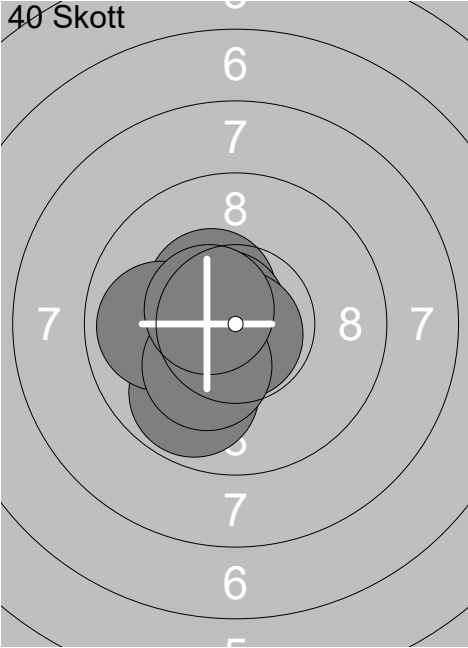
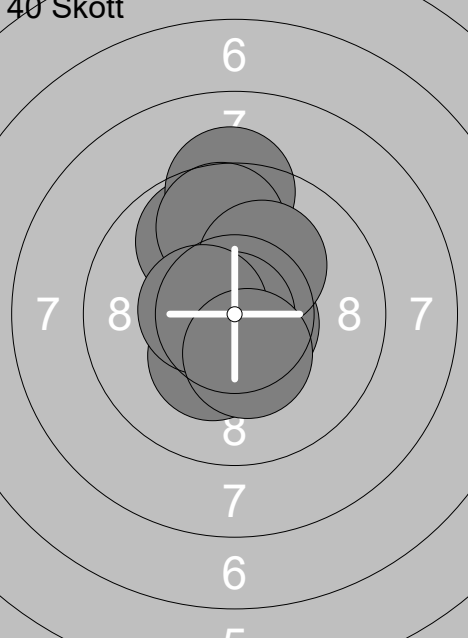
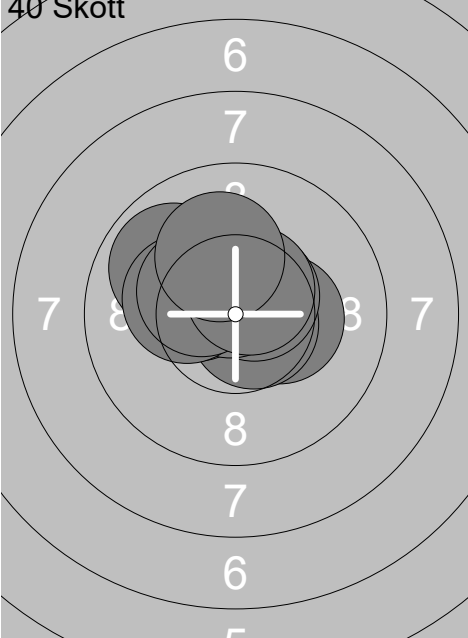
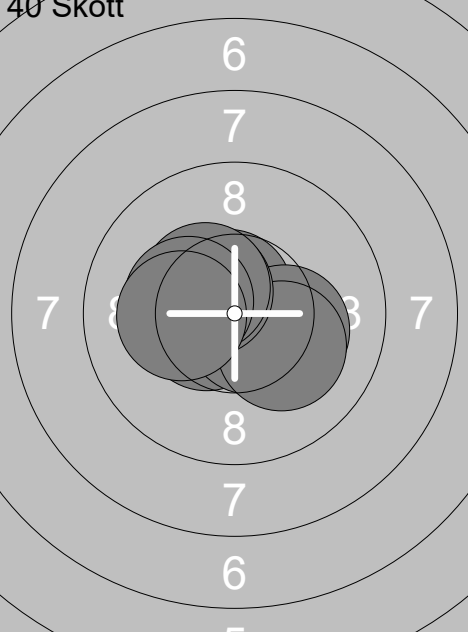

Skjuttag	Tavla	Ellen Alenius	
1	11	Ramselefors	Ramselefors
07.11.2021	Vindelnskyttet 2021	9	Vb
07.11.2021		Vindelnskyttet 2021	Ramselefors SKF
Prov 	1: 10.2x ← 2: 9.6 ↘ 3: 10.8x → 4: 10.4x ← 5: 10.4x ↘ 6: 10.6x ↘ 7: 10.7x → 8: 9.6 ← 9: 9.6 ← 10: 10.5x ↑ Serie 97 Total 0	Prov 	11: 9.9 ← 12: 10.4x ↖ 13: 10.5x ↗ 14: 9.7 → 15: 10.4x ↑ 16: 10.2x ↘ Serie 58 Total 0
40 Skott 	1: 9.9 → 2: 10.9x ↘ 3: 10.9x ↘ 4: 10.4x → 5: 10.6x ↗ 6: 10.5x → 7: 9.7 ↘ 8: 10.5x ↗ 9: 10.5x ↘ 10: 10.2x ← Serie 98 Total 98	40 Skott 	11: 10.1 ↗ 12: 10.0 ↖ 13: 10.6x ↘ 14: 9.0 ↘ 15: 10.0 ↘ 16: 9.7 → 17: 10.6x → 18: 10.4x ↘ 19: 10.7x ← 20: 9.7 ↗ Serie 97 Total 195
40 Skott 	21: 10.7x ↘ 22: 10.4x ← 23: 10.0 ← 24: 10.3x ← 25: 10.2x ↘ 26: 10.1 ↗ 27: 10.2x → 28: 10.3x → 29: 10.2x ↗ 30: 10.1 ↑ Serie 100 Total 295	40 Skott 	31: 10.2x ↘ 32: 10.5x ↗ 33: 9.9 ↘ 34: 10.4x ← 35: 9.8 ↗ 36: 10.2x ↑ 37: 10.4x ↘ 38: 10.7x ↘ 39: 10.7x ↗ 40: 10.2x ← Serie 98 Total 393

Skjutlag	Tavla	Alex Hansson			
1	13	Ramselefors	Vännäs	9	
07.11.2021	Vindelnskytten 2021	Ramselefors SKF			
Prov		1: 9.8 ↓ 2: 8.5 → 3: 9.4 ↓ 4: 9.9 ← 5: 8.4 ↓ 6: 8.5 ↓ 7: 9.6 → 8: 9.8 ↓ 9: 10.0 → 10: 9.3 →	Prov		11: 9.6 → 12: 8.0 → 13: 10.2x ↓
	Serie 88		Serie 27		
	Total 0		Total 0		
40 Skott		1: 9.0 ↓ 2: 9.8 → 3: 8.6 ↓ 4: 10.6x ↗ 5: 10.4x ↘ 6: 9.6 → 7: 10.2x → 8: 10.7x → 9: 9.5 → 10: 10.5x ↗	40 Skott		11: 9.9 → 12: 9.5 ↑ 13: 10.2x ↗ 14: 8.8 ↗ 15: 9.4 ↗ 16: 9.6 ← 17: 10.1 ↗ 18: 10.3x ↓ 19: 9.6 → 20: 9.2 ↓
	Serie 94		Serie 92		
	Total 94		Total 186		
40 Skott		21: 10.2x ↘ 22: 9.5 → 23: 10.3x ↘ 24: 9.2 ↖ 25: 10.6x ← 26: 9.3 ↗ 27: 9.8 ← 28: 10.5x ↓ 29: 10.0 ↖ 30: 10.3x ↗	40 Skott		31: 9.3 ← 32: 10.2x ↖ 33: 9.8 ← 34: 9.6 ← 35: 7.6 ← 36: 9.8 ↗ 37: 10.5x ← 38: 9.7 ← 39: 9.7 ↖ 40: 10.8x ↗
	Serie 96		Serie 91		
	Total 282		Total 373		

Skjutlag	Tavla	Emelie Albihn		
1	14	Ramselefors	Vännäs	13 Vb
07.11.2021	Vindelnskytten 2021	Ramselefors SKF		
Prov 	1: 10.3x ↘ 2: 9.4 → 3: 10.2x ↘ 4: 9.8 ↓ 5: 10.8x ↗ 6: 10.7x ↘	40 Skott 	1: 10.7x ↘ 2: 10.8x ↙ 3: 10.9x ↙ 4: 10.4x ↙ 5: 10.1 ↘ 6: 10.6x ↘ 7: 10.8x ↗ 8: 10.3x ↑ 9: 10.6x ↘ 10: 10.4x ↘	
	Serie 58		Serie 100	
	Total 0		Total 100	
40 Skott 	11: 10.7x ↘ 12: 10.0 ↑ 13: 10.3x ↙ 14: 10.2x → 15: 10.5x ↓ 16: 10.9x ↙ 17: 10.5x ↗ 18: 10.8x ↓ 19: 10.2x ↙ 20: 9.7 ←	40 Skott 	21: 10.1 → 22: 10.7x ↑ 23: 10.1 ↘ 24: 10.7x ↙ 25: 10.2x ↙ 26: 10.6x ↓ 27: 10.3x ↗ 28: 10.3x ↗ 29: 9.8 ↗ 30: 10.3x ↓	
	Serie 99		Serie 99	
	Total 199		Total 298	
40 Skott 	31: 10.5x → 32: 9.6 ↗ 33: 10.7x ↘ 34: 10.5x ↘ 35: 10.3x ↙ 36: 10.4x ↗ 37: 10.3x ↓ 38: 10.3x → 39: 10.2x ↘ 40: 10.3x ↗			
	Serie 99			
	Total 397			

Skjutlag 1	Tavla 15	Henrik Albihn	
Ramselefors	Vännäs	Sitt	Vb
07.11.2021	Vindelnskyttet 2021	Ramselefors SKF	
Prov 	1: 10.3x → 2: 10.3x → 3: 10.4x → 4: 10.2x ↓ 5: 9.4 ↓ 6: 10.5x → 7: 10.0 ← 8: 10.1 ↓ 9: 10.1 → 10: 10.2x → Serie 99 Total 0	40 Skott 	1: 9.8 ↙ 2: 10.4x ↙ 3: 10.3x ← 4: 10.4x ↗ 5: 10.7x ↖ 6: 10.8x ↓ 7: 10.4x ← 8: 9.9 ← 9: 10.3x ↙ 10: 10.5x ↖ Serie 98 Total 98
40 Skott 	11: 10.4x ↗ 12: 10.6x → 13: 9.8 ↗ 14: 9.2 ↑ 15: 9.7 ↑ 16: 10.2x ↗ 17: 10.3x ↓ 18: 10.9x ← 19: 10.5x ← 20: 10.4x ↓ Serie 97 Total 195	40 Skott 	21: 10.3x → 22: 10.7x → 23: 10.6x ↗ 24: 9.9 ↖ 25: 10.4x ↖ 26: 10.6x ↑ 27: 10.2x ↖ 28: 10.4x ↖ 29: 10.6x ↗ 30: 10.1 ↑ Serie 99 Total 294
40 Skott 	31: 10.5x ← 32: 10.9x ↓ 33: 10.7x ↗ 34: 10.6x ↓ 35: 10.2x → 36: 10.2x ↓ 37: 10.5x ↖ 38: 10.4x ↖ 39: 10.3x ← 40: 10.2x ← Serie 100 Total 394		

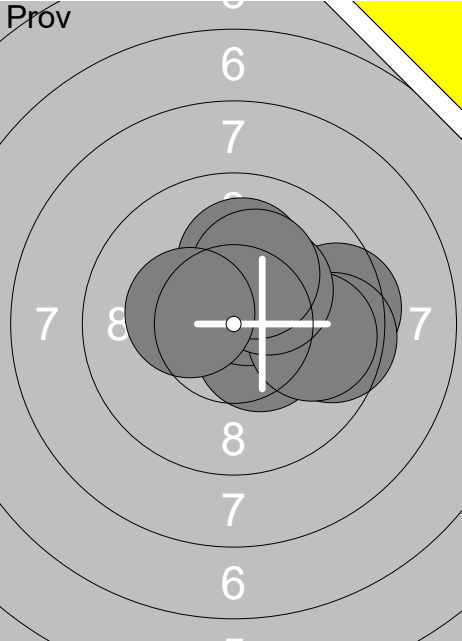
Skjutlag	Tavla	Erika Augustsson			
1	16	Vännäs		Sitt	Vb
07.11.2021		Vindelnskyttet 2021		Ramselefors SKF	
Prov 	1: 9.7 →	Prov 	11: 10.5x ↗		
	2: 10.5x →		12: 9.9 →		
	3: 10.6x ↑		13: 10.5x ↓		
	4: 10.8x ↗		14: 10.3x ↘		
	5: 10.6x ↗				
	6: 10.4x ↑				
	7: 10.7x ←				
	8: 10.6x ↓				
	9: 10.6x ↓				
	10: 10.4x →				
	Serie 99		Serie 39		
	Total 0		Total 0		
40 Skott 	1: 10.4x ↗	40 Skott 	11: 10.7x ↗		
	2: 10.6x ↗		12: 10.8x ↓		
	3: 10.7x ↘		13: 10.1 ↑		
	4: 10.9x ↘		14: 10.6x ↓		
	5: 10.8x →		15: 10.3x ↘		
	6: 10.8x ↘		16: 10.8x ↗		
	7: 10.4x ↗		17: 10.7x ←		
	8: 10.7x ↗		18: 10.6x ↘		
	9: 10.3x ↘		19: 10.6x ↘		
	10: 10.3x ↗		20: 10.5x ↗		
	Serie 100		Serie 100		
	Total 100		Total 200		
40 Skott 	21: 10.6x ↓	40 Skott 	31: 10.6x ↘		
	22: 10.7x ↗		32: 10.5x ↘		
	23: 10.6x ↘		33: 10.7x ↘		
	24: 10.5x ↗		34: 10.5x ↗		
	25: 10.5x ↘		35: 10.2x ↘		
	26: 10.7x ↘		36: 10.3x ↗		
	27: 10.7x ←		37: 10.7x ↗		
	28: 10.7x ↗		38: 10.6x ↘		
	29: 10.6x ↗		39: 9.9 ←		
	30: 9.8 ←		40: 10.4x ↘		
	Serie 99		Serie 99		
	Total 299		Total 398		

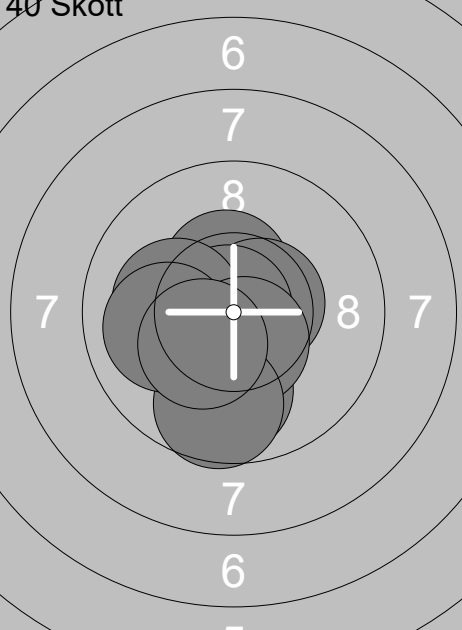
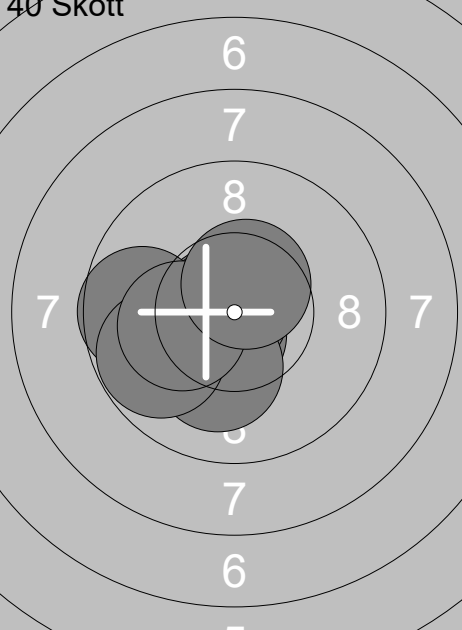
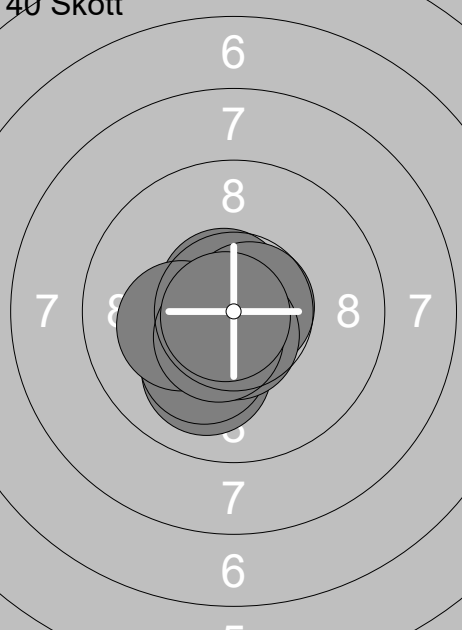
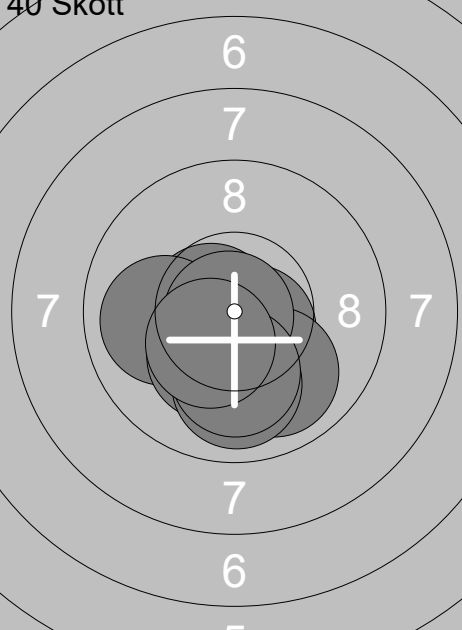
Skjutlag	Tavla	Filip Hansson		Sitt	Vb
1	17	Ramselefors	Vännäs		
07.11.2021	Vindelnskyttet 2021	Ramselefors SKF			
Prov		1: 9.5 →		11: 10.6x →	
		2: 10.8x ↗		12: 10.8x ←	
		3: 9.6 →			
		4: 10.5x ↘			
		5: 10.6x ↗			
		6: 9.8 →			
		7: 10.3x ↗			
		8: 10.1 ↑			
		9: 10.2x ↗			
		10: 10.3x ←			
		Serie 97		Serie 20	
		Total 0		Total 0	
40 Skott		1: 10.4x ↗		11: 10.5x ↘	
		2: 10.6x →		12: 10.3x ←	
		3: 10.7x ↘		13: 10.6x ↘	
		4: 9.9 ↓		14: 10.8x ←	
		5: 10.9x ←		15: 10.8x ←	
		6: 10.2x ←		16: 9.7 ←	
		7: 10.5x ↘		17: 10.2x ↘	
		8: 9.7 ↓		18: 9.8 ←	
		9: 10.0 ←		19: 10.2x ←	
		10: 10.3x ↘		20: 10.5x ↗	
		Serie 98		Serie 98	
		Total 98		Total 196	
40 Skott		21: 10.7x ↘		31: 10.6x ←	
		22: 10.4x ↘		32: 10.1 ↓	
		23: 10.0 ↘		33: 10.0 ←	
		24: 10.2x ↘		34: 10.2x ↘	
		25: 10.7x ↗		35: 10.6x ↘	
		26: 10.7x →		36: 9.9 ↘	
		27: 10.6x ↘		37: 9.9 ↓	
		28: 10.2x ←		38: 10.8x ←	
		29: 10.5x ↘		39: 10.1 ↓	
		30: 10.8x ←		40: 10.4x ↘	
		Serie 100		Serie 98	
		Total 296		Total 394	

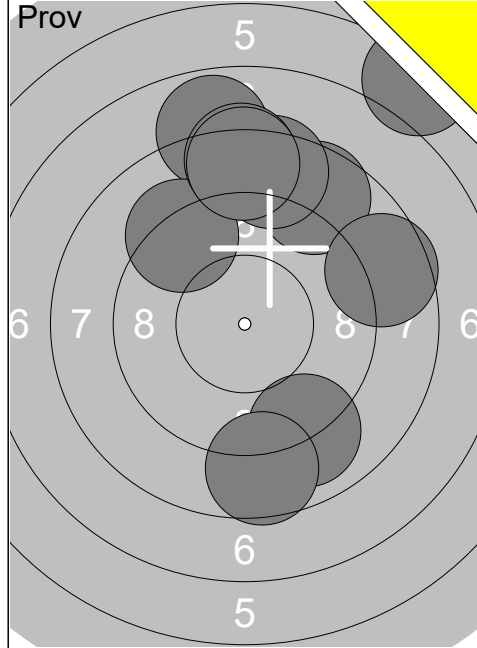

1:	6.2	↗
2:	7.9	↑
3:	8.7	↗
4:	9.2	↖
5:	8.5	↑
6:	8.6	→
7:	8.3	↑
8:	9.0	↓
9:	8.6	↓
10:	8.4	↑
Serie	79	
Total	0	

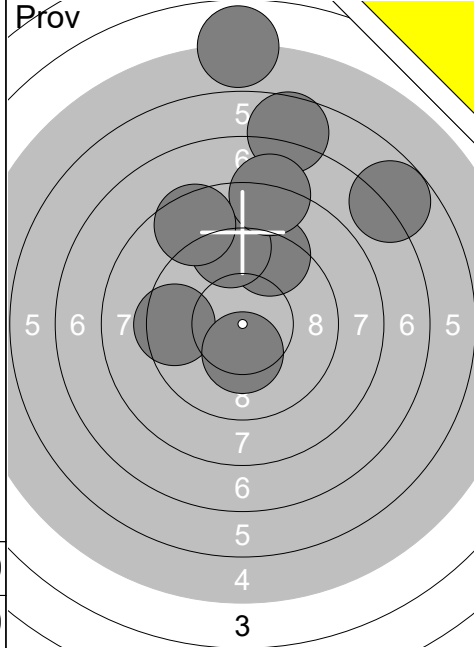

11:	9.5	←
12:	6.8	↗
13:	9.3	↗
14:	4.9	↑
15:	6.7	↑
16:	9.2	↑
17:	8.1	↑
18:	8.6	↖
19:	10.3x	↓
Serie	69	
Total	0	

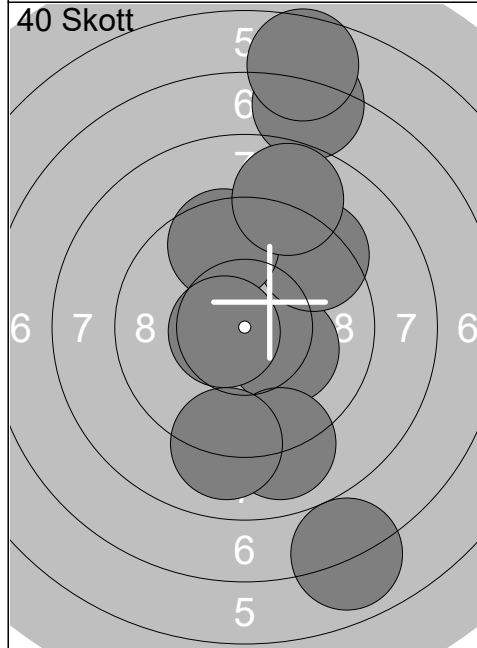

1:	7.2	↑
2:	10.2x	→
3:	9.3	↗
4:	9.6	↑
5:	6.6	↑
6:	8.8	↑
7:	9.0	↓
8:	6.9	↓
9:	10.6x	←
10:	9.1	↓
Serie	83	
Total	83	

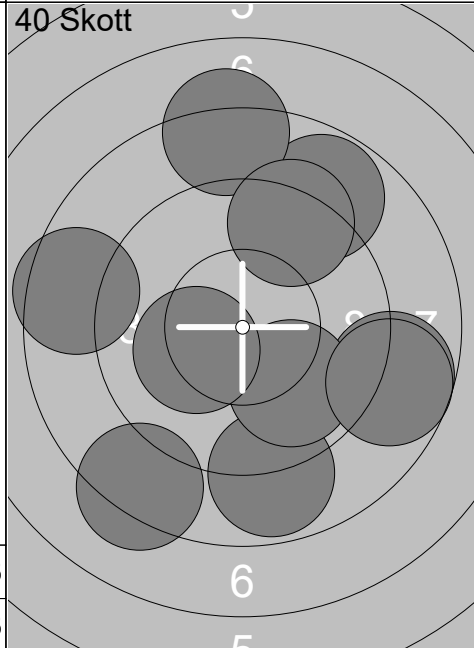

11:	8.8	↗
12:	8.8	↓
13:	8.2	↑
14:	8.7	→
15:	9.9	↓
16:	10.2x	←
17:	8.5	←
18:	8.3	↓
19:	8.7	→
20:	9.3	↗
Serie	84	
Total	167	

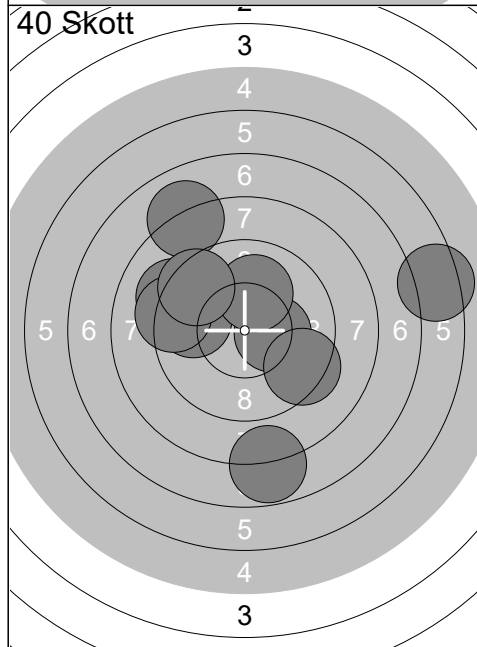

21:	6.4	→
22:	9.2	←
23:	9.7	←
24:	10.3x	→
25:	9.4	↘
26:	10.1	↑
27:	8.0	↗
28:	7.8	↓
29:	9.3	←
30:	9.5	↖
Serie	86	
Total	253	

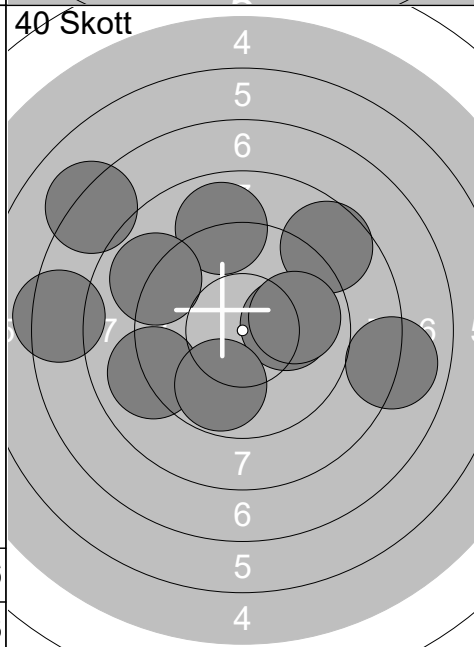

31:	10.1	→
32:	8.9	↑
33:	8.7	↗
34:	9.0	↖
35:	8.0	→
36:	9.9	→
37:	9.0	←
38:	9.8	↓
39:	7.2	↖
40:	7.4	←
Serie	84	
Total	337	

Skjutlag 1	Tavla 21	Emma Hermansson			
Ramselefors	Ramselefors	7	Vb		
07.11.2021	Vindelnskyttet 2021	Ramselefors SKF			
Prov 	1: 10.0 ↗ 2: 10.0 ← 3: 10.0 ↘ 4: 10.2x ↘ 5: 9.2 ← 6: 10.8x ↘	40 Skott 	1: 10.1 ↘ 2: 9.3 ↘ 3: 10.2x → 4: 10.4x ↗ 5: 10.3x → 6: 9.9 ← 7: 10.7x ← 8: 10.0 ↗ 9: 10.4x ↖ 10: 10.8x ←	Serie 59 Total 0	Serie 98 Total 98
40 Skott 	11: 10.6x ↗ 12: 10.6x ↖ 13: 10.1 ↘ 14: 9.8 ← 15: 10.4x ↘ 16: 9.9 ← 17: 10.4x ↘ 18: 9.4 ← 19: 9.9 ↘ 20: 9.3 ←	40 Skott 	21: 10.3x ← 22: 10.7x ↗ 23: 9.2 ← 24: 8.8 ↘ 25: 9.9 ↘ 26: 10.1 ← 27: 9.6 → 28: 10.5x ← 29: 9.9 ↘ 30: 9.3 ↗	Serie 95 Total 193	Serie 93 Total 286
40 Skott 	31: 10.0 ↗ 32: 9.7 ↖ 33: 10.9x ↘ 34: 9.8 ↖ 35: 10.2x → 36: 9.7 ← 37: 9.4 ↗ 38: 9.4 ← 39: 8.9 ↖ 40: 9.3 ↖				
Serie 92 Total 378					

Skjuttag 1	Tavla 22	Oscar Hermansson			
Ramselefors		Ramselefors		7	Vb
07.11.2021		Vindelnskyttet 2021		Ramselefors SKF	
Prov		40 Skott		40 Skott	
		1: 9.9 ↗ 2: 1.0 → 3: 6.5 ↘		1: 5.7 ↗ 2: 10.2x ←← 3: 5.7 → 4: 7.5 → 5: 10.0 ↗ 6: 9.5 ↘ 7: 7.1 ↗ 8: 8.1 ↗ 9: 8.2 ↘ 10: 8.5 →	
		Serie 16		Serie 77	
		Total 0		Total 77	
40 Skott		40 Skott		40 Skott	
		11: 9.7 ↘ 12: 7.4 ↗ 13: 8.5 ↘ 14: 10.1 ↘ 15: 4.8 ↘ 16: 10.1 ← 17: 10.5x ↘ 18: 5.9 ↑ 19: 0.0 ↑ 20: 9.0 →		21: 10.3x ↘ 22: 8.5 → 23: 9.8 ↗ 24: 8.3 ↑ 25: 6.2 ↘ 26: 10.5x ↘ 27: 7.6 ← 28: 6.0 → 29: 6.4 ← 30: 8.8 →	
		Serie 72		Serie 78	
		Total 149		Total 227	
40 Skott		31: 5.0 ↘			
		32: 6.4 → 33: 6.2 ↘ 34: 9.9 → 35: 9.5 ↗ 36: 7.3 ↘ 37: 8.7 ↘ 38: 2.8 → 39: 9.7 → 40: 6.9 →			
		Serie 67			
		Total 294			

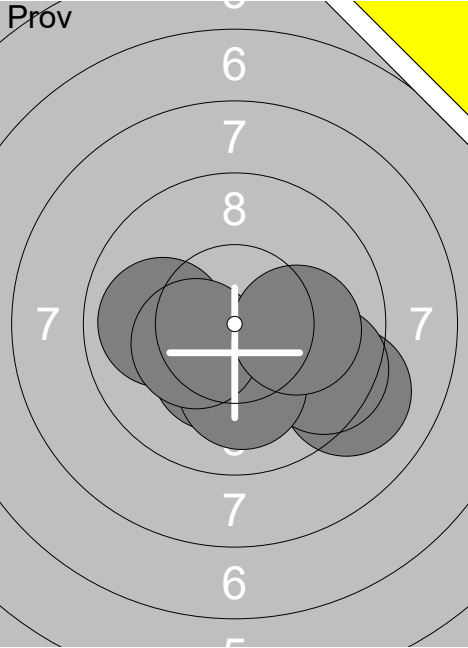
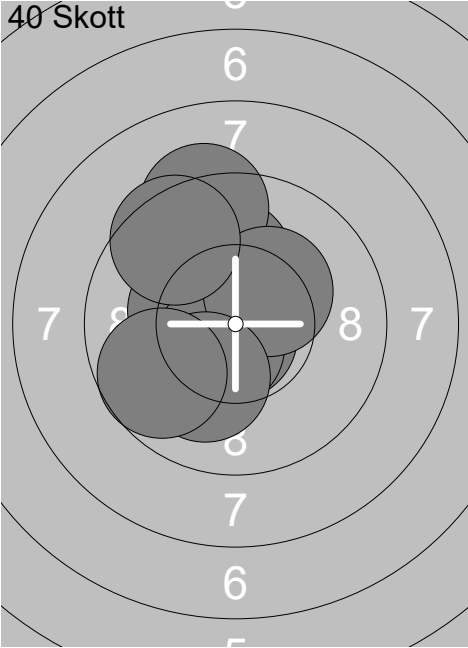
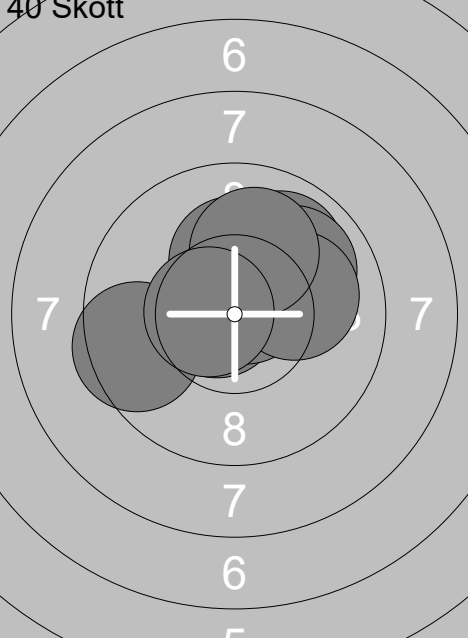
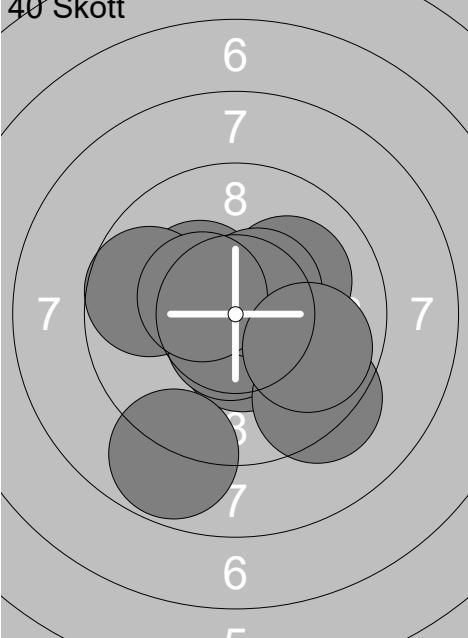
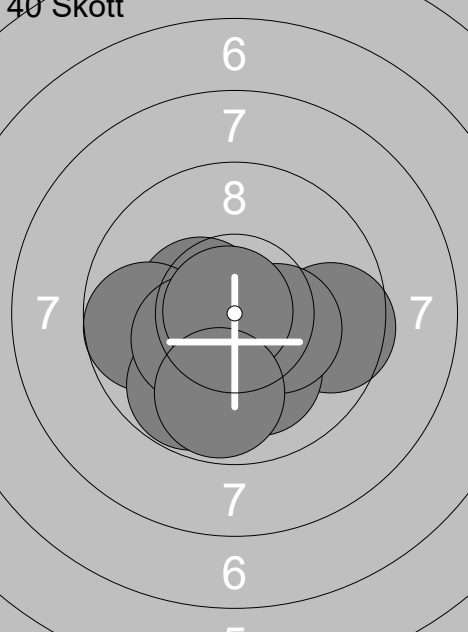
Skjutlag 1	Tavla 24	Oscar Lindberg	
Ramselefors	Ramselefors	11	Vb
07.11.2021	Vindelnskyttet 2021	Ramselefors SKF	
Prov 	1: 9.1 → 2: 9.6 → 3: 10.3x ↓ 4: 10.1 ↓ 5: 10.0 ← 6: 10.3x ↙ 7: 10.1 →	40 Skott 	1: 10.7x ↑ 2: 10.8x ↓ 3: 10.1 ↑ 4: 10.3x ↙ 5: 9.3 ↑ 6: 10.6x ↓ 7: 10.3x ↗ 8: 10.1 ↓ 9: 9.7 ↙ 10: 9.5 ↖
	Serie 68		Serie 97
	Total 0		Total 97
40 Skott 	11: 10.2x ↑ 12: 9.9 ↗ 13: 9.9 ↗ 14: 10.7x ↑ 15: 10.7x ↙ 16: 9.5 ← 17: 10.7x ↗ 18: 10.1 → 19: 10.0 ↑ 20: 10.6x ↙	40 Skott 	21: 10.1 ↗ 22: 10.3x ↙ 23: 10.5x ↓ 24: 10.6x ↓ 25: 10.5x ↗ 26: 9.7 ← 27: 10.4x ↙ 28: 9.3 ↓ 29: 8.8 ↓ 30: 9.8 →
	Serie 97		Serie 95
	Total 194		Total 289
40 Skott 	31: 10.4x ↙ 32: 9.7 ← 33: 10.4x ↓ 34: 9.8 ↓ 35: 9.6 → 36: 10.1 ↓ 37: 10.3x → 38: 10.3x ↙ 39: 10.8x ↙ 40: 9.8 ↓		
	Serie 96		
	Total 385		

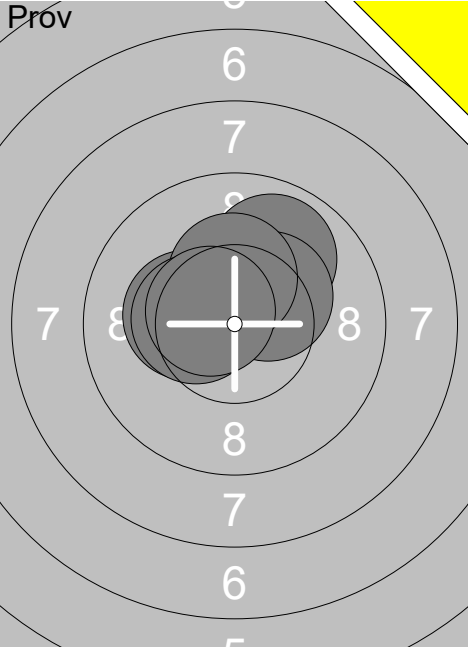
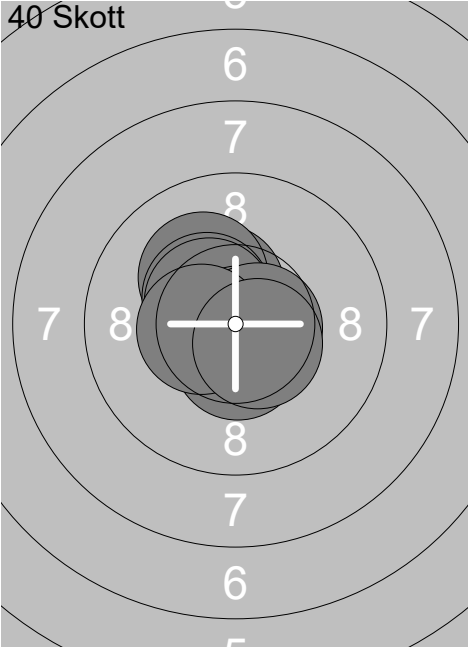
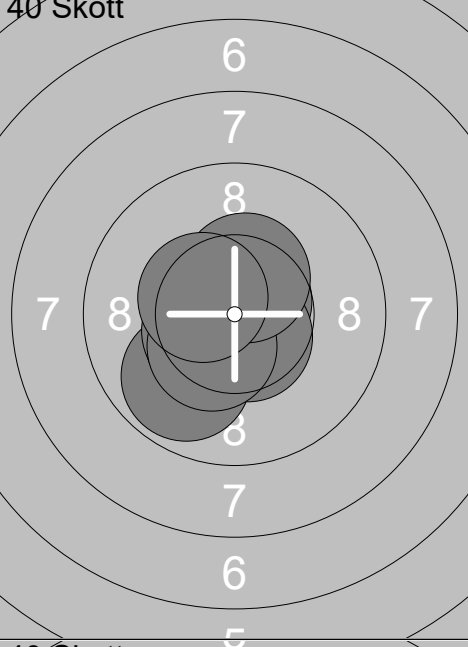
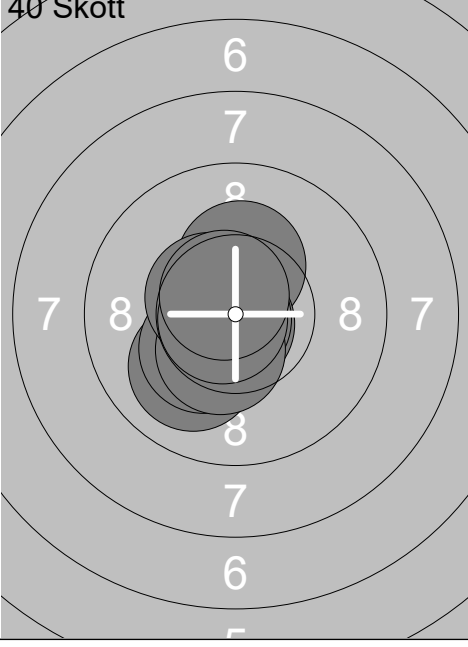
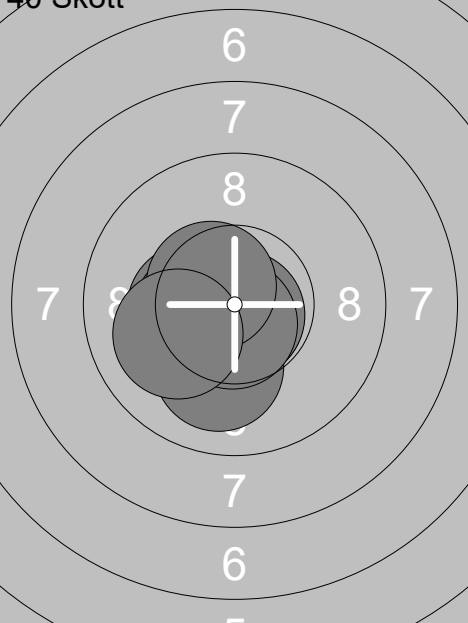
Skjutlag	Tavla	Jennifer Gustafsson	
1	26	Ramselefors	Ramselefors
			Sitt
			Vb
07.11.2021	Vindelnskyttet 2021	Ramselefors SKF	
Prov		40 Skott	
	1: 9.9 ↗ 2: 10.3x ← 3: 10.3x ↗ 4: 10.3x ↑ 5: 10.4x ← 6: 10.6x ↖		1: 10.4x ↗ 2: 10.2x ↖ 3: 10.9x ↑ 4: 10.4x ↖ 5: 10.5x ↖ 6: 10.8x ↓ 7: 10.6x → 8: 10.5x ↓ 9: 10.5x ← 10: 10.5x ↘
	Serie 59		Serie 100
	Total 0		Total 100
40 Skott		40 Skott	
	11: 10.4x ↘ 12: 9.9 ↓ 13: 10.5x ↘ 14: 10.5x ← 15: 10.7x ↗ 16: 10.7x ← 17: 10.6x ↓ 18: 10.4x ↘ 19: 10.4x ↑ 20: 10.5x ↖		21: 10.3x ↑ 22: 10.0 ↓ 23: 10.8x ↘ 24: 10.6x ↘ 25: 10.8x ↘ 26: 10.3x ↘ 27: 10.4x ↓ 28: 10.5x ↖ 29: 10.8x ← 30: 10.6x ↖
	Serie 99		Serie 100
	Total 199		Total 299
40 Skott			
	31: 10.8x ↓ 32: 10.1 ↓ 33: 10.4x ← 34: 10.8x ↓ 35: 10.6x ← 36: 10.8x ↓ 37: 10.4x ← 38: 10.7x ↓ 39: 10.5x ↖ 40: 10.1 ←		
	Serie 100		
	Total 399		

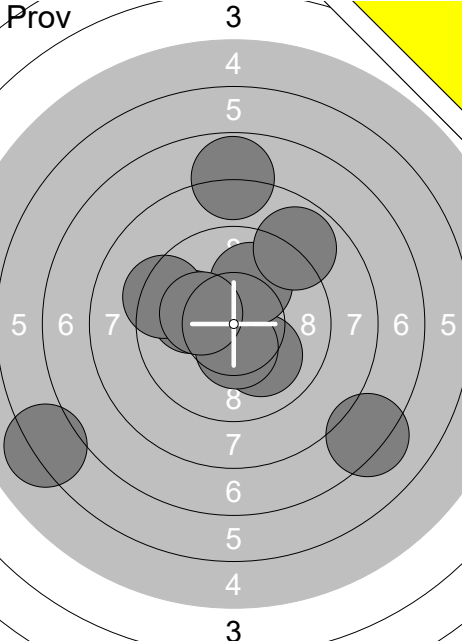
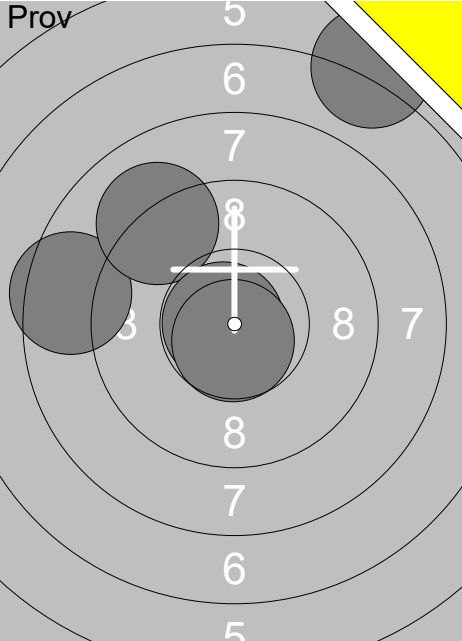
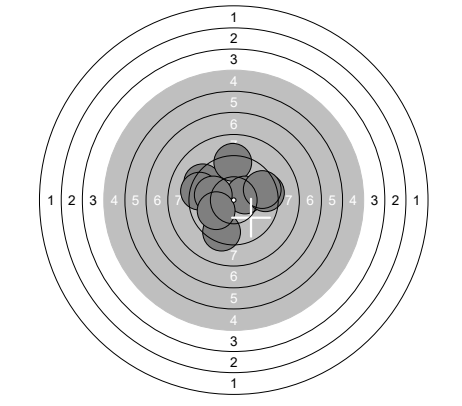
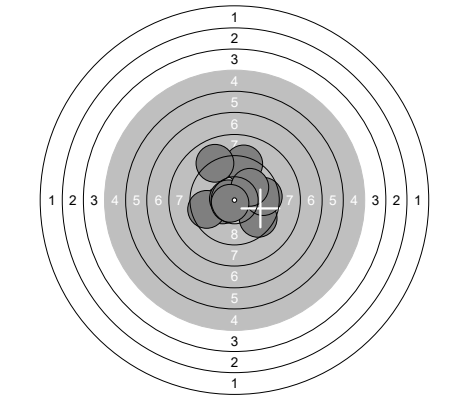
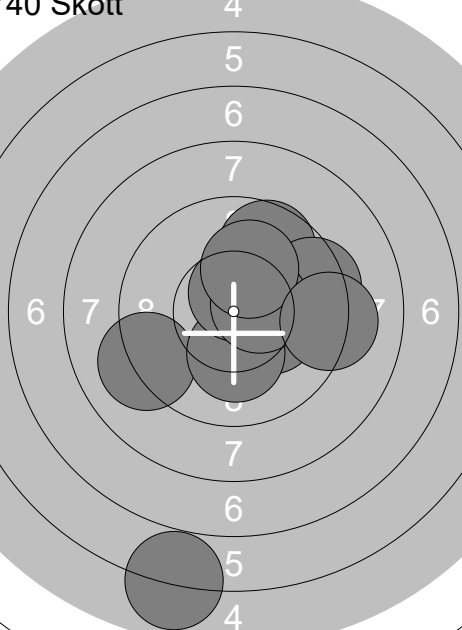
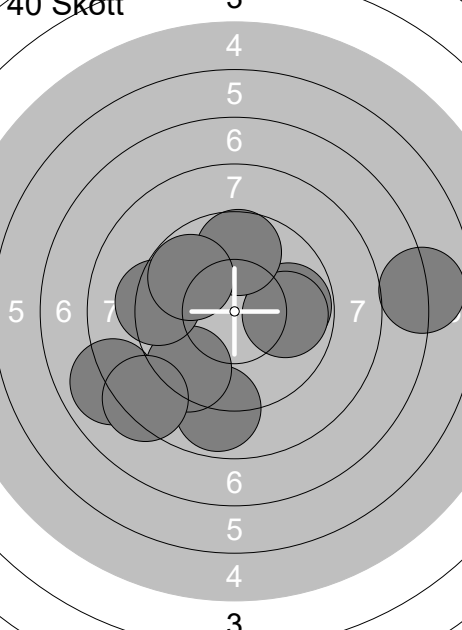
Skjutlag	Tavla	Hugo Persson		
1	28	Ramselefors	9	Vb
07.11.2021	Vindelnskyttet 2021	Ramselefors SKF		
Prov 	1: 10.0 ←	Prov 	11: 6.7 ↗	
	2: 10.1 ↘		12: 8.5 ←	
	3: 10.5x ↘		13: 9.1 ↗	
	4: 7.2 ↘		14: 10.8x ←	
	5: 6.1 ←		15: 10.7x ↘	
	6: 7.8 ↑			
	7: 9.3 ←			
	8: 10.0 ↗			
	9: 8.9 ↗			
	10: 10.2x ←			
	Serie 87		Serie 43	
	Total 0		Total 0	
40 Skott 	1: 0.0 ↘	40 Skott 	11: 9.2 ↑	
	2: 9.3 ↗		12: 9.0 ↗	
	3: 9.3 ←		13: 10.3x ←	
	4: 9.2 ↑		14: 9.6 ←	
	5: 10.4x →		15: 9.6 ↘	
	6: 9.3 ↘		16: 0.0 ↘	
	7: 10.0 ←		17: 9.6 →	
	8: 9.4 →		18: 10.7x ←	
	9: 10.0 ←		19: 10.0 ↗	
	10: 9.5 →		20: 10.7x ↘	
	Serie 84		Serie 85	
	Total 84		Total 169	
40 Skott 	21: 9.7 ↗	40 Skott 	31: 7.0 →	
	22: 9.5 →		32: 9.8 →	
	23: 10.2x →		33: 8.0 ←	
	24: 9.1 ←		34: 9.9 →	
	25: 10.2x ↘		35: 8.9 ↘	
	26: 10.6x ↑		36: 9.4 ↘	
	27: 10.5x →		37: 9.3 ←	
	28: 10.1 ↗		38: 9.7 ↑	
	29: 9.2 →		39: 8.3 ↘	
	30: 5.9 ↘		40: 9.8 ↗	
	Serie 91		Serie 85	
	Total 260		Total 345	

Skjutlag 1	Tavla 30	Elis Granström		
Ramselefors	Ramselefors	9	Vb	
07.11.2021	Vindelnskyttet 2021	Ramselefors SKF		
Prov 	1: 10.7x ← 2: 10.2x ↙ 3: 10.6x → 4: 9.6 ↗ 5: 9.4 ←	40 Skott 	1: 9.5 ↙ 2: 10.3x ↘ 3: 8.8 ↘ 4: 10.3x ↙ 5: 9.7 ← 6: 9.4 ↓ 7: 8.7 ↘ 8: 10.7x ← 9: 9.8 → 10: 9.1 →	
	Serie 48		Serie 91	
	Total 0		Total 91	
40 Skott 	11: 10.2x ← 12: 9.7 ← 13: 9.5 ↑ 14: 9.4 ↗ 15: 10.5x → 16: 6.2 ↘ 17: 9.7 ↘ 18: 8.6 ← 19: 10.6x → 20: 9.7 ↘	40 Skott 	21: 10.7x ↓ 22: 9.0 ↓ 23: 8.8 ↘ 24: 8.6 ↘ 25: 9.2 → 26: 10.4x ↗ 27: 8.6 ↘ 28: 9.8 ← 29: 9.6 ↑ 30: 9.8 ↑	
	Serie 89		Serie 89	
	Total 180		Total 269	
40 Skott 	31: 7.6 → 32: 10.1 ↘ 33: 9.9 ↘ 34: 10.3x ↘ 35: 10.2x ↗ 36: 8.0 ← 37: 10.0 ↑ 38: 9.4 ↘ 39: 8.9 ↗ 40: 9.0 ←			
	Serie 90			
	Total 359			

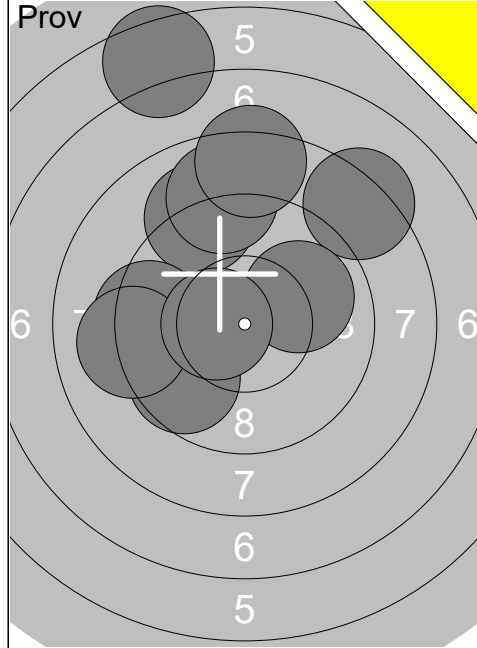

1:	8.3	↗
2:	6.5	↑
3:	9.7	↙
4:	9.1	↑
5:	8.9	↑
6:	9.4	←
7:	8.3	↑
8:	10.0	↗
9:	9.1	←
10:	10.5x	←
Serie		86
Total		0

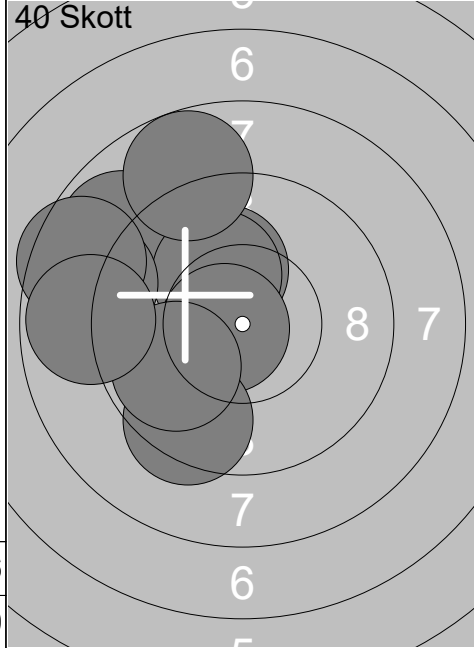

1:	8.9	↖
2:	10.2x	↑
3:	10.2x	↖
4:	8.8	←
5:	10.7x	←
6:	8.6	←
7:	8.8	↑
8:	9.4	↘
9:	9.9	↙
10:	8.8	←
Serie		88
Total		88

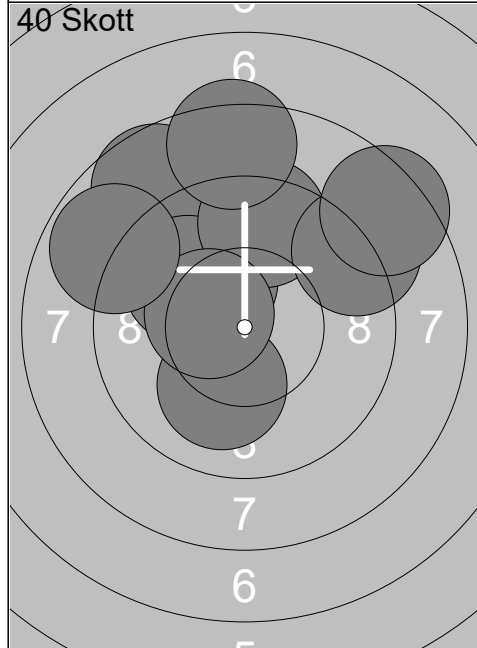

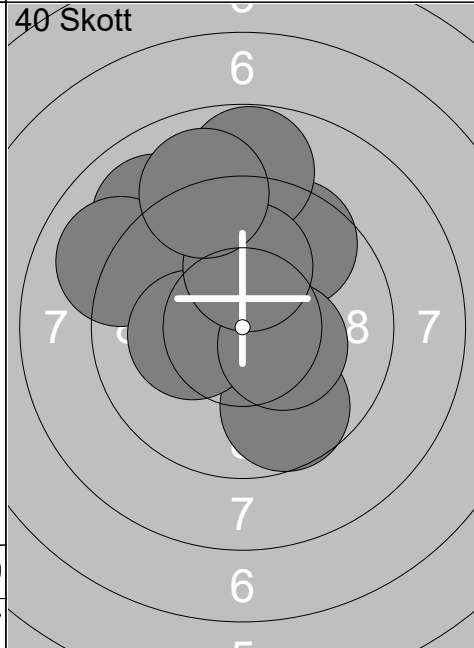

11:	8.7	↖
12:	10.2x	↖
13:	9.9	↖
14:	10.1	↘
15:	9.5	↑
16:	8.4	↑
17:	10.4x	←
18:	8.8	↖
19:	9.1	↗
20:	8.4	↗
Serie		89
Total		177

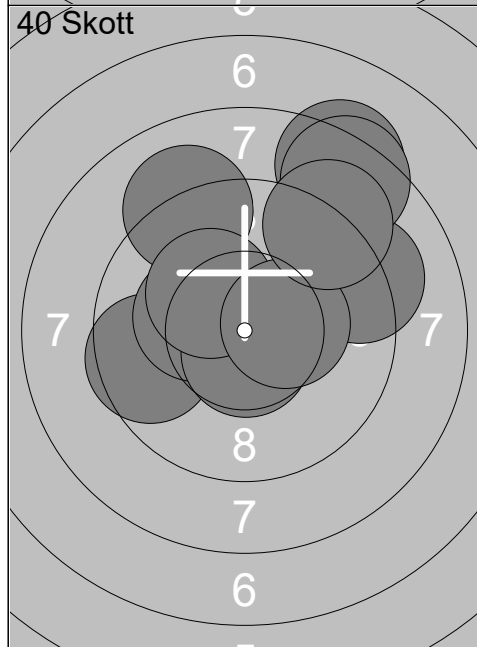

21:	9.6	↗
22:	8.8	↑
23:	10.3x	↖
24:	9.7	↘
25:	9.0	↗
26:	9.0	↖
27:	10.3x	←
28:	10.3x	↗
29:	10.1	↑
30:	9.0	↑
Serie		93
Total		270

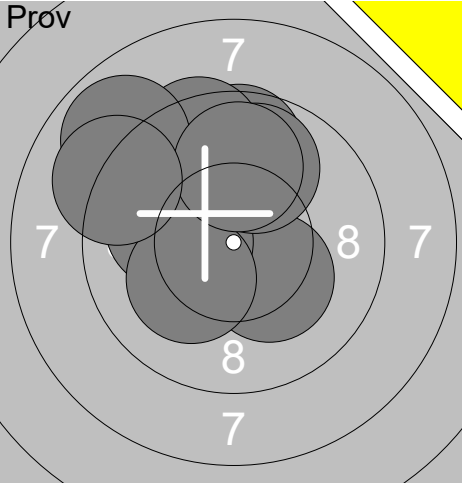

31:	9.2	↗
32:	9.1	↑
33:	8.3	↗
34:	9.6	←
35:	10.3x	←
36:	10.6x	↘
37:	8.4	↗
38:	10.3x	↖
39:	10.4x	→
40:	9.1	↗
Serie		92
Total		362

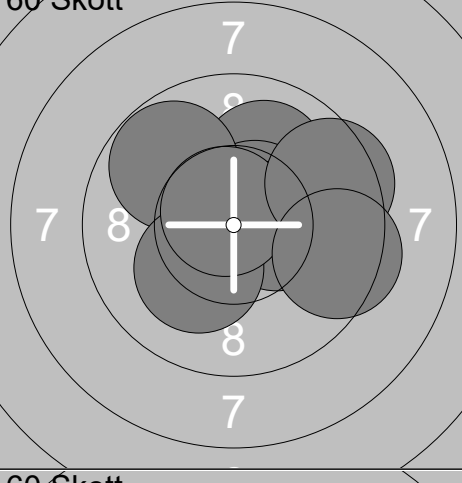
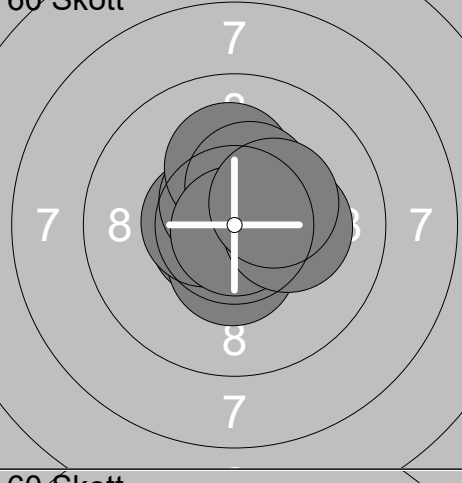
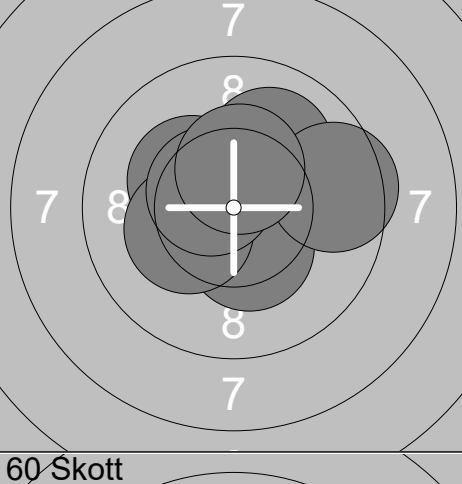
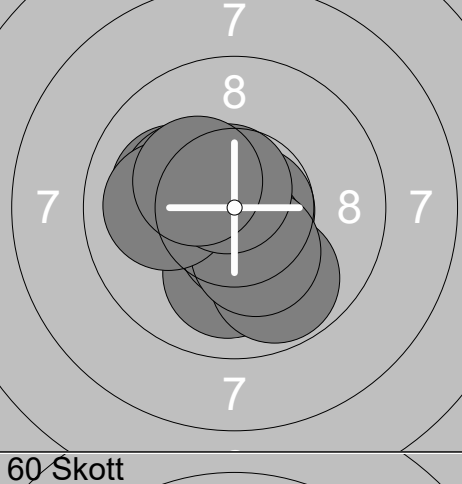
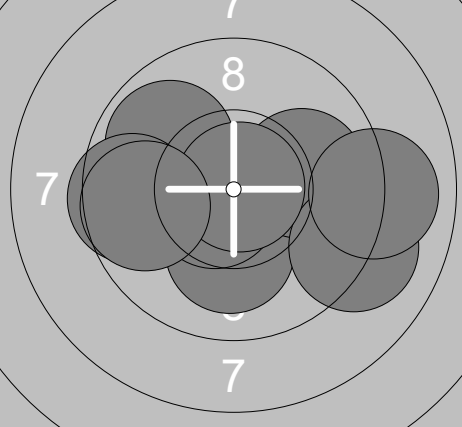
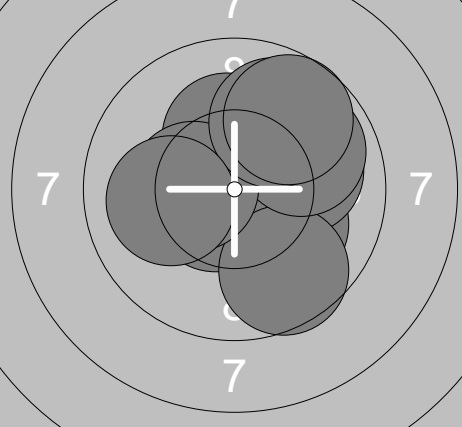
Skjuttag	Tavla	Nicolle Nygren	
2	1	Ramselefors	Umeå
07.11.2021	Vindelnskyttet 2021	17S	Vb
07.11.2021	Vindelnskyttet 2021	Ramselefors SKF	
Prov 	1: 9.7 ↑ 2: 10.3x ↓ 3: 10.3x ← 4: 9.9 ↑ 5: 9.5 ↑ 6: 10.0 ← 7: 8.9 ↗ 8: 10.2x ↘ 9: 9.9 ↑ 10: 9.1 ↖	Prov 	11: 10.0 ↖ 12: 10.2x ↑
Serie 97.8	Total 0.0	Serie 20.2	Total 0.0
60 Skott 	1: 10.6x ↖ 2: 10.0 ↑ 3: 10.5x ↗ 4: 10.7x ↗ 5: 9.8 ↗ 6: 10.3x → 7: 10.2x ↘ 8: 10.7x ↗ 9: 9.5 → 10: 9.5 →	60 Skott 	11: 10.6x ← 12: 10.4x ↗ 13: 10.4x ↓ 14: 10.5x ← 15: 10.6x ↑ 16: 10.2x ↑ 17: 10.4x ↑ 18: 10.9x ↓ 19: 10.2x → 20: 10.3x ↗
Serie 101.8	Total 101.8	Serie 104.5	Total 206.3
60 Skott 	21: 10.7x ↖ 22: 10.1 ↑ 23: 10.7x ↓ 24: 10.3x ↗ 25: 10.4x ↓ 26: 10.3x ← 27: 10.0 ↑ 28: 10.6x ↗ 29: 9.5 → 30: 10.4x ↑	60 Skott 	31: 10.7x → 32: 10.1 ← 33: 10.0 ↓ 34: 10.5x ↓ 35: 10.2x ↖ 36: 9.8 ↓ 37: 10.3x ↓ 38: 10.0 ← 39: 10.7x ↑ 40: 10.3x ↖
Serie 103.0	Total 309.3	Serie 102.6	Total 411.9
60 Skott 	41: 10.2x ← 42: 10.1 ↓ 43: 10.0 → 44: 9.1 ↘ 45: 10.6x ← 46: 9.9 ↗ 47: 10.9x → 48: 9.5 ← 49: 9.0 → 50: 9.7 ←	60 Skott 	51: 10.1 ↘ 52: 10.2x ↑ 53: 10.6x ↖ 54: 10.0 → 55: 9.6 ↓ 56: 9.9 ↗ 57: 10.4x ← 58: 9.9 ↑ 59: 10.1 ← 60: 9.7 ↗
Serie 99.0	Total 510.9	Serie 100.5	Total 611.4

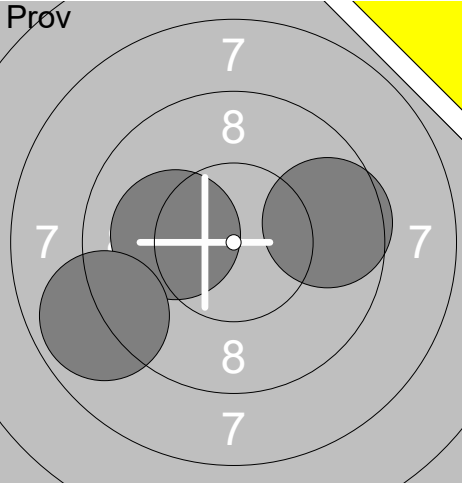
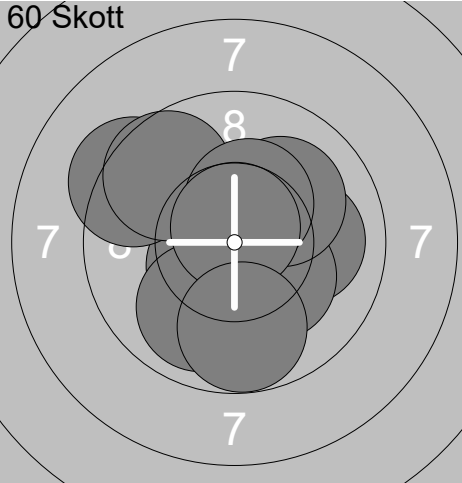
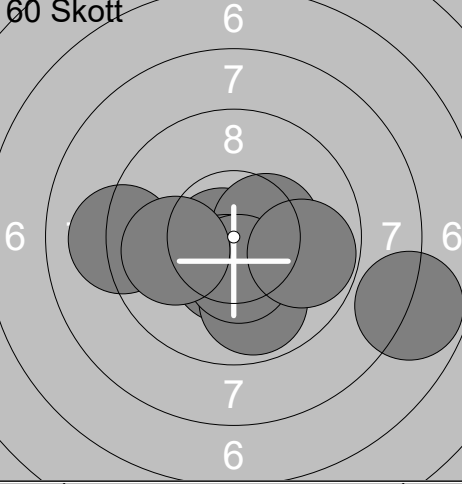
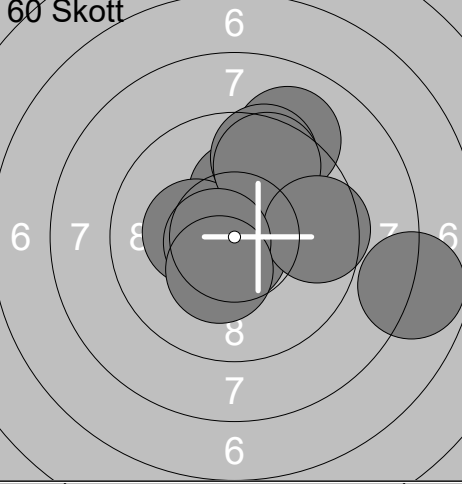
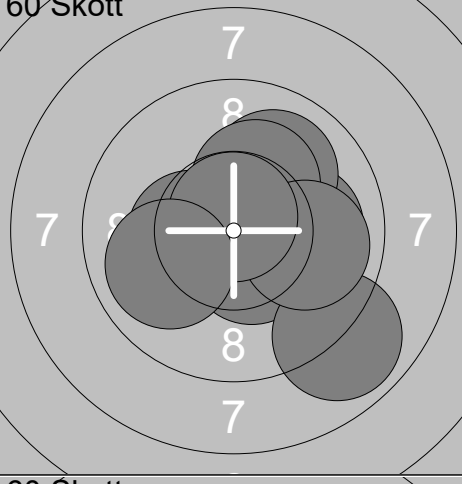
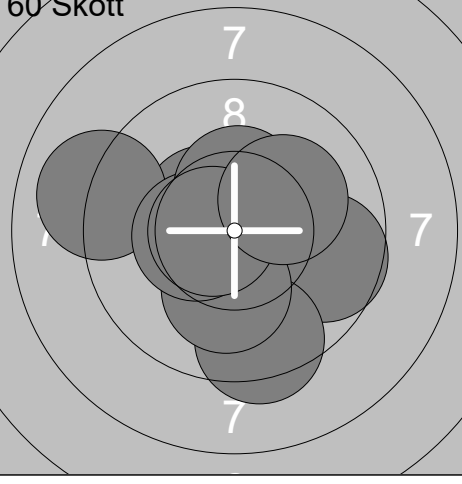
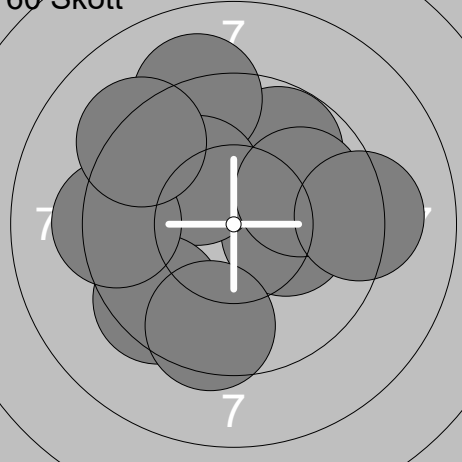
Skjuttag	Tavla		
2	2		
Ramselefors			
07.11.2021	Vindelnskyttet 2021	Ramselefors SKF	
Prøv 	1: 9.6 → 2: 10.1 ← 3: 8.9 ↙ Serie 28.6 Total 0.0	60 Skott 	1: 10.5x ↙ 2: 10.0 → 3: 10.3x ↘ 4: 9.3 ↗ 5: 9.6 ↗ 6: 10.1 ↗ 7: 10.4x ↑ 8: 9.9 ↙ 9: 10.7x ↑ 10: 9.8 ↓ Serie 100.6 Total 100.6
60 Skott 	11: 10.6x ↙ 12: 10.7x ↙ 13: 7.8 → 14: 9.1 ← 15: 10.4x → 16: 10.4x ↙ 17: 9.9 ↙ 18: 10.4x ↙ 19: 10.0 ← 20: 9.8 → Serie 99.1 Total 199.7	60 Skott 	21: 10.2x ↑ 22: 9.1 ↗ 23: 10.3x ← 24: 9.5 ↑ 25: 10.7x ↓ 26: 9.6 ↑ 27: 9.6 → 28: 10.6x ← 29: 7.9 → 30: 10.3x ↙ Serie 97.8 Total 297.5
60 Skott 	31: 10.5x ← 32: 10.0 → 33: 10.4x ← 34: 10.0 ↗ 35: 10.2x ↗ 36: 10.5x ↘ 37: 8.9 ↘ 38: 9.9 → 39: 10.8x ↑ 40: 10.0 ↙ Serie 101.2 Total 398.7	60 Skott 	41: 9.7 → 42: 9.4 ↘ 43: 10.5x ↗ 44: 10.6x ← 45: 10.1 ↓ 46: 9.0 ← 47: 10.4x ← 48: 10.4x ↑ 49: 10.6x ← 50: 10.2x ↗ Serie 100.9 Total 499.6
60 Skott 	51: 9.8 ↗ 52: 10.2x → 53: 9.1 ↗ 54: 10.2x ↗ 55: 9.5 ↙ 56: 9.9 → 57: 9.5 ↓ 58: 9.3 ← 59: 9.2 → 60: 9.2 ↗ Serie 95.9 Total 595.5		

Skjutlag	Tavla	Mats Österlund					
2	4	Ramselefors	Ramselefors	Sen	Vb		
07.11.2021	Vindelnskyttet 2021	Ramselefors SKF					
Prov 	1: 9.8 ↘ 2: 9.7 ↗ 3: 9.6 ↗ 4: 9.8 ↗ 5: 9.5 ↗ 6: 9.4 ↗ 7: 10.3x ↗ 8: 9.4 ↘ 9: 9.3 ↘ 10: 9.9 ↖	Prov 	11: 10.4x → 12: 9.8 ↘ 13: 10.6x →	Serie	96.7	Serie	30.8
	Total	0.0	Total	0.0			
60 Skott 	1: 9.9 ↘ 2: 9.8 ↘ 3: 10.5x ↘ 4: 8.5 → 5: 9.5 ↖ 6: 8.9 ↘ 7: 10.0 → 8: 8.6 ↘ 9: 10.4x ↗ 10: 10.2x ↘	60 Skott 	11: 9.7 ↘ 12: 7.5 ← 13: 9.5 ← 14: 9.1 ↘ 15: 8.1 ↘ 16: 9.1 ↗ 17: 9.5 ← 18: 8.6 ← 19: 10.3x → 20: 9.8 ↗	Serie	96.3	Serie	91.2
	Total	96.3	Total	187.5			
60 Skott 	21: 10.3x ← 22: 10.2x ↘ 23: 9.1 ↘ 24: 10.0 ← 25: 8.6 ← 26: 10.1 ← 27: 10.1 → 28: 9.7 ↘ 29: 9.9 ↘ 30: 8.9 ↗	60 Skott 	31: 8.8 → 32: 10.4x → 33: 9.4 ↗ 34: 9.2 ↘ 35: 8.8 ← 36: 9.0 → 37: 10.0 ↗ 38: 9.2 ← 39: 9.5 → 40: 9.4 ↘	Serie	96.9	Serie	93.7
	Total	284.4	Total	378.1			
60 Skott 	41: 9.9 → 42: 10.1 → 43: 9.7 ↘ 44: 9.6 → 45: 10.2x ↘ 46: 10.6x ↘ 47: 10.1 → 48: 8.9 ↗ 49: 9.6 → 50: 9.3 ↖	60 Skott 	51: 9.7 ↗ 52: 9.7 ← 53: 9.6 ↗ 54: 10.0 ↘ 55: 9.9 ↘ 56: 10.0 ↘ 57: 8.2 ← 58: 9.5 ↗ 59: 10.2x ← 60: 10.7x →	Serie	98.0	Serie	97.5
	Total	476.1	Total	573.6			

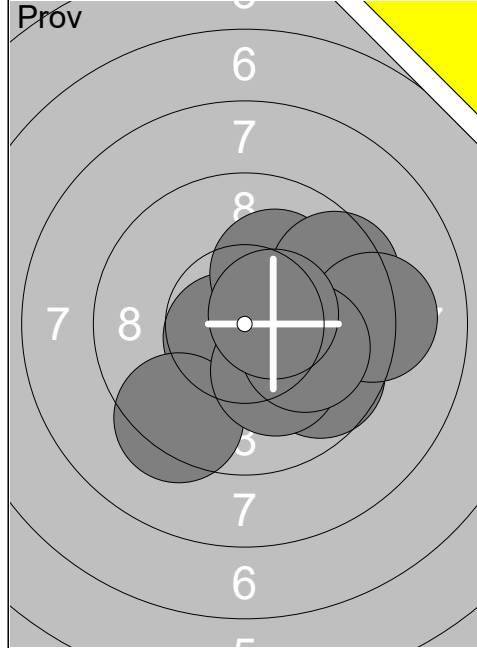

1:	10.6x ↙
2:	9.7 ➡
3:	10.1 ↗
4:	9.4 ↙
5:	9.5 ➡
6:	9.2 ➡
7:	10.2x ↙
8:	10.1 ➡
9:	10.5x ➡
Serie	86
Total	0

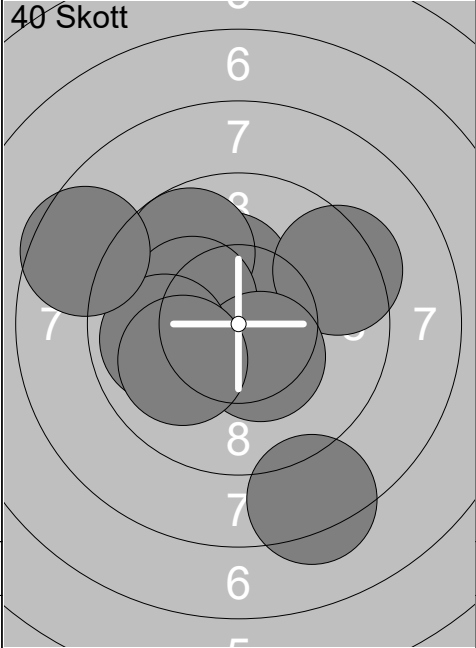

1:	10.0 ↖
2:	10.3x ↑
3:	9.7 ↗
4:	9.4 ➡
5:	10.2x ↙
6:	10.4x ↙
7:	8.3 ↙
8:	9.9 ←
9:	8.6 ↖
10:	10.0 ↙
Serie	93
Total	93

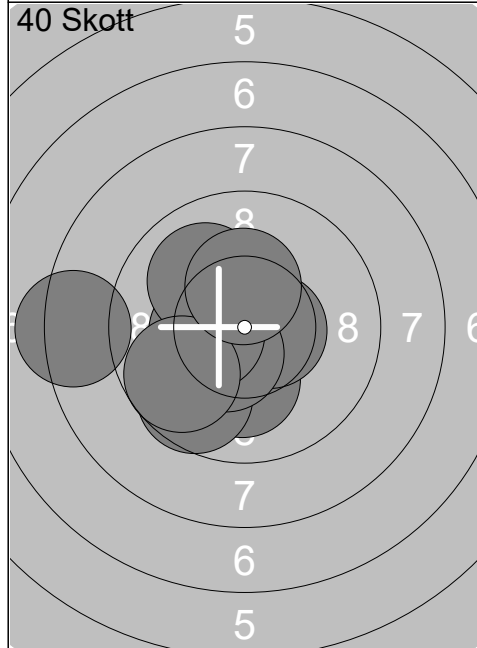

11:	10.1 ↓
12:	8.3 ←
13:	9.6 ↙
14:	10.6x ➡
15:	10.4x ↙
16:	10.4x ↙
17:	10.4x ←
18:	10.0 ↖
19:	9.7 ↙
20:	10.3x ↑
Serie	96
Total	189

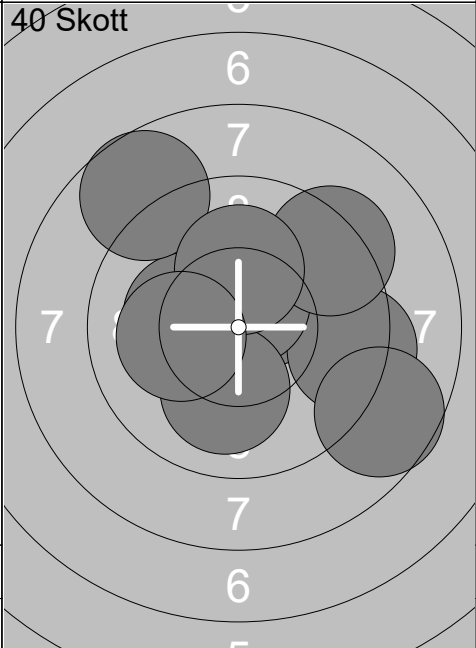

21:	10.5x ↗
22:	9.3 ➡
23:	10.6x ↑
24:	10.2x ↙
25:	10.1 ↓
26:	9.3 ↗
27:	8.7 ➡
28:	8.7 ↗
29:	10.2x ↑
30:	10.1 ←
Serie	94
Total	283

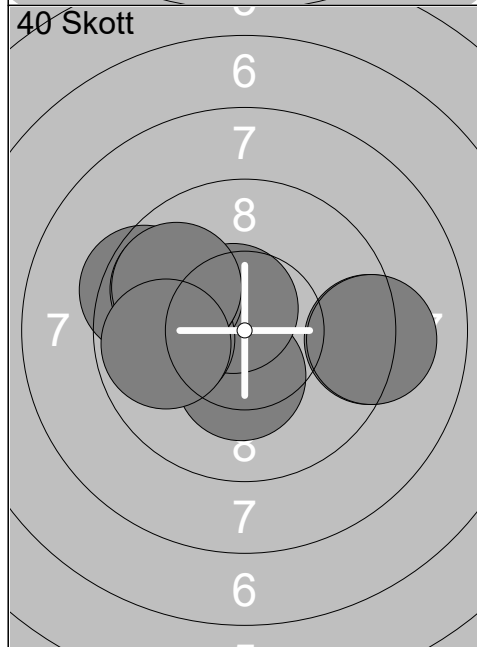

31:	10.3x ↓
32:	9.4 ↖
33:	9.2 ➡
34:	10.6x ↗
35:	9.9 ↖
36:	9.9 ←
37:	9.8 ↖
38:	9.8 ↗
39:	9.2 ➡
40:	9.8 ←
Serie	92
Total	375

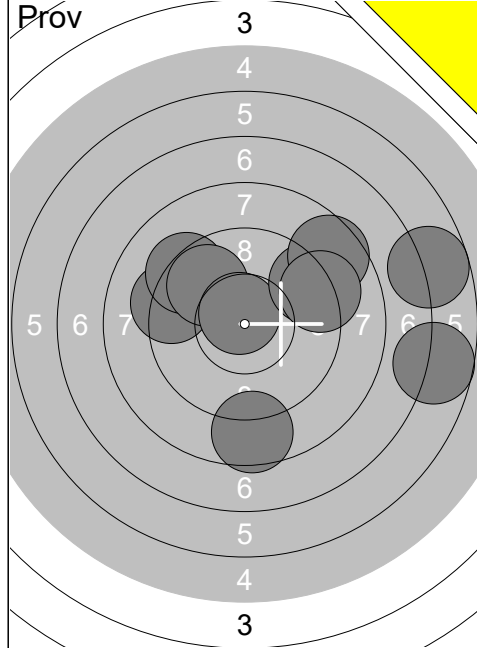

1:	9.3	↖
2:	9.3	↗
3:	9.8	↗
4:	8.6	↓
5:	6.7	→
6:	10.7x	↖
7:	9.3	↗
8:	8.6	↗
9:	6.7	→
10:	9.1	↗
Serie	83	
Total	0	

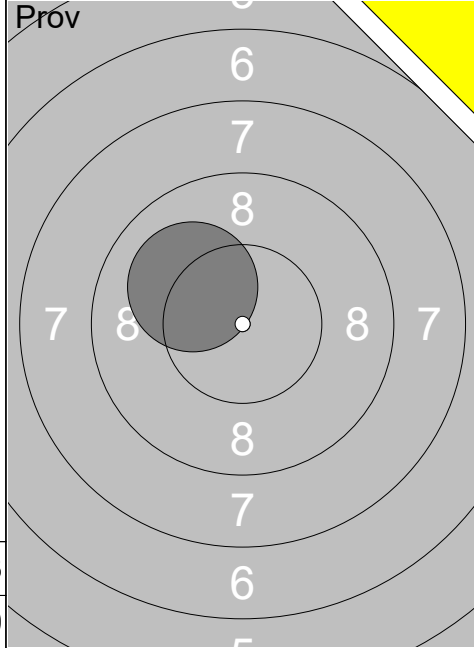

11:	10.1	↖
Serie	10	
Total	0	

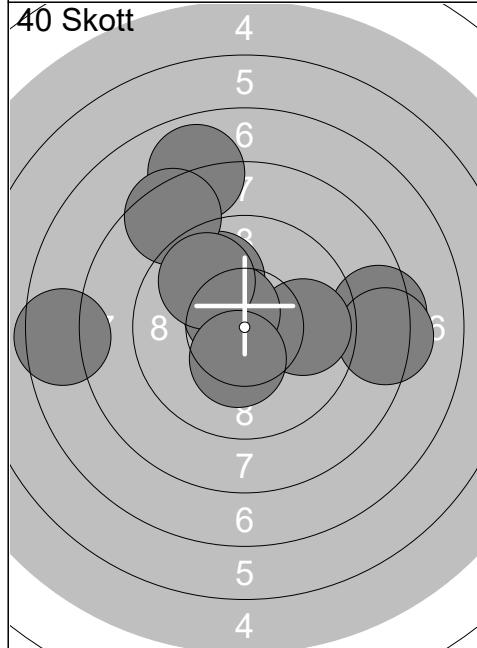

1:	7.9	↖
2:	9.9	↖
3:	8.4	→
4:	8.3	→
5:	9.9	→
6:	8.5	↖
7:	7.5	←
8:	10.6x	↖
9:	9.8	↖
10:	10.3x	↓
Serie	85	
Total	85	

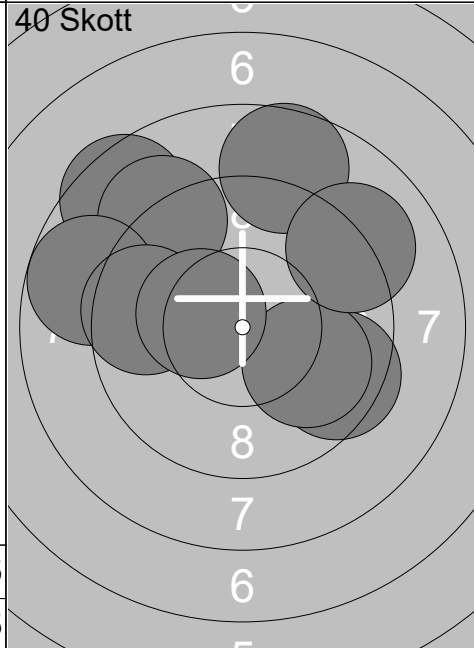

11:	9.3	↖
12:	8.5	↖
13:	8.7	↖
14:	9.5	↘
15:	9.1	↖
16:	9.9	↘
17:	9.1	↗
18:	8.8	←
19:	9.6	←
20:	10.3x	↖
Serie	88	
Total	173	

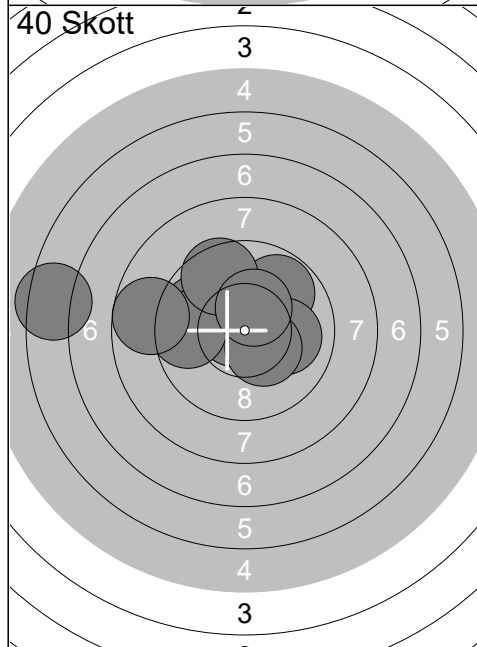

21:	6.4	←
22:	9.8	↖
23:	9.8	←
24:	10.7x	↖
25:	10.0	→
26:	9.6	←
27:	8.7	←
28:	10.4x	↘
29:	9.6	↖
30:	10.4x	↖
Serie	90	
Total	263	

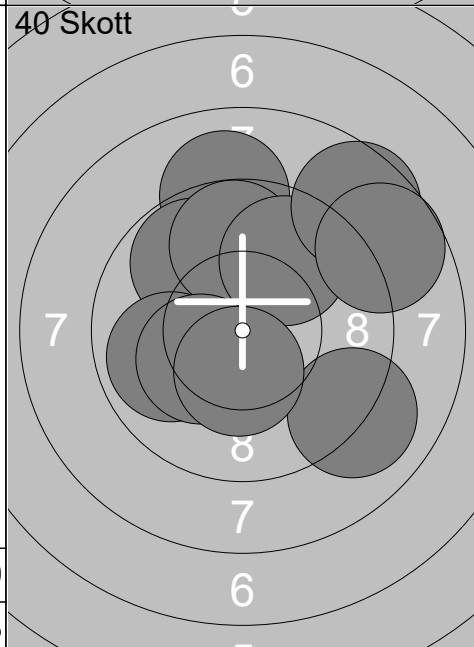

31:	9.1	↖
32:	9.8	↖
33:	9.8	↖
34:	9.9	←
35:	9.0	↘
36:	9.8	↖
37:	8.6	↖
38:	8.7	↗
39:	10.2x	↖
40:	10.4x	↓
Serie	90	
Total	353	

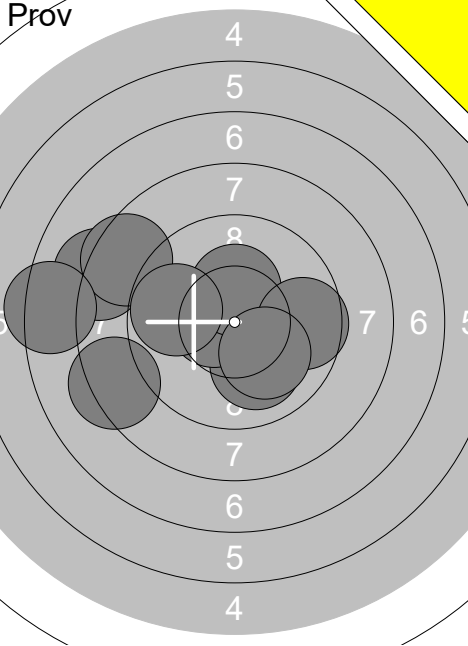
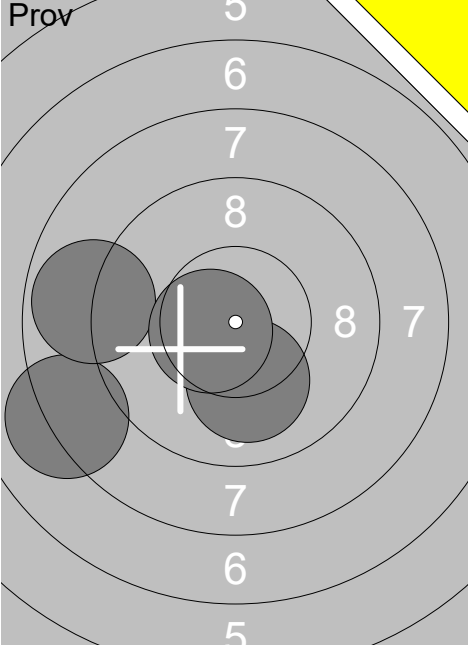
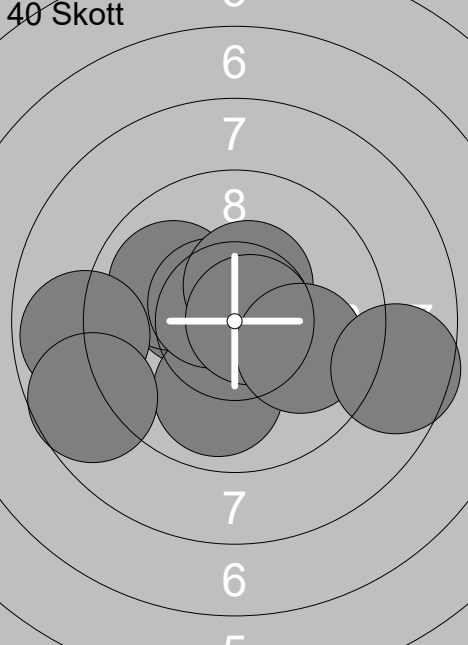
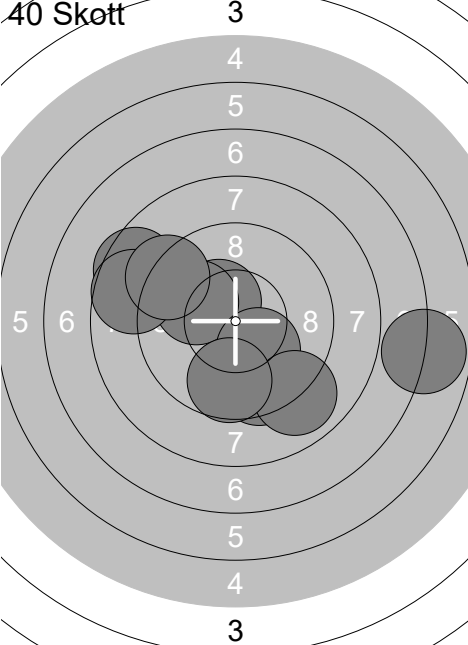
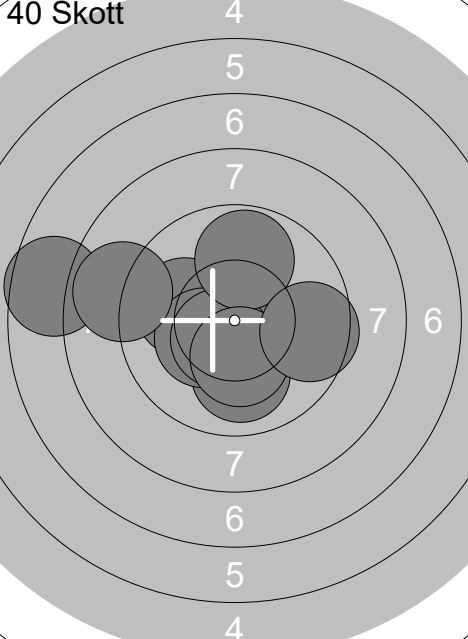
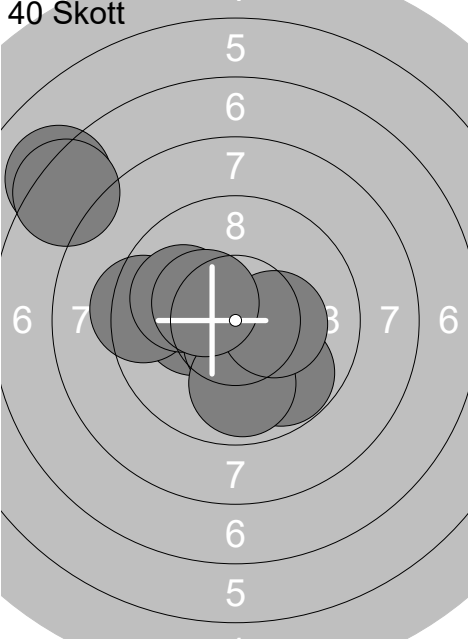
Skjutlag	Tavla	Gämlivare			13S	No
2	8	Gabriella Nilsson Rova				
Ramselefors		Gällivare			13S	No
07.11.2021		Vindelnskyttet 2021		Ramselefors SKF		
Prov		1: 8.2 ← 2: 8.5 ↖ 3: 10.0 ↓ 4: 10.6x← 5: 10.3x↑ 6: 7.3 ← 7: 8.3 ← 8: 9.6 → 9: 10.1 ↓ 10: 9.8 ←	Prov		11: 8.1 ↖ 12: 10.1 ↓ 13: 8.9 ← 14: 10.6x←	
		Serie 89		Serie 36		
		Total 0		Total 0		
40 Skott		1: 10.3x↖ 2: 10.0 ↖ 3: 9.9 ↓ 4: 10.5x↖ 5: 8.9 ← 6: 10.4x↑ 7: 10.7x→ 8: 10.0 → 9: 8.6 → 10: 8.7 ←	40 Skott		11: 9.5 ↓ 12: 10.4x↗ 13: 10.0 ← 14: 8.6 ↖ 15: 10.2x↓ 16: 9.0 ↓ 17: 6.9 → 18: 8.7 ← 19: 9.2 ↖ 20: 9.7 ↓	
		Serie 93		Serie 88		
		Total 93		Total 181		
40 Skott		21: 10.0 ← 22: 10.5x↓ 23: 10.0 ↓ 24: 10.3x↖ 25: 10.5x↖ 26: 7.6 ← 27: 9.8 ↑ 28: 10.3x↓ 29: 8.9 ← 30: 9.6 →	40 Skott		31: 10.3x← 32: 7.1 ↖ 33: 9.4 ← 34: 9.8 ↓ 35: 10.0 ← 36: 7.4 ↖ 37: 10.6x↓ 38: 9.9 ↓ 39: 10.3x→ 40: 10.4x↖	
		Serie 93		Serie 91		
		Total 274		Total 365		

Skjutlag	Tavla	Kristina Hermansson			
2	10	Ramselefors	Ramselefors	Sen	Vb
07.11.2021	Vindelnskyttet 2021	Ramselefors SKF			
Prov 	1: 8.6 ↖ 2: 8.9 ↖ 3: 8.9 ↖ 4: 10.0 ↗ 5: 9.7 ↖ 6: 9.9 ↗ 7: 10.1 ↑ 8: 10.1 ↗ 9: 10.2x ↗	60 Skott 	1: 9.3 ↗ 2: 8.7 → 3: 9.9 ↗ 4: 10.0 ← 5: 8.9 ↖ 6: 10.4x ↖ 7: 9.6 ↗ 8: 10.0 ↑ 9: 10.3x ↗ 10: 9.0 ↖	Serie 86.4 Total 0.0	Serie 96.1 Total 96.1
60 Skott 	11: 10.2x ↑ 12: 10.3x → 13: 10.7x ↖ 14: 10.6x ↗ 15: 10.1 ← 16: 9.2 ← 17: 9.8 ↑ 18: 8.9 → 19: 9.7 ↖ 20: 10.5x ↖	60 Skott 	21: 10.1 ← 22: 9.0 → 23: 8.9 ↖ 24: 10.2x → 25: 10.0 ↗ 26: 9.6 → 27: 10.8x ↖ 28: 9.6 ↖ 29: 10.3x ↖ 30: 9.8 ↖	Serie 100.0 Total 196.1	Serie 98.3 Total 294.4
60 Skott 	31: 10.4x ↓ 32: 8.8 → 33: 9.9 ← 34: 10.7x ↗ 35: 10.6x ↓ 36: 10.7x ↖ 37: 9.4 → 38: 10.1 ↑ 39: 9.8 ↓ 40: 10.2x ↖				
Serie 100.6 Total 395.0					

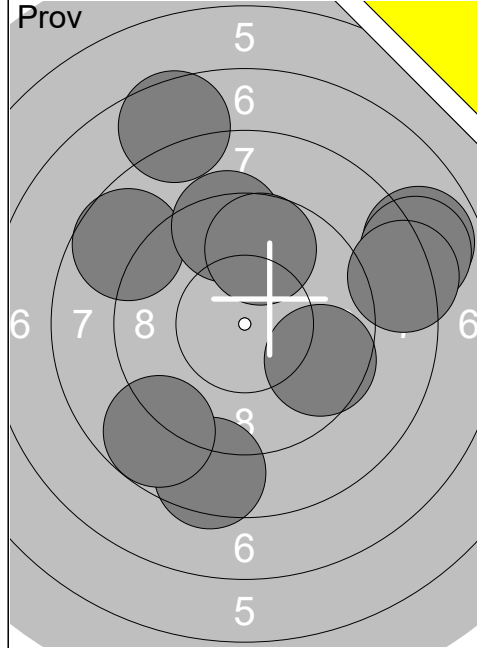

1:	7.9	➔
2:	9.6	➔
3:	8.0	➔
4:	8.5	⬇
5:	8.7	↖
6:	8.7	⬇
7:	8.3	➔
8:	7.6	↖
9:	9.4	↖
10:	9.7	↖
Serie		81
Total		0

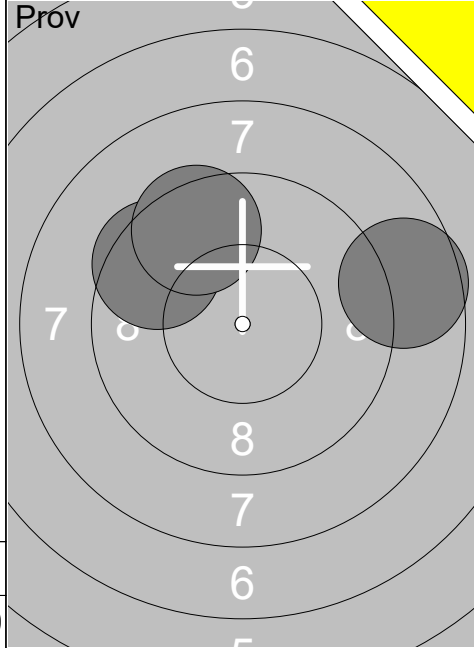

11:	8.6	➔
12:	9.5	↖
13:	9.5	↖
Serie		26
Total		0

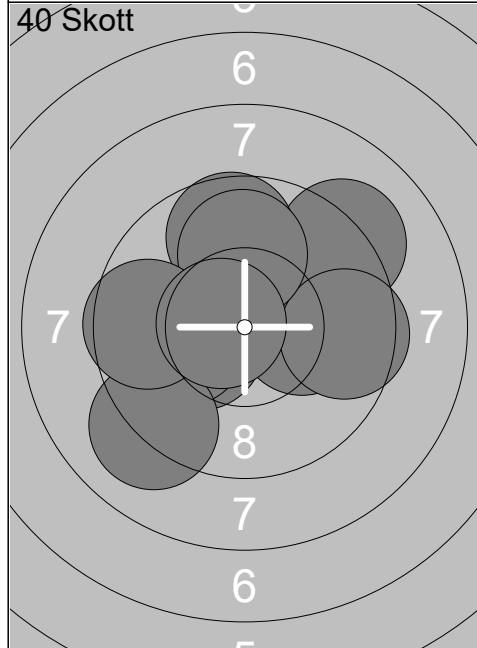

1:	10.2x	➔
2:	9.2	↗
3:	9.7	↖
4:	9.6	➔
5:	10.3x	↖
6:	9.9	↖
7:	10.1	↖
8:	9.1	⬇
9:	9.6	↖
10:	10.6x	↖
Serie		94
Total		94

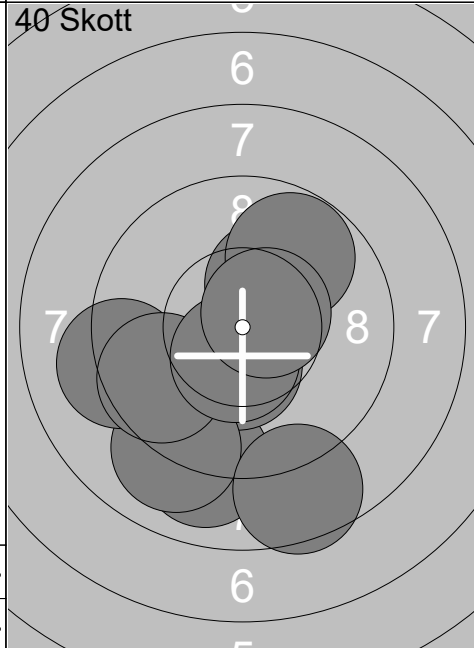

11:	9.0	⬇
12:	10.4x	⬇
13:	10.2x	↗
14:	9.8	↗
15:	9.0	⬇
16:	8.6	⬇
17:	9.2	↖
18:	9.6	↖
19:	10.5x	⬇
20:	10.6x	↗
Serie		93
Total		187

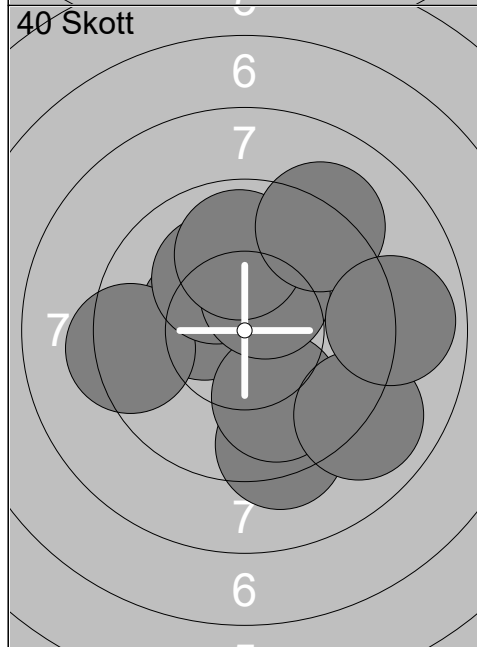

21:	9.3	⬇
22:	10.4x	↖
23:	9.3	↖
24:	10.1	↖
25:	9.9	⬇
26:	10.4x	↗
27:	9.0	⬇
28:	9.9	↖
29:	9.2	↗
30:	8.9	➔
Serie		92
Total		279

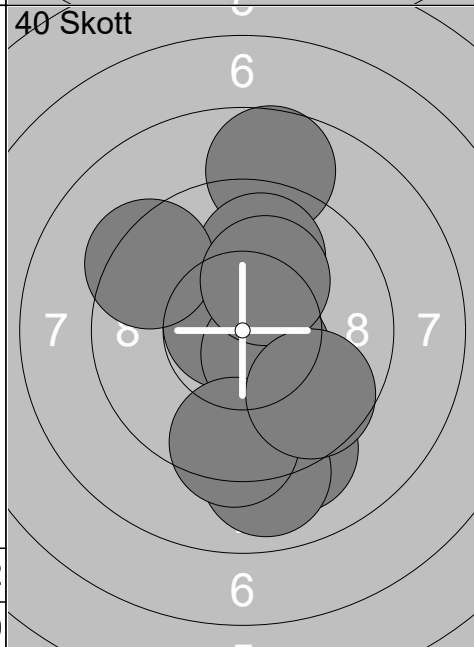

31:	10.7x	↖
32:	8.7	↖
33:	9.9	↖
34:	9.4	↖
35:	9.2	⬇
36:	9.0	⬇
37:	10.5x	⬇
38:	9.4	⬇
39:	10.2x	↗
40:	9.7	⬇
Serie		92
Total		371

Skjutlag	Tavla	Sabina Eriksson Lindberg		
2	12	Ramselefors	Bjurholm-Balsjö	11 Vb
07.11.2021	Vindelnskyttet 2021	Ramselefors SKF		
Prov 	1: 10.2x ↓ 2: 10.1 ↓ 3: 10.0 ↘ 4: 9.9 ↓ 5: 10.6x ↗ 6: 10.2x ↖ 7: 10.2x ↗ 8: 10.2x ↑ 9: 10.4x → 10: 10.5x ←	40 Skott 	1: 10.2x ↓ 2: 10.3x ↘ 3: 10.0 ↓ 4: 10.5x ↗ 5: 10.5x ← 6: 9.2 ↖ 7: 10.1 ↗ 8: 10.7x ↗ 9: 10.6x ← 10: 10.6x ↓	
	Serie 99		Serie 99	
	Total 0		Total 99	
40 Skott 	11: 10.9x → 12: 10.2x ↑ 13: 10.5x ↖ 14: 9.4 ↓ 15: 10.3x ↗ 16: 10.0 ↗ 17: 10.0 → 18: 10.6x ↖ 19: 10.2x ↓ 20: 10.0 ↗	40 Skott 	21: 9.7 ↗ 22: 10.0 → 23: 10.7x ← 24: 10.9x ↑ 25: 9.7 ↖ 26: 10.5x ← 27: 10.7x ↓ 28: 10.4x ↓ 29: 10.7x ↓ 30: 10.3x ↖	
	Serie 99		Serie 98	
	Total 198		Total 296	
40 Skott 	31: 10.0 → 32: 9.8 ↑ 33: 10.1 ↓ 34: 10.5x ↖ 35: 10.3x ↓ 36: 10.5x ← 37: 9.9 ↖ 38: 10.4x ↗ 39: 9.9 ↑ 40: 9.6 ↗			
	Serie 96			
	Total 392			

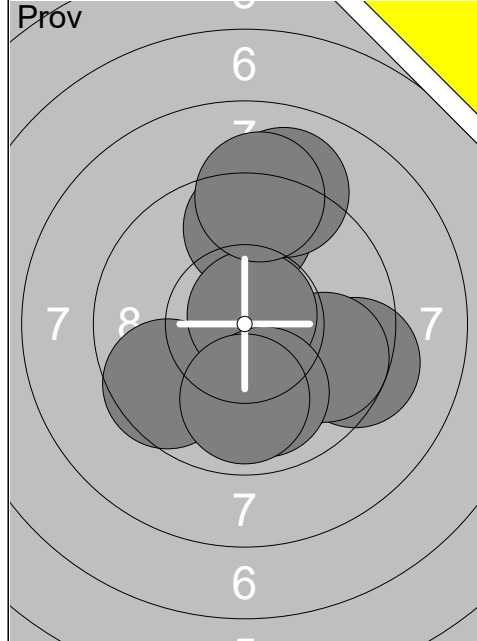

1:	9.6	↙
2:	9.3	→
3:	10.1	↘
4:	9.7	→
5:	9.6	↑
6:	9.0	↑
7:	10.8x	↗
8:	10.0	↓
9:	9.9	↓
10:	9.2	↑
Serie		93
Total		0

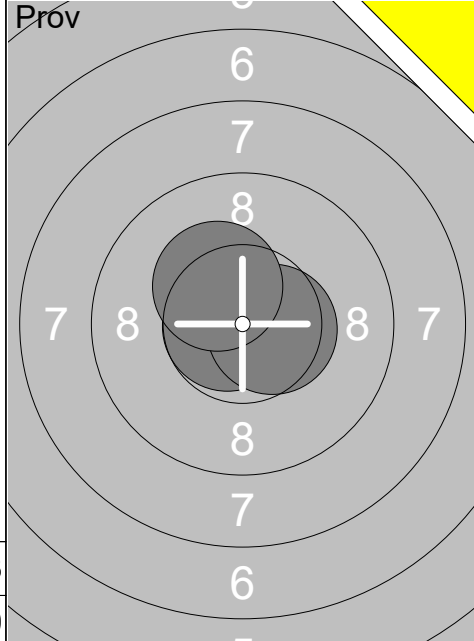

11:	10.7x	↙
12:	10.5x	→
13:	10.3x	↖
Serie		30
Total		0

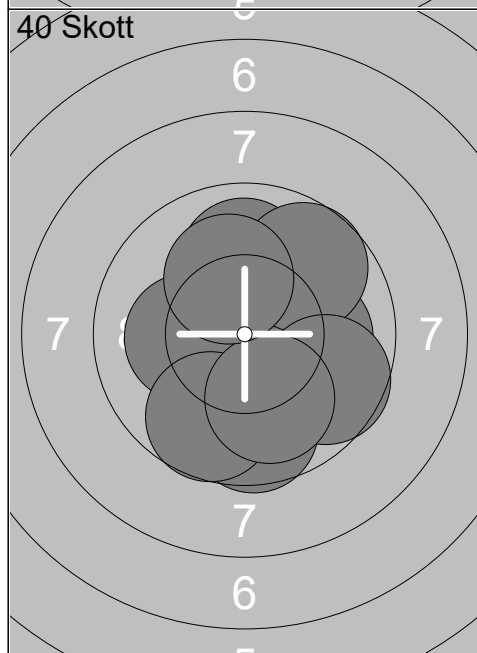

1:	10.2x	↙
2:	10.1	→
3:	10.0	↑
4:	9.6	↓
5:	10.0	↑
6:	9.7	↗
7:	9.7	→
8:	9.7	↓
9:	10.0	↓
10:	10.2x	↑
Serie		96
Total		96

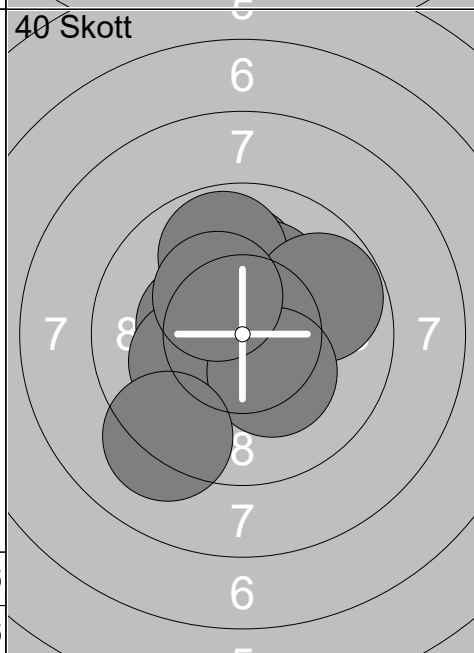

11:	10.0	↑
12:	10.4x	↙
13:	10.6x	→
14:	10.2x	↗
15:	9.8	↑
16:	10.2x	↙
17:	9.8	↗
18:	10.3x	↓
19:	10.3x	↖
20:	9.2	↓
Serie		97
Total		193

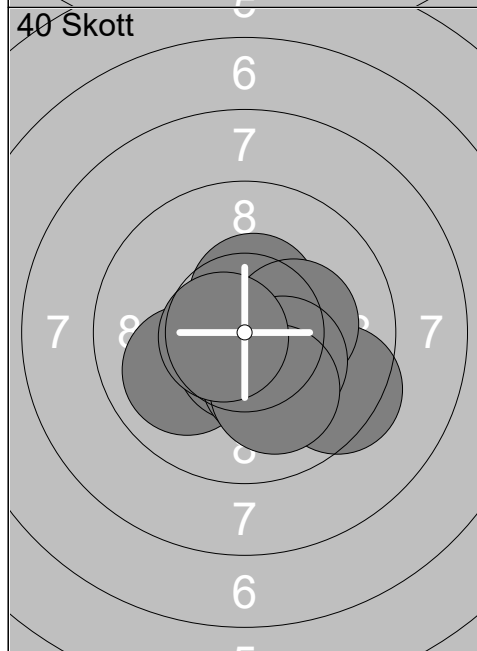

21:	10.5x	↑
22:	10.0	↙
23:	10.6x	↓
24:	9.4	↘
25:	10.6x	↓
26:	10.3x	→
27:	10.3x	↓
28:	10.3x	↘
29:	10.1	↓
30:	10.7x	↙
Serie		99
Total		292

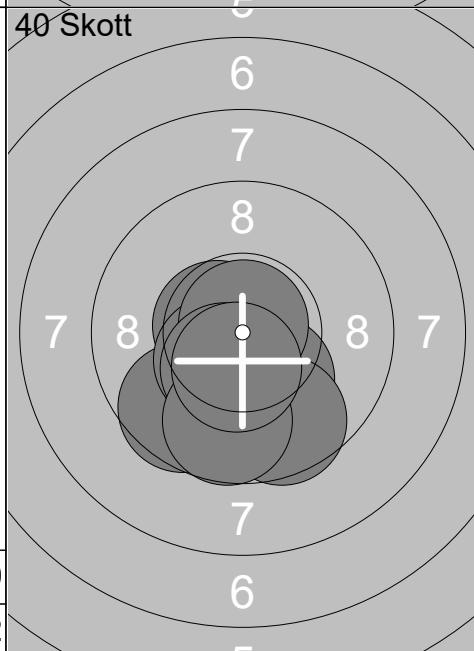

31:	10.6x	↙
32:	10.5x	↓
33:	9.6	↘
34:	10.2x	↓
35:	10.4x	↙
36:	10.8x	↑
37:	10.4x	↘
38:	9.6	↓
39:	9.7	↓
40:	10.5x	↓
Serie		97
Total		389

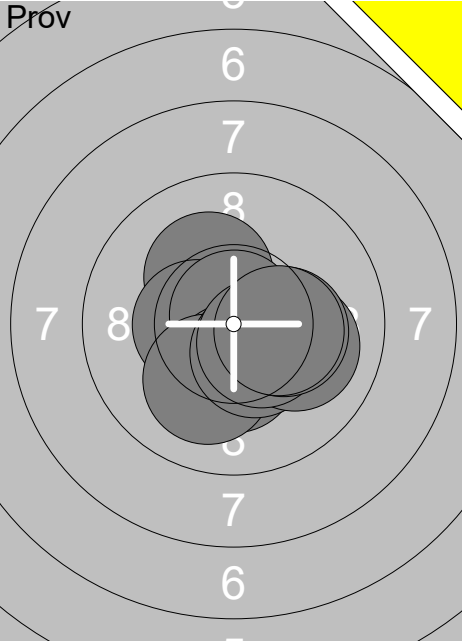
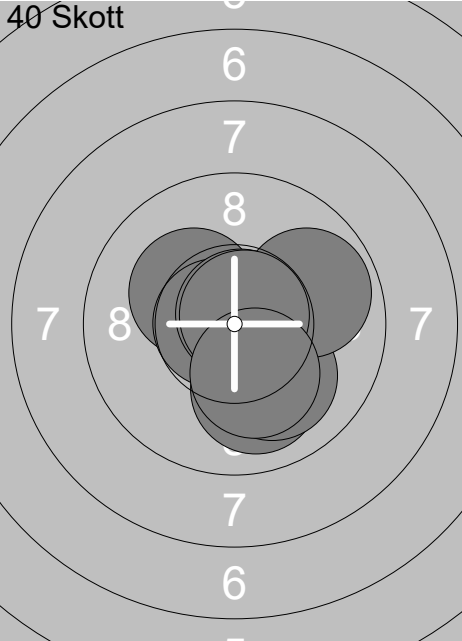
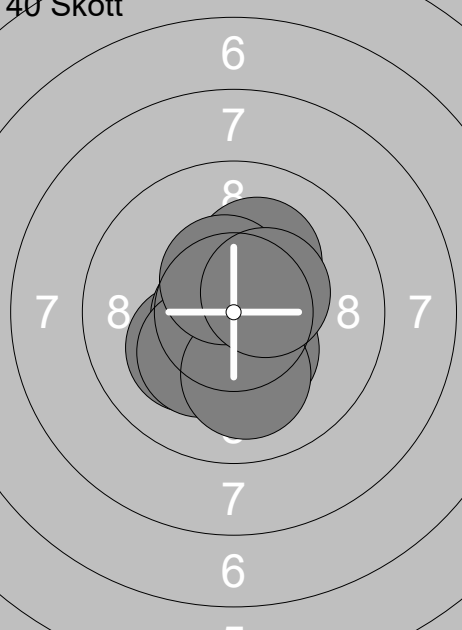
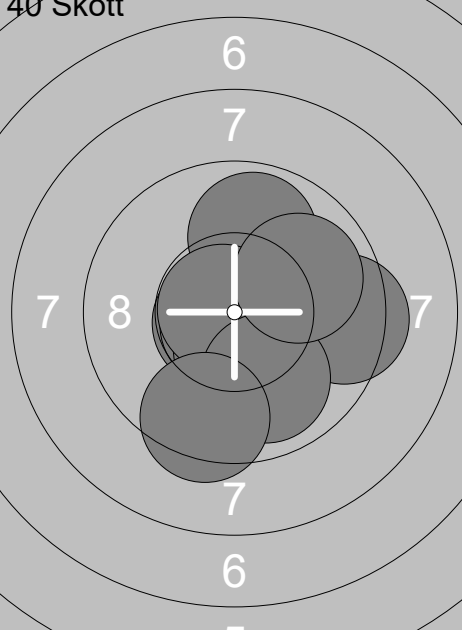
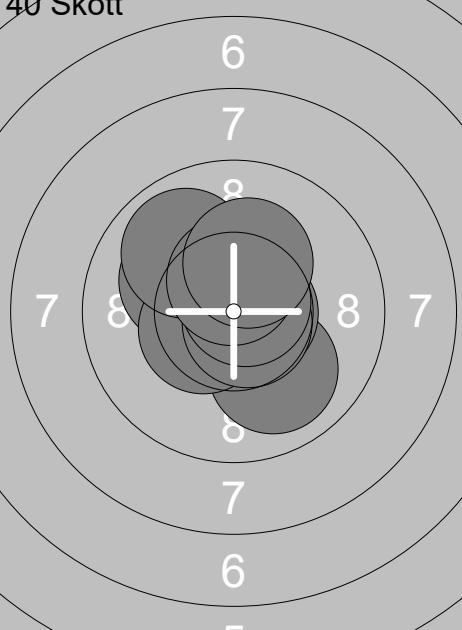
Skjutlag 2	Tavla 15	Ylva Lundstedt	
Ramselefors	Ramselefors	9	Vb
07.11.2021	Vindelnskyttet 2021	Ramselefors SKF	
Prov 	1: 10.2x ↗ 2: 10.4x ← 3: 10.8x ↑ 4: 10.3x ↓ 5: 10.1 ↓ 6: 10.4x ↘ 7: 10.0 → 8: 10.5x ↘ 9: 10.3x → 10: 10.3x → Serie 100 Total 0	40 Skott 	1: 10.0 ↓ 2: 10.5x → 3: 10.2x ↖ 4: 10.1 ↓ 5: 10.7x ← 6: 10.6x ↘ 7: 10.8x ↗ 8: 9.9 → 9: 10.8x ↗ 10: 10.2x ↓ Serie 99 Total 99
40 Skott 	11: 10.7x ↗ 12: 10.5x ↓ 13: 10.2x ↙ 14: 10.2x ↗ 15: 10.7x ← 16: 10.4x ↘ 17: 10.2x ↙ 18: 10.1 ↓ 19: 10.5x ↑ 20: 10.4x ↗ Serie 100 Total 199	40 Skott 	21: 10.7x ↙ 22: 10.0 → 23: 10.7x ↙ 24: 9.9 ↑ 25: 9.4 → 26: 10.4x ↓ 27: 10.8x ↙ 28: 9.9 ↓ 29: 9.4 ↓ 30: 9.9 ↗ Serie 95 Total 294
40 Skott 	31: 10.9x ↓ 32: 10.0 ↓ 33: 10.1 ↖ 34: 10.5x ↙ 35: 10.7x → 36: 10.7x ↘ 37: 10.7x ↗ 38: 9.9 ↖ 39: 10.5x ↑ 40: 10.2x ↗ Serie 99 Total 393		

Skjutlag	Tavla	Dennis Alenius		
2	16	Ramselefors	11	Vb
07.11.2021	Vindelnskyttet 2021	Ramselefors SKF		
Prov 	1: 9.4 → 2: 9.0 → 3: 9.5 ↑ 4: 10.0 → 5: 10.1 ↖ 6: 10.1 ↓ 7: 10.2x → 8: 9.8 → 9: 10.6x ← 10: 10.6x ↙	Prov 	11: 10.8x ↓ 12: 10.5x ↓ 13: 10.8x → 14: 8.3 ↑ 15: 10.6x ↖ 16: 10.1 → 17: 10.7x ↖	
	Serie 96		Serie 68	
	Total 0		Total 0	
40 Skott 	1: 9.9 ← 2: 9.5 ↑ 3: 9.9 ↖ 4: 9.8 ↓ 5: 10.7x ↑ 6: 10.3x ↖ 7: 10.5x → 8: 9.5 ↓ 9: 10.2x ↑ 10: 10.7x ←	40 Skott 	11: 10.4x ↑ 12: 10.8x ↖ 13: 10.4x ↘ 14: 9.9 ↑ 15: 9.8 ← 16: 10.0 ↘ 17: 10.1 ↑ 18: 9.8 → 19: 9.0 ↑ 20: 10.0 ↑	
	Serie 95		Serie 96	
	Total 95		Total 191	
40 Skott 	21: 9.4 → 22: 10.3x ↑ 23: 10.7x ↑ 24: 10.5x → 25: 10.1 ↓ 26: 10.4x ← 27: 9.6 → 28: 9.8 ↑ 29: 10.4x ↓ 30: 10.5x ↓	40 Skott 	31: 9.6 ↓ 32: 10.0 ← 33: 10.4x ↑ 34: 10.5x → 35: 10.7x ↓ 36: 9.9 ↓ 37: 10.5x ↑ 38: 10.6x ↑ 39: 9.7 → 40: 9.1 ←	
	Serie 97		Serie 96	
	Total 288		Total 384	

Ramselefors

Ramselefors

Sitt

Vb

07.11.2021

Vindelnskyttet 2021

Ramselefors SKF

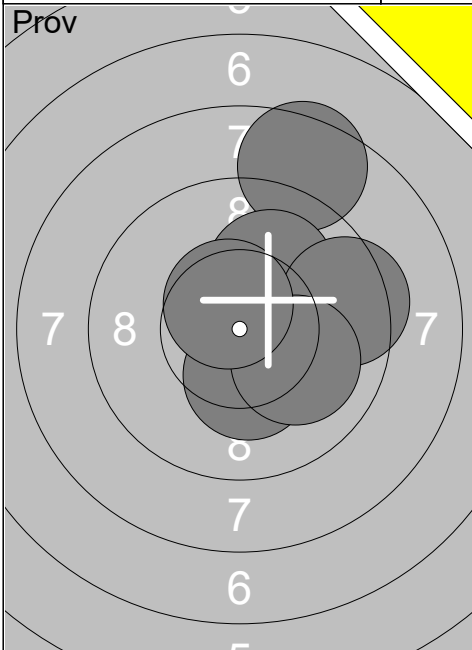

- 1: 8.5 ↗
- 2: 10.1 ↗
- 3: 9.4 →
- 4: 10.3x ↓
- 5: 10.1 ↘
- 6: 10.6x ↖

Serie 57
Total 0

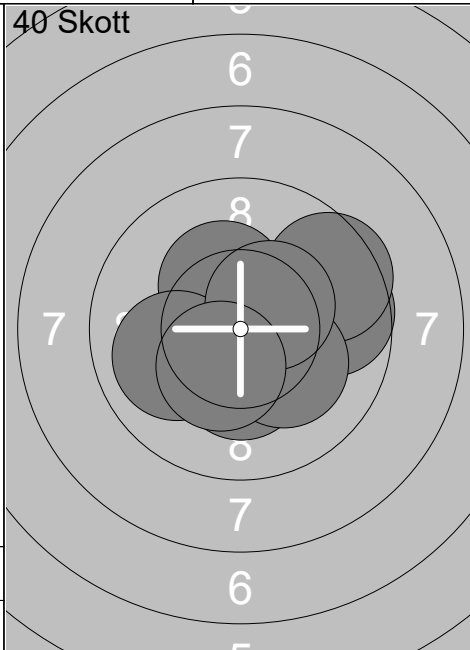

- 1: 10.3x ↓
- 2: 10.5x ↘
- 3: 10.3x ↘
- 4: 10.3x ↗
- 5: 9.7 →
- 6: 9.5 ↗
- 7: 10.2x ↘
- 8: 10.0 ←
- 9: 10.4x ↗
- 10: 10.4x ↘

Serie 98
Total 98

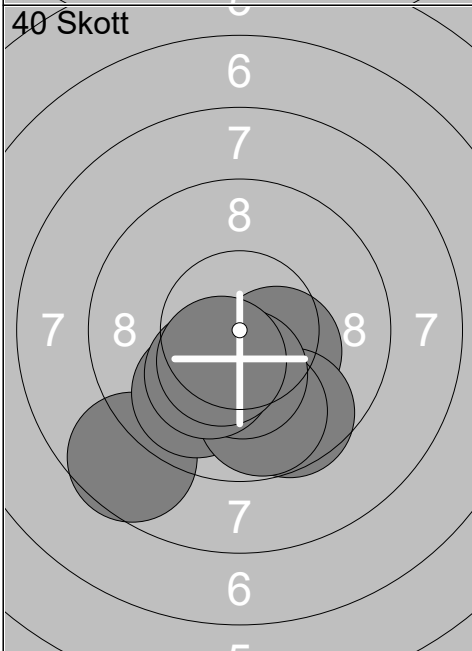

- 11: 10.4x ↓
- 12: 8.6 ↘
- 13: 9.9 ↘
- 14: 10.2x ↓
- 15: 10.4x ↘
- 16: 9.6 ↘
- 17: 9.8 ↘
- 18: 10.3x ↓
- 19: 10.2x ↘
- 20: 10.5x ↘

Serie 95
Total 193

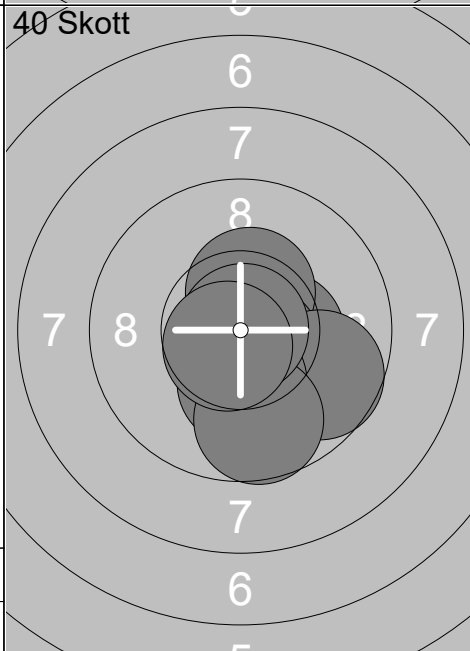

- 21: 10.5x →
- 22: 10.6x →
- 23: 10.4x →
- 24: 10.4x ↗
- 25: 10.6x ↘
- 26: 9.7 ↘
- 27: 10.2x ↓
- 28: 9.7 ↘
- 29: 10.9x ↗
- 30: 10.7x ↘

Serie 98
Total 291

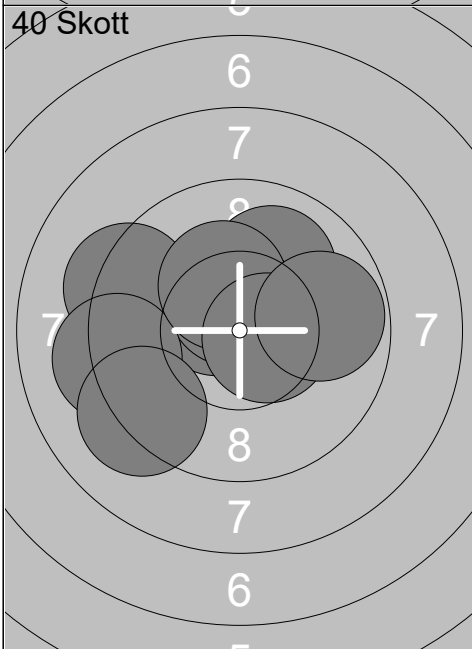

- 31: 10.5x ↗
- 32: 10.5x ↖
- 33: 10.0 ↗
- 34: 9.3 ←
- 35: 10.5x ↗
- 36: 9.2 ←
- 37: 9.2 ↘
- 38: 10.3x ↗
- 39: 10.6x →
- 40: 9.8 →

Serie 96
Total 387

<p>Prov</p>	<table border="1" style="width:100%; border-collapse: collapse;"> <tr><td>1:</td><td>9.0</td><td>↓</td></tr> <tr><td>2:</td><td>9.3</td><td>↙</td></tr> <tr><td>3:</td><td>9.7</td><td>↓</td></tr> <tr><td>4:</td><td>10.4x</td><td>↓</td></tr> <tr><td>5:</td><td>10.4x</td><td>→</td></tr> <tr><td>6:</td><td>10.1</td><td>↗</td></tr> <tr><td>7:</td><td>9.6</td><td>↗</td></tr> <tr><td>8:</td><td>10.1</td><td>↗</td></tr> <tr><td>9:</td><td>9.7</td><td>↗</td></tr> <tr><td>10:</td><td>10.2x</td><td>↗</td></tr> <tr><td colspan="2">Serie</td><td>95</td></tr> <tr><td colspan="2">Total</td><td>0</td></tr> </table>	1:	9.0	↓	2:	9.3	↙	3:	9.7	↓	4:	10.4x	↓	5:	10.4x	→	6:	10.1	↗	7:	9.6	↗	8:	10.1	↗	9:	9.7	↗	10:	10.2x	↗	Serie		95	Total		0	<p>Prov</p>	<table border="1" style="width:100%; border-collapse: collapse;"> <tr><td>11:</td><td>10.4x</td><td>←</td></tr> <tr><td>12:</td><td>10.5x</td><td>↑</td></tr> <tr><td>13:</td><td>10.5x</td><td>↙</td></tr> <tr><td>14:</td><td>10.2x</td><td>↙</td></tr> <tr><td>15:</td><td>10.1</td><td>←</td></tr> <tr><td>16:</td><td>9.6</td><td>←</td></tr> <tr><td>17:</td><td>10.3x</td><td>↗</td></tr> <tr><td>18:</td><td>10.3x</td><td>↘</td></tr> <tr><td>19:</td><td>10.2x</td><td>→</td></tr> <tr><td>20:</td><td>10.5x</td><td>↑</td></tr> <tr><td colspan="2">Serie</td><td>99</td></tr> <tr><td colspan="2">Total</td><td>0</td></tr> </table>	11:	10.4x	←	12:	10.5x	↑	13:	10.5x	↙	14:	10.2x	↙	15:	10.1	←	16:	9.6	←	17:	10.3x	↗	18:	10.3x	↘	19:	10.2x	→	20:	10.5x	↑	Serie		99	Total		0
1:	9.0	↓																																																																									
2:	9.3	↙																																																																									
3:	9.7	↓																																																																									
4:	10.4x	↓																																																																									
5:	10.4x	→																																																																									
6:	10.1	↗																																																																									
7:	9.6	↗																																																																									
8:	10.1	↗																																																																									
9:	9.7	↗																																																																									
10:	10.2x	↗																																																																									
Serie		95																																																																									
Total		0																																																																									
11:	10.4x	←																																																																									
12:	10.5x	↑																																																																									
13:	10.5x	↙																																																																									
14:	10.2x	↙																																																																									
15:	10.1	←																																																																									
16:	9.6	←																																																																									
17:	10.3x	↗																																																																									
18:	10.3x	↘																																																																									
19:	10.2x	→																																																																									
20:	10.5x	↑																																																																									
Serie		99																																																																									
Total		0																																																																									

<p>Prov</p>	<table border="1" style="width:100%; border-collapse: collapse;"> <tr><td>21:</td><td>9.9</td><td>↓</td></tr> <tr><td>22:</td><td>9.9</td><td>↓</td></tr> <tr><td>23:</td><td>10.2x</td><td>↗</td></tr> <tr><td colspan="2">Serie</td><td>28</td></tr> <tr><td colspan="2">Total</td><td>0</td></tr> </table>	21:	9.9	↓	22:	9.9	↓	23:	10.2x	↗	Serie		28	Total		0	<p>40 Skott</p>	<table border="1" style="width:100%; border-collapse: collapse;"> <tr><td>1:</td><td>9.8</td><td>→</td></tr> <tr><td>2:</td><td>9.8</td><td>↗</td></tr> <tr><td>3:</td><td>10.2x</td><td>↓</td></tr> <tr><td>4:</td><td>10.0</td><td>↑</td></tr> <tr><td>5:</td><td>10.7x</td><td>↙</td></tr> <tr><td>6:</td><td>9.8</td><td>↑</td></tr> <tr><td>7:</td><td>9.8</td><td>→</td></tr> <tr><td>8:</td><td>10.2x</td><td>↙</td></tr> <tr><td>9:</td><td>10.6x</td><td>↙</td></tr> <tr><td>10:</td><td>10.7x</td><td>↗</td></tr> <tr><td colspan="2">Serie</td><td>96</td></tr> <tr><td colspan="2">Total</td><td>96</td></tr> </table>	1:	9.8	→	2:	9.8	↗	3:	10.2x	↓	4:	10.0	↑	5:	10.7x	↙	6:	9.8	↑	7:	9.8	→	8:	10.2x	↙	9:	10.6x	↙	10:	10.7x	↗	Serie		96	Total		96
21:	9.9	↓																																																				
22:	9.9	↓																																																				
23:	10.2x	↗																																																				
Serie		28																																																				
Total		0																																																				
1:	9.8	→																																																				
2:	9.8	↗																																																				
3:	10.2x	↓																																																				
4:	10.0	↑																																																				
5:	10.7x	↙																																																				
6:	9.8	↑																																																				
7:	9.8	→																																																				
8:	10.2x	↙																																																				
9:	10.6x	↙																																																				
10:	10.7x	↗																																																				
Serie		96																																																				
Total		96																																																				

<p>40 Skott</p>	<table border="1" style="width:100%; border-collapse: collapse;"> <tr><td>11:</td><td>9.7</td><td>→</td></tr> <tr><td>12:</td><td>10.5x</td><td>↙</td></tr> <tr><td>13:</td><td>9.7</td><td>↙</td></tr> <tr><td>14:</td><td>10.5x</td><td>↙</td></tr> <tr><td>15:</td><td>9.8</td><td>←</td></tr> <tr><td>16:</td><td>10.0</td><td>↙</td></tr> <tr><td>17:</td><td>10.5x</td><td>↓</td></tr> <tr><td>18:</td><td>10.3x</td><td>↓</td></tr> <tr><td>19:</td><td>9.3</td><td>↙</td></tr> <tr><td>20:</td><td>9.9</td><td>↙</td></tr> <tr><td colspan="2">Serie</td><td>95</td></tr> <tr><td colspan="2">Total</td><td>191</td></tr> </table>	11:	9.7	→	12:	10.5x	↙	13:	9.7	↙	14:	10.5x	↙	15:	9.8	←	16:	10.0	↙	17:	10.5x	↓	18:	10.3x	↓	19:	9.3	↙	20:	9.9	↙	Serie		95	Total		191	<p>40 Skott</p>	<table border="1" style="width:100%; border-collapse: collapse;"> <tr><td>21:</td><td>9.0</td><td>←</td></tr> <tr><td>22:</td><td>10.1</td><td>↑</td></tr> <tr><td>23:</td><td>9.7</td><td>↓</td></tr> <tr><td>24:</td><td>10.1</td><td>↗</td></tr> <tr><td>25:</td><td>10.2x</td><td>↗</td></tr> <tr><td>26:</td><td>10.7x</td><td>↙</td></tr> <tr><td>27:</td><td>9.9</td><td>→</td></tr> <tr><td>28:</td><td>10.0</td><td>↗</td></tr> <tr><td>29:</td><td>10.5x</td><td>→</td></tr> <tr><td>30:</td><td>10.7x</td><td>→</td></tr> <tr><td colspan="2">Serie</td><td>97</td></tr> <tr><td colspan="2">Total</td><td>288</td></tr> </table>	21:	9.0	←	22:	10.1	↑	23:	9.7	↓	24:	10.1	↗	25:	10.2x	↗	26:	10.7x	↙	27:	9.9	→	28:	10.0	↗	29:	10.5x	→	30:	10.7x	→	Serie		97	Total		288
11:	9.7	→																																																																									
12:	10.5x	↙																																																																									
13:	9.7	↙																																																																									
14:	10.5x	↙																																																																									
15:	9.8	←																																																																									
16:	10.0	↙																																																																									
17:	10.5x	↓																																																																									
18:	10.3x	↓																																																																									
19:	9.3	↙																																																																									
20:	9.9	↙																																																																									
Serie		95																																																																									
Total		191																																																																									
21:	9.0	←																																																																									
22:	10.1	↑																																																																									
23:	9.7	↓																																																																									
24:	10.1	↗																																																																									
25:	10.2x	↗																																																																									
26:	10.7x	↙																																																																									
27:	9.9	→																																																																									
28:	10.0	↗																																																																									
29:	10.5x	→																																																																									
30:	10.7x	→																																																																									
Serie		97																																																																									
Total		288																																																																									

<p>40 Skott</p>	<table border="1" style="width:100%; border-collapse: collapse;"> <tr><td>31:</td><td>9.8</td><td>←</td></tr> <tr><td>32:</td><td>10.4x</td><td>↙</td></tr> <tr><td>33:</td><td>9.9</td><td>↓</td></tr> <tr><td>34:</td><td>10.4x</td><td>→</td></tr> <tr><td>35:</td><td>10.3x</td><td>↙</td></tr> <tr><td>36:</td><td>10.0</td><td>↙</td></tr> <tr><td>37:</td><td>9.5</td><td>↑</td></tr> <tr><td>38:</td><td>10.8x</td><td>→</td></tr> <tr><td>39:</td><td>10.2x</td><td>↙</td></tr> <tr><td>40:</td><td>10.1</td><td>↗</td></tr> <tr><td colspan="2">Serie</td><td>97</td></tr> <tr><td colspan="2">Total</td><td>385</td></tr> </table>	31:	9.8	←	32:	10.4x	↙	33:	9.9	↓	34:	10.4x	→	35:	10.3x	↙	36:	10.0	↙	37:	9.5	↑	38:	10.8x	→	39:	10.2x	↙	40:	10.1	↗	Serie		97	Total		385		
31:	9.8	←																																					
32:	10.4x	↙																																					
33:	9.9	↓																																					
34:	10.4x	→																																					
35:	10.3x	↙																																					
36:	10.0	↙																																					
37:	9.5	↑																																					
38:	10.8x	→																																					
39:	10.2x	↙																																					
40:	10.1	↗																																					
Serie		97																																					
Total		385																																					

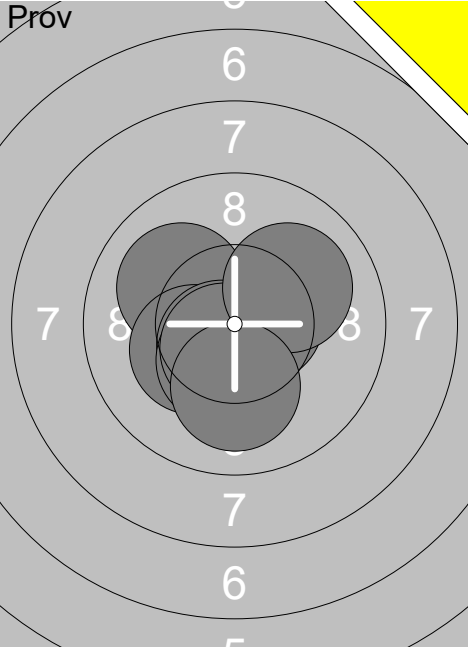
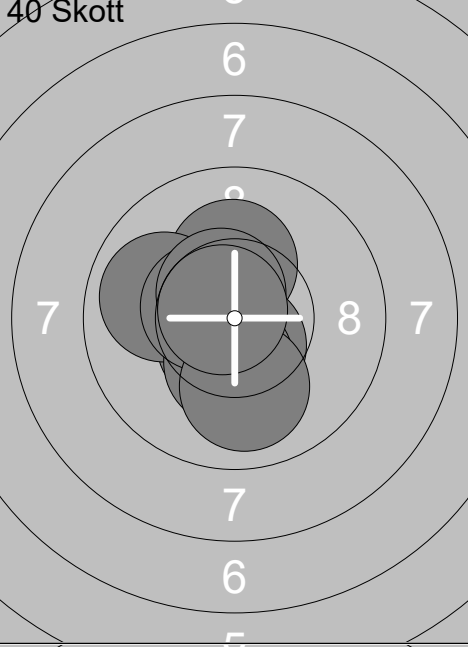
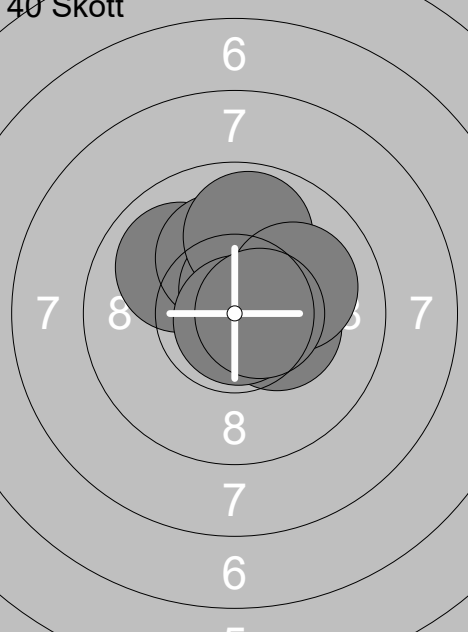
Skjutlag	Tavla	Mattias Näslund		Sitt	Vb
2	19	Ramselefors	Ramselefors		
07.11.2021	Vindelnskyttet 2021	Ramselefors SKF			
Prov		1: 10.6x ←	Prov	11: 10.3x ↗	
		2: 10.6x →			
		3: 10.5x ←			
		4: 10.1 ↖			
		5: 10.3x ↙			
		6: 10.6x ↘			
		7: 10.4x ↘			
		8: 10.6x ↘			
		9: 10.1 ↗			
		10: 10.1 ↓			
		Serie 100		Serie 10	
		Total 0		Total 0	
40 Skott		1: 10.6x ↘	40 Skott	11: 10.0 ↗	
		2: 10.8x ↙		12: 10.3x ←	
		3: 10.2x ↗		13: 10.6x ↙	
		4: 9.9 ←		14: 10.0 ↗	
		5: 10.6x ↘		15: 10.0 ↖	
		6: 10.3x ↘		16: 10.4x ↘	
		7: 10.5x ←		17: 10.4x ↗	
		8: 10.0 ↓		18: 10.3x ↖	
		9: 10.6x ↗		19: 10.7x ↘	
		10: 10.7x ↖		20: 10.3x →	
		Serie 99		Serie 100	
		Total 99		Total 199	
40 Skott		21: 10.4x →	40 Skott	31: 10.7x ↗	
		22: 10.0 ↖		32: 10.3x ↗	
		23: 10.4x ↗		33: 9.9 →	
		24: 10.2x ↗		34: 10.8x ↖	
		25: 10.6x ↗		35: 10.4x ↘	
		26: 9.9 ↗		36: 10.2x ↘	
		27: 10.3x →		37: 9.7 →	
		28: 10.8x ↘		38: 10.2x ↖	
		29: 10.1 ↗		39: 10.3x ↖	
		30: 10.6x →		40: 10.4x ↘	
		Serie 99		Serie 98	
		Total 298		Total 396	

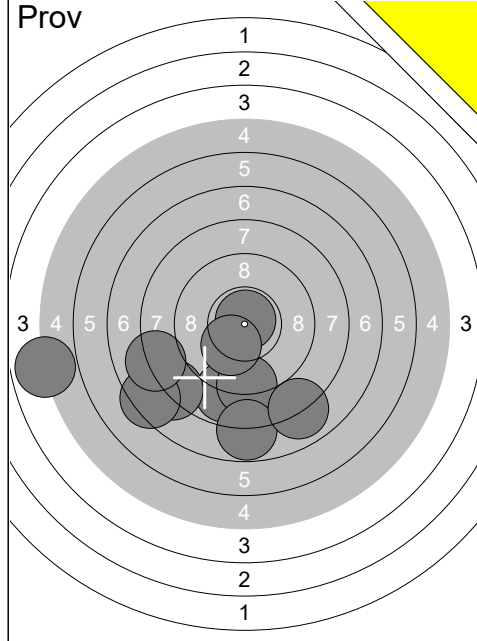

1:	8.8	↓
2:	9.1	↓
3:	8.1	↙
4:	10.8x	↑
5:	7.8	↓
6:	7.4	↙
7:	8.0	↓
8:	10.2x	↓
9:	8.1	↙
10:	4.9	↙
Serie		79
Total		0

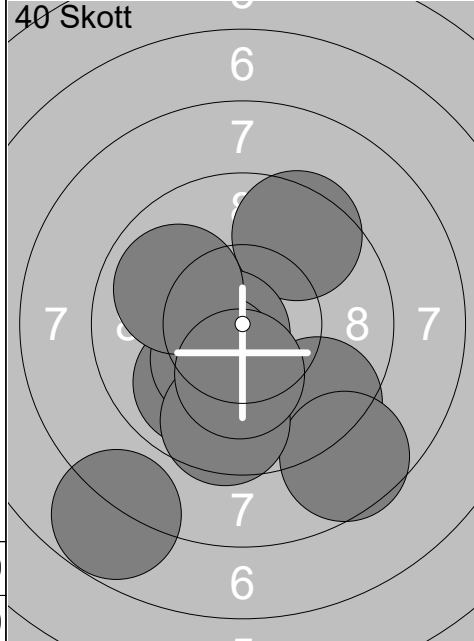

1:	9.5	↗
2:	10.7x	↙
3:	9.4	↘
4:	8.6	↘
5:	9.9	↘
6:	10.3x	↙
7:	9.9	↙
8:	9.6	↓
9:	10.2x	↓
10:	7.8	↘
Serie		90
Total		90

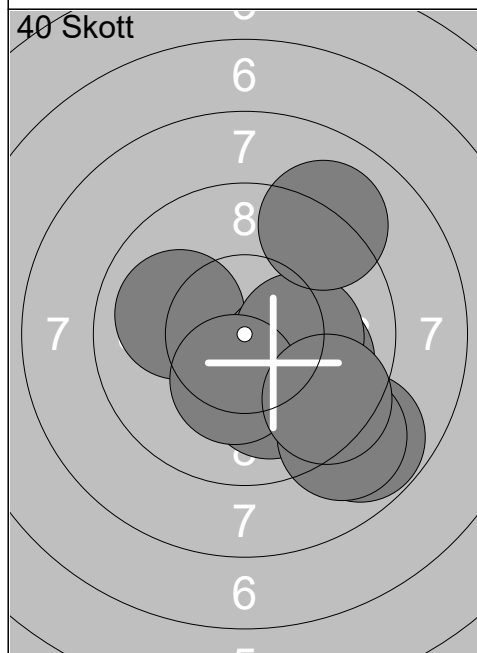

11:	10.0	↙
12:	10.0	→
13:	8.8	↘
14:	10.0	↓
15:	10.3x	↘
16:	9.0	↘
17:	10.2x	→
18:	9.1	↗
19:	10.3x	↓
20:	9.5	↘
Serie		95
Total		185

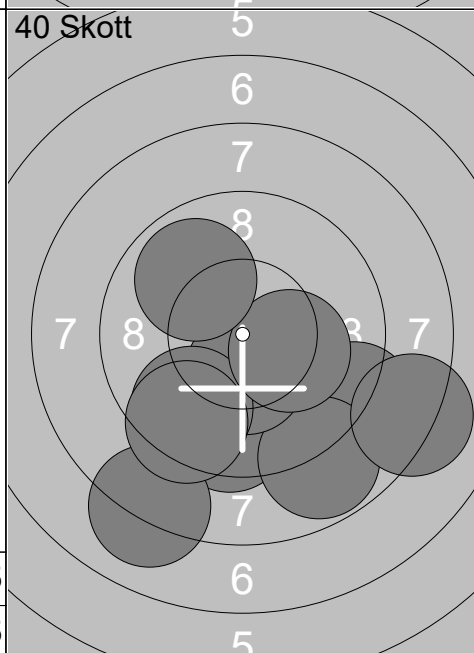

21:	9.0	↘
22:	9.5	↓
23:	8.8	↘
24:	10.4x	↓
25:	8.2	→
26:	9.6	↘
27:	8.1	↘
28:	10.2x	→
29:	9.9	↗
30:	9.4	↘
Serie		89
Total		274

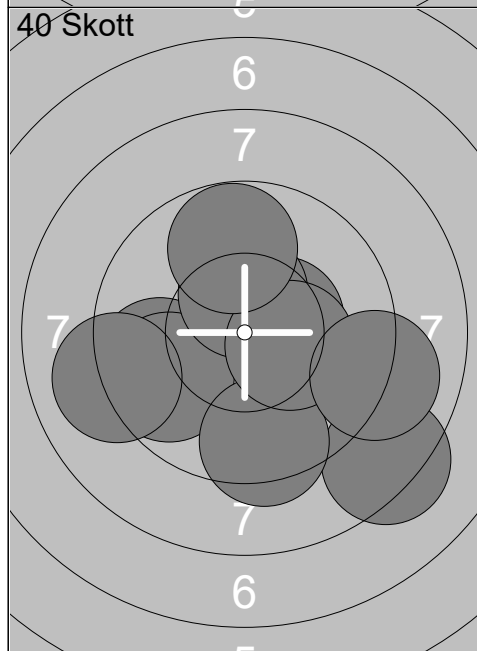





31:	10.4x	→
32:	8.3	↘
33:	9.7	↙
34:	9.7	↙
35:	9.4	↓
36:	10.4x	↑
37:	9.1	↙
38:	10.3x	→
39:	9.0	→
40:	9.8	↑
Serie		92
Total		366

Skjuttag	Tavla	Linus Holmlund		
2	22	Ramselefors	Umeå	9 Vb
07.11.2021	Vindelnskyttet 2021	Ramselefors SKF		
Prov 	1: 10.7x ↑ 2: 9.8 ↑ 3: 10.3x ↗ 4: 10.0 ↖ 5: 10.6x ↘ 6: 10.5x ↑ 7: 10.4x ↗ 8: 10.1 ↓ 9: 9.9 ↓ 10: 10.6x ↓ Serie 98 Total 0	Prov 	11: 9.9 ↓ 12: 9.6 ↖ 13: 10.1 ↑ 14: 9.7 ↑ 15: 10.3x ↘ 16: 10.5x ↓ 17: 10.3x → 18: 10.6x ↖ Serie 77 Total 0	
40 Skott 	1: 10.4x → 2: 10.1 ↘ 3: 10.5x ↗ 4: 10.4x ↖ 5: 10.6x ↑ 6: 9.6 ↗ 7: 10.5x ↑ 8: 10.5x ↖ 9: 10.2x ↖ 10: 10.3x ↓ Serie 99 Total 99	40 Skott 	11: 10.7x ↓ 12: 10.3x → 13: 10.7x → 14: 10.3x ↗ 15: 10.5x ↓ 16: 10.6x ↘ 17: 10.8x ← 18: 10.5x ← 19: 10.5x ← 20: 10.9x → Serie 100 Total 199	
40 Skott 	21: 10.1 ↘ 22: 10.5x → 23: 10.5x → 24: 10.0 → 25: 10.7x ↘ 26: 10.3x ↑ 27: 10.4x ↑ 28: 10.4x ↗ 29: 10.7x ↘ 30: 10.7x ↓ Serie 100 Total 299	40 Skott 	31: 10.5x → 32: 10.6x ↓ 33: 10.1 ↘ 34: 10.7x → 35: 10.3x ↑ 36: 10.3x → 37: 10.2x ↓ 38: 10.8x ↘ 39: 10.4x ↓ 40: 10.4x ↖ Serie 100 Total 399	

Skjutlag	Tavla	Emil Holmlund		
2	23	Umeå	11	Vb
07.11.2021	Vindelnskyttet 2021	Ramselefors SKF		
Prov 	1: 10.2x ↗	Prov 	11: 9.8 ↓	
	2: 10.0 ↑		12: 9.9 ↙	
	3: 9.4 ↖		13: 10.3x ↖	
	4: 9.7 ↖		14: 10.8x ↙	
	5: 10.4x ↗		15: 10.6x ↖	
	6: 10.5x ↙			
	7: 10.4x ↑			
	8: 10.3x ↑			
	9: 10.2x ➡			
	10: 8.5 ↓			
Serie	96	Serie	48	
Total	0	Total	0	
40 Skott 	1: 10.3x ↖	40 Skott 	11: 10.7x ↓	
	2: 10.4x ↖		12: 10.4x ↗	
	3: 10.8x ↙		13: 10.5x ↑	
	4: 10.6x ↖		14: 10.6x ↗	
	5: 10.3x ↓		15: 10.9x ↓	
	6: 10.1 ↓		16: 10.4x ↑	
	7: 10.8x ↓		17: 10.8x ➡	
	8: 10.3x ↖		18: 9.8 ↑	
	9: 10.2x ↙		19: 10.5x ↑	
	10: 9.7 ↑		20: 10.8x ↗	
Serie	99	Serie	99	
Total	99	Total	198	
40 Skott 	21: 10.8x ↖	40 Skott 	31: 10.8x ↓	
	22: 9.9 ↑		32: 10.1 ↗	
	23: 10.7x ↑		33: 10.0 ↗	
	24: 10.3x ↖		34: 10.3x ↖	
	25: 10.7x ➡		35: 10.5x ↙	
	26: 10.3x ↖		36: 10.4x ↑	
	27: 10.3x ↓		37: 10.1 ←	
	28: 10.7x ↖		38: 10.8x ↓	
	29: 9.9 ↑		39: 10.1 ➡	
	30: 10.4x ↗		40: 10.5x ↖	
Serie	98	Serie	100	
Total	296	Total	396	

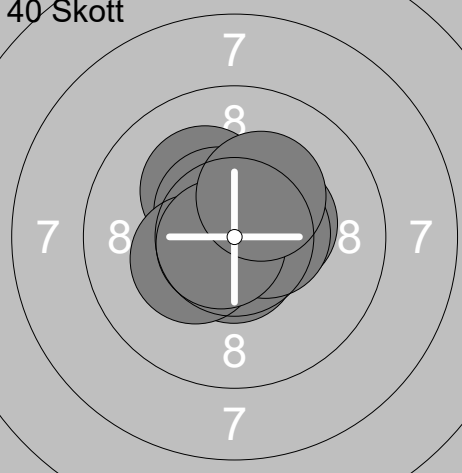
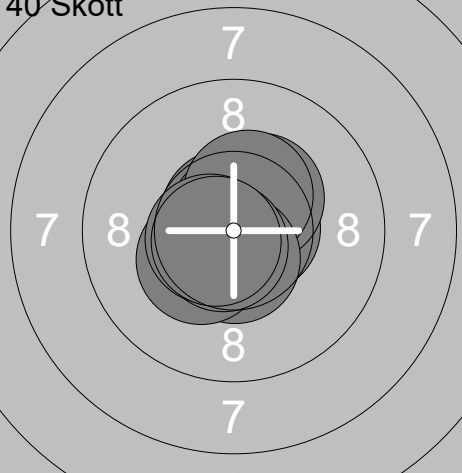
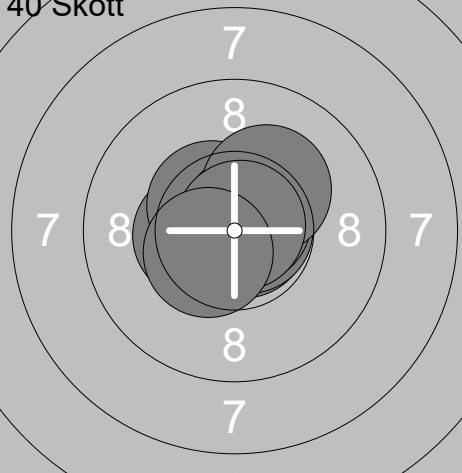
<p>Prov</p>	<table border="1" style="width:100%; border-collapse: collapse;"> <tr><td>1:</td><td>9.8</td><td>→</td></tr> <tr><td>2:</td><td>10.6x</td><td>→</td></tr> <tr><td>3:</td><td>10.4x</td><td>↗</td></tr> <tr><td>4:</td><td>10.1</td><td>↗</td></tr> <tr><td>5:</td><td>10.4x</td><td>↗</td></tr> <tr><td>6:</td><td>9.9</td><td>↗</td></tr> <tr><td>7:</td><td>10.6x</td><td>↓</td></tr> <tr><td>8:</td><td>10.3x</td><td>→</td></tr> <tr><td>9:</td><td>10.6x</td><td>→</td></tr> <tr><td>10:</td><td>9.8</td><td>↓</td></tr> <tr><td colspan="2">Serie</td><td style="text-align: right;">97</td></tr> <tr><td colspan="2">Total</td><td style="text-align: right;">0</td></tr> </table>	1:	9.8	→	2:	10.6x	→	3:	10.4x	↗	4:	10.1	↗	5:	10.4x	↗	6:	9.9	↗	7:	10.6x	↓	8:	10.3x	→	9:	10.6x	→	10:	9.8	↓	Serie		97	Total		0	<p>Prov</p>	<table border="1" style="width:100%; border-collapse: collapse;"> <tr><td>11:</td><td>9.3</td><td>↙</td></tr> <tr><td>12:</td><td>10.2x</td><td>↓</td></tr> <tr><td>13:</td><td>10.7x</td><td>↑</td></tr> <tr><td>14:</td><td>10.4x</td><td>←</td></tr> <tr><td>15:</td><td>10.6x</td><td>↙</td></tr> <tr><td>16:</td><td>10.2x</td><td>↗</td></tr> <tr><td>17:</td><td>10.4x</td><td>←</td></tr> <tr><td>18:</td><td>10.7x</td><td>↓</td></tr> <tr><td>19:</td><td>9.8</td><td>↓</td></tr> <tr><td>20:</td><td>10.6x</td><td>←</td></tr> <tr><td colspan="2">Serie</td><td style="text-align: right;">98</td></tr> <tr><td colspan="2">Total</td><td style="text-align: right;">0</td></tr> </table>	11:	9.3	↙	12:	10.2x	↓	13:	10.7x	↑	14:	10.4x	←	15:	10.6x	↙	16:	10.2x	↗	17:	10.4x	←	18:	10.7x	↓	19:	9.8	↓	20:	10.6x	←	Serie		98	Total		0
1:	9.8	→																																																																									
2:	10.6x	→																																																																									
3:	10.4x	↗																																																																									
4:	10.1	↗																																																																									
5:	10.4x	↗																																																																									
6:	9.9	↗																																																																									
7:	10.6x	↓																																																																									
8:	10.3x	→																																																																									
9:	10.6x	→																																																																									
10:	9.8	↓																																																																									
Serie		97																																																																									
Total		0																																																																									
11:	9.3	↙																																																																									
12:	10.2x	↓																																																																									
13:	10.7x	↑																																																																									
14:	10.4x	←																																																																									
15:	10.6x	↙																																																																									
16:	10.2x	↗																																																																									
17:	10.4x	←																																																																									
18:	10.7x	↓																																																																									
19:	9.8	↓																																																																									
20:	10.6x	←																																																																									
Serie		98																																																																									
Total		0																																																																									
<p>Prov</p>	<table border="1" style="width:100%; border-collapse: collapse;"> <tr><td>21:</td><td>9.9</td><td>↗</td></tr> <tr><td>22:</td><td>10.6x</td><td>↗</td></tr> <tr><td>23:</td><td>10.3x</td><td>↗</td></tr> <tr><td>24:</td><td>10.3x</td><td>↑</td></tr> <tr><td>25:</td><td>10.3x</td><td>→</td></tr> <tr><td>26:</td><td>10.3x</td><td>↗</td></tr> <tr><td colspan="2">Serie</td><td style="text-align: right;">59</td></tr> <tr><td colspan="2">Total</td><td style="text-align: right;">0</td></tr> </table>	21:	9.9	↗	22:	10.6x	↗	23:	10.3x	↗	24:	10.3x	↑	25:	10.3x	→	26:	10.3x	↗	Serie		59	Total		0	<p>40 Skott</p>	<table border="1" style="width:100%; border-collapse: collapse;"> <tr><td>1:</td><td>10.7x</td><td>↙</td></tr> <tr><td>2:</td><td>10.5x</td><td>↓</td></tr> <tr><td>3:</td><td>10.3x</td><td>←</td></tr> <tr><td>4:</td><td>10.1</td><td>↗</td></tr> <tr><td>5:</td><td>10.0</td><td>↓</td></tr> <tr><td>6:</td><td>10.8x</td><td>→</td></tr> <tr><td>7:</td><td>10.6x</td><td>↓</td></tr> <tr><td>8:</td><td>10.5x</td><td>↓</td></tr> <tr><td>9:</td><td>10.5x</td><td>↗</td></tr> <tr><td>10:</td><td>10.0</td><td>↗</td></tr> <tr><td colspan="2">Serie</td><td style="text-align: right;">100</td></tr> <tr><td colspan="2">Total</td><td style="text-align: right;">100</td></tr> </table>	1:	10.7x	↙	2:	10.5x	↓	3:	10.3x	←	4:	10.1	↗	5:	10.0	↓	6:	10.8x	→	7:	10.6x	↓	8:	10.5x	↓	9:	10.5x	↗	10:	10.0	↗	Serie		100	Total		100												
21:	9.9	↗																																																																									
22:	10.6x	↗																																																																									
23:	10.3x	↗																																																																									
24:	10.3x	↑																																																																									
25:	10.3x	→																																																																									
26:	10.3x	↗																																																																									
Serie		59																																																																									
Total		0																																																																									
1:	10.7x	↙																																																																									
2:	10.5x	↓																																																																									
3:	10.3x	←																																																																									
4:	10.1	↗																																																																									
5:	10.0	↓																																																																									
6:	10.8x	→																																																																									
7:	10.6x	↓																																																																									
8:	10.5x	↓																																																																									
9:	10.5x	↗																																																																									
10:	10.0	↗																																																																									
Serie		100																																																																									
Total		100																																																																									
<p>40 Skott</p>	<table border="1" style="width:100%; border-collapse: collapse;"> <tr><td>11:</td><td>10.4x</td><td>→</td></tr> <tr><td>12:</td><td>10.1</td><td>←</td></tr> <tr><td>13:</td><td>10.2x</td><td>→</td></tr> <tr><td>14:</td><td>10.6x</td><td>↙</td></tr> <tr><td>15:</td><td>10.8x</td><td>→</td></tr> <tr><td>16:</td><td>10.6x</td><td>↓</td></tr> <tr><td>17:</td><td>10.8x</td><td>←</td></tr> <tr><td>18:</td><td>10.5x</td><td>↑</td></tr> <tr><td>19:</td><td>10.3x</td><td>↗</td></tr> <tr><td>20:</td><td>10.0</td><td>↖</td></tr> <tr><td colspan="2">Serie</td><td style="text-align: right;">100</td></tr> <tr><td colspan="2">Total</td><td style="text-align: right;">200</td></tr> </table>	11:	10.4x	→	12:	10.1	←	13:	10.2x	→	14:	10.6x	↙	15:	10.8x	→	16:	10.6x	↓	17:	10.8x	←	18:	10.5x	↑	19:	10.3x	↗	20:	10.0	↖	Serie		100	Total		200	<p>40 Skott</p>	<table border="1" style="width:100%; border-collapse: collapse;"> <tr><td>21:</td><td>10.5x</td><td>→</td></tr> <tr><td>22:</td><td>10.7x</td><td>↓</td></tr> <tr><td>23:</td><td>10.6x</td><td>↑</td></tr> <tr><td>24:</td><td>10.1</td><td>←</td></tr> <tr><td>25:</td><td>10.4x</td><td>↗</td></tr> <tr><td>26:</td><td>10.8x</td><td>↗</td></tr> <tr><td>27:</td><td>10.7x</td><td>←</td></tr> <tr><td>28:</td><td>10.7x</td><td>↗</td></tr> <tr><td>29:</td><td>10.3x</td><td>↗</td></tr> <tr><td>30:</td><td>10.0</td><td>↖</td></tr> <tr><td colspan="2">Serie</td><td style="text-align: right;">100</td></tr> <tr><td colspan="2">Total</td><td style="text-align: right;">300</td></tr> </table>	21:	10.5x	→	22:	10.7x	↓	23:	10.6x	↑	24:	10.1	←	25:	10.4x	↗	26:	10.8x	↗	27:	10.7x	←	28:	10.7x	↗	29:	10.3x	↗	30:	10.0	↖	Serie		100	Total		300
11:	10.4x	→																																																																									
12:	10.1	←																																																																									
13:	10.2x	→																																																																									
14:	10.6x	↙																																																																									
15:	10.8x	→																																																																									
16:	10.6x	↓																																																																									
17:	10.8x	←																																																																									
18:	10.5x	↑																																																																									
19:	10.3x	↗																																																																									
20:	10.0	↖																																																																									
Serie		100																																																																									
Total		200																																																																									
21:	10.5x	→																																																																									
22:	10.7x	↓																																																																									
23:	10.6x	↑																																																																									
24:	10.1	←																																																																									
25:	10.4x	↗																																																																									
26:	10.8x	↗																																																																									
27:	10.7x	←																																																																									
28:	10.7x	↗																																																																									
29:	10.3x	↗																																																																									
30:	10.0	↖																																																																									
Serie		100																																																																									
Total		300																																																																									
<p>40 Skott</p>	<table border="1" style="width:100%; border-collapse: collapse;"> <tr><td>31:</td><td>10.6x</td><td>↗</td></tr> <tr><td>32:</td><td>10.8x</td><td>↗</td></tr> <tr><td>33:</td><td>10.0</td><td>→</td></tr> <tr><td>34:</td><td>10.3x</td><td>↗</td></tr> <tr><td>35:</td><td>10.5x</td><td>↑</td></tr> <tr><td>36:</td><td>10.0</td><td>↗</td></tr> <tr><td>37:</td><td>10.6x</td><td>↓</td></tr> <tr><td>38:</td><td>9.4</td><td>↙</td></tr> <tr><td>39:</td><td>10.7x</td><td>↗</td></tr> <tr><td>40:</td><td>10.4x</td><td>↗</td></tr> <tr><td colspan="2">Serie</td><td style="text-align: right;">99</td></tr> <tr><td colspan="2">Total</td><td style="text-align: right;">399</td></tr> </table>	31:	10.6x	↗	32:	10.8x	↗	33:	10.0	→	34:	10.3x	↗	35:	10.5x	↑	36:	10.0	↗	37:	10.6x	↓	38:	9.4	↙	39:	10.7x	↗	40:	10.4x	↗	Serie		99	Total		399																																						
31:	10.6x	↗																																																																									
32:	10.8x	↗																																																																									
33:	10.0	→																																																																									
34:	10.3x	↗																																																																									
35:	10.5x	↑																																																																									
36:	10.0	↗																																																																									
37:	10.6x	↓																																																																									
38:	9.4	↙																																																																									
39:	10.7x	↗																																																																									
40:	10.4x	↗																																																																									
Serie		99																																																																									
Total		399																																																																									

Skjutlag 2	Tavla 26	Rasmus Alfredsson		
Ramselefors		Umeå	13	Vb
07.11.2021		Vindelnskyttet 2021	Ramselefors SKF	
Prov 	1: 10.6x ↗ 2: 10.4x ← 3: 10.6x → 4: 10.7x ↗ 5: 10.4x ↘ 6: 10.8x ↘ 7: 10.5x → 8: 10.6x ↗ 9: 10.6x ← 10: 10.6x ← Serie 100 Total 0	Prov 	11: 10.5x ↘ 12: 10.5x → 13: 10.6x ← 14: 10.7x ↗ 15: 10.7x ↑ 16: 10.4x ↘ 17: 10.9x ↘ 18: 10.7x ↘ 19: 10.7x ↑ 20: 10.4x ← Serie 100 Total 0	
Prov 	21: 10.6x ↗ 22: 10.7x ↗ 23: 10.4x → 24: 10.6x ↗ 25: 10.8x ↗ Serie 50 Total 0	40 Skott 	1: 10.6x ← 2: 10.4x → 3: 10.7x ↑ 4: 10.2x ↗ 5: 10.7x ↘ 6: 10.5x ↗ 7: 10.3x ← 8: 10.5x → 9: 10.7x ← 10: 10.3x ↗ Serie 100 Total 100	
40 Skott 	11: 10.6x → 12: 10.4x ↗ 13: 10.7x ↗ 14: 10.8x ↑ 15: 10.4x ↗ 16: 10.6x ↘ 17: 10.3x ← 18: 10.7x ↘ 19: 10.6x ← 20: 10.7x ← Serie 100 Total 200	40 Skott 	21: 10.7x ↑ 22: 10.4x ← 23: 10.5x ↗ 24: 10.8x → 25: 10.7x ↗ 26: 10.8x → 27: 10.7x ↗ 28: 10.2x ↗ 29: 10.8x ↗ 30: 10.5x ← Serie 100 Total 300	
40 Skott 	31: 10.5x ↑ 32: 10.8x ← 33: 10.7x ← 34: 10.8x ↗ 35: 10.7x → 36: 10.6x ↗ 37: 10.9x → 38: 10.3x ↘ 39: 10.9x ↗ 40: 10.7x ↘ Serie 100 Total 400			

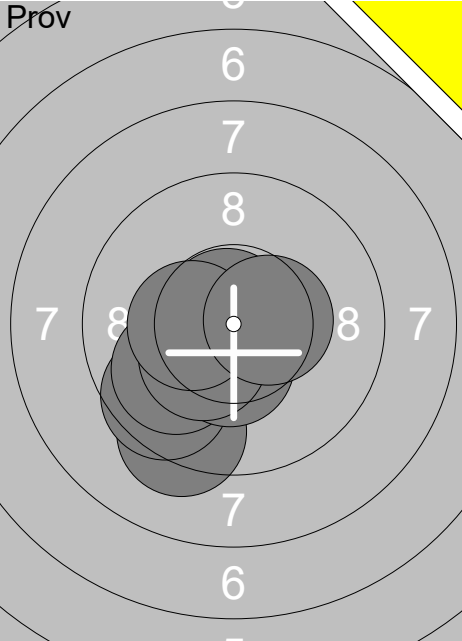
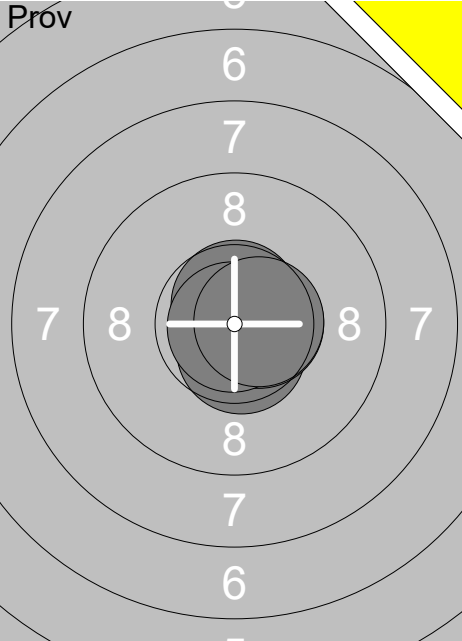
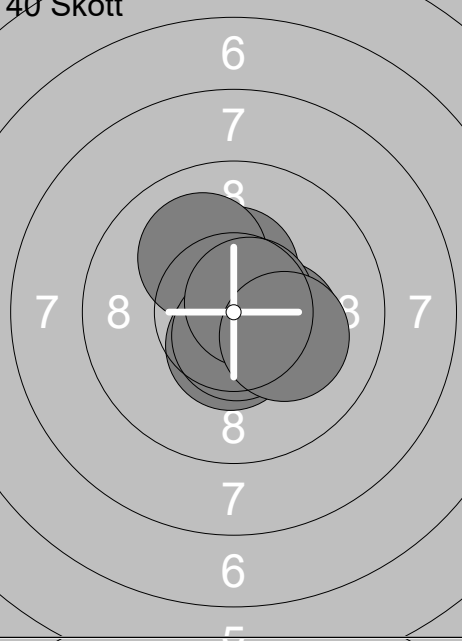
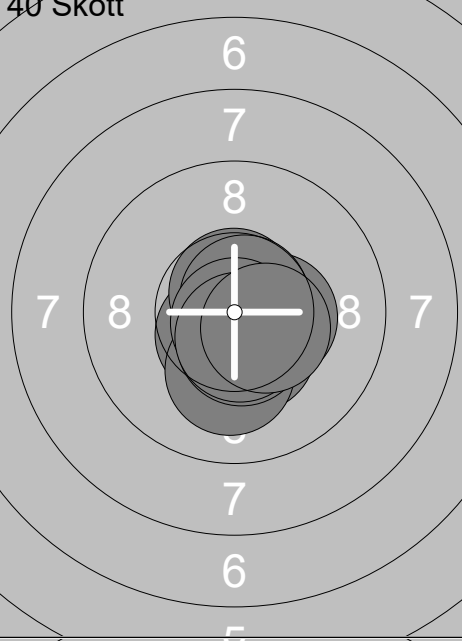
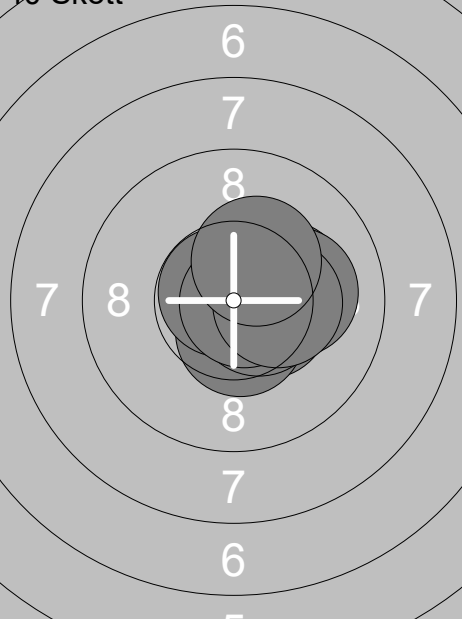
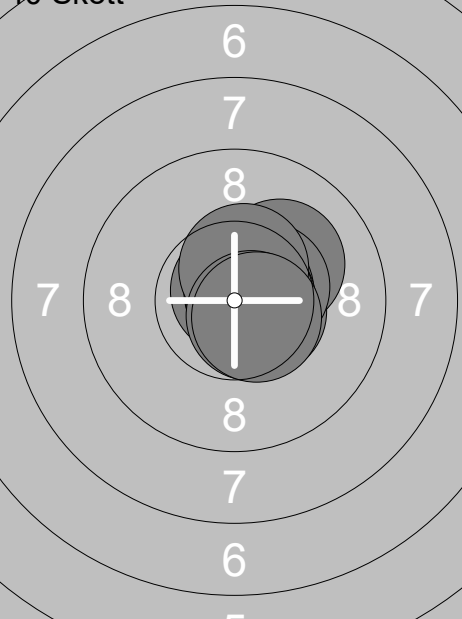
Skjutlag	Tavla	Helena Perkiömäki			
2	27	Ramselefors	Umeå	Sitt	Vb
07.11.2021	Vindelnskyttet 2021	Ramselefors SKF			
Prov 	1: 9.3 ↓	Prov 	11: 10.6x ↓		
	2: 9.6 ↓		12: 10.7x ↑		
	3: 9.9 ↙		13: 10.6x →		
	4: 10.8x ↘		14: 10.9x ↘		
	5: 10.5x ↘		15: 10.6x →		
	6: 10.4x ↓				
	7: 10.3x ↙				
	8: 10.8x ↗				
	9: 10.4x ←				
	10: 10.5x →				
	Serie 97		Serie 50		
	Total 0		Total 0		
40 Skott 	1: 10.9x ↗	40 Skott 	11: 10.4x →		
	2: 10.4x ↑		12: 10.6x ↘		
	3: 10.1 ↗		13: 10.4x ↓		
	4: 10.6x ↘		14: 10.7x ↑		
	5: 10.6x ↘		15: 10.7x ↗		
	6: 10.5x ↓		16: 10.1 ↓		
	7: 10.3x →		17: 10.8x ↓		
	8: 10.6x ↓		18: 10.5x ↓		
	9: 10.7x ↗		19: 10.6x ↓		
	10: 10.2x →		20: 10.5x →		
	Serie 100		Serie 100		
	Total 100		Total 200		
40 Skott 	21: 10.5x →	40 Skott 	31: 10.1 ↗		
	22: 10.5x ↓		32: 10.5x →		
	23: 10.6x →		33: 10.5x →		
	24: 10.8x ↗		34: 10.8x →		
	25: 10.2x →		35: 10.8x ↑		
	26: 10.6x ↗		36: 10.7x ↗		
	27: 10.8x →		37: 10.7x →		
	28: 10.1 →		38: 10.5x ↑		
	29: 10.3x →		39: 10.6x ↘		
	30: 10.3x ↗		40: 10.6x ↘		
	Serie 100		Serie 100		
	Total 300		Total 400		

Skjutlag	Tavla	Nils Fredriksson	
2	28	Umeå	Sitt Vb
07.11.2021	Vindelnskyttet 2021	Ramselefors SKF	
Prov 	1: 10.5x ↑ 2: 10.1 ↘ 3: 10.2x ← 4: 10.1 ↘ 5: 10.3x ← 6: 10.3x ↗ 7: 10.1 ↖ 8: 10.8x ↘ 9: 9.9 ↖ 10: 10.7x ← Serie 99 Total 0	40 Skott 	1: 10.7x ← 2: 9.9 ↘ 3: 9.4 ← 4: 10.7x ↘ 5: 9.4 ← 6: 10.4x ↘ 7: 9.7 ↖ 8: 8.9 ↘ 9: 10.2x ← 10: 10.5x ← Serie 94 Total 94
40 Skott 	11: 9.8 ↑ 12: 10.2x ↖ 13: 10.3x → 14: 9.5 ↖ 15: 10.7x ↗ 16: 10.9x ↗ 17: 9.9 ↘ 18: 10.0 ↑ 19: 10.3x ↖ 20: 10.7x ↗ Serie 97 Total 191	40 Skott 	21: 10.1 ← 22: 10.3x ↘ 23: 10.1 → 24: 10.4x ← 25: 9.7 → 26: 10.7x ← 27: 10.4x → 28: 10.5x ↘ 29: 10.2x ← 30: 10.1 ↘ Serie 99 Total 290
40 Skott 	31: 10.3x ↘ 32: 10.2x ↑ 33: 9.9 ↖ 34: 10.4x ↘ 35: 9.9 ↘ 36: 9.8 → 37: 10.2x ↗ 38: 10.4x ← 39: 10.5x ↖ 40: 10.0 ↘ Serie 97 Total 387		

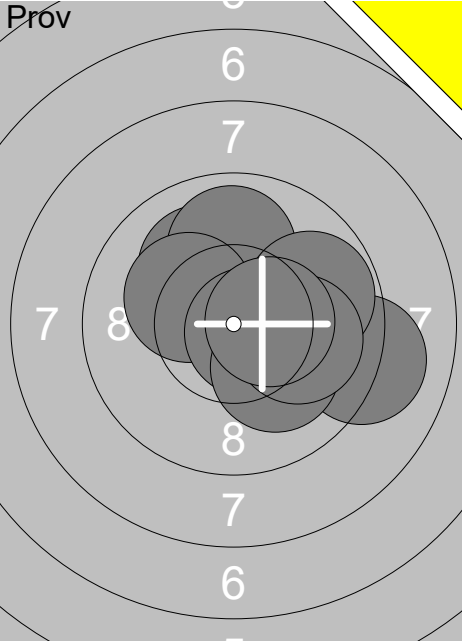
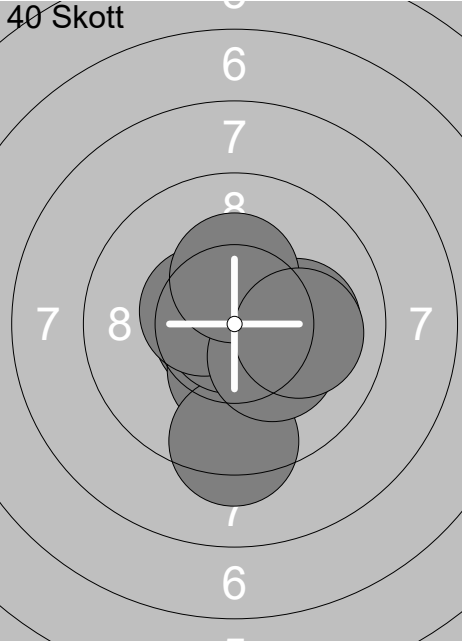
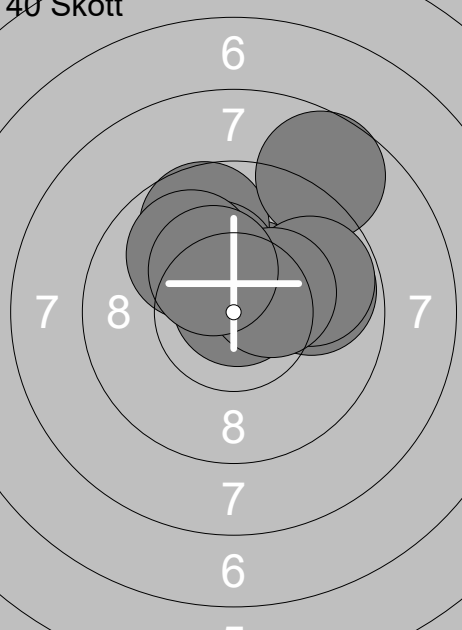
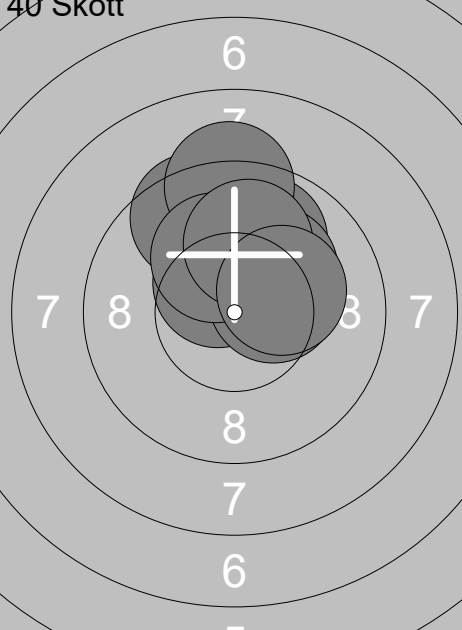
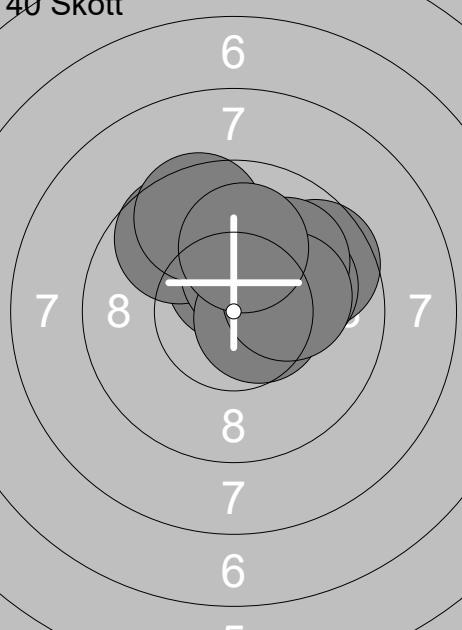
Skjutlag 2	Tavla 30	Theo Frölander		
Ramselefors	Vännäs	9	Vb	
07.11.2021	Vindelnskyttet 2021	Ramselefors SKF		
Prov 	1: 10.1 ↖ 2: 10.4x ↑ 3: 9.1 → 4: 9.9 ↑ 5: 9.8 → 6: 10.2x ↖ 7: 10.7x → 8: 10.1 ↘ 9: 10.0 → 10: 10.4x → Serie 97 Total 0	40 Skott 	1: 10.7x ↙ 2: 10.3x ↓ 3: 10.8x → 4: 10.1 → 5: 9.3 ↓ 6: 10.9x ↙ 7: 10.5x ↖ 8: 10.3x ↘ 9: 10.3x ↑ 10: 10.0 → Serie 99 Total 99	
40 Skott 	11: 10.5x ↗ 12: 9.7 ↑ 13: 10.2x ↖ 14: 10.8x ↗ 15: 8.7 ↗ 16: 10.0 ↖ 17: 9.8 → 18: 9.8 → 19: 10.4x → 20: 10.3x ↖ Serie 95 Total 194	40 Skott 	21: 10.5x ↖ 22: 10.4x → 23: 10.1 ↑ 24: 9.5 ↖ 25: 9.9 ↗ 26: 10.2x ↗ 27: 9.2 ↑ 28: 10.2x ↖ 29: 10.0 ↑ 30: 10.2x → Serie 97 Total 291	
40 Skott 	31: 10.5x ↑ 32: 9.7 ↖ 33: 10.4x ↑ 34: 10.6x → 35: 9.6 → 36: 10.1 → 37: 9.6 ↑ 38: 10.0 ↗ 39: 10.2x → 40: 10.1 ↑ Serie 97 Total 388			

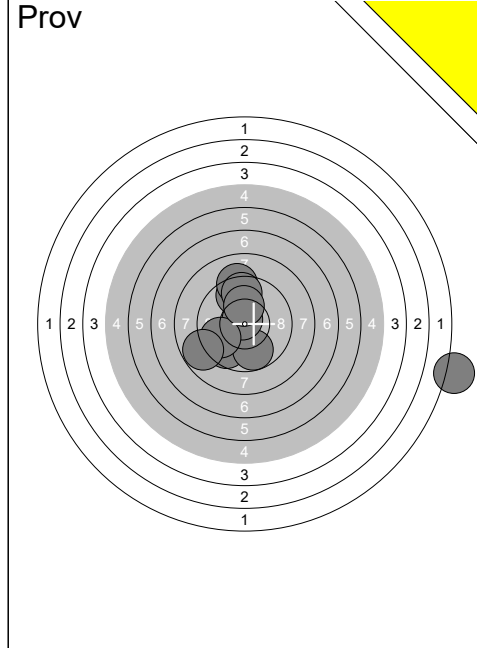

1:	9.6	↙
2:	9.8	↓
3:	10.7x	↖
4:	1.5	→
5:	9.7	↙
6:	9.6	↑
7:	9.2	↑
8:	9.6	↑
9:	10.2x	↑
10:	8.8	↙
Serie		83
Total		0

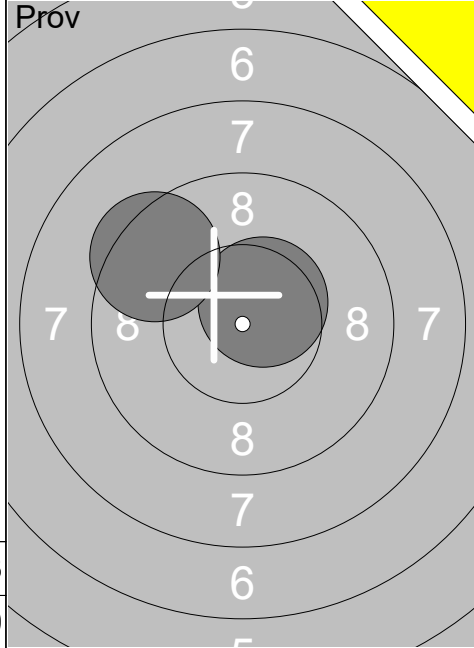

11:	10.5x	↗
12:	9.4	↖
Serie		19
Total		0

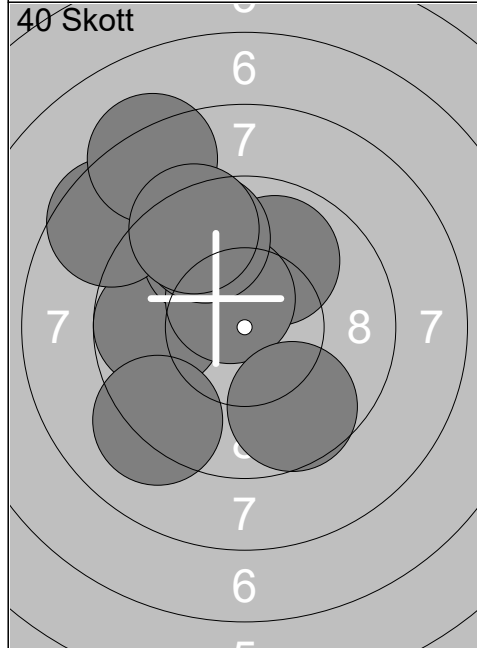

1:	9.8	←
2:	9.8	↗
3:	8.6	↖
4:	9.9	↗
5:	10.5x	↖
6:	8.3	↗
7:	9.6	↗
8:	9.2	↙
9:	9.4	↗
10:	9.7	↘
Serie		89
Total		89

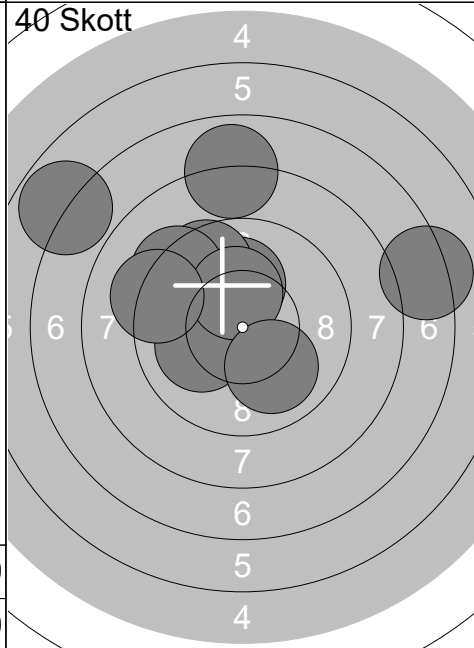

11:	10.1	↑
12:	9.6	↖
13:	9.3	↖
14:	7.9	↑
15:	10.1	↙
16:	7.3	→
17:	10.3x	↑
18:	10.0	↘
19:	9.2	←
20:	6.8	↖
Serie		87
Total		176

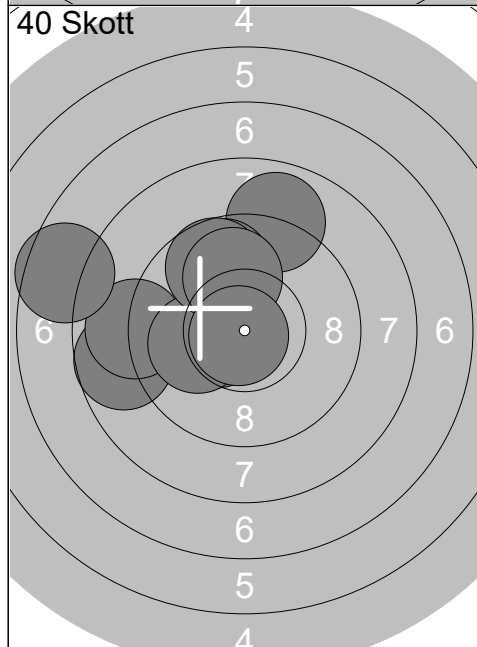

21:	8.9	↑
22:	8.7	←
23:	9.8	↗
24:	9.0	←
25:	10.4x	↙
26:	10.1	←
27:	9.7	↗
28:	10.0	↑
29:	7.5	←
30:	10.8x	↙
Serie		90
Total		266

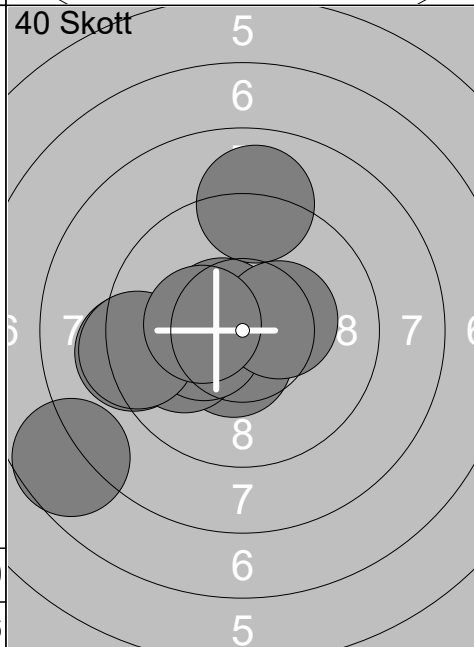

31:	9.2	←
32:	10.5x	↘
33:	10.0	←
34:	9.0	↑
35:	10.6x	↖
36:	10.3x	↙
37:	9.3	←
38:	7.7	↙
39:	10.4x	→
40:	10.3x	↙
Serie		94
Total		360

Skjutlag	Tavla	Martin Albihn	
2	32	Ramselefors	Vännäs
07.11.2021	Vindelnskytten 2021	Ramselefors SKF	Sitt Vb
Prov 	1: 9.8 ← 2: 10.7x ← 3: 9.1 → 4: 9.6 ↑ 5: 10.6x ↓ 6: 10.1 ← 7: 10.7x → 8: 10.2x → 9: 8.8 ↓ 10: 9.7 →	Prov 	11: 10.7x ↙ 12: 8.1 → 13: 10.2x ← 14: 9.7 ↑ 15: 10.3x ↑
	Serie 94		Serie 47
	Total 0		Total 0
40 Skott 	1: 10.2x ↙ 2: 10.7x ↖ 3: 10.4x ↑ 4: 10.8x ↓ 5: 10.5x ← 6: 9.9 ↑ 7: 9.5 ↘ 8: 9.7 → 9: 9.9 ↑ 10: 10.0 ↑	40 Skott 	11: 10.3x ← 12: 10.6x → 13: 9.4 ↑ 14: 9.1 ↙ 15: 9.8 → 16: 10.5x ↘ 17: 9.6 ↑ 18: 10.5x ← 19: 10.1 ↘ 20: 10.3x →
	Serie 96		Serie 96
	Total 96		Total 192
40 Skott 	21: 9.7 → 22: 10.3x ↑ 23: 10.1 → 24: 9.6 ↑ 25: 10.2x ↑ 26: 9.6 ↘ 27: 9.4 ↘ 28: 9.4 ↘ 29: 10.3x ↓ 30: 9.5 →	40 Skott 	31: 9.7 → 32: 10.5x → 33: 9.8 ↓ 34: 10.0 → 35: 9.6 ↑ 36: 9.8 ↘ 37: 9.9 → 38: 9.3 ↑ 39: 10.0 → 40: 9.6 →
	Serie 94		Serie 93
	Total 286		Total 379

Skjuttag	Tavla	Anders Hansson			
2	33	Ramselefors	Vännäs	Sitt	Vb
07.11.2021	Vindelnskyttet 2021	Ramselefors SKF			
Prov 	1: 9.9 ↓	Prov 	11: 9.8 ↓		
	2: 10.3x ←		12: 9.7 ↓		
	3: 10.1 ↓		13: 10.1 →		
	4: 10.2x →				
	5: 9.8 →				
	6: 9.9 →				
	7: 10.7x ↓				
	8: 9.7 ↓				
	9: 10.7x →				
	10: 9.6 ↓				
	Serie 95		Serie 28		
	Total 0		Total 0		
40 Skott 	1: 9.8 ↓	40 Skott 	11: 10.1 ↑		
	2: 10.7x ↓		12: 9.5 ↗		
	3: 10.2x ↖		13: 10.2x ↑		
	4: 10.1 ↓		14: 10.4x →		
	5: 9.9 ↗		15: 10.7x ↖		
	6: 10.0 ←		16: 9.5 ↗		
	7: 10.5x ↑		17: 9.8 ↖		
	8: 10.1 ↓		18: 10.4x ↑		
	9: 10.4x ↖		19: 10.0 ↖		
	10: 9.9 ↖		20: 10.5x ↗		
	Serie 97		Serie 97		
	Total 97		Total 194		
40 Skott 	21: 10.8x ↘	40 Skott 	31: 10.1 ↖		
	22: 10.3x ↖		32: 10.3x ↑		
	23: 10.4x ↓		33: 9.7 ↘		
	24: 10.9x ↗		34: 10.2x ↖		
	25: 10.6x ←		35: 10.1 ↖		
	26: 10.3x ↖		36: 10.7x ↖		
	27: 9.8 ↖		37: 10.2x ←		
	28: 10.5x ←		38: 10.3x ↖		
	29: 10.8x ↖		39: 9.8 ↓		
	30: 10.1 ↖		40: 10.1 ←		
	Serie 99		Serie 98		
	Total 293		Total 391		

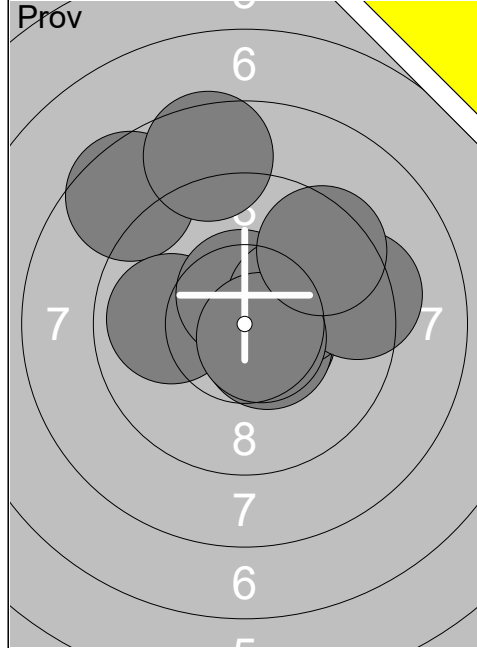

1:	8.6	↗
2:	10.5x	➤
3:	8.6	↑
4:	9.9	←
5:	10.5x	↑
6:	10.5x	➤
7:	10.2x	➤
8:	9.3	➤
9:	10.6x	➤
10:	9.5	↗
Serie		93
Total		0

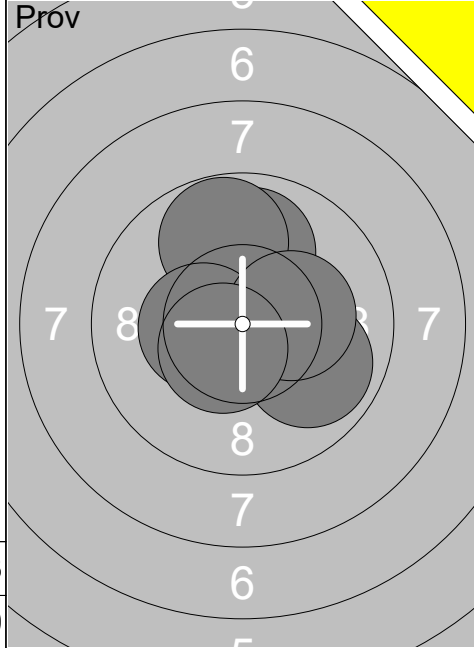

11:	9.9	↑
12:	9.8	↑
13:	10.4x	←
14:	9.9	➤
15:	10.3x	➤
16:	10.5x	↙
Serie		57
Total		0

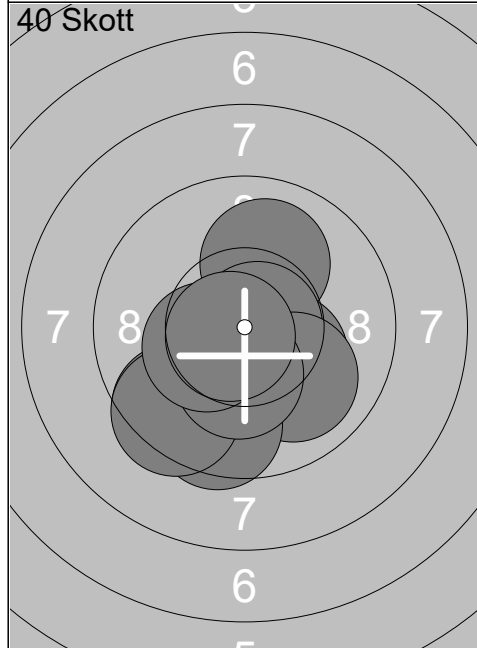

1:	9.5	↙
2:	10.0	↑
3:	10.3x	➤
4:	10.8x	➤
5:	10.0	➤
6:	9.5	↓
7:	9.4	↙
8:	10.3x	↓
9:	10.4x	←
10:	10.7x	↙
Serie		97
Total		97

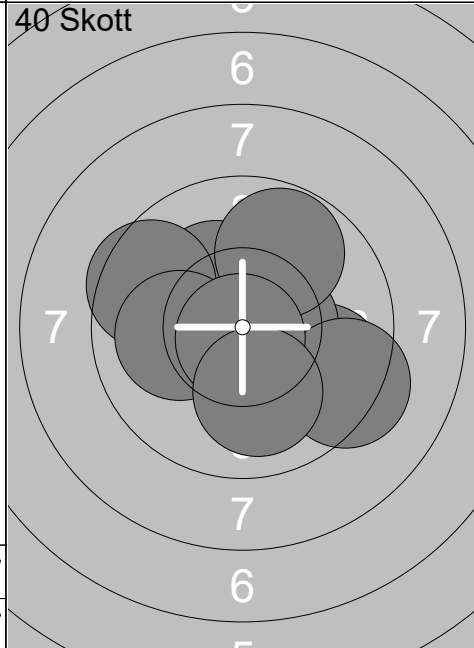

11:	9.7	➤
12:	10.5x	➤
13:	9.9	←
14:	10.3x	↖
15:	9.6	←
16:	9.8	↑
17:	10.1	←
18:	9.3	➤
19:	10.8x	↓
20:	10.0	↓
Serie		95
Total		192

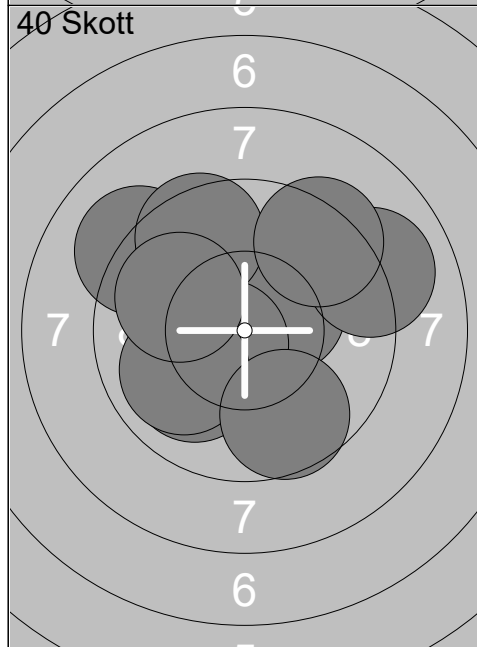

21:	10.4x	➤
22:	10.0	↙
23:	10.6x	↙
24:	9.1	↖
25:	10.0	↖
26:	9.5	↑
27:	9.0	➤
28:	9.9	↖
29:	9.3	↗
30:	9.7	↓
Serie		94
Total		286

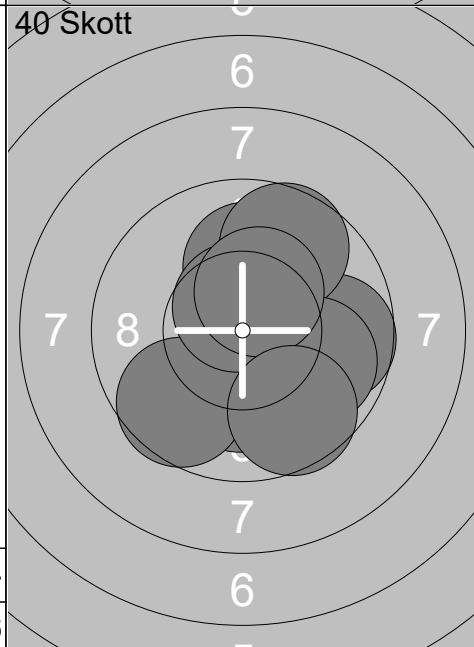

31:	10.8x	➤
32:	10.1	↑
33:	9.7	➤
34:	9.7	↑
35:	10.2x	↓
36:	9.6	↙
37:	9.9	➤
38:	10.6x	↑
39:	10.4x	↑
40:	9.6	↓
Serie		95
Total		381

<p>Prov</p>	<p>1: 8.8 ←</p> <p>2: 9.5 ←</p> <p>3: 9.4 ↙</p> <p>4: 10.2x ↗</p> <p>5: 10.4x ←</p> <p>6: 10.4x ↘</p> <p>7: 9.9 ←</p> <p>8: 10.8x ↗</p> <p>9: 10.4x ↑</p> <p>10: 10.6x ↓</p>	<p>Prov</p>	<p>11: 9.8 →</p> <p>12: 9.5 ↘</p> <p>13: 9.8 →</p> <p>14: 9.9 ↙</p> <p>15: 10.7x ↗</p> <p>16: 10.2x →</p> <p>17: 10.6x ↘</p>
Serie 95		Serie 66	
Total 0		Total 0	

<p>40 Skott</p>	<p>1: 10.5x ↑</p> <p>2: 9.8 ↘</p> <p>3: 10.6x ↓</p> <p>4: 10.2x ↗</p> <p>5: 10.6x ↗</p> <p>6: 10.4x ↙</p> <p>7: 10.4x ←</p> <p>8: 10.5x ↗</p> <p>9: 10.4x ↘</p> <p>10: 10.0 →</p>	<p>40 Skott</p>	<p>11: 10.8x ↓</p> <p>12: 10.4x ↑</p> <p>13: 10.1 ↙</p> <p>14: 10.6x ↗</p> <p>15: 10.6x ↗</p> <p>16: 10.4x ↑</p> <p>17: 10.5x ↗</p> <p>18: 10.4x ↗</p> <p>19: 10.5x →</p> <p>20: 10.6x ↗</p>
Serie 99		Serie 100	
Total 99		Total 199	

<p>40 Skott</p>	<p>21: 9.8 ↗</p> <p>22: 10.5x ←</p> <p>23: 9.9 ←</p> <p>24: 10.6x ↗</p> <p>25: 10.5x ←</p> <p>26: 10.4x ↙</p> <p>27: 9.8 ↗</p> <p>28: 9.8 ↑</p> <p>29: 10.3x ↗</p> <p>30: 9.6 ↑</p>	<p>40 Skott</p>	<p>31: 10.5x →</p> <p>32: 10.3x ↘</p> <p>33: 10.8x ←</p> <p>34: 10.8x ↘</p> <p>35: 9.9 ←</p> <p>36: 9.9 ↑</p> <p>37: 10.3x ↗</p> <p>38: 10.1 →</p> <p>39: 9.6 ↗</p> <p>40: 10.8x →</p>
Serie 95		Serie 97	
Total 294		Total 391	