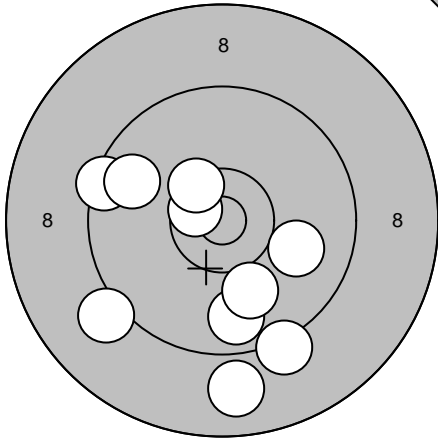
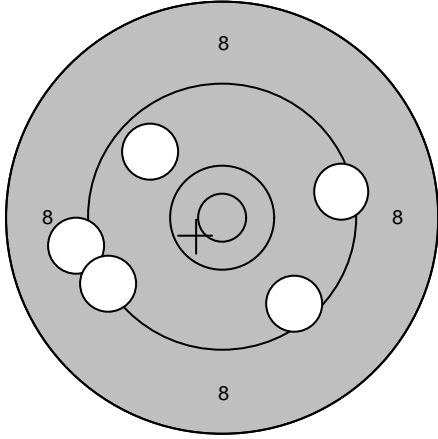
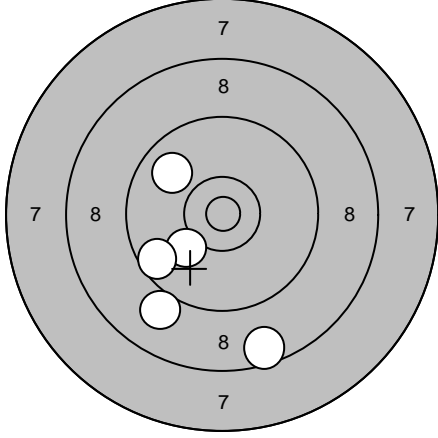
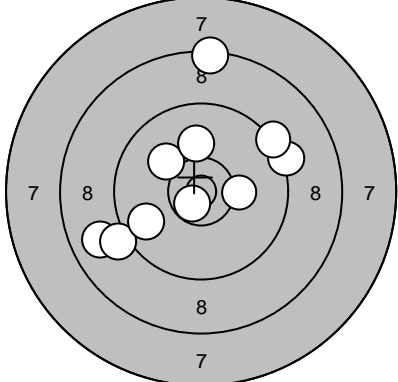
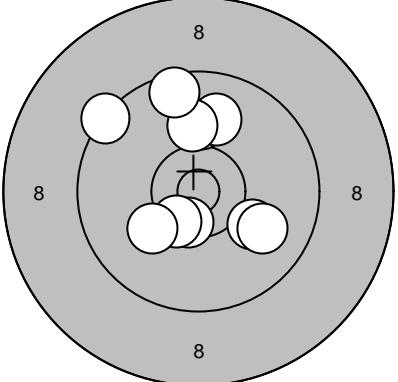
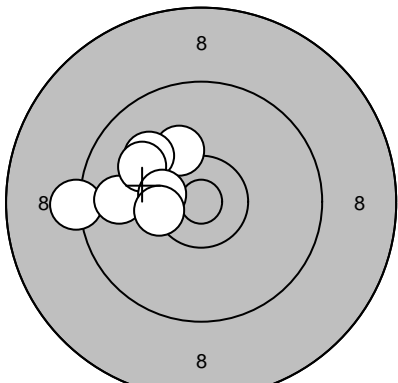
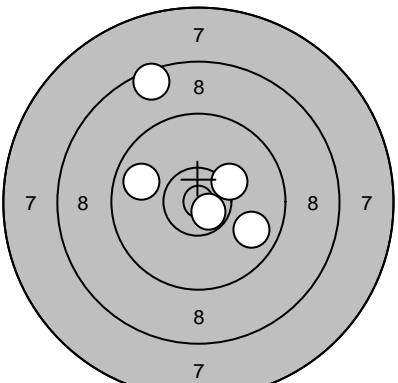
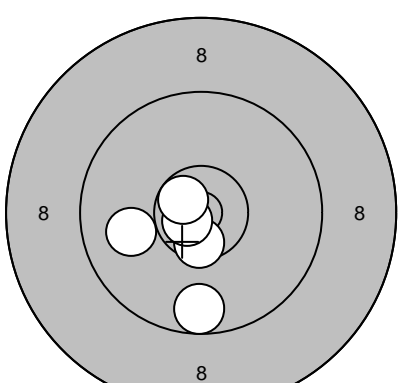
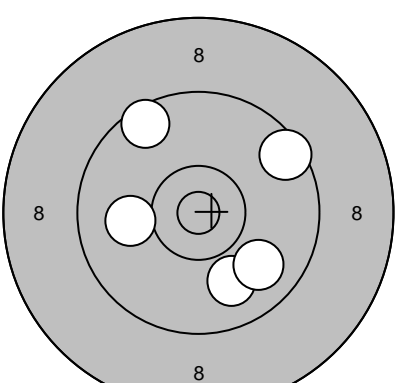
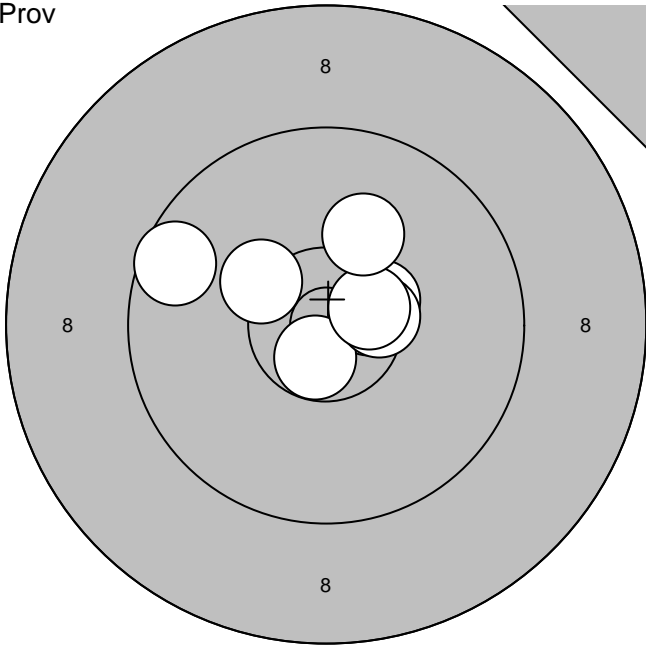
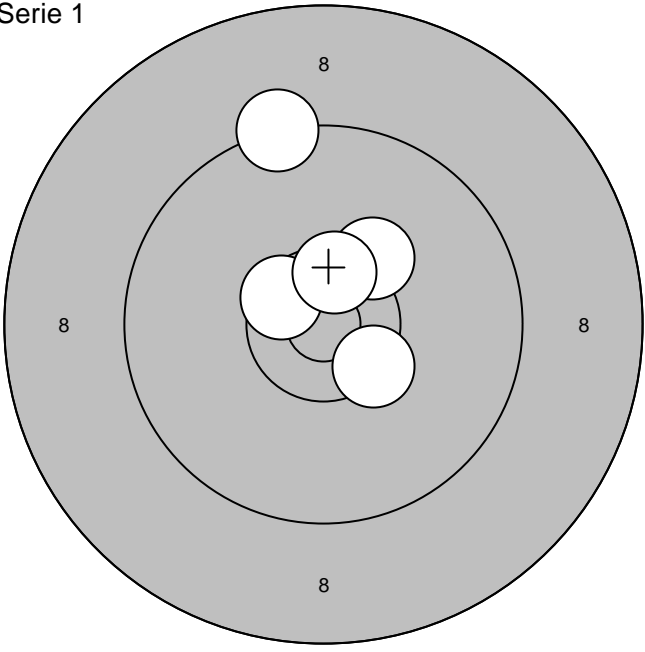
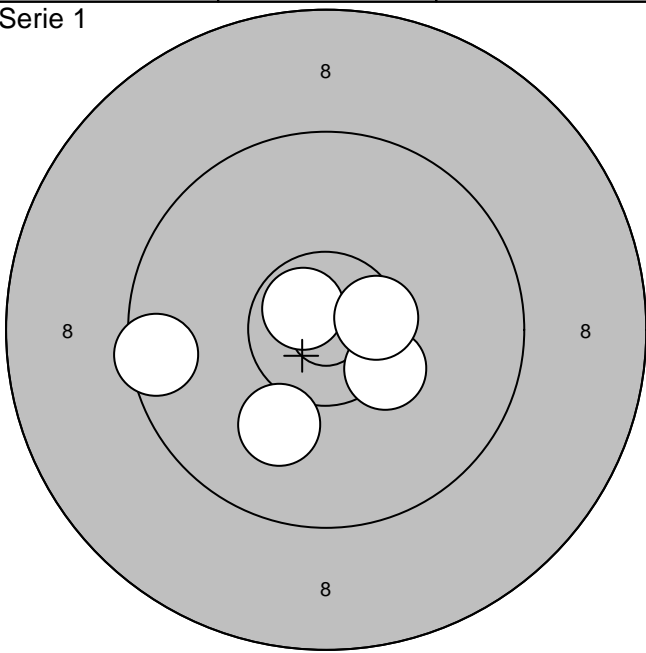
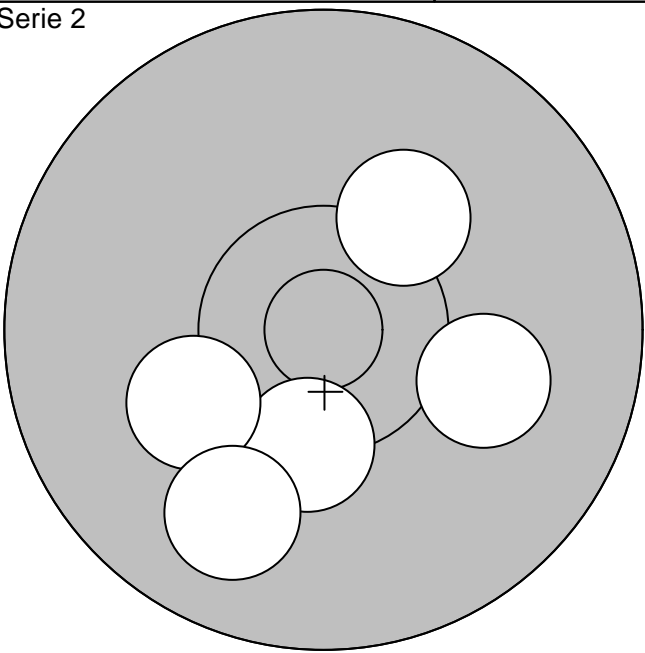
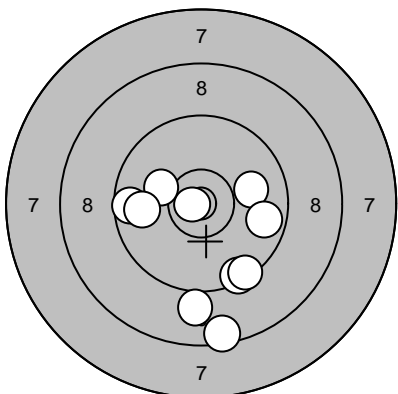
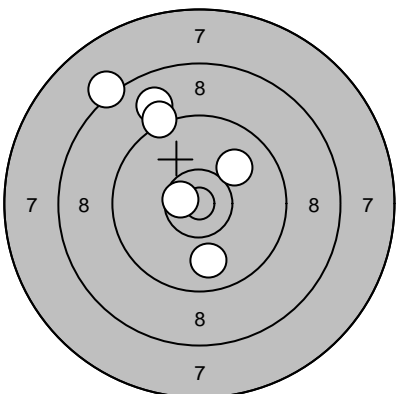
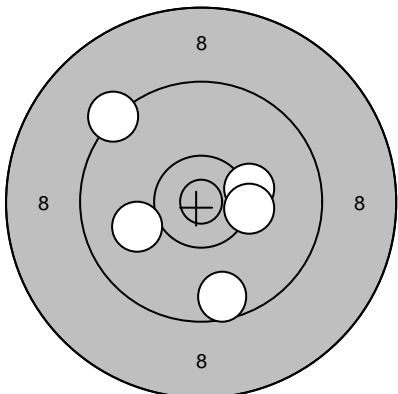
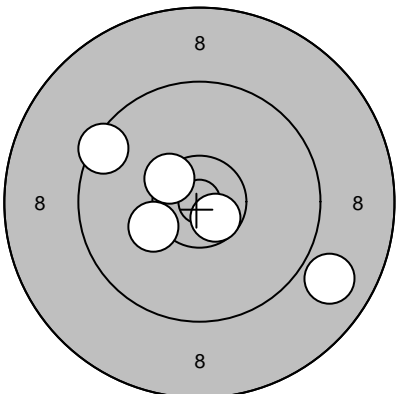
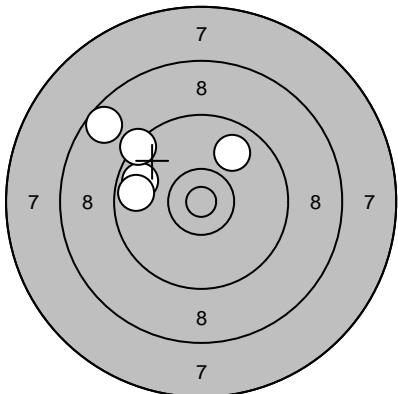
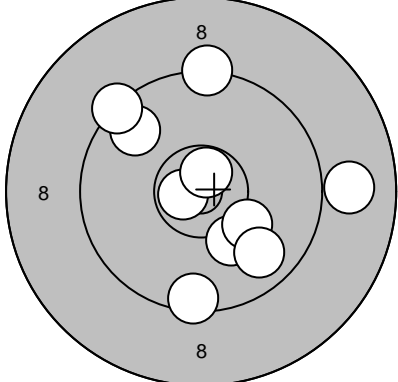
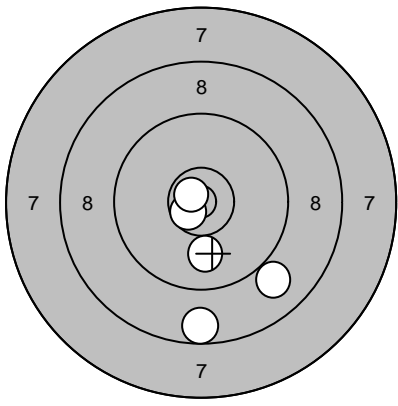
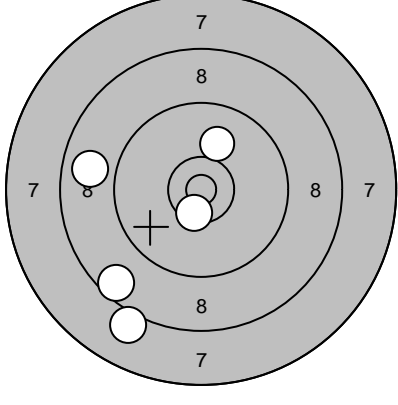

|                      |   |   |              |
|----------------------|---|---|--------------|
| Skjutlag<br><b>1</b> | Tavla<br><b>1</b>   | <b>Johan Nilsson</b>  |              |
|                      |   | Ramselefors   |              |
| 2006-07-08           | Tavelträffen 2006 - Final   | Ramselefors SKF   |              |
| Prov                 |    | 1: 9,4 ←<br>2: 9,8 ↗<br>3: 9,8 ↓<br>4: 10,0 →<br>5: 10,0 ↓<br>6: 10,6* ↗<br>7: 9,1 ↖<br>8: 9,2 ↓<br>9: 10,4* ↗<br>10: 8,9 ↓ | Prov         |
|                      |   | Serie 93,0  | 11: 10,3 ↑   |
|                      |   | Totalt 192,0  | Serie 10,0   |
|                      |   |   | Totalt 192,0 |
| Serie 1              |   | 1: 9,1 ←<br>2: 9,6 ↓<br>3: 9,3 ↖<br>4: 9,8 ↗<br>5: 9,5 →  | Serie 1      |
|                      |   | Serie 45,0  | 6: 10,7* ↓   |
|                      |   | Totalt 237,0  | 7: 10,4* ↖   |
|                      |   |   | 8: 9,9 ↗     |
|                      |   |   | 9: 9,8 ↓     |
|                      |   |   | 10: 8,7 →    |
|                      |   |   | Serie 46,0   |
|                      |   |   | Totalt 283,0 |
| Serie 2              |  | 1: 10,1 ↖<br>2: 8,6 ↓<br>3: 9,8 ↗<br>4: 9,6 ↖<br>5: 9,0 ↖   |              |
|                      |   | Serie 45,0  |              |
|                      |   | Totalt 328,0  |              |

| Skjutlag  | Tavla  | Marie Fjällström   |  |
|---|--|--|--|
| 1   | 2  | Ramselefors  |  |
| 2006-07-08  | Tavelträffen 2006 - Final  | Ramselefors SKF  |  |
| Prov  | 1: 8,4 ↑<br>2: 8,9 ←<br>3: 9,2 ←<br>4: 9,8 ←<br>5: 9,3 →<br>6: 10,1 ↖<br>7: 9,3 ↗<br>8: 10,7* ↘<br>9: 10,1 ↑<br>10: 10,2 → | Prov   | 11: 10,5* ↓<br>12: 10,0 ↑<br>13: 10,4* ↘<br>14: 10,1 ↗<br>15: 9,9 ↑<br>16: 9,4 ↖<br>17: 9,9 ↗<br>18: 10,1 ↑<br>19: 9,6 ↑<br>20: 10,1 ↘ |
|    | Serie 92,0<br>Totalt 192,0   |    | Serie 96,0<br>Totalt 192,0   |
| Prov  | 21: 10,2 ↑<br>22: 9,3 ←<br>23: 10,0 ↖<br>24: 9,8 ←<br>25: 10,0 ↖<br>26: 10,4* ←<br>27: 10,4* ←                             | Serie 1  | 1: 10,7* ↘<br>2: 9,8 ↗<br>3: 8,5 ↑<br>4: 10,3 ↗<br>5: 9,8 ←  |
|   | Serie 68,0<br>Totalt 192,0   |   | Serie 46,0<br>Totalt 238,0   |
| Serie 1   | 6: 10,5* ↓<br>7: 9,6 ↓<br>8: 10,0 ←<br>9: 10,7* ←<br>10: 10,7* ↖   | Serie 2  | 1: 9,5 ↗<br>2: 10,0 ←<br>3: 9,6 ↗<br>4: 9,9 ↘<br>5: 9,9 ↘  |
|  | Serie 49,0<br>Totalt 287,0   |  | Serie 46,0<br>Totalt 333,0   |

|   |  |  |              |
|---|--|--|--------------|
| Skjutlag  | Tavla  | Fredrik Forsgren   |              |
| 1   | 3  | Ramselefors  |              |
| 2006-07-08  | Tavelträffen 2006 - Final  | Ramselefors SKF  |              |
| Prov  | Serie 1  |  |              |
|    |  |  |              |
| 1: 9,6 ↙  | 6:10,5* →  | Serie 79,0   | 1:10,3 ↗     |
| 2:10,3* ↙   | 7:10,6* →  |  | 2: 9,3 ↑     |
| 3:10,6* →   | 8:10,1 ↗   | Totalt 190,0   | 3:10,4* ↘    |
| 4:10,5* →   |  |  | 4:10,5* ↙    |
| 5:10,7* ↓   |  |  | 5:10,5* ↑    |
|   |  |  | Serie 49,0   |
|   |  |  | Totalt 239,0 |
| Serie 1   |  | Serie 2  |              |
|  |  |  |              |
| 6: 9,5 ↙  |  | Serie 49,0   | 1:10,3* ↓    |
| 7:10,7* ↙   |  |  | 2:10,1 →     |
| 8:10,1 ↓  |  | Totalt 288,0   | 3:10,2 ↙     |
| 9:10,4* ↘   |  |  | 4: 9,9 ↓     |
| 10:10,5* →  |  |  | 5:10,2 ↗     |
|   |  |  | Serie 49,0   |
|   |  |  | Totalt 337,0 |

|  |                           |  |              |
|--|---------------------------|--|--------------|
| Skjutlag   | Tavla                     | <b>Marlene Forsell</b>   |              |
| <b>1</b>   | <b>4</b>                  |  |              |
|  |                           | Ramselefors  |              |
| 2006-07-08   | Tavelträffen 2006 - Final | Ramselefors SKF  |              |
| Prov<br>      | 1: 9,0 ↓                  | Prov<br>     | 11: 10,0 ↗   |
|  | 2: 8,5 ↓                  |  | 12: 9,0 ↗    |
|  | 3: 9,4 ↓                  |  | 13: 8,2 ↗    |
|  | 4: 9,4 ↓                  |  | 14: 9,2 ↗    |
|  | 5: 10,0 →                 |  | 15: 9,9 ↓    |
|  | 6: 10,8* ←                |  | 16: 10,6* ←  |
|  | 7: 10,2 ↗                 |  |              |
|  | 8: 9,6 ←                  |  |              |
|  | 9: 9,8 ←                  |  |              |
|  | 10: 9,7 ↘                 |  |              |
|  | Serie 92,0                |  | Serie 55,0   |
|  | Totalt 190,0              |  | Totalt 190,0 |
| Serie 1<br>  | 1: 10,3 →                 | Serie 1<br> | 6: 9,5 ↖     |
|  | 2: 10,3* →                |  | 7: 10,3 ←    |
|  | 3: 9,3 ↗                  |  | 8: 10,4* ↗   |
|  | 4: 10,0 ←                 |  | 9: 10,6* ↓   |
|  | 5: 9,6 ↓                  |  | 10: 8,9 ↘    |
|  | Serie 48,0                |  | Serie 47,0   |
|  | Totalt 238,0              |  | Totalt 285,0 |
| Serie 2<br> | 1: 9,7 ↖                  |  |              |
|  | 2: 9,9 ↗                  |  |              |
|  | 3: 8,6 ↗                  |  |              |
|  | 4: 9,7 ←                  |  |              |
|  | 5: 9,4 ↗                  |  |              |
|  | Serie 44,0                |  |              |
|  | Totalt 329,0              |  |              |

| Skjutlag   | Tavla   | Johan Zakrisson   |   |
|------------|---|---|---|
| 1          | 5   | Ramselefors   |   |
| 2006-07-08 | Tavelträffen 2006 - Final   | Ramselefors SKF   |   |
| Prov       |    | 1: 10,2 ↘<br>2: 8,9 →<br>3: 10,7* ←<br>4: 9,7 ↗<br>5: 9,3 ↑<br>6: 9,4 ↗<br>7: 10,2 ↘<br>8: 9,8 ↘<br>9: 9,5 ↘<br>10: 10,7* ↑ | 11: 8,6 ↘<br>12: 10,4* ←<br>13: 10,0 ←<br>14: 9,9 →<br>15: 9,9 ←<br>16: 10,0 ↘<br>17: 10,3* ← |
|            | Serie 93,0  |   | Serie 66,0  |
|            | Totalt 187,0  |   | Totalt 187,0  |
| Serie 1    |   | 1: 10,7* ↙<br>2: 10,0 ↘<br>3: 8,6 ↘<br>4: 10,7* ↗<br>5: 9,0 ↘   | 6: 9,1 ←<br>7: 9,4 ↘<br>8: 10,5* ↗<br>9: 9,4 ↗<br>10: 10,0 ↑                                  |
|            | Serie 47,0  |   | Serie 47,0  |
|            | Totalt 234,0  |   | Totalt 281,0  |
| Serie 2    |  | 1: 10,5* ↘<br>2: 8,1 ↘<br>3: 8,6 ↘<br>4: 8,8 ←<br>5: 10,1 ↗   |   |
|            | Serie 44,0  |   |   |
|            | Totalt 325,0  |   |   |

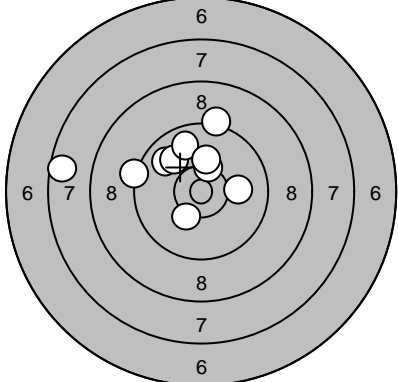
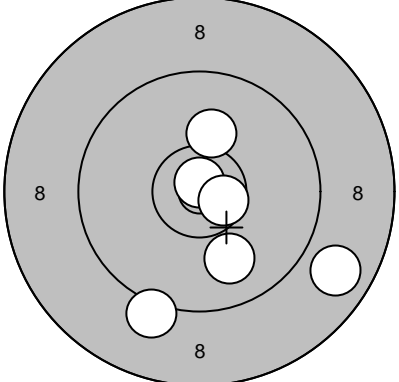
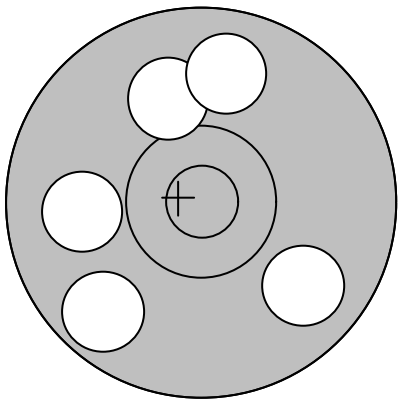
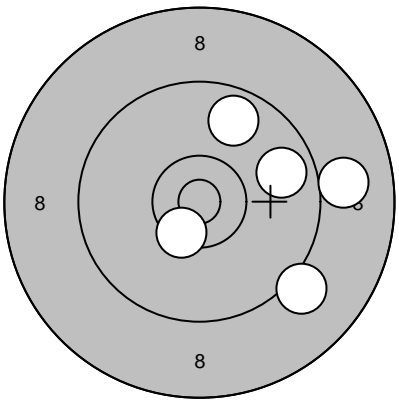
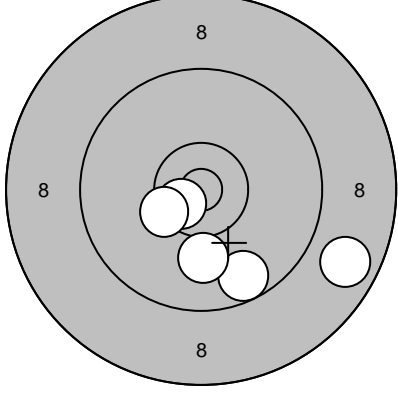
|  |                           |  |              |
|--|---------------------------|--|--------------|
| Skjutlag   | Tavla                     | <b>Daniel Zakrisson</b>  |              |
| <b>1</b>   | <b>6</b>                  |  |              |
| Ramselefors  |                           |  |              |
| 2006-07-08   | Tavelträffen 2006 - Final | Ramselefors SKF  |              |
| Prov<br>      | 1: 7,6 ←                  | Prov<br>     | 11: 10,1 ↑   |
|  | 2: 10,3* ↑                |  | 12: 9,9 ↓    |
|  | 3: 9,3 ←                  |  | 13: 9,2 ↓    |
|  | 4: 9,2 ↑                  |  | 14: 8,8 ↘    |
|  | 5: 9,8 ↗                  |  | 15: 10,8* ↑  |
|  | 6: 9,9 ↗                  |  | 16: 10,6* ↘  |
|  | 7: 9,8 ↑                  |  |              |
|  | 8: 10,2 ↑                 |  |              |
|  | 9: 10,3 ↓                 |  |              |
|  | 10: 10,1 →                |  |              |
|  | Serie 92,0                |  | Serie 56,0   |
|  | Totalt 187,0              |  | Totalt 187,0 |
| Serie 1<br>  | 1: 10,0 ↑                 | Serie 1<br> | 6: 9,8 ↑     |
|  | 2: 9,7 ↓                  |  | 7: 9,1 ↓     |
|  | 3: 9,8 ↘                  |  | 8: 9,0 →     |
|  | 4: 9,8 ↑                  |  | 9: 9,8 →     |
|  | 5: 9,9 ←                  |  | 10: 10,5* ↓  |
|  | Serie 46,0                |  | Serie 46,0   |
|  | Totalt 233,0              |  | Totalt 279,0 |
| Serie 2<br> | 1: 10,6* ↙                |  |              |
|  | 2: 8,8 ↘                  |  |              |
|  | 3: 10,4* ↙                |  |              |
|  | 4: 9,7 ↓                  |  |              |
|  | 5: 10,0 ↓                 |  |              |
|  | Serie 47,0                |  |              |
|  | Totalt 326,0              |  |              |

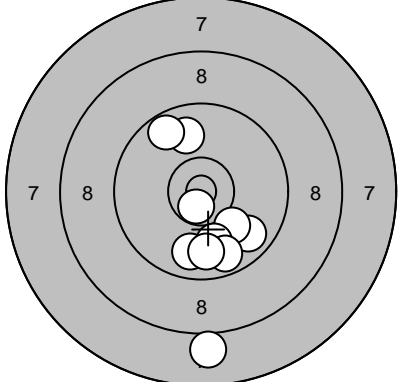
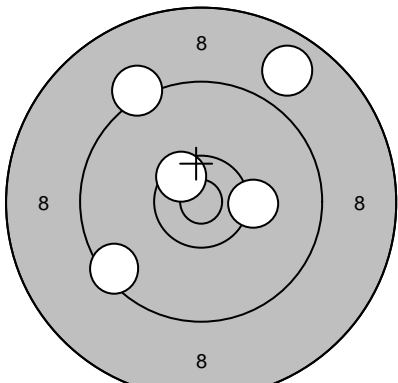
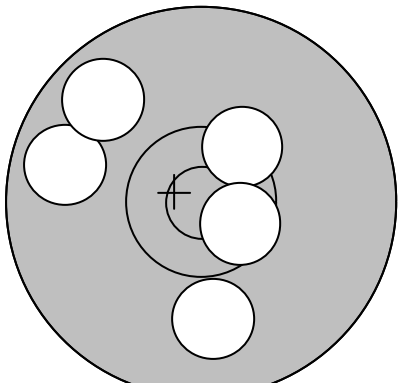
| Skjutlag   | Tavla   | Niklas Westermark   |   |
|------------|---|---|---|
| 1          | 7   | Drängsmark  |   |
| 2006-07-08 | Tavelträffen 2006 - Final   | Ramselefors SKF   |   |
| Prov       |    | 1: 9,8 ↘<br>2: 10,1 ↘<br>3: 8,0 ↓<br>4: 9,8 ↓<br>5: 10,7* ↘<br>6: 9,9 ↑<br>7: 10,0 ↓<br>8: 9,7 ↓<br>9: 9,8 ↓<br>10: 9,7 ↑ | 11: 10,1 ↗<br>12: 9,5 ←<br>13: 9,8 ↑<br>14: 9,2 ←             |
|            | Serie 92,0  |   | Serie 37,0  |
|            | Totalt 186,0  |   | Totalt 186,0  |
| Serie 1    |   | 1: 9,2 ↗<br>2: 9,5 ←<br>3: 10,5* ↗<br>4: 8,8 ↗<br>5: 10,2 →   | 6: 10,5* ↘<br>7: 9,0 ↑<br>8: 9,5 →<br>9: 10,6* ↗<br>10: 9,7 ↗ |
|            | Serie 46,0  |   | Serie 47,0  |
|            | Totalt 232,0  |   | Totalt 279,0  |
| Serie 2    |  | 1: 10,4* ↗<br>2: 10,6* ↘<br>3: 9,8 ←<br>4: 10,0 ↓<br>5: 9,8 ↗   |   |
|            | Serie 48,0  |   |   |
|            | Totalt 327,0  |   |   |

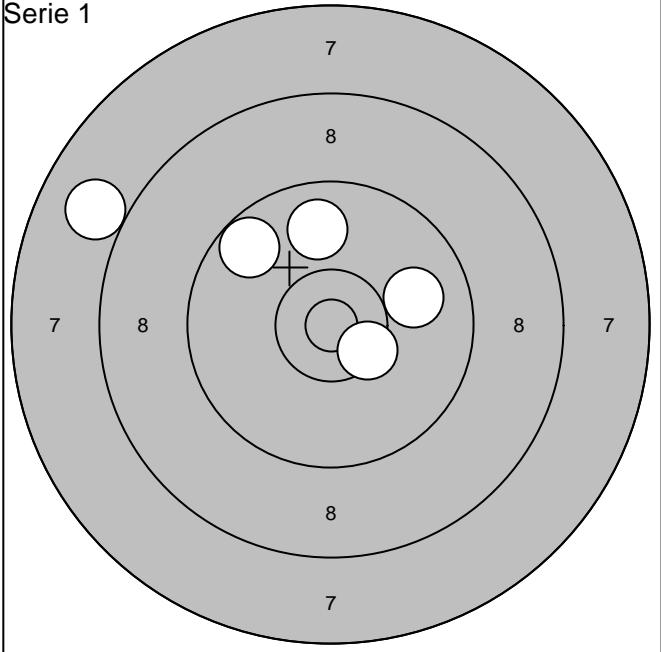
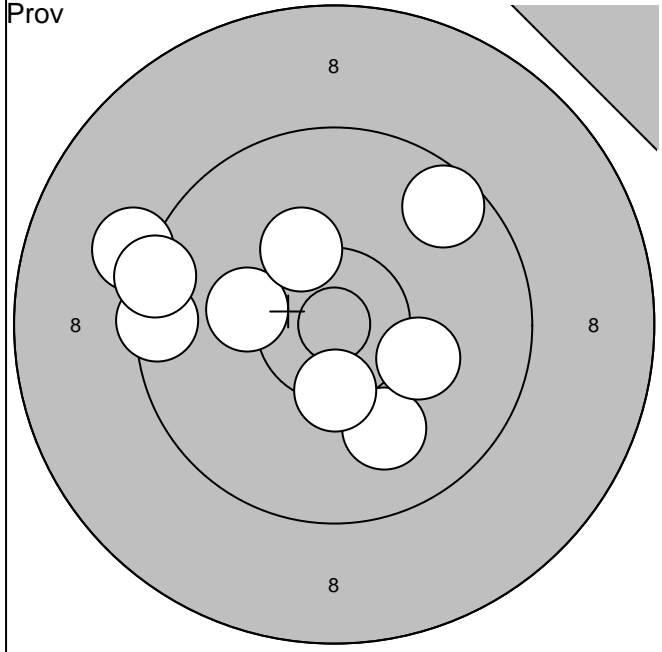

|          |           |        |       |
|----------|-----------|--------|-------|
| 1: 9,6 ↗ | 6:10,2 ←  | Serie  | 86,0  |
| 2: 9,5 ← | 7: 9,4 ←  |        |       |
| 3:10,0 ↓ | 8:10,4* ↓ | Totalt | 186,0 |
| 4: 9,2 ↖ | 9:10,3 ↗  |        |       |
| 5:10,2 → |           |        |       |

|           |        |       |
|-----------|--------|-------|
| 1: 8,0 ↖  | Serie  | 46,0  |
| 2: 9,7 ↗  |        |       |
| 3: 9,9 ↑  | Totalt | 232,0 |
| 4:10,4* ↘ |        |       |
| 5:10,0 →  |        |       |

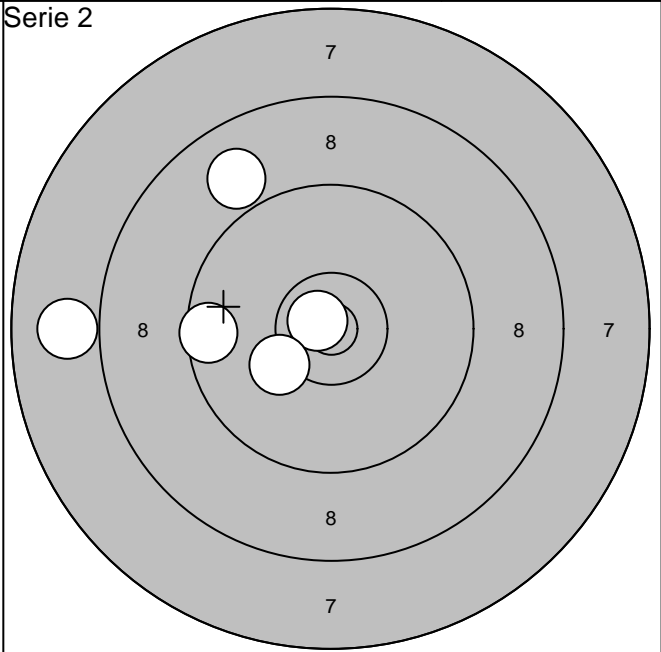
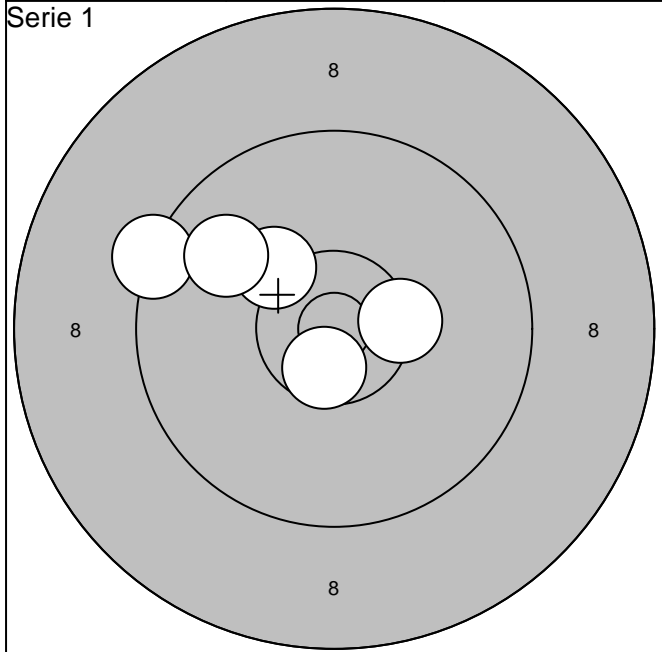

|            |        |       |
|------------|--------|-------|
| 6: 9,3 ↖   | Serie  | 48,0  |
| 7:10,3 ↗   |        |       |
| 8: 9,9 ↗   | Totalt | 280,0 |
| 9:10,4* →  |        |       |
| 10:10,6* ↓ |        |       |

|           |        |       |
|-----------|--------|-------|
| 1:10,8* ↖ | Serie  | 45,0  |
| 2:10,2 ↙  |        |       |
| 3: 9,6 ←  | Totalt | 325,0 |
| 4: 8,0 ←  |        |       |
| 5: 8,9 ↗  |        |       |

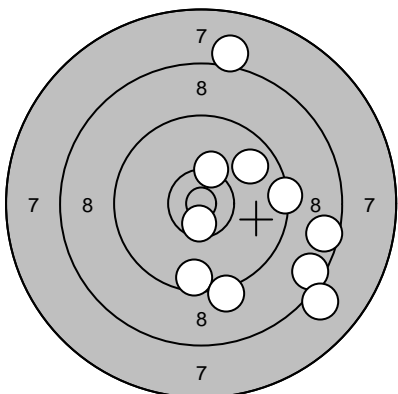
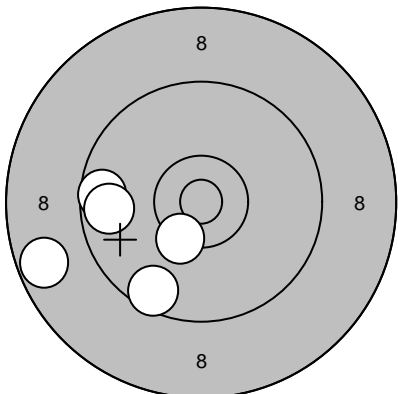
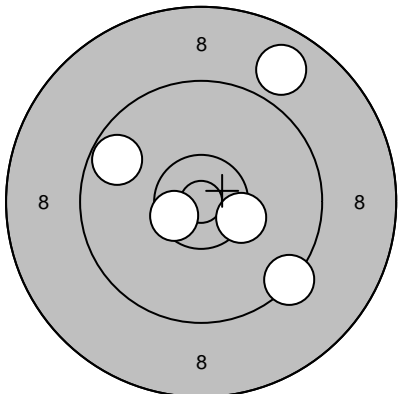

| Skjutlag   | Tavla   | Mikael Gustafsson  |   |
|------------|---|--|---|
| 1          | 10  | Umeå   |   |
| 2006-07-08 | Tavelträffen 2006 - Final   | Ramselefors SKF  |   |
| Prov       |    | 1: 8,1 ↑<br>2: 8,5 →<br>3: 8,1 ↘<br>4: 9,8 ↗<br>5: 9,4 →<br>6: 8,6 →<br>7: 9,6 ↓<br>8: 10,6* ↓<br>9: 9,2 ↓<br>10: 10,3 ↑ | 11: 9,6 ↓   |
|            | Serie 88,0  |  | Serie 9,0   |
|            | Totalt 178,0  |  | Totalt 178,0  |
| Serie 1    |   | 1: 9,6 ←<br>2: 9,7 ←<br>3: 9,6 ↓<br>4: 8,7 ←<br>5: 10,4* ↓   | 6: 8,7 →<br>7: 7,6 ↘<br>8: 9,9 ↓<br>9: 10,5* ↓<br>10: 8,9 ↘ |
|            | Serie 45,0  |  | Serie 42,0  |
|            | Totalt 223,0  |  | Totalt 265,0  |
| Serie 2    |  | 1: 9,3 ↘<br>2: 10,4* →<br>3: 10,5* ←<br>4: 8,9 ↗<br>5: 9,7 ↖   |   |
|            | Serie 46,0  |  |   |
|            | Totalt 311,0  |  |   |

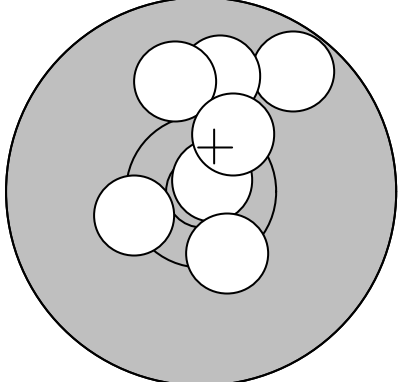
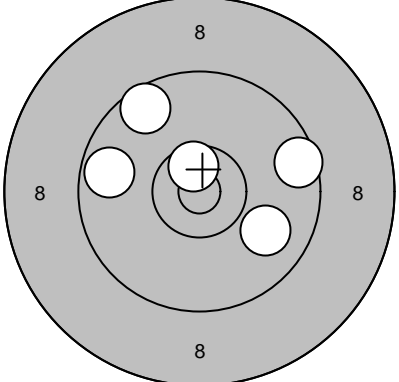
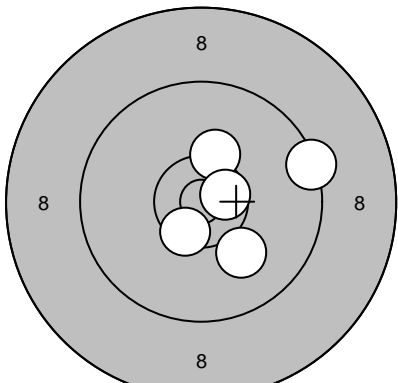
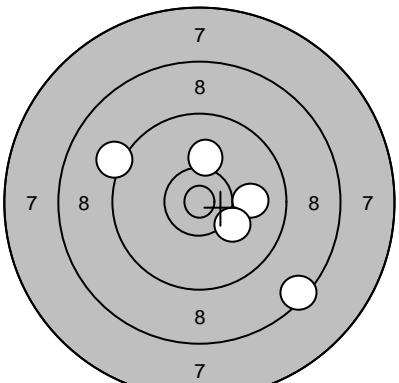
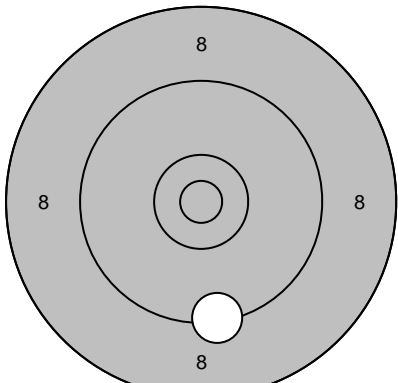
|                      |   |  |  |   |
|----------------------|---|--|--|---|
| Skjutlag<br><b>1</b> | Tavla<br><b>11</b>  | <b>Gunnar Iversen</b>  |  |   |
|                      |   | S 3  |  |   |
| 2006-07-08           | Tavelträffen 2006 - Final   | Ramselefors SKF  |  |   |
| Prov                 |    | 1: 9,7 ↗<br>2: 10,0 ↑<br>3: 10,0 ↑<br>4: 10,8* ↗<br>5: 10,4* ↓<br>6: 10,4* ↑<br>7: 10,4* ← | Serie 1<br>  | 1: 9,9 ↘<br>2: 9,7 ←<br>3: 9,6 ↗<br>4: 10,6* ↑<br>5: 9,5 →  |
|                      |   | Serie 69,0   | Serie 46,0   |   |
|                      |   | Totalt 194,0   | Totalt 240,0   |   |
| Serie 1              |   | 6: 9,4 →<br>7: 10,3 ↑<br>8: 10,1 ↓<br>9: 10,5* ↓<br>10: 10,6* →                            | Serie 2<br> | 1: 10,0 →<br>2: 8,4 ↘<br>3: 9,2 ↖<br>4: 10,1 ↑<br>5: 10,2 ↘ |
|                      |   | Serie 49,0   | Serie 47,0   |   |
|                      |   | Totalt 289,0   | Totalt 336,0   |   |
| Särskjutning         |  | 1: 9,4 ↓   |  |   |
|                      |   | Serie 9,0  |  |   |
|                      |   | Totalt 345,0   |  |   |

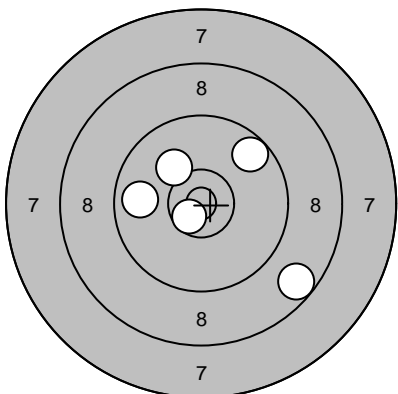
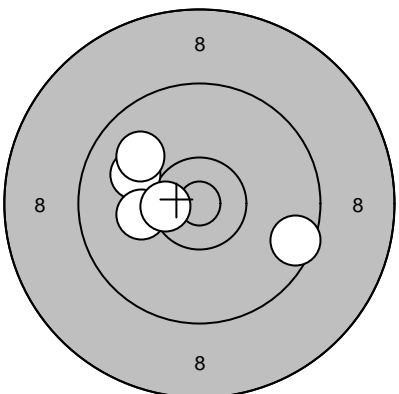
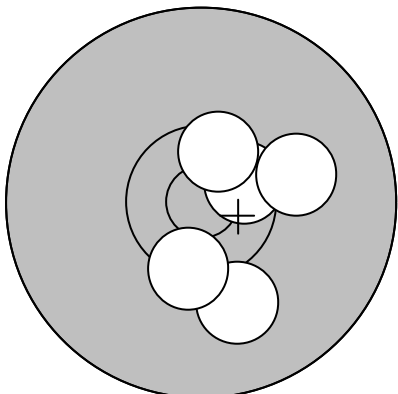
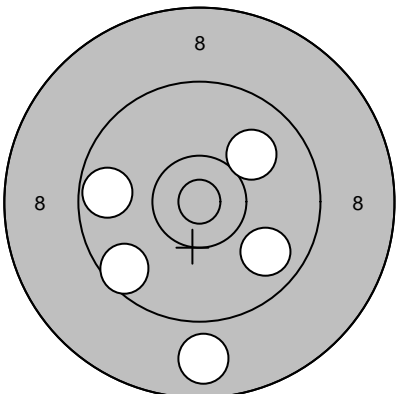
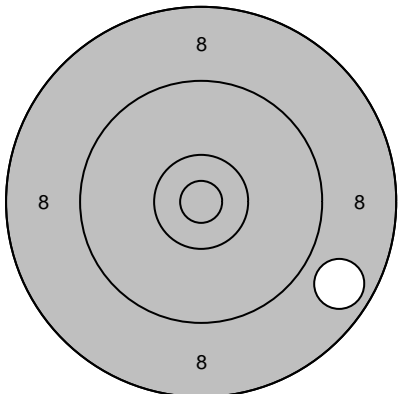
|                      |   |  |   |
|----------------------|---|--|---|
| Skjutlag<br><b>1</b> | Tavla<br><b>12</b>  | <b>Gillis Engman</b>   |   |
|                      |   | Rundvik  |   |
| 2006-07-08           | Tavelträffen 2006 - Final   | Ramselefors SKF  |   |
| Prov                 |    | Serie 1<br>1: 9,8 ←<br>2: 9,7 ↗<br>3: 8,6 ↘<br>4: 10,6* ↙<br>5: 10,1 ↖ |   |
|                      | Serie 46,0  |  | Serie 48,0  |
|                      | Totalt 193,0  |  | Totalt 241,0  |
| Serie 1              |   | Serie 2<br>1: 9,6 ↙<br>2: 8,8 ↓<br>3: 9,7 ←<br>4: 10,0 ↗<br>5: 9,8 ↘   |  |
|                      | Serie 50,0  |  | Serie 45,0  |
|                      | Totalt 291,0  |  | Totalt 336,0  |
| Särskjutning         |  | 1: 8,8 ↘   |   |
|                      | Serie 8,0   |  |   |
|                      | Totalt 344,0  |  |   |

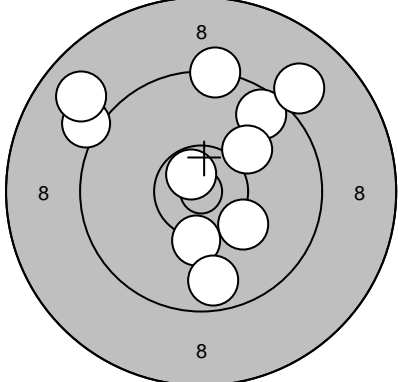
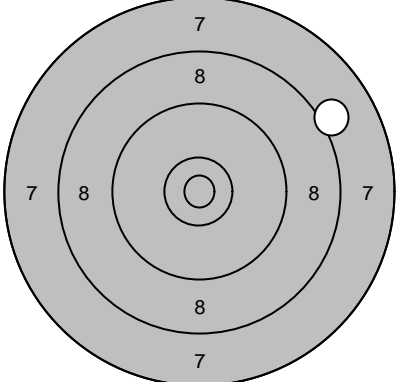
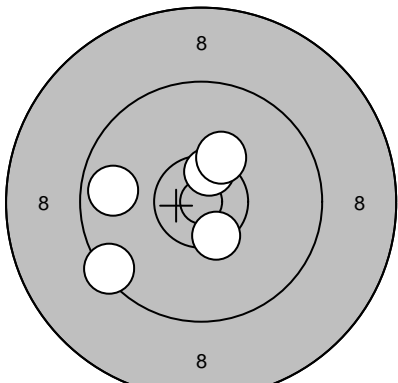
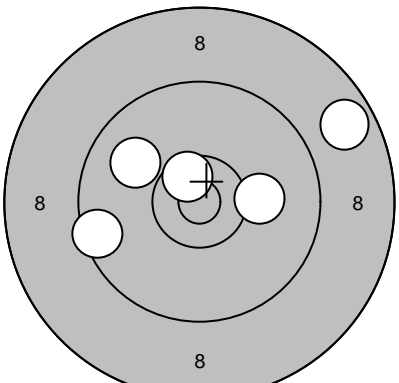
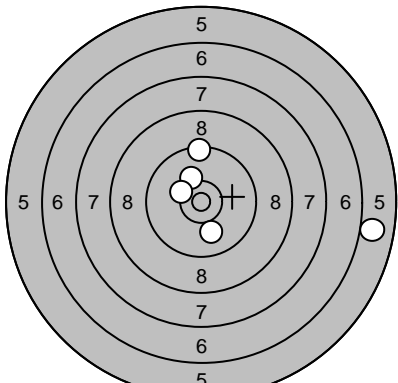
|                      |   |  |  |
|----------------------|---|--|--|
| Skjutlag<br><b>1</b> | Tavla<br><b>13</b>  | <b>Dan-Ivan Karlsson</b>   |  |
|                      |   | Ramselefors  |  |
| 2006-07-08           | Tavelträffen 2006 - Final   | Ramselefors SKF  |  |
| Prov                 |    | 1: 9,6 ↗<br>2: 10,3 ↓<br>3: 9,1 ↖<br>4: 9,0 ↗<br>5: 9,7 ↓<br>6: 10,7* ↗<br>7: 10,2 ↘<br>8: 9,3 ↑<br>9: 10,1 ↗<br>10: 8,9 ↖ | Prov<br>     |
|                      | Serie 93,0  |  | 11: 8,1 ↗  |
|                      | Totalt 191,0  |  | Serie 8,0  |
|                      |   |  | Totalt 191,0   |
| Serie 1              |   | 1: 10,5* ↗<br>2: 10,4* ↓<br>3: 10,3* ↗<br>4: 9,4 ↖<br>5: 9,8 ←   | Serie 1<br> |
|                      | Serie 48,0  |  | 6: 9,5 ←   |
|                      | Totalt 239,0  |  | 7: 9,9 ↖   |
|                      |   |  | 8: 8,7 ↗   |
|                      |   |  | 9: 10,6* ↗   |
|                      |   |  | 10: 10,1 →   |
|                      |   |  | Serie 46,0   |
|                      |   |  | Totalt 285,0   |
| Serie 2              |  | 1: 10,2 ↗<br>2: 10,0 ↓<br>3: 10,3* ↖<br>4: 5,9 →<br>5: 9,5 ↑   |  |
|                      | Serie 44,0  |  |  |
|                      | Totalt 329,0  |  |  |

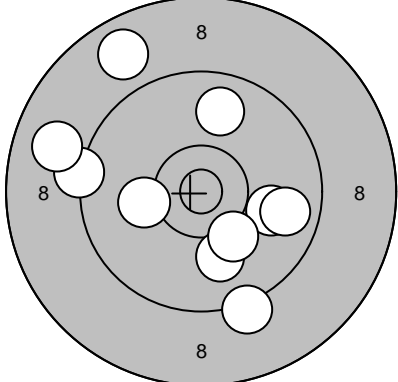
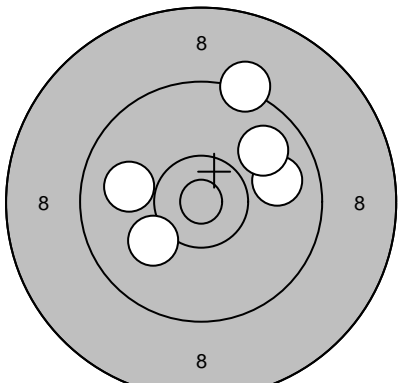
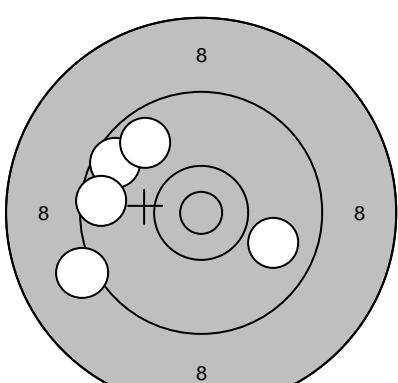
| Skjutlag   | Tavla   | Håkan Lidman  |  |
|------------|---|---|--|
| 1          | 14  | Skellefteå  |  |
| 2006-07-08 | Tavelträffen 2006 - Final   | Ramselefors SKF   |  |
| Prov       |    | 1: 8,8 ↗<br>2: 10,0 ↓<br>3: 10,0 →<br>4: 9,8 ↑<br>5: 9,8 →<br>6: 9,2 ↓<br>7: 10,2 ←<br>8: 10,2 ↓<br>9: 9,3 ←<br>10: 8,9 ↙ | 11: 10,4* ←  |
|            | Serie 92,0  |   | Serie 10,0   |
|            | Totalt 189,0  |   | Totalt 189,0   |
| Serie 1    |   | 1: 9,3 ↑<br>2: 9,9 →<br>3: 9,9 ↗<br>4: 10,0 ←<br>5: 10,1 ↙  | 6: 9,6 ↖<br>7: 9,7 ←<br>8: 10,8* ↗<br>9: 10,3 ↖<br>10: 9,5 ← |
|            | Serie 47,0  |   | Serie 47,0   |
|            | Totalt 236,0  |   | Totalt 283,0   |
| Serie 2    |  | 1: 9,6 ↖<br>2: 9,7 ↗<br>3: 9,6 ←<br>4: 9,1 ←<br>5: 9,9 →  |  |
|            | Serie 45,0  |   |  |
|            | Totalt 328,0  |   |  |

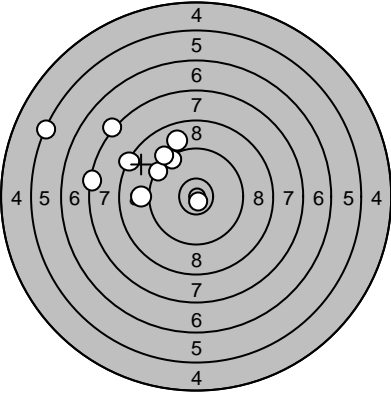
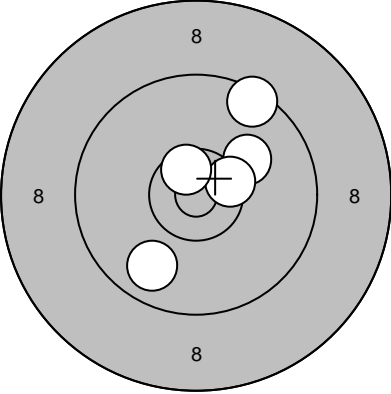
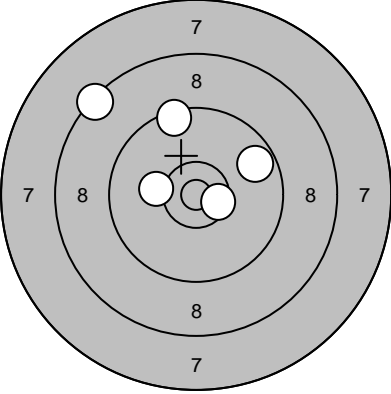
|            |   |   |              |  |
|------------|---|---|--------------|--|
| Skjutlag   | Tavla   | Roland Nilsson  |              |  |
| 1          | 15  |   |              |  |
|            |   | Piteå   |              |  |
| 2006-07-08 | Tavelträffen 2006 - Final   | Ramselefors SKF   |              |  |
| Prov       |    | 1: 5,4 ↙<br>2: 9,5 ↗<br>3: 7,2 ↗<br>4: 9,4 ↗<br>5: 9,2 ↗<br>6: 8,9 ↗<br>7: 8,4 ↗<br>8: 10,8* ↓<br>9: 9,1 ←<br>10: 7,4 ← | Prov         | 11: 9,4 ↗<br>12: 10,1 ↗<br>13: 10,1 ←<br>14: 10,3* ↗<br>15: 10,2 ↓ |
|            |   | Serie 81,0  | Serie 49,0   |  |
|            |   | Totalt 188,0  | Totalt 188,0 |  |
| Serie 1    |  | 1: 10,1 ↗<br>2: 9,5 ↗<br>3: 10,4* →<br>4: 10,6* ↗<br>5: 9,8 ↓   | Serie 1      | 6: 9,3 →<br>7: 10,3 ↗<br>8: 9,4 ↓<br>9: 9,6 ↓<br>10: 10,6* ↗       |
|            |   | Serie 48,0  | Serie 47,0   |  |
|            |   | Totalt 236,0  | Totalt 283,0 |  |
| Serie 2    |  | 1: 10,5* →<br>2: 9,5 ↗<br>3: 8,4 ↗<br>4: 10,2 ←<br>5: 9,7 ↗   |              |  |
|            |   | Serie 46,0  |              |  |
|            |   | Totalt 329,0  |              |  |

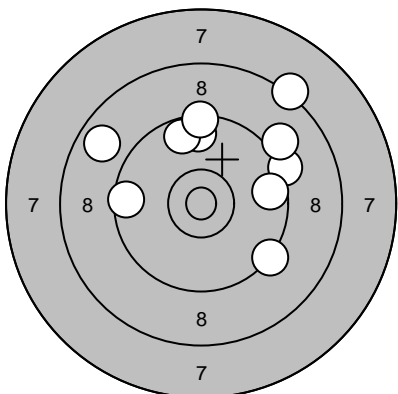
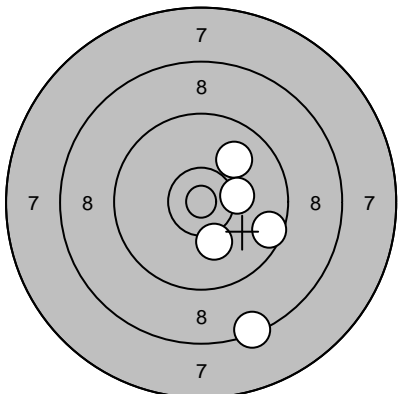
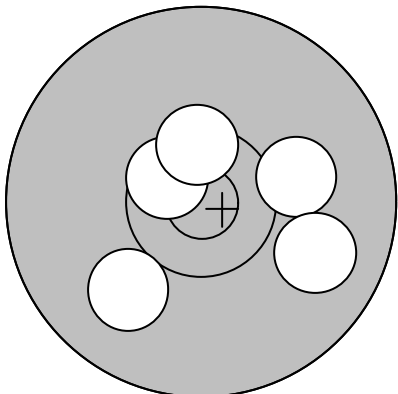
|                      |   |   |  |
|----------------------|---|---|--|
| Skjutlag<br><b>1</b> | Tavla<br><b>17</b>  | <b>Staffan Samuelsson</b>   |  |
|                      |   | Rundvik   |  |
| 2006-07-08           | Tavelträffen 2006 - Final   | Ramselefors SKF   |  |
| Prov                 |    | 1: 9,3 ↘<br>2: 9,6 ↑<br>3: 8,3 ↗<br>4: 8,8 ↖<br>5: 9,7 ↑<br>6: 9,2 →<br>7: 9,6 →<br>8: 9,1 ↗<br>9: 9,6 ←<br>10: 9,4 ↑ | Prov<br>11: 10,4* ↓<br>12: 8,4 ↗                                       |
|                      | Serie 88,0  |   | Serie 18,0   |
|                      | Totalt 184,0  |   | Totalt 184,0   |
| Serie 1              |   | 1: 9,6 →<br>2: 10,0 ↗<br>3: 10,1 ↓<br>4: 8,4 ↓<br>5: 10,3 →   | Serie 1<br>6: 9,6 ↗<br>7: 9,9 ↓<br>8: 10,5* ↖<br>9: 9,2 ↓<br>10: 9,5 ← |
|                      | Serie 47,0  |   | Serie 46,0   |
|                      | Totalt 231,0  |   | Totalt 277,0   |
| Serie 2              |  | 1: 10,6* ↖<br>2: 10,0 ↙<br>3: 10,1 →<br>4: 10,5* ↑<br>5: 9,9 →  |  |
|                      | Serie 49,0  |   |  |
|                      | Totalt 326,0  |   |  |

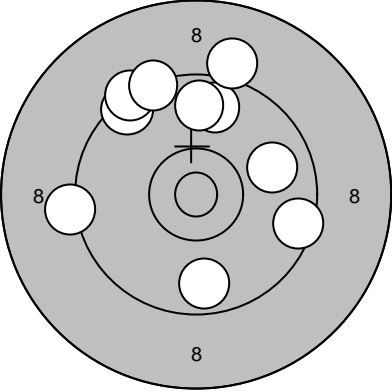
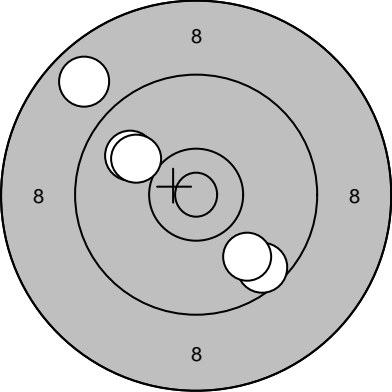
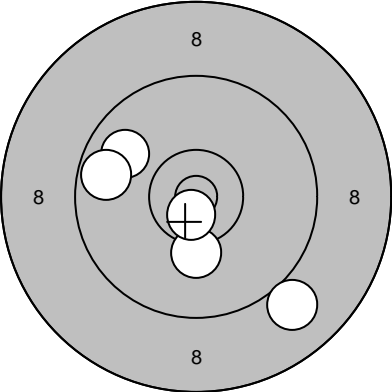
| Skjutlag   | Tavla   | Martin Olofsson   |   |
|------------|---|---|---|
| 1          | 18  | Vännäs  |   |
| 2006-07-08 | Tavelträffen 2006 - Final   | Ramselefors SKF   |   |
| Prov       |    | 1: 9,7 ↑<br>2: 9,8 ↑<br>3: 9,1 ↑<br>4: 9,8 →<br>5: 9,5 →<br>6: 9,5 ↗<br>7: 9,7 ↓<br>8: 9,3 ↗<br>9: 9,4 ↗<br>10: 9,2 ← | 11: 9,3 ↓<br>12: 10,4* ←                                      |
|            | Serie 90,0  |   | Serie 19,0  |
|            | Totalt 182,0  |   | Totalt 182,0  |
| Serie 1    |  | 1: 9,6 ↓<br>2: 9,9 ↓<br>3: 9,9 ↗<br>4: 8,8 ↗<br>5: 10,0 ↗   | 6: 9,4 ←<br>7: 8,8 ↓<br>8: 10,0 ↑<br>9: 10,7* ↑<br>10: 10,2 ↘ |
|            | Serie 45,0  |   | Serie 47,0  |
|            | Totalt 227,0  |   | Totalt 274,0  |
| Serie 2    |  | 1: 9,0 ↓<br>2: 10,2 ↓<br>3: 9,8 ↗<br>4: 9,7 ←<br>5: 10,7* ↓   |   |
|            | Serie 47,0  |   |   |
|            | Totalt 321,0  |   |   |



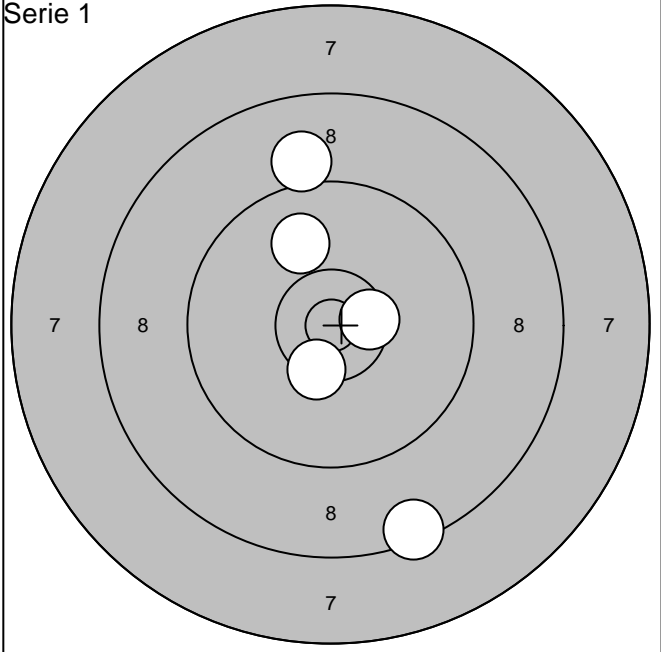
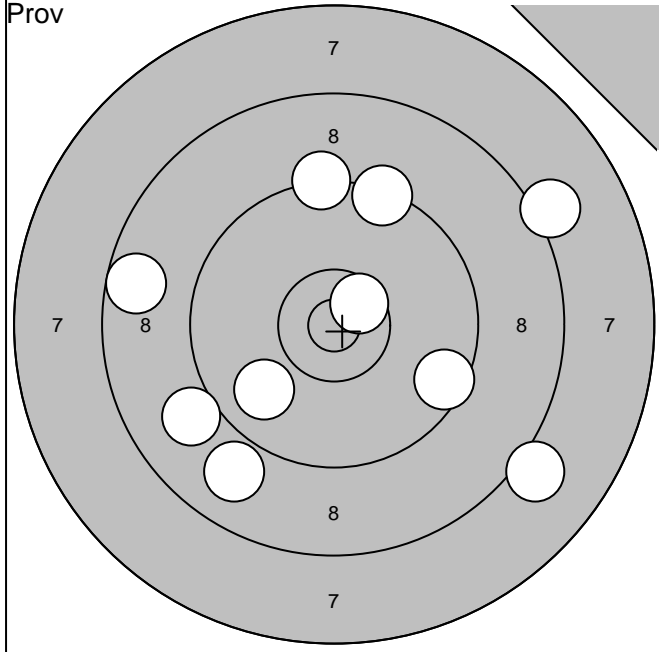

|            |           |        |       |
|------------|-----------|--------|-------|
| 1: 9,5 ↘   | 6: 8,2 ↗  | Serie  | 87,0  |
| 2: 8,9 ↙   | 7: 8,1 ↘  |        |       |
| 3: 10,6* ↗ | 8: 9,4 ↗  | Totalt | 180,0 |
| 4: 9,9 ↙   | 9: 8,6 ↖  |        |       |
| 5: 9,3 ↗   | 10: 9,0 ↙ |        |       |

|            |        |       |
|------------|--------|-------|
| 1: 8,4 ↘   | Serie  | 47,0  |
| 2: 10,5* → |        |       |
| 3: 10,0 ↗  | Totalt | 227,0 |
| 4: 9,1 ↗   |        |       |
| 5: 10,4* ↘ |        |       |

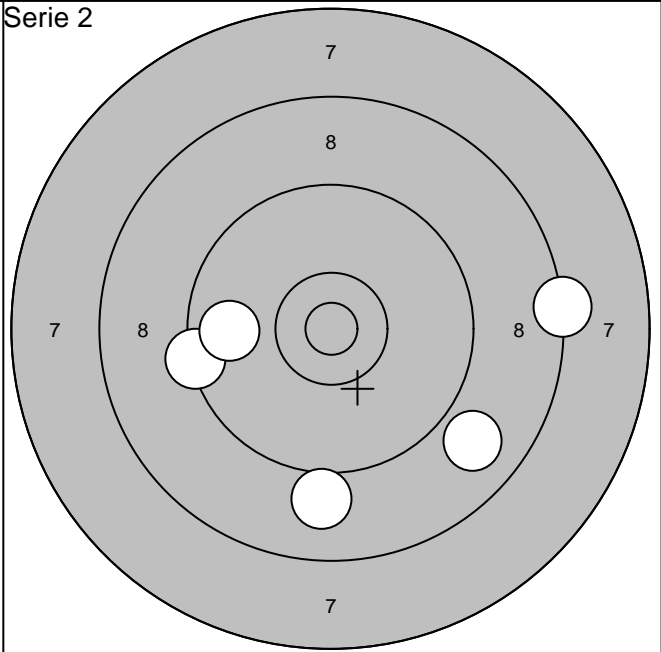
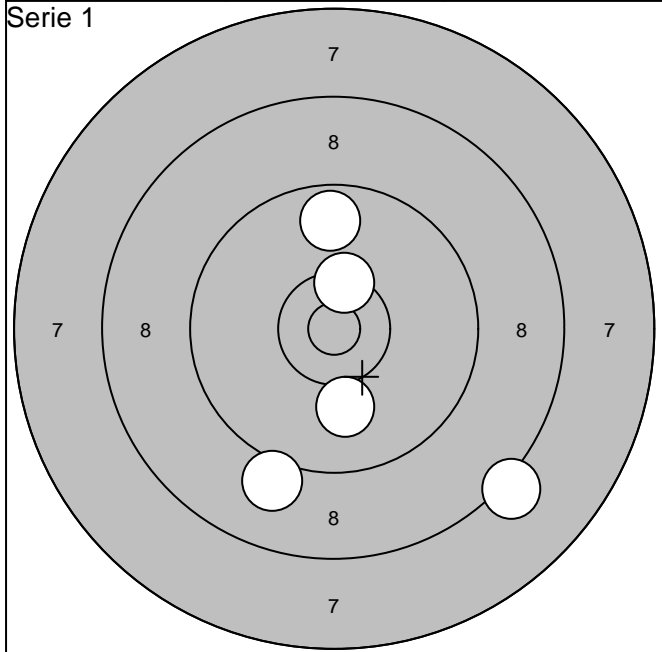

|            |        |       |
|------------|--------|-------|
| 6: 10,0 ↘  | Serie  | 46,0  |
| 7: 9,1 ↘   |        |       |
| 8: 9,7 ↗   | Totalt | 273,0 |
| 9: 10,4* ↗ |        |       |
| 10: 8,2 ↘  |        |       |

|          |        |       |
|----------|--------|-------|
| 1: 9,4 ↖ | Serie  | 43,0  |
| 2: 9,0 ↘ |        |       |
| 3: 8,9 ↘ | Totalt | 316,0 |
| 4: 8,3 → |        |       |
| 5: 9,8 ↖ |        |       |

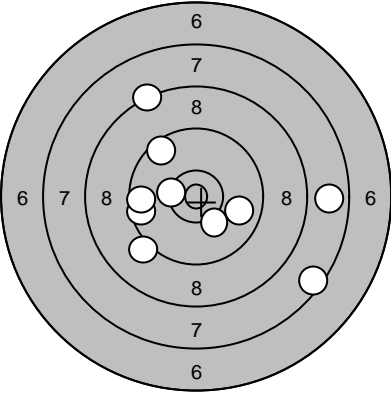
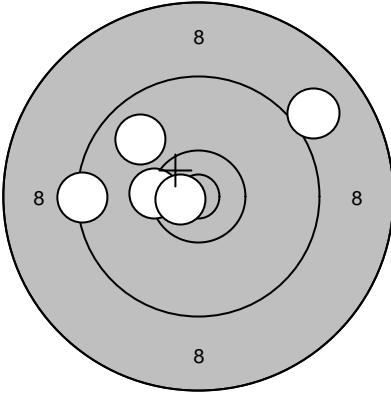
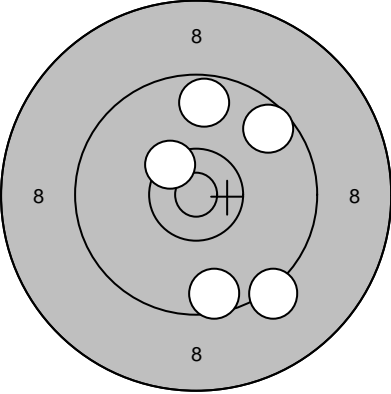
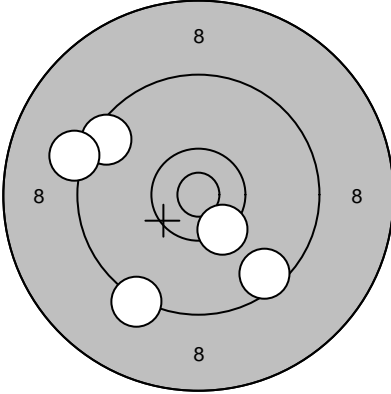
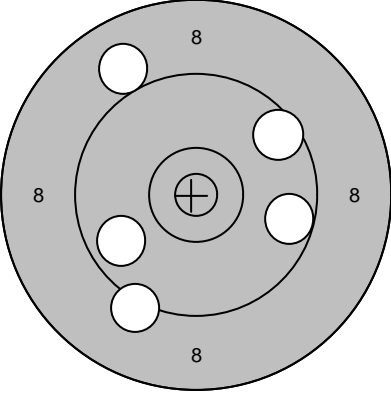
|                      |   |  |   |
|----------------------|---|--|---|
| Skjutlag<br><b>1</b> | Tavla<br><b>20</b>  | <b>Dennis Sundqvist</b>  |   |
|                      |   | Piteå  |   |
| 2006-07-08           | Tavelträffen 2006 - Final   | Ramselefors SKF  |   |
| Prov                 |    | 1: 7,8 →<br>2: 9,6 ↗<br>3: 8,3 ↗<br>4: 7,5 ↘<br>5: 10,2 ↘<br>6: 9,2 ↘<br>7: 9,9 →<br>8: 9,6 ←<br>9: 10,3* ←<br>10: 9,7 ← | Prov<br>      |
|                      | Serie 87,0  |  | 11: 10,4* ←<br>12: 9,4 ←<br>13: 9,0 ↗<br>14: 9,9 ↗<br>15: 10,7* ←                               |
|                      | Totalt 178,0  |  | Serie 47,0  |
|                      |   |  | Totalt 178,0  |
| Serie 1              |  | 1: 10,4* ↗<br>2: 9,3 ↘<br>3: 9,7 ↗<br>4: 9,6 ↗<br>5: 9,6 ↘   | Serie 1<br> |
|                      | Serie 46,0  |  | 6: 9,3 ↘<br>7: 9,5 ↗<br>8: 9,2 ←<br>9: 9,6 ↘<br>10: 10,4* ↘                                     |
|                      | Totalt 224,0  |  | Serie 46,0  |
|                      |   |  | Totalt 270,0  |
| Serie 2              |  | 1: 9,8 ←<br>2: 9,2 ↘<br>3: 9,0 ↗<br>4: 9,6 ↗<br>5: 9,6 →   |   |
|                      | Serie 45,0  |  |   |
|                      | Totalt 315,0  |  |   |

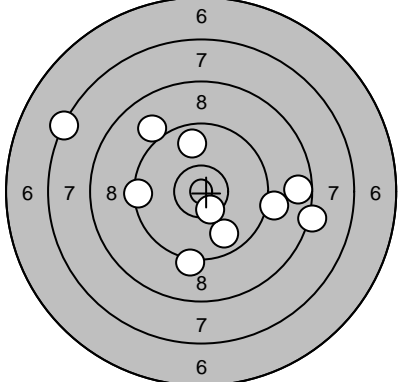
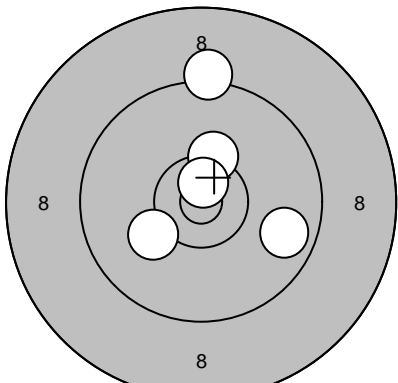
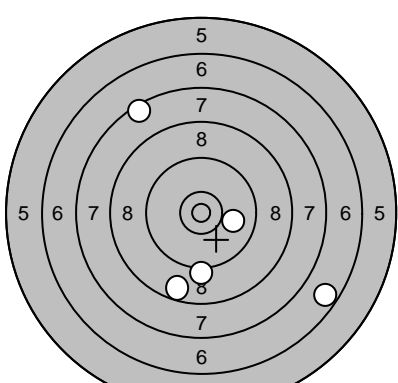
| Skjutlag   | Tavla   | Lennart Westermark  |   |
|------------|---|---|---|
| 1          | 21  | Drängsmark  |   |
| 2006-07-08 | Tavelträffen 2006 - Final   | Ramselefors SKF   |   |
| Prov       |    | 1: 9,5 ←<br>2: 9,8 ↓<br>3: 9,8 ↑<br>4: 10,5* ↓<br>5: 8,6 →<br>6: 8,2 →<br>7: 9,2 ↓<br>8: 9,2 →<br>9: 7,4 ↗<br>10: 9,1 ↗ | 11: 9,8 →<br>12: 8,7 ↗<br>13: 9,2 ←<br>14: 9,7 ↗              |
|            | Serie 87,0  |   | Serie 35,0  |
|            | Totalt 174,0  |   | Totalt 174,0  |
| Serie 1    |   | 1: 9,7 →<br>2: 10,3* ↑<br>3: 9,2 ↑<br>4: 10,2 ←<br>5: 10,7* ↑   | 6: 7,8 ←<br>7: 10,4* ↗<br>8: 8,4 ↓<br>9: 10,5* ↓<br>10: 9,6 ↗ |
|            | Serie 48,0  |   | Serie 44,0  |
|            | Totalt 222,0  |   | Totalt 266,0  |
| Serie 2    |  | 1: 8,7 ↓<br>2: 9,2 ↓<br>3: 7,5 ↗<br>4: 10,0 →<br>5: 6,6 ↓   |   |
|            | Serie 40,0  |   |   |
|            | Totalt 306,0  |   |   |

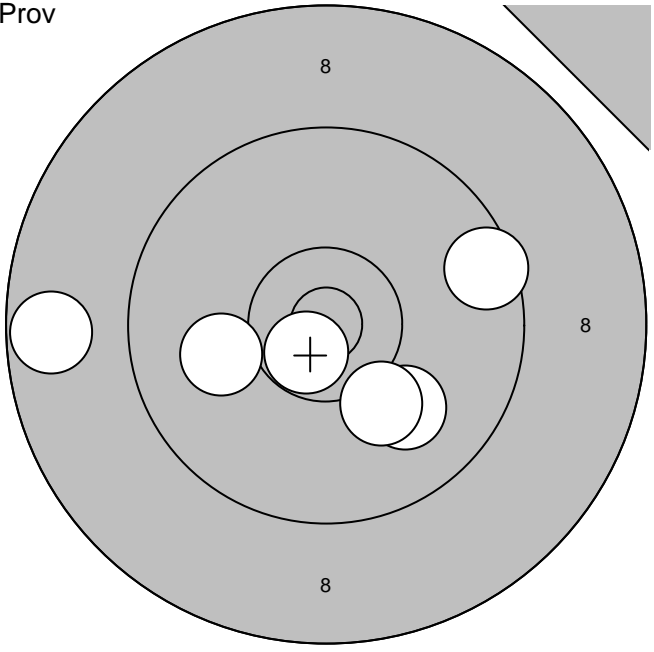
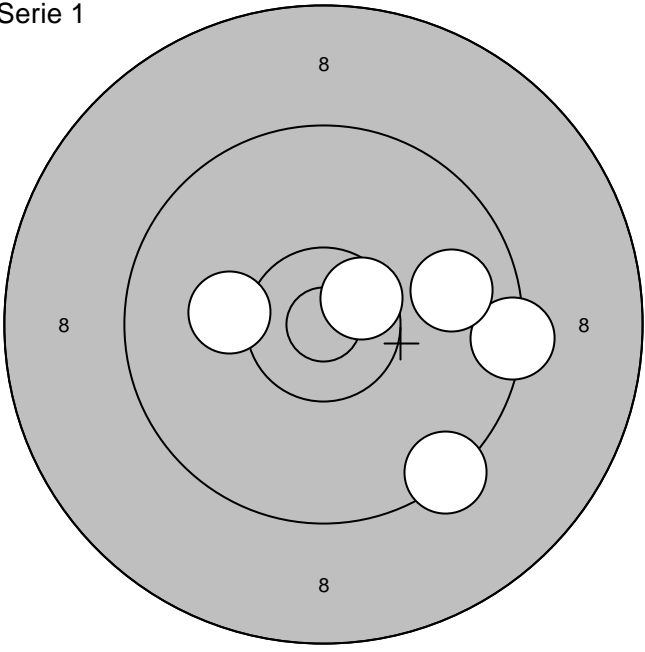
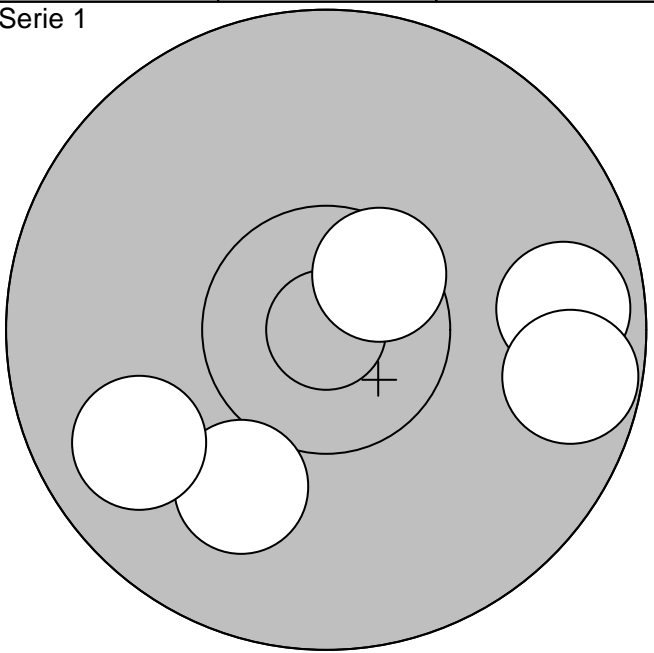
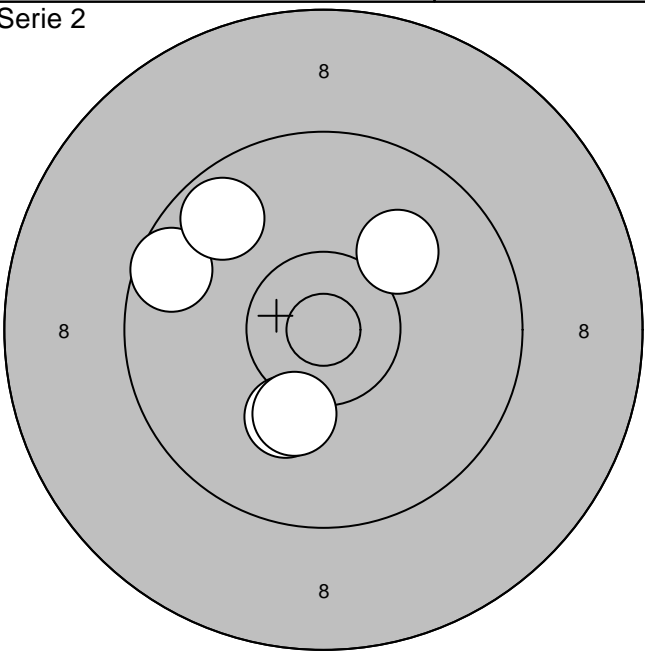
|   |                           |  |              |
|---|---------------------------|--|--------------|
| Skjutlag<br><b>2</b>  | Tavla<br><b>1</b>         | <b>Christian Lejon</b>   |              |
|   |                           | Umeå   |              |
| 2006-07-08  | Tavelträffen 2006 - Final | Ramselefors SKF  |              |
| Prov  |                           | Serie 1  |              |
|    |                           |    |              |
| 1: 9,5 →  | 6:10,7* ↓                 | Serie 57,0   | 1:10,6* ↗    |
| 2:10,0 ↓  |                           |  | 2:10,2 ←     |
| 3: 8,7 ←  |                           | Totalt 197,0   | 3: 9,4 ↓     |
| 4:10,1 ←  |                           |  | 4: 9,4 →     |
| 5:10,1 ↓  |                           |  | 5: 9,9 →     |
| Serie 1   |                           | Serie 2  |              |
|  |                           |  |              |
| 6:10,0 ↓  |                           | Serie 47,0   | 1:10,2 ↓     |
| 7:10,6* ↗   |                           |  | 2: 9,6 ←     |
| 8: 9,8 ←  |                           | Totalt 291,0   | 3:10,2 ↓     |
| 9: 9,7 →  |                           |  | 4:10,1 ↗     |
| 10: 9,7 →   |                           |  | 5: 9,7 ↖     |
|   |                           |  | Serie 48,0   |
|   |                           |  | Totalt 339,0 |

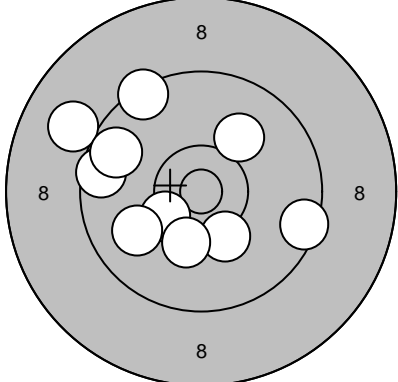
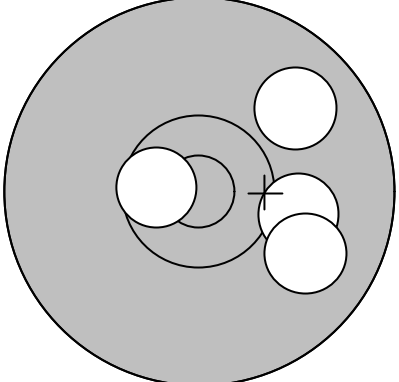
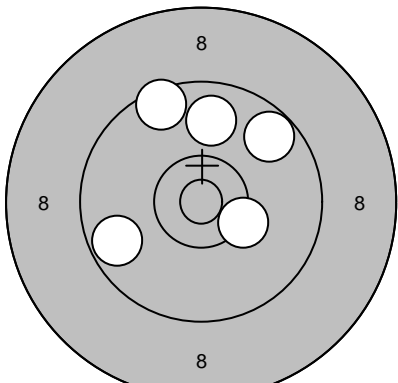
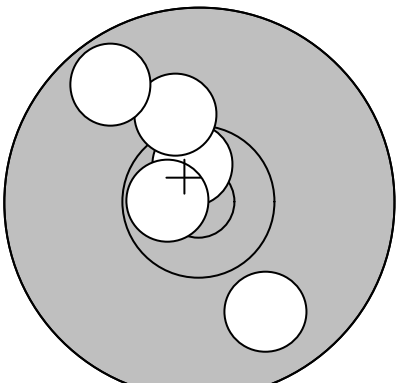
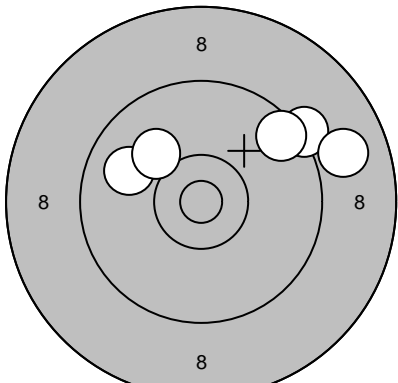
| Skjutlag   | Tavla   | Lars Sandström   |  |
|------------|---|--|--|
| 2          | 2   | Ramselefors  |  |
| 2006-07-08 | Tavelträffen 2006 - Final   | Ramselefors SKF  |  |
| Prov       |    | 1: 9,5 →<br>2: 10,3 ↓<br>3: 10,3* ←<br>4: 9,4 ↗<br>5: 9,0 ↖<br>6: 9,6 ←<br>7: 9,9 ←<br>8: 9,7 ↖<br>9: 10,1 ↗<br>10: 10,2 ↓ | Prov<br>     |
|            | Serie 94,0  |  | 11: 10,1 →   |
|            | Totalt 194,0  |  | 12: 9,9 ↘  |
|            |   |  | 13: 9,9 ↗  |
|            |   |  | 14: 10,6* ←  |
|            |   | Serie 38,0   |  |
|            |   | Totalt 194,0   |  |
| Serie 1    |   | 1: 9,7 ↗<br>2: 10,3* →<br>3: 9,9 ↑<br>4: 9,5 ↗<br>5: 9,7 ←   | Serie 1<br> |
|            | Serie 46,0  |  | 6: 9,9 ↓   |
|            | Totalt 240,0  |  | 7: 10,6* ↑   |
|            |   |  | 8: 10,2 ↑  |
|            |   |  | 9: 9,7 ↗   |
|            |   | Serie 48,0   |  |
|            |   | Totalt 288,0   |  |
| Serie 2    |  | 1: 9,3 ↗<br>2: 9,5 ↗<br>3: 9,9 ←<br>4: 10,1 ↗<br>5: 8,9 →  |  |
|            | Serie 45,0  |  |  |
|            | Totalt 333,0  |  |  |

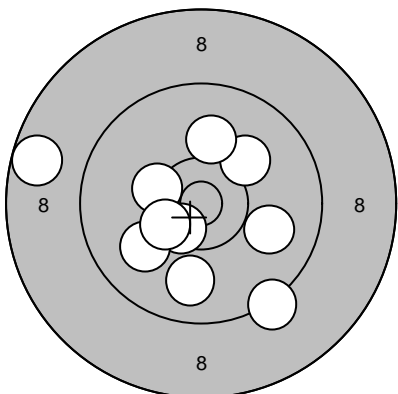
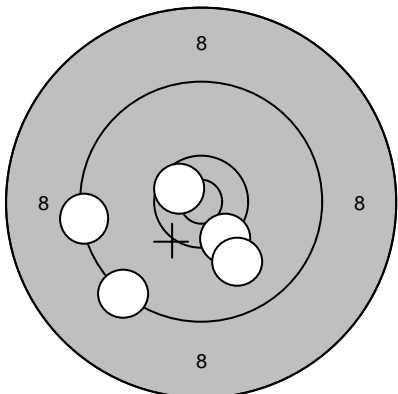
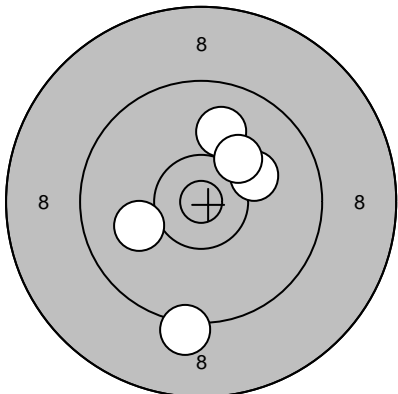
| Skjutlag   | Tavla   | Magnus Lindkvist  |   |
|------------|---|---|---|
| 2          | 3   | Umeå  |   |
| 2006-07-08 | Tavelträffen 2006 - Final   | Ramselefors SKF   |   |
| Prov       |    | 1: 10,1 ↗<br>2: 9,3 ↓<br>3: 8,7 ←<br>4: 10,5* ↙<br>5: 10,0 →<br>6: 10,1 ↑<br>7: 10,3* ←<br>8: 9,9 ↓<br>9: 10,0 ↙<br>10: 10,4* ↙ | Prov<br>11: 10,4* ↙   |
|            | Serie 96,0  |   | Serie 10,0  |
|            | Totalt 192,0  |   | Totalt 192,0  |
| Serie 1    |   | 1: 10,6* ↙<br>2: 10,4* ↓<br>3: 9,4 ←<br>4: 10,0 ↓<br>5: 9,3 ↙   | Serie 1<br>6: 10,2 ↘<br>7: 9,7 ←<br>8: 8,4 ↘<br>9: 10,0 ↗<br>10: 10,3 ↙ |
|            | Serie 48,0  |   | Serie 47,0  |
|            | Totalt 240,0  |   | Totalt 287,0  |
| Serie 2    |  | 1: 9,2 ↓<br>2: 10,2 →<br>3: 10,0 ↑<br>4: 10,0 ←<br>5: 10,2 ↗  |   |
|            | Serie 49,0  |   |   |
|            | Totalt 336,0  |   |   |

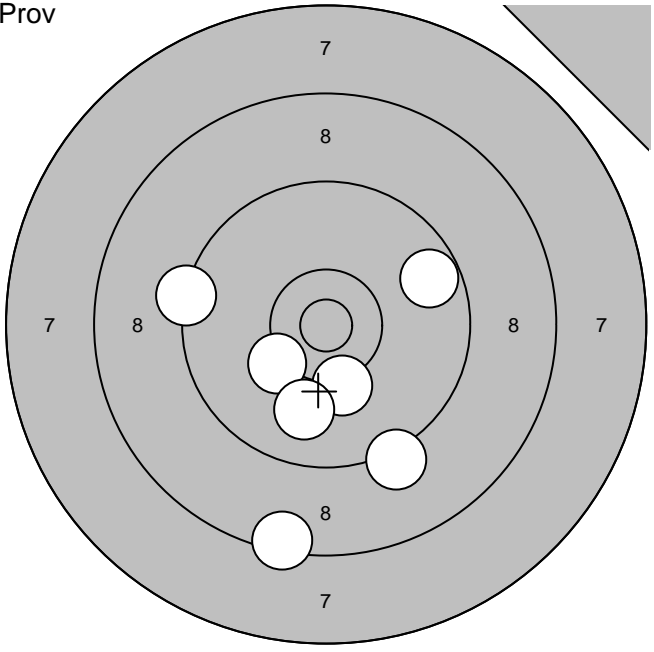
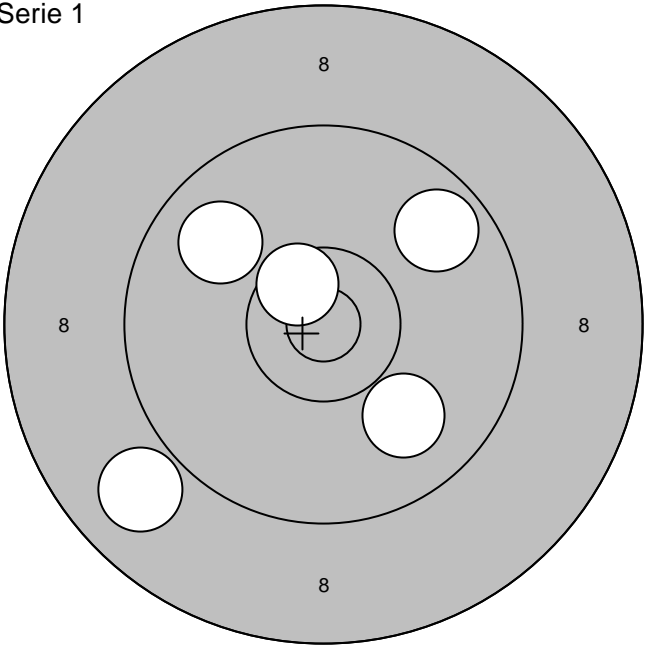
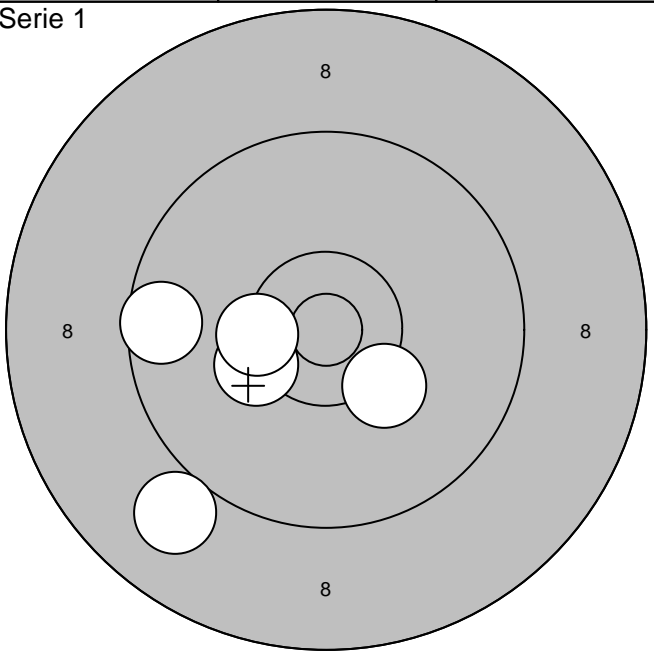
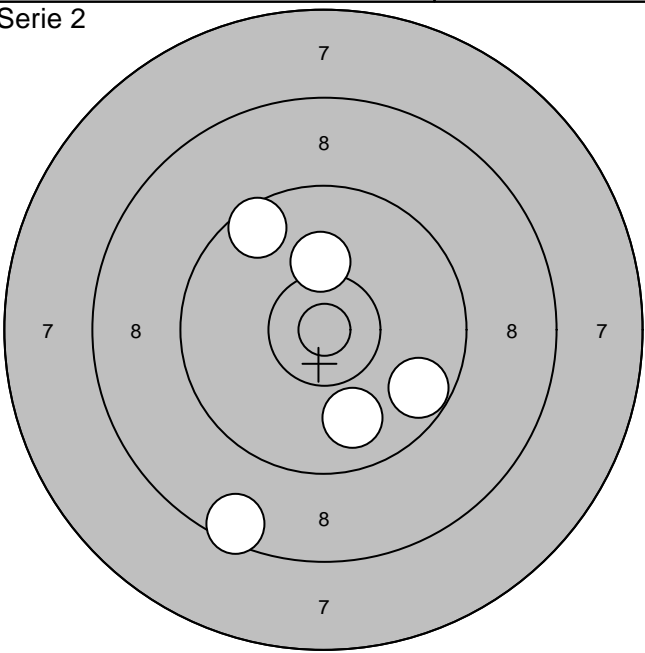
|   |                           |  |              |
|---|---------------------------|--|--------------|
| Skjutlag<br><b>2</b>  | Tavla<br><b>4</b>         | <b>Curt Lejon</b>  |              |
|   |                           | Umeå   |              |
| 2006-07-08  | Tavelträffen 2006 - Final | Ramselefors SKF  |              |
| Prov  |                           | Serie 1  |              |
|    |                           |    |              |
| 1: 8,4 ↓  | 6: 9,3 ←                  | Serie 65,0   | 1: 9,7 ↗     |
| 2: 9,2 ↓  | 7:10,0 ↓                  |  | 2:10,6* ↗    |
| 3:10,2 ←  |                           | Totalt 192,0   | 3: 9,9 ↗     |
| 4: 9,7 ↗  |                           |  | 4: 8,9 ↙     |
| 5:10,2 ↓  |                           |  | 5:10,0 ↓     |
|   |                           |  | Serie 46,0   |
|   |                           |  | Totalt 238,0 |
| Serie 1   |                           | Serie 2  |              |
|  |                           |  |              |
| 6:10,3 ↘  |                           | Serie 48,0   | 1:10,2 ↑     |
| 7: 9,0 ↙  |                           |  | 2: 9,9 ↓     |
| 8:10,3* ←   |                           | Totalt 286,0   | 3: 8,5 ↙     |
| 9: 9,6 ←  |                           |  | 4: 9,6 ↗     |
| 10:10,4* ←  |                           |  | 5: 9,7 ↓     |
|   |                           |  | Serie 45,0   |
|   |                           |  | Totalt 331,0 |

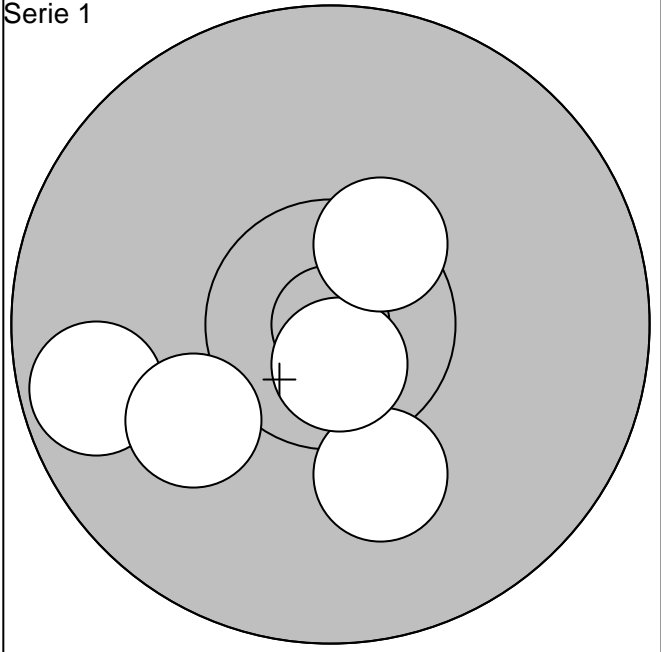
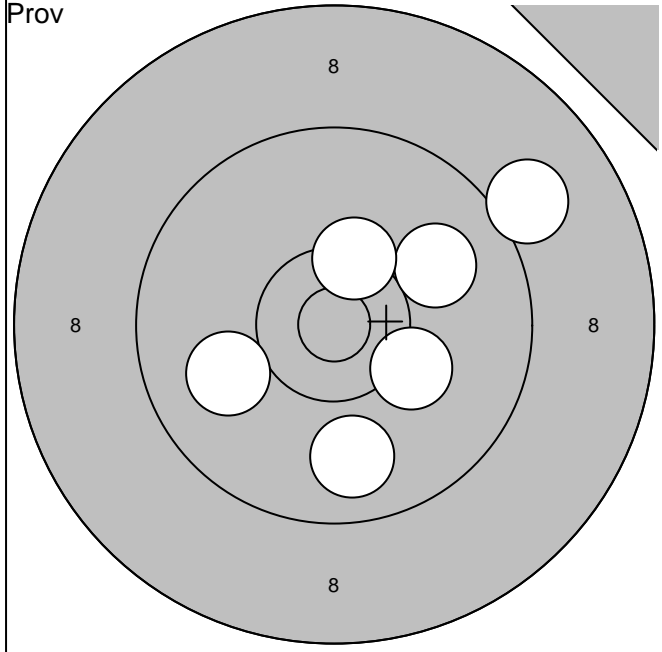

|           |          |        |       |  |  |
|-----------|----------|--------|-------|--|--|
| 1: 9,1 ↗  | 6:10,0 ← |        |       |  |  |
| 2: 9,8 ↓  |          | Serie  | 58,0  |  |  |
| 3:10,2 ➤  |          |        |       |  |  |
| 4:10,0 ↗  |          | Totalt | 190,0 |  |  |
| 5:10,4* ↑ |          |        |       |  |  |

|           |  |        |       |  |  |
|-----------|--|--------|-------|--|--|
| 1:10,1 ↓  |  |        |       |  |  |
| 2: 9,7 ←  |  | Serie  | 49,0  |  |  |
| 3:10,7* ↓ |  |        |       |  |  |
| 4:10,5* ↗ |  | Totalt | 239,0 |  |  |
| 5:10,1 ↙  |  |        |       |  |  |

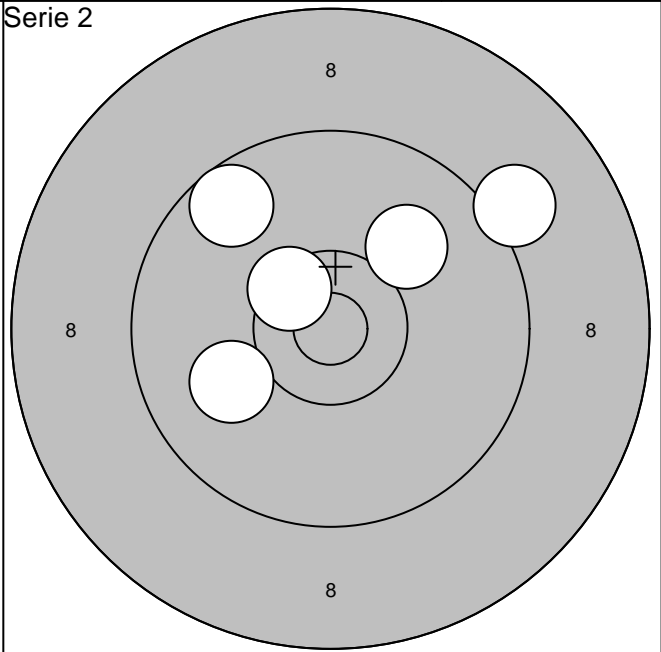
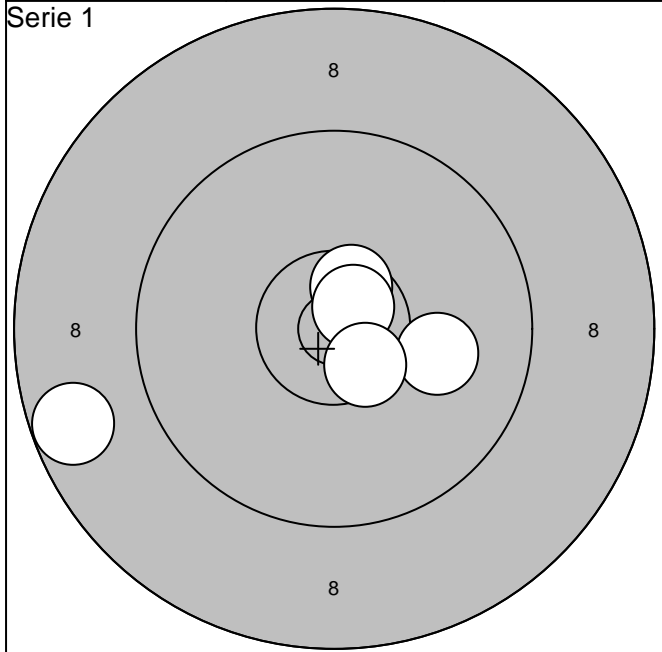

|           |  |        |       |  |  |
|-----------|--|--------|-------|--|--|
| 6:10,6* ↑ |  |        |       |  |  |
| 7:10,1 ➔  |  | Serie  | 48,0  |  |  |
| 8:10,7* ↗ |  |        |       |  |  |
| 9:10,6* ↓ |  | Totalt | 287,0 |  |  |
| 10: 8,7 ← |  |        |       |  |  |

|           |  |        |       |  |  |
|-----------|--|--------|-------|--|--|
| 1:10,0 ↗  |  |        |       |  |  |
| 2: 9,1 ↗  |  | Serie  | 48,0  |  |  |
| 3: 9,7 ↗  |  |        |       |  |  |
| 4:10,5* ↗ |  | Totalt | 335,0 |  |  |
| 5:10,0 ↙  |  |        |       |  |  |



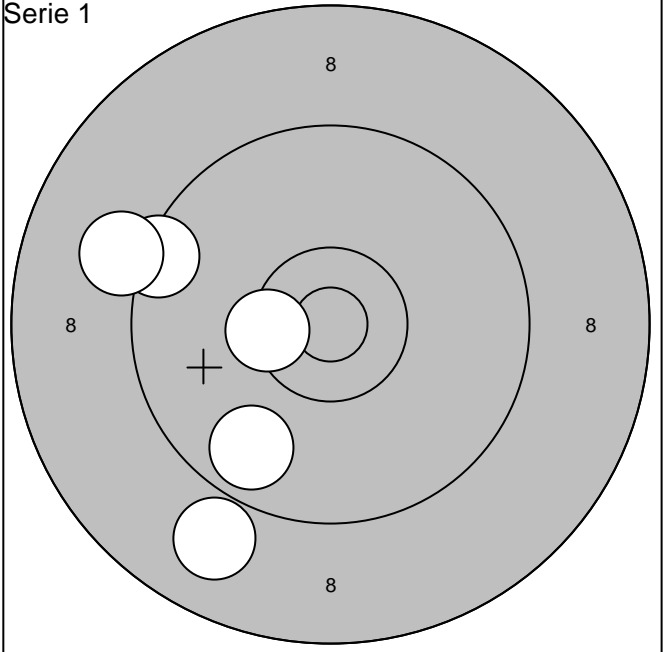
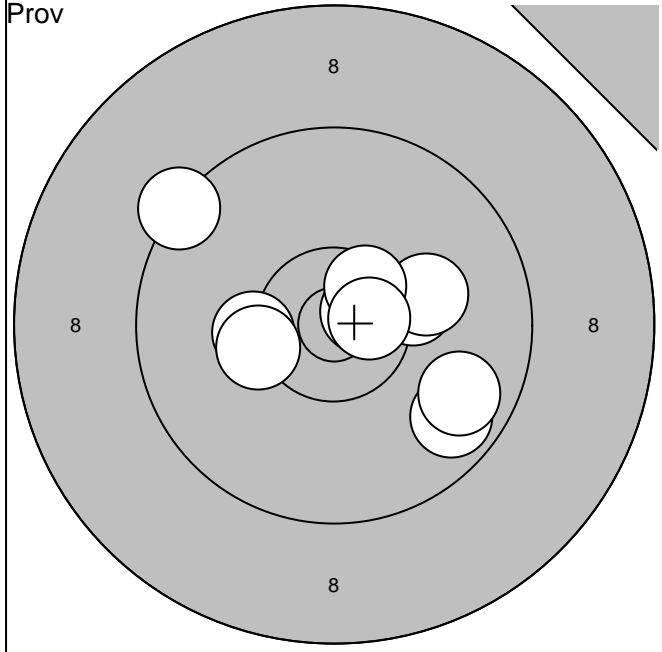

|           |            |        |       |
|-----------|------------|--------|-------|
| 1:10,3 ←  | 6: 9,8 →   | Serie  | 97,0  |
| 2:10,7* → | 7: 9,4 ↖   |        |       |
| 3:10,3 →  | 8:10,5* ↗  | Totalt | 188,0 |
| 4:10,1 →  | 9:10,3* ←  |        |       |
| 5: 9,7 ↘  | 10:10,6* → |        |       |

|           |        |       |
|-----------|--------|-------|
| 1:10,4* ← | Serie  | 45,0  |
| 2: 9,7 ↘  |        |       |
| 3: 8,9 ↘  | Totalt | 233,0 |
| 4: 9,4 ←  |        |       |
| 5: 9,1 ←  |        |       |

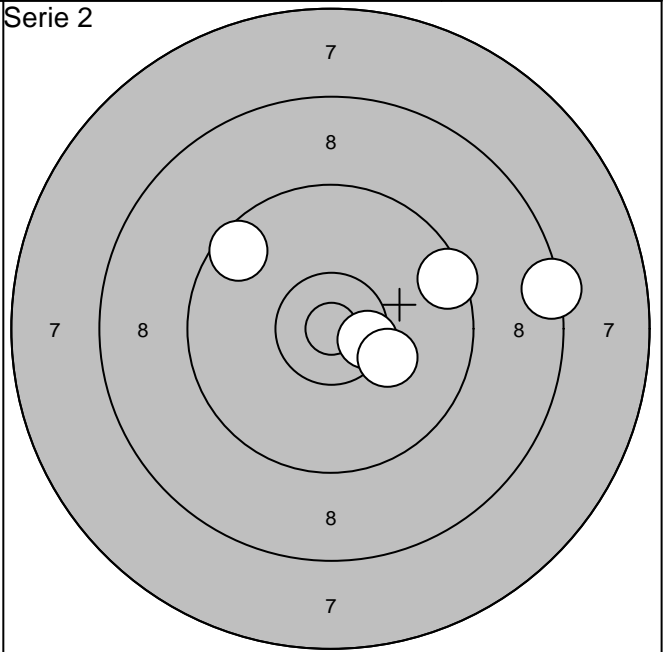
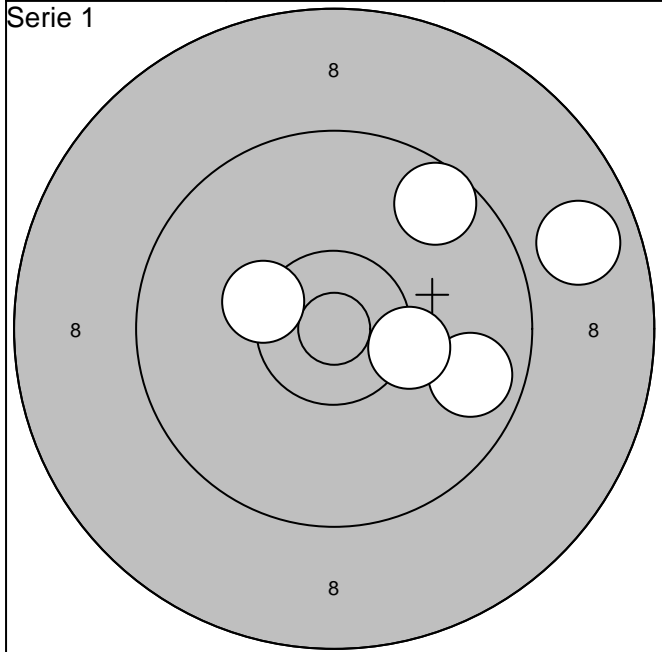

|           |        |       |
|-----------|--------|-------|
| 6: 9,8 →  | Serie  | 46,0  |
| 7:10,3* → |        |       |
| 8:10,3* ↖ | Totalt | 279,0 |
| 9: 9,6 ↗  |        |       |
| 10: 8,8 → |        |       |

|           |        |       |
|-----------|--------|-------|
| 1:10,5* → | Serie  | 46,0  |
| 2:10,2 ↘  |        |       |
| 3: 8,4 →  | Totalt | 325,0 |
| 4: 9,5 →  |        |       |
| 5: 9,6 ↖  |        |       |

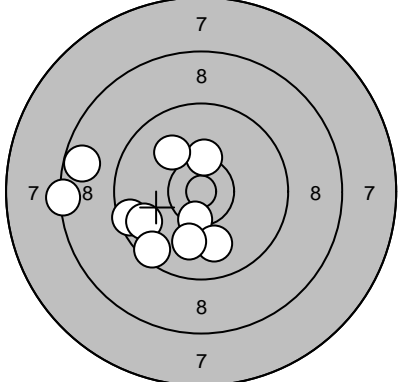
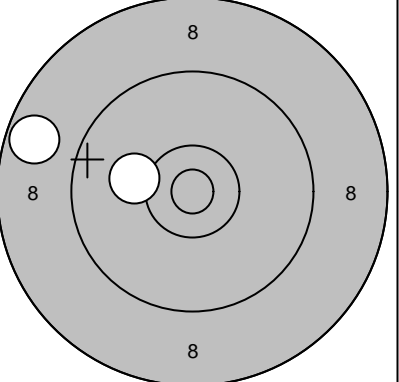
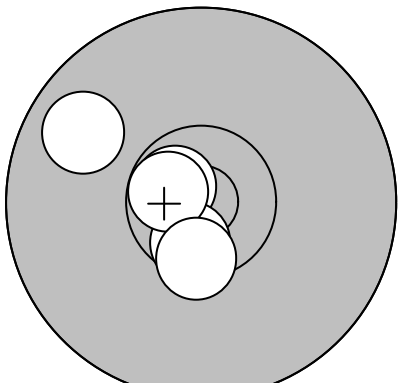
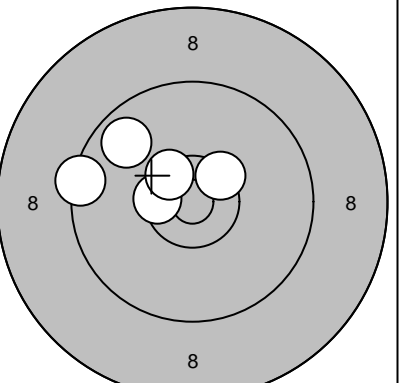
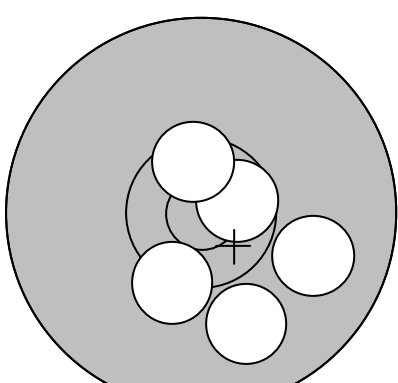
| Skjutlag   | Tavla   | Roger Andersson  |  |
|------------|---|--|--|
| 2          | 7   | Notviken-Björby  |  |
| 2006-07-08 | Tavelträffen 2006 - Final   | Ramselefors SKF  |  |
| Prov       |    | 1: 10,3* ↑<br>2: 9,5 ←<br>3: 9,8 ←<br>4: 9,5 ←<br>5: 10,4* ↓<br>6: 10,0 ↓<br>7: 8,4 ←<br>8: 8,7 ←<br>9: 10,1 ↑<br>10: 10,0 ↓ | Prov<br> |
|            | Serie 93,0  |  | 11: 8,7 ←  |
|            | Totalt 188,0  |  | 12: 10,2 ←   |
| Serie 1    |   | 1: 10,7* ←<br>2: 10,6* ↓<br>3: 10,7* ←<br>4: 10,5* ↓<br>5: 9,8 ←   | Serie 18,0<br>Totalt 188,0   |
|            | Serie 49,0  | Serie 1  | 6: 10,5* ←   |
|            | Totalt 237,0  |   | 7: 9,4 ←   |
| Serie 2    |  | 1: 9,9 ↓<br>2: 10,3* ↓<br>3: 10,6* →<br>4: 9,9 →<br>5: 10,5* ↑   | 8: 10,5* ↑   |
|            | Serie 48,0  |  | 9: 10,4* ↗   |
|            | Totalt 333,0  |  | 10: 9,8 ↖  |
|            |   |  | Serie 48,0   |
|            |   |  | Totalt 285,0   |

Skjutlag

Tavla

2

9

Stefan Thorin

Umeå

2006-07-08

Tavelträffen 2006 - Final

Ramselefors SKF

Prov

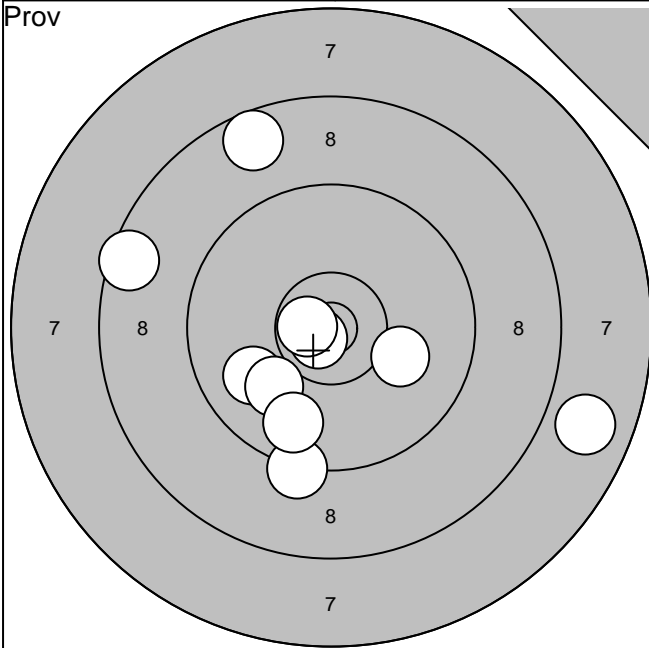

Serie 1

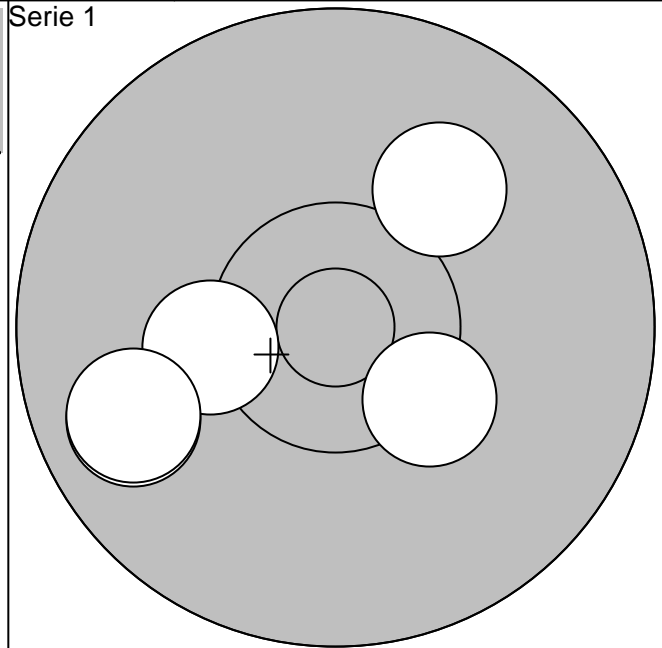

1: 8,6 ↗  
2: 10,8\* ↘  
3: 9,9 ←  
4: 8,5 ←  
5: 10,0 ↘

6: 10,7\* ←  
7: 9,3 ↓  
8: 7,8 →  
9: 10,1 →  
10: 9,8 ↓

Serie 90,0

Totalt 187,0

1: 10,1 ↗  
2: 10,3\* ←  
3: 9,8 ←  
4: 9,8 ←  
5: 10,3\* ↘

Serie 48,0

Totalt 235,0

Serie 1

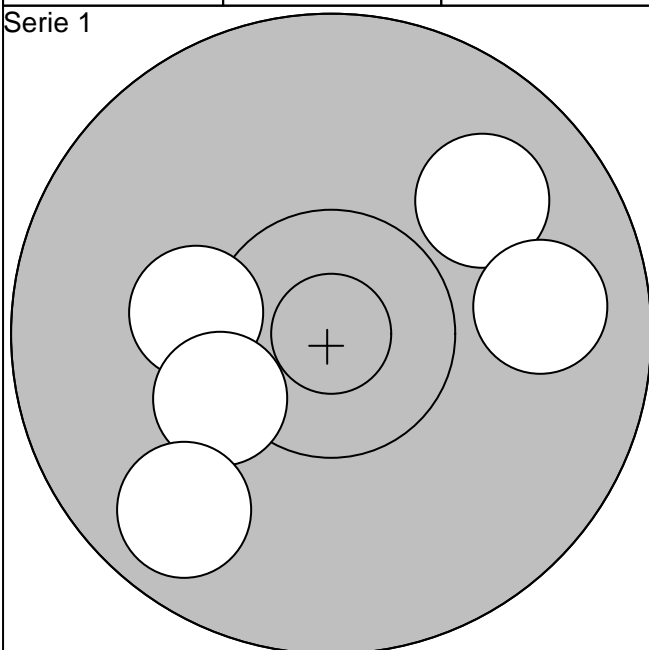

Serie 2

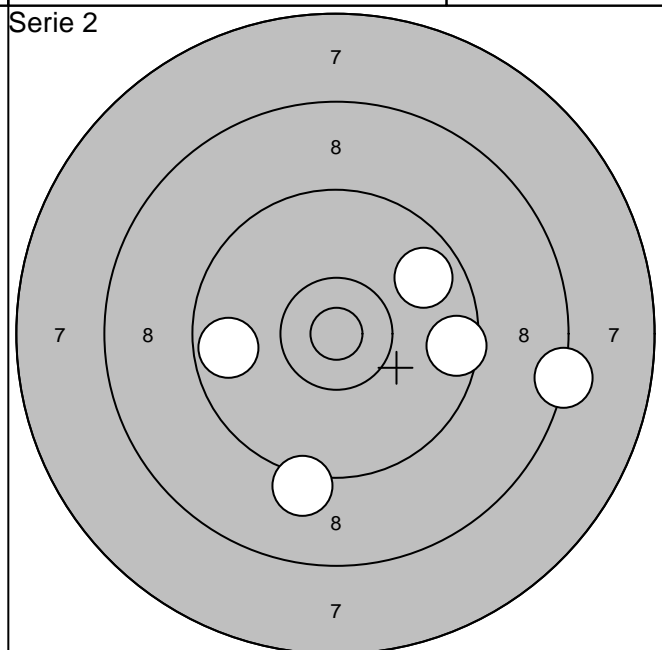

6: 9,9 ↗  
7: 9,9 →  
8: 10,2 ←  
9: 10,3\* ←  
10: 9,8 ↘

Serie 47,0

Totalt 282,0

1: 9,6 →  
2: 8,3 →  
3: 9,8 ↗  
4: 9,2 ↓  
5: 9,7 ←

Serie 44,0

Totalt 326,0

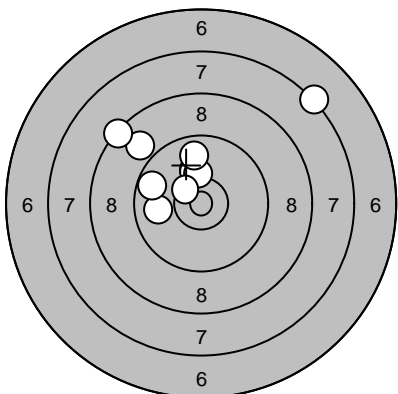
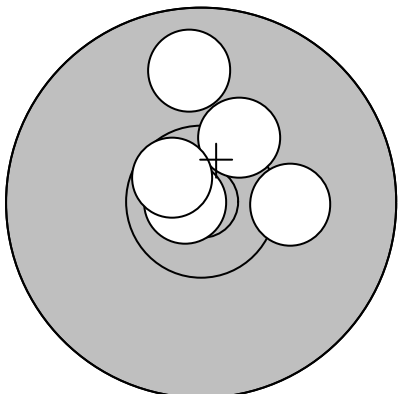
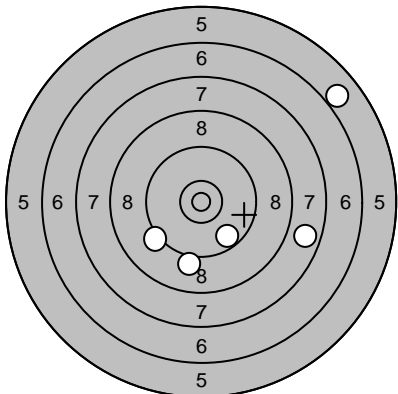
| Skjutlag   | Tavla   | Ronny Nilsson  |   |
|------------|---|--|---|
| 2          | 10  | Piteå  |   |
| 2006-07-08 | Tavelträffen 2006 - Final   | Ramselefors SKF  |   |
| Prov       |    | 1: 7,3 ↗<br>2: 9,0 ↖<br>3: 10,1 ↑<br>4: 10,1 ↑<br>5: 9,9 ←<br>6: 10,2 ↑<br>7: 10,4* ↗<br>8: 9,8 ↑<br>9: 9,7 ↖<br>10: 8,4 ↖ | 11: 10,1 →<br>12: 10,3 ↓<br>13: 9,7 →<br>14: 8,5 ↓<br>15: 10,4* ↗ |
|            | Serie 91,0  |  | Serie 47,0  |
|            | Totalt 186,0  |  | Totalt 186,0  |
| Serie 1    |   | 1: 10,8* ←<br>2: 10,3* ↗<br>3: 10,6* ↖<br>4: 9,8 ↑<br>5: 10,2 →  | 6: 9,9 ↓<br>7: 10,4* ↑<br>8: 10,0 →<br>9: 10,0 ↑<br>10: 9,1 ↓     |
|            | Serie 49,0  |  | Serie 48,0  |
|            | Totalt 235,0  |  | Totalt 283,0  |
| Serie 2    |  | 1: 6,0 ↗<br>2: 7,8 →<br>3: 9,7 ↓<br>4: 9,2 ↖<br>5: 9,1 ↓   |   |
|            | Serie 40,0  |  |   |
|            | Totalt 323,0  |  |   |

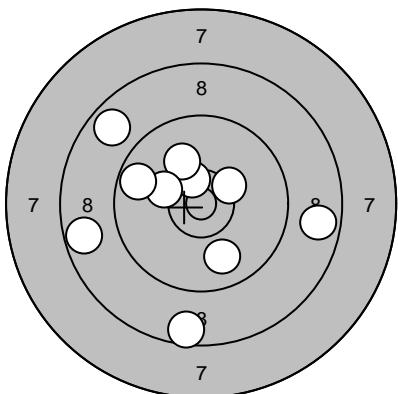
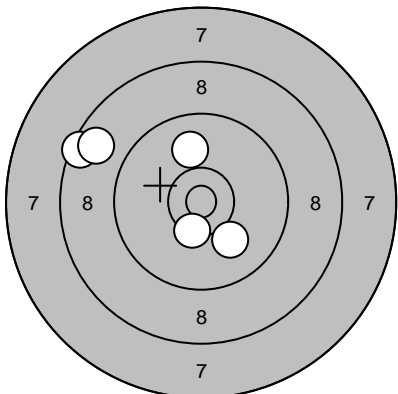
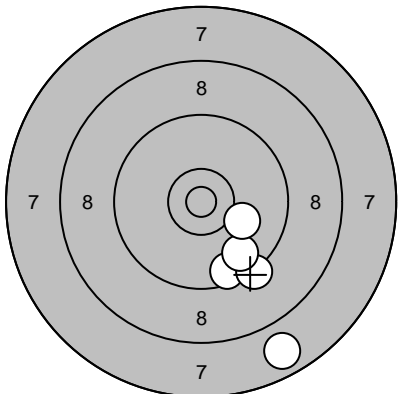
|                      |   |   |   |
|----------------------|---|---|---|
| Skjutlag<br><b>2</b> | Tavla<br><b>11</b>  | <b>Tommy Åkerström</b>  |   |
|                      |   | Niemisel  |   |
| 2006-07-08           |   | Tavelträffen 2006 - Final   | Ramselefors SKF   |
| Prov                 |    | 1: 9,9 ↓<br>2: 10,5* ↑<br>3: 10,3* →<br>4: 8,8 ↗<br>5: 10,1 ↑<br>6: 8,7 →<br>7: 8,6 ↓<br>8: 8,7 ←<br>9: 10,2 ↗<br>10: 9,7 ← | Prov<br>11: 9,5 ↘   |
|                      |   | Serie 90,0  | Serie 9,0   |
|                      |   | Totalt 179,0  | Totalt 179,0  |
| Serie 1              |   | 1: 10,4* ↓<br>2: 10,1 ↓<br>3: 10,0 ↑<br>4: 8,5 ↗<br>5: 8,8 ↗  | 6: 8,3 ↓<br>7: 8,2 ←<br>8: 10,4* ↘<br>9: 9,6 ↗<br>10: 10,7* ↘ |
|                      |   | Serie 46,0  | Serie 45,0  |
|                      |   | Totalt 225,0  | Totalt 270,0  |
| Serie 2              |  | 1: 9,6 ↓<br>2: 9,3 ↓<br>3: 7,8 ↓<br>4: 9,8 ↓<br>5: 10,1 →   |   |
|                      |   | Serie 44,0  |   |
|                      |   | Totalt 314,0  |   |

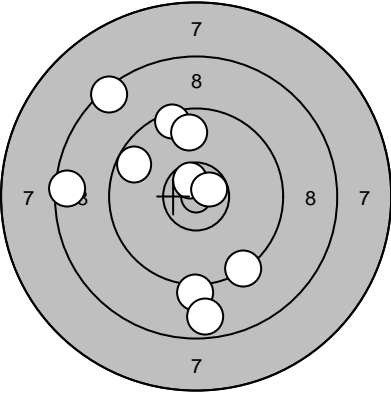
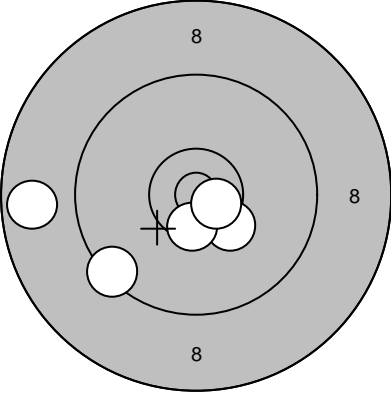
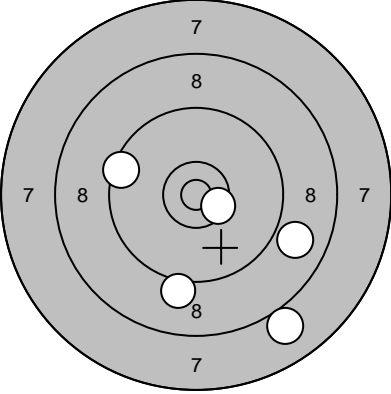
|                      |   |   |  |
|----------------------|---|---|--|
| Skjutlag<br><b>2</b> | Tavla<br><b>12</b>  | <b>Ida Lundmark</b>   |  |
|                      |   | Drängsmark  |  |
| 2006-07-08           |   | Tavelträffen 2006 - Final   | Ramselefors SKF  |
| Prov                 |    | 1: 8,5 ↖<br>2: 9,5 ↑<br>3: 9,3 ↓<br>4: 9,1 ↓<br>5: 8,7 ↓<br>6: 8,5 ←<br>7: 9,8 ↑<br>8: 10,6* ↑<br>9: 9,7 ↖<br>10: 10,7* → | 11: 8,1 ←<br>12: 7,4 ↗<br>13: 8,2 ←<br>14: 10,0 ↓<br>15: 8,1 ← |
|                      | Serie 89,0  |   | Serie 41,0   |
|                      | Totalt 172,0  |   | Totalt 172,0   |
| Serie 1              |  | 1: 8,7 ←<br>2: 10,3* ↘<br>3: 10,5* ↓<br>4: 9,4 ↙<br>5: 10,7* →  | 6: 9,7 ↓<br>7: 7,2 ←<br>8: 8,4 ←<br>9: 8,7 ↑<br>10: 10,3 ↖     |
|                      | Serie 47,0  |   | Serie 42,0   |
|                      | Totalt 219,0  |   | Totalt 261,0   |
| Serie 2              |  | 1: 9,5 ↖<br>2: 8,0 ↓<br>3: 8,9 →<br>4: 10,5* →<br>5: 9,1 ↓  |  |
|                      | Serie 44,0  |   |  |
|                      | Totalt 305,0  |   |  |

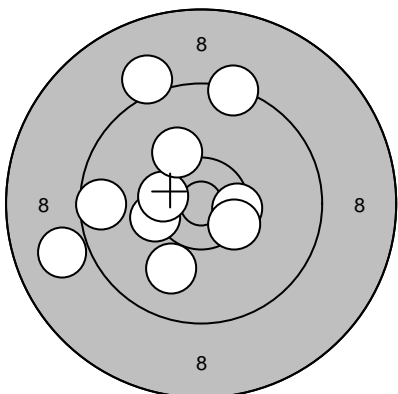
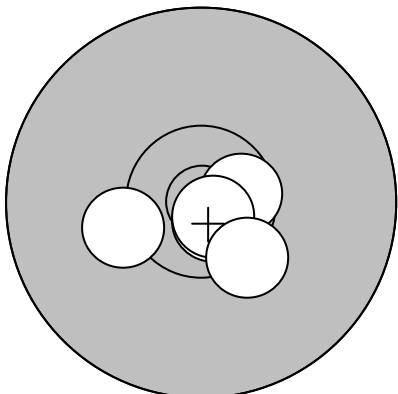
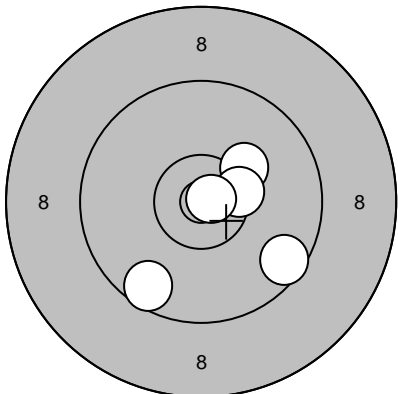
| Skjutlag   | Tavla   | Emil Bergman  |  |
|------------|---|---|--|
| 2          | 13  | Umeå  |  |
| 2006-07-08 | Tavelträffen 2006 - Final   | Ramselefors SKF   |  |
| Prov       |    | 1: 9,4 ↗<br>2: 9,0 ←<br>3: 10,0 ↓<br>4: 10,3* ←<br>5: 10,4* ←<br>6: 10,4* →<br>7: 9,1 ↗<br>8: 10,2 ↗<br>9: 10,4* →<br>10: 9,6 ← | Prov<br>11: 10,7* ↘  |
|            | Serie 96,0  |   | Serie 10,0   |
|            | Totalt 197,0  |   | Totalt 197,0   |
| Serie 1    |   | 1: 10,6* →<br>2: 10,8* ↓<br>3: 10,3 ←<br>4: 10,8* ↓<br>5: 10,3* ↓   | Serie 1<br>6: 8,7 →<br>7: 9,8 →<br>8: 9,5 ↓<br>9: 10,2 ↓<br>10: 10,0 ↖ |
|            | Serie 50,0  |   | Serie 46,0   |
|            | Totalt 247,0  |   | Totalt 293,0   |
| Serie 2    |  | 1: 9,6 →<br>2: 10,2 ↗<br>3: 10,4* →<br>4: 9,6 ↓<br>5: 10,8* →   |  |
|            | Serie 48,0  |   |  |
|            | Totalt 341,0  |   |  |

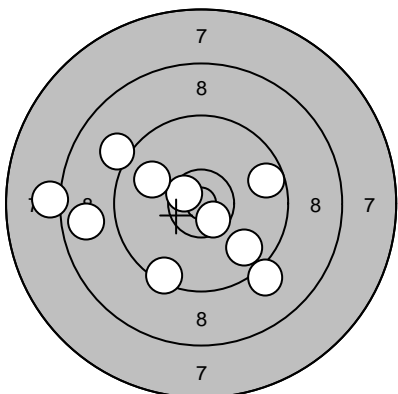
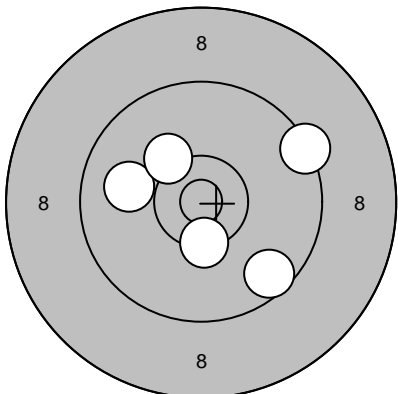
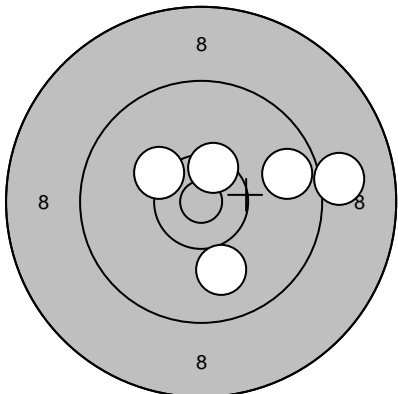
| Skjutlag   | Tavla   | Frida Folkesson   |   |
|------------|---|---|---|
| 2          | 14  | Ramselefors   |   |
| 2006-07-08 | Tavelträffen 2006 - Final   | Ramselefors SKF   |   |
| Prov       |    | 1: 10,6* ↖<br>2: 10,6* ↘<br>3: 9,4 ↘<br>4: 9,1 ↘<br>5: 8,8 ←<br>6: 9,8 ↘<br>7: 9,1 ↗<br>8: 9,9 ↗<br>9: 9,6 →<br>10: 8,1 ← | 11: 10,1 ←<br>12: 10,2 ↗<br>13: 9,9 ↑<br>14: 10,5* ↗<br>15: 10,2 ↗<br>16: 10,0 ↗<br>17: 9,4 ↗ |
|            | Serie 90,0  | Serie 68,0  |   |
|            | Totalt 193,0  | Totalt 193,0  |   |
| Serie 1    |   | 1: 9,4 →<br>2: 9,6 ↘<br>3: 10,4* ↓<br>4: 10,0 ←<br>5: 10,2 ↗  | 6: 10,5* ←<br>7: 9,7 →<br>8: 10,1 ↗<br>9: 9,7 ↗<br>10: 10,0 →                                 |
|            | Serie 48,0  | Serie 48,0  |   |
|            | Totalt 241,0  | Totalt 289,0  |   |
| Serie 2    |  | 1: 10,3 ↖<br>2: 9,7 →<br>3: 10,0 ↓<br>4: 9,0 →<br>5: 10,5* ↗  |   |
|            | Serie 48,0  |   |   |
|            | Totalt 337,0  |   |   |

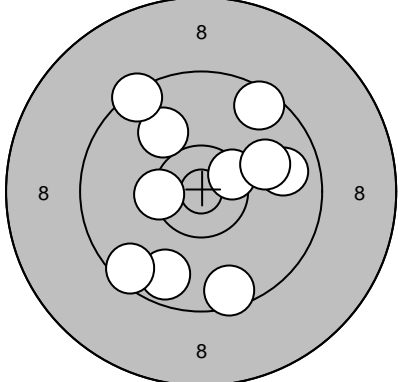
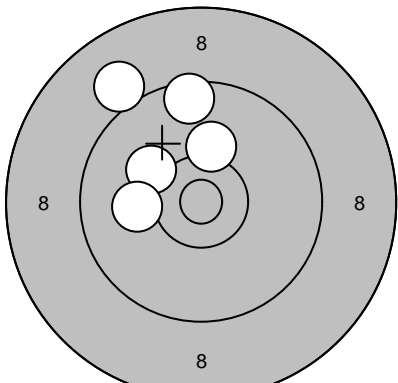
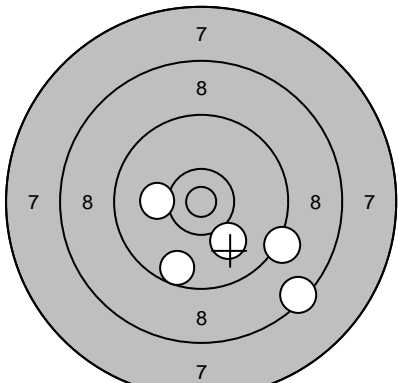

|                      |   |   |   |
|----------------------|---|---|---|
| Skjutlag<br><b>2</b> | Tavla<br><b>15</b>  | <b>Sandra Nilsson</b>   |   |
|                      |   | Piteå   |   |
| 2006-07-08           | Tavelträffen 2006 - Final   |   | Ramselefors SKF   |
| Prov                 |    | 1: 9,5 ↗<br>2: 10,4* ←<br>3: 9,7 ↓<br>4: 10,0 ↗<br>5: 9,5 ↓<br>6: 9,8 →<br>7: 10,5* ↗<br>8: 9,6 ↓<br>9: 10,0 →<br>10: 9,4 ↖ | Prov<br>11: 10,3 →  |
|                      |   | Serie 94,0  | Serie 10,0  |
|                      |   | Totalt 190,0  | Totalt 190,0  |
| Serie 1              |   | 1: 9,6 ↑<br>2: 10,1 ↖<br>3: 10,1 ←<br>4: 9,0 ↖<br>5: 10,2 ↑   | Serie 1<br>6: 9,1 ↖<br>7: 10,1 ↑<br>8: 9,7 ↑<br>9: 10,4* ↖<br>10: 9,4 ↓ |
|                      |   | Serie 48,0  | Serie 47,0  |
|                      |   | Totalt 238,0  | Totalt 285,0  |
| Serie 2              |  | 1: 10,1 ↓<br>2: 9,2 ↓<br>3: 9,6 ↓<br>4: 8,4 ↓<br>5: 10,1 ←  |   |
|                      |   | Serie 46,0  |   |
|                      |   | Totalt 331,0  |   |

Skjutlag

Tavla

2

16

Therese Karlsson

Drängsmark

2006-07-08

Tavelträffen 2006 - Final

Ramselefors SKF

Prov

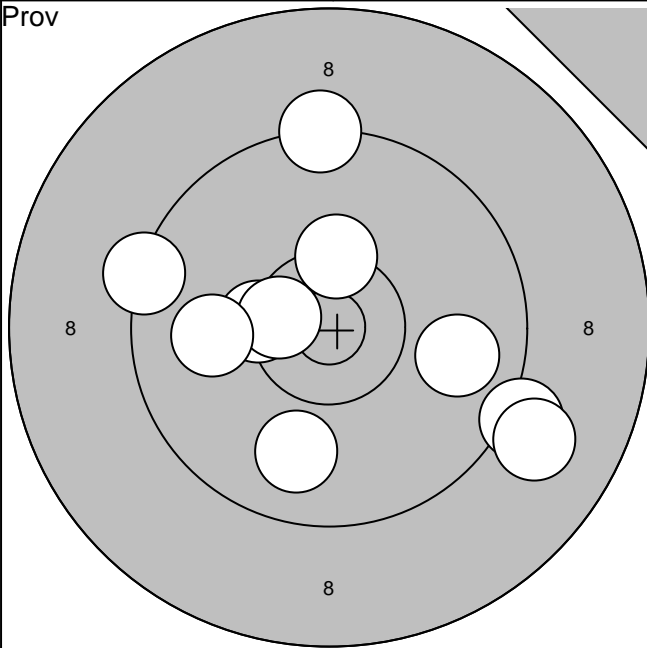

Serie 1

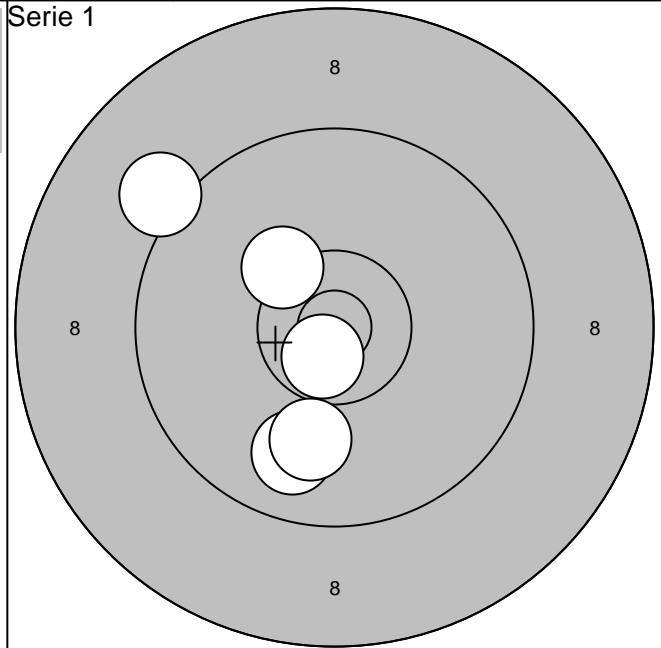

1: 9,3 ↑

6:10,5\* ←

2: 9,2 →

7: 9,9 ↓

3: 9,0 →

8:10,0 ←

4:10,4\* ←

9: 9,4 ←

5:10,4\* ↑

10: 9,9 →

Serie 94,0

Totalt 187,0

1:10,7\* ↓

2: 9,9 ↓

3: 9,1 ↖

4:10,3\* ↖

5:10,0 ↓

Serie 48,0

Totalt 235,0

Serie 1

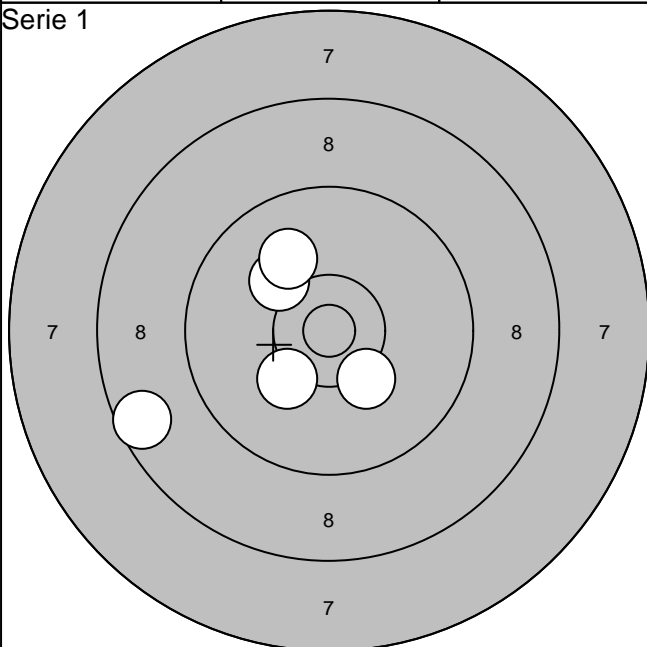

Serie 2

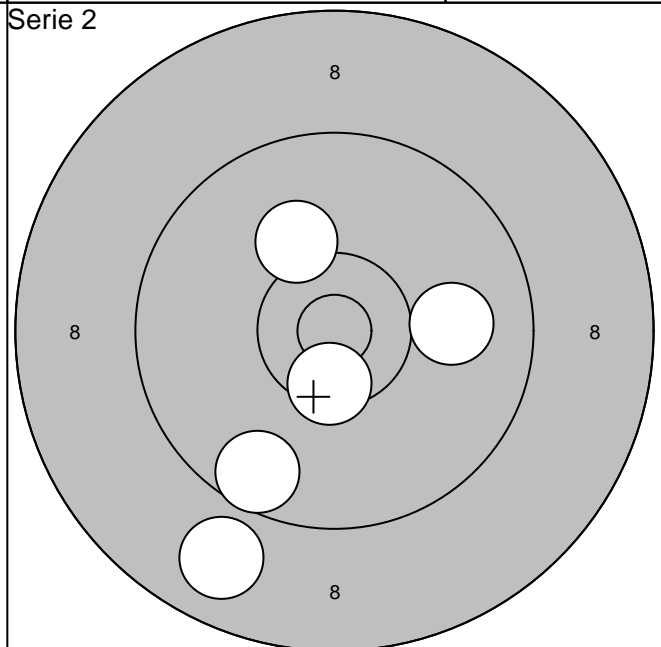

6: 8,6 ←

7:10,2 ↓

8:10,3 ↓

9:10,1 ↗

10:10,0 ↗

Serie 48,0

Totalt 283,0

1: 9,6 ↓

2:10,5\* ↓

3:10,0 →

4: 8,9 ↓

5:10,2 ↗

Serie 47,0

Totalt 330,0

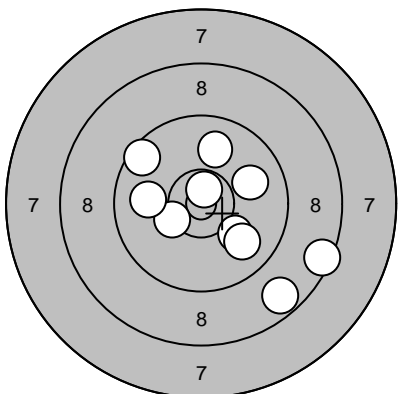
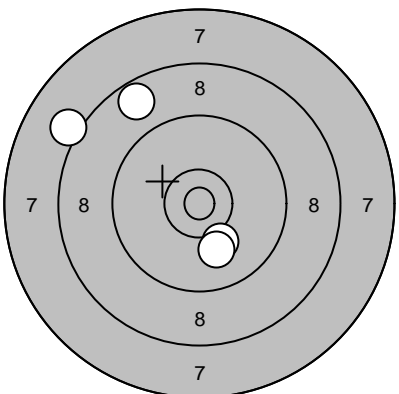
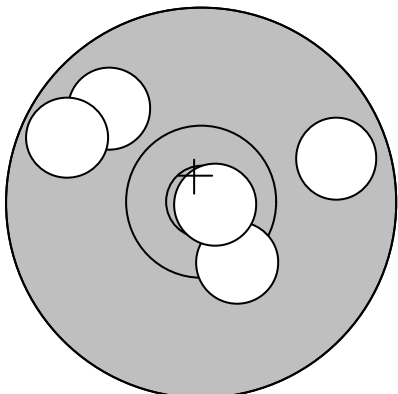
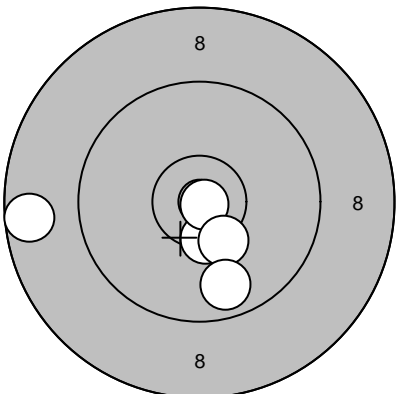
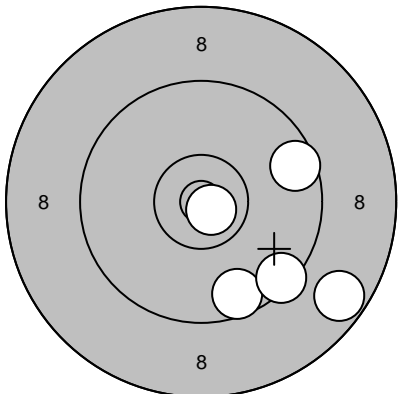
|                      |   |  |  |
|----------------------|---|--|--|
| Skjutlag<br><b>2</b> | Tavla<br><b>17</b>  | <b>Elina Högström</b>  |  |
|                      |   | Ramselefors  |  |
| 2006-07-08           | Tavelträffen 2006 - Final   | Ramselefors SKF  |  |
| Prov                 |    | 1: 8,5 →<br>2: 9,9 ↑<br>3: 10,0 →<br>4: 9,6 ↗<br>5: 8,7 ↓<br>6: 10,3* ←<br>7: 10,7* ↑<br>8: 10,1 ↓<br>9: 9,9 ↓<br>10: 10,0 ← | Prov<br>     |
|                      | Serie 93,0  |  | 11: 10,1 ↓<br>12: 8,2 ↗<br>13: 8,7 ↗<br>14: 10,0 ↓   |
|                      | Totalt 182,0  |  | Serie 36,0   |
|                      |   |  | Totalt 182,0   |
| Serie 1              |   | 1: 9,9 ↗<br>2: 9,7 →<br>3: 10,3* ↓<br>4: 9,7 ↗<br>5: 10,8* →   | Serie 1<br> |
|                      | Serie 47,0  |  | 6: 10,4* ↓<br>7: 10,9* →<br>8: 8,7 ←<br>9: 10,3* ↓<br>10: 9,8 ↓                                |
|                      | Totalt 229,0  |  | Serie 47,0   |
|                      |   |  | Totalt 276,0   |
| Serie 2              |  | 1: 10,8* ↓<br>2: 9,6 ↓<br>3: 9,5 ↓<br>4: 8,7 ↓<br>5: 9,6 →   |  |
|                      | Serie 45,0  |  |  |
|                      | Totalt 321,0  |  |  |

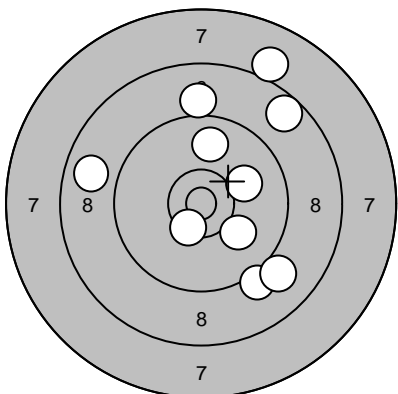
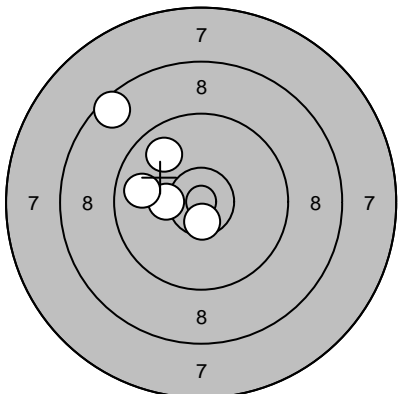
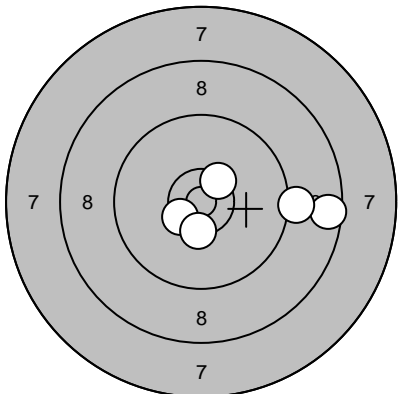
| Skjutlag   | Tavla   | Elina Lövgren   |   |
|------------|---|---|---|
| 2          | 18  | Vännäs  |   |
| 2006-07-08 | Tavelträffen 2006 - Final   | Ramselefors SKF   |   |
| Prov       |    | 1: 8,8 ←<br>2: 9,1 ↓<br>3: 9,0 ↓<br>4: 10,4* ↓<br>5: 10,1 ↓<br>6: 10,1 →<br>7: 8,7 ↗<br>8: 8,0 ↗<br>9: 9,8 ↑<br>10: 9,0 ↑ | 11: 9,4 ↑<br>12: 8,8 ↓<br>13: 10,6* →<br>14: 10,2 →<br>15: 10,0 → |
|            | Serie 90,0  |   | Serie 47,0  |
|            | Totalt 182,0  |   | Totalt 182,0  |
| Serie 1    |   | 1: 10,3* ←<br>2: 10,6* ↓<br>3: 9,8 ↗<br>4: 9,8 ←<br>5: 8,6 ↗  | 6: 10,3* ↓<br>7: 10,2 ↗<br>8: 9,6 →<br>9: 9,5 ↖<br>10: 9,9 ←      |
|            | Serie 46,0  |   | Serie 47,0  |
|            | Totalt 228,0  |   | Totalt 275,0  |
| Serie 2    |  | 1: 10,5* ↙<br>2: 8,6 →<br>3: 10,4* ↗<br>4: 10,4* ↓<br>5: 9,2 →  |   |
|            | Serie 47,0  |   |   |
|            | Totalt 322,0  |   |   |

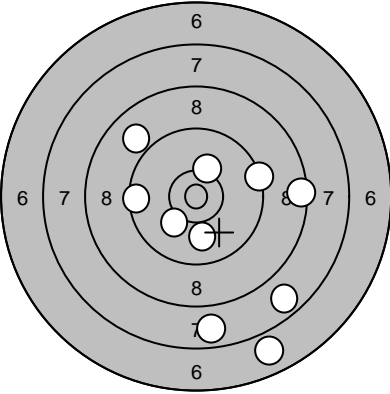
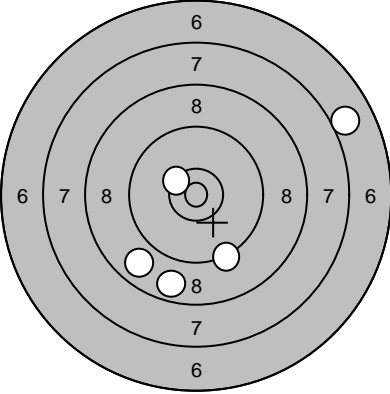
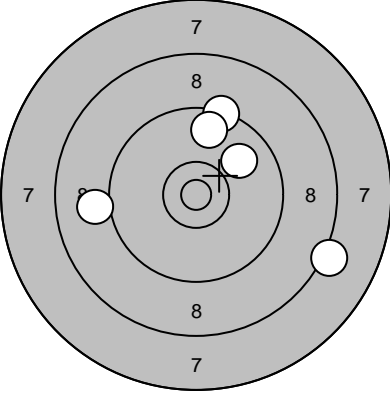
| Skjutlag    | Tavla   | Daniel Sundberg  |  |
|-------------|---|--|--|
| 2           |   | 19   |  |
| Ramselefors |   |  |  |
| 2006-07-08  |   | Tavelträffen 2006 - Final  |  |
| 2006-07-08  |   | Ramselefors SKF  |  |
| Prov        |    | 1: 9,4 →<br>2: 7,7 ↘<br>3: 10,2 ↑<br>4: 7,8 ↓<br>5: 6,9 ↓<br>6: 8,4 →<br>7: 10,1 ↙<br>8: 9,0 ↗<br>9: 10,0 ↓<br>10: 9,5 ← | 11: 10,1 ↘<br>12: 8,5 ←<br>13: 8,9 ↘<br>14: 10,3* ↘          |
|             |   | Serie 85,0   | Serie 36,0   |
|             |   | Totalt 179,0   | Totalt 179,0   |
| Serie 1     |  | 1: 7,0 →<br>2: 8,8 ↙<br>3: 9,3 ↓<br>4: 8,7 ↓<br>5: 10,4* ↖   | 6: 9,2 →<br>7: 10,4* ↓<br>8: 10,2 ↙<br>9: 9,8 ↙<br>10: 9,4 ↘ |
|             |   | Serie 42,0   | Serie 47,0   |
|             |   | Totalt 221,0   | Totalt 268,0   |
| Serie 2     |  | 1: 9,9 ↗<br>2: 9,4 ↑<br>3: 8,2 →<br>4: 9,1 ←<br>5: 9,7 ↑   |  |
|             |   | Serie 44,0   |  |
|             |   | Totalt 312,0   |  |

Skjutlag

Tavla

2

20

Oliver Åkerström

Niemisel

2006-07-08

Tavelträffen 2006 - Final

Ramselefors SKF

Prov

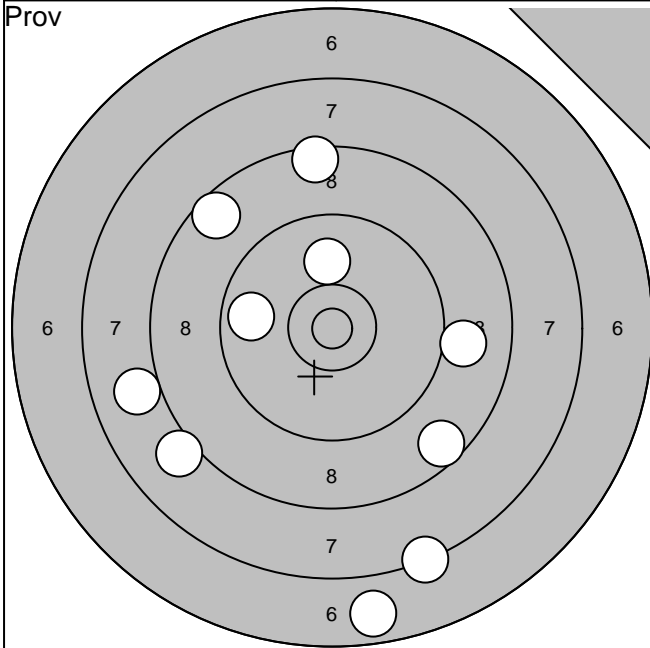

Serie 1

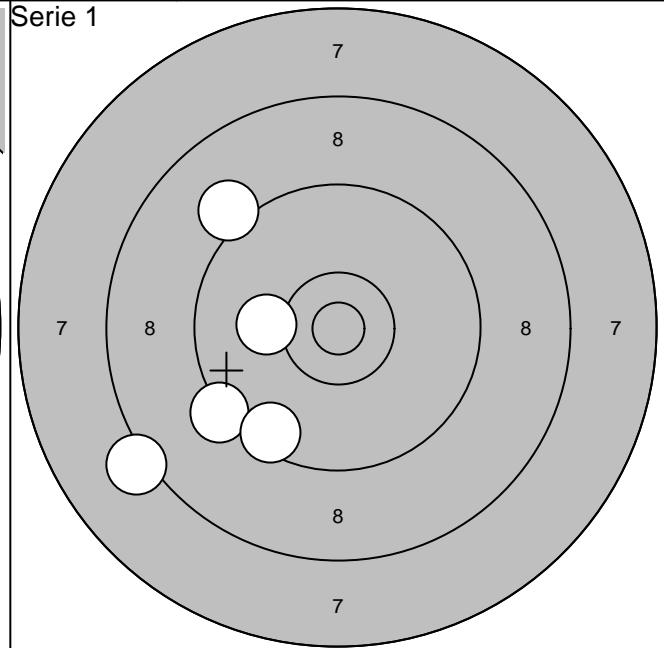

1: 8,5



6: 7,3



Serie

81,0

1: 10,1



Serie

45,0

2: 8,6



7: 9,8



2: 9,3



3: 6,8



8: 8,1



3: 8,2



4: 9,0



9: 10,0



Totalt

176,0

4: 9,1



Totalt

221,0

5: 8,6



10: 8,0



5: 9,5



Serie 1

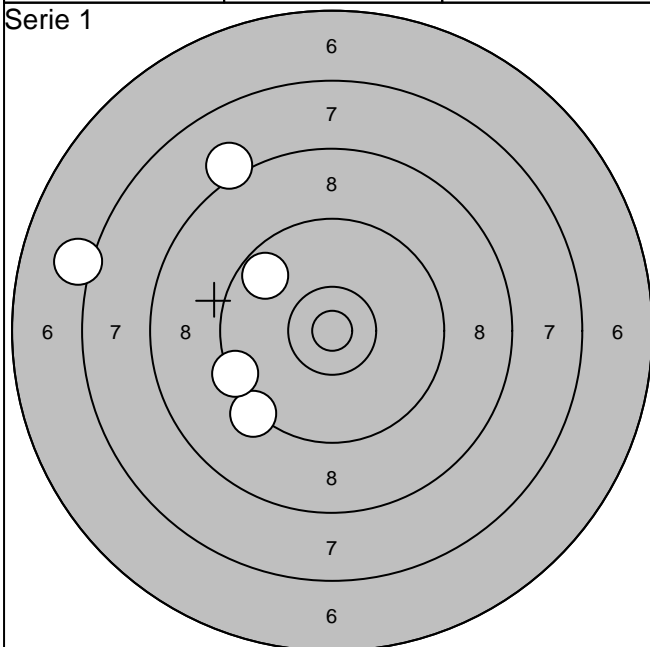

Serie 2

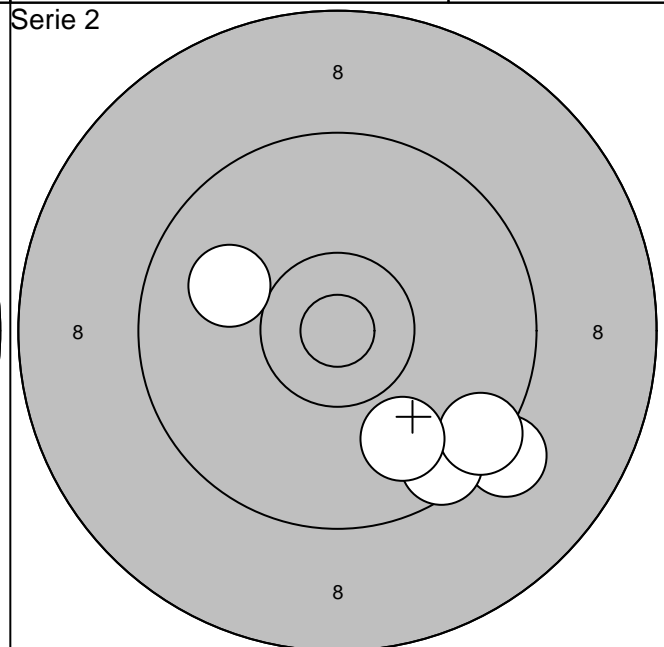

6: 9,3



Serie

42,0

1: 9,2



Serie

46,0

7: 8,1



8: 7,1



9: 9,7



10: 9,4



Totalt

263,0

3: 9,5



4: 9,9



5: 10,0



Totalt

309,0

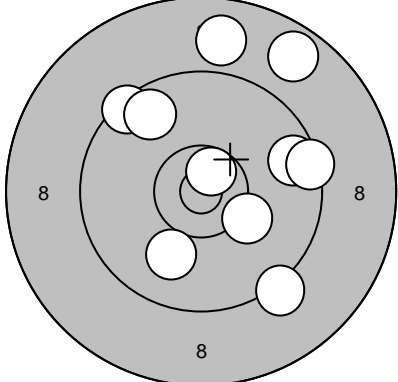
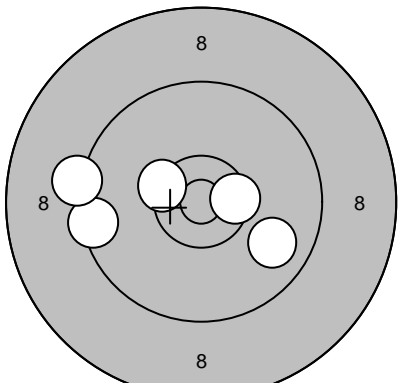
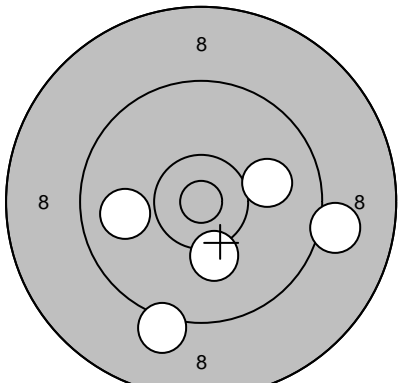
| Skjutlag   | Tavla   | Linnea Jonsson   |   |
|------------|---|--|---|
| 2          | 21  | Umeå   |   |
| 2006-07-08 | Tavelträffen 2006 - Final   | Ramselefors SKF  |   |
| Prov       |    | 1: 8,9    ↗<br>2: 9,6    →<br>3: 9,4    →<br>4: 9,2    ↘<br>5: 10,0   ↘<br>6: 8,7    ↗<br>7: 9,5    ↗<br>8: 9,7    ↗<br>9: 10,7*   ↗<br>10: 10,2   ↘ | 11: 9,7    ↘<br>12: 10,1   ↙<br>13: 9,9    ↗<br>14: 9,2    ↙<br>15: 9,6    ↘<br>16: 9,2    ↗<br>17: 9,5    ↖<br>18: 8,5    ↗<br>19: 10,4*   ↖<br>20: 8,8    ↗ |
|            | Serie 91,0  |  | Serie 90,0  |
|            | Totalt 173,0  |  | Totalt 173,0  |
| Serie 1    |   | 1: 9,5    ←<br>2: 10,5*   →<br>3: 9,3    ←<br>4: 10,4*   ↖<br>5: 9,8    ↘  | 6: 9,2    ↖<br>7: 10,0   ↙<br>8: 9,2    ↗<br>9: 8,5    ↙<br>10: 10,0   ↗  |
|            | Serie 47,0  |  | Serie 46,0  |
|            | Totalt 220,0  |  | Totalt 266,0  |
| Serie 2    |  | 1: 10,2    ↘<br>2: 10,0    →<br>3: 9,1    →<br>4: 9,2    ↘<br>5: 9,9    ←  |   |
|            | Serie 47,0  |  |   |
|            | Totalt 313,0  |  |   |

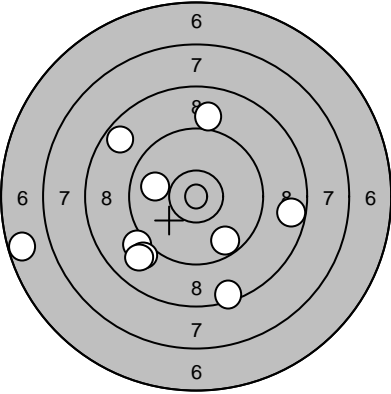
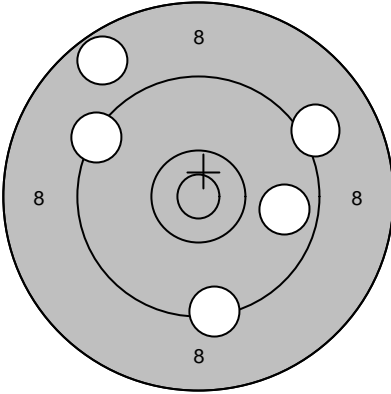
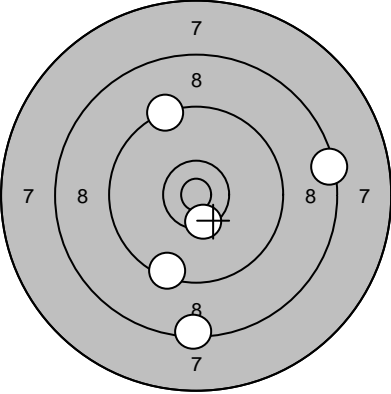
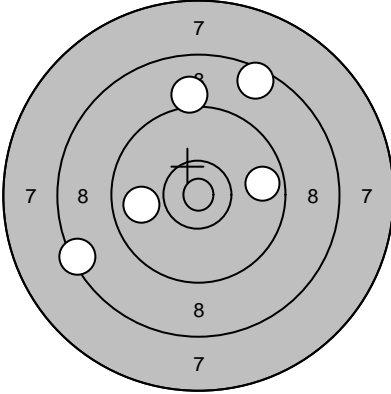
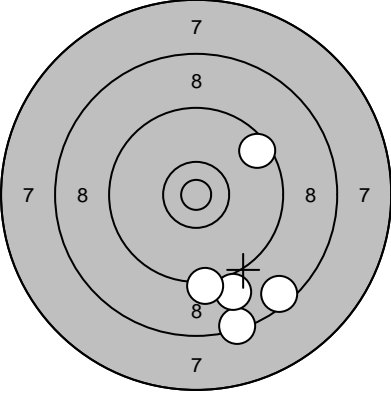
|                      |   |  |   |
|----------------------|---|--|---|
| Skjutlag<br><b>2</b> | Tavla<br><b>22</b>  | <b>Viktor Strand</b>   |   |
|                      |   | Ramselefors  |   |
| 2006-07-08           | Tavelträffen 2006 - Final   |  | Ramselefors SKF   |
| Prov                 |    | 1: 6,7 ←<br>2: 10,0 ←<br>3: 8,5 ↓<br>4: 8,6 →<br>5: 9,2 ←<br>6: 9,1 ←<br>7: 9,0 ←<br>8: 8,7 ↗<br>9: 9,7 ↓<br>10: 9,0 ↑ | Prov<br> 11: 8,7 ↗<br>12: 9,1 ↗<br>13: 9,4 ↗<br>14: 9,4 ↓<br>15: 9,8 →  |
|                      |   | Serie 85,0   | Serie 44,0  |
|                      |   | Totalt 172,0   | Totalt 172,0  |
| Serie 1              |  | 1: 10,4* ↓<br>2: 9,4 ↓<br>3: 8,4 →<br>4: 8,4 ↓<br>5: 9,3 ↗   | Serie 1<br> 6: 8,6 ↗<br>7: 8,4 ←<br>8: 9,7 →<br>9: 9,1 ↑<br>10: 9,9 ← |
|                      |   | Serie 44,0   | Serie 43,0  |
|                      |   | Totalt 216,0   | Totalt 259,0  |
| Serie 2              |  | 1: 8,5 ↓<br>2: 8,4 ↓<br>3: 9,0 ↓<br>4: 9,2 ↓<br>5: 9,5 ↗   |   |
|                      |   | Serie 43,0   |   |
|                      |   | Totalt 302,0   |   |



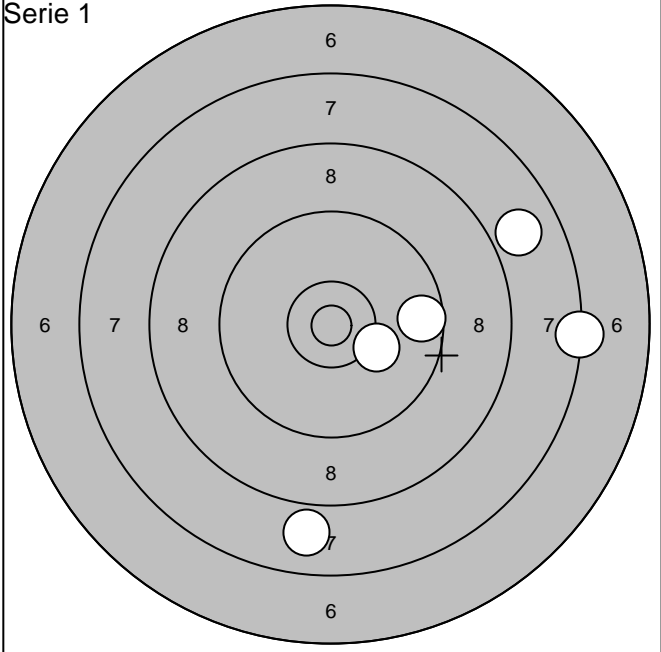
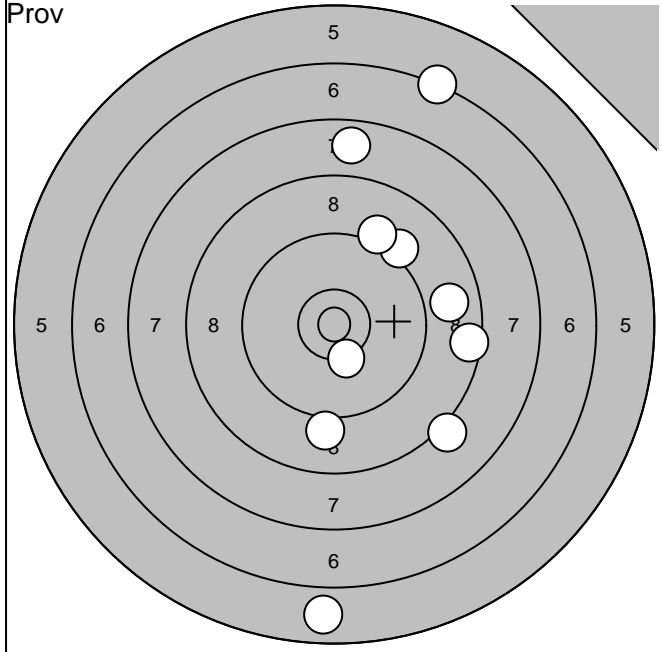

|          |           |        |       |
|----------|-----------|--------|-------|
| 1: 9,2 ↗ | 6: 8,5 →  | Serie  | 79,0  |
| 2: 7,8 ↑ | 7: 9,2 ↗  |        |       |
| 3: 6,4 ↗ | 8: 8,2 ↘  | Totalt | 137,0 |
| 4: 8,9 → | 9:10,3* ↓ |        |       |
| 5: 5,8 ↓ | 10: 9,1 ↓ |        |       |

|          |        |       |
|----------|--------|-------|
| 1: 9,6 → | Serie  | 40,0  |
| 2: 7,3 → |        |       |
| 3: 7,9 ↗ | Totalt | 177,0 |
| 4: 7,9 ↓ |        |       |
| 5:10,2 ↘ |        |       |

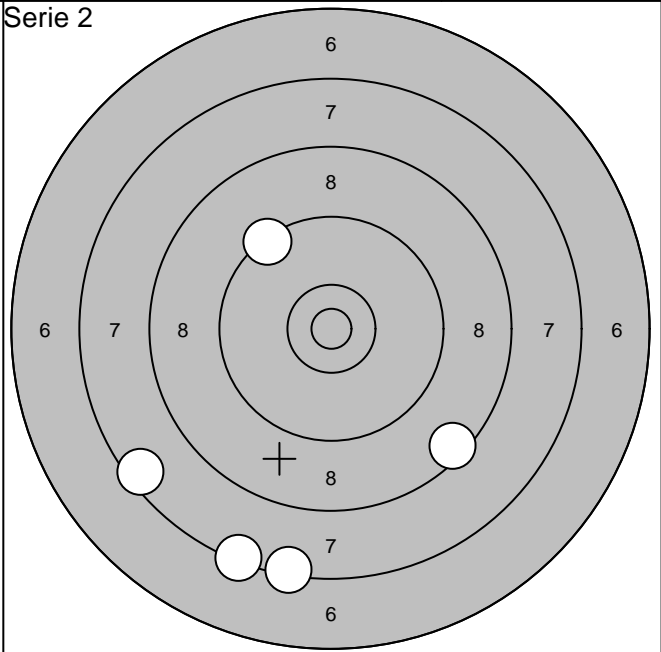
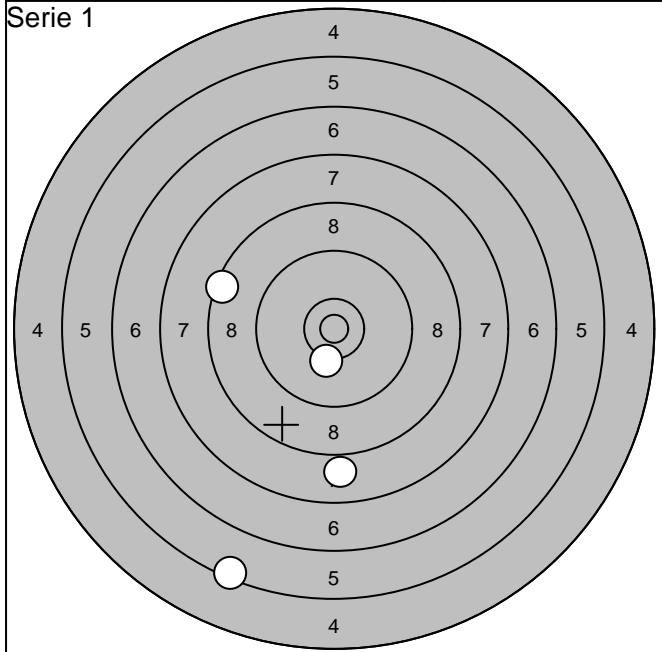

|          |        |       |
|----------|--------|-------|
| 6:10,3 ↓ | Serie  | 31,0  |
| 7: 5,5 ↓ |        |       |
| 8: 8,0 ↓ | Totalt | 208,0 |
| 9: 8,5 ↖ |        |       |

|          |        |       |
|----------|--------|-------|
| 1: 8,5 ↘ | Serie  | 38,0  |
| 2: 9,4 ↗ |        |       |
| 3: 7,4 ↓ | Totalt | 246,0 |
| 4: 7,4 ↓ |        |       |
| 5: 7,5 ↙ |        |       |

|                      |                           |                        |              |
|----------------------|---------------------------|------------------------|--------------|
| Skjutlag<br><b>3</b> | Tavla<br><b>1</b>         | <b>Christian Lejon</b> |              |
|                      |                           | Umeå                   |              |
| 2006-07-08           | Tavelträffen 2006 - Final | Ramselefors SKF        |              |
| Prov                 |                           | Serie 1                |              |
|                      |                           |                        |              |
| 1: 9,5 ↗             | 6: 9,8 →                  | Serie 95,0             | Serie 48,0   |
| 2: 10,6* ↓           | 7: 9,7 ↑                  |                        |              |
| 3: 9,3 ↘             | 8: 10,3* ↙                | Totalt 192,0           | Totalt 240,0 |
| 4: 10,0 ↓            | 9: 9,6 ↑                  |                        |              |
| 5: 10,4* ↖           | 10: 10,2 ←                |                        |              |
| Serie 1              |                           | Serie 2                |              |
|                      |                           |                        |              |
| 6: 9,4 ←             | Serie 46,0                | 1: 10,2 ↗              | Serie 45,0   |
| 7: 9,0 ↖             |                           | 2: 8,3 →               |              |
| 8: 9,8 ↑             | Totalt 286,0              | 3: 10,4* ↑             | Totalt 331,0 |
| 9: 9,2 ↗             |                           | 4: 9,6 ↖               |              |
| 10: 10,1 →           |                           |                        |              |

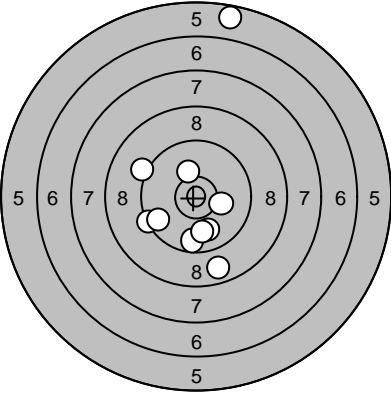
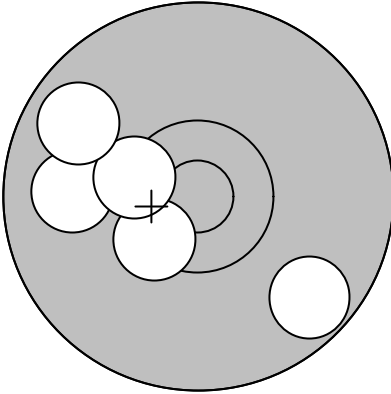
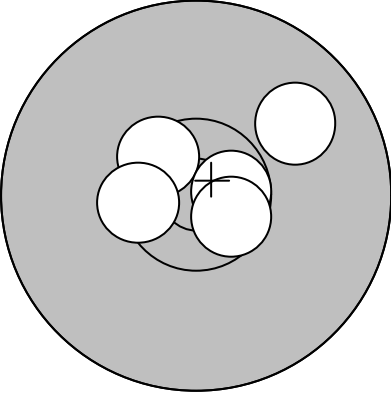
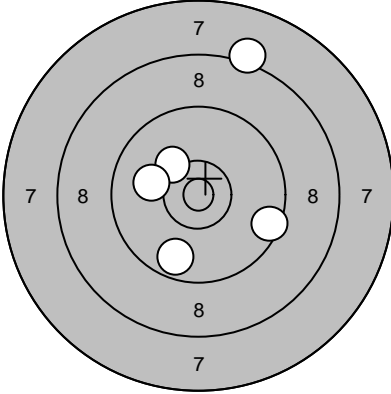
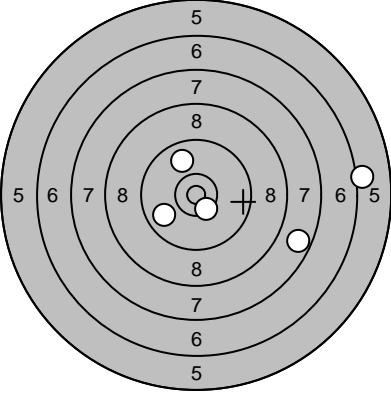
|                      |   |   |   |
|----------------------|---|---|---|
| Skjutlag<br><b>3</b> | Tavla<br><b>2</b>   | <b>Ronny Nilsson</b>  |   |
|                      |   | Piteå   |   |
| 2006-07-08           | Tavelträffen 2006 - Final   | Ramselefors SKF   |   |
| Prov                 |    | 1: 5,7 ↑<br>2: 9,9 ↓<br>3: 9,7 ↓<br>4: 8,8 ↓<br>5: 10,2 ↑<br>6: 9,4 ←<br>7: 9,7 ←<br>8: 9,9 ↓<br>9: 10,2 →<br>10: 9,2 ↖ | Prov<br>      |
|                      | Serie 87,0  | Serie 47,0  | 11: 10,4* ↙<br>12: 9,9 ←<br>13: 10,4* ↖<br>14: 9,8 ↗<br>15: 9,7 ↓                               |
|                      | Totalt 188,0  | Totalt 188,0  |   |
| Serie 1              |  | 1: 10,5* ↖<br>2: 9,9 ↗<br>3: 10,5* ←<br>4: 10,7* →<br>5: 10,6* ↘  | Serie 1<br> |
|                      | Serie 49,0  | Serie 46,0  | 6: 10,2 ↗<br>7: 10,0 ←<br>8: 9,7 ↓<br>9: 9,5 →<br>10: 8,2 ↑                                     |
|                      | Totalt 237,0  | Totalt 283,0  |   |
| Serie 2              |  | 1: 6,1 →<br>2: 9,9 ↑<br>3: 10,4* ↓<br>4: 7,7 →<br>5: 9,8 ↖  |   |
|                      | Serie 41,0  |   |   |
|                      | Totalt 324,0  |   |   |

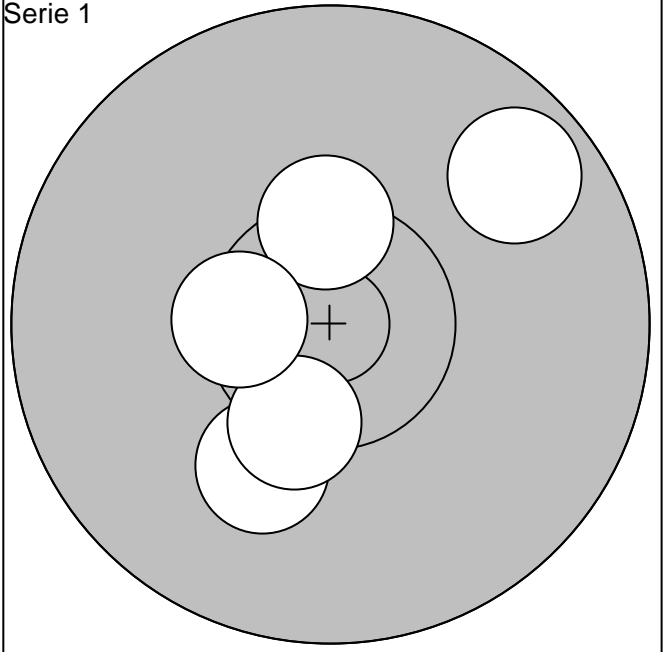
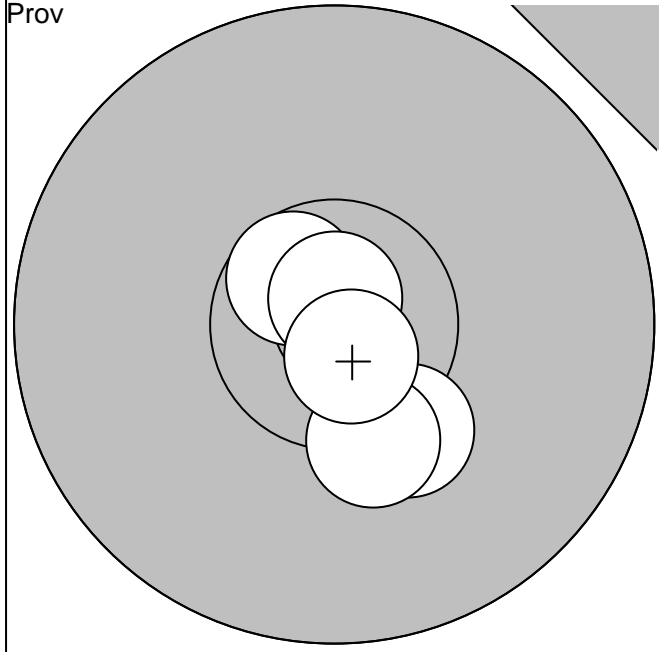

|           |        |       |
|-----------|--------|-------|
| 1:10,6* ↗ | Serie  | 50,0  |
| 2:10,3 ↘  |        |       |
| 3:10,8* ↑ | Totalt | 187,0 |
| 4:10,3* ↘ |        |       |
| 5:10,8* ↘ |        |       |

|           |        |       |
|-----------|--------|-------|
| 1:10,1 ↘  | Serie  | 49,0  |
| 2:10,4* ↑ |        |       |
| 3:10,4* ↘ | Totalt | 236,0 |
| 4:10,5* ← |        |       |
| 5: 9,7 ↗  |        |       |

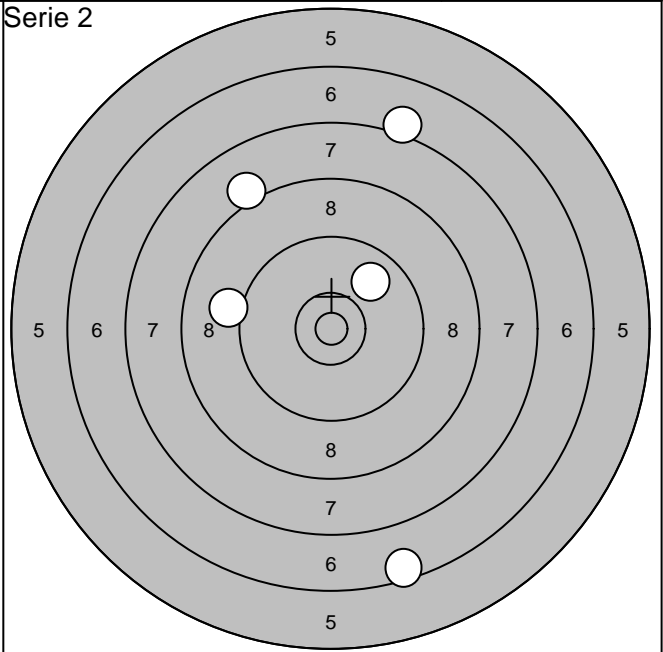
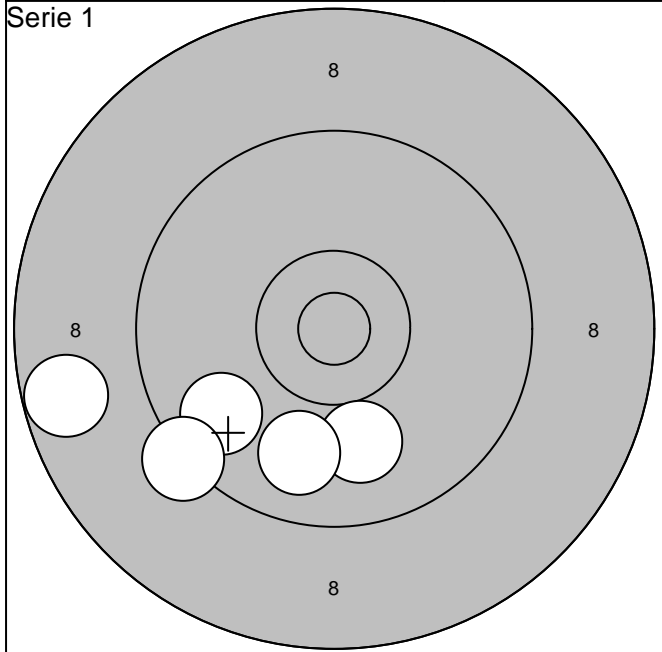

|           |        |       |
|-----------|--------|-------|
| 6: 9,8 ↙  | Serie  | 45,0  |
| 7:10,0 ↘  |        |       |
| 8: 9,9 ↘  | Totalt | 281,0 |
| 9: 9,3 ↙  |        |       |
| 10: 8,7 ← |        |       |

|          |        |       |
|----------|--------|-------|
| 1: 8,1 ↗ | Serie  | 39,0  |
| 2: 7,1 ↑ |        |       |
| 3: 9,1 ← | Totalt | 320,0 |
| 4: 6,5 ↘ |        |       |
| 5: 9,9 ↗ |        |       |

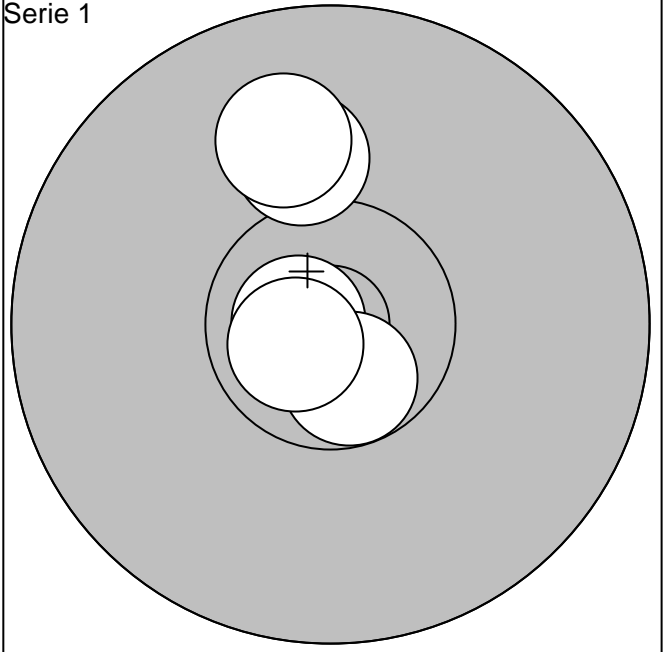
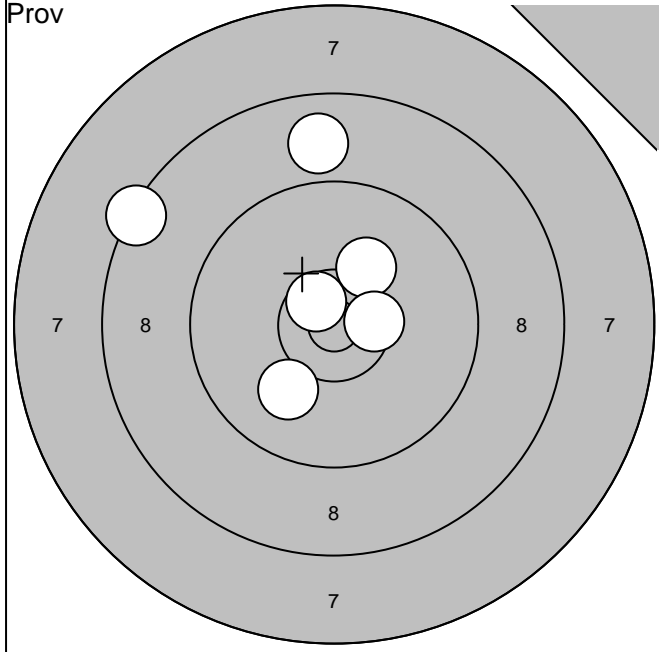

|           |          |        |       |  |  |
|-----------|----------|--------|-------|--|--|
| 1:10,2 ↗  | 6:10,0 ↘ |        |       |  |  |
| 2:10,6* ↗ |          | Serie  | 56,0  |  |  |
| 3: 8,9 ↑  |          |        |       |  |  |
| 4:10,5* → |          | Totalt | 186,0 |  |  |
| 5: 8,4 ↖  |          |        |       |  |  |

|           |  |        |       |  |  |
|-----------|--|--------|-------|--|--|
| 1:10,8* ← |  |        |       |  |  |
| 2:10,1 ↑  |  | Serie  | 50,0  |  |  |
| 3:10,0 ↑  |  |        |       |  |  |
| 4:10,7* ↓ |  | Totalt | 236,0 |  |  |
| 5:10,7* ↙ |  |        |       |  |  |

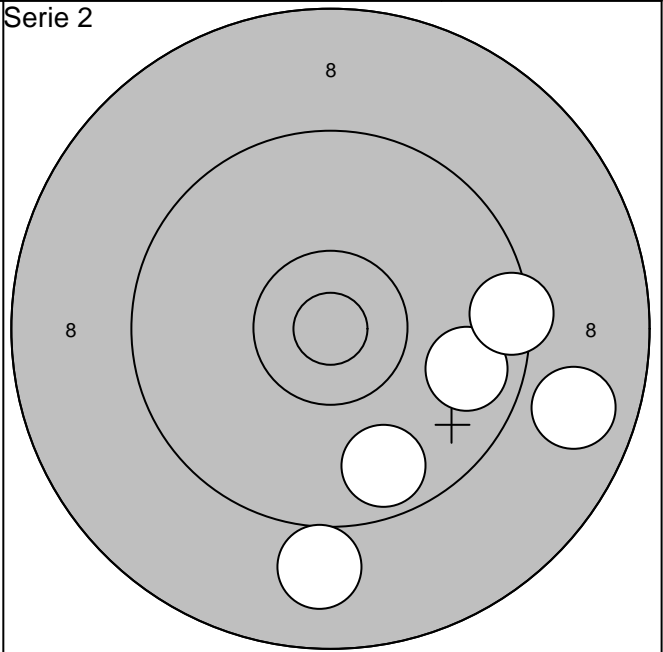
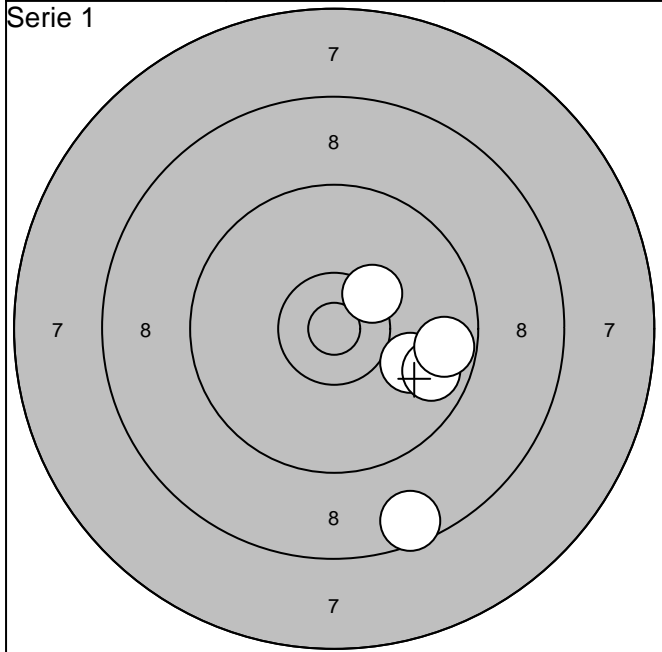

|           |  |        |       |  |  |
|-----------|--|--------|-------|--|--|
| 6:10,4* ↗ |  |        |       |  |  |
| 7:10,0 →  |  | Serie  | 46,0  |  |  |
| 8: 9,7 →  |  |        |       |  |  |
| 9: 8,6 ↓  |  | Totalt | 282,0 |  |  |
| 10: 9,7 → |  |        |       |  |  |

|          |  |        |       |  |  |
|----------|--|--------|-------|--|--|
| 1: 8,8 → |  |        |       |  |  |
| 2: 9,8 → |  | Serie  | 44,0  |  |  |
| 3: 9,5 → |  |        |       |  |  |
| 4: 9,0 ↓ |  | Totalt | 326,0 |  |  |
| 5: 9,7 ↓ |  |        |       |  |  |

|                      |                           |                   |              |
|----------------------|---------------------------|-------------------|--------------|
| Skjutlag<br><b>3</b> | Tavla<br><b>5</b>         | <b>Curt Lejon</b> |              |
|                      |                           | Umeå              |              |
| 2006-07-08           | Tavelträffen 2006 - Final | Ramselefors SKF   |              |
| Prov                 |                           | Serie 1           |              |
|                      |                           |                   |              |
| 1:10,6* ←            | 6:10,0 ←                  | Serie 58,0        | 1: 9,6 ↓     |
| 2: 9,7 ↓             |                           |                   | 2:10,7* ↓    |
| 3:10,6* ↑            |                           | Totalt 185,0      | 3: 9,3 ←     |
| 4:10,1 ←             |                           |                   | 4:10,6* ↓    |
| 5: 9,2 ↓             |                           |                   | 5:10,4* ↓    |
| Serie 1              |                           | Serie 2           |              |
|                      |                           |                   |              |
| 6: 9,9 →             | Serie 43,0                | 1: 9,8 ↓          | Serie 42,0   |
| 7: 9,0 ↓             |                           | 2: 7,2 ↗          |              |
| 8: 9,5 ↓             | Totalt 276,0              | 3: 8,6 ↗          | Totalt 318,0 |
| 9: 7,6 ←             |                           | 4: 8,9 ↓          |              |
| 10: 9,2 ↑            |                           | 5:10,3 ↓          |              |

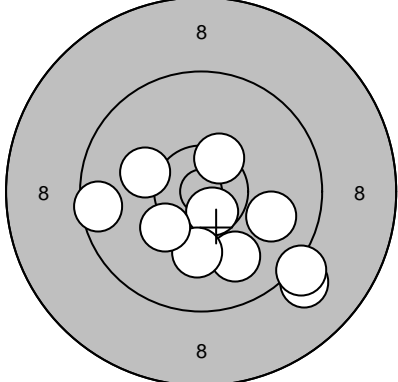
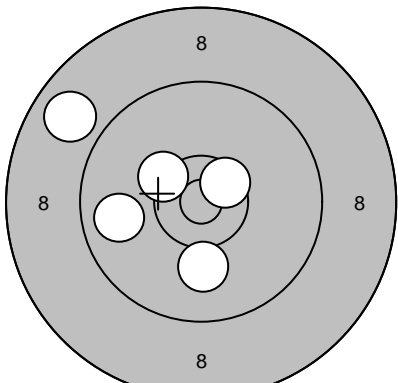
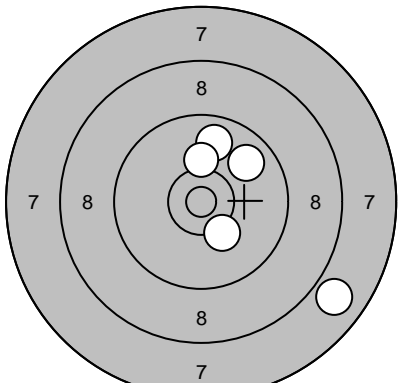
| Skjutlag   | Tavla   | Lars Sandström  |  |
|------------|---|---|--|
| 3          | 6   |   |  |
|            |   | Ramselefors   |  |
| 2006-07-08 | Tavelträffen 2006 - Final   | Ramselefors SKF   |  |
| Prov       |    | 1: 10,4* ↗<br>2: 9,1 ↘<br>3: 9,9 →<br>4: 10,0 ↘<br>5: 9,2 ↘<br>6: 10,2 ←<br>7: 10,6* ↘<br>8: 10,1 ↓<br>9: 10,3 ↙<br>10: 9,5 ← | 11: 10,3* ↖<br>12: 9,4 ↖                                   |
|            | Serie 96,0<br>Totalt 185,0  |   | Serie 19,0<br>Totalt 185,0                                 |
| Serie 1    |   | 1: 10,1 ↓<br>2: 9,8 ←<br>3: 8,8 ↗<br>4: 10,3* ↗<br>5: 10,5* ↗   | 6: 9,2 ←<br>7: 8,4 ←<br>8: 9,9 ←<br>9: 9,5 ↓<br>10: 10,0 ↗ |
|            | Serie 47,0<br>Totalt 232,0  |   | Serie 45,0<br>Totalt 277,0                                 |
| Serie 2    |  | 1: 9,8 ↑<br>2: 10,2 ↑<br>3: 7,9 ↘<br>4: 9,8 ↗<br>5: 10,3 ↘  |  |
|            | Serie 45,0<br>Totalt 322,0  |   |  |

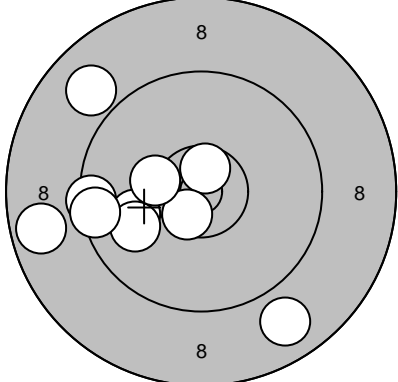
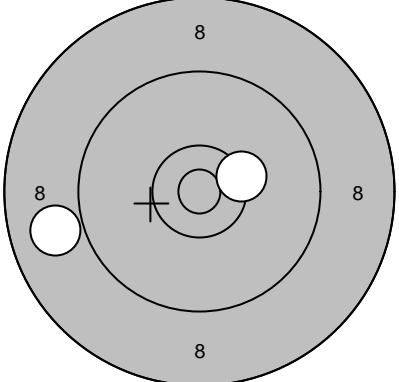
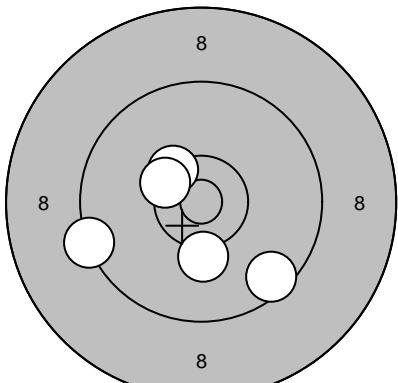
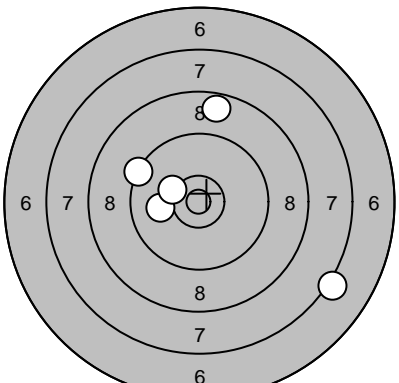
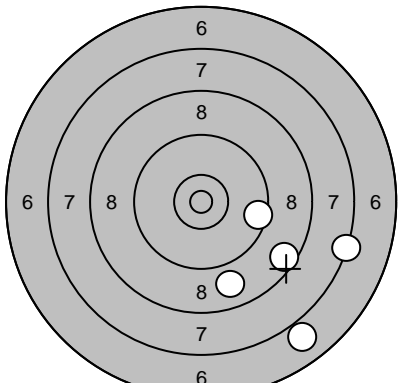
| Skjutlag   | Tavla   | Roger Andersson  |  |
|------------|---|--|--|
| 3          | 7   | Notviken-Björby  |  |
| 2006-07-08 | Tavelträffen 2006 - Final   | Ramselefors SKF  |  |
| Prov       |    | 1: 8,7 ←<br>2: 10,0 ←<br>3: 8,9 ↗<br>4: 8,8 ↘<br>5: 9,9 ←<br>6: 9,5 ←<br>7: 10,6* ↑<br>8: 10,6* ↘<br>9: 9,5 ←<br>10: 10,3* ← | Prov<br>     |
|            | Serie 91,0  |  | 11: 10,3* →  |
|            | Totalt 182,0  |  | 12: 9,0 ←  |
|            |   |  | Serie 19,0   |
|            |   |  | Totalt 182,0   |
| Serie 1    |   | 1: 10,4* ↗<br>2: 10,4* ↗<br>3: 9,3 ←<br>4: 9,6 ↘<br>5: 10,2 ↓  | Serie 1<br> |
|            | Serie 48,0  |  | 6: 7,2 ↘   |
|            | Totalt 230,0  |  | 7: 10,0 ←  |
|            |   |  | 8: 9,4 ↗   |
|            |   |  | 9: 8,7 ↑   |
|            |   |  | 10: 10,3* ←  |
|            |   |  | Serie 44,0   |
|            |   |  | Totalt 274,0   |
| Serie 2    |  | 1: 8,9 ↓<br>2: 9,5 →<br>3: 7,3 →<br>4: 8,6 ↘<br>5: 6,9 ↘   |  |
|            | Serie 38,0  |  |  |
|            | Totalt 312,0  |  |  |



Skjutlag

Tavla

3

8

Stefan Thorin

Umeå

2006-07-08

Tavelträffen 2006 - Final

Ramselefors SKF

Prov

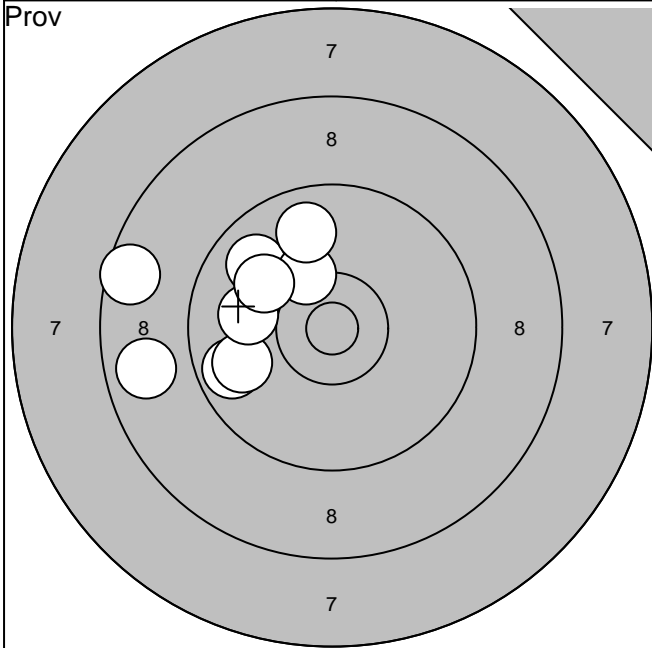

Serie 1

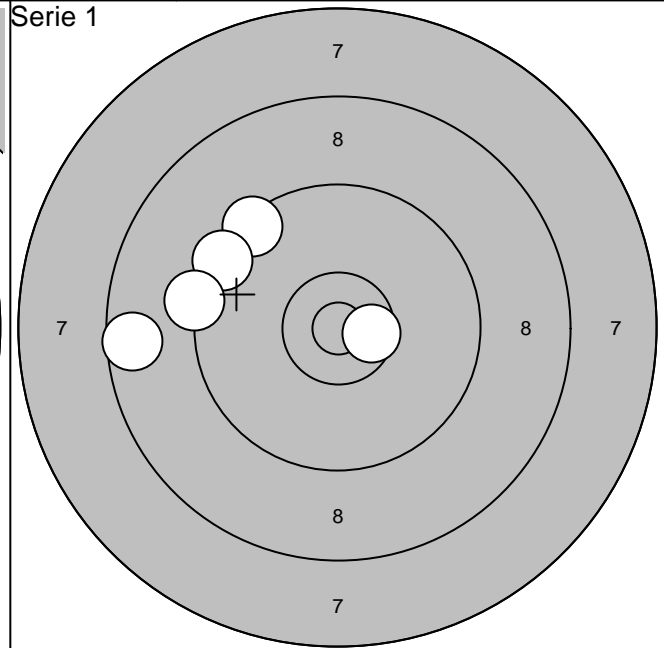

1: 8,6 ←

6: 9,9 ←

Serie 82,0

2: 9,7 ←

7:10,0 ←

3: 9,8 ↗

8: 9,8 ↑

4: 8,8 ←

9:10,0 ←

5:10,3 ↗

Totalt 171,0

1: 9,5 ↗

2:10,6\* →

3: 8,6 ←

4: 9,4 ↗

5: 9,3 ←

Serie 45,0

Totalt 216,0

Serie 1

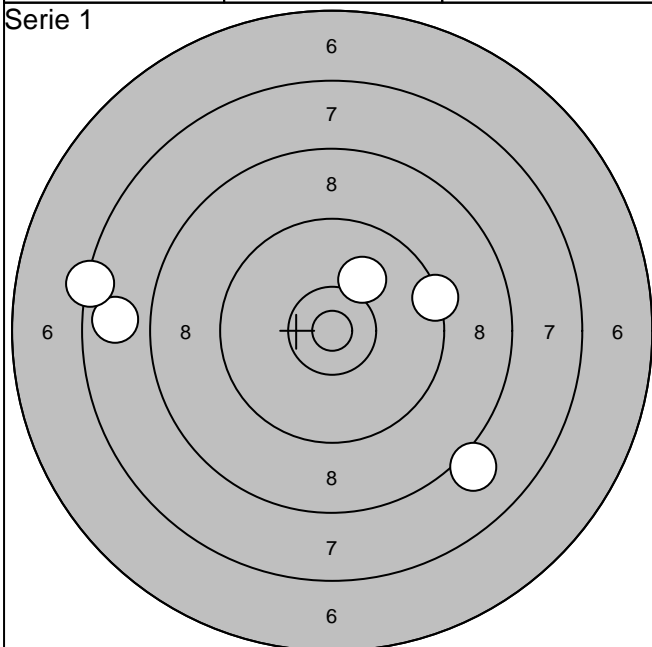

Serie 2

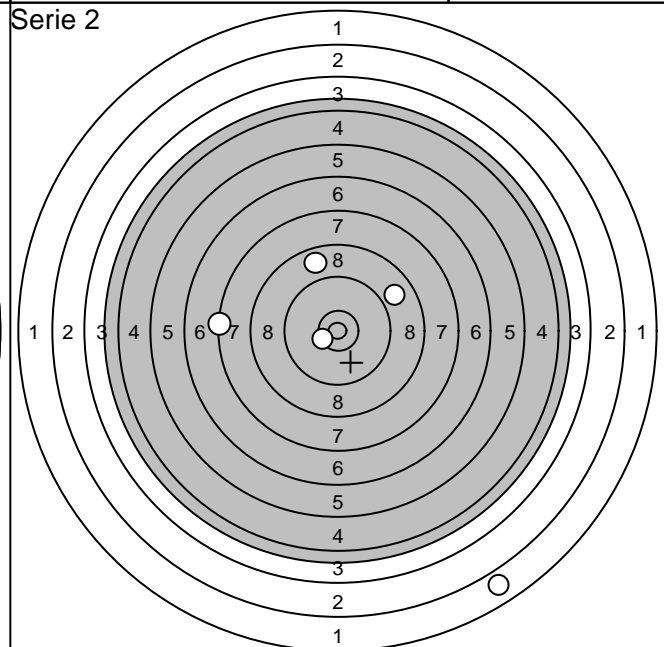

6:10,1 ↗

7: 8,1 ↘

8: 9,4 →

9: 7,8 ←

10: 7,4 ←

Serie 41,0

Totalt 257,0

1:10,4\* ←

2: 1,9 ↘

3: 8,8 ↑

4: 8,9 ↗

5: 7,4 ←

Serie 34,0

Totalt 291,0

Skjutlag

Tavla

3

9

Sture Nilsson

Piteå

2006-07-08

Tavelträffen 2006 - Final

Ramselefors SKF

Prov

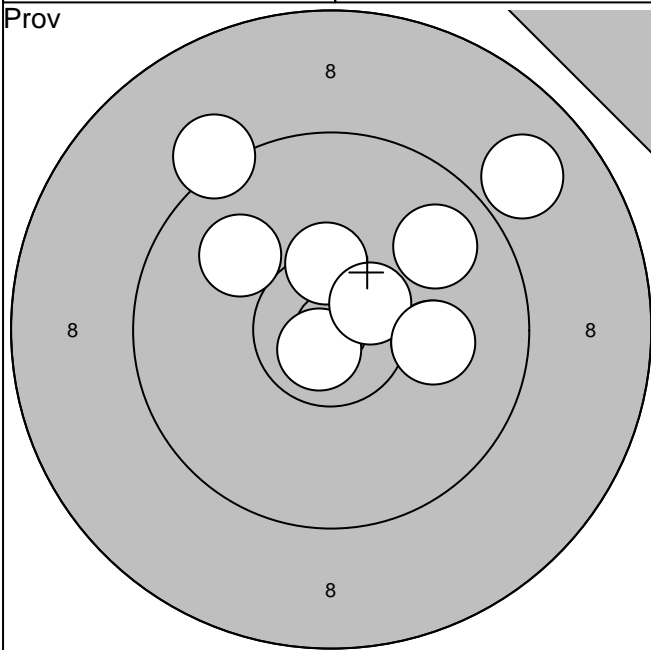

Serie 1

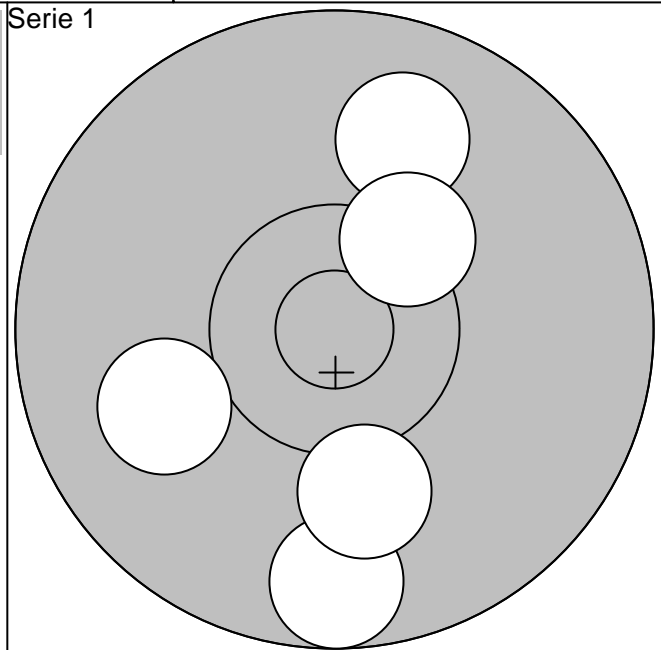

1:10,8\* ↙

6:10,0 ↖

2:10,4\* ↑

7: 8,9 ↗

Serie 86,0

3:10,1 →

8:10,6\* ↗

4: 9,8 ↗

9:10,1 →

Totalt 167,0

5: 9,2 ↖

1: 9,7 ↓

2:10,0 ↖

Serie 48,0

3: 9,9 ↗

4:10,1 ↓

Totalt 215,0

5:10,4\* ↗

Serie 1

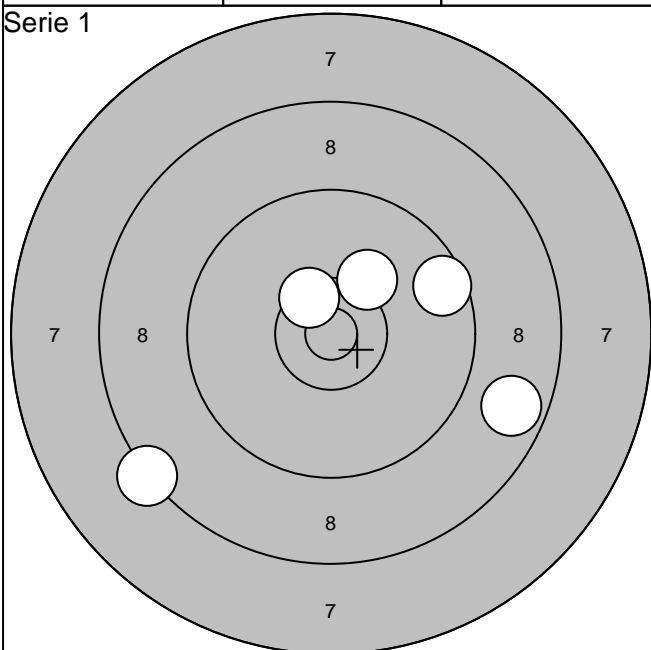

Serie 2

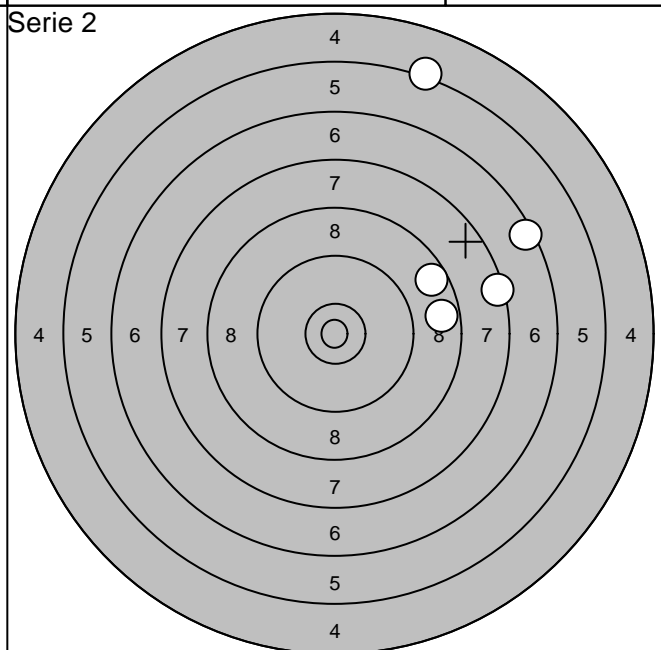

6: 9,6 →

Serie 45,0

7: 8,7 →

8:10,2 ↗

9:10,5\* ↖

10: 8,3 ↙

Totalt 260,0

1: 7,4 →

2: 8,7 →

3: 6,5 ↗

4: 8,7 ↗

5: 5,3 ↗

Serie 34,0

Totalt 294,0

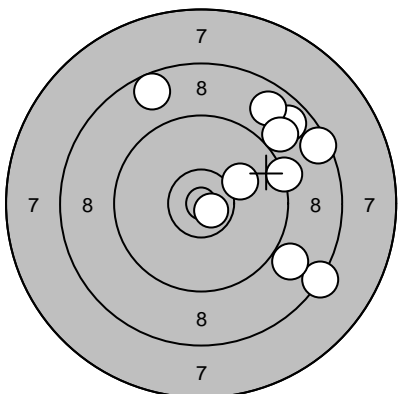
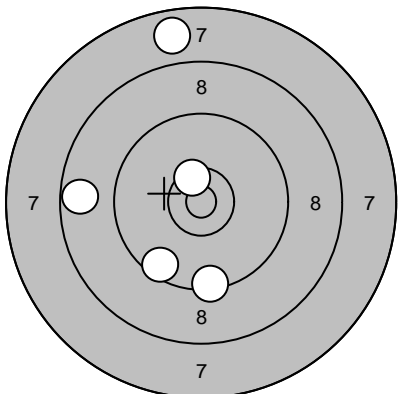
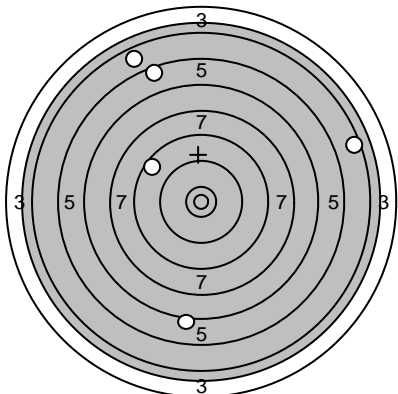
| Skjutlag   | Tavla   | Tommy Åkerström  |  |
|------------|---|--|--|
| 3          | 10  | Niemisel   |  |
| 2006-07-08 | Tavelträffen 2006 - Final   | Ramselefors SKF  |  |
| Prov       |    | 1: 8,8 ↗<br>2: 8,8 ↗<br>3: 10,7* ↘<br>4: 8,7 ↗<br>5: 8,5 →<br>6: 9,0 ↗<br>7: 10,1 ↗<br>8: 9,3 →<br>9: 8,3 ↘<br>10: 9,0 ↘ | 11: 9,5 ↙<br>12: 9,7 ↖<br>13: 10,0 ↗<br>14: 9,5 ↑          |
|            | Serie 87,0  |  | Serie 37,0   |
|            | Totalt 164,0  |  | Totalt 164,0   |
| Serie 1    |   | 1: 9,4 ↓<br>2: 9,5 ↙<br>3: 7,8 ↑<br>4: 8,7 ←<br>5: 10,5* ↗   | 6: 9,1 →<br>7: 8,3 ←<br>8: 9,0 ↗<br>9: 6,4 ←<br>10: 10,1 ↖ |
|            | Serie 43,0  |  | Serie 42,0   |
|            | Totalt 207,0  |  | Totalt 249,0   |
| Serie 2    |  | 1: 4,6 →<br>2: 8,6 ↖<br>3: 5,6 ↗<br>4: 4,8 ↗<br>5: 6,2 ↓   |  |
|            | Serie 27,0  |  |  |
|            | Totalt 276,0  |  |  |

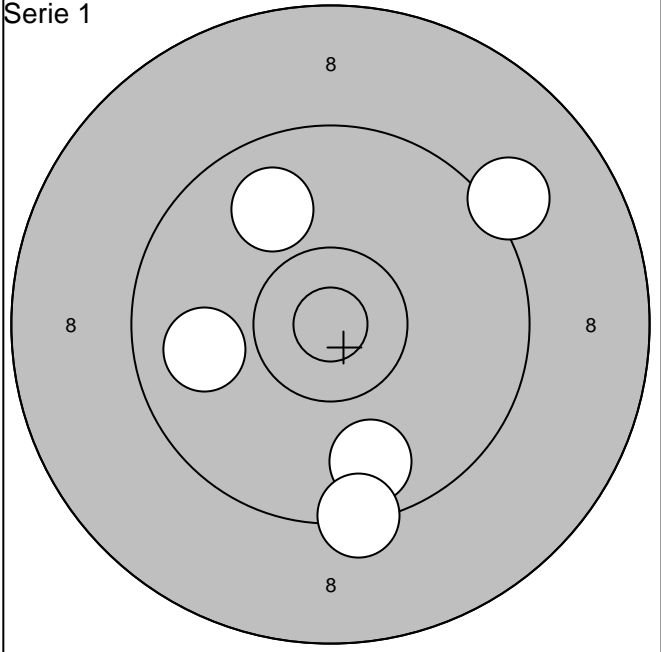
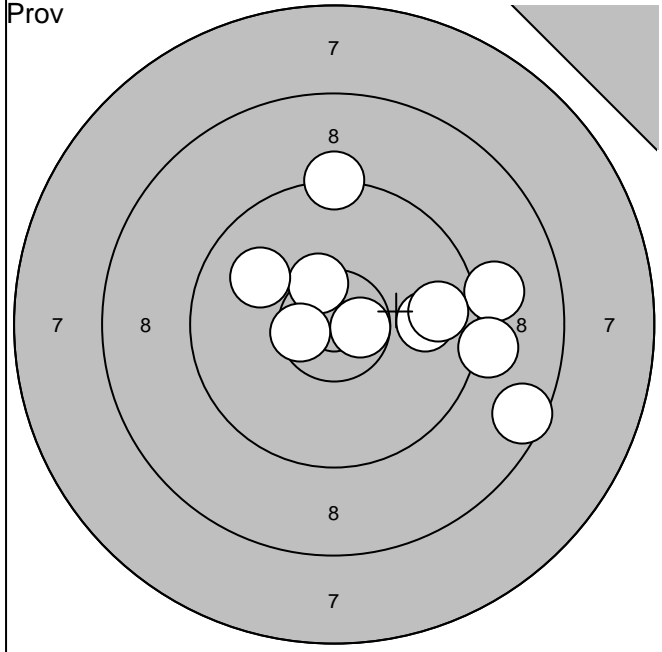

|          |           |        |       |
|----------|-----------|--------|-------|
| 1: 9,1 → | 6: 9,8 →  | Serie  | 93,0  |
| 2: 9,3 ↑ | 7:10,6* → |        |       |
| 3: 9,2 → | 8:10,5* ↗ | Totalt | 180,0 |
| 4: 8,6 ↘ | 9:10,6* ← |        |       |
| 5: 9,9 → | 10:10,0 ↖ |        |       |

|          |        |       |
|----------|--------|-------|
| 1: 9,8 ↓ | Serie  | 45,0  |
| 2: 9,2 ↗ |        |       |
| 3: 9,9 ← | Totalt | 225,0 |
| 4: 9,9 ↗ |        |       |
| 5: 9,4 ↓ |        |       |

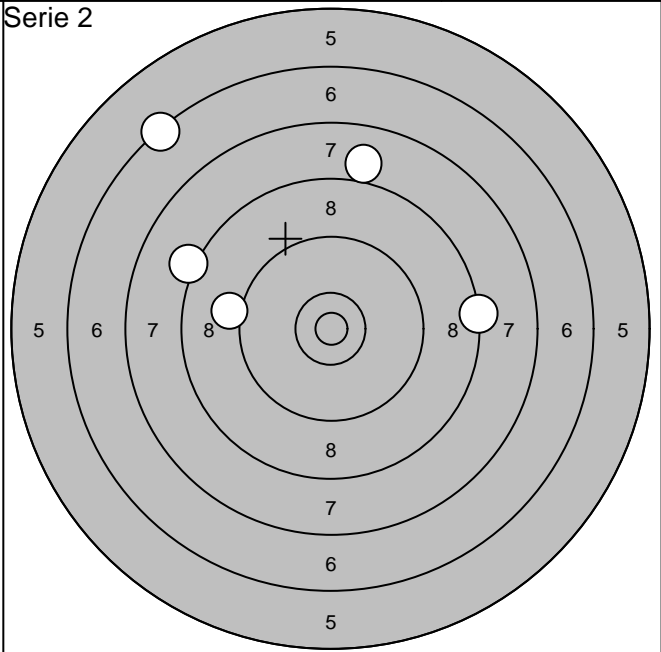
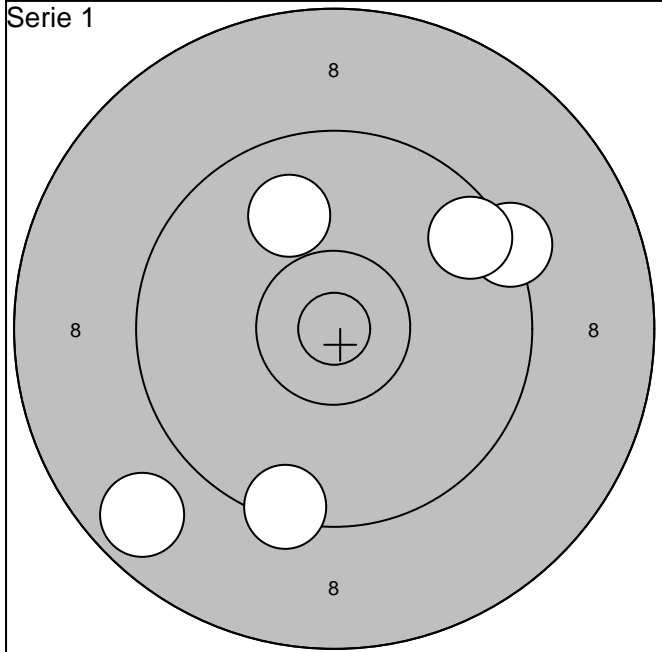

|           |        |       |
|-----------|--------|-------|
| 6: 9,3 ↗  | Serie  | 45,0  |
| 7:10,0 ↗  |        |       |
| 8: 9,6 ↗  | Totalt | 270,0 |
| 9: 9,4 ↓  |        |       |
| 10: 8,7 ↘ |        |       |

|          |        |       |
|----------|--------|-------|
| 1: 8,2 ↖ | Serie  | 39,0  |
| 2: 8,3 → |        |       |
| 3: 9,1 ← | Totalt | 309,0 |
| 4: 8,0 ↑ |        |       |
| 5: 6,4 ↖ |        |       |

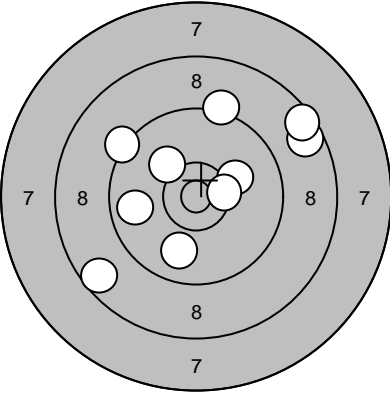
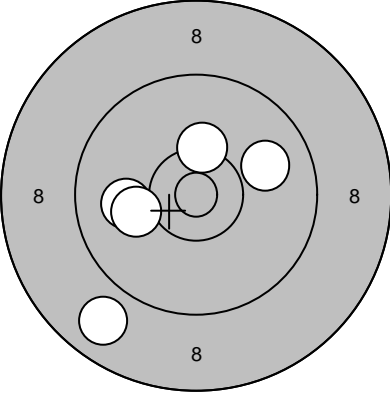
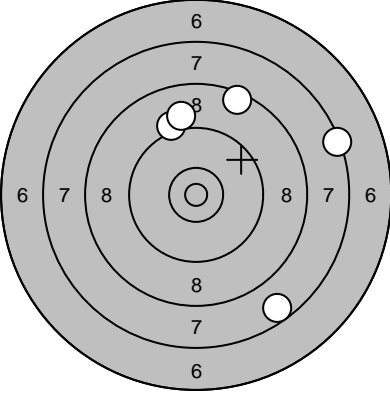
| Skjutlag   | Tavla   | Dennis Sundqvist  |   |
|------------|---|---|---|
| 3          | 12  | Piteå   |   |
| 2006-07-08 | Tavelträffen 2006 - Final   | Ramselefors SKF   |   |
| Prov       |    | 1: 8,7 →<br>2: 8,5 →<br>3: 10,1 ↖<br>4: 9,3 ↖<br>5: 10,1 →<br>6: 9,9 ↓<br>7: 9,8 ←<br>8: 10,4* →<br>9: 8,6 ↙<br>10: 9,2 ↑ | 11: 10,1 ↓<br>12: 10,3* →<br>13: 10,0 ↓<br>14: 10,6* ↙<br>15: 10,6* ↖ |
|            | Serie 90,0  |   | Serie 50,0  |
|            | Totalt 175,0  |   | Totalt 175,0  |
| Serie 1    |  | 1: 8,8 ↙<br>2: 10,0 ←<br>3: 10,1 ←<br>4: 10,3* ↑<br>5: 9,9 →  | 6: 9,6 ↙<br>7: 5,6 ↙<br>8: 8,0 →<br>9: 8,6 ↓<br>10: 10,6* →           |
|            | Serie 47,0  |   | Serie 40,0  |
|            | Totalt 222,0  |   | Totalt 262,0  |
| Serie 2    |  | 1: 9,2 ↑<br>2: 7,6 ↓<br>3: 7,4 →<br>4: 8,5 ↑<br>5: 9,0 ↑  |   |
|            | Serie 40,0  |   |   |
|            | Totalt 302,0  |   |   |

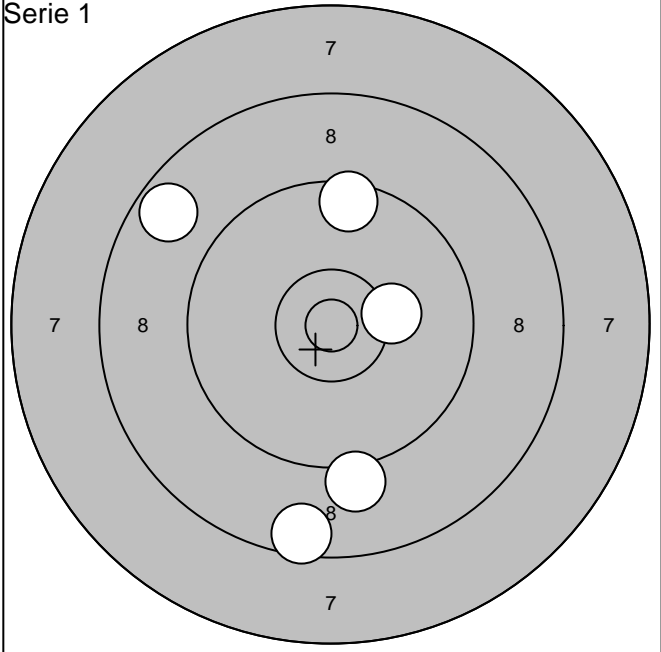
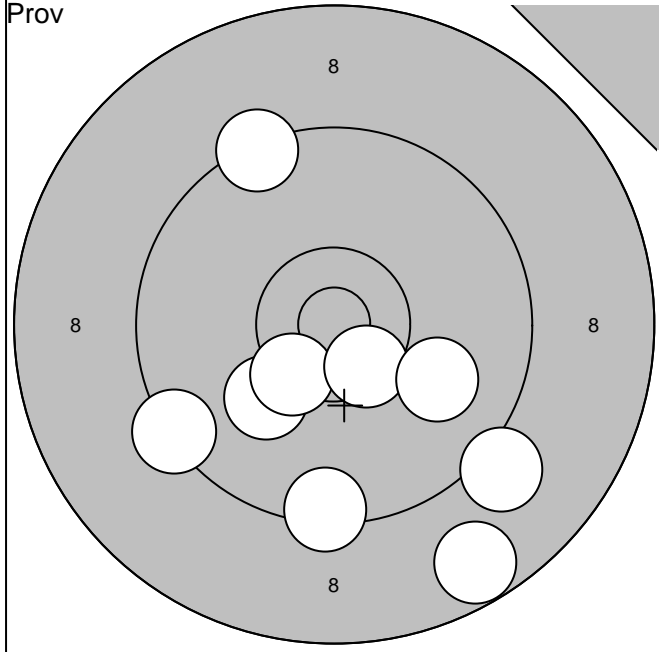

|          |           |        |       |
|----------|-----------|--------|-------|
| 1: 9,4 ↗ | 6:10,4* ↘ | Serie  | 84,0  |
| 2: 9,4 ↓ | 7:10,5* ↘ |        |       |
| 3:10,1 ↘ | 8:10,0 →  | Totalt | 174,0 |
| 4: 8,7 ↓ | 9: 9,4 ←  |        |       |
| 5: 9,1 ↘ |           |        |       |

|          |        |       |
|----------|--------|-------|
| 1: 9,1 ↓ | Serie  | 44,0  |
| 2: 9,5 ↑ |        |       |
| 3: 8,5 ↓ | Totalt | 218,0 |
| 4:10,2 → |        |       |
| 5: 8,7 ↖ |        |       |

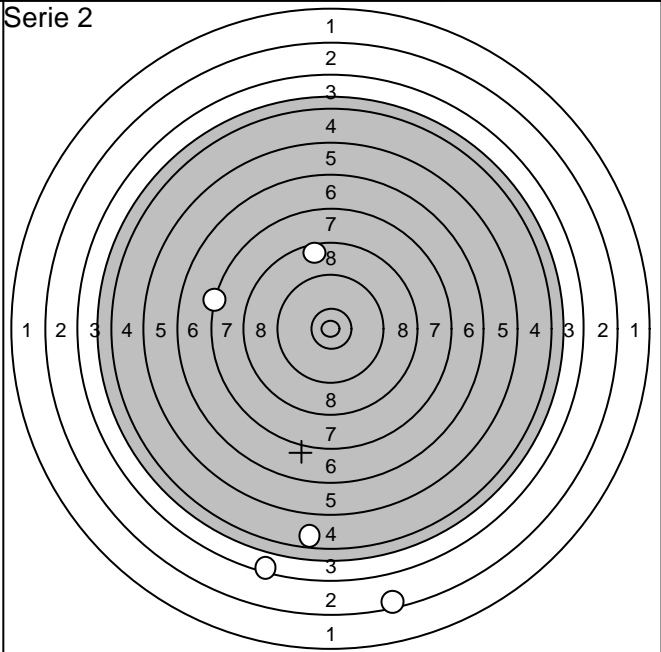
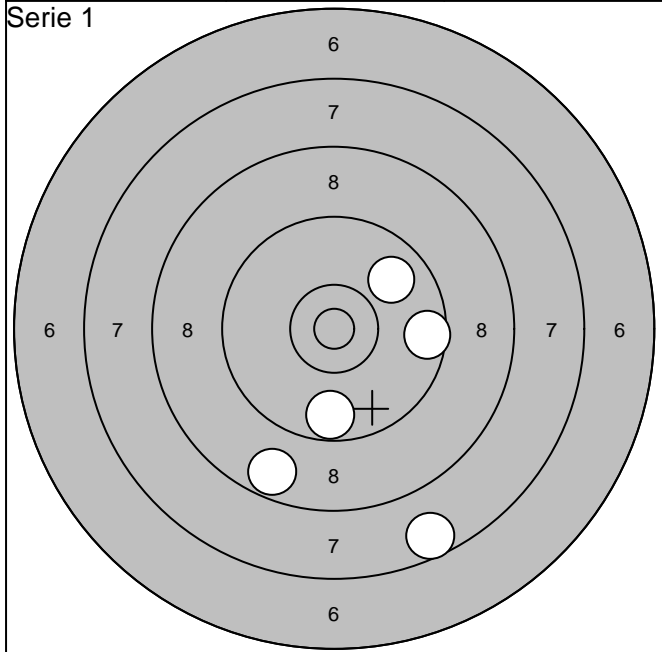

|           |        |       |
|-----------|--------|-------|
| 6: 9,7 ↓  | Serie  | 42,0  |
| 7: 8,7 ↓  |        |       |
| 8: 9,9 ↗  | Totalt | 260,0 |
| 9: 7,6 ↓  |        |       |
| 10: 9,6 → |        |       |

|          |        |       |
|----------|--------|-------|
| 1: 8,6 ↑ | Serie  | 24,0  |
| 2: 2,5 ↓ |        |       |
| 3: 7,4 ← | Totalt | 284,0 |
| 4: 4,7 ↓ |        |       |
| 5: 3,5 ↓ |        |       |

Skjutlag

Tavla

3

14

Martin Olofsson

Vännäs

2006-07-08

Tavelträffen 2006 - Final

Ramselefors SKF

Prov

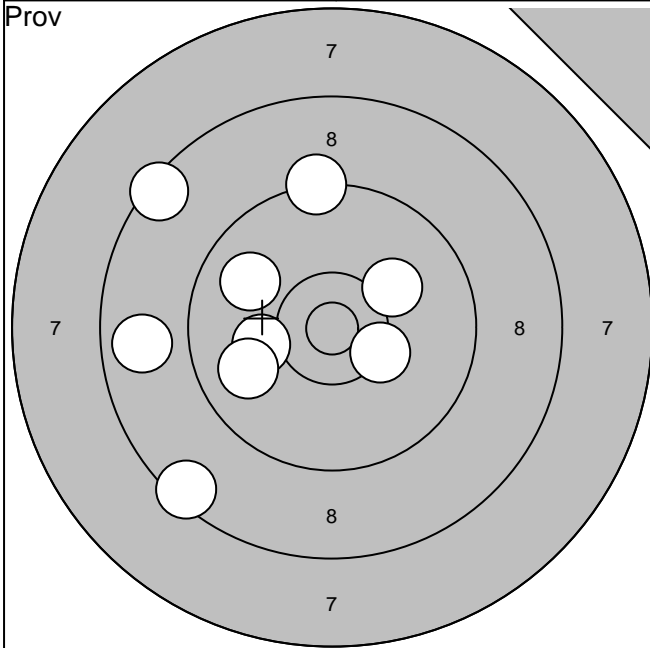

Serie 1

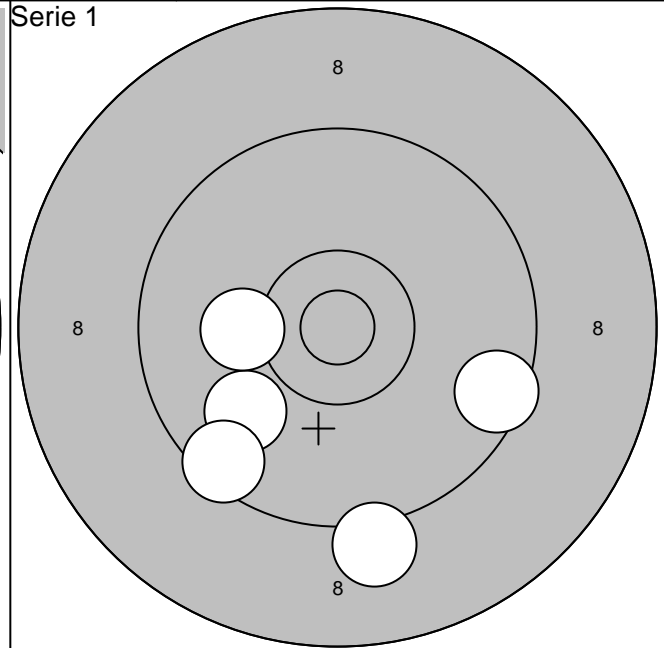

1: 8,8 ←

6:10,1 ←

Serie 81,0

2:10,1 ↗

7: 9,9 ←

1: 9,9 ↙

Serie 46,0

3: 9,9 ↖

8: 9,3 ↑

2:10,2 ←

4: 8,4 ↖

9: 8,5 ↙

Totalt 174,0

3: 9,5 →

Totalt 220,0

5:10,3\* →

4: 9,1 ↓

5: 9,5 ↙

Serie 1

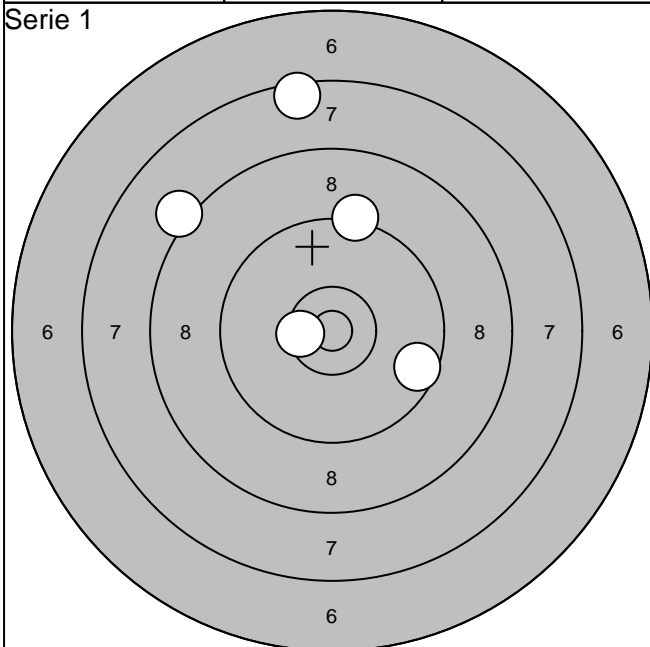

Serie 2

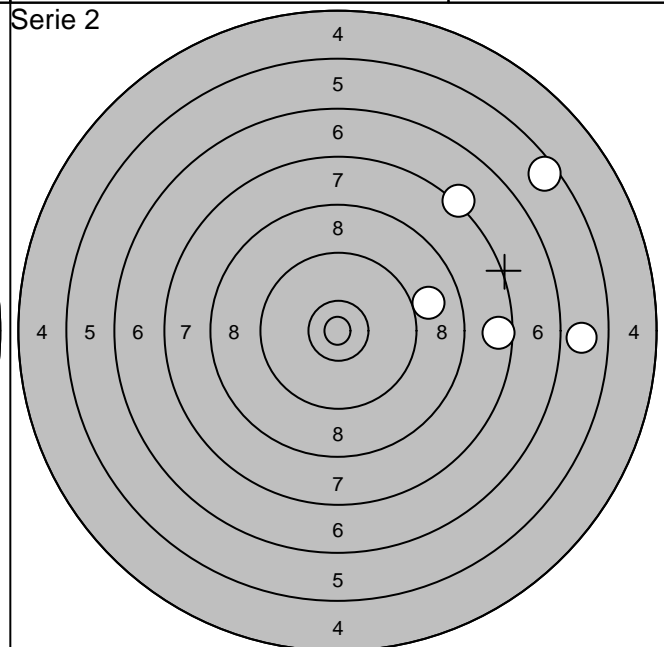

6: 8,2 ↖

Serie 43,0

7: 7,5 ↑

8: 9,3 ↑

9: 9,6 →

10:10,5\* ←

Totalt 263,0

1: 5,9 →

Serie 33,0

2: 7,6 →

3: 5,6 ↗

4: 7,3 ↗

5: 9,0 →

Totalt 296,0

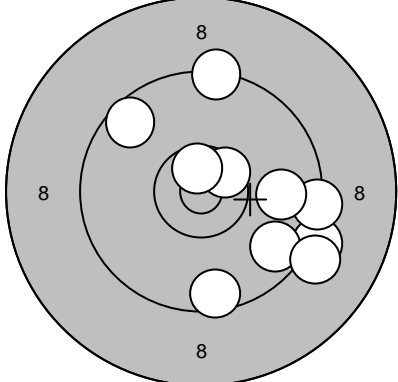
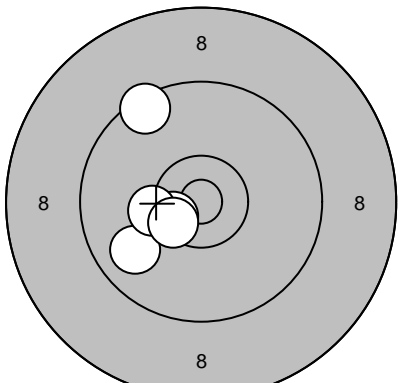
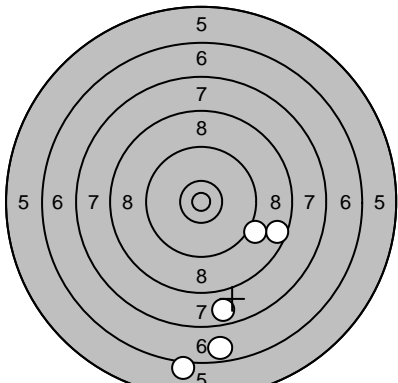
|            |   |   |   |
|------------|---|---|---|
| Skjutlag   | Tavla   | Jan-Erik Karlsson   |   |
| <b>3</b>   | <b>15</b>   |   |   |
|            |   | Ramselefors   |   |
| 2006-07-08 | Tavelträffen 2006 - Final   | Ramselefors SKF   |   |
| Prov       |    | 1: 9,4 ↑<br>2: 9,2 →<br>3: 9,6 ↗<br>4: 9,4 →<br>5: 10,5* ↗<br>6: 9,9 →<br>7: 9,7 ↘<br>8: 10,6* ↑<br>9: 9,1 →<br>10: 9,5 ↓ | Prov<br>11: 10,6* ↓<br>12: 10,0 ↙                                     |
|            | Serie 92,0  |   | Serie 20,0  |
|            | Totalt 174,0  |   | Totalt 174,0  |
| Serie 1    |   | 1: 10,5* ←<br>2: 9,8 ←<br>3: 10,3 ←<br>4: 9,5 ↗<br>5: 10,5* ↙   | Serie 1<br>6: 9,0 ↓<br>7: 9,6 ↓<br>8: 10,2 ←<br>9: 8,7 →<br>10: 9,7 ← |
|            | Serie 48,0  |   | Serie 45,0  |
|            | Totalt 222,0  |   | Totalt 267,0  |
| Serie 2    |  | 1: 8,6 →<br>2: 6,7 ↓<br>3: 9,1 →<br>4: 7,8 ↓<br>5: 6,1 ↓  |   |
|            | Serie 36,0  |   |   |
|            | Totalt 303,0  |   |   |

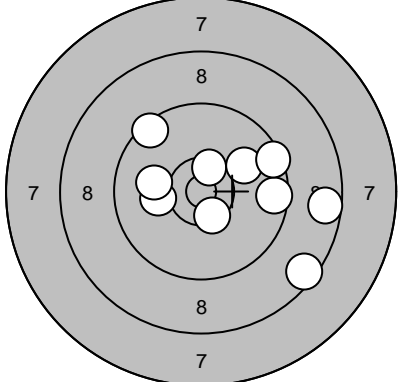
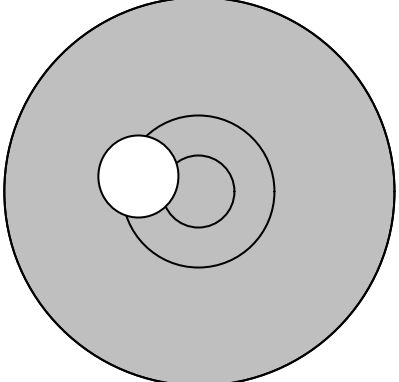
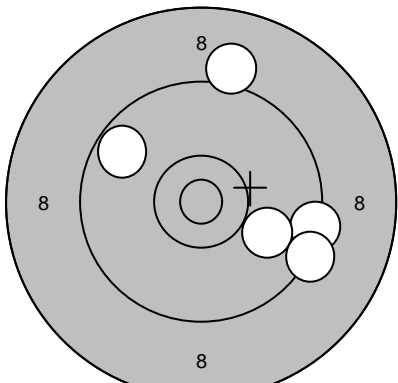
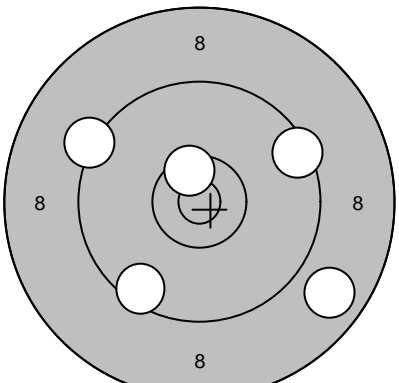
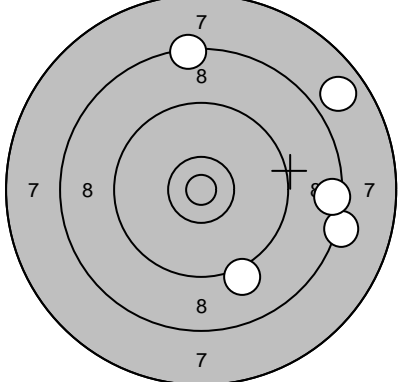

|                      |   |  |  |
|----------------------|---|--|--|
| Skjutlag<br><b>3</b> | Tavla<br><b>16</b>  | <b>Gunnar Iversen</b>  |  |
|                      |   | S 3  |  |
| 2006-07-08           | Tavelträffen 2006 - Final   | Ramselefors SKF  |  |
| Prov                 |    | 1: 8,6 →<br>2: 8,5 ↘<br>3: 9,5 ↗<br>4: 9,6 →<br>5: 10,5* ↗<br>6: 10,5* ↘<br>7: 10,1 ←<br>8: 10,0 ↗<br>9: 9,5 ↗<br>10: 10,1 ← | Prov<br> 11: 10,4* ←   |
|                      |   | Serie 93,0   | Serie 10,0   |
|                      |   | Totalt 173,0   | Totalt 173,0   |
| Serie 1              |   | 1: 9,4 →<br>2: 9,1 ↑<br>3: 10,0 →<br>4: 9,3 →<br>5: 9,7 ↗  | Serie 1<br> 6: 10,5* ↑<br>7: 9,5 ↗<br>8: 8,8 ↘<br>9: 9,3 ↗<br>10: 9,5 ↘ |
|                      |   | Serie 46,0   | Serie 45,0   |
|                      |   | Totalt 219,0   | Totalt 264,0   |
| Serie 2              |  | 1: 8,2 →<br>2: 8,5 →<br>3: 7,8 ↗<br>4: 9,2 ↘<br>5: 8,4 ↑   |  |
|                      |   | Serie 40,0   |  |
|                      |   | Totalt 304,0   |  |

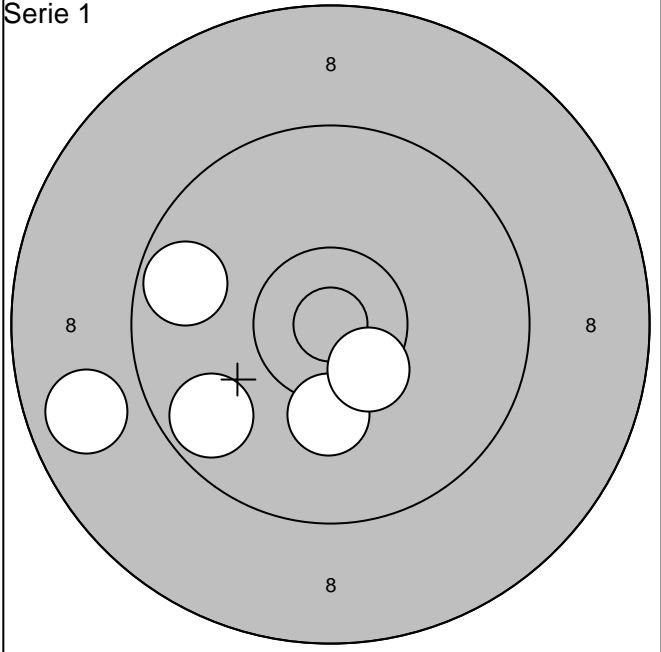
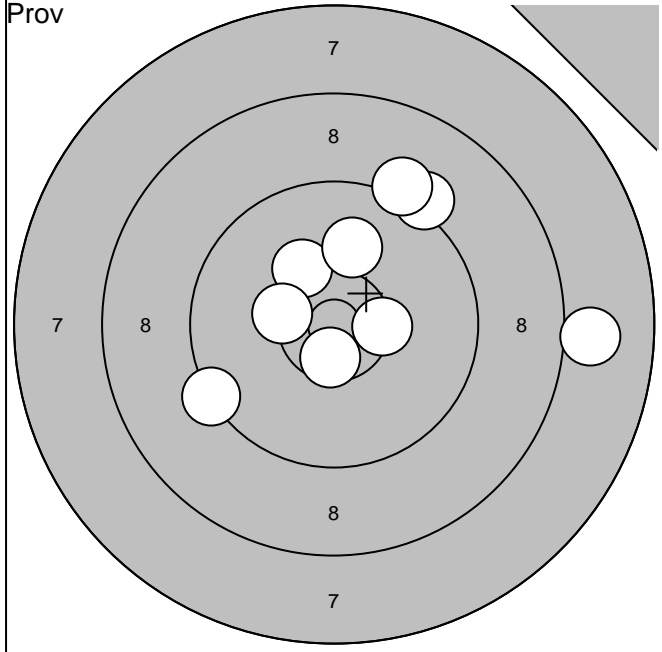

|           |           |        |       |
|-----------|-----------|--------|-------|
| 1:10,6* ↓ | 6: 9,2 ↗  | Serie  | 85,0  |
| 2:10,4* → | 7: 8,0 →  |        |       |
| 3: 9,3 ↙  | 8:10,0 ↗  | Totalt | 163,0 |
| 4:10,2 ↖  | 9:10,3* ← |        |       |
| 5: 9,2 ↗  |           |        |       |

|           |        |       |
|-----------|--------|-------|
| 1:10,2 ↓  | Serie  | 46,0  |
| 2: 9,7 ↙  |        |       |
| 3: 8,8 ↙  | Totalt | 209,0 |
| 4: 9,7 ↙  |        |       |
| 5:10,5* ↘ |        |       |

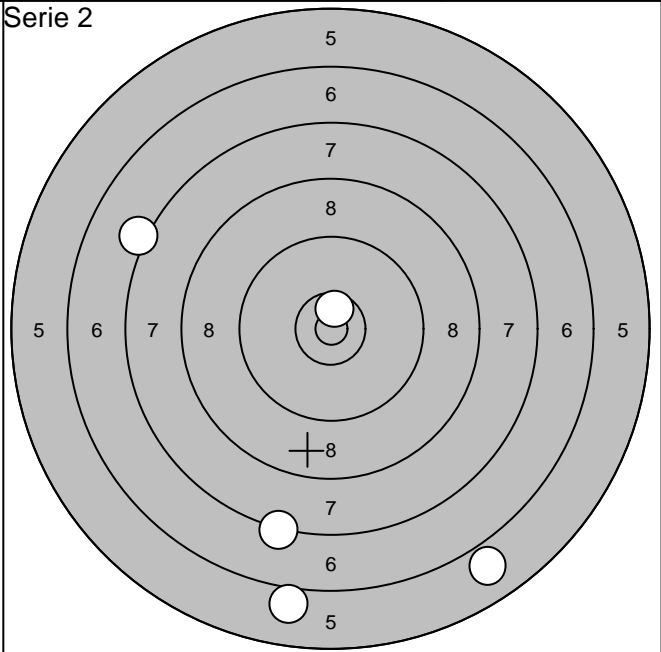
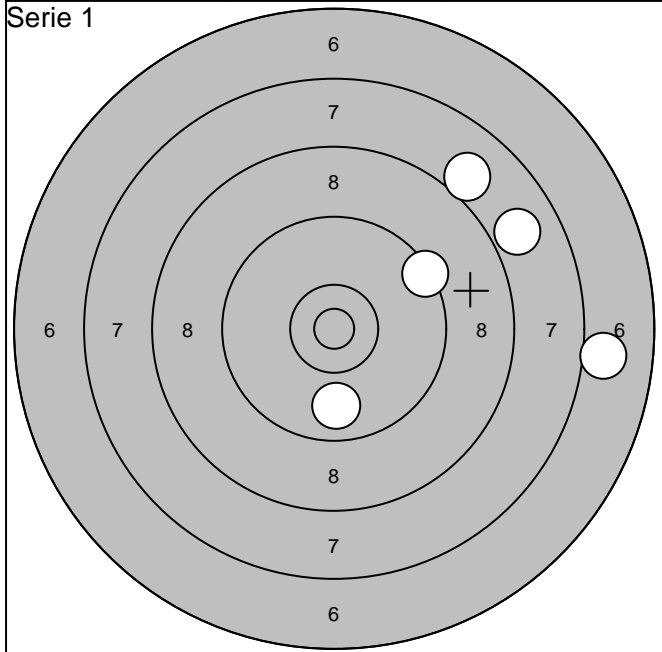

|           |        |       |
|-----------|--------|-------|
| 6: 8,0 ↗  | Serie  | 40,0  |
| 7: 7,0 →  |        |       |
| 8: 7,9 ↗  | Totalt | 249,0 |
| 9: 9,8 ↓  |        |       |
| 10: 9,4 ↗ |        |       |

|           |        |       |
|-----------|--------|-------|
| 1: 7,2 ↙  | Serie  | 35,0  |
| 2:10,6* ↗ |        |       |
| 3: 5,9 ↘  | Totalt | 284,0 |
| 4: 7,3 ↓  |        |       |
| 5: 6,0 ↓  |        |       |

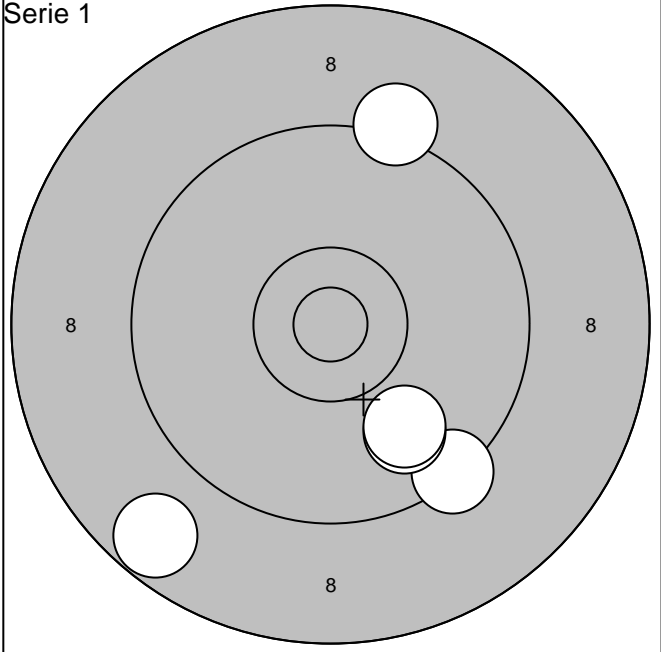
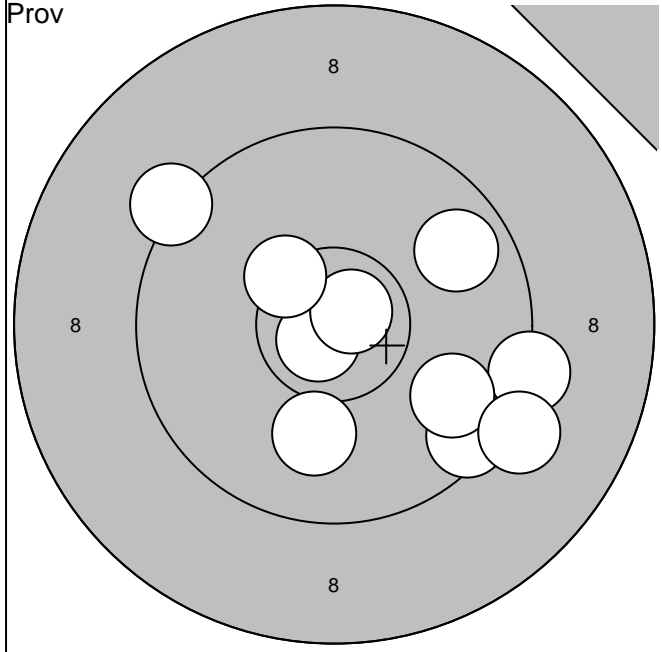

|           |           |        |       |
|-----------|-----------|--------|-------|
| 1: 9,3 →  | 6:10,8* ↗ | Serie  | 94,0  |
| 2: 9,3 ↗  | 7: 9,2 →  |        |       |
| 3: 9,5 ↘  | 8:10,4* ↖ | Totalt | 163,0 |
| 4: 9,8 ↘  | 9:10,0 ↓  |        |       |
| 5:10,8* ↙ | 10: 9,8 ↗ |        |       |

|          |        |       |
|----------|--------|-------|
| 1: 8,7 ↙ | Serie  | 44,0  |
| 2: 9,2 ↗ |        |       |
| 3: 9,4 ↘ | Totalt | 207,0 |
| 4: 9,9 ↘ |        |       |
| 5: 9,9 ↘ |        |       |

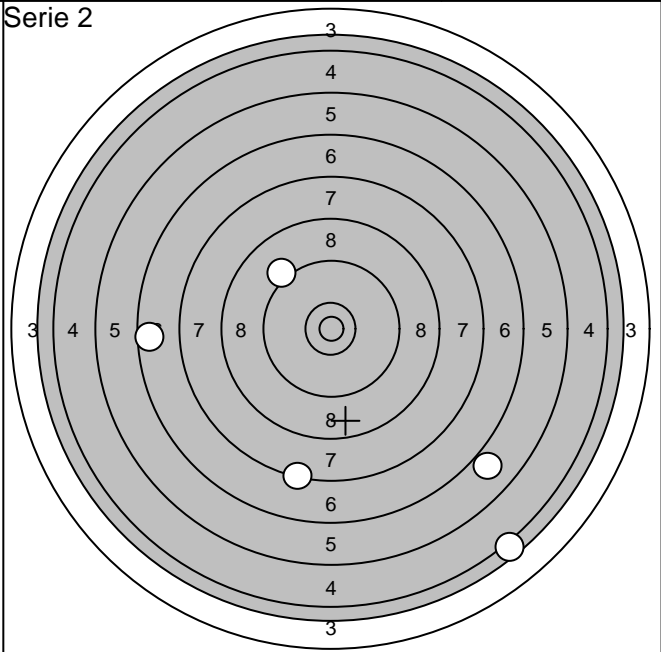
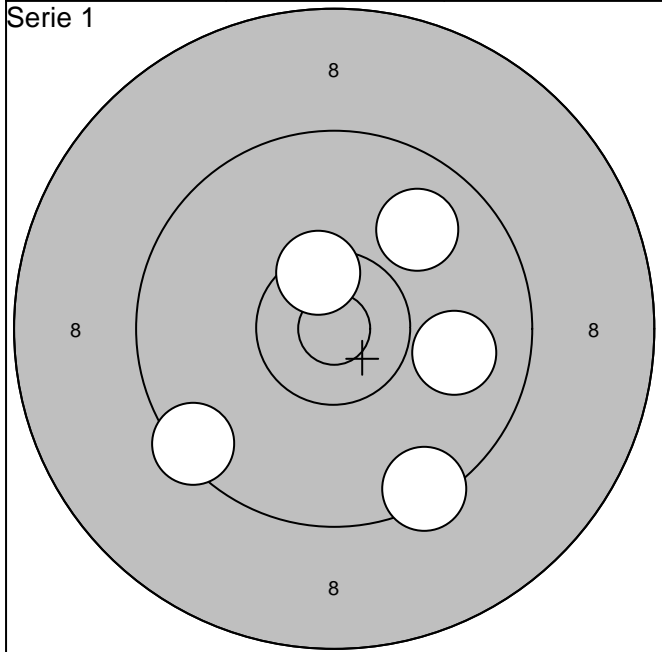

|            |        |       |
|------------|--------|-------|
| 6: 9,9 ↗   | Serie  | 46,0  |
| 7: 9,4 ↙   |        |       |
| 8: 9,4 ↘   | Totalt | 253,0 |
| 9: 9,9 →   |        |       |
| 10:10,5* ↗ |        |       |

|          |        |       |
|----------|--------|-------|
| 1: 7,3 ↘ | Serie  | 32,0  |
| 2: 9,2 ↗ |        |       |
| 3: 6,0 ↘ | Totalt | 285,0 |
| 4: 4,2 ↘ |        |       |
| 5: 6,6 ← |        |       |

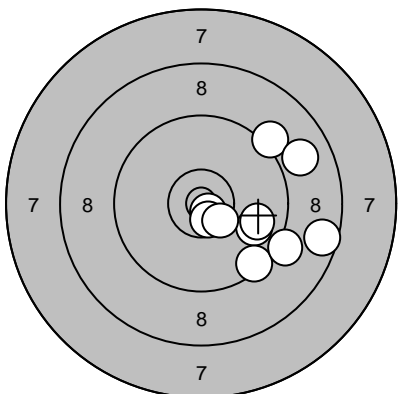
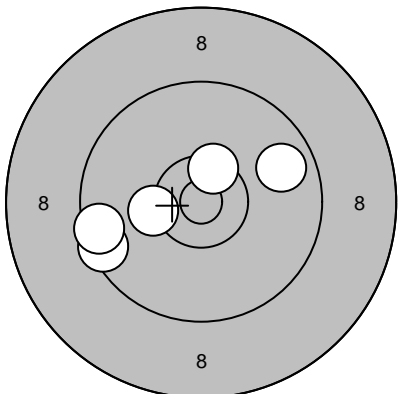
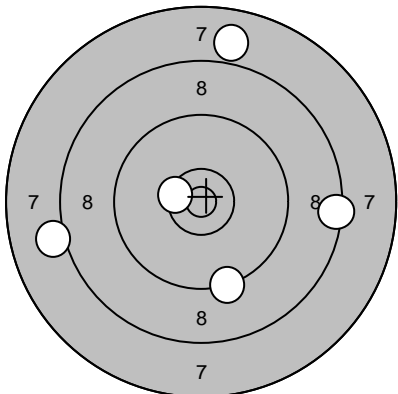
| Skjutlag   | Tavla   | Johan Nilsson   |   |
|------------|---|---|---|
| 3          | 19  | Ramselefors   |   |
| 2006-07-08 | Tavelträffen 2006 - Final   | Ramselefors SKF   |   |
| Prov       |    | 1: 9,2 ↗<br>2: 9,9 →<br>3: 9,8 →<br>4: 9,4 ↓<br>5: 8,9 →<br>6: 9,2 ↓<br>7: 8,6 →<br>8: 10,7* ↓<br>9: 10,6* ↓<br>10: 10,5* ↓ | 11: 9,7 ↓<br>12: 10,0 ↓<br>13: 9,4 ↓<br>14: 9,8 ←<br>15: 9,4 ↖<br>16: 9,8 ←<br>17: 9,7 ←<br>18: 9,8 ←<br>19: 10,0 ← |
|            | Serie 91,0  |   | Serie 83,0  |
|            | Totalt 181,0  |   | Totalt 181,0  |
| Serie 1    |   | 1: 9,5 ←<br>2: 9,5 ←<br>3: 10,3 ←<br>4: 10,5* ↑<br>5: 9,8 →   | 6: 7,6 ←<br>7: 8,9 ←<br>8: 10,2 ↓<br>9: 9,9 →<br>10: 7,6 ←  |
|            | Serie 47,0  |   | Serie 41,0  |
|            | Totalt 228,0  |   | Totalt 269,0  |
| Serie 2    |  | 1: 9,3 ↓<br>2: 7,9 ↑<br>3: 8,1 ←<br>4: 8,4 →<br>5: 10,5* ←  |   |
|            | Serie 42,0  |   |   |
|            | Totalt 311,0  |   |   |

Skjutlag

Tavla

3

20

Fredrik Forsgren

Ramselefors

2006-07-08

Tavelträffen 2006 - Final

Ramselefors SKF

Prov

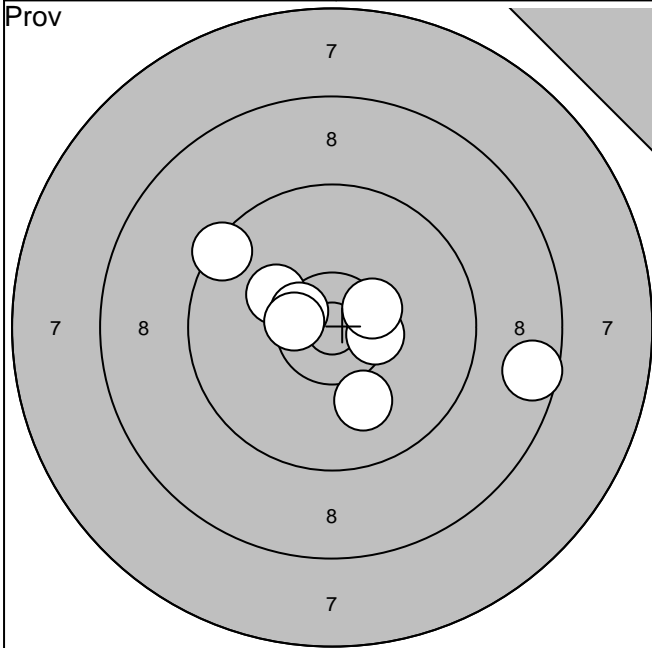

Serie 1

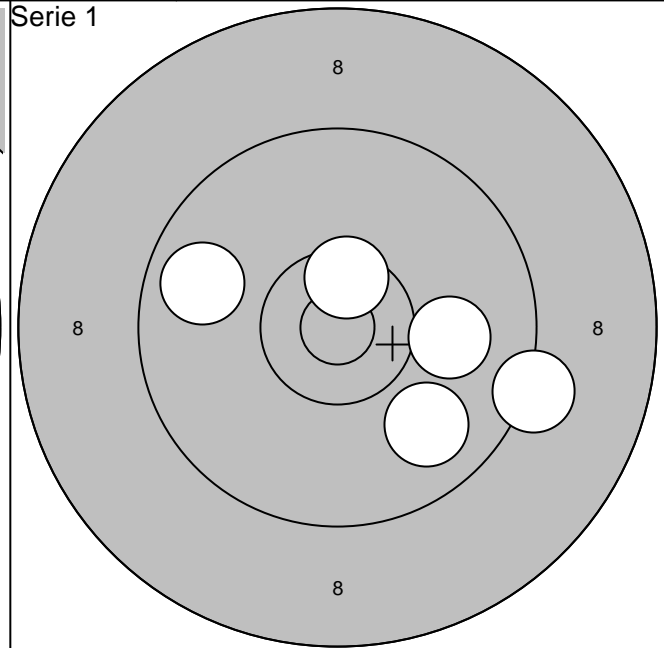

1: 8,6 →

6: 9,4 ↖

2: 10,0 ↘

7: 10,5\* ↖

3: 10,4\* →

8: 10,5\* ←

4: 10,4\* →

5: 10,2 ↖

Serie 77,0

Totalt 177,0

1: 9,9 ↘

2: 10,5\* ↑

3: 9,8 ↖

4: 10,0 →

5: 9,3 →

Serie 47,0

Totalt 224,0

Serie 1

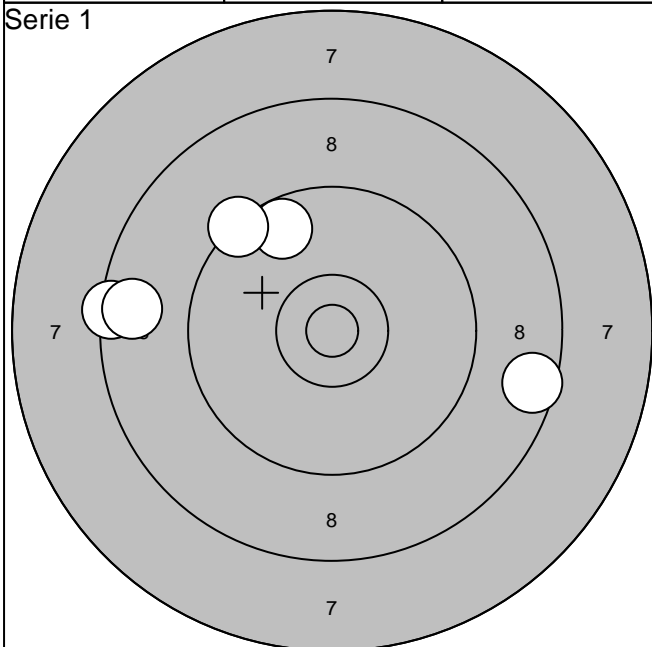

Serie 2

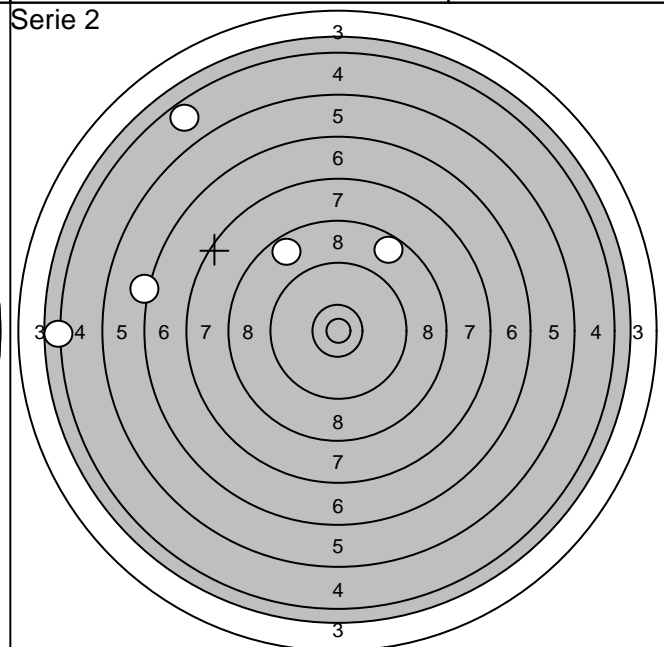

6: 8,6 →

7: 9,7 ↗

8: 9,4 ↗

9: 8,4 ←

10: 8,7 ←

Serie 42,0

Totalt 266,0

1: 4,3 ←

2: 8,7 ↗

3: 6,2 ←

4: 4,7 ↗

5: 8,7 ↗

Serie 30,0

Totalt 296,0

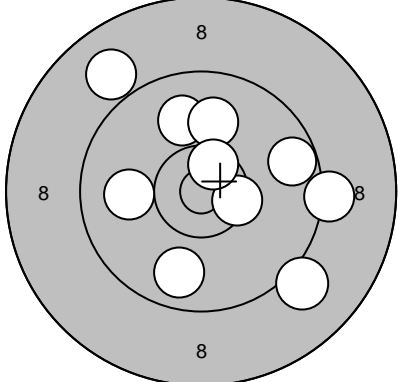
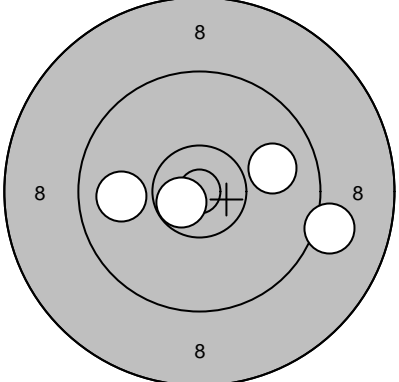
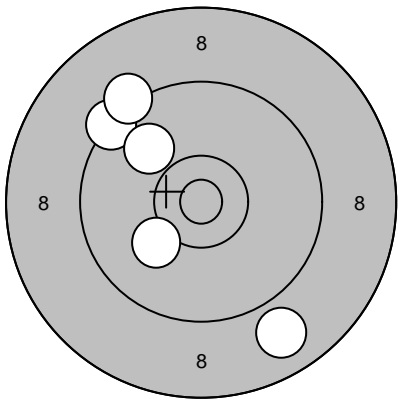
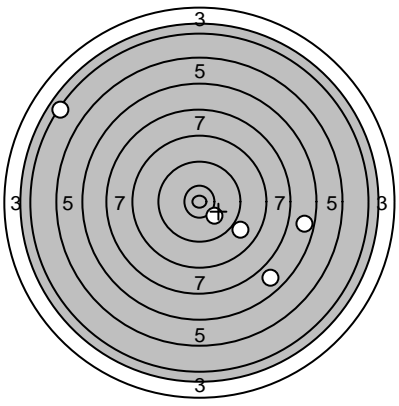
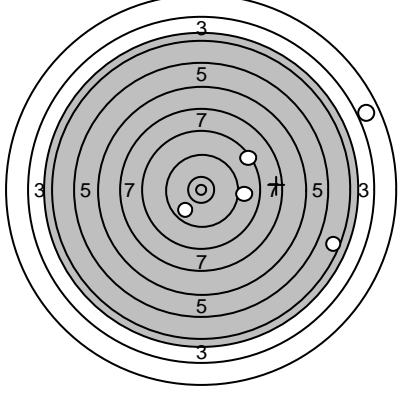
| Skjutlag    | Tavla   | Daniel Zakrisson   |   |
|-------------|---|--|---|
| 3           |   | 21   |   |
| Ramselefors |   |  |   |
| 2006-07-08  | Tavelträffen 2006 - Final   |  | Ramselefors SKF   |
| Prov        |    | 1: 10,0 ↗<br>2: 9,2 →<br>3: 9,0 ↗<br>4: 9,7 →<br>5: 9,8 ↓<br>6: 10,0 ←<br>7: 10,0 ↑<br>8: 9,1 ↘<br>9: 10,5* →<br>10: 10,6* ↗ | Prov<br> 11: 10,7* ↙<br>12: 9,9 ←<br>13: 9,9 →<br>14: 9,1 →             |
|             |   | Serie 95,0   | Serie 37,0  |
|             |   | Totalt 170,0   | Totalt 170,0  |
| Serie 1     |   | 1: 9,4 ↗<br>2: 9,2 ↗<br>3: 10,0 ↗<br>4: 10,1 ↘<br>5: 8,9 ↘   | Serie 1<br> 6: 4,4 ↗<br>7: 6,9 ↘<br>8: 6,7 →<br>9: 10,2 ↘<br>10: 9,0 ↘ |
|             |   | Serie 46,0   | Serie 35,0  |
|             |   | Totalt 216,0   | Totalt 251,0  |
| Serie 2     |  | 1: 9,0 →<br>2: 2,9 →<br>3: 9,8 ↘<br>4: 4,6 →<br>5: 8,4 ↗   |   |
|             |   | Serie 32,0   |   |
|             |   | Totalt 283,0   |   |

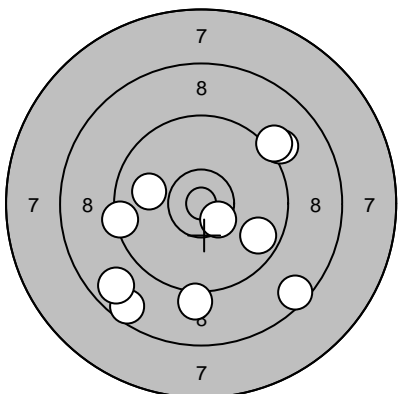
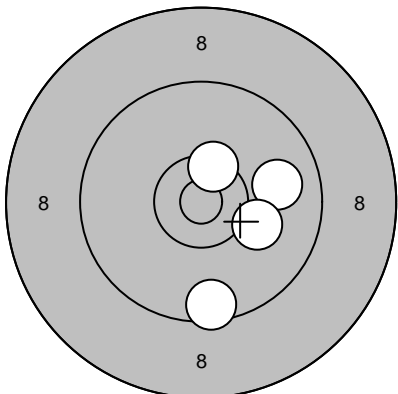
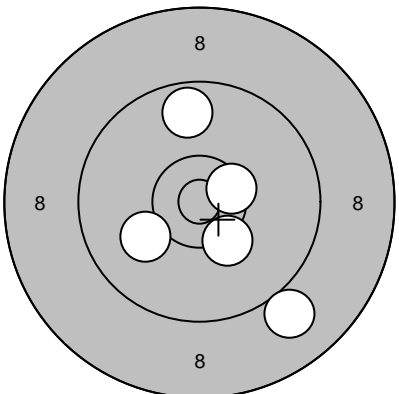
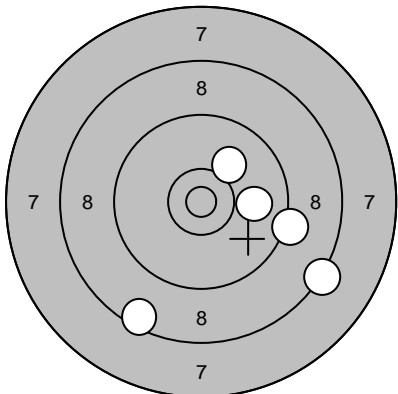
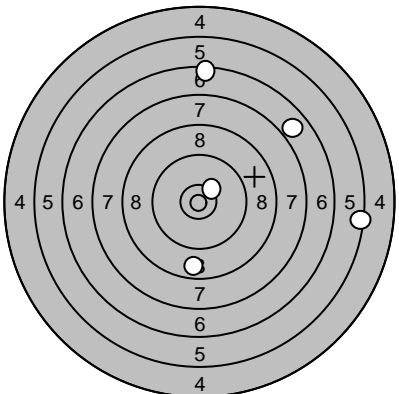
| Skjutlag   | Tavla   | Marie Fjällström   |  |
|------------|---|--|--|
| 3          | 22  | Ramselefors  |  |
| 2006-07-08 | Tavelträffen 2006 - Final   | Ramselefors SKF  |  |
| Prov       |    | 1: 8,6 ↙<br>2: 9,4 ←<br>3: 8,7 ↙<br>4: 9,1 ↗<br>5: 10,0 ←<br>6: 9,1 ↓<br>7: 9,2 ↗<br>8: 9,7 →<br>9: 10,5* ↘<br>10: 8,5 ↘ | 11: 10,9* ←<br>12: 9,7 ↘<br>13: 8,8 ↘<br>14: 9,9 ←<br>15: 9,6 ↓<br>16: 9,0 ↖<br>17: 9,9 ↗<br>18: 9,9 ↗<br>19: 9,4 →<br>20: 9,5 ← |
|            | Serie 89,0  | Serie 90,0   |  |
|            | Totalt 170,0  | Totalt 170,0   |  |
| Prov       |   | 21: 9,5 ↓<br>22: 10,5* ↑<br>23: 9,9 →<br>24: 10,1 →  | Serie 1<br>                                   |
|            | Serie 38,0  | Serie 48,0   |  |
|            | Totalt 170,0  | Totalt 218,0   |  |
| Serie 1    |  | 6: 10,1 ↗<br>7: 8,5 ↘<br>8: 8,3 →<br>9: 10,0 →<br>10: 9,2 →  | Serie 2<br>                                  |
|            | Serie 45,0  | Serie 35,0   |  |
|            | Totalt 263,0  | Totalt 298,0   |  |

Skjutlag

Tavla

3

23

Linda Lidman

Piteå

2006-07-08

Tavelträffen 2006 - Final

Ramselefors SKF

Prov

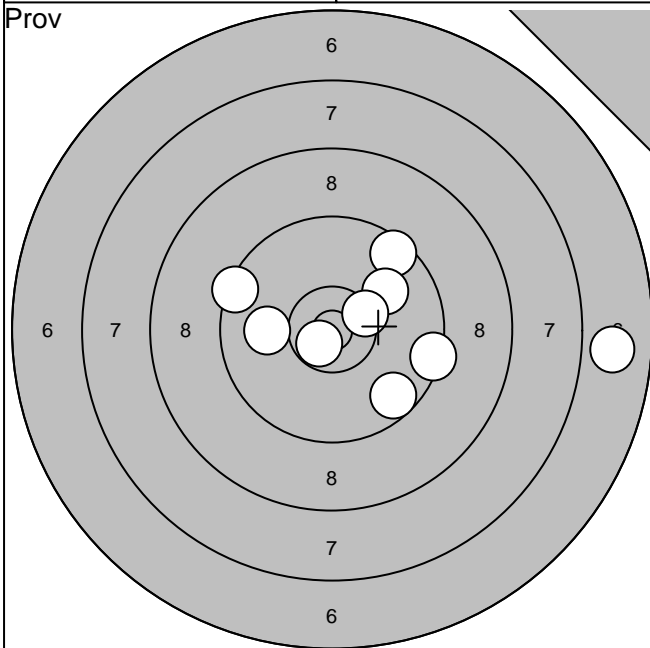

Serie 1

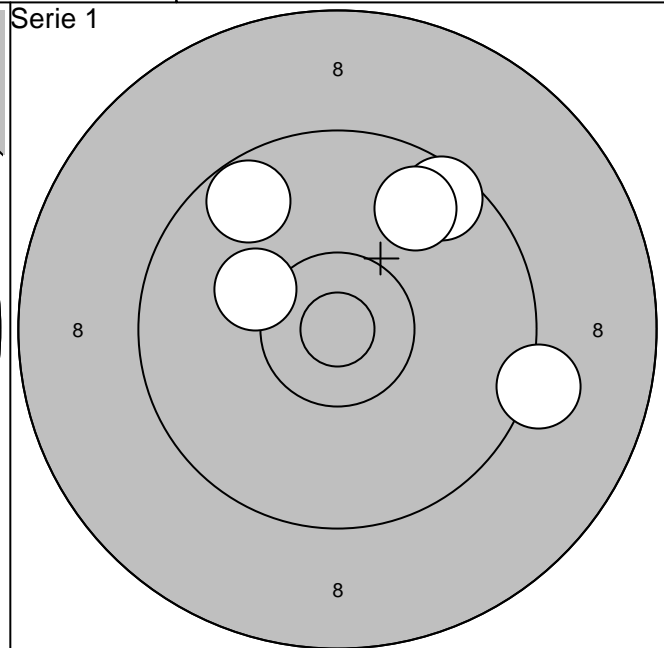

1: 6,9 →  
 2: 9,4 →  
 3: 9,6 ↘  
 4: 9,5 ↗  
 5: 10,0 ↗

6: 10,4\* ↗  
 7: 10,0 ←  
 8: 9,4 ←  
 9: 10,7\* ↘

Serie 82,0

Totalt 167,0

1: 10,2 ↖  
 2: 9,7 ↗  
 3: 9,2 →  
 4: 9,6 ↗  
 5: 9,8 ↗

Serie 46,0

Totalt 213,0

Serie 1

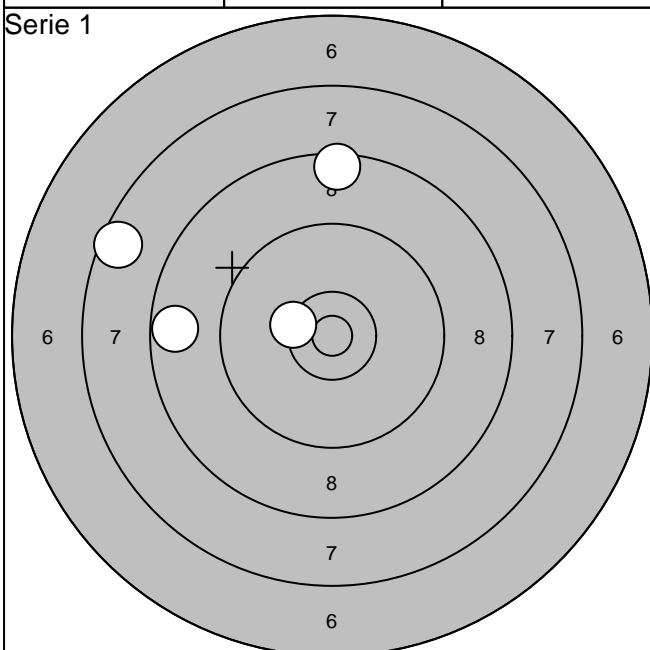

Serie 2

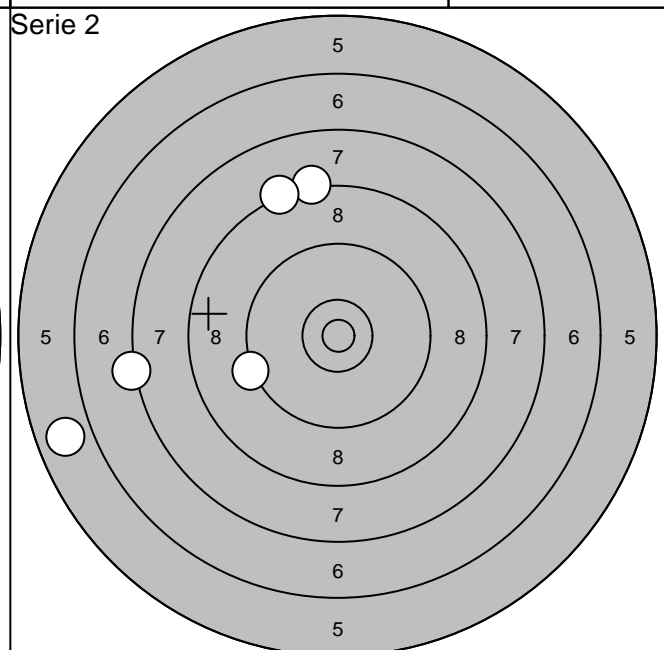

6: 8,5 ↑  
 7: 8,7 ←  
 8: 10,4\* ←  
 9: 7,6 ↖

Serie 33,0

Totalt 246,0

1: 8,3 ↑  
 2: 8,3 ↗  
 3: 5,8 ←  
 4: 7,3 ←  
 5: 9,3 ↖

Serie 37,0

Totalt 283,0

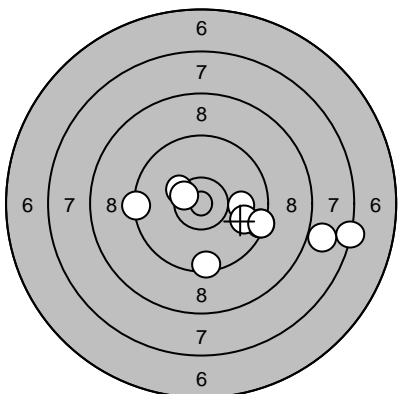
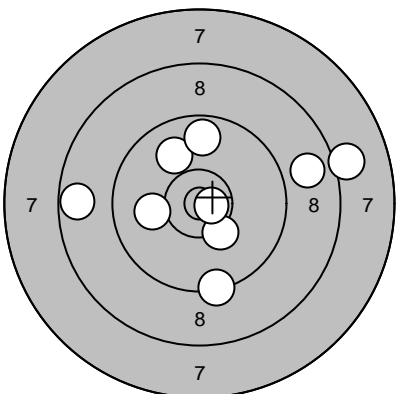
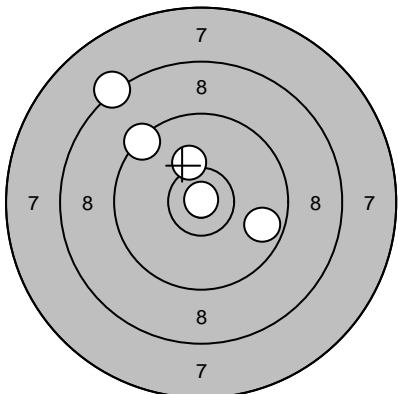
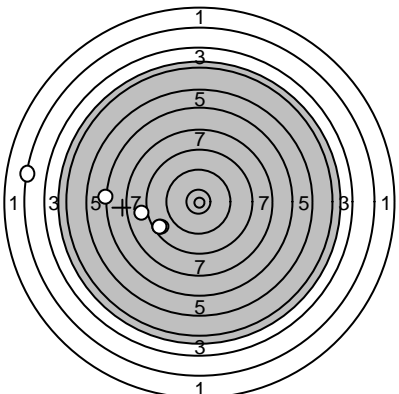
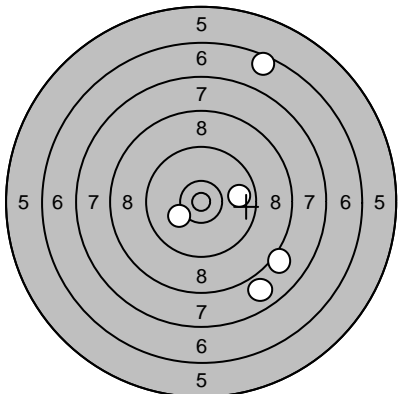

|  |                           |  |              |
|--|---------------------------|--|--------------|
| Skjutlag   | Tavla                     | <b>Johan Zakrisson</b>   |              |
| <b>3</b>   | <b>24</b>                 |  |              |
| Ramselefors  |                           |  |              |
| 2006-07-08   | Tavelträffen 2006 - Final | Ramselefors SKF  |              |
| Prov<br>      | 1: 7,3 →                  | Prov<br>     | 11: 8,7 ←    |
|  | 2: 9,5 →                  |  | 12: 10,1 ←   |
|  | 3: 9,5 ↓                  |  | 13: 10,0 ↗   |
|  | 4: 8,0 →                  |  | 14: 10,3 ↘   |
|  | 5: 10,0 →                 |  | 15: 9,7 ↑    |
|  | 6: 10,3* ↗                |  | 16: 9,4 ↓    |
|  | 7: 9,8 →                  |  | 17: 8,8 →    |
|  | 8: 10,5* ↗                |  | 18: 8,1 →    |
|  | 9: 9,4 →                  |  | 19: 10,7* →  |
|  | 10: 9,4 ←                 |  |              |
|  | Serie 90,0                |  | Serie 82,0   |
|  | Totalt 159,0              |  | Totalt 159,0 |
| Serie 1<br>  | 1: 10,2 ↗                 | Serie 1<br> | 6: 6,4 ←     |
|  | 2: 10,9* ↑                |  | 7: 2,5 ←     |
|  | 3: 8,3 ↗                  |  | 8: 8,1 ←     |
|  | 4: 9,7 →                  |  | 9: 8,8 ↙     |
|  | 5: 9,4 ↗                  |  | 10: 8,7 ↙    |
|  | Serie 46,0                |  | Serie 32,0   |
|  | Totalt 205,0              |  | Totalt 237,0 |
| Serie 2<br> | 1: 10,2 ↙                 |  |              |
|  | 2: 9,8 →                  |  |              |
|  | 3: 8,1 ↘                  |  |              |
|  | 4: 6,6 ↗                  |  |              |
|  | 5: 7,9 ↘                  |  |              |
|  | Serie 40,0                |  |              |
|  | Totalt 277,0              |  |              |