

# Monica Häggström

Click Here to upgrade to Unlimited Pages and Expanded Features

## Ramselefors SKF

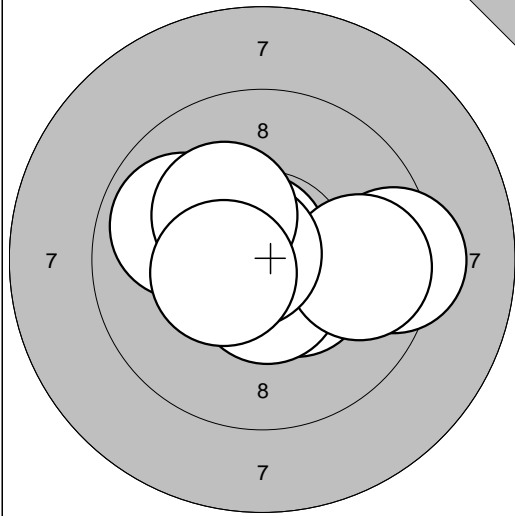

- 0,4\* ↘
- 2:10,8\* ↖
- 3: 9,9 ↖
- 4: 9,3 →
- 5:10,8\* ↗
- 6:10,6\* ↘
- 7: 9,8 →
- 8:10,8\* ↖
- 9:10,2\* ↗
- 10:10,4\* ↖

Serie 97,0  
Sum 0,0

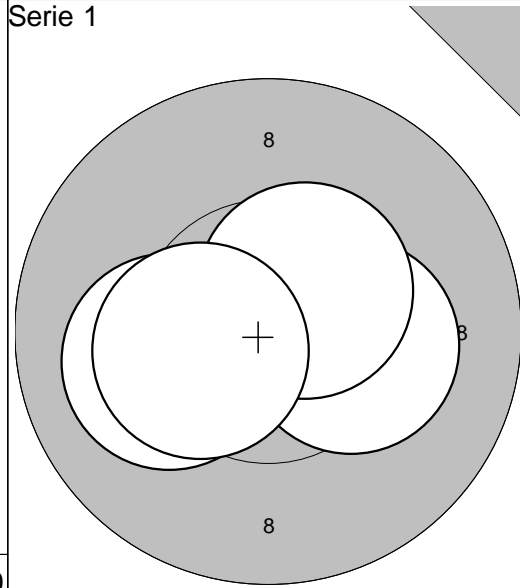

- 11:10,1 ↖
- 12:10,2\* →
- 13:10,5\* ↗
- 14:10,4\* ↖

Serie 40,0  
Sum 0,0

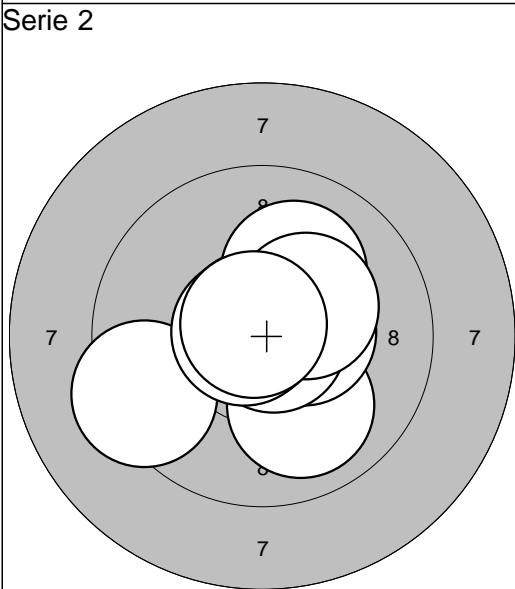

- 1:10,6\* →
- 2:10,1 ↗
- 3:10,0 ↘
- 4:10,4\* →
- 5:10,8\* →
- 6: 9,3 ↖
- 7:10,3\* ↗
- 8:10,8\* ↖
- 9:10,7\* ↖
- 10:10,8\* ↗

Serie 99,0  
Sum 99,0

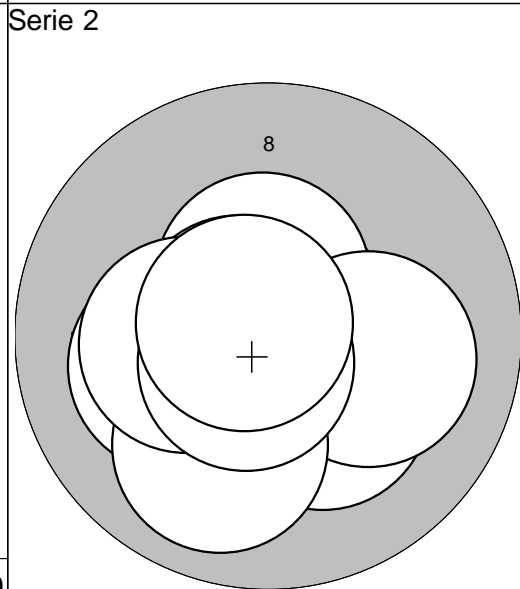

- 11:10,7\* ↖
- 12:10,2\* ↘
- 13:10,5\* ↗
- 14:10,1 →
- 15:10,7\* ↖
- 16:10,1 ↖
- 17:10,0 ↘
- 18:10,3\* ↖
- 19:10,7\* ↘
- 20:10,7\* ↖

Serie 100,0  
Sum 199,0

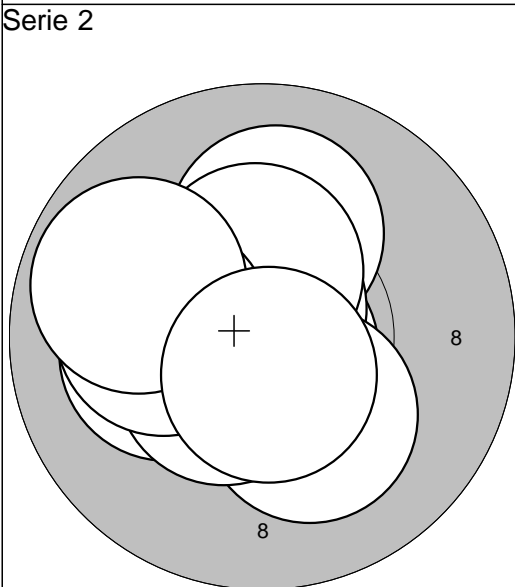

- 21:10,8\* ↘
- 22:10,2\* ↖
- 23:10,1 ↗
- 24:10,7\* ↗
- 25:10,2\* ↘
- 26:10,5\* ↖
- 27:10,4\* ↗
- 28:10,1 ↖
- 29: 9,8 ↖
- 30:10,6\* ↘

Serie 99,0  
Sum 298,0

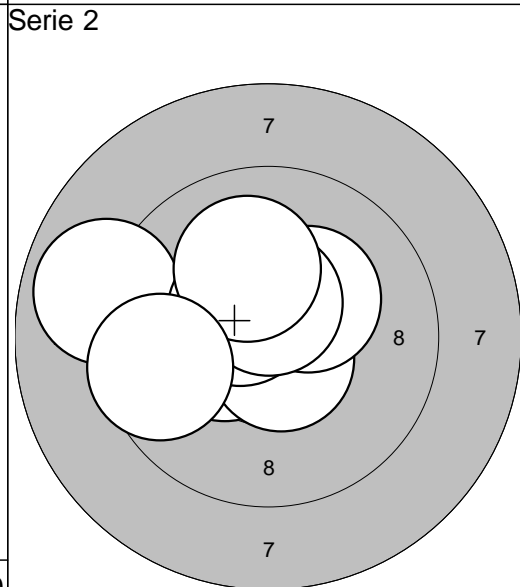

- 31:10,3\* ↖
- 32: 8,9 ↖
- 33:10,8\* ↗
- 34:10,4\* ↖
- 35:10,6\* ↘
- 36:10,5\* ↖
- 37:10,3\* ↗
- 38:10,5\* ↗
- 39:10,1 ↗
- 40: 9,6 ↖

Serie 97,0  
Sum 395,0

# Maria Hägglund

Ramselefors SKF

[Click Here to upgrade to Unlimited Pages and Expanded Features](#)

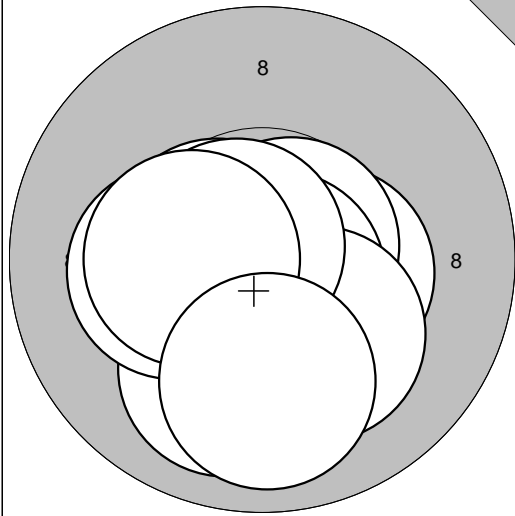

- 0,4\* →
- 2: 10,7\* →
- 3: 10,6\* ←
- 4: 10,7\* ↓
- 5: 10,2\* ↓
- 6: 10,7\* ↗
- 7: 10,0 ↓
- 8: 10,2\* ←
- 9: 10,4\* ←
- 10: 9,9 ↓

Serie 99,0  
Sum 0,0

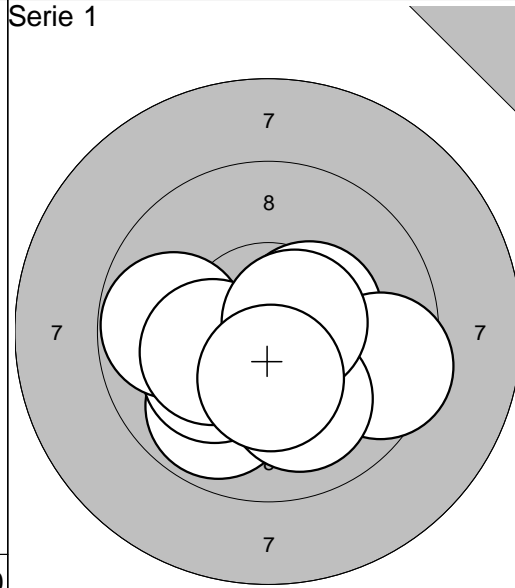

- 11: 10,4\* →
- 12: 9,9 ↓
- 13: 10,4\* ↓
- 14: 10,1 ↓
- 15: 9,8 ←
- 16: 9,5 →
- 17: 10,2\* ←
- 18: 10,0 ↓
- 19: 10,6\* →
- 20: 10,4\* ↓

Serie 97,0  
Sum 0,0

Serie 2

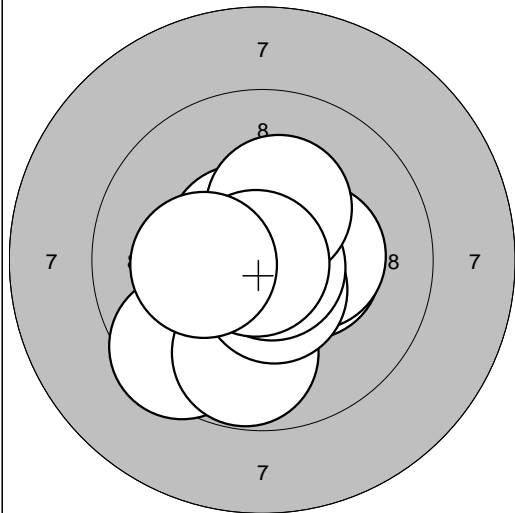

- 1: 10,4\* →
- 2: 10,3\* →
- 3: 9,5 ↓
- 4: 9,8 ↓
- 5: 10,5\* ↓
- 6: 10,8\* ↓
- 7: 10,6\* ↗
- 8: 10,3\* ↗
- 9: 10,9\* ←
- 10: 10,2\* ←

Serie 98,0  
Sum 98,0

Serie 2

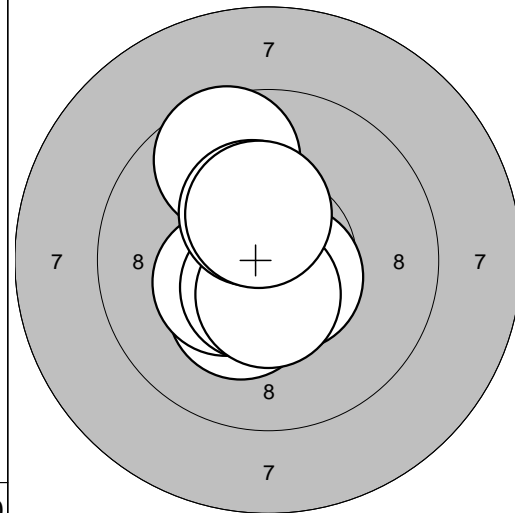

- 11: 10,5\* ↓
- 12: 10,3\* ↓
- 13: 10,7\* ↓
- 14: 10,4\* ←
- 15: 10,6\* ↓
- 16: 10,6\* ↘
- 17: 9,6 ↗
- 18: 10,5\* ↓
- 19: 10,3\* ↗
- 20: 10,4\* ↗

Serie 99,0  
Sum 197,0

Serie 2

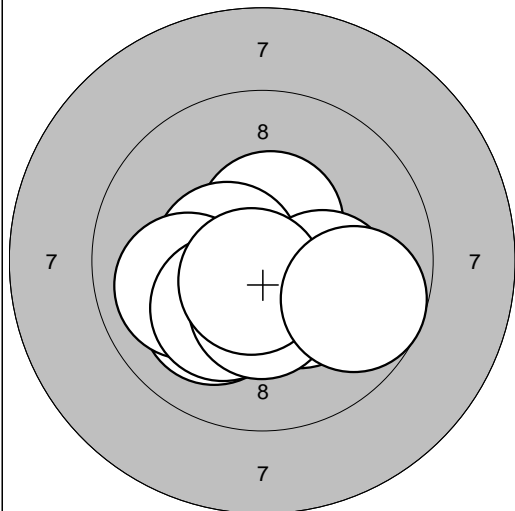

- 21: 10,5\* ↗
- 22: 10,1 ↓
- 23: 10,3\* ↓
- 24: 10,5\* ←
- 25: 10,0 ←
- 26: 10,2\* →
- 27: 10,2\* ↓
- 28: 10,4\* ↓
- 29: 10,7\* ↓
- 30: 9,7 →

Serie 99,0  
Sum 296,0

Serie 2

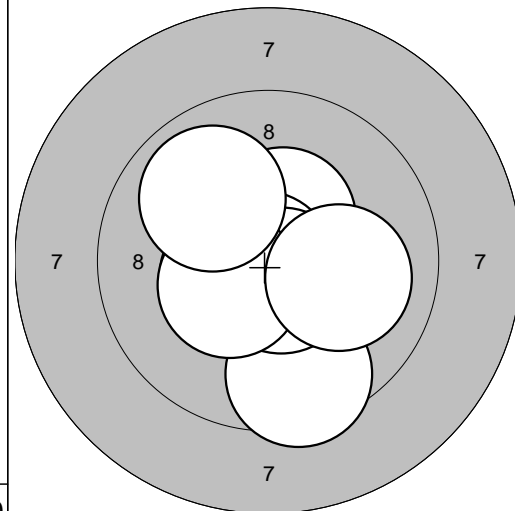

- 31: 10,7\* ↗
- 32: 10,7\* ↗
- 33: 10,4\* ↗
- 34: 10,5\* ←
- 35: 9,5 ↓
- 36: 10,9\* ←
- 37: 10,7\* ↓
- 38: 10,4\* ←
- 39: 10,1 →
- 40: 9,9 ↗

Serie 98,0  
Sum 394,0



Your complimentary use period has ended. Thank you for using PDF Complete.

# Kristina Häggström

Click Here to upgrade to Unlimited Pages and Expanded Features

## Ramselefors SKF

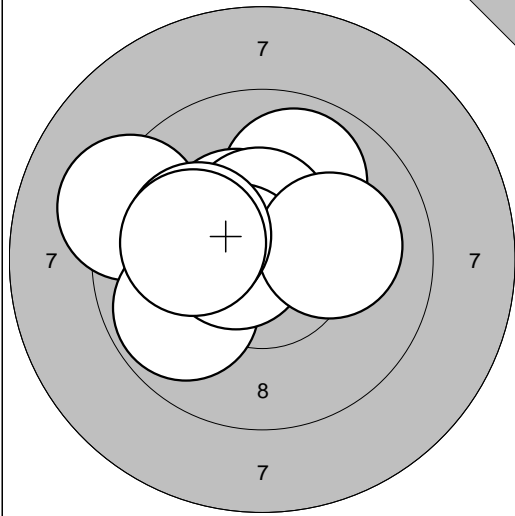

- 9,9 ←
- 2: 9,2 ←
- 3: 9,9 ↗
- 4: 10,4\* ↗
- 5: 9,8 ←
- 6: 10,5\* ↑
- 7: 10,6\* ←
- 8: 10,1 →
- 9: 10,1 ←
- 10: 10,1 ←

Serie	96,0
Sum	0,0

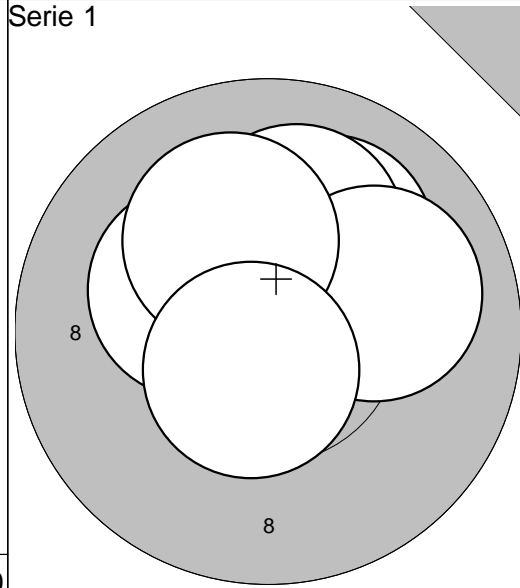

- 11: 10,5\* ↑
- 12: 10,3\* ↖
- 13: 10,1 ↗
- 14: 10,1 ↑
- 15: 10,0 →
- 16: 10,1 ↑
- 17: 10,6\* ↓

Serie	70,0
Sum	0,0

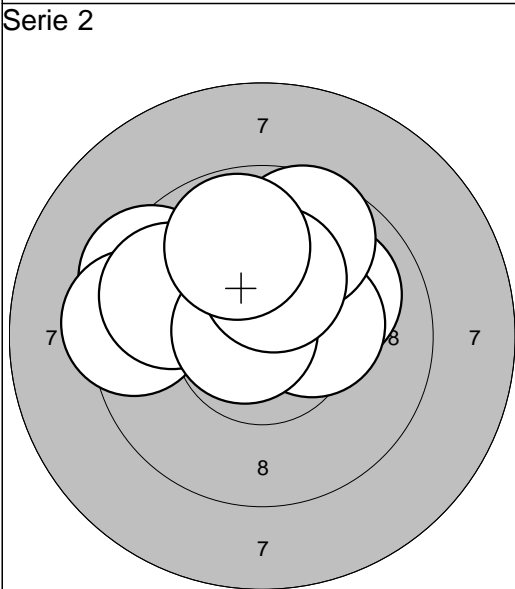

- 1: 9,4 ↖
- 2: 10,0 ↑
- 3: 9,4 ←
- 4: 10,0 ↗
- 5: 9,7 ←
- 6: 10,3\* →
- 7: 10,7\* ←
- 8: 9,7 ↑
- 9: 10,2\* ↑
- 10: 9,8 ↑

Serie	95,0
Sum	95,0

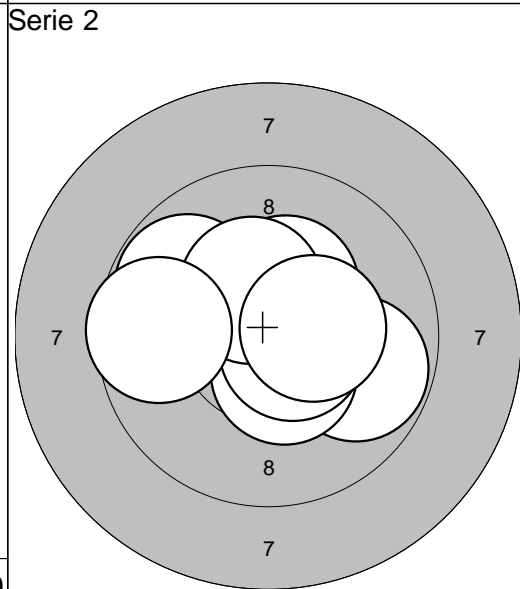

- 11: 10,3\* ↗
- 12: 10,1 ↖
- 13: 10,7\* ↓
- 14: 9,8 ↗
- 15: 9,8 →
- 16: 10,5\* ↓
- 17: 10,6\* ↓
- 18: 10,4\* ↑
- 19: 10,4\* →
- 20: 9,6 ←

Serie	97,0
Sum	192,0

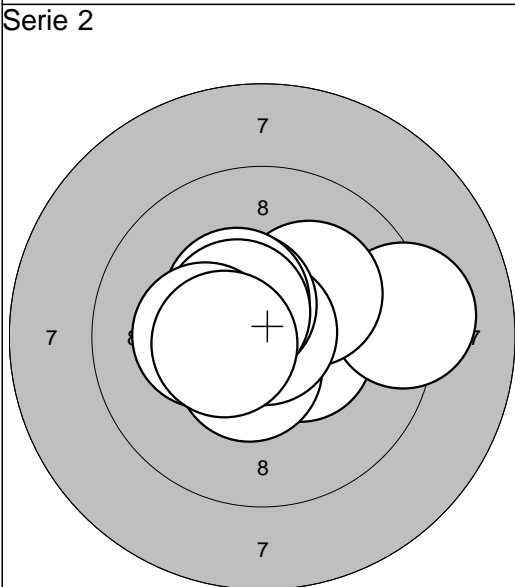

- 21: 10,5\* →
- 22: 9,2 →
- 23: 10,5\* ↓
- 24: 10,2\* ↗
- 25: 10,9\* ↑
- 26: 10,5\* ↗
- 27: 10,4\* ↗
- 28: 10,5\* ↗
- 29: 10,3\* ←
- 30: 10,5\* ←

Serie	99,0
Sum	291,0

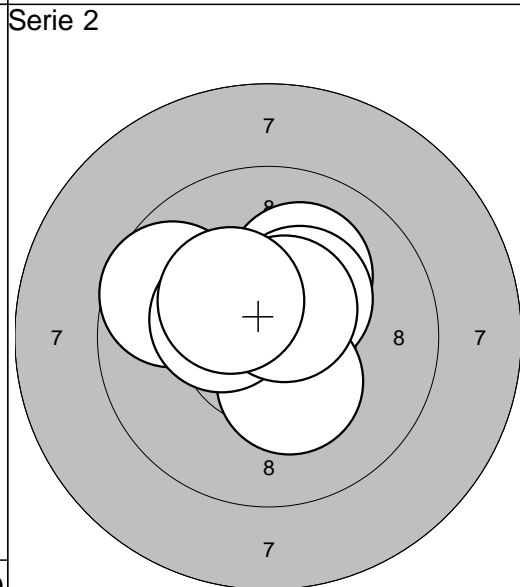

- 31: 10,1 ↗
- 32: 10,3\* ↗
- 33: 10,5\* ↗
- 34: 10,8\* ↓
- 35: 10,7\* ↗
- 36: 10,3\* ↓
- 37: 9,7 ↖
- 38: 10,4\* ↖
- 39: 10,6\* ↗
- 40: 10,3\* ↖

Serie	99,0
Sum	390,0

# Jessika Flodell

Click Here to upgrade to Unlimited Pages and Expanded Features

## Ramselefors SKF

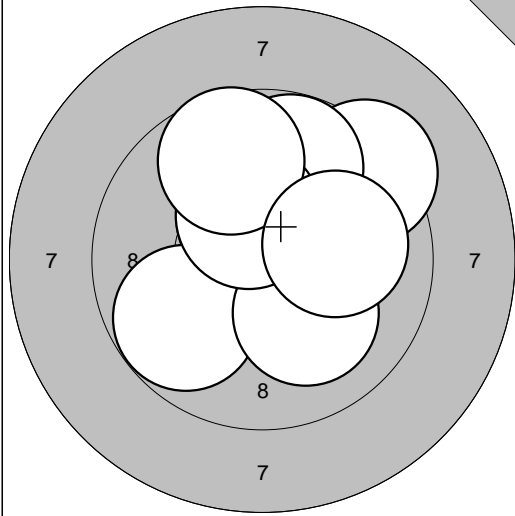

0,4*	↑
2: 9,8	↙
3: 9,3	↗
4: 10,1	→
5: 10,3*	↑
6: 10,1	↘
7: 9,8	↑
8: 10,4*	↑
9: 9,7	↑
10: 10,0	→

Serie	96,0
Sum	0,0

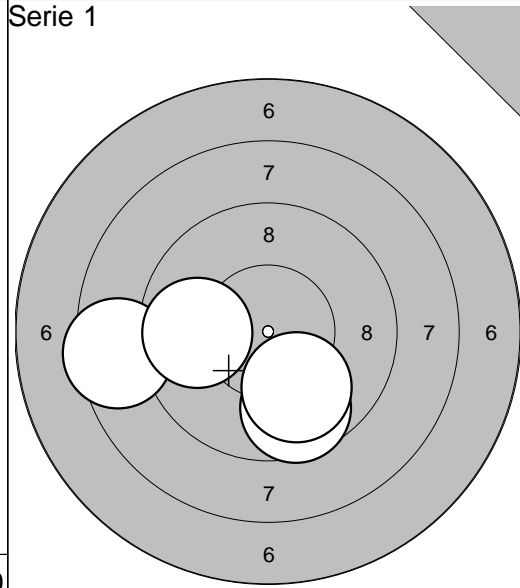

11: 8,5	←
12: 9,6	↘
13: 9,8	←
14: 9,9	↘

Serie	35,0
Sum	0,0

### Serie 2

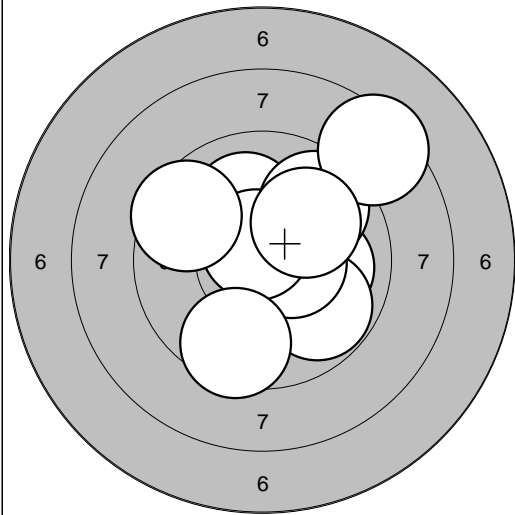

1: 10,0	→
2: 9,8	↘
3: 10,1	↑
4: 10,5*	→
5: 10,7*	↑
6: 9,5	↘
7: 9,7	↗
8: 8,4	↗
9: 9,5	↙
10: 10,0	↗

Serie	94,0
Sum	94,0

### Serie 2

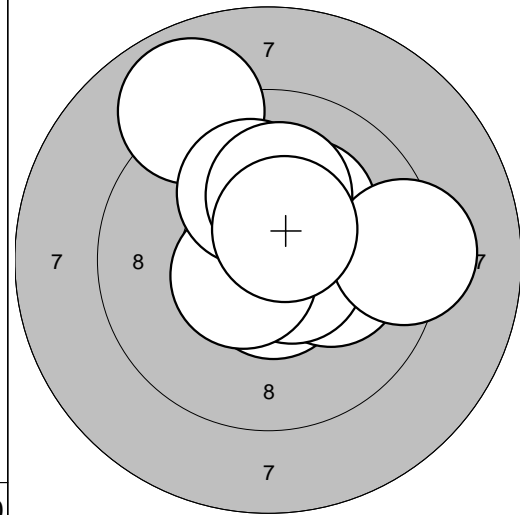

11: 10,2*	↗
12: 10,6*	↘
13: 10,2*	→
14: 10,6*	↘
15: 9,3	→
16: 10,6*	↙
17: 8,9	↑
18: 10,1	↑
19: 10,2*	↑
20: 10,5*	↗

Serie	97,0
Sum	191,0

### Serie 2

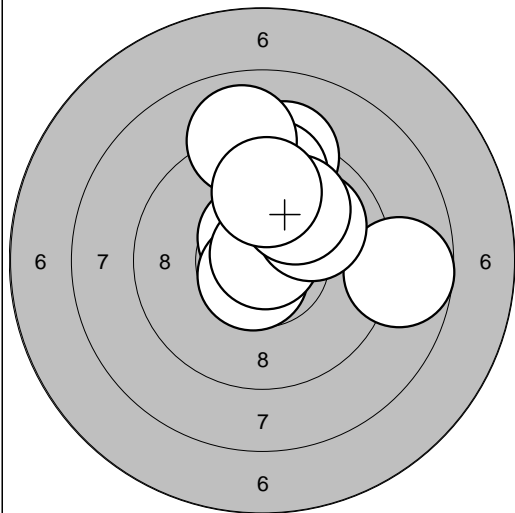

21: 9,2	↑
22: 10,6*	↑
23: 10,7*	↘
24: 10,8*	↑
25: 8,7	→
26: 10,0	↗
27: 9,6	↑
28: 9,0	↑
29: 10,0	↗
30: 9,8	↑

Serie	94,0
Sum	285,0

### Serie 2

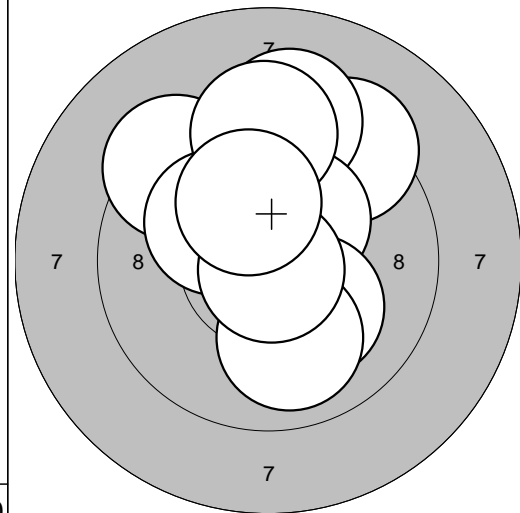

31: 9,3	↗
32: 9,4	↙
33: 10,2*	↙
34: 9,2	↑
35: 10,3*	↗
36: 9,4	↑
37: 10,2*	↘
38: 10,0	↘
39: 10,8*	↘
40: 10,2*	↑

Serie	96,0
Sum	381,0



Your complimentary use period has ended.  
Thank you for using PDF Complete.

[Click Here to upgrade to Unlimited Pages and Expanded Features](#)

Ramselefors SKF

Serie 2

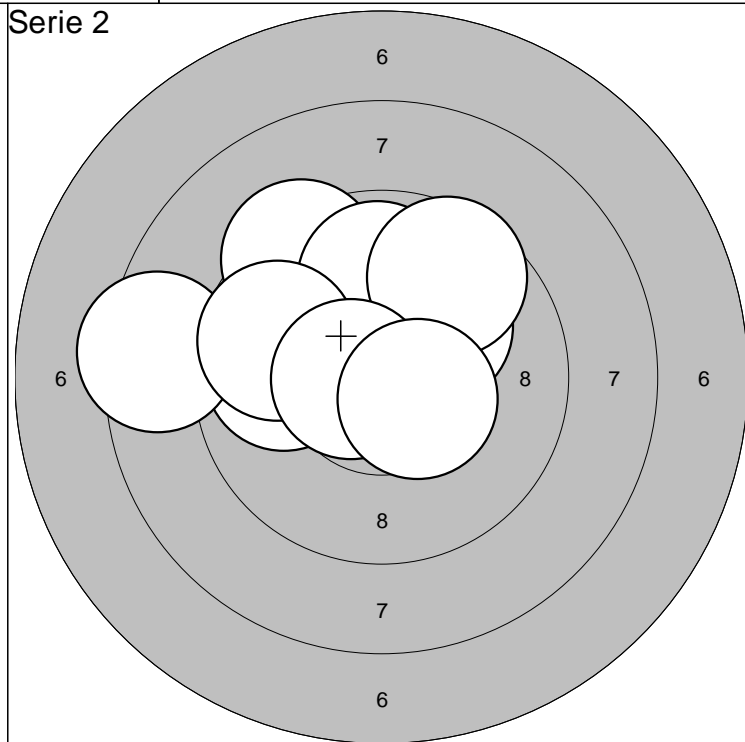
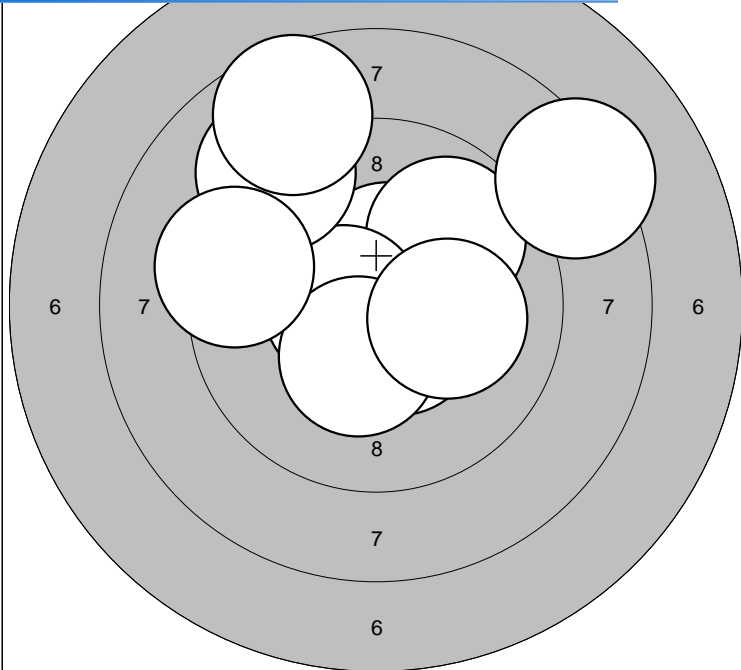

1:10,5*	↑	6: 9,1	↗	Serie	93,0
2: 9,9	↗	7: 9,3	↖		
3:10,5*	↘	8: 8,3	↗	Sum	93,0
4:10,6*	↖	9: 8,6	↗		
5:10,3*	↘	10:10,1	→		

11: 9,9	↖	16: 9,9	↑	Serie	93,0
12: 9,4	↗	17: 9,6	↗		
13:10,6*	↖	18: 9,7	↖	Sum	186,0
14:10,1	↗	19:10,6*	↖		
15: 8,4	↖	20:10,5*	↘		

Serie 2

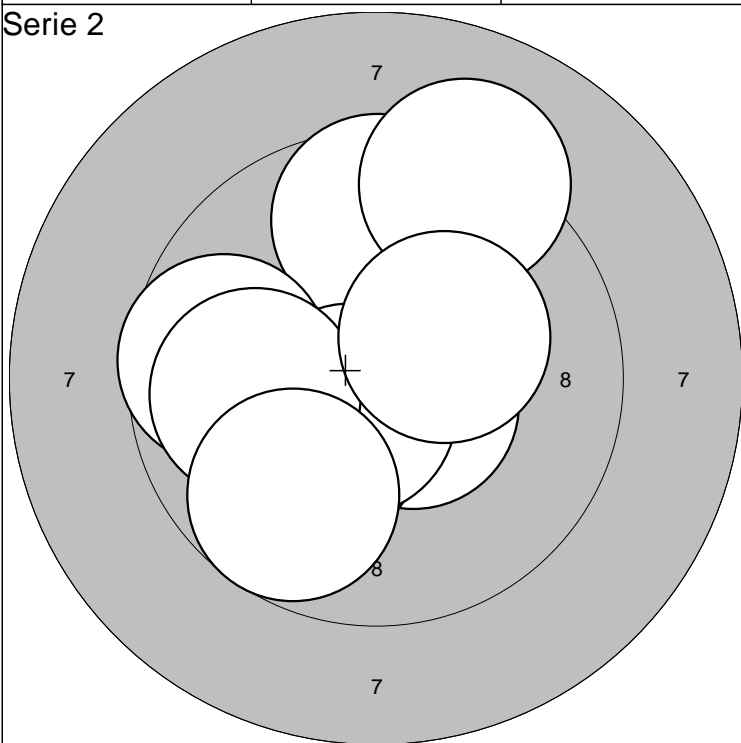

Serie 2

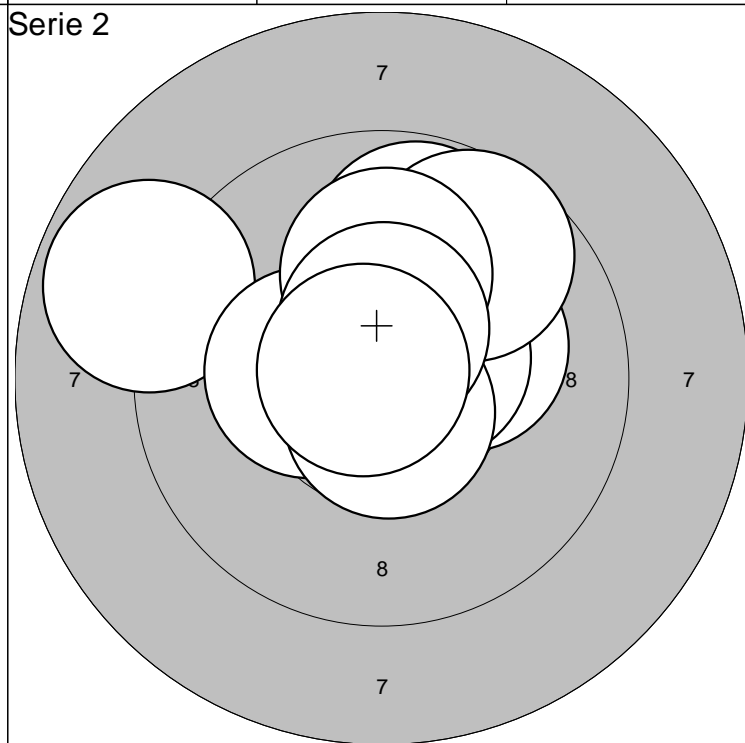

21: 9,6	↑	26: 9,1	↗	Serie	95,0
22:10,1	↖	27:10,6*	↘		
23:10,6*	↘	28: 9,9	↖	Sum	281,0
24:10,2*	↘	29: 9,7	↘		
25: 9,7	↖	30:10,3*	↗		

31:10,2*	↗	36:10,4*	↖	Serie	96,0
32:10,5*	↗	37:10,7*	↘		
33: 9,8	↑	38:10,1	↑	Sum	377,0
34: 9,7	↗	39:10,5*	↑		
35: 8,8	↖	40:10,8*	↖		





Your complimentary use period has ended.  
Thank you for using PDF Complete.

# Jörgen Pålsson

[Click Here to upgrade to Unlimited Pages and Expanded Features](#)

## Ramselefors SKF

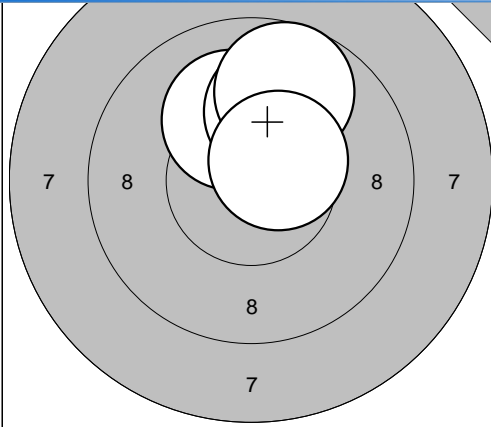

1: 10,1	↗
2: 10,0	↑
3: 9,7	↑
4: 10,5*	↗
<b>Serie</b>	<b>39,0</b>
<b>Sum</b>	<b>0,0</b>

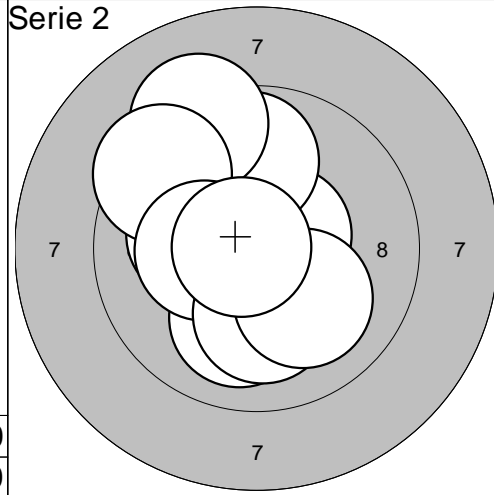

1: 10,6*	↗
2: 10,2*	↖
3: 10,0	↓
4: 9,8	↑
5: 9,2	↑
6: 9,4	↗
7: 10,3*	↖
8: 10,1	↓
9: 10,1	↘
10: 10,8*	↖
<b>Serie</b>	<b>97,0</b>
<b>Sum</b>	<b>97,0</b>

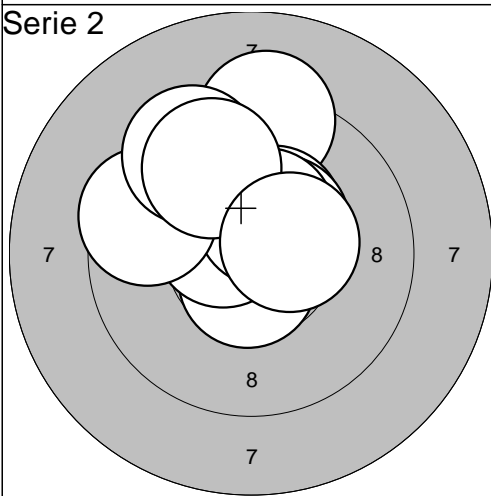

11: 9,2	↑
12: 10,6*	↓
13: 10,4*	↗
14: 10,4*	↗
15: 10,5*	↖
16: 10,5*	↑
17: 9,5	↖
18: 9,5	↑
19: 9,8	↑
20: 10,4*	↗
<b>Serie</b>	<b>96,0</b>
<b>Sum</b>	<b>193,0</b>

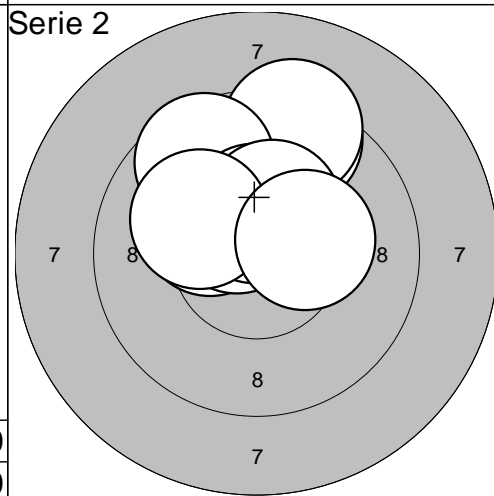

21: 10,3*	↖
22: 10,5*	↗
23: 9,4	↑
24: 10,2*	↑
25: 9,3	↑
26: 9,6	↗
27: 10,4*	↑
28: 10,4*	↑
29: 10,1	↖
30: 10,3*	↗
<b>Serie</b>	<b>97,0</b>
<b>Sum</b>	<b>290,0</b>

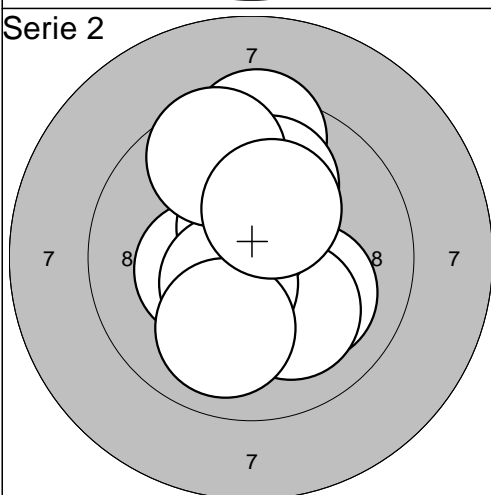

31: 10,1	↘
32: 10,3*	↖
33: 10,1	↓
34: 10,6*	↑
35: 10,5*	↘
36: 10,0	↓
37: 9,4	↑
38: 10,0	↑
39: 9,6	↑
40: 10,3*	↑
<b>Serie</b>	<b>98,0</b>
<b>Sum</b>	<b>388,0</b>

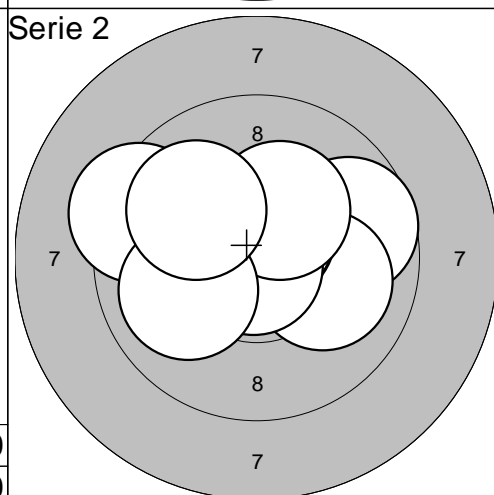

41: 9,7	↗
42: 10,1	↖
43: 10,1	↗
44: 10,6*	↑
45: 10,6*	↑
46: 10,8*	↓
47: 10,3*	↑
48: 9,3	↖
49: 10,0	↖
50: 10,0	↖
<b>Serie</b>	<b>98,0</b>
<b>Sum</b>	<b>486,0</b>

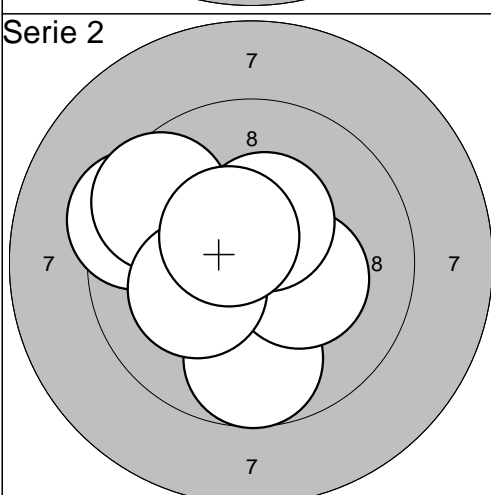

51: 10,3*	↖
52: 9,4	↖
53: 9,7	↓
54: 10,5*	↗
55: 10,3*	↘
56: 10,3*	↗
57: 10,4*	↑
58: 9,6	↗
59: 10,2*	↖
60: 10,5*	↗
<b>Serie</b>	<b>97,0</b>
<b>Sum</b>	<b>583,0</b>

# Saul Johansson

[Click Here to upgrade to Unlimited Pages and Expanded Features](#)

## Ramselefors SKF

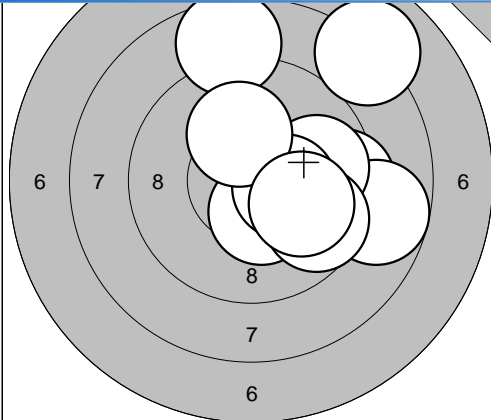

1: 10,4*	↓
2: 10,4	→
3: 8,6	↑
4: 8,8	→
5: 9,8	→
6: 10,4*	→
7: 9,7	↓
8: 8,0	↗
9: 10,1	↑
10: 10,0	→
<b>Serie</b>	<b>91,0</b>
<b>Sum</b>	<b>0,0</b>

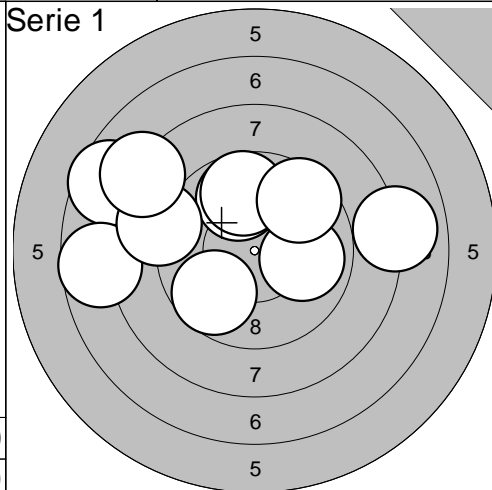

11: 8,0	→
12: 7,6	↖
13: 7,7	←
14: 9,7	↘
15: 9,8	↑
16: 9,9	→
17: 8,9	↖
18: 9,7	↑
19: 8,1	↗
20: 9,5	↗
<b>Serie</b>	<b>83,0</b>
<b>Sum</b>	<b>0,0</b>

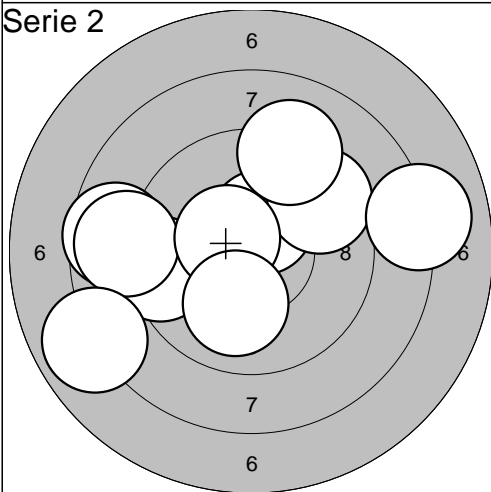

1: 10,4*	↑
2: 9,4	←
3: 8,6	←
4: 9,5	↗
5: 8,8	←
6: 10,5*	↖
7: 10,0	↓
8: 7,9	↖
9: 8,0	→
10: 9,2	↑
<b>Serie</b>	<b>88,0</b>
<b>Sum</b>	<b>88,0</b>

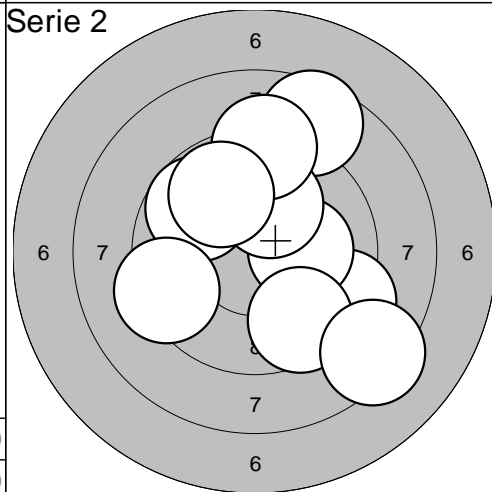

11: 9,8	↖
12: 9,2	→
13: 10,2*	→
14: 9,3	←
15: 9,5	↘
16: 8,6	↑
17: 10,1	↑
18: 9,2	↑
19: 8,3	↘
20: 9,8	↑
<b>Serie</b>	<b>90,0</b>
<b>Sum</b>	<b>178,0</b>

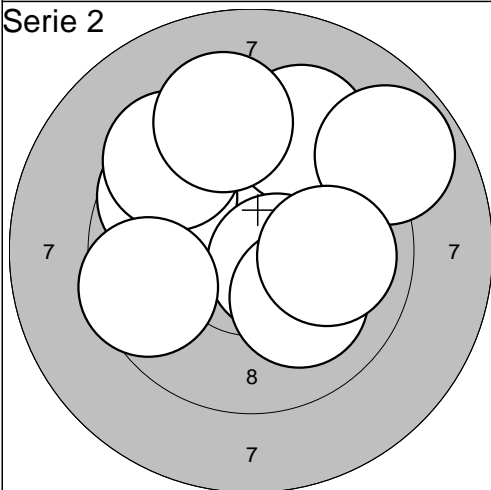

21: 10,4*	↗
22: 9,3	↑
23: 9,7	↖
24: 10,6*	→
25: 9,4	↗
26: 10,1	↘
27: 8,8	↗
28: 9,3	↑
29: 10,0	→
30: 9,6	←
<b>Serie</b>	<b>93,0</b>
<b>Sum</b>	<b>271,0</b>

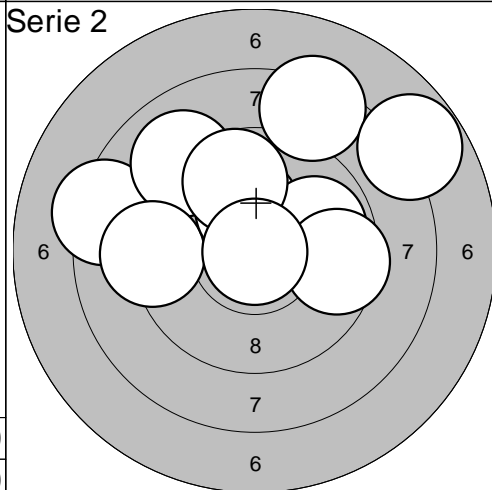

31: 8,4	↑
32: 8,3	←
33: 9,0	↗
34: 9,2	←
35: 10,3*	↑
36: 9,9	→
37: 9,7	↑
38: 9,5	→
39: 7,8	↗
40: 10,9*	↓
<b>Serie</b>	<b>88,0</b>
<b>Sum</b>	<b>359,0</b>

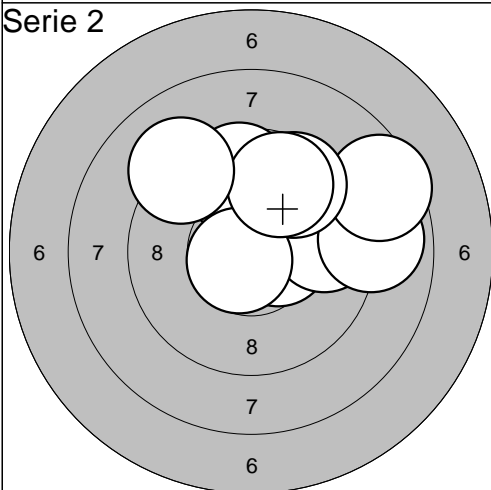

41: 9,7	↑
42: 10,5*	→
43: 9,7	→
44: 9,7	↑
45: 8,9	→
46: 8,5	↗
47: 9,6	↗
48: 10,7*	↖
49: 9,7	↑
50: 9,1	↖
<b>Serie</b>	<b>90,0</b>
<b>Sum</b>	<b>449,0</b>

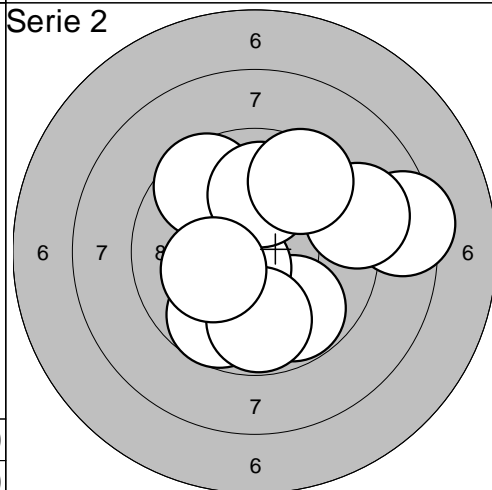

51: 9,8	↘
52: 10,6*	↘
53: 9,7	↘
54: 8,4	→
55: 9,6	↗
56: 9,8	↓
57: 10,0	↑
58: 9,1	→
59: 10,2*	←
60: 9,5	↑
<b>Serie</b>	<b>92,0</b>
<b>Sum</b>	<b>541,0</b>