

1:	6.8	→
2:	8.6	↘
3:	10.2	→
4:	9.5	↘
5:	9.4	→
6:	10.0	→
7:	9.9	↘
8:	9.7	↓
9:	10.7x	↓
10:	10.3x	←
Serie		90
Total		0

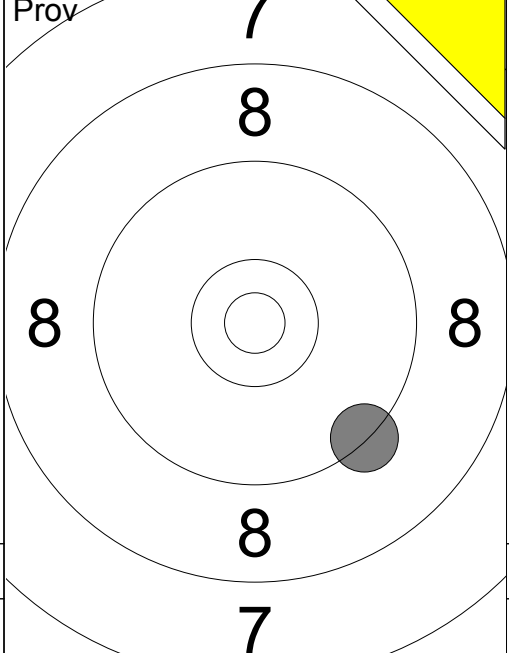

11:	9.3	↘
Serie		9
Total		0

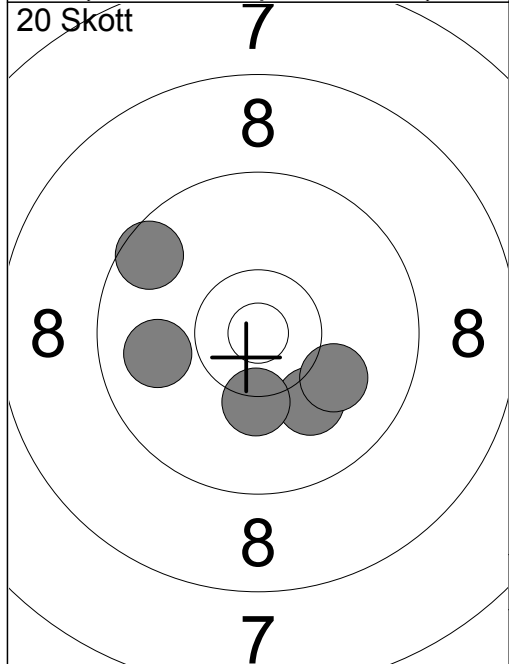

1:	9.6	↖
2:	9.9	←
3:	10.1	↘
4:	10.2	↓
5:	10.1	↘
Serie		48
Total		48

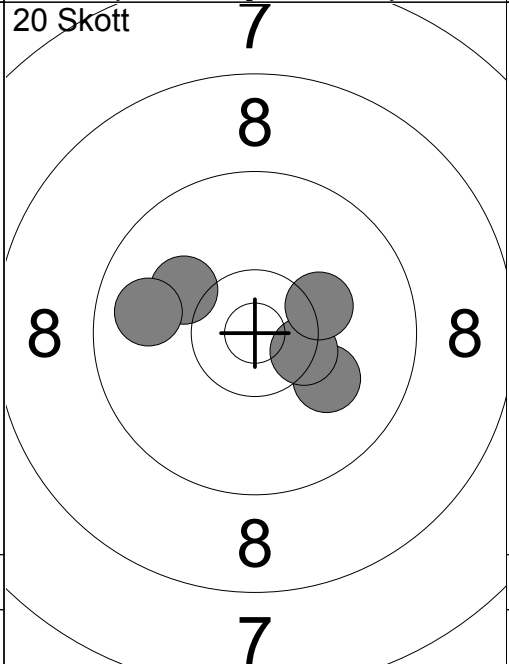

6:	10.1	↘
7:	10.1	↖
8:	10.4x	→
9:	10.2	↗
10:	9.8	←
Serie		49
Total		97

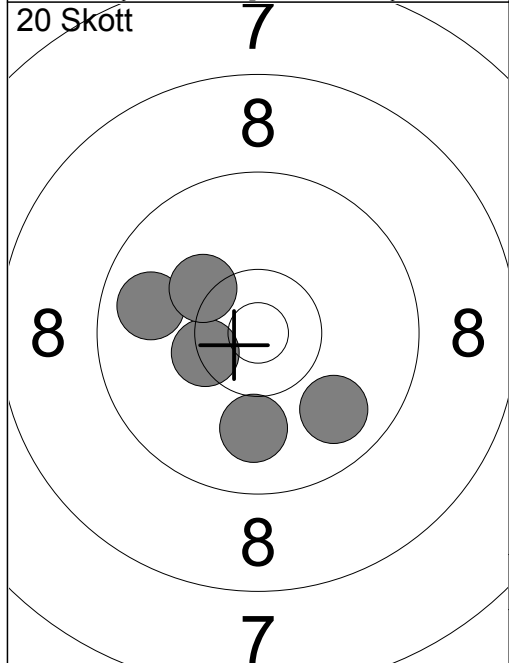

11:	10.4x	←
12:	9.8	↖
13:	10.0	↓
14:	10.2	↗
15:	9.8	↘
Serie		48
Total		145

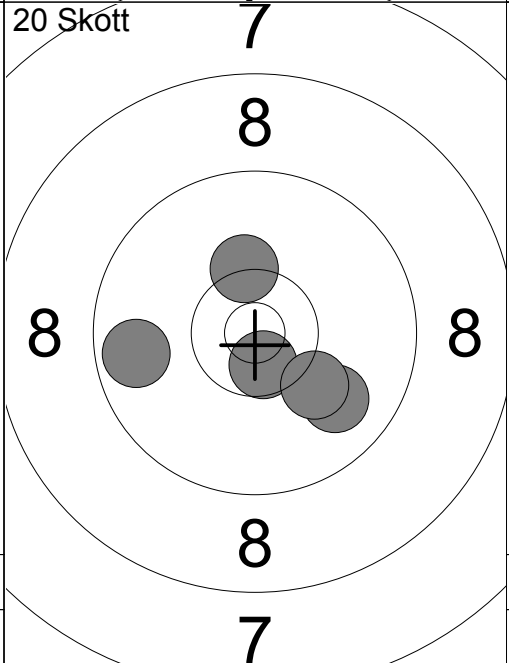

16:	9.9	↘
17:	10.6x	↘
18:	10.3	↑
19:	10.1	↘
20:	9.7	←
Serie		48
Total		193

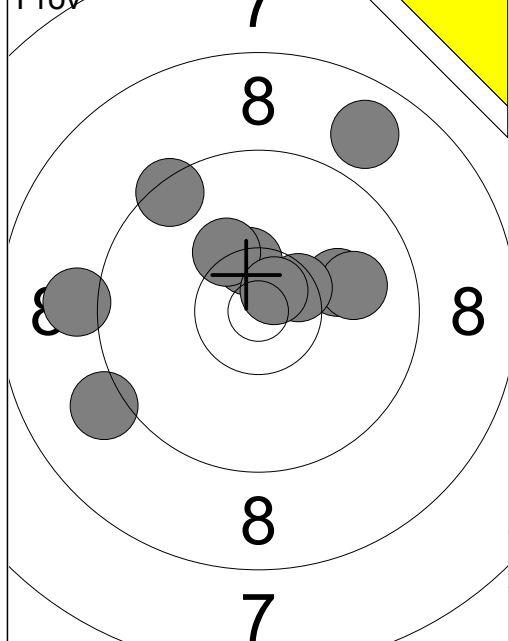

1:	9.1	↙
2:	10.4x	↑
3:	10.1	→
4:	9.1	←
5:	9.9	→
6:	8.8	↗
7:	10.5x	↗
8:	10.3	↗
9:	9.4	↖
10:	10.7x	↗
Serie		94
Total		0

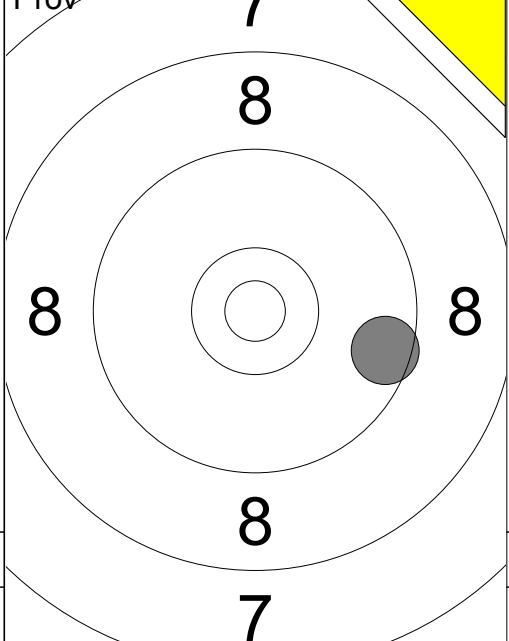

11:	9.6	→
Serie		9
Total		0

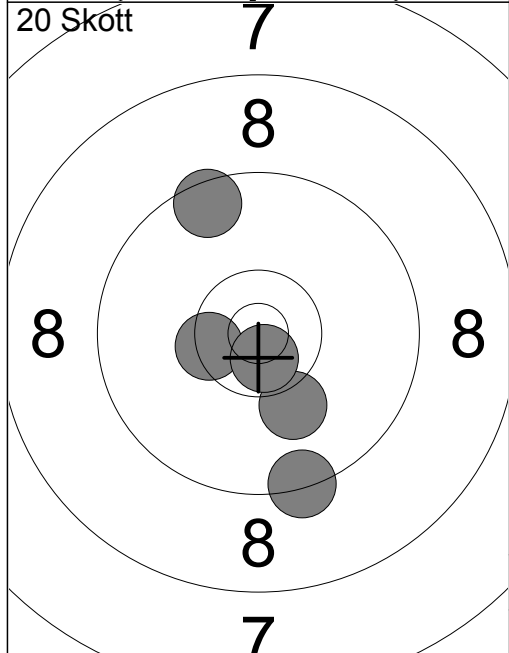

1:	9.5	↖
2:	9.3	↓
3:	10.1	↓
4:	10.4x	←
5:	10.7x	↓
Serie		48
Total		48

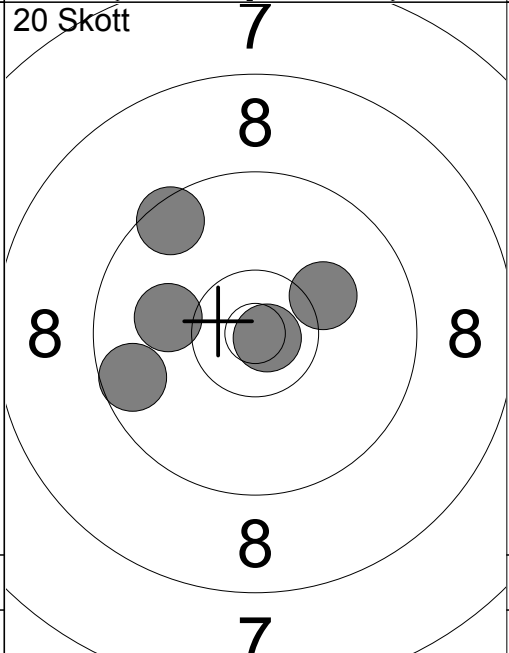

6:	10.2	↗
7:	10.0	←
8:	9.5	↗
9:	9.6	←
10:	10.8x	→
Serie		48
Total		96

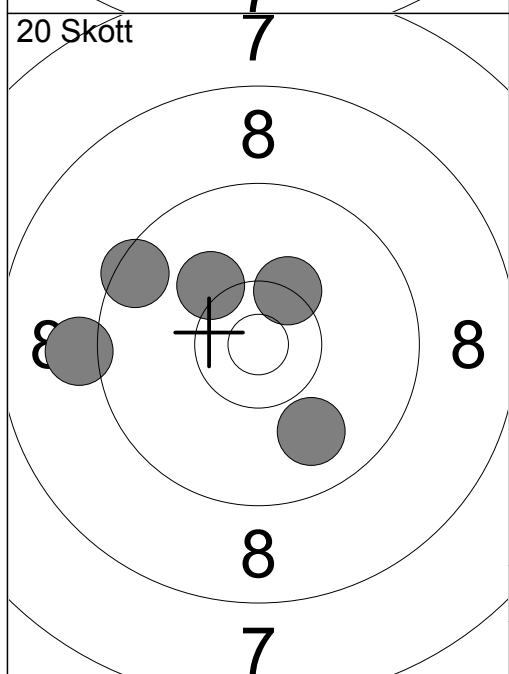

11:	9.1	←
12:	10.2	↗
13:	9.5	↖
14:	9.9	↓
15:	10.3x	↗
Serie		47
Total		143

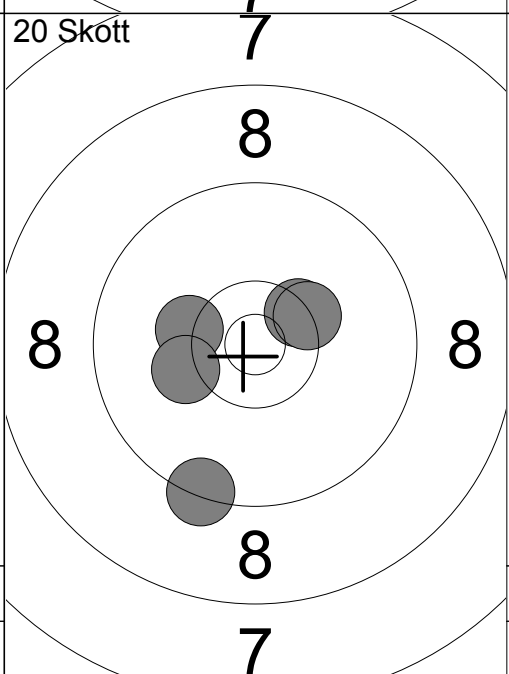

16:	10.4x	↗
17:	10.3	←
18:	10.3x	↗
19:	9.3	↓
20:	10.2	←
Serie		49
Total		192

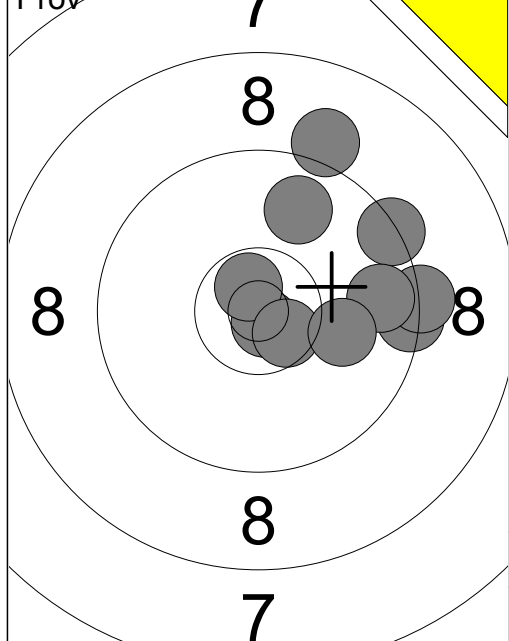

1:	10.8x	↘
2:	9.4	→
3:	9.1	↗
4:	10.7x	↗
5:	9.4	↗
6:	9.3	→
7:	10.6x	↘
8:	9.8	↗
9:	9.7	→
10:	10.1	→
Serie		94
Total		0

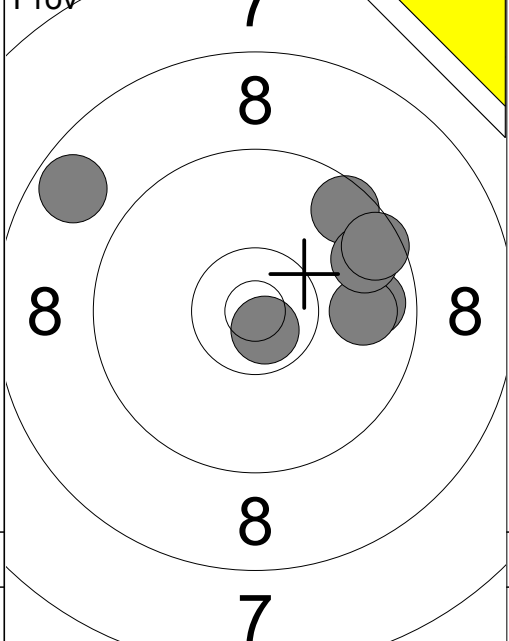

11:	10.7x	↘
12:	9.8	→
13:	9.8	→
14:	9.6	↗
15:	8.7	↖
16:	9.7	↗
17:	9.6	↗
Serie		63
Total		0

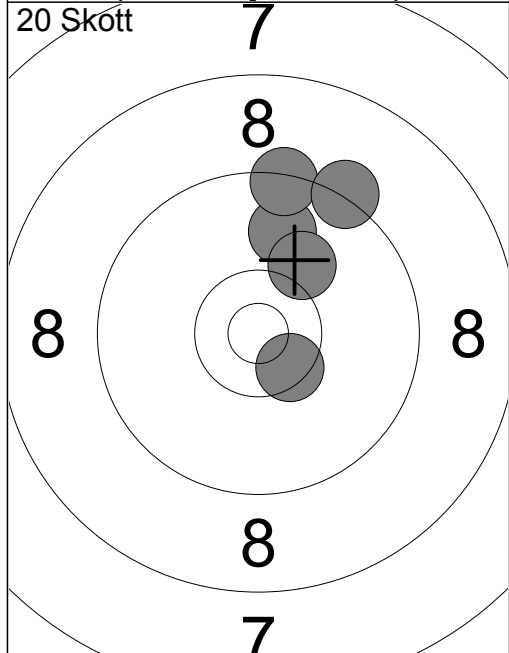

1:	9.9	↗
2:	10.1	↗
3:	9.4	↗
4:	9.3	↗
5:	10.5x	↘
Serie		47
Total		47

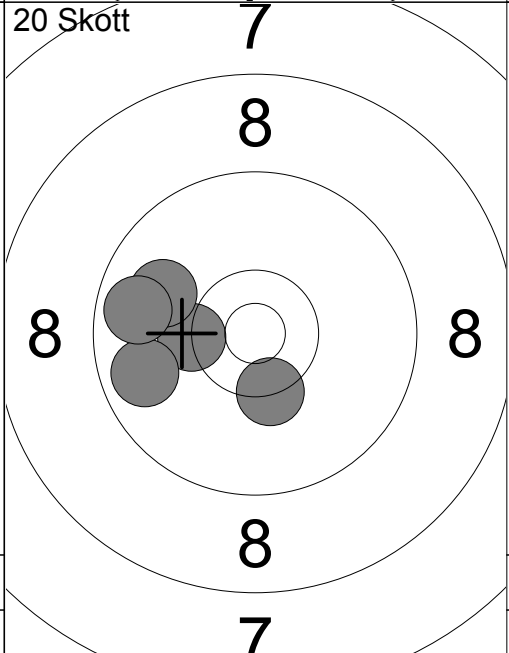

6:	10.3x	←
7:	9.8	←
8:	10.3x	↘
9:	9.9	←
10:	9.7	←
Serie		47
Total		94

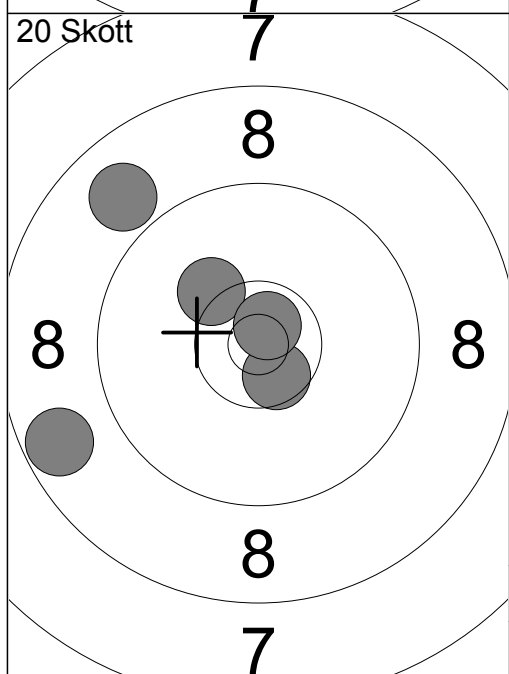

11:	10.6x	↘
12:	8.9	↗
13:	10.2	↗
14:	10.7x	↗
15:	8.7	↖
Serie		46
Total		140

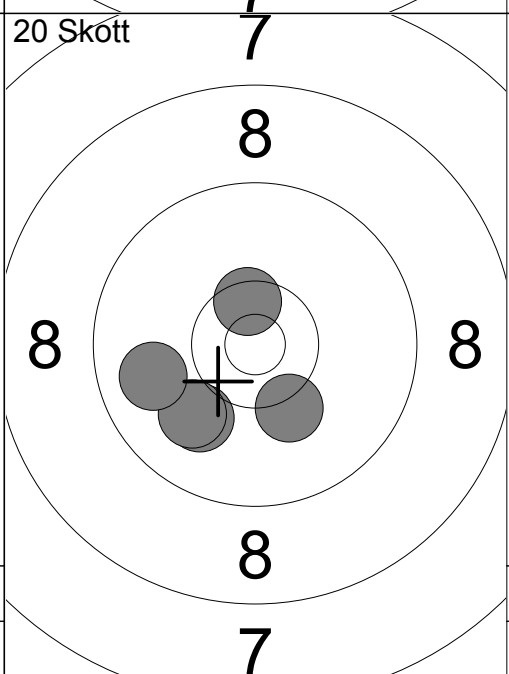

16:	10.2	↘
17:	10.0	↘
18:	10.0	↘
19:	9.9	←
20:	10.5x	↗
Serie		49
Total		189

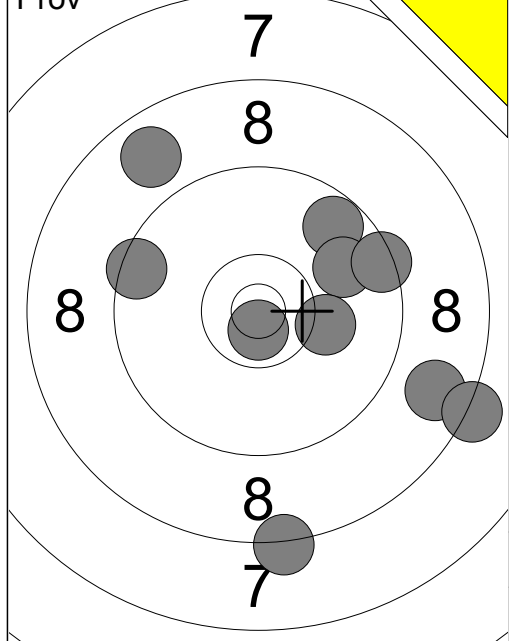

1:	9.7	↗
2:	8.7	→
3:	9.9	→
4:	8.8	↗
5:	9.4	→
6:	9.5	↖
7:	10.7x	↓
8:	8.3	↓
9:	8.2	→
10:	10.2	→
Serie		88
Total		0

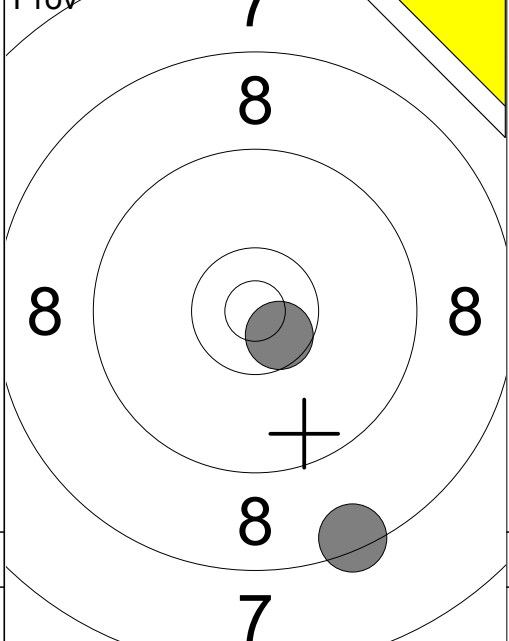

11:	10.6x	↘
12:	8.4	↓
Serie		18
Total		0

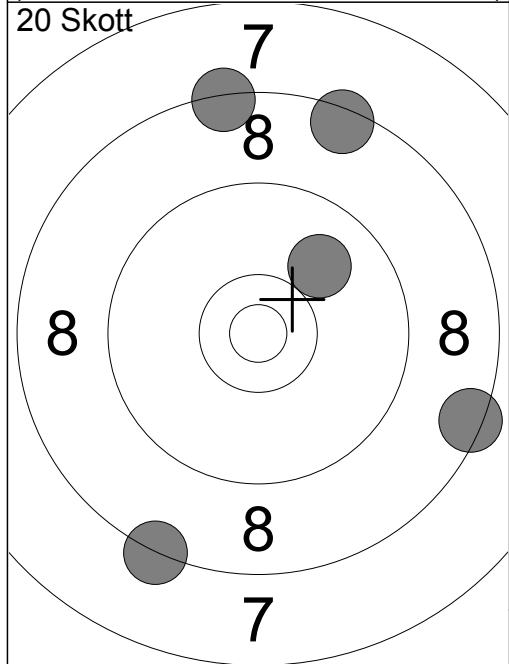

1:	8.4	→
2:	8.3	↘
3:	8.5	↗
4:	8.4	↗
5:	9.9	↗
Serie		41
Total		41

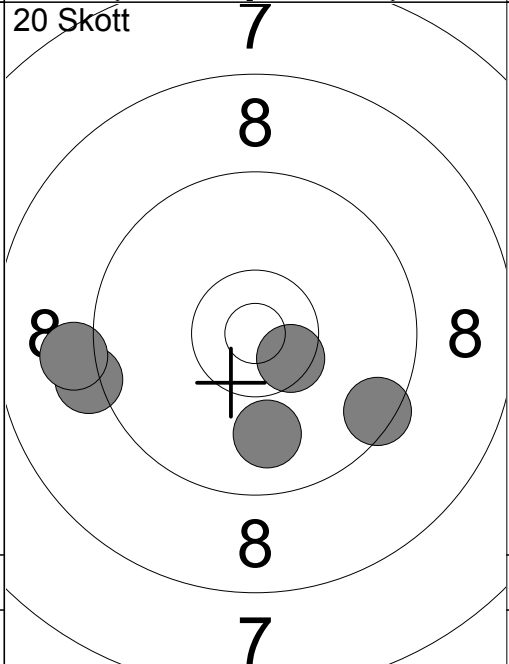

6:	10.5x	↘
7:	9.2	↖
8:	9.1	↖
9:	9.5	↘
10:	9.9	↓
Serie		46
Total		87

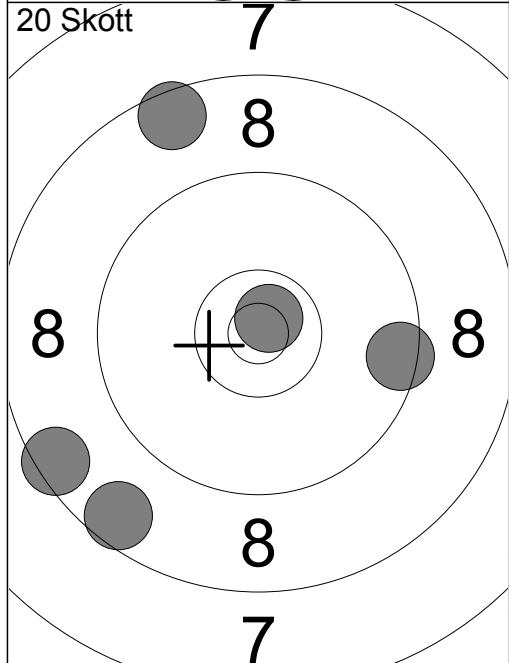

11:	8.6	↖
12:	8.5	↖
13:	8.6	↖
14:	10.8x	↗
15:	9.5	→
Serie		43
Total		130

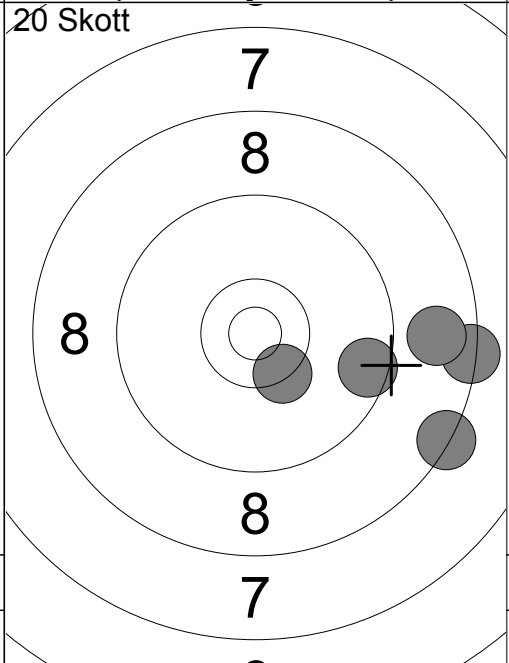

16:	10.4x	↘
17:	9.5	→
18:	8.4	→
19:	8.8	→
20:	8.3	↘
Serie		43
Total		173

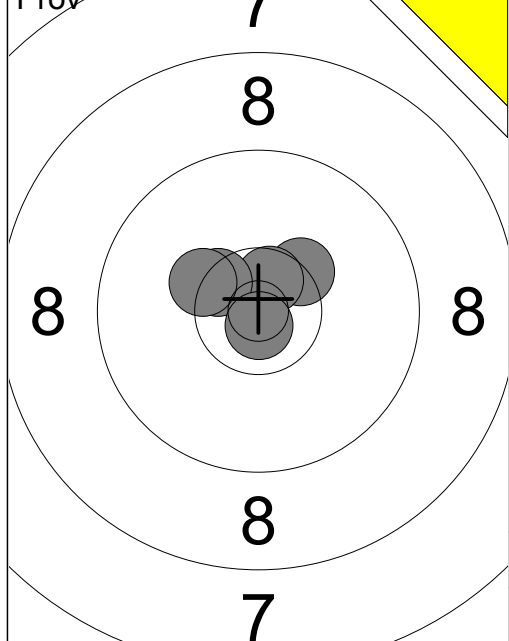

1:	10.4x ↗
2:	10.6x ↑
3:	10.4x ↖
4:	10.3x ↖
5:	10.8x ↓
Serie 50	
Total 0	

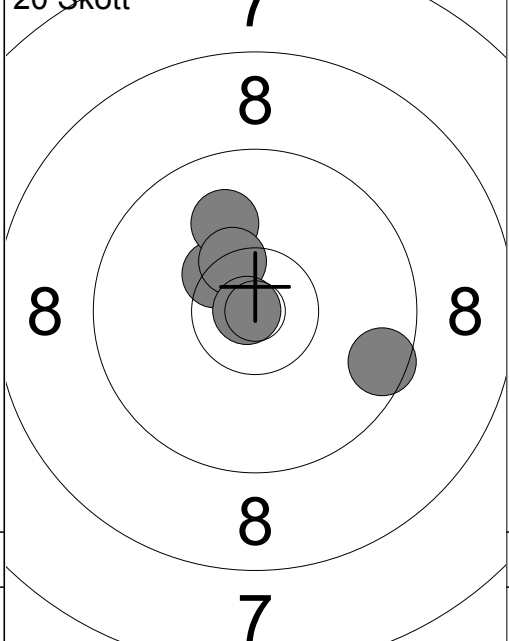

1:	10.4x ↖
2:	10.0 ↑
3:	10.4x ↑
4:	10.9x ←
5:	9.6 →
Serie 49	
Total 49	

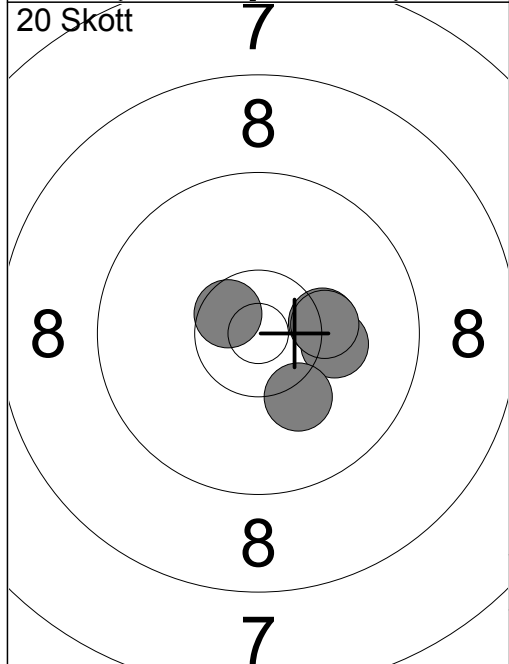

6:	10.6x ↖
7:	10.3 →
8:	10.2 →
9:	10.2 ↓
10:	10.3 →
Serie 50	
Total 99	

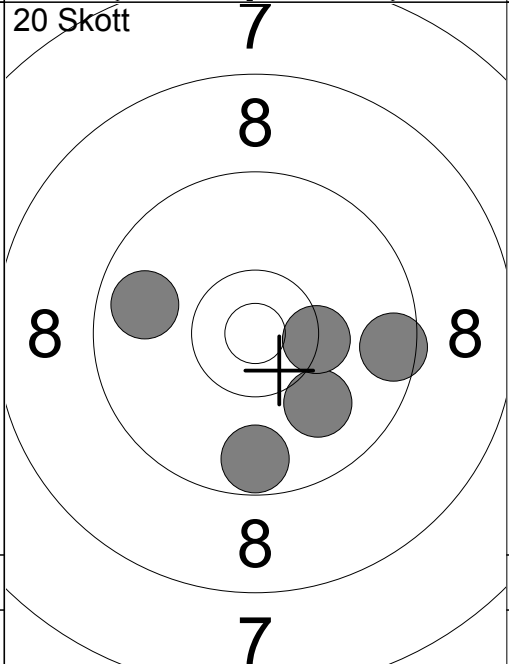

11:	10.0 ↓
12:	10.3x →
13:	9.5 →
14:	9.7 ↓
15:	9.8 ←
Serie 47	
Total 146	

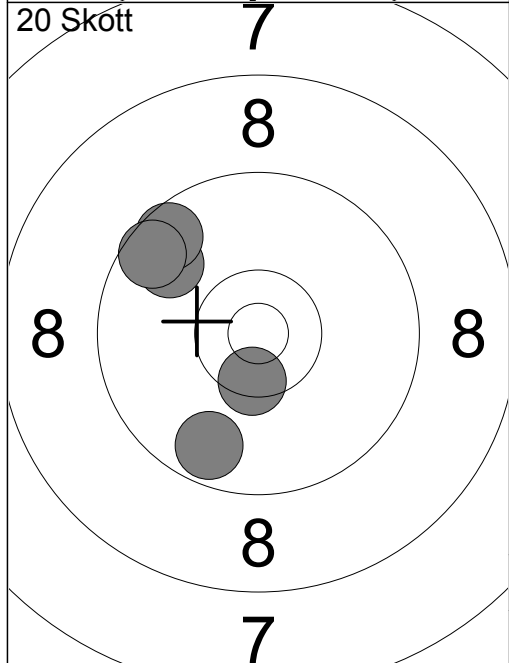

16:	9.7 ↓
17:	9.8 ↗
18:	9.6 ↗
19:	9.6 ↗
20:	10.5x ↓
Serie 46	
Total 192	

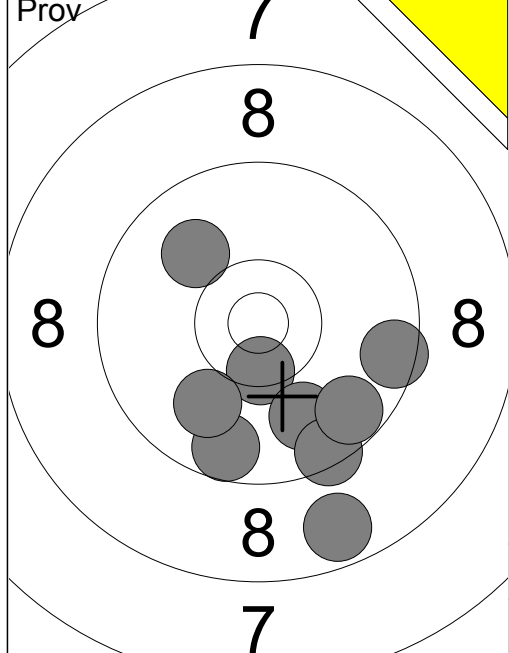

- 1: 9.6 ↘
- 2: 8.7 ↘
- 3: 10.5x ↘
- 4: 10.0 ↘
- 5: 9.9 ↘
- 6: 9.4 ↘
- 7: 10.0 ↗
- 8: 9.7 ↘
- 9: 9.5 →

Serie 83
Total 0

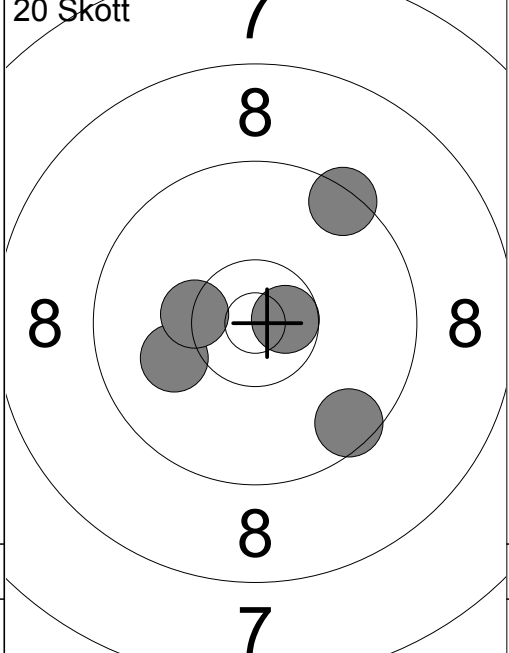

- 1: 9.5 ↘
- 2: 9.4 ↗
- 3: 10.0 ←
- 4: 10.3x ←
- 5: 10.6x →

Serie 48
Total 48

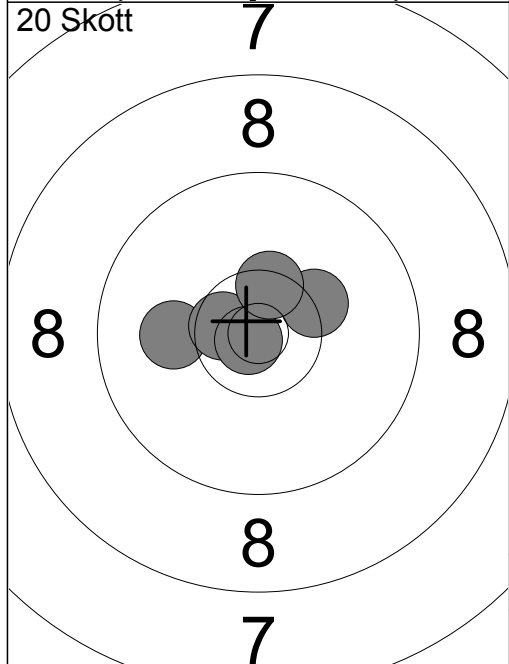

- 6: 10.1 ←
- 7: 10.6x ←
- 8: 10.8x ←
- 9: 10.3x ↗
- 10: 10.4x ↑

Serie 50
Total 98

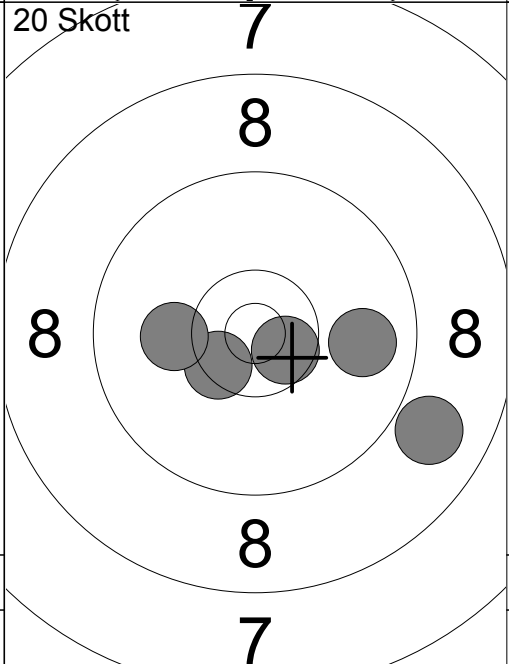

- 11: 8.9 ↘
- 12: 10.4x ↘
- 13: 9.8 →
- 14: 10.1 ←
- 15: 10.6x ↘

Serie 47
Total 145

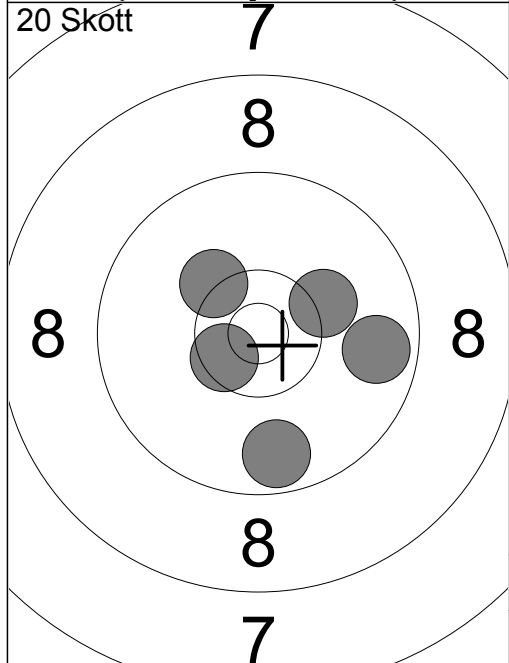

- 16: 10.2 ↗
- 17: 9.7 →
- 18: 9.7 ↘
- 19: 10.5x ↘
- 20: 10.3 ↖

Serie 48
Total 193

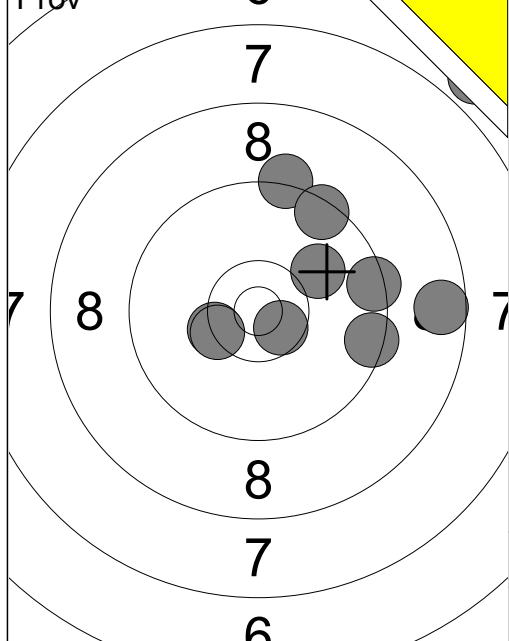

1:	6.9 ↗
2:	9.4 →
3:	8.6 →
4:	9.3 ↑
5:	10.6x ↘
6:	10.0 ↗
7:	9.5 ↗
8:	10.3x ←
9:	9.5 →
10:	10.4x ←
Serie 90	
Total 0	

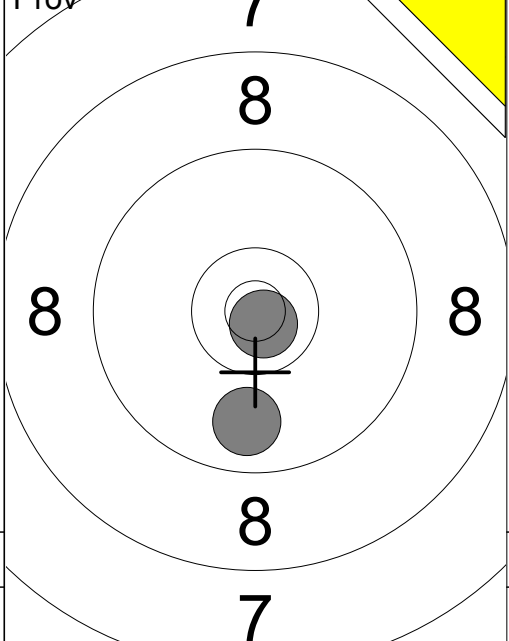

11:	9.8 ↓
12:	10.8x ↘
Serie 19	
Total 0	

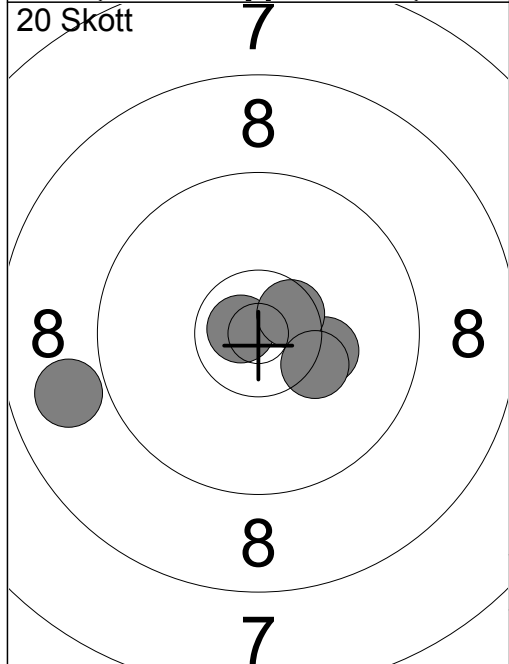

1:	8.9 ←
2:	10.8x ←
3:	10.2 →
4:	10.6x ↗
5:	10.3 ↘
Serie 48	
Total 48	

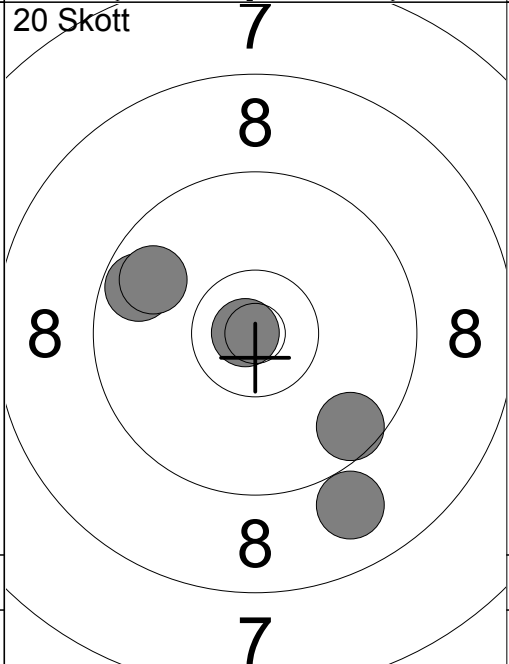

6:	9.7 ←
7:	9.8 ←
8:	9.6 ↘
9:	10.8x ←
10:	8.9 ↘
Serie 45	
Total 93	

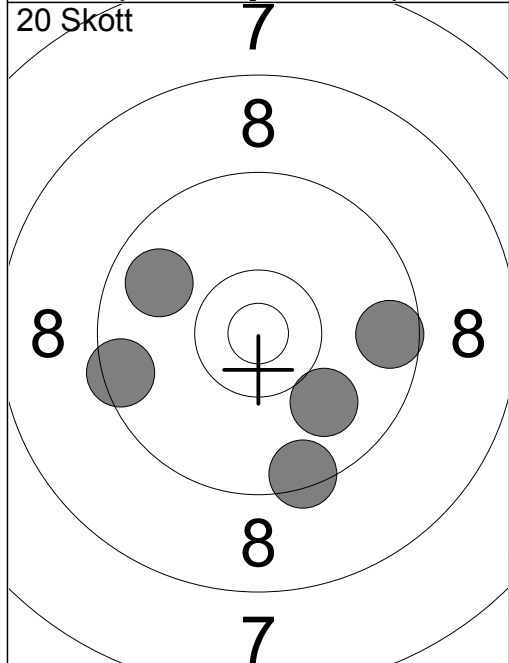

11:	9.4 ↓
12:	10.0 ↘
13:	9.6 →
14:	9.5 ←
15:	9.8 ↖
Serie 46	
Total 139	

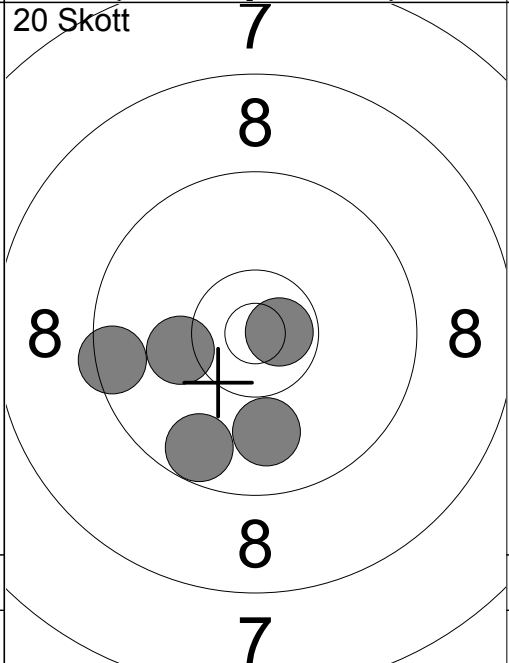

16:	9.5 ←
17:	10.7x →
18:	9.9 ↓
19:	9.7 ↘
20:	10.2 ←
Serie 47	
Total 186	

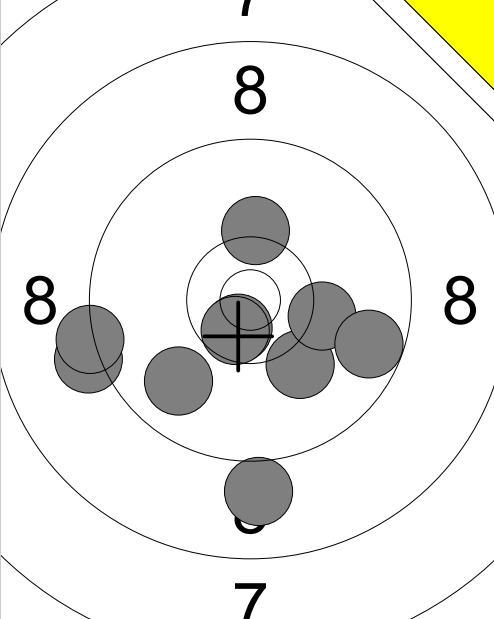
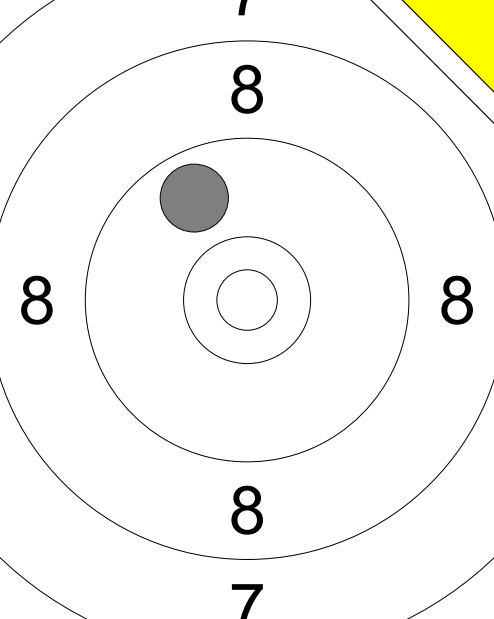
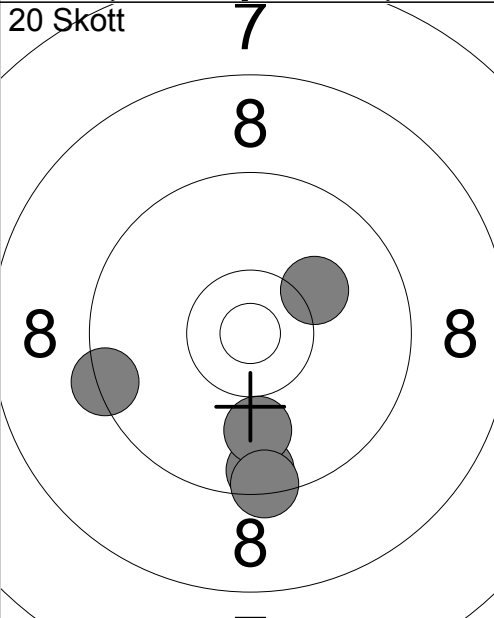
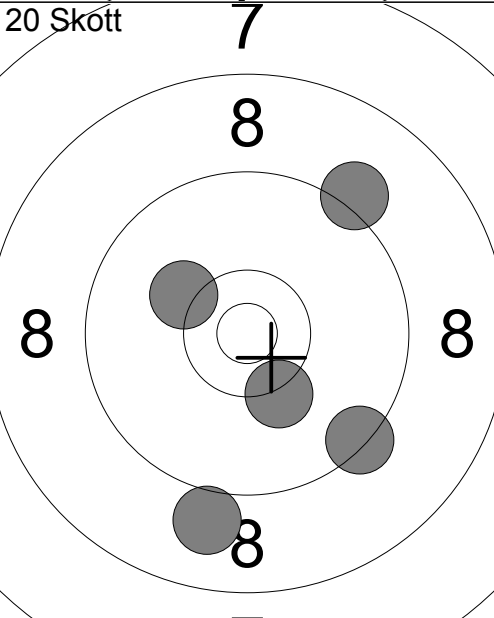
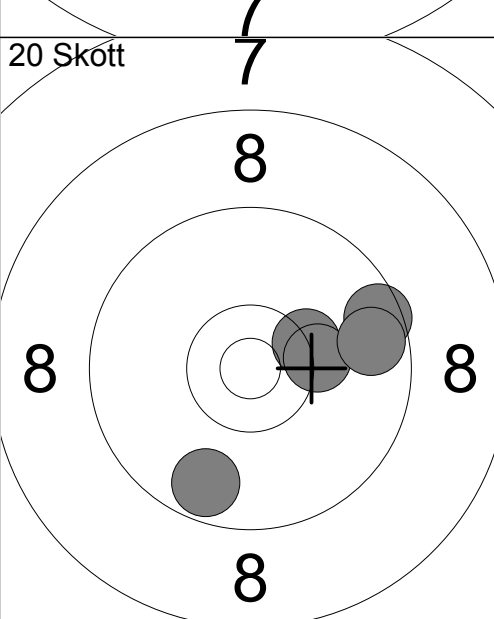
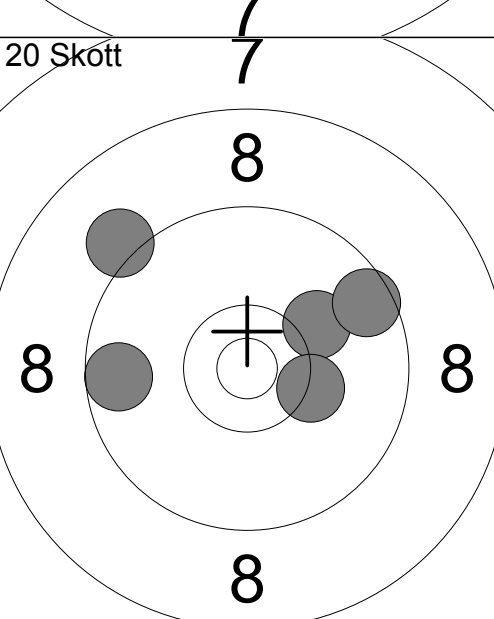
Prov 	1: 9.0 ↓ 2: 9.2 ← 3: 9.8 ↙ 4: 10.1 ↓ 5: 10.6x ↓ 6: 9.3 ← 7: 10.6x ↓ 8: 10.2 → 9: 9.7 → 10: 10.2 ↑	Prov 	11: 9.8 ↗
Serie 95 Total 0		Serie 9 Total 0	
20 Skött 	1: 9.4 ← 2: 9.5 ↓ 3: 10.2 ↗ 4: 10.0 ↓ 5: 9.4 ↓	20 Skött 	6: 9.4 ↓ 7: 9.0 ↓ 8: 10.2 ↗ 9: 10.3 ↓ 10: 9.2 ↗
Serie 47 Total 47		Serie 47 Total 94	
20 Skött 	11: 10.3x → 12: 9.5 → 13: 10.3 → 14: 9.7 ↓ 15: 9.7 →	20 Skött 	16: 9.1 ↗ 17: 9.6 ← 18: 10.1 ↗ 19: 10.3 → 20: 9.6 →
Serie 47 Total 141		Serie 47 Total 188	

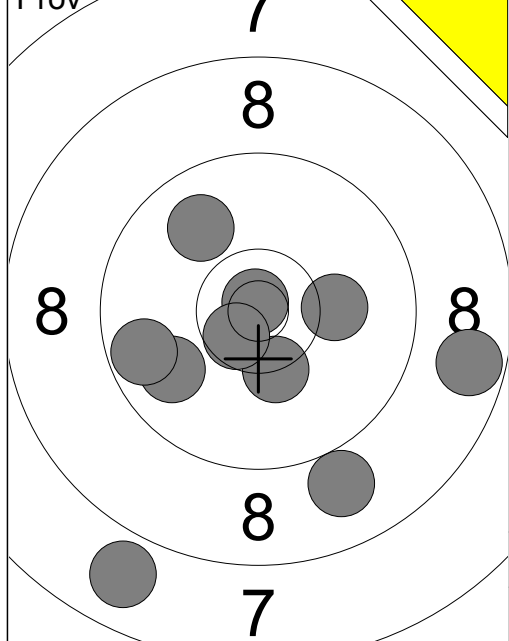

1:	8.7	→
2:	9.0	↓
3:	10.2	→
4:	9.9	↙
5:	10.3x	↓
6:	9.9	↗
7:	7.9	↓
8:	10.8x	↗
9:	10.6x	↙
10:	9.7	↙
Serie		91
Total		0

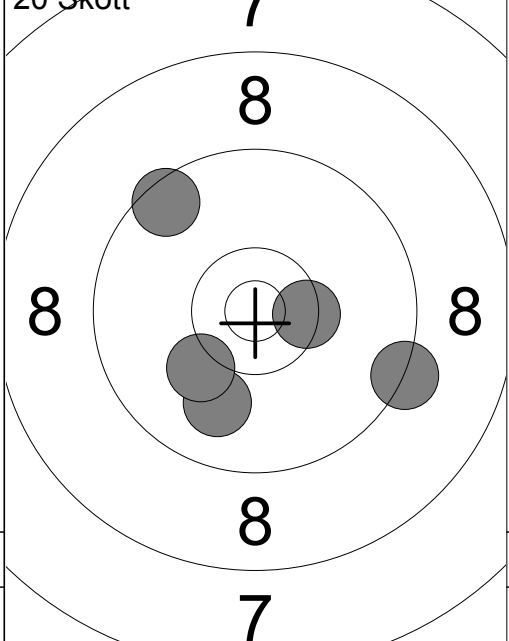

1:	9.5	↖
2:	9.9	↓
3:	9.3	→
4:	10.4x	→
5:	10.1	↙
Serie		47
Total		47

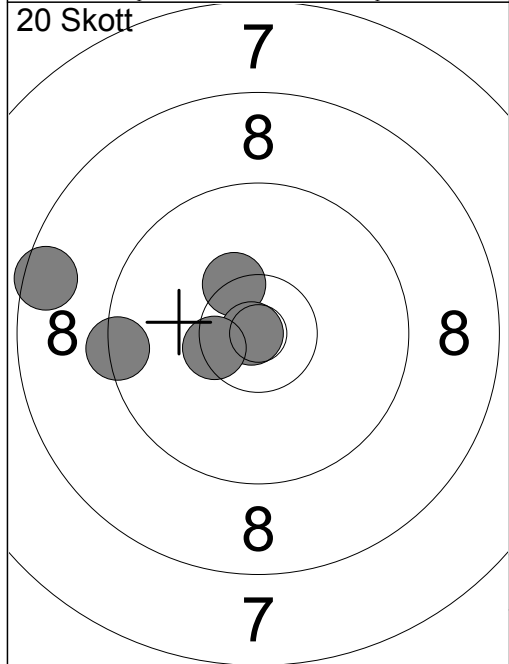

6:	10.3x	↗
7:	8.5	↙
8:	9.4	↙
9:	10.9x	↙
10:	10.4x	↙
Serie		47
Total		94

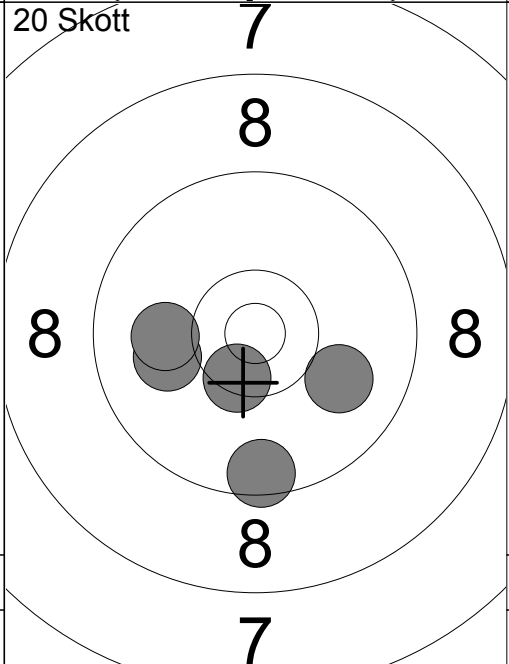

11:	10.0	↙
12:	10.0	↙
13:	10.5x	↙
14:	10.0	→
15:	9.5	↓
Serie		49
Total		143

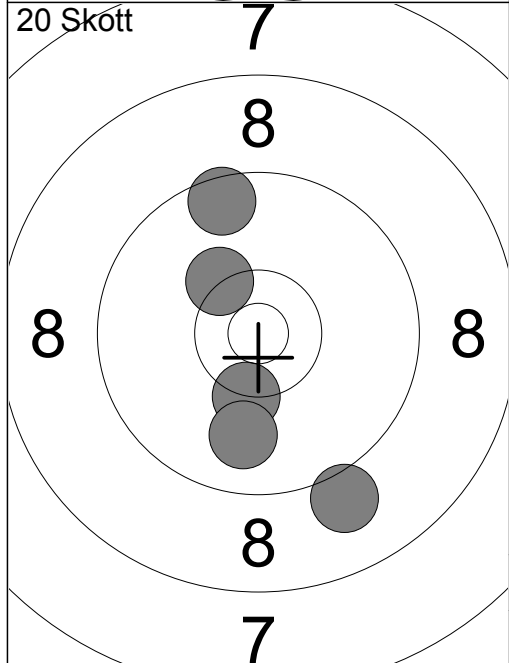

16:	9.0	↓
17:	9.5	↗
18:	10.3x	↓
19:	10.3	↗
20:	9.9	↓
Serie		47
Total		190

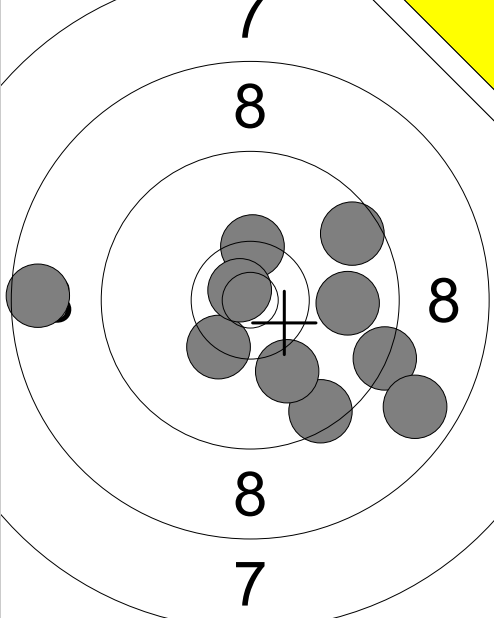
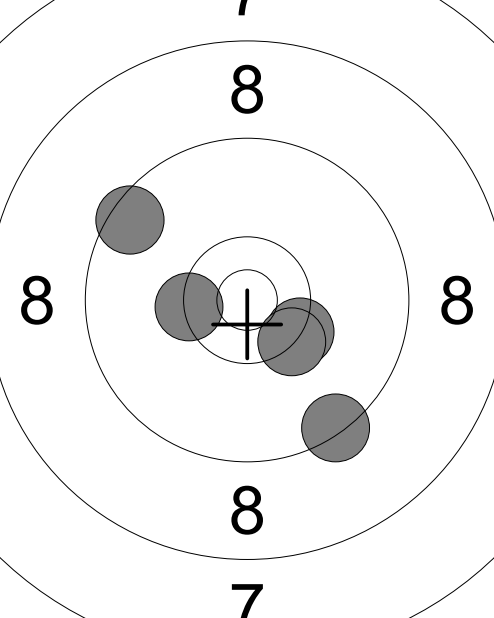
Prov 	1: 9.5 ↘ 2: 10.1 ↘ 3: 9.3 → 4: 10.4x ↑ 5: 9.9 → 6: 8.8 ↘ 7: 10.3x ↘ 8: 9.6 ↗ 9: 10.8x ↖ 10: 8.6 ←	20 Skött 	1: 10.3x ↘ 2: 9.4 ↘ 3: 10.3x ↘ 4: 9.5 ↗ 5: 10.4x ←
Serie	92	Serie	48
Total	0	Total	48

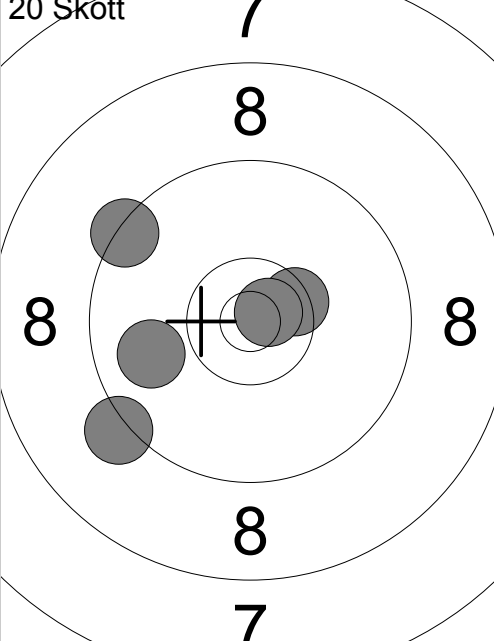
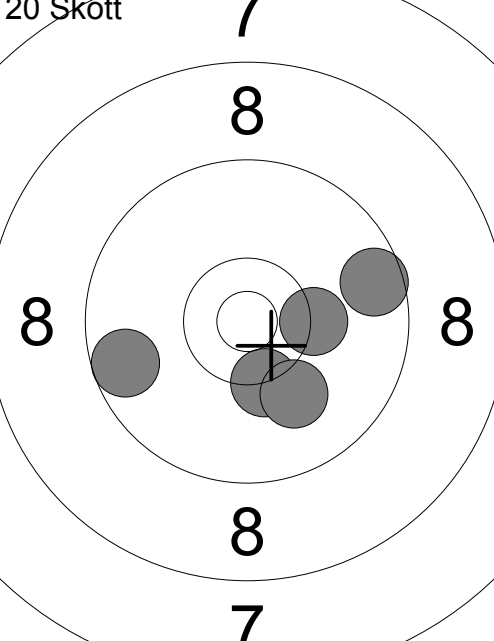
20 Skött 	6: 9.4 ↖ 7: 10.5x → 8: 10.7x → 9: 9.9 ← 10: 9.2 ↘	20 Skött 	11: 9.6 ← 12: 10.3x ↘ 13: 10.3 → 14: 9.6 → 15: 10.1 ↘
Serie	47	Serie	48
Total	95	Total	143

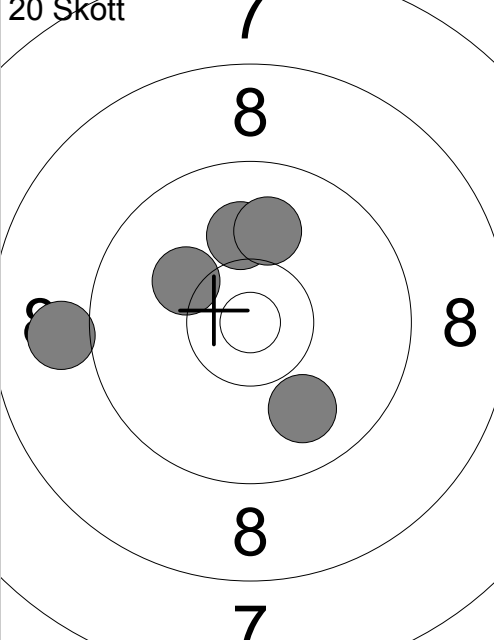
20 Skött 	16: 10.1 ↑ 17: 10.0 ↑ 18: 9.0 ← 19: 9.9 ↘ 20: 10.2 ↖	
Serie	48	
Total	191	

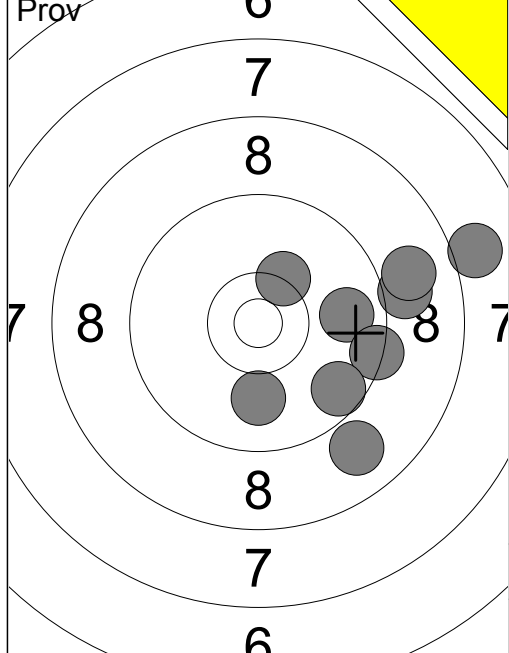

- 1: 8.0 →
- 2: 9.0 →
- 3: 10.0 ↓
- 4: 8.9 ↓
- 5: 10.3x ↗
- 6: 8.9 →
- 7: 9.8 →
- 8: 9.4 →
- 9: 9.6 ↓

Serie 80
Total 0

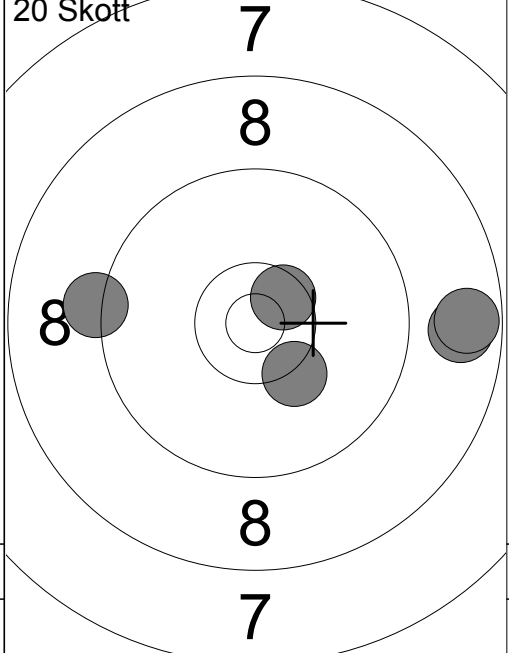

- 1: 10.3 ↓
- 2: 9.2 ←
- 3: 8.7 →
- 4: 10.5x ↗
- 5: 8.7 →

Serie 45
Total 45

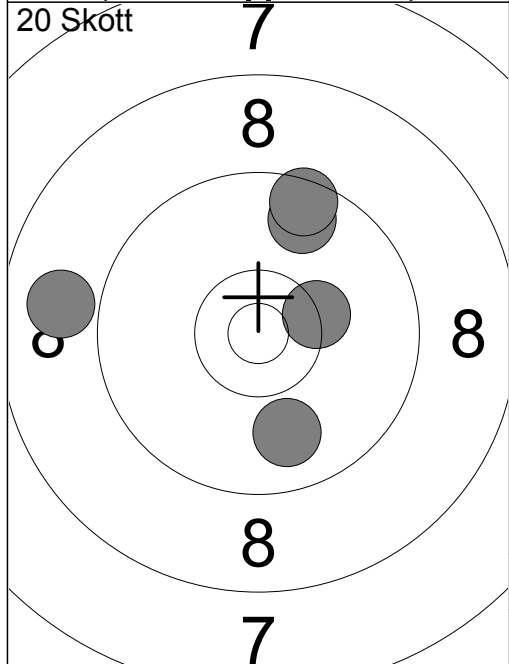

- 6: 10.3x →
- 7: 9.7 ↗
- 8: 9.5 ↗
- 9: 8.9 ←
- 10: 9.9 ↓

Serie 45
Total 90

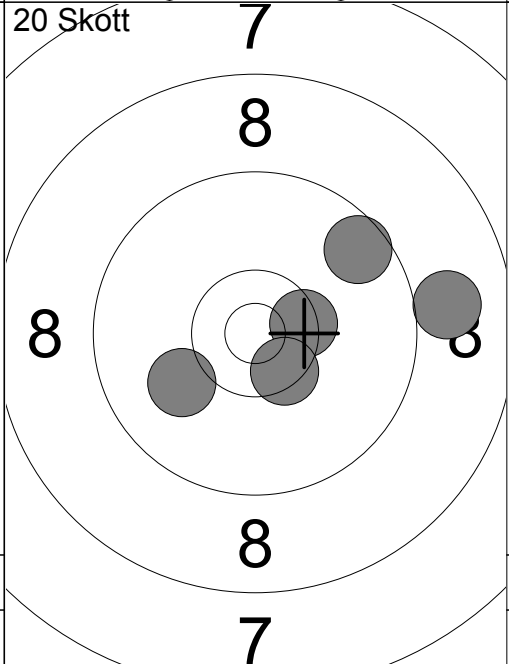

- 11: 10.0 ↙
- 12: 10.4x →
- 13: 9.6 ↗
- 14: 9.0 →
- 15: 10.5x ↓

Serie 48
Total 138

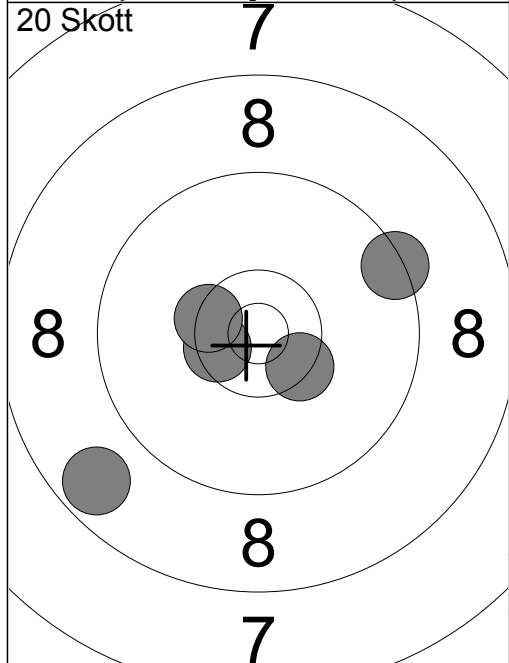

- 16: 8.7 ↙
- 17: 10.5x ←
- 18: 9.4 →
- 19: 10.4x ←
- 20: 10.4x ↓

Serie 47
Total 185

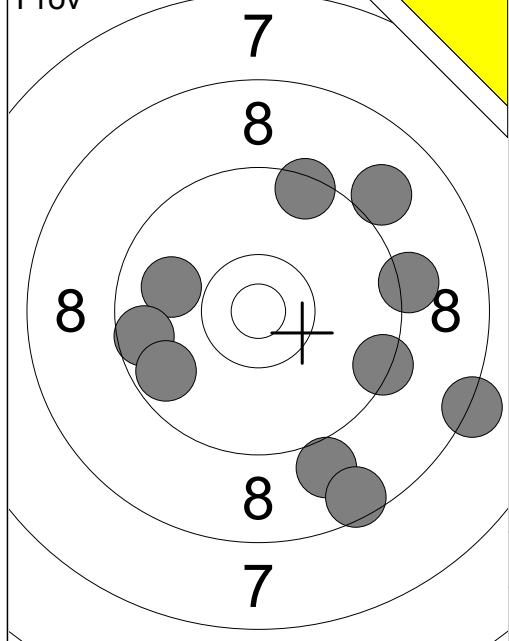

1:	9.4	→
2:	9.0	↓
3:	8.5	↓
4:	8.3	→
5:	9.9	←
6:	9.6	←
7:	9.7	←
8:	9.4	↑
9:	9.2	→
10:	9.0	↗
Serie		88
Total		0

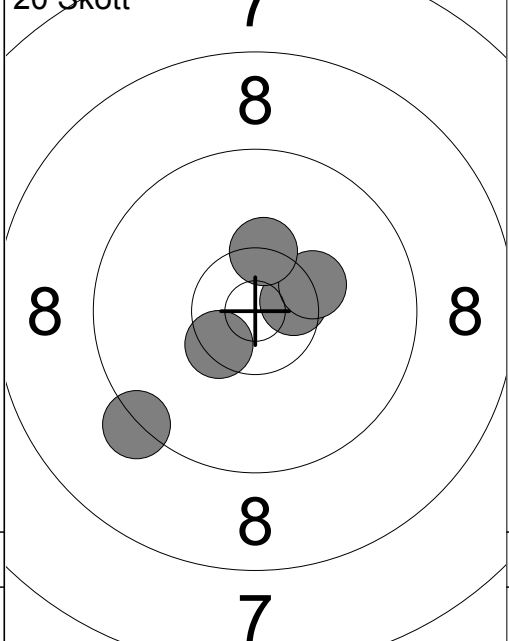

1:	9.3	↙
2:	10.4x	↙
3:	10.5x	→
4:	10.3x	→
5:	10.3x	↑
Serie		49
Total		49

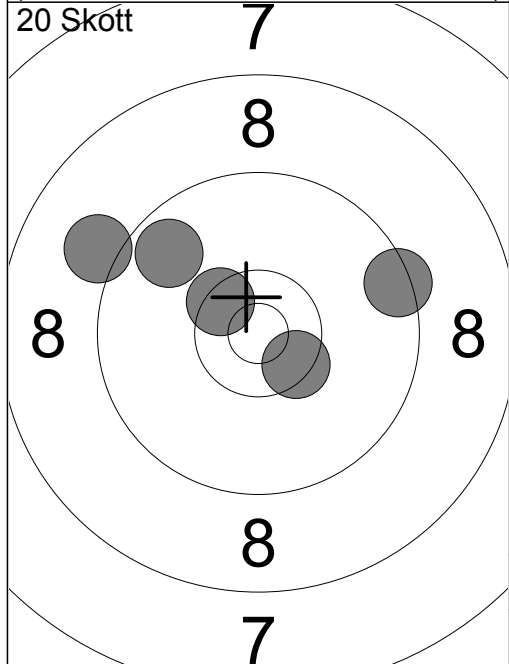

6:	9.1	←
7:	9.4	→
8:	10.4x	↖
9:	9.7	↗
10:	10.4x	↓
Serie		47
Total		96

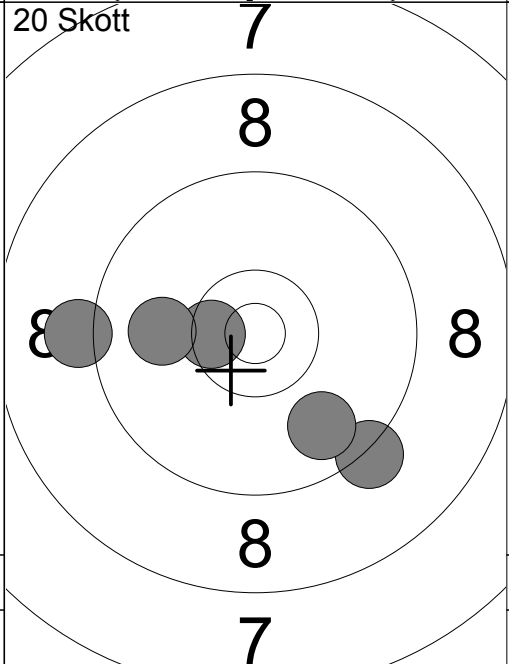

11:	9.2	↓
12:	9.8	↓
13:	9.1	←
14:	10.5x	←
15:	10.0	←
Serie		47
Total		143

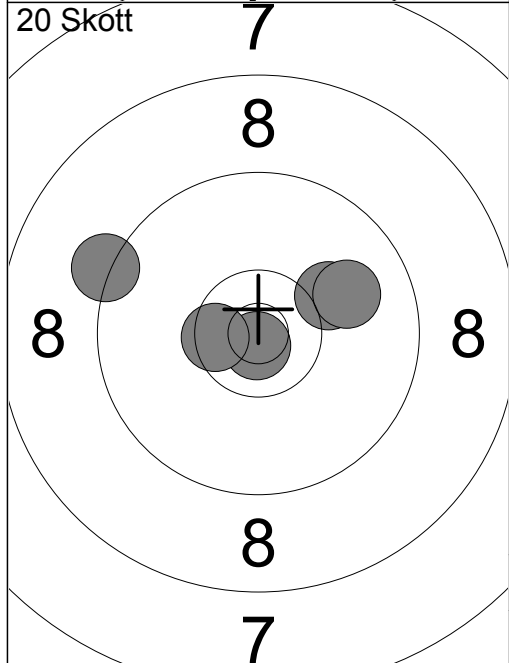

16:	10.8x	↓
17:	10.1	↗
18:	10.0	↗
19:	9.2	←
20:	10.5x	←
Serie		49
Total		192

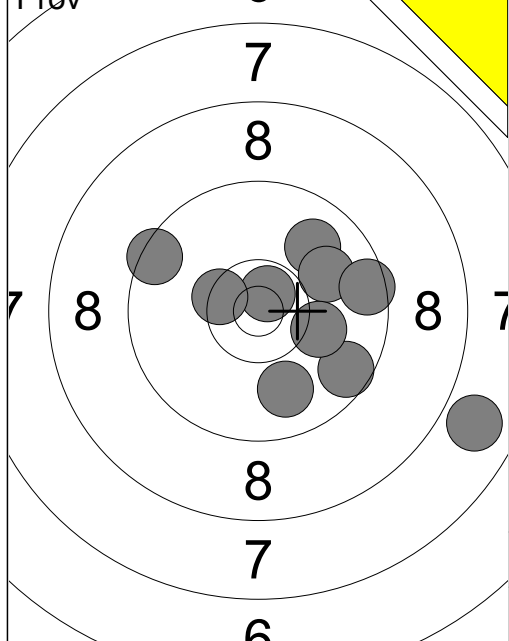

1:	9.6	↘
2:	10.7x	↗
3:	7.9	→
4:	10.4x	↖
5:	9.9	↗
6:	10.0	↗
7:	9.5	→
8:	10.1	→
9:	9.5	↖
10:	9.9	↘
Serie		92
Total		0

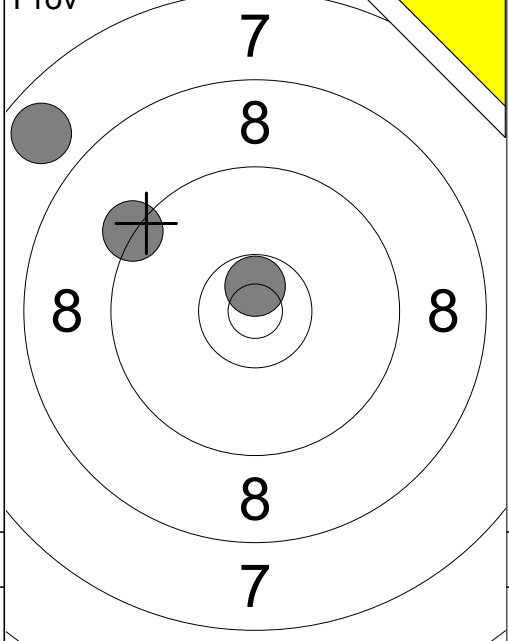

11:	9.3	↖
12:	7.8	↖
13:	10.7x	↗
Serie		26
Total		0

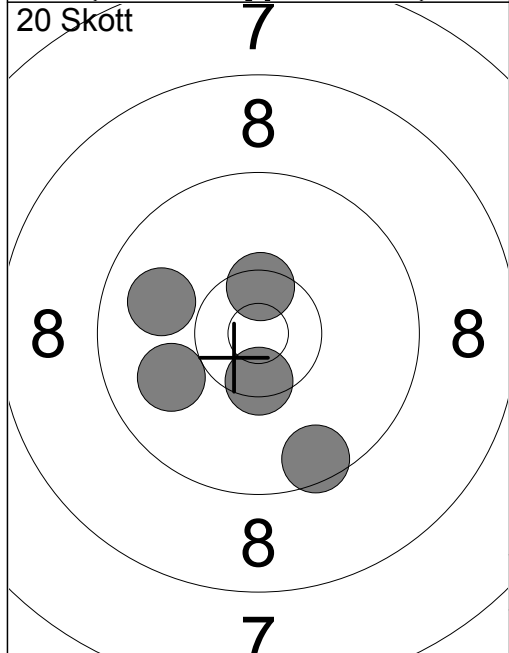

1:	9.9	↖
2:	9.5	↘
3:	10.0	↖
4:	10.5x	↗
5:	10.5x	↘
Serie		48
Total		48

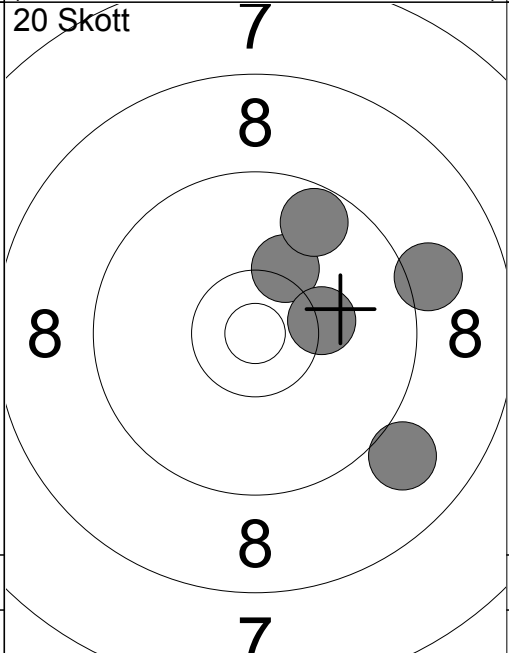

6:	10.2	↗
7:	10.3	→
8:	9.1	→
9:	9.7	↗
10:	9.0	↘
Serie		47
Total		95

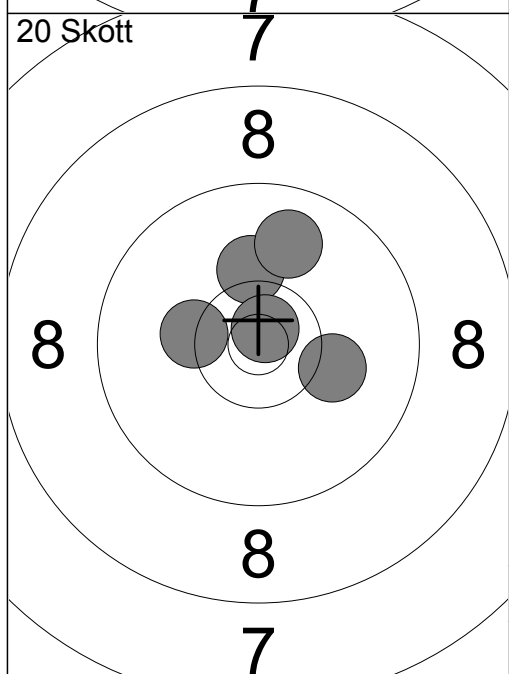

11:	10.2	↗
12:	10.8x	↗
13:	10.3	↖
14:	10.2	→
15:	9.9	↗
Serie		49
Total		144

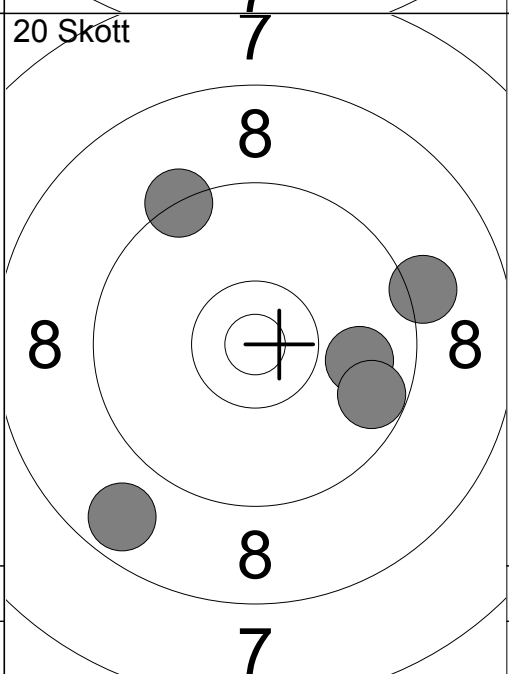

16:	9.1	→
17:	9.9	→
18:	9.3	↗
19:	9.7	→
20:	8.7	↘
Serie		44
Total		188

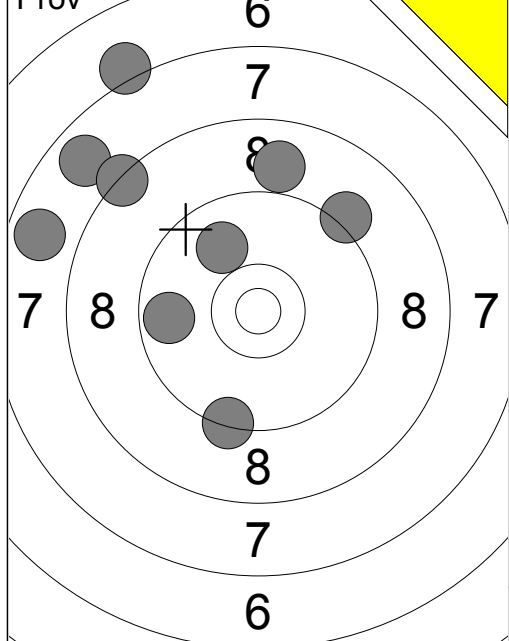

1:	7.8	↖
2:	9.2	↗
3:	8.3	↗
4:	7.8	↖
5:	7.1	↗
6:	9.9	↗
8:	8.9	↗
9:	9.4	↘
10:	9.7	↖
Serie		73
Total		0

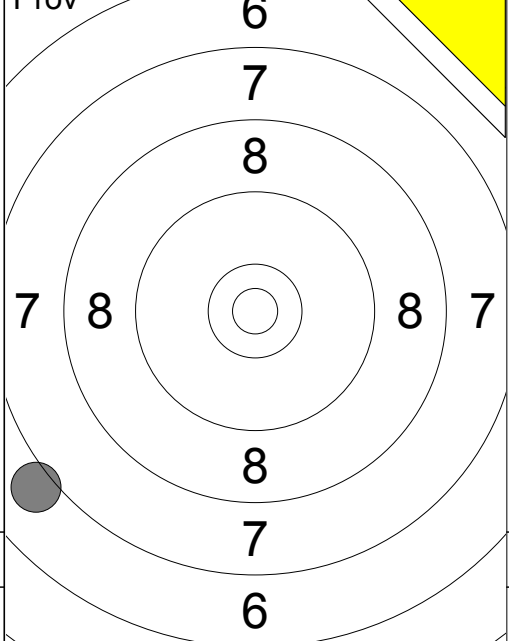

11:	7.1	↘
Serie		7
Total		0

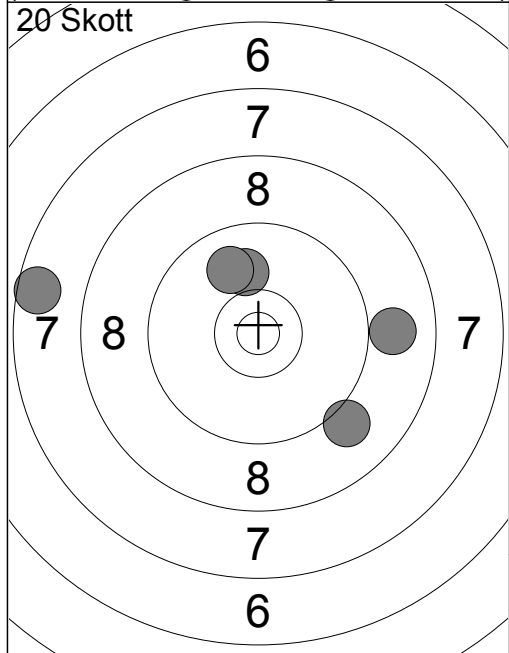

1:	7.6	↖
2:	10.0	↗
3:	9.9	↗
4:	9.1	↘
5:	8.9	→
Serie		43
Total		43

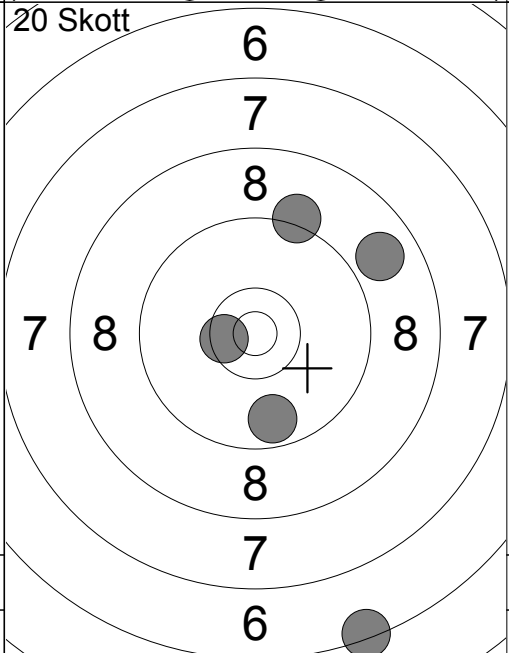

6:	10.5x	↖
7:	8.9	↗
8:	9.2	↗
9:	6.4	↘
10:	9.7	↘
Serie		42
Total		85

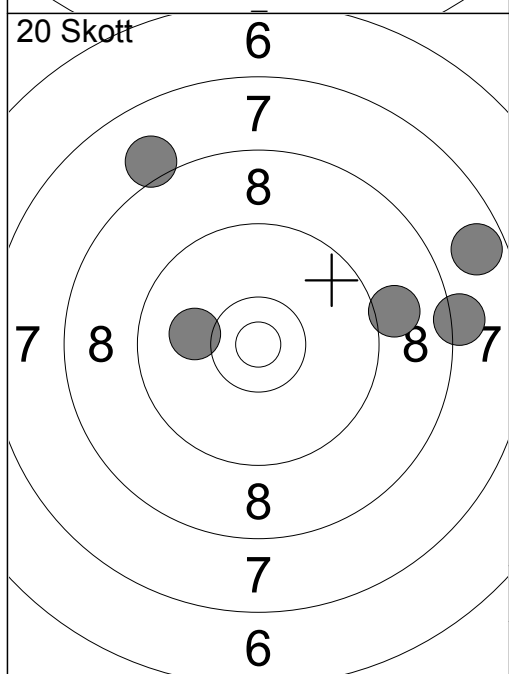

11:	8.2	→
12:	7.7	↗
13:	8.1	↗
14:	10.1	↖
15:	9.0	→
Serie		42
Total		127

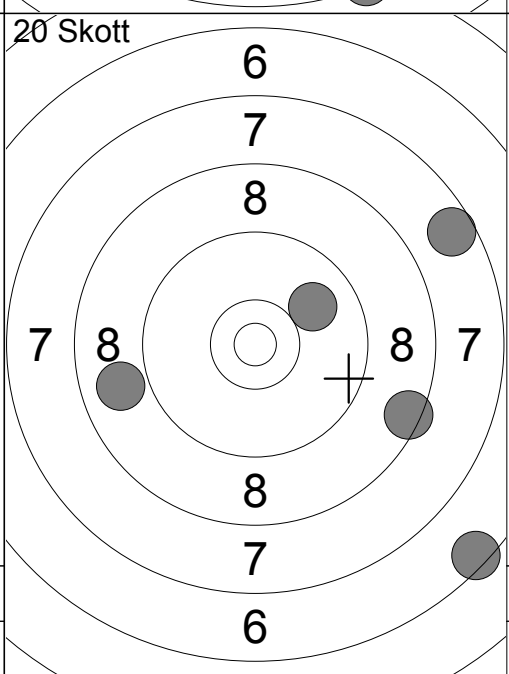

16:	7.6	↗
17:	8.5	→
18:	8.9	↖
19:	9.9	↗
20:	6.5	↘
Serie		38
Total		165

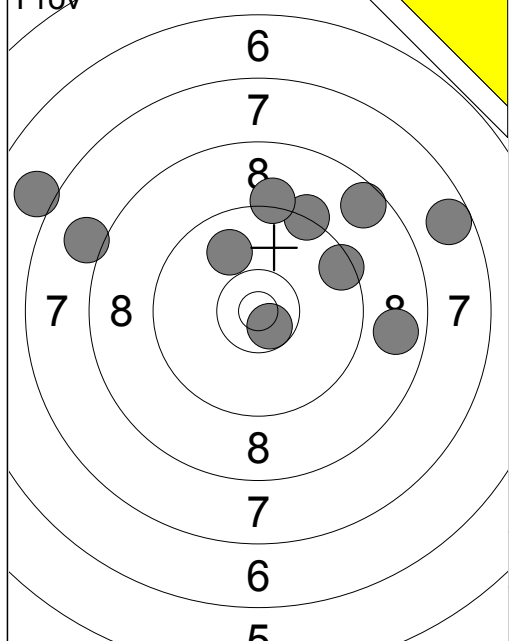

1:	7.0	↖
2:	8.0	↖
3:	9.3	↗
4:	8.6	↗
5:	7.7	→
6:	9.5	→
7:	9.2	↑
8:	8.8	→
9:	10.7x	↘
10:	9.9	↑
Serie		84
Total		0

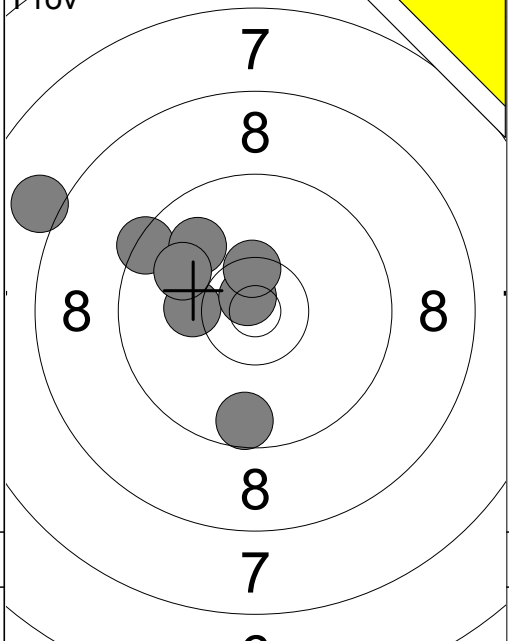

11:	9.4	↗
12:	9.6	↓
13:	9.9	↗
14:	10.2	←
15:	10.8x	↗
16:	10.4x	↑
17:	8.0	↖
18:	10.0	↖
Serie		75
Total		0

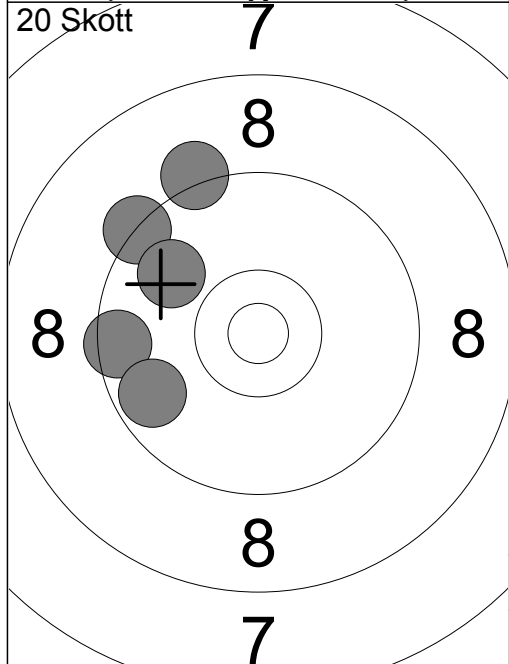

1:	9.3	↖
2:	9.2	↑
3:	9.5	←
4:	9.7	←
5:	9.9	↗
Serie		45
Total		45

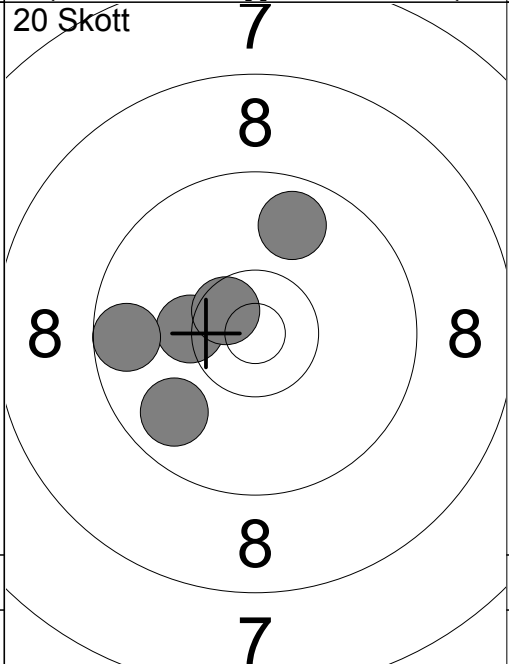

6:	9.8	↘
7:	10.3	←
8:	9.6	←
9:	9.8	↑
10:	10.6x	↖
Serie		47
Total		92

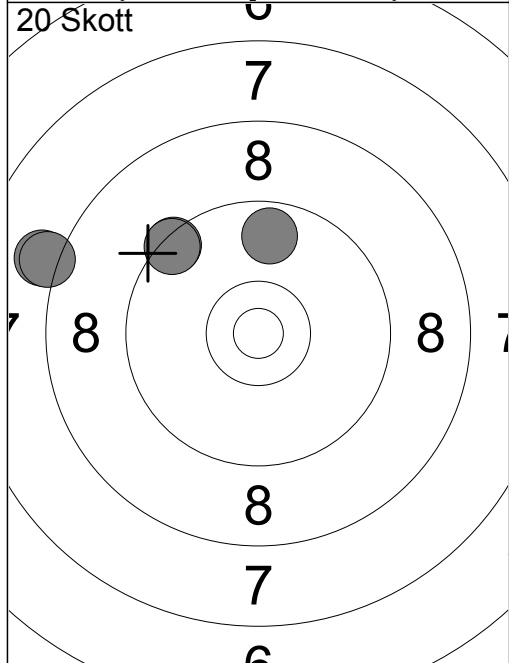

11:	9.7	↑
12:	9.4	↗
13:	8.1	↖
14:	9.4	↗
15:	8.2	↖
Serie		43
Total		135

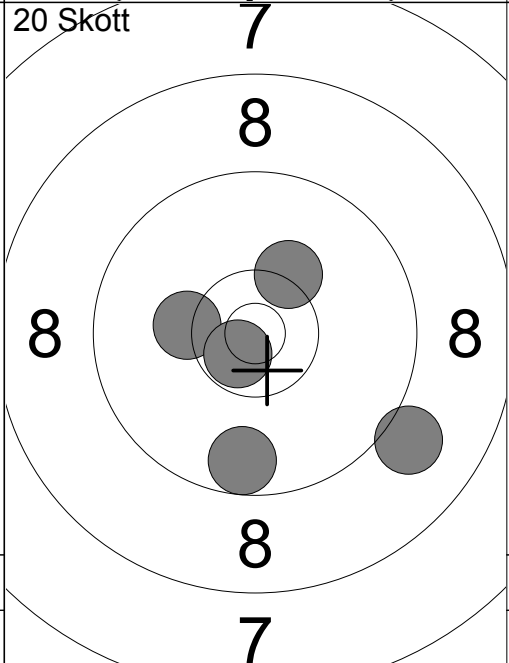

16:	10.2	←
17:	9.6	↓
18:	10.7x	↘
19:	9.0	↘
20:	10.3	↗
Serie		48
Total		183

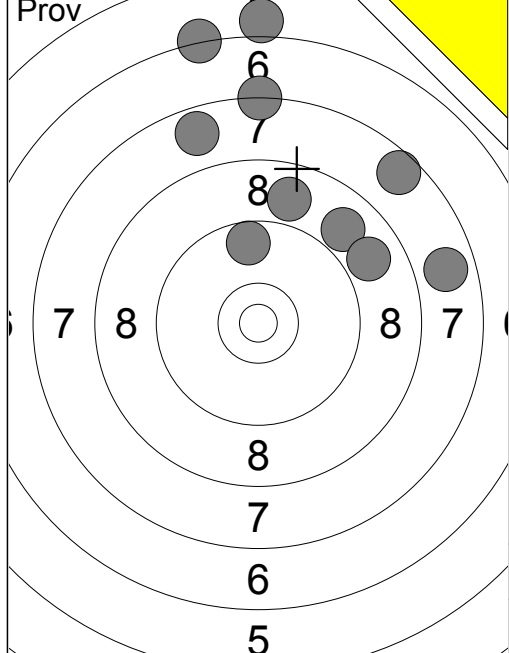

1:	6.3	↑
2:	7.6	↗
3:	8.9	↗
4:	8.9	↑
5:	7.7	↑
6:	9.6	↑
7:	7.3	↑
8:	8.9	↗
9:	7.8	→
10:	6.0	↑
Serie		73
Total		0

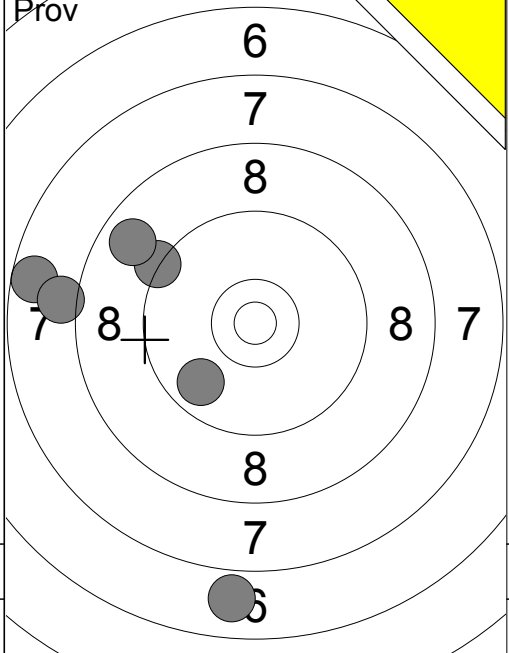

11:	6.9	↓
13:	9.8	↙
14:	9.3	↗
15:	7.6	←
16:	8.1	←
17:	8.8	↗
Serie		47
Total		0

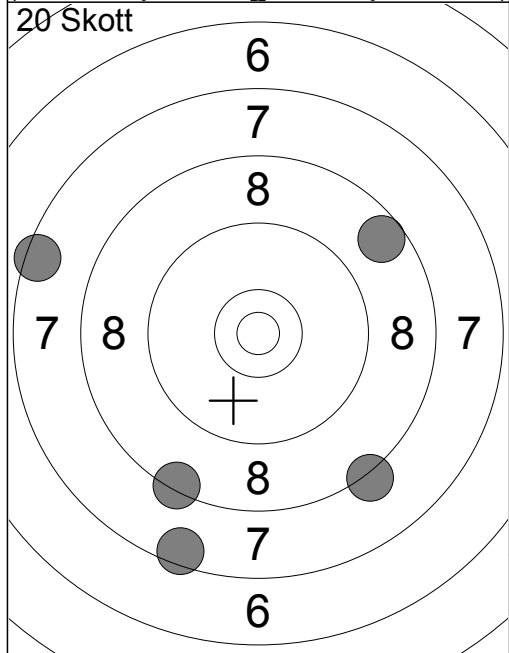

1:	8.2	↘
2:	8.6	↗
3:	8.4	↘
4:	7.5	←
5:	7.5	↘
Serie		38
Total		38

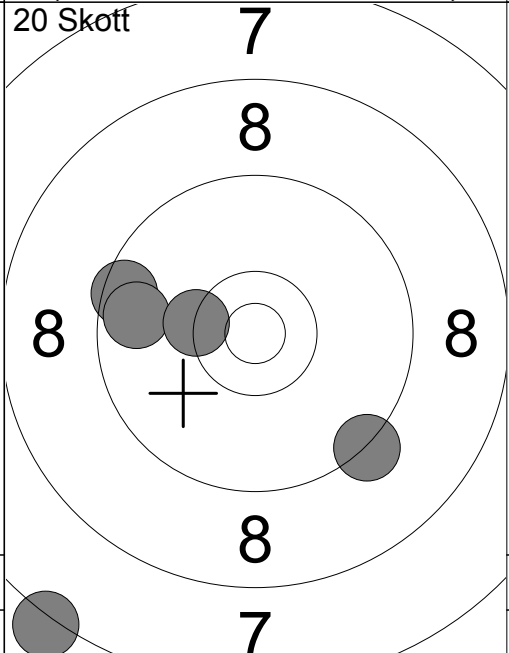

6:	9.3	↘
7:	9.5	←
8:	7.2	↘
9:	9.7	←
10:	10.3x	←
Serie		44
Total		82

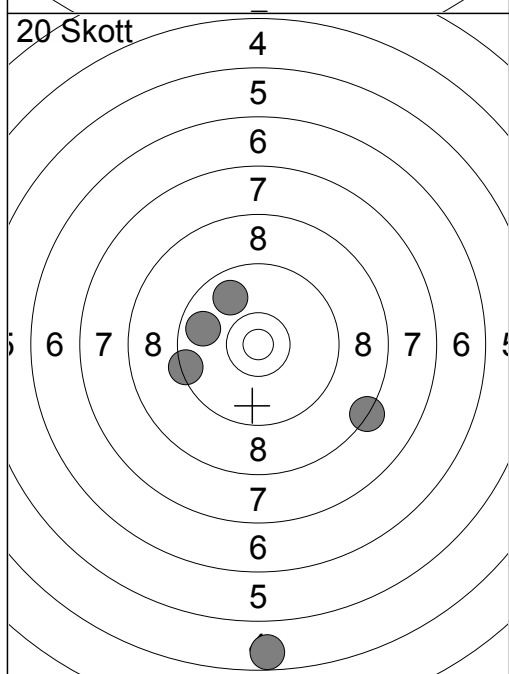

11:	8.3	↘
12:	9.8	↗
13:	9.8	←
14:	9.4	←
15:	4.7	↓
Serie		39
Total		121

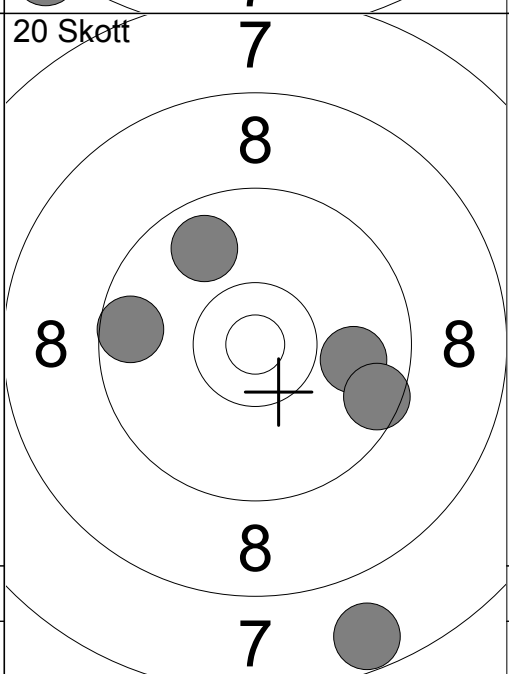

16:	9.8	↗
17:	7.7	↓
18:	9.9	→
19:	9.6	↘
20:	9.6	←
Serie		43
Total		164

05.09.2020	Höstträffen 2020	Ramselefors SKF
------------	------------------	-----------------

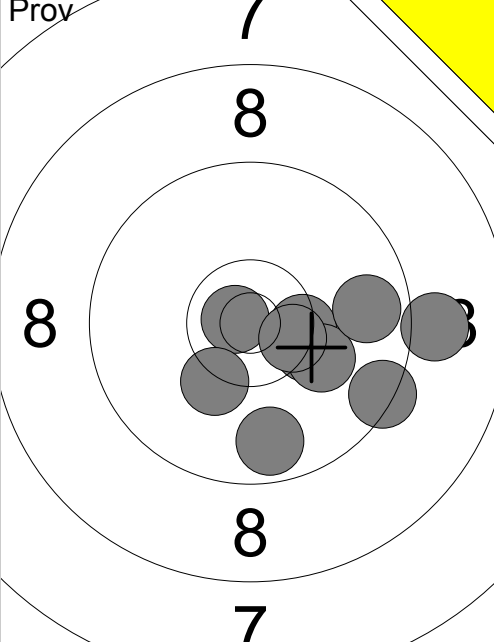
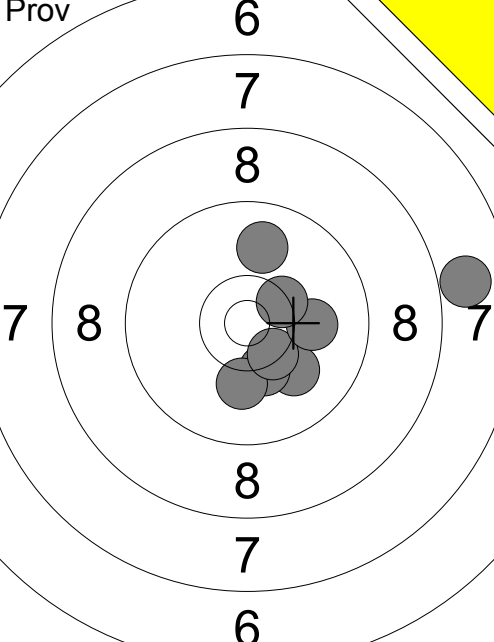
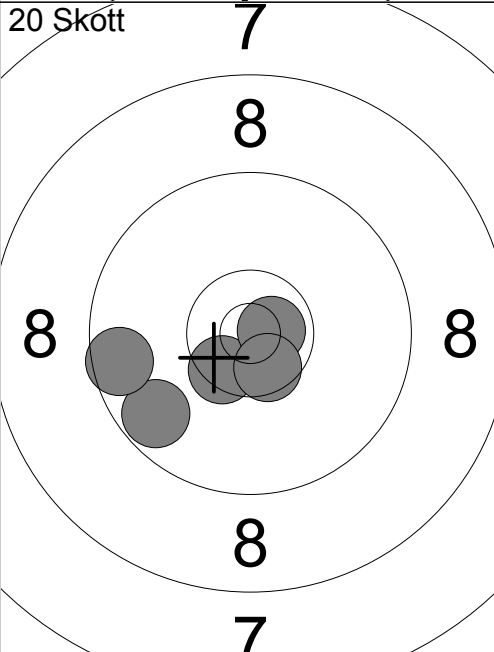
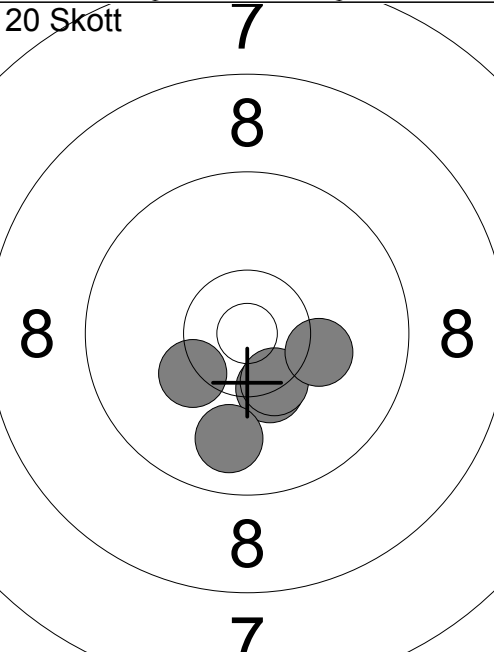
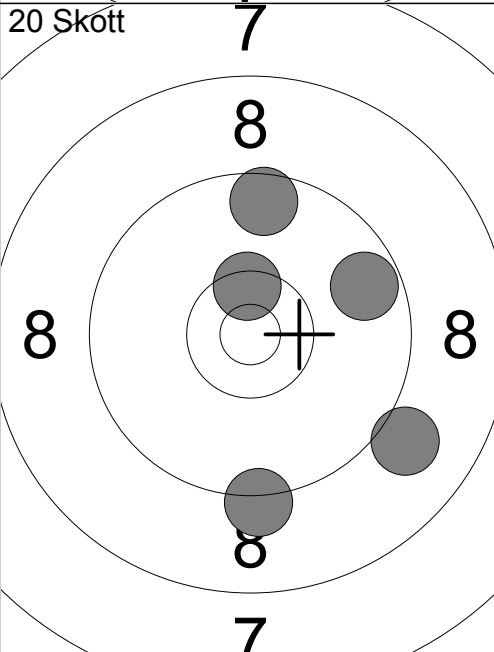
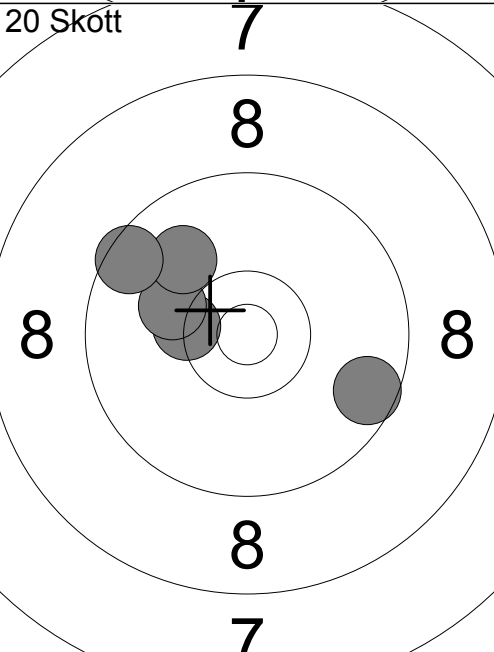
Prov 	1: 9.1 → 2: 10.8x← 3: 10.3x→ 4: 9.4 → 5: 10.4x→ 6: 9.7 ↓ 7: 10.1 → 8: 10.3 ↓ 9: 10.5x→ 10: 9.7 → Serie 96 Total 0	Prov 	11: 10.1 ↓ 12: 7.9 → 13: 10.3 ↓ 14: 10.1 ↓ 15: 10.4x↓ 16: 10.1 → 17: 10.4x↗ 18: 9.9 ↑ Serie 76 Total 0
20 Skott 	1: 10.5x↓ 2: 10.7x→ 3: 10.6x↓ 4: 9.7 ← 5: 9.6 ← Serie 48 Total 48	20 Skott 	6: 10.3x↓ 7: 10.4x↓ 8: 10.3 ← 9: 10.2 → 10: 9.9 ↓ Serie 49 Total 97
20 Skott 	11: 9.6 ↑ 12: 9.0 ↓ 13: 9.7 → 14: 9.2 ↓ 15: 10.5x↑ Serie 46 Total 143	20 Skott 	16: 10.3x← 17: 10.1 ← 18: 9.9 ↗ 19: 9.6 ↓ 20: 9.5 ↗ Serie 47 Total 190

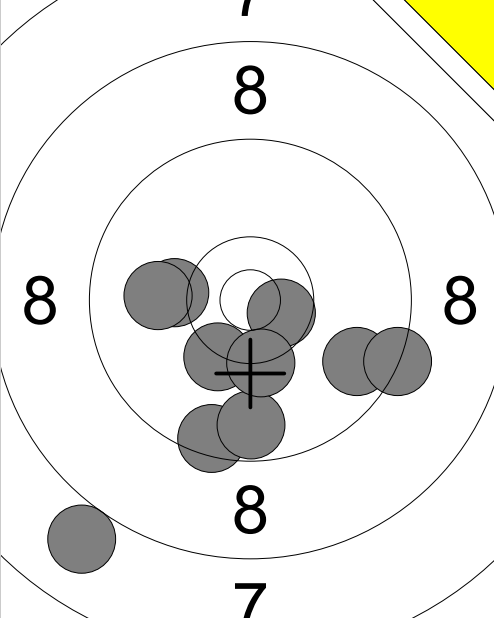
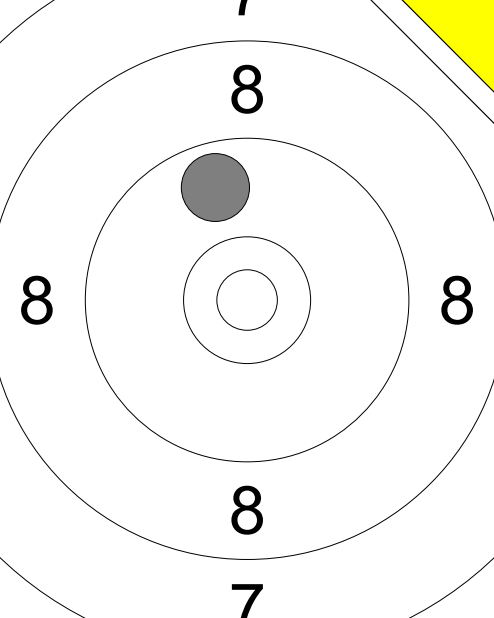
Prov 	1: 9.5 ↓ 2: 8.0 ↓ 3: 10.2 ← 4: 9.7 ↓ 5: 10.6x → 6: 10.3 ↓ 7: 9.7 → 8: 10.0 ← 9: 10.3x ↓ 10: 9.3 →	Prov 	11: 9.7 ↑
Serie	94	Serie	9
Total	0	Total	0

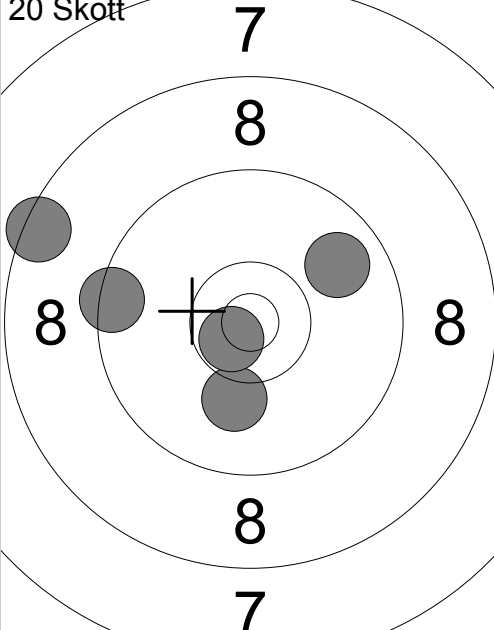
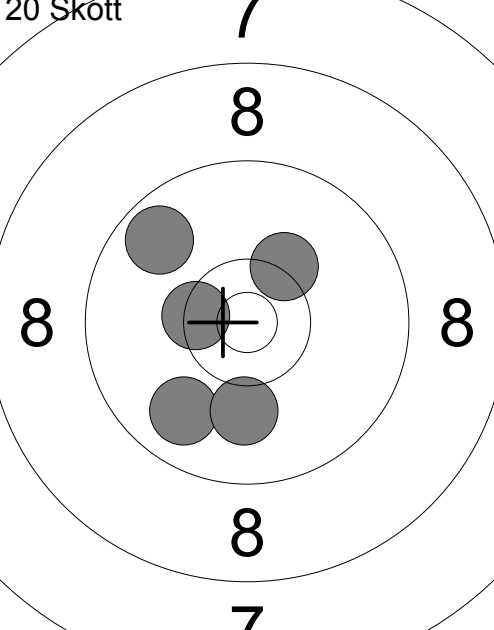
20 Skott 	1: 10.1 ↓ 2: 10.7x ↙ 3: 9.4 ← 4: 8.5 ← 5: 9.8 →	20 Skott 	6: 10.3 ↗ 7: 10.4x ← 8: 9.8 ↓ 9: 10.0 ↓ 10: 9.7 ↖
Serie	46	Serie	48
Total	46	Total	94

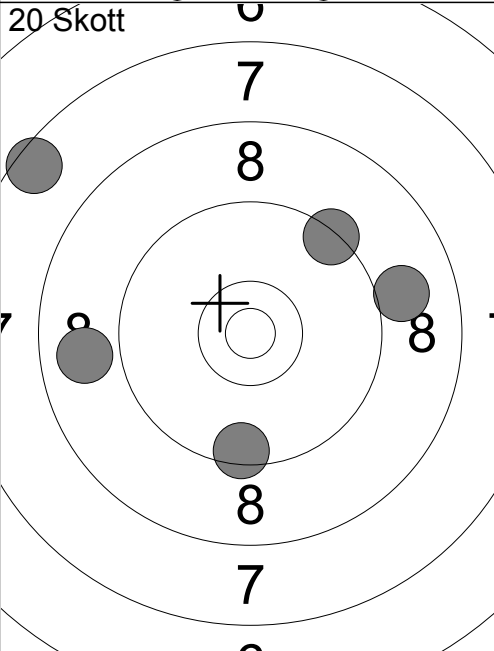
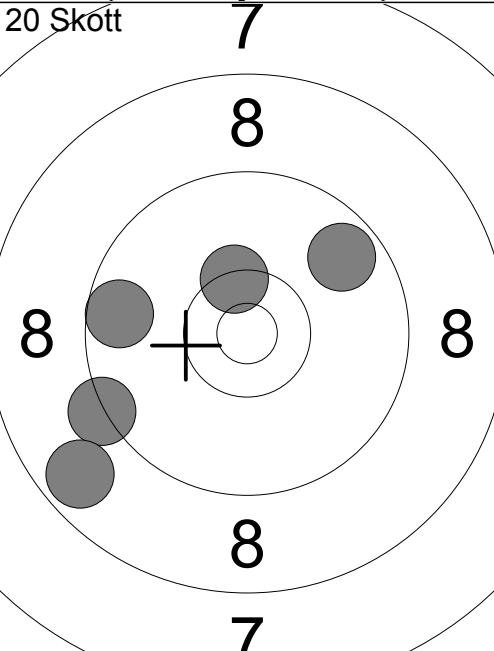
20 Skott 	11: 9.0 → 12: 9.4 ↗ 13: 9.5 ↓ 14: 7.5 ↖ 15: 8.9 ←	20 Skott 	16: 9.3 ← 17: 8.7 ↙ 18: 10.4x ↑ 19: 9.6 ← 20: 9.7 ↗
Serie	42	Serie	45
Total	136	Total	181

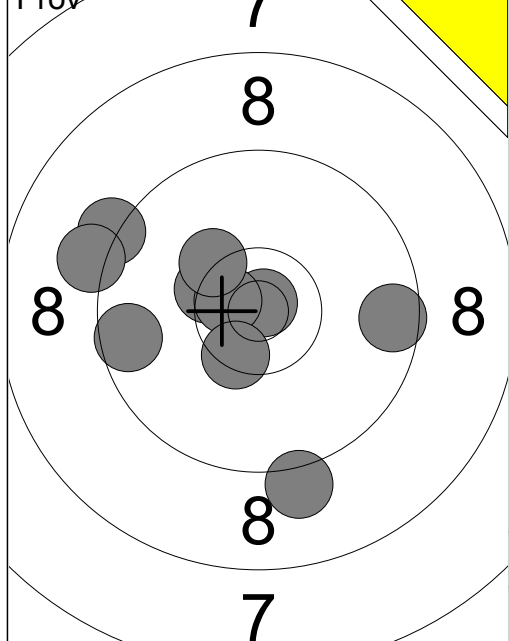

1:	9.1	↓
2:	10.4x	↖
3:	9.2	↗
4:	9.2	↖
5:	9.6	↖
6:	10.8x	↗
7:	10.6x	↖
8:	10.4x	↘
9:	9.6	→
10:	10.3	↗
Serie		95
Total		0

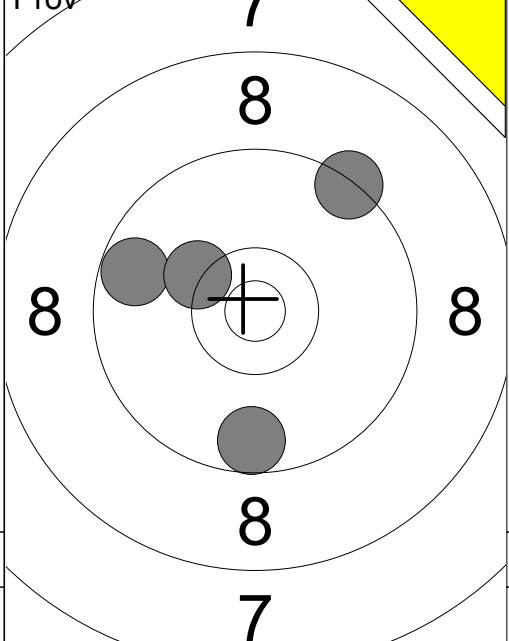

11:	9.7	↖
12:	9.6	↓
13:	9.3	↗
14:	10.3	↖
Serie		37
Total		0

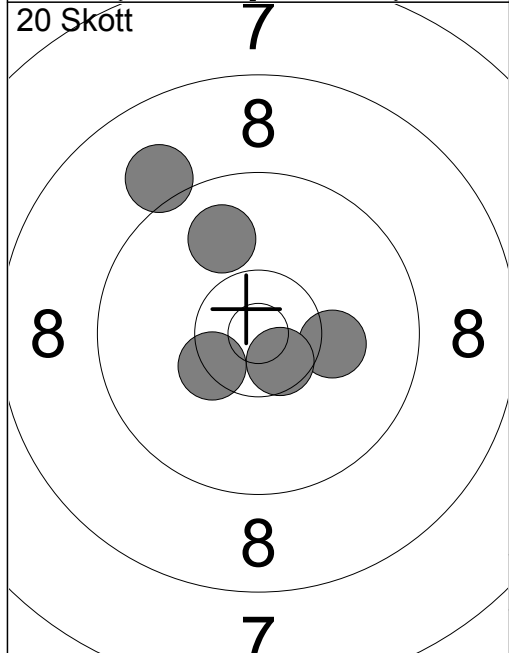

1:	9.1	↗
2:	10.2	→
3:	10.6x	↘
4:	10.4x	↖
5:	9.9	↗
Serie		48
Total		48

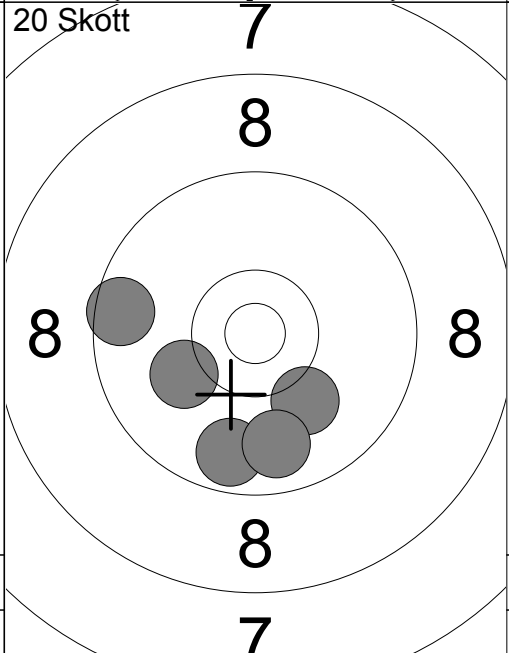

6:	9.7	↓
7:	10.1	↖
8:	9.6	↖
9:	10.1	↘
10:	9.8	↓
Serie		47
Total		95

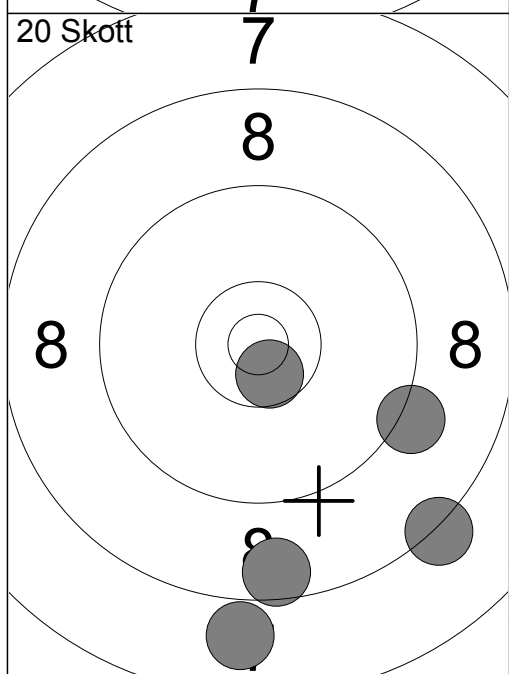

11:	10.6x	↘
12:	8.3	↘
13:	8.6	↓
14:	7.9	↓
15:	9.2	↘
Serie		42
Total		137

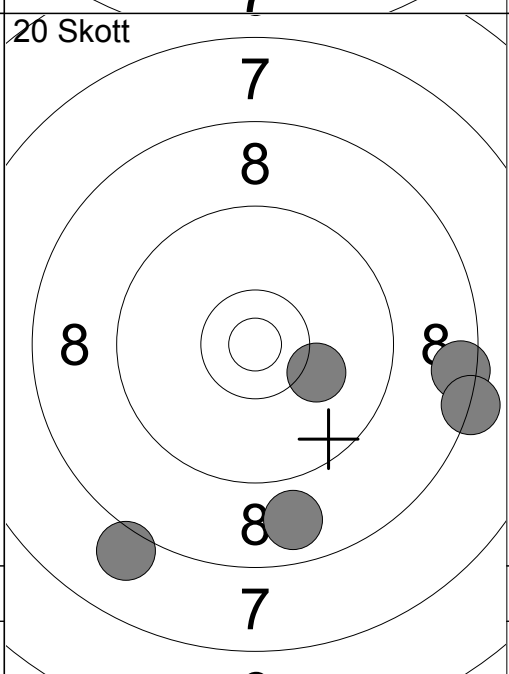

16:	8.5	→
17:	8.8	↓
18:	8.3	→
19:	8.1	↘
20:	10.1	↘
Serie		42
Total		179

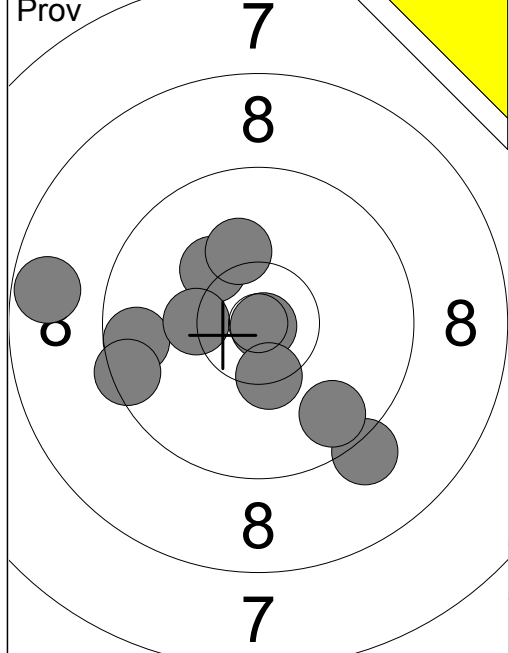

- 1: 9.2 ↘
- 2: 10.9x →
- 3: 8.7 ←
- 4: 9.6 ←
- 5: 10.2 ↗
- 6: 10.2 ↑
- 7: 9.7 ↘
- 8: 10.4x ↓
- 9: 10.3x ←
- 10: 9.5 ←

Serie 94
Total 0

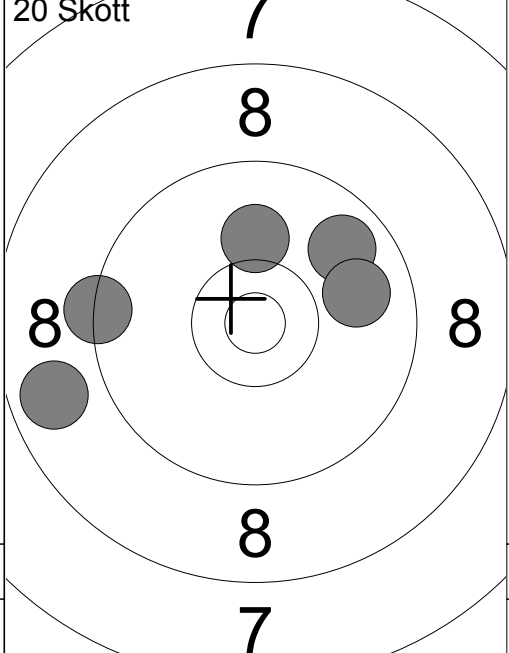

- 1: 9.3 ←
- 2: 8.8 ←
- 3: 9.8 ↗
- 4: 10.1 ↑
- 5: 9.9 →

Serie 45
Total 45

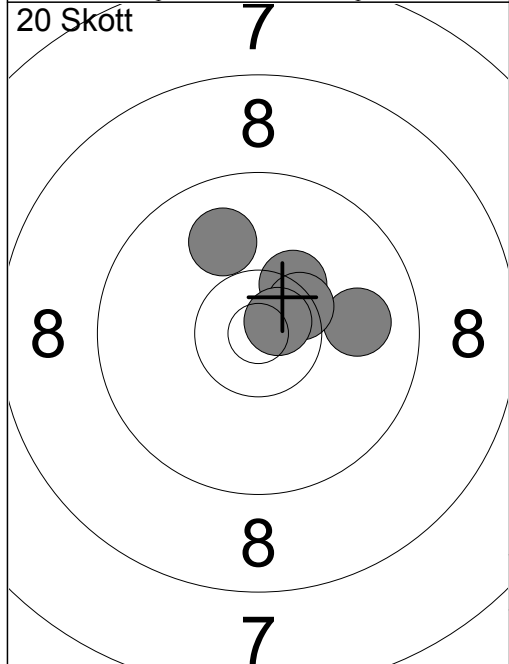

- 6: 9.9 →
- 7: 10.3x ↗
- 8: 9.9 ↖
- 9: 10.4x ↗
- 10: 10.7x ↗

Serie 48
Total 93

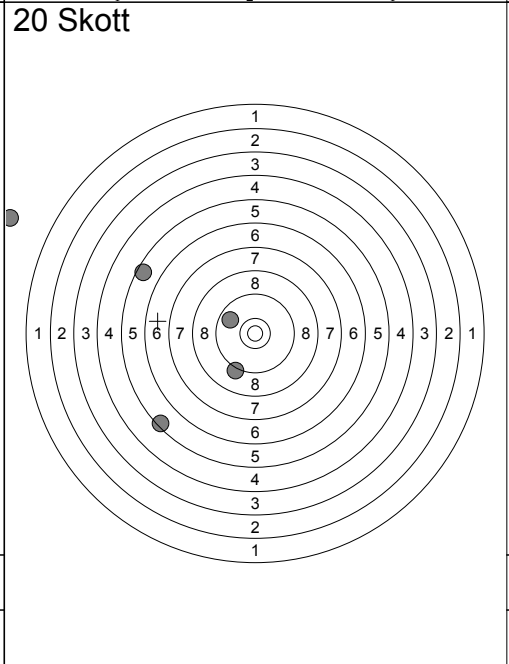

- 11: 5.6 ↖
- 12: 0.0 ←
- 13: 9.7 ↖
- 14: 5.4 ↙
- 15: 9.2 ↙

Serie 28
Total 121

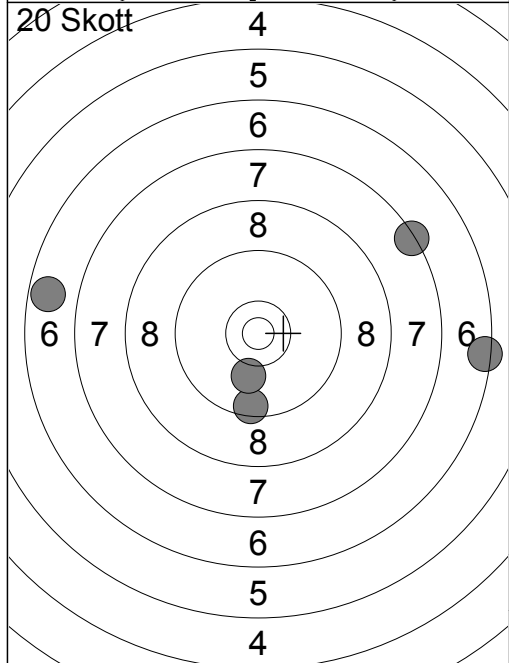

- 16: 6.7 ←
- 17: 6.4 →
- 18: 9.5 ↓
- 19: 10.1 ↓
- 20: 7.4 ↗

Serie 38
Total 159

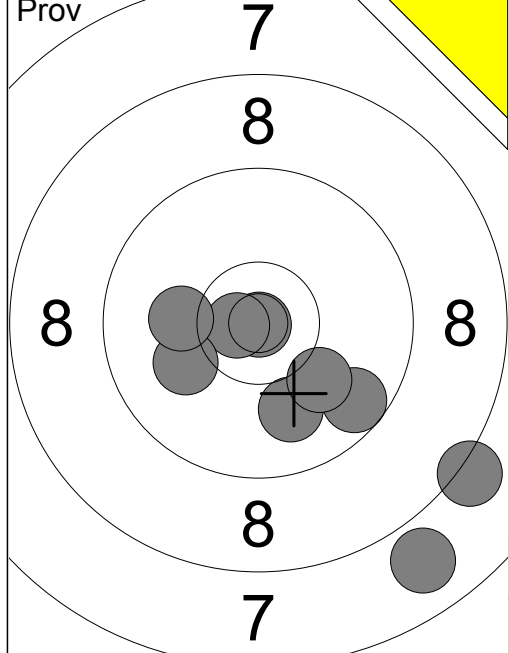

1:	10.0	↘
2:	8.2	↘
3:	7.9	↘
4:	9.6	↘
5:	10.9x	↘
6:	10.7x	←
7:	10.1	←
8:	10.1	↘
9:	10.1	←

Serie	84
Total	0

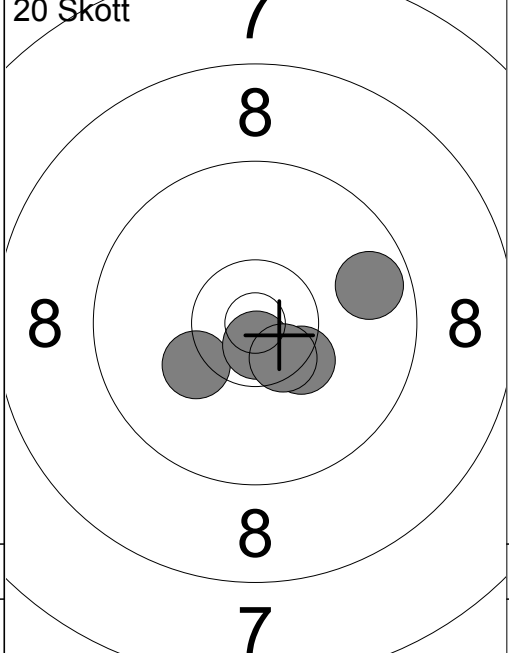

1:	10.3x	↘
2:	10.2	↙
3:	10.7x	↓
4:	10.5x	↘
5:	9.7	→

Serie	49
Total	49

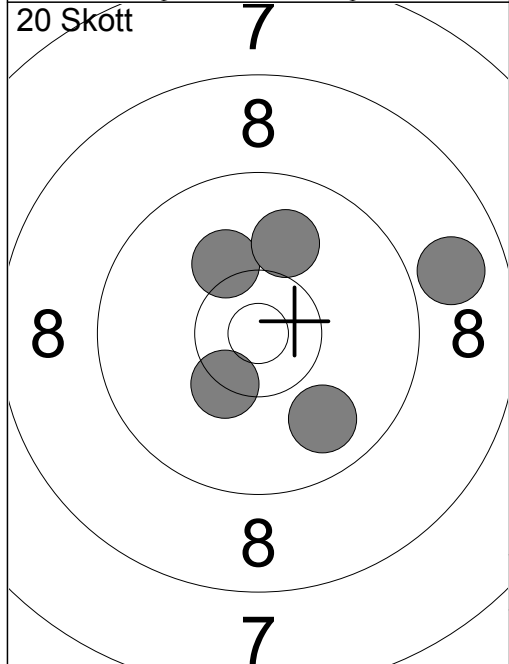

6:	8.9	→
7:	10.3x	↘
8:	10.2	↗
9:	10.0	↗
10:	9.9	↘

Serie	47
Total	96

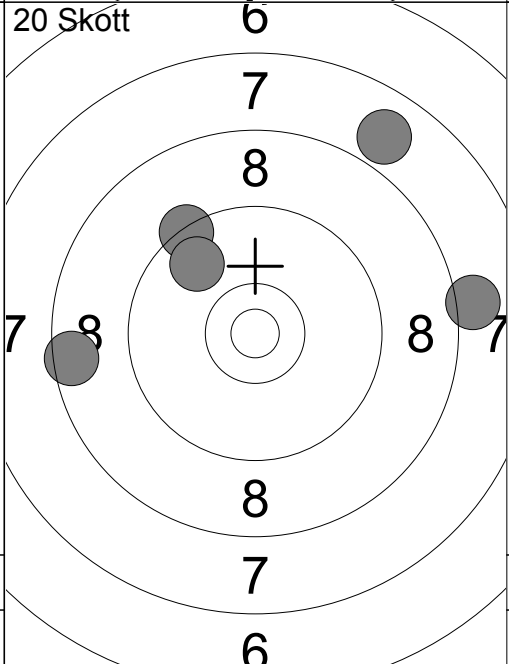

11:	7.9	↗
12:	9.4	↗
13:	8.1	→
14:	8.5	←
15:	9.8	↗

Serie	41
Total	137

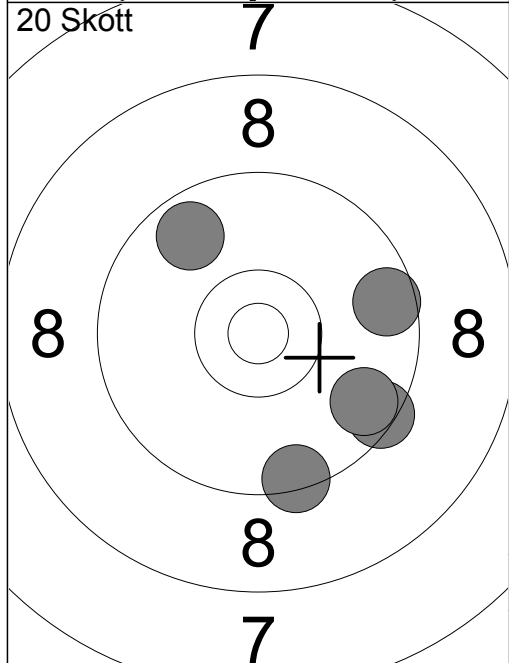

16:	9.4	↘
17:	9.4	↘
18:	9.7	↗
19:	9.6	→
20:	9.7	↘

Serie	45
Total	182

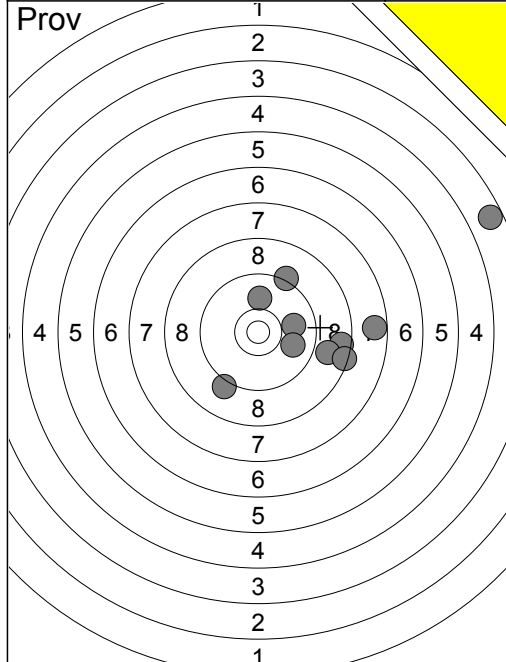

1:	3.7	→
2:	7.7	→
3:	8.6	→
4:	10.0	↑
5:	9.2	↗
6:	9.9	→
7:	8.9	→
8:	8.4	→
9:	9.9	→
10:	9.1	↙
Serie		80
Total		0

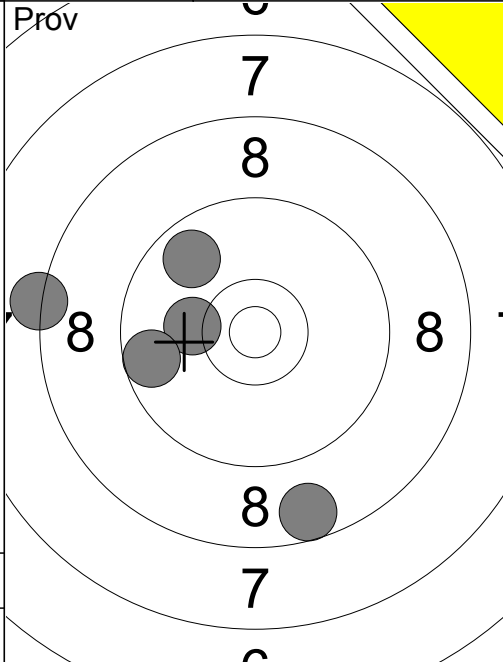

11:	8.6	↘
12:	10.2	←
13:	8.3	←
14:	9.6	←
15:	9.8	↗
Serie		44
Total		0

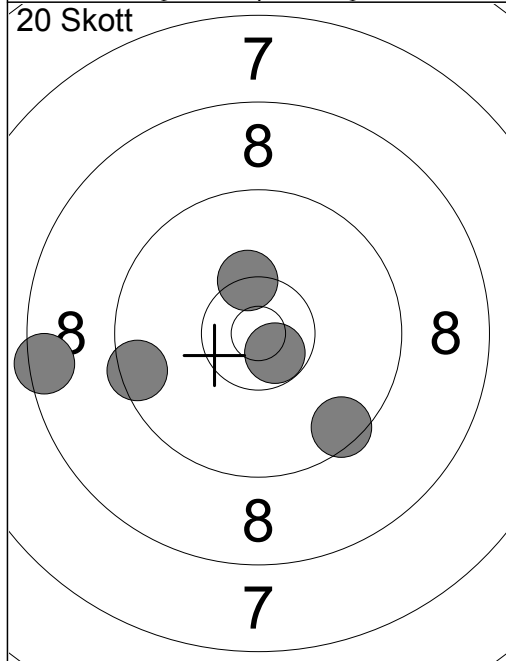

1:	9.5	←
2:	8.5	←
3:	10.3x	↑
4:	10.7x	↘
5:	9.5	↘
Serie		46
Total		46

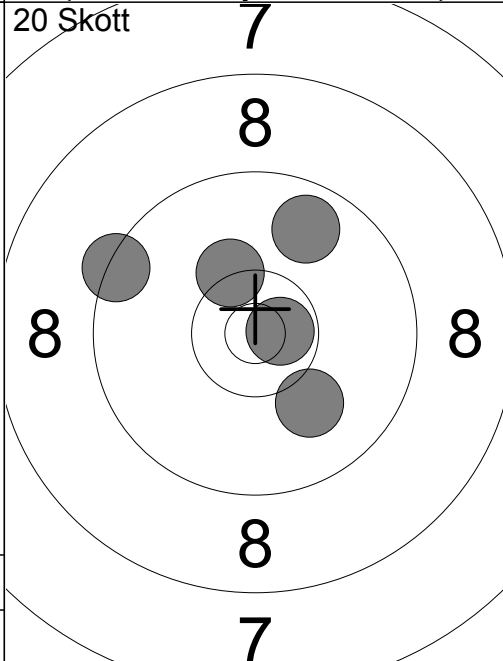

6:	10.7x	→
7:	9.8	↗
8:	10.1	↘
9:	9.4	←
10:	10.3	↗
Serie		48
Total		94

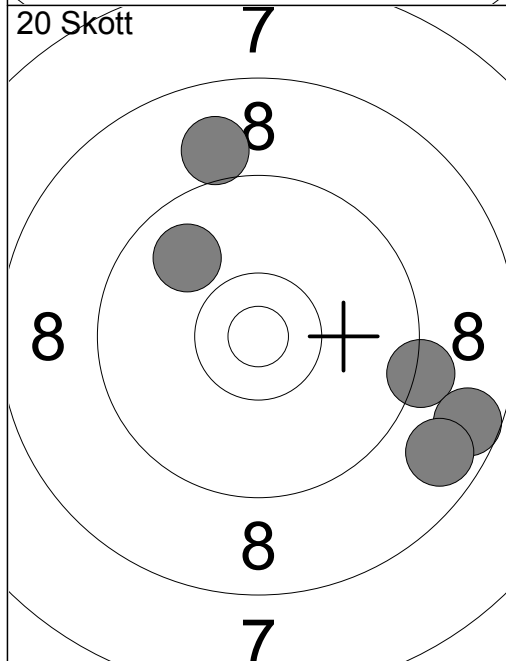

11:	9.0	↑
12:	9.9	↗
13:	9.2	→
14:	8.6	→
15:	8.7	↘
Serie		43
Total		137

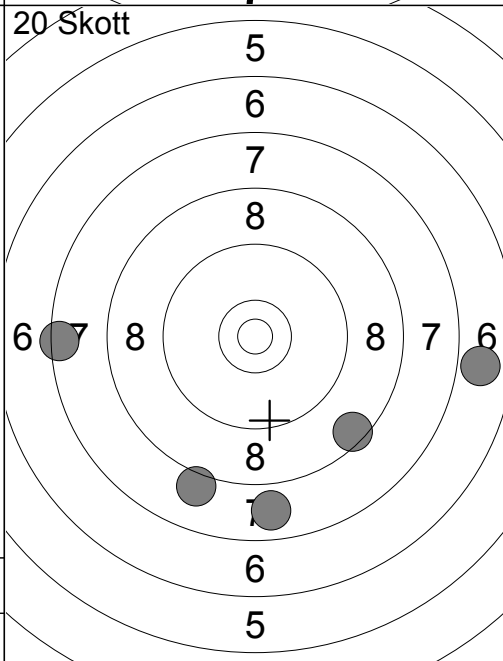

16:	8.5	↘
17:	6.9	→
18:	7.5	←
19:	7.8	↘
20:	8.1	↘
Serie		36
Total		173

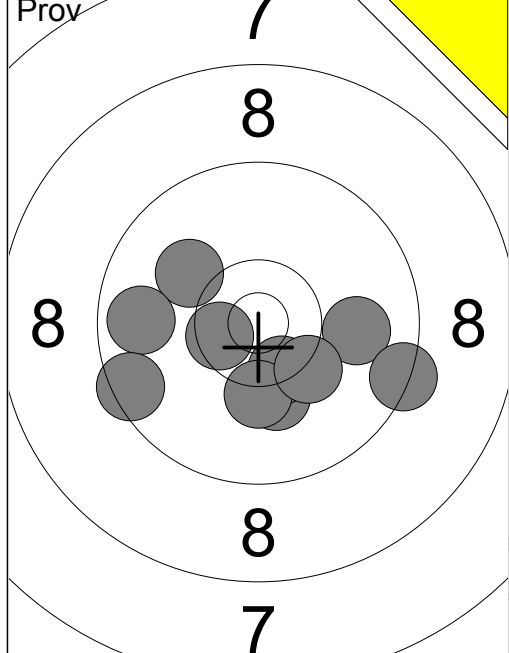

1:	10.2	↘
2:	10.1	↗
3:	9.7	←
4:	9.5	↙
5:	10.4x	↘
6:	9.9	→
7:	10.5x	←
8:	9.4	→
9:	10.2	↘
10:	10.3	↘
Serie		96
Total		0

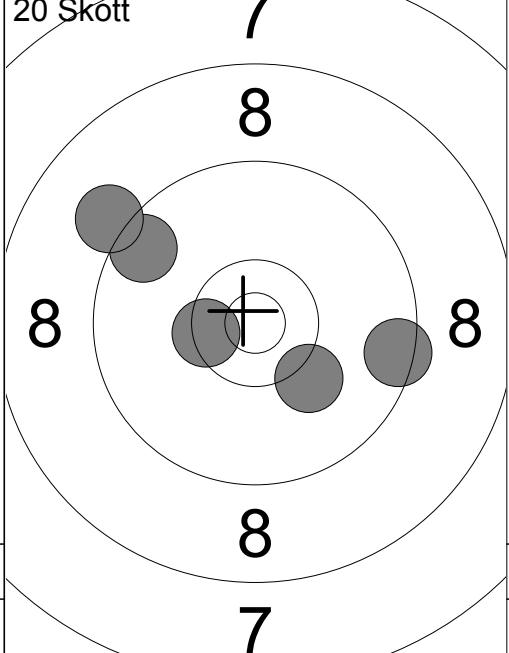

1:	9.5	→
2:	9.6	↗
3:	10.4x	←
4:	10.2	↘
5:	9.1	↗
Serie		47
Total		47

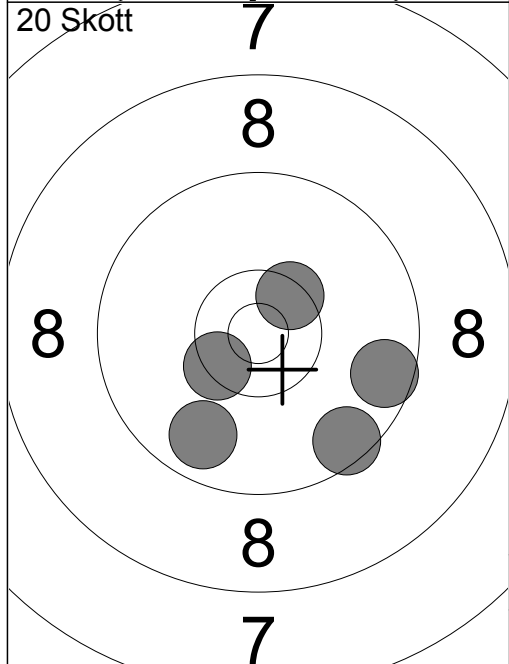

6:	9.5	↘
7:	9.6	→
8:	10.4x	↗
9:	9.8	↘
10:	10.4x	↙
Serie		47
Total		94

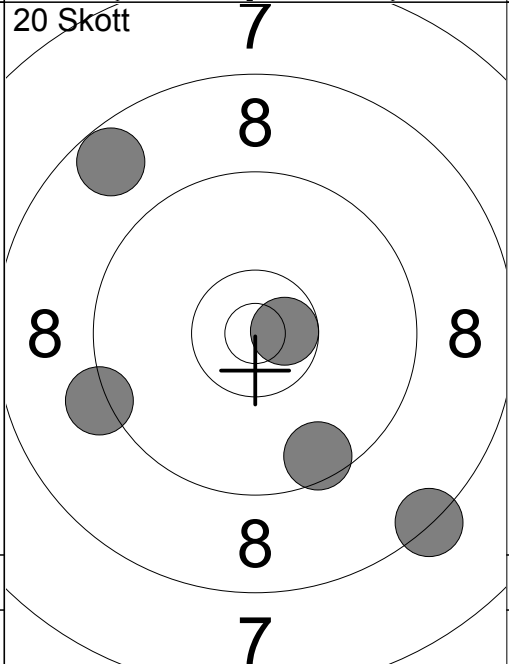

11:	9.5	↘
12:	9.2	←
13:	10.6x	→
14:	8.3	↘
15:	8.7	↗
Serie		44
Total		138

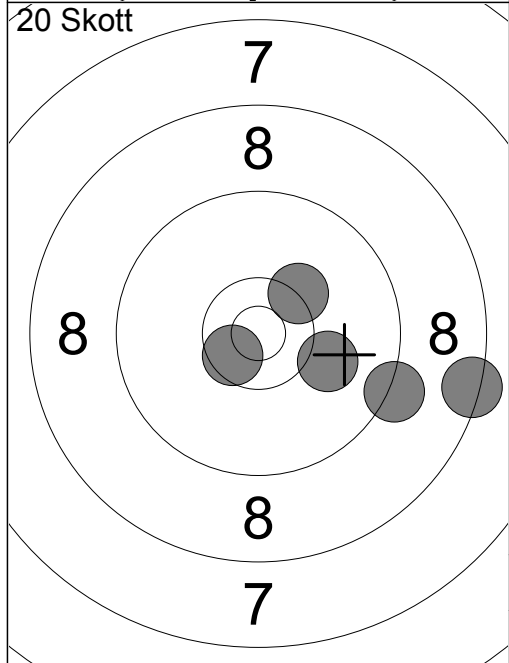

16:	10.3	↗
17:	10.6x	↙
18:	10.1	→
19:	9.2	↘
20:	8.4	→
Serie		47
Total		185

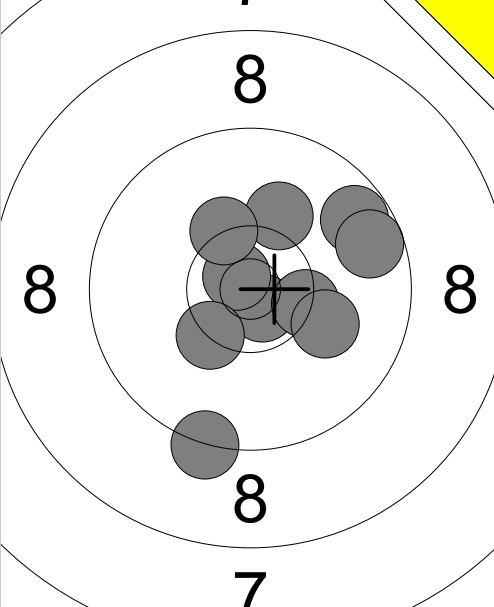
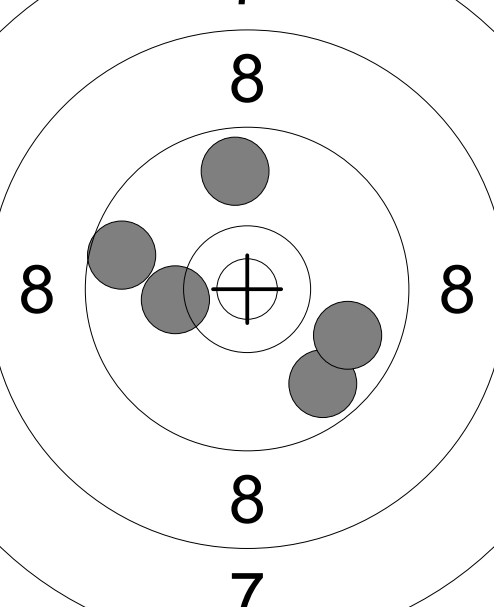
Prov 	1: 9.7 ↗ 2: 10.7x ↘ 3: 10.1 ↗ 4: 10.8x ↖ 5: 10.4x → 6: 10.3x ↗ 7: 10.1 → 8: 9.6 → 9: 9.3 ↘ 10: 10.3x ↘ Serie 97 Total 0	20 Skött 	1: 9.6 ← 2: 9.7 ↘ 3: 9.7 ↗ 4: 10.2 ← 5: 9.8 ↘ Serie 46 Total 46
--	--	--	---

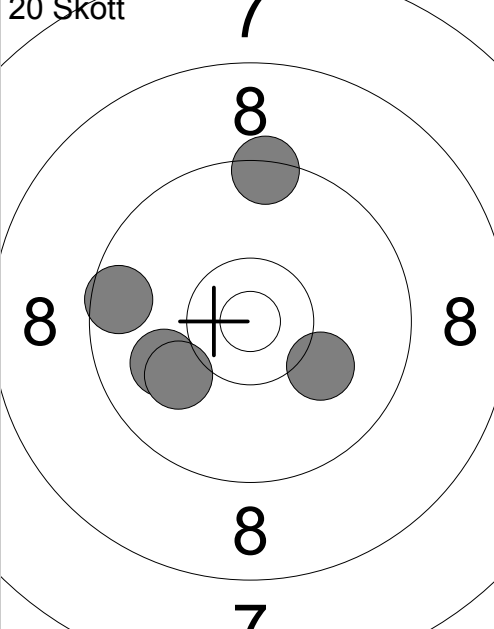
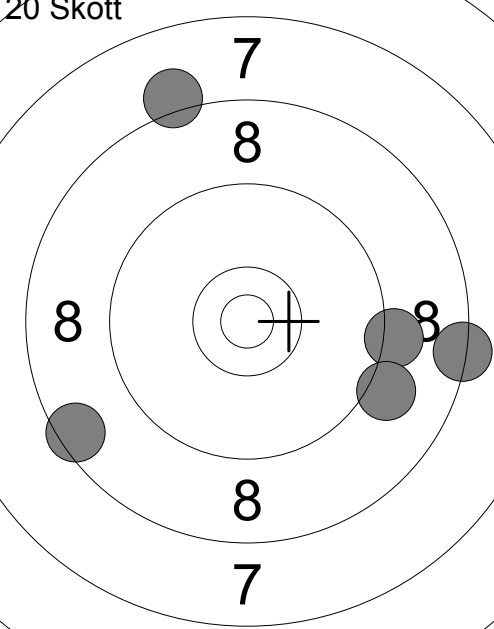
20 Skött 	6: 9.6 ← 7: 9.4 ↗ 8: 10.1 ↘ 9: 10.0 ← 10: 10.0 ↘ Serie 48 Total 94	20 Skött 	11: 8.3 → 12: 9.2 → 13: 9.1 ↘ 14: 8.5 ← 15: 8.1 ↗ Serie 42 Total 136
---	--	---	--

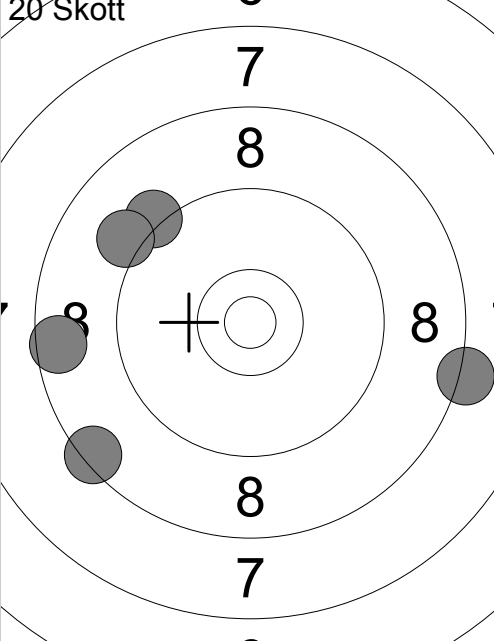
20 Skött 	16: 8.6 ← 17: 8.4 ↘ 18: 9.2 ↗ 19: 9.1 ↗ 20: 8.2 → Serie 42 Total 178		
--	--	--	--

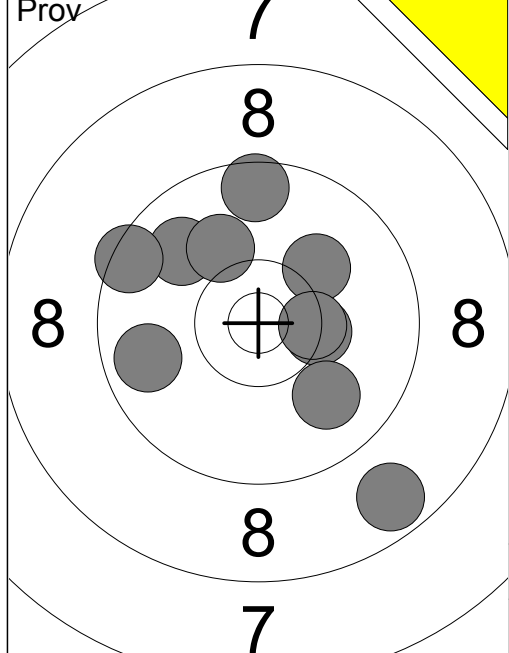

- 1: 10.3x →
- 2: 9.6 ↑
- 3: 9.9 ↗
- 4: 9.5 ↖
- 5: 9.8 ←
- 6: 8.7 ↓
- 7: 9.9 ↓
- 8: 10.1 ↗
- 9: 10.1 ↑
- 10: 10.4x →

Serie 93
Total 0

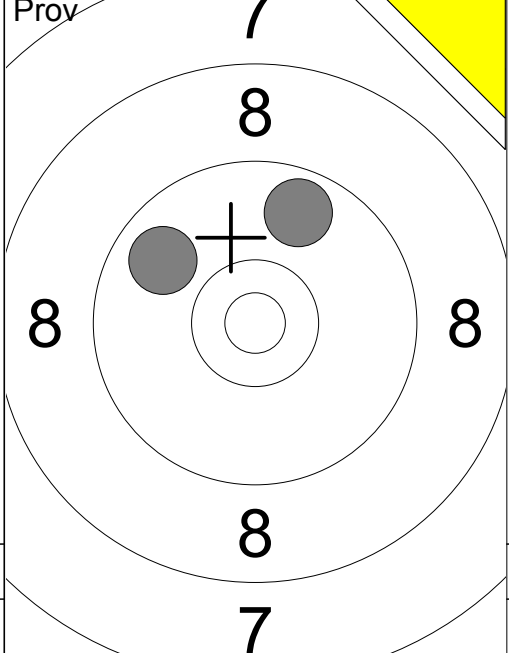

- 11: 9.7 ↗
- 12: 9.8 ↖

Serie 18
Total 0

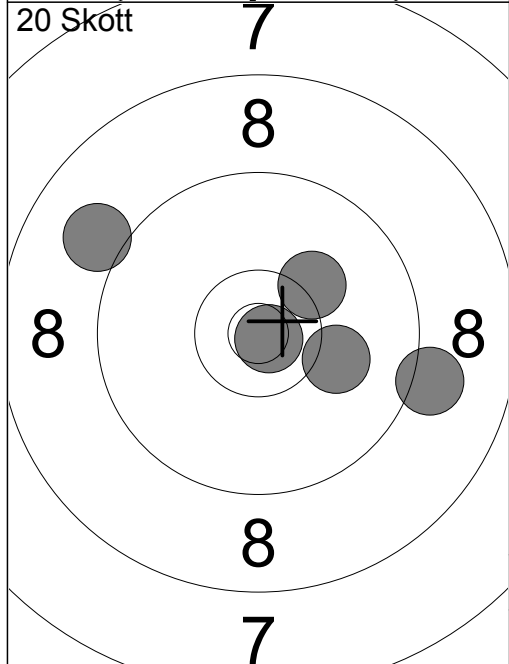

- 1: 9.0 ↖
- 2: 10.1 →
- 3: 10.2 ↗
- 4: 10.8x →
- 5: 9.1 →

Serie 48
Total 48

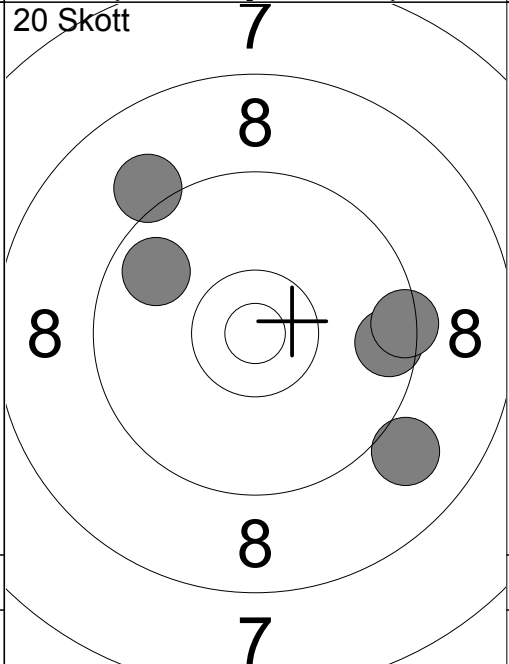

- 6: 9.1 ↗
- 7: 9.0 ↓
- 8: 9.8 ↗
- 9: 9.6 →
- 10: 9.4 →

Serie 45
Total 93

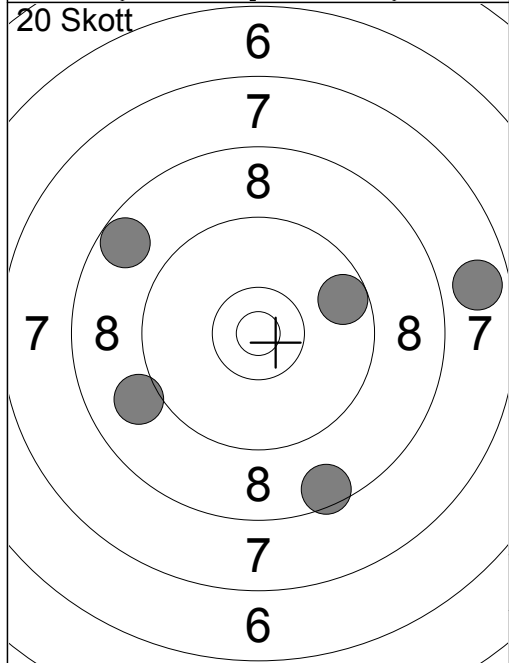

- 11: 9.6 →
- 12: 7.8 →
- 13: 9.0 ←
- 14: 8.7 ↗
- 15: 8.5 ↓

Serie 41
Total 134

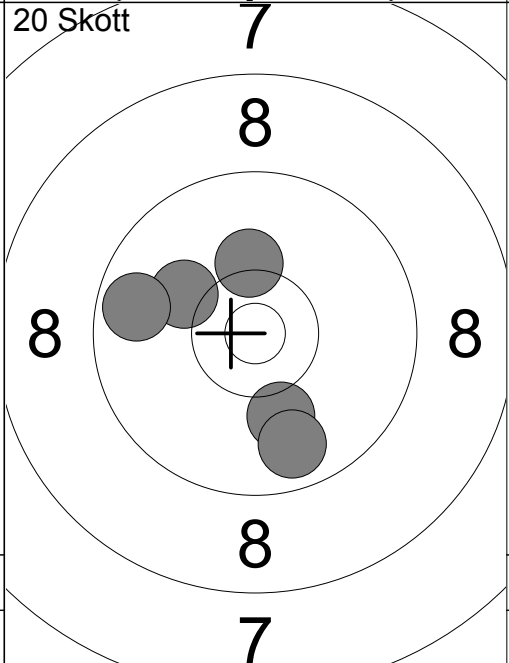

- 16: 10.1 ↓
- 17: 9.8 ↓
- 18: 10.1 ↖
- 19: 10.2 ↑
- 20: 9.7 ←

Serie 48
Total 182

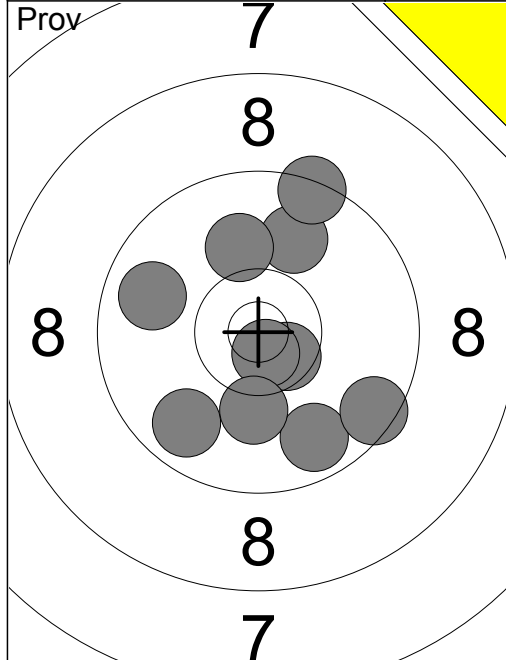

- 1: 9.9 ↗
- 2: 9.8 ↖
- 3: 9.4 ↗
- 4: 9.7 ↘
- 5: 10.1 ↗
- 6: 10.6x ↘
- 7: 9.5 ↘
- 8: 9.8 ↘
- 9: 10.7x ↘
- 10: 10.2 ↘

Serie 94
Total 0

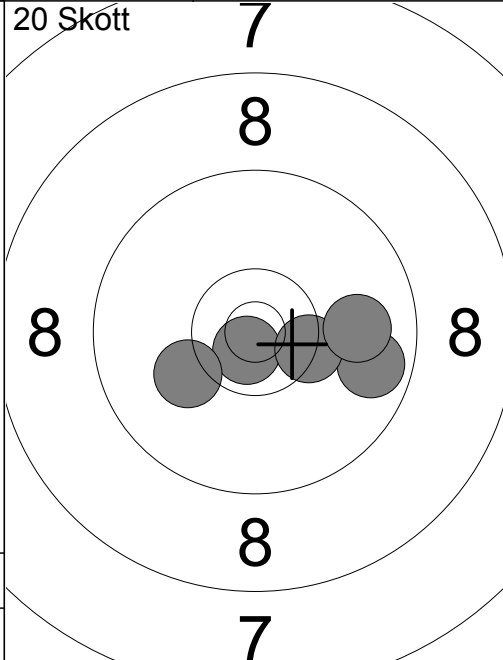

- 1: 10.7x ↘
- 2: 9.7 →
- 3: 10.4x →
- 4: 10.1 ↖
- 5: 9.9 →

Serie 48
Total 48

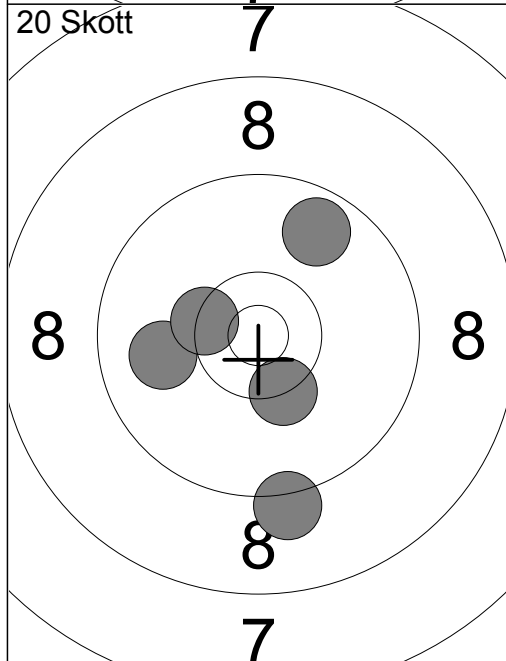

- 6: 10.0 ↖
- 7: 10.3x ↘
- 8: 10.4x ↖
- 9: 9.2 ↘
- 10: 9.7 ↗

Serie 48
Total 96

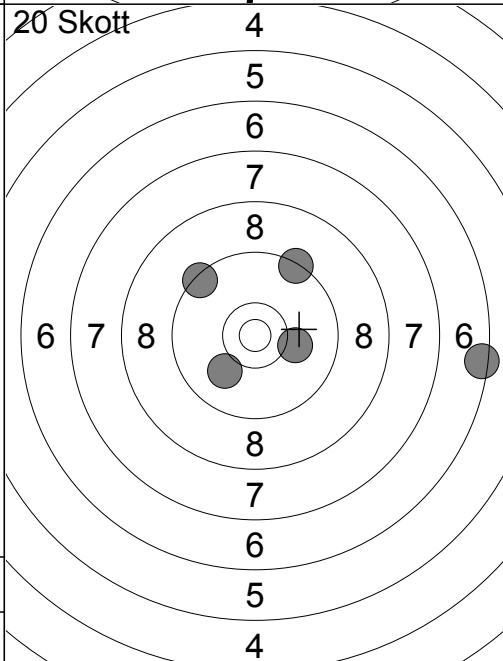

- 11: 10.1 →
- 12: 9.4 ↖
- 13: 9.3 ↗
- 14: 6.4 →
- 15: 10.0 ↘

Serie 44
Total 140

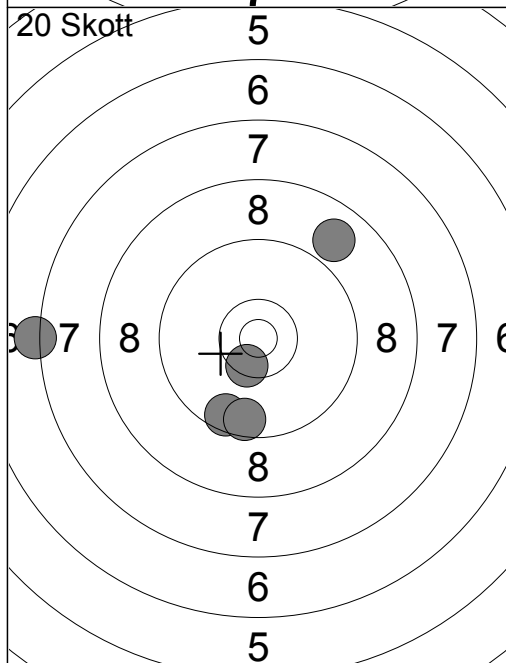

- 16: 9.6 ↘
- 17: 8.9 ↗
- 18: 10.5x ↘
- 19: 9.6 ↘
- 20: 7.2 ↖

Serie 43
Total 183

<p>Prov</p>	<p>1: 9.6 ←</p> <p>2: 9.2 ↓</p> <p>3: 9.6 ↓</p> <p>4: 8.2 ↓</p> <p>5: 9.4 ↓</p> <p>6: 8.4 ←</p> <p>7: 10.0 →</p> <p>8: 10.6x ↓</p> <p>9: 10.5x →</p>	<p>20 Skott</p>	<p>1: 9.7 ↖</p> <p>2: 10.1 ↓</p> <p>3: 10.4x ↗</p> <p>4: 9.4 ←</p> <p>5: 10.0 ↓</p>
Serie 82		Serie 48	
Total 0		Total 48	

<p>20 Skott</p>	<p>6: 10.4x →</p> <p>7: 10.2 ↖</p> <p>8: 10.1 ←</p> <p>9: 10.2 ↓</p> <p>10: 9.6 ↓</p>	<p>20 Skott</p>	<p>11: 10.1 ↓</p> <p>12: 0.0 ←</p> <p>13: 2.5 ↓</p> <p>14: 9.7 ↗</p> <p>15: 3.2 ↖</p>
Serie 49		Serie 24	
Total 97		Total 121	

<p>20 Skott</p>	<p>16: 9.1 ↗</p> <p>17: 9.5 ←</p> <p>18: 9.5 ↓</p> <p>19: 8.3 ←</p> <p>20: 6.7 ↖</p>		
Serie 41			
Total 162			

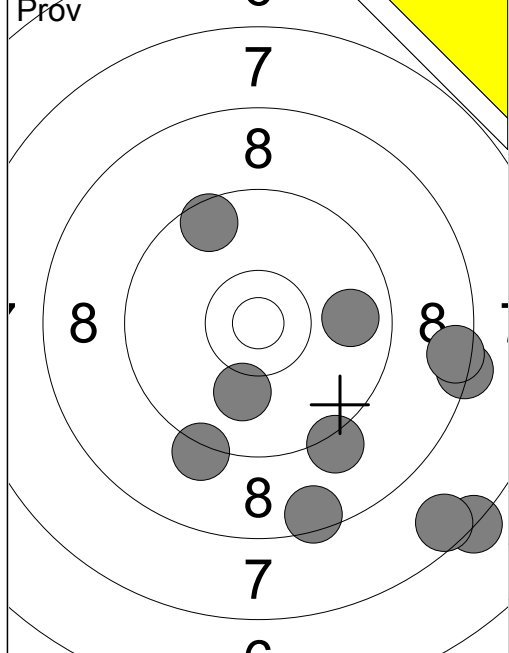

1:	7.3	↘
2:	9.2	↘
3:	10.1	↘
4:	8.5	↘
5:	7.6	↘
6:	9.2	↘
7:	8.3	→
8:	9.8	→
9:	8.5	→
10:	9.6	↗
Serie		84
Total		0

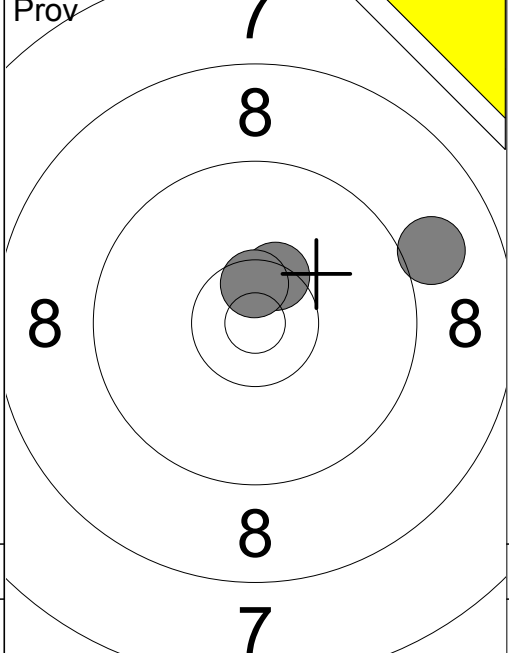

11:	9.0	↗
12:	10.4x	↗
13:	10.6x	↗
Serie		29
Total		0

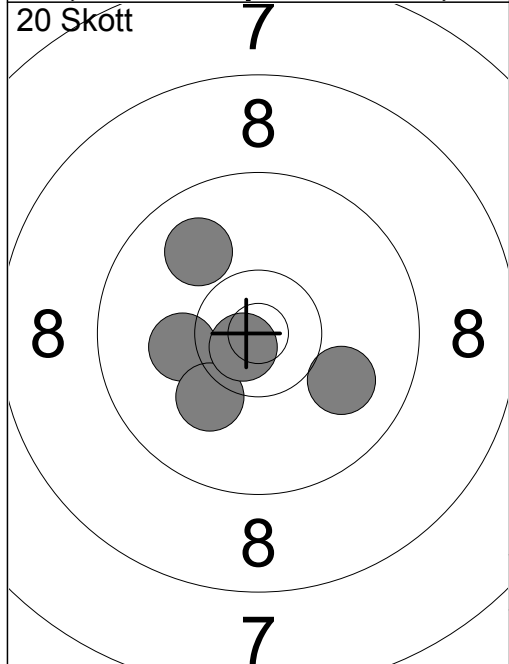

1:	10.0	↗
2:	10.2	←
3:	10.1	↘
4:	10.7x	↘
5:	9.9	↗
Serie		49
Total		49

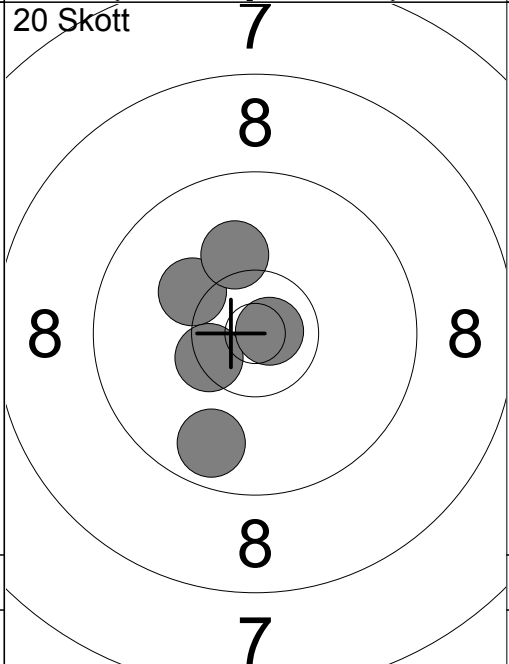

6:	10.2	↖
7:	10.4x	↖
8:	10.1	↗
9:	10.8x	→
10:	9.7	↘
Serie		49
Total		98

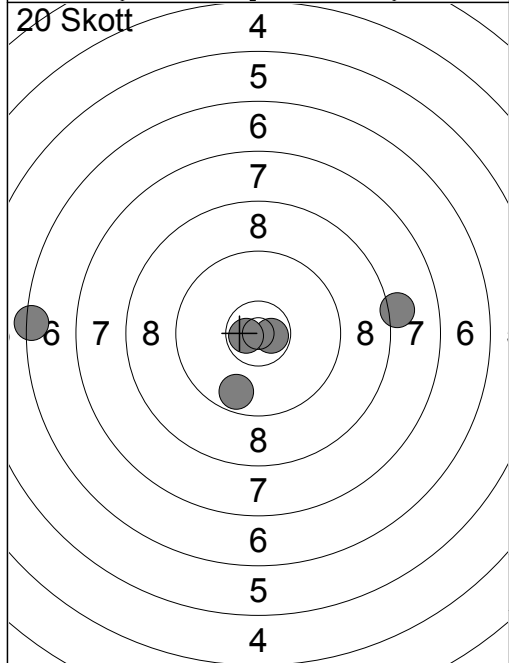

11:	8.1	→
12:	9.7	↘
13:	10.7x	→
14:	6.4	←
15:	10.7x	←
Serie		43
Total		141

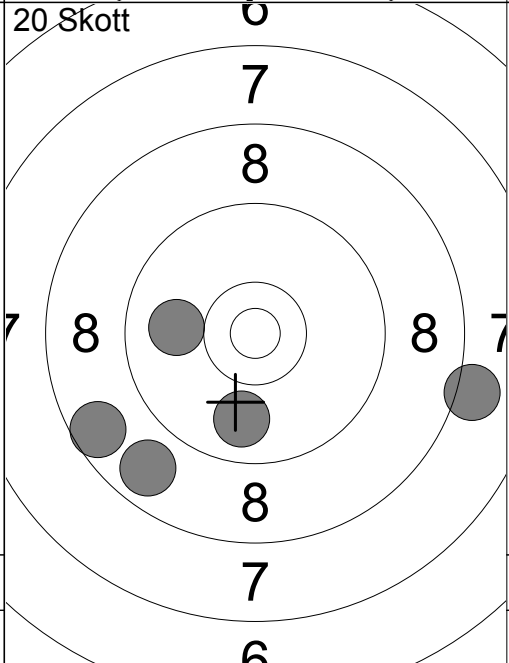

16:	8.1	→
17:	10.0	←
18:	8.8	↘
19:	9.9	↘
20:	8.6	↖
Serie		43
Total		184

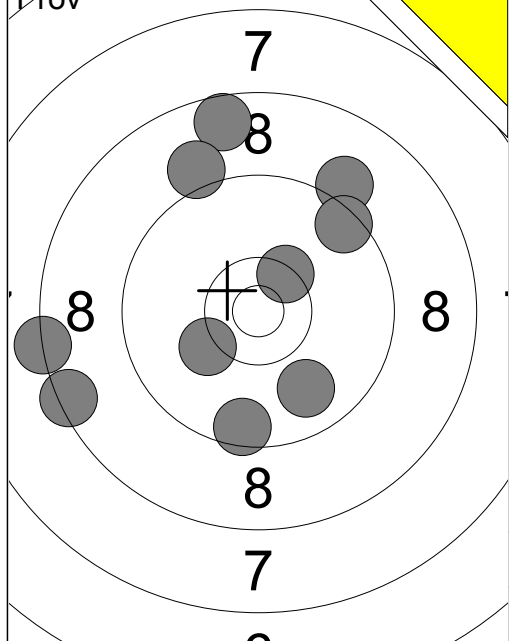

1:	9.5	↓
2:	8.3	←
3:	8.4	←
4:	9.8	↓
5:	8.6	↑
6:	10.4x	↗
7:	9.1	↗
8:	9.5	↗
9:	9.1	↑
10:	10.2	↙
Serie		89
Total		0

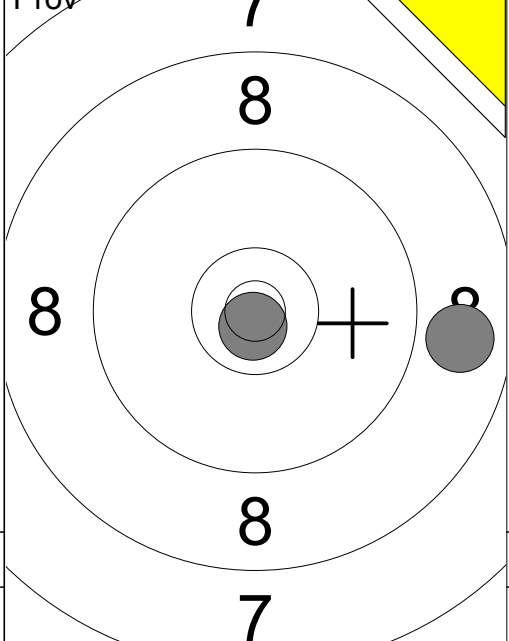

11:	8.8	→
12:	10.8x	↓
Serie		18
Total		0

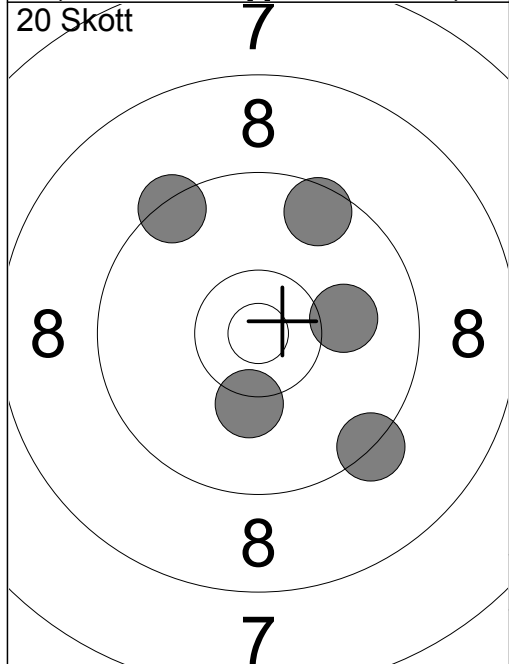

1:	9.3	↓
2:	10.2	↓
3:	9.6	↗
4:	9.4	↗
5:	10.1	→
Serie		47
Total		47

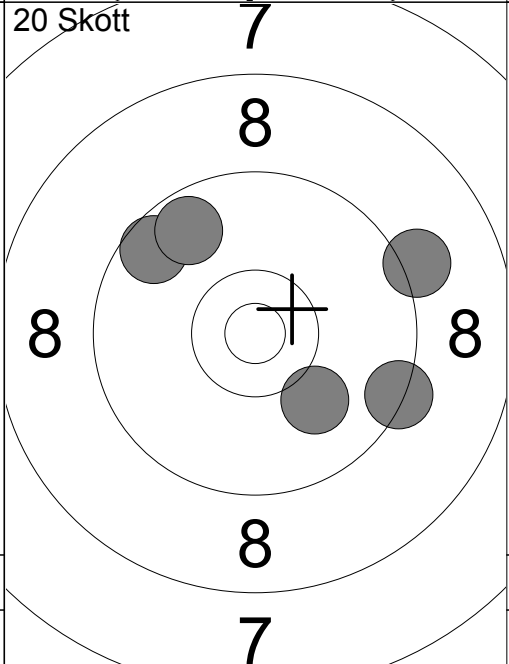

6:	9.1	↗
7:	10.0	↓
8:	9.6	↗
9:	9.4	↘
10:	9.7	↗
Serie		46
Total		93

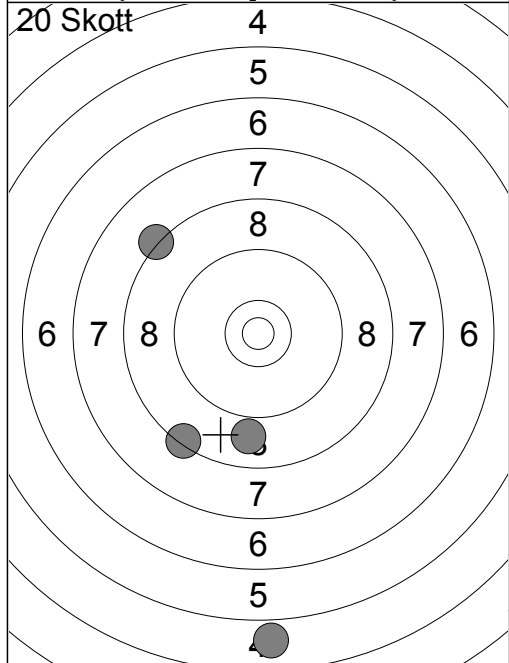

11:	0.0	
12:	8.3	↗
13:	4.9	↓
14:	8.9	↓
15:	8.4	↙
Serie		28
Total		121

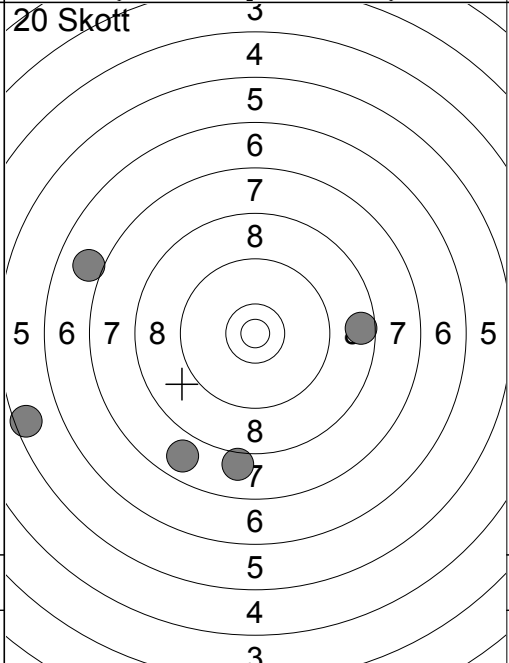

16:	8.6	→
17:	7.8	↙
18:	5.5	←
19:	8.0	↓
20:	7.0	↙
Serie		35
Total		156

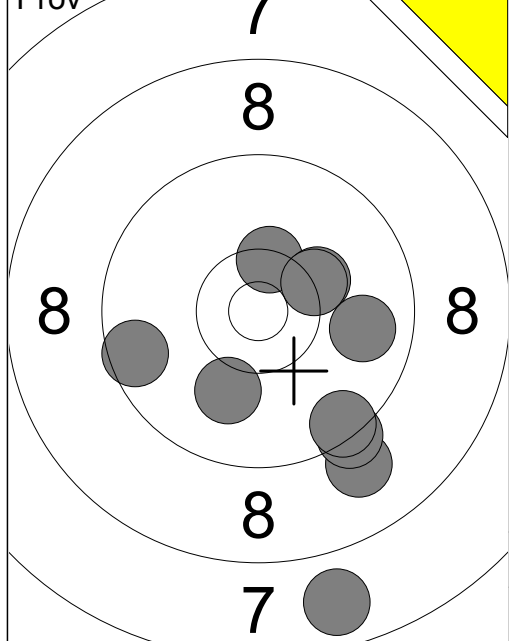

1:	7.8	↓
2:	9.6	←
3:	10.1	↓
4:	10.4x	↑
5:	10.3	↗
6:	9.0	↓
7:	9.3	↓
8:	9.8	→
9:	9.5	↓
10:	10.3x	↗
Serie		92
Total		0

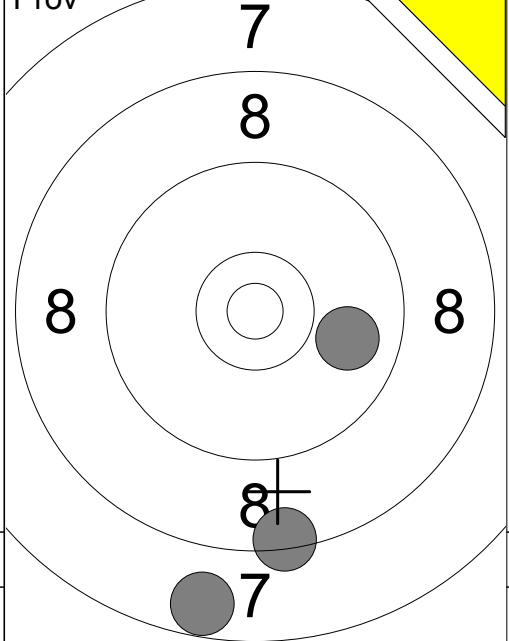

11:	9.9	→
12:	8.4	↓
13:	7.7	↓
Serie		24
Total		0

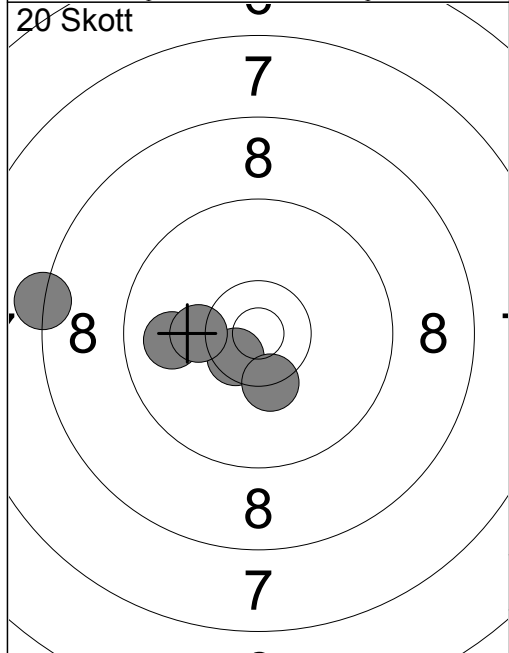

1:	10.5x	↙
2:	9.9	←
3:	8.3	←
4:	10.3x	↓
5:	10.2	←
Serie		47
Total		47

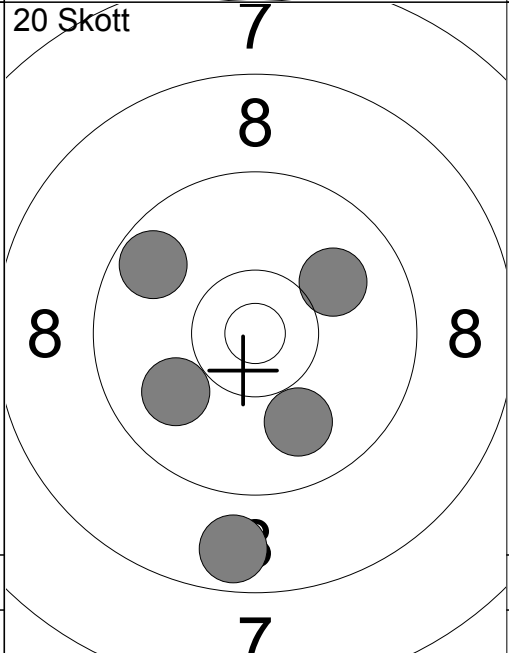

6:	9.9	↓
7:	9.7	↖
8:	8.7	↓
9:	9.9	↖
10:	10.0	↗
Serie		45
Total		92

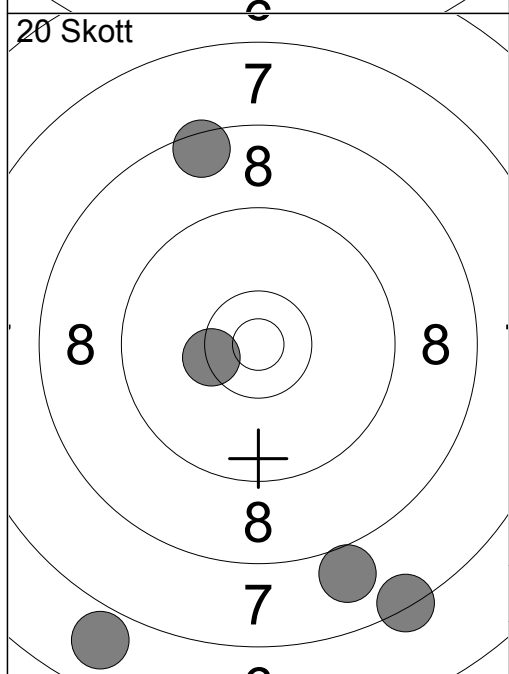

11:	7.4	↓
12:	8.0	↓
13:	10.4x	←
14:	8.5	↑
15:	6.9	↓
Serie		39
Total		131

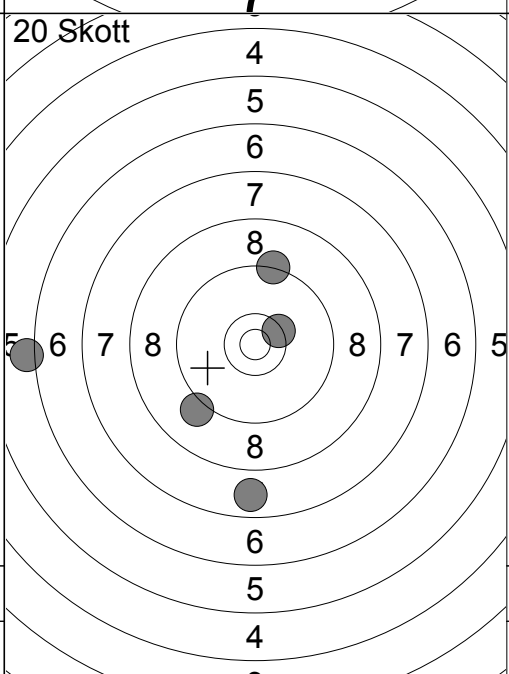

16:	10.4x	↗
17:	6.1	←
18:	9.1	↖
19:	7.8	↓
20:	9.3	↑
Serie		41
Total		172

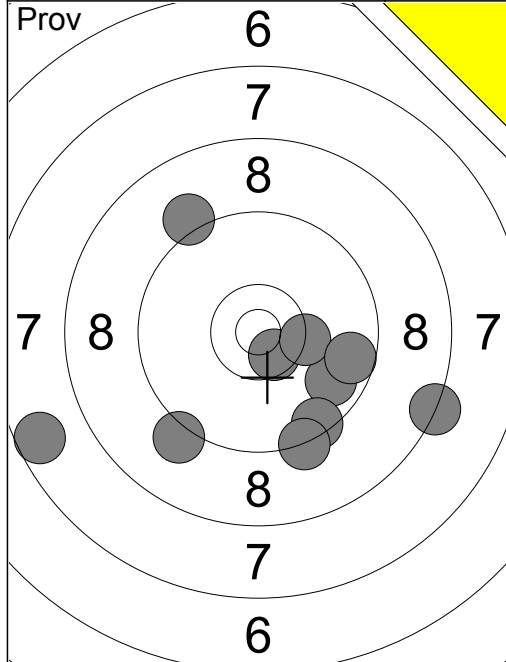

1:	9.1	↙
2:	9.8	↘
3:	7.6	↖
4:	10.6x	↘
5:	10.3x	→
6:	9.1	↗
7:	8.3	↘
8:	9.5	↘
9:	9.6	↘
10:	9.3	↘

Serie	89
Total	0

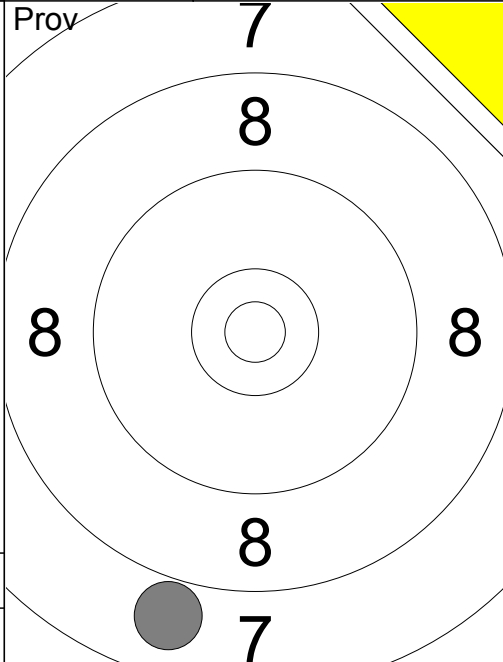

11:	7.9	↘
-----	-----	---

Serie	7
Total	0

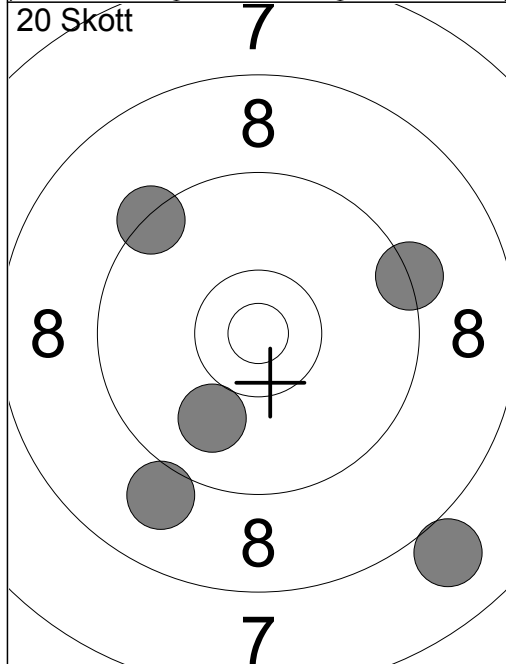

1:	9.4	↗
2:	9.0	↘
3:	8.0	↘
4:	10.0	↘
5:	9.3	→

Serie	45
Total	45

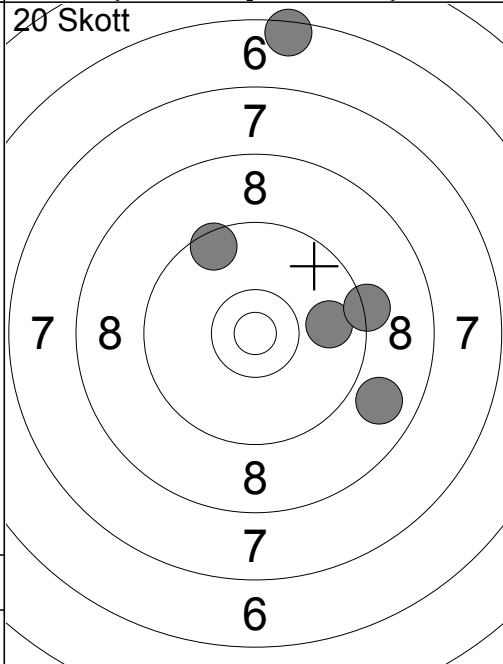

6:	9.5	↗
7:	8.9	↘
8:	9.8	→
9:	9.2	→
10:	6.5	↑

Serie	41
Total	86

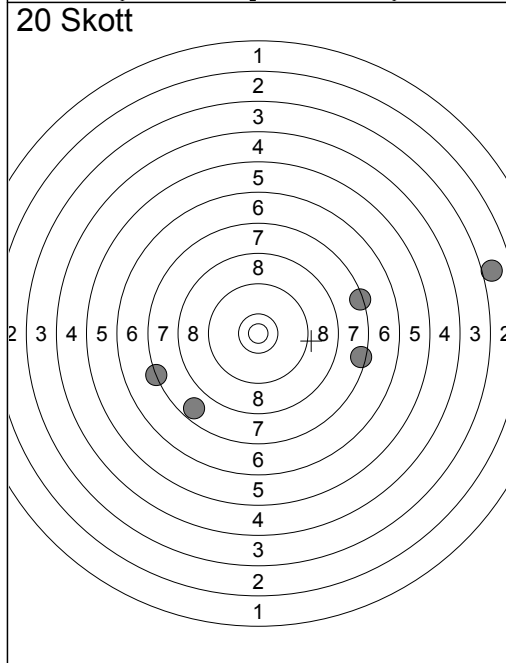

11:	7.4	→
12:	7.5	→
13:	7.3	↖
14:	3.0	→
15:	7.7	↘

Serie	31
Total	117

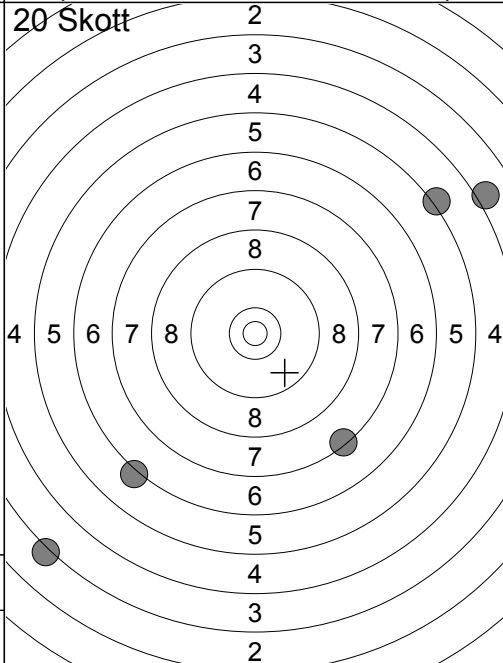

16:	7.4	↘
17:	5.2	↗
18:	3.2	↘
19:	6.2	↘
20:	4.1	↗

Serie	25
Total	142

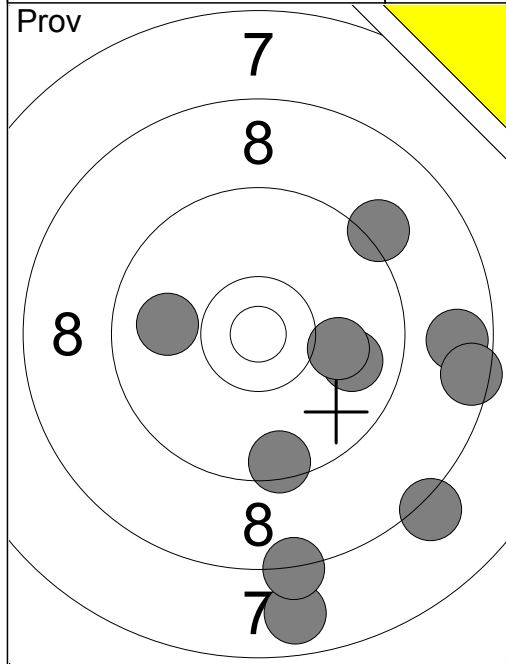

1:	8.2	↘
2:	7.8	↘
3:	8.3	↘
4:	9.5	↘
5:	9.9	→
6:	9.2	↗
7:	10.0	→
8:	8.7	→
9:	9.9	←
10:	8.5	→
Serie		85
Total		0

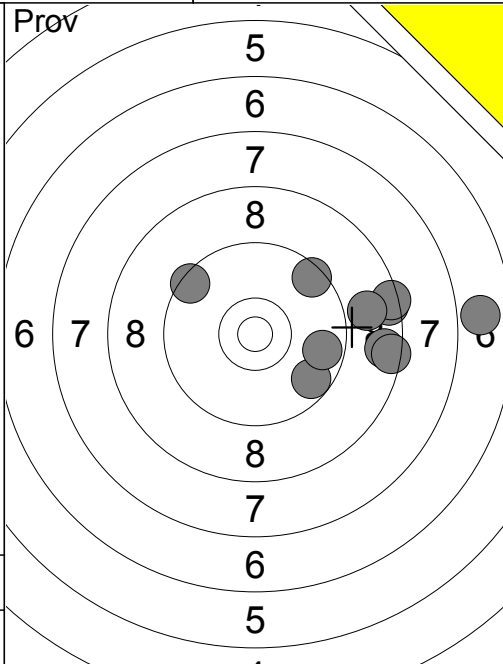

11:	8.6	→
12:	9.7	↘
13:	8.5	→
14:	9.7	→
15:	9.5	↗
16:	6.9	→
17:	8.5	→
18:	8.4	→
19:	8.9	→
20:	9.5	↗
Serie		82
Total		0

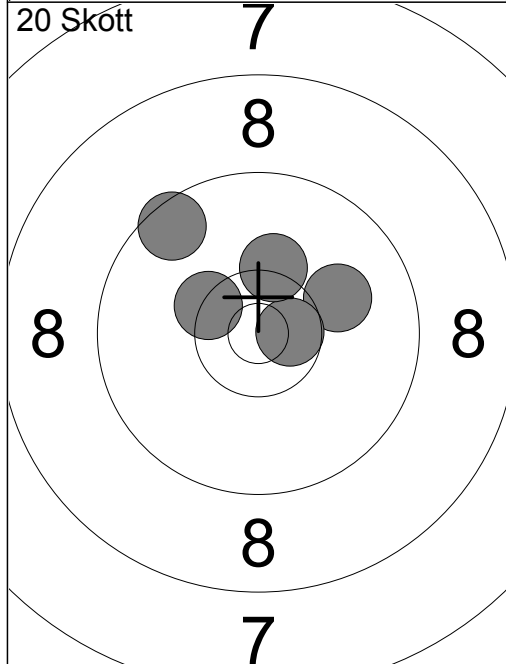

1:	10.1	→
2:	10.4x	↖
3:	9.5	↖
4:	10.6x	→
5:	10.3	↑
Serie		49
Total		49

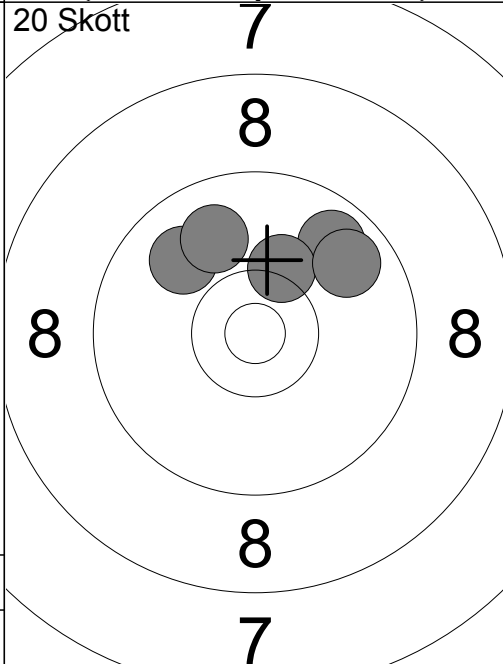

6:	9.7	↗
7:	10.2	↑
8:	9.8	↗
9:	9.9	↖
10:	9.9	↖
Serie		46
Total		95

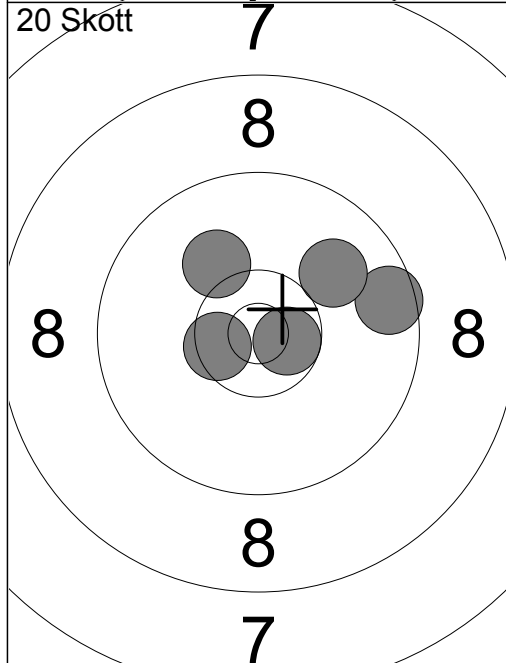

11:	9.6	→
12:	10.5x	↖
13:	10.6x	→
14:	10.1	↖
15:	10.0	↗
Serie		49
Total		144

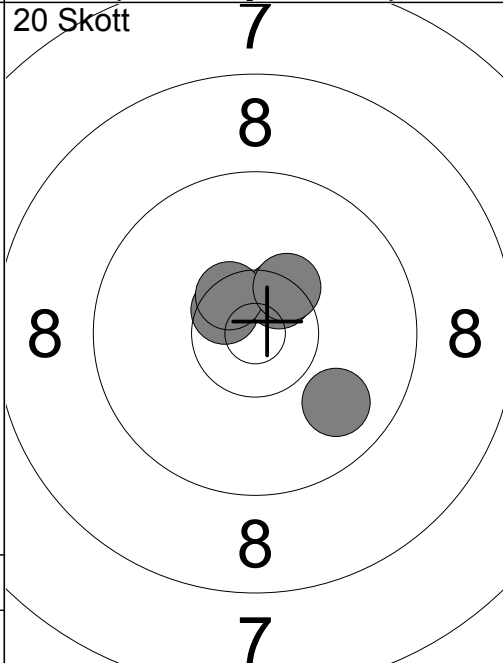

16:	10.6x	↖
17:	10.5x	↗
18:	10.5x	↖
19:	9.9	↘
20:	10.4x	↗
Serie		49
Total		193